

POPULAR SCIENCE

MONTHLY

AUG. 1947
25 CENTS



Polar Prowl Cars

p. 66

Art Proch

Here's Easy High-Speed Self-Instruction

in all 25 Useful Branches of

Mathematics

to help you qualify for a bigger, better job in America's expanding industries

Brought to You by 28 Leading Experts from Columbia, M.I.T., Cornell, Carnegie Tech., Georgia Tech., Many Others! A Practical Mathematics Course in Four Volumes! Used by Over 100,000 Men in Shop and Office!

CCLIMAXING its achievements in adult education, the NATIONAL EDUCATIONAL ALLIANCE offers you—at amazingly low cost—a new streamlined Course in Mathematics especially designed to answer the thousands of urgent new calls for mathematically trained men in virtually EVERY field!

On work bench, in drafting room; in the laboratory; in tool, die and pattern making; in construction and engineering of all kinds, there's hardly a field where a mathematically trained man hasn't a decided advantage. He gets the better job—bigger pay—wins promotion more quickly—and enjoys greater security through all his earning years.

This New N. E. A. Course in Mathematics makes it possible for the average person to acquire—in only a few months—a practical working knowledge of all 25 branches of mathematics and their practical applications. It comes to you complete in four volumes filled with illustrated, fascinating lessons designed for home study.

You receive instruction from 28 foremost instructors chosen from outstanding universities. Each instructor has been selected because of his special knowledge of a

particular branch of mathematics and because of his ability to simplify and streamline his instructions.

Four Volumes—Over 600 Helpful, Graphic Pictures and Diagrams; Nearly 1300 Pages!

No previous mathematics knowledge is needed under this ingenious teaching plan. You start with Basic Arithmetic and proceed by easy stages to an understanding of the most advanced branches of mathematics.

You'll learn how to use Algebra for short-cuts in daily shop problems, in construction work, in tool and die making, in welding, sheet metal work and pattern making, in office and laboratory. You'll learn how to apply Geometry in chemistry, mechanics, electricity and radio, in the drafting room. You'll learn how to employ Trigonometry in gearing, lathe centers, blueprints, die punches, etc.; in range finding, aviation, navigation. You'll learn how to utilize Calculus in the design and production of ships, dams, bridges, motors. You'll learn Practical Applications that you can use to win advancement and bigger pay.

(Continued on opposite page)

These Foremost University Experts Bring You Easy Mastery at Home of 25 Branches of Mathematics

For Use in Every Field

GENERAL EDITOR—R. S. Kimball, Ed. D. Formerly instructor at N. Y. U. Nationally famous organizer of courses in Mathematics for War Service.

Mass. Inst. Technology

Norbert Wiener, Ph.D. Vice-Pres. American Mathematical Society. Borchers Prize Winner.

Columbia Univ.

Edw. Kasner, Ph.D. Member, Committee on Mathematics National Research Council.

Carnegie Inst. Tech.

Lloyd Lyne Dines, Ph.D. Head of Dept. of Mathematics.

Rensselaer Poly Inst.

James McGiffert, C.E., Ph.D. Member, Editorial Board National Mathematics Magazine.

Princeton Univ.

Norman J. Sollenberger, M.A. in C.E. Asst. Prof. of Civil Eng. Head of Materials Testing Laboratories.

Fordham University

Walter A. Hynes, Sc.D. Assoc. Prof. of Analytic Chemistry.

Northwestern Univ.

David Raymond Curtiss, Ph.D. President, Mathematical Association of America.

Stevens Inst. Tech.

Robert Baker, B.S. Asst. Director War Industries Training School.

Cornell Univ.

Ralph P. Agnew, Ph.D. Head of Mathematics Dept.

Univ. of Chicago

Lawrence M. Graves, Ph.D. Professor of Mathematics.

Georgia School Tech.

Ralph A. Hefner, Ph.D. Professor of Mathematics.

University of Notre Dame

Karl Menger, Ph.D. Prof. of Mathematics. Vice-President International Congress of Mathematics.

Paul M. Pepper, Ph.D. Assoc. Prof. of Mathematics.

University of Ill.

O. K. Bower, Ph.D. Asst. Prof. of Mathematics.

Pratt Institute

Otis Benedict, Jr., Assoc. Prof. Machine Shop Practice.

Calif. Inst. of Tech.

William W. Michael, B.S. in C.E. Head of Dept. of Civil Engineering.

William H. Pickering, M.A. in E.E., Ph.D. Assoc. Prof. of Electrical Engineering.

U. S. Naval Academy

Sebastian B. Littauer, C.E., D. Sc. Formerly Instructor at Annapolis; Now on Engineering Staff, Bendix Radio.

R. C. A. Institutes

George F. Maedel, E.E. Chief Instructor N. Y. School of R.C.A. Institutes.

Univ. of Michigan

Carl H. Fischer, Ph.D. **C. J. Nesbitt, Ph.D.** Asst. Prof. of Mathematics.

Univ. of Pennsylvania

Wharton School of Finance and Commerce.

Jeremiah Lockwood, Ph.D. Head of Accounting Dept.

Edward N. Wright, Ph.D. Assoc. Prof. of Accounting.

Oscar S. Nelson, Ph.D. Assoc. Prof. of Accounting.

Univ. of So. Calif.

Park J. Ewart, Ph.D. Head of Dept. of Finance.

Kenneth L. Trefftz, Ph.D. Asst. Prof. of Finance.

Stanford Univ. **Vern James, Ph.D.** Graduate School of Business.

Copyright by the National Educational Alliance, Inc.

MAIL THIS FREE-TRIAL FREE-GIFT COUPON

Hundreds Send UNSOLICITED Praise!

"Wouldn't part with my set for less than \$50!"—
R. L. P., S. Norwalk, Conn. "I have benefited from
your Practical Mathematics Course—in my work, as
well as enjoyment. Worth many times its cost."—
J. G., Detroit, Mich. "You make it easy to learn."
—C. F. C., Detroit, Mich. "These books cover every-
thing!"—A. J., Washington, D. C.

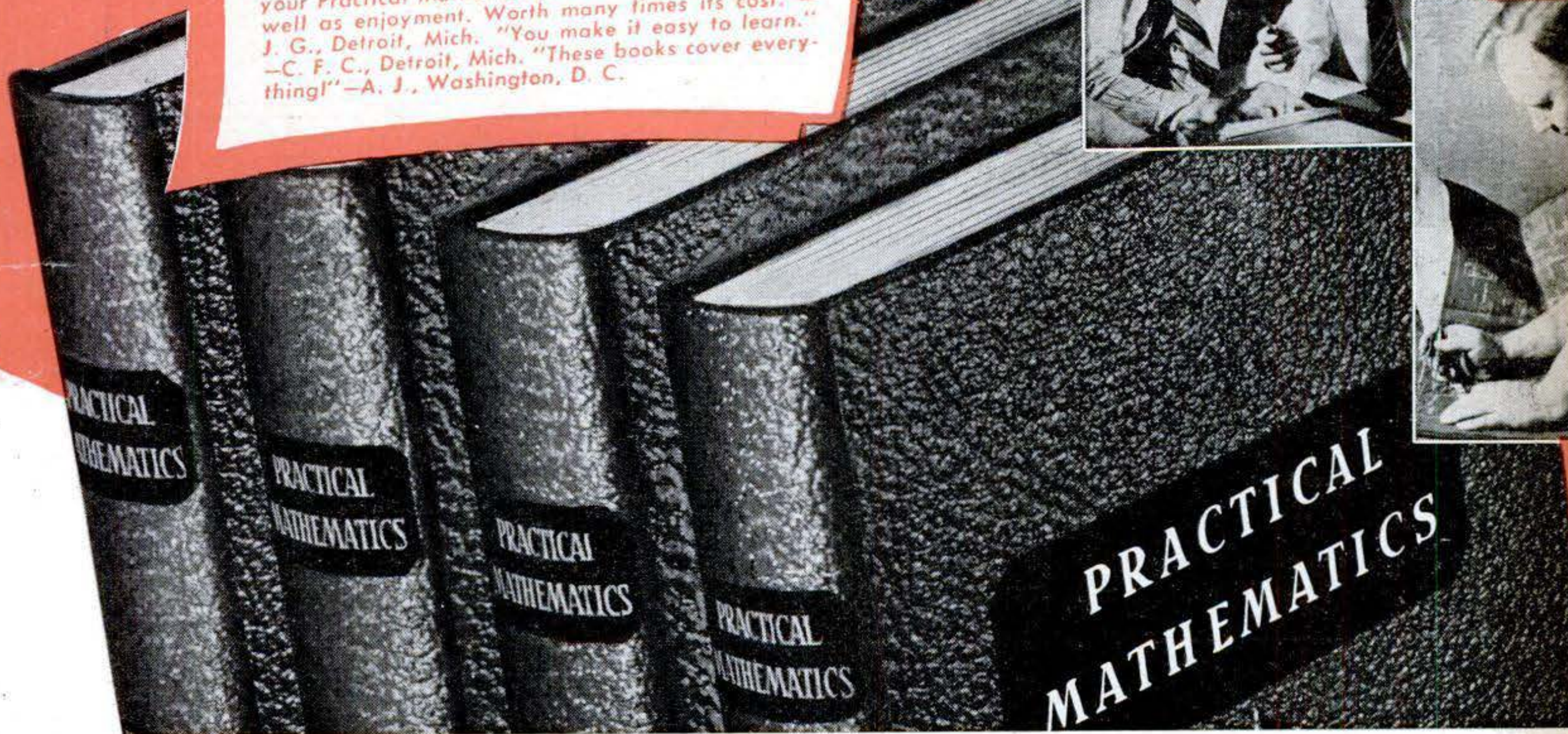
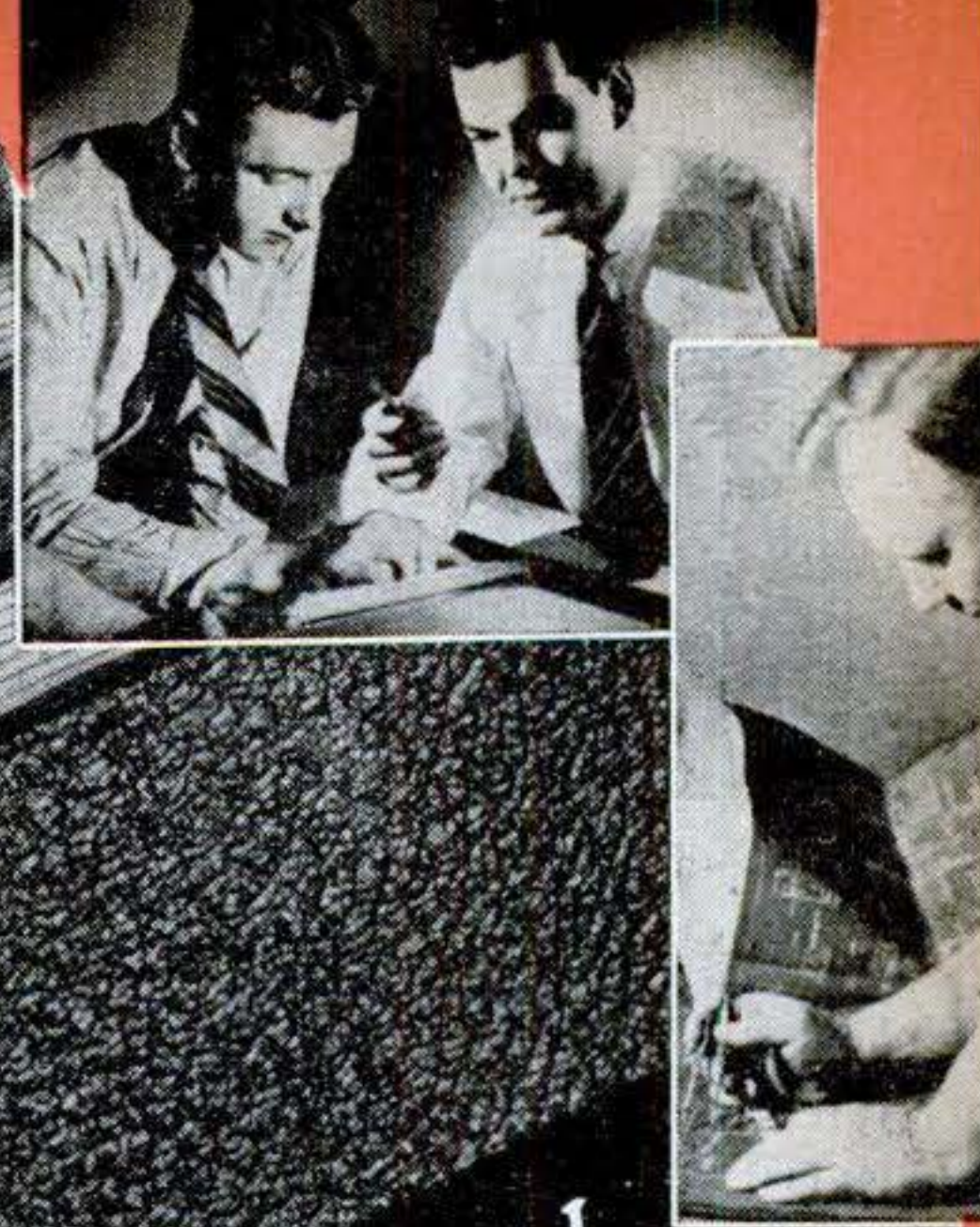

FREE! This Short-Cut to Easy Figuring!

even if you return
the set!



**Does the Work of
a Slide Rule
Faster, Easier
and More Accu-
rately! 160 pages!**

This book of
Logarithms is
the greatest
short-cut ever
devised for
quick and easy
multiplying di-
viding and all
other calculat-
ing. Easier to
learn; gives an-
swers quickly
and far more
accurately than
any Slide Rule.
A complete ex-
planation of the
use of loga-
rithm tables is
given. So simple

you can grasp it and begin to apply it in a few minutes. Covers logs for all numbers to the 6th place; contains much additional information including a table of circular arcs. Invaluable for mechanics, scientists, businessmen, etc. **FREE** even if you return the Mathematics Library!

Yours for FREE TRIAL

Normally, mathematical training as comprehensive as these 25-Courses-in-1 would cost you hundreds of dollars and years of study. Now you get it in these 4 volumes at a small fraction of the cost and time! Test this Course at our risk and expense. Mail coupon below—get the set for a week's FREE Examination. After a week you may return it and owe nothing; however, if you are thoroughly convinced that it can help you advance to bigger earnings, keep it at the incredible bargain price and easy terms shown in coupon. **But you must ACT NOW!** This edition is limited in quantity. There may not be enough to meet nation-wide demand. Avoid disappointment—mail Free-Trial Coupon NOW! National Educational Alliance, 37 W. 47th St., New York 19, N. Y.

Here's a Brief Glimpse of Subjects in This Four Volume Mathematics Course

- | | | |
|--|---|--|
| <p>1. BASIC ARITHMETIC
Shop short-cuts, quick applications of addition, subtractions, etc.</p> <p>2. ADVANCED ARITHMETIC
Percentages, fractions, ratio, rapid calculation.</p> <p>3. BASIC ALGEBRA
Industrial and technical short-cuts; formulas, etc.</p> <p>4. ADVANCED ALGEBRA
Practical use of simultaneous equations, graphs, etc.</p> <p>5. PLANE GEOMETRY
How to measure angles, areas, distances, etc.</p> <p>6. CONIC SECTIONS
Determining path of a shell, design of auto headlights, etc.</p> <p>7. SOLID GEOMETRY
Interpreting blueprints, coordinate points in drawing, etc.</p> <p>8. TRIGONOMETRY
Calculating distance; theodolites and sextants, Vernier scale, etc.</p> <p>9. LOGARITHMS AND SLIDE RULE
Short-cut operations in engineering problems.</p> <p>10. THE CALCULUS
Solves problems that can be solved in no other way.</p> | <p>11. DIFFERENTIAL EQUATIONS
Determining rate of disintegration of radio-active substances; population increase or decrease, etc.</p> <p>12. MENSURATION
Measurement of angles; torque, density, tolerances, etc.</p> <p>13. STRUCTURAL ENGINEERING
Producing a finished structure; stresses; equilibrium, etc.</p> <p>14. MACHINE-SHOP PRACTICE
Computing cutting speeds for lathe, drill press, etc.</p> <p>15. HEAT
Controlling heat, expansion, specific and latent heat, etc.</p> <p>16. CHEMISTRY
Equations, decomposition, replacement, etc.</p> <p>17. HISTORY OF MATHEMATICS
Pythagoras, Euclid, Archimedes, the geniuses of today.</p> <p>18. ELECTRICITY
Measurements; resistances; capacitance; time constants, etc.</p> | <p>19. MILITARY GUNNERY
Range-finding; direction; trajectory; variables, etc.</p> <p>20. NAVIGATION AND AERIAL NAVIGATION
Plotting a course; Mercator chart, great-circle sailing drift, etc.</p> <p>21. RADIO AND TELEVISION
Amplifier stages, tank circuits, television and high frequency transmission, etc.</p> <p>22. LIFE INSURANCE
Annuities; compound interest; mortality tables; dividends, etc.</p> <p>23. ACCOUNTING
Debits and credits, discounts sinking fund; profit and loss etc.</p> <p>24. FINANCE
Capital financing, chain discounts, bonds, etc.</p> <p>25. BUSINESS STATISTICS
Business cycle, index numbers, flow-charts, etc.</p> |
|--|---|--|

THE ABOVE IS ONLY A SMALL FRACTION OF THE SUBJECTS COVERED!

FREE-TRIAL AND GIFT COUPON

National Educational Alliance Inc.,
37 West 47th Street, New York 19, N. Y.

Without obligation to me, ship me prepaid for a week's FREE examination the complete "PRACTICAL MATHEMATICS LIBRARY" in 4 volumes of 1280 pages. After one week's FREE TRIAL examination, I will either return the books and owe you nothing; or keep them and send you only \$2 then and \$2 a month until the bargain price of only \$9.80, plus a few cents postage, is paid.

DO NOT WRITE IN BOXES

FREE GIFT!—Also ship me prepaid the 160-page book "6-PLACE LOGARITHMS" to keep entirely FREE even if I return the set!

SAVE COST OF 5 LB. SHIPMENT PLUS 30c CASH DISCOUNT. Send only \$9.50 with this coupon as full payment. Same return privilege, full refund guaranteed.

MR.
MRS.
MISS

(Print plainly in block letters)

ADDRESS _____

CITY &
ZONE No. _____

STATE _____

Check here if you prefer to examine luxurious De Luxe Edition in Genuine Morocco Grained flexible Artcraft, beautifully embossed. Only \$1 per volume extra. Same terms

TODAY →

POPULAR SCIENCE

Mechanics & Handicraft MONTHLY
REG. U. S. PAT. OFF.

EDITOR:

Perry Githens

MANAGING EDITORS: Fred O. Newman, Volta Torrey

ART EDITOR: Howard C. Jensen

HOME & WORKSHOP EDITOR:
Harry Walton

ASSOCIATE EDITORS: Alden P. Armagnac, Devon Francis, Robert Gorman, Hartley E. Howe, Herbert Johansen, Martin Mann, Frank Rowsome, Jr., John F. Stearns, R. P. Stevenson

WESTERN EDITOR: Andrew R. Boone (Los Angeles, Cal.)

ART DIRECTORS: Harry Samuels, Francis Sweeney

ART ASSOCIATES: Eric Karminski, Jr., Stewart Rouse, Frances Cooper (Production)

STAFF PHOTOGRAPHERS: W. W. Morris, Hubert Lockett, Robert F. Smith

EDITORIAL ASSISTANTS: Mae G. Dyer (Chief), Carol Ennis, Sheldon Gallager, Saverio Rada, Lillian Thalenfeld, Ruth Westphal

PUBLISHER:

Godfrey Hammond

AUGUST 1947

Cover Painting by Ray Pioch

Science News

Mysterious Liquid Acts Like Atoms..... 77
 The Truth About Germ Warfare..... 84
 "Black Light" Guards Freon..... 88
 Catching an Isotope.....121
 Watching Rockets at Work.....121

Science at Work

Picture of the Month..... 65
 Polar Prowl Cars..... 66
 Jet-Driven Bluebird II Aims at Record.... 76
 Mining with a Blowtorch.....102
 Fingerprinting Diamonds.....120
 Meter Aids Fire Patrols.....125
 Lens Puts "Zoom" in Television.....126
 How Good Is a Soap?.....128
 Pictures Train Eyes.....131

PSM Features

Key Uses a Code..... 88
 Trailer Becomes Pleasure Boat.....100
 "Zoot Suit" Reduces Diver's Burden.....108
 How Ocean Cables Are Mended.....110
 Toys Mirror a New Age.....116
 Joint Sealer Rides the Roads.....128
 Mist Sprayer Steps Up War on Insects....130
 Press Seals Plastics.....131
 How a Combine Works.....132
 Chemists Build with Hydrocarbons.....200
 He Makes Fine Paper.....206

Aviation

Flying Ice Laboratory..... 82
 Improved Cub..... 83
 XB-45 (Pin-up)..... 97
 Two Twins Join Navy.....104
 Sit in the Cockpit of a DC-6!.....105
 Tails Down!.....109
 Air Gun Tests Plane Parts.....120
 Battling the Gs.....122
 Test Planes Tooled to Tap Sonic Wall....134

Automobiles

Super Engine Cuts Gasoline Bills..... 89
 Car Folds to Suitcase Size.....129
 Tubeless Tire Seals Holes.....131
 European Motorcycles.....138
 Magnet Forestalls Punctures.....143
 Flexible Wiper Blade.....143
 Gus Is Taken for a Ride.....144

Inventions

New Ideas from the Inventors..... 98
 Water Powers \$300 "Lung".....118
 I'd Like to See Them Make.....119

Photography

View Finder Marks Center.....180
 Flash-Bulb Tester.....181
 Darkroom Doctoring Saves Paper.....182
 Radio Parts Used in Pan-Tilt Head.....184

(CONTINUED ON PAGE 4)

Published monthly at 353 Fourth Avenue, New York 10, N. Y., by Popular Science Publishing Co., Inc. Godfrey Hammond, President and Treasurer; R. C. Wilson, Raymond J. Brown, Stephen P. Glennon, B. Ray Keefer, Vice-Presidents; F. W. Briggs, Secretary. Entered as second-class matter Dec. 28, 1918, at the Post Office at New York under the act of March 3, 1879; additional entry as second-class matter at Dayton, Ohio. Entered as second-class matter at the Post Office Department, Canada. Printed in U. S. A. Copyright, 1947, by Popular Science Publishing Co., Inc. All rights reserved in the United States, Great Britain, and in all countries participating in the International Copyright Convention and Pan-American Copyright Convention. Yearly subscriptions to United States, its possessions and Canada, \$2.50; foreign countries, \$3.50. Subscribers must notify us of change of address four weeks in advance of the next publication date. Be sure to give both old and new addresses, including zone numbers.

Arthur Godfrey says:

"I.C.S. made the impossible—easy!"

YOU'VE often heard Arthur Godfrey, famed "Huck Finn of Radio," now winning new renown with his coast-to-coast "Talent Scouts" and other CBS programs. But this is the first time you've heard the star on the subject of I. C. S.:

"I had to quit high school before the end of my second year. Later in life, at the U. S. Naval Materiel School at Bellevue, D. C., I had to master a working knowledge of math, all the way from simple decimals and fractions through trigonometry, in the first six weeks or be dropped from the course. So I took an I. C. S. Course and finished at the head of the class! I. C. S. made the impossible—easy!"

As usual, the former Navy radio operator and present Lt. Commander in the U. S. Naval Reserve knows what he's talking about. As an I. C. S. graduate, Mr. Godfrey is in the best of all positions to tell you about the educational system that's served so long as talent scout for American industry.

Study his statement. Then mark your interest on the coupon and mail it today for full information on what I. C. S. can do for you!



INTERNATIONAL CORRESPONDENCE SCHOOLS



BOX 7689-L, SCRANTON 9, PENNA.

Without cost or obligation, please send me full particulars about the course *before* which I have marked X:

- | | | | |
|---|--|--|--|
| <input type="checkbox"/> Air Conditioning and Plumbing Courses | <input type="checkbox"/> Structural Engineering | <input type="checkbox"/> Industrial Engineering | <input type="checkbox"/> Textile Courses |
| <input type="checkbox"/> Air Conditioning | <input type="checkbox"/> Surveying and Mapping | <input type="checkbox"/> Industrial Metallurgy | <input type="checkbox"/> Cotton Manufacturing |
| <input type="checkbox"/> Heating <input type="checkbox"/> Plumbing | <input type="checkbox"/> Communications Courses | <input type="checkbox"/> Machine Shop | <input type="checkbox"/> Rayon Weaving |
| <input type="checkbox"/> Refrigeration <input type="checkbox"/> Steam Fitting | <input type="checkbox"/> Electronics | <input type="checkbox"/> Mechanical Drafting | <input type="checkbox"/> Textile Designing |
| <input type="checkbox"/> Chemistry Courses | <input type="checkbox"/> Practical Telephony | <input type="checkbox"/> Mechanical Engineering | <input type="checkbox"/> Woolen Manufacturing |
| <input type="checkbox"/> Chemical Engineering | <input type="checkbox"/> Radio, General | <input type="checkbox"/> Mold-Loft Work | <input type="checkbox"/> Business and Academic Courses |
| <input type="checkbox"/> Chemistry, Analytical | <input type="checkbox"/> Radio Operating | <input type="checkbox"/> Patternmaking—Wood, Metal | <input type="checkbox"/> Accounting <input type="checkbox"/> Advertising |
| <input type="checkbox"/> Chemistry, Industrial | <input type="checkbox"/> Radio Servicing | <input type="checkbox"/> Reading Shop Blueprints | <input type="checkbox"/> Arithmetic <input type="checkbox"/> Bookkeeping |
| <input type="checkbox"/> Chemistry, Mfg. Iron & Steel | <input type="checkbox"/> Telegraph Engineering | <input type="checkbox"/> Sheet-Metal Drafting | <input type="checkbox"/> Business Correspondence |
| <input type="checkbox"/> Petroleum Refining <input type="checkbox"/> Plastics | <input type="checkbox"/> Electrical Courses | <input type="checkbox"/> Sheet-Metal Worker | <input type="checkbox"/> Business Management |
| <input type="checkbox"/> Pulp and Paper Making | <input type="checkbox"/> Electrical Drafting | <input type="checkbox"/> Ship Drafting <input type="checkbox"/> Ship Fitting | <input type="checkbox"/> Certified Public Accounting |
| <input type="checkbox"/> Civil Engineering, Architectural and Mining Courses | <input type="checkbox"/> Electrical Engineering | <input type="checkbox"/> Tool Designing | <input type="checkbox"/> Commercial |
| <input type="checkbox"/> Architectural Drafting | <input type="checkbox"/> Electric Light and Power | <input type="checkbox"/> Toolmaking | <input type="checkbox"/> Cost Accounting |
| <input type="checkbox"/> Architecture | <input type="checkbox"/> Lighting Technician | <input type="checkbox"/> Welding—Gas and Electric | <input type="checkbox"/> Federal Tax |
| <input type="checkbox"/> Bridge and Building Foreman | <input type="checkbox"/> Practical Electrician | <input type="checkbox"/> Railroad Courses | <input type="checkbox"/> First Year College |
| <input type="checkbox"/> Building Estimating | <input type="checkbox"/> Internal Combustion Engines Courses | <input type="checkbox"/> Air Brake <input type="checkbox"/> Car Inspector | <input type="checkbox"/> Foremanship <input type="checkbox"/> French |
| <input type="checkbox"/> Civil Engineering | <input type="checkbox"/> Auto Technician <input type="checkbox"/> Aviation | <input type="checkbox"/> Diesel Locomotive | <input type="checkbox"/> Good English <input type="checkbox"/> High School |
| <input type="checkbox"/> Coal Mining | <input type="checkbox"/> Diesel-Electric | <input type="checkbox"/> Locomotive Engineer | <input type="checkbox"/> Higher Mathematics |
| <input type="checkbox"/> Contracting and Building | <input type="checkbox"/> Diesel Engines <input type="checkbox"/> Gas Engines | <input type="checkbox"/> Locomotive Fireman | <input type="checkbox"/> Illustrating <input type="checkbox"/> Motor Traffic |
| <input type="checkbox"/> Highway Engineering | <input type="checkbox"/> Mechanical Courses | <input type="checkbox"/> Railroad Section Foreman | <input type="checkbox"/> Postal Service |
| <input type="checkbox"/> Lumber Dealer | <input type="checkbox"/> Aeronautical Engineering | <input type="checkbox"/> Steam Engineering Courses | <input type="checkbox"/> Salesmanship <input type="checkbox"/> Secretarial |
| <input type="checkbox"/> Reading Structural Blueprints | <input type="checkbox"/> Aircraft Drafting | <input type="checkbox"/> Boilermaking | <input type="checkbox"/> Sign Lettering |
| <input type="checkbox"/> Sanitary Engineering | <input type="checkbox"/> Flight Engineer | <input type="checkbox"/> Combustion Engineering | <input type="checkbox"/> Spanish <input type="checkbox"/> Stenography |
| <input type="checkbox"/> Structural Drafting | <input type="checkbox"/> Foundry Work | <input type="checkbox"/> Engine Running | <input type="checkbox"/> Steam Electric <input type="checkbox"/> Steam Engines |
| | <input type="checkbox"/> Heat Treatment of Metals | <input type="checkbox"/> Marine Engineering | <input type="checkbox"/> Traffic Management |
| | | <input type="checkbox"/> Steam Electric <input type="checkbox"/> Steam Engines | |

Name _____ Age _____ Address _____

City _____ State _____ Present Position _____

Working Hours _____ A.M. to _____ P.M. Length of Service in World War II _____

Special tuition rates to members of the Armed Forces. Enrollment under the G.I. Bill of Rights approved for War II Veterans.

Canadian residents send coupon to International Correspondence Schools Canadian, Ltd., Montreal, Canada.

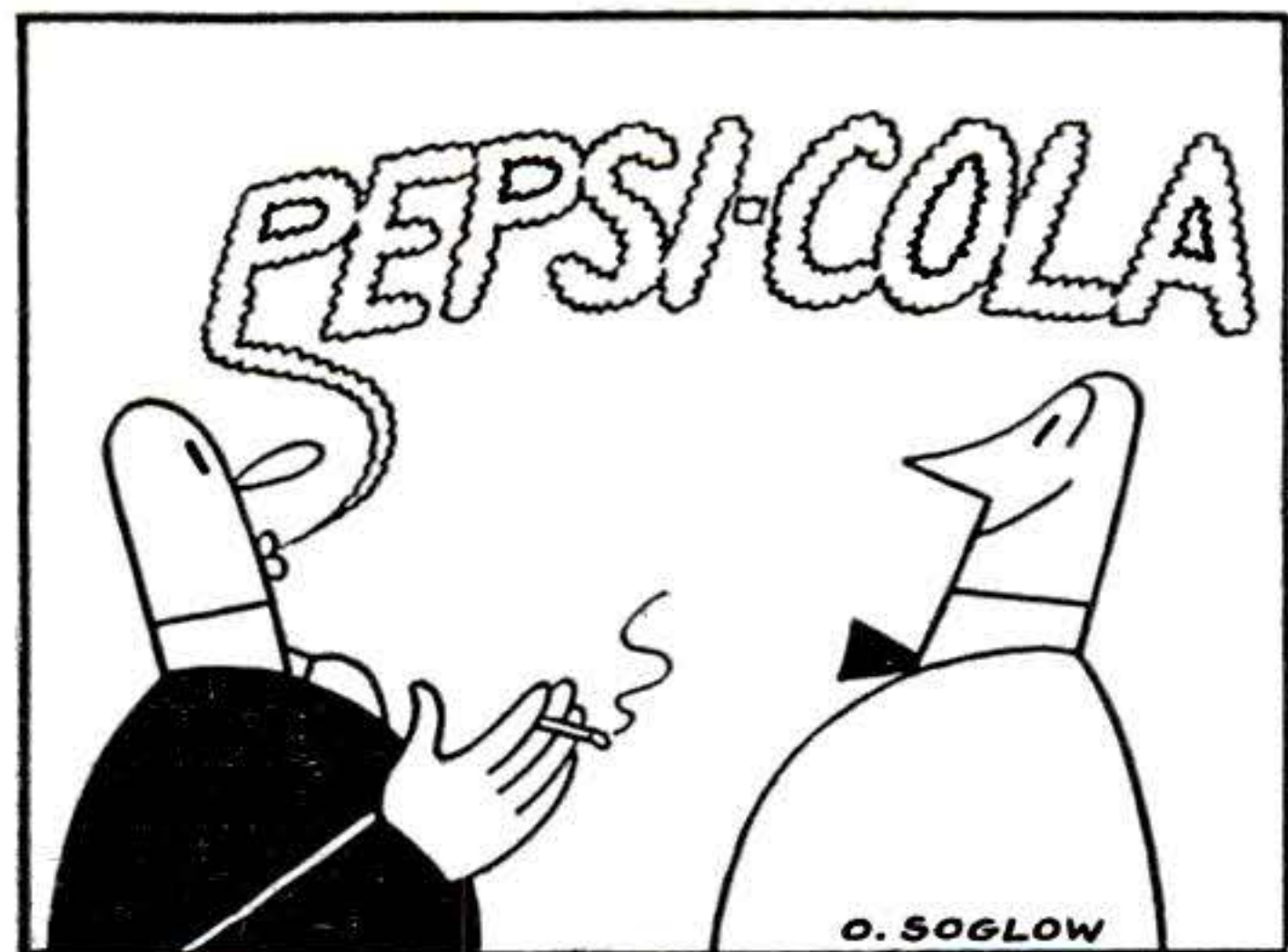
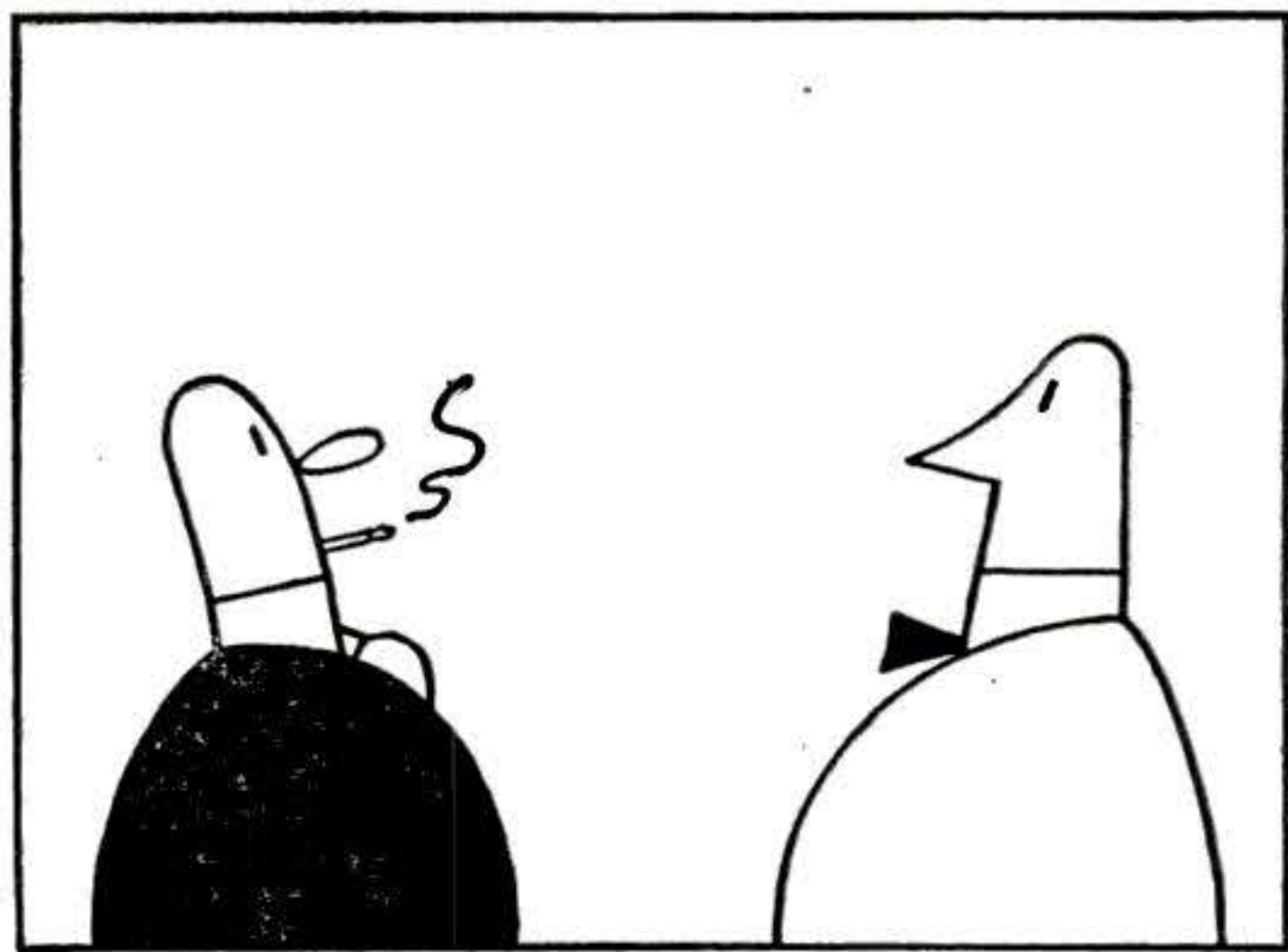
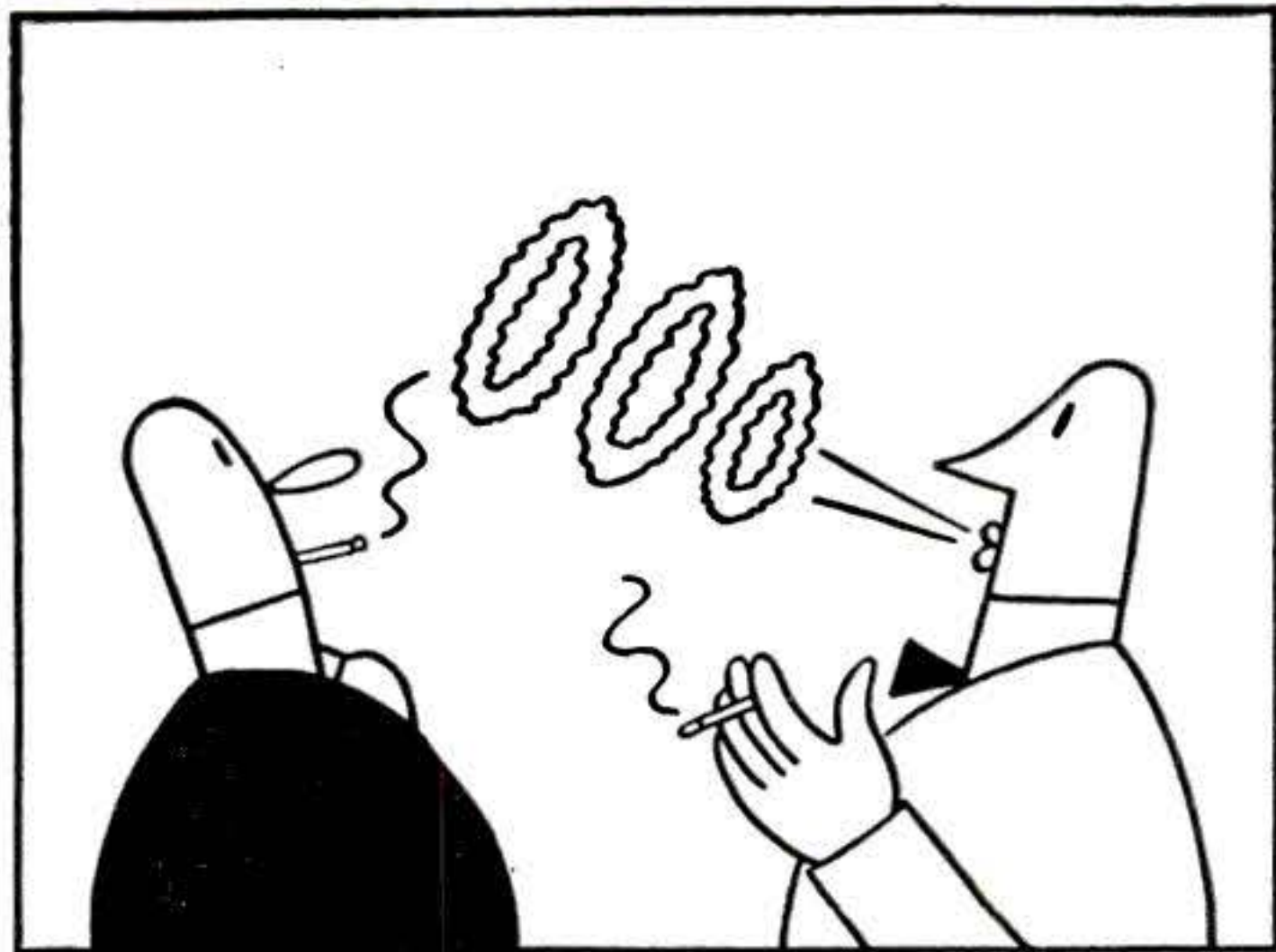
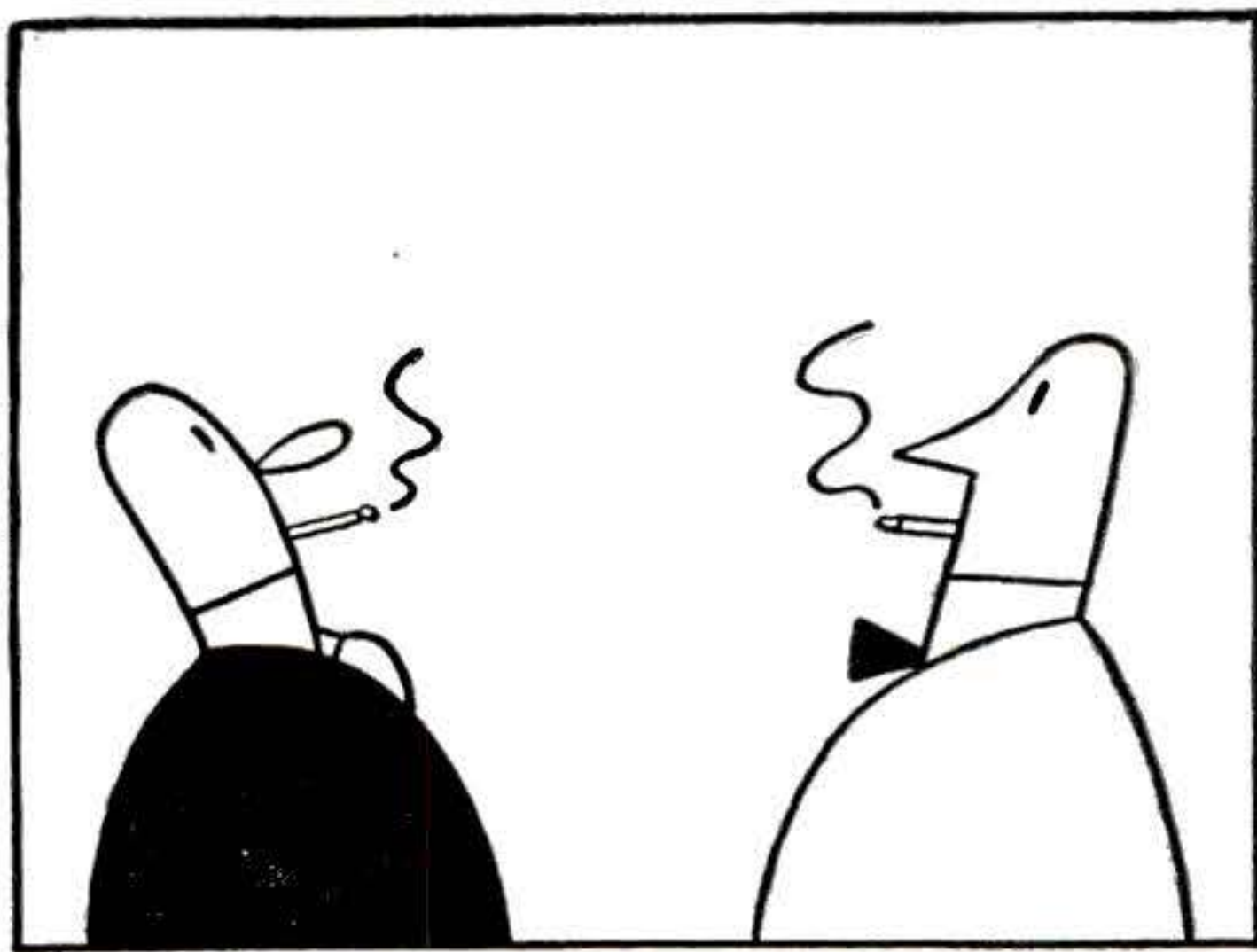

Mechanics & Shopcraft

<u>Improvising V-Blocks.....</u>	172
<u>Keep Your Micrometer on Its Toes.....</u>	174
<u>Grinding-Wheel Rack.....</u>	177
<u>Lathe-Bit Grinding Holder.....</u>	177
<u>Spot Heater Bends Plastic.....</u>	179
<u>Flat Stops Squeak in Hinge.....</u>	185
<u>Tinting Interior White Paint.....</u>	185
<u>Building an Overshot Wheel.....</u>	192
<u>Wing Nut Clamps Hose Stand.....</u>	197
<u>Cleated Board Anchors Scaffold.....</u>	197
<u>How to Glaze a Window.....</u>	204

Home Mechanics & Handicraft

<u>Craftwork Projects of the Month.....</u>	112
<u>Hippo Tops Handy Box.....</u>	148
<u>Plastic Shoes Molded to Foot.....</u>	148
<u>Mahogany Lamp Made of Turnings.....</u>	149
<u>Ornamental Shelf for Kitchen.....</u>	149
<u>Antiqued Aluminum Chest.....</u>	150
<u>Wall Rack Holds Casseroles.....</u>	151
<u>Arrow Adds Novelty to Book Ends.....</u>	151
<u>Push Buttons Fly Model Planes.....</u>	152
<u>Carving Plastic Inside Out.....</u>	160
<u>Box Contrasts Wood Tones.....</u>	165
<u>Snip Yourself a Boat from Dural.....</u>	166
<u>Hollow Tiles Make Doorsteps.....</u>	178
<u>BX Shield Forms Can Spout.....</u>	178
<u>Bent Metal Forms Flashlight.....</u>	179
<u>How to Identify Fuse Boxes.....</u>	179

Radio & Electricity

<u>More Light for Highways.....</u>	88
<u>Hams Are Radio's Vanguard.....</u>	92
<u>Electronics Lights the Stage.....</u>	106
<u>Typewriter Turned Into Telegraph Key..</u>	114
<u>Powering an Iron Horse.....</u>	121
<u>Tune in on High Fidelity.....</u>	186
<u>Houses Wired for Sound.....</u>	190

Departments

<u>Voice of Science.....</u>	7
<u>Letters</u>	14
<u>Aids to Modern Living.....</u>	136
<u>Hobby Shopping.....</u>	157
<u>What's Your Ingenuity Quotient?.....</u>	158
<u>New Tools.....</u>	159
<u>Keeping the Home Shipshape.....</u>	170
<u>New Shop Ideas.....</u>	172
<u>News in Electronics.....</u>	190
<u>For Boats and Boating.....</u>	191
<u>Home Experiments.....</u>	198
<u>For Easier Farming.....</u>	208
<u>Editorial Memo.....</u>	254



If YOU were Boss would YOU promote "YOU"?

valuable asset to any business organization. He never wants for a good job and above average earnings. He gets ahead.

We have helped thousands of men achieve promotion and more money—success sometimes beyond their dreams—a success that was started by a coupon similar to the one below.

Get out of that rut—don't be satisfied with a mediocre job at small pay—be a success in business—this coupon may be your first step.

So send it today—right now—tomorrow never comes for the man who consistently puts things off.

***G. I. APPROVED**

La Salle Extension University *A Correspondence Institution*

Dept. 883-R

417 S. Dearborn, Chicago 5

If you can help me get the ability and knowledge for real promotion, I want to know it. Please send me your free 48 page booklet telling how I can succeed in the field I have checked below. I understand you will send this without obligation to me.

- | | |
|--|--|
| <input type="checkbox"/> Accounting | <input type="checkbox"/> Salesmanship |
| * <input type="checkbox"/> C. P. A. Coaching | * <input type="checkbox"/> Law: LL.B. Degree |
| * <input type="checkbox"/> Bookkeeping | * <input type="checkbox"/> Foremanship |
| * <input type="checkbox"/> Business Management | * <input type="checkbox"/> Industrial Management |
| <input type="checkbox"/> Effective Speaking | * <input type="checkbox"/> Traffic Management |
| <input type="checkbox"/> Stenotypy (Machine Shorthand) | * <input type="checkbox"/> Business English |

Name.....Age.....

Position.....

Address.....Zone, if any.....

City and State.....

AUGUST 1947 **5**

Be honest now—

suppose that a better job had opened up in your company—carrying with it promotion and more money—could you qualify?

If you were boss, would you select "YOU" for that better job?

Consider before you answer.

First of all, could you *fill* the job? Has your experience fitted you for the step forward—have you been preparing for promotion apart from experience gained on the job?

Or have you just been filling a niche, doing daily tasks well but making no real and intelligent effort to learn and qualify for the job ahead so that if an opening should occur you would be ready to fill it?

The man who gets real promotion makes his own breaks—the man who slaves in the ordinary job at low pay just wishes and dreams of promotion and more money. Which are you?

Business is always willing to pay the man who knows—and pay him well. The man who is ready and willing to take responsibilities—and capable of directing the efforts of other men is a



Commercial shipping on the high seas and inland waterways is now freed by radar from delays caused by bad weather.

RCA Radar - enables ships to see through

**fog
darkness
storms**

With shipboard radar, developed and produced by engineers of the Radiomarine Corporation of America—a service of RCA—a pilot watches a viewing screen (similar to a television screen) that shows a large, clear, maplike picture of the area under observation.

With this radar picture he can safely pass through heavy fogs that would ordinarily force the most experienced pilots to anchor, sometimes for days at a time.

The same research at RCA Laboratories that contributed to the achievement of radar—are con-

stantly applied to all RCA products to keep them at the top in their fields. So when you buy an RCA Victor radio, television receiver, Victrola radio-phonograph, phonograph record or radio tube, you know you are getting one of the finest products of its kind science has achieved.

"VICTROLA"—T. M. REG. U. S. PAT. OFF.

A cordial invitation is extended to you to visit the new RCA Exhibition Hall, 36 W. 49 St., Radio City, N. Y., open daily and Sunday—free admission.

Radio Corporation of America, RCA Building, Radio City, New York 20. Listen to the RCA Victor Show, Sundays, 2:00 P. M., Eastern Daylight Saving Time, over NBC.



A twelve-inch viewing screen reveals objects as close as 80 yards—or as far away as 50 miles! For further details, write to Radiomarine Corporation of America, 75 Varick Street, New York, N. Y.



RADIO CORPORATION of AMERICA

Demonstrators Wanted

WHAT this country needs is a good, half-pint atom bomb. Here we are, two years this month after Hiroshima, and too many people still think there's no such animal as a bomb to end bombs. Which is not entirely their fault.

When TVA wired the backwoods for readin', freezin', and cookin' a few years ago, nobody in the barefoot crowd would believe electricity. David Lilienthal, then a director of TVA, told me himself they had to go out into the kerosene country with demonstration kits to show how the invisible stuff that ran along the wires could light lamps and turn machinery.

Lilienthal, as head of the Atomic Energy Commission, might sleep better these nights if he could do the same thing with atomic power, and send out samples of the world's greatest force. A baby bomb that would kill only mice; or a little bottle of radiation that would get rid of moths.

But, so far, there aren't any vest-pocket power piles. Nuclear fission comes only in the big, all-family package. Only the *idea* can be put out in handy, one-brain doses.

So the story of atomic power is being told in many ways in many magazines—including this one. There are books about it in your public library, feature pieces in your newspapers. Read and believe—don't let strange words stop you. Like the intelligent hillbilly seeing his first electric light, it is something to appreciate the power of the smashing atom, whether or not you fully understand it.

Certainly the best thing we can do as participants in this gigantic job of public education is to explain to our children the elementary new facts of their life and death. And we can learn, ourselves, by teaching others. For we are all children in a new world.

Perry Gillman

AUGUST 1947 7

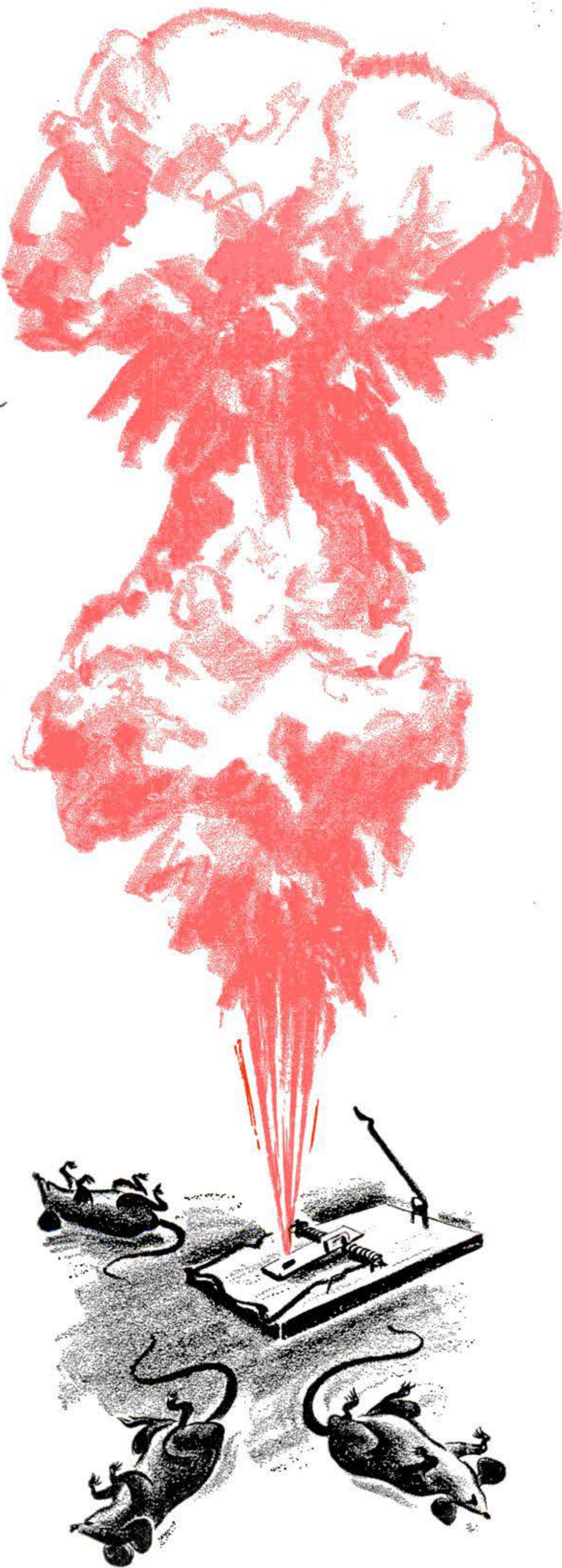

ALL KINDS OF WEATHER— UNDER ONE ROOF!

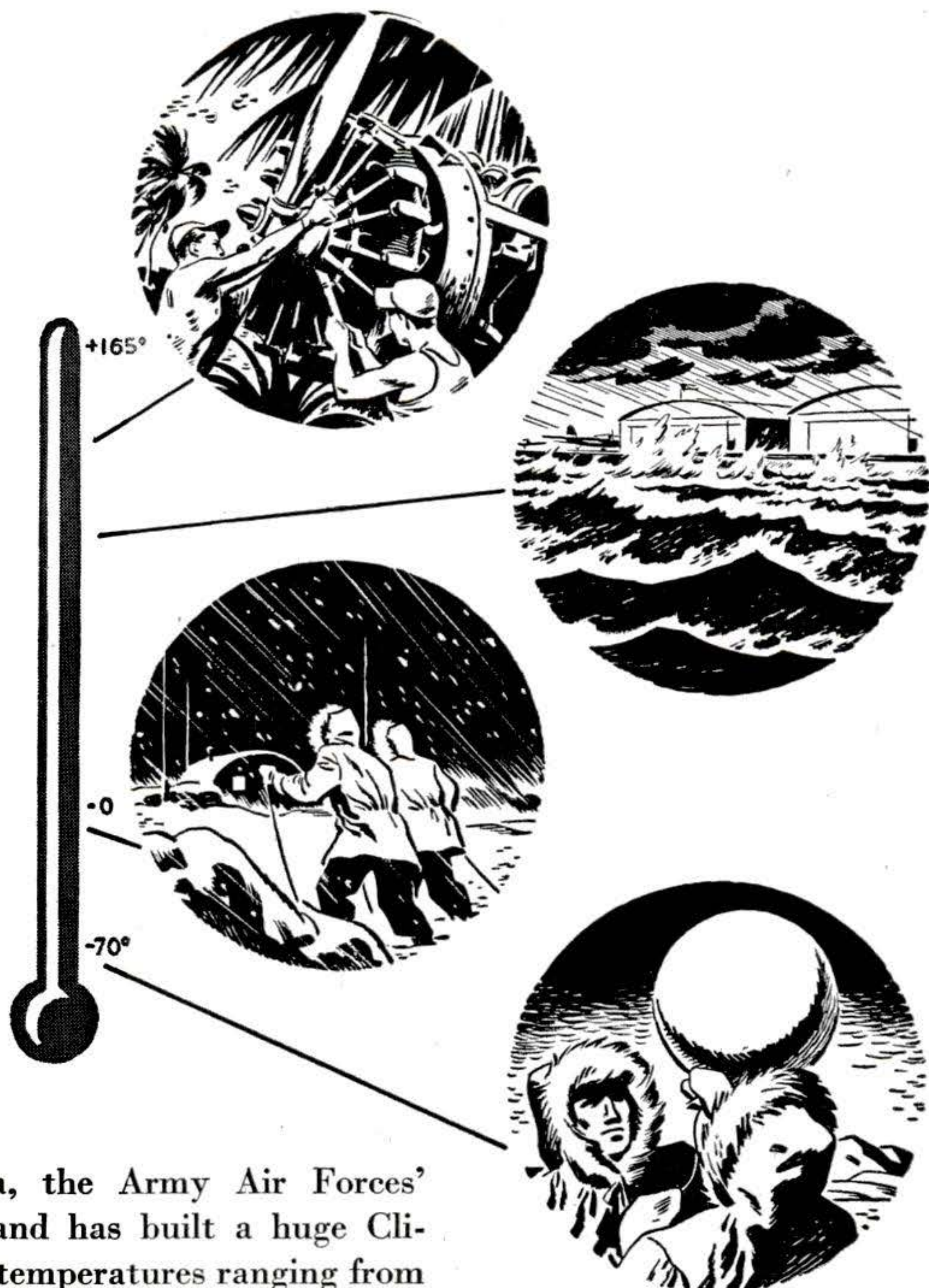

At Eglin Field, Florida, the Army Air Forces' Proving Ground Command has built a huge Climatic Hangar. Inside it, temperatures ranging from an icy 70 degrees below zero to a torrid 165 degrees above can be quickly produced.

Howling 100-mile-an-hour winds, artificial sunlight, strato-chambers, and other built-in facilities make most climatic extremes available—with no costly waiting for suitable outdoor test conditions.

The Climatic Hangar is another step in the Air Forces' quest for better, safer airplanes and equipment. If you are interested in a future in aviation, Air Force Day—August 1—gives you a chance to know your Air Forces better. See your nearest U. S. Army Recruiting Station today for details on AAF enlistments.

U. S. ARMY RECRUITING SERVICE

FROM DESERT HEAT TO ARCTIC ICE

In one building, 200 feet long by 250 feet wide, the Army Air Forces can simulate any one of the extreme weather conditions shown above.



AUDELS REFRIGERATION & AIR CONDITIONING GUIDE.....\$4

New from Cover to Cover—1280 Pages, Fully Illus. Covering basic principles, servicing, operation & repair of household, commercial & industrial refrigeration & air conditioning. A gold mine of essential important facts for engineers, servicemen, users.

AUDELS CARPENTERS & BUILDERS GUIDES—4 Vols.\$6

A practical illustrated trade assistant on modern construction for carpenters, joiners, builders, mechanics and all woodworkers. 4 vols., 1600 pages, 3700 illustrations, flexible covers. Pocket size. Each volume sold separately \$1.50 a vol.

AUDELS AUTOMOBILE GUIDE.....\$4

A practical quick ready reference book for auto mechanics, service men, operators & owners. Explains theory, construction & servicing of modern motor cars, trucks, buses & auto type Diesel engines. 1700 pages, fully illustrated. 55 chapters. Indexed. A standard book for mechanics. New fluid drive covered.

AUDELS DIESEL ENGINE MANUAL..\$2

A practical, concise treatise with questions and answers on the theory, operation and maintenance of modern diesel engines including General Motors 2 cycle Diesel. 384 pages, fully illus., flexible binding, pocket size. All details plainly brought out, this book is of extreme value to engineers, operators & students.

AUDELS WIRING DIAGRAMS.....\$1

210 Pages. Illustrated. Gives practical facts on wiring of electrical apparatus. It shows clearly how to wire apparatus for practically all fields of electricity. Each diagram is complete & self-explanatory. Highly Endorsed Pocket Companion.

AUDELS PLUMBERS & STEAMFITTERS GUIDES—4 Vols.\$6

A Practical Trade Assistant & Ready Reference. Explains in plain language & by clear illustrations, diagrams, charts, graphs, pictures principles of modern plumbing practice including Marine Pipe Fitting and Air Conditioning. 4 Vols.—1670 Pages—3642 Diagrams. Pocket size. Each Vol. Sold Separately \$1.50 a Vol.

AUDELS SHEETMETAL WORKERS HANDY BOOK.....\$1

Practical inside information. Fundamentals of Sheet Metal Work. 388 pages. Illustrated. 11 sections. Clearly written. Essential & important facts, figures, pointers in everyday language. Ref. Index.

AUDELS SHEETMETAL PATTERN LAYOUTS.....\$4

Developed by Experts for Sheet Metal Workers, Layout Men & Mechanics. A Practical Encyclopedia in 10 Sections, size 7 x 10 x 2—1125 Pages—350 Layouts—1600 Illustrations. 1001 Key Facts. Fully indexed for ready reference in answering your layout problems. Covers all phases of sheet metal work including Pattern Cutting, Pattern Development & Shop Procedure.

AUDELS ANSWERS ON BLUE PRINT READING.....\$2

For Mechanics & Builders. Covers all types of blue print reading including ship & airplane. 416 pages, fully illustrated.

AUDELS NEW MACHINIST & TOOLMAKERS HANDY BOOK.....\$4

Covers modern machine shop practice in all its branches. 5 practical books in 1. New from cover to cover. Tells how to set up & operate lathes, screw and milling machines, shapers, drill presses and all other machine tools. 1600 pages, fully illustrated, 5 x 6 1/2 x 2. Indexed. 5 sections. 1—Modern Machine Shop Practice. 2—Blue Print Reading & How to Draw. 3—Calculations & Mathematics for Machinists. 4—Shop Physics. 5—How to Use the Slide Rule. 60 chapters. Easy to read and understand. A shop companion that answers your questions.

AUDELS MATHEMATICS & CALCULATIONS FOR MECHANICS \$2

Mathematics for home study or reference. 700 pages, 550 illus. Practical mathematics from beginning. How to figure correctly. Easy, correct methods covering complete review. Illus. & Indexed.

AUDELS HANDY BOOK OF PRACTICAL ELECTRICITY.....\$4

For maintenance engineers, electricians & all electrical workers. 1440 Pages, 2600 Illus. Covers important electrical information in handy form—including Marine Wiring, Radio Principles, Welding. Indexed. A Key to a practical understanding of electricity.

AUDELS RADIOMANS GUIDE.....\$4

A key to the practical understanding of radio including Frequency Modulation, Television, etc., Aircraft & Marine Radio. For radio engineers, servicemen, amateurs, 914 Pages, 633 Illustrations & Diagrams. Photos. Review Questions & Answers, Reference Index. Authentic, clear, concise.

AUDELS ELECTRONIC DEVICES.....\$2

Tells What You Want to Know About Electric Eye. Easily Understood. Covers photo-electric cells & their applications. Amplifiers, illumination, frequencies, voltage, photocell, tubes, Ohm's Law, wiring diagrams, etc.

AUDELS WELDERS GUIDE.....\$1

A concise, practical text on operation & maintenance of all welding machines for all mechanics. Over 400 pages, illustrated. Covers all methods of electric and acetylene welding including airplane work.

AUDEL, Publishers, 49 W. 23 St., N. Y. 10

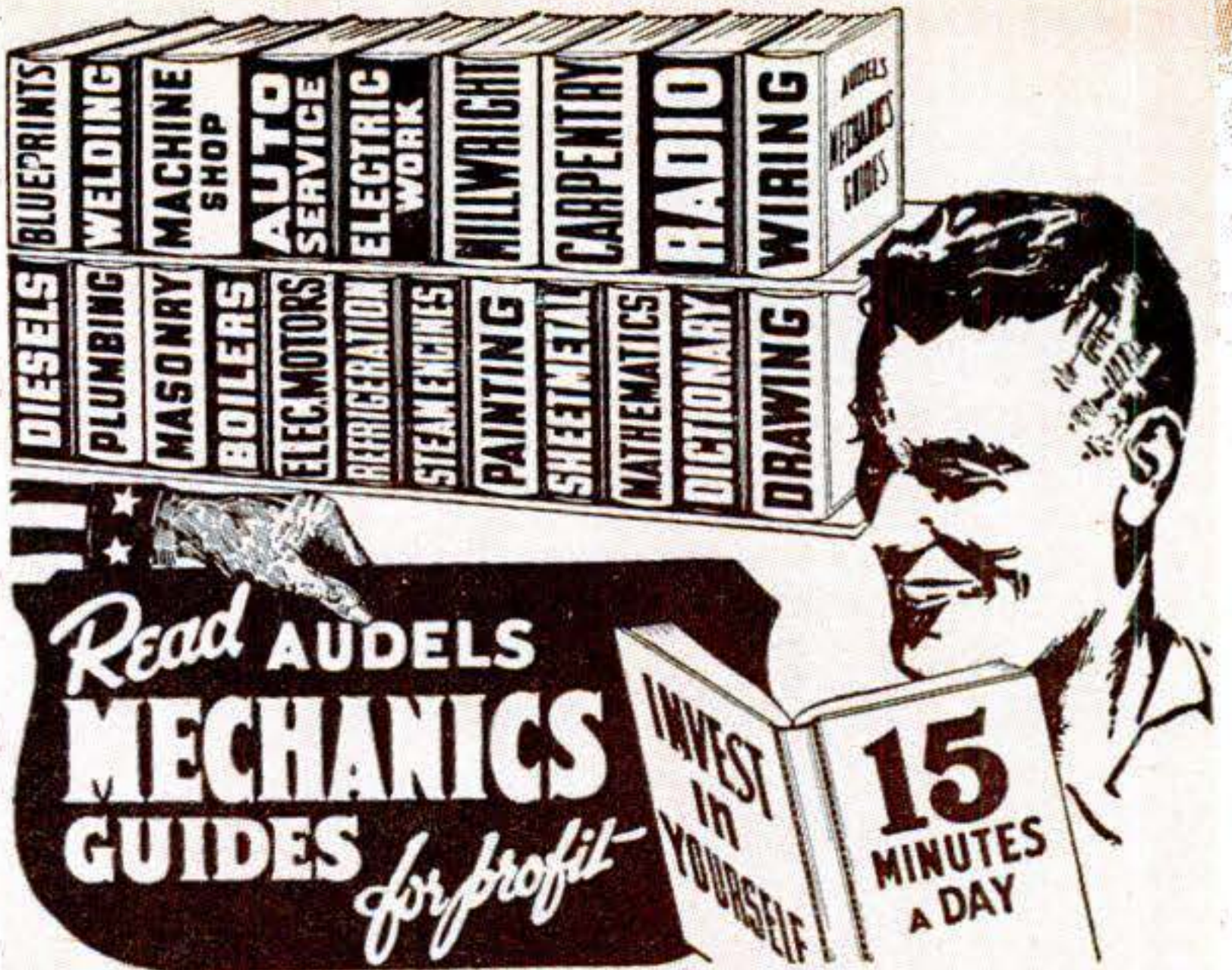

AN AUDEL GUIDE IS A GOOD FRIEND!

Step Up Your Own Skill with the Practical Facts and Figures of Your Trade. Save time and money with right methods, short cuts, labor saving ideas. CHECK NOW! You can look over any Audel Guide in your home. Start the Easy Payments if satisfied.

CUT HERE MAIL ORDER

THEO. AUDEL & CO., 49 W. 23 St., New York 10, N. Y.

Please mail me for 7 days' free examination the books marked (X) below. I agree to mail \$1 in 7 days on each book or set ordered, and to further mail \$1 a month on each book or set ordered until I have paid purchase price. If I am not satisfied with Guides I will return them.

- Audels **ELECTRIC MOTOR GUIDE** \$4.
- Audels **OIL BURNER GUIDE** 1.
- Audels **REFRIGERATION & Air Conditioning Guide** 4.
- Audels **POWER PLANT ENGINEERS GUIDE** 4.
- Audels **PUMPS, HYDRAULICS & AIR COMPRESSORS** 4.
- Audels **WELDERS GUIDE** 1.
- Audels **BLUE PRINT READING** 2.
- Audels **SHEET METAL WORKERS Handy Book** 1.
- Audels **SHEET METAL PATTERN LAYOUTS** 4.
- Audels **AIRCRAFT WORKER** 1.
- Audels **MATHEMATICS and CALCULATIONS** 2.
- Audels **MACHINISTS & TOOLMAKERS Handy Book** 4.
- Audels **MECHANICAL Dictionary** 4.
- Audels **AUTOMOBILE GUIDE** 4.
- Audels **DIESEL ENGINE MANUAL** 2.
- Audels **MARINE ENGINEERS Handy Book** 4.
- Audels **MECHANICAL DRAWING GUIDE** 1.
- Rogers **MECHANICAL DRAWING and DESIGN** 2.
- Audels **MILLWRIGHTS and Mechanics Guide** 4.
- Audels **CARPENTERS and Builders Guides (4 vols.)** 6.
- Audels **PLUMBERS and Steamfitters Guides (4 vols.)** 6.
- Audels **MASONS and Builders Guides (4 vols.)** 6.
- Master **PAINTER and DECORATOR** 2.
- Audels **GARDENERS & GROWERS GUIDES (4 vols.)** 6.
- Audels **ENGINEERS & FIREMANS EXAMINATIONS** 1.
- Audels **ENGINEERS and Mechanics Guides** 12.
- Nos. 1, 2, 3, 4, 5, 6, 7 and 8 complete 12.
- Audels **Answers on Practical ENGINEERING** 1.
- Audels **ELECTRICIANS EXAMINATIONS** 1.
- Audels **WIRING DIAGRAMS** 1.
- Audels **Handy Book of PRACTICAL ELECTRICITY** 4.
- Audels **ELECTRICAL POWER CALCULATIONS** 2.
- Audels **ELECTRONIC DEVICES** 2.
- Audels **ELECTRIC Dictionary** 2.
- Audels **RADIOMANS GUIDE** 4.
- Audels **NEW ELECTRIC LIBRARY at \$1.50 a Volume** 4.
- Vols. I, II, III, IV, V, VI, VII, VIII, IX, X, XI, XII

Name _____
 Address _____
 Occupation _____
 Employed by _____ PSM

It's YOUR future—Make the most of it!



Start now to earn the bigger pay in electrical repair

WAS there ever such an opportunity to get started in electrical maintenance and repair—and at top-notch wages? Are you ready—with experience and ability—to cash in on it? Others are getting just the sort of background needed—quick! practical!—to handle the great variety of electrical maintenance and repair work TODAY—from this well-known electrical library. You can too!

THE LIBRARY OF ELECTRICAL MAINTENANCE AND REPAIR

5 vols., 1826 pages, 1724 illustrations

Gives you the "know-how" to tackle any wiring or motor job. Five books show you HOW—to install all types of motor and generator units—to inspect and repair motor starters and generators—to diagnose motor and generator troubles—to figure new windings for old cores—DC and AC windings—to test armature windings—test induction motors, etc., etc. One book is full of trouble-shooting charts that show quickly symptoms, causes, specific remedies, etc.

Take the first step toward improving YOUR future—Mail this coupon TODAY

No money down—special price—easy payments—FREE trial

McGraw-Hill Book Co., 330 W 42 St., New York 18, N. Y.

Send me for ten days' free examination the Electrical Maintenance and Repair Library. If satisfactory I will send you \$1.50 in 10 days and \$3.00 monthly until the price of \$18.50 is paid. If not wanted I will return books postpaid. (To insure prompt shipment write plainly and fill in all lines.)

Name.....
Home Address.....
City and State.....
Company.....
Position..... PSM-8-47

A SIGN OF Business PROGRESS

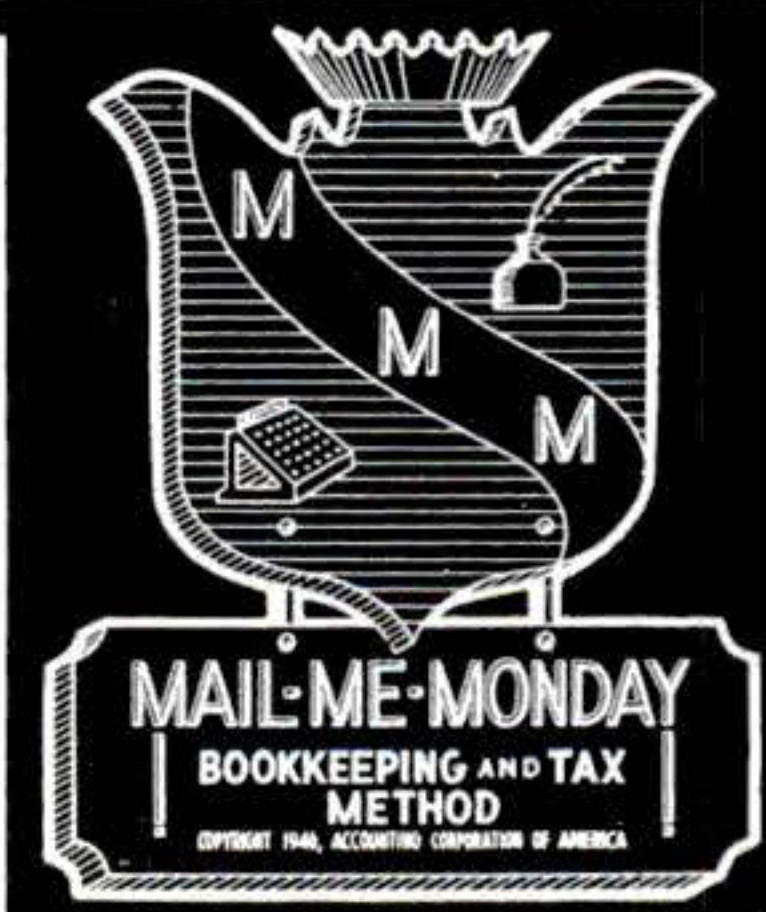

The "Mail-Me-Monday" bookkeeping and tax service is praised by business men and authorities for economy and efficiency.

Monthly statements are computed by IBM electric accounting machines.

See "Bookkeeping" in your telephone book and call

"MAIL-ME-MONDAY" BOOKKEEPING and TAX METHOD

or write to Dept. P-7
1929 FIRST AVE., SAN DIEGO 1, CALIF.

FOR STEREO PICTURES, IT'S

STEREO-TACH!

Take Third Dimension Pictures with the STEREO-TACH and your own camera! There's nothing in photography so startlingly beautiful and lifelike! You can't reproduce a 3-dimension picture in flat 2-dimension printing!

Outfit No. 101—'Tach and Transparency Viewer (for transparencies, with 35MM cameras) **\$22.50***

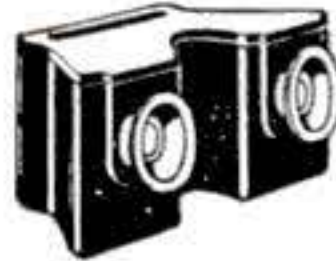

Outfit No. 100—'Tach and Print Viewer (for stereo prints, with both 35MM and other size cameras) **\$16.25***
*Plus Tax.



The Stereo-Tach

For Third-Dimension Projection, the STEREO-FLECTOR! Just Out! See your dealer or write.
ADVERTISING DISPLAYS, INC. Dept. PS-6 COVINGTON, KENTUCKY

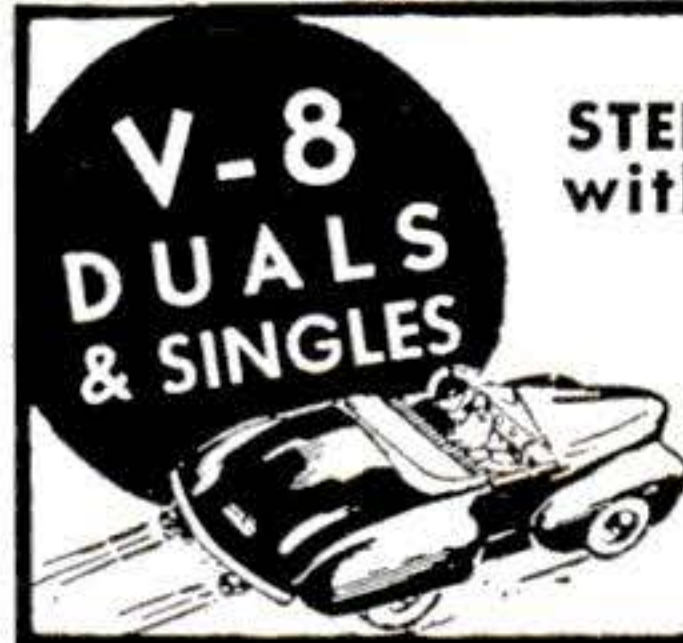

MUFFLERS

STEELS and ALUMINUMS with a motorboat tone

SINGLES, Chev, V-8, Plymouth, Steels \$5.50, Aluminum \$6.50. Chry., Olds., Buicks, etc., Steels \$7.50, Aluminum \$8.50. V-8 and MERCURY DUALS, Steel \$17.50, Aluminum \$20.00. Aluminums are guaranteed for life of your car.

DEALERS WANTED

SANDEE MUFFLER CO.
7523 S. WESTERN AVE., LOS ANGELES 44, CALIF.

ELECTRICAL TRAINING

Intensive 32 weeks residence course in fundamentals of industrial electrical engineering, including radio, electronics. Prepares for technician, engineering aides. Approved for veteran training. 54th year. Write for catalog.

BLISS ELECTRICAL SCHOOL
7614 Takoma Ave., Wash. 12, D. C.



**MASTER MACHINIST • MECHANICAL DRAFTING
TOOL-DIE DESIGNING • TOOL ENGINEERING**

Completely equipped shops and drafting rooms, directed by an accredited staff of engineers and practical instructors. 18 years of successful training of men for industry.

Days, Evenings • Approved for Veteran Training

NEW CLASSES Now Forming • BULLETIN ON REQUEST

ALLIED SCHOOL OF MECHANICAL TRADES, INC.
44 ALLIED BLDG., 1336 S. MICHIGAN AVE. • CHICAGO 5, ILL.

Gain A Complete Science Education Right in Your Own Home, in Your Spare Time!

VAN NOSTRAND'S SCIENTIFIC ENCYCLOPEDIA

The most useful and authoritative fund of information on science ever published. Organized for instant reference, this giant home-study book puts the world of modern science and invention right at your fingertips. 10,000 subjects, 1,800 pages, 1,400 illustrations—PHOTOGRAPHY, AERONAUTICS, RADIO, ELECTRONICS, CHEMISTRY, PHYSICS, CHEMICAL ENGINEERING, ZOOLOGY, BOTANY, GEOLOGY, METEOROLOGY, METALLURGY, MATHEMATICS, STATISTICS, MINERALOGY, MEDICINE, ASTRONOMY, NAVIGATION.

Examine this Great Book FREE!

Fill in and mail the coupon. It will bring you a copy of the SCIENTIFIC ENCYCLOPEDIA for 10 days free examination.

D. VAN NOSTRAND COMPANY, INC.
250 Fourth Avenue, New York 3, New York
Send me Van Nostrand's SCIENTIFIC ENCYCLOPEDIA. Within 10 days I will either return it or send you \$2.00 plus a few cents postage, and \$2.00 monthly for five months. (If you send entire amount of \$12.00 with this coupon, we will pay the postage. Same return privilege guaranteed.)
NAME.....
ADDRESS.....
CITY.....ZONE.....STATE.....
Pop. Sci.—Aug. 1947



I Will Show You How to Learn RADIO by Practicing in Spare Time

**I Send You
Big Kits
of Radio Parts**

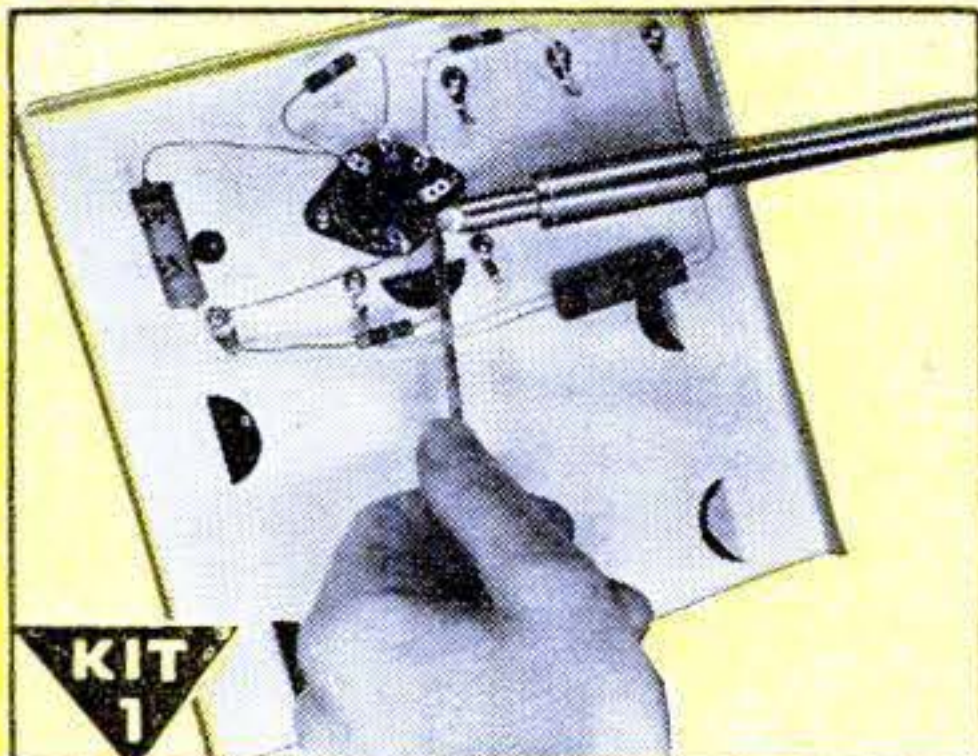

KIT 1
I send you Soldering Equipment and Radio Parts; show you how to do Radio soldering; how to mount and connect Radio parts; give you practical experience.

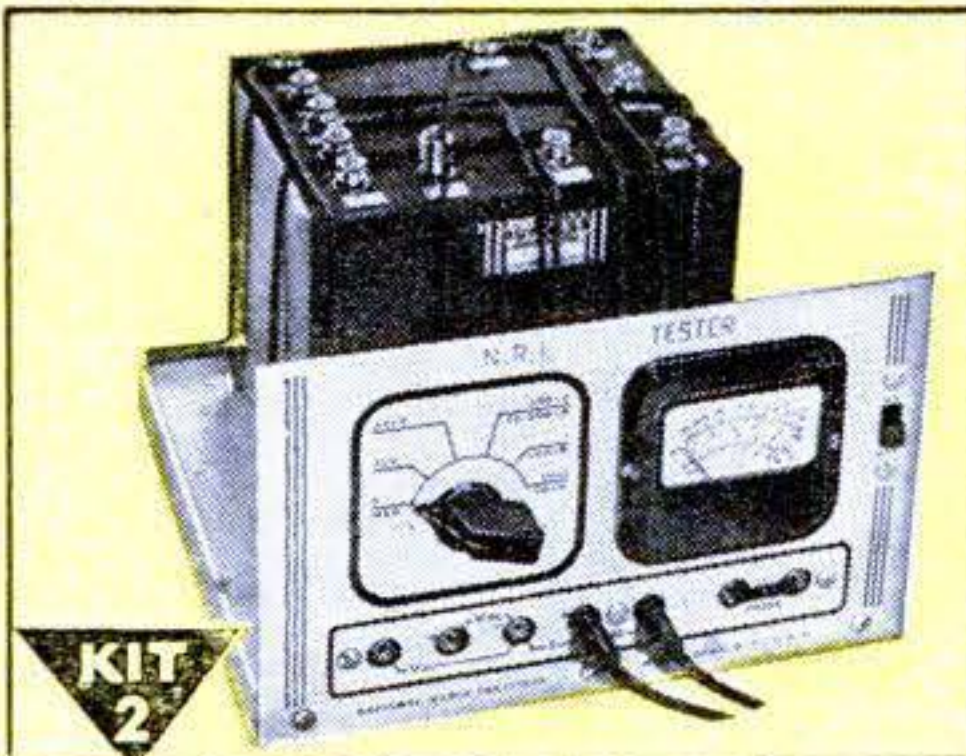

KIT 2
Early in my course I show you how to build this N.R.I. Tester with parts I send. It soon helps you fix neighborhood Radios and earn EXTRA money in spare time.

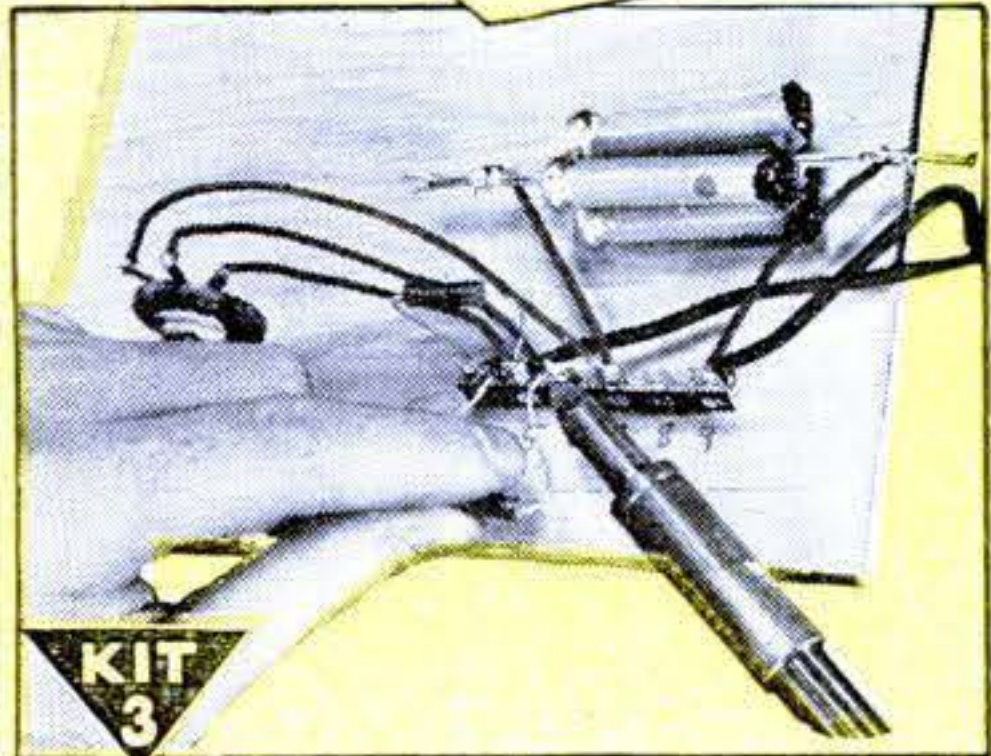

KIT 3
You get parts to build Radio Circuits; then test them; see how they work; learn how to design special circuits; how to locate and repair circuit defects.

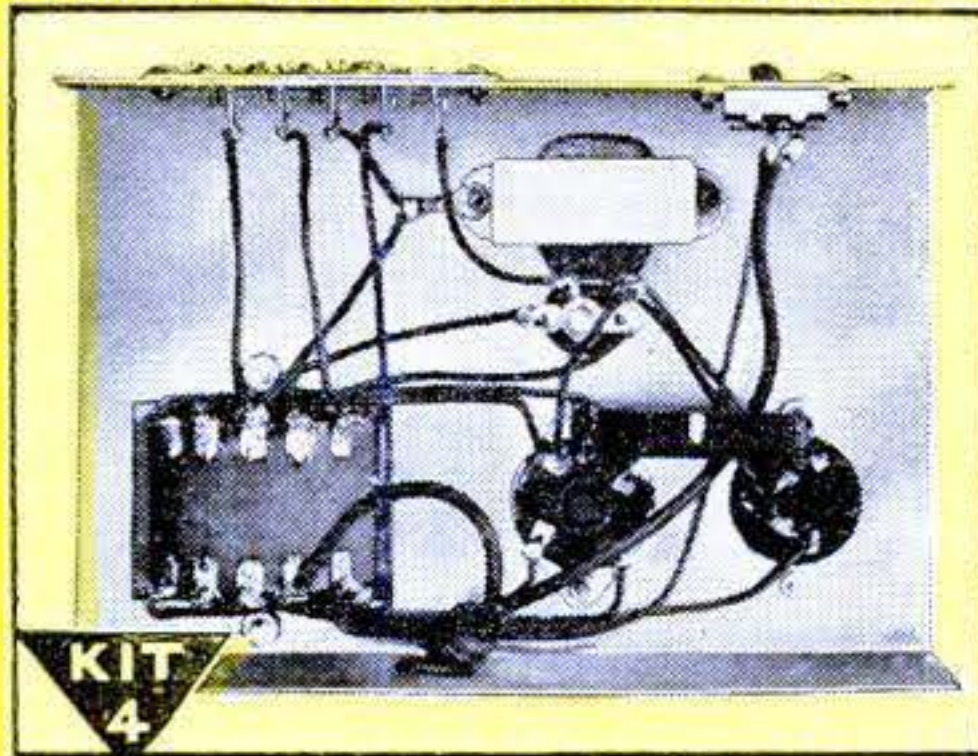

KIT 4
You get parts to build this Vacuum Tube Power Pack; make changes which give you experience with packs of many kinds; learn to correct power pack troubles.

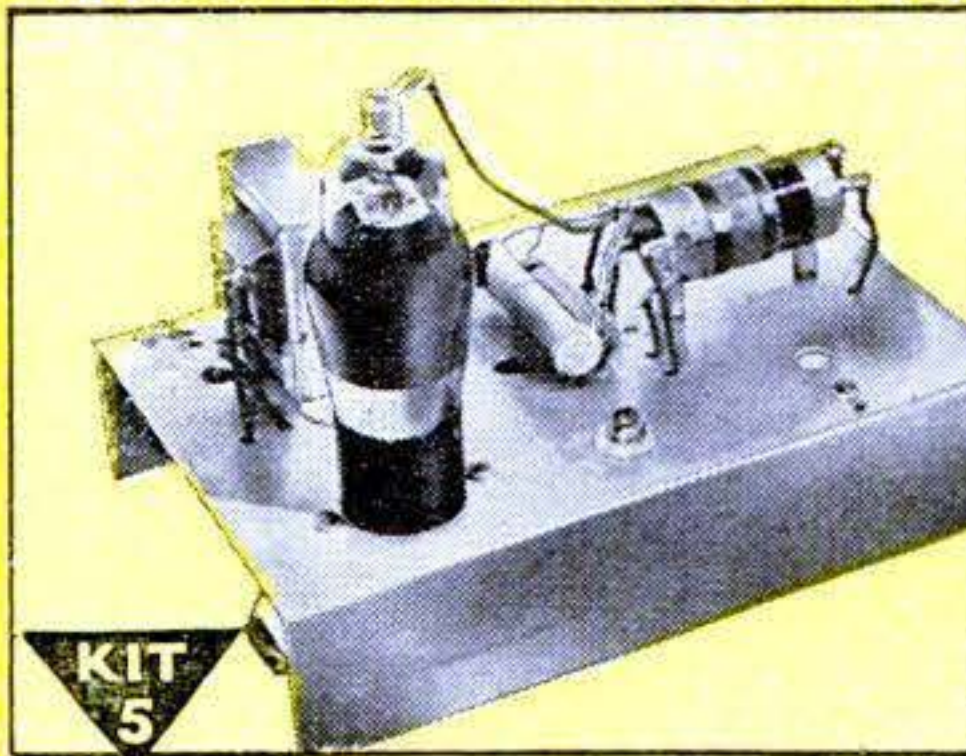

KIT 5
Building this A. M. Signal Generator gives you more valuable experience. It provides amplitude-modulated signals for many tests and experiments.



KIT 6
You build this Superheterodyne Receiver which brings in local and distant stations—and gives you more experience to help you win success in Radio.

KNOW RADIO - Win Success **I Will Train You at Home - SAMPLE LESSON FREE**

Do you want a good-pay job in the fast-growing Radio Industry—or your own Radio Shop? Mail the Coupon for a Sample Lesson and my 64-page book, "How to Be a Success in RADIO—Television, Electronics," both FREE. See how I will train you at home—how you get practical Radio experience building, testing Radio circuits with BIG KITS OF PARTS I send!

get started now than ever before, because the Radio Repair Business is booming. Trained Radio Technicians also find profitable opportunities in Police, Aviation, Marine Radio, Broadcasting, Radio Manufacturing, Public Address work. Think of even greater opportunities as Television, FM, and Electronic devices become available to the public! Send for FREE books now!

Find Out What NRI Can Do For You
Mail Coupon for Sample Lesson and my FREE 64-page book. Read the details about my Course; letters from men I trained; see how quickly, easily you can get started. No obligation! Just MAIL COUPON NOW in envelope or paste on penny postal. **J. E. SMITH, President, Dept. 7HP3, National Radio Institute, Pioneer Home Study Radio School, Washington 9, D. C.**

Many Beginners Soon Make Extra Money in Spare Time While Learning

The day you enroll I start sending EXTRA MONEY manuals that show how to make EXTRA money fixing neighbors' Radios in spare time while still learning! It's probably easier to

Approved for Training under GI Bill

Good for Both - FREE

Mr. J. E. SMITH, President, Dept. 7HP3 National Radio Institute, Washington 9, D. C. Mail me FREE, your sample lesson and 64-page book. (No salesman will call. Please write plainly.)

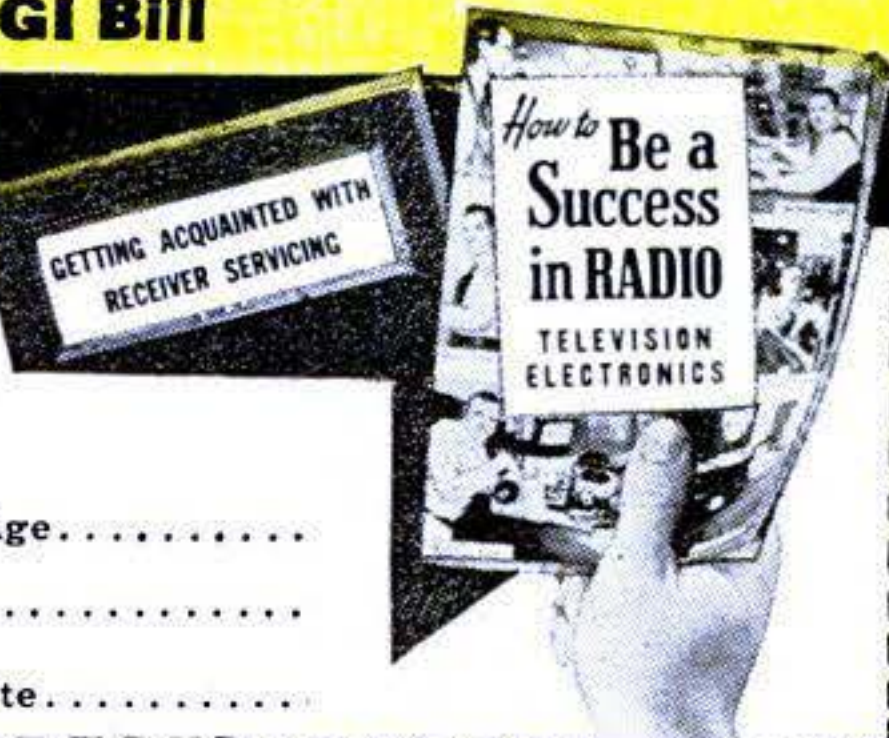

Name.....Age.....
Address.....
City.....Zone.....State.....

VETERANS
You can get this training right in your own home under G. I. Bill. Mail coupon for full details.

SURPLUS BARGAINS

ASSEMBLE YOUR OWN BINOCULARS!

Complete Optics! Complete Metal Parts!
Save More Than 1/2 Regular Cost

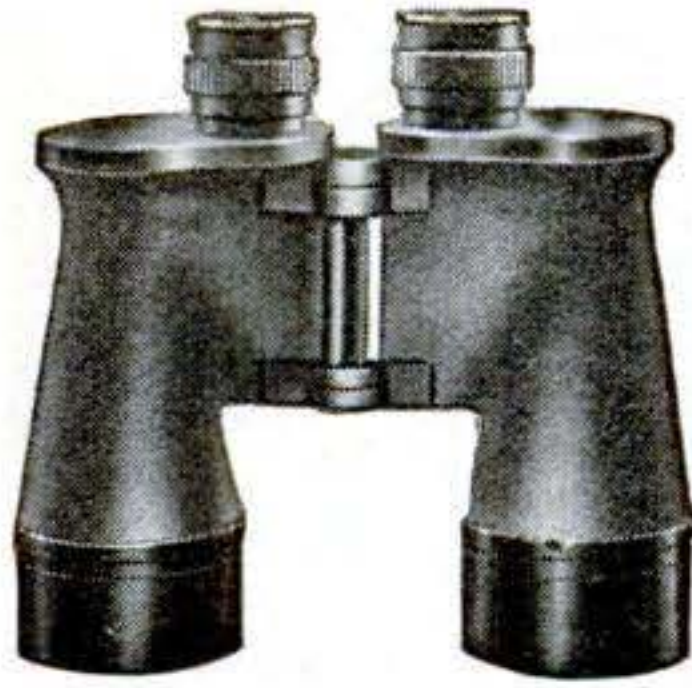

GOVERNMENT'S 7x50 BINOCULARS

Complete Optics, new and ready for assembly. We supply full instructions. Limit—1 Set of Metal Parts and 1 Set of Optics to a customer.

METAL PARTS—Set includes all Metal Parts—completely finished—for assembly of 7 X 50 Binoculars. No machining required. Bodies have been factory hinged and covered. A sturdy Binocular Carrying Case is included with each set of Metal Parts.

Stock #841-N \$36.20 Postpaid

OPTICS—Set includes all Lenses and Prisms you need for assembling 7 X 50 Binoculars. These are in excellent condition—perfect or near-perfect—and have new low reflection coating.

Stock #5102-N \$25.00 Postpaid

NOTICE! If you buy both Binocular Optics and Binocular Metal Parts, add 20% Federal Excise Tax to above prices.

ARMY'S 6 X 30 BINOCULARS—Complete Optics and Metal Parts for Waterproof Model. Would retail \$102 to \$120. All Optics perfect or near-perfect; Metal Parts new and perfect. Assembly instructions included.

Stock #830-N \$40.00 Postpaid,
plus \$8.00 tax—Total—\$48.00

NEVER HAS THERE BEEN SUCH A SENSATIONAL BARGAIN AS THIS! BUBBLE SEXTANT—TYPE A-10

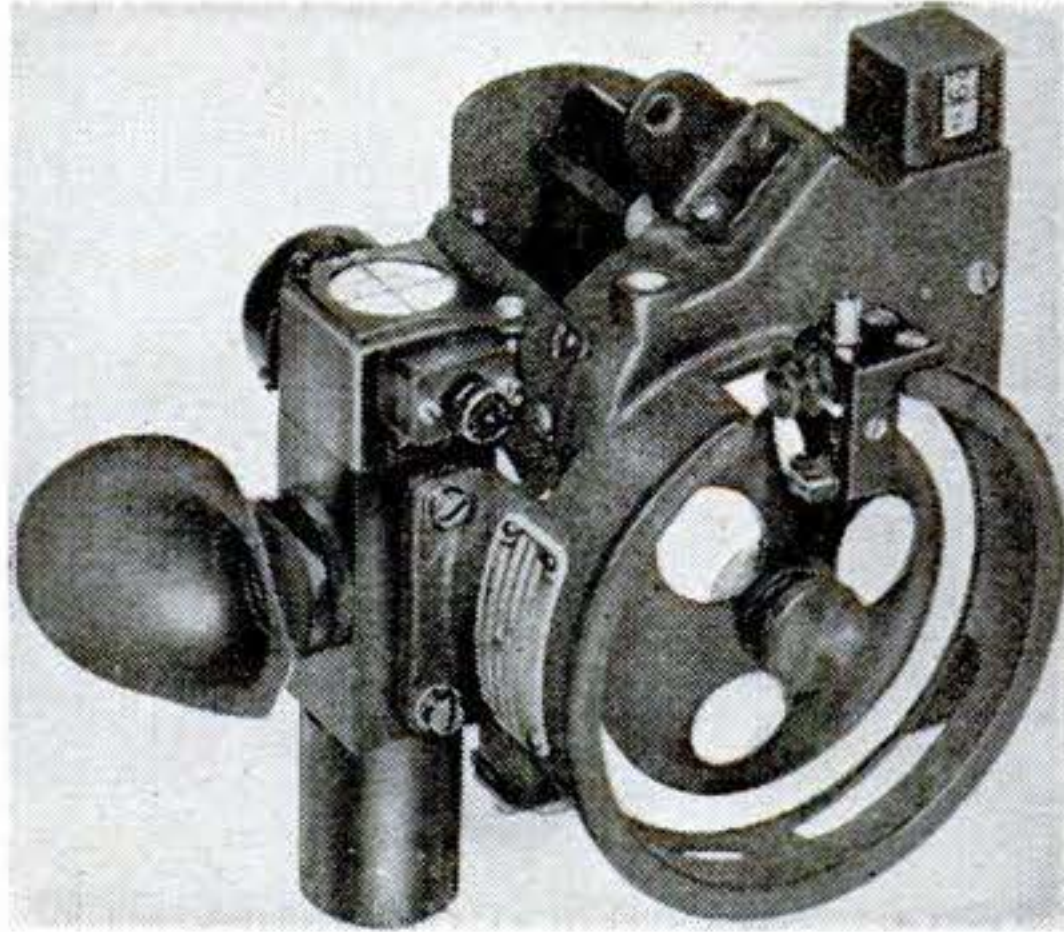

These Army Air Forces Bubble Sextants cost the Govt. about \$200 each. A real bargain at our price of \$12.50! Included with Bubble Sextant shipment is wooden Carrying Case, 5 spare waxed paper discs, flashlight with rheostat for night use (uses ordinary flashlight cells—not furnished) aux. 2-power Galilean Telescope, Allen wrench, 1 spare marking point. Wartime used, but where necessary completely repaired, collimated and put in good working order. If not satisfied that Sextant is exactly as represented, return within 10 days and money will be refunded. Full directions for use accompany each shipment.

Stock #924-N \$12.50 Postpaid

BATTERY COMMANDER'S PERISCOPE With Tripod 6 Power Instrument. Excellent condition. Length 27 1/2 inches—diam. 1 1/2 inches. Cost U. S. Govt. approximately \$175.00.

Stock #717-N \$20.00 F.O.B. Audubon

MOUNTED KELLNER TELESCOPE EYE PIECE—Perfect coated, in Ordnance sealed boxes. F.L. 1 3/4 inches. Outside dia. of steel mount 40 mm.

Stock #6198-N \$3.15 Postpaid

35 MM KODACHROME PROJECTING LENS SET—Consists of Achromatic Lens for projecting, plus a Condensing Lens and piece of Heat Absorbing Glass with directions.

Stock #4025-N \$1.95 Postpaid

SCHMIDT OPTICAL SYSTEM. Black plastic body, size 3-15/16" by 5-1/2". F.L. 2.4".....with amazing speed of F.O.9. Used in Navy's Infra-Red Sniperscope and Signaling Units. Govt. cost \$134. Limit—1 to a customer.

Stock #720-N \$6.00 Postpaid

MOUNTED PROJECTING LENS SYSTEM. F.L. 91.44 mm (just right for 35 mm. Projectors). Speed of F 1.9. Outside dia. of mount at one end 60 mm. Length of mount 64 mm.

Stock #4033-N \$3.00 Postpaid

We have literally millions of war surplus lenses and prisms for sale at bargain prices. Write for Catalog "N"—Sent Free! Satisfaction Guaranteed • Order by Stock No.

EDMUND SALVAGE COMPANY
P. O. AUDUBON NEW JERSEY

AVIATION

Aeronautical University Approved Training meets exacting standards of aviation industry, prepares for key positions, big opportunities.

Courses in:

AERONAUTICAL ENGINEERING. B.S. degree.

AERONAUTICAL ENGINEERING DRAFTING

CERTIFIED ENGINE MECHANICS

ADMINISTRATION—including sales

PRE-ENGINEERING: Special course for high school graduates and veterans deficient in math and science.

Also refresher courses for Gov't. Airplane and Engine Mechanics Licenses for those with aviation experience.

Oldest fully approved aviation school. Outstanding faculty, modern equipment, outside employment, placement service. Day, evening. Approved for Veterans. Send today for FREE catalog "Opportunities in Aviation."

AERONAUTICAL UNIVERSITY

Dept. 87, 116 S. Michigan Avenue, Chicago 3, Illinois

FOUNDED BY CURTISS-WRIGHT

Why spend years learning by hard experience what you can get from a practical book in a few hours.

Write for list of "How-To-Do-It" books on practical subjects. 1000's of pleased customers all over the world.

ADAMS BROWN COMPANY — BOOKS OF APPLIED SCIENCE

Dept. 278 Chestnut Hill 67, Massachusetts, U. S. A.

BE A REAL ESTATE BROKER

PAYS BIG! EASY TO LEARN—Start and run your own business quickly.

Many graduates report making up to \$1000 a month. Course of study covers Sales, Property Management, Appraising, Loans, Mortgages and hundreds of related subjects. Course offered in home study or classroom—Both G. I. Approved. Send post card today for big, new illustrated book from this nationally known school. Dept. 30

WEAVER SCHOOL OF REAL ESTATE, 15 E. Pershing Road, Kansas City 8, Mo.

FREE BOOK TELLS HOW

FREE 5 INCH GENUINE LEATHER Jolly Rogers Patch



Join the Jolly Rogers Club of Insignia Collectors. Send only \$1.00 and get this Genuine Leather Jolly Roger Breast Patch Free with 25 all different Air Force Wings and Officers Collar Insignia. (List Price \$5.00.) Colored Insignia Book FREE with order.

The Insignia Mart, Dept. B-13, 703 Broadway New York 3, N. Y.



\$10, \$15 FOR ONE DRAWING

Be an ARTIST!

—Train at Home in Your Spare Time
Trained Artists are capable of earning \$50, \$60, \$75 a week. The fascinating field of Art offers commercial opportunities to men and women. **COMMERCIAL ART, CARTOONING, DESIGNING** all in one complete course. **TWO ART OUTFITS** furnished. Learn to draw step-by-step. Write today for full information and **FREE BOOK**. "Art for Pleasure and Profit." Course available under G. I. Bill.

FREE BOOK gives details!

Washington School of Art, Studio 138H
1115—15th St., N. W., Washington 5, D. C.

Name.....

Street..... AGE.....

City..... Zone () State.....

I AM ENTITLED TO G. I. TRAINING.



NOT BACK HERE!

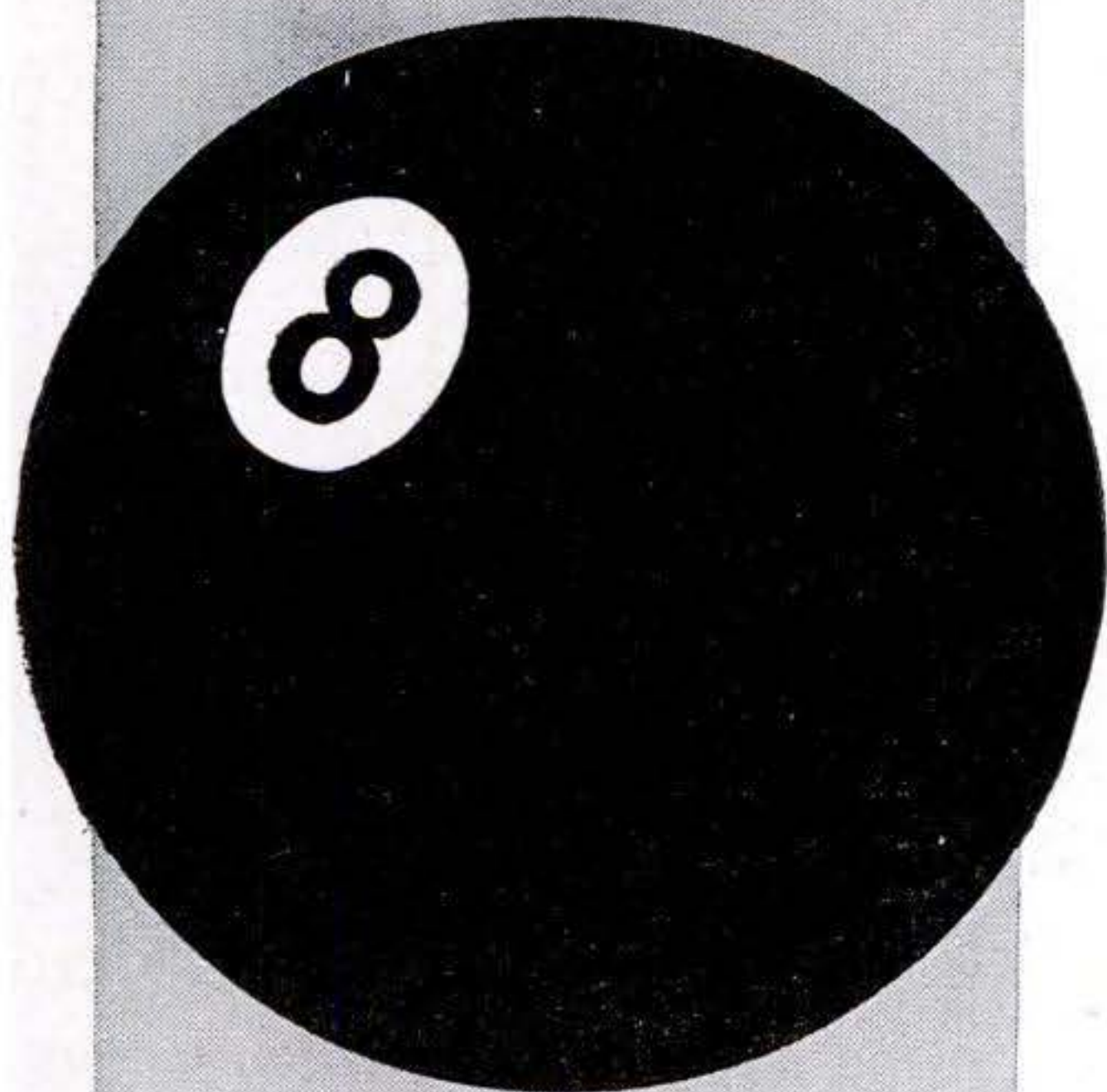

I. C. S. graduates turn up in lots of places — but not “behind the 8-ball.” You’ll find thousands of them in *top* executive posts . . . hundreds of thousands holding good positions and regularly collecting promotions and pay raises.

They realized that the advancements go to the trained men . . . and that practical, authoritative I.C.S. training is just as close to any one as the nearest letter-box. Many of them started drawing the dividends of larger pay checks and increased responsibilities *before* they completed their I.C.S. Courses.

The road they followed to success is open to you. I.C.S. Courses cover more than 400 business and technical subjects. You study in your spare time . . . at low cost . . . in a class by yourself.

If you’re as smart as we think you are, you won’t be caught “behind the 8-ball” with the untrained. You’ll mail the coupon today for full information on how to join the trained men rewarded by this modern world.

INTERNATIONAL CORRESPONDENCE SCHOOLS



BOX 7690-L, SCRANTON 9, PENNA.

Without cost or obligation, please send me full particulars about the course *before* which I have marked X:

- Air Conditioning and Plumbing Courses**
- Air Conditioning
- Heating Plumbing
- Refrigeration Steam Fitting
- Chemistry Courses**
- Chemical Engineering
- Chemistry, Analytical
- Chemistry, Industrial
- Chemistry, Mfg. Iron & Steel
- Petroleum Refining Plastics
- Pulp and Paper Making
- Civil Engineering, Architectural and Mining Courses**
- Architectural Drafting
- Architecture
- Bridge and Building Foreman
- Building Estimating
- Civil Engineering
- Coal Mining
- Contracting and Building
- Highway Engineering
- Lumber Dealer
- Reading Structural Blueprints
- Sanitary Engineering
- Structural Drafting

- Structural Engineering
- Surveying and Mapping
- Communications Courses**
- Electronics
- Practical Telephony
- Radio, General
- Radio Operating
- Radio Servicing
- Telegraph Engineering
- Electrical Courses**
- Electrical Drafting
- Electrical Engineering
- Electric Light and Power
- Lighting Technician
- Practical Electrician
- Internal Combustion Engines Courses**
- Auto Technician Aviation
- Diesel-Electric
- Diesel Engines Gas Engines
- Mechanical Courses**
- Aeronautical Engineering
- Aircraft Drafting
- Flight Engineer
- Foundry Work
- Heat Treatment of Metals

- Industrial Engineering
- Industrial Metallurgy
- Machine Shop
- Mechanical Drafting
- Mechanical Engineering
- Mold-Loft Work
- Patternmaking—Wood, Metal
- Reading Shop Blueprints
- Sheet-Metal Drafting
- Sheet-Metal Worker
- Ship Drafting Ship Fitting
- Tool Designing
- Toolmaking
- Welding—Gas and Electric
- Railroad Courses**
- Air Brake Car Inspector
- Diesel Locomotive
- Locomotive Engineer
- Locomotive Fireman
- Railroad Section Foreman
- Steam Engineering Courses**
- Boilermaking
- Combustion Engineering
- Engine Running
- Marine Engineering
- Steam Electric Steam Engines

- Textile Courses**
- Cotton Manufacturing
- Rayon Weaving
- Textile Designing
- Woolen Manufacturing
- Business and Academic Courses**
- Accounting Advertising
- Arithmetic Bookkeeping
- Business Correspondence
- Business Management
- Certified Public Accounting
- Commercial
- Cost Accounting
- Federal Tax
- First Year College
- Foremanship French
- Good English High School
- Higher Mathematics
- Illustrating Motor Traffic
- Postal Service
- Salesmanship Secretarial
- Sign Lettering
- Spanish Stenography
- Traffic Management

Name _____ Age _____ Address _____

City _____ State _____ Present Position _____

Working Hours _____ A.M. to _____ P.M. Length of Service in World War II _____

Special tuition rates to members of the Armed Forces. Enrollment under the G.I. Bill of Rights approved for War II Veterans.
Canadian residents send coupon to International Correspondence Schools Canadian, Ltd., Montreal, Canada.

add PYROIL



carefree driving

Join the growing ranks of automobile owners who are underwriting car performance with Pyroil. Pyroil prevents undue wear by maintaining a film of oil on cylinder walls . . . it prevents rust and corrosion . . . eliminates the accumulation of dirt, sludge, gum and other contamination on surfaces . . . it reduces carbon formation.

Ask your gas station attendant to add Pyroil—and you'll add miles to your car.

PYROIL FOR AIRCRAFT ENGINES

Use Aircraft Pyroil B for lubricating oil, Aircraft Pyroil A for gasoline.

Manufactured and Guaranteed by Pyroil Company, 242 Main Street, La Crosse, Wisconsin.



PYROIL COMPANY
242 Main Street
La Crosse, Wisconsin

I want my car to last and run properly. Please tell me more about Pyroil and how it can accomplish this for me.

Name.....

Address.....

City or Town.....State.....



Jerry, the talking dog, is entertaining hospitalized veterans, by courtesy of the PYROIL Company. Picture of Jerry sent on request.

LETTERS

Statistics Don't Lie

Sir:

. . . On page 90 of the June number I find: ". . . the coal miner may be released from his daily struggle with death in the dark." Now don't you think that is laying it on just a little thick? Why don't you take a trip to a modern coal mine? I am sure you will find that (1) mechanized methods eliminate the "struggle," (2) modern methods eliminate the "dark" and (3) no one is under the constant fear of "death." A check-up will reveal that coal mining does not have the highest of all poor safety records.

JAMES V. THOMPSON

Calhoun, Ga.

The National Safety Council ranks coal mining as the most hazardous of all occupations in the severity of injuries. Its accident rate on that basis is more than 10 times the average for all industries. And the last decade has seen more than 10,000 miners die—most of them in the dark. Is that laying it on too thick?

Why Not Crash Pads?

Sir:

I read your article "Cars Can Be Safer" (April '47, p. 82), and you stated that the car companies would lose business if they came out with crash pads, safety belts, etc. But if these were put on all cars at once, like the sealed-beam headlamps, I doubt that the sales would decrease much.

BILL KIRKNESS

Burlington, Vt.

Sir:

. . . Your article "Cars Can Be Safer" interested me because of the crash-pad feature. You see, I've been thinking of some such thing for quite some time. . . . What I had in mind was a crash pad so constructed that it would automatically be released either through the braking action or at a certain speed so as to rise upward and cover



INVENTORS



Learn how to protect your invention. The U. S. Patent Laws provide that any new and useful art, machine, article of manufacture, or composition of matter, or any new and useful improvement thereof, may be patented if the act of invention is involved. Therefore, every inventor with a valuable invention should take advantage of the Patent Laws and proceed for patent protection in order to safeguard his rights.

A patent gives the inventor the exclusive right to prevent others from making, using, or selling the invention claimed in the patent for a period of seventeen years.

The Patent Laws were enacted for the benefit of the inventor to give him protection for the features of his invention which are patentable. These features must be properly and concisely set forth and claimed in a formal application for patent, in order to comply with the requirements of the U. S. Patent Office. For that reason, the Patent Office advises the inventor, unless he is familiar with such matters, to engage a competent registered patent attorney or agent to represent him. We maintain a staff of registered patent attorneys ready to serve you in the handling of your patent matters.

A specially prepared booklet entitled "Patent Guide for the Inventor", containing detailed information with respect to patent protection and procedure, together with a "Record of Invention" form will be promptly forwarded to you without obligation upon request.

Patents
Trademarks
Copyrights

Registered Patent Attorneys

CLARENCE A. O'BRIEN
& HARVEY B. JACOBSON

72-H District National Building + Washington 5, D. C.

CLARENCE A. O'BRIEN & HARVEY B. JACOBSON
Registered Patent Attorneys

72-H District National Bldg., Washington 5, D. C.

Please send me copy of "Patent Guide for the Inventor" and also "Record of Invention" form. This request does not obligate me.

Name _____

Address _____

City _____ State _____

(Please write or print plainly.)

Give yourself the Backing of a
GREAT GROWING INDUSTRY



REFRIGERATION AIR CONDITIONING

• Refrigeration and Air Conditioning have leading place in fast growing fields of our time. Trained men paid well to service, install, maintain, repair, rebuild household and commercial refrigerators. Important new developments such as Frozen Foods and many new industrial uses. Demand for commercial installations in restaurants, butcher shops, taverns, florists, bakeries, etc.—air conditioning in homes, offices, shops.



START NOW—Full and Part Time Earnings

There may never again be such opportunities for men who want better jobs or business of their own to get in on ground floor and go up fast! Many started with small investment who built good, growing business. If over 17 and under 60 learn how you can get started. CONSULTATION AND PLACEMENT SERVICE WHETHER YOU ARE INTERESTED IN WORTHWHILE JOB OR SETTING UP YOUR OWN BUSINESS.



Begin Training at Home or Come Directly to Shops

Begin your training at home in spare time, finish in our big, modern shops, or come directly to shops. At home you get C.T.I.'s SHOP PROVED HOME STUDY instruction—actual shop experience has gone into the practical lesson assignments. That is why it is easy for mechanically inclined men to learn by our Home Study training and start on actual refrigeration work.



A NATIONALLY KNOWN INSTITUTION

C.T.I. was only civilian school selected by Army to train service men for refrigeration. Same quality training available to you now. The method that has made rapid progress possible. Commercial Trades Institute has established its place in Air Conditioning and Refrigeration industries, and that is important to you in making your start.

VETERANS

Veterans qualifying under "G.I. Bill" have tuition paid by Government plus monthly subsistence allowance while in school. Just mail coupon, we will handle all details. (LOW TUITION, EASY TERMS if you are not a veteran.)

Commercial Trades Inst., Dept. A-18
1400 W. Greenleaf Ave., Chicago 26, Ill.



FREE—Important Information Telling How to Get Started
CUT COUPON ALONG THIS LINE

Fill Out, Cut Out, Mail Today

FACTS FREE for Men Who Want to Get Ahead
COMMERCIAL TRADES INSTITUTE, Dept. A-18
1400 W. Greenleaf, Chicago 26, Ill.
Send free illustrated Brochures and other information about Refrigeration and Air Conditioning.

Veteran Non Veteran

NAME.....

ADDRESS.....

CITY.....STATE.....

the area that a body would come in contact with when the car operator finds it necessary to make a sudden stop. . . .

MORRIS GREEN

Brooklyn, N. Y.

Readers Kirkness and Green, approaching different aspects of the same subject, may both be on the right track.

Which Way Is Time?

Sir:

Maybe you can set me straight on the "Vertical Clock Face" (June '47, p. 115). It is supposed to be 5:15, but I'll be doggone if I can figure it anything but 5:20. If, as it says, it is 5:15, shouldn't the lower portion be at 3 instead of 4?

J. N. RIGGS, JR.

Oyden, N. C.

As stated in the clock's description, the minutes are read, not vertically, but from left to right in the horizontal width of the column's higher portion.

What an Eye!

Sir:

"Sculping a Television Lincoln," page 119 of the June issue: You fooled me for a minute with that "mirror shot" in the upper left-hand corner that shows the bust of Lincoln with the hair part on the right, the mole on the left and the actor's wrist watch on his right arm. . . .

CLARENCE M. HALL

Pittsburgh, Pa.

It wasn't meant to fool anybody. That's why the lower edge of the mirror and its frame were allowed to show in the picture.

Sense vs. Semantics

Sir:

Practically all flammable materials burn or combust spontaneously, for once the reaction has started, heat from an external source is no longer needed. . . .

The technically correct word for the phenomenon described by Mr. Swezey (May '47, p. 212) . . . is "spontaneous ignition."

MELVIN C. BERGEN

Grosse Pointe Farms, Mich.

"Spontaneous combustion" is far more

INVENTORS

Patent Laws Encourage The Development Of Inventions

The Rules of Practice of the U. S. Patent Office advises—unless an inventor is familiar with such matters—that he employ a competent registered attorney or registered agent, as the value of patents depends largely upon the skillful preparation of the specifications and claims.

The firm of McMorrow, Berman and Davidson is registered to practice before the U. S. Patent Office. Additionally, it maintains a staff of attorneys able to readily understand inventors' disclosures, to advise concerning patentability, and to prepare appropriate specifications and claims for filing with the Patent Office.

If an inventor believes he has an invention, a search of the most pertinent prior U. S. patents should be made and a report obtained relative to its patentability. Where such report indicates that the invention appears patentable, in order to secure protection, diligence should be exercised in making application for a patent.

McMORROW, BERMAN & DAVIDSON

Registered Patent Attorneys

PATENTS — TRADE MARKS — COPYRIGHTS

1427 VICTOR BUILDING, WASHINGTON 1, D. C.

McMORROW, BERMAN & DAVIDSON

Registered Patent Attorneys

1427 Victor Building, Washington 1, D. C.

Send me further particulars as to patent protection and procedure and "Invention Record" form at once. I understand that this request does not obligate me.

Name.....

Address.....

City..... State.....

(WRITE OR PRINT NAME CLEARLY)

SUCCESS BRINGS THE GOOD THINGS OF LIFE



FIND OUT ABOUT OPPORTUNITIES IN INDUSTRIAL ELECTRONICS

It's a perfectly natural human desire to want more money, a better job, prestige and all the other good things of life. Who gets them? Look about you. Success you will see, comes to the man who is trained for his job.

A new world of opportunity is today beckoning to ambitious men. One of the most important and exciting fields is **INDUSTRIAL ELECTRONICS**. It is attracting experienced electrical men as well as younger fellows seeking a way to bigger earnings and a more secure future.

OPPORTUNITY LIES AHEAD

Industrial Electronics is not Radio. It has nothing to do with radio transmitters and receivers. It is totally new application of electric power, applied to modern production by means of the magic of the vacuum tube. Everywhere industrial electronic devices are replacing the old-time electrical controls, and processes. Industrial Electronics is Modern Industrial Electricity.

"Every electrician should know—must know—Industrial Electronics." That's what many Union leaders are telling their members, today. They know that the use of Industrial Electronics devices is growing by leaps and bounds. They know that to install and service this equipment, even the best of present-day electricians must first have had special training.

GET READY NOW!

Now is the time to get into Industrial Electronics, while the field is in its infancy . . . and while it is rapidly developing a need for thousands of trained experts. Tomorrow's leaders are training today. And here is a School equipped in every way to train you for Industrial Electronics work—one of the largest and most completely equipped, and one of the few of its kind in America—a School that already has trained thousands of men for industrial opportunities.

LEARN AT HOME OR COME TO OUR SCHOOL

Learn Industrial Electronics—now, while the time is ripe. You don't need any advanced schooling or previous experience. If you are at all mechanically inclined and have gone to high school for at least one year or have an equivalent education, we can teach you Industrial Electronics.

You can take most of your training at home, in your spare time—or you can come to Chicago and take your entire training in our completely equipped shops and laboratories. Either way you quickly acquire the fine points, practical skill, and broad, technical "know how" that makes the expert Industrial Electronics Technician.

A GUIDE FOR YOUR FUTURE—Complete facts about Industrial Electronics. Packed with pictures. Tells all about our successful training plan. Coupon will also bring details about moneymaking opportunities for trained men and our Life-Time Free Employment Service. No obligation. Mail coupon TODAY. Investigation may start you up the ladder of Success.

AUTHORIZED TO ACCEPT VETERANS FOR G.I. TRAINING

INDUSTRIAL TRAINING INSTITUTE,
2150 Lawrence Ave., Dept. P2HL Chicago 25, Ill.

Please send me, FREE, your "Camera Visit" booklet and information about the opportunity for trained men in **INDUSTRIAL ELECTRONICS**. It is understood that I will be under no obligation.

NAME.....
ADDRESS.....
CITY.....STATE.....
ARE YOU A VETERAN?.....

SEND FOR THIS BOOK IT'S FREE

GET THE FACTS ABOUT AMERICA'S FOREMOST SCHOOL OF PRACTICAL TRAINING.

widely known and understood, both in popular and textbook use.

Wouldn't You Know It?

Sir:

One of the things that interests me most is your "I'd Like to See Them Make" page. With reference to your March issue and one of those ideas, entitled "Magnet to Save Tires," I herewith enclose a cutting from another magazine. . . .

C. S. P. JAYAWARDENA

Katana, Ceylon

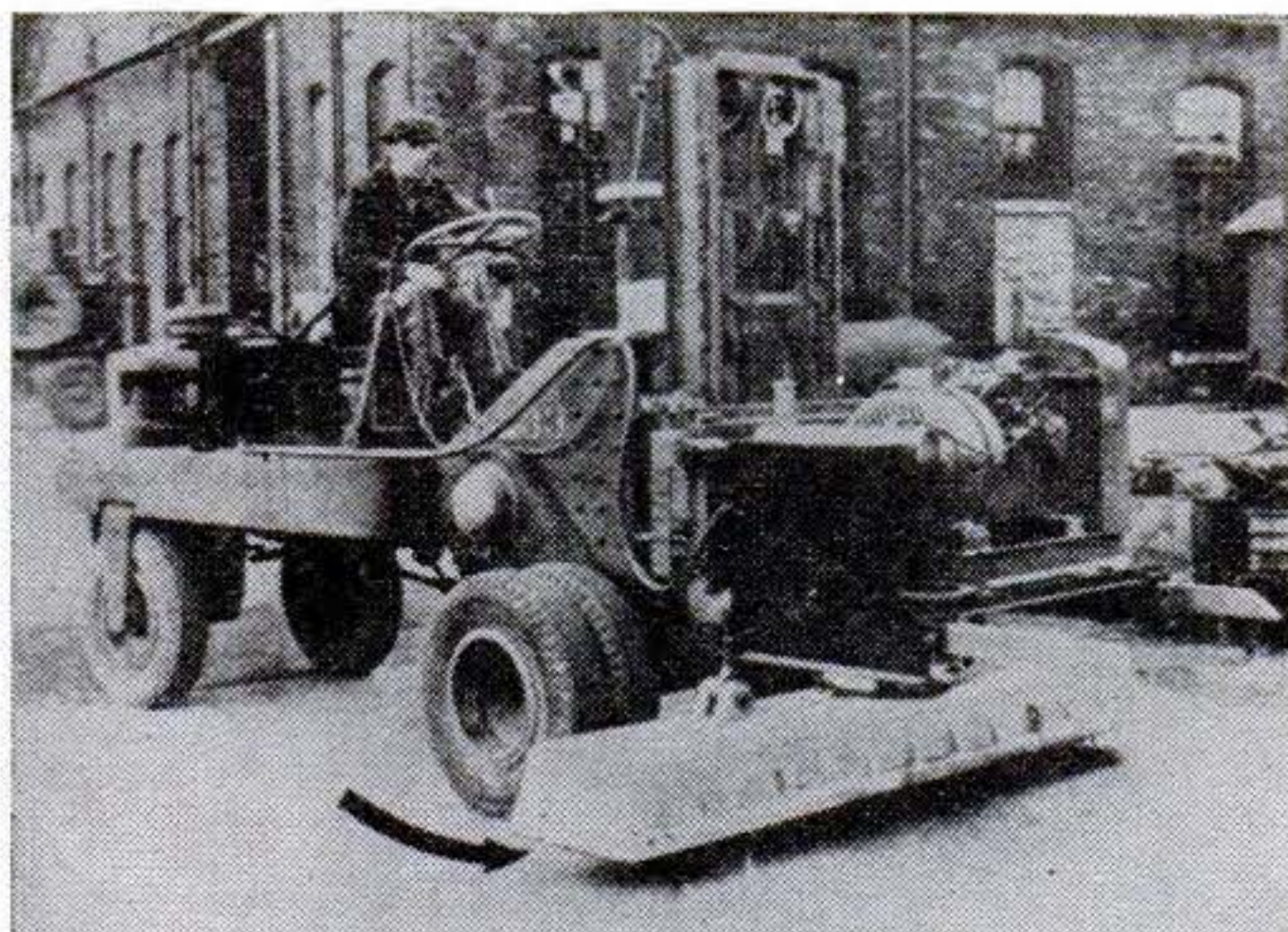

Shown above, the device described in Reader Jayawardena's welcome clipping is a truck-mounted, road-sweeping magnetic unit in use in India to pick up sharp nails and other tire-damaging metallic fragments. In its first day's use, it is said to have collected 300 pounds of nails. The machine, incidentally, is manufactured in America.

Watch Your Atoms

Sir:

. . . In your Letters column recently (June '47, p. 18), one of your readers attempted to devise a sort of "atomic energy machine," using the "well known" chemical principle that "water cracks into hydrogen and oxygen when passed through a hot iron pipe." The Editor, in refutation, merely said something to the effect that "machinery required too cumbersome, etc."

Here is the fly in the ointment. Water does *not* "crack" into hydrogen and oxygen when passed through a hot iron pipe. Its hydrogen is replaced by a metal. The oxygen is *not* released. It combines with the red-hot iron to form magnetic iron oxide. The reaction—plain electron transfer, no nuclear

ADVICE

for the

INVENTOR

The United States Patent Office advises the inventor, unless he is familiar with such matters, to employ a competent, registered patent attorney or agent as the value of patents depends largely upon the skillful preparation of the specification and claims.

PRELIMINARY STEPS *toward* PATENT PROTECTION

The Evidence of Invention form mentioned below is offered as a convenience to the inventor in making his disclosure of invention. The inventor should date and sign his disclosure and have it witnessed by two or more persons who are capable of understanding his invention. The disclosure should then be mailed to the registered patent attorney or agent whom he selects to assist him. The disclosure should be accom-

panied by a letter authorizing the patent attorney or agent to conduct a preliminary search at the U. S. Patent Office among previously granted U. S. Patents for similar types of invention. The patent attorney or agent then prepares a report of the probable patentability of the invention and recommends the further course the inventor should take, provided the report indicates possible patentability.

Victor J. Evans & Company has a staff of experienced registered patent attorneys available to assist inventors in the preparation and prosecution of their cases before the Patent Office.

The **COUPON BELOW** is suggested as a convenience to the inventor in starting action on his invention.

**VICTOR J.
EVANS & Co.**

Merlin M. Evans

REGISTERED PATENT ATTORNEYS

240-J Merlin Building, Washington 6, D. C.

PLEASE SEND DETAILED PATENT INFORMATION TOGETHER WITH CONVENIENT "EVIDENCE OF INVENTION" FORM.

Name.....

Address.....

City and State.....

\$2000

of Old Line Legal Reserve

LIFE INSURANCE

(at age 21) \$ **78** A MONTH*
ONLY — Other ages
in proportion

*One Half Permanent Rate in effect 5th year

Buy as little as \$1500. of this solid protection—or more—at proportionately low rates. *But buy your Postal Policy now!*

Postal Life of New York has specialized for 40 years in insurance by mail and over the counter. The savings due to this direct dealing are passed on to policy holders. Current dividends 9½%. Further savings are made if premiums are paid quarterly, semi-annually or annually.

POSTAL LIFE OF NEW YORK

operates under the rigid New York State Insurance Laws and has paid out over

\$60,000,000.00

to its Policy Holders and Beneficiaries.

Postal issues all Standard Policies to men or women, from ages 10-60, at low cost.

Send coupon today for rates on this Modified "4" Policy at your age and other details. *Life Insurance is vital!*

CLIP AND MAIL COUPON TODAY

POSTAL LIFE INSURANCE COMPANY

511 Fifth Ave., Dept. M-718
New York 17, N. Y.

Mail me without obligation complete information about your low-cost Modified "4" Policy at my age.

Name.....

Date of Birth.....

Occupation.....

Address.....

(Street and No., Zone, City and State)

business—is represented by the formula:

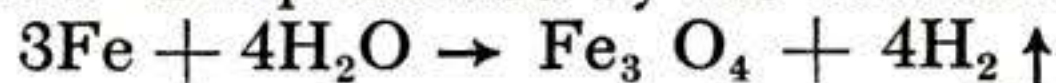

ARTHUR TAUB

Brooklyn, N. Y.

Reader Taub uses chemistry to get the same answer PSM got without it: The idea wouldn't work.

There Will Be Licenses

Sir:

Reference is made to the article entitled "Transmitters Shrink to Lipstick Size" appearing on page 101 of the May issue:

Contrary to your report, the Commission does not and has not at any time contemplated the operation of the Citizens Radio Service in an unlicensed status. It has, however, stated that it is considering every means of making the licensing as easy and convenient as possible . . .

T. J. SLOWIE
Secretary,

Federal Communications Commission
Washington, D. C.

PSM is glad to correct its mistaken assumption that the program envisaged mere registration, rather than licensing in the usual radio sense.

More Power to You

Sir:

In reference to your article on (radio) power supplies in the June issue (p. 204), let me say that it was a good one.

I have two suggestions on how to improve the 400-volt supply. As long as there is an unused filament winding, why not bring it out to two binding posts? Then you would have a source of filament voltage for your power supply.

Another thing that could be done—and should be done for safety's sake—is to put a pilot light in the circuit somewhere. This could be done by placing a 110-volt miniature bulb across the primary of the transformer or a regular pilot light across the filament winding of the transformer.

MARTIN PRAGER

Brooklyn, N. Y.

PSM did not wish to alter Carl Andresen's original design but agrees that these would both be worthwhile improvements.

Choose one of these 2 GREAT FIELDS

- Get Ready **QUICK** at **COYNE!**

ELECTRICITY OR **RADIO-ELECTRONICS TELEVISION**

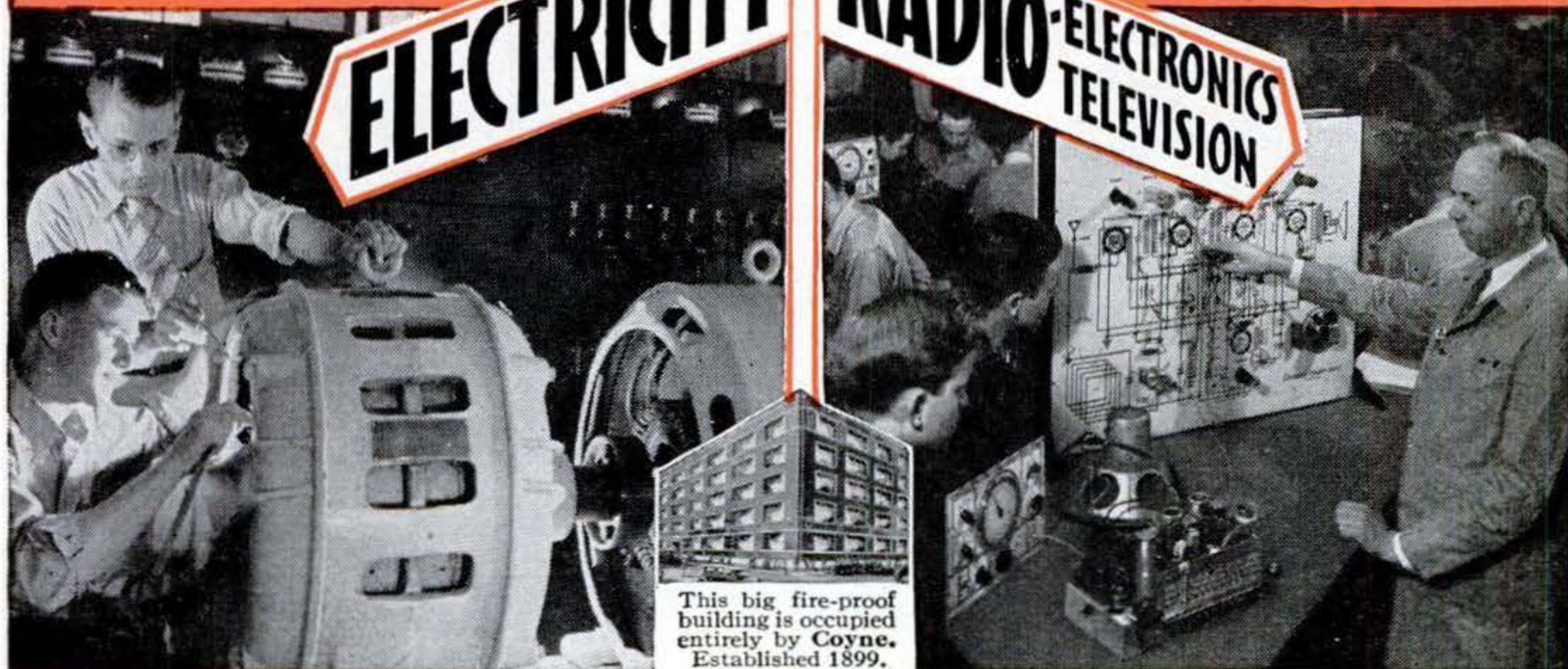

This big fire-proof building is occupied entirely by Coyne. Established 1899.

Prepare for Success in a few short weeks... in the

GREAT SHOPS OF COYNE

Conditions today are different. Many "one-operation" jobs that pay well will not last. Plan for steady pay and advancement by training NOW. Come to the great shops of COYNE in Chicago, for "all-around" training in Electricity or Radio—the 2 great opportunity fields.

NOT A "HOME-STUDY" COURSE

Our famous "Learn-by-Doing" method gives you practical experience on full-size equipment. Not by correspondence, but actual shop work plus necessary theory. You are trained right here in the great Coyne shops that has been training men and young men for over 48 years.

ELECTRICITY RADIO ELECTRONICS TELEVISION

INCLUDING INDUSTRIAL ELECTRONICS

Big future in Power Plant Work, Motors, Armature Winding, Home and Factory Wiring, Appliances, Refrigeration, Maintenance, Illumination, etc. Electricians are in demand everywhere—lifetime job service. Send for BIG FREE BOOK.

A great field now, even greater growth ahead. Here at COYNE you're trained for Construction, Testing, Trouble-Shooting on Radio, Public Address, Sound Picture Units, Training includes FM, Photo-cells, Television, etc. Our training is quick, easy, practical. Many Coyne trained men own well-paying radio businesses of their own.



ELECTRIC REFRIGERATION

Added training in Electric Refrigeration now included with either our Electrical or Radio Course.

Any Man With a Physical Disability whether a Veteran or not may qualify for Coyne training at no cost to them for tuition or subsistence. Check coupon.

VETERANS

COYNE is authorized to train those who qualify for training under G. I. Bill of Rights. Check coupon for our Special G. I. Bulletin.

Non-veterans who are short of cash can finance most of their tuition and pay it in easy monthly payments after graduation.

B. W. COOKE, Director
COYNE ELECTRICAL SCHOOL

500 So. Paulina Street, Dept. C7-73H Chicago 12, Ill.

PICK FIELD YOU LIKE—
SEND FOR BIG BOOK

FREE

—MAIL
COUPON



B. W. Cooke



Whether you prefer Electricity, or Radio, train in a few short weeks at Coyne. We have a big, fully illustrated book on each course, and we'll send you the one you want, without obligation. Mail coupon — TODAY.

B. W. COOKE, Director
COYNE ELECTRICAL SCHOOL
500 S. Paulina St., Dept. C7-73H Chicago 12, Ill.

Send me your BIG FREE BOOK — for the course checked below, also details of your "Student Finance" plan. This does not obligate me.

ELECTRICITY RADIO
 Send special G.I. Bulletin physical disability

NAME.....

ADDRESS.....

CITY..... STATE.....

Will You Let Me PROVE I Can Make YOU a New Man?

LET ME START SHOWING RESULTS FOR YOU

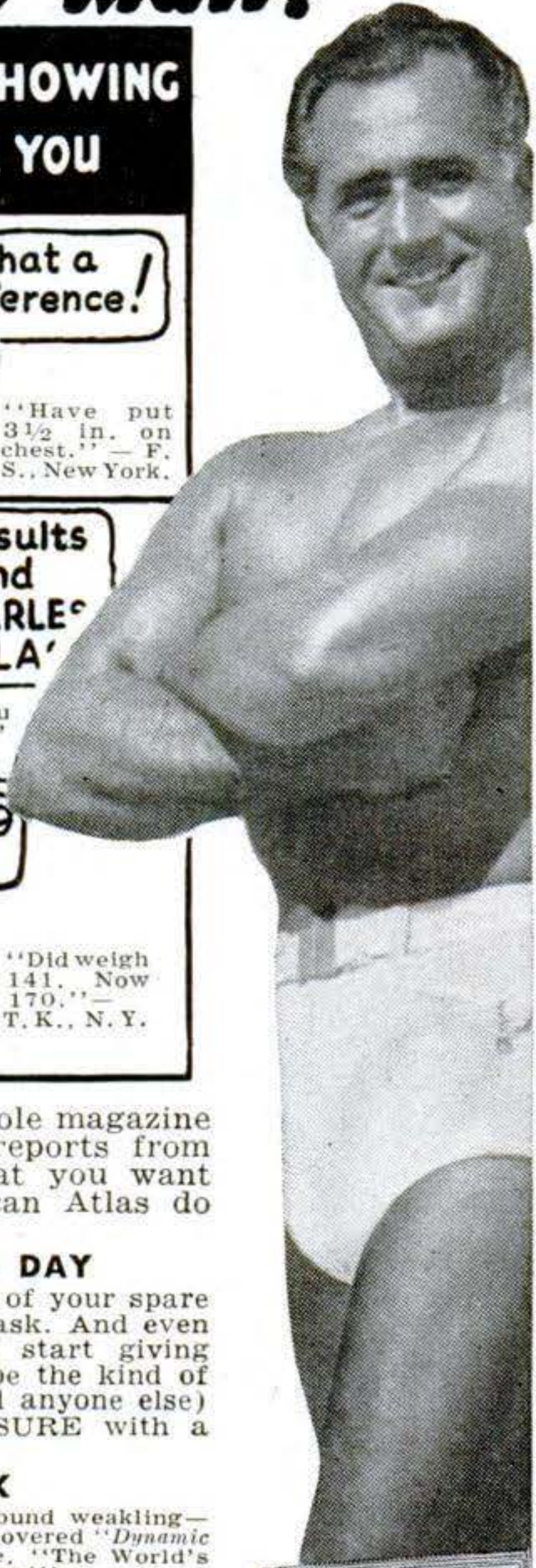

I COULD fill this whole magazine with enthusiastic reports from OTHERS. But what you want to know is—"What can Atlas do for ME?"

15 MINUTES A DAY

Just give me 15 minutes of your spare time daily. That's all I ask. And even in that short time I'll start giving RESULTS. And it will be the kind of RESULTS that you (and anyone else) can SEE, FEEL, MEASURE with a tape.

FREE BOOK

I myself was once a 97-pound weakling—sickly, half-alive. Then I discovered "Dynamic Tension." And I won the title, "The World's Most Perfectly Developed Man!"

"Dynamic Tension" has done so much for other fellows that I simply ask you to let me prove that it can make a New Man of YOU—that it can start new inches of power pushing out your chest—build up your shoulders to champion huskiness—put new, hard, firm muscles on your biceps—make those stomach muscles of yours hard ridges!

Why not risk a postage stamp? Send coupon for my 48-page illustrated FREE BOOK AT ONCE! Address me personally; Charles Atlas, Dept. 18, 115 East 23rd Street, New York 10, N. Y.



CHARLES ATLAS, Dept. 18
115 East 23rd Street, New York 10, N. Y.

I want the proof that your system of "Dynamic Tension" will help make a New Man of me—give me a healthy, husky body and big muscle development. Send me your free book, "Everlasting Health and Strength."

Name.....Age.....
(Please print or write plainly)
Address.....
City.....State.....

SHORTHAND IN 6 WEEKS

LEARN AT HOME—LOW COST

Write 120 words per minute. Easy for adults. Famous Speedwriting system. No signs or symbols; uses ABC's. Easy to learn and use. Fast preparation for a position. Nationally used in leading offices and Civil Service; also by executives, writers, speakers, lawyers, scientists, students at college. Over 100,000 taught by mail. The very low cost will surprise you. Also typing. 24th Year.

WRITE FOR FREE BOOKLET TO

Speedwriting

TRADE MARK, REG. U.S. PAT OFF
Dept. 2608-7, 55 W. 42 St., N. Y. 18

LEARN MOVIE PROJECTION THEATRE MANAGEMENT

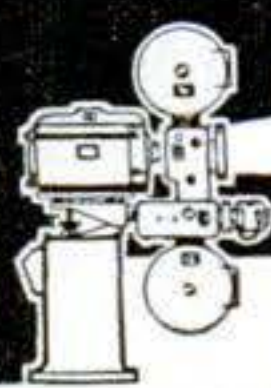

The Motion Picture Theatre Business offers big opportunities for trained men. Get into a fascinating field with a promising future. Train at home in spare time. Free Catalog. Established 20 years.

THEATRE INSTITUTE 385 Washington St., Elmira, New York

EASY WAY TO LEARN RADIO AT HOME

I send you 8 BIG KITS of Radio Parts, including Complete 6-Tube Superhet

Theory alone is the bunk! It takes "Service Bench" practice to learn Radio right! My Course supplies the Equipment you need, shows you how to wire, connect, solder, build Circuits . . . how to test and repair all kinds of Radio-Electronic Equipment. Beginners learn fast! To get full details, send postal for FREE BOOKS:—"How to Make Money in Radio, Electronics and Television", and "How to Read Radio Diagrams and Symbols".

SPRAYBERRY ACADEMY OF RADIO Room 5587 Pueblo, Colorado

LEARN MONEY-MAKING CARTOONING

IN SPARE TIME — by Easy Picture Chart Method Same Simplified Method that has helped train creators of "Terry & Pirates," "Freckles," "Out Our Way," "Winnie Winkle," "Regular Fellers," "Strange As It Seems," "The Neighbors," and many others. Earn while learning. Send 10c for Picture Chart (to test your ability). Samples of successful students, and full details. (State age.)



The Landon School, 4728 Schofield Bldg., Cleveland, Ohio

LAW

STUDY AT HOME for PERSONAL SUCCESS and LARGER EARNINGS. 39 years expert instruction —over 108,000 students enrolled. LL.B. Degree awarded. All texts furnished. Easy payments. G.I. Approved. Send for FREE BOOK.

AMERICAN EXTENSION SCHOOL OF LAW
Dept. 80-5, 646 N. Michigan Ave., Chicago 11, Ill.

Photography for



PLEASURE or PROFIT

Learn at home. Spare time. Practical basic training. Long-established school. Many have earned while learning. Send coupon below for free booklet, "Opportunities in Modern Photography" and full particulars.

AMERICAN SCHOOL OF PHOTOGRAPHY
1315 Michigan Avenue Dept. 136C Chicago 5, Illinois

Send booklet, "Opportunities in Modern Photography," full particulars and requirements. No salesman will call.

Name.....Age.....
Address.....
City.....Zone.....State.....

RADIO and ELECTRONICS offers YOU...

**REAL MONEY, REAL JOB,
AND REAL INDEPENDENCE**

FOLLOW THE ADVICE OF THE MASTERS
PREPARE today SUCCEED tomorrow



• Make good money . . . get a real job . . . be independent by owning your own business . . . follow the advice of the masters . . . "PREPARE TODAY TO SUCCEED TOMORROW."

Whether you are an ex-G.I., a teen-age youth or an older man, few other fields offer you such a vast variety of opportunities for real money and a brighter future as the colorful, fascinating field of RADIO and ELECTRONICS.

Get Late Facts

Use the coupon below! Get the late facts about the exciting news in F.M. Radio, Broadcast Radio, Television, Electronics, Radar, 2-Way Train Radio, Sound Motion Picture Equipment, Sound Recording — and other fast-moving branches of this field.

15 Years Experience In Training Men

Also see how readily YOU can prepare to enter the field of Radio and Electronics by means of the remarkably effective courses and Employment Help of DeForest's Training, Inc. that have been getting results for over 15 years.

DeForest's Training, Inc. is the first school of its kind ever to receive the CERTIFICATE OF MERIT of the New York Museum of Science and Industry. It won this award for the efficiency and thoroughness of its courses.

Prepare now for a job in Radio, Electronics and Communications, by attending RESIDENT LABORATORY courses in Chicago, or in your spare time at home. DeForest's Training, Inc. offers you these 4 BIG HOME TRAINING ADVANTAGES:

- (1) We supply you with a 16 Mm. motion picture machine with 12 reels of fact-packed information;
- (2) Illustrated loose-leaf lessons with handy fold-out diagrams;
- (3) 8 big commercial-type Radio Electronic Kits of assemblies and parts, from which you may work out more than 133 modern experiments including 7 different types of radio receivers at home; and
- (4) After you complete your training, you get the benefit of our effective employment service.

YOU NEED NO PREVIOUS ELECTRICAL OR RADIO EXPERIENCE

If you prefer, you can get ALL of your Training in our—

NEW CHICAGO LABORATORIES

. . . offering you some of the finest Radio-Electronic Training Facilities in the nation. Enjoy many post-war training advantages in a modern, new building, housing a wealth of "LEARN-BY-DOING" Equipment. Visitors invited.

VETERANS!!

Both the Home Study and Chicago laboratory courses of DeForest's Training, Inc. are accepted for your training. If you qualify under the "G. I. Law," you can obtain this training without cost.

DeFOREST'S TRAINING, INC.

2533-41 N. ASHLAND AVE. CHICAGO, ILLINOIS
Affiliated with DeVry Corporation, Chicago

DeFOREST'S TRAINING, INC.
2533-41 N. Ashland Ave., Dept P.S.—D-8
Chicago 14, Illinois, U.S.A.

Send me your big book "VICTORY FOR YOU", showing how I may make my start in Radio-Electronics with your modern home training plan. No obligation.

Name Age
Address Apt.
City Zone State

If under 16, check here If a discharged veteran of World War II, check here.





THOUGHTS HAVE WINGS

You Can Influence Others With Your Thinking

TRY IT SOME TIME. Concentrate intently upon another person seated in a room with you, without his noticing it. Observe him gradually become restless and finally turn and look in your direction. Simple—yet it is a *positive demonstration* that thought generates a mental energy which can be projected from your mind to the consciousness of another. Do you realize how much of your success and happiness in life depend upon your influencing others? Is it not important to you to have others understand your point of view—to be receptive to your proposals?

How many times have you wished there were some way you could impress another favorably—*get across to him or her your ideas?* That thoughts can be transmitted, received, and understood by others is *now* scientifically demonstrable.

This FREE Book Points the Way

The tales of miraculous accomplishments of mind by the ancients are now known to be fact—not fable. The method whereby these things can be INTENTIONALLY, not accidentally, accomplished has been a secret long cherished by the Rosicrucians—one of the schools of ancient wisdom existing throughout the world. Write for the free copy of the fascinating sealed book, "THE MASTERY OF LIFE," which explains how you may receive this unique wisdom and benefit by its application. Address: Scribe K.N.P.

The ROSICRUCIANS

San Jose, (AMORC) California

USE THIS COUPON

Scribe K.N.P.
The Rosicrucians
San Jose, California

I am sincerely interested in an intelligent method of attaining a mastership of life. Send me without obligation, your FREE Book which explains how I may receive and use your age-old method.

Name.....
Address.....
City.....

STUDY AT HOME

With An Educational Institution

Men with specialized training win higher positions, insure larger earnings, and are bigger successes in business and public life. Opportunities NOW greater than ever before. Send for our Catalog.

ARTS and SCIENCES

Courses in Philosophy; Education; Letters; Public Health; Medical Jurisprudence; Psychology; Sociology; Physics; Chemistry; Plastics; Geology; Political Science; Theology; Business and Commerce; Accounting; Mathematics; Statistics; Agriculture.

ENGINEERING

Courses in Electrical, Civil, Mechanical, Drafting, Architectural, Steam, Aeronautical, Radio, Structural, Mining, Industrial, Petroleum, Marine, Chemical, Diesel, Automobile, Refrigeration, and Air Conditioning Engineering.

LAW

Complete Professional Law Course includes 18 Hornbrook Series college grade textbooks. Courses also in Commercial Law, Patent Law and Medical Jurisprudence.

McKinley-Roosevelt Incorporated, 4610-AB, Sheridan Rd., Chicago 40, Ill.

MAKE MONEY CASTING AT HOME FREE FACTS SENT



Cast thousands of perfect Plaques, Book Ends, Ash Trays, Etc. Plaster, Liquid Marble, Etc. ENORMOUS PROFITS. Start in basement or garage. LITTLE CAPITAL NEEDED. QUICK, EASY, NO PREVIOUS EXPERIENCE NEEDED. Rubber molds for speed production. MAKE YOUR OWN. SAMPLE KIT \$1.00. Canadian \$1.50. PLASTIC ARTS STUDIOS, Route 5, Dept. 45, Muncie, Ind.

One of America's Leading Radio and Television Schools NEW YORK TECHNICAL INSTITUTE OF NEW JERSEY

158 Market Street, Newark, New Jersey



CORRESPONDENCE COURSES IN RADIO and ELECTRICAL ENGINEERING

Tuition
\$25

ELECTRICAL ENGINEERING. Get good grasp of wide electrical field. Modern. Very understandable. Theory made easy.
RADIO ENGINEERING. Extra fine course in radio, public address, photo-electric work. Trains you to be super-service man, real vacuum tube technician. Tuition ONLY \$25. either course. Deferred payment plan. Servicemen needed badly.
FREE Write for free copies of school catalogs, student magazines, etc.
LINCOLN ENGINEERING SCHOOL, Box 931-S-104
LINCOLN, NEBR.

STAY HOME AND MAKE MONEY!

—Men! Women! Get into profitable, uncrowded profession you can operate from your home or small office after short home training course. No capital required. No goods to buy. No age limit. Others earn \$50.00 to \$100.00 per week making famous Stephenson corrective foot devices to order. Foot sufferers everywhere pay gladly for relief. Send today for FREE BOOKLET. STEPHENSON METHOD, Established 1894, 12-28 South Market St., Boston, Mass.



Government Jobs!

Start \$1,756 to \$3,021 year

MEN—WOMEN. Thousands positions open. Prepare NOW for next Examinations. Write immediately for free 32-page book, with list of positions and particulars telling how to prepare. Veterans get preference.

FRANKLIN INSTITUTE

Dept. L80
Rochester 4, N. Y.

Now YOU Can Lick Any AUTO REPAIR JOB!

IN LESS TIME—WITH LESS WORK



**FREE
7-DAY OFFER**



MoToR's New AUTO REPAIR MANUAL shows you how to service and repair ANY part of ANY car!

No auto repair job is too tough when you've got MoToR's AUTO REPAIR MANUAL! YOU can repair anything from carburetor to rear end—quickly, easily, right! Just look up make, model, and the job in the quick index—and go to work! Clear, illustrated instructions lead you step by step.

To make such an amazing book possible, the engineer-editors of MoToR Magazine collected and "broke down" 150 official factory shop manuals for you, spotted all the vital repair information you need, dove-tailed it all together into ONE handy, easy-to-understand book.

No Other Manual Like It!

This BIG book—856 pages, 8½x11 inches, bound in sturdy fabric—brings you nearly 200,000 service, repair, adjustment, replacement, tune-up facts on every car built from 1935 through 1946. More than 1000 cut-away photos, diagrams,

drawings show you exactly WHAT to do and HOW to do it! Used by the U. S. Army, trade and technical schools everywhere, thousands of auto servicemen.

Now YOU—without cost—can see for yourself what a wonderbook MoToR's Auto Repair Manual really is. TRY it—FREE for 7 days! Learn first-hand how it can pay for itself the first few times you use it.

SEND NO MONEY 7-Day Free Examination

Just mail coupon below—without money! When the postman brings your book, pay him nothing. First make it show you what it's got! Unless you agree this is the greatest time-saver and work-saver you've ever seen—return book in 7 days and pay nothing. Mail coupon today! Address: MoToR Book Department, Desk 2J, 572 Madison Ave., New York 22, New York.



Clear, Pictured Facts on Every Job on Every Car Built Since 1935!

Nearly 200,000 service and repair facts on all these makes:

American	Dodge	Nash
Bantam	Ford	Oldsmobile
Auburn	Graham	Overland
Austin	Hudson	Packard
Buick	Hupmobile	Pierce Arrow
Cadillac	Lafayette	Plymouth
Chevrolet	La Salle	Pontiac
Chrysler	Lincoln	Reo
Cord	Lincoln	Studebaker
Crosley	Zephyr	Terraplane
De Soto	Mercury	Willys

856 big pages; including 50 pages of carburetor text, charts, illustrations, covering all models. Over 500 charts, tables; Tune-up Chart; Valve Measurements; Compression Pressure; Torque Wrench Reading; Starting Motor; Engine Clearances; Generator; Clutch & Brake Specifications; Front End Measurements, etc., Engines; Electric, Fuel, Cooling, Lubricating Systems; Transmissions; Universals; Front Ends; Wheels; Rear Ends, etc.

Same FREE 7-Day Offer Applies on MoToR's TRUCK REPAIR MANUAL

For mechanics, truck specialists, service stations, fleet owners. Covers EVERY job on EVERY truck made since 1936! 1400 pictures, 952 pages, 300,000 facts. Used by Armed Forces. Warranted to contain every essential fact you need to know. Sturdy binding, size 8½ x 11.

Covers all types Gasoline Engines; Diesels and Hessel-

mans. Fuel Systems, Governors. Lubrication Systems, Ignition Systems, Starters, Generators, Clutches, Transmissions, Axles, Torque Dividers, Transfer Cases, Brakes, Steering, etc., etc.

ALSO SERVICES buses, farm and industrial tractors, contractor and road building equipment, stationary power machinery, etc. (on all parts described in Manual).

Offered on same FREE 7-Day examination as Auto Repair Manual. Check box in coupon at right.



MoToR Published by MoToR, The Leading Automotive Business Magazine. MoToR's manuals assure high standards of repair work.

MAIL COUPON NOW FOR 7-DAY FREE TRIAL

MoToR Book Dept., Desk 2J, 572 Madison Ave., New York 22, N.Y. Rush to me at once: (check box opposite book you want).

MoToR's AUTO REPAIR MANUAL. If O.K. I will remit \$1 in 7 days, (plus 35c delivery charge), then \$2 monthly for 2 months, and a final payment of 95c one month later. (Book's price \$5.95.) Otherwise I will return book postpaid in 7 days. (Foreign price, remit \$8 cash with order).

MoToR's TRUCK REPAIR MANUAL. (Described at left.) If O.K., I will remit \$2 in 7 days, and \$2 monthly for 3 months, plus 35c delivery charge with final payment (\$8.35 in all). Otherwise I will return book postpaid in 7 days. (Foreign price, remit \$10 cash with order).

Print Name.....Age.....

Print Address.....

City.....Zone No. (if any).....

State.....Occupation.....

SAVE 35c! Check here if enclosing full payment. (Check, M. O. or Postal Note) WITH coupon. We pay 35c shipping costs. Same 7-day return-refund privilege.

WANT A KEY JOB OR A BUSINESS OF YOUR OWN!

BIG OPPORTUNITY

REFRIGERATION—AIR CONDITIONING

Take a good look at the man you envy. What has he got that you haven't got? The chances are his success is simply a matter of training. He knows his job. He is a specialist in his field.

Why, then, should you be content with a small job at small pay. The door to opportunity is open today—wider than ever before. Now is the time to do something about your future.

Take a friendly tip. Investigate the field of Refrigeration & Air Conditioning. Here is an industry that offers every opportunity you could ask . . . good jobs, security—plenty of chance for advancement—a business of your own.

The Industrial Training Institute, largest and most completely equipped school of its kind in the world, will give you the practical training you need. You can start at home without giving up your present job and when you have completed your theoretical training, we will bring you to Chicago where you will learn the practical "know-how" by working on actual equipment in our big, expertly staffed shops.

No advanced schooling is needed. Our unique proved methods make everything easy to grasp. We've trained thousands. Pay as you go. Quit when you want to. But in any case our first responsibility is to prepare you for a better job and a happier future. And after you have graduated you enjoy all the advantages of our life-time employment service—wherever you go, whenever you need it.

FACTS ABOUT THE INSTITUTE

Founded in 1916. Has trained more than 400,000 men for practical work in industrial fields. From 1942 through 1945 trained specialized technicians, exclusively, for the Army, Navy and Marine Corps. Now training thousands of veterans under the G.I. Bill, both in its Residence Schools and by home-study. Occupies five buildings of its own. Has over \$500,000 invested in training facilities, with an instruction staff of more than 100 men. Known everywhere as America's foremost school of practical training for industry.

ACT NOW

Don't delay. Time is passing fast. Mark and mail the coupon below. It will bring you, without obligation, full details of this and other courses, from which you may choose. Take the step that may be the turning point in your career to a better job and bigger earnings.

SEND FOR THIS BOOK —IT'S FREE



Industrial Training Institute,
150 Lawrence Ave., Dept P2HR Chicago 25, Ill.

I am interested in getting ahead. Send me FREE copy of your "Camera Visit" book. I would like to train
or _____ (name field).

ame _____

ddress _____

ity _____

Are you a Veteran _____

GET THE FACTS ABOUT AMERICA'S FOREMOST SCHOOL OF PRACTICAL TRAINING



ANALYZE HANDWRITING

Qualify for Certified Grapho Analyst Degree at home, spare time. Credit, Employment, Personnel Managers, Business, Professional men, women use grapho-analysis in their work, earn substantial fees in spare time. Many study solely for personal benefit, no desire to earn money, find it so fascinating they start using it to add to their incomes. Entertainment field pays well, up to \$100 in a week reported. Others establishing profitable practices as Vocational and Family Problem Counselors, Personality Teachers, and lecturers.



GROWING—UNCROWDED PROFESSION

More and more police use grapho analysis handling suspects and criminals. They understand how criminals think. Their handwriting tells. Men like Hugh Dunlap, university student, Harry Allen, retired preacher, use it in court, win cases, earn fees even before graduation. Only school in world devoted to teaching grapho analysis offers thorough training to earnest, ambitious men and women regardless of where you live, small town, farm or city. Send for GRAPHO ANALYST, illustrated lesson, personal handwriting analysis offer, ALL FREE. Must be 21 or over. Address A. I. G. A. Inc., 126, Noel, Missouri.



Learn PLASTICS

Study at home or at school in Los Angeles or New York. Approved for Veterans—Available for non-veterans.

America's Oldest and Largest

PLASTICS INSTITUTE

1601 S. Western Dept. PS7-8 Los Angeles 6, Calif.

ELECTRICIANS' SCHOOL

HOUSE AND COMMERCIAL WIRING • MOTOR REPAIR AND REWINDING • ELECTRIC REFRIGERATION

Approved for Veterans Training

PENNSYLVANIA INSTITUTE SCHOOL OF ELECTRICITY

42nd and SPRUCE STS. PHILADELPHIA 4, PENNA.

THERE'S MONEY IN CARTOONS!

RAYE BURNS will teach you HOW to CREATE ORIGINAL CARTOONS at home that you may SELL! Course contains 26 lessons and over 600 illustrations. All for Only **\$2.85**

Send name and address for free details.

RAYE BURNS SCHOOL, Dept. S, Box 3583, CLEVELAND, OHIO



MECHANICAL DENTISTRY

A profession offering unlimited opportunities. Most modern and complete course embracing every branch from Plate to Porcelain Work, which prepares you to work for Dentists or start your own business. Individual instruction—practical training in day or night school. No books—no classes. Catalog upon request.

MCCARRIE SCHOOL OF MECHANICAL DENTISTRY 207 N. Broad St. Dept. 865 Philadelphia, Pa.

What Every Mason Wants



We have Important Masonic books for Blue Lodge, Chapter, Commandery, Scottish Rite, and Shrine.

OUR RITUALS ARE USED THE WORLD OVER

Send for free catalog of books and rituals for Masons, Odd Fellows, Knights of Pythias, Knights of Columbus, etc. EZRA A. COOK, Publisher, P. O. 796, RA-T Chicago 90, Ill.



ILLUSTRATED COMIC BOOKLETS

THE KIND MEN LIKE! (VEST POCKET SIZE)

They are loaded with rare cartoons. Full of Fun and Humor. 20 DIFFERENT booklets sent prepaid for \$1 in plain wrapper. Sorry . . . no C.O.D.'s.

GRAYKO, Dept. 1071 Box 520, G.P.O., N.Y.C. 1

GET INTO

RADIO

TELEVISION
ELECTRONICS
NOW!

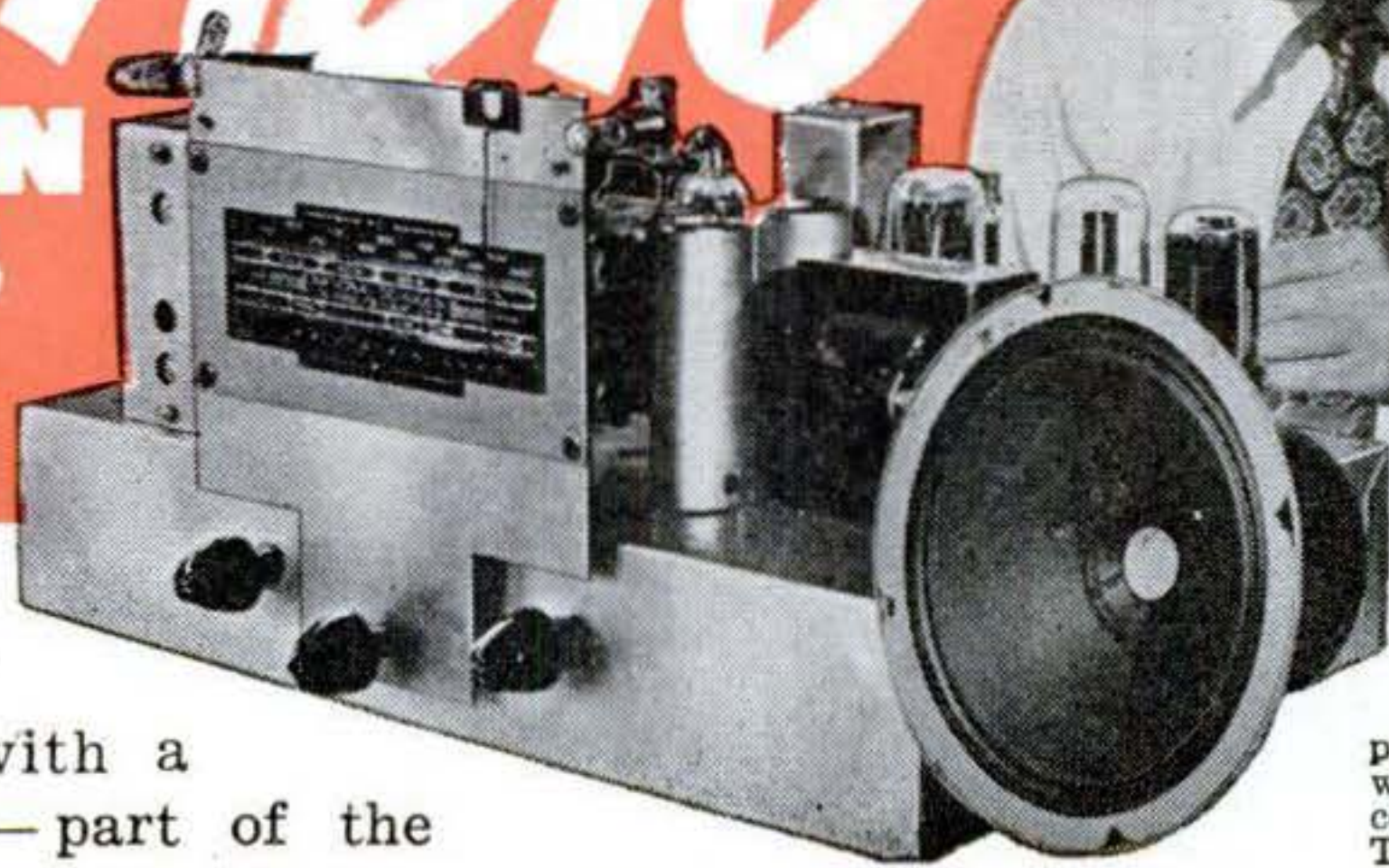

You build this complete, modern superheterodyne receiver with the equipment that comes with your National Training at no cost.

This practical shop instruction system gives you actual experience with a Home Radio Laboratory — part of the

Shop Method Home Training By A Real, Resident Trade School

FOR YOU—A REAL HOME LABORATORY IN MODERN RADIO

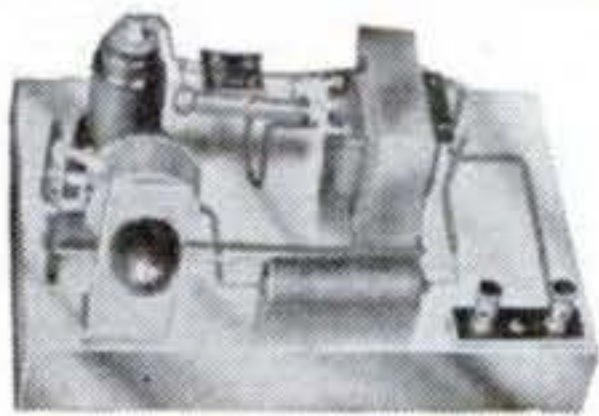

Your National Training Kits include equipment for over a hundred practical electronic experiments in your own home. You

get standard radio parts for this audio oscillator which you get to understand by building it yourself.

You learn modulation, beat frequencies, signal generation by actually building this small radio transmitter with your National shop parts. Your training outfits from National are made up of the most modern radio equipment —

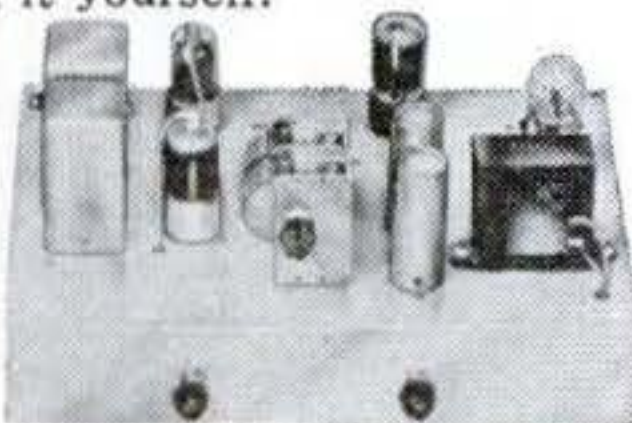

much of it just out of the experimental laboratory. You learn new ways of handling equipment by modern methods. Get the details by mailing the coupon.



much of it just out of the experimental laboratory. You learn new ways of handling equipment by modern methods. Get the details by mailing the coupon.

Send the coupon below immediately. Learn how this improved practical training can fit you for the GREAT BUSINESS OF RADIO—for the NEW AND RAPIDLY EXPANDING FIELD OF FREQUENCY MODULATION (F.M.), TELEVISION AND ELECTRONICS.

This is the thoroughly proved method used so extensively in wartime training—endorsed by the success of National men everywhere—a system by which you study in spare time—off hours, even minutes right in your home and yet have the ADVANTAGE OF REAL SHOP EXPERIENCE behind you.

Trained Radio Men Wanted

The man who really knows modern Radio is in greater demand today than ever before—not only in Radio proper but in Television and Electronics—in Aviation, Transportation, Manufacturing, Communications. Good jobs await the

trained man, in the production, operation and maintenance of modern electronic equipment—in radio stations, in hundreds of industries—in homes, theatres and studios. Good sound training in this important field is absolutely necessary. And now, National Schools brings such training to you no matter where you live or what you may be doing—not only the fundamental theory but the actual experience that comes with knowing shop practice and working with real equipment—demonstrating each step with firsthand knowledge. This is true "learning by doing"—direct from the great shops and laboratories of National Schools where new developments in methods, equipment and applications are constantly going forward.

National offers you such practical training and National has the facilities. Sample this training yourself. MAIL THE COUPON FOR A FREE LESSON.

SUCCESS and SECURITY FOR YOU

Radio is a Well-Established Business. Television and allied fields are just on the threshold of limitless expansion. Would you like to profit from these developments? An excellent job or perhaps into a business of your own? Answer these questions by reading the catalog sent you FREE from National Schools. Get the facts.

Check the Job You Now Have With These Opportunities in RADIO

1. Financial Security Radio has grown from \$100 million to \$5 billion in past few years.
2. Limitless Future predicted by over 1,800 manufacturers of equipment.
3. Television promises unrealized opportunity.
4. Electronics opens wide new fields in home and industrial use.
5. Your Own Business if you wish.

Get the details. Use the coupon!

FREE GET THESE 2 BIG BOOKS



NATIONAL TRAINING WINS BIG JOBS

Finds a Place in Radio Broadcasting

"I graduated from National three years ago at the age of 34. Since then I have been employed at Western Electric Co. and Federal Mfg. Co. On April 30 I joined the engineering staff of WKNE in Keene, New Hampshire, as Transmitter Engineer. Prior to my starting your course I didn't know a thing about Radio. My rapid rise in this field is evidence of what your school can accomplish with anyone who is willing to spend a few hours a day with your training. May I express my sincere thanks to National Schools." FRANK J. SAMMER, Keene, New Hampshire.

More Than Paid For Course in Spare Time

"I can sincerely say that my association in a few months with National Schools had paid off in dividends far greater than the tuition which is charged for the entire Course, while at the same time increased my savings. Since beginning your Course, I have received two promotions and at present hold the position of Radio Communications Chief full time." FRANKLIN A. HILL, Indianapolis, Ind.

VETERANS

If you qualify for training under G.I. Bill, check the coupon for a Special Bulletin.

NATIONAL SCHOOLS

LOS ANGELES 37, CALIFORNIA EST. 1905

MAIL OPPORTUNITY COUPON FOR QUICK ACTION

National Schools, Dept. 8-PS
4000 South Figueroa Street
Los Angeles 37, California

(Mail in envelope or paste on penny postcard.)

Mail me FREE the books mentioned in your ad including a sample lesson of your course. I understand no salesman will call on me.

NAME..... AGE.....

ADDRESS.....

CITY..... ZONE..... STATE.....

Check here if veteran of World War II

FREE

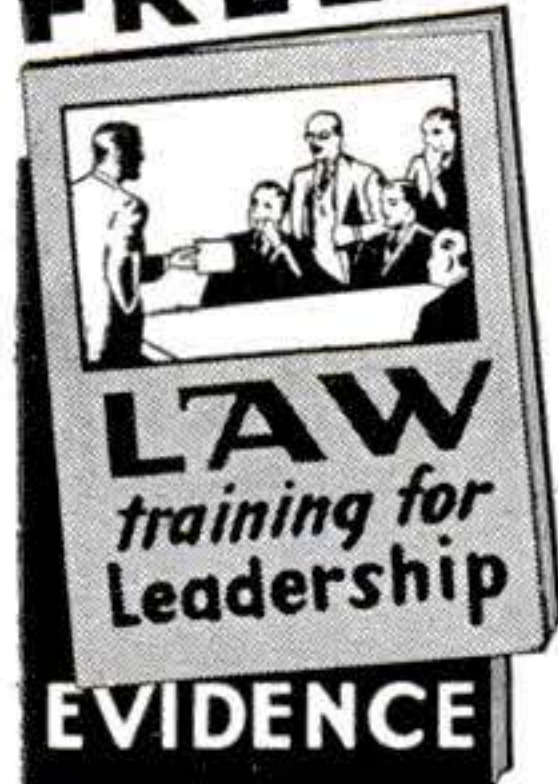

TO the MAN INTERESTED IN LAW

Every question about Law and its value to you is answered in LaSalle's 48-page booklet, "Law Training for Leadership." And the question of *how* you can master Law is answered in the companion booklet, "Evidence"—in which

scores of our students tell how they have advanced through LaSalle Law Training in spare hours at home.

Legal training gives you what the business and professional world prizes highly and rewards liberally—a keen, analytical mind, the ability to judge shrewdly, talk convincingly, and act with confidence.

LaSalle's "Problem Method" of personalized instruction by lawyer-instructors gives you practice in handling legal problems... you *learn by doing*, not by memorizing rules. We guide you step-by-step, furnish all texts, including remarkable 14-volume Law Library prepared by leading law professors and lawyers, and used as reference in many Law libraries and offices. Degree of LL.B. conferred. Low cost, easy terms.

Investigate *your* opportunities in Law. Mail coupon today for free booklets described—without obligation.

G. I. Approved

LA SALLE EXTENSION UNIVERSITY

A Correspondence Institution

417 S. Dearborn St. Dept. 883-L Chicago 5, Ill.

Send me "Law Training for Leadership" and "Evidence"—without obligation.

Name.....Age.....

Street.....

City, Zone & State.....

Get into a Big Branch of the Automobile Industry

Body & Fender Rebuilding

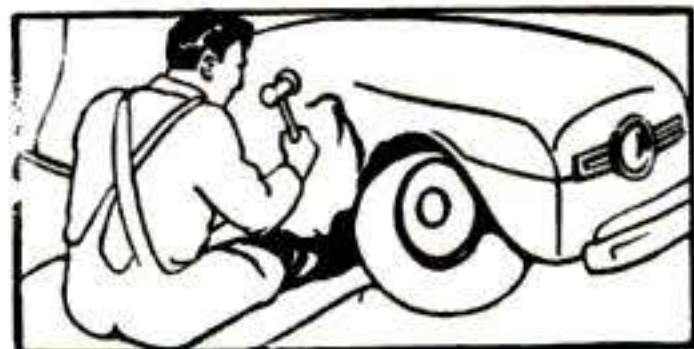

Body and Fender Rebuilding one of best paid fields in automobile industry. Body and Fender shops make good profits in garages, service stations. Excellent opportunities for men who look forward to business of their own.

Begin Training at Home or Come Directly to Shops

Begin your training at home in spare time, finish in our big modern shops, or come directly to shops. At home you get C.T.I.'s SHOP PROVED HOME STUDY instruction—actual shop experience has gone into the practical lesson assignments. That is why it is easy for mechanically inclined men to learn by our Home Study training and start on actual Body and Fender Work. CONSULTATION AND PLACEMENT SERVICE WHETHER YOU ARE INTERESTED IN WORTHWHILE JOB OR SETTING UP YOUR OWN BUSINESS. Opportunities for full and part time earnings.



A NATIONALLY KNOWN INSTITUTION

VETERANS qualifying under "G.I. Bill" have all expenses paid by Government plus monthly subsistence while in school. Just mail coupon, we will handle all details. (LOW TUITION, EASY TERMS if you are not a veteran.)

Fill Out, Cut Out, Mail Today

FACTS FREE for Men Who Want to Get Ahead
CHICAGO MOTIVE TRADES INSTITUTE, Dept. F-18
(Division Commercial Trades Institute)
1400 W. Greenleaf, Chicago 26, Ill.
Send free illustrated Brochures and other information about Body and Fender Rebuilding.
() Veteran () Non Veteran
Name.....
Address.....
City.....State.....



OPPORTUNITIES AHEAD! TRAIN FOR A FUTURE IN DIESEL

● Prepare for the big earning power of Diesel Trained Men. Start learning at home, in spare time. UEI's easy, practical training covers all phases of DIESEL engine operation, fuel systems, auxiliary equipment, repairs and maintenance. When home course is completed, you come to Chicago for actual shop practice on DIESEL MOTORS under expert instructors, at UEI's fine, modern school. BEGIN AT ONCE—GET ALL THE FACTS FREE. WRITE TODAY!
DIESEL UTILITIES ENGINEERING INSTITUTE
DIVISION 2521 Sheffield Ave. • Dept. 387-D • Chicago 14, Illinois

PHOTOGRAPHY

for Today's—and Tomorrow's Better Opportunities

Ever-increasing demand for trained photographers in advertising, industry, science, publishing. N. Y. I.'s success-proved home study training qualifies you. Previous experience unnecessary. Details FREE! Also resident courses.

NEW YORK INSTITUTE OF PHOTOGRAPHY Dept. 5 10 West 33 St. New York 1, N. Y.

Big Money for Workers In Home or Shop

Licensed Concrete Specialists wanted. No experience needed. Make Colorglazed concrete pottery without molds. New, low cost, patented method. Cemetery products, novelties, tiles, floors, etc. Basement leaksealing. Other big pay projects. Booklet, details free. Men only.

NATIONAL POTTERIES COMPANY
415 West Third Ave. Grand Rapids, Minnesota

Free Book

MOUNT BIRDS, ANIMALS, FISH

Yes FREE. Explains Taxidermy. Tells how to learn at home by mail to mount birds, animals, heads... to TAN skins and furs. Great for MEN and BOYS. Fun! Also earn money in spare time. WRITE TODAY—NOW—for free book containing 100 game pictures. State AGE.

N.W. School of Taxidermy, Dept. 339C, Omaha, Neb.

MAIL Postal Today

LEARN MEAT CUTTING At Home—In Spare Time

Get into the vital meat industry. Concise, practical Home Training based on 25 years proven instruction methods used at National's famous resident school. Prepares you for bigger pay as Meat Cutter, supervision, market manager or more money in your own store. Go as rapidly as your spare time permits. Diploma. Start NOW to turn your spare hours into money. Send for FREE bulletin today. No obligation.

National School of Meat Cutting Inc., Dept. 0-57, Toledo 4, Ohio

Learn BAKING At Home

Baking is one of America's high industries in wages. Nearly depression-proof. Thorough basic home course lays sound foundation. If you have aptitude, write for FREE BOOKLET, "Opportunities in Commercial Baking."

National Baking School, 1315 Mich. Ave., Dept. 136C, Chicago 5

THE GEM MAKER

Amateurs or professionals... hobbyists or jewelers... Polish your own gems with a B&I Gem Maker. You will find this a profitable adventure. All necessary lapidary equipment is furnished, including a super-charged diamond blade for sawing, and all wheels for grinding, shaping and polishing, also complete instructions. The complete equipment as shown, less motor and belt, for only \$29.50, f.o.b. Burlington, Wis. Write today for information and literature on the Gem Maker and accessories.

B&I MFG. CO., Dept. M, Burlington, Wis.

New Designs in FRANZITE GRIPS

Modernize Your Gun! Improve Your Score!

Most durable grips made. Positively unbreakable! For Colt, Smith & Wesson, Hi-Standard. Ortgies, Luger & Mausers in a wide choice of beautiful designs in ivory, pearl, walnut, onyx, etc. Low prices. FREE CATALOG. Dealers Wanted.

SPORTS, INC., (Mfrs.) 5501 Broadway, Dept. S-8, Chicago 40, Ill.

Be A MASTER PLUMBER

Earn \$15 To \$50 A Day

DON'T ENVY THE PLUMBER—BE ONE

Every skilled workman will tell you that Plumbers have the best of it. WINTER and SUMMER the Plumber is busy at top wages. No skilled Plumber is ever out of a job—compare his opportunities with any trade, plus the opportunities of having your own shop. We teach you Plumbing with TOOLS (not books) under Licensed Master PLUMBERS in one of the finest equipped schools in America. We make you a Plumber, every branch is taught thoroughly—Lead Work—Blueprint for plan reading—all other tricks.

LEARN IN 30 WEEKS WITHOUT PREVIOUS EXPERIENCE

If you like to work with tools you owe it to yourself to investigate. No need to ever work as an apprentice. Get free bulletin. Write now! G.I. APPROVED. Our 24th year.

UNIVERSAL PLUMBING SCHOOL
819 HOLMES STREET KANSAS CITY, MO.

WHY DON'T YOU WRITE?

Writing short stories, articles on business, homemaking, travel, gardening, shop crafts, local and club activities, etc., will enable you to earn extra money. In your own home, on your own time, the New York Copy Desk Method teaches you how to write the way newspaper men learn—by writing. Our unique "Writing Aptitude Test" tells whether you possess the fundamental qualities essential to successful writing. You'll enjoy this test. Write for it, without cost or obligation.

Veterans: This course approved for Veterans' Training.

NEWSPAPER INSTITUTE OF AMERICA
SUITE 572-M, ONE PARK AVENUE NEW YORK 16, N. Y.

Learn to Service and Repair ELECTRICAL APPLIANCES

Open your own electrical appliance service shop. Complete illustrated course covering washing machines, vacuum cleaners, elec. ranges, motors, fluorescent lights, house wiring, etc. Send today for FREE BOOKLET without obligation.

PACIFIC TRAINING SCHOOL
7217 So. Broadway, Dept. S-108, Los Angeles 3, Calif.



Thrilling Work COLORING PHOTOS

Fascinating vocation learned at home by those with aptitude. Thrilling pastime. National method brings out life-like colors. Free booklet.
NATIONAL PHOTO COLORING SCHOOL
1315 S. Michigan, Dept. 136C, Chicago 5

Learn LANDSCAPE GARDENING

A thorough, interesting, home study course for those who wish to become Landscapers, Gardeners, Designers, etc., for profit or pleasure. Write today for Free Book to

APPROVED NATIONAL LANDSCAPE INSTITUTE
FOR VETERANS Dept. P5-8, 310 So. Robertson, Los Angeles 36

SELL MERCHANDISE by Mail
OPERATE Profitable Lifetime Business Selling Merchandise by Mail. Large Profits on Fast Selling \$1.00 Items. **WRITE TODAY!**
POWELL CO. DEPT. C SAMLINER BLDG., CLEVELAND 3, OHIO



10,000 MEN AND WOMEN WANTED

To use fruit jar conditioner. It levels all standard size screw top jars, removes nicks. Definitely ends all spoilage, mold, darkening of pears, juice extraction, etc. All new and old jars must be conditioned for perfect results. \$7.50 prepaid in U. S. 3% tax in Wash. State. Free circular.

MIKALSON MFG. CO.

Dept. S Box 701

Everett, Wash.

LIQUID MARBLE COLORED POTTERY

Different! Marvelous! Color-glazed. Brush, spray, mold tiles, table-tops, ornaments! **SANITARY COMPOSITION FLOORING**—Dustless, noiseless; put on like plaster, plain or tile designs; yielding as cork, lasting as stone. **RUBBERLASTIC Mold Compound**—For plaster casting, novelties, statuary, toys, plaques, dolls. **TILEX Colored Roofing.** Build Modern PLASTIC HOMES. Illustrated literature free.

RAPID MARBLEIZING SERVICE, Dept. 12-A, Edwardsville, Illinois

SIGNS EASILY AND EXPERTLY PAINTED WITH LETTER PATTERNS
AND SHOWCARDS MANY SIZES & STYLES WRITE FOR FOLDER!
JOHN F. RAHN
1930-33 N. CENTRAL AVE.
CHICAGO 51, ILL.

RADIOMEN! ELECTRICIANS!

Get this Valuable Book

FREE

for Merely Examining
Coyne's NEW Pay-Raising

Tells How to Start Your Own Shop

3 VOLUME SET APPLIED PRACTICAL RADIO

Here's real news for every man interested in Radio. A sensational new **PRACTICAL set of radio books, just off the press!** Nothing like it ever before. Gives you the "know how" on everything in Radio today. Basic principles to the newest in Television and FM—how to construct, install, service. 600 illustrations, nearly 1000 pages. To prove how valuable these great books can be to you, **Coyne will give you a FREE copy of our new 240-page book "Starting & Operating a Profitable Radio or Electrical Business" just for looking over the 3 Volume Set.** For home training or field reference, **APPLIED PRACTICAL RADIO** is backed by Coyne's 48 years of shop experience to help you to bigger pay, better jobs, greater opportunities in Radio.

OFFER LIMITED—ACT NOW! Here's our offer to you—if you act promptly. We will send you the 3 volume set **APPLIED PRACTICAL RADIO** for 7 days' FREE examination, together with the **Business-Starting Book.** Look the set over for 7 days. If you like it, you can then pay the low price at easy terms in coupon below. If you don't want the set, return it and you owe NOTHING. In either event, you keep the **Business-Starting Book** absolutely FREE.

FREE SEND NO MONEY!
BOOK COUPON Coupon below is just a request to see the books free and get your gift book for doing it. **ACT—Send coupon TODAY!**



Educational Book Publishing Division,
COYNE ELECTRICAL & RADIO SCHOOL, Dept. C7-R8
500 South Paulina St., Chicago 12, Illinois

Send me that 3 volume set **APPLIED PRACTICAL RADIO** and my FREE gift book "Starting & Operating a Profitable Radio or Electrical Business". I'll either return the set in 7 days and owe nothing, or send you \$3 within 7 days after I receive the books and \$3 a month until \$10.75 is paid. Or I'll pay \$9.75 cash. Whether or not I keep the 3 Volume Set, the **Business-Starting Book** is mine FREE as a Gift.

NAME _____ AGE _____
ADDRESS _____
TOWN _____ ZONE _____ STATE _____

AVIATION Career

MAXIMUM TRAINING IN MINIMUM TIME

CAL-AERO TECH TRAINING will add dollars to your pay check all the rest of your life. Specializing in **AERONAUTICAL ENGINEERING** and **MASTER AVIATION MECHANICS** since 1929, Cal-Aero Tech training is carefully designed for just one thing—**TO MAKE MORE MONEY FOR YOU.** An alumni of over 6000 successful graduates proves our career training is unsurpassed.

VETERANS —Write us about Aviation Training, as provided under "G.I. Bill of Rights."



CAL-AERO TECHNICAL INSTITUTE
MAJOR C. C. MOSELEY PRES. SINCE 1929
FORMERLY CURTISS-WRIGHT TECHNICAL INSTITUTE

GRAND CENTRAL AIR TERMINAL
GLENDALE 1, CALIFORNIA
LOS ANGELES COUNTY

MAIL THIS COUPON TODAY!

Cal-Aero Technical Institute, Grand Central Airport, Glendale 1, California
Please send full information on Aviation Training FREE—without obligation. Dept P5-8

Name _____ Birth Date _____

Street _____

City _____ State _____



AUTO BOOKS ON APPROVAL



SEND NO MONEY. Just mail the coupon for a complete set of 4 Big, Thick Auto Books. 20th Edition. 2800 Pages! Whether you are a mechanic or helper, expert or apprentice, auto owner or driver, take immediate advantage of this **FREE EXAMINATION OFFER.**

MAKE GOOD MONEY NOW HOLD A PERMANENT JOB

America wants its automobiles kept in good repair. Men with "know how" are in demand, at big pay. These books will help you get and hold an important job, or give you a chance to go into business for yourself now or later. Any man who half tries to improve himself can learn auto servicing and repairing by this quick reference method. Use the **JIFFY INDEX** to find easily understood answer to any auto problem. These wonder books prepared by eleven of America's great automobile engineers. Many hundreds of valuable illustrations. Send the coupon **TODAY.**

[A year's consulting privileges with our engineers now given with these books without extra charge.]

Vocational Publishers Since 1898

CAN YOU FIX IT?

These wonder books tell step by step **HOW** to make difficult repairs and adjustments, how to keep a car at maximum efficiency, including latest improvements in car design and operation. Engine troubles and how to correct them well covered.

4 BIG, THICK VOLUMES

2800 pages, 2000 illustrations, wiring diagrams, etc., including Diesel engines. Beautiful modernistic, washable cloth binding.

AMERICAN TECHNICAL SOCIETY, Dept. AC20
Drexel Ave. at 58th St., Chicago 37, Ill.

I would like to examine your 4 Volume Set of Auto Books. I will pay the delivery charges only, but if I choose I may return them express collect. If after 10 days' use I prefer to keep them, I will send you \$2 and pay the balance at the rate of only \$3 a month until \$24.80 has been paid. Include consulting service as offered above.

Name.....

Address.....

City..... State.....

Please attach letter stating age, occupation, employer's name and address, and name and address of at least one business man as reference. Men in service, also please give home address.

Learn this Profitable Profession



IN 90 DAYS AT HOME

Money-Making Career Open to Men and Women, 18 to 50

Hundreds of men and women between 18 and 50 make \$10 to \$20 in a single day giving scientific Swedish Massage and Hydro-Therapy treatments. There is big demand from doctors, hospitals, sanatoriums and clubs. Graduates earn large full time incomes from these or in private practice in their own offices. Others make good money from home treatments given in spare time. Learn this interesting, money-making profession in your own home, through our home study course. Same instructors as in our nationally known resident school. You can win independence and prepare for future security by qualifying for your Diploma. Course can be completed in 3 to 4 months. Many earn while they learn. Begin your training at once.



Anatomy Charts & Booklet FREE

Enroll now and we will include, at no extra cost, many needed supplies. Fit yourself to help meet growing demand for Scientific Swedish Massage. Send the coupon at once for complete details. Anatomy Charts and 32-Page Illustrated Booklet, **FREE**, postpaid.

THE COLLEGE OF SWEDISH MASSAGE
Dept. 770-K, 100 East Ohio St., Chicago 11, Illinois

Please send me **FREE** and postpaid, Anatomy Charts, 32-page Booklet and complete details on Home Training.

Name.....

Address.....

City..... State.....

Learn To MOUNT BIRDS



Tan SKINS, Make Up FURS

Be a Taxidermist. Double your hunting fun. We teach you at Home. Mount Birds, Animals, Pets, Heads and Fish. Save your hunting trophies; decorate home and den. **MAKE MONEY.** Mount and Krome-tan for others. Big sparetime profits. **INVESTIGATE TODAY.** **FREE BOOK** with 100 game pictures. 48 pages. Hunters, get yours! It's Now Free. Send postal card **TODAY -- This Minute!** State your AGE. **NORTHWESTERN SCHOOL OF TAXIDERMY; Dept. 339C, Omaha, Nebr.**

INDIANA TECHNICAL COLLEGE

B.S. degree in 27 mos. Aeronautical, Chemical, Civil, Electrical, Mechanical and Radio Engineering. 2-yr. diploma. Air Conditioning. Refrigeration. GI approved. Low rate. Earn board. Demand for grads. Enter Sept., Dec., March, June. Catalogue. **687 E. Washington Blvd., Ft. Wayne 2, Ind.**

TRI-STATE COLLEGE

B.S. Degree in 27 months in Engineering (7 branches), Bus. Admin., Acctg. and Sec. Science. Graduates successful. **64th year.** Enter Sept., Jan., March, June. Write for catalog. **587 College Ave., Angola, Ind.**



Begin today. Write now for our Free Book, "How to Become a Good Penman." It contains specimens and tells how others learned to write in spare time. Enclose 10c for your name beautifully written and a pen point suitable for shaded writing. Write today. **THE TAMBLYN SCHOOL OF PENMANSHIP**
N-439 Ridge Building, Kansas City, Mo.

INVENTING

-FOR PROFIT!

If you have an inventive turn of mind, write for free 28-page booklet explaining how the Institute of American Inventors is helping inventors pre-test the profit possibilities of proposed devices to fill today's unprecedented demand for new inventions.

INSTITUTE OF AMERICAN INVENTORS

Dept. 3. 1926 Eye St. NW. Washington 6, D. C.

INVENTORS

The question as to whether a subject matter is patentable can be substantially determined by a search of the U. S. Patent records. Without obligation, write us for full information on what steps an inventor should take to secure a Patent or Trademarks.

RANDOLPH & BEAVERS

Registered Patent Attorneys

905-L Columbian Building, Washington 1, D. C.

PATENTS

AND TRADE MARKS

C. A. SNOW & CO.

REGISTERED PATENT ATTORNEYS

WRITE FOR INFORMATION TO
426 SNOW BUILDING, WASHINGTON 1, D. C.

INVENTORS

IF YOU WISH TO PROTECT YOUR INVENTION, You should take steps to protect it by a U. S. Patent. Write me for "Record of Invention" form.

CARL MILLER REGISTERED PATENT ATTORNEY

Woolworth Bldg., 35th Floor, Dept. 87C, New York City
Please send me "Record of Invention" form.

NAME.....

ADDRESS.....

DO ACTUAL ELECTRICAL WORK DAILY IN OUR LARGE SHOPS

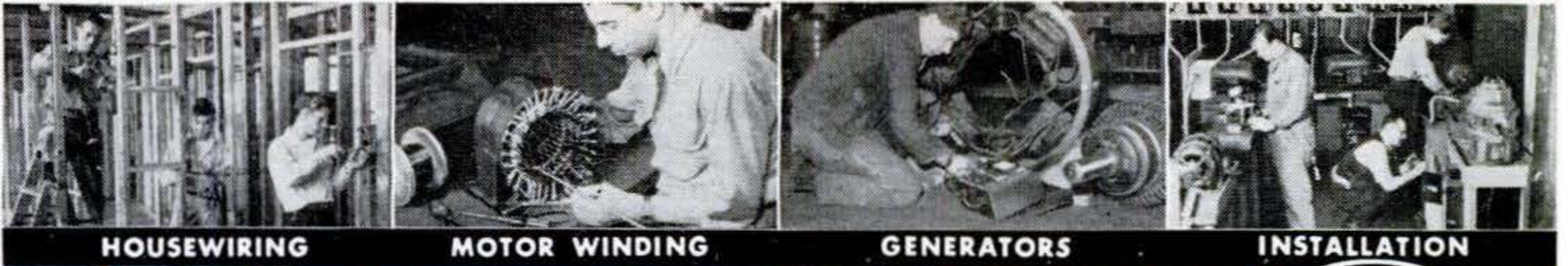

HOUSEWIRING

MOTOR WINDING

GENERATORS

INSTALLATION



GET INTO BIG-PAY

ELECTRICITY

**NATION'S
LARGEST
EXCLUSIVE
ELECTRICAL
SCHOOL**

QUICK, THOROUGH, EASY-TO-LEARN-TRADE

Steady job, good pay, clean work! . . . That's your future in this lifetime trade. Learn-by-doing in a few months on actual equipment . . . not "home study"—not "mail"—not "spare time"—**YOU GET PRACTICAL "A TO Z" EXPERIENCE** in our modern resident shops. Get ready fast for many electrical jobs now open everywhere! New classes start every few weeks. Living quarters arranged.

NO COST TO VETERANS Train at Gov't. expense. Receive \$65 to \$90 month while learning. Coupon brings details.

MICHIGAN TECHNICAL INSTITUTE
Department PS-8, 2281 West Fort Street, Detroit 16, Michigan



**MAIL TODAY FOR
QUICK ACTION**

MICHIGAN TECHNICAL INSTITUTE, Dept. PS-8
2281 W. Fort St., Detroit 16, Michigan

- Send me catalog and complete information.
 I am a GI. Send special information.
 Married. Single.

NAME _____

ADDRESS _____

CITY _____ ZONE _____ STATE _____

To those who think LEARNING MUSIC IS HARD

Just strike these notes and you're playing the beginning of the "Merry



Widow" Waltz. Look at the diagram. The first note of the music is "D." Following the dotted line to the keyboard you'll find "D" is the white key between the two black keys near the middle of the keyboard. Now read below how you can learn to play any instrument quickly and easily.

Easy as A-B-C—Costs just a few cents a day!

● Perhaps you think learning music is a tedious grind. It isn't any longer! Long hours of practicing scales and monotonous exercise are over.

You have no excuse for not getting started toward musical good times now! For through an easy method you can now learn to play right at home—without a teacher—for a few cents a day.

Learn to Play by Playing

The lessons come to you by mail from the famous U. S. School of Music . . . complete instructions, clear diagrams, and all the music you need. You learn to play by playing real tunes by note. First you are told how to do a thing. Then a picture shows you how. Then you do it yourself and hear it. Remember, don't confuse our method with any system claiming to teach music "by ear" or by trick methods. We teach you to play only from real notes!

SUCCESS!

Here's what one of our thousands of pupils writes: "I learned more from your course than many of my friends who studied under private teachers have for years. The fact that I've already taken 2 courses and am now enrolling for a third should speak for itself." F. A. S., Indiana.



Don't delay. Send now for our illustrated Free Booklet and "Print and Picture" Sample which fully explain this remarkable method. So decide which instrument you want to play and mail the coupon today. U. S. School of Music, 88 Brunswick Bldg., New York 10, N. Y. (Successful 49th Year)

FREE! Print and Picture Sample

U. S. School of Music
88 Brunswick Bldg., New York 10, N. Y.

Please send me Free Booklet and Print and Picture Sample. I would like to play instrument checked below.

- | | | |
|--|--|--|
| <input type="checkbox"/> Piano | <input type="checkbox"/> Saxophone | <input type="checkbox"/> Modern Elementary |
| <input type="checkbox"/> Guitar | <input type="checkbox"/> Trumpet, Cornet | <input type="checkbox"/> Harmony |
| <input type="checkbox"/> Hawaiian Guitar | <input type="checkbox"/> Reed Organ | <input type="checkbox"/> Mandolin |
| <input type="checkbox"/> Violin | <input type="checkbox"/> Tenor Banjo | <input type="checkbox"/> Practical Finger |
| <input type="checkbox"/> Piano Accordion | <input type="checkbox"/> Clarinet | <input type="checkbox"/> Control |

Name Have You
Instrument?

Address

City State

Save 2c—Stick Coupon on Penny Postcard



Hey, Joe!
START TO SCHOOL NOW
400 MORE LUCKY "GIs"
CAN LEARN

DIESEL . . DIESEL-ELECTRIC . . ELECTRICITY
RADIO MECHANICS . AIR CONDITIONING . REFRIGERATION

Due to the tremendous demand for Bailey training, students have made reservations far in advance. Applicants have had to "get in line and wait."

Now, however, due to our expansion program, you can enter the Famous Bailey Technical Schools immediately. American industry wants Bailey graduates. Here's a typical comment. W. H. Husmann, president and co-founder of Husmann-Roper Freight Lines, Incorporated, says:

"Bailey School graduates are 'old hands' with Diesels from the first day. Shop training makes them thoroughly competent."

Bailey Schools teach you basic principles, fundamentals, plus the practical application of theory in actual shop work. You get the "tricks" of the trade which would take years to learn starting at the bottom of the job.

If you want a business of your own or an important job in industry, it will pay you to investigate the Bailey School of your choice NOW.



Theory in the Bailey Classroom

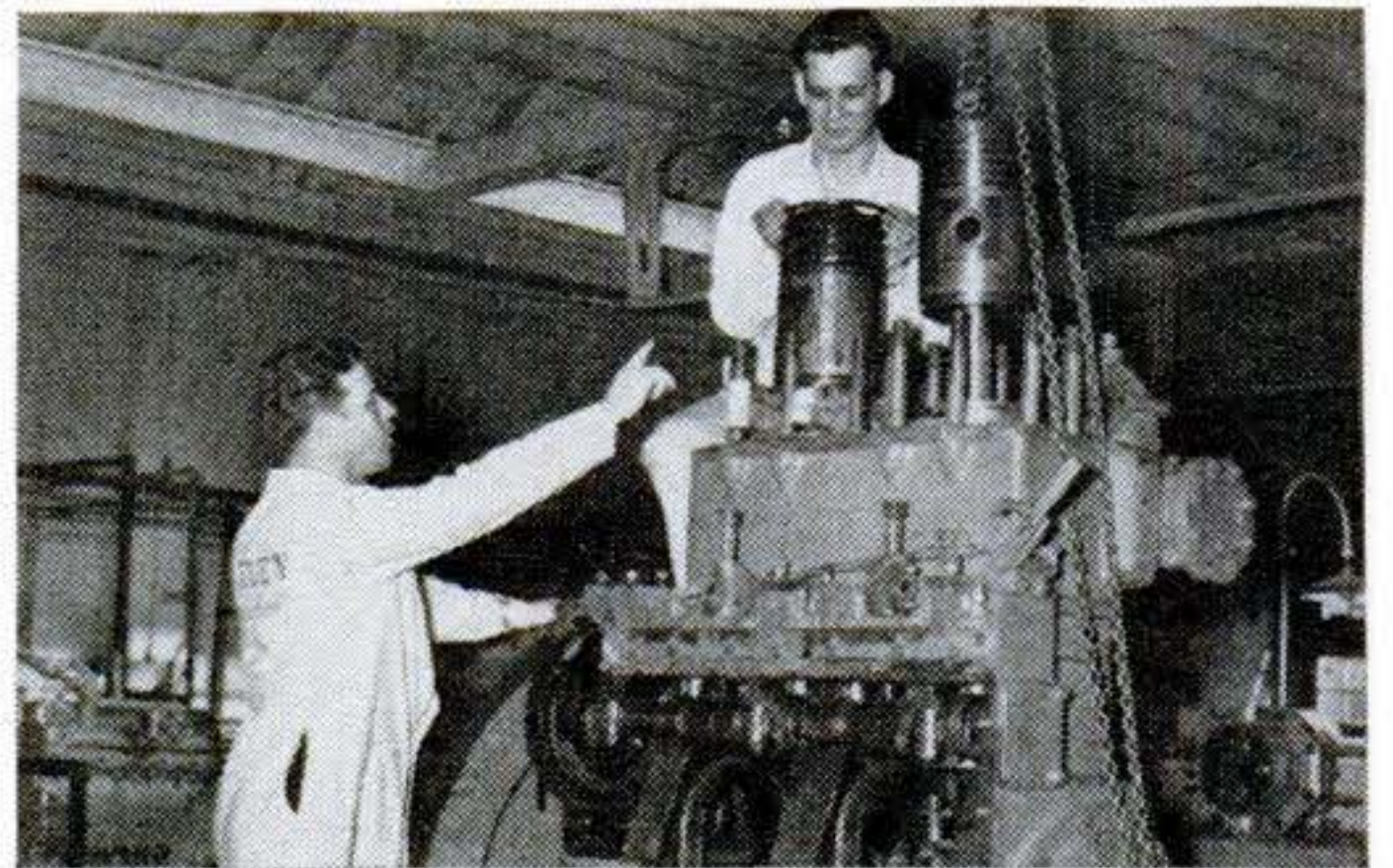

Shop practice

The BAILEY Technical SCHOOLS

Internationally Recognized

1652 S. Grand Blvd.

St. Louis 4, Missouri

SEND THIS APPLICATION

for information about enrollment today; you are under no obligation. Write to: Bailey Technical Schools, 1652 S. Grand Blvd., St. Louis 4, Missouri. Check the school in which you are especially interested.

Diesel Diesel-Electric Electricity
 Radio Mechanics Air Conditioning Refrigeration

Please send information to:

Name.....

Address.....

.....

Bailey Technical Schools are
GI APPROVED
Industry Endorsed

Bailey Technical Schools are approved by the Missouri State Board of Education; approved under Public Law 16 (the highest level of acceptance); approved for State Rehabilitation Training by all states which have a rehabilitation program.

For free catalog giving complete information, cut out the application to the left and send it in.

WAR SURPLUS GADGETEERS' PARADISE



4-POWER PANORAMIC SCOPE
Revolving head telescope; finest prisms and lenses. Contains 90 prism in worm E) gear mounting 11/16 sq. by 3" Dove Prism in worm E) gear mount. Head revolves 360 on double bevel gears. Achromatic objective and Kellner eyepiece, 90 Amic (Roof) Prism. Adjustments controlled and protected. Water, dust and shock-proof. A real buy. Shpg. wgt. 5 lbs. **\$7.95**



3X GUN SIGHT
Precision optical instrument; powerful achromatic color corrected lens; waterproof, shockproof, dust-proof, shockproof. All bronze and brass body; a find for bird and nature study, long distance observation. 22 1/2" long. Gov't. cost approx. \$175.00. Shpg. wgt. 7 lbs. **\$4.95 Each**



100% WOOL SLEEPING BAG
Ideal for vacations, camping. Blanket-type with 30-in. Talon zipper. Renovated -AA1 like new. Shpg. wgt. 4 lbs. **\$2.95**



PORTABLE EXTENSION FLASHLIGHT
Uses 2 dry cell batteries. Excellent for mechanics who need to get light into close quarters, etc. O.D. color. Has rheostat to regulate brightness of light. Sold without batteries. Shpg. wgt. 2 lbs. **\$2.95**

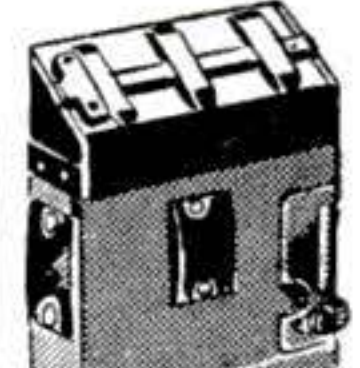

TANK PERISCOPE
Contains 1-power telescope mounted inside. Lens system consists of 6 elements with achromatic objective. Mill scale reticule mounted ahead of eyepiece. Ideal hunting scope sight. Shpg. wgt. 9 lbs. **\$4.95**



6-POWER BATTERY C. O. TELESCOPE
All-prism type instrument. 6 lenses perfectly ground, clear, flat, color-corrected field of vision. Adaptable as right-angle view finders for cameras. Gov't. cost over \$300. Shpg. wgt. 5 lbs. **\$11.95**



ELBOW TELESCOPE
3-power, field view 13 degrees, 20 minutes. Achromatic, color-corrected. Can be converted by shopmen to a "center-scope" for drill press, jig and tool work. Lens suitable for photography and microscopes. Gov't. cost approx. \$150. Shpg. wgt. 3 lbs. **\$6.95**

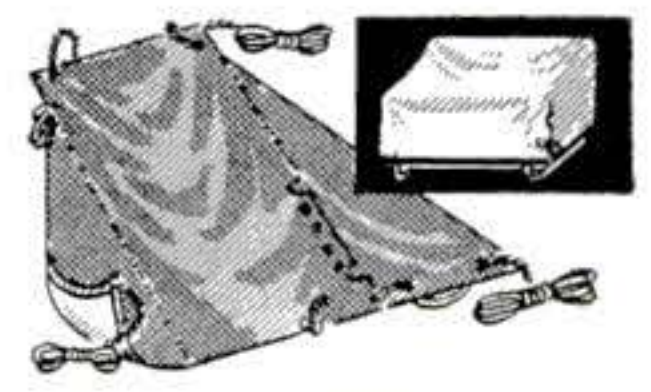

GLIDER COVER
O.D. color. 5' across top, 14' across bottom, approximately 8' in length. Lined inside with white cotton felt cloth. Perfect for covering trailers, small boats, garden furniture, sand boxes. Fitted with gromets and rope. Shpg. wgt. 11 lbs. **\$4.95**



FLARE NUT WRENCH BOXSOCKETS
Ideal for industrial jobs. Set of 6 sizes: 1-11/16", 2 1/4", 2-7/16", 2-5/8", 2-13/16", 2-3/4". Gov't. cost approx. \$9 per set. Shpg. wgt. approx. 7 lbs. Set of 6. **\$3.95**

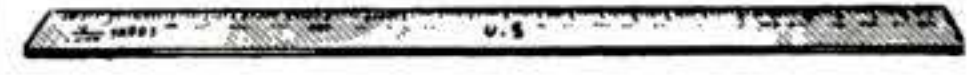

STRAIGHTEDGE
Bright steel, square edge 24" long, 1 1/2" wide. Graduated in yards 1 to 20,000. Originally manufactured for the Engineer Corps at gov't. cost of \$3.37 each. Shpg. wgt. 1 lb. **98c**

SURPLUS DISTRIBUTORS

924-B N. Plankinton Ave.
Milwaukee 3, Wisconsin

All orders shipped FOB Milwaukee, postage collect. Send money order or check. On C.O.D. orders, enclose 20% deposit, balance plus postage on arrival. Money cheerfully refunded if not satisfied. Refer all orders to Dept. B.

WHICH OF THESE *Opportunities* INTERESTS *You* MOST?

● Today, choose the job you want—and prepare for it. Or if you are already engaged in the work you like best, start training now for quicker promotion. Acquire the knowledge that will help you to get ahead faster, make more money and have greater security.

American School, founded in 1897 as an educational institution *not for profit*, can help you to reach your goal just as it has helped others during the past fifty years. Check the coupon at right, add your name and address and mail it at once. The school will send you details on its training plan and outline of study prepared by specialists. There is no charge, no obligation, so send the coupon immediately.

CHECK, CLIP AND MAIL COUPON NOW

AMERICAN SCHOOL, Dept. GC46, Drexel at 58th, Chicago 37, Ill.
Without obligation, Please send FREE and postpaid, bulletin and details of the Subjects checked:

- | | | |
|--|---|--|
| <input type="checkbox"/> PLASTICS ENG'R | <input type="checkbox"/> Accounting | <input type="checkbox"/> Drafting and Design for Men and Women |
| <input type="checkbox"/> Refrigeration | <input type="checkbox"/> Electrical Engr. | <input type="checkbox"/> Radio |
| <input type="checkbox"/> Architecture and Building | <input type="checkbox"/> Electricity-Pract. | <input type="checkbox"/> High School |
| <input type="checkbox"/> Contracting | <input type="checkbox"/> Electronics, Industrial | <input type="checkbox"/> Air Conditioning |
| <input type="checkbox"/> Practical Plumbing | <input type="checkbox"/> Bookkeeping | <input type="checkbox"/> Mechanical Eng. |
| <input type="checkbox"/> Automotive Engr. | <input type="checkbox"/> Private Secretary | <input type="checkbox"/> Shop Management |
| <input type="checkbox"/> Aviation Drafting | <input type="checkbox"/> Diesel Engineering | <input type="checkbox"/> Tool Making |
| <input type="checkbox"/> Aviation | <input type="checkbox"/> Sheet Metal Pattern Drafting | <input type="checkbox"/> Better Foremanship |
| <input type="checkbox"/> Business Management | <input type="checkbox"/> Railway Training | <input type="checkbox"/> Machine Shop Operations |

AMERICAN SCHOOL

Dept. GC46, Drexel at 58th Street, Chicago 37

Name..... Occupation.....
Address..... Age.....
City..... State.....

RHEUMATISM YIELDS TO DRUGLESS METHOD OF TREATMENT

Excelsior Springs, Mo., July 29—So successful has a comparatively new, drugless method proven for treating rheumatism and arthritis that an amazing new book will be sent free to any reader of this magazine who will write for it.

This book entitled, "Rheumatism," fully explains why drugs and medicines give only temporary relief and fail to remove the causes of the trouble.

The Ball Clinic, Excelsior Springs, Mo., has perfected a system of drugless treatment for rheumatism and arthritis combined with the world famous mineral waters and baths. This new method of treatment is fully described in the book and tells how it may be possible for you to find freedom from rheumatism.

You incur no obligation in sending for this instructive book. It may be the means of saving you years of untold misery. For writing promptly, the company will also include a free copy of the book entitled, "Good Health, Life's Greatest Blessing." Address your letter to The Ball Clinic, Dept. 36, Excelsior Springs, Mo., but be sure to write today.



STOP OIL AND FUEL LOSSES!

If your car "eats" gas and oil, chances are, worn piston rings are the cause. Take a tip from race car drivers . . . install a set of quick-seating Burd "Graf-Flox" Piston Rings . . . watch fuel and oil bills go down.

Two free, handy booklets for car-owners, mailed on request. Just print your name and address in margin alongside this ad, clip ad and mail today!



BURD PISTON RING CO., DEPT. PS, ROCKFORD, ILL.



WAKE UP YOUR SCALP Want better looking hair? Embarrassed by falling dandruff, itching scalp? Then try VITABRUSH, new electric driven scalp brush that gives your scalp a vigorous and invigorating "workout" in just three minutes of fun. Cleans scalp. Stimulates blood supply. Restful. Pleasant. Write *today* for complete information and satisfaction-guaranteed offer.. Hershey Mfg. Co. 3740 Field Bldg., Chicago 3

Now CHEAP OIL BURNER
FOR HEATING AND COOKING STOVES - FURNACES
HEAT YOUR HOME, COOK YOUR MEALS WITH CHEAP FURNACE OIL

NO MORE SHOVELING COAL OR ASHES. Sensational Fuelizer Starter Vaporizing System turns Cheap No. 1 Furnace Oil, also Range, Heater, Tractor Distillate, Kerosene and like oils into oil heat—one of the quickest, hottest fires known. **LIFETIME GUARANTEE. \$1.00 Bonus Offer for Testing.**

We will let you try it in your own stove or furnace for one month. Get yours for introducing. Big profits **QUICK.** Be first. Send in your name today for details and cash in on the tremendous demand for this Amazing Invention.

NORTHWEST MFG. CO. 606-K, Mitchell, S. Dak.

Big New Novelty Catalog Now Ready!

500 Pages; 6000 Amazing Novelties
Send 5c today for this mammoth, amazing new catalog of over 6,000 novelties. More fascinating than a World's Fair. Thousands of things you never knew existed—never knew where to get. Includes novelties, tricks, jokes, live animals and pets, scientific supplies, den novelties, hobby supplies, planes and boats, looms, magic, unusual seeds, gadget time savers, cameras and optical goods, movies, projectors, lucky jewelry, religious novelties, telegraph sets, magnets, disguises, easy musical instruments, stamps, coins, puzzles, fortune tellers, occult and supernatural, radios, experimental sets, auto & bike accessories, Western belts and wearing apparel, telescopes, magnifiers, compasses, banks, smokers' gadgets, artists' supplies, printing sets, engines and motors, electric shockers, knives, billfolds, fireworks, guns and rifles, weird articles, archers, swimming helps, 1000 fascinating books, games, locks, live chameleons, rings, watches, charms, barometers, slide rules, exercisers, money savers, curious plants, handy tools, Indian novelties, etc., etc., etc. Jammed and packed with sensational funmakers and useful articles. Big catalog—over 1 inch thick, 6 color cover. (DeLuxe Hard Bound Library Edition 15c). Send 5c to help cover postage with your name and address to: **JOHNSON SMITH & CO., Dept. A-1, Detroit 7, Mich.**

MANY NEVER SUSPECT CAUSE OF BACKACHES

This Old Treatment Often Brings Happy Relief

Many sufferers relieve nagging backache quickly, once they discover that the real cause of their trouble may be tired kidneys.

The kidneys are Nature's chief way of taking the excess acids and waste out of the blood. They help most people pass about 3 pints a day.

When disorder of kidney function permits poisonous matter to remain in your blood, it may cause nagging backache, rheumatic pains, leg pains, loss of pep and energy, getting up nights, swelling, puffiness under the eyes, headaches and dizziness.

Don't wait! Ask your druggist for Doan's Pills, a stimulant diuretic, used successfully by millions for over 50 years. Doan's give happy relief and will help the 15 miles of kidney tubes flush out poisonous waste from your blood. Get Doan's Pills.

Practical Shop Training In REFRIGERATION

Service, Maintenance, Installation
and AIR CONDITIONING

• Domestic • Commercial • Industrial

Approved
for
G. I.
Training

Write for Details
**COMMERCIAL
TRADES INSTITUTE**
202 So. 20th St., Birmingham, Ala.

• Train in the Magic City of the South. •

"JACKPOT" AMUSEMENT MACHINE



• Great fun maker for Rumpus Room, Club or Tavern. Soon pays for itself. Fully automatic payout, three reels, with all the usual winning combinations . . . cherries, lemons, etc. Double jackpot. Rugged lifetime construction. Guaranteed to satisfy or money back. Service manual makes it easy to understand how to operate machine successfully. Takes space only 14 1/2 x 11 1/2 in. Ht. 18 1/2 in. Shpg. wt. 47 lbs. CHOICE OF 5c, 10c, or 25c PLAY. Send \$20.00 deposit, balance C.O.D. plus express charges. Immediate delivery . . . Each, **\$189.50**

WEBB DISTRIBUTING CO. INC.
6 S. KEDZIE AVE., CHICAGO 12, ILL.

METAL FORMING TOOLS



12" VISE BRAKE. Fits in vise, or bolts to bench or plank. Forms angles, channels, boxes and crimps in sheet metal and thin strap iron. \$14.50 PP.
VISE FORMING TOOL. Makes cylinders, ovals, cones, hoops and round corners in sheet metal, wire and 1/8x2 steel strap, 2" to 60" in dia., 18" wide. \$10.00 PP.
VISE IRON BENDER. Easily bends 1/2" square or round; 1/4" up to 2" wide. Makes hooks, rings, brackets, eyelets, etc. Screw adjustment for accurate work. All steel. Price \$10.00 PP. Immediate delivery. Order direct, or send for details. Sheet metal and wire forming booklet, 50c.

VISE BRAKE MFG. CO., Dept. P.S.
1318 So. 30th Ave. Omaha 5, Nebr.

\$ AGENTS SIGN LETTERS

300% Profit

For Store Fronts and Office Windows. Anyone can put them on. Free Samples. Liberal Offer to general agents.
METALLIC LETTER CO., 441 N. Clark, Chicago 10

OLD GOLD JEWELRY WANTED

Dental gold teeth, plates and bridges with metal attached. Any broken pieces of gold jewelry. Immediate payment and free mailing container to you or your friends upon request.
LOWES, DEPT. PS Holland Bldg., St. Louis 1, Mo.

DETECTIVES

Home Study in Detective Training—Professionally Modernized—Recognized Instructors—Easy Payments—Write
INTERNATIONAL DETECTIVE TRAINING SCHOOL
1701-G Monroe St. N. E. Washington 18, D. C.



Electric Light Flower

ONLY \$1.49 Amuse and astonish your friends. Have fun at parties. Electric Light Flower is worn in a man's lapel or woman's hair. Simply press magic button hidden in your pocket and bulb flashes on and off. Complete with attractive flower wire, bulb and batteries. Rush your order today.

ELECTRIC LIGHT BOW TIE \$1.49
Complete with battery & bulbs

Special price to dealers.

BERNARD FINE CO.
501 Sixth Ave., Dept. PS, New York 11, N. Y.

EYE-GLASSES BY MAIL

16 Days Trial

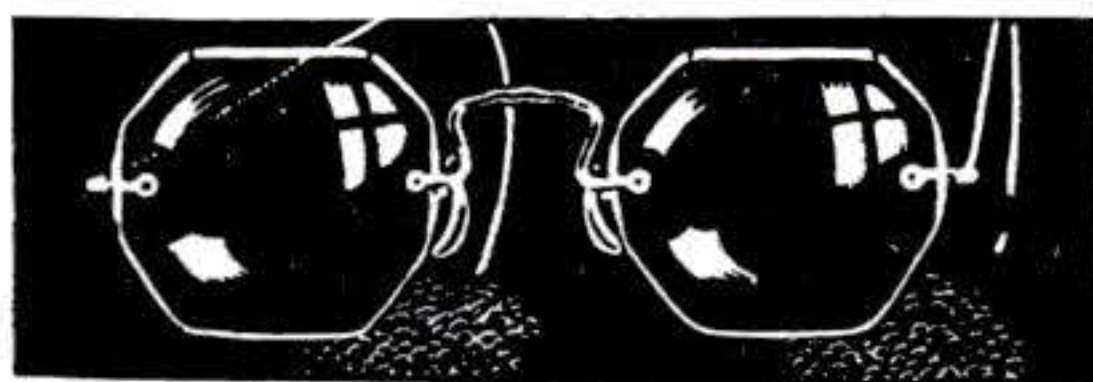

Write Today for Free Catalog. Send no Money
ADVANCE SPECTACLE COMPANY
537 South Dearborn Street, Dept. SP8, Chicago, Illinois



HERE'S A NEW AND VITAL BUSINESS!

LEARN ELECTRICAL APPLIANCE REPAIRING

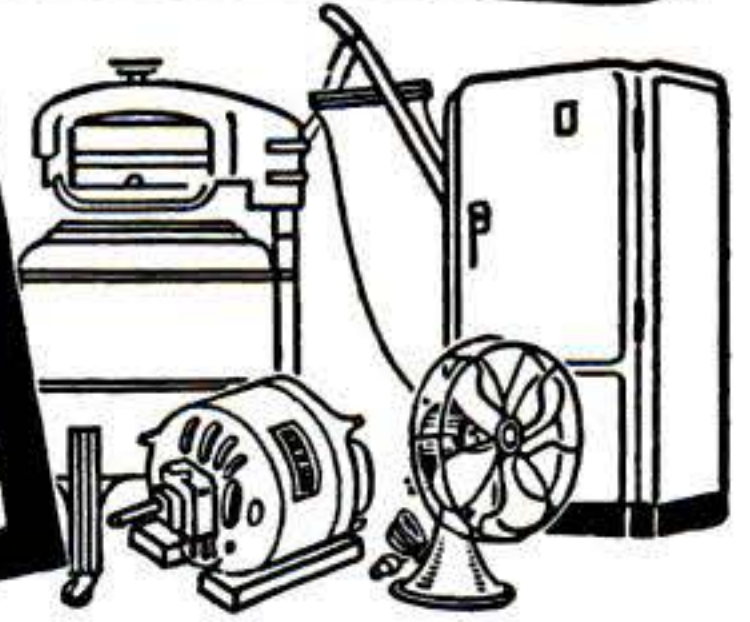

Offers Big Money—Independence

If now employed, start your home appliance repair business NOW in your spare time and be set with a business of your own no matter what happens. Operate from your garage, basement, kitchen, vacant store, etc. Work as many hours as you wish—the home appliance repairman is his own boss. It is a profitable occupation, for on many types of repairs it is not unusual for a repairman to charge on the basis of \$5.00 to \$6.00 per hour! Remember, there are millions of electrical appliances in this country. Appliances such as refrigerators, irons, sewing machines, vacuum cleaners, heaters, toasters, washing machines, motors, etc. To replace them is mighty expensive. That is why the Electrical Appliance Repair Business offers the trained man unlimited earning possibilities.

YOU CAN QUALIFY

All you need to become a successful electrical appliance repairman is ambition plus a little training at home in your spare time. If you are mechanically inclined—that is to say—can hold and use tools, our profusely illustrated course written in simple, easy to understand language will prepare you for the years to come. It does not matter if you have not had a great deal of schooling or have had no previous training along these lines. WE WILL TEACH YOU. Age is no barrier—nor any minor physical handicap.

WE TEACH YOU

Profusely illustrated with photographs and simple drawings we show you what troubles to look for and how to make each repair on an electrical appliance. We give you a good sound working knowledge of electricity, and how to do welding, nickel plating, etc. Our course shows you how to solicit business and keep it coming to you. Not a theory course but an honest to goodness course written by and used by repairmen the country over. Price of course is so low that the savings on your own household appliance repairs will quickly pay for it. Why work for others at the wages they want to pay you? Learn a good trade and operate your own business and determine how long you work each day and the amount of money you make. ACT NOW!

MAIL COUPON TODAY

CHRISTY SUPPLY CO.
2835 N. Central Ave., Dept. D-5501
Chicago 34, Illinois

Please send me free illustrated literature about America's Fastest Growing Industry—ELECTRICAL APPLIANCE REPAIRING.

Name.....

Address.....

City.....State.....



Embry Riddle

TRAINING COUNTS MOST IN AVIATION

Get the right kind of training for a **SUCCESSFUL AVIATION CAREER** at Embry-Riddle's internationally known School of Aviation—in air-minded Miami. Intensive, practical courses—CAA approved. Authorized training under G.I. Bill.

You can become a flying mechanic, certificated A & E mechanic or instrument technician. Or study radio; operation and maintenance; design engineering; flight. Instruction covers whole field of aviation. Immediate enrollment.

It's always Summer in colorful Miami—the aerial crossroads of the Americas!

MAIL THIS COUPON—TODAY!

Dean of Enrollments—Dept. 51
Embry-Riddle School of Aviation
Miami 30, Florida

Send free information on Aviation Training to:

Name.....Age.....

Address.....

City.....State.....

Check One Veteran Non-Veteran

LET HOLLYWOOD EXPERTS HELP YOU

MAKE GOOD IN RADIO TELEVISION ELECTRONICS

APPROVED FOR VETERANS

LEARN FROM MEN CLOSEST TO RADIO-TELEVISION INDUSTRY! Direct from Hollywood, center of America's Broadcasting, Television, Radio, Sound activities comes easy-to-learn, advanced home-instruction that quickly qualifies you for **Steady, Good-Pay Jobs** or business in Radio, Television, Electronics.

GET RADIO SHOP KNOW HOW Radio Training Association of America's (R.T.A.) **Professional Methods** assure quick step-by-step success. R.T.A. is located right "on-the-spot" where new technical developments are introduced. You receive finest shop-type instruction in latest Radio-Television techniques. Every R.T.A. student **Gets Unlimited Consultation** from Hollywood on any subject pertaining to studies.

EXTRA MONEY WHILE LEARNING When you enroll with R.T.A. you get **SPARE TIME JOB SHEETS** showing how

to earn extra money while being trained by R.T.A.'s **Hollywood Experts**. When friends, neighbors know you are studying radio, ample repair jobs are practically assured for you.

GET FACTS—Send for FREE Book telling about R.T.A.'s streamlined training plan developed by veteran technicians in Hollywood, heart of vast Radio-Television field. Mail coupon today. **Send for Free Illustrated Book** showing newest Radio-Television pictures. No obligation. **Approved for Veterans**. Send for big free book now!



RADIO TRAINING ASSOCIATION OF AMERICA

RADIO TRAINING ASSOC. OF AMERICA, DEPT. PS-8
5620 Hollywood Blvd., Hollywood 28, Calif.
Send FREE BOOK showing how to make good in Radio-Television through training by Hollywood experts.

NAME.....AGE.....

ADDRESS.....

CITY.....ZONE.....STATE.....

Check box if **VETERAN** of World War II

5620 HOLLYWOOD BLVD · HOLLYWOOD 28, CALIF.

Learn Penmanship

One should learn **Rapid Business Writing**, both for his own satisfaction and for the convenience of those who must read it. And if **Fancy Shaded Writing** is learned also, it makes one a still more skilful penman. **Good penmanship prevents costly errors and helps to secure and hold good positions**, and, like music or elocution, naturally attracts persons of refinement and artistic inclinations. If you are dissatisfied with your present handwriting and wish to become a **good writer**, write for my **FREE BOOK**, "How to Become an Expert Penman," which contains specimens of penmanship and shows what others have learned by my **Simplified Method**. If you enclose 10c, I will send you one of my **Favorite Pen Points** suitable for plain or shaded writing, and your name with a beautiful flourished bird written on a card. **Begin Now. Write for your copy of the Free Book today.**

T. M. TEVIS, BOX 25-R, CHILLICOTHE, MO.

FREE...

Do You Want to Build Up Your Body... Gain Strength... Become a Champion Athlete... Gain or Lose Weight? **YOU CAN DO SO!**

- Get our large **free** folder for boys and men on our valuable books and courses on fighting, body-building, and all sports.

Send your name, address and ten cents in stamps or coin to cover mailing costs. We do the rest!
Write today to:
CROSS COMPANY Box 389, Dept. B-2
Kenosha, Wisconsin

HORSE MASTERY!

A FINE HOBBY — A GREAT VOCATION!

"The EXPERT HORSEMAN"



FREE BOOK — Tells how You can learn to: BREAK COLTS, GAIT SHOW HORSES, TRAIN RODEO, STOCK and RACE HORSES, BREAK BAD HABITS, HANDLE ANY HORSE. TRAIN CIRCUS TRICK HORSES. **WRITE TODAY!**

ANIMAL LOVERS ASSOCIATION
BOX S-157 TARZANA, CALIFORNIA

SUBSCRIBE TODAY 50¢
One Year

LAW

STUDY AT HOME for **PERSONAL SUCCESS** and **LARGER EARNINGS**. 39 years expert instruction —over 108,000 students enrolled. **LL.B. Degree** awarded. All texts furnished. Easy payments. **G.I. Approved. Send for FREE BOOK.**

AMERICAN EXTENSION SCHOOL OF LAW
Dept. 80-S, 646 N. Michigan Ave., Chicago 11, Ill.

START A BATTERY FACTORY



—at home; the latest achievement; re-cast junk batteries into new. Complete instructions. We supply everything. **Big profits!**

THE BATTERY LABORATORIES
Dept. PS Minneapolis 13, Minn.

NOW

CHANITE SELF-WELDING FLUX—REPAIRS all **ELECTRIC HEATING ELEMENTS**. So simple anyone can make repairs in your broken or burnt-out electrical appliances—irons, toasters, stoves & etc. Guaranteed nothing like it. From our mines to your appliances. **\$1.00** per package. **\$7.50** per doz. Stick form 25c. **\$2.00** per doz.

CHANITE SALES COMPANY, 914 South Main, Fort Worth 4, Texas

MAGIC WONDERS EXPOSED!

Amuse! Confuse! Thrill Everyone! Vanishing light, Ghostly Pellet, Magic Smoke, Mystic Watch, Enchanted Match, Spirit Writing, Magic Fire, Wizzards Candle, Etc. 32 Magic Lessons 25c, Free with order **Big Catalog. The Magician, 2463 Kensington Ave., Phila. 25, Pa. Dept. D.**

RUPTURED?

Get Relief This Proven Way

Why try to worry along with trusses that gouge your flesh—press heavily on hips and spine—enlarge opening—fail to hold rupture? You need the Cluthe. No leg-straps or cutting belts. Automatic adjustable pad holds at real opening—follows every body movement with instant increased support in case of strain. Cannot slip whether at work or play. Light. Waterproof. Can be worn in bath. Send for amazing **FREE** book, "Advice To Ruptured," and details of liberal truthful 60-day trial offer. Also endorsements from grateful users in your neighborhood. Write:

Cluthe Sons, Dept. 14, Bloomfield, New Jersey



Learn DIESEL

at home... **IN YOUR SPARE TIME!**

HEMPHILL DIESEL TRAINING is available to you at home. Study in your spare time, without interfering with your present employment. This pioneer Diesel educational institution, with thousands of successful graduates throughout the world, offers you the opportunity to learn Diesel at home. **THE DAY OF DIESEL POWER IS HERE!** Railroads, shipping, farming, manufacturing, transportation—almost every great industry is turning more and more to Diesel Power. Think of the opportunities which this presents to the qualified, trained Diesel man.

VETERANS

This comprehensive, practical Home Training course is approved under the G.I. Bill of Rights. You can get started quickly. Just mail the coupon today.

NON-VETERANS

Courses available to you on easy TERMS. Improve your worth on your present job—or future as a Diesel operator or mechanic. Mail the coupon today for complete details.

RESIDENT SCHOOLS LOCATED AT:

NEW YORK 31-28 Queens Blvd. Long Island I., N. Y.
LOS ANGELES 1601 S. Western Ave. Los Angeles 6, Calif.
MEMPHIS 311 S. Main St. Memphis 3, Tenn.

34 weeks practical training. If you would prefer to train at one of these three schools, indicate by check on coupon.

HEMPHILL DIESEL AND AUTOMOTIVE SCHOOLS
 Administrative Office: 1601 South Western Ave., Dept. PS-8
 Los Angeles 6, California

Gentlemen: Please send me FREE BOOKLET and information on your Diesel Courses. I am interested in Home Study Resident School at New York Memphis Los Angeles (Check school desired.)

Name..... Age.....
 Street..... Zone.....
 City..... State.....
 Veteran..... Non-Veteran.....

Do you want

- .. to go to College?
- .. or to enter a Profession?
(Such as Accounting, Architecture, Nursing, Dentistry, Teaching, Social Work, Osteopathy, Beauty Culture, Optometry, Embalming, Chiropody, Law, Medicine, etc.)
- .. or get an Office Position?

To get anywhere, you practically **MUST** finish High School **FIRST**. You can complete our simplified High School Course in SPARE time at home, as FAST as your time and abilities permit. Equivalent to resident school work—prepares you for college, pre-professional examinations, business, industry. Standard texts furnished. Diploma. Credit for H.S. subjects already completed. Single subjects if desired. Low tuition, easy terms. American School, Chicago, est. 1897—endorsed by educators. Finish your high school education NOW. Write TODAY!

High School Course at Home

Many Finish in 2 Years

American School, Dept. HC46, Drexel Ave. at 58th St., Chicago 37

Gentlemen: Send me FREE information covering special training in subjects checked below. No obligation on my part.

- | | |
|--|--|
| <input type="checkbox"/> High School Course | <input type="checkbox"/> Diesel Engineering |
| <input type="checkbox"/> Electronics, Industrial | <input type="checkbox"/> Drafting and Design for Men and Women |
| <input type="checkbox"/> Architecture and Building | <input type="checkbox"/> Plastics |
| <input type="checkbox"/> Automotive Engineering | <input type="checkbox"/> Private Secretary |
| <input type="checkbox"/> Business Management | <input type="checkbox"/> Mechanical Engineering |
| <input type="checkbox"/> Electrical Engineering | <input type="checkbox"/> Aviation |
| <input type="checkbox"/> Elec. and Gas Refrigeration | <input type="checkbox"/> Salesmanship |
| <input type="checkbox"/> Air Conditioning | <input type="checkbox"/> Radio |
| <input type="checkbox"/> Railway Training | |

Name.....
 Address.....

RADIO or ELECTRICITY

including Industrial Electronics

Shop Training in a Nationally Known School

LEARN-BY-DOING—

GET READY IN FEW WEEKS
 Vastly increased number of radio receivers, development of FM broadcasting, installation of public address systems, demand services of trained men who can repair, service sets and equipment.



BETTER TRAINING IN BETTER TRADES

Get into big established field of Electricity where pay is high—prepare for tremendous new developments in Industrial Electronics. **PLACEMENT SERVICE WHETHER YOU WANT BETTER JOB OR BUSINESS OF YOUR OWN.** Make rapid progress by our modern shop methods. **VETERANS** qualifying under "G.I. Bill" have tuition paid by Government plus monthly subsistence allowance while in school. Just mail coupon, we will handle all details. (LOW TUITION, EASY TERMS if you are not a veteran.)



RADIO and ELECTRICAL DIVISIONS
COMMERCIAL TRADES INSTITUTE,
 Dept. C 18, 6312 N. Broadway,
 Chicago 40, Ill.

FREE—Important Information Telling How to Get Started

Fill Out, Cut Out, Mail Today

FACTS FREE for Men Who Want to Get Ahead
COMMERCIAL TRADES INSTITUTE, Dept. C 18,
 6312 N. Broadway, Chicago 40, Ill.

Send free illustrated Brochures and other information about the field I have checked below:

() Radio () Electricity

Name.....
 Address.....
 City..... State.....

FREE BIG NEW LAFAYETTE RADIO BOOK

COMPLETE with the greatest values in radio. Send for it now. Typical values:

K10448—All Wave 2 Tube AC-DC Receiver Kit. 110 volts AC-DC; 12SJ7 regenerative detector, 11L7GT power amplifier-rectifier; 4 coils cover 10-200 meters; headphone jack; complete with punched chassis, panel, plug-in coils and tubes. Only \$17.95.

K10451—Battery Operated All Wave Receiver Kit. As above. Only \$16.95 complete.

Lafayette Radio
RADIO WIRE TELEVISION INC.

100 6th Ave., NEW YORK 13
110 Federal St., BOSTON 10
24 Central Ave., NEWARK 2

LAFAYETTE RADIO, Dept. KH-7
100 Sixth Avenue, New York 13, N. Y.
RUSH new big radio catalog to:

Name.....
Address.....
City..... State.....

PASTE COUPON ON POSTCARD — MAIL IT NOW!

TALK-SING thru your own radio with **RADIO MICROPHONE**

Be the life of the party. Put on your own broadcasts at home. Talk-Sing, make announcements from any room. Wonderful voice practice. Microphone easily attached to any radio. Follow enclosed instructions. SEND NO MONEY—pay Postman \$1.98 plus postage. Send Money Order or check and save postage.

EMPIRE RADIO & TELEVISION CO. (Dept. R1) 1521 Bedford Ave., Brooklyn 16, N. Y.

TEXAS COLLEGE OF PHOTOGRAPHIC ART

1st IN THE GREAT SOUTHWEST!

SCENIC and HISTORIC SAN ANTONIO THE PHOTOGRAPHERS' WONDERLAND VETERANS MAY ENROLL UNDER G.I. BILL

LEARN PHOTOGRAPHY NOW
FASCINATING WORK — EXCELLENT PAY
FREE BOOKLET ADDRESS: DEPT. 10

Texas COLLEGE OF PHOTOGRAPHIC Art
SAN ANTONIO, TEXAS

"ONE BLOCK FROM THE ALAMO"



6 TULIP Bulbs 25¢

Your neighbors will admire these blooms next spring. May-flowering bulbs about 1" and over in DIAMETER of different varieties. Worth at least \$1.00, but sold at 25c for the privilege of sending you new FALL PLANTING LIST showing in natural colors every flower we offer, such as Daffodils, Tulips, Hyacinths, Snowdrops, and other healthy, beautiful spring-flowering bulbs.

Send today—no letter necessary—merely wrap quarter in tissue and write name, address and word "TULIP" on back of envelope.

HARTFORD FARMS • America's Largest Bulb Growers
DEPT. M 55 HARTFORD, MICH.

PRESS YOUR OWN PANTS • TIES • LAPELS

SAVE TIME AND MONEY. Plug in AC or DC socket and you're ready to go—no wet cloth, no board, no bother. Two nickel-plated pressing sides do the job. Use at home, office, when traveling. Women like it for skirts, slacks. A fine gift. Free circular, Empire Products, Inc., 817 Main St., Dept. P.S., Cincinnati 2, Ohio.



\$2.49 at stores or send check or money order. C.O.D. accepted. Satisfaction Guaranteed.

Empire PRESSER

6" WHEELS 40c

Moulded RUBBER TIRES to fit 5/16" axle cash required with order.

A. B. McMAHAN, 693 Raymond Ave., St. Paul 4, Minn.

BUILD THIS CONCRETE BLOCK MACHINE

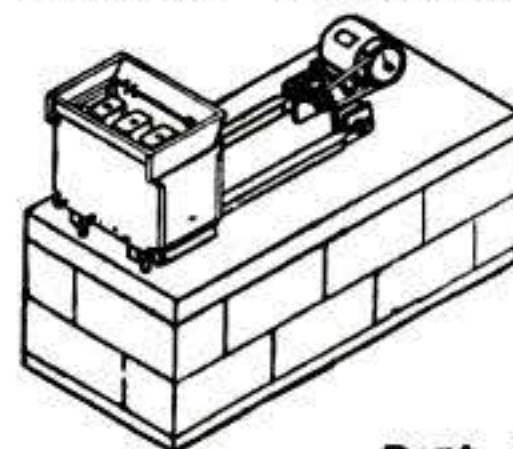

Sell blocks; or build your home, garage, barn, or filling station at 1/3 cost by making and laying your own blocks. This simple machine which you can build yourself at a cost of \$15 (excluding motor) will make a block in 30 seconds using only one form. Mass production can be achieved by a new simple method of removing blocks which allows two to four forms to one vibrator. Power driven concrete mixer plans also. Send dime for details and "How to Make and Lay Blocks" folder.

U-BUILD-IT SERVICE
Dept. 4-A, 206 West Wilder St., Tampa 3, Florida

STAMMER?

This new 128-page book, "Stammering, Its Cause and Correction," describes the Bogue Unit Method for scientific correction of stammering and stuttering—successful for 46 years. Benj. N. Bogue, Dept. 7850 Circle Tower, Indianapolis 4, Ind.

GET THIS FREE BOOK!

LEARN-WATCH REPAIRING at HOME

"FREE information write—American Institute of Specialized Watch Repair—270-276 East Bldg., Grand Rapids Michigan."

WANT TO EARN MORE MONEY?

Learn SILK SCREEN PROCESS At Home. No art experience necessary. FREE big illustrated Book explains how my training enables you to start your own successful business or train for a better job in this well paid, uncrowded Advertising Field. No machinery or previous experience required. Course includes Complete Kits of Supplies. Write TODAY for your Copy.

CALIFORNIA SCHOOL OF SCREEN PROCESS
Dept. SM-87, 3740 Overland Blvd., Los Angeles 34, California

ARTISTS MAKE MONEY

Do you like to draw? Send name, address, age and occupation for FREE ART TEST, to find out your ability.

ART INSTRUCTION, INC.
8147 Art Instruction Bldg., Minneapolis 15, Minn.

STOP

CORROSION and FRICTION

Use Fiendoil on tools, electrical appliances, household devices. It actively Lubricates • Cleans • Prevents Rust

3-oz. Spout Can 40c

FIENDOIL
"The Enemy of Corrosion and Friction"

Ball-Bearing SPEED WHEELS



Juvenile wheels, solid tire
 7" wheels.....60c
 6" wheels.....50c
 4" wheels.....30c

Semi-pneumatic tired wheels
 12 x 1.75".....\$3.25
 10 x 1.75".....\$2.75
 8 x 2".....\$2.00

Industrial wheels, for heavy loads
 10 x 2.75" Semi-Pneu.\$6.75
 10 x 2.75" Single valve tube Pneu. \$7.25
 8 x 1".....\$4.90
 6 x 2".....\$2.80

**Dealers
Wanted**

FREE BLUEPRINTS WITH ALL WHEEL ORDERS
 Enclose check with order

JIM BROWN TOY COMPANY
 1093 Home Ave. Akron 10, Ohio

"YOU ARE UNDER ARREST!"



Help Bring Crooks to Justice Through Scientific
CRIME DETECTION!

I have taught thousands this exciting, profitable, pleasant profession. Let me teach you in your own home. Learn Finger Printing, Firearms Identification, Police Photography, Secret Service Methods thoroughly, quickly, at small cost. 53% of all American Bureaus of Identification employ I. A. S. students or graduates. I can prepare you for this fascinating work, during spare time. Write today, stating age, for "Blue Book of Crime."

INSTITUTE OF APPLIED SCIENCE, 1920 Sunnyside Ave., Dept. 136-C, Chicago 40, Ill.

LEARN CARPENTRY

Get in on the biggest building boom in history. Prepare for a long and profitable career as a big-pay building tradesman. Actual shop training under expert instructors. Write for big free catalog today.

MIDWEST SCHOOL OF BUILDING TRADES
 Dept. C-18, 411 N. Center Street, Bloomington, Ill.



VETERANS ASK FOR GI PLAN

TRAIN Your VOICE!



Results **GUARANTEED**

We build, strengthen the vocal organs—not with singing lessons—but by sound, scientifically correct silent and vocal exercises and absolutely guarantee complete satisfaction with results. Write for Voice Book, FREE. Sent to no one under 17 years old unless signed by parent.

Perfect Voice Studios, Studio 136-C, Kimball Hall Bldg., Chicago 4, Ill.

Jiffy Jr. BOILING HOT WATER IN A JIFFY!!

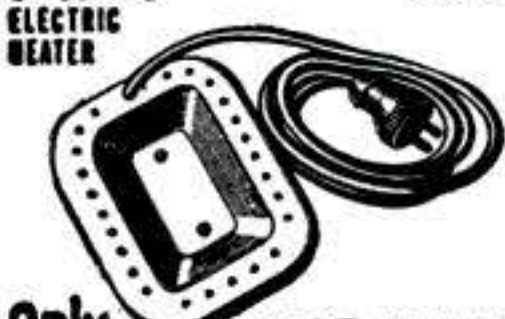

Only **\$2.95** HOT WATER
 IN A JIFFY
 plus twenty five cents for postage

Place the Jiffy Electric Water Heater into the water and insert the plug in the nearest electric wall or light plug. You will have hot water in less than five minutes for baby's bath, your washing, shaving and a great many other uses in the home, camping, business, and on the farm. Mailed complete, including six feet of rubber covered wires and plug. One year guarantee. **JIFFY ELECTRIC COMPANY, Dept. PS1, 21321 Stephenson Highway, Hazel Park, Mich.**

A PENNY POSTCARD MAY CHANGE YOUR FUTURE...

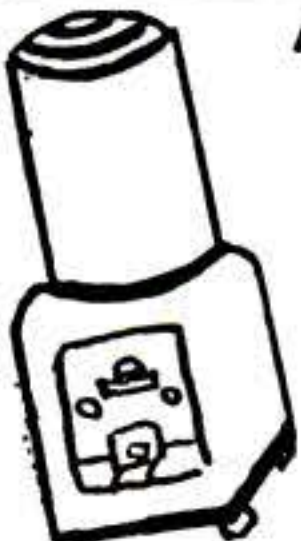

Get full information on the coin-operated vending machine industry. Start with a few machines and build a wonderful future. We'll give you complete advantage of our "know-how." Send for Free Booklet Today—No Routes Sold!

PIONEER VENDING SERVICE

ADDRESS ALL MAIL TO DEPT. PS

461 SACKMAN ST. • BROOKLYN 12, N. Y.

FREE to Ambitious Men and Women

Send today for this FREE book, "Accountancy, the Profession That Pays."

A full explanation of what you must know to be an accountant, opportunities in this well-paying, fascinating field, and how you can, in your spare time, prepare yourself for a better job and more money. A preliminary knowledge of bookkeeping is unnecessary. We train you from the ground up, or start with what you already know, according to your individual needs.

Under the LaSalle Problem Method you can acquire at home, a thorough understanding of Higher Accountancy, master its fundamental principles, become expert in the practical application of these principles. Your training will be under the direct supervision of a staff of Certified Public Accountants, and members of the American Institute of Accountants.

Get all the facts NOW. Our book, "Accountancy, the Profession That Pays" is FREE. Write for it today.

G. I. APPROVED

LASALLE EXTENSION UNIVERSITY A CORRESPONDENCE INSTITUTION

DEPT. 883-H 417 SO. DEARBORN STREET, CHICAGO 5

I would welcome details of opportunities in accounting, together with copy of "Accountancy, the Profession That Pays," without obligation.

HIGHER ACCOUNTANCY

Other La Salle Opportunities:

LaSalle opens the way to success in every important field of business. If interested in one of the fields below, check and mail.

- Business Management
- Modern Salesmanship
- Traffic Management
- Foremanship
- Industrial Management
- Stenotypy (Machine Shorthand)
- Law—Degree of LL.B.
- Commercial Law
- Modern Business Correspondence
- Expert Bookkeeping
- C.P.A. Coaching

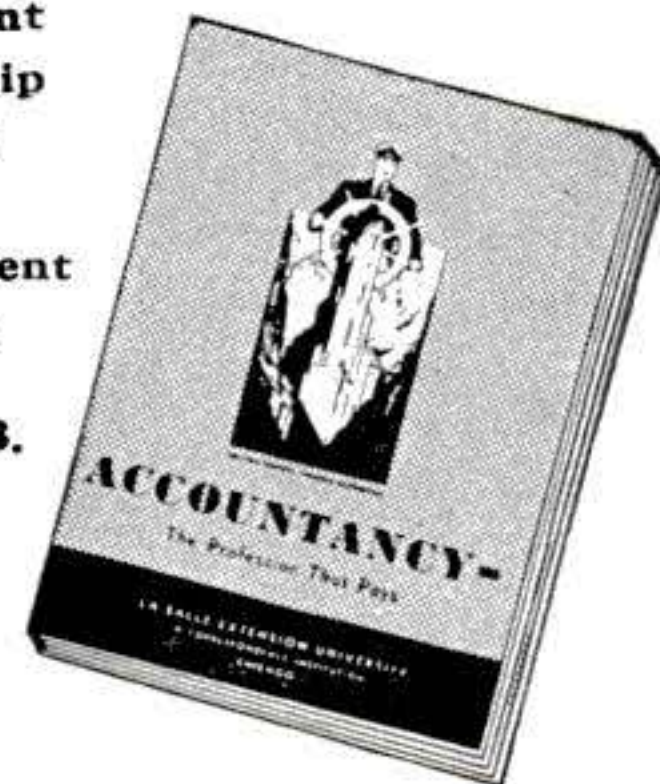

Name.....
 Present Position.....Age.....
 Street.....
 City.....Zone....State.....

BARGAIN 3X ARMY TELESCOPE

Original Cost \$150.00 — Our Price \$7.50



ALL COATED LENSES — BRAND NEW

An ideal gift for viewing objects, landscapes, seashores, etc. The high resolving power of the six coated lenses, five of them achromats will bring out great details. For the experimenter it can be dismantled and used for hundreds of projects. Length 22½ inches, 36° Field, Postpaid \$7.50.

500,000 Lenses and Prisms. Send 3c stamp for "Bargain" List

A. JAEGER

123-26B ROCKAWAY BLVD., SO. OZONE PARK 20, N. Y.

BRAND NEW SOLID BRASS 12 FT. PORTABLE

RADIO ANTENNAS

Real \$15 Value Now Only \$4.95 Postpaid
FOR HOMES, BOATS or AUTOS

Just Out! Gov't surplus

used on Army tanks. These telescopic rustproof antenna have tremendous pickup eliminate dangerous wiring. Solid Brass throughout practically insuring NOISE FREE RECEPTION.

12
Exceptionally Rugged Sections

compress into 1 ft. 4 in. Handy for Camping Trips, also Useful for Transmitting, FM & Television sets.

Each antenna comes with clamps, nut, lug, and wire. Easy to install anywhere.

QUANTITY LIMITED

ORDER TODAY. A real \$15 value for only \$4.95 Postpaid. Mail check or money order now or sent C.O.D. plus postage. Money back in 10 days if not satisfied.

RADIO HOSPITAL 1113 Lexington Ave., Dept. B8
New York 21, N. Y.

NOW READY! Floyd Clymer's Newest and Best Motor Scrapbook of Historical Cars . . . No 4.



Illustrates, describes 200 early cars, motorcycles. Entirely different from books 1, 2, 3 (also available). \$1.50 each postpaid; \$2.50 for De Luxe edition.

CLYMER, Dept. B-8, 2125 W. Pico, Los Angeles 6, Calif.

\$500 to \$5,000 yearly

Raising Angora Rabbits We furnish stock and markets for both wool and young stock. Particulars free.
WILSON'S, 1075 Shryer, St. Paul 8, Minn.

GET THIS HOME MOVIE FEATURE

WALLPAPER WOE

Get this hilarious short comedy. Ben and bride re-decorate living room. Ben gets entangled in roll of wallpaper — falls in paste bucket — finally completes job and everyone happy.



16mm Kodachrome, with Sound.....\$17.50
16mm Black & White, with Sound..... 7.50

See at Your Photo Dealers or Order Direct Catalog and Prices on Request. Write to:

HOLLYWOOD FILM ENTERPRISES, Inc.

6060 Sunset Blvd. Dept. 116 Hollywood 28, Calif.

Refit and Tighten FALSE TEETH

With
AMAZING PLASTI-LINER

If your plates are loose and slip or hurt; reline them better than new, with this pliable, non-porous strip. Just lay on plate, bite and it molds perfectly, hardens for lasting fit and comfort. Ends forever the mess, bother and expense of temporary applications that last only a few hours or few months. Will not injure plates, and guaranteed to give satisfaction or your money back. Write for Plasti-Liner today. Pay postman \$1.25 for one reliner, \$2.25 for both upper and lower--or send money, save C.O.D. charges.
PLASTI-LINER CO., Dept. 41-A Buffalo 2, N. Y.

SHINE WITHOUT 'POLISH'

New Invention! • Sells Like Wild



Replaces messy pastes, liquids. Simply glide over shoes—and PRESTO! — you have a lustrous, long-lasting shine. No mess. No muss. No soiled hands. Clean. Handy. WORKS LIKE MAGIC! For Men's, Women's and Children's Shoes. Low priced. Lightning seller!

SAMPLES FOR AGENTS Sample offer sent immediately to all who send name at once. A penny postal will do. SEND NO MONEY—just your name.
KRISTEE CO., 691 Bar Street, AKRON, OHIO

12 lbs. SURPLUS RADIO PARTS \$2.00

A gold mine of parts for repairmen, amateurs, and experimentors . . . sockets, condensers, resistors, transformers, coils, hardware, wire, etc., etc. An outstanding bargain in usable parts! Send \$2.00 cash, check or M.O. today! (Pay small express charges on receipt.)

ELECTRONIC DISTRIBUTORS, Inc. Dept. B8, 620 W. Randolph St., Chicago 6, Ill.

BECOME A PISTOL EXPERT WITH A HY-SCORE AIR PISTOL

- No Pumping
- Powerful, Fast
- Single Shot
- Precision-Made
- 30½ oz.:
- 10¼" long



HY-SCORE PELLETS FIT ALL PISTOLS Cal. 177 2.50 Cal. 22 3.00 per 1000

SEE YOUR DEALER

Send for Free Circular, Dept. PS8

HY-SCORE ARMS CORP. • BROOKLYN 1, N. Y.

Book of Sea and World Navigation Map \$1.00 Postpaid

64 Page Raft Book by famous Aviator for Flyers downed at Sea. Wealth of information and illustrations on Birds, Fish, Marine Life, Ocean Currents, Weather, Navigational Principles, Map, Star & Planet Chart 22" x 45". Date Scale 45". Send \$1.00 to
NORTH AMERICAN SALES, Inc., 8 S. Dearborn St., Chicago 3, Ill.

If Ruptured

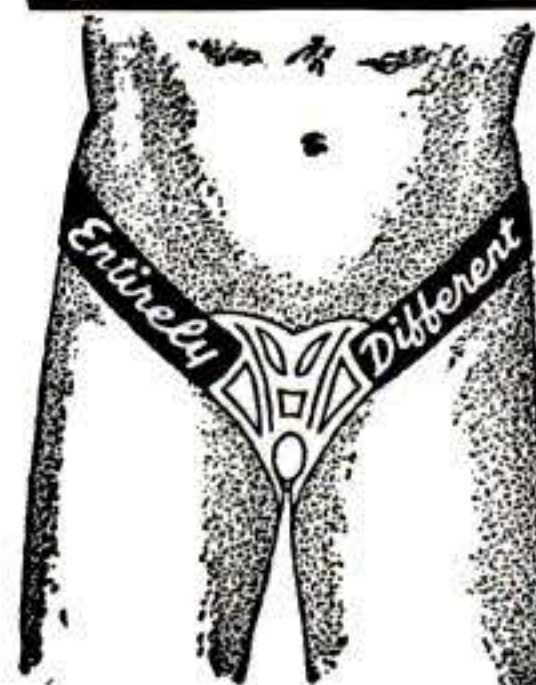

Do What Others Now Do—

Wear a Form Fitting MILLER Truss

which provides natural freedom and comfort in working, walking, playing, horse back riding, dancing, swimming or sleeping. You just cannot afford to be without this protection and convenience.

Wear two weeks then consult your physician before deciding to keep it.

Write me today for **FREE** descriptive circular. Sent in plain, sealed envelope.

FRED B. MILLER Manufacturer
Dept. P.S. Hagerstown, Maryland.

.....
Question: *When is Independence Day?*
Answer: *Every day for the*
Tradio operator!
 Yes, Independence Day comes 365 times a year for the men and women who buy and install TRADIO, the radio functionally designed for coin operation in hotels, tourist camps, clubs, hospitals, etc....**Big earnings....Small investment....A business of your own with no clock to punch.**
TRADIO—TRIED TESTED & PROVEN
 Get in on the ground floor of this flourishing new industry and assure yourself of financial independence for life. Thousands of others like yourself all over the country have learned that "TRADIO Pays While it Plays." For complete information, drop a postcard to:

TRADIO, Inc. Dept. O-91
 ASBURY PARK, N. J.

SHEATH

THE POLARIZED RUST PREVENTIVE FOR GUNS, TOOLS, TACKLE
At your dealers 50c & \$1.00
 Brownell Industries, Inc., Montezuma, Iowa



HOW TO CUT RAFTERS

New vest pocket book gives lengths, Side cuts, Plumb cuts, Deductions. For all rafters for any building from one inch to forty feet wide. Gives numbers to cut on square. Also degrees for same cuts for Radial Saws. All standard pitches from 1/8 to 5/8. Just open book to pitch page and there are your lengths, side cuts, etc. Anyone who knows what a jack rafter is can frame a roof if he has this great book. Price one dollar prepaid. **Builders' Topics, Dept. S, Lock Box 828, Seattle, Washington.** Original teachers of the square in five easy lessons by mail. **SEND FOR FREE LIST OF TECHNICAL BOOKS.** Learn to read blueprints, etc.

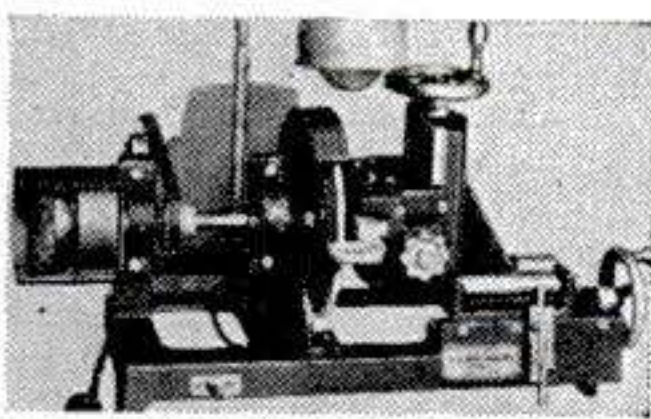

Start a NEW BUSINESS
Sharpen Dull Pipe Wrenches
Or Add to Your Present Repair Business
 Write for information.
J. C. MOORE INDUSTRIES P.O. Drawer 276
 FREDONIA, PA.

Learn RADIO TELEVISION ELECTRONICS

Our proven 2-Way Instruction trains you at home in spare time for a good pay job or a business of your own. For **FREE** book "Your Opportunities in Radio", write: **Hollywood Radio & Television Institute** (Established 1929), Dept. D-7, 810 W. 6th St., Los Angeles, Calif.

RADIO ENGINEERING

Television, FM, Broadcasting, Servicing, Electronics, Aviation, Marine & Police Radio taught thoroughly. 72 weeks' Engineering course equivalent to 3 years' college radio work. Approved Veteran Training. Catalog upon request.
Valparaiso Technical Institute, Dept. 503, Valparaiso, Ind.



COMB-A-TRIM The New Quick Trimmer
 Something New! Trim your hair without any experience. It's easy! The excess hair comes off smoothly and easily by just pulling trimmer through hair like an ordinary comb. Save on hair-cut bills. . . . Trim your own hair or the whole family's. Send 59c and your Comb-A-Trim will be sent at once, postpaid.
59c
SPECIAL OFFER Send \$1.00 for 2 Comb-A-Trims. Save 18c **2 for \$1.50** Extra Blades (Year's Supply) **25c**
COMB-A-TRIM CO., CAREW TOWER, Dept. J-21, Cincinnati, Ohio

Pay Is Good

for Trained mechanics in both these Big Industries

AUTOMOTIVE MECHANICS

LEARN IN A FEW WEEKS IN OUR BIG MODERN TRAINING SHOPS

DIESEL MECHANICS

NOW IS THE TIME TO PREPARE FOR YOUR PLACE IN A GIANT INDUSTRY

Automobile and Diesel industries making up for lost time! There may never again be such opportunities for men who want better jobs or business of their own to get in on ground floor and go up fast! Yes—FOR MEN WHO ACT FAST. THINGS CAN HAPPEN FAST!

TRAIN ON ACTUAL EQUIPMENT
 Chicago Motive Trades Institute makes rapid progress possible by Learn-By-Doing SUPERVISED SHOP TRAINING. In motive trades our institute gained nation wide fame training Auto Mechanics for U.S. Army. Same quality training available to you now. **CONSULTATION AND PLACEMENT SERVICE WHETHER YOU ARE INTERESTED IN WORTHWHILE JOB OR SETTING UP YOUR OWN BUSINESS.**

AUTOMOTIVE MECHANICS

Practical shop training on all types of equipment. Automotive mechanics needed to keep millions of cars, busses, trucks rolling. Efficient auto mechanics get fine pay. Can service, repair, install all mechanical and electrical parts of autos. Learn to overhaul and repair engines, transmissions, differentials, and other assemblies. Good pay, steady work, excellent opportunities for increased earnings for properly trained auto mechanics.



DIESEL MECHANICS

● Diesel engines are used in locomotives, ships, trucks, buses, power plants, tractors, farm equipment. Trained men needed to repair, rebuild, install, maintain, operate equipment. A big field that promises even bigger things in the years right ahead.

A NATIONALLY KNOWN INSTITUTION

Rapid progress possible by supervised learn-by-doing SHOP TRAINING. C.T.I. is an old established school, backed by years of experience—with trained instructors—with completely equipped shops.
VETERANS qualifying under "G.I. Bill" have all expenses paid by Government plus monthly subsistence allowance. Just mail coupon, we will handle all details. (LOW TUITION, EASY TERMS if you are not a veteran.)

CHICAGO MOTIVE TRADES INSTITUTE
 Div. of Commercial Trades Inst.
 1400 W. Greenleaf Ave.
 Chicago 26, Ill.
FREE
 —IMPORTANT INFORMATION
 TELLING HOW TO GET STARTED



→ **Fill Out, Cut Out, Mail Today** ←

FACTS FREE for Men Who Want to Get Ahead
CHICAGO MOTIVE TRADES INSTITUTE, Dept. B18
1400 W. Greenleaf, Chicago 26, Ill.
 Send free illustrated Brochures and other information about the field I have checked below.
 Automotive Mechanics Diesel Mechanics
 Veteran Non-Veteran
 NAME.....
 ADDRESS.....
 CITY.....STATE.....

Here Is a Way YOU Can Get Ready for the BUILDING BOOM

Learn about Earning Opportunities in BUILDING CONTRACTING
FREE FACTS



Do you want to be on the inside in the building boom—where big money is made? Learn about opportunities for Building Contractors whether or not you have previous experience in this field. Millions of dollars are going to be made in home and farm buildings, in construction of stores, garages, small industrial buildings. The building industry uses men with organizing ability by thousands in construction, supervision, management, sales. Properly trained men needed in production, distribution, finance, installation, and marketing.

USE OUR TRAINING PLAN TO LEARN AT HOME IN YOUR SPARE TIME

Easy to Learn in Nationally Known School
Government estimates housing demand at 40 billion dollars! Others are preparing to get in now! Act immediately—get the facts!

HOME BUILDERS TRAINING INSTITUTE, Dept. D18
DIVISION COMMERCIAL TRADES INSTITUTE
1400 W. Greenleaf, Chicago 26, Ill.

Fill Out, Cut Out, Mail Today

FACTS FREE for Men Who Want to Get Ahead
HOME BUILDERS TRAINING INSTITUTE, Dept. D18
1400 Greenleaf, Chicago 26, Illinois

I am interested in the opportunities in the Building Industry. Please send me free information about getting a start as a building contractor.

Name _____
Address _____
City _____ State _____

Get on "UNCLE SAM'S" Payroll

START \$1,756 TO \$3,021 YEAR

MEN—WOMEN
Thousands appointments being made.
32 Page Book FREE
Mail Coupon Today, SURE.

FRANKLIN INSTITUTE
Dept. L-81, Rochester 4, N. Y.
Sirs: Rush without charge, (1) 32-page book with list of U. S. Government Jobs; (2) Tell me how to prepare for one.
Name.....
Address..... Vet?.....

AIR RIFLES BENJAMIN AIR PISTOLS
PIONEERS - LEADERS

SEND FOR FREE FOLDER OF LATEST MODELS TODAY
If you want a REAL GUN for PRACTICAL USE inside or outdoors get a SAFE - CLEAN - ECONOMICAL - BENJAMIN with Adjustable Power and Amazing Accuracy. For BEST RESULTS use BENJAMIN H-C PELLETS. WRITE AT ONCE. BENJAMIN AIR RIFLE CO., 811 MARION ST., ST. LOUIS 4, MO

NOW YOU CAN GET THOSE MOTOR - CLUTCH - NEW

TRANSMISSION & AXLE PARTS IN STOCK

Why worry about parts when we have them. All you want at a BIG SAVING. We ship within 48 hours. We also have REBUILT UNITS for EXCHANGE at Bargain Prices: CARBURETORS—FUEL PUMPS—GENERATORS—STARTERS—SHOCKS & KNEES. It will pay you to GET OUR PRICES.

AUTO PARTS

and SAVE MONEY

Get Our BARGAIN PRICE LIST

for parts you want

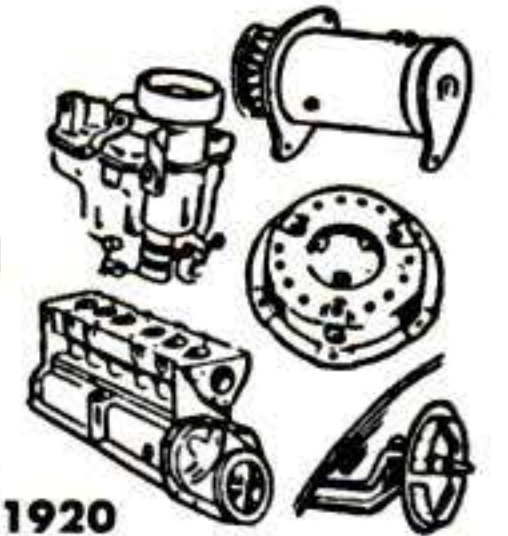

—RUSH YOUR ORDERS—

If Car Owner Specify Make
MECHANICS AUTO PARTS, Factory Warehouse,
3807 No. Ashland Ave., Dept. PS-8

Est. 1920

IMMEDIATE SHIPMENT
Warehouse, CHICAGO 13

Get into Good Paying AUTO BODY and FENDER WORK



BIG DEMAND in Auto Body and Fender work. Start training now in your spare time at home for good pay work. Practical shop experience included. U. E. I. Training covers metal work, welding, painting, etc. Placement service—or we will show you how to start your own shop. Behind U. E. I. TRAINING is a large national organization founded 1927. Write today for FREE FACTS—No obligation.

Approved for Training under G.I. Bill

AUTO-CRAFTS DIVISION • UTILITIES ENGINEERING INSTITUTE
2523 SHEFFIELD AVE., DEPT. 387-X, CHICAGO 14, ILLINOIS

LOW COST PHOTO ENLARGERS



New improved STARLIGHT ENLARGER gives Better Results up-to-the-minute Features. Equipped with FINE ILEX ANASTIGMAT 3 1/2 inch F6.3 LENS and IRIS DIAPHRAGM. Takes negatives up to 3 1/4" x 4 1/4". Makes Low Cost ENLARGEMENTS ANY SIZE for yourself or friends. Profitable easy business or hobby. Work at home. COSTS ONLY \$24 incl. Tax and lens to own and operate. Write today for FREE FOLDER "S2" giving full details.

PHOTO-SPHERE CO. INC.

115 EAST 23RD ST. NEW YORK 10, N. Y.

REPAIR CRACKED BLOCKS AND HEADS—

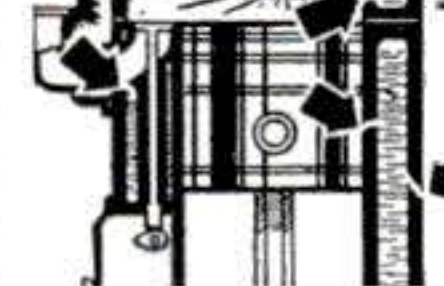

External and internal leaks in blocks, cylinders and valve ports quickly and easily with LUSCO PLASTIC SEAL. 90 day Service Guaranteed or your money back. Send money order or check for full pint—more than sufficient for average repair... **\$3.00** Postpaid

C. F. LUSK CO, 5918 Bonna Ave., Cleveland 3, Ohio



ELECTRIC WELDER

AC or DC 110 Volts

Pre-war type—All metal—No chemical—5 year written guarantee. Welds 1/8" thick metal or money back. Repairs tanks, tools, fenders, machine parts, etc. Comes complete with rods, unit directions and eye shield. We also manufacture a set you can learn with for only \$3.95 complete. On C.O.D. mailing charges extra.

\$6.45

Complete

ESSAY MFG. CO., INC., Dept. P.S., Quincy 69, Mass.

YOU CAN BE THE MOST POPULAR PERSON AT THE PARTY...

EARN BIG MONEY IN YOUR SPARE TIME! LEARN CHARACTER ANALYSIS AND NUMEROLOGY THE SECRETS OF THE COUNTRY'S TOP EXPERT • NOW AVAILABLE TO YOU

A Profitable Profession A Fascinating Hobby Brings you Rich Rewards In Friendship & Popularity Learn this stimulating new profession and build a business of your own with unlimited possibilities! Thousands of men and women today are eager to have their aptitudes and potentialities revealed through character analysis. Easy to learn in a short time No educational requirements. Course includes textbook, six correspondence lessons, plan of operating when course is completed, and sample advertising to be used. ELAINE WHITNEY Internationally Famous Character Analyst of Motion Picture Stars Director Send \$1.00 for Introductory Analysis of YOUR KEY NUMBER and a short introductory treatise of Character Analysis and Numerology

DIPLOMA PRESENTED TO ALL GRADUATES

Dept. PS-78 SCHOOL OF CHARACTER ANALYSIS AND NUMEROLOGY 202 E. Third Street Los Angeles 13, Calif. VAndike 4616

THE CUB MODEL SE-8

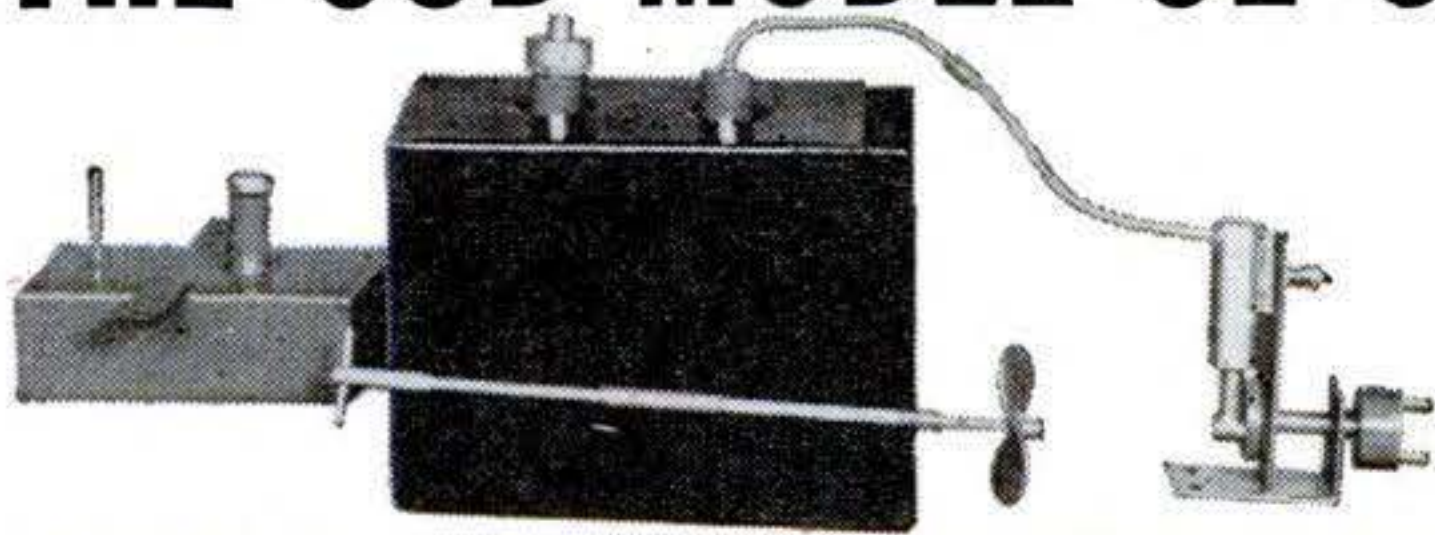

An engine for old timers and beginners in the model boat game. Here is an engine for that small model of yours. The CUB was designed for hulls 16" long and larger. It can also be used as a stationary engine. The CUB is a single-cylinder oscillating type engine of 7/16" bore by 5/8" stroke. Burns alcohol. Runs 8 minutes. Drives a 1 1/2" propeller. Price postpaid, complete ready to run, with boiler, burner, propeller, shaft and fittings, and 70-lb. safety valve. . . . \$4.80

PHILIP STEVENSON COMPANY

Box 162, Station D

Cincinnati 6, Ohio

PULVEX

"DDT"
FLEA POWDER



Kills the fleas
Quickly!
Keeps others off
for Days.

Pulvex also comes with ROTENONE, the original formula. BEST FOR CATS.

Either Kind
25¢ & 50¢

NEW HELP FOR RUPTURE!

is the amazing Treatise which explains simple, inexpensive, easy, proven way for curbing your rupture, right at home. This proven way has helped many rupture sufferers quickly. So don't let your rupture get worse. Send for FREE details today. Mailed to you in plain sealed envelope. No obligation.

BRADNER PUBLISHING CO. (Established 1933) Dept. G Dixon, Ill.



LAWN ORNAMENT-NOVELTY PATTERNS

28 Lawn Ornament Patterns, 25c. Other patterns: 15-20" high; Dutch Girl, Dutch Boy, Pirate, Bull Terrier, Mexican Girl, Mexican Boy, Dwarf, Penguin, Flower Girl, 10c each. 25 Novelty Patterns, 30c. All 62 Full Size Patterns, \$1.00 Postpaid. Strother Pattern Service, Dept. 7-U, Box 383, Belington, W. Va.

RAISE PROFITABLE CHIN-CHINS



No experience needed. A few minutes daily, a few feet of backyard space. Several females and a male starts a large, money making herd. WE FURNISH ALL INSTRUCTIONS. Free booklet explains tremendous demand for live youngsters, delicious meat, gorgeous fur. Write today.

WILLOW BROOK FARM, R-45B, SELLERSVILLE, PENNA.

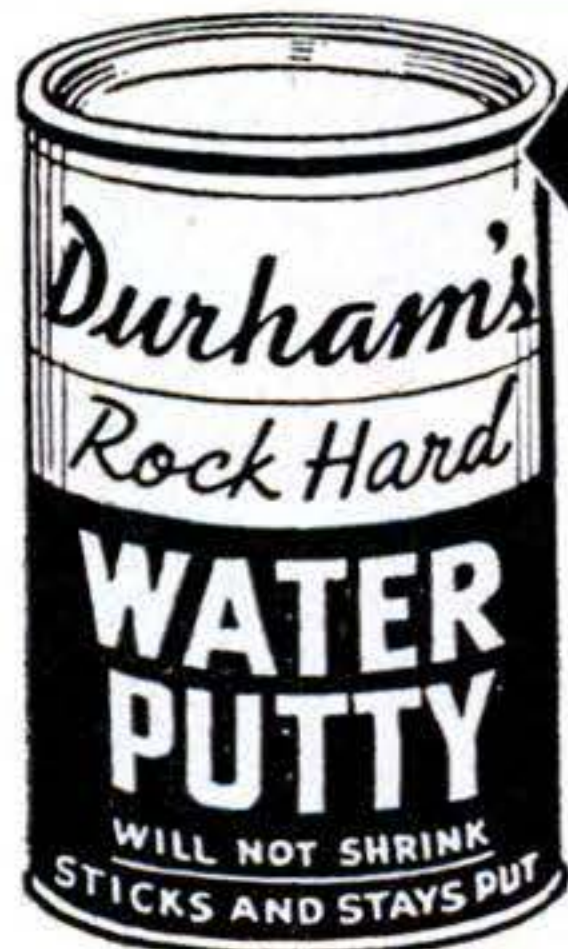

The Modern PLASTIC for lasting Home Repairs

PERMANENTLY mends cracks or holes in wood, tile, stone or plaster. Sticks and stays put—Does not chip, shrink or fall out. Easy to use. Economical. Mold it, chisel it, polish or paint it. If unobtainable from your lumber, paint or hardware dealer, the big 4-lb. can will be sent you post-paid (in U.S.) for only \$1. Full money-back guarantee, order now.

DONALD DURHAM CO.

Box 804-H, Des Moines, Iowa

Now! ALL 5 FAMOUS JOWETT COURSES - COMPLETE MUSCLE BUILDING VOLUME!

FOR ONLY 25¢

AND MY PHOTO BOOK OF FAMOUS STRONG MEN!

FREE!

LET ME PROVE I can make YOU



COMMANDO-TOUGH OR IT WON'T COST YOU A CENT!

says George F. Jowett WORLD'S GREATEST BODY BUILDER

GIVE ME 10 MINUTES A DAY Learn My Time Tested Secrets Of Strength

I'll teach you the "Progressive Power Method" through which I rebuilt myself from a physical wreck the doctors condemned to die at 15, to the holder of more strength records than any other living athlete or teacher! "Progressive Power" has proven its ability to build the strongest, handsomest men in the world. And I stand ready to show you on a money back basis—that no matter how flabby or puny you are I can do the same for you right in your own home. Let me prove I can add inches to your arms, broaden your shoulders, give you a man-sized chest, powerful legs and a Rock-like back—in fact, power pack your whole body so quickly it will amaze you! Through my proven secrets I bring to life new power in you inside and out, until YOU are fully satisfied you are the man you want to be.

PROVE IT TO YOURSELF IN ONE NIGHT

Send only 25c for my 5 easy-to-follow, picture-packed courses now in 1 complete volume "How to Become a Muscular He-Man". Try it for one night! Experience the thrilling strength that surges through your muscles.

10 DAY TRIAL
Think of it—all five of these famous courses now in one picture-packed volume for only 25c. If you're not delighted with this famous muscle-building guide—if you don't actually FEEL results within ONE WEEK, send it back and your money will be promptly refunded!

PHOTO BOOK OF FAMOUS STRONG MEN!

FREE!

Photos that inspire you to might and muscle. Free with order.



I am making a drive for thousands of new friends fast—REGARDLESS OF COST!
SO GET NOW MY 5 Muscle Building COURSES (Valued at \$5 each)
All in 1 Great Complete Volume Packed With How-To-Do-It Pictures! For 25c Only

FREE GIFT COUPON!

Jowett Institute of Physical Culture Dept. PS-78 230 Fifth Avenue, New York 1, N. Y.

George F. Jowett:—Please send by return mail, prepaid, FREE Jowett's Photo Book of Strong Men, along with all 5 Muscle Building Courses. 1. Molding a Mighty Chest. 2. Molding a Mighty Arm. 3. Molding a Mighty Grip. 4. Molding a Mighty Back. 5. Molding Mighty Legs—Now all in One Volume "How to Become a Muscular He-Man". Enclosed find 25c. NO C.O.D.'S.

George F. Jowett
Champion of Champions

NAME.....AGE.....
(Please Print Plainly, Include Zone Number)

ADDRESS.....

PRACTICAL TECHNICAL TRAINING FOR YOU



SPECIALIZE in 6 months to 3 years

OUR time-tested CONCENTRIC SYSTEM enables you to build your career step by step. Each 6-month course is complete in itself yet prepares you for advanced courses. You train as long as circumstances permit—until you reach the "top step" in your desired occupational objective. More than 35,000 former students in industries the world over.

- COURSES**
- SERVICE — 6 months**
Practical Electricity
Practical Welding
Refrigerator Service
Heating Service
 - TECHNICIAN — 1 year**
Electro Technician
Radio Technician
Electronics Technician
Refrigeration, Heating and Air Conditioning Technician
 - PROFESSIONAL — 3 years**
Electrical Engineering
Bachelor of Science Degree
Major in Machinery or Electronics

MILWAUKEE SCHOOL OF ENGINEERING

A Technical Institute

Terms Start September, January, April
MAIL COUPON TODAY!

Milwaukee School of Engineering, Dept. PS-847, N. Broadway & E. State, Milwaukee, Wisconsin

Without obligation, send me free booklet "Career Building" and more details on course in.....

Name.....Age.....

Address.....

City.....State.....

WAR SURPLUS

For the Sportsmen—Young or Old
All Year 'Round Use



Perfect all wool
Olive Drab
SLEEPING BAG

Comes in handy for fishing trips, hunting, camping, boating, just roughing it or use as auto robe and many other purposes. Has warmth of 2 blankets; zipper slide fastener; tie-strap on bottom; approx. Gov't cost \$12.90, our price **\$3.95** Ea.

Outside Cover for Sleeping Bag—Water repellent.....\$2.39
Perfect Without Pole.....**\$2.95**

ARMY PUP TENTS

NEW AIR CORP SUNGLASSES

Manufactured by Bausch & Lomb for U. S. Air Corps. Quality and Style with bone nose cross bar, individual case. Priced at big savings which includes postage.... **\$5.95**

NEW GOGGLES Set comes complete (boxed) with 9 extra interchangeable shatter-proof, flexible, cellulose acetate lenses. Amber, Green and white colors. A rubber flexible chamois lined goggle frame. Back adjustment head strap. Made for A. A. F. Cost Gov't approx. \$4.50. Ea..... **\$1.59**

Add 10% for postage—No COD—Send check or money order
AMERICAN SUPPLY CO., DEPT. P.S., 5TH & BROADWAY
KANSAS CITY, MO.

POWER LAWN MOWER

New Attachment Converts ANY

Hand Mower to a
POWER MOWER

In Less Than

ONE HOUR

MONEY BACK GUARANTEE

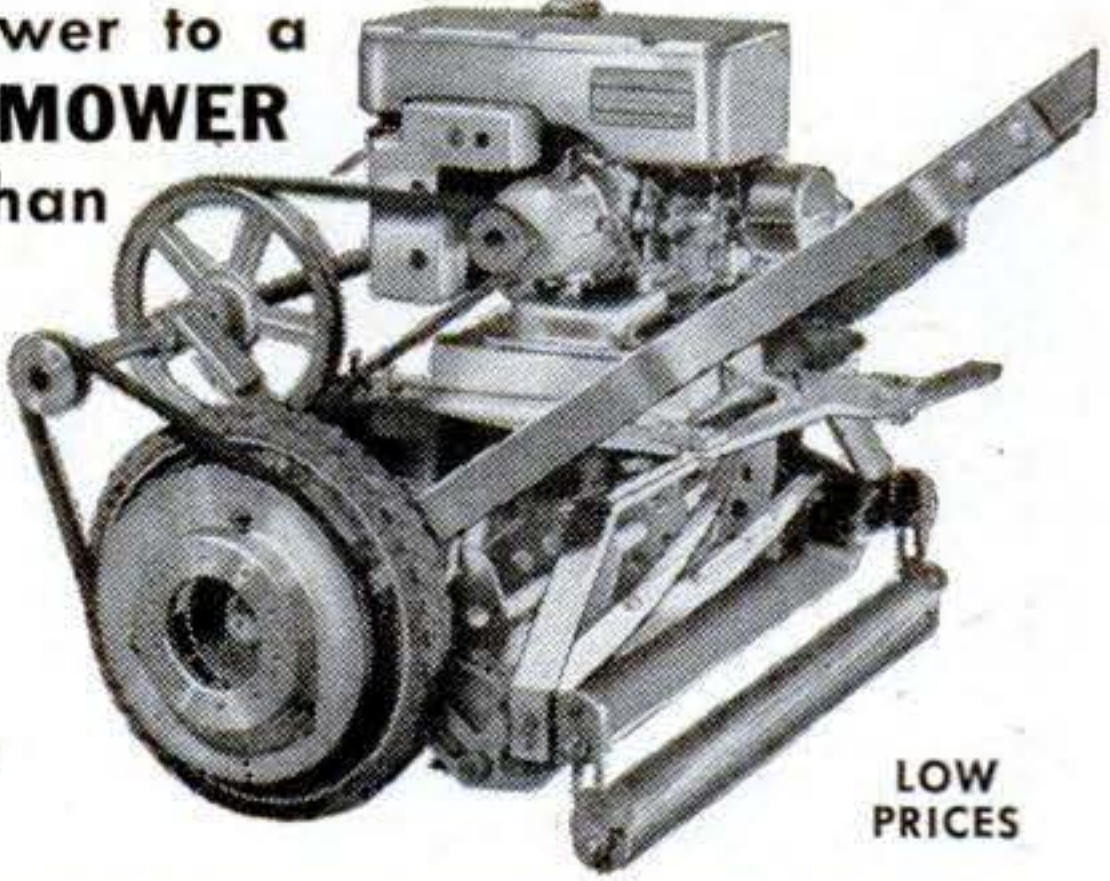

LOW PRICES

We supply complete attachment that fits any make or size of mower, with or without 1 H.P. gas engine. Complete assembly, easily installed in less than one hour. Relieve yourself of that unnecessary back-breaking drudgery and try this attachment on your mower—it'll pay for itself. Thousands in use. Immediate delivery at low prices. Dealers wanted.

ABSOLUTE GUARANTEE

Attachment and engine precision made from the best material available. If you are not completely satisfied, your money will be promptly refunded.

FREE FOLDER

ROYAL OAK LAWN MOWER SHOP

P. O. BOX 48

ROYAL OAK 1, MICH.

LEARN PLASTICS

Start at home . . . learn, and own your own business or prosperous plastics job. Approved G. I. Training. All materials furnished. Write Plastics Tech., 5200 Euclid Ave., Cleveland, Ohio.



LOCKSMITHING & KEY MAKING

COMPLETE UP-TO-DATE COURSE
How to pick locks, decode, make master-keys, repair, install, service, etc. 53 easy illustrated self-instruction lessons for every handy man, homeowner, carpenter, mechanic, hardw're dealers, maintenance men, etc. Satisfaction guarant'd. Send for Success-Catalog Free. Address below.

WATCH AND CLOCK REPAIRING

LEARN at HOME in Your Spare Time
Prepare for a happy future of prosperity and security—and get a good job NOW. A fascinating, thorough self-instruction training in American and Swiss watches, clocks. Special section on alarm clock repairs. Fast-growing field. Success-Catalog Free. **NELSON CO., 1139 S. Wabash Av., Dept. H-01 St. Charles 2, Ill.**



CARTOONING

HAVE FUN! MAKE MONEY! Cash in on your sense of humor at HOME—BY MAIL. No experience needed to start. Write today FOR FREE TRIAL LESSON and full particulars.
Moon Gag Cartoon School, Dept. C, Fall Creek, Wis.

MODELS

Famous true-scale flying model airplane kits. • 14" wing span—Cub—Stinson—Cessna—Aeronca—15¢. • 18" wing span—Thunderbolt—Dauntless—Mustang—King Cobra—25¢. • 21" wing span—Thunderbolt—Ercoupe—Mustang—King Cobra—50¢.

Complete catalog of full line given free with all orders. Save postage, cash with order.
JOE OTT MFG. CO., 111 W. Jackson, Chicago 4, Ill.



THE NEW ORIGINAL DRINKING DUCK

QUACK! QUACK!
WITH THE BIG EYES AND REAL FEATHER TAIL AND STAND
ONLY **\$2.98** This amazing new duck will fascinate young and old with his antics. No motor, no electricity, no springs. He just guzzles.

MYSTERY DRINKING BIRD
Complete with moving eyes and stand.....**\$1.95**
Rush Your Order Today. Special price to dealers

BERNARD FINE CO.
501 Sixth Ave., Dept. PS, New York 11, N.Y.

NEW! MINIATURE DUST MASK



Wear when sanding, grinding, paint spraying, sweeping, dusting, furnace cleaning, etc. Handy as a pair of glasses. Just keep mouth closed and breathe through nose is all you do to operate. Protects against nuisance dusts, lint, coal, cement, grain dust, Hay Fever Pollen. Has 9 sq. in. filter.
For EYE protection against paint spray, dusts, gases, fumes, smoke, order our Fog-Proof Rubber GOGGLES.....\$2.00 p.p.

Order Today **\$1.00** POST PAID

JERRY BRYANT, Dept. PS, 919 N. Michigan Ave., Chicago 11, Ill.

BIG MONEY and YOUR OWN BUSINESS

LIQUID IVORY



FREE INFORMATION ON A GREAT NEW MONEY MAKING OPPORTUNITY

Regardless of your age, sex, previous experience, we will send you astonishing free facts about the great possibilities—in your own business—with amazing LIQUID REPLICA IVORY. To secure this information, absolutely free, fill in coupon below or send a letter or postcard. No salesman will call on you now or ever. Write TODAY! Offer limited!

LIQUID IVORY is one of the most marvelous synthetics developed in years. With it you can easily and simply produce a wide variety of wonderful items that almost defy detection from genuine ivory. No expensive equipment is needed. You can work in a corner of your basement or garage with a few hours of work producing handsome profits. Here is unexcelled opportunity for all ambitious people that want a profitable business of their own.

GREAT OPPORTUNITIES NOW!

Stop being a slave to a time clock! Stop worrying about lay-offs and depressions stealing your livelihood. NOW is the time to line up your own money-making business. We offer this great opportunity to aggressive people. Get into your own profitable business with LIQUID IVORY. Get the FREE FACTS today!

Copyright-1947

EMPIRE TRADES and HANDICRAFTS
Box 1340 PS8 St. Louis, Mo.

MEN ARE NEEDED FOR

RADIO ENGINEERING TELEVISION ELECTRONICS

Thorough training in radio, including fundamentals, math, repair, sales, broadcasting, communications, with modern laboratory facilities and experienced faculty.

APPROVED FOR VETERANS TRAINING

Moderate tuition and living costs.
New Classes Start Each Month.

Dept. 2 Albuquerque, New Mexico

EGGERT RADIO INSTITUTE

MAKE UP TO \$5⁰⁰ AN HOUR

In Your Own YEAR ROUND Business!

ONLY A FEW DOLLARS PUTS YOU IN BUSINESS!

Many Clearing as High as \$20 to \$30 a Day NET Renewing Rugs, Carpets, Upholstery. New Method Now Used for Auto Upholstery. Write for Facts About Quick, Easy Way to Get Started

Here is the chance you've been looking for to step into a pleasant, dignified, big-pay business of your own that offers you a steady, year 'round income. Start on "a shoe-string," full or spare time, right from your own home. Equal opportunities for men and women, young or old, in small towns or big cities. No experience needed. Many making big money with new Americlean System just cleaning auto upholstery. Easy to learn. We send you complete instructions and quick-cleaning supplies so you can start making money the very first day! Quick method cleans upholstery, rugs and carpets like new without taking off floor! Tremendous demand in homes, apartments, hotels, stores, office and public buildings. Steady repeat business. Territories going fast. Write today for full FREE facts. No cost or obligation. Rush letter or postcard now to AMERICLEAN Co., Inc. Dept. H-8; 211 North 7 St., St. Louis 1, Mo.

WRITE FOR FREE DETAILS NOW!

SEND FOR FREE DETAILS

A MONEY-MAKING BUSINESS FOR THE LITTLE MAN! NO EXTENSIVE CAPITAL NEEDED!

Forget big investment worries. We tell you how to get your own fast-moving business going with very little money. We feature only one sound business course. You will never find us confusing this successful vocation with other diverting business ideas. We tell you all about one great business and how you can make money in it exclusively. Write for full FREE information today!

FREE INFORMATION COUPON

EMPIRE TRADES & HANDICRAFTS, BOX 1340-PS8 ST. LOUIS, MO.

Please send me free details about your BIG money making LIQUID IVORY. I am anxious to get started in a profitable business of my own. Please rush!

Name

Address

City State

Prepare yourself

FOR A MASTER AIRCRAFT INSTRUMENT TECHNICIAN'S JOB

RIGHT NOW we have more calls for graduate Aircraft Instrument Technicians than we can supply!

Thirty-four weeks' intensive training includes complete maintenance, servicing, repairing, and testing of instruments in Mechanical, Pressure, Gyroscopic, and Electrical Groups.

There are also many applications of our thorough training to other industrial instrument fields.

Approved FOR VETERANS Available FOR NON-VETERANS APPROVED BY NATIONAL COUNCIL OF TECHNICAL SCHOOLS



IMMEDIATE ENROLLMENT IF YOU QUALIFY

MAIL COUPON BELOW FOR FREE BOOKLET

American Schools of Aircraft Instruments
5145 West San Fernando Road, Dept. PS-8
Los Angeles 26, California

Please send me FREE and without obligation, illustrated booklet describing Aircraft Instrument Field.

name age

address

city zone

state veteran

HAND MICROPHONE



Top quality hand microphone with control button in handle. Highly sensitive. Has rubber covered cord and tel. plug. Fine for use on home recorders, public address systems, etc. Brand new—perfect. Shp. wgt. 2 lbs. Stock No. 170. Each... **\$1.95**

MESS KITS

Regulation two-piece Army Mess Kits with folding handle. Used, but perfect. Weight 2 lbs. No. A116—Ea. **69c**



CANTEENS

Reg. U. S. issue canteens. Plastic screw top chained to body. Slightly used but perfect. Wgt. 1 lb. 117—Metal **69c**



CANTEEN CUPS

All metal. Folding handle. Wgt. 1 lb. No. A120—Each **25c**

CANTEEN COVERS

Heavy canvas. Button fastener. New No. 530—Each **69c**
Used No. 119—Each **35c**

ARMY BANDOLEERS

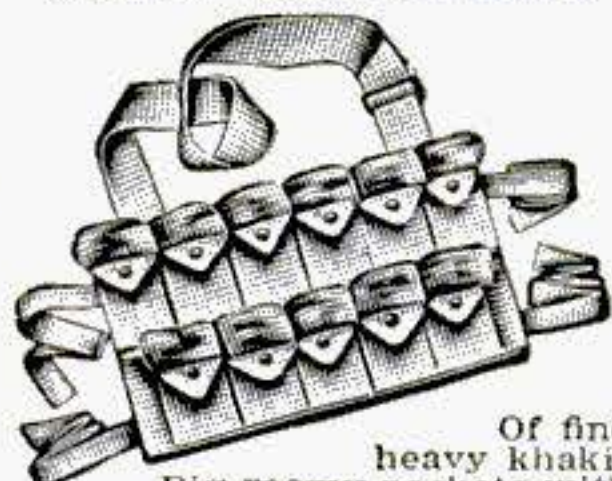

Of fine heavy khaki. Big roomy pockets with snap button fasteners. Fine for hunters, campers, boy scouts, etc., also for shop work in carrying small parts, etc. Material alone is worth this price. Shp. wt. 1 lb. 11 Pocket **49c** 5 Pocket Type No. 129 Each **29c**

WOOL BLANKET

Full size and 100% wool. Used but renovated for re-issue. Use for camping, etc. Shp. wgt. 3 lbs. No. 233—Each **\$4.89**

BAYONET BLADE

Fine forged steel. Ground but not polished. May be made into throwing or hunting knife or spear. Blade 6 3/4 x 7/8 inches, 11 3/4 inches overall. Will take and hold a fine edge. Shp. wgt. 1 lb. No. 664-R—Each **49c**

PROF. TELEGRAPH KEY

Purchased from the gov't. Finest design and construction. Base measures 3x4 3/4 inches. Original value \$2.50. All parts of instrument brass. Adjustable. A-147. Each **98c**



LIFE PRESERVER BELTS

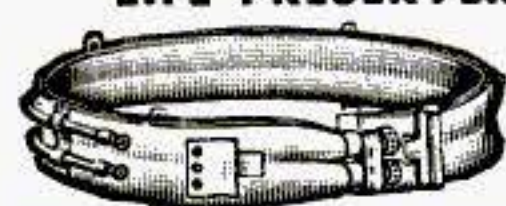

Right from the invasion beaches. Consists of two air chambers. May be inflated automatically with "sparklet" cartridges or manually by attached hose. Adjustable in waist size. One air chamber guaranteed air tight—other may need a tire patch. All belts are used and slightly soiled but a bargain at this low price. No. 1261—Each **\$1.00**

SPARKLET CARTRIDGES

May be used with above belts. In boxes of 10. Stock No. 254. Per Box **50c**

WAR SURPLUS AND HUNDREDS OF OTHER BARGAINS

POPULAR RECORD ASSORTMENT



No A300—25 Records. All Dance. Wgt. 14 lbs. **\$4.88**

Fifty records of modern dance, race, blues and hillbilly selections. No two alike. Famous name bands and artists included. Used in juke boxes, but guar. perfect. Shipped exp. collect only—no exchanges or refunds. Wgt. 28 lbs. No. A303—50 records **\$9.64**

No. A301—25 Records. Hillbilly, Race and Blues. Wgt. 14 lbs. Set... **\$4.88**

No. 302—25 Records. All Hillbilly numbers. Wgt. 14 lbs. Set... **\$4.88**

TELESCOPING BAIT AND FLY ROD

Combination 4 piece telescoping bait and fly casting rod. Screw locking reel seat. Cork grip. Snake guides. Extends to 9 feet, telescopes to 38 inches. Shp. wgt. 1 lb. No. F411—Each **\$3.65**

SATCHEL POUCH

Heavy canvas pouch. Ideal for totting lunches, shopping, books, etc. Has 11x12 inch pocket. Brand new, guaranteed perfect. Has oversize flap with single strap fasteners. A113—EACH **\$1.69**



RADIO HEAD- PHONES



Extremely sensitive with 4000 ohms resistance. Brand new and fully guaranteed. With moisture-proof cord and phone plug. A splendid value for the radio serviceman and experimenter. A106—PAIR **\$2.95**
New supersensitive phones. A108—Pair **\$5.95**

BINOCULAR CASE

Heavy cowhide, hand sewn. Die cut top for compass. Will fit 6x30 Bausch & Lomb or similar binocular. Wgt. 2 lbs. No. A191, Each **\$2.95**



CAVALRY SPURS

Genuine wishbone type cavalry spurs. Nicked brass. A102, Pair... **98c**
A103 Spur straps per set of four... **50c**



SHERRILL COMPASS

A finely balanced liquid immersion accurately calibrated compass with mtg. bracket. Measures 5x3 inches. Compensating adjustments. Worth much more. Shp. wgt. 5 lbs. No. A122, Each **\$9.85**



WOOL SLEEPING BAG

G.I. type 100% wool with 30 inch Talon zipper. Used but renovated for re-issue. Shp. wgt. 3 lbs. No. 165. Each **\$3.95**



7 LB. EXPERIMENTER PARTS ASSORT. KIT



A "gold mine" for the radio serviceman. Hundreds of valuable radio parts, new radar and electronic parts and subassemblies, coils, resistors, trimming condensers—worth many times this low price. A130R—7 lbs. **\$1.79**

FISHING REEL

Exceptional quality for this low price. Has rugged one piece frame. Ratchet drag. Single action. Attractive catalin handles. Brass bearings for smooth operation. Full 100 yard line capacity. Brand new! A splendid value at this low price. No. F412, Each. **98c**



RAIN SUITS

New 2 piece rain suits. Of durable wear resisting water and wind repellent OD fabric. Bib style pants, zipper fly. Jacket has parka attached. Guaranteed 100% weatherproof. Small, medium and large sizes. Shp. wgt. 3 lbs. No. R549. Ea. **\$4.95**



2 Man Mountain Tent

Regulation Army type two man mountain tent, complete with poles, guy ropes, etc. Of durable nylon with reinforced seams. Ideal for outdoorsmen, campers, etc. Shp. wgt. 10 lbs. A splendid value. Stock No. 202—Each... **\$9.95**

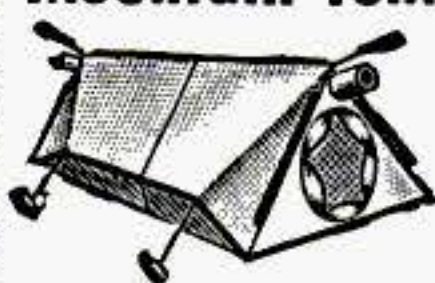

PUP TENTS



Regulation Army Pup Tents of durable, brown canvas. Used, but in good condition. Fine for campers, outdoorsmen, boy scouts, etc. Wgt. 8 lbs. A100—Tent only **\$3.95**
A110—Tent, new... **\$7.95**
A101—Ropes, wooden poles and stakes for above. Per set **\$1.00**

27 LENSES, ALL NEW, PERFECT.

For experimental work in optics. Consists of 27 precision ground and polished prisms and lens elements in assorted diameters and focal lengths. Big variety, positive, negatives, etc. Actual value over \$100.00. A519—27 PIECES... **\$7.95**

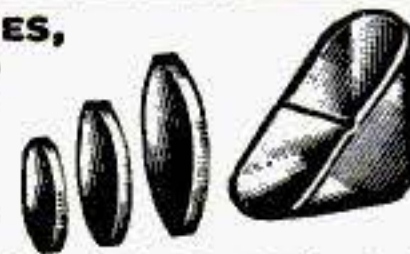

50 LENSES SEMI-FINISHED

Lenses similar to above but not polished. All are blanked and formed ready for polishing. Negatives, positives and prisms in Crown and Flint glass. Worth many times this low price. A520-50—1.95 LENSES, ONLY... **\$1.95**



ONE MAN RUBBER BOAT

Similar to above but smaller. Designed for one man use. Each boat complete with oxygen tank—packed in a special parachute bag. Wgt. 15 lbs. No. 526—Each... **\$17.95**

ORDER DIRECT FROM THIS AD

Values galore! Hundreds of hard-to-find items for home, shop and outdoors. Make remittances by money-order, bank draft or personal check. Send 25% deposit on C.O.D. orders. No C.O.D.'s on orders for less than \$5.00. Include sufficient postage on parcel-post orders—any overage will be promptly refunded. All quotations F.O.B. Chicago. Used items and materials are guaranteed serviceable and as described. Your money back if not more than satisfied.

Big Illustrated Catalog Free
WRITE FOR YOUR COPY TODAY

STARK'S Dept. PS847
509 So. State St.
CHICAGO 5, ILL.

METAL TOOL CHEST

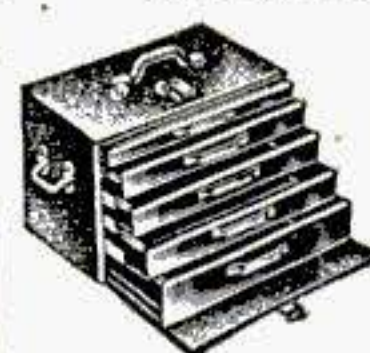

All metal welded construction 16x 8 1/2 x 11 overall. Has 5 roomy, easy sliding drawers. Hinged drop front. Metal top and end handles. Use it for tools, small parts, etc. Shp. wgt. 48 lbs. Stock No. 282. Each... **\$9.75**

CAMERA TRIPOD



Purchased from Gov't. Used but perfect. For cameras up to 8x10 inches. Folds to 32 inches, extends to 58 inches. Needs adapter to mount camera. Wgt. 14 lbs. Stock No. 190, Ea. **\$4.95**



Classified Ads only 60c per word per insertion, payable in advance. Minimum ad 10 words. To be included in September issue copy should be in our office by July 29th. September issue on sale September 1st.

POPULAR SCIENCE MONTHLY—351 FOURTH AVE.—NEW YORK CITY 10

12 AUTOMOBILES

SPEED & Mileage manual—Easily obtain greater speed, mileage, racing performance from any automobile! Includes simplified methods, speed tuning, gas saving secrets—Instructions on building economizers, speed equipment, mufflers, superchargers, duals, racing fuels, fast conversions. \$1.98. Almquist Engineering, Box 660, Brooklyn.

"STREAMLINED ROADSTER"—America's lowest priced car! Light, speedy, two passenger, three wheeled sportster! Amazingly simple construction from inexpensive material—small motor. Complete instructions, drawings. \$1.98. Almquist Engineering, Bx. 660, Brooklyn.

"CUSTOM-Styling" manual—Easily make car look Hollywoodized, custom built, ultra-beautiful! New, Simplified customizing—restyling—streamlining methods! Instructions, illustrations. Plans for accessories, refinishing, mufflers—model changes for new and old cars. \$2. Almquist Engineering, Bx. 660, Brooklyn.

RACING Car performance for all cars. Increase power, speed. Special "Custom built" equipment. Free literature. Write Lee Motorcraft, 1412-B Great Northern Bldg., Chicago 4, Illinois.

BUILD automatic clutch, scooters, midget autos, tractors, shop machines. Catalog Free. Nichols Equipment Co., Dept. 112, Purvis, Miss.

"BURN Water"—Attention Automobile Owners, Taxi Drivers, Tractor, Truck, Fleet Owners! Convert any car or tractor (1917-1947) to "Water Injection" (like late war planes) for only \$1.00 cost. More power, less gas, less oil, more speed, cooler engine. Includes Copyrighted Installation Manual, Complete Printed Diagrams, Detailed Directions, History, etc. Send dollar today. Newhouse Industries, 5941 Hereford "T", Los Angeles 22, Calif.

SELL personal initialed individualized belts, buckles with beautiful racing emblems of big cars, midgets, motorcycles, also available in lapel pins, tie holders. Fast profits. Repeats. Write today. Special outfit offer. Hook-Fast Specialties, Dept. 29, Box 1425, Providence, Rhode Island.

MIDGET Racer plans, blueprints, buying directory 50c. Sibley, Mendon, Mass.

HOLLYWOOD Hot-Rod Manual; plans, photos, instructions, fast Fords, \$1.50 P.P. Racing parts list, 25c. P. P., Hollywood Hot-Rod, Box 9626S, Los Feliz Sta., Hollywood 27, Calif.

AUTOMOBILE Racing Book, Fifth Edition—Revised. Tells how to build dirt tracks bodies, frames, engines. Records, superchargers, rules, formulas, plans, stock conversions, roadster racing, fast Fords. \$1.00 postpaid; \$1.15 C.O.D. Ray Kuns Department 274, Madisonville, Cincinnati, Ohio.

HOTROD and fast stock car equipment. Heads, manifolds, camshafts, dual mufflers. List 25c. Ford-Chevrolet hopup instructions. \$1.00 Specify. Alden Motors, Oakland City, Indiana.

CLYMERTONE Twin Muffler Sets, beautiful sound, complete with necessary welded pipes. E-Z installation. Ford V-8, \$20.00. Chevrolet set with split manifolds, \$37.50. Specify car model. Clymer, Dept. B-84, 2125 W. Pico, Los Angeles 6, Calif.

DUALTONE Chrystalline packed mufflers. Single or twin mufflers for all cars. Duals priced complete V8's \$23.00. Six cylinders \$33.00. Eight cylinders \$36.00. Large chromed tailpipe extensions \$3.30. Polished carburetor velocity stacks \$1.30. Chromed Station Wagon stacks \$15.00. Request catalogue. Dualtone Mufflers, 2636B India Street, San Diego 1, California.

CUSTOMIZE your automobile. Illustrated new restyling ideas, instructions, specific model changes by simple methods, \$1. Speed-wheel, Box 723-C, Arcadia, Calif.

USED-CAR Handbook, "Judging the Used Car." Dealers' tricks exposed, comprehensive simple tests, photographs. Postpaid \$1. Truvalu, Box 723-C, Arcadia, Calif.

AUTO racing magazine subscriptions. Pacific Speedway News, \$6.00 yearly. National Speed Sport, \$4.00 yearly. Illustrated Speedway News, \$4.00. All give complete data midget, big car race results. Sample copy each 50c. Specify publication wanted. Clymer, Dept. B-82, 2125 W. Pico, Los Angeles 6, Calif.

MUFFLER manual. Convert easily to Hollywood, Laguna, Westwood, duals, etc. Includes construction details, regulations, diagrams. Postpaid \$1. Mellotone, Box 723C, Arcadia, Calif.

CLYMER'S Historical Motor Scrapbook No. 4, latest Clymer book old cars and motorcycles. Postpaid \$1.50; De Luxe Edition, \$2.50. Clymer, Dept. B-88, 2125 W. Pico, Los Angeles 6, Calif.

SEE our ad under Motorcycles for midget racer bargains. Midget Motors Directory, Athens, Ohio.

"BUILD speedy Midget Track Racer from castoff parts! Plans, specifications, construction information. \$1.00. Motor Supply, Box CS-1682, Toledo, Ohio."

1947 INDIANAPOLIS "500" Race History Book. Complete details every car, driver competing. 100 photos, charts, drawings. \$1.00 postpaid. Large complete Indianapolis Race History Book, 352 pages, 1100 illustrations, all data 1909 to 1946 inclusive. Postpaid \$3.50; De Luxe Edition Fabrikoid binding, gold lettering, \$5.00. Clymer, Dept. B-80, 2125 W. Pico, Los Angeles 6, Calif.

13 AUTO SUPPLIES & EQUIPMENT

HAVING Car Trouble? New, Used, guaranteed auto, truck parts save money. Transmission specialist. Describe needs; immediate reply. Victory, 2930 1/4 No. Western, Chicago 18.

AUTO parts for all autos and trucks. Trans, motors, differentials, fenders, carburetors. Also Body Parts. Security Auto and Truck Parts, 1941 BP Eddy, Chicago 13.

GRILLES for most all cars, Meyers Auto Parts, 820 Dryades, New Orleans, La.

PRACTICAL Course—Automobile Radiators—Repairing—Recoring—Cleaning. Ralph Hendry, Galt, Canada.

GASOLINE economizer. Ford, Mercury, Chevrolet, 1932-1947. Dodge, Plymouth, 1933-1938. Buicks, AAV16. Prices \$1.00. Walert Co., 3429 No. 10th St., Milwaukee 6, Wisconsin.

DAB, wipe-on auto paint color cards 25c; five \$1.00. Dab Distributors, 1911-N, Lubbock, Texas.

MANIFOLD Whistle—imitates "Wolf Whistle", Siren, etc. Installed on any car manifold in fifteen minutes. Send \$6.00 to Protectrod Company, 4033 Windsor #5, Youngstown 7, Ohio.

NEED Auto Parts? We have them. New and Rebuilt. Prompt Shipment. Write Requirements. Save Money. Buy Direct. Factory Warehouse, Mechanics Auto Parts, 3807-BI North Ashland, Chicago 13.

TIRES—slightly used, all popular sizes for cars and trucks. Also new tubes. Write for complete list. Midwest Tire Co., 2012 Locust, St. Louis 3, Mo. (Dept. 5).

BIG Money in Auto Supplies, parts, radios, ammunition, guns, home supplies. Wholesale catalog for dime. Main Supply, Fairfield 1, Ill.

EQUIP with Sedanlok. Two door safety in four door sedans. Prevents children from opening rear doors, amazingly simple, made of heat treated steel heavily chromed, install by tightening set screws. \$1.50 pair. A. Digioia, 1946 1/2 New England St., Los Angeles 7, Calif.

OIL Filter, Cuno, for filtering oils, self cleaning attachment, app. size 6"x3". New, \$2.95. Tank periscopes (pair makes periscope), \$1.49 pair. Radio headphones, used, \$1.95. Radio hand mikes, used, \$1.95. Chemical water testing set, \$1.95. All prices postpaid. No cod's. Southwest Aero Supply, Drawer 488, South Houston, Texas.

UPHOLSTERY Cleaner and Tint \$1.00 per Qt. Dealers wanted. Wynn and Graff, 5116 Charlotte, Nashville, Tenn.

INSTALL in your car guaranteed swiss musical unit. Much pleasure and satisfaction will be derived from its melodious tone that will play whenever the Glove Box is opened. Send \$3.98 with model, year of car. Postpaid. Installation Time—10 minutes. L. W. Jensen and Co., P.O. Box 454, Spring City, Utah.

AMAZING discovery. Master Glaze, puts brilliant glass-like surface on cars. Free sample, information. Big commissions. Master Glaze, Dept. 617, 7720 Harwood, Milwaukee, Wisc.

SEAT Covers: beautiful, rich-looking, triple-stitched. Mono, 6545 Santa Monica Blvd., Hollywood 38, California.

14 AUTO TRAILERS

BUILD your own Trailer! Save Money! Have every feature you want! Plans for House, Sport, Camp and Utility trailers. Catalog describing 9 models 10c. (15c in Canada and overseas). Jim Dandy, Box 125-B, Wausau, Wisconsin.

TRAILERCOACHES—learn about all types—sports, living or travel. Approximately 100 pages monthly—magazine tells all. Special rate, \$1 the year. Trail-R-News, Box 431-C, Glendale, California.

POPULAR SCIENCE OPPORTUNITIES

91 MOTORCYCLES, BICYCLES, SUPPLIES

"CUSHMAN motorscooter \$15. Shaw bicycle motor \$15. Harley-Davidson Motorcycle \$35! Send 25c for bargain catalog #8, packed with money saving buys in motorscooters, motorbikes, midget cars, motors, wheels, tires and parts. Gail and Company, 538 Erie, Toledo, Ohio."

LARGE stock Indian parts. Expert motor rebuilding. New and rebuilt Chief Motorcycle, motors only. Indian Motorcycle Sales, Kansas City 1, Mo.

WHEELS, Tires, Tubes for Motor Scooters, Midget Cars, Wheelbarrows, and Industrial equipment. All sizes. Bicycle Parts, accessories. Largest stock in United States. Send dime for list. Cycle Transport Company, 1241 S. Michigan Ave., Dept. C, Chicago 5, Illinois.

"PROFESSIONAL Midget Racer, Motor-scooter, Midget Roadster, and Midget Motorcycle. Plans, specifications for all four contained in illustrated handbook, 25c. Big list bargain priced used motors, motorscooters, Servicycles, etc., included free! Midwest, 3839 Drummond, Toledo, Ohio."

WHEELS! Build wagons, scooters, mowers, trailers, wheelbarrows, grocery carts, baby carts, play pens, baby carriages. 4" to 16". Free list. Trulsen Mfg. Co., 811 E. 31, Kansas City, Mo.

WHEELS Of Every Description. 10 x 2.75 Single valve tube pneumatic wheels @ \$7.25 each. 10 x 2.75 Semi-pneumatic wheels @ \$6.75 each. Write us for free catalog. Jim Brown Toy Company, 1093 Home Avenue, Akron, Ohio.

1½ HORSEPOWER from Y and similar Briggs and Strattons. Instructions \$1.00. Parts, Transmissions. Alden Motors, Oakland City, Indiana.

"BUILD America's lowest priced motor-scooter speedster! Complete plans, specifications, \$1.00. Big list bargain priced used motors, etc., included free! Motor Supply, Box 1682-CS, Toledo, Ohio."

1930 TWIN motorcycle \$25; motorscooters less motors \$15.75 up; motors \$3.50 up; Whizzers \$25 up; professional midget track racer; plenty midget racers for highway use; plenty brand new two horsepower motors in original crates; over 6500 small balloon tires for motorscooters and small cars, \$1 up. Mailorder only. Send 25c for Big War-Bargain Catalogue Number Nineteen, just out, listing the above and hundreds of other bargains in both new and used motorscooters, midget cars, motors, outboards, mowers, etc. (35c by First Class Mail). Midget Motors Directory, Athens, O.

HARLEY-Davidson Parts, Accessories, Batteries, Tires, and Repair work. 24 hour Service. Authorized factory dealer. Philadelphia Harley-Davidson Company, 857 North Broad Street, Phila. 23, Penna.

"CUSHMAN Motorscooter \$20 (includes motor and extra tires). Midget Racer \$15! Send 25c for big Summer catalog #938, just printed, listing these and scores of other sensational bargains in motors, wheels, motorscooters, motorbikes, Servicycles, tires, etc. Associated, Box CS-1764, Toledo, Ohio."

MOTOR Scooters, bicycle engines, 120 miles gallon. Dime for catalog. Clymer, Desk B-85, 2125 W. Pico, Los Angeles 6, Cal.

WHEELS, Steel Disc rubber-tired for toys, wagons, scooters, etc. Sizes 5", 6", 7", 8", 10" available. United Wheels Mfg. Co., 11727 La Fayette Ave., Chicago 28, Ill.

SERVI-CYCLE Riders. No More oil and gas mixing, write for details. Kalamazoo Tool Design, 337 S. Burdick St., Kalamazoo, Michigan.

15 AVIATION

ENTER aviation. U. S. or Foreign. I can help you. Free information. Miller, 1333 18th Street, Santa Monica, Calif.

VETERANS: Flight training under the G.I. Bill. Private, Commercial and Flight Instructor Ratings. Write for information. Gottschalk School of Aeronautics, Adrian, Michigan.

PROPELLERS—Airliner 3 Blade, 2 Blade. Designed for ice-snow sleds, boats. Literature. Standard Aircraft, Box 387, Ft. Worth, Texas.

FREE! Rocket to the Moon book list. Box 29, Glen Ellyn, Ill.

"SENSATIONAL bargains in used Cubs, Taylorcrafts, etc! Big, thousand-item catalog, 25c. (Includes listings of 'easy to repair' crackups.) National, Box 1682-CS, Toledo, Ohio."

GIANT Glider Kites. Double, 14x10 ft. Lifts 100 lbs., tows car, etc. Cost Government \$108. Yours for \$20. Satisfaction guaranteed. Great Northern Mart, North Adams, Mass.

4 AVIATION INSTRUCTION

TRAIN For Aviation Mechanics High Salaries. This famous school approved for veterans. Immediate enrollment. For information write California Flyers, Department P-8, Inglewood, California.

49 ELECTRICAL SUPPLIES & EQUIPMENT

VINYLITE Plastic Tubing. Splendid electrical insulation. Sizes 1/10" up to 5/16" diameter. 2c per foot. All New! Available in coils from 250 to 1,000 feet. Send for listing. "Amazing Bachman's", Dept. TC, 23 Herman Street, Rochester 5, N. Y.

ELECTRIC Pencil: Writes, Engraves all Metals. \$1.00 postpaid. Beyer Mfg., 229-C Dixon Blvd., Uniontown, Penna.

ELECTRIC Pencil—writes, engraves all metals. Battery model \$1.00—110 Volt model \$2.00 Postpaid. C.O.D.s accepted. Reb Industries, Dept. 265-Y, Elmhurst, Ill.

ELECTRIC Pen—Burns: Wood, Plastics, etc. Embosses Gold and Silver leaf, \$2.00 Postpaid. C.O.D.s Accepted. Reb Industries, Box 265-Y, Elmhurst, Illinois.

SOLENOID Assembly. All New! Contains over 1 pound magnet wire. Over \$30 value. Special \$1.50 each. Four for \$5. No COD. "Amazing Bachman's", 23 Herman St., Rochester 5, N. Y.

FURNACES, conversions. Gas, oil, L.P. Easily sold. Card for literature. Thuman Equipment, 1225 Fifth Ave., St. Joseph, Mo.

GAS-MIZER. The superior hot water system with automatic convenience: "bucket a day" economy. Soon pays for its low cost in gas saving and comfort. Easily installed. Write for literature. Safty Control Company, 2519 Wilson, Arlington, Va.

ELECTRIC fan assemblies. Assemble your own. Ted Riseman, 207 North Fifth, Springfield, Ill.

A.C. 110-VOLT Motors. Selsyn Syncro Differential—New in original Package. A Bargain at \$1.75 while they last. Lyell Hardware, P.O. Box 5, Rochester 11, N. Y.

140 WELDING, SOLDERING

NEW Model electric welder 110 volt AC-DC; will weld all metals; easy to use, full directions. Complete with power unit, flame and metallic arc attachments, carbons, fluxes, rods, mask; all for \$19.95—Used by the Navy. Magic Welder Mfg. Co., 239-PS—8 Canal St., New York City.

SAVE 50% on Electric Welders, Accessories, etc. Holgerson Co., Canton, Kansas.

WELD, cut, braze with gasoline! Amazing discovery shatters costs. Range jewelry to railroad steel. For farm, factory, shop. New opportunities. New wealth. Important! Investigate. Matthews Mfg. Co., Calgary 22, Canada.

6 AIR CONDITIONING & HEATING

BLOWERS, airconditioning units, gas burners, gas & oil furnaces, complete line MH heating controls, plastic roof coatings. Paramount Supply Co., Lincoln 4, Nebr.

HEATING. L.P. Gases. Floor and Basement Furnaces. Conversion Burners. Free Literature. Peerless Sales, Lincoln 6, Nebr.

80 MACHINERY, TOOLS, SUPPLIES

NEW Band Saws for home or factory use. Special \$14.95. Your check or COD. Circular free. Woodcraft Tools, 147 E. Lake St., Minneapolis, Minn.

ELECTROPLATING booklet includes full directions for plating jewelry, small parts, metallizing baby shoes. 50c. Hoover & Strong, Inc., 115 W. Tupper Street, Buffalo 1, N. Y.

FOUNDRY Castings, Blueprints, Materials for woodworking and metalworking machine tools. Suitable for commercial or home shop production. 23 items. Catalog 10c. Lewis Machine Tool Co., 3217 Union Pacific Avenue, Dept. S, Los Angeles 23, Calif.

NOW you can saw and file with hand drill. Revolutionary tool. Agents wanted. Dingerson, Georgetown, Colo.

HOME workshop labels. Send postcard for free sample. Hinds, 223 Second, Niagara Falls 2, N. Y.

WAR Surplus in small tools for machine shop—Send 10c for bulletin. Travers Tool Co., Dept. S, 5 Court Square, Long Island City 1, N. Y.

SHEBEL Saw Filer, \$7.50. Files all saws. Free trial. Circular. 730A So. 2nd St., Milwaukee 4, Wis.

CONCRETE Building block machines and molds. Catalog free. Concrete Mold Co., 5127 South Compton Ave., St. Louis 11, Missouri.

ORIGINAL Patented Drill Grinding attachment, imitated but never equalled. \$2.80 postpaid. E Z Mfg., 327 California, Burbank, California.

WORK wanted for hand Turretlathe. Glenbern Machine Co., Youngwood, Pa.

TAPS & Dies direct from manufacturers. Equip your shop at small cost. Write for free price list. King Tap and Tool Co., Inc., North Attleboro, Mass.

V BLOCKS at low prices. 10 sizes for all purposes. Free Literature. Miles Products, 2532 Wabash, Chicago 16.

AIR Hose—All New—5 size assortment. Lengths up to 5 feet. Over \$10.00 value. Special \$2. Real buy! No COD. "Amazing Bachman's", Dept. TC, 23 Herman Street, Rochester 5, New York.

DRILL Grinder for twist drills \$2.95. See ad on page 249.

MACHINIST'S tools, supplies. Low prices. Precision Tool Service, 55 E. Washington, Chicago 2, Ill.

WAR Surplus, Machines, Tools, etc. Free literature. Wayne Engineering, Greenville 2, Ohio.

ALNICO V Parallels, 3" long, 1¼" high, ground on four sides. Weigh 1¼ pounds. Regular price \$6.00 pair—introductory special, 1 pair to a customer, \$3.00. B & D Manufacturing Co., 143-20 Franklin Avenue, Flushing, N. Y. C.

17 BATTERIES, GENERATORS, ETC.

MOTOR 25c. Flashlight cell operates. Parts complete plus instructions. Two 45c. Eltro Company, 171D, Deer Park, N. Y.

19 BOATS, OUTBOARD MOTORS, ETC.

FULL size, cut to shape boat patterns, blueprints, 7½—38 feet. Illustrated "Build a Boat" catalog, 10c (coin). "How to Build Boats" book, \$1.00. Cleveland Boat Blueprint Co., Dept. A-77, Cleveland, Ohio.

MARINE Power—Easily convert any Ford and Jeep motor (domestic and foreign) with Osco parts and kits. Complete catalogue 25c (coin). Osco Motors Corp., 2020C E. Orleans St., Phila. 34, Pa.

"PLYWOOD Rowboat and Motor Boat K.D. Kits. Assemble and save up to \$57.50. Three popular models. Resin bonded, waterproof plywood construction. Easy to assemble in spare time. Write for free literature and complete specifications. C. R. Dillagaugh Boat Co., 7928 N. E. Mallory, Portland 11, Oregon."

POPULAR SCIENCE OPPORTUNITIES

NEW, used, rebuilt marine motors. Marine conversions, fittings. Free Catalog. Stokes Marine Supply, Dept. 23, Coldwater, Mich.

"MARINE conversions for Ford and Jeep engines. Catalog 10c. Lehman Manufacturing Company, Department A, Newark 2, New Jersey."

CARTOP Rowboats, Kayaks. Weldwood ready cut kits. Booklet. E. J. Croot Co., #103-E, Basking Ridge, N. J.

FIR Plywood—Waterproof marine grade for boat-building. $\frac{1}{4}$ " thickness 48"x96" \$6.40; 48"x144" \$12.48; 48"x192" \$16.64; $\frac{3}{8}$ " thickness 48"x96" \$9.60; 48"x144" \$15.84; 48"x192" \$21.12; $\frac{1}{2}$ " thickness 48"x96" \$11.20; 48"x144" \$18.24; 48"x192" \$24.32. Terms: Cash with order; shipment by express or freight. Carmen-Bronson Corporation, Dept. M-5, Mount Vernon, N. Y.

OVER 30 Worlds Best Plywood Designs sent with William Deeds book "Plywood Boats". Send \$1.00, Marine Mart, Buffalo 7, N. Y., Dept. B.

CANVAS for Canoes, Boats, Trailers, etc. Airplane wingdope. Sailboat, motorboat, canoe supplies. Alan-Clarke, 96 Chambers, New York City.

51 ENGINES, MOTORS, ETC.

MOTORS! $\frac{1}{2}$ HP.—All New—High Speed 110 volt. 25 or 60 cycle, d.c. converted to a.c., ball-bearing motors with forward and reverse switches. Actual cost about \$100.00. Now \$19.50, three for \$50.—or—same motor without reverse switch \$15. Three for \$40. Countless uses for home mechanics. Order today! No COD orders. "Amazing Bachman's", Dept. CT, 23 Herman Street, Rochester 5, N. Y.

"BUILD Your Own" gas drive arc welder easily with Hobart Generator. Save \$300 to \$500, and need only add used auto engine and chassis to build portable gas drive welder that goes everywhere after profitable construction and repair jobs. Write for free instruction book, further details. Hobart Brothers Co., Box P-874, Troy, Ohio.

SELSYNS—All New! Transformers—GE Model 2J1G1. 57.5—57.5V 400 cy; Generators—GE Model 2J1F1. 115—57.5V 400 cy. With gears. Sensational offer! \$1.50 each. Quantity lots \$15. dozen. Order Now! No COD. "Amazing Bachman's", 23 Herman Street, Rochester 5, N. Y.

WELDING Generator, 150 ampere, \$47.50. Other bargains. Butler, 1885 Milwaukee, Chicago.

ELECTRIFY, modernize your sewing machine, any make. New motor with control. \$21.50. Guaranteed. Installation instructions. Iris Stores, 235 East 59th, N. Y., N. Y.

AMPLIDYNE Motor-Generators. All Packed—New! GE5AM 31Nj9A. Output 60 VDC, input 27 VDC. 530 Watts. Original cost \$120.00. Now! \$7.95 each. Three for \$20. Order Today! No COD. "Amazing Bachman's", Dept. CT, 23 Herman Street, Rochester 5, N. Y.

AC MOTOR Winder, winds concentric coils for Electric Motors, adjustable $\frac{1}{2}$ to 2 H.P. Send for bulletin. Motor Industries, Quincy, Illinois.

DIESEL & Gasoline Engines. New, Used Parts and Batteries. Helwege Marine Service, 108 Floral Blvd., Floral Park, N. Y.

WINDING Data, listing 225 motors, single and three phase, \$1.00. Motor Data, Box 7631, Kansas City 3, Mo.

DYNAMOTORS. All New! 400-cycle. GE5D21Nj3A. 27 VDC to 100VAC. 485 watts. Sensational offer! \$8.95 each. Three for \$25. Order today! No COD. "Amazing Bachman's", Dept. CT, Rochester 5, N. Y.

7 AMERICAN POLICE JIU JITSU

DEADLY Judo—Fiercest fighting technique. Trick knockouts. (200 photographs—plus illustrations.) Expert instructions—Three volumes. Complete \$2.25. Variety House, Box 46-AU Wall Station, N.Y.C. 5.

JIU JITSU Movies, Free list, Stone, Box 171-A, Canal Sta., New York 13, N. Y.

20 BODY-BUILDING COURSES

ACROBATICS — handbalancing, self-taught. Write. Power, 923 W. Vine, Kalamazoo, Michigan.

BAR-BELLS, Dumbbells, Exercise equipment, Courses, Free booklet. Good Barbell Co., Reading, Penna.

BARBELLS! Catalog! Bur Barbell Co., 319 Orient Way, Lyndhurst, N. J.

BARBELLS, Olympic types. Stamp for folders. Jackson Barbells, Dept. 5, Springfield, N. J.

124 SPORTING GOODS, GUNS, FISHING TACKLE, ARCHERY

"AMMUNITION"—"New and Used"—"Shotguns"—"Rifles"—"Revolvers"—"Pistols"—"Fishing Tackle"—List 10c. Rudolph's, Atchison, Kansas.

BOWS-Arrows. Write headquarters for Archery equipment. Quality products. Popular prices. Catalog 10c. Large illustrated Hand Book Instructions, making and shooting, 50c. Archery, 617-A So. State, Chicago 5.

SEND 10c for list 100 new and used guns. Frayseths, Wilmar, Minnesota.

BINOCULAR cases, 7 x 50, 10 x 50, all makes \$4.95; 6 x 30 \$2.95 Postpaid new; Max Zweig Sons, 937 D Street, N.W., Washington, D. C.

5000 BARGAINS, firearms, binoculars, war relics, catalog 40c. Smith Museum, Runnemedede, N. J.

JUMBO Bull Frogs, Wild Rabbits, Fishing Poles, Ball Bats, Land, Vol Brashears, Berryville, Arkansas.

55 FIELD GLASSES, TELESCOPES, ETC.

7x50 BINOCULAR lenses and prisms. Navy surplus. Rejected for chips or minor defects which do not interfere with their performance. Complete optics for Monocular \$3.75; for Binocular \$7.50 postpaid. Assembly diagram included. Brownscope Company, 24 West 45th St., N. Y.

400X COMPOUND microscope easily made. Lenses and instructions \$3.00. Instructions alone 10c. Carl Jamer, Manorsville, New York.

TELESCOPES, Binoculars, Microscopes—big bargain catalog free. Brownscope Company, 24 West 45th Street, New York.

SAVE Money—make own Galilean Telescope, 5, 8, 15 powers. Achromatic, coated objective $7\frac{1}{2}$ inch focal length $1\frac{1}{4}$ inch diameter; 3 eyelenses; complete with instructions \$2.00 postpaid. Ross, B68 West Broadway, New York, N. Y.

REFLECTING Telescope kit, complete optical parts, fully finished; 3" diameter, 39" f.l., mirror and diagonal both hard aluminized, plus 3 lenses for high power eyepieces. Never again a bargain like this. All \$6.00 postpaid. Ross, B68 West Broadway, New York, N. Y.

GENUINE polaroid glass— $2\frac{7}{8}$ " (72 mm) diameter, \$1.25 each, 2 for \$2.00. Ross, B68 West Broadway, New York, N. Y.

INFRA-RED filters glass $1\frac{1}{4}$ " (40 mm) diameter, mounted. Snap on camera or binocular. \$1.00 per set. Ross, B68 West Broadway, New York, N. Y.

REFLECTING Telescope, complete $3\frac{1}{2}$ " diameter, equatorially mounted. View planets, stars, \$19.75. Write Skyscope Co., 475-5th Ave., New York.

TELESCOPES, Microscopes, binoculars, barometers, books; Buy, sell, repair; We guarantee. Lists 10c. Rasmussen & Reece, Amsterdam, N. Y.

POWERFUL astronomical telescopes easily made. Perfect lenses and instructions. 100 power \$2.50, 100 and 200 power \$3.50, 100, 200 and 400 power \$5.50. Clear vision and full power guaranteed. Instructions alone 10c. Suffolk Science Service, Manorsville, N. Y.

43 DOGS, BIRDS, PETS, RABBITS

ANGORAS, Chinchillas, White Giant Rabbits — "Rabbitry Management" tells everything, \$1.00. Self-cleaning Hutch plans \$1.00. Automatic Feeder plans \$1.00. All three \$2.50. Catalog finest Pedigreed Rabbits free! Grinsteads, Dept. 16-D, Edwardsville, Ill.

GUARANTEED Chin-Chin Giant Chinchilla rabbits, Greatest amount of delicious meat. Largest, finest, most valuable furs. Tremendous demand for breeding stock. We buy youngsters. Contact world's largest breeder, Willow Brook Farm, R16, Sellersville, Pa.

\$250 MONTHLY, Raising Angora Rabbits. Particulars free. White's Rabbitry, Newark, Ohio.

FOR Sale—Coon Hounds, Combination Tree Hounds and High Class Fox Hounds, Rabbit Hounds a specialty. Dures Thomas, Route 3, Albertville, Ala.

"RAISE Diamond Seal Rabbits. We pay \$30-\$60 each plus express charges. Literature 25c with Hutch plans \$1.00. Hansen's Rabbit Institute, 1347 Miller Ave., Salt Lake City 6, Utah."

\$50.00 weekly with Angoras. Our co-operative marketing plan assures you of year around market. Free literature. Iowa Angora Association, 1215 34th Northeast, Cedar Rapids, Iowa.

\$2,500 YEARLY raising Angoras. We market your young. Contract Particulars Free. Wilsons, 1065 Shyer, St. Paul 8, Minn.

FOR Sale — Coonhounds, combination treehounds and high class foxhounds, Rabbit hounds a specialty. Raccoon Mountain Kennels, Dures Thomas, Rt. 3, Albertville, Ala.

RAISE Guinea Pigs. Make money at home. Big demand. Booklet free. Taylor, Box 426B, Hapeville, Georgia.

PETS illustrated list 10c Stamps Coin. Snake King, Brownsville, Texas.

ST. BERNARD Pups: Champion sire beauties. Franklin Young, R. 3, Riverhead, Long Island, New York.

SELANNA Kennel Service; Prospective Dog Buyers. Do you want advice on which breed, or at what age, or which sex to buy for your particular purpose? Lists of Breeders of any breed furnished. Enclose One Dollar for reply. 4 W. Chestnut St., Selinsgrove, Penna.

FOR Sale, coonhounds, combination, Fox and Rabbit hounds. Trial, Reasonable. Free list. Bexcreet Kennels, B-101, Herrick, Ill.

83 MILK GOATS

"MONEY from dairy goats!" Booklet free. Introductory 3-month subscription to leading magazine 25c. Dairy Goat Journal, Dept. 768, Columbia, Missouri.

52 FARMS, OTHER REAL ESTATE

OZARK Lands for All purposes. Actual river frontages. 5 acres \$90.00 and upwards. Free list and literature. Hubbard, 424H, Minnesota Ave., Kansas City 4, Kans.

GOOD Farms—Ranches, Washington, Minnesota, Montana, Idaho, Oregon, North Dakota. Dependable crops, favorable climate. Write for literature, lists describing typical postwar farm opportunities. Specify which state. J. W. Haw, 120 Northern Pacific Ry., St. Paul 1, Minn.

STROUT'S Green Farm Catalog—Over 2500 Bargains—money-makers—32 states—Coast to Coast. Mailed Free. Tell us what you want. When? Where? Price? Terms? Save Time, Money. Strout Realty, 255-ZB 4th Avenue, N. Y. 10, N. Y., 20 W. 9th St., Kansas City 6, Mo., 453 S. Spring, Los Angeles 13, Calif.

40 ACRES \$300.00, \$10 down \$10 monthly. R. W. Stewart, Inverness, Florida.

OZARK Guide, Eureka Springs, Arkansas. Magazine for homeseekers. Year \$1.00.

POPULAR SCIENCE OPPORTUNITIES

HOMESITES \$450—convenient payments. California's finest garden section. On Morro Bay's scenic shores. Wonderful fishing, hunting, boating, bathing. Fertile soil, softest water, temperate climate, congenial community. Free literature. Richard Otto, 6560-Z, Hollywood Blvd., Hollywood 28, California.

108 POULTRY AND SUPPLIES

RAISE turkeys the new way, write for free information explaining how to make up to \$3000.00 in your own backyard, address National Turkey Institute, Dept 57, Columbus, Kansas.

RAISE Fryers new scientific way. \$6000 yearly possible in your backyard. Booklet Free. Poultry Guild, 1046-B So. Olive, Los Angeles 15, Calif.

111 PROFITABLE OCCUPATIONS

DETECTIVES Earn Big Money. Excellent opportunity. Detective Particulars free. Write, Wagoner, P-125 West 86th, N. Y.

WELDING—Electric Arc. Learn profitable trade quickly through actual practice. Individual welder instructions at bare cost of materials. Full particulars free. Valuable welding lessons book 50c. Hobart Welding School, Box P-773, Troy, Ohio.

LOCKSMITHING—Profitable Business or Hobby! New course teaches you how to pick locks, fit keys, de-code, masterkey, etc. Easy self-instruction lessons. Bargain price. Fascinating 100-page illustrated catalog Free! Write Nelson Company, Dept. 2-01, Chicago 5.

MUSHROOMS Grown. Boxes, Barrels; Illustrated Instructions, 50c. Spawn \$1.00. Gordons, 553 William, Winnipeg, Manitoba.

\$40.00 WEEKLY. Made growing mushrooms. Fresh. Dried. Dominion Patent 331,583, free spawn. North American, 169Y Yonge, Toronto, Canada.

MAKE beautiful costume jewelry at home for large profits, hobby or therapy. Free illustrated wholesale catalogue of sea shell, metal and plastic parts contains detailed instructions. Florida Supply House, Bradenton, Florida.

\$5000. from half acre growing Ginseng, seed supplied. Crop bought. Particulars 10c. Associated Growers, 203 Bulman Block, Winnipeg, Canada.

MAKE \$150 a Week and more in a profitable business of your own with amazing Liquid Imitation Marble, Fiber-Tite Flooring and Flexible Molds. Full or Spare Time. Experience unnecessary. Work from your own home. Write for Free catalog and full information today. Composition Products Co., Dept. PS7, 5853 Delmar, St. Louis, Mo.

WHOLESALE Catalogue. business opportunities, plans Free. Holmes, Box 12S, Oaklandon, Ind.

SEA Shell Jewelry. Free instruction. Werts, 1429 56th Avenue, Oakland 3, Calif.

METALLIZE Baby Shoes. Correct Modern Method. Information Free. Universal, Box 1076-A, Peoria, Ill.

MAKE beautiful mirrors from inexpensive window glass. No special equipment required. Details Free. Tes-Co., Box 189-SE, Wilkes Barre, Penna.

22 BOOKS, PERIODICALS, ETC.

WHAT Every Mason wants. We have Masonic books for Blue Lodge, Chapter, Commandery Scottish Rite and Shrine. Our rituals are used the world over. Send for our free catalog of books and rituals for Masons, Odd Fellows, Knights of Columbus, etc. Ezra A. Cook, Publisher, Inc., P.O. Box 796-RMY, Chicago 90, Ill.

MAGAZINES (back dated)—foreign, domestic, arts, Books, booklets, subscriptions, pin-ups, etc. Catalog 10c. (refunded). Cicerone's, 863 First Ave., New York 17, New York.

BOOKFINDERS! (Scarce, out-of-print unusual books.) Quickly supplied. Send wants. Clifton, Box 1377-PS, Beverly Hills, Calif.

GOOD "Used" Self-instruction educational books on all subjects bought, sold, rented, exchanged. Satisfaction guaranteed. Complete information and 100-page illustrated bargain catalog Free! Write—Nelson Company, Chicago 5.

BIG Profits Taking Subscriptions For All magazines. Agents' Confidential Catalog listing over 2500 periodicals and complete starting supplies Free. Pines Subscription Agency, Flushing, N. Y.

EDUCATIONAL Books sold cheaply or rented for small fee. Books bought, Money-back guarantee. 4,000 Bargains. Catalog Free. (Courses Bought.) Lee Mountain, Pisgah, Alabama.

NATIONAL Geographic Magazine, 1888-1946. Any issue. Periodical Service, Box 327-S, Swarthmore, Penna.

"FIX It Yourself"—home repair book. How to fix appliances, furniture, plumbing, etc. 256 pages, 163 pictures. \$1.49. Popular Science, Dept. 87-C, 353 4th Avenue, New York 10, N. Y.

"RADIO For The Millions"—practical book. Complete instructions for building 78 radios, phonographs, other sets. 192 pages, 648 pictures. Regular Edition \$1.49. Popular Science, Dept. 87-C, 353 4th Avenue, New York 10, N. Y.

REVEALING Adult photographs! Large Assortment—\$2.00. Box 699-C, Westfield, New Jersey.

TRADE Magazines—Business, Vocational, Diversion. Current single copies. All fields. Choose from 885 periodicals. Free price-list. Commercial Engraving Publishing Co., 34S North Ritter, Indianapolis 19, Indiana.

BOOKS: Psychiatry, Hypnosis, Marriage, etc. Free Catalogue. Abbott-Dunhill Company, 752-A Northwest 66th Street, Miami 38, Florida.

ADULT Books 25c. Five—\$1.00! Free Bookalogues! Hirsch, Spring Valley 3, N. Y.

YES: We are again accepting agents to handle magazine subscriptions, books, greeting cards, complete details 25c (refunded). Cassell Publishers Service, Westfield, New Jersey.

1947 WHOLESALE catalog and Directory 10c. Latshaw Sales, Sunnyside-C, Indianapolis 44, Indiana.

FREE bargain catalogue for adult book buyers. Kissin, Box 134, Madison Sq. Sta., New York City.

ADULT Books sample 50c. Leung, 19 South Village, Rockville Centre, N. Y.

ADULT books. Artist's Pin-ups. Catalog. Sample 10c. Baker Service, Box 1840, Cleveland 6, Ohio.

ALL Pocket Books. Complete list free, includes latest reviews. Gordon's, 3882 Third Ave., Los Angeles 43.

FREE Bargain Catalog. Happiness Books PS, 41 Union Square, N. Y. C. 3.

ADULT Books. Revealing Sex Truths, Five—\$1.00. Kogan, 1032-SG, New York 8.

81 MAGIC TRICKS, PUZZLES, ETC.

MAGICIANS', Gamblers' secrets exposed. Cards, Dice, Punchboards, Slot Machine. Catalog 10c. Book Co., Box 671, St. Louis 1, Mo.

"MAGIC Vanishing Card". Throw it into air, it completely disappears, reproduce it later from spectators pocket. Easy to do. Complete 25c with magic catalog. The Magician, 2463-D, Kensington Ave., Philadelphia, 25, Pa.

WORLD'S largest professional magic shop, keeps you in touch with latest tricks. To receive mailings, send 35c for new catalog. Holden's, 220-P West 42nd St., N. Y.

THE True Secret of Ventriloquism. Free booklet. Quackenbush, Big Flats, N. Y.

FREE! Large Catalog of magical apparatus if you remit 25c for "MAGIC IS FUN" magazine. Robbins Co., 152-F West 42nd Street, New York.

200 ELECTRIC Stunts, 110 volts, \$1. Cutting Sons, Campbell 3, Calif.

500 TRICKS. Send only 10c for Douglas' famous 112-page Catalog 500 Tricks. New magic for amateur, professional. America's fastest service for 25 years. Douglas Magiland, Dept. 2, Dallas, Texas.

VENTRILLOQUISM Taught. 3c stamp brings particulars. Smith, Dept. 410, 801 Bigelow, Peoria 5, Ill.

TRICKS. Secrets, Cards, punchboards, etc., explained. Big illustrated circular free. Mack, Box 1278-P, San Francisco.

VENTRILLOQUISM. Full course \$2.00 postpaid. Elson, 137 Lewis, Phillipsburg, N. J.

HYPNOTISM-Rapid Stage Methods! Known to very few. New subjects hypnotized in few seconds. Results or Money Back. Course—\$5.00. Olney School of Hypnotism, 7022 Garrett Rd., Upper Darby, Pa.

BE a Magician. Large professional magic catalog of latest tricks, 25c. Ireland, F-109 North Dearborn, Chicago.

HYPNOTISM! 25 Lesson Course. \$1.00. Monarch, 38-S Jefferson, Auburn, New York.

GUARANTEED magic tricks! Amateur, Professional. Big 8½ x 11 illustrated catalogue, 10c. Newton's, 121-B Main, Bonham, Texas.

YOU'LL wow 'em—with Deland's spectacular "Card Locator". Name exact location any card in ordinary deck! Deal straight royal flush. Only 10c. magic catalog, startling free offer details included. Magic Shoppe, 19K Springfield Ave., Newark, N. J.

HYPNOTIZE at a glance, by phone—instantly! "Master Course in Hypnotism" reveals astounding secrets. Complete, easy course—\$2.00. Not sold to minors. Magic Shoppe, 19L Springfield Ave., Newark 2, N. J.

DOLLAR Magic Set Free with Mammoth Catalog 25c. Mysto, 4462-PS Germantown, Phila.

SNEEZING, Itching Powders. Eighteen Other Tricks and Joker's Catalog 25c. Factory, 2404N15, Philadelphia.

"VENTRILLO", Professional Voicethrowing Instrument. Free with Catalog 25c. POB-971, Philadelphia.

MAGICIANS pin, ghost illusion, Houdini escapes, giant catalogue. Everything, complete 25c. Magic Wands, 9w Colorado, Pasadena, Calif.

VANISHING Quarter trick and catalog 25c. Sterling Magic Co., Royal Oak, Mich.

63 GAMES, ENTERTAINMENT

HOME Model Slot Machines and Coin Operated Games. Write for catalog. Webb Distributing Co., Dept. P4, 6 South Kedzie Ave., Chicago 12, Ill.

36 COIN COLLECTING

FREE! Foreign coin, banknote and Coin Collectors' Illustrated Catalog to approval service applicants. Send 3c postage. Tatham Coin Co., Springfield-D50, Mass.

UNUSUAL Worldwide collection twelve different foreign coins and bills only 25c. Webb, Box 473, San Bruno, California.

COMMEMORATIVE \$½—Columbus, Washington, Cleveland, Stone Mountain, \$1.50 en. Illustrated Catalogue 25c. Norman Schultz, Salt Lake 9, Utah.

50,000 COINS. Confederate, Foreign bills. Illustrated lists free. Nagy, 8-P South 18th, Philadelphia 3, Penna.

96 OLD STAMPS WANTED

ANNOUNCEMENT—Introductory offer—Cosmopolitan Stamp Co. resumes its well known approval service and desires the privilege of sending you choice selections—General Foreign, U. S.; Air Mails; British Colonies, etc. Send only 25c and receive \$1.00 value of net price stamps from our initial Gigantic Selection. Don't delay. Write today. Cosmopolitan Stamp Co., 1457 Broadway, N. Y. C.

POPULAR SCIENCE OPPORTUNITIES

127 STAMP COLLECTING

WORLD'S Largest Diamond And Triangle Stamps, Free Stamp Magazine. Stamps from Fighting Free French, 20 stamps from 20 different Countries. Pictorials, Airmails, Big Bargain 5c with approvals. Capital Stamps, Dept. 10, Little Rock, Ark.

BRITISH Empire! 55 Different including Batum, Burma, Cyprus, Gwalior, Tasmania, 5c to Approval Buyers. Lyman, 97 Nassau St., New York 7.

DEALER'S Wholesale Catalog. Postage 3c. Franksco, 5031 Queensbury, Baltimore, Maryland.

50 DIFFERENT including scarce diamond-shaped airmail 3c to approval service applicants. Avalon Stamp Co., Dept. S, Springfield 8, Mass.

FINE Approvals, freshly mounted, Fast, personal service. Tell me what countries you prefer and I'll send their stamps. Milton Skinner, 438 Locust, Long Beach 2, Calif.

UNITED STATES approvals complete coverage fine quality, attractive prices. Seminole Stamps, Box 378, Coconut Grove, Florida.

FREE! Negro Triangle; Turks Islands "Cactus"; Dakar; Guinea; Palestine; "Fairy Tale"; Pirate Chart, Map, Ship, Sea Lion and Snake stamps; French, British, Portuguese Colonies, etc., Free for 3c postage. Approvals, Potomac Stampco, Washington 10, D. C.

FREE—Famous Americans Set, plus Flag Set, plus the National Parks set, plus the Presidential Set to the \$5. A total of 90 stamps absolutely Free to customers for our unsurpassed United States or Foreign selections. Send 3c postage for 15 of the above mentioned stamps and full particulars. Triboro Stamp Company, 145 Nassau Street, Dept. 203, New York.

200 DIFFERENT stamps, 6c, to approval service applicants. Tatham Stamp Company, Springfield 50, Mass.

U. S. 797 SPA Sheet only 5c to applicants for U. S. approvals. M. Haycock, 61 O'Brien Pl., Brooklyn, N. Y.

SCARCE U.S. Stamps Nearly 100 Years Old. 1893 Commemorative, \$5-\$10 stamps, Armed Services Pictorials complete, Roosevelt set, large Allegorical Figure of Commerce, Old Revenues, everything 5c to serious approval applicants. Metropolitan, 140 Nassau, New York 7.

ZOWIE-E-E! A Barrel of Fun for only a Dime! 500 United States Stamps—Absolutely unpicked and unsorted, just as received from church missions. Many varieties, including large commemoratives, airmails, high denominations up to \$5.00! Stampdom's biggest package of fun, and you might find something really valuable!! Price only 10c to serious approval service applicants. Money back if not delighted. Illustrated bargain lists with each order. Mystic Stamp Co., Dept. 55, Camden, New York.

FREE—The Stamp Finder. Big new edition—32 pages profusely illustrated! Tells at a glance the country to which any stamp belongs and so where to place it in your album! Also: 25 different stamps from Vatican City, Palestine, Cyprus, San Marino, etc. All sent to Approval Applicants enclosing 3c postage. Garcelon Stamp Co., Box 918, Calais, Maine.

25 DIFFERENT Hungary! Colorful! 3c. Approvals, Star Stamps, Lakewood, N. Y.

VALUABLE Catalogs 10c Each: (1) "United States & British N. America" complete with 1,000 illustrations; (2) "Airmail Stamps"; (3) "British Empire"; (4) "Modern Europe"; (5) "Annual Catalog" of albums, supplies, packets, advice to beginners, etc. Each catalog 128 or more pages, profusely illustrated, wonderfully informative! Harris & Co., 204 Transit Bldg., Boston 17, Mass.

\$10.00 FOR \$1.00. Box full stamps valued Scott's \$10.00 and Stamp Album. Everything \$1.00. Longacre Shop, 100J West 42nd, N. Y. City 18.

PROTECT and Beautify your stamps, blocks, covers, etc., with Crystallmount. Write for free samples. Harris & Co., 204 Transit Bldg., Boston 17, Mass.

SAN MARINO, Roosevelts, Multicolored Dominican Waterfalls, Sarawak Centenary. Everything 5c with approvals. Raymax, 123-X William St., N. Y. C.

FREE! Ten Mints; Ethiopia Red Cross plus Free French. With Approvals. Florida Stamp Company, Box 807, Miami 5, Fla.

FREE—United States Columbian Set—8 Values. Retailing \$3—Absolutely Free to Customers for our Unusual Approvals. Send 3c Postage for Selection Plus full particulars. S. D. Engel, 38 Park Row, New York.

31 DIFFERENT with George Washington Stamps, from Brazil and Ecuador; Pirate Island; Victory issue; Medical set; others—all 4c with approvals. Grayson Stamps, Sherman, Texas.

GIBRALTAR Packet Free—Nice collection Gibraltar—New Zealand Centennial—British Uganda—French Colonials—Early British Colonial—West Indies—South American—War stamps plus Philatopic Monthly Magazine. All for 5c postage. Empire Stamp Co., Dept. P R, Toronto 5, Can.

6 NAZI Hitler Head Stamps, Value 38c, 5c. Approvals. Allen, 252 South Third, Brighton, Colorado.

HINDENBURG Zeppelin Set 5c Approvals. Thode, 14302F 119 Avenue, Jamaica, N. Y.

1000 Well mixed U. S. 25c, Monjar, 1750 Fairmont, Cincinnati 14, Ohio.

FREE!! Finland 20 different to approval applicants. Rosenberg, Box 1303, Chicago.

ERRORS, Sensational offer stamp errors and stamps designed by late President Roosevelt \$1.00. Blue Diamond Stampco, 750 46th Street, B'klyn 20, N. Y.

12 DIFFERENT Persia—3c with approvals. Customer Gifts, Brandwein Stamp Company, Box 92P, Bayonne, N. J.

STAMP Magazine and "Valuable Tips"—Free! "Stamp Post", Station A, Pasadena, Calif.

PIRATES! Head Hunting Natives! Kings! Statesmen! Man-eating Bull of Greece, Nazi Hitler Head, Roosevelt, Churchill and Stalin on stamps in our "Mammoth Collection" containing over hundred interesting stamps. Only 10c to approval applicants. National Stamp Sales, 276-A West 43rd Street, N.Y.C. 18.

MONACO Roosevelt triangle, Hitler-Heads, Persia, others. Big packet 3c with approvals. Baird, P.O. Box 1713, Portland 7, Oregon.

"WORLD'S Best" United States or Foreign Approvals. America's Lowest Selling Prices. Fort Orange, Box Eighty-Seven, Albany 1, New York.

10 SENSATIONAL Rare 25c approvals. Davis, 95 South 10th, B'klyn 11, N. Y.

GOLDEN Mixture, Variety Countries, 25c. MacDonald 30-P, Seaman Ave., New York 34.

UNITED STATES Price list. Send Postage. State Stamp Corp., 1225 Park Bldg., Pittsburgh 22, Penna.

FREE U. S. Price list postage 3c. M. Hanna, 335 5th Ave., Pittsburgh 22, Pa.

50 DIFFERENT United States 10c. Price list free. No approvals. Seidenberg, Cassopolis, Mich.

UNITED States and Foreign stamps sent on approval; outstanding quality, low prices. Fred Herzberg, PS 168 Oak St., Elmhurst, Ill.

20,000 DIFFERENT 1c-5c each! Gordon Davison, Box 1019A, Manchester, N. H.

BRITISH, Spanish and French Colonies, Vatican, Hitler heads, and airmail packet, free with approvals. Pan-American Stampco, Box 145, New York 33, N. Y.

25 SCANDINAVIA 10c with approvals. Bjorn Nielsen, Monmouth 1, Maine.

WHOOPIE! Wowie! 25c worth of U. S. stamps free! No obligations! Write: M & N Co., 742 Sheffield Ave., Brooklyn 7, N. Y.

PERSIA and China packet free to approval applicants. Write "Everglades," Box 3222-S, Station F, Atlanta, Georgia.

"ROOSEVELT, Churchill, Stalin, Hitler, Vatican City stamps free, to approval applicants. Flamingo Stamps, Box 517, Miami Beach, Florida."

10 DIFFERENT U. S. Over 40 Years Old, 5c. Foreign, U. S. approvals. Scott, 22 Middle St., Lexington 73, Mass.

30 BEAUTIFUL Airmails 10c. Selected Approvals. Louis Morrison, Milmont Park 2, Pa.

OLD scarce U.S. Seconds on approval. Slightly defective, nice appearance, bargain prices. Hearnfeld, 551 Clinton, Newark 8, N. J.

WORLDWIDE Different: 200-25c; 500-60c; 1000-\$1.50. Beacon Sales, Maynard 3, Mass.

BRAZIL Diamond shaped set, 10c with approvals. Vargo Stamps, 6044 South Fairfield, Chicago 29, Illinois.

6 DIFFERENT San Marino Roosevelts—10c with 1/4-1/2-1c approvals. Carroll's, 4357-C S. Hoover, Los Angeles 37, Calif.

GEORGEIOUS all mint pictorial packet free with approvals! Wonder Stampco, 3401-B, Council Bluffs, Iowa.

LOOKING for Fair Prices, Courteous Service, Extensive Stock, Generous Commission on Sales? Ask for our Pictorial Approvals. Barrington Smith Co., Halfwaytree, 10, Jamaica, B.W.I.

PENNY Approvals that satisfy. Neil Gronberg, Box 5441S, Philadelphia 43, Pa.

ROGUES Gallery Packet, Hitler-Mussolini, 30 others, 3c. Premium, Hartland 6, Me.

BERLIN Bears Complete set of eight and 100 different stamps only 10c to approval applicants. Reich Stamp Co., 4647 Kenmore, Chicago 40, Ill.

"GOYA NUDE" set, cataloging \$1.05, complete 35c. Approvals. Royal Stamp Co., Tamaqua 2, Penna.

POPULAR Approvals at 1/2c up. Small Stampdealers, 2616 Cortez St., Chicago 22.

POSITIVELY Greatest free offer—Latest Scott's International \$6.00 stamp album—covering entire world, contains 36,000 illustrated descriptive spaces; Scott's 1948 Standard \$6.00 catalogues "Philately's Encyclopedia"—absolutely free to applicants for foreign approvals becoming customers. Bargain Stamp Service, Santa Ana, California.

"BEAUTIFUL Wings Over Norway, Berlin Bears 7, Danish Condor Retailing 39c only 25c to collectors requesting fine world wide approvals. Gridmoor Stamps, Ojai, California."

CUBA Roosevelt Stamp and 25 different Switzerland only 1c to approval service applicants. Littleton Stamp Company, Littleton 47, New Hampshire.

FREE Bargain List Quality Stamp Packets! Write Neptune Stamp Co., Neptune 5, N. J.

WOW! \$10.00 Worth Of Fun Only 10c. What a treasure hunt! Big package 500 Foreign Stamps—just as received from foreign missions other sources. Includes stamps from Africa, South America, Free French, Cape Juby, Palestine, etc., includes airmails, commemoratives, and stamps worth up to 50c. This offer sent for 10c to serious approval applicants only—one to a customer. Jamestown Stamp Co., Dept. 5, Jamestown, New York.

GROUP Approvals! \$1.00 equals \$1.25. Ask for them. Philately, 823 1/2 Maple, Santa Monica, California.

100 DIFF. Bohemia 2.25, 100 diff. Switzerland .95. A. Mont, P.O. Box 204, Forest Hills L. I., N. Y.

POPULAR SCIENCE OPPORTUNITIES

DOLLAR Each: 1200 Better U. S.; 2000 British: 750 Australia: Seiden. 1331-S Intervale, N.Y. 59.

U.S. \$5. Stamp given free. Approvals sent Bala Stamps, Bala Cynwyd, Pa.

SMOKY Mountain Commemorative Souvenir sheet and 30 different U. S. stamps, including commemoratives, Airmail, etc. (catalog value exceeds 65c) for 10c to approval applicants. Curhan Stamp Co., Dept. 1, Gloucester, Mass.

25 **DIFFERENT** Stamps 10c. Tunis And Carpenter, Wakeman Ave., Newark 4, N. J.

WASHINGTON Bicentennial Set 10c. United States-Foreign Approvals. Yokums, Box 1327, San Antonio 6, Texas.

RED Army Pictorials Free with approvals. Granada, 4891 Southwest 5th Street, Miami 34, Fla.

FREE! San Marino #108 catalogue \$1.25. Send postcard requesting approvals. Same day service! Jayson Stamp Company, 1295 Amsterdam Ave., N.Y. 27, N.Y.

70 HOBBIES, COLLECTIONS

INVENTING can be an interesting and profitable hobby. Write for complete particulars. Institute of American Inventors, Dept. 30-E, 2926-Eye St., N. W., Washington 6, D. C.

KLONDIKE! For Hobby Jewelry Makers! Novelty Jewelry Findings swept from tables of large manufacturers—parts for Bracelets—Pins—Earrings, etc.—unfinished. Chains—Rings—Pins—Stones—Clips—Beads—many other items—1 Lb. Bags—\$2.00 Per Bag in 5 Bag Lots. Sample Bag—\$3.00. Prepaid Only. Mdse. Distributing Co., 19 E. 16th St., New York 13, Dept. P.S.

CAMPAIGN Ribbons—Beginner's Package—Introductory Price—50c, contains 15 Assorted Ribbons. L.H.G. Company, 19 E. 16th St., N. Y. 3.

GEM Making—Fascinating! Profitable! Free equipment catalog, or send 25c for complete instruction book. Lapidary Company, 1545 West 49th, Seattle 7, Wash.

COLLECTORS—veterans—start collecting U.S. Army and Marine soldier patch insignia. Send \$1.00 for beginning assortment of ten patches—\$2.00 for 25 to Fox Dept. Store, 593 Third St., San Bernardino, Calif.

INSTRUCTIONS for cutting and polishing stones, description necessary equipment. \$1.00. Westco, 117 23rd St., Manhattan Beach, Calif.

CALLING all Tracks. Illustrated Circular sent free to Racing fans. Write A. Todd, Baileys Bay, Bermuda

UNUSED Match Book Covers, 100 all different \$1.00. 35 Royal Flash Covers \$1.00. Free catalog. Charles Edelman, 1311 P East 84, Cleveland 3, Ohio.

"SWAPPERS" Kollektors Hobbyists. Whatcha got? Whatdye Want? National Bulletin 25c. Royal Oak 128, Michigan.

8 ANTIQUES, RELICS, INDIAN GOODS

ANTIQU-modern pistols, revolvers, swords, daggers, armor, 174-page illustrated catalog 50c. Robert Abels, 860 1/2 Lexington Avenue, New York 21.

ANTIQU Guns, 600 Bargains. Catalogue 25c. Gilbert Hebard, Knoxville, Ill.

4 **FINE** ancient arrowheads \$1.00. Stone Tomahawk \$1.00. List free. Lear's, Box 569, Galveston, Texas.

85 MINERALS & PRECIOUS STONES

JEWELRY stones removed from rings, etc. 100 assorted \$2.40. 50 large ones \$2.40. B. Lowe, P.S. 50, Holland Building, St. Louis 1, Mo.

ARGON Ultra-Violet Light Set with 3 beautiful fluorescent minerals, postpaid \$2.00. Ultra-Violet Prod., Inc., 5205 Santa Monica Blvd., Los Angeles 27, California.

GEMS, precious and semi-precious, all genuine from world wide sources. Deal direct, no overhead, save money. Catalog 10c. Hill Co., Route 7-K, Salem, Oregon.

PETRIFIED Woods. Rare. Beautifully grained. Six cubic inches \$1. Jesse Teer, Roosevelt 2, Oklahoma.

MINERAL specimens and gem material. Fluorescents. Free list. Plummer's, 5068 Brighton, San Diego 7, Calif.

26 CAMERAS, PHOTO SUPPLIES

CASH! Spot cash for cameras, lenses, binoculars, movie and still equipment. Send full description for prompt cash offer. Over 36 years of dependability. Bass Camera Co., Dept SP, 179 W. Madison St., Chicago 2.

BASS Says: Trade Cameras? For 36 years Finest equipment available. Always Satisfaction Guaranteed Or Your Money Back! Bass buy 'em, trades 'em. Bass Camera Co., Dept. SP, 179 W. Madison St., Chicago 2.

PHOTOGRAPHY for pleasure or profit. Learn at home. Practical basic training. Long established school. Write for booklet. American School of Photography, 1315 Michigan, Dept. 1741, Chicago 5.

CAMERA'S-Enlarger's—Movie Film—Big Free Catalog. Cavalier Camera, 1822 Center, Pittsburgh 19, Penna.

ATTENTION! Amateur-Professional Photographers. Get the Best Art Negatives now from Hollywood's Art Center, of Hollywood's famous Cover Girls in full figure artistic poses. Sizes 2 1/4 x 3 1/4, \$1.50, or 4 for \$5.00, and 4 x 5, \$2.00 or 3 for \$5.00. Also, Beautiful Art Prints—4 x 5, 35c—5 x 7, 50c—8 x 10, \$1.00 each. Gorgeous color transparencies, \$4.50 each or 3 for \$11.50. Unretouched originals guaranteed. Our customers are well pleased. Ernest Edwards, Inc., P.O. Box 1987, Hollywood 28, Calif.

LATEST Edition! Everybody's Photo Course 25 lessons Only 50c. Satisfaction Guaranteed! Maniss Photo Co., Colorado City, Texas.

COLOR. New Supercolor movie film. Weston speed 32. Free processing. 100 ft. roll 16mm—\$6.00, or 25 ft. roll Double 8mm—\$3.25. Sent prepaid. Reliance Film Inc., 352 West 44th, New York 18, N. Y.

102 PHOTO FINISHING

NEW Color Process makes full color prints from black and white film or negatives. Send dime for Sample. We have Films. Midwest Photo, Janesville 27, Wis.

PHOTOGRAPHY for pleasure or profit. Learn at home. Practical basic training. Long established school. Write for booklet. American School of Photography, 1315 Michigan, Dept. 1722, Chicago 5.

LARGA-PIC—We have only one offer, but it's an outstanding one! Your roll developed and 8 prints made into brilliant Larga-Pic photos for 30c. Reprints from your negatives 4c each. Write for Free mailers. Larga-Pic, Box Z-4, Brookline 46, Mass.

ROLL Developed and 8 prints 25c or 8 enlargements 30c. Reprints 3c. Enlargements 4c. Young Photo Service, 406-C, Albany 2, N. Y.

THREE prints each 8 exposure roll 40c. Two each 35c. One each 25c. Reprints 3c. Fred A. Eastman, Bode, Iowa.

ROLLS Dev. & Printed Giant size 30c. Reprints 3c. Thrifty, Box 688, Sta. H., Los Angeles, Calif.

EVERY Picture an enlargement... Bigger and Better Snapshots than you have ever seen before! New Electronic developments give you improved lifetime deckled-edge enlargements at our same low prices. Any 8 exposure roll developed and printed Enlarge size 25c; Reprints 3c each. Fast, Accurate Service Guaranteed! Send for free mailers, today! Enlarge Photo Service, Box 791L, Boston, Mass.

50 **VELOX** reprints, \$1. Suburban Studio, 1410-S Bond, Rockford, Ill.

ENLARGEMENTS—5 x 7—10c; 8 x 10—25c. From your negatives. National Film Service, 3111 West Tuscarawas, Canton 3.

FREE! 5x7 enlargement! Rolls developed and eight lifetime doublesize Velox prints made by modern electronic equipment only 30c. Reprints from negatives, same size 3c; doublesize 4c. Candid Rolls, finegrain developed, 3x4 prints 12 exposures 45c. 16 or 18 exposures 65c; 36 exposures \$1.25. Return ad with roll and receive absolutely free 5x7 enlargement. Franklin Finishing, Box PS-8, Framingham, Mass.

ENLARGEMENTS from your negatives. 5x7 Gloss 35c. 8x10 50c. Photo Lab. Service, 4209 Amherst, Dallas 5, Texas.

FASTER! Rolls Developed. Sixteen Sparkling Fadeproof prints, professional 4 x 6 enlargement, beautiful framette—25c. Rolls developed—eight 4 x 6 enlargements—30c. Reprints 2c. Enlargements 4 x 6, 4c. Lifetone Photos, 853-18 Fifth, Des Moines, Iowa.

ROLL developed and 8 prints 30c. Overnight Service. Free Mailers. Tri-Plex Photo Service, Box 375, San Francisco, Calif.

8 **BEAUTIFUL** Double Size pictures and roll developed 30c. 8 hour service. Free Mailers. Pacific Photo Service, Box 666, San Francisco, Calif.

104 PHOTOPRINTS, PHOTOCOPIES

PHOTOS, Documents, etc. Photocopied to wallet size and permanently sealed in transparent plastic, \$1.00. Originals returned. Solfis, Box 1942X, Boston 5, Mass.

90 MOTION PICTURES, SOUND EQUIPMENT

GUARANTEED Fresh anti-halo outdoor movie film! Weston 12 Daylight loading! Processing free! Three spools Double 8mm, \$3.45! Six single 8mm for Univex, \$4.60! Postpaid! Cataog. ESO-S, 828-A, West 39th, Kansas City 2, Missouri.

"MISS America, 1946". Projection length test film, \$1.00. Complete editions, 8mm, 50 ft. Kodachrome, \$7.50, black-white, \$2.00, 16mm, 100 ft. Kodachrome, \$14.75, black-white, \$4.00. 43 subject color catalog, 25c. World In Color, Box 392-A, Elmira, N. Y.

SELECTED Films, Photos, Slides. List 10c. Thomas Productions, 2709 West Ave. 34, Los Angeles 41, California.

BEAUTIFUL Kodachrome Slide and Lists 25c. Slide Supply Service, 3111 West Tuscarawas, Canton, Ohio.

MOVIE Film At Tremendous Savings! Kodak Super X, Weston 32. Government stock. Tested—unconditionally guaranteed. 16mm—100 ft. \$1.95; 50 ft. 98c; 50 ft. magazine \$1.35. Double 8mm 25 ft. 75c. Processing extra—50 ft. 75c; 100 ft. \$1.00; 25 ft. 8mm 75c. Fast Service! Photo Surplus Sales, Box K-2, 12 Duane Street, New York City.

MOVIE Cameras! 16mm electric, magazine-loading, famous mfgs. With telescopic optical viewfinder, famous-make 13.5 anastigmat lens, battery, coupling cord and automatic release. Value over \$200. Complete. Ready-To-Operate Only \$55.00. 100% satisfaction—Money Back Guarantee! Order today! Free booklet. Quality Movie Film Panchromatic, Weston 32, 16mm 50' magazine, \$3.25; 100' \$4.50, 50' \$2.40; Double 8mm 25' \$2.15. Semi-Ortho, Weston 8, 16mm 100' \$2.85; 50' \$1.75; Double 8mm 25' \$1.55. Free Processing. Fotoshop Inc., Room 32, 18 E 42nd St., New York City.

LEARN movie projection, management. Free Catalog. Theatre School, Elmira, N.Y.

RARE 8-16mm, Silent-sound films. International, 2120 Strauss, Brooklyn, N. Y.

BARGAINS! 8-16mm films, equipment! Catalog 10c! Towers, 935 North Fortieth, Philadelphia 4.

FAST Pan Movie Film \$2.75 100'-25', double 8mm \$1.25. 100' 16mm outdoor \$2.25. 3 rolls \$6.00. Ambassador, 479-A Quincy St., Brooklyn 21, N. Y.

EXCHANGES: 8/16mm Silent, \$1.00 Per Reel. Rentals, Sales at Money-Saving Rates. Details for dime. Midland, Box 429, Oak Park 3, Illinois.

POPULAR SCIENCE OPPORTUNITIES

TALKIES: Convert your silent 16mm projector into sound with our guaranteed parts kit. Plays all 16mm sound films. Quickly assembled at home. Special introductory offer. Send this ad now with \$25.00, check or money order, and we will include sound test film, instruction manual and full information on how to use with your radio. Kit includes photocell, exciter lamp, optic, which makes a sound head complete. Or send \$1.50 for complete blue prints showing how to make adapter yourself. Apex Video, Box 3071S, Hollywood 28, California.

CHILD Is Born By Caesarean Delivery. The outstanding home movie production. Project it free. Send postal card immediately. Movies, Hamilton 5, Ohio.

QUANTITY Users: Fresh Ansco 16mm 100' movie film—Black and White, \$5.25; Color, \$7.00—minimum order, six rolls. Gamerman's, Dept. P, 3816 Eastern Avenue, Baltimore 24, Maryland.

FILM Free processing 100 ft. 16mm Weston 12 \$3.25, Weston 24 \$4.90, Weston 64 \$4.95. 25 ft. double 8mm Weston 12 \$1.50, Weston 24 \$1.89, Weston 64 \$1.99. Free circulars Wanted Eastman double 88 camera spools paying 35c. Fromader General, Davenport 5, Iowa.

16mm MOTOR Driven Projectors—\$16.00—Up. Selco Products, Denvers, Mass.

"THE World's Greatest Passion Play". All sizes. Rent or Purchase. Write Hemenway Film, 33 Z Melrose St., Boston 16, Mass.

ART Films: 50' 8mm, \$3.49; 100' 16mm, \$5.50; 100' 16mm Sound, \$6.75. Send for catalog. 16mm Viewer with 50 Art Poses, \$1.10—100 extra poses, \$1.10. Both for \$2.00 postpaid. Bruno Kit with six 120 Art Negatives, \$2.98. 35mm Kodachrome Art Slides, latest releases, 3 for \$1.00. Fresh Ansco 20 exposure 35mm Color Film, 3 rolls for \$4.50. Please include postage. Gamerman's, Dept. P, 3816 Eastern Avenue, Baltimore 24, Maryland.

CAMERAS, Projectors, Films, Silent, Sound, Catalogs 10c, Agents wanted, Liberal Commissions, Richardson, Wyoming 3, Penna.

FREE: Over 1000 home movies, silent, sound, color; available from 196 sources, free to our members. Details and bargain photography catalog 10c. Hobbyguild, 34-G West 33rd St., N. Y.

IMMEDIATE delivery of 16mm Sound projectors. Large stock of Castle, Official, Nu-Art and Pictorial films. Soundies, Comedies, 16mm Anscocolor film. Used 8mm, 16mm Sound. List Titlers, Splicers, Editors, Rewinders. (Home Movies, 41 South Fourth Street, Allentown, Penna.)

35mm VIEWER and strip of twelve beautiful natural color Art Poses, \$2.00 postpaid. Gamerman's, Dept. P, 3816 Eastern Avenue, Baltimore 24, Maryland.

92 MUSIC, MUSICAL INSTRUMENTS

"SONGWRITERS, Send Poem For Free Examination, Outstanding Offer, and Free Instructive Booklet. United Music, 108, Salem, Indiana"

SWISS Musical Movements \$3.25. Music Boxes, 131 W. 42nd, New York 18, N. Y.

PHONOGRAPH Records Cheap. Catalogue, Paramount, SC-313 East Market, Wilkes-Barre, Penna.

PIANO—Play without notes or teacher. System sent Free—includes chart, directions and Hit Song of the Year. Enclose 10c for handling and mailing. Latom Music, 2147A 86th Street, Brooklyn 14, N. Y.

INSTRUMENTS for less and still the best. Send for Bargain Catalog. Harden's Musical Merchandisers, Marion P., Ohio.

122 SONG WRITERS

POEMS Wanted to be set to music. Free examination. Send poems, McNeil, Master of Music, 510-PS, S. Alexandria, Los Angeles, California.

SONGWRITERS, Songs Published Monthly, Advance Royalty. Send your songs or poems today for our exciting offer. Hollywood Tunemiths, Dept. 10F-C, 1537 N. Vine, Hollywood 28, Calif.

"POEMS Wanted For Musical Setting! Send Poem For Free Examination, Outstanding Offer and Free Instructive Booklet. United Music, 107, Salem, Indiana"

SONGWRITERS: \$100 Cash Awarded Each Month For Best Song or Song Poem. Melodies supplied Without Charge By Hollywood composers. Lead sheets and records furnished. Cinema Song Co., Dept. B-48, Beverly Hills, Calif.

REAL Composer of Music will co-operate with lyric writers in song production. Fine publication proposition. Nationwide distribution of publications. Recordings Made. Copyrights secured. Write Now, C. Isabel Mayer, Box 3896, Portland 8, Ore.

POEMS Wanted For Musical Setting. Send poem for immediate consideration. Five Star Music Masters, 646 Beacon Bldg., Boston.

POEMS Wanted for new songs. Send poem for Free examination, Eliot Wright, Master Composer, 206 Rivoli Theater Building, Portland, Oregon.

SONGWRITERS, Lyrics revised, Melodies written. Recordings made. Work done by professionals. Ace Song Service, 27 Spring St., Elizabeth 4, New Jersey.

"SONG Entries open for publication. No charge for publication. Mueller Music, 2907 Pennsylvania, St. Louis 18, Mo."

112 RADIOS, SUPPLIES & EQUIPMENT

MAKE Simple, Tubeless, Batteryless, Distance-Getting Crystal Radios, Crystal and illustrated instructions 25c postpaid. Allen, 427-S, Clinton, Mo.

RADIO Service men and experimenters send stamp for our giant radio catalogue. Save dollars. United Radio Co., (1000-V) Newark 1, N. J.

FREE New Radio Catalog Is Ready! Radionic's catalog lists radios, hard-to-get radio parts, books, amateur, test and P.A. Equipment. All available for immediate shipment. Send today to: Radionic Equipment Co., Dept. 158, 170 Nassau St., New York 7, N. Y.

BUILD your own Radio. Kit of parts \$5.95. Details—Ryco Distributors, P.O.B. #8, Ozone Park, N. Y.

BUILD "Loudest" Crystal Radio. Instructions and Crystal, 25c. Amoroses Radio, Route Four, Richmond, Va.

"RADIOS—Tables, Portable Model, parts. Write for latest Bargains. American Radionics, Wilkes-Barre, Penna."

RECEIVER army aircraft type brand new 6 tube superheterodyne 3 gang tuning condenser vernier dial latest type tubes complete in aluminum case with tubes and circuit diagram prepaid \$6.00. Heath Company, Benton Harbor, Michigan.

RADIO book:—"Everybody's Radio Manual." Tells how to service all radios at home. 256 pages, 216 pictures. DeLuxe edition, \$1.49. Popular Science, Dept. 87-C, 353 4th Avenue, New York 10, N. Y.

ONLY A Few Left—St. Clair V.T.V.M. 6D.C. Ranges—6 A.C. Ranges 0.1 Ohms to 1000 Meg.—Built to Sell For \$52.50 Reduced to \$42.50—Now Closing Out At \$29.75. Hundreds Sold—No Complaints. Mail a Card—Get On Our Mailing List. Radio Equipment Co., 377 E. Main St., Lexington, Ky. (Dept. K).

MINIATURE headphones military surplus similar to hearing aid phones. Ideal for crystal sets, outdoor use, hearing aids, etc., comfortable, comes complete two receivers, soft rubber ear inserts, headband and cord, brand new. Prepaid \$1.00. Heath Company, Benton Harbor, Mich.

HALLICRAFTERS, National, other radios wholesale. Terms. Write, Henry Radio, Butler, Missouri.

25 YEARS Experience radio repairing at your fingertips. I've repaired 45,000 radios and have perfected system you can follow step by step. My methods are far simpler than any course published. Requires no calculations. Total price \$1.00 postpaid or C.O.D. Moneyback guarantee. Ross Radio Company, 14615 Grandriver, Detroit 27, Michigan.

RADIOMEN wanted to operate Electro-System thruout the United States. Address Box 1122, Chattanooga, Tenn.

AMERICA'S Best Buys. Radio Tubes 29c up. Free Bargain lists, Potter, 1314 McGee, Kansas City 6, Mo.

LITTLE Wonder Crystal Radio \$1.75. United Sales, Rt. 21, Parkersburg, W. Va.

24 BUSINESS OPPORTUNITIES

IF you'd like to make \$5,000-\$10,000 yearly in the Collection-Credit Agency business, write us at once. Outstanding opportunity. Cole Associates, Syracuse 2, New York.

\$25 WEEKLY working two hours daily. No canvassing. No Manufacturing. Lycke, Box 2471, Cleveland 12, Ohio.

START Home business making statuary, plaques, art goods, pottery, garden furniture, artificial marble flooring, liquid marble. Make flexible molds yourself. Amazing profits. Folder free. Creative Publishers, Box 236-M, Winnetka, Ill.

OPERATE profitable home business selling merchandise by mail. Fast sellers. Large profits. Powell Service, 5713 Euclid, Cleveland 3, Ohio.

RECAST old batteries into new. Latest achievements. Battery Laboratories, Minneapolis.

BIG Pay jobs in welding. Complete welding lessons and reference books, 516 pages, 41 lessons, \$2.00 copy. Money-back guarantee. Hobartweld, Box P-875, Troy, Ohio.

BOOKKEEPERS—Operate your own simplified "Dollar-A-Week" Bookkeeping & Tax Service. Full or spare time. Details free. Ellis, Box 203, Cedar Grove, N. Car.

MAIL Order Business course shows you how to make money, spare or fulltime. Teaches professional mail order technique—not penny-snatching schemes. Fascinating 100-page illustrated Success-Catalog Free! Write—Nelson Company, Dept. 4-01, Chicago 5.

MANUFACTURE costume jewelry at home for profit, hobby, therapy. Free wholesale supply catalogue. Instructions. Florida Supply House, Bradenton, Florida.

BUYERS Wanted for plaster novelties. Painted—Unpainted. Retail—Wholesale. Write today for free information. Bing Products, 88-X4B Broad, Boston 10, Mass.

MOLD-MAKING, Plaster casting. Money-making Business. Literature Free. Kemilo, Park Ridge, Illinois.

COMPOSITION Flooring—made in most colors. Lifelong. Soundproof. Resilient. Flexible Molds. Cast novelties, plaques, statuary. Big money—your own business. Catalog Free. Write—Bing Products, 88-B3H Broad Street, Boston 10, Mass.

SPECIALTY Manufacturing, the big money business that can be operated anywhere, start on a very small capital; we supply dependable formulas and complete instructions; get interesting Free booklet, "Money-making Opportunities in Specialty Manufacturing." Howard Robinson, Ph. G., 1300-B S. Ohio St., Sedalia, Mo.

I MAKE big money in the mail-order business. You can do the same at home with copyrighted system. Write me I'll tell you how. F. Little, Glenshaw, Box 8, Pa.

137 PLANS to make money local, mail order. Particulars free. Elite Co., 220-A Grand St., N. Y.

WHY Job Worry? Learn Electroplating. Highly Paid, uncrowded. Interesting Business. Gold, Silver, Nickel, Chromium, etc. Send Postcard for Free booklet and proof. Plater Hyde, Dept. SC P. O. Box 176, National City, Calif.

START Mailorder Bookshop—Everything furnished; publisher cooperation. 25c brings booklet, exclusive setup, samples, exciting ideas. General Publications, Ossining 1, New York.

GOOD Paying Business Silvering mirrors, plating autoparts, reflectors, bicycles, bathroom fixtures, etc., by late methods. No tanks or shop required, outfit furnished. Free Booklet. Gunmetal Co., Ave. E, Decatur, Illinois.

COLORGLAZED Concrete Pottery made without molds. New, low cost, patented method. Cemetery products, novelties, tiles, floors, etc. Basement leaksealing. Other money-making projects. Booklet, details free. Men only. National Potteries, Grand Rapids, Minnesota.

POPULAR SCIENCE OPPORTUNITIES

MAKE money casting new line Metal Toys and Novelties. Latest 1947 Scale Model Autos, Original Ashtrays, Savings Banks, Water Pistols, etc. Big wholesale and chain store orders now being placed at high prices assures big business and profits. Spare or full time. No experience or special place necessary. Write for details and illustrations of patterns needed. Metal Cast Products Co., Dept. E, 1696 Boston Road, New York 60, N. Y.

AMBITIOUS. Sell Xmas Cards, Stationery, Big Profits, Colored Catalog Free. Beacon Hill Greetings, 115 Chauncy, S. Boston, Mass.

HANDYMEN—Earn money home operating Community "Fix-it" Shop. Write, Stafford, 708 Rawlings, Carbondale, Ill.

OPPORTUNITY—New York, World Capital, publishes the most complete list of employment and business offerings in the world. Thousands of opportunities. Domestic and Foreign, under thousands of listings from Help-Wanted and Business propositions to Foreign Connections. Latest publications include current civil service tests and data. Complete only \$1.00 Postpaid. City Publications, 2781 Grand Concourse, New York 58, New York.

FREE Water and our concentrates makes flavors, lotions, shampoos. 72 products, labels, bottles furnished. Qualco, F-20030 Russell, Detroit.

EXTRA cash made easy just follow instruction particulars 10c. Douglas Atchison, 210 5th Avenue, N.Y., N.Y.

SEND 10c. The Haven Plan, 708 E. Haley, Santa Barbara, Calif.

NOW you can have an office. Learn credit-collection business by new home study course. May earn up to \$5,000-\$15,000 annually. Free bulletin. Franklin Credit School, Dept. 203-H, Roanoke 7, Virginia.

"HOW to build your own mail order Business", only 25c. Harry H. Friedlander, Spivak, Colo.

OPERATE Profitable Mail Order Business, splendid Opportunity free details. Gustafson, 2111 W. 67 St., Chicago, Ill.

OPERATE profitable mail order business. Splendid opportunity. For details write, Norbert A. Shelton, 924-B Herrick Avenue, Racine, Wisconsin.

AGENT or exclusive distributor for cigarette lighter mfg. MacGregor, Tahoe Valley 15, Calif.

EXCLUSIVE Franchise Distributor for new patented outboard motor carrier. Sportspal, Tahoe Valley 4, Calif.

DISTRIBUTORS wanted for nationally advertised, guaranteed, high-quality Brushless, Wipe-on Auto Paint and 1-coat Auto Spray Paint. Protected territory. No price competition . . . full profit margin. Easily make \$200 per week selling to Jobbers and Dealers. Requires \$500 to handle stock. Address Gold Seal Brands, 673 South Coronado, Los Angeles 5, Calif.

AT Home—Your own manufacturing business; making popular \$1.00 novelties. Cost you 3c to 15c. Everything supplied. Write So-Lo Works, Dept. X-601, Loveland, Ohio.

UNPAINTED Plaster Ornaments 2½c up. Oman, 642 Broadway, St. Paul 1, Minn.

"SELL By Mail! Books And Novelties! 35 different items! Large Profits! Catalog free. Elfco, 432 N. Wells, Chicago 10.

OPERATE profitable mail order business. Splendid opportunity. For details write, Annfred Service, 1227 Princeton Avenue, Philadelphia 11, Penna.

"TATTOOING and Engraving pays big profits. Experience unnecessary. Literature free. William Moore, 412-A South Green, Chicago 7, Ill."

GOT \$24,500 Using "Schemes" from "Schemer" Magazine, Alliance, Ohio, 49th year, \$1.00, Three samples 25c.

BABY Shoes Metalized the durable way. Complete instructions \$1.00. St. Albans Plating Industries, 135-17 135th Ave., So. Ozone, Long Island, New York.

THE Mail Order News (54th year) shows you money making opportunities in every issue. Sample copy 25c. Veterans Business Publications, Charleston 7, Ill.

ASTOUNDING modern mail order plans. Brings quick profits. Darrah, Orono 8, Me.

HOW To Set Up and Run A Mirror Shop! Resilver Mirrors. For Price write—John Sprinkle, V90, Marion, Indiana.

TYPEWRITER Repairing instructions, standard typewriters. Webers', Box 1008, Canton, Ohio.

FELLOW Workers—Down with Bosses—Start own business—Be Independent—Booklet describing 137 Tested Plans, free. P. Padney, 307 York St., Jersey City, N. J.

MEN—Women. All types mail order businesses for sale. Full or part time. Priced from \$100.00 up. L. Turnipseed, Box 681, St. Louis, Mo.

DISTRIBUTORS wanted for unusual \$2.98 Photographic product. Fine Profits. No competition. Fast seller. Repeats for hundreds of dollars. Complete sample \$2.00. Details Free! E. E. Morrison, Box 9312 Sta. S. Los Angeles 5, California.

MAILORDER Beginners. Save money by getting started right! Our new booklet may save you dollars! Only 10c, postpaid. Mail Order Mecca, 30 West Washington St., Chicago 2, Ill.

START a home business in spare time. Make extra money. Experience unnecessary. Literature free. Ellmar Service, Muncy 3, Penna.

QUICK Money! "Repairing Car Batteries." At home! Easy too! Write, Batteryman, Grand Junction 1, Colorado.

"FREE Booklet" "Key To Greater Earnings". James Williams, Box 2215, Hollywood, California.

WOULD you pay 3%—first \$350 made? Color-illustrated book "505 Odd, Successful Enterprises" free! Some offer occasional "day off." Work home. Expect something odd! Pacific-K, Oceanside, Calif.

MAKE Shell Jewelry—Easy, profitable. Illustrated book instructions 75c. Free Catalogue. Florida Shellcraft Co., Box 1840, Sarasota, Florida.

FLEXIBLE Molds to order, also originals. Professional course manufacturing molds and cast novelties. Latex, lacquers, flocks, flocking equipment, supplies. Plastics, Box 1574, Boston 4, Mass.

BRONZING and Metallizing baby shoes! Gold, Silver, Copper, Nickel, Bronze, Pearl, Ivory and "Luminous glow" colors! Big profits! New Field! Details free! Write R. O. Morgan, Box 349, Long Beach 2, Calif.

FLASH. New Novelty Large Profits, Dime, Hurry. Martin, P. S., 57 Hart, New Britain, Connecticut.

300 MONEY Making deals, plans, formulas, tips, schemes. Folio Free. Formico Prod., Box 572, Dayton, Ohio.

HOW To Sell By Mail. "Planned and Profitable" Mail order selling. New, different work-book of ideas and instruction for beginners, aspirants, established dealers. Send 25c for copy of leading mail order trade magazine and complete details. Year's subscription \$3. Mail Order Monitor, 356 South Broadway, Suite 706 PS, Los Angeles 13, California.

NAMES—Addresses. Wholesalers, Manufacturers, etc. Dime each. Three 25c. National, 3537-A South Hoyne, Chicago 9.

PROFIT Opportunities Galore each issue! Home-worker's Money-Maker's Leading Magazine. "Monitor". Rush 25c, sample, Special offer! Jackson, Newfoundland 4, Kentucky.

"INCREASE Your Income" by mail! Free literature tells how. Sackett's, 92 Waring Avenue, Mansfield, Ohio.

DO it with Sea Shells. Big profits. Werts, 1429 56th Avenue, Oakland 3, California.

TRAVEL anywhere anytime. Earn \$85.00 week up. Be your own boss. No experience necessary. Less than \$5.00 investment required. Literature free. Traveler, La Grange 2, Indiana.

INVENTORS. Capital Seekers. Startling Information. Free. Write—Director White, 3439-B, Michigan, Chicago 16.

OPERATE Profitable Mail-order business. Write—Gallagher Publications, Box 6911, Kingsport, Tenn.

METALLIZING baby shoes makes you money! Learn this simple, profitable business from Nationally recognized authority. Get professional results with professional "know-how"! Free particulars. Joseph B. Kushner, Metal Finishing Consultant, Stroudsburg, Penna.

SELL Books By Mail. Large Profits! Free Literature. Cline-Porter, Box 6346 PS, Pittsburgh 12, Penna.

SYNTHETIC Latex with Neoprene base for making flexible molds! Quick drying! Safe! For home, classroom, or industry! Quart \$2.00. Gallon \$5.95. Full instructions. Beginners booklet on molding and plaster casting 25c. Plastercraft Supply Co., 1406 E. 43rd St., Cleveland 3, Ohio.

PROFITABLE mail order business can be yours. Details Free. Coast to Coast, Box 63-B, Station H, Buffalo 14, N. Y.

SWISS Musical Units, install powder. Cigarette boxes. Lloyd Kelley, Hanover, Mass.

SUPER X liquid molding rubber. Sample jar 25c, quart \$3.00, Gallon \$10.00. Free instructions. W. Wooley, 115-B, Donald, Peoria, Ill.

PROFITABLE ideas and items for selling by mail. Write Holdens, 4903 Rhodes Ave., North Hollywood, California.

\$99.50 PUTS you in the Popcorn business. Electric machine and all supplies. Poppers Supply, 145 Walton, Atlanta, Ga.

BIG money weekly! \$1.00 brings facts, sample. Money back guarantee. Kaylon, Box 329, N. Y. C. 10.

BABY Shoes Bronzing supplies. Plasticide or Onyx Bookends, Ash trays, Pen sets. Solidifying solutions. Box 2095-A, Wichita, Kansas.

OPERATE profitable mail order business. Write, Walter Service, 4159-B East 112th, Cleveland 5, Ohio.

DON'T be Mr. Average man. Be your own boss. Earnings unlimited. Operate from home. \$25.00 adequate investment for immediately earning \$200.00 weekly. Postal brings details. J. T. Van Zile, A-79 Mills Street, Morristown, New Jersey.

BY Now You've surely heard of Colorado's Fabulous Oil Boom. Largest new field discovered in last 20 years. More than 240 flowing wells. You'd like shot at \$1,000; \$5,000; \$20,000 on \$140? Then write or wire me immediately for free details. Hundreds of others have already. Dyer (1), 1835 Champa, Denver, Colo.

UP to \$1500 yearly selling by mail in spare time interest you? New ideas and plans every month. Details free. Idea of Month Club, 3023-B Greenmount, Baltimore 18, Md.

MAKE strange plastics—1c pound. Makes durable attractive floors, walls. Build with waste—Save half. Bays Laboratory, Oklahoma City 9.

SELL embossing kits by mail. Profitable circular plan. Small capital. Large returns. Operate spare time. Sample kit and details \$1.00. Kelley Service Bureau, 215 South Monroe, Kansas City 1, Missouri.

"INVESTIGATE Mail Order or Home Business, 140 new ideas. Write Marshall, Box 655, Centralia 12, Washington."

SEND \$1 for pattern and directions for manufacturing "Cute Baby Shoes". Parks, 1618 Rhode Island N. W., Washington, D.C.

START a clock shop while clock repairing is booming. Our easy to learn home study course with pictures and illustrations teaches you how to repair all kinds of clocks. Information free. Houston Clock Shop, P.O. Box 5086B, Houston 12, Texas.

TYPEWRITER Repairmen urgently needed. Earn \$40 to \$50 weekly spare time. Our easy to learn home study course teaches how to repair typewriters. Write for free information. Houston Typewriter Repair Service, P.O. Box 5357, Houston 12, Texas.

LEARN Piano Tuning, Repairing, at home. Tremendous field! Piano parts, tools furnished. Established 1935. Empire School of Piano Tuning, 606-A East University Ave., Champaign, Ill.

POPULAR SCIENCE OPPORTUNITIES

BIG Money In Vending Machines—Smallest capital start brings immediate profits that build permanent profitable business. Starting instructions free. Becker Vendors, 105-P Dewey, Brillion, Wisc.

BUSINESS Starters \$7,000 winners money-making opportunities. Chronicle—quarter, McPlastens, PS1430 Monroe, Chicago.

EARN Big Money metal plating with or without battery. Complete instruction folio \$1.00. Tes-Co, Box 189-SJ, Wilkes Barre, Penna.

RUBBER Molds—We create, for making ash trays, novelties, Religious figures, plaques, book ends, etc. Make big money duplicating hundreds of items, own your own business, start in spare time. Latest factory and shop methods. Also molds made to order. Get our prices. Information free. Write Shop Technician, 314 Westport Rd., Kansas City, Mo.

WOULD you like a profitable, steady business of your own? A business that you can build up in your spare time, at home, with small capital, and gradually expand it into a worthwhile enterprise? Bookkeeping offers just such an opportunity! The demand for a streamlined bookkeeping service is tremendous. No experience necessary. We show you how. Our experience will save you hundreds of dollars in seeking a worthwhile career as your own boss. Now is an ideal time to start. Write for free details. James Argodale & Associates, Zumbro Building, Rochester, Minnesota.

MOTHPROOFING and Cleaning Business Pays Well. I'll show you how to start on amazingly small capital. Write today for details on Eight practical plans. Howard Robinson, Ph.G., 1304-B South Ohio Street, Sedalia, Missouri.

SAVE 550 sprinkling hours. Spectacular Walking Trav-El-Awn Sprinkler. Turn on hose—Set "It" Forget "It". Automatic Shutoff. Dealers Wanted. Free Circular. Gateway Materials Co., 4867 Milwaukee Ave., Chicago 30, Ill.

ELECTRICALLY inclined men: \$100-\$200 weekly possible installing, rebuilding, maintaining Fluorescent Lighting. Amazing literature Free. Write Willis Fluorescent Lighting, Box 6, New York City 35.

OPERATE profitable mailorder business. Large profits. Small's, 6713 Baxter, Cleveland 5, Ohio.

88 MONEY MAKING OPPORTUNITIES

ELITE Collection describes 137 money-making plans; local, mail order. Particulars free. Elite Co., 220-A Grand St., N. Y.

EARN money at home—steady income—Write Successful Income Builders, 508-B, Hollywood 28, California.

\$25 WEEKLY Working two hours daily. No canvassing or manufacturing. Lycke, Box 2471, Cleveland 12, Ohio.

START Your own business! Big money manufacturing novelties, plaques, statuary. Free catalog. Write Bing Products, 88-B3K Broad Street, Boston 10, Mass.

\$246.50 MAKING baffling secret device without skill, machinery, from former top priority war material costing \$1.50! Guaranteed simple, revolutionary new discovery, unbelievably profitable. Universal appeal. Frank, illustrated proofs, free! Rolls Enterprises, 115 W. 16th., New York 11.

SEWING Machine Repairmen make big money lifetime. Start neighborhood shop. Complete repair manual, covering all makes, \$1.98 postpaid. Money Back Guarantee. Sewmachine Serviceman, Hamilton 10-D, Ohio.

DETECTIVES Earn Big Money. Experience unnecessary. Particulars free. Wagoner, P-125, West 86th, N. Y., N. Y.

MANUFACTURE costume jewelry at home for profit, hobby, therapy. Free wholesale supply catalogue. Instructions. Florida Supply House, Bradenton, Florida.

137 TESTED, proven, money-making plans, formulas, sources of supply. Literature free. James Boyle, 29B High, New Brunswick, N. J.

21 POPCORN, Candy Apple, etc. Formulas. All money-makers, \$1.00. We can supply equipment. Concessions Supply Co., Dept. "B", Box 133 Sta. "B", Toledo, Ohio.

METALLIZE baby shoes. Further information free. Metal Crafts, 5501 Suwanee, Tampa 4, Fla.

MAKE big money, build your own lamps and sell. Write for free factory photos. Buddy Products Manufacturing Co., 1123 W. Belmont Ave., Chicago 13, Ill., Dept. 35.

MAKE money six ways. Get orders by mail \$1.00 to \$20.00. Keep half. Complete Guaranteed plan, 25c. Franklin, 22219-S Telegraph, Detroit, Michigan.

SHELLCRAFT Sells! Have fun making genuine marine shell jewelry. Make money selling to stores and friends. Save money buying direct from wholesaler. Large kit \$1.00. Jumbo \$2.49. Instructions free. Eastern Shellcraft, 985 Myrtle Ave., Brooklyn 6, N. Y.

MAKE Perfume, Make Money. Free book tells how. Lawson, 21 Joiner, Saint Augustine, Florida.

WIN money on contests advertised in every magazine and on radio. General Contest Magazine, published monthly, gives hundreds of tips. Lists current contests and rules. Sample 25c. General Contests, 1609-A East 5th, Duluth, Minn.

"THERE'S Big Money In Junk," and repairing Car Batteries! Batteryman, Grand Junction, Colorado.

PRIZE Contest Fans Reap Rich Rewards. Enclose 3c stamp. National Contest Bulletin, Box 2685-S, Miami 31, Fla.

200 OPPORTUNITIES to make money selling by mail, only 50c. Roy Kramer, 329 Cates, Maryville, Tenn.

METALLIZE flowers for profit! It's new, easy, sure fire! Free details; Joseph B. Kushner, Metal Finishing Consultant, Stroudsburg, Penna.

EARN Up To \$2,000 year, inventing simple items for special cash markets. Hendrickson, Argyle 8, Wisconsin.

EARN Money Evenings, copying and duplicating comic cartoons for advertisers. Adservice, Argyle 2, Wisconsin.

PROFIT Opportunities Galore each issue "Monitor"! Home Sparetime workers Leading Magazine. Rush 25c for sample copy, special offer, details! Monitor, Dept. C, 506 1/2 S. 15th St., New Castle, Indiana.

SHELLCRAFT! Make beautiful seashell jewelry! Large! Illustrated! Wholesale! Catalogue 40 designs! plus instructions! Including sensational violet corsage! Scottie! Rooster! Lamb! Butterflies! Barrettes! Indian Head! Tally and Place Cards! etc. \$3.00 Value! 100 shells identified, designs and instructions, (complete 25c) Shells Colored! Package or Gallon! Earrings! Cameos! Chains! Plastics! etc. Complete Line. All illustrated! (Buy direct.) Paces, Box 279, Bradenton, Florida, Dept. G.

EXCELLENT profits raising mink. Details furnished. Franklin Young, Riverhead, N. Y.

VETERANS! Be financially independent. Changes in loan guarantee not generally understood offer amazing possibilities for income and profit. Don't miss your greatest opportunity. H. B. Smith, Box 747, Dept. H, Youngstown, Ohio.

SEE rare snake-headed flesh-eating plants devour live insects. Unequaled in sales appeal. Bring sensational profits. Free particulars. (Sample Guaranteed seeds \$1.00.) Enterprises, 157 Golfdale, Toronto, Canada.

1947 GIGANTIC Directory of Opportunities. Advertisers Supplies, Sources, Trade Information. Mail Order Ideas, Products, Wholesalers. Valuable tips—just published! Descriptive literature Free. Wilkin & Co., Hillsboro 2, Ohio.

START Home Mail Business! Exclusive setups built-to-order for financially responsible beginners, by leading M.O. Association's export staff. Booklet Free! N.M.D.A., 33-A Vassar, Dorchester, Mass.

SOMETHING different, 900% profits. Experience unnecessary. J. W. Arrington, La Grange 5, Georgia.

SEND \$1 for Money Making Career! Parks, 1618 Rhode Island N. W., Washington, D. C.

SHELLCRAFT Instructions—Free! Make beautiful seashell jewelry! Wholesale Catalogue of complete line shells! Plastic discs! Animal Shapes! Pinbacks! Earrings! Cameos! etc. (Buy Direct). Pace's, Box 279, Bradenton, Florida.

UPHOLSTERING Start your own Shop beginners Kit and Instructions. Write Wynn and Graff, 5116 Charlotte, Nashville, Tenn.

SPARE Time Home Work Plans. Write. Business Plans Co., 1242 Park, San Jose, California.

59 FORMULAS, PLANS, ETC.

137 MONEY-making plans, also formulas for salable products. Descriptive booklet free. Elite Co., 220-A Grand St., N. Y.

FORMULAS—All kinds. Latest money-makers; literature Free. Kemi-Kal, Park Ridge, Ill.

10,000 FORMULAS and Trade secrets. Free Literature. Stillmans, 555 Kingston Ave., Brooklyn 3, N. Y.

FORMULAS — Latest Best, Analysis. Giant formula catalog and chemical instruction Sheet 10c. Refunded first order. E-Belfort, Engineering Building, Chicago 6.

100 SINGLE ingredient formulas 25c. Tes-Co, Box 189-SG, Wilkes-Barre, Pa.

106 PLASTICS

PLASTICS, Free List. Swiss Music Box Units \$3.50—New Plexiglas Manual \$1.50. Plastic Supply Co., 2618 St. Louis Ave., Dept. PS70, St. Louis 6, Mo.

MAKE money assembling our pre-fabricated plastic kits. Sample Kit 50c. Catalog free. Fabros, Box 156, Station F-2, Buffalo 12, N. Y.

PLEXIGLAS—Masked—12x12—1/16" 95c Plus 10% postage. Free Listings. Craft Plastics, Box 129-S, Somerville, New Jersey.

METALLIZE plastics for profit! Free particulars. Joseph B. Kushner, Metal Finishing Consultant, Stroudsburg, Penna.

PLEXIGLAS Sheets 1/10" x 12" x 12" 78c; 12" x 15" 96c; 1/8" x 11 1/2" x 12" 98c; 13" x 17" \$1.60; 6" dia. x 12" length x 1/4" wall clear cylinders \$1.60; Ten color rod assortment including phosphorescent \$4.00. Include postage. Julian Rhodes Muench Co., 1527 W. Alabama, Houston 6, Texas.

NEW liquid plastic. Clear, colors. Cast without heat. Embed flowers, insects, coins. Saw, drill, carve. Manual tells how. Send \$3.35 for complete 20 project kit including one pound liquid Castolite. Castolite, Dept. J-24, Box 211, Kenilworth, Ill.

33 CHEMICALS AND APPARATUS

THE House of Winn, home of supplies for amateur chemists. See Winn's New Idea chemical kits and apparatus outfits for home experimenting. Send 10c for retail catalog. Established 1931. John H. Winn, Dept. 607, 124 W. 23rd St., New York 11, N. Y.

CHEMICALS-Lab, Supplies New Catalog 10c. Mel-Glo Chemical Co., 258 Fourth Avenue, Brooklyn 15, N. Y.

SPECTROSCOPE For Quick chemical analysis \$3.00. Cutting Co., Box 457, Campbell 2, California.

LABORATORY Supplies At Wholesale Prices. Chemistry, Biology, Physics, Geology. Catalogue 10c. National Scientific Company, Established 1908, 2204 W. North Ave., Chicago 47, Ill.

LUMINOUS Paints will glow in dark. Six colors. Fairmount Chemical Co., 136 Liberty St., New York City 6.

FREE Catalog: Chemistry, Mineralogy, Biology. Tracey Laboratories, 1907 Harrison, Evanston, Ill.

POPULAR SCIENCE OPPORTUNITIES

CHEMICALS and apparatus for industrial, analytical, and private laboratories. Complete supply service for correspondence school students. Send 3c for catalog. Dept. M-26, Biological Supply Co., 1176 Mt. Hope Ave., Rochester 7, N. Y.

CHEMICALS, ounce quantities, apparatus, catalog 5c. Fleischer's Laboratories, Everett 49, Mass.

NEW laboratory Supply Catalog of Chemicals and apparatus. Contains over 5000 items with illustrations, 212 pages. Send 50c. Standard Science Supply Co., 1232 No. Paulina St., Chicago 22, Ill.

SAVE!! Get "Planning Your Laboratory". 25c Catalog. 10c. Pilgrim's Chemical, 2435 South State, Salt Lake City 6, Utah.

5 AGENTS WANTED

GOOD Paying Business Silvering mirrors, plating autparts, reflectors, bicycles, bathroom fixtures, etc., by late method. No tanks or shop required, outfit furnished. Free Booklet. Gunmetal Co., Ave. G. Decatur, Illinois.

FREE! Latest issue Opportunity Magazine, Salesman's Guide. Inspiring, constructive. Shows how to earn money selling for others or in your own business. Hundreds postwar opportunities. Send name and describe what you have sold or are selling. Illustrated copy sent Free. Opportunity Magazine, 620 N. Michigan, Dept. 18, Chicago 11, Ill.

SELL Personalized soap. Name on every cake. Ideal for gifts. Get sample offer. Dunbar Soap, New Brunswick, N. J.

LICK After-war layoffs; Start own business; home, office. Booklet describing "Collection of 127 Tester Plans" free. Elite Co., 220 Grand St., New York.

AGENTS—300% profit selling genuine gold window letters; stores and offices. Free samples. Metallic Letter Co., 437 N. Clark, Chicago.

SELL Personal Initialed Individualized Belts, Buckles, Cap Badges, Tie Holders, 2,000 emblems to choose. Fast profits. Repeats. Write today special outfit offer. Hookfast Specialties, Box 1425, PS, Providence, Rhode Island.

90c PROFIT Each \$1.00 Sale. Sell Positive mothproofing solution to housewives, stores, agents. Experience unnecessary. Postal brings details. Kinford, Wayne 4, Pa.

\$1. STARTS you in business. Sell DeLuxe ties, 100% wool interlining. Costs you only \$7.00 per dozen, you make \$5.00 Dozen. Send \$1.00 for special introductory offer two DeLuxe ties. Catalog complete line Free. Phillip's Neckwear, 20 West 22nd St., Dept. P-14, New York 10.

GOLD lacquered Window Sign Letters. Large Sizes Penny Each. New Foils. Absolutely Beautiful. Free Samples. Atlas, 544 W. 79th, Chicago 20.

MAKE money in your spare time! Helps furnished. Easy sales. Voluntary repeat orders. Liberal commissions. Write for Free Wholesale Price List Today! McGregor Magazine Agency, Dept. PS-7, Mount Morris, Ill.

"BIG bargains for big profits. Over 100 sensational values. Men's used suits \$2.00, pants 35c, topcoats \$1.25, Overcoats \$2.00, shoes 20c. Experience unnecessary. Free wholesale catalog. Superior, 1250-A Jefferson, Chicago 7."

GREETING Card Agents: "Line Up" with "Pines" for bigger, better and quicker profits. Rush name, address on postcard today. Box 32, Flushing 6, N. Y.

START Your Own Business on Our Capital. Always your own boss. Hundreds average \$6,000 to \$25,000 annual Sales. We supply stocks, equipment on credit. 200 home necessities. Selling experience unnecessary to start. Wonderful opportunity to own pleasant, profitable business backed by world-wide industry. Write Rawleigh's, Dept. H-U-PSC, Freeport, Ill.

JUST Out! History of World War II. Huge Volume. Popular price. Authentic text. Official photographs. Big profits. Riverside Book Company, Iowa Falls, Iowa.

MAGIC Cleaner and laundry soap deal. Hotter than a firecracker. Big Profits. Sample free. Uko, 5007 Irving Park, Chicago.

QUICK Profits selling full or part time, individualized buckles, belts, cap badges, tie holders, uniform shirts, caps, ties. Choice of thousand emblems. Sure repeat orders. Easy-selling outfit offer. Write Hook-Fast Co., Dept. 14, Roanoke, Va.

ADVERTISING Book Matches—Cash In On Political Campaigns—sell Union Labels matches. Cuts for all businesses and political parties—Free powerhouse selling kit—low prices—protection guaranteed on repeat orders—Cash Commissions. Superior Match Co., Dept. P87, 7530 Greenwood, Chicago.

\$50 CASH For Selling 100 Assortments of 21 Christmas cards at \$1.00. Complete line. Free samples 50 for \$1.00 cards. Special offers. Write today. Hedenkamp, 343 Broadway, Dept. T-22, New York 13.

CHRISTMAS Cards. Earn Big Money. Take orders galore from friends. 25 exquisite folders with name, \$1.25. Free samples 10 designs. America's Fastest Selling 21 Christmas Folder Box. Costs 50c. Sells \$1. Request samples today. Sunshine Art, Dept. NC-8, 115 Fulton St., New York 8, N. Y.

AT last! Something new and sensational in Christmas Cards. Amazing "Oilette" Cards. Like costly oil paintings. Designs never before offered. Quick orders. Beautiful 50 for \$1 Cards, name imprinted. Big Profits. 20 other assortments 60c to \$1. Samples on Approval. Puro Co., 2801 Locust, Dept. 741K, St. Louis, Mo.

"PRESSURE Cookers." Now available. Selling like wildfire. Amazing profits. Write quickly. Morris Mandell, Inc., 131-W W. 14th St., New York 11, N. Y.

CHRISTMAS Card Agents! New, exclusive, patented children's linenette books. Four books in attractive packet. Retail 50c. Sample on approval. Also Cut-out Valentine Assortment. Elmcraft Card Co., 5928 South Western, Chicago 36, Ill.

NEW, extra money plan. Up to 100% profit showing friends unusual Personal Christmas cards, Box assortments, gift wrappings, humorous, all occasion, Religious, social notes, personalized stationery. Extra bonus. Request Free 50 for \$1.00. 25 for \$1.00, 25 for \$1.95 name imprinted Christmas Cards and personalized Stationery folder. Special Offer. Thomas Terry Studios, 60 Union Avenue, Westfield, Mass.

SILVER plating Liquid. Apply with cloth. Renews silverplated ware. Cleans, silverplates, polishes, one rubbing. Genuine silverplate. Also silverplates brass and copper. Male and female selling representatives wanted. Part or full time. Exclusive. Wholesale and retail. NuProcess Products, Aurora, Illinois.

BIG Commissions. Boost income quickly. Sell stores, restaurants, bars. Plastic tickets, shelf moulding, menu covers, signs. Write today. Pricing Press, 124 White St., Dept. C, New York 13, N. Y.

MAKE Money Selling Genuine Leather Jackets. Prospects everywhere. Top quality, full cut, exclusive features. Big Cash Commissions. Also 250 styles fine Shoes. Sample Outfit Free. Consolidated, Dept. S-803, Chippewa Falls, Wisc.

MAKE money easily. Sell 50 for \$1.00 Christmas cards. Cost you as low as 45c. Big line Christmas and Everyday assortments. Sell only 50c to \$1.00—your profit 25c to 55c per box. Extra bonus. Write for free samples personal Christmas cards, name imprinted stationery and leader 21 card Christmas. 16 card feature All-Occasion assortments on approval. Special offers. Elmira Greeting Card Co., M-55, Elmira, N. Y.

YOU make \$25 for selling fifty \$1.00 boxes 50 beautiful assorted Christmas cards sell for only \$1.00 your profit 50c. Write today for free samples 50 and 25 for \$1.00 and other boxes on approval. It costs nothing to try. Cheerful Card Co., 130 White Plains, N. Y.

SHINE Shoes Without "Polish". New Invention. Lightning seller. Shoes gleam like mirror. Samples sent on trial. Kristee, 112, Akron, Ohio.

AMAZING New Zipper Shoe sells on sight. Big profits for salesmen. Leads line 200 splendid styles. Territories open. Get Free Sample Outfit. Write Victor Thomas, Dept. V818, Chippewa Falls, Wisc.

QUICK cash. Sell friends wonder-value 50 for \$1.00, extraordinary 25 for \$1.00 personal Christmas cards. Personal stationery. 32 sensational money makers. Up to 100% profit. Bonus. Write for 6 Free self-selling sample portfolios of 50 for \$1.00 to 25 for \$2.50 name imprinted Christmas Cards. Special offers. Rainbow Greeting Card Co., 36 E. 12th St., Dept. 18-A, N. Y.

FAST Selling Carded Auto Accessory and Other Items. write Steele Plastics Co., Ashland, Ky.

EXTRA money so easy. Sell friends beautiful 50 for \$1.00 name imprinted Christmas cards. Extensive line assortments 30c up. Profit to 100%. Extra bonus. Request free samples personal Christmas Cards, stationery and leader \$1.00 Christmas. Everyday assortments on approval. Special offers. Tom-Wat Studios, Dept. PS, Bridgeport, Conn.

FRIENDLY social visits bring you big Christmas card profits. Show 33 different top-quality assortments as low as 30c each. Odd cards 2½c. Up to 100% for you. Cash bonus. Send at once for free samples 25 and 50 for \$1.00 personals, name imprinted stationery and feature \$1.00 assortment on approval. Special offers. New England Art Publishers, Box F, North Abington, Mass.

BIG First Commissions. Sensational automatic repeats, with new Sales Building Plan for retailers. First since V-J Day. Customers get big value tableware; cost retailers nothing. Positively hottest deal in selling. Rush name for facts. Alco Sales Company, 215 West Ontario, Dept. C-616, Chicago 10, Ill.

NO investment. Throw rugs. Big profits. Good repeaters. Investigate this opportunity. Warren Rug Mills, Box 243B, Phillipsburg, N. J.

SALESMEN—Free advertising and demonstrating sales kit to qualified men. Product sold 15 years. Prospects everywhere. First ad for new men since the war. Write 707 Red Comet Bldg., Littleton, Colo.

SELL Christmas Cards! Choice of forty Assortments! Earn 60c on dollar sales! Bulletins Free! Elfco, 434 North Wells, Chicago 10.

"SHOW Jiffy-Till, the midget tractor with "The Magic Hoe". All gardeners want it. Exclusive compact design, gives scientific tillage without fatigue. Box 394, La Mesa, Calif.

SELL Delicious Candies, Nuts, Gum. Immediate delivery. Write Casterline, 2031-L Sunnyside, Chicago 25, Ill.

AGENTS Wanted for our Slot Machines and coin operated amusement games in every town and community. Sell to clubs and homes, or start a route. Webb Distributing Co., Dept. P40, 6 So. Kedzie Ave., Chicago 12, Ill.

SELL Ultra blue stock signs to stores, 1000 slogans, comedy, general, religious. 7 x 11, cost 6c, sells 35c. Make money. Sample free. Lowy, 8 West Broadway, Dept. 328, New York City (7).

WOULD you pay 3%—first \$350 made? Color-illustrated book "505 Odd Successful Enterprises" free! Proven! Work at home, office. Expect something odd! Pacific-L, Oceanside, California.

DISTRIBUTORS Wanted For Unusual Products. Levine's, 15-S Boulevard Station, New York 59, N. Y.

AGENTS—Salesmen. Make \$75 and up weekly on our capital taking orders fast selling Cosmetic line write for Special outfit offer. Lady Raye Cosmetics, 517 E. 43 St., Chicago 15, Dept. PS.

SELL Hangover Tablets for alcoholic hangover. Thousands sold on West Coast. Send \$1.00 for sample and information. Research Clinic, Box 302, Altadena, California.

NAMES—Addresses. Wholesalers, Manufacturers, etc. Dime each. Three 25c. National, 3537-L South Hoyne, Chicago 9.

SENSATIONAL power mowers—\$66.00 up (net). Gas-electric. Rotacut, M-2014, Ex. Springs, Mo.

POPULAR SCIENCE OPPORTUNITIES

SELL New, Different, Exclusive Christmas Cards. 50 with name imprinted \$1. Extra \$\$\$ New Bonus Plan earns you up to and over 100% Profit. Compare our 21-folder "Champion" Assortment, sells for \$1. sent on approval, no investment. Etchings, Panoramas, Florals, Religious, Gift Wraps, Birthdays, also stationery. Free Samples of many extra-profit Imprint Lines. Work with a leader! Write today. Pen-n-Brush Studios, Dept. PS-8, 154 Nassau St., New York 7, N. Y.

\$3 FIRE Extinguisher sells wholesale or direct. "Fire-Killer", 101 Franklin, Syracuse 1, New York.

"**PRESSURE Cookers.**" Now available. Selling like wildfire. Amazing profits. Write quickly. Morris Mandell, Inc., 131-W W. 14th St., New York 11, N. Y.

CHRISTMAS Cards.—DeLuxe, Scripture Text, Oilettes, Mellotone, Humorous, Etchings, Economy Assortments, Personalized Papeteries. Raum, 4154b Fifth Street, Philadelphia 40.

FREE! Big 32 page 8½ x 11 magazine, that tells how to make money in local or mail order selling! "Opportunities Preferred", 33-S Vassar, Dorchester, Mass.

A NATURAL! Big money selling new line one piece lace, Plastic Tablecloths. Sizes to 54x108. Also Women's Aprons; Novel, Embroidered Cotton Pillow Cases. Free, "interesting" details. Royalty, Box 748-L, Passaic, N. J.

MEN and Women—Make extra money. Sell costume and novelty jewelry; retail from \$2.50 to \$5.00 a set. Ask for our free catalogue. C. Setola, 931 Broadway, Bayonne, N. J. Wholesale Distributor.

HOUSE Numbers that glow in the dark. Luminous pictures, etc. Large mfr. wants factory representative. Wonderful new product. Fast seller. Free Samples, Madison Mills, 303 4th Ave., N. Y. C.

69 HIGHGRADE SALESMEN

SALESMEN! First Offering! Agents. New patented auto accessory, sells on sight to jobbers, garages, filling stations, only product of its kind, get repeat orders, exclusive franchise available. Send \$2 for sample display card with 12 fast selling accessories. Law Mfg. Co., P. O. Box 628, San Diego 7, California.

ADVERTISING Book Matches—World's largest direct selling Mfr. of advertising Book Matches offers opportunity for profitable year 'round selling; Every business a prospect; No Exp. needed to start; Full or part time; Factory service; Low prices for high quality; Repeats; Sales Kit Furnished. Match Corp. of America, 3433-43 W. 48th Place, Dept. N-10, Chicago 32, Ill.

AMAZING daily profits, repeat business, selling direct. Colt's sensationally new Whippets, \$6.95 loafer oxford with DuPont neoprene crepe soles. Men buy on sight, stores, garages, colleges, factories. Experience unnecessary. Free catalog, outfit, 216 styles. Colt Shoes, 601-C8 Atlantic, Boston 10, Mass.

50 EMPLOYMENT SERVICE

DRAFTSMEN — valuable information, write Draftsmen's Club, Box 198, Elyria, Ohio.

47 EDUCATIONAL AND INSTRUCTION

MODERN Welding School gives thorough training for one of industry's best paid jobs. Experienced instructors. Individual attention. Nonprofit institution. Qualified under G. I. Bill. Write for literature and details. Hobart Brothers Co., Box P-876, Troy, Ohio.

GOOD "Used" self-instruction educational books on all subjects bought, sold, rented, exchanged, Satisfaction guaranteed. Complete information and 100-page illustrated bargain catalog Free! Write—Nelson Company, Chicago 5.

BE A Pedopractor:—Foot Correctionist. Extension. Degree. Alaska Foot Institute, Juneau, Alaska.

HAVE your own office! Many earn up to \$5,000-\$15,000 Annually. Learn credit-collection agency business by home study course. Experience unnecessary. Write for Free bulletin. No obligation. Franklin Credit School, Dept. 203-H, Roanoke 7, Va.

BIG money rebuilding shoes. Help needed everywhere or start big-income business of your own. Learn practical, sure, easy way in 3 months. Anyone from 18-60 years can learn easily. Approved for G.I. training. Rush postcard today. Modern Shoe Rebuilding School, Est. 1927, 2935 Belmont, Chicago 18, Illinois.

PREPARE for civil service examination. Pay for course after securing position. Write Free School, Dept. PS-8, Kokomo, Ind.

USED Correspondence Courses and Educational Books Bought, Sold, Rented, Catalog Free. Educational Exchange, Hengar, Alabama.

BECOME a Doctor of Psychology or Metaphysics. Teach secret of contentment, happiness. Win degree of PsD. or MsD. Solve mental worries. Free book. College of Universal Truth, 5153-K N. Clark, Chicago.

HOME study courses. Any vocation. Free aptitude test. DeVoto Schools, 35 Vicente, San Francisco 16, California.

CLINICAL Laboratory Technicians in great demand. We train you in your spare time, in your own home. You can practice while studying. Write for free catalogue. Imperial Technical Institute, Box 973-B, Austin, Texas.

AMAZE others. Add faster than adding machine. Free details. Maths Institute, Box 633, Mobile 4, Ala.

LEARN Piano Tuning. Prepare for Career in fascinating profession. \$5000 year easily earned. Real security, pleasant easy work. No profession Paying so well can be mastered so quickly. Natural Aptitude, desire to get ahead chief requirements. Prospectus and full information on request. Harmony School of Piano Tuning, Box 582, Harrisburg, Pa.

HOME Study course, drugless therapy. Free Literature. Inst. of Drugless Therapy, Tama, Iowa.

77 LANGUAGE OUTFITS

29 LANGUAGES by Linguaphone, Russian, Spanish, Portuguese—Direct Conversational Method for Mastering any language quickly, easily, correctly at home. Available under GI Bill of Rights. Send for free Book, Linguaphone Institute, 54 RCA Bldg., New York, CI 7-0830.

10 AUTHORS SERVICE

NEW Writers Needed. Nonfiction material demand is booming. Many magazine editors buy features and "fillers" from new writers. Our Earn As You Learn lessons prepare you to meet their requirements. Experience unnecessary. Reasonable price, unexcelled service. Details, sample lesson free on request. Use postcard. No obligation. Comfort Writer's Service, 210RN S. 7th St., St. Louis 2, Mo.

I WANT New Writers to cash hundreds of checks for \$1 to \$100, offered each month. The easiest way to write for pay. No previous experience necessary. Send for Free details. No obligation. Saunders M. Cummings, 467-S Independence Bldg., Colorado Springs, Colo.

25 BUSINESS SERVICE

GOOD "Used" self-instruction educational books on all subjects bought, sold, rented, exchanged, Satisfaction guaranteed. Complete information and 100-page illustrated bargain catalog Free! Write—Nelson Company, Chicago 5.

TO Whom It May Concern: We will represent you in all principal cities of the world. Representatives wanted. Will send you assignments immediately. James W. Farley, Citizens Building, Cleveland 14, O.

GENERAL Engineering Service to Businesses, small manufacturers, fabricating concerns, individual enterprises, in the fields of Mechanical, Electrical, Electronic, Process, Chemical, Metallurgical and Structural Engineering. Write "Engineering Service," P. O. Box #927, Youngstown, Ohio.

30 CARTOONING, SIGN PAINTING, DRAWING AIDS

"**HOW** To Make Money With Simple Cartoons"—A book everyone who likes to draw should have. It is Free; no obligation. Simply address Cartoonists' Exchange, Dept. 198, Pleasant Hill, Ohio.

TALENT Test Free. American School Commercial Art, Box 8066, Dallas 5, Texas.

MAKE Signs, 9 complete alphabet pattern sets, 3 complete numeral pattern sets and catalog \$1.00. Sign Letter Distributors, P.O. Box 101, Mineola, N. Y.

PAINT beautiful pictures quickly, easily, inexpensively. Free literature. Art Book Shop, Arnold 6a, Mo.

SIGNS made easily. Instructions and ten sets modern alphabets, numerals, patterns. Sizes up to eight inches. All for \$1.00. Co-operative Business, 7 West Madison, Chicago, (2).

31 CHALK TALK STUNTS

CHALK Talks, Laugh Producing Program, \$1.00. Illustrated Catalog 10c. Cartoonist Balda, Oshkosh, Wisconsin.

136 TYPEWRITERS

RECONDITIONED Typewriters, Printing Devices, Office Appliances Supplies Dixiegraph, King, N.C.

110 PRINTING OUTFITS, SUPPLIES

"**PRINTOMATIC**" Selffeeding Post Card Stencil Printing Duplicators \$9.50 Up. Office Size Duplicators, Speedoprints, Hilcos, Excellographs \$33.41 Up. Literature Free. Pittsburgh Typewriter Supply, 336 WE Fourth Ave., Pittsburgh 22, Pa.

PRINTING presses, type, supplies. Send dime for complete illustrated printer's supply book, details and press samples. Kelsey, Inc., A-8, Meriden, Connecticut.

44c TYPE catalogue, lists 10c. National Type, 8508 Harper, Detroit, Mich.

HOME Made Presses. Write Riegel, 1111 Harrison, Philadelphia 24, Penna.

INEXPENSIVE home-made printing press. Details free. Novelty Shop, Downs-ville, Louisiana.

PRINT At Home—Send 10c for Catalogue—Type, Presses, Supplies. Barnhard Co., 6 Columbia St., Newark 8, N. J.

109 PRINTING, MULTIGRAPHING, ETC.

1000 BUSINESS cards printed prepaid \$2.50. Reliable Print Shop, 901 E. Jefferson, Louisville, Ky.

SPECIAL! 500 6¾ Envelopes printed \$2.35. 24 Hour Service. Mango, 555-B South 20th, Newark 3, N. J.

QUALITY Printing: Reasonable prices. State requirements. Samples. Mero Products, 99 Morrison, Punxsutawney, Penna.

SEND 10c Now, for our 36 page price-list—Refunded first order. McCall Press (PSM), 1326 South 27th, Omaha 5, Nebr.

1000 BUSINESS Cards \$2.45, 1000 6¾ Envelopes \$4.95, 1000 8½x11 Letterheads \$4.95 (Postpaid). Madison Printing, Madison, Ohio.

PRINTING—All kinds. Free estimates. Prompt. Reporter, Chelsea, Oklahoma.

98 PATENT ATTORNEYS

INVENTORS: Without obligation, write us for information as to what steps an inventor should take to secure a Patent. Randolph & Beavers, Registered Patent Attorneys, 340-A Columbian Bldg., Washington 1, D. C.

INVENTORS: Write for free brochure "Evidence of Invention." Labiner, World Building, New York 7.

INVENTOR'S Guide free on request. Frank Ledermann, Registered Patent Attorney, 154 Nassau St., New York 7, N. Y.

C. A. Snow & Co.—S-427, Snow Building, Washington 1, D. C. Registered Patent Attorneys. Write for information.

POPULAR SCIENCE OPPORTUNITIES

PATENT and Trade-Mark Practice before U. S. Patent Office, Validity and Infringement Investigations and Opinions. Booklet and form "Evidence of Conception" forwarded upon request. Lancaster, Allwine & Rommel, Registered Patent Attorneys, Suite 413, 815-15th Street, N.W., Washington 5, D. C.

INVENTORS: Learn how to protect your invention. The United States Patent Office advises the inventor to engage a competent, registered patent attorney or agent to represent him. We maintain a staff of registered patent attorneys ready to serve you in the handling of your patent matters. Special booklet "Patent Guide for the Inventor" containing detailed information concerning patent procedure with "Record of Invention" form will be forwarded upon request—without obligation. Clarence A. O'Brien & Harvey Jacobson, Registered Patent Attorneys, 72B-G District National Building, Washington, D. C.

INVENTORS. For "Record of Invention" form, contact Carl Miller, Registered Patent Attorney, Woolworth Building, New York.

INVENTORS—Patent Laws encourage the development of inventions. The Rules of Practice of the U. S. Patent Office advises—unless an inventor is familiar with such matters—that he employ a competent registered attorney or registered agent, as the value of patents depends largely upon the skillful preparation of the specifications and claims. Write for further particulars as to patent protection and procedure and "Invention Record" form at once. No obligation. McMorrow, Berman & Davidson, Registered Patent Attorney, 143-D, Victor Building, Washington 1, D. C.

PATENT Protection—The U. S. Patent Office recommends—"an applicant is advised, unless familiar with such matters, to employ a competent registered Patent Attorney or registered Patent Agent, as the value of patents depends largely upon the skillful preparation of the specification and claims." Preliminary steps to take to obtain patent protection will be sent upon request. Victor J. Evans & Co., 241-J Merlin Building, Washington 6, D. C.

PATENTS—Trade marks. Irving L. McCathran, 316 McLachlen Bldg., Washington 1, D. C. Registered Patent Attorney.

58 FOR INVENTORS

THE Inventor who believes he has a new and useful invention, and needs advice, should consult a competent registered patent attorney. Without obligation, write for full information on how to secure Patents and Trademarks. Randolph & Beavers, Registered Patent Attorneys, 340-E Columbian Bldg., Washington 1, D. C.

"INVENTOR'S Guide" free on request. Frank Ledermann, Registered Patent Attorney, 154 Nassau St., New York 7, N. Y.

INVENTORS: Avoid unnecessary expense. Write for free booklet explaining how our Consulting and Advisory Service can assist you in deriving greatest profit from inventing. Institute of American Inventors, Dept. 30-A, 1926 Eye St., N.W., Washington 6, D. C.

PATENTED, Unpatented inventions promoted. M. Joyce Humphries, 1424 Landtitle, Phila 10, Penna.

INVENTORS—Patent Laws encourage the development of inventions. The Rules of Practice of the U. S. Patent Office advises—unless an inventor is familiar with such matters—that he employ a competent registered attorney or registered agent, as the value of patents depends largely upon the skillful preparation of the specifications and claims. Write for further particulars as to patent protection and procedure and "Invention Record" form at once. No obligation. McMorrow, Berman & Davidson, Registered Patent Attorneys, 143-C, Victor Building, Washington 1, D. C.

HIGHEST Royalties and cash for your inventions when we market them. Free particulars without obligation. Universal Marketing Co., 126 Lexington Ave., New York 16, N. Y.

INVENTORS: Learn how to protect your invention. The United States Patent Office advises the inventor to engage a competent, registered patent attorney or agent to represent him. We maintain a staff of registered patent attorneys ready to serve you in the handling of your patent matters. Special booklet "Patent Guide for the Inventor" containing detailed information concerning patent procedure with "Record of Invention" form will be forwarded upon request—without obligation. Clarence A. O'Brien & Harvey Jacobson, Registered Patent Attorneys, 72A-G District National Building, Washington, D. C.

INVENTORS! Know what experts think! Be sure your invention will click. Get advice of top engineers and sales analysts. Complete engineering surveys and market tests. Patented or unpatented ideas. Strictest confidence. Write today for free information. No obligation. C. W. Eyres Co., 812 Pine, Long Beach, Calif.

MAKE Money from your ideas. Write Grayland, 5312 Grace, Chicago.

LIST of 45 investors, invention developers—\$2.00. Kaylor, Box 329, N.Y.C. 10.

INVENTIONS Wanted. Patented or Pending. Inventors Exchange, Dept. 4, Hartford 1, Connecticut.

75 INVENTIONS WANTED

INVENTIONS Promoted. Patented or Unpatented. Write Adam Fisher Company, 183-A Enright, St. Louis, Mo.

INVENTORS: Hundreds of manufacturers have requested our assistance in locating marketable new products. Complete information, free. Institute of American Inventors, Dept. 30C, 1926 Eye St., N.W., Washington 6, D. C.

INVENTORS! Have you good patentable ideas? Write Patent Agent Metzleer, 11 West 42nd, New York.

FREE Service: Descriptions of your inventions sent to 1000 manufacturers. National Industrial Chamber, 107 Washington Street, New York 6.

"LARGE manufacturer will consider in confidence for purchase or royalty, ideas in the following categories, small specialties, utensils, novelties, or sundries for home, office, kitchen, desk, pocket, automobiles, or sports to be made of plastic, metal, paper, wood or leather. Write C-AJI, Box 5085, St. Paul 4, Minn."

"WANTED—Practical Inventions of All Kinds. Write John D. & Son, 285 Howard Ave., Box 3213, Dept. PS-8, Bridgeport 5, Conn."

HAVE Buyers for practical inventions. Prior patents may kill value of yours. Have patent office search made cost \$6.00. Unique patent application service includes preparation specifications, claims, drawings, filing and help to sell your invention. Details Free. Charles Morton, 11 W. 42nd Street, New York.

WILL sell your Patent on Commission Basis. What have you? Colburn, 408 South Spring, Los Angeles, Calif.

PATENTED, unpatented inventions wanted. We have tremendous lists of manufacturers who may pay cash, royalties. Descriptive booklet free. National Invention Service, 1404-B Mitchell Street, Oakland 1, Calif.

99 PATENTS

INVENTORS: Test the commercial value of your patented or unpatented inventions, quickly and inexpensively. Write for free information. Institute of American Inventors, Dept. 30-B, 1926 Eye St., N. W., Washington 6, D. C.

100 PATENTS FOR SALE

PRACTICAL & efficient Traffic control system Patent No. 2407432. 3759-Cass, Detroit 1, Mich.

"PATENTED Windproof Safety Match Cover For Sale. Cash or Royalty." Goshorn, 3301 E. Thompson St., Philadelphia 34.

82 MANUFACTURING

MANUFACTURE Paints, your garage a factory free information. Industrial Chemist, 1826 60th, Kenosha, Wisconsin.

A BRAND new patentee's service. Write for information. J and M Company, Burlington 2, Kentucky.

MANUFACTURING Stamping Tools, Dies, Special Machinery Parts. Gear Cutting. Since 1896. Baum's Metal Specialists, Kansas City, Mo.

EXPERIMENTAL Devices, Models. Any Material. Reasonable. Nelson Manufacturing, Woodburn, Oregon.

87 MODELS, MODEL SUPPLIES

MOST complete Illustrated Catalog—"O-HO OO" Model Railroad Parts ever published. Send 5c for mailing. Selly, 1377 Gates Ave., Dept. 836, Brooklyn, N. Y.

MODEL Ship Builders! Are you looking for authentic, precision ship models? Send for richly illustrated fully descriptive catalogue in full color of famous ships of all kinds. Only 10c. Halesite Yacht Service Inc., Dept. C-32, Halesite, Long Island, N. Y.

SHIP and Yacht model fittings; blueprints. Send 25c for illustrated catalog No. 20—Listing hundreds of items. A. J. Fisher, 1002-2 Etowah Ave., Royal Oak, Mich.

SHIP Model and yacht supplies, complete large 64 page catalogue, 30c. Wm. Wild, 510 E. 11th St., New York City.

SHIP Model Kits and Fittings . . . most complete stock in New England. Boucher, Fisher, Marine Model and Model Shipways fittings, blueprints and model yacht equipment at standard prices. Send 25c for new illustrated 1947 Catalog and price list. Dept. S., James Bliss & Co., Inc., 220 State St., Boston, Mass.

RAILROADERS new 50 watt 125 ohm rheostats for controlling speed. Regular price \$5.00 our price \$1.00 prepaid. Weston ammeters 0-60 amps brand new with shunt \$2.95 prepaid. Heath Company, Benton Harbor, Michigan.

BUILD Model Ships, Railroads, Catalog 10c. Ideal, 21 West 18th Street, New York 11, N. Y.

RAILWAY models, complete line. Combined HO and O gauge, catalogue, 35c. Walthers, 269 Erie, Milwaukee 2, Wisc.

POWER Models—steam and gasoline engines. Steam traction engine, metals, tools. Catalog 35c. Charles Cole, Ventura, California.

STEAM engines—boilers—castings, Catalog 25c. Anton Bohaboy, 2297 Price, Rahway, New Jersey.

MODEL engines—steam and gasoline. World's most fascinating hobby. Build them yourself in your own shop, using your own tools. Send ten cents for illustrated catalog listing world's largest selection of miniature engine castings and drawings. McAded Models, 1313 So. Talman Ave., Chicago 8, Ill.

BALSA Wood Generous Supply \$1.00 Price List Free. Sanlader, Manitowoc, Wis.

87 A MOLDS AND MOLDING MATERIALS

RED Seal Rubber Company Develops New Compound! DePont Latex Base! Fully Guaranteed! Introductory Offer for \$3.00—Complete Mould Making Course plus Quart of Red Seal Latex. Free Literature upon request. 116 Nassau St., New York 7, N. Y.

LIQUID Rubber for making flexible molds. Qt. \$2.00. Gal. \$5.75. Sample Bottle 25c. Chaney, 1130 E. 16th St., Jacksonville 6, Fla.

SPECIAL Rubber for making Molds. Literature and sample free. Universal, Box 1076-A, Peoria, Ill.

71 HOME CRAFTSMEN

BRASS rods, tube, sheet for home workshops. Send for catalog 202. Meier Brass, 1155 Bellevue, Detroit 7, Mich.

LEATHERCRAFTERS! Send for free catalog listing leathers, tools, supplies. Kit Kraft, 3203 W. Washington Blvd., Los Angeles 16, Calif.

POPULAR SCIENCE OPPORTUNITIES

LEARN Sea-Shell Jewelry and Novelty manufacturing. No tools or experience needed. Learn-earn within a week! Complete, beautifully photographed home instruction course, shows you how to make 110 designs of pins, earrings, brooches, hair ornaments, necklaces, bracelets, plaques, ash trays, dolls, animals, miniatures, etc. Explains pearlizing, tinseling, golding, dyeing, luminous processes. Illustrates 65 species sea shells. Lists 200 raw materials with wholesale prices. Complete course \$1 postpaid. Beginner's Kit \$3 (\$3.50 in Canada). House of Gifts—Box 4550-SA Coral Gables, Fla.

LEARN To make Sea Shell Jewelry, pins, earrings, hair ornaments, novelties. Book of Instructions and Designs free with \$2.00 and \$5.00 Kits. Postpaid. Herbert Diamond Company, Box 4619, Miami 31, Florida.

SHELL Jewelry Supplies. Wholesale only. McFarland Plastic Co., Sarasota, Fla.

MAHOGANY—Shipped direct to you from the tropics. Know the pleasure of working with this beautiful wood. Special offer of No. 1 furniture mahogany to home craftsmen. B. Hansbrough, Box 653, Coronado, Calif.

EXPERIMENTERS! Interested in Electrical, Mechanical devices from war surplus? List Free. F. Siefke, Box 18, Station E, Buffalo, N. Y.

WHAT-NOTS made of wood scraps, 24 inches high, beautiful designs, full size pattern 30c. 4 assorted patterns \$1. Illustrated folder 10c. Joannes, P. O. Box 141, Omaha 7, Nebraska.

LEATHER designs for Tooling or Carving. Ten handbags \$1.00. Twenty billfolds \$1.00. Fifty belts \$1.00. All three, \$2.50. Order includes information about our "No More Tracing" design Transfers. Lampkin Artcrafts, Box 641-S, Culver City, Calif.

\$46 FROM Square Foot Plywood. Jigsaw necessary: Write, Woodarts, X-48, Bridgewater, Mass.

SPECIAL 77 full sized Patterns. Lawn Ornaments, Toys and Novelties \$1.00 Modern Woodcraft, Saginaw, Michigan.

18 BLUEPRINTS AND PLANS

"**BLUEPRINT** Reading Made Easy"—ready reference book for reading any type blueprint, 596 pages, 463 pictures. Formerly \$8.95, now only \$1.98. Popular Science, Dept. 87-C, 353 4th Ave., New York 10, N. Y.

"**AUTOMATIC** Timer Switch for radios, lights. Plans \$1.00. Breese, Box 74, East Side, Providence, R. I."

23 BUILD IT YOURSELF

BUILD concrete block machine. 2 blocks per minute. Build concrete mixer. Easy, inexpensive. Details free. Horne, 206 West Wilder, Tampa, Florida.

HOT Water Free—from Sunlight. System efficient any locality year 'round. Standard materials—easily built—low cost. Facts Free. Solar Water Co., Box 175, Dept. F, Coral Gables, Fla.

BUILD concrete block machines, portable sawmills. Shop, farm, home machines, 70 plans. Catalog-Handbook Free. Nichols Equipment Co., Dept. 204, Purvis, Miss.

"**BUILD** Cabins"—book offers complete instructions and plans for building your own cabin, lodge, tourist home, or wayside stand. 251 Pages, 200 plans and pictures. Only \$1.98. Popular Science, Dept. 87-C, 353 4th Ave., New York 10, N. Y.

HOMES, Garages Build yourself. Cement Blocker \$12. Write Wm. Grant, Dept. B, 1351 Gregan Pl., St. Louis 14, Mo.

AIR Plane Jettison Tanks streamlined, 10½ foot tear drop shaped, 165 gallon of Light weight lead, coated steel weighs 75 pounds floats over 1200 pounds. Ideal for making trim, inexpensive boats, canoes, Kayaks, Dinghys, Duck Boats, Powered Catamarans and Runabouts, prices \$12.50 complete, \$9.75 each for three or more US Freight prepaid. General Sales, 205 Market, Grand Rapids 3, Mich.

OVER 100 full size patterns of easy to make action toys. Special offer \$1.00. Masterprint, White Building, Buffalo, N. Y.

POWER your lawnmower. Electrically or gasoline engine. Either plan \$1.00. Zandar, 2136 Berkley Place, South Bend 16, Ind.

BUILD Your home as a hobby. No rent. No mortgage. Save 50%. Use spare time. No special skill required. Amazing facts sent free. H. C. Lightfoot, Civil Engineer, Richboro 8, Penna.

139 WATCH REPAIRING

WATCH and Clock Repairing—complete practical course in modern horology, 66 illustrated self-instruction lessons. Just out! Low price. Fascinating 100-page illustrated catalog Free! Write—Nelson Company, Dept. 3-01, Chicago 5.

WATCH and clock repairing increasing, complete home study course with drawings and pictures. Information free. Houston Chronometer and Watch Co., P.O. Box 1140B Houston 12, Texas.

95 OLD GOLD, WATCHES, ETC.

CASH for Old, Broken Jewelry, Highest prices paid immediately. Mail gold teeth, watches, rings, silverware, diamonds, spectacles. Satisfaction guaranteed. Information free. Rose Smelting Co., 29-Y East Madison, Chicago.

GOLD \$35.00 Ounce—Mail old gold teeth, diamonds, jewelry, watches—receive cash by return mail. Satisfaction guaranteed. Free information. Dr. Weisberg's Gold Refining Company, 1500-B Hennepin, Minneapolis, Minn.

WATCHES—Broken or Usable: All kinds. Highest prices paid for jewelry, rings, spectacles, gold teeth, diamonds, sterling silver, etc. Cash mailed promptly. Write for free shipping container. Lowe's, Holland Building, St. Louis, Mo.

GOLD \$35.00 Ounce. Highest prices paid for broken or usable watches, diamonds, rings, gold teeth, sterling silver, etc. Cash mailed promptly. Guaranteed satisfaction. Free information. National, 1723 S. 8th St., Phila., Pa.

76 JEWELRY

MANUFACTURE costume jewelry at home for profit, hobby, therapy. Free wholesale supply catalogue, instructions. Florida Supply House, Bradenton, Florida.

CERAMIC Jewelry Supplies, Bar Pins, ear screws, for ceramic and woodworkers, also, glass and sea shell assemblers. Free catalog. Philadelphia Badge Co., 1007 Filbert St., Philadelphia, Pa. Dept. E-1.

TREMENDOUS Profits—Hundred Genuine Rhinestones, Materials, Instructions—Dollar. Herber, 1360 Hicks, N.Y.C. 67.

JEWELRY Findings, Lowest Prices. George Sassen, 154 Nassau Street, New York 7.

MAKE Money, Making Shell jewelry and novelties. Instruction book 75c. Kit \$5.00. Catalogue free. Palm Shellcraft Co., 220 W. 9th St., Sarasota, Fla.

CAMEO samples Rhinestone findings, pricelist 10c. Perry Metros, 34-37 100 St., Corona, N. Y.

132 TOBACCO & PIPES

UNPOLISHED seconds of \$5.00 pipes 75c postpaid. Literature free. Carvapipe, 2829-a Dixie, Hamilton, Ohio.

GOLDLEAF Smoking, Chewing and Turkish Tobacco Write Prices. Belmont Farms, Chatham, Virginia.

113 RAZOR BLADES, SHAVERS

USED Razor Blades wanted. Send us 100 used blades with \$1.00, will send you 100 new double edged precis. ground blades (the finest) Money back if not 100% satisfied. Emile Wolf, 1133 Broadway, N. Y. City.

\$1.00 INGERSOLL Stropper Outfit 50c, \$4.00 Doz. George Pierce, 18 Pryor St., S. W., Atlanta 3, Ga.

86 MISCELLANEOUS

BOOKFINDERS! (Scarce, out-of-print unusual books.) Quickly supplied. Send wants. Clifton, Box 1377 PSM, Beverly Hills, Calif

UNUSUAL Novelties, 5 different samples 10c. Modern, Box 2, New York 2.

GOOD "Used" self-instruction educational books on all subjects bought, sold, rented, exchanged. Satisfaction guaranteed. Complete information and 100-page illustrated bargain catalog Free! Write—Nelson Company, Chicago 5.

HULL Automobile Compass, for accurate road direction, brand new, \$2.50. Prisms for 6x30 or 8x30 Binoculars, brand new, \$1.50, each. Offset prisms to be attached to 7x50 B. & L. Binoculars gives double the field of the ordinary 7x50 Binocular. Cost \$98.00. Special \$25.00. Green Sunshades for Binoculars size 6x30 and 7x50 snap on type, value \$7.50. Special \$1.25 per pair. Forward money order. No C.O.D. shipments. Send coin 25c for new list of Guns, Binoculars and Powder Flasks available for immediate shipment. Public Sport Shops, 13 S. 16th St., Philadelphia, Penna.

MEXICAN-Aztec Featherwork Tropical Bird Picture Cards. Samples 25c. Mexican Products, 126 N. Main, Tulsa 3, Okla.

YES. Men's shoes in Sizes 11½ to 16. Widths AA to EEE. Finest Quality, moderate price. Free Circulars. Write Kingsize 229, Brockton, Mass.

SWISS Music Box Units. Choice of classical, waltz, popular. Already to install. \$3.95 each. Postpaid when cash with order. Information on request. Swiss Novelty Co., Box 1201, Fall River, Mass.

TWO pounds pure maple sugar postpaid \$3.00. Eulalia Turner, Poultney, Vermont.

NAME Plate, 1¼"x6"—House-holders distinctive identification. \$1.00. Novelty Lettering, 612 No. Acacia, Compton, Calif.

SHOES—Save 30% For Entire Family—Buy direct; save the retailer's profit. Send for Free Catalog—Sutton Shoe Co., Dept. B-2, 32 Sutton St., Baltimore, Md.

VIEWS Of The Hereafter. For copy of the remarkable book by Emanuel Swedenborg "Heaven and Its Wonders and Hell." send 5c to cover mailing. Swedenborg Foundation, Room 1648, 51 East 42nd St., N. Y. 17, N. Y.

MAN! Six Daring pocket-size "Art-Photos"—\$1.00. Sample 10c! Box 699-X, Westfield, New Jersey.

SEA-STAR Guaranteed Marine Homing Device Designed for Safety, Entertainment, Simplicity, \$69.50. Complete satisfaction guaranteed. Write: The Electrex Company, 114 Liberty St., NYC.

RAISE Earthworms. Instructions \$1.00. W. Huffman, 391 Pleasant Lake, Rives Junction, Mich.

ALOHA Shirts—Authentic Hawaiian prints. Fine Rayon—Men, women, State size—\$5. Debutante, 1157 Fort St., Honolulu, Hawaii.

GET Lots Of Mail: Name Listed Three Directories 25c. Harvey Teeple, Decatur, Ind.

PANNING Gold—Free Illustrated Booklet—Catalogue, Mining Books—Supplies. Old Prospector, B-12, Dutch Flat, Calif.

CALENDAR 1753 to 2152. 35c. Tracy S. Newton, Decatur, Georgia.

BIG Mails, Magazines, catalogs, samples. Name listed, 10c. American Directory, Robstown, Texas.

THE laugh riot of the century: Get our copyrighted booklet "How To Make A Living Without Working," plus membership in The Lazy Man's Club. Only 25c. Kenarco Press, 401 North Second, Elkhart 13, Ind.

ART Photos! Spicy; sample .50, 3 for \$1.00. Route 1, Box 995, Dept. P, Phoenix, Arizona.

ART Photos of Beautiful Hollywood models 4 x 5—8 for \$1.00, 32—\$3.50 Prepaid. Visual Slides, 853-46 Street, Brooklyn 20, N. Y.

FREE literature how to locate buried treasure and minerals, Fisher Laboratory, Inc., Palo Alto, Calif.

BRYNO'S Hollywood Beauties—75 Startling Art Poses \$2.50 per book prepaid. Visual Slides Co., 853 46 Street, Brooklyn 20, N. Y.

ATTIC Fan blade \$8.00 30 inch \$11.90, 36 inch. Southernaire, 145 Walton, Atlanta, Ga.

POPULAR SCIENCE OPPORTUNITIES

POUR Your Own plastic printing cuts. New Process. Easy. Economical. Proofs free. Pouroplastics, Argyle 2, Wisc.

HYPNOTIZE anyone! Get the most perfect, easily learned, modern scientific course of "Genuine Hypnotism" in the world. Fully illustrated. Only \$1.00. Money back guarantee. Fowler, Box 1284, Boston 4, Massachusetts.

ARTISTIC Pin-Up Girl Photos, 10 for \$1.00. Wilkins, 417 Hill, London, Canada.

SEND \$1 for "Dollars in Your Mail". Parks, 1618 Rhode Island N. W., Washington, D. C.

WASHINGTON "Tourist Inn" reservations \$2 or \$3 day. Parks, 1618 Rhode Island N. W., Washington, D. C.

MODERN Tool has 100 farm uses. Flame thrower kills weeds quickly, economically. Valuable literature free. Sine Equipment, 16S, Quakertown, Penna.

GORGEOUS Models! Ten sensational photos. \$1. Pilgrim, Box 194X, Springfield, Mass.

WHITE Pottery Clay. High grade, 25 lbs. \$1.00. C. C. Thomas, Odenton, Md.

MASONIC Article with Formula for Finding lost word. One Dollar. General Adjustment Co., Jordan Bldg., Waco, Tex.

COLLECTION Letters get Money, retains Customer. One Dollar the Set. General Adjustment Co., Jordan Bldg., Waco, Texas.

A THOUSAND laughs. Unique jackass cigarette dispenser. Holds 10 cigarettes. Simply press donkey's head down, tail rises—presto—out slips cigarette. Satisfaction guaranteed. Sent postpaid for \$1.00 with order or \$1.15 C.O.D. Sanimo Industries, Dept. PS-11, Spencer, Indiana.

59 A FOR SALE—MISCELLANEOUS

FLEXIBLE Drive Cables. All New! Three sizes. 10"—25"—72". Adaptable for many uses. Over \$5.00 value. Combination offer of all 3 sizes, while they last \$1.75. No COD. "Amazing Bachman's", Dept. TC, 23 Herman Street, Rochester 5, N. Y.

138 WANTED MISCELLANEOUS

MERCURY—Highest prices. Free Containers. Write Mercury Terminal, Norwood, Mass.

57 FOR THE HOME

"KILZ" Scientific Mouse Killing Station gets results, six with poison food \$3.49 Prepaid. Chemical Service, 521 Portage, Kalamazoo 6, Michigan.

101 PERSONAL

PSORIASIS Sufferers: Has everything failed to bring even temporary relief from scales, lesions and itching? Then write today for Free important information. You needn't invest one cent! Pixacol Company, Dept. S, Box 3583, Cleveland, Ohio.

RUPTURED? Positive comfort, no understraps, no steel, no elastic. Write Smith Manufacturing Co., Preston, Ontario.

HOW You Can Find Out! Information discreetly developed, any matter, person, problem anywhere. Personal-business assignments, representations, undertaken. Nationwide. Officially Licensed and Bonded Service established 1922. Reasonable. All inquiries confidential. William Herman, 170 Broadway, N. Y.

MAKE C-Thru X-Ray Mirrors. Chemical formula \$5.00. J. Toczko, 93 Great Hill Rd., East Hartford, Conn.

PILES? Guaranteed Permanent Relief. Free particulars. J. Ragno, Berwick, Penna.

GENTLEMEN: Stop Growing Bald and Save Money! Get my instructions and successful formula for Only \$2.00. Send postal note only. Frank Novak, P. O. Box 368, Rahway, N. J.

THICKER, lovelier hair for men and women. All about latest secrets, discoveries free. Write immediately. Bruns, 3307 Fremont, Madison 4, Wisc.

MEN Only! Six Spicy "Art-Photos"—\$1.00. Box 699-D, Westfield, New Jersey.

MAIL everyday. Opportunities unlimited. Name listed 10c. Sibley, Mendon, Mass.

HAIR Falling? Dandruff? Write Trichologist, 139 Lewis Street, Phillipsburg, N. J.

INFORMATION for single people by Human Relations Consultant. University Graduate. Dr. B. Long, Box 375, Los Angeles 53, Calif.

MATRIMONIAL—Sweetheart Magazine, 50c. 6 mos. \$1.00, Yr. \$2.00. Barwood, 2037-E 42nd, Astoria, N. Y.

CIGARETTES by Mail. All popular brands. Three Carton lots \$1.59. Five Cartons \$1.50. Ten Cartons \$1.45. Twenty-five Cartons \$1.43. Fifty Cartons \$1.39. Shipped prepaid or C.O.D. plus postage. The Shop of Knowledge, Springfield 4, Missouri.

HOLLYWOOD Models — Art Photos — see our ad Classification 26.

BUY Vitamins Direct. Amazing Savings. Money Back Guarantee. Our 9th year! Postcard, Matoska Products, White Bear Lake, Minn.

70 BIBLE Lessons 25c. Bulletin, Box 87-S Cathedral Station, New York 25.

PSORIASIS scales, lesions and itching eliminated and completely controlled for 10 yrs., by nature's own remedy. What it is, when and how to use it, completely and simply explained. Mail \$1.00 today to J. A. Riley, 419 Amer. Bank Bldg, Miami 32, Fla.

SEX Truths—Illustrated. Adult Books, Five—\$1.00. Kogan, 1032-SP, New York 8.

FRIENDSHIP is priceless, 10c will bring you copy of my Friendship Magazine, bet you'll like it. Write Jay Wilcox, Box 384, Eastport, N. Y.

ALCOHOLISM is a Disease amenable to our treatment. If this evil threatens your home, job or business. Do Something Now! Write for Free Folder. Established 50 Years. The Murray Institute, 620 S. Tenth St., Minneapolis.

2 ADVERTISING

ADVERTISERS: Mail order ad covering United States—2,200,000 circulation—\$28.00 inch. Classified ad, 24 words, 20 metropolitan Sunday newspapers—\$25.00. Magazine, newspaper, mailing-list rate-book, adwriting assistance—free. Chicago Advertising Agency, 20-PS West Jackson, Chicago 4.

ADVERTISE: 24 words, 40 Newspapers \$3.50. Lists Free. Advertising Bureau, 229-P Dixon Blvd., Uniontown, Penna.

24 WORDS in 64 Weeklies \$4.96. J. Darnell, 730 Hays, Jackson, Tenn.

66 HANDWRITING ANALYSIS

ANALYZE Handwriting for Profit! Complete outfit \$1.00. 4462-R Germantown, Philadelphia.

38 CONSULTING ENGINEERS

QUANTITATIVE analyses. Metals. Water. Textiles. Accurate Routine Determination \$1.00—Industrial Laboratories, 123 Beaver, Albany 7, New York. Analytical Reagents. Standard Solutions Available.

45 DRAFTING INSTRUMENTS

SAVE on drafting materials. Free catalog. Draftsmen's Supply Co., 32 North Wells, Chicago 6.

46 DRAWING & ART SUPPLIES

PERSPECTIVE charts simplify drawing houses, furniture, small products. Complete set \$1.00. Domesticraft, Russell, Mass.

129 TATTOOING SUPPLIES

AMAZING New Book "Tattooing World" For Amateurs, Professionals, and breeders. Successful method of removing tattoos. 250 Illustrations. Sent in plain wrapper. Only \$1.00. Zeis Studio, 728 Leslie, Rockford, Ill.

27 A CANDY MAKING

MEN—Women—"Everybody Likes Candy". Learn to manufacture professionally at home. (Our 36th Year). Ragsdale Candies, East Orange, N. J.

142

WOODS

MYRTLEWOOD turning squares all sizes 50c up. Send 25c for wood sample. Agate Beach Myrtlewood Shop, Agate Beach, Ore. Box 1.

CHRISTMAS Cards of real wood. Write, Cards of Wood, Manlius, N. Y.

81 A MAGNETS

MAGNET, "Alnico" 4 oz. Horseshoe, powerful (lifts about 5 lbs.), \$1.00, 8 oz., (lifts 10 lbs.), \$1.50, 3 lbs. (lifts 20 lbs.), \$6.00 Postpaid. Ross, B68 West Broadway, New York, N. Y.

WRITE For Direct Prices \$14.00 Up. Freight Paid. Guaranteed. Free Catalog. Granite-Marble Factory, A49, Oneco, Fla.

MAGNETS, Alnico—Free List. Terry Sales Company, 3726 South Detroit Avenue, Toledo 9, Ohio.

134 TREASURE FINDERS

SEEK Buried Treasure. Methods, mysteries, devices explained. Circulars free. Century Press, Box 151-D, Glen Ellyn, Ill.

METAL Detectors. The Very Latest Circuit. Free Literature. Hedden Metal Detectors, 538 North Homewood Avenue, Pittsburgh 8, Penna.

MT-SCOPE Metal Locator fully guaranteed and unsurpassed in efficiency. Time payment plan, trade-in and accessories. Free literature. Fisher Research Laboratory, Inc., Palo Alto, Calif.

11 ARCH SUPPORTS

MANUFACTURE, sell custom arch supports. J. Corssen, 2638 Geyer, St. Louis 4, Mo.

42 DETECTIVES

DETECTIVE Training. Phillips Secret Service, 1917C, N. Kenneth, Chicago 39, Ill.

DETECTIVES—Work home—Travel, Experience unnecessary. Write Wagoner P-125 West 86th, N. Y., N. Y.

RELIABLE confidential investigations made in all states. Write or wire us. Devine National Detective Agency, 1286 California St., San Francisco.

DETECTIVE Investigator training. New method. Hanna, 3911 Tacon, Tampa 6, Fla.

74 INFORMATION

NAMES—Addresses. Wholesalers, Manufacturers, etc. Dime each. Three 25c. National, 3537-B South Hoyne, Chicago 9.

SAVE Money—Buy wholesale! Indexed Directory; Over 200 Wholesalers. 50c. Acme, Covington 7, Virginia.

93 NAME LISTS

MAILING Lists, certified, productive, inexpensive, \$5.00 1000. Homeworkers, agents, buyers, etc. Write Dixie Service, King, N.C.

84 MILITARY INSIGNIA

FIRST Again: United Nations Insignia 30c. Military Emblems 2c up. Send 10c for price lists. Hobbyguild, X-35 West 32nd St., N. Y.

50 DIFFERENT army patches postpaid for only \$1.00. (factory rejects) Catalog free with order. Insignia Mart, 703 Broadway, N. Y.

123 SOUVENIRS

FREE German War Relics with each purchase. Send 10c for price list of captured Foreign medals, daggers, uniforms and receive 4 German Ration Potato stamps, free. Hobbyguild, S35, West 32nd St., N. Y.

FREE: German War Relics: Send 10c for prices of captured foreign medals, daggers, uniforms; and receive four German Ration Stamps free. Hobbyguild, S-35 West 32nd St., N. Y.

"THE QUAD-CITY LATHE"



only \$32.50
F.O.B. Rock Island, Ill.

Here is an exceptionally well made machine. Has 8" swing, 4 speed ball-bearing head on a cast bed. 27" between centers. Write Dept. PS.

QUAD-CITY PRODUCTS CO., Box 42, Rock Island, Ill.



Magi-Klips Kit

Teach Yourself Radio & Electronics!
Build 18 Experiments Without Tools!

You've read about this radically new kit designed by former Navy radar engineers. Pre-wired chassis enables you to build 18 different circuits—radio receiver, code oscillator, home broadcaster, photoelectric relay, etc.—by "clipping in" basic components as directed in simply-diagrammed manual.

Magi-Klips Kit ready for experiments.....\$29.75 postpaid
Knocked-down Magi-Klips Kit with complete instructions for assembling.....\$19.75 postpaid

Send for FREE booklet, "Electronics Made Easy."

DEER & TAYLOR COMPANY
Dept. M, 1340 Milvia St. Berkeley 9, California



Bar Bells
...at Factory Prices

WRITE FOR FREE BOOKLET **\$8.95** up
AND PRICE LIST

INDEPENDENT IRON WORKS
2416 East 23rd Street, Dept. P81
Los Angeles 11, Calif.

Say You Saw It
In Popular Science

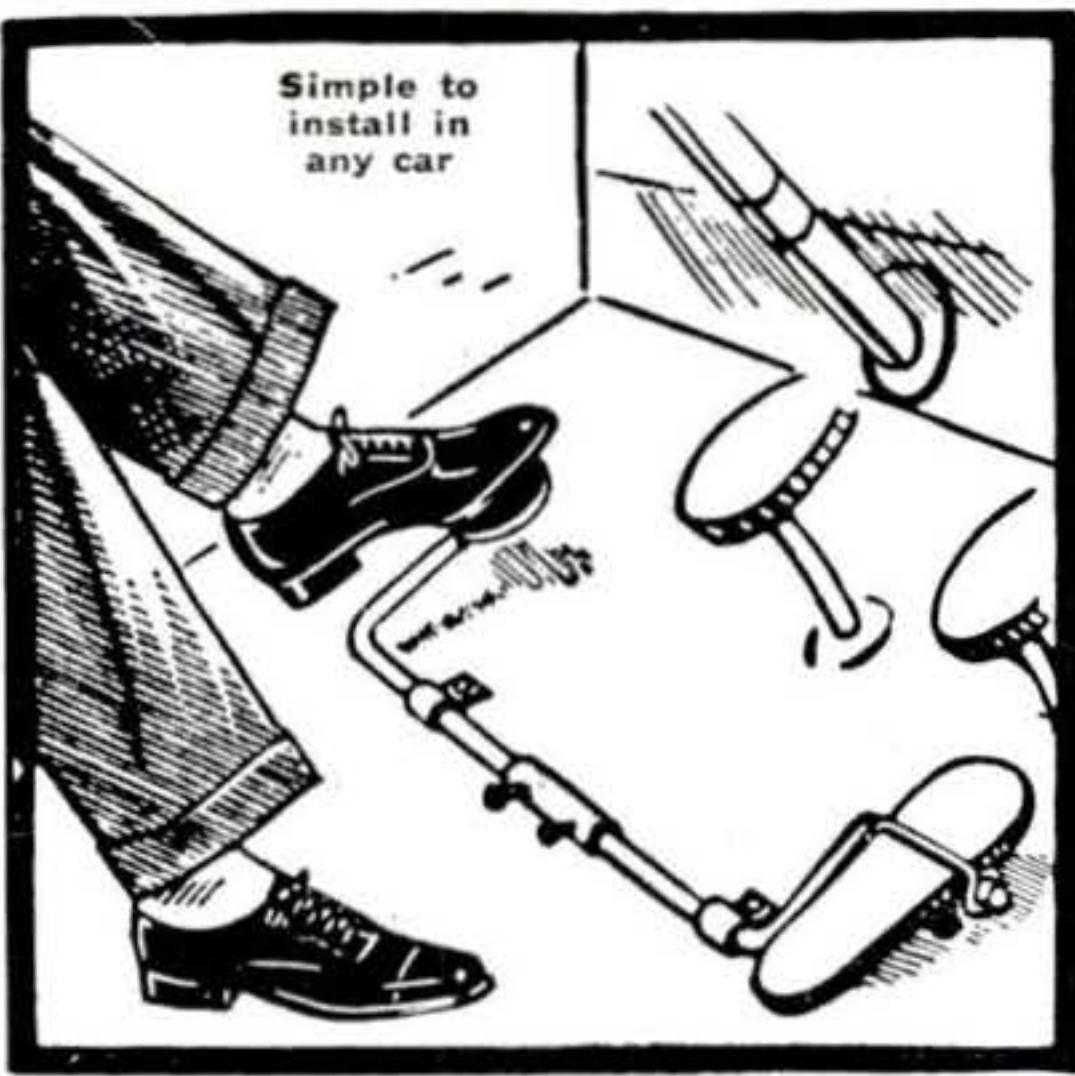

Simple to install in any car

AMAZING INVENTION FOR AUTO OWNERS!
NOW! DRIVE ALL DAY WITHOUT FATIGUE

WITH THE **L & P** LEFT-SIDE ACCELERATOR

Only \$1

Postpaid (Money-back Guarantee)

CLIP COUPON

If you are a good driver now, this Left Side Accelerator will make you sensational—for it gives you the complete maneuverability you could never attain before. Now at last you can accelerate with either foot, relieve constant strain on the right. In traffic you have one foot free for brake, and on hills you can use accelerator and brake together!

HARLO DISTRIBUTORS, Dept. M4
30 West Washington St., Chicago 2, Ill.
Enclosed is \$1.00 for one L & P Left Side Accelerator, \$8.40 for one dozen. Includes complete instructions.

Name _____
Street _____
City _____ State _____

Earn up to \$5.00 PER HOUR installing in other cars. Rock-bottom price of 70c per unit given to agents when purchased in dozen lots. You make money on both sale and installation.

WAR SURPLUS BARGAIN SPECIAL

BELT DRIVEN CENTRIFUGAL PUMP

READY TO USE ON ANY PUMPING NEED

NOW ONLY \$29.75



FOR HOME WATER SYSTEMS, IRRIGATION, FIRE PROTECTION, DRAIN BASEMENTS, PONDS, ETC.

● A super value for all types of intermittent service in pumping large volumes of liquid for stock watering, home and shop water systems, irrigation, draining pools, basements, etc. At 1750 RPM on 23 foot head will pump 42 gallons per minute; at 3600 RPM on 52 foot head will move 88 gallons per minute. Cast aluminum housing. Accurately machined bronze impeller vanes. Complete with mounting bracket and 4 inch V belt pulley. Run with electric motor, gasoline engine, power take-off on tractor, etc. Shaft rotates on sealed ball bearings with grease gun fitting. Has 2 inch intake, two 1 inch outlets. Use one or both as necessary. Made for Packard Motor Car Co. for use in Rolls-Royce Merlin Aircraft engines. Comes complete with pulley and mounting bracket. Original cost approx. \$147.00. Sold F.O.B. Chicago. Shipping weight 23 pounds. Complete engineering reports and operating instructions free with pump. You can't beat this pump value at anywhere near this price. Satisfaction guaranteed.

ORIGINAL COST APPROX. \$147.00
IMMEDIATE DELIVERY FOB CHICAGO
SPECIAL PRICE, WHILE THEY LAST
\$29.75

GROBAN SUPPLY CO. 1522 So. MICHIGAN AVENUE
Dept. PS 8, Chicago 5, ILL.

Extra! JUST OUT Extra!

INSTANT NICKEL U. S. PAT. PEND. NO. 702581

NO CURRENT OR BATTERIES USED COMPLETE KIT **\$250** POST PAID
COVERS 15 FT. AGENTS WANTED

Iron, Steel, Aluminum, Brass, Bronze, Copper and practically all Industrial Metals can now be HEAVILY nickel-plated WITHOUT equipment, vessels, electricity or previous copper plating, a blessing to Hobbyists, Doctors, Hospitals, Restaurants, Bar and Beauty shop owners. Recommended for Auto, Bicycle and Machinery parts and accessories, Musical Instruments, Electrical appliances, Coffee Urns, and practically anything made of metal.

IN THIS MARVELOUS NEW PROCESS the principles of the battery and electroplating have been harnessed in the INSTANT NICKEL formula, so when it is applied with a wet applicator on a clean metallic object, a permanent nickelplate instantly appears! Thickness of plating is regulated by number of applications.

JUMBO SHOP SIZE (nickelplates 75 ft.) only \$8.75 postpaid. Sample offer \$2.50 postpaid. Nothing else to buy, free particulars. Send check or money order today! C.O.D.'s few Cts. extra for Postage.

INSTANT PLATING PRODS., 3439 Michigan Ave., Chicago 16, Ill.

WAR SURPLUS BARGAIN SPECIAL

BRAND NEW! VACUUM-AIR HYDRAULIC FUEL PUMP

Original Cost
\$45.00
Now Only
\$9.95

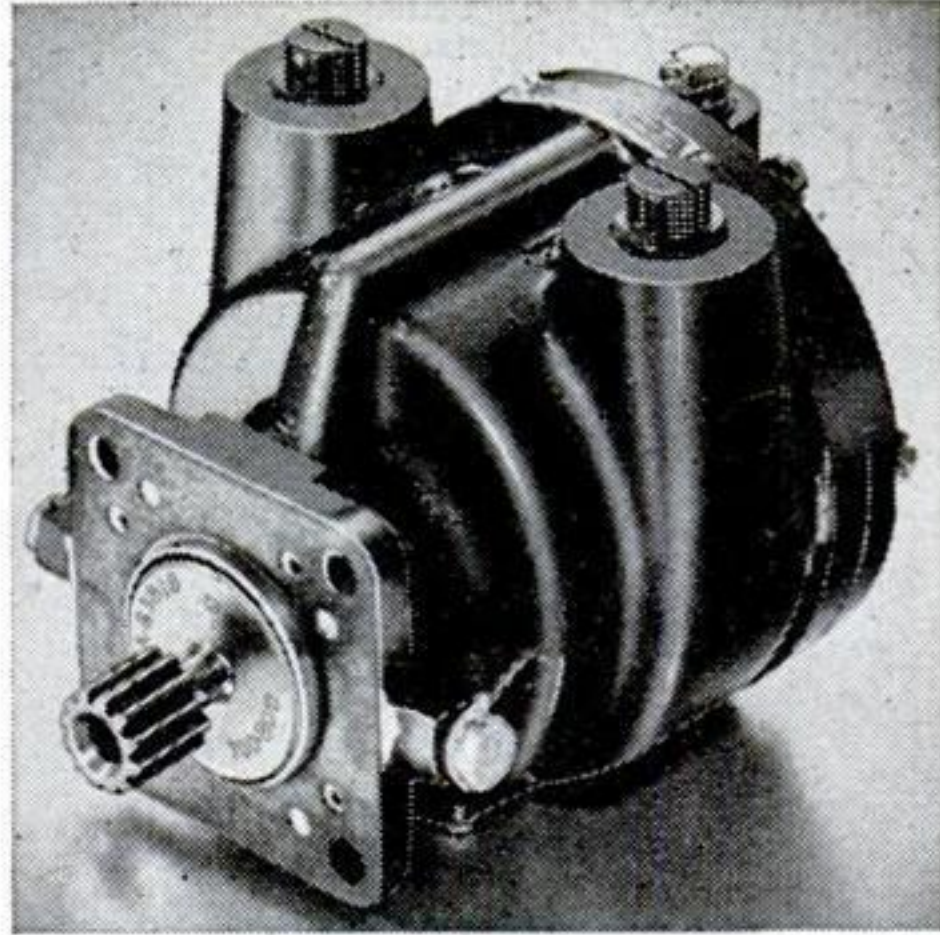

Postpaid in U.S.A.
WORTH MANY TIMES THIS LOW SALE PRICE

- USE THEM FOR
- OIL BURNERS**
- SPRAYING MACHINES**
- MILKING MACHINES**
- COMPRESSORS**
- VACUUM PUMPS**
- HYDRAULIC SYSTEMS**
- MANURE LOADERS**
- PRESSES, etc.**

● Originally cost \$45.00. Used by the Air Corps to drive bomber de-icer boots, gyroscopes, automatic pilots, etc. May be used as air or fluid pump—for pressure or vacuum. Standard 3/8 inch pipe thread with interchangeable ports. Will pump 7 1/2 gal. SAE 30 oil per minute at 300 RPM. Builds air pressure of 30 lbs. per sq. in. at 1000 RPM. Vacuum will draw 26 inches of mercury at 1750 RPM. Develops up to 120 lbs. per sq. inch of hydraulic pressure, which in conjunction with a 3 inch hydraulic cylinder, will lift 840 lbs. minimum. Runs forward or reverse. Self-aligning shaft. Die cast aluminum housing 6x4x4 inches. Has stainless alloy steel vanes and impeller. Made by Bendix Avia, Corp. Spline terminal for direct drive—readily replaced with a pulley. Recommend a 1/4 H.P. or stronger electric motor as source of power. Rated capacity 1500 RPM with high overload factor. Special price for quantity users. Complete illustrated report and instruction booklet FREE with every pump. Send check or money order today. Postpaid in U.S.A.

\$9.95

GROBAN SUPPLY CO. 1522 So. Michigan Avenue
Dept. PS8 Chicago 5, Ill.

Learn **DRAFTING**
I Will Train You at Home Until You Have a **GOOD PAY JOB!**
Engineer Dobe

Give Yourself a Chance to Make Good in this Big Opportunity Field

Don't be a fellow who "never had a chance"—for your big chance is right here now—in Drafting. The field for draftsmen is bigger now than ever before, for drafting is the basic profession and all new products start with the draftsman.

Get into Drafting now. I will train you at home, in your spare time and give you actual experience on actual work—the same kind of jobs you will do for the best paying firms. I will train you until you are competent, fully experienced and holding a position that will bring advancement and pay raises as deserved. Write me today!

WORKING TOOLS INCLUDED

You get drafting instruments, table and other equipment when you start. Nothing for you to buy.



EXPERIENCE WHILE LEARNING

Don't forget! I train you through practical jobs—I give you experience. And I list this experience as a reference to employers when you are ready to go to work. Lack of starting knowledge or higher education should not hold you back. Low cost—and monthly payments, if desired.

ACT NOW!

Mail coupon to me today! No salesman will call, but you will get my big book and all details. Give your age to get reply.

MAIL COUPON FOR VITAL FACTS

Engineer Dobe, Div. 2A, Libertyville, Ill.

Send me the Vital Facts on Drafting and Industrial Designing, your Free Book and advertised list of positions for Draftsmen and Designers wanted.

Name..... Age.....
Address.....
City..... Zone..... State.....

FIREWORKS!

CHINESE FIRE CRACKERS

Immediate Delivery

80/16—1 1/2 Jolly Brand \$4.50 per bundle
80/20—1 1/2 Jolly Brand 5.35 per bundle
80/16—1 5/8 Cock Brand 5.50 per bundle
80/20—1 5/8 Cock Brand 6.50 per bundle

SMOKE BOMBS Per Case of 25 **\$10.00**

TERMS CASH WITH ORDER

UNITED FIREWORKS MFG. CO., INC.
DAYTON 7, OHIO



A Penny May Bring You HAPPINESS!

Would you gamble a penny to win Happiness, Companionship, Love, Financial Success, through the help of a mysterious International Secret Organization? Then just send name and address on a post-card TODAY for your

FREE Copy of great Book "Mayan Mysteries". It can change your whole life! Address Rose Dawn, The Mayan Order, Dep't. 767, P.O. Box 2710, San Antonio, Tex.

PHILMORE LITTLE WONDER RADIO!

Good entertainment is less expensive than ever before! This brand new pocket sized radio is housed in an attractive durable cabinet. It features slide contact tuning—enabling you to get your favorite stations loudly and clearly. Tubes, Batteries, Plug-In—All Unnecessary! **GUARANTEED TO PLAY** when simple directions sent with each radio are used. Send No Money! Pay postman \$1.98 plus postage charges on arrival—or send \$1.98 (cash, money order, check) and receive your radio postpaid.

Singer Sales, 1014 College Ave., New York 56, N. Y.

INVENTIONS

WANTED AT ONCE

Patented or unpatented inventions, all types needed by manufacturers. Write for free booklet "MARKETING YOUR INVENTION" and Protective Disclosure Form. We have a tremendous list of firms who may pay cash or royalties for good inventions. For full particulars, write today.

NATIONAL INVENTION SERVICE

1404 Mitchell Street, Dept. A Oakland 1, Calif.

GET INTO CARTOONING!



Learn cartooning from a professional cartoonist! Create original cartoons and ideas. Send for free details about course. Also cartoonists' magazine. Full of lessons, plans, etc. Only 25c coin postpaid.

Hartman Studios, 2776 California Court, Lincoln 8, Nebr.

Amazing! **POCKET OR PURSE SIZE**
New **RADIO**

WORLD'S SMALLEST RADIO KNOWN!

Wt. only 1/4 lb. Beautiful Silver Black plastic case. Has Inductive Slide Tuner—W4 Crystal Diode—NO TUBES, BATTERIES OR ELECTRIC "PLUG IN" NEEDED!

GUARANTEED TO PLAY • NEW 1948 MODEL

on local stations if complete instructions sent are followed. Use it at home, in bed, in many offices, hotels, cabins—most anywhere! Hundreds of satisfied customers all over the world!
SEND ONLY \$1.00 (Cash, M.O., Check) and pay postman \$2.99 plus delivery fees on arrival or send \$3.99 for Post Paid delivery. Complete as shown—ready to play with self contained personal phone . . . **WONDERFUL GIFT FOR CHILDREN!** Order now at this low bargain price.—Prompt shipment on orders sent now—today! Be first to get YOUR Pakette Radio! (All foreign orders \$5.00 U.S. cash with order).

Pa-Kette Radio Co., Inc. Dept. PS-8 Kearney, Nebraska

**A BRAND NEW
DISCOVERY FOR
YOUNG MEN**

VARSITY

The Young Man's Magazine

VARSITY's the sure fire formula for reading pleasure! Every issue is packed with an All-American lineup... there's sports, fiction, hobbies, careers, dating, grooming, humor, pin-ups, movies, records... just about everything a fellow wants to know about, talk about, think about. Look what's coming in the BIG September issue!



THE PICK OF THE PIGSKIN PARADE—With this season, pre-war football comes back into its own. What the giants of former years will do is a question all gridiron fans are asking. Caswell Adams, noted sports writer looks over the new crop of players and picks the ten top teams of the 1947 pigskin parade.

YOUR FUTURE ON ICE—12 billion dollars a year, when the ball gets rolling! That's what the experts are predicting for the Frozen Food field! Read the forceful, enlightening article by Hiram K. Smith, Jr., who gives you the lowdown on how to break into this promising industry.



FRED ASTAIRE'S SWING TROT—The man who has thrilled audiences the world over has created a new, rhythmic foxtrot which will be a sensation wherever the swing set gathers. In a series of action pictures, he demonstrates the correct way of doing the "ASTAIRE SWING TROT."

TED WILLIAMS' GREATEST THRILL
The Bomber from Boston has had more than his share of thrills in his spectacular career! In an intriguing, nostalgic account, Ted Williams describes the thrill every fan will remember—the thrill he will never forget.



And

- NATURE'S HOT FOOT**—The real dope on Athlete's foot
- MUD VS. MISS**—An action-packed story of boy gets girl
- ON THE RECORD**—A chatty visit with Duke Ellington
- GREAT GUNS**—How to buy your first rifle
- UNDER THE PUBLIC EYE**—Varsity's Date Clinic

Pin-Ups • Cartoons • Gags • Dating
**PLUS LOADS OF OTHER
FICTION • FEATURES • ARTICLES**

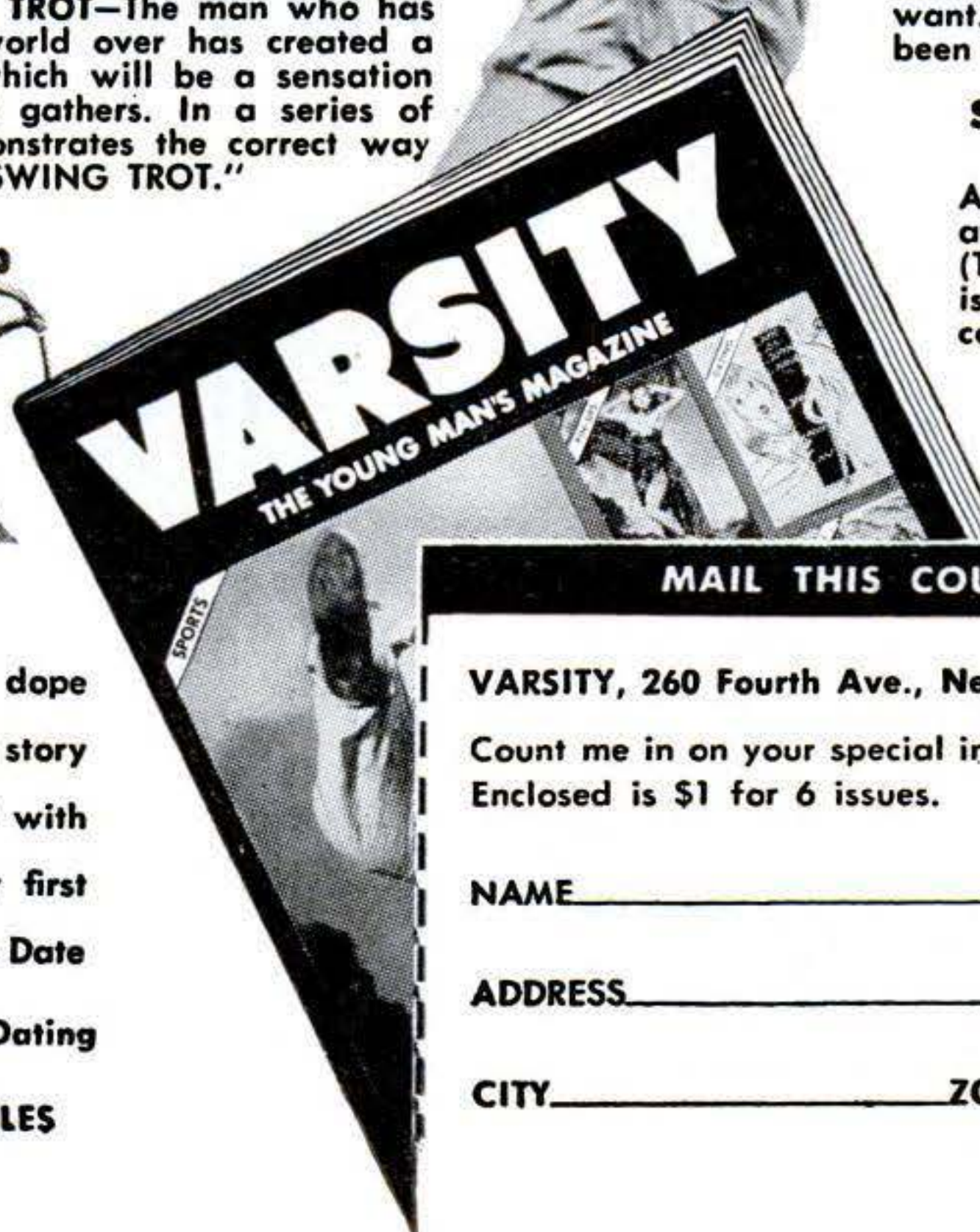

VARSITY'S for YOU

No wonder fellows in all parts of the country are hailing VARSITY as the magazine find of the year

—there's no other magazine like it! VARSITY speaks YOUR language... knows YOUR interests... gives the thrills, laughs and information YOU want. It's the magazine YOU have been waiting for.

SPECIAL INTRODUCTORY OFFER

Act now and get 6 big issues at the special low price of \$1! (The regular price of VARSITY is \$3 for 12 issues.) Mail the coupon TODAY and SAVE.

6 MONTHS \$1

MAIL THIS COUPON TODAY

PS-A

VARSITY, 260 Fourth Ave., New York 10, N. Y.

Count me in on your special introductory offer to VARSITY!
Enclosed is \$1 for 6 issues.

NAME _____

ADDRESS _____

CITY _____ ZONE _____ STATE _____

The girls look twice
at the man with P.A.*

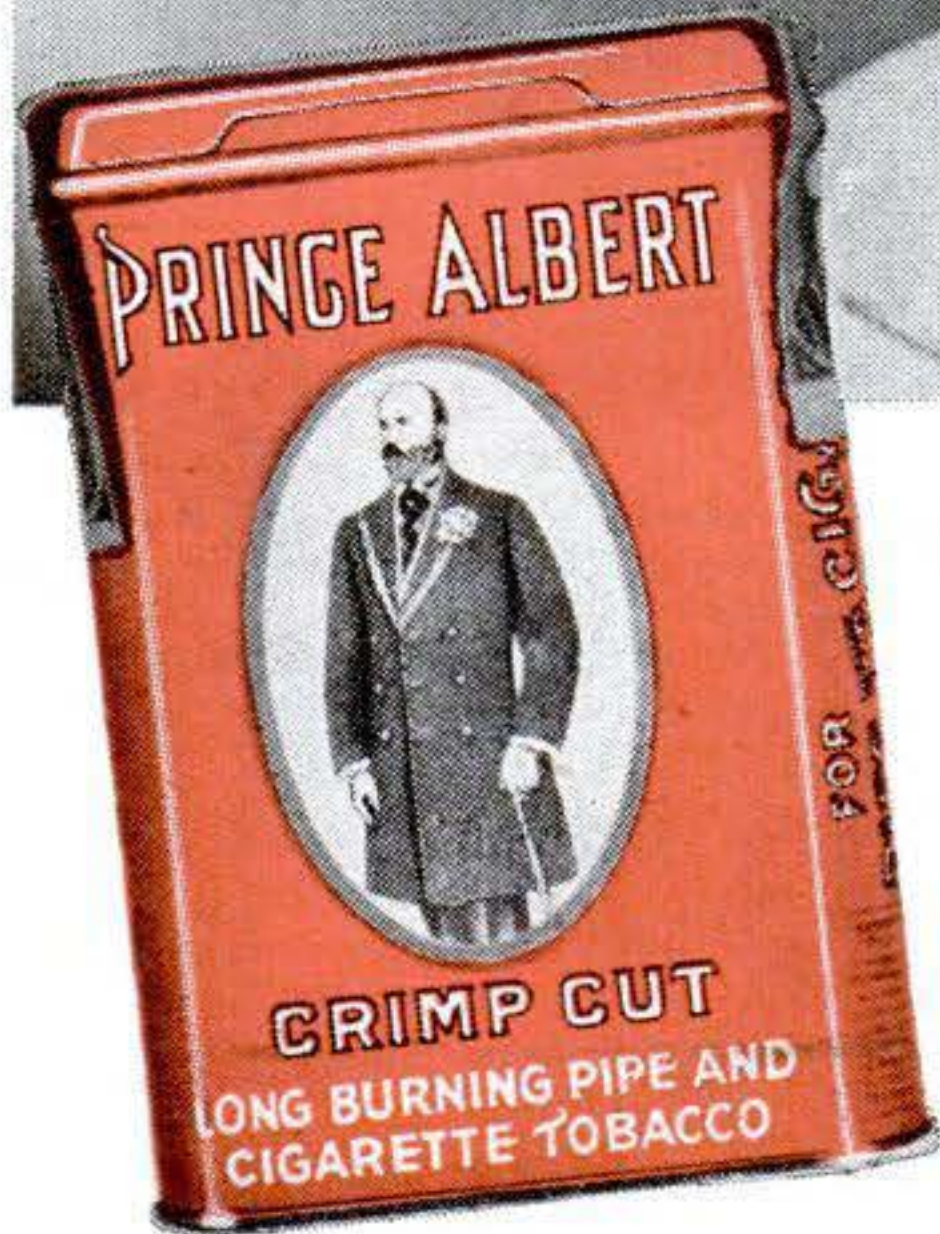

P.A.*

means Pipe Appeal

A man with a pipe gets *extra* attention ... for there's something so *masculine* about men smoking pipes. Women find it appealing.

means Prince Albert

R. J. Reynolds Tobacco Co., Winston-Salem, N. C.



GREAT FOR CIGARETTE "MAKIN'S" TOO!

CRIMP CUT P.A.

ROLLS UP FAST AND NEAT

...RICH-TASTY-COOL!

A man with a pipeful of Prince Albert tobacco gets real smoking joy and comfort. P.A. is specially treated to insure against tongue bite. It's mild and easy on the tongue. Try crimp cut P.A.—and you'll see why more pipes smoke Prince Albert than any other tobacco!

THE NATIONAL JOY SMOKE

AUG. 1947

**POPULAR
SCIENCE**
MONTHLY



Reaching for Lightning . . . Thirteen hundred feet above Manhattan, these riggers are installing a lightning rod atop the television antenna on the Empire State Building. The installation marks the resumption of General Electric's studies, discontinued during the war, of the thunderbolts attracted by the towering structure—as many as a dozen of them in a single storm. Limited to instrument recordings at first, the research program will later include further photographic studies.

AUGUST 1947 65



Polar Prowl Cars Will

By Fred Sparks PSM Special Correspondent

In this airborne age the shortest route between many great nations is across the top of the world—over the North Pole itself. For two years now the Army and Navy, working with private scientific groups, have been studying polar living conditions. They hope eventually to establish and maintain permanent bases near the pole.

Last winter, when darkness and extreme

cold halted operations in the Far North, the Navy sent an expedition to Antarctica, then enjoying summer. Although poles apart, many conditions in the two polar regions are similar. At Little America 197 men, including this writer, lived for a month. This is a report on how we and our machines reacted to the polar clime, and how our findings will be used.



These two Marine Corps LVTs pushed 125 miles into the unknown wastes of Antarctica

without mishap. Trek leader is now using data to design prowl car for future polar travel.



Trail flags are often the only guide in this milky world of white—without them the traveler might never get home. Dropping them off end of sledge train is a cold job.



Hitched to the rear of a sled and connected to a meter, these bicycle wheels are the only accurate way to measure mileage. As a double check, each wheel is attached to separate meter.

Mechanize Arctic Living

Photos by Fred Sparks and U.S. Navy. Drawings by Phil Santry

TO THE regret of all Jack London fans, the dog sled as the sole means of polar travel is a thing of the past. Its limited load and slow speed are all right for a small exploring party but rule it out for hauling the ponderous tackle needed for permanent stations, mining or oil developments—or a modern army.

At Little America, tracked vehicles designed for amphibious operations proved almost as good at crossing icy terrain as they were at landing on palm-fringed islands. And the weasel turned out to be an excellent polar jeep where true jeeps were useless.

But for regular polar travel over land a new vehicle, to be designed along the lines of the Marine Corps LVT-4, an alligator tractor, will prove invaluable. Captain Vernon Boyd led two LVTs in a cross-country trek, hauling giant sleds loaded with supplies. Now he is working with the Navy's Bureau of Ships on a machine that may well become the polar "locomotive."

"Snowshoes" for Tractors

As shown at right, proposed special features include a bubble turret to protect a driver while enabling him to sit high enough to see crevasses lurking ahead. One thing any caterpillar vehicle for polar use requires is "snowshoes"—steel additions to the treads making them wide enough to distribute the weight. Otherwise they sink in soft ice.

The Navy has already experimented with snow trains in northern Alaska. There the Construction Corps has used them to supply its remote Naval Petroleum Reserve. They have gone 300 miles without support, hauling hundreds of tons of equipment. Men slept and cooked meals on sled-mounted cabins hauled by the trains, and put on weight doing it. Speeds averaged five m.p.h. Much information about different types of tractors and equipment has been gained in the last three years—and will pay off at the poles.

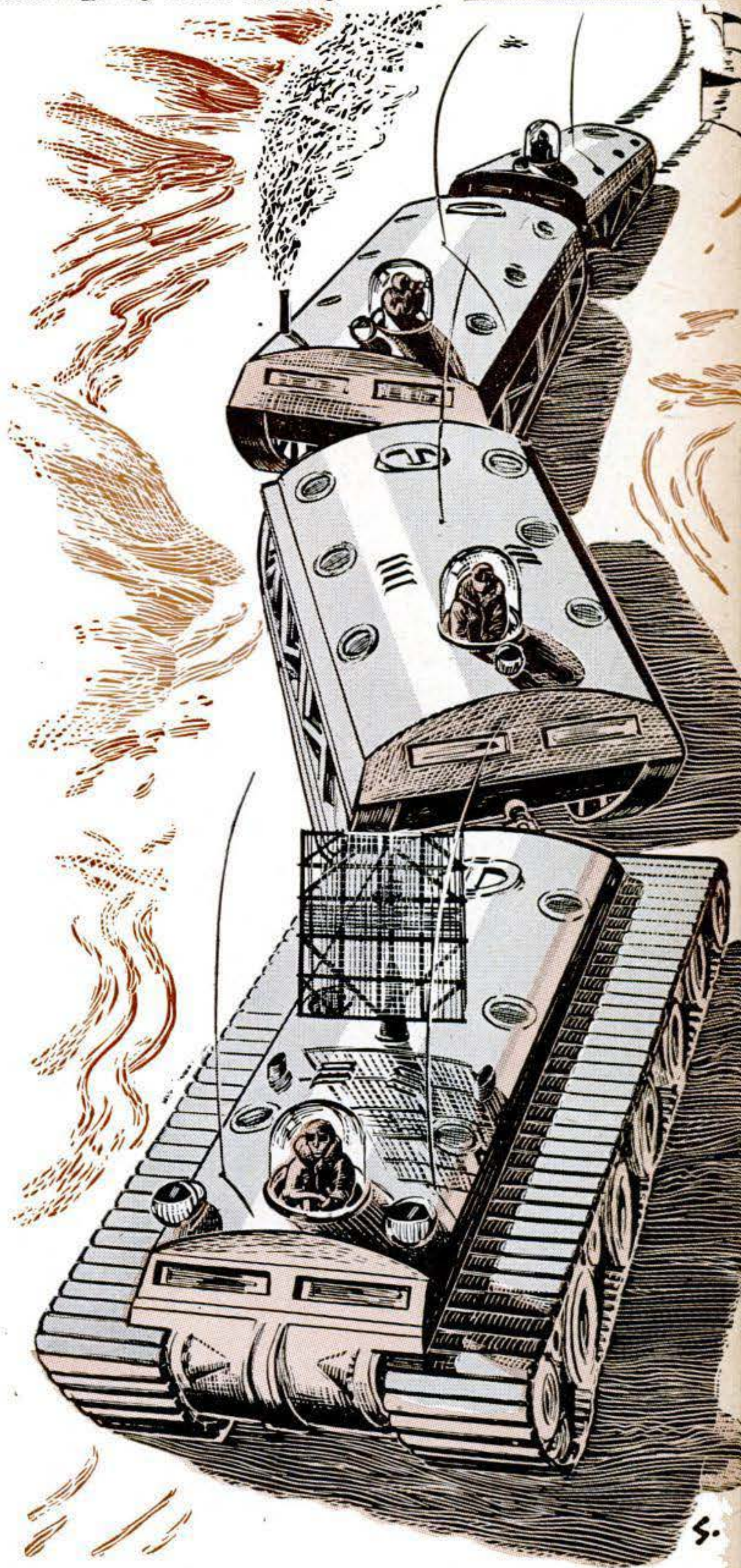

Polar tractor of the future pulls streamlined personnel-carriers. Third vehicle spews aluminum foil to permit radar tracking of party. Automatic device on last sled drops trail flags. ➔

It Takes Polar Ships To Navigate Polar Seas

ONE night last January, I stood on the bridge of the Coast Guard icebreaker *Northwind* with Rear Admiral Richard H. Cruzen, commander of the Navy's Antarctic task force. We were watching a great six-hour battle. Four Navy ships, helpless in the grip of floating pack ice, were threatened as gigantic bergs closed in.

The *Northwind* pushed her spoon-shaped bow over slabs of 15-foot ice, then crushed them under her 6,000 tons and cut the ships free. But the Admiral summed it up:

"If we mean to navigate freely through these waters we'll have to throw our concepts of ship building out the window; we'll have to build a truly polar fleet."

This means that every ship must be designed like an icebreaker. Because our ships were not, it took us two weeks to cross 750 miles of pack ice to Little America. On the way, the pack twisted frames like empty toothpaste tubes, smashed one ship's bow, sheared two propeller blades off another, and knocked the rudder off a third so that it had to be towed to New Zealand.

Diving Isn't Easy

A submarine with us bogged down in the pack after a few miles on the surface, and was towed to safety. It was supposed to dive under the solid floe and come up in ice-free spots. But to do this, subs are going to need vastly better sonar gear to warn of the reef-like underbodies of icebergs. And shipborne radar also needs improvement to pass polar tests. Our scopes looked as if they had the measles when we passed through heavy ice fields: You couldn't tell heavy bergs from thin sheet.

Until radar improves, the bow lookout is the ship's eyes—and he can't do a good job when the sub-zero wind howls about him. He needs a shelter, largely of glass treated to protect his eyes from ice glare.

Unloading at a polar destination is a tedious job. The ice is too weak to support concentrated weight. Telescoping Bailey bridges from ship to thick ice or land, with widespread supports to distribute their weight, may be the answer.

Whalers, explorers, Navy men—each has his special knowledge of the Arctic. We need it all if polar navigation is to become a matter of operations, not expeditions.



The helicopter, shown above flying over a sub trapped in the ice, was useful but because of its short range too often guided ships up a "dead-end street" in the pack. Invaluable to polar sea



A thin-skinned cargo ship feels its way through the ice pack. Sharp chunks like these punched holes in all the ships. For pack travel, ships should have several inches of steel armor.



This ship is moored to the ice by a "dead man"—an eight- by eight-inch timber placed in a hole chopped in the ice and secured by pouring in sea water, which freezes immediately.



travel would be a long-range helicopter that could scout the entire ice pack while flying low at slow speeds to check thickness of ice. The ships above cannot turn over their screws

because pack ice endangers the propeller blades. To avoid contact with floating blocks of solid ice, a ship's screw and rudder should be well below the level of its waterline.

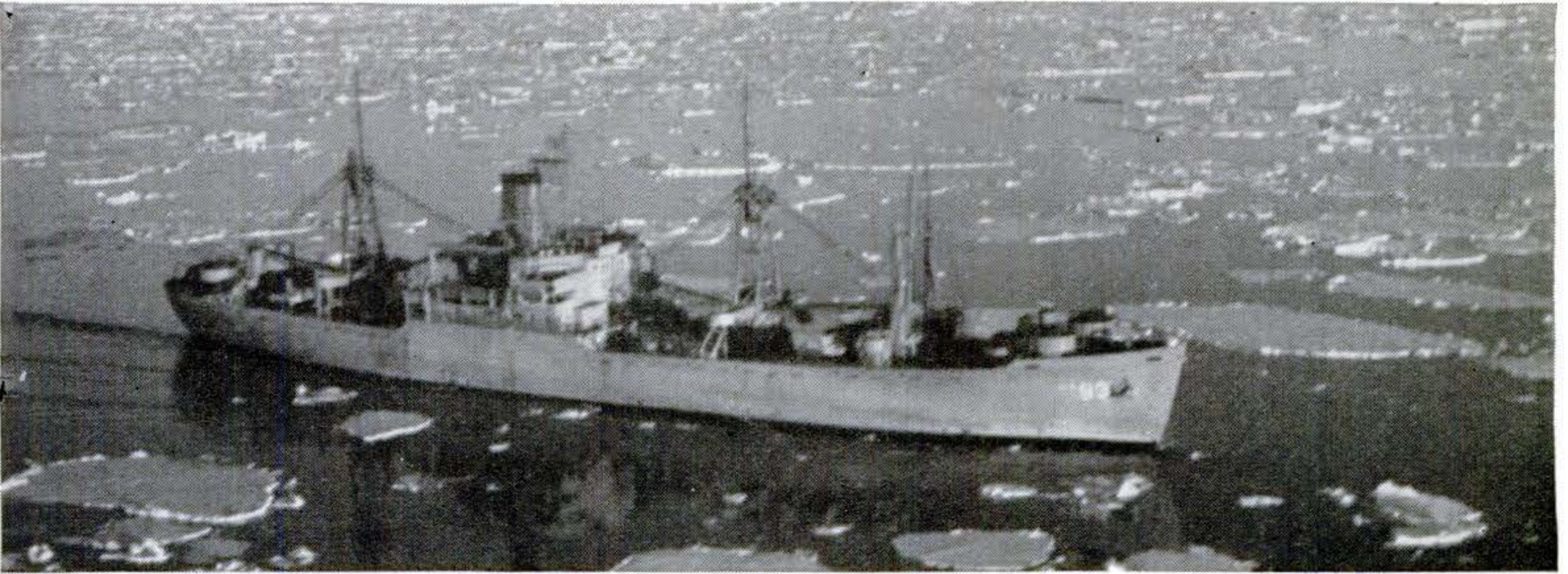

This ship is gingerly nosing her way through the guardian of the poles, the floating ice pack. This is the most dangerous navigation in the world today. Recent experience shows that any

ship not especially strengthened must have an icebreaker escort through the pack. For really efficient polar sea travel, a fleet of specially designed ships is needed.



1. Artist's sketch shows how explosives could be used to blast a path for a carrier. During the 1947 pack crossing one ship rode atop floe, could not break through or back down.

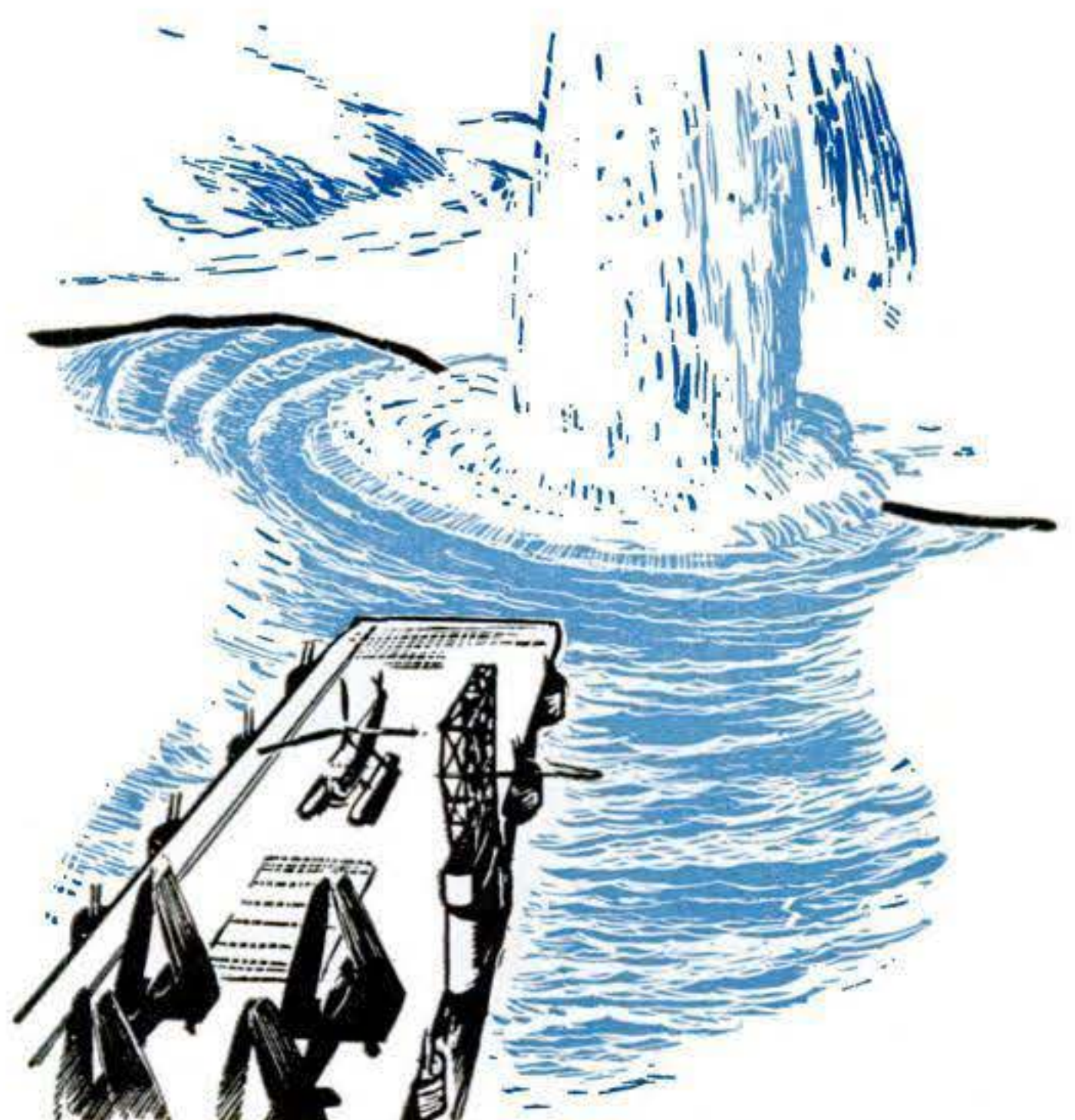

2. Specially trained demolition squads were put on the ice and buried explosives in end of floe. Blast cracked ice, freed ship. Navy is trying out various ways of blasting ice pack. ➔

Polar Flying Is World's Toughest, Most Risky

I WAS sitting with a group of pilots around an old fashioned, pot-bellied stove. They were awaiting clear weather for their first flights in Little America. Their C.O., Commander Bill Hawkes, spoke:

"If anyone's forced down in the interior, sit tight. We'll try to get you out. Don't leave the plane. If you try to walk to camp

—even if it's only 50 miles—I give you five miles the first day, two miles the second. The third day you'll be dead."

Flying over polar wastes is the most dangerous flying in the world. There are no accurate charts, no weather reports 200 miles out. A forced landing away from the coast usually means frozen death. A ship rescued six survivors of a plane crash along the coast early in our expedition. Three died in the crash, a fourth froze his legs, which were later amputated above the knees.

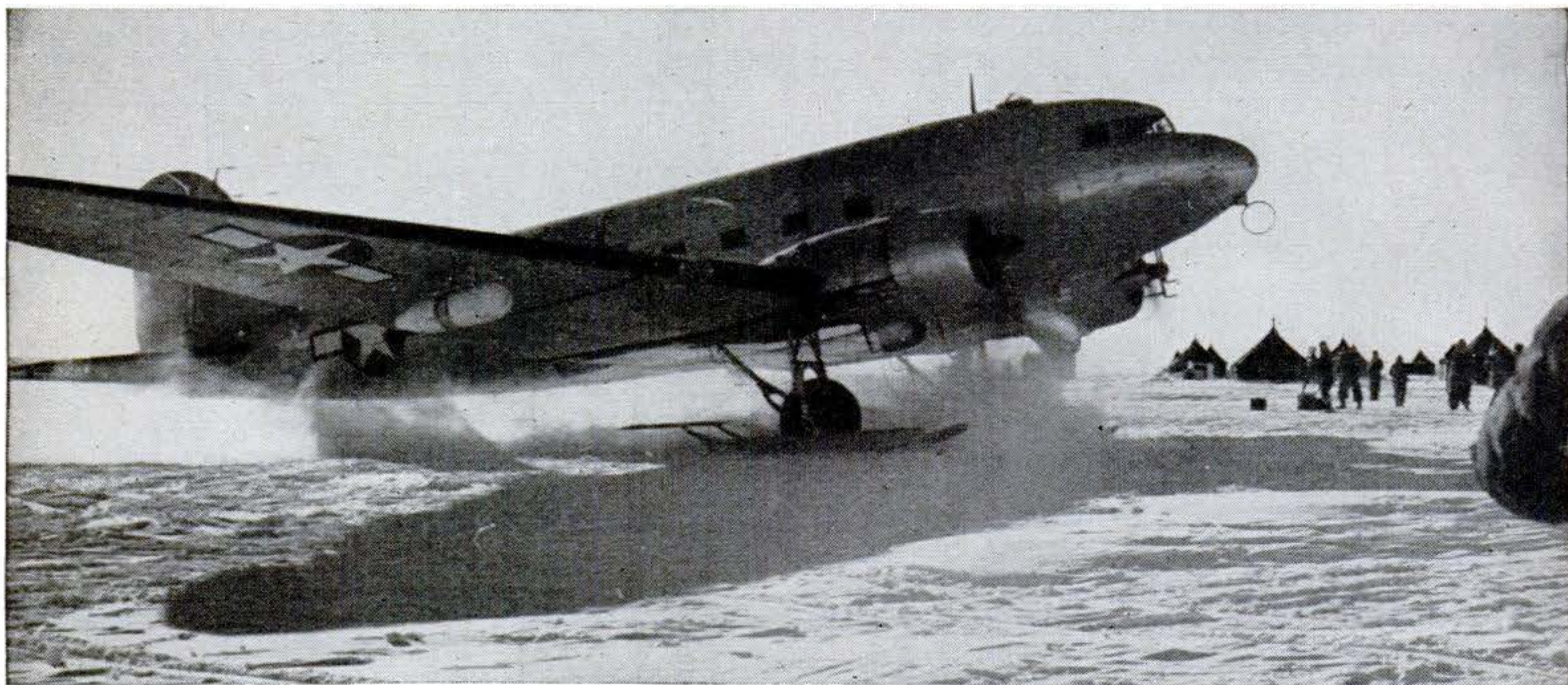

This plane used wheels to take off from a carrier—and is landing at Little America on skis. The wheels were inserted through the skis,

raising them six inches above the deck. When the wheels hit the snow on landing, they sank in until the skis took over the load.

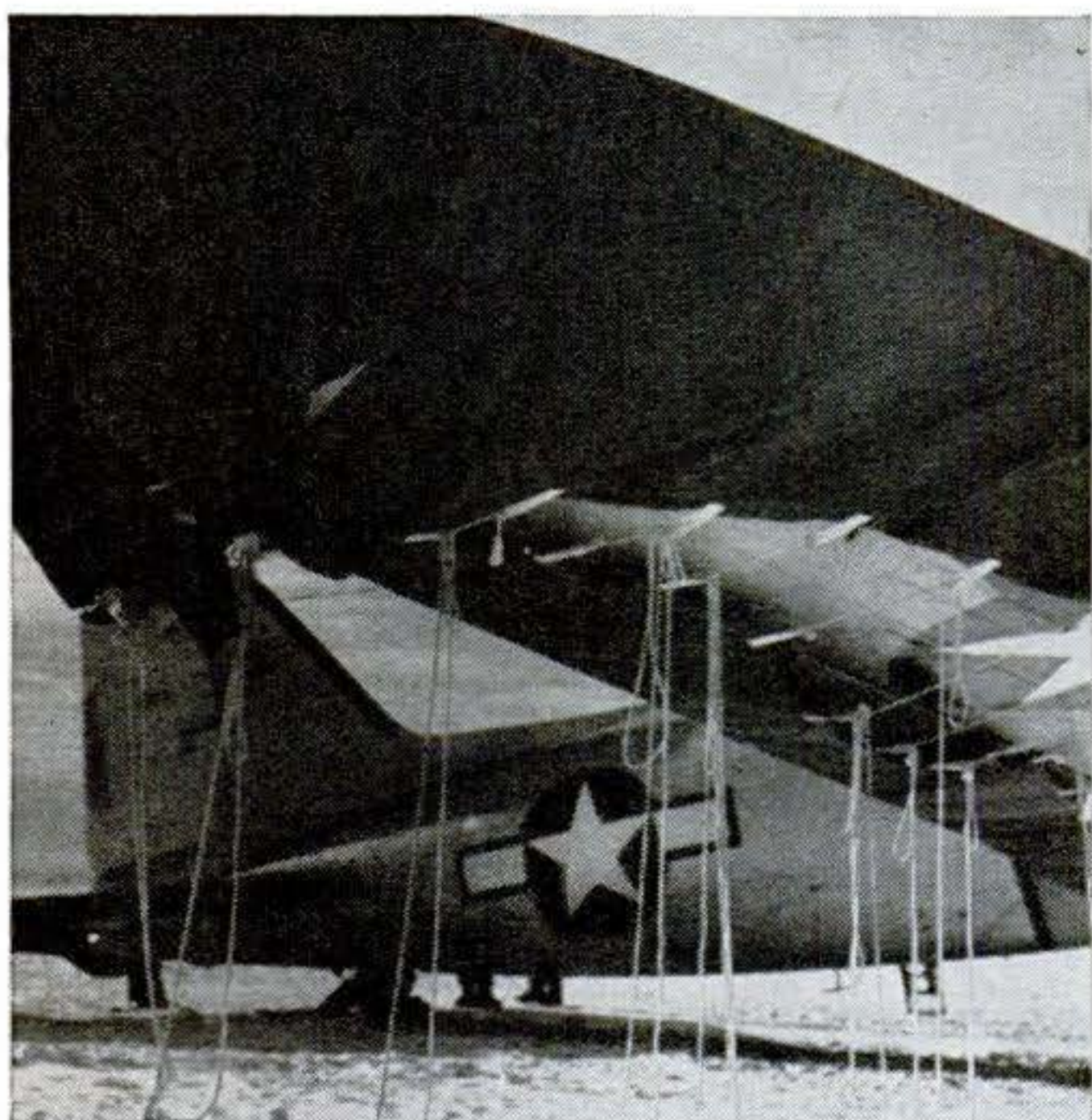

Experts want to see what happens to the six planes left, like this one, at Little America. Tail ski is buried in the ice; wings are covered with a tarpaulin anchored in the ground.



This plane's skis are frozen to the airstrip, so a crew must rock its wings up and down to pry them loose. Wheels would be preferable to skis if they could be adapted to Arctic conditions.

The plane was flying low when it rammed a small mountain of ice on a "white day." On such days, haze curtains the sun, there are no clouds, no shadows and no horizon—earth and sky meeting in a cottonlike sweep. As Commander Hawkes put it: "It's like flying in a bottle of milk." Pilots need airborne radar to warn of invisible ice hills ahead, and should drop trails of "window" to provide a radar track to base.

In flight, metal instruments often fail as they contract from the cold. Oil-pressure

gauges sometimes give no positive reading at all. Heating systems fail regularly when feed lines freeze, dropping the cabin to -45° . Planes should be pressurized. Designers must allow for the contraction of every metal part.

The miseries of the fliers were mild compared to those of the ground crewmen. Working in the open, their skin stuck to metal, which sears like a flame at -30° . A silk glove prevents metal burns, but no glove gives them both freedom and warmth.



Planes must be kept clear of snow, for the tiniest opening lets it drift in. Hours must also be spent preheating planes before they take off.

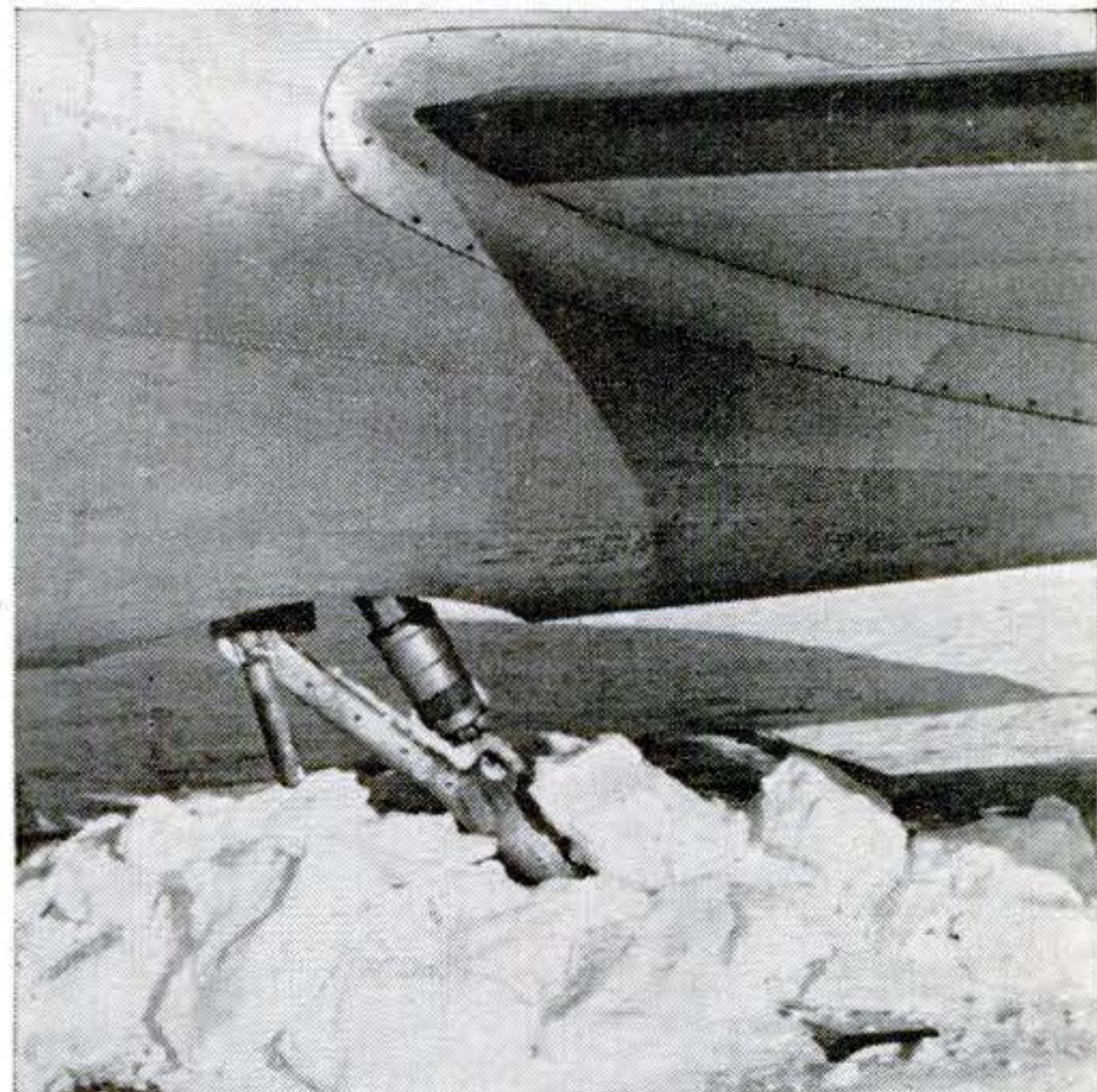

This plane's take-off was delayed when a polar squall buried its skis. Tools left outside disappear in snow; tool rack on skis is planned.

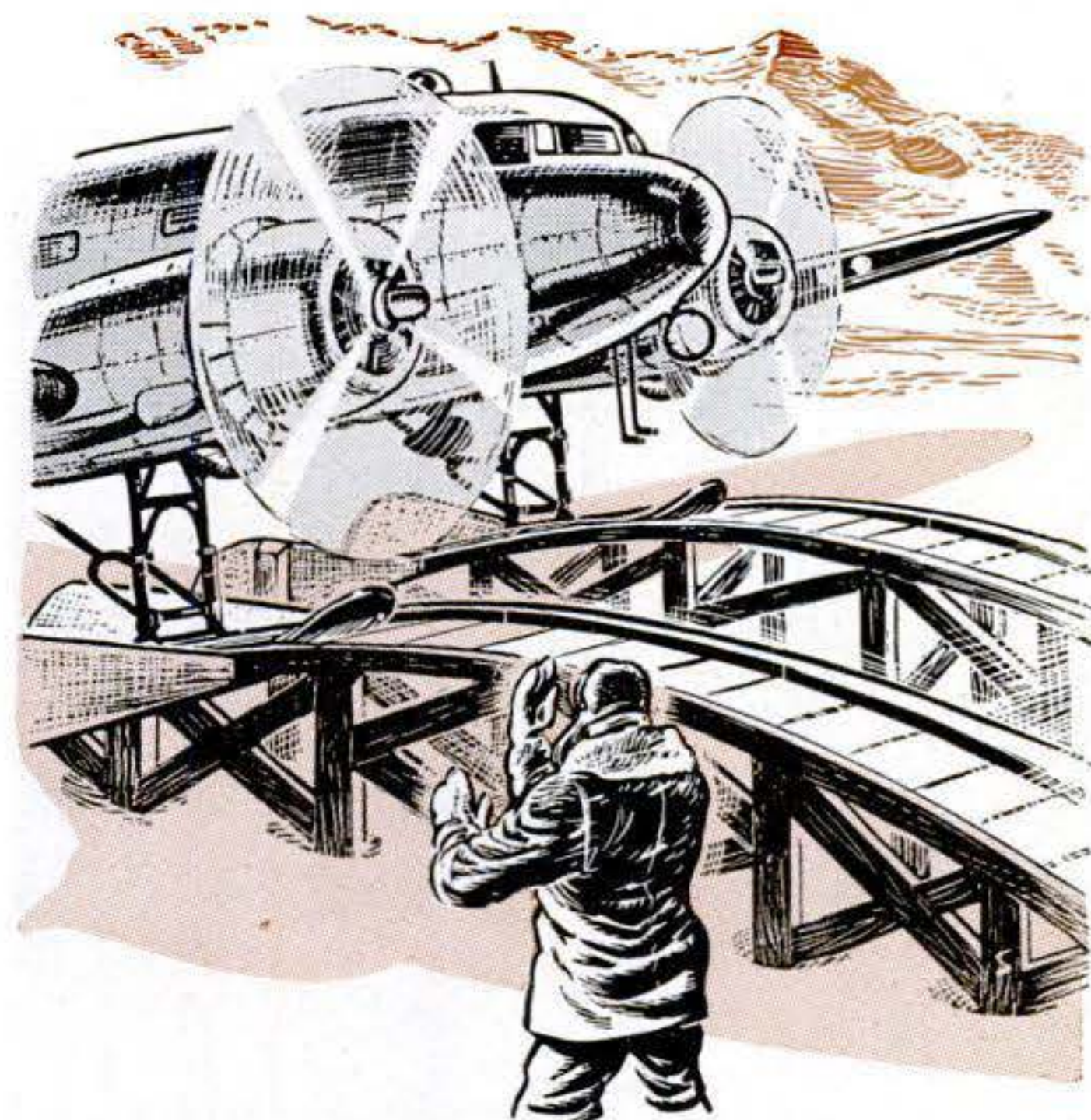

To protect planes from drifts and keep skis from freezing down, an elevated structure like this arched bridge has been suggested. A protective "horse blanket" is also planned.

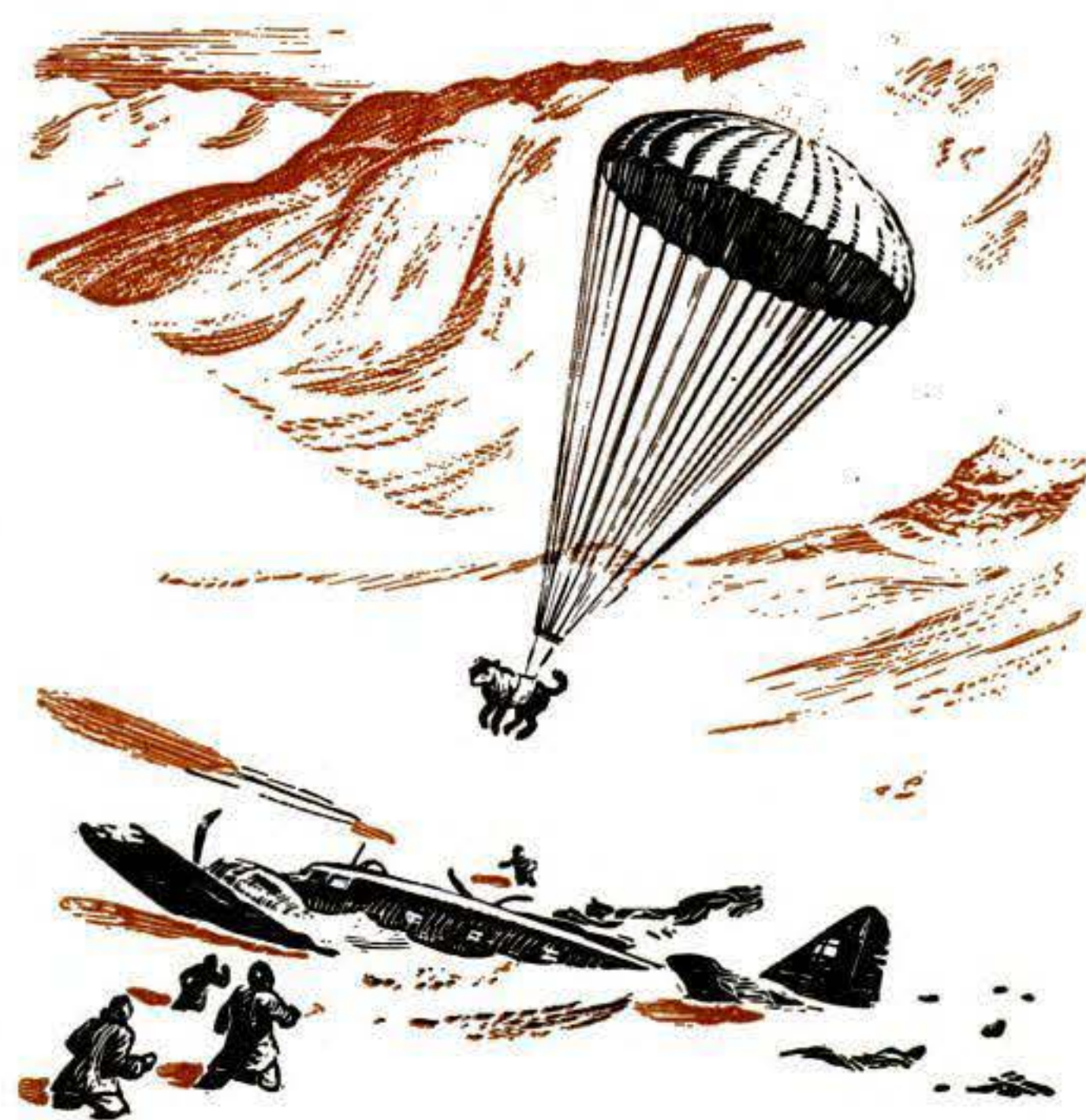

Future rescues of personnel from polar plane crashes might be made by dropping completely equipped dog teams and their drivers. Another way would be for each plane to carry a weasel.

Polar Housing: Men Burrow to Escape Cold

WE TOOK the temperature in our tent at Little America one day. My roommate held the thermometer a few feet away from the stove; it read 50° . Then he held it over my cot, which was at the far side of the tent. It read -10° .

The tent was originally intended for use in the Pacific. It was flimsy canvas, had no insulation, and there was a naked opening around the top of the tent pole. The cots, from the same tropical unit, came complete with mosquito bars. We used the netting to stuff the hole; before we left it supported a small mountain of snow.

Commander C. O. Rheinhardt, the Seabee engineer who built Little America, has recommended the design of a new type of prefabricated house. Two men should be able to assemble this structure without screws, bolts, nails—or anything that cannot be handled with mittens. Sealed joints would prevent the entrance of snow. The house should have a better heater than the pot-bellied stoves we used. And it will have to stand polar winds of 100 m.p.h. Important is some kind of protected latrine system; Chic Sale isn't so funny at the poles.

When I recall the pile of snow that filtered in through the flap during one night's blizzard and buried our shoes, I know Commander Rheinhardt is on the right track. Housing is a big factor in polar morale.

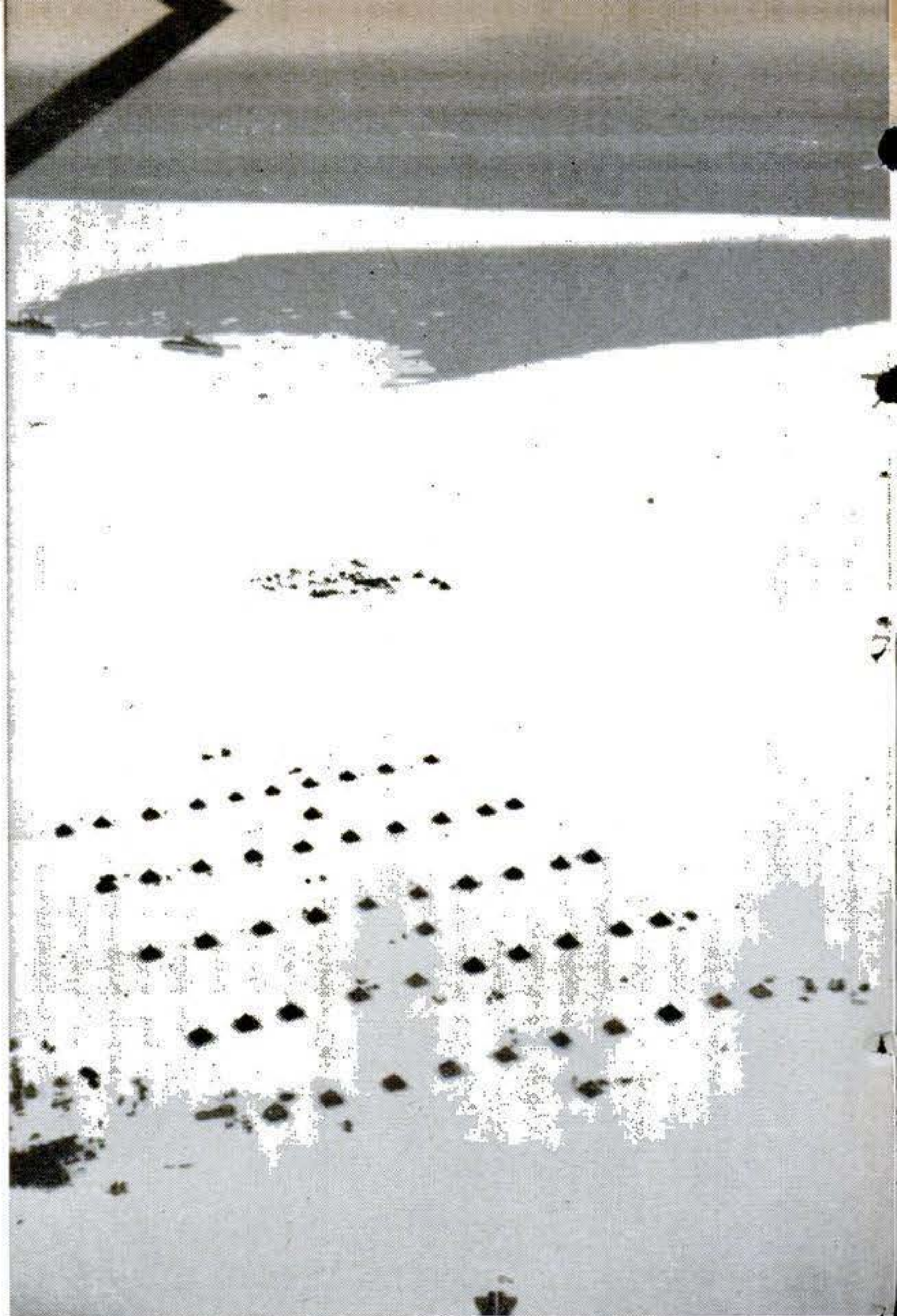

This tent city is Little America IV. Break in solid ice in background is Bay of Whales, where Byrd's ships unloaded. Galley and mess tents are at lower left, air operations are in center.

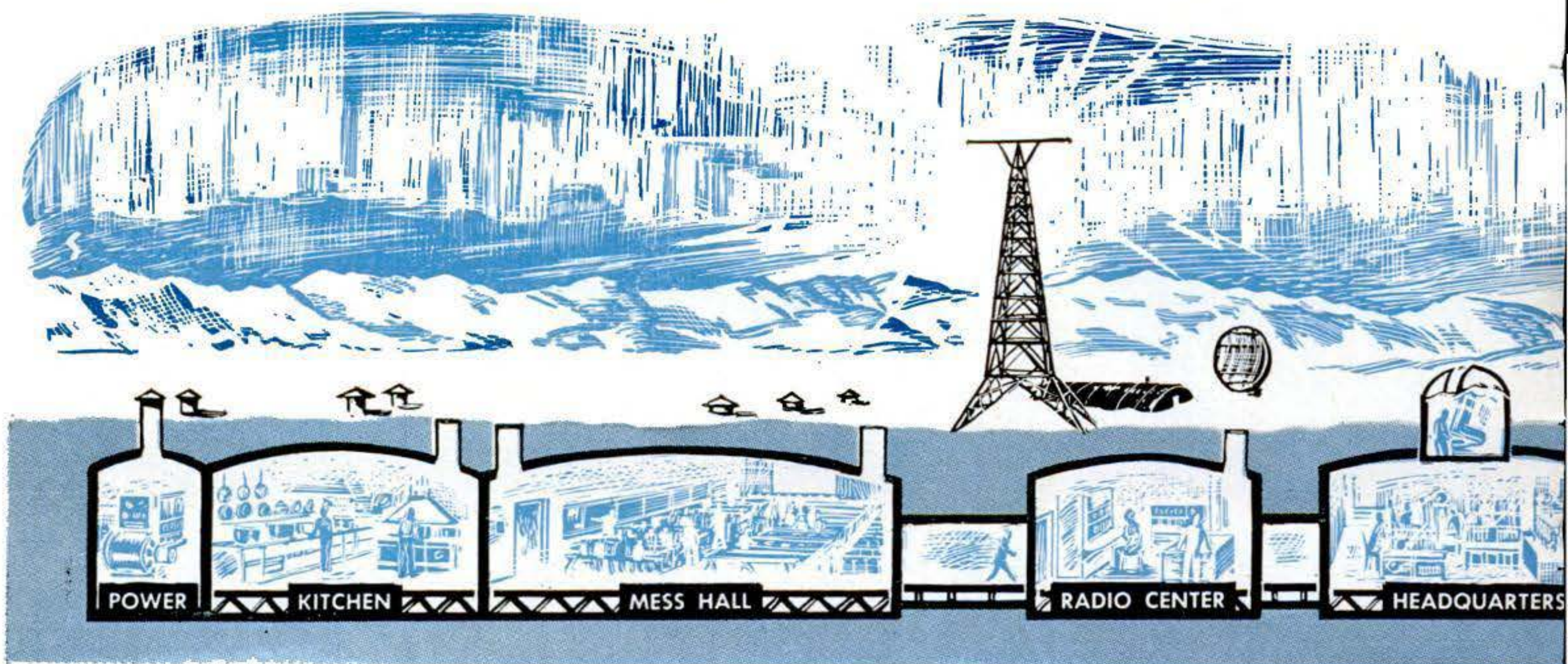

Surface travel is almost impossible during the long winter nights, so bases will be buried.

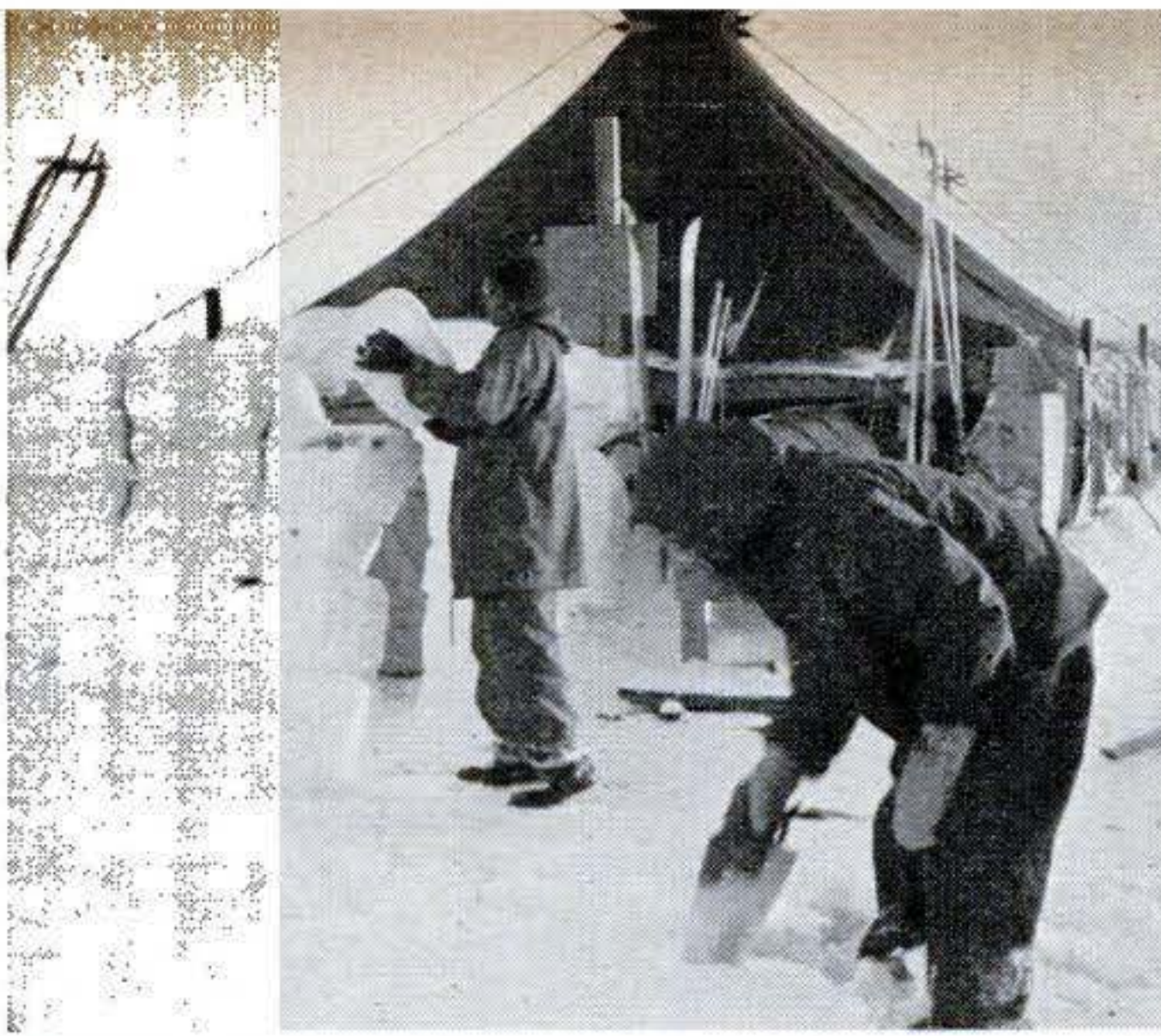

Walls of ice blocks were built waist-high around tents to protect them from polar winds. Man in foreground is sawing a block out of the frozen ground. Plexiglas formed tent windows.



It took 600 man-hours to erect this Quonset hut. Although very warm, the Quonset is not practical on deep snow because of the difficulty in obtaining support for the foundation.



Refrigeration is no polar problem. This bread was baked a month ago—and is still fresh. A rough framework, lined with ice blocks and covered with tarpaulin, makes perfect icebox.



These men have dug out the skylight of Byrd's old snow melter and are lowering in Captain Vernon Boyd. Polar snows bury a house in a few days, so roofs must bear a load of 50 lb. per sq. ft.

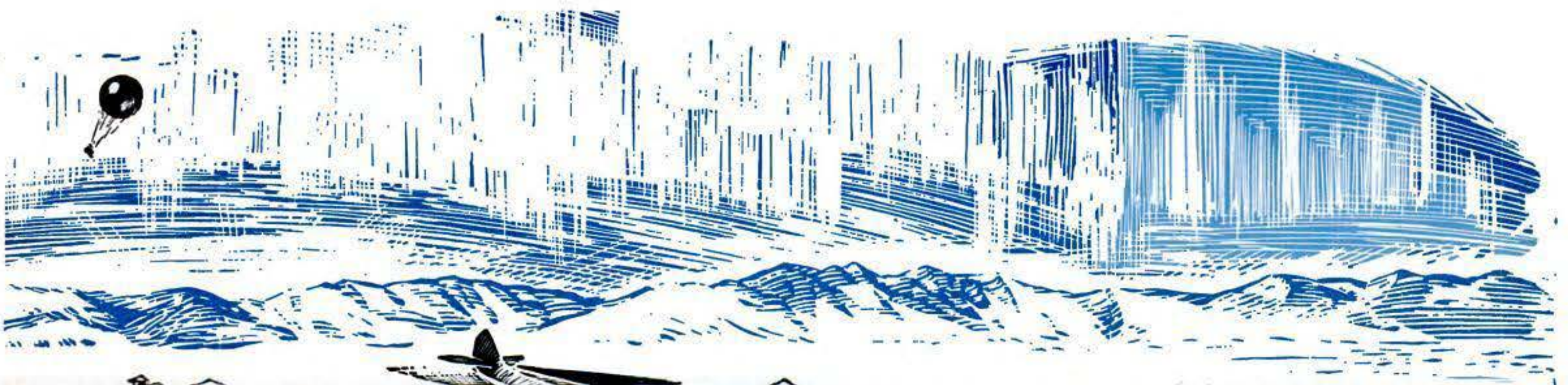

Buildings will be connected by tunnels, with exits at central hatches. Elbowroom helps morale.

Living at the Poles Means New Way of Life

THE challenge of the poles is for us to adapt ourselves to a way of living utterly unlike anything we have known. From mittens to airstrips, we have a lot to learn.

Most Americans see their country from automobiles. Let's assume you are in one of the new tractors crossing a polar region. You'd find no landmarks or signposts. Unless you're near a charted, ice-free mountain—and there are no mountains at all in the Arctic Ocean—sun navigation is your only guide. The magnetic compass is as reliable as a Ouija board because of the proximity of the magnetic pole. Hills of ice and snow grow or disappear overnight, for this world is still gripped by the ice age, and the great glaciers move as much as 100 feet a day. Outposts must be set up if radio beams are to guide vehicles across the wastes.

The wick in your lighter will freeze if you step outside. Until a foolproof gadget is found, you'll have to keep your vehicle full of freezing air while "motoring," or your windshield will freeze over from the heat inside. And your car will pitch and toss like a ship in a heavy storm.

World's Healthiest Region

But in planning the polar city of tomorrow there is a lot to be thankful for:

Hospital facilities need not be expensive, for the polar regions are the healthiest places in the world. Germs are smarter than explorers—they shun extreme cold. Past records show that base personnel often grow sick only after a new ship arrives. When permanent polar settlements are established, new men and gear will be isolated until proven germ-free. One thing that is essential is a heated sled-ambulance, since it is impossible to treat injured men in the open.

Garbage disposal is a cinch. One man in the mess hall poured a bucket of hot water on the snow the first night. It made a four-foot hole. Whenever garbage reached the top more hot water was added. When we left, the hole was more than 60 feet deep.

Camouflage is relatively simple: To match the countryside you just have to look white. A Nazi freighter avoided our ships near Greenland during the war by covering every inch with white canvas. It was only revealed and captured when a gale tore off chunks of the canvas.

END



This weird face mask breaks the wind, but in a few minutes your breath freezes into chunks of ice around the nose and mouth pieces. An electrically heated glass helmet is being considered.



This crevasse—a huge crack in the ice—is a threat to anyone leaving the immediate camp area. Often crevasses lurk in ambush, covered by a carpet of snow so that you walk into them.



Seals, high in nutritional value, are a major item in the polar larder and would be a valuable food source for a permanent base. All hands on the Navy's expedition were served "sealburgers."



Here's how to get water near the pole. First step is to spade up a solid chunk of ice from the millions of tons of it about you.



Put the ice inside a GI can, packing the can until it is filled to the top. It's a tedious job—so men tend to go without washing.



Next, start the automatic steam-making machine, operating on Diesel oil. Expedition found need for more than the one steam-maker taken along.



Finally, you turn the live-steam hose into the can. Soon you will have pure drinking water. All polar barracks need hot-water machines.



It is important to put shoes and socks near the stove before going to bed at night. Otherwise the moisture on the bottom of shoes and inside socks will cause them to freeze solidly to the

floor. One man dropped his socks on the floor when he turned in. In the morning, when he tugged at them, they broke—not tore—in half. The same thing happens to damp shoelaces.

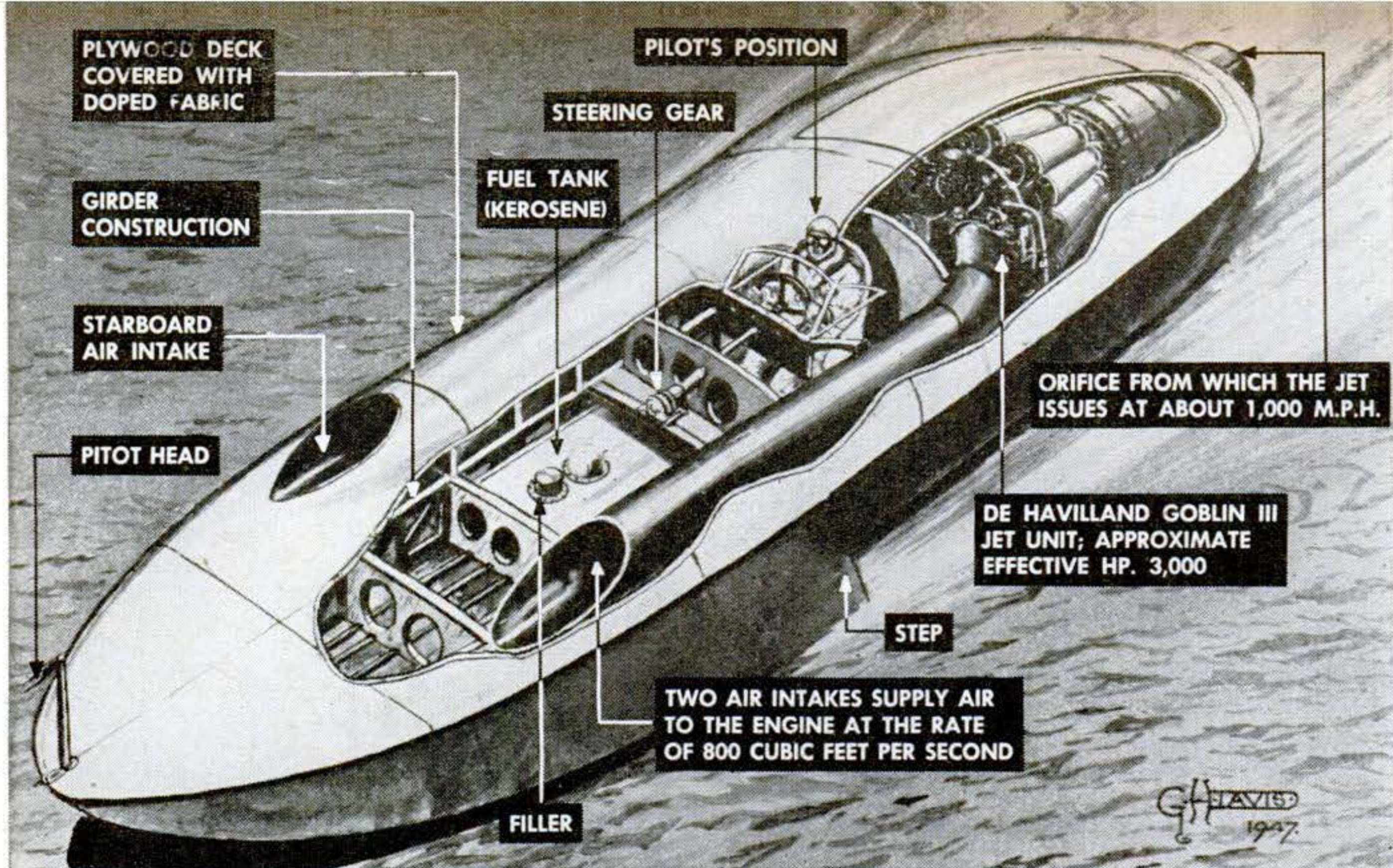

Jet version of Bluebird II is shown in cutaway view. The Goblin engine occupies approximate-

ly the same position as the Rolls-Royce reciprocating engine did in the vessel's original hull.

Jet-Driven Bluebird II Aims at Record

JET propulsion has taken to the water in a spectacular way. With the announced purpose of surpassing his prewar world speedboat record of 141 miles an hour, Sir Malcolm Campbell has converted his famous Bluebird II and fitted it with a 3,000-pound-thrust De Havilland Goblin jet power plant.

Before redesigning the hull of the Bluebird, its original designers wanted to obtain knowledge of the aerodynamic factors involved at the greatly increased speed they hoped the boat would achieve. To do this, they called upon British jet aircraft experience for assistance and tested a scale model of the motorboat in a wind tunnel.

Although not in a class with Sir Malcolm's major effort, some interest has been shown recently in adapting jets to water transportation. One example is a three-horsepower outboard jet engine for rowboats (PSM, Sept. '46, p. 85), said to be capable of eight m.p.h. Another, using a water jet, is a propellerless boat powered by "hydropulsion"—the pushing force of a solid stream of water ejected at high velocity under hy-

draulic pressure (PSM, July '47, p. 214).

Compared to these, the new Bluebird is a jet water monster. The two forward intakes will supply air to the engine at the rate of 48,000 cubic feet per minute. The hull has been streamlined to improve its performance at the high speeds the Goblin engine is capable of producing.

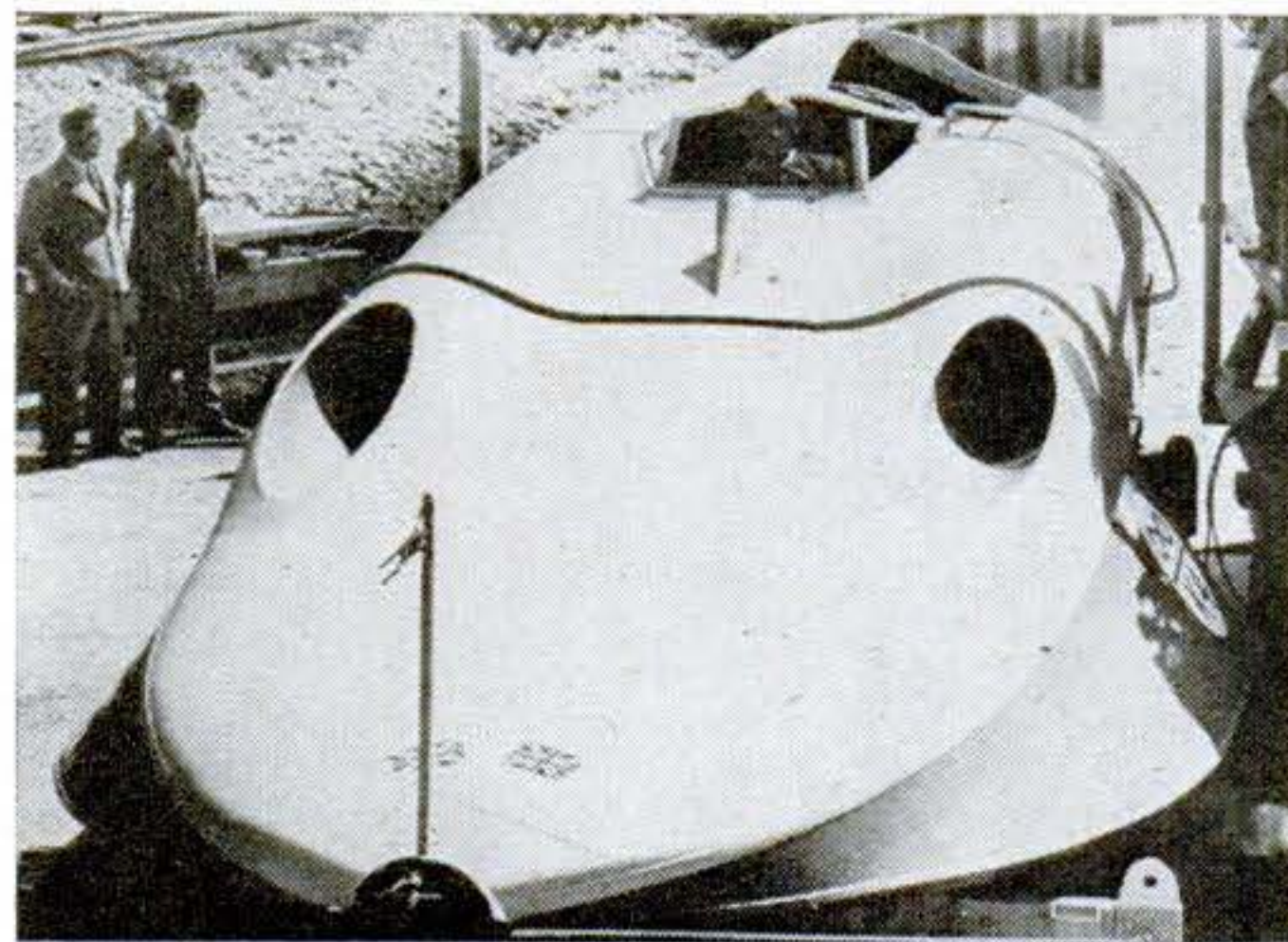

Bug-eyed look is created by the twin ports that carry air to the jet. Lower hull is much like 1939 version. Redesigned Bluebird has a beam of 10 feet 10 inches, is 27 feet 2 inches long.

Mysterious Liquid Acts Like Atoms

Scientists of U. S. and U. S. S. R. race to explain the baffling tricks helium plays as a fluid near absolute zero.

By Herbert Yahraes

A LIQUID that behaves like an individual atom instead of like any other liquid on earth is being scrutinized by American and Russian physicists to determine how its curious properties can be put to work for science and industry.

This strange substance is liquid helium. Its characteristics are so peculiar that no one can say where the present research—a race between scientists here and in the U.S.S.R.—will lead. It may lead to the development of a superconductor that would chop your electric bill by carrying power over great distances without loss.

It may also lead to delicate heat-measuring machines—for astronomers, perhaps, and rocket-ship pilots.

It will almost certainly be of immense assistance in enabling us to understand and harness our friendly enemy, the atom.

Liquid helium is the oddest fluid man ever dabbled with, and the coldest. It exists only at temperatures close to absolute zero, which is 459° below the zero of our back-porch thermometers.

At the temperature of liquid helium, gold, which is ordinarily an excellent conductor of electricity, becomes worthless as such, while tin and lead, ordinarily worthless, become perfect conductors. Following up this lead, Westinghouse researchers are considering the possibility of encasing certain con-



Dr. Cecil Lane decants some liquid air. Liquid helium, far colder, would vaporize much faster.

ductors in liquid helium. Other scientists point out that by studying what happens to metals in the realm of absolute zero, metallurgists may be able to develop an alloy that will conduct electricity perfectly at normal temperatures.

All liquid gases do strange things—liquid helium by far the strangest. It can run uphill. It can make the ancient legend of the bottomless pitcher come true. Also, it has what the chemists call an extremely low viscosity—so low that if you put some of the stuff into a pan at absolute zero and stirred it with a circular motion, it would go 'round and 'round almost indefinitely.

A Dual Personality

Strictly speaking, there are two kinds of liquid helium. The first, designated liquid helium I, is liquid helium in the temperature range between 4.2° and 2.2° on the Kelvin thermometer, which means it is that many degrees Centigrade above absolute zero. It is a colorless, odorless, effervescent fluid that looks like carbonated water.

The second is liquid helium II, in the temperature range between 2.2° K. and absolute zero. It is helium II that has physicists excited because it runs uphill and behaves like an atom. It, too, is without color and odor, but it is also without bubbles. Even if a red-hot poker were thrust into it, helium II would not fizz—because it is an excellent conductor of heat. Other liquids bubble because of differences in temperature; in a good conductor, no such differences exist.

The current chapter in low-temperature physics begins with the work of Dr. Peter Kapitza, now of the Institute for Physical Problems, Moscow. Kapitza developed a machine for liquefying helium while he was working at the University of Cambridge, in England.

One of the outstanding American workers in the field, young Dr. Cecil T. Lane, associate professor of physics at Yale, wrote to England for drawings of the Kapitza machine. He got some, but he had to fill in an awful lot of the lines himself. Nevertheless, working in spare time for three years, he had a helium liquefier in 1941 that was even better than Kapitza's.

It was a long time, though, before he was to get much use of it. For, strangely enough, the war curtailed work in low-temperature physics in every country except Russia. Why? Did the Russians see that liquid helium might lead to a new, all-powerful

weapon? American physicists don't know. They do feel sure that in this field there has been no iron curtain. During the shooting and since, the Russians have published their findings, apparently with nothing held back.

In any event, the Kapitza-type helium liquefier built at the Sloane Physics Laboratory at Yale was the first in the United States. But with scientists, and governments, eager to explore the possibilities of the strange fluid, five more machines have been put into operation within the last year.

The Kapitza machine produces liquid helium at a fraction of the cost and time and without the danger of earlier methods, in which hydrogen—explosive and inflammable—is used.

Currently the Americans and Russians are working on "second sound," which was discovered and named by a Soviet scientist in 1944. Second sound is a phenomenon that occurs only in helium II. It travels through the liquid at 70 feet a second, whereas the speed of the normal sound wave in this fluid is 10 times as great.

The name is a little confusing, for second sound is really a temperature wave. It is produced by sending an alternating current through a wire in a flask of helium II. This current causes a fluctuating evaporation at

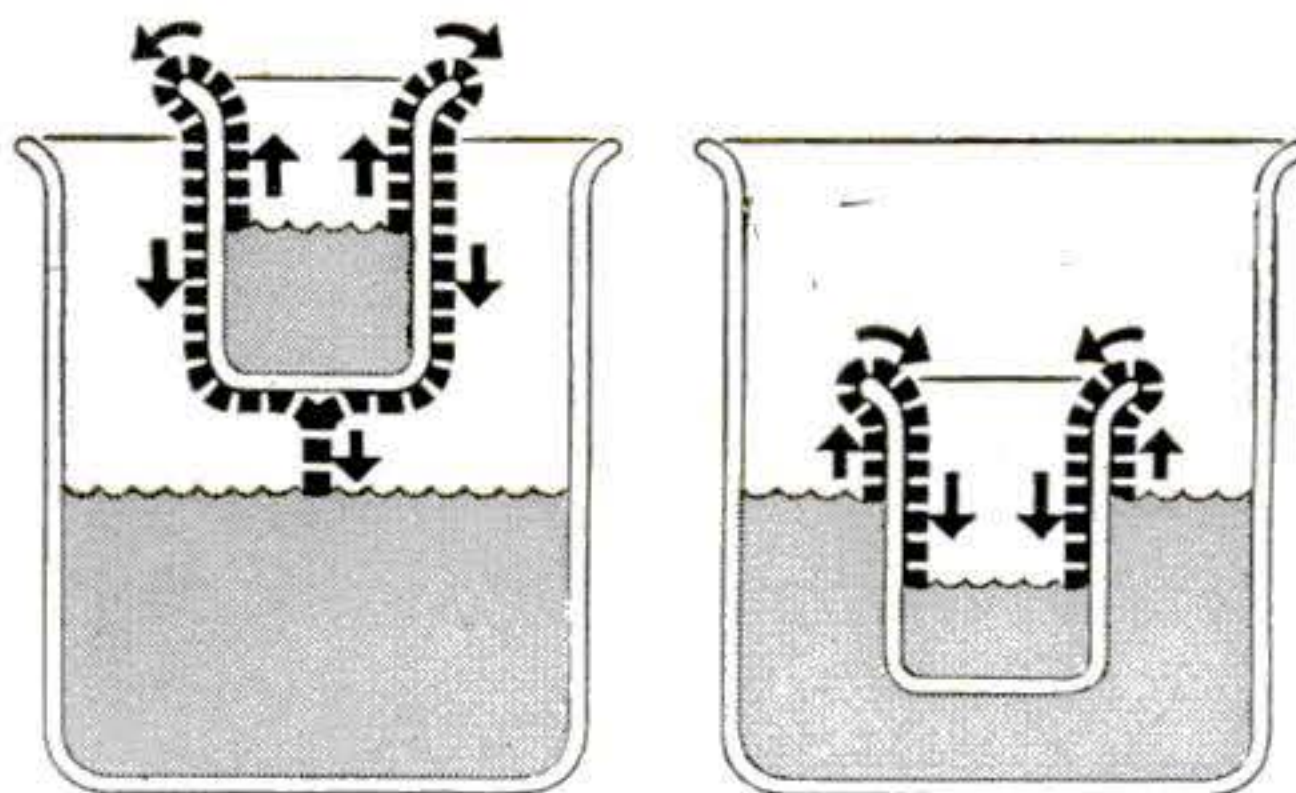

Flowing uphill is one of liquid helium's neatest tricks. Drawing shows how it climbs out of a full cup suspended over a larger quantity, and how it climbs into an empty one partly submerged. In the first case, the process goes on until cup is empty; in the second, until it is full.

the surface of the liquid, and therefore creates changes in pressure.

In ordinary sound, what the ear detects are changes in pressure. In the case of second sound, these changes are not heard directly because second sound travels only in liquid helium, but a microphone can pick up the pressure changes.

What it sounds like depends upon the current used to generate the heat waves;

researchers at Yale used a 1,000-cycle alternating current and heard a thin, organlike sound. If the heat had come from a telephone circuit, says Dr. Lane, the sound would have been of voices—or whatever other noise was coming over the wire.

So far, no one knows the implications of second sound. At the moment it is only further—and the newest—evidence of the peculiar properties of helium II.

Lane calls the stuff “a magician’s substance”; another physicist has described it as “the most exciting fluid in nature.” It is exciting because it does not obey the usual mathematical laws—the laws that apply to ordinary substances.

Here’s an example: Place an empty cup in a saucer containing the stuff, and the liquid will immediately start creeping *up* the outside of the cup and then down the inside. Or suspend a tiny cup partly filled with helium II over a large saucer of the same liquid, and immediately the stuff in the cup will start climbing out to join the fluid in the larger container.

Flasks Balk Heat

Because of the intense coldness of liquid helium, physicists take great pains to prevent evaporation during such experiments. Instead of a saucer they use a Dewar flask, with a vacuum between its inner and outer walls to prevent heat transference. To turn back heat rays, its outside surface is silvered except for a couple of slits through which the experiment can be watched—and projected, if desired, on a screen.

Cups that fill and empty by themselves are odd enough, but helium II makes possible something still odder. A tiny bottle filled with the stuff is placed on its side in a bath of the liquid. At the mouth of the bottle a little paddle wheel is rigged up, its aluminum blades not much bigger than a bee’s wings. Current is passed through a wire in the base of the bottle, and almost immediately the paddle wheel begins turning.

What is happening is fairly simple. The liquid helium, warmed by the electric current, is flowing out of the bottle and making the blades revolve. But here’s the funny part: There is always just as much of it in the bottle as there was at the beginning.

Evidently the liquid is flowing not only out of the bottle, but also back into it. But if it is flowing back into it, why doesn’t it stop the paddle wheel?

The answer to that one explains some of

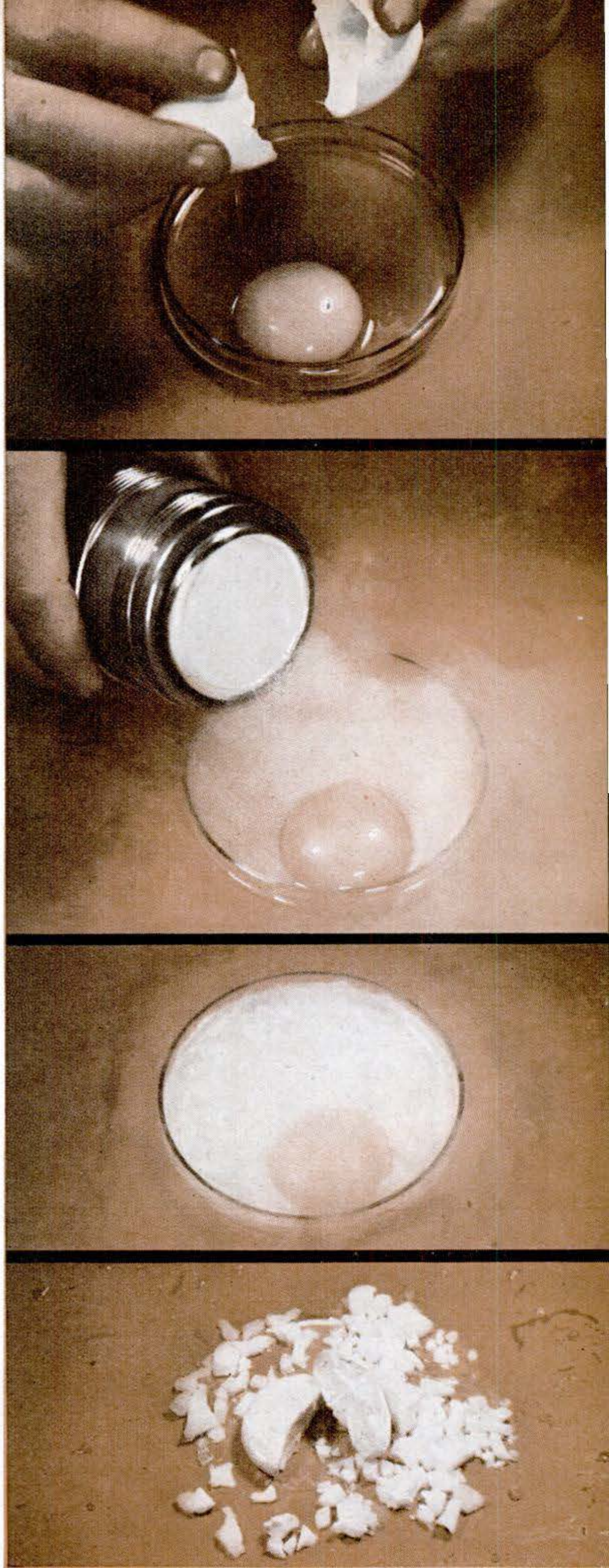

The fate of an egg, frozen in a saucer of liquid air, illustrates effect of extremely low temperatures. Egg is so brittle it shatters like glass. Liquid helium does this even to steel.

the peculiarities of this substance. Helium II is two kinds of atoms. Ordinarily its atoms are what physicists designate as *superfluid*—the kind that run uphill. The heat at the base of the bottle changes them into the other, or *normal*, kind. The normal ones flow out and turn the wheel. Once outside they become superfluid again and slip back, ghostlike, into the bottle.

Obviously, the ordinary mathematical laws can no more explain the behavior of liquid helium II than they can solve the behavior of atoms, neutrons and protons. To explain the action of such particles, scientists have resorted to quantum mechanics—atomic mechanics, in other words. Now physicists find that they have to use quantum mechanics, too, in dealing with this magic fluid. Because when liquid helium II flows uphill, or runs two ways at once in the same place, it is obeying the rules that govern atomic activity—defying time-honored principles of physics just the way a nuclear particle does when it feels inclined. So researchers who watch the odd tricks of liquid helium II are actually getting a blown-up picture of how an atom acts.

What the commercial uses of helium in its liquid state will be, nobody yet knows. Some other liquid gases (sulphur dioxide, am-

monia, Freon) are used as refrigerants, but their temperatures are comparatively high, about -35° F. Liquid oxygen, at -280° , is one of the propellants of the V-2 rocket. Liquid nitrogen, at -300° , helps preserve the toughness of carbon steel drills.

Liquid helium presumably is too cold for any such applications. Instead, more exciting possibilities lie ahead. For liquid helium makes it possible to study materials at temperatures so low that there is no interference from heat. This is because heat is a manifestation of molecular energy, and at absolute zero, molecular energy ceases.

"The removal of heat," says Dr. Lane, "strips away a sort of mask and permits the scientist to study the material unhampered by interfering phenomena."

So far as Lane can see, the work with liquid helium is not likely to lead to a practical development in the immediate future. However, he points out that the atomic bomb was the outgrowth of work like that in low-temperature physics.

And of course there is the fact that the Russians, who have some of the most intelligent physicists in the world, continued to explore the strange territory of absolute zero even when Moscow was in danger of being overrun. END

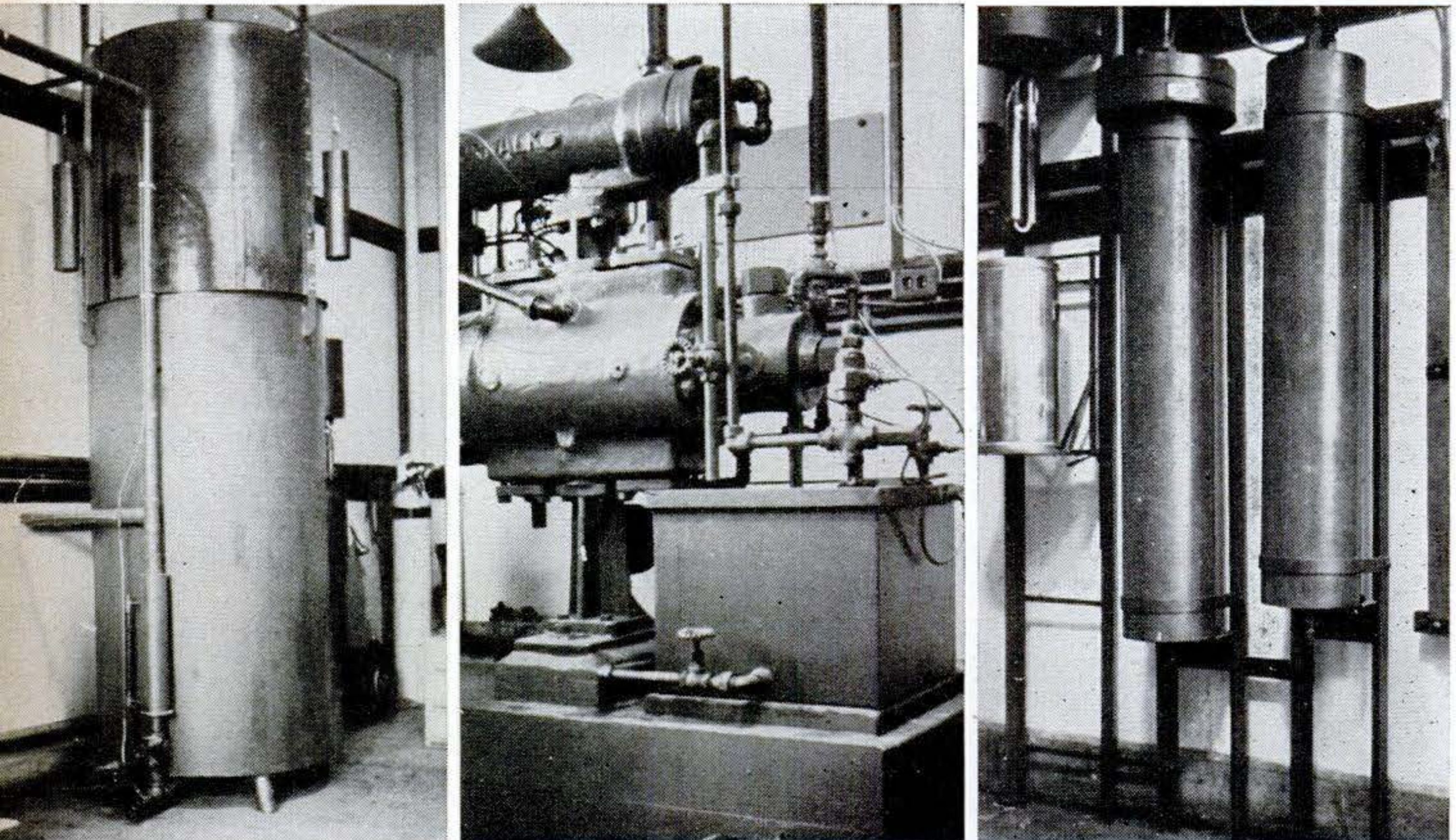

First stages of Kapitza-type helium liquefier are (left to right) the gasometer, which holds 44 cubic feet of gaseous helium; the compressor, which puts it under a pressure of 500 p.s.i.;

and the three purifiers, which remove oil, water, nitrogen and oxygen. Freed of these dangerous impurities, helium flows to the final stage of liquefier, shown on opposite page.

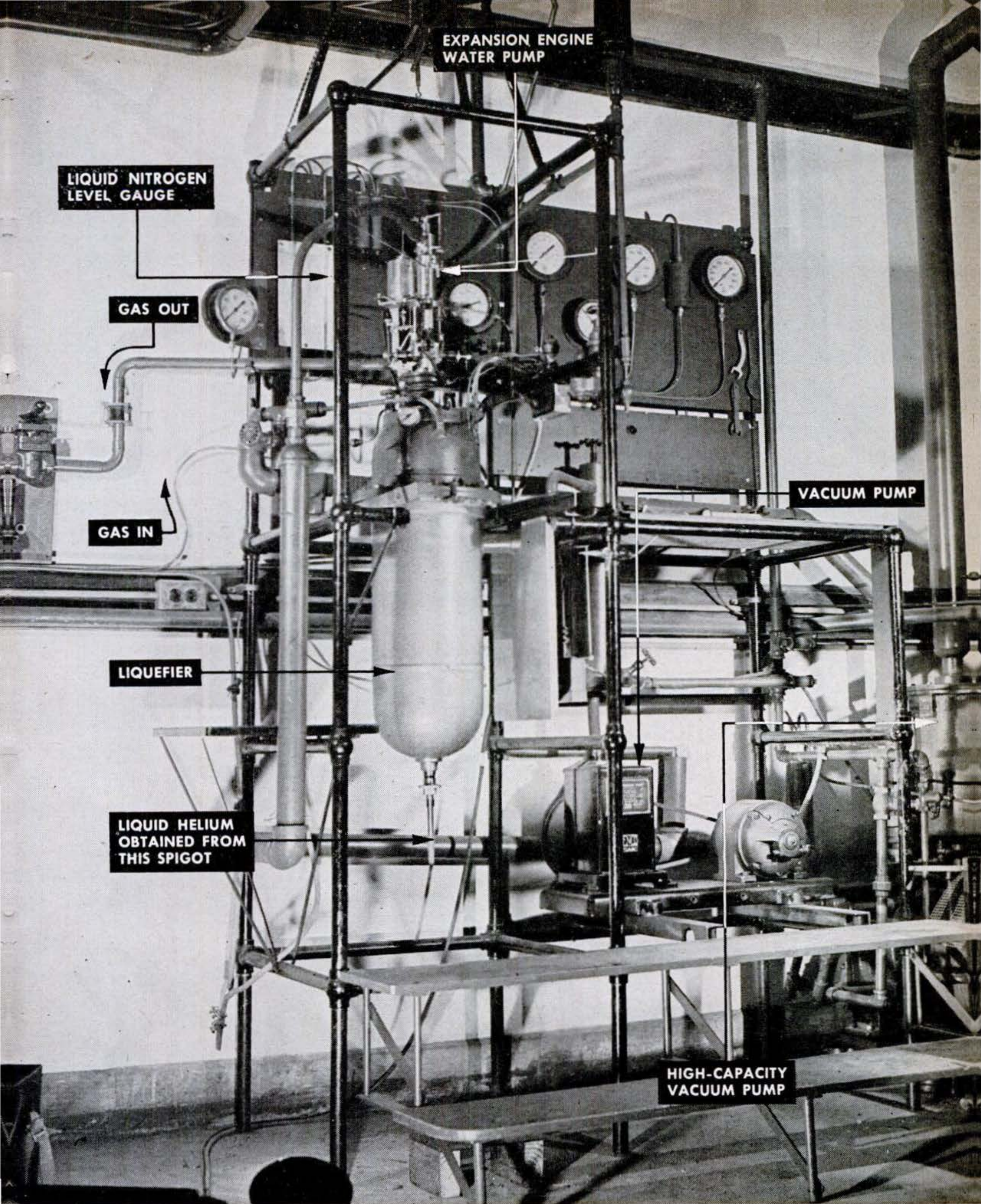

Cooled to -300° F. by liquid nitrogen, helium enters an expansion engine, which takes it down to -425° . Continuing to expand by itself, the helium begins to liquefy at -452° . About five

percent of the gas liquefies each hour, and the rest goes back to start final process again. Drawn off in Dewar flasks, liquid is measured in liters; one liter equals 25 cubic feet of gas.

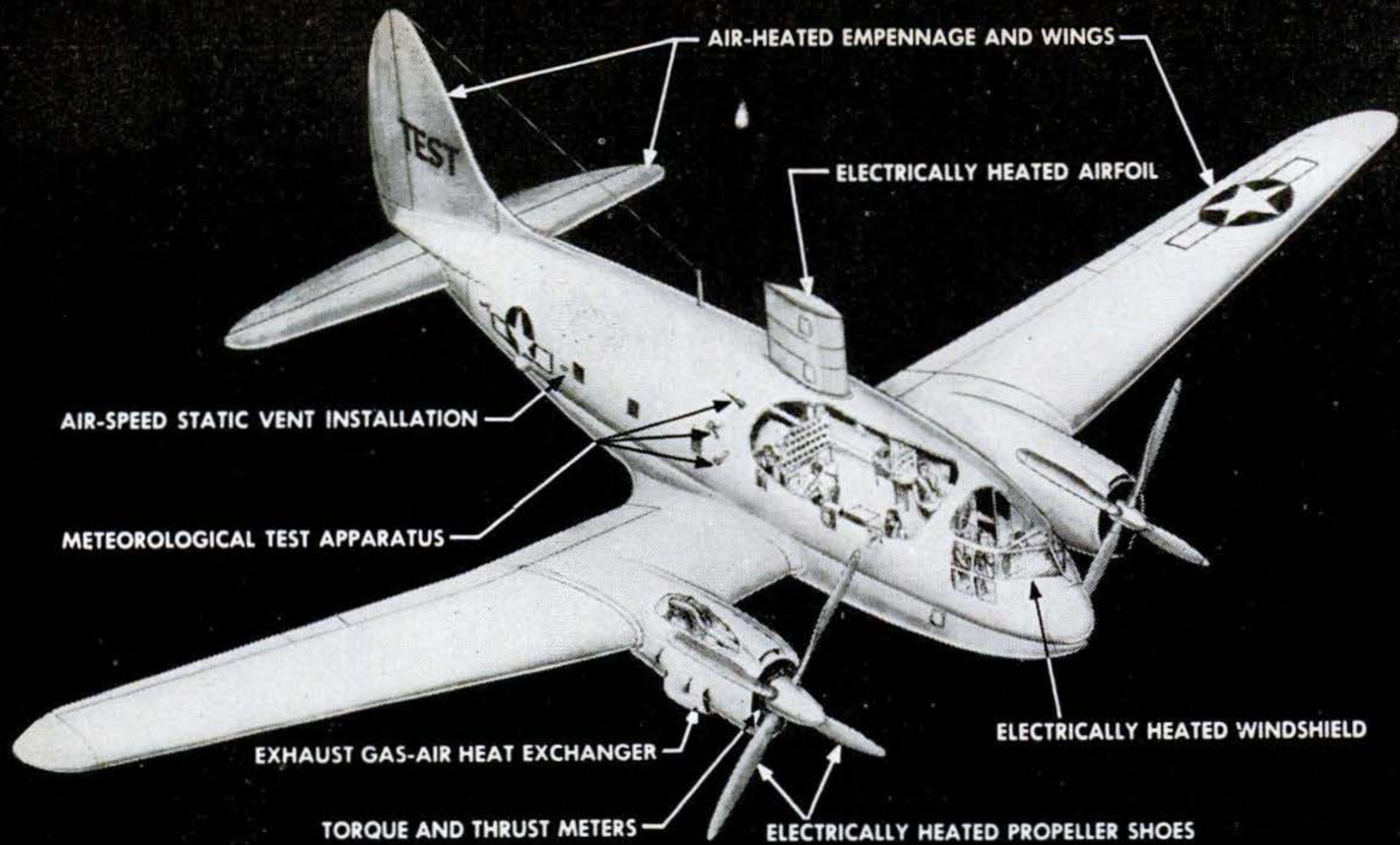

Flying Ice Laboratory. Cutaway drawing above shows the special C-46 Commando used for icing research by the National Advisory Committee for Aeronautics. With a crew of eight technicians, it goes up in bad weather to study icing conditions and to test equipment for ice prevention and removal. The *electrically heated airfoil* shown is one of the NACA low-drag series,

being tested to obtain data on the exact amount of heat needed to guard wings against ice formation. The *torque and thrust meters* are important because their readings provide an index of propeller efficiency, which varies with temperature. The *exhaust gas-air heat exchanger* protects the research plane against ice formation, permitting flight even under severe icing conditions.

Helicopter Dons Floats. The doughnut-shaped "water wings" attached to the three wheels of a Coast Guard helicopter enable it to land on water or marshy

ground during rescue operations. The rubber floats are deflated for land operation (left), and can be inflated by the pilot for a water landing (right).

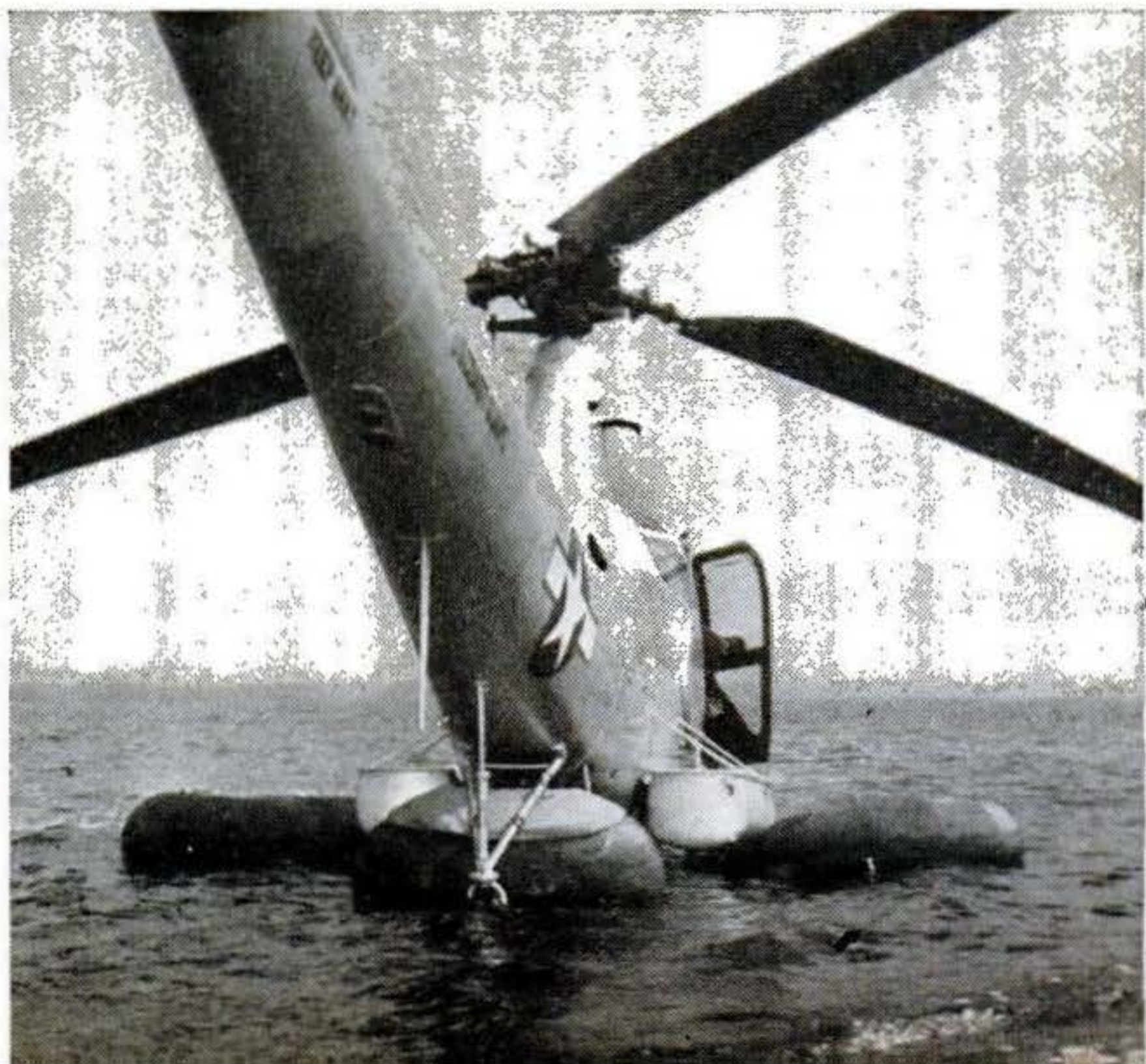

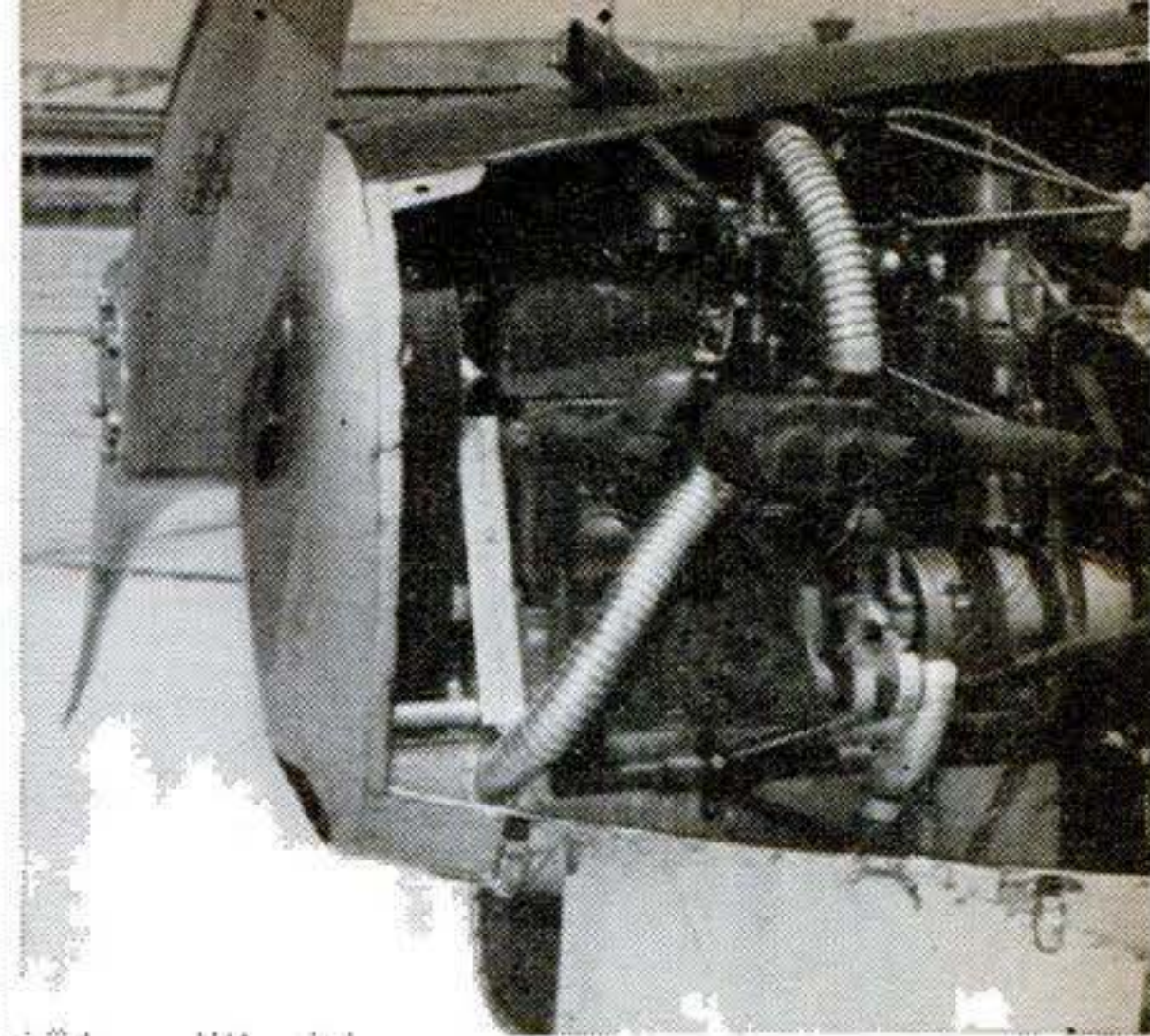

Midget Tries Its Wings. Designed around the 25-hp. Crosley auto engine (right) by Mooney Aircraft, of Wichita, this little job cruises at 100 m.p.h. and is said to

get 400 miles out of its eight-gallon tank. It weighs 415 lb., is 18 feet long with a 27-foot span, and has retractable tricycle gear. An experimental model is under test.

WHAT'S NEW in AVIATION

Improved Cub. More than 100 new features are credited to the latest version of the Piper tandem-seat Cub, shown at right. Called the PA-11, it is a successor to the J3, which it resembles. The range of the new model has been nearly doubled; it can cover more than 300 miles with 16½ gallons of fuel. It is powered by a 65-hp., four-cylinder Continental engine.



Fueling "Up". Delivering up to 200 gallons of gasoline a minute, a new underwing system speeds fueling of such planes as this Martin 2-0-2 transport. The heart of

the unit, designed by the Parker Appliance Co., is the valve shown on the right. Built into the wing, it automatically cuts off the flow when the tank is full.

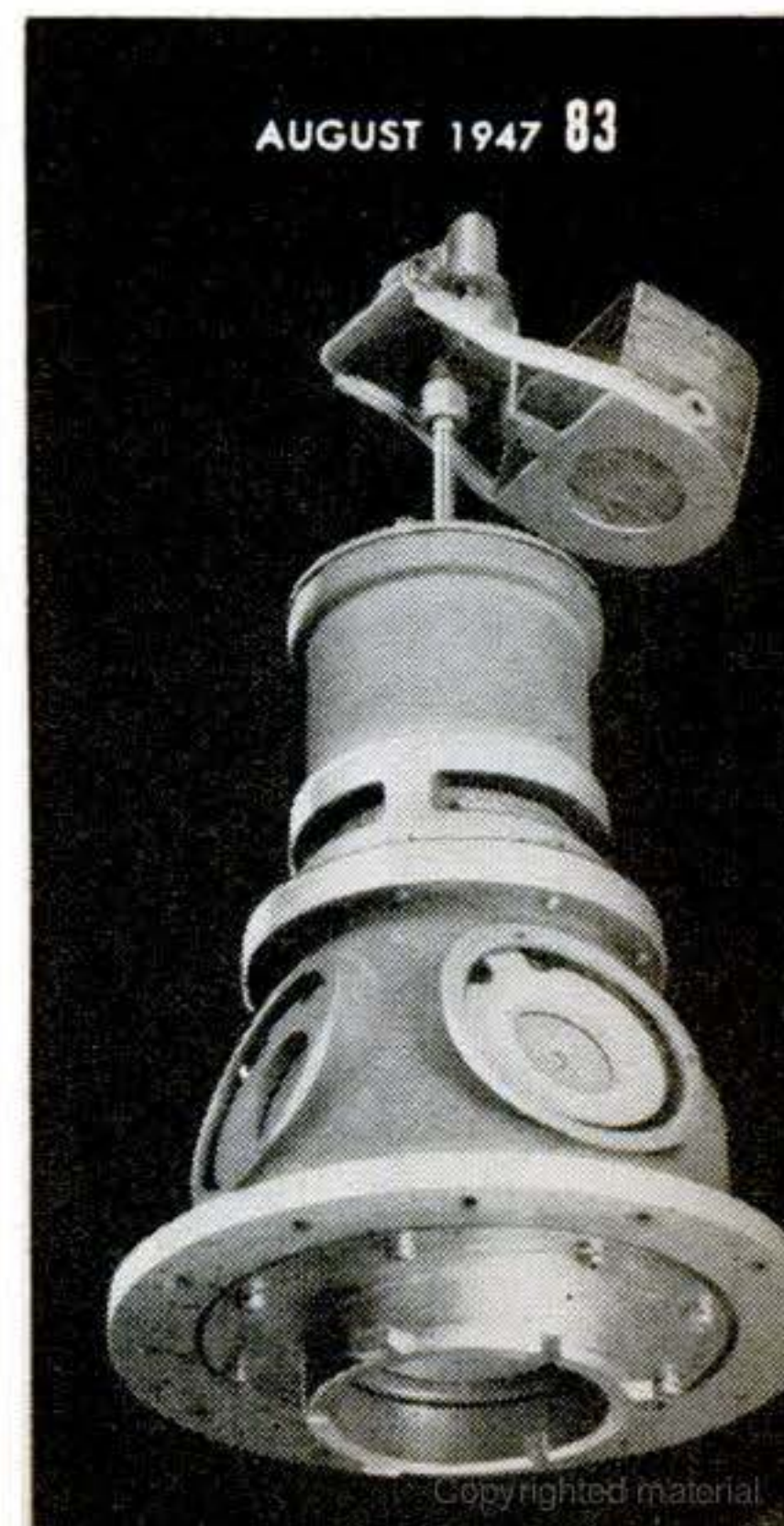

AUGUST 1947 83

The Truth About Germ Warfare

Startling official report on bacterial warfare reveals that U. S. is specially vulnerable as a target for it.

By Alden P. Armagnac

BEHIND guarded laboratory doors, as World War II ended, finishing touches were being applied to a new and untried weapon—an instrument of mass annihilation comparable to the atomic bomb. Bacterial warfare, no longer a fantasy of sensational fiction, was ready for action.

Today, any country bent on aggression could launch a germ offensive overnight. Few countries upon the globe would make a more tempting target than the United States.

So that Americans may know what we face, and what can be done about it, military authorities recently approved publication of one of the most remarkable documents that ever passed censorship in this or any other country. Originally prepared for the National Research Council—and kept secret for five years—a printed, 89-page wartime report reveals exactly what the objectives and technique of biological warfare would be, what germs would be used, and what countermeasures would be available to the defense.

Strategic aims of germ war would be to knock out the enemy's troops and all the complex home-front organization needed to support them in modern war: munitions factories, home industries, transportation

RESERVOIRS MAKE IDEAL TARGETS

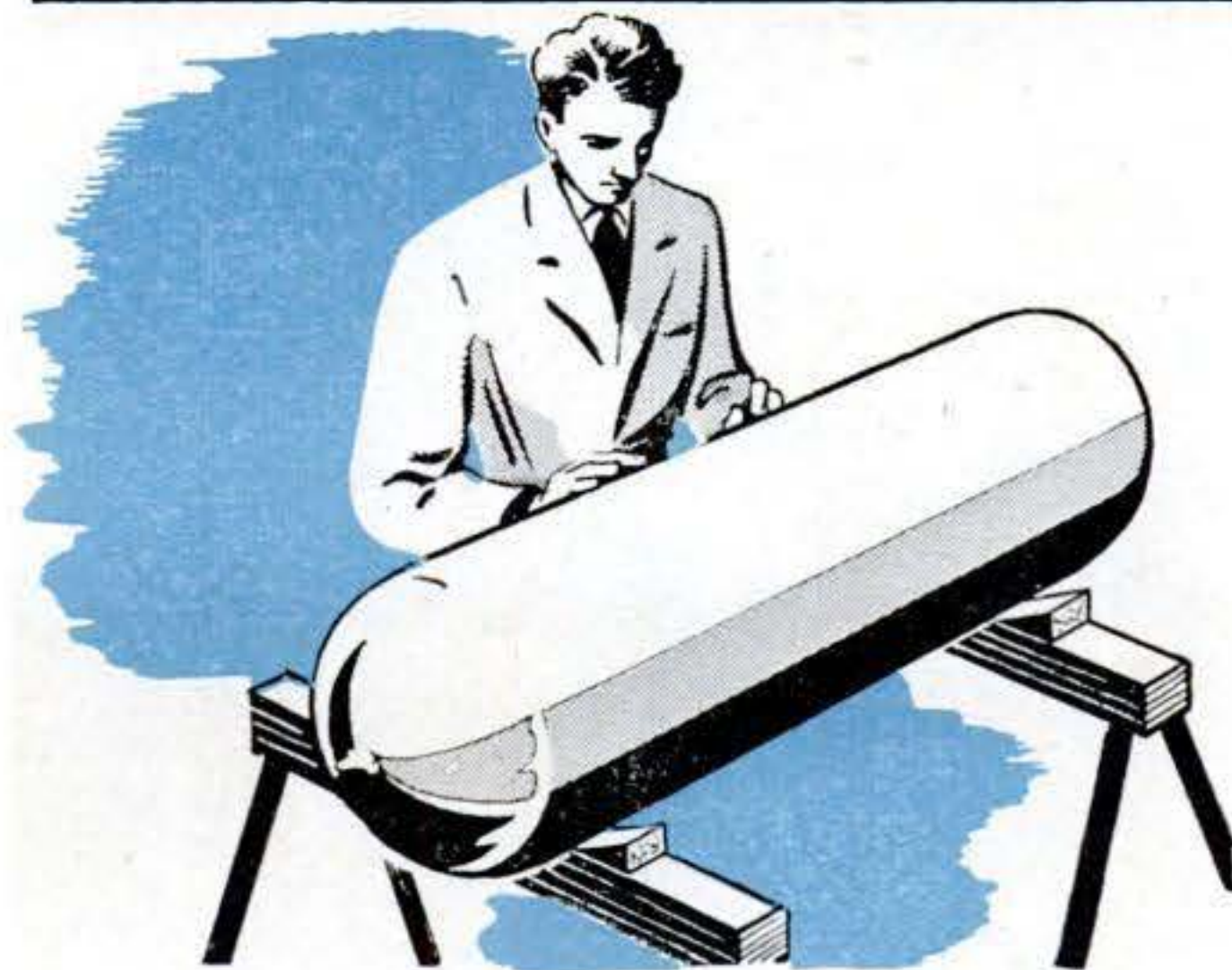

Holding 350 pounds apiece of botulism toxin, an ultradeadly poison, glass "bombs" like this could be carried by the hundred aboard a plane.

lines and power plants. Any "terror" effect upon civilian morale would be purely incidental to this fundamental purpose, whose speedy accomplishment should suffice to crush an enemy's resistance and dictate the terms of his surrender.

Spearhead of a germ offensive, the report anticipates, would be specially fitted aircraft bearing capacity loads of bacteria-laden dust. Transocean and carrier-borne planes, adaptable with equal ease, could be equipped like the airplanes used for crop-dusting. Over the target area, their crews could spread a blanket of the lethal powder at a height beyond the range of effective anti-aircraft fire, unheard and unseen from the ground. Slowly settling, the invisible dust would descend upon crowded city streets and military encampments in sufficient concentration to launch a deadly epidemic. To vary the technique, planes might use a harmless-looking smoke screen of a standard type such as titanium chloride, whose particles would actually be teeming with germs.

While these raiders were rendering a city's air unfit to breathe, others would attack its water supply with "germ bombs"—thin-walled glass capsules filled with germs or toxin, and designed to burst, under gas pressure, after being dropped in reservoirs.

Far from a fantastic idea, it would be perfectly feasible and perhaps militarily useful for planes to toss out screened cages that would open automatically on reaching earth, liberating swarms of plague-bearing insects that would spread disease by their bites. Air bombs of fragmentation type, shrapnel

shells, and hand grenades might carry germs to complicate the injuries they inflict, if the highly resistant spores of some bacilli could withstand the explosion of a projectile.

Not only would human beings be attacked. Animals furnishing meat and milk, and food and industrial crops, would be certain targets of a total germ war.

What particular germs would be used? Weighing the pros and cons of known human maladies from a cold-blooded military standpoint, the authors of the report—Drs. Theodor Rosebury and Elvin A. Kabat, of Columbia University College of Physicians and Surgeons—reach surprising conclusions.

21 Germs for War

Some of the most dreaded scourges of mankind, including cholera, tetanus, typhoid, and smallpox, head a list called clearly unsuitable for use in warfare. Sure protection by preventive measures, such as vaccination, rules them out. Others are eliminated as not "catching" enough, too easily cured, or impossible to spread artificially. There remain exactly 21 diseases affecting man that might be expected to be used in combat.

Often mentioned in past discussions of biological warfare, the germ of botulism, or canned-food poisoning, produces the deadliest stomach poison known to man. Drop 350 pounds of it into a 10,000,000-gallon reservoir, and one sip of the water would be fatal! It might be done in wartime, Drs. Rosebury and Kabat anticipate. But constant tests made by inoculating white mice with the water would immediately detect

FOR A GERM-BOMB ATTACK

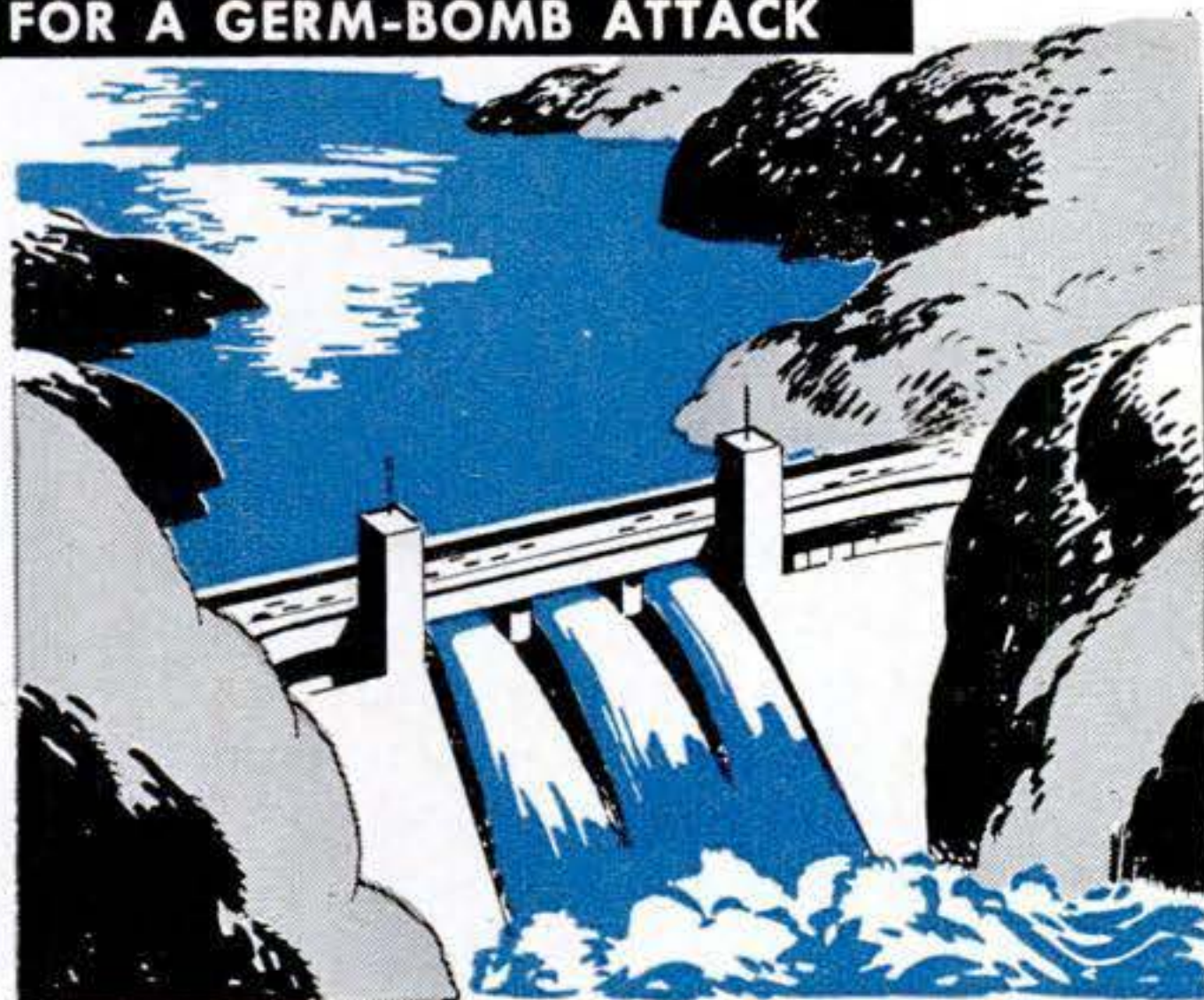

One bomb of this size, dropped from an airplane into a 10,000,000-gallon reservoir of drinking water, would suffice to poison it.



A single sip of toxin-poisoned water would be fatal. Lethal quantity is less than a fourth of ounce, or amount in bottom of glass above.

the toxin; mice can survive less than 1/100 of the lethal human dose. Warned in time, users could make the water perfectly safe to drink simply by boiling it.

"Almost ideal choices" for bacterial warfare, in odd contrast, prove to be the measles and the mumps! Introduced on a fighting front by picked troops, who have recovered from these so-called "childhood" diseases, the germs would work havoc among the defenders, while the attackers would be immune. Disabling your foe may be just as effective as killing him, to win a battle or a campaign.

Strange and little-known maladies may figure prominently in germ war, the report indicates: parrot fever, or psittacosis; "Rift Valley fever," of which there was an African epidemic in 1930; and others such as the mysterious and usually fatal Far Eastern disease, melioidosis, of which available medical literature records only 95 cases up to 1933. Readily obtainable from biological laboratories, these viruses and bacilli would rate high in military favor, since difficulty in diagnosing rare diseases would hamper defense efforts to control an epidemic.

Better-known germs that might be unleashed against a populace include those of anthrax, influenza, meningitis, and pneumonic plague, the last called a "superlative" weapon. A single bacillus of pneumonic plague can kill a guinea pig and, the report states, "there seems no reason to believe man less susceptible." The germs could be released from planes in heavy smoke that would not only take effect in the open air, but would also penetrate closed windows.

Former Concepts Outmoded

When Major L. A. Fox, of the U. S. Army Medical Corps, wrote in 1933 that bacterial warfare seemed to him of doubtful feasibility, he was fully justified by the state of medical knowledge at that time, the Rosebury-Kabat report states. Later developments have changed all that. By way of example, yellow fever has long been thought transmissible only by the bite of the tropical *Aedes aegypti* mosquito. But accidental cases of infection among laboratory workers handling the concentrated virus of yellow fever, in the form of a dry powder, now lead to the remarkable conclusion that it can be contracted simply by breathing air containing the organisms. Implications are startling. Hitherto the disease has been limited to equatorial regions, which provided

the climate required by its mosquito carriers. Now, virus-spreading planes might introduce yellow fever anywhere on earth.

Much has been made in the past of the argument that an attacker would hesitate to use germ warfare for fear that it would boomerang upon his own forces, if they entered the affected area. That argument, shaky at best, falls down completely for a geographically isolated target—an island naval or air base, say—that the attacker simply wants to put out of business, with no intention of occupying it. An attack upon Hawaii with malaria-bearing mosquitoes (unknown there, despite a favorable climate) might mean a second Pearl Harbor.

Safeguards Are Gone

Likewise, on a larger scale, America's isolation by two oceans now becomes a liability rather than an asset to defense. It renders this country peculiarly vulnerable to all types of germ attack that might be launched from the safety of another continent. That its mere size would offer any protection is a dangerous fallacy. Actually a third of its population, and half of its industries, huddle together in 33 key locations *totaling less than two percent of its land area!* Our own Department of Commerce saves any potential enemy's general staff the trouble of mapping the targets in order of priority, according to number of industrial workers: No. 1, New York City-Newark-Jersey City; No. 2, Chicago; and so on, down to No. 33, Toledo. Raiders could hardly ask a more perfect setup.

Until we can abolish war altogether, there is only one way we can prevent that nightmare from coming true, Drs. Rosebury and Kabat declare. *It lies in grim preparedness to guarantee an aggressor a double dose of his own medicine—to promise retribution in kind, so swift, so sure and so terrible as to banish any temptation to attack us with germs.* Just such a warning from President Roosevelt and Prime Minister Churchill, they point out, stopped Axis use of poison gas in World War II, for the enemy well knew we could and would carry it out.

Fortunately we are prepared today to back up a similar ultimatum against germ warfare, as a result of top-secret biological research by the Army at Camp Detrick, Md., and by the Navy at the University of California. We can preserve the lead in research that insures our safety, just so long as Americans support these programs. END

FRONT-LINE AND LONG-RANGE GERM WEAPONS

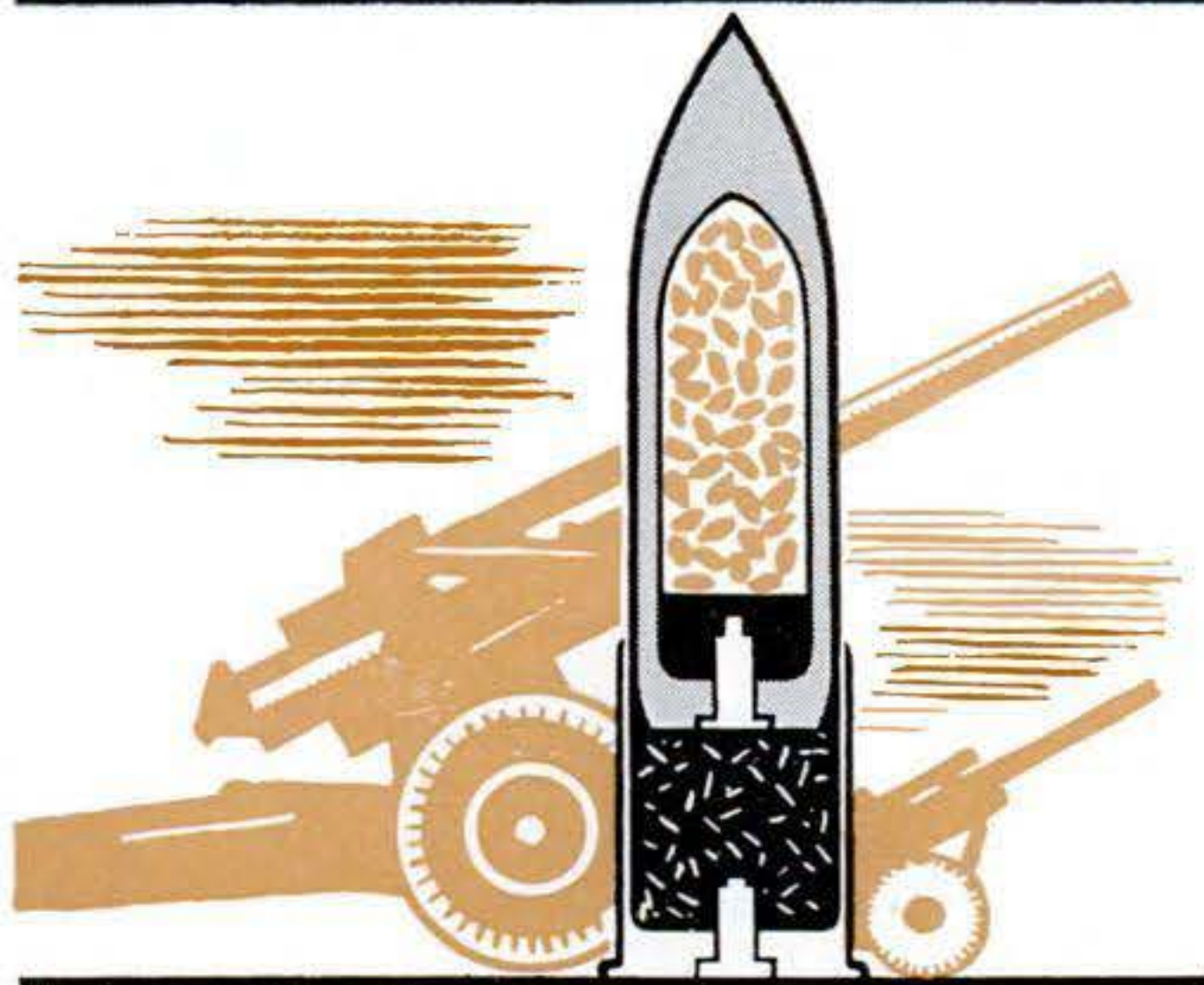

Projectiles may scatter germs, if experiments confirm the ability of some kinds of spores to withstand the heat and pressure of detonation.

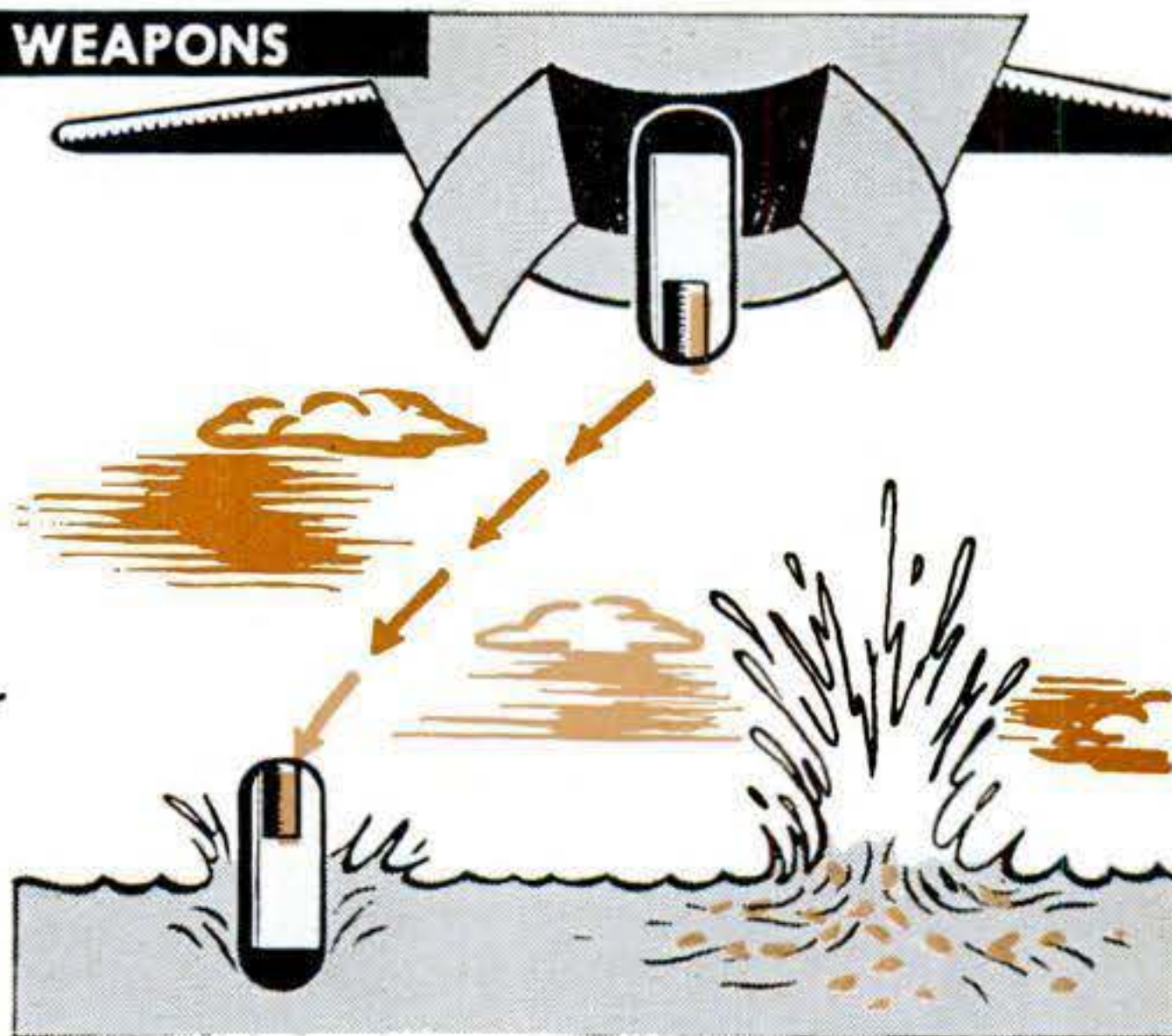

Glass "bombs," weighted to turn over in water, loose germs or toxin when burst by gas pressure generated as in inverted fire extinguisher.

OBJECTIVES FOR A "BACTERIAL BLITZKRIEG"

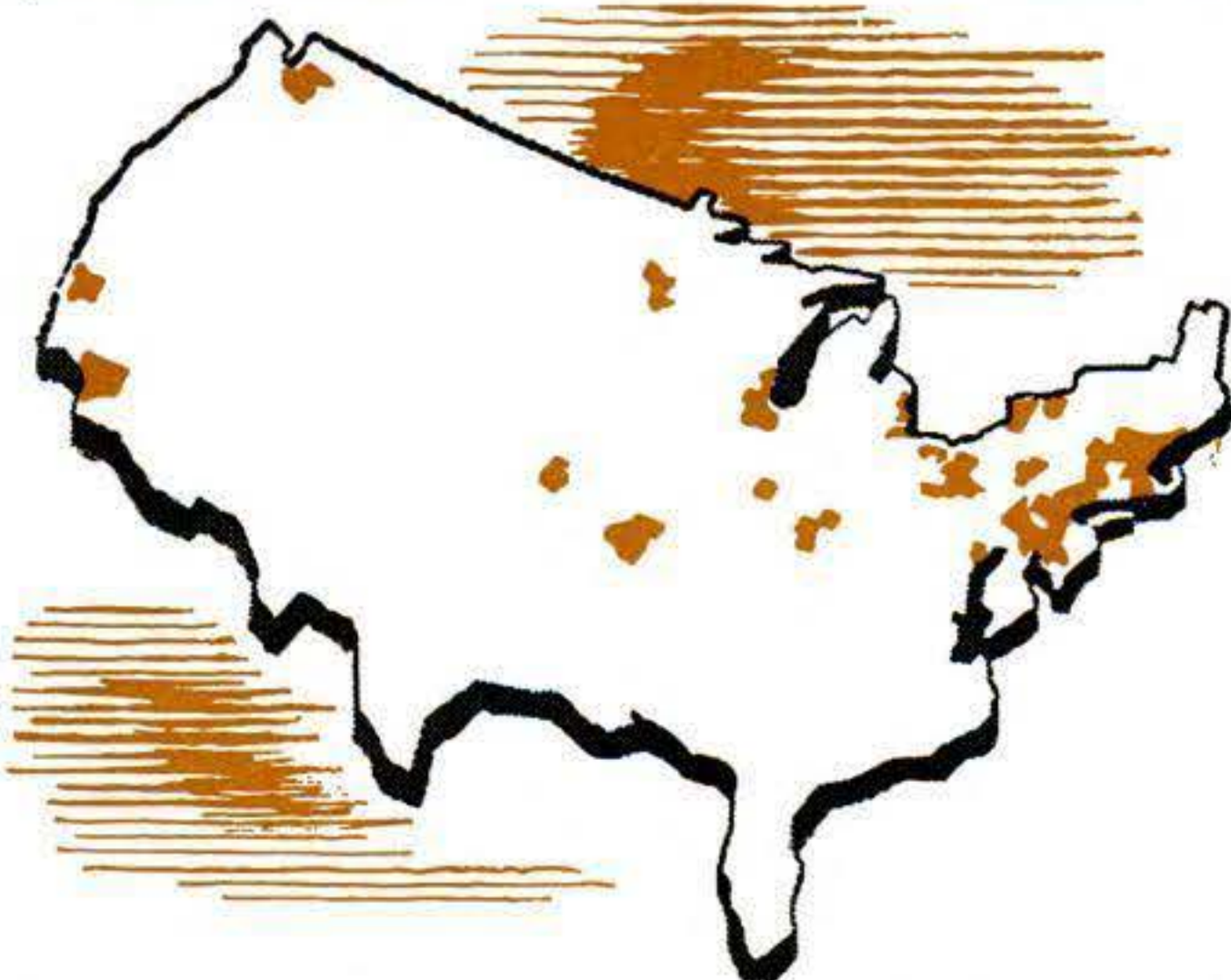

U. S. is setup for germ attack. Hitting only 33 key points would strike a third of country's population and paralyze half of our factories.

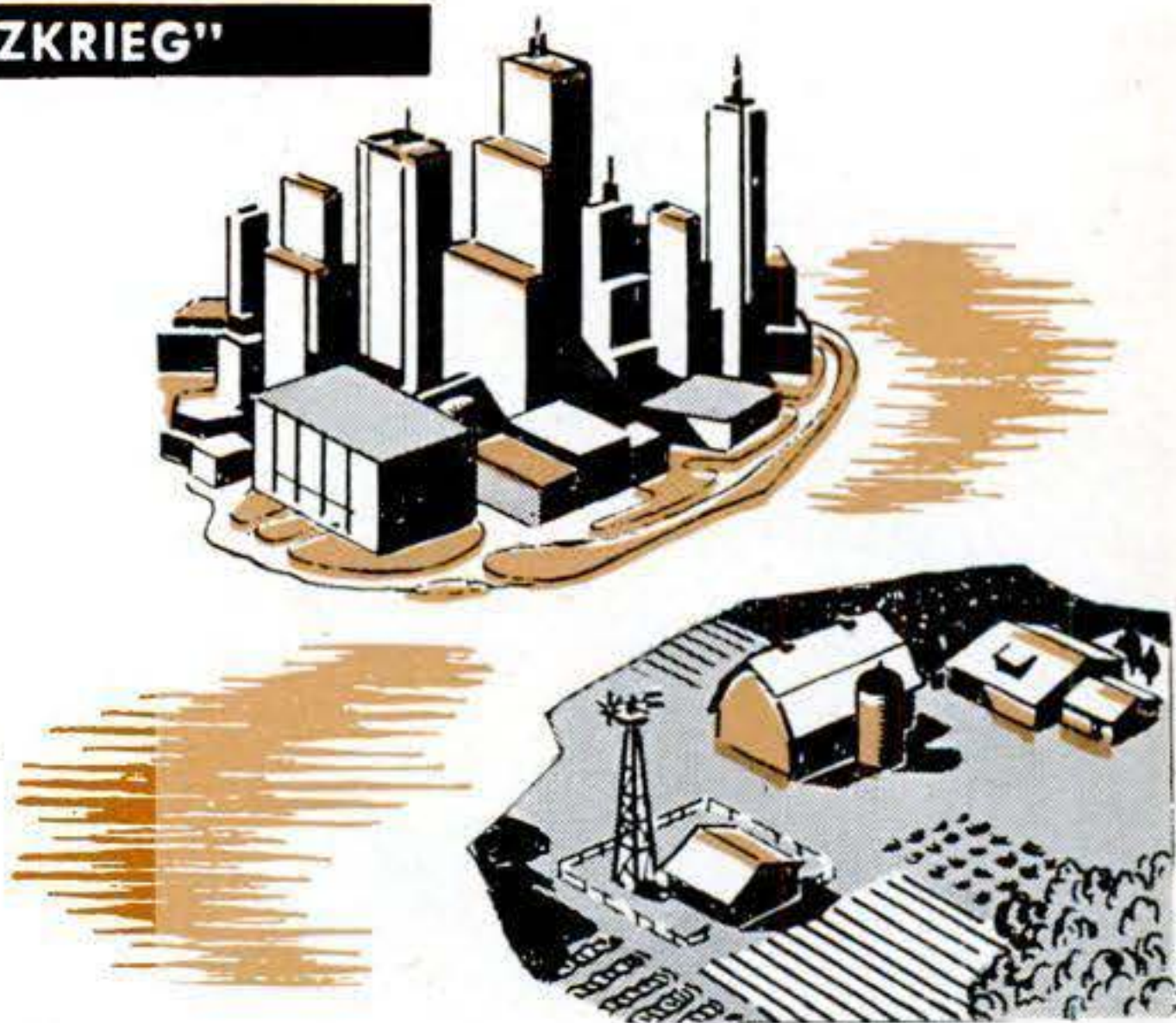

Great cities rank as top-priority targets for planes sowing human epidemics. Other types of germs can be used against animals and crops.

COUNTERMEASURES AGAINST GERM WARFARE



Specialists in diagnosing rare diseases, and experts constantly testing water supply on white mice, will lead defense against germ war.



Decontamination squads must sterilize everything that falls from air—including enemy planes shot down, which may be germ-laden.

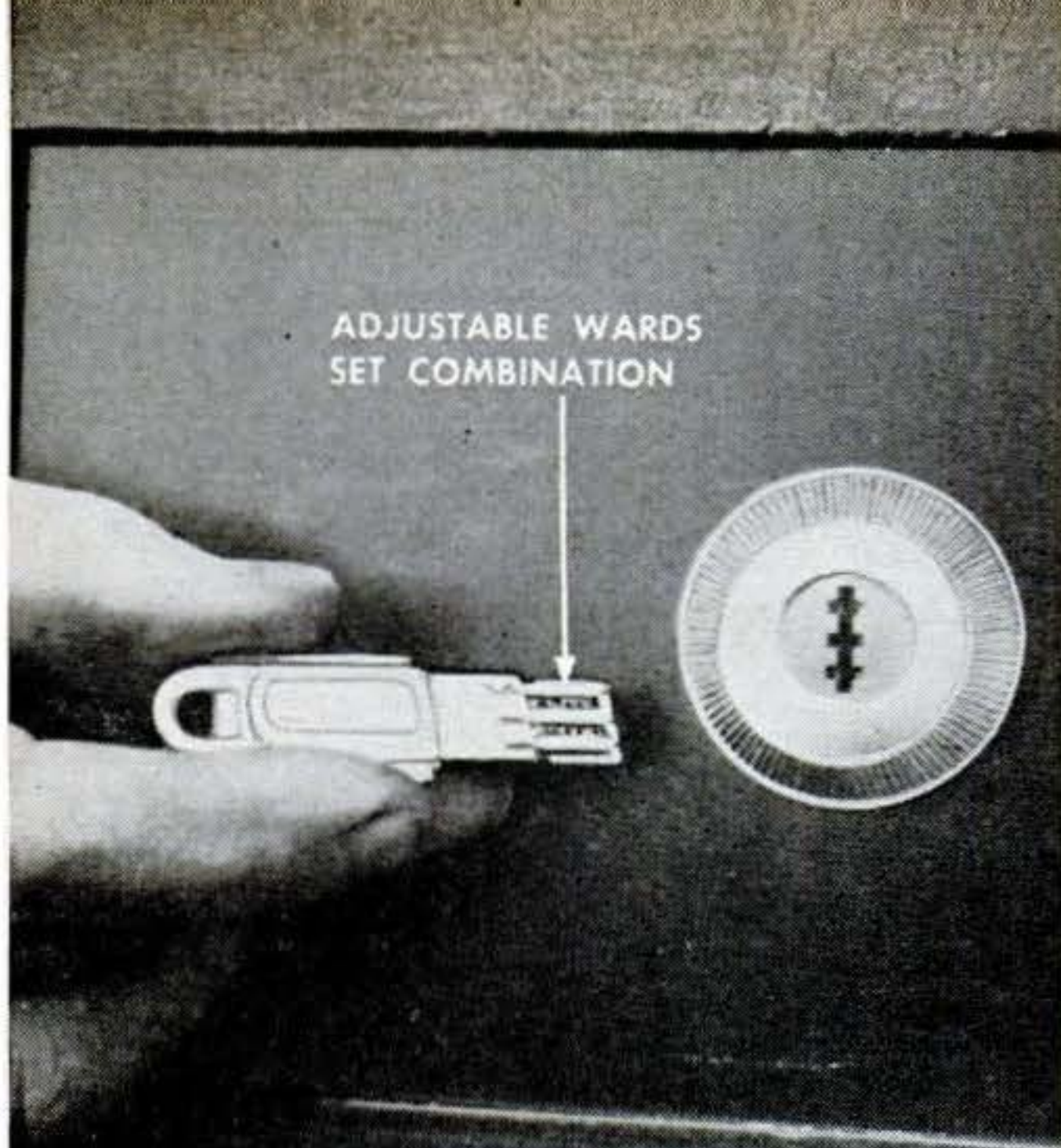

Key Uses a Code. Having at least a million combinations, this lock and key, developed by the British government and Scotland Yard during the war, is now being placed on the market. The key has six adjustable wards, and the code or combination is automatically changed by inserting the key in the lock.



Conveyer Turns Corners. Taking advantage of the open network of a new wire conveyer belt, these doughnuts are drying on the way from oven to loading platform. Made by a U. S. Steel subsidiary, the versatile steel belt can turn corners without tipping, move a product up- or downhill, and even run in circles.

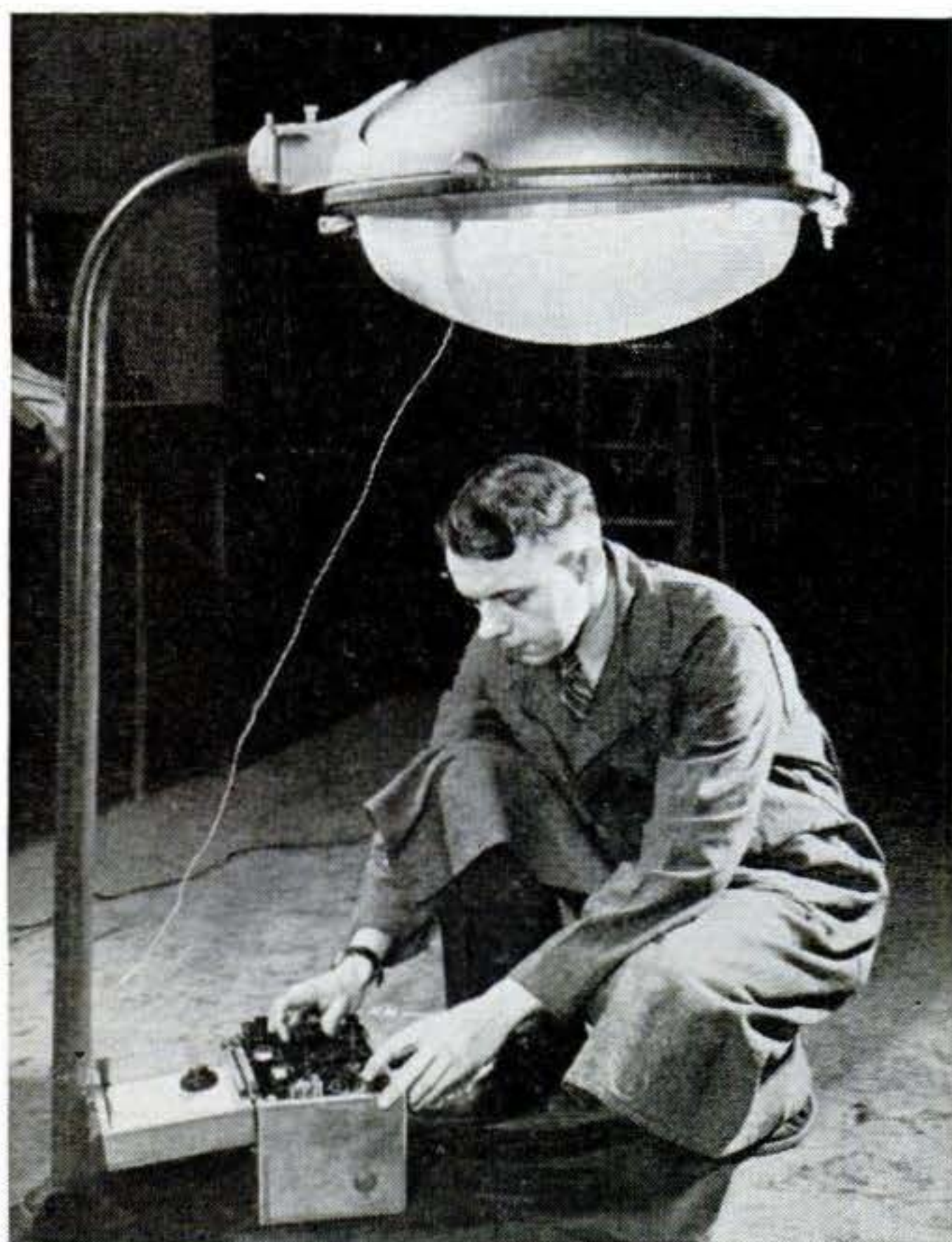

More Light for Highways. To lessen the hazards of night driving, this unit utilizes a powerful new 400-watt, 20,000-lumen mercury lamp plus its oval shape to throw a larger pattern of glareless light on the roadway. Resembling a two-foot long silver football, it was developed by Westinghouse lighting engineers.



"Black Light" Guards Freon. More delicate than chemical methods, this infrared light helps produce water-free refrigerants of the Freon type by detecting one part in a million of trouble-making moisture. The new technique, developed by du Pont, promises refrigerators that run 10 years without requiring service.

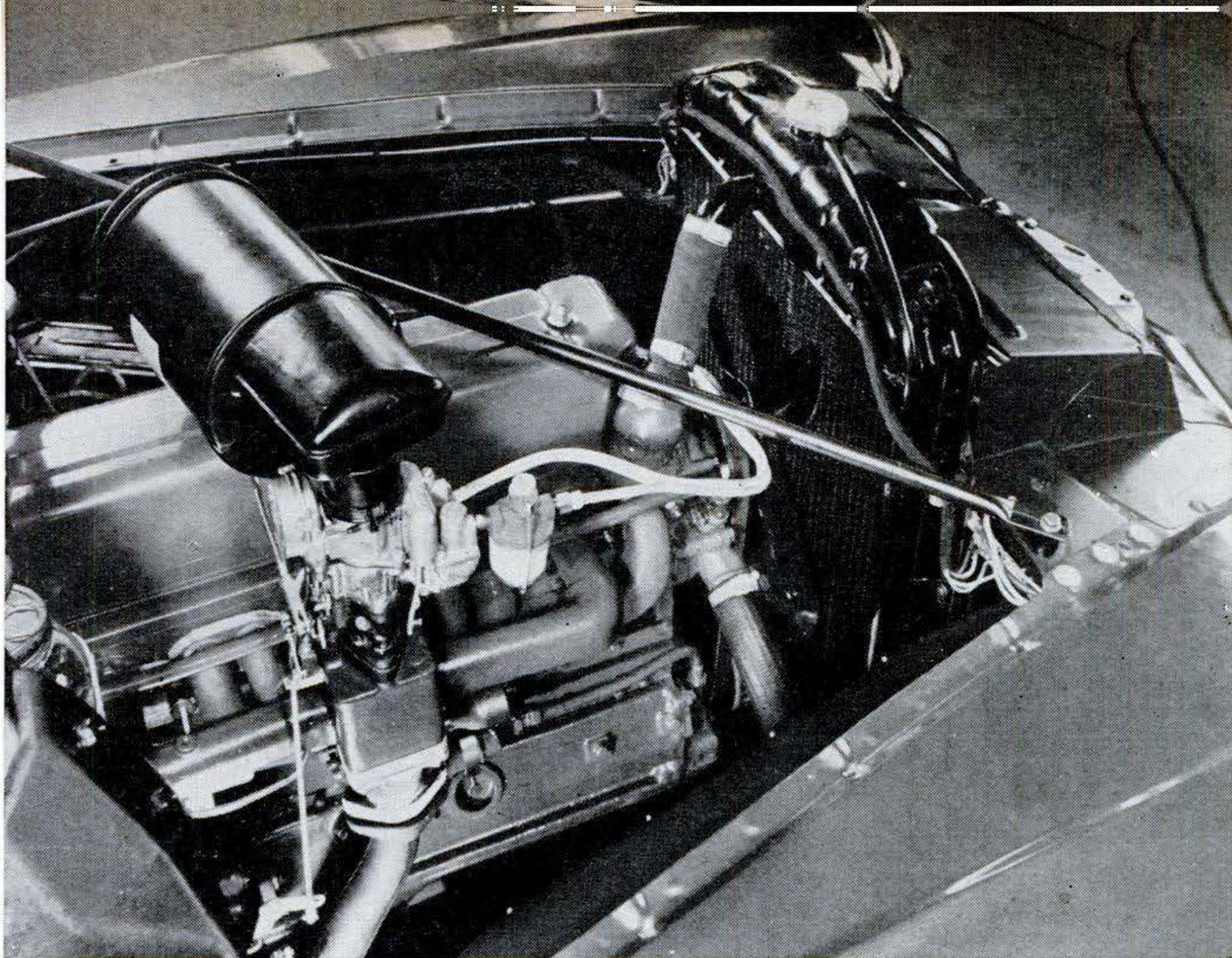

Under the hood of a stock car, this looks like any other engine. But it packs a compression ratio almost double that of present-day cars of equal power, burns 33 to 40 percent less gas.

Super Engine Cuts Gasoline Bills

Kettering's high-compression design saves on 100-octane—but don't look for it in new cars this year or next.

ENGINES and fuels that together cut gasoline consumption by one-third are possible today, so far as engineering goes. GM's famed Charles F. Kettering has built a high-compression engine that uses 100-octane gasoline. With it, he gets 26.5 miles to the gallon at 40 m.p.h., compared to 18.5 for a six-cylinder 1946 model of the same weight and power.

"Boss" Kettering warns, however, that there is no prospect of immediate production of the new engine. Overnight retooling by the auto industry is impossible—and so would be the conversion of the gasoline industry to a 100-octane product. The engineer hopes, however, that his experimental

model will point the way to the design of an engine in which the compression ratio can be increased from time to time with a minimum of retooling. In this way, successive models can be adapted to ever-higher ratios, while at the same time higher octane gasoline is put on the market.

Compression ratio of the experimental engine is 12.5 to one, almost double the 6.4 ratio of the standard type. This is made possible by designing it with great rigidity to withstand the added stress.

Kettering mounted his engine in a stock car for tests and reported that the economy was gained with no loss in smoothness or performance.

Kettering is now looking forward to the eventual use of triptane gasoline. If it comes, it will require ratios as high as the efficient Diesels—15 or 17 to one.

For a chalk-talk on what high compression means to you, turn the page. 

HIGHER COMPRESSION RATIO IS KEY TO RAISING EFFICIENCY AND REDUCING FUEL COST

HERE'S WHAT
"COMPRESSION RATIO"
MEANS!

- ① At upward limit of piston travel, fuel is compressed to minimum volume
- ② At downward limit of travel, exploding fuel expands to maximum volume

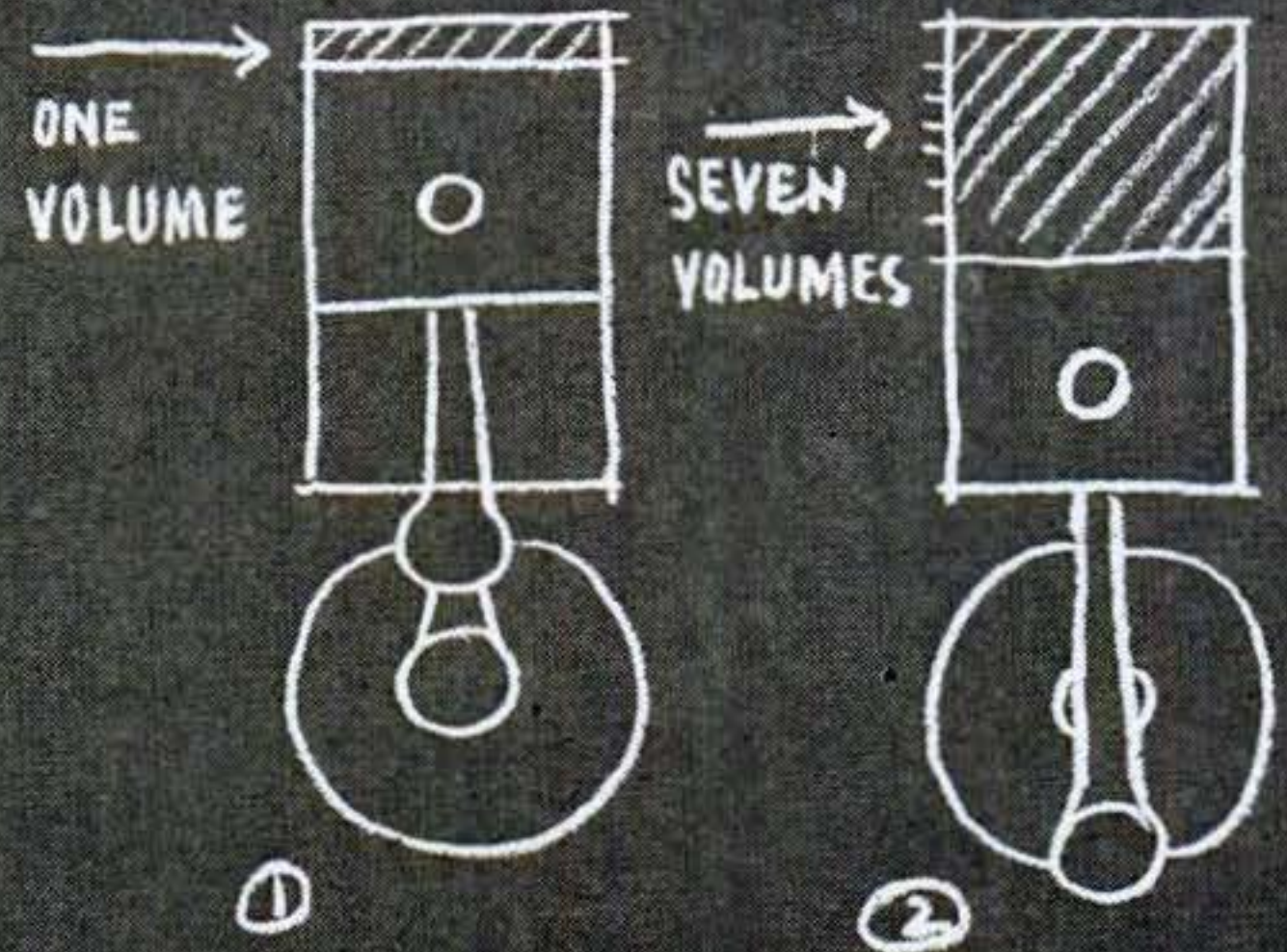

$$\frac{\text{MAXIMUM VOLUME}}{\text{MINIMUM VOLUME}} = \text{COMPRESSION RATIO}$$

(IN THIS CASE - 7 TO 1)

1. MODERN DIESEL ENGINE

The remarkable efficiency of the Diesel engine (up to 40%) shows advantage of high compression ratio



2. CARS OF 1917

Low efficiency of early gasoline engines meant high gasoline consumption

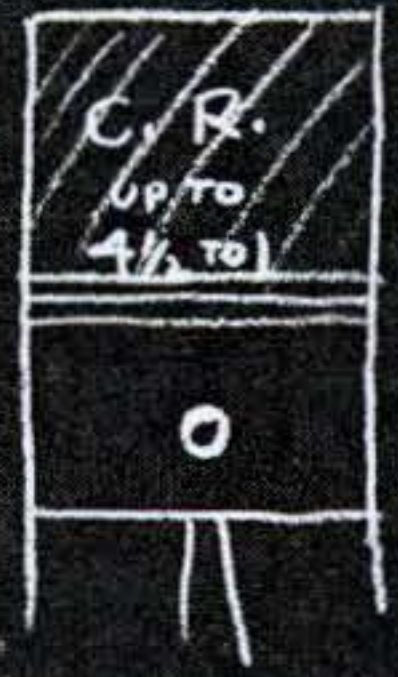

3. PRESENT-DAY CARS

Efficiency of 1947 gasoline engines (up to 25%) has reduced gasoline consumption by 1/3 saving motorists \$1,000,000,000 a year



4. FUTURE CARS

Experimental motors indicate future efficiency up to 40% and only 60-67% of present gasoline consumption



MOTOR PROBLEM IS ADDED STRENGTH

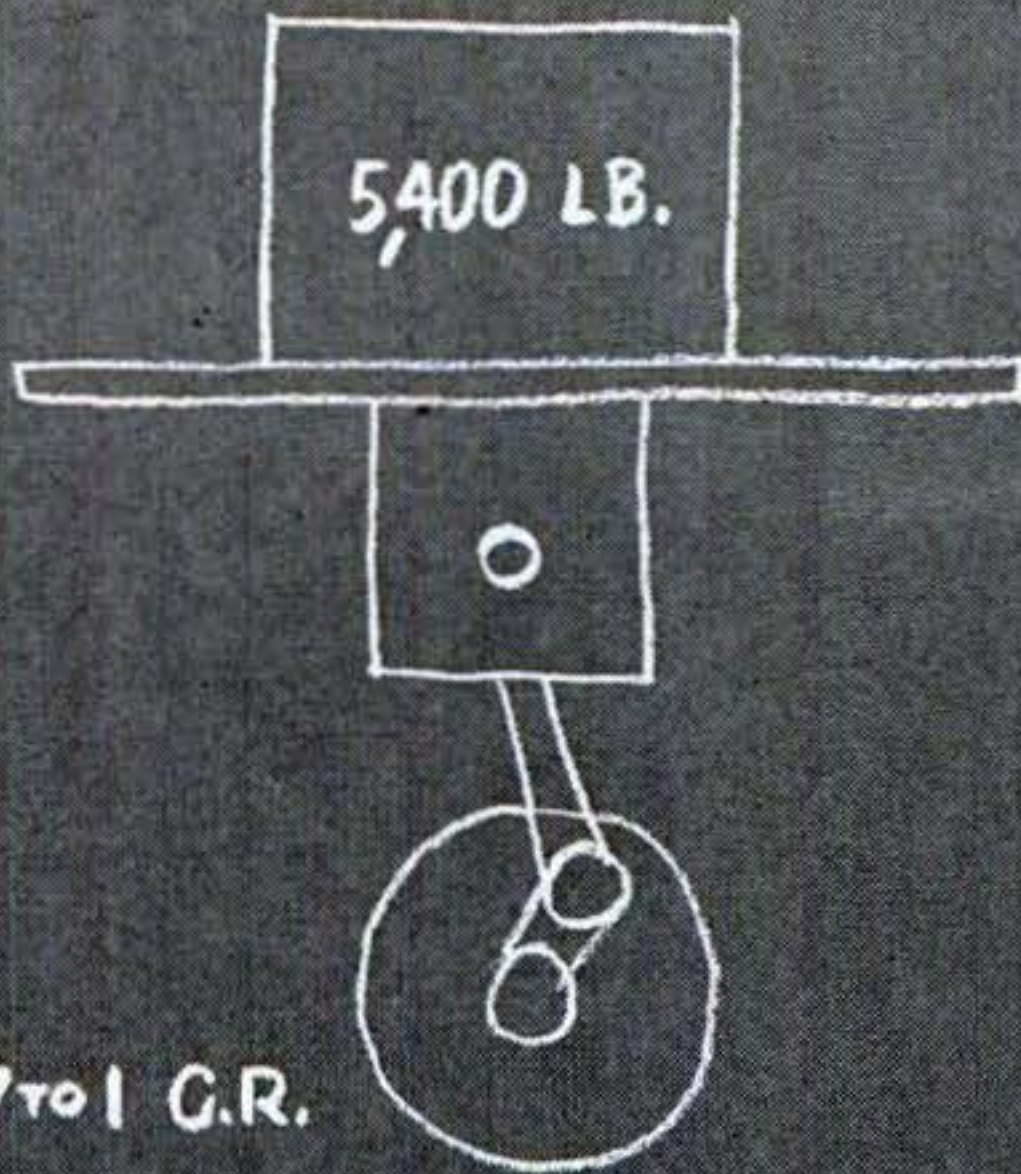

7 to 1 C.R.

Peak pressure on piston of auto engine with 7 to 1 C.R. reaches 600 lb. to square inch — equivalent to about 2½ tons

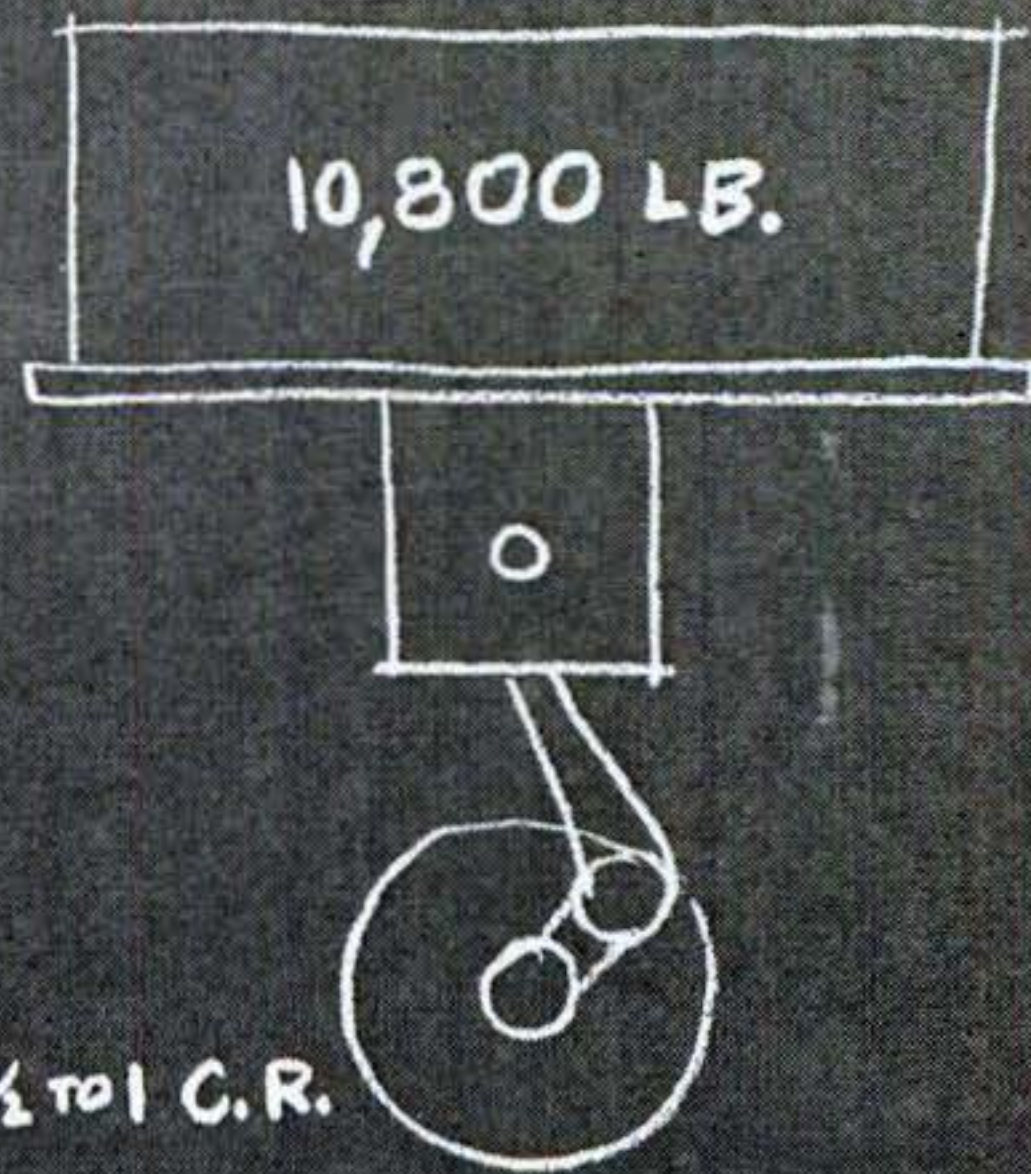

12½ to 1 C.R.

Peak pressure on piston of engine with 12½ to 1 C.R. will reach 1,150 lb., or a force of about 5 tons

FUEL PROBLEM IS PREVENTING KNOCK

Fuel for proposed engines would not be required for the 30,000,000 cars on road today. Solution will probably be to make change to new motors and fuels gradually

1. HEPTANE



Long chain of carbon atoms in heptane (common gasoline ingredient) gives tendency to knock at high compression

2. ISO-OCTANE

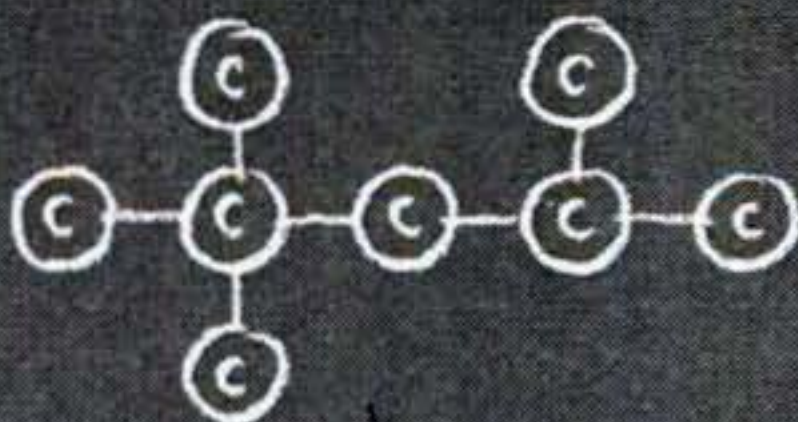

More "bunched" arrangement in iso-octane fuel improves anti-knock characteristics

3. TRIPTANE

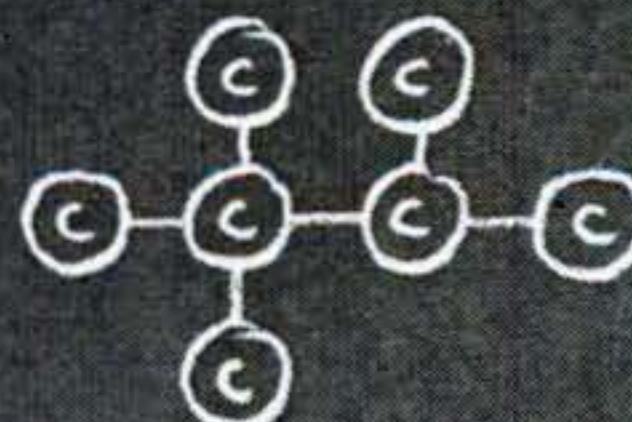

Compact atoms in triptane permit even higher compression ratios

Hams Are Radio's Vanguard

The amateurs, a rapidly growing clan, are still cooking up improvements for the industry they helped to create.

By George H. Waltz, Jr.

PSM Photos by Hubert Lockett

THE headlines that remind you of America's 80,000 radio hams are deceptive. You have seen them: "RADIO AMATEUR SENDS HELP TO FLOOD AREAS" is one, and "HAM SAVES PLANE CREW ON ICE FLOE" is another.

These news items, of course, are true, but saving the lives of stranded, desperate people is only part of the tremendous service for which everyone is indebted to the radio amateurs. They are the unsung explorers and conquerors of the electronic world, and the developers of its tremendously useful industries.

Such achievements have not been so spectacularly publicized. Yet even Marconi proudly spoke of himself as an amateur, and from the dots and dashes and tinkering of such "hams" as Lee DeForest, FM's Major Armstrong, and RCA's David Sarnoff, and

the thousands of hams who have followed them, have come our present-day high-fidelity broadcasting systems and our super-de-luxe, multiple-tube home receivers.

Without the hams, Fred Allen's voice would still be in a theater rather than in your parlor, and we would not know what rockets encounter in the far reaches of the atmosphere. The radio amateur, moreover, is still pioneering, still contributing, not only to radio and communications techniques, but also to the creation of a truly international fraternal understanding.

Who is the average ham? What is he like? What makes him spend a good portion of his spare time in his "shack," which may be anything from a corner of his crowded attic to an outbuilding in his back yard? How does he earn a living?

According to the latest cross-sectional portrait made by the American Radio Relay League—the hams' father confessor, guiding hand, and fraternal lodge—the ham is just a typical science-minded American. He is married, about 31 years old, and in what statisticians call "the middle-income bracket." Mentally, he leans toward mechanics and electricity. Socially, he is fairly gregarious. He likes people and he likes to talk—particularly to people in out-of-the

How the Hams Talk

Amateur radio jargon is unintelligible to the average layman, but many of its terms are only a sort of telegraphic shorthand. For instance, a ham message might go something like this:

"W9YMV de W1PEK R ge om tnx fr cl. Thot ant bkn fr cld CQ 3 times wid nd. Ur sigs RST 599 hr Hrtfd Conn. Wx clr es cld. Xmtr hr 5514s in fnl wid abt 400 wts. Rcvr hr SX28A; ant is 3.5 mc folded dipole. Use xtal mstli but nw hv VFO. QTH? Hw? ar W9YMV de W1PEK K."

Freely translated, this would run as follows:

"W9YMV from W1PEK, your last transmission received OK. Good evening, Old Man; thanks for call. I thought my antenna

had broken, for I called the general inquiry call, CQ, three times without results. Your signals were perfectly readable, extremely strong and had purest direct-current note as received here at Hartford, Conn. The weather is clear and cold. The transmitter here is push-pull type 5514 vacuum tubes in the radio frequency final amplifier stage with about 400 watts input. The receiver here is a manufacturer's type SX28A; the antenna is a folded dipole dimensioned to resonate at 3.5 megacycles. I use crystal frequency control mostly but now have a variable frequency oscillator. What is the location of your station? How are you receiving my signals? End of message. W9YMV from W1PEK. Go ahead with your answer."

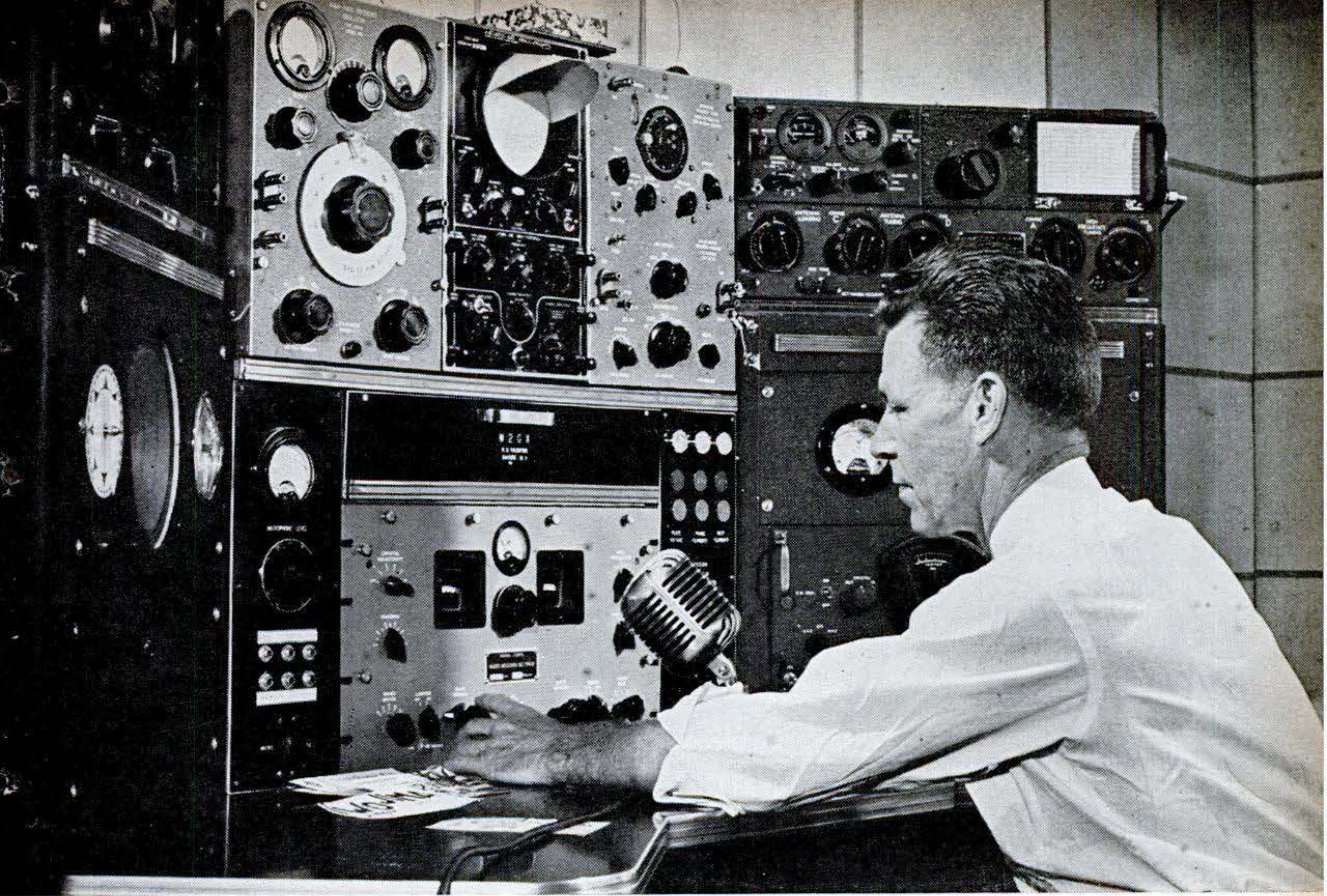

Like many hams, Russell Valentine finds it hard to tell where business stops and hobby begins. Chief engineer of New York's WQXR, which he

has built and rebuilt more than 10 times, he has no trouble in giving his ham rig, W2GX, a professional look—as its control panel testifies.

way places. His wife is at least mildly tolerant of his pastime; many wives become so enthusiastic that they, too, acquire amateur licenses.

Significantly, the ham is a tinkerer, an experimenter. His station represents an investment of about \$400, and he spends about \$150 a year to keep it operating and up-to-date. His receiver is probably factory-made, but his transmitter is apt to be pretty much a product of his own know-how.

He averages about 96 minutes a day on the air. Of this total, 38 minutes go for normal "over-the-back-fence" gossip with other hams ("ragchewing," he calls it); 26 minutes are spent contacting stations that are a long distance away (DX); 20 minutes go for trying out new experimental rigs and equipment; and 13 minutes are taken up with "traffic," or relaying messages from one corner of the globe to another.

If the radio ham has a second hobby, it is likely to be photography. The Morse code and camera-toting seem to go together. Nobody knows why.

The ham's job is likely to be in some branch of the electrical or communications industries. At last count, a check of executive positions in the radio industry showed that 45 presidents, 16 vice-presidents, 5 general managers, 69 managers, 37 owners, 324 engineers, 19 announcers, and 11 directors had started out in their own ham stations. In one of the largest broadcasting stations, nearly all of the operators and engineers are licensed amateurs. About nine-tenths of all the broadcasting engineers and operators in the country are, or have been, amateurs. In radio manufacturing, the figures are similar.

To those of us whose main interest in radio is twisting a dial or pushing a button to hear a comedian, a ball game or a newscast, this wedding of full-time business and spare-time hobby is important. It is a union that has brought, and will continue to bring, many advances in radio and electronics. Because the ham is a born experimenter, and generally not hampered by the preconceived ideas of the experts, he often

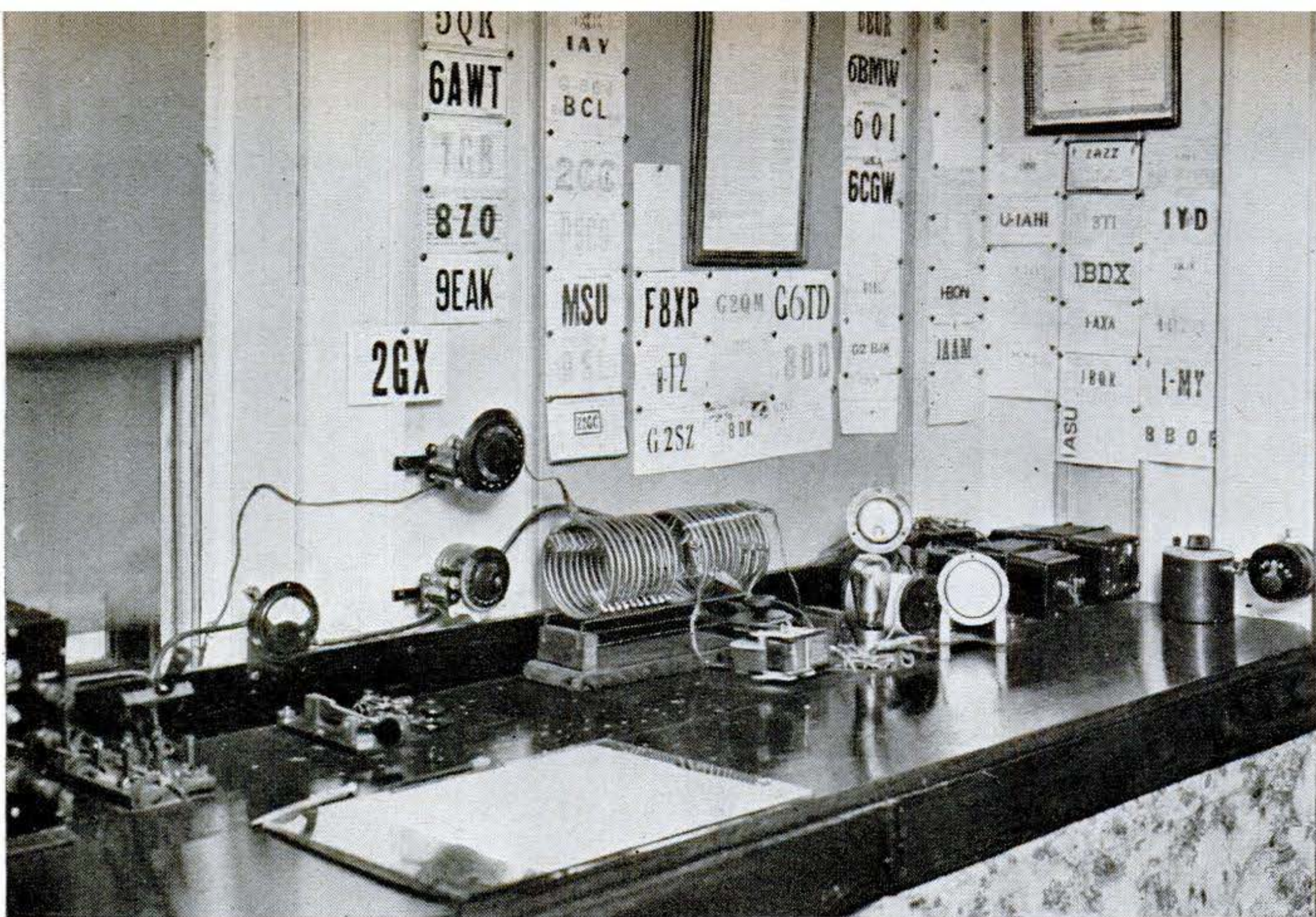

Back in 1923, Valentine's "shack" looked like this. The array of QSL cards, acknowledgments

from stations with which he had communicated, typifies DX efforts by amateurs, then and now.

attacks problems that far more learned men have thought unsolvable. Sometimes he solves them.

Nothing illustrates this better than the early history of amateur radio itself. In 1912 there was a great clamor among the commercial operators to limit the upstarts who called themselves amateurs to specified frequencies. On Aug. 17, President Taft signed the Alexander Bill, which provided for the licensing of all ham stations and operators, limited them to 1,000 watts of power (a ruling still in effect), and confined them to a wave band of 200 meters. The 200-meter band and any of the shorter wave lengths then were considered worthless for communications.

The amateurs, however, not only found a way to make good use of the "worthless" 200-meter band, but also helped to pioneer the way into the shorter and shorter wave lengths—the ultra ultra-short waves. In 1912, head-wagging theorists thought that a radio wave that measured as little as 200 meters (a little over a tenth of a mile) from crest to crest was useless, but radio amateurs today are playing successfully with tiny wavelets about .06 of an inch long.

Relegated from the beginning to the shorter waves and the higher frequencies, the radio ham has made the most of them—a

fact that opened the relatively new and valuable fields of radar and microwaves. The future of the microwaves—the shorter and still shorter wave lengths—should be watched, and you can bet your radio-phonograph combination that the amateur is watching—and what's more, experimenting. Microwaves provide a region for communication far wider than that of all the other wave lengths combined.

There's a Ham Behind It

Find some new radio development and you will find at least one ham or ex-ham mixed up in the maze of wires and tubes. Not long ago, for example, the Army announced that it had bounced a radar beam off the moon. Four out of the five experts operating the Army's equipment in that test were hams. The lieutenant colonel in charge of the project had attempted a similar experiment with homemade equipment in his own ham station down in Tennessee some years before!

It is seldom that a single radio amateur's name is attached to a new radio development. There have been exceptions, of course, such as the perfection of the radio noise eliminator by James Lamb, a ham who later did a great deal toward developing the television guided bomb. On the whole,

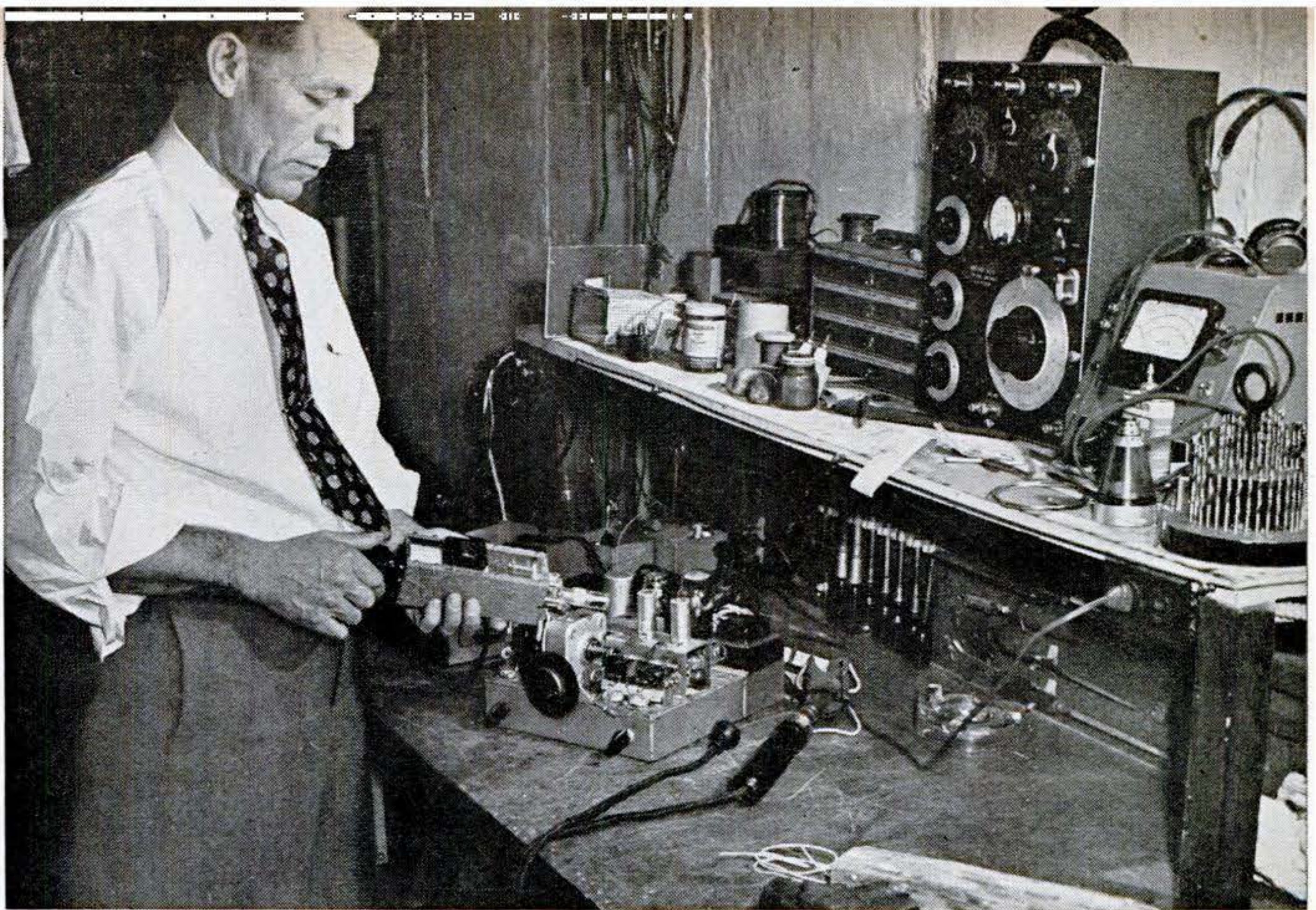

Hams are a creative bunch. Valentine holds "grid dipper" made by W. M. Scherer (W2AEF)

to measure resonant frequencies. Black cabinet on shelf is a hand-made impedance bridge.

however, the ham's contribution to radio is made on a teamwork basis. A good portion of that 38 minutes a day that the average ham spends in chewing the rag on the airwaves is spent talking to other hams about what he found out during his daily average of 20 minutes of experimenting. In this way, no ham's idea is ever completely his own; it's a group achievement.

The National Bureau of Standards in Washington makes good use of this tendency whenever it has a broad radio-testing project. By mustering amateur observers, the Bureau has a large reservoir of first-rate, widely scattered monitoring stations to help study what happens to radio reception during solar eclipses, or investigate the skip effect in short-wave transmissions. Each participating amateur spends specified hours listening in on assigned frequencies and forwards his reports to Washington. How else, except for the amateurs, could such large-scale, nation-wide research be carried on? Not even the largest commercial research organization could afford the cost if the thousands of monitoring stations had to be built and manned by salaried employees.

During the war years—from December 8, 1941, to August 21, 1945, to be exact—the ham, as such, was off the air. His "shack" was closed and his frequencies were taken

over by the War Department. He wasn't silenced, though. About 26,500 U. S. hams served with the Armed Forces (17,700), the Merchant Marine (900), Civil Service (3,600), and in industry (4,300). And along with the hams went many of their cherished receivers and transmitters.

Reconnaissance — with Cash

War caught the Signal Corps without much in the way of modern communications equipment. Many of its transmitters had seen service in World War I. Where could a supply of modern rigs be obtained quickly? The radio manufacturers could not meet the demand immediately. The one answer was the amateur. With the aid of the American Radio Relay League, caravans of Signal Corps trucks, each carrying an officer armed with a pocketful of money, spread out across the country. Pulling up in front of a ham's house, the officer would pay off in cold cash and stow another up-to-date transmitter or receiver in his truck.

The story is told about one amateur who sold his receiver to the government in this way and not long afterward was drafted and assigned to the Signal Corps. When he reported to his field station in North Africa, he took one look at the equipment and gulped. There stood his own receiver, with

his amateur call letters painted across it! Since the war ended, the ranks of the hams have grown considerably, and the rate of growth is increasing. According to the latest figures available, some 1,000 new licenses are being issued every month. At the war's beginning, there were approximately 60,000 amateurs in the U. S. Today's count shows upwards of 80,000, and 250,000 are forecast in five years.

That should be a good omen for radio. With three times as many amateurs, there are sure to be a larger number of new developments. But it goes farther than that. With 250,000 American hams chewing the rag with about 25,000 foreign hams, there should be a better meeting of minds on a good many subjects besides radio. You can't call a man OM (ham language for "old man") and end up with 73s ("best regards") without feeling pretty friendly. National and military barriers are harder to overcome than geographical ones—contact with Russian amateurs still is a rarity, and there aren't many hams in an occupied zone—but the gregarious, information-sharing ham is on the right track. **END**



Mounted in a tree over his Bayside, N. Y., home, Valentine's directional antenna can be rotated by a switch on the control panel to aid signals.

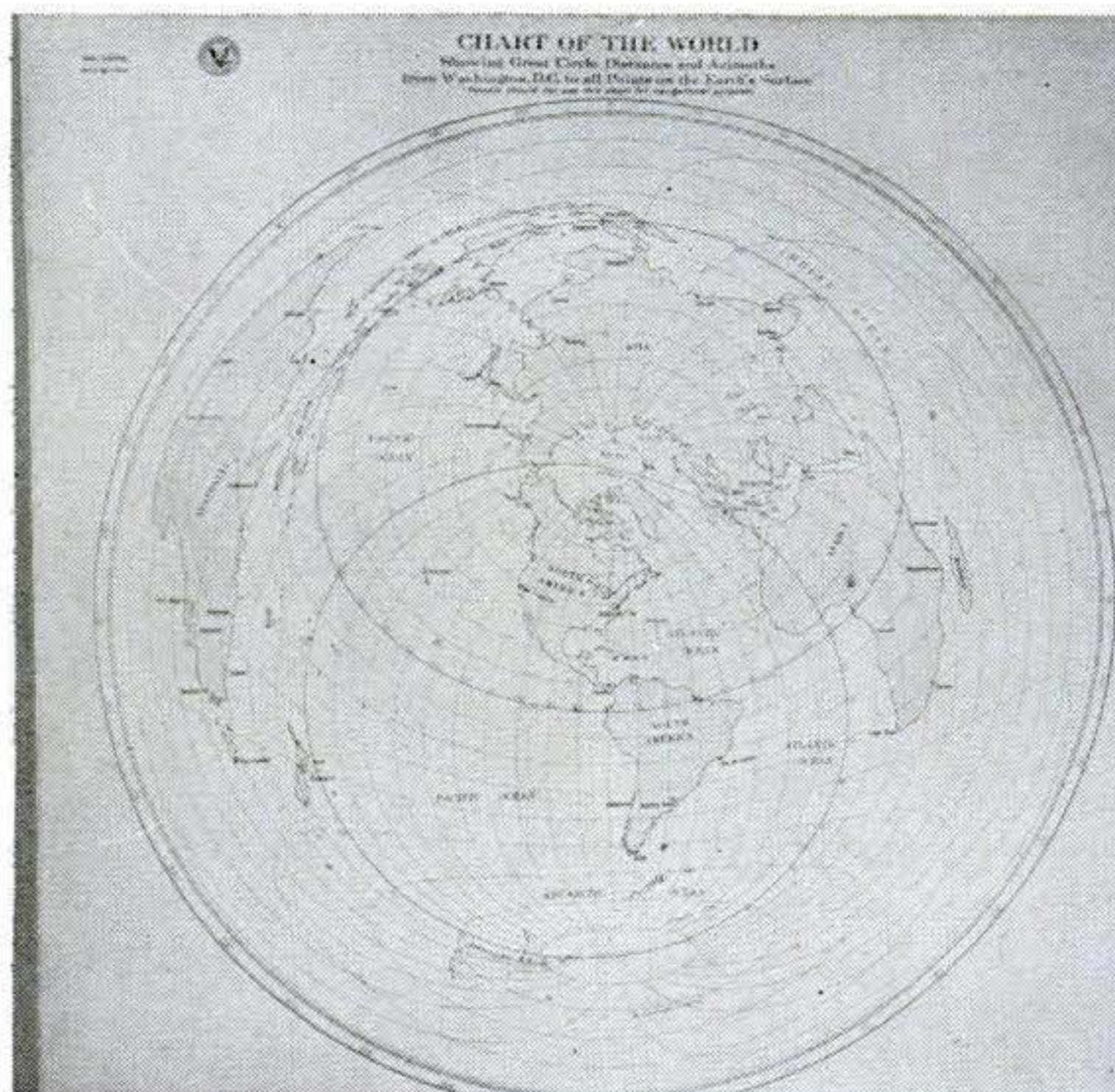

Long-distance work is more than luck. A world map and a compass rose, above the antenna

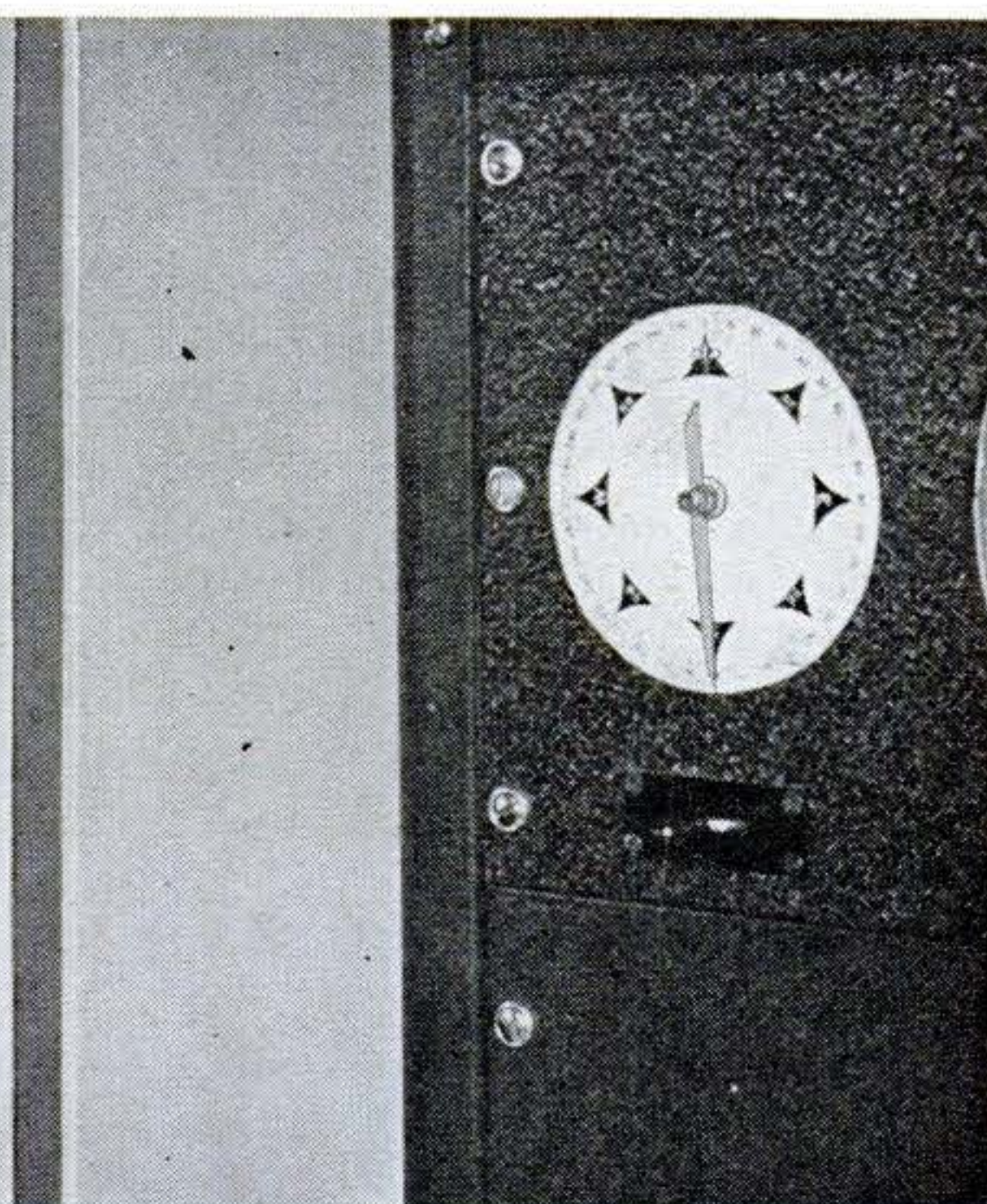

direction switch, help Valentine find the most favorable radio path to any point on the earth.

This Month's Pin-up

NORTH AMERICAN'S XB-45, powered by a quartet of General Electric J-35 jet engines, is one of several multiple-jet bombers being tried out by the AAF. Sleekly streamlined

for extremely high speeds, the plane carries its engines in two twin-unit nacelles that project well forward of the wing. Length is 74 feet; wing span, 89½ feet.



NEW IDEAS
from the
INVENTORS



Fire Trucks Spread Life Net. A life net that can operate virtually unattended, releasing valuable fire-fighting personnel for other duties, is the invention of George

Bauerlein, Sr., of Talladega, Ala. Stretched between two fire engines, it is wound on square poles that cannot slip once the net has been pulled taut.

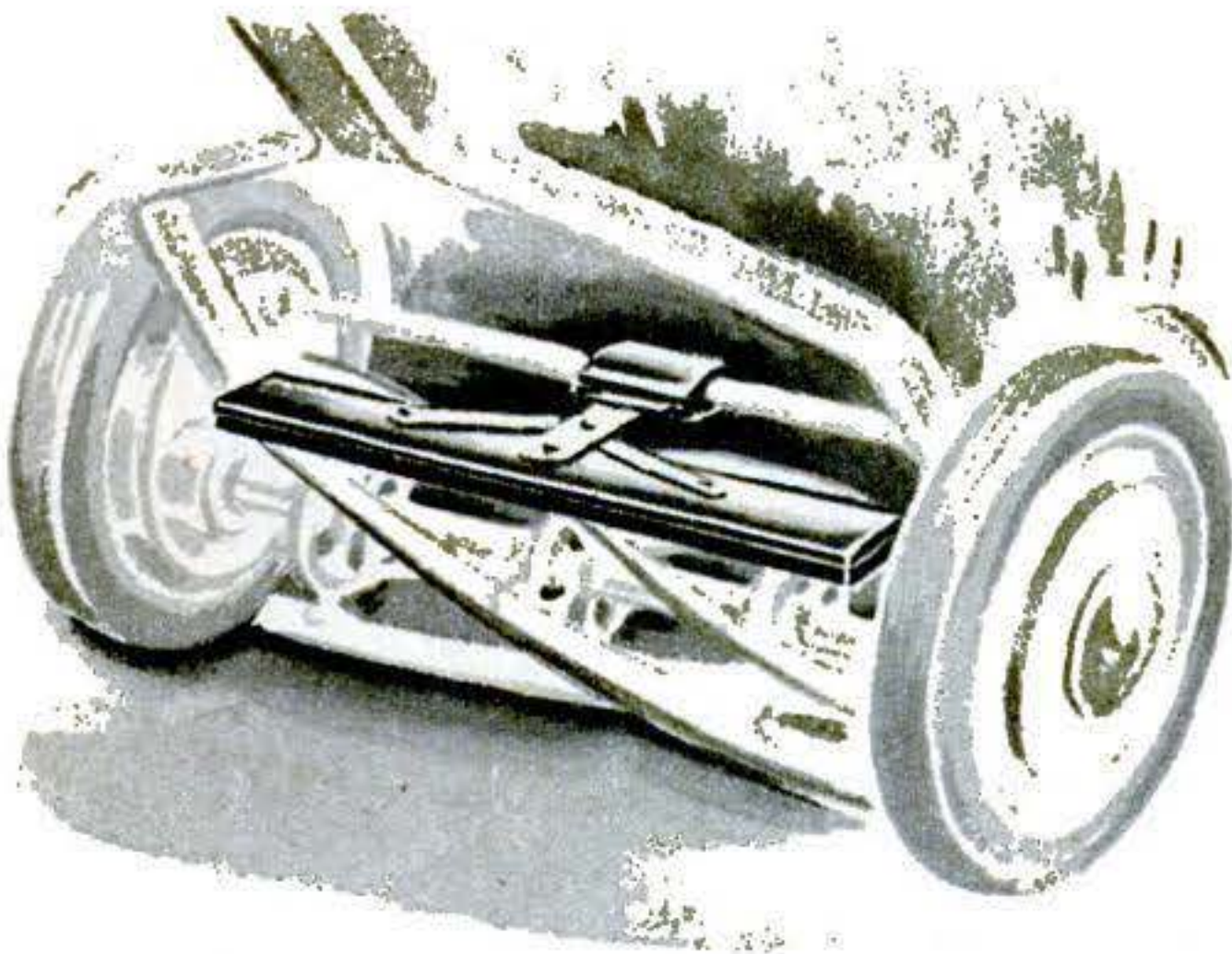

Lawn Mower Sharpens Itself. You won't have to stop in the middle of cutting your lawn to put a fresh edge on the mower blades if an invention of Theodore Brien, of Cherry Valley, N. Y., is put into use. This device is designed to clamp onto the mower's guard bar and hold a long strip of abrasive material against the blades as they turn. You just keep cutting, and the blades sharpen themselves at the same time.



Pilot's Aid Measures Maps. A computing instrument for pilots that shows flight time and distances by simply rolling across a map has been patented by Franklin Reece, of Brookline, Mass. To find the time necessary to travel between two cities, you set it at your speed, roll it along your course on the map, and then read the result directly. The instrument will also tell how far you can go in a given time.

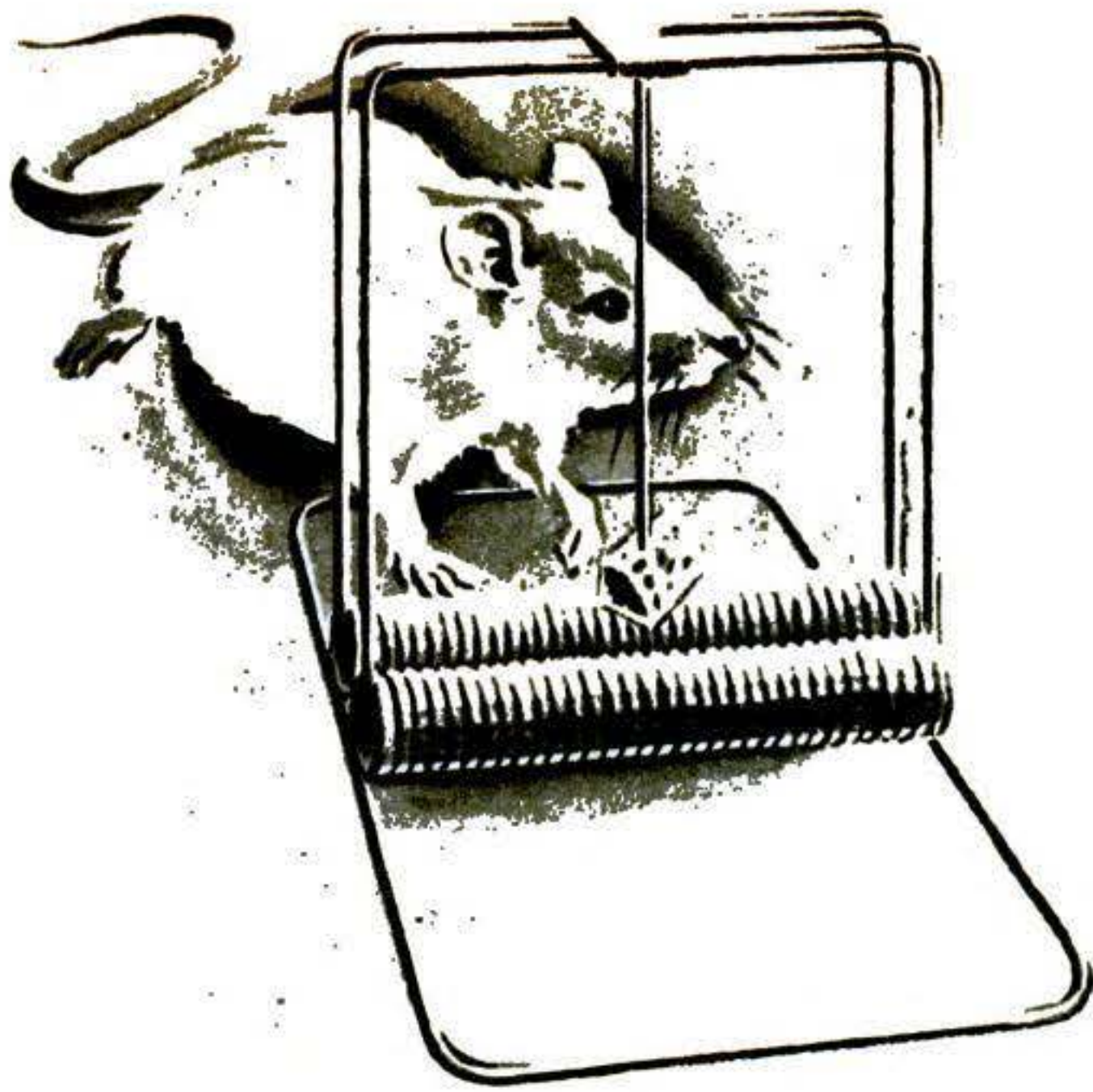

Two-Way Trap Leaves No Exit. Built like two traps set back to back, this double-spring rat-killer is calculated to catch the wariest rodent no matter on which side he stalks the cheese. Its inventor, William Hayden, of Bryn Mawr, Pa., claims also that its wire base has more mouse appeal than wooden ones and is easier to keep clean.

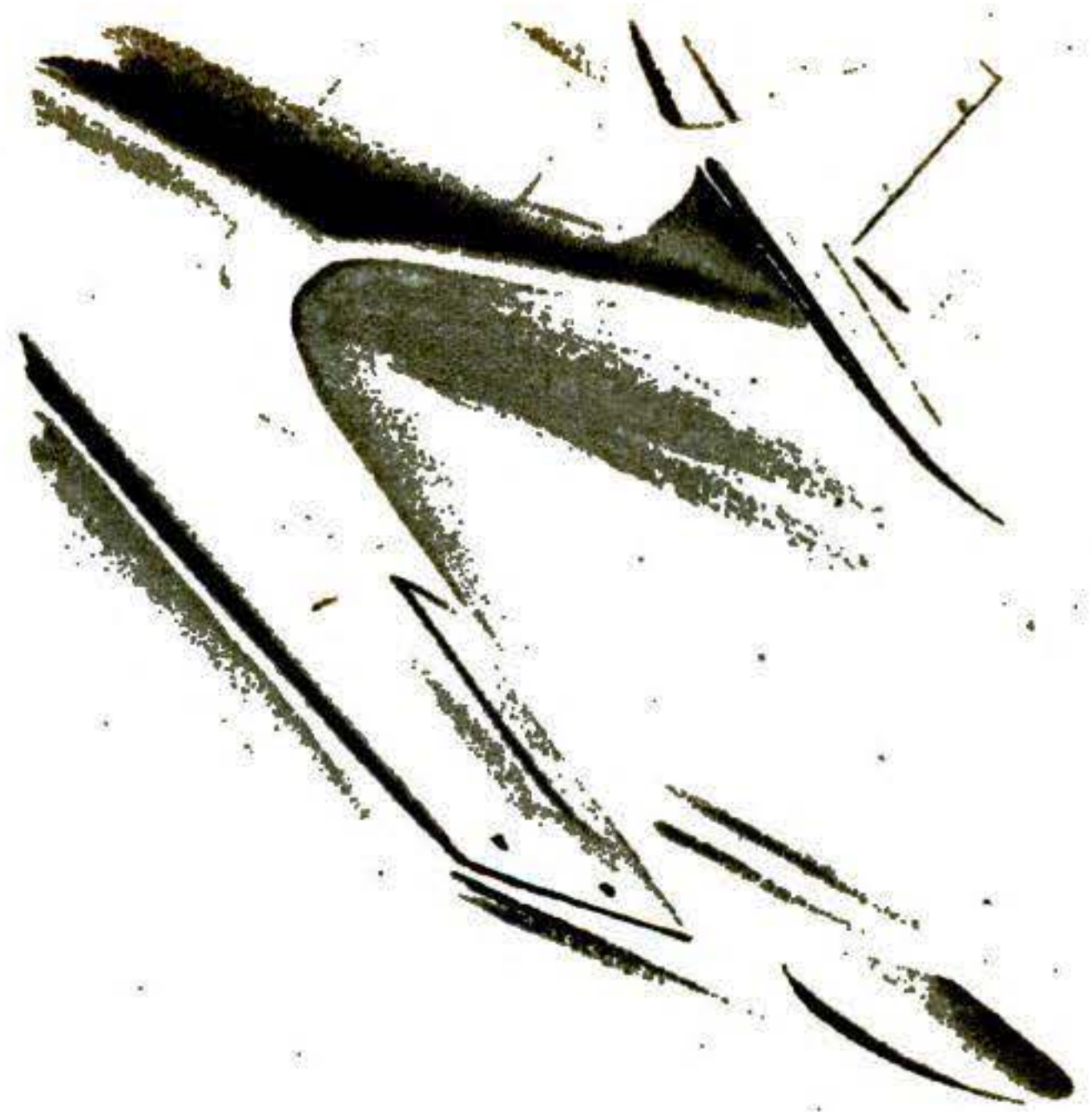

Tank Forms A Wing Tip. To replace the external type of auxiliary fuel tank, Myron Lerche, of Hilbert, Wis., has invented a tank that forms part of an airplane wing, eliminating drag and contributing to the lift. The tank is jettisoned when empty, by means of a cockpit control, leaving a finished wing tip where it was fastened.



Propeller Does Rudder's Work. Like an outboard motor, this steering assembly for inboards combines rudder and propeller in a single unit. A universal joint in the propeller shaft plus a ball and socket (inset)

allow the whole assembly to move freely in all directions. A vertical fin protects the propeller, while a horizontal one keeps it at the proper depth and angle. It is patented by Brett Law, of Merced, Calif.

Trailer Becomes Pleasure Boat

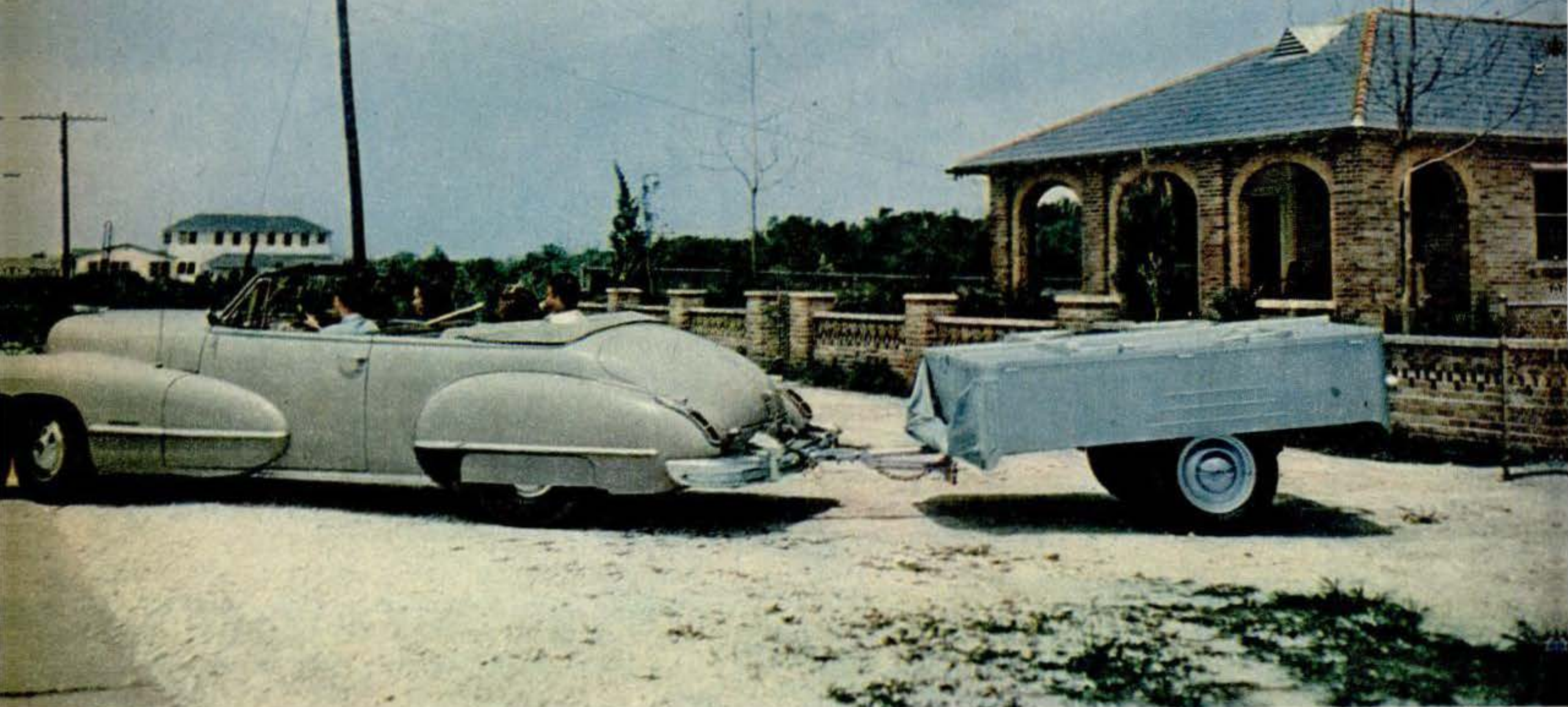

Here's a trailer that goes to sea. A new development in camping equipment, you can take it anywhere your car or an ordinary boat can go. It is like any small auto-towed, two-wheeled trailer when on the road, but can be converted in a few minutes into a

canopied, pontooned raft when you hit the beach. It operates under its own power with the aid of a small outboard motor and, for even faster travel, can be towed by a speedboat. When you reach your camping place, you just haul it ashore and use it as a tent.

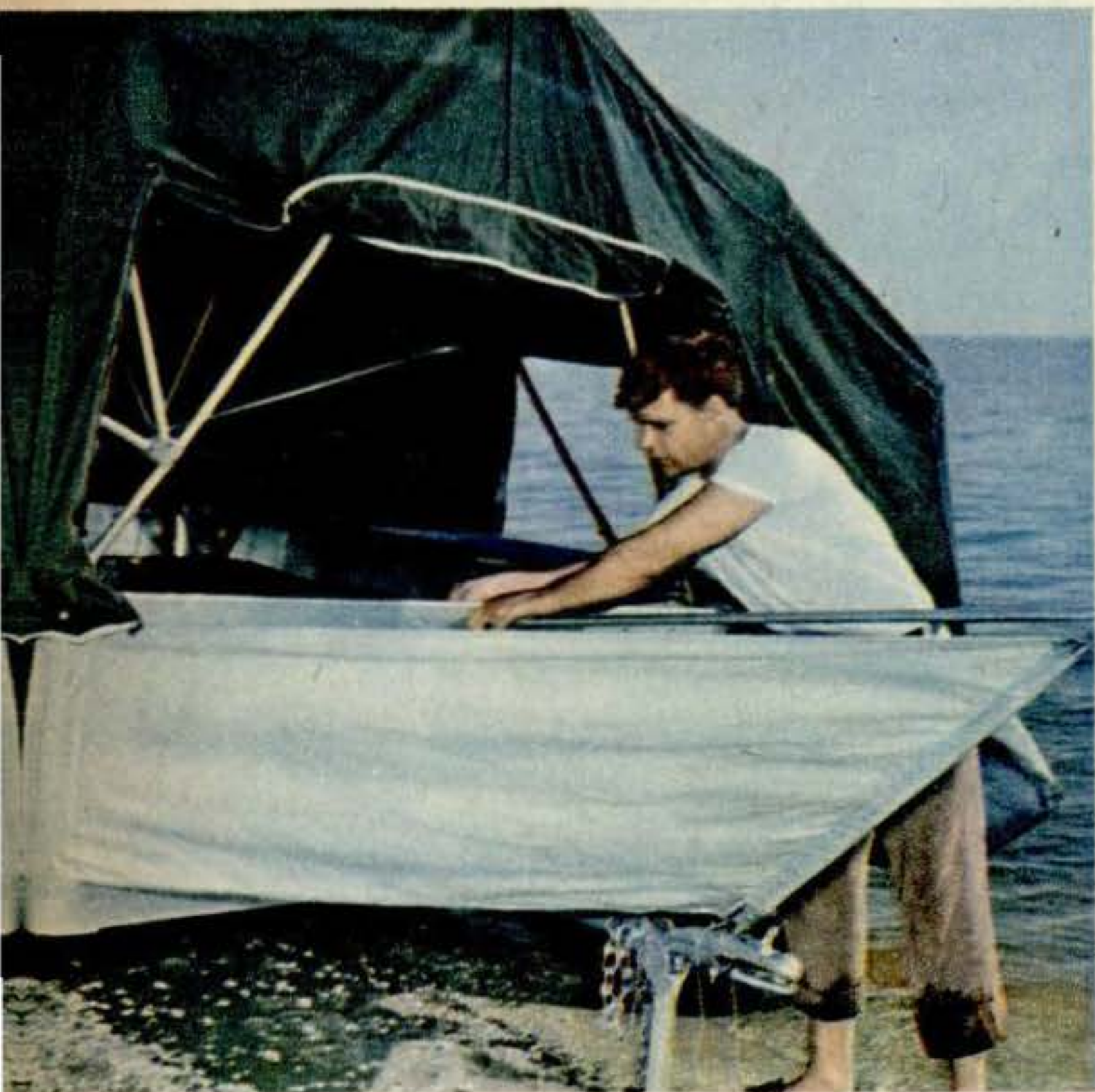

A separate bow, formed of canvas over a metal frame, increases speed and maneuverability when craft is towed or propelled.



Stability of the wide-set pontoons is so great that all aboard can concentrate their weight on either side without danger of capsizing.



Its pontoons pumped full of air at a nearby gas station, the amphibious trailer begins to take shape. Next, the top will be opened out like a double door over the rubber-lined, canvas air bags, increasing the width of the usable space to about 12 feet.

With the erection of its tentlike top, the transformation from trailer to boat will be nearly complete. Made by Higgins, Inc., the 10-foot-long, 829-pound all-aluminum raft sleeps up to four on bunks equipped with air mattresses and can sleep six.



To make the most of the weather, the flexible covering is adjustable to let in the sun or keep out the rain as desired. In addition

to compartments for ice, food, clothing and equipment, there is also space for a table large enough to seat four or five persons.

Mining with

Flame-piercing process helps iron miners by melting charge holes for explosives in obdurate ore.

A 4,000° flame is opening up large new areas of native American iron ore.

Literally melting the rock, this revolutionary fusion-piercing method makes six-inch blast holes 10 times faster than drilling. This high speed makes it profitable to work the very hard iron ore (taconite) deposits in northeastern Minnesota. Too hard to be mined economically with ordinary drilling methods, these ores are an important future supply of iron.

A high-temperature flame from a rotating blowpipe is directed against the surface of the rock. This flame is fed by oxygen and a flux-bearing petroleum base fuel, which emerge from separate openings in a multiple-port burning tip. The flux-bearing element is important, reducing the melting

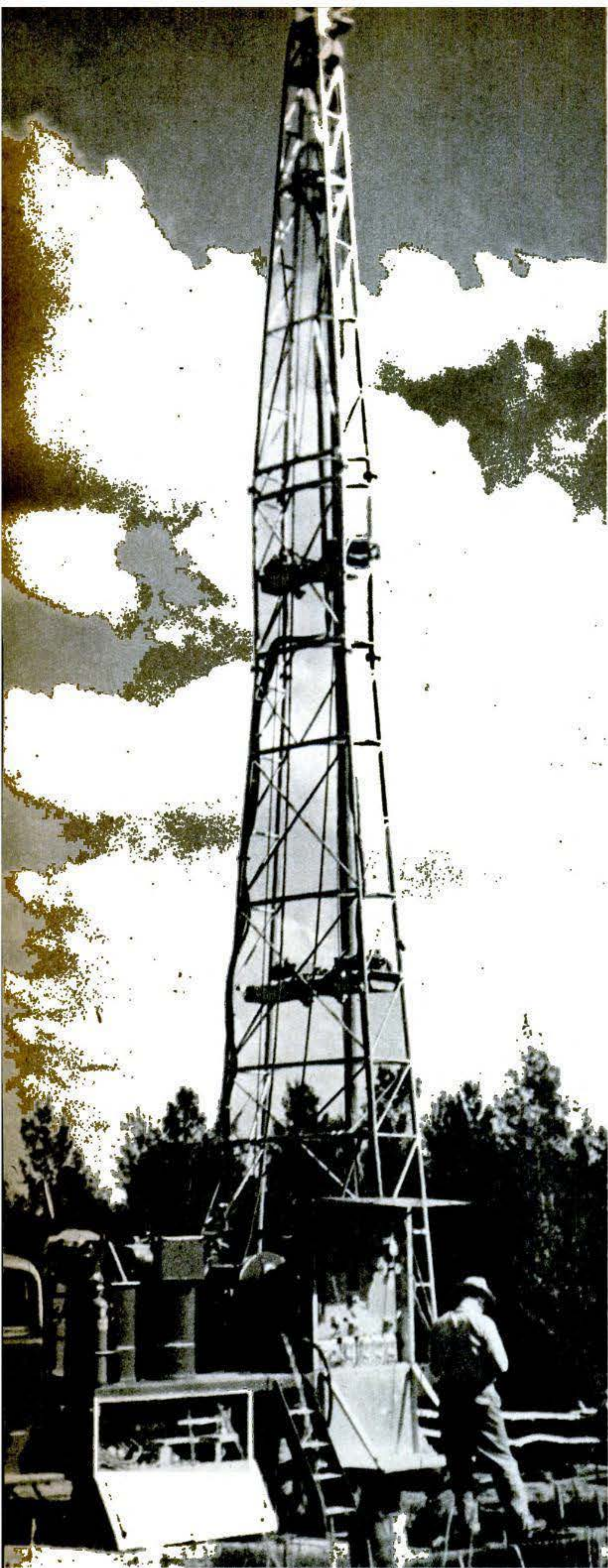

Experimental fusion-piercing gear set up ready for test run. Oxygen is supplied by cylinders on truck at left. In commercial model, one man can control operation.

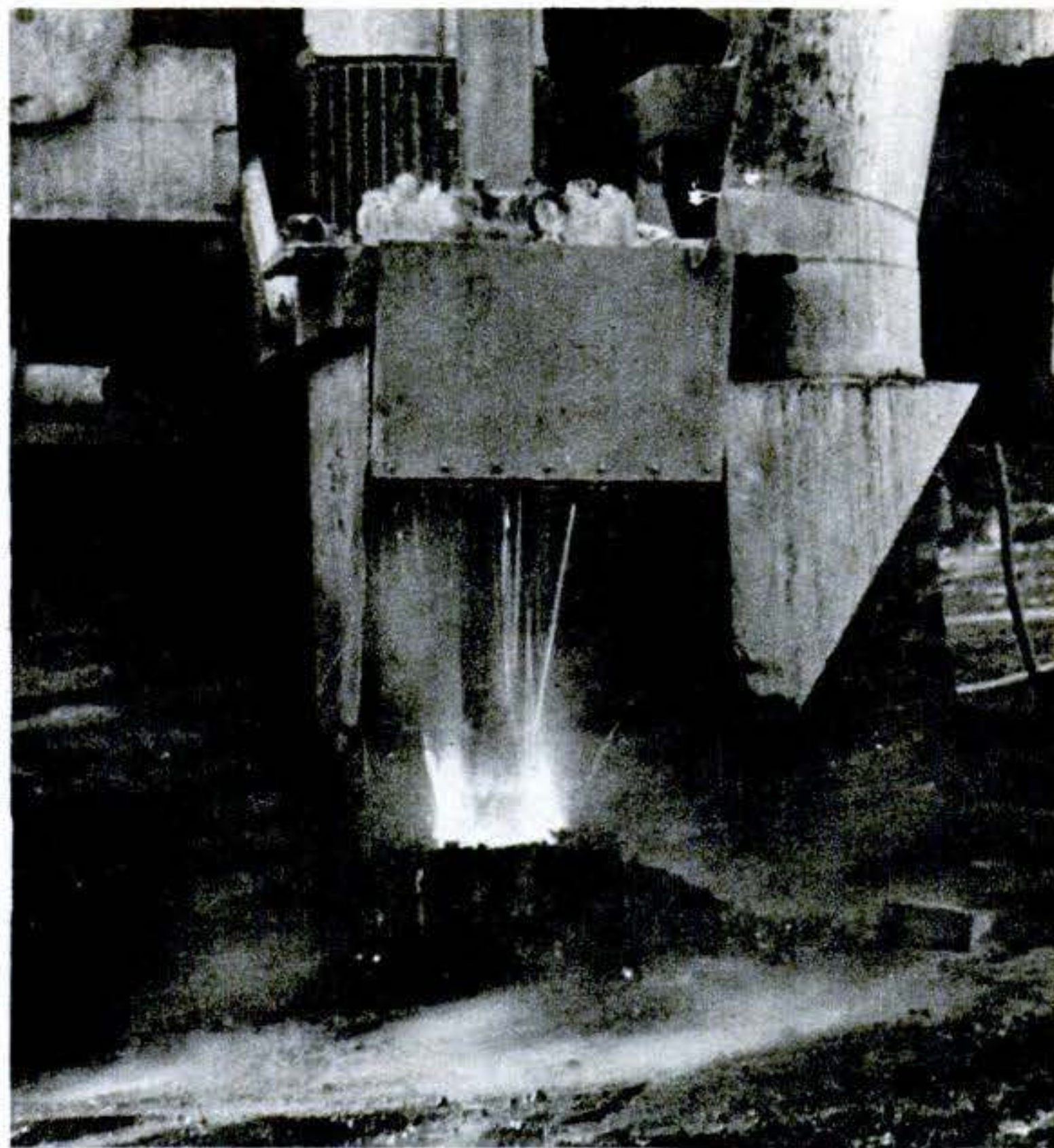

Blazing tip of blowpipe begins to burn through rock. By means of winch, operator adjusts lowering of blowpipe to piercing speed, which depends on hardness of rock.

a Blowtorch

point of the rock by as much as 600 degrees.

As the flame burns down into the rock, a water spray keeps the burner tip cool and makes the molten rock brittle. The water also produces steam that combines with the exhaust gases to force the slag up to the surface through the space between the blowpipe and the side of the hole.

Blades mounted on the shaft above the burner tip and water ports are not for reaming, but serve to break up large particles and to smooth the sides of the hole.

Extensive experiments with fusion piercing have been made on Reserve Mining Co. property at Babbitt, Minn., by the Linde Air Products Co., developers of the process. The flame seared through the rock at an average rate of 10 feet an hour, and hit 17 feet an hour for short periods.

Fusion piercing has other advantages for mining taconite. Cracks radiating from the hole during piercing produce better fragmentation during blasting. And the hole tends to enlarge by chipping, permitting the use of economical split charges.

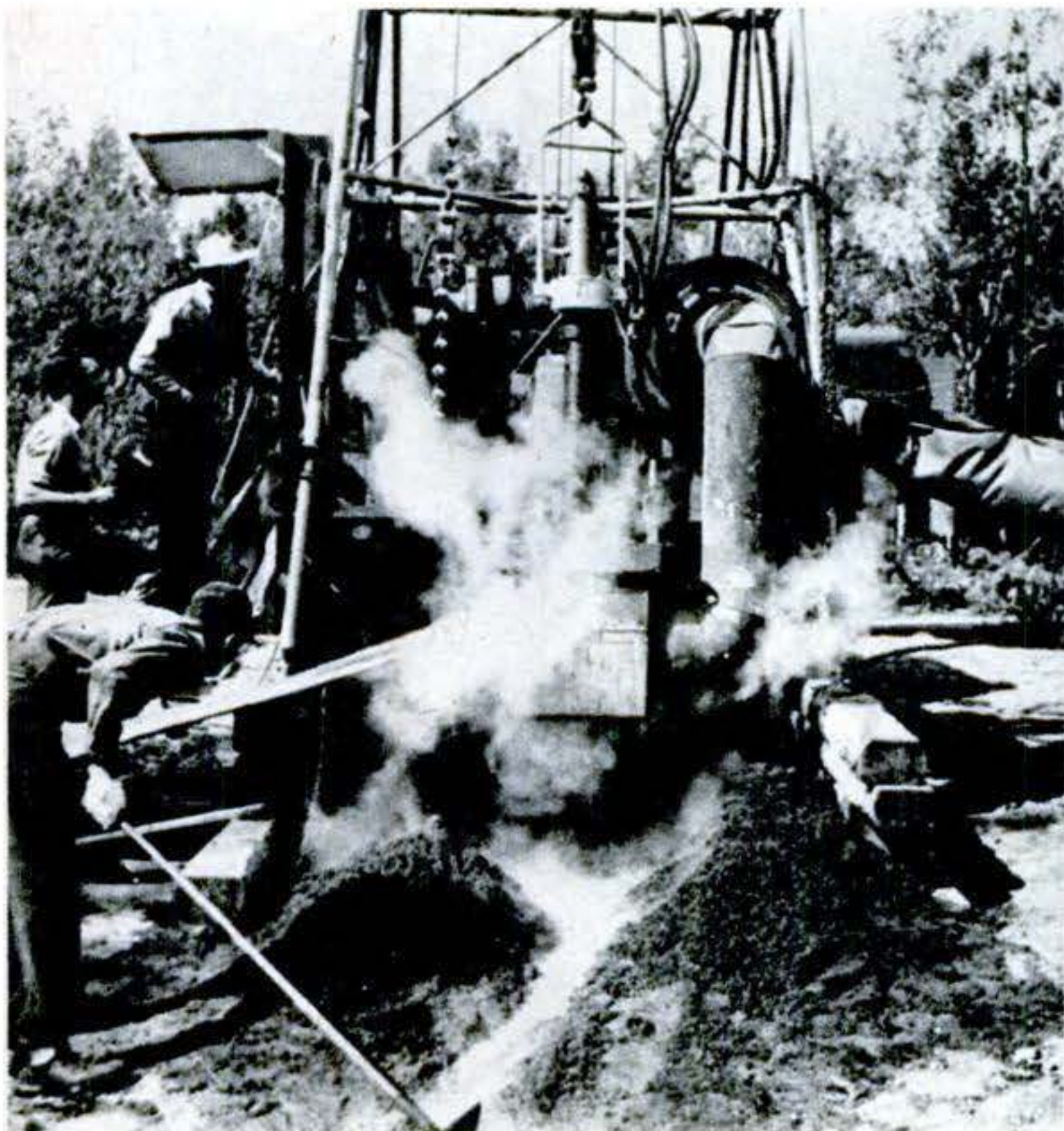

Fusion piercing under way, with blowpipe approaching full depth of pierce. As slag is forced up around hole, it is removed by helper. Gas-exhaust outlet is seen at right.

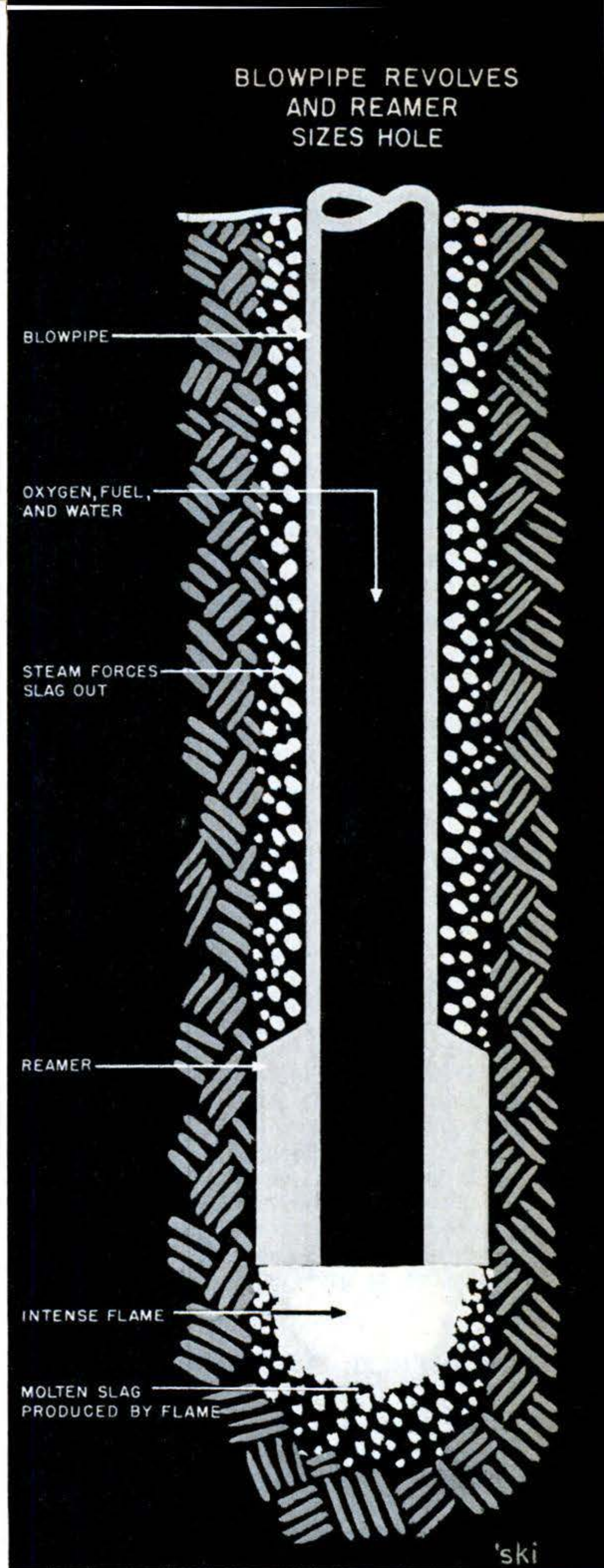

Cutaway of 30-foot blowpipe that does the job. Oxygen, fuel and water flow through separate channels in blowpipe, and are ejected from individual ports at operating end.



Two Twins Join Navy

THE Navy's "egg beater," first twin-engine helicopter to join the U. S. fleet, hovers above another Navy first, the XF2D-1 Phantom, a twin-jet fighter. The McDonnell Whirlaway helicopter has an 87-foot span, cruises at better than 100 miles per hour, and carries 12 men including crew.

With wings folded as shown at right, the span of the McDonnell Phantom is reduced to 16 feet 3 inches for compact storage aboard ship. It is powered by two Westinghouse 19B jet engines, each developing a 1,600-pound thrust. Packing four machine guns, its combat weight is 8,580 pounds. Its long nose helps pilot's aim. Fifty Phantoms are expected to join carrier squadrons soon.

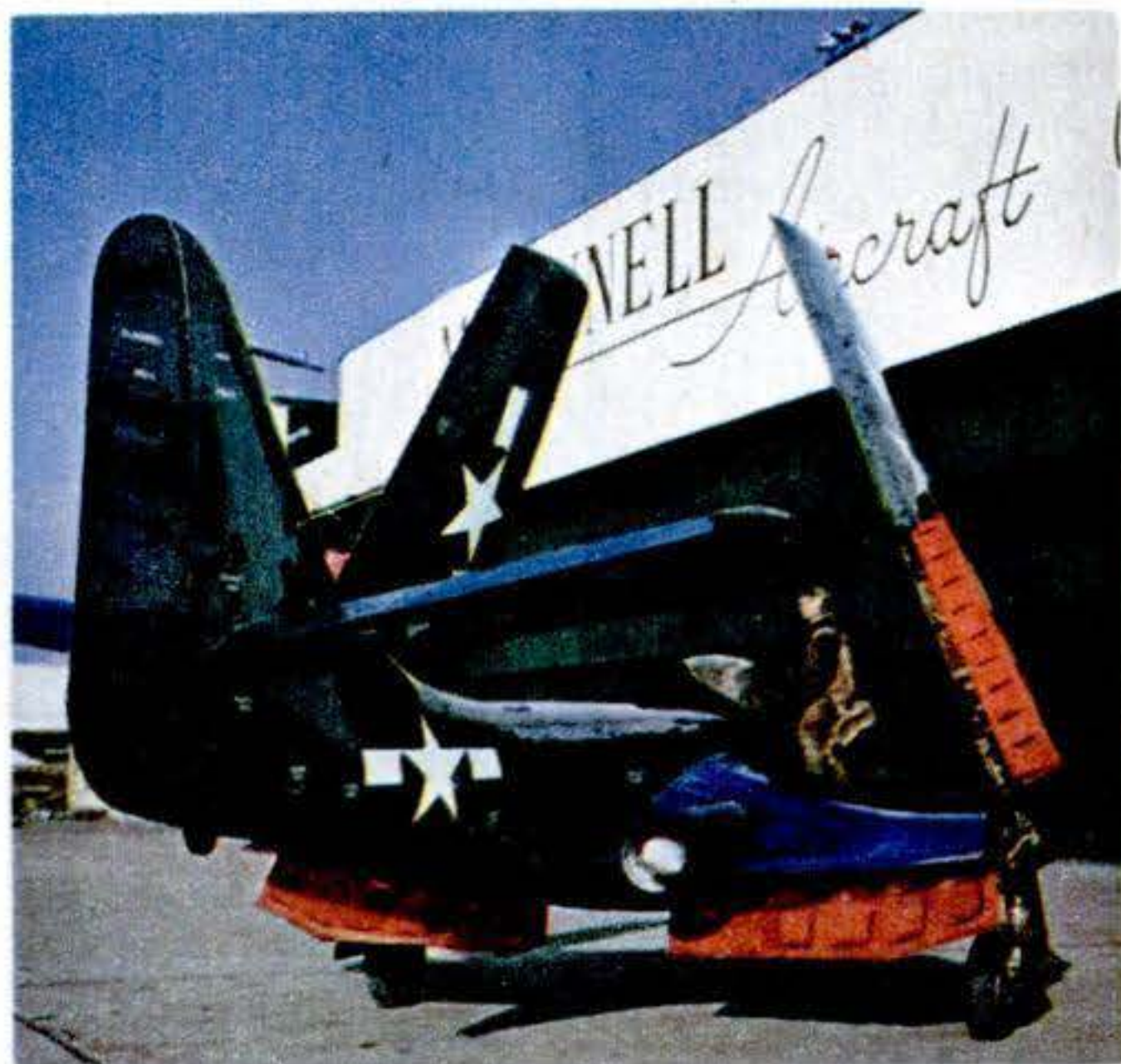

Take a Seat—in the Cockpit of a DC-6! →

WOULD you like to take this 52-passenger DC-6 into Los Angeles Municipal Airport, gleaming ahead? Then you'll have to know every dial in that bewildering maze.

At extreme top center you see part of the ignition- and electrical-control panel. The white dials directly below are fuel-quantity indicators. Fuel-pressure gauges and carburetor gauge are at far left and cabin-supercharger control instruments at far right. The device between the windshields is a magnetic compass. The red buttons di-

rectly below the windshields control automatic fire extinguishers for engines and baggage compartments. The collection of dials in front of the duplicate sets of throttles comprises the main engine-instrument panel. At each side, mostly hidden by pilots, are identical sets of flight instruments, including radio compasses, for pilot and co-pilot. The four panels below the throttles are (l. to r.) pilot radio-selector, automatic direction-finder indicator, tuning meter and co-pilot radio-selector.

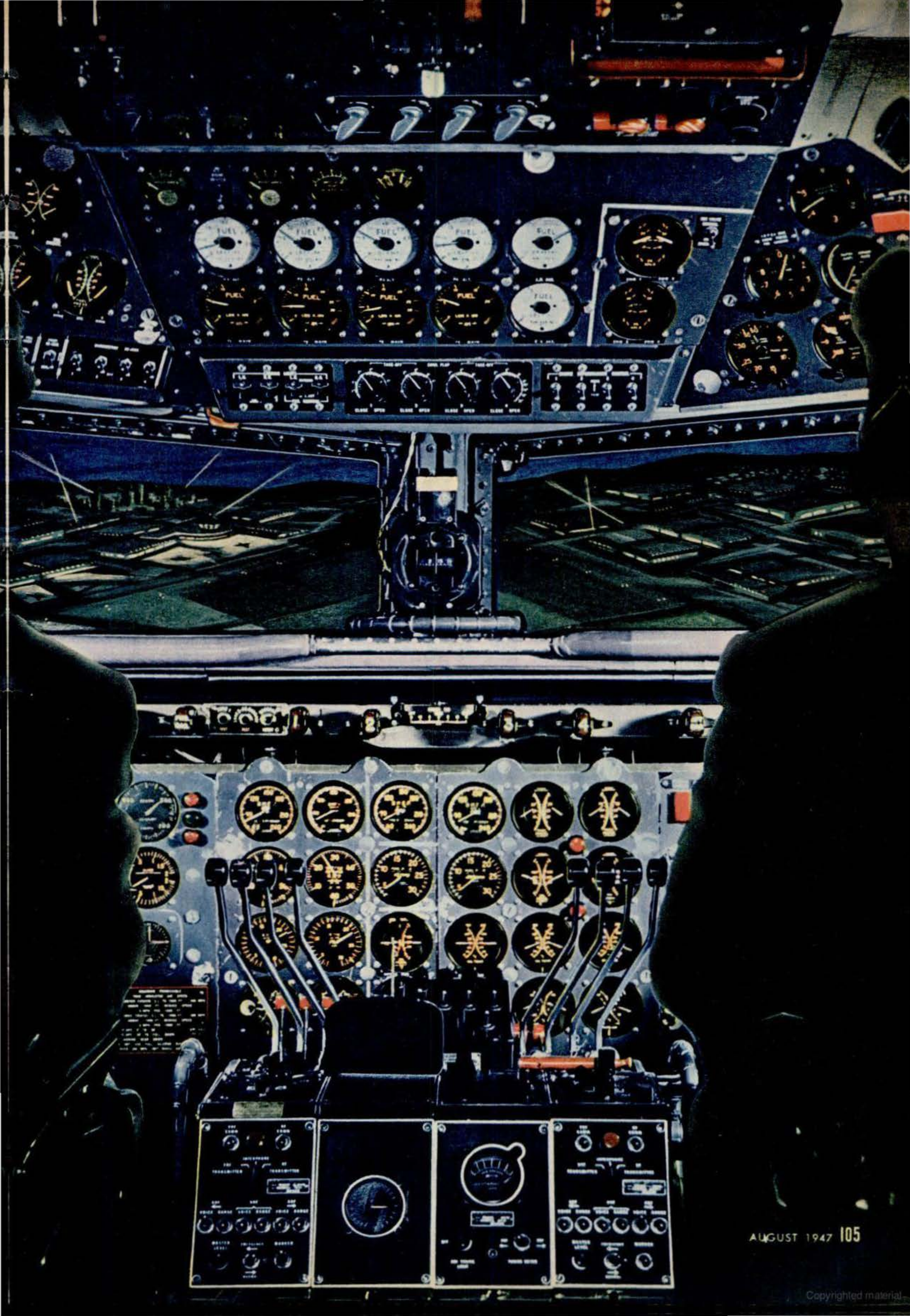

Electronics Lights the Stage

Electrician at new console
can do work of a dozen men.

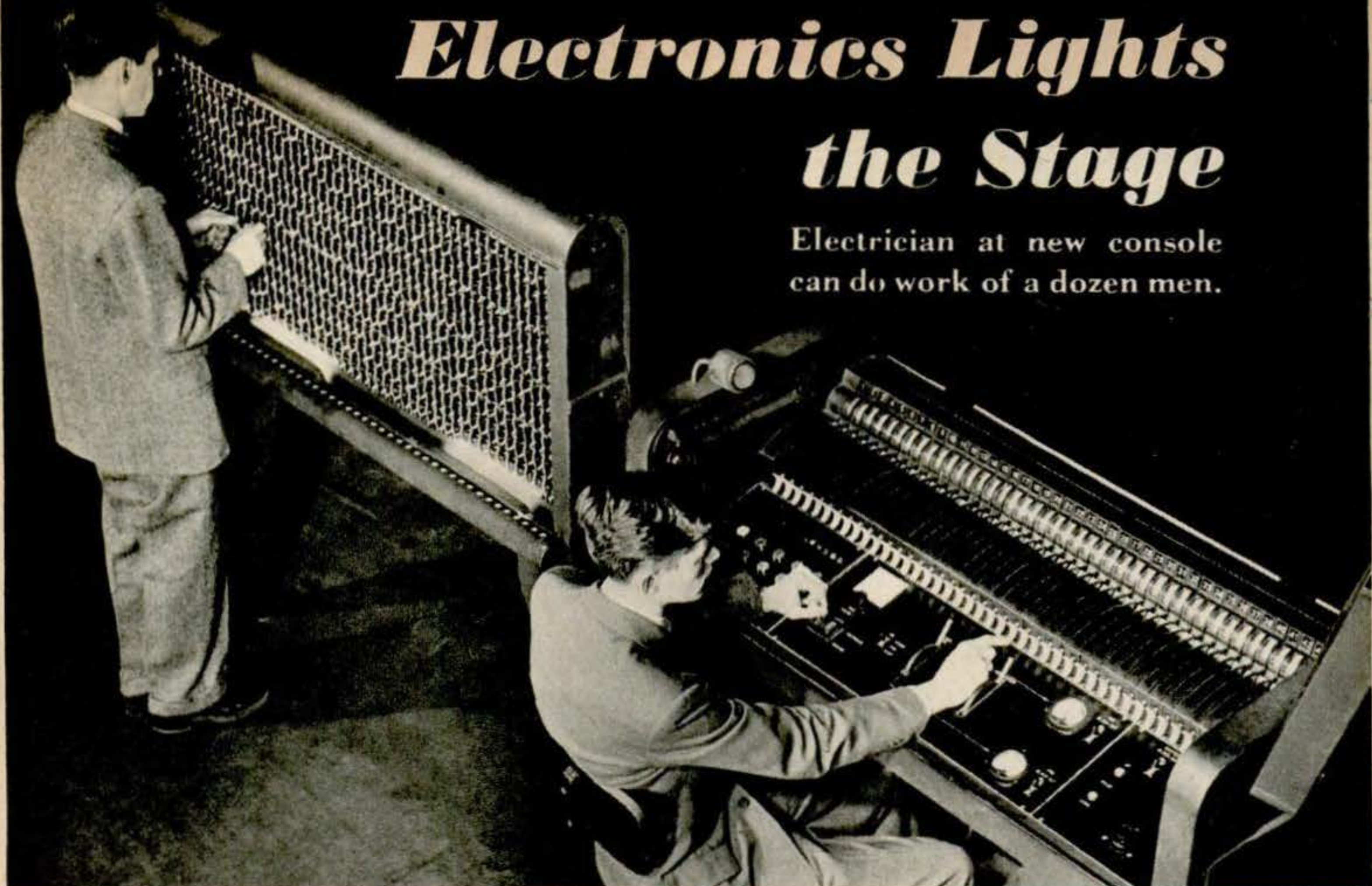

One pair of hands does a better job than a dozen with this new electronic control unit for stage lighting, now in use at Yale University. Instead of the large crew of electricians usually needed, one man at the

console at right can adjust 44 different lights, change from one complete lighting design to another, and produce striking theatrical effects never before possible. Panel at left sets lighting designs in advance.

A close-up of the console's "keyboard" shows the centralized controls. The dials and switches for individual lights are at the top. Numbered pilot lights at left indicate which one of the 10 preset designs is on and which

is next. The clutch (center) engages a motor that automatically fades one design into the next, while knob above it sets fading time. The levers are manual faders, the right for individual lights and the left for groups.

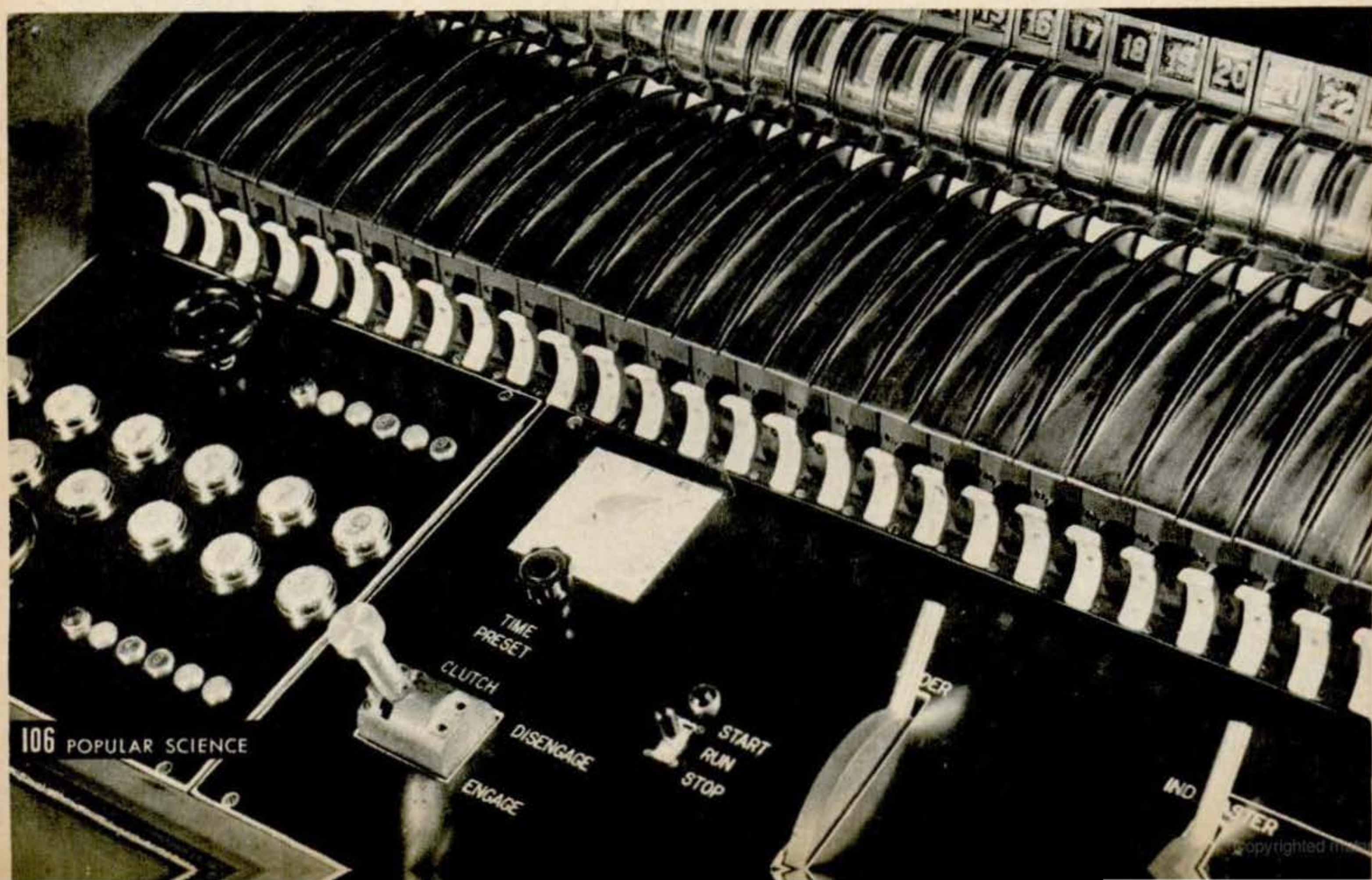



Professor George C. Izenour of Yale University, inventor of the electronic lighting control, adjusts one of the 44 switching and dimming units operated from the console. Each unit has one vacuum tube that controls

two thyratrons carrying the heavy current for the circuit. Professor Izenour, whose field is drama rather than electronics, expects his device to inspire new lighting techniques, expanding the scope of the theater.

To fade designs together, the left motor drives a potentiometer regulating the vacuum tube circuits, while also moving the selsyn motor at right that controls indicator dials and provides manual fading.

Small levers on this panel set potentiometers controlling light intensity. One horizontal row handles all 44 lights—a complete design. With 10 rows, 10 designs can be made up for later selection from the console.

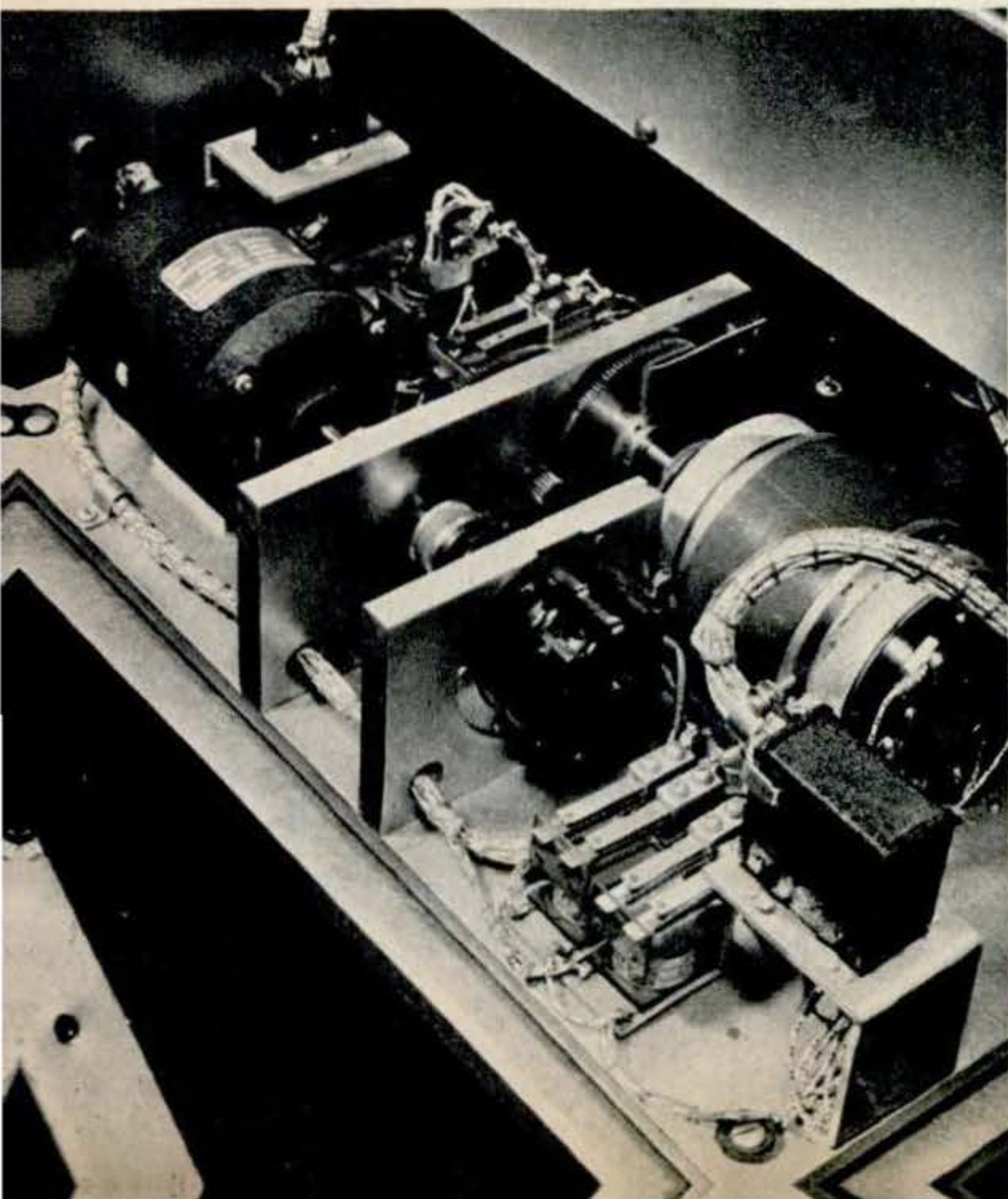

"Zoot Suit" Reduces Diver's Burden

WEIGHING only 10 pounds without shoes, as against 85 pounds for the regulation brass-helmet diving dress, a new light-weight suit is making life easier for men in the Deep Sea Diving School at the Washington Navy Yard. It is made of rubberized canvas, and a face mask straps around the diver's head. A canister worn around the neck purifies air for rebreathing. Eighteen-pound shoes complete the dress, which is used for moderate depths.

Mosaics Go Modern

USING a single piece of ceramic-like plastic instead of the hundreds of tiny pieces that make up a true hand-set mosaic, two artist-inventors have patented a method that permits quantity production of what they call "Mosamics." The process can be adapted to framed pictures like the one shown below, or to colorful plates, trays and other furnishings.

The design is cast in one piece of the plastic, which is then colored and glazed. Then the spaces between the "stones" are filled with a cement to give the outward appearance of hand-set work. The Mosamics Co., of Brooklyn, produces the designs.

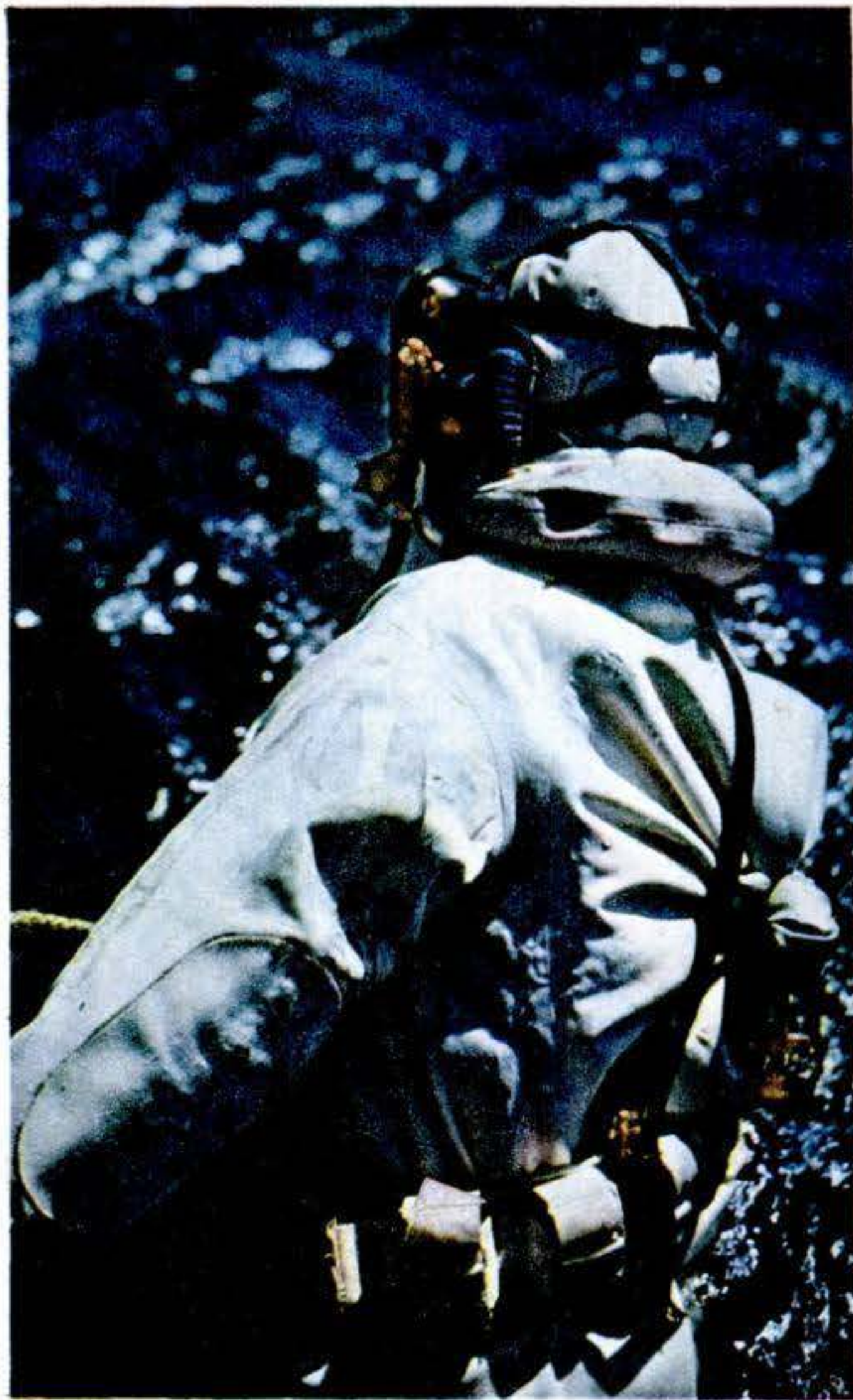



The towering tail of this AAF C-97 Stratofreighter illustrates the problem of getting it to fit inside the hangar.

Tails Down!

BIG airplanes need big tails; tall tails call for a lot of hangar clearance. To avoid the need for new hangars big enough to admit Stratocruisers and Stratofreighters, with their four-story vertical fins, Boeing designers worked out a hinged tail that folds down like a box top. Besides cutting the planes' height to less than 27 feet, this engineering trick also simplifies tail-assembly servicing. The rudder can be more easily removed from the "down" position, eliminating the need for the usual overhead crane.

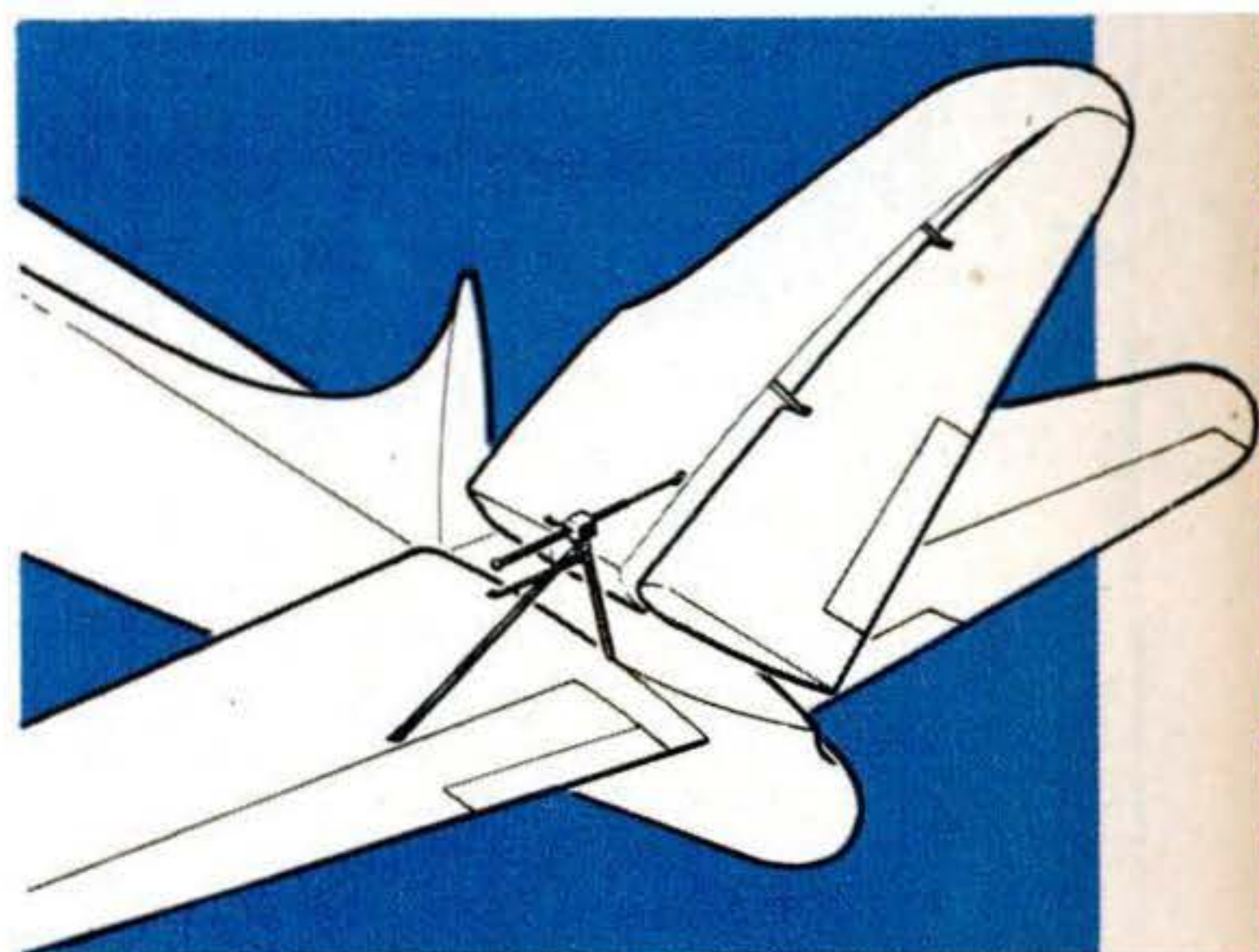

"Fin-folding jack" has a tripod that fits onto the left stabilizer to support the fin on its way down.

With hinge pins substituted for four bolts, the fin is lowered to a horizontal position on the right stabilizer.



How Ocean Cables Are Mended

MAINTEINING more than 23,000 miles of submarine cable, resting on ocean bottoms to depths of three and a half miles, is a big job. The fleet of repair ships maintained by the Commercial Cable Company may be called to the mid-Atlantic or the mid-Pacific. Their task may be to repair damage caused by Newfoundland icebergs or the ravages of a Philippine Sea earthquake; to mend breaks made by razor-sharp coral reefs or the drags of fishing trawlers.

Submarine cables vary in size from more than four inches in diameter at the shore ends to one inch in the deep-sea sections.

Although the cables rest on the bottom of the ocean, they are laid with sufficient slack so that they can be lifted by a repair ship's grapnel without excessive strain.

When a break occurs in a cable, special testing apparatus on land determines the location, and a cable repair ship is sent to the spot. On arrival at the break, the ship drops a marker buoy. It then steams to a point several miles off to one side of the cable and drops the grapnel and "fishes" until a dynamometer, registering strain on the grapnel rope, indicates that the broken cable has been hooked.



3. On the ship's foredeck is the machinery that picks up and pays out cable as desired. Accuracy in controlling speeds under all sea conditions requires the steam-operated machines to be manned by experts.

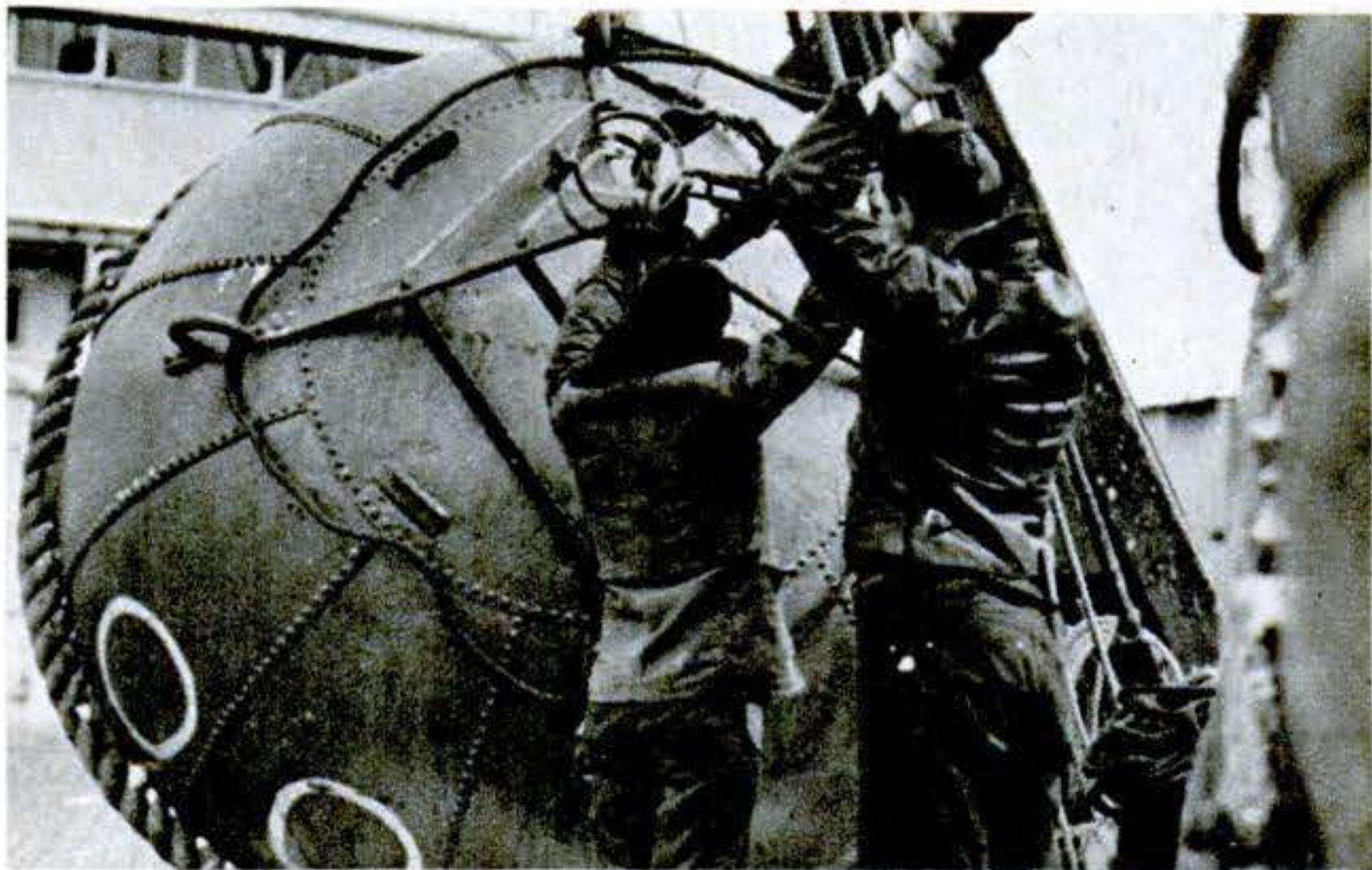

4. A cable buoy is fitted with a long staff. When the trouble area is located, the buoy is lowered over the ship's side by means of skids and moored to ocean bottom. The staff guides ship in grappling operations.



7. A damaged cable, crushed by an iceberg, is lifted up by grapnel off St. Johns, Newfoundland. Man over the side is putting on a "stopper" to permit one end of smashed cable to be brought into ship for repairs.

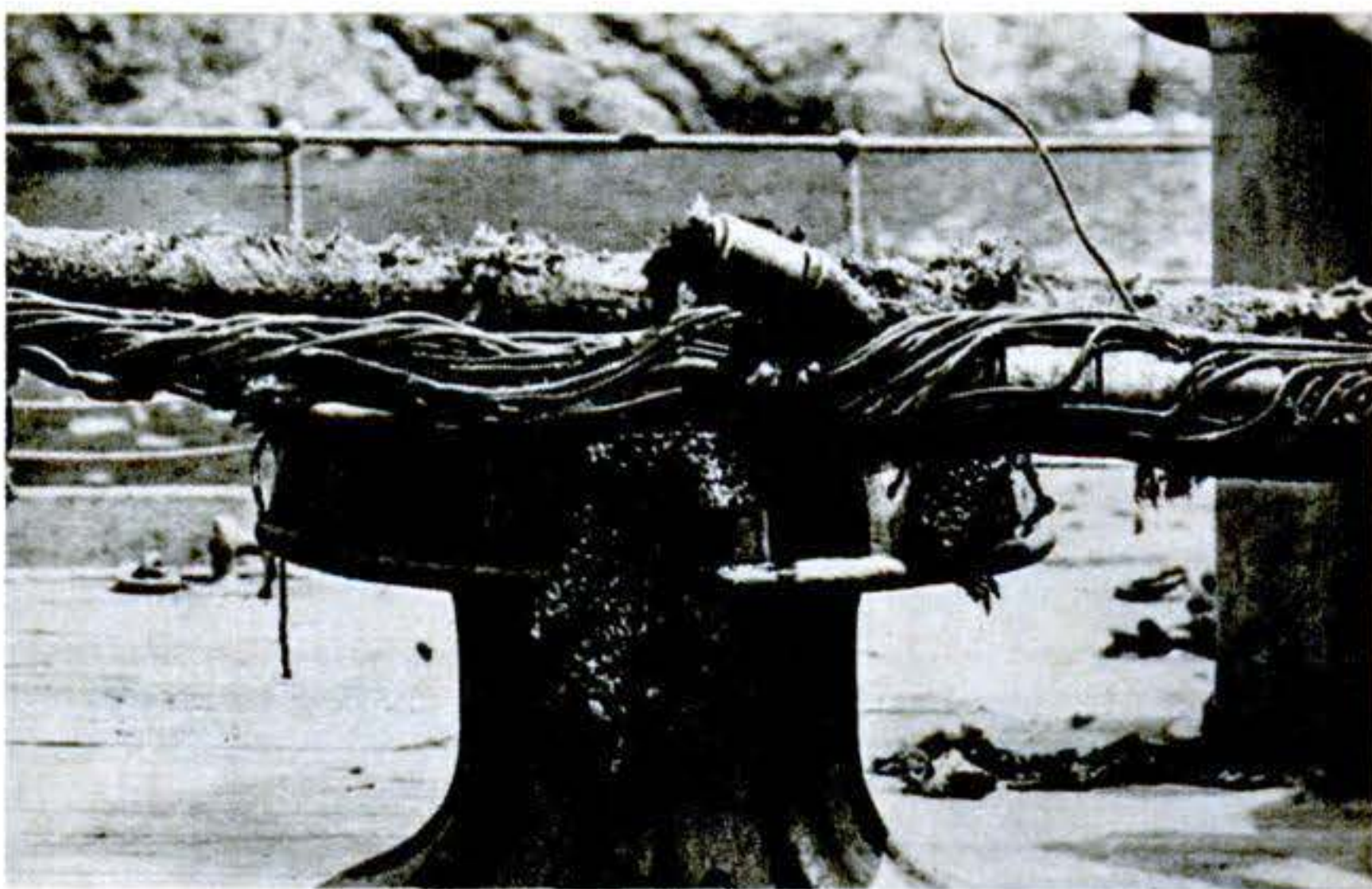

8. Close-up of a damaged cable shows what can happen when it meets an iceberg. Although infrequent, such accidents have sent cable ships speeding north three times in a year. Heavy seas often impede repairs.

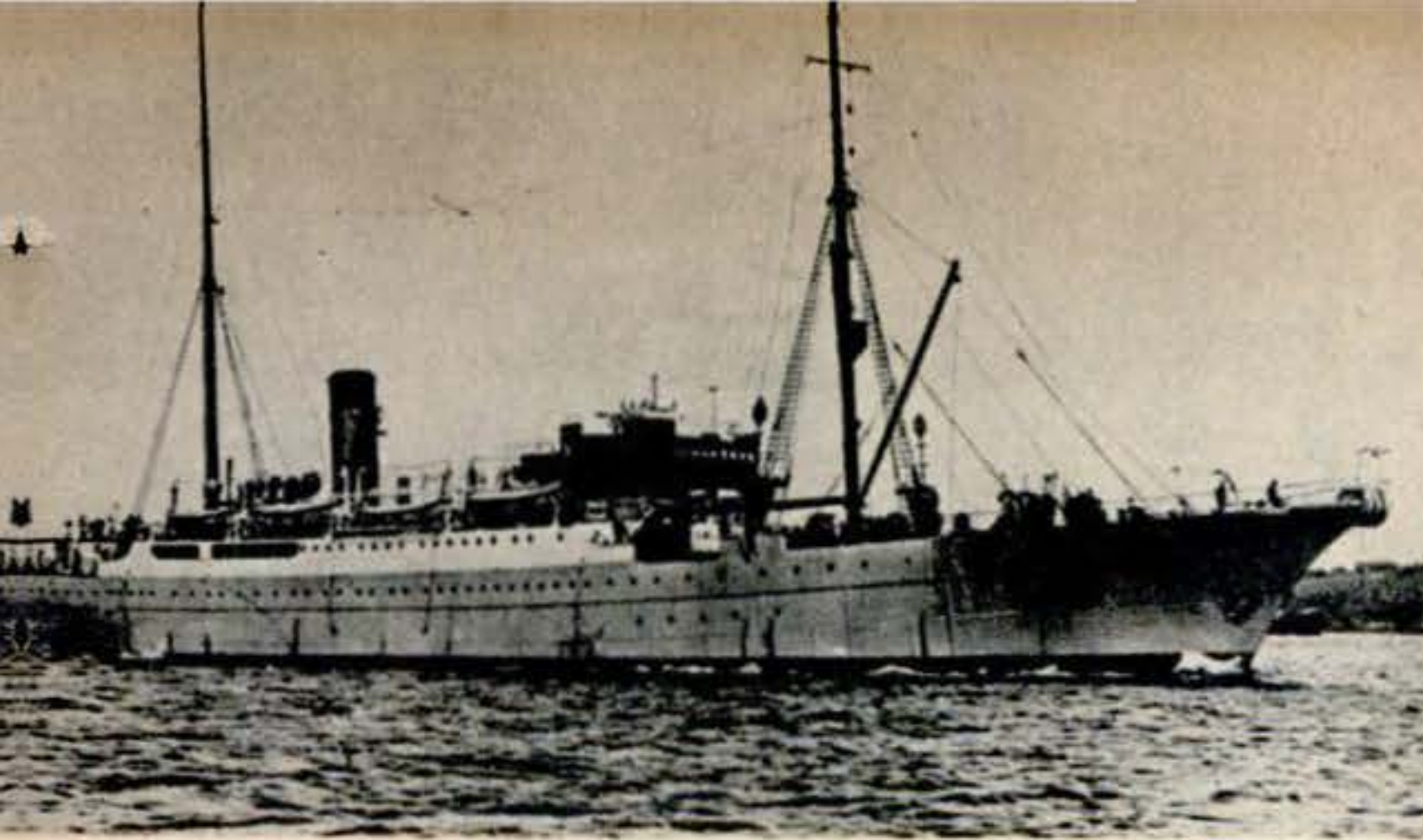

1. Since its launching in 1923, cable ship *John W. Mackay* has made ocean-bottom repairs the world over. Its trouble-shooting career includes hazardous operations in the Atlantic Ocean during World War II.

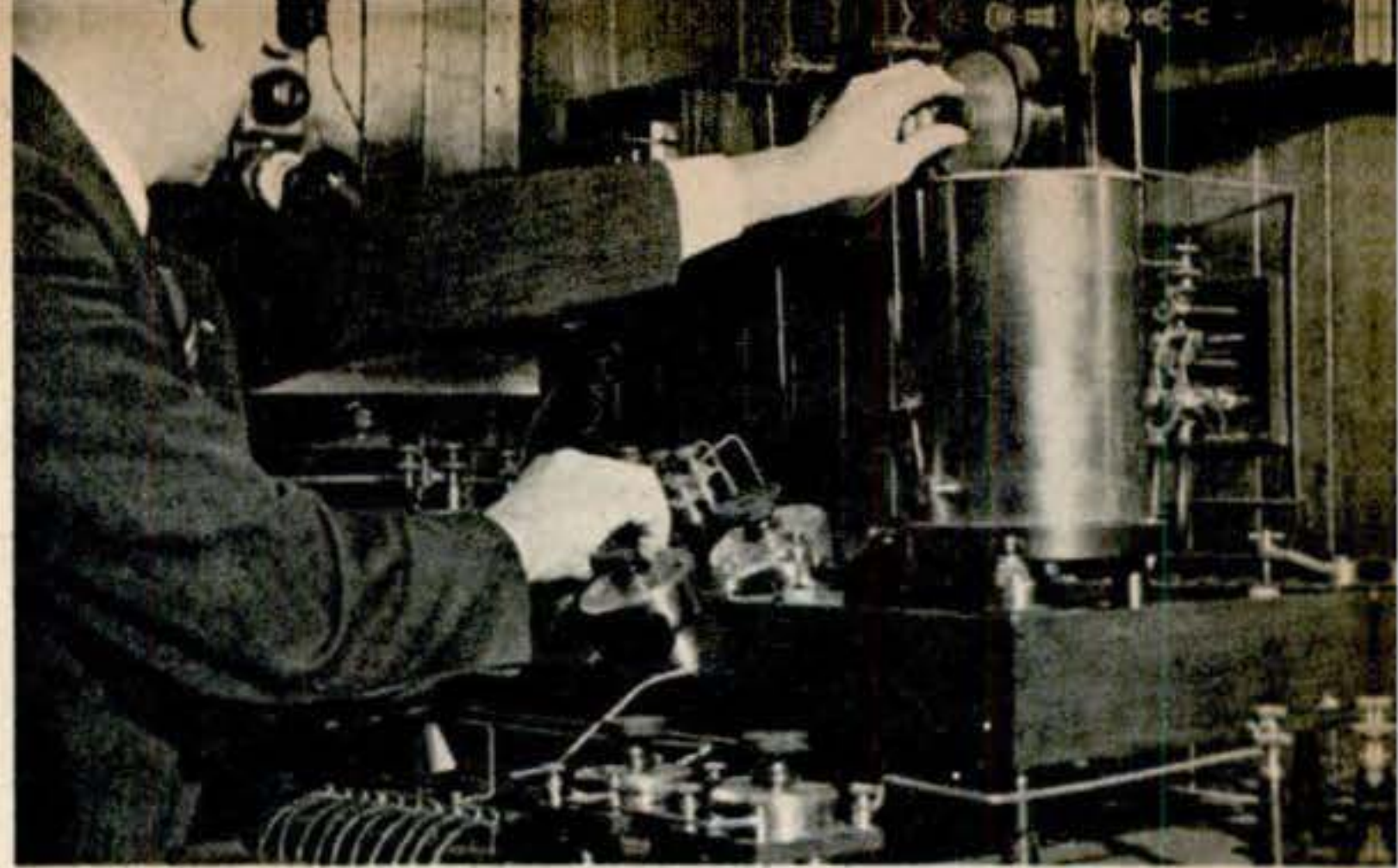

2. Brain of the cable ship is the testing room. Electrical apparatus locates breaks and determines what is wrong. After the cable has been hooked and repaired, the equipment checks it for proper functioning.



5. Swift current swirls a wake around a marker buoy during operations in the Gulf Stream. Bracket on the staff holds two lamps that are visible for nine miles. Buoy is hauled back on ship after repairs.

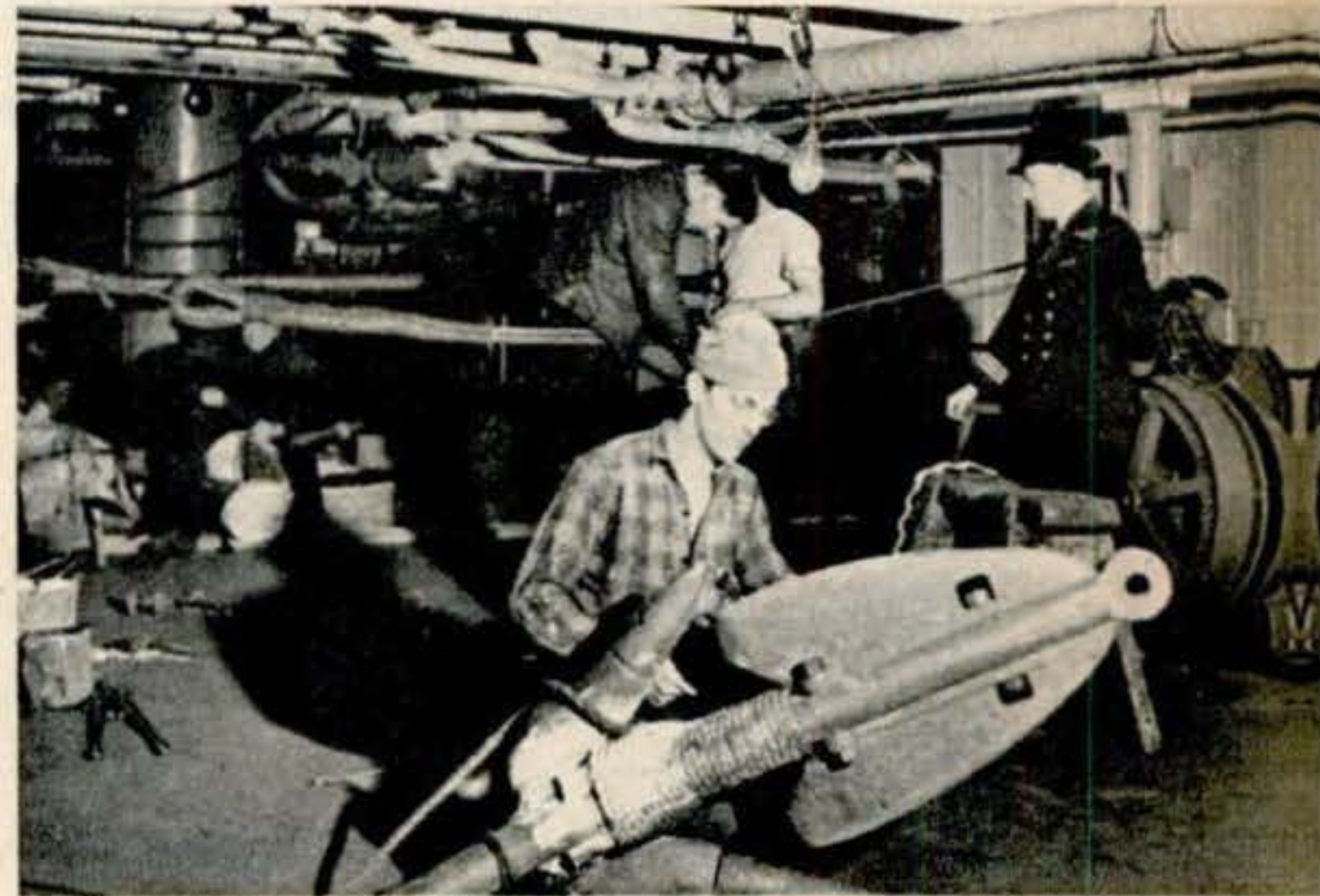

6. Cable machinery and machine shop are located on lower deck where the general repair work is done. Crew members are largely recruited from Nova Scotia and, like these men, dress lightly even in winter.

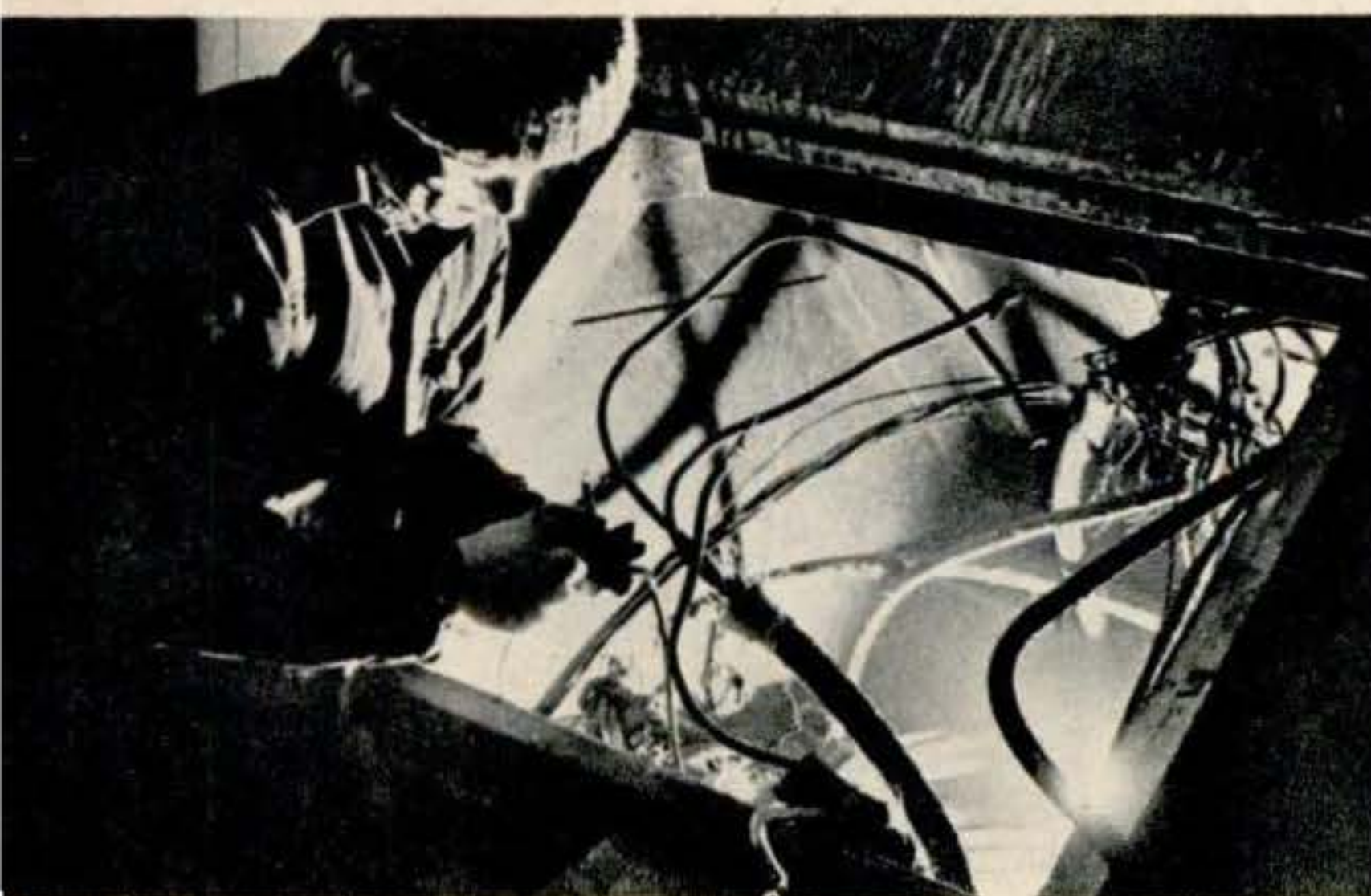

9. In this operation, called "connecting the ends" of the cable, electrical tests are made prior to starting repairs. The apparatus is the Cable End Box, a central point inside the cable ship's well-equipped testing room.



10. Storage tanks for cable are located below decks. Numerals on back wall indicate the amount of cable available at all times. There are four such tanks, each having a storage capacity of 300 miles of cable.

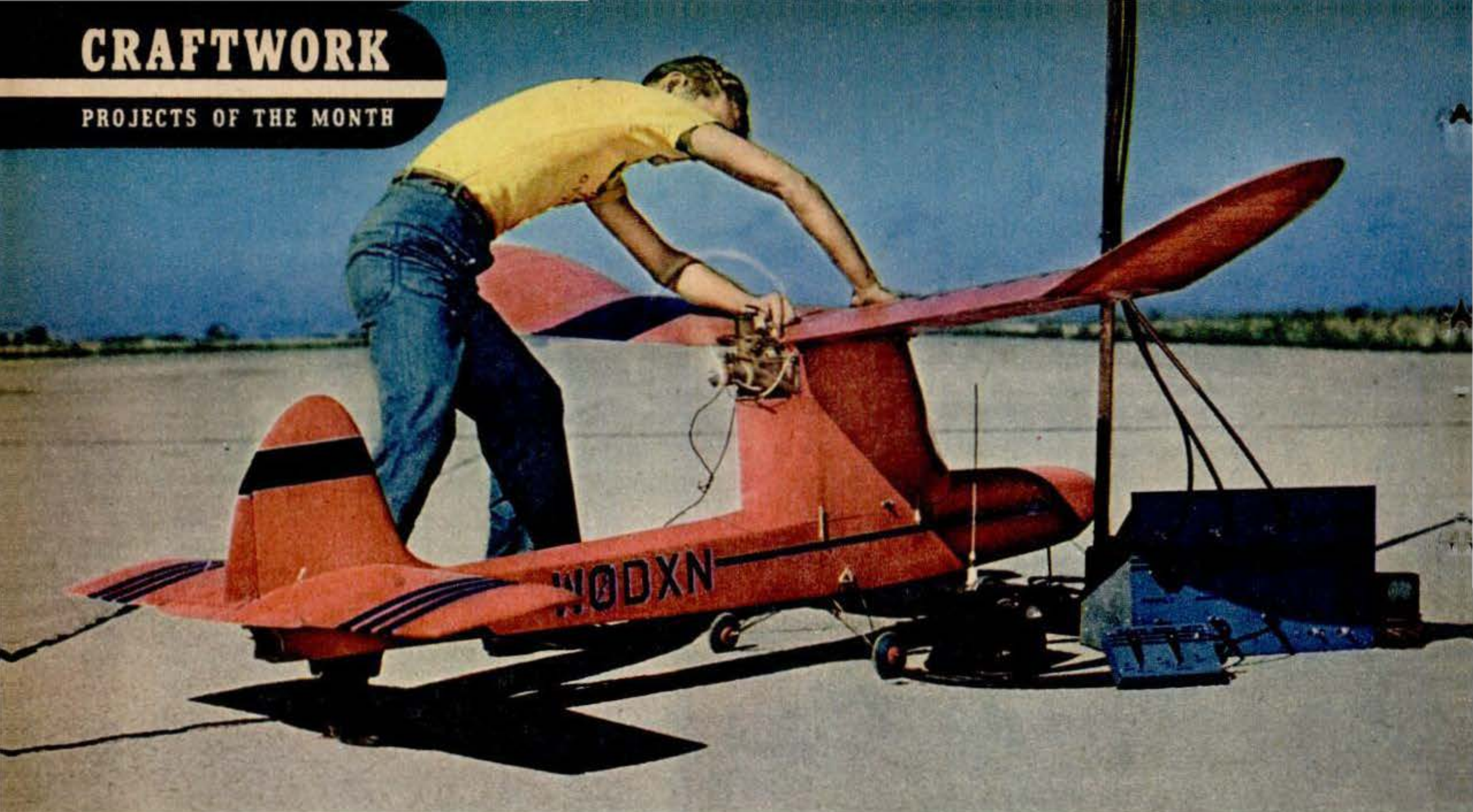

Push-Button Pilot. Telecontrol of model airplanes, using one or more radio channels, receivers weighing but a few ounces, and clever actuating mechanisms,

is a fast-growing hobby among modelers. Claude McCullough, whose three-control, $\frac{3}{4}$ -hp. plane is warming up above, tells how it's done in his article beginning on page 152.



Crayon Craftwork. Plaques for children's rooms, Colonial or Pennsylvania Dutch projects, and leather work can be ornamented with wax crayons. Outlines are burned with an electric pencil. It's quick, clean, and permanent. See page 185.



Plastic Beach Sandals. The craftsman who likes working with plastic can mold these sandals right to the wearer's feet. With colorful canvas straps, they're smart, modern, and sure to please. Easily followed instructions are on page 148.

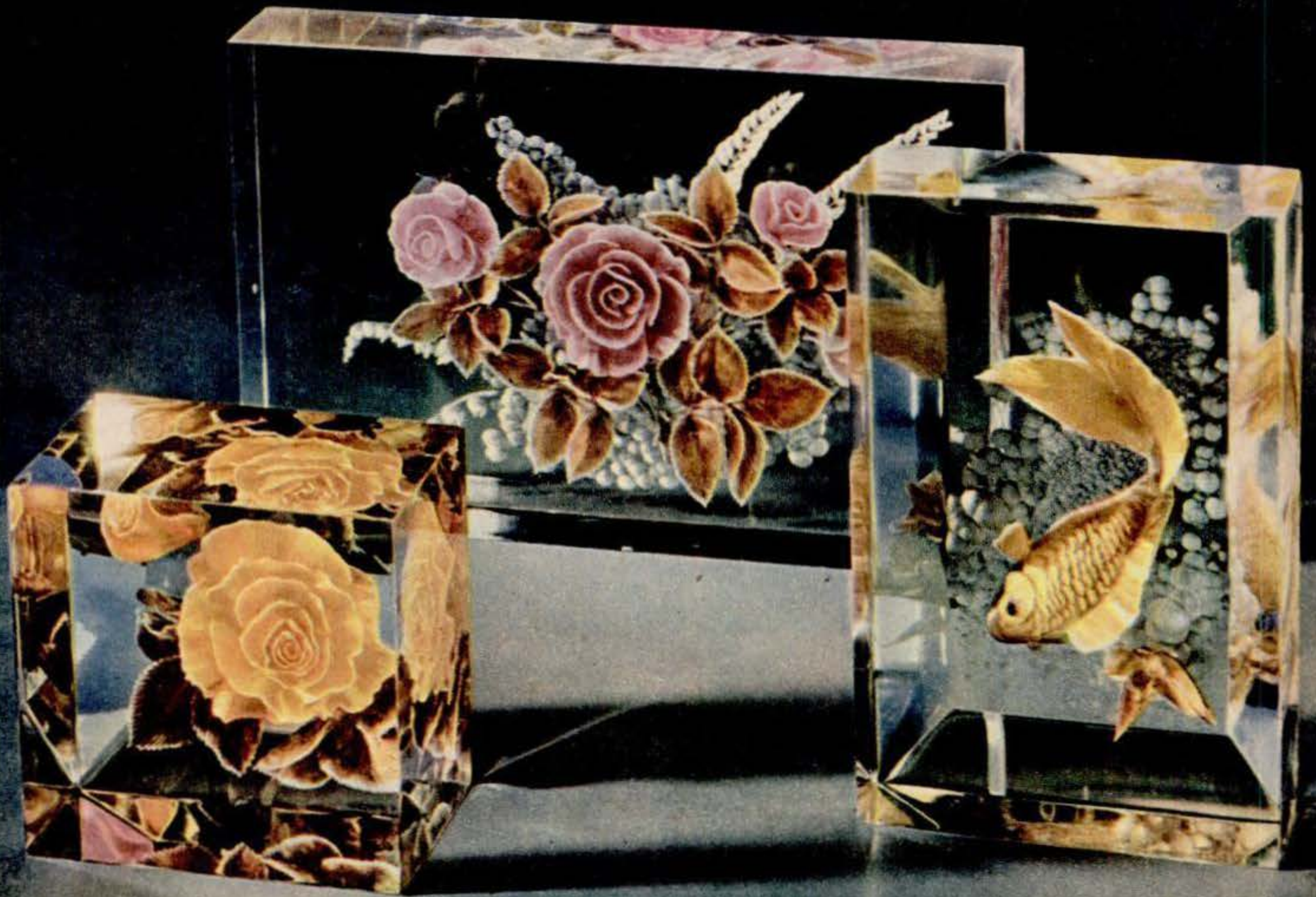

Inside-out Carving. In this kind of craftwork, you're looking at what isn't there. Three-dimensional forms are created inside clear plastic by drilling holes, the shape of which determines what you see. The technique is so different from any other that even the craftsman is amazed as flowers, leaves, fins, and feathers take form

under his hands. Invariably others ask him, "But how do you get the flowers in?"

Not only flowers, but submarine scenes, birds and butterflies in flight, abstract design, and a world of possibilities challenge your initiative. These fine examples are by Robert Barry, of the Rohm and Haas Company. Instructions start on page 160.

PSM color photos by Robert F. Smith

AUGUST 1947 113

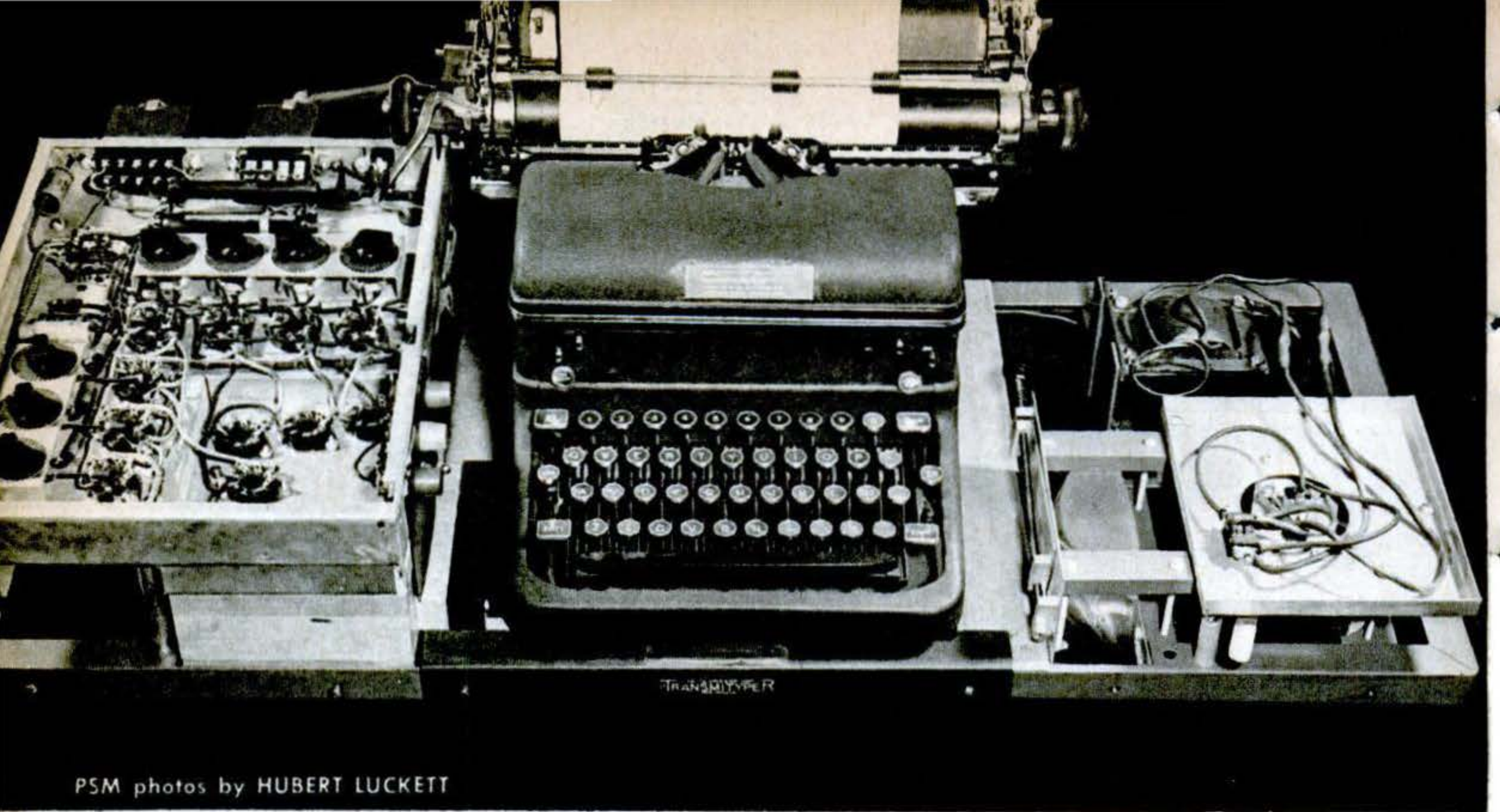

PSM photos by HUBERT LUCKETT

A Transmityper ready for work. Covers have been removed to show arrangement of tubes and light source.

Typewriter Turned Into Telegraph Key

SENDING typed messages over telegraph lines now takes no more skill than pecking out a letter. A new conversion unit turns ordinary typewriters into teletypewriters, using light beams, shutters and photoelectric cells to change typewriter key strokes to electrical impulses.

Designed by the Teleregister Corporation, of New York, as part of an automatic air-traffic control system, the device permits operators to send messages as fast as they like, unlimited by mechanical restrictions inherent in teletypewriter machines. On a typewriter an expert can reach 800 letters a minute in spurts, but a teletypewriter does not work in spurts. It must be keyed at an even rate below 400 letters per minute. By using a standard typewriter and the conversion unit, control-tower operators may type as they please—and save time, too.

The "Transmityper" uses an automobile headlight bulb and a spherical parabolic condensing lens to send light into seven metal-separated channels passing from right to left across the bottom of the typewriter keyboard. Notched aluminum shutters attached to the key levers interrupt one or more of these seven light beams when the

keys are pressed, the notched arrangement determining which light beams are cut off. Pressing the "g" key, for example, moves the "g" shutter into position and blocks all beams except number one, number three and half of number six.

Each light beam is aimed at a photoelectric cell at the left side of the unit. When a shutter cuts off one of the light beams, the companion photocell stops producing current. This tells a thyatron "trigger" tube to send an electric impulse over the line. Carriage return and line spacing have their own signals originating in relays attached to the typewriter.

The receiver used with the Transmityper is a standard teletypewriter, which has only capital letters and uses the upper-case position of each letter key for numerals and symbols. For shifting to these upper-case positions, channel six is used. The typewriter shift key blocks half of this channel, while the shutters on most of the letter keys block the other half. Thus, when both shift key and letter key are pressed at the same time, channel six is completely shut off and the shift signal is sent to the receiver. The numeral keys on the Transmi-

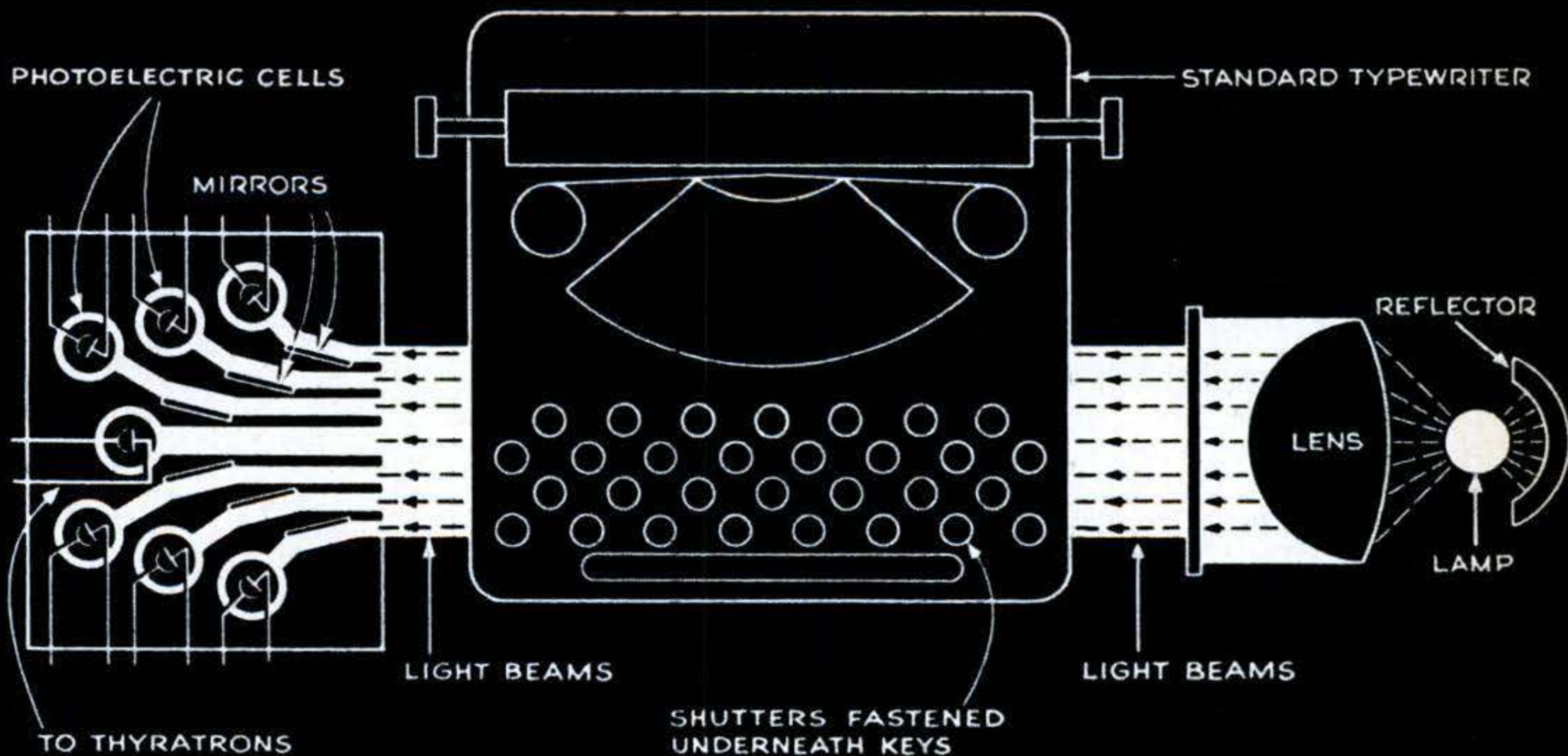

Diagrammatic drawing shows how mirrors route light beams to the proper photocells when channels are open.

typer have shutters that block all of channel six, so they also send the shift signal.

In practice, impulses from the Transmitter are fed to a tape perforator, which punches holes in a paper tape to correspond to the various letters. This tape then passes through a standard transmitter, operating relays that send out impulses to the teletypewriter at the receiving end.

In addition to its application to air-traffic control, the new unit is expected to be used wherever specialized teletype operators are not available—possibly for wire press service from small towns, or interoffice communication in large industrial plants. Its cost, complete with the tape perforator and transmitter, is about the same as that of a standard teletypewriter. **END**

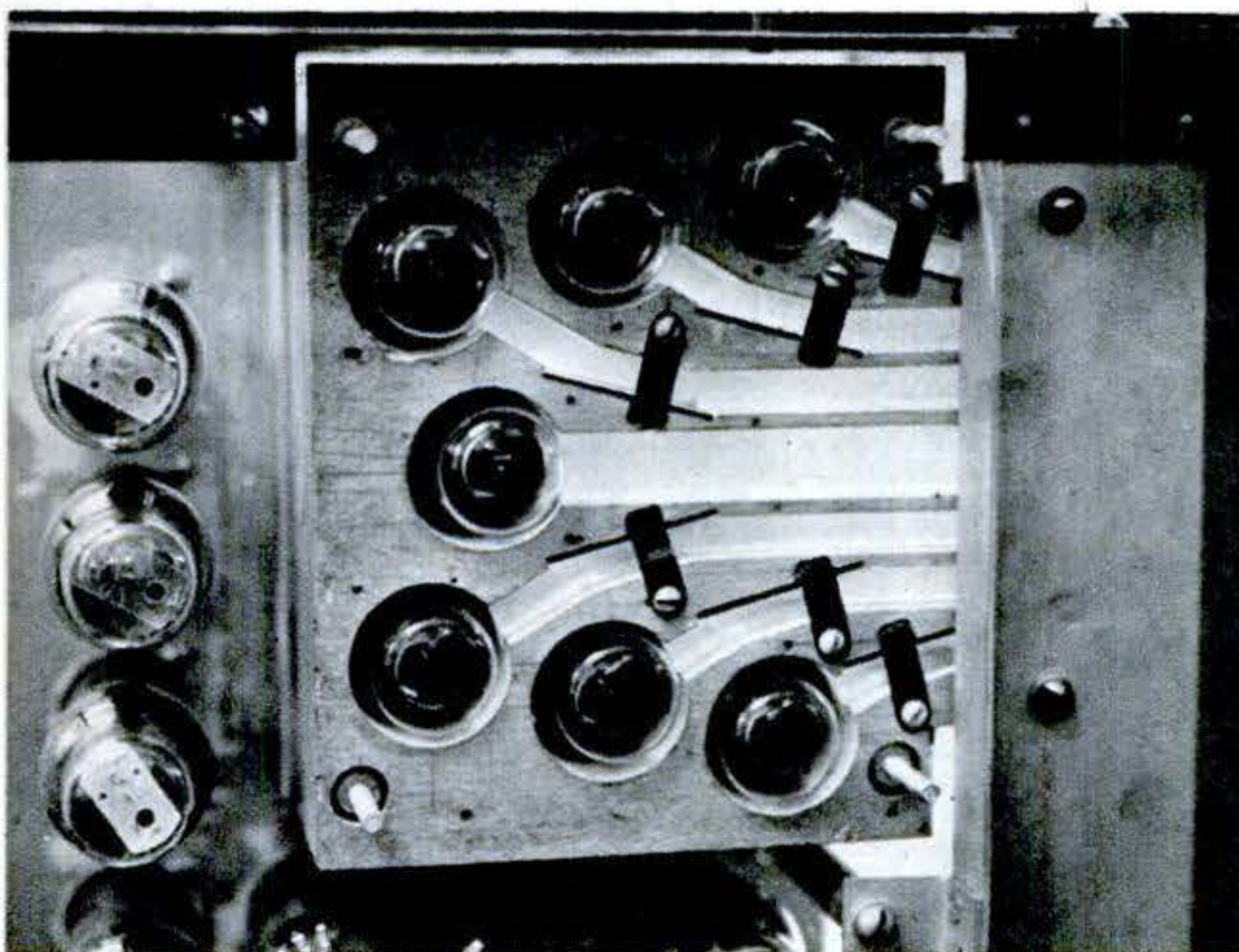

The unit was turned upside down for this view of the photoelectric cells, which hang down from the chassis. Because of their size, these tubes had to be arranged in a rough semicircle. A new model will have smaller tubes set in a straight line at the ends of light channels, eliminating mirrors.

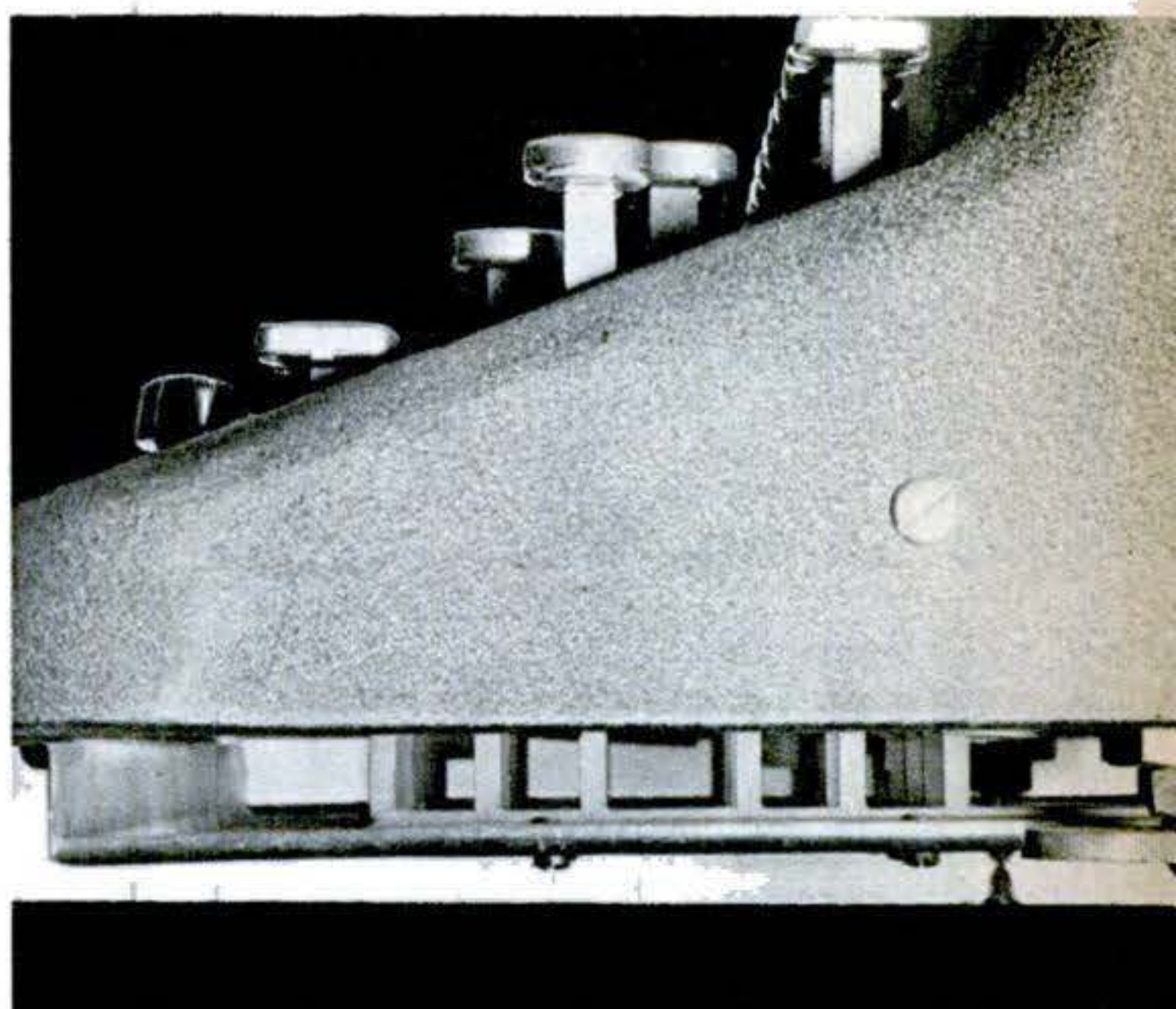

Looking straight down the light channels, one of the shutters can be seen part way toward the closed position as a letter key is pressed. Even when several keys are in motion at once—as they often are in fast typing—only the one that is actually striking the paper produces the impulse.

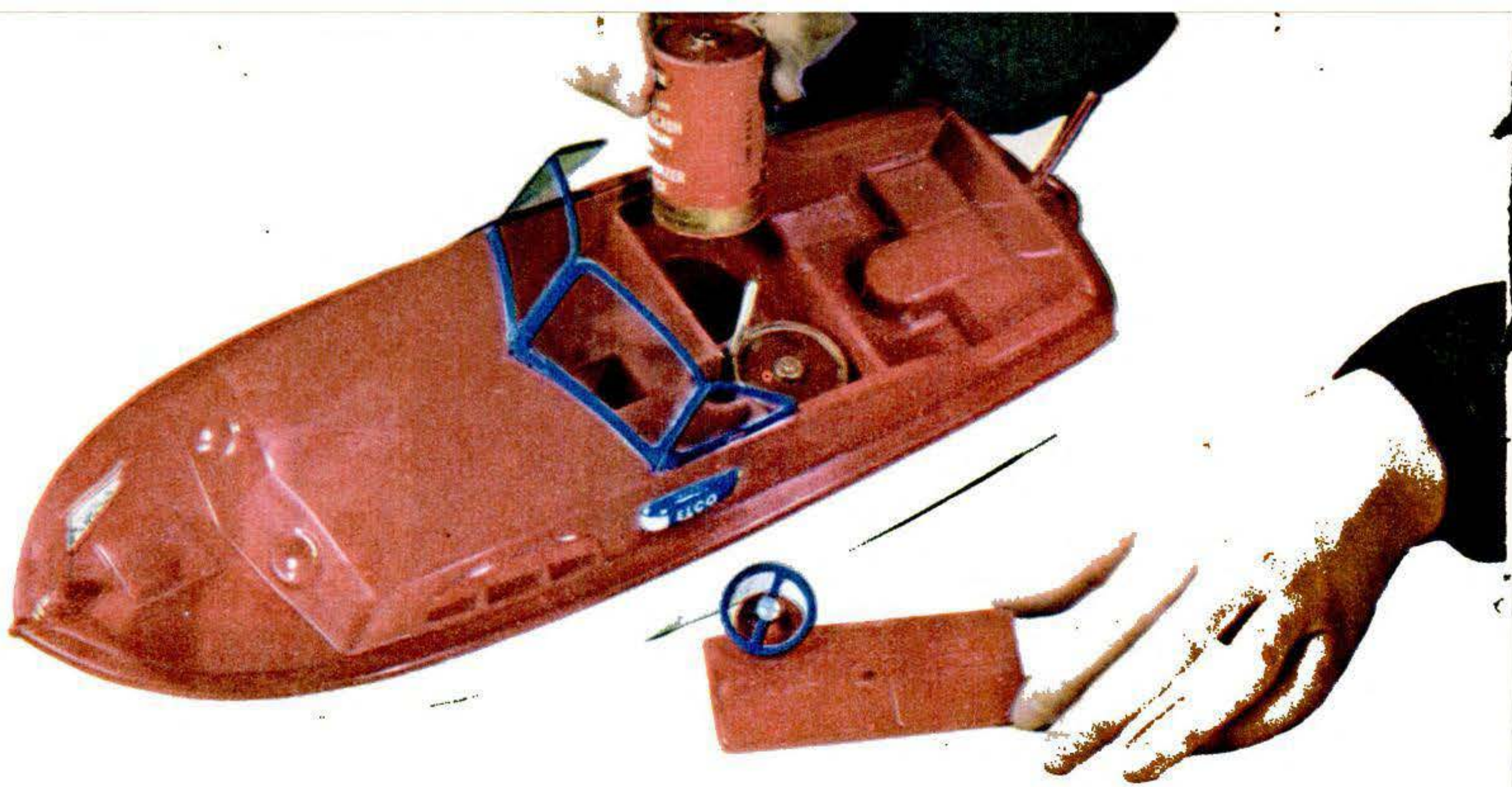

A 1/200-hp. electric motor, operating on two hidden flashlight batteries, drives this plastic repro-

duction of the 27-foot Elco Sport Cruiser for as long as eight hours. Made by J. L. Schilling Co.

Toys Mirror A New Age

THE history of toys has long been described as the history of the world in miniature. Never before, however, has this been so graphically evident as it is today.

Never before have toys so accurately imitated their adult models and offered such variety and versatility; never before have they kept so closely abreast of the times, achieved such realism, and sought so effectively to instruct as well as to amuse.

As evidence of the importance of toys in our economy and culture, Americans are spending well over \$200,000,000 a year on more than 10,000 different types of playthings made by nearly 2,000 manufacturers.



A tiny hose sprays real water on a toy car in this model Keystone garage. Also featured are a lubrication shaft that can be raised and lowered, an elevator to an upper floor, and an inclined exit ramp.



A fifth wheel keeps this novel windup Magikar from plunging to destruction. Concealed underneath, the transverse wheel catches hold when toy encounters a table edge, reversing car's direction.



Samples of uranium ore, a radioactive screen, and a spintharoscope showing radiation help children to

learn the principles of atomic energy in this newest Chemcraft set, made by Porter Chemical Co.

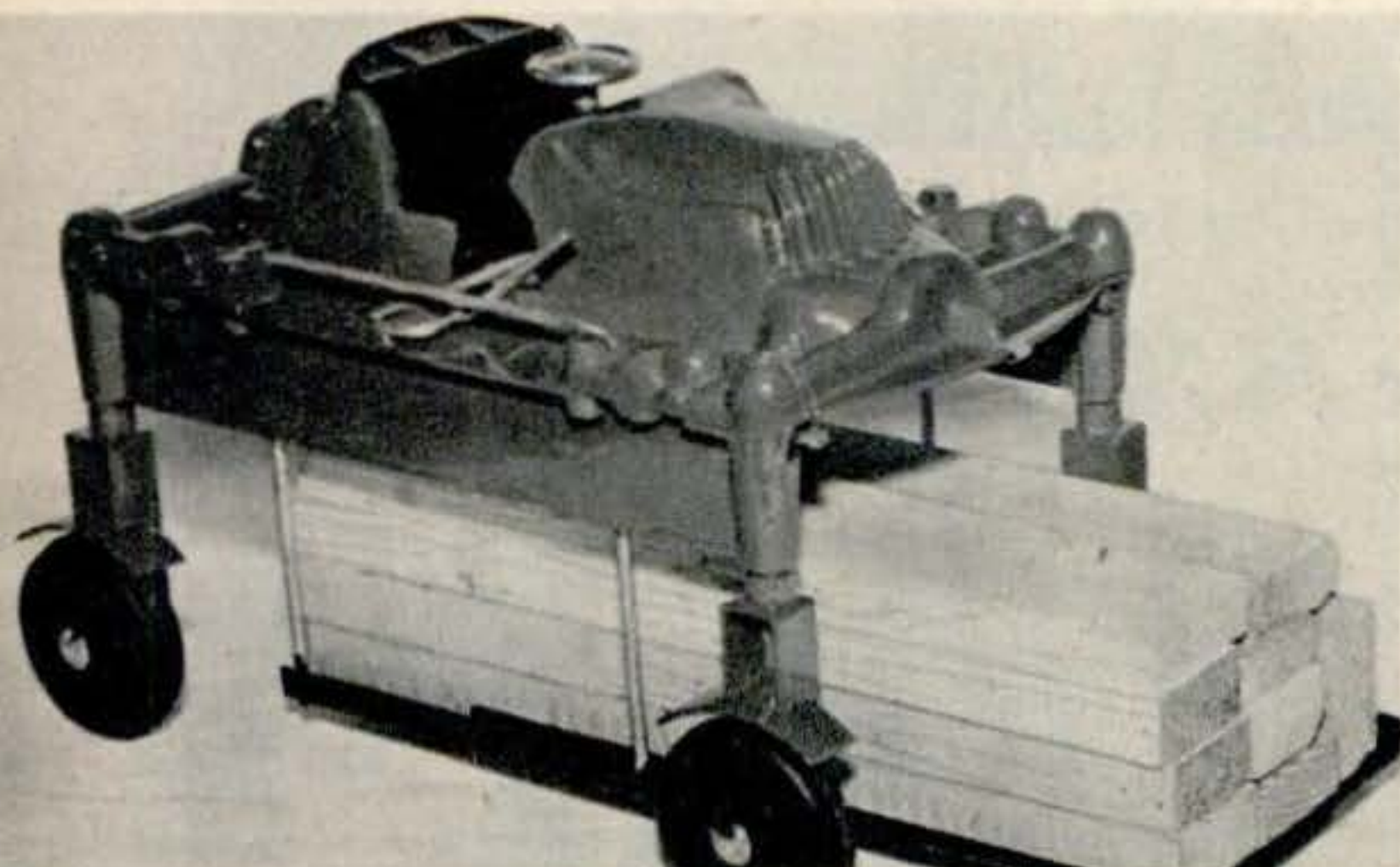

A lever loads and unloads this rubber-tired steerable Mason, Beall & Horton toy lumber carrier.



Real pumps dispense syrup and soda water from five concealed containers in this Kamkap fountain.



A miniature cement mixer that can make real concrete is the latest in a series of scale-model road machines made by the Charles Wm. Doepke Mfg. Co. It is a model of the Jaeger mixer.

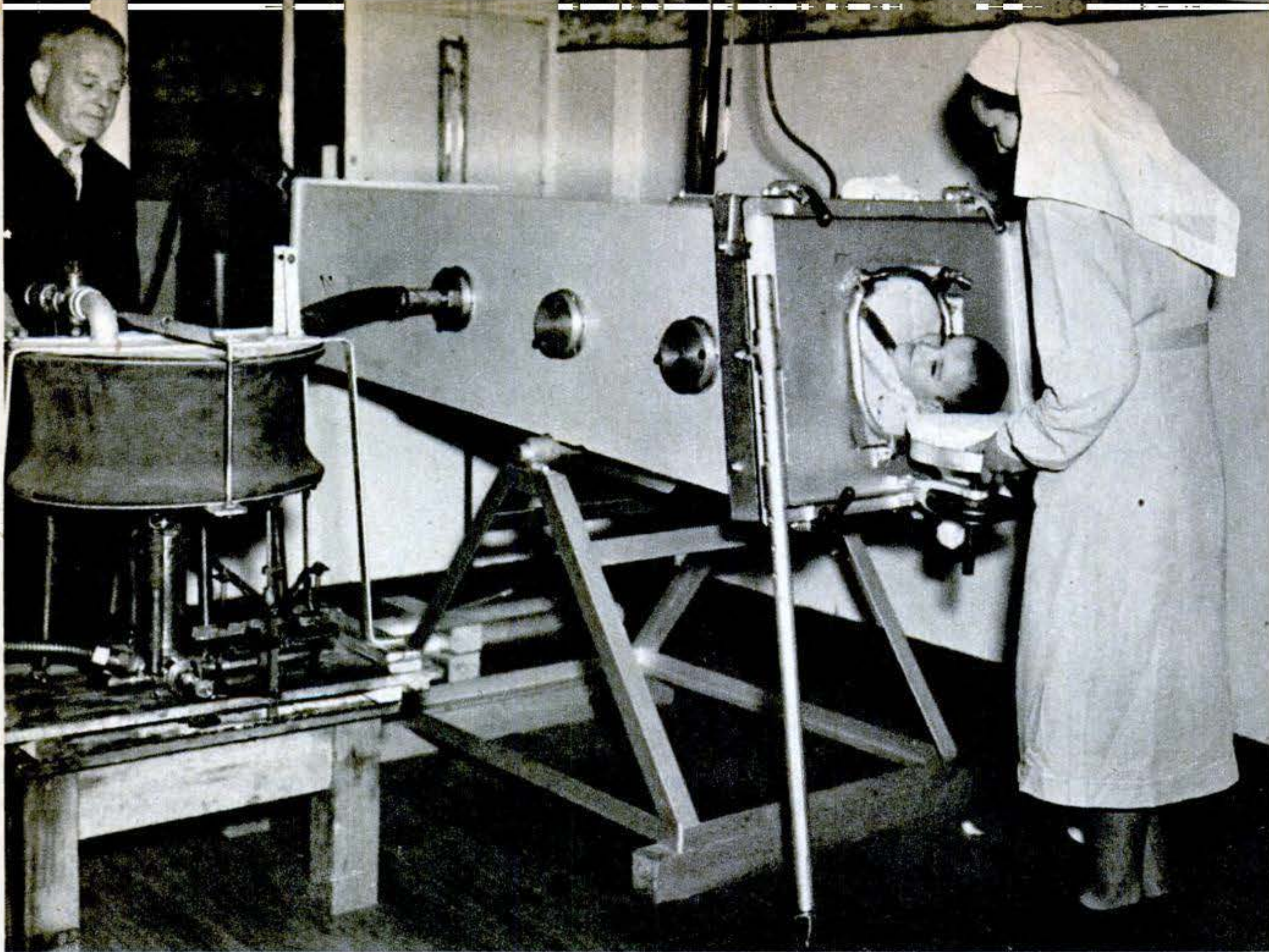

The inventor operating the first working model of his respirator, powered by water supply.

Water Powers \$300 "Lung"

WHEN an Australian polio sufferer died in an iron lung because of power failure, E. O. Cartwright, an engineer in a Melbourne hospital, decided to do something about it. Seven weeks later he came up with a simple respirator that can be operated from almost any household water supply.

The "lung" of the machine, a cylindrical rubber and fabric bag 22 inches in diameter and 9 inches high when expanded, is connected by a rubber hose to the respirator cabinet in which the patient lies.

Underneath the bag is a double-action hydraulic ram. First action of the ram is to expand the bag, withdrawing air from the cabinet and causing the patient to breathe in; this is followed by a contraction of the "lung," forcing air back into the respirator, making the patient exhale.

A bridle valve controlled by the motion of the ram directs the flow of water for the two actions of the "lung." From eight to 40 respirations a minute are claimed for the pulsator, as compared to the 17 to 36 of an electrically operated iron lung.

The inventor has patented his respirator, but has made plans and details available free to anyone who needs them. He estimates that it can be built for about \$300.

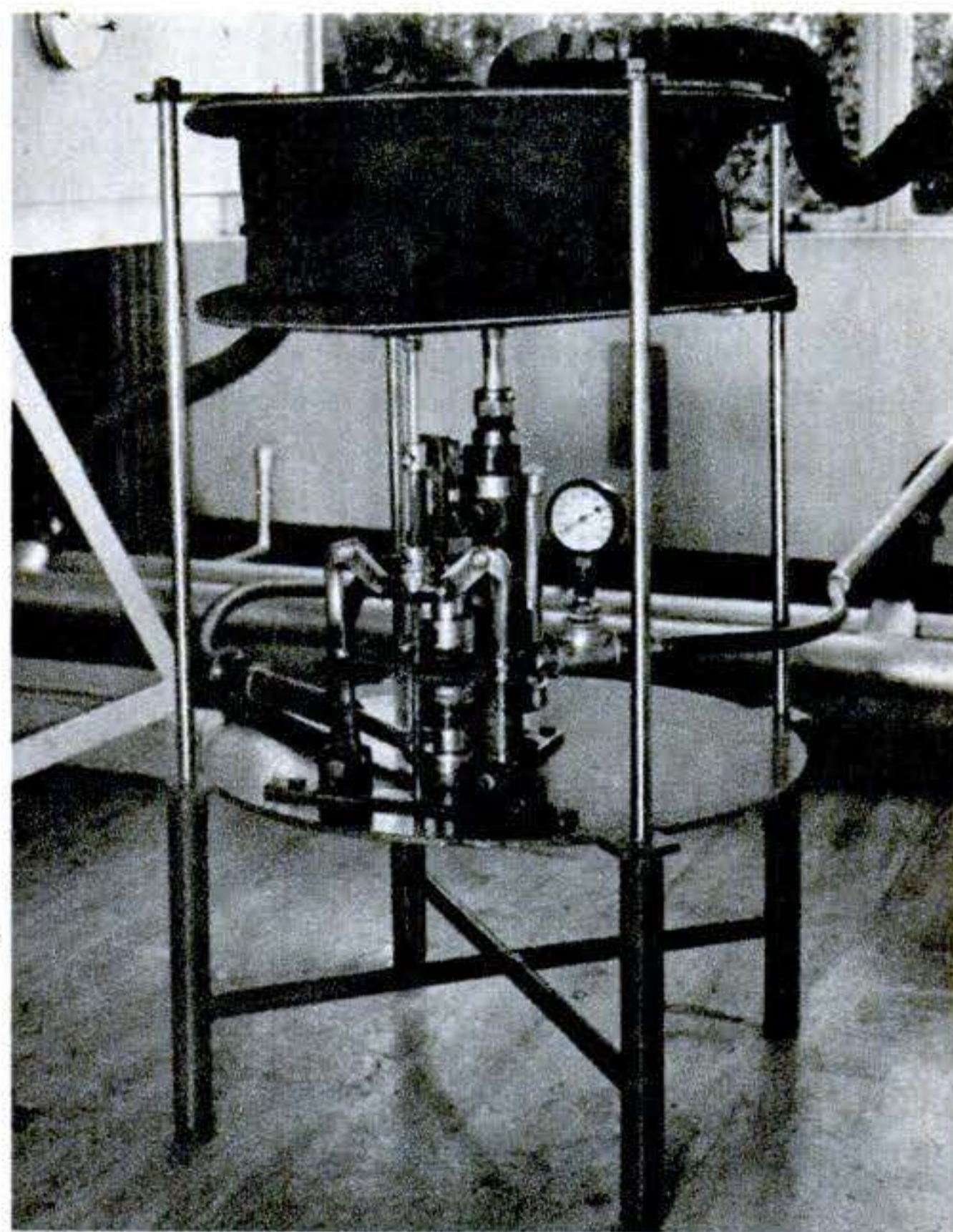

A water pressure of only 40 pounds is required to operate the ram that inflates and deflates the "lung" of the pulsator.

Everybody has his own pet idea of some gadget he would like to see in general use. What is YOURS? *Popular Science Monthly* will pay five dollars for every such suggestion that its editors decide to publish. Suggestions cannot be acknowledged or returned.

I'd like to see them make

Cartoons by SYD LANDI



Easy-Reach Washbowl. There would be no stooping or stretching at a sink that could be adjusted to suit the whole family; says Louis Goodman, of Los Angeles.



Self-Extinguishing Matches. For the absent-minded, Joseph Krosetz, of Bethlehem, Pa., suggests matches that would die out before burning down to the fingers.



Safety Side Lights. A light on the left front fender would mark a car's outer parts, often obscured by its headlights, claims George Morton, of Bristol, Tenn.



Adjustable Bumpers. Extended when parking, they would keep other cars from crowding you into a tight spot, points out Marcella Wilkinson, of Gaylord, Mich.



Tin-Can Detopper. To keep can tops from falling in after removal, Paul Johns, of Berkeley, Calif., would equip the can opener with a suction cup to grip them.



Circular Refrigerator. One with revolving trays would end hunting for food that is always at the back, declares Donald Rademaker, of Detroit, Mich.

Fingerprinting Diamonds

TAKE a good look at this microphotograph of a diamond and you'll see tiny flecks—there's one just to the right of center. With their help, it may become impossible to disguise a stolen diamond. For these specks may identify the gem as surely as the ridges on your fingertips identify you.

Each fleck is an "imprint," a natural variation in the stone's structure. Experts of J. R. Wood & Sons, diamond ring makers, believe that the imprints of every diamond differ from those of every other. If so, a microphotograph provides a permanent record that even recutting cannot alter.

Officially, a "perfect" diamond is one that shows no flaws under a 10-power microscope—even the finest is believed to reveal an imprint when photographed through a 30-power lens. The "huge" gem pictured is really less than a carat.

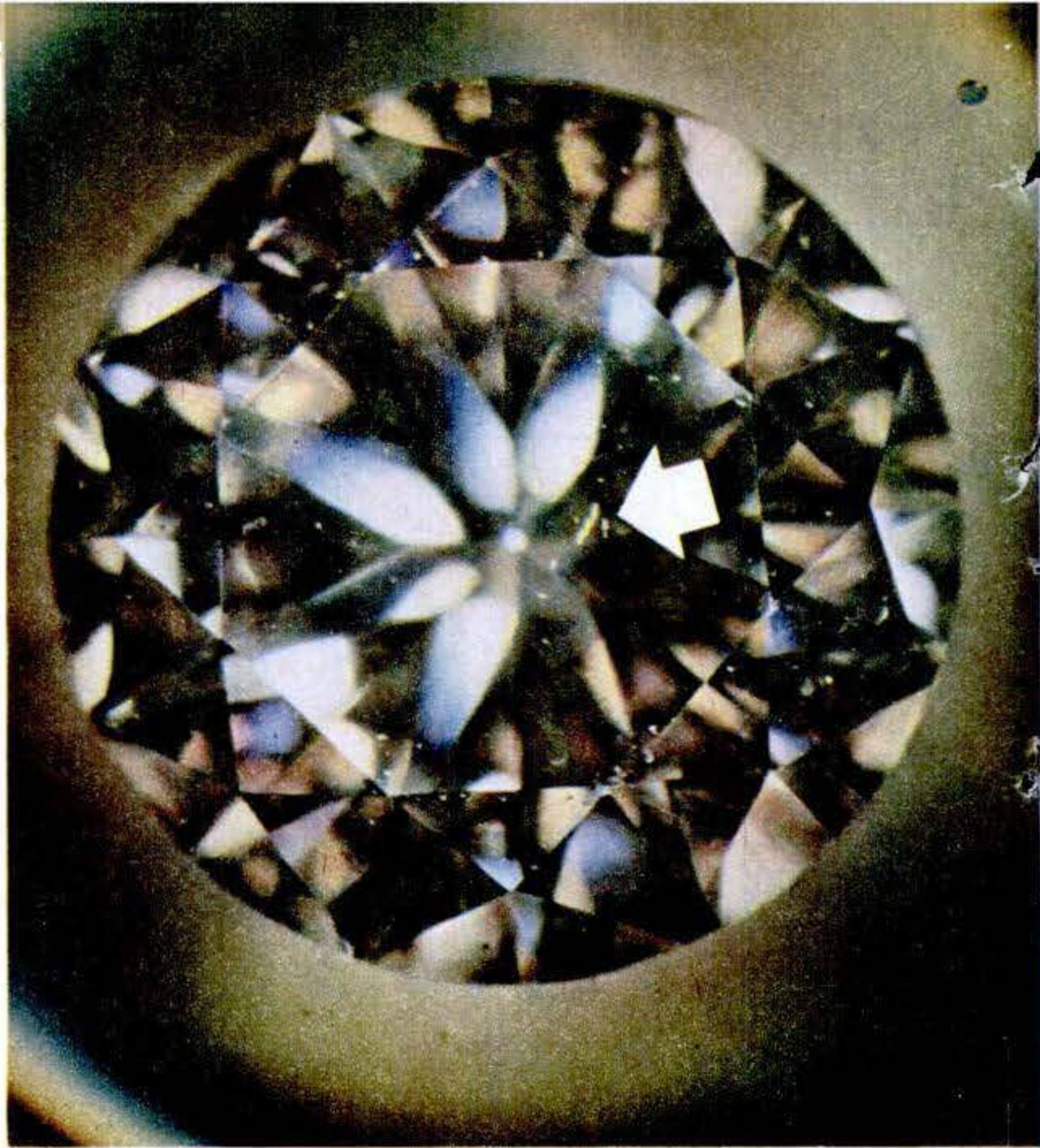

Air Gun Tests Plane Parts

BOEING'S Accelerator Test Mortar at right is probably the biggest popgun ever made—and every time it goes off it helps make aircraft safer. Compressed air fires a cartridge carrying parts for high-speed planes or guided missiles. Fifty m.p.h. is reached in just nine inches, testing the equipment with a strain equal to 100 Gs. A cushion of compressed air halts the cartridge in 90 to 100 inches. The mortar's control board is shown below: the engineer at left stands by the trigger. Gauges on board show air pressure while the oscillograph and scope record the behavior of electrical equipment under test.

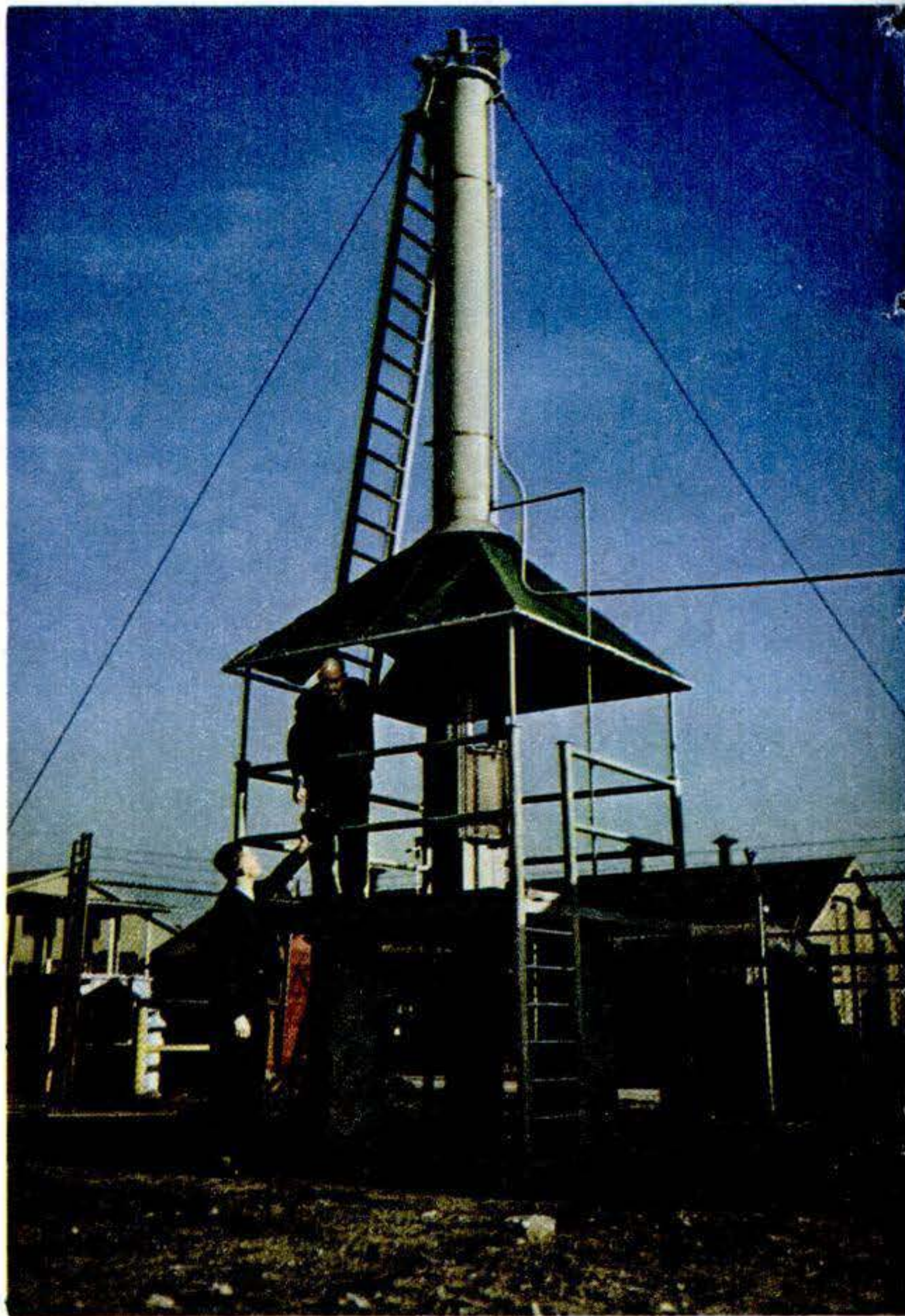

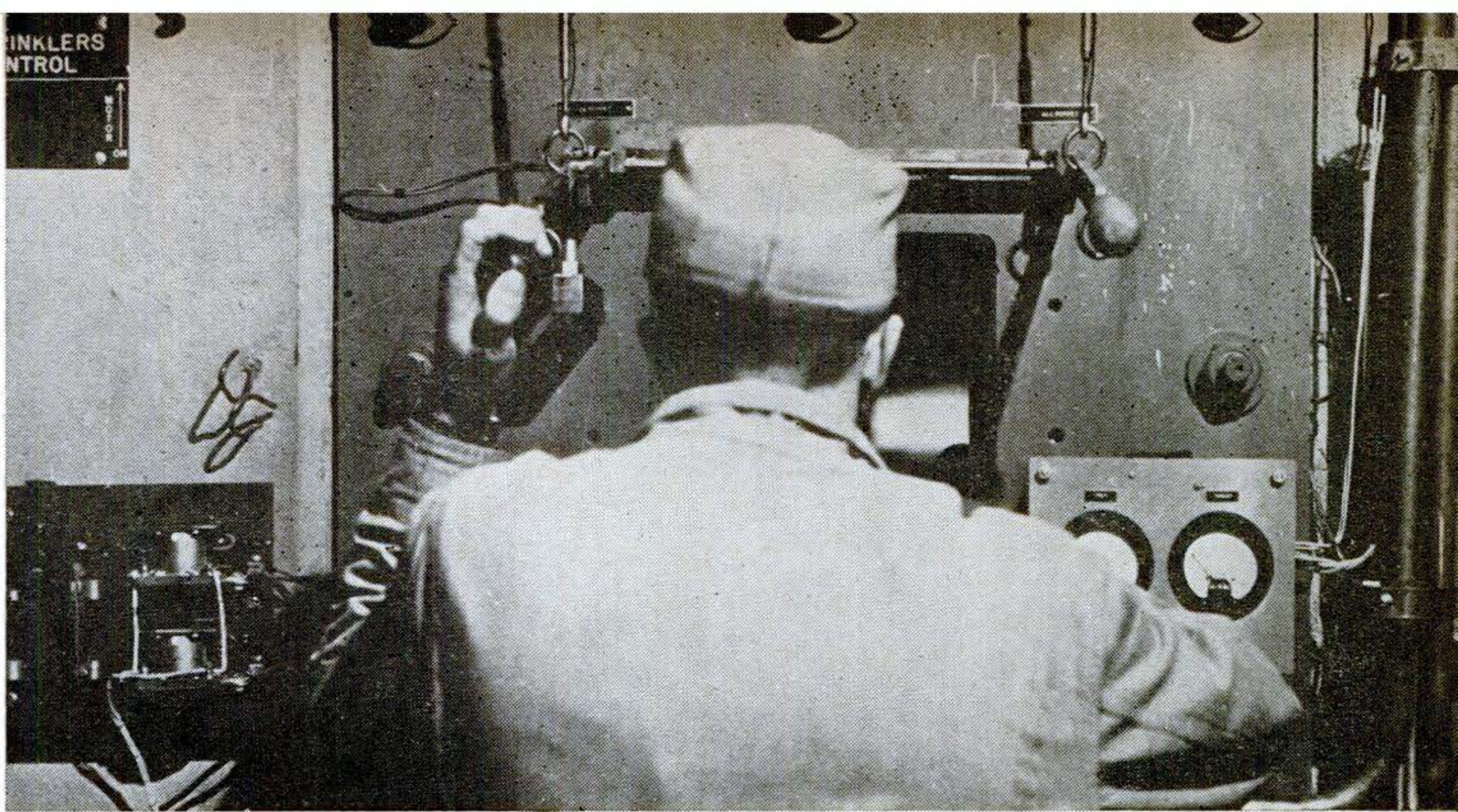

Watching Rockets at Work. Protected by three feet of concrete and nine inches of bulletproof glass, this technician is observing the exhaust blast of a rocket motor he has just set off in a test pit at the GE-

Army Ordnance rocket research station near Schenectady, N. Y. First of its type in the U. S., the isolated station has been providing ground-test data on rocket performance for more than a year.

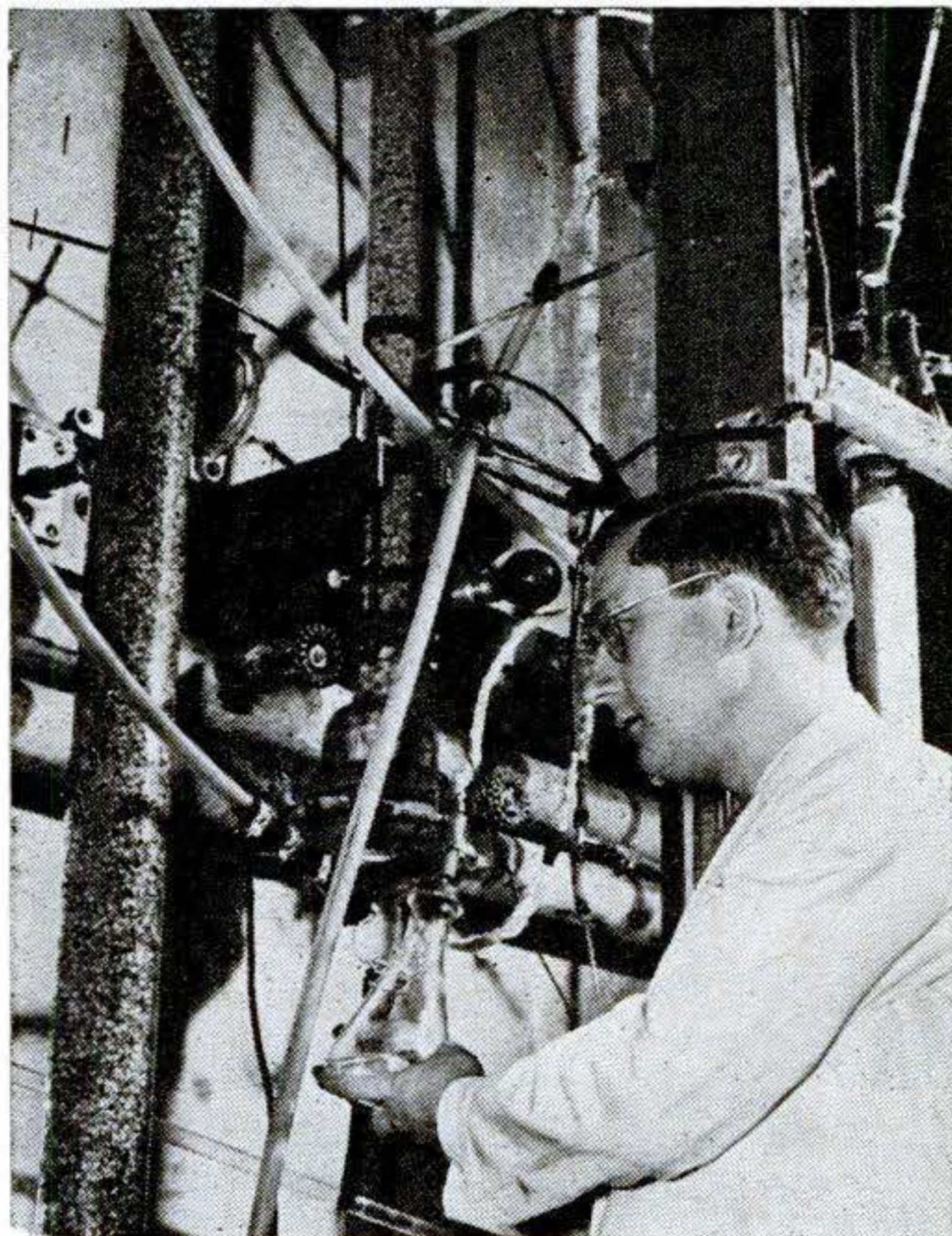

Catching an Isotope. Carbon 13 for "tracer" research on cancer is being produced by Eastman in concentrations twice as rich as previously available. Here some of the 50-percent concentrate is drawn from one of two new fractionating columns.

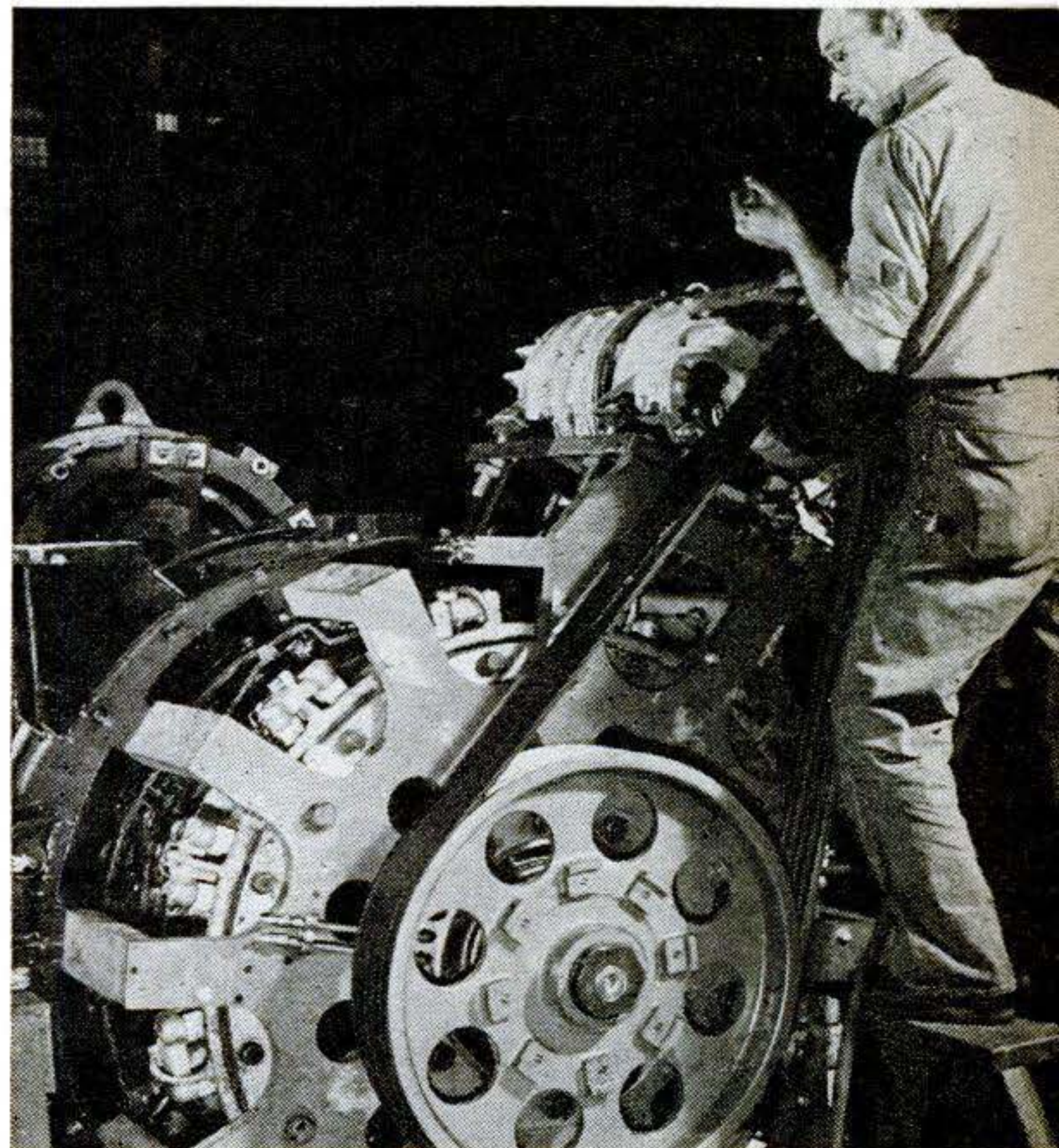

Powering an Iron Horse. This husky generator, being assembled at the Westinghouse plant in Pittsburgh, will feed 1,500 hp. to the driving motors of a Diesel-electric locomotive. One engine of the latest type has five such generators.

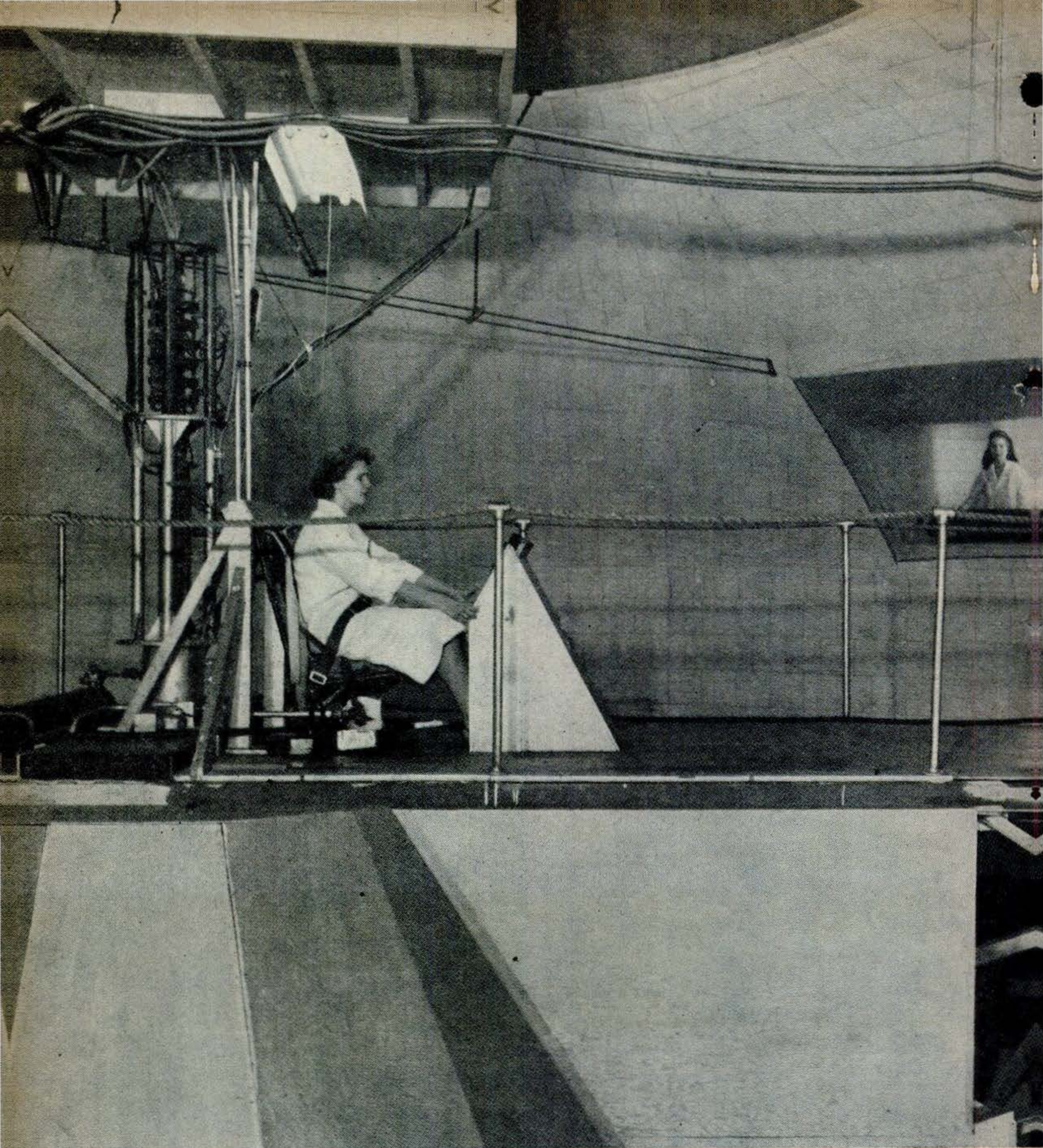

Pilot under test sits at end of turntable arm, at right. To test him under 5G strain, the 46-

foot turntable revolves 32 times a minute. It can make 166 r.p.m., but the pilot couldn't take it.

Battling the Gs

X-rays taken on "Whirling Dervish" show what internal stresses do to pilots.

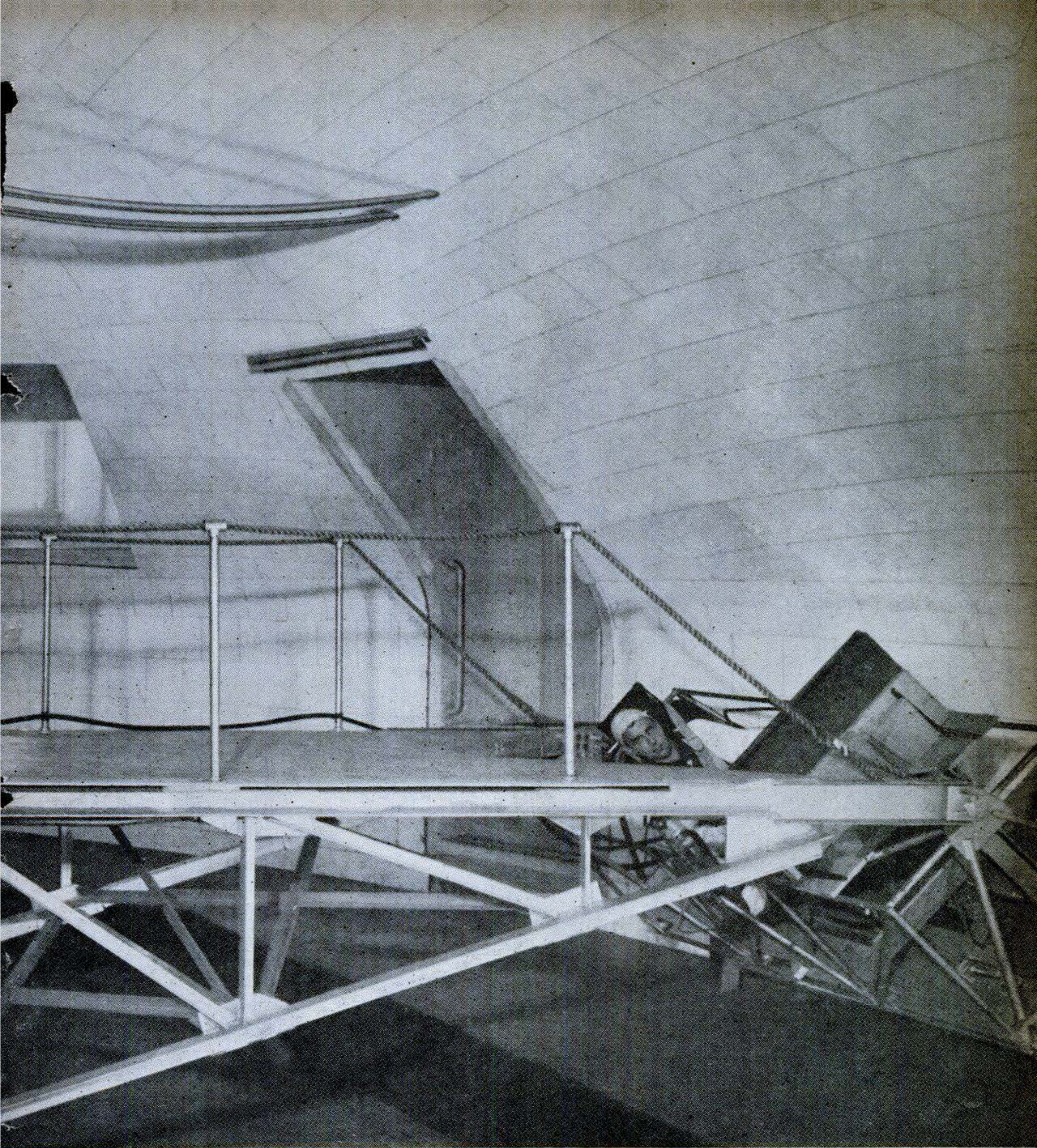

WHAT happens to a pilot's innards when he pulls his plane out of a screaming dive? With new experimental superspeed planes coming up, that's an increasingly important question, and University of Southern California scientists are getting an inside view of the answer. A portable X-ray camera snaps pictures as a turntable whirls

a pilot at high velocity, producing internal stresses similar to those caused by sharp changes of speed or direction during flight.

The X-ray plates reveal the resulting distortion of his internal organs. From them, Army and Navy researchers have learned that under 5G pressures the abdominal wall bulges, while the diaphragm and heart drop



This pilot is about to be tested under negative G—a force pushing the blood and organs toward the head, as in an outside loop.

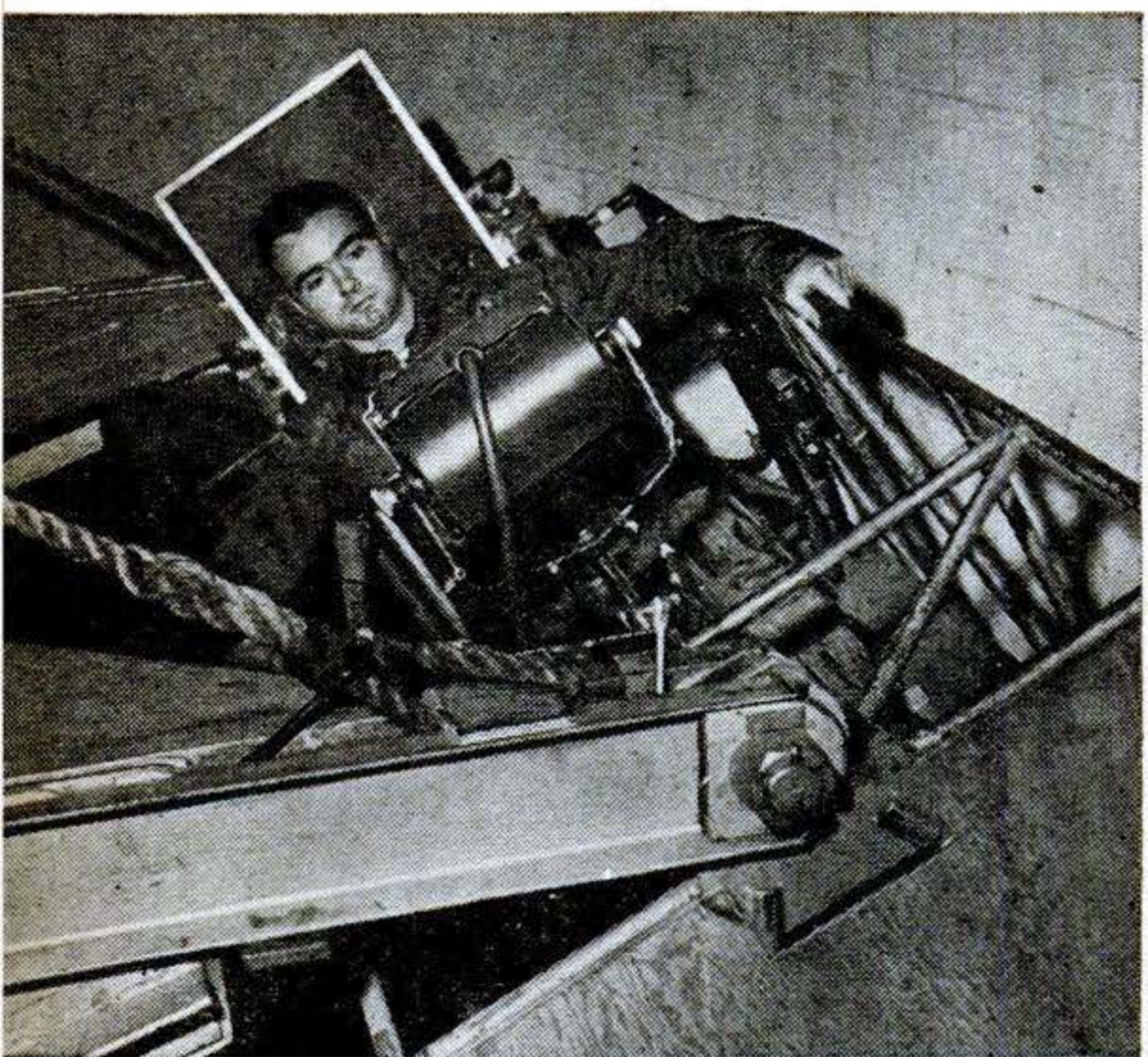

Testing a Navy G-4 antiblackout suit, pilot sits back against a 14- by 36-inch X-ray negative. Wide-angle X-ray machine faces him.

as much as two inches. With an antiblackout suit, however, pressure on the abdomen lifts the diaphragm as much as $3\frac{1}{2}$ inches. The heart is elevated a lesser amount to provide about $\frac{1}{2}$ G protection, altering blood pressure in both heart and brain.

The turntable arm also carries a meter that passes the air flow in and out of the

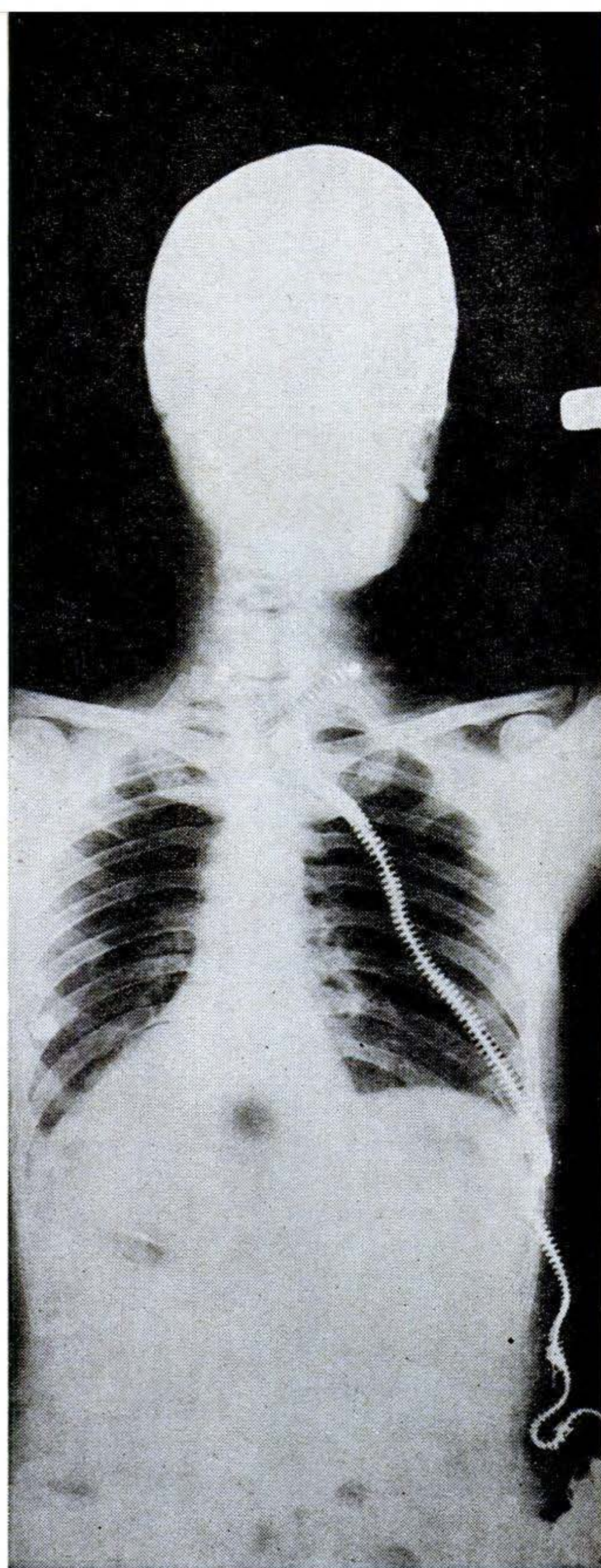

X-ray of pilot under 5G shows distortion in distance from heart (in center) to skull, and position of lungs (large dark areas).

subject's lungs through a fine-mesh copper screen. The slight change in pressure records the rate of flow. At the same time, a spirometer catches each breath in a water-sealed, oxygen-filled bell that bobs up and down, inking a graph. This measures the rate and volume of breathing and the changes of volume inside the lungs. **END**

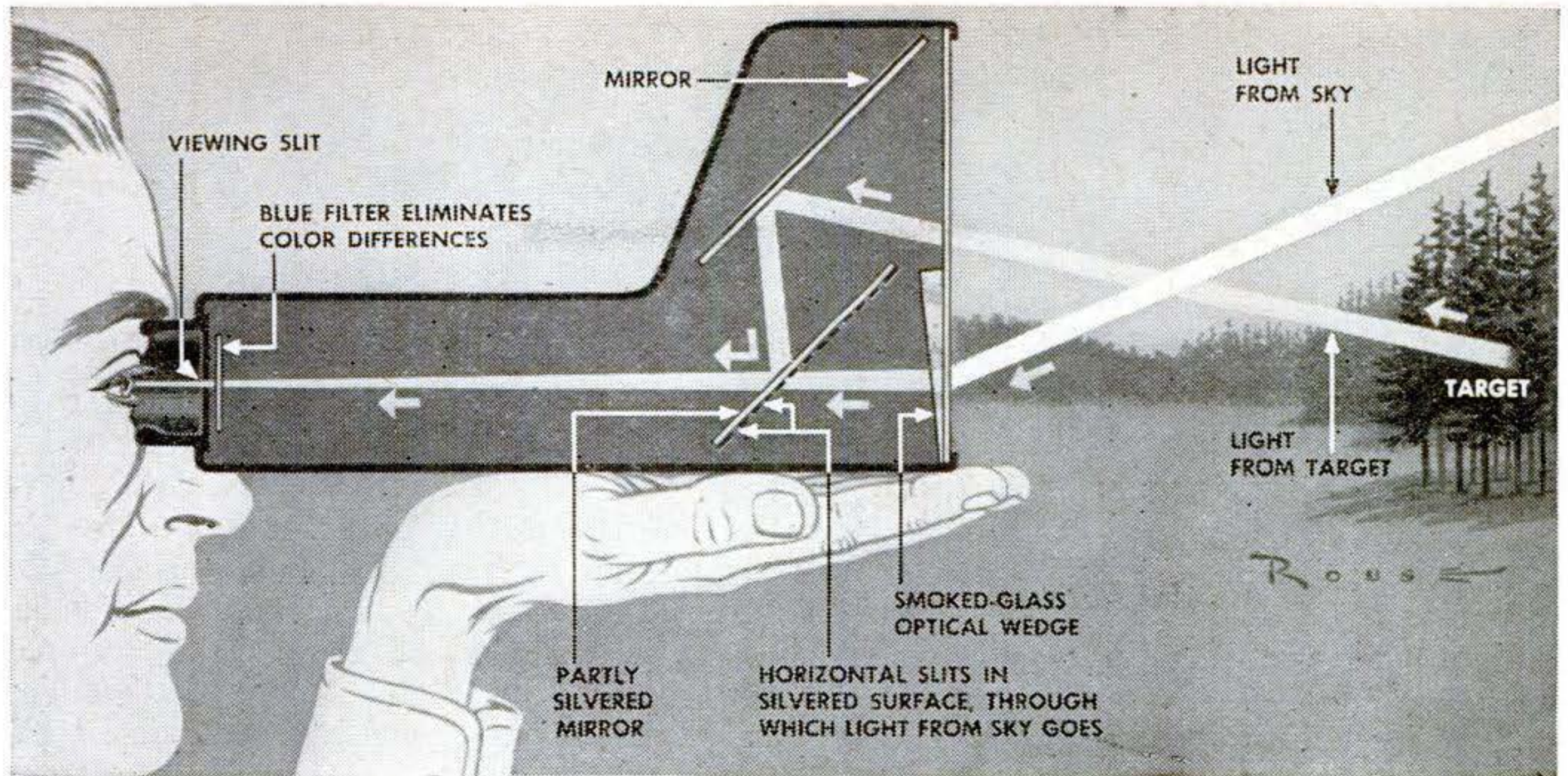

How meter works is shown in cutaway drawing. Periscope view of trees, and strips of sky

seen through wedge and clear parts of lower mirror, give a composite image.

Meter Aids Fire Patrols

New optical instrument for foresters tells how far off a blaze can be seen and where watchers must be posted.

HOW far away can a forest fire be spotted? The answer to that puzzler is given by a meter invented by George M. Byram, of the Appalachian Forest Experiment Station, Asheville, N. C. With its aid, forestry experts find how far apart to space lookout towers, and when to order emergency lookouts to intermediate points.

What the meter measures directly is the amount of haze in the air. To use it, the observer points the cameralike device at a target (such as the shady side of a clump of trees) a known distance away. He sees 13 horizontal bands of graduated brightness

Haze meter is compact and simple to use. What observer sees is shown at right, below. Meter is registering No. 2 haze. (Middle band

alternating with glimpses of the landscape.

Tilting the meter, he brings different bands against the target until one band matches and merges with it. Noting the number of this band and referring to tables giving visibility in terms of haze, he finds the greatest distance that smoke from a small fire would be visible.

Two mirrors give a view of the target, as through a periscope. The lower mirror, not completely silvered, has narrow clear strips. Through these and a wedge-shaped glass prism, transparent at its point and darkening toward its base, light from the sky completes the composite image of a target crossed by bands. When a band disappears, target brightness must equal that of sky light through an indicated thickness of the wedge. Calibration of the wedge thus gauges target brightness and haze.

disappears against target.) Some of bands are omitted and differences in gradation are greatly exaggerated for the sake of clarity.

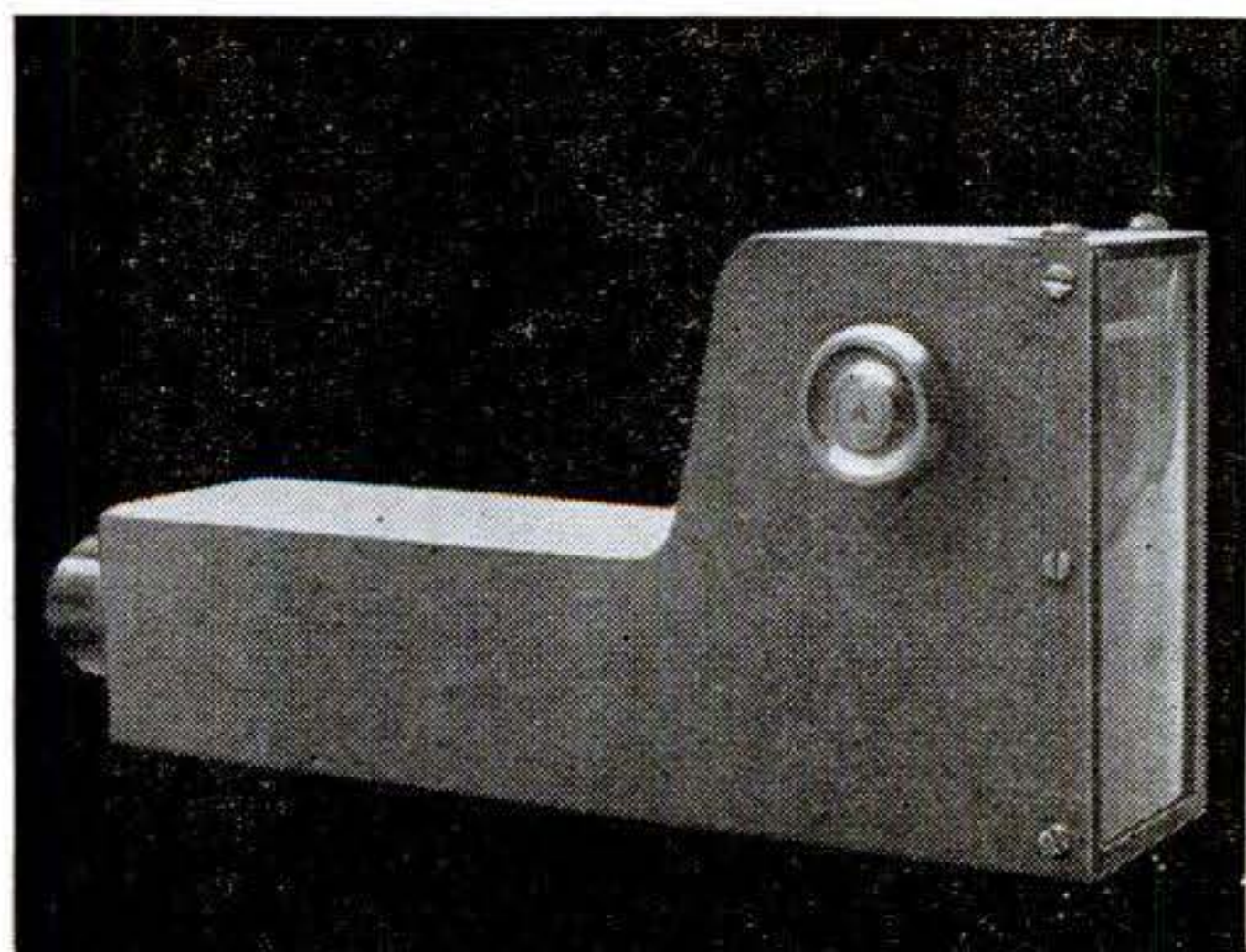

Lens Puts "Zoom" in Television

OUTDOOR television programs, long restricted by photographic difficulties, may soon rival studio techniques with a new varifocal lens that permits tricky changes from long shots to close-ups—formerly obtained only with moving dollies or booms.

Called the Zoomar lens, it is a combination of movable and fixed lenses that enables a photographer, using one stationary camera, to exert slight pressure on a lever or grip that will enable him to "zoom" from an over-all shot to a close-up.

In televising a large outdoor ceremony, for example, he will be able, without moving the camera or changing the lens, to shift from a long shot of the crowd to a spot pick-up of any individual.

Although not designed to replace standard lenses, the Zoomar will also aid studio shots, supplementing dollies and booms.

The Zoomar lens was invented by Dr. Frank G. Back for use with a 16-mm. movie camera, and has recently been developed for 35-mm. filming and television in association with Jerry Fairbanks, an independent movie producer.

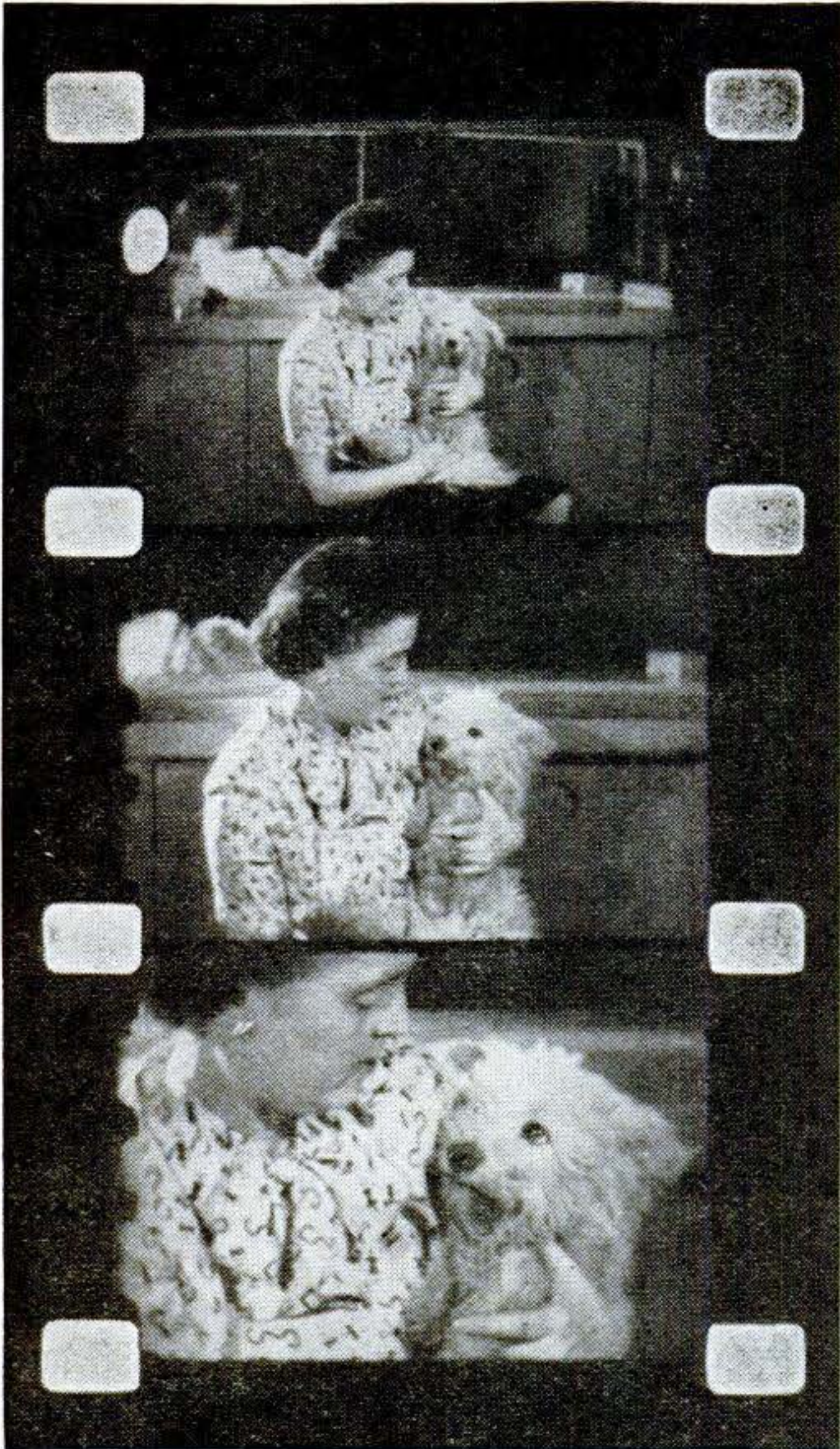

Three pictures, taken from one position without moving camera or subject or changing lenses, show zooming effect of the new lens.

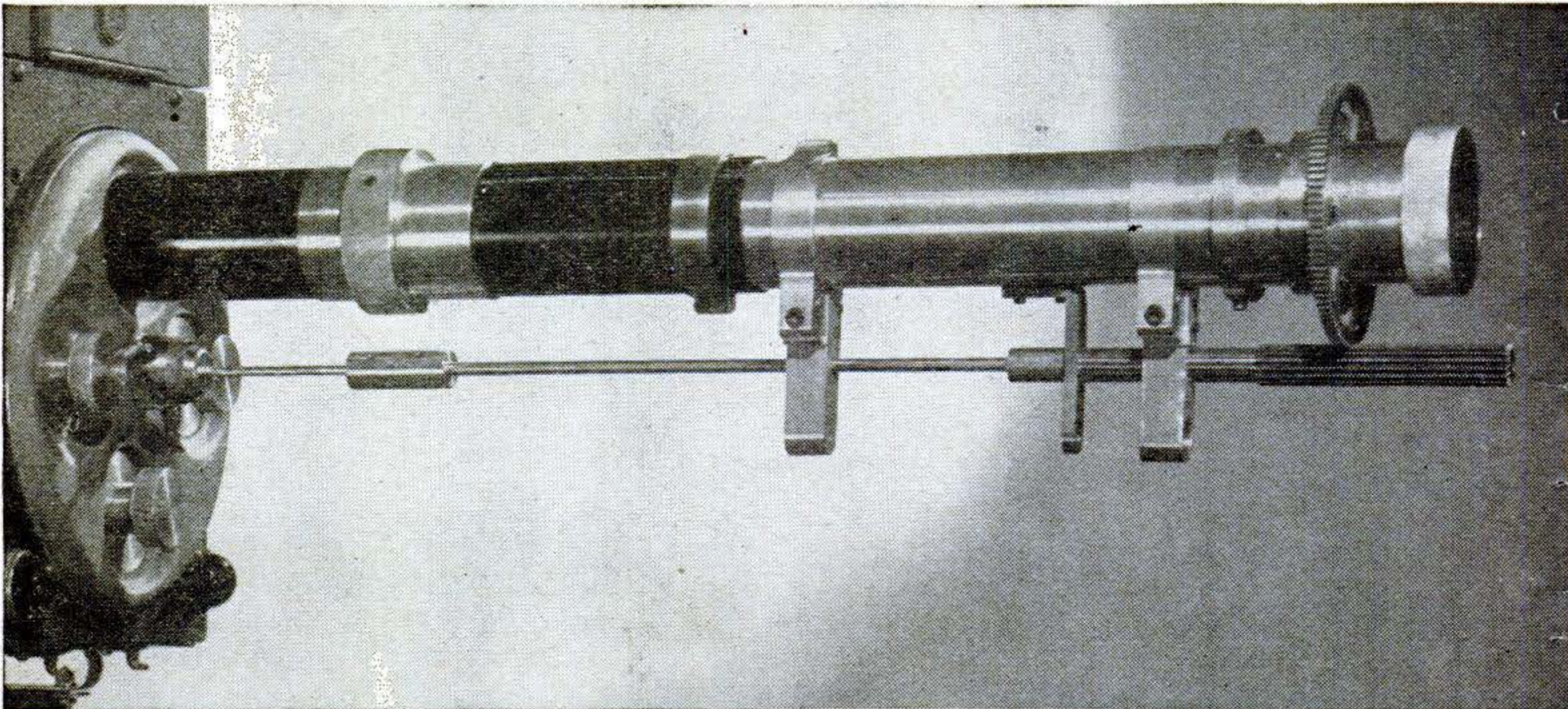

A television camera's Zoomar lens. Pistol-grip handle on camera (not visible in photo) enables photographer to shift smoothly from extremely

short to extremely long focal lengths in a continuous presentation, thus doing job of present battery of turret lenses.

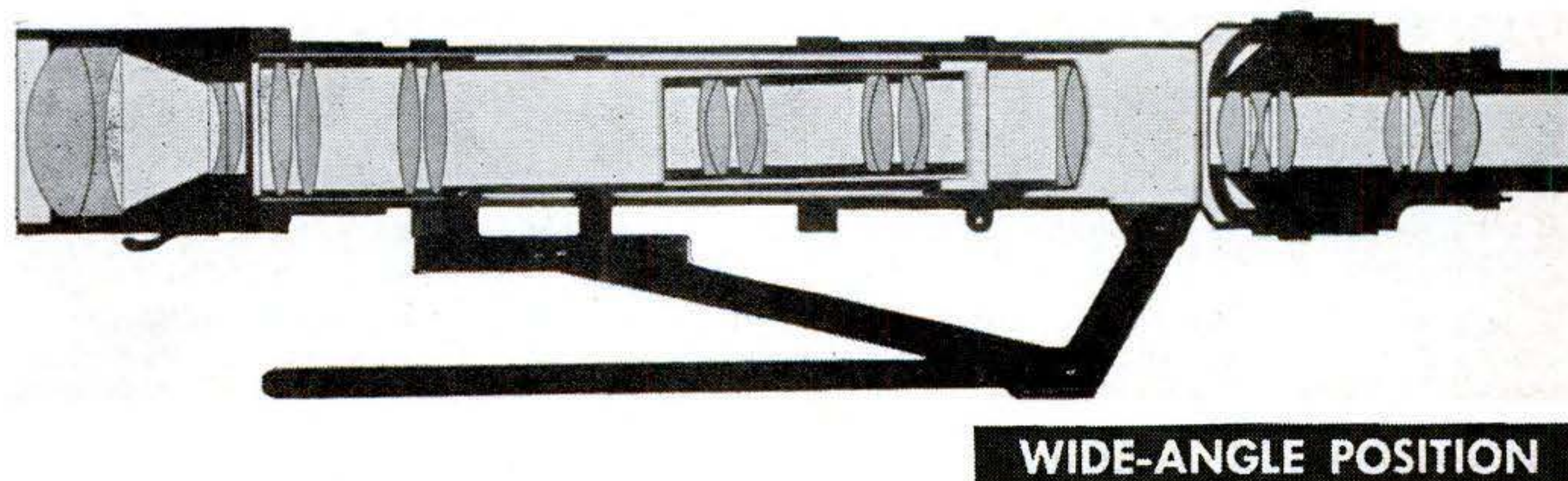
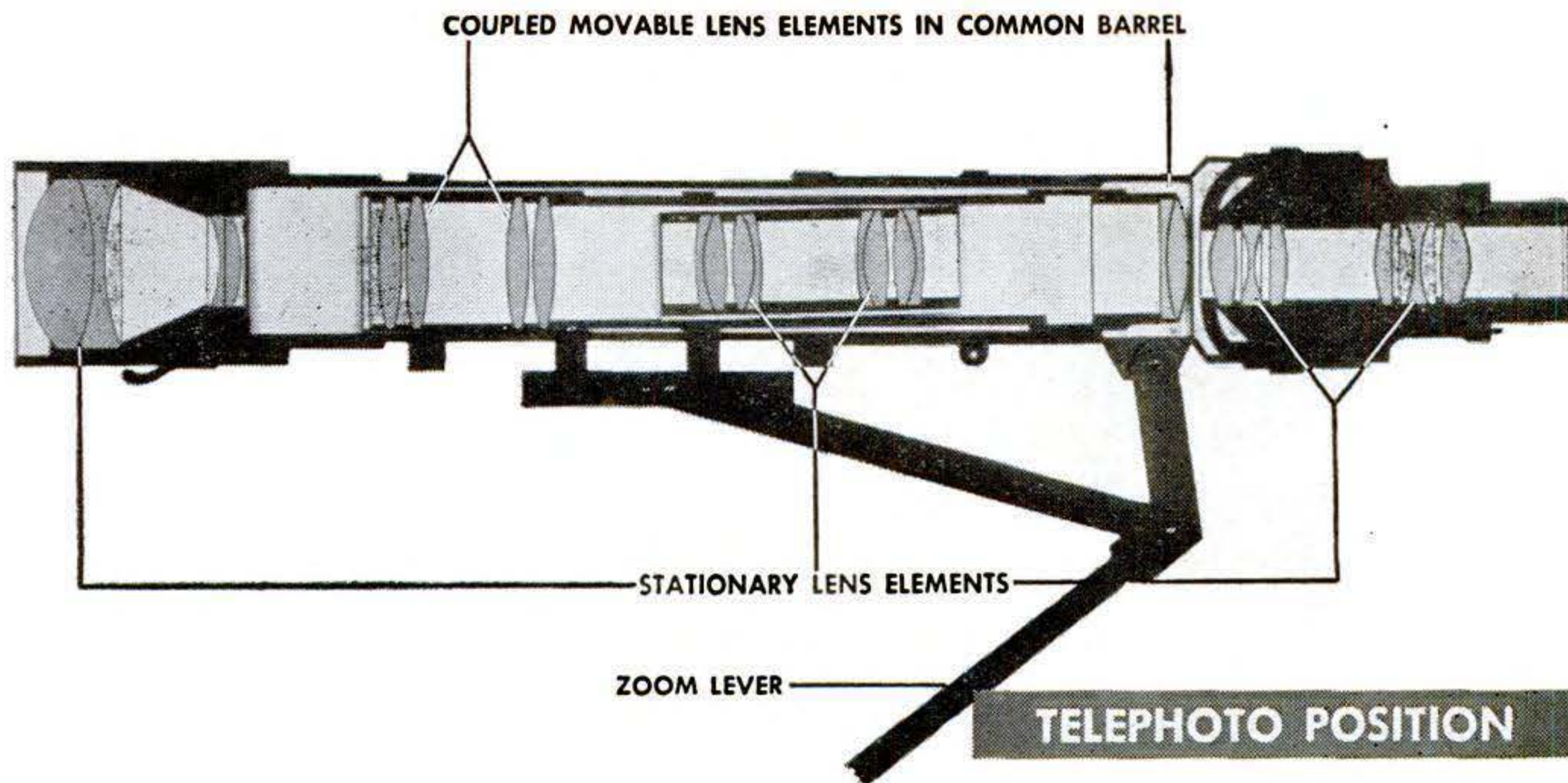

Lever action: Top drawing shows Zoomar lens with lever down for close-up shot. In bottom drawing it is in position for over-all shot. Zooming effect is obtained by shifting from one to

the other. Note changed positions of the movable lens units. The Zoomar technique is ideal for newsreels, sports films, or where a shift to details or individuals is desirable.

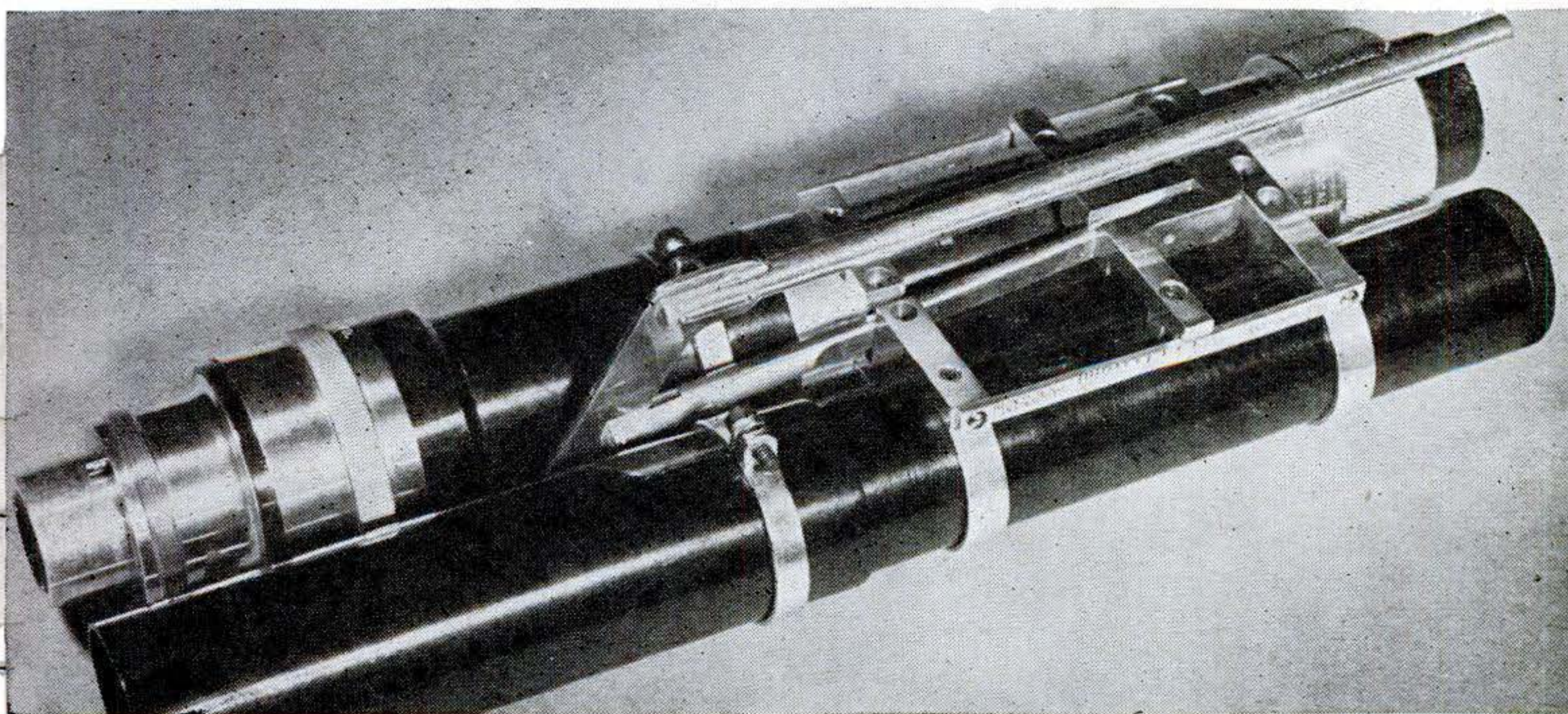

Close-up of a 16-mm. Zoomar unit now on the market. The view finder (outside tube) operates in conjunction with the zoom lever, and shows

exactly the same frame that the lens produces on the film. Television and 35-mm. units have not yet reached the production stage.

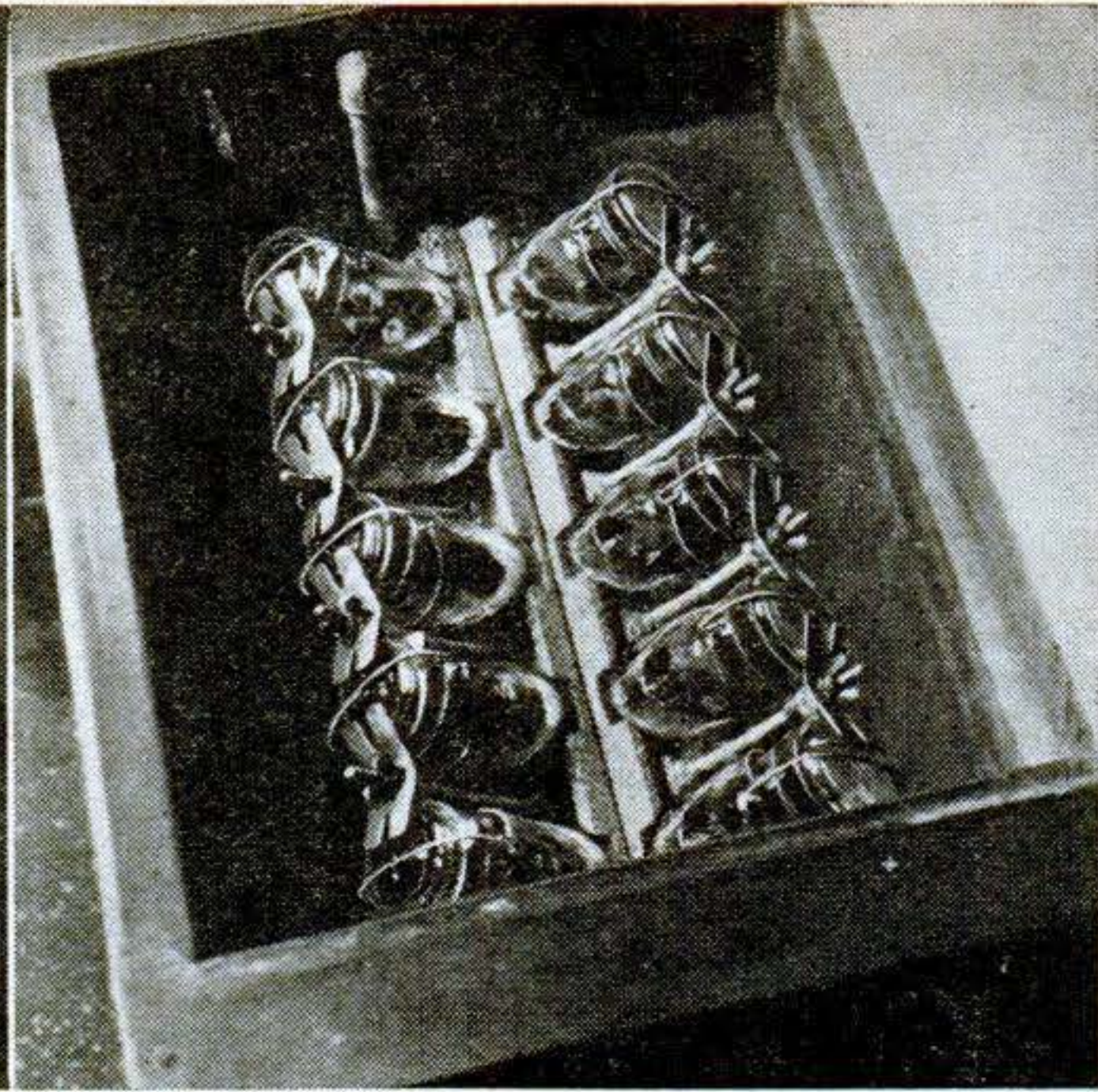
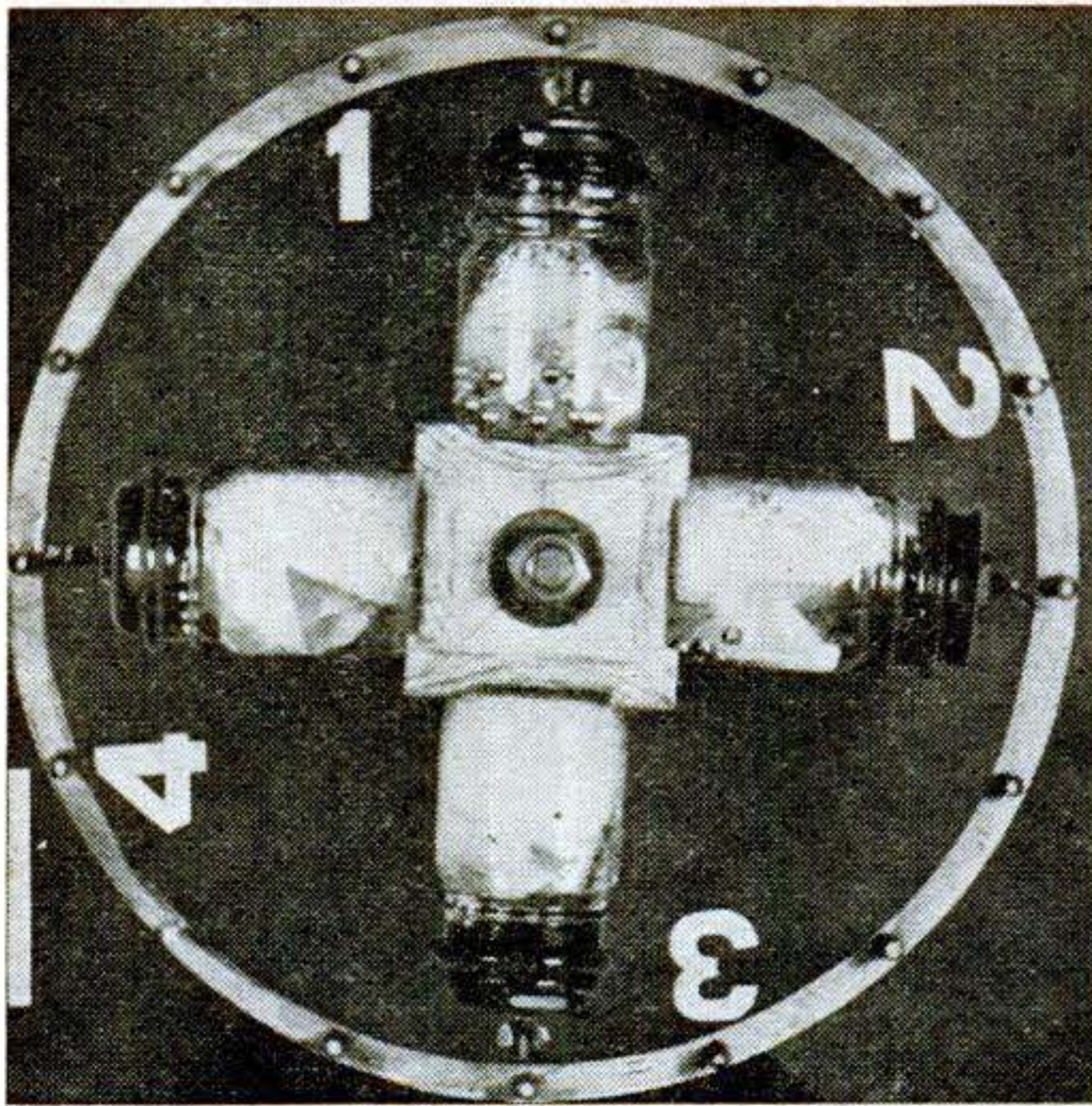

How Good Is a Soap? Du Pont researchers now measure the cleansing power of various soaps with the Launderometer, a machine that whirls jars containing small steel balls and squares of dirty cotton. The balls move up and down as the jars spin, and the amount of work they do in beating out the dirt can be calculated from their

weight, the speed of rotation and the time required. Since soap merely loosens dirt, the amount of work needed tells how good a soap is. The photo on the left, above, taken at 1/500 second, shows the machine at work; the steel balls are just falling to the bottom of jar No. 1. On the right is a whole battery of jars arranged for testing.

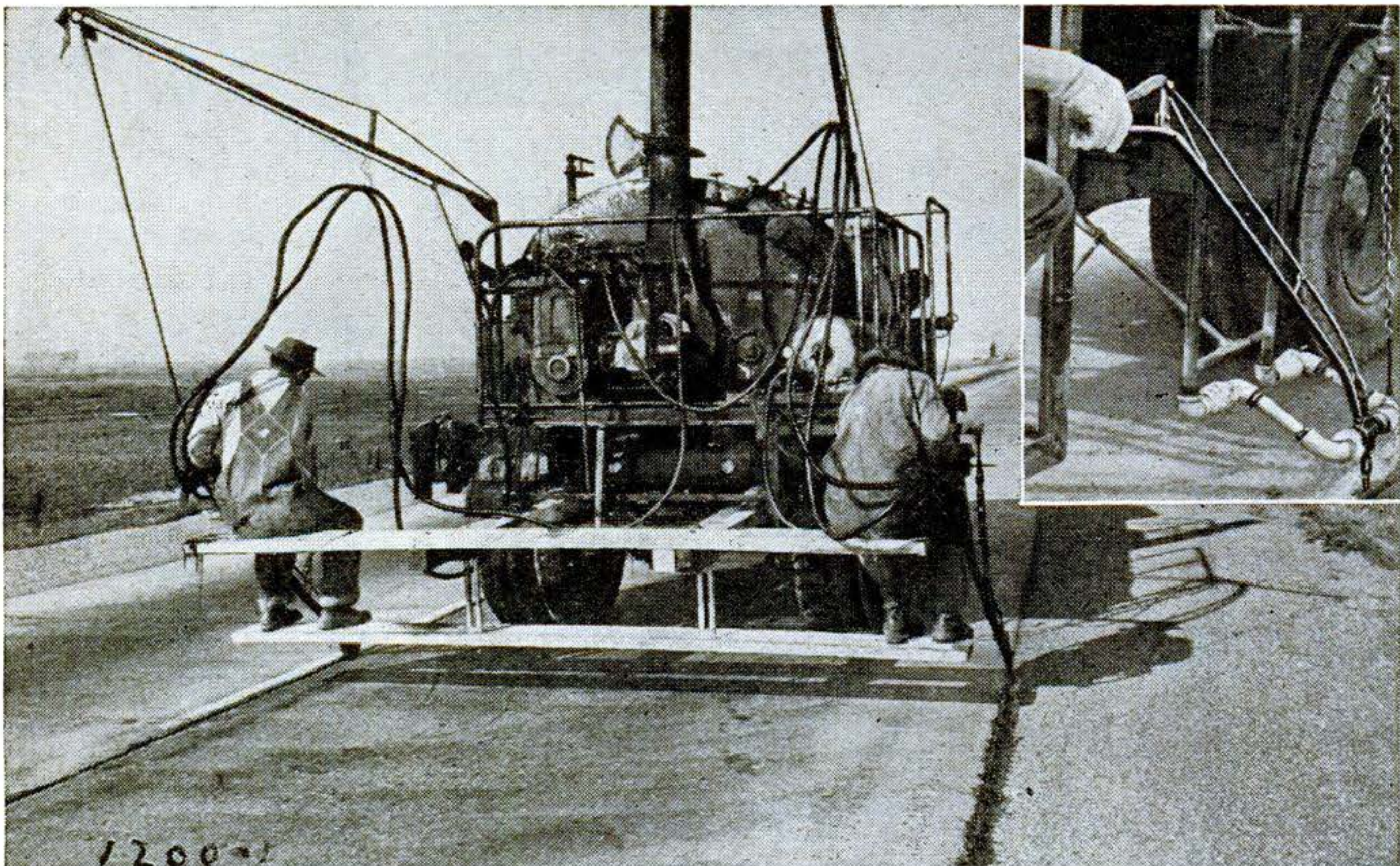

Joint Sealer Rides the Roads. Highway workers in California are able to seal expansion joints in concrete roads at the rate of 15 miles a day with this tank-truck unit. Air-blown liquid asphalt, heated to 350° in the tank, flows through pipes or

metal hoses to swivel assemblies, then out through nozzles directly into the joints. Inset shows hand-operated lever and rod controlling flow of asphalt. Proper sealing keeps out pebbles and other material that might prevent expansion of the concrete.

Car Folds to Suitcase Size



After unloading luggage, these motorists can fold up the car and check it with their bags.

MIDGET is really the word for this compact folding car that can carry two full-grown men, yet folds up into a package no bigger than a suitcase. Designed by the Aircraft Products Co., of Wichita, Kan., for transporting private plane owners to and

from airports, the "Airscoot" carries a payload of 450 pounds, weighs only 72 pounds, is 37 inches long and 20 inches tall. It has a top speed of 25 miles an hour, holds three-tenths of a gallon of gas and can average 60 miles to the gallon.

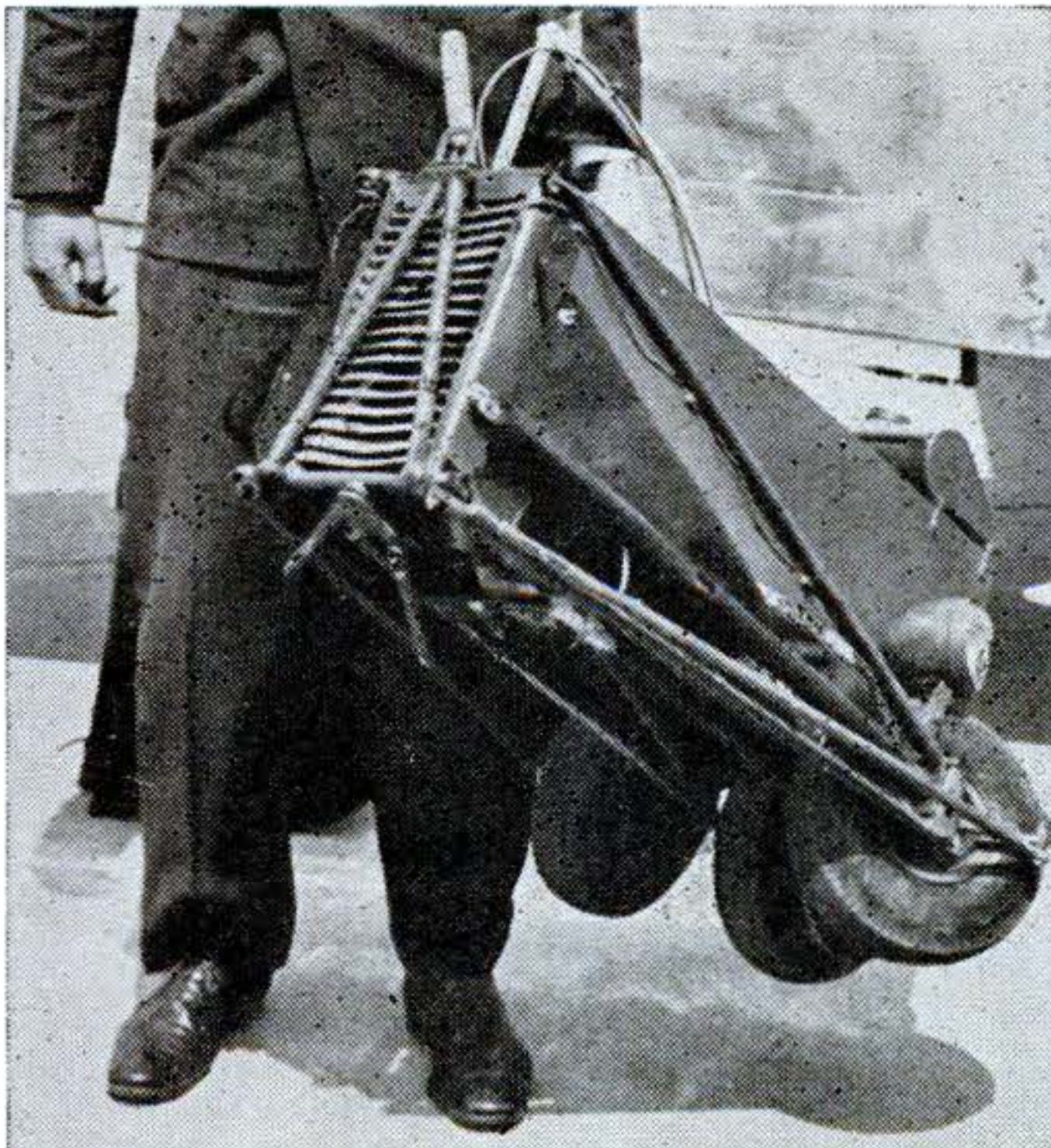

Made of aluminum and magnesium tubing, the folding car is carried like a suitcase. It can be unfolded and under way in one minute.

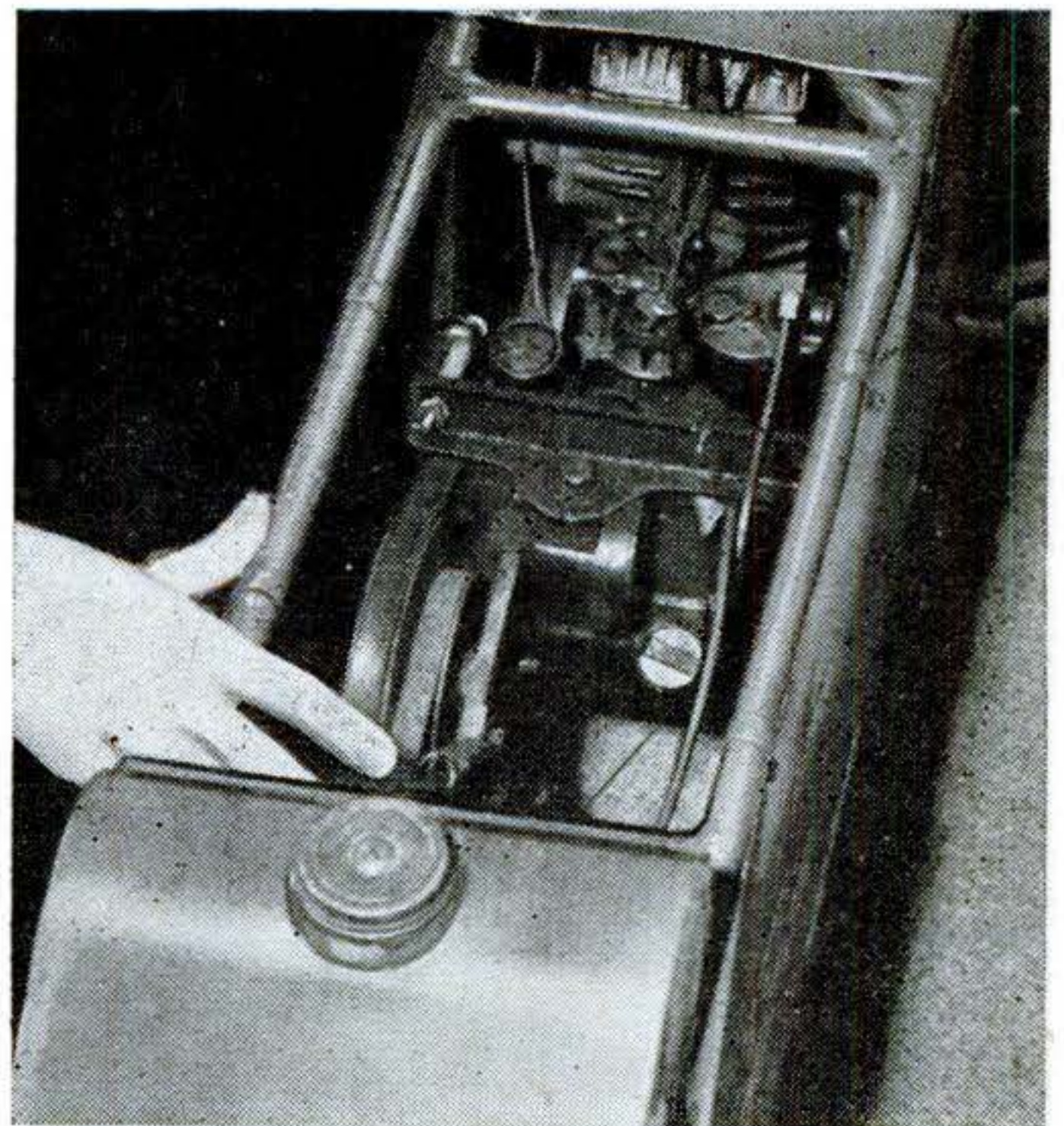

Close-up of the "Airscoot's" small, one-cylinder, four-cycle, 2.6-horsepower engine. Using no battery, the lights work off the generator.

Mist Sprayer Steps Up War On Insects

Hurling a concentrated airborne fog, new power blower puts older types of pest-control apparatus in the shade.

ON THE old principle of making a little go a long way, two Connecticut agricultural experts have developed a "mist sprayer" for trees and crops that is said to be up to 1,000 times more efficient than conventional equipment. Lighter and more compact than ordinary sprayers, it throws an atomized fog that can cover tall trees or float downwind for several hundred feet without losing insect-killing power.

Like ordinary power-spray apparatus, it consists of an engine, pump, tank, blower and nozzle. But it depends on air instead of liquid as a carrier and is designed to handle a small volume of concentrated spray instead of a large volume of a dilute solution. With a half-pint mixture containing two ounces of DDT, the mist blower can cover a sizable tree that would require six to seven gallons in an ordinary spray.

Developed by S. F. Potts and Dr. R. B. Friend, both members of Connecticut's agriculture research staff, the new blower is to be produced in several models.

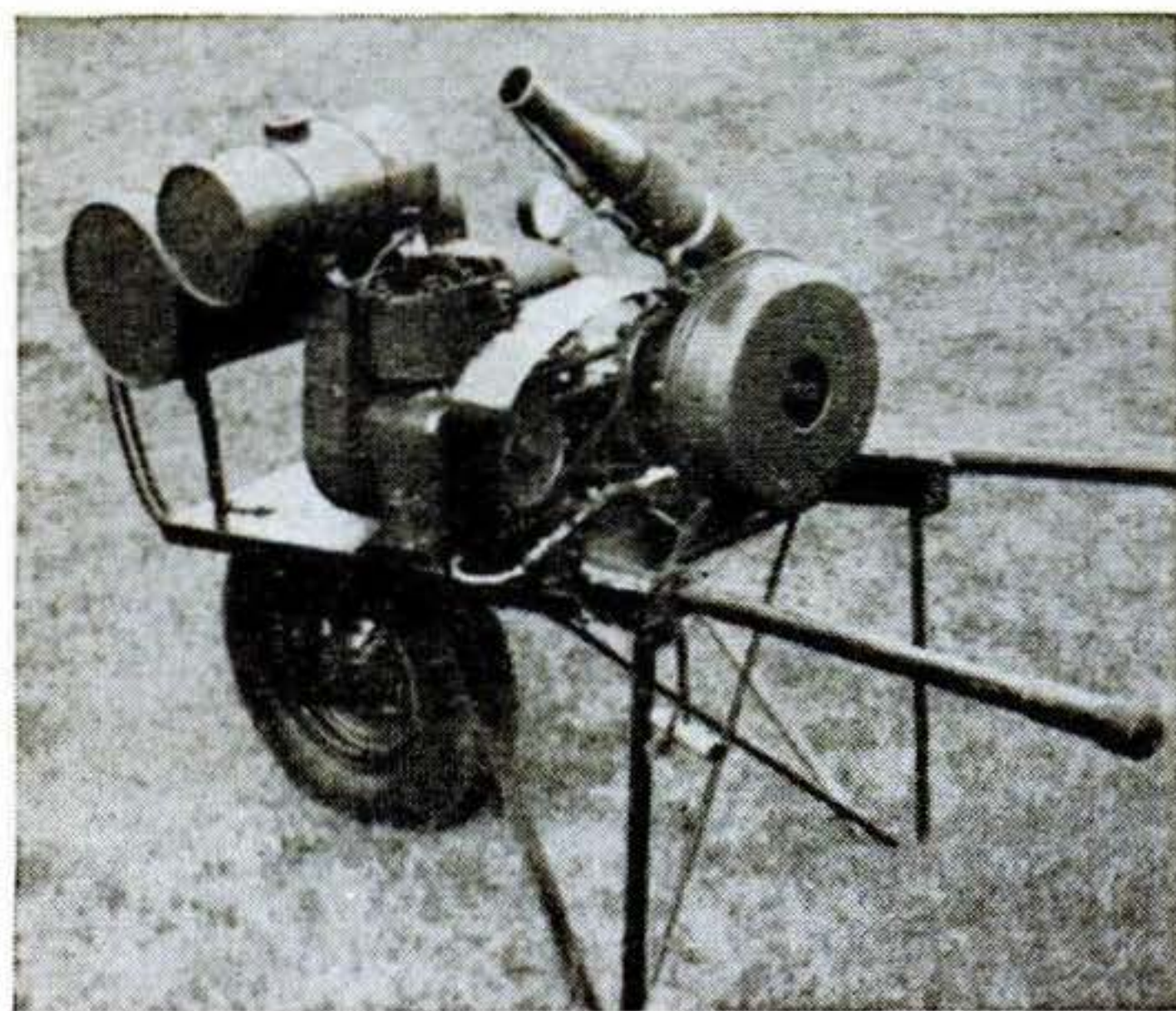

Wheelbarrow model has 1½-hp. motor, throws spray as high as 35 feet. Turning left handle of barrow controls amount of spray; turning right handle rotates spray nozzle through 180° arc.

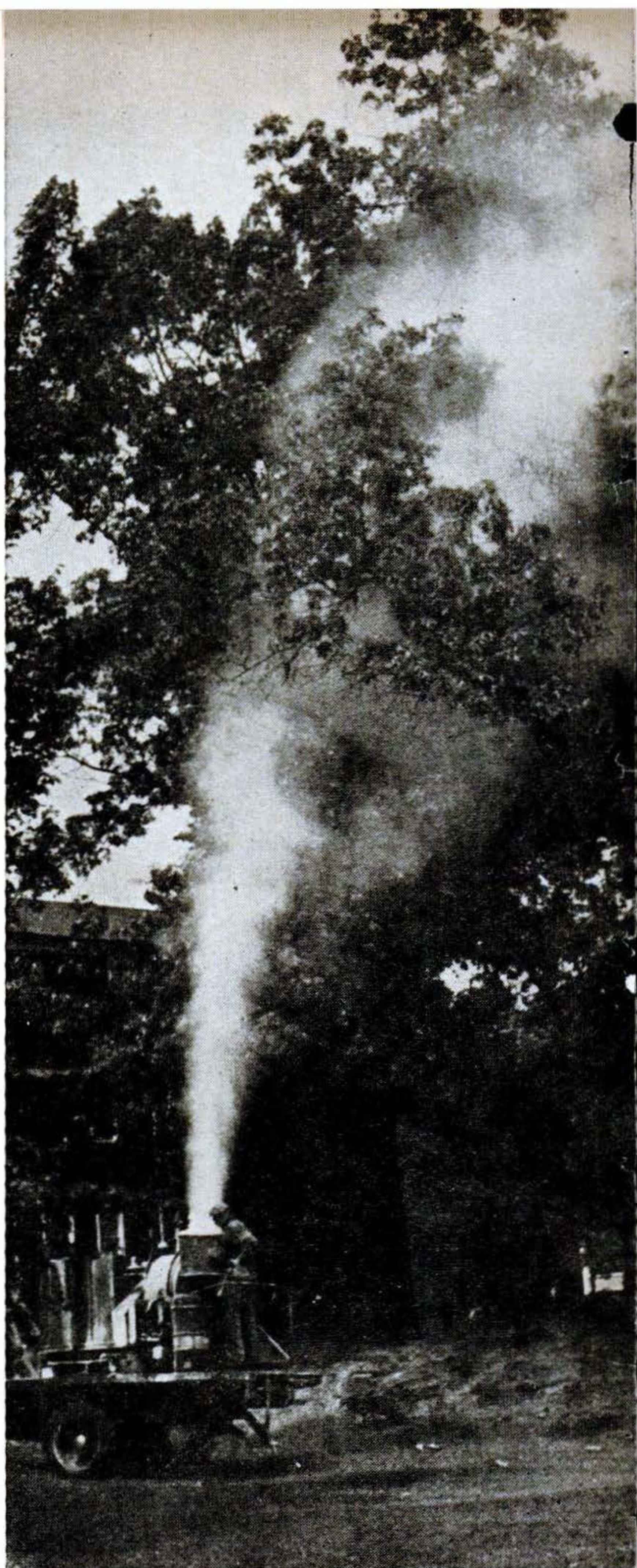

Truck model, with 25-hp. motor, can blow spray as high as tallest trees or up to 300 feet horizontally. Sprayers can handle dilute mixtures, if desired, and can do wet- and dry-dusting.

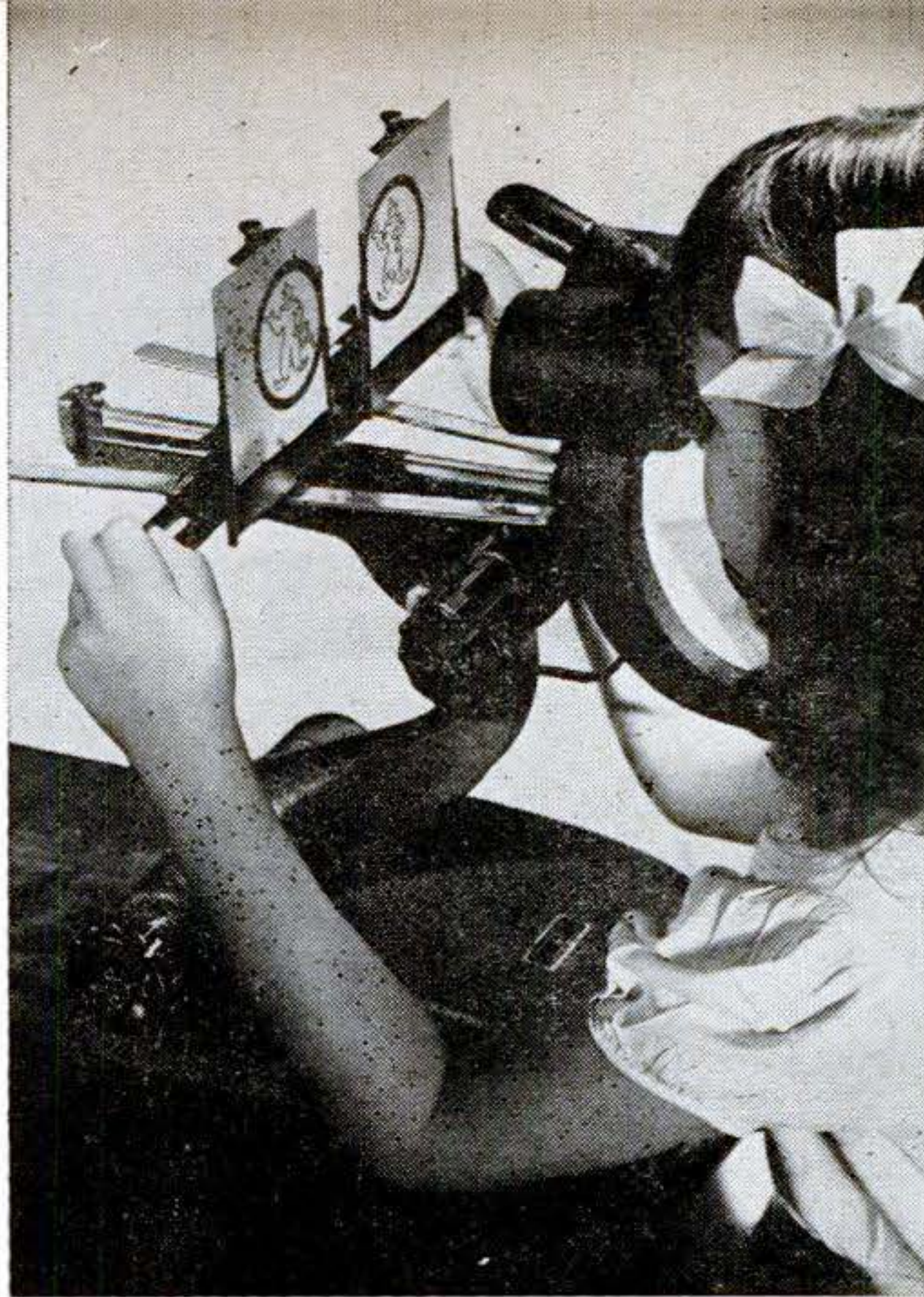

Pictures Train Eyes. It looks like an ordinary stereoscope, but adjustable tracks for the pictures on this AO-Renshaw Stereo Disparator train the eyes by allowing them to focus and converge simultaneously, as in normal vision.

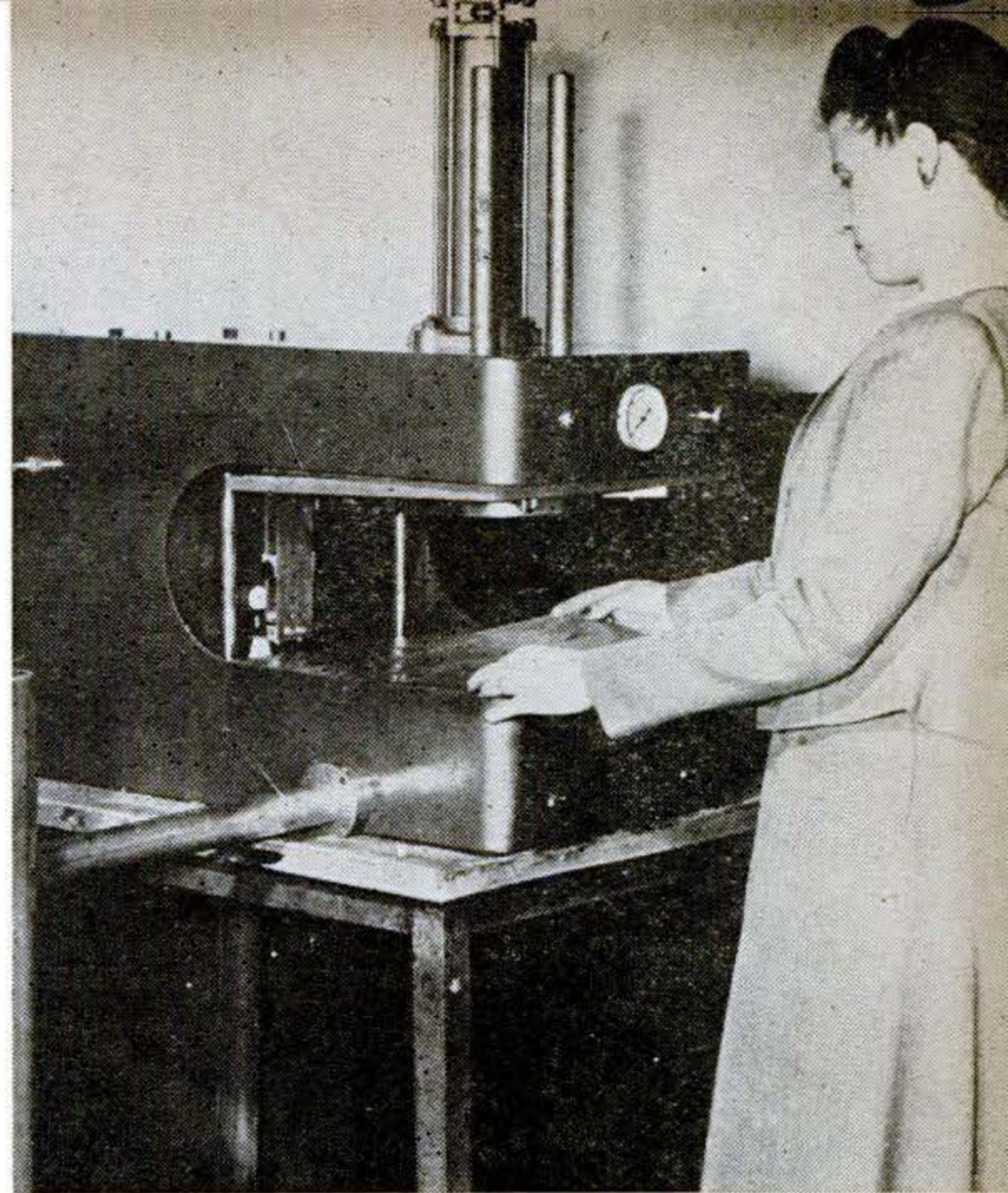

Press Seals Plastics. Completing intricate seams on thermoplastic material in a single operation is the job of this RCA electronic sealing press. Adjustable to fit any pattern, it eliminates the need for a variety of expensive machined dies.

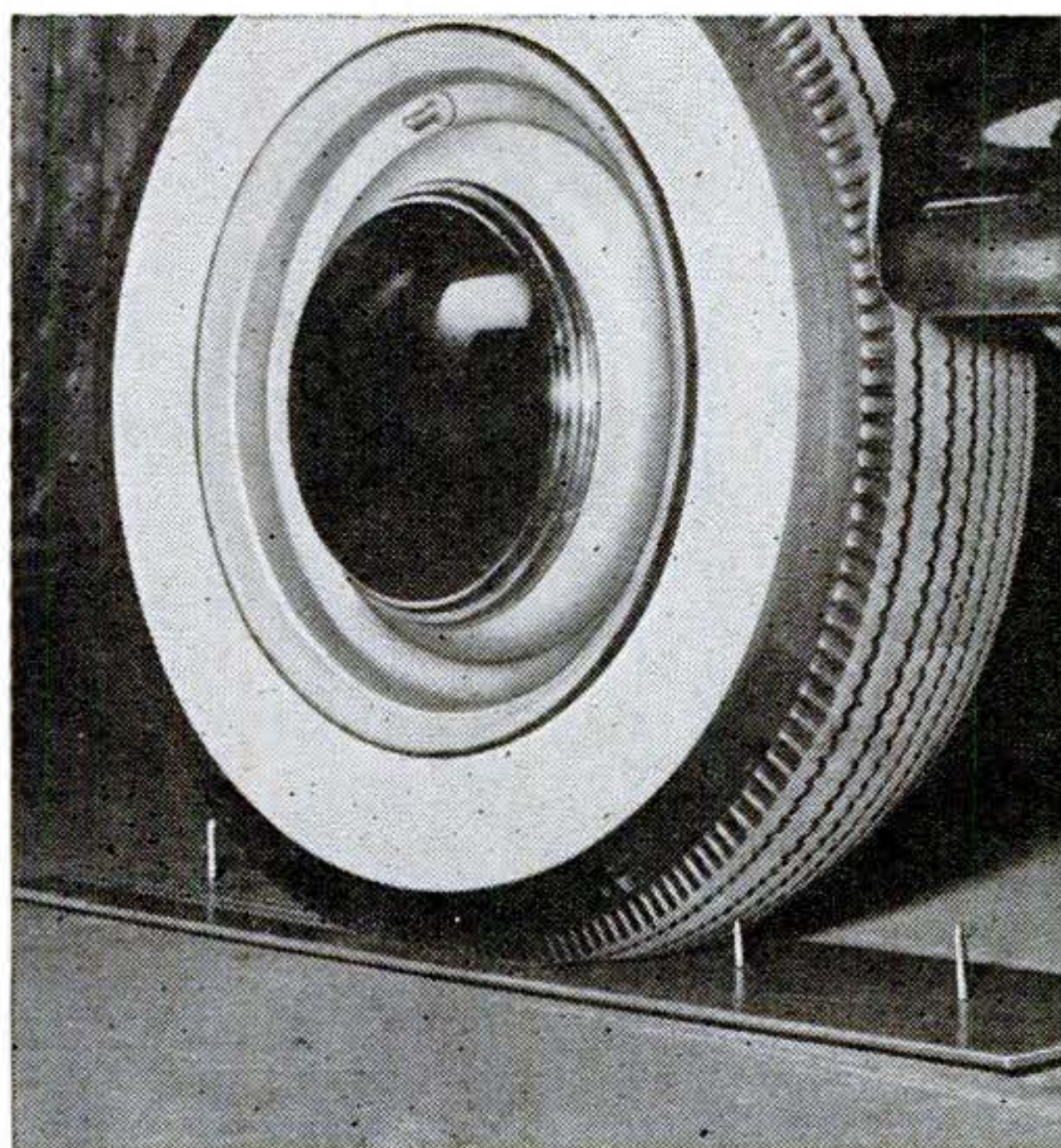

Tubeless Tire Seals Holes. This tubeless tire undergoes rigid spike-board test at the Goodrich Akron plant. A gummy inner layer closes hole when the piercing object is withdrawn. At present, distribution of the tire is limited.

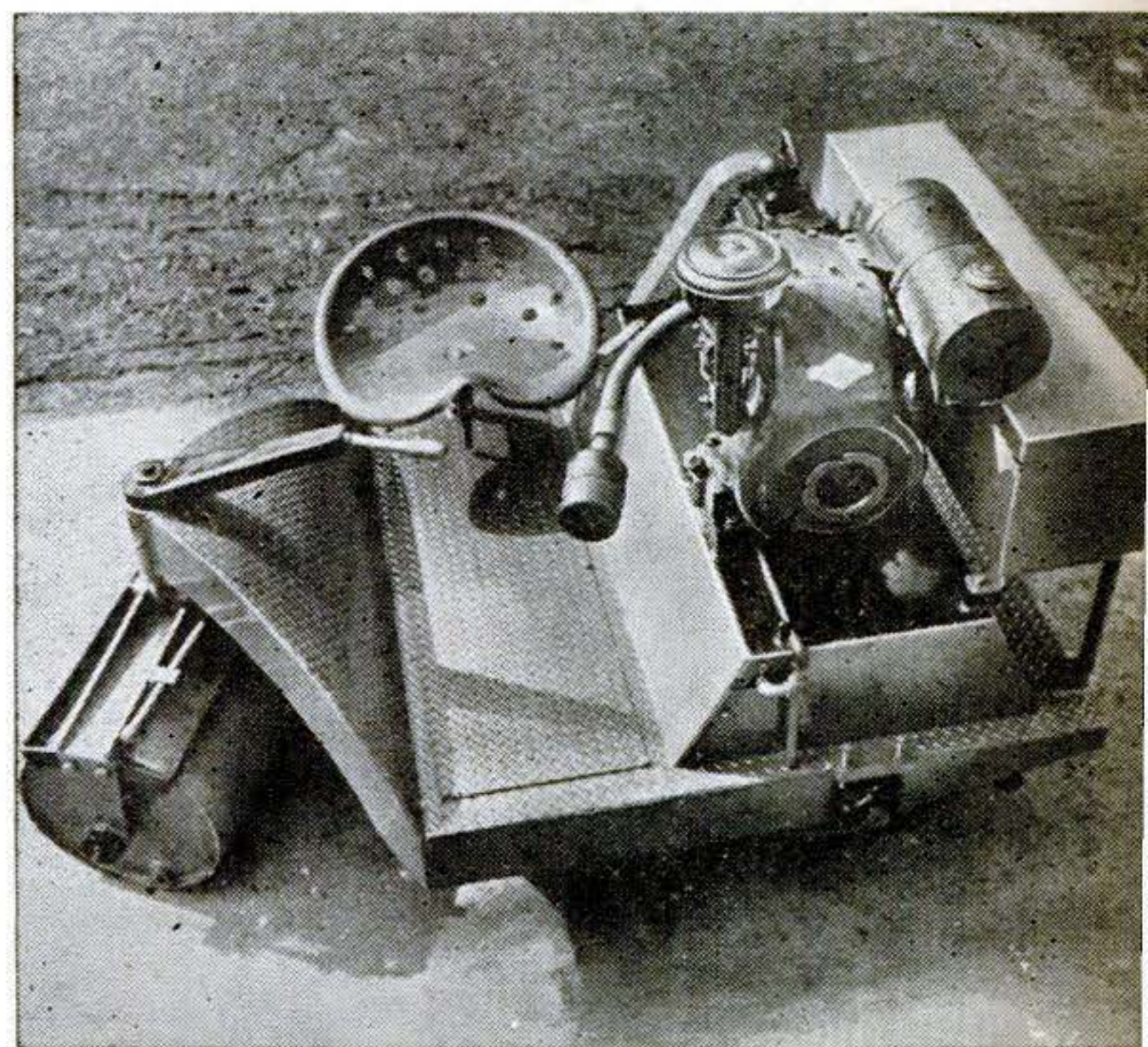

One-Ton Midget. Small but husky is this midget roller, developed by the Steel Equipment Co., of Cleveland. It has a 42-inch wheelbase and weighs about a ton, but can carry an extra 600-lb. concrete block for rolling lawns, golf courses, etc.

How a Combine

CYRUS McCORMICK invented the reaper in 1831; its big brother, the combine, came along about 1875. But only in recent years have the full benefits of mechanical harvesting been available to thousands of American farmers. The machine that did it is the small, self-propelled combine, or reaper-thresher, capable of one-man operation and specially designed for efficient harvesting of 200- to 400-acre grain stands.

Inside the combine is a complex mechanism that cuts the standing grain, beats out the kernels, blows off chaff in one direction while dropping the kernels in another, lifts the cleansed grain into a hopper, and spreads straw in its wake.

As the combine makes its way through a field of grain at two to three miles an hour, curved *dividers* separate the grain in its path from that in the remaining stand. Then a six-bat *revolving reel* pulls the upper part of the grain backward and into position for the *cutter bar* to sever the stalk close to the ground.

The *augurs* take over next, forcing the grain onto an *endless conveyer canvas*. Slats hold the grain against an *endless conveyer chain* moving at the same speed as the can-

vas, preventing bunching. From the conveyer the grain passes under a *beater and retarder* that holds the grain and distributes it to the *threshing cylinder*, where it is rubbed and dropped through slots onto a corrugated *grain pan*. This removes three-fourths of the grain.

From this point, straw goes in one direction and grain in another. The straw is first thrown against a *straw beater* cylinder that knocks some more grain into the pan; then it passes onto *straw walkers* where most of the remaining grain is removed before the straw is ejected.

Going back to the grain that has fallen into the pan: A pitching motion delivers it to the *chaffer*, which separates grain from rough material. The grain then drops into a *shoe sieve*, is shaken onto an incline and slides to *grain augurs* that move it to an elevator for delivery to *grain tank* or bags. Meanwhile, coarse material and rough heads have moved to the *chaffer extension* and to a return elevator for rethreshing.

These operations are assisted by the *chaffer fan*, which blows air through the *chaffer* and *shoe sieve*, helping push lighter stuff away while the grain drops through.

Two helpers are needed to operate this model, equipped with bagging platform and chute. It has an International six-cylinder engine with four speeds forward, one reverse.

Pickup attachment shown here is for gathering a windrowed or already cut crop such as these beet stalks. The pickup platform "floats," thus following any unevenness of the ground.

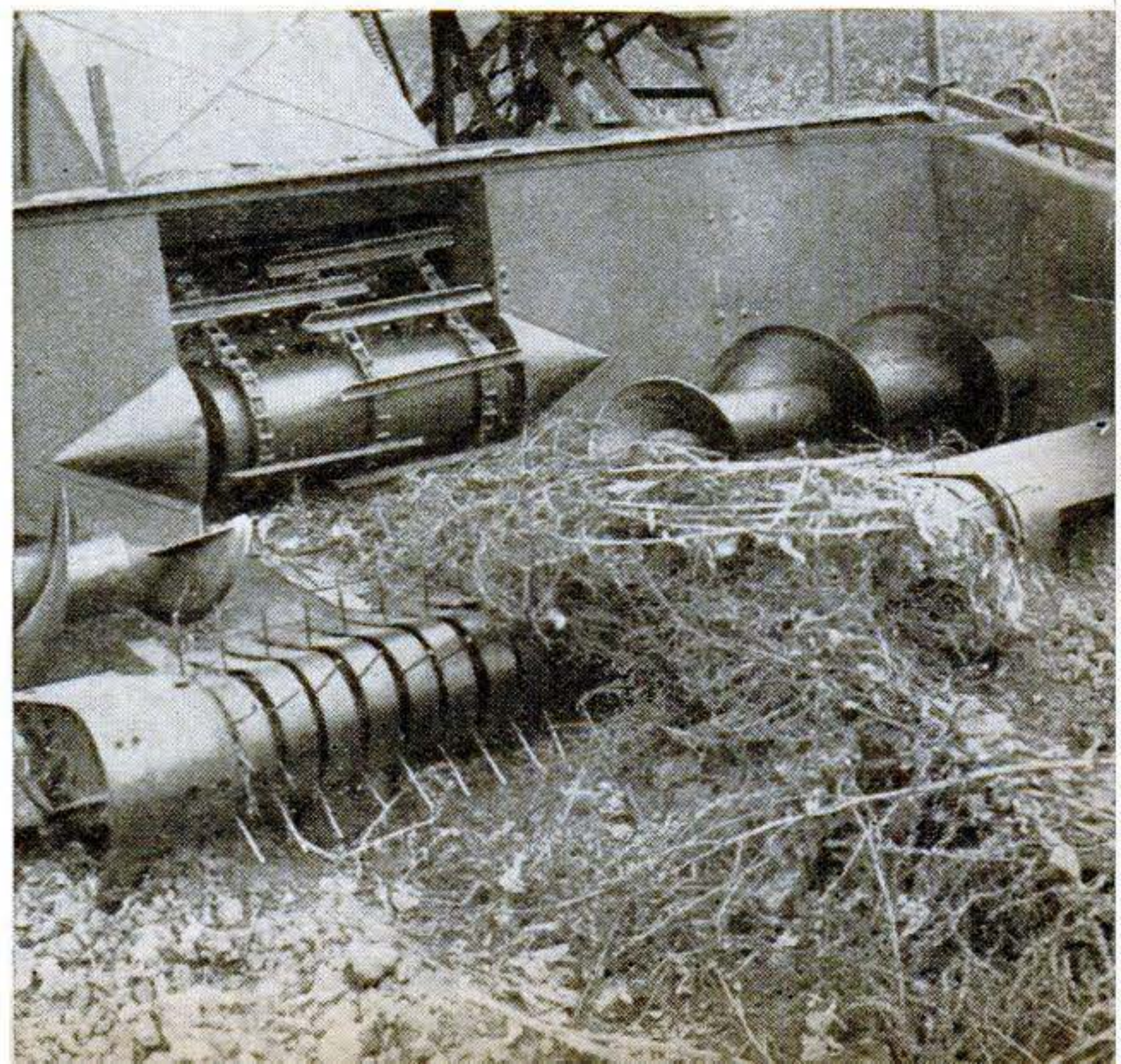

Works

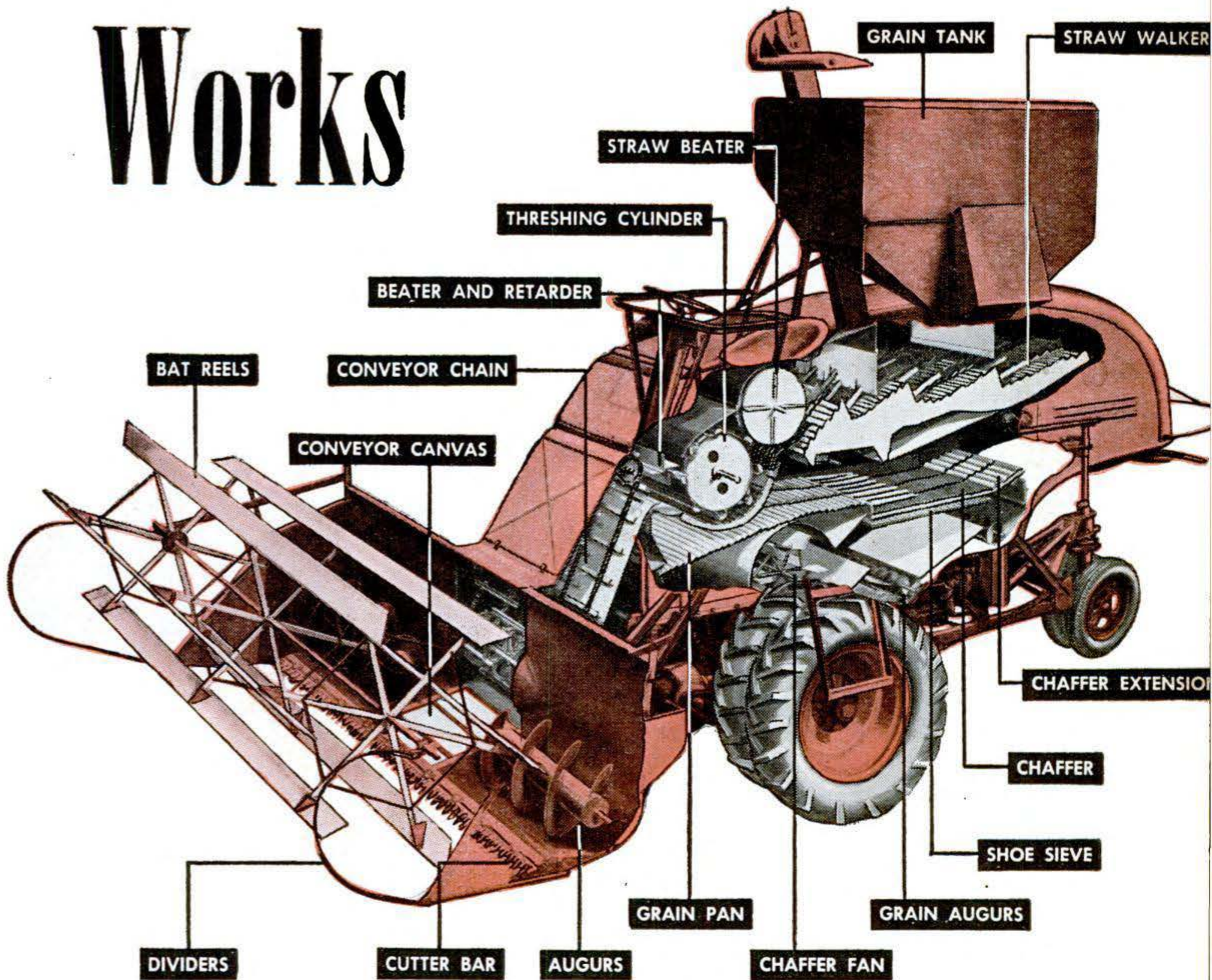

Cutaway shows operating parts of the McCormick-Deering self-propelled, one-man combine.

Only six seconds elapse between the instant a stalk of grain is cut and the moment its life-sustaining grain is delivered into the storage tank. This model permits one-man operation,

since the driver can empty the tank into a truck without leaving the platform. Straw presents no handling problem; it is ejected from rear of combine and left to fertilize the field.

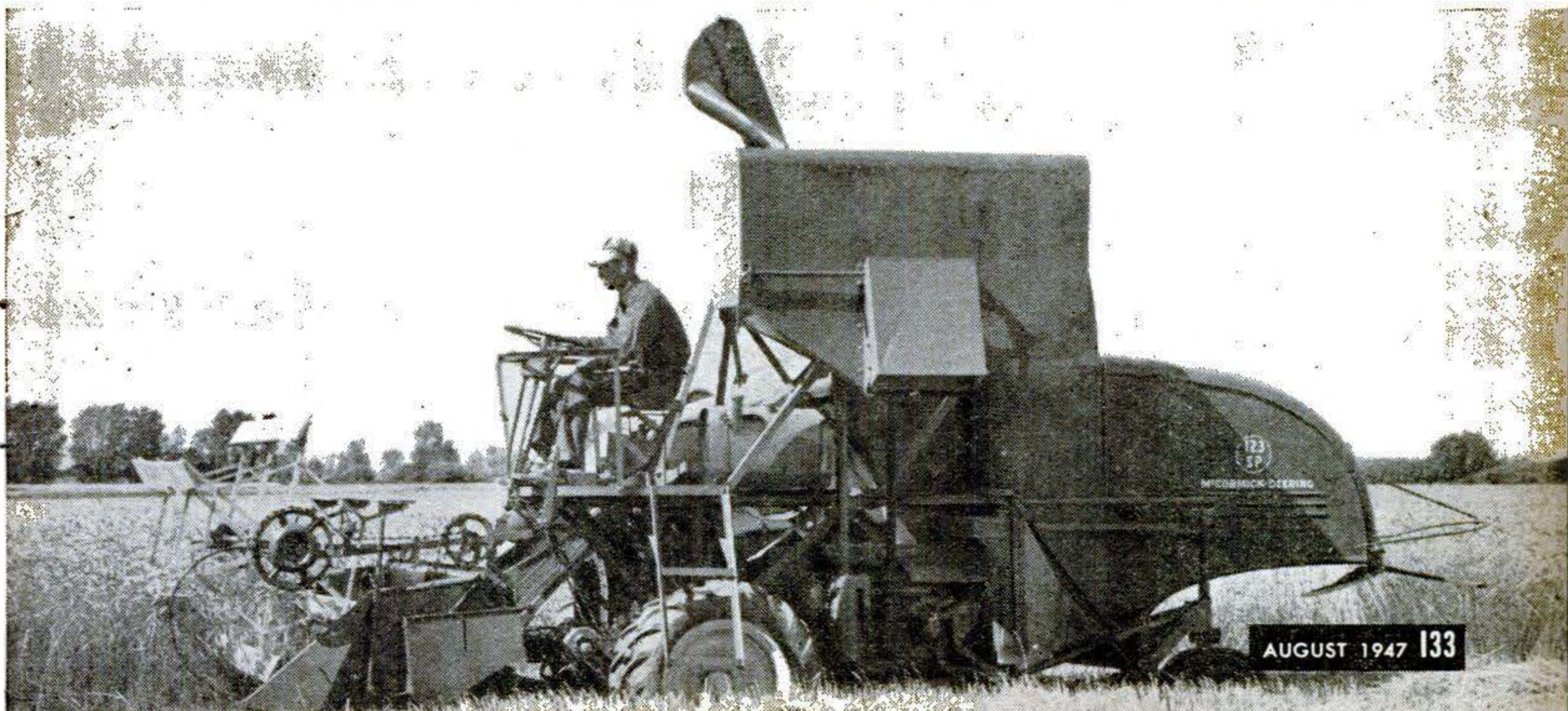

Test Planes Tooled to Tap Sonic Wall

When Skystreak and XS-1 try to slam past speed of sound, instruments will know more about it than their pilots.

WHEN two of the world's fastest airplanes attempt to smash the sonic barrier, a quarter of a ton of intricate research instruments will go along to record what happens.

To learn the exact behavior of wings, fuselage and control surfaces at transonic speeds (600-900 m.p.h.) and thus help to determine the most efficient characteristics for supersonic aircraft, the Bell XS-1 rocket plane and the Douglas D-558 jet will carry similar sets of more than 20 precision instruments for collecting, transmitting and recording the valuable flight data. Chief among these are:

Slide resistors: Attached to all control surfaces, small slides moving along wires change electrical resistance and record the control's movements.

Strain gauges: Mounted on spars within the wing, these measure structural stresses. Similar gauges, attached to the plane's controls, register the force the pilot has to exert in moving them.

Recording accelerometer: Three vanes, displaced by sudden movement of the plane, record deviation from steady flight.

Airspeed indicator head: This records static and dynamic pressure, the difference between the two roughly equaling airspeed. The difference between the static pressure in flight and that at the point of take-off approximates the plane's altitude.

Sideslip vane: Always headed into the wind, it provides a constant measure of the plane's angle of sideslip.

Pressure orifices: Four hundred tiny holes in wing and tail register air pressure, from which aerodynamic loads, pressure distribution and air-flow changes are analyzed.

Because of the possible destructiveness of transonic turbulence, the most important

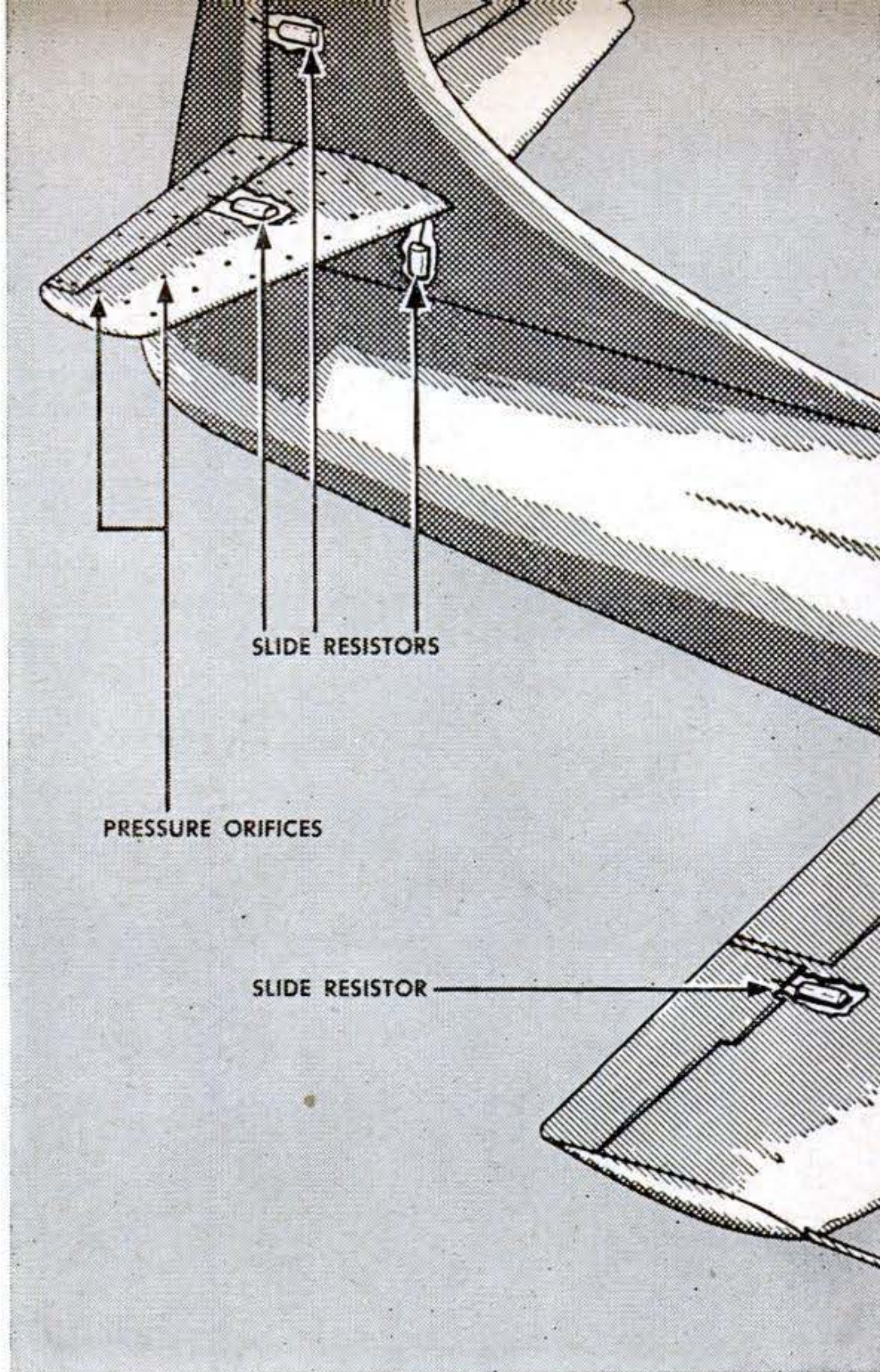

records are telemetered to the ground regularly throughout the flight. In addition, ground radar, tracking the plane, permits geometric analyses of its speed and altitude.

In the plane's recording instruments, tiny beams of light, tracing wavy lines on photographic film, provide a permanent record of the information collected at various points in the plane. A gunsight camera, located behind the pilot and aimed at the instrument panel, makes a motion-picture record of the instrument readings.

Virtually identical to those on the D-558, shown in cutaway above, XS-1 instruments assembled at right are: (1) sideslip vane, (2) recording accelerometer, (3) turn meter, (4) airspeed and altitude recorder, (5) control box, (6) sideslip recorder, (7) timer, (8) power supply, (9) pilot's wheel force recorder, (10) pilot's wheel force transmitter, (11) 12-channel oscillograph, (12) altitude and acceleration pickups, (13) control transmitter, (14) telemeter transmitter, (15) airspeed pickup, (16) control pickup, (17) thermocouple for temperatures, (18) sideslip dynamotor, (19) oscillograph control box, (20) telemeter dynamotor, (21) telemeter channel selector.

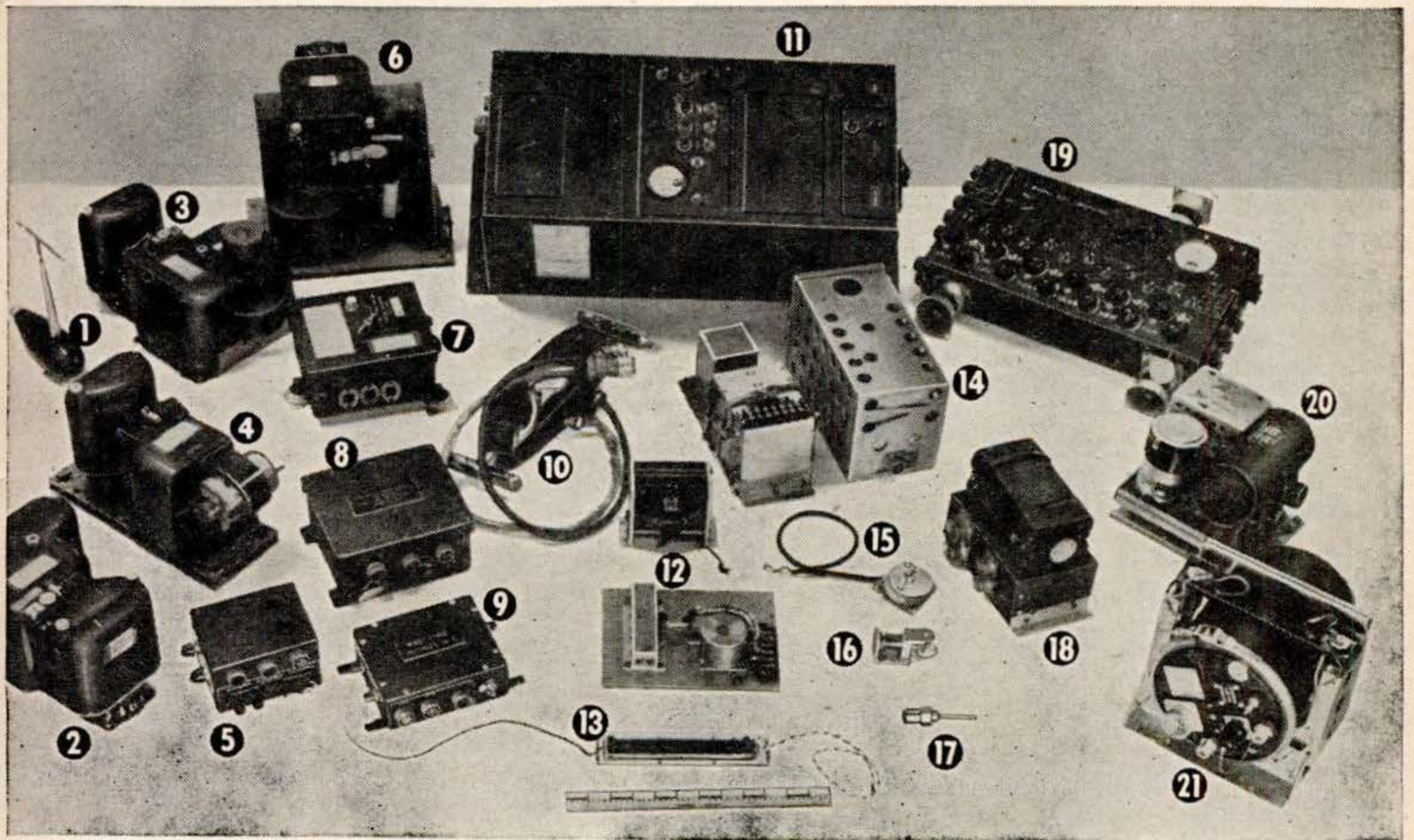
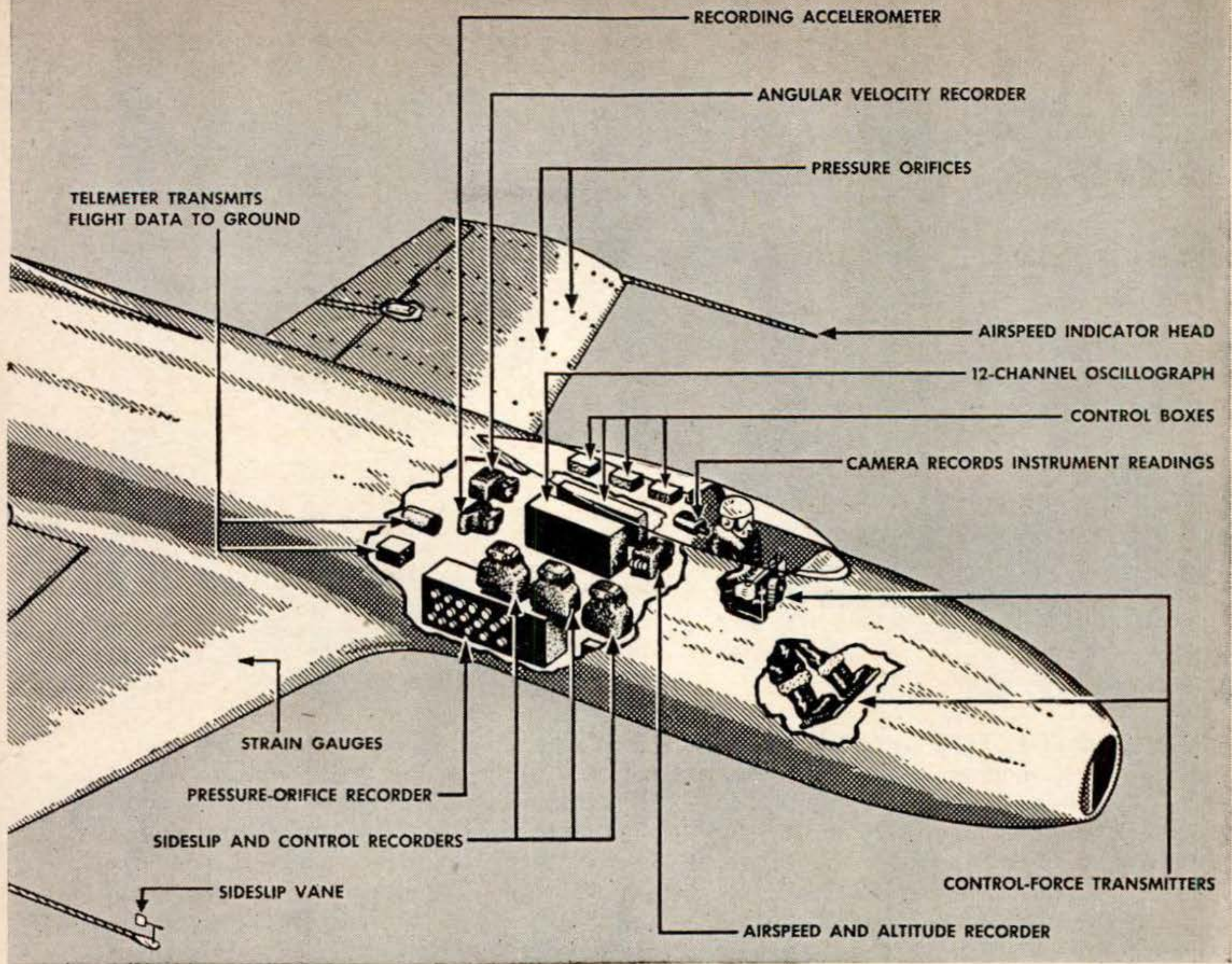

AIDS TO MODERN LIVING

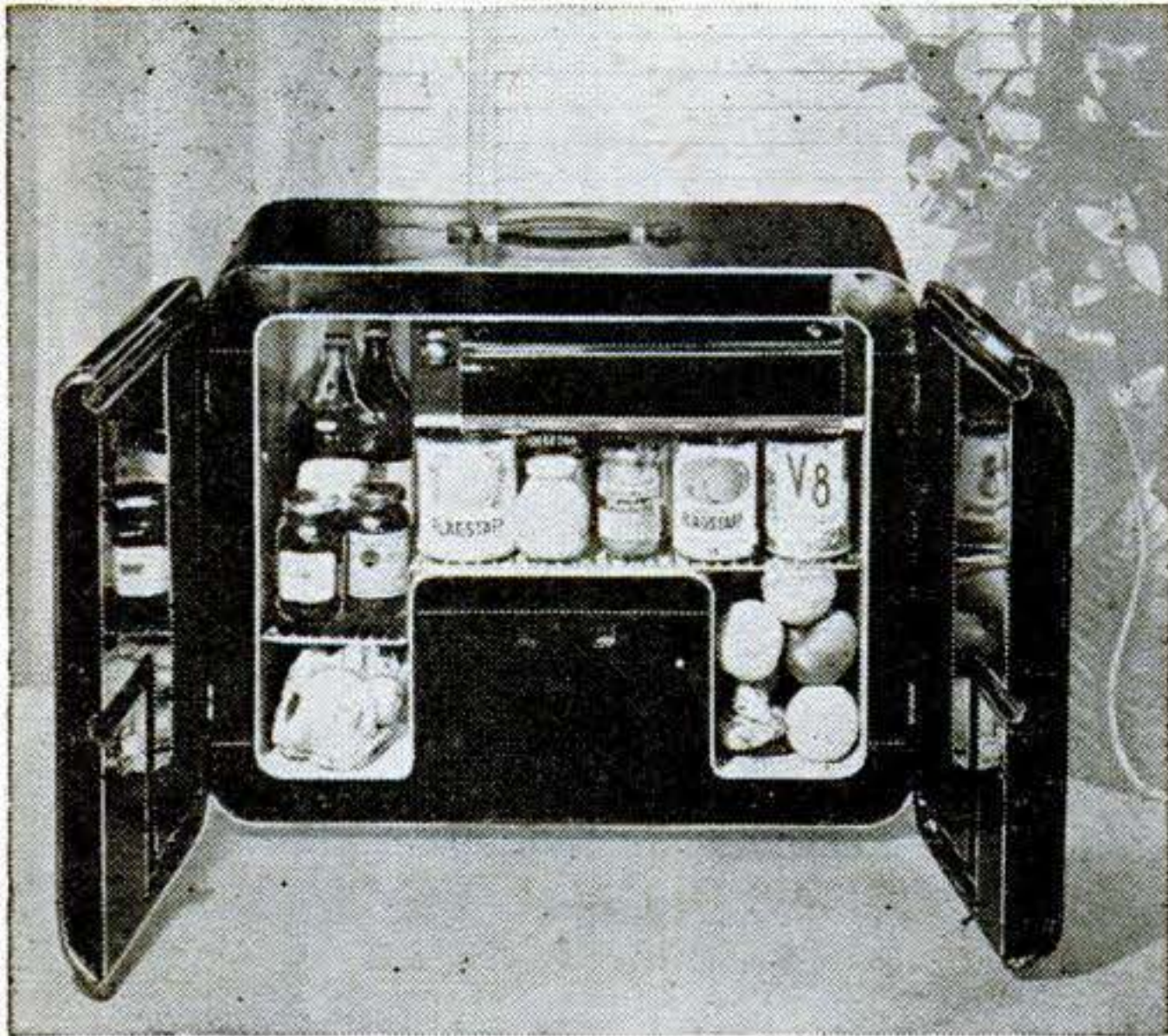

Refrigerator Is Portable. Weighing only 55 lb. and usable wherever AC or DC is available, this compact portable refrigerator has a capacity of 2½ cu. ft. Measuring 16" deep, 22" high, and 28" long, it is built with an inner and outer aluminum shell between which 2" of insulation is sandwiched. The refrigerator sells for about \$130 and is manufactured by the Freez-Pak Corporation, of Royersford, Pa.



Elevator Raises Turntable. A chairside radio-phonograph manufactured by Electronic Laboratories, Inc., of Indianapolis, has a built-in electric mechanism to raise and lower the automatic record player. When a knob on the radio dial is turned, the turntable rises out of the set. After the records have been put into place, another turn of the knob causes the player to descend out of sight. The set retails for approximately \$350.

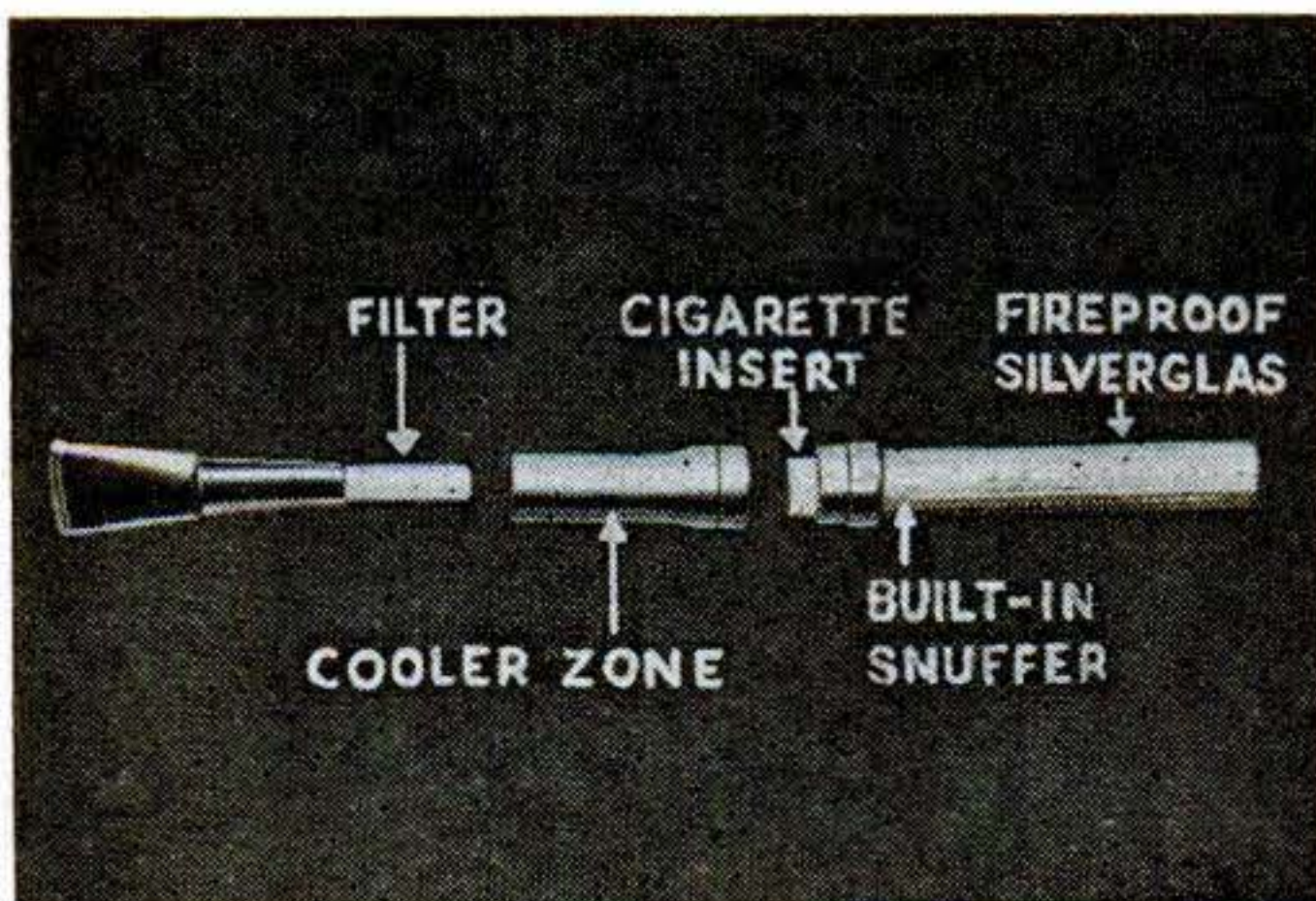

Makes Smoking Safer. This cigarette holder produced by the Safe-Gard Mfg. Co., Cleveland, does almost everything except puff the cigarette. In addition to cooling and filtering the smoke, the holder keeps the ash from scattering, while a built-in snuffer puts the butt out. Since the cigarette is inside a fireproof cylinder, it cannot set a fire if put aside and forgotten.

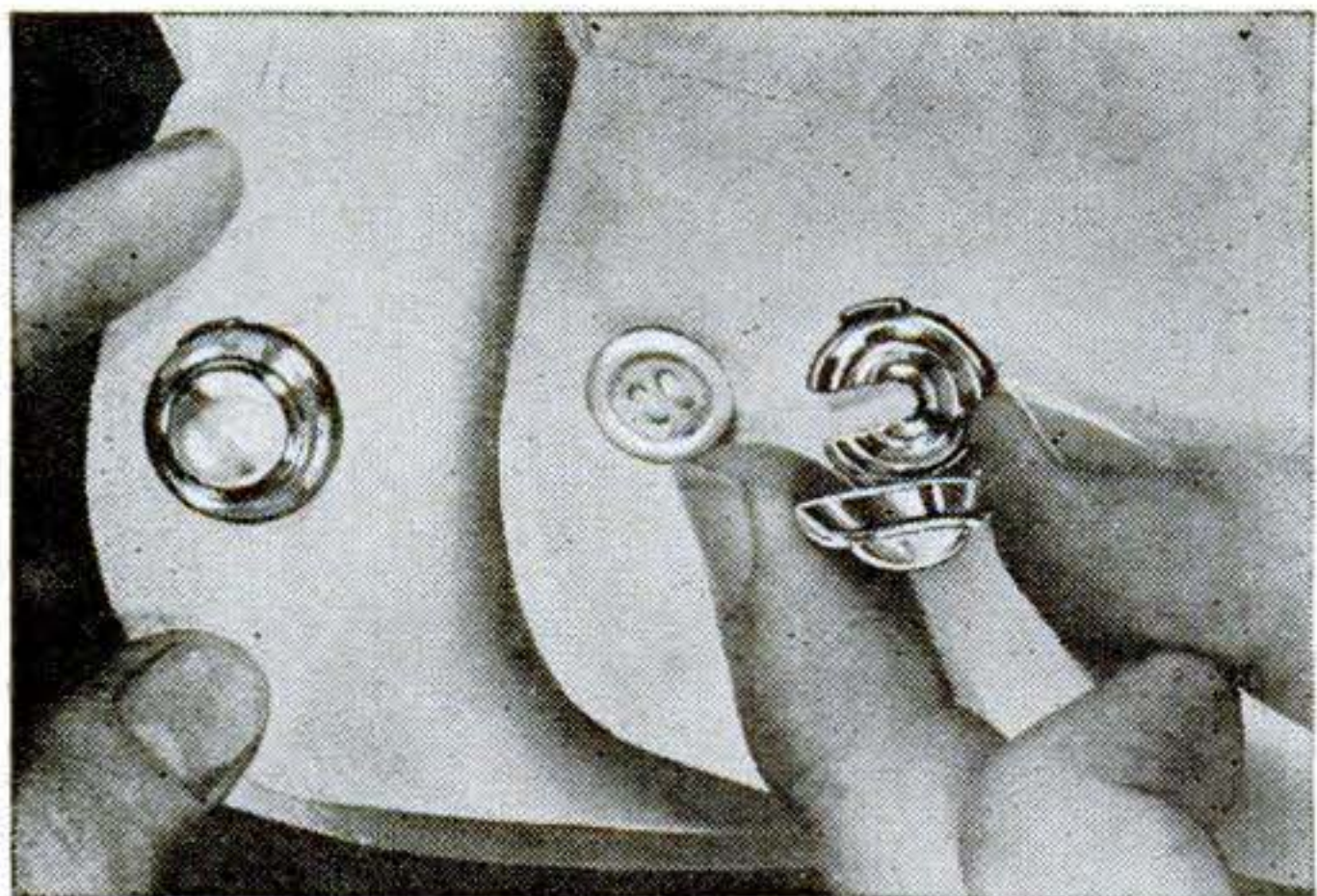

Imitation Cuff Links. If you'd like to give the appearance of wearing cuff links with an ordinary sleeve-button shirt, a new product put on the market by Crafters, Inc., Chicago, will do the job. They can be installed right on the buttons. A bottom disk, with a cut-out center, slides under the button, and the hinged top then may be snapped down, locking the "link" securely.

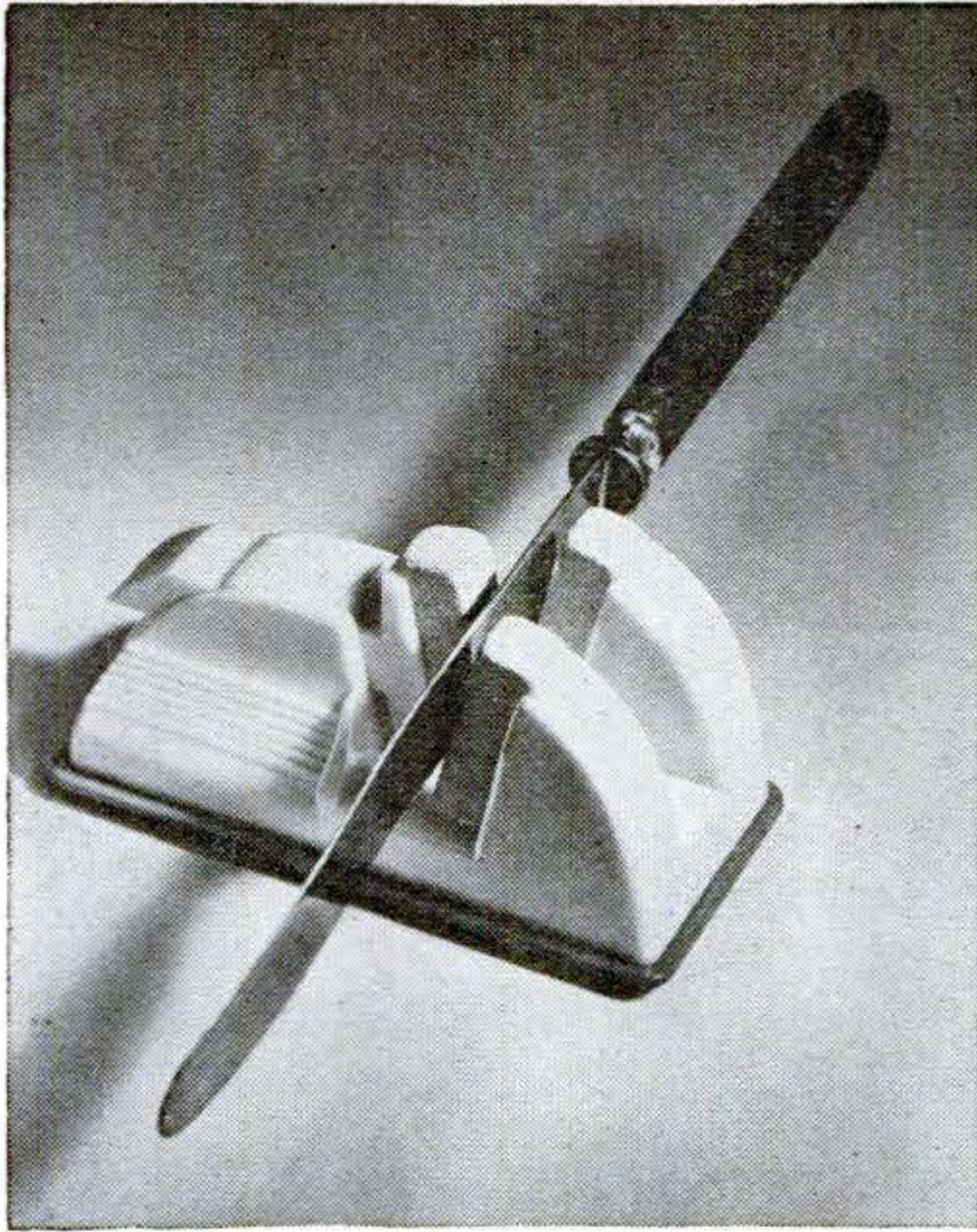

New Knife Sharpener. Modern styling is a feature of a knife sharpener just put on the market by Superedge Products, Inc., of Erie, Pa. Honing stones, angled to form a V-shaped cutting edge, are spring-held in constant contact with the knife as it is pushed forward and down between the stones in a motion similar to that used in cutting bread. The body of the sharpener is made of plastic.

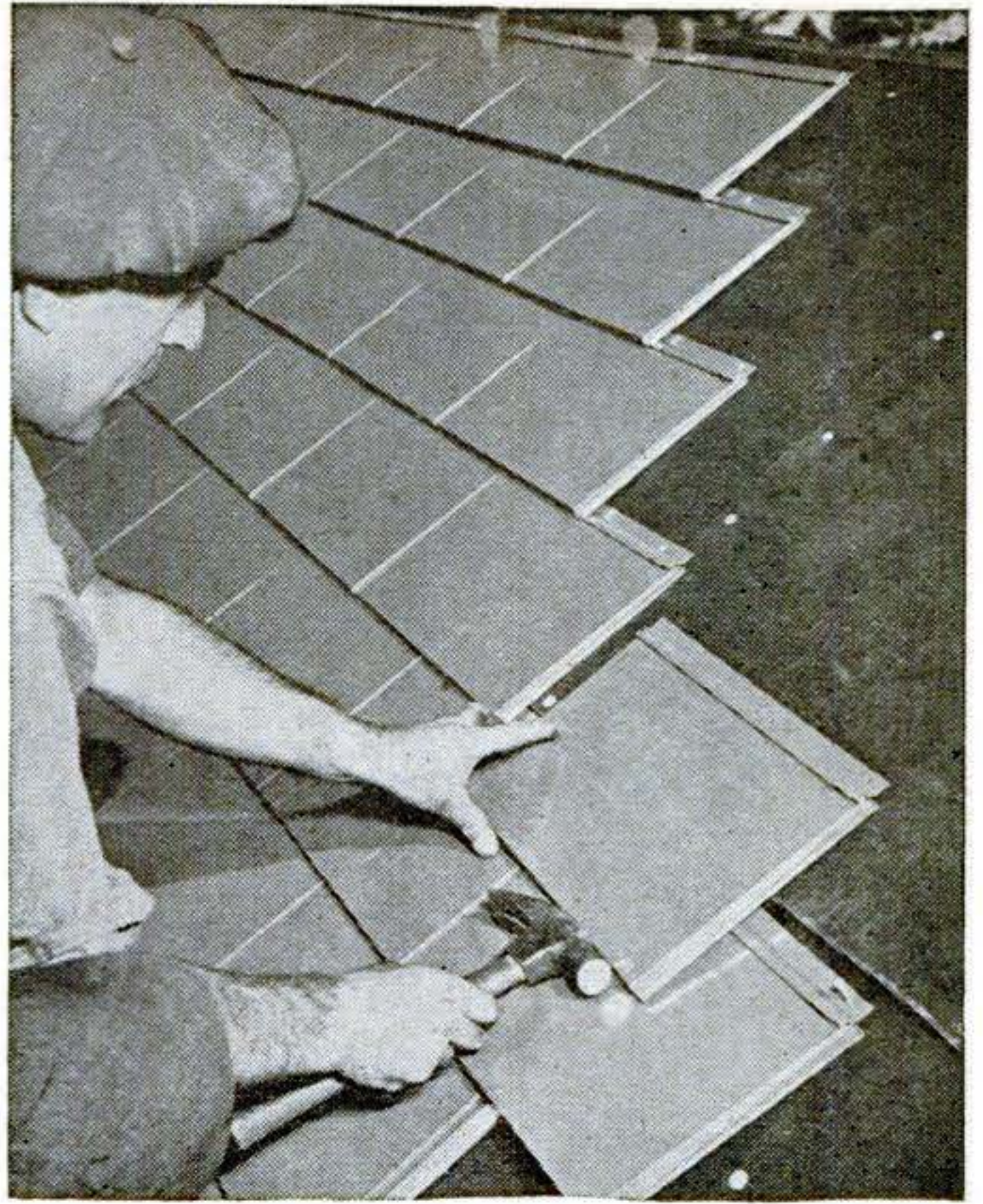

Aluminum Shingles. Rotproof, rust-proof, and fireproof metal building materials are said to give extra safety and service. The shingles pictured above are part of a new line of aluminum building products made by the Reynolds Metals Company. It includes clapboard, roofing, and large-unit sidings. The shingles are raised, forming an air space which increases the metal's ability to reflect heat from either direction.



Soap Dish Folds Up. A molded plastic soap tray made by the Waldonn Corporation, Greenwich, Conn., lifts up to conceal a cake of soap inside a neat pastel-colored box. Shaped to hold soap clear of water, the tray is readily removable for cleaning, and the entire unit can be glued or screw-fastened to any wall. It is offered in a variety of colors and color combinations.

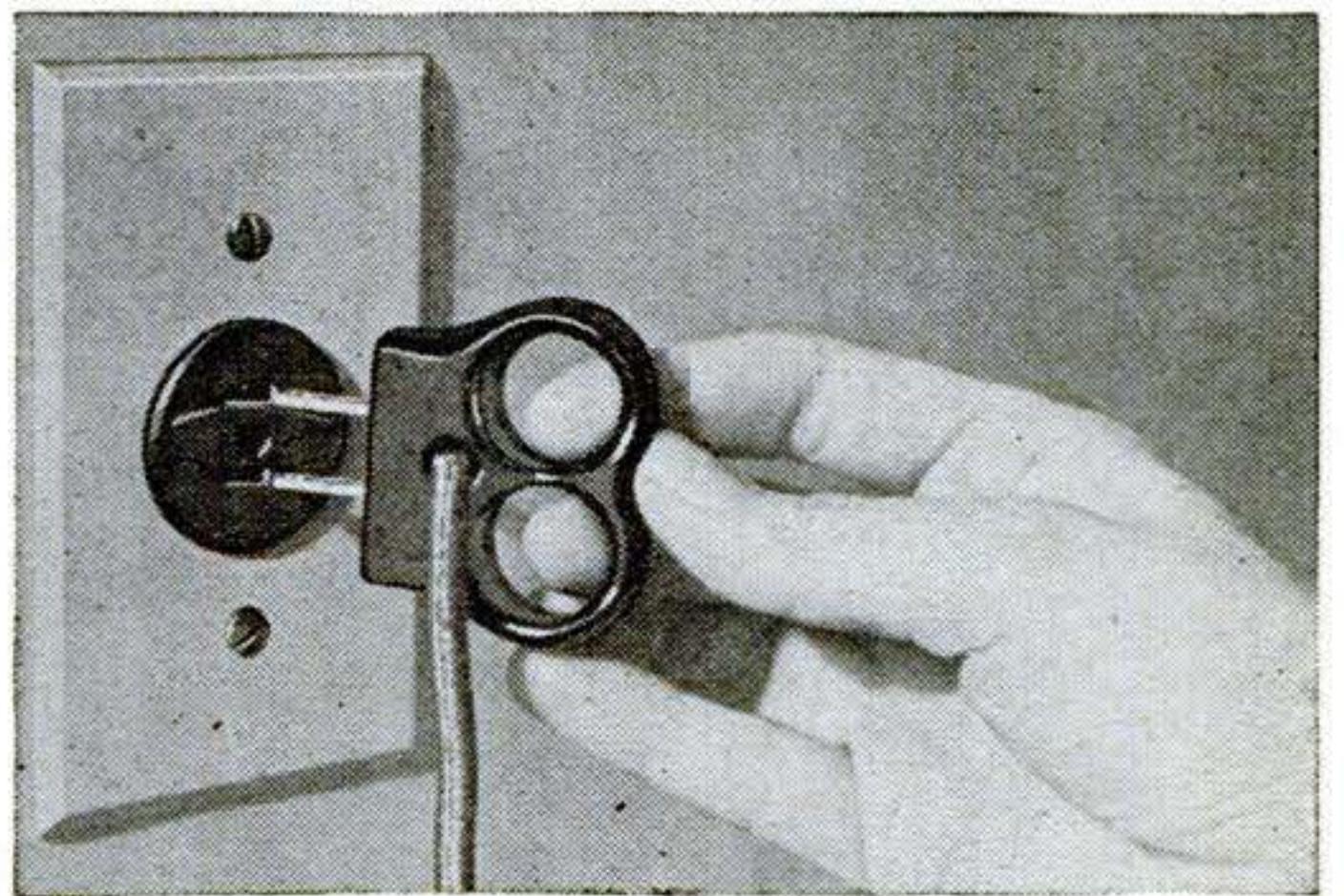

Plug Fits the Fingers. Especially suitable for appliances that are frequently plugged into outlets, this new device makes it easier and safer to pull a plug from its socket. Two finger holes are placed behind the line-cord opening so that none of the pull is transferred to the wire or contacts. L. G. Fiske Co., of Los Angeles, distributes the item.

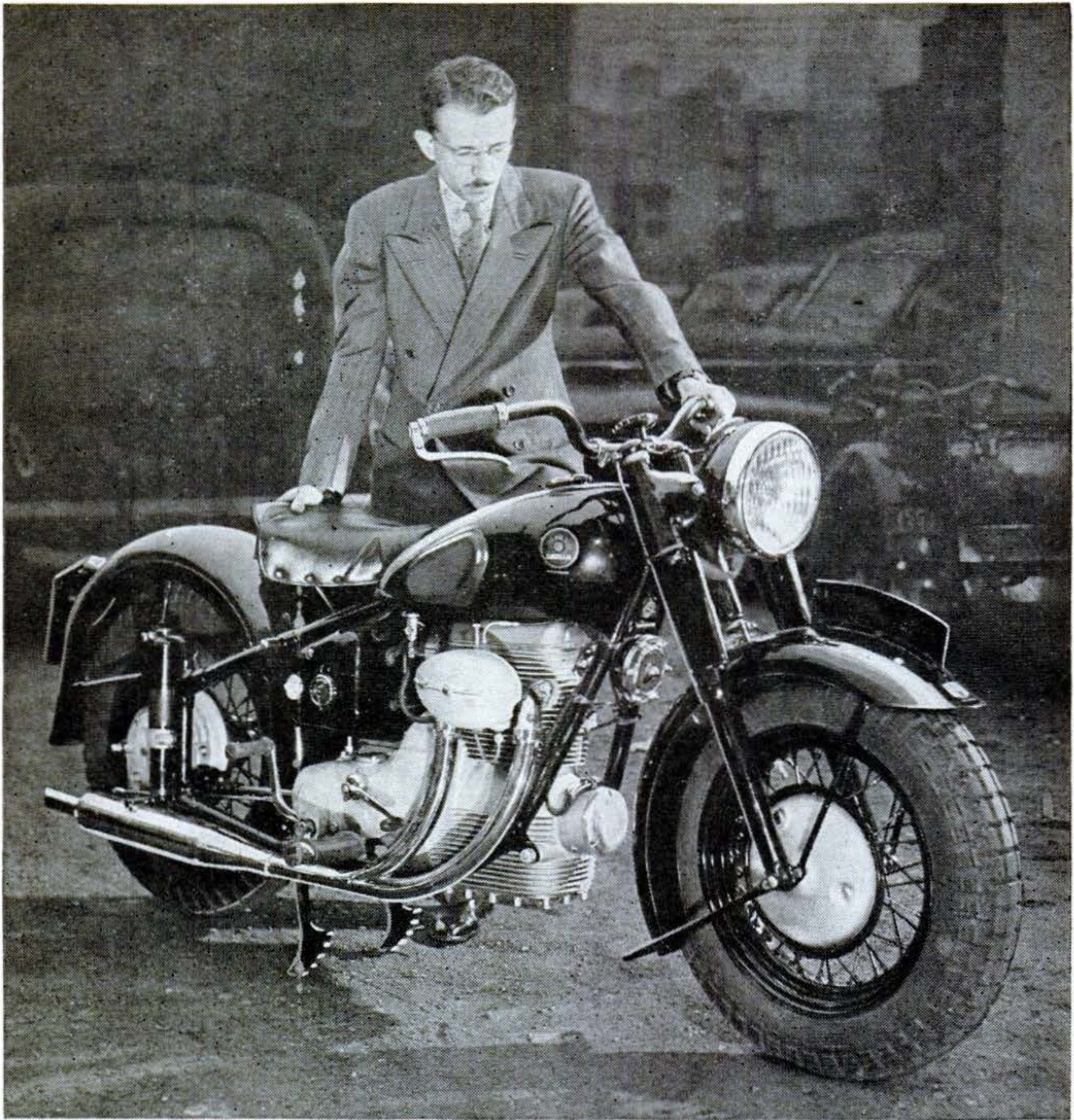

Designed for luxurious touring, the 385-lb. Sunbeam has a shaft drive and a vertical twin in-line engine.

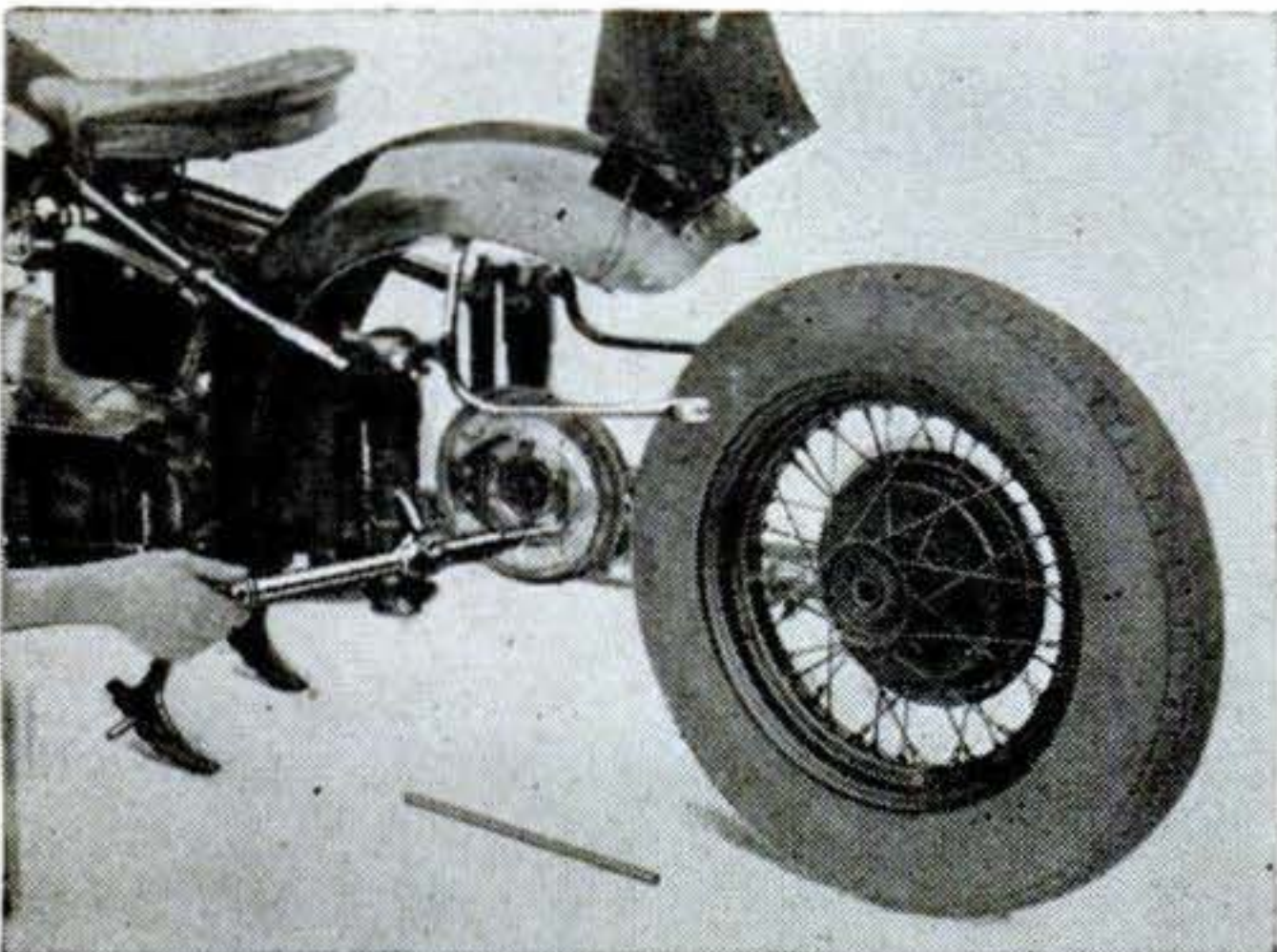

For repairs, the Sunbeam rear wheel may be quickly removed. Power is transmitted from the shaft by an internally splined worm wheel and sliding sleeve.

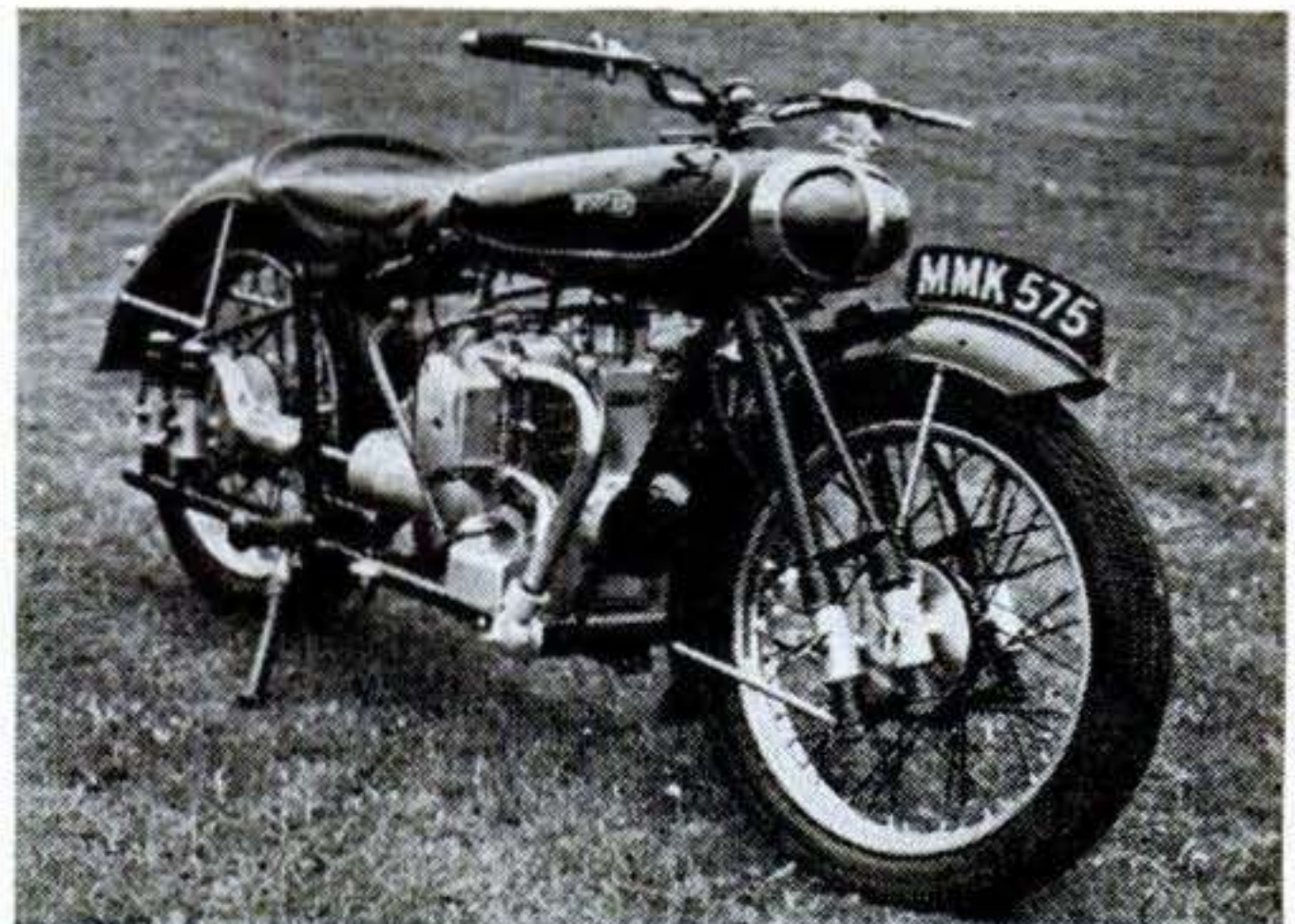

A four-cylinder opposed engine, a shaft drive, and a car-type shift lever are features of the Wooler. This is one of Britain's newest motorcycles.

Europe Puts Its Best Wheels Forward

New motorcycles from abroad strike out along experimental lines with radical design features.

By R. P. Stevenson

EUROPEAN motorcycles now arriving here in considerable numbers are remarkably light in weight and clean in line. The majority have a foot shift and hand clutch. Compact, high-compression engines zip them along with pleasing power and speed. Telescopic front forks, many of them hydraulically damped, and various types of ingenious rear suspensions produce an unusually comfortable ride.

In price, limited-production imported motorcycles aim to meet the domestic price lines between \$600 and \$900. Several exceptionally light utility vehicles are delivered in the United States for a little less. A few de-luxe machines, such as the shaft-driven Sunbeam and the Ariel Big Four, sell for slightly more than \$1,000. Most of the imports are coming from Great Britain, with some from Czechoslovakia and France.

The British Sunbeam would take anybody's eye. Built as a unit with the four-speed transmission, the 500-cc. (30.50 cu. in.) vertical twin, overhead-camshaft engine

bears little resemblance to the power units we are accustomed to seeing in motorcycles, and its quiet performance equals its clean appearance. The transmission shaft has a sliding joint and drives an underslung worm, an internally splined worm wheel transmitting power to the wheel by a floating sleeve splined at both ends. A light-alloy crankcase and cylinder unit help keep down the total weight of the machine to 385 lb. The maximum speed is 77 m.p.h.

Another British motorcycle with a shaft drive is the new Wooler. This machine is also one of only a few European motorcycles with a four-cylinder engine. In this case, the 500-cc. engine is horizontally opposed. Gears are shifted with a car-type lever on the side.

Working in hidden shops, Czech engineers secretly designed several new motorcycles during the war. One of these, the streamlined Jawa, is now being advertised in the United States for about \$500. This machine introduces a novel transmission to motorcycling. The hand clutch lever is used only when low gear is engaged in starting out. Thereafter, all shifts in the upper three ratios are made with the foot pedal alone, movement of the pedal automatically disengaging the clutch while the shift is being effected. Lights on a dial atop the tank indicate the gear that is engaged.

Powered by a one-cylinder, two-cycle



Enclosing the springs in telescopic forks gives a neat appearance in front. This is a Matchless.

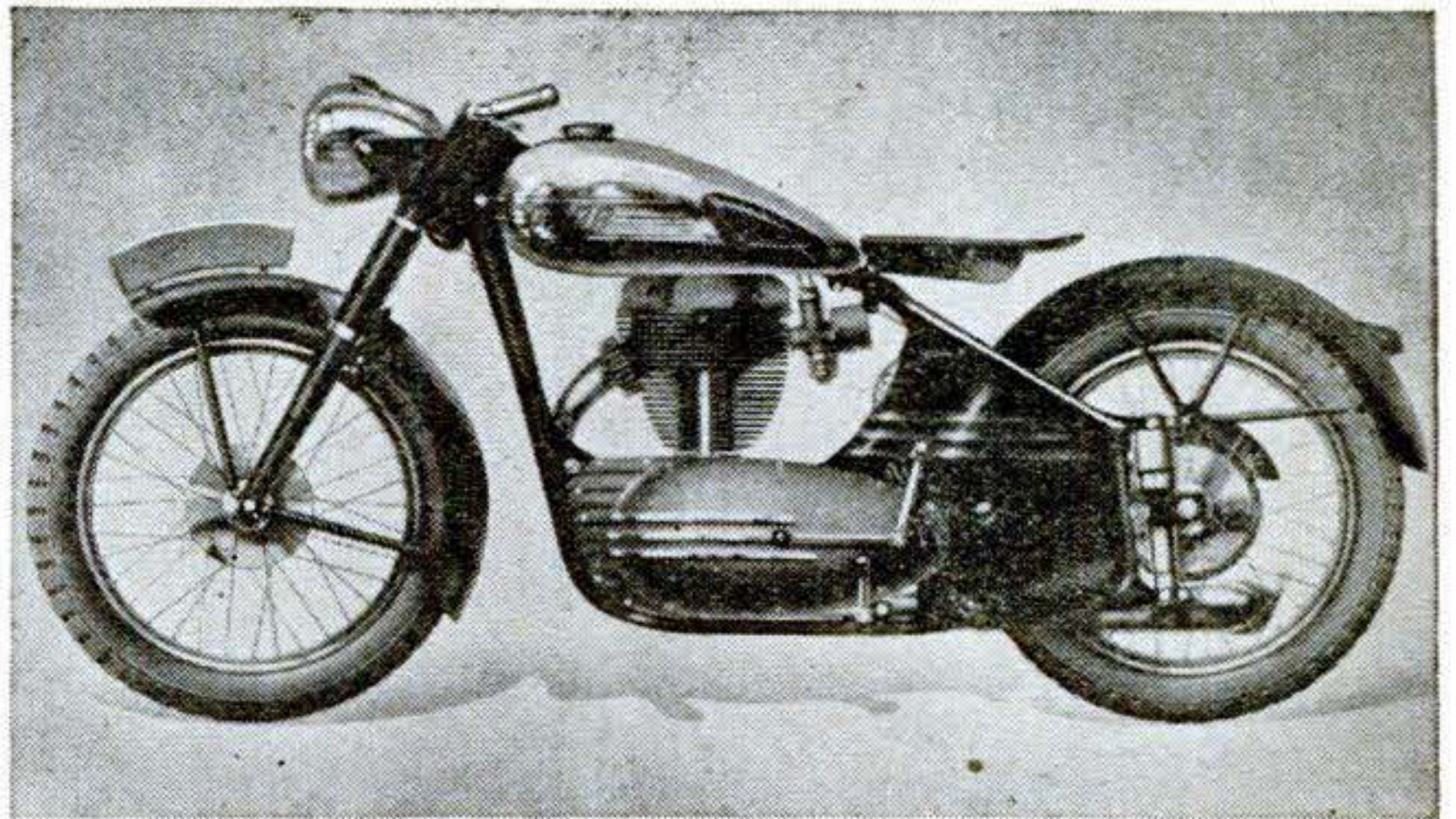

Czech engineers secretly designed this streamlined beauty during the war right under the noses of the occupying Germans. It is an Ogar, powered by a one-cylinder, 350-cc (21.35 cu. in.) engine.

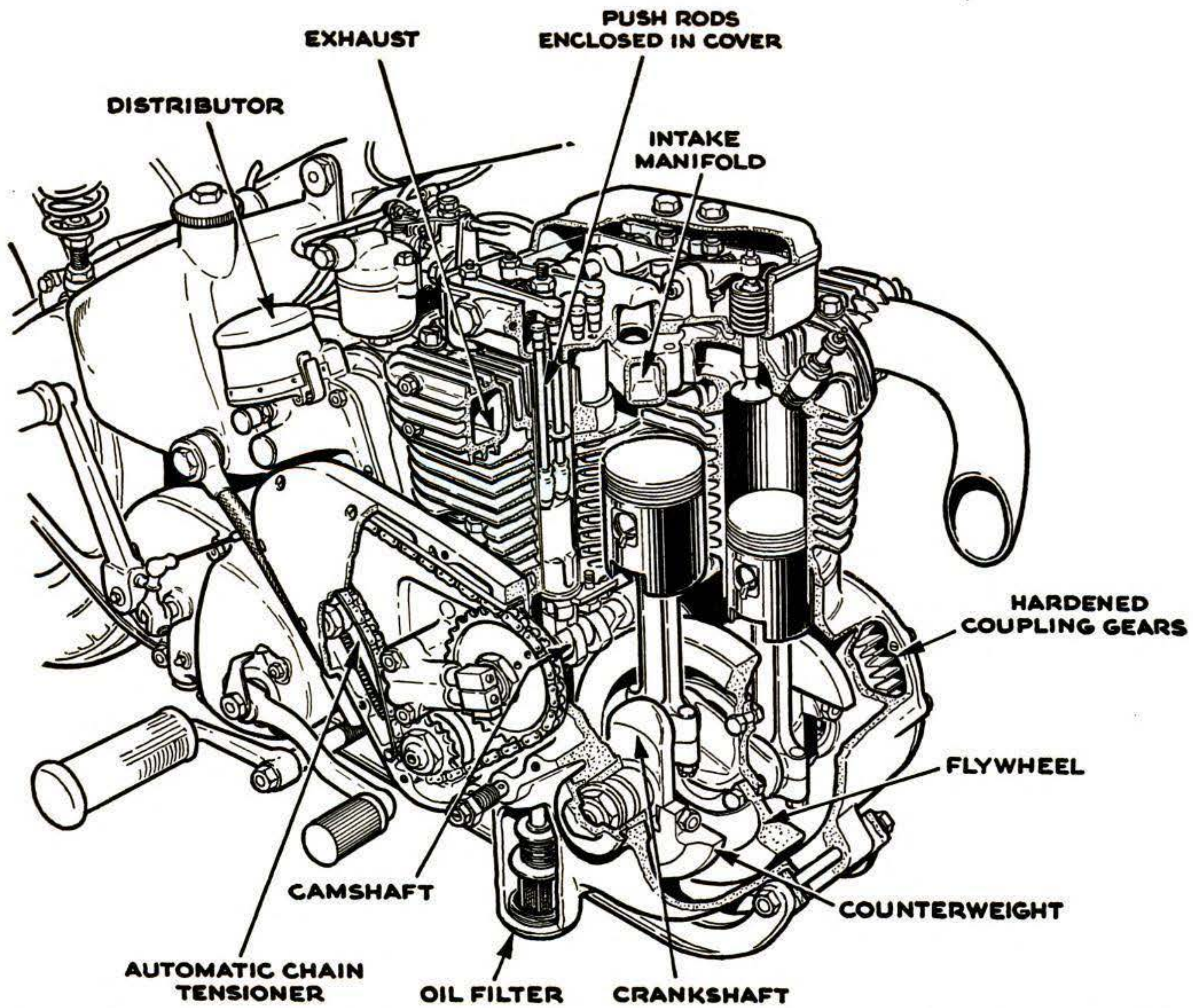

In the Ariel Square Four engine, four cylinders are cast in square formation, each pair driving one of the twin transverse crankshafts that transmit power through spur gears. The capacity is 1,000 cc. (61 cu. in.).

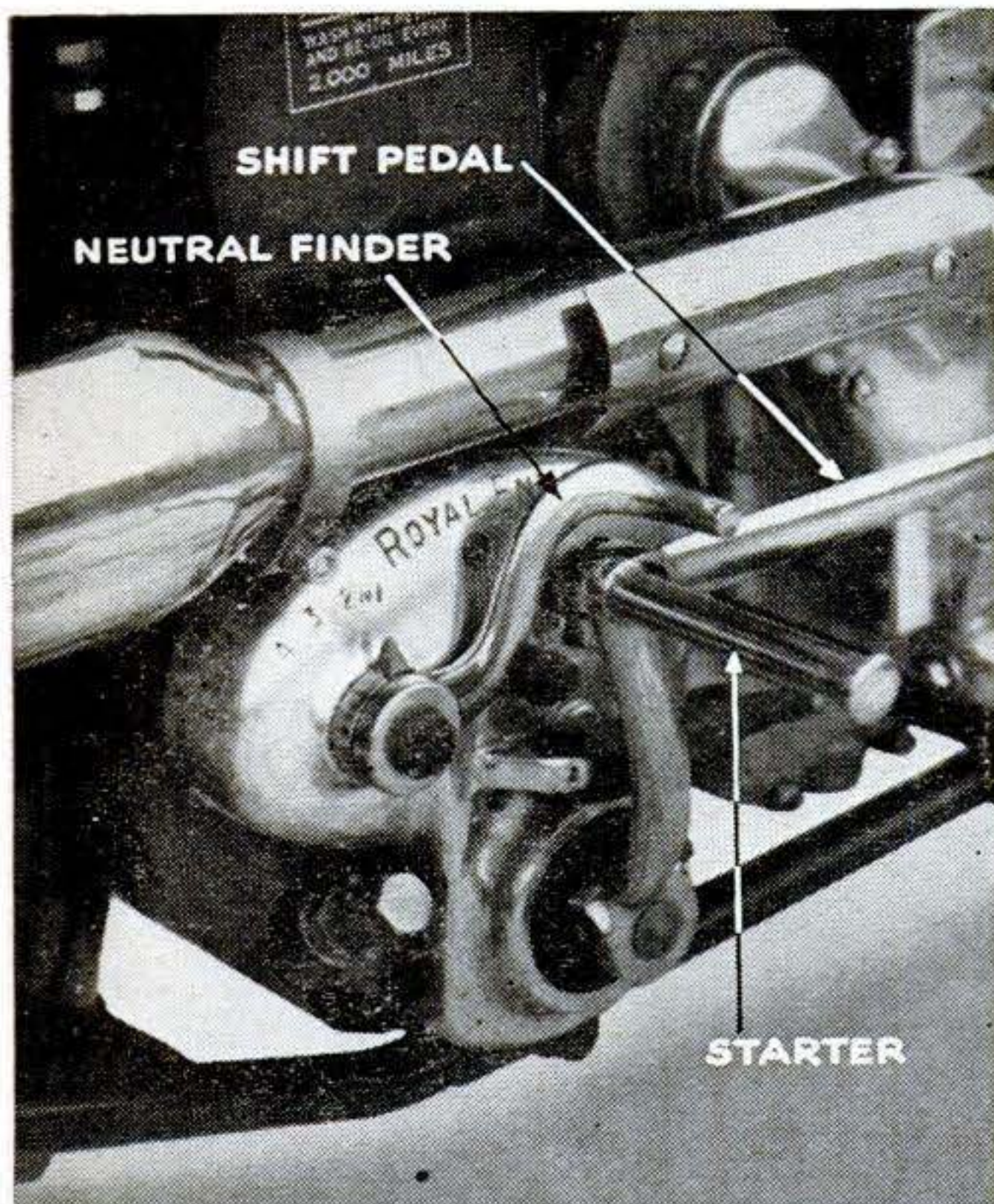

With a foot shift, it is sometimes hard to locate neutral, but a special finder on the Royal Enfield gives positive selection if touched with the heel.

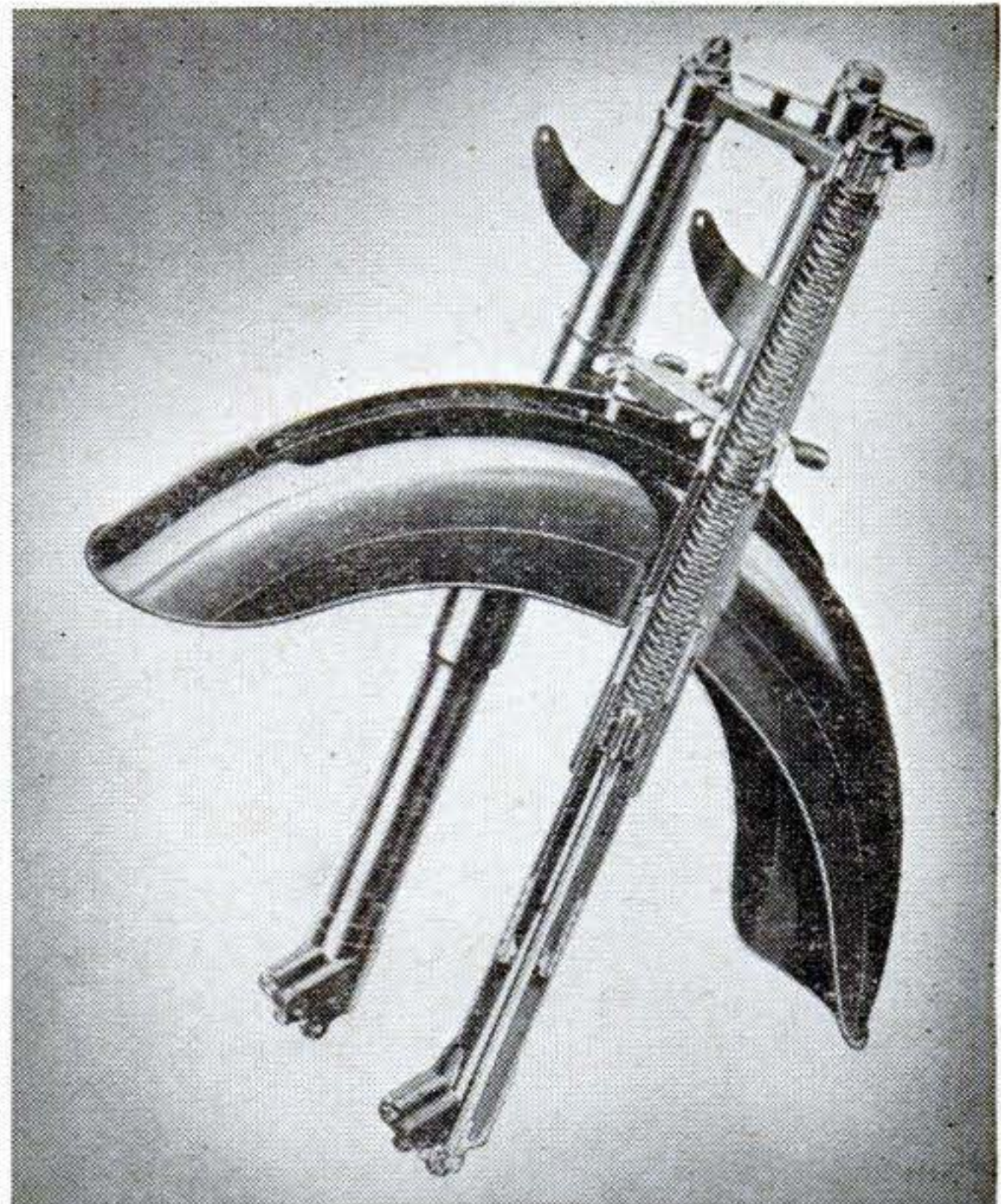

Telescopic forks with hydraulic damping are common in Europe. The Royal Enfield fork, above, allows a 3" movement on either side of the normal position.

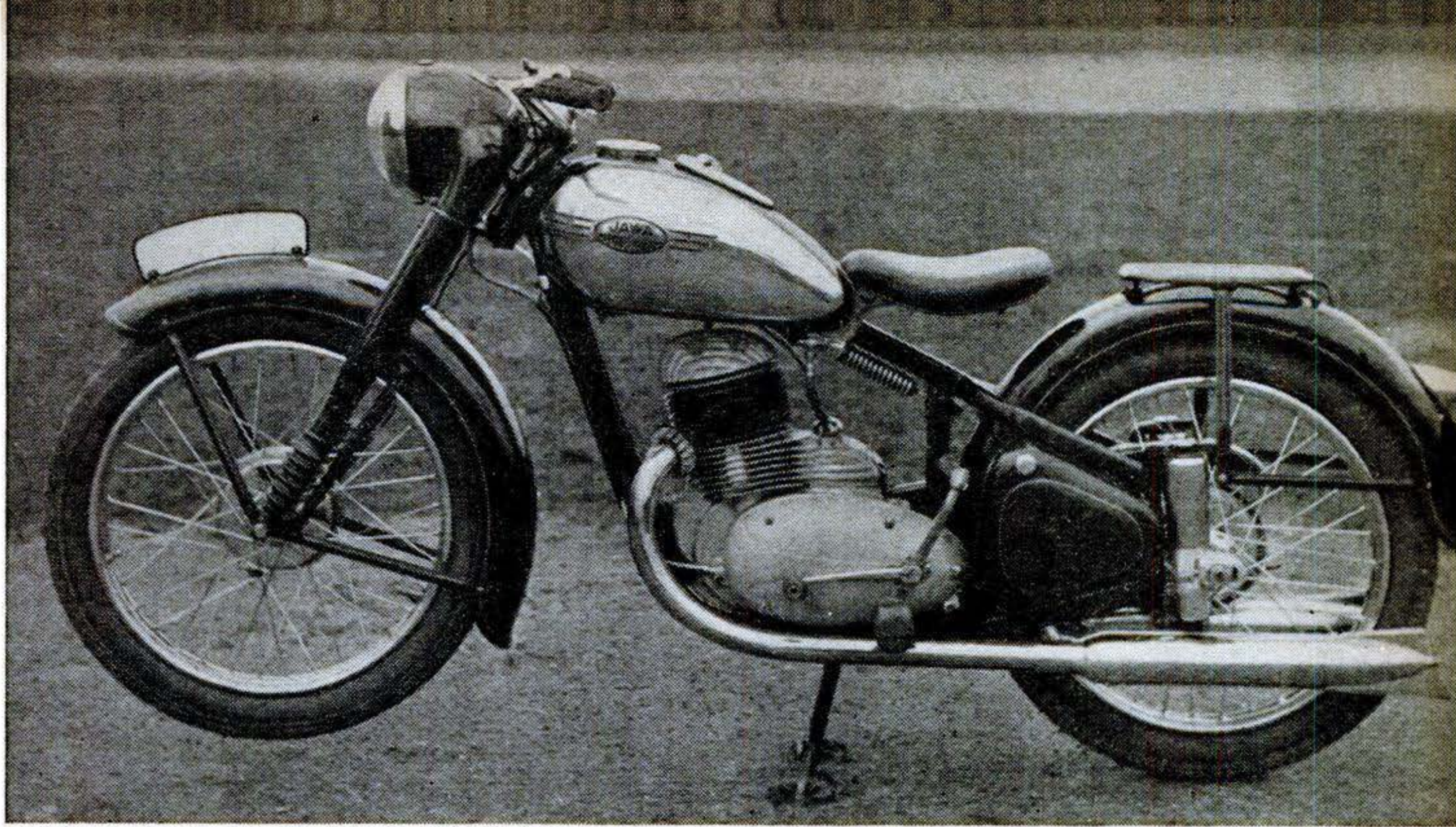

Produced in Czechoslovakia, the clean-lined Jawa introduces a new type of transmission to motorcycling.

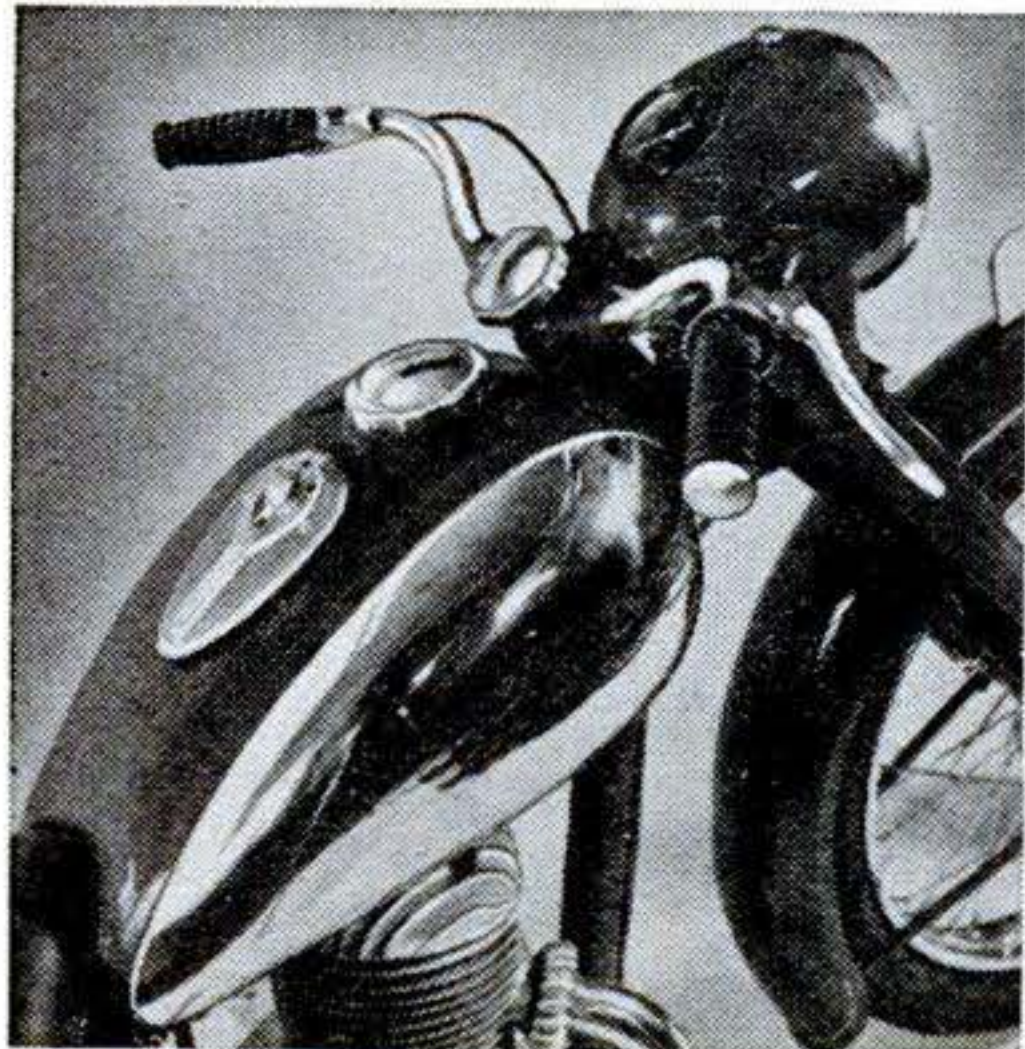

When starting, a clutch is used for low gear, but other changes are made with the foot shift alone. An indicator on the tank shows the gear engaged.

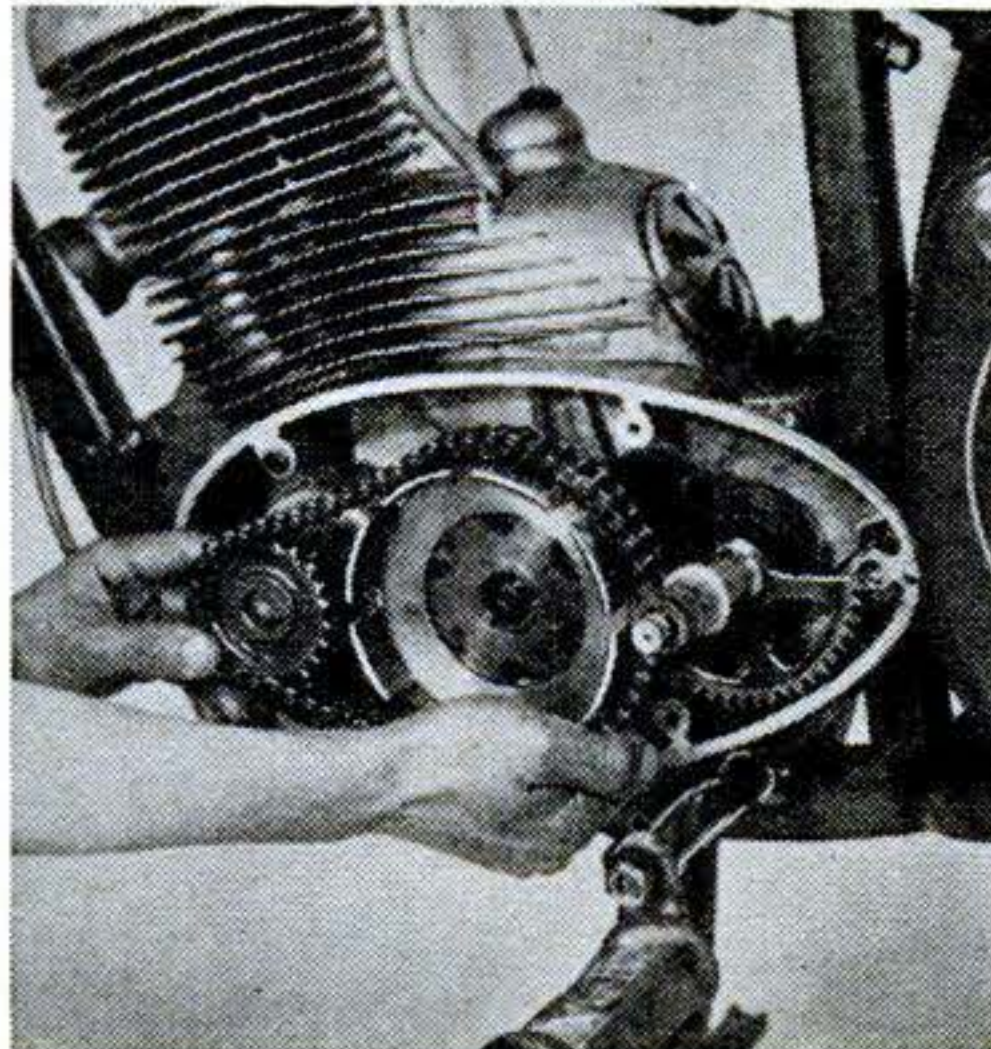

The 250-cc. engine and four-speed gear box form a unit. An air filter also is a feature. A spring under the top frame tensions the seat.

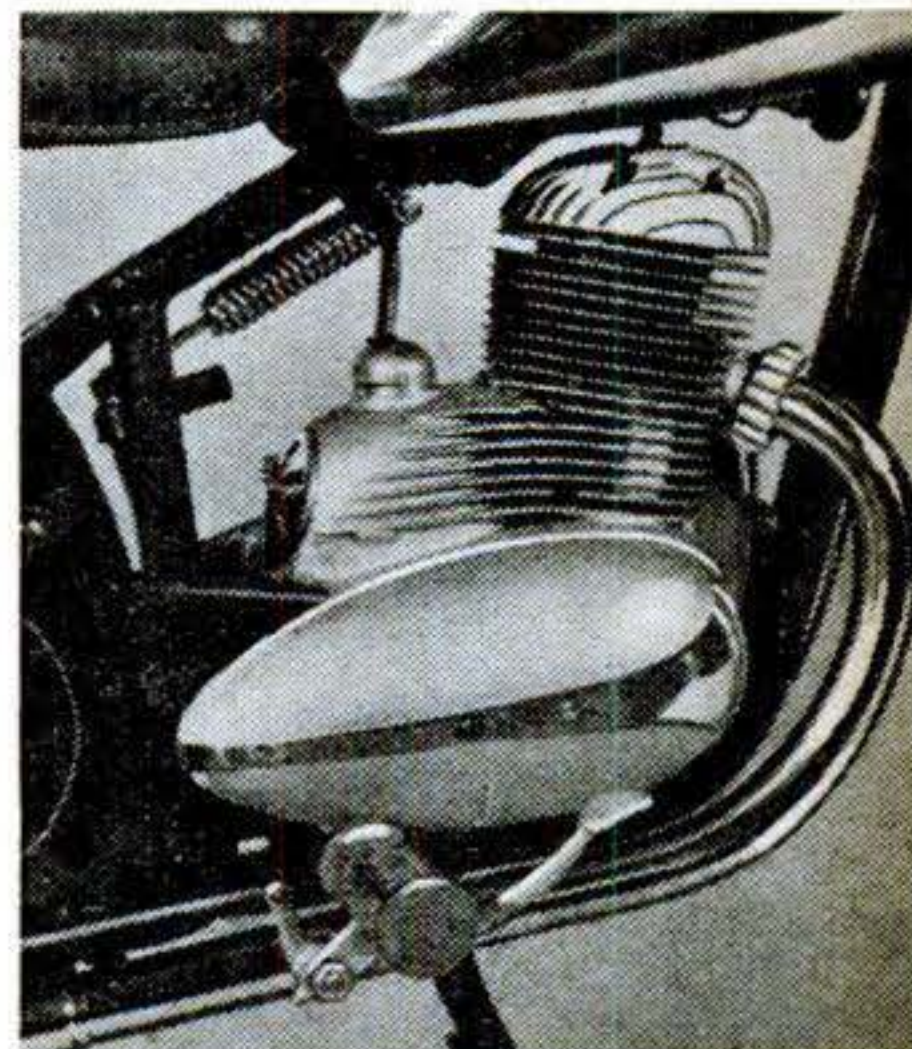

engine that develops 9 hp., this 240-lb. Czech motorcycle has a maximum speed of 62 m.p.h. and gives 94 miles per gallon at an average of 30 m.p.h. Engine displacement is 250 cc. (15.25 cu. in.).

At the international motorcycle show in Switzerland this year, a V-belt drive on a small Swiss machine, the Motascoche, drew considerable attention. This vehicle has no gear box, variation in ratio being achieved by lateral movement of the pulley flanges to alter their effective diameters. A hydraulic mechanism actuated by the oil pump produces this movement automatically.

Consistent with their objective of keeping down the overall weight, Europeans always

have favored a small capacity power unit of high efficiency. British motorcycles show considerable variety in twin-cylinder layout. The vertical cylinders of the Sunbeam are placed in line with the frame. In the Triumph models and in the new BSA vertical twin, they are side by side across the machine. The Douglas uses a flat twin, positioned transversely. In the big Vincent H.R.D. "Rapide," the arrangement is a 50-degree V.

Developed in 1939 but delayed in production because of the war, the new BSA 500-cc. vertical twin was especially designed for good cooling. By placing all the overhead-valve push rods in a tunnel cast in-

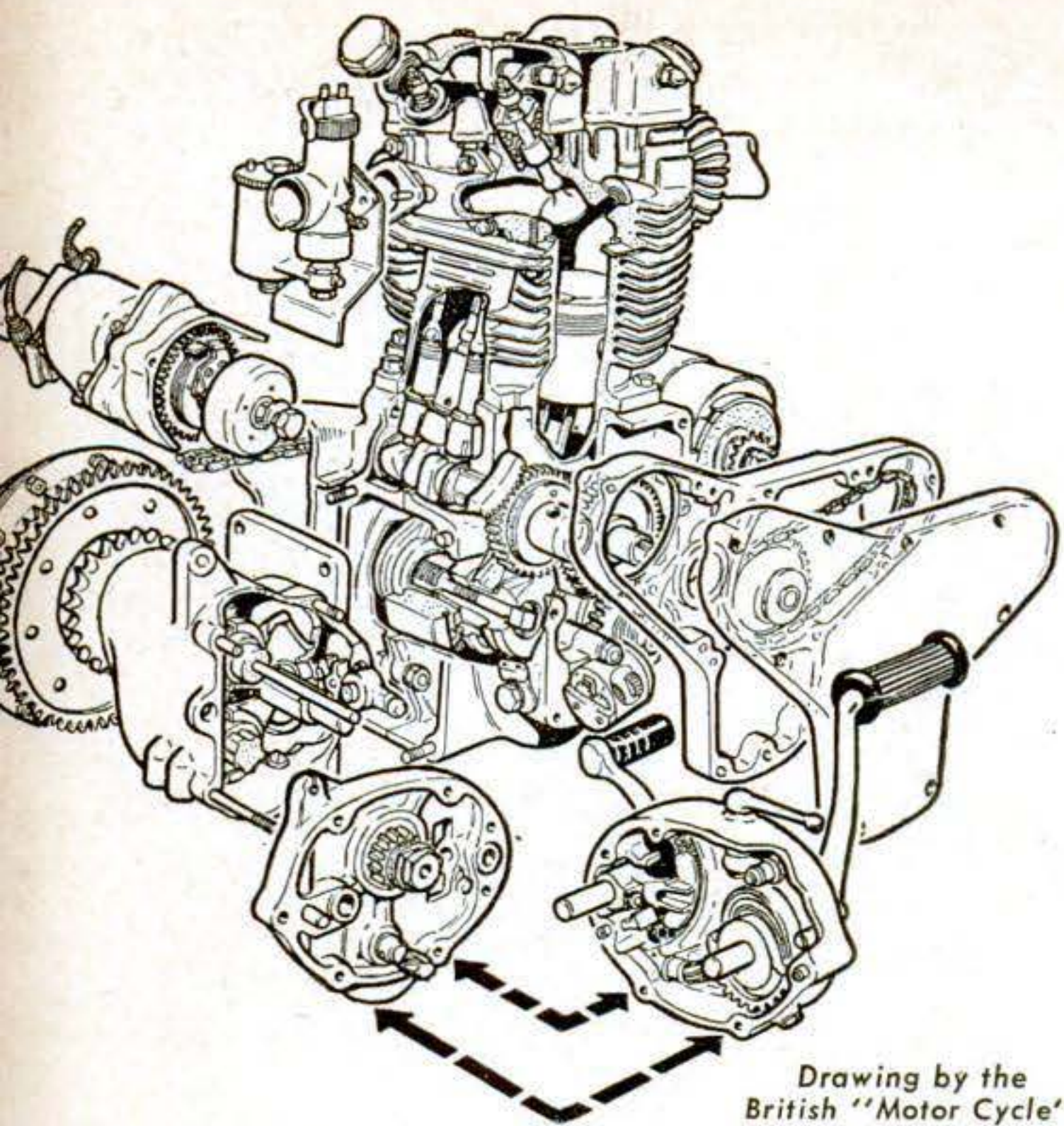

tegrally with the rear part of the block and also locating the camshaft at the rear, the designers produced an engine with nothing to impede the air flow around and between the barrels. Operating on a compression ratio of 7-to-1, this engine develops 26 hp. at 6,000 r.p.m. The top speed is above 90 m.p.h.

An engine that would attract attention anywhere is the 61 cu. in. Ariel Square Four, four vertical cylinders being cast in one block in square formation. Each pair drives one of twin transverse crankshafts and transmits power through a pair of ground spur gears. This machine, weighing 466 lb. without fuel, does around 100 m.p.h.

Water cooling never has been considered a particularly practical idea for motorcycles, but it is employed in the Scott Flying Squirrel, a British machine driven by a two-cylinder, two-cycle engine displacing 36.29 cu. in. Top speed is 80 m.p.h.

Triumph has just introduced a neat type of rear suspension. Hidden inside the hub shell, the mechanism includes three springs—one above the spindle and two below, one inside the other. These springs are curved like the plunger guide in which they operate. Embracing the guide and springs is a two-part guide box, free to move up and down in an arc of a radius equal to the distance from the center of the gear-box sprocket. Chain tension thus remains constant. **END**

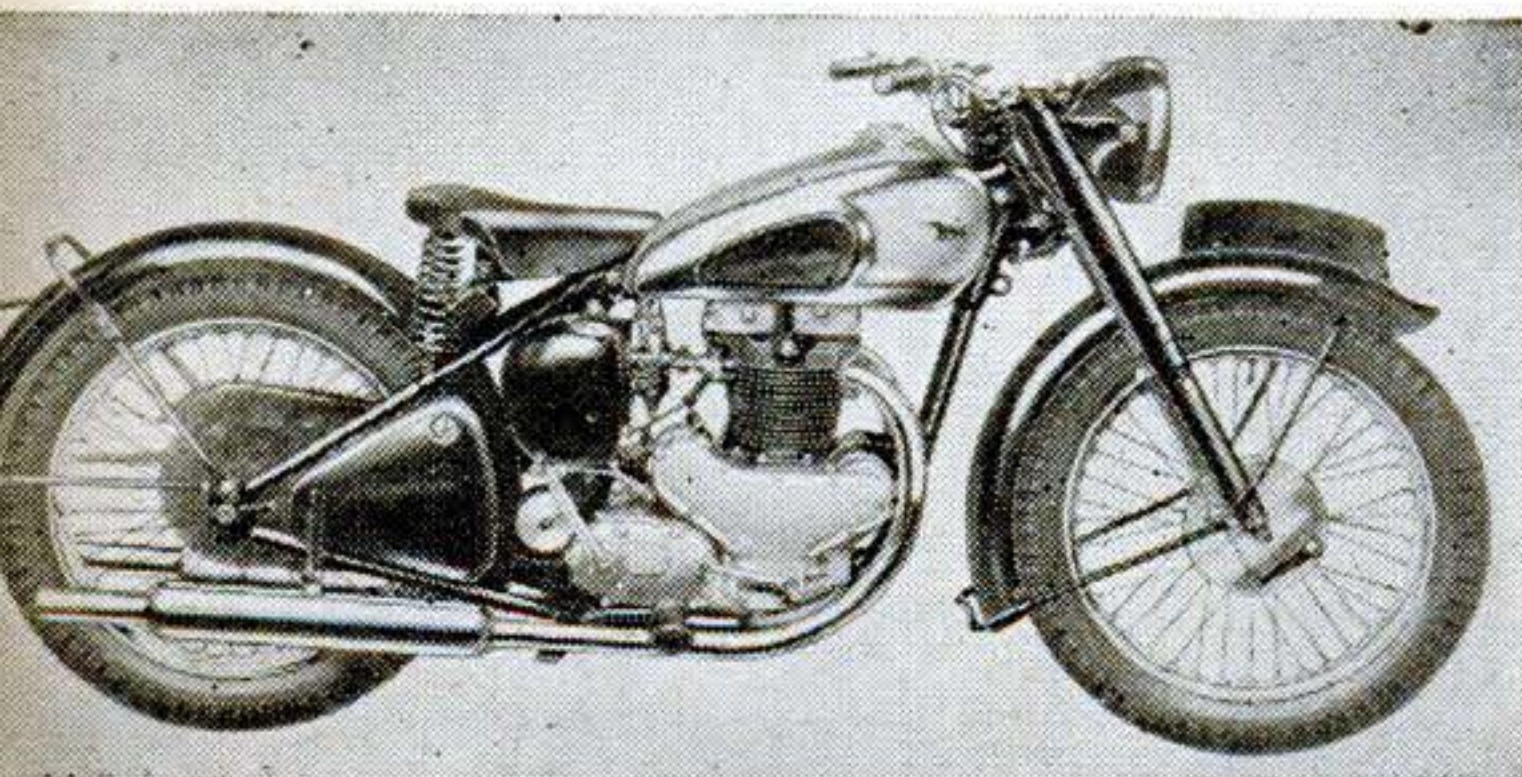

In the new BSA vertical twin, air flow around and between the transverse cylinders is unimpeded, the push rods and camshaft being located at the rear.

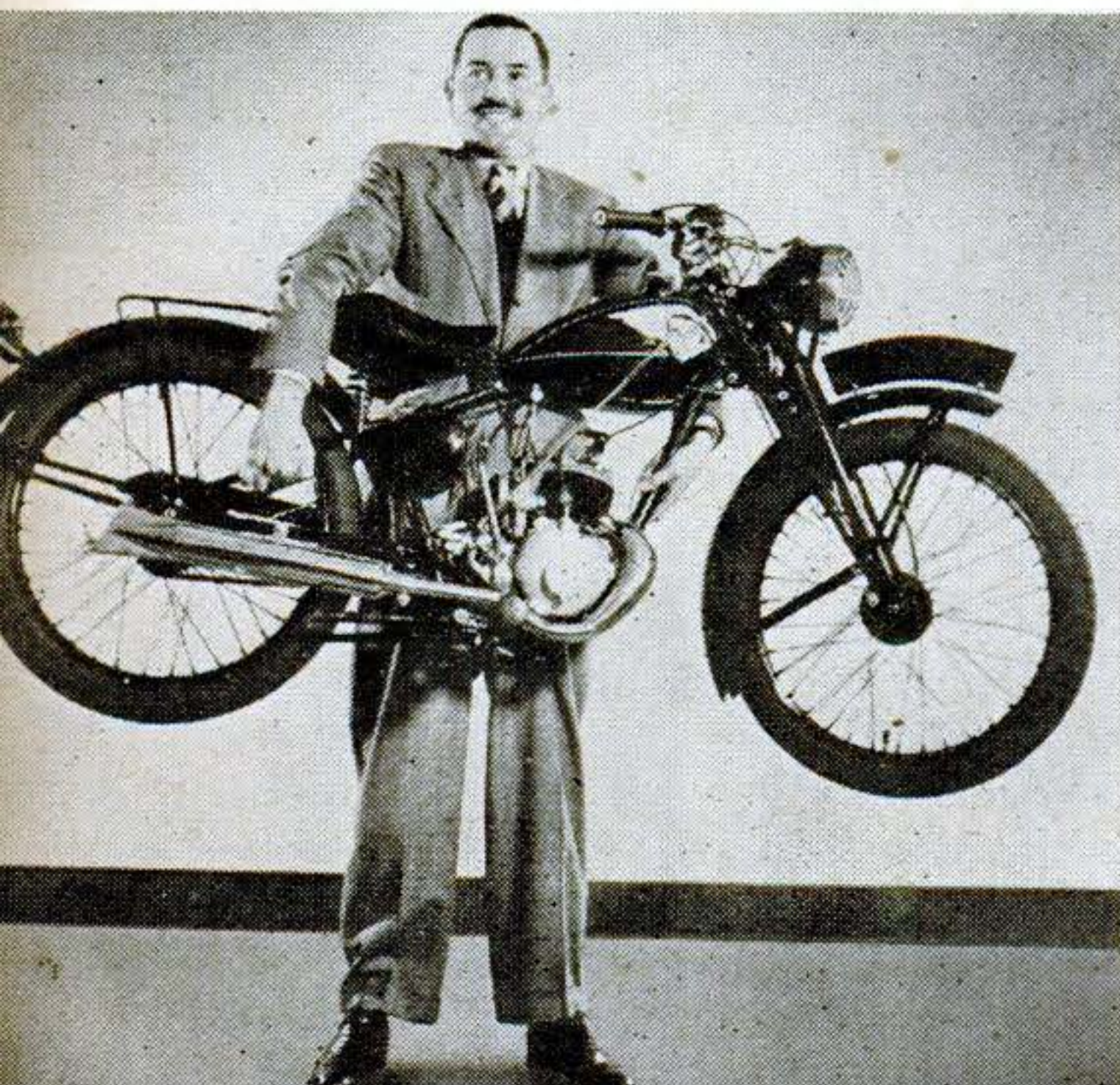

Light enough to heft around, this 135-lb. Enfield travels at about 40 m.p.h. and does 100 miles per gallon. It is typical of European utility cycles.

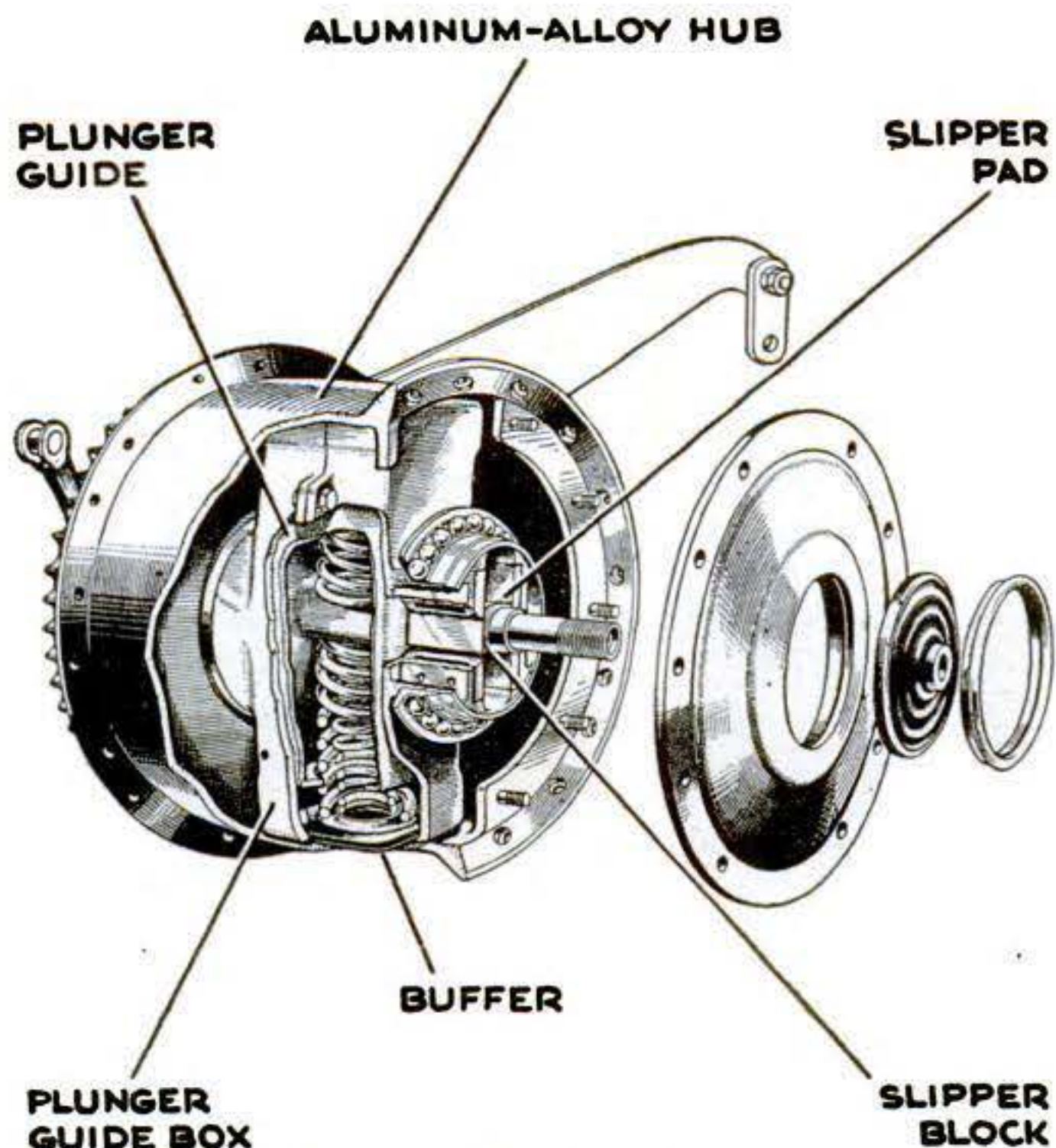

In the Triumph rear wheel, coil springs above and below the spindle operate inside a plunger guide. Replaceable slipper pads absorb the wheel thrust.



Magnet Forestalls Punctures.

Designed to locate nails and other ferrous metals in tire casings, a magnetic tool introduced by Modern Merchandisers, Inc., of Chicago, contains a bulb that glows when the magnet comes near the embedded metal. Said not to be affected by the rim, lugs, or reinforcing wire in tires when properly used, the device is furnished as either a self-contained battery model or for 115 volts.

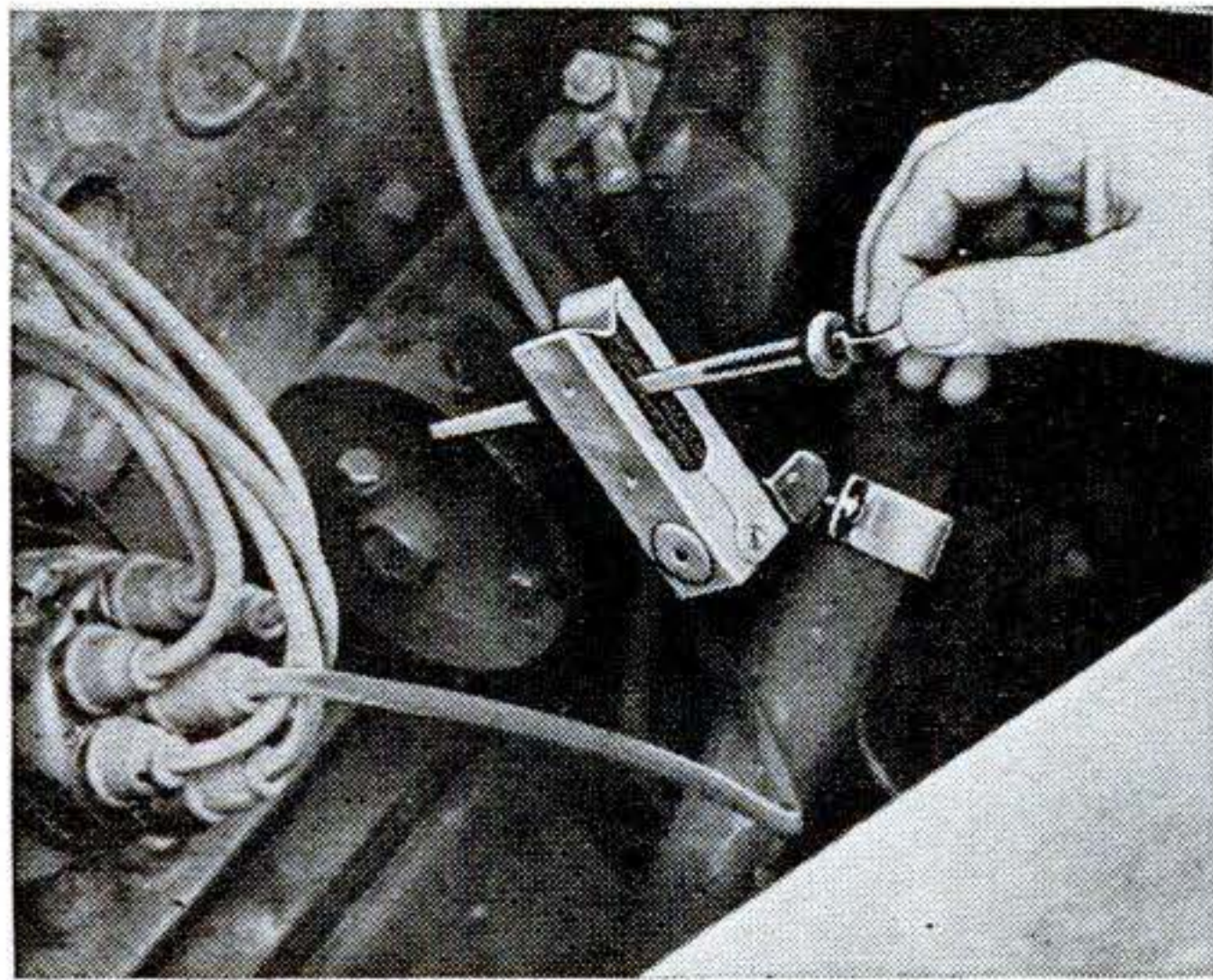

Pads Clean Dip Stick. A dip-stick cleaner made by Bishman Manufacturing Company, of Osseo, Minn., makes it unnecessary to search for a wiping cloth each time you check the oil. Consisting of two felt pads held together by a spring, the unit may be mounted in a convenient spot.



Powder Suppresses Static. Powder that is said to overcome the insulation property of rubber tires and prevent static electricity from building up in a moving car will soon come on the market. An air hose and a special container are used to inject a tablespoonful into each tube after the valve core has been removed. The United States Rubber Company developed the powder as an outgrowth of research on conductive tires for vehicles in industrial plants where a spark would be dangerous.

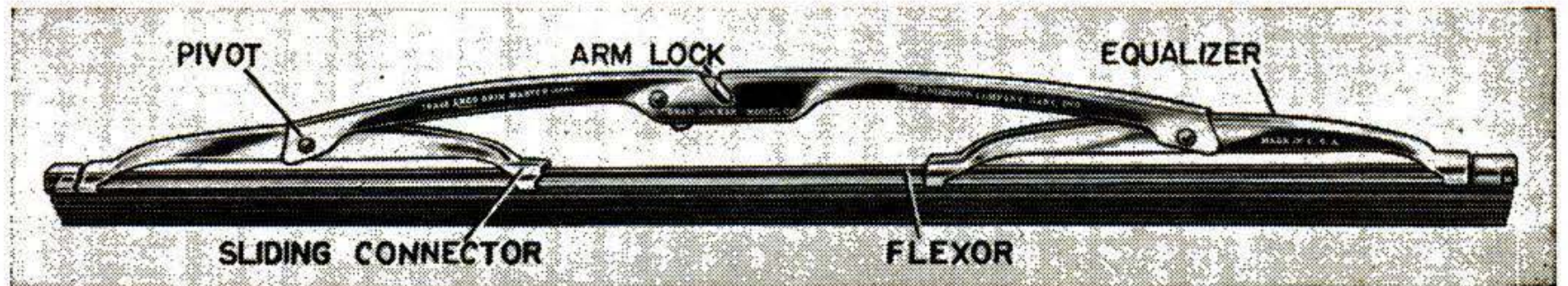

Flexible Wiper Blade. A new wiper blade made by the Anderson Company, of Gary, Ind., bends to conform to a curved windshield or to reach depressions in a flat one. Pressure exerted by the arm is

transmitted through a spanner to two equalizers that slide on a thin flexor forming the backbone of a one-piece molded wiping element. The flexor bends freely up and down but resists sidewise flexing.

Gus Is Taken for a Ride

By Martin Bunn

IT WAS just the sort of Saturday afternoon that Gus Wilson had been wishing for all summer. Hot and sticky, the outdoors couldn't tempt him, and the coolness of his Model Garage shop was doubly inviting. For the first time in many months, there was no unfinished job on the floor.

As he packed the bowl of his brier, he laid out his afternoon. He'd be back from lunch by two, and then he'd get busy on his old coupe. Of course, there wasn't anything really wrong with it, but he had been so busy with other people's cars in the past six months that it needed a couple of hours' work to bring it back to the operating perfection he considered only normal.

Then along about four o'clock George Knowles and Doc Marvin, and maybe a few of the other regulars, would drift in and fill the shop with tobacco smoke and argument. It would be, Gus told himself as he scratched a match on the seat of his coveralls, just like one of those lazy summer Saturdays he used to enjoy before the war.

The urgent honking of a horn jarred him out of his pleasant thoughts. A car rolled in through the open door and stopped with a jerk. Gus recognized it as the sedan for which—and a nice piece of cash—the Millers had traded the ancient Rolls-Royce with which Mrs. Miller had for a while outshone her friends and social rivals.

"Now what," Gus thought, his jaw sagging, "does *she* want?"

According to habit, Mrs. Miller got out talking. "Oh, Mr. Wilson," she burred, "this is just too, *too* provoking. I must be in Middleburg by two o'clock—but *positively*, I mean—and something's gone wrong with my transmission or carburetor or something. But I know you'll be able to fix it for me in a *jiffy*—you're so wonderful with cars."

Gus had learned from experience never to pay any attention to what Mrs. Miller says about her car. He motioned her to a chair, closed his mind to her nonstop chatter, and started checking. In a few minutes he discovered the clutch was slipping badly.

"Half a day's job," he told her. "I'll start first thing Monday morning."

"But I absolutely *must* get to Middleburg right away," she wailed. "If you're *sure* you can't fix my car now, I'll just have to drive it the way it is."

Gus shook his head. "That clutch will never get you over those hills," he warned. "You'll get stalled on the road."

"But I've *got* to be there by two o'clock," Mrs. Miller insisted, dabbing at her eyes with a tiny handkerchief. "It's *vital*—you can't realize how *utterly* vital!"

Gus looked at her suspiciously, but the tears that were beginning to well in her eyes convinced him that she must have some urgent reason for wanting to get to Middleburg, some 40 miles upstate. He would never admit it, but he's a soft touch for a sob story. Foreseeing the ruin of his afternoon of tinkering and talk, he glanced without having to at the shop clock. It was half past twelve, and there wouldn't be a bus or train to Middleburg until three.

"If you really have to get to Middleburg," he said grudgingly, "I'll drive you up in my car."

"Oh, Mr. Wilson," Mrs. Miller gushed, now all smiles, "that's just *too* sweet of you. But I wouldn't *think* of putting you to all that trouble. If you'd just work on my car so I could have it when I get back, and let me drive yours . . ."

Gus blanched—he knows what Mrs. Miller can do to a car. "Oh, my old jalopy is so out-of-date and cranky it would give you no end of trouble," he hedged hastily. "I'll be glad to take you. But we'd better get going to get there by two."

Clear of town and on the highway, Gus speeded up to the State's 45-mile limit and held his old car there. Mrs. Miller, sitting beside him, chirped cheerily on.

"Your car," she told Gus, "runs like a dream—an absolute *dream*. Why don't my cars ever run like that?"

Gus could have told her, but he didn't. He was thinking hard about something else. Halfway to Middleburg they had turned into a short-cut dirt road with a series of steep grades, and the car was beginning to lose power, finding each succeeding hill harder than the one before. Gus was thinking that, if he had had a chance to go



Gus took out the fuel pump, looked at it, and scratched his head discouragedly. "I must have been a nut . . ."

over his car in the past six months, this would never have happened. Then, 50 yards short of the crest of the longest hill they had come to, the engine sputtered and stopped.

"Now, Mr. Wilson," Mrs. Miller giggled as Gus applied the emergency brake, "don't tell me *you've* run out of gas."

"Not out of gas," Gus answered ruefully, "out of luck." He pressed the starter button, and the engine turned over but wouldn't take hold. "It seems to be the fuel pump—and we're at least five miles from a garage."

"You don't mean we're stuck, do you?" Mrs. Miller squeaked. "That would be perfectly *terrible!* I've just *got* to be in Middleburg by two, and you *promised* to get me there!"

Without replying, Gus got out on the dust-thick road. Perspiring in the humid atmosphere, he removed his coat, rolled up his sleeves, raised the hood, and began checking. He removed the carburetor feed line and found what he expected—that the fuel pump wasn't pumping. When he took

off the fuel pump, his face turned red—and it wasn't from the hot sun.

"This would have to happen right in front of the gabbiest dame in town," he told himself. "She'll spread it all over. I'll never hear the end."

Mrs. Miller's eyes were becoming moist again. "What are you fooling with *that* thing for?" she sniffled. "*Do something!*"

Gus turned redder, and this time it was anger instead of embarrassment. "If you'd just keep quiet for a minute, maybe I could do something!" he snapped. "I can't even think with you jabbering."

"O-o-oh, Mr. Wilson," she moaned, but she cut short her talk, and Gus saw why the fuel pump had stopped pumping. Long wear on the push rod and rocker-arm linkage had progressed so far the movement of the push rod was no longer sufficient to take up the play and still move the diaphragm enough to pump gas.

"No answer to that but a new fuel pump," he told himself discouragedly. "I must have been a nut . . ." Then he said out



loud: "By gum, that might work at that!"

Mrs. Miller forgot her feelings had been hurt. "Why, Mr. Wilson," she gurgled, "I do believe you have an *idea*."

"Yes," Gus grinned. "It may be a nutty one, but it's worth trying."

She watched him paw hurriedly through the tool box and then quickly reassemble the fuel pump and lower the hood.

"Jump in," he told her, "and we'll see if it works."

It did. Gus stepped on the starter, and after it had ground for a few seconds the engine took hold and ran smoothly. "Let's go," Gus laughed.

They made Middleburg on time. The clock on the town-hall tower showed exactly two as they drove into the village.

"That's the place," Mrs. Miller pointed excitedly as they reached a tumble-down old house in front of which a small crowd was gathering. "I won't be long."

She darted up the path, and when Gus got out to see what was going on, his eyes caught a sign that proclaimed, "Auction."

He had to laugh. "So that's it," he muttered. "I *am* a fall guy."

Ten minutes later a large and opulent

limousine stopped at the gate, and a chauffeur helped a large and opulent woman out. As she started up the path, Mrs. Miller came out of the house, an expression of triumph on her face and a large green-glass pitcher in her arms.

"Good afternoon, Mrs. Grigsby," she smiled sweetly to the rapidly purpling Mrs. Grigsby. "I'm *so* afraid you're late." Then she got into Gus's car. "It's *hideous*," she told Gus confidentially, "but it's *authentic* Colonial or early Federal or something, and Mrs. Grigsby has been after it for *ages*. I was determined to beat her to it, and I knew she had a club meeting that wouldn't let her get here until after two o'clock."

HENRY MILLER strode into the shop about six that evening while Gus was at last working on his car.

"What's this about you stalling your car on a back road with my wife?" he began.

For the third time that day, Gus turned red. "Now, Henry," he interrupted.

Miller laughed out loud. "What I want to know," he demanded, "is how you fixed a busted fuel pump. I've always thought when one went you needed a new one."

"Oh, that," Gus grinned with relief. "You see, the push rod and rocker-arm assembly had worn so much the movement of the push rod wasn't enough to work the diaphragm and pump gas. I laid a thin nut on top of the push rod to take up play."

"Say," Miller whistled, "what in the world gave you that bright idea?"

"I was thinking what a nut I had been not to have checked my car sooner," Gus grinned sheepishly. END

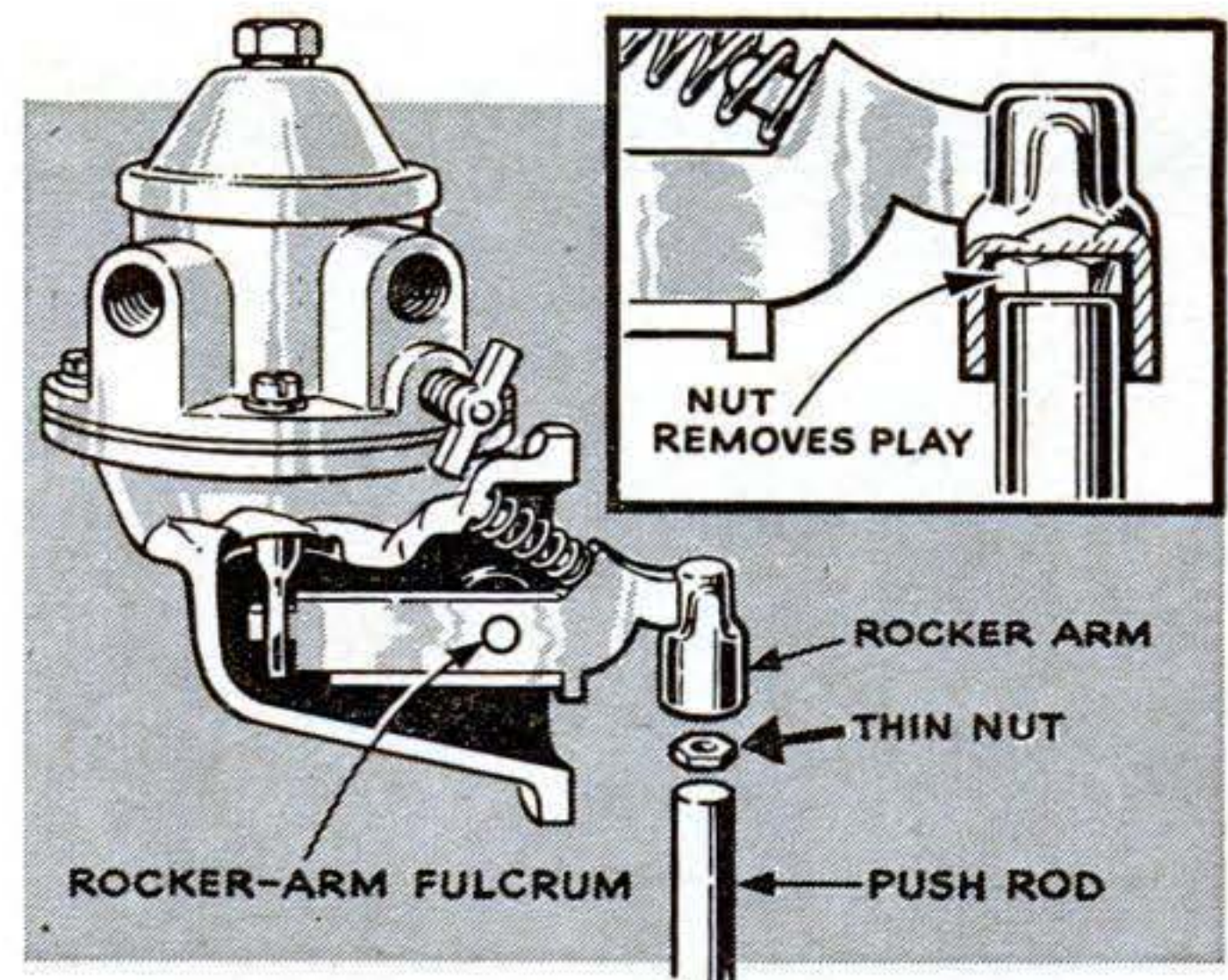

Laying a thin nut on top of the push rod took up the play of the worn parts and enabled the rod to work the diaphragm to pump gas.

MECHANICS AND HANDICRAFT



- **Overshot Water Wheel**
- **Radio Control for Models**
- **Carving Inside Plastic**
- **Aluminum Dinghy**
- **Chemistry of Hydrocarbons**

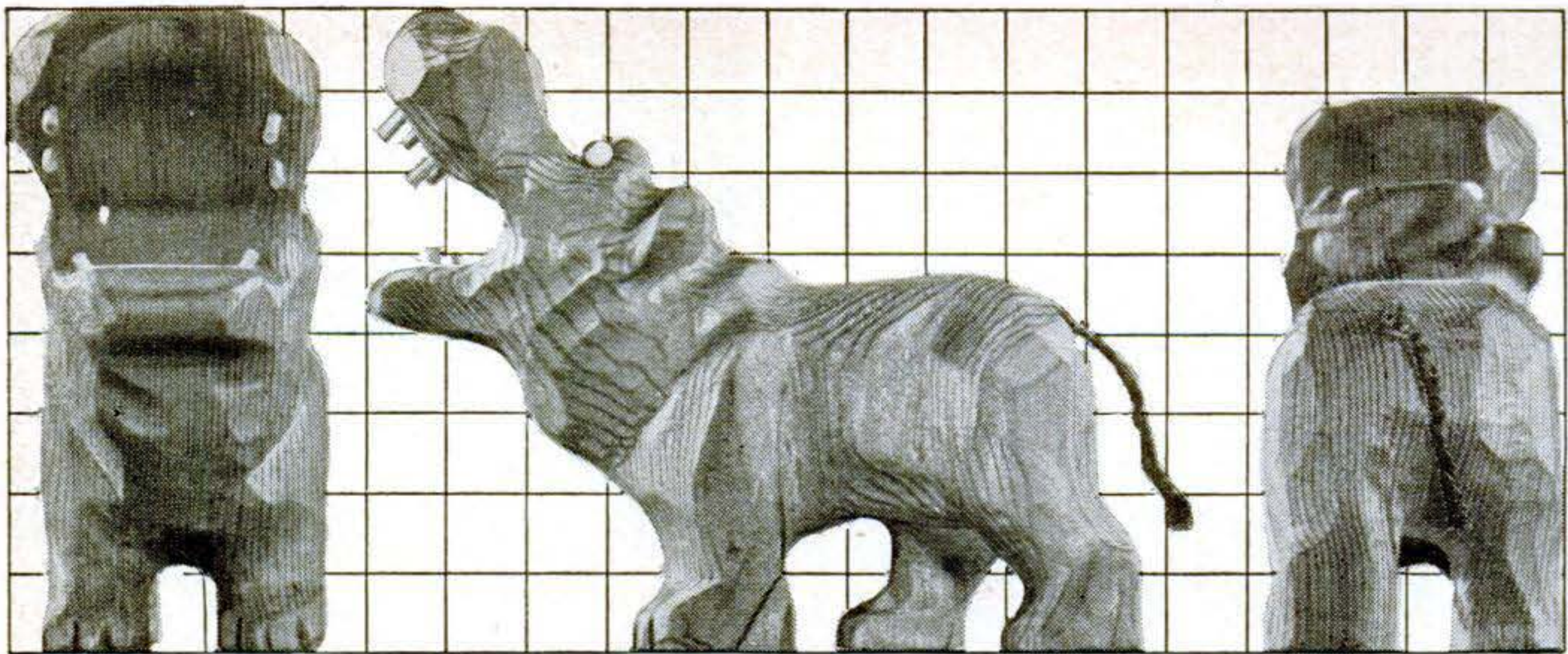

Hippo Tops Box

HANNIBAL HIPPO, with his toothy grin, makes an eye-catching handle on the lid of a handkerchief or stamp box. The project is a rough carving and should be sanded only sparingly.

Complete the squares across the front and side views with ink and transfer the profile to $\frac{1}{2}$ " or larger squares. You'll find the front and back views a help in carving. Glue in bits of round toothpicks for teeth. Eyes are map pins with painted pupils, and the tail is cord.—ELMA WALTNER.

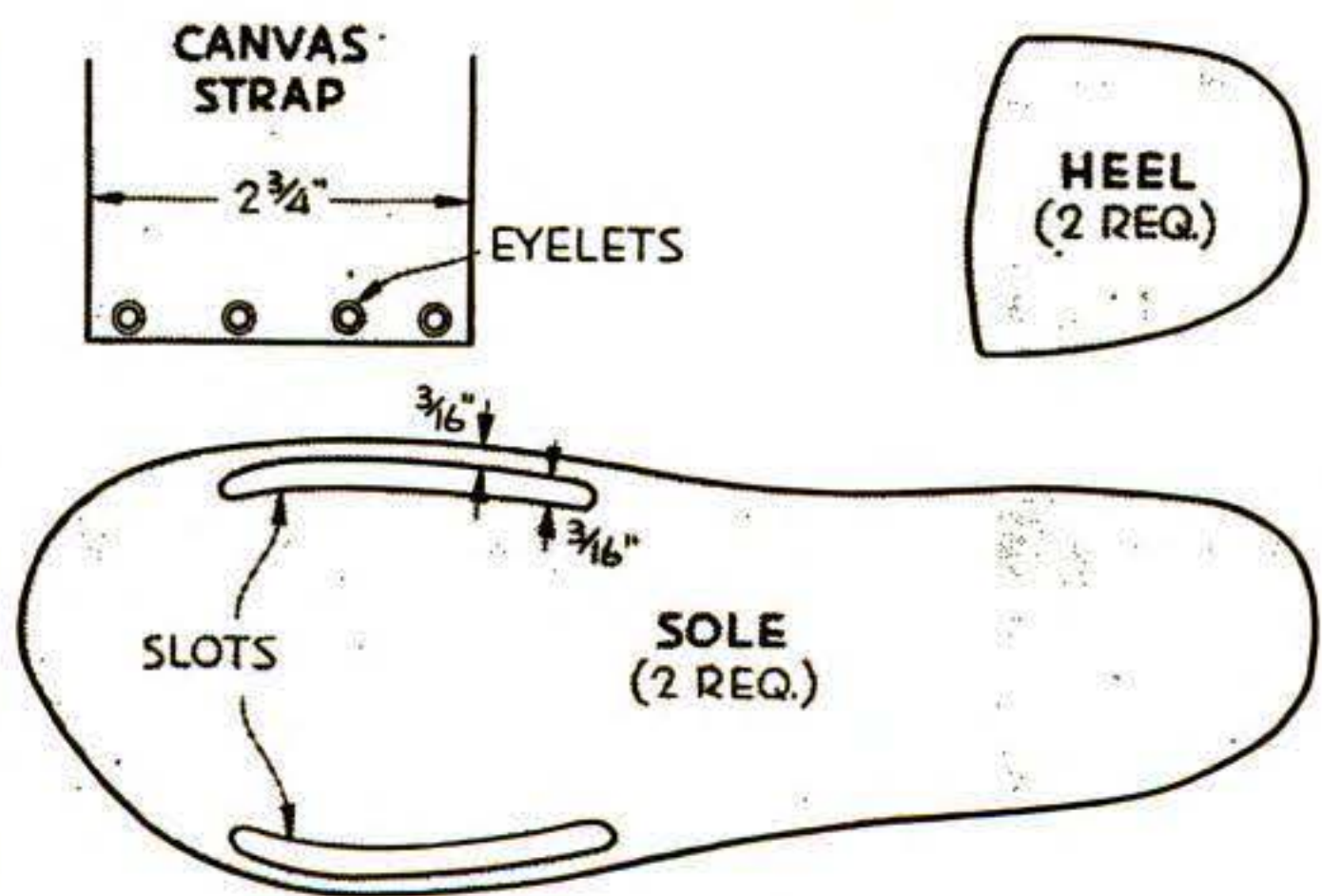
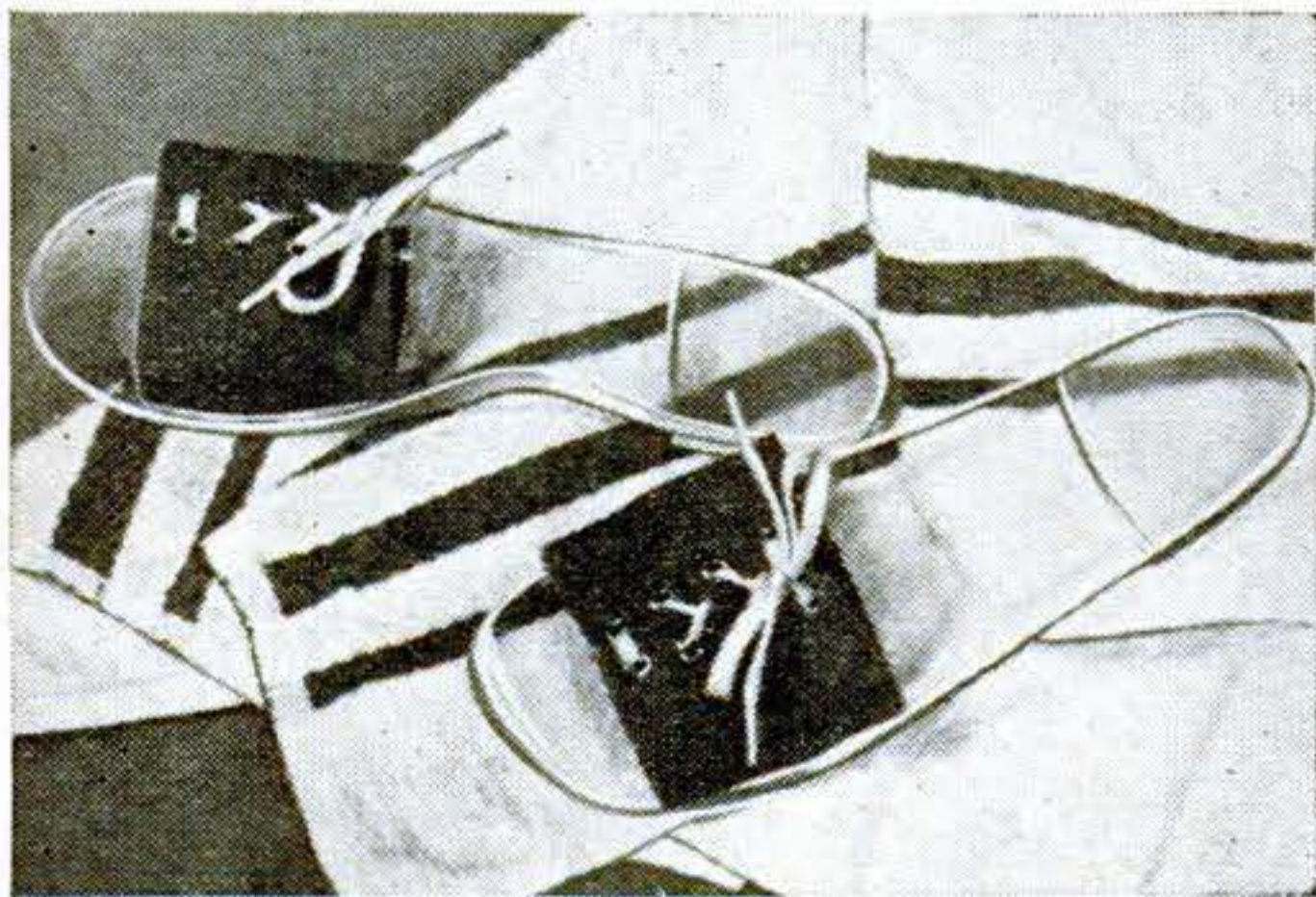
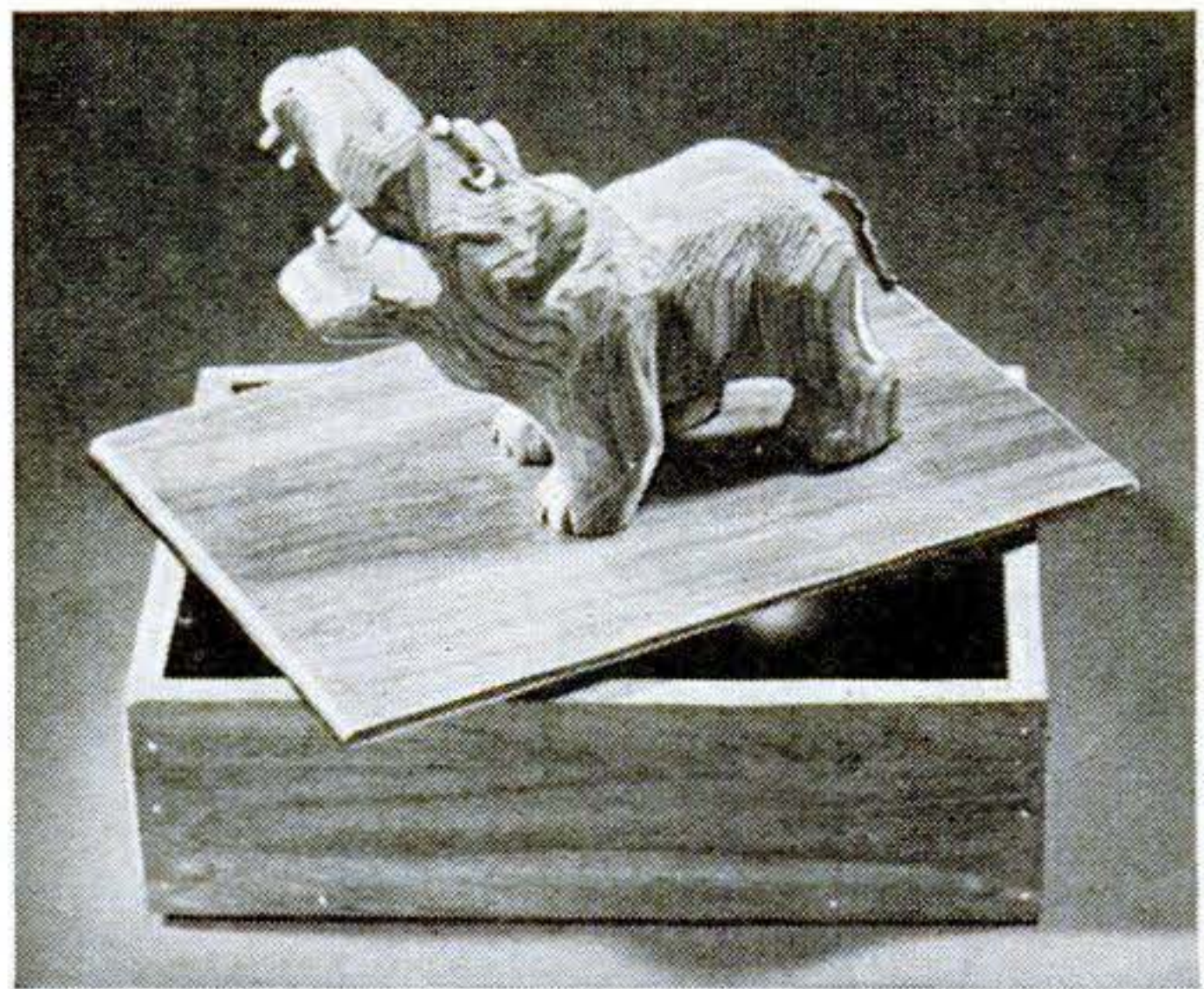

Plastic Shower Shoes Are Molded to Fit Foot

THESE plastic-sole shower shoes with colorful canvas toe straps, shown in color on page 112, take advantage of the hot-shaping characteristics of the material.

Have the wearer-to-be place each foot on a sheet of $\frac{3}{16}$ " plastic, and trace around it on the masking paper. Saw out two soles and two heels; then drill and saw strap slots.

Fit one sole at a time. Heat it until pliable in a 250-deg. oven, and have the wearer,

protected by heavy wool socks, place a foot on it. Slip the unheated heel underneath and, with gloved hands, press the plastic snugly against the instep and curve the front up. Hold in place until the plastic cools. Cement the heel on.

The straps are doubled pieces of canvas cut to length and provided with eyelets for lacing. Under the soles, they serve as a non-skid surface.—DORIS ALLER.

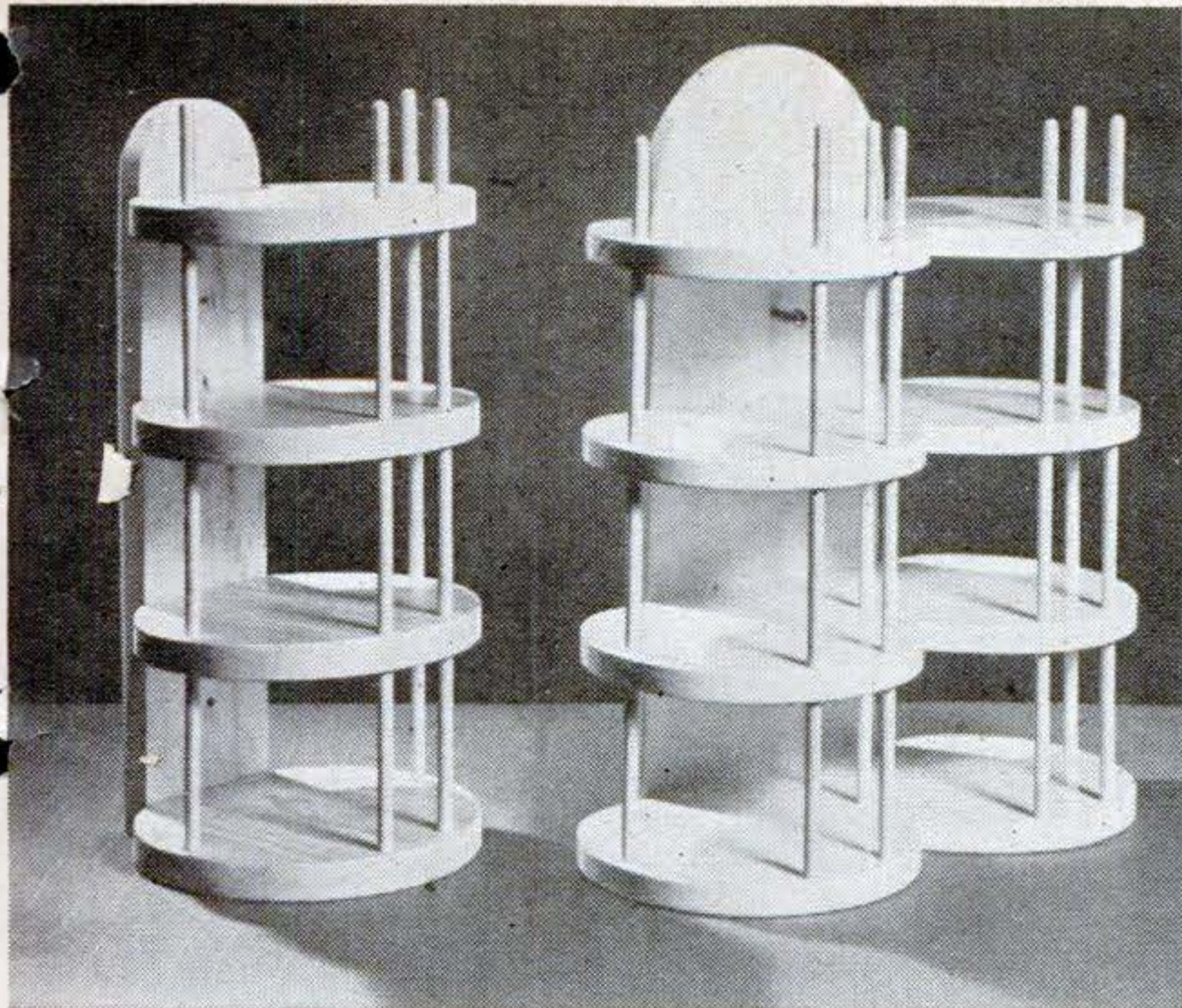

Loose dowels in the front of the racks are easily withdrawn to permit the removal or replacing of casseroles. The other dowels are glued in.

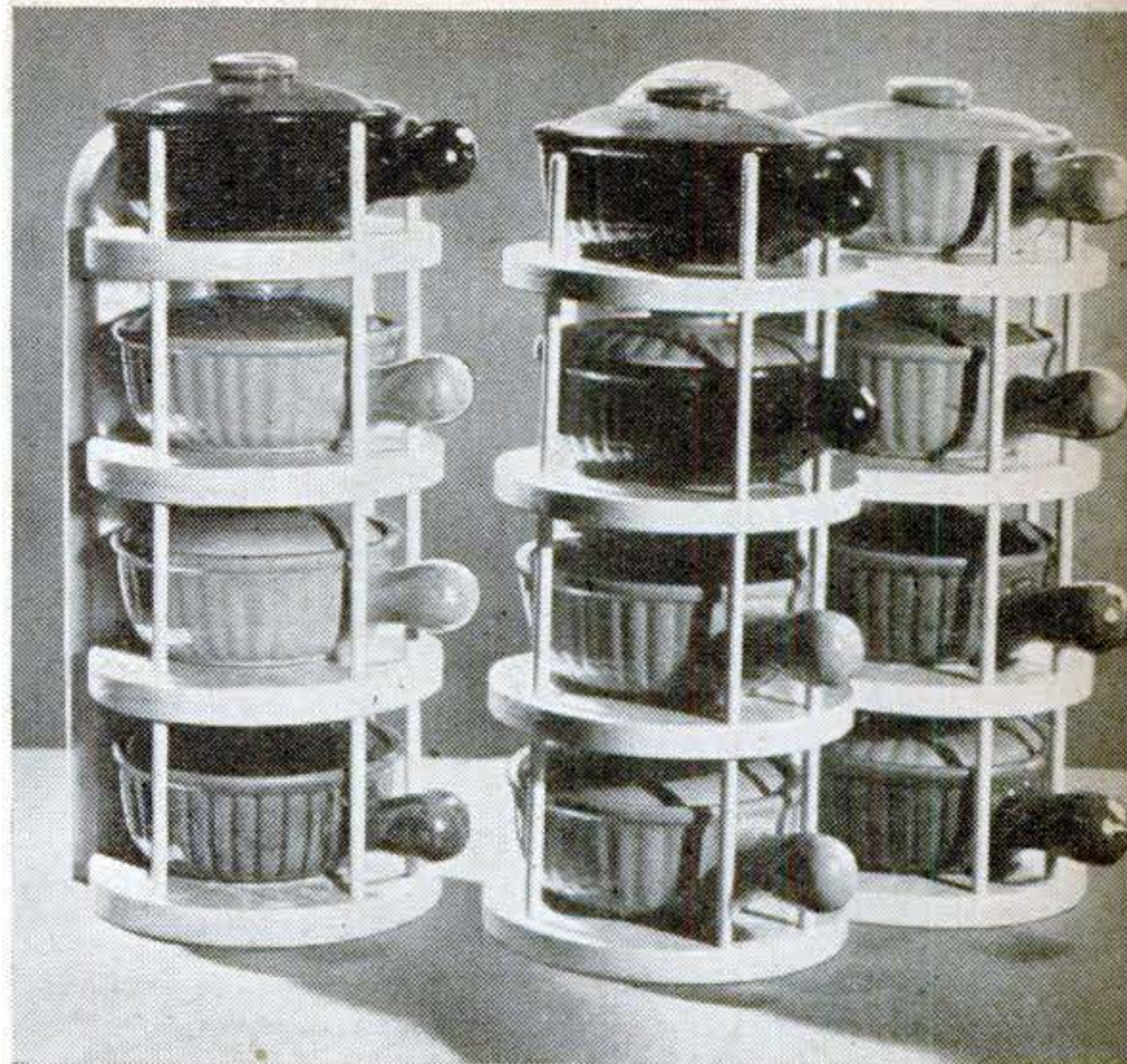

Each of these racks will hold a set of casseroles—the single one at left, a set of four, and the double rack at right, a set of eight pieces.

Kitchen Wall Rack Holds Set of Casseroles

IN A KITCHEN where storage is at a premium, a wall rack for casseroles will save needed space. These pottery utensils, attractive in themselves, when so displayed become a decorative asset as well.

Lay out circles for the shelves 2" larger than the greatest diameter of the casseroles, and scribe a chord at the back as long as the width of the backplate. Clamp the four together for drilling so the dowel holes will be perfectly aligned. The pairs at the

front should be a free sliding fit for $\frac{1}{4}$ " dowels and those at the sides a push glue fit. Stop the drill at a depth of $\frac{3}{8}$ " in the bottom shelf.

Dimensions are not critical, except that the space between shelves should just be high enough for a casserole and its cover. Stock $\frac{1}{2}$ " thick is suitable. Assemble with long flathead screws driven through the backplate into the shelves, and mount with two roundhead screws.—N. D. HARTLEY.

Glued-In Arrow Shaft Adds Novelty to Book Ends

DESPITE their simple construction, these arrow book ends are a pleasing accessory for a library table, especially if they are made of nicely grained hardwood. Cut the bases and uprights to size, and chamfer the ends. Take care in spotting the holes to receive the arrow shaft, for the slightest misalignment will spoil the illusion that the books are being pierced.

Taper the stock for the arrow head only at top and bottom; there is no need to bring it to an actual point. The three slots for feathers in the nock end of the shaft may be routed in the drill press with a $\frac{1}{32}$ " bit; but saw kerfs will serve if they are cut a trifle long and the tapered inside ends plugged with filler.—E. J. WIECZOREK.

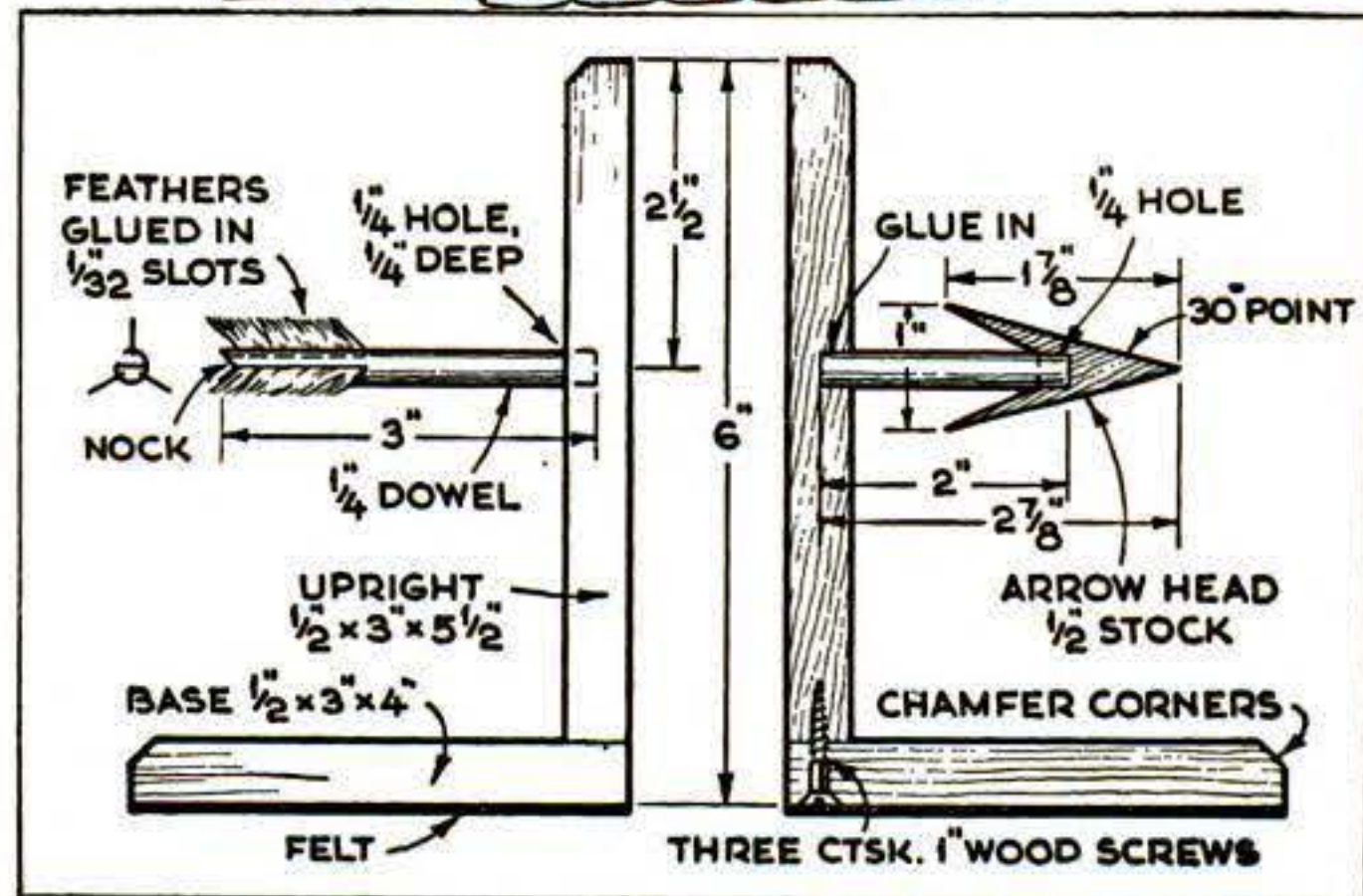
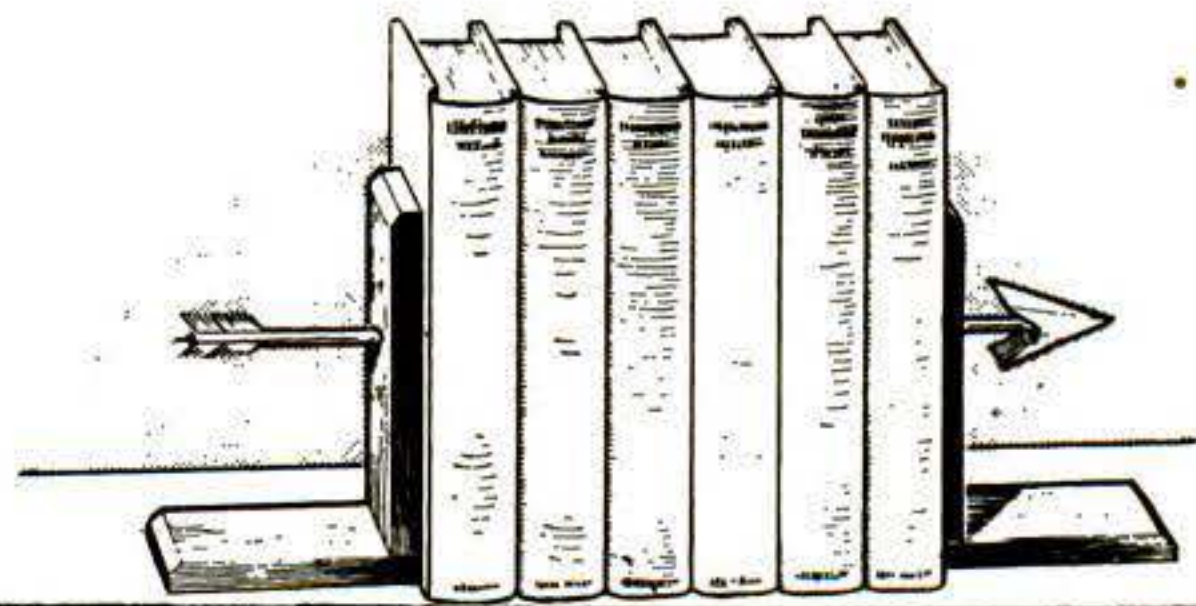

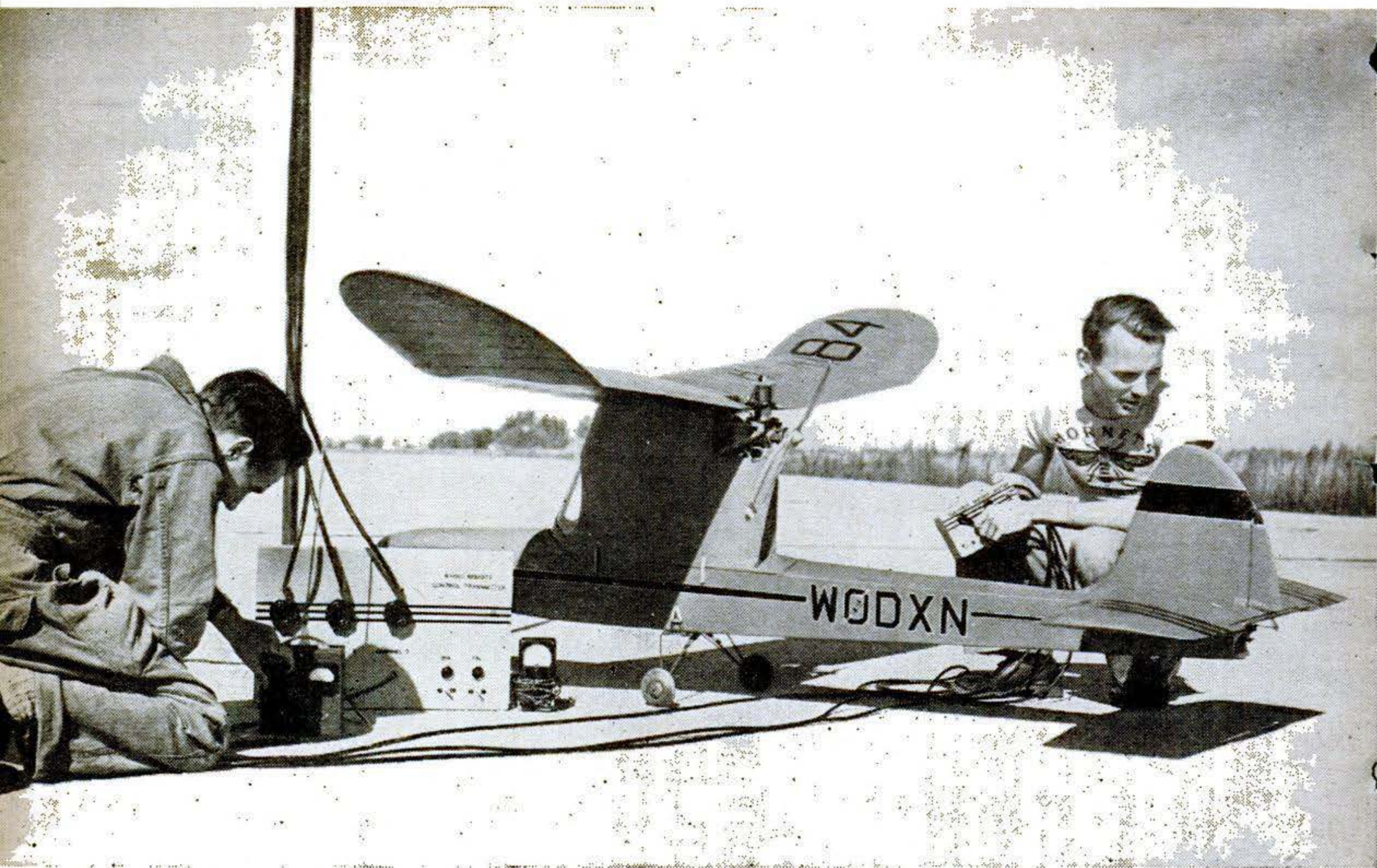

The author and a friend check the operation of the controls on the author's 14-lb., 8'-span radio plane.

Push-Button Pilots Fly Model Planes

Homemade drones, ingeniously controlled by radio signals, do aerobatics at the command of craftsman-fliers.

By Claude McCullough

THE coming king of all workshop hobbies may well be the radio control of model planes and boats. Since V-J Day, many new war-developed parts and techniques have given a boost to this fast-growing hobby. Here's a primer on amateur radio-control flying as it is practiced today:

Tiny receivers, light enough to be borne aloft in a tissue-and-balsa aircraft, and tough enough to withstand takeoff and landing bumps and the vibrations of a high-speed

gas engine, are at the heart of radio control. Built with hearing-aid and proximity-fuse components, a receiver typically employs a single tube in a sensitive superregenerative circuit. A tube frequently used is the Raytheon RK-61, a minute triode that contains a trace of an inert gas. Ionization of this gas causes a great variation in the plate current, triggering a relay that in turn operates electric motors, solenoids, or escapements to move the controls. Operating in the 50-54-megacycle amateur band, the transmitter is often a one-tube oscillator with an output of a few watts, providing control over a range of several miles.

Probably the most popular setup uses a single transmitter and receiver to control movement of the rudder. Rudder control alone, in the hands of an experienced push-

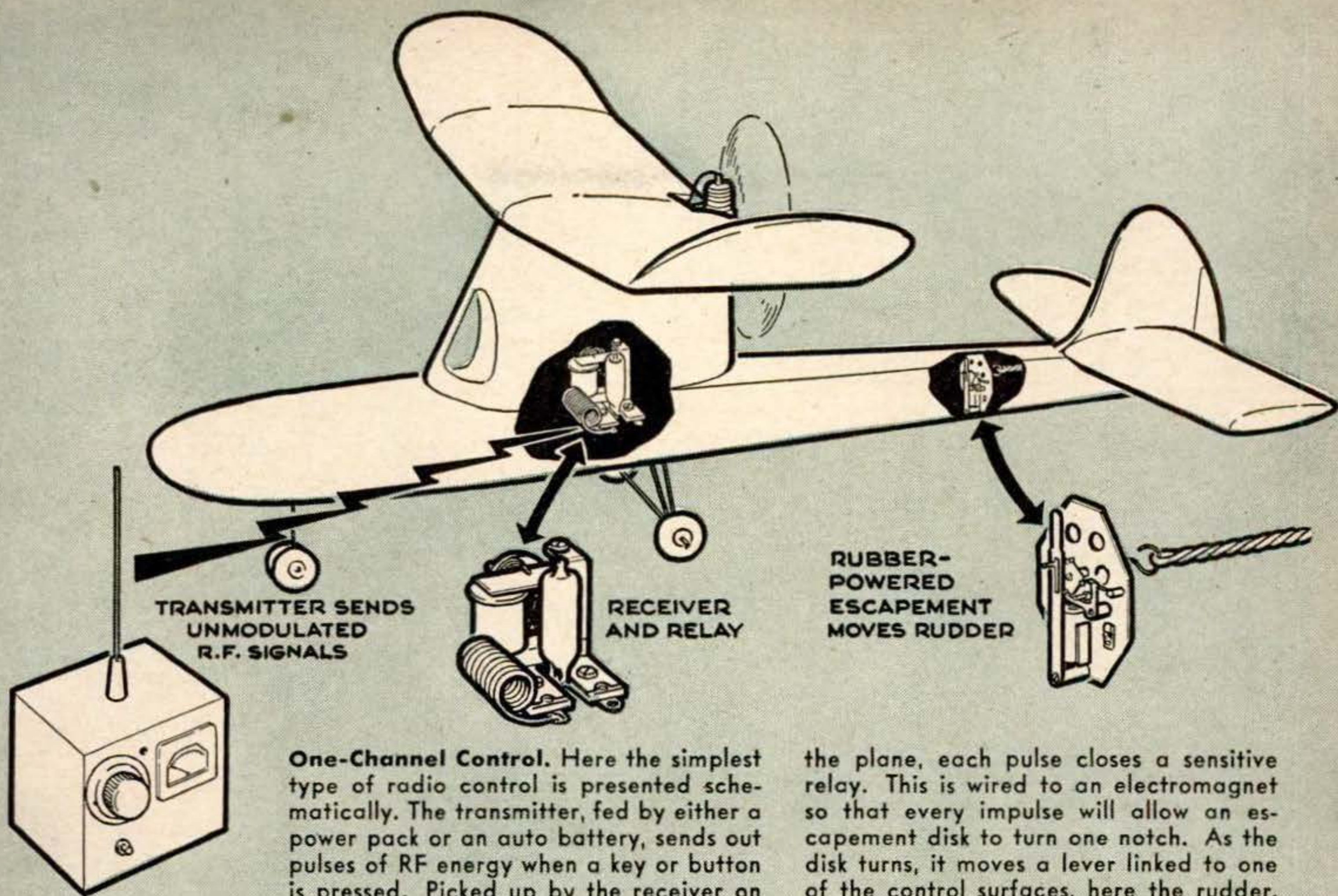

One-Channel Control. Here the simplest type of radio control is presented schematically. The transmitter, fed by either a power pack or an auto battery, sends out pulses of RF energy when a key or button is pressed. Picked up by the receiver on

the plane, each pulse closes a sensitive relay. This is wired to an electromagnet so that every impulse will allow an escapement disk to turn one notch. As the disk turns, it moves a lever linked to one of the control surfaces, here the rudder.

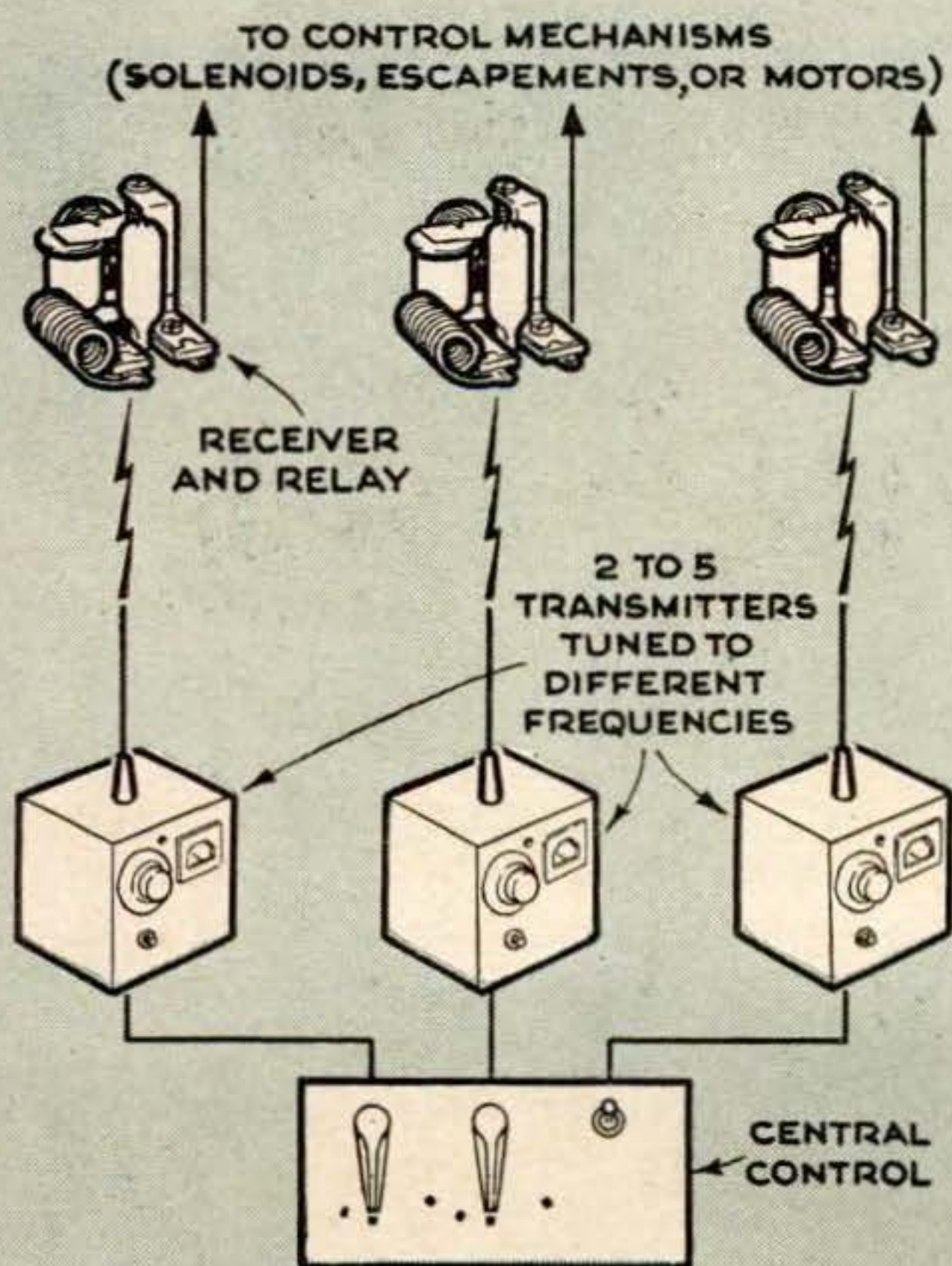

Ganged Transmitters and Receivers. This is one way of adding extra control channels. It has the special advantage of permitting the simultaneous operation of different controls.

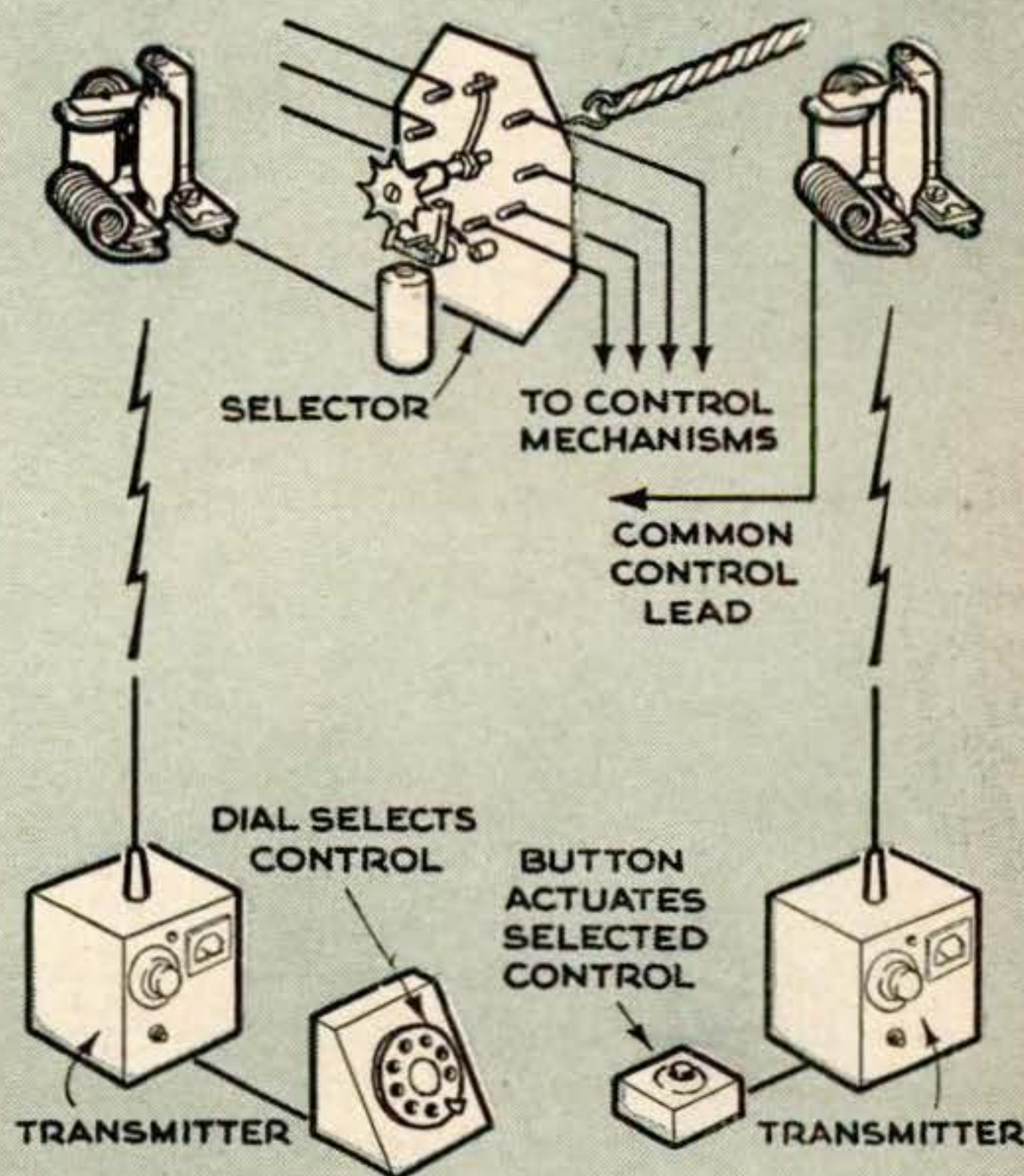

Selector Control. A magnetic selector switch in the plane picks out the particular control circuit desired, while the signal to operate this control comes from a second transmitter.

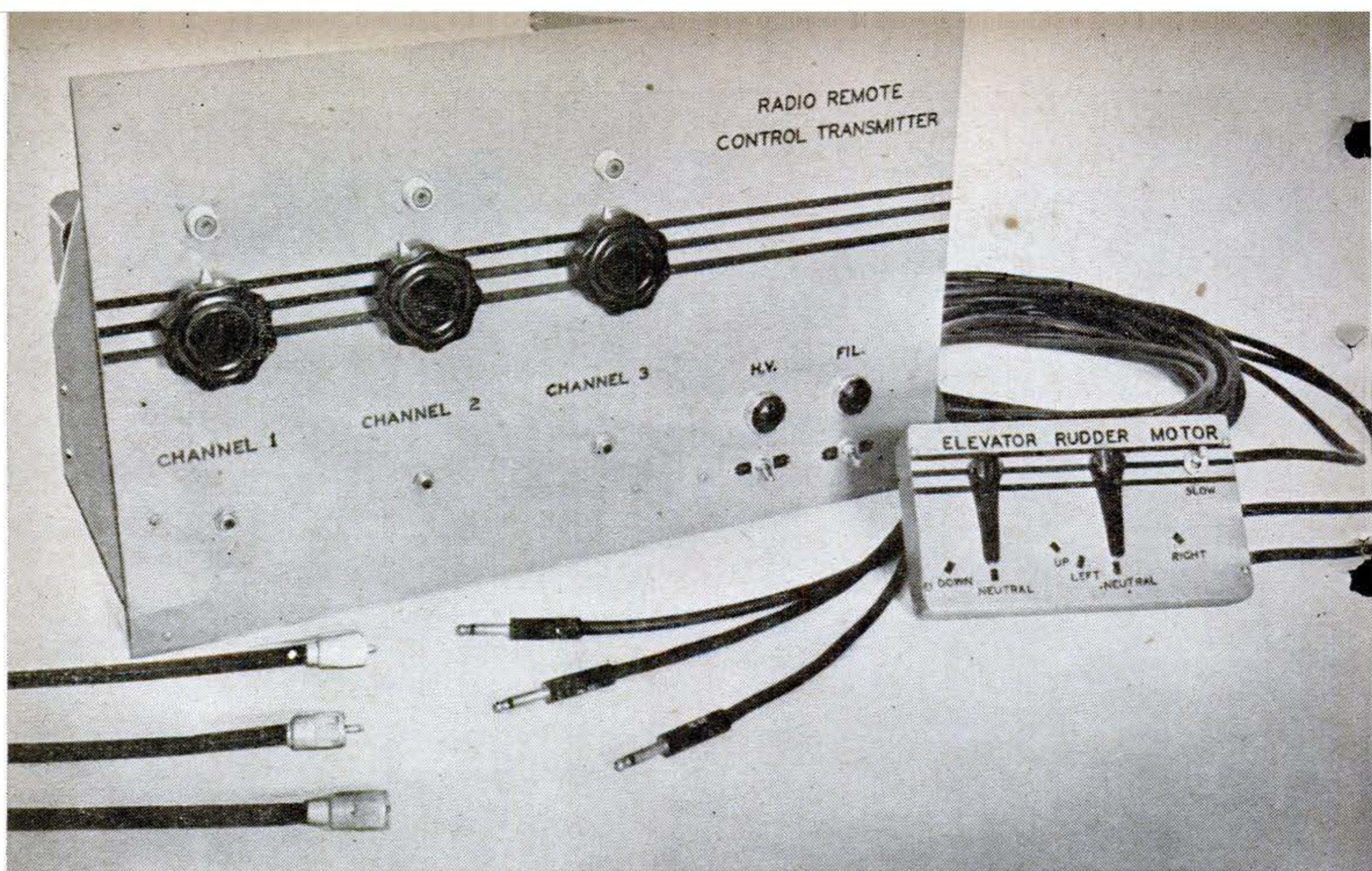

The transmitter the author uses to fly the plane on pages 112 and 152. A Federal radio license is needed.

button pilot, gives an astonishing variety of maneuvers; not only right and left turns but circles, figure eights, spiral climbs and glides, and even loops are possible.

Another common arrangement uses separate transmitters and receivers for each channel of control. Receivers can still be very simple, and the method permits the simultaneous operation of different controls. The duplication of receivers involves less extra weight than might be expected, since they can use a common power supply. However, there is a practical limit of about five control channels, for closer spacing across the amateur band is likely to cause accidental interaction of the receivers.

This problem doesn't occur in a third control system, which uses a single receiver to obtain multichannel control. Here a selector, essentially a rubber-band-powered rotary switch, is placed in the plane to hook up any one of eight individual control circuits. Keyed by transmitter pulses, a ratchet wheel moves to the desired position where a wiper arm closes the circuit. While it is passing by intermediate contacts, their circuits are kept from functioning by a time-delay device, either thermostatic or electronic, which requires that the wiper arm remain on the contact for a second or two before the control circuit is activated. A telephone dial is some-

times used to key the transmitter, for it provides accurately spaced and numbered impulses.

A variant method dispenses with the time-delay device, replacing it with a second transmitter and receiver. The relay of the latter is wired into the common lead of all control circuits. The phone dial and its transmitter are then used to send out the pulses that will "set up" the required control circuit, while the second transmitter sends the "execute" signal.

Maximum control is secured by the transmission of different audio tones, between which the receiver differentiates by tuned band-pass filters. This method was adopted by the armed forces for radio-controlled target planes, and is the basic one used with full-sized drones. Familiarly known as the "beep" system, it permits the use of 10 or more channels. The receiver is generally a superregenerative one having conventional "peanut" tubes and one or more audio stages to amplify the "beeps." Fed to a bank of filters, the audio tone builds up through resonant action enough voltage in the proper filter to trigger a relay tube and operate its associated control. While the "beep" system gives a large number of channels, disadvantages from the amateur's viewpoint include greater complexity and weight.

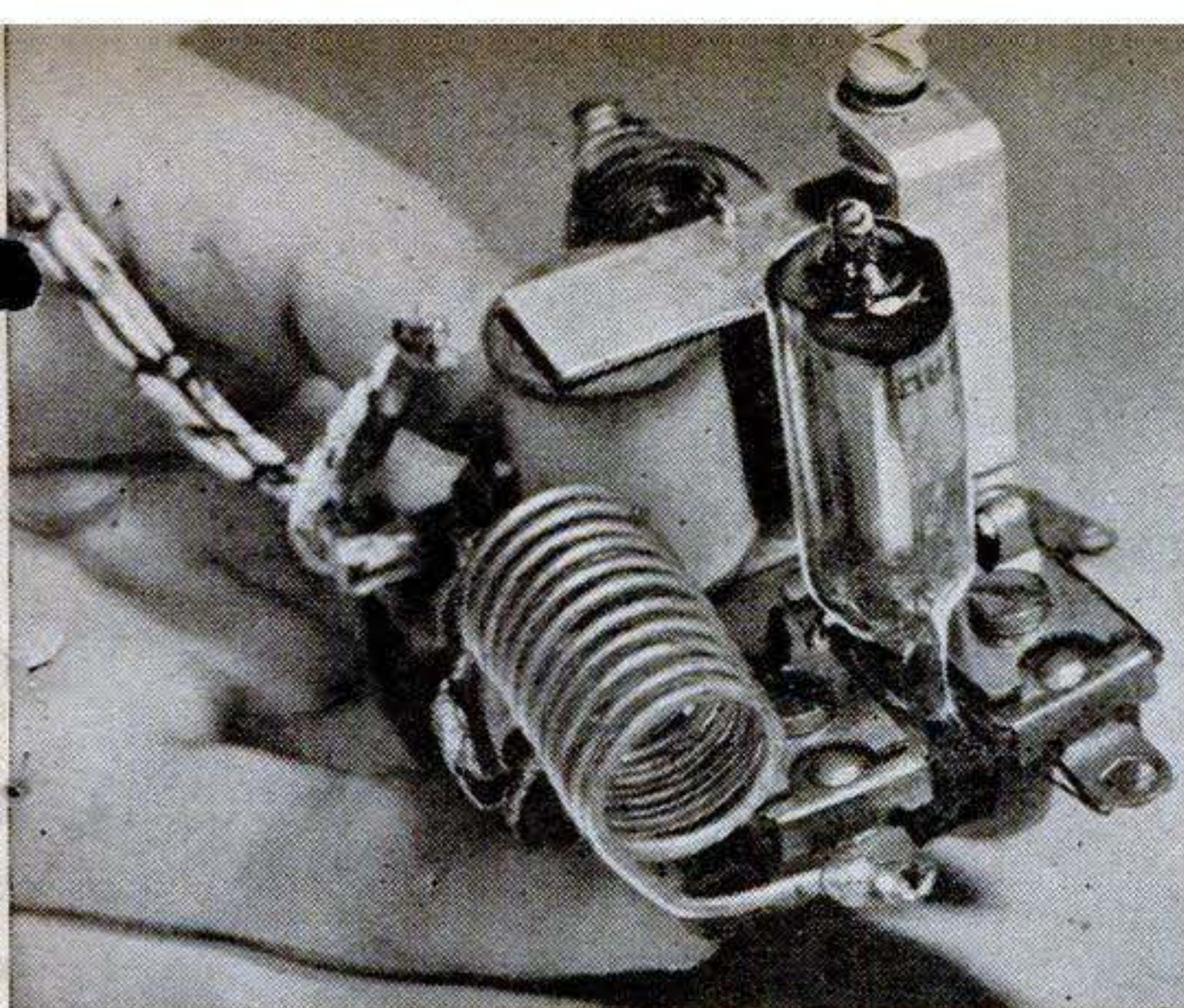

This radio receiver weighs only 3.5 oz. complete with a plate relay. A flashlight cell lights the filament; a hearing-aid battery is the B supply.

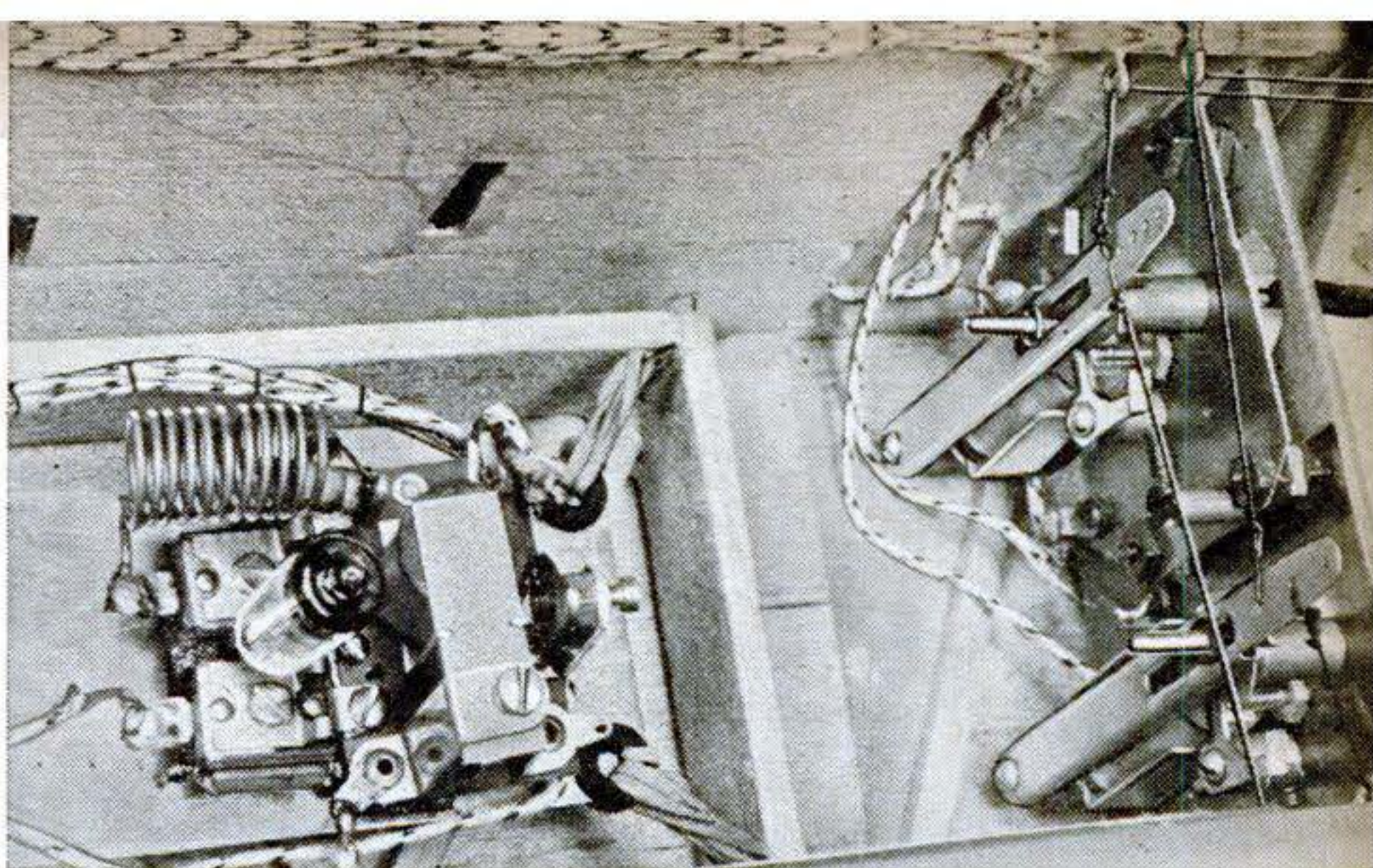

Here is one of the three receivers in place in the plane. Note the rubber-band chassis support. Shown also are escapements for the rudder and elevators.

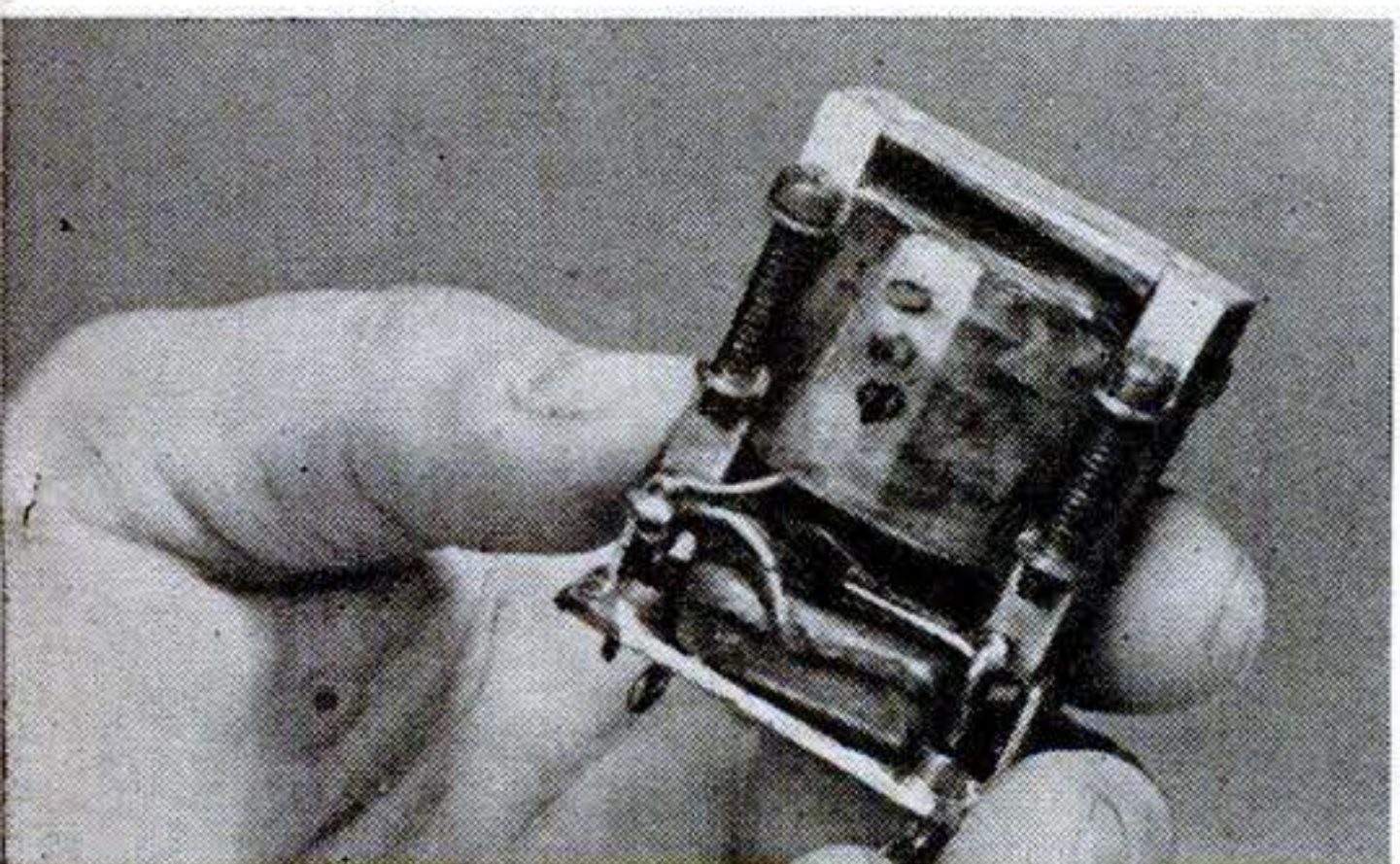

An audio band-pass filter of the type employed in the "beep" control system. It consists of a choke coil, a condenser, and a resistor, made as a unit.

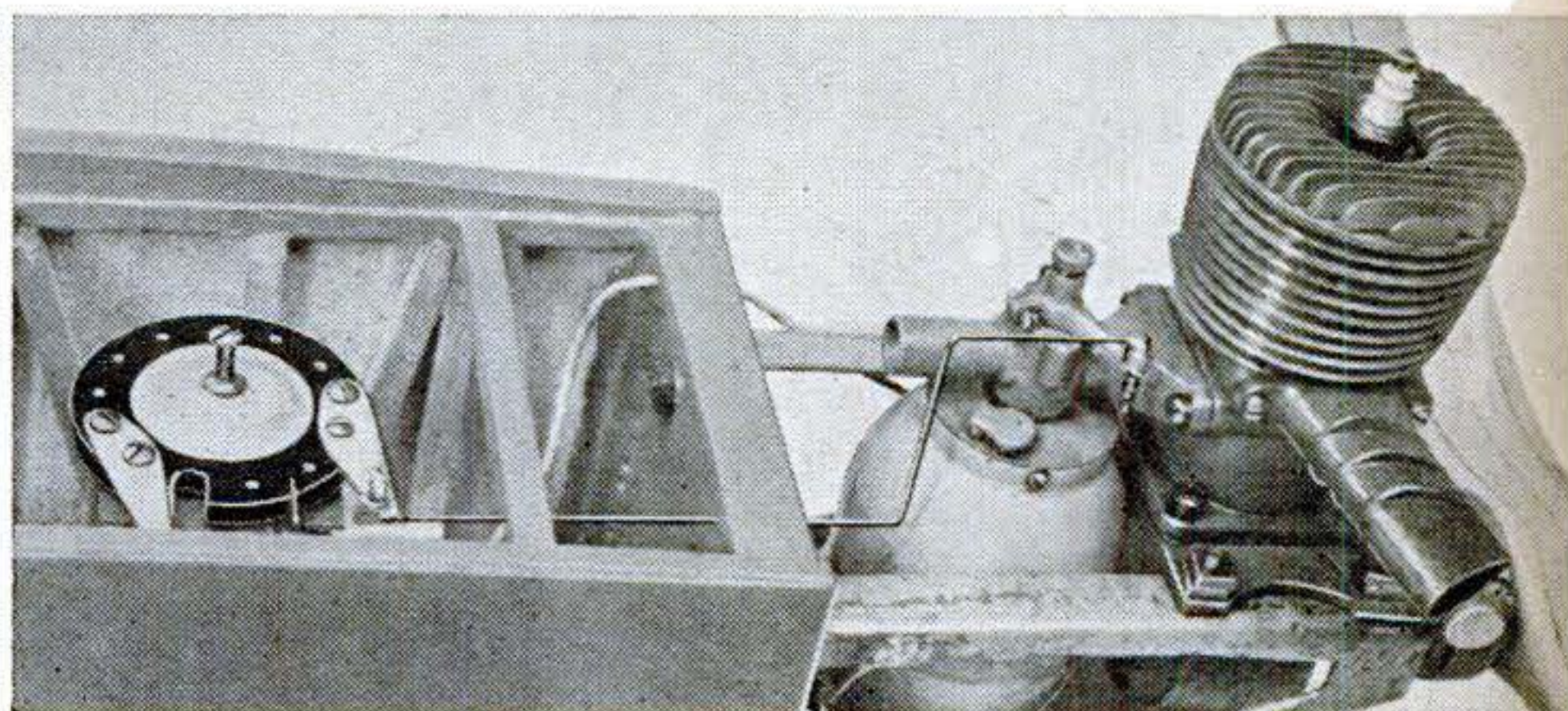

The throttle of this 3/4-hp. gas engine is moved by a wire linking it with the geared electric motor at the left to give speeds from idling to wide open.

The mechanisms that actually move the controls on signal from the receiver are a vital part of any control system. For operating the rudder and elevator, escapements that control the release of energy stored in twisted rubber strands are commonly used. A ratchet wheel is prevented from turning by a double pawl; when the pawl is depressed by an electromagnet, the ratchet wheel is allowed to turn through a fraction of a revolution. This moves a linked lever to which the controls are attached by thread, fishline, or wire. Some escapements are so small they can be mounted directly inside the rudder or elevator. Two pen-light cells supply the needed current.

A typical application is an escapement having a four-position ratchet disk applied to rudder control. Assuming that the plane is traveling with rudder neutral, one pulse will apply left rudder, the second pulse neutral rudder, the third pulse right rudder, and the fourth back to neutral. Thus it can be

seen that it may be necessary to pass through the cycle to get a desired position. This isn't a serious drawback, since the operation can be performed rapidly. A more serious disadvantage is the lack of graduated control; the model has either left or right rudder or none.

Reversible DC motors weighing as little as 5 oz. are sometimes used for such specialized jobs as steering nose wheels or adjusting engine-throttle position. Adjustable travel-limiting switches stop rotation of a geared-down disk (to which cables or push rods are attached) at the end of a predetermined arc, and a separate centralizing circuit returns the motor to a neutral position either automatically or on receipt of a centralizing signal. Toggle-action solenoids are often used for onetime jobs such as lowering landing gear or flaps, releasing a parachute or bomb, or cutting the motor.

One promising new system independently developed by several experimenters makes

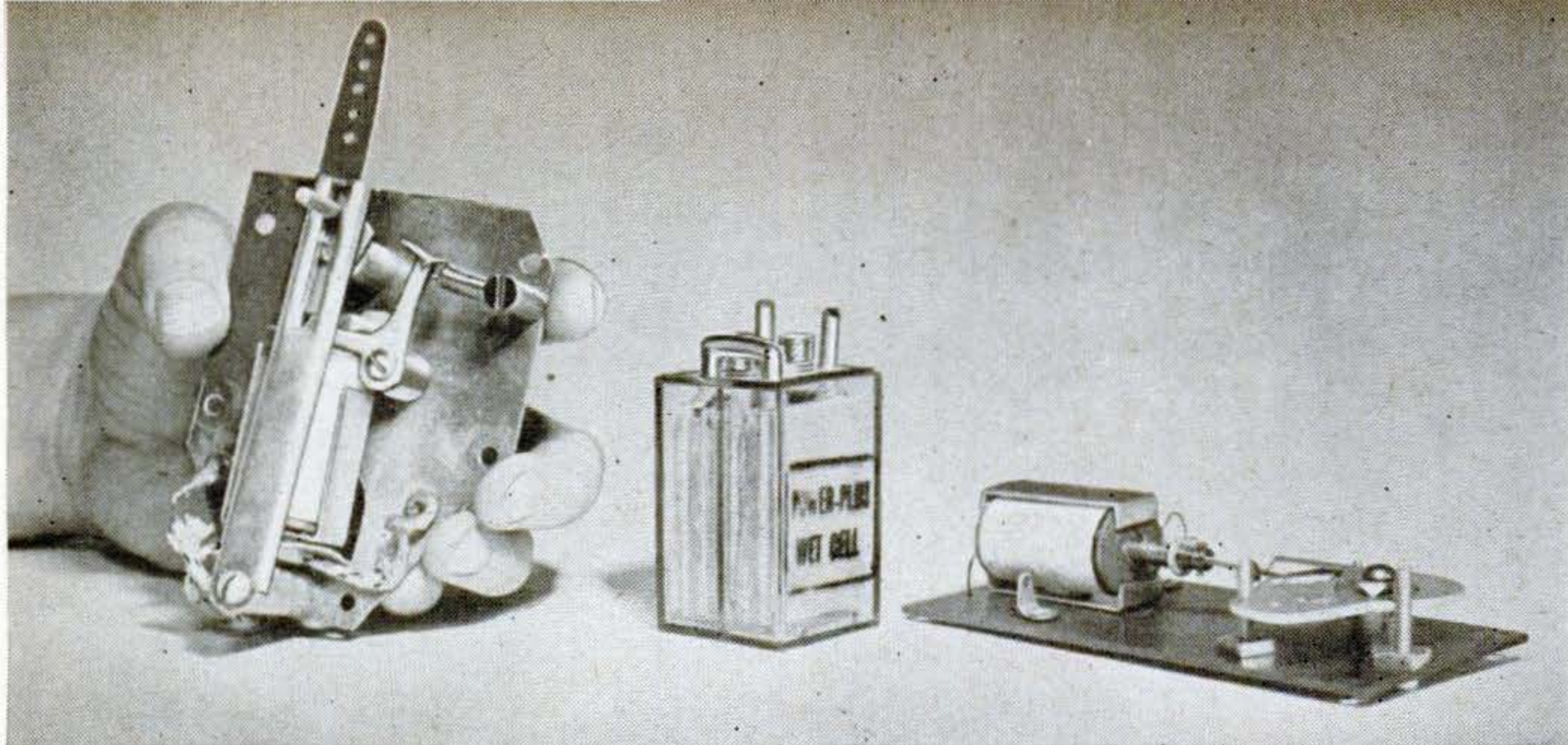

An escapement, a 4.4-volt battery, and a solenoid that locks in or out without taking constant current.

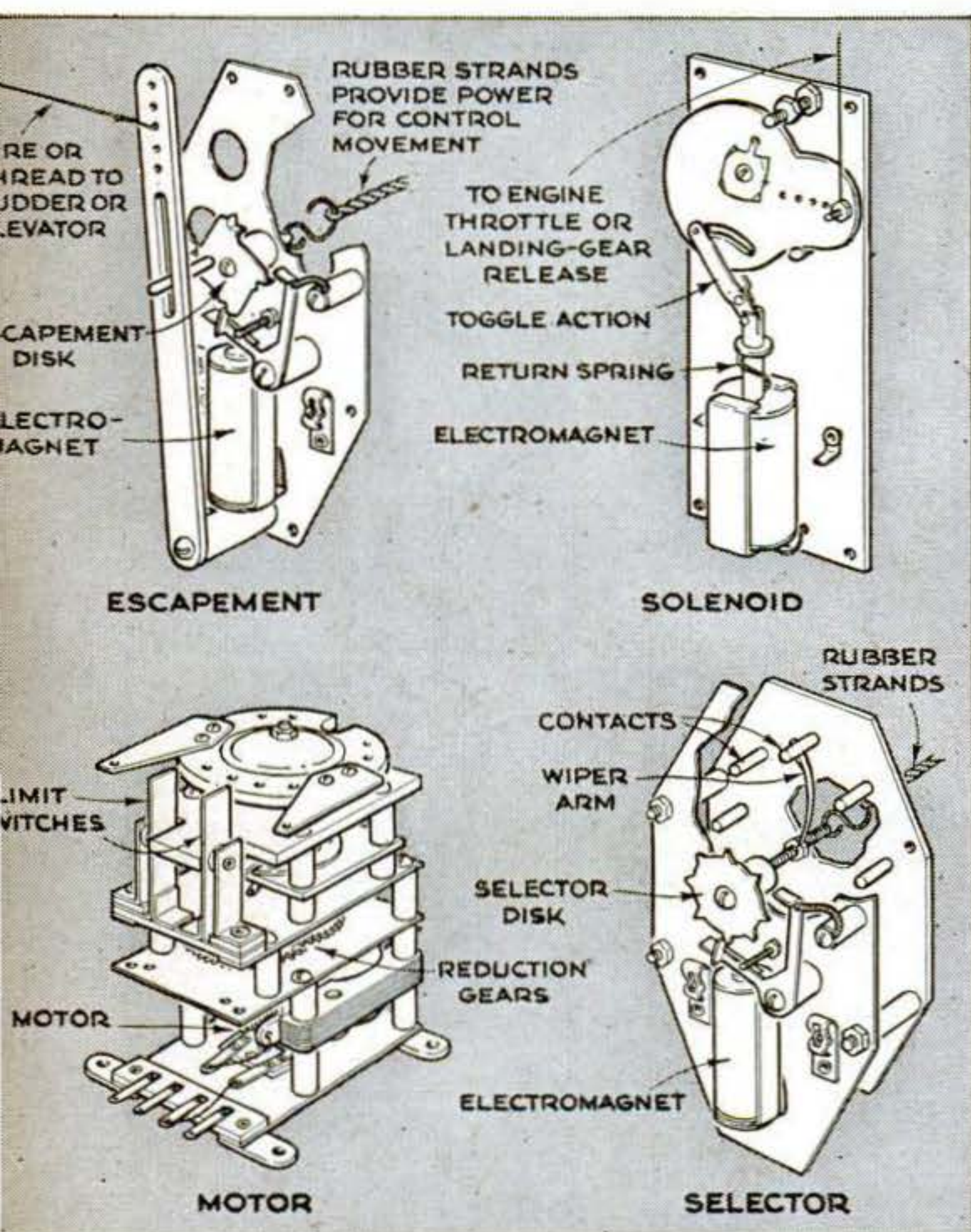

Adapted from RCH

Here are three actuating mechanisms and a selector switch. Some escapements are self-neutralizing, returning to center as soon as the relay is opened.

use of compact little actuators in which a rotor can be moved to and held at any position within almost 180 deg. An electromagnet opposing a permanent magnet is fed transmitter-controlled pulses, the rapidity of which determines the effective pull of the electromagnet and hence the position of the rotor. Thus the rudder or elevator respond in degree as well as direction.

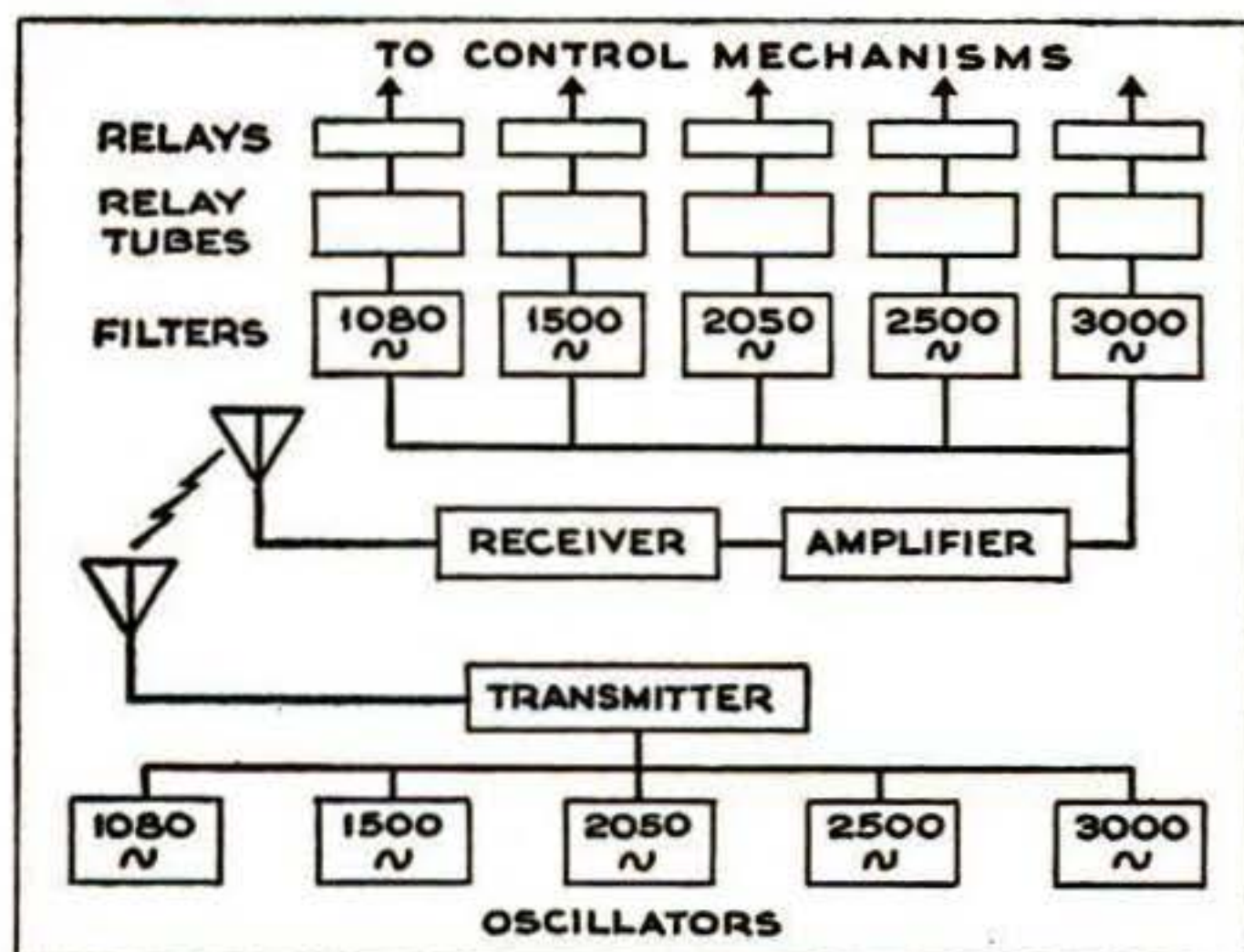

This block diagram shows the "beep" system, favored by the armed forces. Though providing many channels, it's not light enough for small models.

Radio control has its headaches and heartaches. Until the grounding pilot earns his wings, a crash can easily occur. Even if the novice pilot can train his unruly reflexes to change when the plane changes direction (left rudder when the plane is flying toward you produces the same effect as right rudder when it is flying away from you), plenty of other things can go wrong. Outflying the transmitter range casts the plane adrift on the not-always-tender mercies of free flight. An overwound escapement may jump two places, or a transmitter failure can leave the plane locked in a fatal dive. Piloting a plane with dwindling fuel supply upwind to a landing field can be a nerve-wracking affair. To the radio-control experimenter, though, near and actual crashes are not serious discouragement; instead, they're incentives to build better craft and fly them more skillfully and with greater precision.

HOBBY SHOPPING



Bucket Serves Live Bait. A double-walled container made of fibreglas changes water constantly to keep a supply of live minnows floating within a fisherman's reach. The new bucket, made by the Motor Tool Manufacturing Co., of Detroit, is rot-proof and can't tip or sink.

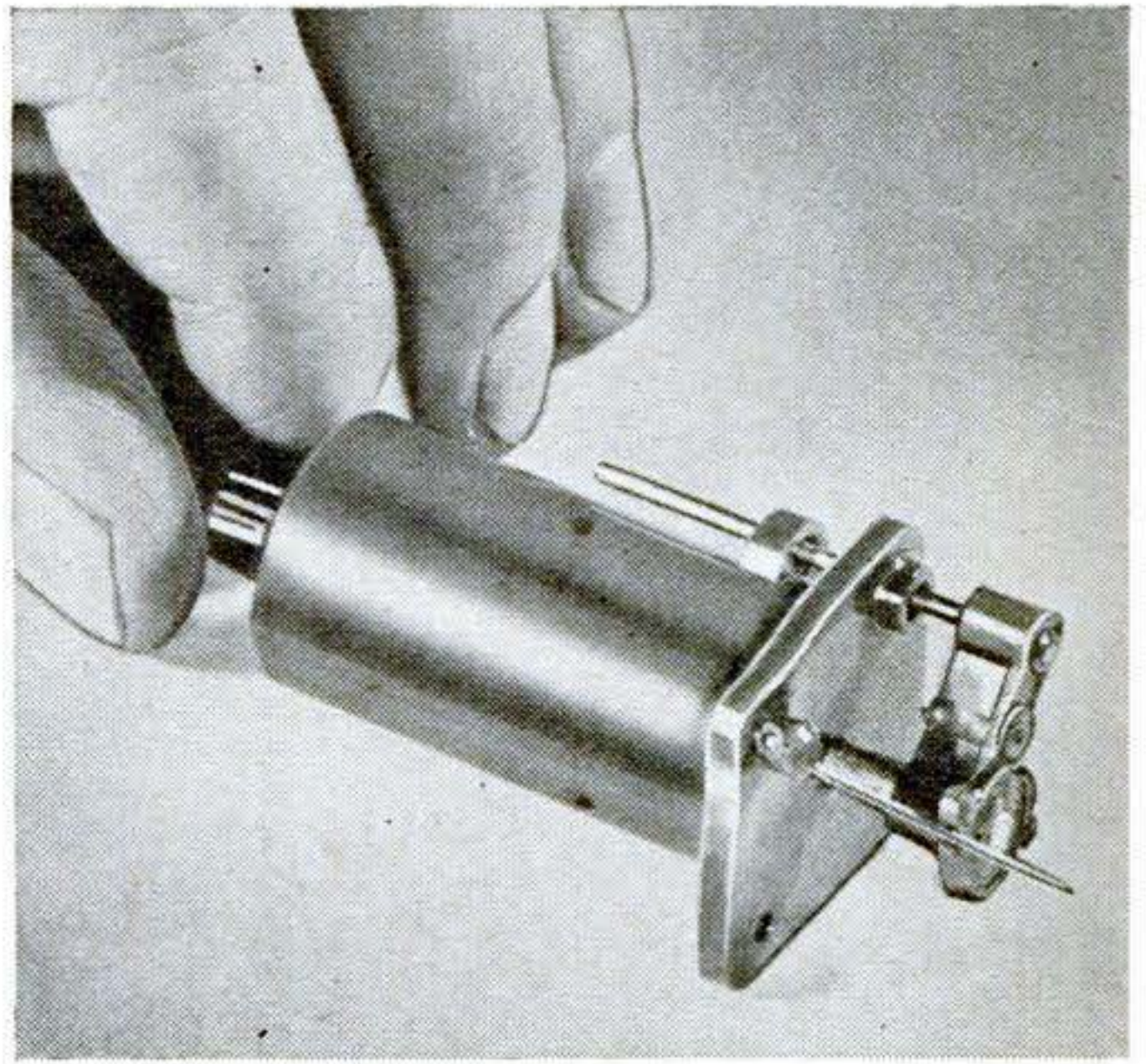

Miniature Timer. Adapted from a Navy developed device used to release radar decoys, this small plastic timer is being made by Hillcrest Mfg. Co., of Los Angeles, for gas-powered model planes. Duration is adjustable up to 10 min. It weighs less than 1 oz. and is only 2" long.

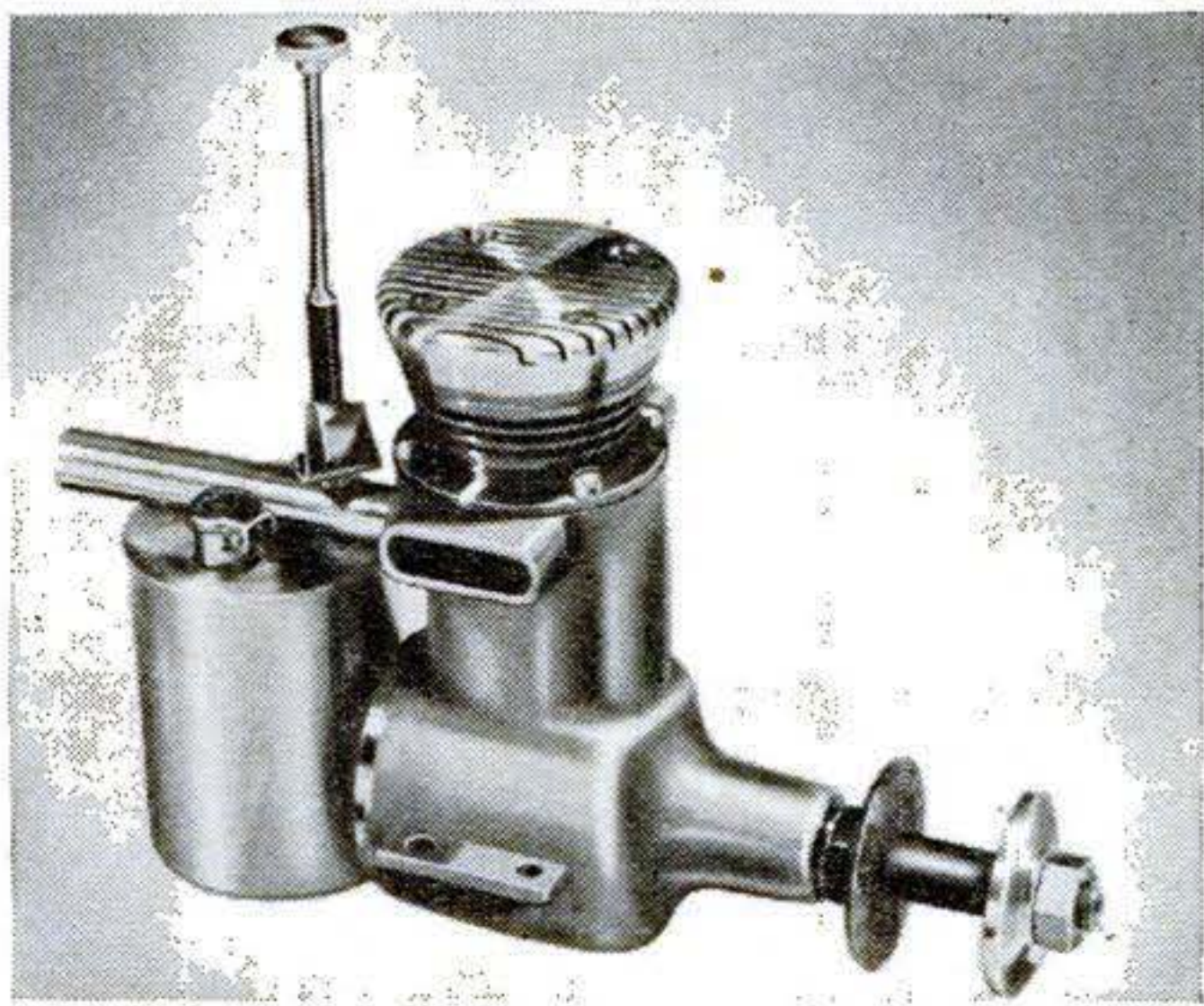

Diesel Drives Models. A Class C noninjection diesel engine of .450 cu. in. displacement has been announced by Engineering Development Company, of Del Mar, Calif. It features easy starting and has a large fuel tank which makes it especially suitable for control-line flying. Since ignition is by compression heat, it requires no batteries or spark plug. Moving parts are hardened, and crankshaft and piston are ground to tolerances of .0001". The price is \$18.50.

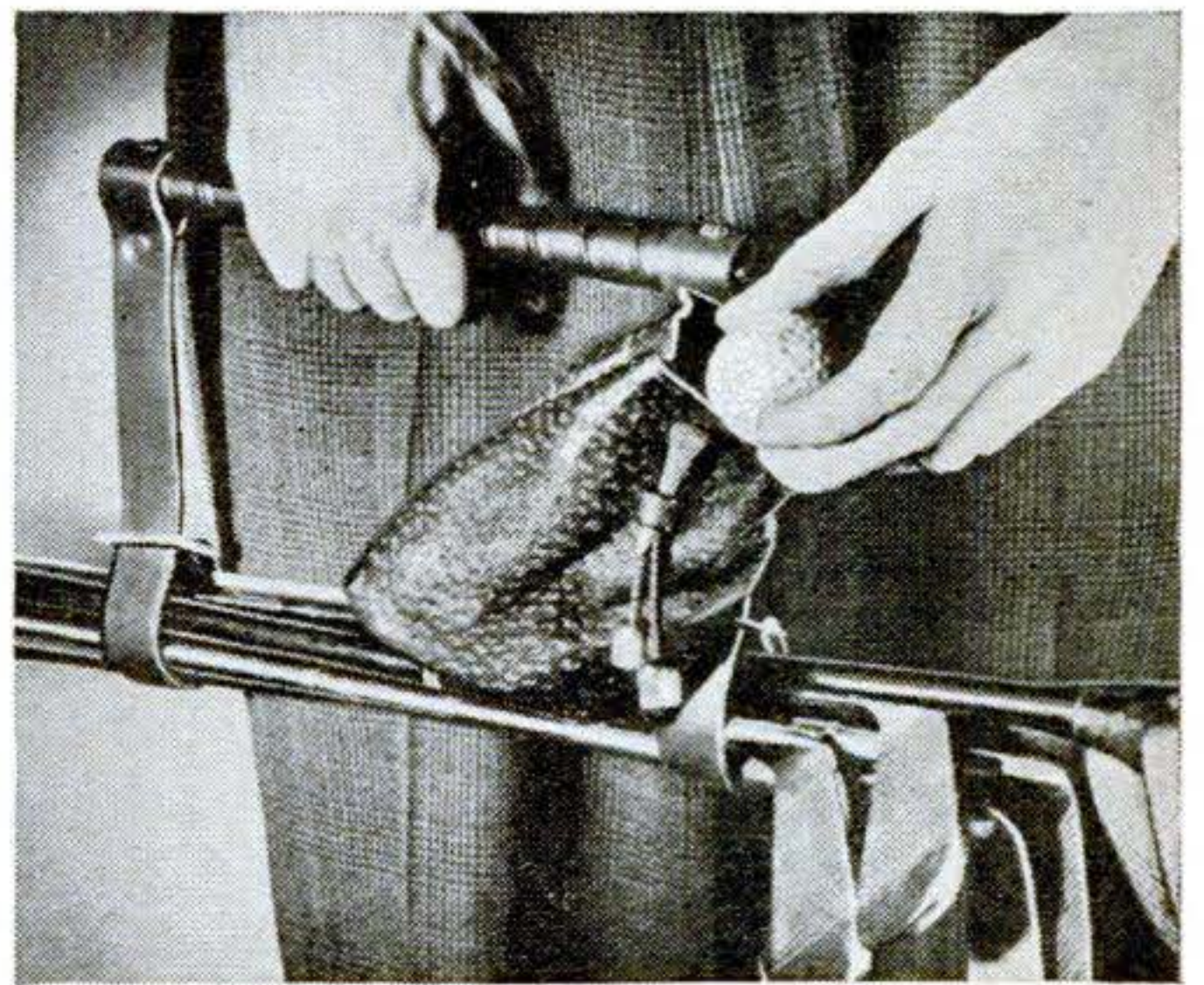

Golf-Club Carrier. Four ounces plus the weight of the clubs is all that a modern golfer will have to tote around the course. From the Duncan-Morris Co., of Akron, comes word of the Go-Lite, a club carrier that consists of a handle and two leather loops. The weight of the clubs tightens the straps and prevents slipping. Lifting an aluminum tube that lies parallel to the handle loosens the loops. A small pouch is attached for carrying balls and tees. Two models are priced at \$2.50 and \$3.50.

IQ

**WHAT'S YOUR
INGENUITY QUOTIENT?**

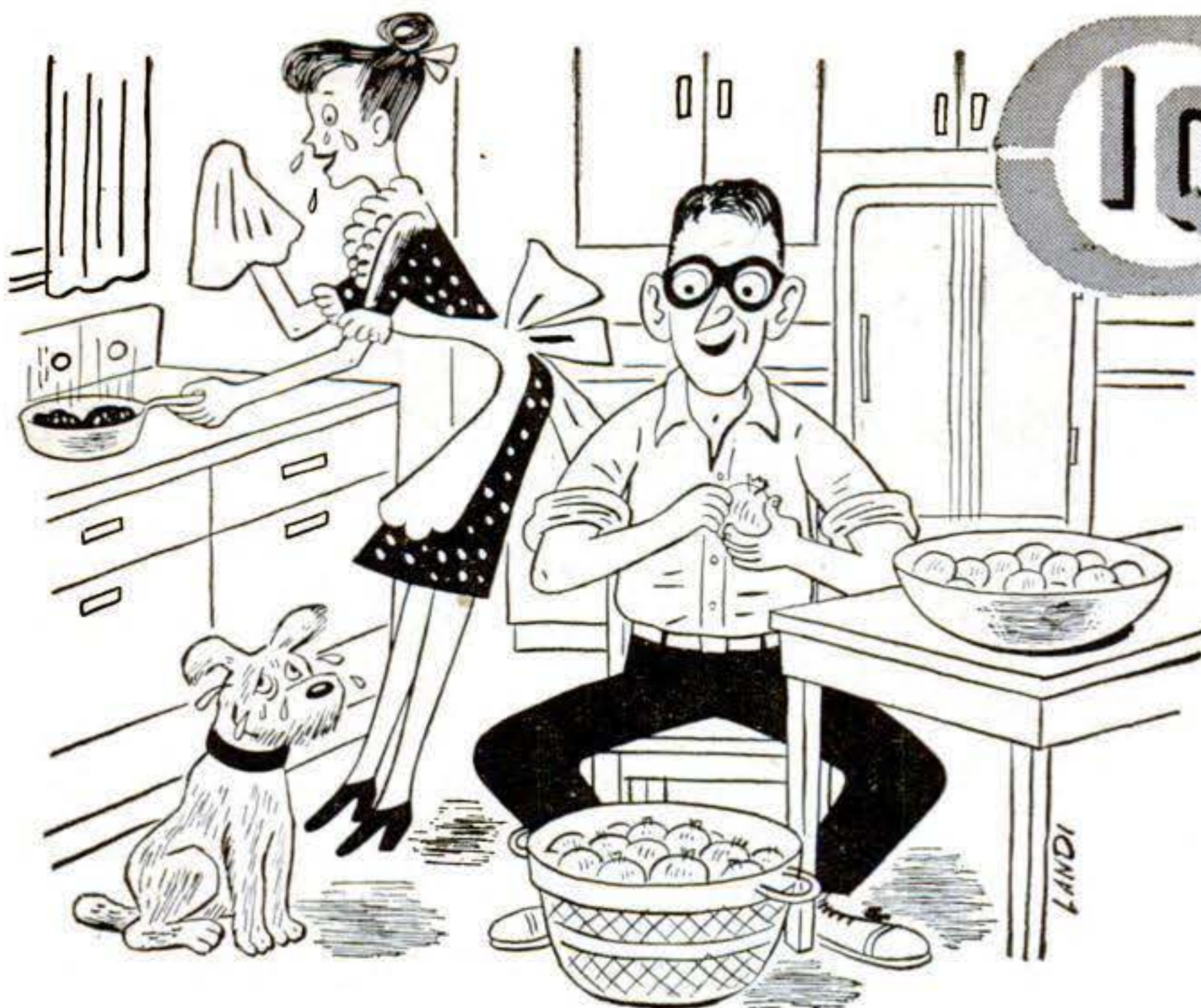

Weep No More, My Lady. You can sing, not cry for your supper—even when it involves cutting up onions to go with a skilletful of hamburgers. I can slice through a bushel of Bermudas without shedding a tear since I bought myself a pair of underwater goggles. Their closely fitted watertight rims keep the tear-jerking fumes from my eyes.—ELMER MELAND.

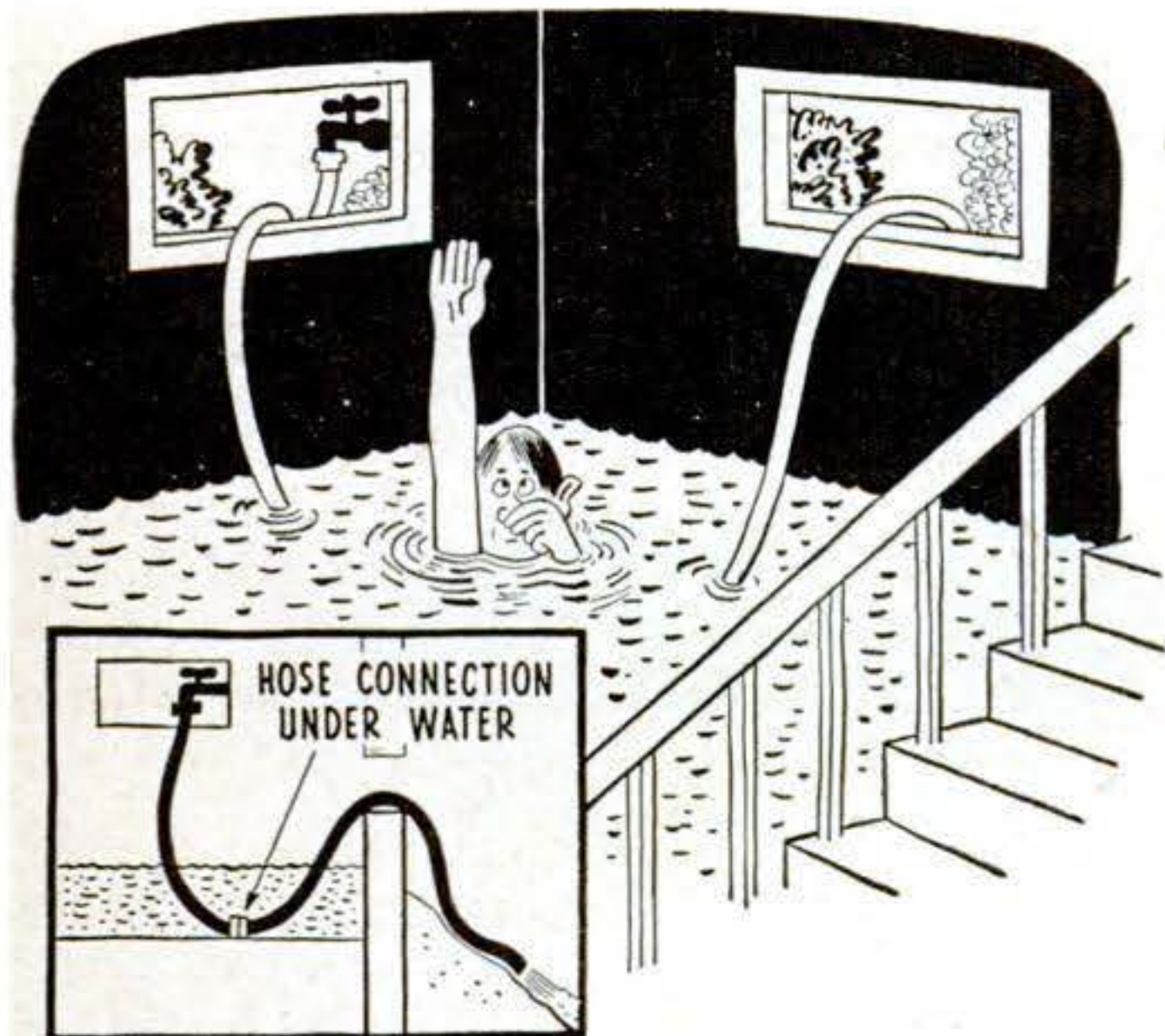

I Was All Wet when a cloudburst hit my cellar. Running a hose from the floor to lower ground outdoors, I attached a second hose from a tap to fill the first with water. Disconnecting the two under water started a cellar-emptying siphon.—W. PATTESON.

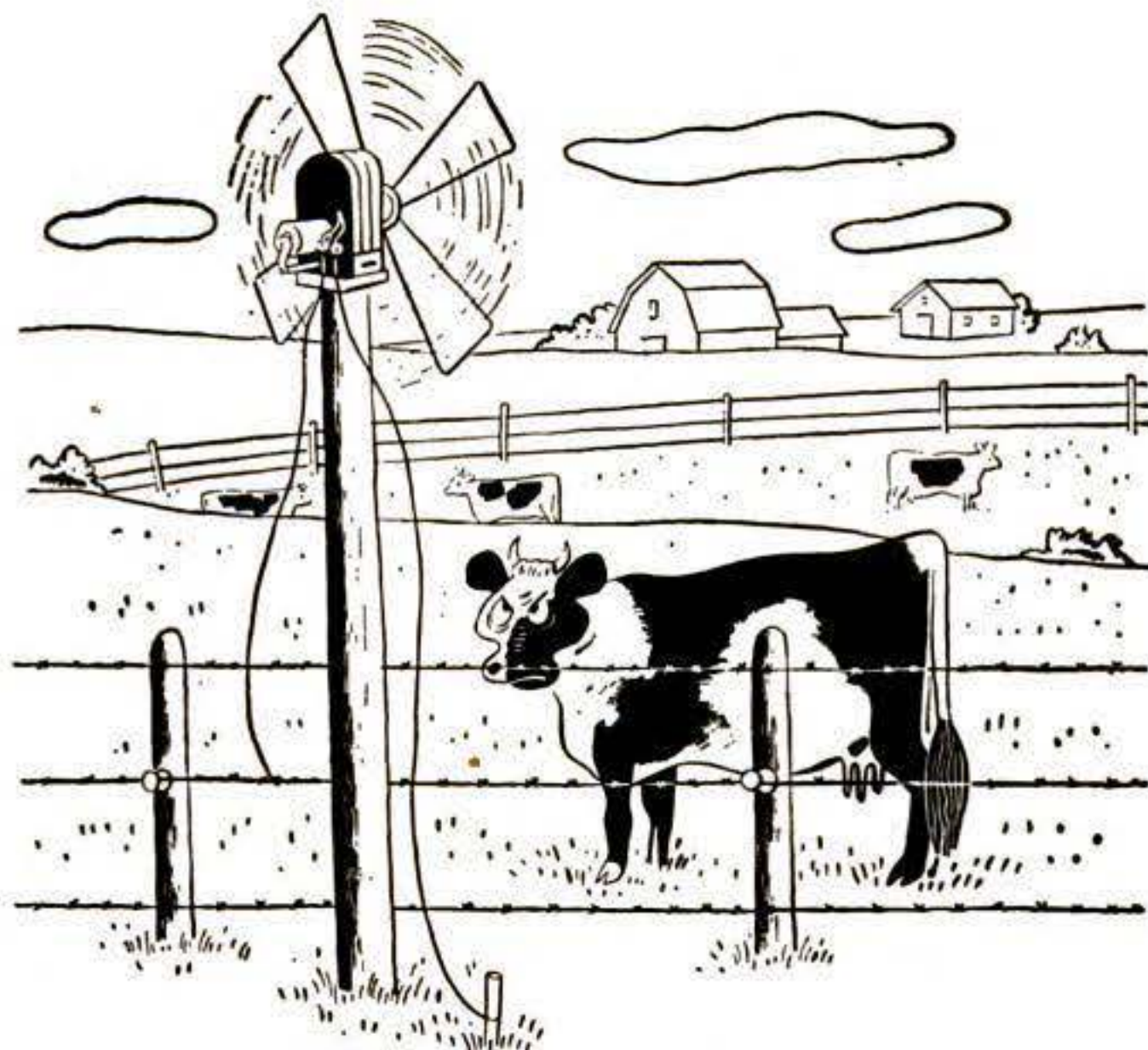

Our Fence Was a Pushover for cattle who wanted to stray. But they stay home since we hooked an old magneto to a homemade windmill. So far Bossy hasn't learned the fence isn't hot when the wind dies.—LAURICE DELAURANT.



No Matter Where We Roam, our fish get fed by long-distance phone. A spoon tied to the clapper gives out vitamins when I call home.—A. CUNNINGHAM.

Have you pulled off a smart one lately? We will pay for acceptable contributions showing ingenious solutions of problems in the home, shop, garage, or camp. It doesn't matter if it's wacky — if it works.

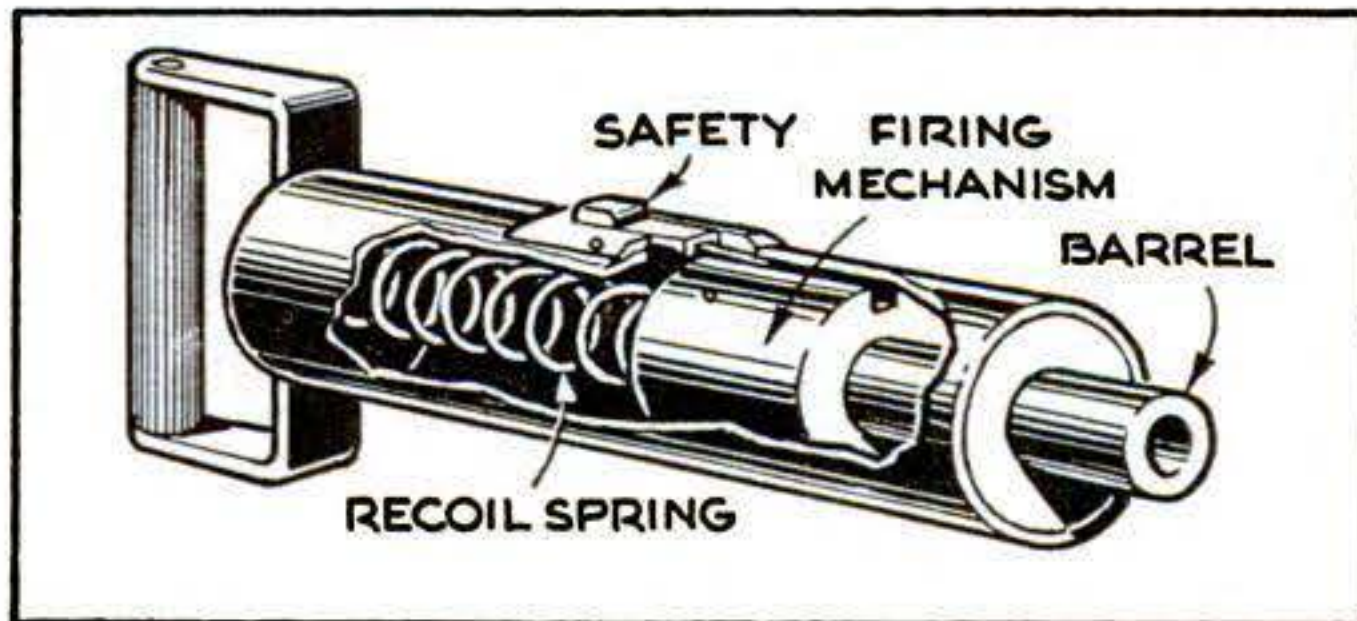
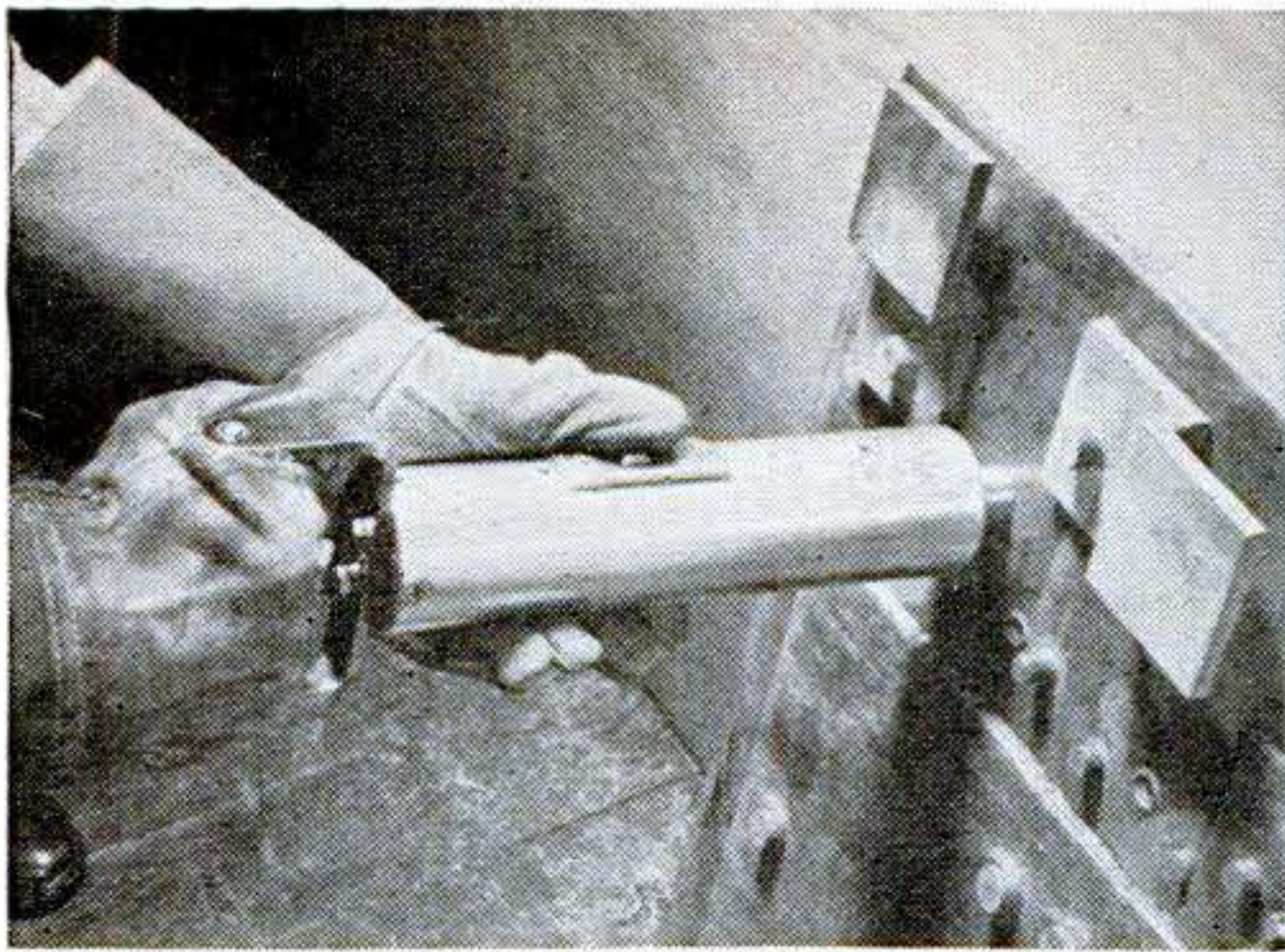

Rivet Gun Uses Explosive. A powerful hand-held rivet gun manufactured by Meco, Inc., of Portland, Ore., is capable of delivering 150,000-lb. blows, pinning $\frac{3}{8}$ " steel plates together or punching deep holes into concrete. When the operator releases a safety, places the tool against the work, and pushes, a special explosive encased in a small pistol cartridge is fired, driving in the rivet or stud or punching a circular hole. The guns are made in several sizes, weighing from 7 to 19 lb.

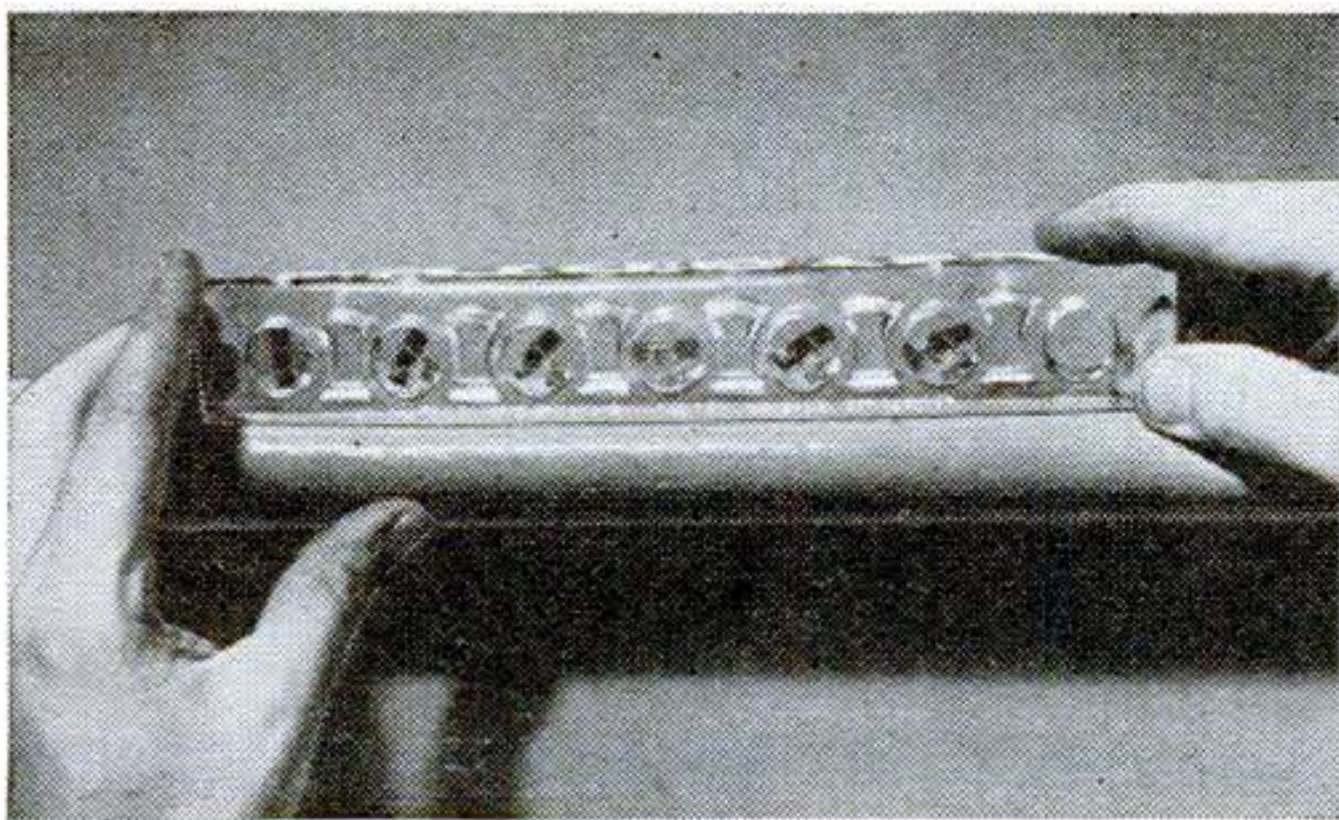

Level Indicates Six Angles. Molded from clear plastic, a pocket-size spirit level produced by Lawco Plastic Products Company, of Chicago, and Sobenite, Inc., of South Bend, Ind., contains indicators for six angles— $22\frac{1}{2}$, 30, 45, 60, 90, and 180 deg. To simplify identification, the value of each angle is molded into the plastic and fluids of different colors are used in the indicators for the various angles.

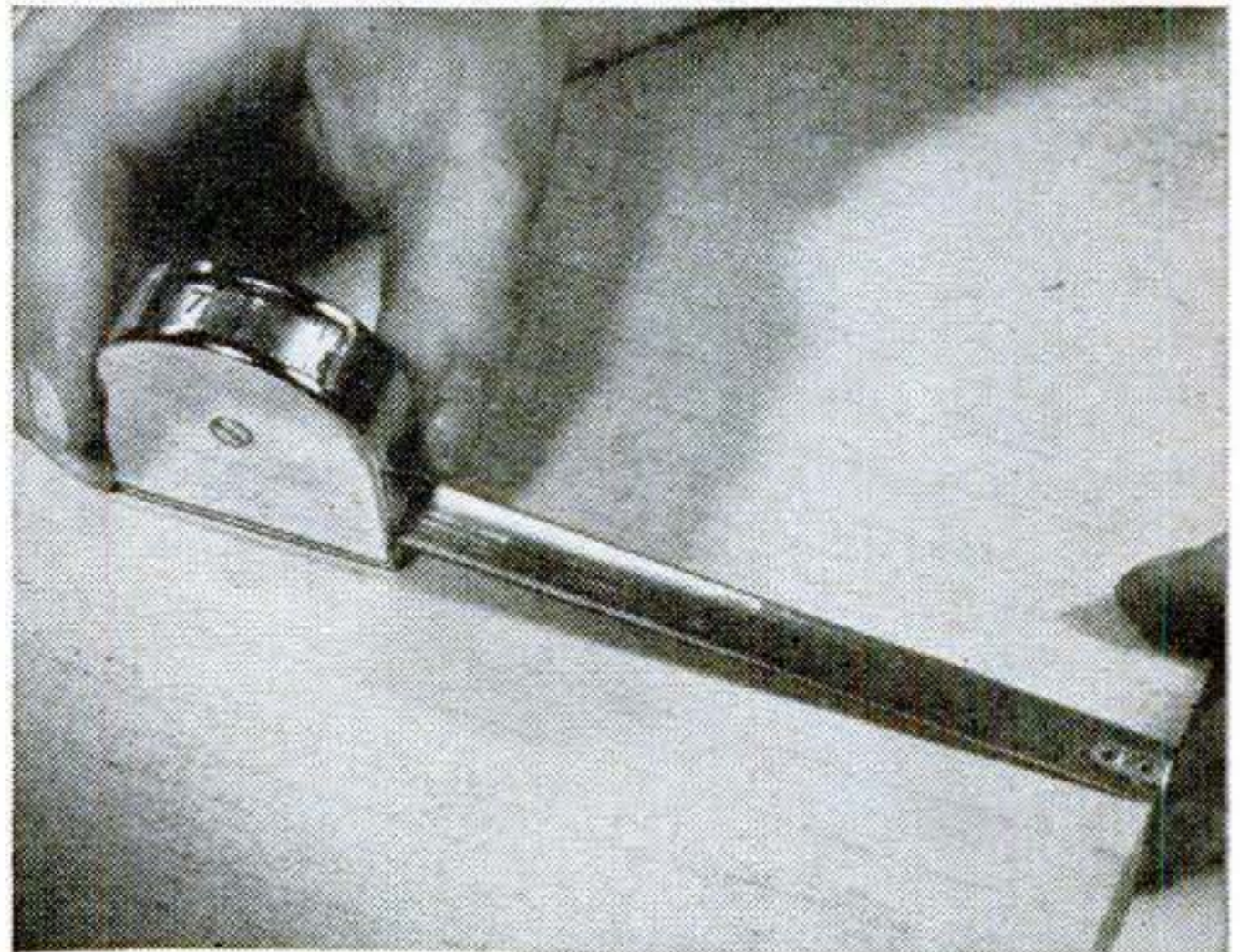
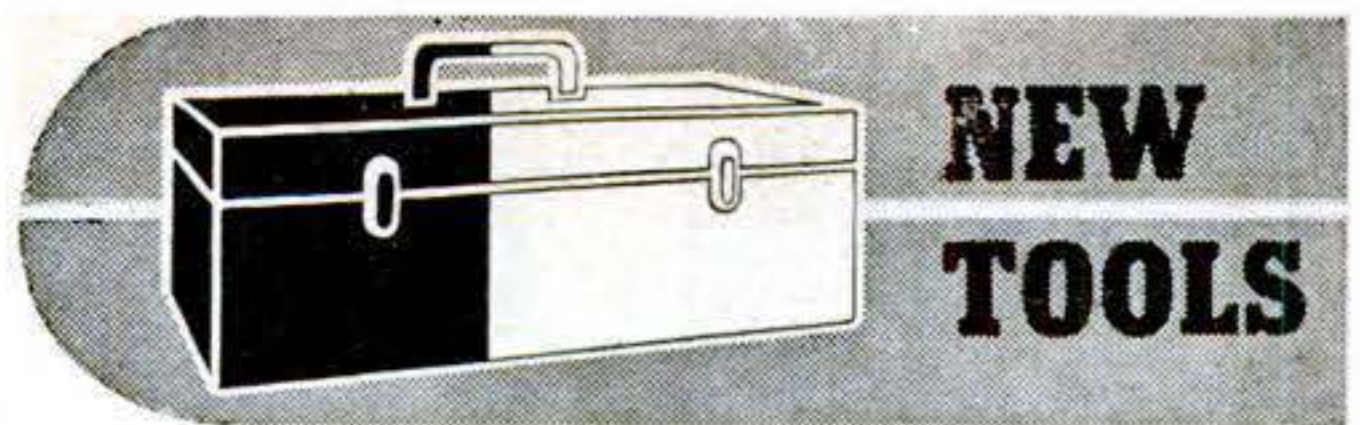

Tape Rule Scribes Work. With this rule, a measurement can be quickly read under a hairline on the plastic dial. Since the dial figure includes the width of the chrome case, no computation is necessary to get inside measurements. Built into the far edge of the case is a scriber that recedes inside a protective shoe when not in use. An oil-saturated wiping pad in the case keeps the nickel-plated tape in good condition. It is made by the Dart Manufacturing Co., Mason, Mich.

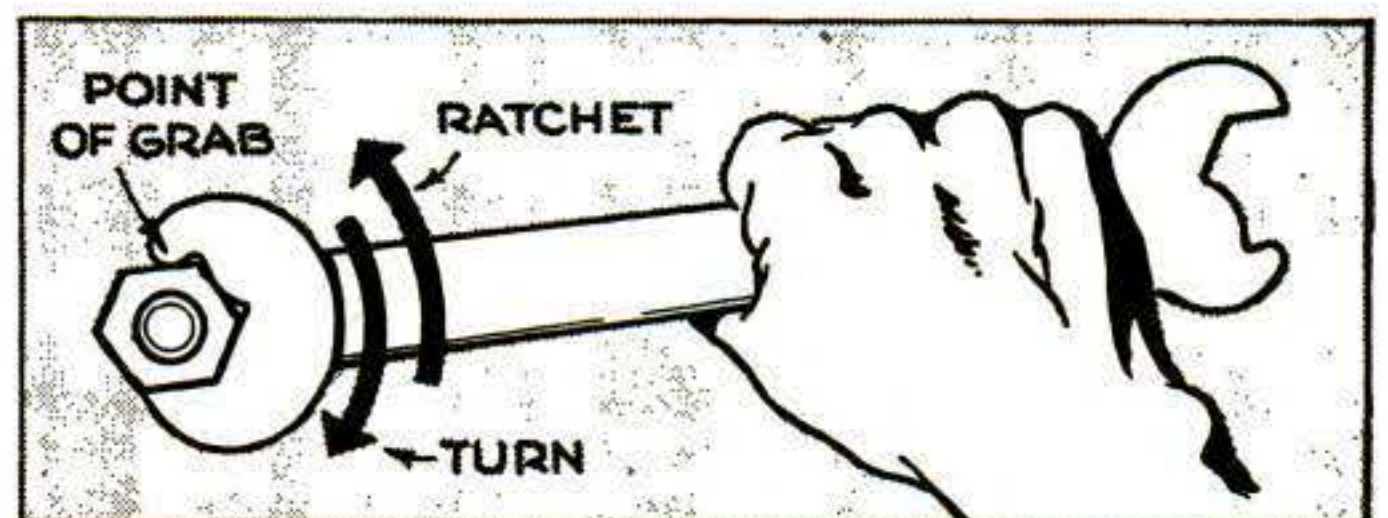

Wrench Is Self-Ratcheting. Embodying a new design, an open-end wrench made by the Eazon Tool Company, of St. Paul, Minn., works like a ratchet on either hexagon or square nuts, making it unnecessary to pull off the wrench at every turn.

Because of the inner shape of the head, the wrench grips hexagon nuts at three points of contact instead of two, but slides smoothly back for each new purchase. Manufactured in all standard sizes, the wrench is said to do everything an ordinary open-end wrench can do, and to be particularly effective in restricted spots.

Carving Plastic Inside Out

A ROSE, seemingly frozen at the height of its bloom and embedded in a crystal-clear block of plastic, can add breathtaking detail to your next craftwork project. Goldfish immobile in a piece of ice, butterflies that never light, and birds forever in flight can lend decorative drama to your work. Internal carving in plexiglas or other acrylic plastic breathes an air of reality that is downright startling—yet what you look at isn't actually there.

Anyone who has drilled clear plastic knows the hole at once becomes a milky, opaque cylinder, apparently more solid than the transparent substance around it. Internal carving takes advantage of this. With suitable drills, a cavity is formed the shape of the object represented. Color is added by dyeing the internal surfaces. The result is, to all appearances, a three-dimensional object embedded in plastic.

Other properties of the plastic heighten the effect. The carving is visible from all four sides as well as the top. As may be seen in the full-color illustrations on page 113, the design is reflected and multiplied by angles and facets. Edge lighting can be employed with startling results.

Although this article will deal with techniques rather than specific projects, the possibilities are tremendous. A spray can be carved in the lid of a jewel box. With a suitable base a carved block becomes a book end. Two pieces clamped back to back may form a lamp standard. A daisy $\frac{3}{8}$ " in diam-

eter may enhance an earring or lapel pin.

You'll need a high-speed hand grinder or a flexible-shaft tool with at least three bits (those shown in the photo below). Two, a ball or spherical cutter, and a cylinder cutter or end mill, are standard. A spiral drill can be purchased from hobby supply stores or by mail. Or you can make one from a $\frac{3}{32}$ " or $\frac{1}{8}$ " high-speed twist drill (carbon-steel drills dull rapidly).

Chuck the drill in the grinder or hand-piece and hold it in motion against an ordinary grinding wheel so as to form a long, sharp taper. Be careful not to burn the steel, especially at the tip. Don't grind out the flutes; they should continue right to the tip. The pointed end should have sharp, chisel-like edges. Try it in plastic; it should not have to be forced in. You can use a miniature abrasive wheel in the hand grinder to touch up the cutting edge and to back off the metal behind it to provide clearance for free cutting.

Properly ground, the drill should pierce freely without being pushed, and should cut sideways almost as readily as straight ahead. Never use any but the gentlest pressure—let the drill do the work and the cutting proceed at its own pace. Be careful never to let the drill break through the top surface; aside from spoiling the work, this may jam the tool and break the drill or flexible shaft.

Safety first is a must, too. These drills are *sharp*; keep fingers off the plastic not only ahead of them, but also alongside portions where they may break through. Especially in shallow stock, the cut has a way of creeping out of the work.

Besides the tools, you'll need some thick plastic (at least $\frac{3}{4}$ " for the daisy shown in the step-by-step photos, and preferably thicker). Work can be done in thinner stock after practice. Always sand and polish the edges of the block before you begin carving; not only will you do better work, but you'll be less likely to poke the drill out accidentally. Masking paper is removed, of course.

Cold-dip dyes, consisting of dyes in an acetone and water solution, are commercially available. You can experiment, though,

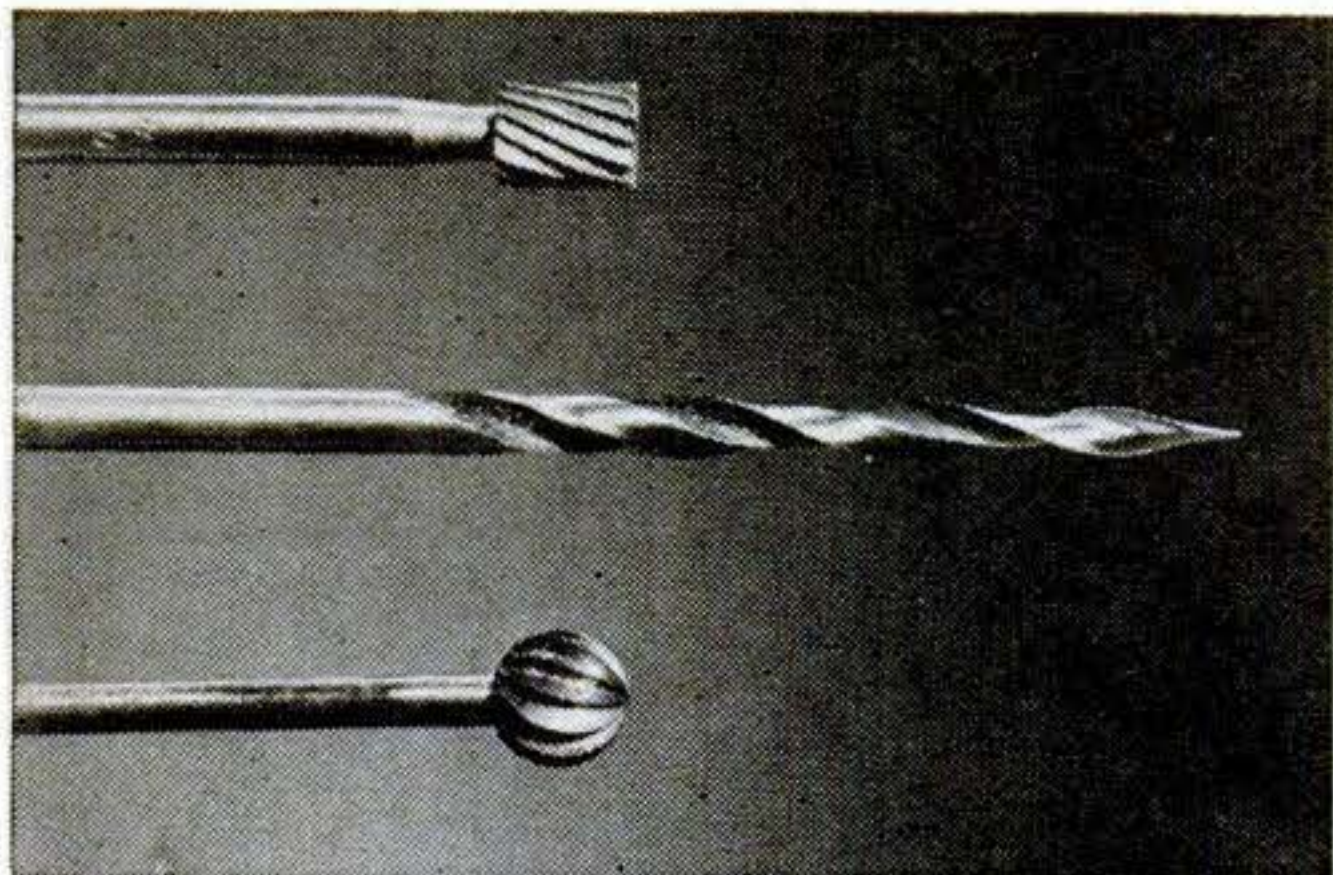

All projects shown here and in color on page 113 can be made with three bits. Top, $\frac{3}{16}$ " end mill; center, spiral drill ground from an ordinary $\frac{1}{8}$ " high-speed bit; bottom, $\frac{1}{4}$ " ball cutter.



As natural as though frozen in a block of ice, this daisy is carved in plastic and dyed natural colors.

with tempera colors, nail polish, and even iodine and mercurochrome.

The photos on these pages show the carving of a daisy, a good project for the beginner. Make the center with the ball cutter, working from the back of the piece; that is, look directly at the tool just as in carving wood. After the center has been dyed and is dry, the work is turned over and the carving done from underneath, the spiral drill being observed through the block. Each petal is made by inserting the drill to form one tip, then withdrawing it slightly, working it sidewise at the same time, and again advancing it to form the double tip. Petals are started from the side of the center cavity, as in a real daisy. Leaves are carved both ways from their center ribs.

Roses are more difficult. Polish the faces of a block at least 1" thick. The piece is then held in the left hand, the drill is inserted at 90 deg. to the face, and a hole is drilled about $\frac{3}{4}$ " deep. As you reach the full depth, turn the point in a small tight circle, just enough so the end of the hole appears from the front as a rounded tip.

All the cuts will now revolve around this center hole, and the drill will be inserted at its opening for all succeeding cuts, though

at different angles. The first cut is made by inserting the drill so that its point will be about $\frac{1}{16}$ " from the center hole when it is $\frac{3}{8}$ " deep. After the drill point reaches full depth, it is swung a quarter circle, as in Fig. 1, page 164, for line A. As the right hand twists the drill to the left towards the body, the left hand can also twist the piece against the drill. A second cut is made at the same angle as the first, and overlaps it a bit. The drill is then swung a third time, overlapping the second cut. Overlapping gives the petals a natural folded appearance. The fourth cut (*D* in Fig. 2) overlaps both the first and third cuts, forming a closed circle of four folded petals.

For the next layer of petals, the first cut, *E*, is made at a wider angle. The point of the drill when it reaches about halfway into the piece is about $\frac{1}{16}$ " from the nearest petal of the first layer. Again each cut overlaps the previous cut, and a fourth, which is not shown in the drawing, would overlap *E* and *G* to close the circle.

If space warrants, a third and looser layer may be made at a still wider angle. It should not penetrate as deeply. You can work the drill about to give these outer petals both an irregular edge and a wavy contour. Some ends may even be folded

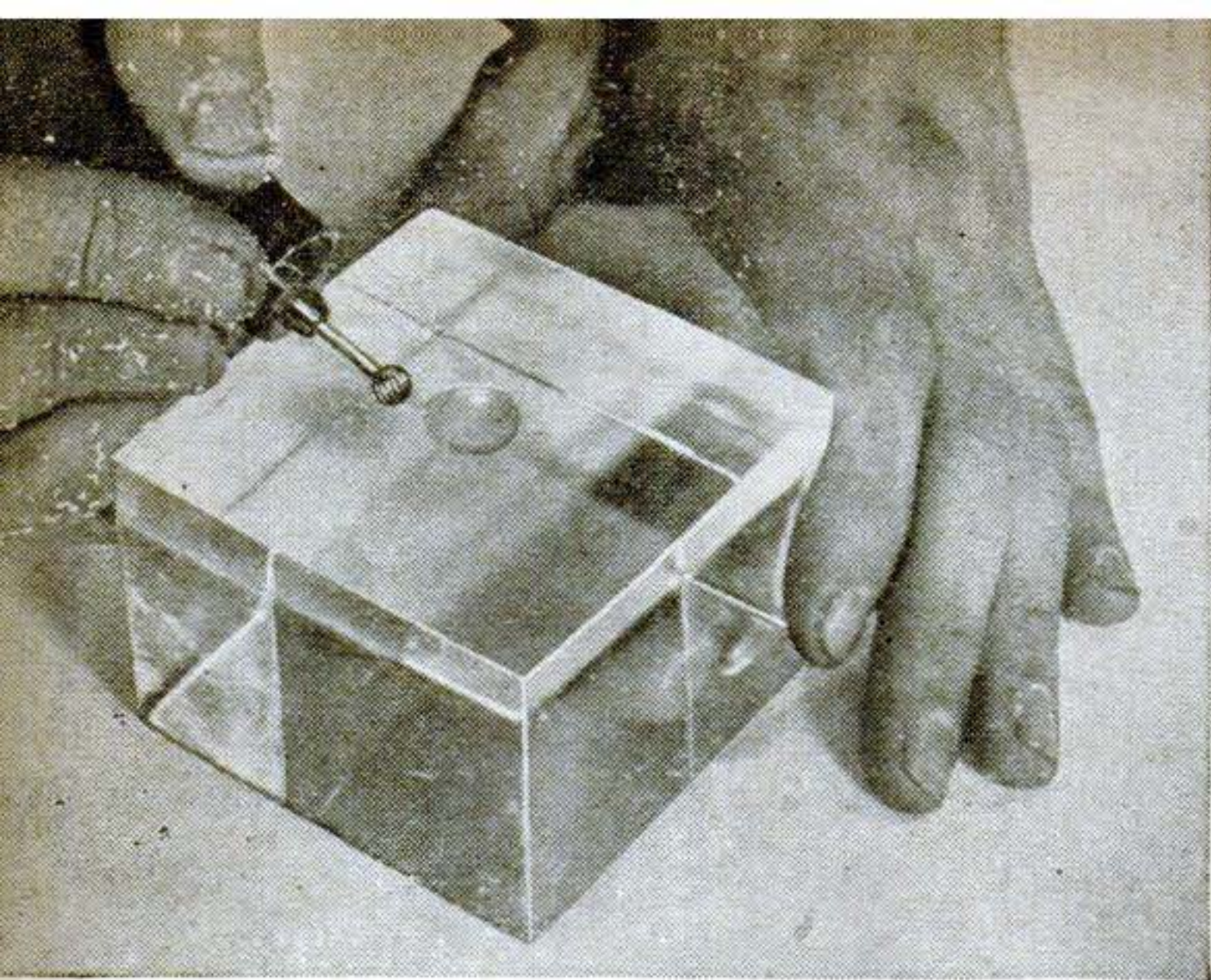

1 These photos show how Robert Barry, of Rohm & Haas Company, makers of plexiglas, carves a daisy. The ball cutter first forms a cavity $\frac{1}{2}$ " in diameter and $\frac{1}{4}$ " deep to make the center.

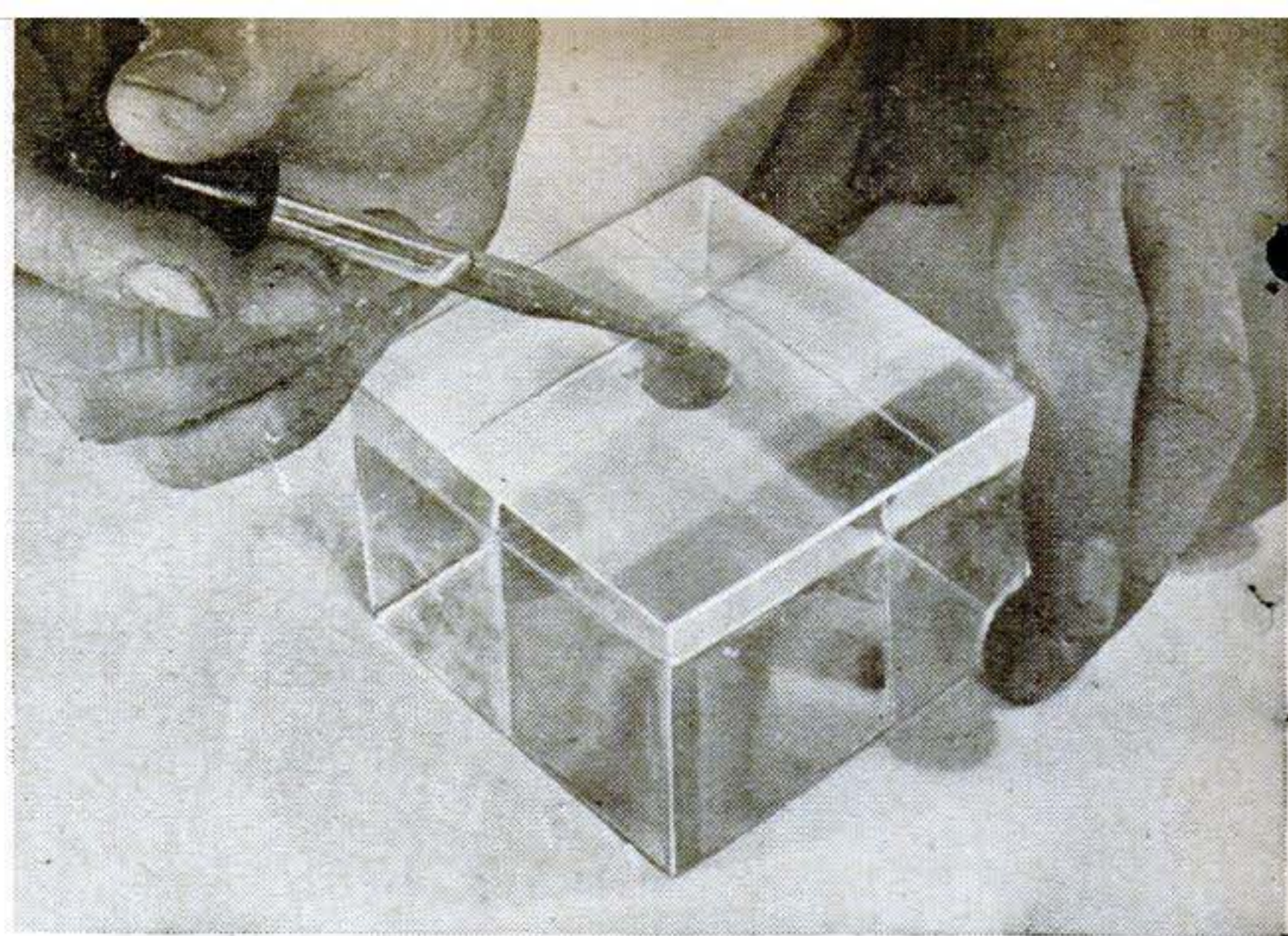

2 Yellow cold-dip dye is next applied inside the center. A few drops will do; the time the dye works governs the depth of color. When the tone is right, the surplus is poured out.

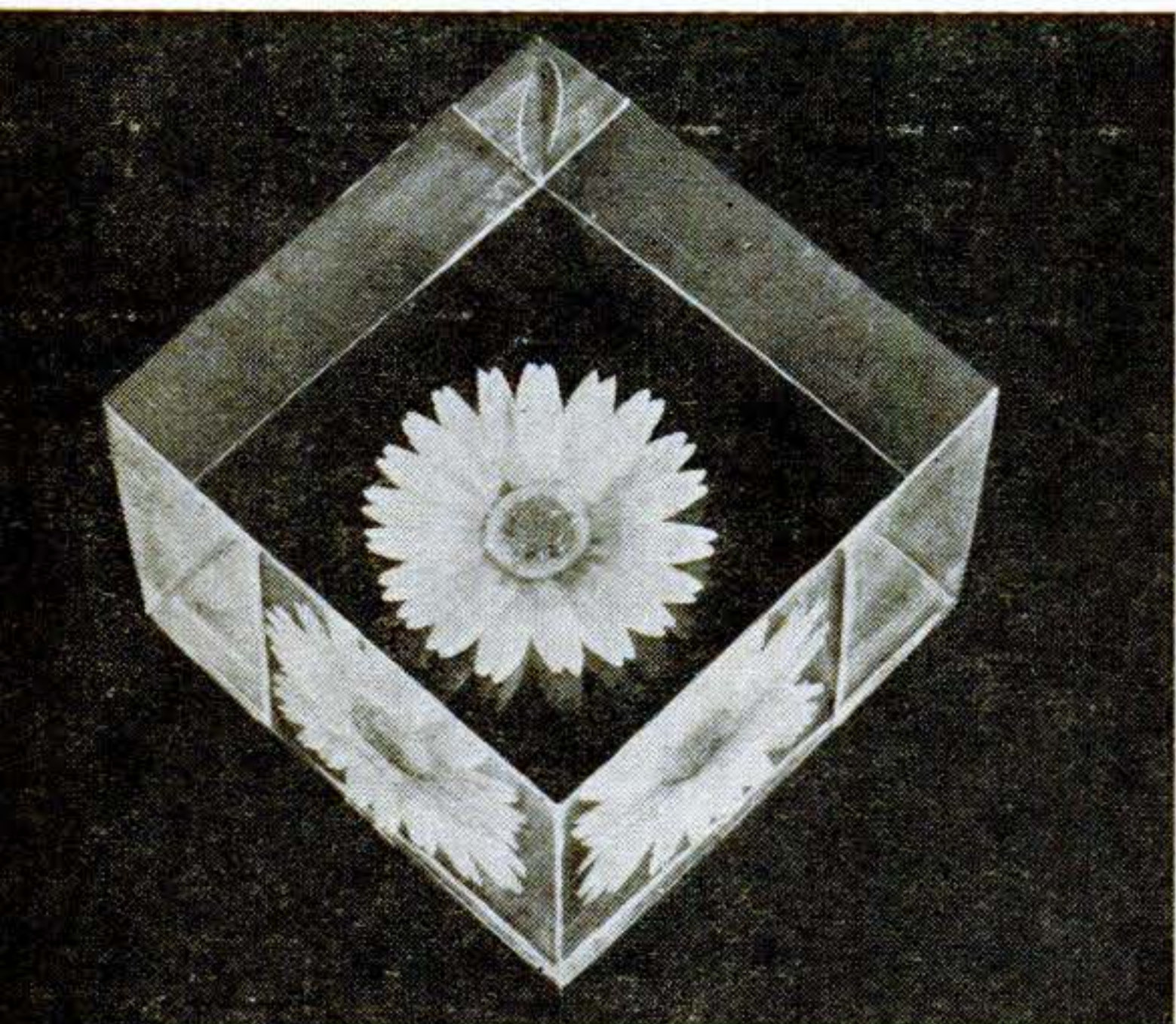

5 Petals are evenly spaced freehand. Instead of being left plain, the daisy center can be textured by pin-point touches of the drill for the result shown in color on page 161.



6 Leaves are made with the drill angle somewhat greater than for the petals. Forward thrusts cut the points. Starting at the centerline, one side is completed first and then the other.

back. Where needed, the drill can be re-inserted to push out a bit more and round off the petal ends.

In carving goldfish, hollow the body first with the ball cutter, working with the piece upside down. Carve bulges for the eye and mouth. Then turn the piece back over and with the tapered drill make the fins the same way as the petals in flowers. The drill is inserted at the edge of the body and a wide sweep made with the drill point. Watch the shank carefully so as not to widen the point of entrance excessively.

Loose chips and shavings must be thoroughly cleaned out with a needle or pin

before dyeing to avoid dark spots. Insert just a few drops of dye with a small brush or an eyedropper. After a few seconds the dye is rinsed out in water. The longer it is left before rinsing, the deeper the color will be. A velvetlike finish can be obtained by dropping in a little aluminum, bronze, or gold dust before the dye is applied.

The opening in the back can be filled with plaster of Paris or dental plaster. The latter gives a hard white finish, but has to be used quickly as it hardens rapidly. This irregular white spot can be covered in jewelry by cementing over it a cup from an earring or thumbtack. Be sure the cup is

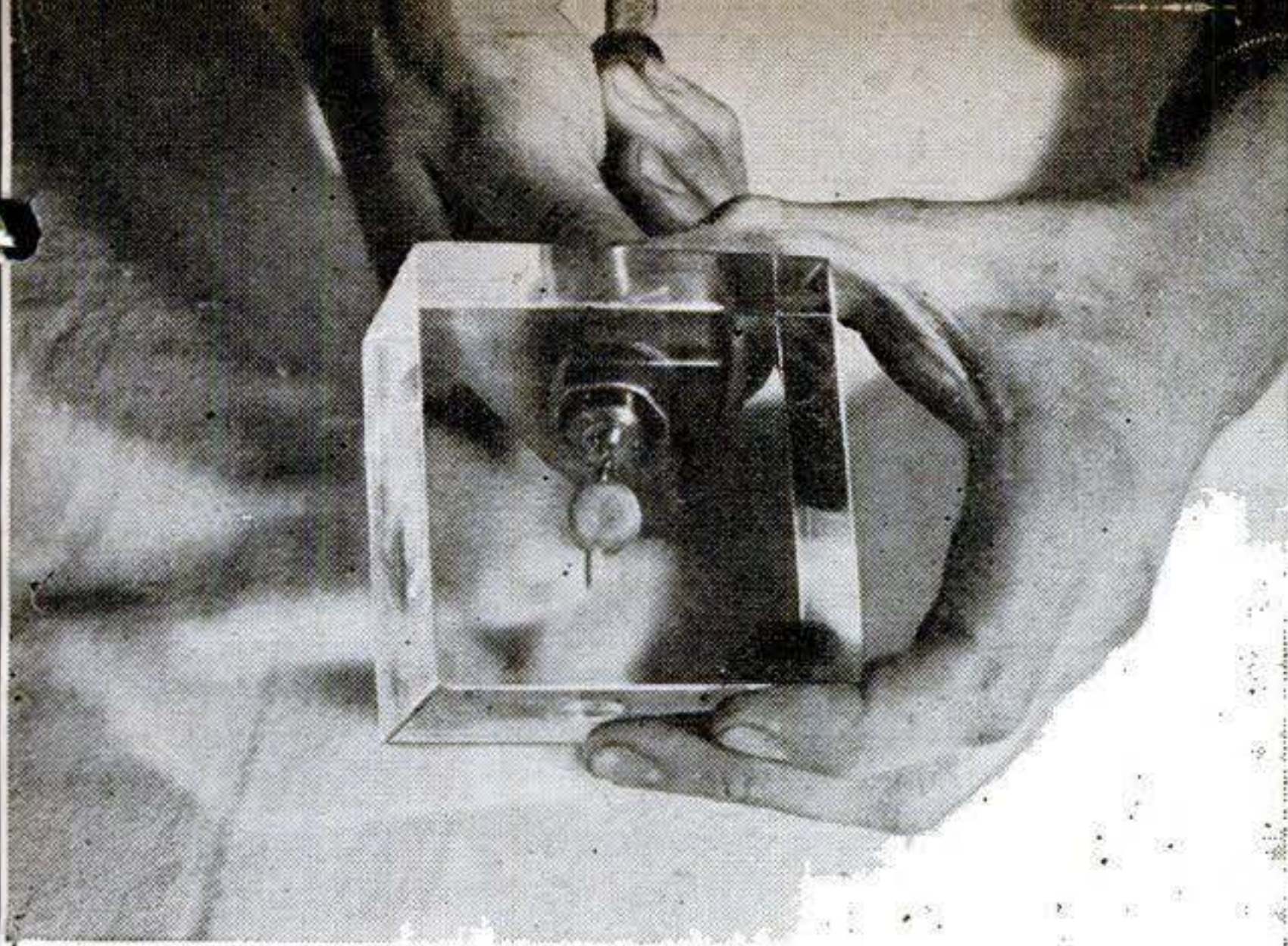

3 With the work turned over and watched through the top, the spiral drill comes into play. It is inserted in the edge of the cavity and held at as flat an angle as possible (about 25 deg.).

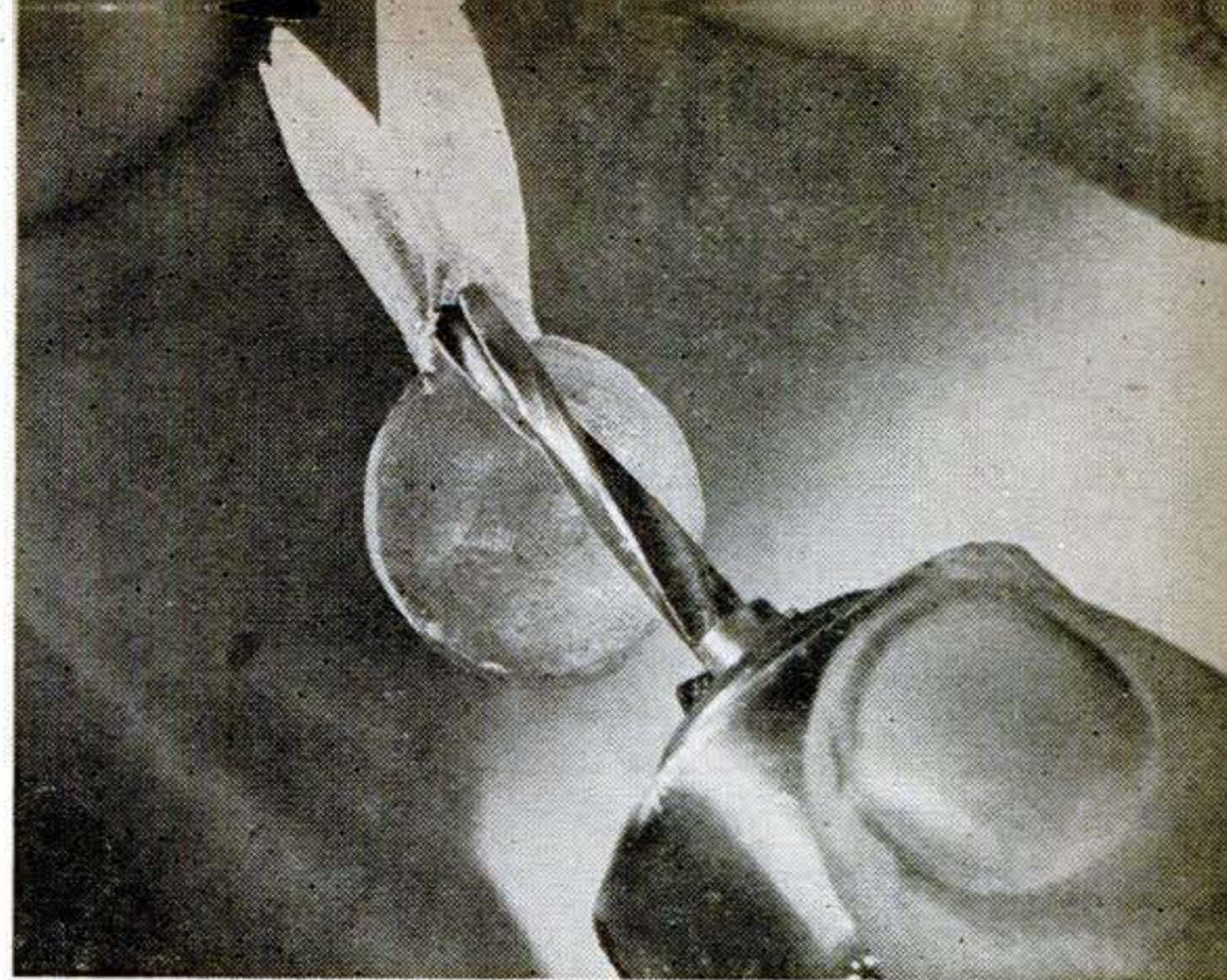

4 Here one petal is finished and a second begun. The drill is inserted, withdrawn with slight pressure to one side to round the end, and then advanced again to form a notched petal tip.

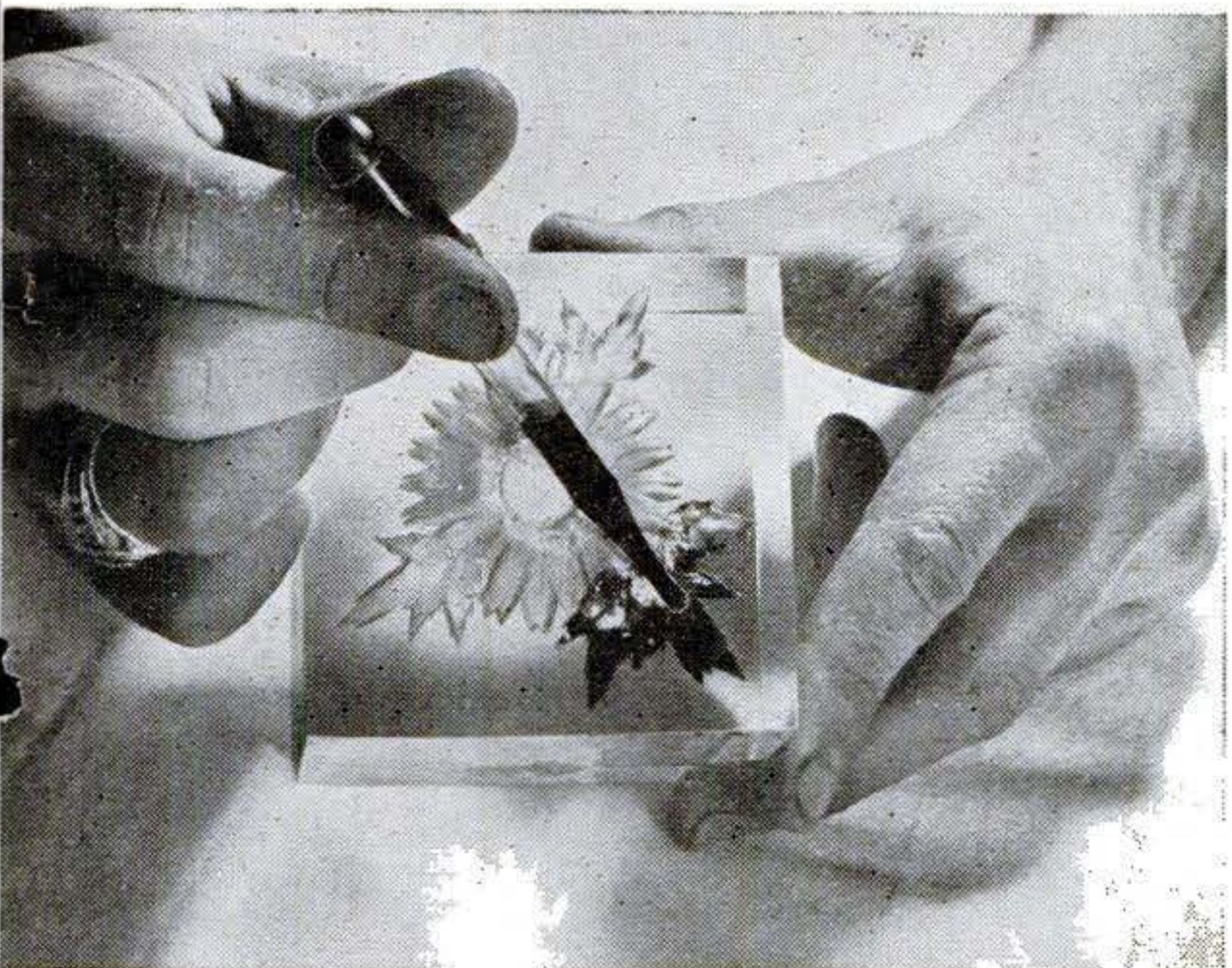

7 Leaf groups are tinted by dropping in dye. A tone gradation is possible if dye is applied first at the tips and works longer there. Petals can be dyed or, as here, left a frosty white.

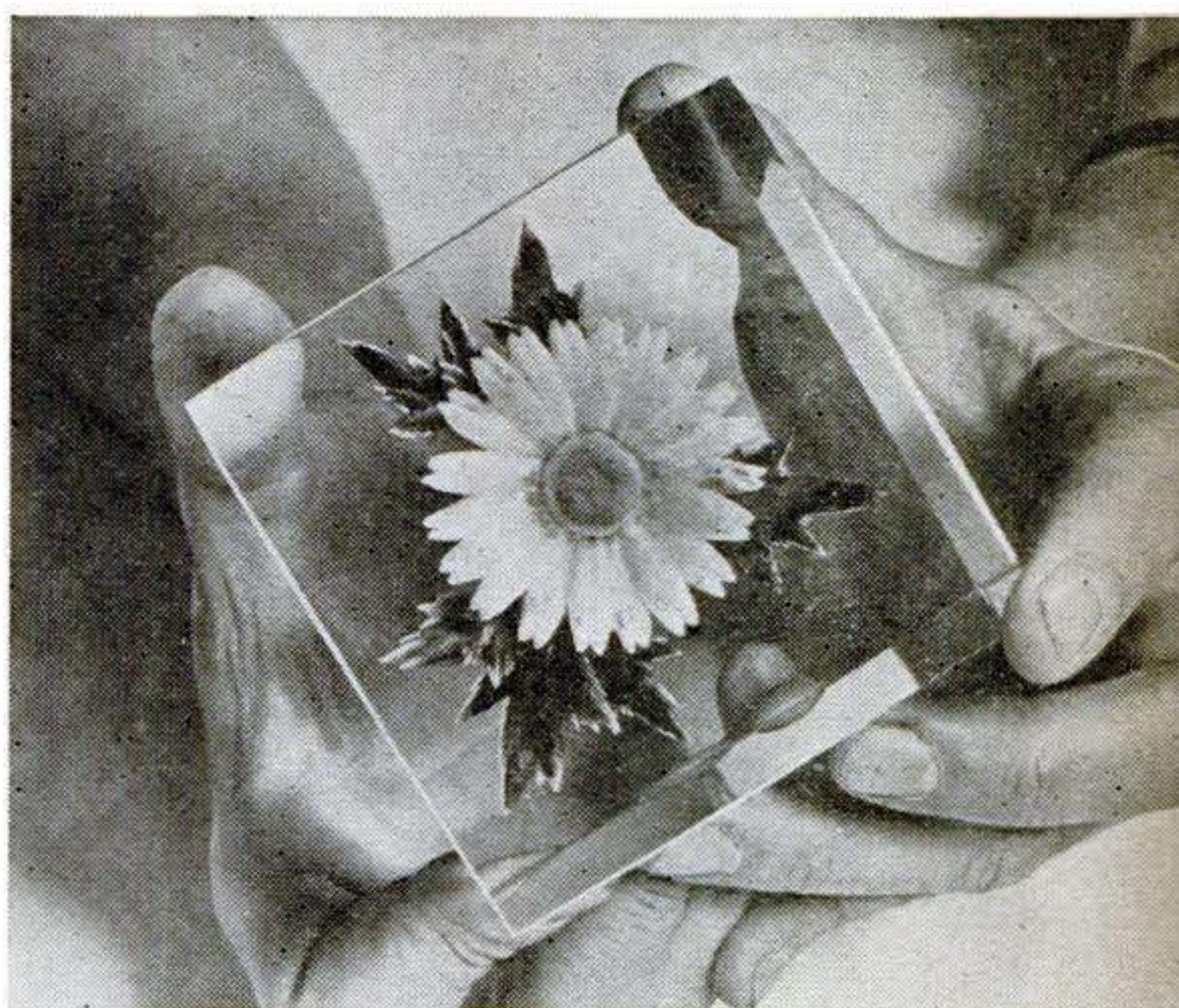

8 The finished daisy, with yellow center, white petals, and green leaves. Seen from any edge, the carving has lifelike, three-dimensional depth. The cavity beneath may be filled or covered.

of smaller diameter than the flower so it will not show when viewed from the front. Larger pieces can be backed with metal covered with a sheet of opaque plastic, or cemented to any surface that will set off the design.

In making earrings, if you get an earring screw with a peg in the cup, you can fill the cup with the plaster also. Insert the peg in the plaster in the hole, wait a few seconds till it starts to harden, wipe off the excess plaster forced out from under the cup, and you will have a perfect bond.

When carving leaves, don't be afraid to work the drill about to form wrinkled edges,

overlaps, and other realistic details. You can form two or more layers of leaves, one above the other. Occasionally try carving a leaf at right angles to the others so it will be seen end-on through the top of the block. Such variations will help you create forms that look as lifelike from the edges as from the top. Buds and the smaller flowers may also be carved at various angles.

Don't overlook surface carving for less emphatic elements that serve as backgrounds to deep-cut motifs. Ferns, grasses, and seaweed are suitable subjects. Other flower forms, ranging from forget-me-nots to thistles, are only variations of the same

techniques. You can get patterns from illustrations in seed and bulb catalogs.

Butterflies involve symmetrical carving, and it is best to make an outline drawing of the wing on tracing paper and attach this to the underside of the plastic with water-soluble glue (don't use model-airplane or household cement, which may dissolve the plastic). Insert the spiral drill along the front line of the wing, starting about 1/16" away from the centerline. Watch the shank of the drill as closely as the tip, so that you don't cut across the body centerline; the drill will readily chew away too much there if you let it. Half the wing can be cut in a higher plane to overlap the other.

Take special pains, following the pattern closely, to get both wings the same. Then turn the work over and, with the spiral drill held as flat as possible, touch it at the centerline to form the tapering body. You can, of course, add wing spots, patterns, antennae, and so forth.

Birds are begun with a ball-carved body and head. The beak is made with a touch of the spiral drill, and wings are similar to petals except that the forward edge may curve. To form this curve with the spiral drill, make the first thrust to the wing tip with the entering point at the wing root some distance back of the edge. Withdraw and swing the drill slightly before advancing it to form the first feather edge or point. The drill thus lies tangent to an arc that forms the curve.—HARRY WALTON.

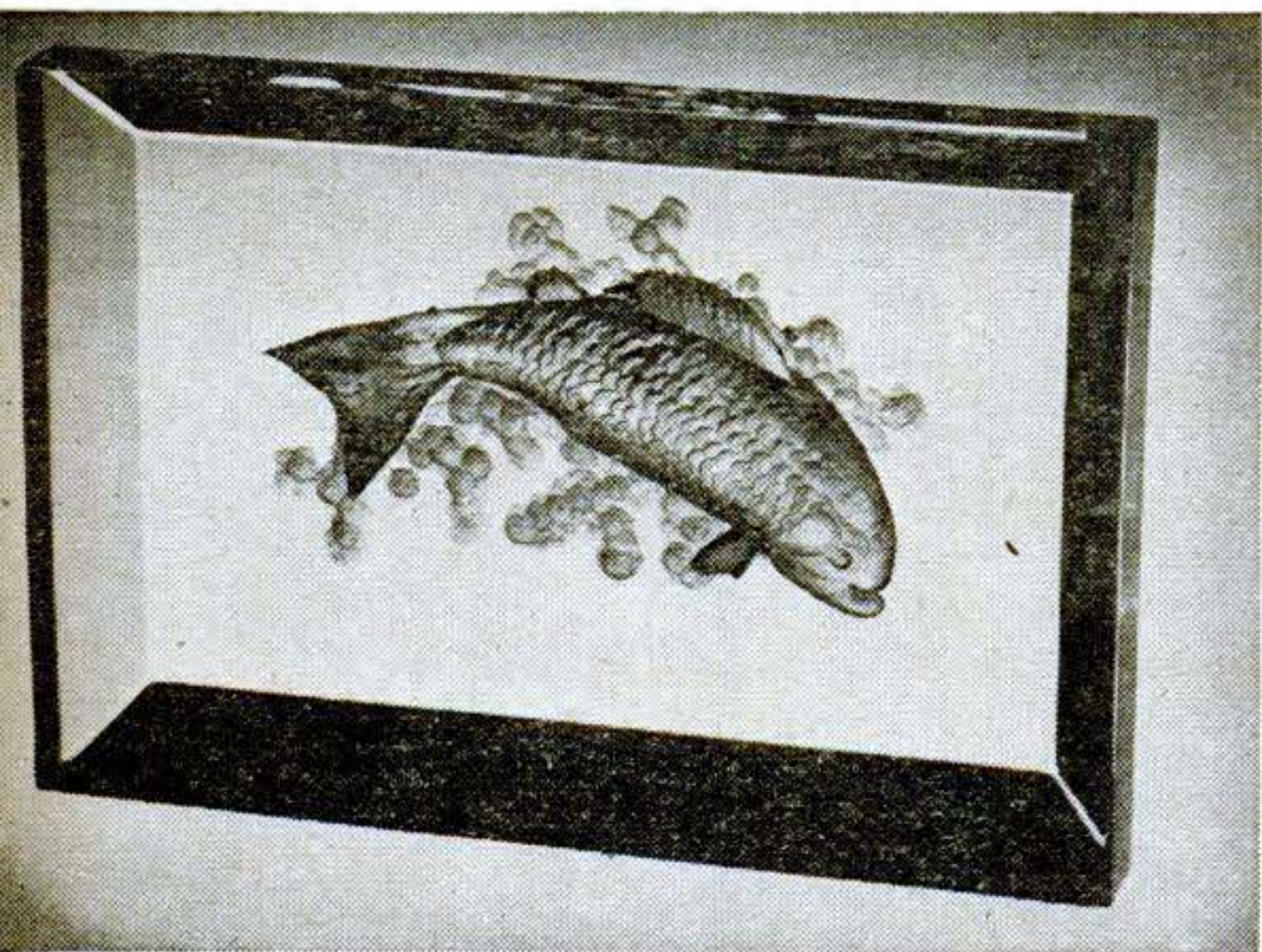

Like the daisy center, the body of this fish is made with the ball cutter. Scales are added with touches of one side of the end mill at an angle, and a bulge forms the eye. The spiral drill is used for the fins and tail, which sweep upward at 45 deg. Bubbles are the work of the ball tool.

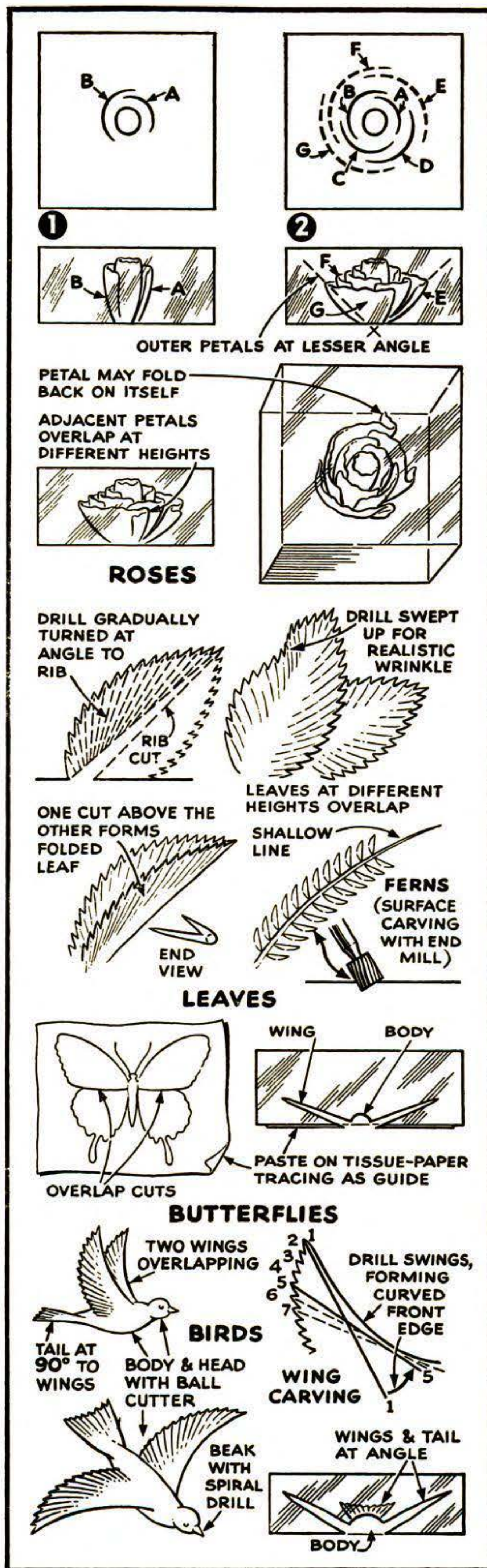

Kerchief Box Contrasts Wood Tones

WORKING with a maple turning and odd bits of walnut or mahogany, you can make a modern handkerchief box in a single evening.

Bandsaw the maple to form a T-shaped blank for the lid, and scribe 3" circles on the end of the projections as a guide for rounding the back. A pivot jig used with the sanding disk will speed shaping. It consists of two uprights spaced to receive the T-blank and nailed to a baseboard. The blank is pivoted on nails driven through the uprights and centered in the circles. Hold the jig against the sander table and swing the blank up and down until it is rounded. Make a template for the curve at the front, rough with a chisel, and shape on the sander.

An auger bit with the square shank and part of the screw point removed is a handy drill-press tool for hollowing the lid. Set the depth stop for $\frac{1}{4}$ " above the table and bore holes close together. Finish with a chisel, a twist drill in the corners, and a rotary file, if available, for smoothing.

Make the base somewhat oversize and trim flush with the lid after hinging. Rout out grooves to receive the four sides, which are simply butted at the corners, and assemble with glue. The ornamental balls are turned hemispheres. Recess the lid for them with a circle cutter, finishing with a router bit. Use small brass hinges.—E. M. LOVE.

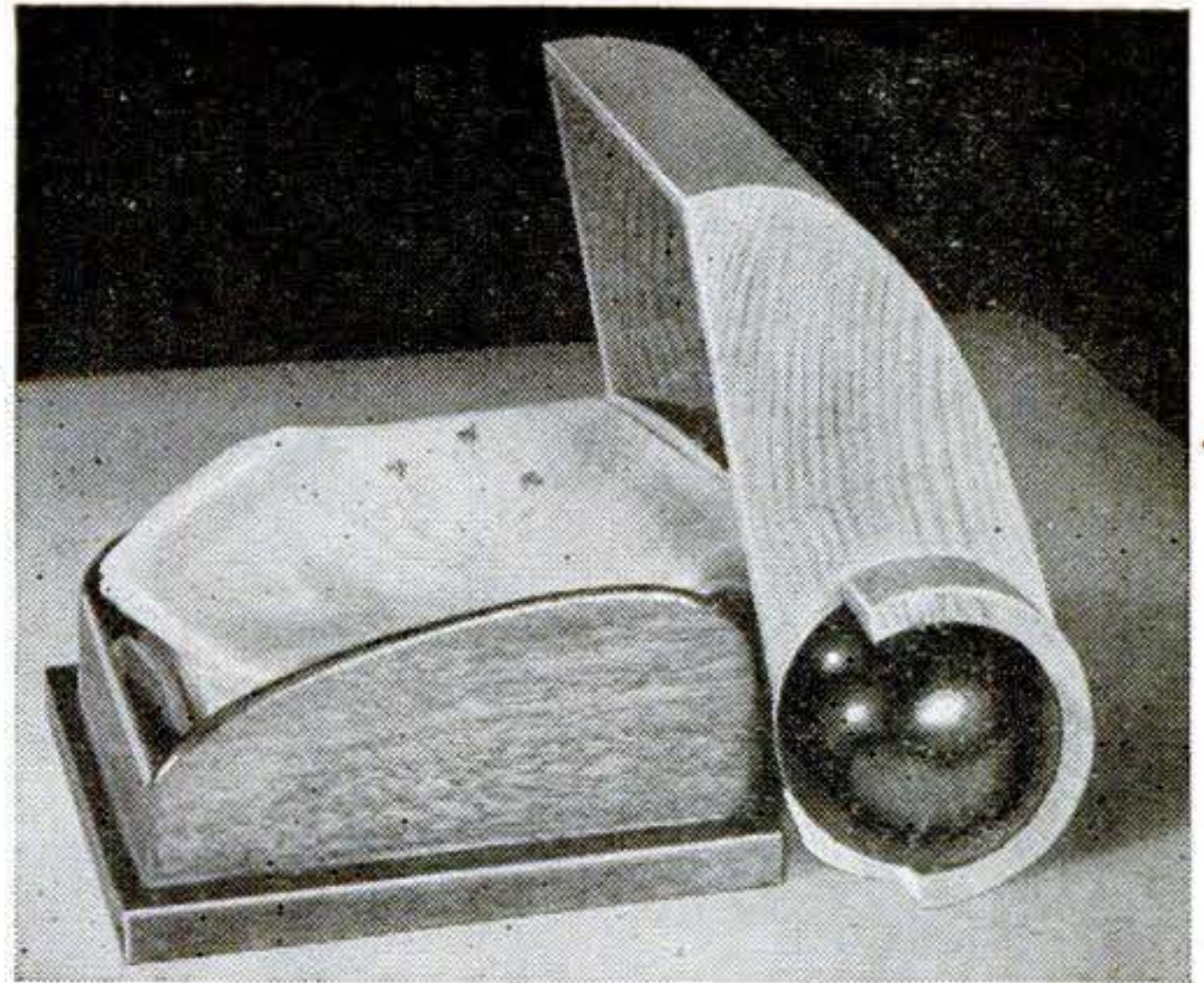

Though small, this box will hold close to a dozen men's handkerchiefs and a larger supply of women's.



Rounding the back on a pivot jig. The lid blank is swung on two nails. Shape the front freehand.

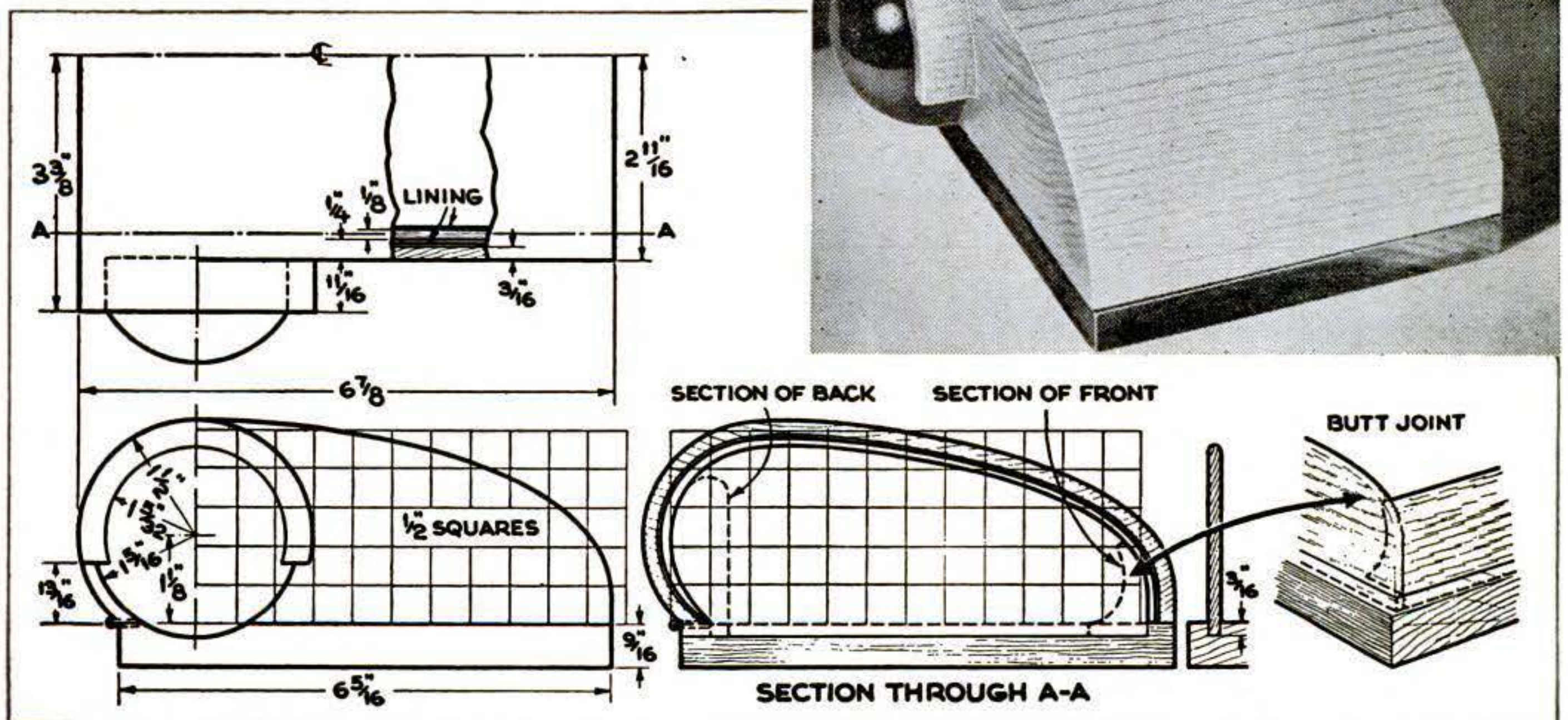
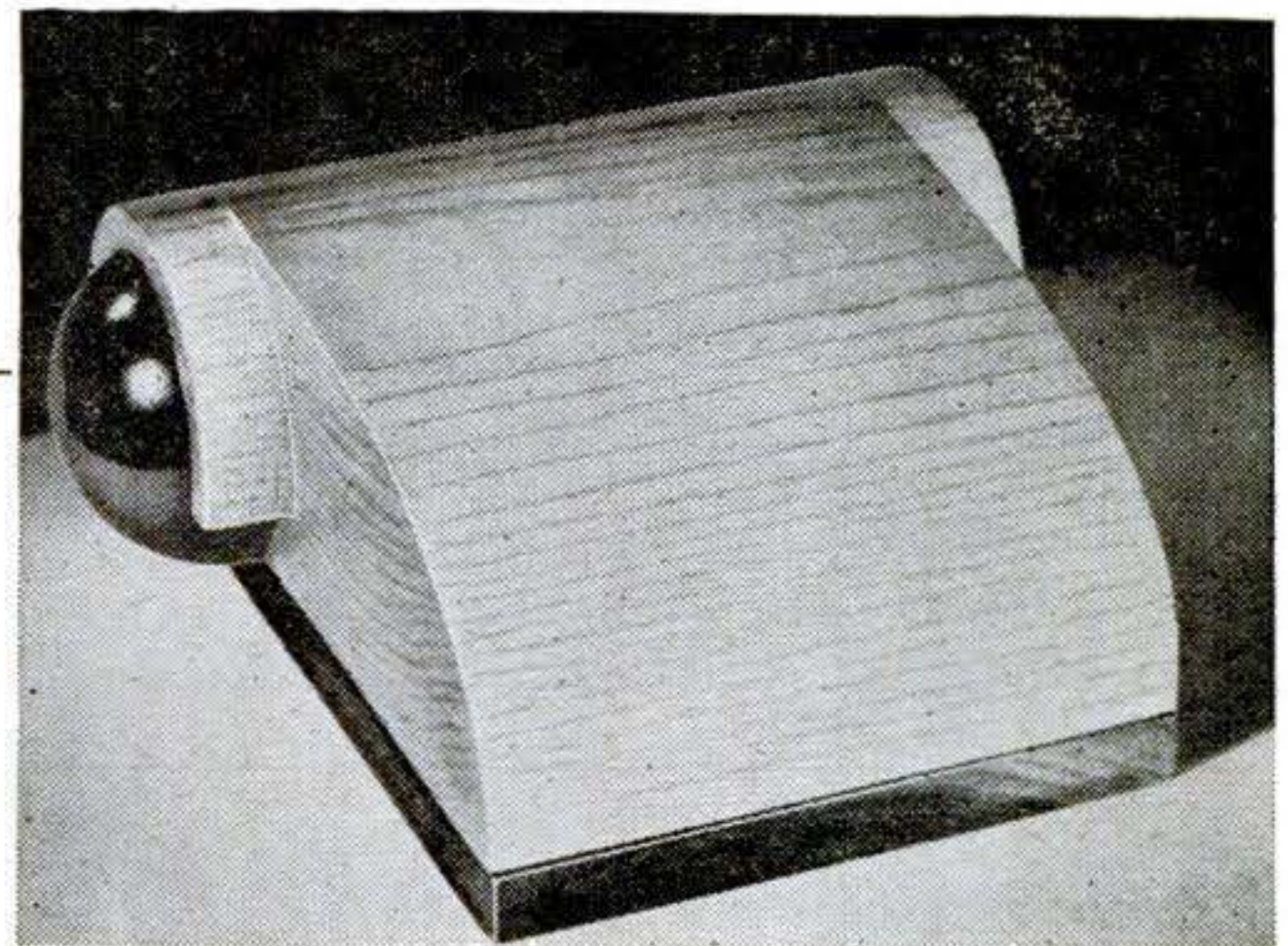

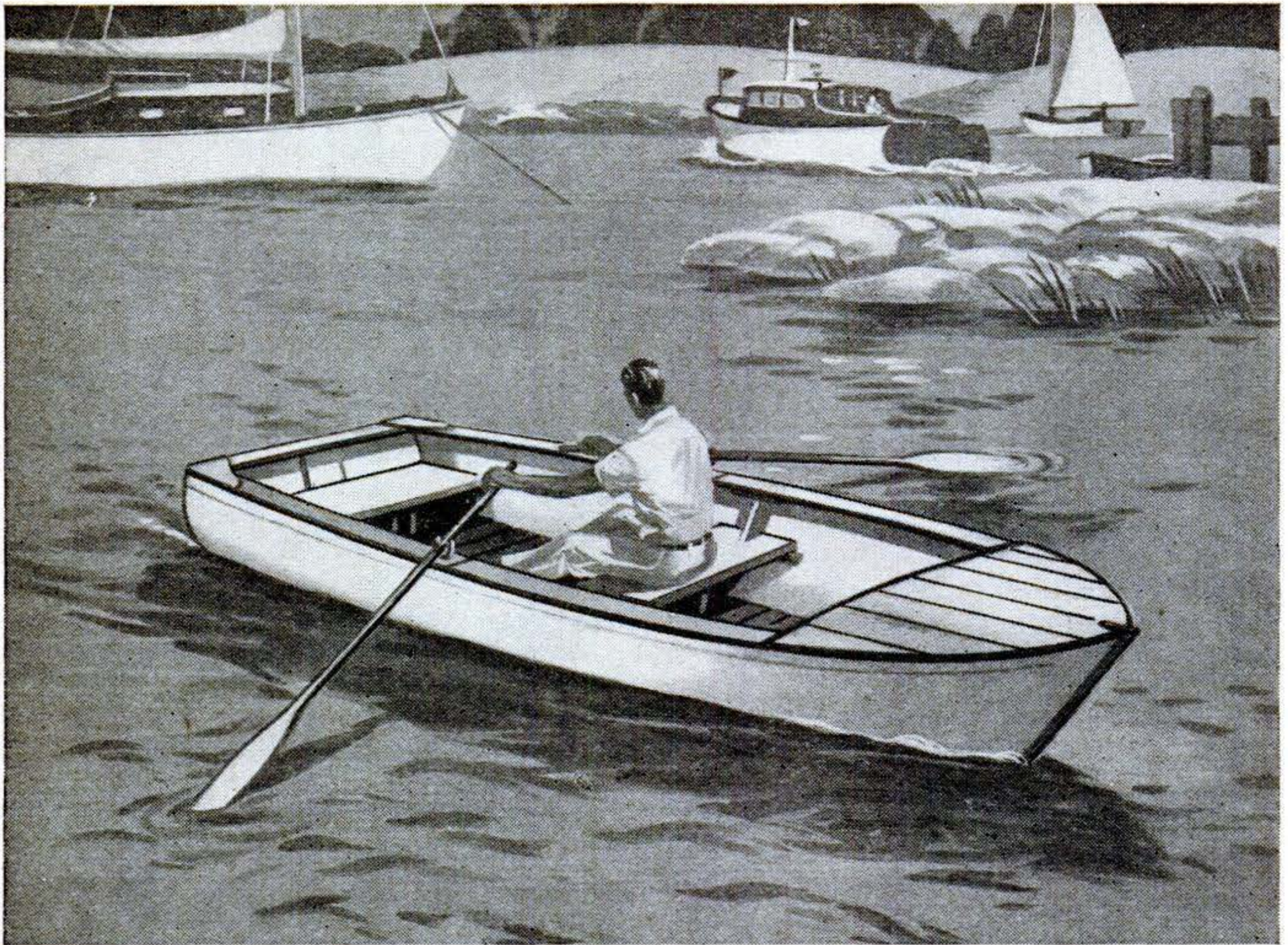

Good lines make this boat easy to handle. Its hull is a single sheet of surplus aluminum alloy.

Snip Yourself a Boat from Dural

Here's a durable, lightweight dinghy you can make with tin snips and a few other common hand tools.

By John D. Noble

THIS is one type of homemade boat that calls for neither laborious planking procedures nor the tricky fitting of plywood panels. The skin of this dinghy is a single sheet of .051" aluminum alloy, widely available in surplus outlets at present. Construction time is surprisingly short, and the cost is well below that of comparable boats built in the conventional manner.

While boatbuilding experience isn't needed to produce a shipshape job, you will want to exercise the careful attention to layout and forming that's essential to all good

sheet-metal work. Tools will be no problem; you can get by with little more than a pair of good tin snips, a hand drill, prick punch, hammer, saw, plane, screwdriver, and small wrench.

Obtain a 5' by 12' sheet of 61SO alloy about .051" thick for the shell and standard 1" lumber (13/16" net) for the framing. Use air-dried hardwood, if you can get it, to minimize the risk of warping. All screws, bolts, and fittings should preferably be brass; failing this, get hot-dipped galvanized hardware. Steer clear of cadmium-plated parts.

Clear out enough floor space to take the sheet with ample working clearance, cover the floor with enough opened newspapers to make a protective pad, and roll out the dural. Lay out the centerline and sufficient 6" squares for scribing the curves shown in Fig. 2. Locate and prick-punch all holes, but don't drill any until you have carefully

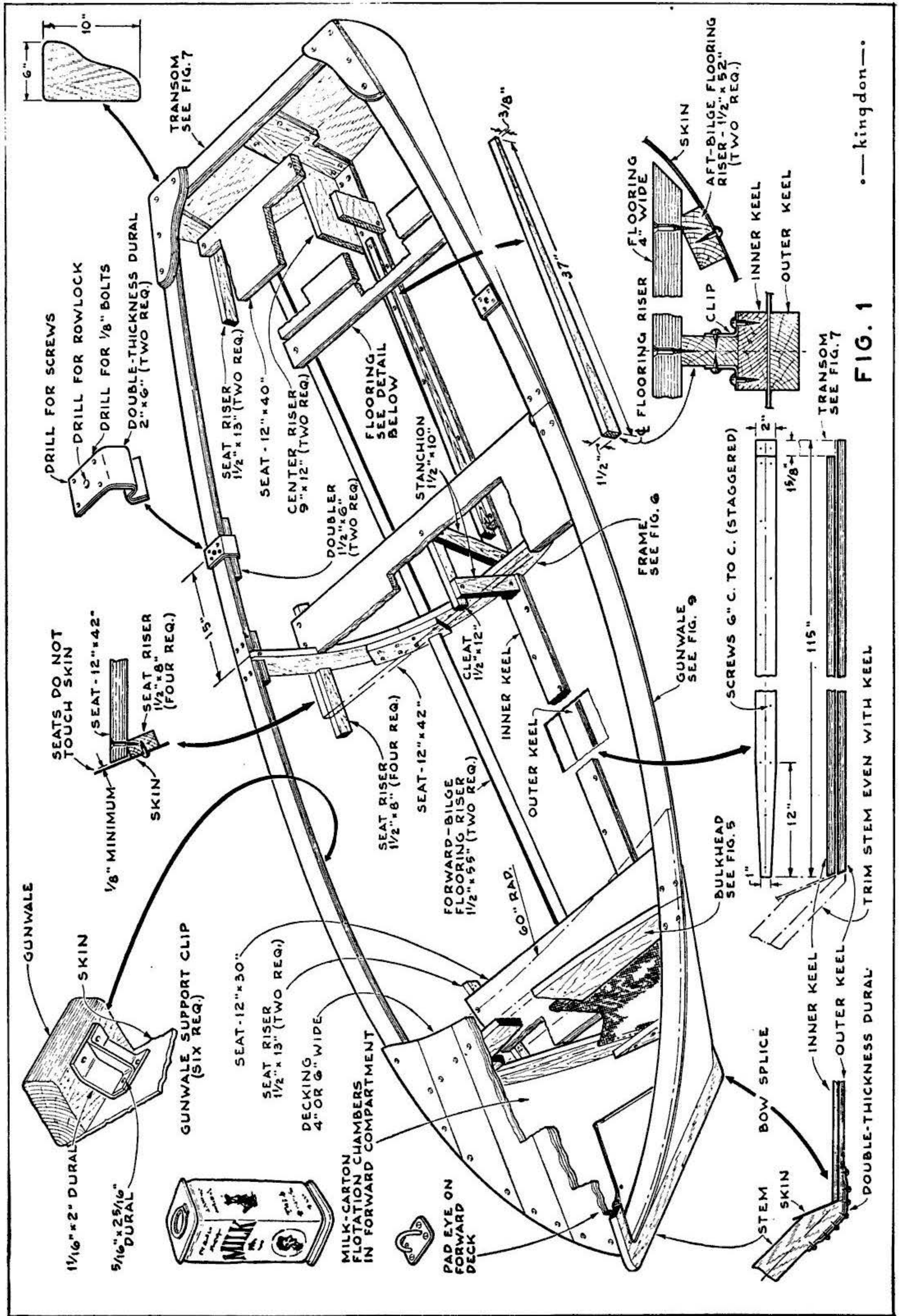

FIG. 1

—kingdon—

crosschecked the locations. Then drill them and cut the curves.

A bending jig for shaping the bow is shown in Fig. 3. Place the dural sheet on a couple of sawhorses, bolt it in the jig, and bend by turning the crank slowly until the metal is brought to approximate shape. Remove the jig and bolt the two forward points together temporarily. Don't attempt further forming at this time.

Saw out, sand, and insert the stem in the fold of the dural bow, as in Fig. 4, holding it in place with a bolt, two screws, and washers. Dip the bolts, screws, and washers in roofing cement or a similar sealing compound just before insertion. Excess can be removed with alcohol. Make sure also that both keels are coated with the sealer where they come in contact with the dural, and coat as well the attaching screws.

Figures 5, 6, and 7 show the construction of the bulkhead, frame, and transom. All must be symmetrical about a vertical centerline. The transom sealing strip, which may be felt, roofing paper, or several thicknesses of cloth, should be saturated with sealing compound. Place the transom on the keel, pull the skin up, and fasten temporarily at top with one screw on each side. Then place and secure the frame and bulkhead the same way, as in Fig. 8. The bulkhead may need to be leaned slightly forward or aft to allow the skin to form a graceful contour. Reinforce the frame with a temporary batten. Then screw the skin to the bulkhead and frame, driving the screws 4" apart, and to the transom, setting the screws 2" on centers. These screws, of course, should also be dipped in sealer before driving. The transom has an outboard-motor mount.

A method of laying out and cutting the gunwales from three hardwood strips for

each side is shown in Fig. 9. Brads driven in at intervals parallel to the skin will indicate the cutting angle for the saw. Splice blocks are used under the joints to stiffen them. Space screws about 6" apart.

The seats and their supporting parts are next installed, as in Fig. 1, which also shows the construction and installation of the floor and its supports. The center support strip may need to be planed down slightly to allow the flooring to rest on all three points of support. No center support is required forward of the center seat. All wood parts below should be cleaned and varnished before the flooring is installed. Varnish each floor board as it is put in, and allow 1/2" space between boards.

Sand, clean, and varnish all the remaining wood parts, and varnish also all metal parts within the area forward of the bulkhead. Before installing the forward deck, utilize the space under it as a buoyancy chamber, filling it with empty paraffined-cardboard milk cartons. Rinse the cartons thoroughly and seal the lids closed. If still more buoyancy is desired, the space below the transom seat may be closed off and used likewise.

Install the decking next, allowing the after ends of the deck boards to extend 6" beyond the bulkhead. Scribe an arc of 60" radius along the after edge of the deck, and cut along the scribed line with a compass saw. Sand all edges, and varnish the exposed surface (the underside of the boards should be varnished before installation). Cut, varnish, and screw on the two gusset plates at the stern. If 1/4" waterproof plywood is available for the deck and gusset plates, considerable weight will be saved.

No finish is needed on the duralumin, though it may be enameled if a color is preferred. END

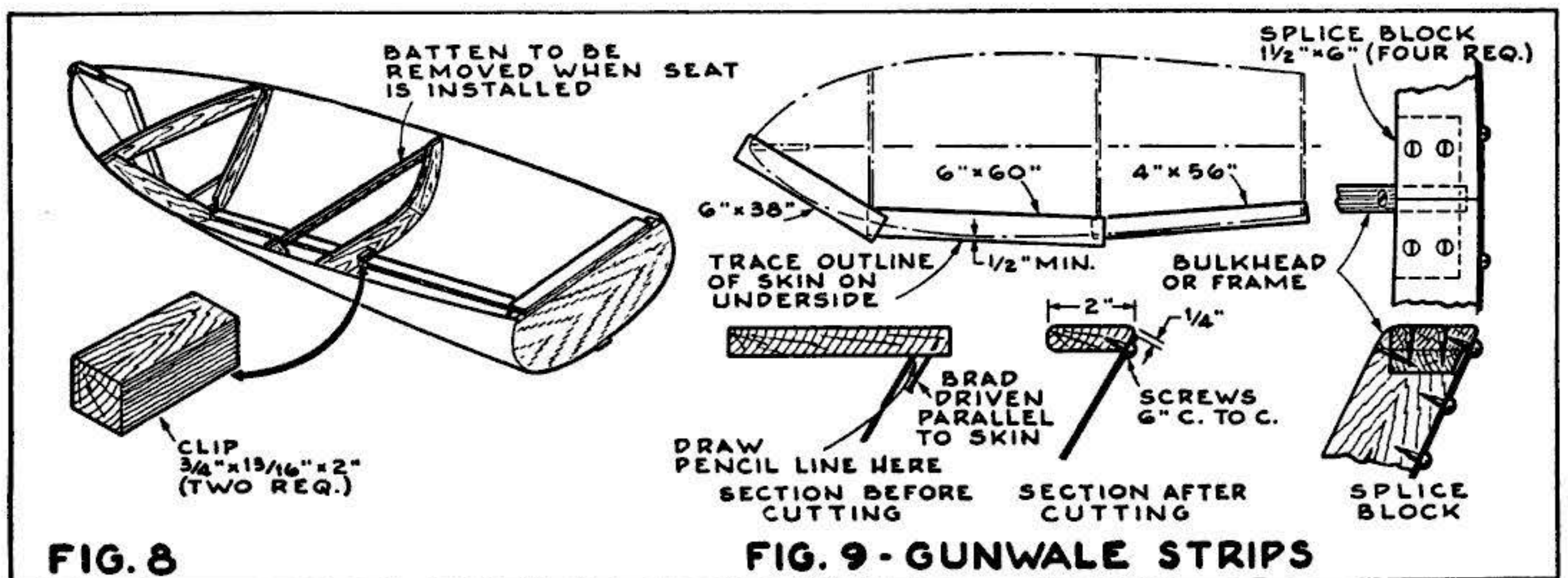

KEEPING the HOME SHIPSHAPE



CELLULOSE TAPE

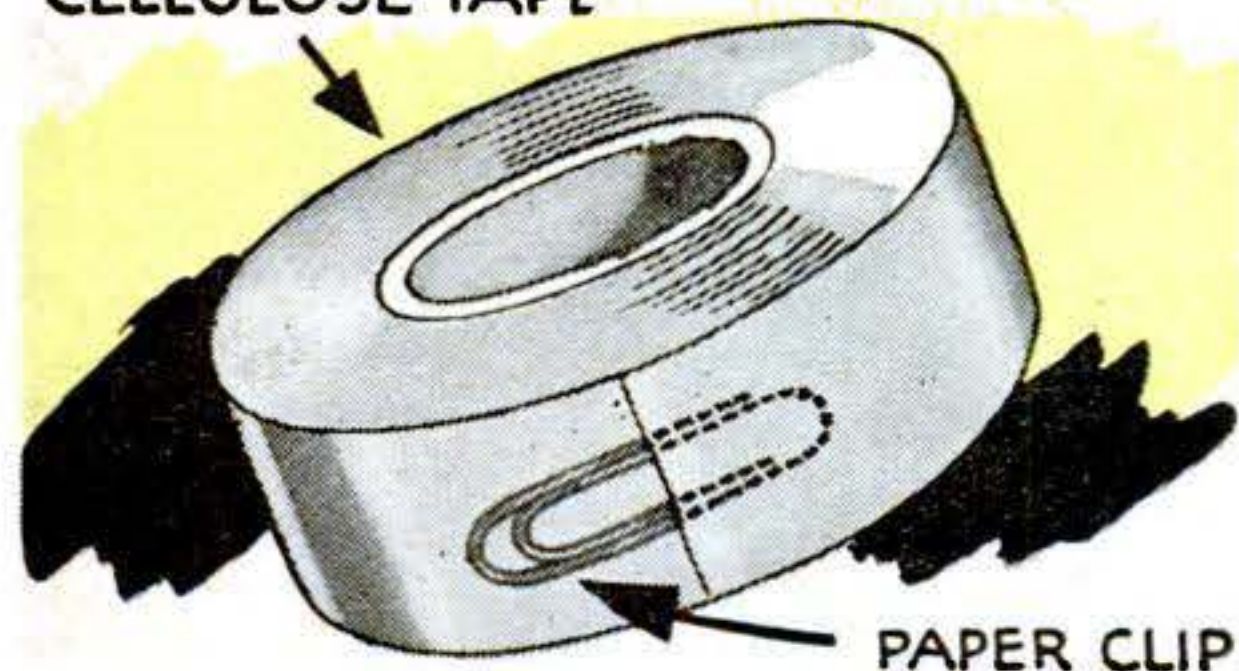

PAPER CLIP

An ordinary paper clip makes an excellent starter for cellulose or masking tape not used in a dispenser. Insert part of the clip under the end and press the tape tightly back on the roll. Lift the protruding part of the clip to start the tape.

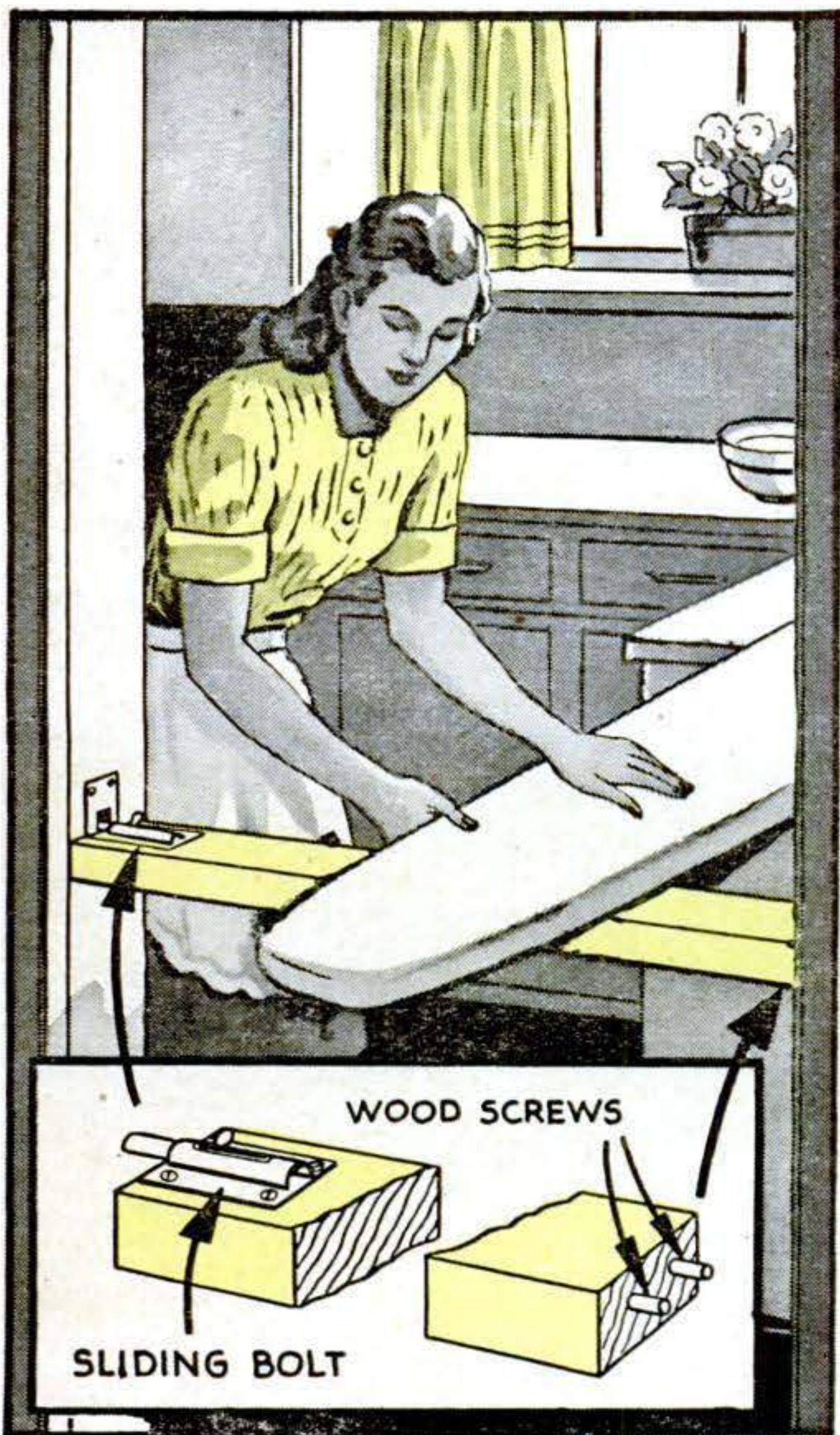

WOOD SCREWS

SLIDING BOLT

Need space for your ironing board? Perhaps you can make use of the distance from kitchen door to work table. Screws with heads cut off act as dowels at one end of a two-by-four crosspiece, and a sliding bolt does the job at the other. Small wooden blocks on the underside of the board keep it from sliding.

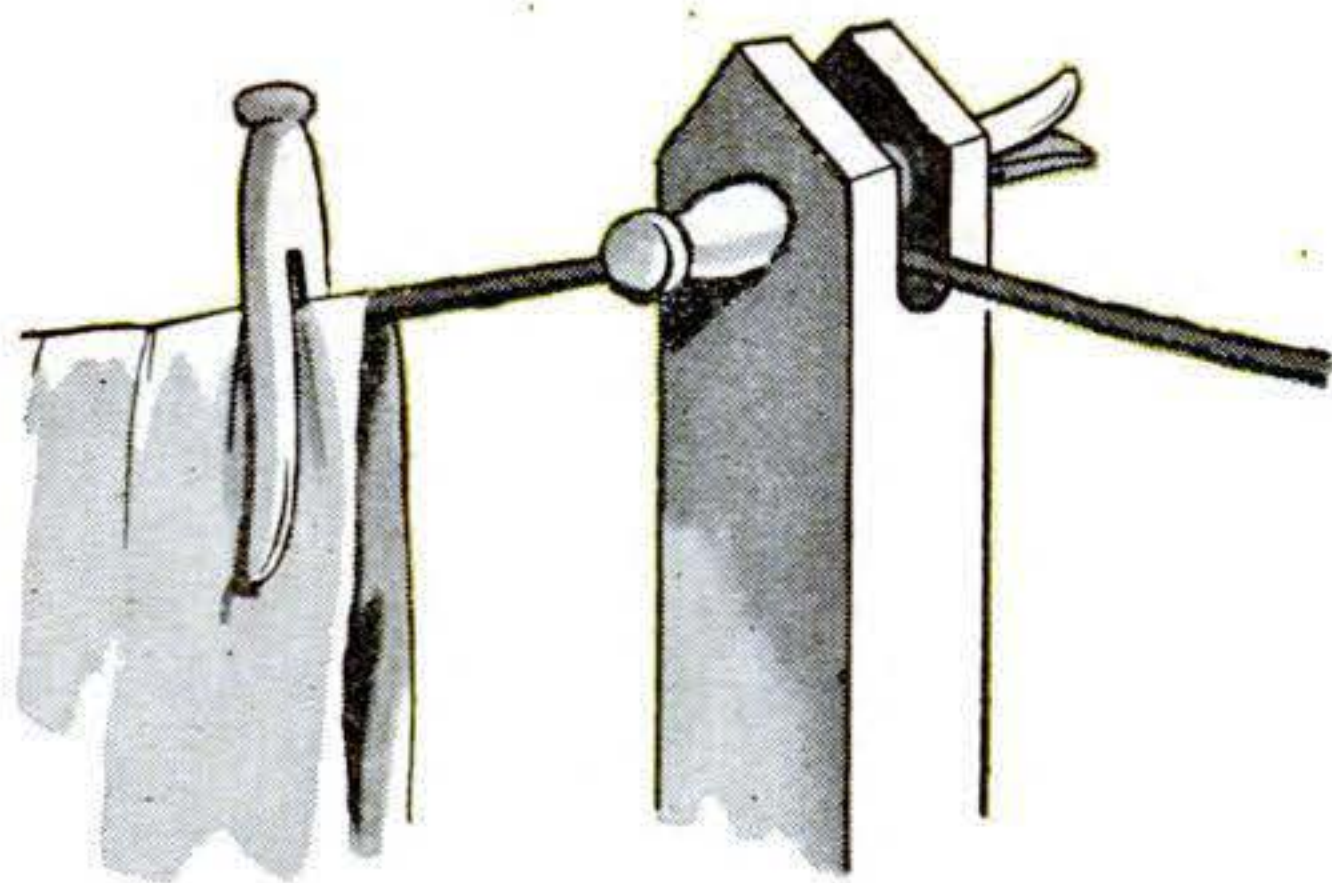

To keep your clothesline from blowing out of the notch of a clothes pole, drill $\frac{1}{2}$ " holes across the pole as shown. Press in a split-type clothespin.

1" DOWEL WITH SLANTED KERFS

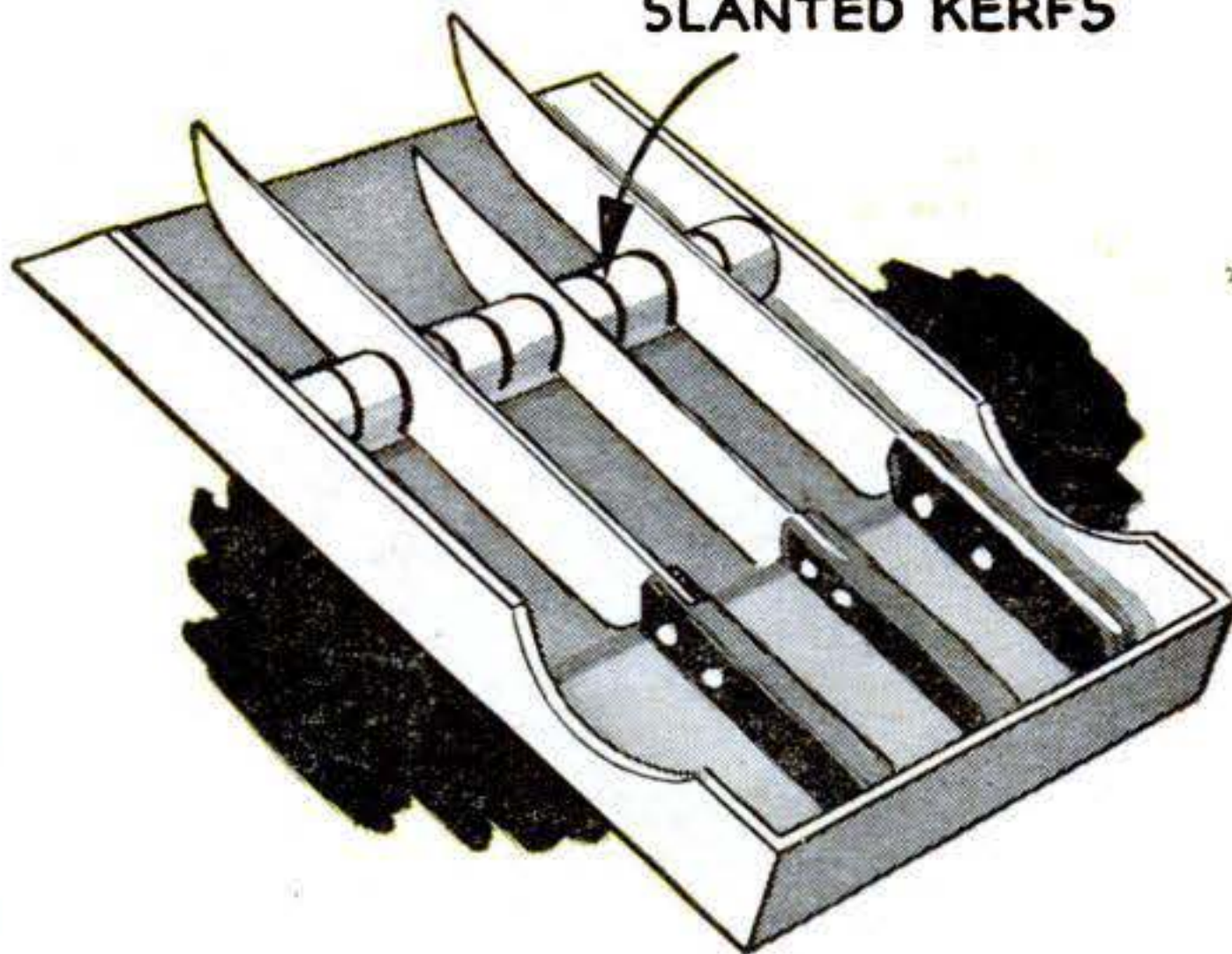

Kitchen knives will stay sharp longer if they do not rub against each other in your knife box or drawer. Saw kerfs in a hardwood dowel located as shown will keep the blades separated and upright.

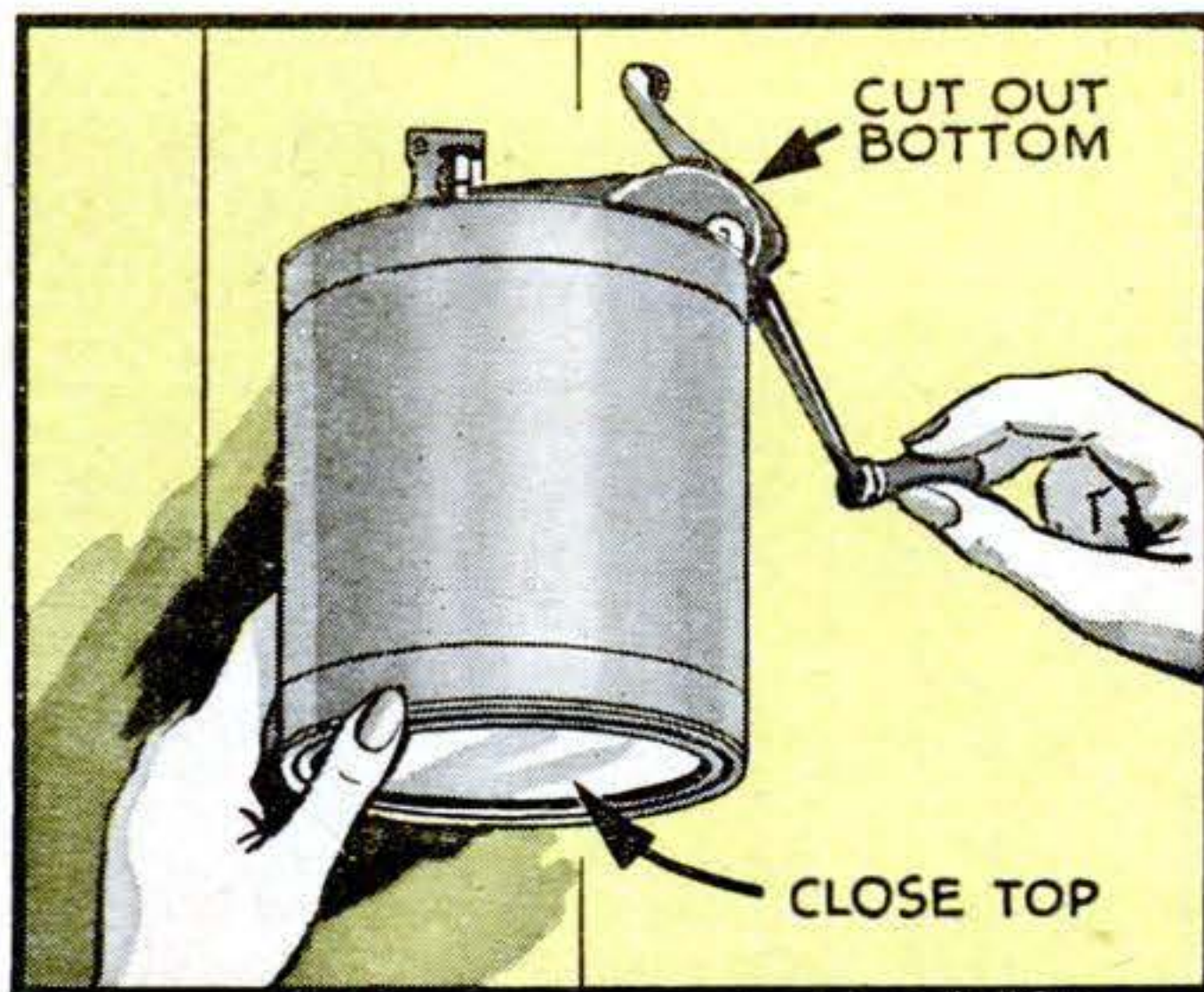

CUT OUT BOTTOM

CLOSE TOP

Cans with pry-out lids, such as are used for baby foods and many similar products, are hard to empty completely. If the metal rim on top keeps you from getting your full money's worth, press in the top, turn over the can, and cut out the bottom with one of the newer type of clean-cutting can openers.

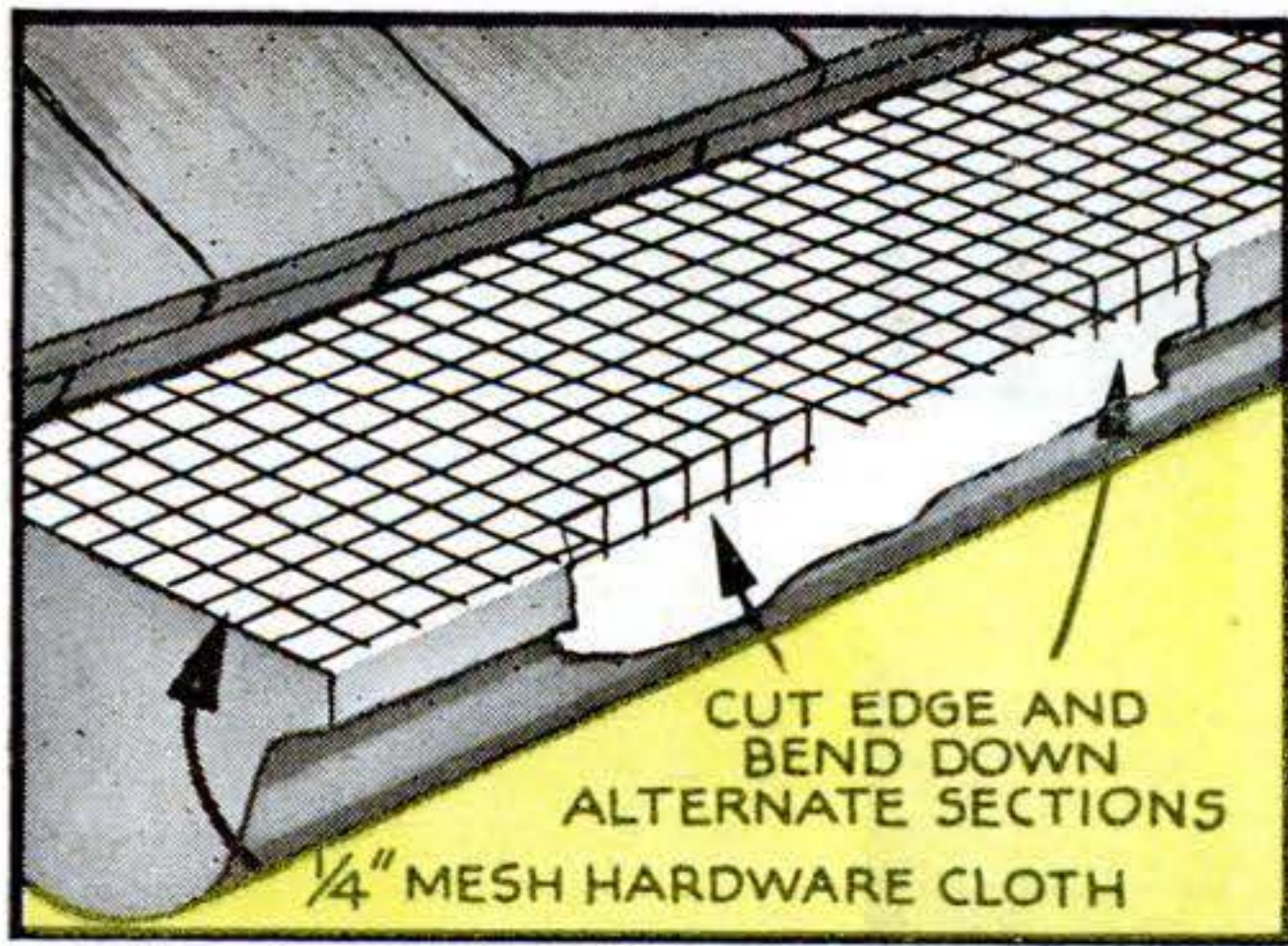

Falling leaves won't clog your rain gutters if you make wire-mesh covers. Cutting and bending alternate sections of the wire insures a nonslip fit.

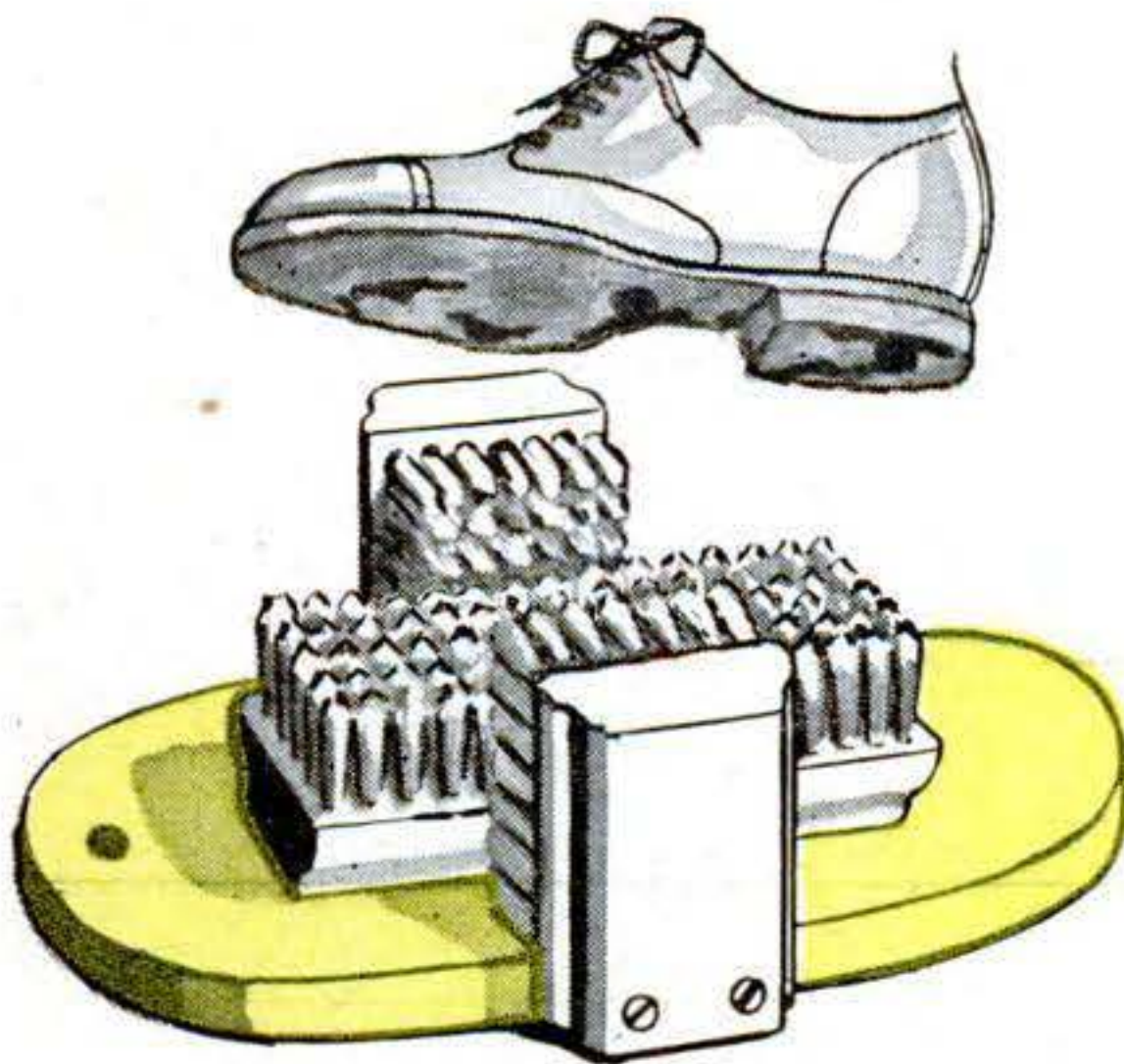

1/2 BRUSH ON EACH SIDE

With this shoe cleaner placed near the door your visitors will find it easy to wipe their feet before entering. Two old scrub brushes are used. Saw one in half and mount the three pieces on a base.

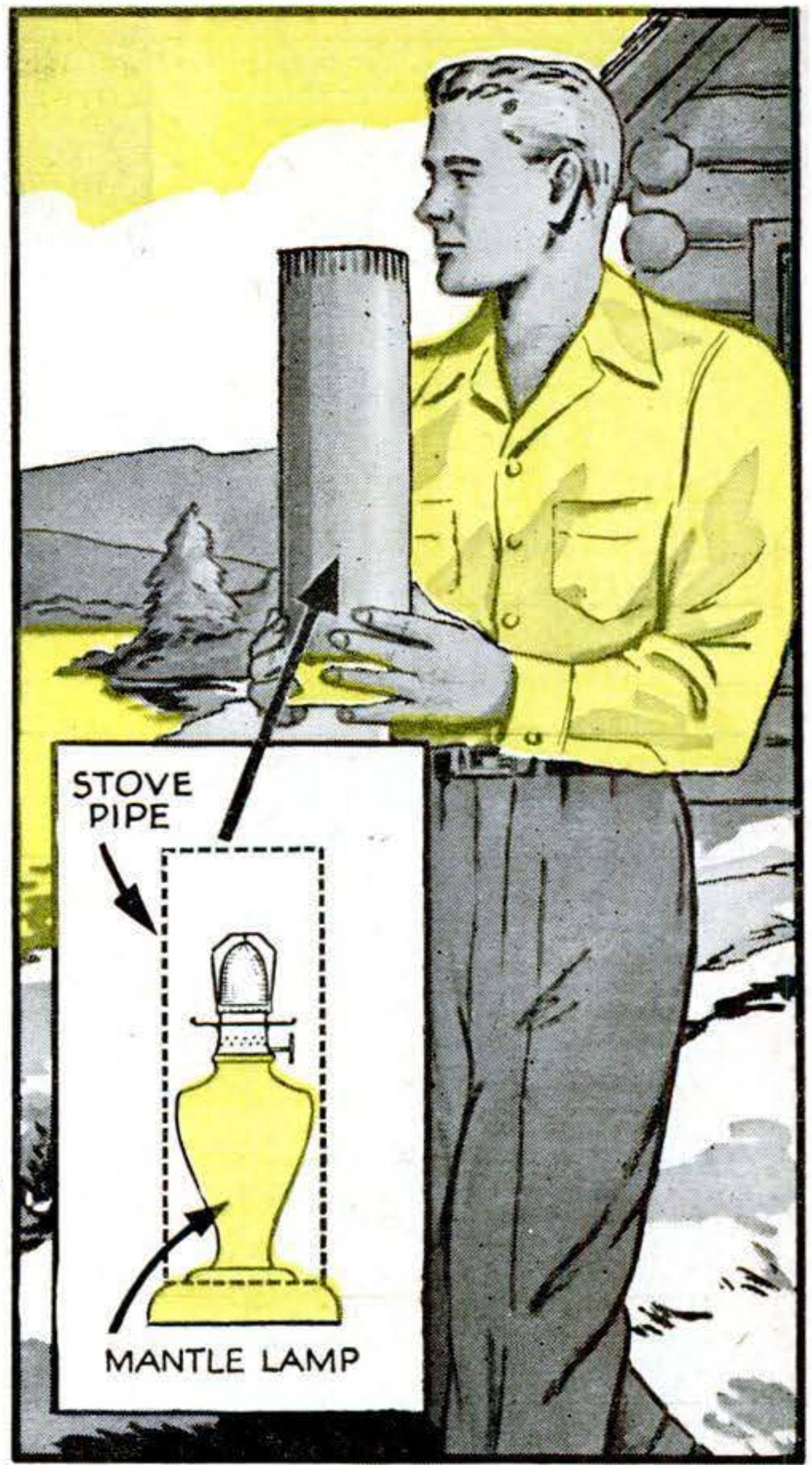

Even with the chimney in place, the fragile mantle in a kerosene mantle lamp will often be damaged if you must transport it between buildings. A length of stovepipe will help protect it from the wind.

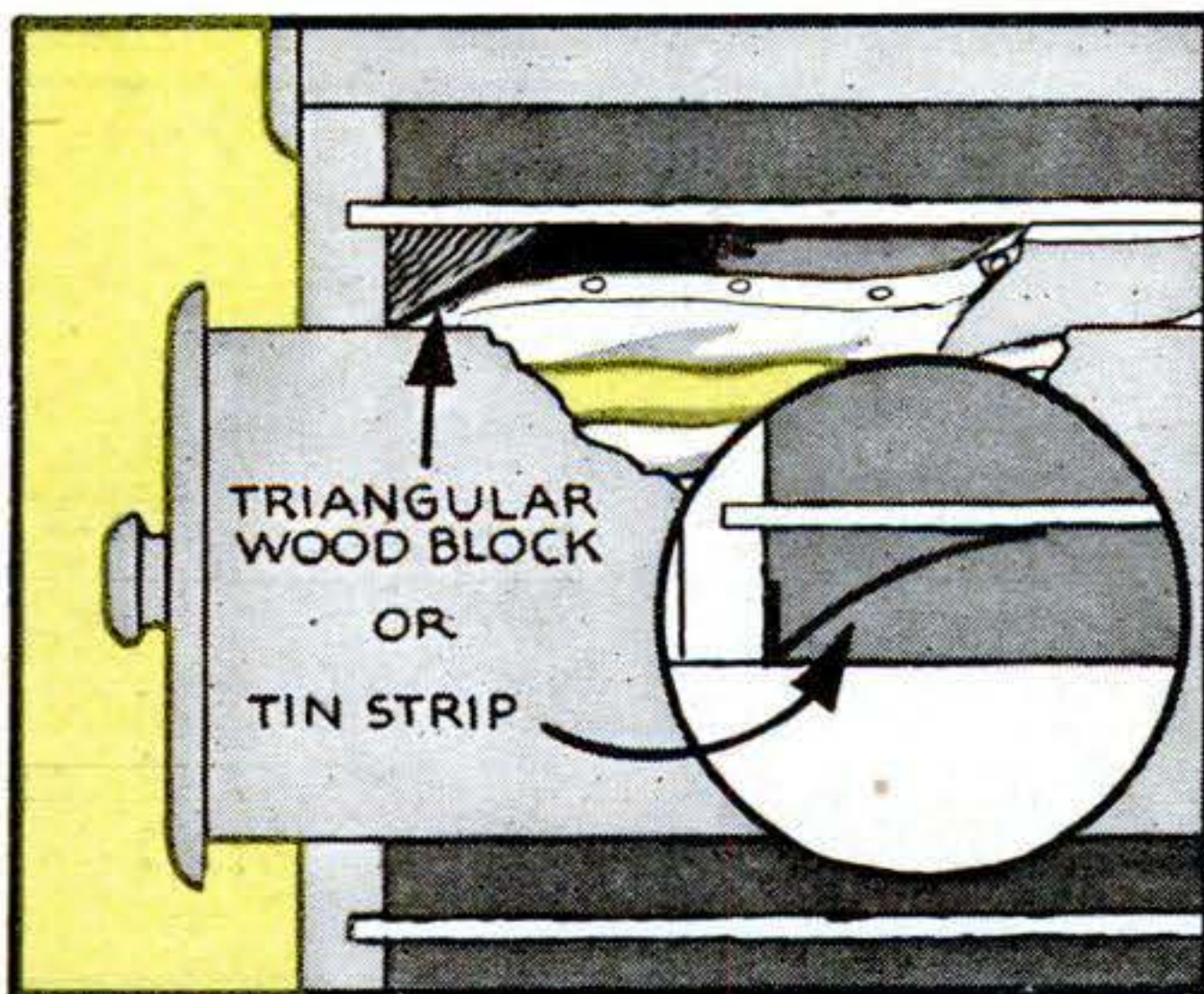

Desk and dresser drawers often become so crowded that items on top press up and catch against the inside of the rail. When this happens it is difficult to open the drawer without wrinkling some of its contents. A wood block or tin strip fastened as shown will slide the high objects down and clear.

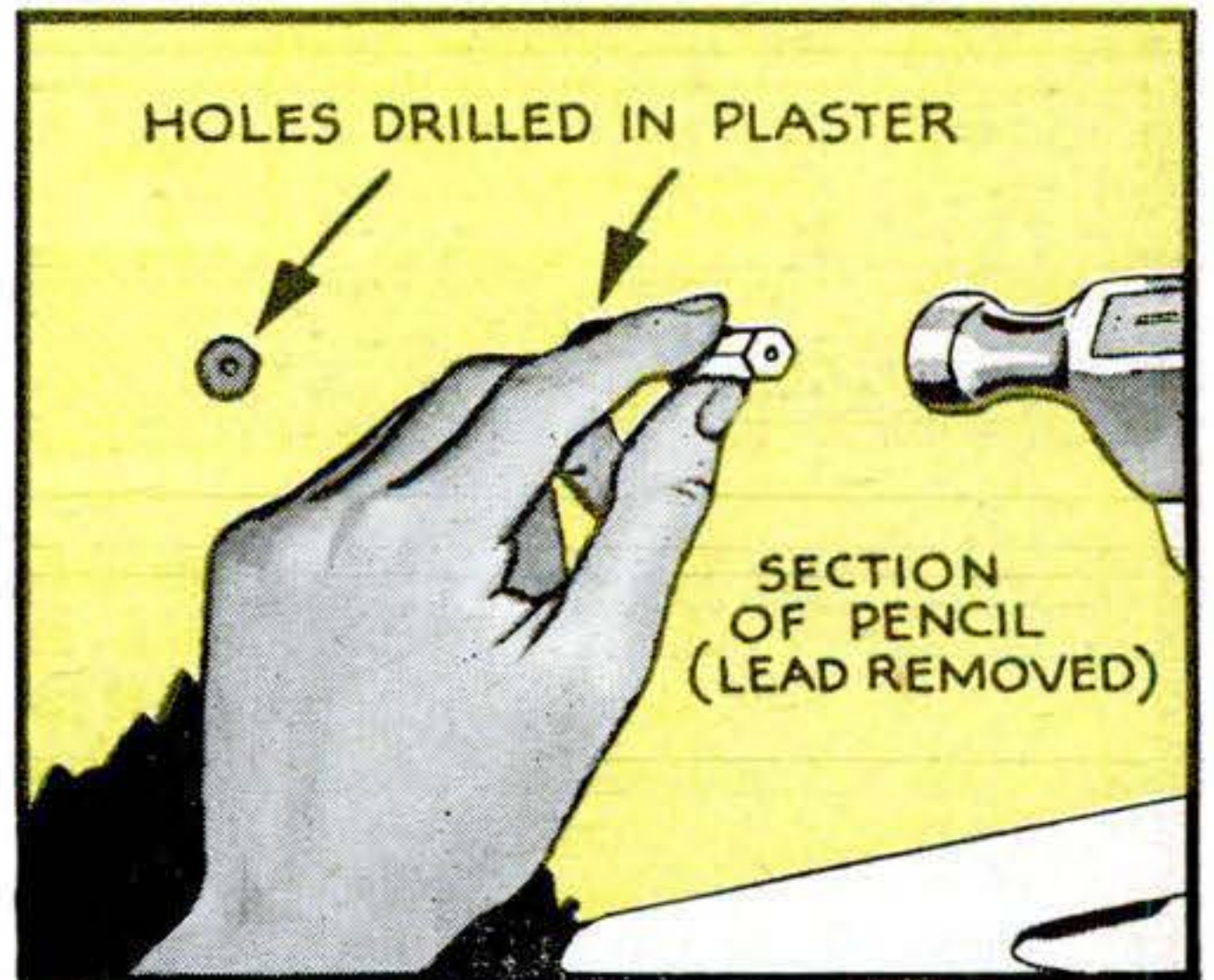

Ordinary hexagonal lead pencils can be used in a pinch as expansion plugs when you have to locate wood screws in a plaster wall. Cut a pencil into 3/4" sections and push the lead out. Drill the wall a snug fit for the pencil lengths. Then drive in the screws, which will split and expand the wood.

NEW SHOP IDEAS

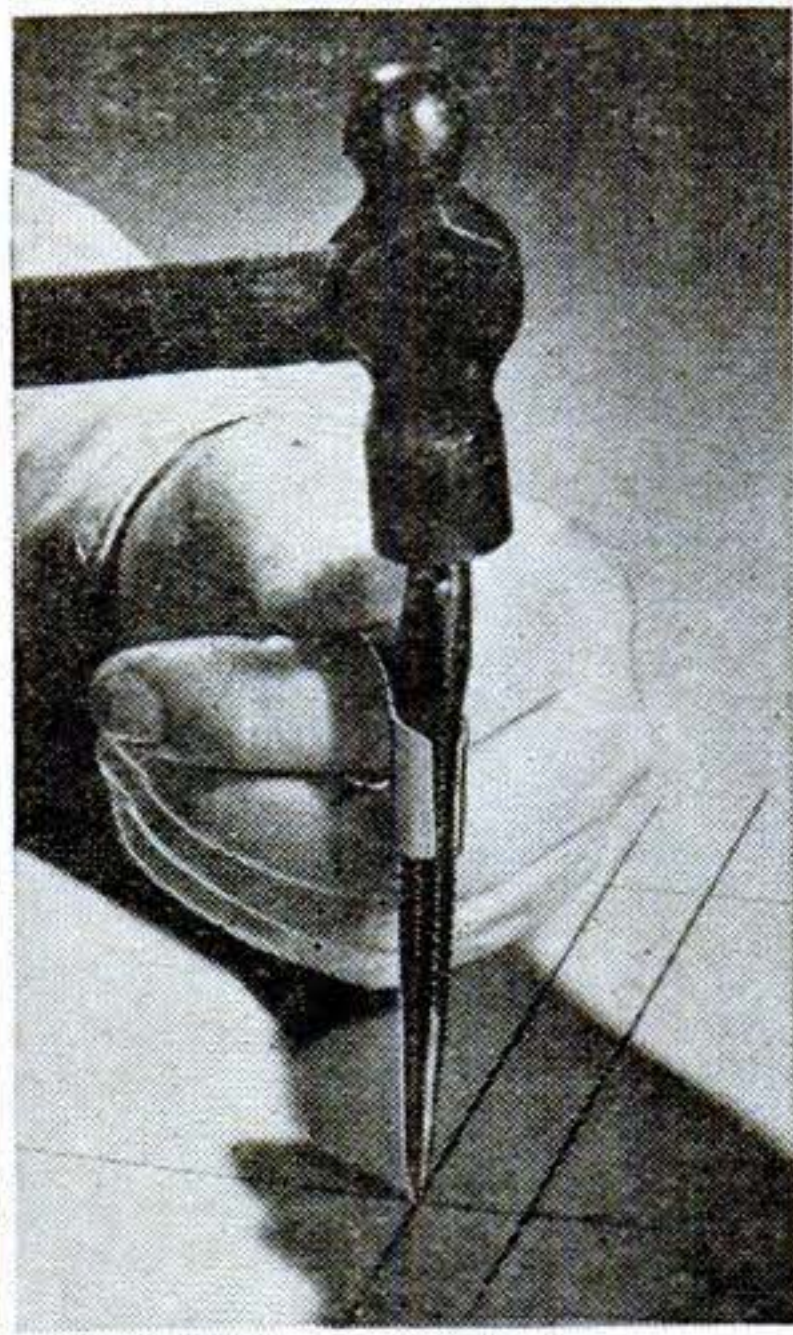
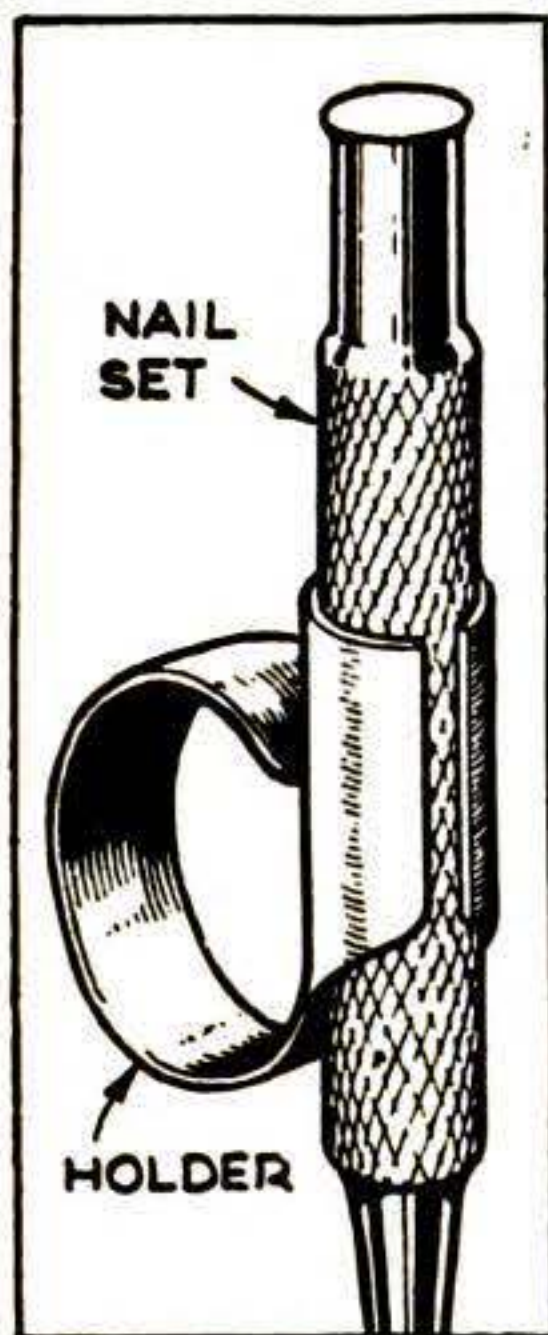

Punch Holder. When you have a large number of nails to set, or must prick-punch many layout points, you'll work faster and more accurately with this punch holder. It's merely a strip of sheet metal with a broadened end, this end curved around the punch while the narrower part of the strip is shaped for the fingers.—J. A. WALKER.

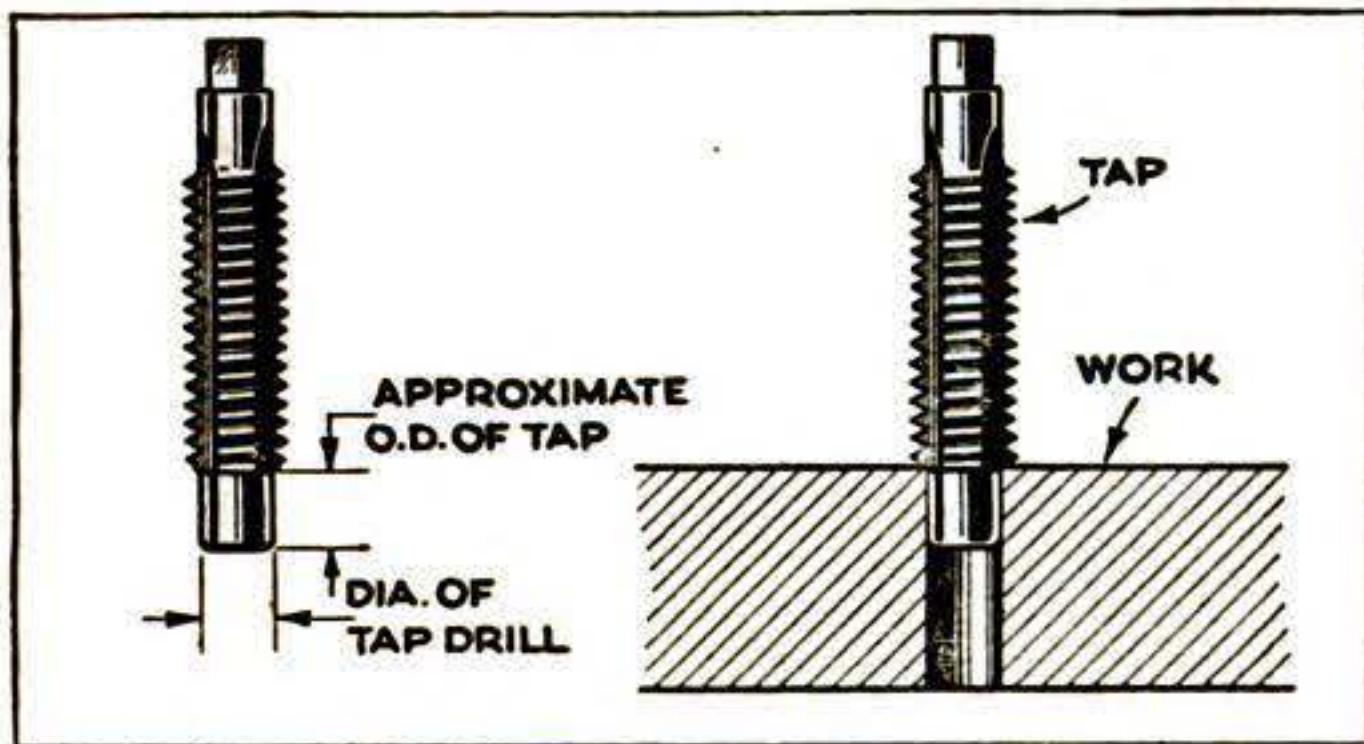

Pilot Tap. The end of a tap ground to the diameter of the tap drill will start threads straight in the work. The pilot must of course be concentric with the tap body, so it should be formed with a tool-post grinder while the tap is mounted between lathe centers. Back off the first threads with a hand grinder to get a starting thread. Worn taps prepared in this fashion may be used for starting threads to be finished with new taps. A set of pilots in the common sizes is a shop asset.—THEODORE KANAKOS.

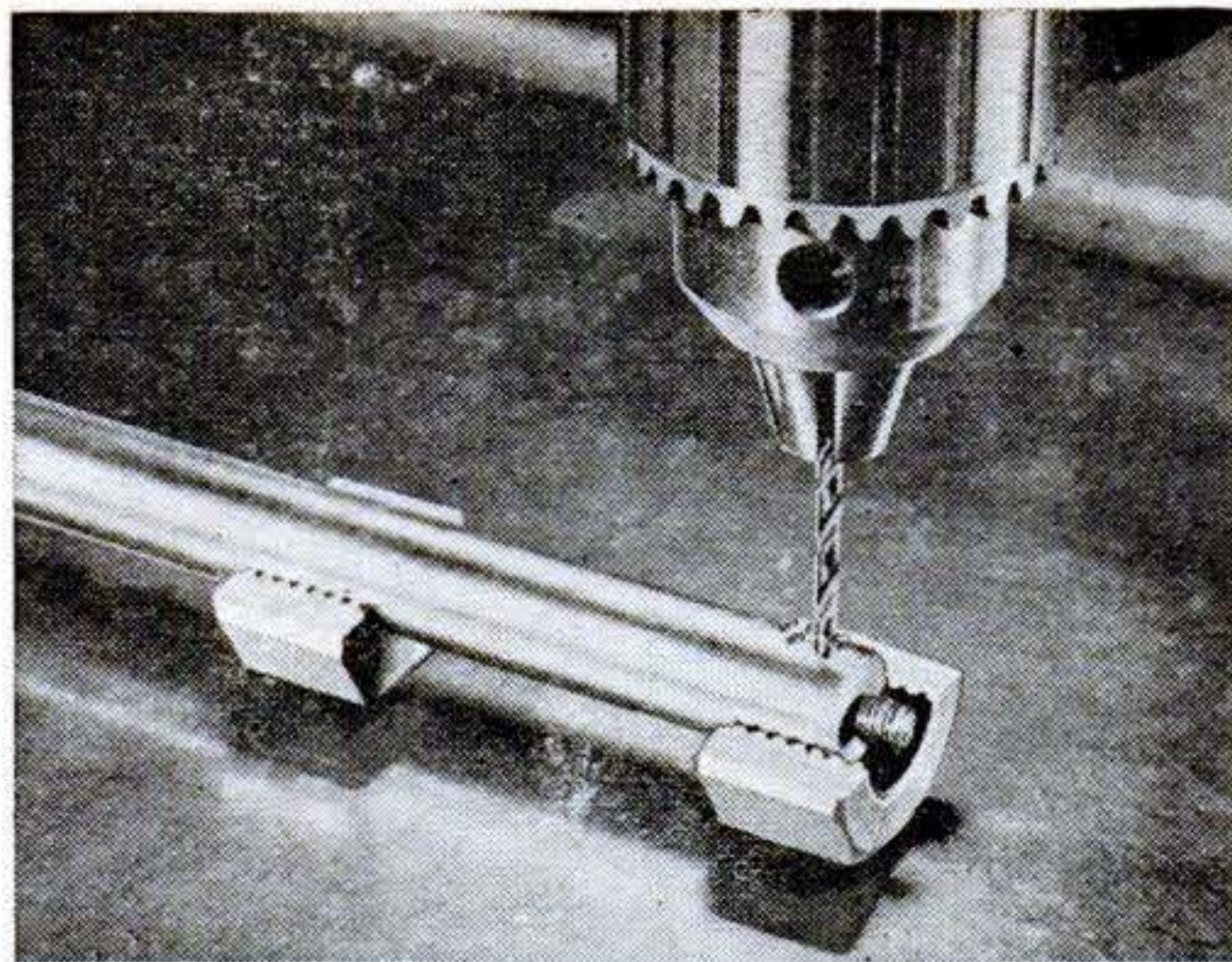

Improvising V-Blocks. If, when drilling small round stock, you need a V-block in a hurry, get a hex nut the work will just slip into, and cut it in two. The threads in the nut will tend to hold the work. For cross drilling threaded work, use a nut with a thread that matches that of the work as closely as possible.—C. W. WOODSON.

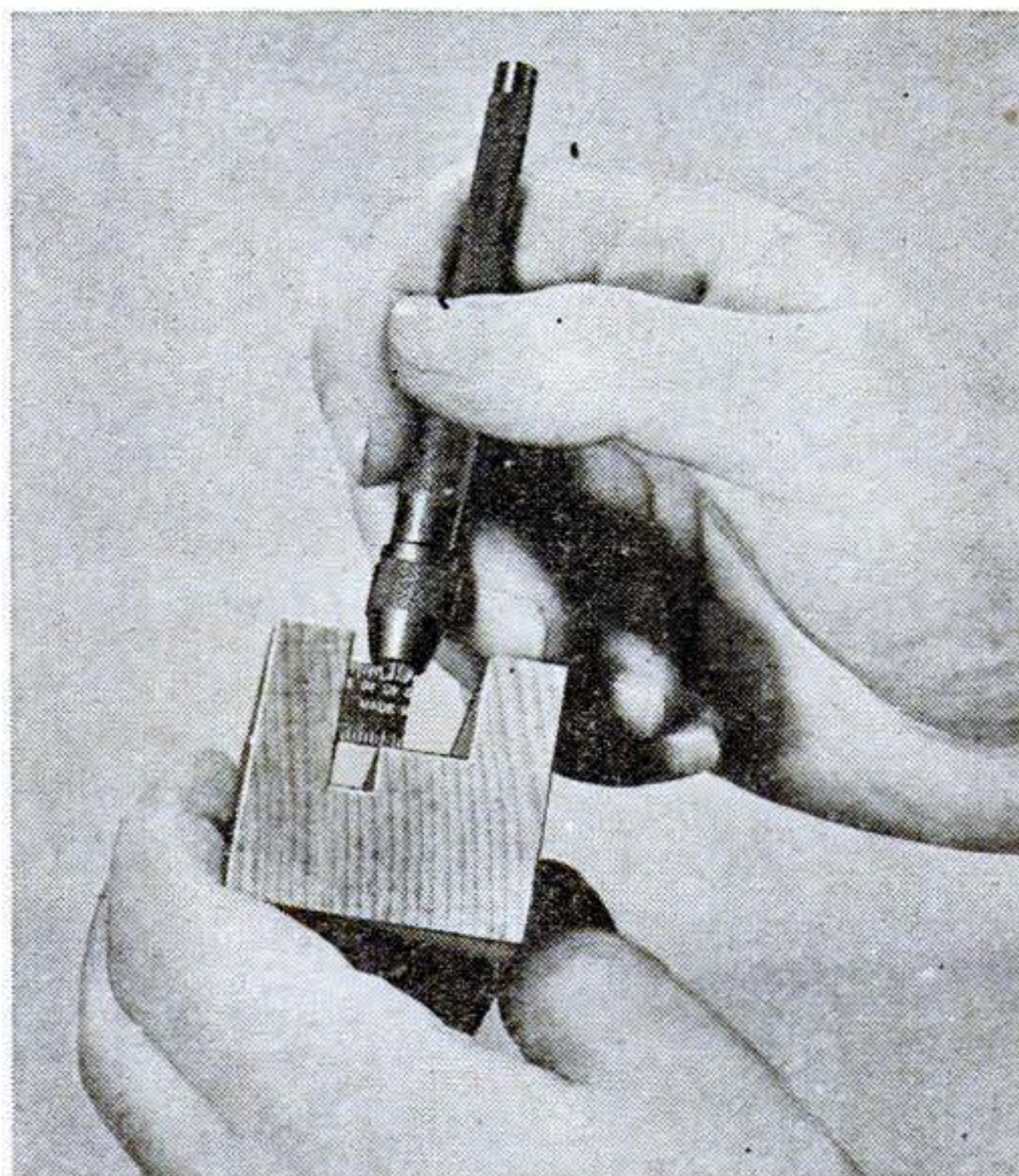

For Inside Measurements. That battered old steel rule in the bottom of your tool box can be converted into a handy set of short rules for measuring inside recesses or other hard-to-reach places.

Break the rule into several different sizes and discard kinked and rusted portions. Select pieces that are slightly oversize and carefully grind the metal down to the dimension lines. To get down into a recess, grip the rule with a pair of locking tweezers or a small pin vise.

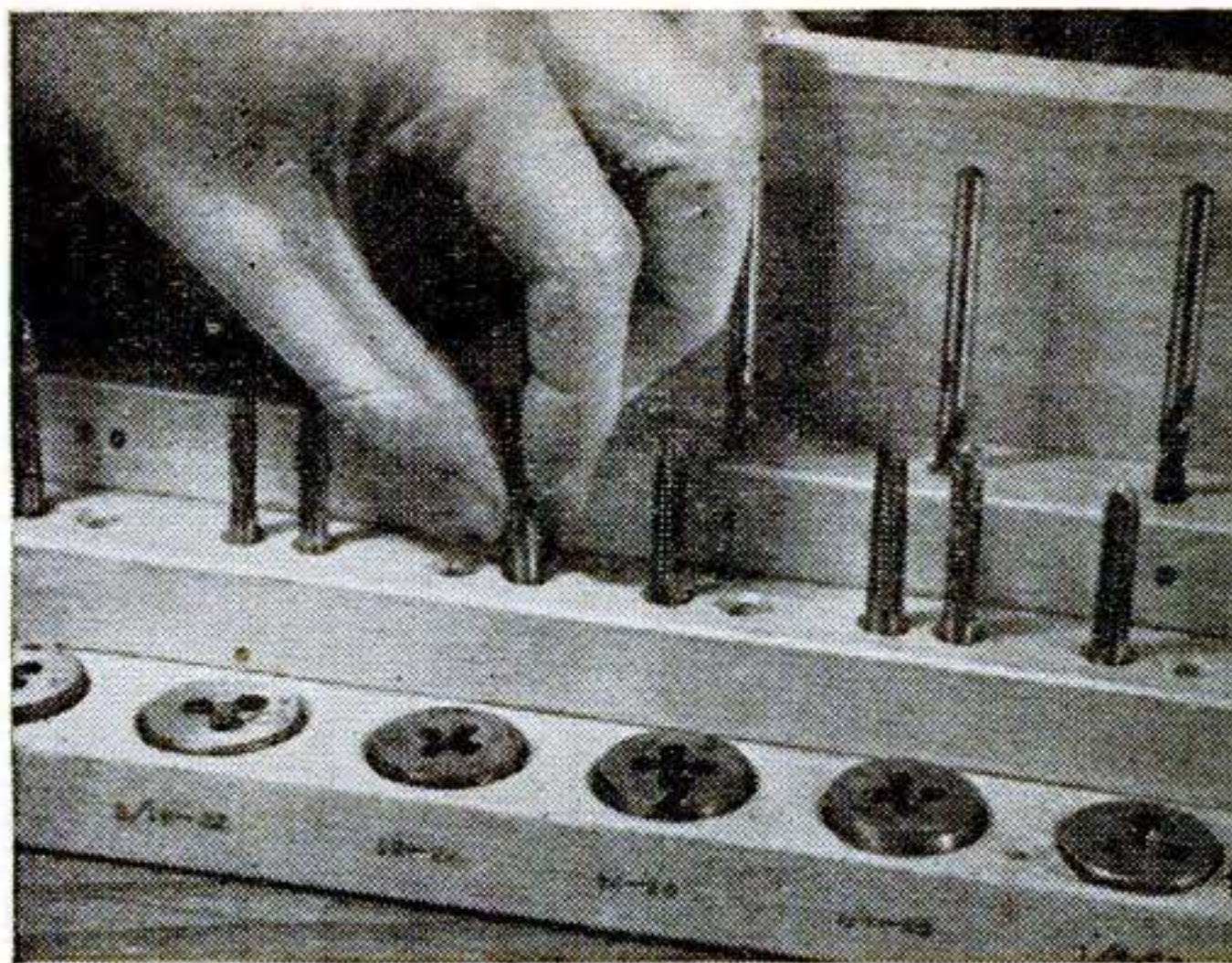

Tap-and-Die Rack. Here's a shop fixture that reduces to its simplest form the problem of selecting the right die, tap, or tap drill for any job. A few strips of lumber of varying width are nailed together in steps as shown. The widest piece, at the bottom, is bored for the dies; holes should be shallower than the dies so that enough metal

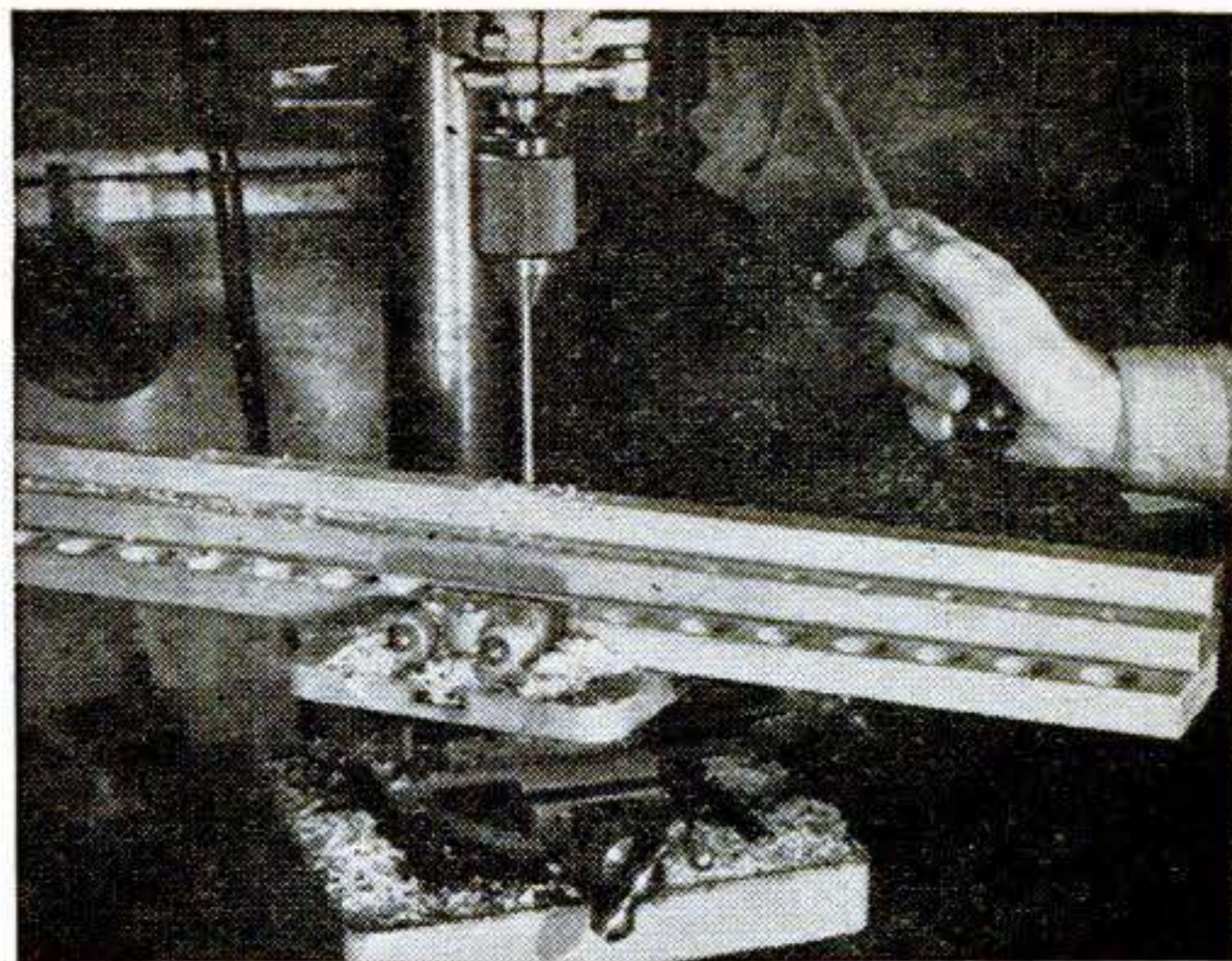

projects for an easy grip. On the next step drill holes for the shanks of matching taps. Make two holes if both plug and bottoming taps are used. The top strip is for the tap drills. A backing piece, high enough to protect the projecting drills, is also recommended unless the rack is fastened to a wall.—WALTER E. BURTON.

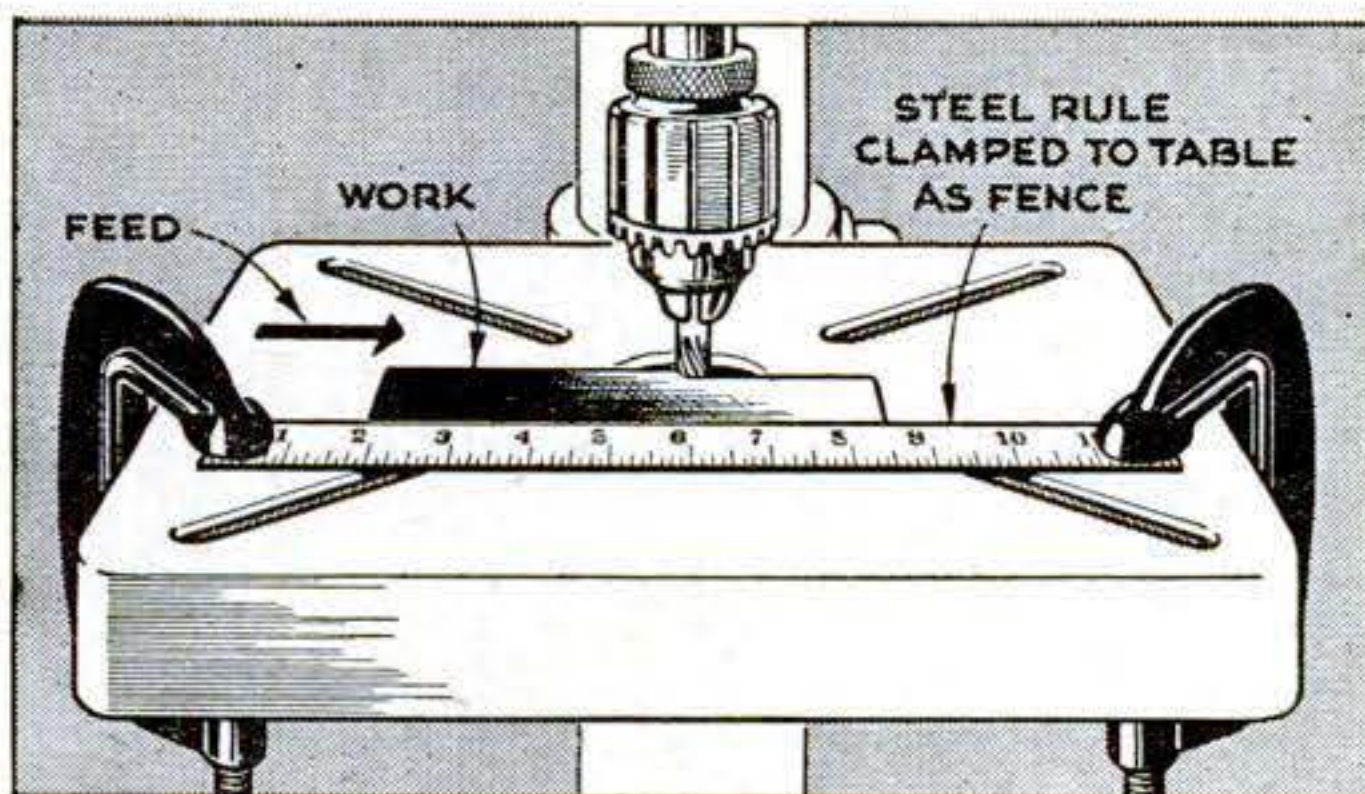

Putting Old Reamers to Work.

If you've ever tried to file a long strip of thin metal without producing the high and low spots that almost always show up in hand filing, you'll appreciate this use for worn-out spiral-flute reamers. The tool may be made of any reamer worn undersize, preferably one that is $\frac{3}{8}$ " or more in diameter. If a cut-off wheel is available, cut it to a length of about 3"—roughly half shank and half fluting.

To dress a strip of brass, aluminum, or other soft sheet metal, clamp a fence to the drill-press table so that the cutter will remove about $\frac{1}{32}$ ". With the reamer chucked short in the drill, feed the metal along the fence against rotation, using the lowest spindle speed. The finished piece will require only a touch of an abrasive cloth to remove the remaining tool marks. Work close to the chuck to minimize chatter, but vary the cutter position for extended runs.—HERBERT PFISTER.

Cutting Oil. When you have pork for dinner, ask your wife to save the fat that drains off. This lard base is a top-notch lubricant for all metal-cutting operations. Reaming, threading, and cutting are made smoother, and require less power than with ordinary oils. The fat will harden, but just brush it on and let the friction of the operation melt it.—JOHN A. BLAKER.

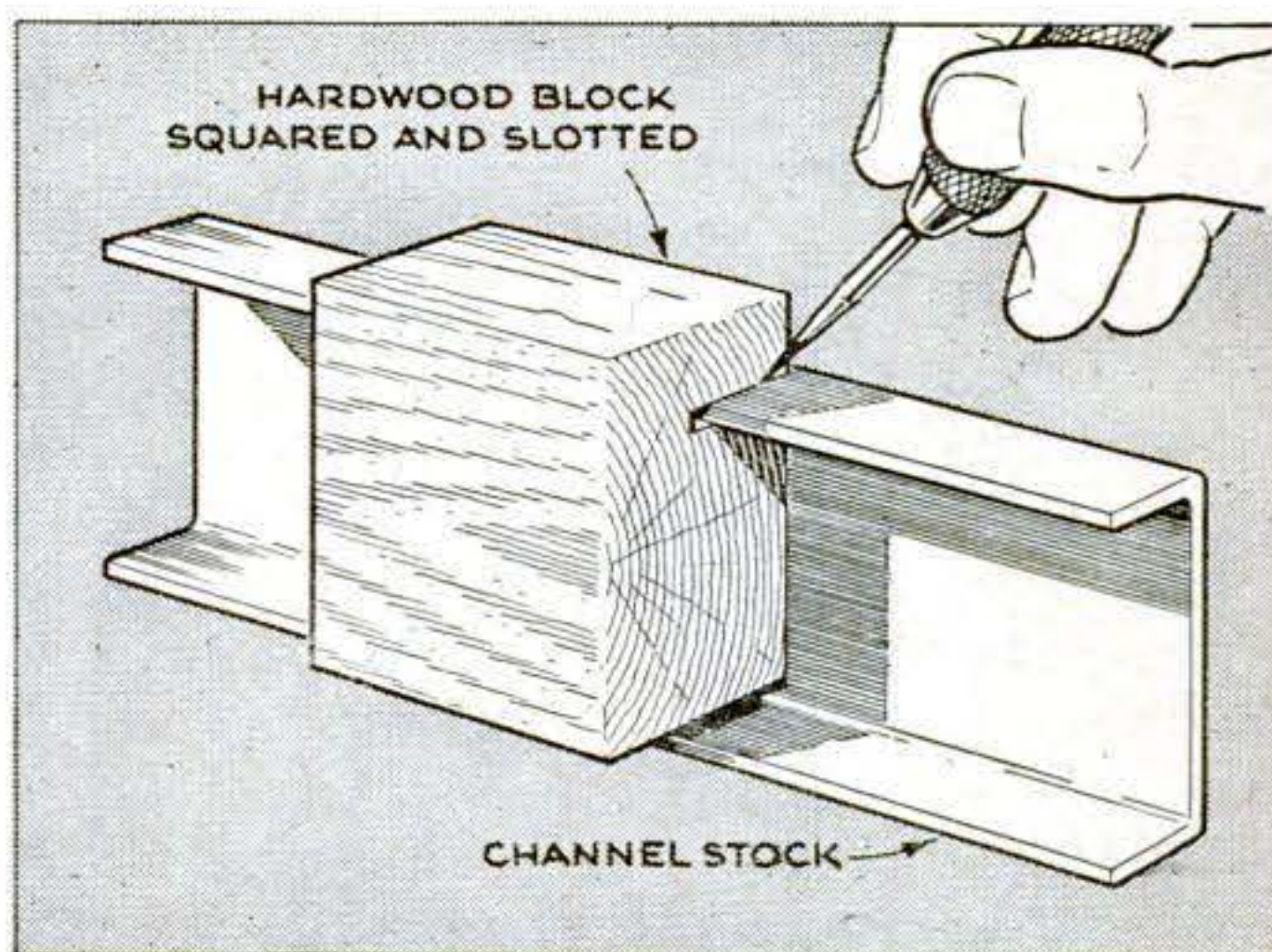

Block Transfers Measurements. When carrying measurements from one surface to another, as, for example, around a piece of angle or channel stock, a block of wood will help you to transfer the lines quickly and with great accuracy. The block, made of hardwood, should be carefully squared and slotted. Make up one for each type of stock used.

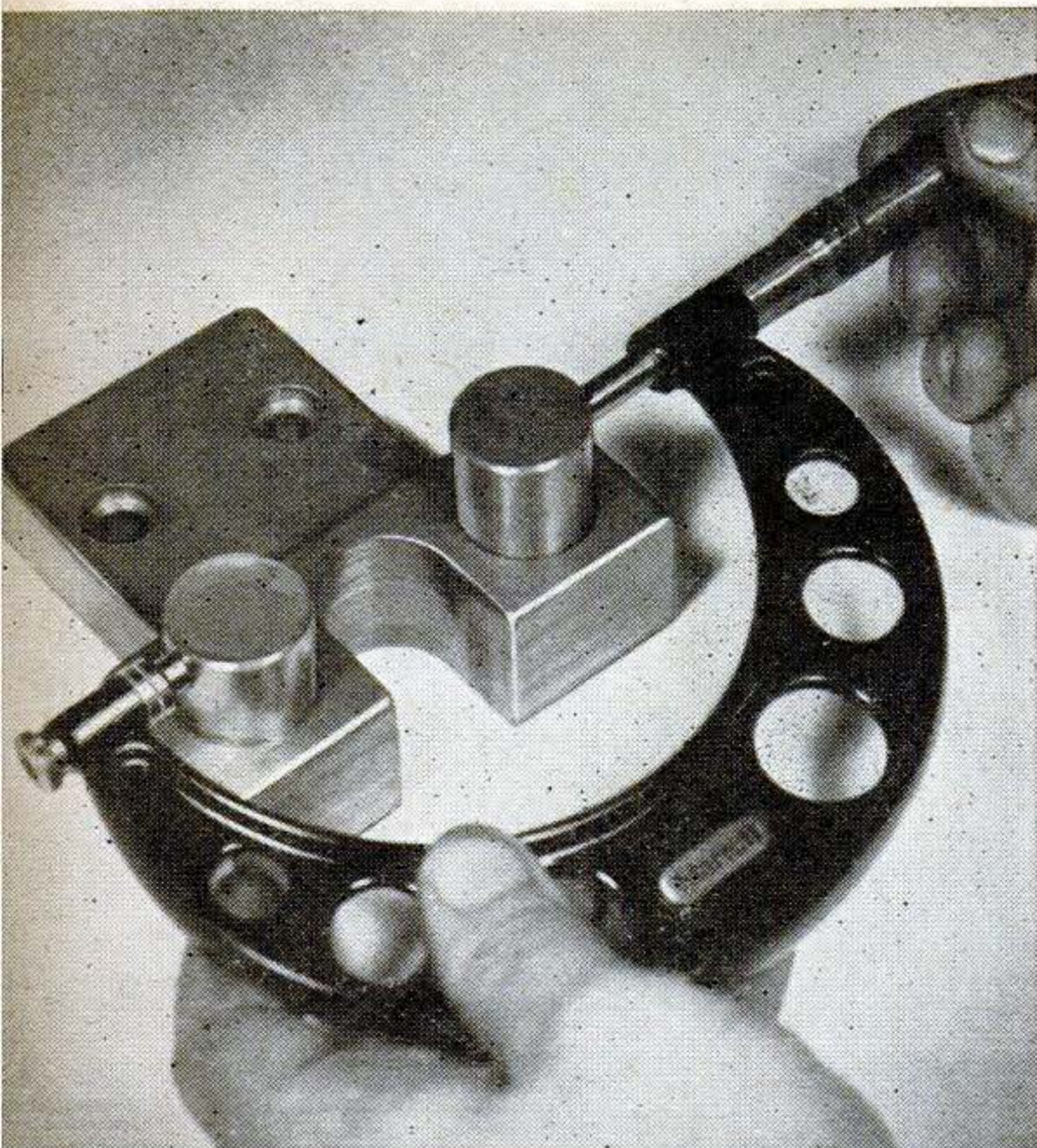

Work measured on the bench. The left hand holds the micrometer, and the right turns the thimble.

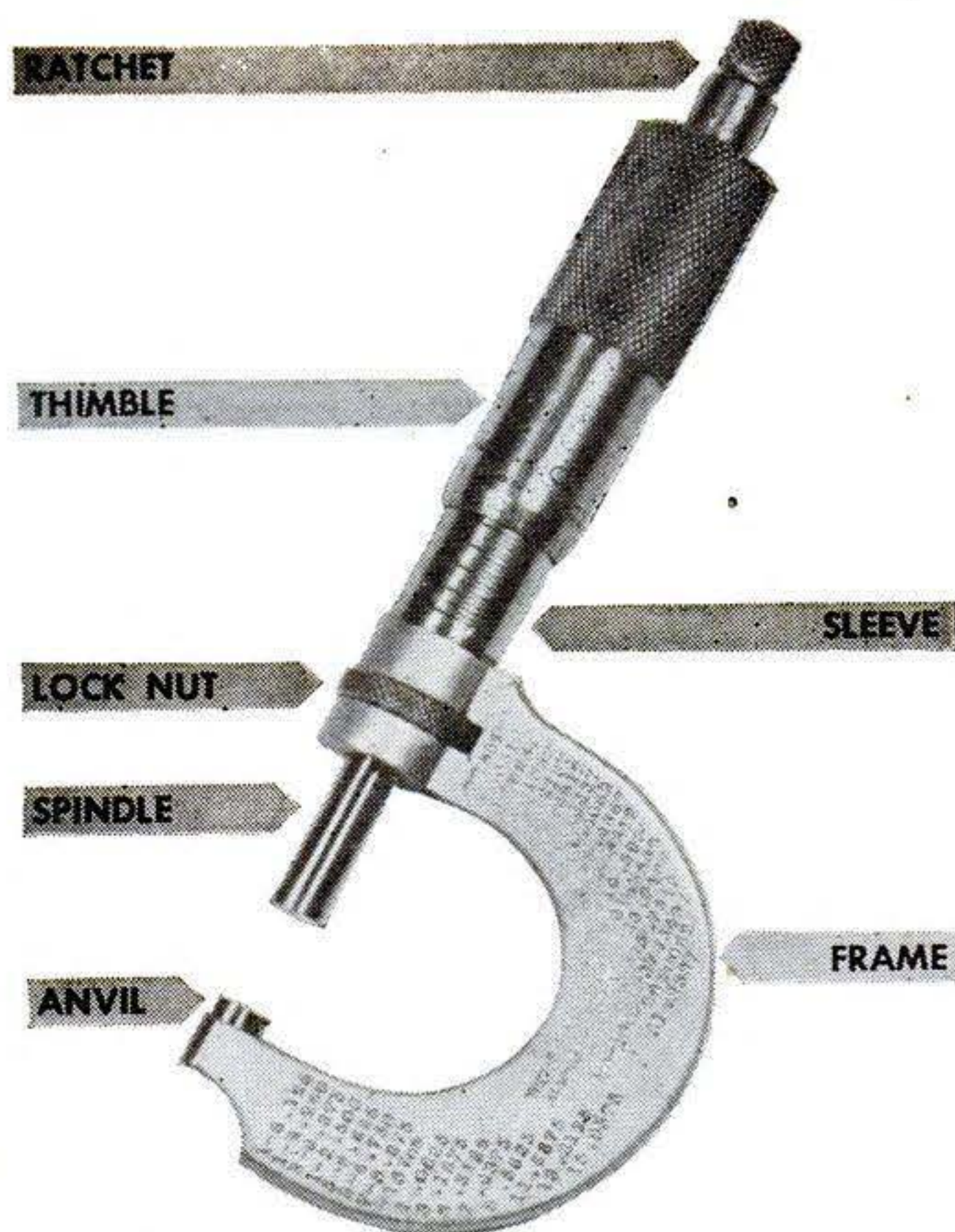

A typical 1" micrometer with ratchet. Readings are taken from graduations on the sleeve and thimble.

Keep Your Micrometer on Its Toes

By J. C. Magee

QUITE accurate measurements, to plus or minus .0002", are possible with a standard micrometer if it is handled intelligently and treated with care. Being a precision instrument, a micrometer—or micrometer calipers, to use the full name—won't tolerate abuse. Even if you use yours only rarely, you'll find it worth while to exercise all the caution necessary to keep its accuracy unimpeachable.

Many makes are now equipped with a ratchet—essentially a tiny spring clutch—by which the thimble is turned against the work. This ratchet slips when the spindle is in contact, so that only optimum pressure, controlled by the ratchet spring, can be applied to the screw. Comparatively few experienced machinists use the ratchet, most preferring their developed sense of "feel."

If you use a micrometer only occasionally, you may prefer to stick to the ratchet nevertheless. So long as you are consistent, you'll

probably get accurate readings. It isn't wise, of course, to shift from ratchet to feel and back again, especially when measuring parts of the same assembly.

The old-timer's sense of feel can be attained only through practice, and naturally it remains reliable only through constant use. Probably the surest way to get the practice is by continued measuring of objects of standard size, such as accurate plug gauges, gauge blocks, or the check gauge usually furnished with the micrometer. Make each setting entirely by feel, without looking at the reading, and then check the results. If your readings are on the plus side, the pressure applied is too light; if on the minus side, it is too great. If they vary from plus to minus, more practice is indicated. Consistently correct ones will mean you've mastered micrometer feel. It's always vital, of course, that the micrometer frame be held at right angles to the surfaces in contact with anvil and spindle.

The micrometer should, of course, be set



To adjust for accurate readings, the spindle is touched to the anvil and the sleeve turned by a spanner wrench until the zero lines match.

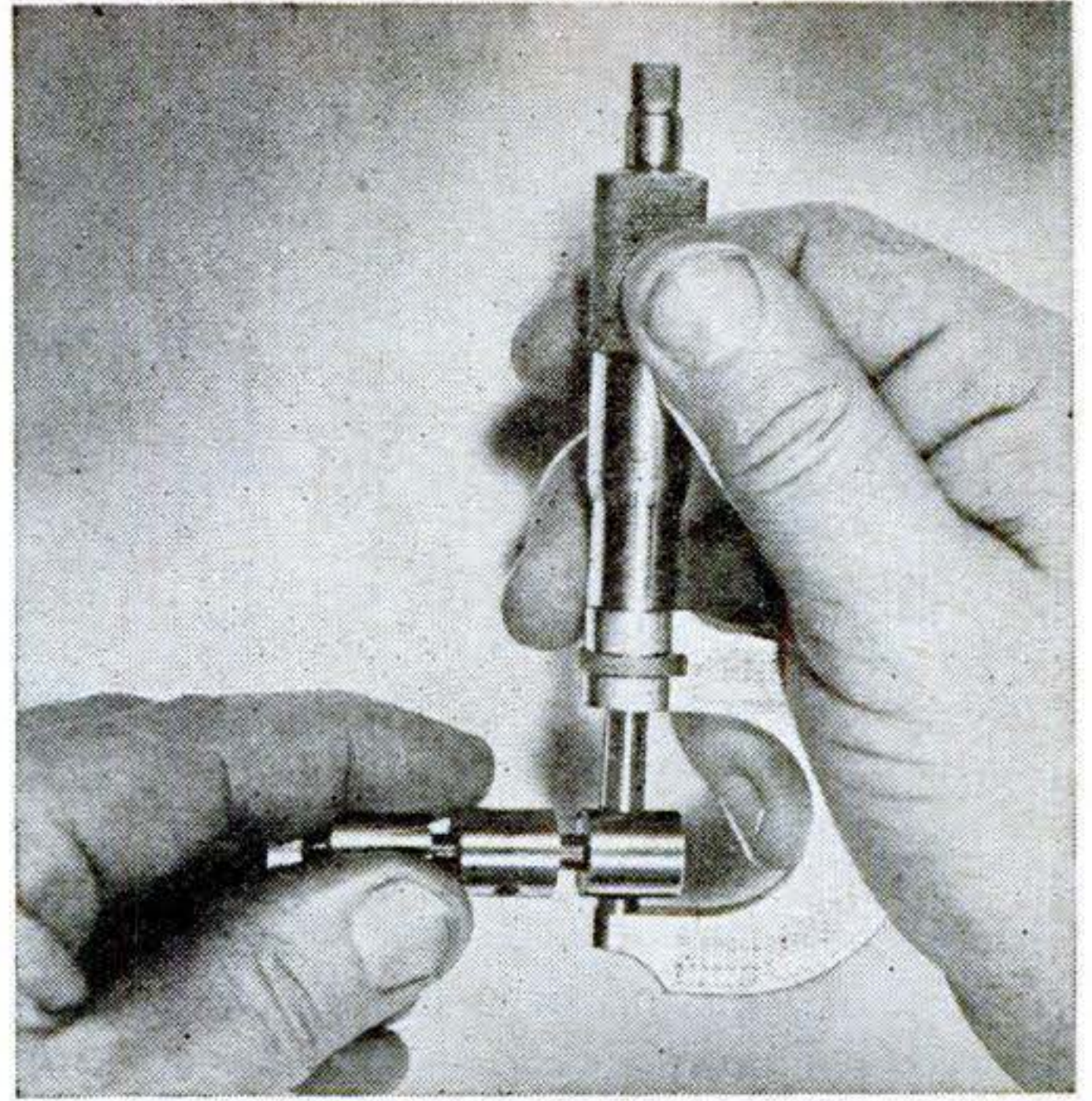

Small work is held in the left hand when possible and the micrometer in the right. Press the frame against the palm while setting the spindle.

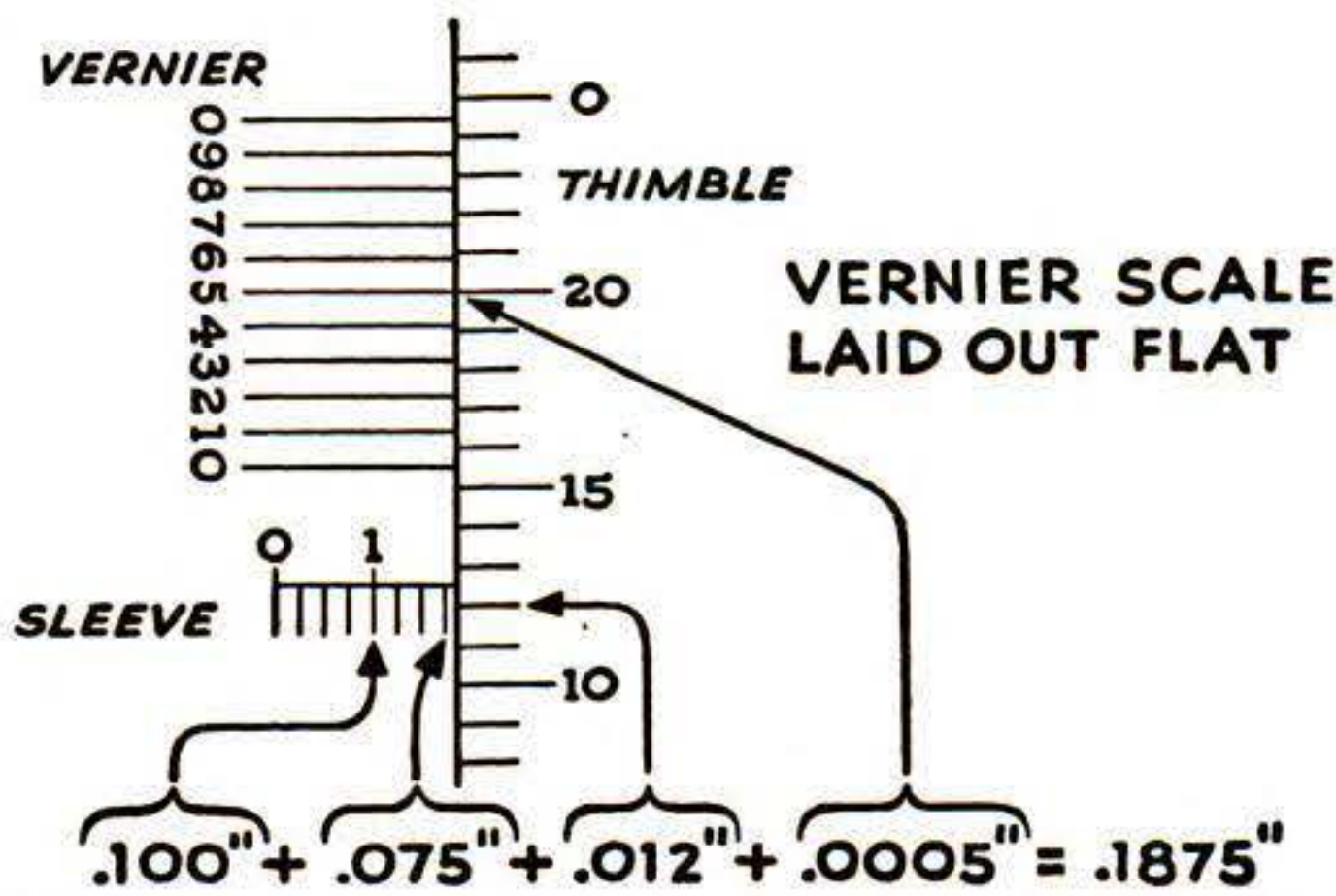
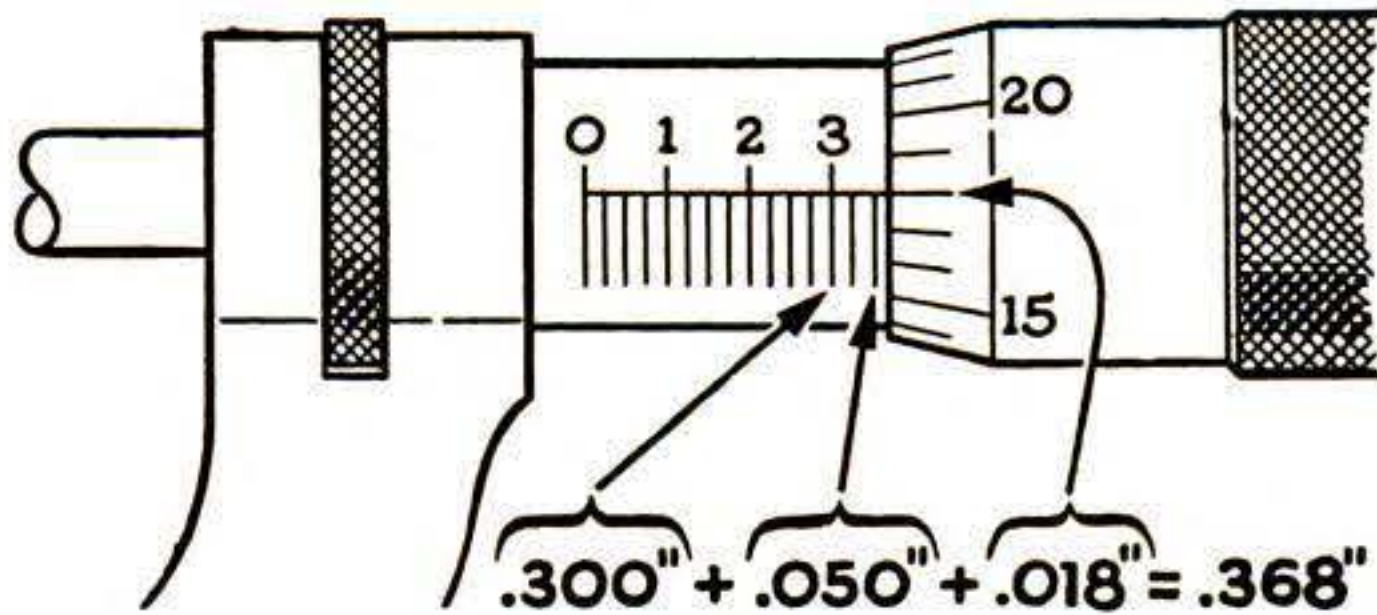

How to read a mike. Experienced users mentally divide thimble markings to read between as close as .0002". Vernier scales (below) do it for you.

accurately at zero; that is, when the spindle touches the anvil a zero reading should be indicated. Adjustment varies somewhat, but on most micrometers it is done with a small spanner wrench furnished with the instrument. Clean all dirt from the measuring faces and bring them together carefully with the same pressure used in measuring work; then insert the wrench in the small

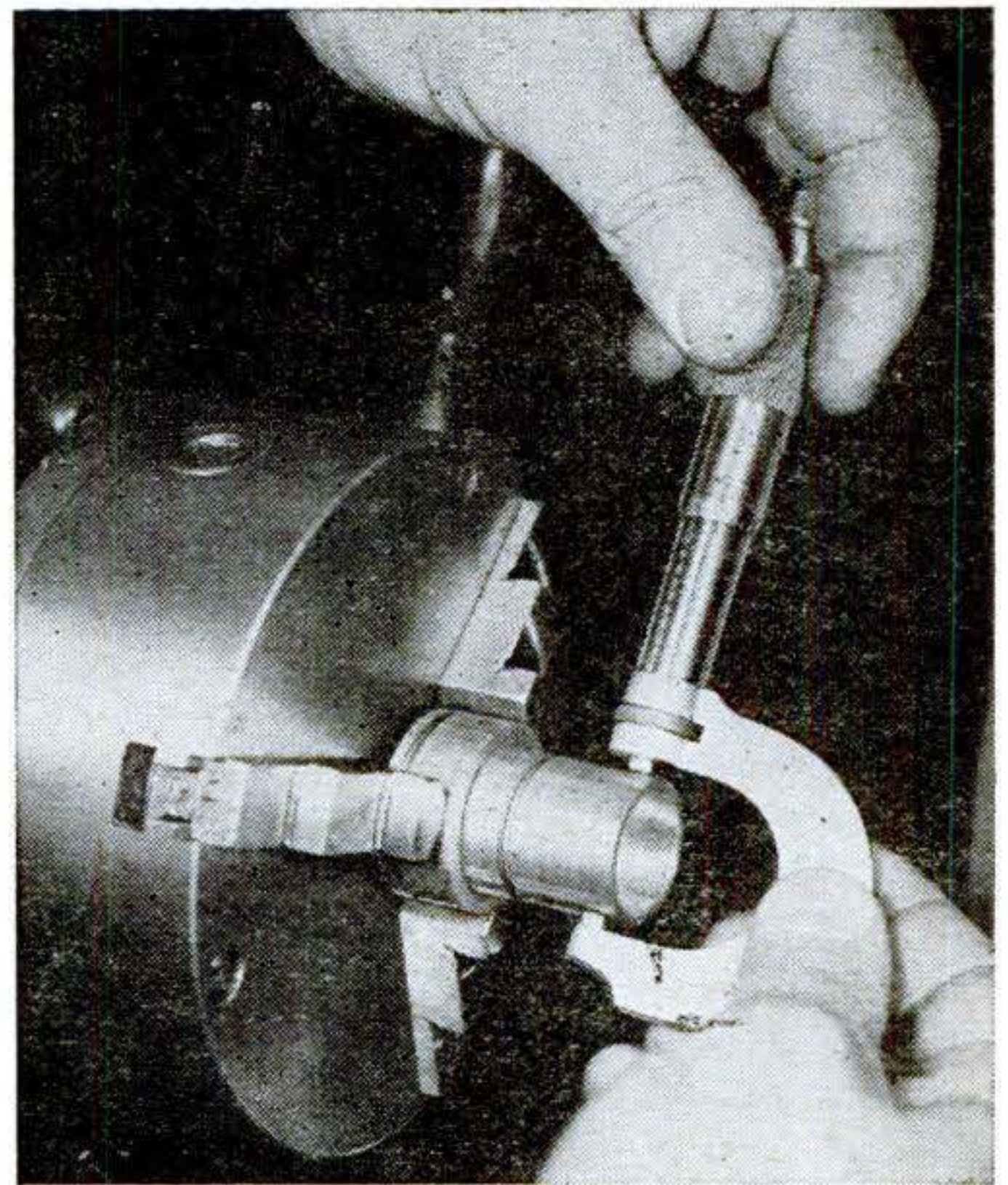

Measuring lathework. The micrometer is held in the right hand and the thimble turned by the left. Of course the lathe must be fully stopped.

hole in the sleeve and turn the sleeve until the zero lines on it and the thimble match exactly. To check the result, close the spindle by feel a few times.

A compensating nut on the end of the sleeve can also be adjusted with this spanner wrench to take up wear in the micrometer thread, but extreme care must be used to avoid damage. Turn the nut just enough

to remove all play and still maintain a smooth running fit in the spindle. The thimble must be taken off before the adjustment is made.

Small work should be held in one hand and the micrometer in the other with the frame pressed to the palm by the third finger, as in a photograph. Round work should be measured squarely across a diameter and in several places. After one reading, rotate it slowly with the micrometer slightly open, and close again for the next reading. Hold the micrometer square to the axis.

On lathework, leave the micrometer in place while the reading is being made, to eliminate all possibility of the spindle slipping. The frame is held in the right hand and the thimble turned with the thumb and first two fingers of the left. Never hold the micrometer close to the work while the lathe is coasting to a stop.

The lock nut, for locking the spindle at a given reading, should be used cautiously. Occasionally it comes in handy, but long-continued use at one setting wears the anvil and spindle unevenly. For production repeat work, fixed gauges are preferable. However, if your micrometer anvil and spindle surfaces do wear, you can return the instrument to the manufacturer for repair. If you feel equal to doing the job yourself, a micrometer lapping kit can be purchased that will include instructions.

If treated with care, your micrometer will give accurate service for years. Wipe it occasionally with a clean, oily rag to prevent rusting from perspiration. If you carry it in coveralls or a shop apron, keep it in a swing pocket so it won't fall on the floor when you bend over. It will pay to keep the instrument in a clean felt-lined box

when not in use rather than let it lie around on the bench with tools.

When you are in a hurry, don't hold your micrometer by the thimble and swing the frame around to open or close it. The thimble can be quickly turned by running it across the palm of one hand, which also gives it support. Never jam the spindle against the anvil or the work. When the micrometer is put away leave at least $\frac{1}{8}$ " opening between the anvil and spindle.

If you want to mark your micrometer for identification, it's best to have your name engraved or written with an electric pencil. Stamping it on the frame may cause distortion.

Micrometers come in standard sizes designated by the largest opening, such as 1" 2", 3", and so on. Usually only the last inch is measured in thousandths. A combination micrometer with interchangeable anvils is shown at right below. It will measure from zero to 4".

Learning to read a micrometer is fairly simple. The screw has 40 threads to the inch, so one revolution moves the spindle $\frac{1}{40}$ " or .025". On the sleeve there are 40 divisions, each representing one turn of the spindle, or .025". Every fourth division is marked, meaning .100", .200", .300", and so on. The thimble has 25 divisions, each a twenty-fifth of a revolution, or .001". In addition, it is possible to interpolate between marks on the thimble to obtain readings in ten thousandths.

Some micrometers also have a vernier scale. When no graduations on the thimble line up with the line on the sleeve, the line on the vernier scale that coincides with any line on the thimble is read to take the measurement to the fourth decimal place. END

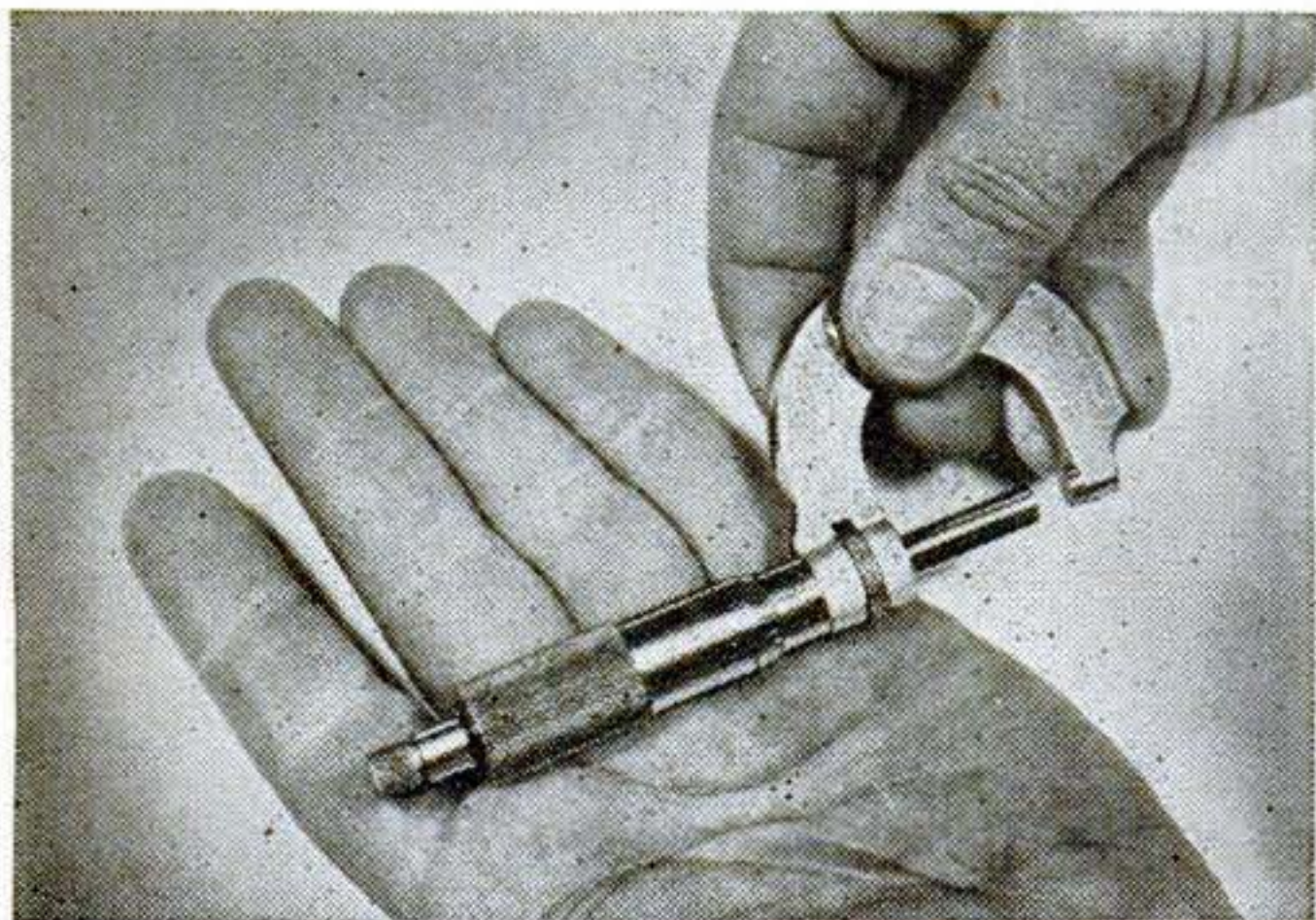

Rolling the thimble on the palm of the hand will open or close a micrometer quickly without danger of damaging the delicate threads.

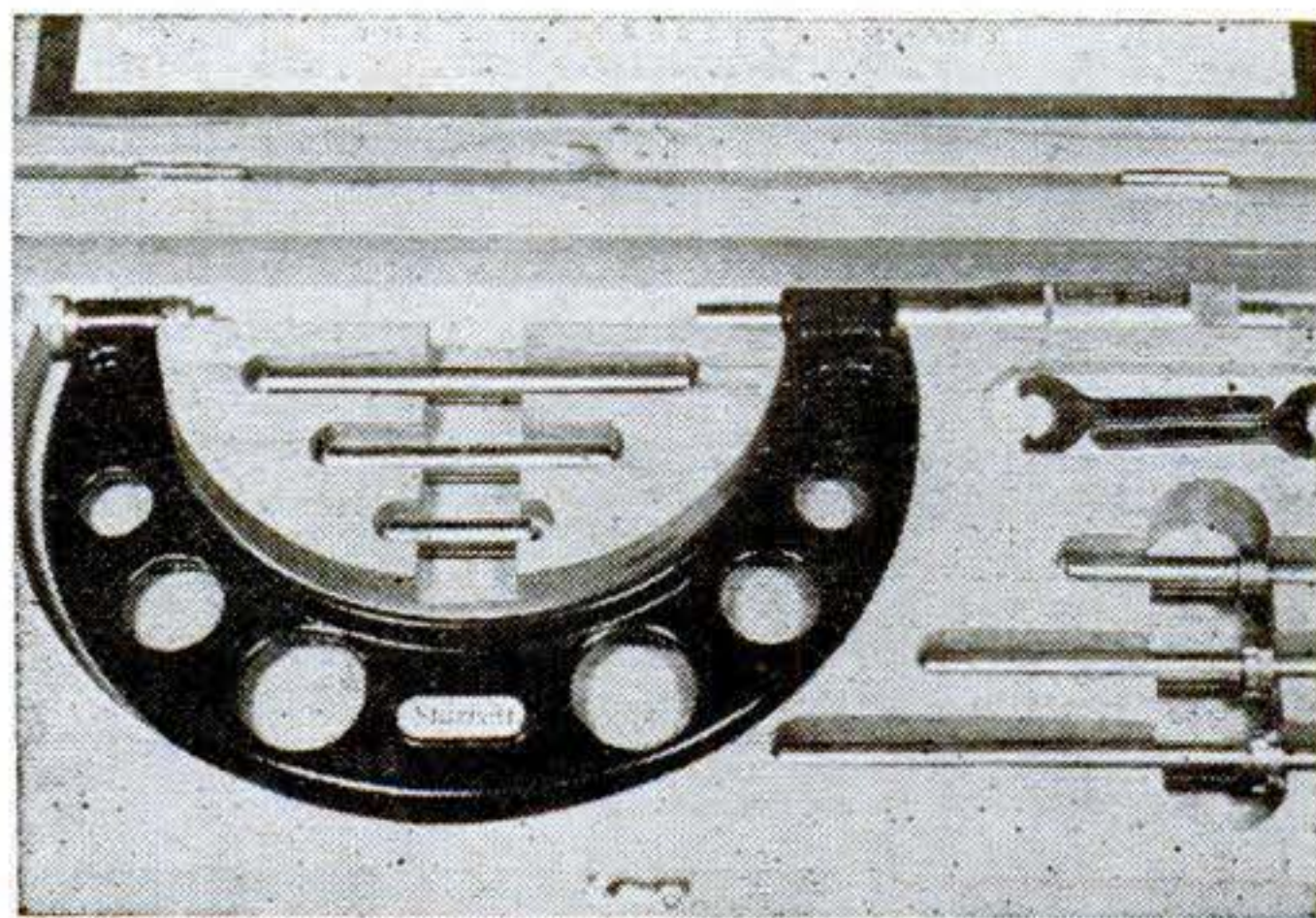

Extra anvils for this 4" combination micrometer bring small work up to the spindle. Only the last inch of any measurement is read in thousandths.

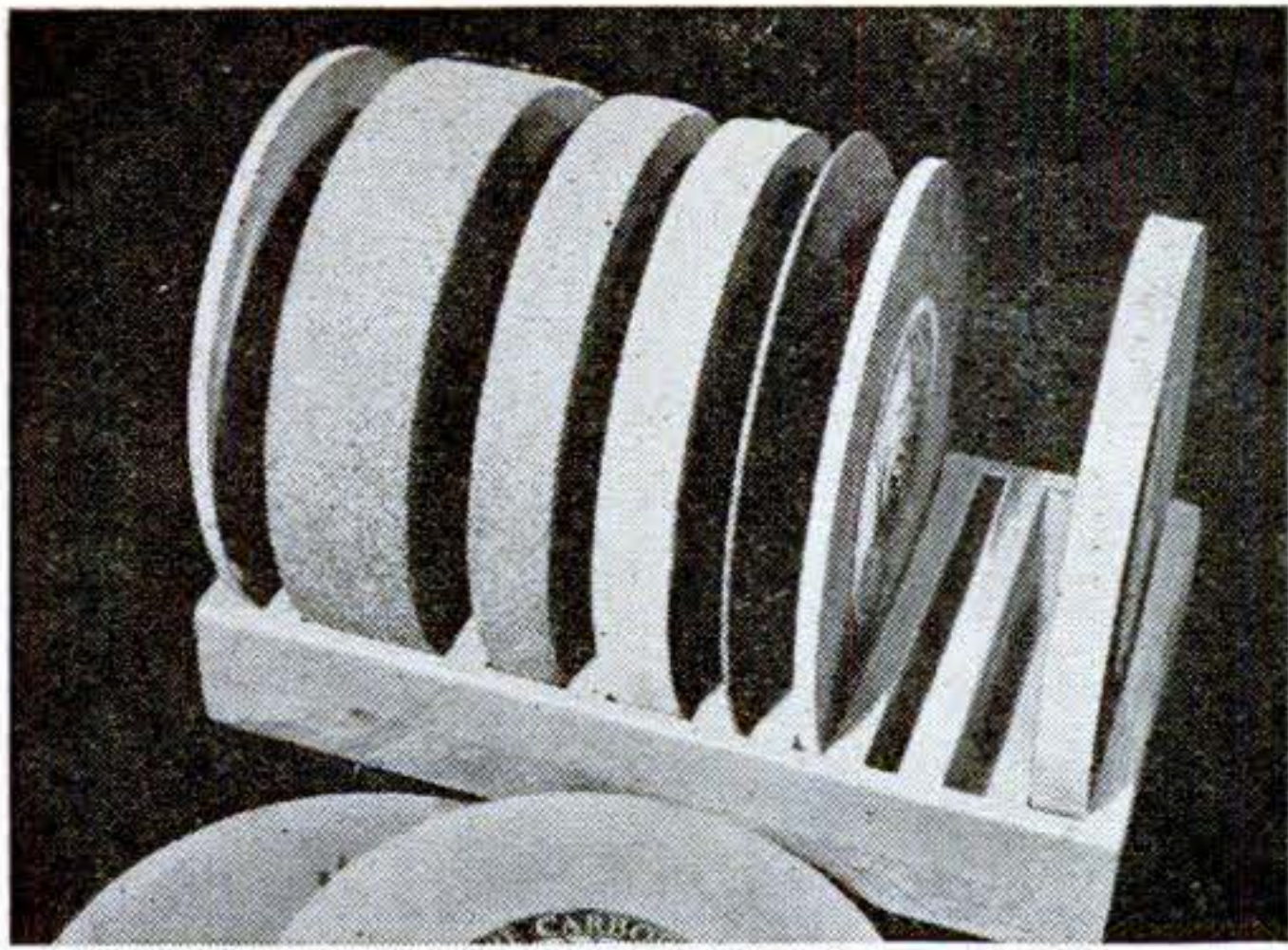

Wheels of various widths are held upright in the slots, with clearance between for grasping them.

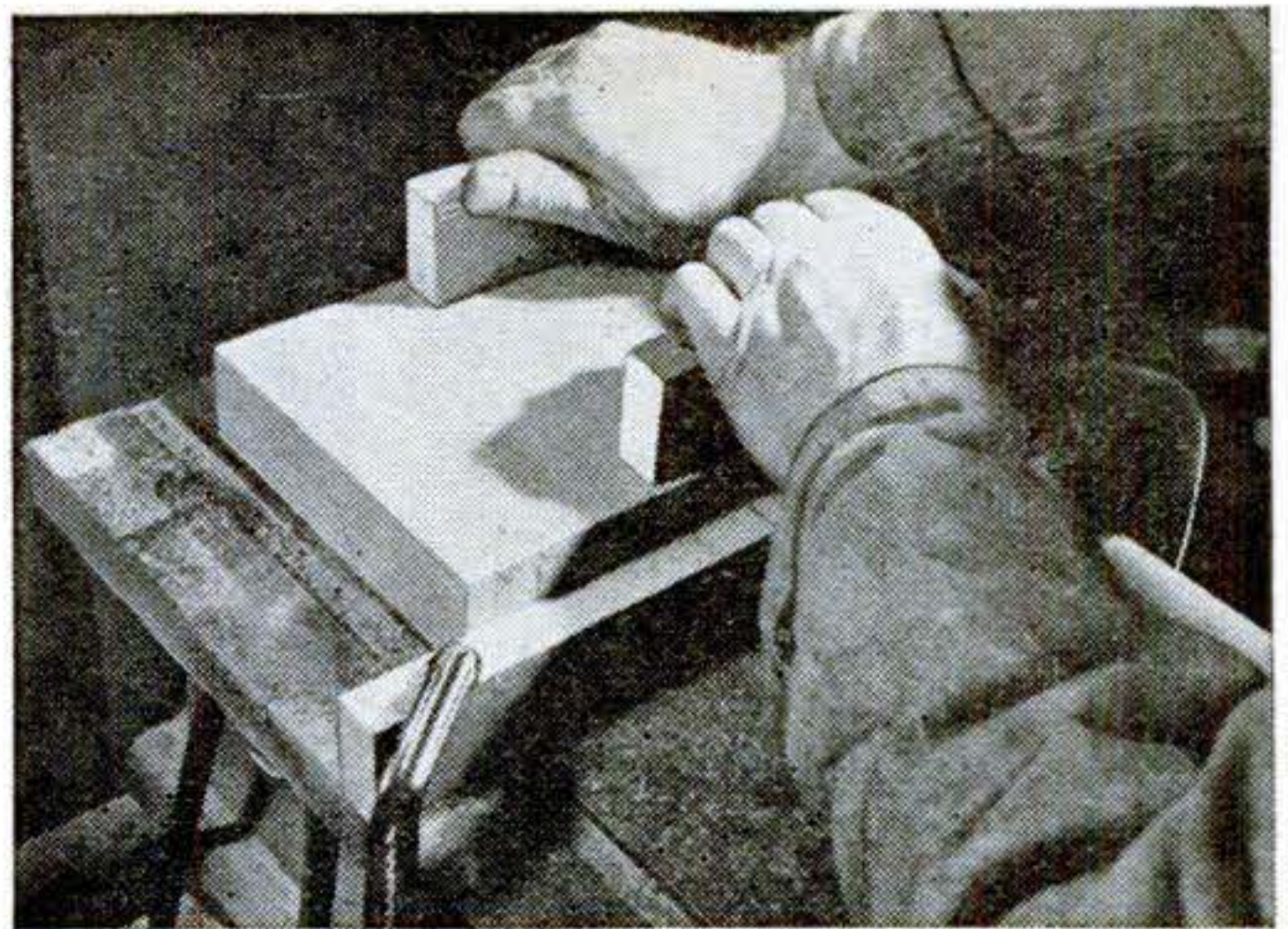

The slots are cut quickly by lowering the block onto the saw by means of two temporary handles.

Grinding-Wheel Rack Is Sawed from Solid Block

THIS concave-slotted stand for a set of grinding wheels can be made in part of an evening by a method as unusual as the project is practical. You will need a saw blade of the same diameter as your grinding wheels. Select a suitable hardwood block, or glue it up from two thicknesses, and square to the required dimensions, having the grain along the grooves to be cut.

Lay out the slots on the end grain, leaving finger width between, and screw temporary

handles to the bottom at the end-grain edges. Clamp a fence to the table at right angles to the blade and $7/16$ " from the blade edge when the table is set for a $1\frac{1}{2}$ " cut. Lay a straightedge along the blade and mark the fence for blade width.

Now lower the block on the saw, using the layout lines as a guide. Make outside cuts first; then clear out between. Sand and finish. Add rubber feet at the corners to prevent slipping.—WILL THOMAS.



Grooves turned on the handle improve the grip. The same result can be obtained with a knurling tool.

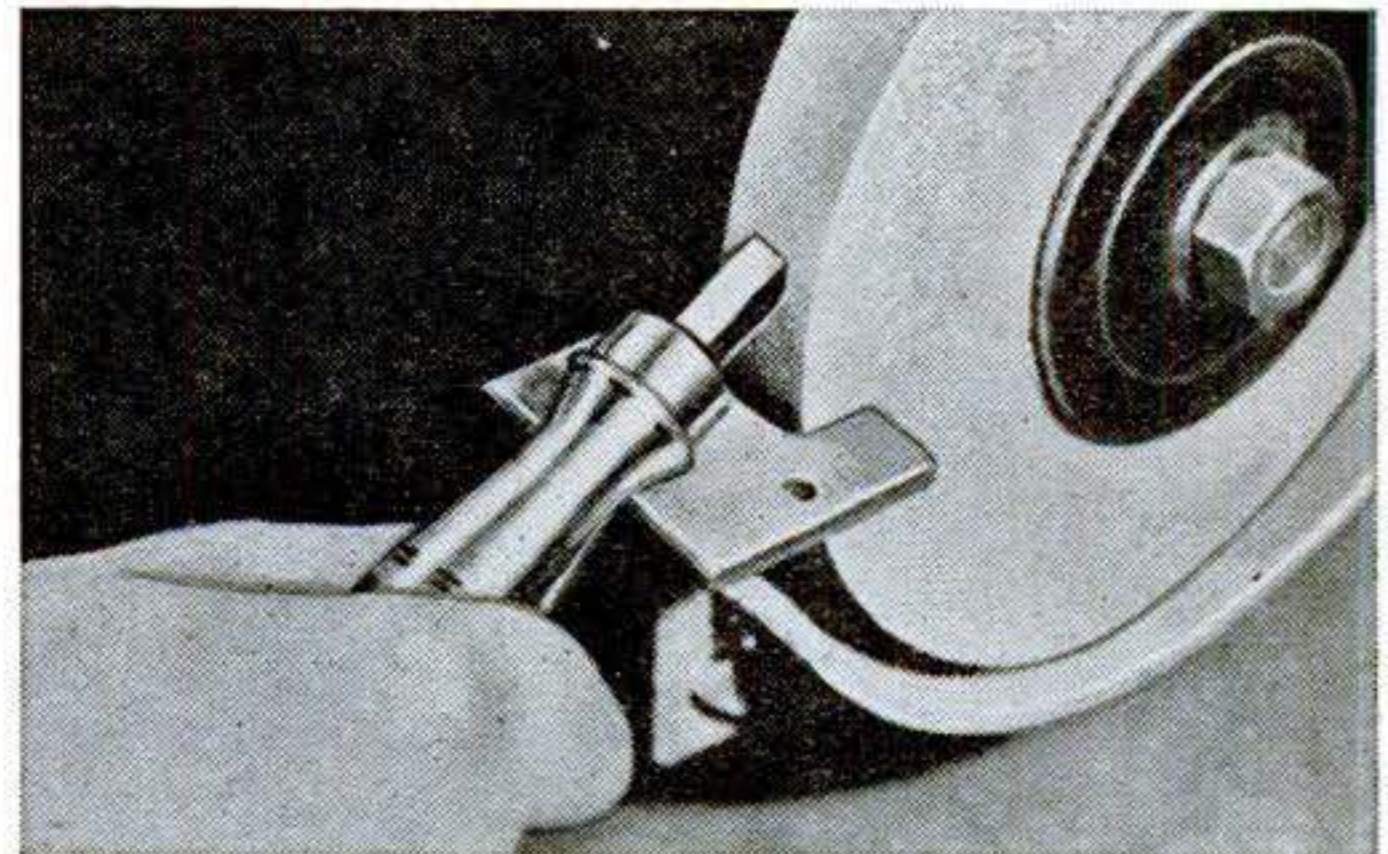

Supported on the rest, the holder steadies the bit and keeps the fingers safe from burns and scrapes.

Lathe-Bit Grinding Holder Protects Fingers

BITS used in a lathe tool holder are often awkward to sharpen on a grinding wheel when their shanks become short. However, with a handle turned from scrap brass or steel, they can be ground easily and more accurately, and at the same time the fingers will be at a safe distance.

The holder shown was turned to $\frac{3}{4}$ " at its greatest diameter and cut off at a length of $4\frac{1}{4}$ ", but the dimensions should suit the hand of the user. After shaping, a square hole was

put in the end to take the bits. Since a set-screw will hold the bits, a round hole will suffice, but a square one is much neater and is easy to make, especially in brass. A simple method is to scribe a $\frac{1}{4}$ " square on the tool end and centerpunch it at the corners and middle. The corners are first drilled to required depth with a $1/16$ " or other small drill, and then the center is drilled $\frac{1}{4}$ " to the same depth. Squaring with a small file completes the job.

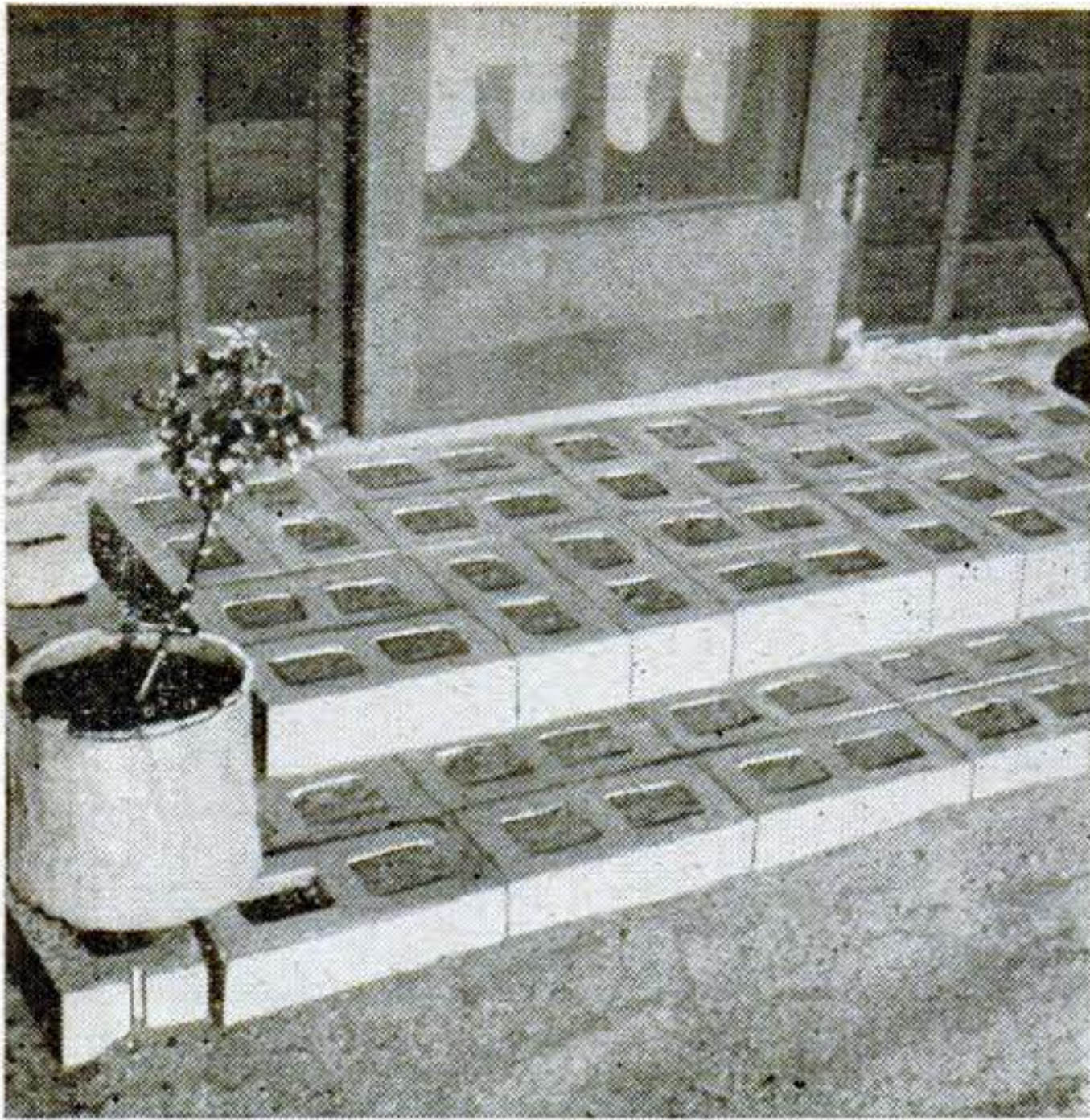

Hollow Tiles Make Doorsteps

FILLED with cement to which dry color has been added, hollow tiles can be used for mosaic-type doorsteps and even terraces. Lay the tiles just as you would bricks or stones, placing the hole ends up and applying mortar between to provide firmness. Then fill with the colored cement, using either all one color or two or more colors in a definite design arrangement.

Various colors for cement can be obtained as dry powders. Mix in with the dry cement before adding water.—BOB DOWNER.

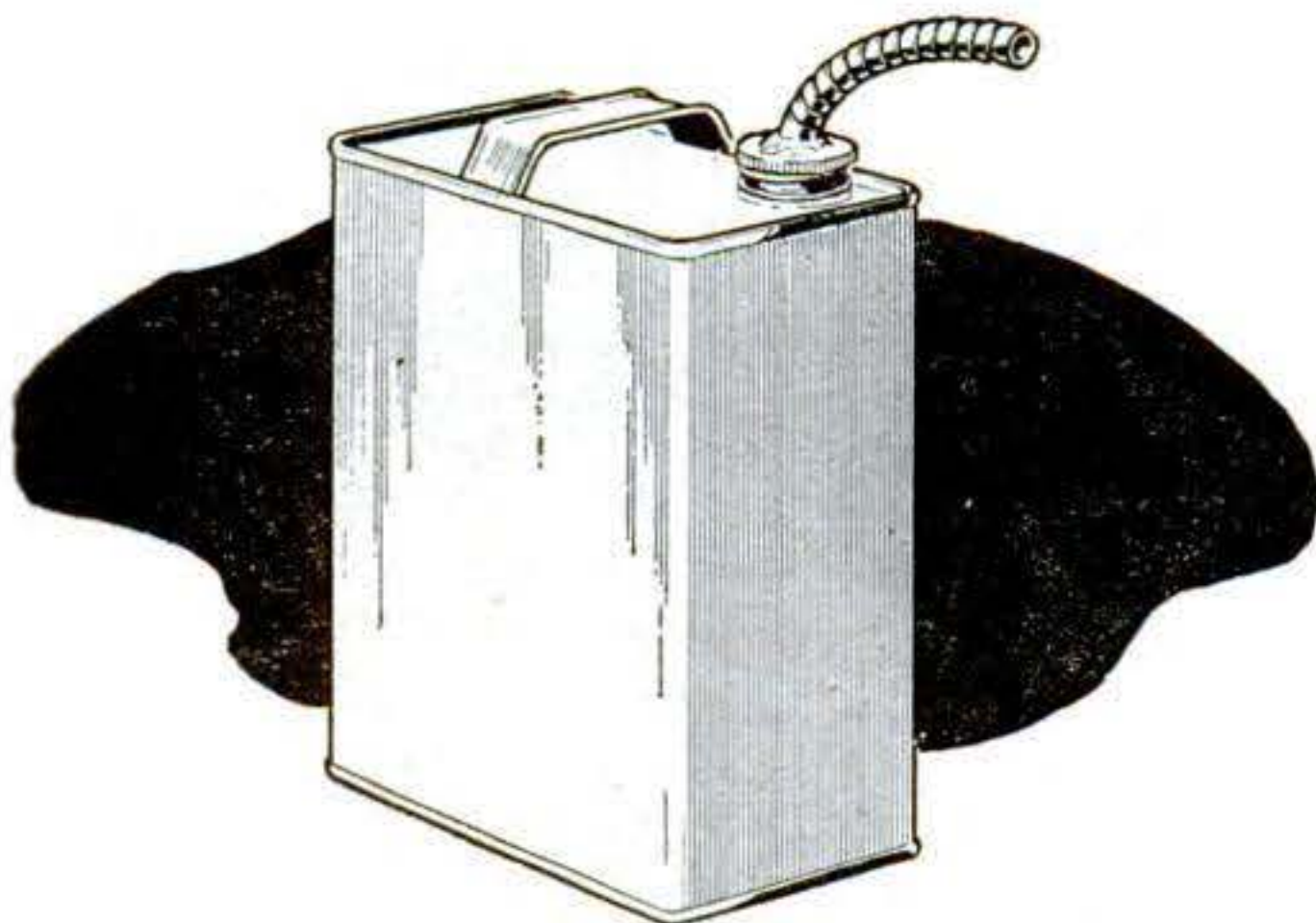

BX Shield Forms Can Spout

CONTAINERS, such as 1-gal. cans, are sometimes more convenient to use if equipped with a flexible spout. A 9" or 12" length of the armor from BX cable is ideal for the purpose. Remove the cover from the can opening, cut a hole of the required size in it, and solder or braze the shielding in the hole.—DONALD REISER.

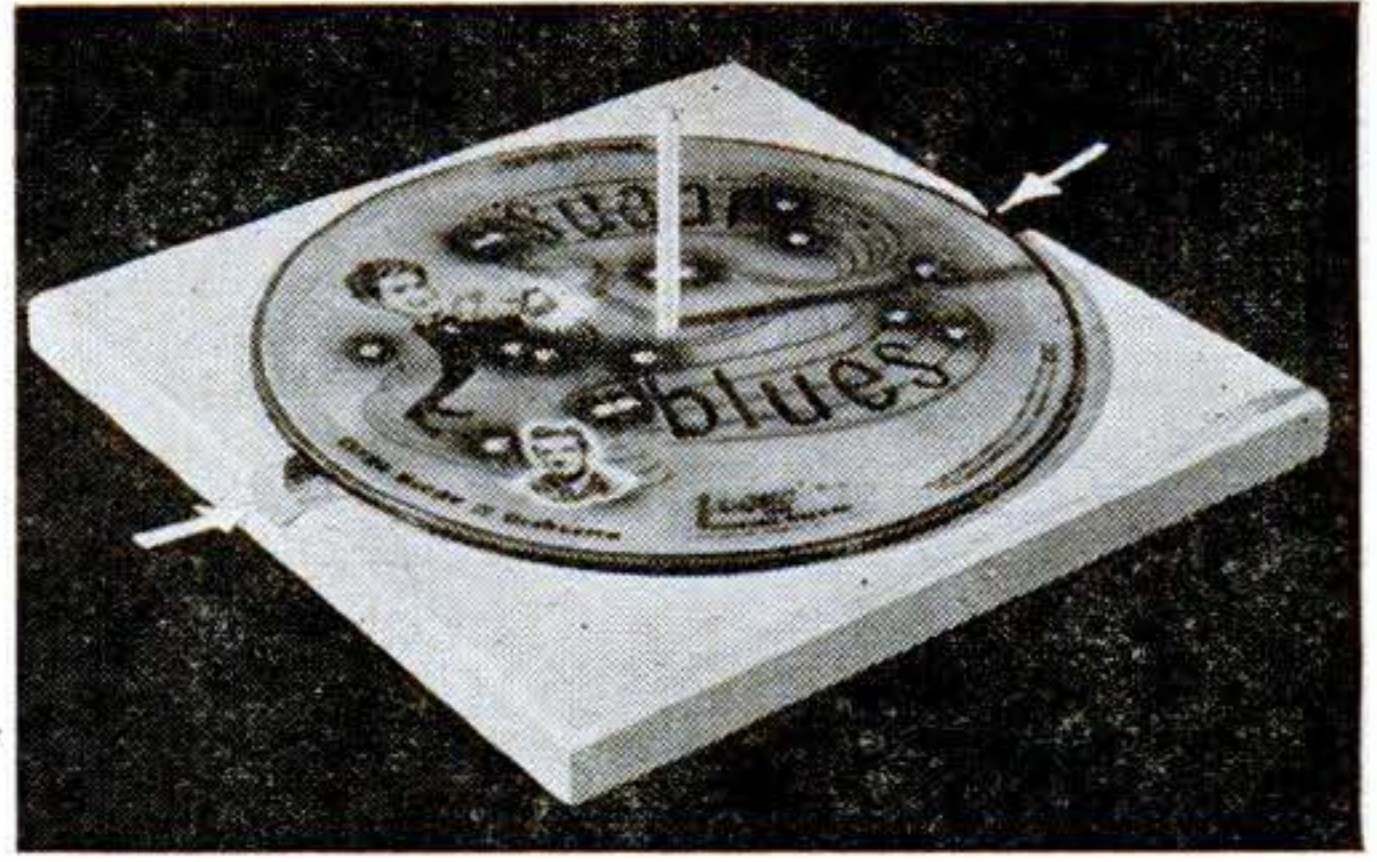

Holder Contains Complete Set of Records Used in Program

TIME can be saved when guests arrive to hear your latest records if the playing program is arranged beforehand. An ideal holder from which the records can be taken in the order they are to be played is merely a square board with a dowel inserted in the center. For a neat job, the edges of the board may be chamfered, and for an additional refinement, the board can be painted and felt glued on the bottom to protect the table surface on which it is set. The arrows show finger holes on two sides that permit you to take off a whole set of records at one time if they are to be transferred to an automatic record changer.

Glue in the dowel permanently, or leave it removable for storage of one or several of the holders.—LARRY MORRIS, JR.

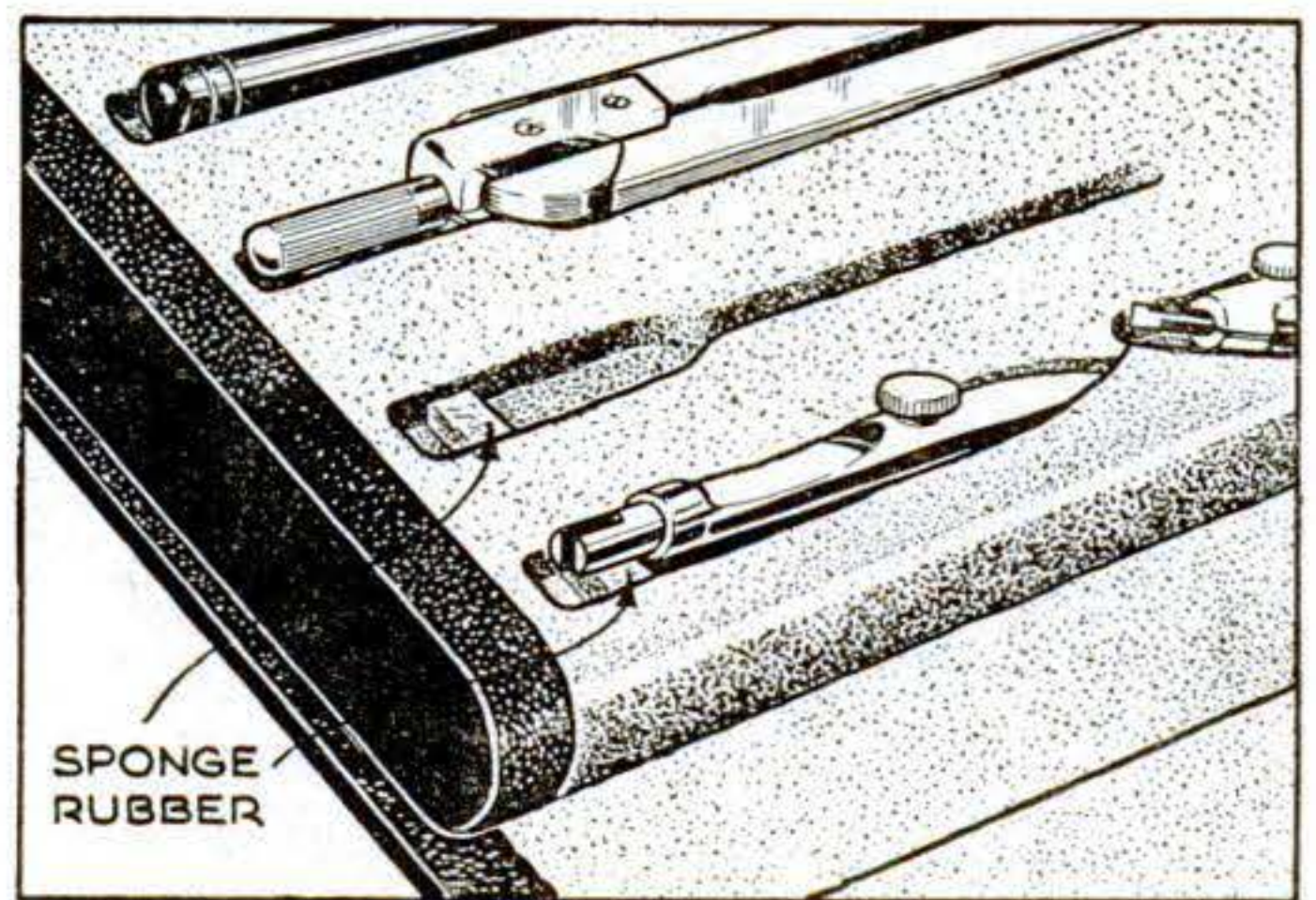

Drawing Instruments Pop Up

SPONGE rubber glued into the individual instrument compartments will provide you with a handy pop-up carrying case. The handle of each drawing instrument will spring partly out of its depressed compartment as soon as the lid is raised, making removal possible without the necessity of prying with fingernails.—THOMAS TRAIL.

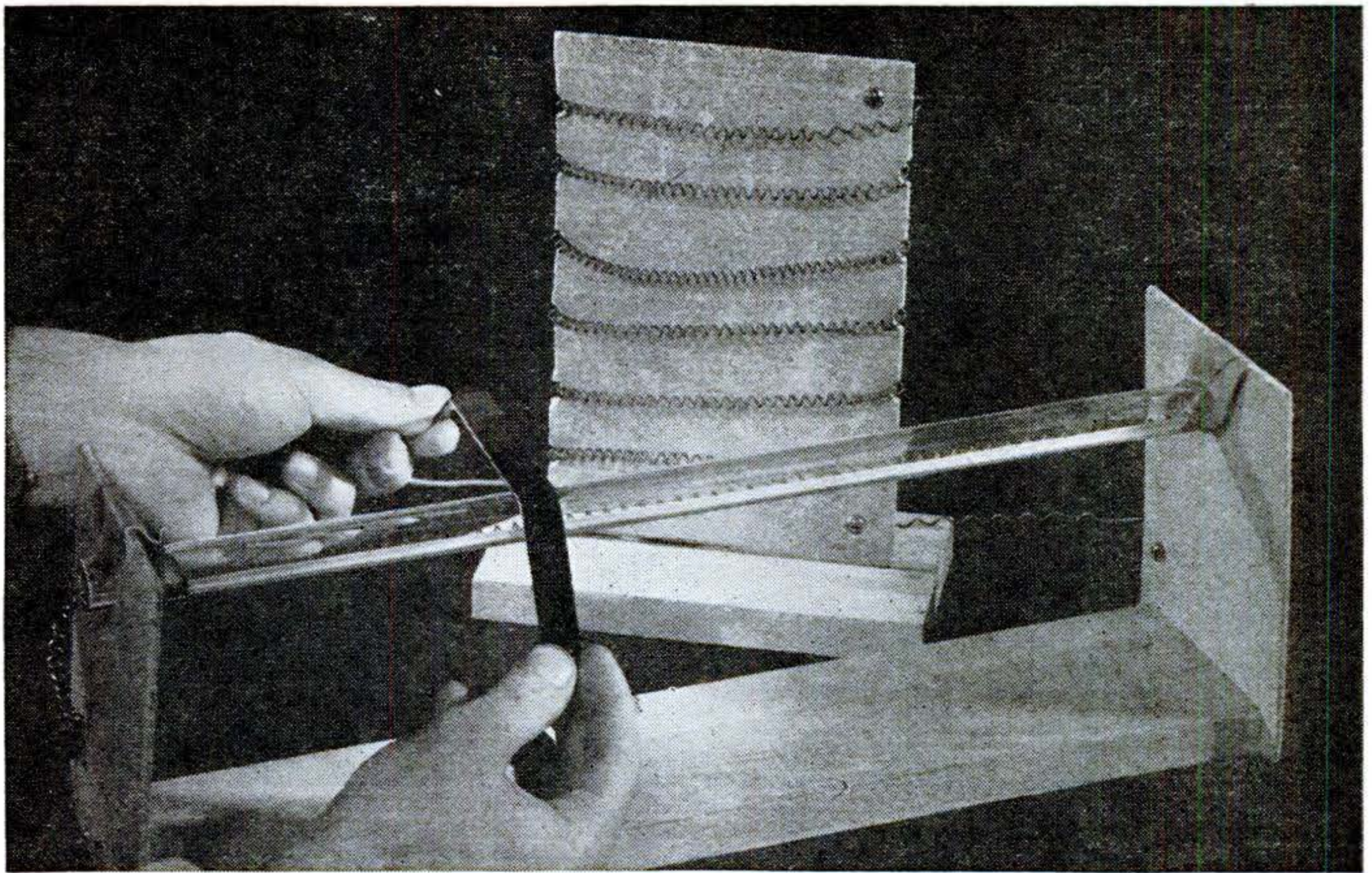

Spot Heater Makes Jig Unnecessary in Bending Plastic

WHEN heat is applied only to that part of a strip of plastic that is to be bent, forming jigs won't be necessary for many projects. This spot heater, operating on household current, is a heat-resistant glass tube, such as a boiler water gauge, through which is inserted a length of coiled nichrome wire. It is mounted in holes in two upright asbestos sheets. Additional wire, connected

in series, is wrapped on a third asbestos board set in a grooved base. Stretch the coiled wire in the tube to reduce the heat, which should not cause the wire to glow. The best surface heat is 400 to 600 deg.

At 550 deg. 1/16" plastic can be softened for bending in 37 seconds. Plastic 1/4" or thicker should be heated first on one side and then the other.—ELI S. EISENHARD.

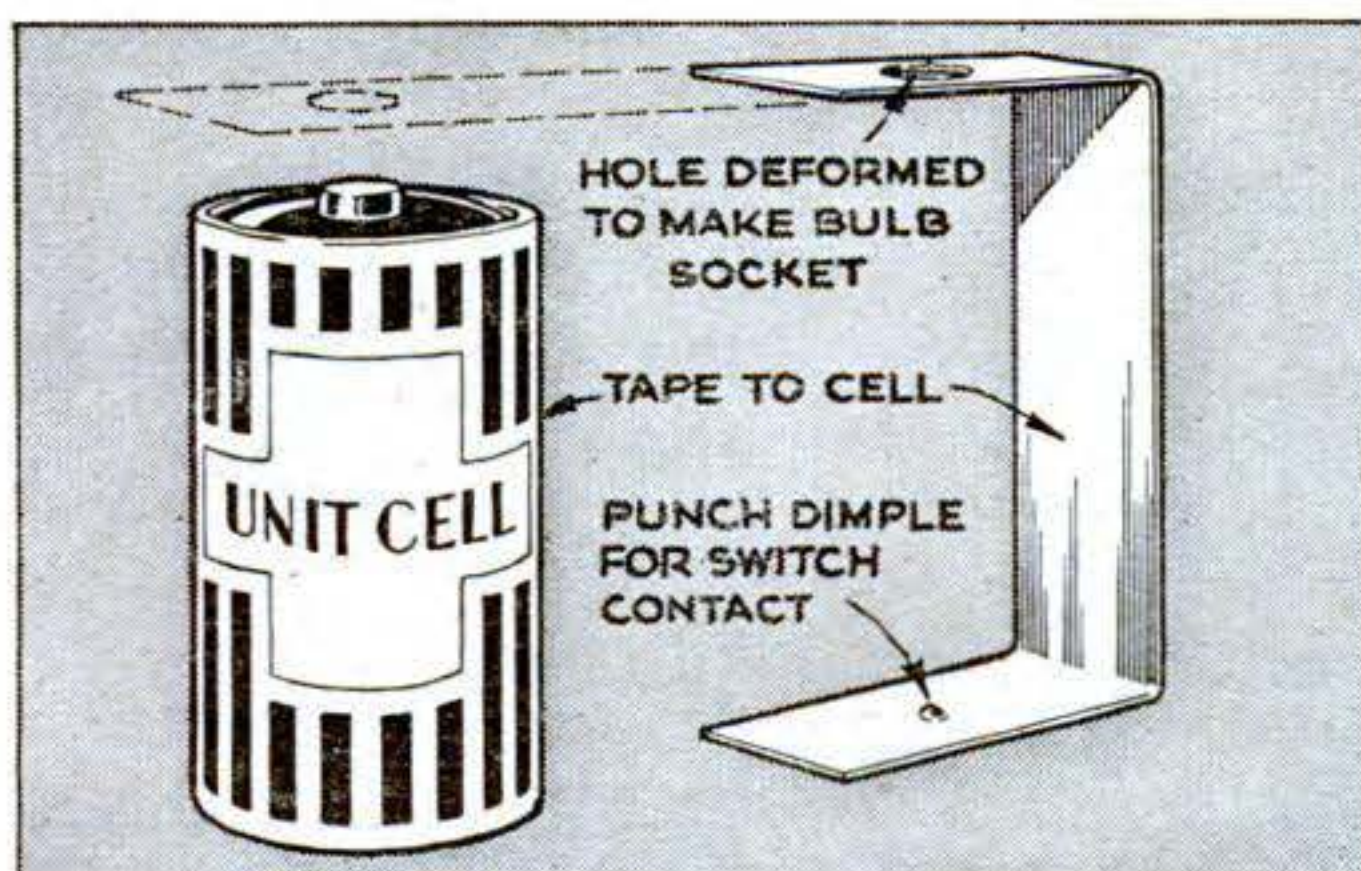

Bent Metal Forms Flashlight

OLD flashlight cells, too weak for regular duty, make handy emergency lamps or instructive toys for youngsters. Drill the hole for the bulb undersize and distort with pliers to form a threadlike socket. Tape the cell on to make contact with the bulb, and press the dimple or stand the cell on end to put on the light.—MILES KUCKUK.

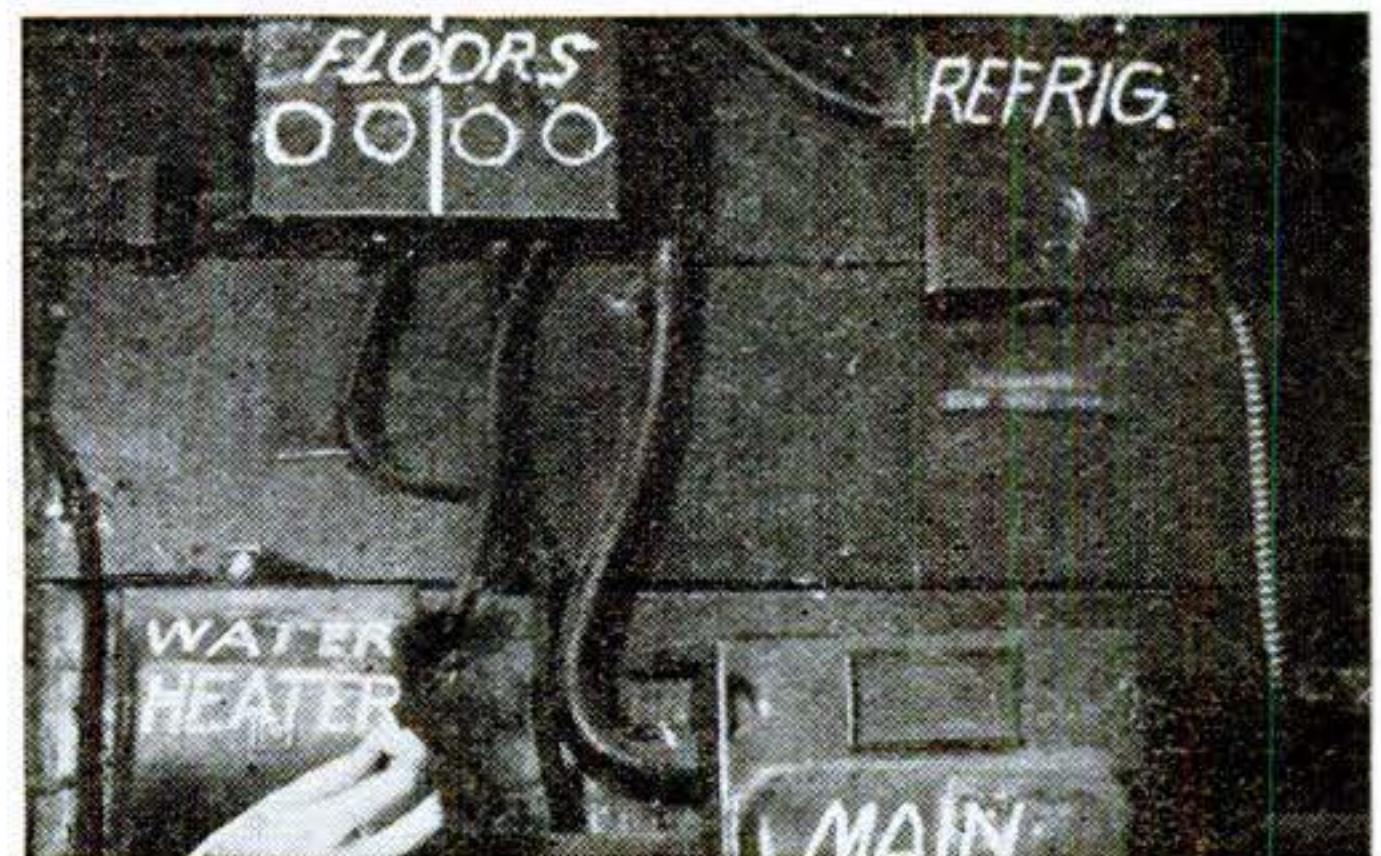

Identifying Fuse Boxes

MARKING the fuse boxes in a home to identify the circuits they control will save a lot of time spent in hunting when a fuse blows. Ordinary white chalk serves, but white paint lasts longer. Check the circuits first by having someone note those affected as the fuses are unscrewed or switches in the boxes opened one by one.—H. LEEPER.

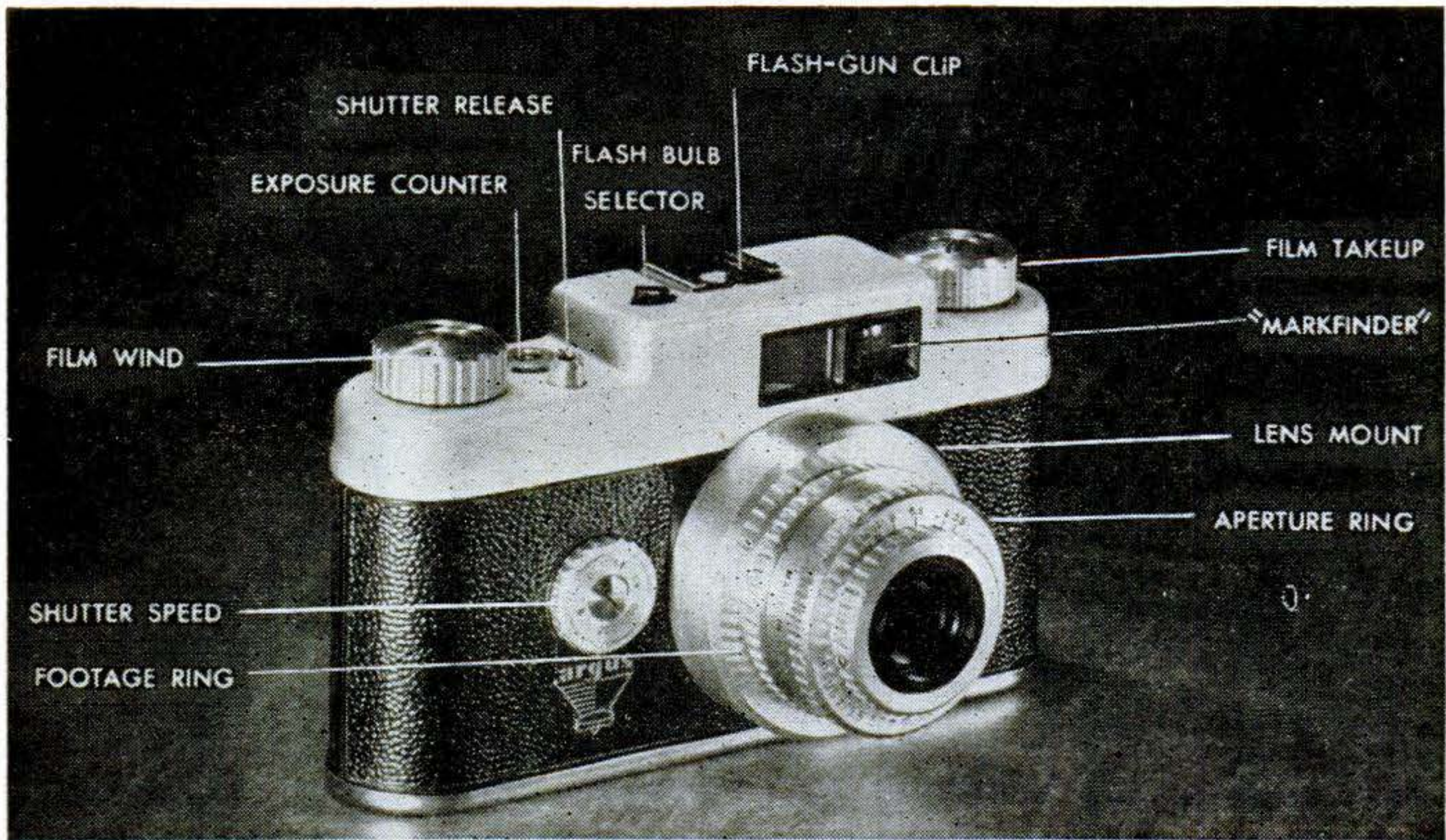

View Finder Marks Center.

Illuminated cross hairs, called by the maker a "markfinder," incorporate the principles of aircraft gunnery in the view finder of the new 35-mm. Argus. The device enables the photographer to spot the center of his picture immediately. It is particularly suitable

for action shots, where the cross marks can pick up and follow a moving object to help stop action. Three lenses, two mirrors, and a reticle plate are used in the finder. The camera has also a behind-the-lens shutter that permits removal of the lens without exposing the film.



Three-in-One Photo Funnel. A novel plastic combination funnel made by Eastman for pouring liquids into either large- or small-mouth bottles is intended to be a timesaver in the darkroom lab. The funnel is in two sections that can be used separately or fitted together with the spout of one in the bowl of the other.

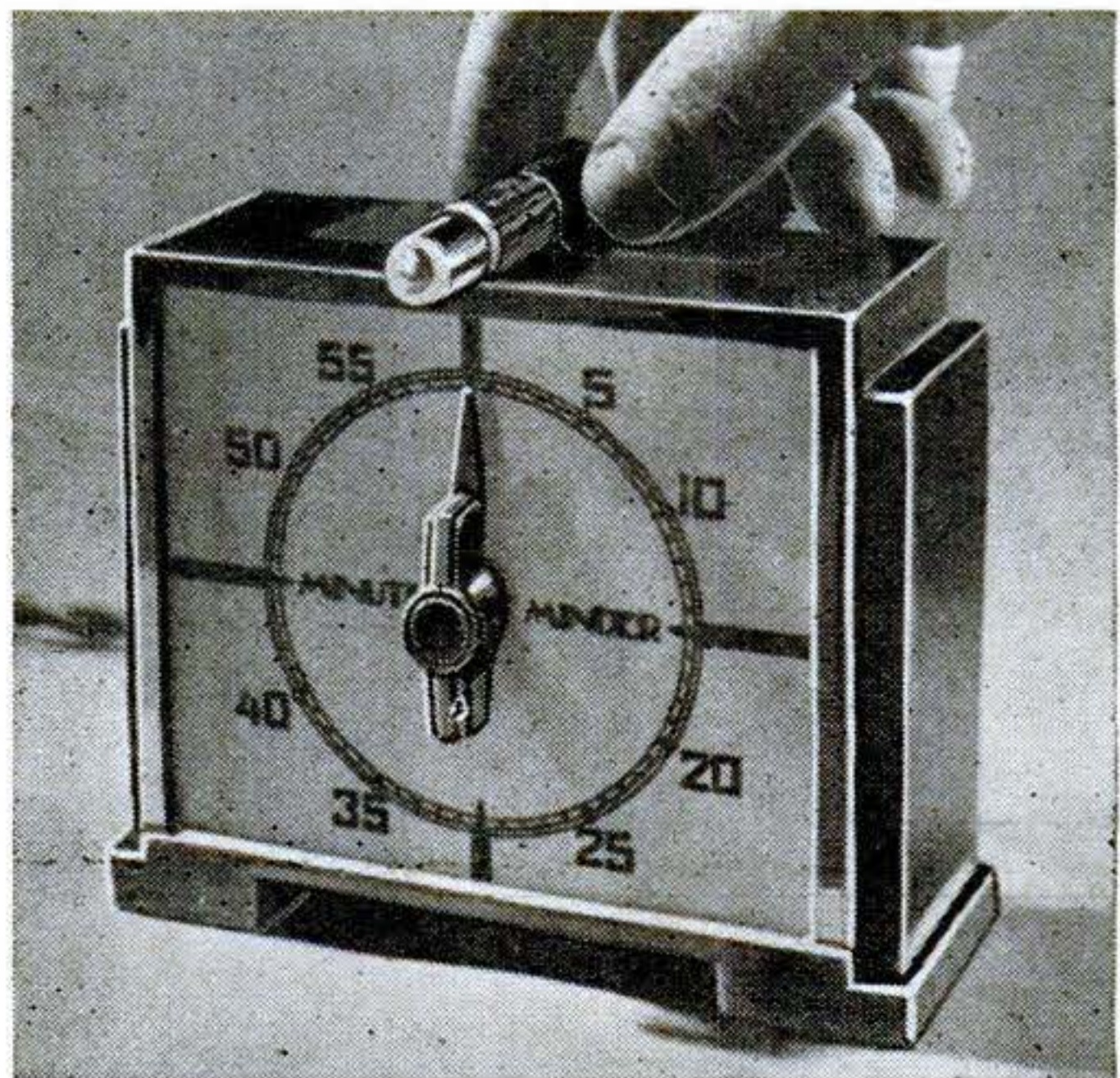

Illuminating Your Timer. Attached to the top of a darkroom timer with masking tape, a small neon circuit tester will make the dial visible in its soft, red glow. The dim light is not bright enough to fog even panchromatic film if screened to avoid direct rays. Neon testing lamps can be plugged into 115-volt house current.

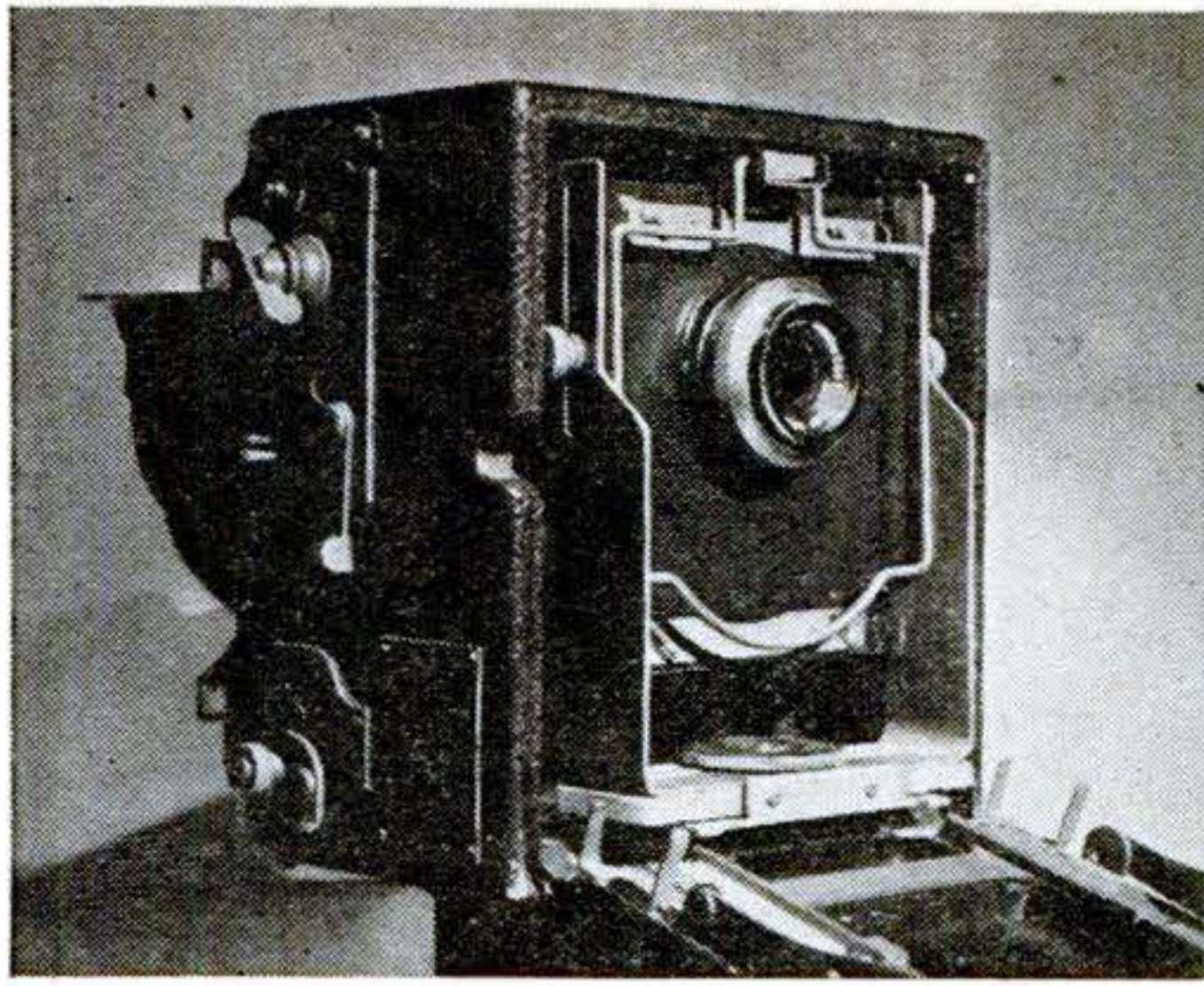

Eccentric Lens Mount. You can double the vertical and horizontal adjustment range of a lens used on a removable lens board by mounting it off center. This is especially advantageous with wide-angle objectives that are used at short extensions. To permit centering for normal work, the lens should be mounted off center the same distance the lens front can be raised. With lenses of longer focal length, take care to see that the bellows will not cut off any of the image.—ALVIN J. BRAULT.

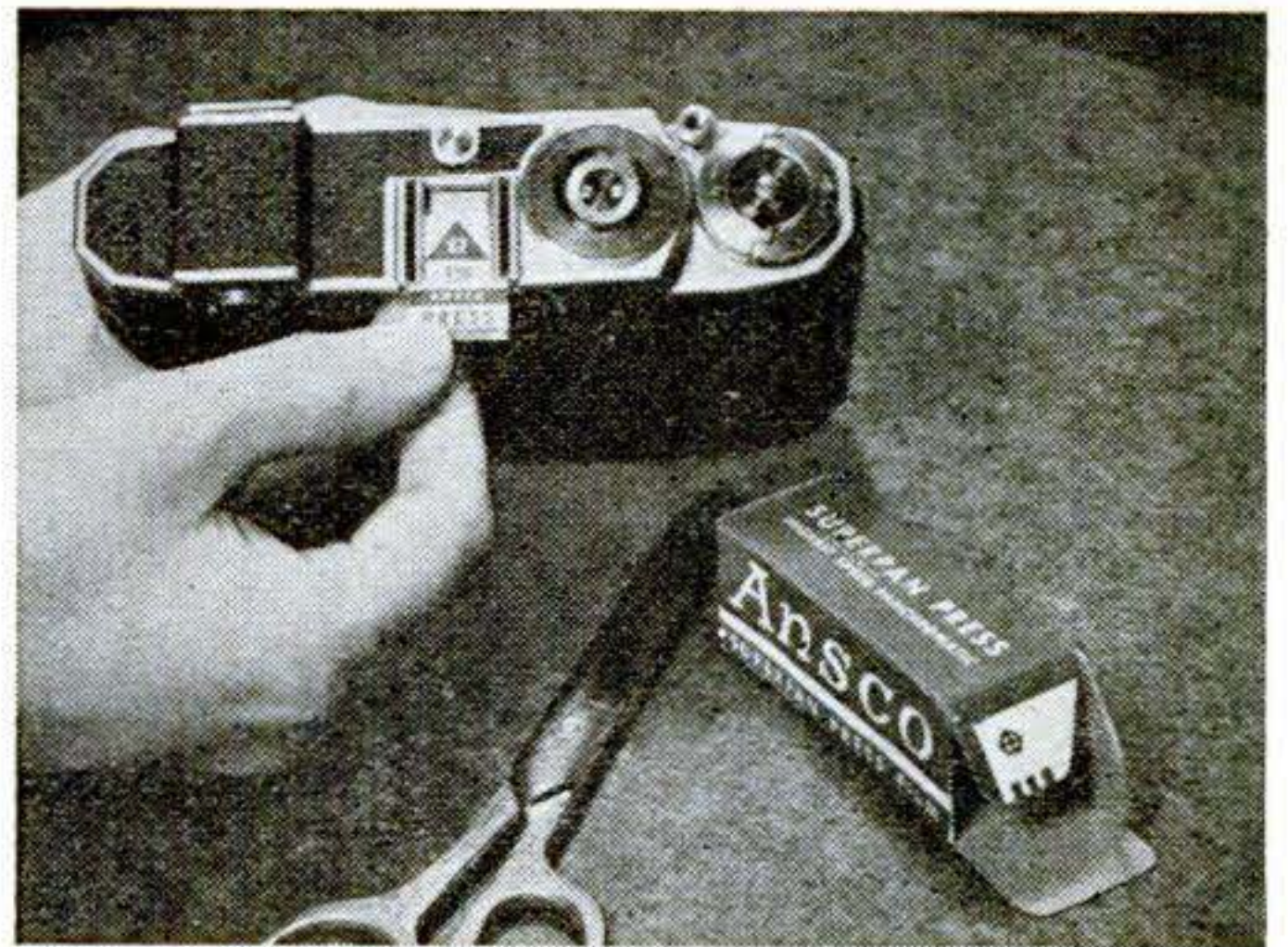

Visual Film Reminder. When several types of film are used, markings cut from the ends of film packages and slipped in the accessory clip will show with what kind the camera is loaded. Tape will hold such a tag to a camera having no clip.

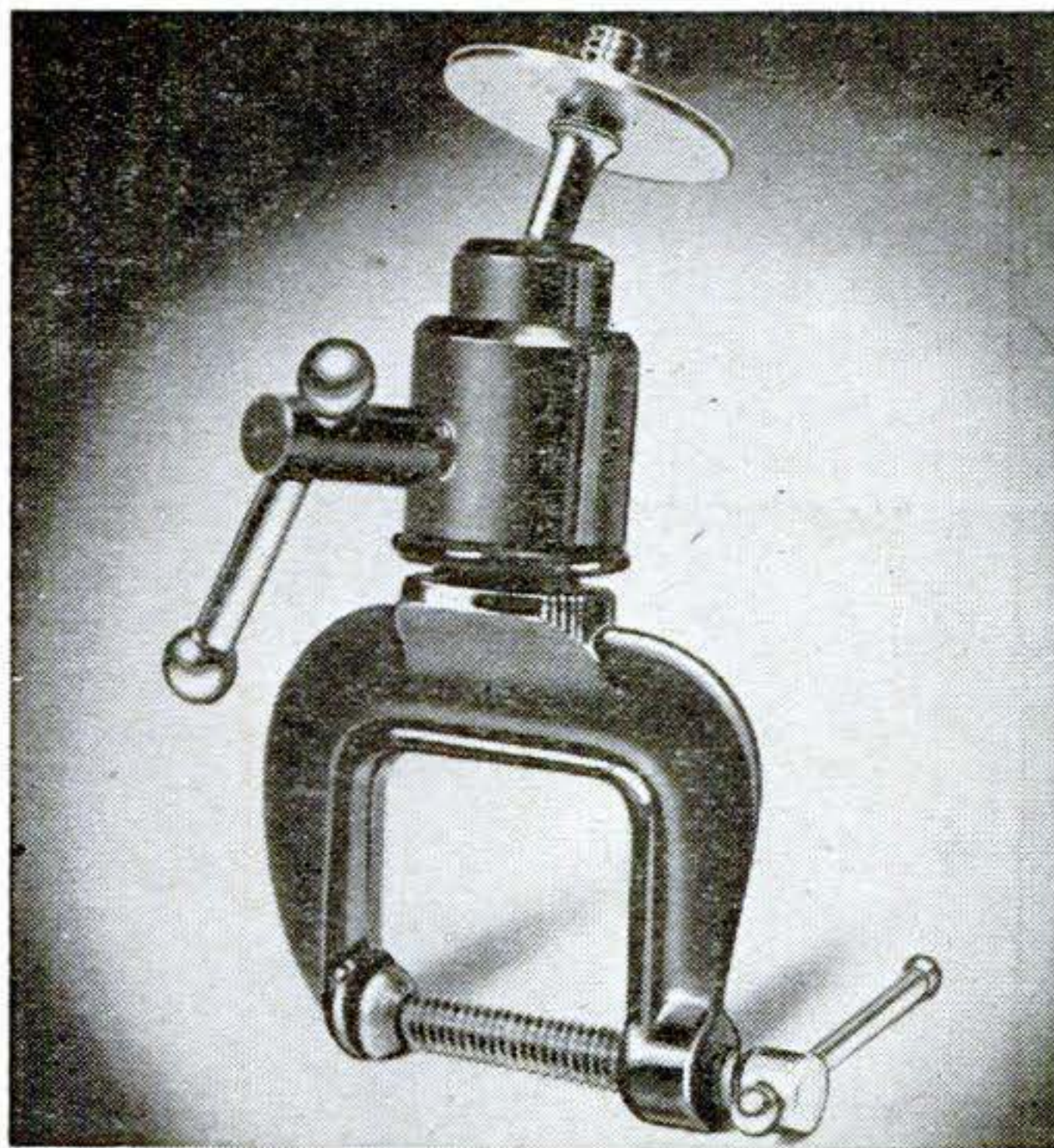

Clamp-On Camera Support. A $\frac{1}{4}$ "-20 tripod screw brazed to the frame of a small C-clamp provides a lightweight support that is easy to carry when a tripod would be inconvenient. The camera may be attached directly, but framing and composing is easier if a tilt-top tripod head is screwed on first.—RICHARD C. THOMPSON.

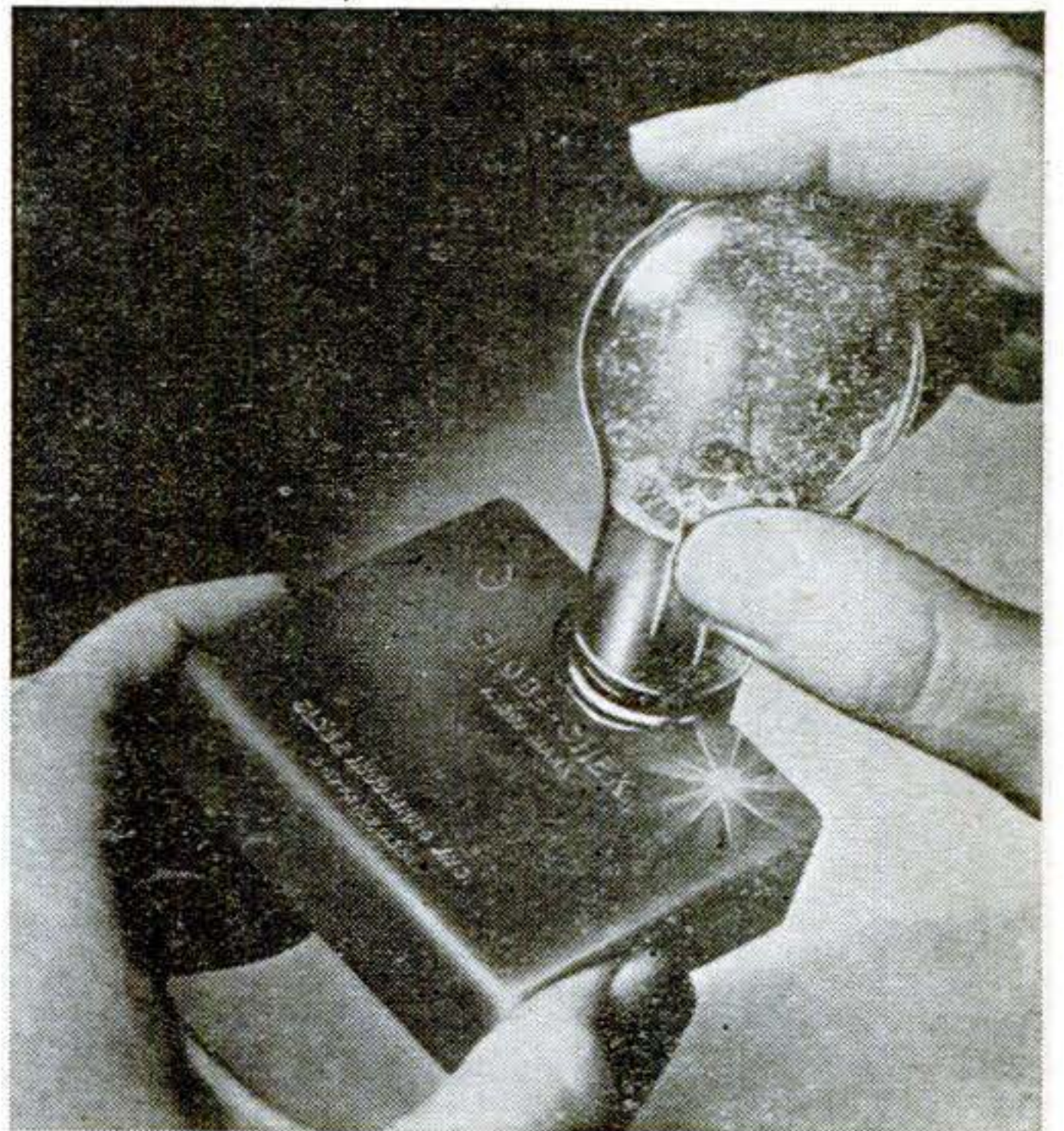

Flash-Bulb Tester. A pilot lamp in a pocket-size flash-bulb tester lights up when a good bulb is inserted, thus eliminating the danger of missing a shot because of a dud bulb. The tester is operated by a battery. It will test any flash bulb, including both bayonet-base midget and standard screw-base types.

Darkroom Doctoring Saves Photo Paper

By Robert Wortham

RATHER than discard enlargements that just miss being satisfactory because of some error in the making, why not remedy the defect by employing redevelopment or reduction? While these procedures do not replace burning in or dodging, one of them frequently offers an alternative or supplementary means of control to bring a print up to snuff. Properly used, they will keep a lot of projection paper from the wastebasket.

In many instances where an area of a print has a washed-out appearance because of overexposure in a part of the negative, local redevelopment will produce a more pleasing tonal range than if the area is burned in during enlarging. Until discovering redevelopment, I had always relied upon burning in to correct this fault, but more often than not several sheets of paper were wasted before I had a good print.

With redevelopment, the worker has complete control of tone and gradation at all times, and progress of the development can be observed and halted when a good print has been produced. Moreover, small areas

that may be difficult to burn in lend themselves well to spot redevelopment.

The requirements for redeveloping are simple. In addition to the customary trays, set up a fourth near your safelight. If you intend to use local control, leave the tray empty and place a small graduate of redeveloping solution near by. Ordinarily, this solution may consist of 1 part stock developer and 3 parts water, but if your regular developer is faster than 90 sec. when diluted 1 to 2, make the solution 1 to 4.

If you are working with a negative that has a washed-out area or one where there is little detail, as in a cloud portion, expose the print for the best overall tone and place it in the regular developer for the specified time. Then, after 20 sec. in the short stop, place the print in the empty tray and begin the intensification.

Small areas can be intensified by applying the solution with a small brush or the fingers. Work it into the emulsion with a circular motion, dipping often into the graduate for fresh developer. The image should come up rather slowly, allowing ample time for inspection. The more briskly the print is



Overexposed under the enlarger, this print came up too dark in some areas and much desirable detail was lost. Instead of discarding such prints . . .



. . . Save them by using a reducer. Here is the same print after it has been reduced. Details are now seen in the leaves and the girl's face is lighter.



Redevelopment of a washed-out area saved this print from the wastebasket. Compare it with the one below.

rubbed with the fingers, the faster the image will intensify, for heat generated by the friction speeds up the developing process. This is a trick long used by commercial finishers to bring up a thin area.

When a large area requires treatment, it is better to place the solution in the tray and dip in the part of the print that you want to strengthen, holding it at an angle so none of the solution reaches the fully developed part. Keep the print in motion to assure even gradation of tone with no sharp breaks.

Reduction, the direct opposite of redevelopment, also will save many prints. It is particularly useful in the case of prints that have been overexposed under the enlarger. Many amateurs pull such prints before complete development has taken place, but this practice results in a muddy photo. A better method is to leave the print in the developer for the full period, fix and wash it, and then place it in a tray of reducer. Main-



When taken from the original developer, the print lacked detail in the upper lefthand corner. After passing through the stop bath, the print was held under a safelight and diluted developing solution was worked into the light area with the fingers.



A brush gives you better control when very small areas are to be reduced. Reducing solutions may be made from such household bleaches as Clorox.

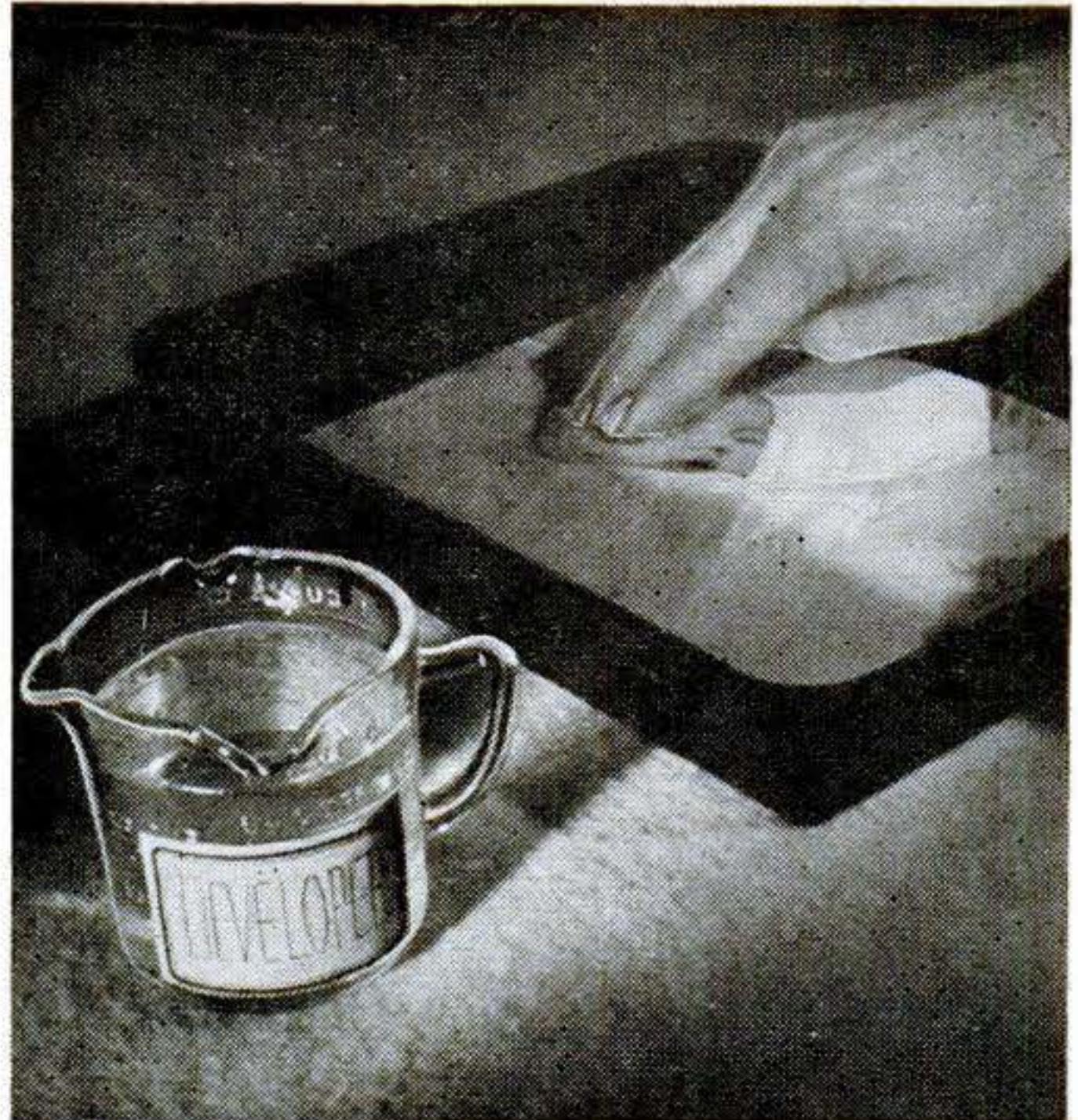

For local redevelopment, dip your fingers into the solution and rub the area with a circular motion. Heat generated by friction speeds up the process.

tain the reducing solution at about 68 deg.

Many commercial reducers are available, but you can make your own from one of the household bleaches sold under such names as Clorox, Hypro, Purex, etc. Stir $\frac{1}{4}$ oz. of the bleach into 32 oz. of water. This "soup" should reduce a fairly dark print in about 15 min. It may be best, however, to check its speed on a few test strips before trying a

print, since the various brands of bleach differ in strength.

As in redeveloping, you can use the reducer for spot control of small areas or you can immerse part or all of the print. In local reduction, I often use a No. 1 spotting brush, for this makes it easier to restrict the reducer to the desired area. After reducing a print, fix and wash it again. END.

Radio Parts Used in Building Pan-Tilt Head

SCRAP parts from an old radio provided most of the material for this pan-tilt head. The entire cost was a dime spent for a screwdriver that serves as the handle.

The base is an old bakelite dial with a brass flange. This flange was threaded $\frac{1}{4}$ "-20 underneath for the tripod screw. Resting on the $\frac{1}{4}$ " vertical shaft that serves as the panning axis is a pulley taken from a radio condenser shaft, its setscrew replaced with a rheostat shaft and knob as a locking device. Two binding posts of $\frac{5}{16}$ " hexagonal brass attached vertically to the pulley support the horizontal shaft.

For the top assembly, a camera-mount screw was fitted in a brass plate. Under this, two angle pieces were bolted parallel to the axis and two small blocks were soldered between. After its end was cut off, the screwdriver was threaded to function as a set-screw against a horizontal shaft that gives the tilting action.—LEONARD J. BOGERT.

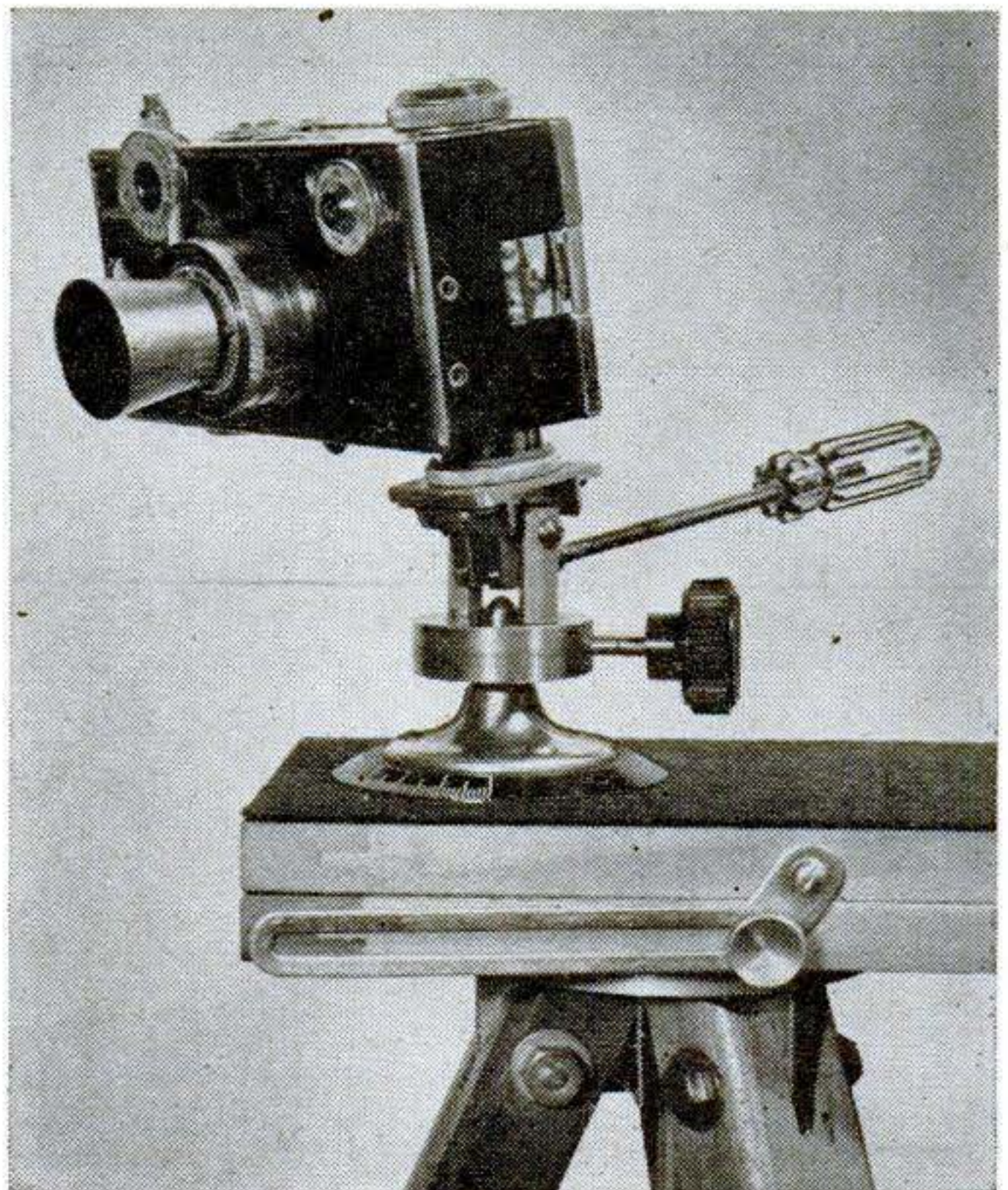

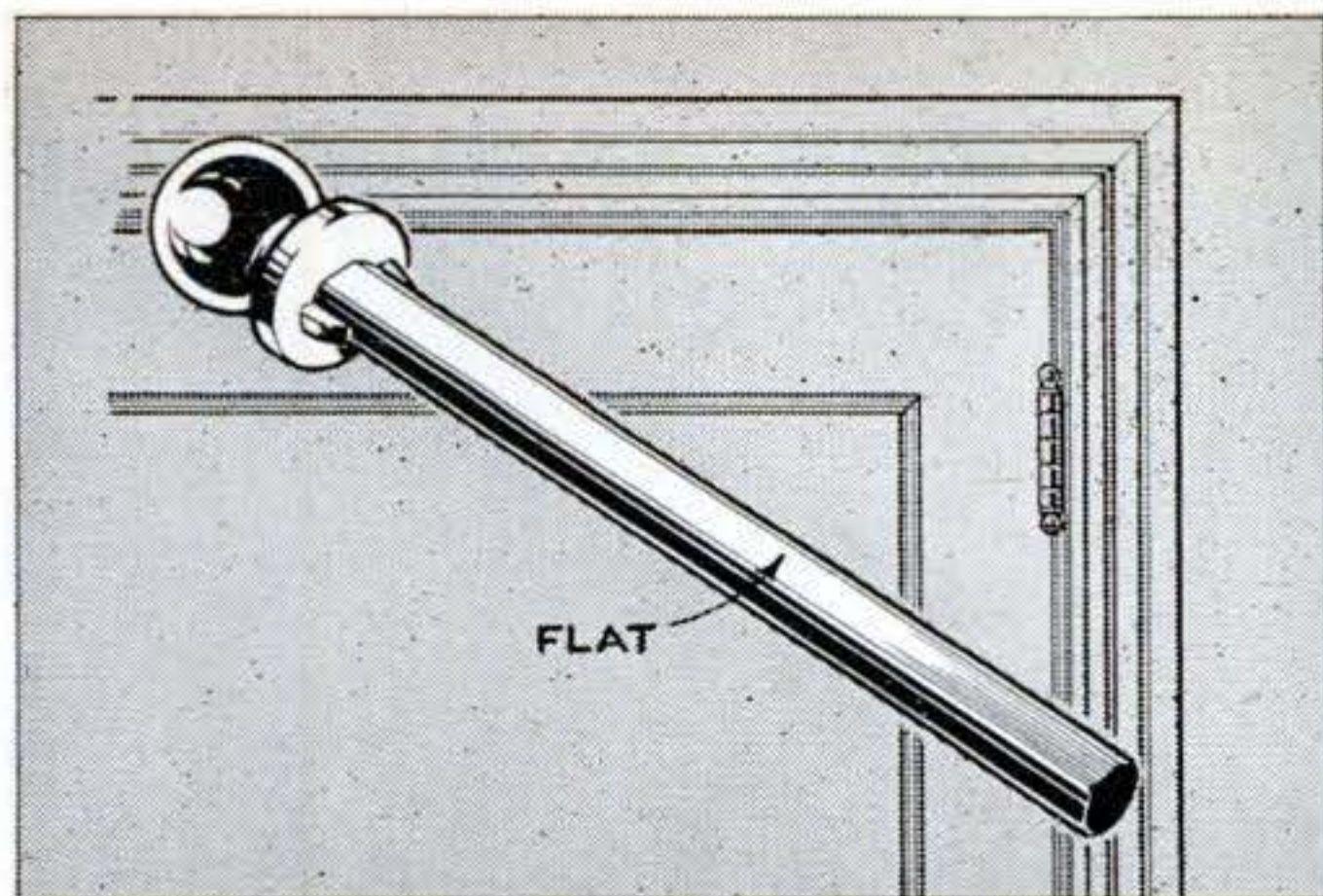

Flat Stops Squeak in Hinge

WHEN there is no clearance between a hinge pin and socket, a door sometimes squeaks even when properly oiled. File a flat on such a pin for its entire length, and then replace it in the hinge. The flat not only conducts oil all the way down the hinge but also retains a small reserve to lessen the need for frequent oiling.

Jar Rings Identify Plants



GARDEN plants that require special foods, insecticides, or the like can be identified by rubber jar rings. Place the rings over them as they show above ground and let them grow on through the opening.—T. NICHOLS.

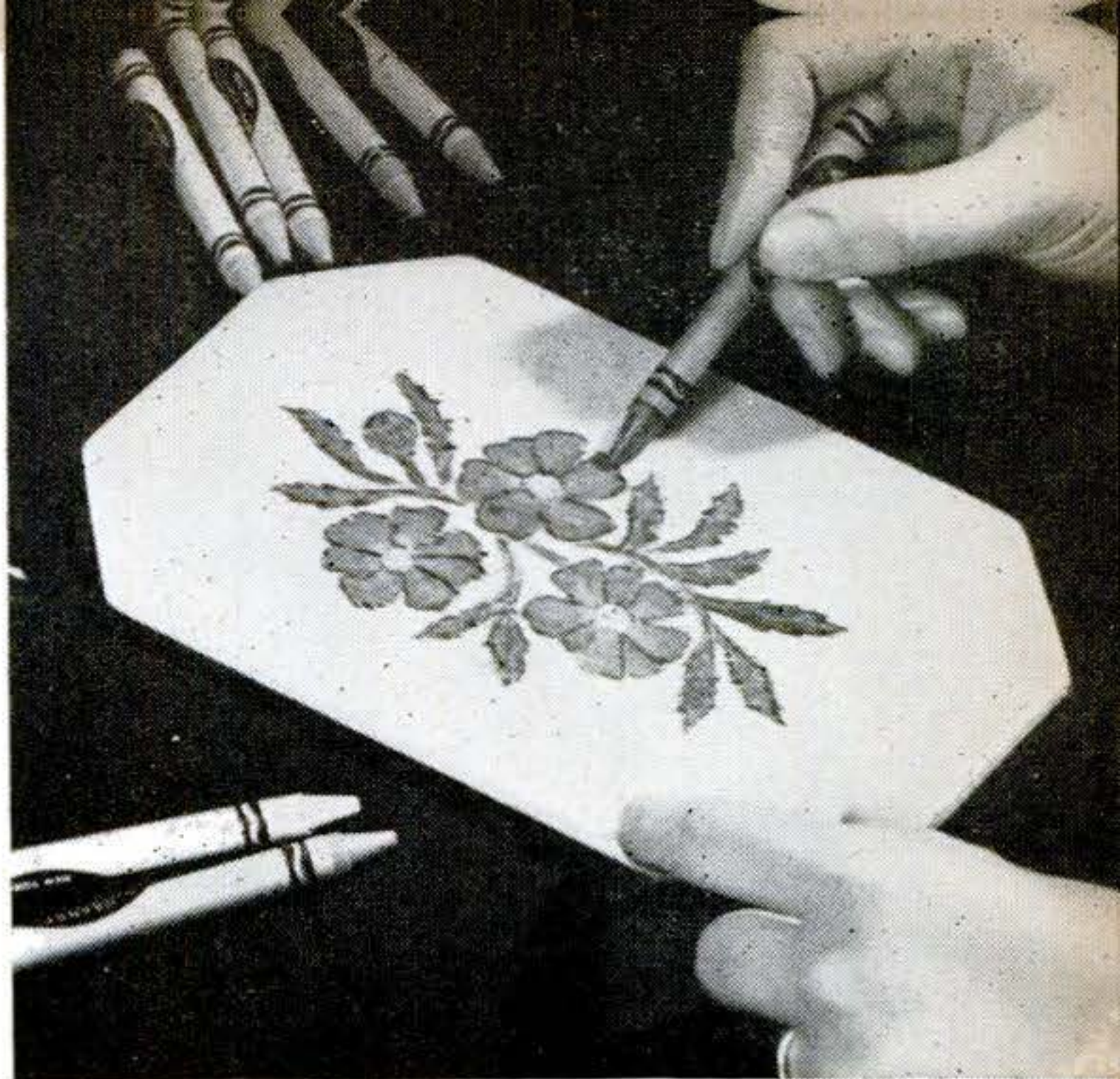

Wax Crayons Burned in Wood

PERMANENT colored decorations are possible in wood with common wax crayons and an electric burning pencil. The outline is drawn on the wood freehand or traced with carbon paper and then burned in with the electric pencil. Color with crayons and melt the wax colors into the wood with the burning pencil for results such as that shown in full color on page 112. For large surfaces a flatiron can be used.

A burning pencil with a narrow, flat point works best, but a rounded point can also be used satisfactorily. For softer effects, the burned outline may be omitted.

The same method can be employed for decorating leather.—RALPH S. WILKES.

TINTING INTERIOR WHITE, II

[PAINTING]

Yellows: Tint with *chrome yellow light* and a small amount of *raw sienna*. *Venetian red* and a trace of *lampblack* may be used with the *yellow* for tint variations.

Pinks: For a light rose, add equal amounts of *raw sienna* and *Venetian red*. For medium rose, use 3 parts *raw sienna* to 1 part *Venetian red*. For peach, use *chrome yellow orange* with traces of *Venetian red* and *lampblack*.

Orchids: For a salmon, add 3 parts *chrome yellow orange*, 2 parts *Red Lake*, and a trace of *Indian red*. For coral, add 3 parts *Venetian red* and 1 part *Red Lake*. Lavender can be obtained by adding *Red Lake*, and this is turned into lilac by using a bit of *ultramarine blue*. It becomes orchid if the *Red Lake* and *ultramarine* are used in proportions of 3 to 2 with a trace of *Indian red*.

NOTE: Start with a flat or interior semigloss or gloss white of the quantity needed for the job, and stir it thoroughly. Then mix small amounts of each oil color with a little turpentine to fluid consistency. Add oil colors, a little at a time, to the white, stirring thoroughly after each addition. Be wary of using too much color; tones are easily darkened, but they cannot be made lighter without waste.

POPULAR SCIENCE MONTHLY SHOP DATA

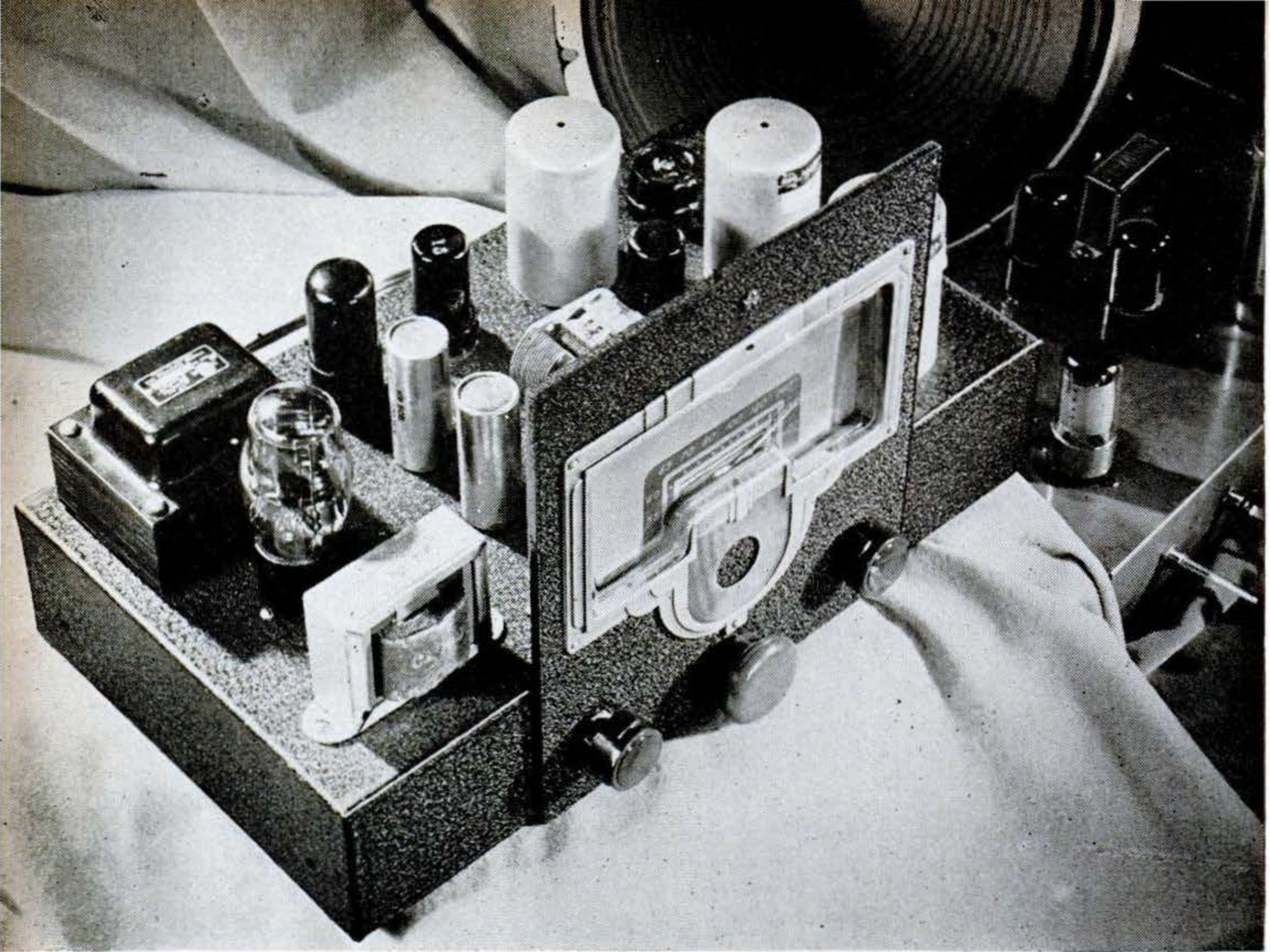

The versatile tuner-receiver. In the background is PSM's hi-fi amplifier, which will be described next month.

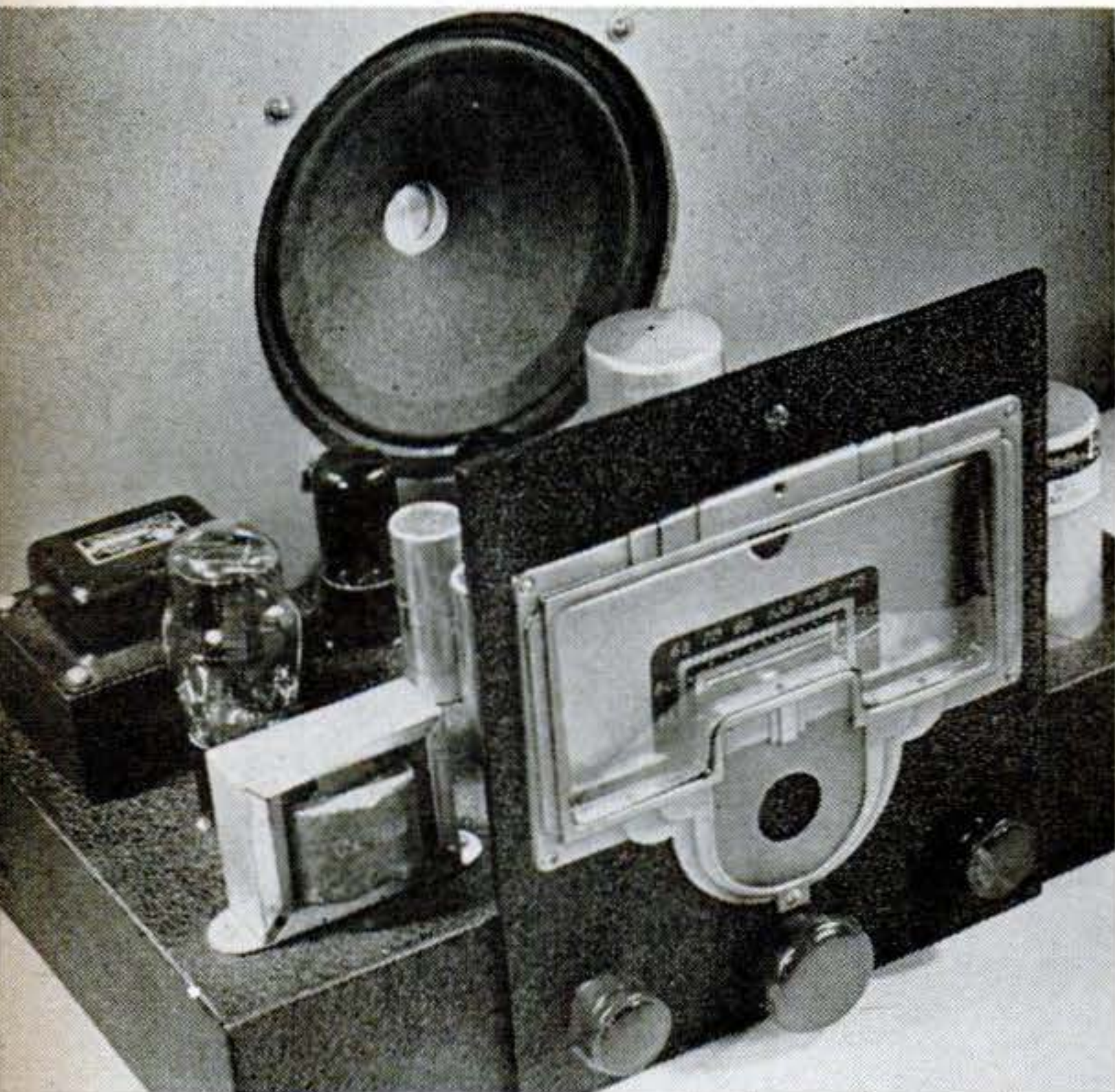

Working into a single dynamic speaker, the tuner becomes a complete, better-than-average receiver. It separates stations sharply, has ample room volume, and its fidelity and tone are excellent.

PSM photos by HUBERT LUCKETT

LIST OF PARTS

- R1: 10,000-ohm volume control.
 - R2: 750-ohm, 1-watt carbon.
 - R3: 15,000-ohm, 2-watt carbon.
 - R4: 5,000-ohm, 2-watt carbon.
 - R5: 10,000-ohm, 10-watt wire-wound.
 - R6: 20,000-ohm, 2-watt carbon.
 - R7, R11: 150,000-ohm, 2-watt carbon.
 - R8: 240,000-ohm, 2-watt carbon.
 - R9: 350,000-ohm tone control, with switch, S3.
 - R10: 40,000-ohm, 2-watt carbon.
 - R12: 2,000-ohm, 10-watt wire-wound.
 - R13: 125,000-ohm, 1-watt carbon.
 - R14: 1-meg., 1-watt carbon.
 - C1, C4, C16: .25-mfd., 600-volt paper.
 - C2a, b, c: Three-gang, 365-mmf. tuning condenser.
 - C3, C10: .1-mfd., 600-volt paper.
 - C5, C6, C7: .0001-mfd. mica.
 - C8, C11, C12: .02-mfd., 600-volt paper.
 - C9: 8-mfd., 450-volt dry-electrolytic.
 - C13, C14, C15: 8-mfd., 450-volt can-type electrolytic.
 - L1, L2, L3: Matched set shielded TRF coils, powdered-iron core.
 - L4: 2.5-mh., air-core RF plate choke.
 - L5: 15-h., 75-ma. filter choke, 400 ohms DC res.
 - T1: 90-ma. power transformer, 350 volts each side of centertap, 6.3-volt filament, 5-volt rectifier windings.
 - S1: DPDT toggle.
 - S2: SPDT toggle.
 - S3: SPST switch on R9.
- Electrodynamic speaker with output trans. and 1,500-ohm field coil; tubes, sockets, dial, misc. hardware.

Tune In on High Fidelity

This TRF unit can be used with an amplifier or as a self-sufficient high-quality radio receiver.

By Edward Blanton

SOUND systems, like chains, are only as good as their weakest parts. Here is a really strong beginning for that high-quality, high-fidelity system you've been planning to build—a tuner or receiver that will give you perfect, undistorted reception of every note sent out on the air by your local broadcasting stations. The set pictured at the left is a complete radio receiver. Used alone, it will give excellent frequency coverage and ample room volume. It may also be used with an amplifier as part of a more powerful and elaborate setup. Next month PSM will publish a design for an amplifier that will do full justice to the pure sound of this tuner.

But before you start, note the phrase "local broadcasting stations." A tuned radio frequency (TRF) circuit such as is employed here allows the full signal to come through to the detector stage. It does not have the tendency of the superheterodyne to clip the side bands of broadcast signals, often eliminating the high-frequency response. The disadvantage of TRF is that it lacks the ability to pull in and sharply separate distant stations. What this adds up to is simply that this tuner is recommended for those who live in or near metropolitan areas and who do most of their listening to nearby transmitters. For remote, rural listeners, a superhet tuner will prove more advantageous. However, if the stations are close by, you needn't worry about the selectivity of this set. Its three tuned circuits give plenty of separation between stations even in radio-crowded areas.

Primary and secondary windings of the antenna and RF coils are inductively coupled, and, in addition, the windings of the two RF coils are coupled through small-capacity condensers built into the units. This construction allows a flat band of

frequencies to pass through to the detector stage. All coils are shielded.

To do justice to the full-frequency response, an infinite-impedance detector circuit is employed. As can be seen in the diagram, the output from the 6SF5 detector is taken from the cathode rather than the plate of the tube. This design, better known as a cathode follower, requires no plate bypass condensers, which usually dampen the high notes; linearity of such a detector is straight from the lowest to the highest tones.

But again, the increase in fidelity is not achieved without cost. While a cathode follower passes a signal faithfully, it adds nothing to its strength, and another stage of amplification is therefore needed. This stage is built around the 6V6-GT.

When the set is connected as an independent receiver, the 6V6 acts as a pentode. Flicking two switches changes the unit to a tuner and modifies the tube connections to those of a triode. This reduces the output, all of which is not now needed, and which might overload the amplifier. As a receiver, provision is made for the use of a dynamic speaker with a 1,500-ohm field. In order to change over to tuner position, it is necessary to make contact across the field-coil terminals and also to achieve a compensating voltage drop. This is accomplished by R12 and S2 when the latter is in position B. Still another change is needed: when the set is used as a receiver, two terminals of the four-prong speaker socket are connected to the output transformer of the dynamic speaker. As a tuner the set feeds directly into an amplifier, so the transformer terminals must be shorted to complete the circuit. The shorting connection is made by a jumper plug (indicated by the broken lines in the socket diagram) in which the corresponding prongs have been wired together.

In order to keep the unit self-sufficient, separate power supply and filter systems are employed in this tuner and the forthcoming amplifier. This results in slightly higher parts cost but makes the units completely independent for all future uses.

Layout isn't critical, but you will note

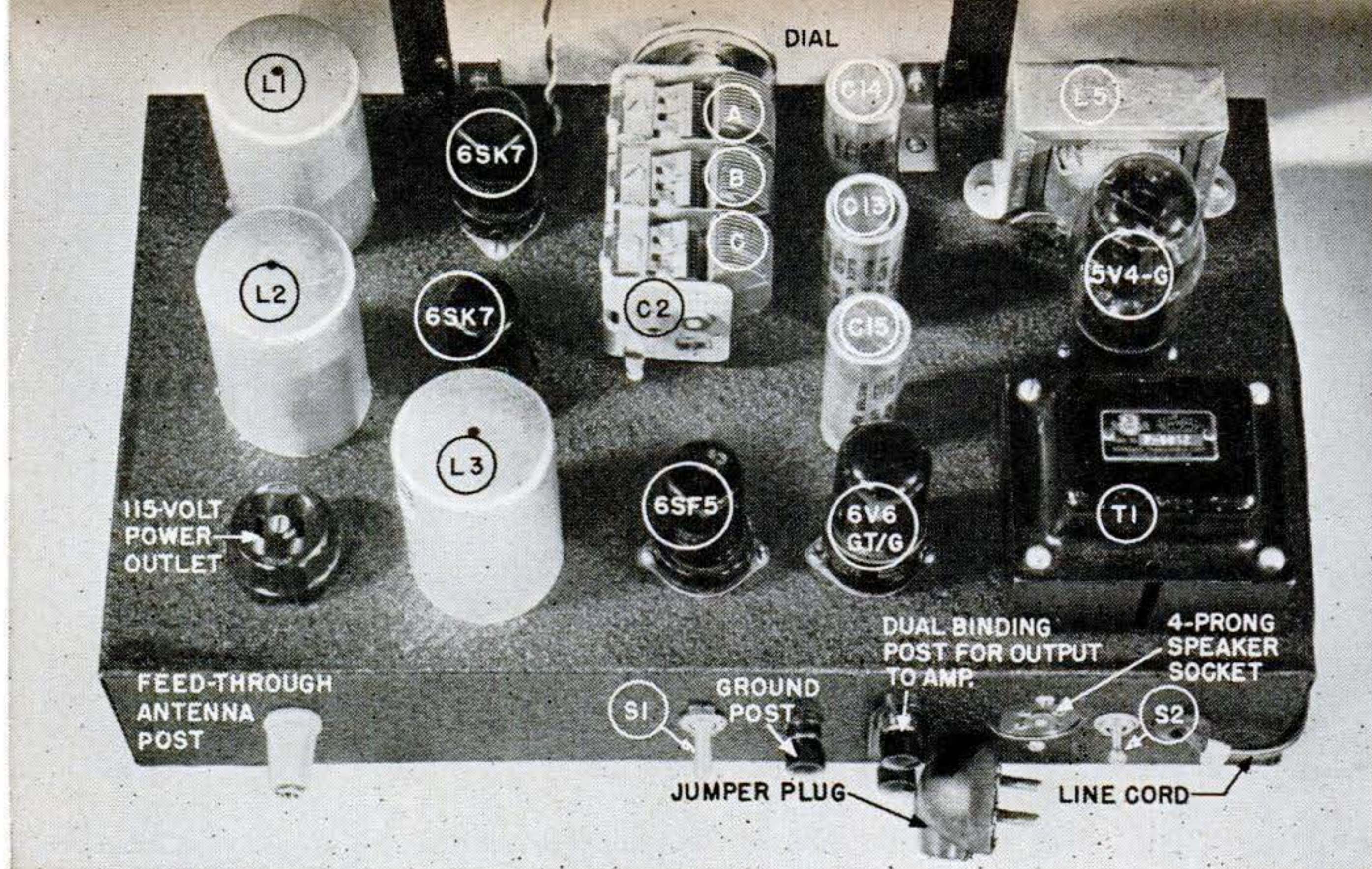

Top view of the chassis. Jumper plug replaces the dynamic-speaker plug when the set is used as a tuner.

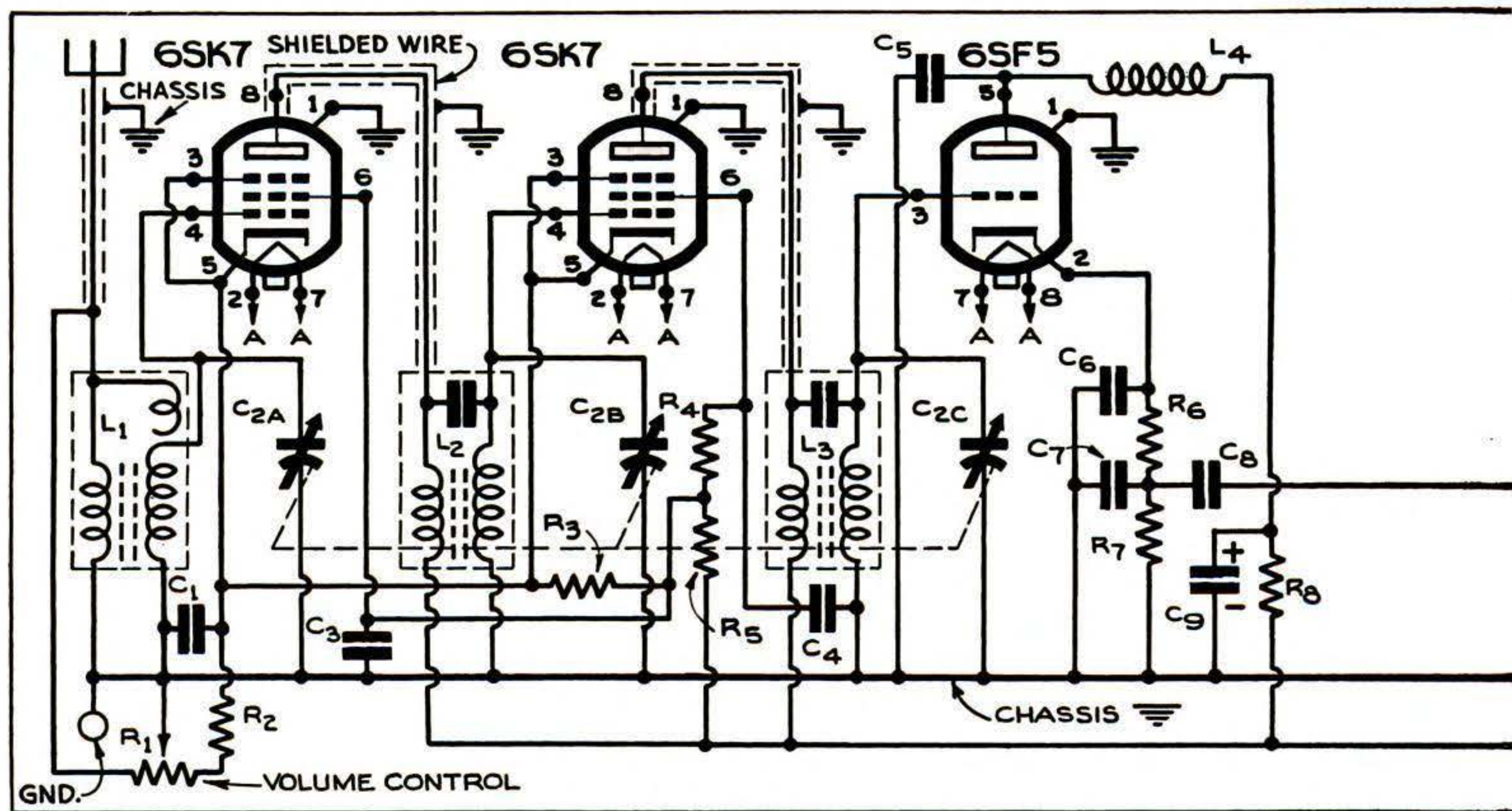

in the photographs that the three basic sets of components—RF, power supply, and detector-audio—are grouped and placed at maximum distance from each other. Especially in a circuit of this sort where detection and amplification give such faithful reproduction of the signal that passes the RF stages, it is important that stray pickups be held to a minimum. In addition to spacing, therefore, shielded conductors are used

in the antenna lead and in the plate connections of both 6SK7 tubes as well as in the grid lead of the 6V6.

To use the set as a receiver, plug in a dynamic speaker having a 1,500-ohm field coil, turn S1 to the position marked "receiver," and S2 to position A. Connect an outside antenna to the insulated jack, and ground the chassis to a water pipe.

Should you want the set to feed an am-

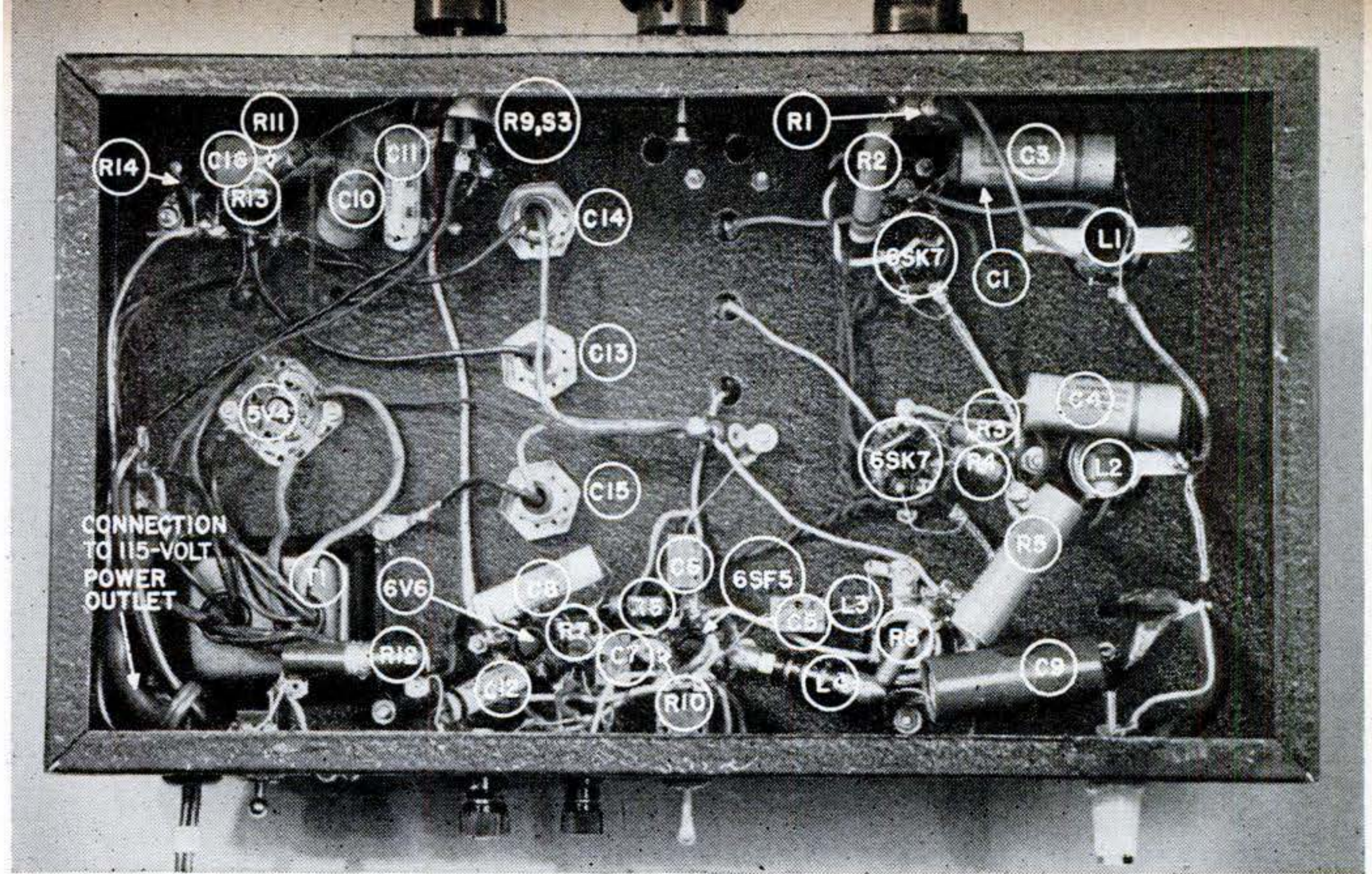

Parts placement isn't critical, but try to keep space between components that might cause interference.

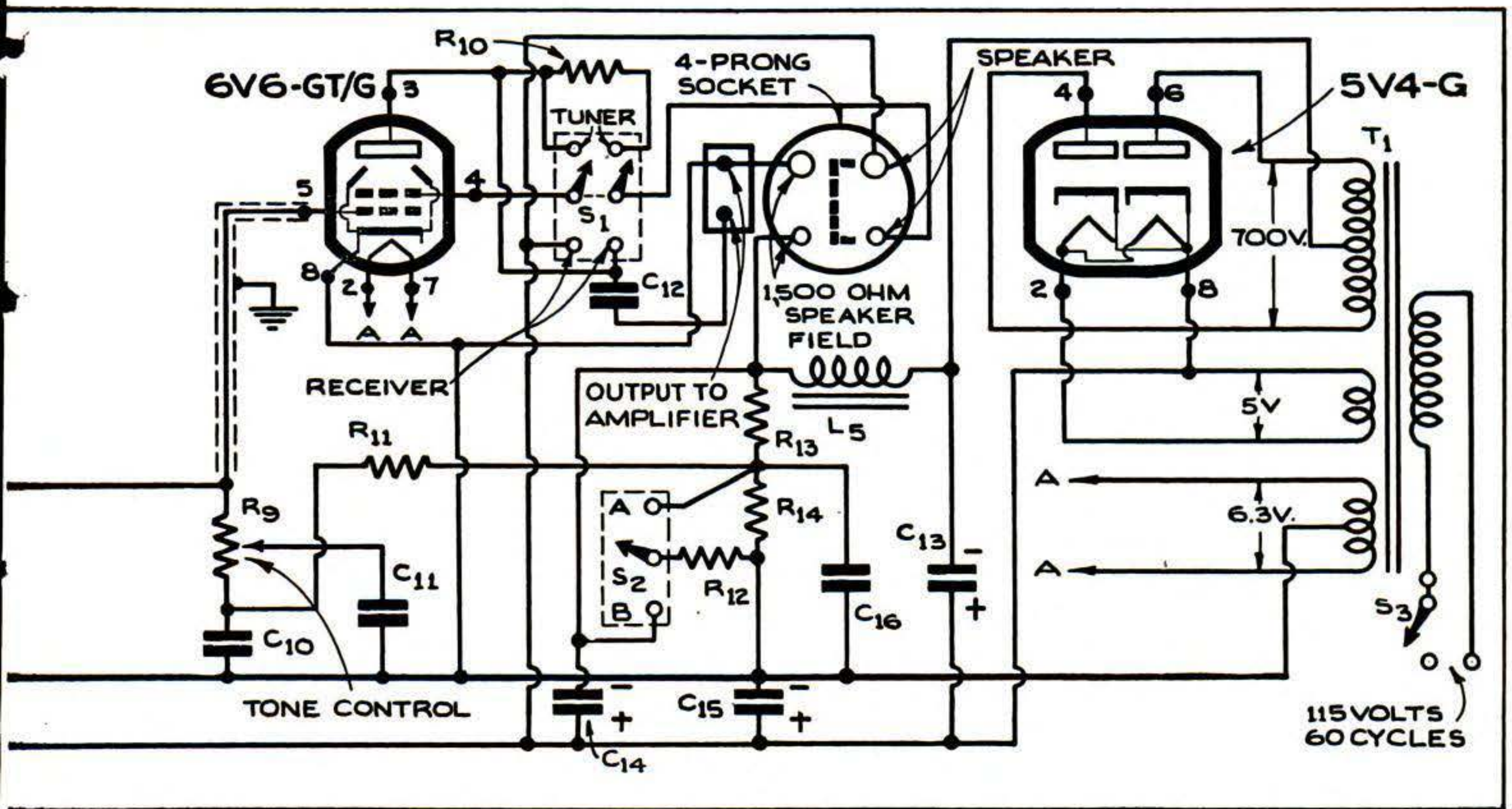

plifier, reverse the positions of both S1 and S2 and replace the speaker plug with the jumper described above. Run a single-conductor cable with a braided external shield from the binding posts to the input connections of the amplifier. The braided shield of the cable, of course, goes to the grounded terminals at tuner and amplifier.

A parallel line from the 115-volt supply is brought out to a separate socket on the

chassis. By connecting it at a point beyond S3, in parallel with the transformer primary, S3 will then serve as a master switch. An amplifier may be plugged into this socket and turned on or off by the switch mounted on the tone control of the tuner. This arrangement will facilitate housing of the multiple units in a cabinet, since all controls on the amplifier can then be preset and left in fixed positions. END



Houses Wired for Sound.

Builders of new homes can solve the problem of selecting appropriate radios and phonographs by having these units built right into the structure. The installation pictured at the right was engineered by Reeves Sound Studios, New York, and consists of a single amplifier and record player and as many built-in loudspeakers as required. A portable tuner can be plugged into one of the several outlets provided, and programs may be heard over any or all speakers.

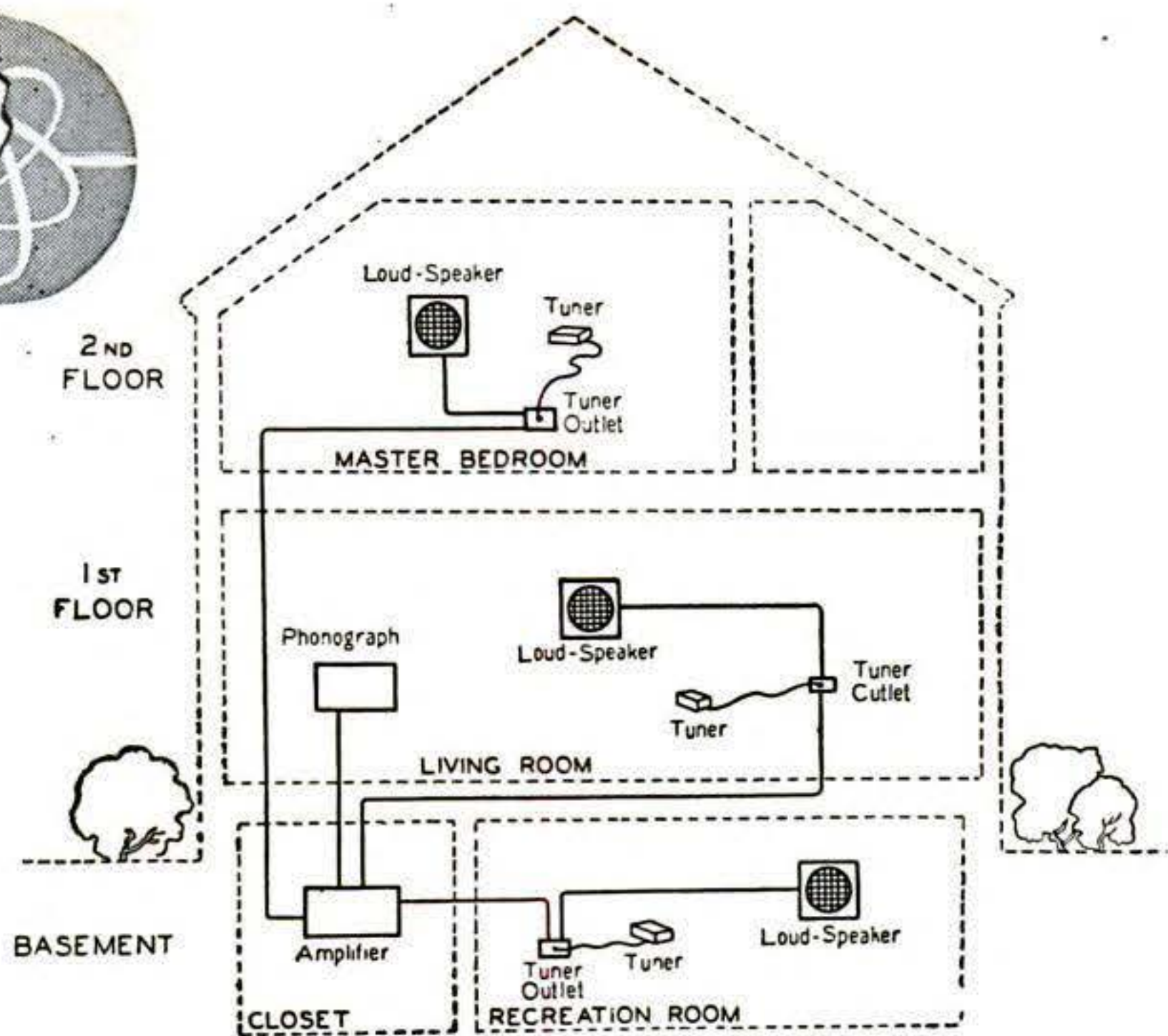

Either recordings or radio programs selected by a plug-in tuner may be amplified and sent to any speaker in the house.



Pocket-Size Ohmmeter. To provide radio, electrical, and auto repairmen with an instrument for making quick preliminary tests, chiefly as a basis for estimating repair costs, Sylvania has announced a 0-to-10,000-ohm meter housed in a pencil-like case. It uses a standard penlight cell.

Snap-In Socket.

A low-loss, high-insulating tube socket made by American Phenolic Corporation has only to be pressed into a pre-punched chassis hole to be automatically held without springs or screws.

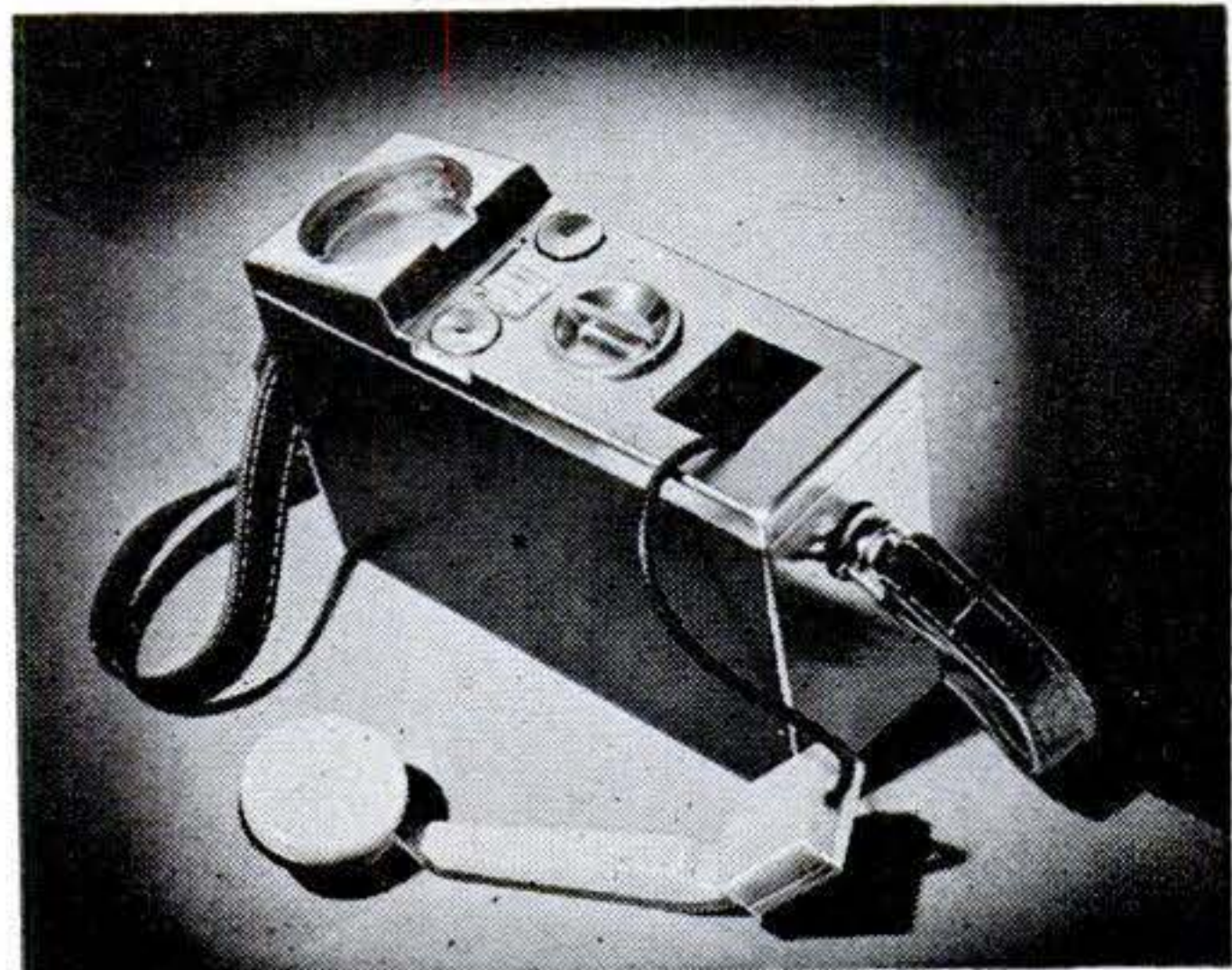

Handie Talkies Coming Up.

Among the new items scheduled for commercial production is the two-way portable shown above. The 4-lb. communicator has a range of approximately seven miles. Hallcrafters engineered the set; exterior design is by Raymond Loewy Associates.

Nylon Grommet.

This newly developed strain-relief bushing locks a cord securely as it passes through a metal chassis. External stresses can't be transferred to the electrical contacts on the other side of the grommet.

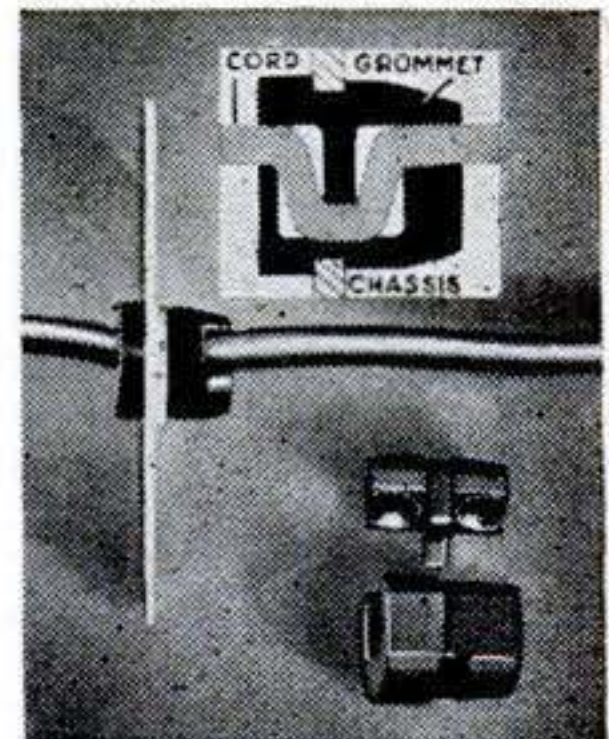

No Calking Needed.

Small plastic boats made by the Winner Manufacturing Co., of Trenton, N. J., are said to have double the impact strength of craft of conventional construction. Compound curves at the bow improve the appearance and increase the speed. Since the hull is molded as one piece, there are no seams to require seasonal calking. Color is molded in. The boats are made in three lengths—10', 12', and 14'. The latter can do 40 m.p.h. with a big outboard.

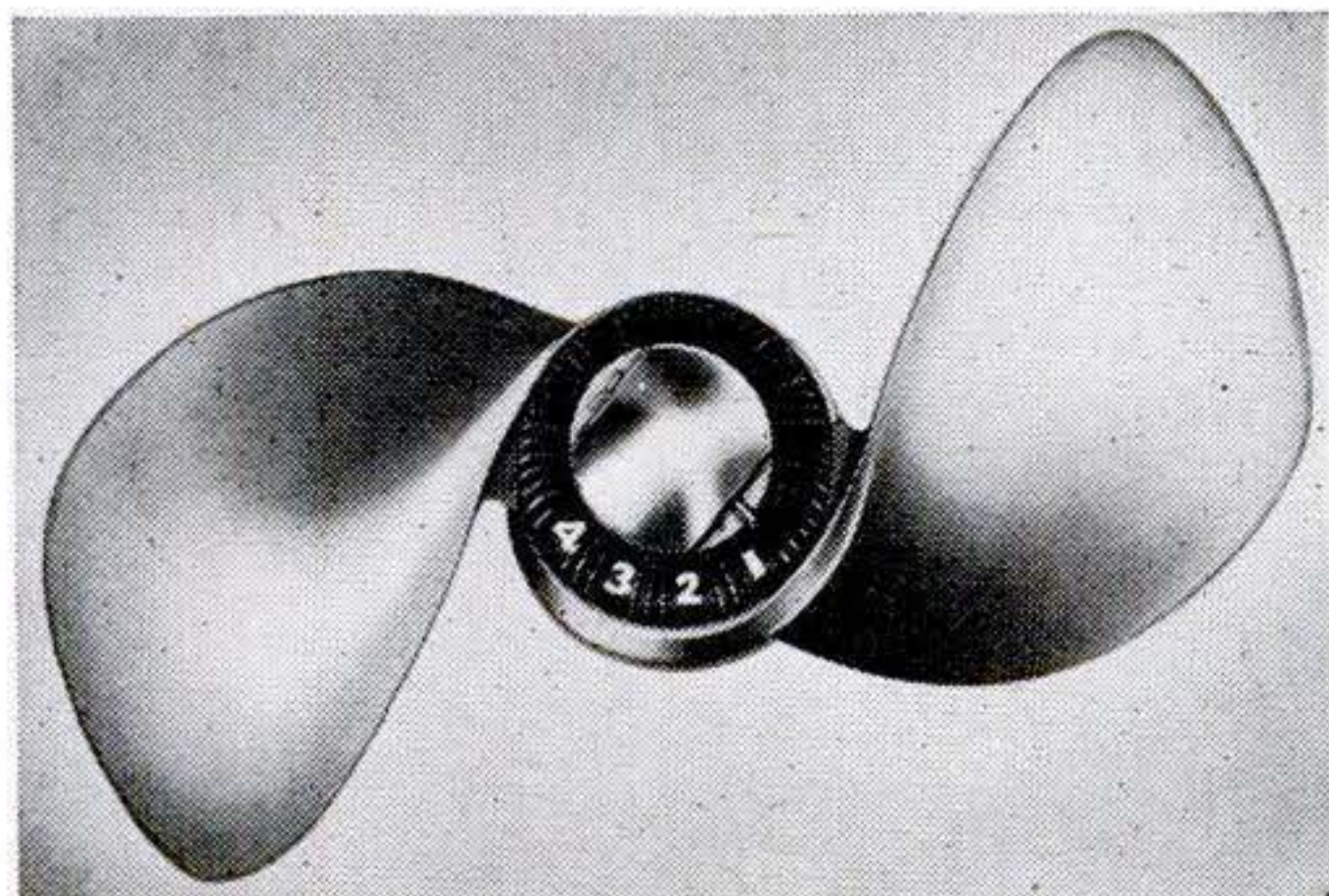

Propeller Has Variable Pitch.

A new outboard-motor propeller introduced by the Paul Bunyan Bait Company, of Minneapolis, can be quickly adjusted to any one of four settings to provide that best suited for the boat and load. Models are available to fit most outboards.

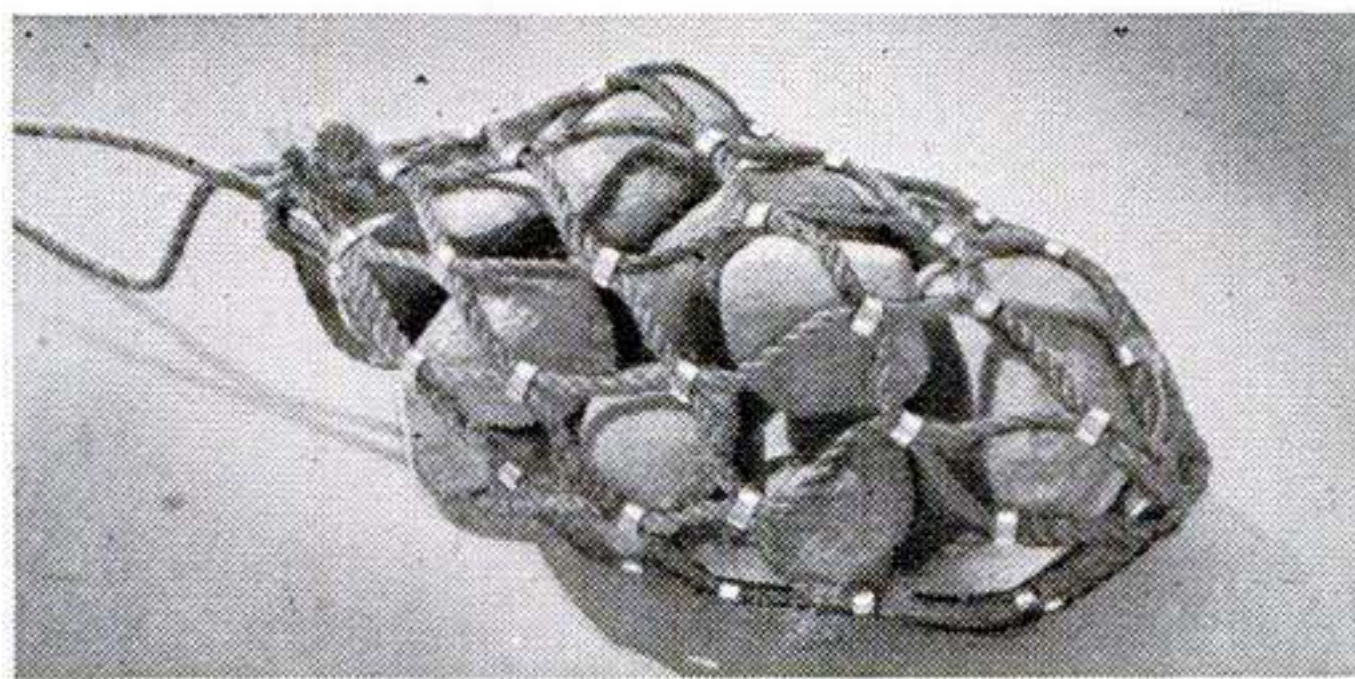

Anchor Is Also a Cooler. Made of sisal and easily folded for carrying, a bag produced by Alcraft, Inc., of Bronxville, N. Y., is intended to serve two purposes. It may be loaded with stones as an anchor for small boats, or bottles and canned goods may be placed in it and lowered into the water to cool. It holds 25 lb. of stones.

FOR BOATS AND BOATING

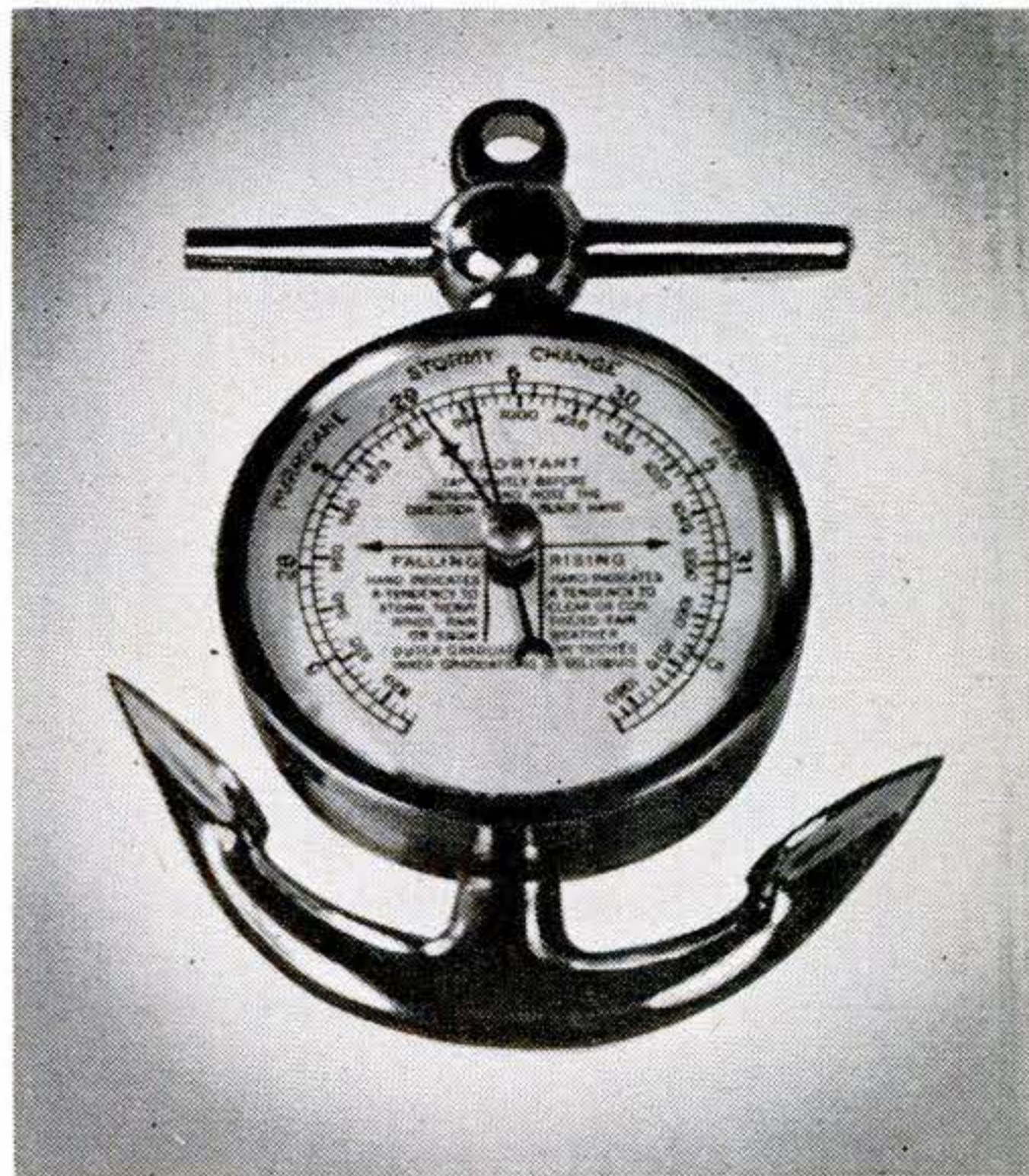

Barometer in Anchor Design.

Intended for either desk or wall use, this barometer has a simplified dial to make it easier to read the instrument and interpret its indications. As in other barometers, one hand serves as a reference for the deviation of the other to show whether pressure is rising or falling. For desk use, the anchor stock at the top of the dial is swiveled around 90 deg. to support the barometer at an angle. For wall use, it is turned parallel to the instrument, as above.



Gravity turns the overshoot wheel. Water-carrying buckets on one side overbalance the empty ones opposite.

Building an Overshot Wheel

Besides furnishing power, it brings an old-time air to its surroundings. Here are plans for a 5' wheel.

Part Five

By C. D. Bassett

OFTEN seen beside a picturesque rural mill, an overshoot water wheel possesses two excellent characteristics—considerable mechanical efficiency and easy maintenance. Many have remained in service for decades, and now lend a nostalgic charm to their surroundings.

Operated by gravity, the overshoot wheel derives its name from the manner in which water enters the buckets set around its

periphery. Pouring from a flume above the wheel, the water shoots into buckets on the down-moving side, overbalancing the empty ones opposite and keeping the wheel in slow rotation.

Since such a wheel may be located near but not actually in the stream, it offers endless landscaping possibilities for a country home where a stream with sufficient flow is available. If a site on dry ground is chosen, the foundation may be constructed dry and the water led to the wheel and a tailrace excavated. With very little effort, the scene may be turned into an attractive garden spot, the wheel becoming both a landscaping feature and a source of power.

It should be noted, however, that an overshoot wheel is practical only for a small-capacity output. How much power it will

produce depends upon the weight of water the buckets hold and its radius, or lever arm. Expressed in another way, the output depends upon the weight of water transported and the height, or head, through which it falls while in the buckets. For maximum efficiency, the wheel must use the weight of the water through as much of the head as possible. Therefore, the buckets should not spill or sling water until very near tail water.

Power Increases with Width

Although of simple construction, an over-shot wheel is cumbersome in size. For this reason, before attempting to build one be certain you have the facilities to move and lift it into place when completed. Also allow yourself plenty of working floor space. It must be understood, too, that such a wheel is a sizable project and requires a lot of material and time. Extreme care in cutting and assembling the parts is not essential, however, because the wheel, operating at slow speed, need not be accurately balanced.

Accompanying this article are drawings that illustrate the construction of a small wheel suitable for a water head of 6' 3". The wheel itself has a diameter of 5', leaving a flume head of 15" to propel the water

into the buckets. As shown in the table at the bottom of page 195, you may build the wheel to give a power output ranging from ½ hp. to 1 hp. at 10 r.p.m. All dimensions remain the same except the width, the horsepower increasing as this is increased. For ½ hp., the wheel should be 15 31/32" wide. For 1 hp., it should be 31 29/32". Before deciding on the wheel size, you'll want to make a survey of the power available in the stream (PSM, April and May '47).

Virtually all large wheels are built with wood or steel arms, as in the drawing below, and have a shroud plate only around the outer edge, but you may find it simpler and more satisfactory to build the drum-type wheel described here. In this case, each shroud plate is a disk of ½" sheet steel. Each disk is braced by a ½" sheet steel sole plate to which it is continuously welded, by the buckets, by one of the two large diameter ¼" steel hub flanges to which it also is continuously welded, and by the long hub itself.

Large Sheet Required

If preferred, the shroud plates may be made of wood. If so, care should be taken to bolt them securely to the hub flanges. Bushings pressed into the wood for the bolts

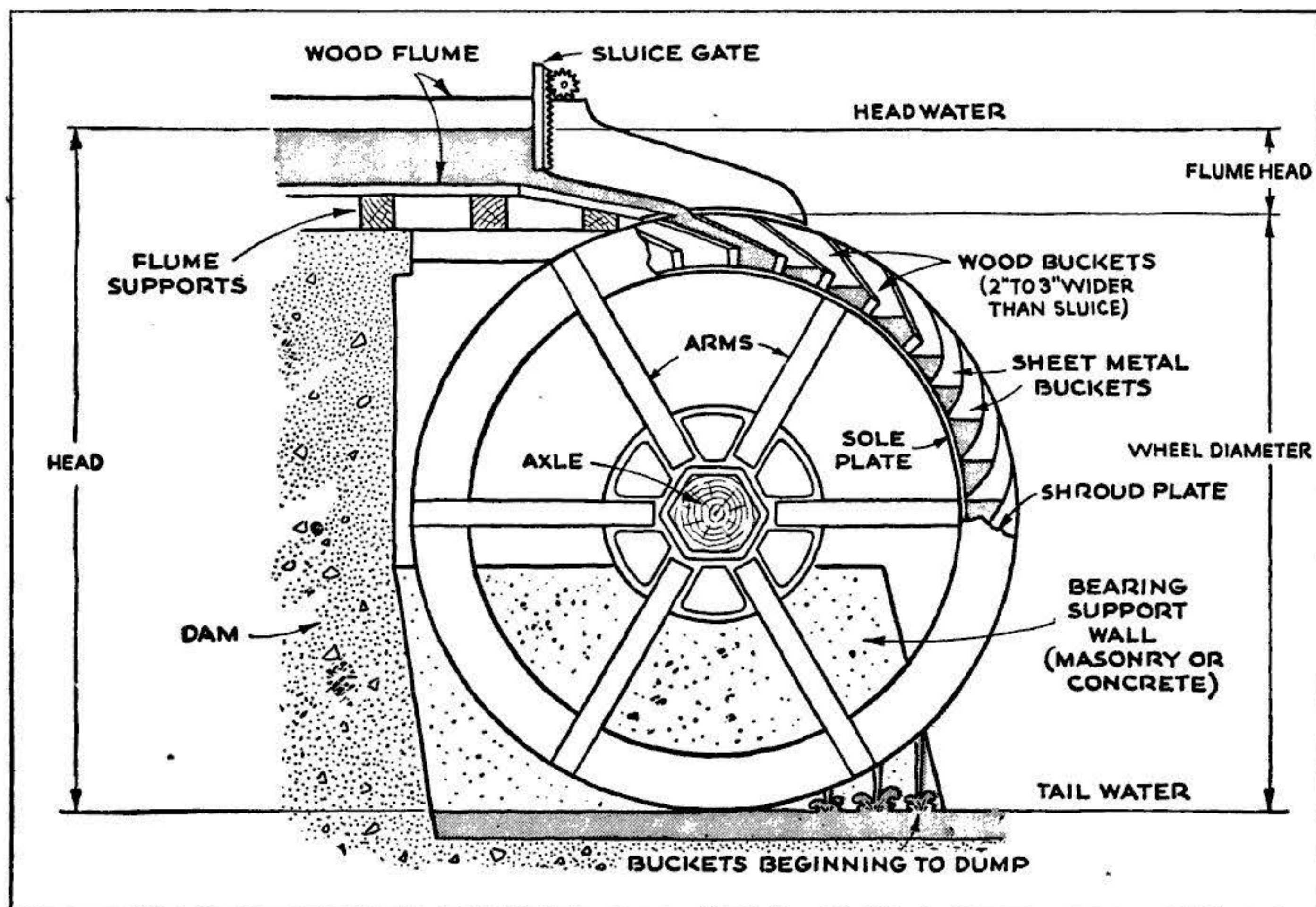

For highest efficiency, the buckets must carry their load almost to tail water before beginning to spill.

will give the wheel a longer life expectancy.

Sheet steel for the disks may be ordered direct from several large steel companies in case your local supply house is unable to furnish it. Ordinarily, such steel comes in standard 48" widths, so you may have to weld together two or more sheets to get the required 5' diameter, using either a butt weld or a backing plate. This will produce some distortion or ripple, as will the welding on of the numerous clips required. So long as distortion is local, however, and the main lines of wheel and shaft remain true, this will do no harm.

• After the sheet has been prepared, scribe a 5' circle on it and cut it with the cutting flame of a gas welding torch. With ordinary care, this method should give sufficient accuracy. Vent and drainage holes should be drilled as indicated around each disk to lessen corrosion within the drum.

Good Buckets Important

The buckets are the most important element of the wheel. To give maximum efficiency, they must be formed so that the water enters smoothly at the top of their travel and remains in them until just before they reach the bottom. For this reason, the bucket form indicated on the facing page should be followed faithfully. Either sheet metal or wood is an acceptable material, but metal is better suited to cold climates, since wood is damaged when absorbed water freezes. Because the buckets are subject to wear from the water and sediment that it carries along, you may want to install them so they can be easily replaced.

In laying out and making wooden buckets, follow these steps:

Using a common center, strike off two arcs, one with a 21½" radius and the other with a 2' 6" radius. Then draw a radius line intersecting these arcs.

From the point where the radius crosses the inner arc, measure 2¾" farther along the line and mark the point *E*.

From the point where the radius crosses the outer arc, draw a chord 10½" long and from the new point where this intersects the outer arc draw a line to point *E*. You now have the inner trace of the bucket.

Take a piece of the bucket stock and lay it along the upper edge of this inner trace and draw a line representing the thickness of the stock. Repeat this along the outer edge of the inner trace, and you have a cross section through the bucket. Cut your stock

accordingly, making the length equal to *B* in the table of dimensions.

Steel Buckets Require Jig

Steel buckets are only slightly more difficult if you follow these steps:

Using a common center, strike off two arcs on a piece of plywood, one with a 21½" radius and the other with a 2' 6" radius.

Draw a radius line and then a tangent to the inner arc, making it vertical to the radius. From the point of tangency, measure 5" along the tangent. Mark this point.

Using this mark as a center, strike off an arc with a 5" radius. This is part of the inner trace of the bucket.

At the point where the original radius line (Step 2) crosses the outer arc, draw a chord 10½" long, and at point *F* where this chord intersects the outer arc draw a new radius line. Also at point *F* measure off 15 deg. below the new radius and draw line *FG* 11½" long.

Then, using *G* as a center, strike an arc with a 11½" radius. This forms the rest of the inner trace of the bucket.

Cut the plywood along this line and along the lines that form a quarter ellipse. Using this as a pattern, cut several more quarter ellipses from scrap. Nail these to stretchers to make a bending jig around which the buckets may be formed.

Weld Wheel Parts

Welding of the various parts of the wheel produces an exceptionally strong construction. After getting together or making all the required parts, begin the assembly by welding four clips to each end of the hub sleeve. Then weld the required number of clips to the shroud plates for the sole plate, and weld the shroud plates to the clips on the hub sleeve. After welding both hub flanges to the shroud plates and the sleeve with a continuous weld, attach the sole plate to the clips on the shroud plates with No. 8 self-tapping screws. Also weld the sole plate to the shroud plates with a continuous weld, and the bucket-support angles to the sole plate.

Attach wooden buckets to the supports with ¾" No. 10 roundhead wood screws, and then drill holes 2" from center to center through the shroud plates for 1¾" No. 10 roundhead wood screws. If you use steel buckets, rivet or screw 10 clips to each side of each bucket and attach the buckets to the angles with No. 8 self-tapping screws. Then

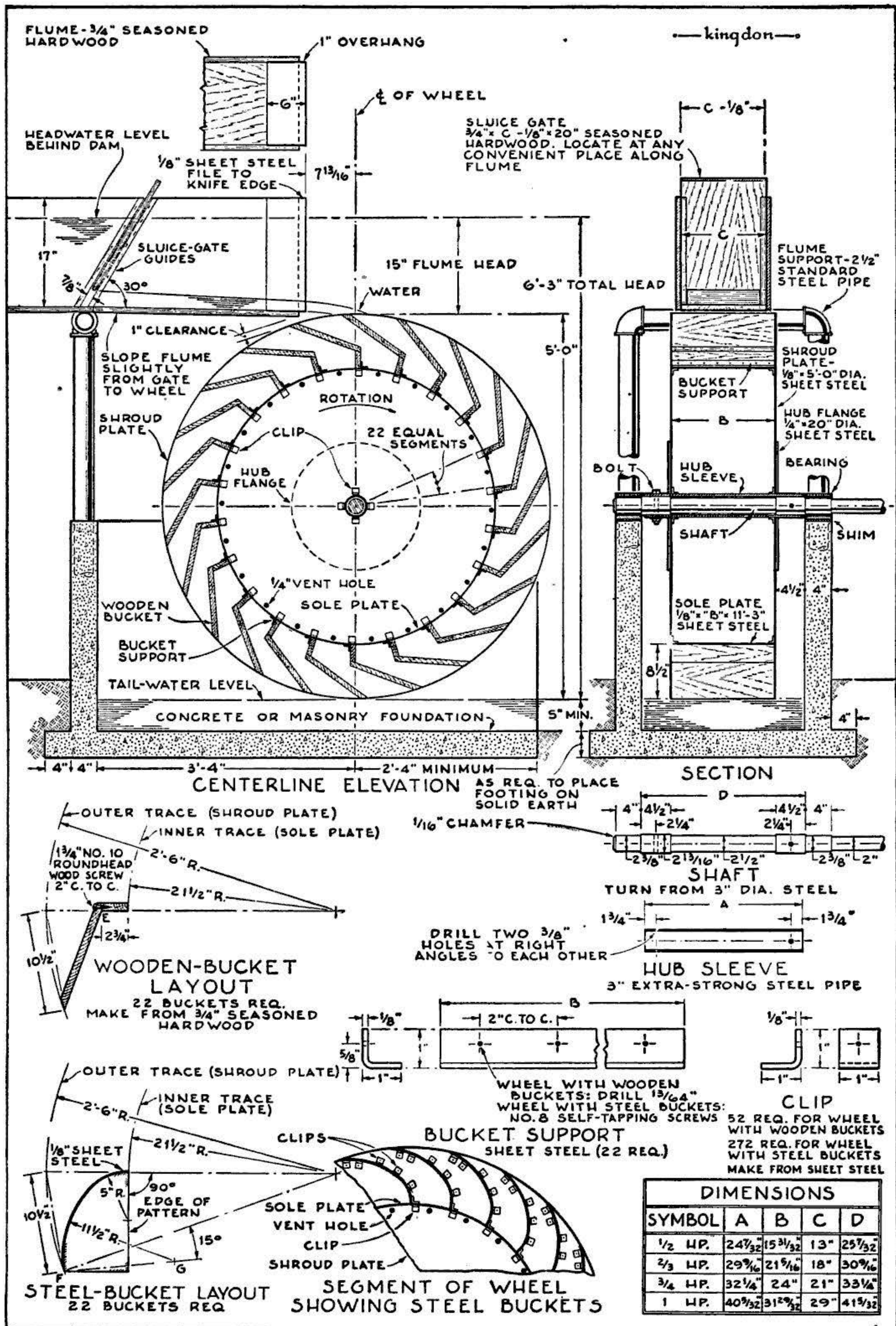

Increasing the width of the wheel will boost its horsepower output. All other dimensions remain the same.

drill holes through the shroud plates in the way of the clips for the same type of screws.

Lubricate Bearings Well

Using locknuts and washers, fasten the hub sleeve to the shaft with two $\frac{3}{8}$ " by $4\frac{1}{2}$ " bolts, placed at right angles to each other. Two bearing mountings having $2\frac{3}{8}$ " renewable liners with shoulders should be bolted to the foundation. Place shims about $\frac{1}{4}$ " thick under the bearings.

Standard bearing mountings, variously called pedestals or blocks, may be bought complete with wick oiler or cup oil reservoir and with built-in self-aligning features. Standard bronze bearing metal liners or inserts likewise may be bought from any machine component supplier. Babbitt liners are equally satisfactory.

Although the wheel turns slowly, it is heavy and will be running almost constantly, so good lubrication of the bearings is essential. To this end, care should be taken to insure that the bearing liners are finished to the correct fit. Porous inserts or inserts containing graphite are excellent for this application, but may cost more than regular bearing inserts.

It is important that the foundation be carried deep enough so that water falling from

the buckets will not undermine it. Avoid a long flume if possible, in order to keep the construction as simple as possible. Strengthen it along its entire length with an exterior frame and support it well from dam to wheel with pipe uprights.

Sluice Governs Wheel

The sluice gate may be located at any convenient place along the flume. Since it is the governing mechanism of the wheel, its installation should be anything but slipshod. If it is installed at an angle as on page 195, water pressure will keep it at any desired position. If installed vertically, some mechanism, such as a rack and pinion, should be provided to keep it in place.

Adjust the sluice so that the buckets will run one-quarter full. This will give a wheel speed of 10 r.p.m. If the buckets are allowed to run more than one-quarter full, the efficiency of the wheel will drop for two reasons. Because of the increased speed, centrifugal force will throw water from the buckets. They also will begin to spill before approaching tail water. Although this practice does waste water, it may be profitably employed during a freshet to increase the power output, for at such times the excess water would be wasted anyway. **END**

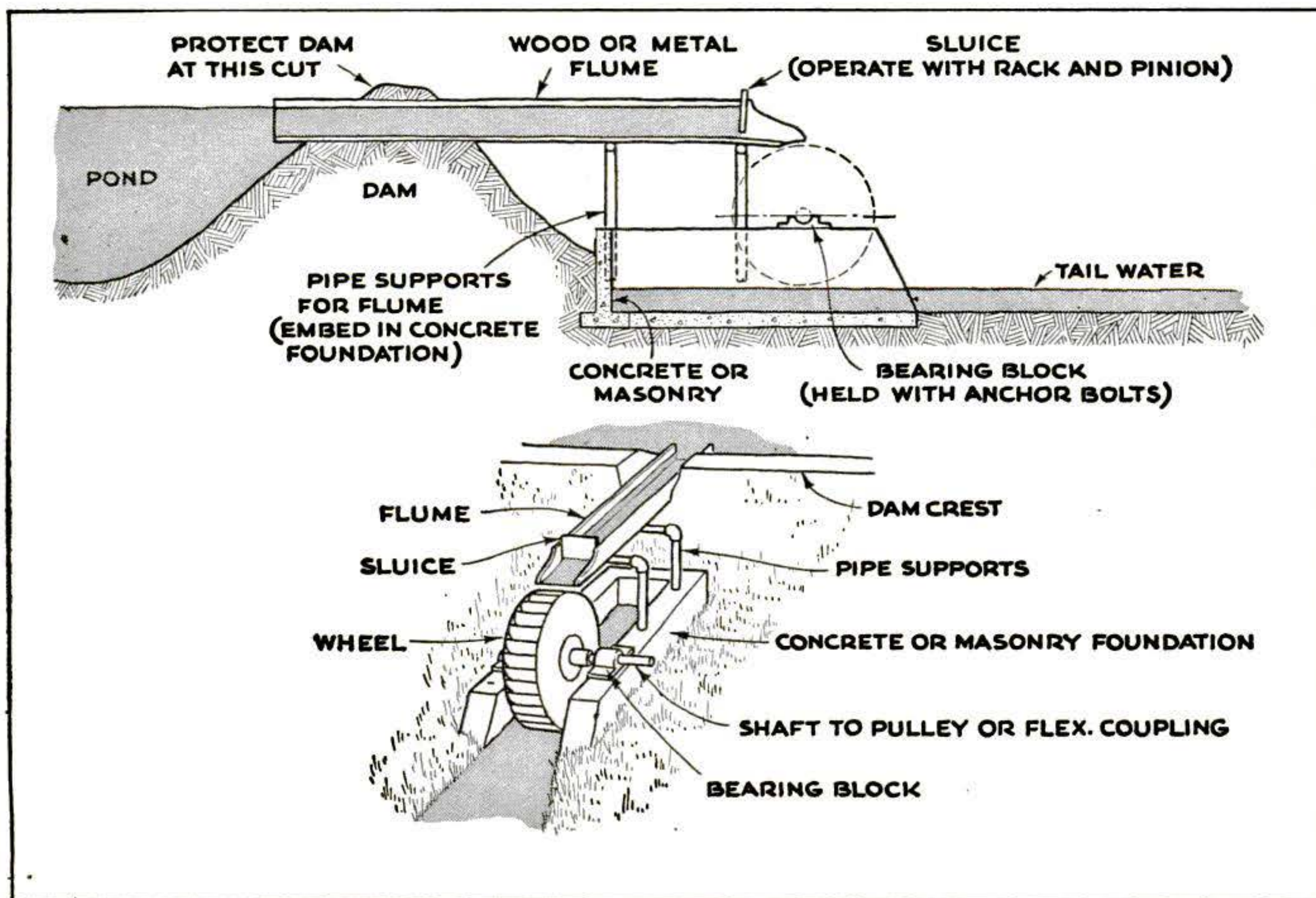

As the headwater rises or falls, the sluice gate may be adjusted to meter the correct flow to the wheel.

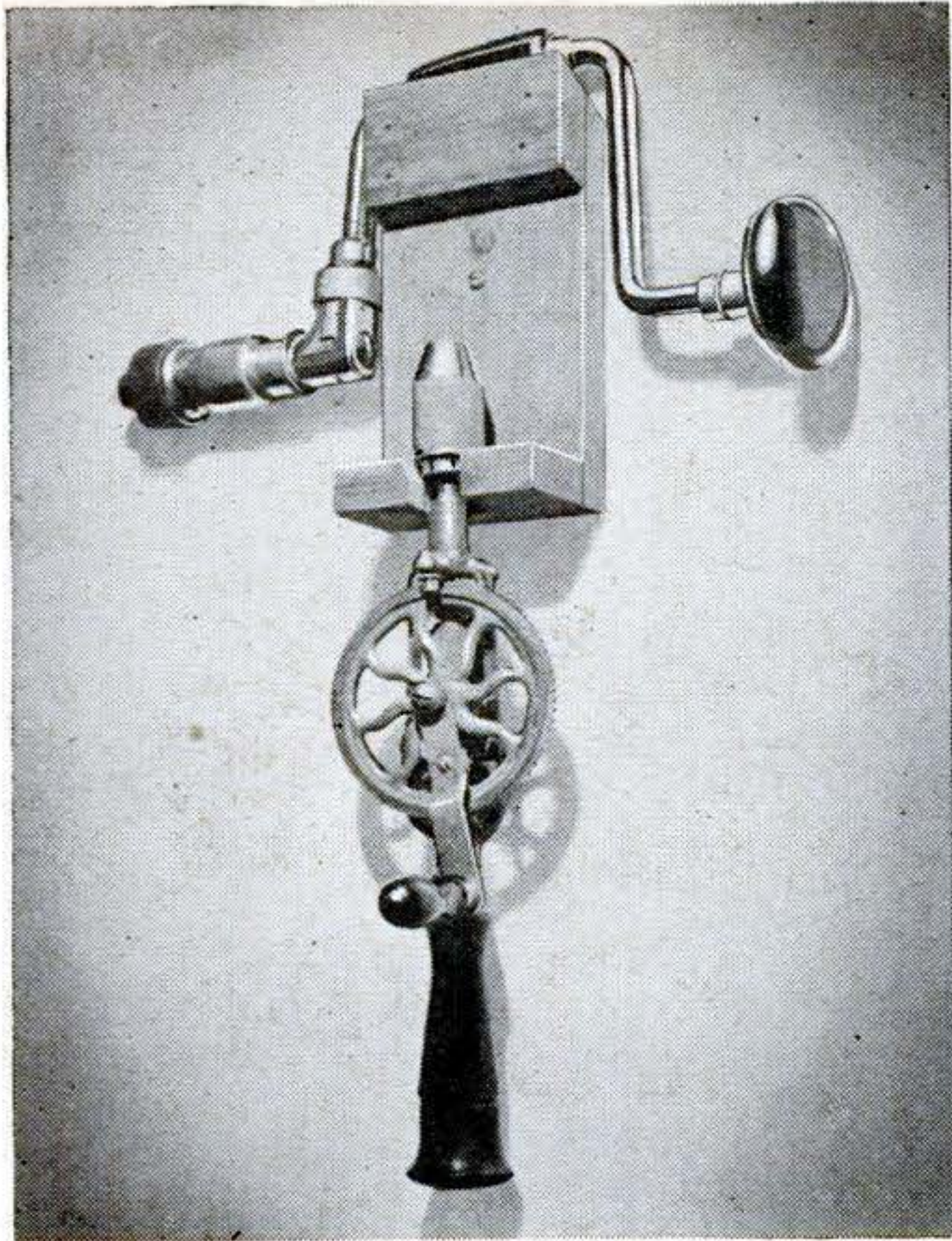

Rack Holds Boring Tools

YOUR brace can be kept near your hand drill in a rack like that shown above. Bevel both the backplate and block toward the wall so the brace can't fall off. If you have both a breast drill and a hand drill, the lower rack may be notched on the sides instead of the front in order to accommodate them.—JAMES A. RICHARDS.

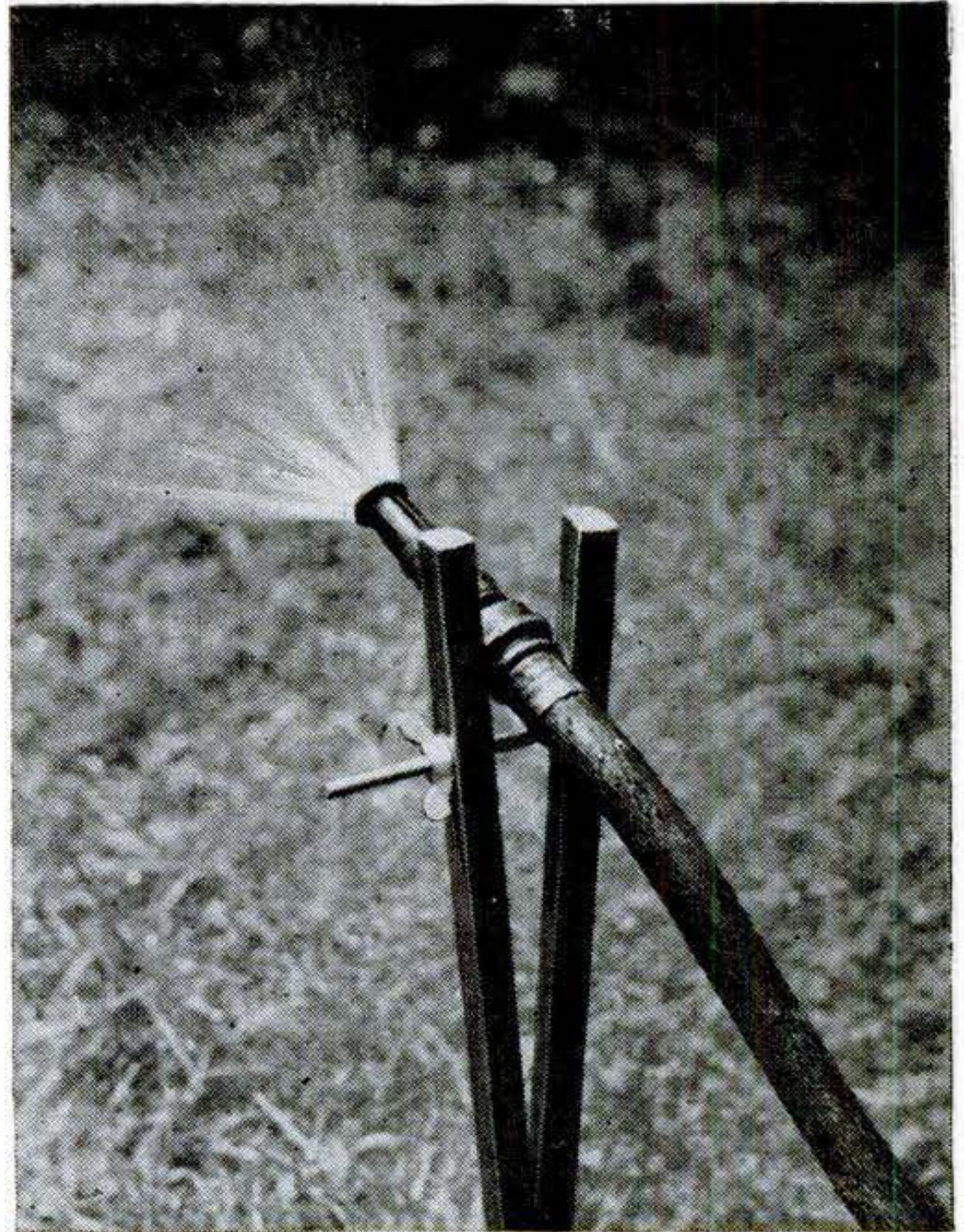

Wing Nut Clamps Hose Stand

THIS Y-shaped stand made from two unequal lengths of 1" by 1" stock will hold a garden hose for spraying. A bolt equipped with a wing nut is inserted for a clamp about 3" from the end. Bevel the bottom of the short piece and screw or bolt it firmly to the long one. Push the long end into the ground up to the crotch.—HAROLD EPSTEIN.

Cleated Roof Board Anchors Hook Supporting Scaffold

ONE way to support a scaffold from the sloping side of a roof is with cleated oak boards tied fast to a chimney or some other solid projection on or near the roof. The one shown has a bent U-shaped iron in the end that fits lightly against the inside of the gutter to prevent slipping when weight is shifted on the scaffold.

Threaded ends on the "U" with nuts and washers on both sides of the board provide a means of adjustment so none of the weight of the stage will be put on the gutter. Unless you have means of forging iron, it may be necessary to have a blacksmith bend the side curves in this piece and also shape the iron to which the anchor rope is tied.

Drill crosswise through both ends of the main board and drive rods through to prevent splitting.—HAROLD R. TERPENY.

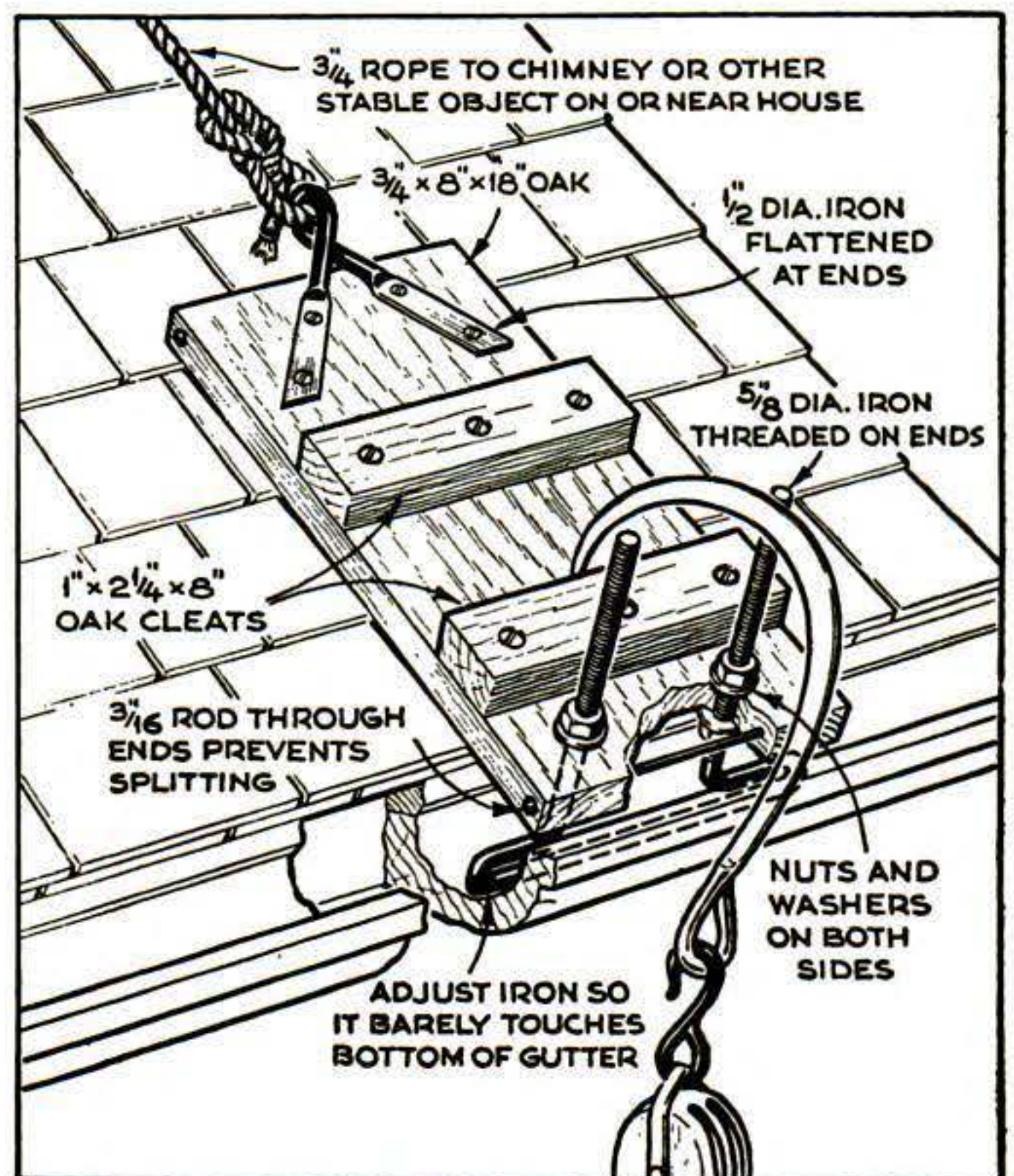

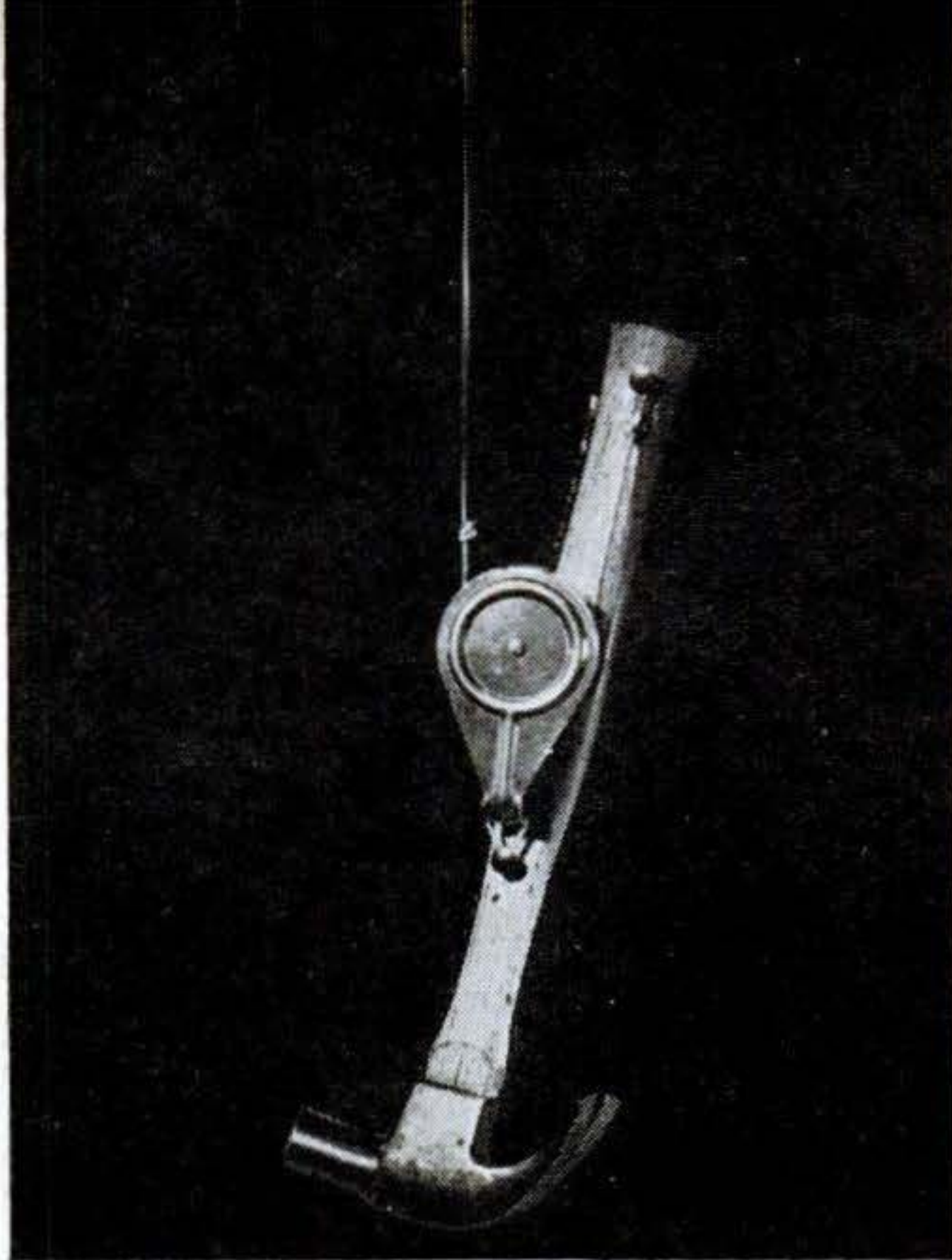
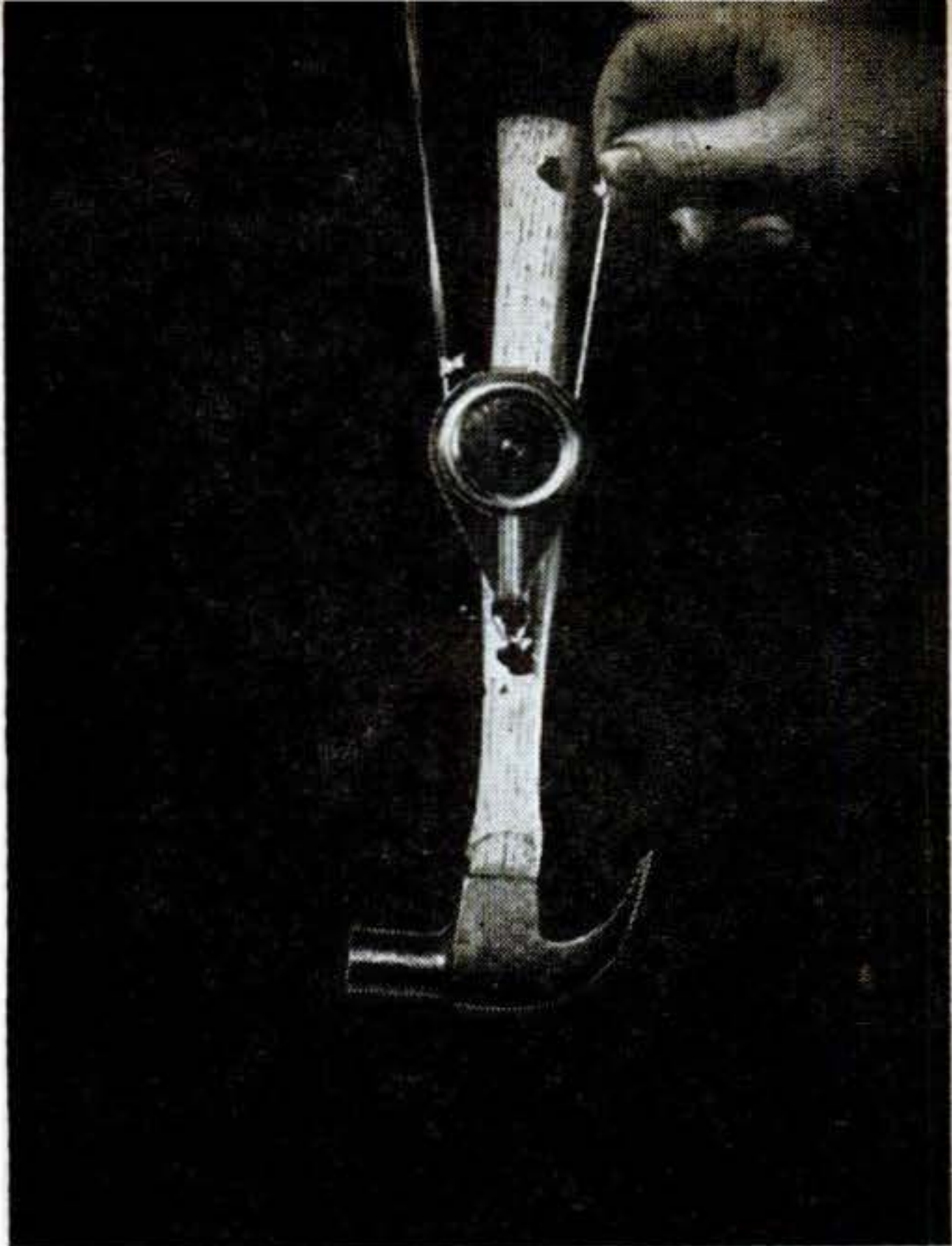

Sharing the Weight. With a pulley and thumbtack on the handle of a hammer, you can demonstrate the mechanical advantage a pulley gives. Attach a rubber band to a nail in a wall, tie a cord to it, pass the cord over the pulley, and hold the end even

with the tack (left above). But hook the cord to the thumbtack, and the rubber band stretches far more. This is because half the weight was supported by your hand in the first case. Rubber bands give clues to mechanical laws by making stresses visible.

Rubber-Band Models

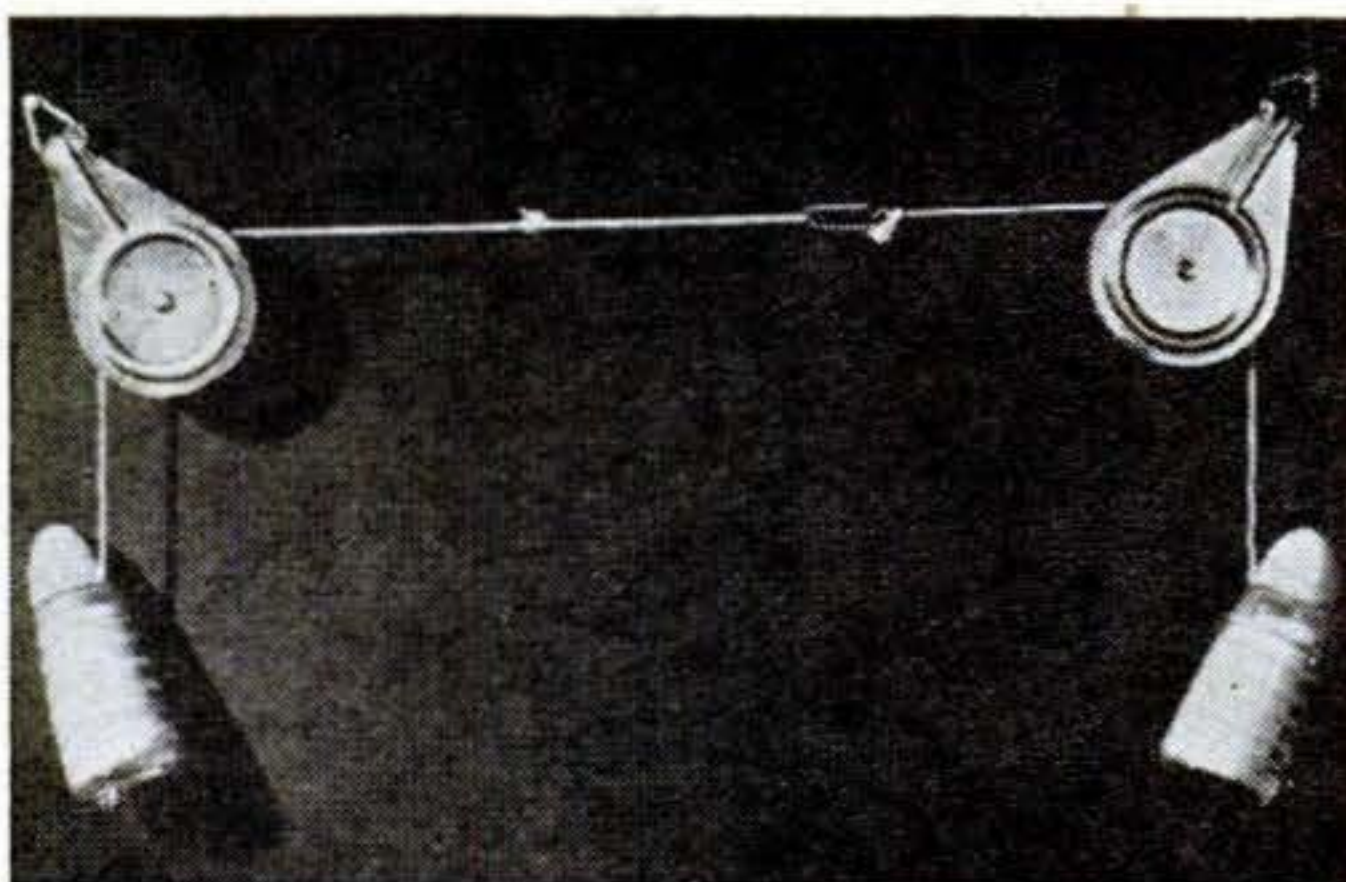
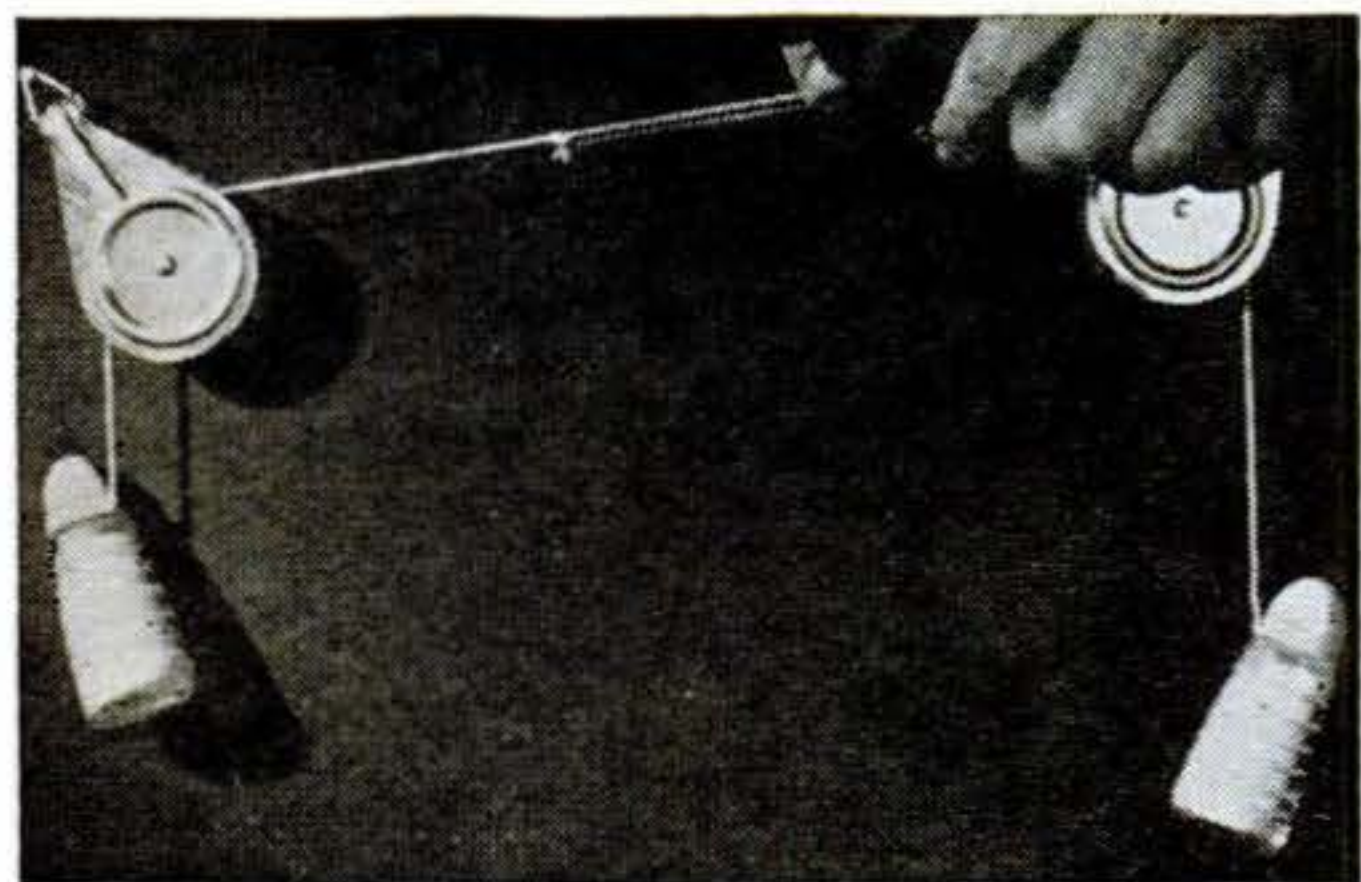

Tug-of-War Paradox. Do two teams exert more force on a rope than one team would alone? Try it with a rubber band and two cords tied to it and passed over pulleys. Hold one end of the band and note its stretch under the weight of a saltcellar tied to the cord. Now tie on a second saltcellar and let its weight pull against the

first. The stretch will remain the same because the second saltcellar merely replaces the pull of your hand.

While demonstrations with rubber bands show at a glance which forces are greater than others, the stretch of rubber is too erratic to indicate the exact amount of the forces exerted.

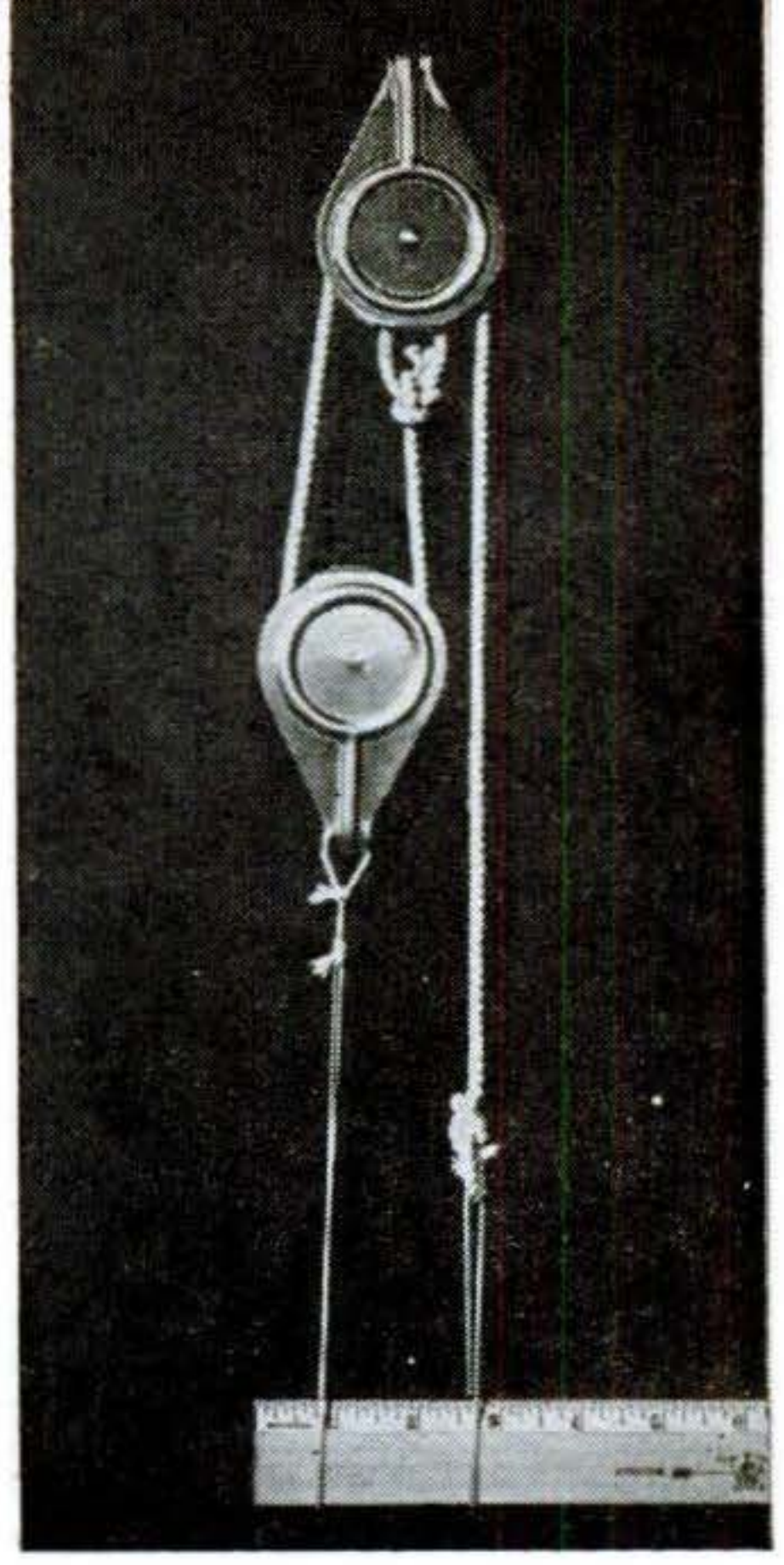
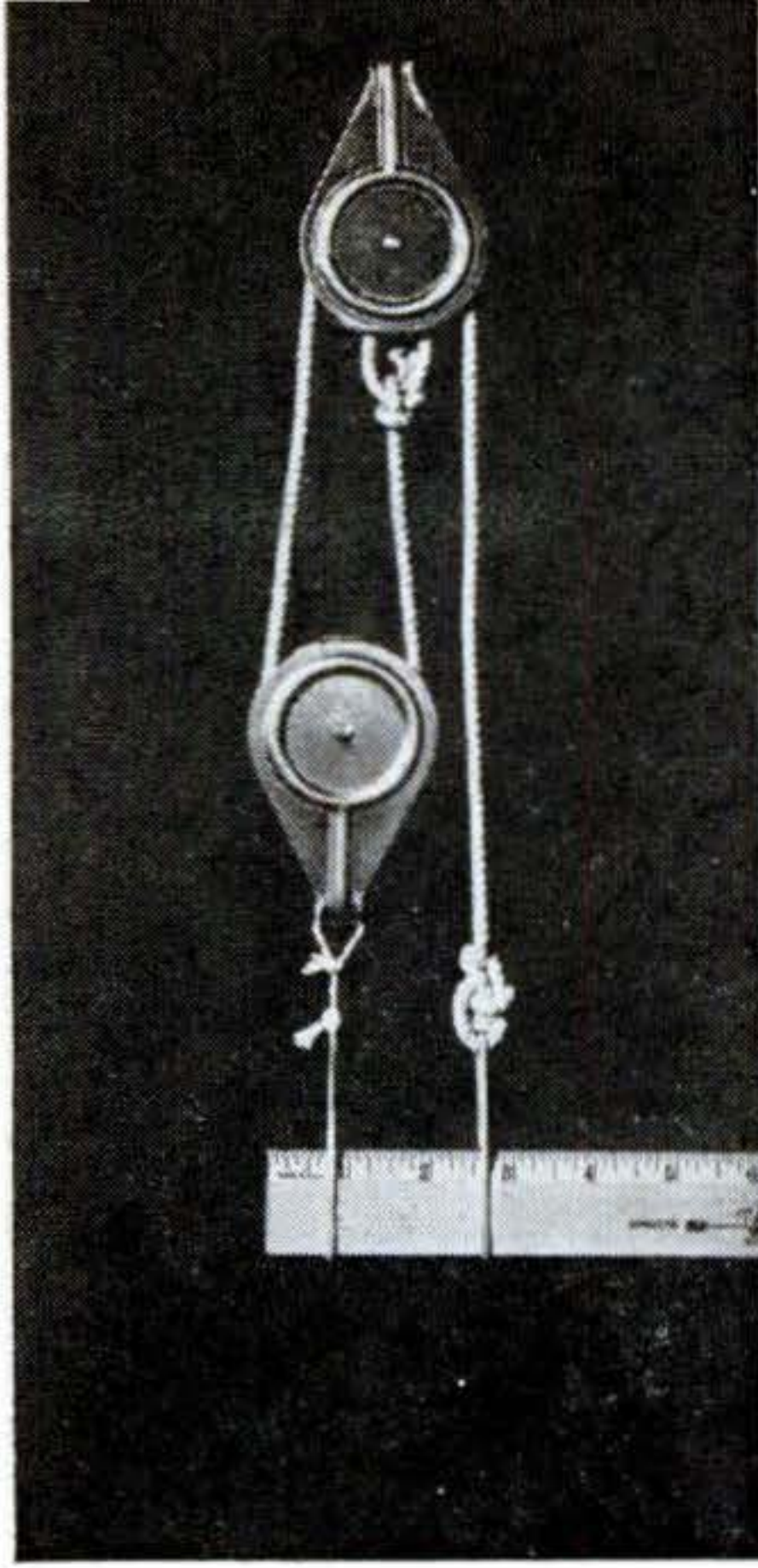
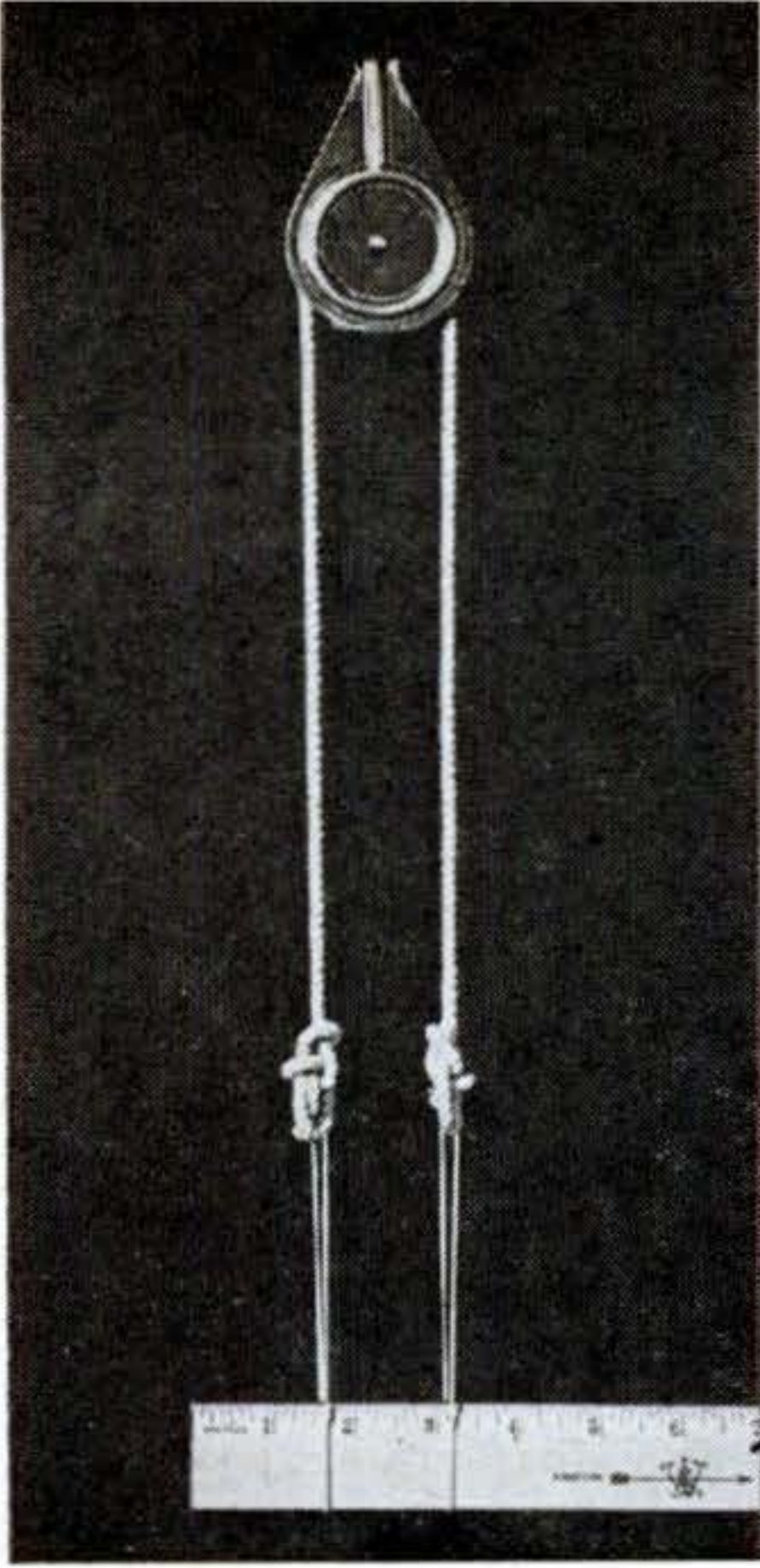

Principle of Pulleys. Attach two matched rubber bands to the ends of a cord passed over a single pulley and exert force on them with a ruler. They will stretch the same amount. Rig a second pulley into the setup, as at center above. When no force is

exerted on the ruler, there will be no stress on the bands, and consequently they will be of equal length. But pull down as at the right, and the force exerted by the movable pulley will be greater. Such a system is said to have a mechanical advantage of two.

Show Laws of Mechanics

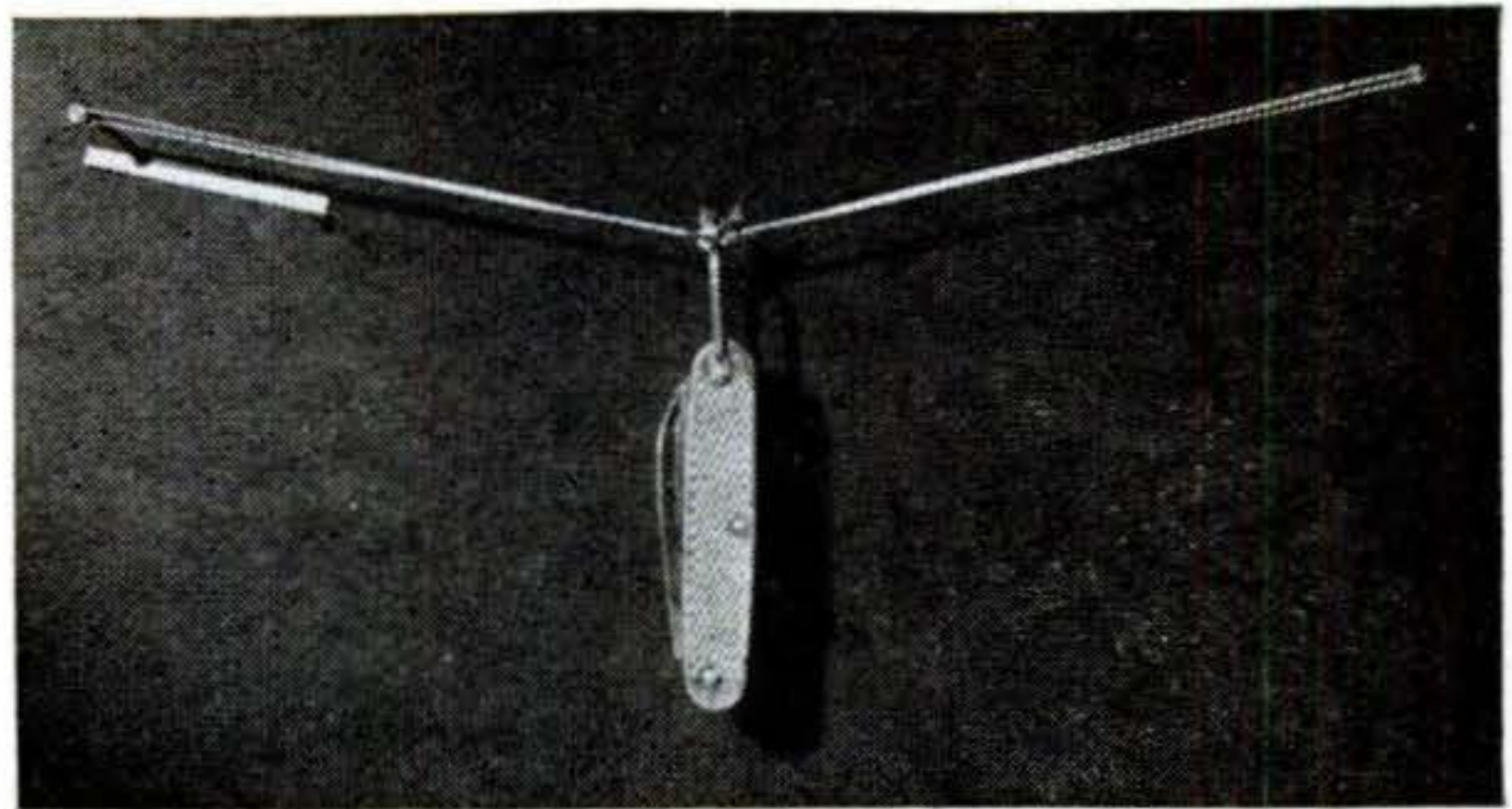
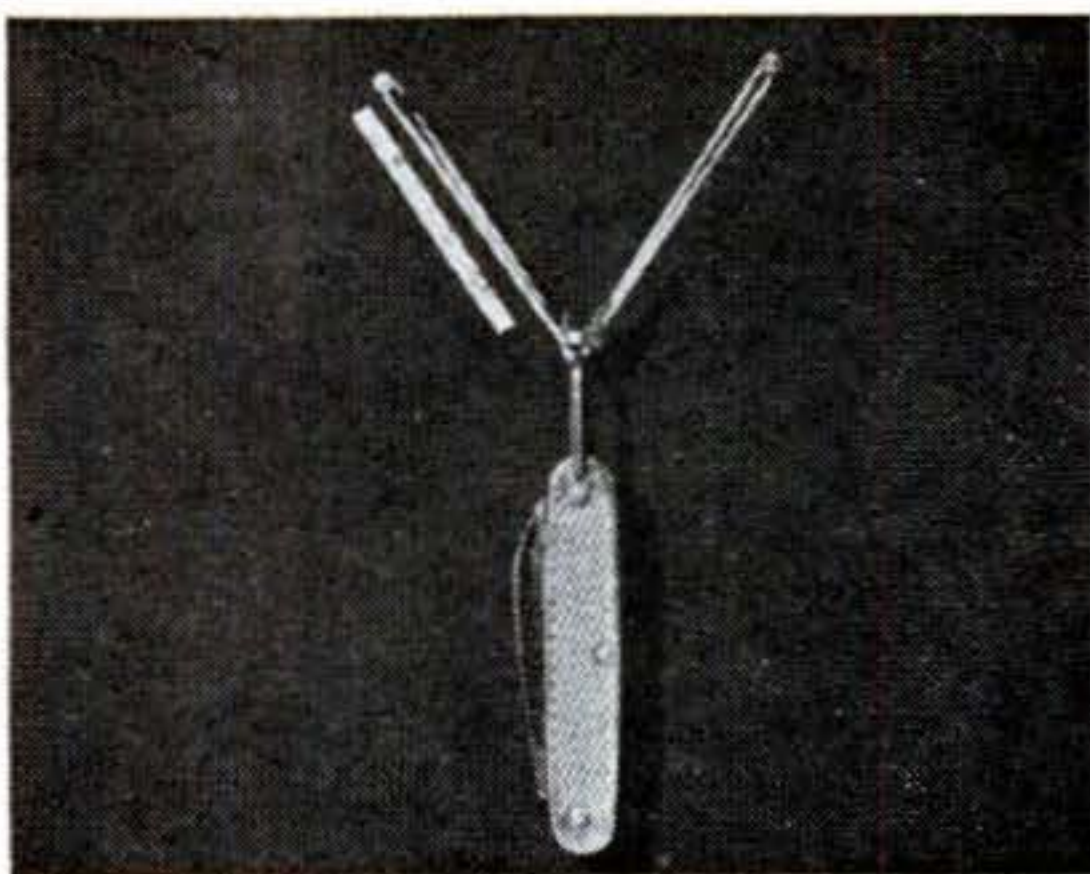

Suspension Engineering. When is a bridge safe? Tie two matched and equal bands together and fasten a light weight at their juncture. Cut a strip of paper to the unstretched length of one band. If you hold the bands so that they are vertical and parallel, the weight will hardly stretch them at all, but if, as at left above, you spread

them at a small angle, the stretch increases perceptibly. If the bands are spread so they approach a straight line with each other, right, the same weight produces a vastly greater stretch. In back-yard hammocks or great steel suspension bridges the same principle applies: the more the suspending cords droop, the less strain there is on them.



MINIATURE OIL REFINERY MAKES GASOLINE. Mineral oil is broken down like petroleum in this home-lab cracking plant consisting of two test tubes and a Bunsen burner. The wing-tip flame spreader heats both the oil and steel wool packed loosely in the neck of the test tube at left, driving off gas and gasoline into the tube at right. Vapors escaping from the jet in the side neck will burn with a bright flame when ignited. Crude oil is at present our most important source of hydrocarbons, containing as it comes from the ground several dozen—most of them liquids, but some gases and solids.

Chemists Build with Hydrocarbons

By **Kenneth M. Swezey**

FEW of us may recognize hydrocarbons by their technical names, but they are really the most familiar, plentiful, and useful of organic chemical compounds. As the chief constituents of coal, petroleum, and natural gas, they supply nearly all the fuel used for heat and power. Like molecular blocks, they form the starting point for synthesizing dyes, drugs, explosives, plastics, nylon, synthetic rubber, and other modern marvels of the chemical laboratory.

As the name suggests, hydrocarbons are composed of hydrogen and carbon. Because of the ability of carbon atoms to link up with other carbon atoms to form chains, rings, and more complex molecular structures, hundreds of different hydrocarbon compounds are known. A few of the simpler ones can be experimented with your home lab.

Hydrocarbons fall into several distinct series, the chief of which is called the *paraffin series* because many of its components are in paraffin. The simplest member of this series is the gas *methane*, which consists of

one carbon atom surrounded by four hydrogen atoms. Then next comes another gas, *ethane*, consisting of two atoms of carbon and six of hydrogen. In this regular order—always increasing by one carbon atom and two hydrogen atoms—the series continues until finally we find giant molecules of 60 carbon and 122 hydrogen atoms.

Physical characteristics change uniformly as molecular size increases. The first four members of the series are gases; the next four are components in variable degree of gasoline; then follow kerosene, heating oil, Diesel oil, and finally heavy lubricating oils, grease, and paraffin wax.

When crude oil, or petroleum, which contains dozens of hydrocarbons, is heated to about 300 deg. C. and passed as hot oil and vapor into the bottom of a high "fractionating" tower, gas and gasoline are drawn off from the upper part of the tower and naphtha, kerosene, gas oil, and heavy oil from progressively warmer lower sections.

New techniques enable chemists to link light gas molecules in the series to make heavier liquids as well as to "crack" heavier members to make lighter ones. Gasoline is

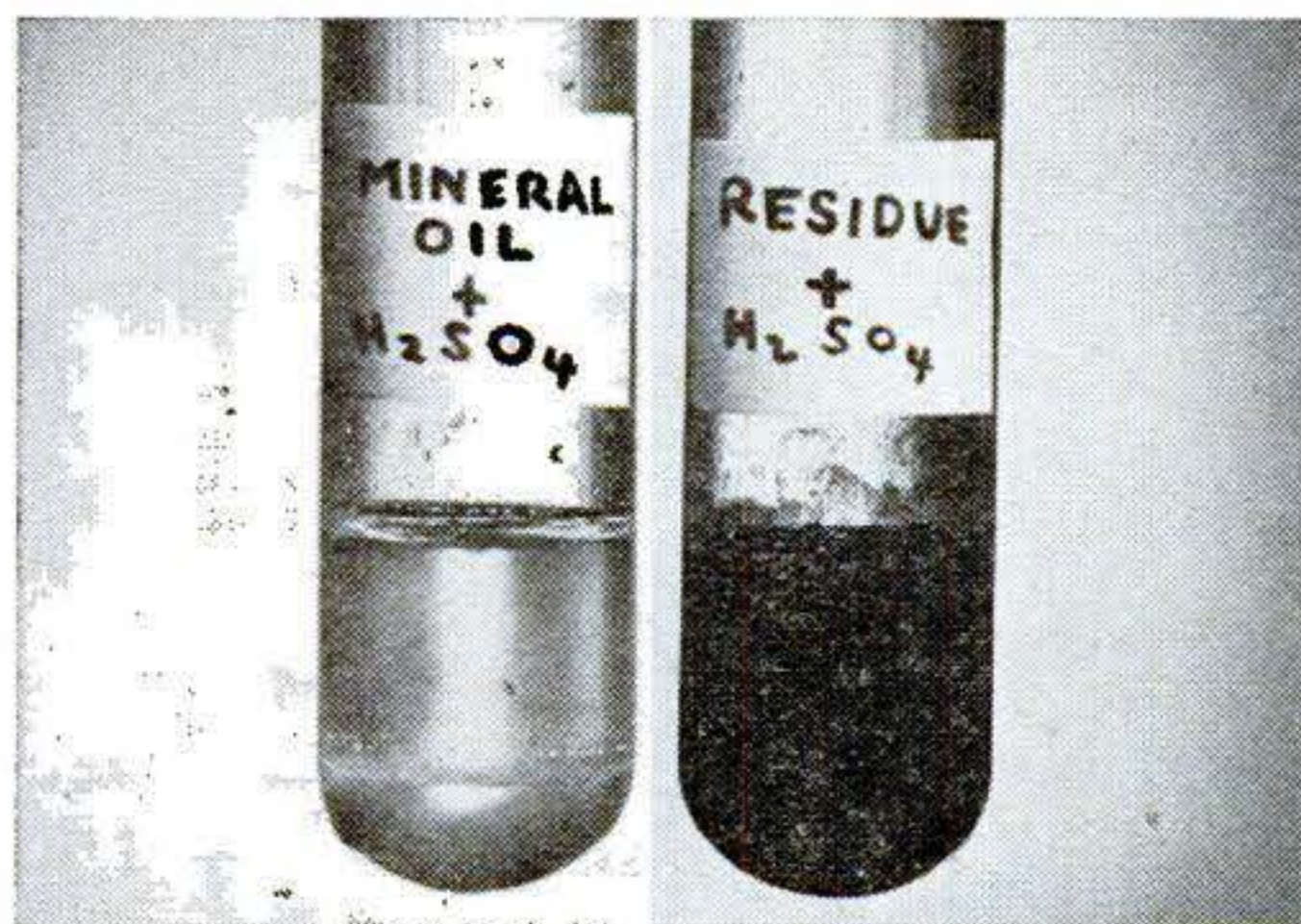

SATURATED HYDROCARBONS. Chemically inert, molecules of mineral oil and related hydrocarbons hold all the hydrogen atoms they can, but cracked molecules are deficient in hydrogen. Sulphuric acid has no effect on mineral oil, but reacts with the residue from cracking and turns it brown.

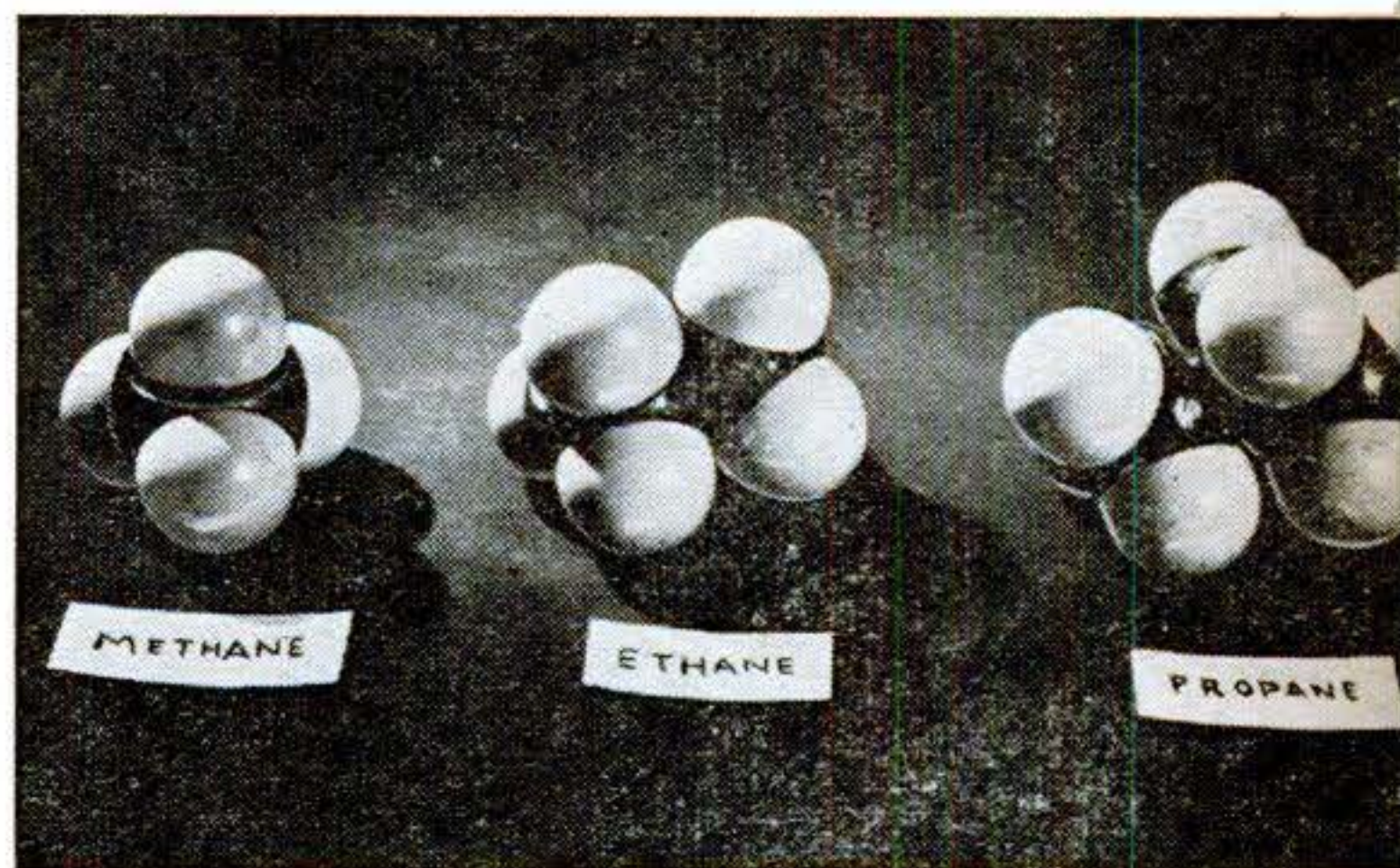

PROGRESSIVE SERIES. Saturated hydrocarbons belong to the paraffin series. The members start with molecules containing one carbon atom and four hydrogen atoms, and progress in regular order by always adding one carbon and two hydrogen atoms. The lightest are gases, the heaviest solids.

produced by both building up small molecules and breaking down big ones.

Though crude oil is generally cracked in industry by the use of heat, pressure, and catalysts, you can demonstrate cracking by the use of heat alone. The apparatus is shown in the photo on page 200. Pour 5 ml. of mineral oil in the test tube at left and fill the upper part with loosely packed steel wool. Through a one-hole cork stopper (the heat and oil will destroy rubber) run a bent glass tube and extend the tube through another one-hole stopper to within 1" of the bottom of the side-necked test tube shown at right. Draw another glass tube into a jet and attach it to the side neck with a short rubber coupling. The wing-tip flame spreader of the Bunsen burner heats both the oil and the steel wool above it.

Start heating gently, and increase the

heat gradually. When the oil boils, white fumes will pour into the side-necked tube, some streaming from the jet. In passing through the hot steel wool, some of the molecules of the oil vapor are cracked, or broken down, into smaller molecules much as they are in commercial gasoline cracking plants. A match applied to the jet ignites the mixture of gas, gasoline, and other vapors, and they burn with a brilliant flame.

Hydrocarbons of the paraffin series are colorless and show little or no reaction with most reagents. In fact, the name paraffin comes from the Latin *parum*, "little," and *affinis*, "akin." Shake some pure mineral oil with an equal amount of concentrated sulphuric acid, and there will be no discoloration or other sign of reaction.

One reason for this inertness is that all possible places at which other atoms can

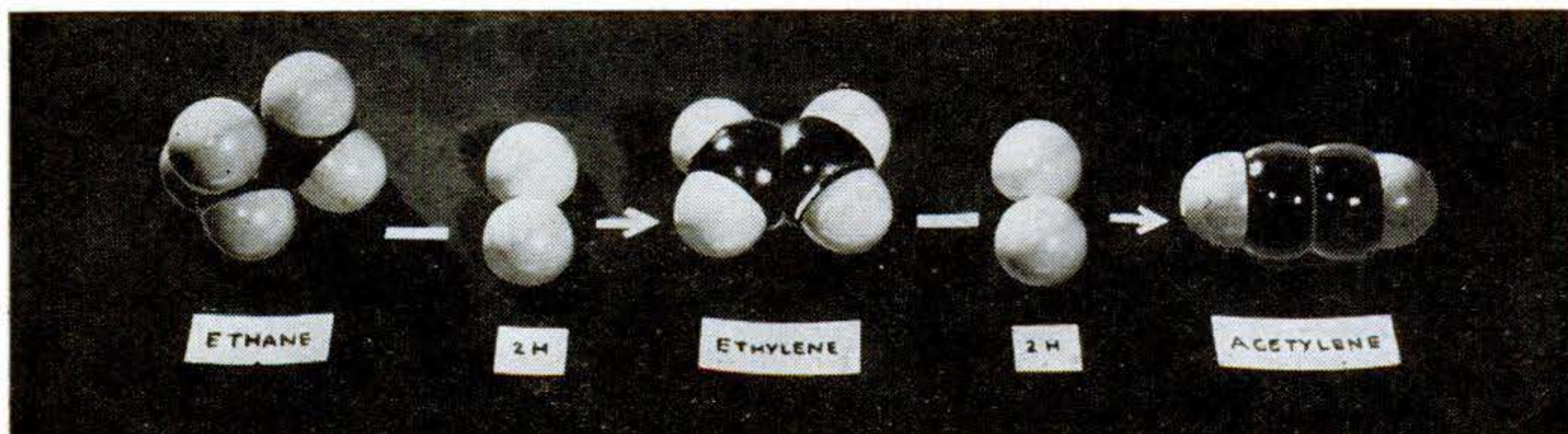

One method of forming unsaturated hydrocarbon compounds is by breaking off hydrogen atoms from saturated hydrocarbons. Ethylene can be made by taking two from ethane, acetylene by subtracting four.

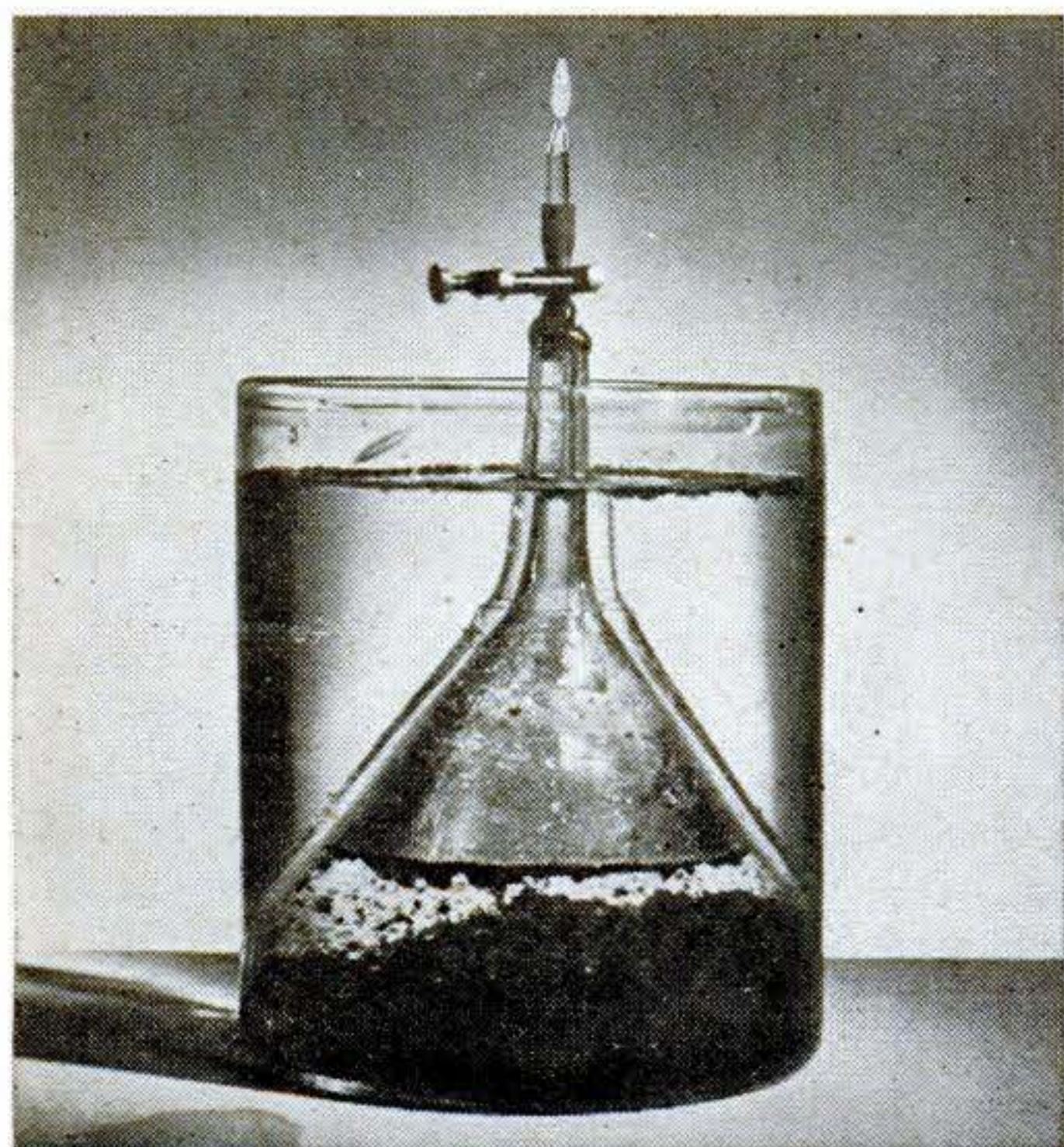

METHANE COMES FROM COAL. That this gas is given off spontaneously can be shown by covering powdered coal with water. Methane collects in the funnel after several days and can be burned.

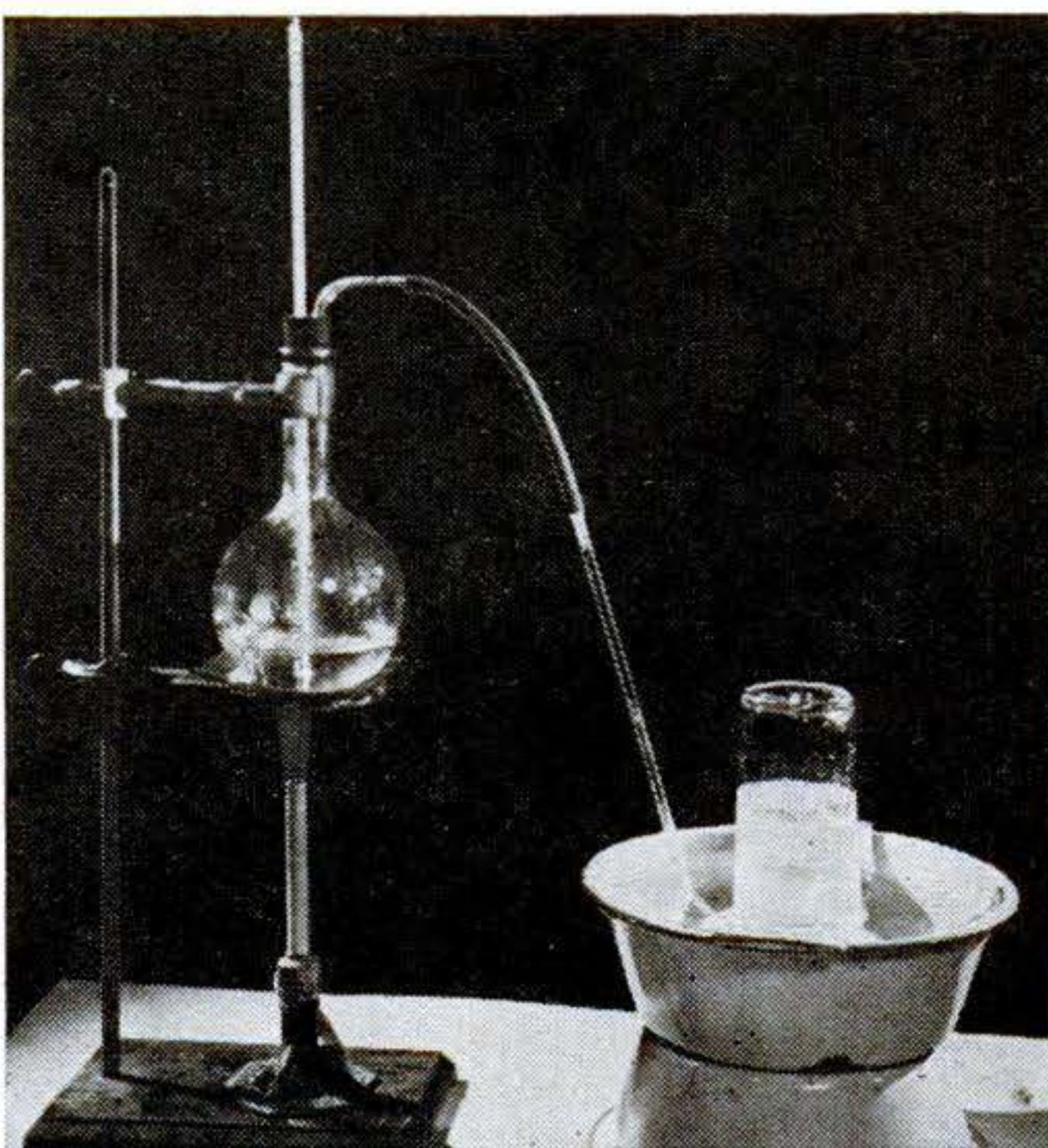

ETHYLENE IN THE HOME LAB. Ethyl alcohol mixed with concentrated sulphuric acid and heated gives off ethylene. The gas can be collected by displacing water in an upturned tumbler.

combine with the carbon atoms are already occupied by hydrogen atoms. Because of this, members of the paraffin series are known as "saturated" hydrocarbons. When a paraffin hydrocarbon is broken down by cracking, however, there are not enough hydrogen atoms available to fill all the places on the two resulting molecules. One of these, no longer a member of the series, becomes an *olefin*, a type of "unsaturated" hydrocarbon.

Some of these olefins condense in the bottom of the side-necked test tube when the mineral oil is cracked. When a little of this residue, or condensate, is shaken with concentrated sulphuric acid, the unsaturated olefins react immediately with the acid and become dark brown.

Methane is sometimes called "marsh gas" because it is the gas formed by decaying vegetable matter in marshes and stagnant pools. It also issues from coal seams and, mixed with air, has been the cause of mine explosions. Most important is its occurrence as the chief constituent of natural gas.

To show how methane is given off slowly and spontaneously by coal, heap a large handful of finely pulverized coal in the bottom of a large can or jar of water and place an inverted glass funnel over the coal. Attach a glass jet to the end of the funnel by means of a short length of rubber tubing. Prepare the apparatus by sucking

up water to fill the funnel tube, and close off the rubber with a pinchcock. After several days, the methane gas will rise from the coal and drive some of the water from the funnel. Open the pinchcock and ignite the gas. It will burn with a hot, pale flame.

Unsaturated hydrocarbons are obtained also by breaking off hydrogen atoms from members of the paraffin series. The gas, ethylene, C_2H_4 , comes from taking hydrogen from ethane, C_2H_6 . Ethylene helps make illuminating gas luminous, helps to ripen fruit, and is an anesthetic and a reducing agent in chemical synthesis. It can be made by heating ethyl alcohol with sulphuric acid.

Pour into a 500-ml. flask 20 ml. of 95-per cent ethyl alcohol (denatured alcohol will do) and 50 ml. of concentrated sulphuric acid. Add 10 grams of powdered pumice or anhydrous aluminum sulphate to help the reaction. Shake thoroughly, and then support the flask on an asbestos-center wire gauze. Close with a two-hole stopper having a thermometer in one hole and a bent delivery tube in the other. Heat to 155 deg. C. and, after the air has been displaced, collect several jars of gas by upward displacement of water. Pour a weak solution of potassium permanganate, acidified with a drop of sulphuric acid, into a jar of ethylene, and the reducing gas will rob the rose-colored solution of oxygen and turn it colorless.

The still less saturated gas acetylene, C_2H_2 , is produced when four atoms of hydrogen are broken off a molecule of ethane or two hydrogen atoms off an ethylene molecule. This is the gas commonly made for lamp use by decomposing calcium carbide with water, and sold in cylinders as the fuel for oxyacetylene torches.

Since the two carbon atoms are able to hold four more of some other element, the gas enters actively into many chemical reactions. This can be shown by generating it in the presence of chlorine, or gas from $\frac{1}{2}$ " of sodium hypochlorite solution (household chlorine bleach) in the bottom of a large beaker. Add a little hydrochloric acid to release the chlorine and cover the beaker loosely with cardboard.

After several minutes, remove the cardboard and sprinkle a little calcium carbide into the solution. Bubbles of acetylene will break through the surface, and as each mixes with the chlorine it reacts violently and bursts into flame.

END

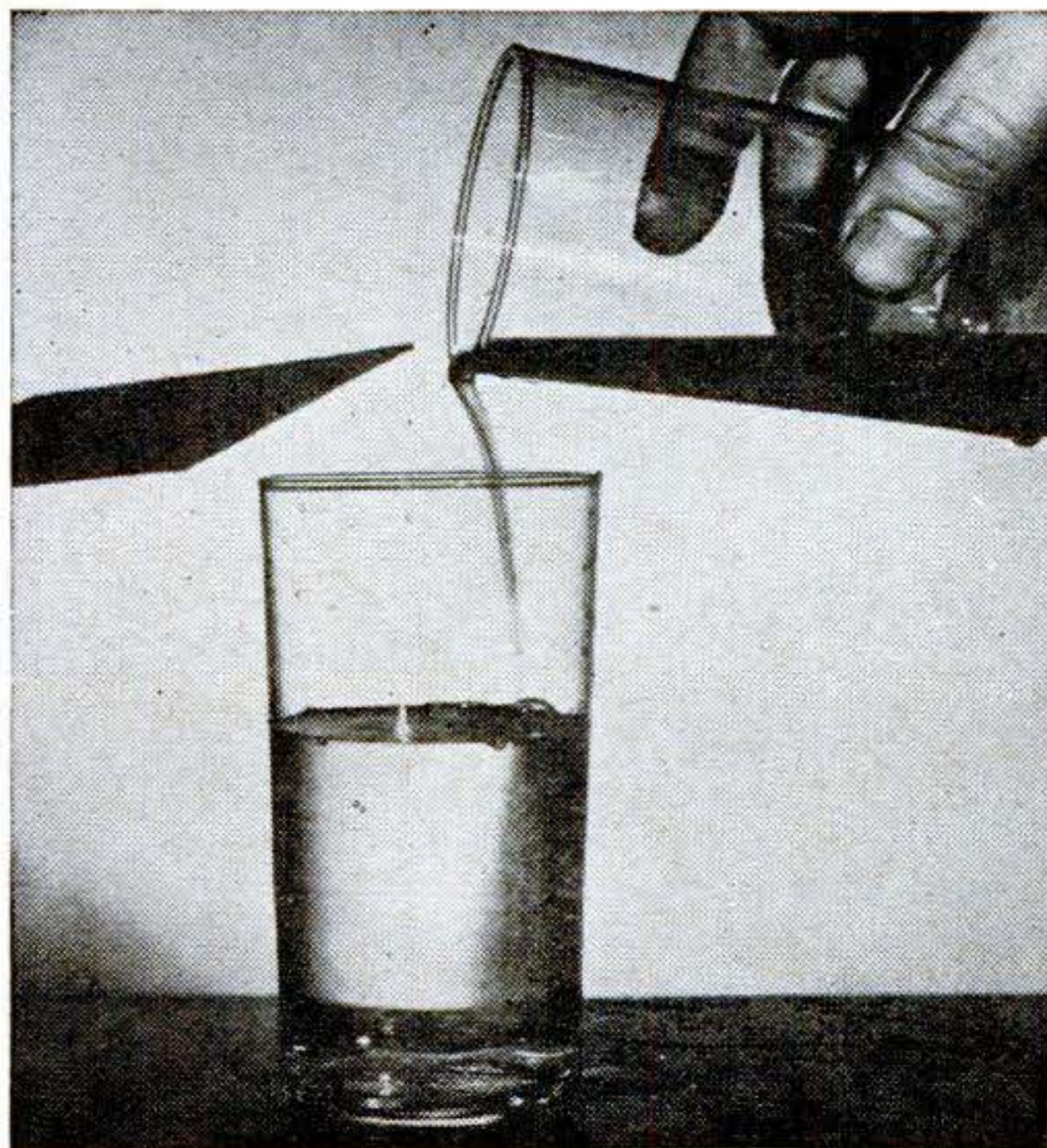

REDUCING ACTION OF ETHYLENE. Rose-colored potassium permanganate is reduced, or robbed of oxygen, when poured into a glass of ethylene gas. The reaction turns it colorless.

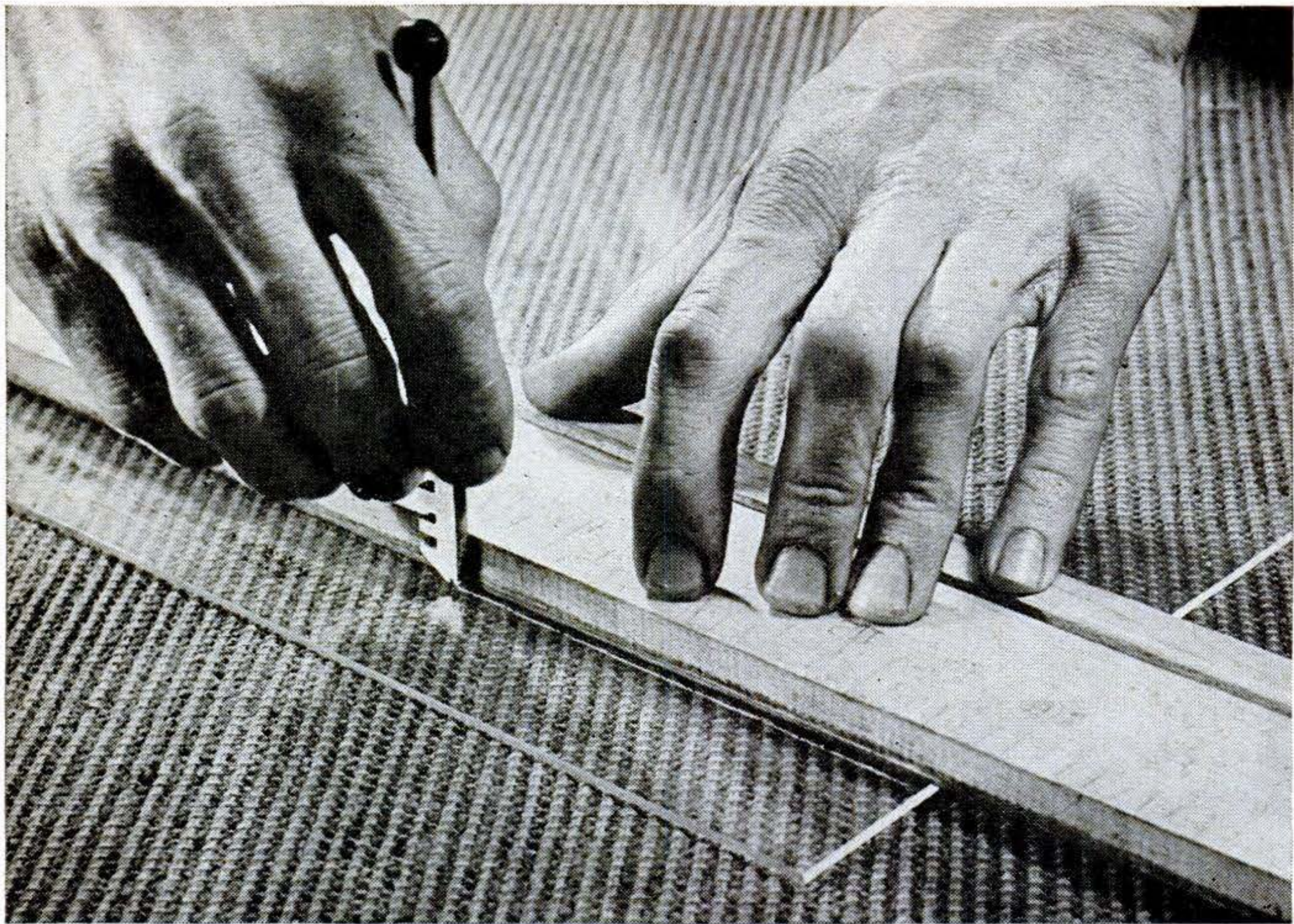

Carpeting under the glass will keep it from slipping. Score with a single firm stroke of the cutter.

How to Glaze a Window

ONE of the cheapest tools to buy is a glass cutter; in use, it can be one of the most expensive. Everyone has occasion at some time to replace broken glass in sash, French doors, and picture frames. You needn't have any trouble doing a workman-like job if you follow a few rules and acquire the simple knack necessary.

To replace a broken pane, remove all the old glass, including slivers clinging to the putty. It is best to wear gloves for this to avoid cutting your hands. Then take out all the old putty with a chisel. If it is too hard, a hot soldering iron will sometimes soften it. Examine the sash corners, and if they appear weak strengthen them with small metal angle braces. Measure for the glass, allowing $1/16''$ to $1/8''$ total clearance.

A glass cutter must be sharp. Dip it in turpentine and try it on a scrap piece of glass from the old pane. The new glass must be dry and not cold. Lay it flat on an even, firm surface. Professionals put carpeting under it to keep it from slipping. An uneven surface may cause the glass to crack under

the cutter. Use a pad of newspapers if you have no carpeting. Chalk the underside of the straightedge to prevent slipping.

Dip the cutter again and take one even stroke, beginning about $1/16''$ from one edge. Never go over a scored line; it ruins a wheel. If the cutter skips, recut the blank spaces without going over the previous cuts.

Place the scored line directly over the edge of the bench with the waste over the edge, and break with a quick snap. Try the glass in the sash and, if it is a little large, undercut the rabbet with a chisel. Don't try to trim the glass.

Prime the rabbet with paint so it won't absorb the oil from the putty. Then make a bed of putty and lay the glass in it. Tap in two glazier's points on each side fairly near the corners but not evenly spaced, and add more putty, beveling with a putty knife. Use only a good grade of putty containing one part white lead, four parts whiting, and linseed oil, or make your own. Outside paint may be substituted for the lead and oil.—DEXTER W. ALLIS.

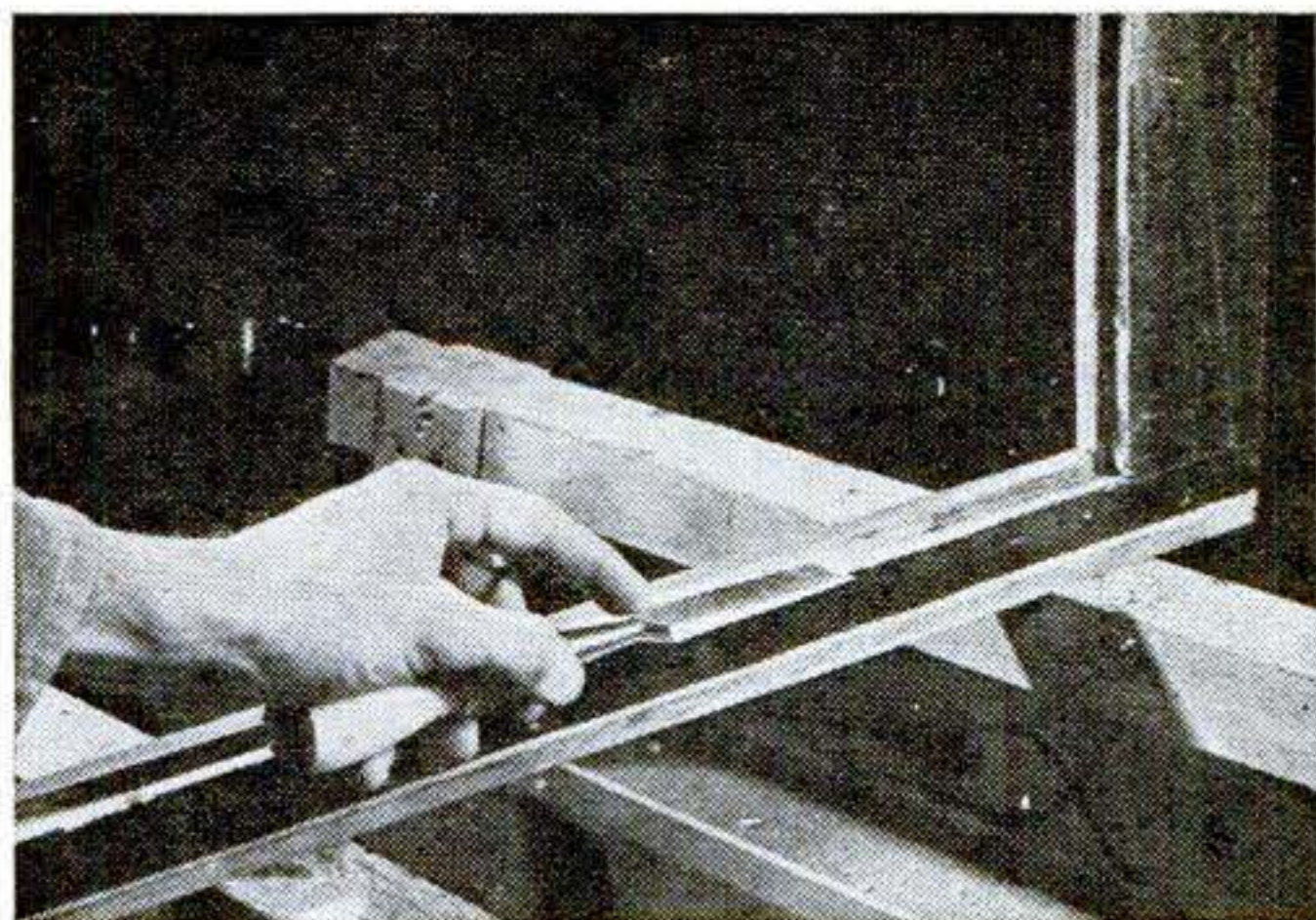

Remove hardened old putty by running a chisel lengthwise and parallel to the rabbet. If glass is too big, undercut the rabbet in the same way.

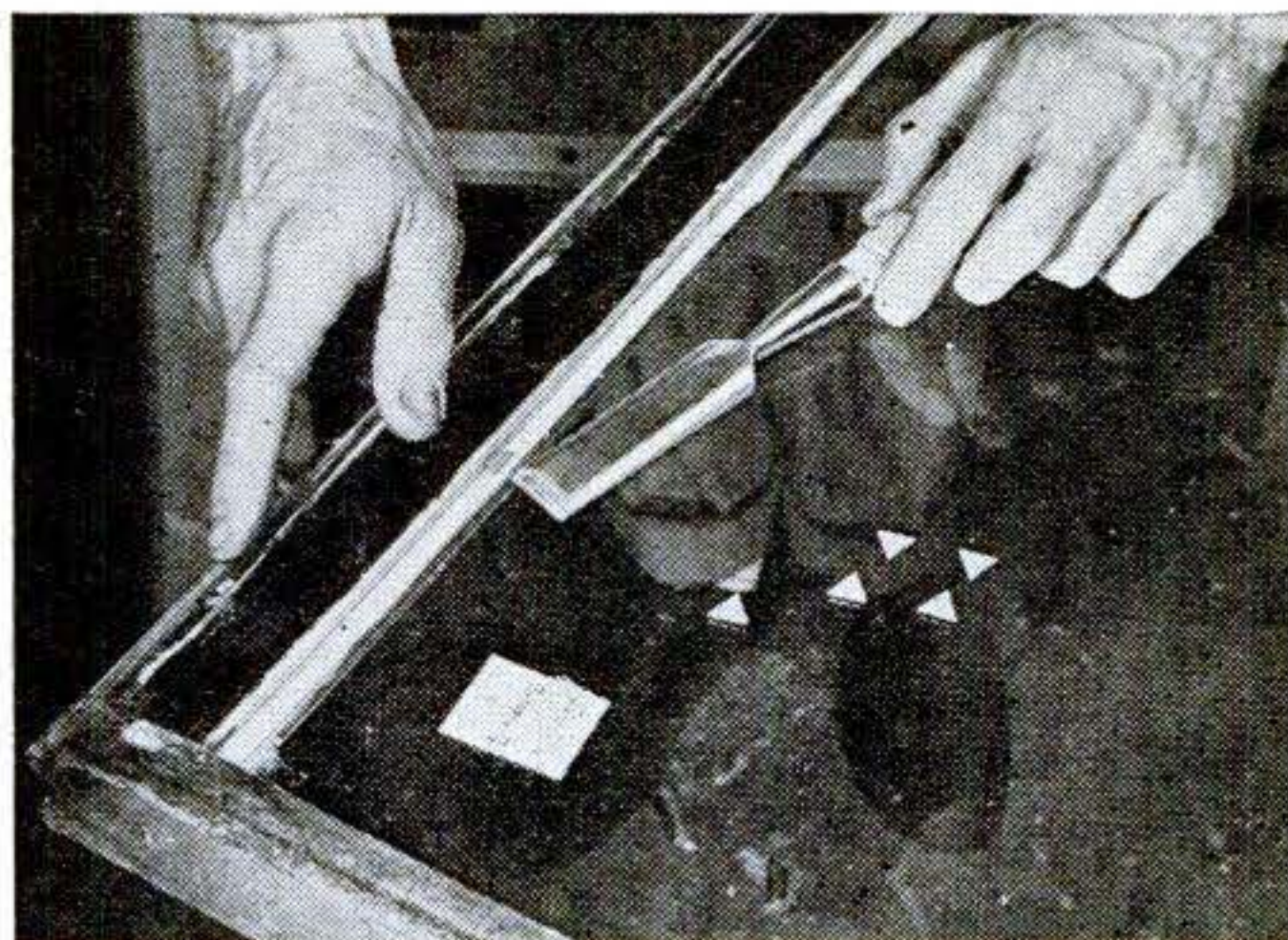

Tap in glazier's points with the edge of a chisel held flat. Don't put them too tight against the glass. Space them unevenly at the corners.

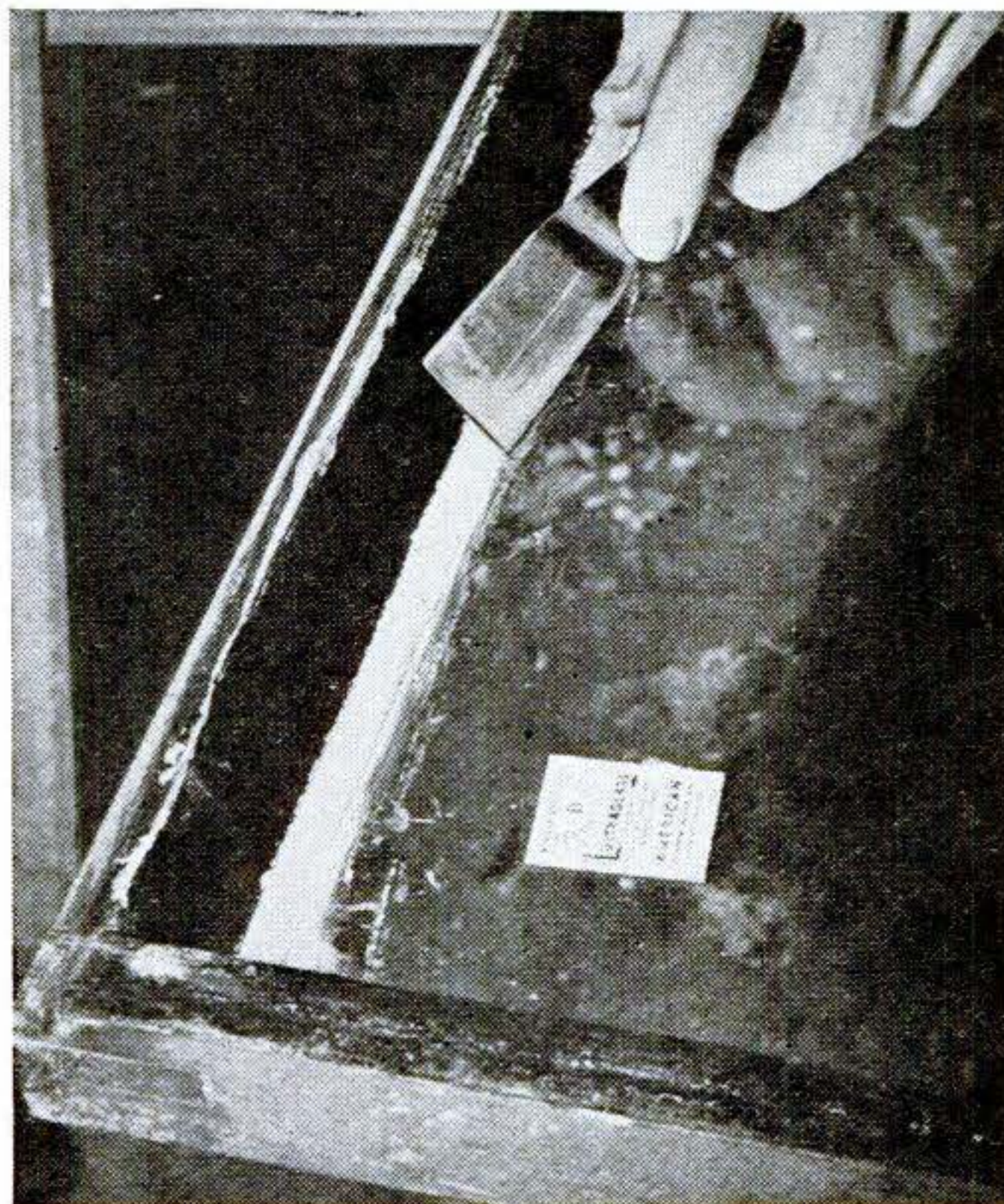

Smooth off and bevel with a putty knife, keeping the edge of the putty back even with the rabbet. Scrape the pane clean after the putty hardens.

Tips on Glass Work

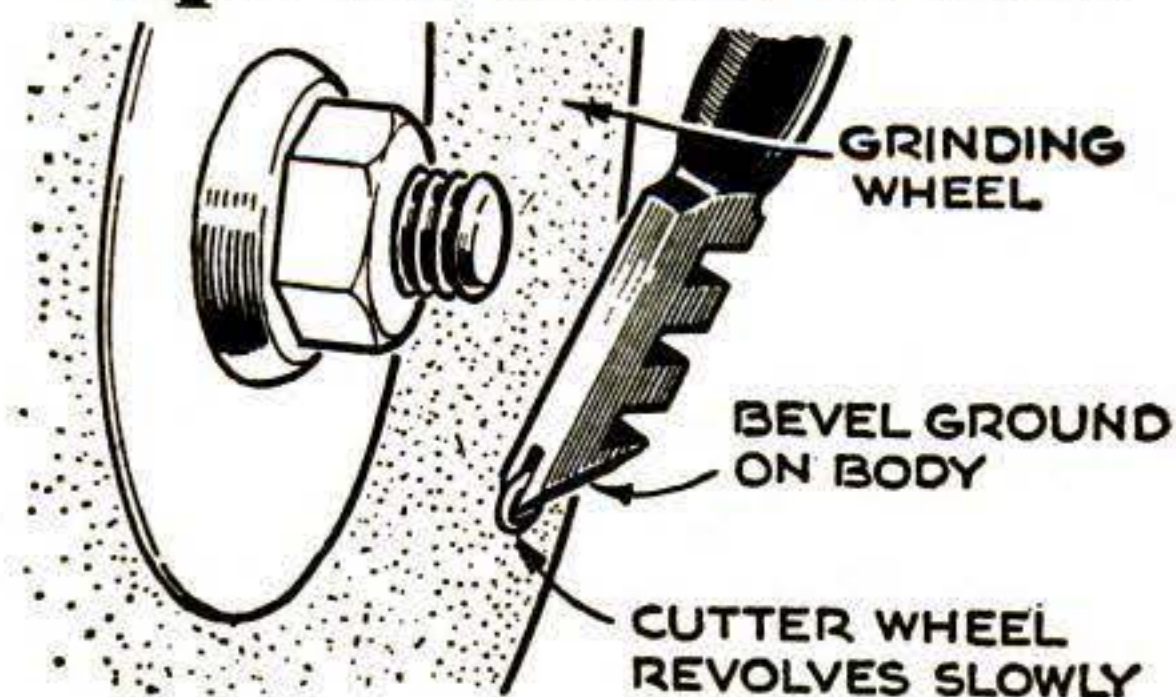

Sharpening a Cutter

GLASS cutters must have a keen wheel to be of any service. A dull one can be sharpened easily on a fine-grain emery wheel.

Grind off a bit of the holder so the cutter wheel will touch the stone. Hold the cutter at an angle that permits the wheel to turn slowly as it is ground.

Drilling Holes in Glass

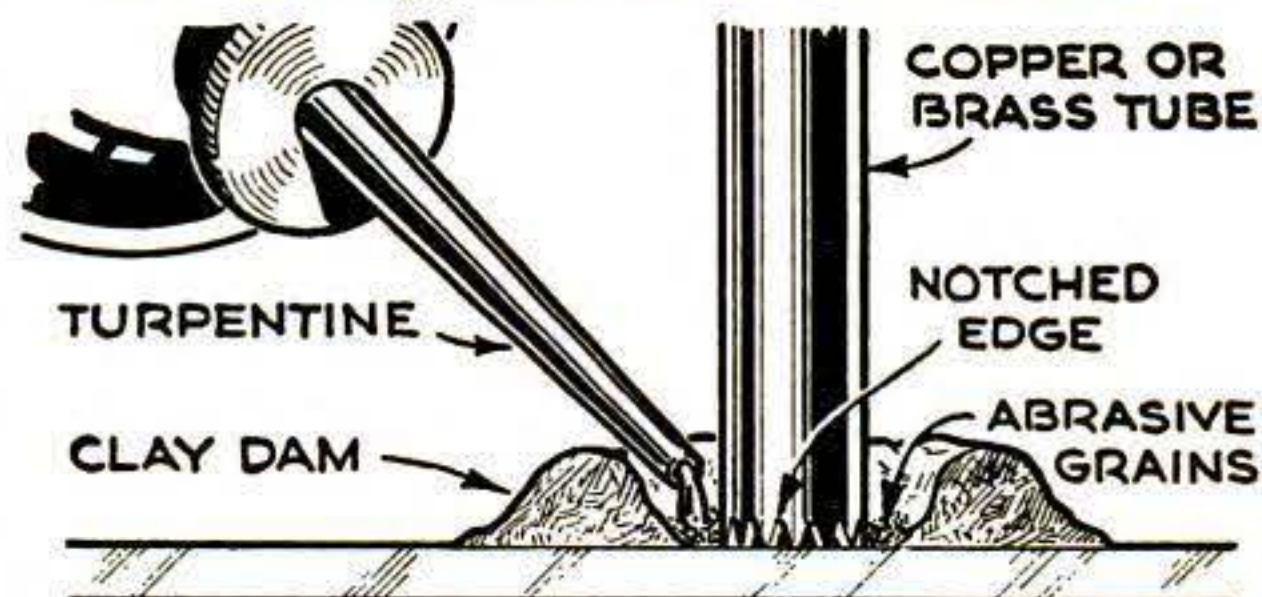

COPPER or brass tubing chucked in the drill press is effective in drilling glass. File notches in the end. Use a rubber cushion under the glass and build a clay dam on it to retain turpentine and grains of carborundum or emery. Start drilling with light pressure. When half through, drill from the other side to finish. Another way, below, is to use a tube with a saw cut across one end. Fill the tube 2" deep with abrasive.

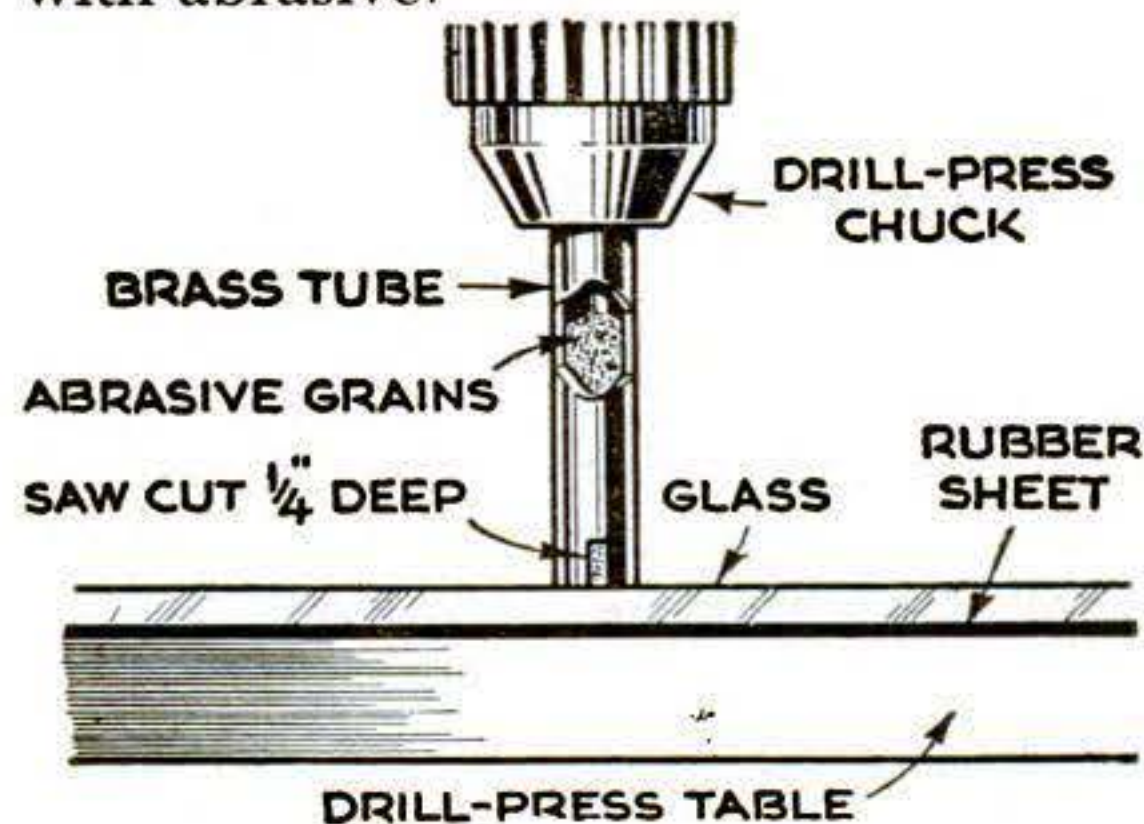

He'd Give His Shirt

AS LONG as he can find an old shirt, some worn-out pajamas, or a ragged linen sheet or two, Harrison Elliott is never bothered by paper shortages. He makes his own—and especially fine paper, too. Close friends like nothing better than to receive a box of his paper as a gift.

The process Elliott employs originated in China about the year 105 A.D. and was the only method in use until the invention of paper machines in 1798. Elliott has been learning about this ancient craft for more than 15 years; he spends all his spare time at it. His one-man mill is in the New York office building where, during the day, he is advertising director for a paper company. How he makes paper is shown on this and the facing page. Though the product he turns out is of high quality, the process is too expensive to be of commercial value.

Elliott has made paper for the Duchess of Windsor bearing her own special watermark. But mostly his hobby pleases him for the craftsman's thrill of achieving fine color and texture effects from old rags.

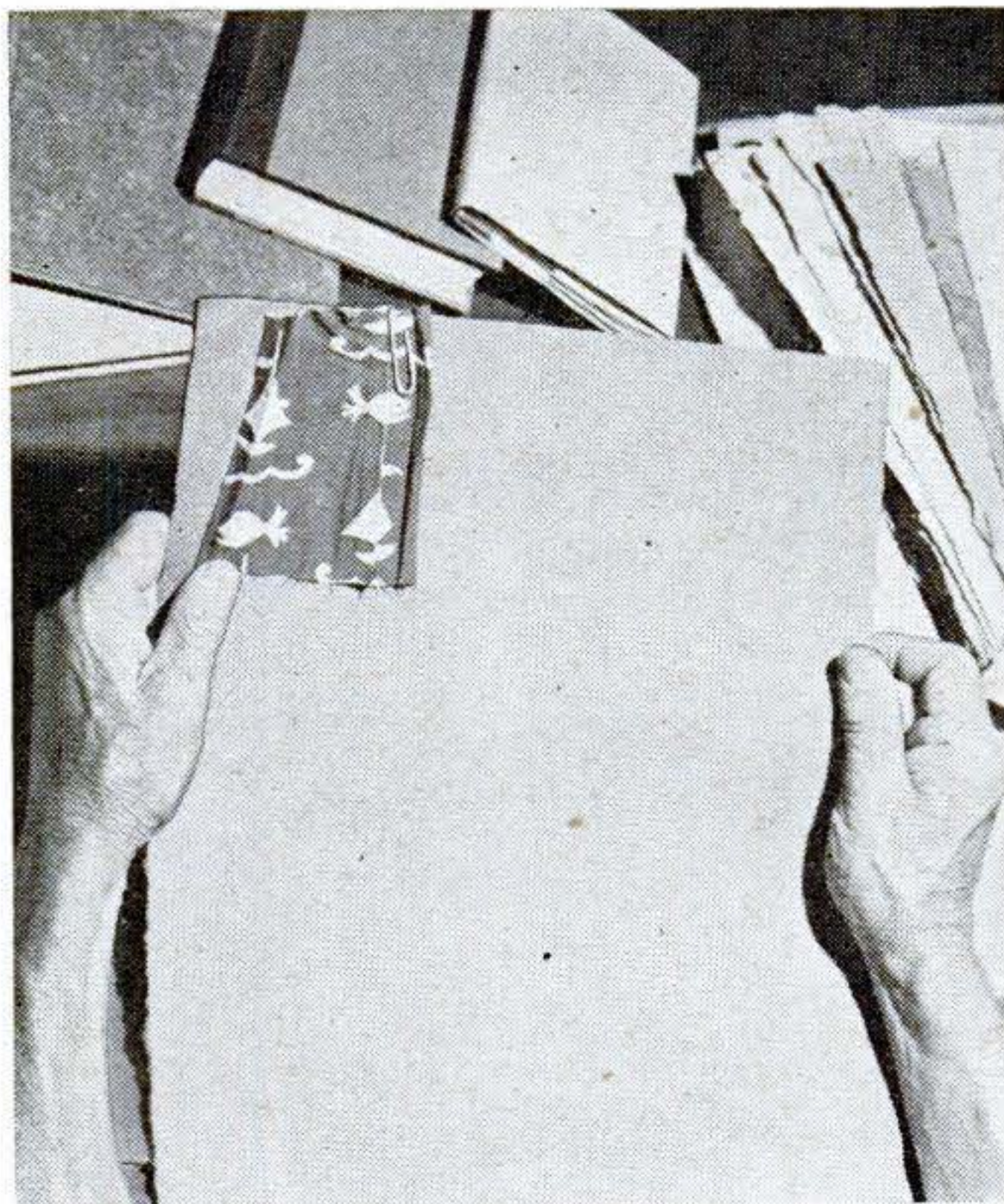

Some of Harrison Elliott's fine papers. The sheet being displayed was made of pulp from cloth like the attached sample and takes its color from the dye in the cloth. Interesting colors are obtained from fabrics used in his spare-time paper mill.

Photos by Joseph Kostin and J. F. Mangi



Thin films of pulp are formed one at a time on a wire-mesh hand mold dipped into the vat. Excess water drains through the fine mesh, and the sheet of paper begins to appear. The process is slow, but the result is gratifying. A continuous sieve replaces the hand mold in commercial practice.



Further drying is done by couching. The deckle, or frame, is removed from the mold, and the sheet of pulp is transferred from the wire cloth to a felt blanket by placing the screen face down on the pad and then taking it up. Here a pulp sheet is inspected and smoothed out on the felt.

to Make Fine Paper



Only the best of materials can be used in making the finest papers. Here Elliott reduces a shirt to shreds as the first step in preparing pulp. Worn-out clothing provides an endless source of materials, but it must be of excellent grade.



Nothing but rags and water go into the vat where they are converted into a liquid, fibrous mass by the blades of a motor-driven beater. The process is watched carefully so the pulp will be mixed to exactly the correct consistency.



Several layers of felt blankets, each containing its sheet of damp paper, are placed between heavy plates and prepared for the press. The blankets absorb the last remaining traces of moisture, and the sheets of paper will come out perfectly dry and in finished form ready for use.

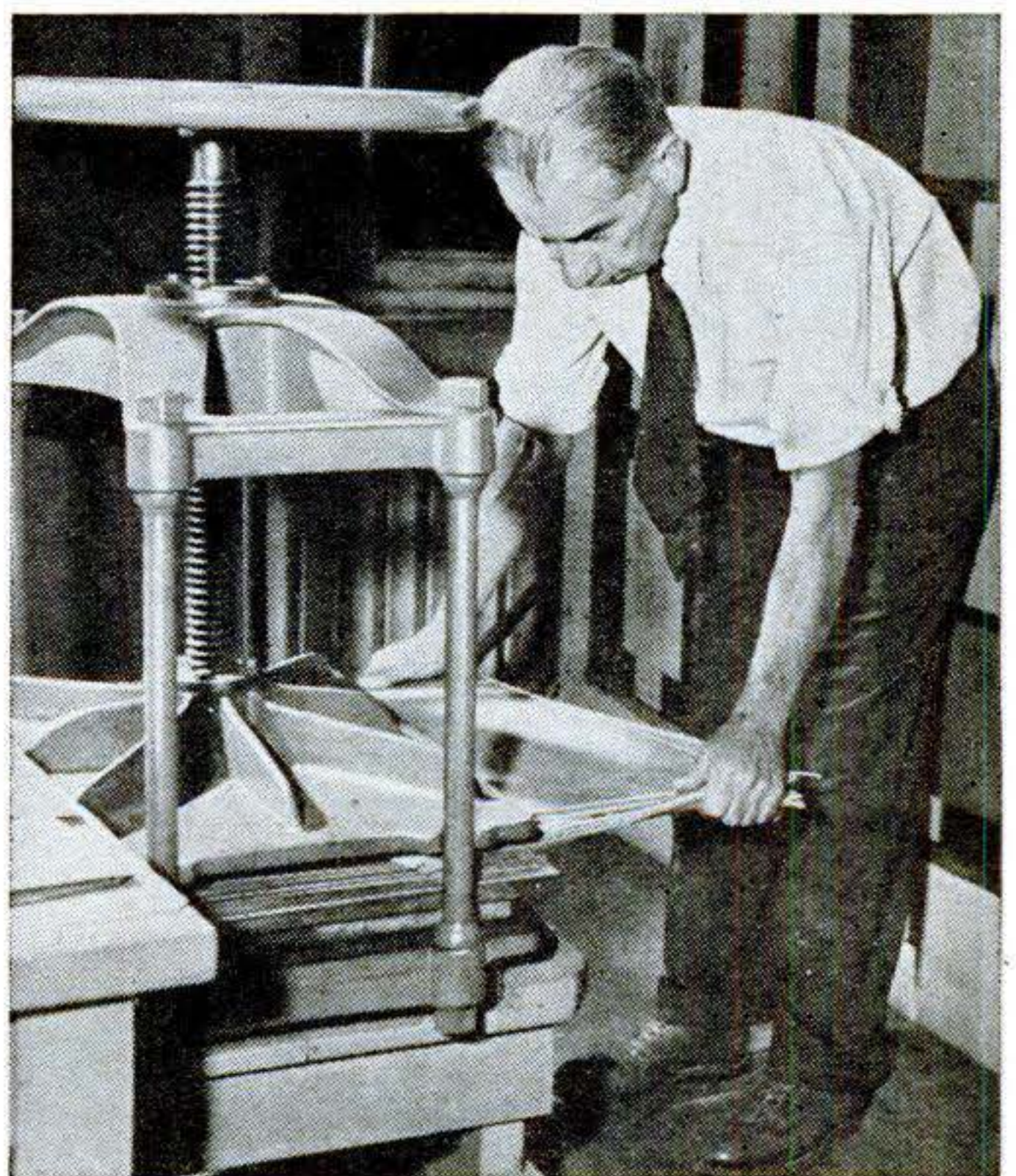

This is the last step in papermaking. The paper and blankets sandwiched between the zinc plates are put in a hand press and pressure is applied. The amount of pressure brought to bear by turning down the screw governs the finish gloss. Texture and watermarks show in the final product.

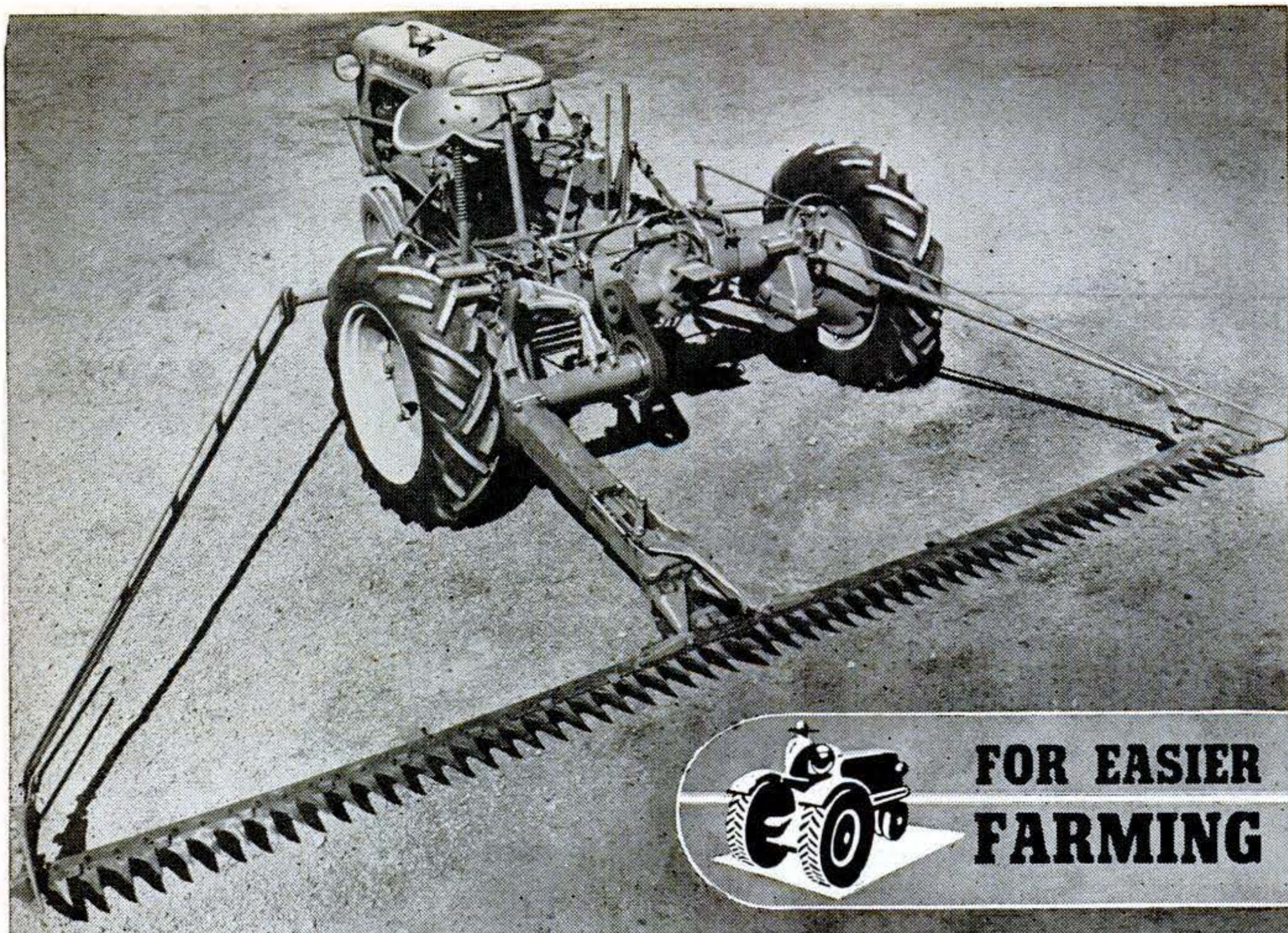

**FOR EASIER
FARMING**

All Hay and 14' Wide. That's what this new tractor mower, the Twin Seven, cuts with its double-width floating cutting bar. Made in two parts, the bar is said to follow the terrain as evenly as a single one.

It is detachable for road transport. The mower is mounted on the rear of a tractor, which is run backward, the operator having full view of the work. The Mountain Mfg. Co., of Murray, Utah, makes it.



Pumps Grease from Pail. This pressure lubricator is designed for using light or viscous lubricants direct from a 25-lb. can. It punctures the top close to the rim and is ready for use with the tightening of a setscrew. Up to 5,000-lb. pressure is possible. The manufacturer is the Aro Equipment Corporation, of Bryan, Ohio.

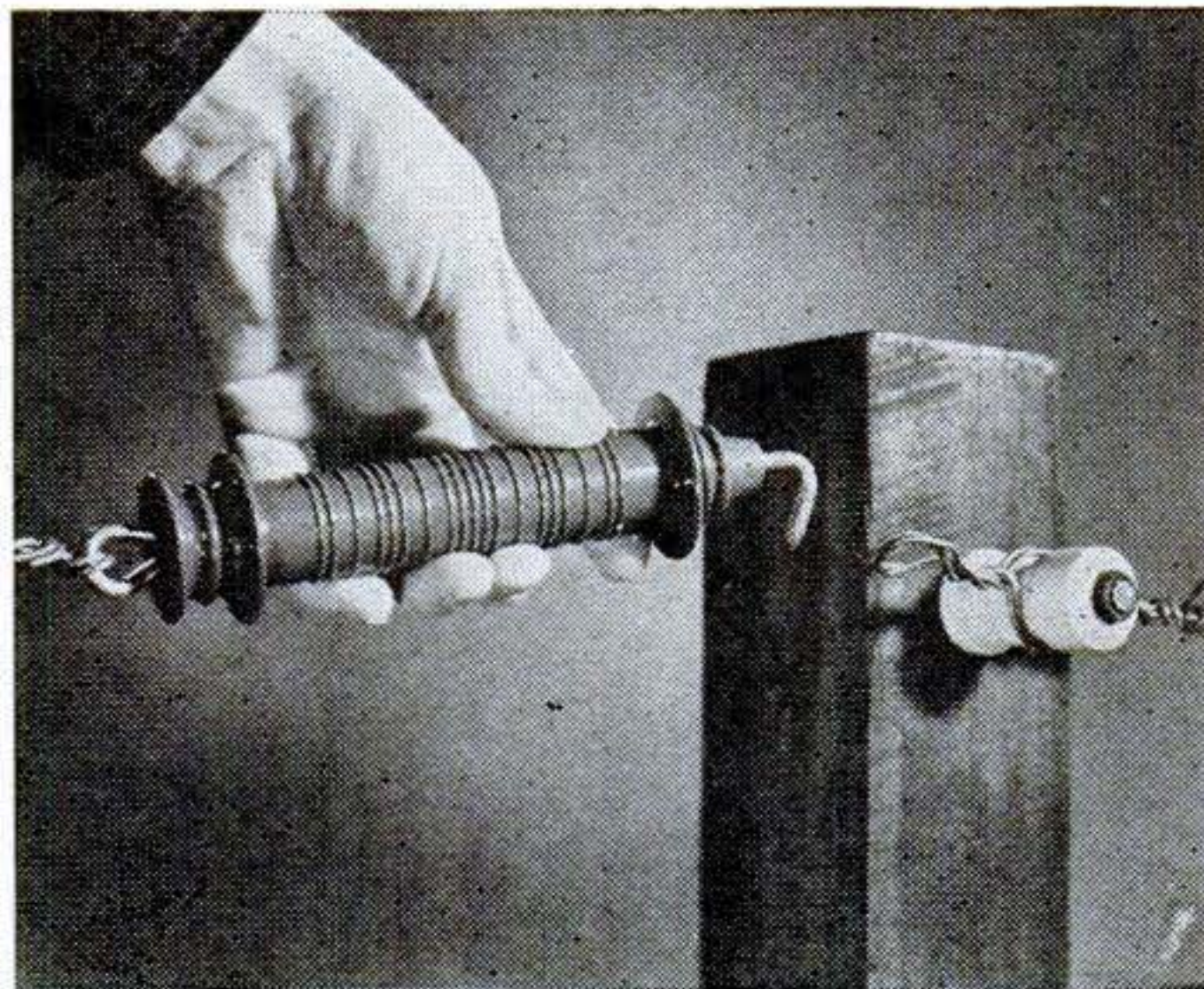

Gate for Electric Fence. A handle for opening the gate of an electric fence with safety is made of Tenite. It has a metal spring to maintain current contact with the fence when the gate is closed. The handle is shockproof in wet weather. It is made by Accessories Manufacturing Co., Inc., of Kansas City.



Announcing the new 1000-watt
Kodaslide Projector
Master Model
 for home or auditorium

This handsome, compact instrument delivers more light to your home screen than was ever before possible with any 2 x 2-inch slide projector . . . brings out shades and shadow detail you never dreamed existed.

Fast Lenses and Powerful Lamps . . . snap a vivid image onto the screen even in a room only half-dark. That's a great help, at your club, school, or church. The crisp image shines bright throughout, no dingy corners or hot-spot center.

Entire Optical System Lumenized . . . condensers and projection lenses are Lumenized (hard-coated) to supply maximum light. A new type of heat-absorbing glass blocks 85% of the heat . . . and it's one solid piece, which leaves no black streaks on the image.

Five superb Kodak Projection Lenses . . . For theatres and auditoriums, a powerful 11-inch $f/3.7$ Kodak Projection Ektar; for club, church, or school, two $7\frac{1}{2}$ -inch lenses—the $f/2.3$ Ektar or $f/4$ Ektanon; for home shows, two 5-inch lenses—the $f/2.3$ Ektar or $f/3.5$ Ektanon.

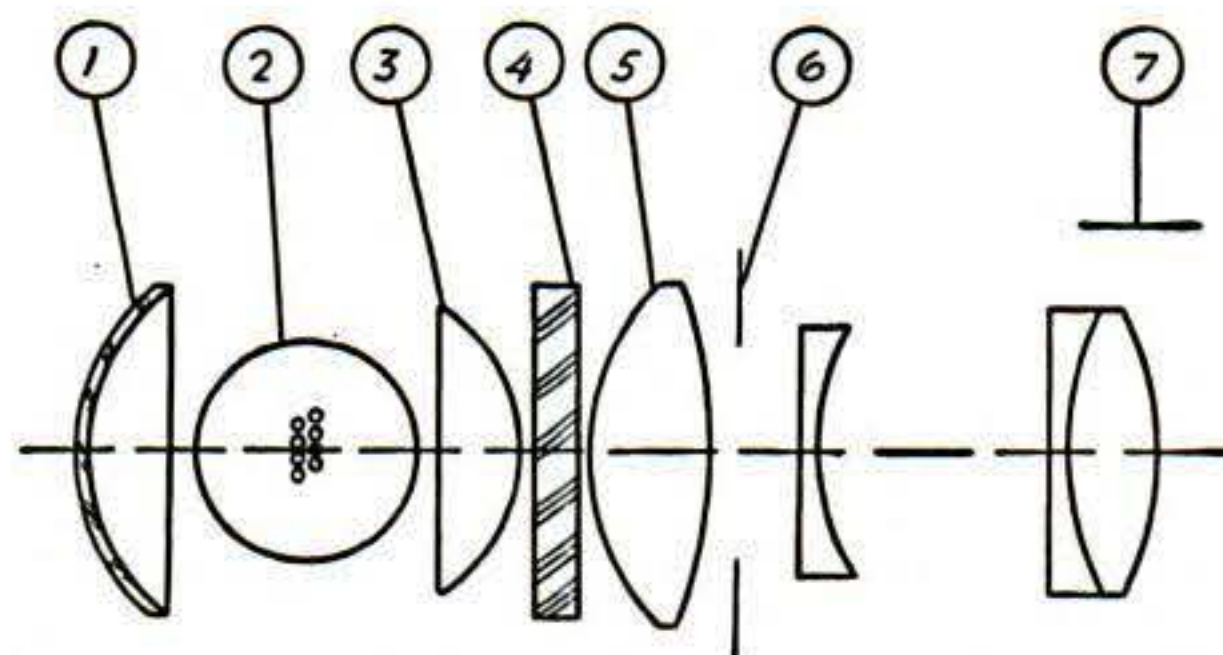

Optical System of Kodaslide Projector, Master Model
 (1) Spherical Reflector, (2) Projection Lamp—300 to 1000 watts, (3) Rear Condenser Lens, (4) Heat-Absorbing Glass, (5) Front Condenser Lens, (6) Aperture for Transparency, (7) Kodak Projection Ektar or Ektanon Lens (relative position depends upon choice of lens).

Keeps Kodachrome Transparencies Cool . . . a quiet turbine-type fan in the base forces cool air *three ways*—to the lamp, to the condenser system, and to both sides of the slide.

Descriptive, full-color folder free at your Kodak dealer's . . . EASTMAN KODAK COMPANY, ROCHESTER 4, N. Y.



KODASLIDE PROJECTOR,
Master Model, is supplied
 with a carrying case. Price,
 from \$181 to \$295, depend-
 ing upon lens selected.

Kodak

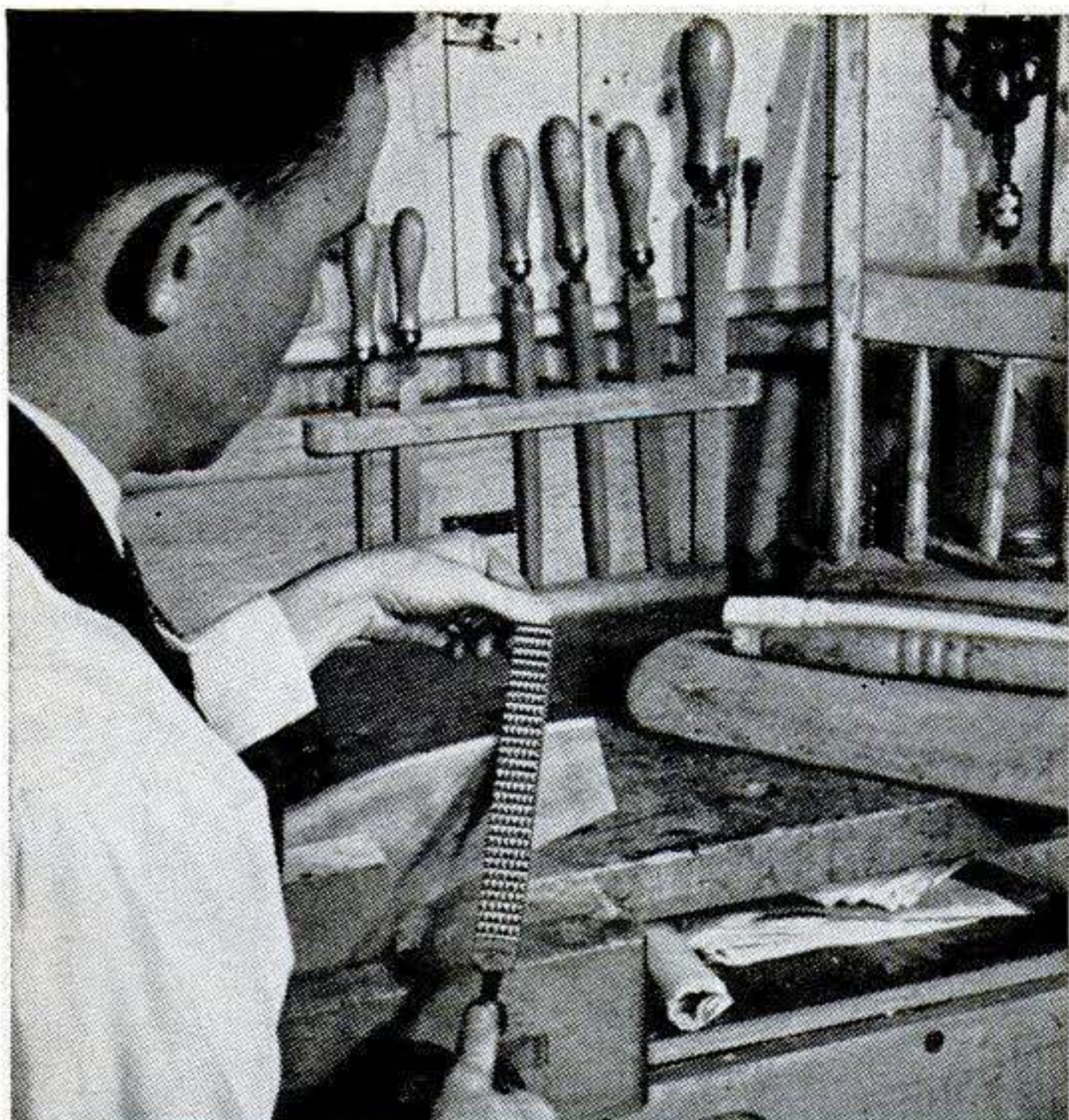

there's always a **JOB FOR FILES**

A new back is needed for a plank-bottom chair . . . a drawer or a door sticks . . . there's a saw to be sharpened or a home-appliance part to be fitted—jobs like these are always cropping up around the house. Then, too, there's "the other kind" of jobs: those done for the sheer satisfaction of creating—like building a working model . . . finishing up a workshop project . . . making toys and games for the kids.

Yes, there's always a job for files. That's why it's a good idea to keep a popular assortment of Nicholson or Black Diamond files on hand. Then, for both hobbying and repairing, you can be sure of choosing and using *The right file for the job*. Your hardware dealer has them—or can get them—in cuts, shapes and sizes to meet your every need.

Write for Free Book, "FILE PHILOSOPHY"

NICHOLSON
U.S.A.

NICHOLSON FILE CO.
19 Acorn St., Providence 1, R. I.
(In Canada, Port Hope, Ont.)



NICHOLSON
FILES FOR EVERY PURPOSE

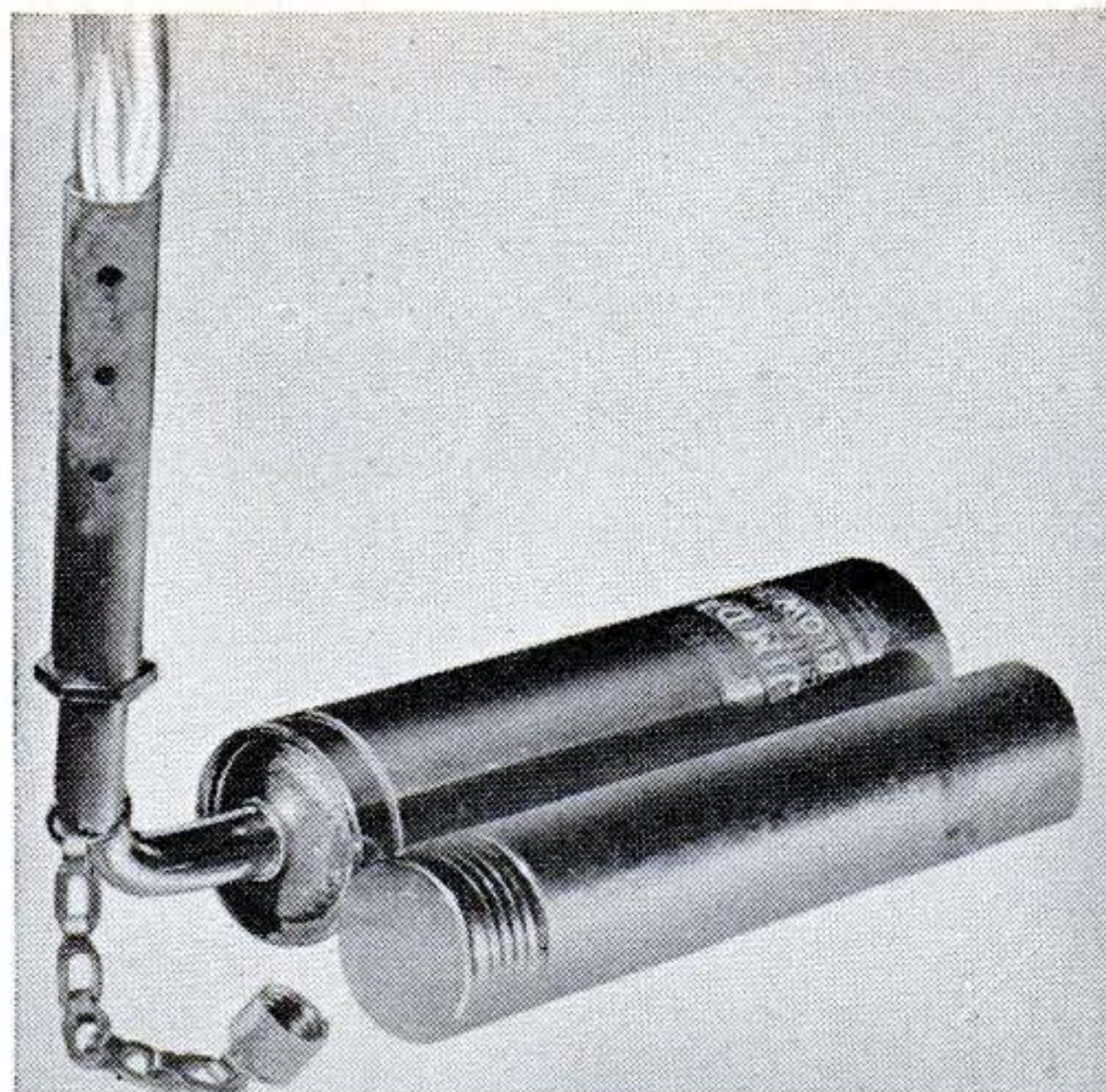

Torch Cooks for Campers

OUTDOORSMEN will find this alcohol-type combination blowtorch-cookstove, with adjustable nozzle, handy for camping trips. Placed flat, as shown in photo, it is ready to cook for two hours. Manufactured by Modern Metal Products Co., of Cambridge, Mass., the torch develops 2,200°, is non-explosive and fits into a pocket.



Fangs Are Plastic

THESE realistic gaping jaws are actually only plastic bridgework. Made for stuffed animals by C. M. Moore Co., of Kansas City, Mo., the teeth and jaws are better than natural ones, which tend to discolor, lose their luster and drop out.

Twist...It's Open

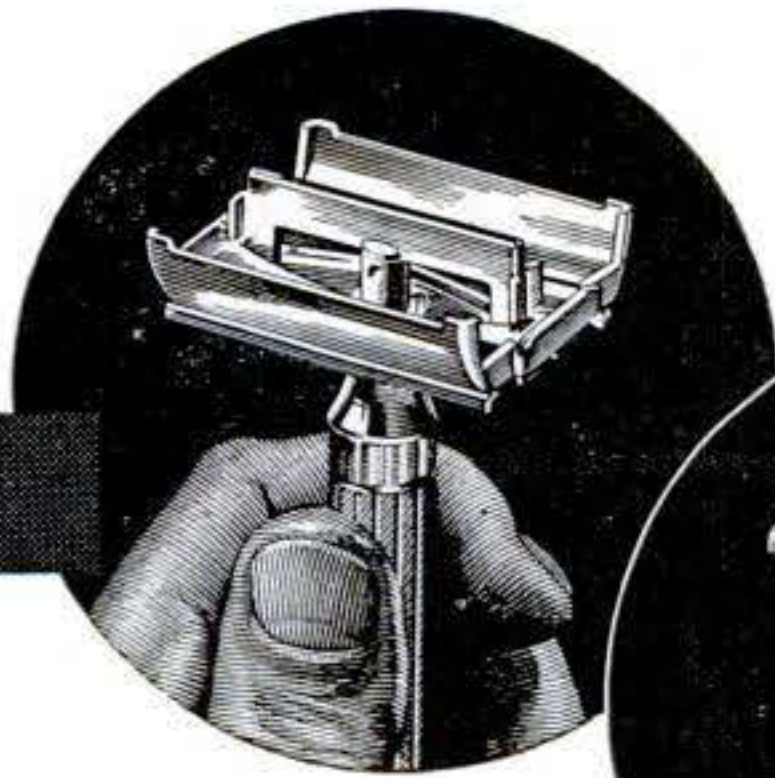

Twist...It's Closed



See how quick and easy shaving can be... with the modern

Gillette One-Piece Razor

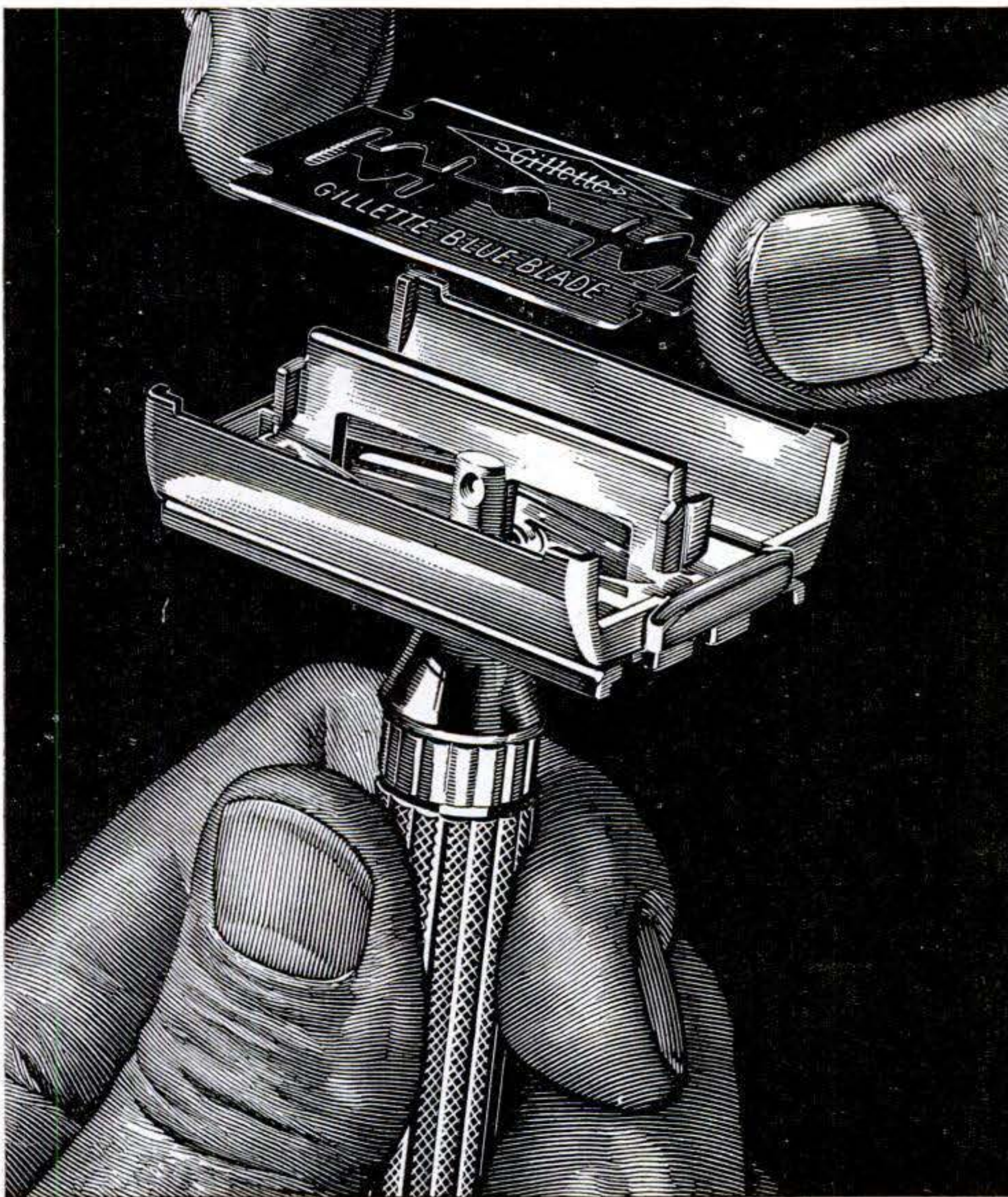

YOU get utmost shaving comfort and convenience with a Gillette One-Piece Razor. There's nothing to take apart or put together. Blade changing's a cinch. Twist . . . the razor opens. Twist again . . . your blade's locked in position. To clean, just loosen the holder, rinse, shake.

Enjoy the quickest, easiest shaves you ever had. Ask for the superb Gillette Aristocrat One-Piece Razor or the Gillette Milord.

Gillette Safety Razor Co., Boston 6, Mass.

Copyright, 1947, by Gillette Safety Razor Co.



Gillette Aristocrat One-Piece Razor, 10 Gillette Blue Blades \$3⁷⁹



Gillette Milord One-Piece Razor, 5 Gillette Blue Blades \$2⁵⁰

look^{SHARP!} feel^{SHARP!} be^{SHARP!} use Gillette Blue Blades WITH THE SHARPEST EDGES EVER HONED

AUGUST 1947 211



ZEPHYR



LIGHTFOUR



SPRINT

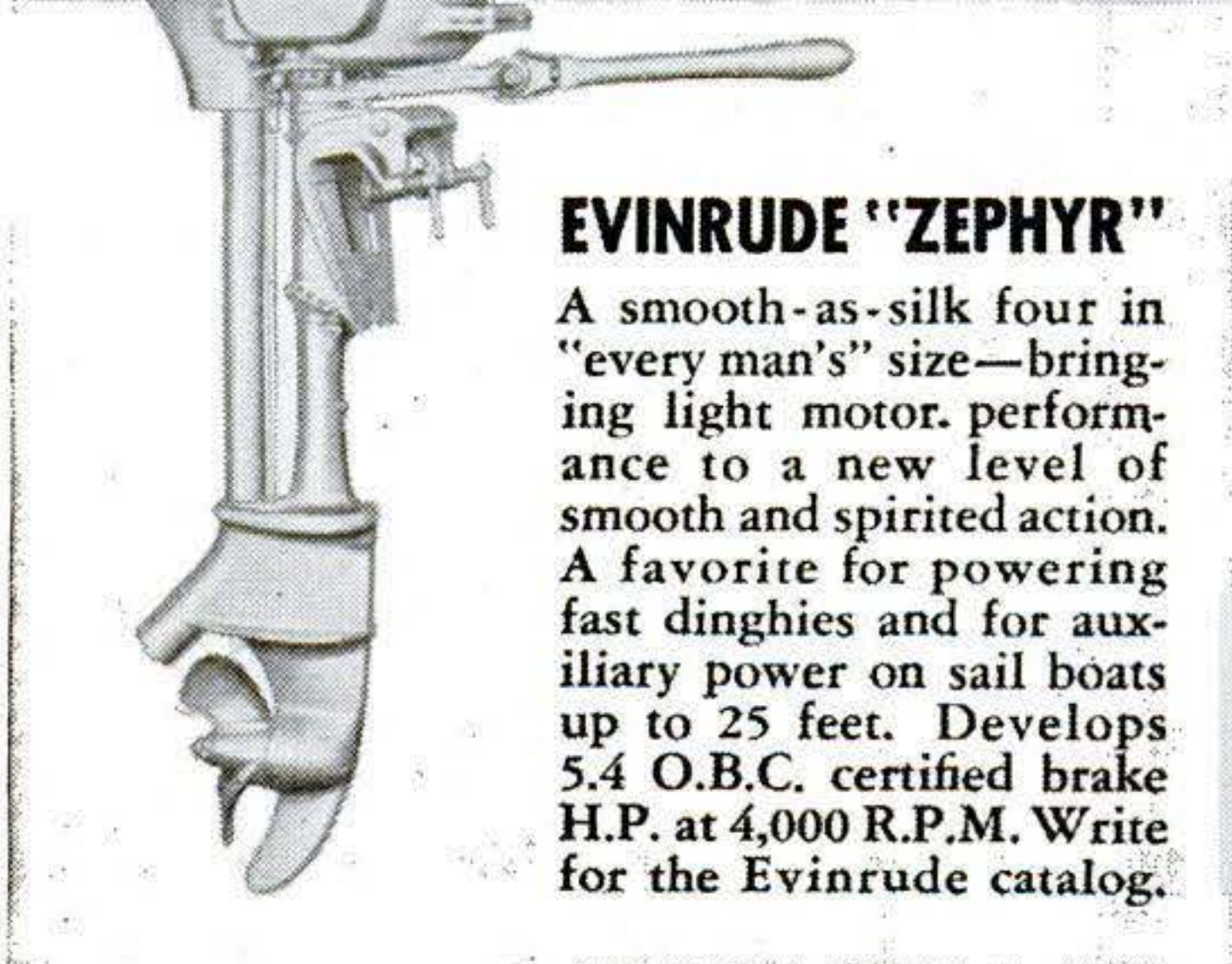

EVINRUDE "ZEPHYR"

A smooth-as-silk four in "every man's" size—bringing light motor performance to a new level of smooth and spirited action. A favorite for powering fast dinghies and for auxiliary power on sail boats up to 25 feet. Develops 5.4 O.B.C. certified brake H.P. at 4,000 R.P.M. Write for the Evinrude catalog.

There's a "Four" for YOU—

—just right in size, power, performance . . . in Evinrude's complete line of 3 thrilling four-cylinder models!

If you want a motor developing 5 horsepower or more — why not enjoy the *extra* smoothness — the *extra* thrill of performance — *that are yours with an Evinrude "four"?*

There's nothing like them — for any boat, or any kind of service! No other type of outboard motor to match their velvety surge of power, their responsiveness and flashing get away!

See your Evinrude dealer — look for his name under "Outboard Motors" in your classified telephone directory. Catalog of the complete Evinrude line of 7 models sent on request. Write for it today—address, EVINRUDE MOTORS, 5606 North 27th Street, Milwaukee 9, Wis.

EVINRUDE

FIRST IN OUTBOARDS • 38TH YEAR

In Canada: Evinrude Motors, Peterboro, Ontario.

IT'S A
GRAND FEELING.
TO BUILD A
MINIATURE HOUSE



IT'S A GRAND FEELING, TOO,
WHEN YOUR CAR IS
CUSHIONED WITH MARFAK
CHASSIS LUBRICATION

THAT CUSHIONY FEELING LASTS LONGER WITH MARFAK!

It's a grand feeling to work at your hobby . . . the same grand feeling you get from your smooth riding, *Marfak* lubricated car.

A smooth riding car means *Marfak* is doing its job . . . and it sticks to the job for a thousand miles and more. *Marfak* is scientifically designed to cling to bearing surfaces, to resist wash-out, jar-out and squeeze-out. Now is the time to see your Texaco Man and say: "*Marfak*, Please!"



THE TEXAS COMPANY

TEXACO DEALERS IN ALL 48 STATES



Tune in: TEXACO STAR THEATER presents the TONY MARTIN show every Sunday night. See newspaper for time and station

AUGUST 1947 213

NOW TRY Dustless SWEEPING



**Reduce Germ Laden Dust
Eliminate Sweeping Compound**

Dustless brushes used with Arbitrin sweeping fluid eliminate up to 97% of germ laden dust and reduce sweeping costs 20%. Arbitrin fluid, poured into a metal reservoir in the brush back, filters through the tufts and keeps dust down as you sweep. Dustless brushes are used in thousands of schools, factories, offices, stores, and institutions. There is a Dustless brush to fit your needs. Write for sizes, styles and prices today.



Milwaukee Dustless Brush Co.
530 N. 22nd St., Milwaukee 3, Wis.
Please send complete facts about Dustless Brushes.

Name _____

Street Address _____

City, State _____

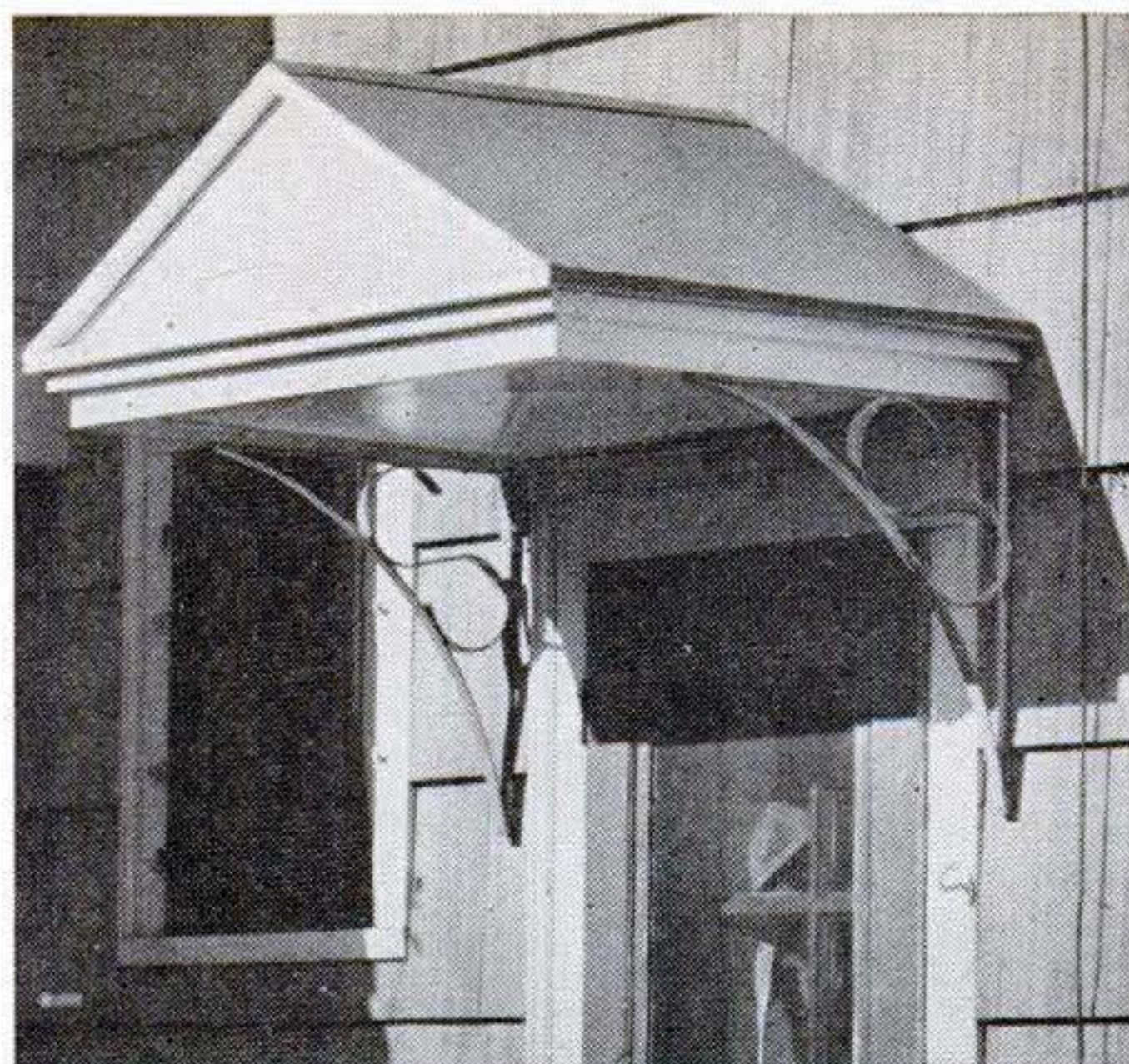

Canopy Is Ready-Made

INSTALLED in a few minutes over any outside door, a prefabricated canopy that offers shelter from rain and snow has been introduced by the Tel-O-Post Co., Akron, Ohio. Ornamental brackets support the aluminum structure, finished in white with green top.

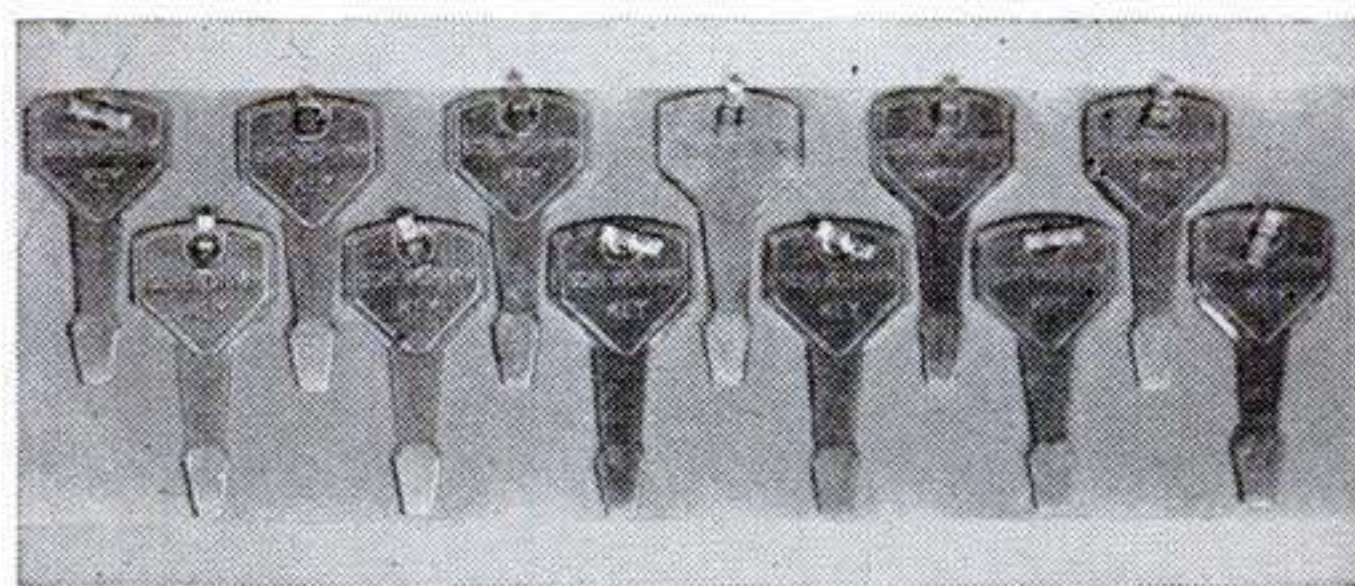

Key-Ring Screwdriver

SHAPED like a key and carried on a key ring, the pocket screwdriver displayed above always is at hand for use around the home. The Screwdriver Key Co., Hollywood, Calif., distributes the tool.



Model Builders Attention!

	V	V-2	V-3
Hex	1/2"	3/8"	5/16"
Thread	3/8"-24	1/4"-32	1/4"-32
Thread Length	7/32	7/32	5/32
Weight, Grams	8	3 1/2	2 1/2

Actual Size V-Plug

Champion Spark Plugs for model gas engines give the same dependable performance as regular Champions. Champion Ceramic insulation—Sillment sealed. Alloy needlepoint electrodes for easy starting. One piece construction.

CHAMPION

SPARK PLUG COMPANY • TOLEDO 1, OHIO

Dependable

CHAMPION

AMERICA'S FAVORITE SPARK PLUG

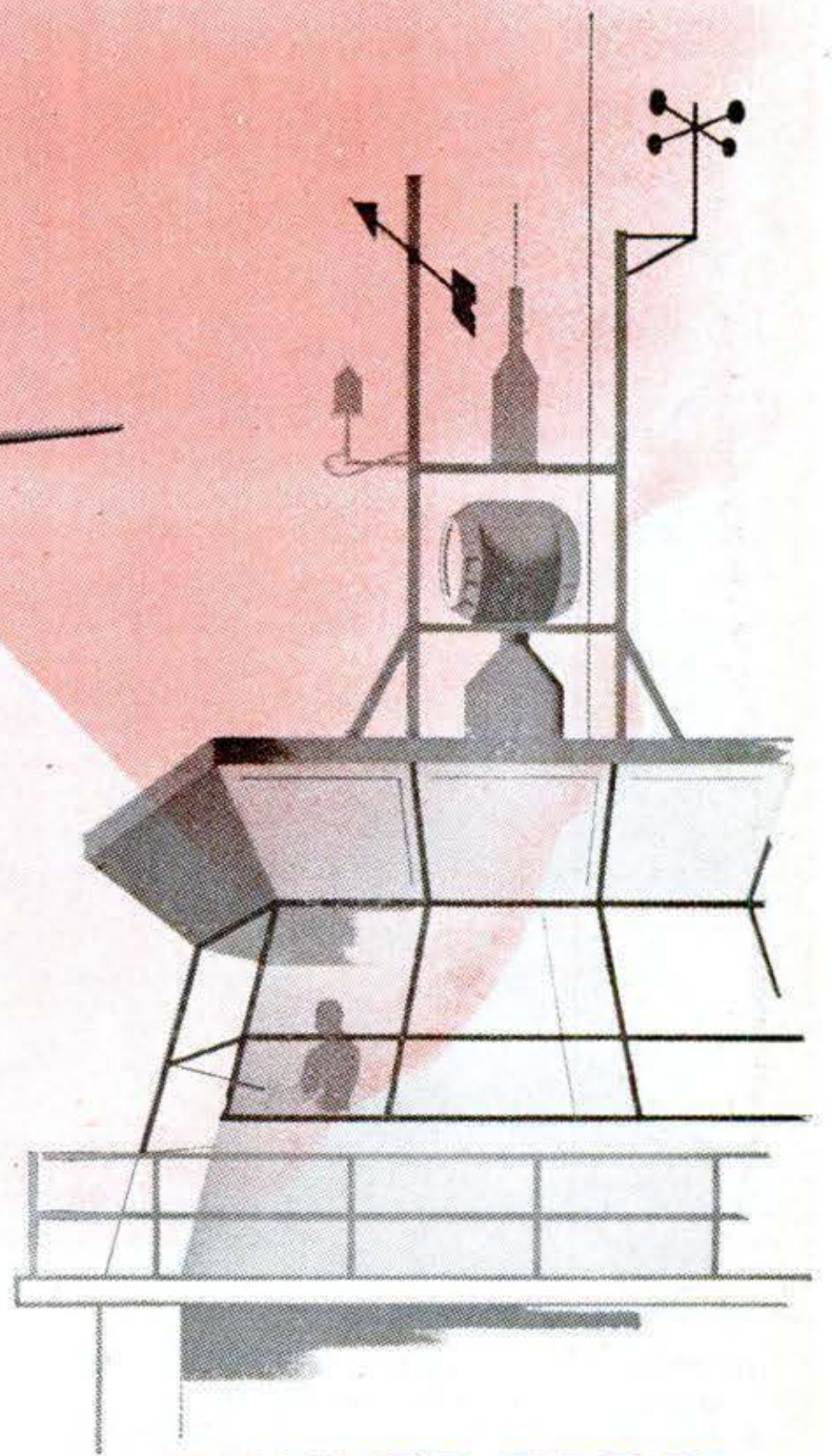

AIR TRAVEL IS A HIGHLY ORGANIZED AND STABLE BUSINESS . . . To handle increased traffic, no other form of public transportation has had to expand its facilities so rapidly. Last year more passengers were carried more miles than ever before, with the finest safety record in airline history—one that compares favorably with any other form of public transportation. The use of dependable Champion Spark Plugs by most airlines is a vote of confidence you should consider when buying spark plugs for your car. Specify *Champion* for better performance—it's America's favorite spark plug. Champion Spark Plug Company, Toledo 1, Ohio.

FOLLOW THE EXPERTS

**DEMAND NEW DEPENDABLE
CHAMPIONS FOR YOUR CAR**

Listen to the **CHAMPION ROLL CALL . . .** Harry Wismer's fast sportscast every Friday night, over the ABC network

AUGUST 1947 215

How Ford brakes eliminate

"Nutcracker Squeeze"

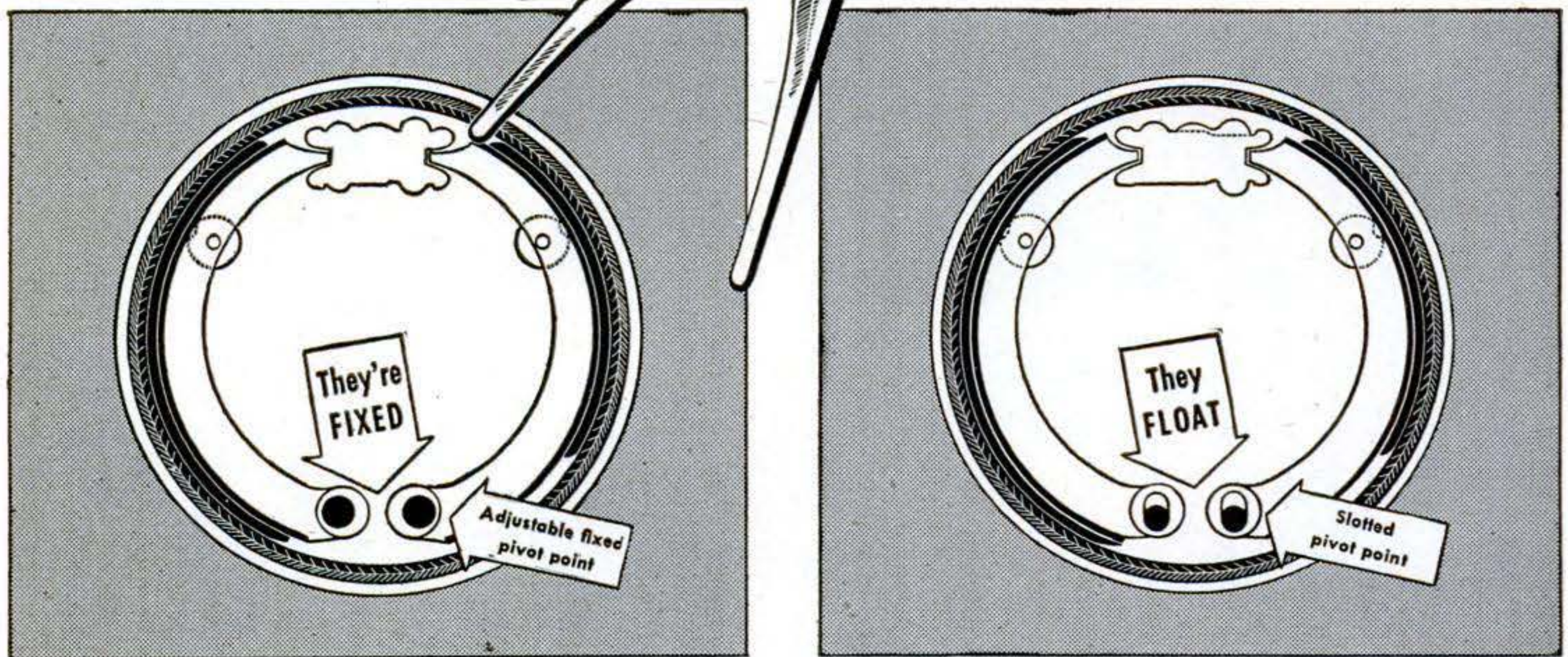

Old-type brakes use a nutcracker-type pivot. They have adjustable pivot points using eccentric anchor bolts on the bottom pivots, and a spread at the top. To eliminate the uneven contacts of such a pivot, Ford has developed a completely new type of hydraulic brake.

New type Ford brakes are *self-centering*. This design allows the brake shoes to *float* into complete contact with the drums for evenly distributed contact pressures and increased braking efficiency with 15% softer pedal action. And they're oversized for greater safety.



They're "King-size" Ford oversized hydraulic brakes have 162 square inches of lining area, 264 square inches of drum area—the largest in their price class. This gives you braking areas greater in relation to car weight than even some of the heavier, higher-priced cars. 12-inch cast iron brake drums mean greater safety.

They're Self-centering

Ford's new floating shoe design, with fixed anchor and slotted brake-shoe pivot, centers the brakes against the drum for full-lining contact. This gives brakes even, long life . . . easier, less frequent adjustment.

They're Long-lasting

Hydraulics . . . Ford brakes get their longer life not only from their self-centering feature, but also from the long-lasting cast iron brake drums. *With features like these, no wonder "Ford's Out Front" for safety.*

There's a **Ford** in your future





WHEN IT'S AN **Exide** . . . YOU START

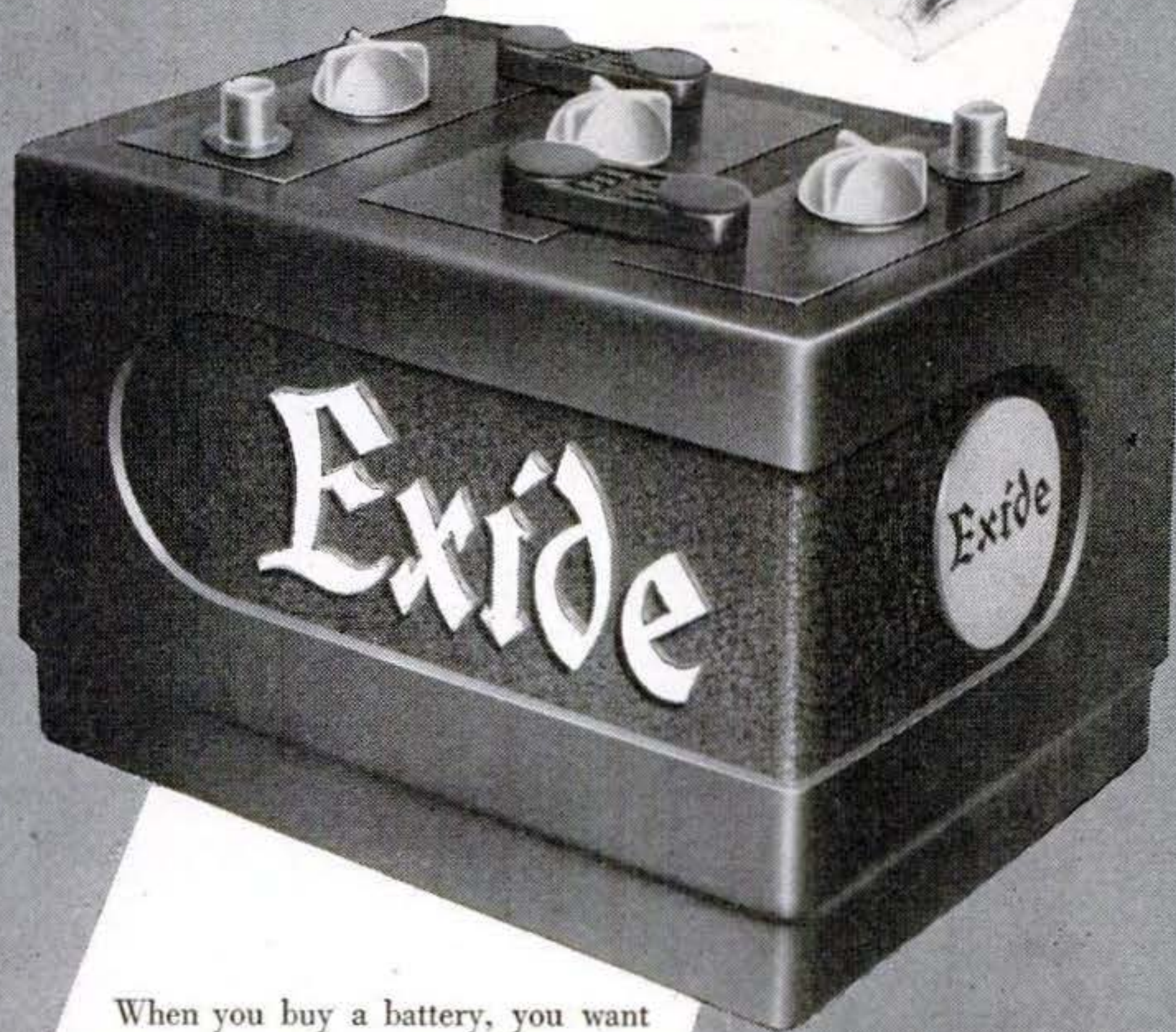

When you buy a battery, you want to be sure it will start your car . . . today, tomorrow, this winter. You might be tempted to get a cheaper battery, hoping it will last as long as you keep your car. But remember—*just one starting failure* can be far more costly than the little extra you pay for an Exide Battery that you know you can depend upon.

Play safe. Buy starting assurance. When it's an Exide . . . you start!

Depend on your Exide dealer for good products, good service

THE ELECTRIC STORAGE BATTERY COMPANY • Philadelphia 32

Exide Batteries of Canada, Limited, Toronto

USE AC's FOR
**UTMOST
 RELIABILITY**

"The mail must go through"—and does, with the help of today's AC's in thousands of mail cars and trucks. You can enjoy utmost reliability in spark plug performance by having your spark plugs checked to be sure they are right for today's driving and fuels.



Look for this sign



Spark Plugs cleaned and adjusted "By the AC Method" may save as much gas as 1 gallon in 10

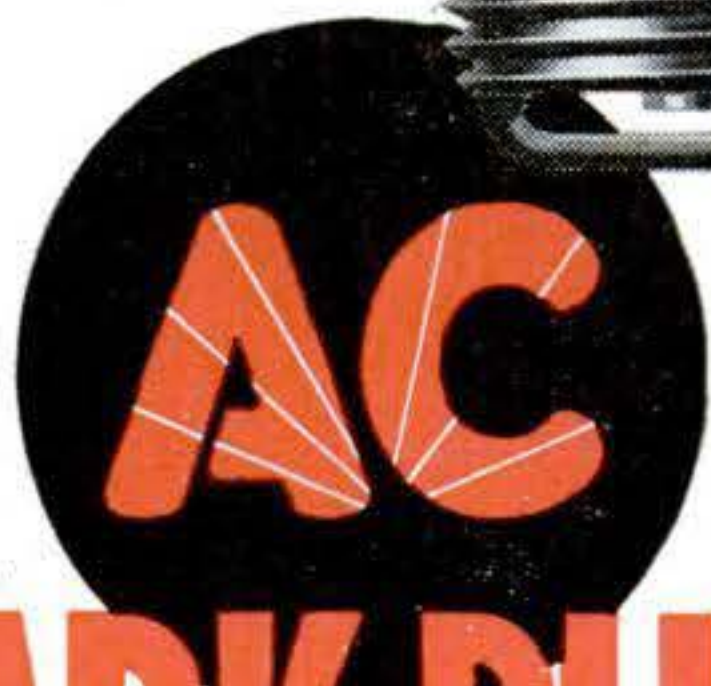

SPARK PLUGS

AC SPARK PLUG DIVISION - GENERAL MOTORS CORPORATION

218 POPULAR SCIENCE

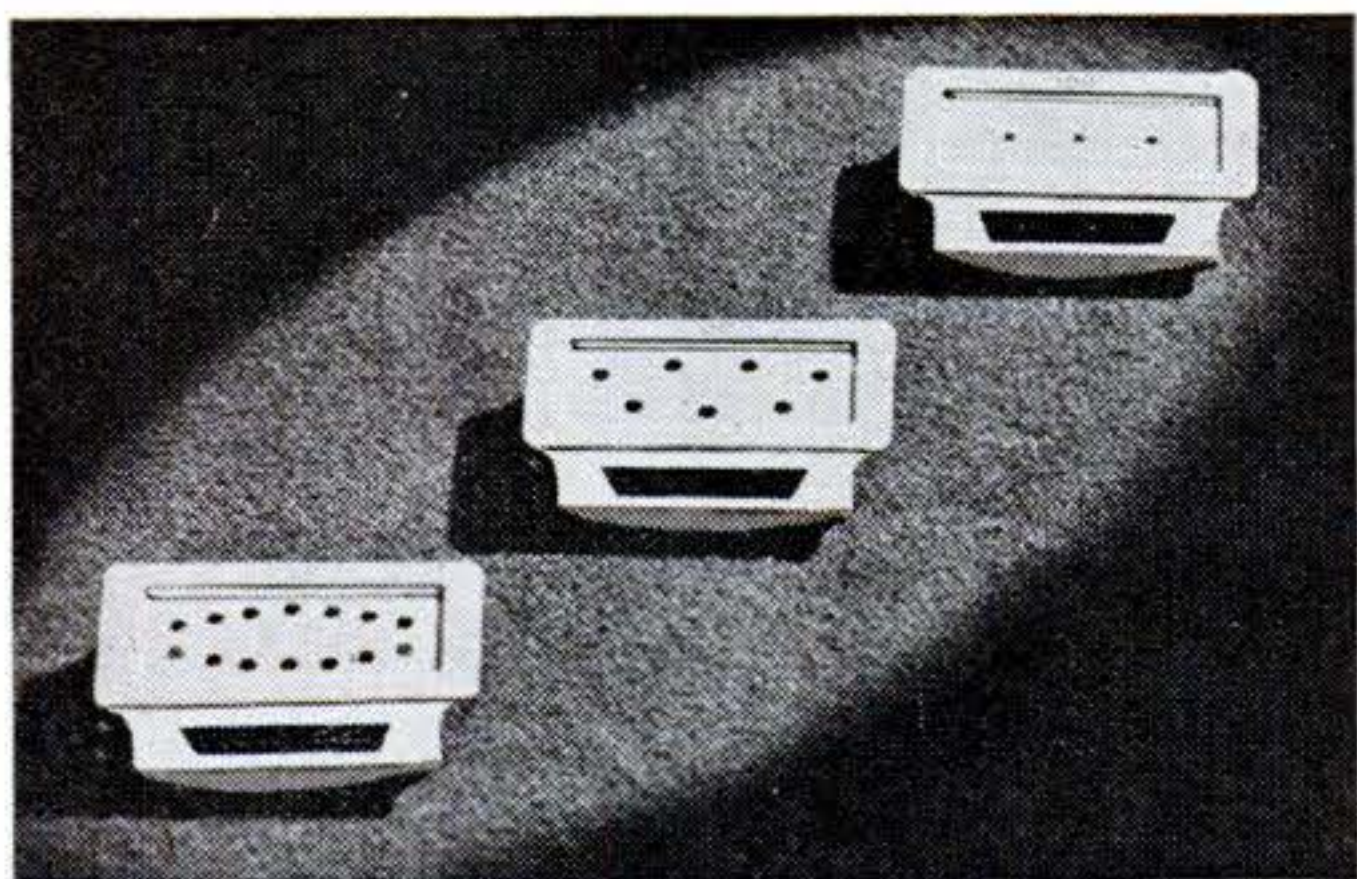

Gauging Bright Lights

WITH these little "multipliers" you can vastly increase the upward range of a GE exposure meter. Clipped to the meter after the hood has been removed, they use the "incident light" method of measuring exposures. The three available sizes, shown above, measure illumination intensity up to 700, 1,400 and 7,000 foot-candles.



Vibration Aids Shave

STRAIGHT-EDGE closeness and safety-razor smoothness are claimed for the new Electro-Shav. It uses ordinary safety-razor blades, but vibrates them electrically 120 times a second, producing a cross-cutting action. Without electricity, it can be used as an ordinary safety razor. It is made by the H. D. Campbell Co., Rochelle, Ill.

**Piston rings
wear out, too!**

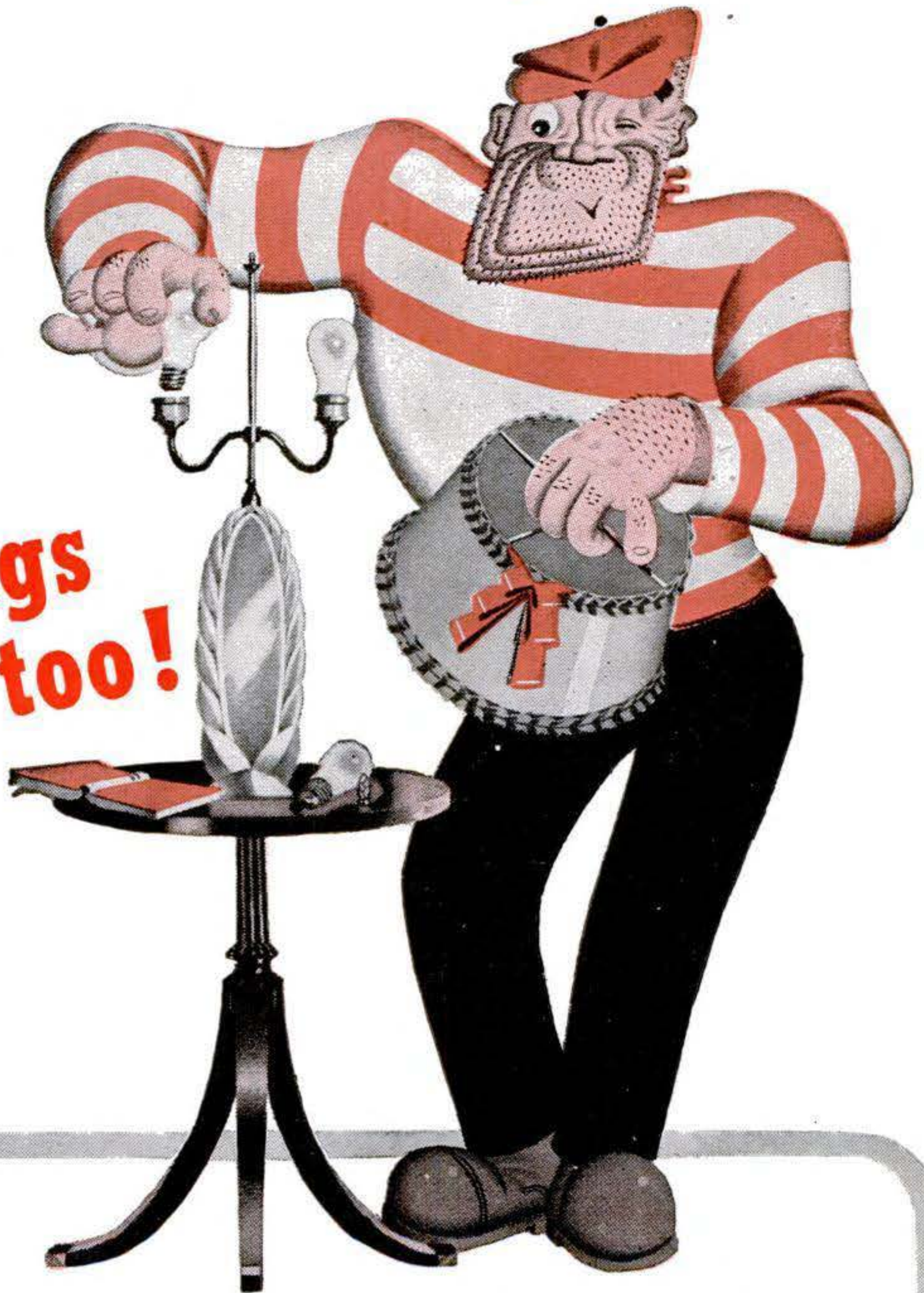

Engine wear is mostly *parts* wear. Certain parts, like piston rings, are designed to "take" the wear and be replaced again and again.

When your car begins to smoke, waste oil or lose power,

it will pay you to install Hastings Piston Rings *at once*. They *stop* oil-pumping, *check* cylinder wear, *restore* performance. It's the best money you can spend on your car.

Hastings Manufacturing Company, Hastings, Mich.
Hastings Ltd., Toronto



HASTINGS

STEEL-VENT PISTON RINGS

TOUGH on Oil-pumping **GENTLE** on Cylinder Walls

**MORE
Good Implement Dealers
Sell Bolens HUSKI
Than Any Other Garden
Tractor!**

YOUR NEARBY BOLENS HUSKI DEALER is a good man to know, for he's sincerely interested in selling and serving you the best. Let him show you the complete Bolens HUSKI line of economical 2-Wheel Tractors and "Packaged" Implements for plowing, harrowing, seeding, fertilizing, cultivating, mowing, snowplowing. All tools easily, quickly attached. 2 popular models — 3 H.P. Gardener — 1½ H.P. Power-Ho. Buy attachments when and as needed.

WRITE TODAY for name of nearest dealer and illustrated literature.

BOLENS PRODUCTS DIVISION

**Bolens HUSKI
2-WHEEL
TRACTORS**

FOOD MACHINERY CORP.
267½ Park Street
Port Washington, Wisconsin

The Standard for Over 30 Years

Completely New and COMPLETE

**Federal's Low Price INCLUDES
A Highly Corrected
Enlarging Lens**

When you examine the price tags of the new Federal Enlargers remember that the price on the tag is for a complete enlarger... LENS AND TAX INCLUDED.

For Federal's low prices are not arrived at by stripping off important enlarger parts and listing them as separate items in order to give the impression of low price.

Federal's prices are low! . . . the result of years of specialized experience in designing and building "America's Fastest Selling Enlargers" . . . undeniably America's greatest enlarger values.

MODEL 312. For miniature to 2¼" x 3¼" negatives. Fedar: 3½" F:6.3 Anastigmat with Iris Diaphragm.

Complete with lens **\$53⁰⁰**
Tax Included

Model 315 (as illustrated) \$89.50



FEDERAL MANUFACTURING & ENGINEERING CORP.
Makers of Photographic & Electronic Devices
213 STEUBEN STREET • BROOKLYN 5, N. Y.



DRIVING AN OIL-EATER?

Cut fuel and oil bills . . . give your car new zip . . . install a set of quick-seating Burd "Graf-Flox" Piston Rings.

Send, today, for two free, handy booklets for car-owners. Print name and address in margin, clip and mail ad today!



BURD PISTON RING CO., DEPT. PS, ROCKFORD, ILL.



**Off to Vacationland
BY HULL AUTOMOBILE COMPASS**

Drive by the time-proved, sure guide of motorists. Don't let direction worries, wrong-way travel, lost time upset your vacation trip. Beaconlite illuminated (shown), \$5.95; Streamline, \$3.95. At your dealer's. Write for circular.



HULL MFG. CO.
P. O. Box 246-E7
Warren, Ohio

**FOR SAFER DRIVING IN STORMS AHEAD
ASK YOUR GAS PUMP MAN TO PUT ON FOR YOU**

New "DEAD-LOCKER" Models
**ANCO RAIN-MASTER
Windshield Wiper Arms and Blades**

Made in U. S. A. by
THE ANDERSON COMPANY GARY, INDIANA

**arc welding
manual and text
book...\$2⁰⁰**

Teaches you how to become an arc welding operator — one of highest paid trades today. Write today!

Hobart Bros. Co., Troy, Ohio Box P-562

**UTICA TOOLS
FOR MORE TOOL MILEAGE**

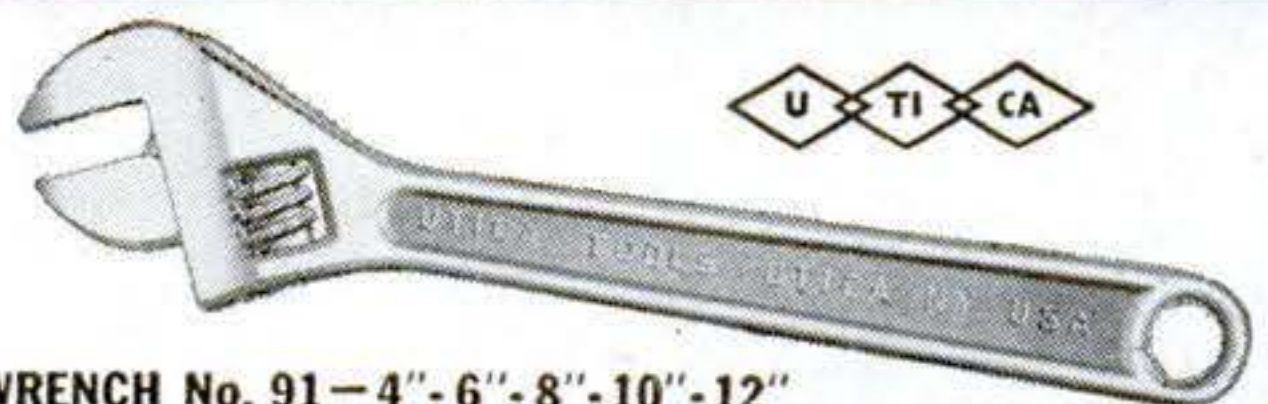

WRENCH No. 91 — 4" - 6" - 8" - 10" - 12"

**UTICA DROP FORGE & TOOL
CORPORATION
UTICA 4, NEW YORK**

**NEW
WHIZZER
"STATION
WAGON"
DOUBLES YOUR
BIKE'S
USEFULNESS**

Here's a great new bike trailer that's built to last. What's more, the extra-light, extra-strong WHIZZER "Station Wagon" fits *any* bike. Full swivel hitch. Quickly attached and detached . . . makes an ideal hand cart around the yard and for shopping in stores. Carries bulky loads easily, safely . . . does not affect balance or control of bike. For low-cost delivery . . . drug stores and groceries . . . paper routes . . . personal shopping—get a WHIZZER "Station Wagon" today! Ideal for week-end trips and summer camping. Comes in knock-down package form.

Only
\$14.95

F.O.B. PONTIAC, MICH.

SPECIFICATIONS—Rated over 200 pounds capacity. Strong steel undercarriage, natural finish wood "station wagon" sides. Semi-pneumatic 10-in. tires. 24" long, 18" wide, 20" deep.

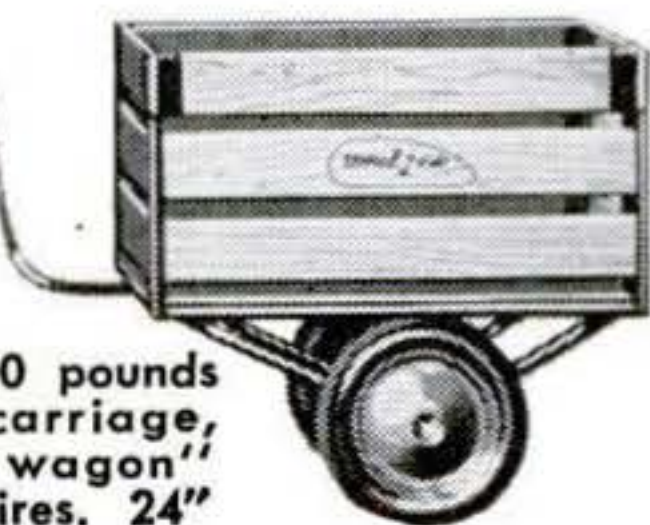

See your local bike dealer or order from

WHIZZER MOTOR SALES CO.
PONTIAC, MICHIGAN

**CONGRESS
PULLEYS**

Still at
**PRE-WAR
PRICES**

America's finest pulleys—diamond-bored, tested for true-running—in all popular sizes, at your hardware store. Insist on Congress—your best buy in pulleys.



Sign of an Authorized Congress Dealer



CONGRESS *DIAMOND BORED* **DRIVES**

3750 EAST OUTER DRIVE

DETROIT 12, MICHIGAN

**LOW PRICED
FOR THE FIRST TIME IN YEARS!**

REGULAR \$23.45 VALUE
NOW ONLY

\$14.95

Real fractional horsepower AC-DC Electric Motor



**FAMOUS CASCO
POWER WORKSHOP**

New portable all-purpose Electr-O-Tool Kit

**FOR MECHANICS,
HOBBYISTS, HOME CRAFTSMEN**

Works on wood, metal, glass, plastics, leather. Long life, powerful 20,000 RPM motor in unbreakable plastic case, oil-less bearings, air-cooled. Exclusive built-in finger grip for perfect control. Fully guaranteed. 20 interchangeable precision-made accessories in fitted chest. Free descriptive literature on request.

SPECIAL LOW PRICE OFFER

Price of power tool alone \$14.95
20 accessories and valuable Project Book 8.50
Total Value \$23.45
ALL 21 PIECES FOR ONLY \$14.95

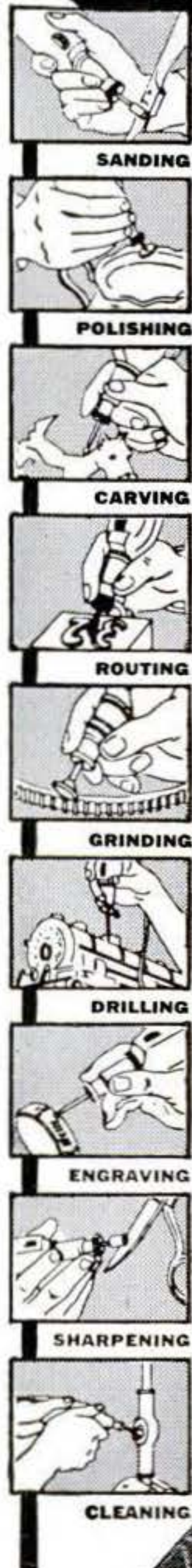

ENGRAVING

SHARPENING

CLEANING



CASCO

See Casco's other big value: Casco Electri-Craft Power Tool Kit, complete with 36 accessories in fitted steel chest. \$32.95 value for only \$22.50.

CASCO PRODUCTS CORPORATION • BRIDGEPORT 2, CONN.

HOW TO MAKE LOOSE FIXTURES STAY TIGHT



Hinges, door handles, coat hooks, drawer pulls, knobs, casters, bathroom fixtures, tool and cutlery handles, set in Smooth-On No. 1 Iron Cement, do not work loose. Mix the cement with water, apply it to the hole in which the screw, bolt, tang or other part fits, and insert the part. The Smooth-On hardens quickly and holds the part firmly in place.

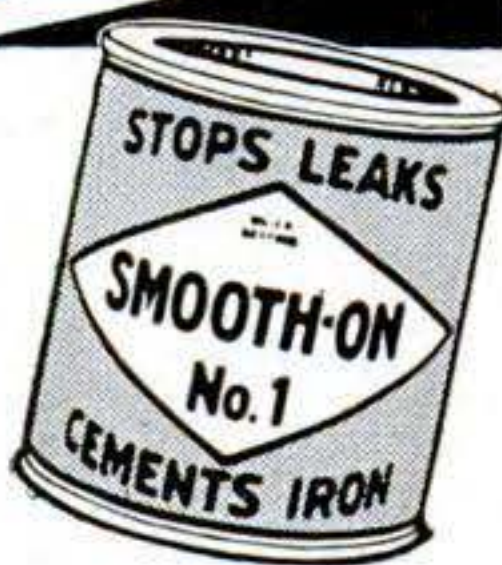

Smooth-On No. 1 has been a repair standby for over fifty years, sealing cracks, stopping leaks, tightening loose parts and fixtures. Get it in inexpensive 1¾-oz., 7-oz. or larger size at your hardware store. If they haven't it, write us:

FREE REPAIR HANDBOOK

40 pages. 170 diagrams. Simple instructions. Tested, short-cut repairs on home, garage and shop equipment. Pocket size. Paste the coupon on a postcard and send for YOUR free copy today.



..... Sign and Send Now

SMOOTH-ON MFG. CO., Dept. 58H,
570 Communipaw Ave., Jersey City 4, N. J.
Please send me a Smooth-On Handbook.

NAME.....

ADDRESS.....

8-47.....

Do it with **SMOOTH-ON**
Iron Cement of 1000 Uses

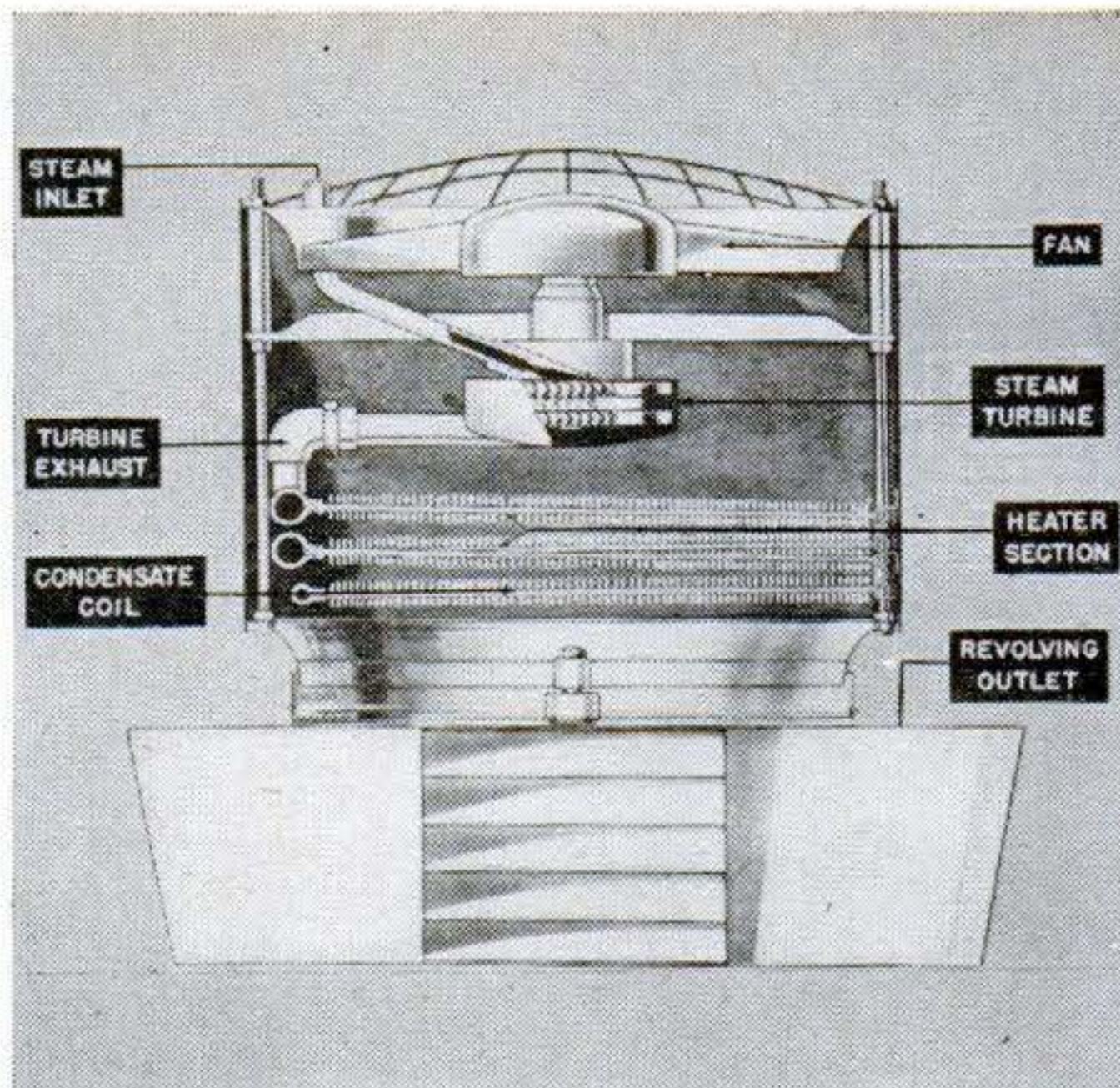

Steam Fans Its Own Heat

STEAM does double duty in a heater developed by the L. J. Wing Mfg. Co., of New York. First the vapor is shot through an all-steel turbine that drives a fan. Then it is piped through a heating unit, and the resulting hot air is blown out revolving vents in the bottom by the turbine-activated fan. The condensed steam goes back to the boiler through an open return system. Advantages claimed for the heating system include elimination of electric motor, no back pressure, no packing and no traps.



Case Holds Camera Aids

PHOTOGRAPHERS' pockets can be a bit less cluttered, thanks to a new case put out by Eastman Kodak. One of its compartments holds a lens hood and adapter ring with filter; the other carries three more filters in separate leather pouches.



Snap-on's BLUE-POINT BOXOCKETS combine socket wrench grip with direct leverage!

Straight handle Boxocket wrenches are designed with heads set at a 15° angle so that they can be used in many corners where an offset wrench might prove cumbersome.

The 15° angle provides ample clearance from obstructions . . . avoids skinned knuckles . . . and gives you long, direct, pulling leverage. Add to this the many advantages of Boxocket construction, including the fact that they need only half the space required by an end wrench when handle movement is limited, and you have a husky, "no-slip, no-spread" Boxocket wrench to speed your work. Sizes range from 3/16" to 1 1/4" with different size openings in each end for double duty service. Other Boxocket styles, 3/16" to 3 1/8". Available through Snap-on's nationwide, direct-to-user tool service.

SNAP-ON TOOLS CORPORATION
 8060-H 28th AVENUE • KENOSHA, WISCONSIN
 International Division: Kenosha, Wisconsin, U.S.A.



XD-6K BOXOCKET SET

12 popular wrench sizes ranging from 7/16" to 1" without duplication, offset at 15° angle on 6 long-leverage handles. Complete in sturdy leatherette kit for **\$1100** only

MAIL YOUR ORDER . . . Our local representative will deliver the set to you. Give business address if possible.



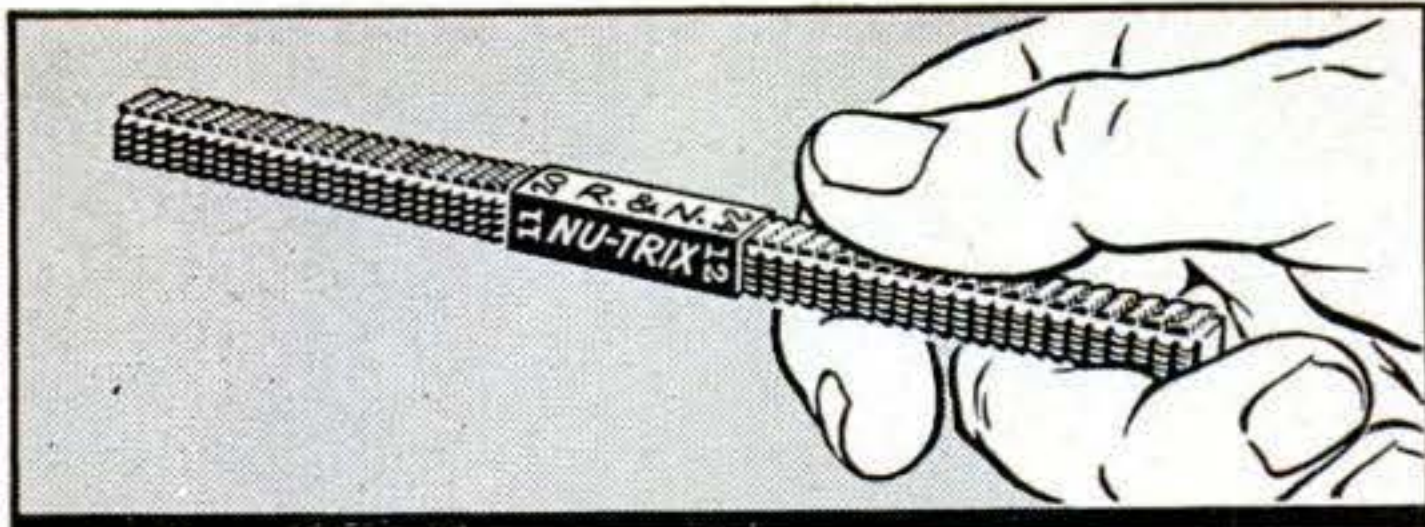

U. S. Pat. No. 1694229

NU-TRIX THREAD RESTORER

Use it Like a File, Fix Battered Threads on Bolts, Shafts or Studs, etc., with a Few Strokes.

A Tool Box necessity—8 Tools in one

No. 1 Nu-Trix for 11, 12, 13, 14, 16, 18, 20, & 24 Thds. per in.

No. 2 Nu-Trix for 9, 10, 15, 16, 20, 26, 28, 32 Thds. per in.

Price 2.00 ea. P.P. Prepaid

REIFF & NESTOR COMPANY

Box G

Lykens, Pa., or your local jobber

Enclosed Money Order \$..... or Check please send No. 1 No. 2 Nu-Trix

Name.....

Street.....

City..... Zone.....

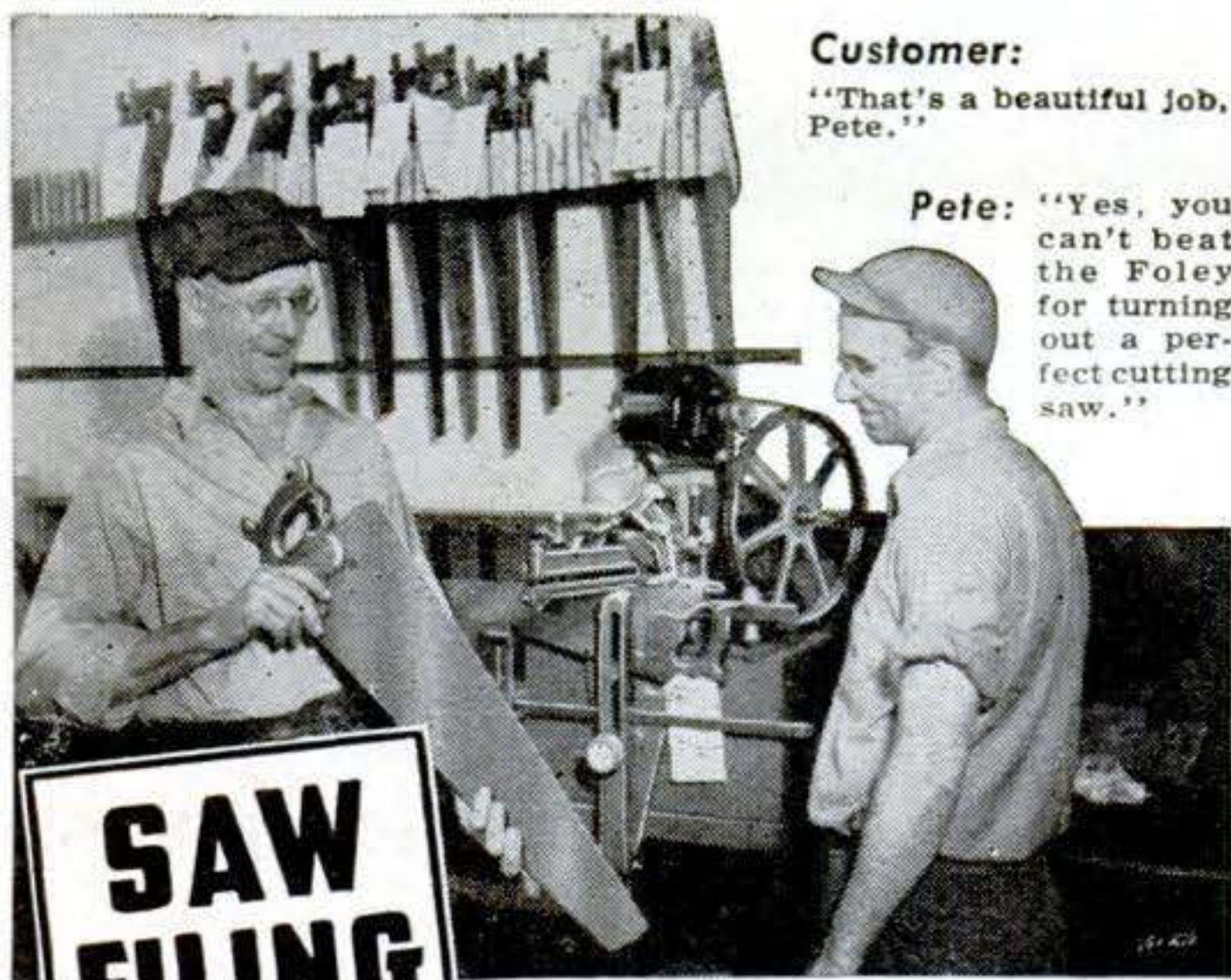

Customer:

"That's a beautiful job, Pete."

Pete: "Yes, you can't beat the Foley for turning out a perfect cutting saw."

SAW FILING

is a Good Business

With the Foley Automatic Saw Filer you can put yourself into a fine cash business with steady customers and make a good living. The Foley automatically joints the saw, making all teeth even in size, shape, spacing. The Foley is the only machine that files all hand saws, also band and cross-cut circular saws. **SEND FOR FREE PLAN**—Shows how to start a saw repair shop. No canvassing. Send coupon today.

FOLEY Automatic SAW FILER

FOLEY MANUFACTURING CO.

819-7 Foley Bldg., Minneapolis 18, Minnesota
Send Free Plan on Saw Filing business, no obligation

Name.....

Address.....



MOW-MASTER Rotary Mower

Cuts Tall Grass and Weeds Easily--Quickly

It's fun to mow with the MOW-MASTER! Powered by famous POWER-PAK 2 H. P. air-cooled gasoline motor with muffler. Light weight. Advanced design.

AT YOUR DEALER'S

PROPULSION ENGINE CORP.
Dept. 302 7th & White Eagle Rd.
Kansas City, Kansas

USE YOUR BENCH SAW

FOR JOINTING & CUTTING MOULDINGS



With our six inch tool steel cutters make mouldings, casings, drop-leaf tables, grooves beading and jointing. Moulding cutters, A 1 in. wide \$1.50. 1 1/2 in. \$2.00. Jointing cutters, B 1 in. \$1.50. 1 1/2 in. \$2.00. E 1 in. for drop-leaf tables, \$1.50. E 1 1/2 in. Makes 3/4 in. cove & Quarter. \$2.00. Postpaid. Guaranteed. State size hole. List & Folder free.

JOHN A. SANDSTROM
Rt. 1-P. Clearwater, Fla.



DOWELS Make Your Own And SAVE

Let this amazing tool start saving its cost in making your mahogany, maple or any kind of dowel. **SPEE-DOWL** Only \$1 each size.

Model 8 (shown) 2, 3, 4, 5, 6, 7 & 8/16" **SPECIAL:** 4—\$3.50; 7—\$6.
Model 20 (not shown) \$2.65 each. Sizes 9 to 20/16" 12—\$25.

Guaranteed. Postpaid in North America.

FREE LITERATURE on this and never dull carbide tipped wood turning tools.

JOHNS MFG. CORP.

Dept. B-11, DUNELLEN, N. J.

SEALED POWER PISTON RINGS

save oil, save gas, restore original power

Send postal for free booklet on oil-saving.

SEALED POWER CORP., DEPT. H6, MUSKEGON, MICH.

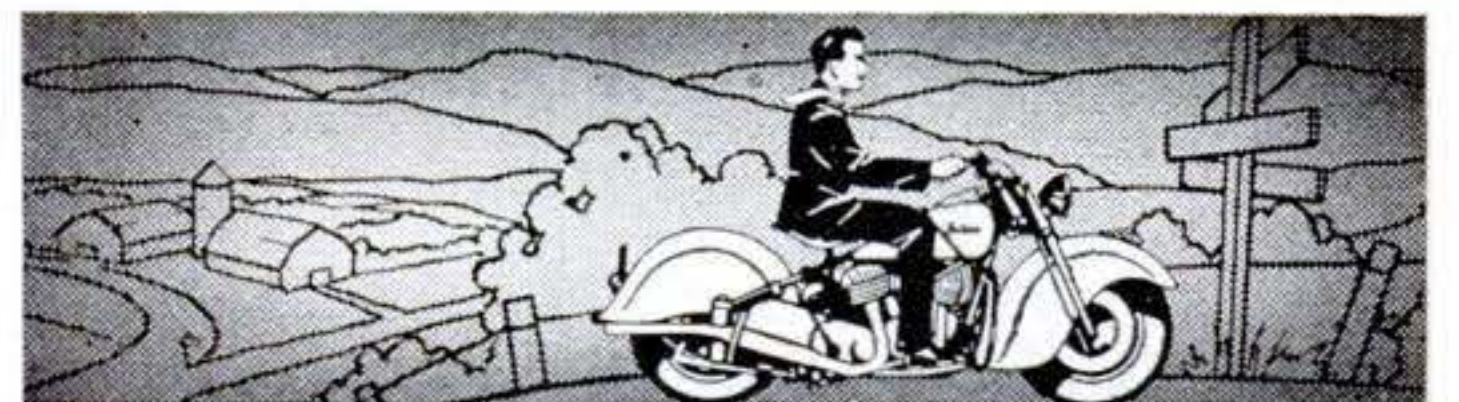

Indian

WORLD'S FINEST MOTORCYCLE
SPRINGFIELD, MASSACHUSETTS

SMALL EFFICIENT SPEED REDUCER

Just the thing for the Home Work Shop, Hobby Shop, Bench Work, Animated Displays, Light Production work. Used daily in thousands of homes and shops. Sturdy, compact, (see dimensions). Case of aluminum. Gears, SAE 65 (British) Gear Bronze. Worm of case hardened steel. Timken Bearings throughout. Torque capacity 100 inch pounds Available in 4 different assemblies (shown below) and in these standard ratios:

4-1	25-1	64-1	200-1
8-1	30-1	75-1	200-1
10-1	40-1	80-1	400-1
16-1	50-1	100-1	600-1
20-1	60-1	150-1	800-1

When ordering be sure to specify assembly and ratio required. Shipping weight in carton, 8 lbs. Full money back guarantee. Prompt deliveries.

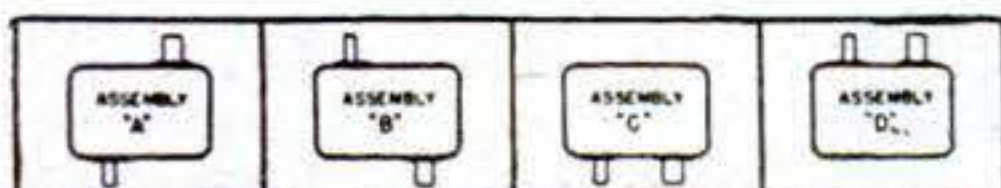

THE OHIO GEAR CO.
1428 EAST 179th ST. • CLEVELAND 10, OHIO



\$18.56

NET - POSTPAID

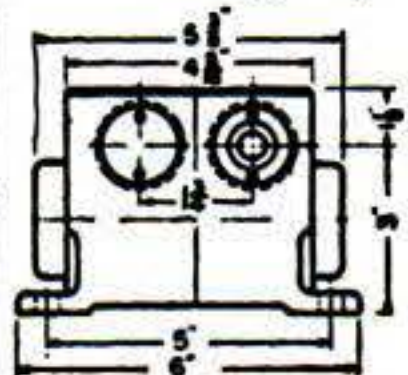
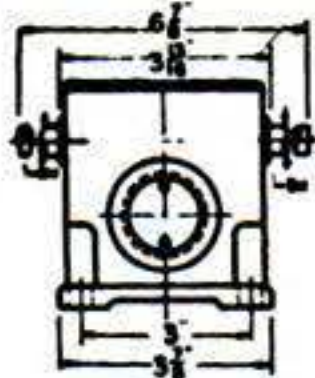

SHOOT LIKE A PRO WITH METEOR

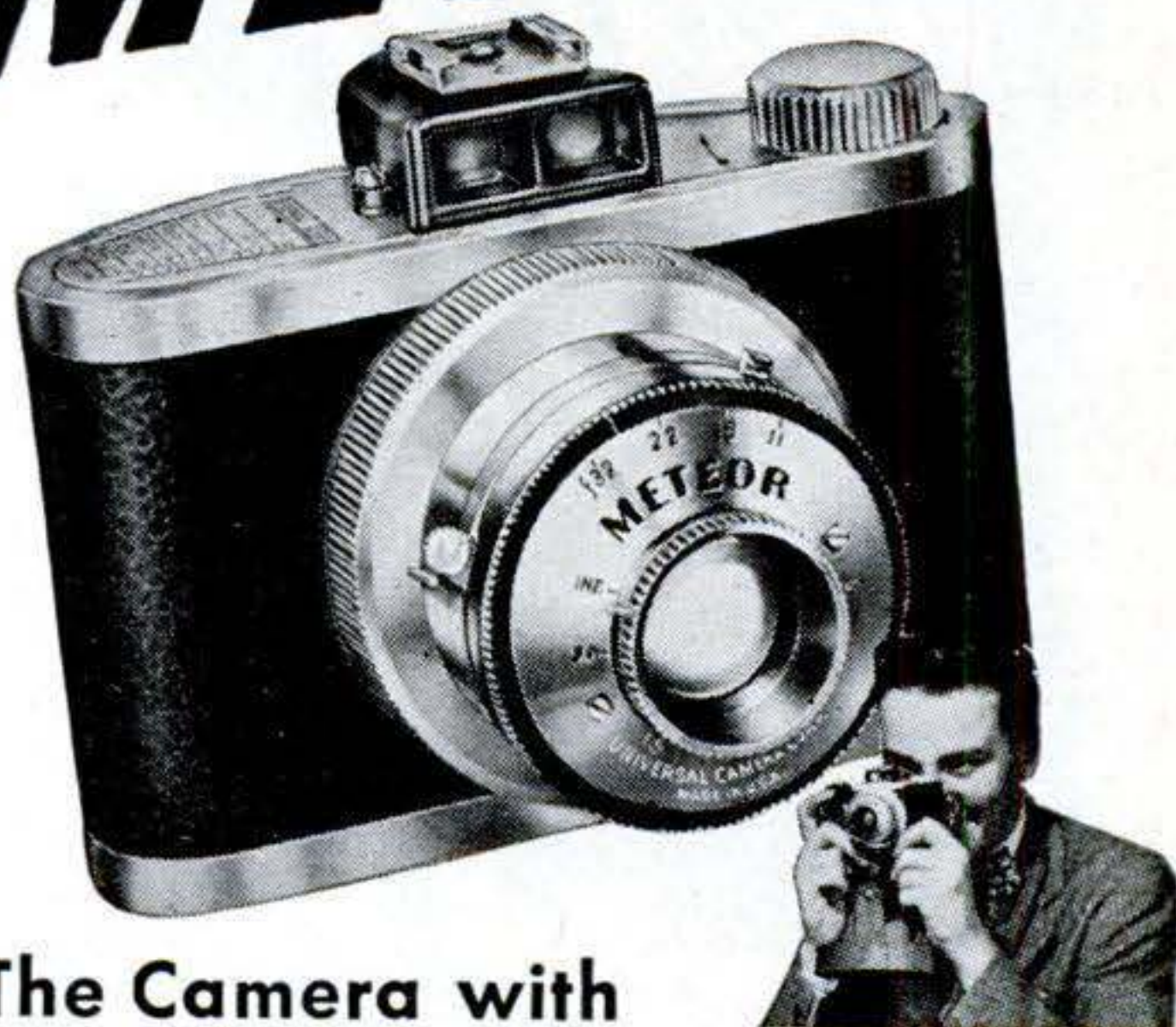

The Camera with 12 "Professional" Features...

Action! Close-ups! Indoor Shots! . . . all easy with the Meteor - Universal's smart new low-priced camera with twelve "professional" features.

Streamlined Design! All-metal construction - lightweight aluminum - with pebble-grained cover.

Coated Miniscus Lens! For clear, sharp pictures every time!

Adjustable Diaphragm! For better pictures under any light conditions!

Collapsible Lens Mount! Ready for action at the flick of the wrist!

Rotary-Focusing Mount! No special attachments needed for close-ups, landscapes, etc.

Built-in Lens-Shade! Protects pictures from glare!

Built-in Exposure Meter, Calculator! Makes it easy to get proper exposures every time!

Built-in Synchronized Flash! Get those "professional" indoor shots!

Optical View Finder! See what you're getting before you shoot!

Chamber Loading! Takes standard 620 film in a unique chamber-loading device.

Tripod Socket!

Square Pictures! 2 1/4 x 2 1/4 exposures mean no gymnastics - camera never needs to be re-oriented!

See the Meteor at your dealer's today. It's the camera-bargain of the year at... **ONLY \$15**

UNIVERSAL CAMERA CORPORATION
NEW YORK CHICAGO HOLLYWOOD

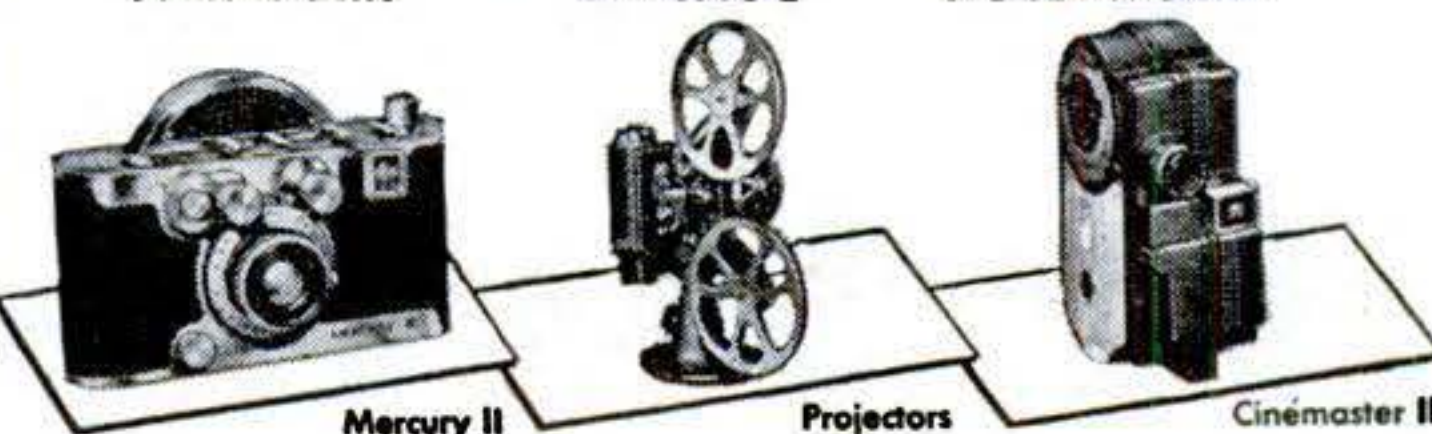

Why spend years learning by hard experience what you can get from a practical book in a few hours.

Write for list of "How-To-Do-It" books on practical subjects. 1000's of pleased customers all over the world.

ADAMS BROWN COMPANY - BOOKS OF APPLIED SCIENCE
Dept. 278 Chestnut Hill 67, Massachusetts, U. S. A.

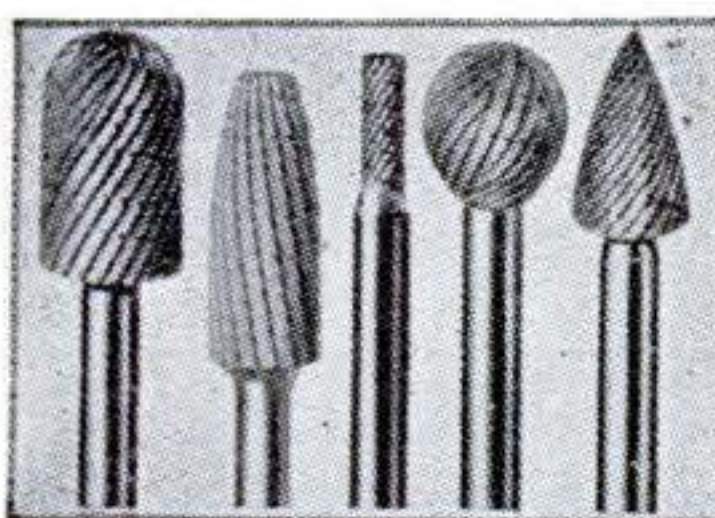

HIGH SPEED ROTARY FILES

Set of 5 Assorted.....	\$2.00
Set of 10 Assorted.....	\$3.75
Set of 20 Assorted.....	\$7.25
Set of 30 Assorted.....	\$10.00

1/4" shank
Send for circular on High Speed DRILLS & TAPS. Enclose 3c stamp for mailing.

SID TOOL CO.
MACHINE SHOP SUPPLIES
183 Grand St., New York 13, N.Y.

LAW

STUDY AT HOME for PERSONAL SUCCESS and LARGER EARNINGS. 39 years expert instruction - over 108,000 students enrolled. LL.B. Degree awarded. All texts furnished. Easy payments. G.I. Approved. Send for FREE BOOK.

AMERICAN EXTENSION SCHOOL OF LAW
Dept. 80-S, 646 N. Michigan Ave., Chicago 11, Ill.

BUILD YOUR OWN POWER LAWN MOWER

WHY BREAK YOUR BACK MOWING FIELD OR LAWN?

WRITE FOR FREE LITERATURE The Rite-Way Mower Attachment Ball Bearing



SAVE MONEY SAVE TIME

Now anyone can save time and effort mowing field or lawn by building their own whirl type power mower. Build according to your own ideas and needs at small cost. Cut close to fences, walks, buildings, etc. Build in short time with parts and instructions we furnish. Save hours of time and back breaking labor. Write today for FREE information.



IT'S FUN TO BUILD

T & H MFG. CO., Dept. S-5
811 E. 31, Kan. City 3, Mo.

RUNNING HOT WATER INSTANTLY!

From Your Cold Water Faucet

with **ROLEY Instant Hot Water Heater**



\$8.49

Guaranteed to give running hot water instantly.

Here's one of the greatest household inventions of all time . . . back again for the first time in many years. Now you can actually have all the hot water you need the instant you need it . . . FROM YOUR COLD WATER FAUCET! This new postwar type heater quickly attaches to any cold water faucet . . . in the basement for extra hot laundry work . . . in the bathroom for bathing needs . . . in the kitchen for dishes, cooking and cleaning. You regulate the temperature and quantity with your faucet handle. Just plug the cord in any electric outlet (AC or DC, 110-120 volts), turn the faucet and **PRESTO—Hot Water**, anytime of day or night, as much and as hot as you want. Easy to install, complete with 6-foot extension cord. Order one or more **TODAY.**

SEND NO MONEY

Just write today . . . order your Roley electric Water Heater and pay the postman \$8.49 plus postage when delivered, or send \$8.49 and we will pay the postage. Try for 5 days and if not completely satisfied return to us and we will gladly refund full purchase price. No C.O.D.'s outside U. S. A.

ROLEY SALES CO., INC. Dept. FJ-70 15 Spruce St. New York 7, N. Y.

Name
 Address
 City & Zone State

IMMEDIATE DELIVERY!

Complete as shown

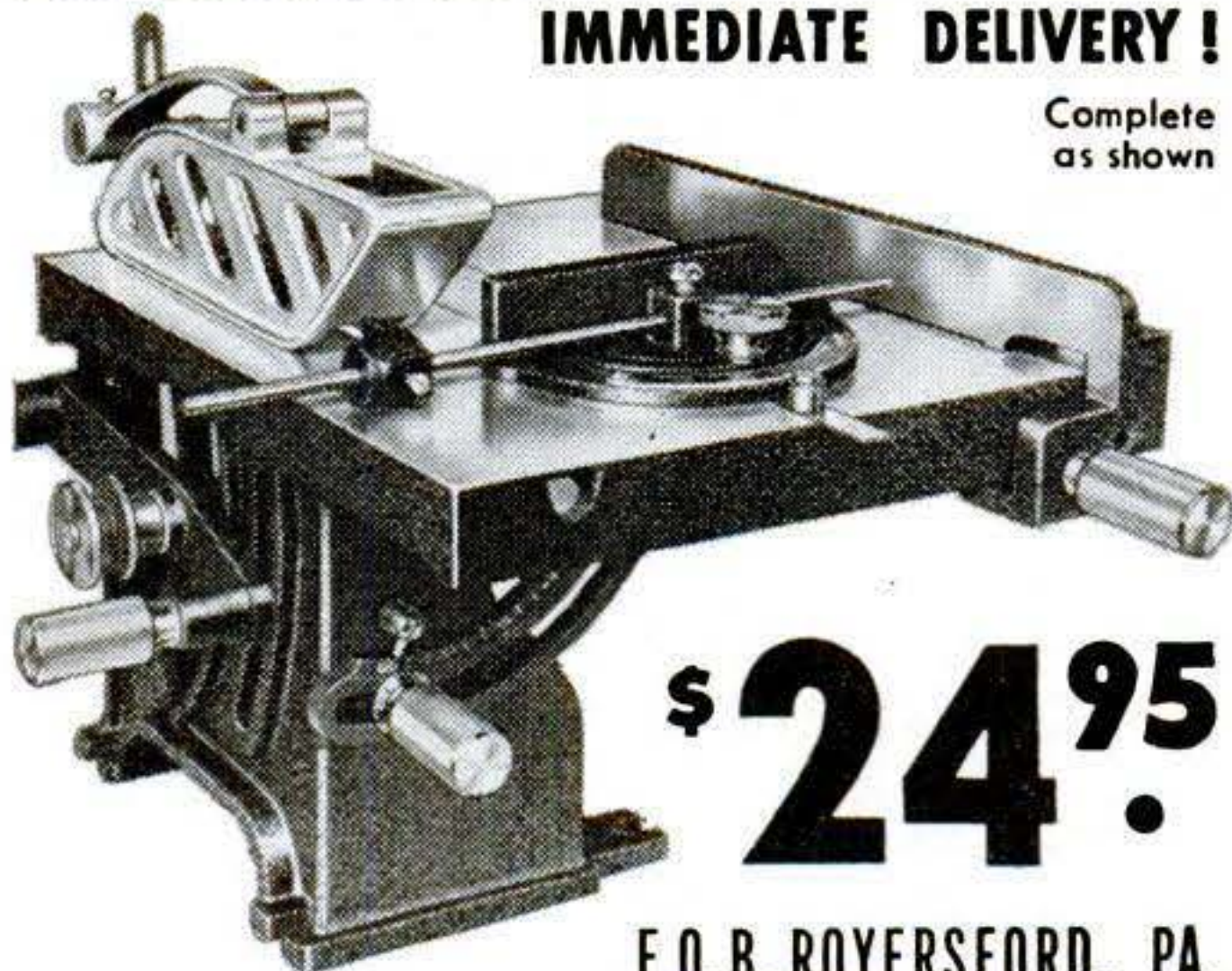

\$24.95

F.O.B. ROYERSFORD, PA.

QUALITY 8" BENCH SAW
 CUTS THROUGH 2⁵/₁₆"

UNCONDITIONALLY GUARANTEED ONE YEAR

(Write for Free Booklet and Guarantee Bond)

Comes complete with Floating motor mount—miter gauge with adjustable stop—aluminum guard—soft aluminum insert—spring steel splitter—heavy gray iron fence—(no motor—no blade).

Table 12" x 14". Tilts to 45°—Oilite bearings. Shipping Wt. 50 lbs.

AMERICAN MACHINE & TOOL CO. Inc.

DEPT. 200

ROYERSFORD, PA.

A TOOL... NOT A BRUSH

\$1.00 POST PAID

NOW! PAINT STRIPING MADE EASY!

PAINTERS' STRIPING TOOL

Easy to use as a pencil! Draws parallel lines, straights, curves, circles with paint, enamel, lacquer, etc. Do your own striping on autos, furniture, toys, bikes, model planes, signs, linoleum . . . make wall board look like tile. Painters—craftsmen, order today! Type "M" Master Painters' Striping Tool complete with tip for 1/16" stripe, \$1.00. Extra tips 1/64", 1/32", 3/64", 1/16", 5/64", 3/32", 1/8" — 75c each. Tool with complete set of 7 tips \$5.00 (C.O.D. orders 25c extra.) Dealers write!

WENDELL MFG. CO.
 4234-A Lincoln Ave., Chicago 18, Illinois



SHAW GARDEN TRACTORS and MOWERS

Get FREE FOLDER NOW!

Get details on 1 to 9 H. P. walking and riding tractors. Do 1000 jobs on small farms, estates, orchards, gardens. Low-priced. Send postcard!

SHAW MFG. CO.

5708 Front St., Galesburg, Kans. 668PSN. 4th St., Columbus, Ohio

A. C. CURRENT ANYWHERE!

Kato Konverters furnish standard 110 volts, 60 cycle A.C. from a source of 32, 115 or 230 volts direct current. Ideal for operating radio and electronic equipment. Mfgs. of A.C. generators, light plants, D.C. motors 1/4 - 1/3 & 1/2 Totally enclosed 3 phase in 2 & 3 H.P. sizes.

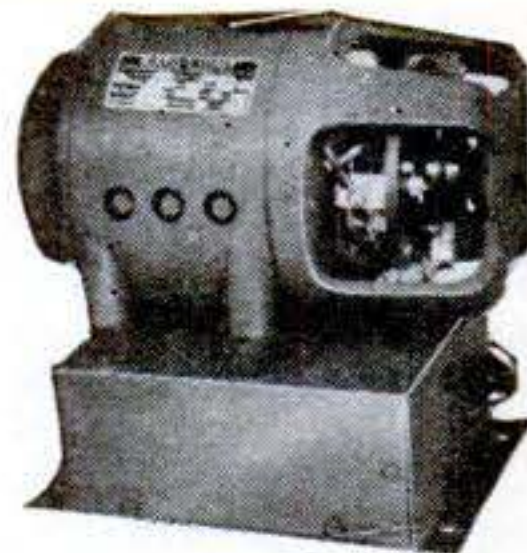

KATOLIGHT 1401 First Ave., Mankato, Minn.

\$13.50 Value for Only \$2.49

8000 ohm impedance Head Phones, produced to Air and Signal Corps specs. Extremely sensitive, lightweight (only 9 oz.). With 5 1/2 ft. cord, plug, jack and ear cushions. Every One **BRAND NEW.**

No. 17A37, Special Per Pair..... **\$2.49**
 Plus 25c each for Postage.



Burstein-Applebee Co. 1012 McGee, Kansas City 6, Mo.

\$2.95

TORNADO GAS TORCH

The Modern Way of Soldering

Ideal for hard and soft soldering. Will heat quickly; solder will flow freely and smoothly. No compressed air required. Nothing to pump. Self-adjusting. Safe. Economical. Can be used for annealing small parts and bending metal parts. Generates a heat of 1700° Fahrenheit. Simply connect to any illuminating (manufactured) gas jet with a rubber hose and operate. Tornado Torch No. 119 comes with three (3) tips, (1/8", 1/4", 3/8" blast).

The Tornado Gas Torch No. 119, complete with three tips, is \$2.95. See your dealer or order direct. Send check or money-order—post paid.

Robco Corporation, 204 E. 44th Street, New York 17, N. Y.

NEW MIDGET ELECTRIC ARC WELDER

FULLY
GUARANTEED

RETAILS
ONLY
\$3.95

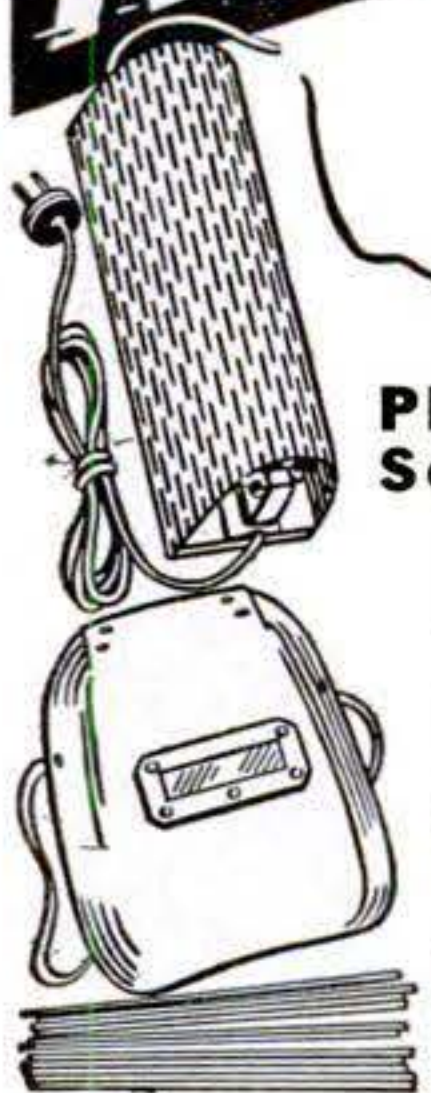

Plugs into Light
Socket AC or DC

It's new! It's handy! It's efficient! Use the Midget Electric Arc Welder for hundreds of light-metal jobs. Does comparable welding work with a 1/16 inch welding rod on thin metal as that of larger and higher priced welders. Operates on 15 ampere fuse, 110 volt 60 cycle A.C. or D.C. current, by use of our special standard-coated 1/16-inch welding rods. Generous supply of rods supplied with machine. Recommended for all light welding like automobile fenders, etc. Take the Midget Arc anywhere to the job. Sturdily built and fully guaranteed. Comes complete—ready to use. Nothing else to buy. No previous welding experience needed to strike an arc. In a short time.



anyone mechanically inclined can learn to weld with this machine.

You'll find hundreds of money-saving, time-saving uses for the Midget Arc around your home, garage, or workshop. Also in garages, factories, repair shops, tin shops, mechanics, farmers, inventors, etc. Order a Midget Electric Arc Welder now! SEND NO MONEY. We'll rush one to you, complete with rods and helmet (equipped with APPROVED welding glass). Pay postman only \$3.95 plus postage charges. If not satisfied, return Midget Arc in 5 days from receipt and we'll refund your money immediately. RUSH YOUR ORDER NOW.

MIDGET ARC WELDER CO., Strader Ave., Dept. B-205, Cincinnati 26, Ohio

\$\$\$ if trained in arc welding

Big income jobs await you. Learn quickly and thoroughly. Enroll under G. I. Bill. Write today. Hobart Trade School, Inc., Box P-563, Troy, O.

LEARN ELECTROPLATING

Highly Paid. Uncrowded, Interesting Business. Part or Full Time, Common School Education Sufficient. Gold, Silver, Nickel, Chromium, etc. Money Making Secrets, Processes. Send postcard for FREE Electroplating Booklet and proof. PLATER HYDE, Dept. S, P. O. Box 176, National City, California.



SAFE AS A HAND SAW
JUST GUIDE IT!

More like magic than any tool you ever saw. Imagine an electric scroll saw only slightly heavier than a hand coping saw . . . a tool that takes no effort to run, no pressure to feed. Works at any angle—on big assembly jobs or on the tiniest piece you can hold in your fingers. Runs 7200 strokes a minute . . . so fast the blade seems to stand still. Sturdily built . . . only two moving parts . . . never needs oiling. Easily cuts intricate designs—so smooth it eliminates sanding. A thrill awaits you when you get a Moto-Saw in your hand. Thousands of satisfied users.



U. S. Patent 2233862
Other Patents Pending
DREMEL MFG. CO.
Dept. S127-H
Racine, Wisconsin

No limit to length of stock it will cut. Saws to center of 19" widths

It's fast . . . cuts on an average of 1 ft. per minute up to 3/4" medium hard wood. Operates on 110-120 V. 50 or 60 cycle alternating current. If your dealer does not yet have Moto-Saw, send \$5.85 . . . we'll pay postage. Or send \$1, pay postman balance plus postage. MONEY BACK if not delighted after 5 days trial.

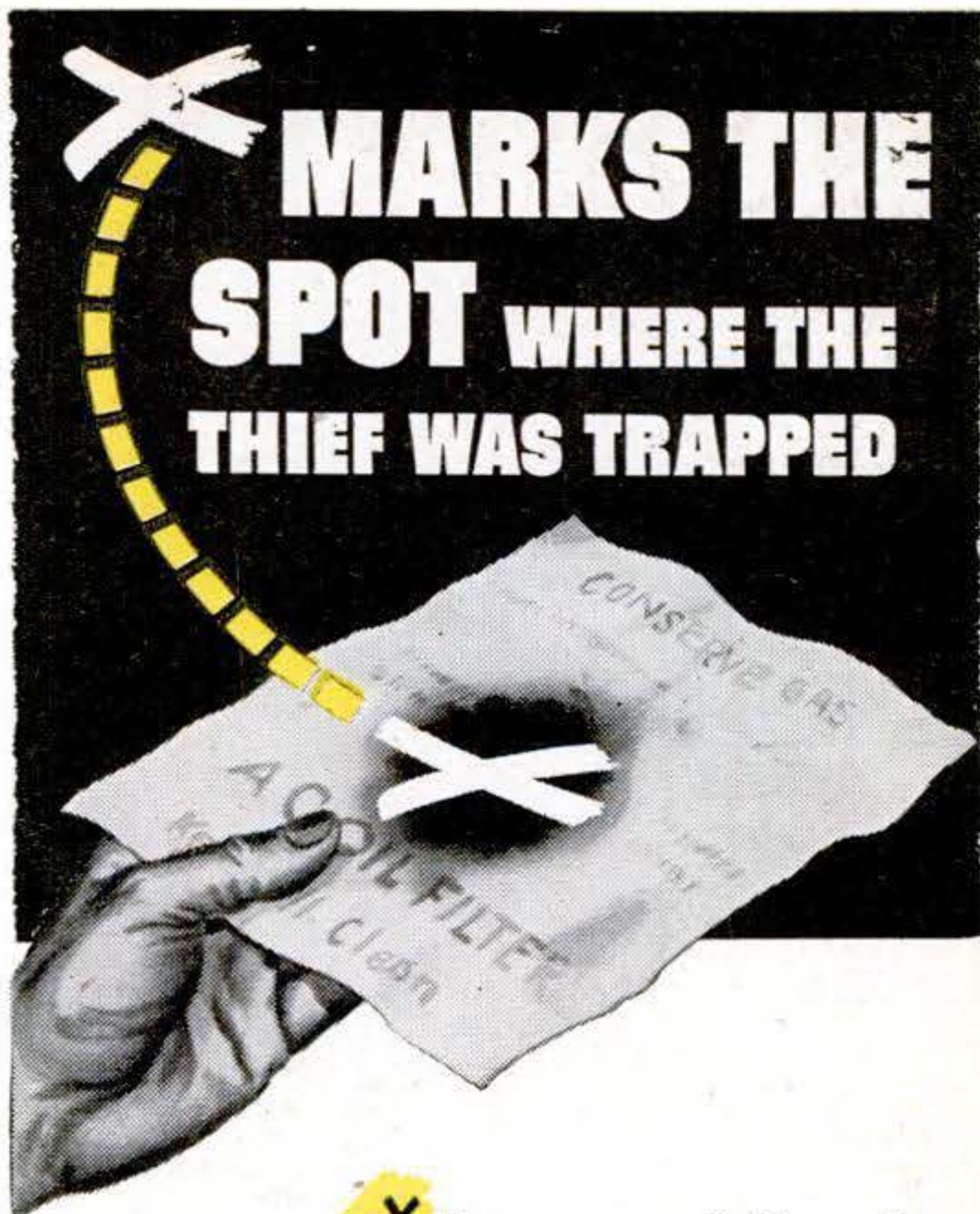

**MARKS THE
SPOT WHERE THE
THIEF WAS TRAPPED**

X is a smear of dirty oil on an AC Oil Test Pad—oil from a car whose owner didn't know he needed an oil filter. The evidence shows clearly on the white pad.

You can get this oil test FREE—and in a jiffy—at any official AC Oil Filter Service Station. The attendant simply wipes the dipstick on the Pad, instead of a rag, and you can see for yourself whether your oil is safe to use.

Dirty oil is a power thief. It clogs piston rings and slots—makes valves stick—hastens engine wear—wastes fuel and oil—steals more and more power as the days go by.

Every engine needs an oil filter. The AC oil test will show you why. And the AC Oil Filter Service Station will show you why the AC Oil Filter gives you tops in protection—and why the AC Replacement Element is the one you should use in your present filter. AC makes quality replacement elements for nearly all filters.

So see your AC Official Oil Filter Service Station today and trap the thief that's stealing your power.



**AC
OIL
FILTERS**

AC SPARK PLUG DIVISION—GENERAL MOTORS CORPORATION

a
Bigger Income
for You

Be Independent!
Start your own **ARC WELDING** business



Hobart arc welders

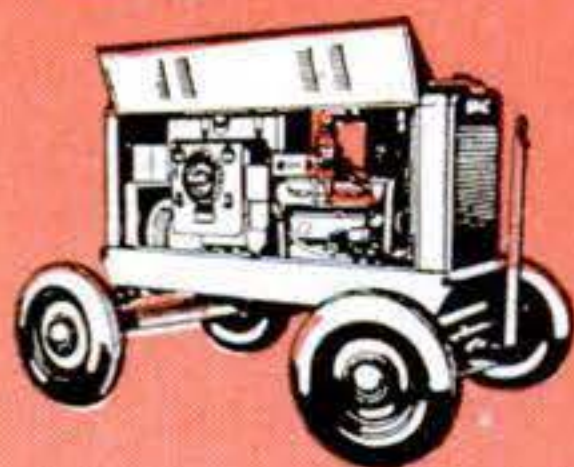

..... make welding better and more profitable

They're Simplified . . . to give you wide-range current control for superior welding on all sizes and types of jobs. You save time and money with a HOBART Welder.

Small Investment . . . makes it easy for you to start your own business. HOBART Arc Welders are available for every type of work, pay for themselves in no time at all.

"Build Your Own" road type welder . . . using a HOBART Multi-Range Generator and a reconditioned auto engine for the big pay jobs in the field. Save \$300-\$500. Ask us for FREE book also.

HOBART a c Type . . . for single phase 220 Volt lines. Costs you less, yet lets you in on the big profit possibilities of arc welding.

HOBART Arc Welding School —modern building with latest welding equipment and experienced instructors. Operates under G. I. Bill.



Hobart Brothers Company
BOX P-87, TROY, OHIO

Hobart "One of the
World's Largest Builders of Arc Welders"

Ask for the new catalog on HOBART Arc Welders

Free!

HOBART BROTHERS CO., BOX P-87, TROY, OHIO

YES, I'm interested in how HOBART Arc Welders can start me out in a profitable business of my own, with big earnings. Send me information on items checked below:

- HOBART Electric Drive
- Gas Engine Drive
- "Build Your Own" Arc Welder
- HOBART AC Transformer Welder
- FREE BOOK "How to Build Your Own."

NAME _____

ADDRESS _____



Spray for Weed-Killers

FASTENED to a rubber-socketed screw cap that fits any gallon jug, two plastic tubes and a spray head form a handy device for administering weed-killing mixtures to dandelions, thistles and similar vegetable pests. The sprayer, which has a shut-off valve on the cap, is made by Ray-Craft, Inc., for Sherwin-Williams, both of Cleveland.

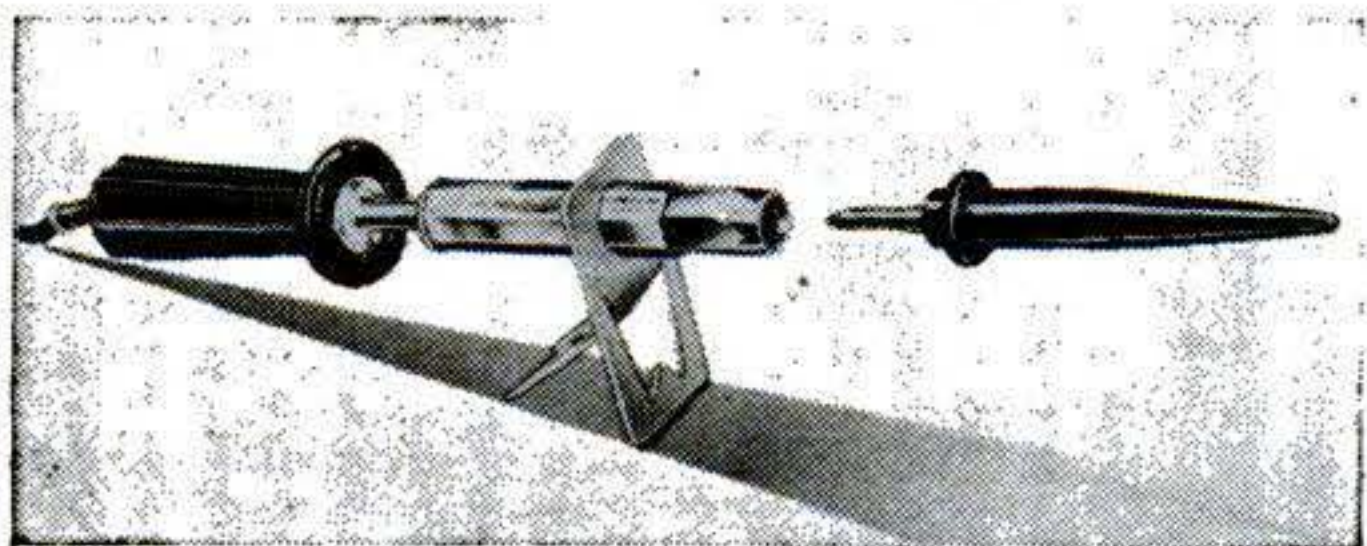

Cordless Soldering Tool

DESIGNED for work in tight spots, a pencil-type, cordless soldering tool is being made by the Sound Equipment Corp., of Glendale, Calif., to fit any size of that concern's Kwikheat irons. The tellurium-copper alloy tip holds heat for nearly a minute, and can be reheated in 20 seconds. The tool is used with a screw-in heater receptacle that replaces the normal soldering tip of the cord iron.

Now you'll stay stuck-darn you!

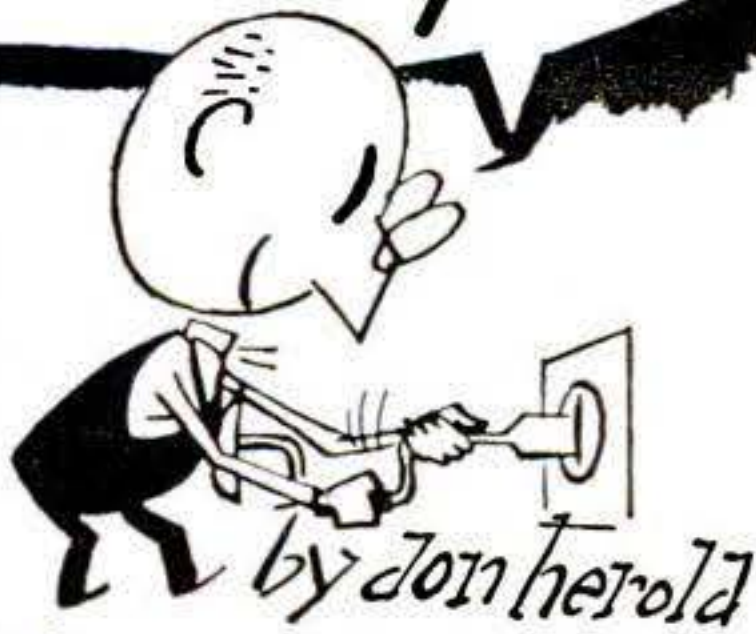

RESEATS SCREWS

Fix loose screws with Reardon's non-shrinking Water Putty. Also plug holes and cracks in wood, tile, metal or plaster.

Add water to powder as used. No waste, no caking in the can. Dries hard for nailing or painting.

Get a can at your hardware, paint, variety or department store **25c** Lb. Can

Made by The Reardon Co.

St. Louis • Montreal
Makers of BONDEX Cement Paint



REARDON'S WATER PUTTY



**AMAZING NEW
READY! MAGNETIC
JIG SAW!**

WRITE FOR
**FREE
SYNCR
CIRCULAR**

Ready for Delivery!

SYNCR... new, remarkable, patented, magnetic jig saw... needs no belts... no motor... no gears

... no oiling! Just plug into any 60 cycle A.C. 110-130 volt outlet—and saw! Portable... world's

safest saw! Cuts clean, smooth... no sanding necessary! Ideal for hobbyists, craftsmen, light production. Perfect for models, displays, inlays, etc. Cuts intricate designs on 3/4" soft wood, 1/2" plywood and thinner hardwoods, metals, plastics... NOT for ordinary lumber. Leaves NO ragged undersides on plywood or heavy cardboard. Special magnetic safety stroke features! Nothing else like it! Sold on 10 days Moneyback Trial! Prompt delivery guaranteed. Rush name, address on postcard for FREE details, Trial Offer. Hurry!

SYNCR SAW CORP. Dept. B-87 Rochester, Mich.

MUFFLERS

STEELS and ALUMINUMS with a motorboat tone

SINGLES, Chev, V-8, Plymouth, Steels \$5.50, Aluminum \$6.50. Chry., Olds., Buicks, etc., Steels \$7.50, Aluminum \$8.50. V-8 and MERCURY DUALS, Steel \$17.50, Aluminum \$20.00. Aluminums are guaranteed for life of your car.

DEALERS WANTED

**V-8
DUALS
& SINGLES**



SANDEE MUFFLER CO.
7523 S. WESTERN AVE., LOS ANGELES 44, CALIF.

**A TOOLSHOP
IN YOUR HAND!**



- GRIND • DRILL • ROUT
 - POLISH • ENGRAVE
 - CUT • SAND • SAW • etc.
- MAKE THINGS FROM WOOD
PLASTICS—METALS—GLASS
LINOLEUM—LEATHER
ALLOYS—HORN—STONE
BONE, etc.

HANDEE TOOL OF 1001 USES

THE ORIGINAL TOOL OF THIS TYPE AND TODAY'S FINEST! Smooth, steady power at your fingertips! Perform precision operations not possible with any other portable tool! With a Handee you can turn out professional looking projects for pleasure or profit—ship, plane and train models, delicate, internally carved costume jewelry, wood carvings, puppets, initialed tumblers, etc. AC or DC. 25,000 r.p.m. Wt. 12 oz. Over 500 accessories made especially for the Handee!

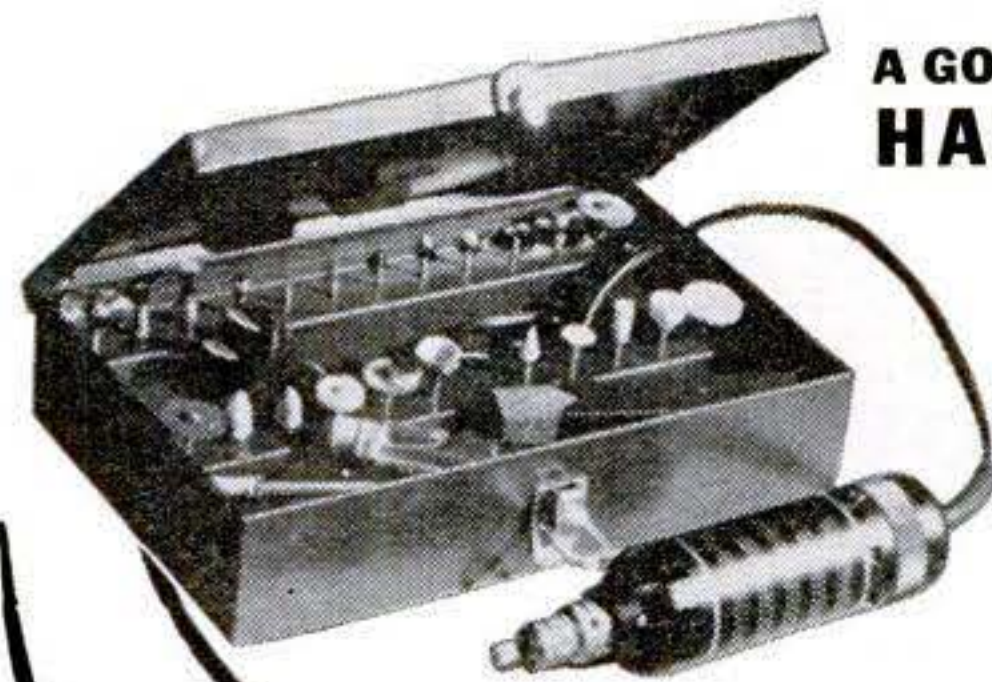

**A GOOD START—THE
HANDEE KIT**

HANDEE Tool and 40 most popular accessories packed in compact steel carrying case. You'll be amazed at what you can accomplish! Complete, postpaid.

\$27.50

Handee only, with 7 accessories, \$20.50

FOR YOURSELF OR A FRIEND...
THE GIFT OF A LIFETIME!

NEW PRECISION ATTACHMENTS

Fit Handee only, enable novice or craftsman to do perfect work. Magically, easily, your offhand carving, routing, shaping will be exact as to depth of cut, accuracy of line. Set of 6 attachments with instructions, postpaid

\$7.95

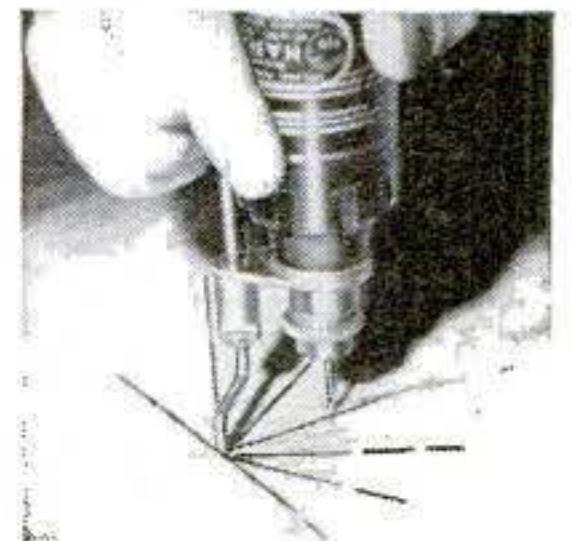

ORDER NOW! Send check or money order today or have it sent C.O.D. Satisfaction guaranteed! Free 52-page manual on request.

CHICAGO WHEEL & MFG. CO.

1101 W. Monroe St. Dept. PO. Chicago 7, Ill.

Send Handee Kit Handee Tool Precision Attachments C.O.D. Remittance enclosed Send Manual

Name.....

Address.....

ONE GALLON = 125 MILES!

Put a Whizzer Motor on your bike and discover really thrifty transportation! 125 miles to the gallon! 35 MPH! Fits any man's balloon tire bike. Complete with all attachments necessary to motorize your bike! See your local Whizzer Dealer!

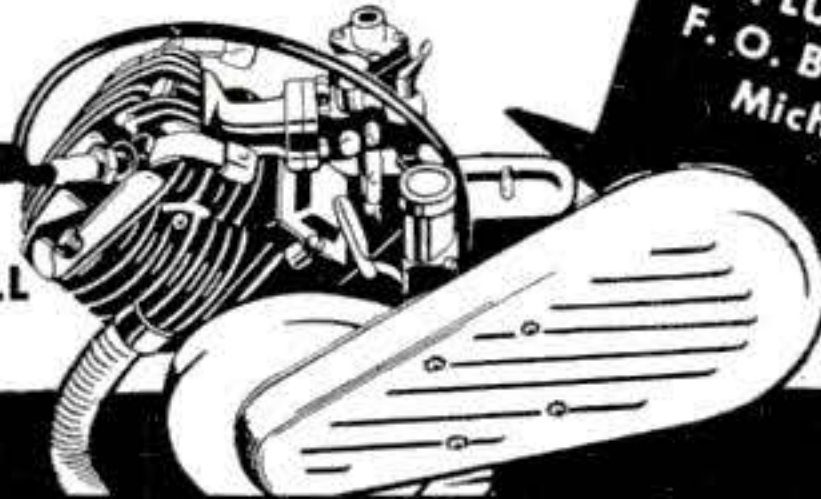

RIDE ONE AND YOU'LL BUY ONE!

\$97.55
PLUS TAX
F. O. B. Pontiac,
Michigan

ON A

WHIZZER

Whizzer Motor Company, Dept. 538, Pontiac, Michigan. I enclose \$99.97, which includes \$2.42 Federal Excise Tax () check or () money order. Send me one Whizzer Motor complete, ready for installation. If descriptive literature only is desired, check here ().

Name _____ City _____
Street _____ State _____

Now for EVERY WORK SHOP!

NEW Invention Electroplates by BRUSH



Easy to Plate CHROMIUM GOLD, SILVER, NICKEL, COPPER . . . For Pleasure and Profit!

If you have a workshop—at home or in business—you need this new Warner Electroplater. At the stroke of an electrified brush, you can electroplate models and projects—you can replate worn articles, faucets, tools, fixtures, silverware, etc. with a durable, sparkling coat of metal . . . Gold, Silver, Chromium, Nickel, Copper or Cadmium. Method is easy, simple, quick. Everything furnished—equipment complete, ready for use. *By doing a bit of work for others, your machine can pay for itself within a week.* So make your shop complete by getting a Warner Electroplater right away. Send today for FREE SAMPLE and illustrated literature. ACT AT ONCE! *Mail Coupon.* **WARNER ELECTRIC CO., DEPT. N-5 1512 Jarvis Avenue, Chicago 26, Ill.**

FREE Details & Sample!

WARNER ELECTRIC CO., 1512 Jarvis Avenue, Chicago 26, Dept. N-5
Gentlemen: Send Free Sample and Details to:

Name _____
Address _____
City _____ State _____

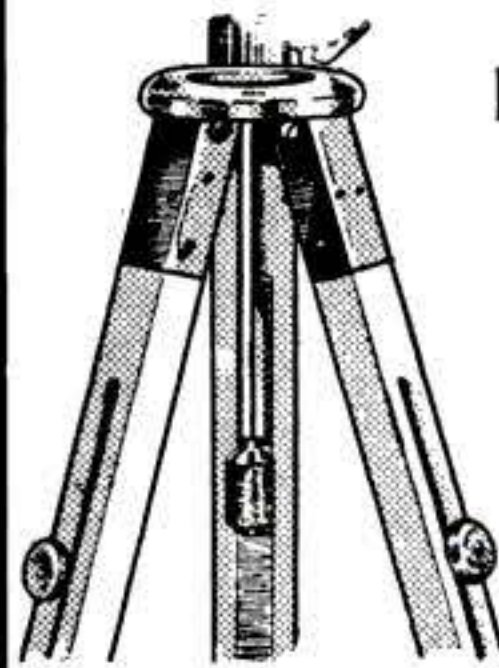

U. S. GOVERNMENT SURPLUS TRIPODS

Strong Wooden Tripods with adjustable metal legs. 5½ foot extension. Used by Government for engineers levels and transits. Can be used for holding Telescopes, Cameras, etc.

Value 24.50 **\$4.95**

WHEATSTONE BRIDGES

Used in excellent condition. Mfg. by Thompson Lever Mfg. Co., Philadelphia. Value \$150.00 **SPECIAL \$49.50**

Engineers All Metal Army Type Hand-Sighting

LEVELS

\$2.00 PRECISION QUALITY



PUBLIC SPORT SHOPS

13 S. 16th St., Phila. 2, Pa.

No COD's

NOW 93% MORE ENERGY, LONGER LIFE

Get the New "Eveready" Flashlight Batteries

The term "Eveready" is a registered trade-mark of National Carbon Co., Inc.

BUILD YOUR OWN MACHINE TOOLS!

Blueprints \$1.00-Catalog FREE

We supply quality Foundry Castings for Lewis Shapers, Milling Machines, Drill Presses, 8" Circular Saws, 6" Jointers, etc. Construction Blueprints for above 6 tools postpaid \$1.00. Illustrated 32 page Catalog sent free with Blueprint Order—describes 23 Lewis Tools. Write today!

LEWIS MACHINE TOOL CO.

P. O. Box 7446, Sta. L, Dept. S, Los Angeles 23, Calif.



AMAZING LOW COST BRONZE FOUNDRY

Cast Aluminum, Silver, Etc.—All Non Ferrous Metals

Make money in the foundry business casting Engines, Machinery, Art Objects, Statues, Inventions and all other foundry work. Castings up to 6" made quickly with new inventions called Foundryette. Operates on 110V AC and Domestic Gas. Write for complete FREE information. **Kans. City Specialties, Box 6022, Kans. City, Mo.**

Sand Casting Forging-Heat Treating-Case Hardening

Everything in Radio!

Make Radolek your buying headquarters for Radio-Electronic repair and replacement needs. Large stocks assure finest, most complete selections of all available items at lowest prices. Your orders receive special attention for fastest delivery. Send today for FREE **Radolek Buying Guide.** **RADOLEK CO., Dept. A-129, 601 W. Randolph St., Chicago 6, Ill.**



FREE RADIO BUYING GUIDE

★ PRICE REDUCTIONS ★ EXPANDED STOCKS ★

Aluminum flats to 4", squares, rounds, hexagons, angles, tubing. Drill rod in rounds, squares, flats and octagons. Plastic in sheets, rods and tubing, clear and color. Also Decorative Panels. Many other items. Listing (A47) on above 5c. Catalog 1046-D and Listing A47 which lists tools, supplies, equipment, etc. 15c. **METPLAS SUPPLY COMPANY, 1420 South 16th, Maywood, Illinois.**

148 PAGE WOODWORKERS CATALOG

ONLY 15 CENTS-REBATED ON FIRST ORDER

SHOWS IN NATURAL COLOR

22 inlay and overlay insets
32 veneer bandings—matched woods
30 kinds of world's finest woods in character grains and color
31 mouldings, rosettes, ornaments and home wood working labor-saving tools and hard-to-find hardware.

CRAFTSMAN WOOD SERVICE CO.
2729 S. Mary St., Dept. B-84, Chicago 8, Ill.

LISTS OVER 300 PIECES OF ARTISTIC FURNITURE SHOWN including cost of plans, lumber, hardware and finishing material. Choice of MAHOGANY, WALNUT, BIRCH or MAPLE LUMBER—PLYWOOD—VENEERS. UN-EQUALLED BARGAINS.

Make beautiful furniture at only 20% store prices.

X-acto*

**HANDICRAFT
KNIVES & TOOLS**



Choice of experts in every art and craft field. Singly and in sets, 50c to \$50.00. (Slightly higher in Canada.)

Buy where you see this sign —
At hobby, hardware and gift shops.

X-acto Crescent Products Co., Inc., N.Y.
In Canada, Handicraft Tools, Ltd., Toronto
*Reg. U.S. Pat. Off.

BUILD YOUR OWN FAN



with that old motor

One piece cast aluminum propeller used for cooling and ventilating. Also available to dealers at discount.

Size Inches	Polished		Unpolished		Bore Inches
	Blade 2	Blade 3	Blade 2	Blade 3	
15	\$2.50	\$3.50	\$2.00	\$3.00	1/2 5/8 3/4
18	3.00	4.00	2.50	3.50	1/2 5/8 3/4
20	3.25	4.25	2.75	3.75	1/2 5/8 3/4
24	3.50	5.00	3.00	4.25	1/2 5/8 3/4
30	5.00		4.00		1/2 5/8 3/4

Let us give you our prices on your aluminum castings.

KLOPPENBORG ALUMINUM FOUNDRY, Dept. P.S. 87, Davenport, Iowa

MORE PROFITS

with

MODERN LAWN MOWER SHARPENER

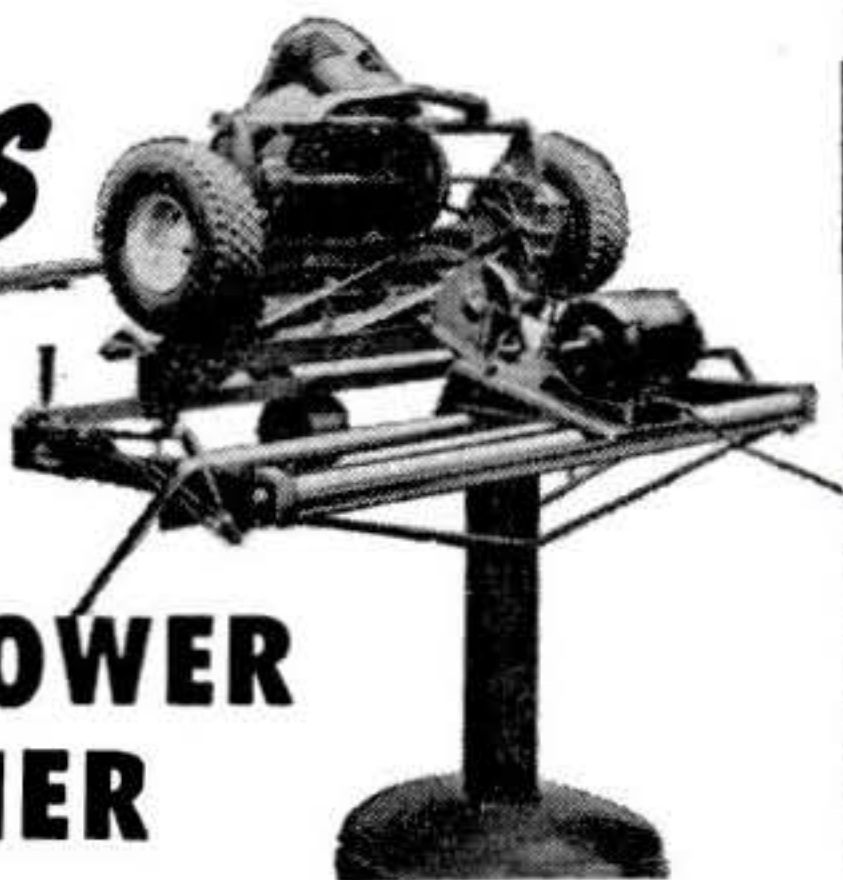

SHARPEN ANY LAWN MOWER from 5-inch Edger to 36-inch Power Mower in ten to twenty minutes with a MODERN LAWN MOWER SHARPENER because dismantling is unnecessary — neither handle, roller, wheels nor motor need be removed when sharpening any mower. . . . the MODERN SHARPENER eliminates all hand filing; it precision grinds to the extreme ends of both left or right reel blades. Bottom knife is held in same brackets for sharpening. NO EXTRA ATTACHMENTS! Order today! Price \$241.50 (less motor) f.o.b. Pasadena (1/3 or 1/4 H.P., single phase motor recommended.)

Modern Mfg. Co., 160 N. Fair Oaks, Pasadena 1, Calif.

FREE!



SEND FOR
**ALLIED'S
BIG 164-PAGE
RADIO
CATALOG**

Everything in Radio at Lowest Prices!

Here is *everything* you want in Radio! New home radios and phono-radios, Ham receivers and gear, new kits, thousands of parts, tubes, tools, complete PA equipment, diagrams, latest radio books. The most complete stocks anywhere—in one *big* book—all at money-saving low prices!

BUILD THIS AMAZING 5 TUBE RADIO

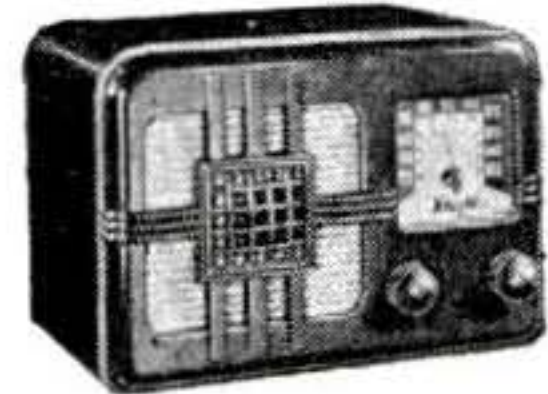

LOW-COST SUPERHET KIT Complete with Plastic Cabinet, Loop Antenna, and Tubes

It's here! The first ultra-modern 5 Tube AC-DC Superhet kit at so low a price! Here's what you get—full broadcast band coverage (550-1600 Kc); built-in loop antenna;

latest 5" PM dynamic speaker; handsome walnut plastic cabinet. Unbelievably easy to build; no special tools required. Sockets are riveted in place on chassis base; just assemble, wire and slip into cabinet. Outstanding for power and tone quality. Highest grade components only. Complete with all parts, tubes and full instructions. **ONLY \$14.95** No. 83-275. Complete.....

GET THESE VALUABLE ALLIED RADIO BOOKS!



- Radio Formulas & Data No. 37-752.....10c
- Dictionary of Radio Terms No. 37-751...15c
- Radio Circuit Handbook No. 37-753.....25c
- Radio Builders' Handbook No. 37-750...15c
- Simplified Radio Servicing No. 37-755...10c
- Radio Data Handbook No. 37-754.....25c
- ALL 6 BOOKS above No. 37-799.....\$1.00
- Parallel Resistance and Series Capacitance Calculator. No. 37-960...25c
- R-F Resonance and Coil Winding Calculator. No. 37-955.....25c

ALLIED RADIO

ALLIED RADIO CORP.
833 W. Jackson Blvd., Dept. 7-H-7
Chicago 7, Ill.

FREE CATALOG

- Rush FREE 164-page Catalog
 - Send Kit No. 83-275
 - Send 6 Books No. 37-799
 - Send Calculators checked above
- } \$.....enclosed

Name.....

Address.....

City.....Zone.....State.....

YOU CAN'T BEAT AN *American*

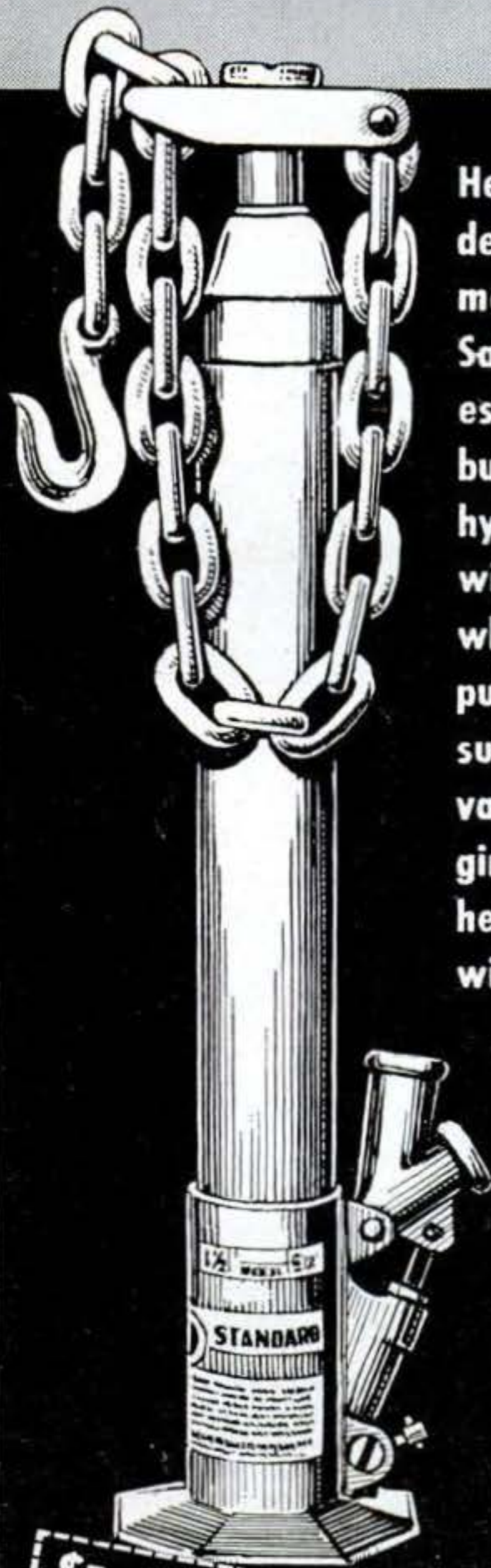

Here it is—the greatest development in automobile bumper jacks! Safest, quickest, easiest to use on any car built. Also an all-around hydraulic utility jack with hundreds of uses where easy lifting or pulling is required. Result of 15 years of advanced precision engineering. Extra long, heavy duty steel chain with forged steel grab hook picks up loads from 4" BELOW bottom of jack to 22" ABOVE. Base, handle socket, head and chain plate are all tough malleable iron castings. 17" hydraulic lift, 3000 lb. capacity.

\$14.50 Complete with chain, hook and handle

Order now at your dealer or write to

American Hydraulics
Inc.
SHEBOYGAN, WISCONSIN

© 1947 AH, Inc.

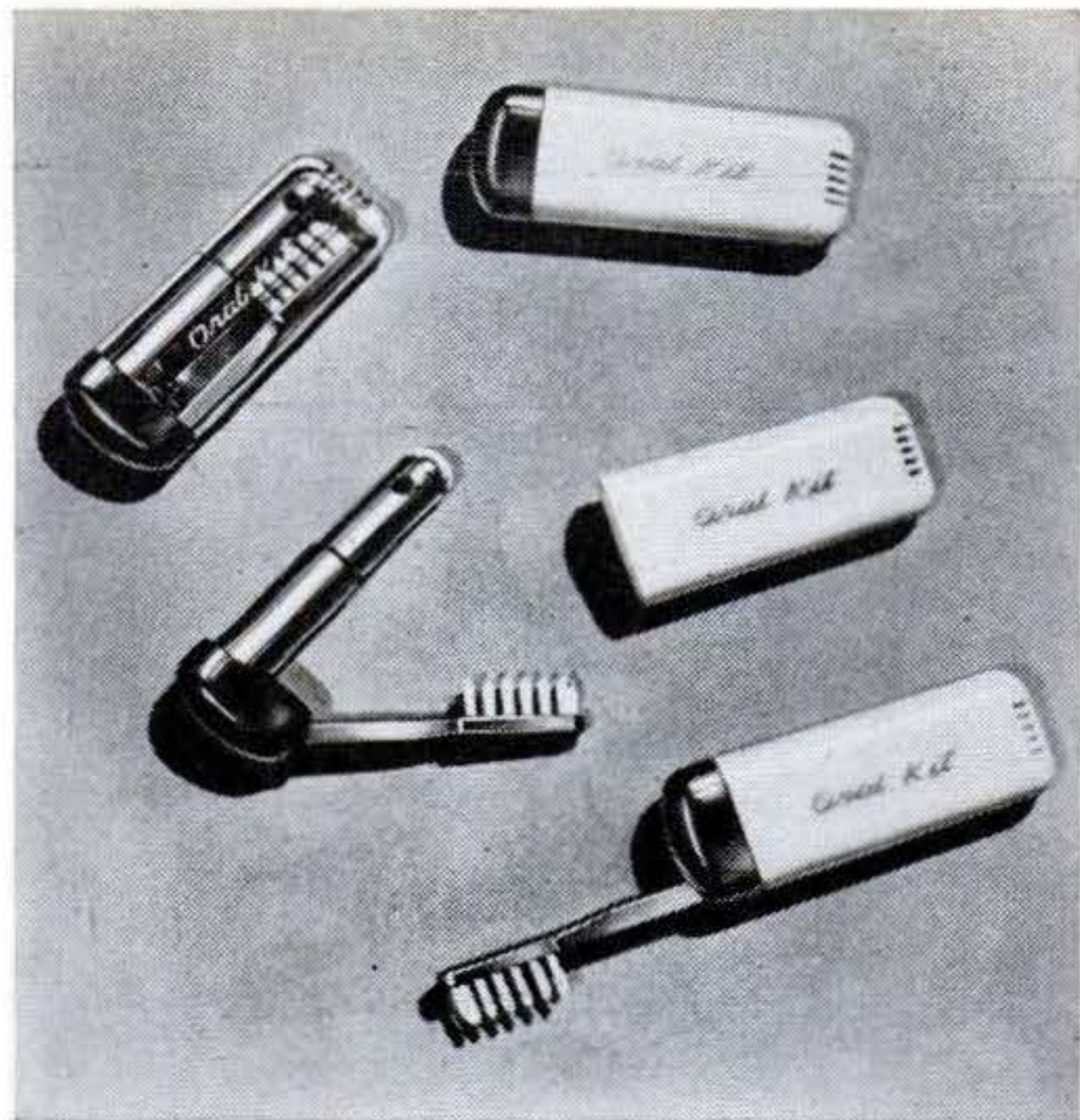

It Folds for Travelers

THE ventilated plastic case of this folding toothbrush holds a supply of tooth powder for the convenience of a traveler, and the whole unit is small enough to fit easily into pocket or purse. Manufactured by the Federal Tool Corp., of Chicago, the case serves as a handle for the nylon-bristled brush when it is in use.

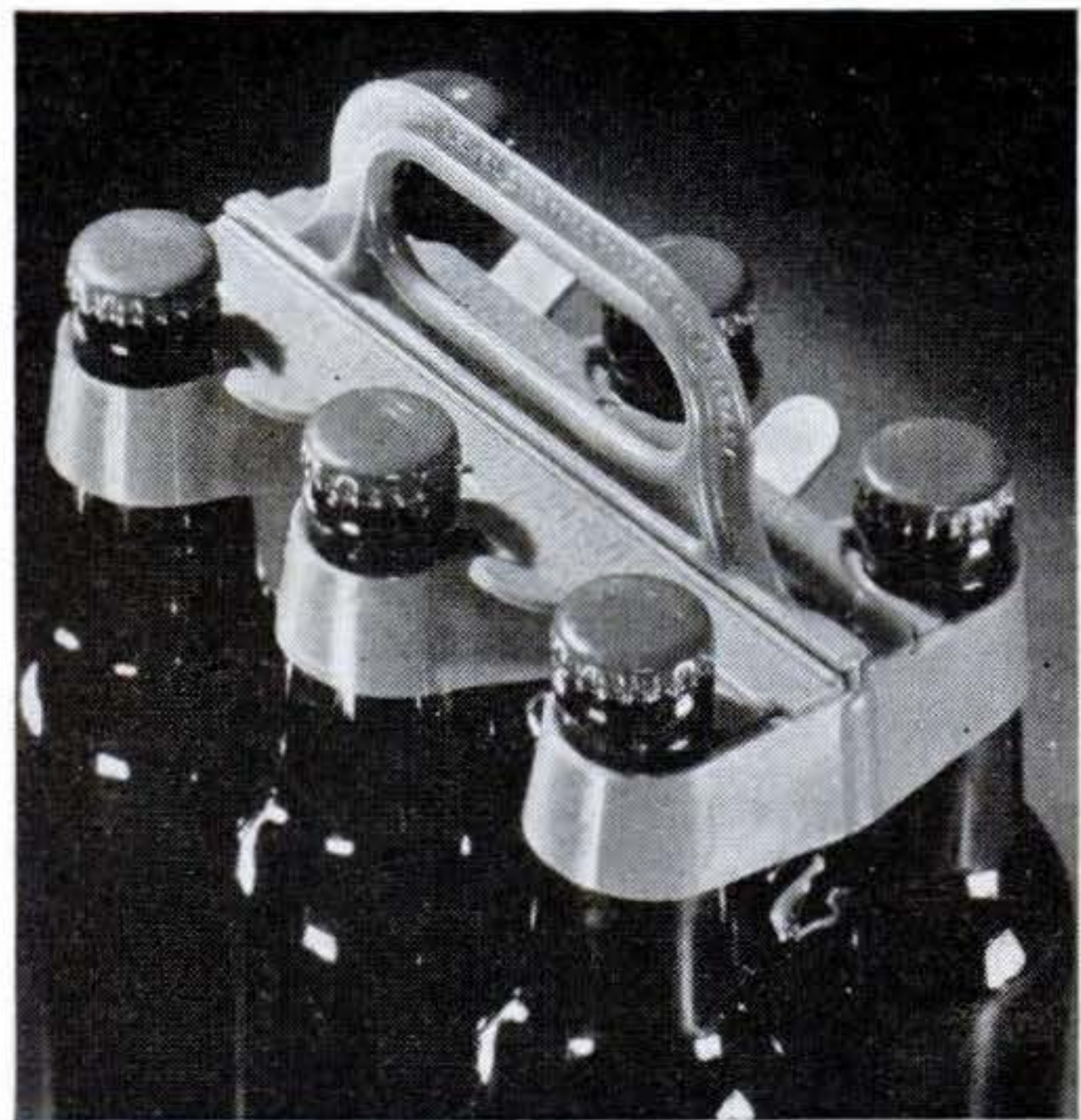

Carrier Grips Bottles

FOR carrying bottles without fear of breakage, a six-place rack with snap-down holders is made of Tenite by Amos Molded Plastics, of Edinburgh, Ind. Coil springs keep the holders tight.

MARGIE



**DIRT and DUST
YOUR DOUBLE-TROUBLE?**



Fix it with **Mortite**

a household friend

Shut out dirt and dust! Press pliable Mortite around windows, doors, baseboards, etc. It's done in a jiffy. Keeps out ants, insects; fine for calking, stops rattles; the ideal weather-stripping. Roll covers about 80 ft. At Hdwe., Paint, Dept. Stores, Lumberyards.

\$1.25 *Higher West of Rockies and Canada*

WRITE FOR FREE BOOKLET.

J. W. MORTELL CO., 534 Burch St., Kankakee, Ill.



A BIG 25¢ WORTH OF TOOL TIPS



● Everything about tools . . . at a glance. More than 2000 views of boring and cutting tools, squares, gauges, jigs, etc. Years of tool experience in one, low-priced book . . . 25¢ postpaid. Write today. Stanley Tools 287 Elm St., New Britain, Connecticut.

STANLEY

Trade Mark

ELECTRICITY *Anywhere*

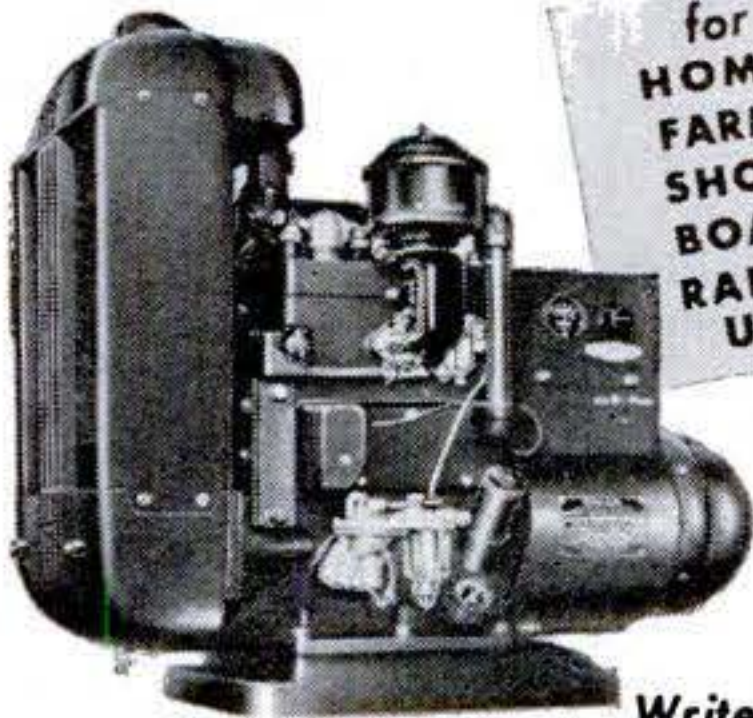

for
HOMES
FARMS
SHOPS
BOATS
RADIO
USE

● Onan gasoline-engine-driven Electric Plants supply reliable, economical electric service for any use. Portable, stationary or stand-by models. Water or air-cooled, compact and rugged.

A.C.: 350 to 35,000 watts in all standard voltages and frequencies. D.C.: 600 to 10,000 watts, 115 and 230 volts. BATTERY CHARGERS: 500 to 3,500 watts; 6, 12, 24, 32 volts.

Write for folder

D. W. ONAN & SONS INC.

2774 Royalston Ave., Minneapolis 5, Minn.



FOR **TOP-NOTCH**
Vacation Thrills!



See the country on a
HARLEY-DAVIDSON

Enjoy the most thrilling vacation of your life on a Harley-Davidson Motorcycle! Visit the country's natural wonders and historic places. Your Harley-Davidson will take you anywhere fast and economically. You can do more and see more on a Harley-Davidson — "explore" the out-of-the-way regions and beauty spots not reached by other methods. What's more, your Harley-Davidson turns evenings, holidays and weekends into *extra pleasure time* — as you go gypsy touring with other fun-loving riders, or take in race meets, hillclimbs, and other thrill-packed motorcycle events. See your Harley-Davidson dealer NOW — and mail the coupon today!

HARLEY-DAVIDSON
Motorcycles

HARLEY-DAVIDSON MOTOR CO.
Dept. PS, Milwaukee 1, Wis.

Please send me free copy of 24-page ENTHUSIAST Magazine, filled with motorcycle action pictures and stories; also catalog.

Name.....

Address.....

City..... State.....

*"Soft Pedal Stops
are yours with
Grizzly"*



"Like my new hat, Joe?" she asks. "The boy friend says it gives me that angel look."

"Humph," I snort.

"Why the gloom, sour-puss?" she asks. "Indigestion?"

"No," I shoot back. "It's just I'm thinkin' if you don't reline those brakes, you may *really* look like an angel."

"Oh," she says casually, "I can still stop can't I?"

"Not quick enough or easy enough," I reply.

"Well, it does take a lot of pressure to stop this old bus," she admits grudgingly. "Will new lining make it easier to stop?"

"My Grizzly Brake Lining will," I tell her. "Plus giving you greater stopping safety, Grizzly also permits you to slow down and stop with a 'soft' pedal. That's why Grizzly is the perfect lining for both men and women drivers and—"

"Whoa," she laughs, "that's enough. Reline 'er with Grizzly, Joe, and I'll drive relaxed!"



BIG FOOT . . . LITTLE FOOT
Grizzly Brake Lining is designed to give sure, smooth stops to both. Demand Grizzly—a leading brand of brake lining—for over 30 years! Grizzly Manufacturing Company, Paulding, Ohio.

"Bear in Mind" . . . ask for

GRIZZLY
REG. U. S. PAT. OFF.
BRAKE LINING

WHEREVER BRAKES ARE SERVICED

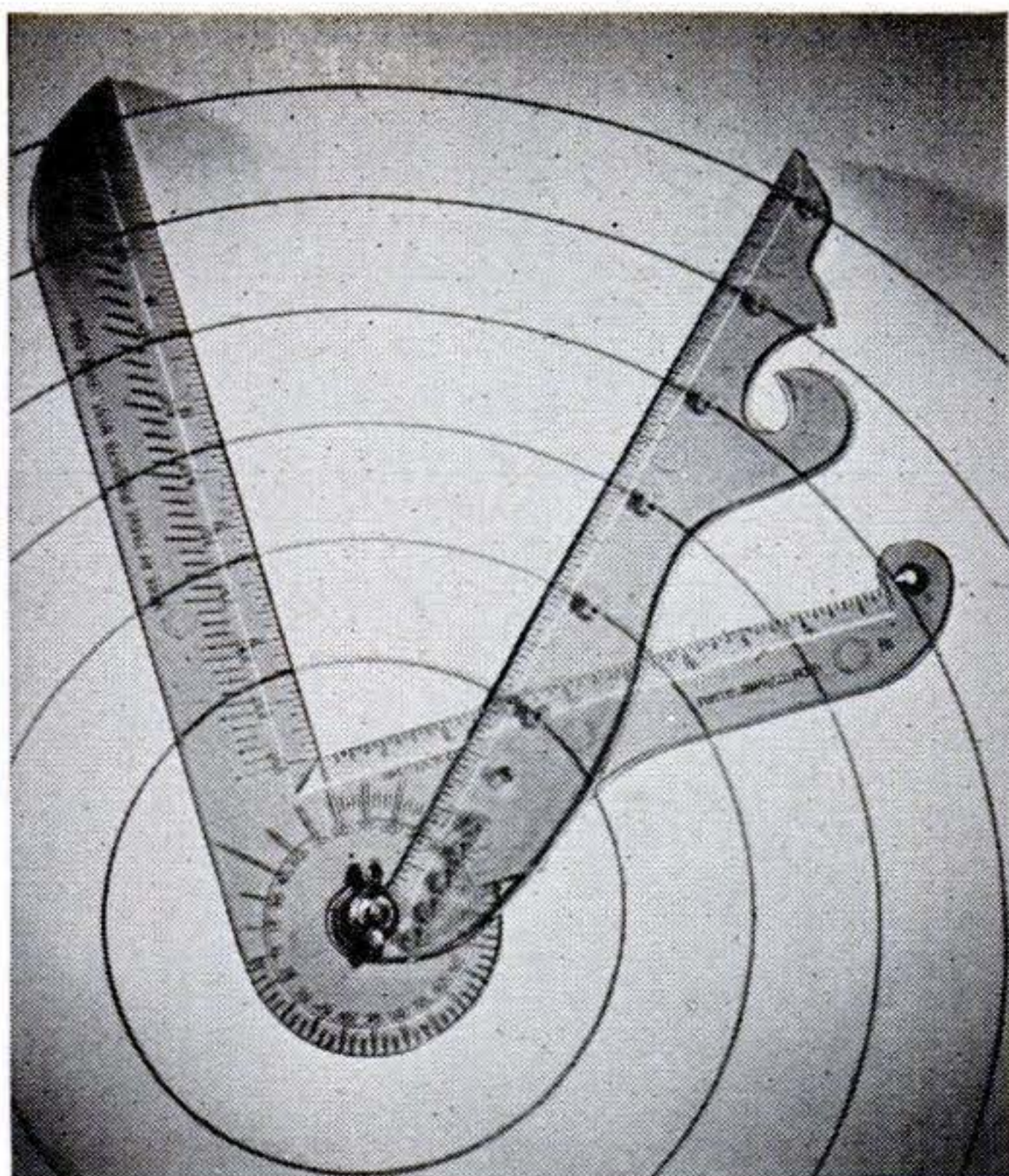

Versatile Drawing Aid

A PLASTIC square and removable miter arm combine to form a drawing and measuring instrument that performs many jobs for draftsmen, carpenters or architects. Distributed by the Parva Products Co., of West Haven, Conn., the transparent combination is molded of yellow Tenite. It serves as square, dividers, triangle, ruler, protractor and French curve.



Magnifying Flashlight

DEvised primarily as an aid to stamp collectors, a recent product of the Micro-Lite Co., of New York, has an adjustable magnifying glass on the barrel of a five-inch flashlight. The glass slides up and down the barrel for focusing, and a ball-and-socket joint permits quick angular adjustment. Besides helping to spot marks or breaks in stamps, the light is useful in examining many other small items.

PRESSURE QUEEN

FOUR CYLINDER
PORTABLE AIR COMPRESSOR
SPRAY PAINTING OUTFIT

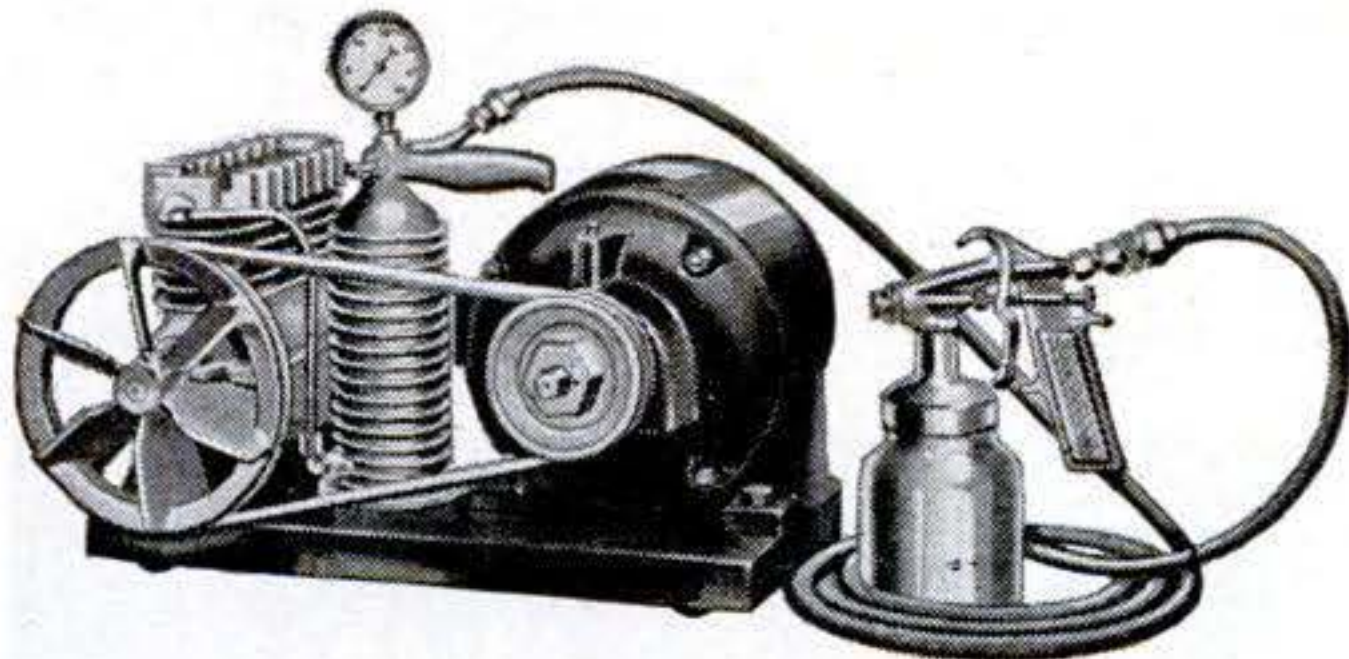

COMPACT • RUGGED • POWERFUL

The ideal air supply for home and farm workshop, machine shop, garage and contracting painter; for product finishing, inflating tires, painting automobiles, trucks, machinery, etc. Indispensable for building maintenance, interior and exterior. Handles any paint, insecticide or disinfectant.

This 4 cylinder compressor has drop forged crankshaft, stainless steel, heat treated valves; bronze bearings and positive forced feed lubrication. Maximum pressure 50-60 lbs., free from pulsation. Standard equipment includes the compressor mounted on steel base with carrying handle, belt, compressor pulley, air chamber, air gauge, 15-ft. hose, spray gun. Requires 1/2 or 1/3 h.p. motor or gas engine.

If your dealer does not sell Pressure Queen write direct

THE CAMPBELL-HAUSFELD CO.

151 RAILROAD AVE., HARRISON, OHIO

ONE-MAN SAWMILL LESS THAN

Easy To Turn Trees Into Money \$200⁰⁰

Makes Lumber ties, shingles, crates, lath, studding, siding.



BELSAW MODELS

in 10 to 24 foot sawing lengths. MECHANICAL FEED, accurate set works and positive dogs. Use tractor or old auto engine for low cost power. Thousands used for commercial sawing. Pays for itself quickly. Send post card today for FREE booklet, "How To Make Lumber" and Catalog of Woodworking Equipment.

BELSAW MACHINERY COMPANY

2846 Field Bldg., 315 Westport Rd., Kansas City 2, Mo.



Insist on the
Genuine

WISE-GRIP
WRENCH

REG. U.S. PAT. OFF.

• The original, the strongest, the best designed. Never equalled. Most powerful, most useful hand tool. Exerts more than ton pressure. Locks to work with hands removed. Superplier action. Fine alloy steel. Specially hardened. Nickel plated. Two sizes — still \$1.65, \$1.95.

Sold thru Dealers and Tool Jobbers

Invented, Developed and Made World-Famous by
PETERSEN MFG. CO., Dept. 36, DeWitt, Nebr.
Export Dept.: Irwin Herzfelder, 130 Water St., N. Y. City

Only 10¢

FOR THIS TIMESAVING
WOODWORKING TOOL

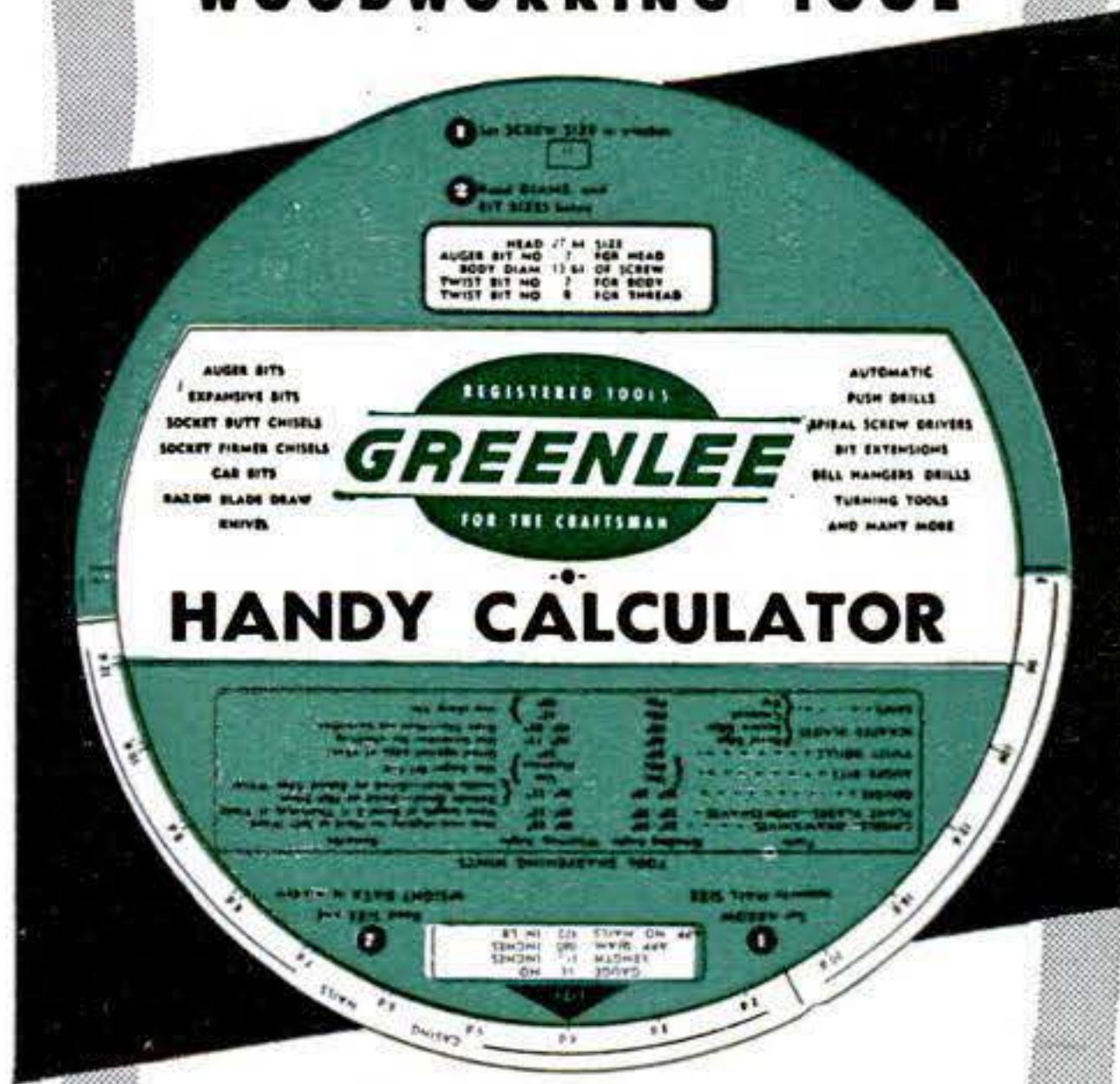

• This easy-reading GREENLEE HANDY CALCULATOR swiftly solves your woodworking problems. Just set the dial - convert linear feet to board feet; get slope per foot in degrees; compare hardness, weights, shrinkage, warping and working ease of various woods. More, too-bit sizes for head, body, thread of screws; nail specifications; tool sharpening hints; protractor. 6" diameter, fits your tool kit. Heavily varnished cardboard. Special offer. Order now, send 10¢ (not stamps) in next mail. Greenlee Tool Co., 2128 Columbia Ave., Rockford, Ill.

REGISTERED TOOLS

GREENLEE

FOR THE CRAFTSMAN



TRIUMPH

**TIGER
100**
CAPABLE OF
100 M.P.H.

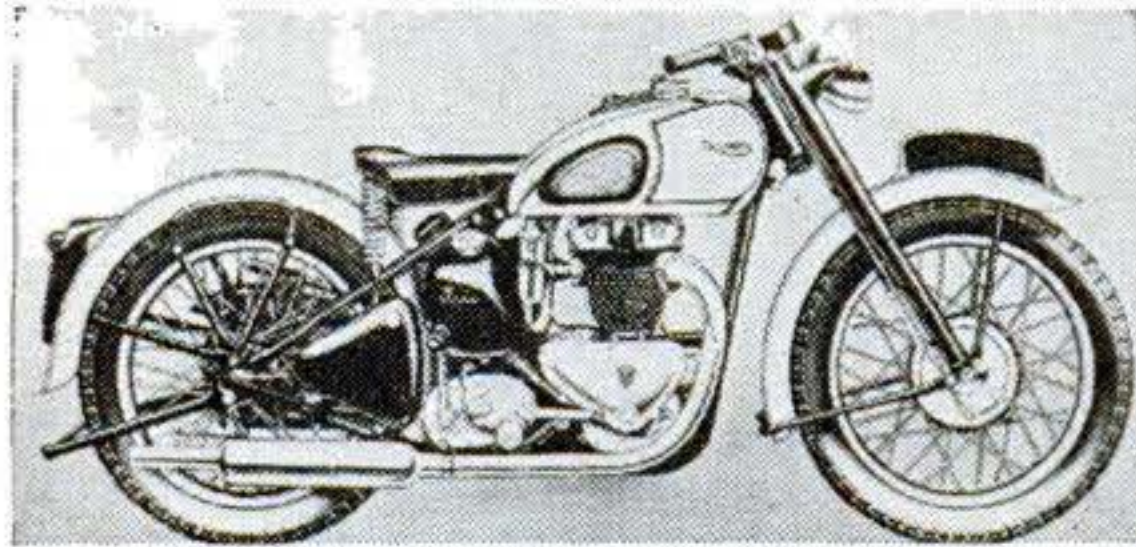

WORLD'S PRE-EMINENT

VERTICAL TWIN MOTORCYCLE ARIEL MOTORCYCLES

INTERNATIONALLY FAMOUS

500 cc. Red Hunter . . . 1000 cc. Square Four

SEND 10c FOR FOLDERS

Johnson Motors, Inc.

267 W. COLORADO

U. S. A. DISTRIBUTORS

PASADENA 1, CAL.

Portable Paint Sprayers

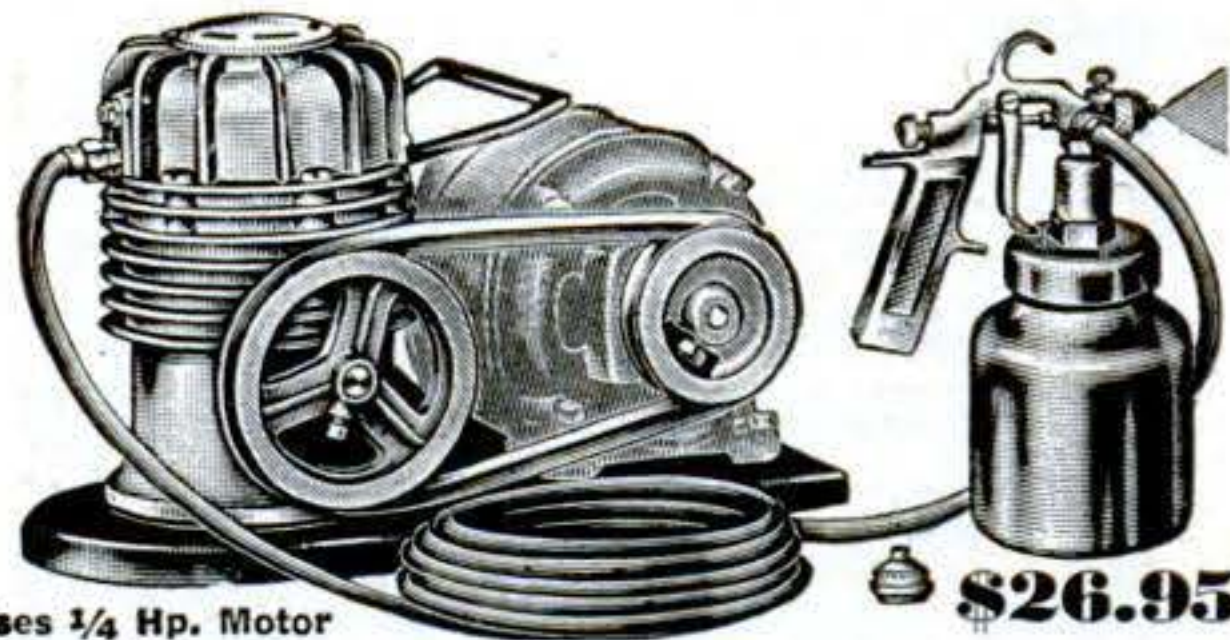

Uses 1/4 Hp. Motor

\$26.95

Complete as illustrated, less motor. Sprays all kinds of paint, lacquer, varnish, etc....Oil-less ball bearing compressor, 2 cu. ft. air per minute. 15 to 50± pressure. Sprays paint 5 times faster than hand brushing.

No. 890. Outfit complete as shown with "V" Belt, motor pulley, 15 ft. high test air hose and No. 112 gun, but without motor. \$26.95

No. 444. Outfit, Twin cyl. 4 cu. ft. production type gun, 15 ft. air hose, reg. and gauge. "V" belt and motor pulley. \$47.50

Uses 1/2 hp. motor. Complete less motor, IMMEDIATE DELIVERY—Check or M.O. with order, shipped prepaid. Or we will ship C.O.D., plus charges.

Write for **FREE** Catalog today!

INDIANA APPLIANCE CO.

20 E. Sycamore

Dept. P.S. 120

Evansville, Indiana

MACHINE SHOP EQUIPMENT



Just off the press!—Every man who owns a workshop should have a copy of our new, up-to-the-minute, 200 page catalog of Machine Shop Equipment—the latest tools made by the biggest manufacturers in the U. S. Replete with illustrations, descriptions, prices. Prompt delivery on most tools listed in this book. Available at cost of printing—50c a copy—get yours today! **Price of Catalog Refunded on First Order over \$5.00.** Send Check or Money Order to

CENTER TOOL CO., 153 Centre St., Dept. D, N. Y. C. 13

Cut NEW TEETH in 3 Min.

With FOLEY RETOOTHER

For All
HAND SAWS

Cuts 20 sizes of teeth from 4 to 16 points per inch. Immediate delivery



No need to grind off old teeth — cut new ones over them. Fast, accurate, no eyestrain. Cuts filing time in half.

FOLEY MFG. CO. 891-7 Foley Bldg., Minneapolis 18, Minn.

Send full details on Foley Retooter.

Name.....

Address.....

Do a Better Job WITH ONE OF THESE EMPIRE LEVELS

Smallest, most handy and accurate Level made. "Cigar-shaped"—no sharp corners to tear pocket. Aluminum stock. Only 3 oz. wgt. 9" long. Has Level, Plumb, 45° Vials.

EMPIRE TORPEDO LEVEL



No. 26.....\$1.75



ALUMINUM LEVEL — No. 151

Cast and Machined, a Beautiful Tool, with Patented, Removable Level and Vial.

With 2 Plumb, 2 Levels, 2 — 45° Vials. 18".....\$6.00

24".....\$6.50 28".....\$7.00

Order **EMPIRE LEVELS** from your local dealer.

Write direct for literature.

EMPIRE LEVEL MFG. CO.

707 S. 6th St.

Milwaukee 4, Wis.

New THOR "B" ENGINE—\$6.95

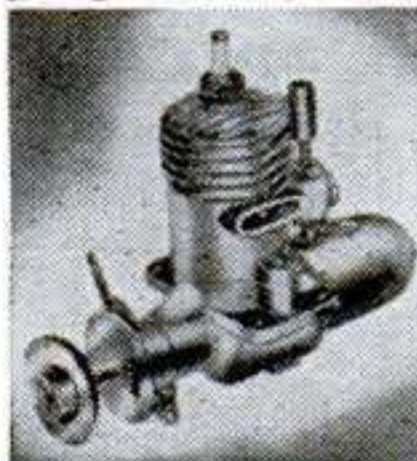

The new THOR "B"—Sensational miniature gasoline engine that really works. Super-power performance. Smooth, velveted power that roars into action with a "twist of the wrist." Over 25,000 already sold. 1/6 H.P. Complete with coil and condenser. Ready to run, only \$9.95. In KIT form, fully machined, 5 minutes to assemble, \$6.95, without coil and condenser. Powers all models. Fully illustrated instructions. Send \$1.00—shipped collect same day C.O.D.

FREE. SEND FOR 24-PAGE ILLUSTRATED HOBBY CATALOG. AMERICA'S HOBBY CENTER

DEPT. S-87, 156 WEST 22ND STREET, NEW YORK 11, NEW YORK

HOLD-E-ZEE

AUTOMATIC GRIP
SCREWDRIVERS

**MORE WORK
IN LESS
TIME!**



UPSON
BROS., INC.,
86 Exchange St.,
Rochester 4, N.Y.

Hold-E-Zees do the job better, faster. They excel wherever screwdrivers are used. Gripper instantly released by spring action, sliding up out of way when not in use. All materials highest quality.

AT LEADING DEALERS EVERYWHERE



GIVE YOUR CAR WINGS!

After a Burd re-ring job, you can "hit it up" the first mile... no need to lose time in "run-in." Try a set of quick-seating Burd "Graf-Flox" Piston Rings; feel the difference in power and pep.

Free on request... two handy booklets for car owners. Print your name and address in margin of this ad, clip ad and mail today!



BURD PISTON RING CO., DEPT. PS, ROCKFORD, ILL.

NEW TOOL READY!

QUICKLY SHAPES, SANDS, CARVES, PROFILES, GRINDS, BEVELS, SMOOTHS, POLISHES, CLEANS! Industry's most versatile machine, The Mead Bandsander—now available to hobbyists, craftsmen, model makers, pattern makers, home workshops—cuts fast and clean on wood, metal, plastics! Works equally well on inside cut-out openings or irregular outside edges, on intricate scrolls, curves, saves hours of tiresome hand work—does better job. Nothing else like it. **IDEAL TO GIVE OR GET FOR WORKSHOP!** Sold on 5 Days' Trial, money back **GUARANTEE.**

Bandsander



FREE!

Write for free, lavishly illustrated Circular describing how Bandsander—the machine that amazed the experts—saves time, money, trouble. Write now—a post card will do!



MEAD SPECIALTIES CO.
4114 North Knox Ave., Dept. 287, Chicago 41, Ill.

BLOWERS

Blower wheels, bearings, etc. Cooling equipment. Coils. Exhaust fans. Gas & Oil burners & furnaces. Floor furnaces. Fire boxes. Liquid petroleum gas burners. Free literature. Wholesale & Retail. Card for details.

PEERLESS SALES

4318 Sheridan Blvd. Lincoln 6, Nebraska



MODERN, LOW-COST HEAT for Your Home or Shop

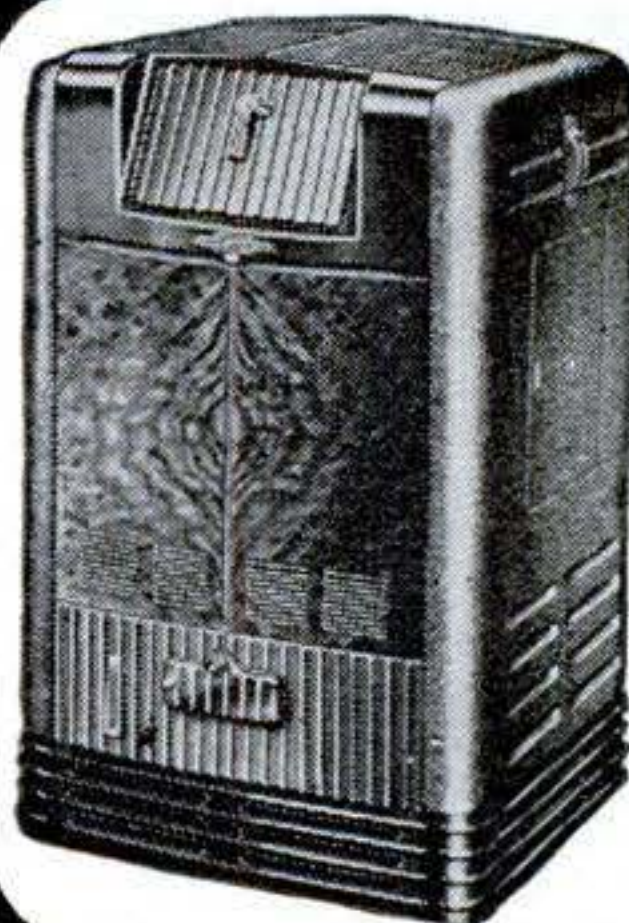

MODEL 420-A with Built-in Automatic Draft Regulator. 100-lb. Coal Capacity.

Other Models from 60-lb. to 200-lb. Coal Capacity. All exclusive, patented construction.



WARM MORNING COAL HEATER

No other heater like the WARM MORNING! Exclusive, patented interior brings amazing heating results and big fuel saving. Burns any kind of coal, coke or briquets. Heats all day and night without refueling. Holds fire several days on closed draft. Start a fire but once a year. The lowest cost dependable heat that you can buy. Be sure to see the WARM MORNING at your dealer's. Four models from which to choose.

Get This SMALL HOMES PLAN BOOK!

A handsome 16-page book in full colors with 12 beautiful, low-cost homes designed by nationally-known architect. A regular 50c book for only 25c. Send a quarter for your copy... NOW!



LOCKE STOVE COMPANY
Dept. N, 114 W. 11th St., Kansas City 6, Mo.

4-A

Say You Saw It In Popular Science



Balance 4" x 9" Base
With either Metric or Av-
oirdupois Weights. **\$6.00**

Catalog with 3000 illustrations of laboratory Apparatus sent for \$1.00. Catalog of 100 scientific books, 10 cents.
LABORATORY MATERIALS CO.
7317 Vincennes Ave. Chicago 21, Ill.

"I'LL TAKE THE WHITE ONE EVERY TIME!"



WYTEFACE
TRADE MARK
STEEL MEASURING TAPES



KEUFFEL & ESSER CO.

SpeedWay



No. 89
1/2" ELECTRIC DRILL
\$29.95

No. 209
Drill Stand
(less drill)
\$12.95

*Light in weight, convenient and handy, this improved drill has a special aligning grip that makes straight drilling natural. Backed by 35 years of electric drill manufacturing, produced in great quantities by modern methods, this is today's best drill buy. For every day farm, garage, construction and maintenance use, you can't get a better drill at any price. Specially wound, long life, high torque, fan-cooled motor. Cut steel gears, self-lubricating bearings, sturdy die cast case and a full sized snap action chuck (No key to lose).

With a No. 209 Drill Stand, the 89 Drill makes a capable lever operated drill press. Order from your local SpeedWay dealer.

SPEEDWAY MANUFACTURING CO.
1864 S. 52nd Ave., Cicero, Ill.

Special! BUILD YOUR OWN "Personal Radio" NEW MEISSNER RADIO KITS

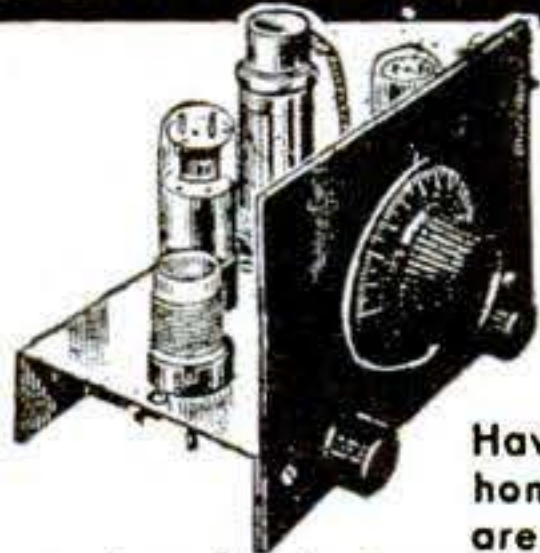

2-TUBE \$5.65
AC-DC Model

3-TUBE \$6.30
AC-DC Model

Have your own "Personal Radio" at home. These fine new Meissner kits are not toys, but real radio sets that receive signals from great distances. Supplied with plug-in coils for broadcast bands. Two controls. Pictorial diagram makes assembly very simple with screwdriver, pliers and soldering iron. All parts and material supplied, except tubes, phones, aerial. For 110 volts AC or DC. 5 lbs. No. A-10998 2-Tube, No. A-10999 3-Tube Kit.

Kit of 2-Type 76 Tubes for above.....\$1.48
Kit of 3-Type 76 Tubes.....\$2.22
Set of Head Phones.....\$1.95



T-17B MICROPHONE

All Brand New — Perfect Carbon Hand Mikes. Light Weight, 200 ohms. Single button, press-to-talk switch. 5 ft. rubber cord, plug, dust cover. Terrific at **99¢** F.O.B. N. Y. or Chicago • Send for Bargain Bulletins

NEW YORK
Offices & Warehouse
242 W. 55th St., N.Y. 19

NEWARK
ELECTRIC COMPANY, INC.

CHICAGO
323 W. Madison St.
Chicago 6, Ill.

New York City Stores: 115-17 W. 45th St. & 212 Fulton St.



LAM **CARBIDE SCRIBER**
NON-MAGNETIC

Tungsten Carbide — carefully ground on diamond laps, brazed into stainless steel 6" handle for marking steel and other metals — for etching, marking, cutting glass. In plastic case with pocket clip.

\$2.00
PRICE POST PAID



PRICK PUNCH with Carbide Tip..... **\$1.50**
Price Post Paid

LUCAS-MILHAUPT ENGINEERING CO.
5051 SOUTH LAKE DRIVE • CUDAHY, WISCONSIN



DRILL-INDEX A compact container for indexing and filing twist drills. Eliminates search. Made entirely of steel in ten sizes. See your dealer or write to

HUOT MANUFACTURING CO.
553 N. Wheeler St. Paul 4, Minn.

WOODWORKERS... Get this

CONSTANTINE MASTER MANUAL

Get the Most Fun From Your Hobby Indispensable to woodworkers. Newest, biggest edition, more pages, more color, helpful how-to-do-it articles, pre-war and new items, more bargains. Send 25c today and we will include **FREE! FULL YRS. SUBSCRIPTION** to Chips and Chats, published bi-monthly. Keeps you up-to-date on everything in woodworking, offers big money-saving bargains. Send now.

ALBERT CONSTANTINE & SON, Inc.
793-H 135th Street, New York 54, N. Y.



FREE!
FAMOUS
BLUE BOOK
CATALOG

GAME SUPPLIES

Club Furniture - Counter Games - Punchboards - Magic Cards Readers, Read the backs - Inks - Daubs - Poker Chips - Tops Flats - Layouts - Game Boxes.



K.C. CARD CO., 838 South Wabash Ave., Chicago 5, Ill.



Arc Welded Design "Know-How"

Only \$3.50 each
3 different volumes
\$10.00 postpaid

Each volume contains over 100 welding designs. Write Hobart Bros. Co. Box P-561, Troy, O.

WATCHES WANTED

BROKEN OR USABLE
All kinds. Highest Prices paid for jewelry, rings, spectacles, gold teeth, diamonds, Sterling Silver, etc. Cash mailed promptly. Write for free shipping container.
LOWE'S, Dept. PS, Holland Bldg., St. Louis 1, Missouri

PLANS FOR 5 PROJECTS

that are fun to build

— only **\$1.00** postpaid

Special combination offer includes easy-to-read plans for: 1. Folding Lawn Chair 2. Child's Teeter Totter 3. Child's Glider Swing 4. 24-room Swallow House 5. Bird Feeder

Mail your dollar bill today! Ask for Package "Z".

DELTA MANUFACTURING DIVISION
Rockwell Manufacturing Co.
682H E. Vienna Ave., Milwaukee 1, Wis.



Deltacraft®

H-50



MOTO-TOOL ★ THE "POCKET-SIZE" MACHINE SHOP

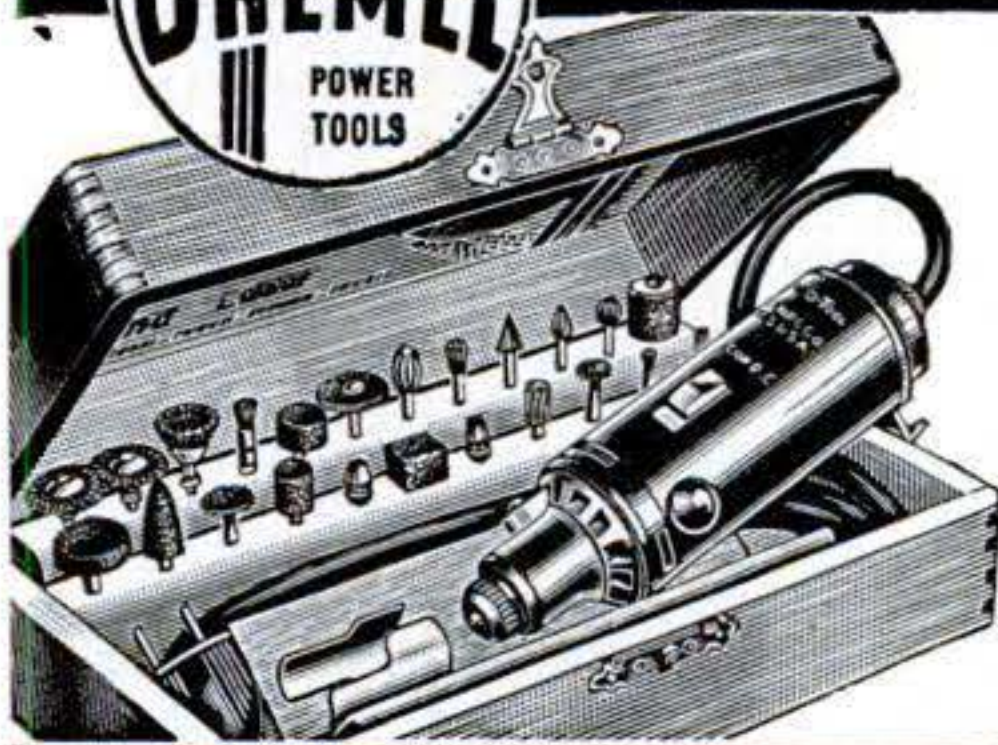

"MAN . . . WHAT A POWERHOUSE!"

A TOOL THAT PACKS YEARS OF PLEASURE

Here's a tool to please a man's heart . . . one that holds promise of endless creative hours. Dremel Moto-Tool . . . the little grinder that does big jobs . . . is a "war veteran" . . . used by all branches of the armed forces in far-flung repair bases . . . helped set production records at General Electric, Westinghouse, Remington Arms, Ford and others. Hobbyist or expert craftsman, first choice is Model 2 Moto-Tool Kit with its handsome felt-lined, highly finished wood case with rows of tools begging to be put to work. Write for FREE catalog of Moto-Tool attachments and accessories.

MOTO-TOOL FEATURES:

Oil-less, sealed, bearings • Patented automatic chuck lock pin • Oversize armature shaft, hardened, ground, polished • 110 Volt, AC-DC motor • Sliding snap-type switch • Cord protector • Shockproof bakelite housing • Dust-filtered, air-cooling system • Weighs only 13 oz. • Dynamically balanced for vibrationless operation.

MONEY BACK GUARANTEE: Buy Dremel Moto-Tool and Accessories from your dealer. If he cannot supply you, order direct from factory on 10 day trial. Shipped postpaid for cash in full; or for \$2.00 sent C.O.D. for balance plus postage.

DREMEL MFG. CO.

Dept. 127-H . . . Racine, Wisconsin

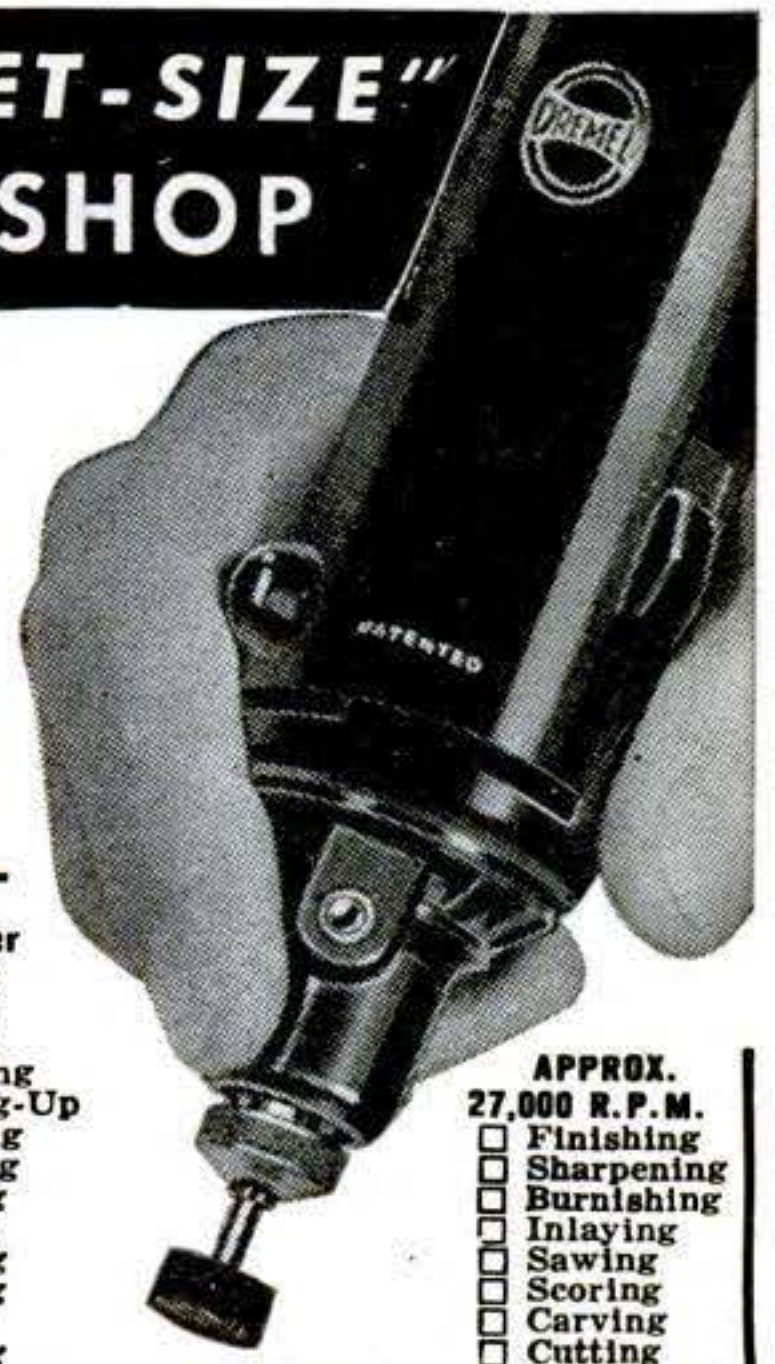

Do These Better-Faster

- Drilling
- Routing
- Sanding
- Engraving
- Touching-Up
- Mortising
- Polishing
- Cleaning
- Rasping
- Brushing
- Dressing
- Burring
- Grinding

- APPROX. 27,000 R.P.M.**
- Finishing
 - Sharpening
 - Burnishing
 - Inlaying
 - Sawing
 - Scoring
 - Carving
 - Cutting

Moto-Tool Kit No. 2, with 23 accessories (high speed steel cutters, grinding wheels, polishing accessories) and heavy-duty professional Model 2 Moto-Tool in natural-finish, hardwood case . . . \$23.50. (Items purchased separately would cost about \$30.00; you save \$6.50.)

Moto-Tool No. 2 with one emery point \$16.50. **Moto-Tool Kit No. 1** with 34 accessories and Model 1 Moto-Tool in wood case . . . \$17.50. **Model 1 Moto-Tool** with one wheel point \$9.85.

FREE TRAILER PARTS CATALOG

"Safety Engineered"



BULL DOG Hitches & Parking Jacks. TORQ-LESS Axles,

Drop a card to Dept. D-16 HAMMER BLOW TOOL CO., WAUSAU, WIS.

Ottawa Self-Propelled Buzz Master

CLEAR LAND FAST! Powerful 7-HP motor with friction clutch for safe operation. Cuts down timber, brush and hedge; turn blade vertically and saw logs to length. Also furnished with post hole diggers. Has clutch pulley for belt work.



No Other Like It!

OTTAWA MFG. CO., 1-701 Brush Ave., Ottawa, Kansas

EXHAUST BLOWERS • PEDESTAL FANS

PHOTOGRAPHERS • HOSPITALS • LABORATORIES • WORK SHOPS • LAUNDRIES
OFFICES • RESTAURANTS • PRINTERS • PLAYROOMS

SOLVE ANY VENTILATION PROBLEM WITH 2 AIR CONDITIONERS

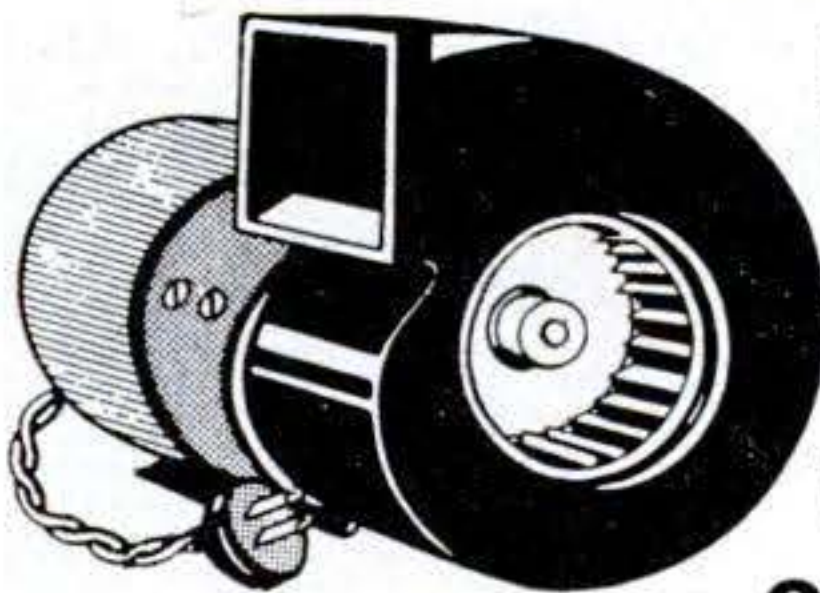

At last! A real post war fan to banish summer heat. Far superior to any pre-war product. Made of the finest materials to give perfect service indefinitely.

- 18" Fan Blades • Adjustable from 6½ ft. to 8 ft.
- Aluminum Blades • Chromium Slide Bar • Chromium Guard.

Continuous duty Ball Bearing Motor guarantees exceptionally quiet operation. 110 Volts, A.C., 50-60 cycles.

SEND CHECK OR MONEY ORDER FOR \$65

This RUGGED BLOWER & EXHAUST DELIVERS 100 CU. FT. AIR PER MINUTE. Quick and simple to install. Anyone can do it with ordinary household tools.

Continuous duty BALL BEARING MOTOR assures quiet, trouble free operation. Tough housing insures long life. 110 Volts, A.C., 50-60 cycles.

Only \$15.85

Send check, money order. No C.O.D.'s. West of Mississippi add \$1.00 for mailing, handling.

ONLY \$65.00

FOB Yonkers
Freight Collect

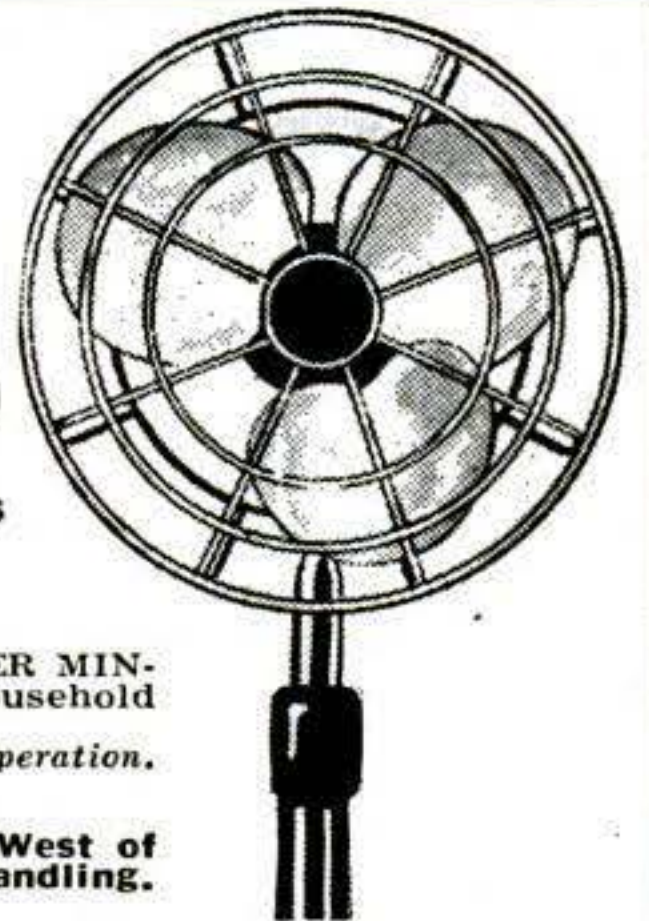

UNIVERSAL YONKERS CORP. (Dept. S-8)

41 Locust St., Yonkers 2, N. Y.

WRITE FOR YOUR FREE COPY OF THE NEW KRW HYDRAULIC PRESS BOOK

Describes all manner of Production and Shop Work on KRW Hydraulic and Bench Type Arbor Presses. 32 pages illustrating the new KRW Hand-operated, Electric-operated and Air-operated Hydraulic Presses. Write for your copy today.

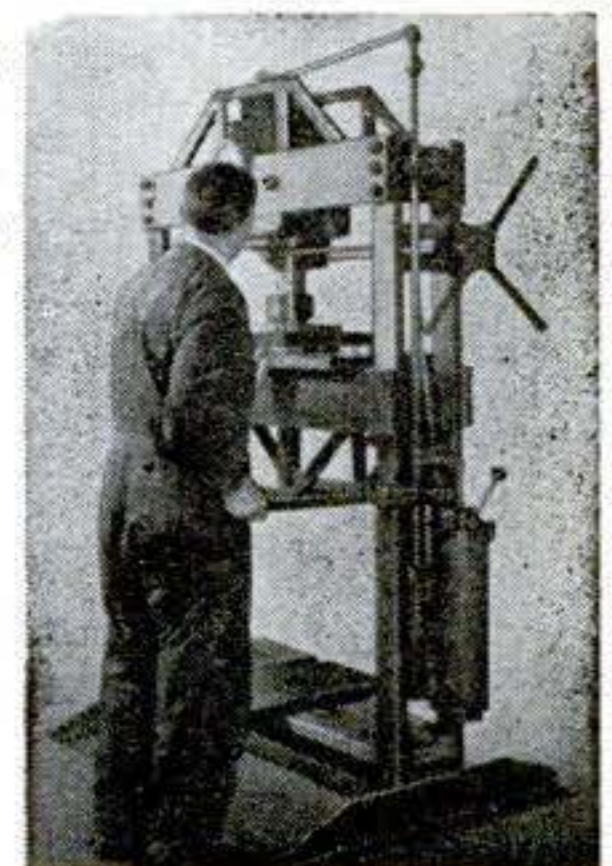
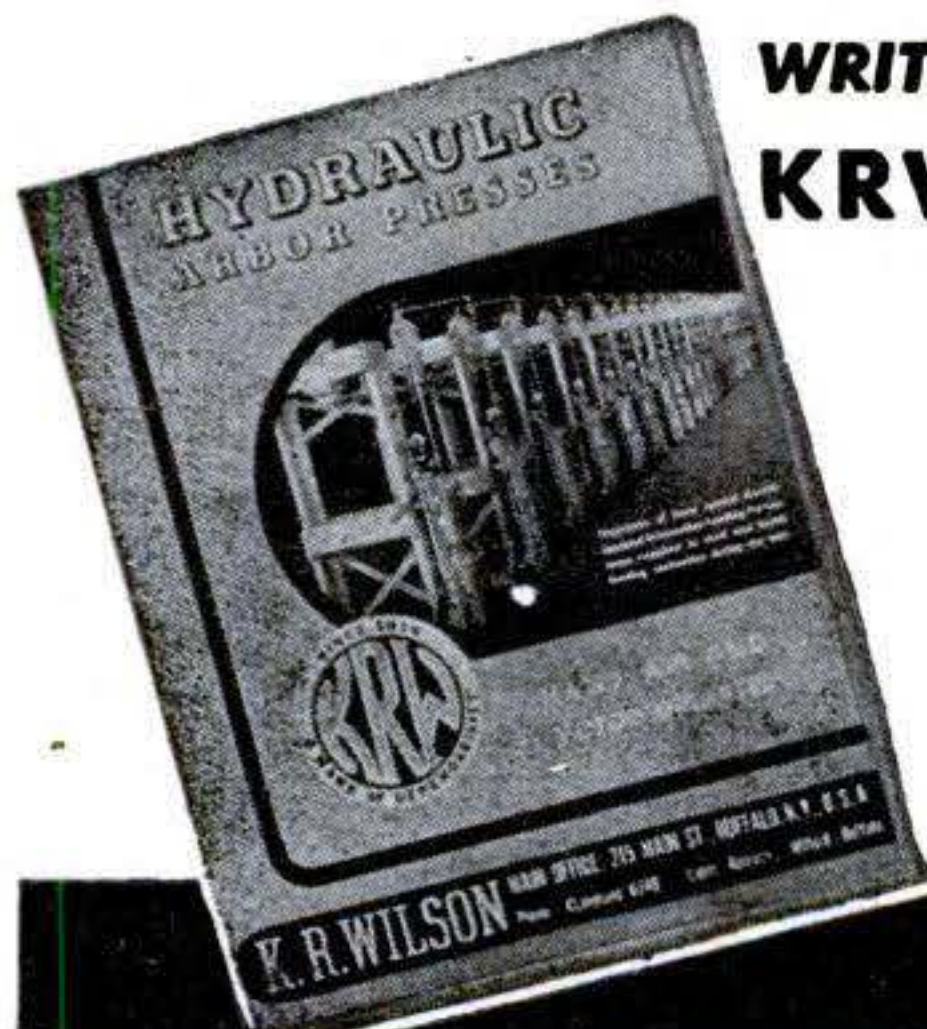

K. R. WILSON, DEPT. 54, 215 MAIN ST., BUFFALO 3, N. Y.

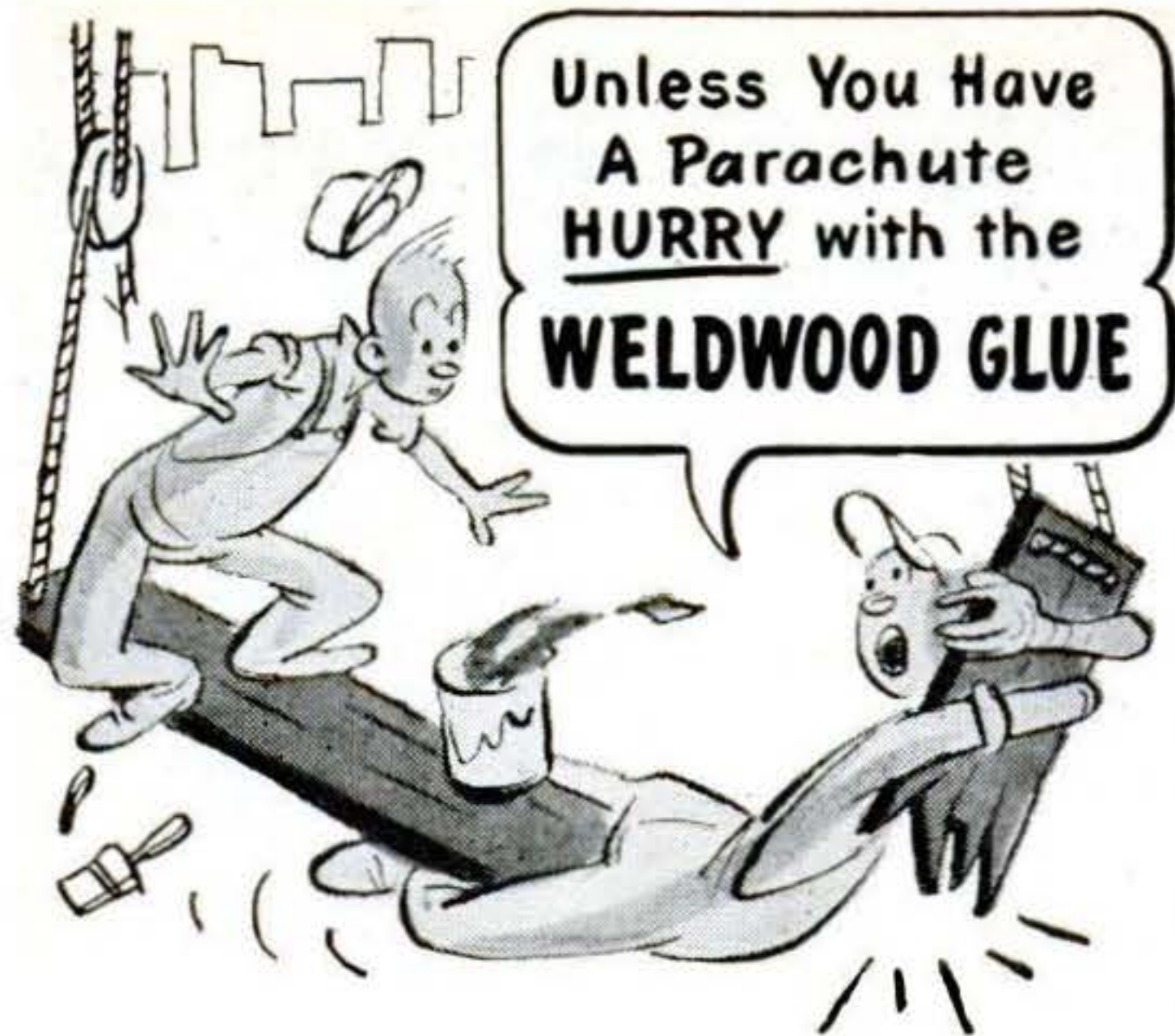

When you want to fix things fast . . . remember Weldwood Glue. It's quick to mix . . . easy to use . . . tremendously strong . . . stain-free . . . rot-proof . . . and permanent. At hardware stores, lumber yards, chain stores.



WELDWOOD PLASTIC RESIN WATERPROOF GLUE

United States Plywood Corporation, New York 18, N. Y.

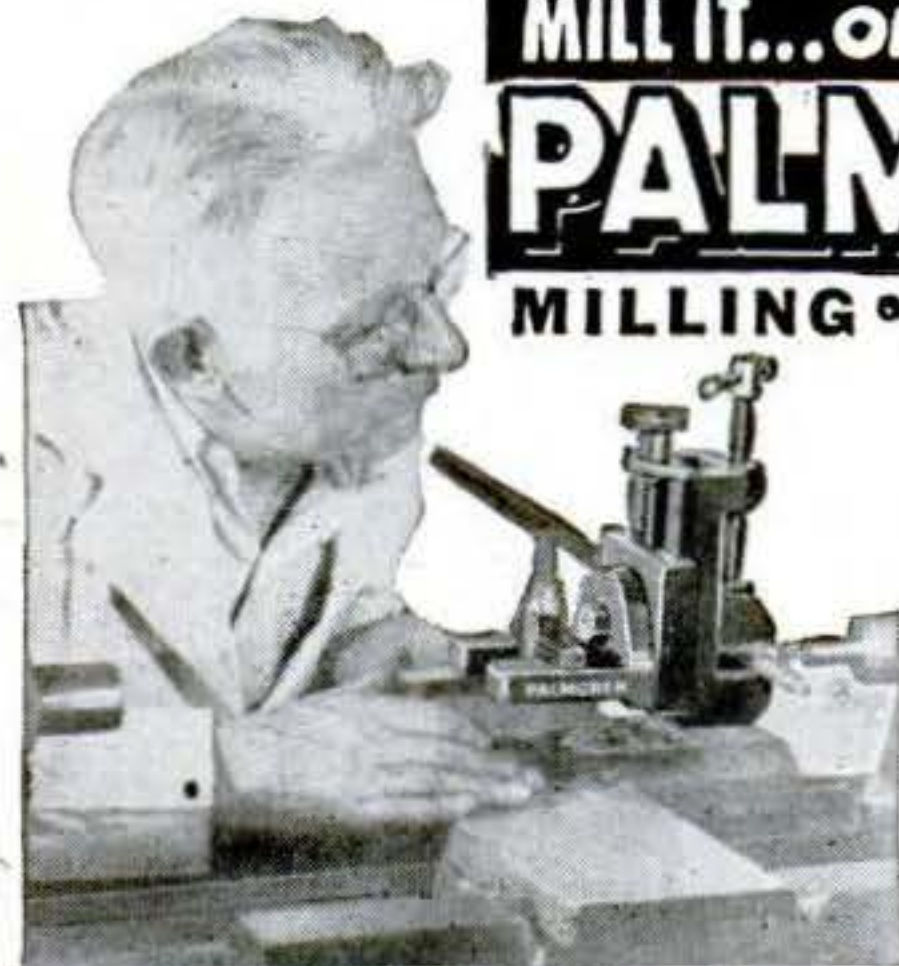

MILL IT...ON YOUR LATHE! PALMGREN MILLING ATTACHMENT

3 SIZES
No. 250 Illustrated
2 1/2" JAW Only
\$24.75
CONVERT LATHE IN 10 SECONDS

Now you can Mill, Slot, Grind, Groove, Square Shafts, Saw at Angles, Recess and many other important jobs. **SAVE TIME and MONEY!** Why send work out or use costly methods when a PALMGREN MILLING ATTACHMENT will solve your problem. Precision built, it has accurate graduations for rotary angle adjustments, also graduated vertical feed screw. Fits South Bend, Atlas, Craftsman, Logan, Sheldon and all other lathes. Thousands now in use in small and large machine shops, repair shops, railroads, schools, home work shops, etc. **ORDER SIZE NEEDED TODAY!**—it will quickly pay for itself.

IMMEDIATE DELIVERY

Nos.	Width Jaws	Depth Jaws	Jaws Open	Weight Pounds	Fits Tool Post	Price F.O.B. Factory
150	1 1/2"	1"	1 5/8"	6 1/2	1" Dia.	\$18.75
250	2 1/2"	1 7/16"	2 1/2"	11	1 1/4" Dia.	24.75
400	4"	1 1/2"	4"	25	2" Dia.	39.75

Order From Your Dealer or Jobber: Write for Circular No. 351
Mfrs. of PALMGREN PRODUCTS
Since 1915
8396 South Chicago Ave.
Chicago 17, Ill.

**CHICAGO TOOL and
ENGINEERING CO.**

JUST A FEW OPERATIONS YOU CAN DO ON YOUR LATHE!

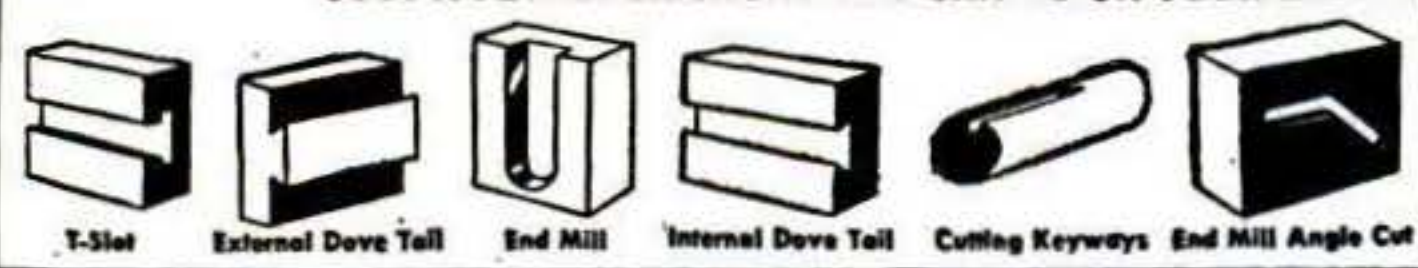

PRESS-TITE CAULKING AND SEALING CORDS



Keep cold out!
Seal holes and cracks!

Soft, rope-like Press-Tite Cords effectively seal windows and doors against cold and dust. Save fuel.

Press-Tite Cords will not harden—they stay soft and seal tight. Use also to fill any cracks or holes in wood, plaster, masonry or brick. Just press into place—no tools needed.



PRESSTITE ENGINEERING CO.

3976 Chouteau Ave., St. Louis 10, Mo.

60 POWER TELESCOPE \$2.95

VARIABLE EYEPIECE 20X-40X-60X
NEW! Three telescopes in one, 3 different magnifications. 20 power for ultra-bright images with 40 and 60 power for extra long range. Guaranteed to bring distant objects, people, sports events, ships, moon, stars, etc., 60 times as close.



Most powerful for anywhere near the money. 5 sections. Closes to 1 ft. long. Not one of our high precision instruments but the biggest value. Contains 4 ground and polished lenses. The tubes are made of Kraft fiber, brass bound. It may also be used as a powerful compound microscope for examining objects too small to be seen with the naked eye. Directions included. Mass production methods enable us to sell this high-powered instrument at the amazing price of only \$2.95. We pay the postage. Get yours immediately.

BROWSCOPE CO.

Dept. 8P 24 West 45 St. New York 19, N. Y.
Catalog of big values in binoculars, microscopes, etc., free on request



MASTER CHAMPION

LAWN MOWER SHARPENER
Also Mfg., Saw Sharpening
& Key Machines

FRANK'S MFG. CO.

Dept. PS-8, 3312 Tweedy Bl.
SOUTHGATE, CALIF., U.S.A.

Heavy Duty - Ball Bearing - All Purpose MANDREL

Length Overall 14"
Diameter OD 1 3/4"
Shaft 1/2" or 5/8" Optional
Lugs 1/4" x 1 1/4" x 3 3/8"
2" between collars
Right or left hand in U.S.
Thread Optional
\$8.00 Postpaid and shop-saws, shapers, fans, power take-off, wind mills, etc. Be sure to state shaft size and thread (R or L) desired. Send Money Order or Certified Check. Full money back guarantee. If your dealer cannot supply you, write.

TRIO MACHINE CO. Box 187 Dept. PS Willoughby, Ohio

Print Your Own

Cards, stationery, circulars, tags, labels, photo and movie titles, advertising, etc. Save money. **Print for Others, Good Profit!** easy rules sent. Raised Printing like Engraving, too. Send dime for press samples, supply book, all details and advice on your needs. No obligation. **KELSEY INC., B-33, Meriden, Conn.**

Raise GOLDEN HAMSTERS

The new wonder animals from Syria. Look like Toy Red Bears. Delightful pets. Everybody wants them. Thousands needed by laboratories. Make money, get started now. Send 10c for illustrated literature, or send \$5 for a pair of hamsters and literature.



GULF HAMSTERY 1540 BASIL ST., MOBILE 17, ALA.

BUILD YOUR OWN Battery Driven ELECTRIC LAWN MOWER.. PLANS ONLY



This ultra-modern rotary-blade mower can be made from inexpensive parts and an old auto generator. Plans complete, easily followed. Mower cuts forward or backward, tall or short grass, weeds.

35¢

WRITE TODAY

LEJAY MFG. CO.

823 LeJay Bldg., Minneapolis 8, Minn.

AUTOMATIC SAW SET

HAND AND
BAND SAWS

Set saw teeth automatically—400 per minute without effort. Perfect hammer and anvil action sets teeth uniformly—tensions metal. No tooth breakage. Write today!

SAW SHOPS NEED THESE MACHINES

WITH
MOTOR

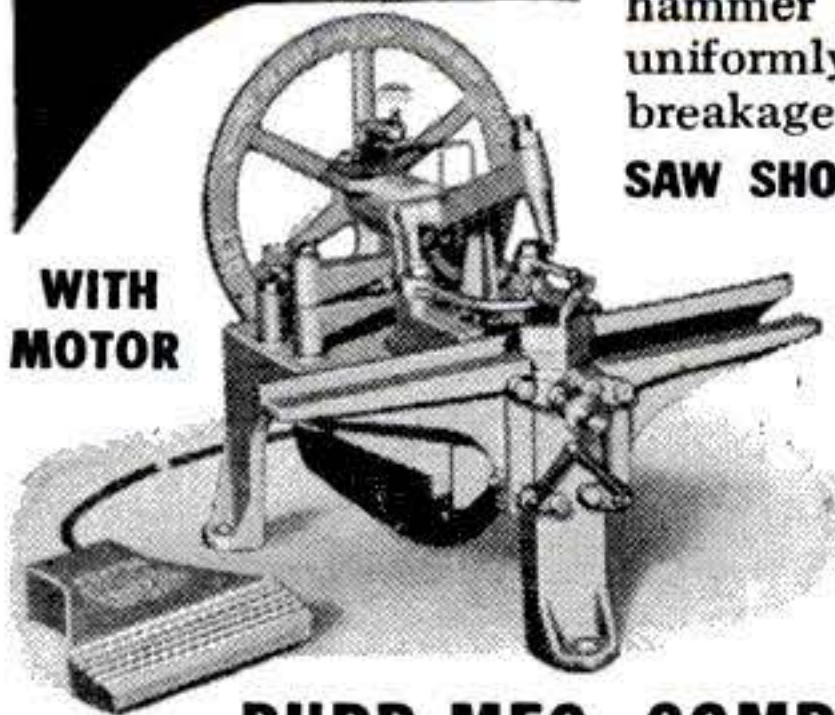

AUTOMATIC SAW RETOOTHER

Cuts new saw teeth in 50 seconds—any size 4 to 16 points. Old teeth fall off as chips. Simple to operate. A perfect job.

BURR MFG. COMPANY 8931-G Venice Blvd.
Los Angeles 34, Calif.

THE UNIVERSAL LIQUID CEMENT

AMBROID

The "Mr. Fix-it"
for "a million things"

Tops in quality for 37 years. Uses unlimited . . . sticks and mends permanently. Waterproof . . . quick drying. Keep a tube on hand always. Extra quality . . . extra strength. Ready to use. LOOK! Get acquainted with Ambroid quality. At your dealers or send 25c for big 2-oz. tube postpaid (U.S.A. only). Money back guarantee. **25¢**



Also 50c 4-oz. tube.
Pts., qts., gals. for
industrial use.

AMBROID CO.

307 Franklin St., Boston 10, Mass.

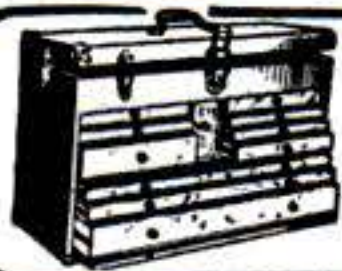

MACHINISTS — TOOLMAKERS

Your good tools deserve the care that only a Gerstner chest can provide. Free Catalog.

GERSTNER TOOL CHESTS
547 Columbia St., Dayton 7, Ohio

ATTENTION HOMECRAFTSMEN!

PLANS For Dutch Windmills, Lighthouses, Bird Houses, Lawn Chairs, Arbors, Trellises, many kinds of fine furniture, also a great variety of Lawn Figure patterns. SEND 10c FOR CATALOG ILLUSTRATING OVER 100 PRACTICAL PROJECTS
Craftsman's Model Co., 2030 N. 41st St., Dept. K20, Milwaukee, Wis.

LAW

STUDY AT HOME for PERSONAL SUCCESS and LARGER EARNINGS. 39 years expert instruction—over 108,000 students enrolled. LL.B. Degree awarded. All texts furnished. Easy payments. G.I. Approved. Send for FREE BOOK.

AMERICAN EXTENSION SCHOOL OF LAW
Dept. 80-S, 646 N. Michigan Ave., Chicago 11, Ill.

TRUCK BUYERS!

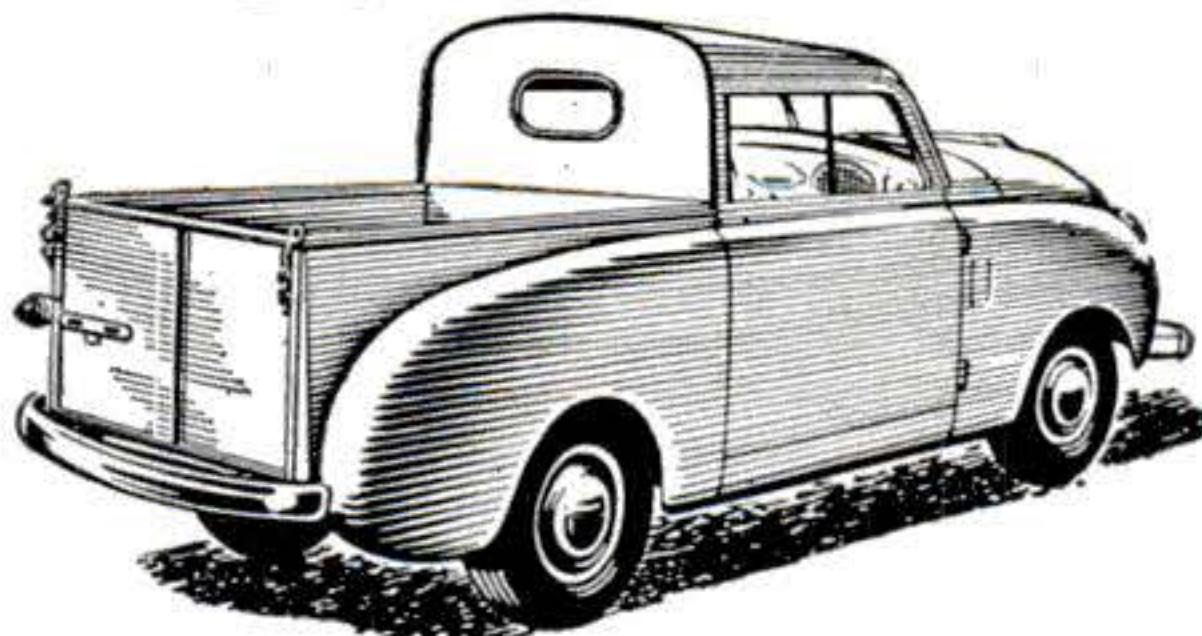

Here's America's Lowest-Cost
Transportation . . . the great, new

CROSLEY

a FINE car

You can save money with the new, fine Crosley! Get 35 to 50 miles on a gallon of ordinary gasoline! Both the new Crosley Pick-Up Truck and the Crosley Sedan are more maneuverable in traffic (20 inches narrower at the fenders than most cars); park easily in "impossible" places!

FOR YOUR SALESMEN—The comfortable 4-Passenger Sedan is ideal for salesmen and for light delivery. Plenty of leg-room for 4 huskies—ample baggage space—seats are removable. Plenty of speed, power, pep. All-steel body, extra low center of gravity. America's lowest price car—lowest operating costs as well!

FOR LIGHT HAULING—The Crosley Pick-Up Truck has steel body, full quarter-ton capacity; steel drop tailgate. Big, roomy cab. Plenty of power, too. Can operate inside the plant. America's lowest price, lowest cost truck!

NEW CROSLEY COBRA ENGINE
(Copper Brazed) Weighs only 59 lbs. All steel, copper brazed. 4 cylinder, valve-in-head, water cooled. Most revolutionary development in 40 years. Delivers 26.5 horsepower; 35-50 miles per gallon; speeds to 60-plus! Precision-built for long, trouble-free operation. Get facts and figures today!

See your local Crosley Dealer or write for full information.

CROSLEY MOTORS, Inc.

2532-JC Spring Grove Ave., Cincinnati, 14, O.



GET INTO BUSINESS WITH SMALL CAPITAL working at home or shop. There is big money making HOLLYWOOD STYLE cement pottery, birdbaths and garden ornaments without moulds. Also imitation marble, water-paints, chemical staining, etc. 10c brings sample, details and pictures.

HOLLYWOOD CEMENTCRAFT
8527-B Wonderland Ave., Hollywood 46, Calif.

Say You Saw
It In Popular Science

ROCHESTER'S world-famous industries

WANT

PATENTS

For further information, write to the Division of Public Relations, Rochester Department of Commerce, 54 Court St., Rochester 4, New York.

"A City of Rochester Service"

A Real Sensation!

Here's something needed in every shop

the **New**

L-W Medium Duty 4-Jaw Independent CHUCKS for Small Lathes

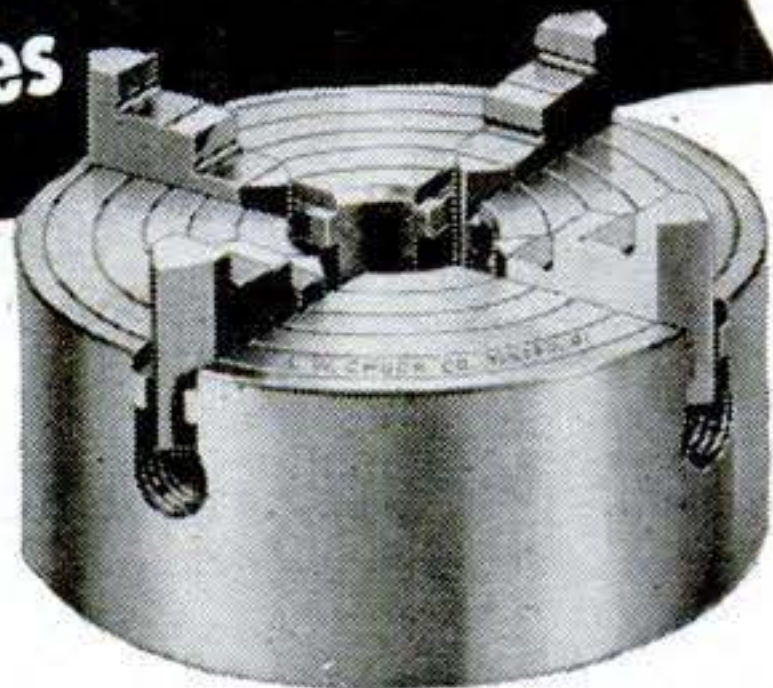

They will save you a lot of time and labor and permit much more accurate work.

PRICED WITHIN THE REACH OF ALL!

Semi-steel bodies. Face and outer edge surfaces ground. Steel jaws. Hardened and ground steps. Heat-treated steel screws. Complete with wrench.

Finished adapter back plates are suitable for some models of Atlas, Clausing, South Bend and Logan lathes.

6" HEAVY DUTY \$16.95

Semi-finished, ready to mount adapter back plate, 1 1/2" - 8 thread \$3.00. Rough adapter back plate casting, \$1.25.

RUGGED 8" MEDIUM DUTY \$21.

Semi-finished, ready to mount adapter back plates, 1 1/2" - 8 thread \$3.60. Rough adapter back plate casting, \$1.50.

ORDER TODAY or write for complete catalog

MFGRS. UNIVERSAL AND INDEPENDENT LATHE CHUCKS • MILLING MACHINE VISES • POWER HACK SAWS • DIVIDING HEADS • MAGNETIC CHUCKS • RECTIFIERS • DEMAGNETIZERS

L.W. CHUCK CO., 32 So. St. Clair St., Toledo 4, Ohio

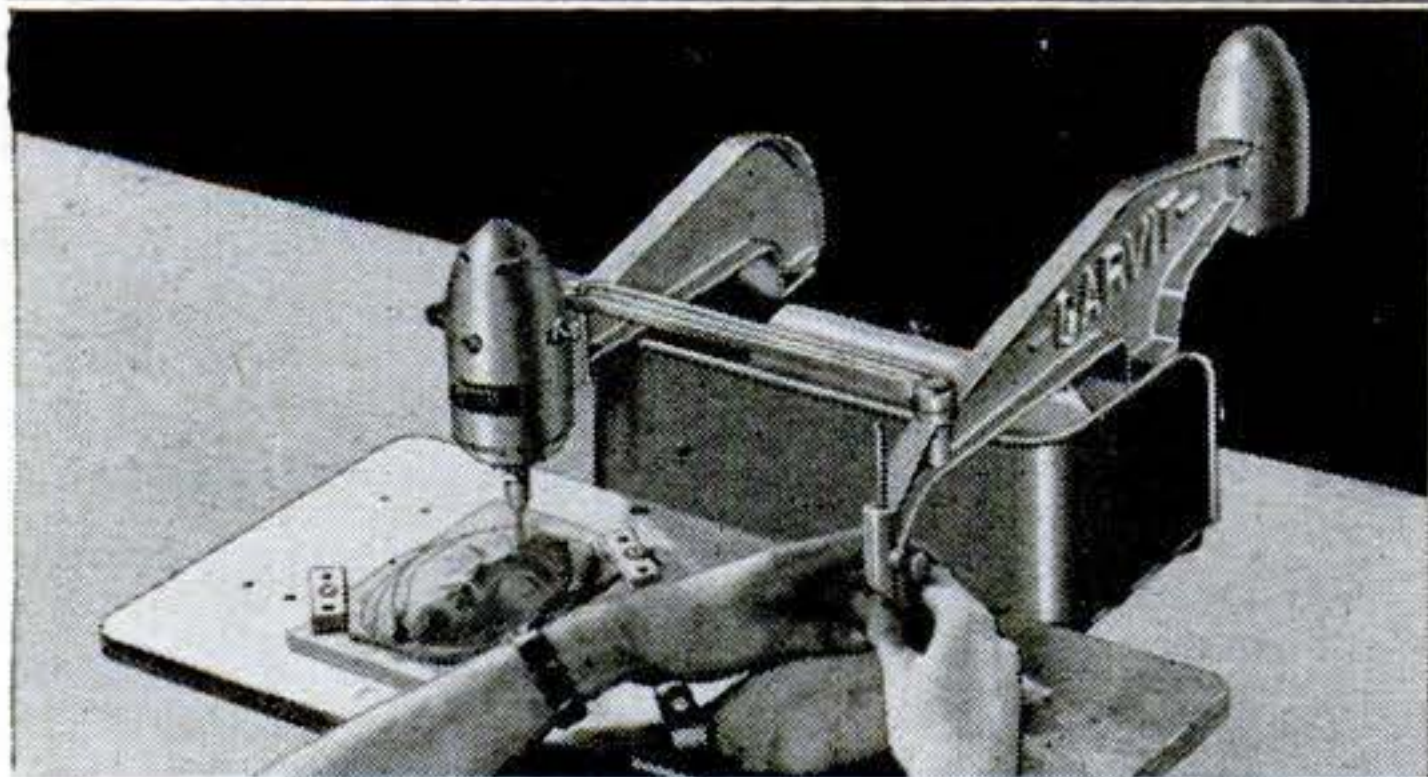

New! Sensational! Carvit makes you a skilled wood carver in 20 minutes!



Here's a fascinating new hobby — complete in one tool! The unbelievable perfection of your first carving amazes your friends! Experienced craftsmen use the Carvit to give their projects that professional touch.

With the Carvit, you make beautiful replicas of inexpensive objects you can find in any dime store or gift shop — in mahogany, walnut, and other fine woods: useful ornaments for your home, distinctive gifts for your friends — fine carvings that *sell!*

TEAR OUT THIS COUPON AND MAIL TODAY!

The Dumore Company, Dept. H-52, Racine, Wis.

Please send complete information on the Carvit.
 Please send one Carvit. \$48.50 enclosed. Shipping charges C.O.D.

Name _____

Address _____

City _____ (____) State _____

H-3

CROSMAN *Silent* RIFLE



POWER without POWDER

You'll like a Crosman because there is no recoil to spoil your aim... no noise... no odor... no cleaning! Rifled barrel for greater accuracy... adjustable power, too, for short or long range shooting indoors or out. Available in .177 and .22 cal. models.

AT YOUR DEALER OR WRITE DIRECT

CROSMAN ARMS CO., INC.

9A HENRIETTA ST., ROCHESTER 7, N. Y.

Shoot CROSMAN *SuperPells*

The BETTER Ammunition for ALL .177 and .22 caliber Air Pistols and Rifles.

.177 cal. . . \$2.50 per M
.22 cal. . . \$3.00 per M



POSTAGE PREPAID

At your dealer or order direct

FOR GREATER ACCURACY MAXIMUM POWER

CROSMAN ARMS CO. HENRIETTA ST., ROCHESTER 7, N. Y.

Build Your Power Tools With OUR BALL BEARING ARBORS

New Departure Self Lubricating Bearings 10,000 rpm

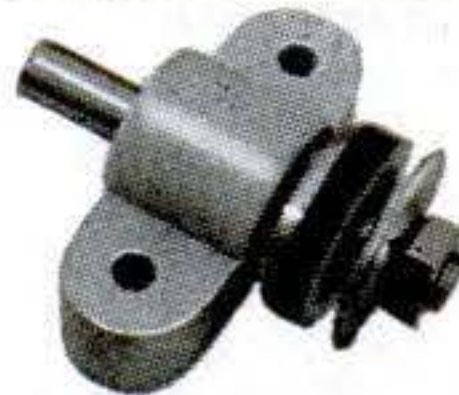

(No extra charge for left hand threads)
B33—\$4.95 PP
5/8x4 1/2 Spindle
B15 Plain Spindle \$3.45

C4—1 1/2 x 12 1/2 Spindle, housing 2x8 \$8.25 PP.
C5—5/8 x 12 1/2 spindle, housing 2x8 \$8.25 PP.
C6—3/4 x 12 1/2 spindle, housing 2 1/4 x 8 \$9.25 PP.
D8—1 x 17 1/2 spindle, housing 2 5/8 x 11 \$16.95 PP.
1 INCH BETWEEN WASHER AND COLLAR
Shaper Arbor^c. C4, C5, C6 or D8, 3 inches between collars, add \$6.00. Plain Spindle Models less threads and collars C4—\$8.00, C5—\$8.00, C6—\$9.00, D8—\$16.00. All P.P. V Belts and Pulleys. SANDING DISCS, 8"—\$3.50 PP., 10"—\$5.00 PP. Center Hole 1/2, 5/8 or 3/4. State hole size. Dealers wanted.

POLY PRODUCTS, 406 S. Chester, Ct. 1b, Pasadena 5, Calif.

Assemble KING MIDGET



Practical highway racer runabout. New model. We supply all parts. Just bolt together. Low cost. Ready for delivery NOW. One or two cylinder, 40 m.p.h., up to 100 miles per gallon. Send 25c for complete new literature with large picture, 4-view drawings, price of parts, or send \$1 (refunded with first order) for the above, plus 24-page assembly book with 42 photographs and drawings.

MIDGET MOTORS Athens, Ohio

BUILD YOUR OWN ARC-WELDER

For Light or Heavy Work
No rewinding necessary—use coils taken from old auto generators. Works on 110 or 220 A.C. Has 20 different heats. Complete plans and BIG Catalog 35c. LEJAY MFG., 3323 Lejay Bldg., Minneapolis, Minn.



Thompson BEATS the World on BOATS



Better Built Lower Prices



Canoes

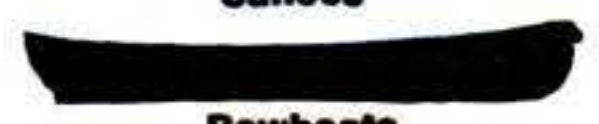

Rowboats



Outboards



Light Boat for Auto

Safe Boats With Full Length Spray Rails
Keep passengers perfectly dry—even at high speeds. Catalog also shows two new models of "Take-Along" Boats. Two big factories—save you freight.

CATALOG FREE
Write for your copy. State kind of boat in which you are interested.

THOMPSON BROS. BOAT MFG. CO. (151)
219 Ann St. PESHTIGO, WIS. (Write to either place) 119 Elm St. CORTLAND, N.Y.



Blades of finest custom made steel, **HAND HONED** under oil. Ask your good neighbor, the local hardware or sporting goods dealer. We're doing our best to keep him supplied.



Kä-MILL-us

No. 72
3 3/8" closed

CAMILLUS CUTLERY COMPANY, New York 17, N. Y.
Established 1876 . . . Factory at Camillus, N. Y.

D. C. CONVERTER

Eliminates need for tricky, expensive rewiring of war surplus radios, motors.



110 volt A.C. to 24 volt D.C. power pack for only **\$15.95**

For the first time, and for only \$15.95, you can get, by return parcel post, a direct current supply especially engineered for 24 volt **WAR SURPLUS** electrical equipment! The exact type of power for which aircraft radios, motors, etc., were designed.

This fully enclosed powerful 3 Amp. unit plugs directly into your 110 volt A.C. wall socket and delivers pure D.C. to operate **WAR SURPLUS** motors, radios, instruments relays, solenoids.

Now you can take full advantage of the tremendous bargains being offered by Uncle Sam. No technical knowledge necessary, just plug in and use. Contains full-wave bridge type selenium rectifier, 150-Watt stepdown transformer, 1000 microfarad condenser, on-off switch and resetting fuse.

Send check or money order for \$15.95. Will be shipped express collect (or parcel post, providing shipping charges are included in remittance.) Shipping weight 15 lbs.

SCINTILLA RAIL & POWER WORKS, INC.
54 Macdougall St., New York 12, N. Y.

How to Start YOUR OWN BUSINESS

And Reap BIG Profits!

Plastics, one of the most revolutionizing and rapidly expanding industries, offers a great opportunity to all enterprising men and women. This is one of the few industries in which home manufacturers thrive and prosper. You can start even on a spare time basis in your own home, and expand rapidly into a full time business, paying good profits.

LIQUID MARBLE

Make **LIQUID MARBLE** the amazing Plastic, with a thousand uses. **LIQUID MARBLE** can be poured into **FLEXIBLE MOLDS** for casting all kinds of artistic and serviceable articles such as: ornaments, novelties, desk sets, paper weights, book-ends, souvenirs, stationery, toys, etc.

FLEXIBLE MOLDS

Make your own **FLEXIBLE MOLDS**. The cost is low—in fact, a large sized mold costs but a few cents. Hundreds of casts can be taken from a single mold.

NO EXPERIENCE NEEDED!

No skill or previous knowledge is necessary. All you do is follow our easy-to-understand instructions.

UNLIMITED MARKET

The market is literally unlimited. You will find steady year-round demand in your own community. Your problem will not be in selling but in supplying the huge pent-up demand. Moreover, we supply you with names of buyers for your finished products.

WRITE TODAY

Bing Products will show you how to start with a small investment and build a permanent, independent, profitable business! Don't fail to grasp this opportunity! Write today for **FREE CATALOG**.

BING PRODUCTS

Dept. B-22, 88 Broad Street Boston 10, Mass.

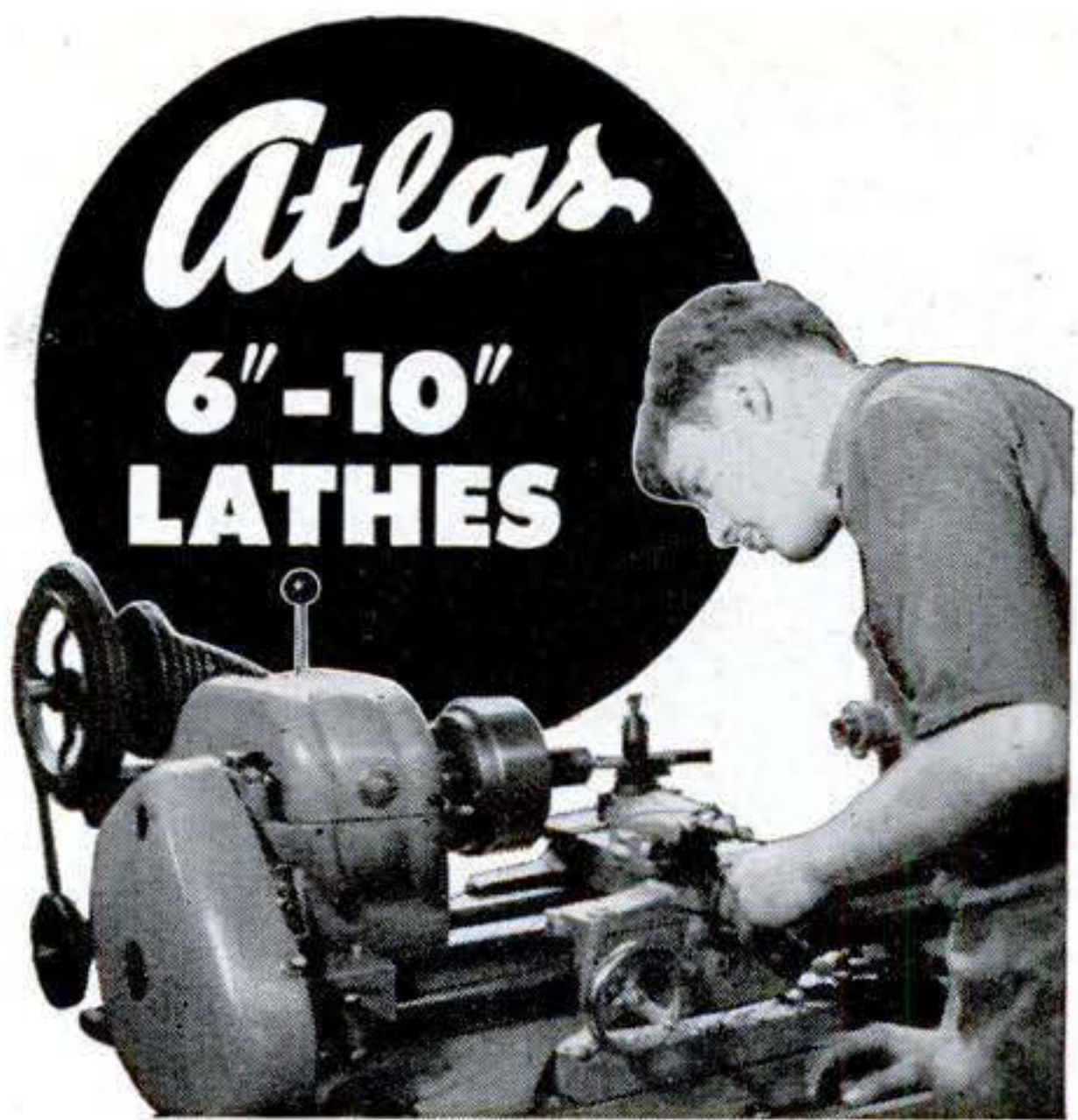

Atlas
**6"-10"
LATHES**

**Now Available at
NEW LOW PRICES**

Good news for home shop owners! Now you can equip your shop for precision metalworking—with today's greatest values in compact precision lathes! See them at your Atlas distributors, or send for literature. Prices, less motor, F.O.B. Kalamazoo: 6"—\$104.75; 10"—\$195.00



ATLAS PRESS CO.

855 N. PITCHER ST., KALAMAZOO 13D, MICH.

LATHES • DRILL PRESSES • SHAPERS • MILLING MACHINES

MAKE \$ MORE M \$ O \$ N E \$ Y

Applying or Selling

CORKSTONE

A General Purpose Magnesium Oxychloride Flooring

THE MODERN PLASTIC FLOORING

EASY TO APPLY

Here's your opportunity to get into business for yourself applying or selling **Corkstone**, the economical, top-grade plastic flooring. Plenty of profit. Act without delay!

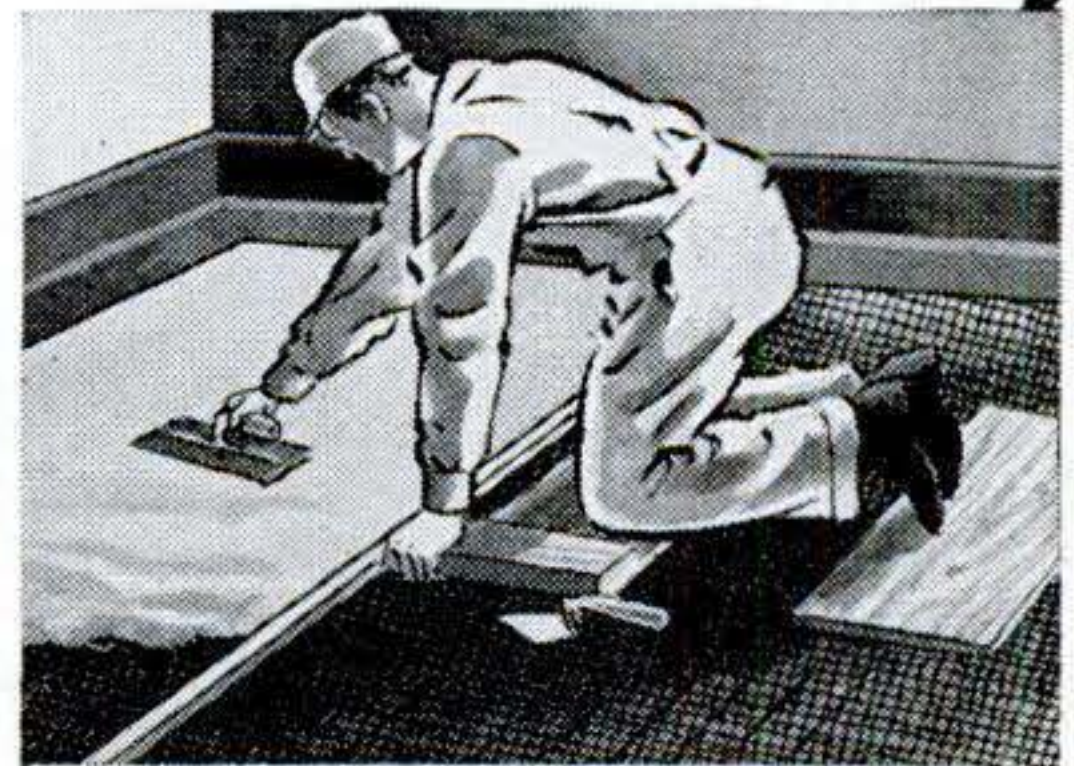

Dealers & Agents Wanted

WRITE FOR DETAILS

LASTING PRODUCTS COMPANY

200 Block S. Franklinton Rd., Baltimore 23, Md.

For . . . **BIG Money-Making . . . Doing ALL Work**
 . . . the **NEW, EIFEL-LINE SUPER-TOOLS**
4 Great KITS, with 10 Attachments
 . . . to Make 17 World-Beating Combinations
EIFEL-GEARED PLIERENCH KIT

- 1) The 7" KIT, Famous in the Small-work field, makes Universal-PIPE-WIRE Combinations.
 - 2) The Famous 8½" KIT, with same Combinations for the HUSKY Work and much surprisingly Fine work too!
 - 3) The New GIANT-KIT . . . the 8½" Kit with the 4" GIANT-Jaw added . . . to give a Million Sizes from 0" to 3"!
 - 4) **THE MASTER KIT** Comprises the 8½" Plierench + PIPE-Jaw + WIRE-Jaw + TUBING—Cutter-Set + Grip-CLAMP . . . in a Handy 3 Pocket Holster. It Folds to 3" x 1¼" x 11" . . . It's THE Kit of the Atomic Age!
- These 3 great Accessories Can be Used in All Eifel-GEARED Plierenches . . . made since 1932.
- Also there are those famous Eifel PICK-ALLS . . . 11", 15", 24" and 30"; and the Eifel-Multitool pictured below . . . the "world's Most Useful Little tool."
 - Current Orders leave only a Small supply for New customers, and this First Ad' in 6 years is meant specially for inactive past Plierench Salesmen; and to help Users bring their Kits up to date. Tools beyond repair have a small Trade-in Value.

MAIL this Part of Ad TODAY, with your address (on a Postcard will do). Get **FREE**—this 6-Edge-End & Angle **SCREWDRIVER** (It Turns Screws in ALL Positions and does many useful things) . . . and **101-PICTURE MANUAL OF MECHANICS**, with . . . User Offer; or, with . . . **DISTRIBUTOR, Territory and Demo. Kit Offers!**



AMERICAN PLIERENCH CORP'N 4611 N. Ravenswood Avenue
 Dept. PS-87, Chicago 40, Illinois

DUAL TAIL PIPE EXTENSION FOR YOUR CAR. \$2.95
 DEEP TONE,
 PRODUCED BY 2½ IN. OUTLETS
 Chrome Plated -- Fits All Cars
 Postage Free on Money Order, Check or Cash
LYONS PRODUCTS Co. 2319 Ridgeley Dr. Los Angeles 16, Cal.

free
CONCORD
Radio
Catalog



RADIO PARTS • RADIO SETS • RECORD CHANGERS — PLAYERS • KITS • HAM GEAR • AMPLIFIERS • TESTERS

It's here! The big, new 1947 Concord Catalog with a vast, complete selection of everything in Radio and Electronics for building, experimenting, testing, repair and maintenance. Thousands of items—hundreds now available for first time—latest 1947 prices. Now LOWER prices on Radio Sets, Receivers, Kits, Record Changers, Players, Portables, Amplifiers. Latest listing standard items. Complete stocks—**IMMEDIATE SHIPMENT.** Write for **FREE COPY**—please address Dept. PS-87.

CONCORD RADIO CORP.
 LAFAYETTE RADIO CORPORATION
CHICAGO 7 **ATLANTA 3**
 901 W. Jackson Blvd. 265 Peachtree Street

GASOLINE ENGINE

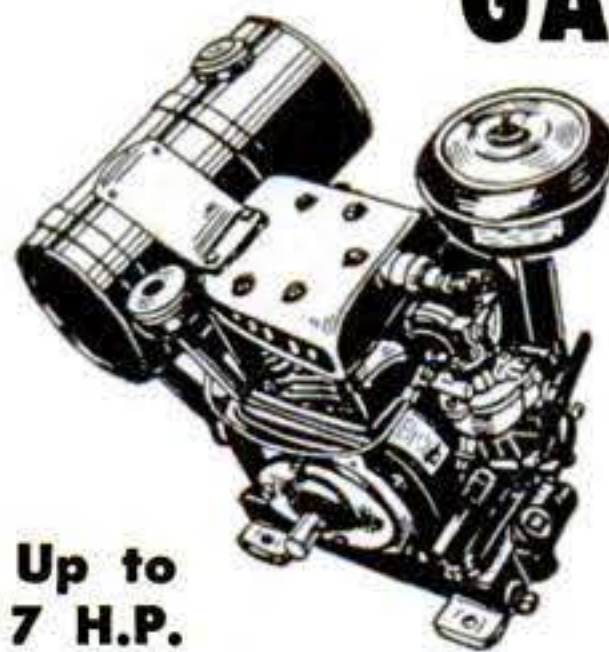

Used Gov't Surplus—Air-Cooled Briggs-Stratton or Wisconsin Engine—**REBUILT**—**GUARANTEED** in good mechanical and operating condition. Our price, FOB, **\$99.50** Kansas City . . . Write for illustrated circular—**Immediate delivery**

Up to 7 H.P.

MIDWEST SURPLUS SALES 1520 Locust St. Kansas City, Mo.

MAKE YOUR OWN DISC SANDER

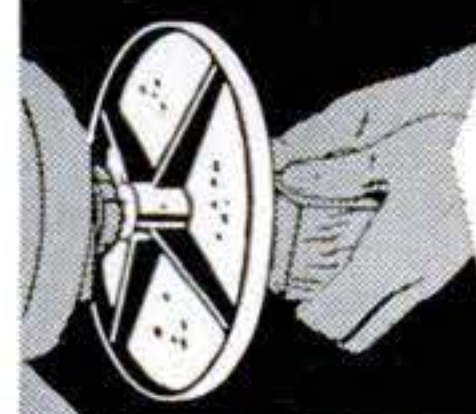

Mount this 8" cast aluminum sanding disc on any ½", 5/8" or ¾" spindle. Sturdy ribbed design. Order direct—\$2.00 postpaid. Threaded bore 25¢ extra. Abrasive paper discs, 8"—1 doz. asst. grits \$1.25. 1758 Clinton Street **EMRICK INC. KALAMAZOO, MICH.** **WRITE FOR FREE TOOL LIST.**

NORDEN BOMB SIGHT STABILIZERS

This instrument is about ½ the bulk of the famed **NORDEN BOMBSIGHT**. 26 vt DC 10,000 RPM. Heavy rotor mounted in gimbals. Precision motor with magnetic clutches. Shipping weight 96 lbs. New, \$25.00. **Navy Radar Stabilizers \$17.50—Army Tank Telescopes \$17.50—Dynamotors \$8.00—Parallax Computers \$50.00—Motor driven Fuel pumps \$12.00.** Send for bulletin. These bargains won't last—order today. All items FOB Chicago cash with order. **L. P. WEIS & CO., 2929 N. Pulaski Rd., Chicago 41, Illinois**

3 NEW PLASTICS MANUALS

FABRICATING
CARVING
CASTING
MANUAL
 Now Only **\$1.00**

Make beautiful objects of Plexiglas, Lucite, Catalin, Polystyrene and Castolite at home. Jewelry, novelties, accessories. Three new manuals show how to fabricate, cast and carve. 20,000 words, 23 special designs, 45 photos, charts, diagrams and hundreds of suggestions. Price prepaid \$1.00. **HOUSE BEAUTIFUL PLASTICS, Dept. J-4, 5534 W. Harrison St., Chicago 44, Ill.**

Say You Saw It
 In Popular Science

NEW
Liquid
Plastic

Special Castolite Kit

- Cast without heat or pressure.
- Crystal clear or dye brilliantly to any color—transparent, opaque, phosphorescent, fluorescent.
- Can be sawed, drilled, carved, turned.
- Embed real flowers, butterflies, photos, advertising novelties.
- Make figurines, statuettes, other beautiful objects in New Flexible CASTO-MOLD.
- Easy, fascinating to use. Illustrated manual tells how.
- Send \$3.35 for kit prepaid, or order COD. For manual alone, send 25c.
- Write: **THE CASTOLITE COMPANY** Dept. J-4, Box 211, Kenilworth, Illinois

20-Project KIT \$3.35

PROVEN POWER TOOLS FOR A VALUE AND QUALITY CONSCIOUS MARKET

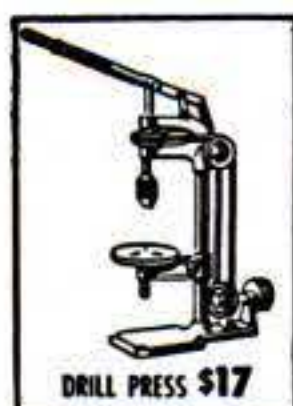

DRILL PRESS \$17



HG SAW \$12.50



LINE SHAFT & HANGER ASSEMBLY \$10

The Searjeant Line is the result of my 20-year experience as a user, designer, and manufacturer of power tools. Acceptance proves that it is just what craftsmen want. (Signed) Will Searjeant.

A 6" BENCH SAW THAT CUTS 2" STOCK

\$19.00 Delivered
C.O.D. or outside U.S.A., add 25c



A husky, durable saw heavily built of gray iron and steel. TORRINGTON NEEDLE BEARINGS for long life and friction-free operation. 12" x 14" table tilts to 45° angle; adjustable guide; adjustable, removable guard; miter gauge; hardened & ground shaft. ARBOR adjustable for depth of cut. Uses standard 6" blade (available at extra cost of \$4.00). A great saw at a really low price.

Send for literature describing entire line Satisfaction Guaranteed or Money Back

SEARJEANT METAL PRODUCTS, INC.
87-89 Allen St., Rochester 6, N. Y.

ACTUALLY \$50.00 WORTH OF GRINDING WHEELS

Abrasive discs, felt and buffing wheels, mandrels, rotary files, sheets, etc.

327 PIECES ASS'T. SIZES FOB CHICAGO ALL for ONLY **\$6.95**

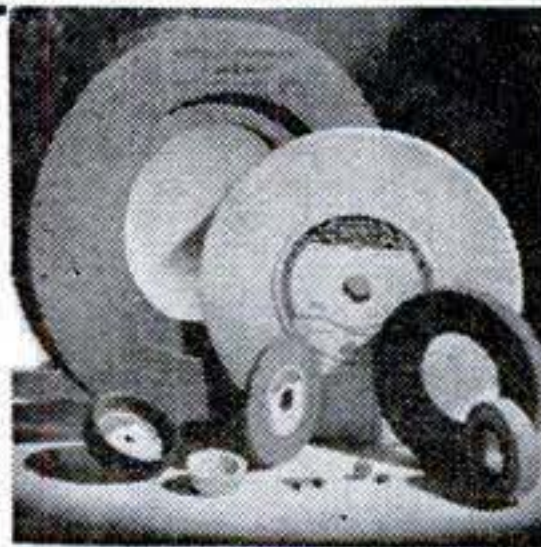

A BONANZA FOR THE HOME WORKSHOP

The buy of a lifetime! 327 pieces including 35 ass't. Grinding and Cut-off wheels up to 10 inches diameter, 1/16 to 1 1/4 in. face, 1/8 to 3 in. holes. Assorted grits—all brand new—made by Norton, Carborundum, Macklin, Bay State, etc. Also included are 100 slotted disc cloths; 100 paper discs; 3 round wire brushes on handles; 2 felt bobs; 2 felt wheels; 1 4" rag buff; 3 honing stones; 10 abrasive sleeves; 10 mounted stones, 1/8 and 1/4 shank; 2 mandrels; 2 rotary files, 1/4 shank; 50 abrasive discs; 2 7/2" abrasive belts; 5 9x11 abrasive sheets. Satisfaction guaranteed. Order today. It's better than a \$50.00 value for only **\$6.95**

GROBAN SUPPLY CO. 1522 So. Michigan Avenue Dept. PS 8, Chicago 5, Ill.

WORLD'S LOWEST PRICED ADDING MACHINE

VEST POCKET SIZE IDEAL FOR BUSINESS OR PERSONAL USE

FREE TRIAL
ONLY \$2.50
TOTAL COST
SEND NO MONEY

Each Baby Calculator in Beautiful, rich-looking Leatherette case—at no extra cost. **FREE!!**



Fits vest pocket or purse. Guaranteed accurate. Operated as easily, and as reliable, as machines costing many times as much. Not a toy. Substantially made of 28-gauge steel—guaranteed for life against defects in construction. You positively can't buy a calculator of equal quality for as little money. **ACCEPTED AS THE FINEST LOW PRICED CALCULATOR FOR OVER 30 YEARS!** Operates with a flick of your finger. Adds, subtracts, multiplies, divides—counts up to ten million. Pays for itself over and over in mistakes avoided, and time saved. **MAKES IDEAL GIFT.**

Sold on a positive money back guarantee. Send only \$2.50. Calculator sent postpaid, or send name and address and pay postman \$2.50 plus postage. **MONEY BACK IN 10 DAYS IF NOT DELIGHTED!** (If outside U. S., send \$3.00.) **AGENTS WANTED.**

CALCULATOR MACHINE CO., (Mfrs.)
Dept. 481 P.O. Box 248, Glenview, Illinois

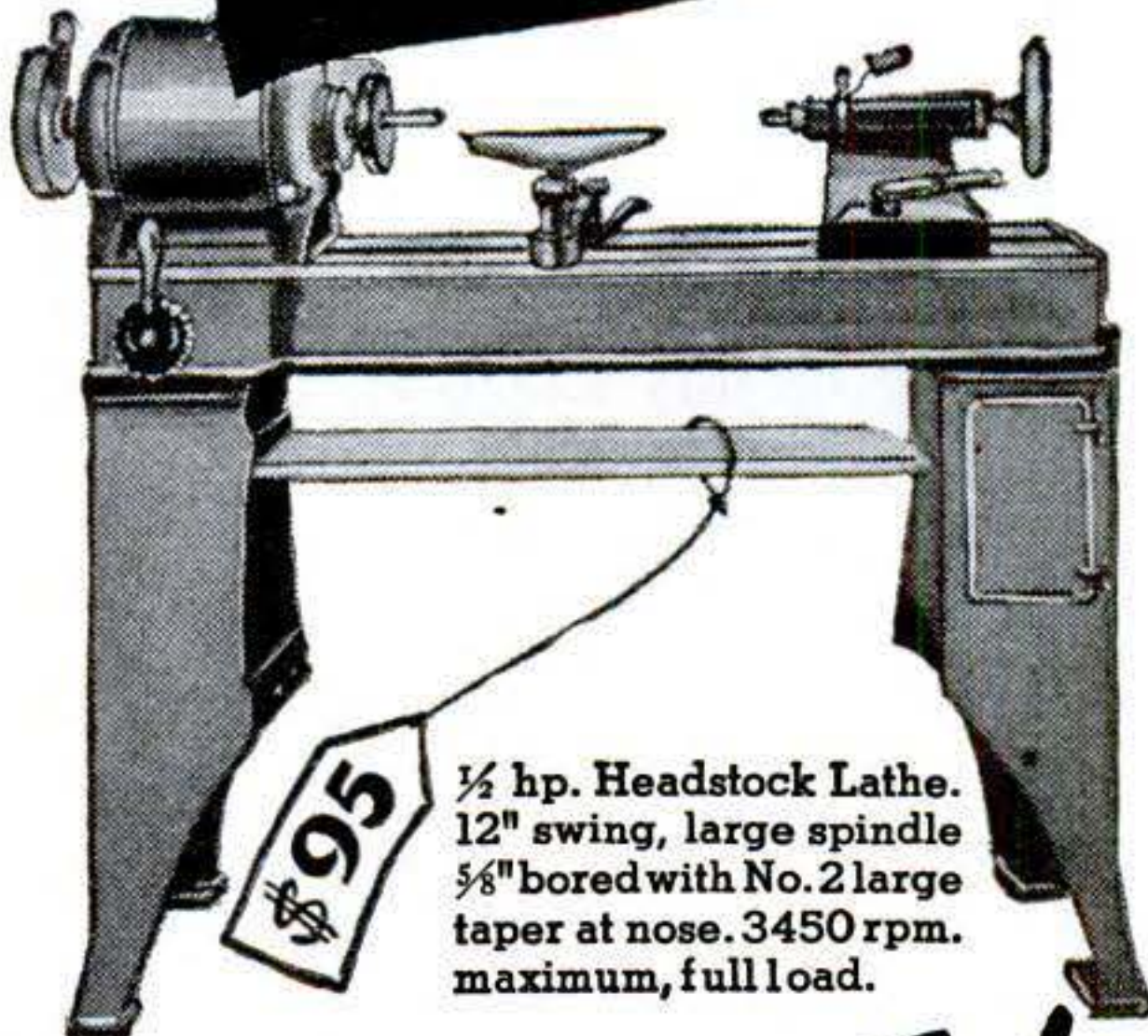

1/2 hp. Headstock Lathe. 12" swing, large spindle 5/8" bored with No. 2 large taper at nose. 3450 rpm. maximum, full load.

Get Yours Today

- Take your pick from hundreds of models
- All priced 25% or more below used market
- No priorities needed to get prompt delivery
- Price lists from your WAA office



Offices located at: Atlanta • Birmingham • Boston • Charlotte • Chicago • Cincinnati • Cleveland • Denver • Detroit • Grand Prairie, Tex. • Helena • Houston • Jacksonville • Kansas City, Mo. • Little Rock • Los Angeles • Louisville • Minneapolis • Nashville • New Orleans • New York • Omaha • Philadelphia • Portland, Ore. • Richmond • Salt Lake City • St. Louis • San Antonio • San Francisco • Seattle • Spokane • Tulsa 1103-2

Customer Service Centers in these and many other cities.

9 BIG NEW BOOK

EVERY ONE AN UNBEATABLE VALUE!

Prepared by the Editors of POPULAR SCIENCE MONTHLY, these great books are bursting with up-to-the-minute information, pictures and diagrams that will save you both time and money! You need not hesitate to order one or all for your own enjoyment or to use as gifts. We guarantee complete satisfaction or your money back!

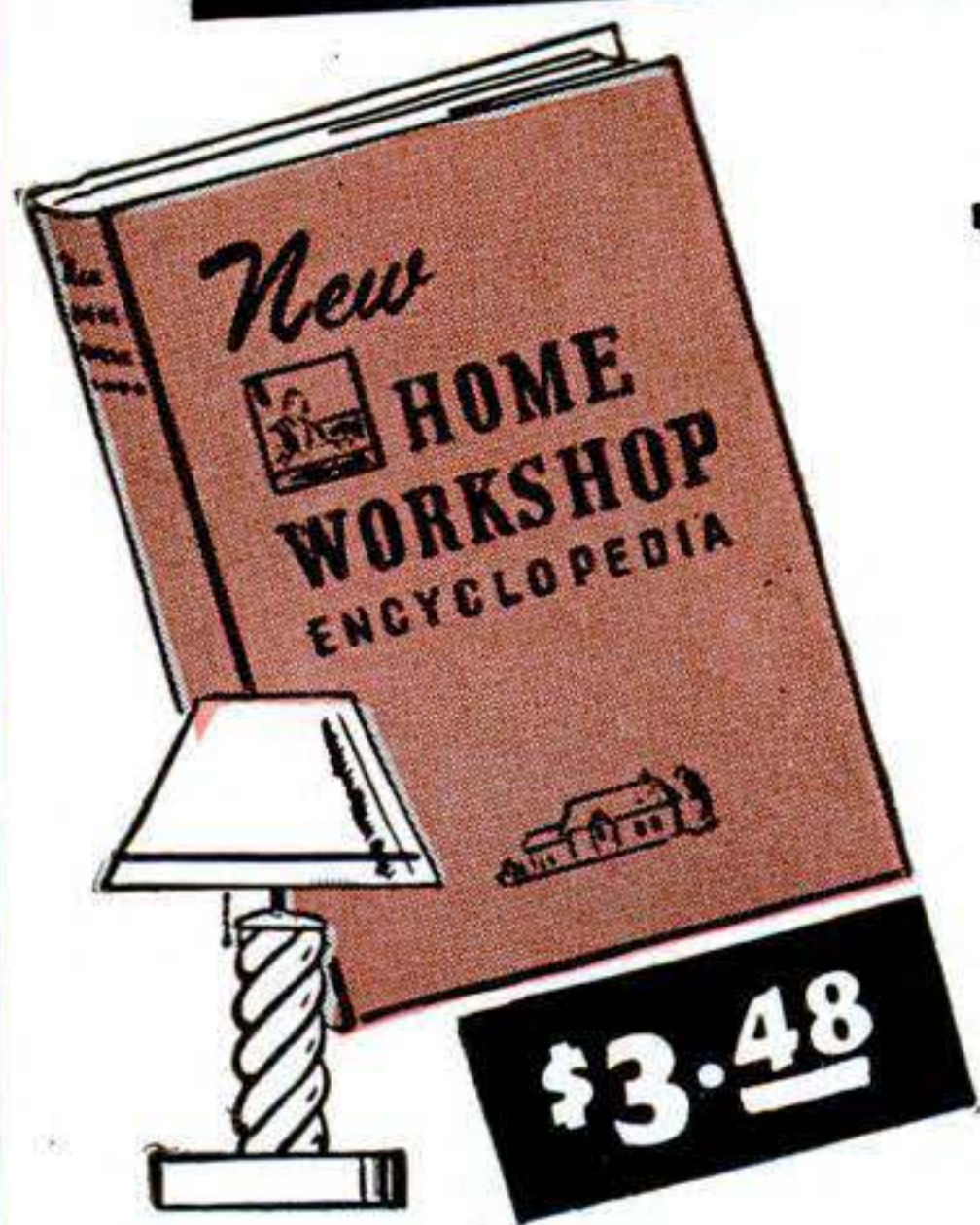

NEW HOME WORKSHOP ENCYCLOPEDIA

Here's a giant book that's jam-packed with over 840 thrilling things to make and do in your own home workshop! It's filled with over 1500 pictures and diagrams that show you how to build bookcases, furniture, cabinets, toys, games, gifts . . . how to repair radios, autos, electrical appliances . . . and no end of ideas for keeping the home shipshape! Yes, you'll even find dozens of chemical experiments, hints for the garden, photographic ideas and woodcarving projects. 580 pages! Handsome DeLuxe edition! Printed in 5 colors!

TINKERING WITH TOOLS

\$1.49

It's *easy* to do your own repairing—and lots of fun—if you follow the simple instructions in this big 260-page book! Everything you need to know about carpentry, plastering, plumbing, painting, masonry, shingling, wallpapering, electric wiring, etc. 215 pictures. DeLuxe edition.

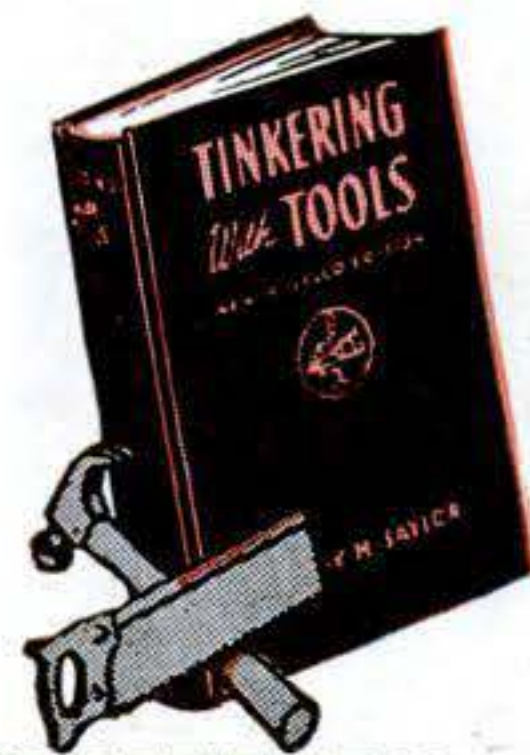

THE HOME CHEMIST

Shows you how to set up an inexpensive lab and perform hundreds of thrilling experiments. How to do amazing chemical tricks, and magic. 192 pages. DeLuxe edition.

\$1.49

BOOK OF FORMULAS

A wealth of formulas, recipes, and secret processes for making soap, ink, insect spray, glue, furniture polish, hundreds of other useful household items! 250 pages. DeLuxe.

\$1.49

WONDERS through the MICROSCOPE

Hundreds of exciting experiments you can do with *any* microscope! How to secure specimens, build apparatus, make slides and photo-micrographs, etc. 192 pages! DeLuxe.

\$1.49

DECORATIVE METAL

How to make useful, attractive articles out of sheet metal, pewter, bronze, steel and precious metals. Directions for bending, shaping, finishing, antiquing, etc. DeLuxe.

\$2.00

BARGAINS FOR YOU

EVERYBODY'S RADIO MANUAL

\$1.49

How to build and repair your own radios — tiny portables, F-M receivers, radio-phonographs, short-wave sets, recorders, wireless record players, etc! Written in simple, non-technical language with a wealth of drawings, diagrams and wiring circuits that make every step easy to follow! 256 pages. 216 pictures. DeLuxe edition.



FIX IT YOURSELF

Home repairs made easy. Be your own handy-man! Simple directions and easy-to-understand diagrams show how to fix and repair furniture, electric outlets, windows, doors, leaky pipes, floor boards, chimneys, boilers, weather proofing, apply wallpaper, lay linoleum, and hundreds of other construction and repair jobs around the house. You will be surprised how easily you can do things after reading "Fix It Yourself." 256 pages, 163 helpful illustrations, complete index, DeLuxe edition.

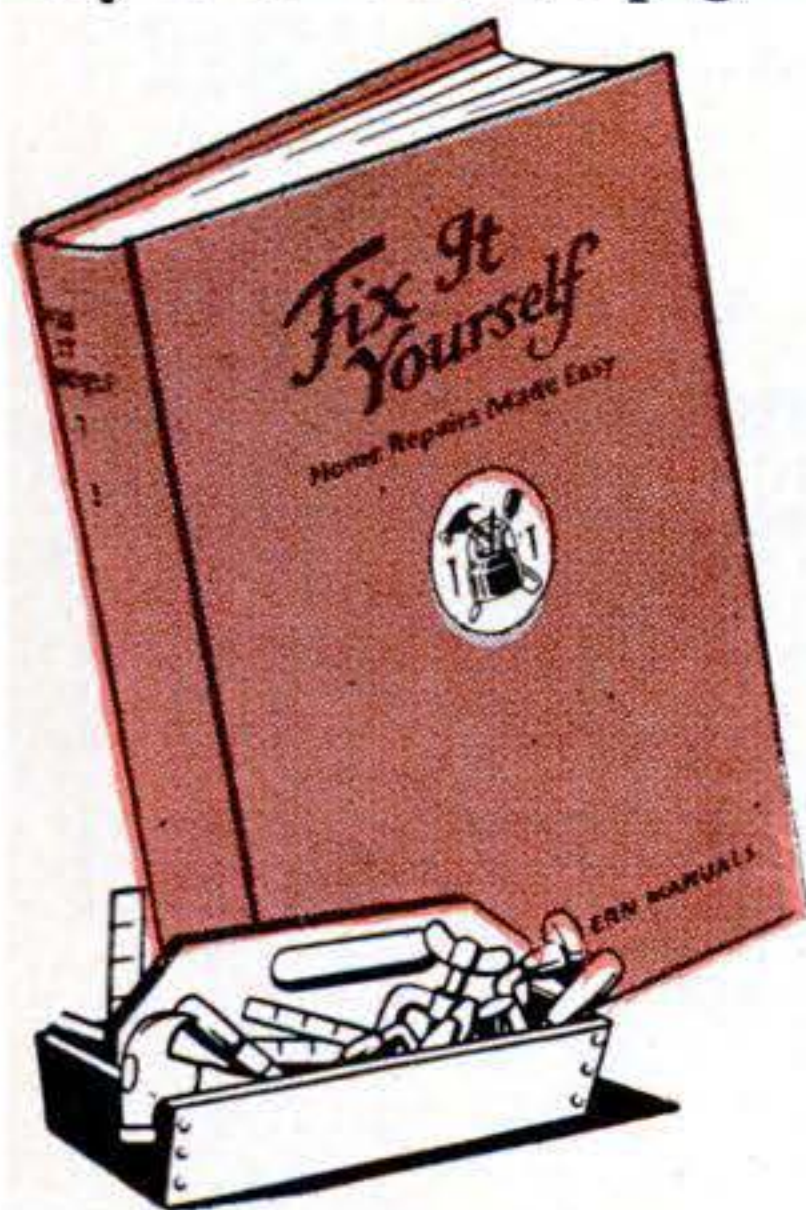

\$1.49

WOODCARVING AND WHITTLING

Here's a fascinating hobby anyone can learn with this *completely illustrated, easy-to-follow* book! You'll find step-by-step instructions for making scores of ornaments, jewelry cases, furniture of all kinds, treasure chests, trays, chairs . . . and even wooden figures of men and animals! Over 270 pages, with 150 pictures to explain your every move! A gold mine of ideas packed in one big book!

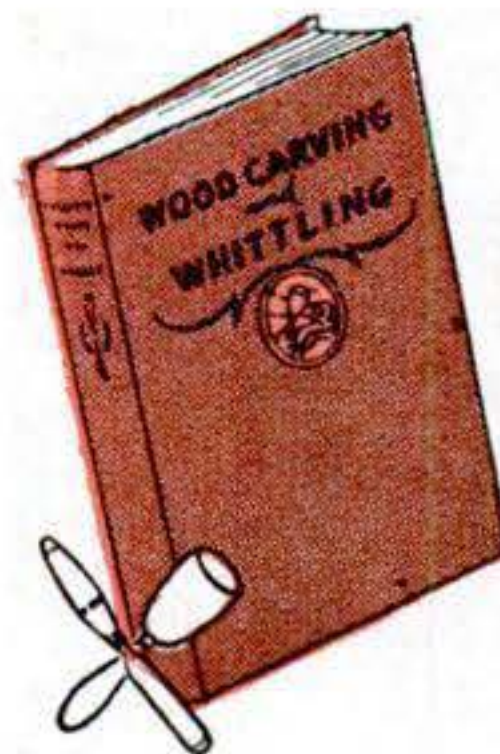

\$2.00

SEE THESE BOOKS AT OUR EXPENSE!

Send no money now—mail this Order Form! When postman delivers books pay listed prices plus few cents postage. Read them 7 days free—if not delighted return for full refund!

**POPULAR SCIENCE, Dept. 87
353 Fourth Avenue, New York 10, N. Y.**

Please send me the book(s) checked below. I will pay postman the price shown, plus few cents postage, on delivery. You guarantee complete satisfaction or I may return books in 7 days for a full refund.

- | | |
|--|---|
| <input type="checkbox"/> NEW HOME WORKSHOP . . . \$3.48 | <input type="checkbox"/> RADIO MANUAL \$1.49 |
| <input type="checkbox"/> TINKERING \$1.49 | <input type="checkbox"/> FIX IT YOURSELF \$1.49 |
| <input type="checkbox"/> WOODCARVING \$2.00 | <input type="checkbox"/> HOME CHEMIST \$1.49 |
| <input type="checkbox"/> BOOK OF FORMULAS . . . \$1.49 | <input type="checkbox"/> DECORATIVE METAL . . . \$2.00 |
| <input type="checkbox"/> WONDERS through the MICROSCOPE . . . \$1.49 | |

NAME.....

ADDRESS.....

CITY..... ZONE..... STATE.....

Check here if you remit now, and we will pay postage. Same refund guarantee.

PLASTIC-CRAFT HOBBYISTS

Save \$1.00 with this special offer

\$4.00
WORTH OF
BARSPECIAL
PLASTIC
SUPPLIES
FOR ONLY
\$3.00

Present this ad to your plastic supply, hobby or hardware dealer. He will allow you \$1.00 discount on any purchase of BARSPECIAL supplies totalling \$4.00 or more. You can't go wrong with BARSPECIAL quality products. They have been used by hobbyists from Coast to Coast for years • BARSPECIAL dealers carry everything needed for quality plastic work. PORT-O-TOOL plastic decorating sets, plastic-craft kits, plastic dyes, cements, cleaning and polishing compounds and jewelry parts. If your dealer does not carry them, write direct and we will mail you our free catalog. This discount offer good on direct orders. As a favor please include your dealer's name and address so we can contact him.

BARNETT SPECIALTY CO. 5104 HOLLYWOOD BLVD. HOLLYWOOD 27, CALIF.

I have purchased _____ worth of BARSPECIAL supplies from
DEALER _____
ADDRESS _____
CITY _____ STATE _____
YOUR NAME _____
ADDRESS _____
CITY _____ STATE _____
This offer expires Jan. 1, 1948.

PAINT YOUR CAR WITH WYPE for \$3.95 Amazing NEW AUTO ENAMEL You WIPE ON Instead of Brushing & Spraying

GET BEAUTIFUL MIRROR-LIKE FINISH THAT LOOKS LIKE SPRAY JOB! ONE QUART DOES ENTIRE JOB!

At last—you can paint your car with WYPE for \$3.95 and get a beautiful, high-gloss finish that rivals an expensive, professional spray job. With WYPE you need NO BRUSH, NO SPRAY, NO MASKING! You just

WIPE ON with Powder Puff, furnished. Takes about an hour to apply. No streaks, no lap-marks. WYPE dries dust-free in one hour. Guaranteed for TWO years not to peel, chip, crack or fade, if simple directions are followed.

DRIES TO GLISTENING, PROFESSIONAL FINISH!

WYPE is a new Miracle Enamel for autos. It is NOT a wax or polish but a hard, high-lustre ENAMEL finish. With WYPE, anyone can do a beautiful job! Get a quart to paint your car or to get started in this BIG-MONEY business! See your dealer or order direct.

SEND NO MONEY!
Order WYPE Today!

8 POPULAR COLORS:
Black Brewster (dark) Green
Red Jewel (light) Green
Maroon Washington (dark) Blue
Gray Monticello (light) Blue

All \$3.95 per Quart

Order one quart or more today! Just send postcard. Then pay mailman for WYPE plus postal charges. Or send money with order and WE pay postage.

WYPE CORP., Dept. 46-H, 2214 Dolman St., St. Louis, Mo.

NEW MONEY-MAKING BUSINESS! WYPE 2 Cars Daily for \$25.00 each—Gross up to \$260 Weekly!

Start making BIG MONEY now! Sell WYPE in cans or go into business painting cars yourself (or hire others). Send for FREE details of powerful money-making plan. Why wait? Start now by ordering one quart or more of WYPE today!

NOW YOU CAN PAINT WITH PLASTICS

The brilliant glistening beauty of pure phenolic plastics is now yours for as large a surface as you want, at an infinitesimal fraction of the cost of solid plastics. A block of the cheapest wood or other material can be made as beautiful, as durable, as chemical-proof, as brilliantly polished, as a block of pure plastic, for PHENOPLAST is nothing but 100% phenolic resin which due to new scientific compounding methods, can now be made to actually "set" or "polymerize" ON YOUR WORK, instead of requiring huge ovens or gigantic molding-presses. ALL THE ADVANTAGES OF SOLID PLASTICS ARE RETAINED—yet you just BRUSH IT ON, WIPE IT ON, or DIP it.

COAT ANYTHING WITH PHENOPLAST—and you have an object that looks, feels, shines, lasts and acts like solid plastic. You can turn burlap or cotton batting into strong shockproof automobile bodies, you can carve small objects in pine and make them look like ruby or jade, you can put down a floor finish that never needs waxing, you can paint a boat-hull that resists fungi, teredos and barnacles and cannot peel, you can turn linoleum into "tile," you can put a permanent finish, with a permanent polish, on ANYTHING with PHENOPLAST—it sets with the highest gloss and the hardest surface of ANY finish.

PHENOPLAST the new cold-setting liquid phenolic resin was developed by A. J. Lockrey, plastics expert and author of "PLASTICS," the text book used in most vocational schools.

SEND FOR TRIAL PACKAGE—a quart of clear transparent PHENOPLAST, three bottles of ruby, jade and amber dyes and complete instructions for dozens of fascinating uses, only **\$3.00**

LOCKREY PLASTIC PRODUCTS CO.

40-16 150th St. Flushing, N. Y.

LET "GRIME BUSTER" BOOST YOUR INCOME

A sensational seller for cleaning painted, enameled or varnished surfaces, metal, tile, autos, etc. Cleans dirty greasy hands without water. It's the hottest thing on the market!

REAP HUGE PROFITS UP TO 250%

Sell housewives, garagemen, mechanics, painters, printers, brick layers, cement finishers, industrial workers and hosts of others. Profits start at 122% and go up to 250%. Write for complete details at once!

SCHAFFNER LABORATORIES

Schaffner Bldg. Box 4222 Dept. PS-3 Pittsburgh 2, Pa.

WOOD SHAPER

3/4", 5/8" and 1/2" ball bearing spindle. Bench type with adjustable table. Write for free details.

WOODCRAFT TOOL & SUPPLY CO., Sylacauga, Alabama

PLASTIC SUPPLIES

Plexiglas, Lucite, Sheets, Rods, Tubes, Cement Dyes, Buffs, Equipment, Etc. Lowest prices. Send 3c stamp for catalog. **PLASTICS MFG. & SUPPLY CORP., Dept. 5-8, 4707 Euclid Ave., Cleveland 3, Ohio.**

Say You Saw It
In Popular Science

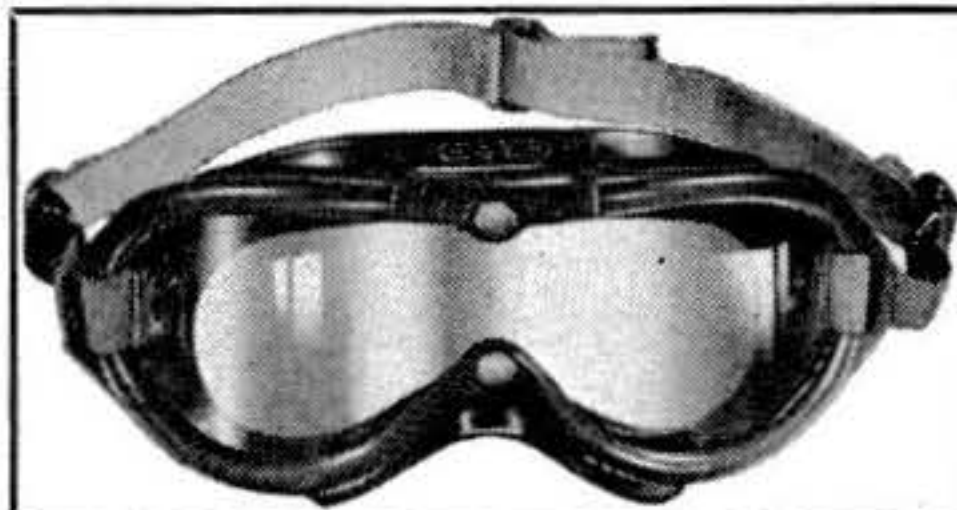

U. S. SURPLUS BARGAIN

New NAVY GOGGLES

Brand new! In original packing. Each with three interchangeable lenses.

SHOCK PROOF FRAME—SHATTERPROOF LENSES

Use them for all outdoors sports, beach, motoring, boating—anything. Heavy wind-proof sponge rubber ventilated frame with chamois sweat lining! Adj. elastic head band. Red, green, amber flexible shatterproof lenses, all instantly interchangeable. They won't last long at this price—it's smart to buy an extra. Post paid in U.S.A.

**GROBAN SUPPLY CO., Dept. PS 8
1522 S. Michigan Ave., Chicago 5, Ill.**

\$1.00
POST PAID

SAVE up to 85% on NEW HYDRAULIC CYLINDERS



**VALVES, PUMPS, FITTINGS,
HOSE, TANKS**

The World's Largest Supply, 1001 labor saving adaptations for pulling, pushing, lifting operations. Finest precision workmanship and materials. Liquid and/or air operation. 15% GOVERNMENT COST

PNEUMATIC RIVET GUNS

Chicago, Cleveland and All Other Standard Makes

Used but in Swell Condition.

Send for Free War Surplus Catalogue



#181
\$895

PALLEY SUPPLY CO. Dept. PS-87
6321 San Fernando Rd.
Glendale 1, California

STATION WAGON BODIES

**AND CABS FOR JEEPS, ALL IN
SMART MAPLE—OAK WOODS!**



Year-round comfort & class for Jeep owners. Kiln dried hardwoods, safety glass. FINE hardware, varnishes, top materials, only. Full-opening rear door, locks inside or out. Immediate U. S. shipments! Send 25% with order; balance C.O.D. **\$165.** F.O.B. Cleveland.....
STATION WAGONS, INC., (S7)
6619 Euclid Ave., Cleveland, O.

GIANT

Astronomical Telescope

100 diameters magnification. (10,000 area magnification) 3 inch diameter steel main tube 50 inches long. Brass focusing tube. Tripod 6 feet high. Equatorial mounting. Ready to set up and use. Full power and clear vision guaranteed. Price \$12.50. 25% deposit on C.O.D. orders.
DEPT. BT, SUFFOLK SCIENCE SERVICE, MANORVILLE, N. Y.

AIR OR LIQUID TANKS

Airplane oxygen tanks (used) good condition, holds up to 400 lbs. pressure; non-rusting stainless steel, weighs 18 lbs., 10 1/2 gal. capacity, 24" long x 12" diam., **\$4.98.** Same specifications 24" long x 6" diam., weighs 5 lbs., 3 gal. capacity, **\$2.98.** Ends tapped for 1/4" standard pipe thread. Air Check-valve to fit tanks, \$5.00 value, **98c.** Ideal for compressed air tanks, any bottled gas, or liquids, water supply for house trailers, compressors, floating rafts, buoys, net floats, air horns, air brakes, etc.

Prices FOB, Kansas City — No COD orders

MIDWEST BUY ANYTHING CO.

1520 Locust St.

Kansas City, Mo.

Hundreds of other bargains—Write for circular

MODELS

Build your own model house—complete in all detail. All materials included. True scale 3/8" model size. When complete, a real five-room house is yours, to plan your next home. Send \$1.00 with your order to save postage. Complete catalog sent with each order.
HALL INDUSTRIES, 111 W. Jackson Blvd., Chicago 4, Illinois

NEW DRAWING DEVICE

DRAW ANYTHING YOU CAN SEE WITH LUCY!

No talent needed to draw scenery, objects, profiles, portraits or reduce copy, in perfect undistorted perspective, indoors or outdoors.

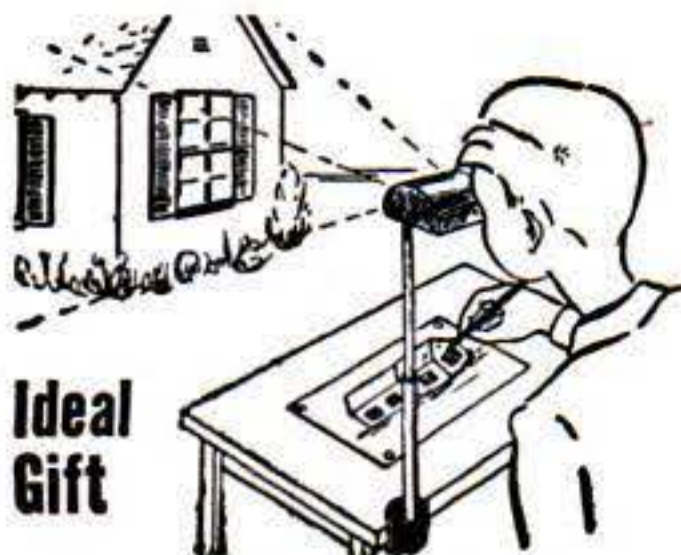

Ideal Gift

Commercial artists, fashion designers, architects, patent attorneys, hobbyists, doctors, children, find many practical uses for LUCY.

FINE FOR ART STUDENTS

A student looking thru LUCY draws, let us say, the outline of a building. Then, looking directly at the paper without benefit of LUCY'S magic, he fills in other details. Then a glance into LUCY shows where he drew them and where they should have been BOTH AT THE SAME TIME. A perfect art instructor, not a crutch.

LUCY IS AMUSING TOO

If you want to liven up a party, mount LUCY on a table so the guests can draw profiles of each other. Forget all other games. They'll play with LUCY by the hour.

DURABLY MADE, LOW COST

All metal, life-time construction, nothing else to buy, mounts on drawing board or table, no electricity needed, fully guaranteed. Only \$6.95 postpaid with easy instructions. No COD or open accounts please. One day shipment. A precision instrument you'll be proud to own.

BEELER ENTERPRISES

Dep't G

North Hollywood, Calif.

ONLY ONE UNIT * NO SEPARATE BATTERIES

The ONLY
HEARING AID

with the
"Magic Mike"

ALL YOU WEAR

VACOLITE

★ MINIMUM SIZE plus
★ MAXIMUM EFFICIENCY
Write for FREE booklet

Vacolite Company, Dept. PS

3003 N. Henderson Ave., Dallas 6, Texas

Name.....

Address.....

Town..... State.....

NONE BETTER!

SUPER DRILL GRINDER



Sharpens round shank drills from 3/32" to 1 1/16" in diameter, up to 11" long. Grinds old drills like new in 4 different point angles, using hand or power grinding wheels. Money-back guarantee.

Price only \$2.95

At Dealers or Postpaid

Crاندall Mfg. Co. 1512 W. Stauson, Dept. FB-20 Los Angeles 44, Calif.

HAVE YOUR OWN BUSINESS!

Operate pleasant, profitable Silk Screen Printing Shop. NO experience needed. Work at home in spare room or basement. Big demand! Large profits! Few dollars starts you. Start small, grow big. Real future possibilities! Eye-opening literature FREE.
W. E. WOLFF CO., 817-A High St., Anderson, Indiana



HOW IT WORKS

To the operator at B looking thru eyepiece of LUCY at A, a phantom view of subject to be drawn C appears already on the paper D in full perspective. Drawing becomes simple tracing. LUCY does NOT project view of subject to paper. The magic of LUCY'S clever optical system makes it look that way in eyepiece, and its just as easy to draw as though it was actually there. Adjustable to vary size of drawing.



**7 X 50 NAVY
BINOCULARS
\$135.00**

COATED OPTICS!

Mfgd. to U.S. Navy Standards! (Alignment guaranteed to .001"). Brand new glasses. Dust proof! Climate proof! Individual eye adjustment. Instant focusing. Coated optics insure sharp, clear images! Ideal for long range hunting, yachting, watching planes, etc. This magnificent 7-power 50 mm. Navy Binocular gives better detail, heightening image contrast. Complete with carrying case only \$135.00 plus 20% Federal tax.

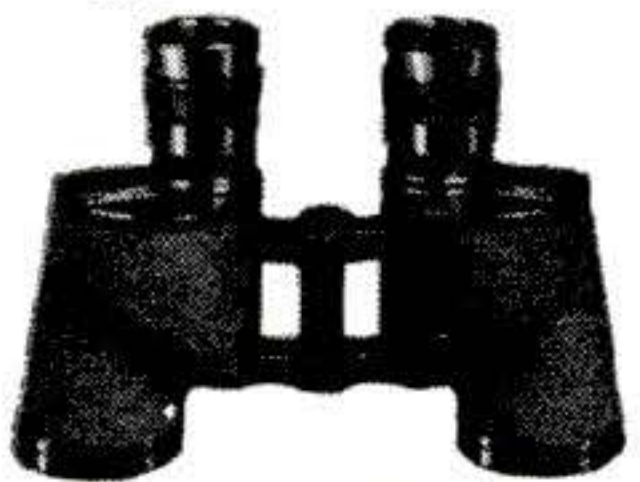

**6 X 30 ARMY
BINOCULARS
\$62.50**

Brand new! Lightweight! Made to rigid Army specifications. Individual focusing eye pieces. Compact glasses made to withstand rough usage. Come complete with case and straps ready to use. **WHILE THEY LAST!** \$62.50 plus 20% tax.

OTHER BINOCULARS (3 to 16 POWER!)

12x40 Carl Zeiss. Like new.....	\$200.00
16x50 Carl Zeiss. Used.....	225.00
16x40 Weerasport. Used.....	125.00
16x45 French Monte Carlo. New.....	135.00
12x38 French Monte Carlo. New.....	100.00
10x32 French Monte Carlo. New.....	79.00
10x50 German Dienstglass. Used.....	140.00
9x50 Sportscope. Monocular.....	77.00
8x40 Carl Zeiss Field Glass. Used.....	49.50
8x34 French Monte Carlo. New.....	67.00
8x30 Wollensack. Coated. New.....	85.00
8x30 French Monte Carlo. New.....	62.00
8x25 French Monte Carlo. New.....	57.00
8x25 French Monte Carlo. Used.....	45.00
7x50 Carl Zeiss. Used.....	150.00
7x50 Barr-Stroud. British Admiralty. Lens Shades. Used.....	90.00
7x50 Same as above, but Coated.....	110.00
7x50 Bausch & Lomb. Coated. New.....	140.00
7x50 German Dienstglass. Used.....	130.00
7x50 Sard. U. S. Navy. Coated. New.....	152.00
8x30 Carl Zeiss. Used.....	90.00
6x30 Bausch & Lomb. Used.....	37.50
6x30 Carl Zeiss. Used.....	75.00
6x30 Talbot. U. S. Army. Used.....	36.50
6x30 German Dienstglass. Used.....	65.00
6x30 Wollensack. Coated. New.....	75.00
6x25 Ross. London. Used.....	50.00
6x30 Bausch & Lomb. Coated. Objectives. Used.....	49.50
6x30 Naval Gun Factory. Used.....	34.50
6x30 Navy. Navigation. Coated. Used.....	45.00
6x30 Universal. Navy. Lightweight. Coated. Used.....	47.50
6x30 Universal. Navy. Lightweight. Coated. New.....	62.50
6x30 Universal. Navy. Lightweight. Used.....	38.50
6x24 USN. Turner Reich. Lightweight. Used.....	50.00
5x40 Nat'l. Field Glass. Coated Optics. New.....	29.75
4x50 Super Eye Field Glass. No Case. New.....	12.00
4x40 Airguide Field Glass. New.....	20.00
5x40 Airguide Field Glass. New.....	22.00
4x40 Wollensack Field Glass. New.....	16.25
10x, 20x, 30x, 40x, Variable Telescope. Not Taxable. New.....	42.50

5 TO 15 POWER VARIABLE TELESCOPE



Simply twist dial to change power! Sturdily made of durable Aluminum! Achromatic Lens. Compact! BRAND NEW. \$27.50 not taxable. Add 20% For Federal Excise Tax. Carrying case and straps included. Supply limited. Give second choice.

MONEY BACK GUARANTEE

Use for 20 days at our risk and expense. If not fully satisfied, return for full refund of your money. **ORDER TODAY!** Send \$2.00 deposit and we will ship C.O.D. for balance. Cash orders sent postpaid.

UNITED PRODUCTS CO.

7941 S. Halsted Dept. ARF-216 Chicago 20, Ill.
(Reference Dun & Bradstreet)

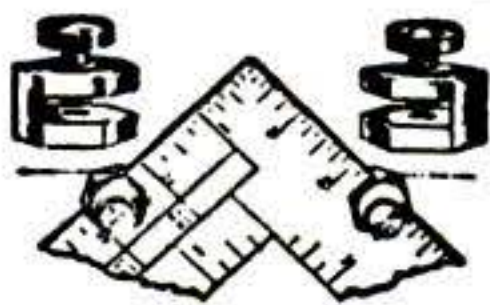

SUPER STAIR GAGES NOW

Precision fixtures clamp on carpenters' steel squares. Ideal for laying out stair angles, etc. Nickel plated steel—brass thumb screws—Set No. 49.

Only 75c Pair At Dealers or Postpaid.
A. D. MCBURNEY
939 W. 6th St., Dept. PS-8, Los Angeles 14, Calif.

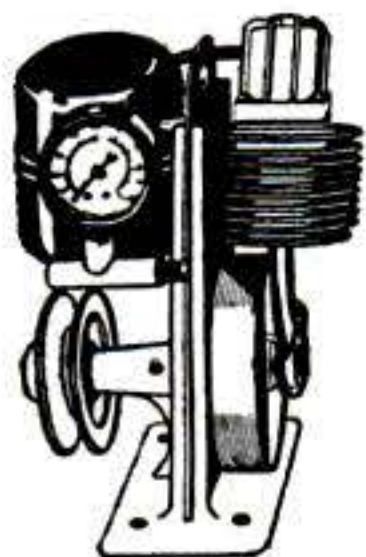

COMPRESSED AIR INSTANTLY, Anywhere!!

Portable Air Compressor and storage tank. Ruggedly built of best materials using lifetime lubricated ball-bearing on connecting rod and oil impregnated main bearing on shaft. Unusual design forever eliminates valve trouble, the most common fault in air compressors. **PATENTED** unique air intake system increases efficiency tremendously over other compressors so that air output is much greater than that from larger compressors powered by heavier motors. Will deliver approximately 3500 cu. inches of air per minute at maintained pressure of 30 lbs., or will inflate a 90 lb. truck tire in less than one minute. Comes complete with 100 lb.

gauge, although finger-tip adjustment allows setting of output pressure at any value, which will automatically be maintained. Works from any 1/4 H.P. motor. Useful for spraying paints or lacquers, disinfectants, insecticides, annealing or brazing with natural gas, inflating tires, etc. Price \$14.50 postage prepaid anywhere in the U. S. Efficient, completely adjustable syphon type spray gun complete with 12 ft. of 100 lb. tested hose available for only \$7.75 with pint container, also prepaid. 25% required on all C.O.D. orders. Send for free catalogs of radio parts and surplus items.

BUFFALO RADIO SUPPLY; 219-221 GENESEE ST., DEPT. S7, BUFFALO, N. Y.

**NOW YOU TOO CAN BUILD
15 RADIOS**



**Absolutely no Knowledge
of Radio Necessary**

You Need NO Additional Parts

The **PROGRESSIVE RADIO KIT** is THE ONLY COMPLETE KIT. Contains everything you need. Instruction Book, Metal Chassis, Tubes, Condensers, Resistors and all Radio parts. The 36-Page Book written by Expert Radio Instructors teaches you to build radios in a Professional Manner. You start with a 1-tube receiver. Before you are done with this kit, you will have built 11 Receivers, 1 Public Address System and 3 Transmitters.

SPECIAL FREE OFFER!

Electrical and Radio Tester sent absolutely FREE with each Progressive Radio Kit. PLUS FREE membership in Progressive Radio Club. Entitles you to free expert advice and consultation service with licensed radio technicians.

Write for further information, or **ORDER your KIT NOW!** ONLY \$14.75

Postage prepaid with check or money order.
(Postage not prepaid with C.O.D. orders)

PROGRESSIVE ELECTRONICS CO., Dept. 87
22 Havemeyer Street Brooklyn 11, N. Y.

A GREAT SURPLUS BARGAIN

REDUCING GAUGE

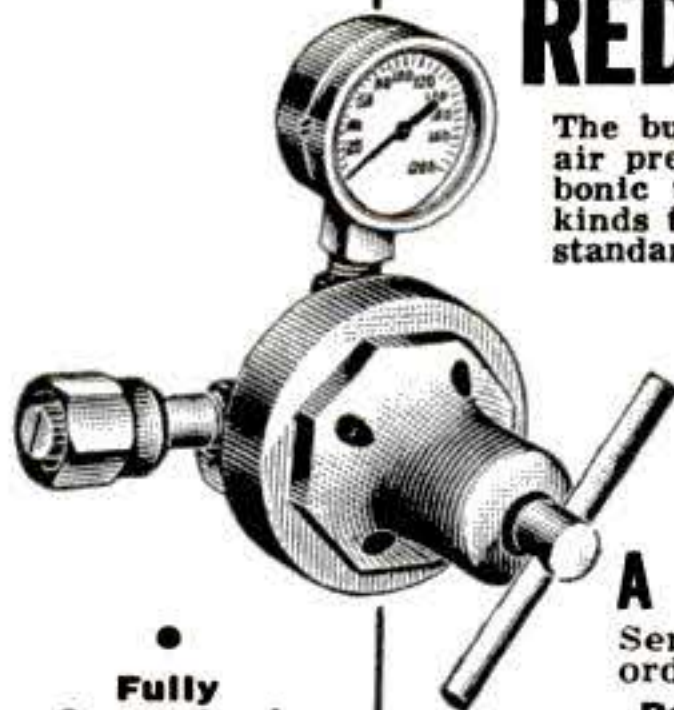

The buy of a lifetime in a standard make air pressure regulator. Used on liquid carbonic tanks and air pressure tanks of all kinds to regulate the pressure. Fitted with standard 1/2 inch pipe thread. Dial calibrated 0 to 200 lbs. Made by U.S. Gauge, Air Reduction Co., Walter Kiddie - all famous makers. Used by artists for air brush work, sign painters, retouchers, etc. Used by soda fountains and taverns. All units are brand new. Satisfaction guaranteed.

A \$15.00 Value \$5.95

Send check or money order. Ship same day.
Postpaid in U.S.A.

GROBAN SUPPLY CO.

1522 So. Michigan Ave. (Dept. PS8) Chicago, Ill.

Fully Guaranteed
All Brand New and in Perfect Condition

EARN \$25.00 to \$50.00 PER DAY

Be a **MASTER WATCH REPAIRER NOW!** QUICKLY!
Prepare At Home For A Secure, Happy Future Brand New, Low-cost, Short-cut Self-training Designed By A World's Foremost Instructor. Rush Postal For Complete Details NOW! TO-DAY!
Modern Watch Repair System Box 414 Greenville, N. C.



ICELESS ICE

ICELESS REFRIGERATION

Colder — Cleaner — Cheaper. Instructions 25c

DUFFY, P. O. Box 523 - E, Covington, Ky.

PLASTICS

WORK IN A FASCINATING AND PROFITABLE HOBBY

We carry a complete line of plastic supplies and accessories. Send 10c today for our latest catalog and fabricating manual.

HOUSE OF PLASTICS

8648 Linwood MO Dept. Detroit 6, Michigan

Say You Saw

It In Popular Science

KAYAKS
AQUA VIR
Easy to Build
OUTBOARDS ROWBOATS

BOATS for Home Assembly
"U-MAK-IT"
 KAYAKS, ROWBOATS, DINGHIES, INBOARDS, OUTBOARDS, RUNABOUTS
 Cut-To-Fit for Quick Assembly. Everything Complete plus Illustrated Instructions. No Experience Necessary. Simple as A. B. C.

25¢ COIN FOR ALL THREE

SEND 25c POSTAGE (COIN) TODAY FOR 3 MONEY SAVING ILLUS. CATALOGS Showing all '47 Models (marine plywood) and construction details.

AQUAMOBILE V-18
 Designed for Auto Engines. Open or with cab. Length 18 ft.
 Fast VEE Bottom Hull.

KAYAK BOAT CO., 152R EAST 129th ST., NEW YORK 35, N. Y.

FIND OUT WHY THE DEAF

CALL THE ONE-UNIT **Beltone** HEARING AID A "MIRACLE"

Write for FREE BOOKLET
 BELTONE HEARING AID CO., Dept. PS-78
 1450 W. 19th Street, Chicago 8, Ill.

SHALLOW WATER DIVING UNIT

For salvage, rescue, exploration dives and pool cleaning. Comfortable and efficient; seals absolutely. Low cost with long life. Also, complete line deep-diving gear. Write for details.

- Mask
- Weighted Belt
- Air Hose
- Portable Compressor

DIVING EQUIPMENT & SUPPLY CO.
 1121 N. Water Street, Milwaukee 2, Wis.

New Expiring Patent Digest Get Your Copy **\$1.50**

publishes 500 recently expired patents in a 100 pg. bound volume. Post Paid

SCIENTIFIC PUBLISHING CORP., 49 W. 45th St., New York 19, Dept. S

MARCOT KEY MACHINE

Immediate Delivery

Marcot No. 8 Key Machine Mounted on Cabinet.....\$ 82.50
 Book on Modern Locksmithing.... 3.95
 Auto Code Book and Auto Depth Keys 12.50
 162 Doz. Popular Key Blanks.... 77.76
 Set Key Files, Tools, Pins, Springs, Thimble..... 10.50

\$187.21

A. J. MARCOTTE CO., 1200 N. KEDZIE AVE., DEPT. PS. CHICAGO 51, ILL.

It's Here!
BARRON ALL METAL SHAPER FENCE
 Fits ANY Drill Press

\$7.95

A beautifully designed, accurately machined, fully guaranteed, fully adjustable, all-metal shaper fence. Made throughout of aluminum and non-rusting steel. No cast iron—no wood! Complete with anchor bolts, 2 hold down springs. A real value. See it at your dealer or shipped direct

FAMOUS 5-IN-1 DRILL PRESS PLANER
 Planes•Rabbets
 Panels
 Tenons
 Grooves
\$7.50
 COMPLETE

NEW 2 1/2" DRUM SANDER
 Fits All Makes of Drill Presses or Motor Shafts
\$3.95
 Includes 5 sanding sleeves

OTHER DRILL PRESS ACCESSORIES
 4" ROTARY SURFACE SANDER \$5.95 1/2" DOVETAIL CUTTER \$1.85
 ALL-METAL AUXILIARY DRILL PRESS PLANING AND SHAPER TABLE \$9.85
 TAPERED AND THREADED SPINDLE ADAPTERS
 ROUTER AND ROUND END MORTISING BITS 1/8" TO 1/2" SET OF 6 \$9.50

Liberal 10 Day Money Back Guarantee

Workshop Guide FREE

BARRON TOOL CO.
 570 Architects Bldg., Detroit 1, Mich.

BARRON PRECISION WORK SHOP TOOLS

Say You Saw It In Popular Science

HOTTER GAS TORCH

100% PRIMARY AIR KELLER GAS TORCH. **\$3.45**
 Burns Regular House Gas (Natural, Mfgd., or Butane)—No Compressed Air, No Adjusting Needed—Develops 2100°! POSTPAID
 Guaranteed to silver solder, light brazes, solders, removes paint rapidly. Precision-engineered. 1500 B.T.U. per hour.
 Order today C.O.D. from
KELLER GAS APPLIANCES
 P. O. Box 261 Monrovia, California

Now A DYNAMIC Super-charged WELDER

IDEAL FOR AUTO • HOME APPLIANCE • FARM REPAIRS

DESIGNED TO DO HIGH GRADE WELDING INEXPENSIVELY!
 Maintenance Men; Farmers; Mechanics; Machine Shops; Foundries; Auto, General Repair and Job Welding Shops; all using the DYNAMIC find it so indispensable and useful that they cannot afford to be without it. If inexperienced you can easily learn to do a variety of high grade welding jobs by following the practical, simplified operating and welding instructions furnished. Once you see a DYNAMIC in operation, you won't want to be without it. Its simplicity will amaze you. In a year the DYNAMIC only costs you about 6c a day. Helmet, rods, cables, holder and operating instructions, etc., furnished.

SAVES YOU VALUABLE TIME AND MONEY!

This portable industrial transformer type DYNAMIC WELDER easily carried right to the job, can be operated from any convenient, properly wired 110 Volt, 60 Cycle Line — has 8 metallic and carbon arc welding heat stages — does work you would think only possible with a larger more expensive machine. Can also be supplied for 220 volt, 60 cycle operation and other voltages and cycles at slight additional cost. Works on Iron, Steel, Brass, Bronze & other metals.

DYNAMIC WELDER CO., 13 East 23rd St., SH, Chicago 16, Ill.

ONLY \$28.50 COMPLETE Available Now IMMEDIATE DELIVERIES

Write Today for Particulars
GET DETAILS on our 10 day Trial Offer.
 Member Chicago Association of Commerce.

A GIANT IN YOUR HAND!

NEW!

1,000's of Uses

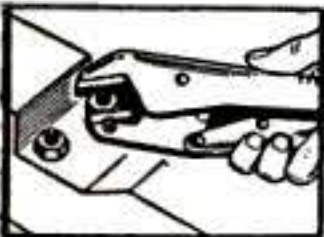
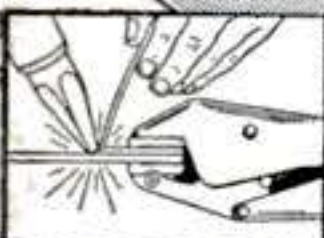
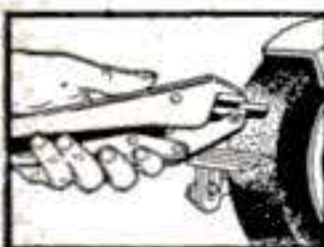

Serves as a plier or wrench—jaws can be quickly locked tight, so that hand pressure can be released and tool used as a hand vise or clamp. PARALLEL-UNIVERSAL JAWS afford full grip on either straight or angular objects. Terrific grip; any object held in jaws can not slip or be twisted loose! Pressed steel body, hardened (replaceable) jaws. *Guaranteed.* 10" size, \$2.25; 7", \$1.75. If not yet at your dealer's, order from us but give his name.

Send for free circular.

SEYMOUR SMITH & SON INC.
900 P Main Street, Oakville, Conn.

PLASTICS

Fabricating plastics offers you a fascinating hobby or a profitable business. New Carmen-Bronson Plastics Handbook tells you how; gives construction plans. New

Carmen-Bronson Catalog lists all needed materials—Plexiglas, Lucite, Bakelite, Lignolite, Tenite II, Lumarith in sheets, rods, tubes, special shapes—clear and glowing colors. Also plastics dyes, cements accessories and supplies. 25c (refundable with first order), brings you both catalog and handbook. Send for them today.

CARMEN-BRONSON CORPORATION

165 East 3rd Street, Dept. 8-A Mount Vernon, N. Y.

110 VOLT - 60 CYCLE - 2500 WATT

WAR SURPLUS POWER PLANT GENERATOR

WEIGHT 200 LBS LIST PRICE \$276.00

NEARLY NEW Ranchers, taverns, sportsmen generate your own electricity. Powerful portable plant. (Complete except engine). Small engines easy to pick up or you can use water or wind power. Fine standby power for farms. Contractors use for on-job power saws, drills, etc. Full instr. installing, using.

Guaranteed perfect. Order now or write for details.

LECO ENGINEERING CO., Box 908 PS-B, Lincoln, Nebr.

Only **\$89.40**
FREIGHT PREPAID U.S.A. ONLY

No. 3 Hawaiian Wiggler

gets bass in lily pads

Many excellent catches are being made with the No. 3 in stumps, weeds and lily pads where big bass often hide. Write for free catalog.

FRED ARBOGAST & CO., 1708 North St., Akron 3, Ohio



\$1.10

MAGIC LIQUID CASTS PLASTICS



THE GREATEST THING IN PLASTICS! A new liquid Plastic. Pour **PLASTICAST** into any kind of mold (rubber, metal, glass, plaster, etc.) and it hardens in a few minutes into a solid clear-as-glass plastic! No machinery or tools required. **PLASTICAST** has unlimited possibilities . . . novelties, toys, jewelry, knick-knacks; fascinating, brilliant, clear or colored plastic articles, including sparkling **GOLD** and **SILVER!** Being transparent it is ideal for imbedding flowers, coins, photos, souvenirs—an endless variety of useful things. Can also be cast into rods, sheets, blocks, ANY SHAPE! No experience required; start casting 10 minutes after you receive your outfit. Full instructions, molds, dye and accessories provided. **COMPLETE MASTER OUTFIT**, will make over 200 articles . . . **\$3.00 ppd.**

FREE Valuable book on **MOLD MAKING** and **CASTING** of plastics, rubber, plaster, wax, metal and every known substance used for casting! Sent free for 3c stamp.

PLASTICAST CO., (Dept. A)

(Send order to nearest office)

5961 Madison St., Chicago 44, Ill.

P. O. Box 987, Palo Alto, Calif.

AMAZING MYSTERY BUTTON



Startles Everybody. With this **Electronic Button** you can make your own Telephone-Amplifier-Detectophone. Attach this button to piece of cardboard—transmit conversation to another room. Music also transmitted to distant places. Most interesting electrical apparatus ever discovered. Enables you to perform hundreds of experiments. So tiny it can be concealed in dozens of places. A Pre-War Product. **Electronic Button** including 5000 word instruction booklet with 50 illustrated experiments, postpaid, only **\$1.00**

ELECTRONIC PRODUCTS COMPANY, SAINT CHARLES 2, ILL.

LEARN TO WHITTLE



with **BEN HUNT WHITTLING KITS**

• Ready sawed blanks of clear, soft pine, all ready to whittle. Complete, illustrated, easy-to-follow instructions for whittling and painting. Box of 3 diff. 4 inch Miniature Decoy Ducks, \$1.20. Box of 3 diff. 4 inch Hopi Cachina Dolls, 60c.

BEN HUNT, ROUTE 2 BOX 450 HALES CORNERS, WIS.

HYPNOTIZE ANYONE

Yes, anyone in 5 seconds. Secrets revealed. Exciting experiments. Use hypnotism to overcome excessive smoking, drinking, nail-biting, nervousness, insomnia, stuttering, inferiority complexes, stagefright, and improving memory. Complete course.....\$2 **POWERS INSTITUTE OF HYPNOTISM 2932 Wilshire Blvd. Dept. 11, Los Angeles 5, Calif.**

NEWEST OTTAWA LOG SAW

SELF-PROPELLED - MOVES ANYWHERE on OWN POWER

World's fastest Log Saw. Powerful 6 H-P air-cooled motor. Attachments for sawing down trees, buzzing limbs, post hole digging and pulley for belt jobs. Big demand for wood, pulp, posts. Make big money sawing wood this easy way. Low factory-to-user prices. Nothing like it. **FREE** details.

OTTAWA MFG. CO., 7-701 Pine St., Ottawa, Kansas



A New COMPLETE power driven workshop . . .



The greatest power tool value ever offered to American craftsmen

\$69⁵⁰

**6 Major Power Tools
Complete with Motor
and Full Assortment of Accessories**

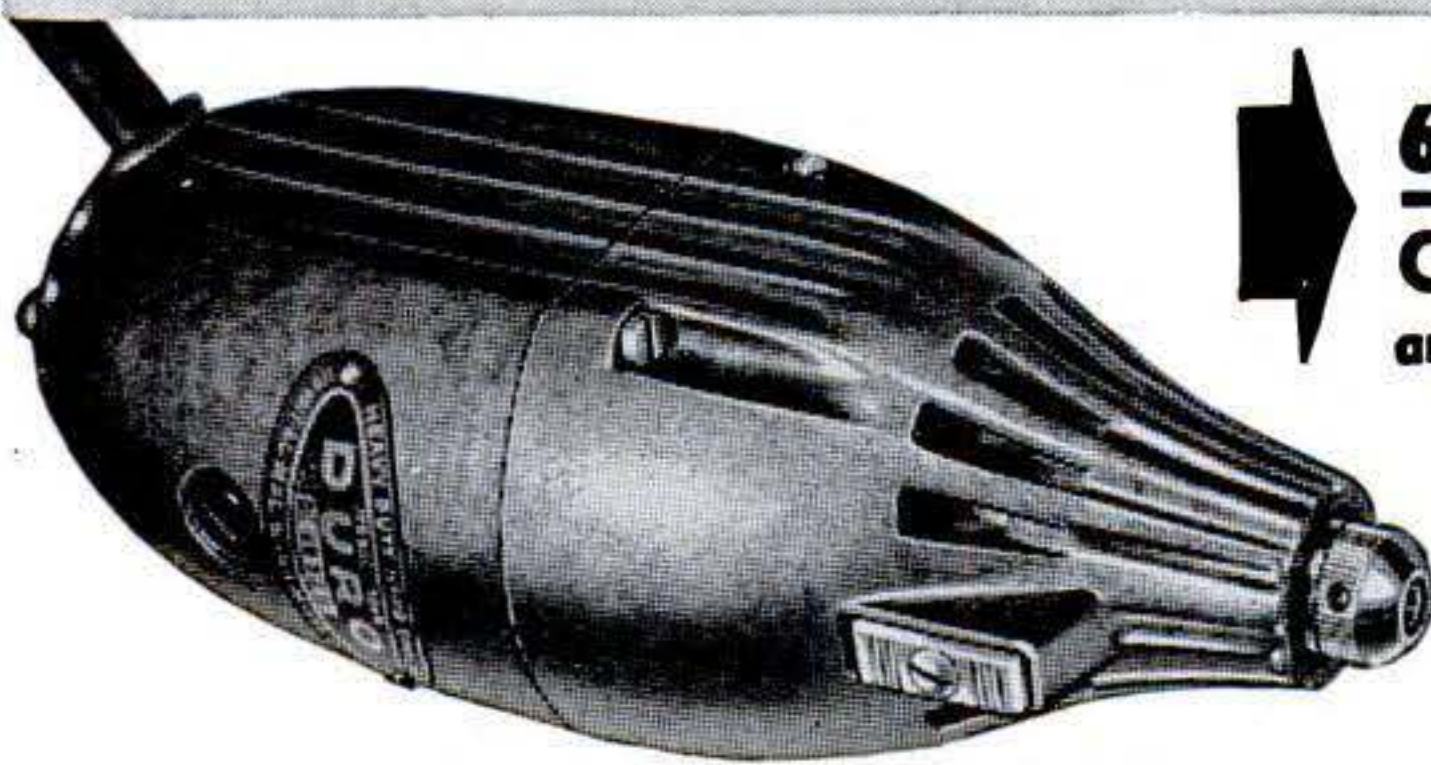

Made by a long-established power tool builder, many thousands of Duro tools have been used for years in home workshops, schools and industry. The motive power of this shop—the sturdy, rugged, Duro Hand Grinder—has long been recognized as one of the finest light grinders on the market—and is today in wide use in both industry and home shops.

Send for FREE Circular

giving complete description, specifications, and showing photographs of many unusual jobs that you can do with this shop. Also names of nearest dealers where you can see the shop on display. Mail coupon today!

Here is the greatest value in power tools ever offered to the American craftsman. Consider this: You get a Power-driven Drill Press, Lathe, Shaper, Router, Bench Grinder, Hand Grinder—complete with AC-DC motor, all ready to operate—with a compact accessories kit containing 50 sanding, grinding, drilling, polishing accessories—all for only \$69.50.

Handles Scores of Operations

Designed primarily for light work in wood, plastics and light metals—this remarkable shop can be used in many ways by home craftsmen and model builders for—routing, shaping, engraving, grinding, polishing, carving, cleaning, buffing, de-burring, sanding, drilling, turning, etc.

DURO METAL PRODUCTS CO.

2674 North Kildare Avenue, Chicago 39, Illinois

Gentlemen: Please rush me your free illustrated circular giving complete specifications and photos of the New Duro Workshop . . . plus a list of dealers where I can see the shop on display.

Name _____

Street Address _____

City _____ State _____

DURO METAL PRODUCTS CO.
2674 N. KILDARE AVE., CHICAGO 39, ILL.

TO:

Reader

FROM:

Editor

Thinking in Pictures

A BIG part of *Popular Science Monthly* is what you see before you read a word. I mean the pictures: the four to five hundred photographs, diagrams, plans and sketches in any issue.

Pictures are not just illustrations in PSM. They work hard. Often they tell a whole story. Sometimes they tell that part of the story which explains how something works, leaving to the text the history of the device, or process, and what it means.

Most of the pictures in PSM are made by our own photographers and artists, or are assigned to outside artists who have special knowledge of the subject. Working drawings call for special care; all PSM readers seem to be experts!

Some of the things PSM artists are called on to picture don't even exist. Then they have to imagine what a rocket would have to look like in order to do what it is supposed to do. Stewart Rouse did his pencil-thinking so well in his cutaway drawing of the Wac Corporal (PSM, May '46) that it differed little from the official pictures which were released months later.

Take the cover of this issue: Polar Prowl Cars have not yet been built, but those illustrated are no idle doodlings. Fred Sparks, who represented PSM on the Antarctic expedition last winter, saw their crude beginnings and their great possibilities. Art Director Samuels went to Washington to confer with those planning just such vehicles. Artist Ray Pioch used all this background to make the dream visible and practicable.

* * *

Every PSM editor has to be picture-minded, but after all of us have stopped talking, somebody has to make some pretty definite marks on paper. That somebody is the Art Editor—Howard Jensen.

Jensen is a soft-spoken individual who covers temperament with a conservative

manner and a double-breasted business suit. He went to art school in Seattle and New York. He designed stage sets for a small stock company, did typography for the glossy pages in the Sears Roebuck catalogue, worked in advertising agencies.



HOWARD JENSEN

His first job in magazines was on *Picture*, one of the earliest experiments in picture magazines. He was art director of *Parade* when that magazine was started. He worked on *Look* and was art editor of the book division. Two of the books he designed won places in the "Fifty Books of the Year" for 1945 and 1946—*One Nation* and *Look at America*.

Jensen calls PSM "a documentary magazine." I had never thought of it before, but that is exactly the difference between PSM and the other big general magazines. PSM is more like *The House on 92nd Street*, or *Boomerang*, than the typical glamorous productions of Hollywood. PSM deals in facts rather than fiction—even good old Gus is a documentary character.

As Art Editor, Jensen's job is to picture the facts, to give you a magazine which is easy to see and easy to read. I hope you have *not* noticed the recent changes in PSM's headlines and captions. Because the toughest task of the Art Editor is to create an arrangement of words-and-pictures-on-paper so clear and unobtrusive that the ideas shine right through.





My druggist
took a
prescription
from me!

ED'S MY DRUGGIST... a good one, too! And since I've been his Doctor of Motors for years, I could talk to him like a Dutch uncle.

"Look, Ed," I said, "you're happy with the way your car runs now, but you have only had part of my prescription."

Then I told him what I'd done. Ground the valves, replaced the gaskets, installed a set of Perfect Circle Piston Rings to stop her oil pumping—and a lot of other things she'd needed for a long time.

"If you want to *keep* your car in tip-top shape," I said, "Here's the rest of my prescription—just bring it in regularly for periodic checkups. Then I can correct little troubles before they become big ones—and save you a lot of worry and money."

Ed said he would follow that suggestion and that it sounded like a good prescription for every car owner. He's right, too!

R_x FOR CAR OWNERS: When piston rings are needed, get Perfect Circles, available at any automotive repair shop. Your mechanic—your Doctor of Motors—recommends them. Perfect Circle Corporation, Hagerstown, Ind. The Perfect Circle Company, Ltd., Toronto, Ont.

Your Doctor of Motors
restores power... saves gas
... saves oil with...

**PERFECT
CIRCLE** PISTON
RINGS



SOUTH BEND LATHE

The Basic Shop Tool

A FEW
OF THE MANY
OPERATIONS
YOU
CAN PERFORM



TURNING

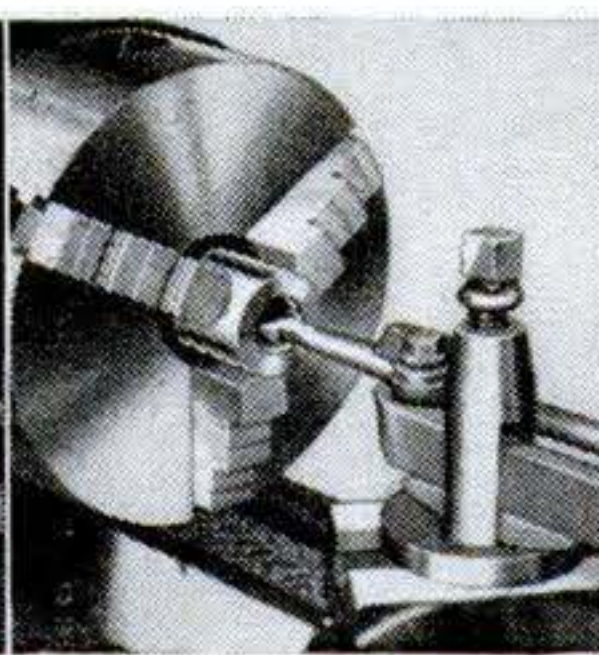

BORING

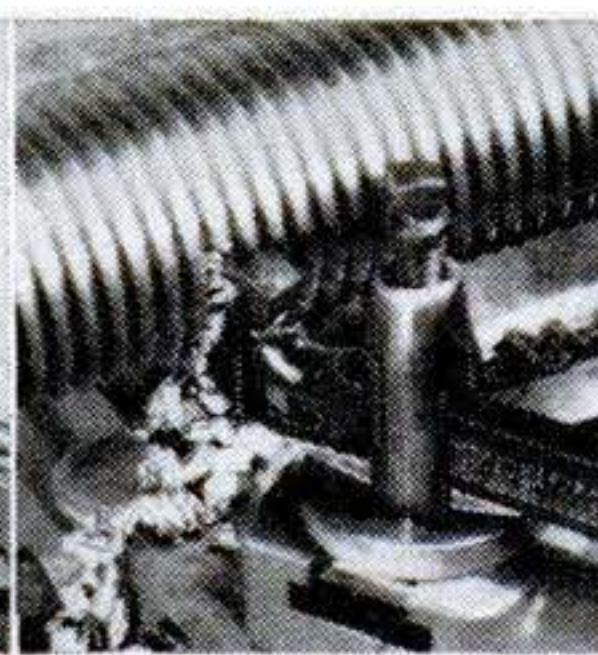

THREADING

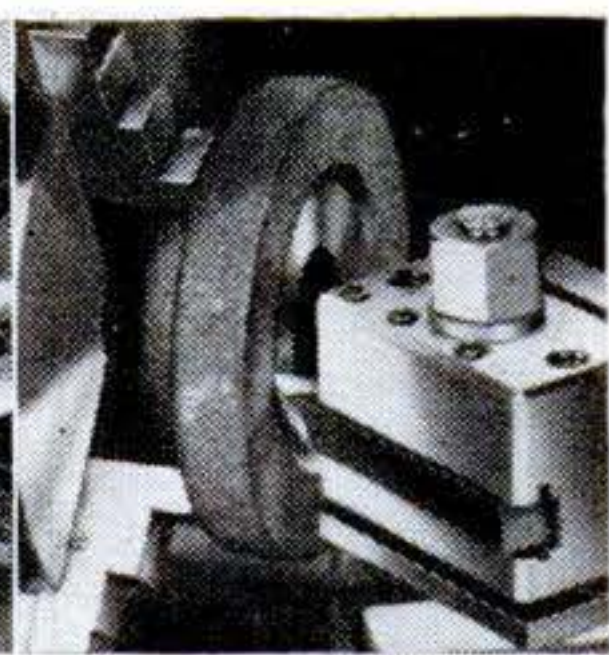

FACING

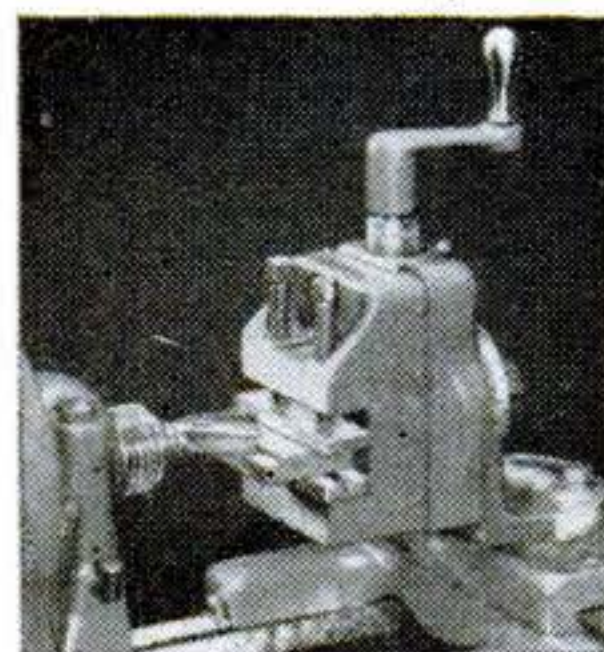

MILLING

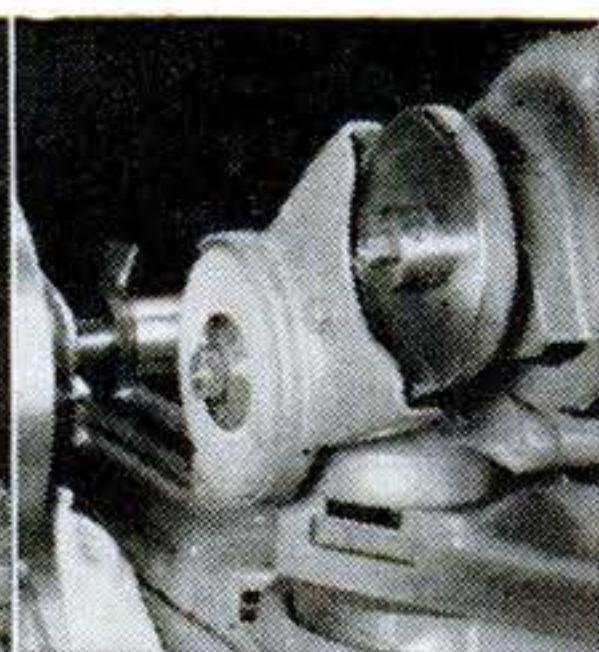

GRINDING

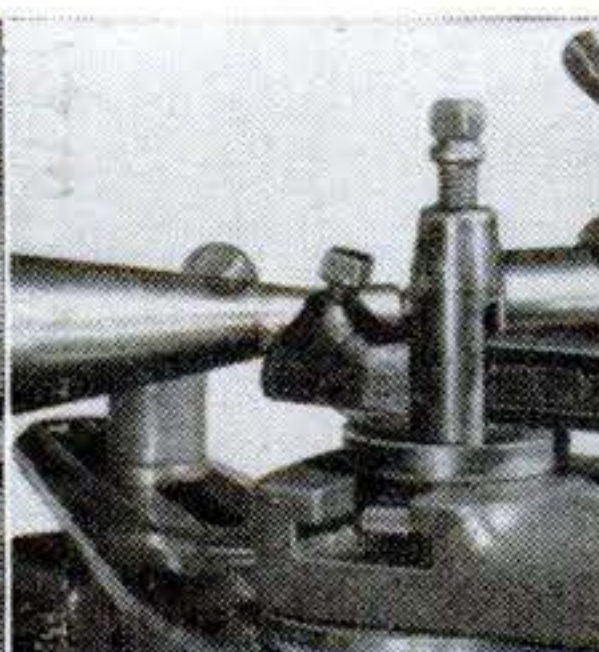

TAPER TURNING

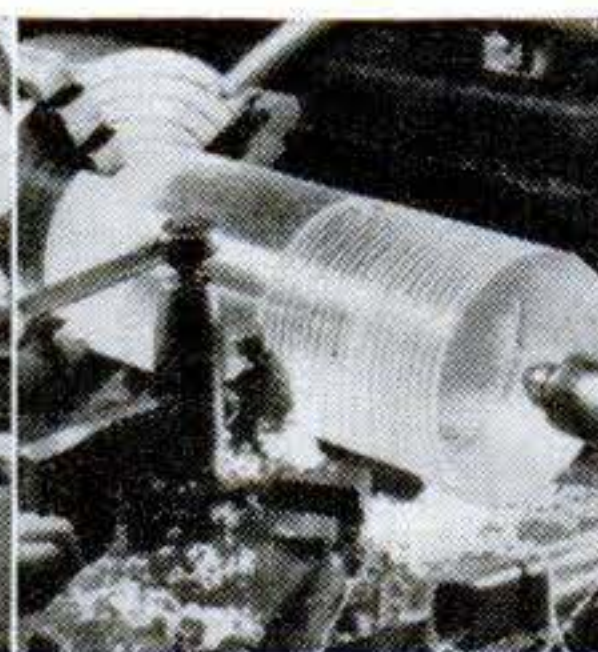

PLASTICS WORK

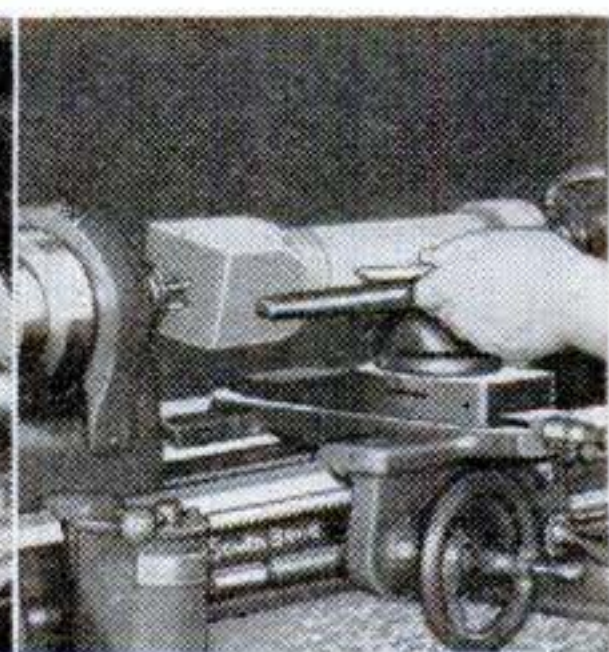

WOOD TURNING

A South Bend Lathe is the basic tool for your shop. It enables you to accurately perform the same full range of machining operations that are done on South Bend Lathes in the toolrooms and machine shops of industry.

With a South Bend Lathe as the basic tool in your shop, greater value for each dollar

invested is assured. Write today for catalog — please mention the size lathe you require.

PROMPT DELIVERY—Immediate delivery from distributors' stocks or early delivery from factory.

PRICES—Start at \$145.00, f.o.b. factory. Average price increase over prewar level less than 15 per cent.

TIME PAYMENTS—Factory Time Payment Plan. 25% down, 12 mo. to pay. Moderate finance charge.

BUILDING BETTER LATHES
SINCE 1906



SOUTH BEND LATHE WORKS
456 EAST MADISON STREET • • SOUTH BEND 22, INDIANA

For radiator
PURR-FECTION...

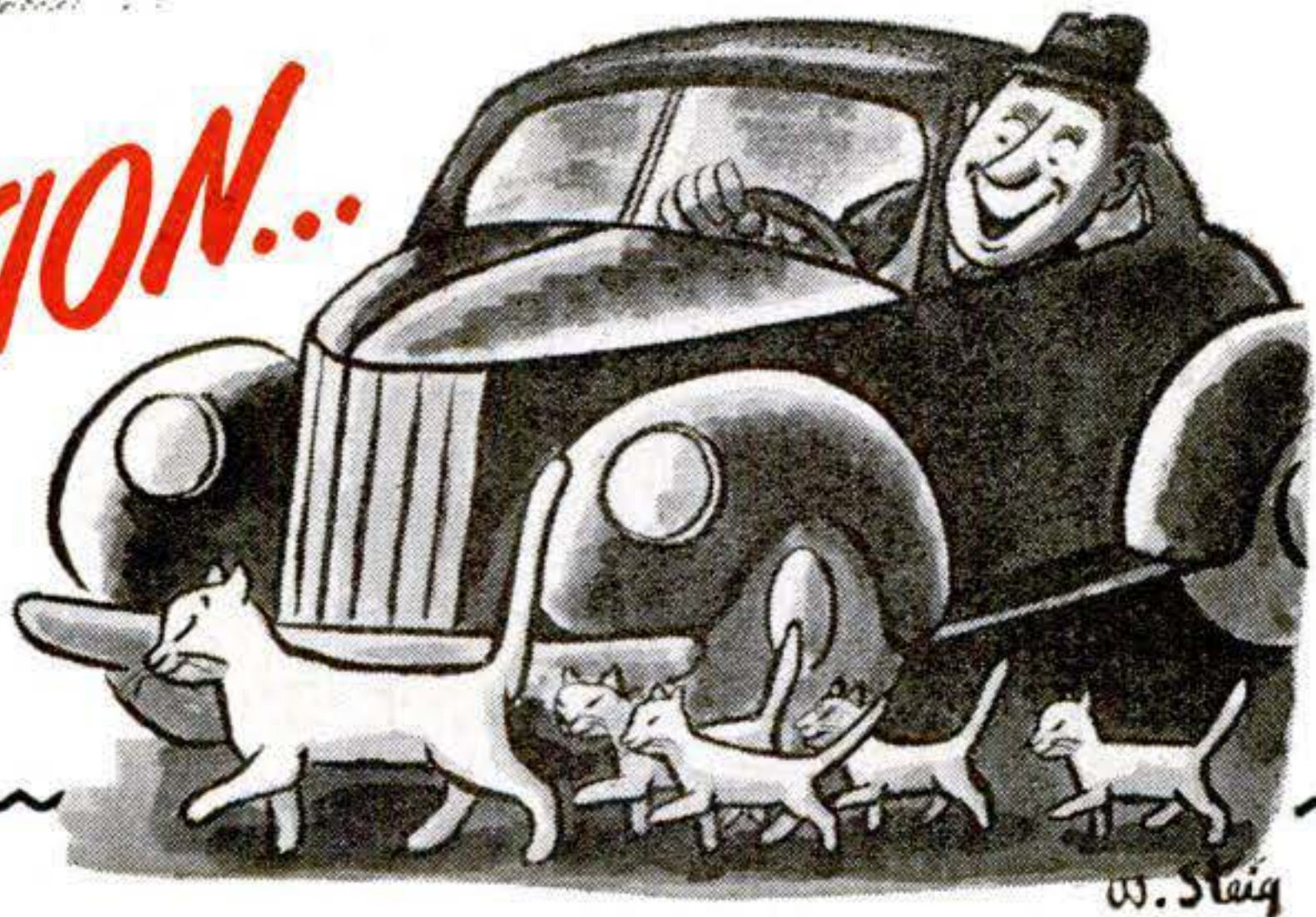

Clean out rust with

DU PONT Cooling System CLEANSER

Here's a safe, sure way to clean out rust and scale—to avoid engine overheating. Just pour a can of DU PONT COOLING SYSTEM CLEANSER into your radiator, run the engine for 30 minutes or more, and drain. No reverse flushing needed. No fussing with the hose or flush gun. A clean cooling system paves the way for top engine efficiency.



Keep out rust with

DU PONT Acid and Rust INHIBITOR

After cleaning out the radiator, you can keep it free from rust all season by pouring in a can of DU PONT ACID AND RUST INHIBITOR. It prevents rust forming, and keeps out acid, too.



Avoid radiator leaks with

DU PONT Cooling System SEALER

You can stop leaks quickly and securely—and make the cooling system LEAK-PROOF—by pouring in DU PONT COOLING SYSTEM SEALER. It will not clog the radiator or harm hose or metal parts.

DU PONT

REG. U.S. PAT. OFF.

BETTER THINGS FOR BETTER LIVING
...THROUGH CHEMISTRY

**EXPERIENCE IS THE
BEST TEACHER!**



*Walter
Ader*

ACE MIDGET-AUTO RACER

IT'S TRUE IN RACING...
IN CIGARETTES TOO!
I LEARNED FROM
EXPERIENCE THAT
CAMELS SUIT ME
BEST!

More people are smoking **CAMELS** than ever before!

With millions of smokers who have tried and compared, Camels are the "choice of experience"!

REMEMBER the cigarette shortage during the war? That was the biggest comparison test in cigarette history. From day to day... pack to pack... people smoked whatever was available: more different brands than they would normally try in a lifetime.

The results speak for themselves. More people are smoking Camels than ever before! But, no matter how great the demand:

We don't tamper with Camel quality. Only choice tobaccos, properly aged, and blended in the time-honored Camel way, are used in Camels.

According to a recent Nationwide survey:

MORE DOCTORS SMOKE **CAMELS** than any other cigarette

When 113,597 doctors from coast to coast were asked by three independent research organizations to name the cigarette they smoked, more doctors named Camel than any other brand!

**YOUR "T-ZONE"
WILL TELL YOU...**

T for Taste...
T for Throat...

That's your proving ground for any cigarette. See if Camels don't suit your "T-Zone" to a "T"



R. J. Reynolds Tobacco Co.
Winston-Salem, N. C.