

POPULAR SCIENCE

SEPT. 1947
25 CENTS

MONTHLY

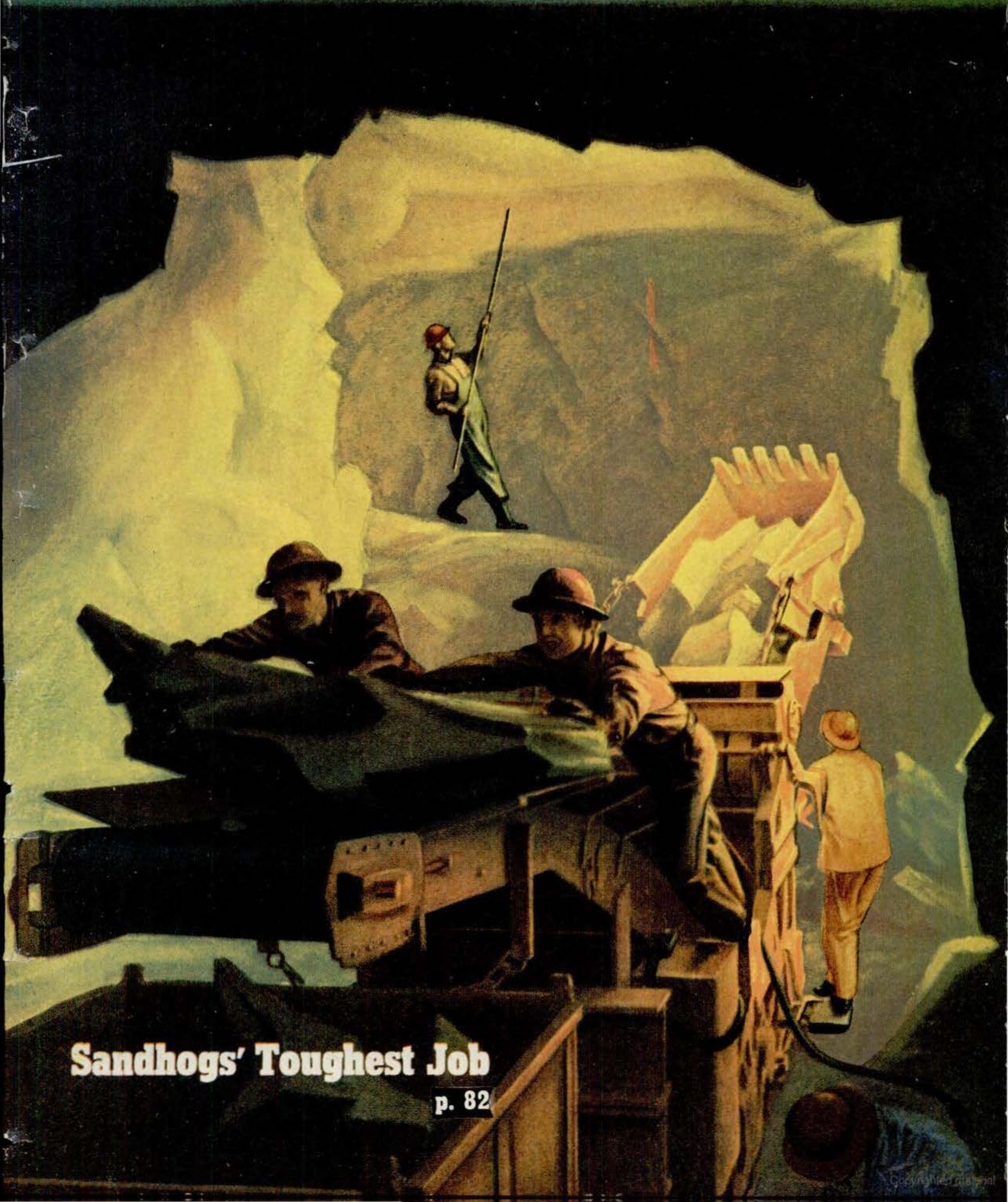

Sandhogs' Toughest Job

p. 82

IT'S FUN TO BE YOUR

and enjoy the home of your dreams!

The COMPLETE HOME HANDYMAN'S GUIDE

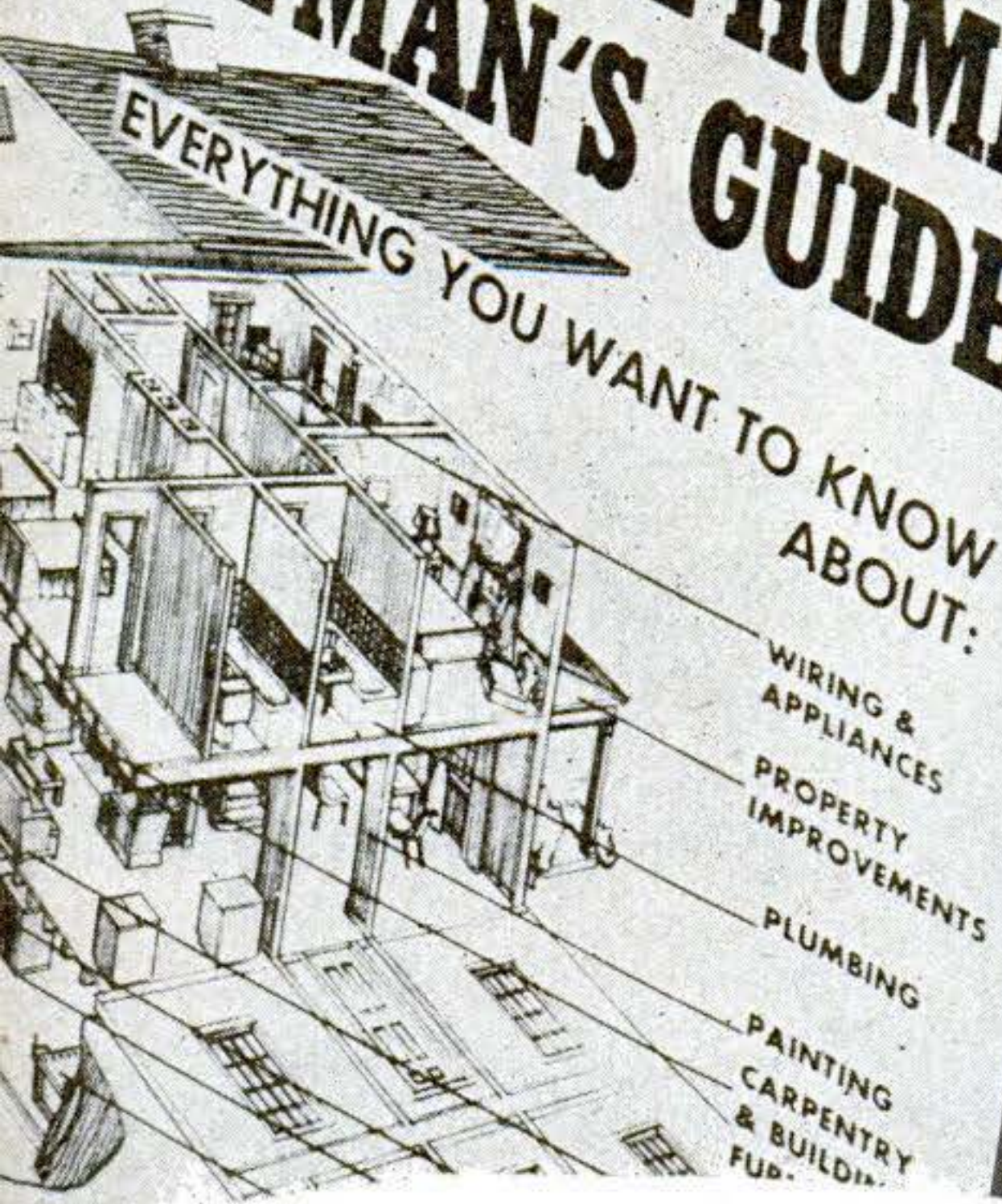

with the aid of the

COMPLETE HOME

Save Hundreds of Dollars Each Year by Being Your Own Handy Man

THIS amazingly comprehensive volume shows you how to do yourself all of the jobs around the house that have long needed doing—and a lot more you've wished *could* be done. It shows you not only how to make your own repairs on your plumbing, wiring, electrical appliances, masonry, plaster, heating system, furniture, etc., but also how to *make improvements* in your home, from a new bookshelf to a whole new roof.

No longer need today's high costs keep you from having the kind of home you'll be proud of—attractive, smooth-running, free from hazards, and equipped with every comfort! This book makes even the most unfamiliar job easy to do—and *fun* to do! You not only save time and money, but you also enjoy the thrill of showing your handiwork to admiring and envious friends!

More than 1,200 "How To Do It" Illustrations! 300,000 Words!

Here is Just a Partial List of the Hundreds of Handyman Subjects Covered in this One Book:

YOUR TOOL KIT

Selecting Tools
Use of Hammer and Handsaws
Screwdrivers, Chisels
Brace and Bit
Hand Drills
Awls, Planes
Pincers, Files
Measuring Tools
How to Sharpen Tools
Nailing Wood
Sandpapers, Glues, etc.

Furniture Upkeep, Cleaning, Removing Water Stains, Marks, Scratches, etc.
Loose Joints
Broken Chairs
Polishes and Polishing
Staining, etc.

PAINTS AND PAINTING

Types of Paint Brushes
Types of Paint
Varnishes, Enamels
Lacquers, Shellac
Calcimine
Paint Thinners
Mixing Paints
Surface Preparation
Removing Paint
Painting a New Surface
Porch Floors and Steps

Painting Metal
Preparing Plaster
Fillers, Staining, etc.

ELECTRICITY IN THE HOME

Approved Electrical Equipment
Home Generators
Fuse Boxes and Fuses
Appliance and Extension Cords
Replacing Fixture Sockets
Electric Motors
Home Signalling Systems
Burglar Alarms, etc.

HEATING THE HOUSE

Chimneys
Coal Furnaces, Oil Burners
Automatic Draft Regulators
Thermostats
Fuel Economy
Warm Air Heating Systems
Steam Heating Systems

Cleaning, Adjusting Radiators
Noise in Steam System
Hot Water Heating System
Repacking Leaky Valves
Cleaning Boilers
Cleaning the Furnace
Insulating Materials
Storm Windows
Weather Stripping, etc.

PLUMBING

Water Supply
Cause of Dirty Water
Repairing Sewage System
Cesspools, Septic Tanks
Stopped Up Sewer Pipes
Stopped Up Drains
Chemical Drain Cleaners
Plumbing Traps
Noisy Plumbing
Repairing Hot Water Tank
Thawing Frozen Pipes
Water Softening Equipment
Repairing Faucets, Flush Tanks, Leaky Pipes, etc.

EXTERIOR REPAIRS

Waterproofing Damp Basements
Waterproofing Masonry Walls
Repairing Cracks in Foundation, Stucco Walls

Repairing Brick Walls
Repairing Leaky Roofs
Caulking Seams
Gutters and Downspouts
Ridding the House of Termites, etc.

YOUR GARDEN

Building Garden Paths
Building Garden Pool
Care and Use of Garden Tools
Cold Frames
Rustic Screens and Arches
Building an Outdoor Fireplace
Erecting Garage, Summer Guest House or Play House in Garden, etc.

HOUSE CONSTRUCTION AND MATERIALS

Foundation
Girders, Sills
Floor Joists
Building Materials
Types of Lumber
Roofing Materials—Asphalt, Asbestos, Aluminum, Wood Shingles
Concrete forms, mixing
Soldering Equipment, Technique
"Sweating" a Patch
Equipping the Workshop, etc.

FURNITURE CARE AND REPAIR

Upholstery of Chairs, Sofas, etc.
Replacing Worn Springs
Strengthening Frame



(Above) A simple little trick like knotting the wire inside extension plugs can save you severe burns, blown-out fuses, and fire hazards. Protect your home and family with the advice in this book!

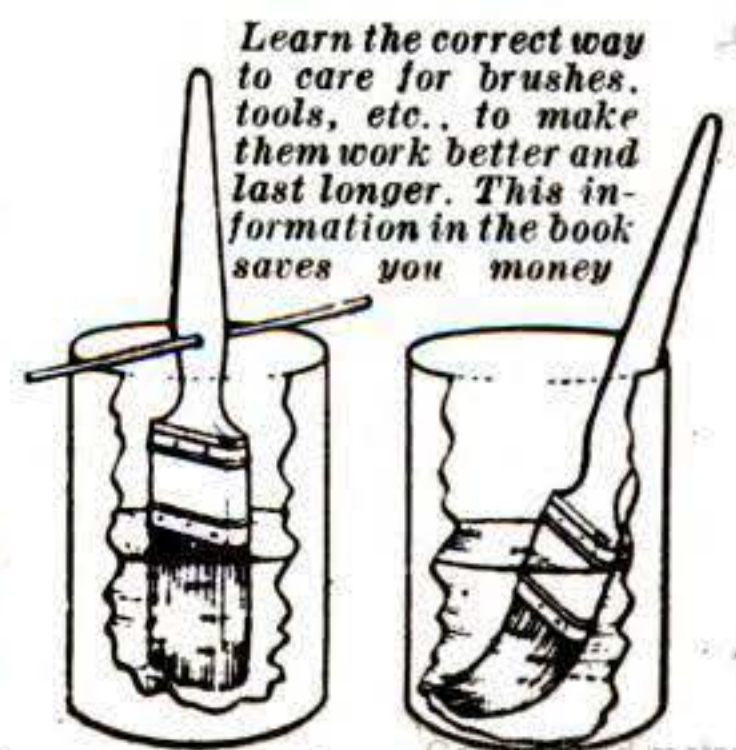
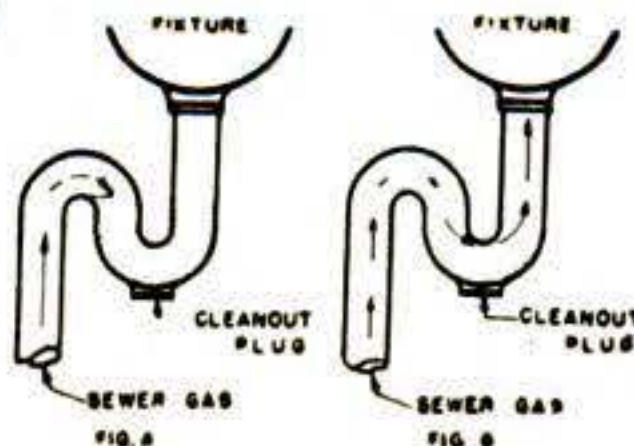

(Left) You SEE diagrams that help you locate and, with little effort, fix plumbing noises, leaks, and drain stoppages.

OWN HANDYMAN!

Here's Everything You Need to Know to Do Your Own Repairing, Beautifying, Modernizing, Converting! The A to Z of CARPENTRY, PLUMBING, PAINTING, DECORATING, WIRING AND APPLIANCES, MASONRY, FURNITURE REPAIR, HEATING SYSTEMS—all in one book!



HANDYMAN'S GUIDE

Make a New Kitchen, Game Room or Bathroom! Build an Extra Apartment and Live Rent-Free!

Here's 1,001 methods to help make your house more liveable—and add hundreds, even thousands of dollars to its value. Need new closet space? Want to eliminate that dangerous draft in the baby's room? Redecorate sister's room? Build a garden walk? Lay a new linoleum floor? Get better winter heat for less money?

Want to convert your basement or attic into an extra apartment, as so many are now doing, to help relieve the housing shortage and bring you a very substantial new income?

You can make these improvements yourself, at surprisingly low cost, with the help of *The Complete Home Handyman's Guide*.

Easy Step-by-Step Instructions in Clear Pictures and Simple Text!

This book assumes no mechanical knowledge or skill on your part. It starts from the very beginning, explaining how to select and use tools and materials. It gives you detailed information every step of the way, from repairing a lamp or iron to installing a complete wiring system; from repairing a chair-leg to rebuilding your upholstery; from buying a paintbrush to repainting the house inside and out. More than 1,200 ILLUSTRATIONS, accurately and explicitly drawn, make the instructions easy to follow. This is the *number one* book for your home. It will repay its astonishingly small cost many times over within a short time!

How to locate and repair short-circuits and other defects in your iron and other electrical appliances is shown in the *COMPLETE HOME HANDYMAN'S GUIDE*.

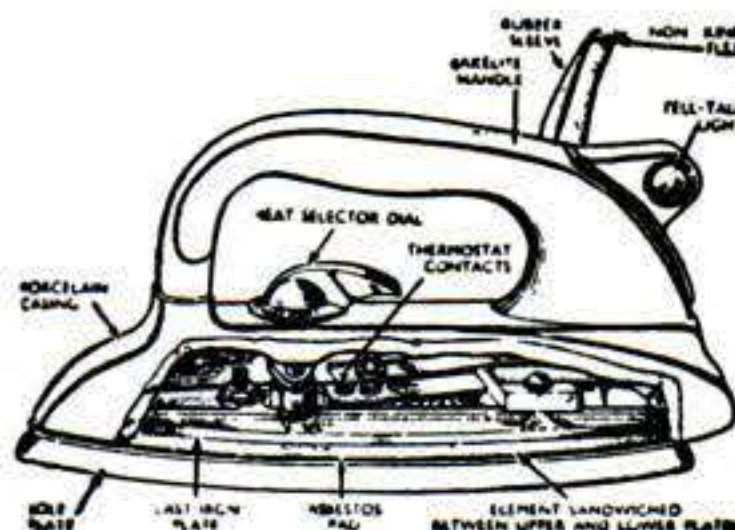

How to equip a workshop, how to use all types of tools, how to use sandpaper and glues—all are fully covered in this "show-me-how" volume.

Yours for a Whole Week Free Trial!

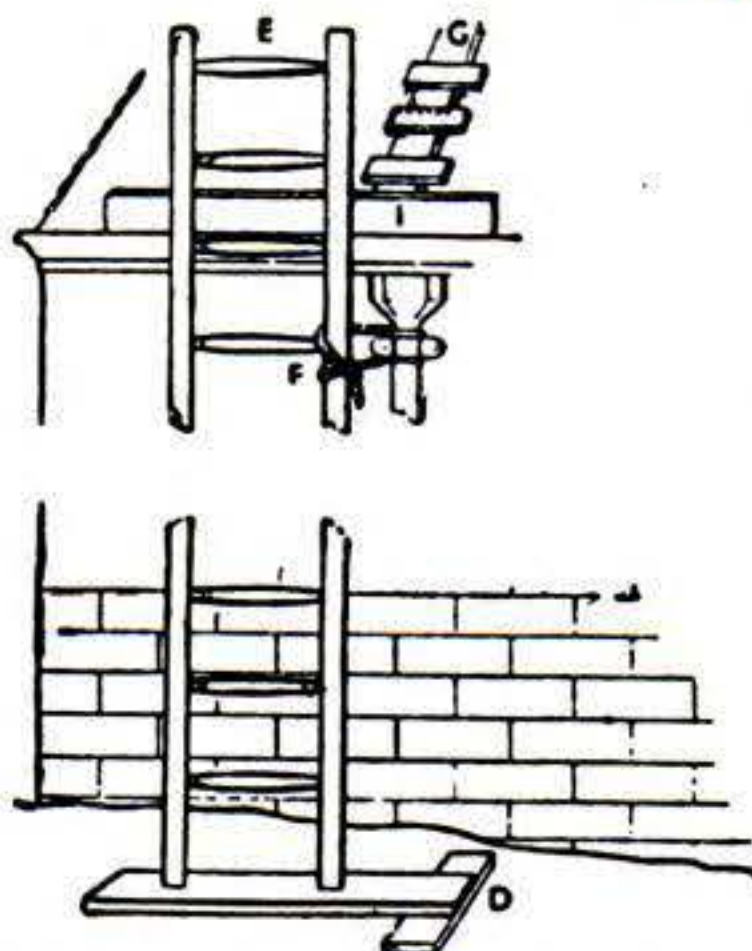

Avoid hazards. This illustration shows how to secure a ladder when you make roof repairs. The book is packed with ideas that save time and work and eliminate risks.

Think of getting in this one big 512-page volume all the practical information you need to do a good professional-looking job of repairing or improving any part of your home—from cellar to chimney-top! Think of getting all this—not for the \$15.00 or \$10.00 you would expect to pay—but for the miracle price of only \$3.95! But don't take our word for this big value. Examine FREE, at our risk and expense, a copy of the *Complete Home Handyman's Guide*. Just mail the coupon below. When the book arrives, test it a full week FREE! If you don't agree it's the best money-saving buy ever, return it without further obligation. If you keep it, pay the small price in small monthly installments. But act at once. Our limited printing is inadequate to meet the demand. Wm. H. Wise & Co., Inc., 50 W. 47th St., New York 19, N. Y.

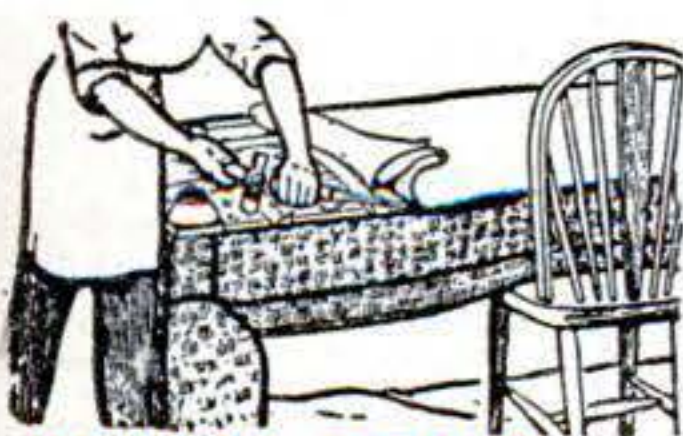

(Left) Furniture upholstery and repair is a fascinating and money-saving hobby when you follow the easy step-by-step instructions in this book.

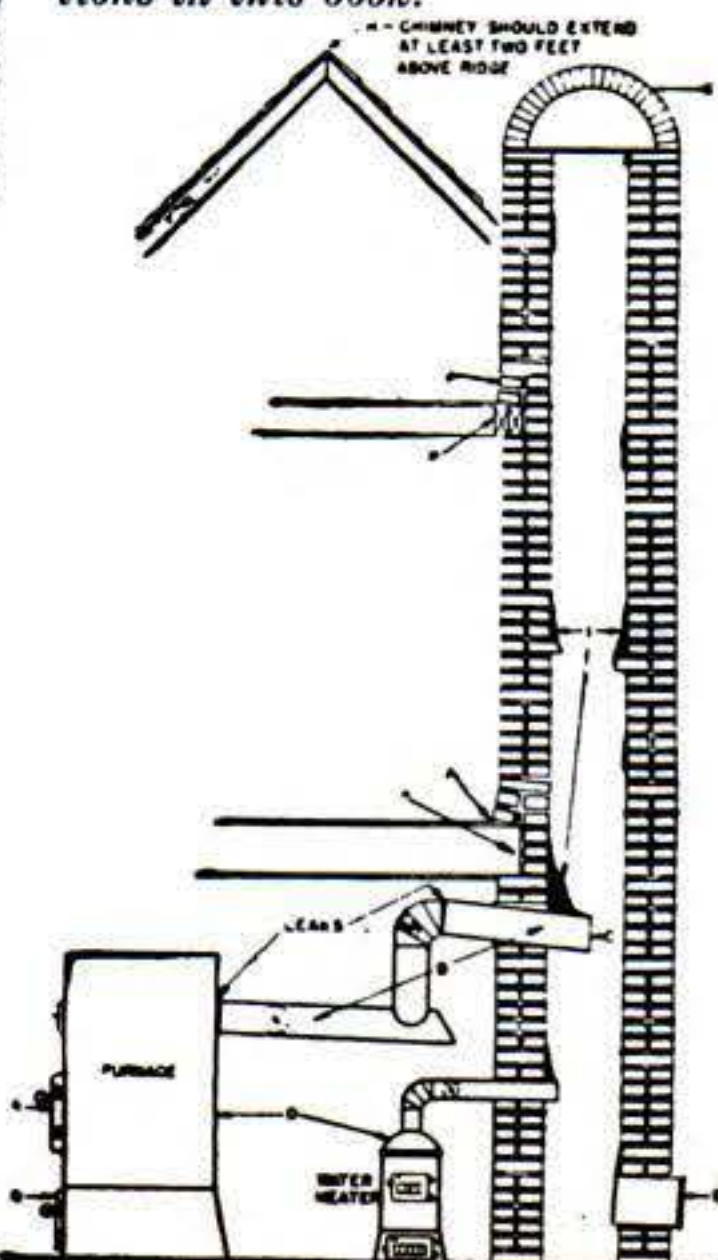

INTERIOR REPAIRS

- Repairing Creaky Floors
- Refinishing Floors
- Repairing and Storing Screens
- Repairing Windows—sash cord, windowpanes; loosening stuck windows
- Linoleum-laying, patching
- Repairing Plaster
- Fixing Loose Tiles
- Care of Carpets
- Repapering the Room
- Cleaning Wallpaper
- Mending China, Metal Utensils
- Repairing Door Locks, Hinges
- Fire Fighting Equipment
- Basement into Game Room
- Building Partitions
- Laying Hardwood Flooring, etc.

Is your chimney losing heat, wasting fuel? Make the checks suggested in this illustration (reduced in size) then follow the book's easy directions for repair.

MAIL THIS FREE-TRIAL COUPON!

Wm. H. Wise & Co., Inc., 50 West 47th Street, New York 19, N. Y.

Without obligation to me, rush me immediately, for Free Examination, a copy of the big new 512-page "COMPLETE HOME HANDYMAN'S GUIDE", bound in sturdy rich Novelex and profusely illustrated with more than 1,200 "How-to-do-it" pictures. After a full week's free trial, I will either return the book promptly and owe you nothing, or I will keep it and remit only \$1 then and \$1 monthly until the amazingly low price of only \$3.95 plus a few cents postage, is paid in full. Check here for De Luxe Edition at only \$1 extra.

SAVE CHARGES on 3 LB. SHIPMENT. Send only \$3.95 with this coupon and we will stand all shipping charges. Same return & refund privilege.

MR. _____
MRS. _____
MISS _____
(Print Plainly in Block Letters)

ADDRESS _____

CITY & ZONE NO. _____ STATE _____

COMPANION VOLUME. Initial here to reserve "PRACTICAL AND TECHNICAL ENCYCLOPEDIA" to be shipped you for FREE trial in about 3 months. 640 pages, over 1,000 pictures, thousands of subjects. Covers Mechanical, Electrical, and Aeronautical Engineering, Building, Plumbing, Metallurgy, Chemistry, Printing, Sheet Metal Work, Radio, Autos, etc. Only \$4.95 plus postage. Same easy terms.

DO NOT WRITE IN BOXES

153

809

POPULAR SCIENCE

Mechanics & Handicraft MONTHLY
REG. U. S. PAT. OFF.

EDITOR:

Perry Githens

MANAGING EDITORS: Fred O. Newman, Volta Torrey

ART EDITOR: Howard C. Jensen

HOME & WORKSHOP EDITOR:

Harry Walton

ASSOCIATE EDITORS: Alden P. Armagnac, Devon Francis, Robert Gorman, Hartley E. Howe, Herbert Johansen, Martin Mann, Frank Rowsome, Jr., John F. Stearns, R. P. Stevenson

WESTERN EDITOR: Andrew R. Boone (Los Angeles, Cal.)

ART DIRECTOR: Harry Samuels

ART ASSOCIATES: Herbert Anthony, Eric Karminski, Jr., Stewart Rouse, Frances Cooper (Production)

STAFF PHOTOGRAPHERS: W. W. Morris, Hubert Luckett, Robert F. Smith

EDITORIAL ASSISTANTS: Mae G. Dyer (Chief), Julia Charnif, Carol Ennis, Sheldon Gallager, Saverio Rada, Lillian Thalendorf, Ruth Westphal

PUBLISHER:

Godfrey Hammond

SEPTEMBER 1947

Cover Painting by Ray Pioch

Science News

Blockhouse Cages Split Atoms..... 97
How to Create Silk, Skin or Serum.....103
X-Rays Paint Gems.....116
'Chutes Save Rocket Secrets.....124
Electrons Light Own Path.....146

Science at Work

"Echo Flashlight"..... 91
Night View at Noon.....102
Smallest Glass Factory.....107
Buttons Relay Telegrams Faster.....112
Laboratories Match Men and Machines..122
World's Weather Under One Roof.....138
Camera Speeds Testing.....143
Tubes Guide Atom Smashers.....146
"Fireworks" Aid Lab Studies.....147

PSM Features

Sandhogs' Toughest Job..... 82
Ballast "Broom" Rides the Rails..... 96
Logging at Full Throttle..... 99
5,000 Acres of Sudden Death.....110
Man-Made River Pierces Great Divide....119
U. S. Tests Russia's Colored Cotton.....129
These Stairs Block Fires.....132
Mountain "Moved" to Camera.....145
How the New Taximeter Works.....148
How Chemistry Softens Water.....218

Aviation

Lightning Strikes Thrice..... 92
One-Hand Control..... 93
Glider Gets "Outboard"..... 94
New Light Ends Stargazing..... 95
Thunderjet (Pin-up).....113
How Navy Keeps Jets on the Job.....130
Last Word in Illusion.....137
P-80 Double-Checked on Record Run....150

Automobiles

Picture of the Month..... 81
Paint Needs No Brush..... 90
Sway-Backed Bus Cuts Corners.....108
Farm Jeep Offers Four-Wheel Drive.....111
Auto Ideas.....154
Auto Hints.....155
Must You Break In a New Car?.....156
Rear-Engine Car Boasts Kitchen.....159
Gus Comes Home to Trouble.....160

Inventions

New Ideas from the Inventors.....114
Coffee Under Pressure.....118
I'd Like to See Them Make.....135
Farmer Makes Water Run His Pump.....144

Photography

Cleaner Dries Reel.....196
Doctoring a Negative.....196
Lights Move with Camera.....197
Focus on Sports.....198

(CONTINUED ON PAGE 4)

Published monthly at 353 Fourth Avenue, New York 10, N. Y., by Popular Science Publishing Co., Inc. Godfrey Hammond, President and Treasurer; R. C. Wilson, Raymond J. Brown, Stephen P. Glennon, B. Ray Keefer, Vice-Presidents; F. W. Briggs, Secretary. Entered as second-class matter Dec. 28, 1918, at the Post Office at New York under the act of March 3, 1879; additional entry as second-class matter at Dayton, Ohio. Entered as second-class matter at the Post Office Department, Canada. Printed in U. S. A. Copyright, 1947, by Popular Science Publishing Co., Inc. All rights reserved in the United States, Great Britain, and in all countries participating in the International Copyright Convention and Pan-American Copyright Convention. Yearly subscriptions to United States, its possessions and Canada, \$2.50; foreign countries, \$3.50. Subscribers must notify us of change of address four weeks in advance of the next publication date. Be sure to give both old and new addresses, including zone numbers.

An Invitation To Readers of This Magazine

FROM THE PUBLISHERS OF THE

FUNK & WAGNALLS *New Standard* ENCYCLOPEDIA

Please Accept WITH OUR COMPLIMENTS

Volume One of the New 1947 Edition—Now On Press!

[ALL WE ASK YOU TO PAY IS TEN CENTS TO COVER COST OF MAILING IT TO YOU]

WE are now on press with our latest 1947 Edition of Funk & Wagnalls New Standard Encyclopedia.

This latest edition, newly revised, we have allocated among the newspapers and magazines carrying our current advertising program. In accordance with this plan we have set aside 1500 sets for readers of this magazine and now invite you to become the owner of a set—making this extraordinary offer to enable you to become acquainted with the volumes before you decide to buy.

We want to send you Volume I with our compliments. Merely send us 10c to cover our mailing cost — more as evidence of your good faith than anything else. If, after examining Volume I, you want the rest of the 27-volume set, you may receive it at a ridiculously low price through our book a week plan. If you want no further books, merely drop us a postcard saying so, and that ends the matter.

Some Facts About This Encyclopedia

But first, we want to give you a few facts to interest you in taking the trouble to send for Volume I.

The newest 1947 Edition contains over 52,000 articles. Compare this with any other encyclopedia in the world. You will find that this number is at least 30% greater than in encyclopedias costing you up to four times as much as ours.

Each volume is as up-to-date as human ingenuity can make it. This edition has been revised to cover events of the past year, and each volume, as it goes to press, is brought up-to-the-minute. Our unique book a week delivery plan, bringing you the volumes as they come off the presses, makes it the most up-to-date of encyclopedias.

Easy-Reading, Handy Volumes

Editor-in-Chief of original edition was Frank H. Vizetelly, editor of the Funk & Wagnalls New Standard Dictionary. Surrounded by a host of authorities, he brought this immense work into being.

Yet the books are so easy to read! Your children in school can

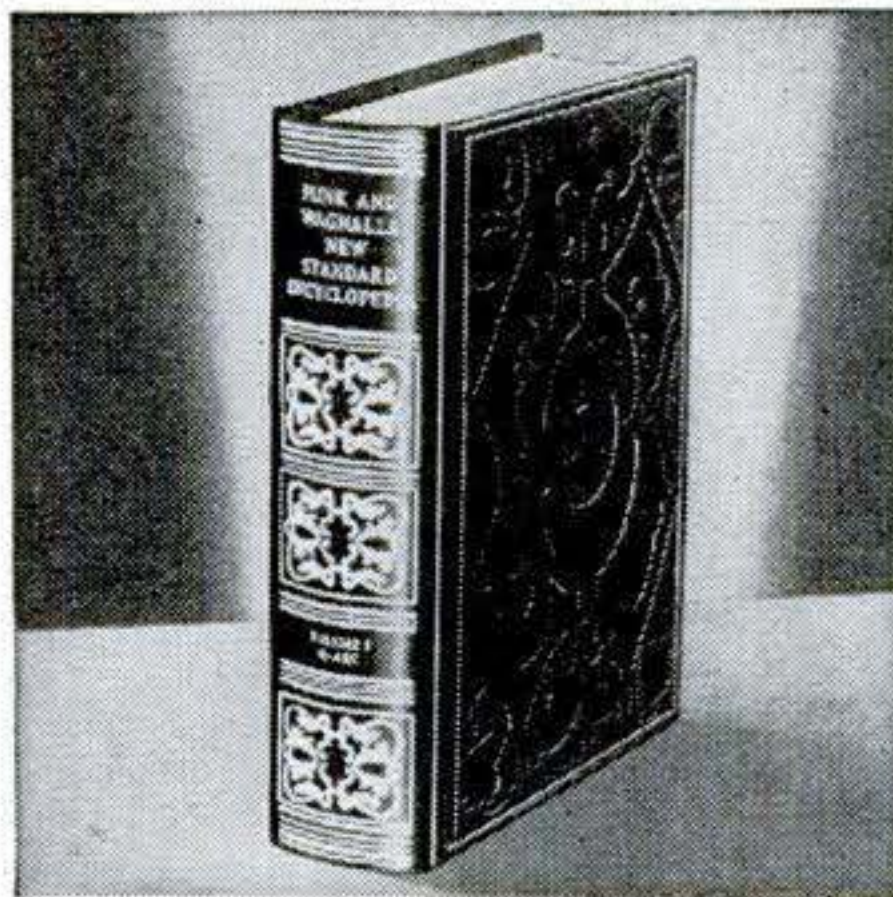

Copyright 1947, Unicorn Press

use them with profit. Free of abstruse wording—and free also of fact-omitting brevity—this grand encyclopedia will serve you for years to come.

And in spite of their enormous contents, each volume can be held in one hand! Here is a new streamlined, usable set, handy for daily reference.

Nor does the incredibly low price we have set on the remaining volumes indicate the quality of materials and labor that went into them, as of course you will soon see for yourself.

Unique Book a Week Plan

Our plan gives you the books as quickly as they come off the presses.

Volume I is delivered to you immediately. Two weeks later, unless you cancel your reservation, the next two volumes are mailed to you. Two weeks after that the following two volumes are sent, and so on. You thus receive your volumes, freshly off the press, at the rate of a volume a week.

You do not pay for any books in advance. We enclose a bill with each two volumes which you pay within 5 days after receiving the books. Considering the amazingly low price of the set and the fact that you pay for it at the rate

of only a book a week, our pay-as-you-go plan therefore puts no strain on any pocketbook.

How much are the volumes? Here's the surprise. You pay only \$1.39 for the De Luxe Binding, plus 11¢ mailing cost. The complete set thus costs you only a small fraction of what other high grade encyclopedias would cost you—and we want only the opportunity to PROVE to you that ours is unexcelled for your use.

A Choice of Editions

With this announcement we offer you a choice between our De Luxe Edition and our Library Edition of the encyclopedia.

The De Luxe Edition, at \$1.39 per volume, is bound in dark blue, leather-grained cloth, stamped in red and gilt, as illustrated here, with head and tailbands, and harmoniously stained page-tops. End papers and frontispieces are color reproductions of woodcuts by Hans Alexander Mueller, renowned artist in that medium, the frontispieces being a set of woodcut portraits of American Presidents.

The Library Edition costs slightly more (\$1.89 per volume plus the same 11¢ mailing cost), and has all the features described above, plus a more expensive binding. The covers of this superfine edition are in a tan linen-weave cloth, with red and black title panels, decorated with genuine 22 carat gold leaf, bright and untarnishing—making in all an extremely handsome and dignified set of books.

You may have your choice of these editions in sending for Volume One, at the same 10¢ mailing cost. However, before indicating your choice of editions in the coupon below, please remember, the difference in price. And hurry! Fifteen hundred sets are not many for a magazine of such large circulation as this one. First come, first served. Send off the coupon TODAY!

UNICORN PRESS, *Authorized Publishers*
Brooklyn 1, New York

I enclose 10¢ in coin or stamps, for which send me Volume I of the latest 1947 Funk & Wagnalls New Standard Encyclopedia in edition checked below:

DE LUXE

LIBRARY

Please also reserve balance of a set for me in same edition.

If I decide to cancel reservation after examining Volume I, I will write you saying so, and there will be no further obligation; otherwise you may send me two more volumes every two weeks, and I will pay within 5 days after receiving them, at the rate of \$1.39 per volume plus 11¢ mailing cost for De Luxe Edition (or \$1.89 per volume plus same mailing cost for Library Edition)—and that is all! *Volume I is mine to keep in any event.*

Name

Address

City, Zone, State.....3071

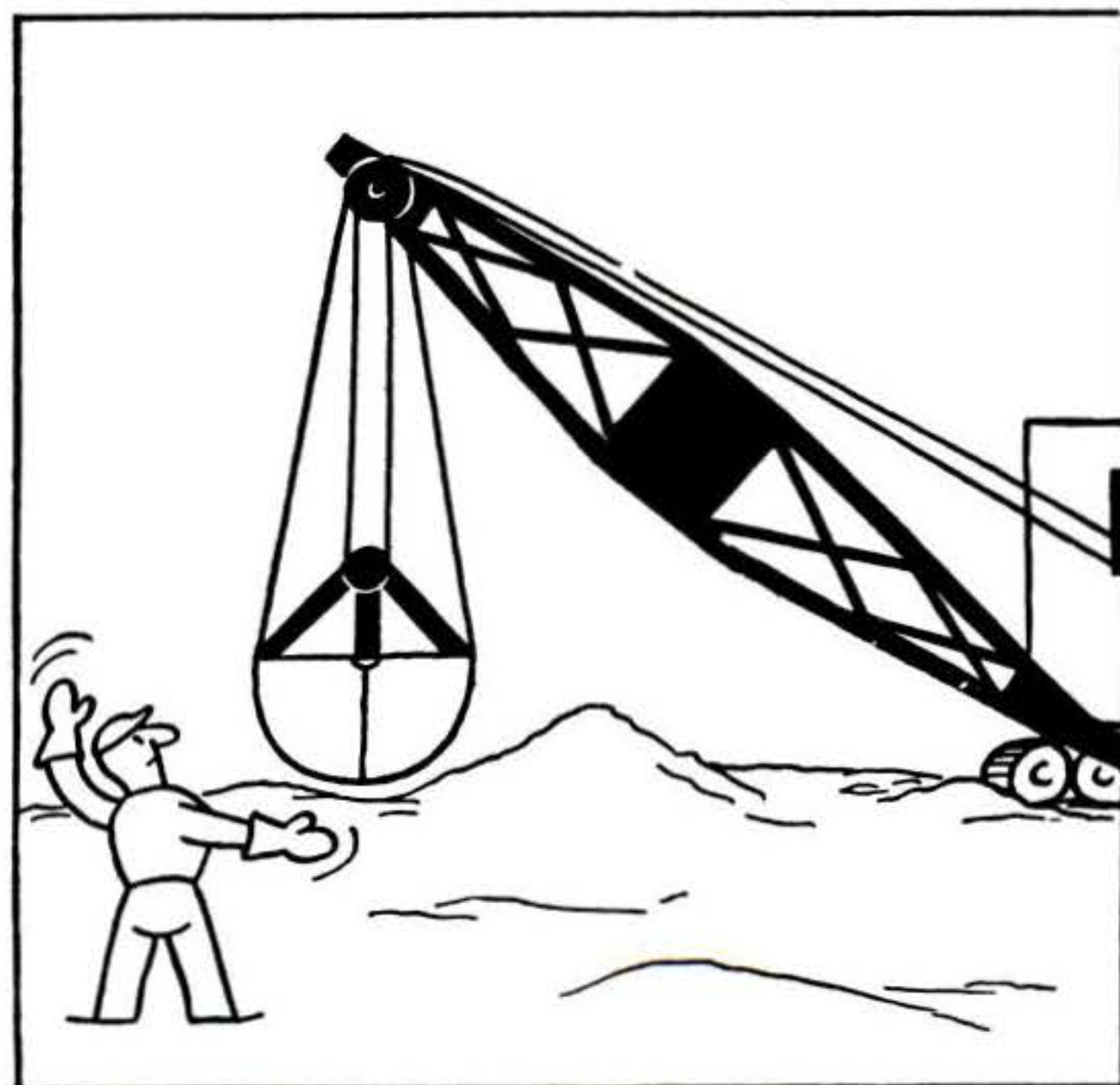
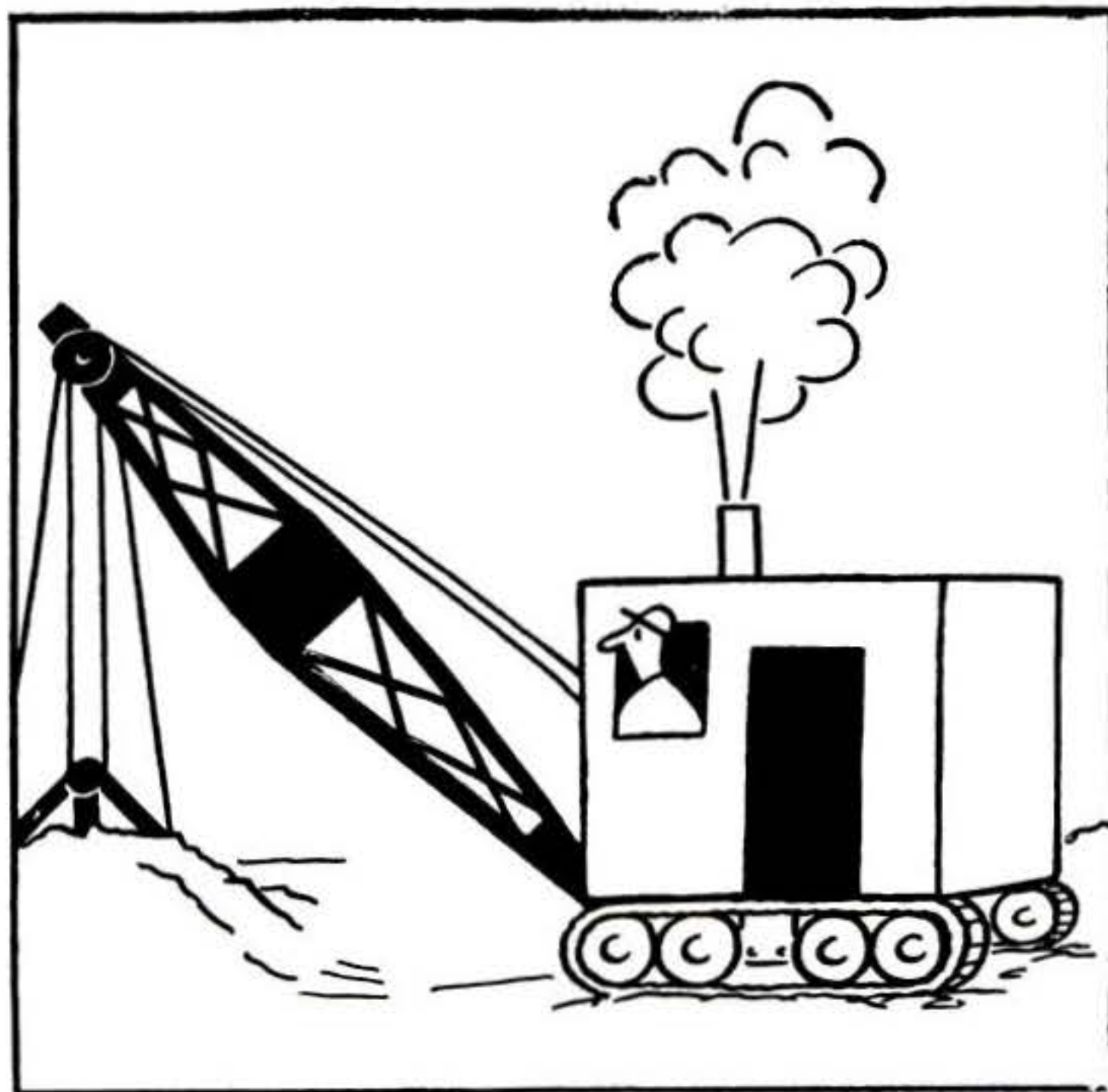

Mechanics & Shopcraft

Paper Handles for Hacksaw Blades.....	180
Good Layout Starts the Job Right.....	182
Power Oilstone Sharpens Blades.....	184
Flexible Couplings Smooth Power Flow..	188
How to Make Rotary Files.....	191
New Shop Ideas.....	192
Coated Abrasives.....	193
Welded Pipe Forms Foot Bridge.....	213
Posts Guard Sliding Doors.....	213
Tool Rest Gauges Depth.....	216

Home Mechanics & Handicraft

Craftwork Projects of the Month.....	136
Coffee Table Has Ax-Handle Legs.....	164
Portable Fence Grows with Baby.....	165
Pie-Tin Decal Displays.....	166
Wheelbarrow Serves Tidbits.....	167
It's Copper for Candlelight.....	168
Antiquing Copper.....	171
Model-Train Table Folds Up.....	172
Floating Boathouse Has Picnic Terrace..	176
Rack Holds Dishes Aboard Boat.....	177
Vanishing Towel Rack.....	179
Plastic Bracket Holds Shaver.....	180
Junked Fixture Provides Lamp Parts.....	187
How to Paper a Roof.....	194
Buffet Sandwich Board.....	209
Servicing the Gas Range.....	210
Making a Door Stay Shut.....	216
Kitchen-Match Pipe Rack.....	217
Laboratory Equipment You Can Make....	222

Radio & Electricity

Boosting Coulee Power.....	98
Hilltop Tower Relays Radio.....	147
Hi-Fi Amplifier.....	202
News in Electronics.....	206
Contact Mike Boosts Music.....	207
Condenser Cuts Interference.....	208

Departments

Voice of Science.....	7
Letters	16
Aids to Modern Living.....	152
New Tools.....	173
Keeping the Home Shipshape.....	174
What's Your Ingenuity Quotient?.....	178
Craftsmen at Work.....	181
Hobby Shopping.....	186
Home Experiments.....	214
What's Wrong.....	217
For Easier Farming.....	224
Editorial Memo.....	294

WARNING TO THE CURIOUS!

Don't read another word of this advertisement unless you're interested in a better job, a larger salary, greater responsibility! I. C. S. messages are not addressed to the idly curious—they're for the man who is curious with a purpose.

If you want to know how to start achieving advancement and success, we have important information for you.

We want to tell you that I. C. S. Courses covering more than 400 commercial and technical subjects are available for spare-time study at surprisingly low cost.

We want you to know that pay increases and job betterments are consistently reported to us by I. C. S. students in a volume as high as 600 and more letters a month.

Note, too, that successful I. C. S. graduates are numbered in the thousands and include presidents, board chairmen, production and research heads, superintendents, foremen in almost every branch of industry.

If you're truly curious, you'll want to know the details of what I. C. S. did for these men—and what it can do for you. The coupon brings you this full information. Mark and mail it *right now!*

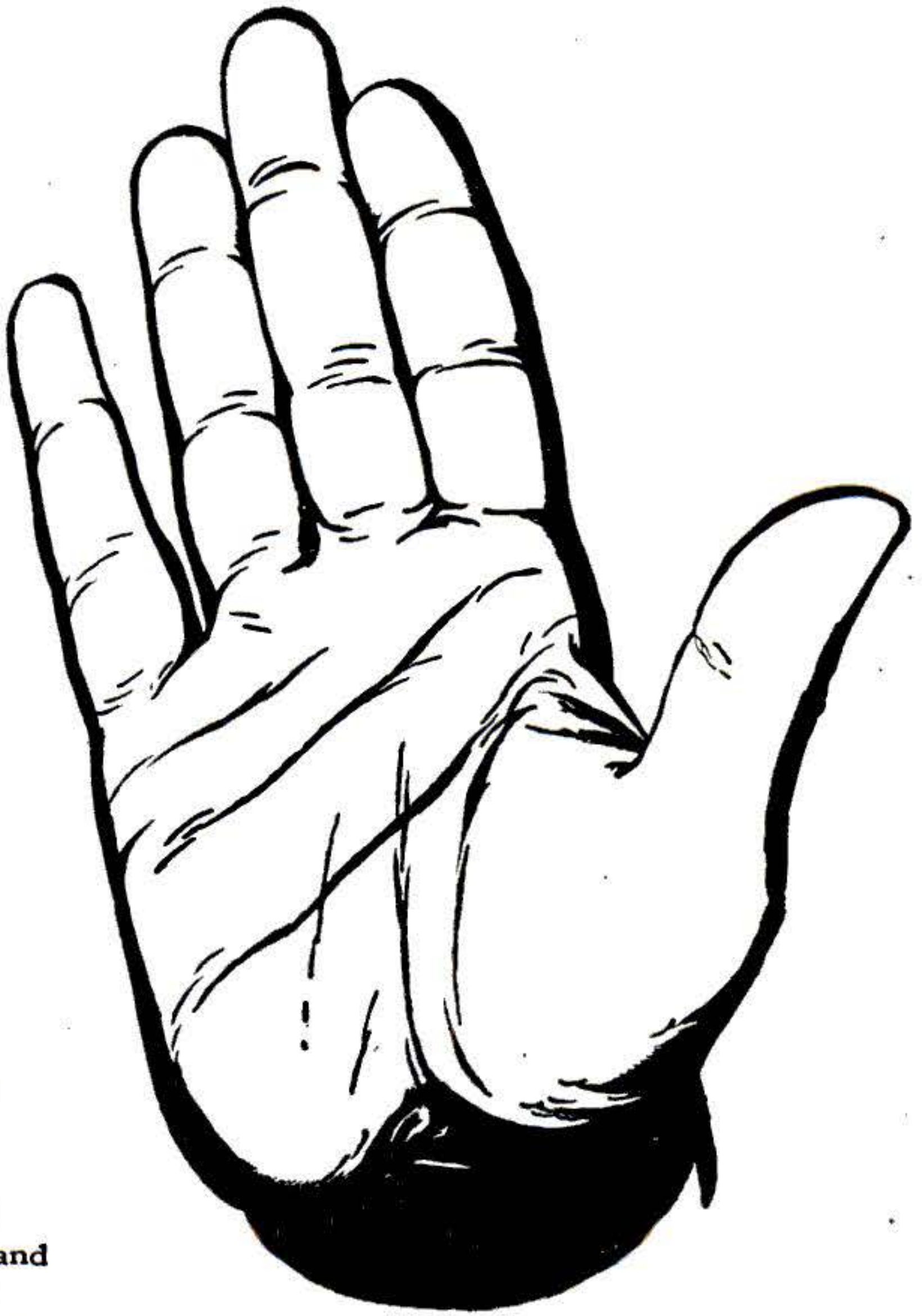

INTERNATIONAL CORRESPONDENCE SCHOOLS



BOX 7691-L, SCRANTON 9, PENNA.

Without cost or obligation, please send me full particulars about the course BEFORE which I have marked X:

- | | | | | |
|--------------------------------------------------------------------------------------------------------------------------------------------------------------------------------------------------------------------------------------------------------------------------------------------------------------------------------------------------------------------------------------------------------------------------------------------------------------------------------------------------------------------------------------------------------------------------------------------------------------------------------------------------------------------------------------------------------------------------------------------------------------------------------------------------------------------------------------------------------------------------------------------------------------------------------------------------------------------------------------------------------------------------------------------------------------------------------------------------------------------------------------------------------------------------------------------------|------------------------------------------------------------------------------------------------------------------------------------------------------------------------------------------------------------------------------------------------------------------------------------------------------------------------------------------------------------------------------------------------------------------------------------------------------------------------------------------------------------------------------------------------------------------------------------------------------------------------------------------------------------------------------------------------------------------------------------------------------------------------------------------------------------------------------------------------------------------------------------------------------------------------------------------------------------------------------------------------------------------------------------------------------------------------------------------------------------------------------------------------------------|----------------------------------------------------------------------------------------------------------------------------------------------------------------------------------------------------------------------------------------------------------------------------------------------------------------------------------------------------------------------------------------------------------------------------------------------------------------------------------------------------------------------------------------------------------------------------------------------------------------------------------------------------------------------------------------------------------------------------------------------------------------------------------------------------------------------------------------------------------------------------------------------------------------------------------------------------------------------------------------------------------------------------------------------------------------------------------------------------------------------------------------------------------------------------------------------------------------------------------------------------------------------------------------------------------------------------|----------------------------------------------------------------------------------------------------------------------------------------------------------------------------------------------------------------------------------------------------------------------------------------------------------------------------------------------------------------------------------------------------------------------------------------------------------------------------------------------------------------------------------------------------------------------------------------------------------------------------------------------------------------------------------------------------------------------------------------------------------------------------------------------------------------------------------------------------------------------------------------------------------------------------------------------------------------------------------------------------------------------------------------------------------------------------------------------------------------------------------------------------------------------------|---------------------------------------------------------------------------------------------------------------------------------------------------------------------------------------------------------------------------------------------------------------------------------------------------------|
| <p>Air Conditioning and Plumbing Courses</p> <input type="checkbox"/> Air Conditioning
<input type="checkbox"/> Heating
<input type="checkbox"/> Refrigeration
<p>Chemistry Courses</p> <input type="checkbox"/> Chemical Engineering
<input type="checkbox"/> Chemistry, Analytical
<input type="checkbox"/> Chemistry, Industrial
<input type="checkbox"/> Chemistry, Mfg. Iron & Steel
<input type="checkbox"/> Petroleum Refining
<input type="checkbox"/> Pulp and Paper Making
<p>Civil Engineering, Architectural and Mining Courses</p> <input type="checkbox"/> Architecture
<input type="checkbox"/> Architectural Drafting
<input type="checkbox"/> Bridge and Building Foreman
<input type="checkbox"/> Building Estimating
<input type="checkbox"/> Civil Engineering
<input type="checkbox"/> Coal Mining
<input type="checkbox"/> Contracting and Building
<input type="checkbox"/> Highway Engineering
<input type="checkbox"/> Lumber Dealer
<input type="checkbox"/> Reading Structural Blueprints
<input type="checkbox"/> Sanitary Engineering
<input type="checkbox"/> Structural Drafting | <p><input type="checkbox"/> Plumbing
 <input type="checkbox"/> Steam Fitting</p> <p>Communications Courses</p> <input type="checkbox"/> Electronics
<input type="checkbox"/> Practical Telephony
<input type="checkbox"/> Radio, General
<input type="checkbox"/> Radio Operating
<input type="checkbox"/> Radio Servicing
<input type="checkbox"/> Telegraph Engineering <p>Electrical Courses</p> <input type="checkbox"/> Electrical Drafting
<input type="checkbox"/> Electrical Engineering
<input type="checkbox"/> Electric Light and Power
<input type="checkbox"/> Lighting Technician
<input type="checkbox"/> Practical Electrician <p>Internal Combustion Engines Courses</p> <input type="checkbox"/> Auto Technician
<input type="checkbox"/> Diesel-Electric
<input type="checkbox"/> Diesel Engines
<p>Mechanical Courses</p> <input type="checkbox"/> Aeronautical Engineer's, Jr.
<input type="checkbox"/> Aircraft Drafting
<input type="checkbox"/> Flight Engineer
<input type="checkbox"/> Forging
<input type="checkbox"/> Heat Treatment of Metals | <p><input type="checkbox"/> Structural Engineering
 <input type="checkbox"/> Surveying and Mapping</p> <p>Industrial Engineering</p> <input type="checkbox"/> Industrial Metallurgy
<input type="checkbox"/> Machine Shop
<input type="checkbox"/> Mechanical Drafting
<input type="checkbox"/> Mechanical Engineering
<input type="checkbox"/> Mold-Loft Work
<input type="checkbox"/> Patternmaking—Wood, Metal
<input type="checkbox"/> Reading Shop Blueprints
<input type="checkbox"/> Sheet-Metal Drafting
<input type="checkbox"/> Sheet-Metal Worker
<input type="checkbox"/> Ship Drafting
<input type="checkbox"/> Tool Designing
<input type="checkbox"/> Toolmaking
<input type="checkbox"/> Welding—Gas and Electric <p>Railroad Courses</p> <input type="checkbox"/> Air Brake
<input type="checkbox"/> Diesel Locomotive
<input type="checkbox"/> Locomotive Engineer
<input type="checkbox"/> Locomotive Fireman
<input type="checkbox"/> Railroad Section Foreman <p>Steam Engineering Courses</p> <input type="checkbox"/> Boilermaking
<input type="checkbox"/> Combustion Engineering
<input type="checkbox"/> Engine Running
<input type="checkbox"/> Marine Engineering
<input type="checkbox"/> Steam Electric | <p><input type="checkbox"/> Ship Fitting
 <input type="checkbox"/> Car Inspector</p> <p>Textile Courses</p> <input type="checkbox"/> Cotton Manufacturing
<input type="checkbox"/> Rayon Weaving
<input type="checkbox"/> Textile Designing
<input type="checkbox"/> Woolen Manufacturing <p>Business and Academic Courses</p> <input type="checkbox"/> Accounting
<input type="checkbox"/> Arithmetic
<input type="checkbox"/> Business Administration
<input type="checkbox"/> Business Correspondence
<input type="checkbox"/> Certified Public Accounting
<input type="checkbox"/> Commercial
<input type="checkbox"/> Commercial Art
<input type="checkbox"/> Cost Accounting
<input type="checkbox"/> Federal Tax
<input type="checkbox"/> First Year College
<input type="checkbox"/> Foremanship
<input type="checkbox"/> Good English
<input type="checkbox"/> Higher Mathematics
<input type="checkbox"/> Motor Traffic
<input type="checkbox"/> Salesmanship
<input type="checkbox"/> Sign Lettering
<input type="checkbox"/> Spanish
<input type="checkbox"/> Traffic Management | <p><input type="checkbox"/> Advertising
 <input type="checkbox"/> Bookkeeping</p> <p><input type="checkbox"/> French
 <input type="checkbox"/> High School
 <input type="checkbox"/> Postal Service
 <input type="checkbox"/> Secretarial
 <input type="checkbox"/> Stenography</p> |
|--------------------------------------------------------------------------------------------------------------------------------------------------------------------------------------------------------------------------------------------------------------------------------------------------------------------------------------------------------------------------------------------------------------------------------------------------------------------------------------------------------------------------------------------------------------------------------------------------------------------------------------------------------------------------------------------------------------------------------------------------------------------------------------------------------------------------------------------------------------------------------------------------------------------------------------------------------------------------------------------------------------------------------------------------------------------------------------------------------------------------------------------------------------------------------------------------|------------------------------------------------------------------------------------------------------------------------------------------------------------------------------------------------------------------------------------------------------------------------------------------------------------------------------------------------------------------------------------------------------------------------------------------------------------------------------------------------------------------------------------------------------------------------------------------------------------------------------------------------------------------------------------------------------------------------------------------------------------------------------------------------------------------------------------------------------------------------------------------------------------------------------------------------------------------------------------------------------------------------------------------------------------------------------------------------------------------------------------------------------------|----------------------------------------------------------------------------------------------------------------------------------------------------------------------------------------------------------------------------------------------------------------------------------------------------------------------------------------------------------------------------------------------------------------------------------------------------------------------------------------------------------------------------------------------------------------------------------------------------------------------------------------------------------------------------------------------------------------------------------------------------------------------------------------------------------------------------------------------------------------------------------------------------------------------------------------------------------------------------------------------------------------------------------------------------------------------------------------------------------------------------------------------------------------------------------------------------------------------------------------------------------------------------------------------------------------------------|----------------------------------------------------------------------------------------------------------------------------------------------------------------------------------------------------------------------------------------------------------------------------------------------------------------------------------------------------------------------------------------------------------------------------------------------------------------------------------------------------------------------------------------------------------------------------------------------------------------------------------------------------------------------------------------------------------------------------------------------------------------------------------------------------------------------------------------------------------------------------------------------------------------------------------------------------------------------------------------------------------------------------------------------------------------------------------------------------------------------------------------------------------------------------|---------------------------------------------------------------------------------------------------------------------------------------------------------------------------------------------------------------------------------------------------------------------------------------------------------|

Name _____ Home Address _____

City _____ State _____

Age _____ Present Position _____ Working Hours _____ A.M. to _____ P.M.

Special tuition rates to members of the Armed Forces. Enrollment under the G.I. Bill of Rights approved for World War II Veterans.
Canadian residents send coupon to International Correspondence Schools Canadian, Ltd., Montreal, Canada.

**OWN
NEW
8 mm 16 mm
CASTLE
FILMS**

VARIETY! ACTION! THRILLS!



SPILLS AND THRILLS
Fate-tempting stunts and daredevil chances make you gasp, laugh, thrill and wonder how they do it and live! Own this exciting home movie!



LION-TIGER FIGHT
An epic of the jungle! Gripping battle of savage beasts locked in thrilling combat! Acclaimed as the greatest fight of big cats ever filmed!



STAMPEDE! . . . A knockout Western! Cowpunchers' dispute over water-hole builds trouble and suspense! Flaming prairie drives a thousand cattle mad with fear as guns blaze in spectacular ending!



PANTRY PANIC . . . A new Woody Woodpecker cartoon by Walter Lantz! Woody and tomcat in riot of fun and laughs with big moose! You'll howl at this one!

HOME MOVIE PROJECTOR OWNERS!

Enjoy your projector more with these new, thrilling Castle Films.

8 mm - 16 mm SILENT - 16 mm SOUND

Join the tens of thousands of home movie fans who collect their own personal Castle Film libraries of the world's finest professional motion pictures. Adventure — sports — travel — historic events and famous cartoon characters.

A great variety of subjects to select from. See your photographic dealer now while his stocks of Castle Films are complete.

Available in these five sizes

AT THESE LOW PRICES:

8 mm	16 mm
Headline (50 ft.) \$1.75	Headline (100 ft.) \$ 2.75
Complete \$5.50	Complete \$ 8.75
	Sound \$17.50

FREE! To All Projector Owners!
SEND COUPON NOW!



DIVISION OF UNITED WORLD FILMS INC.

445 PARK AVENUE FIELD BLDG. RUSS BUILDING
NEW YORK 22 CHICAGO 3 SAN FRANCISCO 4

Dept. 09

Please send me the new 1947 Castle Films Deluxe Catalogue describing more than 170 thrilling home movies.

NAME _____

ADDRESS _____

CITY _____

ZONE _____ STATE _____

Ready, Set . . .

Here are the mousetraps on the table. Dr. Van der Grinten is about to drop a marble representing a neutron on the first "atom."



Go . . .

The "atoms" are "exploded" in an uncontrolled reaction. This is the theory behind the atomic bomb.

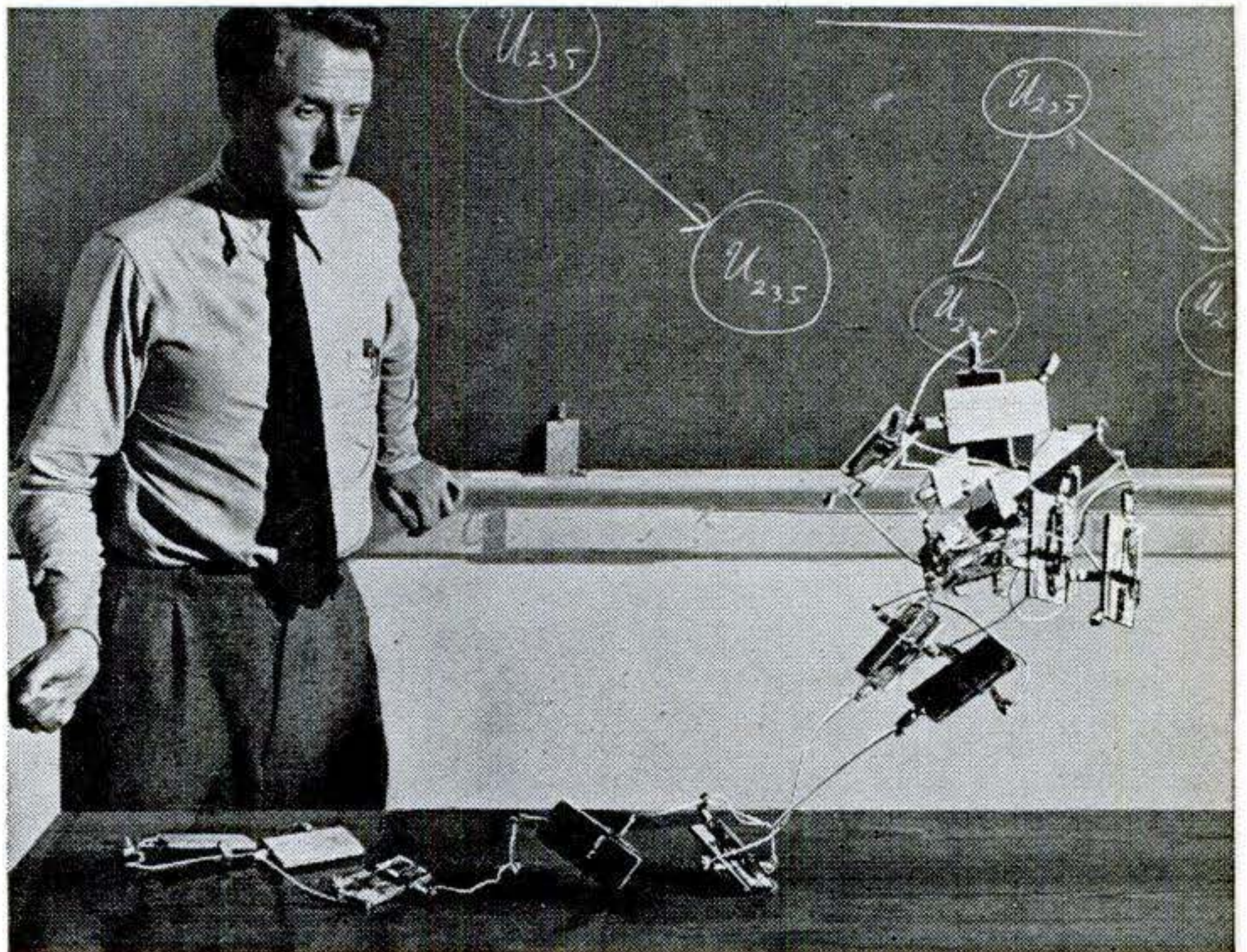

Mousetraps Catch Big Idea

LAST month, on this page, an "Atomic Mousetrap" was cartooned as a desirable, if impossible, demonstration. But, I wrote, "while nuclear fission comes only in the big, all-family package . . . the *idea* can be put out in handy, one-brain doses."

This is exactly what three serious physicists with a sense of humor proceeded to do. It was a coincidence that they used mousetraps to illustrate the chain reaction. PSM was still on the press when Dr. Richard M. Sutton, of Haverford College, started playing with snappers. Meanwhile, in the General Electric Laboratories in Schenec-

tady, Dr. William Van der Grinten and Dr. Lewi Tonks were rigging up their version of traps for ideas.

The contraptions are simple and cheap. Just rig up the traps with string, set them, touch them off, and watch the "reaction" race through the chain with a clatter as satisfying to school children as it is to Ph.Ds.

This month, when school opens, I hope every teacher who reads PSM will send out for mousetraps. This is the kind of teaching that makes learning easier.

Perry Githens

SEPTEMBER 1947 7



At Philadelphia, a testboard man answers as an electronic watchman calls attention to conditions on one of the coaxial systems to Baltimore and Washington.

"Send Help to Manhole 83"

Strung out along every Bell System coaxial cable, electronic watchmen constantly mount guard over your voice. Some are in manholes under city streets; some are in little huts on the desert. Most situations they can deal with; if things threaten to get out of hand, they signal the nearest testboard.

Principal care of the electronic watchman is the transmission level. Sun-warmed cables use up more energy than cold ones, so a transcontinental call may take a millionfold more energy to carry it by day than by night. Each

watchman — an electronic regulator — checks the transmission level and adjusts the amplification which sends your voice along to the next point. Many hundreds of regulators may be at work on a single long distance call.

Without automatic regulation, the precise control of energy in the Bell System's long distance circuits would be a superhuman task. So Bell Telephone Laboratories, which in 1913 developed the first high-vacuum electronic amplifier, went on to devise the means to make them self-regulating in

telephone systems. This is one reason why your long distance call goes through clearly, summer or winter.

BELL TELEPHONE LABORATORIES

Exploring and inventing, devising and perfecting for continued improvements and economies in telephone service.



“What’s he got that I haven’t got?”

LOOK at the successful men you know. “What have they got” that you haven’t?

Very little, probably. In most ways these men are no brighter or naturally more capable than average. Many of them probably have no more formal education or better natural aptitudes than you.

But that little extra they have is important. They have the special knowledge and ability for which business is glad to pay well—they know the what, why and how of business. They have also the confidence and aggressiveness which come from knowing that they know and can apply their knowledge.

You may add that extra—may get that same profitable knowledge and ability—that same confidence and aggressiveness—if you are willing to pay the price in earnest, necessary study. For LaSalle has spent 38 years developing, testing and proving, with over a million student members, spare-time success training in certain specialized business fields. What scores of thousands of men and women—many just like you—have done, you should be able to do.

You need not leave your home or interrupt your job; you need pay comparatively little money. But you must be ambitious and willing to study seriously. And soon after you start training, the results will begin to show up in your own confidence and in your work. For what you learn at home tonight is so practical that often you can apply it on the job tomorrow.

How much do you want success—more money, a promotion or a new job, prestige and responsibility? If you really want it, you will use the coupon below to find out what LaSalle training can do for you. It costs only a postage stamp, but a coupon like it has been the starting point to real success for scores of thousands—and can be for you.



***G. I. APPROVED**

LA SALLE Extension University
A Correspondence Institution

Dept. 983-R • 417 S. Dearborn • Chicago 5, Ill.

I want to know how LaSalle can help me win success in the field I have checked below. Please send me your free 48-page booklet about that field and your success training in it.

- | | |
|----------------------------------------------|--------------------------------------------------------|
| * <input type="checkbox"/> Accountancy | <input type="checkbox"/> Salesmanship |
| * <input type="checkbox"/> Bookkeeping | <input type="checkbox"/> Effective Speaking |
| * <input type="checkbox"/> C.P.A. Coaching | * <input type="checkbox"/> Business Management |
| * <input type="checkbox"/> Business English | * <input type="checkbox"/> Industrial Management |
| * <input type="checkbox"/> Law: LL.B. degree | * <input type="checkbox"/> Traffic Management |
| * <input type="checkbox"/> Foremanship | <input type="checkbox"/> Stenotypy (Machine Shorthand) |

Name.....Age.....

Position.....

Address.....

City, Zone and State.....

LA SALLE EXTENSION UNIVERSITY
A Correspondence Institution

**I Will
Show You
How to**

Learn RADIO

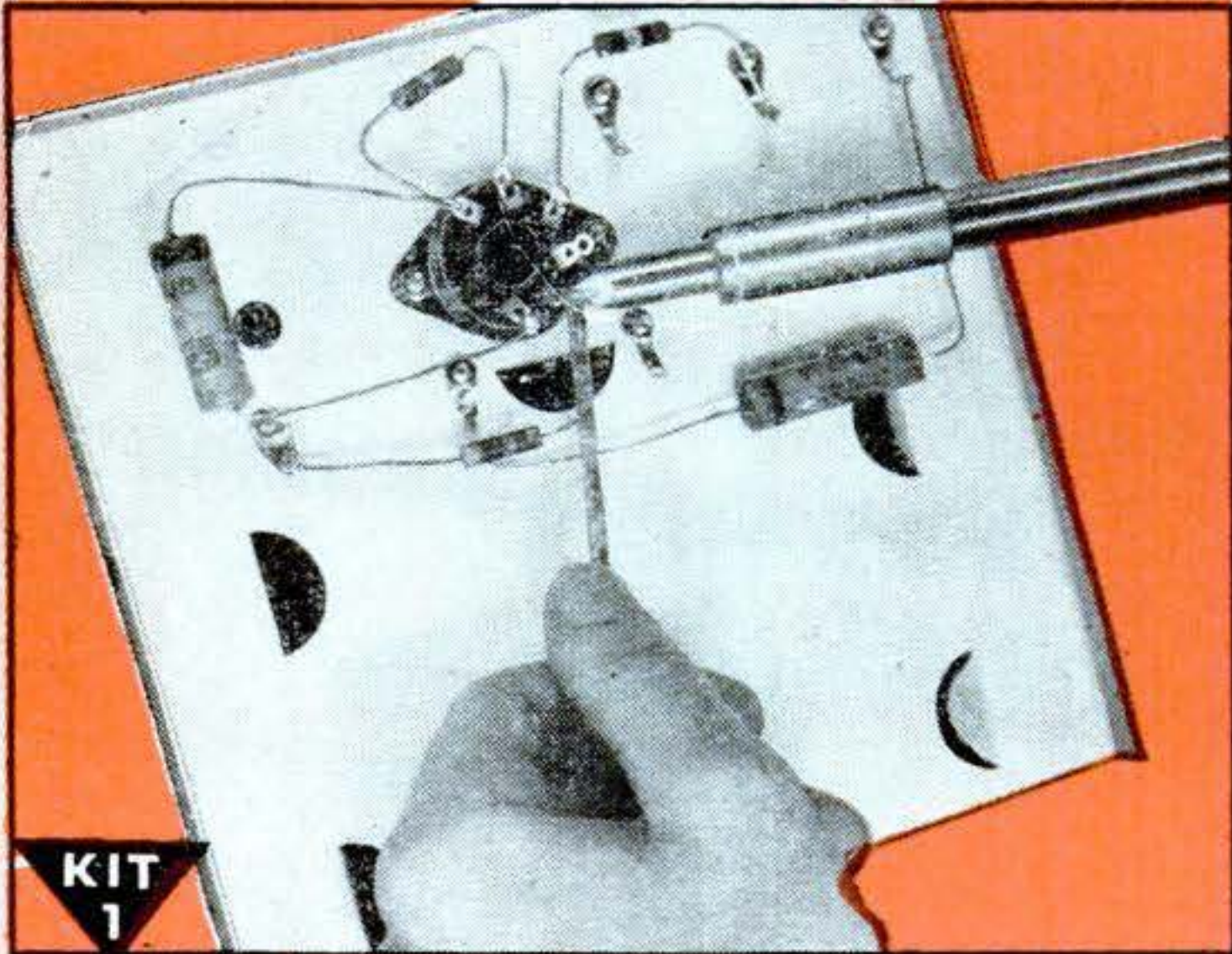

**KIT
1**

I send you Soldering Equipment and Radio parts; show you how to do Radio soldering; how to mount and connect Radio parts; give you practical experience.

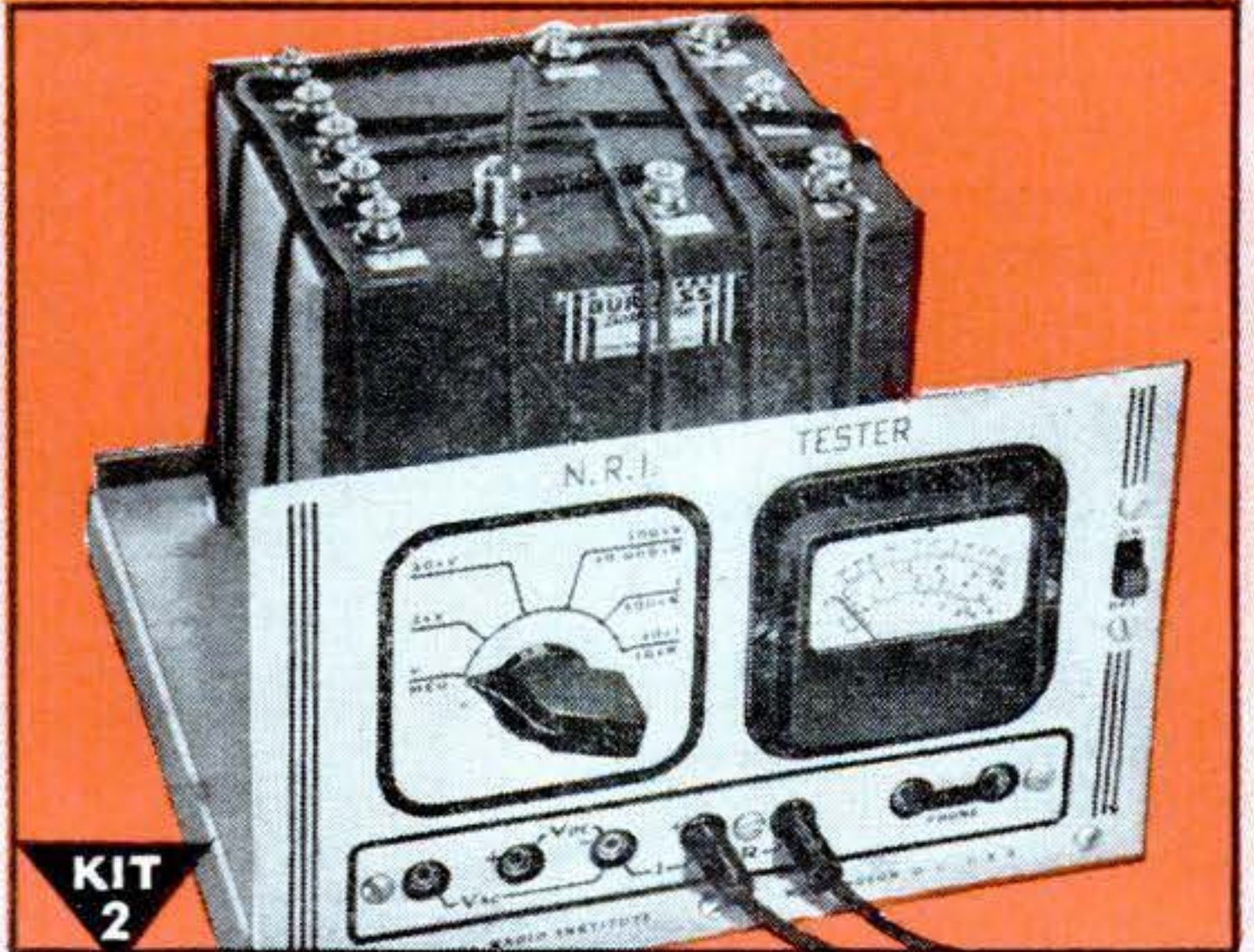

**KIT
2**

Early in my course I show you how to build this N.R.I. Tester with parts I send. It soon helps you fix neighborhood Radios and earn EXTRA money in spare time.

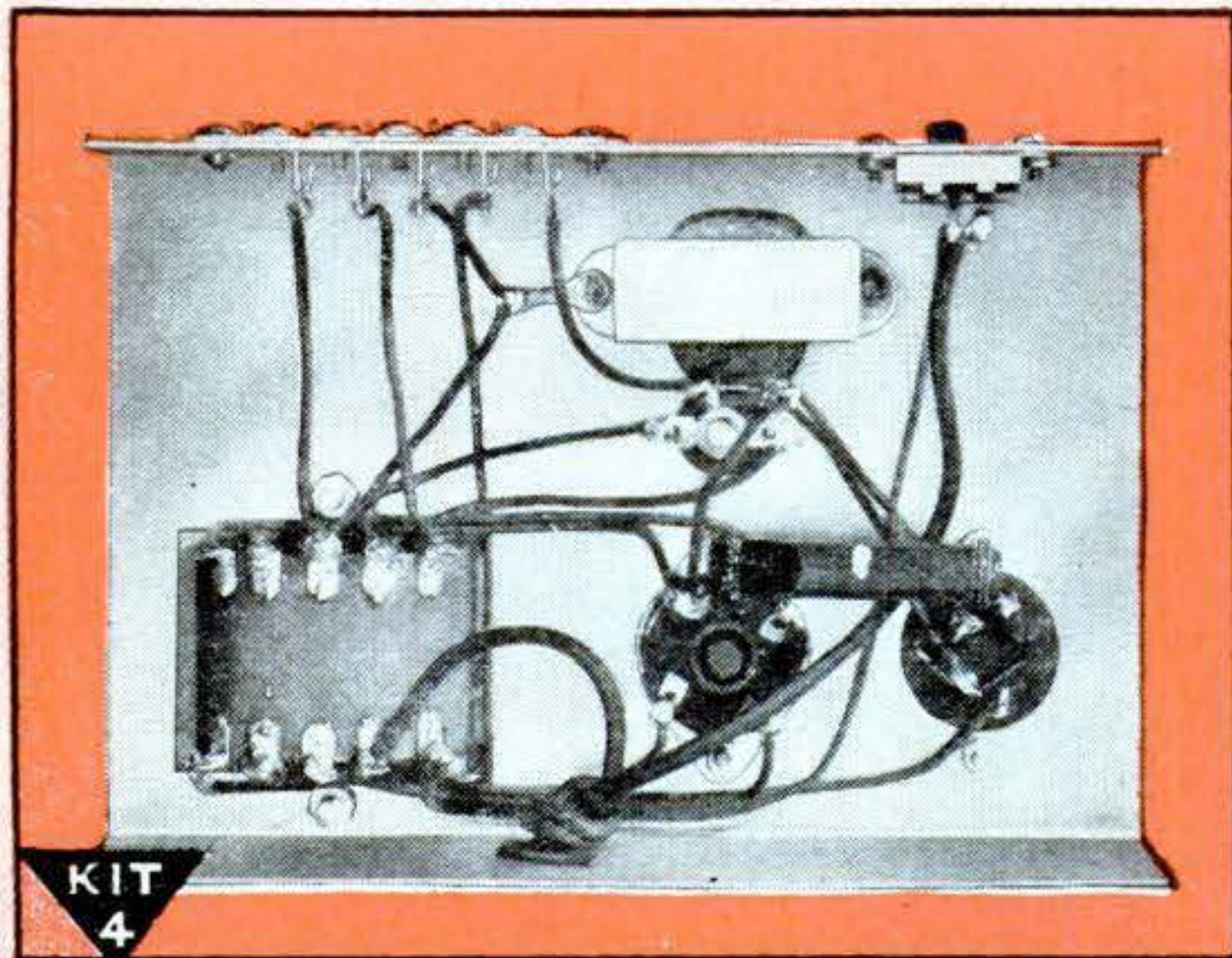

**KIT
4**

You get parts to build this Vacuum Tube Power Pack; make changes which give you experience with packs of many kinds; learn to correct power pack troubles.

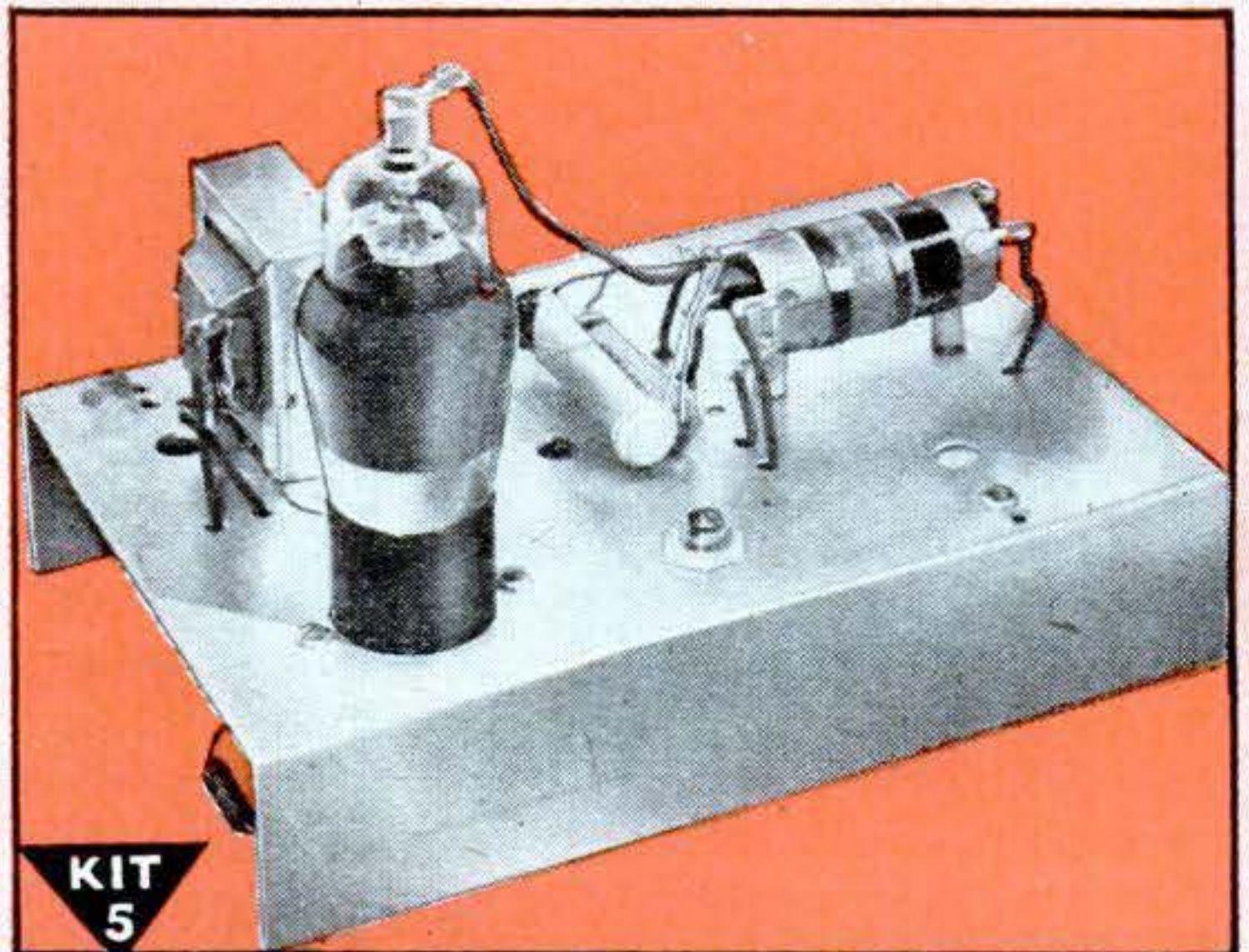

**KIT
5**

Building this A. M. Signal Generator gives you more valuable experience. It provides amplitude-modulated signals for many tests and experiments.

MEN I TRAIN AT HOME GET GOOD JOBS LIKE THESE

Made \$612, in 12 Months, Spare Time

"Soon after I finished my experimental kits lessons I tackled my first Radio service job. The neighbors were very cooperative. I soon had all the repair jobs I could handle in spare time. I have made \$612 in the past 12 months in spare time."—J. W. CLARK, Wilmington, N. C.



Minister Makes \$10-\$20 Weekly Spare Time

"I am a minister. I am in a county seat now trying to serve the people in my church, also trying to keep their Radios playing. I have been making from \$10 to \$20 per week in spare time."—L. H. SMITH, Benton, Tenn.



Knew Nothing About Radio

"I knew nothing about Radio when I enrolled. At present I am doing spare time work. I have more than paid for my Course and I have about \$200 worth of equipment which has paid for itself."—RAYMOND HOLT CAMP, Vandalia, Ill.



Doing Good Spare Time Business

"I have been getting receivers to repair right along lately, and by using the methods taught me in the NRI Course, I don't have to spend much time on any of them."—STANLEY N. STRICKLAND, 191 Dale Homes, Portsmouth, Va.



by Practicing in Spare Time

**I Send You
Big Kits
of Radio Parts**

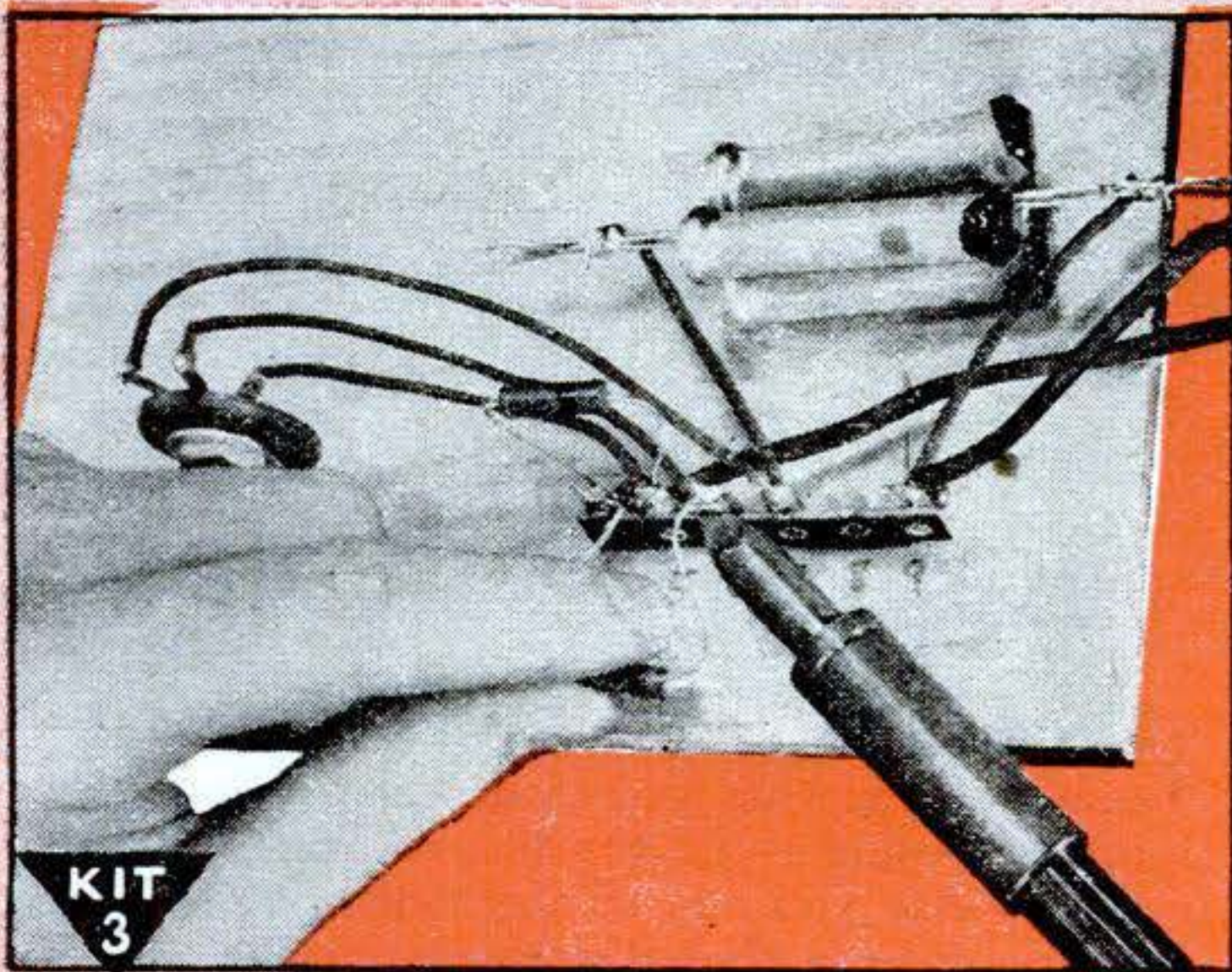

**KIT
3**

You get parts to build Radio Circuits; then test them; see how they work; learn how to design special circuits; how to locate and repair circuit defects.

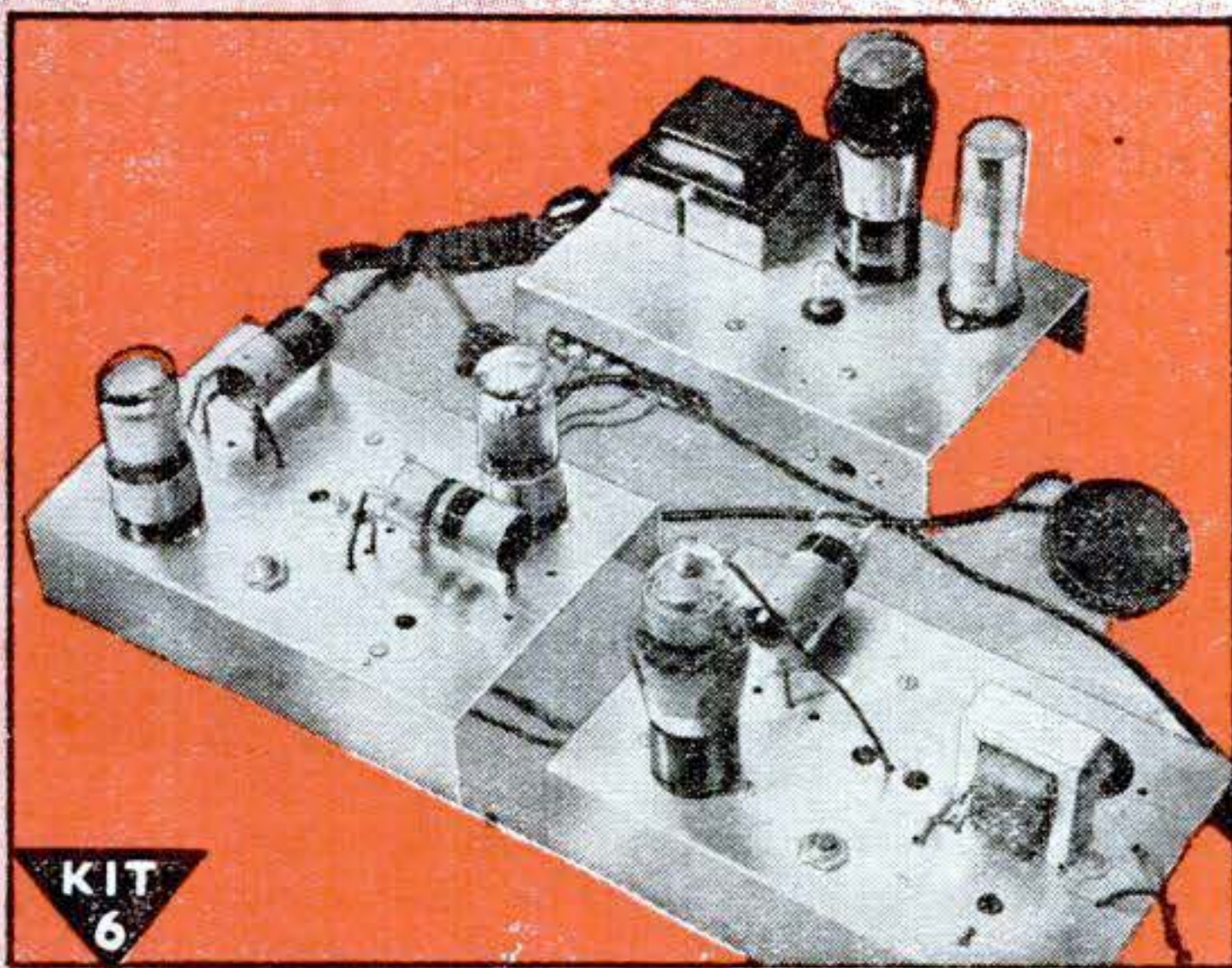

**KIT
6**

You build this Superheterodyne Receiver which brings in local and distant stations—and gives you more experience to help you win success in Radio.

SAMPLE LESSON

FREE

Gives hints on Receiver Servicing, Locating Defects, Repair of Loudspeaker, I.F. Transformer, Gang Tuner, Condenser, etc. Mail Coupon

GETTING ACQUAINTED WITH
RECEIVER SERVICING

**My Radio Course Includes
TELEVISION • ELECTRONICS
FREQUENCY MODULATION**

KNOW RADIO *Win Success* I Will Train You at Home

DO YOU want a good-pay job in the fast-growing Radio Industry—or your own Radio Shop? Mail the Coupon for a Sample Lesson and my 64-page book, "How to Be a Success in RADIO—Television, Electronics," both FREE. See how I will train you at home—how you get practical Radio experience building, testing Radio circuits with BIG KITS OF PARTS I send!

VETERANS

You can get this training in your own home under G.I. Bill. Mail coupon for full details.

Many Beginners Soon Make Extra Money in Spare Time While Learning

The day you enroll I start sending EXTRA MONEY manuals that show how to make EXTRA money fixing neighbors' Radios in spare time, while still learning! It's probably easier to get started now than ever before, because the Radio Repair Business is booming. Trained Radio Technicians also find profitable opportunities in Police, Aviation, Marine Radio, Broadcasting, Radio Manufacturing, Public Address work. Think of even greater opportunities as Television, FM, and Electronic devices become available to the public! Send for FREE books now!

Find Out What NRI Can Do For You

Mail Coupon for Sample Lesson and my FREE 64-page book. Read the details about my Course; letters from men I trained; see how quickly, easily you can get started. No obligation! Just MAIL COUPON NOW in envelope or paste on penny postal. J. E. SMITH, President, Dept. 7JP3, National Radio Institute, Pioneer Home Study Radio School, Washington 9, D. C.

Our 33rd Year of Training
Men for Success in Radio

MAIL NOW!

Mr. J. E. SMITH, President, Dept. 7JP3
National Radio Institute,
Washington 9, D. C.

Mail me FREE, your sample lesson
and 64-page book. (No salesman
will call. Please write plainly.)

Age.....

Name.....

Address.....

City..... State.....
(Please include Post Office zone number)

Approved for Training under GI Bill



In your Mind's Eye

The Secret of MENTAL CREATING

IF you just like to dream, read no further. There comes a time when your fancies *must be* brought into light—and stand the test of every-day, hard realities. Are you one of the thousands—perhaps millions—whose thoughts never get beyond the stage of *wistful wishing*? Do you often come to from a daydream with the sigh, "If only I could bring it about—*make it real*?"

All things begin with thought—it is what follows that may take your life out of the class of those who hope and dream. Thought energy, like anything else, can be dissipated—or it can be made to produce actual effects. *If you know how to place your thoughts* you can stimulate the creative processes within your mind—through them you can assemble things and conditions of your world into a happy life of accomplishment. *Mental creating* does not depend upon a magical process. It consists of *knowing how* to marshal your thoughts into a power that draws, compels and organizes your experiences into a worth-while design of living.

ACCEPT THIS *Free* BOOK

Let the Rosicrucians tell you how you may accomplish these things. The Rosicrucians (not a religious organization), a world-wide philosophical fraternity, have preserved for centuries the ancients' masterful knowledge of the functioning of the inner mind of man. They have taught men and women how to use this knowledge to *recreate their lives*. They offer you a free copy of the fascinating book, "The Mastery of Life." It tells how you may receive this information for study and use. Use coupon opposite.

The ROSICRUCIANS
(AMORC)

SAN JOSE

CALIFORNIA

SCRIBE: F.X.N.
The Rosicrucians (AMORC),
San Jose, California.

Please send free copy of "The Mastery of Life,"
and I shall read it as directed.

Name.....

Address.....

City.....

AUDELS REFRIGERATION & AIR CONDITIONING GUIDE.....\$4

New from Cover to Cover—1280 Pages, Fully Illus. Covering basic principles, servicing, operation & repair of household, commercial & industrial refrigeration & air conditioning. A gold mine of essential important facts for engineers, servicemen, users.

AUDELS CARPENTERS & BUILDERS GUIDES—4 Vols.\$6

A practical illustrated trade assistant on modern construction for carpenters, joiners, builders, mechanics and all woodworkers. 4 vols., 1600 pages, 3700 illustrations, flexible covers. Pocket size. Each volume sold separately \$1.50 a vol.

AUDELS AUTOMOBILE GUIDE.....\$4

A practical quick ready reference book for auto mechanics, service men, operators & owners. Explains theory, construction & servicing of modern motor cars, trucks, buses & auto type Diesel engines. 1700 pages, fully illustrated. 55 chapters. Indexed. A standard book for mechanics. New fluid drive covered.

AUDELS DIESEL ENGINE MANUAL..\$2

A practical, concise treatise with questions and answers on the theory, operation and maintenance of modern diesel engines including General Motors 2 cycle Diesel. 384 pages, fully illus., flexible binding, pocket size. All details plainly brought out, this book is of extreme value to engineers, operators & students.

AUDELS WIRING DIAGRAMS.....\$1

210 Pages. Illustrated. Gives practical facts on wiring of electrical apparatus. It shows clearly how to wire apparatus for practically all fields of electricity. Each diagram is complete & self-explanatory. Highly Endorsed Pocket Companion.

AUDELS PLUMBERS & STEAMFITTERS GUIDES—4 Vols.\$6

A Practical Trade Assistant & Ready Reference. Explains in plain language & by clear illustrations, diagrams, charts, graphs, pictures principles of modern plumbing practice including Marine Pipe Fitting and Air Conditioning. 4 Vols.—1670 Pages—3642 Diagrams. Pocket size. Each Vol. Sold Separately \$1.50 a Vol.

AUDELS SHEETMETAL WORKERS HANDY BOOK.....\$1

Practical inside information. Fundamentals of Sheet Metal Work. 388 pages. Illustrated. 11 sections. Clearly written. Essential & important facts, figures, pointers in everyday language. Ref. Index.

AUDELS SHEETMETAL PATTERN LAYOUTS.....\$4

Developed by Experts for Sheet Metal Workers, Layout Men & Mechanics. A Practical Encyclopedia in 10 Sections, size 7 x 10 x 2—1125 Pages—350 Layouts—1600 Illustrations, 1001 Key Facts. Fully indexed for ready reference in answering your layout problems. Covers all phases of sheet metal work including Pattern Cutting, Pattern Development & Shop Procedure.

AUDELS ANSWERS ON BLUE PRINT READING.....\$2

For Mechanics & Builders. Covers all types of blue print reading including ship & airplane. 416 pages, fully illustrated.

AUDELS NEW MACHINIST & TOOLMAKERS HANDY BOOK.....\$4

Covers modern machine shop practice in all its branches. 5 practical books in 1. New from cover to cover. Tells how to set up & operate lathes, screw and milling machines, shapers, drill presses and all other machine tools. 1600 pages, fully illustrated, 5 x 6 1/2 x 2. Indexed. 5 sections. 1—Modern Machine Shop Practice. 2—Blue Print Reading & How to Draw. 3—Calculations & Mathematics for Machinists. 4—Shop Physics. 5—How to Use the Slide Rule. 60 chapters. Easy to read and understand. A shop companion that answers your questions.

AUDELS MATHEMATICS & CALCULATIONS FOR MECHANICS \$2

Mathematics for home study or reference. 700 pages, 550 illus. Practical mathematics from beginning. How to figure correctly. Easy, correct methods covering complete review. Illus. & Indexed.

AUDELS HANDY BOOK OF PRACTICAL ELECTRICITY.....\$4

For maintenance engineers, electricians & all electrical workers. 1440 Pages, 2600 Illus. Covers important electrical information in handy form—including Marine Wiring, Radio Principles, Welding. Indexed. A Key to a practical understanding of electricity.

AUDELS RADIOMANS GUIDE.....\$4

A key to the practical understanding of radio including Frequency Modulation, Television, etc., Aircraft & Marine Radio. For radio engineers, servicemen, amateurs. 914 Pages, 633 Illustrations & Diagrams. Photos. Review Questions & Answers, Reference Index. Authentic, clear, concise.

AUDELS ELECTRONIC DEVICES.....\$2

Tells What You Want to Know About Electric Eye. Easily Understood. Covers photo-electric cells & their applications. Amplifiers, illumination, frequencies, voltage, photocell, tubes, Ohm's Law, wiring diagrams, etc.

AUDELS WELDERS GUIDE.....\$1

A concise, practical text on operation & maintenance of all welding machines for all mechanics. Over 400 pages, illustrated. Covers all methods of electric and acetylene welding including airplane work.

AUDEL, Publishers, 49 W. 23 St., N. Y. 10

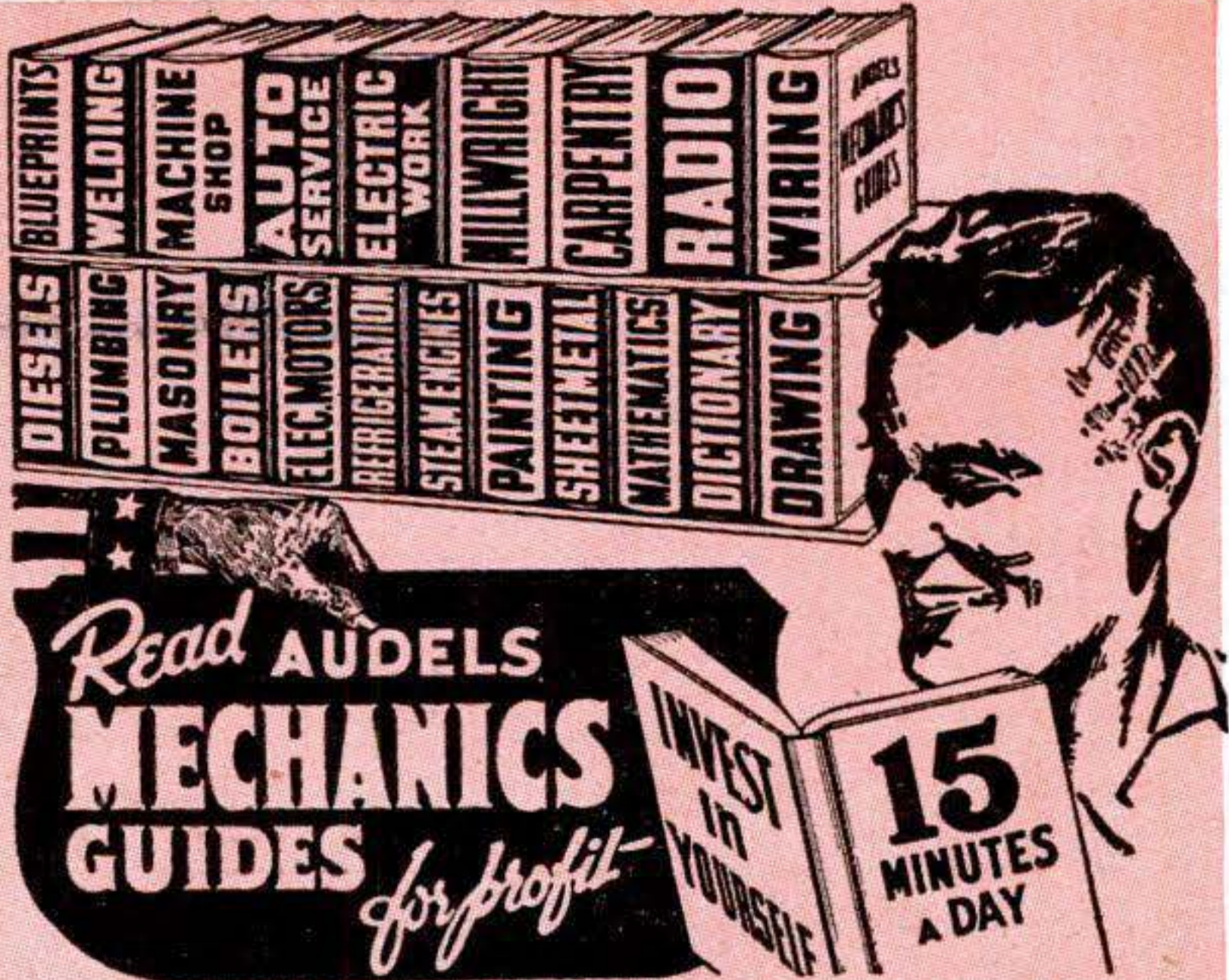

AN AUDEL GUIDE IS A GOOD FRIEND!

Step Up Your Own Skill with the Practical Facts and Figures of Your Trade. Save time and money with right methods, short cuts, labor saving ideas. CHECK NOW! You can look over any Audel Guide in your home. Start the Easy Payments if satisfied.

CUT HERE MAIL ORDER

THEO. AUDEL & CO., 49 W. 23 St., New York 10, N. Y.

Please mail me for 7 days' free examination the books marked (X) below. I agree to mail \$1 in 7 days on each book or set ordered, and to further mail \$1 a month on each book or set ordered until I have paid purchase price.

If I am not satisfied with Guides I will return them.

- Audels **ELECTRIC MOTOR GUIDE** \$4.
- Audels **OIL BURNER GUIDE** 1.
- Audels **REFRIGERATION & Air Conditioning Guide** 4.
- Audels **POWER PLANT ENGINEERS GUIDE** 4.
- Audels **PUMPS, HYDRAULICS & AIR COMPRESSORS** 4.
- Audels **WELDERS GUIDE** 1.
- Audels **BLUE PRINT READING** 2.
- Audels **SHEET METAL WORKERS Handy Book** 1.
- Audels **SHEET METAL PATTERN LAYOUTS** 4.
- Audels **AIRCRAFT WORKER** 1.
- Audels **MATHEMATICS and CALCULATIONS** 2.
- Audels **MACHINISTS & TOOLMAKERS Handy Book** 4.
- Audels **MECHANICAL Dictionary** 4.
- Audels **AUTOMOBILE GUIDE** 4.
- Audels **DIESEL ENGINE MANUAL** 2.
- Audels **MARINE ENGINEERS Handy Book** 4.
- Audels **MECHANICAL DRAWING GUIDE** 1.
- Rogers **MECHANICAL DRAWING and DESIGN** 2.
- Audels **MILLWRIGHTS and Mechanics Guide** 4.
- Audels **CARPENTERS and Builders Guides (4 vols.)** 6.
- Audels **PLUMBERS and Steamfitters Guides (4 vols.)** 6.
- Audels **MASONS and Builders Guides (4 vols.)** 6.
- Master **PAINTER and DECORATOR** 2.
- Audels **GARDENERS & GROWERS GUIDES (4 vols.)** 6.
- Audels **ENGINEERS & FIREMANS EXAMINATIONS** 1.
- Audels **ENGINEERS and Mechanics Guides** 12.
- Nos. 1, 2, 3, 4, 5, 6, 7 and 8 complete 12.
- Audels **Answers on Practical ENGINEERING** 1.
- Audels **ELECTRICIANS EXAMINATIONS** 1.
- Audels **WIRING DIAGRAMS** 1.
- Audels **Handy Book of PRACTICAL ELECTRICITY** 4.
- Audels **ELECTRICAL POWER CALCULATIONS** 2.
- Audels **ELECTRONIC DEVICES** 2.
- Audels **ELECTRIC Dictionary** 2.
- Audels **RADIOMANS GUIDE** 4.
- Audels **NEW ELECTRIC LIBRARY at \$1.50 a Volume** 4.
- Vols. I, II, III, IV, V, VI, VII, VIII, IX, X, XI, XII

Name _____
 Address _____
 Occupation _____
 Employed by _____

PSM



I'll Send You 8 Big Kits of Training Equipment including
TWO-BAND 6 TUBE SUPER RECEIVER
AND 16 RANGE METER SET-UP
for Testing

Learn Fast . . . Earn Fast
HOME TRAINING
Planned For Your Needs
You Build All These
TESTERS . . . and MORE!

I give you a fine, moving-coil type Meter Instrument on Jewel Bearings—with parts for a complete Analyzer Circuit Continuity Tester. You learn how to check and correct Receiver defects with professional speed and accuracy.

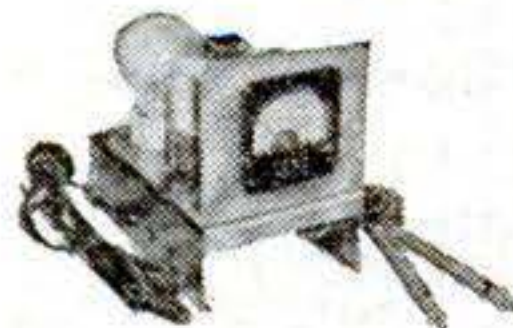

Practice Does It!
 Soldering, wiring, connecting Radio Parts . . . building circuits with your own hands—you can't beat this method of learning. When you construct this Rectifier and Filter Resistor and Condenser Tester, etc., you get a really practical slant on Radio that leads to a money-making future.

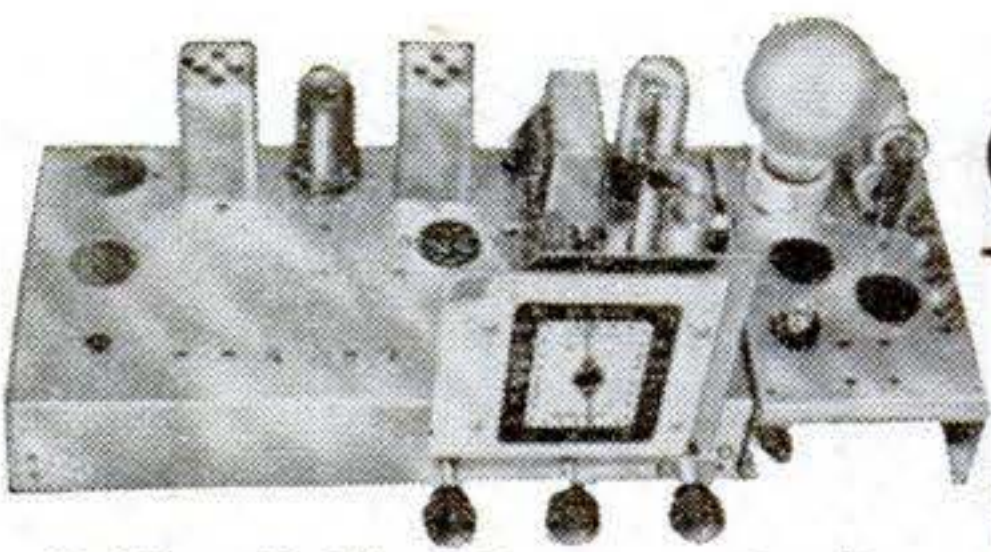
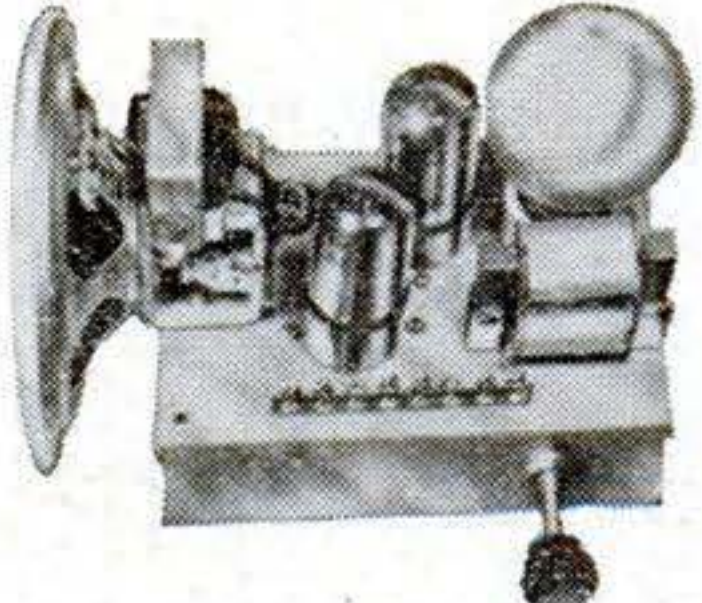

Building this Signal Generator and multi-purpose Tester will give you the kind of valuable experience and practice that is so important as a foundation for making good money in Radio. It makes a breeze out of fixing Radios, and you don't have to spend money on ready-made Equipment.

VETERANS
 YOU CAN GET SPRAYBERRY TRAINING AT HOME UNDER G.I. BILL. MAIL COUPON FOR FULL DETAILS.



PRACTICE WITH YOUR OWN HANDS!
 Mind training through hand practice, that's the only way to LEARN and REMEMBER Radio. It's the most successful of Home Training methods.



OVER 175 PRACTICAL EXPERIMENTS
 You'll find out how to build countless Radio Circuits. You'll learn a new, fast way to test Radio Sets without mfg. Equipment.

LOW COST HOME RADIO TRAINING!
Easy Monthly Payments!

The answer to the PRACTICAL results, I show my Students lies in the way I train you. Not books and lessons alone. But "sight demonstrations" with real Radio Parts worked out with your own hands. You LEARN! You UNDERSTAND! You REMEMBER! Pay special attention to the quality and completeness of the Equipment which comes with the Sprayberry Course. You get a big 6 Tube Super Receiver and a 16 Range Meter Set-up for testing. When I put you to work with the 8 big Kits of Radio Parts I send you, you'll really LEARN Radio and learn it RIGHT! You'll get the practical experience

and pre-conditioning you need to be useful in Radio, and that's what it takes to make money. You don't need any previous experience. The Sprayberry Course starts right at the beginning of Radio—you can't get lost!
 Soon after you begin your Sprayberry Course, I'll send you my sensational BUSINESS BUILDERS. You'll learn how to get and do neighborhood Radio repair jobs for nice profits and rich experience. With the kind of Training I give you, you will be able to set up your own Business, or step into a good-pay job in Radio, Television, FM, Radar, Industrial Electronics. Don't waste time! Make your start NOW!

MAIL COUPON FOR THESE 2 BOOKS!



"How to Read Radio Diagrams and Symbols" and "How to Make Money in Radio, Electronics and Television." Immense, practical value to you—and they're yours FREE!

SPRAYBERRY ACADEMY OF RADIO
 F. L. Sprayberry, President
 Room 5597, Pueblo, Colorado

Please rush my FREE copies of "How to MAKE MONEY in RADIO, ELECTRONICS and TELEVISION" and "How to READ RADIO DIAGRAMS and SYMBOLS."

Name _____ Age _____

Address _____

City _____ State _____

(Mail in envelope or paste on penny postcard)



INVENTORS



Learn how to protect your invention. The U. S. Patent Laws provide that any new and useful art, machine, article of manufacture, or composition of matter, or any new and useful improvement thereof, may be patented if the act of invention is involved. Therefore, every inventor with a valuable invention should take advantage of the Patent Laws and proceed for patent protection in order to safeguard his rights.

A patent gives the inventor the exclusive right to prevent others from making, using, or selling the invention claimed in the patent for a period of seventeen years.

The Patent Laws were enacted for the benefit of the inventor to give him protection for the features of his invention which are patentable. These features must be properly and concisely set forth and claimed in a formal application for patent, in order to comply with the requirements of the U. S. Patent Office. For that reason, the Patent Office advises the inventor, unless he is familiar with such matters, to engage a competent registered patent attorney or agent to represent him. We maintain a staff of registered patent attorneys ready to serve you in the handling of your patent matters.

A specially prepared booklet entitled "Patent Guide for the Inventor", containing detailed information with respect to patent protection and procedure, together with a "Record of Invention" form will be promptly forwarded to you without obligation upon request.

Patents

Trademarks

Copyrights

Registered Patent Attorneys

**CLARENCE A. O'BRIEN
& HARVEY B. JACOBSON**

72-J District National Building + Washington 5, D. C.

CLARENCE A. O'BRIEN & HARVEY B. JACOBSON
Registered Patent Attorneys

72-J District National Bldg., Washington 5, D. C.

Please send me copy of "Patent Guide for the Inventor" and also "Record of Invention" form. This request does not obligate me.

Name _____

Address _____

City _____ State _____

(Please write or print plainly.)

BETTER JOBS BETTER PAY FOR SKILLED MEN!

QUICK TRAINING BOOKS SHIPPED for Examination

SEND NO MONEY! Prepare for a better job at bigger pay by sending the coupon NOW for any set of easy-to-understand self-training text books. These great books, prepared by long experienced experts, can help you to acquire the "know how" that wins promotions and puts more money in your pocket. Any set of books sent for 10 days examination.

AUTOMOBILE ENGINEERING



4 Big, Thick Books
20th Edition, 2800 Pages

These wonder books tell how—step by step—to make the repairs and adjustments that keep any make of car at maximum operating efficiency. More than 2000 illustrations, wiring diagrams, data sheets, etc. Total price only \$24.80. Low monthly payments. Sent on trial.

BUILDING, ESTIMATING and CONTRACTING

Up-to-Date Edition
8 Volumes — 3787 Pages

These 8 practical books can help you to make more money by becoming foreman, superintendent, or running your own business. Drawing plans, estimating, building, remodeling, heating, painting and many other subjects included. 3195 illustrations and tables. Total price only \$34.80. Low monthly payments. Sent on trial.

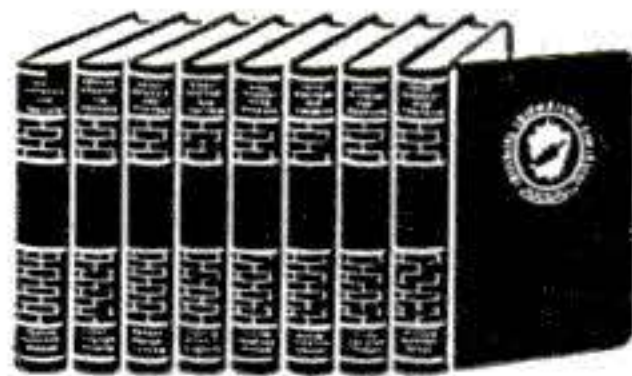

APPLIED ELECTRICITY INCLUDING RADIO AND REFRIGERATION

New 19th Edition
8 Books — 3700 Pages

NEW, up-to-date edition contains many new subjects in detail, including blueprint reading, electronics, F.M. radio, fluorescent lighting and other modern electrical topics as well as full range of standard practices. 2700 illustrations, 134 tables. Total price only \$34.80. Low monthly payments. Sent on trial.



tions, 134 tables. Total price only \$34.80. Low monthly payments. Sent on trial.

Vocational Publishers Since 1898

(A year's consulting privileges with our engineers)
(now given with these books at no extra charge.)

AMERICAN TECHNICAL SOCIETY

Dept. X620 Drexel at 58th St. Chicago 37, Ill.

CLIP AND MAIL COUPON TODAY

AMERICAN TECHNICAL SOCIETY, Dept. X620

Drexel at 58th Street, Chicago 37, Ill.

Send for 10 days' free use, the following set of books:

I will pay the delivery charges only, and if fully satisfied, will send you \$2.00 in 10 days and then \$3.00 a month until the total price of \$_____ is paid. If I return the books in 10 days I will owe you nothing. You are to include a Year's Consulting Privileges with your engineers without extra charge.

Name _____

Address _____

City _____ State _____

Please attach letter stating age, occupation and name and address of employer, and at least one business man's name and address as reference. Men in service also please give home address.

LETTERS

Mixing Up Mosquitoes

Sir:

Your articles on harnessing streams (April through August) were quite thorough . . . but I think you omitted a very important phase: mosquito control. Particularly in the South, but elsewhere, too, this health menace should be considered.

If the pond has rather sharply sloping sides, with no grass in the water, minnows may solve the problem without help. But if the "eager beaver" is not so fortunate, he may still be able to avoid unsightly oil by using for a spillway two sets of drainage tiles, one set with the heads about five inches above the other.

By alternately covering and uncovering the lower set every four or five days during the mosquito season, he can destroy the larvae, either flooding them so that minnows can reach them, or leaving them high and dry. He should, however, make sure that there are no pools left around the edges at the low stage.

WILLIAM E. TOWNSEND

Memphis, Tenn.

Sound suggestions. PSM is happy to pass them along to supplement the articles, which were restricted by space to the mechanical problems involved.

Counting a Googol

Sir:

Is there such a word as "googol"? A friend tells me it's a mathematical term for infinity, but I think it's a gag. . . .

WALTON HERRIES

New York City

It's not a gag, but your friend is wrong. A googol, so named by a nine-year-old boy, is 1 followed by 100 zeros, written exponentially 10^{100} . It is not infinity, but it's big. According to Kasner and Newman, authors of Mathematics and the Imagination, all the words ever printed total only about 10^{16}

INVENTORS

Patent Laws Encourage The Development Of Inventions

The Rules of Practice of the U. S. Patent Office advises—unless an inventor is familiar with such matters—that he employ a competent registered attorney or registered agent, as the value of patents depends largely upon the skillful preparation of the specifications and claims.

The firm of McMorrow, Berman and Davidson is registered to practice before the U. S. Patent Office. Additionally, it maintains a staff of attorneys able to readily understand inventors' disclosures, to advise concerning patentability, and to prepare appropriate specifications and claims for filing with the Patent Office.

If an inventor believes he has an invention, a search of the most pertinent prior U. S. patents should be made and a report obtained relative to its patentability. Where such report indicates that the invention appears patentable, in order to secure protection, diligence should be exercised in making application for a patent.

McMORROW, BERMAN & DAVIDSON

Registered Patent Attorneys

PATENTS — TRADE MARKS — COPYRIGHTS

1428 VICTOR BUILDING, WASHINGTON 1, D. C.

McMORROW, BERMAN & DAVIDSON

Registered Patent Attorneys

1428 Victor Building, Washington 1, D. C.

Send me further particulars as to patent protection and procedure and "Invention Record" form at once. I understand that this request does not obligate me.

Name.....

Address.....

City..... State.....

(WRITE OR PRINT NAME CLEARLY)

PYROIL SCORES AGAIN

SIX OF THE TEN WINNERS OF 500 MILE RACING CLASSIC USE PYROIL

This year, as in all past years since 1933, the men who know best depend upon Pyroil. Six of the ten winners of the 500 mile Memorial Day Race at Indianapolis kept their racing motors lubricated with the help of Pyroil.

Pyroil gives oil the property of clinging to cylinder walls—removes sludge and carbon. Ask your station attendant to add Pyroil—add life to your car.

PYROIL for Aircraft Engines

Use Aircraft Pyroil B for lubricating oil, Aircraft Pyroil A for gasoline.

Manufactured and Guaranteed by
Pyroil Company, 250 Main Street,
La Crosse, Wisconsin.

Canadian Distributors: Central Purchasing Agency, Ltd., Toronto, Ontario



PYROIL COMPANY
250 Main Street
La Crosse, Wisconsin

I want my car to last and run properly. Please tell me more about Pyroil and how it can accomplish this for me.

Name.....

Address.....

City or Town.....State.....



Jerry, the talking dog, is entertaining hospitalized veterans, by courtesy of the PYROIL Company. Picture of Jerry sent on request.

(10 million billion). And Eddington has calculated all the electrons in the universe to be only 10^{79} . If you want a still bigger number, Dr. Kasner's little nephew gives you the googolplex, which is 1 followed by a googol of zeros, or $10^{10^{100}}$. If we devoted an entire issue of PSM, over a million copies, to nothing but printing this number (in small type), we still wouldn't get it all down. But even the googolplex is still finite.

Which End Is Which?

Sir:

I have long had a question in my mind about electromagnetic waves emitted from one end of a tube that is accelerating in the direction of the wave propagation and striking the other end.

Since the tube is accelerating while the waves are passing along the tube, won't the receiving end be traveling at a greater speed when a particular wave strikes it than the emitting end was when that wave left it? And therefore, won't the Doppler effect be observed at the receiving end, infinitesimal as it may be at low acceleration?

HARTLEY M. THOMPSON

West Hartford, Vt.

Mr. Thompson may go to the head of the class. His conclusions are entirely right.

Turn Off That Glass!

Sir:

A few days ago I met a man who claimed to have invented a new lighting system. Part of it I recognized as the old Geissler tube, forerunner of the neon-tube sign, but part of it has me stumped.

I was in a cafe when the fellow came in. He had a box about 18 by 10 by 6 inches, covered with black oilcloth. After the bartender plugged in the cord, the man laid a couple of Geissler tubes on the oilcloth. They glowed. Then he had the barkeep set several wine and whisky glasses on it, and they did likewise. . . .

When he touched them, they turned all colors of the rainbow. . . . When you ran a finger up and down the wineglass stems, you would have a rainbow on each side. . . . But if you lifted the glass up some inches, the stem would turn a very dark but bright blue.

Now I'm guessing he had some kind of high-frequency outfit in the box. Of course,



Union Leader

"About the same time that Philip Murray was studiously pursuing a Course in Business Methods with I.C.S., I was devoting my spare time to a Course in Mining Engineering. In due time I completed it, and what you taught me has meant a great deal to me through the years. I am very proud to be the possessor of an I.C.S. diploma."

VAN A. BITTNER

**Assistant to the President,
United Steelworkers of America**



Railroad President

"Following my graduation from the University of Illinois, I subscribed for and took a course with The International Correspondence Schools. I thought then, as I do now, that the course was excellent. It is my opinion that adult education is real education."

WAYNE A. JOHNSTON

President, Illinois Central System

INTERNATIONAL CORRESPONDENCE SCHOOLS



BOX 7692-L, SCRANTON 9, PENNA.

Without cost or obligation, please send me full particulars about the course BEFORE which I have marked X:

- | | | | |
|------------------------------------------------------------------------------------------------------------------------------------------------------------------------------------------------------------------------------------------------------------------------------------------------------------------------------------------------------------------------------------------------------------------------------------------------------------------------------------------------------------------------------------------------------------------------------------------------------------------------------------------------------------------------------------------------------------------------------------------------------------------------------------------------------------------------------------------------------------------------------------------------------------------------------------------------------------------------------------------------------------------------------------------------------------------------------------------------------------------------------------------------------------------------------------------------------------------------------------------------------------------------------------------------------------------------------------------------------------------------------------------------------------|-------------------------------------------------------------------------------------------------------------------------------------------------------------------------------------------------------------------------------------------------------------------------------------------------------------------------------------------------------------------------------------------------------------------------------------------------------------------------------------------------------------------------------------------------------------------------------------------------------------------------------------------------------------------------------------------------------------------------------------------------------------------------------------------------------------------------------------------------------------------------------------------------------------------------------------------------------------------------------------------------------------------------------------------------------------------------------------------------------------------------------------------------------------------------------------------------------------------------------------------------------------------------------------------------------------------|----------------------------------------------------------------------------------------------------------------------------------------------------------------------------------------------------------------------------------------------------------------------------------------------------------------------------------------------------------------------------------------------------------------------------------------------------------------------------------------------------------------------------------------------------------------------------------------------------------------------------------------------------------------------------------------------------------------------------------------------------------------------------------------------------------------------------------------------------------------------------------------------------------------------------------------------------------------------------------------------------------------------------------------------------------------------------------------------------------------------------------------------------------------------------------------------------------------------------------------------------------------------|-----------------------------------------------------------------------------------------------------------------------------------------------------------------------------------------------------------------------------------------------------------------------------------------------------------------------------------------------------------------------------------------------------------------------------------------------------------------------------------------------------------------------------------------------------------------------------------------------------------------------------------------------------------------------------------------------------------------------------------------------------------------------------------------------------------------------------------------------------------------------------------------------------------------------------------------------------------------------------------------------------------------------------------------------------------------------------------------------------------------------------------------------------------------------------------------------------------------------------------------------------------------------------------------------------------------------------------------------------------------------------------------------------------------------------|
| <p>Business and Academic Courses</p> <input type="checkbox"/> Accounting <input type="checkbox"/> Advertising
<input type="checkbox"/> Arithmetic <input type="checkbox"/> Bookkeeping
<input type="checkbox"/> Business Administration
<input type="checkbox"/> Business Correspondence
<input type="checkbox"/> Certified Public Accounting
<input type="checkbox"/> Commercial
<input type="checkbox"/> Commercial Art
<input type="checkbox"/> Cost Accounting
<input type="checkbox"/> Federal Tax
<input type="checkbox"/> First Year College
<input type="checkbox"/> Foremanship
<input type="checkbox"/> Good English
<input type="checkbox"/> Higher Mathematics
<input type="checkbox"/> Motor Traffic
<input type="checkbox"/> Salesmanship
<input type="checkbox"/> Sign Lettering
<input type="checkbox"/> Spanish
<input type="checkbox"/> Traffic Management
<p>Air Conditioning and Plumbing Courses</p> <input type="checkbox"/> Air Conditioning
<input type="checkbox"/> Heating
<input type="checkbox"/> Refrigeration
<input type="checkbox"/> French
<input type="checkbox"/> High School
<input type="checkbox"/> Postal Service
<input type="checkbox"/> Secretarial
<input type="checkbox"/> Stenography
<input type="checkbox"/> Plumbing
<input type="checkbox"/> Steam Fitting | <p>Chemistry Courses</p> <input type="checkbox"/> Chemical Engineering
<input type="checkbox"/> Chemistry, Analytical
<input type="checkbox"/> Chemistry, Industrial
<input type="checkbox"/> Chemistry, Mfg. Iron & Steel
<input type="checkbox"/> Petroleum Refining <input type="checkbox"/> Plastics
<input type="checkbox"/> Pulp and Paper Making
<p>Civil Engineering, Architectural and Mining Courses</p> <input type="checkbox"/> Architecture
<input type="checkbox"/> Architectural Drafting
<input type="checkbox"/> Building Estimating
<input type="checkbox"/> Civil Engineering <input type="checkbox"/> Coal Mining
<input type="checkbox"/> Contracting and Building
<input type="checkbox"/> Highway Engineering
<input type="checkbox"/> Lumber Dealer
<input type="checkbox"/> Reading Structural Blueprints
<input type="checkbox"/> Sanitary Engineering
<input type="checkbox"/> Structural Drafting
<input type="checkbox"/> Structural Engineering
<input type="checkbox"/> Surveying and Mapping
<p>Communications Courses</p> <input type="checkbox"/> Electronics
<input type="checkbox"/> Practical Telephony
<input type="checkbox"/> Radio, General
<input type="checkbox"/> Radio Operating | <input type="checkbox"/> Radio Servicing
<input type="checkbox"/> Telegraph Engineering
<p>Electrical Courses</p> <input type="checkbox"/> Electrical Drafting
<input type="checkbox"/> Electrical Engineering
<input type="checkbox"/> Electric Light and Power
<input type="checkbox"/> Lighting Technician
<input type="checkbox"/> Practical Electrician
<input type="checkbox"/> Power House Electric
<input type="checkbox"/> Ship Electrician
<p>Internal Combustion Engines Courses</p> <input type="checkbox"/> Auto Technician <input type="checkbox"/> Aviation
<input type="checkbox"/> Diesel-Electric
<input type="checkbox"/> Diesel Engines <input type="checkbox"/> Gas Engines
<p>Mechanical Courses</p> <input type="checkbox"/> Aeronautical Engineer's, Jr.
<input type="checkbox"/> Aircraft Drafting
<input type="checkbox"/> Flight Engineer
<input type="checkbox"/> Forging <input type="checkbox"/> Foundry Work
<input type="checkbox"/> Heat Treatment of Metals
<input type="checkbox"/> Industrial Engineering
<input type="checkbox"/> Industrial Metallurgy
<input type="checkbox"/> Machine Shop
<input type="checkbox"/> Machine Shop Inspection | <input type="checkbox"/> Mechanical Drafting
<input type="checkbox"/> Mechanical Engineering
<input type="checkbox"/> Mold-Loft Work
<input type="checkbox"/> Patternmaking—Wood, Metal
<input type="checkbox"/> Reading Shop Blueprints
<input type="checkbox"/> Sheet-Metal Drafting
<input type="checkbox"/> Sheet-Metal Worker
<input type="checkbox"/> Ship Drafting <input type="checkbox"/> Ship Fitting
<input type="checkbox"/> Tool Designing <input type="checkbox"/> Toolmaking
<input type="checkbox"/> Welding—Gas and Electric
<p>Railroad Courses</p> <input type="checkbox"/> Air Brake <input type="checkbox"/> Car Inspector
<input type="checkbox"/> Diesel Locomotive
<input type="checkbox"/> Locomotive Engineer
<input type="checkbox"/> Locomotive Fireman
<input type="checkbox"/> Railroad Section Foreman
<p>Steam Engineering Courses</p> <input type="checkbox"/> Boilermaking
<input type="checkbox"/> Combustion Engineering
<input type="checkbox"/> Engine Running
<input type="checkbox"/> Marine Engineering
<input type="checkbox"/> Steam Electric <input type="checkbox"/> Steam Engines
<p>Textile Courses</p> <input type="checkbox"/> Cotton Manufacturing
<input type="checkbox"/> Rayon Weaving <input type="checkbox"/> Textile Designing
<input type="checkbox"/> Woolen Manufacturing |
|------------------------------------------------------------------------------------------------------------------------------------------------------------------------------------------------------------------------------------------------------------------------------------------------------------------------------------------------------------------------------------------------------------------------------------------------------------------------------------------------------------------------------------------------------------------------------------------------------------------------------------------------------------------------------------------------------------------------------------------------------------------------------------------------------------------------------------------------------------------------------------------------------------------------------------------------------------------------------------------------------------------------------------------------------------------------------------------------------------------------------------------------------------------------------------------------------------------------------------------------------------------------------------------------------------------------------------------------------------------------------------------------------------|-------------------------------------------------------------------------------------------------------------------------------------------------------------------------------------------------------------------------------------------------------------------------------------------------------------------------------------------------------------------------------------------------------------------------------------------------------------------------------------------------------------------------------------------------------------------------------------------------------------------------------------------------------------------------------------------------------------------------------------------------------------------------------------------------------------------------------------------------------------------------------------------------------------------------------------------------------------------------------------------------------------------------------------------------------------------------------------------------------------------------------------------------------------------------------------------------------------------------------------------------------------------------------------------------------------------|----------------------------------------------------------------------------------------------------------------------------------------------------------------------------------------------------------------------------------------------------------------------------------------------------------------------------------------------------------------------------------------------------------------------------------------------------------------------------------------------------------------------------------------------------------------------------------------------------------------------------------------------------------------------------------------------------------------------------------------------------------------------------------------------------------------------------------------------------------------------------------------------------------------------------------------------------------------------------------------------------------------------------------------------------------------------------------------------------------------------------------------------------------------------------------------------------------------------------------------------------------------------|-----------------------------------------------------------------------------------------------------------------------------------------------------------------------------------------------------------------------------------------------------------------------------------------------------------------------------------------------------------------------------------------------------------------------------------------------------------------------------------------------------------------------------------------------------------------------------------------------------------------------------------------------------------------------------------------------------------------------------------------------------------------------------------------------------------------------------------------------------------------------------------------------------------------------------------------------------------------------------------------------------------------------------------------------------------------------------------------------------------------------------------------------------------------------------------------------------------------------------------------------------------------------------------------------------------------------------------------------------------------------------------------------------------------------------|

Name _____ Home Address _____
 City _____ State _____
 Age _____ Present Position _____ Working Hours _____ A.M. to _____ P.M.

Special tuition rates to members of the Armed Forces. Enrollment under the G.I. Bill of Rights approved for World War II Veterans.
 Canadian residents send coupon to International Correspondence Schools Canadian, Ltd., Montreal, Canada.

Bigger Opportunities Than Ever in . . .



AUTO BODY AND FENDER REPAIR

●THE FIELD IS STILL GROWING after more than 40 years . . . expanding with the giant auto industry! Millions of new cars are getting to market, millions of old ones are still on the road—THE NEED for MAN-POWER in the service field is INCREASING!

TRAIN NOW . . . FOR THE OPPORTUNITIES AHEAD!

Don't be stuck in a low-pay job! Opportunity here is big enough for thousands to find big-pay work either in a reliable job or in their own shops. UEI teaches Auto Body & Fender Repairing the *easy* way. No special education or experience needed . . . you can start in your spare time, right at home . . . keep your job while you learn. Then, when home study is finished, you continue at the well-equipped UEI shops getting practical experience. Fix and refinish damage, replace panels and tops. Learn up-to-date methods in use of tools, spray painting, welding, metal work—all under expert supervision.

GET THE FACTS . . . FREE!

UEI HAS TRAINED THOUSANDS for opportunity fields, and students are making good. If you want to get ahead, send coupon today for free facts on AUTO BODY AND FENDER REPAIRING. Don't delay!

**AUTOCRAFTS DIVISION
UTILITIES ENGINEERING
INSTITUTE**
2523 Sheffield Ave., Dept. 397X
Chicago 14, Illinois

Approved for
training under
G. I. Bill

Founded
1927



FILL OUT AND MAIL . . . TODAY!

**Autocrafts Division
Utilities Engineering Institute, Dept. 397X,
2523 Sheffield Ave., Chicago 14, Ill.**

Yes, I'm interested! Send me those Free Facts about Auto Body and Fender Repairing.

NAME _____ Age _____

ADDRESS _____

CITY _____ Zone or County _____ STATE _____

If veteran of World War II check here
 Check here for Special Information if under 17.

the oilcloth may have had something to do with the color change. And I noticed that when he put the glasses on the corner of the box they failed to glow. Or maybe he had an ultraviolet light in the box covered with a specially treated oilcloth cover. . . .

V. E. HARPER

San Francisco, Calif.

As Mr. Harper suggests, a high-frequency outfit would explain the lighting of the Geissler tubes, but the rest leaves PSM wondering, too. The glasses may have contained special fluids that fluoresce under ultraviolet light. Or perhaps the demonstration was colored a little by its—hmm—environment.

A Wish Comes True

Sir:

In the June issue, in "I'd Like to See Them Make," a Mr. Cottingham, of Rowland, N. C., said he'd like to see a portable traffic light.

I am submitting for your inspection a photograph of a portable emergency traffic signal of which I am the inventor. . . .

This was first used in front of St. Gertrude's Church in Stockton from March 24 through April 1 to control the crowds gathering there for their annual Novena. . . .

During the time the signal was in use, we had no accidents whatever. Even on the first night in operation, there was no confusion, although it was the first time a machine of this type had been seen in this town.

SCOTT STETSON

Stockton, Calif.



Shown above in operation, Inventor Stetson's portable light has two small wheels at its base on which it is rolled like a dolly.

LEARN EITHER **Electricity OR Radio** IN A FEW WEEKS in the **GREAT SHOPS of COYNE**

**NOT "Home Study" Courses
...All Practical Training and
Necessary Theory Given in
Our Famous Chicago Shops!**

Why spend years learning Electricity or Radio, when COYNE prepares you for good jobs in either field in a few short weeks? Our training not only saves time; you're ready to step into the better pay that much sooner. You make rapid progress because you work under expert instructors here in our great shops. We do not teach by mail. Select course you prefer and send coupon TODAY!

ELECTRICITY



Including Industrial Electronics

Big future in Power Plant Work, Motors, Armature Winding, House and Factory Wiring, Industrial Electronics, Home Appliances, Lighting, Auto Electricity, Electrical Maintenance — all covered at COYNE. Here you get "all-around" Electrical training!

TRAIN ON REAL EQUIPMENT

You use, test, repair full-size apparatus — just like you'll later handle on the job. Previous experience unnecessary.

FREE ELECTRICAL BOOK

Send now for big, illustrated book on COYNE Electrical Training. Many large pictures of our shops. Tells about Free Lifetime Employment Service to Coyne graduates. Other vital facts. Check coupon for "ELECTRICITY" and mail today.

RADIO including **SOUND and TELEVISION**

If you prefer Radio, COYNE gives quick, practical training in Radio Construction, Testing, Repair; also Public Address, Sound Systems, FM, Television. Many branches of Radio open to you.

Want to be Your Own Boss?

Hundreds of Coyne graduates have successful Radio shops of their own. We show you how to start, how to build for a lifetime future. No previous experience required to take Coyne Radio Course.

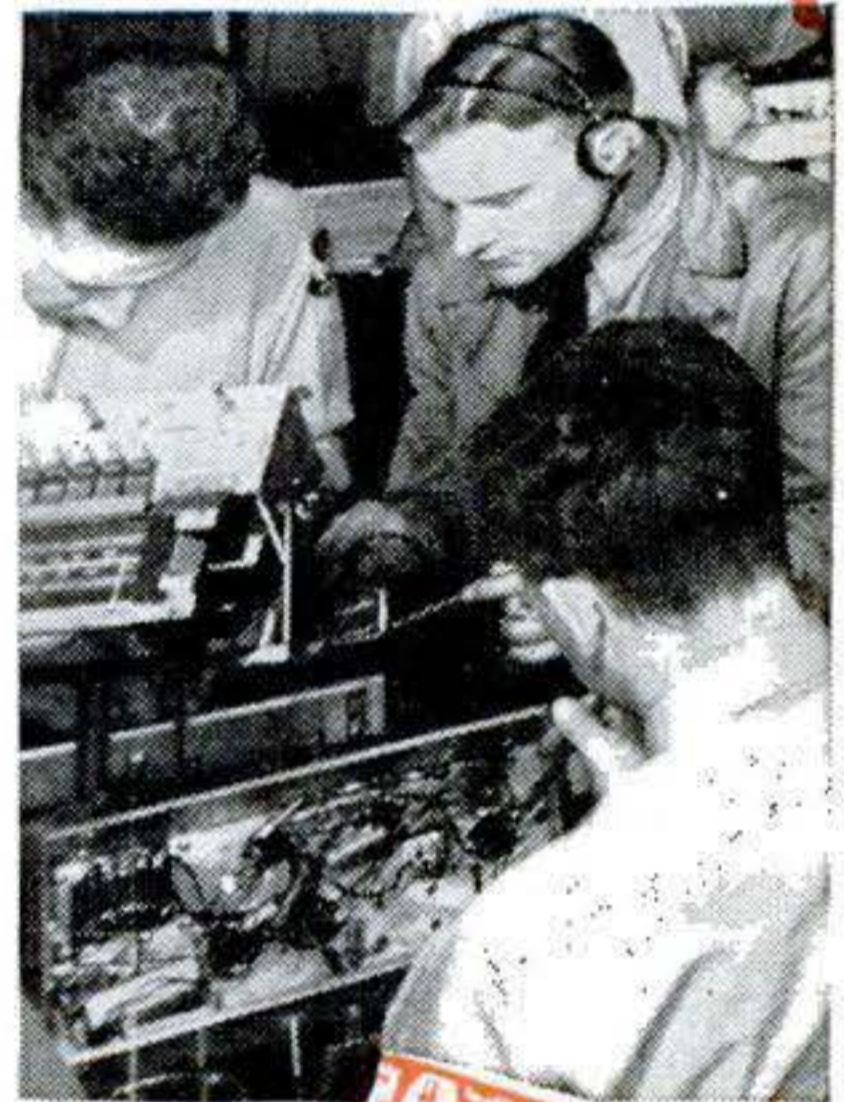

FREE RADIO BOOK

Check coupon for "RADIO" to receive our big FREE book of photos and facts about Coyne Training in Radio, Sound and Television. Describes the vast new opportunities in this field, and how we make it easy to get ahead. Rush coupon NOW.



B. W. COOKE

COYNE HAS BEEN TRAINING MEN SINCE 1899

For nearly 50 years, the great shops of COYNE have been turning out men and young men trained for better jobs in practical fields. Coyne graduates hold responsible positions in many leading electrical and radio firms.

NON-VETERANS who are short of cash can finance their tuition and pay it in easy monthly payments after graduation.

VETERANS! Coyne is authorized to accept veterans for G. I. training. Coupon brings bulletin.

ADDED TRAINING in **ELECTRIC REFRIG-ERATION** included with either course

COYNE ELECTRICAL SCHOOL
Dept. 67-73H
500 S. Paulina Street, Chicago 12, Ill.

CHECK COUPON FOR ELECTRICITY OR RADIO—MAIL NOW!

B. W. COOKE, Director,
COYNE ELECTRICAL SCHOOL,
500 S. Paulina St., Dept. 67-73H Chicago 12.
Send me your **BIG FREE BOOK**—for the Course checked below, and tell me about your special plans to help me. This does not obligate me and no salesman will call.

ELECTRICITY

RADIO

NAME.....

ADDRESS.....

CITY.....STATE.....

Pay Is Good

for Trained mechanics in both these Big Industries

LEARN IN A FEW WEEKS IN OUR BIG MODERN TRAINING SHOPS

AUTOMOTIVE MECHANICS

DIESEL MECHANICS

NOW IS THE TIME TO PREPARE FOR YOUR PLACE IN A GIANT INDUSTRY

Automobile and Diesel industries making up for lost time! There may never again be such opportunities for men who want better jobs or business of their own to get in on ground floor and go up fast! Yes—FOR MEN WHO ACT FAST. THINGS CAN HAPPEN FAST!

TRAIN ON ACTUAL EQUIPMENT

Chicago Motive Trades Institute makes rapid progress possible by Learn-By-Doing SUPERVISED SHOP TRAINING. In motive trades our institute gained nation wide fame training Auto Mechanics for U.S. Army. Same quality training available to you now. CONSULTATION AND PLACEMENT SERVICE WHETHER YOU ARE INTERESTED IN WORTHWHILE JOB OR SETTING UP YOUR OWN BUSINESS.

AUTOMOTIVE MECHANICS

Practical shop training on all types of equipment. Automotive mechanics needed to keep millions of cars, busses, trucks rolling. Efficient auto mechanics get fine pay. Can service, repair, install all mechanical and electrical parts of autos. Learn to overhaul and repair engines, transmissions, differentials, and other assemblies. Good pay, steady work, excellent opportunities for increased earnings for properly trained auto mechanics.



DIESEL MECHANICS

● Diesel engines are used in locomotives, ships, trucks, buses, power plants, tractors, farm equipment. Trained men needed to repair, rebuild, install, maintain, operate equipment. A big field that promises even bigger things in the years right ahead.

A NATIONALLY KNOWN INSTITUTION

Rapid progress possible by supervised learn-by-doing SHOP TRAINING. C.T.I. is an old established school, backed by years of experience—with trained instructors—with completely equipped shops.

VETERANS qualifying under "G.I. Bill" have all expenses paid by Government plus monthly subsistence allowance. Just mail coupon, we will handle all details. (LOW TUITION, EASY TERMS if you are not a veteran.)

CHICAGO MOTIVE TRADES INSTITUTE

Div. of Commercial Trades Inst.

1400 W. Greenleaf Ave., Dept. B19
Chicago 26, Ill.

FREE

— IMPORTANT INFORMATION
TELLING HOW TO GET STARTED



CUT COUPON ALONG THIS LINE

Fill Out, Cut Out, Mail Today

FACTS FREE for Men Who Want to Get Ahead

CHICAGO MOTIVE TRADES INSTITUTE, Dept. B19
1400 W. Greenleaf, Chicago 26, Ill.

Send free illustrated Brochures and other information about the field I have checked below.

- () Automotive Mechanics () Diesel Mechanics
() Body and Fender
() Veteran () Non Veteran

NAME.....

ADDRESS.....

CITY..... STATE.....

Try This on For Size

Sir:

I found the article "Mapping the Milky Way" in the July issue both interesting and informative, as are most features

However, I believe that a mistake was made in the number given for the length of a cubic light-year's side. It was stated that the side was 3,900 billion miles long, while it should have been 5,880 billion miles, the distance that light travels in one year.

PAUL MUTSCHLECNER

Fort Wayne, Ind.

Abashed at the sheer size of the mistake, PSM is boning up on its arithmetic; 5,880 billion miles is the correct approximation.

For Pig's Sake!

Sir:

. . . Page 208 of the July issue carried an illustration and story entitled "Modern Pigpen of Steel." The picture shown was taken on our experimental farm at Paris, Ky., and shows an experimental hog house that was developed by our Product Development Division. . . . We are, therefore, very much interested to read that this hog house is made by the E. A. Strout Realty Agency, according to your magazine. . . .

EARL D. ANDERSEN

Republic Steel Corporation
Cleveland, O.

PSM naturally regrets the error, but disclaims responsibility. It was the result of completely misleading publicity material that accompanied the photo.

Don't Bank on It

Sir:

. . . In your explanation of the cutaway of the Pratt & Whitney Wasp Major aircraft engine (July, p. 112), you refer to it as having seven banks of four cylinders. Don't you mean four banks of seven cylinders each?

SGT. J. F. H.

Bolling Field, D. C.

Pratt & Whitney engineers insist that the engine has seven banks of four cylinders each, and since they made it, they ought to know. Remember, the cylinders are arranged helically around the engine, not radially. That's the difference.

PATENT PROTECTION *for* INVENTORS

A PATENT IS A VALUABLE RIGHT

On the basis of a provision in the Constitution of the United States, Congress has established a system under which inventors may secure the exclusive right to prevent the unauthorized use, manufacture and sale of their inventions for periods of seventeen years. The inventor secures this protection by obtaining a patent from the United States Patent Office.

VICTOR J. EVANS & CO., has a staff of experienced registered patent attorneys, available to assist inventors in the preparation and prosecution of their cases before the Patent Office. Detailed information and the steps to be taken in obtaining patent protection will be furnished upon request.

FORM BELOW FOR MAILING CONVENIENCE

**VICTOR J.
EVANS & Co.**

Merlin M. Evans

REGISTERED PATENT ATTORNEY

240-K Merlin Building, Washington 6, D. C.

Please forward to me detailed information regarding procedure to obtain Patent Protection, together with your convenient "Evidence of Invention" form.

Name.....

Address.....

City and State.....

PATENTS • TRADEMARKS • COPYRIGHTS

SEPTEMBER 1947 23

How to Make YOUR Body Bring You

FAME

Instead of SHAME!

Will You Let
Me Prove I Can
Make You a
New Man?

I KNOW what it means to have a body that people pity! I was once a skinny, 97-lb. weakling—such a poor specimen that I was constantly self-conscious, embarrassed. But later I discovered the secret that turned me into the holder of the title, "The World's Most Perfectly Developed Man." I'd like to prove that the same system can make a NEW MAN of YOU!

7 DAY TRIAL OFFER

I don't say I can do all this for you in 7 days. But I DO want to prove I can show you enough results in even THAT short time to convince you that my system of "Dynamic Tension" will give you the kind of body you have always longed to have!

Do you want powerful shoulders—a fine, deep chest—biceps like iron—arms and legs rippling with strength—a stomach ridged with sinewy muscle—a build to be proud of? Then let me prove that "Dynamic Tension" is what you need.

FREE BOOK It costs only a stamp—or a postcard—to mail coupon below. I'll send my new, free book, "Everlasting Health and Strength." It tells about my "Dynamic Tension"

method; shows, from actual photos, how I have developed my pupils—explains about my 7 DAY TRIAL OFFER. Charles Atlas, Dept. 19, 115 East 23rd St., New York, N. Y.

CHARLES ATLAS, Dept. 19
115 East 23rd Street, New York, N. Y.

I want the proof that "DYNAMIC TENSION" will help make a new man of me—give me a healthy, husky body and big muscle development. Send me your free book, "Everlasting Health and Strength."

Name Age.....
(Please print or write plainly)

Address

City State.....

24 POPULAR SCIENCE

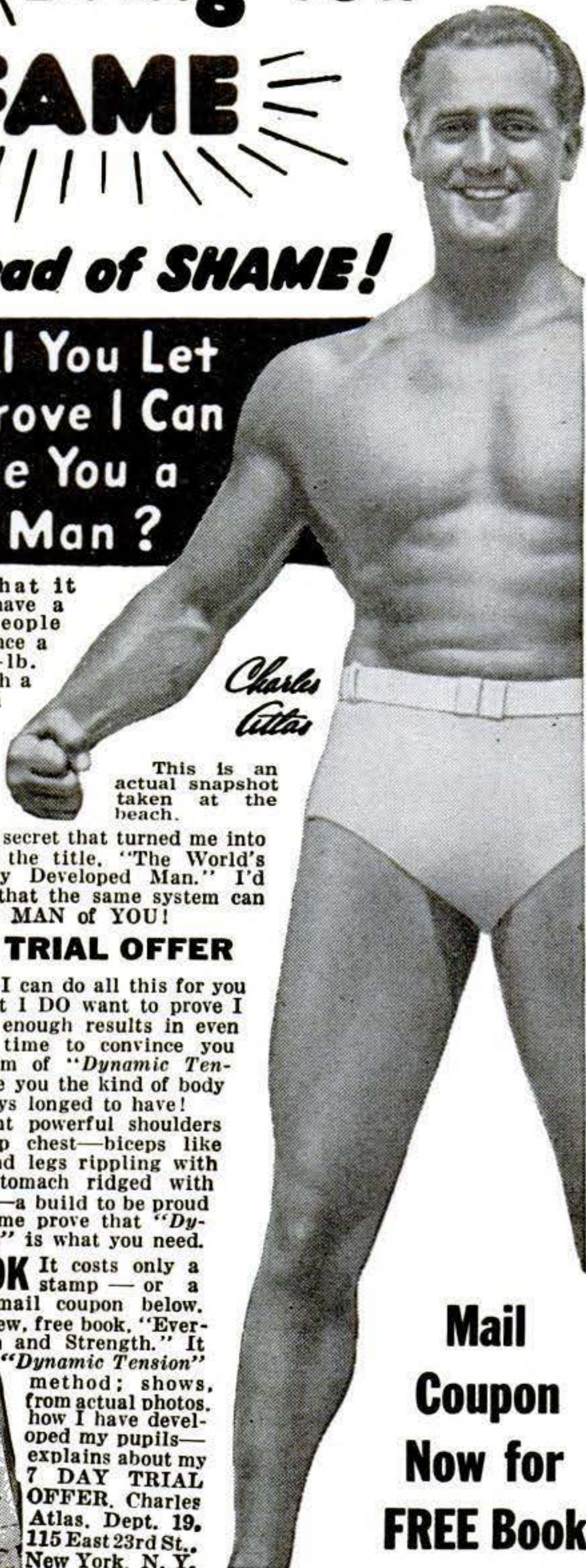

This is an actual snapshot taken at the beach.

Mail
Coupon
Now for
FREE Book

AVIATION

Aeronautical University Approved Training meets exacting standards of aviation industry, prepares for key positions, big opportunities.

Courses in:

AERONAUTICAL ENGINEERING, B.S. degree.
AERONAUTICAL ENGINEERING DRAFTING
CERTIFIED ENGINE MECHANICS
ADMINISTRATION—including sales

PRE-ENGINEERING: Special course for high school graduates and veterans deficient in math and science.

Also refresher courses for Gov't. Airplane and Engine Mechanics Licenses for those with aviation experience.

Oldest fully approved aviation school. Outstanding faculty, modern equipment, outside employment, placement service. Day, evening. Approved for Veterans. Send today for FREE catalog "Opportunities in Aviation."

AERONAUTICAL UNIVERSITY
Dept. 87, 116 S. Michigan Avenue, Chicago 3, Illinois

FOUNDED
BY
CURTISS-
WRIGHT

PHOTOGRAPHY

for PLEASURE
or PROFIT

Qualify at Home! Learn expert photography as a joy-full hobby, or to qualify for a well-paid position or your own studio. Previous experience unnecessary with N.Y.I.'s success-proved home study training. Details FREE. Also resident courses.

NEW YORK INSTITUTE OF PHOTOGRAPHY, Dept. 5
10 West 33 St., New York 1, N. Y. (37th Year)

BE A REAL ESTATE BROKER

PAYS BIG! EASY TO LEARN—Start and run your own business quickly.

Many graduates report making up to \$1000 a month. Course of study covers Sales, Property Management, Appraising, Loans, Mortgages and hundreds of related subjects. Course offered in home study or classroom—Both G. I. Approved. Send post card today for big, new illustrated book from this nationally known school. Dept. 30
WEAVER SCHOOL OF REAL ESTATE, 15 E. Pershing Road, Kansas City 8, Mo.

FREE
BOOK
TELLS
HOW

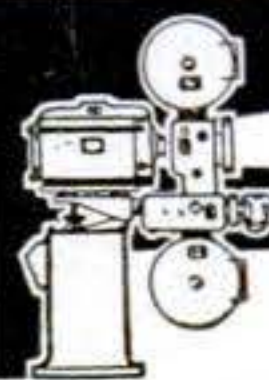

LEARN MOVIE PROJECTION THEATRE MANAGEMENT

The Motion Picture Theatre Business offers big opportunities for trained men. Get into a fascinating field with a promising future. Train at home in spare time. Free Catalog. Established 20 years.

THEATRE INSTITUTE 385 Washington St., Elmira, New York

THERE'S MONEY IN CARTOONS!

RAYE BURNS will teach you HOW to CREATE ORIGINAL CARTOONS at home that you may SELL! Course contains 26 lessons and over 600 illustrations. All for Only... **\$2.85**

Send name and address for free details.

RAYE BURNS SCHOOL, Dept. 8, Box 3583, CLEVELAND, OHIO

Good Handwriting

HELPS YOU WIN SUCCESS!

It's so important to write a good hand for business and social advancement. Poor illegible penmanship often causes costly errors and marks you for failure. Why write a poor hand? It's so easy to learn at home in spare time. Write for our new free booklet today. If you wish, send 10c for a penpoint suitable for shaded writing and your name beautifully written.

In Business Since 1895

The **TAMBLYN SCHOOL OF PENMANSHIP**
H-439 Ridge Bldg., Kansas City, Mo., U.S.A.

What Every Mason Wants



We have Important Masonic books for Blue Lodge, Chapter, Commandery, Scottish Rite, and Shrine.

OUR RITUALS ARE USED THE WORLD OVER

Send for free catalog of books and rituals for Masons, Odd Fellows, Knights of Pythias, Knights of Columbus, etc.
EZRA A. COOK, Publisher, P. O. 796, RS Chicago 90, Ill.

Now IN YOUR OWN HOME Learn

RADIO ELECTRONICS

The Practical
"HOME-TESTED"
Modern "A-B-C" Way

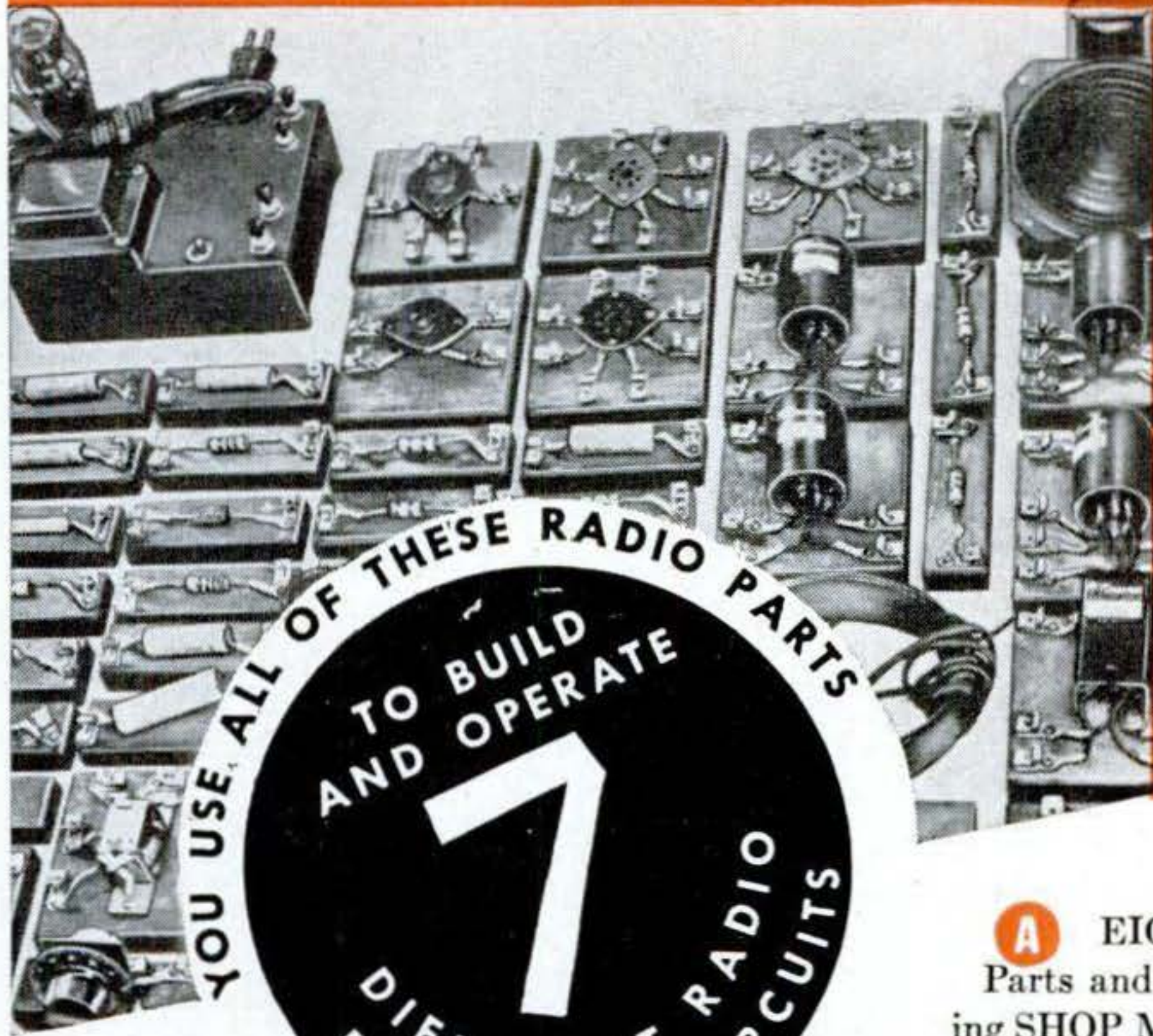

YOU USE ALL OF THESE RADIO PARTS
TO BUILD AND OPERATE
7
DIFFERENT RADIO RECEIVING CIRCUITS

WITH THE HELP OF

A EIGHT Big Kits of Actual "Learn-by-Doing" Radio Parts and Assemblies with which you make 133 fascinating SHOP METHOD EXPERIMENTS in your own home! Imagine building 7 different Radio Receivers that operate!

B A 16 mm Home Movie Projector and Twelve Reels of "Learn-by-Seeing" Home Movie Films . . . for picture-clear, fast understanding of Radio Fundamentals!

C Modern, well-illustrated, Loose-leaf Lessons, prepared in clear, simple, understandable language . . . to guide you throughout your training!

NO PREVIOUS RADIO OR ELECTRICAL EXPERIENCE NECESSARY

DeForest's Training, Inc. provides every major home study aid to help you learn Radio-Electronics rapidly and thoroughly . . . to give you the *experience* and *confidence* needed for a responsible, Good-Pay Job, or to Start a Business of Your Own! Here is a REAL opportunity field for YOU . . . when you are a trained Radio-Electronics man! Just think of the tremendously exciting future ahead of FM Radio, Aviation and Broadcast Radio, Sound Motion Picture Equipment, Servicing and Sales of Radio Equipment, etc. Put yourself in this picture . . . See how you can benefit from a PRACTICAL training in this fascinating work! Think, too, of the coming possibilities ahead of Radar, Facsimile and Television. Send TODAY for the interesting, opportunity-revealing book, "Victory for You!" See how others probably no more talented or ambitious than you, have advanced in earning power after this training . . . how YOU can do it too! Mail the coupon NOW!

INCLUDING:

1. Simple Receiver
2. Two Tube Receiver
3. Tuned Radio-Frequency Receiver
4. Short Wave Receiver
5. Aviation Band Receiver
6. 4-Tube Superheterodyne
7. 5-Tube Superheterodyne with Magic Tuning Eye

THEN GET THE HELP OF OUR EFFECTIVE EMPLOYMENT SERVICE

... PLUS SCORES OF OTHER FASCINATING, INSTRUCTIVE RADIO-ELECTRONIC EXPERIMENTS

16 MM MOVIE PROJECTOR
YOU USE "LEARN-BY-SEEING" MOVIES



DEFOREST'S TRAINING, INC. INCLUDES INSTRUCTION IN MOTION PICTURE SOUND EQUIPMENT, FM RADIO AND TELEVISION . . . RESIDENTIAL TRAINING IN OUR MODERN CHICAGO LABORATORIES ALSO AVAILABLE—ASK US FOR INFORMATION!

VETERANS!

Big things are happening at DeForest's Training, Inc. for veterans! See how you can prepare yourself WITHOUT COST for a GOOD JOB or a BUSINESS OF YOUR OWN in the vast Radio-Electronic opportunity field.



E. B. DEVRY, President
DeFOREST'S TRAINING, INC
2535-41 North Ashland Ave., Dept. PS-D9
Chicago 14, Illinois, U.S.A.

Send FREE "VICTORY FOR YOU!" BOOK, showing how I may make my start in Radio Electronics.

Name _____ Age _____

Address _____ Apt. _____

City _____ Zone _____ State _____

If under 16, check here for special information.

If a discharged Veteran of World War II, check here.

DeFOREST'S TRAINING, INC.
CHICAGO 14, ILLINOIS

HOW TO EFFECT ANY KIND OF MOTION or MOVEMENT

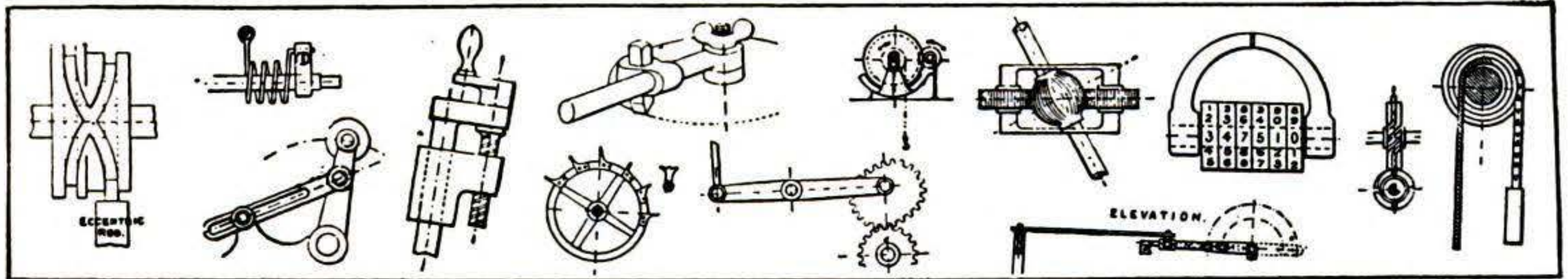

A Book That Shows You

3000 ILLUSTRATIONS and DESIGNS of Mechanical Movements, Devices, Contrivances & Details!

Every conceivable kind of mechanical motion and work is explained and illustrated in this unusually helpful book. As far as known, the only work in existence which aims to provide side by side suggested sketches of the various methods in use for accomplishing any particular mechanical movement or work, in a form easily referred to. Every engineer, inventor or mechanic finds the need of devising, simplifying or improving

some mechanical process or method. In doing this he has to rely on memory or experience. Here is a reference book of nearly 3000 MEANS AND METHODS for producing any kind of movement or work, classified and arranged for easy reference!

SUCH AS: Accumulators, Anti-friction, Ball and Socket, Bearings, Blowings, Brakes, Cams, Chain Gear, Chopping, Chucks, Circular Motions, Clutches, Conveying, Cranes, Cranks, Cutting, Doors, Drilling, Eccentrics, Engines, Expanding, Filtering, Gears, Governors, Grips, Grinds, Heating, Hinges, Hydraulics, Indicators, Journals, Levers, Links, Lowerings, Lubricators, Measuring and Weighing, Mixing, Nozzles, Parallel Motions, Pipes, Pivots, Power, Propulsion, Raising, Ratchets, Rotary Engines, Safety Appliances, Shafting, Signals, Slides, Sounds, Speed, Spindles, Springs, Starting, Striking, Swivels, Tanks, Traps, Turbines, Valves, Water Wheels, Winding, Wipers, etc.

If you work with machinery of any kind, you need this ENGINEERS' SKETCH BOOK by Thomas W. Barber—355 pages, durably printed and bound in cloth. Mailed postpaid if you send order with \$2.98 or sent C.O.D. if preferred plus postage. Money back guarantee if not exactly as described or if not satisfied.

KNICKERBOCKER PUB. CO., Dept. M-2, 120 Greenwich St., New York 6, N. Y.

Send me a copy of ENGINEERS' SKETCH BOOK. If I am not satisfied, I can return book and my money will be refunded.

I enclose \$2.98; send book postpaid.
 Send book C.O.D. for \$2.98 plus postage.

Name.....
 Address.....
 City & Zone..... State.....

Get This "THE PICKPOCKET" Feature Comedy

Ben, feature character of this fast moving comedy, goes a trifle "insane" as professional pickpocket. Captured, escapes, recaptured.



16 mm K., Sound \$17.50

16mm B&W, Sound \$7.50

"GOLF SLAPPY"

Laughs galore watching dub golfer break all rules! Features EDDIE GRIFFEN & other slapstick comedy stars.

400 ft. 16mm, sound, per print.....\$25

Also feature WALT DISNEY cartoons of Mickey Mouse and Donald Duck. See at Your Dealer or Order Direct, Catalog and Prices on Request.

Write to: **HOLLYWOOD FILM ENTERPRISES, Inc.**
 6060 Sunset Blvd. Dept. 116 Hollywood 28, Calif.

ELECTRICIANS' SCHOOL

HOUSE AND COMMERCIAL WIRING • MOTOR REPAIR AND REWINDING • ELECTRIC REFRIGERATION

Approved for Veterans Training

PENNSYLVANIA INSTITUTE SCHOOL OF ELECTRICITY

42nd and SPRUCE STS.

PHILADELPHIA 4, PENNA.

One of America's Leading Radio and Television Schools
NEW YORK TECHNICAL INSTITUTE OF NEW JERSEY

158 Market Street, Newark, New Jersey

Now a DYNAMIC Super-charged WELDER

IDEAL FOR AUTO • HOME APPLIANCE • FARM REPAIRS

DESIGNED TO DO HIGH GRADE WELDING INEXPENSIVELY!
 Maintenance Men; Farmers; Mechanics; Machine Shops; Foundries; Auto, General Repair and Job Welding Shops; all using the DYNAMIC find it so indispensable and useful that they cannot afford to be without it. If inexperienced you can easily learn to do a variety of high grade welding jobs by following the practical, simplified operating and welding instructions furnished. Once you see a DYNAMIC in operation, you won't want to be without it. Its simplicity will amaze you. In a year the DYNAMIC only costs you about 6c a day. Helmet, rods, cables, holder and operating instructions, etc., furnished.

SAVES YOU VALUABLE TIME AND MONEY!

This portable industrial transformer type DYNAMIC WELDER easily carried right to the job, can be operated from any convenient, properly wired **110 Volt, 60 Cycle Line**—has 8 metallic and carbon arc welding heat stages—does work you would think only possible with a larger more expensive machine. Can also be supplied for 220 volt, 60 cycle operation and other voltages and cycles at slight additional cost. Works on Iron, Steel, Brass, Bronze & other metals.

DYNAMIC WELDER CO., 13 East 23rd St., S K Chicago 16, Ill.

ONLY \$28.50 COMPLETE

Available Now IMMEDIATE DELIVERIES

Write Today for Particulars
GET DETAILS on our 10 day Trial Offer.
 Member Chicago Association of Commerce.

FARM IMPLEMENTS

BICYCLE REPAIRS

SHOP WORK

HOME APPLIANCES

AUTOMOBILE REPAIRS

Accountancy Home-Study

made *interesting and practical*
thru *problem method*

YOU know as well as we do that Accountancy fits many men for positions that pay three and five and ten thousand dollars a year—gives many other men unusual opportunity to start a profitable growing business of their own.

You probably realize also that the accounting profession faces the greatest opportunity it has ever had.

The only question is—just how practical is it for *you* to train yourself adequately in Accountancy through home study?

And the answer lies in the LaSalle Problem Method.

For this modern plan of training not only makes Accountancy study at home thoroughly practical but makes it interesting as well.

And here's how:

You Learn by Doing

Suppose it were your privilege every day to sit in conference with the auditor of your company or the head of a successful accounting firm. Suppose every day he were to lay before you in systematic order the various problems he is compelled to solve, and were to explain to you the principles by which he solves them. Suppose that one by one you were to work those problems out—returning to him every day for counsel and assistance—

Granted that privilege, surely your advancement would be far faster than that of the man who is compelled to pick up his knowledge by study of theory alone.

Under the LaSalle Problem Method you pursue, to all intents and purposes, that identical

plan. You advance by solving problems.

Only — instead of having at your command the counsel of a single individual—one accountant—you have back of you the organized experience of a great business training institution, the authoritative findings of scores of able accounting specialists, the actual procedure of the most successful accountants.

Thus—instead of fumbling and blundering—you are coached in the solving of the very problems you must face in the higher accounting positions or in an accounting practice of your own. Step by step, you work them out for yourself—until, at the end of your training, you have the kind of ability and experience for which business is willing and glad to pay real money.

One-Tenth of All C. P. A.'s Are LaSalle Trained

If you want still more proof, remember that over 2300 C.P.A.'s—approximately one-tenth of all those in the United States who have passed the difficult examination for this coveted degree—are LaSalle alumni.

And knowing these facts, ask yourself if there can be any further question about the practicability of this training for you—ask rather if the real question is not about the size of your own ambition and the quality of your determination.

For Accountancy is no magic wand for the lazy or the fearful or the quitter—it offers success only to the alert adult who has the courage to face the facts and the will to carry on till the job is done.

If you are that individual, the coupon below, filled out and mailed, will bring you free the information that may open up to you the future of which you have dreamed — ability and income and success. Is it not worth getting that information?

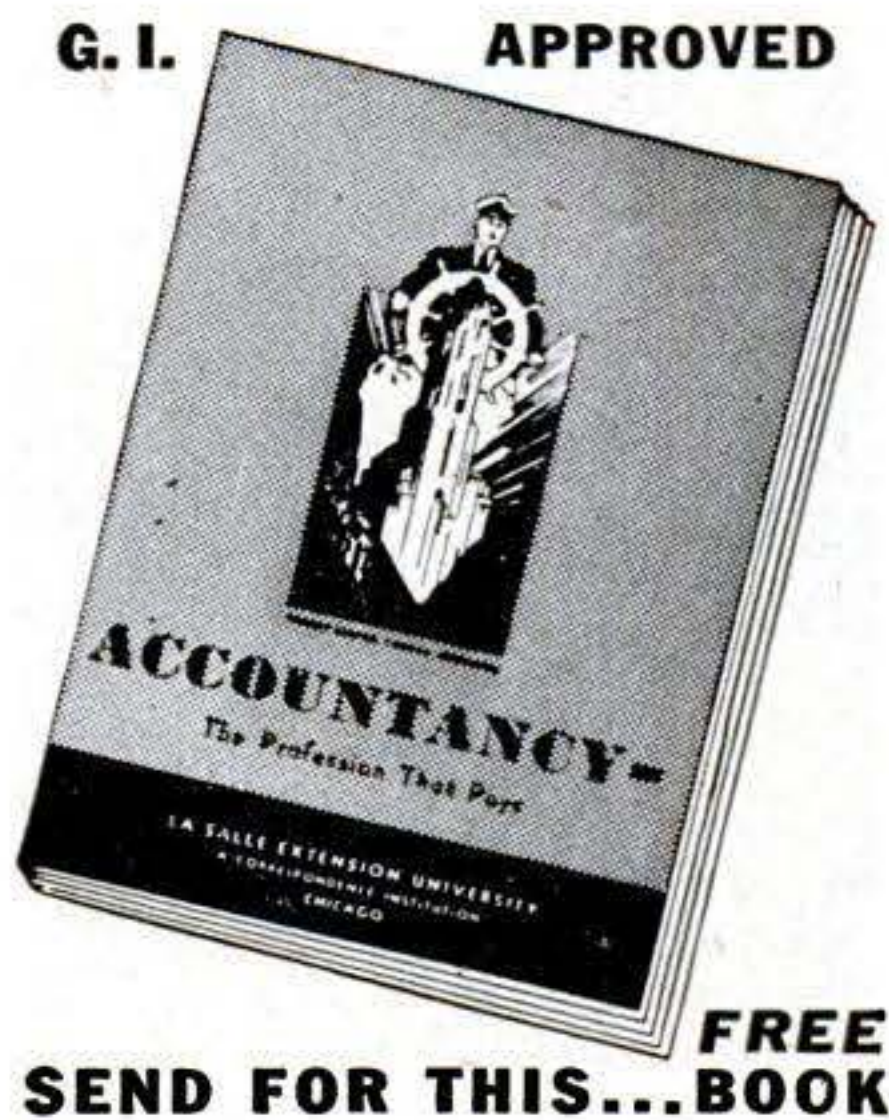

FREE
SEND FOR THIS...BOOK

LaSalle Extension University

A Correspondence Institution

Dept. 983-H 417 S. Dearborn St., Chicago 5, Ill.

Please send me, free of all cost or obligation, your 48-page illustrated book "Accountancy, the Profession That Pays," telling about the profession of accountancy and your training for success in that field.

Name.....

Address.....City & Zone.....

Position.....Age.....



YOUR OPPORTUNITY IN *Watchmaking*

Here is a career field which offers opportunity at every "tick" of a watch or a clock. Millions of watches and clocks need fixing—millions more will continue to need repairs. Here is an interesting, top-bracket opportunity to start an independent business of your own, or work for good pay in a factory, repair shop or store. AMERICAN SCHOOL OF WATCHMAKING has trained many men who are now making good. At A. S. W. you get proven, practical training under QUALIFIED, patient instructors who delight in the success of their students and graduates. MAIL THE COUPON BELOW for illustrated booklet. It is FREE — and will give you a fine picture of our complete facilities.

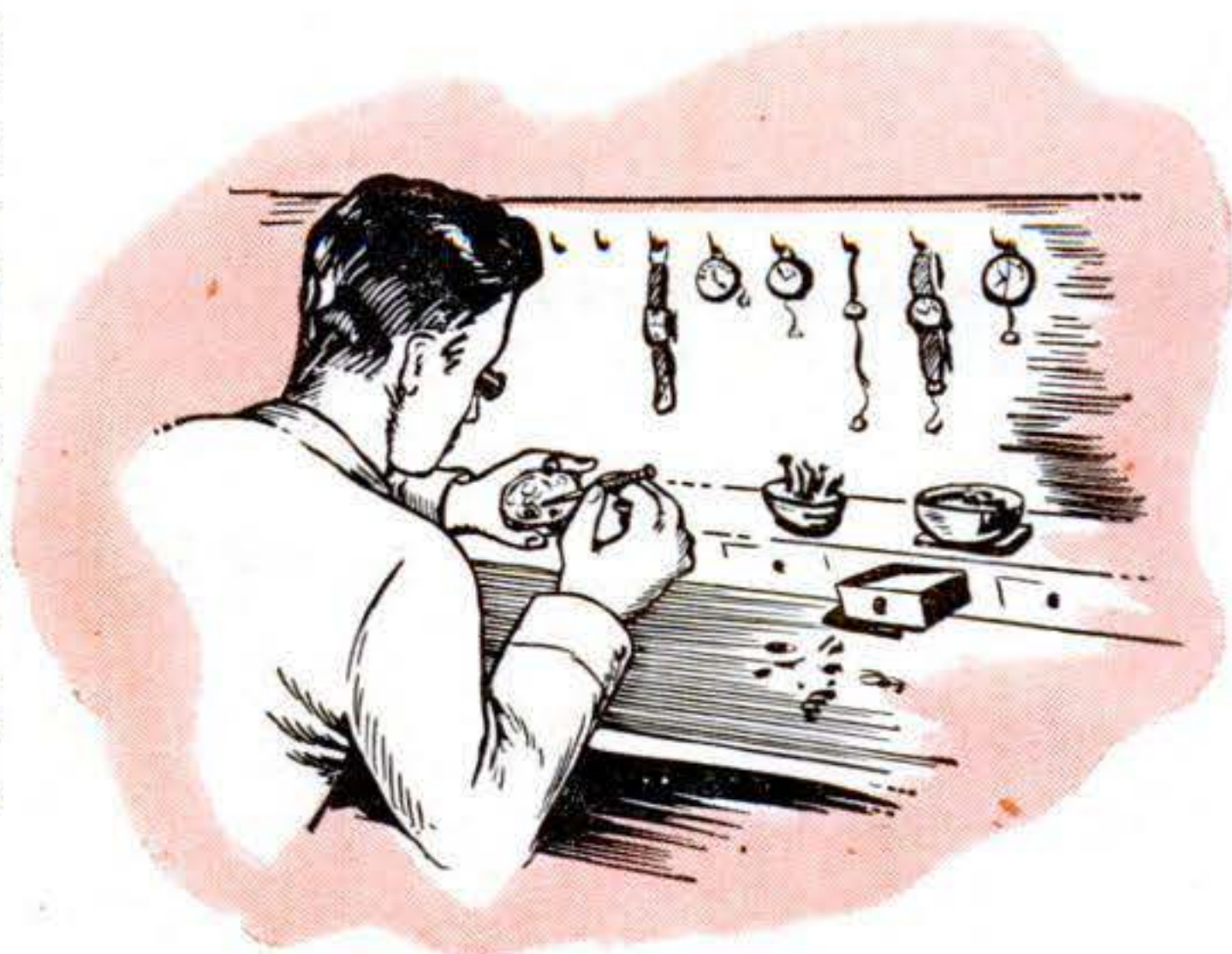

APPROVED FOR VETERANS

American School of Watchmaking
Dept. PS 49-7, 5145 W. San Fernando Rd.
Los Angeles 26, Calif.
Gentlemen: Please send me free booklet and information on your training.

Name (Print) _____

Street _____ Age _____

City _____ Zone _____ State _____

Veteran _____ Non-Veteran _____



TECHNICAL

TRAINING

STUDY IN LOS ANGELES, CALIFORNIA

Enroll at American School of Watchmaking and study in Southern California, the glamor spot of the country. Beach and mountains, Catalina and Hollywood, the Hollywood Bowl and the Rose Bowl—yes, indeed, here is much to interest the student in off hours and over weekends. DECIDE NOW to investigate the field of Watchmaking for your future.

YOUR OPPORTUNITY — — — As AN *Aircraft*

INSTRUMENT TECHNICIAN

Do you like Aviation? Do you like airplanes? Do you like to take things apart and see what makes them tick? THEN YOU WILL LIKE AIRCRAFT INSTRUMENTS. Here is a vital part of the great aviation industry—and necessary part. As long as planes fly there must be trained men to service, repair, and maintain the instruments that make flight possible. AMERICAN SCHOOLS OF AIRCRAFT INSTRUMENTS teaches men to perform this important, interesting and well-paid work.

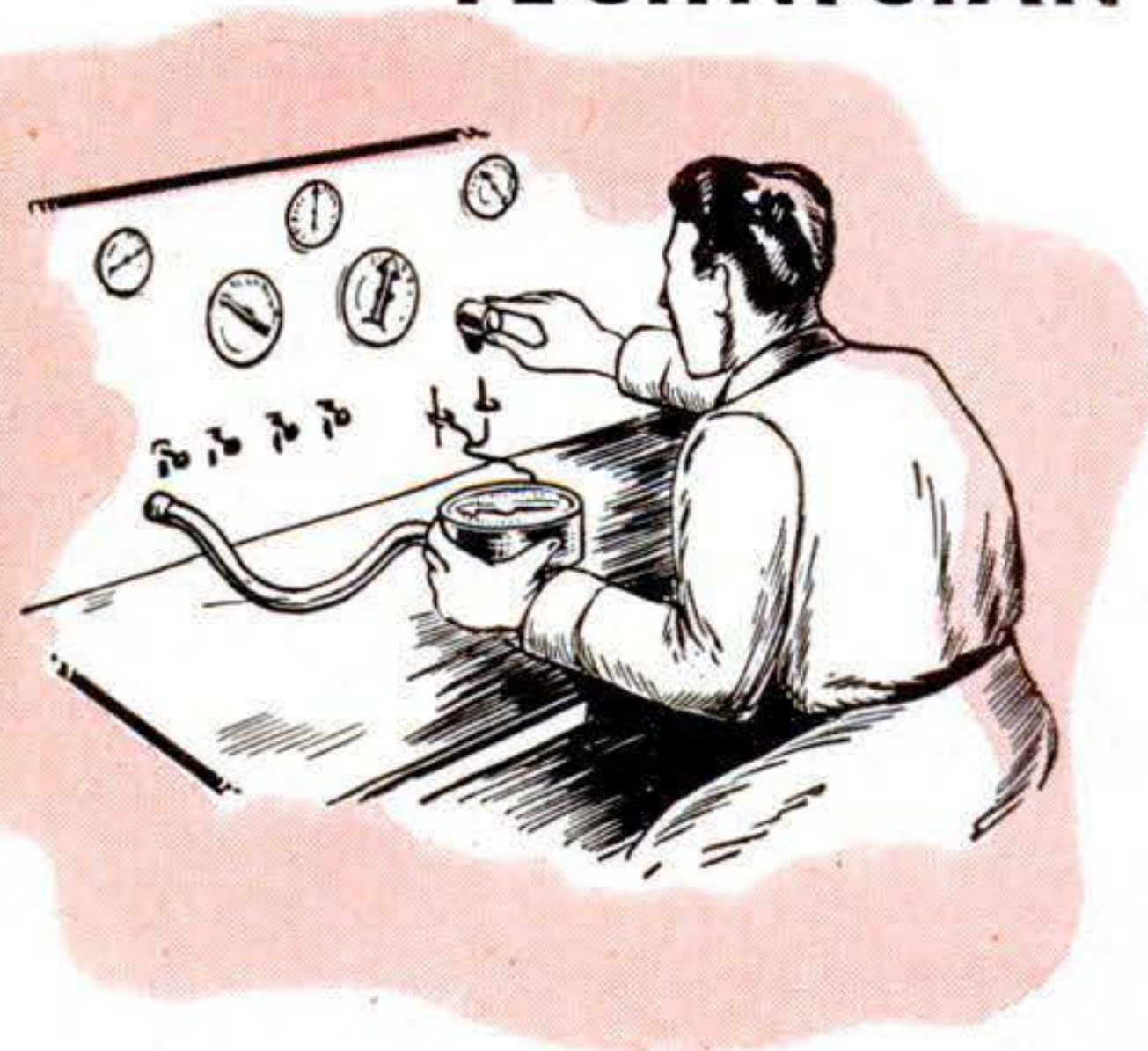

DO YOU WANT A SPECIALIZED CAREER IN AVIATION? Then be an Aircraft Instrument Technician and get your training NOW. 34 Weeks intensive course. Hundreds of A.S.A.I. graduates employed in the industry or have own business. Mail coupon below TODAY for free booklet and complete information.

APPROVED FOR VETERANS

American Schools of Aircraft Instruments
Dept. PS 49-7, 5145 W. San Fernando Rd.
Los Angeles 26, Calif.

Gentlemen: Please send me FREE and WITHOUT OBLIGATION, illustrated booklet describing Aircraft Instrument field.

Name (Print) _____

Street _____ Age _____

City _____ Zone _____ State _____

Veteran _____ Non-Veteran _____

INSTRUMENT TRAINING VALUABLE

A sound training in Aircraft Instruments is also applicable to many industrial fields. Many large, important industries use delicate instruments at some point in their operation — and trained instrument men are needed to install, service and maintain them. Here, then is further opportunity for you as an Expert Instrument Technician.

YOUR OPPORTUNITY IN *Plastics*

Consider the growing, important field of Plastics for your future. Many have compared the Plastics Industry with the Radio and the Automobile industries before their great and rapid growth. Today such a comparison seems warranted because more products are being manufactured from various types of plastic materials than ever before—requiring **TRAINED MEN** to develop, design, and fabricate them. Mail the coupon below for complete information and free literature which show, in actual photographs, the many uses of plastics and what trained men must know to get the better paying positions in this field. This literature tells you about Plastics Institute, the oldest and largest exclusively plastics training school in the United States. Read what graduates say about Plastics Institute training and the progress they have made since graduating.

LEARN BY MAIL OR COME TO CALIFORNIA (IMMEDIATE ENROLLMENT)

You can study at home, in your spare time, without interfering with your present employment — or, if you prefer, you can attend Plastics Institute's large, modern school in Los Angeles, the city that "has everything." Please check the coupon to indicate your choice and **MAIL TODAY.**

APPROVED FOR VETERANS

Plastics Industries Technical Institute
Dept. PS 49-7, 1601 S. Western Ave., Los Angeles 6, Calif.
Gentlemen: Please send me free literature and information on your practical courses. I am interested in Home Training attending school in Los Angeles .

Name (Print) _____

Street _____ Age _____

City _____ Zone _____ State _____

I am a Veteran _____ Non-Veteran _____

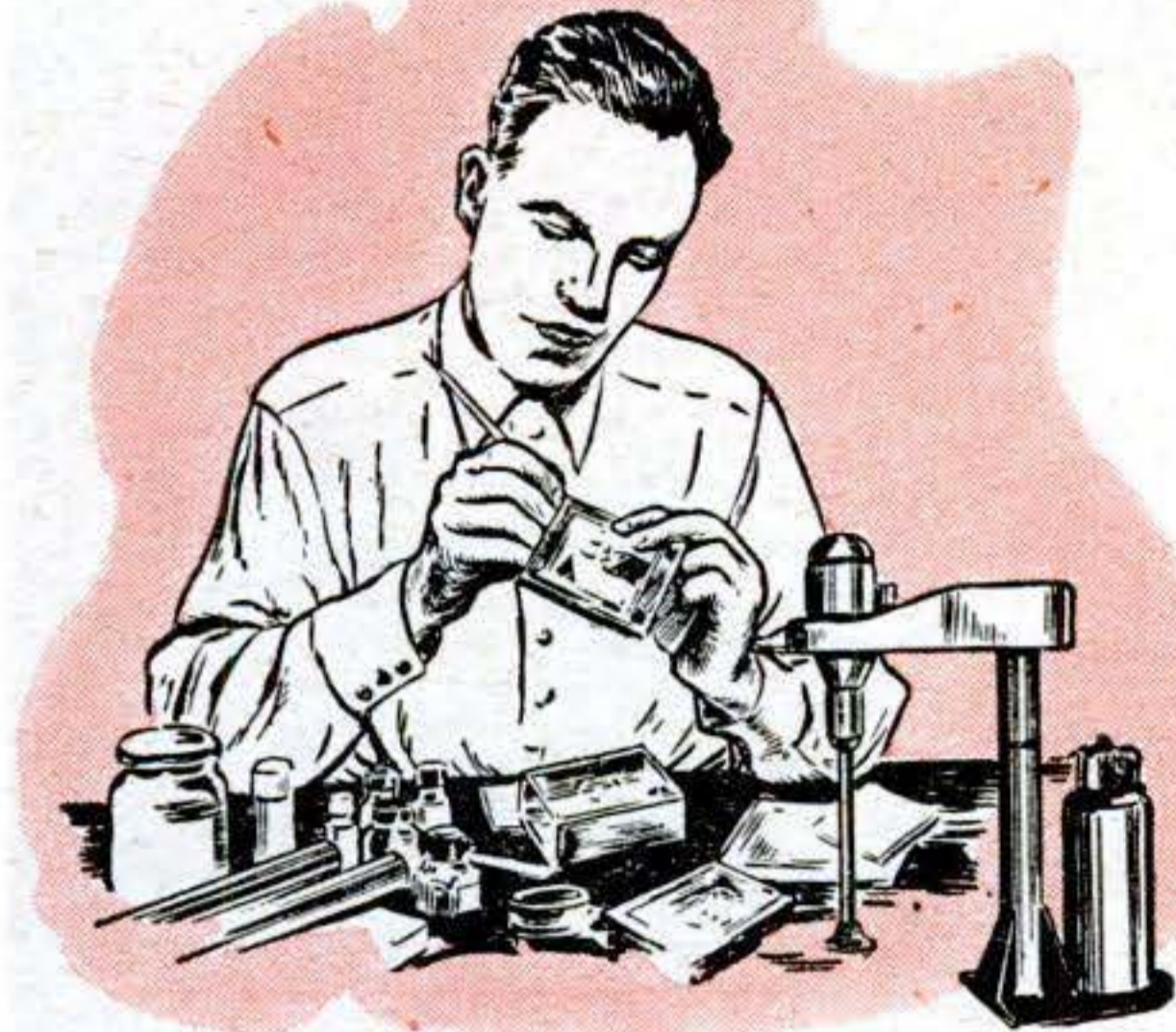

LEARN BY DOING

You get practical experience making useful, attractive articles from plastic materials which we supply. Many students have earned extra money selling articles of their own manufacture.



FOR

SUCCESS

YOUR OPPORTUNITY AS AN *Aeronautical*

ENGINEER OR MASTER AIRCRAFT (A E) MECHANIC

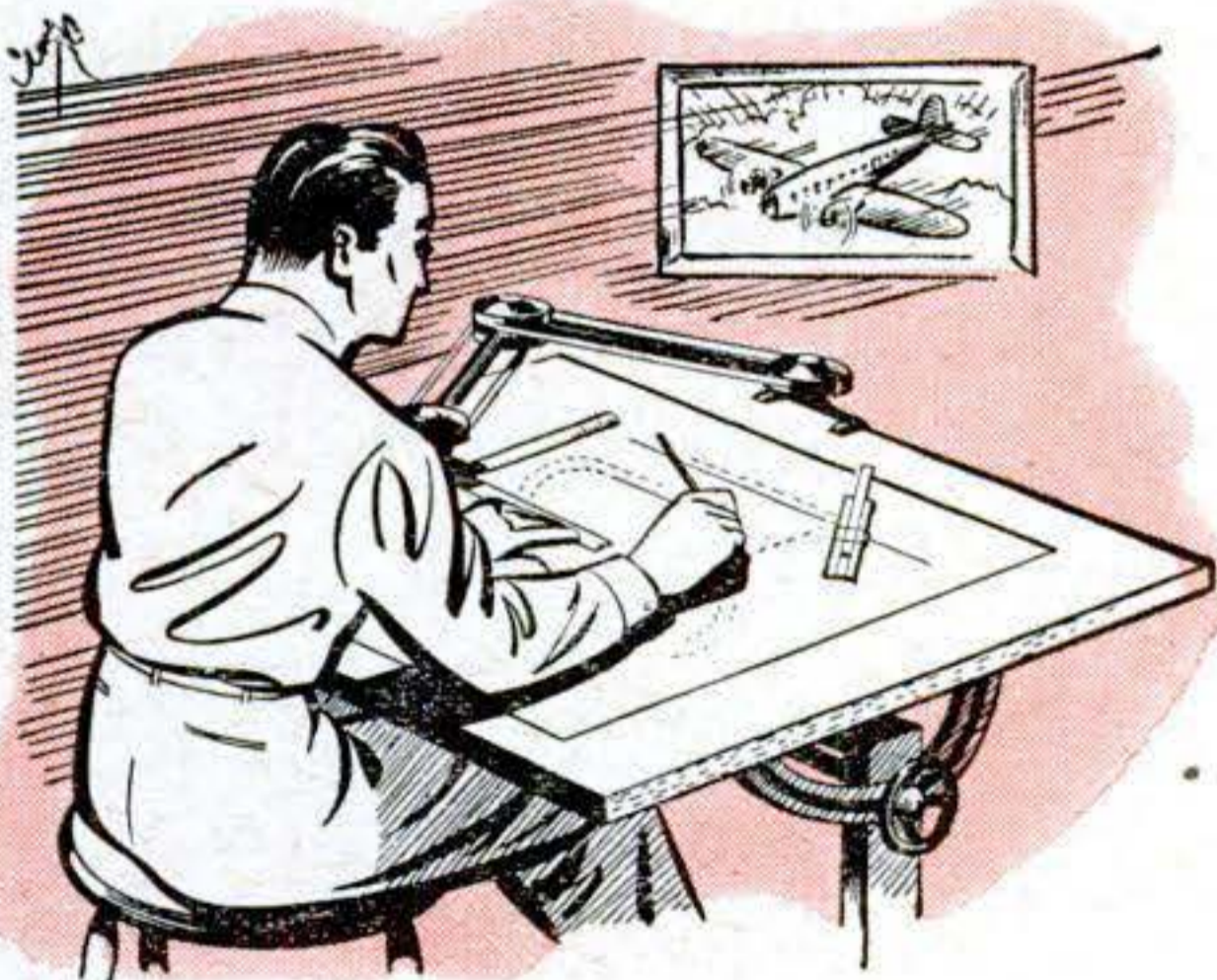

Intensive, practical training courses at AERO TECH have been designed as carefully as a fine airplane . . . with but one thought in mind — **SUCCESSFUL GRADUATES.** Working closely with executives of airlines and large aircraft plants, the training program at Aero Tech is tailored to meet their specific needs. Many important phases of Aero Tech training have been suggested by men who **ARE NOW SUCCESSFUL IN AVIATION,** but who had to first prepare for the road ahead by study and training. **AERO TECH** training prepares you to qualify for your **CAA LICENSE.**

WORK WHILE YOU LEARN

At Aero Tech you can get a full day's training between the hours of 7:00 a.m. and 1:00 p.m., thus allowing ample time for the obtaining of part time employment if desired. Many of our students—Veterans and Non-Veterans—are taking advantage of this plan.

APPROVED FOR VETERANS

Aero Industries Technical Institute
Dept. PS 49-7, Oakland Municipal Airport
Oakland 14, California

Gentlemen: Please send me complete free information about Aero Tech training.

Name (Print) _____

Street _____ Age _____

City _____ Zone _____ State _____

Veteran _____ Non-Veteran _____

STUDY ON A GREAT METROPOLITAN AIRPORT IN CALIFORNIA

At Aero Industries Technical Institute you get the advantage of being in the center of the great Pacific Coast Aircraft Industry, plus all the chance for recreation and fun which comes with living in California. Room and board are available at reasonable rates — and **YOU CAN OBTAIN IMMEDIATE ENROLLMENT. MAIL THE COUPON TODAY!**

Learn

WATCH REPAIRING

from
An Approved School
The Largest of Its Kind

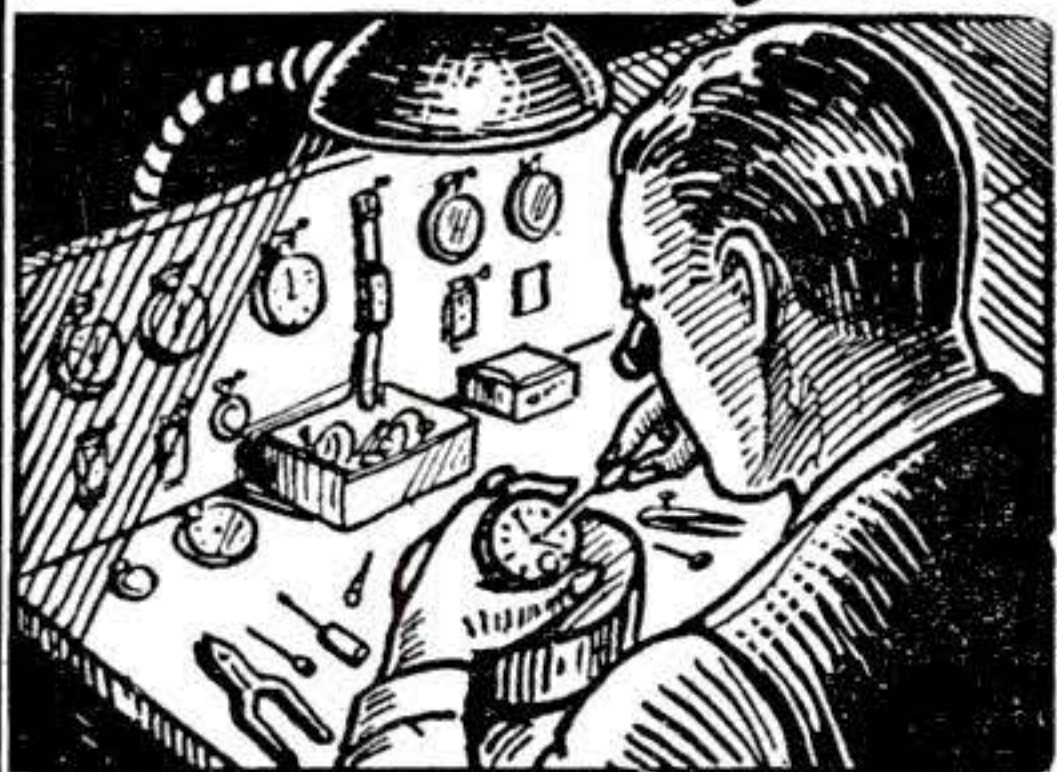

EARN
WHILE
LEARNING

**SPARE TIME HOME TRAINING
PREPARES YOU FOR BIG PAY**

FREE WATCH working tools and watch included as part of our Watch Repairing Course

The demand for skilled watch repairers—men and women—is increasing with the step-up in the manufacture of watches. Now is the time to prepare yourself in this fascinating profession with the aid of our highly practical HOME TRAINING COURSE—in your spare time at home. Start your own business or accept a big pay position.

WRITE TODAY FOR FREE DETAILS—Earn while you learn with an "approved" school. Get the facts—then judge.

ILLINOIS SCHOOL OF WATCH REPAIRING
2870 Elston Ave., Dept. PS-9, Chicago 18, Illinois

FREE



LAW
training for
Leadership

EVIDENCE

TO the MAN
INTERESTED IN
LAW

Every question about Law and its value to you is answered in LaSalle's 48-page booklet, "Law Training for Leadership." And the question of how you can master Law is answered in the companion booklet, "Evidence"—in which

scores of our students tell how they have advanced through LaSalle Law Training in spare hours at home.

Legal training gives you what the business and professional world prizes highly and rewards liberally—a keen, analytical mind, the ability to judge shrewdly, talk convincingly, and act with confidence.

LaSalle's "Problem Method" of personalized instruction by lawyer-instructors gives you practice in handling legal problems . . . you learn by doing, not by memorizing rules. We guide you step-by-step, furnish all texts, including remarkable 14-volume Law Library prepared by leading law professors and lawyers, and used as reference in many Law libraries and offices. Degree of LL.B. conferred. Low cost, easy terms.

Investigate your opportunities in Law. Mail coupon today for free booklets described—without obligation.

G. I. Approved

LA SALLE EXTENSION UNIVERSITY

A Correspondence Institution

417 S. Dearborn St. Dept. 983-L Chicago 5, Ill.

Send me "Law Training for Leadership" and "Evidence"—without obligation.

Name..... Age.....

Street.....

City, Zone & State.....

MEN ARE NEEDED FOR **RADIO** ENGINEERING TELEVISION ELECTRONICS

Thorough training in radio, including fundamentals, math, repair, sales, broadcasting, communications, with modern laboratory facilities and experienced faculty.

APPROVED FOR VETERANS TRAINING

Moderate tuition and living costs.

New Classes Start Each Month.

Dept. 2 Albuquerque, New Mexico

EGGERT RADIO INSTITUTE

SHINE WITHOUT 'POLISH'

New Invention! • Sells Like Wild



Replaces messy pastes, liquids. Simply glide over shoes—and PRESTO!

—you have a lustrous, long-lasting shine. No mess. No muss. No soiled hands. Clean. Handy.

WORKS LIKE MAGIC!

For Men's, Women's and Children's Shoes. Low priced. Lightning seller!

SAMPLES FOR AGENTS Sample offer sent immediately to all who send name at once. A penny postal will do. **SEND NO MONEY—just your name.** KRISTEE CO., 692 Bar Street, AKRON, OHIO

LAW

STUDY AT HOME for PERSONAL SUCCESS and LARGER EARNINGS. 39 years expert instruction—over 108,000 students enrolled. LL.B. Degree awarded. All texts furnished. Easy payments. G.I. Approved. Send for FREE BOOK.

AMERICAN EXTENSION SCHOOL OF LAW
Dept. 81-S, 646 N. Michigan Ave., Chicago 11, Ill.

MODELS

Famous true-scale flying model airplane kits. • 14" wing span—Cub—Stinson—Cessna—Aeronca—15c. • 18" wing span—Thunderbolt—Dauntless—Mustang—King Cobra—25c. • 21" wing span—Thunderbolt—Ercoupe—Mustang—King Cobra—50c.

Complete catalog of full line given free with all orders. Save postage, cash with order.

JOE OTT MFG. CO., 111 W. Jackson, Chicago 4, Ill.



CARTOONING

HAVE FUN! MAKE MONEY! Cash in on your sense of humor at HOME—BY MAIL. No experience needed to start. Write today FOR FREE TRIAL LESSON and full particulars.

MOON Gag Cartoon School, Dept. C, Fall Creek, Wis.



AGENTS
300% Profit

SIGN LETTERS

For Store Fronts and Office Windows. Anyone can put them on. Free Samples. Liberal Offer to general agents.

METALLIC LETTER CO., 441 N. Clark, Chicago 10

6" WHEELS 40c

Moulded RUBBER TIRES to fit 5/16" axle cash required with order.

A. B. McMAHAN, 693 Raymond Ave., St. Paul 4, Minn.

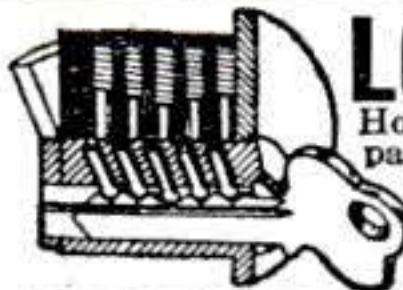

LOCKSMITHING & KEY MAKING

COMPLETE UP-TO-DATE COURSE How to pick locks, decode, make master-keys, repair, install, service, etc. 53 easy illustrated self-instruction lessons for every handy man, home-owner, carpenter, mechanic, hardw're dealers, maintenance men, etc. Satisfaction guaranteed. Send for Success-Catalog Free. Address below.

WATCH AND CLOCK REPAIRING

LEARN at HOME in Your Spare Time Prepare for a happy future of prosperity and security—and get a good job Now. A fascinating, thorough self-instruction training in American and Swiss watches, clocks. Special section on alarm clock repairs. Fast-growing field. Success-Catalog Free. **NELSON CO.**, 1139 S. Wabash Av., Dept. J-01, Chicago 5, Ill.



RHEUMATISM

ARTHRITIS-NEURITIS-SCIATICA

If you suffer the agonizing pains of these diseases when the usual remedies have failed, learn about a new trustworthy, modern, non-surgical treatment method. This marvelous treatment is completely explained in the Ball Clinic's FREE Book. Write today. No obligation. **BALL CLINIC Dept. 36 Excelsior Springs, Mo.**

**GET INTO
TELEVISION
ELECTRONICS
NOW!**

RADIO

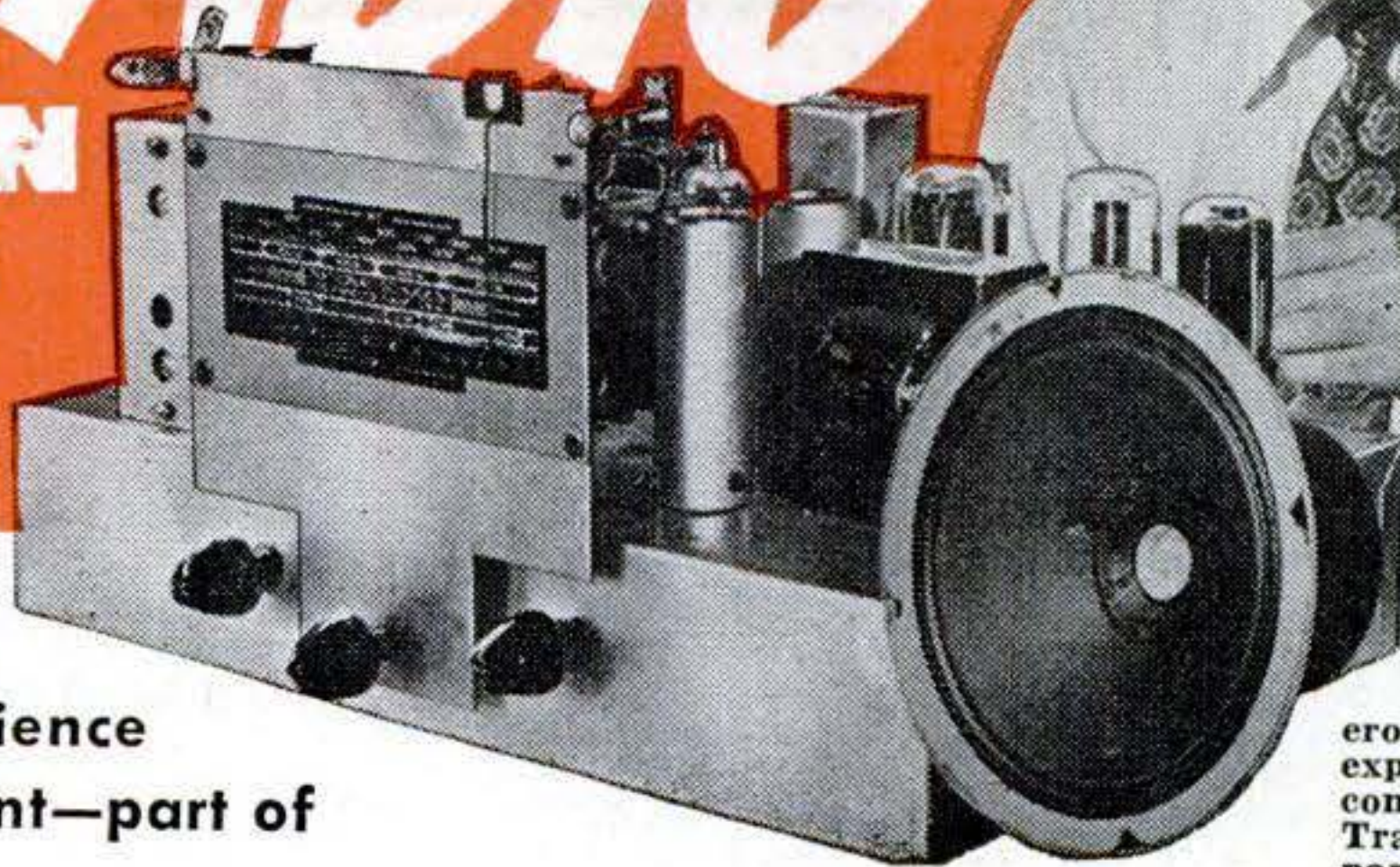

You build this complete, modern superheterodyne receiver with the experimental equipment that comes with your National Training. You keep all apparatus sent you.

Practical shop-type training gives you actual experience with Home Radio Equipment—part of

SHOP METHOD HOME TRAINING

By **National Schools of Los Angeles**
A Practical Technical Resident Trade School
for over 40 years

FOR YOU—A REAL HOME LABORATORY IN MODERN RADIO

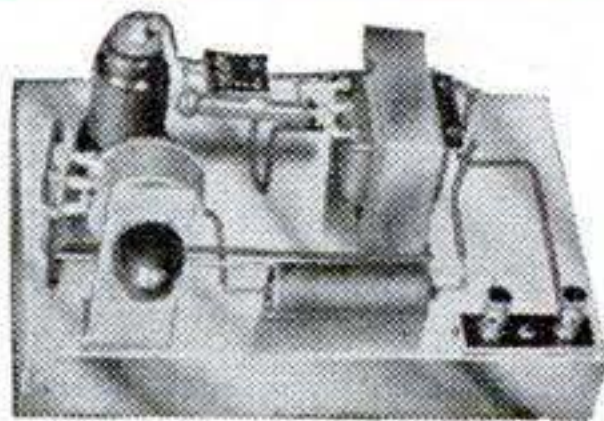

Your National Training Kits include equipment for over a hundred practical electronic experiments in your own home. You

get standard radio parts for this audio oscillator which you get to understand by building it yourself.

You learn modulation, beat frequencies, signal generation by actually building this small radio transmitter with your National shop parts.

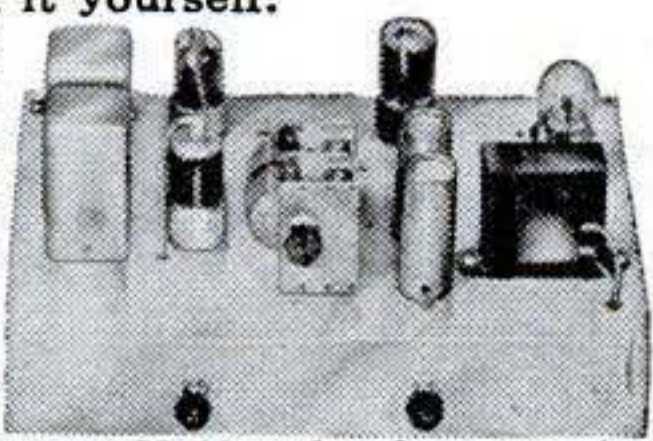

Your training outfits from National are made up of the most modern radio equipment—



much of it just out of the experimental laboratory. You learn new ways of handling equipment by modern

methods. Get the details by mailing the coupon.

A permanent faculty of experienced instructors and engineers stands behind all training from National Schools. These men are teaching every day right in our own **Television and Broadcasting Studios, Service Shops and Laboratories.** From first hand experience with students here at School, our instructors understand the aims and ambitions of men like you. All of our instructors, both home study and resident, have ideal facilities to make your training **practical, up-to-the-minute and interesting.**

Fine Opportunities Ahead

Learn how National training can fit you in your spare time for the **GREAT FIELD OF RADIO**—for the **NEW AND RAPIDLY EXPANDING BRANCHES—FREQUENCY MODULATION (F.M.), TELEVISION AND ELECTRONICS.** You train right in your own home yet have the **ADVANTAGE OF REAL SHOP EXPERIENCE** behind you. **The man who really knows modern Radio**

is in greater demand today than ever before—not only in Radio proper but in Television and Electronics—in Aviation, Transportation, Manufacturing, Communications. **Good jobs await the trained man,** in the production, operation and maintenance of modern Electronic equipment—in Radio stations, in hundreds of industries—in homes, stores, theatres and studios.

Send For Facts Today

You owe it to yourself to investigate how National Schools will prepare you for a **CAREER THAT WILL ASSURE YOUR SUCCESS AND SECURITY.** Send for the **FREE Manual.** **SEE FOR YOURSELF** just how you may readily qualify for opportunities in Radio, Television and Electronics. Read the catalogue we will send you. Then, make up your own mind. **For full information, without obligation, send your name and address on the coupon and mail it TODAY!**



VET-ERANS

During the War, National trained enlisted men under contract with the War Department. Now, we are training veterans, both resident and home study. If you are a Veteran qualified for training under the G.I. Bill, check the coupon below for special bulletin.

Here's Just a Few of the Interesting Facts you Learn with the

FREE MANUAL

1. Routine for diagnosing Radio Troubles.
2. Preliminary inspection of Receivers.
3. How to Test and Measure Voltages.
4. How to Test Speaker in Audio Stages.
5. How to Trace the Circuit and Prepare Skeleton Diagram.
6. Complete Reference Table for Quickly Locating Receiver Troubles.

G. I. APPROVED

NATIONAL SCHOOLS

LOS ANGELES 37, CALIFORNIA EST. 1905

MAIL OPPORTUNITY COUPON FOR QUICK ACTION

National Schools, Dept. 9-PS
4000 South Figueroa Street
Los Angeles 37, California

(Mail in envelope or paste on penny postcard.)

Mail me **FREE** the books mentioned in your ad including a sample lesson of your course. I understand no salesman will call on me.

NAME..... AGE.....

ADDRESS.....

CITY..... ZONE.... STATE.....

Check here if veteran of World War II

NATIONAL GRADUATES ARE SUCCESSFUL

Finds a Place in Radio Broadcasting

"I graduated from National three years ago at the age of 34. Since then I have been employed at Western Electric Co. and Federal Mfg. Co. On April 30 I joined the engineering staff of WKNE in Keene, New Hampshire, as Transmitter Engineer. Prior to my starting your course I didn't know a thing about Radio. My rapid rise in this field is evidence of what your school can accomplish with anyone who is willing to spend a few hours a day with your training. May I express my sincere thanks to National Schools." **FRANK J. SAMMER, Keene, New Hampshire.**

More Than Paid For Course in Spare Time

"I can sincerely say that my association in a few months with National Schools has paid off in dividends far greater than the tuition which is charged for the entire course, while at the same time increasing my savings. Since beginning your course, I have received promotions and at present hold the position of Radio Communications Chief full time." **FRANKLIN A. HILL, Indianapolis, Ind.**

**GET THE DETAILS.
USE THE COUPON!**

It's YOUR future—Make the most of it!



Start now to earn the bigger pay in electrical repair

WAS there ever such an opportunity to get started in electrical maintenance and repair—and at top-notch wages? Are you ready—with experience and ability—to cash in on it? Others are getting just the sort of background needed—quick! practical!—to handle the great variety of electrical maintenance and repair work TODAY—from this well-known electrical library. You can too!

THE LIBRARY OF ELECTRICAL MAINTENANCE AND REPAIR

5 vols., 1826 pages, 1724 illustrations

Gives you the "know-how" to tackle any wiring or motor job. Five books show you HOW—to install all types of motor and generator units—to inspect and repair motor starters and generators—to diagnose motor and generator troubles—to figure new windings for old cores—DC and AC windings—to test armature windings—test induction motors, etc., etc. One book is full of trouble-shooting charts that show quickly symptoms, causes, specific remedies, etc.

Take the first step toward improving YOUR future—Mail this coupon TODAY

No money down—special price—easy payments—FREE trial

McGraw-Hill Book Co., 330 W 42 St., New York 18, N. Y.

Send me for ten days' free examination the Electrical Maintenance and Repair Library. If satisfactory I will send you \$1.50 in 10 days and \$3.00 monthly until the price of \$16.50 is paid. If not wanted I will return books postpaid. (To insure prompt shipment write plainly and fill in all lines.)

Name.....
Home Address.....
City and State.....
Company.....
Position..... PSM-9-47

THE ONLY GENUINE WEBSTER IS THE

Merriam
WEBSTER

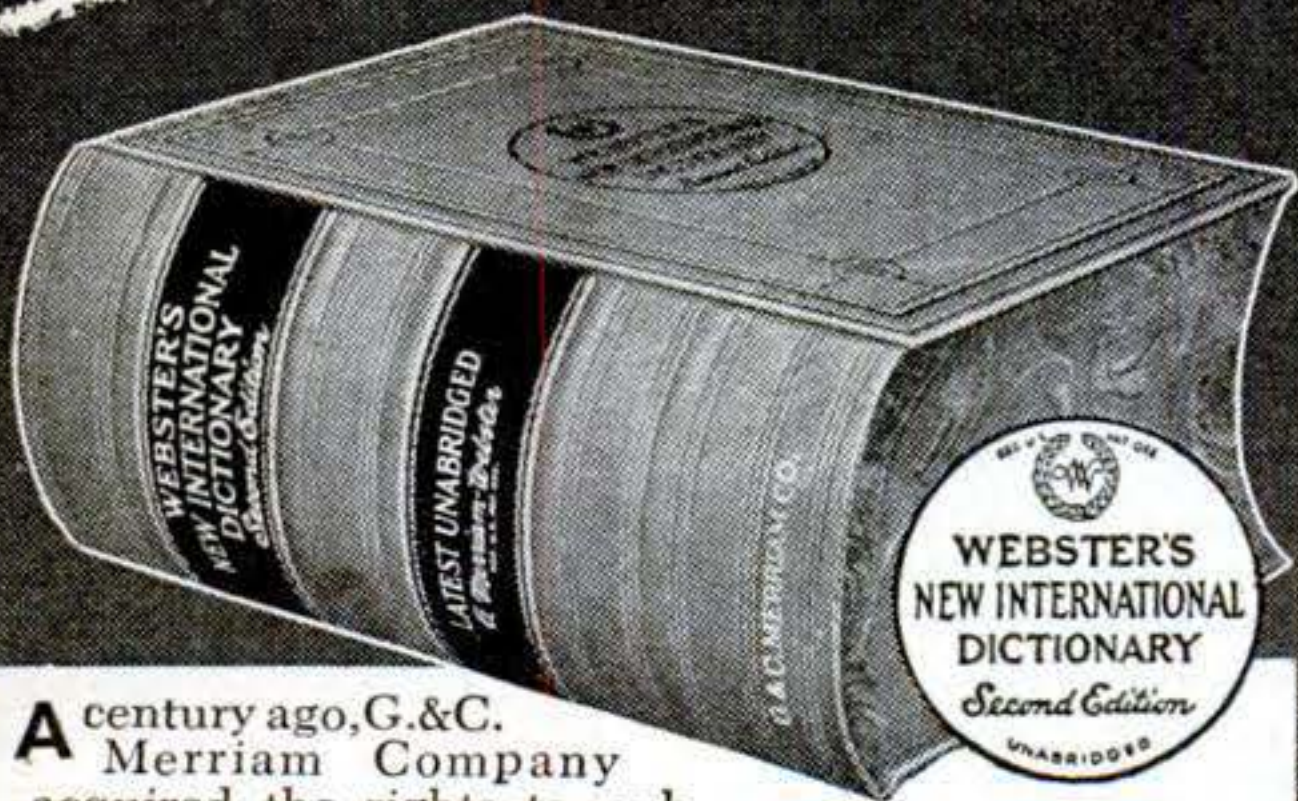

A century ago, G. & C. Merriam Company acquired the rights to publish Webster's Dictionary. Through the years, with each new edition, Merriam has constantly enlarged the scope and usefulness of Noah Webster's original work, until today the names MERRIAM and WEBSTER are equally important in identifying "The Supreme Authority." Ask for WEBSTER'S NEW INTERNATIONAL DICTIONARY, Second Edition—the great unabridged Merriam-Webster.

G. & C. MERRIAM Co., Springfield 2, Mass.

1847 A CENTURY OF PUBLISHING MERRIAM-WEBSTERS 1947

"THE SUPREME AUTHORITY"



THIS CAN BE YOU IN A FEW MONTHS!
BIG MONEY in Your Own

REFRIGERATION and APPLIANCE REPAIR BUSINESS

Do actual work daily in school shops. Train to repair all makes of ELECTRIC APPLIANCES, install and service oil burners. Learn basic electricity-motor rebuilding, etc. Fast, thorough 2-way training includes REFRIGERATION. Learn to install, service, maintain all types of domestic and commercial refrigeration equipment. VETERANS—your G. I. Bill pays you \$65 to \$90 a month PLUS entire cost of this training.



Write for FREE ILLUSTRATED FOLDER

MICHIGAN SCHOOL OF TRADES Inc.
31 MELBOURNE DEPT. PS-9 DETROIT 2, MICH.

BUILD THIS CONCRETE BLOCK MACHINE

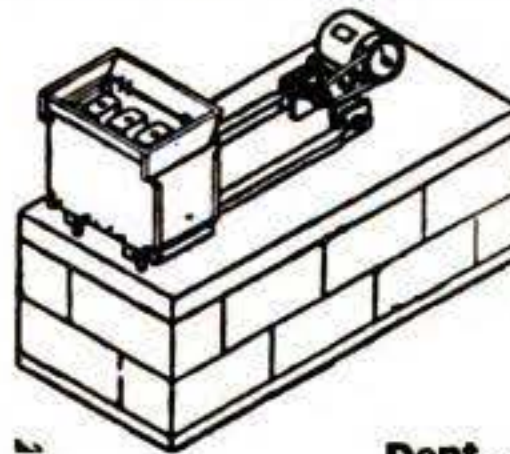

Sell blocks; or build your home, garage, barn, or filling station at 1/3 cost by making and laying your own blocks.

This simple machine which you can build yourself at a cost of \$15 (excluding motor) will make a block in 30 seconds using only one form. Mass production can be achieved by a new simple method of removing blocks which allows two to four forms to one vibrator. Power driven concrete mixer plans also. Send dime for details and "How to Make and Lay Blocks" folder.

U-BUILD-IT SERVICE

Dept. 4-A, 206 West Wilder St., Tampa 3, Florida



AMAZING DISCOVERY! Corrects poor penmanship in few days—big improvement in three hours, no failures. Complete Outline Free. Write, C. Ozment, 35-B, St. Louis, Mo. IMMEDIATELY.

STAY HOME AND MAKE MONEY!

—Men! Women! Get into profitable, uncrowded profession you can operate from your home or small office after short home training course. No capital required. No goods to buy. No age limit. Others earn \$50.00 to \$100.00 per week making famous Stephenson corrective foot devices to order. Foot sufferers everywhere pay gladly for relief. Send today for FREE BOOKLET. STEPHENSON METHOD, Established 1894, 12-62 South Market St., Boston, Mass.

New Designs in FRANZITE GRIPS

Modernize Your Gun! Improve Your Score!
Most durable grips made. Positively unbreakable! For Colt, Smith & Wesson, Hi-Standard, Ortgies, Luger & Mausers in a wide choice of beautiful designs in ivory, pearl, walnut, onyx, etc. Low prices. FREE CATALOG. Dealers Wanted.

SPORTS, INC., (Mfrs.) 5501 Broadway, Dept. S-9, Chicago 40, Ill.

LEARN TO WRITE

The Magazine Institute, a private school owned, operated, and staffed by successful writers and editors, offers an up-to-the-minute course in writing for magazines, which makes it easy for beginners to get started in this rich field. You work in spare time at home. You may concentrate on either fiction or non-fiction. Send today for the FREE CATALOG describing the Magazine Institute method. VETERANS: THIS COURSE APPROVED FOR VETERANS' TRAINING.

The Magazine Institute, Inc.
Dept. 469-E, 50 Rockefeller Plaza,
Rockefeller Center, New York 20, N. Y.

Please send free catalog, without obligation, to:

Name.....
Address.....

Check here if eligible under G. I. Bill
(Inquiries confidential. No salesman will call)

Now Any AUTO REPAIR JOB Can Be a "Push-Over" for You!

**IN LESS TIME —
WITH LESS WORK —
AND MORE PROFITS!**

MoToR's new AUTO REPAIR MANUAL shows you how to service and repair ANY part of ANY car! Now you can lick even the toughest jobs when you have this amazing Manual to make your work easier!

Every job on every car built since 1935 is explained as simply as A-B-C. Clear, illustrated instructions lead you step by step. NOW you can tackle ANY job from carburetor to rear end—and do it quick, easy, right, the FIRST time! Just look up make, model, and the job in the quick index of MoToR's AUTO REPAIR MANUAL—and go to work!

ONLY Manual of Its Kind

No wonder this manual is used by the U. S. Army, Navy, trade and technical schools everywhere, and thousands of successful auto servicemen!

To make this great book possible, the engineer-editors of MoToR Magazine condensed all the meat from 150 official factory manuals for you. They dug out all the information you need; made sure every word is crystal-clear; and put "the whole works" into this one great, handy book!

MoToR's AUTO REPAIR MANUAL is a big book: 856 large pages, 8½ x 11 inches, bound in sturdy covers. Nearly 200,000 ser-

vice, repair, adjustment, replacement, tune-up facts on every car built from 1935 through 1946!

Over 1,000 Pictures!

More than 1,000 cutaway photos, diagrams, drawings, charts, SHOW you what the clear text TELLS you! No wonder thousands of men call this amazing book their Auto Repair "Bible"! No wonder it will save YOU countless hours of work—and help you make MORE MONEY from auto repairs!

See for yourself—without cost!—what a work-saver, time-saver, and "life-saver" MoToR's AUTO REPAIR MANUAL will be for you! TRY it FREE—for 7 days. Learn first-hand how it can pay for itself the first few times you use it!

**FREE
7-DAY OFFER
SEND NO MONEY**

Just mail coupon below—without money! When the postman brings your book, examine it thoroughly. Make it show you what it's got! Unless you agree this is the greatest time-saver and work-saver you've ever seen—return book in 7 days and pay nothing. Mail coupon today! Address: MoToR Book Department, Desk 2-E, 572 Madison Ave., New York 22, New York.



Same FREE 7-Day Offer Applies on MoToR's Truck Repair Manual

For mechanics, truck specialists, service stations, fleet owners. Covers EVERY job on EVERY truck made since 1936! 1400 pictures, 952 pages, 300,000 facts. Used by Armed Forces. Warranted to contain every essential fact you need to know. Strong binding, size 8½x11.

Covers all types Gasoline Engines; Diesels and Hesselmans. Fuel Systems, Governors. Lubrication Systems, Ignition Systems, Starters, Generators, Clutches, Transmissions, Axles, Torque Dividers, Transfer Cases.

Brakes, Steering, etc., etc. Also services buses, farm and industrial tractors, contractor and road building equipment, stationary power machinery, etc. (on all parts described in Manual.)

Offered on same FREE 7-Day examination as Auto Repair Manual. Check box in coupon at right.



Published by MoToR, The Leading Automotive Business Magazine. MoToR's manuals assure high standards of repair work.



Clear, Pictured Facts on Every Job on Every Car Built Since 1935!

Nearly 200,000 service and repair facts on all these makes:

American	Crosley	La Salle	Packard
Bantam	De Soto	Lincoln	Pierce
Auburn	Dodge	Lincoln	Arrow
Austin	Ford	Zephyr	Plymouth
Buick	Graham	Mercury	Pontiac
Cadillac	Hudson	Nash	Reo
Chevrolet	Hupmobile	Oldsmobile	Studebaker
Chrysler	Lafayette	Overland	Terraplane
Cord			Willys

856 big pages; including 50 pages of carburetor text, charts, illustrations covering all models. Over 500 charts, tables: Tune-up Chart; Valve Measurements; Compression Pressure; Torque Wrench Reading; Starting Motor; Engine Clearances; Generator; Clutch & Brake Specifications; Front End Measurements, etc.; Engines; Electric, Fuel, Cooling, Lubricating Systems; Transmissions; Universals; Front Ends; Wheels; Rear Ends, etc.

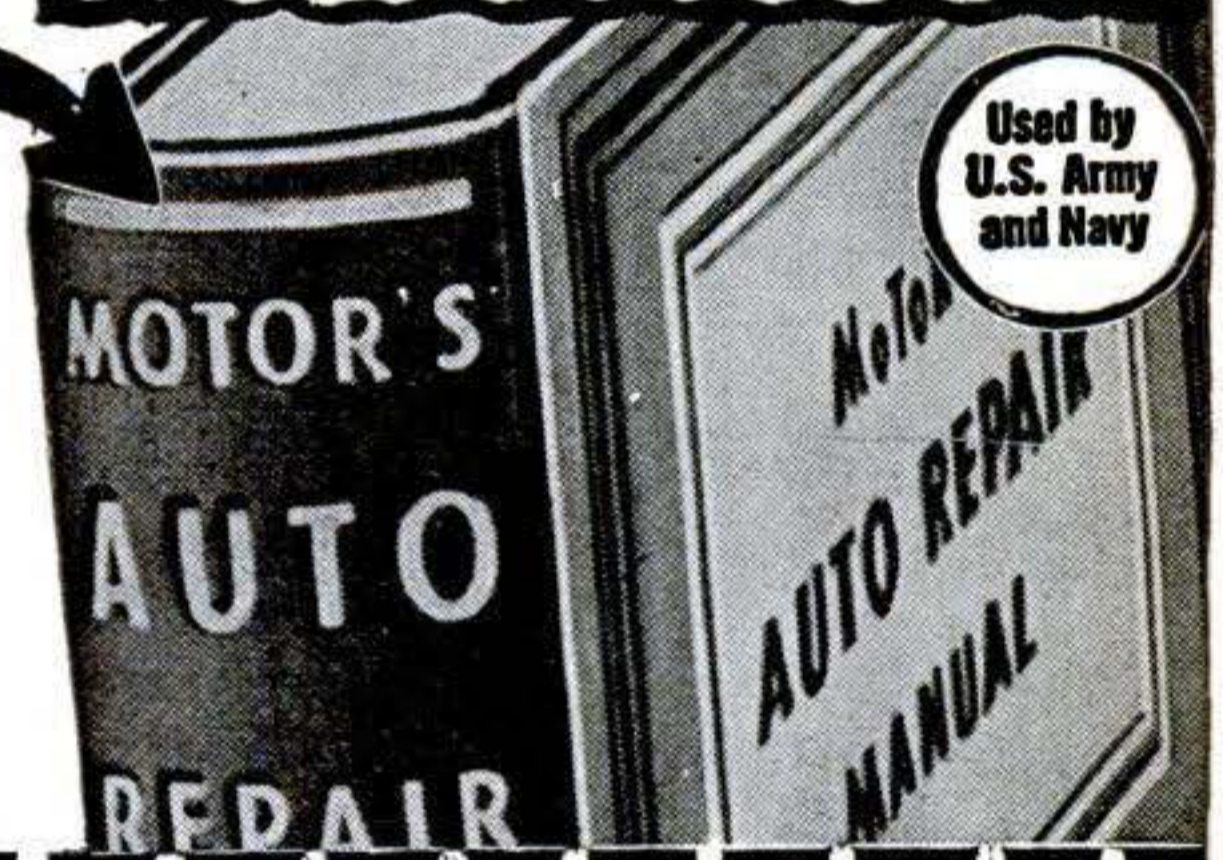

MoToR Book Dept., Desk 2-K, 572 Madison Ave., N. Y. 22
Rush to me at once: (Check box opposite book you want)

MoToR's AUTO REPAIR MANUAL. If O.K. I will remit \$1 in 7 days, (plus 35c delivery charge;) \$2 monthly for 2 months and a final payment of 95c a month later. (Book's price \$5.95.) Otherwise I will return book postpaid in 7 days. (Foreign price, remit \$8 cash with order.)

MoToR's TRUCK REPAIR MANUAL. (Described at left.) If O.K. I will remit \$2 in 7 days, and \$2 monthly for 3 months, plus 35c delivery charge with final payment (\$8.35 in all). Otherwise I will return book postpaid in 7 days. (Foreign price, remit \$10 cash with order.)

Print Name..... Age.....

Print Address

City..... (if any).....

State..... Occupation.....

SAVE 35c SHIPPING CHARGE! ENCLOSE full payment (check, m. o. or postal note) and we pay postage. Same 7-day return-refund privilege.

Learn to MOUNT Birds and Animals

Send Today for Free Book
Old reliable school (250,000 students) will teach you **AT HOME** to Mount **BIRDS, ANIMAL HEADS, FISH and TAN SKINS and FURS.** Write now—at once.

SPORTSMEN: Save your trophies. Game is growing scarcer—every **Specimen** is valuable. Keep them—save them—mount them. Decorate your den. Fun and fascination. Profits, too.

TAN heavy and light skins and furs. Make real **HARNESSE LEATHER, BUCK SOLE LACE, ETC.** Best method known, but easy and simple. Don't sell those hides cheap. Tan them for your own use. Make leather vests, belts, gloves, etc. **TAN FOR OTHERS.**

FUR-WORK for men and women. Tan and make up scarfs, capes, coats, muffs, mitts, trimmings. Quickly, easily learned.

EXTRA MONEY \$40 to \$80 a month, even more some students report. Big demand for **TAXIDERM, TANNING AND FUR-WORK.** A real spare-time business—good in every community. If you need extra money, **WRITE!**

FREE BOOK
48 pages, 100 beautiful pictures, tells **ALL** about Taxidermy, Tanning, Fur-Work. Write Today—this minute for this **STRANGE, MARVELOUS FREE BOOK.** A postal will do. State **AGE.**
N. W. School of Taxidermy, 9396 Elwood Bldg., Omaha, Neb.

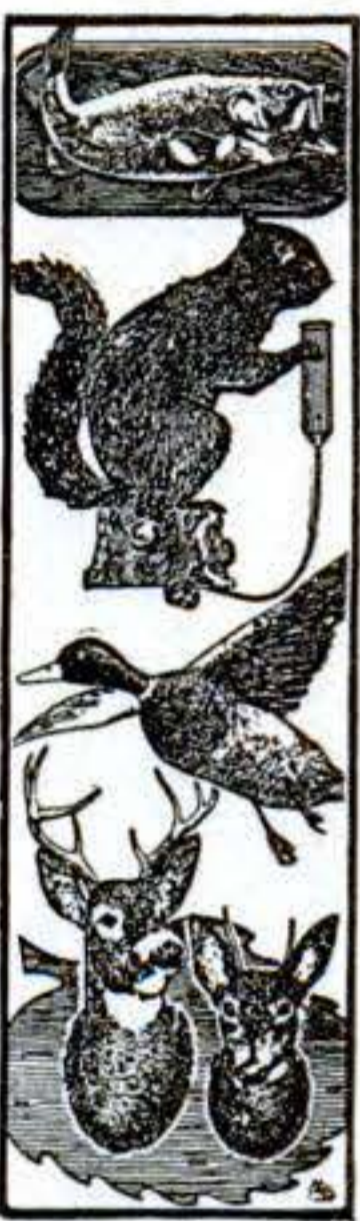

AVIATION Career

MAXIMUM TRAINING IN MINIMUM TIME
CAL-AERO TECH TRAINING will add dollars to your pay check all the rest of your life. Specializing in **AERONAUTICAL ENGINEERING** and **MASTER AVIATION MECHANICS** since 1929, Cal-Aero Tech training is carefully designed for just one thing—**TO MAKE MORE MONEY FOR YOU.** An alumni of over 6000 successful graduates proves our career training is unsurpassed.

VETERANS —Write us about Aviation Training, as provided under "G.I. Bill of Rights."
CAL-AERO TECHNICAL INSTITUTE
MAJOR C. C. MOSELEY PRES. SINCE 1929
FORMERLY CURTISS-WRIGHT TECHNICAL INSTITUTE
**GRAND CENTRAL AIR TERMINAL
GLENDALE 1, CALIFORNIA
LOS ANGELES COUNTY**

MAIL THIS COUPON TODAY!

Cal-Aero Technical Institute, Grand Central Airport, Glendale 1, California
Please send full information on Aviation Training **FREE**—without obligation. Dept. PS-9

Name _____ Birth Date _____
Street _____
City _____ State _____

Amazing! POCKET OR PURSE SIZE NEW RADIO

WORLD'S SMALLEST RADIO KNOWN!
Wt. only 1/4 lb. Beautiful Silver Black plastic case. Has Inductive Slide Tuner—W4 Crystal Diode—NO TUBES, BATTERIES OR ELECTRIC "PLUG IN" NEEDED!

GUARANTEED TO PLAY • NEW 1948 MODEL
on local stations if complete instructions sent are followed. Use it at home, in bed, in many offices, hotels, cabins—most anywhere! Hundreds of satisfied customers all over the world!

SEND ONLY \$1.00 (Cash, M.O., Check) and pay postman \$2.99 plus delivery fees on arrival or send \$3.99 for Post Paid delivery. Complete as shown—ready to play with self contained personal phone . . . **WONDERFUL GIFT FOR CHILDREN!** Order now at this low bargain price.—Prompt shipment on orders sent now—today! Be first to get YOUR Pakette Radio! (All foreign orders \$5.00 U.S. cash with order).

Pa-Kette Radio Co., Inc. Dept. PS-9 Kearney, Nebraska

Thrilling Work COLORING PHOTOS

Fascinating vocation learned at home by those with aptitude. Thrilling pastime. National method brings out life-like colors. Free booklet.

EASY TO LEARN **NATIONAL PHOTO COLORING SCHOOL**
1315 S. Michigan, Dept. 1366, Chicago 5

Learn LANDSCAPE GARDENING

A thorough, interesting, home study course for those who wish to become Landscapers, Gardeners, Designers etc.. for profit or pleasure. Write today for Free Book to

APPROVED NATIONAL LANDSCAPE INSTITUTE FOR VETERANS Dept. PS-9, 310 So. Robertson. Los Angeles 36

Begin today. Write now for our Free Book. "How to Become a Good Penman." It contains specimens and tells how others learned to write in spare time. Enclose 10c for your name beautifully written and a pen point suitable for shaded writing. Write today.

THE TAMBLYN SCHOOL OF PENMANSHIP
N-439 Ridge Building, Kansas City, Mo.

INVENTING

—FOR PROFIT!

If you have an inventive turn of mind, write for free 28-page booklet explaining how the Institute of American Inventors is helping inventors pre-test the profit possibilities of proposed devices to fill today's unprecedented demand for new inventions.

INSTITUTE OF AMERICAN INVENTORS
Dept. 3, 1926 Eye St. NW. Washington 6, D. C.

INVENTORS

The question as to whether a subject matter is patentable can be substantially determined by a search of the U. S. Patent records. Without obligation, write us for full information on what steps an inventor should take to secure a Patent or Trademarks.

RANDOLPH & BEAVERS
Registered Patent Attorneys
905-L Columbian Building, Washington 1, D. C.

PATENTS AND TRADE MARKS

C. A. SNOW & CO.
REGISTERED PATENT ATTORNEYS
WRITE FOR INFORMATION TO
426 SNOW BUILDING, WASHINGTON 1, D. C.

INVENTORS

IF YOU WISH TO PROTECT YOUR INVENTION, You should take steps to protect it by a U. S. Patent. Write me for "Record of Invention" form.

CARL MILLER
REGISTERED PATENT ATTORNEY

Woolworth Bldg., 35th Floor, Dept. 97C, New York City
Please send me "Record of Invention" form.

NAME _____
ADDRESS _____

Here's the **NEW CAMERA** that

SNAPS, DEVELOPS and PRINTS PICTURE
On the Spot in only 10 minutes



• Here at last, fully guaranteed on this by mail offer . . . the miracle camera everyone's talking about! It's the famous compact, well made SPEED-O-MATIC that SNAPS, DEVELOPS and PRINTS your picture on the spot in less than 10 minutes. Startling, yet the amazing thing is even folks who never handled a camera before can get professional results . . . clear, sharp, clean pictures . . . every time! Simple, this wonder camera practically does everything for you. And you SEE that picture right after taking it. Economical, 12 pictures, film paper, prints and all are only \$1 complete, less than 8½c each!

Delivery now by mail at nationally advertised \$12.95 price if you mail the coupon! Each camera fully guaranteed.



- Takes and prints 3" x 2" pictures (5" x 3" enlargements 3 for 25c)
- 5 lens openings
- No focusing
- No negative . . . picture printed direct on film paper
- Own built in light meter
- Camera convenient 3 x 4 x 5 size . . . handsome, lifetime construction
- Price only \$12.95
- Film, 12 pictures, complete \$1
- Fully guaranteed

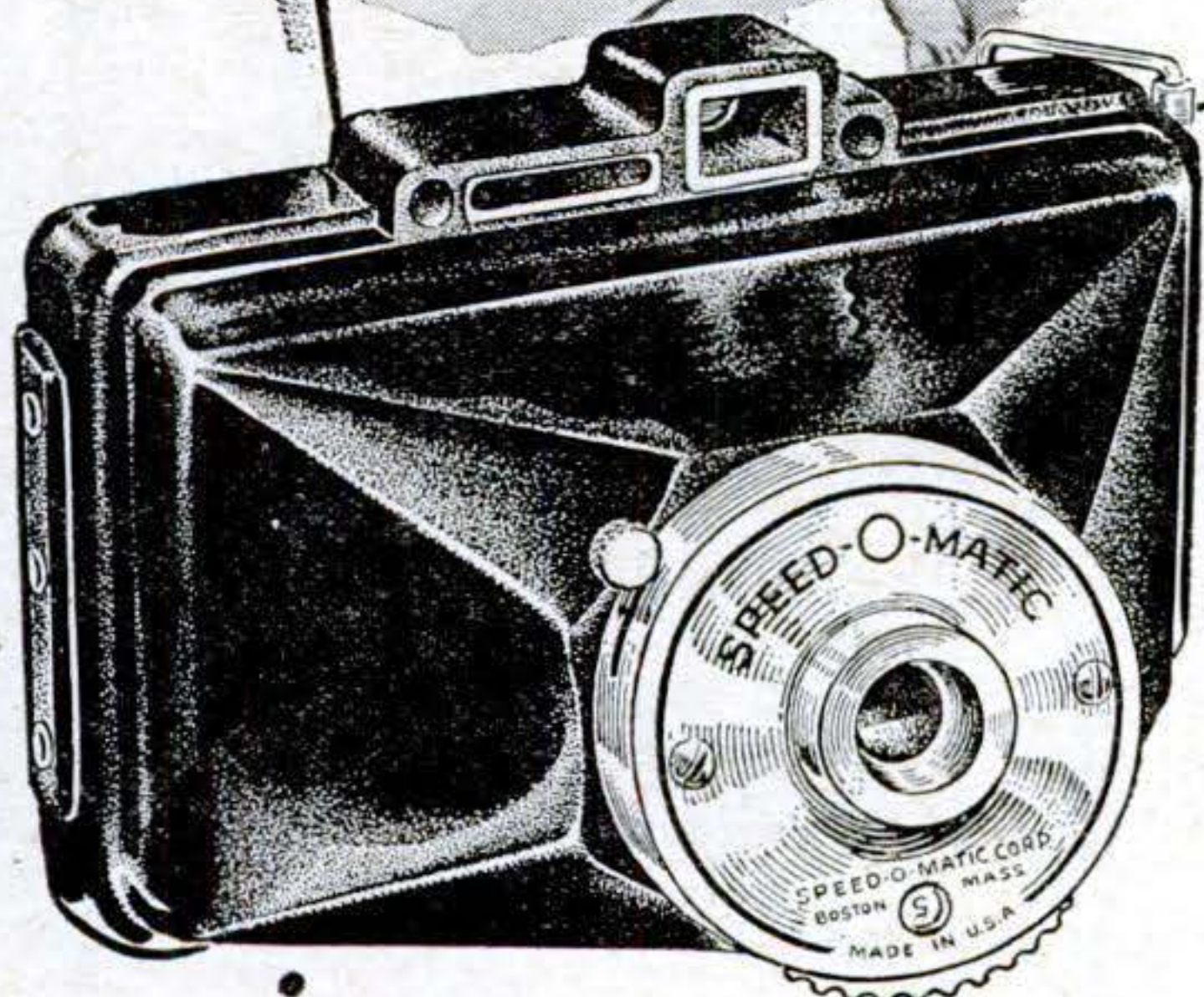

SEND NO MONEY *Trial Convinces*

Send for this amazing new camera invention that snaps, develops and prints own picture on the spot in 10 minutes. Send no money. On arrival deposit only \$12.95 for camera and \$1 for each film pack ordered (12 pictures) plus C.O.D. postage. Camera carries maker's registered guarantee so you take no chances. Don't wait. Mail your order for camera today. (State how many film packs you want). Cash orders mailed postage prepaid.

WONDER CAMERA CO., Dept. 48-L

Authorized Mail Order Distributors

2445 E. 85th St.

Chicago 17, Ill.

SUCCESS BRINGS

THE GOOD THINGS OF LIFE



FIND OUT ABOUT OPPORTUNITIES IN INDUSTRIAL ELECTRONICS

It's a perfectly natural human desire to want more money, a better job, prestige and all the other good things of life. Who gets them? Look about you. Success you will see, comes to the man who is trained for his job.

A new world of opportunity is today beckoning to ambitious men. One of the most important and exciting fields is **INDUSTRIAL ELECTRONICS**. It is attracting experienced electrical men as well as younger fellows seeking a way to bigger earnings and a more secure future.

OPPORTUNITY LIES AHEAD

Industrial Electronics is not Radio. It has nothing to do with radio transmitters and receivers. It is totally new application of electric power, applied to modern production by means of the magic of the vacuum tube. Everywhere industrial electronic devices are replacing the old-time electrical controls, and processes. Industrial Electronics is Modern Industrial Electricity.

"Every electrician should know—must know—Industrial Electronics." That's what many Union leaders are telling their members, today. They know that the use of Industrial Electronics devices is growing by leaps and bounds. They know that to install and service this equipment, even the best of present-day electricians must first have had special training.

GET READY NOW!

Now is the time to get into Industrial Electronics, while the field is in its infancy . . . and while it is rapidly developing a need for thousands of trained experts. Tomorrow's leaders are training today. And here is a School equipped in every way to train you for Industrial Electronics work—one of the largest and most completely equipped, and one of the few of its kind in America—a School that already has trained thousands of men for industrial opportunities.

LEARN AT HOME OR COME TO OUR SCHOOL

Learn Industrial Electronics—now, while the time is ripe. You don't need any advanced schooling or previous experience. If you are at all mechanically inclined and have gone to high school for at least one year or have an equivalent education, we can teach you Industrial Electronics.

You can take most of your training at home, in your spare time—or you can come to Chicago and take your entire training in our completely equipped shops and laboratories. Either way you quickly acquire the fine points, practical skill, and broad, technical "know how" that makes the expert Industrial Electronics Technician.

A GUIDE FOR YOUR FUTURE—Complete facts about Industrial Electronics. Packed with pictures. Tells all about our successful training plan. Coupon will also bring details about moneymaking opportunities for trained men and our Life-Time Free Employment Service. No obligation. Mail coupon TODAY. Investigation may start you up the ladder of Success.

AUTHORIZED TO ACCEPT VETERANS FOR G.I. TRAINING

INDUSTRIAL TRAINING INSTITUTE,
2150 Lawrence Ave., Dept. P2JL Chicago 25, Ill.

Please send me, FREE, your "Camera Visit" booklet and information about the opportunity for trained men in **INDUSTRIAL ELECTRONICS**. It is understood that I will be under no obligation.

NAME.....

ADDRESS.....

CITY..... STATE.....

ARE YOU A VETERAN?.....

SEND FOR THIS BOOK —IT'S FREE



GET THE FACTS ABOUT AMERICA'S FOREMOST SCHOOL OF PRACTICAL TRAINING.

STUDY AT HOME

With An Educational Institution

Men with specialized training win higher positions, insure larger earnings, and are bigger successes in business and public life. Opportunities NOW greater than ever before. Send for our Catalog.

ARTS and SCIENCES

Courses in Philosophy; Education; Letters; Public Health; Medical Jurisprudence; Psychology; Sociology; Physics; Chemistry; Plastics; Geology; Political Science; Theology; Business and Commerce; Accounting; Mathematics; Statistics; Agriculture.

ENGINEERING

Courses in Electrical, Civil, Mechanical, Drafting, Architectural, Steam, Aeronautical, Radio, Structural, Mining, Industrial, Petroleum, Marine, Chemical, Diesel, Automobile, Refrigeration, and Air Conditioning Engineering.

LAW

Complete Professional Law Course includes 18 Hornbrook Series college grade textbooks. Courses also in Commercial Law, Patent Law and Medical Jurisprudence.

McKinley-Roosevelt Incorporated, 4610-AB, Sheridan Rd., Chicago 40, Ill.

"YOU ARE UNDER ARREST!"



Help Bring Crooks to Justice Through Scientific CRIME DETECTION!

I have taught thousands this exciting, profitable, pleasant profession. Let me teach you in your own home. Learn Finger Printing, Firearms Identification, Police Photography, Secret Service Methods thoroughly, quickly, at small cost. 53% of all American Bureaus of Identification employ I. A. S. students or graduates. I can prepare you for this fascinating work, during spare time. Write today, stating age, for "Blue Book of Crime."

INSTITUTE OF APPLIED SCIENCE, 1920 Sunnyside Ave., Dept. 1366, Chicago 40, Ill

"How to Make Money With Simple Cartoons"

A book everyone who likes to draw should have. It is free; no obligations. Simply address

CARTOONISTS' EXCHANGE

Dept. 199-D

Pleasant Hill, Ohio



CORRESPONDENCE COURSES IN RADIO and ELECTRICAL ENGINEERING

Tuition \$25

ELECTRICAL ENGINEERING. Get good grasp of wide electrical field. Modern. Very understandable. Theory made easy.

RADIO ENGINEERING. Extra fine course in radio, public address, photo-electric work. Trains you to be super-service man, real vacuum tube technician. Tuition ONLY \$25. either course. Deferred payment plan. Servicemen needed badly.

FREE Write for free copies of school catalogs, student magazines, etc. **LINCOLN ENGINEERING SCHOOL, Box 931-S-105 LINCOLN, NEBR.**

APTITUDE TESTS

discover the kind of work or studies best for your success! You get a personal report—a guide for life—more happiness—more prosperity. (for men, women, boys, girls.) Write for complete facts

VOCATIONAL COUNSELING INSTITUTE
5057 Woodward Ave., Detroit 2, Michigan



MECHANICAL DENTISTRY

To make Crowns, Plates, Bridgework, etc., for Dentists. Easy practical way to learn mechanical dentistry at home in spare time. FULL EQUIPMENT OF TOOLS AND MATERIALS INCLUDED WITH COURSE. Low tuition. Easy terms. Write for FREE BOOK about this money making profession that is not affected by the machine age.

MCCARRIE SCHOOL OF MECHANICAL DENTISTRY
207 N. Broad St. Dept. 866 Philadelphia, Pa.



LEARN MEAT CUTTING At Home — In Spare Time

Get into the vital meat industry. Concise, practical Home Training based on 25 years proven instruction methods used at National's famous resident school. Prepares you for bigger pay as Meat Cutter, supervisor, market manager or more money in your own store. Go as rapidly as your spare time permits. Diploma. Start NOW to turn your spare hours into money. Send for FREE bulletin today. No obligation.

National School of Meat Cutting Inc., Dept. O-58, Toledo 4, Ohio

Now

YOU CAN HAVE IMPROVED NO-DRIFT FM
in the Sensational New 1948
MIDWEST RADIOS

NEW SERIES
16*
SUPER DE LUXE
AM-FM
CHASSIS

Here is the finest radio Midwest has ever produced in its 28 years of manufacturing—a world-ranging, 5-band radio with improved Midwest No-Drift FM . . . plus Standard Broadcast and 3 short wave bands, Television Audio Switch-over, and Color-Ray Tone Selection. The Series 16* Super De Luxe Chassis is a powerful, magnificently-toned radio that challenges comparison for performance, sensitivity, selectivity, and advanced engineering features. Supplied with satin stripe copper finish panel—ready to mount in your present cabinet. Send today for the FREE 1948 Midwest Radio Catalog. Buy your radio direct from the manufacturer on Easy Terms and 30 Days Trial and SAVE!



14 1/2"
PANASONIC
SPEAKER

5
WAVE
BANDS

*SERIES
16 CHASSIS USES ALL
THESE LATEST-TYPE TUBES

30
DAYS
TRIAL

LOW
FACTORY-
TO-YOU
PRICES

EASY
TERMS

A COMPLETE LINE OF FINE RADIOS AND RADIO-PHONOGRAPHS . . . Available in Separate Chassis Like the Powerful Series 16* AM-FM Model above, or in beautiful Radio-Phonograph Consoles like this:



SYMPHONY GRAND AM-FM
RADIO-PHONOGRAPH CONSOLE
 with **NEW Intermix AUTOMATIC**
(RECORD CHANGER)

Our Finest! A superbly beautiful musical instrument . . . a masterpiece of furniture design and radio engineering that offers the sensational Midwest NO-DRIFT FM, Automatic Intermix Record-Changer, Exclusive Color-Ray Tone Selection, World-ranging 5-Band Reception, Television Audio Switch-Over, and many more new and exclusive features.

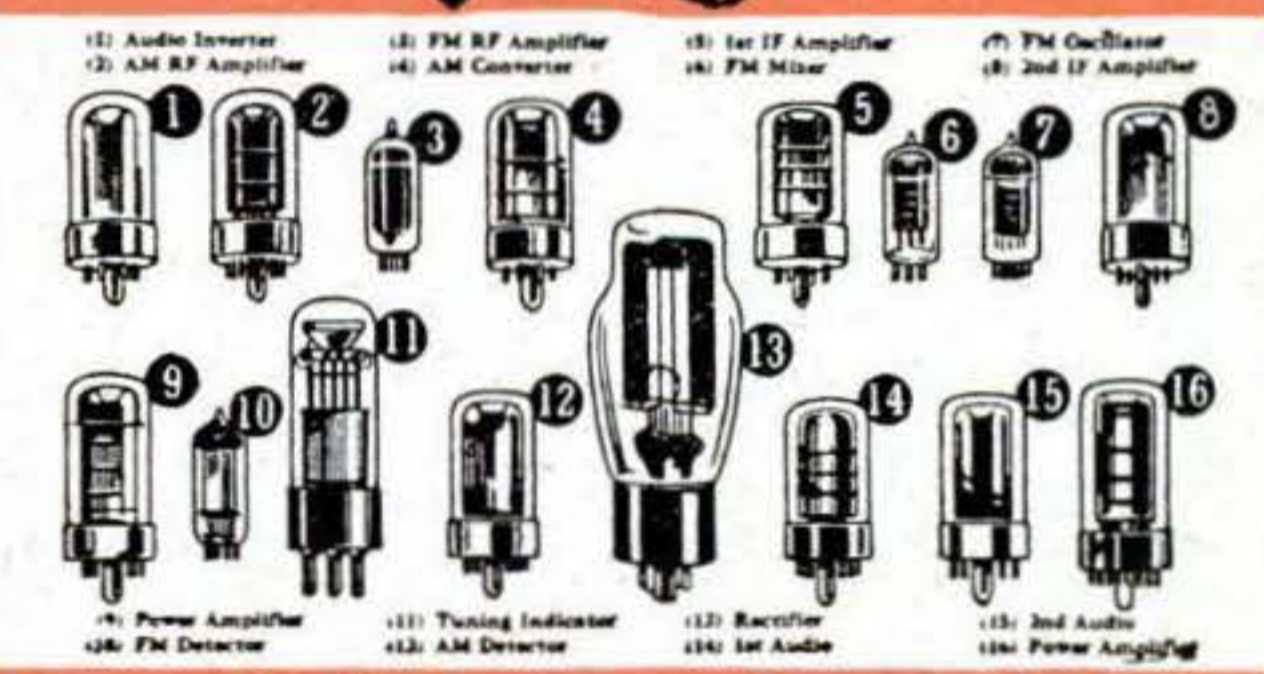

Scores of NEW Features such as the Exclusive **MIDWEST TRI-MAGNADYNE COIL SYSTEM** and **COLOR-RAY TONE SELECTION**

Rush for Free Catalog!
 FILL IN COUPON AND MAIL TODAY OR JUST SEND YOUR NAME AND ADDRESS ON 1c POSTCARD

MIDWEST RADIO CORP.
 Dept. 24-K, 909 Broadway
 Cincinnati 2, Ohio

Gentlemen: Please send me your new FREE catalog and details of your liberal 30 Days Trial.

Name _____
 Address _____
 City _____ Zone _____ State _____

MIDWEST RADIO CORP.
 Dept. 24-K • 909 BROADWAY • CINCINNATI 2, OHIO



TRAINING COUNTS MOST IN AVIATION

Get the right kind of training for a **SUCCESSFUL AVIATION CAREER** at Embry-Riddle's internationally known School of Aviation—in air-minded Miami. Intensive, practical courses—CAA approved. Authorized training under G.I. Bill.

You can become a flying mechanic, certificated A & E mechanic or instrument technician. Or study radio; operation and maintenance; design engineering; flight. Instruction covers whole field of aviation. Immediate enrollment.

It's always Summer in colorful Miami—the aerial crossroads of the Americas!

MAIL THIS COUPON—TODAY!

Dean of Enrollments—Dept. 51
Embry-Riddle School of Aviation
Miami 30, Florida

Send free information on Aviation Training to:

Name.....Age.....

Address.....

City.....State.....

Check One Veteran Non-Veteran

Get into a Big Branch of the Automobile Industry

Body & Fender Rebuilding



Body and Fender Rebuilding one of best paid fields in automobile industry. Body and Fender shops make good profits in garages, service stations. Excellent opportunities for men who look forward to business of their own.

Begin Training at Home or Come Directly to Shops

Begin your training at home in spare time, finish in our big modern shops, or come directly to shops. At home you get C.T.I.'s SHOP PROVED HOME STUDY instruction—actual shop experience has gone into the practical lesson assignments. That is why it is easy for mechanically inclined men to learn by our Home Study training and start on actual Body and Fender Work. CONSULTATION AND PLACEMENT SERVICE WHETHER YOU ARE INTERESTED IN WORTHWHILE JOB OR SETTING UP YOUR OWN BUSINESS. Opportunities for full and part time earnings.



A NATIONALLY KNOWN INSTITUTION

VETERANS qualifying under "G.I. Bill" have all expenses paid by Government plus monthly subsistence while in school. Just mail coupon, we will handle all details. (LOW TUITION, EASY TERMS if you are not a veteran.)

Fill Out, Cut Out, Mail Today

FACTS FREE for Men Who Want to Get Ahead
CHICAGO MOTIVE TRADES INSTITUTE, Dept. F-19
(Division Commercial Trades Institute)
1400 W. Greenleaf, Chicago 26, Ill.

Send free illustrated Brochures and other information about Body and Fender Rebuilding.
() Veteran () Non Veteran

Name.....

Address.....

City.....State.....

Learn Penmanship

One should learn **Rapid Business Writing**, both for his own satisfaction and for the convenience of those who must read it. And if Fancy Shaded Writing is learned also, it makes one a still more skilful penman. **Good penmanship prevents costly errors and helps to secure and hold good positions**, and, like music or elocution, naturally attracts persons of refinement and artistic inclinations. If you are dissatisfied with your present handwriting and wish to become a **good writer**, write for my **FREE BOOK**, "How to Become an Expert Penman," which contains specimens of penmanship and shows what others have learned by my **Simplified Method**. If you enclose 10c, I will send you one of my Favorite Pen Points suitable for plain or shaded writing, and your name with a beautiful flourished bird written on a card. **Begin Now. Write for your copy of the Free Book today.**

T. M. TEVIS, BOX 25-R, CHILLICOTHE, MO.

Now CHEAP OIL BURNER

FOR HEATING AND COOKING STOVES - FURNACES
HEAT YOUR HOME, COOK YOUR MEALS
WITH CHEAP FURNACE OIL

NO MORE SHOVELING COAL OR ASHES. Sensational Fuelizer Starter Vaporizing System turns Cheap No. 1 Furnace Oil, also Range, Heater, Tractor Distillate, Kerosene and like oils into oil heat—one of the quickest, hottest fires known. **LIFETIME GUARANTEE. \$1.00 Bonus Offer for Testing.** We will let you try it in your own stove or furnace for one month. Get yours for introducing. Big profits **QUICK**. Be first. Send in your name today for details and cash in on the tremendous demand for this Amazing Invention.

NORTHWEST MFG. CO. 606-L, Mitchell, S. Dak.

INVENTIONS WANTED AT ONCE

Patented or unpatented inventions, all types needed by manufacturers. Write for free booklet "MARKETING YOUR INVENTION" and Protective Disclosure Form. We have a tremendous list of firms who may pay cash or royalties for good inventions. For full particulars, write today.

NATIONAL INVENTION SERVICE
1404 Mitchell Street, Dept. A Oakland 1, Calif.

RELEASE the Full Power of YOUR MIND

Send for free booklet telling how you can achieve success and reach your personal goals. Find out how to remove frustrations, inferior feelings and worry thru **PSYCHO-MENTALISM**. Learn how to make your subconscious mind work for, not against, you. Write today. No obligation. **PSYCHO-MENTALIST INSTITUTE**, Administration Building, Dept. 11-J, Covina, California



A PENNY POSTCARD MAY CHANGE YOUR FUTURE...

Get full information on the coin-operated vending machine industry. Start with a few machines and build a wonderful future. We'll give you complete advantage of our "know-how." Send for Free Booklet Today—No Routes Sold!

PIONEER VENDING SERVICE

ADDRESS ALL MAIL TO DEPT. PS

461 SACKMAN ST. • BROOKLYN 12, N. Y.



ILLUSTRATED COMIC BOOKLETS

THE KIND MEN LIKE!
(VEST POCKET SIZE)

They are loaded with rare cartoons. Full of Fun and Humor. **20 DIFFERENT** booklets sent prepaid for \$1 in plain wrapper. Sorry... no C.O.D.'s.

GRAYKO, Dept. 1072 Box 520, G.P.O., N.Y.C. 1

MICROSCOPES & SCIENTIFIC INSTRUMENTS
SUPPLIES-ACCESSORIES
B&L SPENCER NEW & USED LEITZ ZEISS
BOUGHT-SOLD-EXCHANGED-REPAIRED
Send for **FREE LIST**
NATIONAL SCIENTIFIC INSTRUMENT CO. 119 CHAMBERS ST. NY. 7
MEDICAL INDUSTRIAL AMATEUR



NOW! ... Build Your Future on

DIESEL OPPORTUNITIES

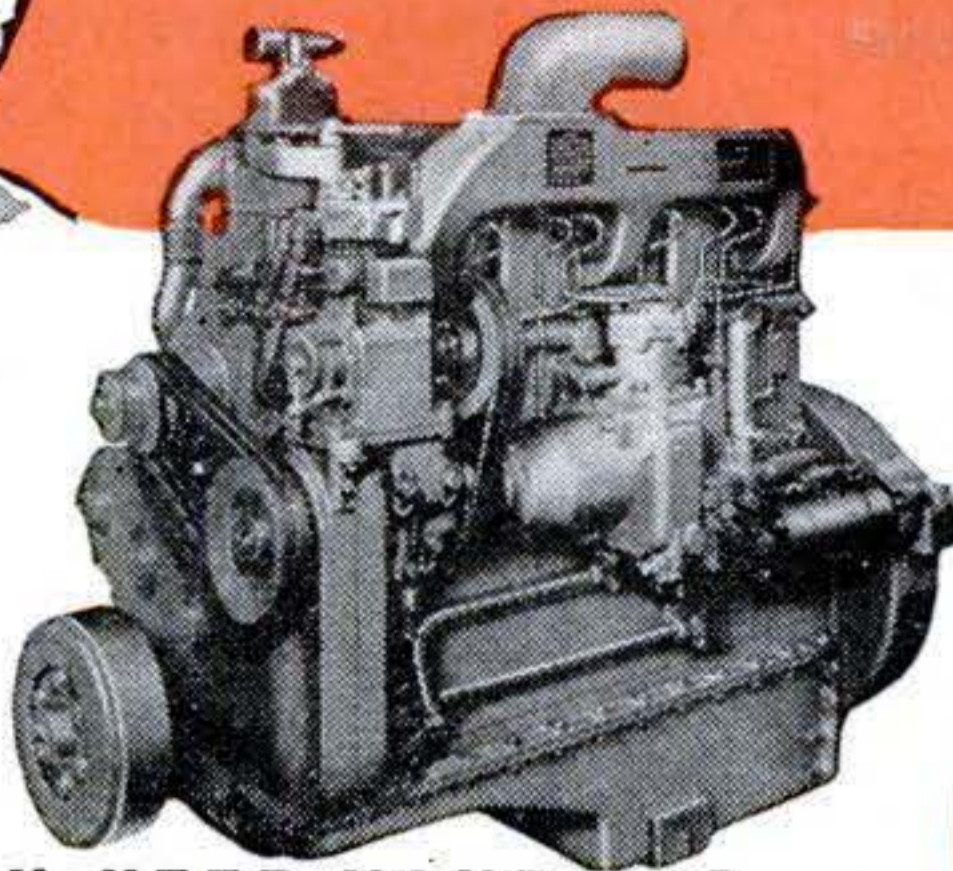

Compact Diesel Truck Engine

6 cylinders, 5- $\frac{1}{8}$ " bore and 6" stroke, maximum horse power rating 200 H.P. at 2100 RPM.

Prepare Now

WHILE YOU KEEP YOUR JOB ...

If you are between 17 and 60 and mechanically inclined, you can get thorough, individual instruction at home. With U.E.I. balanced training, you learn first through home study the fundamentals of Diesel in all its phases, in practical, easy to understand lessons. We show you how Diesel Engines operate, how fuel systems work, repairs, latest accessories & auxiliary equipment.

ACTUAL SHOP PRACTICE

Then you get valuable practice in our big shop, working on costly equipment under expert Diesel men. This course is new, up to the minute, includes latest techniques. UEI offers placement service for graduates and numerous other features. Now in our 21st year. Coupon brings complete information.

DO IT NOW! It costs you nothing to get all the facts about Diesel opportunities and training. But time is important—send coupon today!

Diesel Power is Going Places

You don't have to look far to see Diesel Power in action these days. Trucks, buses, tractors, railroads, ships, power plants, farm and road equipment—more and more depend on Diesel each day. On the farm, in factories, in communities, large and small—Diesel is growing as it proves to be efficient, economical, dependable, streamlined power.

DIESEL KNOWLEDGE is Earning Power

THE NEW AND INCREASING USES OF DIESEL open a broad field for trained men who can install, maintain, operate and repair DIESEL EQUIPMENT. Now is the time to prepare for these opportunities.



ON LAND



ON WATER



IN INDUSTRY

Mail Coupon for FREE FACTS

UTILITIES ENGINEERING INSTITUTE, Dept. 397D, Diesel Division, 2521 N. Sheffield Ave., Chicago 14, Ill. Please send me FREE facts about U.E.I. training and opportunities in the field checked below.

- Diesel Refrigeration Welding
 Auto Body & Fender Repair Air Conditioning

NAME _____ Age _____

ADDRESS _____

CITY _____ Zone or County _____ STATE _____

If World War II veteran give length of service. Check here for special information if you are under 17.

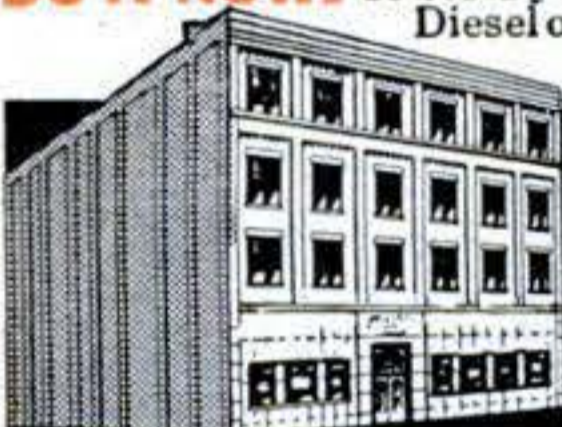

UTILITIES ENGINEERING INSTITUTE

2521 N. Sheffield Ave.

Dept. 397D

Chicago 14, Ill.

Make MORE MONEY

Learn

Screen Process Printing I SHOW YOU HOW This Easy Way at Home!

1 HOW TO START YOUR OWN BUSINESS

—My training shows you how you may start your own business and cash in on the tremendous field open to you in Screen Process—with an investment of a few dollars.

2 HOW TO GET A GOOD PAY POSITION

—Many of my students earn extra money in spare time at home, while learning. My special "Earn While You Learn" lessons, with the Kit of Supplies I give you—show you how.

3 HOW TO EARN EXTRA MONEY IN SPARE TIME

—If you are in the rut of a low pay, uninteresting job, Screen Process work offers you the opportunity to earn good wages and the better things of life for you and your family.

Send for FREE BOOK

My big free illustrated book, "Opportunities in Screen Process," explains the big demand for Screen Process printed Signs and Displays, Toys and Games, Textiles, Decal Transfers, Plastics and Glass, Pictures and Greeting Cards, Advertising Agencies and other businesses. No art or previous experience required. You Learn While Doing with the 2 BIG KITS of SUPPLIES I give you. Write TODAY. STATE IF VETERAN.



No machinery. Print thru stencil mounted on silk stretched frame.



Make own stencils. Trace lines on stencil film. No art experience necessary.



You can print signs, displays, toys, etc., with this simple equipment.

CALIFORNIA SCHOOL OF SCREEN PROCESS
3740 OVERLAND BLVD., DEPT. PS 97 LOS ANGELES 34, CALIF.

Do you want

→ .. to go to College?

→ .. or to enter a Profession?

(Such as Accounting, Architecture, Nursing, Dentistry, Teaching, Social Work, Osteopathy, Beauty Culture, Optometry, Embalming, Chiropody, Law, Medicine, etc.)

→ .. or get an Office Position?

To get anywhere, you practically MUST finish High School FIRST. You can complete our simplified High School Course in SPARE time at home, as FAST as your time and abilities permit. Equivalent to resident school work—prepares you for college, pre-professional examinations, business, industry. Standard texts furnished. Diploma. Credit for H.S. subjects already completed. Single subjects if desired. Low tuition, easy terms. American School, Chicago, est. 1897—endorsed by educators. Finish your high school education NOW. Write TODAY!

High School Course at Home

Many Finish in 2 Years

American School, Dept. H646, Drexel Ave. at 58th St., Chicago 37

Gentlemen: Send me FREE information covering special training in subjects checked below. No obligation on my part.

- | | |
|------------------------------------------------------|----------------------------------------------------------------|
| <input type="checkbox"/> High School Course | <input type="checkbox"/> Diesel Engineering |
| <input type="checkbox"/> Electronics, Industrial | <input type="checkbox"/> Drafting and Design for Men and Women |
| <input type="checkbox"/> Architecture and Building | <input type="checkbox"/> Plastics |
| <input type="checkbox"/> Automotive Engineering | <input type="checkbox"/> Private Secretary |
| <input type="checkbox"/> Business Management | <input type="checkbox"/> Mechanical Engineering |
| <input type="checkbox"/> Electrical Engineering | <input type="checkbox"/> Aviation |
| <input type="checkbox"/> Elec. and Gas Refrigeration | <input type="checkbox"/> Salesmanship |
| <input type="checkbox"/> Air Conditioning | <input type="checkbox"/> Radio |
| <input type="checkbox"/> Railway Training | |

Name

Address

SEPTEMBER 1947 39

GET INTO DIESEL

AUTOMOTIVE AND ALLIED MECHANICS

GET THIS FREE LESSON AND TRY IT. OPPORTUNITY BOOK TOO

Good jobs, interesting and profitable jobs are available for men who really know the new **MOTORS**—Carburetion, Ignition, Fuel-injection and Motor Tune-up. Train NOW to be an **EXPERT** in power and transportation. Send the coupon below for facts packed with opportunity. Learn Diesel, Automotive and Allied Mechanics with—

SHOP METHOD HOME TRAINING BY A REAL ESTABLISHED RESIDENT SCHOOL. Trained Men are constantly needed to keep this pulsating industry moving ahead. If you are mechanically inclined, you too can find your opportunity by knowing Diesel-electric—Internal Combustion Engines, including Diesel, Gasoline and Butane Types. High-octane fuels—Automotive Drive Systems—developed direct from the Shops and Laboratories of this world-famous training organization, National Schools. Take the first step TODAY! Learn how you may establish yourself successfully in a good job or a business of your own. Get the details. **FREE!**



MAIL OPPORTUNITY COUPON

D Paste this on a post card or mail in envelope.

NATIONAL SCHOOLS, Dept. 9-PSD
4000 S. Figueroa Street, Los Angeles 37, Calif.

Send me your **DIESEL AND MODERN MOTORS** book together with a sample lesson **FREE**. I understand I may keep and use this information without obligation.

Name..... Age.....
Address.....
City..... State.....
Include zone. Check if Veteran of World War II

APPROVED FOR TRAINING UNDER GI BILL



HERE'S A NEW AND VITAL BUSINESS!

LEARN ELECTRICAL APPLIANCE REPAIRING

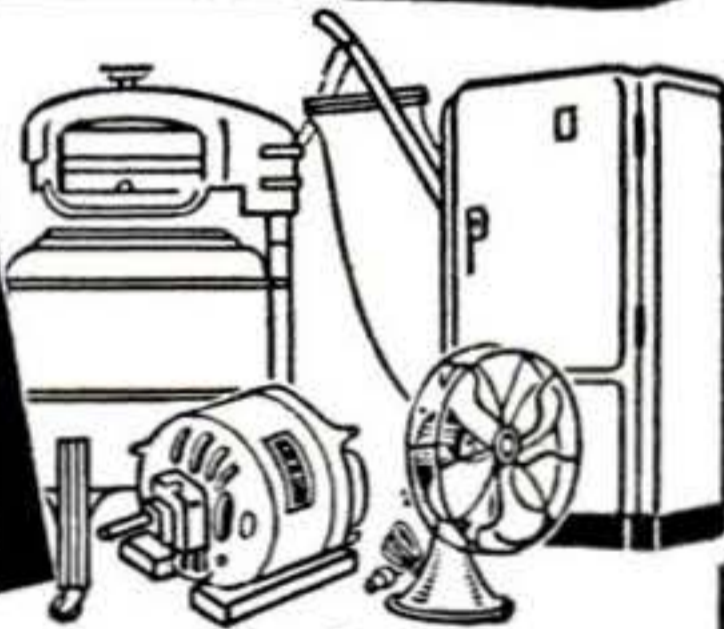

OFFERS BIG MONEY—INDEPENDENCE

If you are mechanically inclined—can hold and use tools will pay you to learn electrical appliance repairing. Operate from your garage, basement, etc. Work as many hours as you wish—the appliance repairman is his own boss. On many types of repairs it is usual for a repairman to charge on the basis of \$5.00 to \$6.00 an hour!

NO PREVIOUS EXPERIENCE NEEDED

Profusely illustrated our new course shows you in simple, easy to understand language plus drawings and photographs, how to make each repair on refrigerators, vacuum cleaners, washing machines, motors, fans, irons, etc., etc. Explains and gives you a working knowledge of electricity, welding, nickel plating, etc. Shows you how to build the power tools you need and how to solicit and keep business coming to you. Not a theory course but an honest to goodness practical course written by and used by repairmen the country over. Price of course is so low that the savings on your own household appliances will pay for it. Act now! Send today for **FREE** literature. **Christy Supply Co., 2835 N. Central Ave., Dept. D-5601, Chicago 34, Illinois**

Practical Shop Training In REFRIGERATION

Service, Maintenance, Installation and AIR CONDITIONING

• Domestic • Commercial • Industrial

Approved for G. I. Training

Write for Details
COMMERCIAL TRADES INSTITUTE
202 So. 20th St., Birmingham, Ala.
• Train in the Magic City of the South. •



WORLD'S SMALLEST RADIO

\$2.98

USE ANYWHERE
• NO Tubes • NO Batteries • NO Electricity
Sensationally tiny! But with this remarkable little RADA-PHONE, you can get strong reception . . . indoors or outdoors!

Just connect one clip to ground and another to a bit of aerial wire. Or, for **DOUBLE** fun, attach two RADA-PHONES for a walkie-talkie, hear up to 100 feet. Trim unbreakable hard rubber receiver, 2 attachment clips, 5 feet insulated rubber wire. **SEND NO MONEY.** Just pay postman \$2.98 each, plus postage—or order C.O.D. Order **TODAY!** Special Price to Dealers.

BERNARD FINE CO., Dept. PSI, 501 Sixth Ave., New York 11, N. Y.



LAWN ORNAMENT-NOVELTY PATTERNS

28 Lawn Ornament Patterns, 25c. Other patterns: 15-20" high; Dutch Girl, Dutch Boy, Pirate, Bull Terrier, Mexican Girl, Mexican Boy, Dwarf, Penguin, Flower Girl, 10c each. 25 Novelty Patterns, 30c. All 62 Full Size Patterns, \$1.00 Postpaid. Strother Pattern Service, Dept. 7-V, Box 383, Belington, W. Va.

SELL MERCHANDISE by mail

OPERATE Profitable Lifetime Business Selling Merchandise by Mail. Large Profits on Fast Selling \$1.00 Items. **WRITE TODAY!**
POWELL CO. DEPT. C SAMLINER BLDG., CLEVELAND 3, OHIO

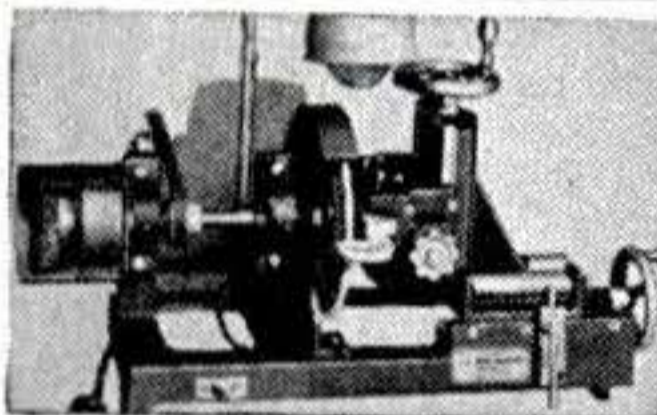

Start a NEW BUSINESS Sharpen Dull Pipe Wrenches

Or Add to Your Present Repair Business
Write for information.

J. C. MOORE INDUSTRIES P.O. Drawer 276 FREDONIA, PA.

MARCOT KEY MACHINE

Immediate Delivery



Marcot No. 8 Key Machine Mounted on Cabinet.....\$ 82.50
Book on Modern Locksmithing.... 3.95
Auto Code Book and Auto Depth Keys 12.50
162 Doz. Popular Key Blanks.... 77.76
Set Key Files, Tools, Pins, Springs, Thimble..... 10.50
\$187.21

A. J. MARCOTTE CO., 1200 N. KEDZIE AVE. DEPT. PS. CHICAGO 51, ILL.

NOW **CHANITE SELF-WELDING FLUX—REPAIRS** all **ELECTRIC HEATING ELEMENTS.** So simple anyone can make repairs in your broken or burnt-out electrical appliances—irons, toasters, stoves & etc. Guaranteed nothing like it. From our mines to your appliances. **\$1.00** per package. **\$7.50** per doz. Stick form 25c. **\$2.00** per doz.
CHANITE SALES COMPANY, 914 South Main, Fort Worth 4, Texas

REAL RELIEF FOR RUPTURE



Thousands of wearers tell of **real relief.** Scientifically shaped, made of strong washable materials, gives the **RIGHT** support **WHERE NEEDED.** Satisfaction **GUARANTEED.** Write for **FREE** literature **NOW.**

The WEB Truss Co. Dept. S-16, Hagerstown, Md.

You Can Grow With PLASTICS!

Plastics is one of the fastest growing industries—offering you unusual opportunities for an interesting, successful career and security in the years ahead. Trained men, with plastics know-how will fill the important, well-paying positions. YOU can be one of them. Mail the coupon below for a big, colorful, free catalog on Plastics and complete details

about Plastics Institute, America's oldest and largest plastics school. Resident School located in beautiful Southern California. Comprehensive Home Training Courses to prepare you in your spare time at home for a career in plastics. You can enroll immediately! Write Plastics Institute, Dept. PS7-9, 1601 S. Western Ave., Los Angeles 6, Calif

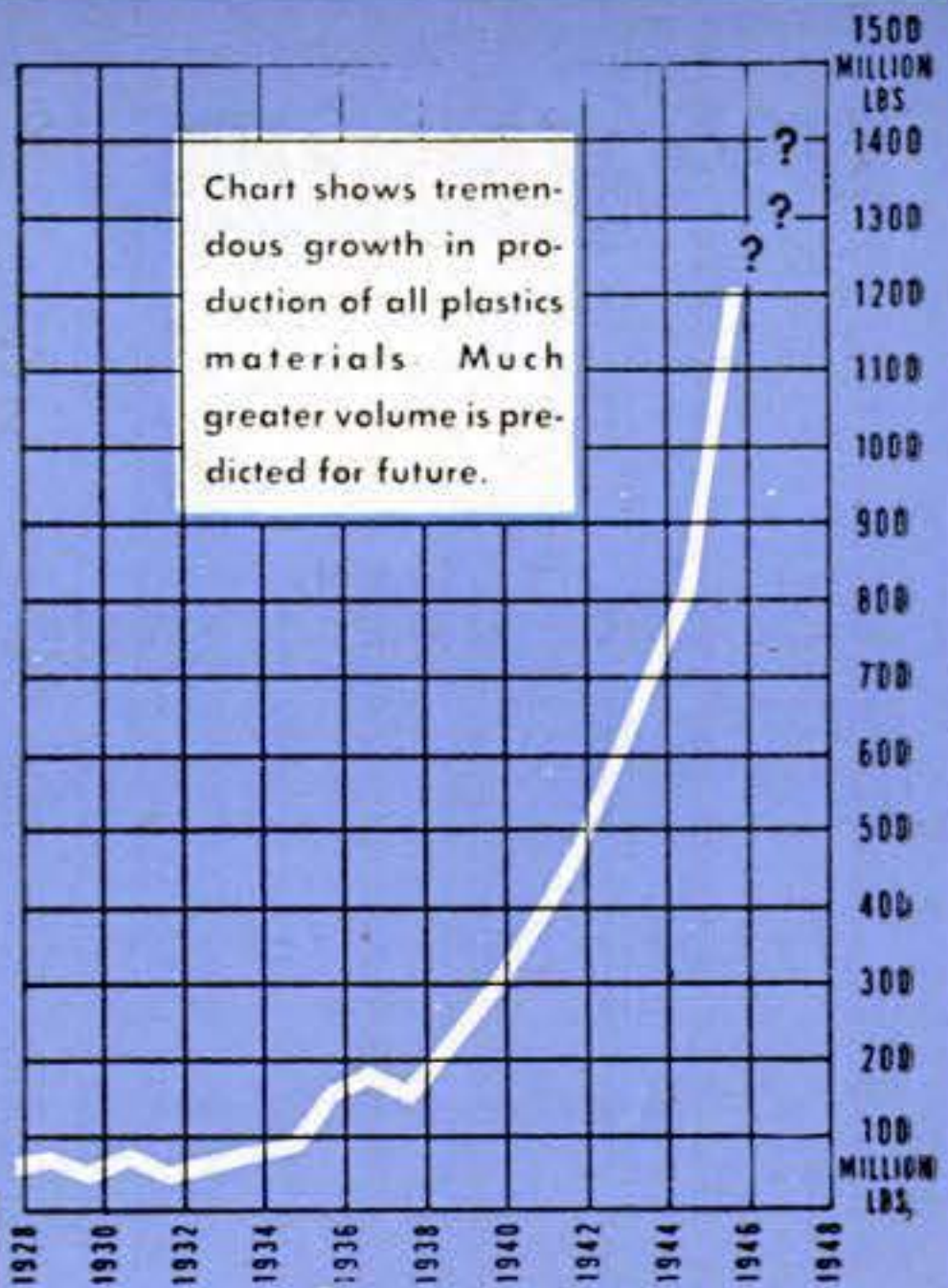

APPROVED FOR VETERANS

LEARN BY DOING

To give you practical experience we supply colorful plastics to make useful, attractive creations. You can also make and sell plastics articles to earn while learning.

Plastics

INDUSTRIES TECHNICAL INSTITUTE
NEW YORK CHICAGO LOS ANGELES



PLASTICS INSTITUTE in the heart of sunny Los Angeles. Here modern laboratories and shops give Resident School students facilities for practice on the finest of industry-type plastics equipment. Also the headquarters for HOME TRAINING.

FREE BOOKLET

Plastics Industries Technical Institute
Dept. PS7-9, 1601 S. Western Ave., Los Angeles 6, Calif. Mail in Envelope or paste on penny postcard

Gentlemen: Please send me free literature and information on your Resident School Courses () Home Training Courses (). I understand there is absolutely no obligation.

Name (PRINT) Occupation

Street (PRINT) Age

City Zone State

Important: Please fill out coupon **completely**. If non-veteran, please check. ()
If in Armed Services now, please check. ()

WHICH OF THESE Opportunities INTERESTS You MOST?



● Today, choose the job you want—and prepare for it. Or if you are already engaged in the work you like best, start training now for quicker promotion. Acquire the knowledge that will help you to get ahead faster, make more money and have greater security.

American School, founded in 1897 as an educational institution *not for profit*, can help you to reach your goal just as it has helped others during the past fifty years. Check the coupon at right, add your name and address and mail it at once. The school will send you details on its training plan and outline of study prepared by specialists. There is no charge, no obligation, so send the coupon immediately.

CHECK, CLIP AND MAIL COUPON NOW

AMERICAN SCHOOL, Dept. G646, Drexel at 58th, Chicago 37, Ill.
Without obligation, Please send FREE and postpaid, bulletin and details on the Subjects checked:

- | | | |
|----------------------------------------------------|-------------------------------------------------------|----------------------------------------------------------------|
| <input type="checkbox"/> PLASTICS ENG'ER | <input type="checkbox"/> Accounting | <input type="checkbox"/> Drafting and Design for Men and Women |
| <input type="checkbox"/> Refrigeration | <input type="checkbox"/> Electrical Engr. | <input type="checkbox"/> Radio |
| <input type="checkbox"/> Architecture and Building | <input type="checkbox"/> Electricity-Pract. | <input type="checkbox"/> High School |
| <input type="checkbox"/> Contracting | <input type="checkbox"/> Electronics. Industrial | <input type="checkbox"/> Air Conditioning |
| <input type="checkbox"/> Practical Plumbing | <input type="checkbox"/> Bookkeeping | <input type="checkbox"/> Mechanical Eng. |
| <input type="checkbox"/> Automotive Engr. | <input type="checkbox"/> Private Secretary | <input type="checkbox"/> Shop Management |
| <input type="checkbox"/> Aviation Drafting | <input type="checkbox"/> Diesel Engineering | <input type="checkbox"/> Tool Making |
| <input type="checkbox"/> Aviation | <input type="checkbox"/> Sheet Metal Pattern Drafting | <input type="checkbox"/> Better Foremanship |
| <input type="checkbox"/> Business Management | <input type="checkbox"/> Railway Training | <input type="checkbox"/> Machine Shop Operations |

Name Occupation

Address Age

City State

AMERICAN SCHOOL
Dept. G646, Drexel at 58th Street, Chicago 37

YOUR SKILL
DESERVES
THIS
Engineered Instrument!
NEW BRUNING

Refillable Draftsman's Pencil

Designed by engineers for engineers and draftsmen, this new Bruning Draftsman's Refillable Pencil is built on an entirely new principle. No metal grip to nick or score leads—new type rubber clutch provides freedom from lead breakage! Pencil holds full length leads from .073" to .081"—including degrees HB to 9H of any popular drafting lead.

A Fine Tool for Skilled Work
Precision built, this pencil is worthy of a place beside your finest drafting instruments! *Adjustable cap* provides easy identification of degree of leads most commonly used—just turn the cap to indicate degree desired. Knurled grip provides a firm hold, prevents slip-

ping whether pencil is held close to or away from point. The all-plastic barrel is finished in an attractive rust red.

You'll want one or more of these Bruning Refillable Draftsman's Pencils—order now while the supply still lasts at this low price. Just mail the coupon!

List Price Only \$1.00 Postpaid

Charles Bruning Co., Inc.
4710-20 Montrose Avenue
Chicago 41, Illinois

NO C.O.D. ORDERS

Gentlemen: Please send me (indicate number of pencils wanted) _____ Bruning Draftsman's Refillable Pencils at \$1.00 each. Enclosed is (give amount) \$ _____ in payment.

Name _____
Address _____
City _____ State _____

ELECTRICIANS
Get this Great Book
FREE

Book of 150 Shop Prints, Wiring Diagrams, Full Size 8 1/2" x 11"



For Merely Examining Coyne's NEW Pay Raising

7 Volume Set APPLIED ELECTRICITY

Here's a brand new set of electrical books to give you the "know how" on all branches of electricity from appliance repairing to D. C. and A. C. equipment, electrical refrigeration, etc. 3,000 subjects, 10,000 facts, latest methods all explained in easy to follow instructions. In order to prove how valuable and Practical this set of electrical books is I'm willing to give you a FREE copy of my book "150 Shop Prints and How to Read Them" just for looking over this set. Written by the Coyne Technical Staff and backed by 47 years' experience, this set has helped many ambitious electrical workers to bigger pay, better jobs & added opportunity.

OFFER LIMITED • ACT NOW! Here's my offer to you — if you act promptly. I'll send you the 7 volume set **Applied Practical Electricity** for 7 days FREE examination . . . together with the 150 Shop Print Book. Look the set over 7 days. If you like it send either \$19.75 cash or send \$3.00 after 7 days and \$3.00 per month until \$21 is paid. If you don't want the set, return it and YOU OWE NOTHING. In either event, however, you keep the 150 Shop Print Book absolutely FREE.

SEND NO MONEY! Coupon below is just a request to see the books free and to get my gift book for doing it. **ACT—Send coupon Today!** Technical Book Div., COYNE ELECTRICAL SCHOOL, 500 S. Paulina Street, Dept. 67-R8, Chicago 12, Ill.

FREE BOOK
Coupon



C. W. Cooke
Director
**COYNE ELECTRICAL SCHOOL, Dept. 67-R8,
500 SOUTH PAULINA STREET, CHICAGO 12, ILLINOIS**

Send me that 7 volume set APPLIED PRACTICAL ELECTRICITY and your FREE gift of a copy of "150 Shop Prints and How to Read Them". I'll either return the set in 7 days and owe nothing or send you either \$3 in 7 days and \$3 a month until \$21 is paid or \$19.75 cash. Regardless of whether or not I keep the 7 Volume Set the 150 Shop Prints is mine FREE as a Gift.

NAME _____ AGE _____
ADDRESS _____
TOWN _____ ZONE _____ STATE _____

Have an OFFICE of YOUR OWN!

LEARN NEW PROFITABLE PROFESSION
At Home in 60 Days, Men & Women, 18 to 70!

Be Your Own Boss and the Boss of Others. Be Respected. Meet Interesting People.

Earnings of men and women in this profession run as high as \$5,000-\$15,000 yearly. Others make good money in spare time. Little money needed to start. A business where your earnings begin sooner. Easy to learn. No selling or goods to buy. No experience necessary. A depression-proof business. A course of action to guide you step by step as you earn. All 53 lessons sent at once to use as operating manuals. Easy terms. Diploma. Money-back agreement. Write for FREE BULLETIN.



FRANKLIN CREDIT SCHOOL
Dept. 71-J ROANOKE 7, VIRGINIA

BY MAIL in Easy Lessons



BUILD YOUR OWN ZEOLITE WATER SOFTENER

Troubled by water hardness? Build a LAR water softener for as little as \$40.00. Requires only a wrench. Quickly pays for itself by savings in soap and clothing alone. Send \$1.00 for complete plans and operating instructions. Money back if not satisfied.

LAKE REGION MFG. CO., BOX 2732-S, Minneapolis 7, Minn.



GET INTO CARTOONING!

Learn cartooning from a professional cartoonist! Create original cartoons and ideas. Send for free details about course. Also cartoonists' magazine. Full of lessons, plans, etc. Only 25c coin postpaid. Hartman Studios, 2776 California Court, Lincoln 8, Nebr.

WALKIE SIREN
Formerly \$15.00 - Now Only \$3.95

GOV'T SURPLUS. A precision instrument. Easy turn of crank produces CLEAR, FULL SIREN TONE. Can be heard for great distance. Ideal for Boats, Autos, Schools, Sporting Events, etc. Dimensions 7" x 8" x 5". Wt. 4 1/2 lbs. Price includes shoulder strap and waterproof cover. **SEND NO MONEY.** Just name and address. We'll ship C.O.D. for \$3.95 plus postage, or send money in advance, we'll ship prepaid. Canadian price \$4.50. ILLINOIS MERCHANTISE MART, Dept. 401-B, 1227 Loyola Ave., Chicago 26, Ill.

BECOME A PISTOL EXPERT WITH A HY-SCORE AIR PISTOL

- No Pumping
- Powerful, Fast
- Single Shot
- Precision-Made
- 30 1/2 oz.;
- 10 1/4" long

HY-SCORE PELLETS FIT ALL PISTOLS Cal. 177 2.50 Cal. 22 3.00 per 1000

SEE YOUR DEALER
Send for Free Circular. Dept. S-9

HY-SCORE ARMS CORP. - BROOKLYN 1, N. Y.

PLASTIC HOMES

New Building Material! Resurface old homes; build new ones. Colorful, beautiful! **LIQUID MARBLE**—Color-glazed! Molded, brushed, sprayed. **SANITARY COMPOSITION FLOORING**—Dustless, noiseless; put on like plaster; resilient—yielding as cork; lasts like stone; plain or marked in tile design. **RUBBERLASTIC Mold Compound**—Mold novelties, statuary, toys, gifts, plaques, plaster animals. **COLORED POTTERY**—Birdbaths, garden furniture, vases. **TILEX** colored roofing. Illustrated literature FREE.

RAPID MARBLEIZING SERVICE, Dept. 12-B, Edwardsville, Ill.

MAGIC WONDERS EXPOSED!

Amuse! Confuse! Thrill Everyone! Vanishing light, Ghostly Pellet, Magic Smoke, Mystic Watch, Enchanted Match, Spirit Writing, Magic Fire, Wizzards Candle, Etc. 32 Magic Lessons 25c, Free with order Big Catalog. The Magician, 2463 Kensington Ave., Phila. 25, Pa. Dept. D.

TALK-SING thru your own radio with RADIO MICROPHONE

Be the life of the party. Put on your own broadcasts at home. Talk-Sing, make announcements from any room. Wonderful voice practice. Microphone easily attached to any radio. Follow enclosed instructions. **SEND NO MONEY**—pay Postman \$1.98 plus postage. Send Money Order or check and save postage.

EMPIRE RADIO & TELEVISION CO. (Dept. R1) 1521 Bedford Ave., Brooklyn 16, N. Y.



AMBITIOUS MEN! HERE'S YOUR
 CHANGE TO LEARN ELECTRICITY AT THIS
 NATIONALLY RECOGNIZED, FAMOUS SCHOOL!

**Enrollments Increased! Room For 150
 More Who ACT NOW!**

Regardless of whether you are a civilian or a "G.I.", it is of vast importance to you, when you invest your money or entitlement, to choose a school like Bailey Technical—a school with a national reputation for highest quality training. Because Bailey Technical Schools are recognized and approved by industry, this increases your possibilities of obtaining the position you want and making rapid, increasingly-profitable progress.

Bailey graduates get the high-paying jobs! Or maybe you want a business of your own. Remember: Bailey Schools teach you basic principles, fundamentals, plus the practical application of theory in actual shop work. You get the "tricks" of the trade which would take years to learn starting at the bottom of the job.

Bailey Technical Schools are approved by the Missouri State Board of Education. G. I. approved. Approved under Public Law 16 (the highest level of acceptance). Approved for State Rehabilitation Training by all states which have a rehabilitation program.

**Act now. Send for free catalog.
 Cut out application at right and mail TODAY!**

The BAILEY Technical SCHOOLS
 INTERNATIONALLY RECOGNIZED
 1652 SO. GRAND BLVD., ST. LOUIS 4, MO.

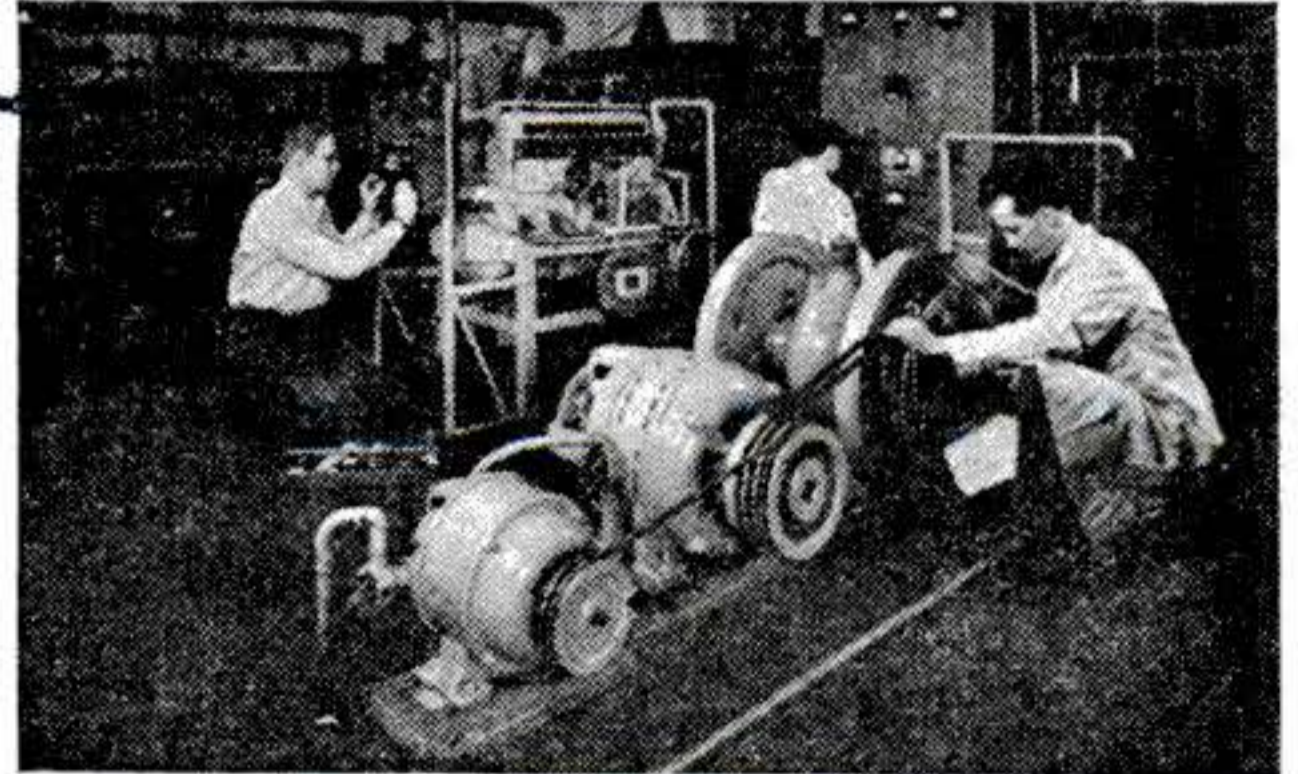

Shop practice at Bailey Electrical School

SEND THIS APPLICATION to:
 Bailey Technical Schools, 1652 South Grand Blvd,
 St. Louis 4, Missouri

Please send me free catalog giving complete information about the Bailey Technical School which I have checked below.

Electricity Diesel Diesel-Electric
 Radio Mechanics Air Conditioning
 Refrigeration

Please send information to:

Name.....
 Address.....
 (2)

YOU MAY BE ABLE TO TRIPLE YOUR INCOME IN YOUR SPARE TIME

MAKE BIG MONEY at HOME
FULL OR PART TIME
IN A CORNER OF YOUR GARAGE OR BASEMENT

LEARN TO METALIZE BABY SHOES Heirlooms, Jewelry Bookends, Novelty Items, Flowers, etc. . . Processing in Bronze, Gold, Silver, Pearl . . . Start a Profitable Business Of Your Own With A Real Future!

No other business gives you such LARGE RETURNS for so LITTLE INVESTED! Synthetically processed baby shoes retail at approximately \$5.00 per pair. Cost of materials is 5c to 10c per pair. Think—a profit of \$4.90 for your labor! It's easy to learn (you can learn in your spare time in a few weeks). . . EASY WORK (Your equipment does most of the work for you) . . . EASY TO SELL! . . . A NEW FIELD WITH UNLIMITED POSSIBILITIES! Every parent cherishes the first little shoes of their baby and wants them preserved permanently in this beautiful way. All the "Tricks Of The Trade" and Special Secret Formulas Now Available To You. **WRITE FOR FREE LITERATURE**

Dept. PS-97 KIKTAVI School of Metallic Arts, 8620 S. Ruthelen Ave., Los Angeles 44, Calif.

COMPLETE KIT OF SUPPLIES INCLUDED!

DEEP TONE DUAL MUFFLERS LONG LIFE

1935 TO 1947—V-8 FORD AND MERCURY

- More Horse Power
- Better Gas Mileage
- Less Back Pressure
- Blow-Out Proof
- Straight Thru Mufflers

FORD & MERCURY DUAL SETS
 \$20.00 C.O.D.
 F.O.B. LOS ANGELES

ORDER BY YEAR AND MODEL

- SIMPLIFIED INSTALLATION
- No Welding, Cutting, Drilling of Holes.
- All Fixtures Furnished
- Rubber Insulated Clamps

DEEP TONED SINGLE MUFFLER
 Ford, Chevrolet, Ply. \$4.86
 All others \$5.50

2 1/2" CHROME TAIL PIPE TIPS. \$1.75

ADVANCE MUFFLERS DEPT. 1 ● 6800 So. Vermont Ave. ● Los Angeles 44, Calif.

WANT A KEY JOB OR A BUSINESS OF YOUR OWN?

BIG OPPORTUNITY

THIS COUPON MAY BE YOUR

REFRIGERATION—AIR CONDITIONING

Take a good look at the man you envy. What has he got that you haven't got? The chances are his success is simply a matter of training. He knows his job. He is a specialist in his field.

Why, then, should you be content with a small job at small pay. The door to opportunity is open today—wider than ever before. Now is the time to do something about your future.

Take a friendly tip. Investigate the field of Refrigeration & Air Conditioning. Here is an industry that offers every opportunity you could ask . . . good jobs, security—plenty of chance for advancement—a business of your own.

The Industrial Training Institute, largest and most completely equipped school of its kind in the world, will give you the practical training you need. You can start at home without giving up your present job and when you have completed your theoretical training, we will bring you to Chicago where you will learn the practical "know-how" by working on actual equipment in our big, expertly staffed shops.

No advanced schooling is needed. Our unique proved methods make everything easy to grasp. We've trained thousands. Pay as you go. Quit when you want to. But in any case our first responsibility is to prepare you for a better job and a happier future. And after you have graduated you enjoy all the advantages of our life-time employment service—wherever you go, whenever you need it.

FACTS ABOUT THE INSTITUTE

Founded in 1916. Has trained more than 400,000 men for practical work in industrial fields. From 1942 through 1945 trained specialized technicians, exclusively, for the Army, Navy and Marine Corps. Now training thousands of veterans under the G.I. Bill, both in its Residence Schools and by home-study. Occupies five buildings of its own. Has over \$500,000 invested in training facilities, with an instruction staff of more than 100 men. Known everywhere as America's foremost school of practical training for industry.

ACT NOW

Don't delay. Time is passing fast. Mark and mail the coupon below. It will bring you, without obligation, full details of this and other courses, from which you may choose. Take the step that may be the turning point in your career to a better job and bigger earnings.

SEND FOR THIS BOOK —IT'S FREE



Industrial Training Institute, 2150 Lawrence Ave., Dept P2JR Chicago 25, Ill.

I am interested in getting ahead. Send me FREE copy of your "Camera Visit" book. I would like to train for _____ (name field).

Name _____

Address _____

City _____

Are you a Veteran _____

GET THE FACTS ABOUT AMERICA'S FOREMOST SCHOOL OF PRACTICAL TRAINING



Learn to Repair ELECTRIC APPLIANCES

WRITE TODAY for FREE BOOK

Prepare now for a permanent future, independence and security with a business of your own. Our practical, easy-to-learn home course teaches you, during your spare time, how to repair washing machines, vacuum cleaners, electric ranges, lamps, motors, irons, etc., and do house wiring. Also how to get started on little capital. Write today for FREE BOOKLET. No obligation.

PACIFIC TRAINING SCHOOL
7217 S. Broadway, Dept. S-109, Los Angeles, 3

Big Money for Workers In Home or Shop



Licensed Concrete Specialists wanted. No experience needed. Make Colorglazed concrete pottery without molds. New, low cost, patented method. Cemetery products, novelties, tiles, floors, etc. Basement leaksealing. Other big pay projects. Booklet, details free. Men only.

NATIONAL POTTERIES COMPANY
415 West Third Ave. Grand Rapids, Minnesota

TRI-STATE COLLEGE

B.S. Degree in 27 months in Engineering (7 branches), Bus. Admin., Acctg. and Sec. Science. Graduates successful. 64th year. Enter Sept., Jan., March, June. Write for catalog. 597 College Ave., Angola, Ind.

INDIANA TECHNICAL COLLEGE

B.S. degree in 27 mos. Aeronautical, Chemical, Civil, Electrical, Mechanical and Radio Engineering. 2-yr. diploma. Air Conditioning, Refrigeration, GI approved. Low rate. Earn board. Demand for grads. Enter Sept., Dec., March, June. Catalogue. 697 E. Washington Blvd., Ft. Wayne 2, Ind.

Learn BAKING At Home

Baking is one of America's high industries in wages. Nearly depression-proof. Thorough basic home course lays sound foundation. If you have aptitude, write for FREE BOOKLET, "Opportunities in Commercial Baking."



National Baking School, 1315 Mich. Ave., Dept. 1366, Chicago 5

FIND OUT WHY THE DEAF

CALL THE ONE-UNIT



HEARING AID A "MIRACLE"

Write for FREE BOOKLET

BELTONE HEARING AID CO., Dept. PS-9
1450 W. 19th Street, Chicago 8, Ill.

THE GEM MAKER



Amateurs or professionals . . . hobbyists or jewelers . . . Polish your own gems with a B&I Gem Maker. You will find this a profitable adventure. All necessary lapidary equipment is furnished, including a super-charged diamond blade for sawing, and all wheels for grinding, shaping and polishing, also complete instructions. The complete equipment as shown, less motor and belt, for only \$29.50, f.o.b., Burlington, Wis. Write today for information and literature on the Gem Maker and accessories. **B&I MFG. CO., Dept. M, Burlington, Wis.**

FREE 5 INCH GENUINE LEATHER Jolly Rogers Patch



Join the Jolly Rogers Club of Insignia Collectors. Send only \$1.00 and get this Genuine Leather Jolly Roger Breast Patch Free with 25 all different Air Force Wings and Officers Collar Insignia. (List Price \$5.00.) Colored Insignia Book FREE with order.
The Insignia Mart, Dept. B-14, 703 Broadway New York 3, N. Y.



ON-THE-JOB METHODS

ON-THE-JOB EQUIPMENT...

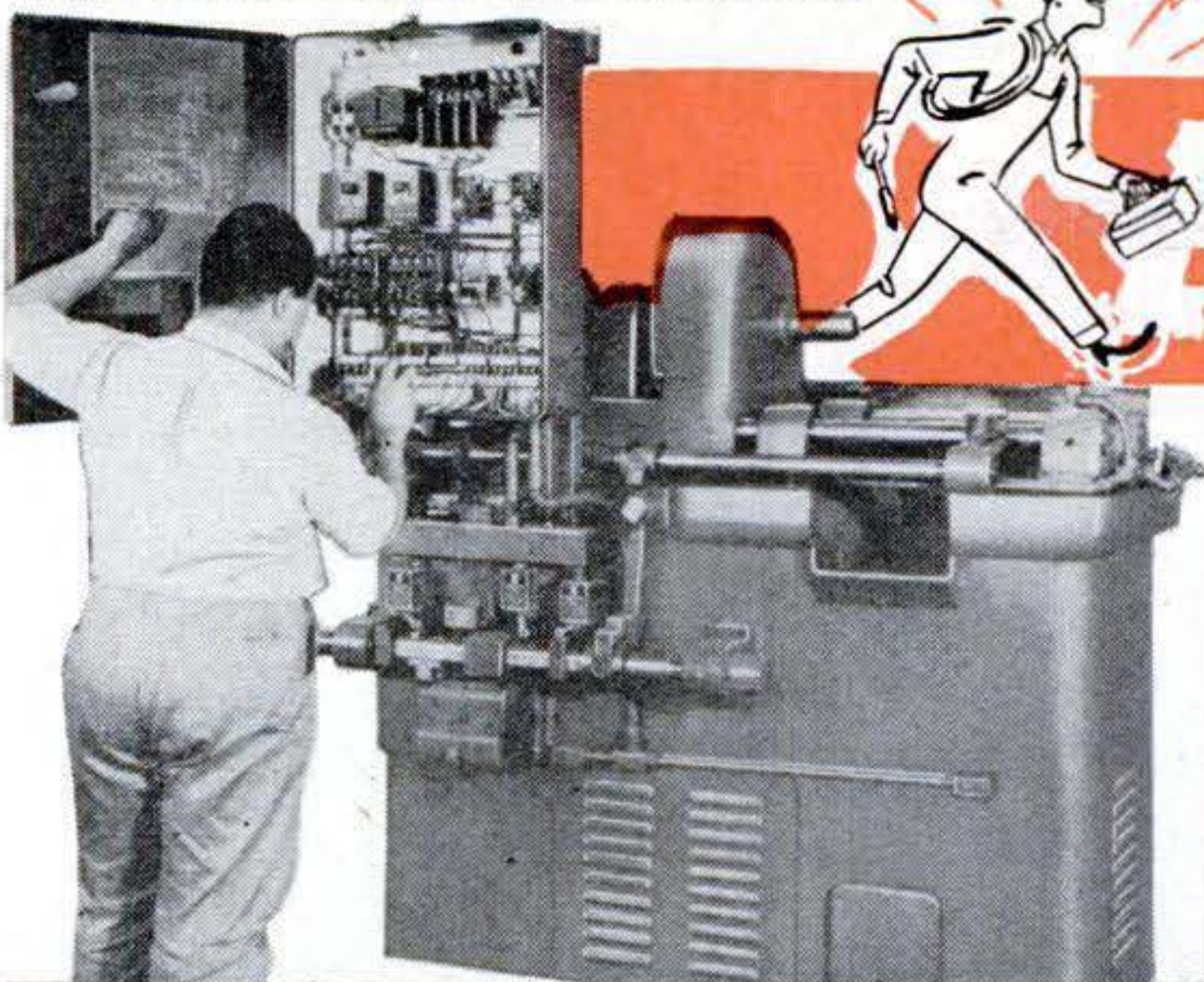

ELECTRICITY

LEARN THE PRACTICAL WAY

on equipment like this in the large shops of the nation's largest exclusive electrical school!



ABOVE: WIRING IN FACING MACHINE

RIGHT: TROUBLE SHOOTING ON LARGE CONTROL PANEL

Electricians are always in demand—make big money... Get "A to Z" experience quickly in our large shops—not "home-study"... **YOU DO ACTUAL WORK** on real equipment. Learn housewiring, armature wiring, motor rebuilding, factory installation, etc. New classes start every few weeks. Living arrangements made.

NO COST TO VETERANS Train at Gov't. expense Receive \$65 to \$90 month while learning Coupon brings details.

MICHIGAN TECHNICAL INSTITUTE

Department PS-9, 2281 West Fort Street, Detroit 16, Michigan

MICHIGAN TECHNICAL INSTITUTE, Dept. PS-9
2281 W. Fort St., Detroit 16, Michigan

- Send me catalog and complete information.
- I am a GI. Send special information.
- Married. Single.

NAME _____

ADDRESS _____

CITY _____ ZONE _____ STATE _____

Raise **GOLDEN HAMSTERS**

The new wonder animals from Syria. Look like Toy Red Bears. Delightful pets. Everybody wants them. Thousands needed by laboratories. Make money. get started now. Send 10c for illustrated literature. or send \$5 for a pair of hamsters and literature.



GULF HAMSTERY 1540 BASIL ST., MOBILE 17, ALA.

New Advertising Machine



Prints & Illustrates 1¢ Post Cards

FREE! Learn how thousands of merchants and business men are boosting sales in spite of product shortages with 1c messages—printed in a few minutes on gov't postcards—with amazing new, patented **CARDMASTER**. Your "todays" ideas for specials, read by prospects next morning. Not a toy, but a sturdy, advertising machine, built to last many years. Low price, sold direct. Guaranteed, five years.

SEND NAME We'll send free illustrated book of money-making ideas for your business and complete, unique advertising plans. Rush your name today.

CARDMASTER COMPANY
4546 Ravenswood, Dept. 169, Chicago 40, Ill.



MY DOBE TRAINING WAS ALL PRACTICAL EXPERIENCE!

I WILL TRAIN YOU AT HOME UNTIL YOU GET A

GOOD PAY JOB!



Get Started NOW in **DRAFTING**

EXPERIENCE WHILE LEARNING

Your training will be experience because I give you practical jobs to do. And I list your experience and send it to employers as a reference when you are ready. All Dobe trained men start out with experience. You will too, because I will train you until you get a good pay job in drafting.

Take the first step now and step into Drafting—the big opportunity field—as an experienced, well paid draftsman. Act now for a better job, better pay and better working conditions. The field for draftsmen is bigger now than ever before for all new products, machines, construction start with the draftsman. Get into drafting now. I will train you at home in your spare time, and give you actual experience on actual work—the same kind of jobs you will do with the best paying firms. I will train you until you are competent, fully experienced, and holding a position that will bring advancement and pay raises. Write me today.

WORKING TOOLS SENT WHEN YOU START

All drafting instruments and table and other needed equipment sent when you start. Nothing to buy. Act today. Mail coupon to me now and be sure to give age.



MAIL COUPON FOR VITAL FACTS

Engineer Dobe, Div. 2B Libertyville, Ill.

Send me the Vital Facts on Drafting and Industrial Designing, your Free Book and advertised list of positions for Draftsmen and Designers wanted.

Name..... Age.....

Address

City..... Zone..... State.....

NOW! Enjoy Learning to Speak SPANISH AT HOME

FRENCH-GERMAN-ITALIAN

BIG OPPORTUNITIES and JOBS waiting for those who can speak SPANISH. Millions of dollars being invested in Mexico, Central and South America—**BUSINESS** and **TRAVEL** increasing every day. Now the ability to speak SPANISH will mean more to you than ever before.



Only 15 Minutes a Day

The **CORTINA METHOD**, famous for **OVER 60 YEARS**, teaches you to speak **SPANISH LIKE A NATIVE**. Right in your own home, relaxed and at ease, you learn as easily as a child learns—**BY LISTENING** to native instructors on these **30 NEW, easy-to-understand CORTINA recordings**. **EVERY WORD CLEAR AS A BELL.**



Sent on 5 Days Approval

THOUSANDS have learned Spanish, this quick, easy way for **PLEASURE** and **BUSINESS**. Why not you? Free, 32-page book, "The Cortina Short-Cut," describes this famous method fully and tells how you can try it in your own home for 5 days. **NO COST IF NOT DELIGHTED.** Mail coupon for free book.



Write Today-NOW!

CORTINA ACADEMY (Established in 1882)
Dept. 129, 105 W. 40th St., New York 18, N. Y.

Please send me—without obligation—your free book. I am interested in (check):

SPANISH French Italian German

Name.....

Address.....

City..... State.....

AIR RIFLES **BENJAMIN** AIR PISTOLS PIONEERS - LEADERS

SEND FOR FREE FOLDER OF LATEST MODELS TODAY
If you want a **REAL GUN** for **PRACTICAL USE** inside or outdoors get a **SAFE - CLEAN - ECONOMICAL - BENJAMIN** with Adjustable Power and Amazing Accuracy. For **BEST RESULTS** use **BENJAMIN H-C PELLETS**. **WRITE AT ONCE**. **BENJAMIN AIR RIFLE CO., 811 MARION ST., ST. LOUIS 4, MO**

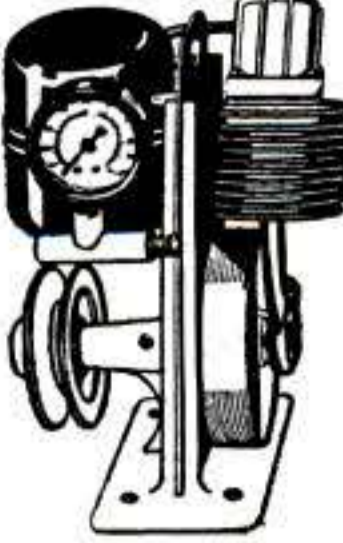

COMPRESSED AIR INSTANTLY, Anywhere!!

Portable Air Compressor and storage tank. Ruggedly built of best materials using lifetime lubricated ball-bearing on connecting rod and oil impregnated main bearing on shaft. Unusual design forever eliminates valve trouble, the most common fault in air compressors. **PATENTED** unique air intake system increases efficiency tremendously over other compressors so that air output is much greater than that from larger compressors powered by heavier motors. Will deliver approximately 3500 cu. inches of air per minute at maintained pressure of 30 lbs., or will inflate a 90 lb. truck tire in less than one minute. Comes complete with 100 lb.

gauge, although finger-tip adjustment allows setting of output pressure at any value, which will automatically be maintained. Works from any 1/4 H.P. motor. Useful for spraying paints or lacquers, disinfectants, insecticides, annealing or brazing with natural gas, inflating tires, etc. Price \$14.50 postage prepaid anywhere in the U. S. Efficient, completely adjustable syphon type spray gun complete with 12 ft. of 100 lb. tested hose available for only \$7.75 with pint container, also prepaid. 25% required on all C.O.D. orders. Send for free catalogs of radio parts and surplus items.

BUFFALO RADIO SUPPLY; 219-221 GENESEE ST., DEPT. S7, BUFFALO, N. Y.

DON'T FUMBLE IN THE DARK..

KEEP LIGHT



KEE-LITE, the combination Flashlight & Key-Holder, is indispensable to Car-Owners, Home-Owners, Sportsmen and Theatre-Goers. Fits easily into your pocket. Standard Pencil Battery, Genuine Leather Case. Complete with battery, only \$1.00 (we pay postage). No C.O.D. Send for yours today.

ONLY \$1.00 POSTPAID

CARVER-HAMPTON Co. 974 Fulton St., Dept. KS9 Brooklyn 16, N. Y.

ARMY RADIO PHONES

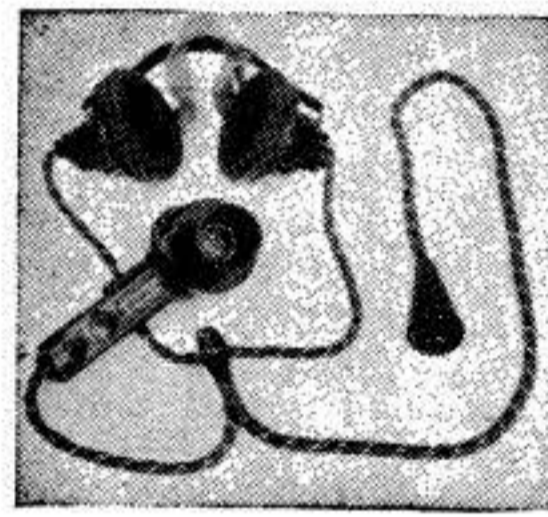

They're Weather — Water and Shock Proof

When we say they are made to Army specifications, that's enough assurance they must be of best quality. These Army Radio Phones are perfect and were O.K.'d by Signal Corps Inspectors. These Dynamic Mikes and Receivers, were used on aircraft and tank inter communication systems. Use them for recording, for battery-less phone, for pocket size set loud

speaker or talk through your radio set. We bought a good many of these Radio Phones, they are brand new, and cost a great deal more than you can get them for. A complete dynamic hand mike, 2 earphones, headband, cord set. A wonderful buy for only... **\$3.45**

LEEDS RADIO CO.

75 Vesey St. Dept. PS9 New York City 7

ARTISTS MAKE MONEY

Do you like to draw? Send name, address, age and occupation for **FREE ART TEST**, to find out your ability.

ART INSTRUCTION, INC.

9147 Art Instruction Bldg., Minneapolis 15, Minn.

OLD GOLD JEWELRY WANTED

Dental gold teeth, plates and bridges with metal attached. Any broken pieces of gold jewelry. Immediate payment and free mailing container to you or your friends upon request.

LOWES, DEPT. PS Holland Bldg., St. Louis 1, Mo.



CORROSION and FRICTION

Use Fiendoil on tools, electrical appliances, household devices. It actively Lubricates - Cleans - Prevents Rust

3-oz. Spout Can **40c**

FIENDOIL

"The Enemy of Corrosion and Friction"



Learn DIESEL

at home... **IN YOUR SPARE TIME!**

HEMPHILL DIESEL TRAINING is available to you at home. Study in your spare time, without interfering with your present employment. This pioneer Diesel educational institution, with thousands of successful graduates throughout the world, offers you the opportunity to learn Diesel at home. **THE DAY OF DIESEL POWER IS HERE!** Railroads, shipping, farming, manufacturing, transportation—almost every great industry is turning more and more to Diesel Power. Think of the opportunities which this presents to the qualified, trained Diesel man.

VETERANS
This comprehensive, practical Home Training course is approved under the G.I. Bill of Rights. You can get started quickly. Just mail the coupon today.

NON-VETERANS
Courses available to you on easy TERMS. Improve your worth on your present job—or future as a Diesel operator or mechanic. Mail the coupon today for complete details.

RESIDENT SCHOOLS LOCATED AT:

NEW YORK 31-28 Queens Blvd. Long Island 1, N. Y.
LOS ANGELES 1601 S. Western Ave. Los Angeles 6, Calif.
MEMPHIS 311 S. Main St. Memphis 3, Tenn.

34 weeks practical training. If you would prefer to train at one of these three schools, indicate by check on coupon.

HEMPHILL DIESEL AND AUTOMOTIVE SCHOOLS
Administrative Office: 1601 South Western Ave., Dept. PS-9
Los Angeles 6, California

Gentlemen: Please send me FREE BOOKLET and information on your Diesel Courses. I am interested in Home Study Resident School at New York Memphis Los Angeles (Check school desired.)

Name..... Age.....
Street..... Zone.....
City..... State.....
Veteran..... Non-Veteran.....

IMAGINE THEIR JOY WHEN THEY FOUND THEY COULD PLAY

This easy-as-ABC way!



LEARNED QUICKLY AT HOME
"I didn't dream I could actually learn to play without a teacher. Now, when I play for people they hardly believe that I learned to play so well in so short a time."
*H.C.S., Calif.



PLAYS AT DANCES
"Your lessons have been most satisfactory. I can play all of the popular songs. I have earned money playing at dances."
*E.N.J., New York.



PLAYS ON RADIO
"I can't keep from telling you that I have a good position playing from KTHS, Hot Springs, Ark., every morning."
*J. S., Okla.

What Instrument Would You Like to Play?

JUST name your instrument and we'll show you how you can learn to play it—quickly, easily, in spare time at home. Never mind if you don't know one note of music from another—don't worry about "special talent." And forget all you've ever heard about music being hard to learn.

The truth of the matter is that *thousands now play who never thought they could!* Yes, men and women everywhere have discovered this amazingly easy way to learn music at home. Now they are enjoying the thrilling satisfaction of playing the piano, violin, guitar, saxophone or other favorite instruments. Some of them are playing in orchestras and over the radio; others are teaching music, making money in spare or full time. And thousands are having the time of their lives playing for their own enjoyment and the entertainment of their friends.

- LEARN TO PLAY BY NOTE**
Piano Guitar
Violin Saxophone
Organ Mandolin
Tenor Banjo
Hawaiian Guitar
Piano Accordion
Or Any Other Instrument

No tedious study and practice, no tiresome exercises. You learn to play *by playing*—start right in with the melody of a simple tune! It takes only a few minutes a day; the cost is trifling. Does it sound too good to be true? Mail the coupon and get the FREE PROOF!

FREE PRINT AND PICTURE SAMPLE

Fascinating illustrated booklet answers all your questions; free Print and Picture Sample shows how method works. If interested, just mail coupon. U. S. School of Music, 89 Brunswick Bldg., New York 10, N. Y. (49th year)
*Actual pupils' names on request. Pictures by professional models

U. S. SCHOOL OF MUSIC
89 Brunswick Bldg., New York 10, N. Y.

I am interested in music study, particularly in the instrument indicated. Please send me your free illustrated booklet, "How to Learn Music at Home" and the Free Print and Picture Sample.

Name.....
(PLEASE PRINT)
Address.....
Instrument..... Have you Instrument?.....

RADIOMEN! ELECTRICIANS!

Get this Valuable Book

FREE

Tells How
to Start
Your Own
Shop



for Merely Examining
Coyne's NEW Pay-Raising

3 VOLUME SET APPLIED PRACTICAL RADIO

Here's real news for every man interested in Radio. A sensational new PRACTICAL set of radio books, just off the press! Nothing like it ever before. Gives you the "know how" on everything in Radio today. Basic principles to the newest in Television and FM—how to construct, install, service. 600 illustrations, nearly 1000 pages. To prove how valuable these great books can be to you, Coyne will give you a FREE copy of our new 240-page book "Starting & Operating a Profitable Radio or Electrical Business" just for looking over the 3 Volume Set. For home training or field reference, APPLIED PRACTICAL RADIO is backed by Coyne's 48 years of shop experience to help you to bigger pay, better jobs, greater opportunities in Radio.

OFFER LIMITED—ACT NOW! Here's our offer to you—if you act promptly. We will send you the 3 volume set APPLIED PRACTICAL RADIO for 7 days' FREE examination, together with the Business-Starting Book. Look the set over for 7 days. If you like it, you can then pay the low price at easy terms in coupon below. If you don't want the set, return it and you owe NOTHING. In either event, you keep the Business-Starting Book absolutely FREE.

FREE SEND NO MONEY!
BOOK COUPON

Coupon below is just a request to see the books free and get your gift book for doing it. **ACT—Send coupon TODAY!**



Educational Book Publishing Division,
COYNE ELECTRICAL & RADIO SCHOOL, Dept. 67-R5
500 South Paulina St., Chicago 12, Illinois

Send me that 3 volume set APPLIED PRACTICAL RADIO and my FREE gift book "Starting & Operating a Profitable Radio or Electrical Business". I'll either return the set in 7 days and owe nothing, or send you \$3 within 7 days after I receive the books and \$3 a month until \$10.75 is paid. Or I'll pay \$9.75 cash. Whether or not I keep the 3 Volume Set, the Business-Starting Book is mine FREE as a Gift.

NAME _____ AGE _____
ADDRESS _____
TOWN _____ ZONE _____ STATE _____

Big New Novelty Catalog Now Ready!

500 Pages; 6000 Amazing Novelties

Send 5c today for this mammoth, amazing new catalog of over 6,000 novelties. More fascinating than a World's Fair. Thousands of things you never knew existed—never knew where to get. Includes novelties, tricks, jokes, live animals and pets, scientific supplies, den novelties, hobby supplies, planes and boats, looms, magic, unusual seeds, gadget time savers, cameras and optical goods, movies, projectors, lucky jewelry, religious novelties, telegraph sets, magnets, disguises, easy musical instruments, stamps, coins, puzzles, fortune tellers, occult and supernatural, radios, experimental sets, auto & bike accessories, Western belts and wearing apparel, telescopes, magnifiers, compasses, banks, smokers' gadgets, artists' supplies, printing sets, engines and motors, electric shockers, knives, billfolds, fireworks, guns and rifles, weird articles, archers, swimming helps, 1000 fascinating books, games, locks, live chameleons, rings, watches, charms, barometers, slide rules, exercisers, money savers, curious plants, handy tools, Indian novelties, etc., etc., etc. Jammed and packed with sensational funmakers and useful articles. Big catalog—over 1 inch thick, 6 color cover. (DeLuxe Hard Bound Library Edition 15c). Send 5c to help cover postage with your name and address to: **JOHNSON SMITH & CO., Dept. A-2, Detroit 7, Mich.**

Say You Saw
It In Popular Science

RUPTURED?

Get Relief This Proven Way

Why try to worry along with trusses that gouge your flesh—press heavily on hips and spine—enlarge opening—fail to hold rupture? You need the Cluthe. No leg-straps or cutting belts. Automatic adjustable pad holds at real opening—follows every body movement with instant increased support in case of strain. Cannot slip whether at work or play. Light. Waterproof. Can be worn in bath. Send for amazing FREE book, "Advice To Ruptured," and details of liberal truthful 60-day trial offer. Also endorsements from grateful users in your neighborhood. Write:

Cluthe Sons, Dept. 14, Bloomfield, New Jersey

48 POPULAR SCIENCE

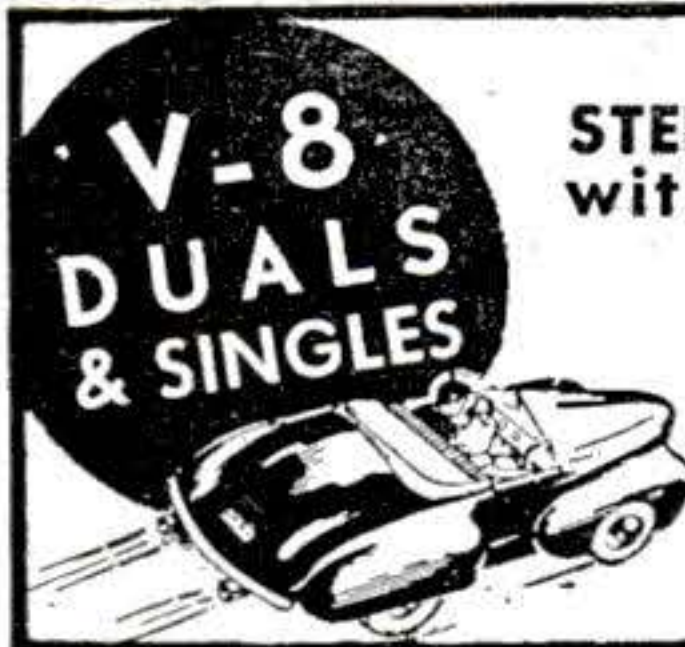

MUFFLERS

STEELS and ALUMINUMS
with a motorboat tone

SINGLES, Chev, V-8, Plymouth, Steels \$5.50, Aluminum \$6.50. Chry., Olds., Buicks, etc., Steels \$7.50, Aluminum \$8.50. V-8 and MERCURY DUALS, Steel \$17.50, Aluminum \$20.00. Aluminums are guaranteed for life of your car. **DEALERS WANTED**

SANDEE MUFFLER CO.

7523 S. WESTERN AVE., LOS ANGELES 44, CALIF.



NEW WHITE WINDPROOF SKI PARKAS

\$1.25

Made of white twill. Can be dyed any color. Sizes, small, medium, and large. Suitable for hunting and outdoor wear. \$4.00 value.

P.P. 25c

I. GOLDBERG & CO., 429 Market St., Phila. 6, Pa.

SEND FOR FALL & WINTER CATALOG DEPT. P.S.

"Beautiful XMAS Cards"

All Hand-Screened, All Original. Send One (\$1.00) Dollar for 20 Cards. Money back guarantee if not delighted. Distributors Wanted—Write for Details.

JORUTH PRODUCTS, 1026 39 St., Brooklyn 19, N. Y.

FREE-Sports BOOK FOLDER

All sports for boys, men and women—from chess to body-building, judo and street fighting. Just send us a postcard with your name and address.

NOTE: If you include 10¢ for postage, we'll also send free an inspiring 3"x5" wallet-size actual photograph of America's Best Developed Athlete. Write to:

CROSS CO., Box 389, Dept. D-2 Kenosha, Wis.

Learn MASONRY CARPENTRY



In a few short weeks you can be making big money in the building trades. Learn now while opportunities are greatest. Prepare for the future. You receive your training in our completely equipped shops under expert instructors. Fully approved for G.I. Training.

MIDWEST SCHOOL OF BUILDING TRADES

Dept. M-29,

411 N. Center Street,

Bloomington, Ill.

HOW TO GET THE MOST OUT OF YOUR HOME WORKSHOP

Here's how to DOUBLE the use and enjoyment you get from your Home Workshop! In this brand-new book, experts reveal know-how knacks of woodworking craftsmanship with both hand and power tools that will enable you to build furniture, make money-saving home repairs and improvements, enjoy scores of additional workshop hobbies! 690 illustrations! Order this big, handsome workbench manual now! Pay postman only \$1.98 plus postage when book arrives. (Or, if you want special DeLuxe Edition, Buckram bound, stamped in brilliant aluminum foil, pay only \$2.73.) Use it a whole week. Then, if not fully convinced it can DOUBLE the value of your Home Workshop to you, you may return it for refund of every penny! Write:

POPULAR SCIENCE PUBLISHING CO.

Dept. 97, 353 Fourth Avenue, New York 10, N. Y.



REFRIGERATION

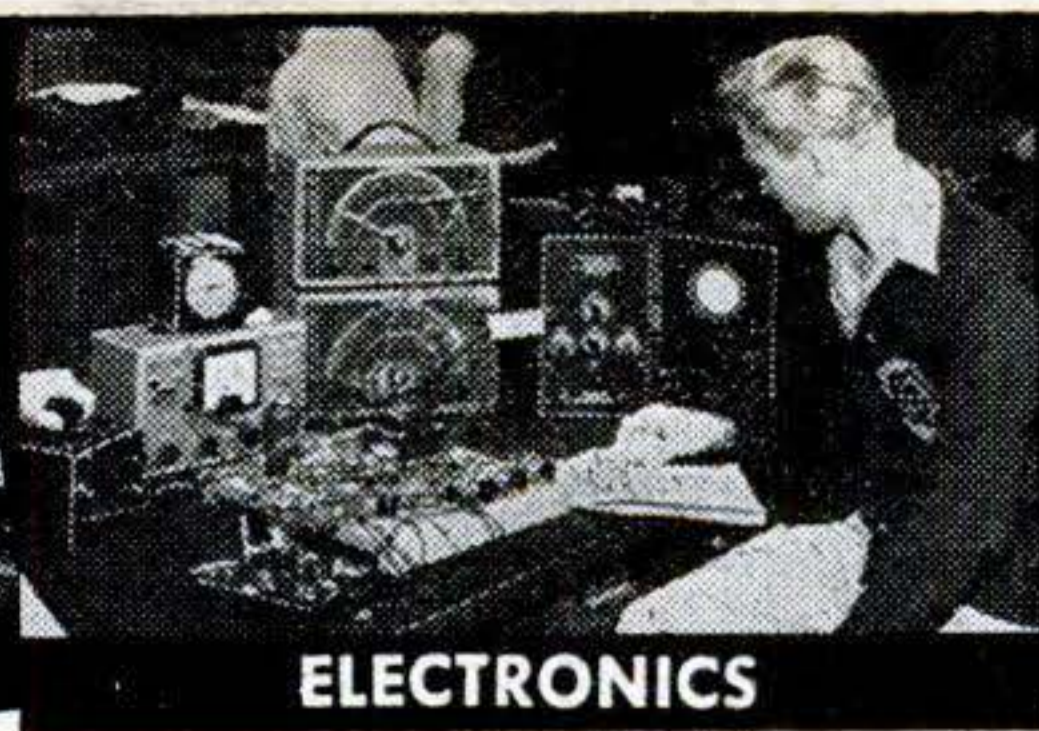

ELECTRONICS

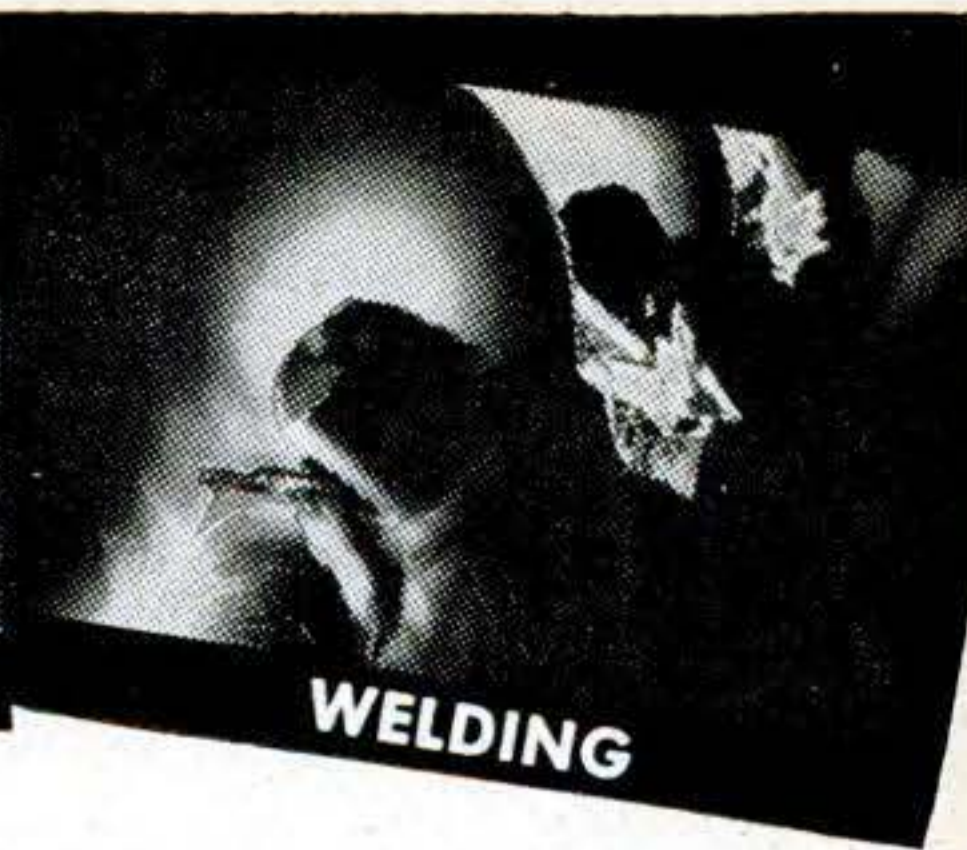

WELDING

**Specialize in
6 months to 3 years
COURSES**

SERVICE-6 Months

Practical Electricity
Practical Welding
Refrigeration Service
Heating Service

TECHNICIAN-1 Year

Electro Technician
Radio Technician
Electronics Technician
Refrigeration, Heating and
Air Conditioning Technician

PROFESSIONAL-3 Years

Electrical Engineering
Bachelor of Science Degree
Major in Machinery or Electronics

PRACTICAL TECHNICAL TRAINING

Our time-tested **CONCENTRIC SYSTEM** enables you to build your career step by step. Each 6-month course is complete in itself. Stay as long as circumstances permit—until you reach your desired occupational objective. For 44 years this school has specialized in technical training. More than 35,000 former students in industries the world over. 1,292 students now enrolled from 48 states and 8 overseas countries. Faculty of 63 specialists. World-wide alumni counselor committee. *Terms start September, January, April.* **SEND COUPON TODAY!**

MILWAUKEE SCHOOL OF ENGINEERING
A Technical Institute

Milwaukee School of Engineering, Dept. PS-947
N. Broadway and E. State, Milwaukee, Wis.
Without obligation, send me free booklet "Career Building" and more details on course

Name Age

Address

City State

**SEND FOR THIS
FREE!**

**HOW to
BREAK
and
TRAIN
HORSES**

Make money with horses. Every farmer, every lover of horseflesh should have a copy of this booklet. If you want to know how to break, train and make money with horses, *write today for full information FREE*, together with my special offer of a course in Animal Breeding. If you are interested in Gaiting and Riding the saddle horse check here. *Do it today—now. You'll never regret it.*

BEERY SCHOOL OF HORSEMANSHIP
Dept. 589 Pleasant Hill, Ohio

**EARN
BIG MONEY! METAL TRADES**

Courses offered in:

- Machinist-Toolmaking
- Mechanical Drafting
- Tool and Die Designing & Engineering

Practical training in fully equipped shops and drafting rooms by accredited engineers and instructors. Established two decades. Approved for Veterans • Day and Evening Classes Free Employment Service • Dormitory Accommodations

Call or write for Free Bulletin

ALLIED SCHOOL OF MECHANICAL TRADES
44 Allied Bldg., 1338 S. Michigan Ave., Harrison 3915, Chicago 5, Ill.

WANT \$1,756 to \$3,021 A YEAR?

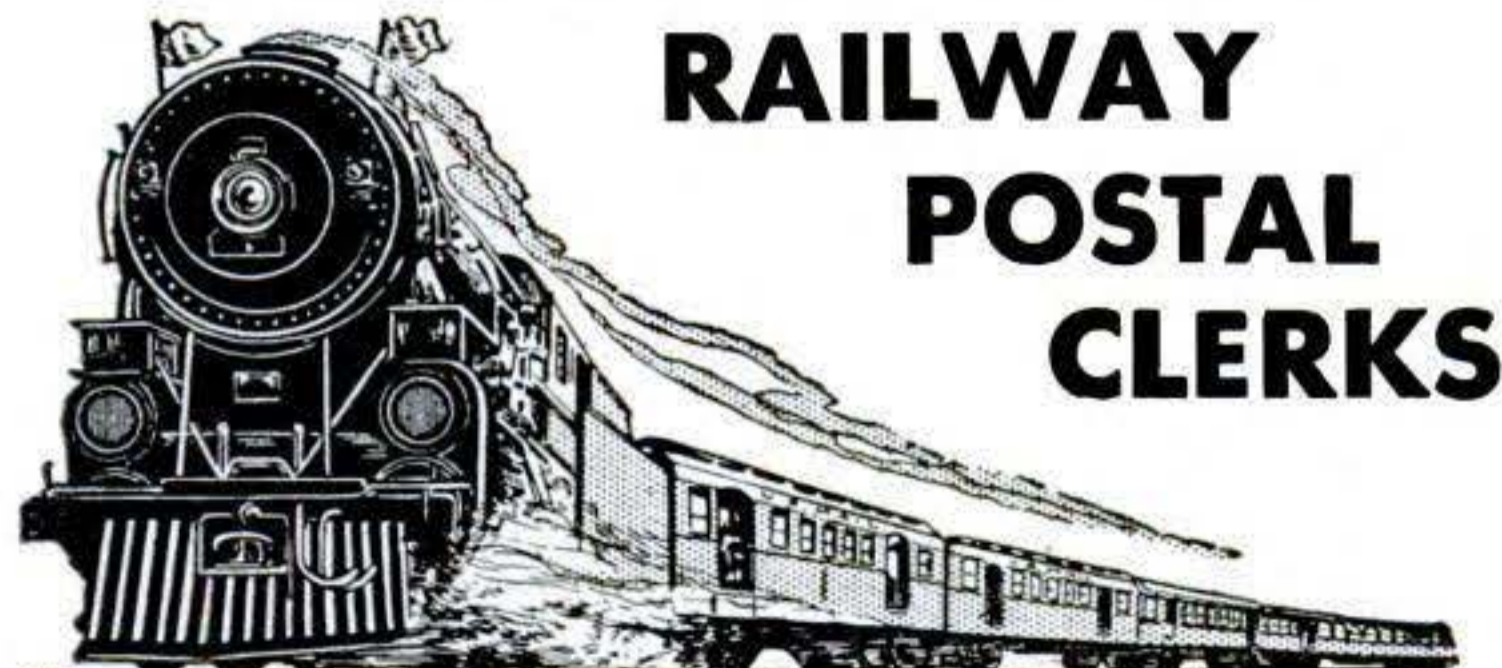

**RAILWAY
POSTAL
CLERKS**

City and Rural Carriers—Postoffice Clerks—
Inspectors—Accountants—Clerks at Washington
—Many other Government Jobs

TRAVEL FOR "UNCLE SAM"

Prepare Now for Many Coming Examinations
Veterans Get Special Preference

FRANKLIN INSTITUTE, Dept. M80, Rochester 4, N. Y.

Sirs: Rush to me, without charge, copy of 32-page book, "How to get a U. S. Government Job," list of positions, and full particulars telling how to prepare for them.

Name.....

Address..... Vet?.....

BARGAIN 3X ARMY TELESCOPE

Original Cost \$150.00 — Our Price \$7.50



ALL COATED LENSES — BRAND NEW

An ideal gift for viewing objects, landscapes, seashores, etc. The high resolving power of the six coated lenses, five of them achromats will bring out great details. For the experimenter it can be dismantled and used for hundreds of projects. Length 22 1/2 inches, 36° Field, Postpaid \$7.50.

500,000 Lenses and Prisms. Send 3c stamp for "Bargain" List

A. JAEGER

123-26B ROCKAWAY BLVD., SO. OZONE PARK 20, N. Y.

SOLID BRASS 12 FT. PORTABLE

RADIO ANTENNAS

Real \$15 Value Now Only \$4.95 Postpaid
FOR HOMES, BOATS or AUTOS

Just Out! Gov't surplus used on Army tanks. These telescopic rustproof antenna have tremendous pickup eliminate dangerous wiring. Solid Brass throughout practically insuring NOISE FREE RECEPTION.



12

Exceptionally Rugged Sections

compress into 1 ft. 4 in. Handy for

Camping Trips, also Useful for Transmitting,

FM & Television sets.

Each antenna comes with clamps, nut, lug, and wire. Easy to install anywhere.

QUANTITY LIMITED

ORDER TODAY. A real \$15 value for only \$4.95 Postpaid. Mail check or money order now or sent C.O.D. plus postage. Money back in 10 days if not satisfied.

RADIO HOSPITAL 1113 Lexington Ave., Dept. B9
New York 21, N. Y.

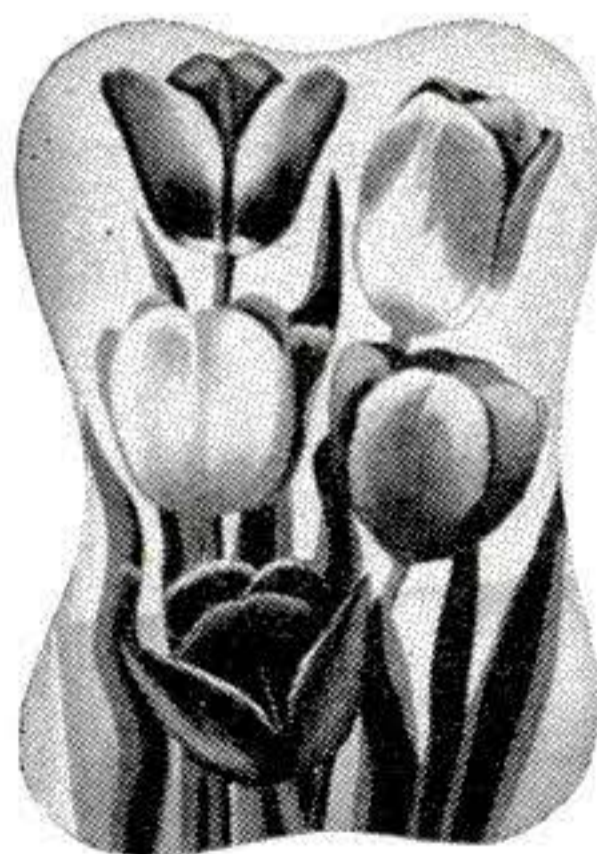

TULIPS

the envy of
your neighbors

Imagine the admiration of your friends when these gorgeous tulips bloom next spring. America's largest bulb GROWER offers you Tulip bulbs at prices which now make it easy for you to have all the Tulips you want.

100 for only \$3.75
50 for \$2.00

C. O. D. plus postage. Postage prepaid if you send check or money order now.

These are blooming—size guaranteed, May-Flowering bulbs, approximately 1" or over in DIAMETER. Order will contain at least 12 named but unlabeled varieties, of graceful heights, in admired colors. This surprising offer is good only while supply lasts. Shipment will be made late August in plenty of time for fall planting.

HARTFORD FARMS • America's Largest Bulb Grower
DEPT. MT 55 HARTFORD, MICH.

FIREWORKS!

CHINESE FIRE CRACKERS

Immediate Delivery

80/16—1 1/2 Jolly Brand\$4.50 per bundle
80/20—1 1/2 Jolly Brand 5.35 per bundle
80/16—1 5/8 Cock Brand 5.50 per bundle
80/20—1 5/8 Cock Brand 6.50 per bundle

SMOKE BOMBS Per Case \$10.00
of 25

TERMS CASH WITH ORDER

UNITED FIREWORKS MFG. CO., INC.

DAYTON 7, OHIO

LEARN To Repair and Service

Electrical Appliances, Sewing machines, motors, bicycles, lawn mowers, saw filing, cutlery grinding, etc.

Postcard Brings Free Details

Start with \$20.00 and a few common tools! Build low cost equipment while earning. Make up to \$6.00 an hour! Complete illustrated course \$5.50 only

5 Days Free Examination C.O.D. 35c Extra

REPAIRMAN'S SERVICE 222-S 4th Ave.,
Janesville, Wis.

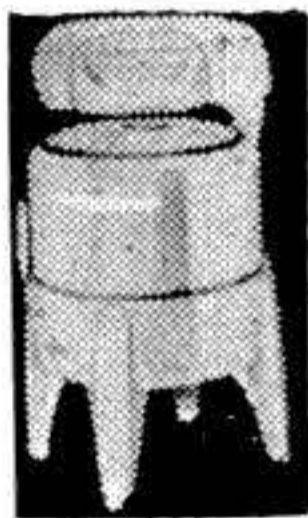

METAL FORMING TOOLS

12" BRAKE. Fits in vise, or bolts to bench or plank. Forms angles, channels, boxes and crimps in sheet metal and thin strap iron. \$14.50 PP. in U. S. A.

WISE FORMING TOOL. Makes cylinders, ovals, cones, hoops and round corners in sheet metal, wire and 1/8x2 steel strap. 2" to 60" in dia., 18" wide. \$10.00.

WISE IRON BENDER. Easily bends 1/2" square or round; 1/4" up to 2" wide. Makes hooks, rings, brackets, eyelets, etc. Screw adjustment for accurate work. All steel. Price \$10.00 PP. Immediate delivery.

Drill steel easily with your 1/4 to 1/2-in. electric or air drill, or brace and bit. 48" chain, lever feed. Soon pays for itself.

Price, \$3.50. SHEET METAL PLIERS, 2 1/2". Forms angles, channels, etc.

\$2.00. Sheet Metal and Wire Forming booklet, 50c. All items guaranteed. Order direct, or send for details.

WISE BRAKE MFG. CO., 1318 So. 30th Ave., Omaha 5, Nebr.



"JACKPOT" AMUSEMENT MACHINE



• Great fun maker for Rumpus Room, Club or Tavern. Soon pays for itself. Fully automatic payout, three reels, with all the usual winning combinations . . . cherries, lemons, etc. Double jackpot. Rugged lifetime construction. Guaranteed to satisfy or money back. Service manual makes it easy to understand how to operate machine successfully. Takes space only 14 1/2 x 11 1/2 in. Ht. 18 1/2 in. Shpg. wt. 47 lbs. CHOICE OF 5c, 10c, or 25c PLAY. Send \$20.00 deposit, balance C.O.D. plus express charges. Immediate delivery . . . Each, \$189.50

WEBB DISTRIBUTING CO. INC.
6 S. KEDZIE AVE., CHICAGO 12, ILL.

Now She Shops "Cash And Carry"

Without Painful Backache

Many sufferers relieve nagging backache quickly, once they discover that the real cause of their trouble may be tired kidneys.

The kidneys are Nature's chief way of taking the excess acids and waste out of the blood. They help most people pass about 3 pints a day.

When disorder of kidney function permits poisonous matter to remain in your blood, it may cause nagging backache, rheumatic pains, leg pains, loss of pep and energy, getting up nights, swelling, puffiness under the eyes, headaches and dizziness.

Don't wait! Ask your druggist for Doan's Pills, a stimulant diuretic, used successfully by millions for over 50 years. Doan's give happy relief and will help the 15 miles of kidney tubes flush out poisonous waste from your blood. Get Doan's Pills.

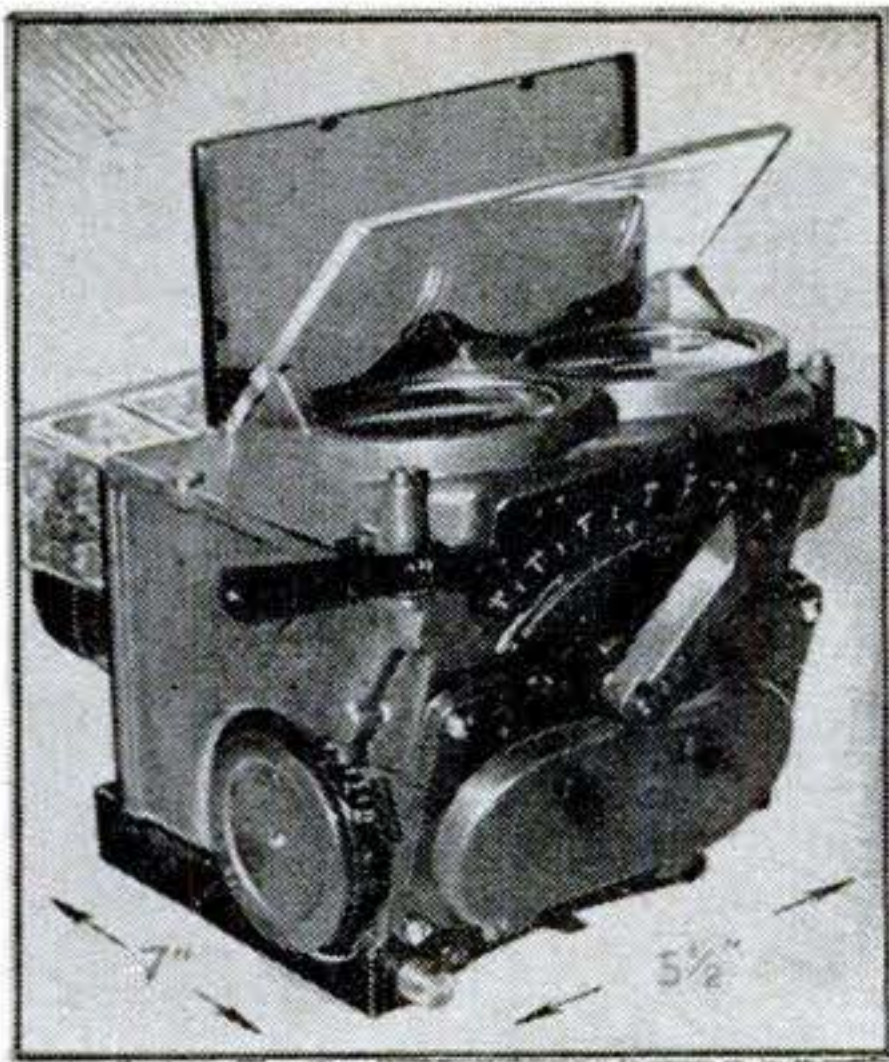

The Famous
**MARK
GUN
SIGHT...**

The Miracle
**OPTICAL
GYROSCOPE!**

\$6.95

Yours For Only.....

Send Check, Cash or Money Order, No C.O.D.—FOB, New York

COLUMBO TRADING CO., INC.

304 Canal Street

New York 13, N. Y.

PRECISION JEWELERS SCREW DRIVERS

Complete Set of 8 for Every "Hobbyist"



At last—a complete set of precision screw drivers to meet the needs of every model builder. Not a miniature but the same type set used by U. S. Navy for precision instruments and watches during the war. Brass knurled handles, hexagon heads, finest tempered steel blades. Sizes 2-9. Never before a set of this quality and precision at such a low price. Your money back if not satisfied. C.O.D. \$2.00 plus postage or send \$2.00 and we pay postage.

■ PINE WATCH CO., Rm. 40, 29 Eldridge St., New York 2, N. Y. ■

TO OUR OLD AND NEW CUSTOMERS

• Send for our new larger than ever free catalog, listing hundreds of new and used items of war surplus and nationally advertised merchandise at extremely low prices; For home, shop, factory, ranch, farm. Items to please men, women, and children. **DON'T FAIL TO SEND FOR YOUR FREE CATALOG NOW.** We give you our personal guarantee of big savings.

MIDWEST BUY ANYTHING COMPANY

1520 Locust St.

Kansas City, Mo.

Learn RADIO TELEVISION ELECTRONICS

Our proven 2-Way Instruction trains you at home in spare time for a good pay job or a business of your own. For **FREE** book "Your Opportunities in Radio", write: Hollywood Radio & Television Institute (Established 1929), Dept. D-8, 810 W. 6th St., Los Angeles, Calif.

RADIO ENGINEERING Television, FM, Broadcasting, Servicing, Electronics, Aviation, Marine & Police Radio taught thoroughly. 72 weeks' Engineering course equivalent to 3 years' college radio work. Approved Veteran Training. Catalog upon request.

Valparaiso Technical Institute. Dept. 503, Valparaiso, Ind.

Enjoy — **WORLD'S MOST FASCINATING HOBBY! SEND FOR FULLY ILLUSTRATED BOOK TODAY!**



GET THE FACTS on model railroading! Leading authority shows how easily, inexpensively you can join in the absorbing hobby enjoyed by thousands of mechanics, business and professional men. Scale model railroads look, perform like the real thing!

GET STARTED NOW! Send 10¢, coin or stamps, for fully illustrated booklet, "Model Railroading for You".

MODEL RAILROADER MAGAZINE
Dept. 1609 Milwaukee 3, Wisconsin

Give yourself the Backing of a GREAT GROWING INDUSTRY



**REFRIGERATION
AIR CONDITIONING**

• Refrigeration and Air Conditioning have leading place in fast growing fields of our time. Trained men paid well to service, install, maintain, repair, rebuild household and commercial refrigerators. Important new developments such as Frozen Foods and many new industrial uses. Demand for commercial installations in restaurants, butcher shops, taverns, florists, bakeries, etc.—air conditioning in homes, offices, shops.



START NOW—Full and Part Time Earnings

There may never again be such opportunities for men who want better jobs or business of their own to get in on ground floor and go up fast! Many started with small investment who built good, growing business. If over 17 and under 60 learn how you can get started. **CONSULTATION AND PLACEMENT SERVICE WHETHER YOU ARE INTERESTED IN WORTHWHILE JOB OR SETTING UP YOUR OWN BUSINESS.**



Begin Training at Home or Come Directly to Shops

Begin your training at home in spare time, finish in our big, modern shops, or come directly to shops. At home you get C.T.I.'s **SHOP PROVED HOME STUDY** instruction—actual shop experience has gone into the practical lesson assignments. That is why it is easy for mechanically inclined men to learn by our Home Study training and start on actual refrigeration work.



A NATIONALLY KNOWN INSTITUTION

C.T.I. was only civilian school selected by Army to train service men for refrigeration. Same quality training available to you now. The method that has made rapid progress possible. Commercial Trades Institute has established its place in Air Conditioning and Refrigeration Industries, and that is important to you in making your start.

VETERANS

Veterans qualifying under "G.I. Bill" have tuition paid by Government plus monthly subsistence allowance while in school. Just mail coupon, we will handle all details. (LOW TUITION, EASY TERMS if you are not a veteran.)



Commercial Trades Inst., Dept. A-19
1400 W. Greenleaf Ave., Chicago 26, Ill.

FREE—Important Information Telling How to Get Started
CUT COUPON ALONG THIS LINE

Fill Out, Cut Out, Mail Today

FACTS FREE for Men Who Want to Get Ahead
COMMERCIAL TRADES INSTITUTE, Dept. A-19
1400 W. Greenleaf, Chicago 26, Ill.

Send free illustrated Brochures and other information about Refrigeration and Air Conditioning.

Veteran Non Veteran

NAME.....

ADDRESS.....

CITY.....STATE.....

TELEVISION IN YOUR HOME

NOW FOR \$159.50 ONLY Complete



This easy-to-assemble Transvision kit plus a few hours' time gives you a highest quality television set in operation... at about half the price you'd pay for the lowest priced set on the market!

Designed by television experts, this kit contains everything... dipole antenna, 7" picture tube, pre-tuned R. F. unit... even solder! Nothing extra to buy. All you need is a screw driver and soldering iron. Assembly instructions are non-technical and simple to follow. All complex units are pre-assembled at the factory.

EQUALS HIGH-PRICED SETS IN PERFORMANCE

Perfectly focused, clear picture even in brightly-lit room. Over 9,000 Transvision sets assembled by novices are in perfect operation today!

Each set has an unqualified guarantee. Order one now and see the ball games in the comfort of your living room!

BEACON TELEVISION, Inc., Distributors for Transvision Television Kits, 143 East 49 St., New York 17, N. Y.

MAIL THIS FOR FREE DETAILS

Beacon Television, Inc., Dept. C
143 East 49 St.
New York 17, N. Y.

Gentlemen:

I'm interested in your easy-to-assemble Transvision Television Kit. Please send me more information without obligation.

Name.....

Street.....

City..... State.....

THE Natural WAY TO LIGHT A PIPE

- Windproof
- Lightweight
- Large Flame

DOWN-DRAFT CHIMNEY-ACTION

\$3.50 AT YOUR DEALER

Unconditionally Guaranteed

Nimrod PIPELITER

If your dealer is unable to supply you, send \$3.50 direct.

WARD-NIMROD COMPANY

Dept. 36-E, 2968 Jessamine St., Cinti. 25, Ohio

How to Start YOUR OWN BUSINESS

And Reap BIG Profits!

Plastics, one of the most revolutionizing and rapidly expanding industries, offers a great opportunity to all enterprising men and women. This is one of the few industries in which home manufacturers thrive and prosper. You can start even on a spare time basis in your own home, and expand rapidly into a full time business, paying good profits.

LIQUID MARBLE

Make LIQUID MARBLE the amazing Plastic, with a thousand uses. LIQUID MARBLE can be poured into FLEXIBLE MOLDS for casting all kinds of artistic and serviceable articles such as: ornaments, novelties, desk sets, paper weights, book-ends, souvenirs, stationery, toys, etc.

FLEXIBLE MOLDS

Make your own FLEXIBLE MOLDS. The cost is low—in fact, a large sized mold costs but a few cents. Hundreds of casts can be taken from a single mold.

NO EXPERIENCE NEEDED!

No skill or previous knowledge is necessary. All you do is follow our easy-to-understand instructions.

UNLIMITED MARKET

The market is literally unlimited. You will find steady year-round demand in your own community. Your problem will not be in selling but in supplying the huge pent-up demand. Moreover, we supply you with names of buyers for your finished products.

WRITE TODAY

Bing Products will show you how to start with a small investment and build a permanent, independent, profitable business! Don't fail to grasp this opportunity! Write today for FREE CATALOG.

BING PRODUCTS

Dept. B-23, 88 Broad Street Boston 10, Mass.

Learn to MOUNT BIRDS

Tan SKINS, make up FURS

Be a Taxidermist. Double your hunting fun. We teach you at Home. Mount Birds, Animals, Fish, Heads, common specimens. Fun and profits. Decorate home and den **MAKE MONEY**. Mount game, tan for others. Big profits in spare time. **WRITE TODAY.** 100 game pictures in **FREE BOOK** Hunters, get your copy. It's **Now Free**. Send post card. State your AGE. **NORTHWESTERN SCHOOL OF TAXIDERMY** Dept. 3396 Omaha, Nebraska

HORSE MASTERY!

A FINE HOBBY — A GREAT VOCATION!

"The EXPERT HORSEMAN"

FREE BOOK — Tells how You can learn to: BREAK COLTS, GAIT SHOW HORSES, TRAIN RODEO, STOCK and RACE HORSES, BREAK BAD HABITS, HANDLE ANY HORSE, TRAIN CIRCUS TRICK HORSES. **WRITE TODAY!**

ANIMAL LOVERS ASSOCIATION
BOX S-157 TARZANA, CALIFORNIA

SUBSCRIBE TODAY 50¢
One Year

EYE-GLASSES BY MAIL

16 Days Trial

Write Today for Free Catalog. Send no Money

ADVANCE SPECTACLE COMPANY

537 South Dearborn Street, Dept. SP9, Chicago, Illinois

If Ruptured

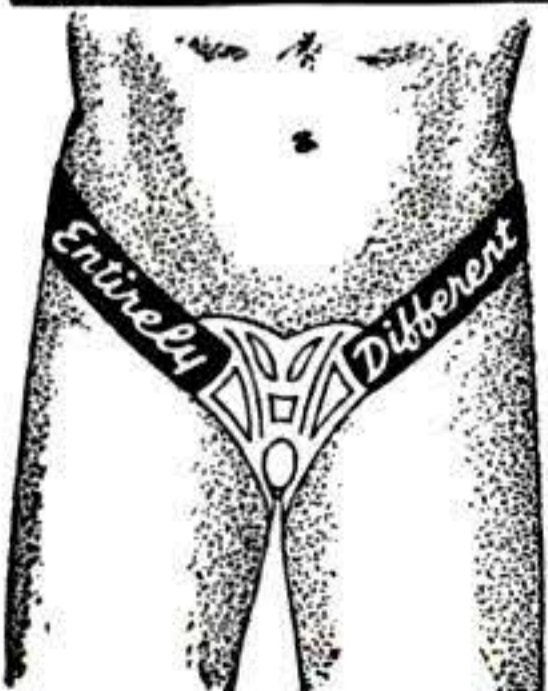

Do What Others Now Do—
Wear a Form Fitting MILLER Truss
which provides natural freedom and comfort in working, walking, playing, horse back riding, dancing, swimming or sleeping. You just cannot afford to be without this protection and convenience.

Wear two weeks then consult your physician before deciding to keep it.

Write me today for **FREE** descriptive circular. Sent in plain, sealed envelope.

FRED B. MILLER Manufacturer
Dept. P.S. Hagerstown, Maryland.

PAIN'T YOUR CAR WITH WYPE for \$3.95

Amazing NEW AUTO ENAMEL

YOU WIPE ON Instead of Brushing & Spraying

Get Beautiful Mirror-Like Finish That Looks Like Spray Job!

At last! Practically anyone can now paint his car with WYPE and get a beautiful high-gloss job that gives you an expensive finish such as is sprayed on by Professional Auto Painters—at a fraction of regular cost! With WYPE you need NO BRUSH, NO SPRAY, NO MASKING! Just WIPE ON with Powder Puff—which we furnish at no extra charge. You get a brilliant, glossy finish that is truly "factory-like." No streaks. No lap-marks. Guaranteed for TWO years not to crack, peel, chip or fade, if simple directions are followed. Takes about an hour to apply. Dries dust-free in an hour. WYPE comes in eight most popular shades including those on newest model cars. Goes over any other color, lacquer or enamel.

NEW MONEY-MAKING BUSINESS!
WYPE 2 CARS DAILY for \$25.00 each—
Gross Up to \$260.00 Weekly Profit!

Start making BIG MONEY Now! Sell WYPE in cans or go into business painting cars yourself (or hire others to do work). Send for FREE details of powerful money-making plan. Why wait! Start now by ordering one quart or more of WYPE!

SEND NO MONEY! ORDER WYPE TODAY!

Color	Price Per Quart
BLACK	\$3.95
GREEN (Brewster-Dark or Jewel-Light)	3.95
BLUE (Washington-Dark or Monticello-Light)	3.95
GRAY	3.95
RED or MAROON	3.95

Order one quart or more today! SEND NO MONEY! Mail penny postcard. Then pay your mailman for WYPE plus postal charges. Or, if you send money with order, WE pay postage. See your dealer or order direct.

WYPE CORP.

Dept. 60-J, 2214 Dolman St.

ST. LOUIS, MO.

2-YR Guarantee
NO MASKING NEEDED
NO STREAKS or LAP-MARKS
Looks like SPRAY JOB



ANYONE CAN DO BEAUTIFUL JOB

ONE QUART DOES ENTIRE JOB! DRIES TO GLISTENING PROFESSIONAL FINISH!

WYPE is a new Miracle Enamel for Autos. It is NOT a wax or polish but a hard high lustre ENAMEL finish! With WYPE, ANYONE can do a beautiful job! Order a quart to paint your car or to get started in this BIG-MONEY Business!

PULVEX

"DDT" FLEA POWDER

Guaranteed by Good Housekeeping
IF DEFECTIVE OR NOT AS ADVERTISED THEREIN

Kills the fleas **Quickly!**
Keeps others off for Days.

Either Kind
25¢ & 50¢

Pulvex also comes with ROTENONE, the original formula. BEST FOR CATS.

MOTORS

110 VOLT—A.C.
HEAVY DUTY CONSTRUCTION

Fractional H.P. ball bearing—brand new. Ideal for power tools, fans, models—100 other uses. \$15.00 value.

IN LOTS OF 10 . . . \$4.50 ea.

ALL PRICES F.O.B. N. Y. CITY
REMIT 20%—BALANCE C.O.D.

MANUEL KLEIN 74 CORTLANDT ST.
NEW YORK 7, N. Y.

\$4.95

DRAW for MONEY . . . Be an ARTIST!

Trained Artists are Capable of Earning \$50-\$60-\$75 OR MORE A WEEK!
You can learn to draw at home in your spare time the well-known WSA way. COMMERCIAL ART, DESIGNING, CARTOONING—all in ONE complete course. No previous art experience necessary—we teach you step-by-step. Prepare now for a fascinating hobby or profitable career. For 33 years WSA graduates have been making good—WHY NOT YOU?

VETERANS!
WSA is approved for training under the G. I. Bill

Write today for FREE BOOK, "Art for Pleasure & Profit." It fully describes our well-known course, instruction service, and commercial opportunities for you. TWO ART OUTFITS and other features included with training.

WASHINGTON SCHOOL OF ART, Studio 139H
1115—15th St., N.W., Washington 5, D. C.
Please send me full information and your Free Book, "Art for Pleasure and Profit."

Name AGE
Street
City Zone State
 I am entitled to training under the G.I. Bill

MAKE UP TO \$5⁰⁰ AN HOUR In Your Own YEAR ROUND Business!

ONLY A FEW DOLLARS PUTS YOU IN BUSINESS!

Many Clearing as High as \$20 to \$30 a Day NET Renewing Rugs, Carpets, Upholstery. New Method Now Used for Auto Upholstery. Write for Facts About Quick, Easy Way to Get Started

Here is the chance you've been looking for to step into a pleasant, dignified, big-pay business of your own that offers you a steady, year 'round income. Start on "a shoe-string," full or spare time, right from your own home. Equal opportunities for men and women, young or old, in small towns or big cities. No experience needed. Many making big money with new Americlean System just cleaning auto upholstery. Easy to learn. We send you complete instructions and quick-cleaning supplies so you can start making money the very first day! Quick method cleans upholstery, rugs and carpets like new without taking off floor! Tremendous demand in homes, apartments, hotels, stores, office and public buildings. Steady repeat business. Territories going fast. Write today for full FREE facts. No cost or obligation. Rush letter or postcard now to
AMERICLEAN CO., Inc.
Dept. H-9, 211 North 7 St., St. Louis 1, Mo.

WRITE FOR FREE DETAILS NOW!

AIRCRAFT SUPERCHARGER LUBE PUMP

Designed for pumping liquids up to 3 G.P.M.

A gear type impeller pump with two pumping units in one housing. Precision built of aluminum, cast iron, bronze and steel. Compact construction—only 3 1/2" Dia. x 8 1/2" long.

- Vacuum, 29 1/2 inches of mercury.
- 1/2" Dia. Threaded and keyed shaft.
- Brand new! Sealed in Pliofilm.
- With Test Sheet and Instructions.

Immediate delivery. Order now! Post paid anywhere in U.S.A. upon receipt of check or M. O. C.O.D. orders include postage and extra fees.



Pressures up to 200 lbs. per Sq. In.

From 1 to 3900 R.P.M.

Originally cost \$24.00. Now only

\$3⁹⁵

FISCHER LABS 1729 N. MOBILE, CHICAGO, 39, ILL.

Have Your Own **ELECTRO-PLATING** Business

Profitable-Simple-Pleasant

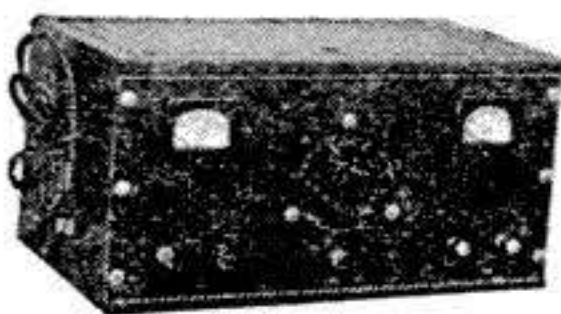

The **VARI-PLATER**—110 V. A.C.—plus a glass or rubber tank and chemicals, which are always available, and accompanying handbook, that is illustrated and easy to understand, will give you many money making opportunities.

You can **PLATE** Gold—Silver—Chromium—Nickel—Copper—Cadmium, etc. on metals and non-metals with the **VARI-PLATER**.

FREE Write today for descriptive literature and price list.

LEWIS ELECTRICAL MFG. CO. 1266-B GunHill Rd. New York 67, N. Y.

PROTECT YOUR HOME

with these **MODERN Low Cost FIRE EXTINGUISHERS**

A little foresight now may save **LIVES and property later!** Equip your home, your garage, your boat with **AUToFYRSTOP**, the modern fire extinguisher and alarm that is setting new efficiency records. Write for free literature:

AUToFYRSTOP CO. Dept. PS-947 2035 Washington Av., Philadelphia 46, Pa.

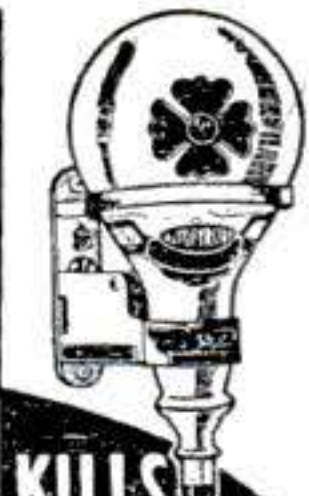

KILLS FIRE BY ITSELF

MONEY MAKING OPPORTUNITY

We have openings for high grade salesmen in choice territories. Write for Plan.



BE FAIR TO YOUR Hair

WAKE UP YOUR SCALP Want better looking hair? Embarrassed by falling dandruff, itching scalp? Then try **VITABRUSH**, new electric driven scalp brush that gives your scalp a vigorous and invigorating "workout" in just three minutes of fun. Cleans scalp. Stimulates blood supply. Restful. Pleasant. Write today for complete information and satisfaction-guaranteed offer. Hershey Mfg. Co. 3768 Field Bldg., Chicago 3

THE BEST POCKET SIZE RADIO MADE ONLY \$1.98

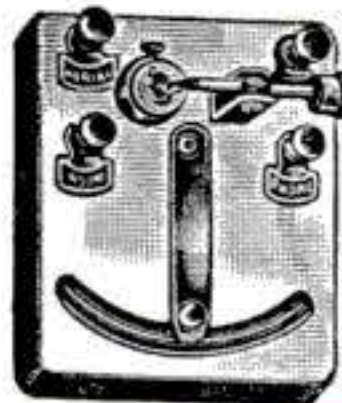

Yes—good entertainment is less expensive than ever before. This new radio is housed in an attractive bakelite cabinet. It features slide contact tuning—enabling you to get stations loudly and clearly. No Tubes, Batteries or Plug-In. **GUARANTEED TO PLAY** when simple directions sent with each radio are used. C.O.D. orders O.K. or send \$1.98 (cash, money order, check) and receive your radio postpaid. **Singer Sales, 1014 College Ave., N.Y. 56, N.Y.**

LAW

STUDY AT HOME for PERSONAL SUCCESS and LARGER EARNINGS. 39 years expert instruction—over 108,000 students enrolled. **LL.B.**, Degree awarded. All texts furnished. Easy payments. G.I. Approved. Send for **FREE BOOK.**

AMERICAN EXTENSION SCHOOL OF LAW Dept. 81-S, 646 N. Michigan Ave., Chicago 11, Ill.

Jiffy Jr. ELECTRIC HEATER

BOILING HOT WATER IN A JIFFY!!



Only **\$2.95** **HOT WATER IN A JIFFY** plus twenty five cents for postage

Place the Jiffy Electric Water Heater into the water and insert the plug in the nearest electric wall or light plug. You will have hot water in less than five minutes for baby's bath, your washing, shaving and a great many other uses in the home, camping, business, and on the farm. Mailed complete, including six feet of rubber covered wires and plug. One year guarantee. **JIFFY ELECTRIC COMPANY, Dept. PS1, 2122 Stephenson Highway, Hazel Park, Mich.**

Become a Doctor of PSYCHOLOGY

Win the degree of **Ps.D.** Teach the secret of contentment, happiness. Solve mental worries. Experience the revelation of truth. Chartered college. Individual help. Write for **FREE** book. **COLLEGE OF UNIVERSAL TRUTH, 5153-A North Clark St., Chicago.**



LEARN-WATCH REPAIRING at HOME

"FREE Information write—American Institute Of Specialized Watch Repair—270-276 East Bldg., Grand Rapids Michigan."

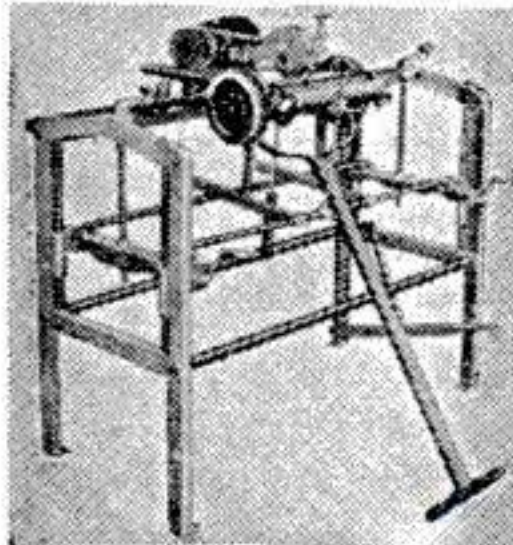

MASTER CHAMPION

LAWN MOWER SHARPENER Also Mfg., Saw Sharpening & Key Machines

FRANK'S MFG. CO.

Dept. PS-9, 3312 Tweedy Bl. SOUTHGATE, CALIF., U.S.A.

OTTAWA TRACTOR SAW



350 Cuts Per Minute—cuts them down, saws them up, one man operates. Thousands in use, stiff heavy blade, built to last, safety clutch control, uses power take-off any tractor. Low price. **OTTAWA MFG. CO., 2-701 Forest Avenue, OTTAWA, KANSAS**

SHORTHAND IN 6 WEEKS

LEARN AT HOME—LOW COST

Write 120 words per minute. Easy for adults. Famous Speedwriting system. No signs or symbols; uses ABC's. Easy to learn and use. Fast preparation for a position. Nationally used in leading offices and Civil Service; also by executives, writers, speakers, lawyers, scientists, students at college. Over 100,000 taught by mail. The very low cost will surprise you. 24th Year.

WRITE FOR FREE BOOKLET TO

Speedwriting

TRADE MARK, REG. U.S. PAT. OFF
Dept. 2609-7, 55 W. 42 St., N. Y. 18

ELECTRICAL TRAINING

Intensive 32 weeks residence course in fundamentals of industrial electrical engineering, including radio, electronics. Prepares for technician, engineering aides. Approved for veteran training. 54th year. Write for catalog.

BLISS ELECTRICAL SCHOOL
7616 Takoma Ave., Wash. 12, D. C.



MAKE MONEY CASTING AT HOME FREE FACTS SENT



Cast thousands of perfect Plaques, Book Ends, Ash Trays, Etc. Plaster, Liquid Marble, Etc. ENORMOUS PROFITS. Start in basement or garage. LITTLE CAPITAL NEEDED. QUICK, EASY, NO PREVIOUS EXPERIENCE NEEDED. Rubber molds for speed production. MAKE YOUR OWN. SAMPLE KIT \$1.00. Canadian \$1.50. PLASTIC ARTS STUDIOS, Route 5, Dept. 45, Muncie, Ind.

Why spend years learning by hard experience what you can get from a practical book in a few hours.

Write for list of "How-To-Do-It" books on practical subjects. 1000's of pleased customers all over the world.

ADAMS BROWN COMPANY — BOOKS OF APPLIED SCIENCE
Dept. 279, Chestnut Hill 67, Massachusetts, U. S. A.

LEARN MONEY-MAKING CARTOONING

IN SPARE TIME — by Easy Picture Chart Method Same Simplified Method that has helped train creators of "Terry & Pirates," "Freckles," "Out Our Way," "Winnie Winkle," "Reg'lar Fellers," "Strange As It Seems," "The Neighbors," and many others. Earn while learning. Send 10c for Picture Chart (to test your ability). Samples of successful students, and full details. (State age.) The Landon School, 4729 Schofield Bldg., Cleveland, Ohio



Photography

for

PLEASURE or PROFIT

Learn at home. Spare time. Practical basic training. Long-established school. Many have earned while learning. Send coupon below for free booklet, "Opportunities in Modern Photography" and full particulars.

AMERICAN SCHOOL OF PHOTOGRAPHY

1315 Michigan Avenue Dept. 1366 Chicago 5, Illinois

Send booklet, "Opportunities in Modern Photography," full particulars and requirements. No salesman will call.

Name..... Age.....

Address.....

City..... Zone..... State.....

HOW TO Fight! Wrestle! Jiu-Jitsu!

FREE WITH THIS OFFER!



PLUS WEIGHT LIFTING! STRONG MAN STUNTS!

Be prepared to protect your family, friends, yourself in any emergency! Be admired! George F. Jowett, Champion of Champions, gives you free his "SMASHING CHAMPION SECRETS". Contains many "HOW-TO-DO-IT" pictures that quickly and simply show you how to powerfully deliver a knockout, how to break any hold, how to overpower any opponent plus weight lifting and strong man stunts! Inside professional "Tricks of the Trade" proved successful by police, armed forces, fighters, wrestlers, etc! Free for a limited time with this sensational offer!

You Need He Man Fitness To Handle Any Tough Situation!

NOW! ALL 5 FAMOUS JOWETT COURSES

— 1 COMPLETE MUSCLE BUILDING VOLUME! FOR ONLY 25¢

LET ME PROVE I CAN MAKE YOU

COMMANDO-TOUGH OR IT WON'T COST YOU A CENT!

says George F. Jowett WORLD'S GREATEST BODY BUILDER



GIVE ME 10 MINUTES A DAY

LEARN MY TIME TESTED SECRETS OF STRENGTH

I'll teach you the "Progressive Power Method" that rebuilt me from a physical wreck condemned to die at 15, to the holder of more strength records than any other living athlete or teacher! Has proven it builds the strongest, handsomest men in the world. Let me prove on a money back basis—that no matter how flabby or puny you are that I can add inches to your arms, broaden your shoulders, give you a man-sized chest, powerful legs and a Rock-like back—in fact power pack your whole body so quickly it will amaze you—right in your own home! I'll bring to life new power in you inside and out, until YOU are satisfied you are the man you want to be.

PROVE IT TO YOURSELF IN ONE NIGHT

Send only 25c for my 5 easy-to-follow picture-packed courses now in 1 complete volume "How to Become a Muscular He-Man." Try it for one night! Experience thrilling strength that surges through your muscles.

10 DAY TRIAL!

Think of it—all five of these famous courses now in one picture-packed volume for only 25c. If you're not delighted with this famous muscle-building guide—if you don't actually FEEL results within ONE WEEK, send it back and your money will be promptly refunded!

Photo Book Of Famous Strong Men!

FREE!



Photos that inspire you to might and muscle. Free with order.

I am making a drive for thousands of new friends fast—REGARDLESS OF COST!
SO GET NOW MY 5 Muscle Building COURSES (Valued at \$5 each)

All in 1 Great Complete Volume Packed With How-To-Do-It Pictures!

Now, this "get-acquainted," extremely low price of only 25c is your chance to build a body you'll be proud of! Follow Jowett's easy method of muscle building NOW!

For Only 25c



2 FREE GIFTS!

Jowett Institute of Physical Culture
230 Fifth Avenue, New York 1, N.Y. Dept. PS-79

George F. Jowett
Champion of Champions

George F. Jowett: Please send by return mail, post-paid, FREE "Smashing Champion Secrets", and FREE Jowett's Photo Book of Strong Men, along with all 5 Muscle Building Courses. 1. Molding a Mighty Chest. 2. Molding a Mighty Arm. 3. Molding a Mighty Grip. 4. Molding a Mighty Back. 5. Molding Mighty Legs—Now all in One Volume "How to Become a Muscular He-Man". Enclosed find 25c. NO C.O.D.'s.

NAME..... AGE.....
(Please Print Plainly, Include Zone Number)

ADDRESS.....

AVIATION NEEDS YOU

... if you have the training and **EXPERIENCE ALLEN gives you!**

Yes, Allen not only gives you mechanical training, but **ACTUAL MECHANICAL EXPERIENCE** on operational equipment as well. Look at these requests to our Vocational Director from nationally known aviation concerns. "We are enclosing ten of our regular employment application forms which we would like to have completed and returned to us." ... "We have employment opportunities for qualified, licensed Aircraft and Engine Mechanics WHO HAVE HAD PREVIOUS EXPERIENCE."* Employers want men with **EXPERIENCE!** You get that experience at Allen where more than 25% of your time is spent working on *operational, commercial, aircraft.* You graduate from Allen as a fully **LICENSED** and **EXPERIENCED** Aircraft and Engine Mechanic in a minimum time of one year.

*Name and address on request.

VETERANS — ALL costs covered under GI Bill.

Immediate enrollment possible. Act now and assure yourself of a position in the new fall class!

ALLEN Airways & School
Founded 1930

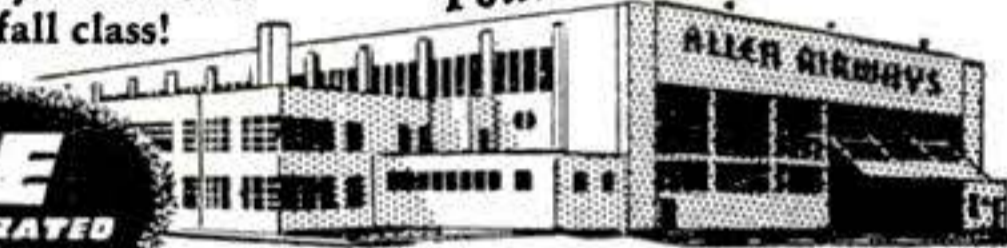

FREE

BIG, ILLUSTRATED CATALOGUE

Allen Airways, State Airport, Hillsgrove, R. I.
Please send me your free catalogue

Name..... Age.....

Street.....

City..... State.....

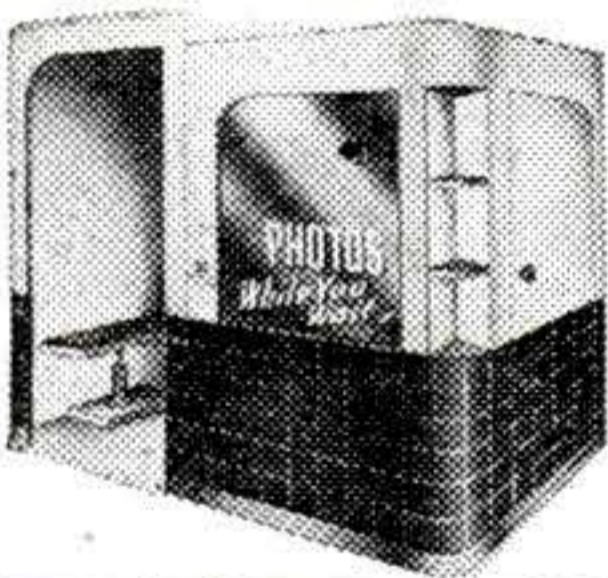

Up to \$600 Weekly

with new
5 MIN. PHOTO EQUIPMENT
No experience necessary

Booth models—for your own small store location, arcades, department, variety, other stores, lobbies, depots, carnivals, parks, beaches, etc. **Portable models** for street corners, parks, picnics—anywhere. Send 3c stamp for **BIG PROFITS Plan.**
FEDERAL IDENTIFICATION CO.
Dept. B2, 1012 N.W. 17th, Oklahoma City, Oklahoma

ADD TO YOUR INCOME

Profit by Increasing Demand for Belts, Purses, Gloves Woolskin Toys—

with **LARSON Leathercraft**

No Experience Necessary

Sell popular, useful, easy-to-assemble items from Leathercraft Headquarters. Complete stock. All tools and accessories. Instructions come with materials. Immediate delivery.



101 Ideas
Send ten cents at once for catalog of money-making ideas.

For new, 16-page catalog, write to **J. C. LARSON COMPANY**
178 N. Wacker Dr., Chicago 6, Ill.

A GREAT SURPLUS BARGAIN REDUCING GAUGE

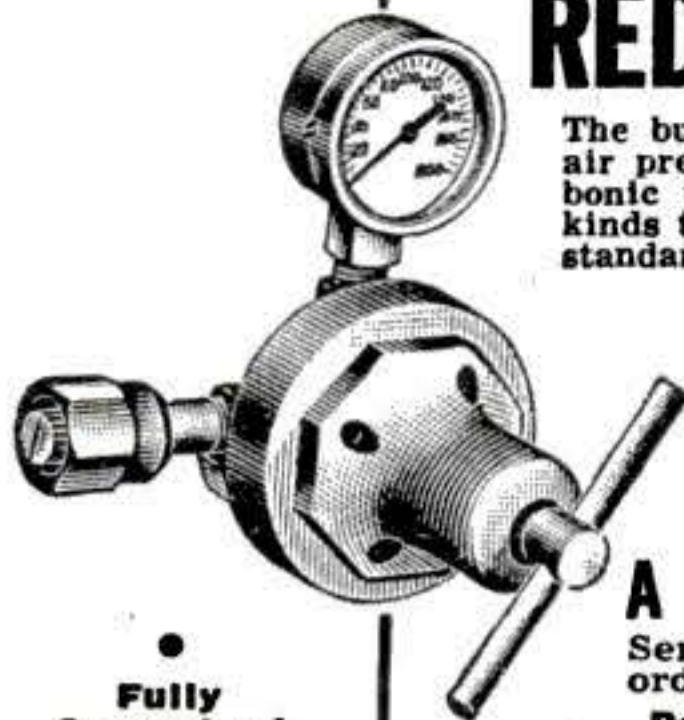

The buy of a lifetime in a standard make air pressure regulator. Used on liquid carbonic tanks and air pressure tanks of all kinds to regulate the pressure. Fitted with standard 1/2 inch pipe thread. Dial calibrated 0 to 200 lbs. Made by U.S. Gauge, Air Reduction Co., Walter Kiddle — all famous makers. Used by artists for air brush work, sign painters, retouchers, etc. Used by soda fountains and taverns. All units are brand new. Satisfaction guaranteed.

A \$15.00 Value \$ **5.95**

Send check or money order. Ship same day.
Postpaid in U.S.A.

Fully Guaranteed

All Brand New and in Perfect Condition

GROBAN SUPPLY CO.

1522 So. Michigan Ave. (Dept. PS9) Chicago, Ill.

MONEY for MEN ALL DATA FREE

THE PLASTEX Industry needs manufacturers on small scale and for big production of Lamp and Clock Stands. Art Goods and Novelties in Plastex and Marble imitation. Experience unnecessary. 1/2c material makes regular 10c store sellers. Rubber moulds furnished for speed production. Small investment brings good returns. Big chain store orders now being placed. Ambitious men have chance for real prosperity. Our Free booklet will interest and benefit you.

PLASTEX INDUSTRIES, Dept. 2, 1085 Washington Av., New York 56, N.Y.

STAMMER?

This new 128-page book, "Stammering, Its Cause and Correction," describes the Bogue Unit Method for scientific correction of stammering and stuttering—successful for 46 years. **Benj. N. Bogue**, Dept. 7851 Circle Tower, Indianapolis 4, Ind.

GET THIS
FREE
BOOK!

DETECTIVES

Home Study in Detective Training—Professionally Modernized—Recognized Instructors—Easy Payments—Write
INTERNATIONAL DETECTIVE TRAINING SCHOOL
1701-P Monroe St. N. E. Washington 18, D. C.

TRAIN



Your VOICE!

Results **GUARANTEED**

We build, strengthen the vocal organs—not with singing lessons—but by sound, scientifically correct silent and vocal exercises and absolutely guarantee complete satisfaction with results. Write for Voice Book, **FREE**. Sent to no one under 17 years old unless signed by parent.

Perfect Voice Studios, Studio 1366, Kimball Hall Bldg., Chicago 4, Ill.

MODELS

Build your own model house—complete in all detail. All materials included. True scale 3/8" model size. When complete, a real five-room house is yours. to plan your next home. Send \$1.00 with your order to save postage. Complete catalog sent with each order.
HALL INDUSTRIES, 111 W. Jackson Blvd., Chicago 4, Illinois

50 BEAUTIFUL
PHOTO STUDIES
OF ARTISTS' MODELS



Money Back Guarantee

Sent prepaid on receipt of CASH or MONEY ORDER only... (no CHECKS or STAMPS.)
\$1.00

On 16mm film complete with movie viewer that fully encloses and protects the film. Lovely models in charming poses... with lighting data for photographers... an aid to artists and sculptors. Extra reel (series 3-4-5-6, all different poses) of studies for 25c each.

PARISIAN ART STUDIOS, Dept. PS2
142 West 32 St., New York 1, N. Y.

Don't Envy The PLUMBER BE ONE!

Plumbers Make Up To \$15⁰⁰ To \$50⁰⁰ A Day!

Every skilled workman will tell you that Plumbers have the best of it. WINTER and SUMMER the Plumber is busy at top wages. No skilled Plumber is ever out of a job—compare his opportunities with any trade, plus the opportunities that are offered in this field to have your own shop.

At the Universal Plumbing School you become a Plumber by working with tools (not books) under Licensed Master PLUMBERS—all experts in their line. Here you get plumbing in one of the finest equipped schools in America. Every branch of Plumbing is covered—Leadwork—Blueprint for plan reading—Roughing In—Heating and all the other tricks of the business that mean profits for you.

Own Your Own Plumbing Business —Or Be A Journeyman Plumber

No other field offers more opportunity for the ambitious man to have his own business than plumbing. The trained plumber with a kit of tools stands a better chance of getting into business for himself, than a man with money who has not had the training to do expert work.

Whether you want to become a Master Plumber and OWN YOUR OWN BUSINESS, or work for someone as a Journeyman Plumber our training makes no distinction. The expert Journeyman Plumber is the HIGHEST PAID craftsman in the United States today. We show you how to become a qualified Master Plumber, or a Journeyman Plumber in just 32 weeks . . . No previous plumbing experience is necessary.

Over A Quarter Century's Experience Making Plumbers

School Operated By Master Plumbers

Let us show you how to master this profitable field in just 32 weeks—No need to ever work as an apprentice. It's the training system and our years of experience that does the trick. The Universal Plumbing School is America's oldest school devoted exclusively to plumbing. Since 1923 it has been owned and operated by Licensed Master Plumbers. Over 6,000 successful graduates testify their success was largely due to our proven methods.

For complete FREE information about this school and its proved methods of making plumbers, simply fill out and mail coupon—no obligation—no salesman will ever call. If you like to work with tools you owe it to yourself to investigate. Just send name and address on a 1c postcard for full information.

G. I. APPROVED

MAIL THIS COUPON FOR
FREE INFORMATION

No Obligation
No Salesman Will Call

Name.....

Address.....

City..... State.....

Fill Out—Paste On 1c Postcard and Mail

UNIVERSAL PLUMBING SCHOOL

821 HOLMES ST.
KANSAS CITY, MISSOURI

BIG MONEY and YOUR OWN BUSINESS



FREE INFORMATION ON A GREAT
NEW MONEY MAKING OPPORTUNITY



Regardless of your age, sex, previous experience, we will send you astonishing free facts about the great possibilities—in your own business—with amazing LIQUID REPLICA IVORY. To secure this information, absolutely free, fill in coupon below or send a letter or postcard. No salesman will call on you now or ever. Write TODAY! Offer limited!

LIQUID IVORY is one of the most marvelous synthetics developed in years. With it you can easily and simply produce a wide variety of wonderful items that almost defy detection from genuine ivory. No expensive equipment is needed. You can work in a corner of your basement or garage with a few hours of work producing handsome profits. Here is unexcelled opportunity for all ambitious people that want a profitable business of their own.

GREAT OPPORTUNITIES NOW!

Stop being a slave to a time clock! Stop worrying about lay-offs and depressions stealing your livelihood. NOW is the time to line up your own money-making business. We offer this great opportunity to aggressive people. Get into your own profitable business with LIQUID IVORY. Get the FREE FACTS today!

Copyright—1947

EMPIRE TRADES and HANDICRAFTS
Box 1340 PS9 St. Louis, Mo.

A MONEY-MAKING BUSINESS FOR THE LITTLE MAN! NO EXTENSIVE CAPITAL NEEDED!
Forget big investment worries. We tell you how to get your own fast-moving business going with very little money. We feature only one sound business course. You will never find us confusing this successful vocation with other diverting business ideas. We tell you all about one great business and how you can make money in it exclusively. Write for full FREE information today!

FREE INFORMATION COUPON

EMPIRE TRADES & HANDICRAFTS, BOX 1340-PS9 ST. LOUIS, MO.

Please send me free details about your BIG money making LIQUID IVORY. I am anxious to get started in a profitable business of my own. Please rush!

Name.....

Address.....

City..... State.....

RADIO or ELECTRICITY

including Industrial Electronics

Shop Training in a Nationally Known School

LEARN-BY-DOING—

GET READY IN FEW WEEKS

Vastly increased number of radio receivers, development of FM broadcasting, installation of public address systems, demand services of trained men who can repair, service sets and equipment.

BETTER TRAINING IN BETTER TRADES

Get into big established field of Electricity where pay is high—prepare for tremendous new developments in Industrial Electronics. **PLACEMENT SERVICE WHETHER YOU WANT BETTER JOB OR BUSINESS OF YOUR OWN.** Make rapid progress by our modern shop methods. **VETERANS** qualifying under "G.I. Bill" have tuition paid by Government plus monthly subsistence allowance while in school. Just mail coupon, we will handle all details. (LOW TUITION, EASY TERMS if you are not a veteran.)

RADIO and ELECTRICAL DIVISIONS
COMMERCIAL TRADES INSTITUTE,
Dept. C 19, 6312 N. Broadway, Chicago 40, Ill.



FREE—Important Information Telling How to Get Started



Fill Out, Cut Out, Mail Today

FACTS FREE for Men Who Want to Get Ahead
COMMERCIAL TRADES INSTITUTE, Dept. C 19
6312 N. Broadway, Chicago 40, Ill.

Send free illustrated Brochures and other information about the field I have checked below:

() Radio () Electricity

Name
Address
City State

NEW original HOME TRAINING COURSE



Prepares You In The ART of

JEWELRY REPAIRING
DESIGNING AND
MANUFACTURING

EARN AS YOU LEARN

The First and Only Course of Its Kind
By The Largest Approved School of Its Kind

Now—for the first time—a fascinating, 20-lesson, practical Home Training Course in Jewelry Repairing, Designing, Engraving, Enameling, Stone Setting, Plating, Polishing, Casting, Gem Setting, Soldering, and Manufacturing. Prepares you for big earnings as an Expert Jewelry Repairman and a Master of Jewelry Designing and Manufacturing in an uncrowded field.



FREE DIAMOND INCLUDED

With Working Tools as Part of Our Course.

FREE FOLDER

Write today! Get the full facts—then judge. Hurry—enormous need for jewelry

repair experts with jewelry in constant need of repairs. Turn your spare time into profit.

ILLINOIS SCHOOL OF WATCH REPAIRING

2870 Elston Ave. Dept. JS-9 Chicago 18, Ill.

MAKE BIG MONEY IN LIQUID SYNTHETIC MARBLE

FEW DOLLARS STARTS YOUR OWN PROFITABLE BUSINESS!

Here are 3 amazing, new opportunities to get into your own highly-profitable, dignified business—without previous experience—regardless of your age or sex. **1. LIQUID Synthetic MARBLE**—Easy to make and install beautiful synthetic Marble Slabs—pouring from liquid state. Big Demand for kitchen and bathroom walls, etc. **2. FIBRE-TITE FLOORING**—Easy to make and install—In any color or color combination. Many years wear. Dustproof. Soundproof. Verminproof. **3. FLEXIBLE MOLDS**—for Plaster Casting. \$1.00 in raw materials makes up to \$25 worth finished products. F. B., Iowa, writes: "Am on job that will net me \$150 for 4 days work." Get FREE details. No obligation. Write today!

Write for FREE DETAILS NOW!

COMPOSITION PRODUCTS CO.

5853 Delmar Blvd. Dept. 92 St. Louis 12, Mo.

GIANT

Astronomical Telescope

100 diameters magnification. (10,000 area magnification) 3 inch diameter steel main tube 50 inches long. Brass focusing tube. Tripod 6 feet high. Equatorial mounting. Ready to set up and use. Full power and clear vision guaranteed. Price \$15.00. 20% deposit on C.O.D. orders.

DEPT. BT, SUFFOLK SCIENCE SERVICE, MANORVILLE, N. Y.

CRAFT FINISHES SUPPLIES

Materials to produce a professional finish on every type article. Industrial finishes for the home craftsman's use on wood, metal, plastics, plaster, etc. Electroplating and shop supplies, novelty finishes. Catalog free.

CRAFT FINISHES Box S 467 Arlington, Virginia

MAKE BIG MONEY!

Be a floor surfacing contractor and sand both new and old floors. Sanders are easy to operate and better still, you're your own boss. Write for latest "tell-all" booklet entitled "Opportunities In Floor Surfacing", enclosing 25 cents in coin or stamps to cover handling.

AMERICAN
FLOOR SURFACING MACHINE CO.
532 So. St. Clair Street • Toledo 3, Ohio

NOW READY FOR FIRST TIME Natural Rubber Latex FOR BETTER MOLDS

MOLD MAKERS: Now for the first time since the war, you can get superior natural rubber molding compound at new low prices. Natural Rubber gives you best physical properties; 70% concentration, high elasticity, freedom from permanent set, unusual elongation. Use FRANCIS Natural Rubber Red Latex to make longer-lasting molds. At our reduced prices you can produce more and better casts per mold, at lower cost. New Illustrated Instruction Manual, showing how to mold and produce valuable novelties, gifts, accessories, mailed for only 10c (stamps or coin). Price list free. Francis Supply Company, Dept. K-3, 1836 East Fulton St., Columbus 9, Ohio.

PILOTS JACKETS

(Left) NEW AIR-CORPS SURPLUS. B-15 Style. Green poplin. Warm alpaca lining. Genuine Mouton fur collar. 4 Pockets. 36-46 \$14.75.
(Right) NEW A-2 Style Brown Leather, cloth lined. Zipper front. 36-46 \$14.75

Write for FREE illus. list Army Surplus Orders sent postpaid except C.O.D. Satisfaction or Money Back

CONSUMERS CLOTHING CO.
2066 First Ave. New York 29

The New Twin Cylinder, 2-Cycle

Maytag Multi-Motor

An Economical, All-Purpose Gasoline Motor



IDEAL FOR USE ON

- Lawn Mowers
- Compressors
- Pumps • Scooters
- Milking Machines
- Many Other Uses

AVAILABLE NOW!
See Your Nearest Maytag Dealer
or Write Direct for Informative Folder to

THE MAYTAG COMPANY
NEWTON, IOWA

LEARN CHEMISTRY AT HOME

The demand for men trained in chemistry is great. Big pay job opportunities are growing by leaps and bounds. If you want to get into this fast growing, fascinating, high pay field by studying chemistry at home, write today.

INSTITUTE OF PRACTICAL CHEMISTRY
45 PROSPECT AVENUE, HAGERSTOWN, MD.

SOMETHING NEW IN FIRE EXTINGUISHERS

ALL YEAR JOB! TOP MEN ONLY PLEASE!

If you're selling successfully today, send your name and address on a penny postal. We'll send details by return Air Mail. Dealers earnings up to \$15,000 yearly. In business since 1931. See why our men are biggest earning salesmen in selling.

RED COMET, INC., 702 RC BLDG., LITTLETON, COLO.

NEW! MINIATURE DUST MASK



Wear when sanding, grinding, paint spraying, sweeping, dusting, furnace cleaning, etc. Handy as a pair of glasses. Just keep mouth closed and breathe through nose is all you do to operate. Protects against nuisance dusts, lint, coal, cement, grain dust, Hay Fever Pollen. Has 9 sq. in. filter.

For EYE protection against paint spray, dusts, gases, fumes, smoke, order our Fog-Proof Rubber GOGGLES.....\$2.00 p.p.

Order Today \$1.00 POST PAID

JERRY BRYANT, Dept. PS, 919 N. Michigan Ave., Chicago 11, Ill.

WALL PAPER REMOVER

Helps remove wallpaper quickly, safely and economically. One pint makes five gallons of solution. Merely apply with brush, allow to soak in thoroughly and strip off with scraper or putty knife. One pint \$1.00 postpaid.

BEST WAY PRODUCTS COMPANY BOSTON 30, MASS.

Ready to work for you!

THE OPEN SECRET OF LIFE MASTERY....

Did you know, You do not have to remain as you are? That you can become something better?

Why not wake up and stop being pushed around? Dare to claim good health, the respect of friends, and success in your chosen field. Unleash the sleeping powers and energies equal to life's demands. Our Home-Study Self-Discovery-Development Plan may be the very thing you need right now. Money back if you do not get results satisfactory to you. Write for FREE LECTURE and full details without obligation, TODAY.



School of PERSONAL Psychology

Chartered non-profit correspondence education
10th Floor Washington Bldg. Louisville 2, Ky.



LEARN A TRADE NOW in Sunny CALIFORNIA

- **REFRIGERATION, RADIO, ELECTRICAL APPLIANCE Service and Repair**... a Combination Course in three opportunity fields.
- **PLASTERING**—a busy field these days!
- **UPHOLSTERING**—available, Los Angeles or Chicago.

Here are three career fields offering many opportunities to trained men, either in good paying positions or through a business of your own. GENERAL TRADE SCHOOLS' courses are PRACTICAL, INTENSIVE. Instructors are master craftsmen who know the practical side of each job.

School hours are concentrated so that time is available for taking part-time employment if desired.

Immediate Enrollment. Courses Approved for Veterans Available for Non-Veterans

MAIL THE COUPON NOW FOR COMPLETE INFORMATION

General Trades Schools
1601 S. Western, Dept. PS 9-7, Los Angeles 6, Calif.

Please send me FREE information on your courses as checked below:

Refrig., Radio, Elect. Appl. _____ Plastering _____ Upholstering _____

Name _____ Age _____

Street _____

City _____ Zone _____ State _____

Veteran _____ Non-Veteran _____

WANT A GOVERNMENT JOB?



START \$1,756 to \$3,021 Year

Prepare NOW For next Examinations

VETERANS GET SPECIAL PREFERENCE

Railway Postal Clerks
City Mail Carriers
City Postoffice Clerks
Ass't Statistical Clerks
Stenographers-Typists
Storekeeper-Gaugers, Etc.

32-Page Civil Service Book FREE

Mail Coupon today—SURE

★

FRANKLIN INSTITUTE

Dept. M81
Rochester 4, N. Y.

Rush to me, entirely free of charge. 32 page book with: (1) A full description of U. S. Government jobs; (2) A list of U. S. Government jobs; (3) Tell me how to prepare for a job.

Name.....

Address.....

..... Vet?.....

WAR SURPLUS BARGAIN SPECIAL

BRAND NEW! VACUUM-AIR HYDRAULIC FUEL PUMP

Original Cost
\$45.00
Now Only
\$9⁹⁵

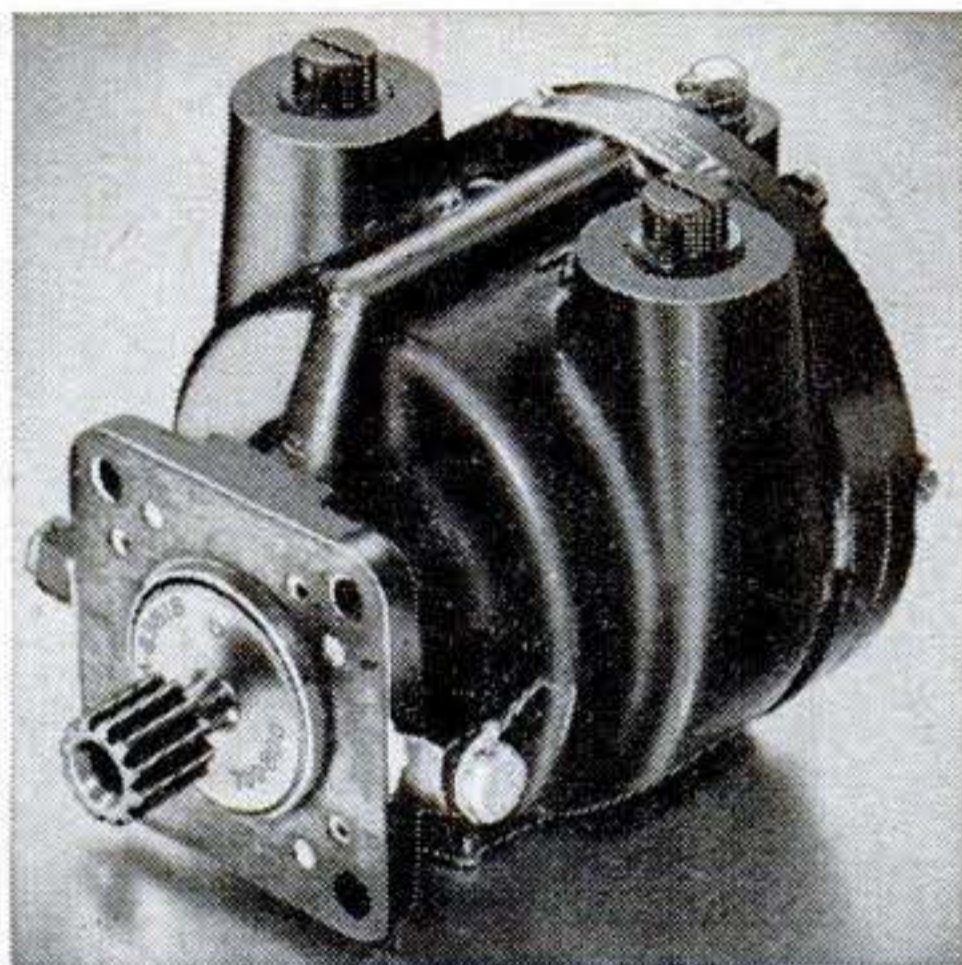

Postpaid in U.S.A.

WORTH MANY TIMES THIS LOW SALE PRICE

USE THEM FOR
OIL BURNERS

SPRAYING
MACHINES

MILKING
MACHINES

COMPRESSORS

VACUUM PUMPS

HYDRAULIC
SYSTEMS

MANURE
LOADERS

PRESSES, etc.

Originally cost \$45.00. Used by the Air Corps to drive bomber de-icer boots, gyroscopes, automatic pilots, etc. May be used as air or fluid pump—for pressure or vacuum. Standard 3/8 inch pipe thread with interchangeable ports. Will pump 7 1/2 gal. SAE 30 oil per minute at 300 RPM. Builds air pressure of 30 lbs. per sq. in. at 1000 RPM. Vacuum will draw 26 inches of mercury at 1750 RPM. Develops up to 120 lbs. per sq. inch of hydraulic pressure, which in conjunction with a 3 inch hydraulic cylinder, will lift 840 lbs. minimum. Runs forward or reverse. Self aligning shaft. Die cast aluminum housing 6x4x4 inches. Has stainless alloy steel vanes and impeller. Made by Bendix Avia, Corp. Spline terminal for direct drive—readily replaced with a pulley. Recommend a 1/4 H.P. or stronger electric motor as source of power. Rated capacity 1500 RPM with high overload factor. Special price for quantity users. Complete illustrated report and instruction booklet FREE with every pump. Send check or money order today. Postpaid in U.S.A.

\$9⁹⁵

GROBAN SUPPLY CO. 1522 So. Michigan Avenue
Dept. P59 Chicago 5, Ill.

Learn this Profitable Profession



**IN 90 DAYS
AT HOME**

Money-Making Career Open to Men and Women, 18 to 50

Hundreds of men and women between 18 and 50 make \$10 to \$20 in a single day giving scientific Swedish Massage and Hydro-Therapy treatments. There is big demand from doctors, hospitals, sanatoriums and clubs. Graduates earn large full time incomes from these or in private practice in their own offices. Others make good money from home treatments given in spare time. Learn this interesting, money-making profession in your own home, through our home study course. Same instructors as in our nationally known resident school. You can win independence and prepare for future security by qualifying for your Diploma. Course can be completed in 3 to 4 months. Many earn while they learn. Begin your training at once.

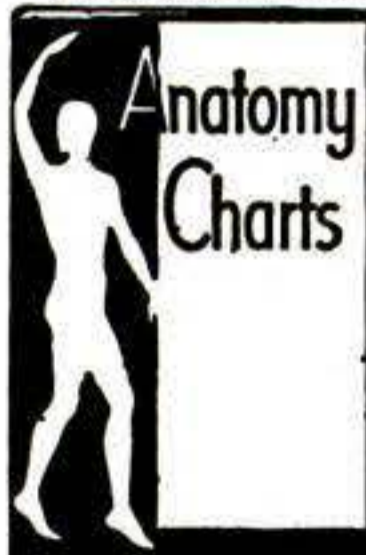

Anatomy Charts & Booklet FREE

Enroll now and we will include, at no extra cost, many needed supplies. Fit yourself to help meet growing demand for Scientific Swedish Massage. Send the coupon at once for complete details, Anatomy Charts and 32-Page Illustrated Booklet, FREE, postpaid.

THE COLLEGE OF SWEDISH MASSAGE
Dept. 770-L, 100 East Ohio St., Chicago 11, Illinois

Please send me FREE and postpaid, Anatomy Charts, 32-page Booklet and complete details on Home Training.

Name.....
Address.....
City..... State.....

Ever Sit On A Gold Mine?



YOU can build your own business NOW in the new and flourishing field of coin-operated radios. We can show you the way to big earnings and a steady income with TRADIO, the radio functionally designed for coin-operation in hotels, tourist camps, hospitals, etc. Only a small investment is needed to assure yourself of financial independence for life. Write, wire or phone for complete information. No routes sold.

TRADIO, Inc., Dept. O-9, Asbury Park, N. J.
Tel: Asbury Park 2-7447

Made to U. S. Army Specifications!

15-JEWEL ELGIN \$18⁹⁵



Sturdy 15-Jewel ELGIN men's wrist watches. Waterproofed. Sweep second hand. Stainless Steel back. Unbreakable crystal. QUALITY! American made. Fully reconditioned with ONE YEAR GUARANTEE! Made for the U. S. Army Air Corps. They HAD to be good. SEND NO MONEY. Simply pay postman \$18.95 plus 10% tax and postage on delivery. Cash orders sent postpaid. Limited supply. UNITED PRODUCTS CO., 7941 S. Halsted St., Dept. WES-220, Chicago 20, Ill.

AIR OR LIQUID TANKS

Airplane oxygen tanks (used) good condition, holds up to 400 lbs. pressure; non-rusting stainless steel, weighs 18 lbs., 10 1/2 gal. capacity, 24" long x 12" diam., \$4.98. Same specifications 24" long x 6" diam., weighs 5 lbs., 3 gal. capacity, \$2.98. Ends tapped for 1/4" standard pipe thread. Air Check-valve to fit tanks, \$5.00 value, 98c. Ideal for compressed air tanks, some bottled gas, or liquids, water supply for house trailers, compressors, floating rafts, buoys, net floats, air horns, air brakes, etc.

Prices FOB, Kansas City — No COD orders
MIDWEST BUY ANYTHING CO.,
1520 Locust St. Kansas City, Mo.
Hundreds of other bargains—Write for circular

Say You Saw It In Popular Science

NORDEN BOMB SIGHT STABILIZERS

This instrument is about 1/2 the bulk of the famed NORDEN BOMBSIGHT. 26 vt DC 10,000 RPM. Heavy rotor mounted in gimbals. Precession motor with magnetic clutches. Shipping weight 96 lbs. New, \$25.00.
Navy Radar Stabilizers \$17.50—Army Tank Telescopes \$17.50—Dynamotors \$8.00—Parallax Computers \$50.00—Motor driven Fuel pumps \$12.00.
Send for bulletin. These bargains won't last—order today. All items FOB Chicago cash with order.

L. P. WEIS & CO., 2929 N. Pulaski Rd., Chicago 41, Illinois

Make MONEY in California

SAVE TIME AND TROUBLE
by Knowing The FACTS About...
BUSINESS AND JOB OPPORTUNITIES, HOUSING, ETC.
IN THE GARDEN SPOT OF AMERICA.

Send for this practical and RELIABLE guide on every phase of post-war Los Angeles, compiled by an Economist at the University of California at Los Angeles. 70 pages include - Business and Employment opportunities... Housing conditions... Complete list (over 3000) of employers in every trade, including names and addresses of personnel directors... Seasonal conditions... Places of interest... Amusements.

\$1.00 POSTPAID. SEND CHECK OR MONEY ORDER TODAY TO
RESEARCH ENTERPRISES BOX G, Dept. 2
WEST LOS ANGELES 25, CALIFORNIA



SEWING MACHINE MOTOR KIT

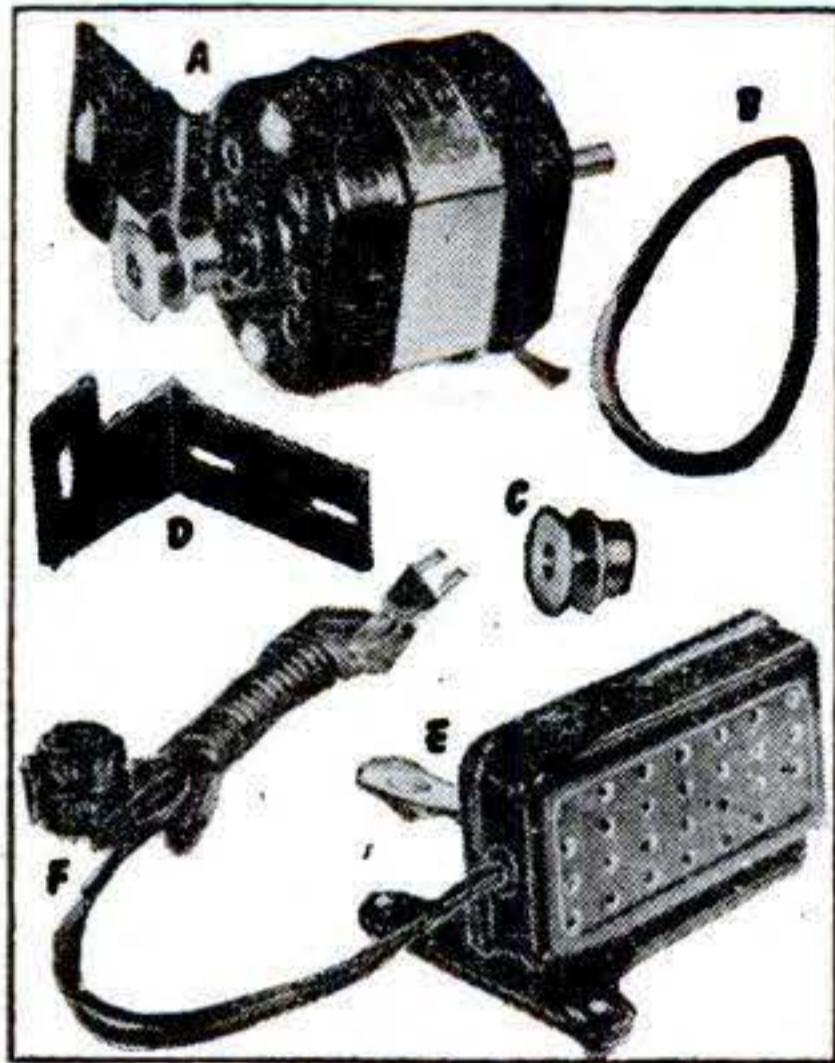

\$18.95
COMPLETE

Shipping Wt. 4 lbs.
ADJUSTABLE FOR USE WITH ANY TYPE OF SEWING MACHINE ANYBODY CAN INSTALL IT!
Takes but a few seconds
Complete set consists of:
A—MOTOR & BRACKET, Universal AC or DC, 60 cycle, 115 V. B—BELT, Long Wearing Rubber Belt. C—PULLEY, Single Grooved Steel Hubbed Pulley. D—BRACKET, New and Improved. E—FOOT CONTROL, 7 Step Rheostat. F—CORD SET, Extension cord fitted with plug and socket.

JOSEPH PASAAK, Box 153, Canal St., N. Y. 13, N. Y., Dept. P.S.

We Sell 5c To \$5 Items

TO THE LARGEST USERS.
SO, CAN SELL YOU TOO.



Genuine Leather Billfolds, 3 Way zipper Picture, \$8 doz. Other 3 Way, or straight zipper and without zipper, from \$6 to \$30 Doz.
Big profits . . . Big Commissions. Discounts Large Orders. We make also, Belts, School Bags, Key Cases and other related items, and advertising specialties.
Cost of samples small . . . Minimum Charge. Circulars Free.

CUTTING LEATHER NOVELTY CO.

48a Howard St.

New York 13, N. Y.

EXTRA INK CARTRIDGE

with BALL POINT

included

YOURS

AT NO EXTRA COST WHEN YOU BUY THIS AMAZING



NEW BALL PEN!

extra cost, one easy-to-change Ink Cartridge with new Ball Point! When pen needs refilling, insert extra "Gift" cartridge and keep writing! Meanwhile, return other dry cartridge—we'll re-fill for only 15c plus 3c stamp. Satisfaction guaranteed. Pen has plastic barrel, nickel-plated cap, gold-plated clip. **Hurry**—before bargain offer withdrawn! **SEND** only 98c plus 2c for postage (\$1 bill)—or we'll ship COD, you pay postman 98c plus postage, fee. **Order now! COMPRO CORP.**, Dept. B-9, 4840 N. Linder Ave., Chicago 30, Illinois.

To quickly introduce our new, smooth-writing Compro Ball Pen, we'll include free of

Ball-Bearing

SPEED WHEELS



Juvenile wheels, solid tire

7" wheels.....60c

6" wheels.....50c

4" wheels.....30c

Semi-pneumatic tired wheels

12 x 1.75".....\$3.25

10 x 1.75".....\$2.75

8 x 2".....\$2.00

Industrial wheels, for heavy loads

10 x 2.75" Semi-Pneu.....\$6.75

10 x 2.75" Single valve tube Pneu.....\$7.25

8 x 1".....\$4.90

6 x 2".....\$2.80

Dealers Wanted

FREE BLUEPRINTS WITH ALL WHEEL ORDERS
Enclose check with order

JIM BROWN TOY COMPANY
1093 Home Ave. Akron 10, Ohio

FREE

SEND FOR

ALLIED'S Big 164 Page RADIO CATALOG!

WRITE TODAY!



SAVE ON EVERYTHING IN RADIO!



NEW HOME RADIOS

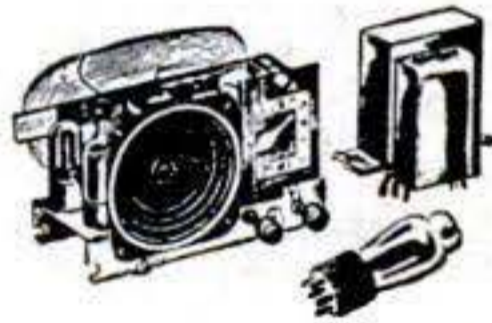

SERVICE SUPPLIES BUILDERS' SUPPLIES



AMATEUR GEAR



SOUND SYSTEMS

164 Value-Packed Pages

Send for your FREE copy of the most complete Buying Guide for Everything in Radio! Here's the Catalog for Servicemen, Dealers, Soundmen, Amateurs, Builders and Experimenters. Features the world's largest and most complete stocks of radio and electronic supplies—quality equipment at lowest prices! Get the speedy service and expert help you want from ALLIED—Radio's Largest Supply House. Depend on ALLIED!

MORE THAN 10,000 ITEMS

Get everything for every radio use: Latest type home radio models, phono-radios, recorders, communications receivers, Ham kits, and gear, code apparatus, radio parts, tubes, tools, test instruments, public address equipment, low-cost easy-to-build radio kits, diagrams and matched parts lists, largest selection of instructive radio books—all at lowest prices!

ALLIED RADIO

ALLIED RADIO CORP.
833 W. Jackson Blvd., Dept. 7-JJ-7
Chicago 7, Illinois

Rush FREE 164-Page Catalog

Name.....

Address.....

City.....Zone.....State.....

FREE CATALOG

HAND MICROPHONE



Top quality hand microphone with control button in handle. Highly sensitive. Has rubber covered cord and tel. plug. Fine for use on home recorders, public address systems, etc. Brand new—perfect. Shp. wgt. 2 lbs. Stock No. 170. Each... **\$1.95**

MESS KITS

Regulation two-piece Army Mess Kits with folding handle. Used, but perfect. Weight 2 lbs. No. A116—Ea. **69c**



CANTEENS

Reg. U. S. issue canteens. Plastic screw top chained to body. Slightly used but perfect. Wgt. 1 lb. 117—Metal **69c**



CANTEEN CUPS

All metal. Folding handle. Wgt. 1 lb. No. A120—Each... **25c**

CANTEEN COVERS

Heavy canvas. Button fastener. New No. 530—Each... **69c**
Used No. 119—Each... **35c**

ARMY BANDO-LEERS

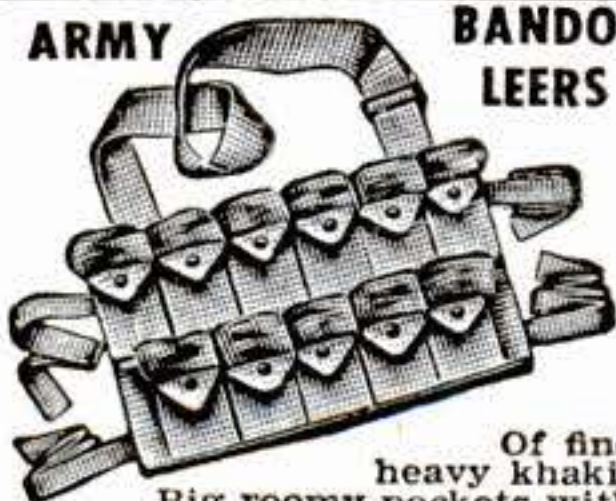

Of fine heavy khaki. Big roomy pockets with snap button fasteners. Fine for hunters, campers, boy scouts, etc., also for shop work in carrying small parts, etc. Material alone is worth this price. Shp. wt. 1 lb. 11 Pocket **49c** 5 Pocket **29c**
Type No. 129 Each **49c** Type No. 128 Each **29c**

LEATHER JACKET

The leather coat buy of the year! Brand new Army Air Force type A2 with full length zipper, shoulder straps, knitted waist band and wrists and full satin lining. Finest horsehide—finest tailoring. Order by chest size. Shp. wgt. 5 lbs. No. 201—Each... **\$19.95**

BAYONET BLADE

Fine forged steel. Ground but not polished. May be made into throwing or hunting knife or spear. Blade 6 3/4 x 7/8 inches, 1 1/4 inches overall. Will take and hold a fine edge. Shp. wgt. 1 lb. No. 664-R—Each... **49c**

STOP WATCH

Genuine Elgin 15 Jewel movement. Ideal for split second timing in racing, sports, time study, etc. Full sweep split second hand graduated in 1/10th seconds. Stem wind, start, stop and reset. Used but guaranteed perfect. A splendid value. Shp. wgt. 1 lb. No. 200—Each... **\$9.95**



LIFE PRESERVER BELTS

Right from the invasion beaches. Consists of two air chambers. May be inflated automatically with "sparklet" cartridges or manually by attached hose. Adjustable in waist size. One air chamber guaranteed air tight—other may need a tire patch. All belts are used and slightly soiled but a bargain at this low price. No. 1261—**\$1.00** Each...

SPARKLET CARTRIDGES
May be used with above belts. In boxes of 10. Stock No. 254. **50c** Per Box...

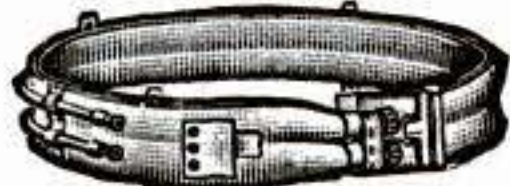

WAR SURPLUS AND HUNDREDS OF OTHER BARGAINS

POPULAR RECORD ASSORTMENT



No A300—25 Records. All Dance. Wgt. 14 lbs. **\$4.88**

No. A301—25 Records. Hillbilly, Race and Blues. Wgt. 14 lbs. Set... **\$4.88**

No. 302—25 Records. All Hillbilly numbers. Wgt. 14 lbs. Set... **\$4.88**

Fifty records of modern dance, race, blues and hillbilly selections. No two alike. Famous name bands and artists included. Used in juke boxes, but guar. perfect. Shipped exp. collect only—no exchanges or refunds. Wgt. 28 lbs. No. A303—50 records... **\$9.64**

FLEX. NECK FLASH LIGHT

Ideal trouble shooter's flash light. Flexible neck lets you direct light around corners and inaccessible spots. Brand new! Plastic case with BX type neck. Uses 2 standard flash light batteries. (Less batteries) Shp. wgt. 2 lbs



No. 205 Each **\$1.69**

SATCHEL POUCH

Heavy canvas pouch. Ideal for toting lunches, shopping, books, etc. Has 11x12 inch pocket. Brand new, guaranteed perfect. Has oversize flap with single strap fasteners. A113—**EACH \$1.69**



Plastic 8 oz. Flask

For hunters, scouts, fishermen. Waterproof and transparent. Use it for matches, flies, bait, etc. Has screw cap top for liquids, plus full open top. Size 5 1/2 x 4 1/8 x 1 1/8 ins. Has hundreds of other uses. Wgt. 1 lb. No. A347. Each **29c**



7 LB. EXPERIMENTER PARTS ASSORT. KIT



A "gold mine" for the radio serviceman. Hundreds of valuable radio parts, new radar and electronic parts and subassemblies, coils, resistors, trimming condensers—worth many times this low price. A130R—7 lbs... **\$1.79**

RADIO HEAD-PHONES



Extremely sensitive with 4000 ohms resistance. Brand new and fully guaranteed. With moisture-proof cord and phone plug. A splendid value for the radio serviceman and experimenter. A106—PAIR... **\$2.95**
New supersensitive phones. A108—Pair... **\$5.95**

BINOCULAR CASE

Heavy cowhide, hand sewn. Die cut top for compass. Will fit 6x30 Bausch & Lomb or similar binocular. Wgt. 2 lbs. No. A191, Each... **\$2.95**



CAVALRY SPURS

Genuine wishbone type cavalry spurs. Nickered brass... **98c**
A102, Pair... **98c**
A103 Spur straps per set of four... **50c**



SHERRILL COMPASS

A finely balanced liquid immersion accurately calibrated compass with mtg. bracket. Measures 5x3 inches. Compensating adjustments. Worth much more. Shp. wgt. 5 lbs. No. A122, Each... **\$9.85**



WOOL SLEEPING BAG

G.I. type 100% wool with 30 inch Talon zipper. Used but renovated for reissue. Shp. wgt. 3 lbs. No. 165. **\$3.95** Each...



FISHING REEL

Exceptional quality for this low price. Has rugged one piece frame. Ratchet drag. Single action. Attractive catalin handles. Brass bearings for smooth operation. Full 100 yard line capacity. Brand new! A splendid value at this low price. No. F412, Each... **98c**



RAIN SUITS

New 2 piece rain suits. Of durable wear resisting water and wind repellent OD fabric. Bib style pants, zipper fly. Jacket has parka attached. Guaranteed 100% weatherproof. Small, medium and large sizes. Shp. wgt. 3 lbs. No. R549. Ea. **\$4.95**



2 Man Mountain Tent

Regulation Army type two man mountain tent, complete with poles, guy ropes, etc. Of durable nylon with reinforced seams. Ideal for outdoorsmen, campers, etc. Shp. wgt. 10 lbs. A splendid value. Stock No. 202—Each... **\$9.95**



PUP TENTS

Regulation Army Pup Tents of durable, brown canvas. Used, but in good condition. Fine for campers, outdoorsmen, boy scouts, etc. Wgt. 8 lbs. A100—Tent only **\$3.95**
A110—Tent, new... **\$7.95**
A101—Ropes, wooden poles and stakes for above. Per set **\$1.00**



27 LENSES, ALL NEW, PERFECT.

For experimental work in optics. Consists of 27 precision ground and polished prisms and lens elements in assorted diameters and focal lengths. Big variety, positive, negatives, etc. Actual value over \$100.00 A519—27 PIECES... **\$7.95**



50 LENSES SEMI-FINISHED

Lenses similar to above but not polished. All are blanked and formed ready for polishing. Negatives, positives and prisms in Crown and Flint glass. Worth many times this low price. A520-50... **\$1.95** LENSES, ONLY...

RUBBER SUIT

Fits over your regular clothes and shoes. Can be cut apart for waist high waders, hip high or knee high boots, also arm length rubber gloves. Heavy gum rubber over fabric. Fine for those who work in the water, commercial fishermen, sewer diggers, etc. All brand new! Wgt. 14 lbs. No. 183 **\$4.95** —Each...



METAL TOOL CHEST



All metal welded construction 16x 8 1/2 x 11 overall. Has 5 roomy, easy sliding drawers. Hinged drop front. Metal top and end handles. Use it for tools, small parts, etc. Shp. wgt. 48 lbs. Stock No. 282, **\$9.75** Each...

CAMERA TRIPOD



Purchased from Gov't. Used but perfect. For cameras up to 8x10 inches. Folds to 32 inches, extends to 58 inches. Needs adapter to mount camera. Wgt. 14 lbs. **\$4.95** Stock No. 190, Ea.

ORDER DIRECT FROM THIS AD

Values galore! Hundreds of hard-to-find items for home, shop and outdoors. Make remittances by money-order, bank draft or personal check. Send 25% deposit on C.O.D. orders. No C.O.D.'s on orders for less than \$5.00. Include sufficient postage on parcel-post orders—any overage will be promptly refunded. All quotations F.O.B. Chicago. Used items and materials are guaranteed serviceable and as described. Your money back if not more than satisfied.

Big Illustrated Catalog Free
WRITE FOR YOUR COPY TODAY

STARK'S

Dept. PS947
509 S. State St.
CHICAGO 5, ILL.

POPULAR
SCIENCE

Classified Opportunities

Save time - Save Money



Classified Ads only 70c per word per insertion, payable in advance. Minimum ad 10 words. To be included in October issue copy should be in our office by August 29th. October issue on sale October 1st.

POPULAR SCIENCE MONTHLY—351 FOURTH AVE.—NEW YORK CITY 10

12 AUTOMOBILES

BUILD automatic clutch, scooters, midget autos, tractors, shop machines. Catalog Free. Nichols Equipment Co., Dept. 212, Purvis, Miss.

SELL personal initialed individualized belts, buckles with beautiful racing emblems of big cars, midgets, motorcycles, also available in lapel pins, tie holders. Fast profits. Repeats. Write today. Special outfit offer. Hook-Fast Specialties, Dept. 29, Box 1425, Providence, Rhode Island.

HOLLYWOOD Hot-Rod Manual; plans, photos, instructions, fast Fords, \$1.50 P.P. Racing parts list, 25c. P. P., Hollywood Hot-Rod, Box 9626S, Los Feliz Sta., Hollywood 27, Calif.

RACING Car performance for all cars. Complete specifications, \$1.00. Increase power, speed. Special "Custom-built" equipment. Free literature. Write Lee Motorcraft, 1412-B Great Northern Bldg., Chicago 4, Ill.

DUALTONE Chrystalline packed Mufflers. Single or Twin Mufflers for all cars. Duals priced complete V8's \$23.00, Six Cylinders \$33.00, eight cylinders \$36.00. Large Chromed Tailpipe extensions \$3.30, small curved \$1.70. Carburetor Velocity Stacks \$1.30. Chromed station wagon stacks \$15.00. Fenders skirts Torpedo, Streamline, Tear-drop, square \$19.95. Request Catalogue. Dualtone Mufflers, 2636B India Street, San Diego 1, Calif.

PERSONALIZE your car with your own handsome name plate on dash. Choice of red, green, onyx or black \$2 each postpaid. Free literature. William Redmond, 95 Summit Avenue, Summit, New Jersey.

AUTOMOBILE Racing Book. Fifth Edition—Revised. Tells how to build dirt tracks bodies, frames, engines. Records, superchargers, rules, formulas, plans, stock conversions, roadster racing, fast Fords, \$1.00 postpaid; \$1.15 C.O.D. Ray Kuns Department 274, Madisonville, Cincinnati, Ohio.

PHOTOGRAPHS. World's Finest Automobiles. List 10c. Box 1028, Minneapolis, Minnesota.

HOTROD and fast stock car equipment. Heads, manifolds, camshafts, dual mufflers. List 25c. Ford-Chevrolet hopup instructions, \$1.00 Specify. Alden Motors, Oakland City, Indiana.

CLYMERTONE Twin Muffler Sets, beautiful sound, complete with necessary welded pipes, E-Z installation. Ford V-8, \$20.00. Chevrolet set with split manifolds, \$37.50. Specify car model. Clymer, Dept. B-94, 2125 W. Pico, Los Angeles 6, Calif.

"BUILD speedy Midget Track Racer from castoff parts! Plans, specifications, construction information, \$1.00. Motor Supply, Box CS-1682, Toledo, Ohio."

AUTO racing magazine subscriptions. Pacific Speedway News, \$6.00 yearly. National Speed Sport, \$4.00. Illustrated Speedway News, \$4.00. All give complete data midget, big car race results. Sample copy each 50c. Specify publication wanted. Clymer, Dept. B-92, 2125 W. Pico, Los Angeles 6, Calif.

CLYMER'S Historical Motor Scrapbook No. 4, latest Clymer book old cars, motorcycles. Postpaid \$1.50; De Luxe Edition, \$2.50. Clymer, Dept. B-98, 2125 W. Pico, Los Angeles 6, Calif.

KAISER-FRAZER. Floyd Clymer's new book (no connection with K-F factory) gives complete uncensored, impartial report 3000-mile test run with Kaiser. 100 photographs; describes new Pike's Peak closed car record, Kansas City-Denver record run, economy test. Opinions of 3000 K-F owners. Complete breakdown of equipment, units used. Read good and bad about K-F cars. No punches pulled. \$1.50 postpaid. De Luxe edition \$2.50. Clymer, Dept. B-91, 2125 W. Pico, Los Angeles 6, Calif.

1947 INDIANAPOLIS "500" Race History Book. Complete details every car, driver competing. 100 photos, charts, drawings. \$1.00 postpaid. Large complete Indianapolis Race History Book, 352 pages, 1100 illustrations, all data 1909-1946 inclusive. Postpaid \$3.50; De Luxe Edition Fabrikoid binding, gold lettering, \$5.00. Clymer, Dept. B-90, 2125 W. Pico, Los Angeles 6, Calif.

MAKE your Ford fast! Complete details, photographs. How to construct 120 mph Hotrod. \$1 postpaid. California Bill, Box L-2, Eaglerock, Los Angeles 41, Calif.

AUTOMOBILE Racing Sixth Edition. 100 illustrations. Working drawings with building instructions for Ford-60 midget. California roadster. Offenhauser racer. Details on racer parts. Sample entrance blank. World's record 158.5 M.P.H. rear engine four-wheel drive car. Interesting information for fans, drivers, mechanics. \$2.00 postpaid; \$2.25 C.O.D. Ray Kuns, Department 62, Cincinnati 27, Ohio.

"CUSTOM-Styling" Manual. Easily make car look Hollywoodized, custom built, ultra-beautiful! New, simplified customizing—Restyling—Streamlining methods. Instructions. Illustrations. Plans for accessories, refinishing, mufflers, model changes—custom, sport, continentals, "Town & Country", etc. \$2. Almqvist Engineering, Box 660-S, Brooklyn 1.

WATER Injection For your car. More power, smoother performance. Wrench installs in half hour. \$14.65. Free booklet sent on request. Spee-Dee Products, 2409 South 10th Street, Tacoma 6, Washington.

SPEED & Mileage Manual—Obtain greater speed, mileage, racing performance from any automobile! Includes simplified methods, speed tuning, gas saving secrets—Instructions on building economizers, speed equipment, duals, mufflers, superchargers, racing fuels, fast conversions, "Hot-Rods", Parts lists, \$1.98. Almqvist Engineering, Box 660-S, Brooklyn 1.

FORD Fuel Pump Revived on car in 2 minutes. Complete instructions \$1.00. Details 10c. Research Mechanic, 1416 Glenwood, Glendale 1, Calif.

CUSTOMIZE your automobile. Over 50 photographs, up-to-minute book intelligently presents numerous restyling ideas, instructions, specific changes, etc., postpaid \$1. Post Publications, Box 723-SC, Arcadia, California.

SEE our ad under Motorcycles for midget racer bargains. Midget Motors Directory, Athens, Ohio.

MUFFLER Manual. Convert your own! Hollywood mellotone construction details; duals on Vee, straight engines; diagrams. postpaid \$1. Post Publications, Box 723-MC, Arcadia, California.

1947 SUPERIGNITIONER, \$5.50. Atomic pep, starting, mileage, 12 improvements. 50 cents. EG Mfg., Elmsford, N. Y.

USED-CAR Handbook, saves you dollars, grief. Photographs, complete comprehensive tests, dealers' tricks exposed. "Judging the Used Car," postpaid \$1. Post Publications, Box 723-TC, Arcadia, California.

13 AUTO SUPPLIES & EQUIPMENT

HAVING Car Trouble? New, Used, guaranteed auto, truck parts save money. Transmission specialist. Describe needs; immediate reply. Victory, 2930 1/4 No. Western, Chicago 18.

GRILLES for most all cars. Meyers Auto Parts, 820 Dryades, New Orleans, La.

NEED Auto Parts? We have them. New and Rebuilt. Prompt Shipment. Write Requirements. Save Money. Buy Direct. Factory Warehouse. Mechanics Auto Parts, 3807-BI North Ashland, Chicago 13.

BURN Water! Easily convert any automobile or tractor (1917-1947) to amazing "Water Injection" (like fighter planes) for only \$1.00 cost. Five gallons gasoline saved pays for installation—Many owners save that much fuel in one day's driving! More power—Cooler, smoother engines—Up to 33 miles per gallon. Copyrighted Installation Manual, complete Diagrams, Instructions, Directions, etc. Send dollar today. New-house Industries, 5941-P Hereford, Los Angeles 22, Calif.

FILLING Station Operators. Use your air compressor to make interlocking concrete building block. Good profit possibilities with four hundred dollar investment. Free literature. Delaware Industries, Dept. 25, Muncie, Indiana.

BURN water in your car. Costs less than gas, more power; Cleaner motor. Mail card for data on \$17.50 Octa-Gane Water injecting Carburetor. Ralph A. Shade, 563 Lake Road, Webster, N. Y.

GOLD Decal Automobile Initials 1 1/2" 5c each. Breth Decal Service, 1242 No. Pershing, Wichita 6, Kansas.

GUARANTEED air vent needle valve replaces idling screw. Saves gas. More power, smoother motor. Dollar. Free information. William Redmond, 95 Summit Ave., Summit, New Jersey.

MANIFOLD Whistle—imitates "Wolf Whistle", Siren, etc. Installed on any car manifold in fifteen minutes. Send \$6.00 to Protecturod Company, 4033 Windsor #5, Youngstown 7, Ohio.

BODY And Fender Repairs easy, profitable with New Hobart A.C. Welder. Ranges for sheet metal to heavy frame work. Write for Free Catalog. Hobart Welders, Box P-972, Troy, Ohio.

AMAZING discovery. Master Glaze, puts brilliant glass-like surface on cars. Free sample, information. Big commissions. Master Glaze, Dept. 621, 7720 Harwood, Milwaukee, Wisc.

POPULAR SCIENCE OPPORTUNITIES

TIRES—Slightly used, all popular sizes for cars and trucks. Write for complete list, Midwest Tire Co., 2012 Locust, St. Louis 3, Mo. (Dept. 5).

OIL pumping motors—brought back to normal without ring job. Send address on postcard for free details. Mullner Co., Box 3102, St. Paul 1, Minn.

14 AUTO TRAILERS

BUILD your own Trailer! Save Money! Have every feature you want! Plans for House, Sport, Camp and Utility trailers. Catalog describing 9 models 10c. (15c in Canada and overseas). Jim Dandy, Box 125-B, Wausau, Wisconsin.

TRAILERCOACHES—learn about all types—sports, living or travel. Approximately 100 pages monthly—magazine tells all. Special rate, \$1 the year. Trail-R-News, Box 431-C, Glendale, California.

91 MOTORCYCLES, BICYCLES, SUPPLIES

LARGE stock Indian parts. Expert motor rebuilding. New and rebuilt Chief Motorcycle, motors only. Indian Motorcycle Sales, Kansas City 1, Mo.

WHEELS, Tires, Tubes for Motor Scooters, Midget Cars, Wheelbarrows, and Industrial equipment. All sizes. Bicycle Parts, accessories. Largest stock in United States. Send dime for list. Cycle Transport Company, 1241 S. Michigan Ave., Dept. C, Chicago 5, Illinois.

WHEELS! Build wagons, scooters, mowers, trailers, wheelbarrows, grocery carts, baby carts, play pens, baby carriages. 4" to 16". Free list. Trulsen Mfg. Co., 811 E. 31, Kansas City, Mo.

WHEELS Of Every Description. 10 x 2.75 Single valve tube pneumatic wheels @ \$7.25 each. 10 x 2.75 Semi-pneumatic wheels @ \$6.75 each. Write us for free catalog. Jim Brown Toy Company, 1093 Home Avenue, Akron, Ohio.

HARLEY-Davidson Parts, accessories, batteries, and tires, 24 Hour Service. Authorized factory dealer. Philadelphia Harley-Davidson Company, 857 North Broad Street, Philadelphia 23, Penna.

"CUSHMAN motorscooter \$15. Shaw bicycle motor \$15. Harley-Davidson Motorcycle \$35! Send 25c for bargain catalog #8, packed with money saving buys in motorscooters, motorbikes, midget cars, motors, wheels, tires and parts. Gail and Company, 538 Erie, Toledo, Ohio."

"PROFESSIONAL Midget Racer, Motor-scooter, Midget Roadster, and Midget Motorcycle. Plans, specifications for all four contained in illustrated handbook, 25c. Big list bargain priced used motors, motorscooters, Servicycles, etc., included free! Midwest, 3839 Drummond, Toledo, Ohio."

1½ HORSEPOWER from Y and similar Briggs and Strattons. Instructions \$1.00. Parts, Transmissions. Alden Motors, Oakland City, Indiana.

"BUILD America's lowest priced motor-scooter speedster! Complete plans, specifications. \$1.00. Big list bargain priced used motors, etc., included free! Motor Supply, Box 1682-CS, Toledo, Ohio."

"CUSHMAN Motorscooter \$20 (includes motor and extra tires). Midget Racer \$15! Send 25c for big Summer catalog #938, just printed, listing these and scores of other sensational bargains in motors, wheels, motorscooters, motorbikes, Servicycles, tires, etc. Associated, Box CS-1764, Toledo, Ohio."

MIDGET Racer with three speed transmission \$35; Briggs motorscooter \$25; Three wheeled motorscooter \$45; English motorcycle \$100; gasoline motors \$5 up; outboards \$25 up; plenty brand new 2 horsepower motors in factory crates; plenty midget racers for highway use; over 6200 small balloon tires for motorscooters and small cars. (Mailorder only). Send 25c for Big War-Bargain catalogue Number Twenty-One, just out, listing the above and hundreds of other bargains in new and used motorscooters, motorcycles, midget cars, motors, transmissions, automatic clutches, parts, plans, etc. (35c by First Class mail.) Midget Motors Directory, Athens, Ohio.

MOTORCYCLE, Parts, new and used, Harley, Indian, Henderson, Super-X, List 10c. Ballak, 811 N. 9th, St. Louis 1, Mo.

MOTOR Scooters, bicycle engines, 120 miles gallon, Dime for catalog. Clymer, Desk B-95, 2125 W. Pico, Los Angeles 6, Cal.

15 AVIATION

GIANT Glider Kites. Double, 14x10 ft. Lifts 100 lbs., tows car, etc. Cost Government \$108. Yours for \$20. Satisfaction guaranteed. Great Northern Mart, North Adams, Mass.

PROPELLERS—Especially designed 3 Blade, 2 Blade, for ice-snow sleds, boats. Literature. Standard Aircraft, Box 387, Ft. Worth, Texas.

"SENSATIONAL bargains in used Cubs, Taylorcrafts, etc! Big, thousand-item catalog, 25c. (Includes listings of 'easy to repair' crackups.) National, Box 1682-CS, Toledo, Ohio."

VETERANS: Flight training under the G.I. Bill. Private, Commercial and Flight Instructor Ratings. Write for information, Gottschalk School of Aeronautics, Adrian, Michigan.

4 AVIATION INSTRUCTION

TRAIN For Aviation Mechanics High Salaries. This famous school approved for veterans. Immediate enrollment. For information write California Flyers, Department PS9, Inglewood, California.

49 ELECTRICAL SUPPLIES & EQUIPMENT

ELECTRIC Pencil: Writes, Engraves all Metals. \$1.00 postpaid. Beyer Mfg., 229-C Dixon Blvd., Uniontown, Penna.

FURNACES, conversions. Gas, oil, L.P. Easily sold. Card for literature. Thuman Equipment, 1225 Fifth Ave., St. Joseph, Mo.

LAMPS—All parts to build or repair. Catalog 10c. Gyro Lamps, 5416B Clark, Chicago 40.

ALUMINUM fan blades, correctly balanced. ½" bore \$2.25 each. All welded 18" guard \$2.50. Ted Riseman, 207 North Fifth, Springfield, Illinois.

ELECTRIC Pencil—writes, engraves all metals. Battery model \$1.00—110 Volt model \$3.00 Postpaid. C.O.D.s accepted. Reb Industries, Dept. 265-CP, Elmhurst, Ill.

SOLENOID Assembly. All New! Contains over 1 pound magnet wire. Over \$30 value. Special \$1.50 each. Four for \$5. No COD. "Amazing Bachman's", Dept. UA, 23 Herman St., Rochester 5, N. Y.

GAS-MIZER. The superior hot water system with automatic convenience: "bucket a day" economy. Soon pays for its low cost in gas saving and comfort. Easily installed. Write for literature. Safty Control Company, 2519 Wilson, Arlington, Va.

A.C. 110-VOLT Motors. Selsyn Syncro Differential—New in original Package. A Bargain at \$1.75 while they last. Lyell Hardware, P.O. Box 5, Rochester 11, N. Y.

JONES Cable Stripper—\$7.50. Send for folder. Jones Tool Co., 4505 Rainier Ave., Seattle 8, Wash.

BLOWERS, Exhaust fans. Oil and gas furnaces, floor furnaces, burners, circulating heaters, Water heaters, unit heaters. Stokers, Sump pumps, Hot Water Circulators. Users, Dealers. Superior, 120 Elnido, Monrovia, Calif.

SELSYN motors, Bendix 3½" x 5½" heavy duty 115 volts, 60 cycles, \$10.25 per pair. J. A. Weber, 150A Maple, Hershey, Pa.

ELECTRICAL Examination preparation. See Quiz Book ad under Educational and Instruction.

FLUORESCENT lights. Make you own ideal for home and shop. Complete electrical parts for 20-watt fixture with detailed instructions. Postpaid only \$2.00. Write Fluorokit, 332 E. Reservoir, Milwaukee, Wisconsin.

140 WELDING, SOLDERING

"BUILD-UR-OWN" portable arc Welder. Save \$300. Easy with Hobart Generator plus auto engine. Write for Free Book. Hobart Welders, Box P-973, Troy, Ohio.

NEW Model electric welder 110 volt AC-DC; will weld all metals; easy to use, full directions. Complete with power unit, flame and metallic arc attachments, carbons, fluxes, rods, mask; all for \$19.95—Used by the Navy. Magic Welder Mfg. Co., 239-PS—9 Canal St., New York City.

A.C. WELDERS. 110v welds ½" steel \$29. Paul Morris, 1850B State St., Schenectady 4, New York.

COMPLETE new welding outfit including Torch with four tips, Two gauge Regulators, Hose, etc. \$59.75. We sell Oxygen and Acetylene Cylinders outright. No Rental, free literature. A-A Welding Supply Co., P9228 Ada St., Chicago 20, Ill.

SAVE 50% on Electric Welders, Accessories, etc. Holgerson Co., Canton, Kansas.

WELD, cut, braze with gasoline! Amazing discovery shatters costs. Range jewelry to railroad steel. For farm, factory, shop. New opportunities. New wealth. Important! Investigate. Matthews Mfg. Co., Calgary 22, Canada.

NEW Aircraft Generators—War Surplus—Only \$39.50. Original cost \$250.00. Can be converted for use as welder, electric plater, fast battery charger, auxiliary power unit, etc. Model R. 2, volts 25 to 30, 300 amp. d.c., shipping weight 69 lbs. Size 16"x7". Air cooled. Immediate shipment. Original crates. Check with order to save time. Greer, 460 South State Street, Dept. 297, Chicago 5, Ill.

SILVER Solder Brazing makes strong unbreakable leak-proof joints all metal. Simplified instructions 50c. Supplier handled. American Products, 831 Lowell Bldg., Chicago 5.

SILICON steel 29 gauge strips 30"x2"—5" 50 pounds \$6.00 F.O.B. Ernest Noyes, 32328 Brush, Royal Oak R5, Mich.

6 AIR CONDITIONING & HEATING

HEATING, L.P. Gases. Floor and Basement Furnaces. Conversion Burners. Free Literature. Peerless Sales, Lincoln 6, Nebr.

HEATING and airconditioning equipment. Write Moore Equipment Company, Lincoln 6, Nebraska.

80 MACHINERY, TOOLS, SUPPLIES

ELECTROPLATING booklet includes full directions for plating jewelry, small parts, metallizing baby shoes. 50c. Hoover & Strong, Inc., 115 W. Tupper Street, Buffalo 1, N. Y.

DRILL GRINDER—Grinds drills to factory accuracy. Calipers with direct reading scales. Circle cutters. New Tool grinder. Lowest prices. Free literature. Factory, 811-A East 31st, Kansas City 3, Mo.

MACHINE Tool Castings for woodworking and metalworking tools. Machine them yourself, save up to 80%. Catalog describing 23 Lewis Tools and projects sent for 10c. Lewis Machine Tool Co., 3217 Union Pacific Avenue, Dept. S, Los Angeles 23, Calif.

GEARS For inventors, experimenters, model makers, schools, work shops, laboratories, etc. Government surplus made of brass, bronze, dural steel and stainless steel. 12 matched pairs; 24 gears, bevel, spur and ratchet. List price \$12.00, our price \$2.50. 25 matched pairs; 50 gears, includes larger gears, also sets of worm gears. List price \$30.00, our price \$5.00. Limited quantity. Order now. Write for our bulletins on ball bearings, rectifiers, Relays, Selsyns, Horns and government surplus materials. Met Exchange, 323 Canal Street, New York.

WORK wanted for hand Turretlathe. Glenbern Machine Co., Youngwood, Pa.

ORIGINAL Patented Drill Grinding attachment, imitated but never equalled. \$2.80 postpaid. E Z Mfg., 327 California, Burbank, California.

WE offer 60 tons of new war surplus bolts, nuts, washers, screws, etc. All popular sizes. A good mixture for hobby shops, garages, machine shops & farms. A big 40 lb box for only \$6.85. War Surplus Co., Morris & John Sts., New Brunswick, N. J.

AIR Driven Rivet Guns Used but Guaranteed to Work. \$5.95. Art's Surplus Mart, 1329W Florence Ave., Los Angeles, Calif.

SHEBEL Saw Filer, \$7.50. Files all saws. Free trial, Circular, 730A So. 2nd St., Milwaukee 4, Wis.

POPULAR SCIENCE OPPORTUNITIES

WAR Surplus in small tools for machine shop—Send 10c for bulletin, Travers Tool Co., Dept. S, 5 Court Square, Long Island City 1, N. Y.

WELDERS, electric arc. Models and sizes for all requirements. D.C., A.C. 150-600 Amp. Portable, Stationary. Prompt delivery. Reasonable Terms. Write for Free Catalog. Hobart Welders, Box P-974, Troy, Ohio.

12" BAND Saw, tilting table, Oilite bearings, all grey iron castings. \$35.00. Write for circular, Backus Machine Co., Boyd, Wisc.

V BLOCKS at low prices. 10 sizes for all purposes. Free Literature. Miles Products, 2532 Wabash, Chicago 16.

MECHANICS—Machinists—Hobbyists—Note!—Amazing Dual-Drive Assembly, geared 7 to 1 reduction, is driven by powerful 1/5 HP AC or DC Motor. Operates on 6 - 27 - or 110 volts with transformer. Simple standard attachments convert this amazing unit into a dual-hand or table drill—polisher—buffer—router—sander—countless other uses. May be used as individual drill—sander—etc., by detaching flexible drive shaft. This wonder machine shop all in one comes set-up as drill equipped with 3 flexible drive cables and mounting bracket. Original cost to Government over \$300.00. Now! While they last, \$19.50. No COD. "Amazing Bachman's", Dept. UA, 23 Herman St., Rochester 5, N. Y.

ELECTRIC Hand Sander complete \$14.85, free circular. Kalder Engineering, 255PS Charles, Grand Rapids 6, Mich.

GEAR Reductions! Values ranging from \$500 to \$1100 each. All New! Complete with 1/2 HP motor AC or DC 110 volt. 25 to 60 cy. Single phase. Variable speeds. Bearing assembly with machined gears. Absolutely the thing for sanders—polishers—winches—hoist—conveyers. Adaptable for many uses. Special \$39.50. No COD. "Amazing Bachman's", Dept. UA, 23 Herman Street, Rochester 5, N. Y.

LONG'S Index Head for the Lathe, Milling Machine, Drill Press, etc. Write for folders. Satisfaction guaranteed. Box 537, Torrington, Wyoming.

FLEXIBLE Drive Cables. All New! Three sizes. 10"—25"—72". Adaptable for many uses. Over \$5.00 value. Combination offer of all 3 sizes, while they last \$1.75. No COD. "Amazing Bachman's", Dept. UA, 23 Herman St., Rochester 5, N. Y.

DRILL GRINDER for twist drills \$2.95. See ad on page 258.

WANTED machinist tools. Send tools, get cash. Satisfaction guaranteed. Wm. Gruer, 460 Ryerson, Elgin, Illinois.

MACHINIST'S tools, supplies. Low prices. Precision Tool Service, 55 E. Washington, Chicago 2, Ill.

LOW-PRICED Power Tools, Metalworking and Woodworking. Machine Service, Newfane 1, Vermont.

17 BATTERIES, GENERATORS, ETC.

MOTOR 25c. Flashlight cell operates. Parts complete plus instructions. Two 45c. Eltro Company, 171D, Deer Park, N. Y.

19 BOATS, OUTBOARD MOTORS, ETC.

FULL size, cut to shape boat patterns, blueprints. 7 1/2"—38 feet. Illustrated "Build a Boat" catalog. 10c (coin). "How to Build Boats" book, \$1.00. Cleveland Boat Blueprint Co., Dept. A-77, Cleveland, Ohio.

MARINE Power—Easily convert any Ford and Jeep motor (domestic and foreign) with Osco parts and kits. Complete catalogue 25c (coin). Osco Motors Corp., 2020C E. Orleans St., Phila. 34, Pa.

"PLYWOOD Rowboat and Motor Boat K.D. Kits. Assemble and save up to \$57.50. Three popular models. Resin bonded, waterproof plywood construction. Easy to assemble in spare time. Write for free literature and complete specifications. C. R. Dillagaugh Boat Co., 7928 N. E. Mallory, Portland 11, Oregon."

NEW, used, rebuilt marine motors. Marine conversions, fittings. Free Catalog. Stokes Marine Supply, Dept. 23, Coldwater, Mich.

"MARINE conversions for Ford and Jeep engines. Catalog 10c. Lehman Manufacturing Company, Department A, Newark 2, New Jersey."

MOULDED hull kits ready to assemble; plywood building kits \$35.00 up; marine type sheet plywood. Send \$1.00 for literature plus Wm. Deeds Book—"Plywood Boats." Marine Mart, Buffalo 7, N. Y.

KAYAK Blueprints, Deluxe Models—catalogue 10c. Viking Kanoes, Merrick, N. Y.

MARINE catalogue 15,000 deliverable items, pictures and prices. Send \$1.00. Marine Mart, Buffalo 7, N. Y.

"\$35 SEA Shell pre-fabricated 8' plywood rowboat. Free illustrated catalog. Hagerty, Cohasset, Massachusetts."

CATALOGUE—over 30 world's best plywood designs sent with Wm. Deeds book, "Plywood Boats." Send \$1.00. Marine Mart, Buffalo 7, New York.

CARTOP Rowboats, Kayaks, Weldwood ready cut kits. Booklet. E. J. Croot Co., #103-E, Basking Ridge, N. J.

FIR Plywood—Waterproof marine grade for boat-building. 1/4" thickness 48"x96" \$6.40; 48"x144" \$12.48; 48"x192" \$16.64; 3/8" thickness 48"x96" \$9.60; 48"x144" \$15.84; 48"x192" \$21.12; 1/2" thickness 48"x96" \$11.20; 48"x144" \$18.24; 48"x192" \$24.32. Terms: Cash with order; shipment by express or freight. Carmen-Bronson Corporation, Dept. M-5, Mount Vernon, N. Y.

SEXTANT—plastic, colorful, accurate to five miles. Excellent for cruiser or den. Decorative and practical. Only \$10.00 postpaid. Joel, 103-09 Farragut Road, Brooklyn 12, New York.

51 ENGINES, MOTORS, ETC.

MOTORS! 1/2 HP.—All New—High Speed 110 volt. 25 or 60 cycle, d.c. converted to a.c., ball-bearing motors with forward and reverse switches. Actual cost about \$100.00. Now \$19.50, three for \$50.—or—same motor without reverse switch \$15. Three for \$40. Countless uses for home mechanics. Order today! No COD orders. "Amazing Bachman's", Dept. UA, 23 Herman Street, Rochester 5, N. Y.

WINDING Data, listing 225 motors, single and three phase. \$1.00. Motor Data, Box 7631, Kansas City 3, Mo.

SELSYNS—All New! Transformers—GE Model 2J1G1. 57.5—57.5V 400 cy; Generators—GE Model 2J1F1. 115—57.5V 400 cy. With gears. Sensational offer! \$1.50 each. Quantity lots \$15. dozen. Order Now! No COD. "Amazing Bachman's", Dept. UA, 23 Herman Street, Rochester 5, N. Y.

WELDING Generator, 150 ampere, \$47.50. Other bargains. Butler, 1885 Milwaukee, Chicago.

AMPLIDYNE Motor-Generators. All Packed—New! GE5AM 31N9A. Output 60 VDC, input 27 VDC. 530 Watts. Original cost \$120.00. Now! \$7.95 each. Three for \$20. Order Today! No COD. "Amazing Bachman's", Dept. UA, 23 Herman Street, Rochester 5, N. Y.

GAS Drive Arc Welders, "Build Your Own". Portable, goes everywhere after profitable jobs. Save \$300 with Hobart Generator plus auto engine. Write for Free Instruction Book. Hobart Welders, Box P-975, Troy, Ohio.

DYNAMOTORS. All New! 400-cycle. GE5D21N3A. 27 VDC to 100VAC. 485 watts. Sensational offer! \$8.95 each. Three for \$25. Order today! No COD. "Amazing Bachman's", 23 Herman St., Dept. UA, Rochester 5, N. Y.

27 VOLT D.C., 250 R.P.M., P.M. motors at \$2.00 each. G & G Mfg., 656 Broadway, New York City.

RANGER Engine—Aircraft—All New in original case. 570 HP. 12 cyl. V type. Engine Spec. No. 177. Complete with spark plugs. Original Government cost over \$12,000.00 each. Special offer \$200. Crated weight 1200 lbs. No COD. Write for complete description. "Amazing Bachman's", Dept. UA, 23 Herman Street, Rochester 5, N. Y.

AC MOTOR Winder, winds concentric coils for Electric Motors, adjustable 1/8 to 2 H.P. Send for bulletin. Motor Industries, Quincy, Illinois.

7 AMERICAN POLICE JIU JITSU

DEADLY Judo—Fiercest fighting technique. Trick knockouts. (200 photographs—plus illustrations.) Expert instructions—Three volumes. Complete \$2.25. Variety House, Box 46-AV Wall Station, N.Y.C. 5.

JIU JITSU Movies. Free list. Stone, Box 171-A, Canal Sta., New York 13, N. Y.

20 BODY-BUILDING COURSES

HANDBALANCING—Acrobatics, easily learned. Write. Power, 923 W. Vine, Kalamazoo, Michigan.

BAR-BELLS, Dumbbells, Exercise equip-ment. Courses, Free booklet. Good Barbell Co., Reading, Penna.

BARBELLS! Catalog! Bur Barbell Co., 319 Orient Way, Lyndhurst, N. J.

BARBELLS, unexcelled, Stamp for fold-ers. Jackson Barbell Co., Springfield, N. J.

MUSCLES (Free Pictured List), Bar-bells, Cables, Equipment. Nat Berent, 1090 W. 43rd, Norfolk 8, Va.

124 SPORTING GOODS, GUNS, FISHING TACKLE, ARCHERY

"AMMUNITION"—"New and Used"—"Shotguns"—"Rifles"—"Revolvers"—"Pistols"—"Fishing Tackle"—List 10c. Rudolph's, Atchison, Kansas.

BOWS—Arrows. Write headquarters for Archery equipment. Quality products. Popular prices. Catalog 10c. Large illustrated Hand Book Instructions, making and shooting, 50c. Archery, 617-A So. State, Chicago 5.

SEND 10c for list 100 new and used guns. Frayseths, Wilmar, Minnesota.

5000 BARGAINS, firearms, binoculars, war relics, catalog 40c. Smith Museum, Runnemede, N. J.

NEW and Used Guns—Shooting Supplies—Trades—Stamp for list. Tobin's, Cambridge, Vermont.

EMBROIDERED Emblems, Machine Made, in lots of 50 or more, for Sport, Industrial, Advertising purposes. Send 10c for Sample. William Otto, 4215 Park Ave., Union City, N. J.

JUMBO Bull Frogs, Wild Rabbits, Fish-ing Poles, Ball Bats, Land. Vol Brashears, Berryville, Arkansas.

FREE! New and Used Gun and Hunting Equipment Catalog. 52 exciting pages, fully illustrated. Thousands of fresh new sporting goods items; hundreds of available used and new guns, all types, from America's greatest gun traders. Get the Best "sell or swap" deal at Klein's. Satisfaction guaranteed. Mail description or ship your guns! Easy terms available. Klein's Sporting Goods, Dept. TS, 227 W. Washington St., Chicago 6, Ill.

HUNTING Knives: 6" hardened steel blade. Made by Razor Blade Manufacturer. Genuine leather case. Unbreakable handle. \$1.50 postpaid. Link's Tackle Shop, Farmington, Conn.

55 FIELD GLASSES, TELESCOPES, ETC.

7x50 BINOCULAR lenses and prisms. Navy surplus. Rejected for chips or minor defects which do not interfere with their performance. Complete optics for Monocular \$3.75; for Binocular \$7.50 postpaid. Assembly diagram included. Brownscope Company, 24 West 45th St., N. Y.

REFLECTING Telescope, complete 3 1/2" diameter, equatorially mounted. View planets, stars. \$19.75. Write Skyscope Co., 475-5th Ave., New York.

INFRA-RED filters glass 1 1/4" (40 mm) diameter, mounted. Snap on camera or binocular. \$1.00 per set. Ross, B68 West Broadway, New York, N. Y.

ULTRA Powerful Compound microscope easily made. Perfect lenses and detailed instructions for making microscope that gives 50, 200 and 400 diameters magnification. See the digestive processes of a mosquito. \$3.00. Instructions alone 10c. Suffolk Science Service, Manorville, N. Y.

TELESCOPES, Microscopes, binoculars, barometers, books; Buy, sell, repair; We guarantee. Lists 10c. Rasmussen & Reece, Amsterdam, N. Y.

POPULAR SCIENCE OPPORTUNITIES

SAVE Money—make own Galilean Telescope. 5, 8, 15 powers. Achromatic, coated objective 7½ inch focal length 1¼ inch diameter; 3 eyelenses; complete with instructions \$2.00 postpaid. Ross, B68 West Broadway, New York, N. Y.

GUN Sights. All New! Experimentalists—Hobbyists. Beat this one! Original value of this assortment of 3 sights over \$250.00 Now! All for \$15. Order today. No C.O.D. "Amazing Bachman's", 23 Herman Street, Rochester 5, N. Y.

REFLECTING Telescope kit, complete optical parts, fully finished; 3" diameter, 39" f.l. mirror and diagonal both hard aluminized, plus 3 lenses for high power eyepieces. Never again a bargain like this. All \$6.00 postpaid. Ross, B68 West Broadway, New York, N. Y.

POWERFUL Astronomical telescope easily made. Perfect lenses and instructions. 100 power \$2.50. 100 and 200 power \$3.50. 100, 200 and 400 power \$5.50. Clear vision and full power guaranteed. Instructions alone 10c. Suffolk Science Service, Manorville, N. Y.

GENUINE polaroid glass—2⅞" (72 mm) diameter. \$1.25 each. 2 for \$2.00. Ross, B68 West Broadway, New York, N. Y.

43 DOGS, BIRDS, PETS, RABBITS

GUARANTEED Chin-Chin Giant Chin-chilla rabbits. Greatest amount of delicious meat. Largest, finest, most valuable furs. Tremendous demand for breeding stock. We buy youngsters. Contact world's largest breeder, Willow Brook Farm, R16, Sellersville, Pa.

\$250 MONTHLY Raising Angora Rabbits. Particulars free. White's Rabbitry, Newark, Ohio.

\$2,500 YEARLY raising Angoras. We market your young. Contract Particulars Free. Wilsons, 1065 Shyer, St. Paul 8, Minn.

FOR Sale—Coon Hounds. Combination Tree Hounds and High Class Fox Hounds. Rabbit Hounds a specialty. Dures Thomas, Route 3, Albertville, Ala.

RAISE Guinea Pigs. Make money at home. Big demand. Booklet free. Taylor, Box 426B, Hapeville, Georgia.

EXCELLENT Opportunity raising Giant Chinchilla Rabbits. Waters Rabbit Farm, Glennville, Georgia.

RAISE Diamond Seal Rabbits. We pay \$30 to \$60 each. Breeding stock furnished for half cash, balance paid in stock produced. Literature 25c. with hutch plans \$1. Hansen's Rabbit Institute, 1347 Miller Avenue, Salt Lake City 6, Utah.

\$50.00 weekly with Angoras. Our co-operative marketing plan assures you of year around market. Free literature. Iowa Angora Association, 1215 34th Northeast, Cedar Rapids, Iowa.

ST. BERNARD Pups: Champion sired beauties. Franklin Young, R. 3, Riverhead, Long Island, New York.

SEE "Golden Hamsters" ad on page 45. Shows hamster picture.

83 MILK GOATS

"MONEY from dairy goats!" Booklet free. Introductory 3-month subscription to leading magazine 25c. Dairy Goat Journal, Dept. 768, Columbia, Missouri.

62 FARMS, OTHER REAL ESTATE

OZARK Lands for All purposes. Actual river frontages. 5 acres \$90.00 and upwards. Free list and literature. Hubbard, 424H, Minnesota Ave., Kansas City 4, Kans.

GOOD Farms—Ranches. Washington, Minnesota, Montana, Idaho, Oregon, North Dakota. Dependable crops, favorable climate. Write for literature, lists describing typical postwar farm opportunities. Specify which state. J. W. Haw, 120 Northern Pacific Ry., St. Paul 1, Minn.

HOMESITES \$450—convenient payments. California's finest garden section. On Morro Bay's scenic shores. Wonderful fishing, hunting, boating, bathing. Fertile soil, softest water, temperate climate, congenial community. Free literature. Richard Otto, 6560-Z, Hollywood Blvd., Hollywood 28, California.

OZARK FARMS. Large list free. E. Frank, Mountain View, Mo.

SOUTHERN Ozarks. full acres on state highway near town. Twenty dollars down. Hunt, Fish, Trap. Building Costs low. Details owner, Harry M. Parker, Mountain Home, Arkansas.

108 POULTRY AND SUPPLIES

RAISE turkeys the new way, write for free information explaining how to make up to \$3000.00 in your own backyard, address National Turkey Institute, Dept 57, Columbus, Kansas.

RAISE Fryers new easy way. \$6000 yearly possible in your backyard. Booklet Free. Poultry Guild, 1046-B So. Olive, Los Angeles 15, Calif.

111 PROFITABLE OCCUPATIONS

DETECTIVES Earn Big Money. Excellent opportunity. Detective Particulars free. Write, Wagoner, P-125 West 86th, N. Y.

LOCKSMITHING—Profitable Business or Hobby! New course teaches you how to pick locks, fit keys, de-code, masterkey, etc. Easy self-instruction lessons. Bargain price. Fascinating 100-page illustrated catalog Free! Write Nelson Company, Dept. 2-01, Chicago 5.

MUSHROOMS Grown. Boxes, Barrels; Illustrated Instructions, 50c. Spawn \$1.00. Gordons, 553 William, Winnipeg, Manitoba.

\$40.00 WEEKLY. Made growing mushrooms. Fresh, Dried, Dominion Patent 331,583, free spawn. North American, 169Y Yonge, Toronto, Canada.

MAKE beautiful costume jewelry at home for large profits, hobby or therapy. Free illustrated wholesale catalogue of sea shell, metal and plastic parts contains detailed instructions. Florida Supply House, Bradenton, Florida.

\$5000. from half acre growing Ginseng, seed supplied. Crop bought. Particulars 10c. Associated Growers, 203 Bulman Block, Winnipeg, Canada.

TYPISTS—Profitable business at home. Complete copyrighted information. 50c. Gaunt, 3521B Broadway, Chicago 13, Ill.

CASH in on Television. now! Amazing opportunity to start profitable business. Technical knowledge unnecessary. Write for free details. Marlowe Television, 10 Radio City, N.T.C.

LADY'S Novelty Lapel Pins; Manufacture at home, fast selling, materials cent dozen. Easily made. Circular, Plastex Products, 1025 Prague St., San Francisco.

START Your Own Business at home, spare time. Pleasant work. Write Gantz, 1778 Crawford Rd., Cleveland 6, Ohio.

FLORIDA Highlands:—Beautiful acre farms \$40. (200 ft. above sea-level) \$4.00 Monthly. 40 miles north of Pensacola. Delker, 2219 Venango, Philadelphia ?????

ENTER aviation. U. S. or Foreign. I can help you. Free information. Miller, 1333 18th Street, Santa Monica, Calif.

"UNPAINTED Plaster Ornaments. beautiful designs easily decorated with water colors or oil paints. Illustrated List free. Midwest Novelty Mfg. Co., 108 Cedar St., Anaconda, Montana."

LOCKSMITHING Secrets—Key Fitting—Lock Picking—Repairing—Prices to Charge—Sources of Supplies. Illustrated Book only \$1.00. Wechsler Supply, 7 West 36, N.Y.C.

HOME Manufacturing pays big. Free literature. Wayne Engineering, Greenville 2, Ohio.

BEAT method piano tuning entirely. Mechanical \$1, two lessons chart. Oscar Fyling, 841 Robinson, Oroville, Calif.

LEARN Air Conditioning at home. New practical courses by Engineers actually engaged in Air Conditioning. Exclusive new forms simplify procedures. Free information. Technical Services, Inc., Indianapolis, Indiana.

STARTLING \$1 Books: "Destruction of World." "New History of Jesus Discovered." "How Miracle Shrines Cure." World-Press, Columbia City, Ind.

SHELLCRAFT—Beginners kit \$1.00. Catalog free. Burton, Box 27, Station A, St. Petersburg, Fla.

22 BOOKS, PERIODICALS, ETC.

WHAT Every Mason wants. We have Masonic books for Blue Lodge, Chapter, Commandery Scottish Rite and Shrine. Our rituals are used the world over. Send for our free catalog of books and rituals for Masons, Odd Fellows, Knights of Columbus, etc. Ezra A. Cook, Publisher, Inc., P.O. Box 796-RMY, Chicago 90, Ill.

MAGAZINES (back dated)—foreign, domestic, arts, Books, booklets, subscriptions, pin-ups, etc. Catalog 10c. (refundable). Cicerone's, 863 First Ave., New York 17, New York.

BOOKFINDERS! (Scarce, out-of-print unusual books.) Quickly supplied. Send wants, Clifton, Box 1377-PS, Beverly Hills, Calif.

GOOD "Used" Self-instruction educational books on all subjects bought, sold, rented, exchanged. Satisfaction guaranteed. Complete information and 100-page illustrated bargain catalog Free! Write—Nelson Company, Chicago 5.

BIG Profits Taking Subscriptions For All magazines. Agents' Confidential Catalog listing over 2500 periodicals and complete starting supplies Free. Pines Subscription Agency, Flushing, N. Y.

"FIX It Yourself"—home repair book. How to fix appliances, furniture, plumbing, etc. 256 pages, 163 pictures, \$1.49. Popular Science, Dept. 97-C, 353 4th Avenue, New York 10, N. Y.

EDUCATIONAL Books sold cheaply or rented for small fee. Books bought, Money-back guarantee. 4,000 Bargains. Catalog Free. (Courses Bought.) Lee Mountain, Pisgah, Alabama.

"RADIO For The Millions"—practical book. Complete instructions for building 78 radios, phonographs, other sets. 192 pages, 648 pictures. Regular Edition \$1.49. Popular Science, Dept. 97-C, 353 4th Avenue, New York 10, N. Y.

ADULT Books 25c. Five—\$1.00! Free Bookalogues! Hirsch, Spring Valley 3, N. Y.

BOOKS Found free! All Subjects. Send Wants! Jaher Book Service, 620-K East 178 Street, New York 57.

BORROW "Best Sellers". No need to buy them. Our new reading plan for book lovers brings books to your door postage prepaid at amazingly small cost. Send post card for details. Postal Book Exchange, 116 S. Michigan Ave., Chicago 3, Ill.

TRADE Magazines—Business, Vocational, Diversion. Current single copies. All fields. Free price-list. Commercial Engraving Publishing Co., 34S North Ritter, Indianapolis 19, Indiana.

FREE bargain catalogue. Correspondence courses. Helpful books. Baker, 5509-A Winthrop, Chicago 40.

EARN Extra Money handling Magazine Subscriptions. Books, Greeting Cards. Excellent Commissions. Cassel Publishers, Westfield, New Jersey.

MAGAZINE Subscriptions—Write for prices on those you are interested in. Victory Service, PS-9, Emmaus, Penna.

ADULT Publications. Fascinating subjects, illustrations. Roy, Box 531-A, Waterbury 85, Conn.

ALL pocket books. Catalog, latest reviews free. Gordon's, 2613b Crenshaw, Los Angeles.

ADULT Books. Revealing Sex Truths—Illustrated. 50c. Kogan, 1032-SB, New York 8.

MEN Only. Fresh stuff in little Books. 15 for \$1.00. DuLaw Novelties, Box #297, East Chicago, Indiana.

ADULT books. Artist's Pin-ups. Catalog, Sample 10c. Baker Service, Box 1840, Cleveland 6, Ohio.

OZARK Guide. 50c; Square Dance calls, instructions. \$1.00; Fifty Ozark view cards \$1.00.—Rayburne, Eureka Springs, Ark.

BACK issues magazines, reasonable. Reedmor, 240 East 9th, N. Y., N. Y.

1947 WHOLESALE catalog and Directory 10c. Latshaw Sales, Sunnyside-C, Indianapolis 44, Indiana.

FREE Book with every purchase. Booklist. Baker-Alexander, 1472 Broadway, N. Y. 18.

POPULAR SCIENCE OPPORTUNITIES

SIX Daring pocket-size Art Photographs for men—\$2.00. Satisfaction or refund. Sample 25c. Fast Service. Box 699-BBA, Westfield, New Jersey.

BOOKS, new, used, out-of-print, promptly supplied. Argus Book Service, P. O. Box 258-A, Waterbury, Conn.

ARCHITECTURAL, Fine art and handcraft books. Catalog 10 cents. Artcraft, Box 6827, Baltimore 4, Maryland.

ANATOMY San Francisco Cable Car Complete Mechanical Drawings Sixteen Photographs Two Dollars. Delkin, Stanford University, Calif.

BACK-Date Magazines, Books, Specific Issues—years. Arkell's, Tarzana, Calif.

"LOVE Ruthbella!" Intimate Diary Confessions;—privately published \$5 book now reprinted, price only \$2.00! Make this excitingly beautiful, picturesquely revealing tome your secret delight! Confidential listing: "Lonely Hour Books" included. Send two dollars today for the book thrill of your life! Poets Corner Press, 436 Center Street, Fort Lee, N. J.

81 MAGIC TRICKS, PUZZLES, ETC.

MAGICIANS', Gamblers' secrets exposed. Cards, Dice, Punchboards, Slot Machine. Catalog 10c. Book Co., Box 671, St. Louis 1, Mo.

"MAGIC Vanishing Card". Throw it into air, it completely disappears, reproduce it later from spectators pocket. Easy to do. Complete 25c with magic catalog. The Magician, 2463-D, Kensington Ave., Philadelphia, 25, Pa.

WORLD'S largest professional magic shop, keeps you in touch with latest tricks. To receive mailings, send 35c for new catalog. Holden's, 220-P West 42nd St., N. Y.

THE True Secret of Ventriloquism. Free booklet. Quackenbush, Big Flats, N. Y.

200 ELECTRIC Stunts, 110 volts, \$1. Cutting Sons, Campbell 3, Calif.

GUARANTEED magic tricks! Amateur. Professional. Big 8½ x 11 illustrated catalogue. 10c. Newton's, 121-B Main, Bonham, Texas.

DOLLAR Magic Set Free with Mammoth Catalog 25c. Mysto, 4462-PS Germantown, Phila.

SNEEZING, Itching Powders, Eighteen Other Tricks and Joker's Catalog 25c. Factory, 2404N15, Philadelphia.

"VENTRILLO", Professional Voice-throwing Instrument. Free with Catalog 25c. POB-971, Philadelphia.

500 TRICKS. Send only 10c for Douglas' famous 112-page Catalog 500 Tricks. New magic for amateur, professional. America's fastest service for 25 years. Douglas Magicland, Dept. 2, Dallas, Texas.

BE a Magician. Large professional magic catalog of latest tricks. 25c. Ireland, F-109 North Dearborn, Chicago.

DANDY Surprise offer. Magical, Hobbies, Novelties. Catalog. All Postpaid 25c. Magic, Box 35C, Irvington 11, N. J.

MAGIC Cards. Readable backs! Samples 10c. (Refundable). Box 531-A, Waterbury 85, Conn.

VENTRILLOQUISM. Full course \$2.00 postpaid. Elson, 137 Lewis, Phillipsburg, N. J.

HYPNOTISM! 25 Lesson Course. \$1.00. Monarch, 38-S Jefferson, Auburn, New York.

MAGICIANS pin, ghost illusion, Houdini escapes, giant catalogue. Everything, complete 25c. Magic Wands, 9w Colorado, Pasadena, Calif.

500 PAGE catalog, 6,000 novelties, gadgets, timesavers, hobbies, fun-makers, etc. 10c. Johnson Smith, A-74, Detroit 7.

VANISHING Quarter trick and catalog 25c. Sterling Magic Co., Royal Oak, Mich.

ILLUSTRATED "Easy-do" Magic Catalog, 3c. Lee's, 2231-S, McKinley, Berkeley 3, Calif.

NEW Magic Monthly, Year 25c. Sample copy and New Magic Catalogue Free. Magic Store, Minneapolis 2, Minn.

63 GAMES, ENTERTAINMENT

HOME Model Slot Machines and Coin Operated Games. Write for catalog. Webb Distributing Co., Dept. P4, 6 South Kedzie Ave., Chicago 12, Ill.

"FLYING Discs" fascinating, gyrating "Whirling Dervish" discs. See them whirl and twirl. \$1. dozen guaranteed. Associated Researchers, 135 Henry St., N. Y.

36 COIN COLLECTING

FREE! Foreign coin, banknote and Coin Collectors' Illustrated Catalog to approval service applicants. Send 3c postage. Tatham Coin Co., Springfield-D50, Mass.

LARGE cents—Indian Heads. Reasonable. Free lists. Hutchinson, 3463 "I" Street, Philadelphia 34, Pa.

WORLD Coins 30 different \$1.00. Harry Elsholz, Box 9014, Pittsburgh 24, Penna.

100 FOREIGN Coins \$4.00 Postpaid. Parker, 1122 Market, San Francisco 2, Calif.

\$2.00 TO \$200 each paid for hundreds of Old or Odd Coins, Indian-Lincoln-Foreign Wanted. Keep all until posted. Send 20 Cents for illustrated Coin Value Book, 4x6. Guaranteed Prices. 40 years in business. Coin Exchange (1), Le Roy, N. Y.

COMMEMORATIVE \$½ — Columbus, Washington, Cleveland, Stone Mountain, \$1.50 en. Illustrated Catalogue 25c. Norman Schultz, Salt Lake 9, Utah.

RINGLING Brothers Circus Scrip, Single 20c; Set (6) \$1.00. Twelve Wooden Nickels \$1.00. New Half Dollars—Iowa \$3.85; Booker T. Washington \$1.15; Stone Mountain \$1.25. Four Whitman Folders \$1.00; Handbook 50c. 10c Postage Extra. Bebee Coin Company, 1180 East 63rd, Chicago 37, Ill.

10 DIFFERENT Indian Cents 35c, 1851 Large Cent 50c, Large Coin book 35c, All three for \$1.00. Coins, Box 77, Alameda, Cal.

COINS, papermoney, checks, newspapers 1732-1800. Illustrated Catalogue 10c. Nagy, 8-M South 18th, Philadelphia 3, Pa.

LINCOLN Cent Collectors—Scarce 1922 D 15c. Complete lists free. Reynolds, 1118-B Mathews, Flint 3, Michigan.

96 OLD STAMPS WANTED

FREE!! 19th Century U.S., Commems, Civil War Revenues, Battleships, a total of 30 stamps to serious approval applicants. Equal value in foreign given to applicants for foreign approvals. Enclose 5c postage with request. Cosmopolitan Stamp Co., 1457 Broadway, N. Y. C.

127 STAMP COLLECTING

WORLD'S Largest Diamond And Triangle Stamps, Free Stamp Magazine. Stamps from Fighting Free French, 20 stamps from 20 different Countries, Pictorials, Airmails, Big Bargain 5c with approvals. Capital Stamps, Dept. 10, Little Rock, Ark.

BRITISH Empire! 55 Different including Batum, Burma, Cyprus, Gwallor, Tasmania, 5c to Approval Buyers, Lyman, 97 Nassau St., New York 7.

DEALER'S Wholesale Catalog. Postage 3c. Franksco, 5031 Queensbury, Baltimore, Maryland.

50 DIFFERENT including scarce diamond-shaped airmail 3c to approval service applicants. Avalon Stamp Co., Dept. S, Springfield 8, Mass.

FINE Approvals, freshly mounted. Fast, personal service. Tell me what countries you prefer and I'll send their stamps. Milton Skinner, 438 Locust, Long Beach 2, Calif.

UNITED STATES approvals complete coverage fine quality, attractive prices. Seminole Stamps, Box 378, Coconut Grove, Florida.

200 DIFFERENT stamps, 6c, to approval service applicants. Tatham Stamp Company, Springfield 50, Mass.

U. S. 797 SPA Sheet only 5c to applicants for U. S. approvals. M. Haycock, 61 O'Brien Pl., Brooklyn, N. Y.

FREE—Famous Americans Set, plus Flag Set, plus the National Parks set, plus the Presidential Set to the \$5. A total of 90 stamps absolutely Free to customers for our unsurpassed United States or Foreign selections. Send 3c postage for 15 of the above mentioned stamps and full particulars. Triboro Stamp Company, 145 Nassau Street, Dept. 209, New York.

FREE! Negro Triangle; Turks Islands "Cactus"; Dakar; Guinea; Palestine; "Fairy Tale", Pirate Chart, Map, Ship, Sea Lion and Snake stamps; French, British, Portuguese Colonies, etc.. Free for 3c postage. Approvals. Potomac Stampco, Washington 10, D. C.

SCARCE U.S. Stamps Nearly 100 Years Old, 1893 Commemorative, \$5-\$10 stamps, Armed Services Pictorials complete, Roosevelt set, large Allegorical Figure of Commerce, Old Revenues, everything 5c to serious approval applicants. Metropolitan, 140 Nassau, New York 7.

ZOWIE-E-E! A Barrel of Fun for only a Dime! 500 United States Stamps—Absolutely unpicked and unsorted, just as received from church missions. Many varieties, including large commemoratives, airmails, high denominations up to \$5.00! Stampdom's biggest package of fun, and you might find something really valuable!! Price only 10c to serious approval service applicants. Money back if not delighted. Illustrated bargain lists with each order. Mystic Stamp Co., Dept. 55, Camden, New York.

FREE—The Stamp Finder. Big new edition—32 pages profusely illustrated! Tells at a glance the country to which any stamp belongs and so where to place it in your album! Also: 25 different stamps from Vatican City, Palestine, Cyprus, San Marino, etc. All sent to approval Applicants enclosing 3c postage. Garcelon Stamp Co., Box 918, Calais, Maine.

ERRORS. Sensational offer stamp errors and stamps designed by late President Roosevelt \$1.00. Blue Diamond Stampco, 750 46th Street, B'klyn 20, N. Y.

PIRATES! Head Hunting Natives! Kings! Statesmen! Man-eating Bull of Greece, Nazi Hitler Head, Roosevelt, Churchill and Stalin on stamps in our "Mammoth Collection" containing over hundred interesting stamps. Only 10c to approval applicants. National Stamp Sales, 276-A West 43rd Street, N.Y.C. 18.

GOLDEN Mixture, Variety Countries, 25c. MacDonald 30-P, Seaman Ave., New York 34.

CUBA Roosevelt Stamp and 25 different Switzerland only 1c to approval service applicants. Littleton Stamp Company, Littleton 47, New Hampshire.

WOW! \$10.00 Worth Of Fun Only 10c. What a treasure hunt! Big package 500 Foreign Stamps—just as received from foreign missions other sources. Includes stamps from Africa, South America, Free French, Cape Juby, Palestine, etc., includes airmails, commemoratives, and stamps worth up to 50c. This offer sent for 10c to serious approval applicants only—one to a customer. Jamestown Stamp Co., Dept. 5, Jamestown, New York.

VICTORY Packet Free—Includes stamps from Tanganyika—British Cayman Islands—Animal—Scarce Babyhead—Coronation—Early Victorian—Airmail—Map Stamps—Including big illustrated catalogue. Send 5c for postage. Gray Stamp Company, Dept. P. R. Toronto, Canada.

25,000 AUSTRALIAN (States, Commonwealth) 70 varieties; 10,000 foreign for exchange. Keith Sharrock, Gordon, Victoria, Australia.

FREE! Complete Balkan aviation set with approvals. Beaman, Elliston 10, Va.

FREE! Tiny Chinese "Midget" War set Approvals. Seminole, Elliston 10, Va.

BET You Haven't These! South Georgia, South Orkneys, Grahamland, South Shetlands—Shortlived Falkland Dependencies—Everything 3c with approvals. Viking, 130-PP Clinton St., Brooklyn, N. Y.

SARAWAK Centenary, San Marino, Roosevelts, Multicolored Dominican Waterfalls. All 5c with approvals. Raymax, 123-X William St., N.Y.C.

POPULAR SCIENCE OPPORTUNITIES

25 DIFFERENT India—3c with approvals. Premiums with purchases. Brandwein Stamp Co., Box 92-P, Bayonne, N. J.

FREE—Pleasing approvals. Davis, 95 South 10th, B'klyn 11.

FREE U. S. Price list postage 3c. M. Hanna, 335 5th Ave., Pittsburgh 22, Pa.

FREE! Ten Mints: Ethiopia Red Cross plus Free French. With Approvals. Florida Stamp Company, Box 807, Miami 5, Fla.

300 DIFFERENT given free with approvals. Postage 3c. Windsor Stamps, 1435 E. 67th Place, Chicago 37.

POSITIVELY Greatest Free Offer—Latest Scott's International \$6.00 stamp album—covering entire world, contains 36,000 illustrated descriptive spaces; Scott's 1948 Standard \$7.00 catalogues "Philately's Encyclopedia"—absolutely free to applicants for foreign approvals becoming customers. Plymouth Specialty Company, Dept. A3, Bell, California.

FREE Hitler Head, French Colonial, Air Mail, Vatican City Packet to approval applicants. Nitta Yuma Stamp Co., Harrods Creek, Kentucky.

UNITED STATES Price list, Send-Postage, State Stamp Corp., 1225 Park Bldg., Pittsburgh 22, Penna.

UNITED States and Foreign stamps sent on approval; outstanding quality, low prices. Fred Herzberg, PS 168 Oak St., Elmhurst, Ill.

20,000 DIFFERENT 1c-5c each! Gordon Davison, Box 1019A, Manchester, N. H.

OLD scarce U.S. Seconds on approval. Slightly defective, nice appearance, bargain prices. Hearnfeld, 551 Clinton, Newark 8, N. J.

JUST A Postcard with your name and address brings Pleasant surprise. Stamp World, 536 South 30th, Omaha 5, Nebraska.

FLAG Stamp Free With U. S. Approvals. E. Wenigman, 929 Oakdale, Chicago.

GENUINE "Goya Nude" set, cataloging \$1.05, complete 35c. Approvals. Royal Stamp Co., Tamaqua 2, Penna.

UNRIVALED Bargain! Includes set Seychelles, set Cyprus, assortment Libia, assortment Uruguay, also Bolivia, Albania, Angola, etc. Everything 10c to approval applicants. Wollaston Stamps, Wollaston 70, Mass.

PONY Express Stamp and 99 different 10c to approval applicants. Tibbett, 1118 Clay, Pelham Manor, N. Y.

WHOOPIE! Wow! 25c worth of U. S. stamps free! No obligations! Write: M & N Co., 742 Sheffield Ave., Brooklyn 7, N. Y.

10 DIFFERENT U. S. Over 40 Years Old, 5c. Foreign, U. S. approvals. Scott, 22 Middle St., Lexington 73, Mass.

50 DIFFERENT United States 10c. Price list free. No approvals. Seidenberg, Cas-sopolis, Mich.

"ROOSEVELT, Churchill, Stalin, Hitler, Vatican City stamps free, to approval applicants. Flamingo Stamps, Box 517, Miami Beach, Florida."

WORLDWIDE Different: 200-25c; 500-60c; 1000-\$1.50. Beacon Sales, Maynard 3, Mass.

LOOKING for good U.S. approvals? Large selections, fast personal service. Write today. Panther's, Dorchester 24, Mass.

RED Army Pictorials Free with approvals. Granada, 4891 Southwest 5th Street, Miami 34, Fla.

UNITED STATES Bargain. It sounds unbelievable, but it's true! 50 different United States stamps ranging in age as far back as over 60 years and in face value as high as one dollar. Only postage, commemorative, and air mails included. Nothing else. Extra 2 Jap Occupation of Philippines, all for only 10c to approval applicants. Please state whether approvals shall consist of U.S. or Foreign stamps or both. Globus Stamp Company, 268 Fourth Avenue, New York 10, N. Y., Dept. 221.

128-PAGE United States Catalog, 1000 illustrations, 10c. Harris & Co., 202 Transit Bldg., Boston.

FREE!! Finland 20 different to approval applicants. Rosenburgh, Box 1303, Chicago.

ROGUES Gallery Packet, Hitler-Mussolini, 30 others. 3c. Premium. Hartland 6, Me.

U.S. \$5. Stamp given free. Approvals sent Bala Stamps, Bala Cynwyd, Pa.

YOURS! Dominica, Antigua, Gilberts, St. Vincent, Cooks, Rhodesia (Royal Visit), Brunei, Cayman, set Morocco, set Tunis, numerous others. Everything 10c with approvals. Keen Service, Box 457, Arnold, Nebr.

FALKLAND ISLANDS Map Stamps, Three values Mint, 5c to approval Applicants. Middleton Stamp Company, 78-14 Woodside Avenue, Elmhurst, L. I., N. Y.

HOBBY parcel (three hobby magazines, 100 stamps). One quarter. Dr. Korstoft, Randers, Denmark.

BEST Mixtures on Market! Every stamp worth over 10c. No ordinary material. \$2.00, \$3.00, \$5.00. John R. Nabholtz, 6683 Lakewood Blvd., Dallas 14, Texas.

"ROOSEVELT Triangle free with approvals. Pelican Stamps, 665 N. E. 120th Street, Miami, Florida."

NO Junk. Good stamps only on our honestly priced foreign approvals. Inter-Continental Stamps, Englewood 4, Florida.

EXOTIC Pictorial collection: Tahiti spearfishing, Melanesian idol, Ingavi battle, Reunion, Madagascar, St. Pierre Miquelon, Djibouti, Wurttemberg, Dutch Indies, Newfoundland, many others. This outstanding offer only 5c. Imperial, Box 1491, Tampa, Florida.

PENNY Approvals that satisfy. Neil Gronberg, Box 5441S, Philadelphia 43, Pa.

BERLIN Bears Complete set of eight and 100 different stamps only 10c to approval applicants. Reich Stamp Co., 4647 Kenmore, Chicago 40, Ill.

"BEAUTIFUL Wings Over Norway, Berlin Bears 7, Danish Condor Retailing 39c only 25c to collectors requesting fine world wide approvals. Gridmoor Stamps, Ojai, California."

FRENCH Colonies free with approvals. Hill Stamps, Box 732S, Woodmere, N. Y.

NICARAGUA Managua diamond set, 10c with approvals. Vargo Stamps, 6044 South Fairfield, Chicago 29, Illinois.

"WORLD'S Best" United States or Foreign Approvals. America's Lowest Selling Prices. Fort Orange, Box Eighty-Seven, Albany 1, New York.

6 DIFFERENT San Marino Roosevelts—10c with 1/4-1/2-1c approvals. Carroll's, 4357-C S. Hoover, Los Angeles 37, Calif.

POPULAR Approvals at 1/2c up. Small Stampdealers, 2616 Cortez St., Chicago 22.

25 DIFFERENT Stamps 10c. Tunis And Carpenter, Wakeman Ave., Newark 4, N. J.

FREE—18 different Switzerland with approvals. Excel Stamp Service, Box 1315, Chicago 90.

FREE Gift to approval applicants. Stamps, 1267 Tutwiler, Memphis 7, Tenn.

AGENTS Wanted, sell stamps, no investment. William Waugh, 2140 N. NW, Washington 7, D. C.

MIXTURES price per pound—Argentina \$2.50; Denmark \$1.75; France \$1.60; Germany \$2.00; Holland \$1.60; Italy \$1.25; World \$2.00. Longacre Shop, 100-j West 42nd, New York City 18.

PERSIA and China Packet Free to approval applicants. Write "Everglades", Box 3222-S, Atlanta, Georgia.

UNITED STATES #94, #157, #225, #226, #272, #408, #409. Only 50c. Approvals accompany. Whiton-Stamps, Westport 1, Conn.

PICTORIAL Packet! Philippines, Panama, Palestine, Paraguay, Portugal, Porto Rico, Poland, Peru, Persia. Free to Approval Applicants. Elliot Stamps, 86-31 Eliot Avenue, Rego Park, N. Y.

SAN MARINO, F.D. Roosevelt Commemoratives, (6); free stamp gift, 5c to approval applicants. William Deems, Ravenswood, W. Va.

55 DIFFERENT United States—5c. Approvals. Utechts, 1143-D North Keeler, Chicago 51.

66 STAMPS from 33 Countries, 10c. Garrow, 84-P Montevista, Chula Vista, Cal.

\$27.00 CHINESE Airmail and 50 others 10c to approval applicants. Burmaster, Box 1910P, Los Angeles 53.

BIG VALUE—12 sets—12 countries—Triangle, maps, animals. With approvals, only 25c. Wirth, Norwichtown 2, Conn.

FREE—World-wide stamps with first approvals. U. S. want lists Solicited. Peter Nerger, Palisade, N. J.

FREE 25 Different Canada; Approvals. Knight Stamps, Box 3770, Portland 8, Ore.

APPROVALS, United States, Foreign. Edwards, Route 1, Box 228, Vale, Ore.

BIG bargains, scarce set free to approval applicants Sending 10c postage. L. De Milla, 72 Shore St., Brooklyn 6, N. Y.

STAMP Magazine and "Valuable Tips"—3c! "Stamp Post", Station A, Pasadena, Calif.

SEE them first. United States approvals plus unique premiums. Jarr, Box 217-S, Madison Square, New York 10.

FREE Colorful San Marino Airmails 3 values to new applicants requesting approvals. Wesken Stamp Co., Box 66P, Queens Village, N. Y.

WASHINGTON Bicentennial Set 10c. United States-Foreign Approvals. Yokums, Box 1327, San Antonio 6, Texas.

ALL different—25 Egypt 20c; 100 Germany 45c; 50 Hungary 15c; 25 Russia 20c. Elzea, Bowling Green, Ohio.

50 STAMPS of South Africa, Swaziland, Rhodesia, Basutoland for \$1.00. Holz, Box 6743, Johannesburg, South Africa.

STANLEY-Williams, 3709 Fannin Street, Houston 4, Texas, complete mail service illustrated lists.

70 HOBBIES, COLLECTIONS

INVENTING can be an interesting and profitable hobby. Write for complete particulars. Institute of American Inventors, Dept. 30-E, 2926-Eye St., N. W., Washington 6, D. C.

GEM Making—Fascinating! Profitable! Free equipment catalog, or send 25c for complete instruction Book. Lapidary Company, 1545 West 49th, Seattle 7, Wash.

"GENUINE" deep red Arizona Rubies (Garnets). Send quarter for packet. Mineral Specimens Company, Box 2651, Phoenix, Arizona.

CALLING all Tracks. Illustrated Circular sent free to Racing fans. Write A. Todd, Baileys Bay, Bermuda.

UNUSED Match Book Covers, 100 all different \$1.00. 35 Royal Flash Covers \$1.00. Free catalog. Charles Edelman, 1311 P East 84, Cleveland 3, Ohio.

MILITARY Insignia—Metal Regimental Crests; campaign ribbons, sample crest 25c. Free catalog. Bon-Lee Company, 5801 15th Avenue, Brooklyn 19, N. Y.

500 PAGE catalog, 6,000 novelties, gadgets, timesavers, hobbies, fun-makers, etc. 5c. Johnson Smith, A-75, Detroit 7.

CIRCUS Photographs! List and Sample 10c. Box 1028, Minneapolis, Minnesota.

KLONDIKE! For Hobby Jewelry Makers! Novelty Jewelry Findings swept from tables of large manufacturers—parts for Bracelets—Pins—Earrings, etc.—unfinished, Chains—Rings—Pins—Stones—Clips—Beads—many other items—1 Lb. Bags—\$2.00 Per Bag in 5 Bag Lots, \$3.00 Sample Bag. Prepaid Only. Mdse. Distributing Co., 19 E. 16th St., New York 3, Dept. P.S.

CAMPAIGN Ribbons—Beginner's Package—Introductory Price—50c, contains 15 Assorted Ribbons. L.H.G. Company, 19 E. 16th St., N. Y., 3.

VETERANS. Send 10 cents today for bulletin of thousands of official war combat photos, 4" x 5" glossy finish. These are the war's greatest photos of every campaign, every branch of service, that you wanted all during the war and after! Special sets of 25 German atrocities \$2.00, 50 Tokyo scenes \$3.50. U. S. Sales Service, P. O. Box 2706-A, Washington 13, D. C.

POPULAR SCIENCE OPPORTUNITIES

8 ANTIQUES, RELICS, INDIAN GOODS

ANTIQUA-modern pistols, revolvers, swords, daggers, armor. 174-page illustrated catalog 50c. Robert Abels, 860 1/2 Lexington Avenue, New York 21.

ANTIQUA Guns, 600 Bargains. Catalogue 25c. Gilbert Hebard, Knoxville, Ill.

4 FINE ancient arrowheads \$1.00. Stone Tomahawk \$1.00. List free. Lear's, Box 569, Galveston, Texas.

85 MINERALS & PRECIOUS STONES

GEMS, precious and semi-precious, all genuine from world wide sources. Deal direct, no overhead, save money. Catalog 10c. Hill Co., Route 7-K, Salem, Oregon.

MINERAL specimens and gem material. Fluorescents. Free list. Plummer's, 5068 Brighton, San Diego 7, Calif.

JEWELRY stones removed from rings, etc. 100 assorted \$2.40. 50 large ones \$2.40. B. Lowe, P.S. 50, Holland Building, St. Louis 1, Mo.

26 CAMERAS, PHOTO SUPPLIES

CASH! Spot cash for cameras, lenses, binoculars, movie and still equipment. Send full description for prompt cash offer. Over 36 years of dependability. Bass Camera Co., Dept SP, 179 W. Madison St., Chicago 2.

BASS Says: Trade Cameras? For 36 years Finest equipment available. Always Satisfaction Guaranteed Or Your Money Back! Bass buy 'em, trades 'em. Bass Camera Co., Dept. SP, 179 W. Madison St., Chicago 2.

PHOTOGRAPHY for pleasure or profit. Learn at home. Practical basic training. Long established school. Write for booklet. American School of Photography, 1315 Michigan, Dept. 1741, Chicago 5.

CAMERA'S-Enlarger's - Movie Film - Big Free Catalog. Cavalier Camera, 1822 Center, Pittsburgh 19, Penna.

LATEST Edition! Everybody's Photo Course 25 lessons Only 50c. Satisfaction Guaranteed! Maniss Photo Co., Colorado City, Texas.

ATTENTION! Amateur-Professional Photographers. Get the Best Art Negatives now from Hollywood's Art Center, of Hollywood's famous Cover Girls in full figure artistic poses. Sizes 2 1/4 x 3 1/4, \$1.50, or 4 for \$5.00, and 4 x 5, \$2.00 or 3 for \$5.00. Also, Beautiful Art Prints—4 x 5, 35c—5 x 7, 50c—8 x 10, \$1.00 each. Gorgeous color transparencies, \$4.50 each or 3 for \$11.50. Unretouched originals guaranteed. Our customers are well pleased. Ernest Edwards, Inc., P.O. Box 1987, Hollywood 28, Calif.

FREE 2X2 Color Slide and Fine Grain Negative! Send self addressed stamped envelope for samples and catalog. Slidecraft, 5855 Hollywood Blvd., Hollywood 28, Calif.

ELECTRONIC Photoflash all components. GE lamp, \$34.90. Lectronic Research, Philadelphia 24.

SPEED-O-COPY; groundglass focusing attachment for Leica, Contax, Perflex, Kodak Ektra, Argus C-2 & C-3. Send for literature. D. Paul Shull, Dept. PS-9, 240 S. Union Avenue, Los Angeles, Calif.

WARPLANE & Ship Photo Slides. Fits all slide projectors. Mixed. Postpaid, 25 for \$1.95. Aero Parts, Municipal Airport, Houston, Texas.

102 PHOTO FINISHING

PHOTOGRAPHY for pleasure or profit. Learn at home. Practical basic training. Long established school. Write for booklet. American School of Photography, 1315 Michigan, Dept. 1722, Chicago 5.

LARGA-PIC—We have only one offer, but it's an outstanding one! Your roll developed and 8 prints made into brilliant Larga-Pic photos for 30c. Reprints from your negatives 4c each. Write for Free mailers. Larga-Pic, Box Z-4, Brookline 46, Mass.

THREE prints each 8 exposure roll 40c. Two each 35c. One each 25c. Reprints 3c. Fred A. Eastman, Bode, Iowa.

EVERY Picture an enlargement . . . Bigger and Better Snapshots than you have ever seen before! New Electronic developments give you improved lifetime deckle-edge enlargements at our same low prices. Any 8 exposure roll developed and printed Enlarge size 25c; Reprints 3c each. Fast, Accurate Service Guaranteed! Send for free mailers, today! Enlarge Photo Service, Box 791L, Boston, Mass.

FREE! 5x7 enlargement! Rolls developed and eight lifetime doublesize Velox prints made by modern electronic equipment only 30c. Reprints from negatives, same size 3c; doublesize 4c. Candid Rolls, finegrain developed, 3x4 prints 12 exposures 45c. 16 or 18 exposures 65c; 36 exposures \$1.25. Return ad with roll and receive absolutely free 5x7 enlargement. Franklin Finishing, Box PS-9, Framingham, Mass.

SENSATIONAL Introductory Offer! Send snapshot or negative, this ad and 10c. We'll send you a beautiful 7 x 5" enlargement! Or, Kodak roll developed and printed (with free coupon) only 25c; or 8 Giant prints from roll, 30c. Reprints from negatives—any quantity—regular size, 3c; Giant size 4c. Candid rolls—36 exp. 35mm developed, vaperated, enlarged to 3 x 4, \$1.00. 18 exp. 50c. Free Mailers. Free Premium offers sent on request. American Studios, Dept. 365, Lacrosse, Wisconsin.

OIL coloring photographs can be a fascinating hobby or profitable sideline for those with artistic talent. Learn at home. Easy simplified method. Send for free booklet. National Photo Coloring School, 1315 Michigan, Dept. 1722, Chicago 5, Ill.

FOUR Beautiful Girls, 5x7 Photograph, 15c. Artcraft, 1600 Coney Island, Brooklyn 30, N. Y.

FASTER, rolls developed, sixteen sparkling fade-proof prints, professional 4x6 enlargements 25c. Rolls developed eight 4x6 enlargements 30c. Reprints 2c, enlargements 4x6, 4c. Lifetone Photo, 853-18 Fifth, Des Moines, Iowa.

50 VELOX reprints, \$1. Suburban Studio, 1410-S Bond, Rockford, Ill.

ROLL developed and 8 prints 30c. Overnight Service. Free Mailers. Tri-Plex Photo Service, Box 375, San Francisco, Calif.

8 BEAUTIFUL Double Size pictures and roll developed 30c, 8 hour service. Free Mailers. Pacific Photo Service, Box 666, San Francisco, Calif.

AMAZING new process. Perfectly toned premium quality prints. Any size roll, any number of exposures developed and printed 19c. Overnight service, 30 day offer. Perfect-Tone Photos, Janesville 23, Wisc.

HAVE you photo finishing worries? Forget them. Newly invented camera snaps, develops and prints finished pictures. Write today for our free illustrated folder. Complete details and copy of photo. Pittsburgh Photo Shop, Dept. B-1, 1618 Westmont Avenue, Pittsburgh 10, Penna.

PHOTO Prints On Metal, All Kinds, Box 466, Clinton, Iowa.

PHOTO Finger Ring, Bracelet or Lavaliere. Send photo, size and \$1.00. Richardson, Wyoming 3, Pa.

ENLARGEMENTS—5 x 7—10c; 8 x 10—25c. From your negatives. National Film Service, 3111 West Tuscarawas, Canton 3.

104 PHOTOPRINTS, PHOTOCOPIES

PHOTOS, Documents, Etc. Photocopied to Wallet size and permanently sealed in plastic, \$1.00. Originals returned. Solfis, Box 1942X, Boston 5, Mass.

FIVE Professional 4x5 reproductions of any Picture or Portrait \$1.00. Quad Photos, 5710 Kingsessing Ave., Philadelphia 43, Pa.

90 MOTION PICTURES, SOUND EQUIPMENT

GUARANTEED Fresh anti-halo outdoor movie film! Weston 12 Daylight loading! Processing free! Three spools Double 8mm, \$3.45! Six single 8mm for Univex, \$4.60! Postpaid! Catalog, ESO-S, 828-A, West 39th, Kansas City 2, Missouri.

SELECTED Films, Photos, Slides, List 10c. Thomas Productions, 2709 West Ave. 34, Los Angeles 41, California.

LEARN movie projection, management. Free Catalog. Theatre School, Elmira, N.Y.

MOVIE Film At Tremendous Savings! Kodak Super X, Weston 32, Government stock. Tested—unconditionally guaranteed. 16mm—100 ft. \$1.95; 50 ft. 98c; 50 ft. magazine \$1.35. Double 8mm 25 ft. 75c. Processing extra—50 ft. 75c; 100 ft. \$1.00; 25 ft. 8mm 75c. Fast Service! Photo Surplus Sales, Box K-3, 12 Duane Street, New York City.

MOVIE Cameras! 16mm electric, magazine-loading, famous mfgs. With telescopic optical viewfinder, famous-make f3.5 anastigmat lens, battery, coupling cord and automatic release. Value over \$200. Complete. Ready-To-Operate Only \$55.00. 100% satisfaction—Money Back Guarantee! Order today! Free booklet. Quality Movie Film Panchromatic, Weston 32, 16mm 50' magazine, \$3.25; 100' \$4.50, 50' \$2.40; Double 8mm 25' \$2.15. Semi-Ortho, Weston 8, 16mm 100' \$2.85; 50' \$1.75; Double 8mm 25' \$1.55. Free Processing. Fotoshop Inc., Room 44, 18 E 42nd St., New York City.

RARE 8-16mm, Silent-sound films. International, 2120 Strauss, Brooklyn, N. Y.

DISCOUNTS! 8-16mm Films, Equipment, Catalogue 3c. Towers, 935 North 40th, Philadelphia 4.

8 AND 16 mm movie films, fast machine processing service, bulk film, free circular, Atlantic Films, 28D North Fourth St., Reading, Penna.

BEAUTIFUL Kodachrome Slide and Lists 25c. Slide Supply Service, 3111 West Tuscarawas, Canton, Ohio.

PROCESS your own 8-16mm movie film. Literature. Duro Movie Products, 1519 Eggert Road, Eggertsville 21, N. Y.

RENT 16mm, sound films 50c reel. Large selection; free catalog. U. C. Film Service, 128 Chestnut Street, Roselle Park, N. J.

EXCHANGES: 8/16mm Silent, \$1.00 Per Reel. Rentals. Sales at Money-Saving Rates. Details for dime. Midland, Box 429, Oak Park 3, Illinois.

IMMEDIATE delivery of 16mm Sound projectors. Large stock of Castle, Official, Nu-Art and Pictorial films. Soundies, Comedies, 16mm Anscocolor film. Used 8mm, 16mm Sound, List Titlers, Splicers, Editors, Rewinders. (Home Movies, 41 South Fourth Street, Allentown, Penna.)

SEND 25c for 1947 catalogue. Sterling's, 679 Northampton, Easton, Penna.

CHILD Is Born By Caesarean Delivery. The outstanding home movie production. Project it free. Send postal card immediately. Movies, Hamilton 5, Ohio.

ART model films 16mm rentals exclusively, adults list. Enclose stamp. Revere Films, Box 1051, Detroit 31, Mich.

"THE World's Greatest Passion Play". All sizes. Rent or Purchase. Write Hemenway Film, 33 Z Melrose St., Boston 16, Mass.

16mm SOUND Movies, Western Features. Free List. I. E. Film Exchange, 833 Main Street, Southbridge, Mass.

16mm MOTOR Driven Projectors—\$16.00—Up. Selco Products, Denvers, Mass.

FILM Movetone is back. It's Weston 12 nonhalation. Free processing 100 ft. 16mm \$3.25. 25 ft. double 8mm \$1.50. Bulk film without processing 100 ft. 16mm \$2.25, double 8mm \$2.45. Free circulars. Fromader Genera, Davenport 5, Iowa.

FAST Pan Movie Film \$2.75 100'-25', double 8mm \$1.25. 100' 16mm outdoor \$2.25. 3 rolls \$6.00. Ambassador, 479-A Quincy St., Brooklyn 21, N. Y.

QUANTITY Users: Fresh Ansco 16mm 100' movie film—Black and White, \$5.25; Color, \$7.00—minimum order, six rolls. FOB Baltimore. Gamerman's, 3816-C Eastern Avenue, Baltimore 24, Maryland.

ART Films: 50' 8mm, \$3.49; 100' 16mm, \$5.50; 100' 16mm Sound, \$6.75. Send for catalog, 16mm Viewer with 50 Art Poses, \$1.10—100 extra poses, \$1.10. Both for \$2.00 postpaid. Bruno 2 1/4 x 3 1/4 Art Negatives, 6 for \$3.00 postpaid, 35mm Kodachrome Art Slides, 3 for \$1.00—Seconds, 6 for \$1.00. Fresh Ansco 20 exposure 35mm Color Film, 3 rolls for \$4.50. Please include approximate postage. Gamerman's, 3816-C Eastern Avenue, Baltimore 24, Md.

POPULAR SCIENCE OPPORTUNITIES

16mm OLDTIME Movies Broncho Billy, Ben Turpin, Bill Hart, Others. Jubilee, 723 7th Ave., New York.

BEFORE The White Man Came. All-Indian feature. 16mm Sound. Jubilee, 723 7th Ave., New York.

EXCEPTIONAL Subjects. Projectors. (Catalogues free). Distributor. Box 211A, Oceanside, N. Y.

GUARANTEED Film. Weston 50. 100' 16mm \$3.45; 25' (88) \$1.55. Free Processing!! MK Photo. 451 Continental. Detroit 14, Michigan.

JOIN World's largest cinematographic society. Details free. International Cine Society. Suite 218. 6770 1/2 Hollywood Blvd., Hollywood 28, Calif.

92 MUSIC, MUSICAL INSTRUMENTS

FINGER Gymnastics. save hours of practice few minutes daily away from instrument eliminates stiffness. gain speed; transposing system. play in all keys. both \$1. Felix De Cola. 736 N. Martel. Hollywood 46, Calif.

MUSIC-LOVERS Best offer! Set of six songs \$1.00. Art Music. 1658 Broadway, New York 19.

PHONOGRAPH Records Cheap. Catalogue. Paramount. SE-313 East Market, Wilkes-Barre, Penna.

INSTRUMENTS for less and still the best. Send for Bargain Catalog. Harden's Musical Merchandisers. Marion P., Ohio.

PIANO—Play without notes or teacher. System sent Free—includes chart and directions. Enclose 10c for handling and mailing. Latom Music, 2147A-86th Street, Brooklyn 14, N. Y.

122 SONG WRITERS

POEMS Wanted to be set to music. Free examination. Send poems. McNeil, Master of Music, 510-PS, S. Alexandria, Los Angeles, California.

SONGWRITERS. Songs Published Monthly. Advance Royalty. Send your songs or poems today for our exciting offer. Hollywood Tunemasters, Dept. 10F-C, 1537 N. Vine, Hollywood 28, Calif.

SONGWRITERS: \$100 Cash Awarded Each Month For Best Song or Song Poem. Melodies supplied Without Charge By Hollywood composers. Lead sheets and records furnished. Cinema Song Co., Dept. B-49, Beverly Hills, Calif.

POEMS Wanted For Musical Setting. Send poem for immediate consideration. Five Star Music Masters, 646 Beacon Bldg., Boston.

"SONGWRITERS: Send Poems for Free Examination and Outstanding offer. United Music, 116, Salem, Indiana."

SONGWRITERS—send your song poem at once for immediate examination and Free Rhyming Dictionary. Richard Brothers, 46 Woods Building, Chicago.

SONGWRITERS! Outstanding. ethical offer. Hibbeler, C15, 2157 N. Avers, Chicago.

SONG-WRITERS Best offer! Write—Art Music Co., 1658 Broadway, N. Y. 19.

DISCOVER Songwriting Facts! Write: Songwriter's Educational Committee, 1650-PS, Broadway, New York.

REAL Composer of Music will co-operate with lyric writers in song production. Fine publication proposition. Nationwide distribution of publications. Recordings Made. Copyrights secured. Write Now. C. Isabel Mayer, Box 3896, Portland 8, Ore.

POEMS Wanted for new songs. Send poem for Free examination. Eliot Wright, Master Composer, 206 Rivoli Theater Building, Portland, Oregon.

SONGWRITERS! Honest Outstanding Music Writing Offer. Dick Reynolds, Leonard, Texas.

SONG poems wanted. Al Sanders, 1261 North La Salle, Chicago, Ill.

SONGWRITERS—Protect your songs. Get the facts first. Free booklet. attractive offer. Song Service, 331-J West 46th, N. Y.

PROFESSIONAL Melody to your song poem. \$2. Professionals, Mill Valley 339, Calif.

112 RADIOS, SUPPLIES & EQUIPMENT

MAKE Simple, Tubeless, Batteryless, Distance-Getting Crystal Radios. Crystal and illustrated instructions 25c postpaid. Allen, 427-S, Clinton, Mo.

FREE New Radio Catalog Is Ready! Radionic's catalog lists radios, hard-to-get radio parts, books, amateur, test and P.A. Equipment. All available for immediate shipment. Send today to: Radionic Equipment Co., Dept. 159, 170 Nassau St., New York 7, N. Y.

BUILD "Loudest" Crystal Radio. Instructions and Crystal. 25c. Amoroses Radio. Route Four, Richmond, Va.

RADIO book:—"Everybody's Radio Manual." Tells how to service all radios at home. 256 pages, 216 pictures. DeLuxe edition. \$1.49. Popular Science, Dept. 97-C, 353 4th Avenue, New York 10, N. Y.

U.S. Signal Corps Featherweight Ear-phones \$1.00. Radio Service men and experimenters send stamp for our giant radio catalogue. Save dollars. United Radio Co., (100-V) Newark 1, N. J.

ATTENTION! Prospectors—Explorers. Do you seek hidden treasures? Construct a U. S. Army type of Metallic Mine Detector from a U. S. Army Mine Detector Amplifier we are offering at ridiculously low prices. Complete Amplifier (less tubes and batteries) with Battery Case and cables; cables, headphone cord and Jack (no phones), complete Army wiring diagram. Amplifier Type AN/PRS-1. Only \$2.95. Newark Surplus Materials Co., 58 Market St., Newark, N. J. Dept. S.

6 PLANS Tube Sets, including catalog. "Radiobuilder"—25c. 3 "Radiobuilders"—25c. Laboratories, Eye-t, San Carlos, Calif.

HALLICRAFTERS. National, other radios wholesale. Terms. Write, Henry Radio, Butler, Missouri.

TELEVISION Opportunity knocks now. See Marlowe Ad under Profitable Occupations.

AMERICA'S Best Buys. Radio Tubes 29c up. Free Bargain lists. Potter, 1314 McGee, Kansas City 6, Mo.

LITTLE Wonder Crystal Radio \$1.75. United Sales, Rt. 21, Parkersburg, W. Va.

TUBES, parts, wholesale, retail 50 off list. Radio Mail Order Co., 46-13 188th St., Flushing, N. Y.

25 YEARS Experience radio repairing at your fingertips. I've repaired 45,000 radios and have perfected system you can follow step by step. My methods are far simpler than any course published. Requires no calculations. Total price \$1.00 postpaid or C.O.D. Moneyback guarantee. Ross Radio Company, 14615-B Grandriver, Detroit 27, Michigan.

24 BUSINESS OPPORTUNITIES

\$25 WEEKLY working two hours daily. No canvassing. No Manufacturing. Lycke, Box 2471, Cleveland 12, Ohio.

START Home business making statuary, plaques, art goods, pottery, garden furniture, artificial marble flooring, liquid marble. Make flexible molds yourself. Amazing profits. Folder free. Creative Publishers, Box 236-M, Winnetka, Ill.

OPERATE profitable home business selling merchandise by mail. Fast sellers. Large profits. Powell Service, 5713 Euclid, Cleveland 3, Ohio.

RECAST old batteries into new. Latest achievements. Battery Laboratories, Minneapolis.

BOOKKEEPERS—Operate your own simplified "Dollar-A-Week" Bookkeeping & Tax Service. Full or spare time. Details free. Ellis, Box 203, Cedar Grove, N. Car.

MAIL Order Business course shows you how to make money, spare or fulltime. Teaches professional mail order technique—not penny-snatching schemes. Fascinating 100-page illustrated Success-Catalog Free! Write—Nelson Company, Dept. 4-01, Chicago 5.

MANUFACTURE costume jewelry at home for profit, hobby, therapy. Free wholesale supply catalogue, Instructions. Florida Supply House, Bradenton, Florida.

BUYERS Wanted for plaster novelties. Painted—Unpainted. Retail—Wholesale. Write today for free information. Bing Products, 88-X5B Broad, Boston 10, Mass.

MOLD-MAKING. Plaster casting. Money-making Business. Literature Free. Kemilo, Park Ridge, Illinois.

COMPOSITION Flooring—made in most colors. Lifelong. Soundproof. Resilient. Flexible Molds. Cast novelties, plaques, statuary. Big money—your own business. Catalog Free. Write—Bing Products, 88-B3M Broad Street, Boston 10, Mass.

SPECIALTY Manufacturing, the big money business that can be operated anywhere, start on a very small capital; we supply dependable formulas and complete instructions; get interesting Free booklet, "Money-making Opportunities in Specialty Manufacturing." Howard Robinson, Ph. G., 1300-B S. Ohio St., Sedalia, Mo.

I MAKE big money in the mail-order business. You can do the same at home with copyrighted system. Write me I'll tell you how. F. Little, RD #1, Glenshaw, Pa.

137 PLANS to make money local, mail order. Particulars free. Elite Co., 220-A Grand St., N. Y.

GOOD Paying Business Silvering mirrors, plating autoparts, reflectors, bicycles, bathroom fixtures, etc., by late methods. No tanks or shop required, outfit furnished. Free Booklet. Gunmetal Co., Ave. E, Decatur, Illinois.

COLORGLAZED Concrete Pottery made without molds. New, low cost, patented method. Cemetery products, novelties, tiles, floors, etc. Basement leaksealing. Other money-making projects. Booklet, details free. Men only. National Potteries, Grand Rapids, Minnesota.

MAKE money casting new line Metal Toys and Novelties. Latest 1947 Scale Model Autos. Original Ashtrays. Savings Banks. Water Pistols, etc. Big wholesale and chain store orders now being placed at high prices assures big business and profits. Spare or full time. No experience or special place necessary. Write for details and illustrations of patterns needed. Metal Cast Products Co., Dept. E, 1696 Boston Road, New York 60, N. Y.

AMBITIOUS. Sell Xmas Cards, Stationery. Big Profits. Colored Catalog Free. Beacon Hill Greetings, 115 Chauncy, S. Boston, Mass.

FREE Water and our concentrates makes flavors, lotions, shampoos. 72 products, labels, bottles furnished. Qualco, F-20030 Russell, Detroit.

NOW you can have an office. Learn credit-collection business by new home study course. May earn up to \$5,000-\$15,000 annually. Free bulletin. Franklin Credit School, Dept. 203-J, Roanoke 7, Virginia.

"SELL By Mail! Books And Novelties! 35 different items! Large Profits! Catalog free. Elfco, 432 N. Wells, Chicago 10.

"TATTOOING and Engraving pays big profits. Experience unnecessary. Literature free. William Moore, 412-A South Green, Chicago 7, Ill."

HOW To Set Up and Run A Mirror Shop! Resilver Mirrors. For Price write—John Sprinkle, V90, Marion, Indiana.

MEN-Women. All types mail order businesses for sale. Full or part time. Priced from \$100.00 up. L. Turnipseed, Box 681, St. Louis, Mo.

MOTH-PROOFING and Cleaning Business Pays Well. I'll show you how to start on amazingly small capital. Write today for details on Eight practical plans. Howard Robinson, Ph. G., 1304-B South Ohio Street, Sedalia, Missouri.

IF you'd like your own, high income but easily learned office business, write for free details today. Cole Associates, Syracuse 2, N. Y.

GO in magazine renewal and subscription business. Pays big—Repeat orders come automatically. Supplies furnished. Get free catalog and commission list. Write today. McGregor Magazine Agency, PS-8, Mount Morris, Ill.

PROFITABLE Mail Order Business. Write Beier's, 837-R Heffert, Bethlehem, Pa.

POPULAR SCIENCE OPPORTUNITIES

PLASTICIZE Lasting beauty-protection for autos. Used like polish. Entirely new. Opp. Excl. distributors earn \$15,000 annually. Plasticize, 2254 N. W. 62nd St., Miami, Fla.

MAKE over \$50 a week selling greatly in demand oil burners for kitchen stoves—Oil Burner Supply Outlet, Box 327, Cambridge, Mass.

BUSINESS Opportunities Rackets Exposed in "Racket Exposé" Newsstands or \$1.00. Falcon Press, Box 779, Newark 1, N. J.

METALLIZE Baby-Shoes. New Ideas. Particulars Free. Krall, Box 8087, Pittsburgh 16, Penna.

RE-NEW Leather and Leatherette—Make cloth into imitation leather with plastic discovery called Leather-New. Opportunity to make real profits taking care of sales resulting from national advertising. Write for Free sample of Leather-New covered material and complete deal. 704 Land Bank, A.X. Kansas City, Missouri.

MEXICAN and biological novelties. Wholesale list free, retail 10c. Quivira Specialties, Topeka, Kansas.

MAKE Plastic Jewelry. Free information. Attler Company, 23-60 29th, Long Island City 5, New York.

"ILLUSTRATED", Wholesale Catalog 10c—Bargain's Galore, Stafford, Box 5211-PS, Indianapolis 1, Indiana.

"BUILD your own independent, fascinating and very profitable business at home, spare or full time. \$75.00 and upwards weekly easily possible making beautiful brilliant, sparkling Novelties, Religious Figures and Popular Sports Souvenirs. Fast sellers through you, salesmen, stores. Quickly learned and few dollars starts you making real money. Successful manufacturer can tell you how and furnish everything. Start small, grow big. Write for full information and "Amazing story of my success" at once. Inghram Company, 2845 Sixth Street, Detroit 1, Michigan."

MAILORDER Beginners. Save money by getting started right! Our new booklet may save you dollars! Only 10c. postpaid. Mail Order Mecca, 30 West Washington St., Chicago 2, Ill.

SELL Books By Mail. Large Profits! Free Literature. Cline-Porter, Box 6346 PS, Pittsburgh 12, Penna.

UP to \$1500 yearly selling by mail in spare time interest you? New ideas and plans every month. Details free. Idea of Month Club, Box 118-B, Baltimore 18, Md.

START your own Electroplating Business. Highly Paid. Uncrowded Field. Learn at Home. G. I. Approved. Send postcard for Free Electroplating Booklet and Proof. Plater Hyde, Room 523, 432 "F" Street, San Diego 1, California.

BABY shoes bronzing supplies, plasticide and Onyx Bookends, ash trays, frames, pen sets—Hardening solutions—Shoes Metal-sealed for only \$1.00. Box 2095A, Wichita, Kansas.

OPERATE profitable mail order business. Splendid opportunity. For details write. Anfred Service, 1227 Princeton Avenue, Philadelphia 11, Penna.

GOT \$24,500 Using "Schemes" from "Schemer" Magazine, Alliance, Ohio, 49th year, \$1.00. Three samples 25c.

TYPEWRITER Repairing instructions, standard typewriters. Webers', Box 1008, Canton, Ohio.

FELLOW Workers—Down with Bosses—Start own business—Be Independent—Booklet describing 137 Tested Plans, free. P. Padney, 307 York St., Jersey City, N. J.

MAKE strange plastics—1c pound. Makes durable attractive floors, walls. Build with waste—Save half. Bays Laboratory, Oklahoma City 9.

ELECTRICALLY inclined men: \$100-\$200 weekly possible installing, rebuilding, maintaining Fluorescent Lighting. Amazing literature Free. Write Willis Fluorescent Lighting, Box 6, New York City 35.

START Mailorder Bookshop—Everything furnished; publisher cooperation. 25c brings booklet, exclusive setup, samples, exciting ideas. General Publications, Ossining 1, New York.

HOW and Where to obtain capital. Particulars free. Star Service, Wapakoneta, O.

EXTRA cash made easy just follow instruction particulars 10c. Douglas Atchison, 210 5th Avenue, N.Y., N.Y.

BABY Shoes Metalized the durable way. Complete instructions \$1.00. St. Albans Plating Industries, 135-17 135th Ave., So. Ozone, Long Island, New York.

ASTOUNDING modern mail order plans. Brings quick profits. Darrah, Orono 8, Me.

START a home business in spare time. Make extra money. Experience unnecessary. Literature free. Ellmar Service, Muncy 3, Penna.

QUICK Money! "Repairing Car Batteries." At home! Easy too! Write, Batteryman, Grand Junction 1, Colorado.

"FREE Booklet" "Key To Greater Earnings". James Williams, Box 2215, Hollywood, California.

PROFITABLE mail order business can be yours. Details Free. Coast to Coast, Box 63-B, Station H, Buffalo 14, N. Y.

SWISS Musical Units, install powder. Cigarette boxes. Lloyd Kelley, Hanover, Mass.

OPERATE profitable mail order business. Write. Walter Service, 4159-B East 112th, Cleveland 5, Ohio.

BOOKKEEPERS—Operate your own bookkeeping and tax service. Part or full time. Free course, "How to Operate a Contract Bookkeeping Service." A. J. Hawthorne, Public Accountant, Decatur, Ala.

HANDYMEN—Earn money home operating Community "Fix-it" Shop. Write, Stafford, 708 Rawlings, Carbondale, Ill.

WOULD you pay 3%—first \$350 made? Color-illustrated book "505 Odd, Successful Enterprises" free! Some offer occasional "day off." Work home. Expect something odd! Pacific-K, Oceanside, Calif.

HOW To Sell By Mail. "Planned and Profitable" Mail order selling. New, different work-book of ideas and instruction for beginners, aspirants, established dealers. Send 25c for copy of leading mail order trade magazine and complete details. Year's subscription \$3. Mail Order Monitor, 356 South Broadway, Suite 706 PS, Los Angeles 13, California.

DON'T be Mr. Average man. Be your own boss. Earnings unlimited. Operate from home. \$25.00 adequate investment for immediately earning \$200.00 weekly. Postal brings details. J. T. Van Zile, A-79 Mills Street, Morristown, New Jersey.

CASH in! Local; mail Specialties, hobbies, opportunities. Literature 10c Central, Simpson, Kansas.

OPERATE Successful Mailorder business. For Details write: McKinzie, 6320 Southern St., Detroit 10, Mich.

"MONITOR"—Leading Mail Trade Business Magazine for beginners, established dealers! Rush 25c for sample copy, special subscription offer, details. A. J. Shutt, Dept. E. 506½ S. 15th St., New Castle, Ind.

BE Your Own Boss! Let us show you how to make big money right at home! Free details. Kiktavi, 8620 South Ruthelen, Los Angeles 44, California.

GENUINE Natural Latex for rubber molds. Only two coats necessary for thick mold. Make money reproducing statuary, plaques, novelties. Low cost. Write: Major Chemical Company, 131 Inman St., Cambridge 39, Mass.

RECEIVE Information, booklets, samples, etc., from over 40 of the Best "Business and Money-Making Opportunities" advertised this and other magazines. Send \$1.00.. (Satisfaction or refund)..to: Box 502-A, Elizabeth, New Jersey.

SELL By Mail Inexpensive course tells How Magazine free. McKitrick, Box 58, Mt. Vernon 2, Ill.

DOES \$1,500 Yearly in spare time by Mail interest you? Free details. Lamson, Box 1302-A10, Detroit 31.

START Profitable Mail Order Business On \$5. Write Duncan, Ortega Station, Jacksonville, Florida.

UNPAINTED plaques, statues. Variety of designs, free list. ArBo Products, B195 E. 7th, St. Paul, Minn.

METALLIZING baby shoes makes you money! Learn this simple, profitable business from Nationally recognized authority. Get professional results with professional "know-how"! Free particulars. Joseph B. Kushner, Metal Finishing Consultant, Stroudsburg, Penna.

WHITE Liquid Rubber for making flexible molds! Quick drying! Safe! For home, classroom, or industry! Quart \$2.00. Gallon \$5.95. Full instructions! Beginners booklet on molding and plaster casting 25c. Free with order! Plastercraft Supply Company, 1406 East 43rd Street, Cleveland 3, Ohio.

OPPORTUNITY through mail order business. Gustafson, 2111 W. 67 St., Chicago 36, Illinois.

MAKE Money At Home Like I do. Write Immediately. Duffy, Covington, Ky.

DOLLARS daily! Cleared \$1,900 in two months by mail! Write immediately! Loeb, D-9, Silverton, Cincinnati 13.

IDEA Men! Let's get together and get some money out of our ideas instead of promises. James Corrubia, Lakewood, N. J.

METALLIZE Baby Shoes. Correct Modern Method. Information Free. Universal, Box 1076-B, Peoria, Ill.

300 MONEY Making deals, plans, formulas, tips, schemes. Folio Free. Formico Prod., Box 572, Dayton, Ohio.

AMAZE others. Add faster than adding machine. Free details. Maths Institute, Box 633, Mobile 4, Ala.

SPECIAL Rubber for making Molds. Literature and sample free. Universal, Box 1076-A, Peoria, Ill.

\$99.50 PUTS you in the Popcorn business. Electric machine and all supplies. Poppers Supply, 145 Walton, Atlanta, Ga.

"INVESTIGATE Mail Order or Home Business. 140 new ideas. Write Marshall, Box 655, Centralia 14, Washington."

START a clock shop while clock repairing is booming. Our easy to learn home study course with pictures and illustrations teaches you how to repair all kinds of clocks. Information free. Houston Clock Shop, P.O. Box 5086B, Houston 12, Texas.

TYPEWRITER Repairmen urgently needed. Earn \$40 to \$50 weekly spare time. Our easy to learn home study course teaches how to repair typewriters. Write for free information. Houston Typewriter Repair Service, P.O. Box 5357, Houston 12, Texas.

DISTRIBUTORS. Unusual \$2.98 Photographic Product. Fine Profits. Fast Seller. Repeats for Hundreds of Dollars. Details Free. Morrison's, Box 9312-S, Station S, Los Angeles 5, California.

MAKE big spare or full time earnings in Mail Order. Easy Pleasant work. Small Capital. Interesting details Free. Holdens, Dept. 127, 4903 Rhodes Avenue, North Hollywood, California.

BIG money in auto supplies, parts, radios, ammunition, guns, home supplies. Wholesale catalog for dime. Main Supply, Fairfield, Illinois.

FREE Premiums. Wholesale Catalogue. Free. Holm Sales, 12B, Oaklandon, Indiana.

RUBBER Molds. Make your own. Aircure liquid. Quart \$2.95. Free Model. Plasticwood, concentrated plaster hardener, quart \$2.50. Lusterglaze, quart \$2.50. Directions. "Model-A-Month Club", membership (25c annually) brings information, free model offer each month. Rubbercoat, 3873-K California Street, San Diego 1, California.

VENETIAN Blind Factory Liquidation... Below cost. Slat painting, cutting, washing machines. Aluminum, Wood slats, Tape, Cord, Hardware. Wholesale prices. Everything for establishing profitable business. Decorators' Service, Box 423, Gloversville, New York.

HOME Workers wanted to hand-spin Angora Wool. Either Sex. House of Angora, S9, Springfield, Ill.

FLORIDA—Land of Opportunity. Up-to-the-minute information covering Business, Farming, Citrus Growing, Fishing, Etc., with large picture map and confidential opportunity table. Send \$1.00 to Fla. Research Bureau, Box 403, Melbourne, Fla.

POPULAR SCIENCE OPPORTUNITIES

SAWDUST. Turn it into cash. Instructions 25c. Charles, 12-EJ, Norwood, Ohio.

BETTER Job and Money by proven short Cost Study Course Complete. Send one dollar to Costems Company, Box 63, Buffalo, New York.

MAKE Rubber Stamps! Enormous Profits. Resilver Mirrors. Brush Plating. Universal, Box 1076-B, Peoria, Ill.

MAILING postcards selling repeat merchandise is profitable. Everything supplied. Details free. Gordon Publishers, Box 23, Pawtucket, R. I.

SUPER X Molding Latex for Better Molds. Liquid sample 25c. Literature and Sample free. W. Wooley, 115-A Donald, Peoria, Ill.

INCORPORATE in Delaware. Many advantages. Free details. Corporation Fiscal Company, Inc., Delaware Trust Building, Wilmington, Delaware.

NUPLAMOLD Molds are permanent, will not shrink or deteriorate. Made to order. Own your own business, start spare time. Make big money duplicating hundreds of decorative ornaments or industrial items. Start now—Get our price list. Write the Shop Technician, 314 Westport Road, Kansas City, Mo.

WANTED—Retired Gadgeteer, experienced organizer, manager, sales executive, to incorporate, implement and conduct hobby enterprise. Workshop, (1200 Sq. Ft.), 8 cottages available. Beautiful, healthful seaside. Bathing, boating, fishing, hunting, golf. Full particulars please. Orr, Villa Tasso, (Niceville), Florida.

AGENT or exclusive distributor for cigarette lighter mfg. MacGregor, Tahoe Valley 15, Calif.

FLEXIBLE Molds to order, also originals. Professional course manufacturing molds and cast novelties. Latex, lacquers, flocks, flocking equipment, supplies. Plastics, Box 1574, Boston 4, Mass.

DO it with Sea Shells. Big profits. Werts, 1429 56th Avenue, Oakland 3, California.

BY Now You've surely heard of Colorado's Fabulous Oil Boom. Largest new field discovered in last 20 years. More than 240 flowing wells. You'd like shot at \$1,000; \$5,000; \$20,000 on \$140? Then write or wire me immediately for free details. Hundreds of others have already. Dyer (1), 1835 Champa, Denver, Colo.

LEARN Import-Export! Represent Manufacturers! Study at home. Uncrowded fields, unlimited opportunities. ITP trains you in a few weeks. Five years free information service. Folder Free! International Trade, 246-S Fifth Ave., New York 1.

RUBBER—Airflex "Makes molds overnight" pint \$1.25. Gallon \$7.00 with instructions. Plastic Products, 3151-W Southport, Chicago.

OPERATE your own bookkeeping business under new national setup. Territories still open. Write, giving your business background. James Argodale & Associates, Zumbro Building, Rochester, Minnesota.

PLASTIC—Intermix makes ordinary casting plaster "Shatterproof" Gallon develops 100 pounds. Quart \$2.00. Gallon \$4.50. Plastic Products, 3151-W Southport, Chicago.

COMPLETE Electroplating outfits for hobby or profit. Set up your own small business for \$20.50. Write, Fisher Mfg. Co., Box 178, Galion, Ohio.

PLASTIC—Liquid glass. China glazes, protects plaster, wood etc. Pint \$1.00. Gallon \$4.00. Plastic Products, 3151W Southport, Chicago.

AT Home—Your own manufacturing business; making popular \$1.00 novelties. Cost you 3c to 15c. Everything supplied. Write So-Lo Works, Dept. A-601, Loveland, Ohio.

TRAVEL anywhere anytime. Earn \$85.00 week up. Be your own boss. No experience necessary. Less than \$5.00 investment required. Literature free. Traveler, La Grange 2, Indiana.

BUSINESS Starters \$7,000 winners money-making opportunities. Chronicle—quarter. McPlastens, PS1430 Monroe, Chicago.

\$46 FROM Square Foot Plywood. Jigsaw necessary: Write, Woodarts, X-49, Bridgewater, Mass.

BIG Money In Vending Machines—Smallest capital start brings immediate profits that build permanent profitable business. Starting instructions free. Becker Vendors, 105-P Dewey, Brillion, Wisc.

REMNANTS. Amazing Values. Good Profit. Write B & M Textiles, 415 E. 26th St., Paterson 4, N. J.

INDUSTRIAL sites Free. City property with clear title. Locate in Northwest Florida's year round climate. Chamber of Commerce, Lynn Haven, Florida.

88 MONEY MAKING OPPORTUNITIES

ELITE Collection describes 137 money-making plans; local, mail order. Particulars free. Elite Co., 220-A Grand St., N. Y.

EARN money at home—steady income—Write Successful Income Builders, 508-B, Hollywood 28, California.

\$25 WEEKLY Working two hours daily. No canvassing or manufacturing. Lycke, Box 2471, Cleveland 12, Ohio.

START Your own business! Big money manufacturing novelties, plaques, statuary. Free catalog. Write Bing Products, 88-B3N Broad Street, Boston 10, Mass.

SEWING Machine Repairmen make big money lifetime. Start neighborhood shop. Complete repair manual, covering all makes, \$1.98 postpaid. Money Back Guarantee. Sewmachine Serviceman, Hamilton 10-E, Ohio.

DETECTIVES Earn Big Money. Experience unnecessary. Particulars free. Waggoner, P-125, West 86th, N. Y., N. Y.

MANUFACTURE costume jewelry at home for profit, hobby, therapy. Free wholesale supply catalogue. Instructions. Florida Supply House, Bradenton, Florida.

METALLIZE baby shoes. Further information free. Metal Crafts, 5501 Suwanee, Tampa 4, Fla.

BIG money in wire novelties: Names Bracelets, Earrings, Swords, etc. Copyrighted instruction booklet, over 200 diagrams only \$1.00. Lee Brandy, 69 Bay 29 St., Brooklyn 14, N. Y.

SCHOOL Seniors—Sell classmates America's most beautiful Graduation Name Cards. Largest selection. 40% commission. Outsell all others. Send for free sample kit. Printcraft, 1425 E. Elm St., Scranton 5, Penna.

21 POPCORN. Candy Apple, etc. Formulas. All money-makers, \$1.00. We can supply equipment. Concessions Supply Co., Dept. "B", Box 133 Sta. "B", Toledo, Ohio.

MAKE big money, build your own lamps and sell. Write for free factory photos. Buddy Products Manufacturing Co., 1123 W. Belmont Ave., Chicago 13, Ill., Dept. 35.

MAKE Perfume. Make Money. Free book tells how. Lawson, 21 Joiner, Saint Augustine, Florida.

SOMETHING different. 900% profits. Experience unnecessary. J. W. Arrington, La Grange 5, Georgia.

EXCLUSIVE supply sources benefits. Etc. 25c. Satisfaction or money back. Evergreen Enterprises, Darrington 1, Wash.

INCOME Increase! Beat wage slavery. Roy, Box 531-A, Waterbury 85, Conn.

BABY Shoes preserved, coppered without electricity. Formulas, instructions, 50c. Box 531-A, Waterbury 85, Conn.

"**BIG** money making sun tan oils, insect repellents. Latest formulas for \$1. Noral Laboratories, Galveston, Texas."

WIN money on contests advertised in every magazine and on radio. General Contest Magazine, published monthly, gives hundreds of tips, Lists current contests and rules. Sample 25c. General Contests, 1609-A East 5th, Duluth, Minn.

"**THERE'S** Big Money In Junk," and repairing Car Batteries! Batteryman, Grand Junction, Colorado.

METALLIZE flowers for profit! It's new easy, sure fire! Free details; Joseph B. Kushner, Metal Finishing Consultant, Stroudsburg, Penna.

315 GOLDEN opportunities, how to make money, selling by mail. Send for free details. A. Warren, P.O. Box 6S, N. Y. 19.

VETERANS! Be financially independent. Changes in loan guarantee not generally understood offer amazing possibilities for income and profit. Don't miss your greatest opportunity. H. B. Smith, Box 747, Dept. J, Youngstown, Ohio.

REVOLUTIONARY Mail Order Plan! This isn't guess work but a newly-tested practical idea that can help you put extra dollars into your pocket every day. Quick action necessary. Send for convincing details today. Kutz, National Mail Sales Service, P. O. Box 2001, Natural Bridge, St. Louis, Mo.

PRIZE Contest Fans Reap Rich Rewards. Enclose 3c stamp. National Contest Bulletin, Box 2685-S, Miami 31, Fla.

EXCELLENT profits raising mink. Details furnished. Franklin Young, Riverhead, N. Y.

ELECTRIC Clocks are everywhere you go, buildings, homes, parking-lots, factories. Repairs increasing. Our easy to learn course with pictures and drawings teach You how to repair these clocks. Electronic Supply Co., Box 2350-B, Houston 1, Texas.

EARN Money Evenings, copying and duplicating comic cartoons for advertisers. Adservice, Argyle (2), Wisconsin.

EARN Up To \$2,000 year, inventing simple items. Special cash markets. Hendrickson, Argyle (8), Wisconsin.

QUICK Money operating mail order business. Splendid Opportunity. Details, write Russ, P. O. Box 611, Butler, Penna.

TIN Cans. Turn them into cash. Instructions 25c. Charles, 12-EK, Norwood, Ohio.

INCREASE your income with new improved Supermemory Course. For Free details write today. Thor Books, CS9, Box 1210, Chicago.

1947 GIGANTIC Directory of Opportunities. Advertisers Supplies, Sources, Trade Information. Mail Order Ideas, Products, Wholesalers. Valuable tips—just published! Descriptive literature Free. Wilkin & Co., Hillsboro 2, Ohio.

START Home Mail Business! Exclusive setups built-to-order for financially responsible beginners, by leading M.O. Association's expert staff. Booklet Free! N.M.D.A., 33-A Vassar, Dorchester, Mass.

GIGANTIC Mails—Trade Magazines—Name listed 15c. Jackson, Newfoundland 4, Kentucky.

SPARE Time Home Work Plans. Write. Business Plans Co., 1242 Park, San Jose, California.

59 FORMULAS, PLANS, ETC.

137 MONEY-making plans, also formulas for salable products. Descriptive booklet free. Elite Co., 220-A Grand St., N. Y.

FORMULAS—All kinds. Latest money-makers; literature Free. Kemi-Kal, Park Ridge, Ill.

ANY Formula Or Trade Process Supplied. \$2.00. Jackson, Newfoundland 4, Kentucky.

UNPAINTED plaques, statues, novelties. Variety of designs free list. Arbo Products, B195 E. 7th, St. Paul, Minn.

10,000 FORMULAS and Trade secrets. Free Literature. Stillmans, 555 Kingston Ave., Brooklyn 3, N. Y.

96 CENTS profit every \$1.00 sale. Make perfect auto cleaner and polish. Easy, complete formula \$1.00. Central Laboratories, 312 David Whitney Bldg., Detroit 26, Mich.

106 PLASTICS

PLASTIC—Sheets, Rods, Tubes, etc. Free List. Plastic Supply Co., 2618 St. Louis Avenue, St. Louis 6, Mo.

"**PLASTICS** Trade Secrets. Write for free literature. Plastics Research, Box 346, Alhambra, Calif."

POPULAR SCIENCE OPPORTUNITIES

PLEXIGLAS masked sheets 12" x 12" 1/16" \$1.00, 1/8"—\$1.25, 3/16"—\$1.55, 1/4"—\$1.85. Include 10% postage. Dyes, Rods, cements, shells, jewelry findings, tools, buffing compounds, free listings. Craft Plastics, Box 129-S, Somerville, N. J.

MAKE money assembling our pre-fabricated plastic kits. Sample Kit 50c. Catalog free. Fabros, Box 156, Station F-2, Buffalo 12, N. Y.

METALLIZE plastics for profit! Free particulars. Joseph B. Kushner, Metal Finishing Consultant, Stroudsburg, Penna.

TEN Fascinating Detailed Plexiglas Projects. \$1. Original Plasticplans. Box 181, Cincinnati 1, Ohio.

PLASTIC Tablecloth Covers, Curtains, Drapes, Baby Pants, Bowl Covers and other Plastic Articles selling like wildfire! Make big money now! Free Details. Write Plastics, Dept. 59-J, 206 N. Fourth, St. Louis, Mo.

PLASTICS—Supplies—Kits. List. Plasmet Sales & Engineering, 4648 Shirley Pl., St. Louis 15, Mo.

HOME Training through Plastic Hobby Kit: 2 pounds Plexiglas, Lucite, one bottle cement, three bottles dye. (Free with Kit: Instructions, Projects, Designs)—\$3.25 postpaid. All Plastics books. Request literature. Modern Technical Book & Tool Co., Dept. MS, 55 West 42nd Street, New York 18.

IMPORTANT news for molders and fabricators! Technicraft, 1156 Commonwealth, Boston 34, Mass.

33 CHEMICALS AND APPARATUS

THE House of Winn, home of supplies for amateur chemists. See Winn's New Idea chemical kits and apparatus outfits for home experimenting. Send 10c for retail catalog. Established 1931. John H. Winn, Dept. 607, 124 W. 23rd St., New York 11, N. Y.

CHEMICALS—Lab. Supplies New Catalog 10c. Mel-Glo Chemical Co., 258 Fourth Avenue, Brooklyn 15, N. Y.

SPECTROSCOPE For Quick chemical analysis \$3.00. Cutting Co., Box 457, Campbell 2, California.

LUMINOUS Paints will glow in dark. Six colors. Fairmount Chemical Co., 136 Liberty St., New York City 6.

NEW laboratory Supply Catalog of Chemicals and apparatus. Contains over 5000 items with illustrations, 212 pages. Send 50c. Standard Science Supply Co., 1232 No. Paulina St., Chicago 22, Ill.

CHEMICALS and apparatus for industrial, analytical, and private laboratories. Complete supply service for correspondence school students. Send 3c for catalog. Dept. M-26, Biological Supply Co., 1176 Mt. Hope Ave., Rochester 7, N. Y.

FREE Catalog: Chemistry, Mineralogy, Biology. Tracey Laboratories, 1907 Harrison, Evanston, Ill.

CHEMICALS, ounce quantities, apparatus, catalog 5c. Fleischer's Laboratories, Everett 49, Mass.

SAVE!! Get "Planning Your Laboratory", 25c Catalog. 10c. Pilgrim's Chemical, 348-A Edith Ave., Salt Lake City 6, Utah.

68 HELP WANTED

INTERESTED in Latin American & Foreign Employment??? \$1 Brings Foreign Service Directory Just Off The Press Listing Oil, Mining, Aviation, Construction, Transportation, Manufacturing concerns by Personnel Expert. Hot Tips for Immediate Application. Global Reports, 6417 Homewood, Dept. PS, Hollywood 28, California.

ALASKA—The Last Frontier offers thousands of opportunities. \$1 brings 1947 Copyrighted Report describing potential opportunities. Listings of firms in Commercial Fishing, Mining, Aviation, Construction. Pertinent facts about Prospecting, Fur Farming, Homestead Lands. Tips for Application. Free—Map of Alaska. Alaska Opportunist, 6417 Homewood, Dept. PS, Hollywood 28, Calif.

5 AGENTS WANTED

SELL Personalized soap. Name on every cake. Ideal for gifts. Get sample offer. Dunbar Soap, New Brunswick, N. J.

GOOD Paying Business Silvering mirrors, plating autoparts, reflectors, bicycles, bathroom fixtures, etc., by late method. No tanks or shop required, outfit furnished. Free Booklet. Gunmetal Co., Ave. G, Decatur, Illinois.

SELL Personal Initialed Individualized Belts, Buckles, Cap Badges, Tie Holders, 2,000 emblems to choose. Fast profits. Repeats. Write today special outfit offer. Hookfast Specialties, Box 1425, PS, Providence, Rhode Island.

FREE! Latest issue Opportunity Magazine, Salesman's Guide. Inspiring, constructive. Shows how to earn money selling for others or in your own business. Hundreds postwar opportunities. Send name and describe what you have sold or are selling. Illustrated copy sent Free. Opportunity Magazine, 620 N. Michigan, Dept. 18, Chicago 11, Ill.

LICK After-war layoffs; Start own business; home, office. Booklet describing "Collection of 127 Tested Plans" free. Elite Co., 220 Grand St., New York.

AGENTS—300% profit selling genuine gold window letters; stores and offices. Free samples. Metallic Letter Co., 437 N. Clark, Chicago.

90c PROFIT Each \$1.00 Sale, Sell Positive mothproofing solution to housewives, stores, agents. Experience unnecessary. Postal brings details. Kinford, Wayne 4, Pa.

GOLD lacquered Window Sign Letters. Large Sizes Penny Each. New Foils, Absolutely Beautiful. Free Samples. Atlas, 544 W. 79th, Chicago 20.

"**BIG** bargains for big profits. Over 100 sensational values. Men's used suits \$2.00, pants 35c, topcoats \$1.25, Overcoats \$2.00, shoes 20c. Experience unnecessary. Free wholesale catalog. Superior, 1250-A Jefferson, Chicago 7."

GREETING Card Agents: "Line Up" with "Pines" for bigger, better and quicker profits. Rush name, address on postcard today. Box 32, Flushing 6, N. Y.

START Your Own Business on Our Capital. Always your own boss. Hundreds average \$6,000 to \$25,000 annual sales. We supply stocks, equipment on credit. 200 home necessities. Selling experience unnecessary to start. Wonderful opportunity to own pleasant, profitable business backed by world-wide industry. Write Rawleigh's, Dept. I-U-PSC, Freeport, Ill.

JUST Out! History of World War II. Huge Volume. Popular price. Authentic text. Official photographs. Big profits. Riverside Book Company, Iowa Falls, Iowa.

MAGIC Cleaner and laundry soap deal. Hotter than a firecracker. Big profits. Sample free. Uko, 5007 Irving Park, Chicago.

ADVERTISING Book Matches—Cash In On Political Campaigns—sell Union Labels matches. Cuts for all businesses and political parties—Free powerhouse selling kit—low prices—protection guaranteed on repeat orders—Cash Commissions. Superior Match Co., Dept. P97, 7530 Greenwood, Chicago.

\$50 CASH For Selling 100 Assortments of 21 Christmas cards at \$1.00. Complete line. Free samples 50 for \$1.00 cards. Special offers. Write today. Hedenkamp, 343 Broadway, Dept. S-22, New York 13.

CHRISTMAS Cards. Earn Big Money. Take orders galore from friends. 25 exquisite folders with name, \$1.25. Free samples 10 designs. America's Fastest Selling 21 Christmas Folder Box. Costs 50c. Sells \$1. Request samples today. Sunshine Art, Dept. NC-9, 115 Fulton St., New York 8, N. Y.

NEW, extra money plan. Up to 100% profit showing friends unusual Personal Christmas cards. Box assortments, gift wrappings, humorous, all occasion, Religious, social notes, personalized stationery. Extra bonus. Request Free 50 for \$1.00, 25 for \$1.00, 25 for \$1.95 name imprinted Christmas Cards and personalized Stationery folder. Special Offer. Thomas Terry Studios, 60 Union Avenue, Westfield, Mass.

AT last! Something new and sensational in Christmas Cards. Amazing "Oilette" Cards. Like costly oil paintings. Designs never before offered. Quick orders. Beautiful 50 for \$1 Cards, name imprinted. Big Profits. 20 other assortments 60c to \$1. Samples on Approval. Puro Co., 2801 Locust, Dept. 714L, St. Louis, Mo.

CHRISTMAS Card Agents! New, exclusive, patented children's linenette books. Four books in attractive packet. Retail 50c. Sample on approval. Also Cut-out Valentine Assortment. Elmcraft Card Co., 5928 South Western, Chicago 36, Ill.

BIG Commissions. Boost income quickly. Sell stores, restaurants, bars. Plastic tickets, shelf moulding, menu covers, signs. Write today. Pricing Press, 124 White St., Dept. C, New York 13, N. Y.

MAKE Money Selling Genuine Leather Jackets. Prospects everywhere. Top quality, full cut, exclusive features. Big Cash Commissions. Also 250 styles fine Shoes. Sample Outfit Free. Consolidated, Dept. S-803, Chippewa Falls, Wis.

MAKE money easily. Sell 50 for \$1.00 Christmas cards. Cost you as low as 45c. Big line Christmas and Everyday assortments. Sell only 50c to \$1.00—your profit 25c to 55c per box. Extra bonus. Write for free samples personal Christmas cards, name imprinted stationery and leader 21 card Christmas. 16 card feature All-Occasion assortments on approval. Special offers. Elmira Greeting Card Co., M-70, Elmira, N. Y.

YOU make \$25 for selling fifty \$1.00 boxes 50 beautiful assorted Christmas cards sell for only \$1.00 your profit 50c. Write today for free samples 50 and 25 for \$1.00 and other boxes on approval. It costs nothing to try. Cheerful Card Co., 158 White Plains, N. Y.

SHINE Shoes Without "Polish". New invention. Lightning seller. Shoes gleam like mirror. Samples sent on trial. Kristee, 113, Akron, Ohio.

AMAZING New Zipper Shoe sells on sight. Big profits for salesmen. Leads line 200 splendid styles. Territories open. Get Free Sample Outfit. Write Victor Thomas, Dept. V-819, Chippewa Falls, Wis.

"**IDEAL** business stamping metal key protectors, social security plates. Information upon request. General Products, 11 No. Pearl (PS), Albany, N. Y."

QUICK Profits selling personal initialed buckles with belts, cap badges, tie holders, emblems, uniforms, shirts, caps, ties, etc. Sure repeat orders. Easy-selling outfit offer. Write. Hook-Fast Company, Dept. 14, Roanoke, Virginia.

GOLDEN money making opportunity. Sell friends others new 1947 assortment 21 irresistible Christmas cards and outstanding 50 for \$1.00 personals. Extraordinary gift wrapping, religious everyday, economy boxes. Up to 100% profit. Tremendous demand, sensational values. Easy sales. Experience unnecessary. Request free samples name imprinted Christmas cards and customer winning 21 box on approval. Holiday Card Co., 463 Congress Street, Dept. C, Portland, Maine.

BE renewal headquarters for all magazines. Christmas gift sales starting now. Big profits. No experience. No capital needed. Free catalog tells how. Write: McGregor Magazine Agency, Dept. PS-2, Mount Morris, Ill.

QUICK Cash. Sell friends wonder-value 50 for \$1.00 extraordinary 25 for \$1.00 personal Christmas Cards. Personal Stationery. 32 sensational money makers. Up to 100% profit. Bonus. Write for 6 Free self-selling sample portfolios of 50 for \$1.00 to 25 for \$2.50 name imprinted Christmas Cards. Special offers. Rainbow Greeting Card Co., 36 East 12th St., Dept. 18-B, N. Y.

BUILD your own local shoe business. No investment. Free outfit starts you. Advance commissions plus bonus. Amazing comfort features. Tanners Shoes, 101, Boston, Mass.

POPULAR SCIENCE OPPORTUNITIES

EXCELLENT Sideline for printing and advertising salesmen. Decalcomania name plates in small quantities. Great demand. Also, make money with our line of Automobile Initials and Sign Letters. Free Samples. "Ralco", XL-Roxbury, Boston 19, Mass.

DISTRIBUTORS Wanted For Unusual Products. Levine's, 15-S Boulevard Station, New York 59, N. Y.

SILVER Plating Liquid. Apply with cloth. Renews silverplated ware. Cleans, silverplates, polishes, one rubbing. Genuine silverplate. Also silverplates brass and copper. Female and male selling representatives wanted. Part or full time. Big profits. Exclusive territory. Sells by demonstrating. Retail and wholesale. NuProcess Products, Aurora, Illinois.

UNUSUAL photographic product—good profits—free sample. Kingston, 3500 Avenue H, Brooklyn, New York.

AGENTS—Big Line Including Food Products. Fast selling premium and bargain deals. Low prices. Send card for big outfit offer with gift Ho-Ro-Co., 2726 Dodier, St. Louis 7, Mo.

COMIC Greeting Cards. Christmas and Everyday Boxed Assortments. A laugh wallop in every card! People can't resist them. Only line like it in America! \$1 or more profit on each box. Sell on sight! Write Novo Products, A-922 Diversey, Chicago, Ill.

SCHOOL Seniors—Earn 40% commission selling classmates America's most beautiful Graduation Name Cards. Largest selection. Outsells all others. Send for free sample kit. Printcraft, 1425 E. Elm St., Scranton 5, Penna.

AMAZING New Glow in the Dark House Numbers. Switch Plates. Decals. Pictures. Religious Articles, etc. Factory Representative wanted. Wonderful Opportunity. Free samples. Madison Mills, 303 Fourth Avenue, New York, N. Y.

\$1. STARTS you in business. Sell DeLuxe ties, 100% wool interlining. Costs you only \$7.00 per dozen, you make \$5.00 Dozen. Send \$1.00 for special introductory offer two DeLuxe ties. Catalog complete line Free. Philip's Neckwear, 20 West 22nd St., Dept. P-12, New York 10.

WE Pay \$25 for selling 50 boxes of Christmas Cards. Attractive 21-in box sells for \$1—your profit 50c. Costs nothing to try. Write for samples to Timely Greetings, Box 268, Dept. A-2, Port Chester, N. Y.

PROFITS To 100% selling Xmas and everyday Greeting card assortments. Details and assortment on approval. Glorian (Dept 12) 515 East 45th St., Brooklyn 3, N. Y.

QUICK money—profit to 100% bonus. Sell friends peak value Christmas, Everyday cards, gift wrappings, stationery. Free samples 50 and 25 for \$1.00 Personals. Etching-type Christmas card. Initial Stationery. 21-card \$1.00 Christmas. 14-card \$1.00 Everyday assortments on approval. Special offers. Regal Greeting Card Co., 17394 Mendota Ave., Dept. B, Detroit, Mich.

NO Money or experience needed. Spare or full time. Steady income writing orders guaranteed men's hose. Variety 20 styles. We deliver and collect. Liberal advance profit. 33% cash bonus. Write today for complete free sales outfit. Kentcraft, Dept. SS, 44 Court St., Brooklyn 2, N. Y.

BE amazed. Fast profits selling Miracle Cushion Wonder Worker shoes. Also complete line, men, women, children. Advance commission, bonus. Experience unnecessary. Free outfit. Samples supplied. Paragon Shoes, Dept. M2, 716 Columbus, Boston.

AGENTS—Sell Nurses, Beauticians, Doctor's & utility uniforms, below store prices, 25% commission. Write Medicote Co., Rockville Centre, N. Y.

SELL an item that repeats, repeats and repeats. Grimebuster Mechanics Waterless Handcleaner. Our agents are making over \$75.00 weekly. For details write Schaffner Laboratories, Dept. PS-2, Pittsburgh 2, Pa.

EARN steady income selling beautiful nylon hosiery. Amazing written guarantee gives free replacement if Kendex hose runs or snags within guarantee period! No money or experience needed. Full or part time. Write orders. We deliver and collect. Write today for complete free money-making sales outfit. Kendex Co., Dept. 106, Babylon, N. Y.

GREETING Cards: Easy money, quick. Free literature tells all! Evers, Elmhurst, N. Y.

SELL Ultra blue stock signs to stores, 1000 slogans, comedy, general, religious. 7 x 11, cost 6c, sells 35c. Make money. Sample free. Lowy, 8 West Broadway, Dept. 328, New York City (7).

FAST Selling Carded Auto Accessory and Other Items, write Steele Plastics Co., Ashland, Ky.

AGENTS Wanted for our Slot Machines and coin operated amusement games in every town and community. Sell to clubs and homes, or start a route. Webb Distributing Co., Dept. P40, 6 So. Kedzie Ave., Chicago 12, Ill.

AGENTS. Sell finest Food Products direct to homes. Successfully sold for 25 years. Big profits. Powerful combination sale plans make sales easy. Permanent repeat business. Samples furnished. Live territories open to Distributors. Mother Hubbard Products Co., 4139 Grand, Dept. PS, Chicago.

SELL Delicious Candies, Nuts, Gum. Immediate delivery. Write Casterline, 2031-T Sunnyside, Chicago 25, Ill.

WOULD you pay 3%—first \$350 made? Color-illustrated book "505 Odd Successful Enterprises" free! Proven! Work at home, office. Expect something odd! Pacific-L, Oceanside, California.

EARN Up To \$480 Month part or full time keeping books for small firms. Simplified System. Write Tax-Saver System, Dept. G, Ft. Worth, Texas.

SELL Mexican Pecan pralines. Samples \$1. Box 712, Corsicana, Texas.

"HARD-hitting salesmen, selling Baby Shoe Permalizing. Commission. Write Dodge Studio, 37 Gravel Street, Meriden, Connecticut."

CRACK The Market. Rotacut Gas Mower (Maytag engine)—\$99.50; electric model—\$89.50. New 1948 models. Drop shipments. Prepaid. Deposit payment secures appointment. Catalog Free. Act quick. Farm Products Co., M-2015, Excelsior Springs, Mo.

JUST Take Orders. We deliver. "Gadgets", 210k 5th Ave., N. Y. C.

\$20 TO \$30 a day easy; sensational new Raised Letter Nameplate, beautifully framed in Mahogany; amazing seller to homes, stores, offices, etc. Get our tested plan. Write Raised Letter Metal Company, Dept. 201, Fox Bldg., Phila. 3, Penna.

\$50 UP, spare time. Magic money making opportunity. Sell beautiful personalized Xmas cards, 25 & 50 for \$1. Costs nothing to try. Samples free. Victory Studios, Mt. Vernon, N. Y.

MAKE Own Products, keep all Profits! 500 formulas, rush 25c. Wilde, W-9, Ross-moyne, Ohio.

SMOKE without fire. Sensational cigarette invention. Quick money. Safe-Gard, Perry-Payne Bldg., Cleveland 13, Ohio.

SCHOOL Seniors: Sell classmates superb Craftcards for super profits. Write Craftcards, Box 235 (AH), Pittsburgh 30, Pa.

EARN \$100 weekly selling curtains, related items. Housewives buy quickly. Write, Sherry's, 14 E. Burnside Ave., Bronx 53, N. Y.

WE buy old type Singer sewing machines, your profit up to \$25.00 on each, write for literature. Essex Shop, 172 Washington St., Newark 2, N. J.

HUNDREDS Direct Selling, Local, Mail Order money-making plans, ideas, etc., in Big 32 page 8 1/2 x 11 Magazine, Copy Free! "Opportunities Preferred", 33-S Vassar, Dorchester, Mass.

SCHOOL Seniors!!! Your postal will bring our wonder, Kwick-Sell Catalog of popular Graduation Name Cards. Biggest profits \$! Only firm giving free souvenir chest and Card Case. Don't miss out! Hurry that postal!! Craftcards, Box 235 (M), Pittsburgh 30, Pennsylvania.

CHRISTMAS Cards. Earn easy money. New 1947 leading luxurious box assortments. Sell on sight, 100% profit. Free literature. Torres Company, 8E Saint Francis Place, Brooklyn, N. Y.

"SOLVEX" cleans dirty hands without water. Exclusive territory. Solvex, Monticello, Iowa.

SELL my Vegetable Tablets for health also my Health Publications. Dr. McFerrin, Orlando, Florida.

\$3 FIRE Extinguisher sells wholesale or direct. "Fire-Killer", 101 Franklin, Syracuse 1, New York.

A NATURAL! Big money selling new line one piece lace. Plastic Tablecloths. Sizes to 54x108. Also Women's Aprons; Novel, Embroidered Cotton Pillow Cases. Free, "interesting" details. Royalty, Box 748-L, Passaic, N. J.

EXTRA Christmas Money. Sell Plain and Imprinted Christmas Cards for Personal and Business Use. Details P.O. Box 26, Allenhurst, N. J.

MONUMENTS. 1,000 salesmen wanted all over the United States. Old reliable monument company. Make good money. We furnish everything to close the sale. Write at once for big outfit and instructions. U. S. Marble and Granite Co., Oneco, 50, Florida.

AMAZING new two way mirror Inter-viewer—Knocker protects family from intruders. Be Manufacturers Representative. Free literature. U.S. Hardware Mfg. Co., 1421 Locust Ave., Brooklyn 30, N. Y.

NEW sensational seat covers. Mono, 6545 Santa Monica Blvd., Hollywood 38, Calif.

69 HIGHGRADE SALESMEN

ADVERTISING Book Matches—World's largest direct selling Mfr. of advertising Book Matches offers opportunity for profitable year 'round selling; Every business a prospect; No Exp. needed to start; Full or part time; Factory service; Low prices for high quality; Repeats; Sales Kit Furnished. Match Corp. of America, 3433-43 W. 48th Place, Dept. N-11, Chicago 32, Ill.

AUTHORIZED wagon salesmen. Write for sample new Wise Grip Release. F. G. McCann, 4667 1/2 Alabama Street, San Diego 3, California.

47 EDUCATIONAL AND INSTRUCTION

GOOD "Used" self-instruction educational books on all subjects bought, sold, rented, exchanged. Satisfaction guaranteed. Complete information and 100-page illustrated bargain catalog Free! Write—Nelson Company, Chicago 5.

HAVE your own office! Many earn up to \$5,000-\$15,000 Annually. Learn credit-collection agency business by home study course. Experience unnecessary. Write for Free bulletin. No obligation. Franklin Credit School, Dept. 203-J, Roanoke 7, Va.

PREPARE for civil service examination. Pay for course after securing position. Write Free School, Kokomo, Ind.

BIG money rebuilding shoes. Help needed everywhere or start big-income business of your own. Learn practical, sure, easy way in 3 months. Anyone from 18-60 years can learn easily. Approved for G.I. training. Rush postcard today. Modern Shoe Rebuilding School, Est. 1927, 2935 Belmont, Chicago 18, Illinois.

SHORTHAND quickly self-taught. Free start. Cook's Uniscript, Bartow, Fla.

POPULAR SCIENCE OPPORTUNITIES

PERSONALITY and Aptitude Testings \$3.00 Complete. Field's, Box 112, Brooklyn P. 12, N. Y.

WHY Don't You Write? Writing short stories, articles, etc., will enable you to earn extra money. In your spare time we teach you to write the way newspaper men learn—by writing. Free "Writing Aptitude Test" tells whether you possess the fundamental qualities essential to successful writing. Veterans: This course approved for Veterans' Training. Write today! Newspaper Institute Of America, Suite 572-P, One Park Avenue, New York 16, New York.

GET A Government Job! \$1756-\$3021 year. Men—Women. Prepare for next examinations. Veterans get preference. 32-page Book on Civil Service Free. Franklin Institute, Dept. M-23, Rochester, N. Y.

HOME Study course, drugless therapy. Free Literature. Inst. of Drugless Therapy, Tama, Iowa.

LEARN how to make medicines from herbs. Particulars free. Home Service, Forestville 3, Va.

USED Correspondence Courses and Educational Books Bought, Sold, Rented, Catalog Free. Educational Exchange, Hensgar, Alabama.

BEST Training U.S. Hobart Welding School. Complete equipment. Non-profit. G.I. Bill. Write for Free Booklet. Hobart Welding School, Box P-976, Troy, Ohio.

MACHINIST'S Pamphlets. Mill Bevel Gears 50c. Identify Metals 35c. List supplied. R. Dyke, 1616 W. 12th, Vancouver, Canada.

CLINICAL Laboratory Technicians in great demand. We train you in your spare time, in your own home. You can practice while studying. Write for free catalogue. Imperial Technical Institute, Box 973-B, Austin, Texas.

HOME Study Courses. Any vocation. Free Bulletin. DeVoto School, 35 Vicente, San Francisco 16, California.

LEARN How to Sell Real Estate. We teach you at home in your spare time step by step! Get going Now! Write for Free booklet. National School of Real Estate, 703 Albee Building, Washington 5, D. C.

VETERANS: Train for High paying positions in drafting. Specialize in Tool and Die, Machine Design, Architectural, Structural drafting. Limited Registrations. Send for free Bulletin. Accommodations and Part Time Jobs for out of town students. Cleveland Engineering Institute, 2325 Chester Avenue, Cleveland 14, Ohio.

PIANO Tuning Learned quickly at home. Big demand! Empire School, Dep't. 3A, Champaign, Ill. Established 1935.

3800 LATEST used correspondence courses. Catalog 50 cents. EG, Elmsford, N. Y.

LEARN Piano Tuning. Prepare for Career in fascinating profession. \$5000 year easily earned. Real security, pleasant easy work. No profession Paying so well can be mastered so quickly. Natural Aptitude, desire to get ahead chief requirements. Prospectus and full information on request. Harmony School of Piano Tuning, Box 582, Harrisburg, Pa.

ELECTRICAL Examination Preparation. Quick—Easy—Interesting. Electrical Quiz Book. A true-false exam on theory, practice and code. Price \$1.00. Electric Wiring diagram quiz book—Exam on apparatus and circuit connections. Price \$1.00. Quiz-book Company, Department PS, 603 Brighton Beach Avenue, Brooklyn 24, N. Y.

39 CONTESTS

\$25,000, \$20,000 FREE!—Contests. You can win. Need help? Write. Research, 13 Earl St., Red Bank, N. J.

77 LANGUAGE OUTFITS

29 LANGUAGES by Linguaphone. Russian, Spanish, Portuguese—Direct Conversational Method for Mastering any language quickly, easily, correctly at home. Available under GI Bill of Rights. Send for free Book. Linguaphone Institute, 54 RCA Bldg., New York, CI 7-0830.

10 AUTHORS SERVICE

NEW Writers Needed. Nonfiction material demand is booming. Many magazine editors buy features and "fillers" from new writers. Our Earn As You Learn lessons prepare you to meet their requirements. Experience unnecessary. Reasonable price, unexcelled service. Details, sample lesson free on request. Use postcard. No obligation. Comfort Writer's Service, 210RN S. 7th St., St. Louis 2, Mo.

I WANT New Writers to cash hundreds of checks for \$1 to \$100, offered each month. The easiest way to write for pay. No previous experience necessary. Send for Free details. No obligation. Saunders M. Cummings, 467-S Independence Bldg., Colorado Springs, Colo.

25 BUSINESS SERVICE

GOOD "Used" self-instruction educational books on all subjects bought, sold, rented, exchanged. Satisfaction guaranteed. Complete information and 100-page illustrated bargain catalog Free! Write—Nelson Company, Chicago 5.

INCOME TAX, bookkeeping record for any business. Postpaid \$3.75. SA Bookkeeping, 10116 St. Charles Rd., St. Louis 14, Mo.

TO Whom It May Concern: We will represent you in all principal cities of the world. Representatives wanted. Will send you assignments immediately. James W. Farley, Citizens Building, Cleveland 14, O.

INVESTORS; Operate stock market safely. Weekly advisory letter. Month trial \$1.00. B. Patten, Box 3, East Williamson, N. Y.

30 CARTOONING, SIGN PAINTING, DRAWING AIDS

"HOW To Make Money With Simple Cartoons"—A book everyone who likes to draw should have. It is Free; no obligation. Simply address Cartoonists' Exchange, Dept. 199C, Pleasant Hill, Ohio.

"WHY didn't I think of that?" Guaranteed Dollar Book reveals the mainspring of "gags"—comedy. Free details. Cartoon-O-Mart, Box 6263S, West Palm Beach, Fla.

MAKE Signs, 9 complete alphabet pattern sets, 3 complete numeral pattern sets and catalog \$1.00. Sign Letter Distributors, P.O. Box 101, Mineola, N. Y.

TALENT Test Free. American School Commercial Art, Box 8066, Dallas 5, Texas.

LEARN Showcard Writing at home in Spare Time. Fascinating lifetime Business of your own. No special skill needed. Free information. Sherwood Publishing Co., Irvington 11-P, N. J.

PAINT beautiful pictures quickly, easily, inexpensively. Free literature. Art Book Shop, Arnold 6-B, Mo.

SIGN painting taught at home by an old master. Ben Kerns, Box 812, Greenville, S. C.

SIGNS made easily. Instructions and ten sets modern alphabets, numerals, patterns. Sizes up to eight inches. All for \$1.00. Co-operative Business, 7 West Madison, Chicago, (2).

31 CHALK TALK STUNTS

CHALK Talks, Laugh Producing Program, \$1.00. Illustrated Catalog 10c. Cartoonist Balda, Oshkosh, Wisconsin.

136 TYPEWRITERS

RECONDITIONED Typewriters, Printing Devices, Office Appliances Supplies Dixie-graph, King, N.C.

RECONDITIONED Standard Typewriters, Underwood, Remington, etc. Free details. Ben Mueller, North Tonawanda 2, N. Y.

118 RUBBER STAMPS

3 LINES 40c. Pads 35c. Signatures \$2.40. Print-Right, Wauwatosa, Wisc.

RUBBER Stamps all kinds catalogue 10c. Print and Stamp Co., Box 172, Boston 1, Mass.

110 PRINTING OUTFITS, SUPPLIES

"PRINTOMATIC" Selffeeding Post Card Stencil Printing Duplicators \$9.50 Up. Office Size Duplicators, Speedoprints, Hillcos, Excellographs \$33.41 Up. Literature Free. Pittsburgh Typewriter Supply, 336 WE Fourth Ave., Pittsburgh 22, Pa.

PRINTING presses, type, supplies. Send dime for complete illustrated printer's supply book, details and press samples. Kelsey, Inc., A-8, Meriden, Connecticut.

PRESSES, Type Supplies, Specimens, 3c. LaGarza, 8 Walden, Cambridge, Mass.

44c TYPE catalogue, lists 10c. National Type, 8508 Harper, Detroit, Mich.

INEXPENSIVE home-made printing press. Details free. Novelty Shop, Downsville, Louisiana.

PRINTING Presses, Type, Supplies, Lists 3c. Turnbaugh Service, Loysville, Penna.

109 PRINTING, MULTIGRAPHING, ETC.

1000 BUSINESS cards printed prepaid \$2.50. Reliable Print Shop, 901 E. Jefferson, Louisville, Ky.

500 6 3/4 ENVELOPES printed \$2.35. Mango, 555-C South 20th, Newark 3, N. J.

CUT Printing Costs; 1,000 offset 8 1/2 x 11 printed \$3.95. 5,000, \$15.75; larger quantities less; 48 hour service; samples, price list free. Fidelity Company, Parkersburg 12, W. Va.

DESK Stationery Personalized, 125 notes in easel \$1.00. Petite Notes, Box 149, Hazleton, Penna.

ADDRESSOGRAPH Machines, Multilith "70", New But shelfworn, 40 @ \$15.00 each; Electrofiles Machines, shelfworn, 9 @ \$5.00 each; KRZAK, Pawtucket, R. I.

MIMEOGRAPHING—24 Hour Service. Reasonable Rates. Free Samples. Jay Service, 1028s East 63rd, Chicago 37, Ill.

MIMEOGRAPHING, vari-typing, offset printing. Postal brings samples and prices. Compare. Business Service, Box 33, Forest Hills, N. Y.

SEND 10c Now, for our 36 page price-list—Refunded first order. McCall Press (PSM), 1326 South 27th, Omaha 5, Nebr.

QUALITY Mimeographing 200 copies \$2.00; immediate service. Carter's, 314-39, Latonia, Kentucky.

125 HAMMERMILL Letterheads \$1.00. Envelopes same. Race Printers, Hudson, New York.

QUALITY Printing; Reasonable prices. State requirements. Samples. Mero Products, 99 Morrison, Punxsutawney, Penna.

PRINTING—All kinds. Free estimates. Prompt. Reporter, Chelsea, Oklahoma.

98 PATENT ATTORNEYS

INVENTORS: Without obligation, write us for information as to what steps an inventor should take to secure a Patent. Randolph & Beavers, Registered Patent Attorneys, 340-A Columbian Bldg., Washington 1, D. C.

INVENTORS: Write for free brochure "Evidence of Invention." Labiner, World Building, New York 7.

INVENTOR'S Guide free on request. Frank Ledermann, Registered Patent Attorney, 154 Nassau St., New York 7, N. Y.

C. A. Snow & Co.—S-427, Snow Building, Washington 1, D. C. Registered Patent Attorneys. Write for information.

PATENT and Trade-Mark Practice before U. S. Patent Office. Validity and Infringement Investigations and Opinions. Booklet and form "Evidence of Conception" forwarded upon request. Lancaster, Allwine & Rommel, Registered Patent Attorneys, Suite 413, 815-15th Street N.W., Washington 5, D. C.

POPULAR SCIENCE OPPORTUNITIES

INVENTORS: Learn how to protect your invention. The United States Patent Office advises the inventor to engage a competent, registered patent attorney or agent to represent him. We maintain a staff of registered patent attorneys ready to serve you in the handling of your patent matters. Special booklet "Patent Guide for the Inventor" containing detailed information concerning patent procedure with "Record of Invention" form will be forwarded upon request—without obligation. Clarence A. O'Brien & Harvey Jacobson, Registered Patent Attorneys, 72B-G District National Building, Washington, D. C.

INVENTORS. For "Record of Invention" form, contact Carl Miller, Registered Patent Attorney, Woolworth Building, New York.

INVENTORS—Patent Laws encourage the development of inventions. The Rules of Practice of the U. S. Patent Office advises—unless an inventor is familiar with such matters—that he employ a competent registered attorney or registered agent, as the value of patents depends largely upon the skillful preparation of the specifications and claims. Write for further particulars as to patent protection and procedure and "Invention Record" form at once. No obligation. McMorrow, Berman & Davidson, Registered Patent Attorneys, 143-F, Victor Building, Washington 1, D. C.

PATENTS—Trade marks. Irving L. McCathran, 316 McLachlen Bldg., Washington 1, D. C. Registered Patent Attorney.

58 FOR INVENTORS

THE Inventor who believes he has a new and useful invention, and needs advice, should consult a competent registered patent attorney. Without obligation, write for full information on how to secure Patents and Trademarks. Randolph & Beavers, Registered Patent Attorneys, 340-E Columbian Bldg., Washington 1, D. C.

"**INVENTOR'S Guide**" free on request. Frank Ledermann, Registered Patent Attorney, 154 Nassau St., New York 7, N. Y.

IDEA Men! Let's get together and get some money out of our ideas instead of promises. James Corrubia, Lakewood, N. J.

INVENTORS—Patent Laws encourage the development of inventions. The Rules of Practice of the U. S. Patent Office advises—unless an inventor is familiar with such matters—that he employ a competent registered attorney or registered agent, as the value of patents depends largely upon the skillful preparation of the specifications and claims. Write for further particulars as to patent protection and procedure and "Invention Record" form at once. No obligation. McMorrow, Berman & Davidson, Registered Patent Attorneys, 143-E, Victor Building, Washington 1, D. C.

INVENTORS: Avoid unnecessary expense. Write for free booklet explaining how our Consulting and Advisory Service can assist you in deriving greatest profit from inventing. Institute of American Inventors, Dept. 30-A, 1926 Eye St., N.W., Washington 6, D. C.

INVENTORS: Learn how to protect your invention. The United States Patent Office advises the inventor to engage a competent, registered patent attorney or agent to represent him. We maintain a staff of registered patent attorneys ready to serve you in the handling of your patent matters. Special booklet "Patent Guide for the Inventor" containing detailed information concerning patent procedure with "Record of Invention" form will be forwarded upon request—without obligation. Clarence A. O'Brien & Harvey Jacobson, Registered Patent Attorneys, 72A-G District National Building, Washington, D. C.

INVENTORS: Send us your inventions. Polk, 4857 State St., Chicago 9, Ill.

HIGHEST Royalties and cash for your inventions when we market them. Free particulars without obligation. Universal Marketing Co., 126 Lexington Ave., New York 16, N. Y.

PATENTED, Unpatented inventions promoted. M. Joyce Humphries, 1424 Landtitle, Phila 10, Penna.

WONDERING what to invent? Booklet, \$1. John Kline, Lititz, Penna.

RELIABLE Patent searches complete with patent copies \$6.00. Protection forms free. Write Raymond L. Smith, Patent Searcher, 703-S Albee Building, Washington 5, D. C.

INVENTIONS Wanted. Patented or Pending. Inventors Exchange, Dept. 4, Hartford 1, Connecticut.

FREE consultation regarding your problems. Complete service. Write J M Company, Burlington 2, Kentucky.

MAKE Money from your ideas. Write Grayland, 5312 Grace, Chicago.

75 INVENTIONS WANTED

INVENTIONS Promoted. Patented or Unpatented. Write Adam Fisher Company, 183-A Enright, St. Louis, Mo.

INVENTORS: Hundreds of manufacturers have requested our assistance in locating marketable new products. Complete information, free. Institute of American Inventors, Dept. 30C, 1926 Eye St., N.W., Washington 6, D. C.

PATENTED, unpatented inventions wanted. We have tremendous lists of manufacturers who may pay cash, royalties. Descriptive booklet free. National Invention Service, 1404-B Mitchell Street, Oakland 1, Calif.

CASH-Royalty. We manufacture, nationally advertise your ideas, patents. Bonded. Federal Identification Co., Robert Burbridge, Pres., Dept. H 1, Burbridge Bldg., Oklahoma City 6, Okla.

INVENTORS — Booklet "Self-Testing Your Patent Or Invention" free on request. Address: Direct Contacts, 11106-B2 Longwood, Chicago 43.

"**WANTED—Practical Inventions of All Kinds.** Write John D. & Son, 285 Howard Ave., Box 3213, Dept. PS-9, Bridgeport 5, Conn."

HAVE Buyers for practical inventions. Prior patents may kill value of yours. Have patent office search made cost \$6.00. Unique patent application service includes preparation specifications, claims, drawings, filing and help to sell your invention. Details Free. Charles Morton, 11 W. 42nd Street, New York.

99 PATENTS

INVENTORS: Test the commercial value of your patented or unpatented inventions, quickly and inexpensively. Write for free information. Institute of American Inventors, Dept. 30-B, 1926 Eye St., N. W., Washington 6, D. C.

100 PATENTS FOR SALE

PATENT Pending. Rock-it's-self baby bed. Metal. Brockway's, Box 192, Huntsville, Alabama.

PRACTICAL Shaving Brush with self lathering device including razor, blades, comb, mirror, in a convenient form. Garriga, 629 Goldengate, San Francisco 2, Cal.

82 MANUFACTURING

EXPERIMENTAL Devices, Models. Any Material. Reasonable. Nelson Manufacturing, Woodburn, Oregon.

MANUFACTURE Paints, your garage a factory free information. Industrial Chemist, 525 Donnelly, Kansas City, Mo.

87 MODELS, MODEL SUPPLIES

MOST complete Illustrated Catalog—"O-HO OO" Model Railroad Parts ever published. Send 5c for mailing. Selly, 1377 Gates Ave., Dept. 836, Brooklyn, N. Y.

MODEL Ship Builders! Are you looking for authentic, precision ship models? Send for richly illustrated fully descriptive catalogue in full color of famous ships of all kinds. Only 10c. Halesite Yacht Service Inc., Dept. C-33, Halesite, Long Island, N. Y.

SHIP Model and yacht supplies, complete large 64 page catalogue, 30c. Wm. Wild, 510 E. 11th St., New York City.

SHIP and Yacht model fittings; blueprints. Send 25c for illustrated catalog No. 20—Listing hundreds of items. A. J. Fisher, 1002-2 Etowah Ave., Royal Oak, Mich.

SHIP Model Kits and Fittings . . . most complete stock in New England. Boucher, Fisher, Marine Model and Model Shipways fittings, blueprints and model yacht equipment at standard prices. Send 25c for new illustrated 1947 Catalog and price list. Dept. S., James Bliss & Co., Inc., 220 State St., Boston, Mass.

BUILD Model Ships, Railroads, Catalog 10c. Ideal, 21 West 18th Street, New York 11, N. Y.

POWER Models—steam and gasoline engines, steam traction engine, metals, tools. Catalog 35c. Charles Cole, Ventura, Calif.

RAILWAY models, complete line. Combined HO and O gauge, catalogue, 35c. Walthers, 269 Erie, Milwaukee 2, Wisc.

BALSA Wood Generous Supply \$1.00 Price List Free. Kaysun, Inc., Manitowoc, Wis.

PLASTIC Blocks and Deadeyes are better. 25c brings samples and lists, refunded. Gullmars, Westhill, Ontario.

"**SHIP Models of lasting Beauty**", Copper Sails, Construction Sets, assembled Models, Folder Free. Trade Wind Models, P. O. Box 171-A, Lakewood, N. J.

MODEL engines—steam and gasoline. World's most fascinating hobby. Build them yourself in your own shop, using your own tools. Send ten cents for illustrated catalog listing world's largest selection of miniature engine castings and drawings. McAded Models, 1313 So. Talman Ave., Chicago 8, Ill.

BRASS Gears and model supplies for the inventors. Send 10c for catalog. Pierce Model Works, Tinley Park, Ill.

STEAM engines—boilers—castings, Catalog 25c. Anton Bohaboy, 2297 Price, Rahway, New Jersey.

87A MOLDS AND MOLDING MATERIALS

RED Seal Rubber Company Develops New Compound! DePont Latex Base! Fully Guaranteed! Introductory Offer for \$3.00—Complete Mould Making Course plus Quart of Red Seal Latex. Free Literature upon request. 116 Nassau St., New York 7, N. Y.

LIQUID Rubber for making flexible molds. Qt. \$2.00. Gal. \$5.75. Sample Bottle 25c. Chaney, 1130 E. 16th St., Jacksonville 6, Fla.

CREATE your own products "Snego Flexible Mold Master" teaches amazingly simple method for making rubber molds for plaster novelties. Complete with illustrations, \$1.00. Snego, 1628 Blue Island Ave., Chicago 8, Ill.

71 HOME CRAFTSMEN

BRASS rods, tube, sheet for home workshops. Send for catalog 202. Meier Brass, 1155 Bellevue, Detroit 7, Mich.

LEARN Sea-Shell Jewelry and Novelty manufacturing. No tools or experience needed. Learn-earn within a week! Complete, beautifully photographed home instruction course, shows you how to make 110 designs of pins, earrings, brooches, hair ornaments, necklaces, bracelets, plaques, ash trays, dolls, animals, miniatures, etc. Explains pearlizing, tinseling, gilding, dyeing, luminous processes. Illustrates 65 species sea shells. Lists 200 raw materials with wholesale prices. Complete course \$1 postpaid. Beginner's Kit \$3 (\$3.50 in Canada). House of Gifts—Box 4550-SA Coral Gables, Fla.

GENUINE Leather scraps for leathercraft items, assorted colors, 6 pounds, \$2.00. Send 10c for sample. International Cushion Co., 515 No. Halsted, Chicago 22, Illinois.

MAHOGANY—Shipped direct to you from the tropics. Know the pleasure of working with this beautiful wood. Special offer of No. 1 furniture mahogany to home craftsmen. B. Hansbrough, P. O. Box 503, Coronado, Calif.

POPULAR SCIENCE OPPORTUNITIES

SPECIAL Offer: 80 full size toy, novelty and lawn ornament patterns only \$1.00. Lynds. Medway. Mass.

LEATHER designs for Tooling or Carving. Ten handbags \$1.00. Twenty billfolds \$1.00. Fifty belts \$1.00. All three, \$2.50. Order includes information about our "No More Tracing" design Transfers. Lampkin Artcrafts. Box 641-S. Culver City. Calif.

LEATHERCRAFTERS! Send for free catalog listing leathers, tools, supplies. Kit Kraft. 3203 W. Washington Blvd., Los Angeles 16. Calif.

LEARN To make Sea Shell Jewelry. pins, earrings, hair ornaments, novelties. Book of Instructions and Designs free with \$2.00 and \$5.00 Kits. Postpaid. Herbert Diamond Company. Box 4619. Miami 31. Florida.

EXPERIMENTERS! Interested in Electrical, Mechanical devices from war surplus? List Free. F. Siefke, Box 18, Station E. Buffalo, N. Y.

ELECTRIC Pen—Burns: Wood, Plastics, etc. Embosses Gold or Silver leaf. \$3.00 Postpaid. C.O.D.s Accepted. Reb Industries. Box 265-CR. Elmhurst. Illinois.

WHAT-NOTS made of wood scraps. 24 inches high. beautiful designs. full size pattern 30c. 4 assorted patterns \$1. Illustrated folder 10c. Joannes. P. O. Box 141. Omaha 7. Nebraska.

MODERN jewelry findings. postpaid. Instructive list 10c. Cameo assortment. \$1. Doremby Company. Chisholm. Maine.

HUNDREDS Patterns: Plywood Novelty Furniture—Lawn Ornaments—Silhouettes—Weathervanes—Letters—Numerals—200 Craftsmen's Books & Booklets—Hundreds Decal Transfer Decorations. Other lines. Large Illustrated Catalog. Write Wo-Met Shop. Ashburn. Georgia.

18 BLUEPRINTS AND PLANS

"**BLUEPRINT** Reading Made Easy"—ready reference book for reading any type blueprint. 596 pages. 463 pictures. Formerly \$8.95. now only \$1.98. Popular Science, Dept. 97-C. 353 4th Ave., New York 10. N. Y.

23 BUILD IT YOURSELF

HOT Water Free—from Sunlight. System efficient any locality year 'round. Standard materials—easily built—low cost. Facts Free. Solar Water Co., Box 175. Dept. K. Coral Gables, Fla.

BUILD concrete block machines. portable sawmills. Shop. farm. home machines. 70 plans. Catalog-Handbook Free. Nichols Equipment Co., Dept. 304. Purvis. Miss.

"**BUILD** Cabins"—book offers complete instructions and plans for building your own cabin. lodge. tourist home. or wayside stand. 251 Pages. 200 plans and pictures. Only \$1.98. Popular Science. Dept. 97-C. 353 4th Ave., New York 10. N. Y.

OVER 100 full size patterns of easy to make action toys. Special offer \$1.00. Masterprint. White Building. Buffalo. N. Y.

HOBBYISTS. shop owners \$1.00 brings extra strong bench-leg print. Materials available locally or will build to order. More on request. F. H. Dodge. Box 169. Booneville. Miss.

PLANS instructions for 8' hydroplane. \$1.00. Paul Pichette. Lake Linden. Mich.

"**BUILD** your Cedar Chest. Wardrobe. Quilt Chest from Tennessee Red Cedar. We furnish everything in our knockdown kit. Write us for anything in cedar. Craftsman Cedar Works. Fayetteville. Tenn., Box 217.

"**HOW** to Construct Your Own Home". 7500 words. drawings. Practical "how to do it" instructions. \$1.00. Red Tower. 2435 Baker St., Baker. Oregon.

"**CONCRETE** Block Homes". 24 page booklet: drawings. instructions on how to build. \$1.00. H. C. Lightfoot. Civil Engineer. Richboro. Penna.

BUILD Your home as a hobby. No rent. No mortgage. Save 50%. Use spare time. No special skill required. Amazing facts sent free. H. C. Lightfoot. Civil Engineer. Richboro 8. Penna.

AIR Plane Jettison Tanks streamlined. 10 1/2 foot tear drop shaped. 165 gallon of Light weight lead. coated steel weighs 75 pounds floats over 1200 pounds. Ideal for making trim. inexpensive boats. canoes. Kayaks. Dinghys. Duck Boats. Powered Catamarans and Runabouts. prices \$12.50 complete. \$9.75 each for three or more US Freight prepaid. General Sales. 205 Market. Grand Rapids 3. Mich.

BUILD Concrete block machine. Easy. Inexpensive. Vibrator or hand. Capacity 125 standard blocks per hour. Also make mixer and brick molds. Free details. Clyde Lee. Mountain View 1. Oklahoma.

BUILD concrete block machine. 2 blocks per minute. Build concrete mixer. Easy. inexpensive. See illustrated ad. page 30. U-Build-It Service.

139 WATCH REPAIRING

WATCH and Clock Repairing—complete practical course in modern horology. 66 illustrated self-instruction lessons. Just out! Low price. Fascinating 100-page illustrated catalog Free! Write—Nelson Company, Dept. 3-01. Chicago 5.

WATCH and clock repairing increasing. complete home study course with drawings and pictures. Information free. Houston Chronometer and Watch Co., P.O. Box 1140B Houston 12. Texas.

95 OLD GOLD, WATCHES, ETC.

CASH for Old, Broken Jewelry. Highest prices paid immediately. Mail gold teeth, watches, rings, silverware, diamonds, spectacles. Satisfaction guaranteed. Information free. Rose Smelting Co., 29-Y East Madison, Chicago.

GOLD \$35.00 Ounce—Mail old gold teeth, diamonds, jewelry, watches—receive cash by return mail. Satisfaction guaranteed. Free information. Dr. Weisberg's Gold Refining Company, 1500-B Hennepin. Minneapolis. Minn.

WATCHES: Jewelry. Wholesale. Free Catalog. John Green. 210 Fifth Avenue. New York 10.

76 JEWELRY

MANUFACTURE costume jewelry at home for profit, hobby, therapy. Free wholesale supply catalogue. Instructions. Florida Supply House. Bradenton, Florida.

CERAMIC Jewelry Supplies. Bar Pins. ear screws. for ceramic and woodworkers. also. glass and sea shell assemblers. Free catalog. Philadelphia Badge Co., 1007 Filbert St., Philadelphia. Pa. Dept. E-1.

JEWELRY; Watches. Wholesale. Free Catalog. John Green. 210 Fifth Avenue. New York 10.

JEWELRY Findings. Lowest Prices. George Sassen. 154 Nassau Street. New York 7.

MAKE Money. Making Shell jewelry and novelties. Instruction book 75c. Kit \$5.00. Catalogue free. Palm Shellcraft Co., 220 W. 9th St., Sarasota, Fla.

132 TOBACCO & PIPES

UNPOLISHED seconds of \$5.00 pipes 75c postpaid. Literature free. Carvapipe, 2829-a Dixie. Hamilton. Ohio.

86 MISCELLANEOUS

BOOKFINDERS! (Scarce, out-of-print unusual books.) Quickly supplied. Send wants. Clifton, Box 1377 PSM, Beverly Hills. Calif.

GOOD "Used" self-instruction educational books on all subjects bought, sold, rented, exchanged. Satisfaction guaranteed. Complete information and 100-page illustrated bargain catalog Free! Write—Nelson Company, Chicago 5.

SHOES—Save 30% For Entire Family—Buy direct; save the retailer's profit. Send for Free Catalog—Sutton Shoe Co., Dept. B-3. 32 Sutton St., Baltimore. Md.

"**MEXICAN** Gift Shop Items—Feather Cards. Pottery. Drawnwork. Wholesale, retail. Mexican Products, 126 N. Main, Tulsa 3. Okla."

TWO pounds pure maple sugar postpaid \$3.00. Eulalia Turner, Poultney, Vermont.

KODACHROME movies! "Beauty Brevities" plus 42 similar subjects. 8mm. 16mm. Catalog. 25c; with projection length sample. \$1.00. World In Color, Box 392-BA, Elmira. N. Y.

HULL Automobile Compass. for accurate road direction brand new. \$2.50. Prisms for 6x30 or 8x30 Binoculars. brand new. \$1.50 each. Offset prisms to be attached to 7x50 B. & L. Binoculars. gives double the field of the ordinary 7x50 Binocular. Cost \$98.00. special \$25.00. Green Sunshades for Binoculars size 6x30 and 7x50 snap on type. value \$7.50. special \$1.25 per pair. Forward money order. No C.O.D. shipments. Send coin \$1.25 for Third Annual Edition of Gun Digest together with our complete catalog of new and used guns, ammunition, rifles, binoculars and powder flasks. Our separate catalog 25c. Public Sport Shops. 13 S. 16th St., Philadelphia, Penna.

MEN'S Shoes. sizes 11 1/2 to 16. widths AA to EEE. Finest quality. prompt delivery. Free circular. Kingsize, 264. Brockton. Mass.

FREE Girlie Photos. We're so sure we have the best photos and the loveliest girls that we want to send you a Free sample set. Just send 25c to cover cost of mailing and handling. etc. Print your name and address clearly and we'll ship this terrific sample set. But hurry. Merit Photos Studios. Box 137. Washington Bridge Sta., Dept. 709. New York 33. N. Y.

UNUSUAL Novelties. 5 different samples 10c. Modern. Box 2. New York 2.

GET Lots Of Mail: Name Listed Three Directories 25c. Harvey Teeple, Decatur, Ind.

WHAT Shall We Believe? For free copy of 78 page digest of "The True Christian Religion" by Emanuel Swedenborg. send name and address to Swedenborg Foundation. Room 1648. 51 East 42nd St., New York 17. N. Y.

MAKE Magic Photos—Render photographic image invisible. indefinitely; Reappears instantly through (Your Secret). Stamp brings sample and literature. Invisible specimens with magic slip 25c. Photo Specialties. 812-S North 18th. St. Louis. Mo.

METAL Fabricated—Your specifications—Boxes. Pans. Tanks. Brackets. Circles—Welding. Shearing. Rolling. Bending—Any Material—Send sketch for price. William Scheck. 353 Shaler Blvd., Ridgfield. N. J.

ART Photos of Beautiful Hollywood models 4 x 5—8 for \$1.00, 32—\$3.50 Prepaid. Visual Slides. 853-46 Street. Brooklyn 20. N. Y.

BRUNO'S Hollywood Beauties—75 Startling Art Poses \$2.50 per book prepaid. Visual Slides Co., 853 46 Street. Brooklyn 20. N. Y.

HYPNOTIZE anyone! Get the most perfect, easily learned, modern scientific course of "Genuine Hypnotism" in the world. Fully illustrated. Only \$1.00. Money back guarantee. Fowler. Box 1284. Boston 4. Massachusetts.

ADULTS Publications—Revealing Sex Truths—Illustrated. 50c. Kogan. 1032-SM. New York 8.

RAISE Earthworms. Instructions \$1.00. W. Huffman. 391 Pleasant Lake. Rives Junction. Mich.

CALENDAR 1753 to 2152. 35c. Tracy S. Newton. Decatur. Georgia.

FREE literature how to locate buried treasure and minerals. Fisher Laboratory, Inc., Palo Alto, Calif.

ART Photos! Sample 50c. 3 for \$1.00. Post Office Box 2011. Phoenix. Arizona.

PANNING Gold—Learn How. 160 page instruction book. three large blueprints \$3.00. C.O.D. Illustrated literature Free. Old Prospector. B-25. Dutch Flat. Calif.

CREATIVE Psychology! Illuminating interpretation of Scriptures. Transformation through renewal of Mind. Send for free booklet. Menticulture. Box 832D. Chicago 90.

137 SUCCESSFUL Business plans described in free literature. Profit-Builders. 14 Mellen St., Cambridge. Mass.

POPULAR SCIENCE OPPORTUNITIES

"90 COLORED Postcards \$1.00 postpaid. Western States. all different. Ernest Hall, Box 3660. San Francisco 19."

ARTISTIC Pin-Up Girl Photos. 10 for \$1.00. Wilkins. 417 Hill. London. Canada.

THOUSAND laughs. Unique jackass cigarette dispenser. Holds 10 cigarettes. Simply press donkey's head down. tall rises. presto out slips cigarette. Satisfaction guaranteed. Sent postpaid for \$1.00 with order. or \$1.15 C.O.D. Ideal for Christmas Gifts. Sanimo Industries. Dept. PS 12. Spencer. Indiana.

RECEIVE Free samples. magazines. Money-making offers! Mail Galore! Your name listed two years. \$1.00. Four months. 25c. Stanford. 6220-N 16th. Philadelphia 41.

MODERN Tool has 100 farm uses. Flame thrower kills weeds quickly. economically. Valuable literature free. Sine Equipment. 16S. Quakertown. Penna.

SEXTANT—plastic. colorful. accurate to five miles. Excellent for cruiser or den. Decorative and practical. Only \$10.00 postpaid. Joel. 103-09 Farragut Road. Brooklyn 12. New York.

101 PERSONAL

PSORIASIS Sufferers: Has everything failed to bring even temporary relief from scales, lesions and itching? Then write today for Free important information. You needn't invest one cent! Pixacol Company. Dept. S. Box 3583. Cleveland. Ohio.

RUPTURED? Positive comfort, no understraps, no steel, no elastic. Write Smith Manufacturing Co., Preston. Ontario.

HOW You Can Find Out! Information discreetly developed, any matter, person, problem anywhere. Personal-business assignments, representations, undertaken. Nationwide. Officially Licensed and Bonded Service established 1922. Reasonable. All inquiries confidential. William Herman. 170 Broadway. N. Y.

GENTLEMEN: Stop Growing Bald and Save Money! Get my instructions and successful formula for Only \$2.00. Send postal note only. Frank Novak. P. O. Box 368. Rahway. N. J.

ALCOHOLISM is a Disease amenable to our treatment. If this evil threatens your home, job or business. Do Something Now! Write for Free Folder. Established 50 Years. The Murray Institute. 620 S. Tenth St., Minneapolis.

INFORMATION for single people by Human Relations Consultant. University Graduate. Dr. B. Long. Box 375. Los Angeles 53. Calif.

MATRIMONIAL—Sweetheart Magazine. 50c. 6 mos. \$1.00. Yr. \$2.00. Barwood. 2037-E 42nd. Astoria. N. Y.

STOP Tobacco. Enjoy better Health—New Method Breaks Cigarette Habit Quickly. pleasantly. Guaranteed Harmless. Booklet Scientific Instructions. \$1.00. Psychogenic Science. Dept. A. Box 402. Canton 1. Ohio.

REJUVENESCENCE. Scientific discoveries conquer age. Health-Center. Columbia City. Indiana.

HAIR Falling? Dandruff? Write Trichologist. 139 Lewis Street. Phillipsburg. N. J.

FRIENDSHIP is priceless. 10c will bring you copy of my Friendship Magazine. bet you'll like it. Write Jay Wilcox. Box 384. Eastport. N. Y.

STOP Falling Hair: Educational pamphlet entitled "How To Keep Your Hair Till Ninety" mailed free. James Hilton. 4819B Fourth Avenue. Brooklyn 20. N. Y.

TEN Ranch postcards. you address return we remail. Box 712. Corsicana. Texas.

DISCOVER your possibilities for success. Write: Janet Caldwell. P. O. Box 330. Chicago 90. Illinois.

MEXICAN Law General Practice Attorney. 1203 Arizona St., El Paso. Texas.

WIN Cash . . Home . . Car Prizes! \$1 brings you "winning answers". Also free information. Prize Contests Company. 69 East 96th St., Brooklyn 12. N. Y.

CASE for (Genesis) Creation. 85c. Christian Evidence League. Malverne. N. Y.

HOW Christ Returns. 25c. Bulletin. Box 87. Cathedral Station. N. Y. 25.

BUY Vitamins Direct. Amazing Savings. Money Back Guarantee. Our 9th year! Postcard. Matoska Products. White Bear Lake. Minn.

ATHLETES foot remedy guaranteed \$1.00 prepaid. Dr. Renz. Room Three. Chavanne Bldg., Lake Charles. La.

BALD Men: We make natural appearance toupees. Safe, invisible, durable. New method fit by mail. Perfection Crafts. 126 Lexington Ave., New York.

ATHLETE'S Foot. Sporeen is Guaranteed. Write Sporeen. 726 Summit. Toledo 4. Ohio.

WINE with a wallop. Inexpensive. Most sublime ever tasted. Formula \$1.00. Aydel Co., Box 1. Pasadena 3. California.

2 ADVERTISING

ADVERTISERS: Mail order ad covering United States—2,200,000 circulation—\$28.00 inch. Classified ad, 24 words, 20 metropolitan Sunday newspapers—\$25.00. Magazine, newspaper, mailing-list rate-book, adwriting assistance—free. Chicago Advertising Agency, 20-PS West Jackson, Chicago 4.

ADVERTISE: 24 words, 40 Newspapers \$3.50. Lists Free. Advertising Bureau. 229-P Dixon Blvd., Uniontown. Penna.

24 WORDS in 64 Weeklies \$4.96. J. Darnell, 730 Hays, Jackson, Tenn.

20 WORDS 60,000 Readers \$2.00. inch \$6.00. Renick. Holland 3. N. Y.

INCH Display Advertisement Mail-order World. year \$24. Wood's Popular Services. Atlantic City. New Jersey.

CHRONICLE excellent advertising medium. Inch \$9.00. Sample quarter. McPlas-tens. PS 1430 Monroe. Chicago.

66 HANDWRITING ANALYSIS

ANALYZE Handwriting for Profit! Complete outfit \$1.00. 4462-R Germantown. Philadelphia.

45 DRAFTING INSTRUMENTS

SAVE on drafting materials. Free catalog. Draftsmen's Supply Co., 32 North Wells, Chicago 6.

129 TATTOOING SUPPLIES

AMAZING New Book "Tattooing World" For Amateurs, Professionals, and breeders. Successful method of removing tattoos. 250 Illustrations. Sent in plain wrapper. Only \$1.00. Zeis Studio, 728 Leslie, Rockford, Ill.

119 SCIENTIFIC EQUIPMENT

EXPERIMENTERS. Student scientists—Experimental science manuals & kits. Send for list. Queens Experimental Company. 25-12 Steinway Street, Long Island City 3. N. Y.

ATOMIC Laboratory—For few cents. in few hours make and operate remarkable atomic energy devices. All absolutely harmless. Easily made. intensely fascinating. Flash Chamber—You actually see vivid, frenzied flashes caused by released atomic energy. Instructions \$1.00. Electroscope—You test minerals, rocks, earth, etc. for atomic activity. Instructions \$1.00. Wilson Chamber—Phenomenal display of ionized particles in violent action. Instructions \$1.00. Easily understood scientific explanations. All three above with captivating Booklet "Essential Atomic Theory", list of easily obtainable material, much other valuable information. \$2.75 complete. Alpha-Atom Products. 475 Fifth Avenue. N. Y. C. 17.

27 A CANDY MAKING

MEN—Women—"Everybody Likes Candy". Learn to manufacture professionally at home. (Our 36th Year). Ragsdale Candies. East Orange. N. J.

135 TREES, SHRUBS, ROOTS, HERBS

FIFTEEN Baby Evergreens 3 to 7 inches \$2. Immediate shipment postpaid: Your choice Arvorvitaes—Junipers—Yews—Taxus—Hemlocks—Colorado Blue Spruce—Norway Spruce—Retinsporas. Fischer's Nursery Service. Box 36. Bakerstown. Pa.

142

WOODS

CHRISTMAS Cards of real wood. Write. Cards of Wood. Manlius. N. Y.

81 A MAGNETS

ALNICO Magnet—Lifts Ten Pounds! \$1.00. Five smaller magnets—\$1.00. Ronald Eyrich. Box 849. Milwaukee 1.

ALNICO Magnets. Twelve. plus 100 experiments. \$3.00. Experiments. 25c. Powerful Disc Magnets. Pair \$2.00. Micro Switches. 120V. 10A. \$1.00. Eljay. Box 891. Newark 1. N. J.

MAGNET. "Alnico" 4 oz. Horseshoe. powerful (lifts about 5 lbs.). \$1.00. 8 oz. (lifts 10 lbs.). \$1.50. 3 lbs. (lifts 20 lbs.). \$6.00 Postpaid. Ross. B68 West Broadway. New York. N. Y.

134 TREASURE FINDERS

SEEK Buried Treasure. Methods, mysteries, devices explained. Circulars free. Century Press. Box 151-D. Glen Ellyn. Ill.

METAL Detectors. The Very Latest Circuit. Free Literature. Hedden Metal Detectors. 538 North Homewood Avenue. Pittsburgh 8. Penna.

MT-SCOPE Metal Locator fully guaranteed and unsurpassed in efficiency. Time payment plan, trade-in and accessories. Free literature. Fisher Research Laboratory, Inc., Palo Alto. Calif.

\$20.00 MAGIC Indicator locates lost money and mineral deposits guaranteed. Charles Horton. BelleRive. Illinois.

TREASURE Hunters! Radically new Goldak locators. New featherweight Model 87 weighs only 11 pounds! Revolutionizes location of Gold, Silver and Minerals. Money-back guaranteed superior any other. Write The Goldak Co., 1544 W. Glenoaks, Glendale 1. Calif.

42 DETECTIVES

DETECTIVE Training. Phillips Secret Service. 1917C. N. Kenneth. Chicago 39. Ill.

DETECTIVES—Work home—Travel, Experience unnecessary. Write Wagoner P-125 West 86th. N. Y., N. Y.

BE A Detective—Send for price list of self-instructional courses at reduced prices. Perkins Publications. 300-C Brandies Theatre Building. Omaha. Nebr.

LEARN Detective Work And Fingerprints. Send \$2.00 for full \$20.00 course on week's trial. If satisfied, send \$3.00 more, if not, money back. Frank Mashak. 4114-a Olive. Saint Louis, Missouri.

89 MONUMENTS

WRITE For Direct Prices \$14.00 Up. Freight Paid. Guaranteed. Free Catalog. Granite-Marble Factory. A49. Oneco. Fla.

93 NAME LISTS

MAILING Lists. certified, productive, inexpensive. \$5.00 1000. Homeworkers, agents, buyers, etc. Write Dixie Service. King. N.C.

84 MILITARY INSIGNIA

FIRST Again: United Nations Insignia 30c. Military Emblems 2c up. Send 10c for price lists. Hobbyguild. X-35 West 32nd St., N. Y.

50 DIFFERENT army patches postpaid for only \$1.00. (factory rejects) Catalog free with order. Insignia Mart. 703 Broadway. N. Y.

123 SOUVENIRS

FREE German War Relics with each purchase. Send 10c for price list of captured Foreign medals, daggers, uniforms and receive 4 German Ration Potato stamps, free. Hobbyguild, S35, West 32nd St., N. Y.

FREE: German War Relics: Send 10c for prices of captured foreign medals, daggers, uniforms; and receive four German Ration Stamps free. Hobbyguild, S-35 West 32nd St., N. Y.

USEFUL Souvenir and list of unusual Photo Novelties 25c. Photo Novelty Co., Box 238A. Trinidad. Colo.

ANALYZE HANDWRITING

Qualify for Certified Grapho Analyst Degree at home, spare time. Credit, Employment, Personnel Managers, Business, Professional men, women use grapho-analysis in their work, earn substantial fees in spare time. Many study solely for personal benefit, no desire to earn money, find it so fascinating they start using it to add to their incomes. Entertainment field pays well, up to \$100 in a week reported. Others establishing profitable practices as Vocational and Family Problem Counselors, Personality Teachers, and lecturers.



GROWING—UNCROWDED PROFESSION

More and more police use grapho analysis handling suspects and criminals. They understand how criminals think. Their handwriting tells. Men like Hugh Dunlap, university student, Harry Allen, retired preacher, use it in court, win cases, earn fees even before graduation. Only school in world devoted to teaching grapho analysis offers thorough training to earnest, ambitious men and women regardless of where you live, small town, farm or city. Send for GRAPHO ANALYST, illustrated lesson, personal handwriting analysis offer, ALL FREE. Must be 21 or over. Address A. I. G. A. Inc., 126, Noel, Missouri.



WAR SURPLUS 110 VOLT - 60 CYCLE - 2500 WATT
POWER PLANT GENERATOR
WEIGHT 200 LBS LIST PRICE \$276.00

NEARLY NEW Ranchers, taverns, sportsmen generate your own 110-volt single phase A-C electricity. Powerful portable plant. (Complete except engine). Small engines easy to pick up or you can use water or wind power. Fine standby power for farms. Contractors use for on-job power saws, drills, etc. Full instr. installing, using. Guaranteed perfect. Order now or write for details.
LECO ENGINEERING CO., Box 908 PS-C, Lincoln, Nebr.

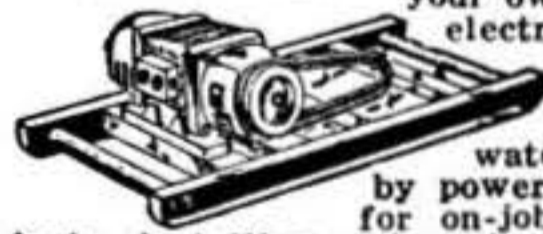

Only \$89.40
FREIGHT PREPAID U.S.A. ONLY

Say You Saw It In Popular Science



MAKE HOLLYWOOD STYLE CEMENT POTTERY, birdbaths, benches, coffee tables, stucco-rock, rustic garden walks, etc. Many more. Color concrete with chemicals. Start with small capital. 10¢ brings sample, pictures, details.

HOLLYWOOD CEMENTCRAFT
8527-B Wonderland Ave. Hollywood 46, Calif.

HYPNOTIZE ANYONE

• Yes, anyone in 5 seconds. Secrets revealed. Exciting experiments. Overcome inferiority complexes, excessive smoking, alcoholism, stuttering, nailbiting, phobias, insomnia, fear, stagefright and improving your memory. Private and class instruction available at Institute. Complete practical home-study course...\$2
POWERS INSTITUTE OF HYPNOTISM 2932 Wilshire Blvd. Dept 12, Los Angeles 5, Calif.

BE A Successful TOOL & DIE DESIGNER

Write TODAY...find out how YOU can earn up to \$10,000 a year as urgently needed Tool & Die Designer. Study under America's outstanding instructors. Day or eve. Courses in MECHANICAL DRAFTING. Free Employ. Service. G.I. approved.

MIDWESTERN TECHNICAL INSTITUTE Dept. Y, 431 S. Wabash, Chicago 5, Ill.



Hollywood Experts Help you Make Good in RADIO-TELEVISION at Home

Direct from Hollywood, nerve-center of broadcasting, Television, Radio & Sound activities, comes R-T-A's time-proven and tested home training. Here at last—easy to learn, home instruction that quickly qualifies you for steady, good-pay jobs or your own Radio business. Get full details at once! Send postal for **FREE BOOK** "How to Make Good In Radio-Television."

RADIO TRAINING ASS'N OF AMERICA, Dept. PS9
5620 Hollywood Blvd. Hollywood 28, Calif.

Make \$100 TO \$300 a week with any of these

101 WAYS to be YOUR OWN BOSS

By MICHAEL GORE



Why knock yourself out as somebody else's "wage slave" when you can be sitting pretty in an easy-to-start, big-money business of your own? If you're fed up with begging for raises, lay-offs, shut-downs and catering to company "big shots," get a copy of the book that has put thousands into money-lifetime businesses of their own—101 WAYS TO BE YOUR OWN BOSS, by Michael Gore.

You Don't Need Much Money or Experience

With really small capital, with little or no experience, but with this gold mine of a book to guide you, you can start from scratch and build yourself a big-money future with REAL SECURITY. Many of the opportunities revealed by Mr Gore are in little-known, uncrowded, easy-to-enter fields. Many have the perfect set-up for 1-man, partnership or husband-and-wife operation. All are fully explained, with step-by-step instructions for making the smallest possible investment pay you a good living from the very beginning.

101 WAYS TO BE YOUR OWN BOSS puts at your fingertips the wealth of actual experience so hard for the newcomer to get. In it, 200 successful businessmen have crammed a million dollars' worth of "know how" to help the new boss make a real success of his enterprise. They show you what businesses hold today's biggest opportunities, how to get started fast and grow fast, how to make a little capital go a long way, get fixtures and merchandise on time, pick the just-right location, keep down overhead, bring in all the business you can handle.

Time Is Precious! Don't Waste It!

Experts agree the time is ripe for thousands of more new businesses. But whether you're quite ready or not, take the first step toward \$100 to \$300 a week in a business of your own by getting your copy of 101 WAYS TO BE YOUR OWN BOSS. We're so sure you will find it the gold mine of opportunity we say it is, that WE'LL LOAN YOU THE BOOK FOR 7 DAYS FREE EXAMINATION. Your copy will be rushed to you immediately upon receipt of the coupon below.



COMPLETE "INSIDE INFORMATION" helps you succeed in these and other **PROFITABLE BUSINESSES**

- (Partial Contents)
RETAILING: Sport Goods Store; Electrical Appliances; Filling Stations; Dress Shops; Men's Clothing; Boys' Wear; Beauty Shops; Florist; Book Store; Rental Library; Gift & Art Shop; Meat Market; Restaurants; Bakeries, etc.
MAIL ORDER BUSINESSES — Full-time and spare-time.
SERVICE BUSINESSES: Laundries; Retail Dry-Cleaning; Diaper Supply; Linen Supply; Coin Machines; Employment Agencies; Country Newspaper; Trucking; Export & Import; Auto Repair; Photography; Junk & Scrap; Exterminating; Radio Repair; Metal Service Shops, etc.
MANUFACTURING: Ceramics; Precision Casting; Metal Working, etc.
FARMING: Small Commercial Farms; Specialty Farms; Poultry Farming.
REAL ESTATE: Management; Buying and Selling, etc.

Send No Money!

FREE FOR 7 DAYS

SUCCESS BOOKS, Dept. 32, 206 Division St., New York 2, N. Y. Please rush, for 7 DAYS' FREE EXAMINATION, a copy of 101 WAYS TO BE YOUR OWN BOSS. I will deposit with postman only \$2.00, plus C.O.D. charges. If I am not fully satisfied that it is worth many times the price to me, I may return it within 7 days for immediate refund.

Name.....

Address.....

City.....Zone.....State.....

CHECK HERE if you prefer to enclose \$2.00 and we will pay all delivery charges. Same Free-Trial Money-Back Guarantee!



The RCA Metal Detector "blows the whistle" on any particle of metal that may have crept into the package.

RCA Electronic Metal Detector—

arrests "stowaways" in packaged products!

It stands guard over everything from breakfast cereals to after-dinner mints, from cigarettes to cough drops . . . eliminating any bit of foreign metal that might slip by.

It helps American industry—that employs every precaution to assure product purity—to protect automatically the foods you buy. High-frequency radio waves form an invisible wall—sound the alarm, if any metal is accidentally present.

The RCA Metal Detector was developed by RCA product engineers with the co-operation of RCA Laboratories. Moreover, similar pioneer-

ing and research keep *all* RCA products at the top in their fields.

So when you buy anything bearing the RCA emblem—an RCA Victor radio, television receiver, Victrola radio-phonograph, phonograph record or radio tube, you get one of the finest instruments of its kind science has achieved.

"Victrola" T.M. Reg. U. S. Pat. Off.

When you're in New York, don't miss seeing the radio and electronic wonders at RCA Exhibition Hall, 36 West 49th Street. Free admission. *Radio Corporation of America, RCA Building, Radio City, New York 20.*

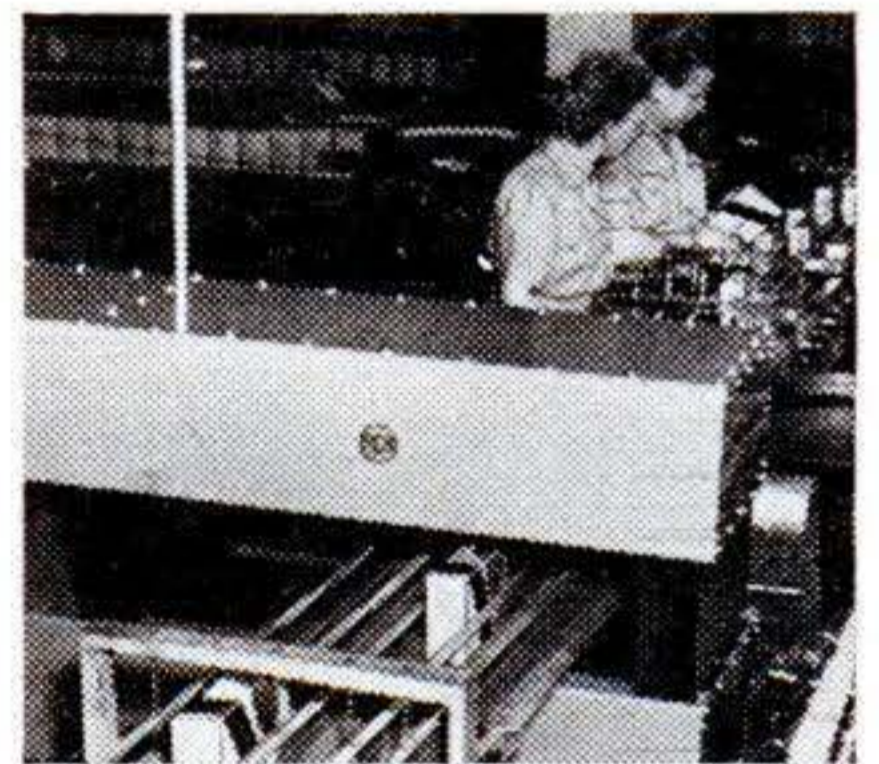

The RCA Metal Detector operates through a rejection device, or by stopping the conveyor belt, or giving an alarm or signal.



RADIO CORPORATION of AMERICA

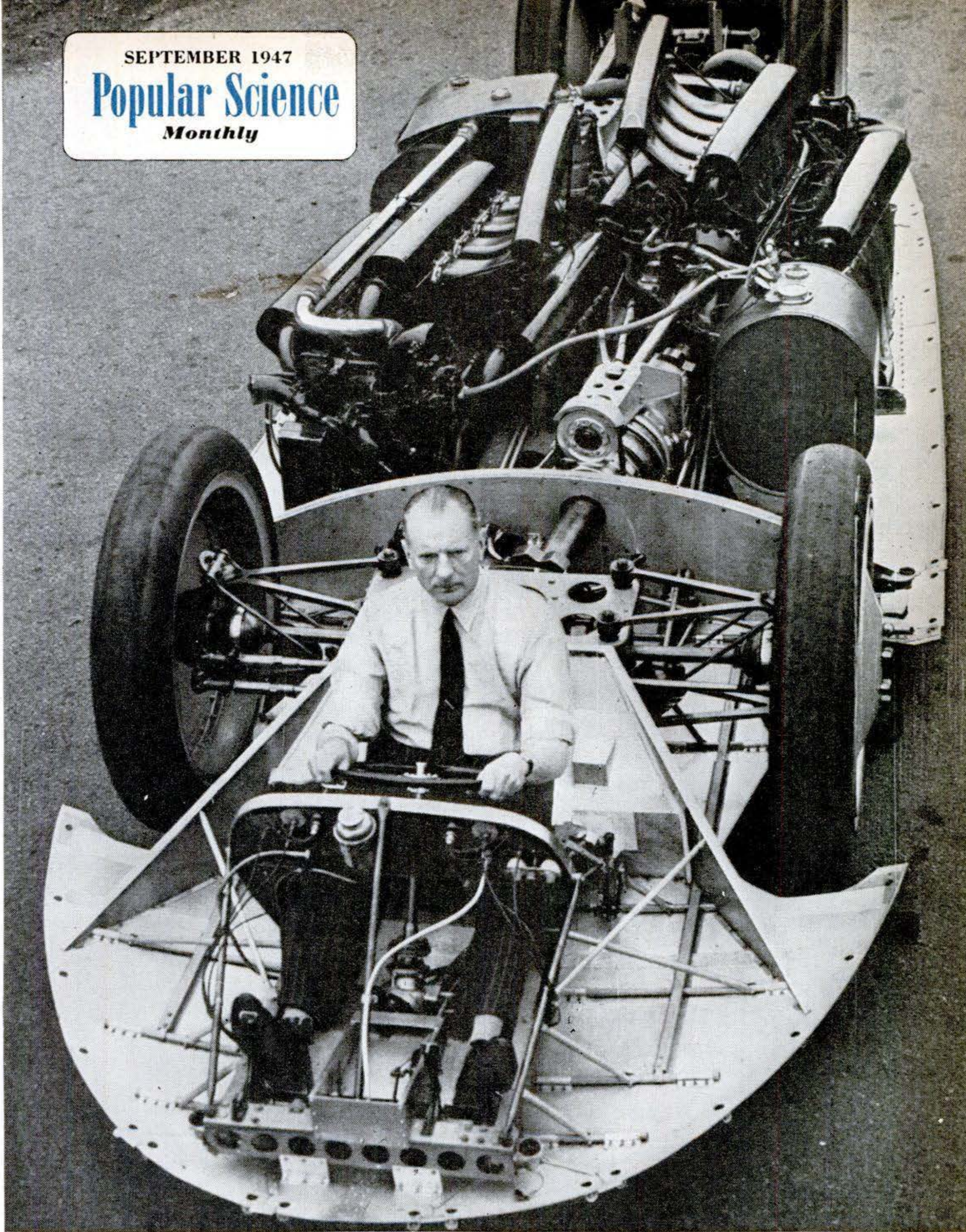

The Champ Gets Set . . . This impressive collection of machinery is the world's fastest automobile, with the titleholder, John Cobb, at the wheel. Back in August 1939, Cobb drove the Railton Special at 369.7 m.p.h., a new world's land speed record, on Bonneville Salt Flats, Utah. Now he's bringing it back again, expecting to go even faster. Here, the streamlined shell of the Railton Special has been removed to show its two Napier 12-cylinder, 1,250-hp. engines. The big car is 28 feet 8 inches long and 8 feet wide.



MANHATTAN
PLAZA

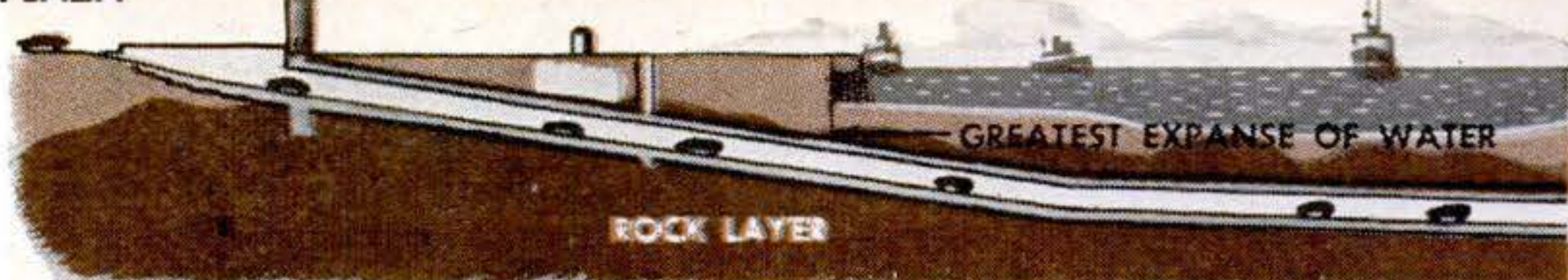

The Brooklyn-Battery Tunnel will carry four lanes of traffic

Sandhogs'

PSM's reporter and cameramen take you beneath a harbor for a preview of the new Brooklyn-Battery Tunnel.

By Alden P. Armagnac

PSM photos by W. W. Morris, Hubert Luckett, and Robert F. Smith.

SANDHOGS won the toughest battle of many a veteran's career when the shields driving the twin tubes of the Brooklyn-Battery Tunnel beneath New York Harbor slid to a stop in the safety of solid rock. The half-mile stretch through the treacherous bottom of Buttermilk Channel was

passed recently, and solid walls of cast-iron rings shut out forever the tons of water that a single false move, before then, would have loosed upon the tunnelers.

Ahead, only a few hundred feet of mica-flecked stone separated them from 4,000-foot rock tunnels, already driven to meet them from the Manhattan side. By the time you read this, the greatest and costliest of all vehicular tunnels may be holed through.

Figures prove the audacity of the \$76,000,000 project. From portal to portal, the Brooklyn-Battery Tunnel measures 9,117 feet. It is 654 feet longer than the Holland

Concrete bulkhead with air locks is being demolished after having served its purpose.

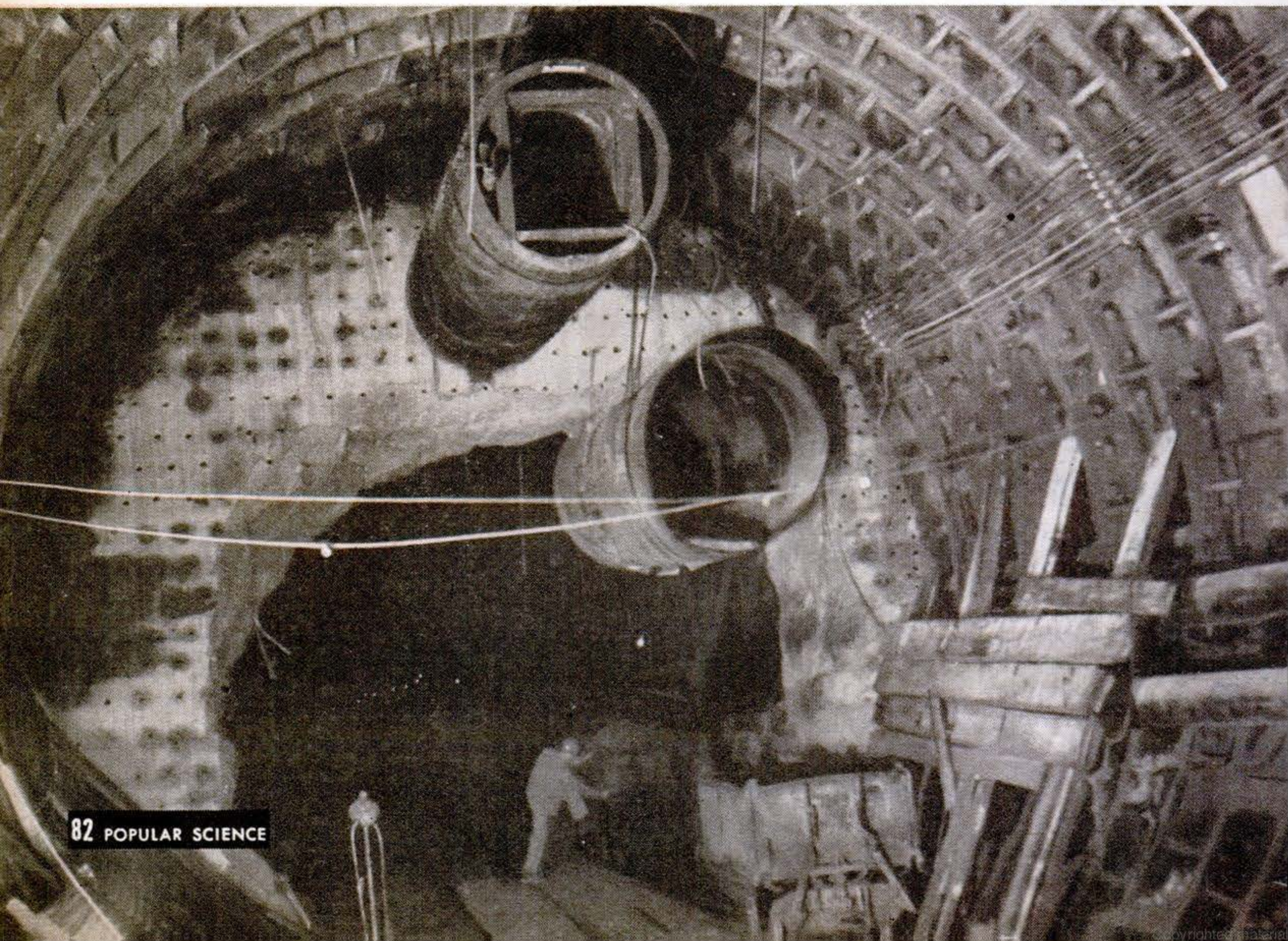

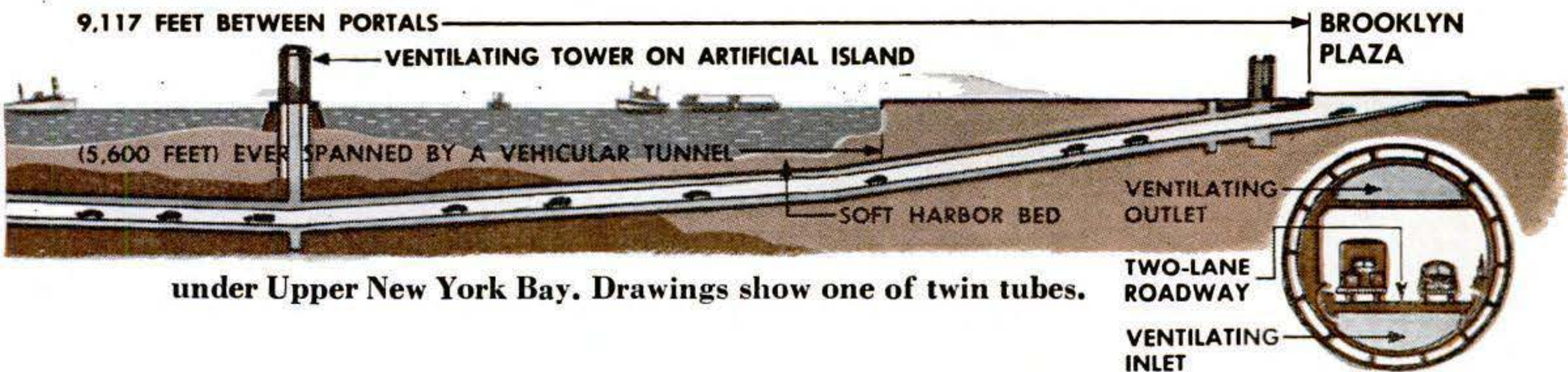

under Upper New York Bay. Drawings show one of twin tubes.

Toughest Job

vehicular tube, the world's longest when it was opened. England's combination highway-and-tramway Mersey River tunnel stretches 10,584 feet between Liverpool and Birkenhead, but even this great single-tube tunnel will be surpassed by the new one as a motor route. The size of the ventilating plants that remove exhaust fumes is the tip-off, since it depends upon the cubic volume of space earmarked for motorists. And the ventilating system of the Brooklyn-Battery tubes, delivering 4,200,000 cubic feet or 160 tons of fresh air every minute, has no rival on earth.

Manhattan and Brooklyn are separated

by 5,600 feet of green water, the widest body traversed by any vehicular tunnel in the world. The Holland Tunnel spans 5,480 feet of open water; the Mersey, less than 4,000. And the Mersey shaft, driven all the way through red sandstone, never needed compressed air to keep the river out. In contrast, sandhogs "locked in" and "locked out" of compressed air more than 1,000,000 times to build the new tunnel.

They forced their shields through mud, sand, gravel, boulders, peat, and ledge. When they're done they'll have excavated enough earth and rock, some 540,000 cubic yards, to fill up lower Broadway's famed

A tunnel locomotive brings up the dynamite car for a blast, in cross-drift between tubes.

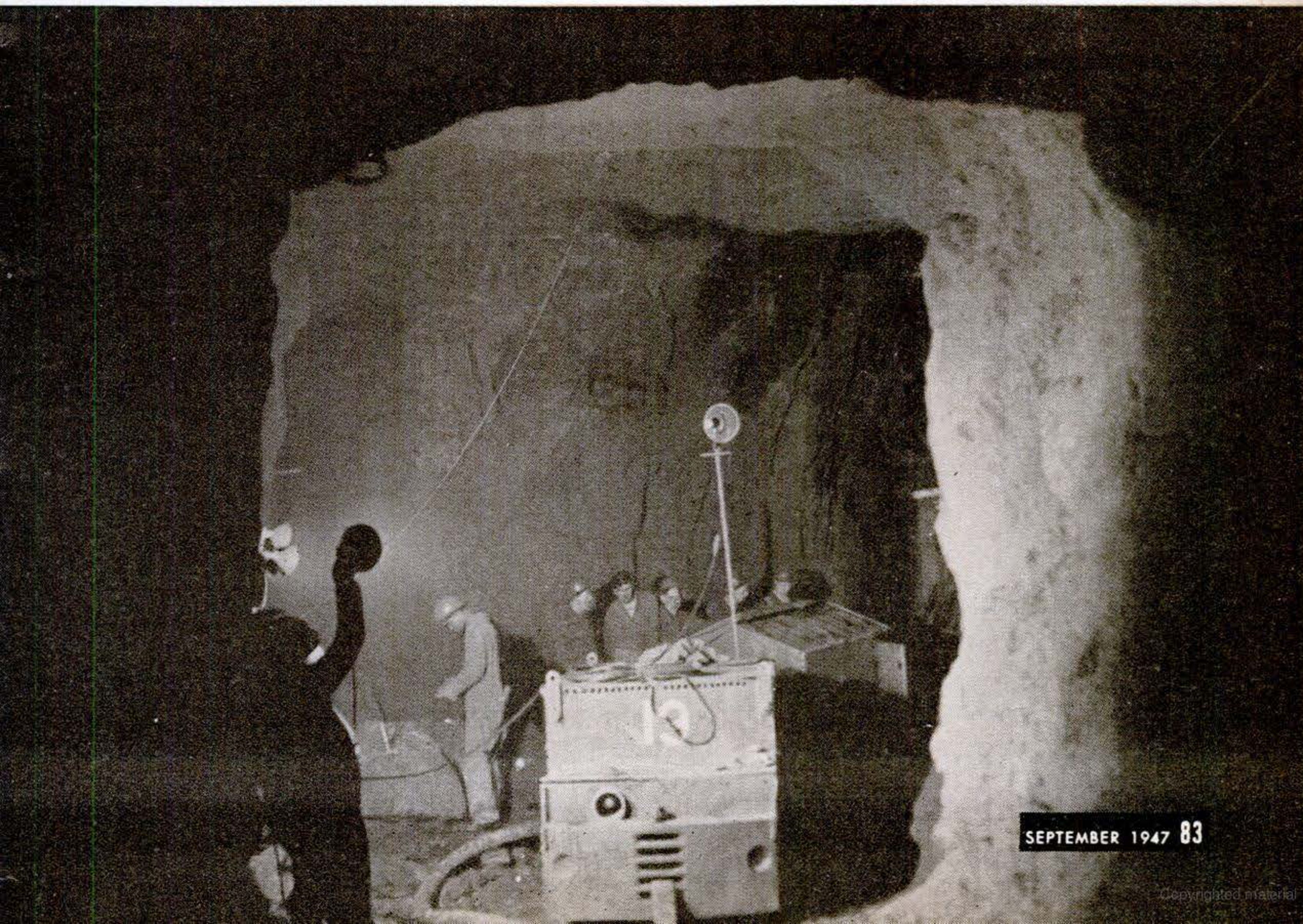



Drill holes are loaded and men atop the Jumbo check electric wires that will fire the blast.

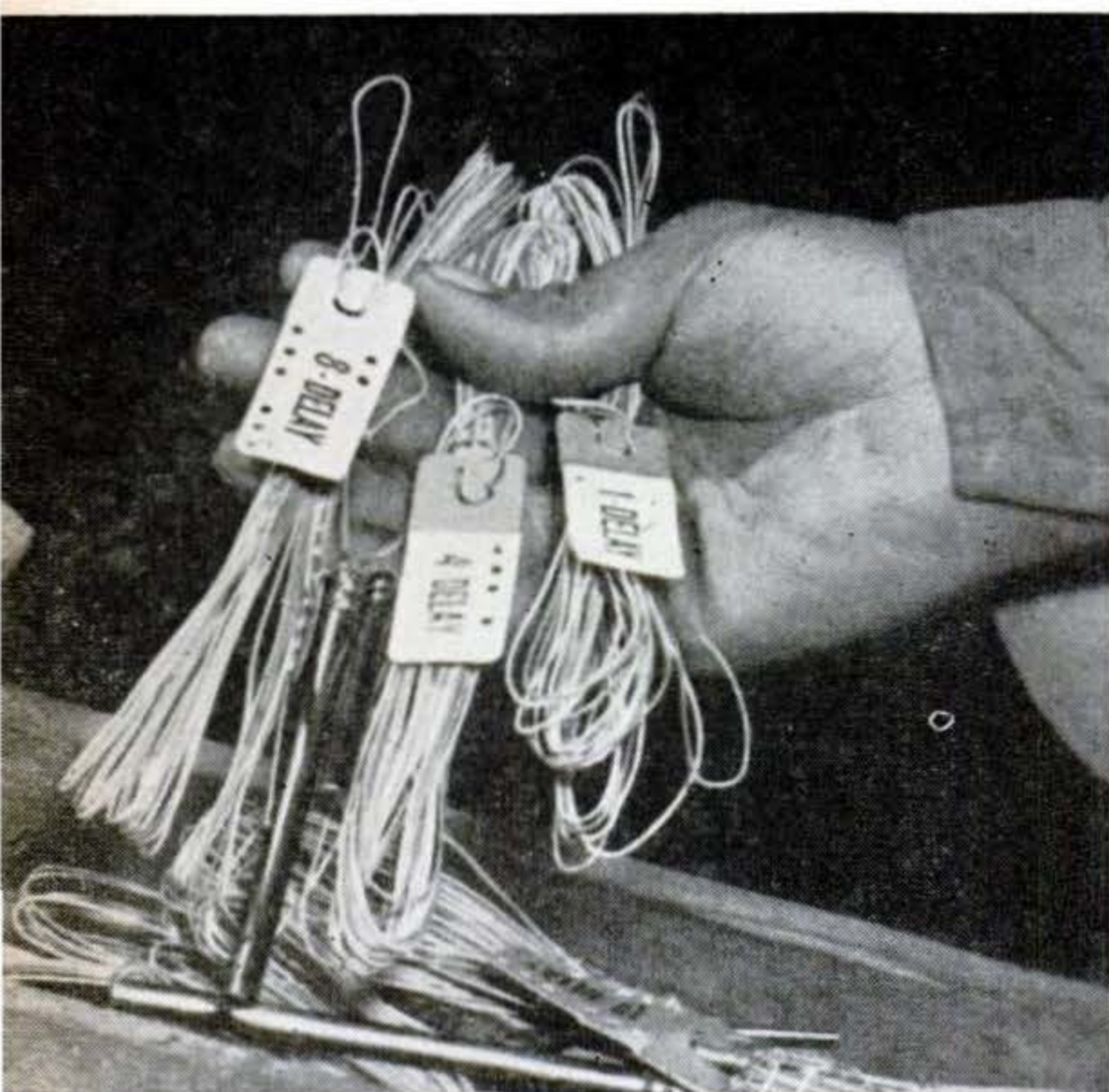

Electric delay caps touch off the dynamite after predetermined number of seconds indicated by numerals on their varicolored tags.

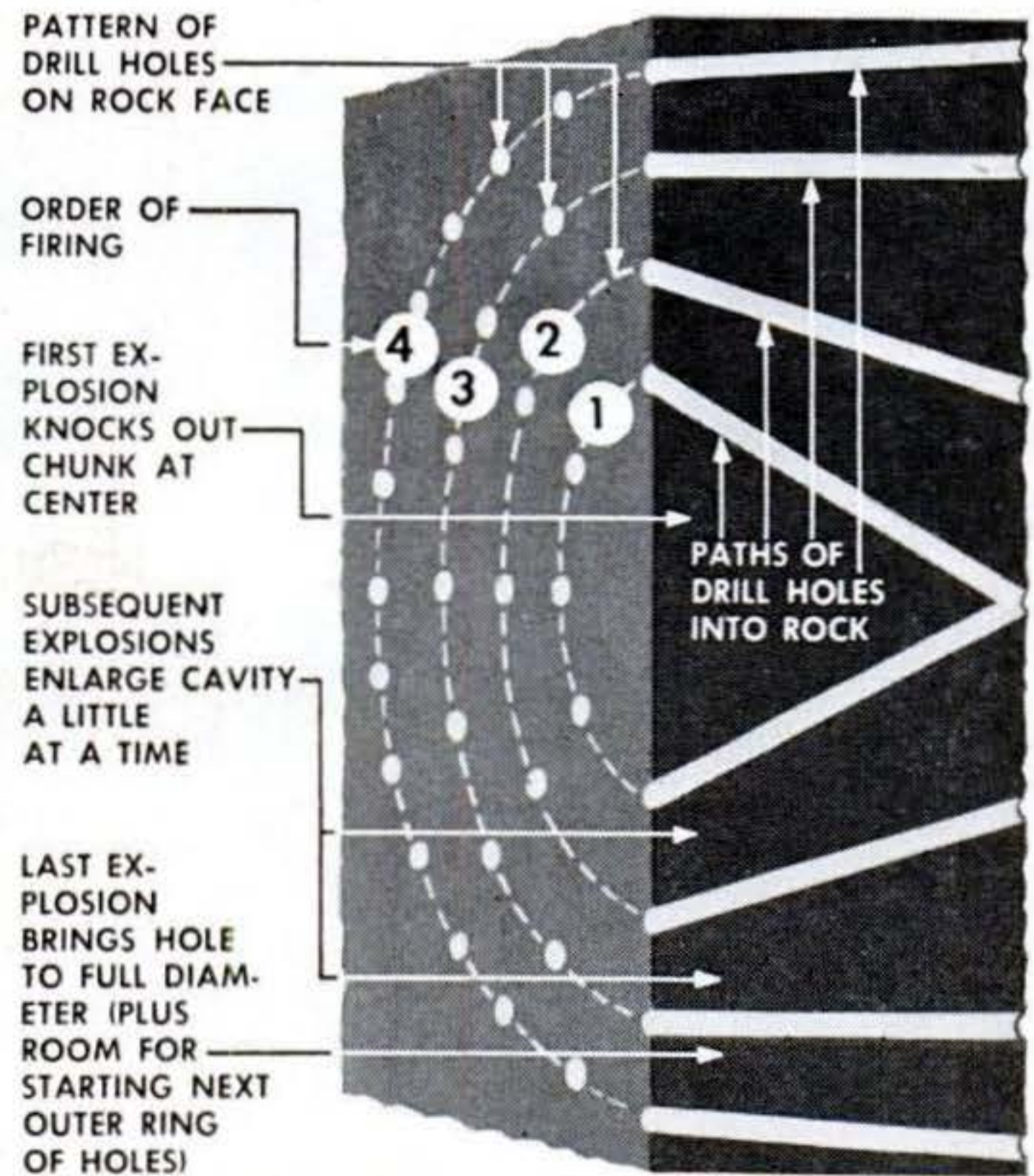

Diagram shows how multiple explosion carves a hole with simple circular outline. More elaborate patterns produce variety of shapes.

canyon to the fourth-story windows from Bowling Green to City Hall.

Scheduled to open in 1949, the tunnel's four traffic lanes will carry up to 16,000,000 cars yearly. Anyone who pays two bits at a toll booth may have a look at its slick bathroom-tiled interior and its fancy fluorescent lighting then. Now, however, only a privileged few can go behind the scenes where the newest wonder of the world is in the making.

Bring Your Rubbers

Come along with Popular Science's reporter and cameramen and see it. Wear your oldest clothes and, rain or shine, bring rubbers along. We'll meet at one of the field construction offices of the Triborough Bridge and Tunnel Authority—designers and builders of the tunnel—just outside the Brooklyn construction shaft of the east tube. There you can choose a sandhog helmet that fits you. That hard crown and shock-absorbing lining may save you a nasty jolt.

Two flights down rough wooden stairs and you're where the tunnelers started. You face the opening of one of the great 31-foot tunnels. Those massive iron rings, lining the tunnel as far as you can see, end peril of floods and cave-ins.

It's nearly three-quarters of a mile to the heading, where things are happening. Let's hop a ride on the back of a tunnel locomotive. Forget about keeping clean and lie flat—we go through tight places. Hang on, now, for a rough ride.

River Seeps Through

Duck your head! The doorway in the bottom of that concrete bulkhead nearly took our helmets off. The walls are bare rock now, and the tunnel is smaller. Our ride comes to an end in the pilot tunnel, through solid rock, under the mouth of the East River. Buttermilk Channel, overhead, seeps through the roof, runs down our necks, and spatters our faces with brine.

That noise like a million pavements being torn up comes from the Jumbo up ahead, the big drilling carriage on rails that reaches nearly to the tunnel ceiling. Seven high-speed drills at its forward end are going full blast. Using high-pressure air—80 pounds to the square inch—they penetrate nine feet of rock in 12 minutes.

Our locomotive is back again with a red car labeled "EXPLOSIVES" in white letters and reflector buttons. Floodlights blaze on



Scaler pries down loose rocks after a blast. His job looks deceptively unexciting, but tunnel men consider it the riskiest of all.



Mucking machine attacks the pile of rock thrown down by the blast. PSM's cover gives another view of the machine in action.

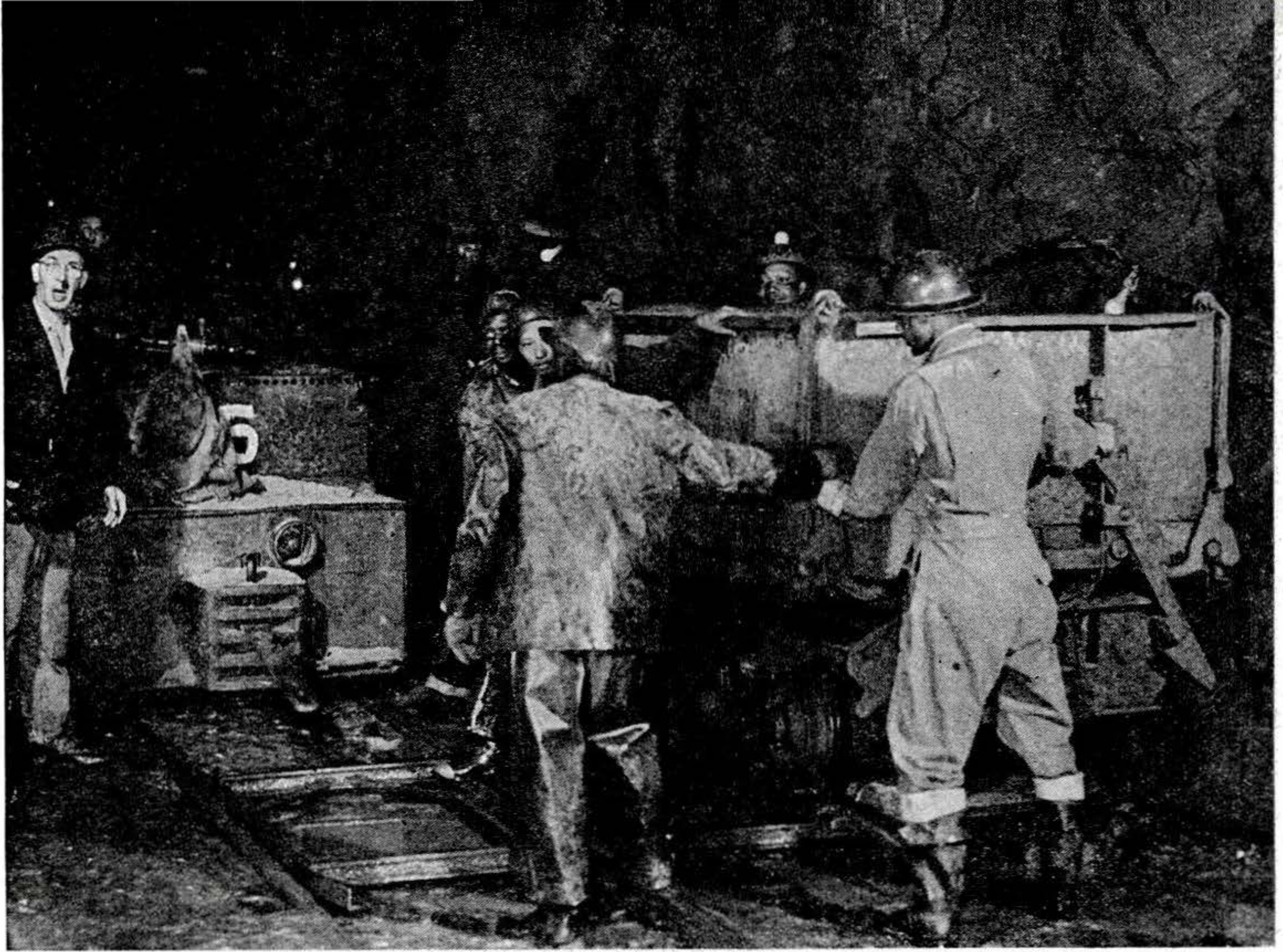

Shunting maneuvers with California switch prevent runaways on downgrade to the heading.

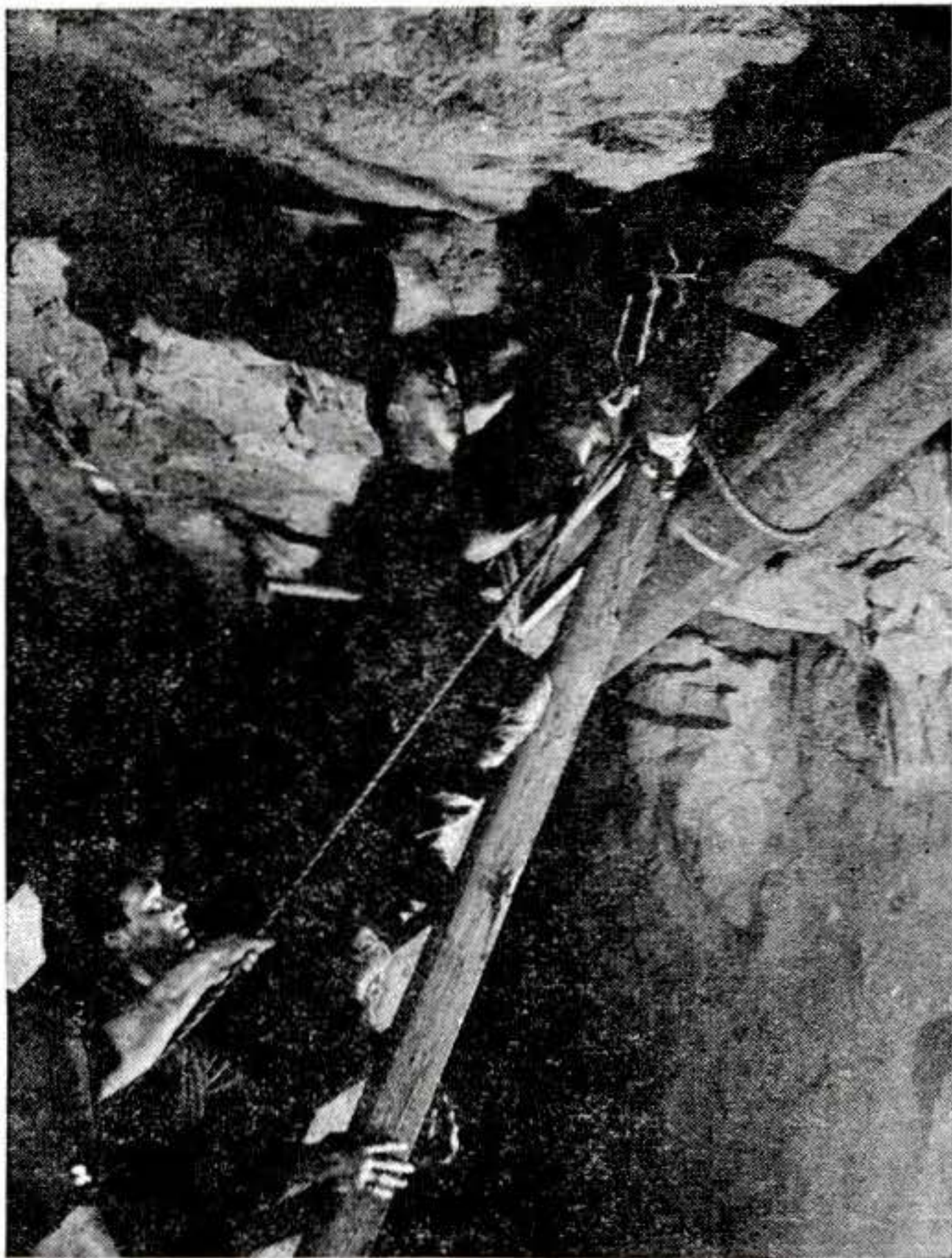

End of compressed-air operations permits installation, above, of pipes bringing fresh air to workers. (Smokers can now light up.)

men loading drill holes with 736 sticks of dynamite. Colored tags on the wires going into the holes bear labels like "Delay-4" and "Delay-6." Those are the number of seconds that will elapse, after the firing switch is closed, before each pencil-shaped blasting cap touches off the charge. There'll be a rapid-fire series of explosions, each one making room for rock to be knocked out by the next. If the rock has no place to go, the dynamite would simply blow the tamping out of the drill holes.

Like the blasting crew, we retreat 500 feet and flatten ourselves against the iron rings. A shock wave of air almost knocks us down. Then come the crashes of a heavy-artillery barrage. When we return to the heading, a husky "scaler" with a long crowbar is already prying down a chunk of roof loosened by the blast. He has to guess right about where the rock will fall, or else!

Below the ledge where he stands, a "mechanical mucker" (see cover) goes into action. Running on rails, it backs up, then lunges forward at the pile of blast-loosened rock, scooping it up in a bucket. Then the rising scoop wriggles from side to side, shak-



Iron rings consolidate sandhogs' possession of the shaft they wrested from the river bed.

ing its contents rearward onto a conveyer belt that deposits the rock in a rail car. Dancing on foot pedals and manipulating hand levers, the operator of the machine makes it seem almost alive.

The men roll back the rock-filled car and shunt it sideways off the main track, on a "California switch," to let a locomotive get past and push it out. A car coming uncoupled and running wild, downgrade to the tunnel heading, might plow into the workers crowded there. There are derailleurs to avert this, but the locomotive comes in ahead of cars and goes out behind them as an added safeguard.

Now for a closer look at the sights as we start walking back toward the entrance. About 200 feet from the heading, the rings end and the rock tunnel begins. Cars run through the lowest and largest opening in a great drum-shaped object of steel that fills up the whole tunnel. This is the shield, the underground bulldozer that led the sandhogs' drive through the rough going. A circle of 200-ton hydraulic jacks shoved it forward, 32 inches at a time. Each shove left room for an erector arm at its rear to



Sealing ring joints with waterproof calking of solid lead marks end of victorious battle to keep out the tons of water overhead.

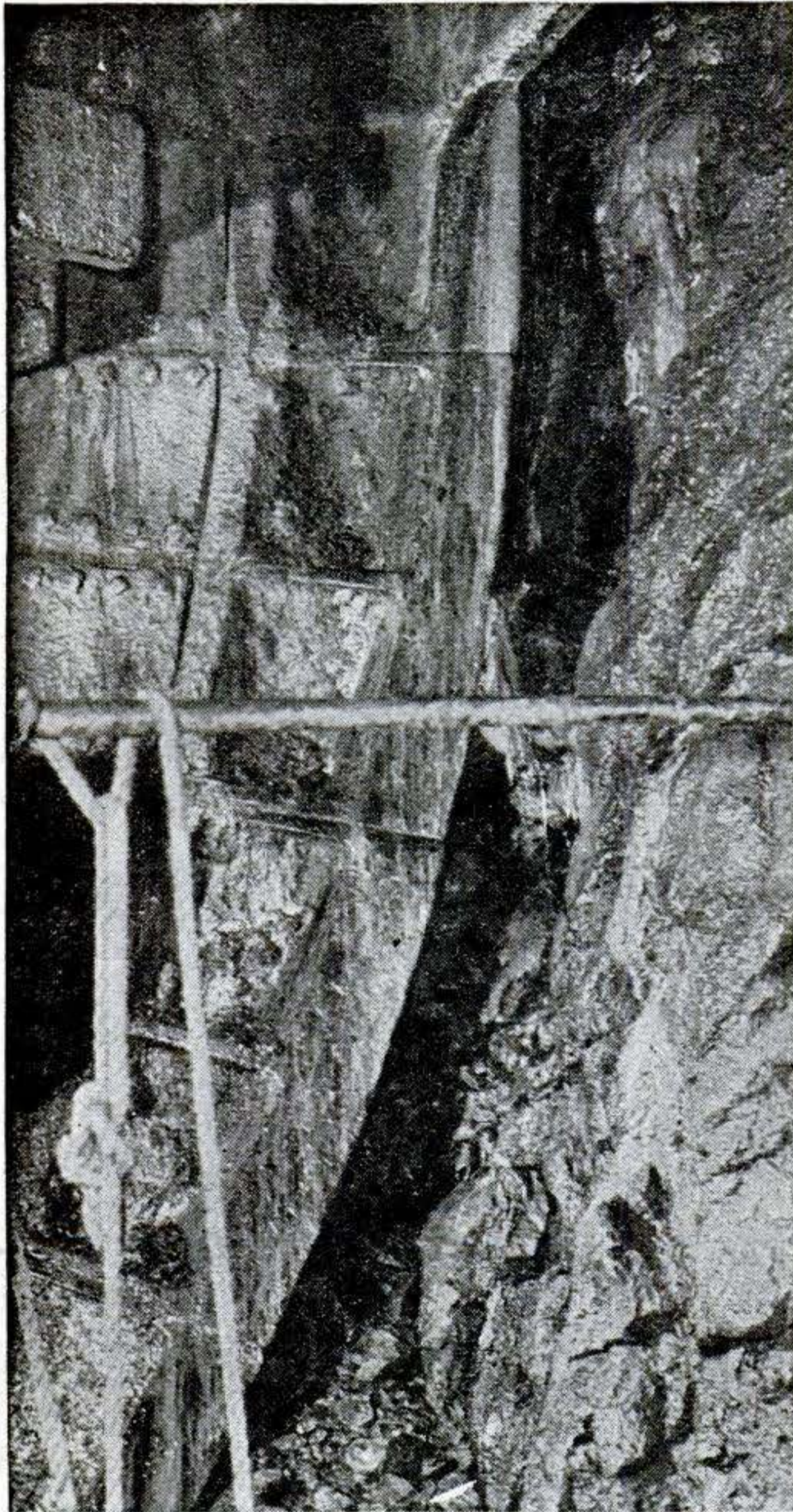

Cutting edge of 350-ton tunneling shield stopped here in solid rock after its perilous journey through the ooze of New York's harbor.

assemble a new ring, from 14 segments and a key section. (Those bolts fastening the rings together are no watch charms—they weigh 10 pounds apiece.)

A shield driver's idea of paradise is the kind of soft Hudson River silt that the builders of the Holland and Lincoln Tunnels struck. You can close all but one or two openings in the shield, shove it "blind"—simply by main force—and the river bed comes out at the back like toothpaste from a tube. You advance just as fast as you can erect iron behind the shield; 19 rings in 24 hours was the Lincoln Tunnel record.

But the East River bottom, encountered by the Queens Midtown and Brooklyn-Battery tubes, is the tunnelman's purgatory. Men had to get out in front of the shield and dig, chip and blast out the mixture of soft stuff with boulders and sloping rock before it could move an inch. Actual "shoving" takes only 5 to 15 minutes, but one or two rings a day was good progress for this tunnel when the going was tough.

A few steps more bring us to a solid wall of concrete across the tunnel, with iron cylinders protruding through the 10-foot thickness of the bulkhead. That little one at the top is the emergency lock; the one on the side, the man lock; the bottom one, which we rode in through, is the "muck lock" for cars. Men and materials passed through these locks while compressed air held the river out.

Man locks of this tunnel had new helium-oxygen inhalation kits for sandhogs having trouble going under pressure. No matter how much a man waggles his jaws and

CONCRETE BULKHEAD WITH AIR LOCKS

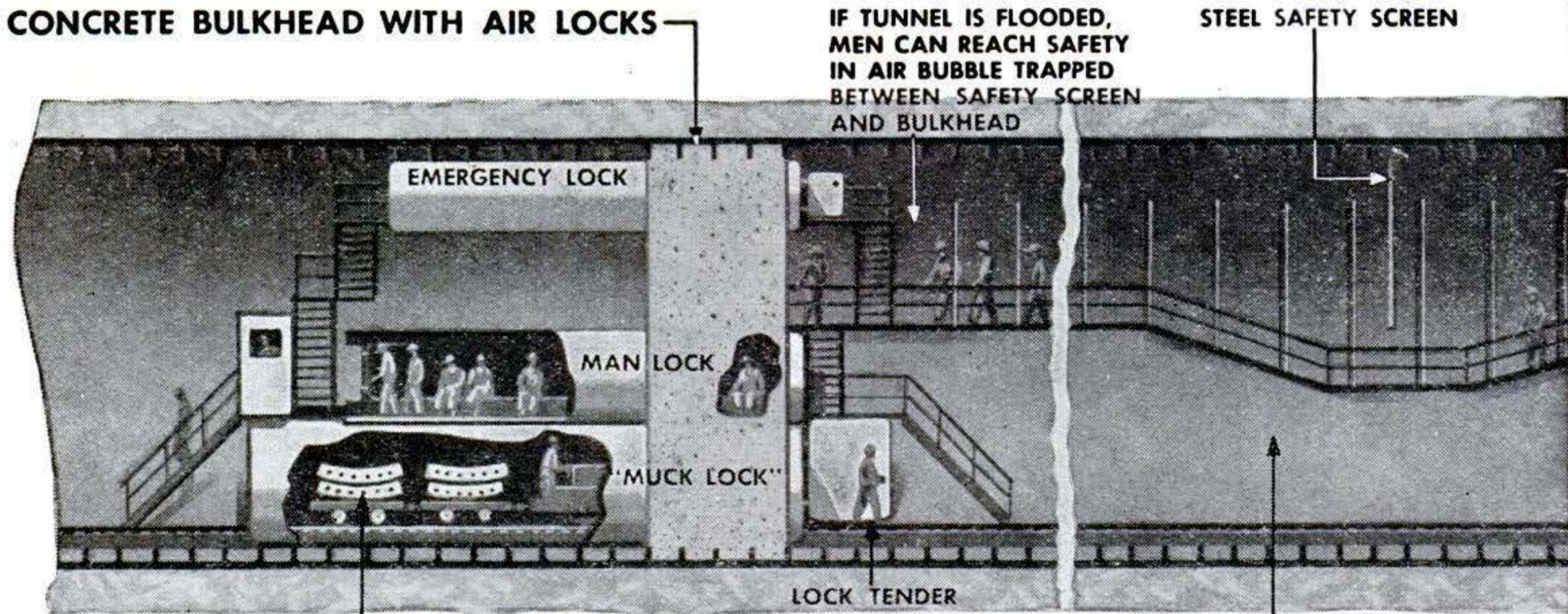

CAST-IRON SEGMENTS FOR BUILDING TUNNEL RINGS

TUNNEL SECTION UNDER COMPRESSED AIR

Compressed air held river out while sandhogs drove shaft through soft harbor bed with aid



Man lock in concrete bulkhead admitted sandhogs to section of tunnel under compressed air.

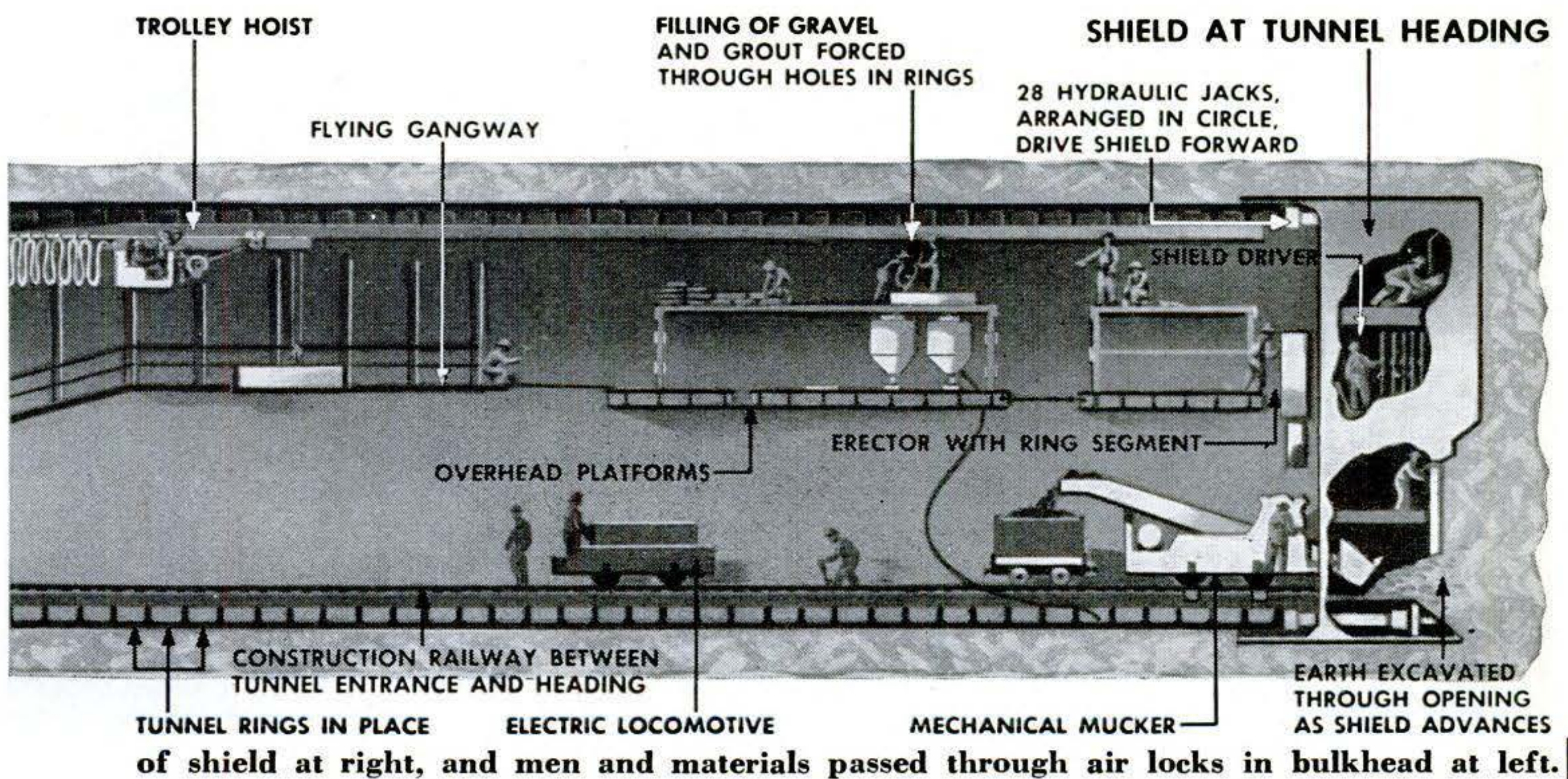

swallows, there's sometimes a stoppage in his ears and severe pain from the rising pressure in the lock. If he grins and bears it, rather than face the others' jibes, he risks permanently injured eardrums. Otherwise, the lock tender must decompress a gang of 50, "lock out" the sufferer, and start over.

Now, at the first sign of trouble in the man lock, the sandhog takes out a black rubber mask, resembling a football nose-guard. A few whiffs of a mixture of helium and oxygen gas, from a cylinder attached to the kit, and he is OK again. The thinness of the gas, compared to ordinary air, enables it to penetrate his air passages and relieve the stoppage. The outfit was specified for the first time as standard equipment by the Brooklyn-Battery contracts.

"Bends" remain to be licked. Within a couple of hours after leaving the tunnel, one man out of every 700 was likely to be overtaken by this painful, sometimes temporarily paralyzing illness. So that he wouldn't be mistaken for a drunk if he passed out cold, every sandhog wore a metal badge pinned to his shirt. It read: "Compressed Air Worker. If ill rush by ambulance to hospital lock located at 98 Hamilton Ave., Brooklyn, N. Y."

Digging a tunnel under 38 pounds' pressure, the maximum used here, was so strenuous that two shifts of an hour and a half apiece, with a 4½-hour rest period between, constituted a good day's work. If a cave-in flooded the heading, the men would dash for the safety of an overhead gangway, behind a solid steel "safety screen" extending halfway down the tunnel's diameter. An enormous bubble of air trapped between the safety screen and the concrete bulkhead would keep water from reaching them, while they escaped through an emergency lock; the bulkhead would wall off the river from the rest of the tunnel. This never happened on this job, but 20 men drowned for lack of such a precaution when the first Hudson River rail tunnel was built.

Now that the concrete bulkheads have served their purpose, they'll be blasted away to clear the tunnel. This next one we're coming to is already partly demolished. Only traces show where a third has been.

Back at the entrance and up the stairway, we step from the cool, dank atmosphere of the tunnel into the hot sunshine. We look like scarecrows, but we've seen the toughest tunneling job in the world on the eve of its completion. END

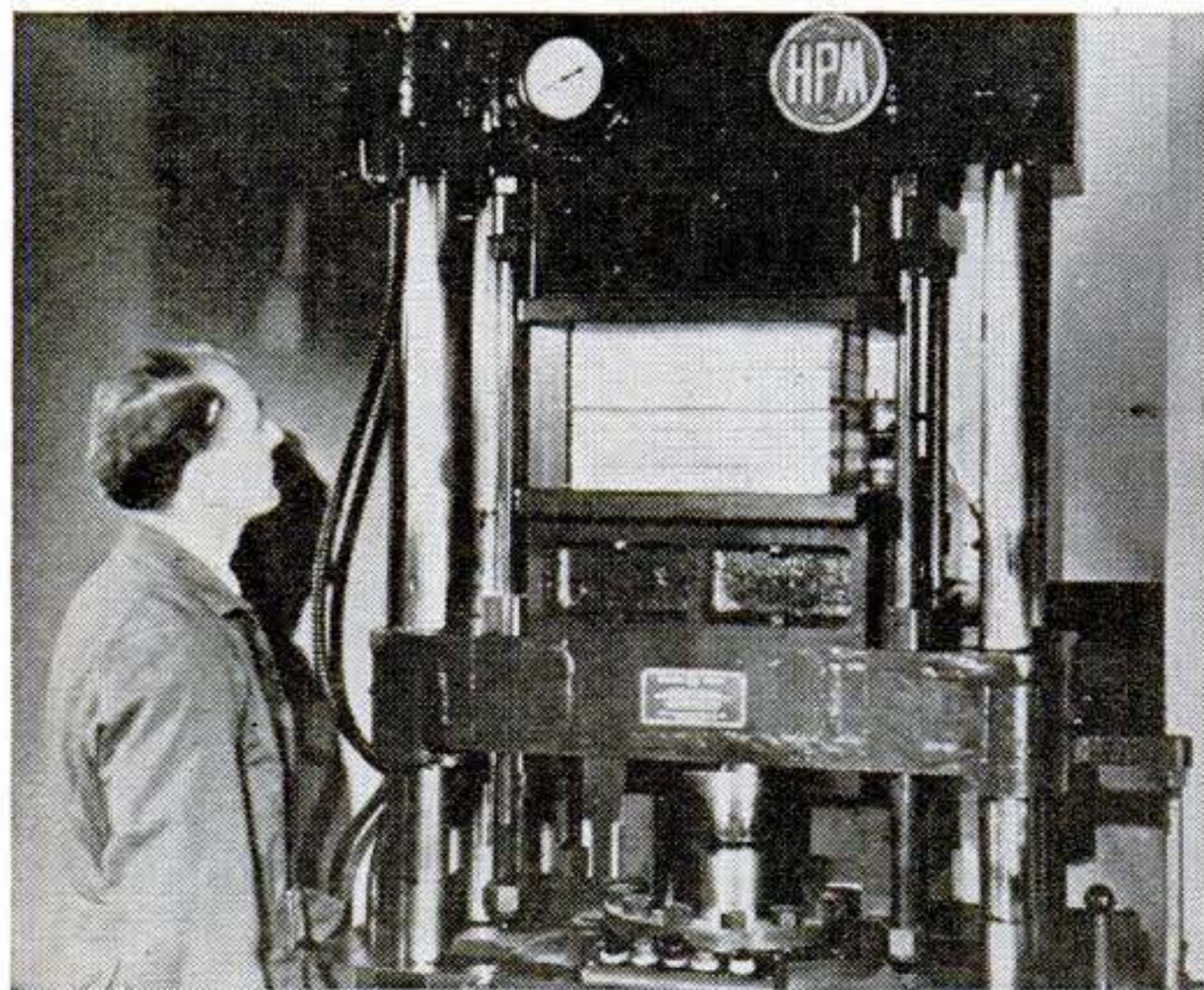

Plywood by the Foot

IN A laboratory demonstration of the efficiency of high-frequency radio waves for dielectric heating, Westinghouse engineers have constructed plywood more than a foot thick. The experimental chunk was made up of 148 layers of birch veneer, and it proved to have a tensile strength equal to that of aluminum—15,000 p.s.i.—although it weighed only half as much.

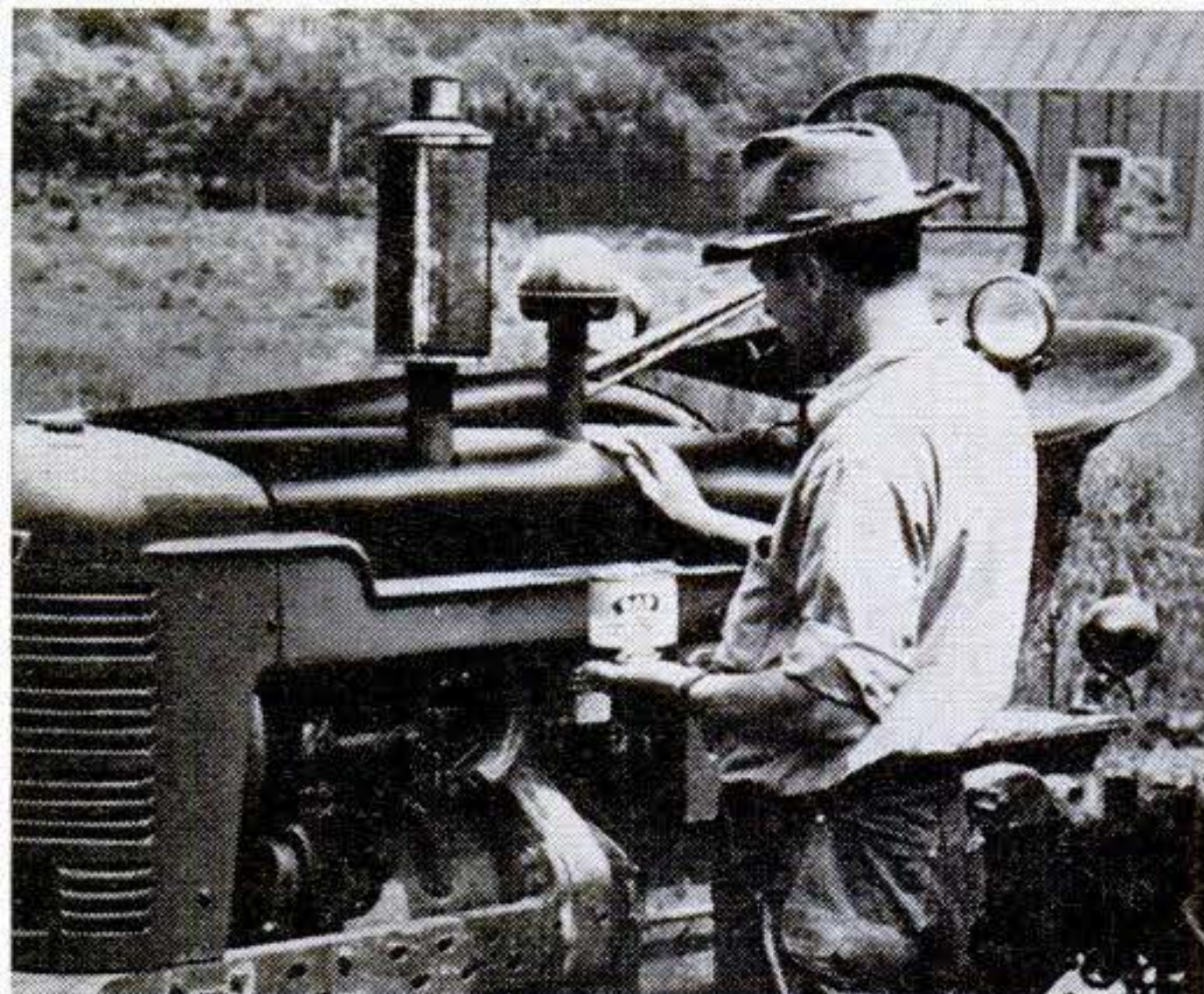

Paint Needs No Brush

WIPED on with an applicator pad, a new paint for cars, farm equipment and other metal objects is said to give a glossy, professional-looking finish with a minimum of trouble. It is called Dab, for obvious reasons, and its lasting qualities as an automobile finish are guaranteed for a period of two years. It is being distributed by the Nu-Way Paint and Supply Co.

'Echo Flashlight' Helps the Blind Find Their Way

A "SOUND FLASHLIGHT" that enables the blind to use their ears for eyes has been developed at New York's City College. Smallest, lightest and least expensive device of its type yet developed, the apparatus has the effect of hanging a warning noise on any obstacle in a blind person's path.

It is the size and shape of an ordinary flashlight, but instead of a beam of light it projects a narrow beam of sound that is barely audible to the user when nothing lies ahead. Any obstacle, however, such as a lamppost, tree or fence, reflects the directed beam and changes its low, steady whine to a louder warning screech.

The device has three principal parts: an audio oscillator; a small headphone unit, or transducer, that converts the electrical oscillations to sound; and a parabolic reflector. An absorbent baffle is mounted around the rim of the reflector to prevent the sound from traveling directly to the user's ears.

The sound flashlight was developed by three City College undergraduates—two biology students and a former Army photographer who is studying physics—with the help of a faculty member. They planned the device as a scientific refinement of cane-

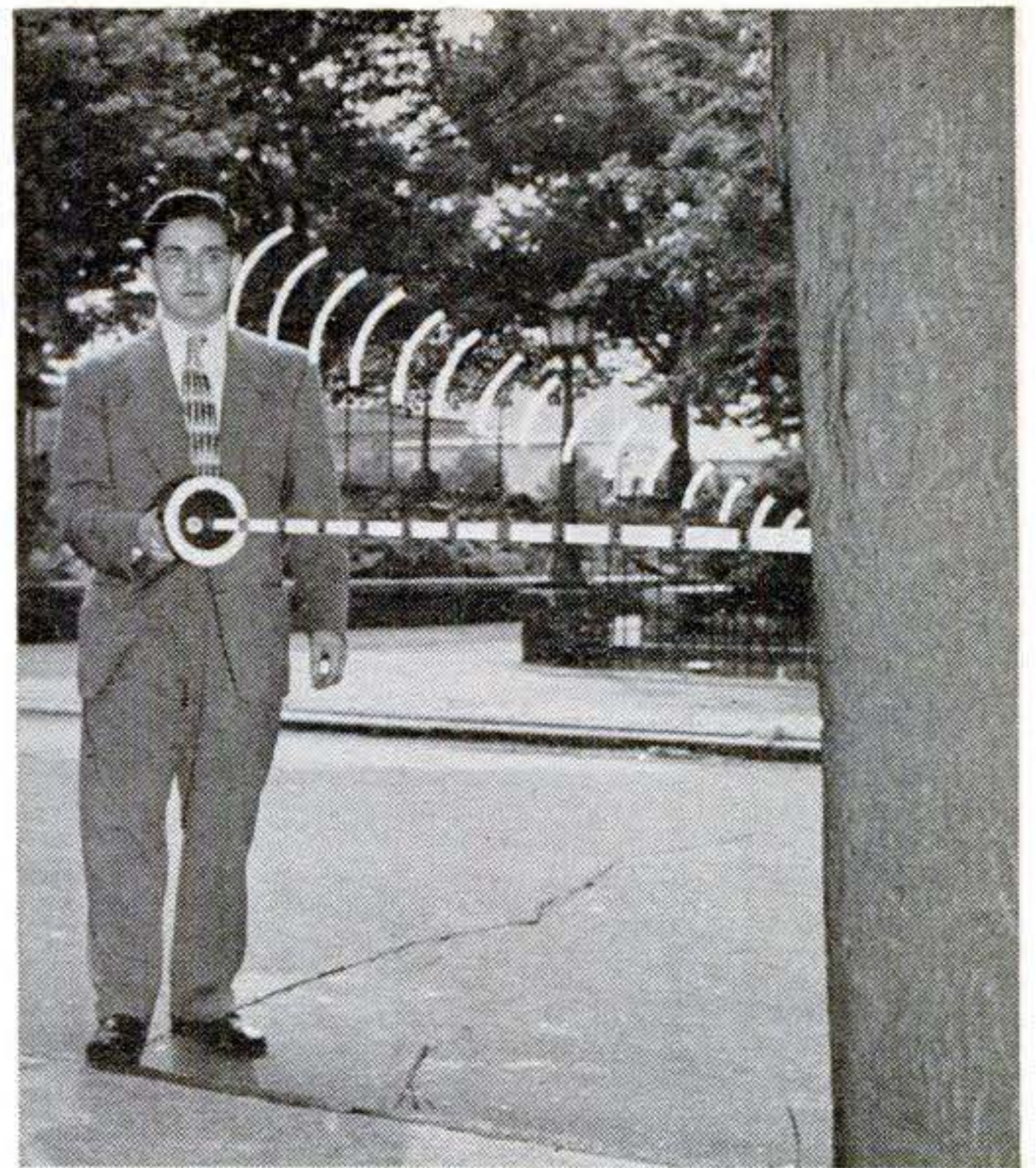

Projected beam of "sound flashlight" is shaped by the reflector, but when it bounces off tree it is audible to the user and anyone else near by.

tapping and finger-snapping—one that would aid blind persons in training their sense of hearing to build up acoustical images in compensation for their loss of sight.

The original model cost \$75, but commercial versions probably can be produced for much less. Also, while the working models are eight inches or more in length, manufacturing techniques may produce an apparatus that will fit in the head of a cane.

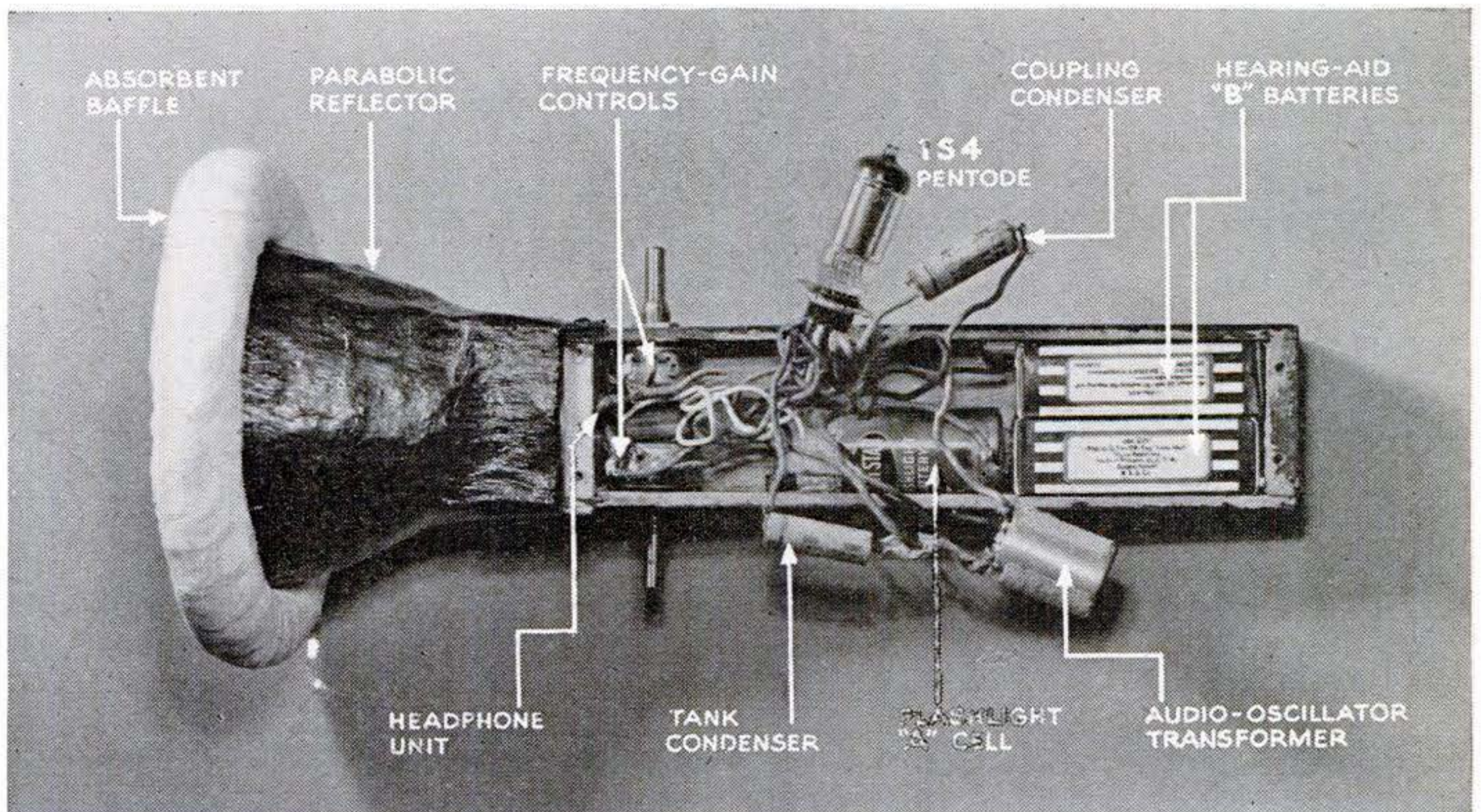

Cutaway of working model shows simplicity of construction; all parts normally fit inside case.



WHAT'S NEW IN AVIATION



Lightning Strikes Thrice. This birdcage is a man-made thundercloud that can blast the Northrop F-15 with three bolts of lightning, but the bubble canopy will not

shatter. A protective strip on the canopy carries away the 200,000 amps the generator produces for 1/10,000 second. Test was at Lightning and Transients Research Institute.

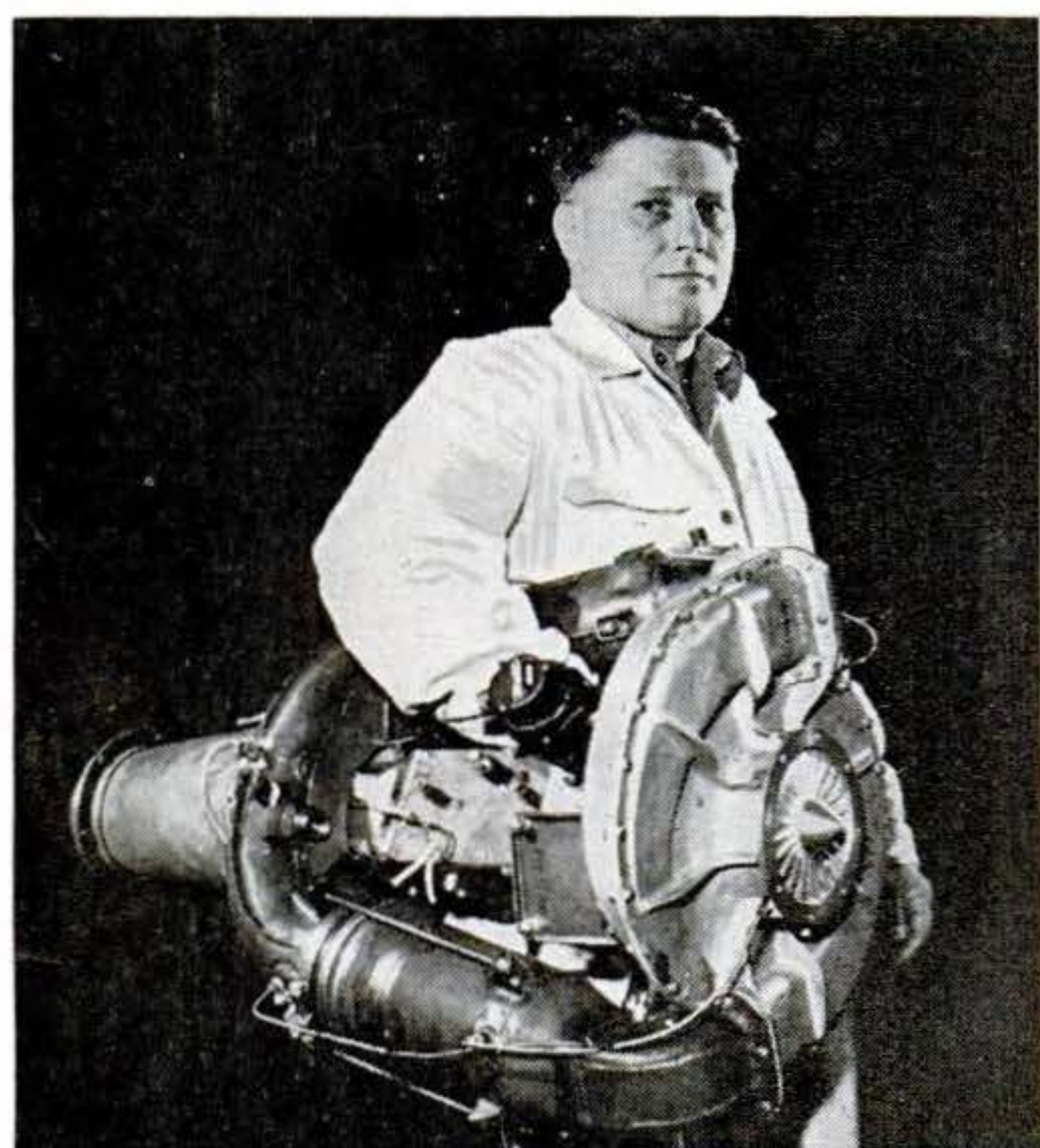

Jet Sheds Weight. You can tuck this 85-lb. turbojet under your arm, but it delivers a 150-lb. thrust. The Boeing Model 500, only 29 inches long and 22 inches in maximum diameter, is adaptable to aircraft, missiles or target planes. High-velocity exhaust gases, heated to 1,500° F., drive its turbine wheel, which is 7½ inches in diameter.



Smallest Man-Flier. This plane, and its twin, are the smallest man-carrying aircraft in the world—and they make 200 m.p.h. Weighing only 530 lb. including an 85-hp. engine, each is 15 feet long, four feet high, and has a 19½-foot wing span. The pair are entries in the new 190-cubic-inch class in the Cleveland Air Races.

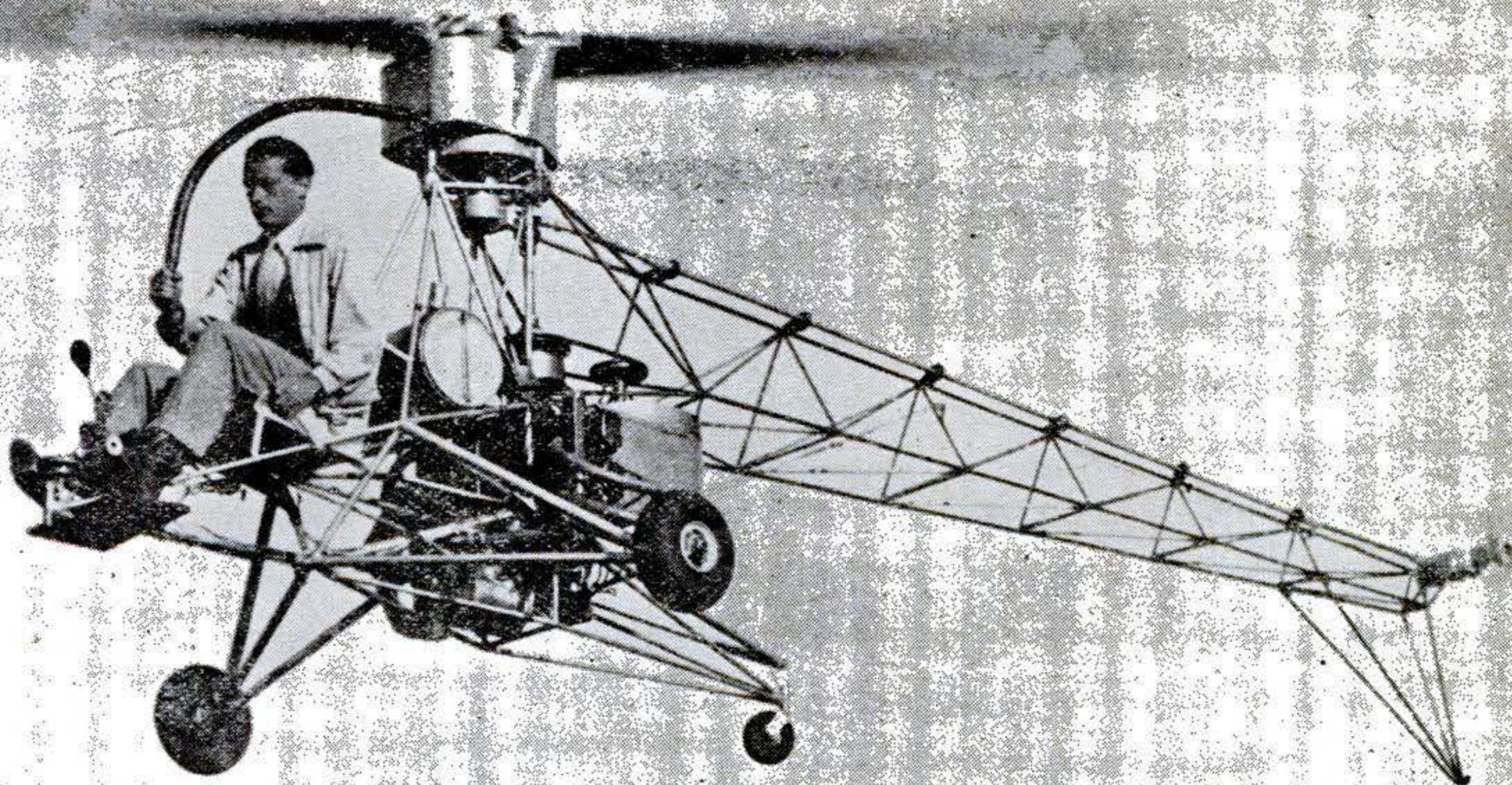

One-Hand Control. The “elephant trunk”-this helicopter pilot grasps is a new simplified control. Replacing the usual “wobble plate” with a direct connection to the rotor head, it “rolls” the rotor into the desired plane. This increases pitch in one

blade and decreases it in the other, steering the 'copter. The new system sharply cuts the number of moving parts, reducing weight and upkeep costs. Developed by United Helicopters, Inc., its principles will be used in a new commercial model.

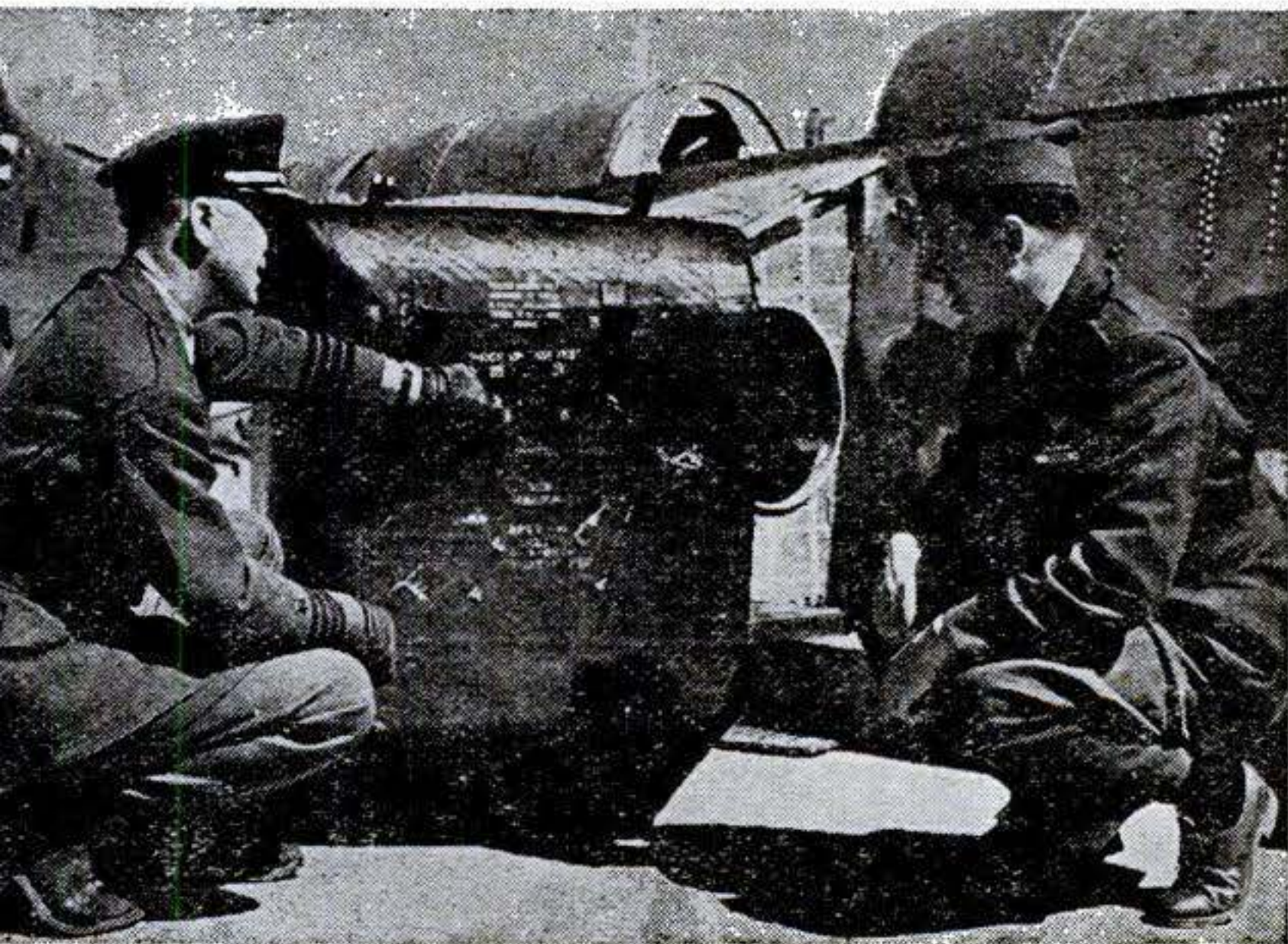

Lighter Self-Sealer. This new self-sealing fuel tank is 40 percent lighter than previous types, which means better performance for the Navy's planes. It is made of the same materials—mostly synthetics—but with improved curing and processing. The Navy and the United States Rubber Company developed the tank.



Heaviest 'Copter Checks Out. The Kellett XR-10, heaviest and most powerful helicopter in the world, has completed its first test flight. Its twin 525-hp. Continentals make over 100 m.p.h.; range is 350 miles. The Air Forces' largest 'copter, it carries 10 passengers or 2,000 lb., plus two pilots. Gross weight is almost 11,000 lb.



WHAT'S NEW IN AVIATION

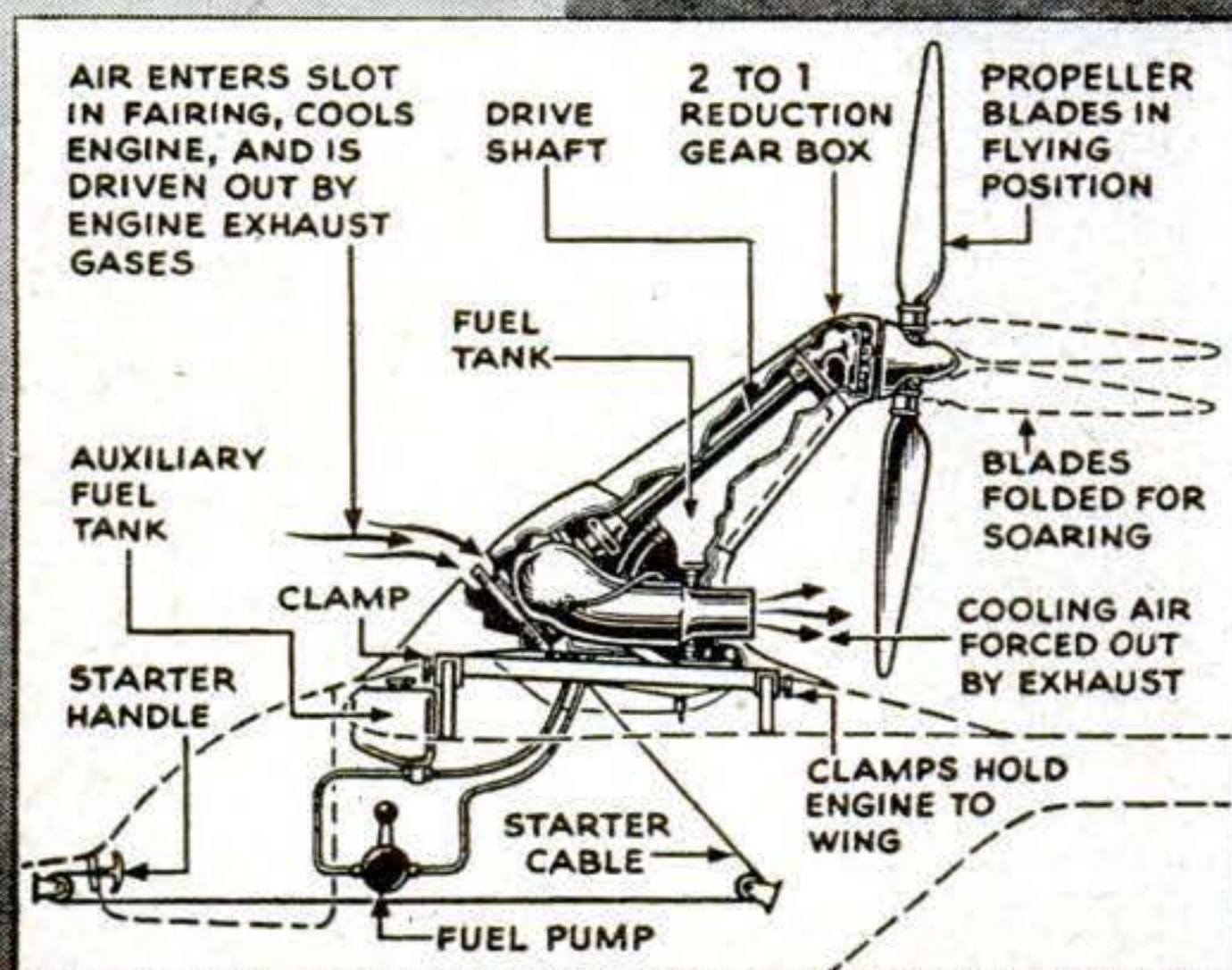
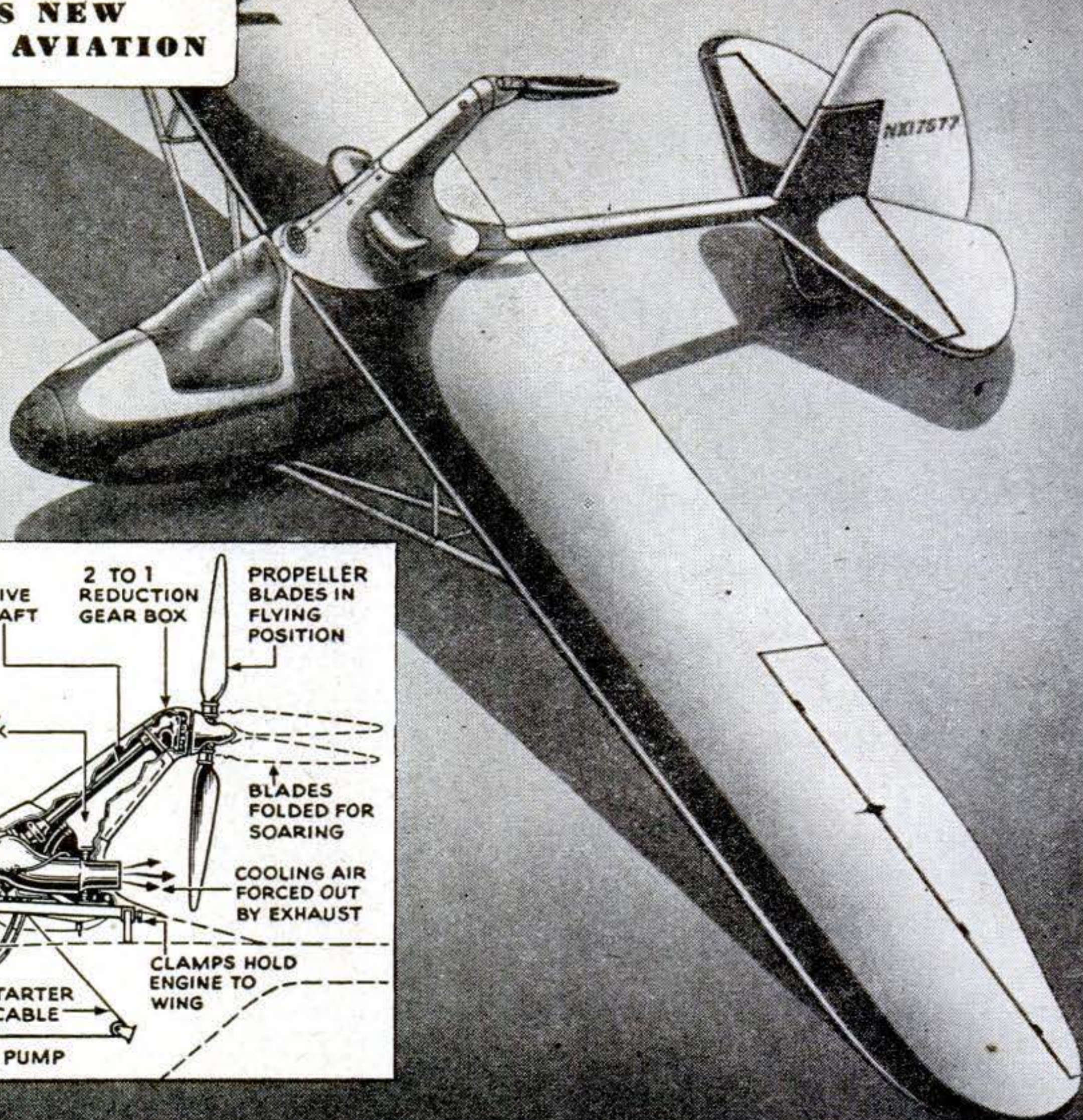

Glider Gets "Outboard." Gliders will be able to take off without help of winch or tow with a new auxiliary engine that clips on like an outboard. The whole unit, including fuel and propeller, weighs only 80 lb., so one man can carry and attach it. The 22-

hp. engine will take a glider off the ground in less than 500 feet, climb 300 feet a minute, and cruise for an hour. For soaring, the propeller automatically folds back. The flying outboard was designed by E. H. Rowley, Boeing flight-test chief.



Antenna Cuts Drag. These two antennas do the same job, but the new RCA slotted type (top) eliminates drag on high-speed planes. Set flush, it is plastic-covered.

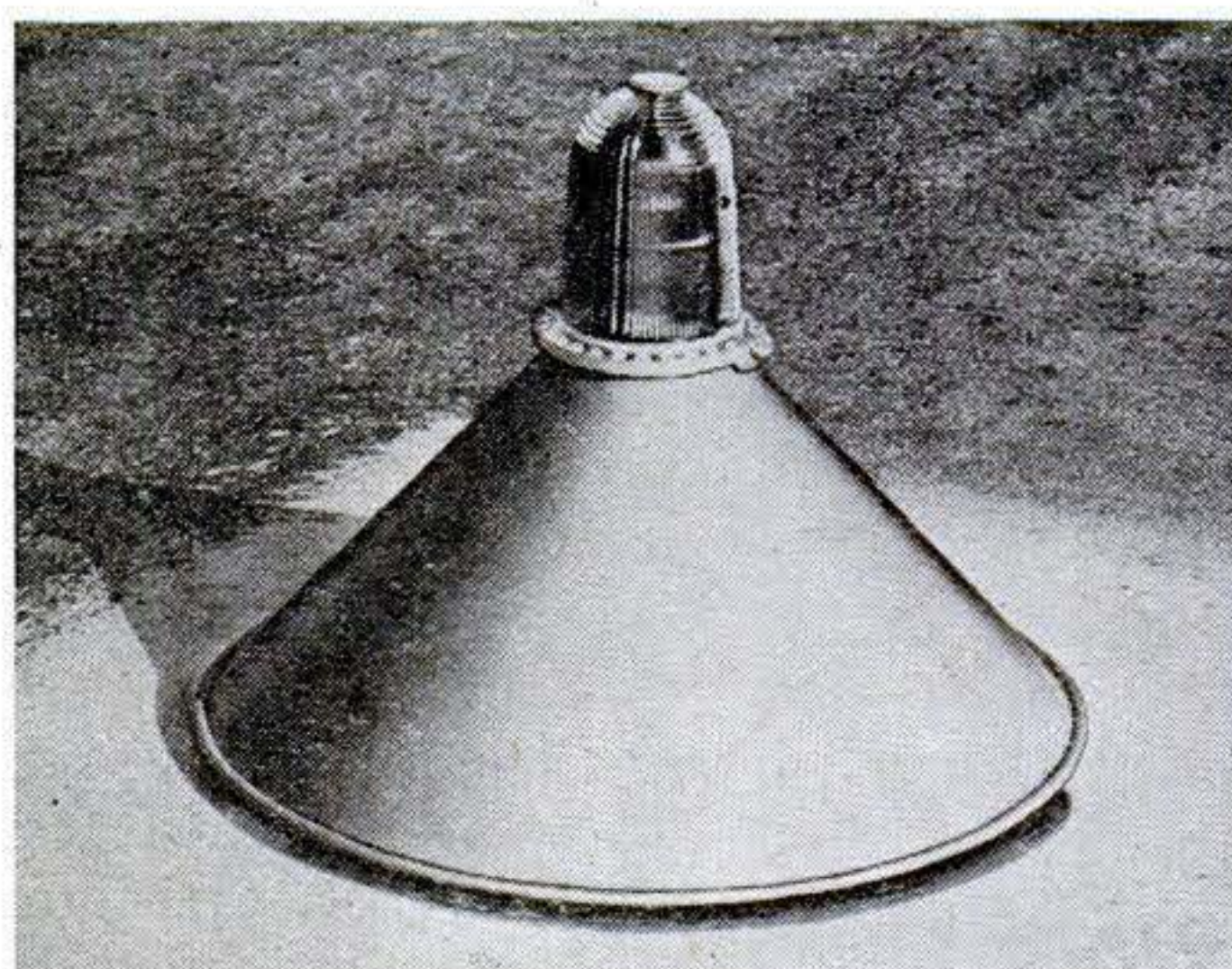

Better Runway Light. This runway marker light sticks its neck out so you can see it. The American Gas Accumulator Co. says it's more visible than semiflush type.



New Light Ends Stargazing. No pilot is likely to confuse a star or ground light with these new plane lights, which outline tail and wing tips with lucite. The

Navy developed them after finding that fliers in night formations would miss a single light or, worse, suffer the illusion that it was dipping and crash trying to follow.

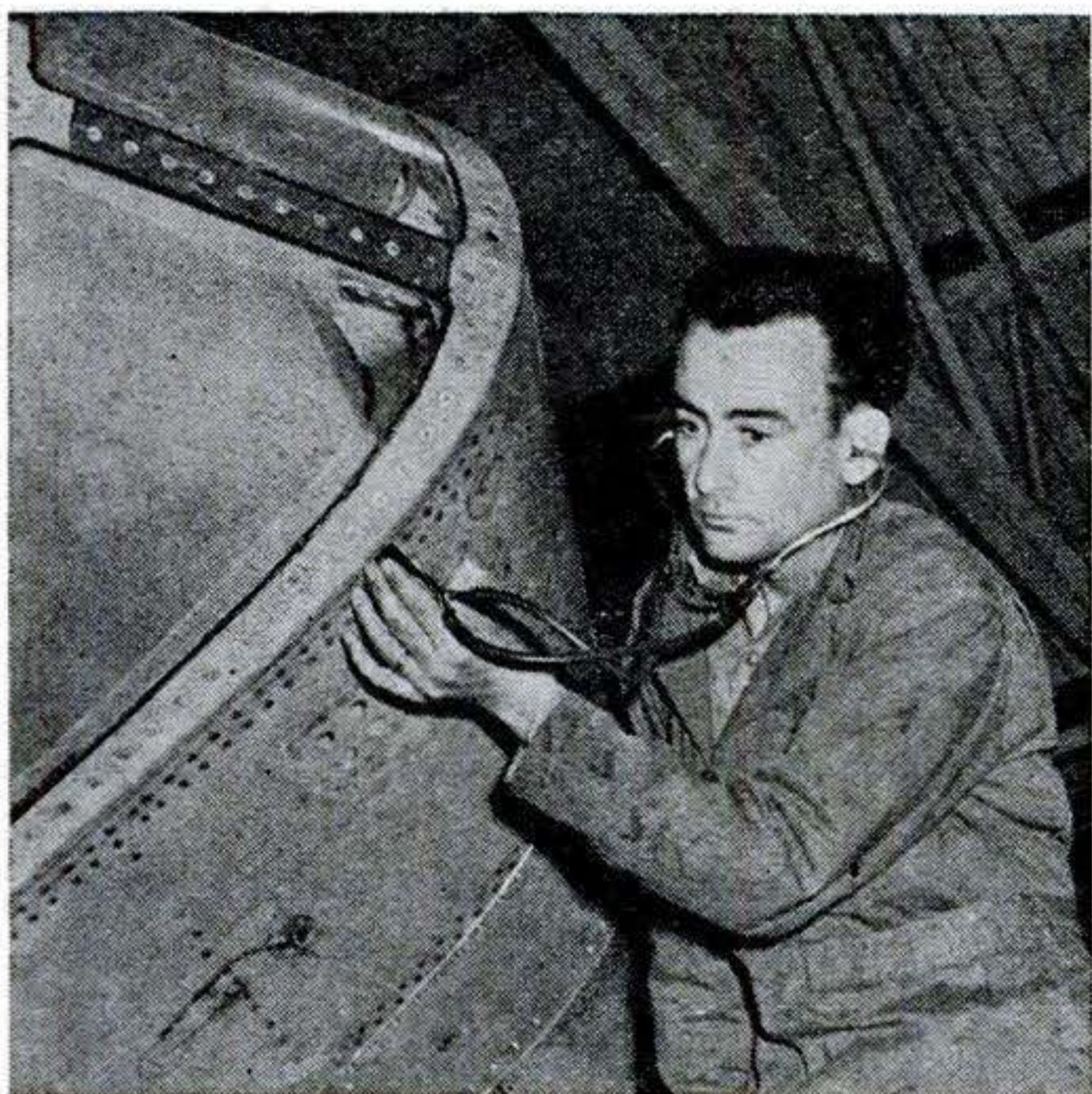

Listens to Leaks. Stethoscope applied to rivets catches the hiss of air leaks from pressurized cabin of Northrop's eight-jet YB-49. Leaks are then sealed with compound.

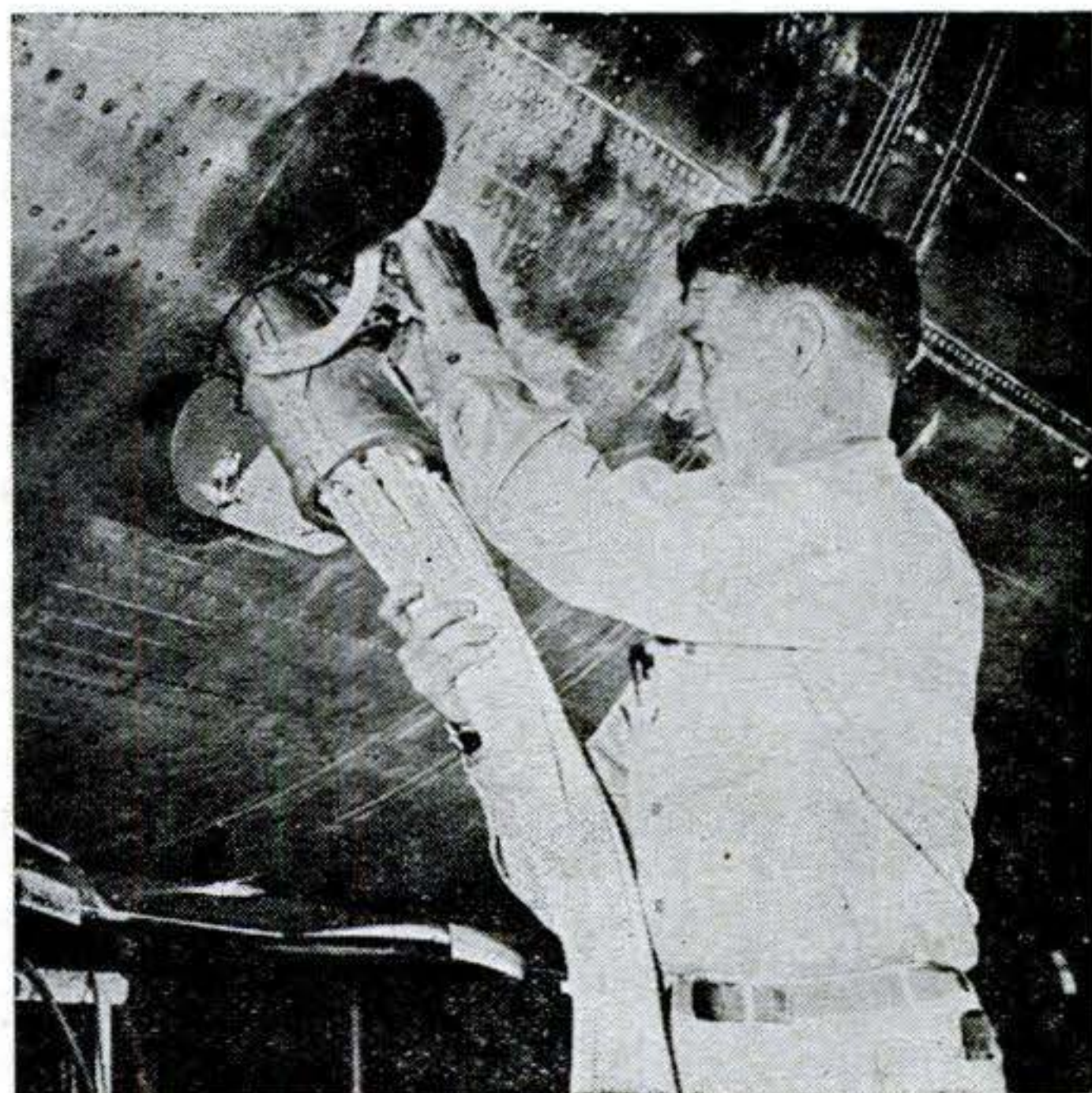

Plugged-In Power. Boeing Stratocruisers have power for air conditioning even when grounded with engines off. Service truck drives up and 28-volt DC is plugged in.

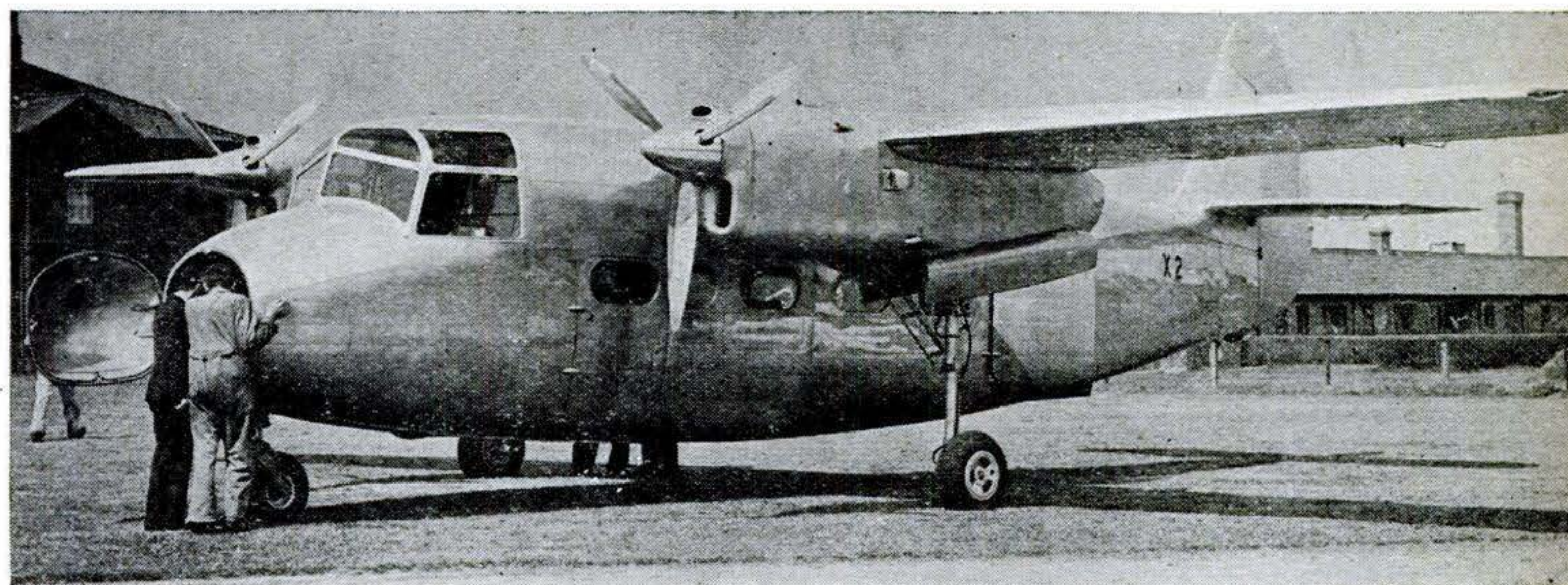

It Packs a Load. Britain's new Percival Merganser may look small, but its cabin

holds eight passengers or 1,825 lb. of freight. High wings and low floor help loading.

Ballast "Broom" Rides the Rails

KEEPING track ballast cleaned and properly stacked along thousands of miles of U. S. railroads need no longer be a job for pick-and-shovel crews. A single machine, standing 20 feet high on its special flatcar, now gulps up the rock, cleans it and leaves it neatly piled along the ties in a continuous operation.

The ballast cleaner has two giant revolving wheels, driven independently by gasoline engines. Plows shape the ballast into ridges so that buckets in the wheels can scoop it up and dump it onto a series of steel "grizzlies," or shaking screens, consisting of closely spaced bars. As the grizzlies rattle, delivering the cleaned rock to the rear of the machine, baffles trap the dirt and deflect it to endless belts that toss it outward on the right-of-way.

Other baffles kick the rock back down on the track shoulder, knocking stray pieces off the ties and returning the ballast to its proper slope and position. Rock fragments too small to qualify as good ballast are tossed aside.

The machine is mounted on special adjustable arms, which allow it to operate over any sort of track conditions.



Front view of a Santa Fe ballast cleaner shows plow and wheel, attached to car by arms that keep it vertical when it is raised or lowered.

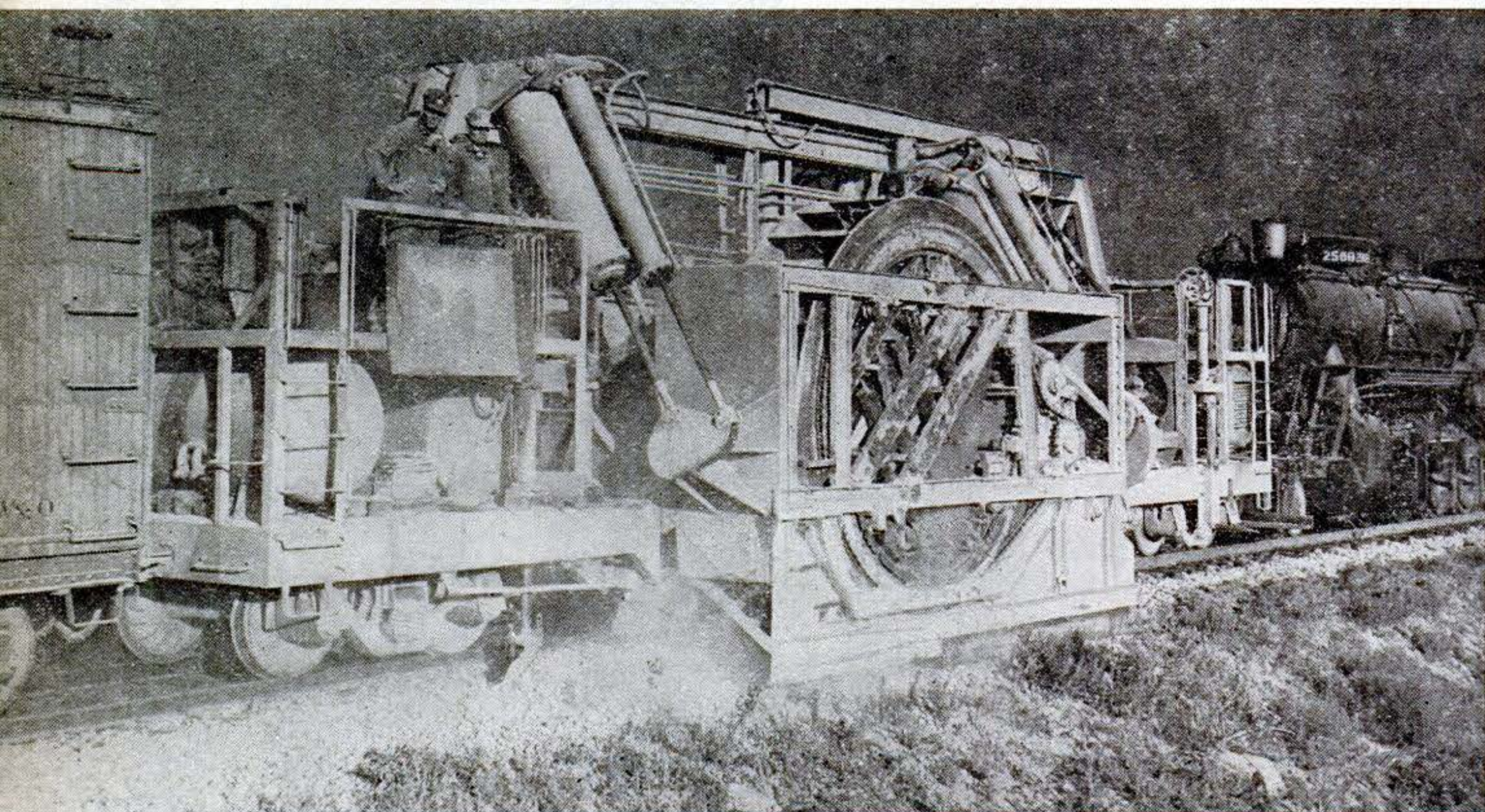

Drawn by locomotive in reverse, cleaner goes 2½ m.p.h. and can cover 1,250 miles a year.

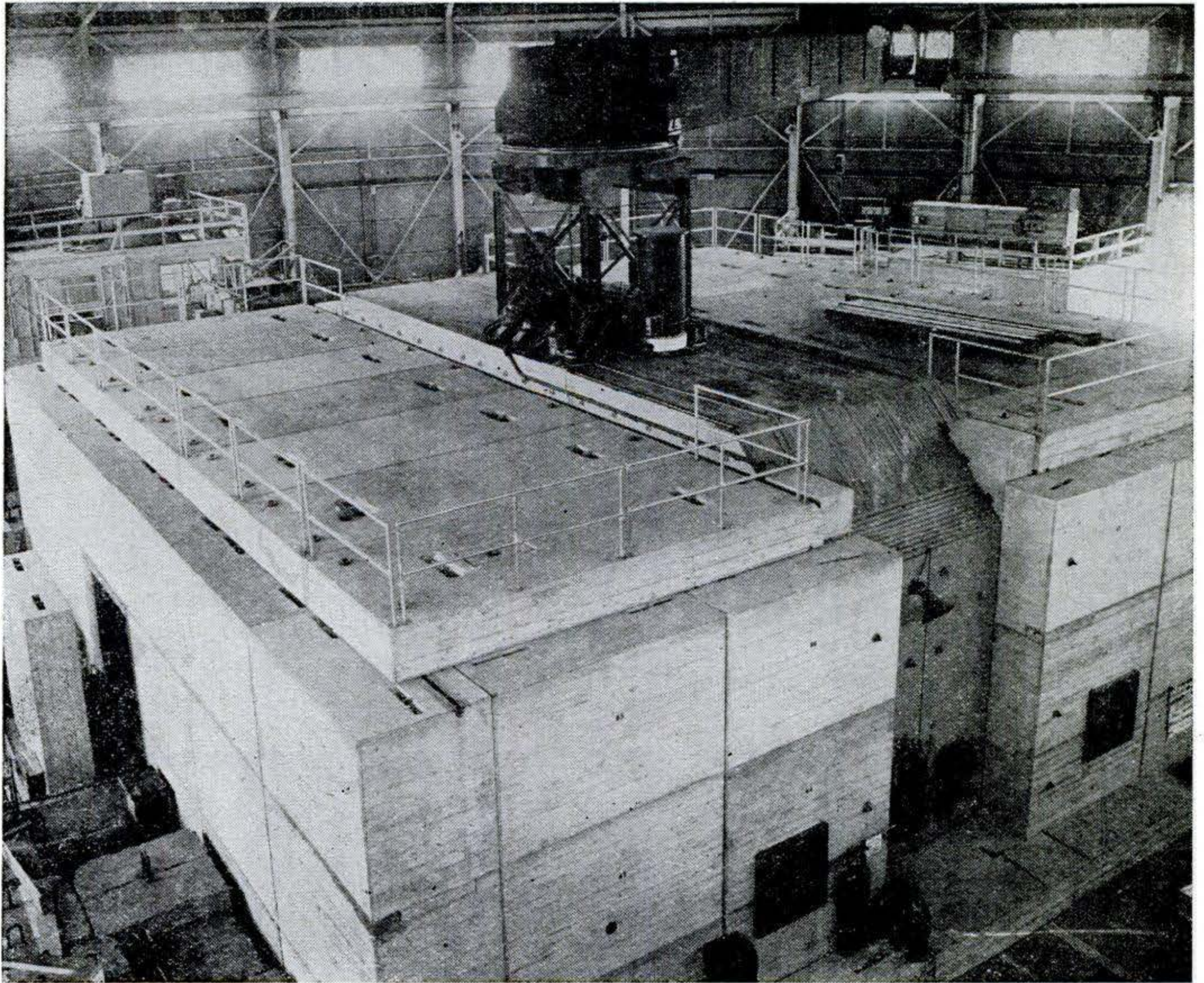

Like a huge bomb shelter, concrete surrounds cyclotron's magnet and acceleration chamber.

Concrete Blockhouse Cages Split Atoms

A CONCRETE blockhouse with walls five feet thick shrouds the University of California's 4,000-ton cyclotron, the giant now engaged in knocking atomic nuclei to smithereens. Built of 20-ton blocks, the walls shield workers from the deadly radiations of nuclear disintegration.

Concrete was second only to copper among the shielding materials tested, and the five-foot walls whittle the machine's 100-million-electron-volt neutron radiation down to one hundredth of its original strength. So powerful is the cyclotron, however—it blasts out 20-odd nuclear particles as against the two or three freed by prewar atom smashers, and it can be made stronger still—that eventually the already massive shield will have to be doubled in thickness.

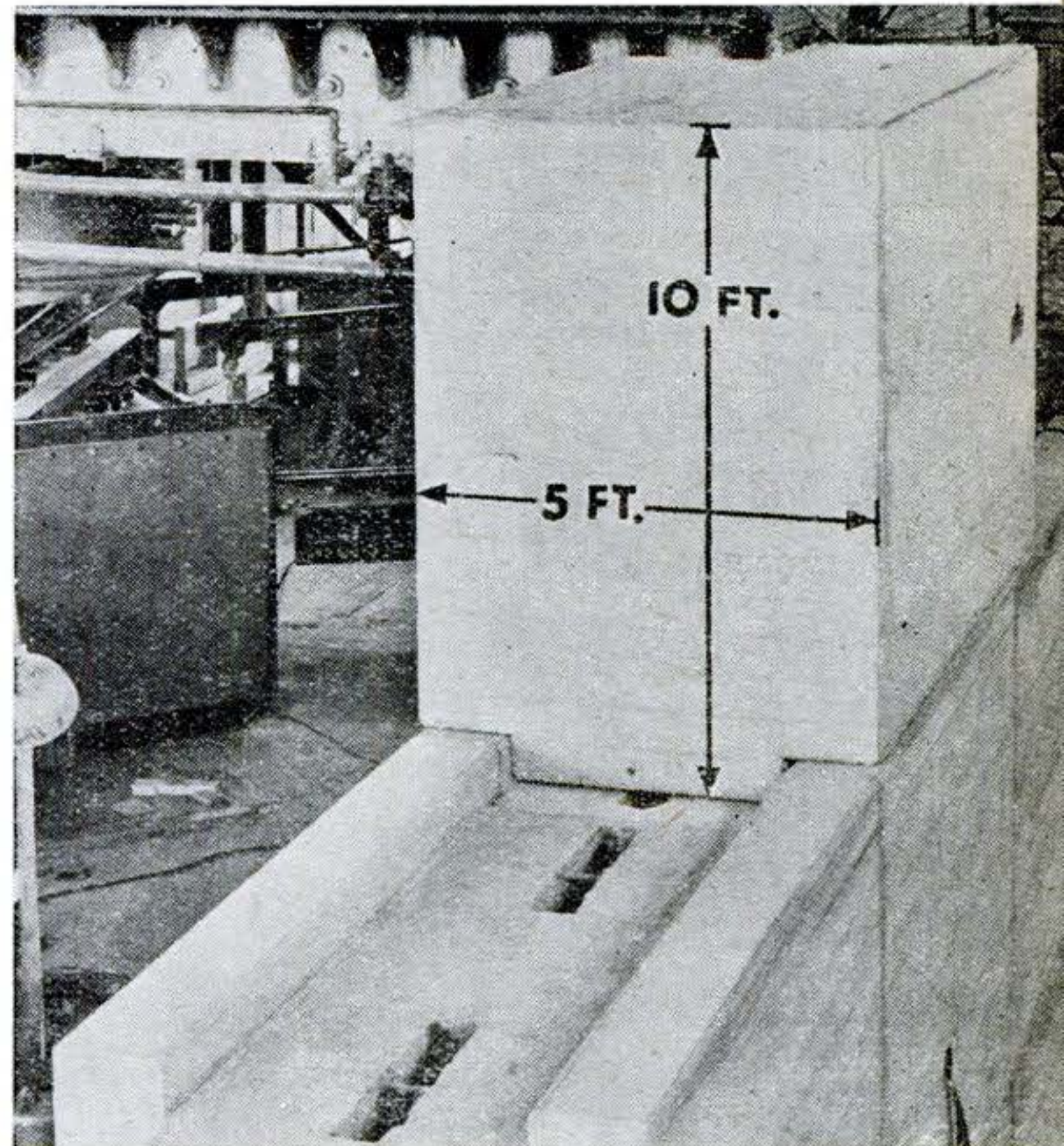

Partly completed wall shows how blocks interlock to bar possible leakage through joints.

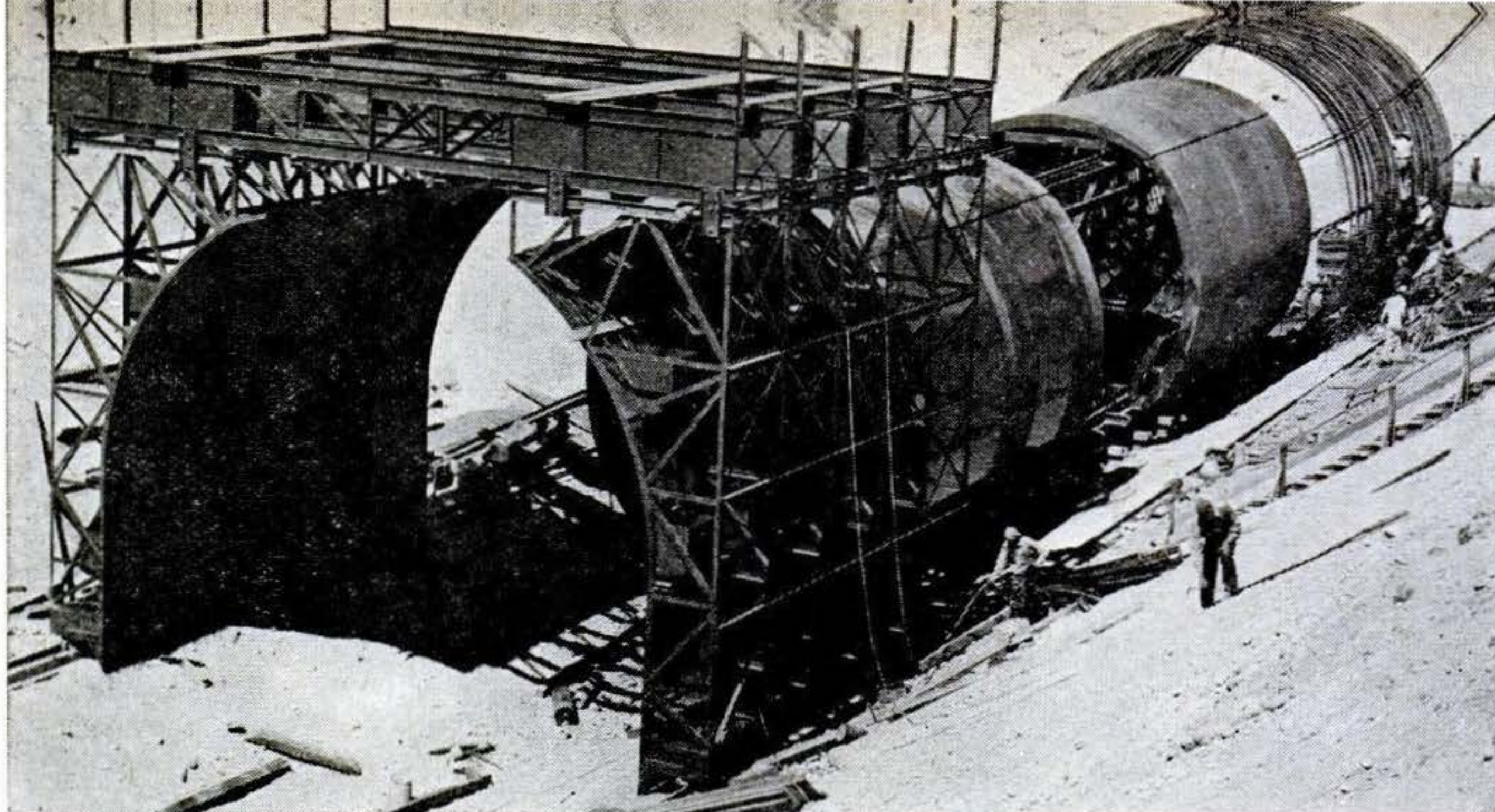

Builds Big "Barrels"

THIS \$57,000 contraption builds 25-foot irrigation siphons for the Columbia Basin.

Concrete is shaped by telescoping inside forms and an outside clamp, then reinforced with the steel hoops at right. The machine can be used repeatedly.

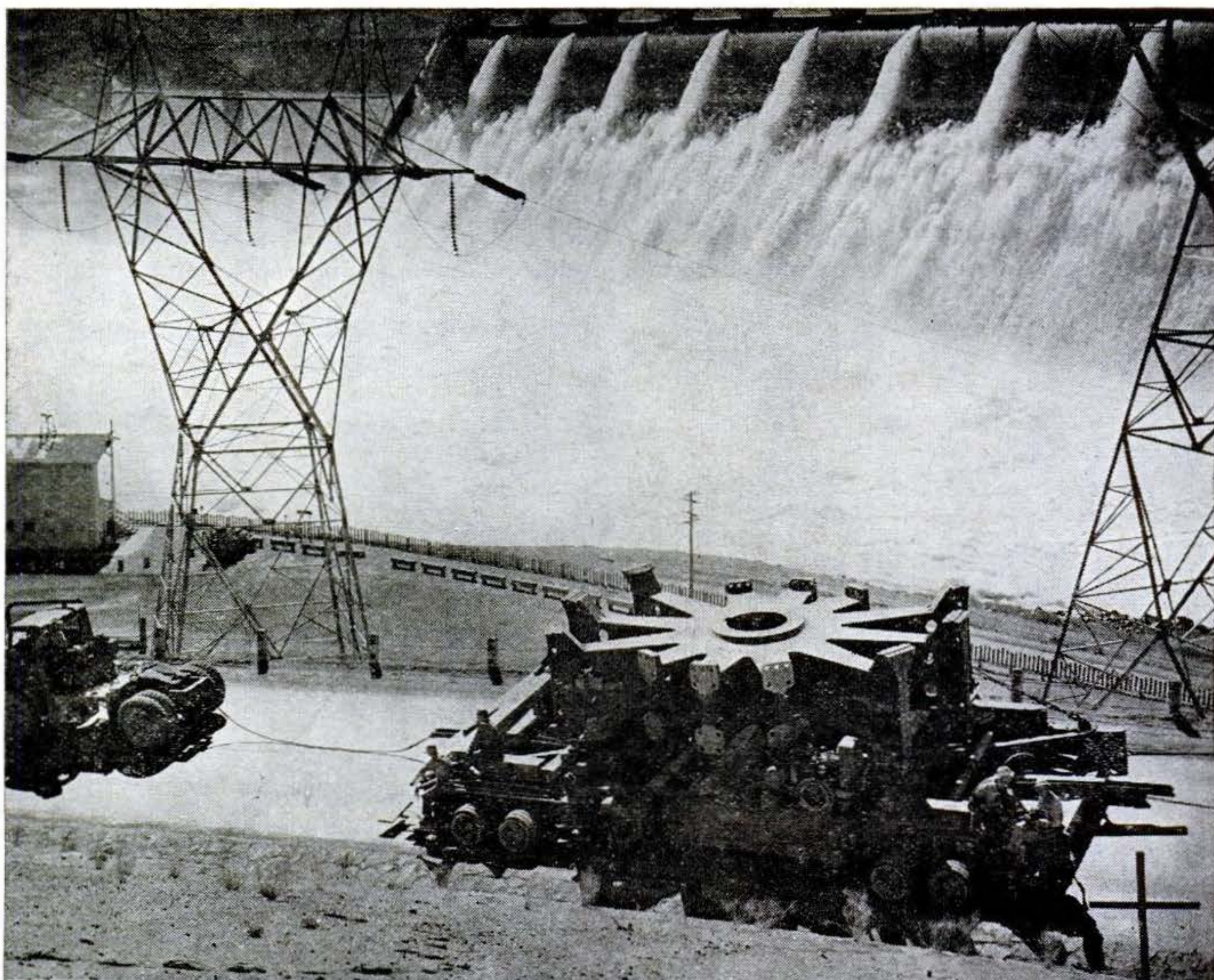

Boosting Coulee Power

EASED downgrade on a 16-wheel trailer, this spiderlike rotor is on its way to the

west powerhouse at Grand Coulee Dam, in Washington. There the 60-ton Westinghouse unit will be installed as part of L-7, Coulee's first new postwar generator.



Logging at Full Throttle

The roar of the machine replaces the yell of the lumberjack in America's biggest peacetime lumber boom.

By Thomas E. Riley

THANKS to the gasoline and Diesel engines that serve as the modern logger's muscles, wood is being sped to homebuilders from Pacific Coast forests without devastating the land as of old. Compact motors drag the saws back and forth, and powerful machines rush the big sticks to the mills. As the modern trucks and archcats wind through the smaller trees, they leave seed trees or long blocks of virgin timber, or come back and plant young seedlings, for some western lumbermen are trying to perpetuate valuable timberlands.

In the mornings, the forest is roused by the deep roar of Diesel engines and the staccato barks from the king of the loggers. Once the highclimber, who dared to top the tall spar trees, was king; now the highest wages go to the men in tin helmets—the modern fallers who swing stuttering power saws against the tree trunks.

Speed and Economy

Driven by small one- and two-cylinder engines, the chain saws cut closer to the ground—saving lumber—and they will fall in five minutes a tree that formerly took an hour. Since the fallers are paid by the number of board feet they cut, some of them draw \$1,000 a month.

Once a tree is down and trimmed by the buckers, the huge Diesel cats roar forward, grab the logs and drag them over the rough mountainside. Called archcats because of their massive arches, these machines tow the big sticks to the yarding areas. The yarders are strong spar trees, usually Doug-

las fir, braced and rigged with steel cables to handle the logs.

A loader must be able to judge by eye the approximate weight of a log. One man picks out a log from the pile and sets the cable tongs in it. The head loader stands by the truck and signals the winch operator to raise or lower the cables until he is satisfied the log is resting solidly on the truck and trailer.

Loaded, the huge truck roars away. There's a peculiar set of rules for this kind of driving—and no room for mistakes. If you should ever be driving up a private logging road remember that the right-of-way

is with the truck going out. *And he takes the bank side of the road.* That truck has an immense load: 20 tons of logs when driving on public roads and up to 40 tons when private roads extend clear to the mill-pond. The driver must stay away from the outer edge of the road where it might crumble. And those private mountain roads are one-way because of the cost of construction.

The roads are nearly always downhill for the loaded trucks, so they must constantly use their brakes as well as the drag of their geared-down motors. Each truck and trailer carries 150-gallon tanks of water under air



Cutting the niche to direct the fall of Douglas fir, power saws have replaced the crosscut and ax. Note how man at right pushes with stick.



Power-bucking comes next. These men use power saws to trim branches and cut trees into the right lengths for trucking to the mill.

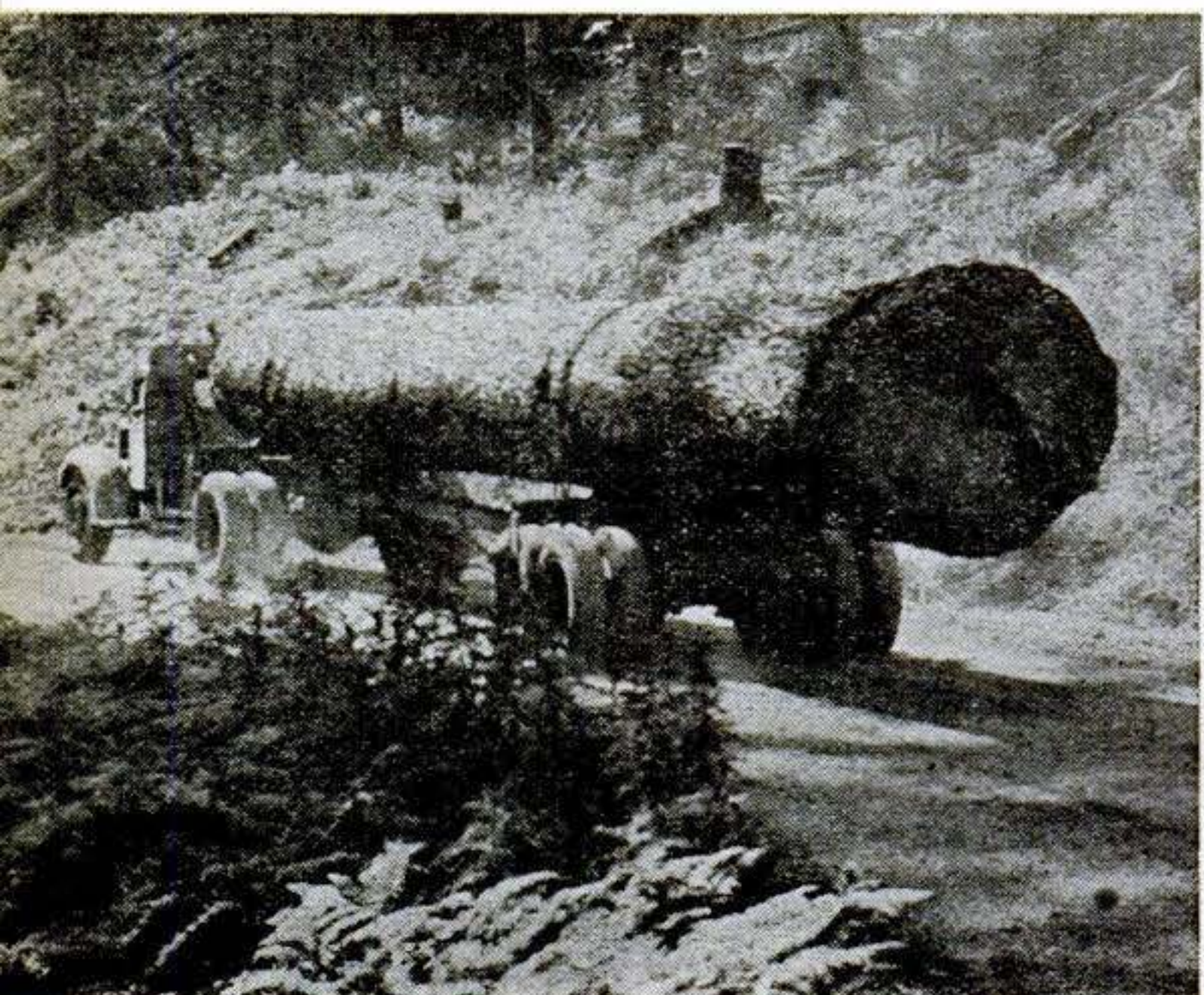

Now the logs roar down the 25 miles to the Willamette River. That's steam, not dust, rising from the water-cooled trailer brakes.



At the end of the private road, the scaler measures the logs and calls them off to the recorder in the shack. Now for the unloading dock.

pressure. These squirt streams of cold water on the trailer brakes throughout the trip. Even with the cold spray, the brake drums heat tremendously, turning the water jets into clouds of steam.

After all the big timber is logged, the area is logged again! At first glance, this seems a final blow to the timberland. Actually, one of the main reasons for the second logging is reforestation. The relogging is on a smaller scale with lighter machines, and no more trees are felled. A small Diesel-electric sawmill is set up on the spot and only the tops of the fallen giants, the snags and the other leftovers are cut up into

timber. This relogging saves about 7,000 board feet of lumber per acre. It removes much of the slash—worst fire hazard in the woods. And it leaves the land in better condition for the growth of young evergreens.

After relogging, the area is set aside. With the seed trees, it is not the completely denuded stumpland of old. In 20 years the by-passed second growth will be ready to log, and in 40 to 60 years the cones from the seed trees will produce "pole" logs for harvesting. Throughout the area, meanwhile, the gravel roads are left ready to bring in pumping engines and fire-fighting crews in case of fire. END



An archeat drags logs to loading point. Arch, on rear of tractor, handles a separate line to each log; it replaces the dangerous high line.

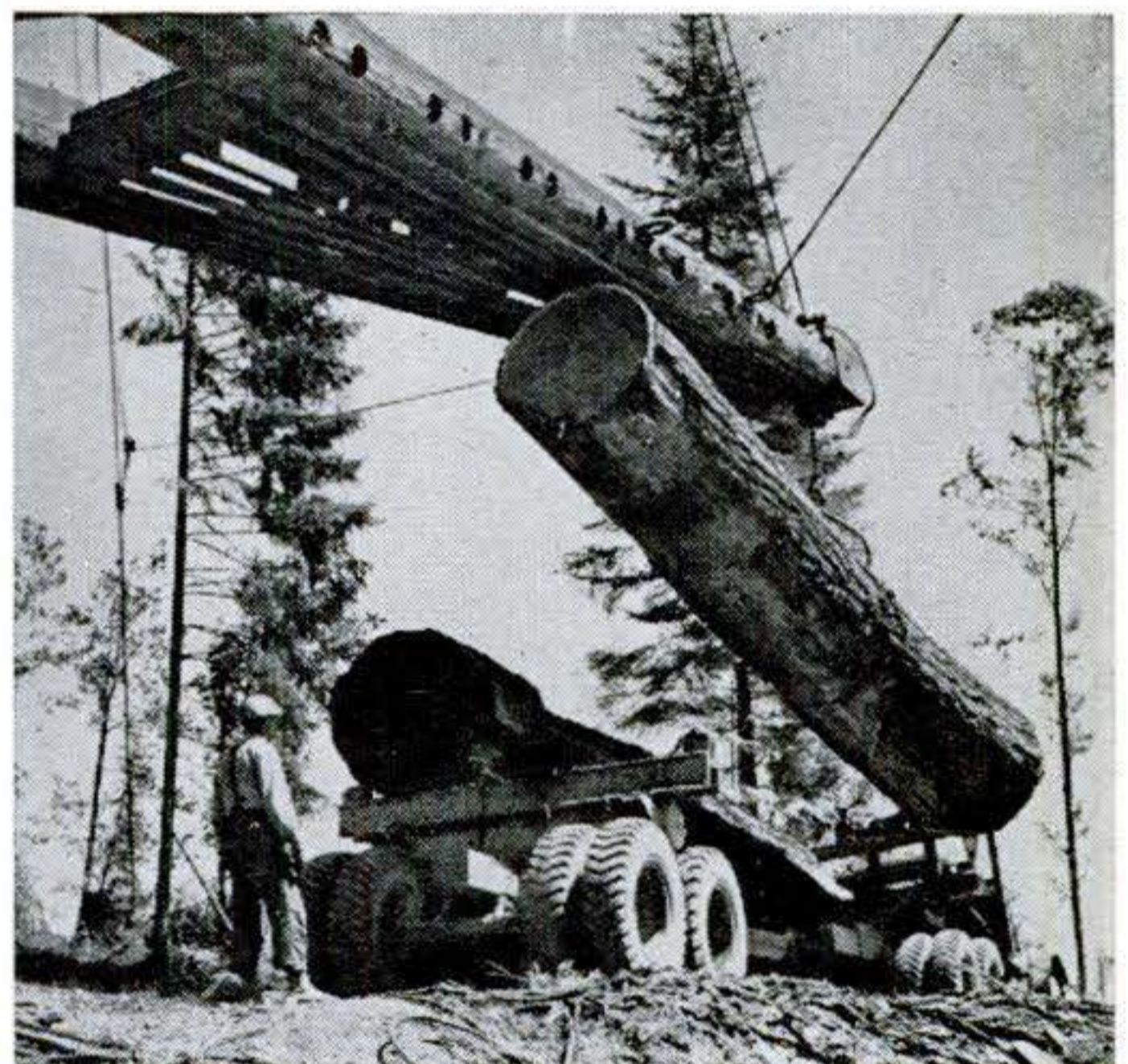

In the yard, the loader groups the logs and loads them on the trucks. A Diesel tractor, powers the yarder tree used as a derrick.



The river, 17 miles farther on, is the end of the trail. The dumper, powered by a gas winch, rolls logs into water, ready for the mill.



Far-sighted lumber companies realize that they must replenish their timberlands. America uses 50 percent more wood than is being grown.

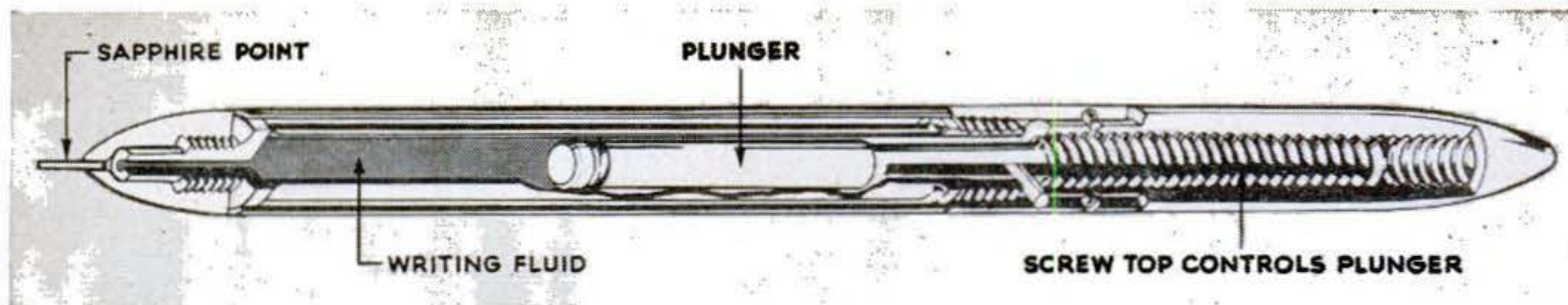

Drawing Pen Inks Itself

HERE'S a draftsman's dream come true—a drawing pen that inks itself. Unlike a fountain pen, it produces an even line for fine work, and the quick-drying lacquer used for ink will not spread under a ruler. Capillary action draws the fluid from the reservoir through a fine opening between wall and sapphire tip. Turning the screw top forces down more ink for a thicker line. The pen was developed by L. A. Paul, of Beechcraft Aircraft. So far, only enough are being made for Beechcraft's own use.

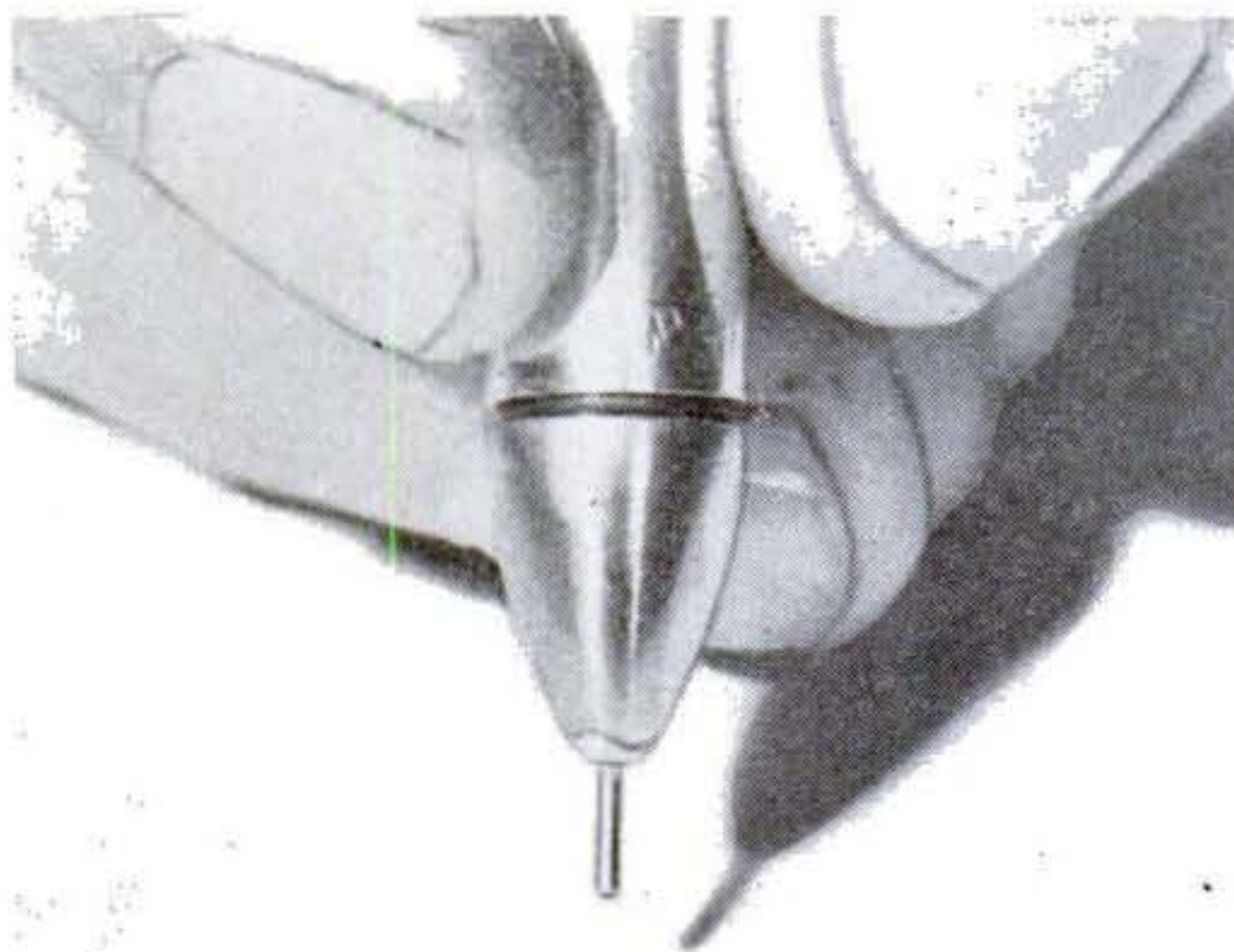

Night View at Noon

THE man squatting in the road at right is seeing just how that traffic line looks in the dark. Night drivers often blame tired eyes when markers show up too late for comfort, but the sign may fail to reflect enough light. To find out, this 25-lb. Hunter Night Visibility Meter projects a beam from a six-volt auto lamp onto the paint or sign under test. Through the eyepiece the operator sees a narrow strip of light reflected from the subject, surrounded by light reflected from an illuminated panel of known brightness that can be varied. He adjusts the panel until its reflected brightness just matches the slit, then reads the reflectance value on a scale. An ordinary white traffic marker may read less than 1; a glass-beaded sign, as much as 50.

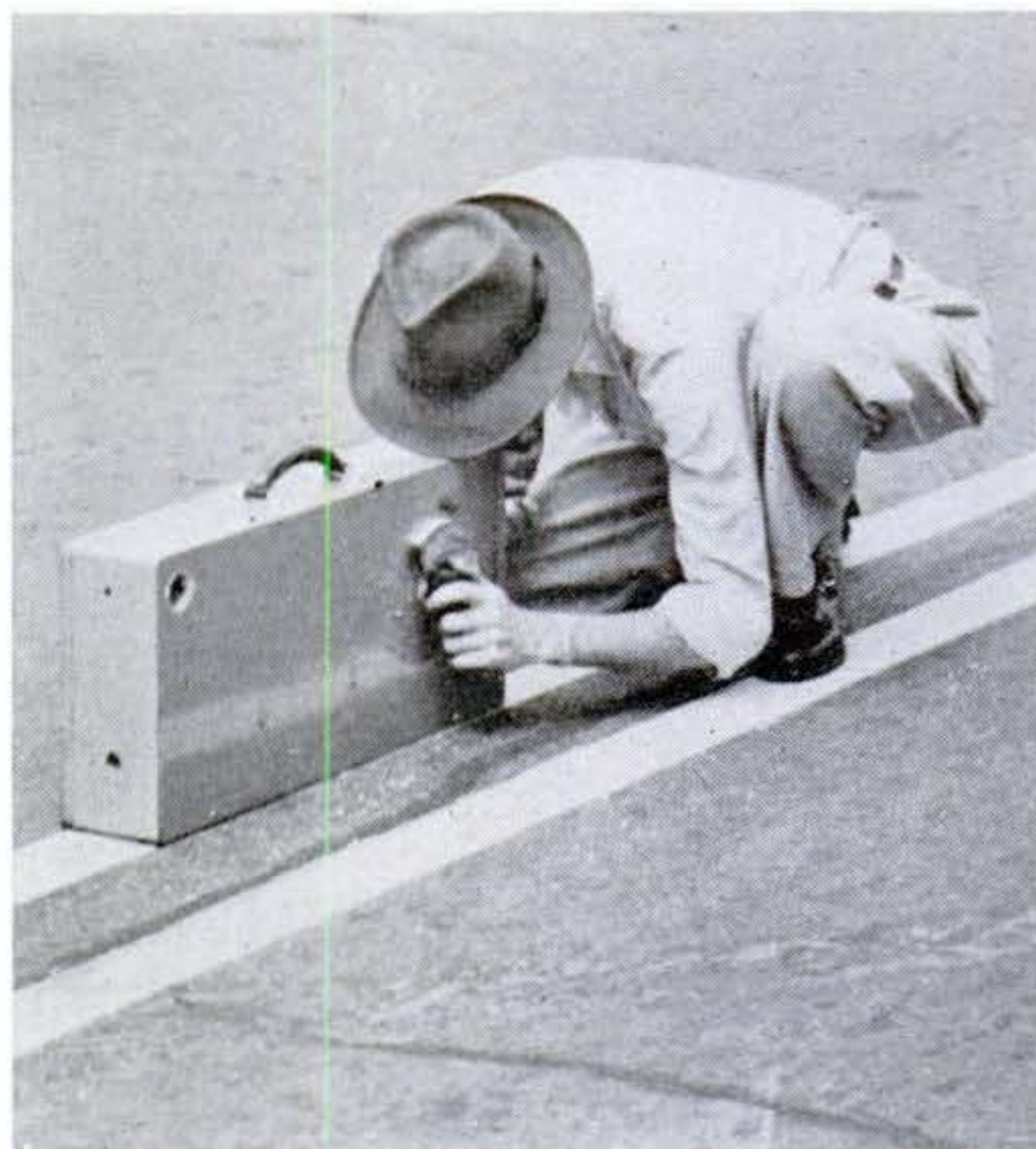

V-Paddles Run Better

THIS odd paddlewheel may help the stern-wheeler stage a comeback. Ease of repair gives this type advantages for river use, but heavy shock loads on the machinery as each paddle in succession spans the water cause high maintenance costs. With the new V-paddles, the center of one pair hits the water as the tips of another leave it, providing a continual action and constant wheel speed. Tests by the American Rolling Mill Co., which developed the wheel, also show a nine percent cut in fuel consumption.





Squirting out of that hypodermic needle is silk that never saw a silkworm—it was produced in a

laboratory at Harvard University by Dr. Robert B. Woodward (above) and Charles H. Schramm.

How to Create Silk, Skin or Serum

Chemists find way to link atoms into gigantic molecular masterpieces that rival nature's own proteins.

By Martin Mann

PSM photos by Robert F. Smith

MINK fur is protein. So are silk, beefsteak, and all other animal hair, skin and muscle. The viruses that cause infantile paralysis and influenza are also proteins. The new germ-killers like gramicidin and tyrocidin, while not actually proteins, resemble them in structure. Nature has been producing proteins for millions of years, but men never were able to duplicate these materials until this year.

In a laboratory at Harvard University, Dr. Robert B. Woodward, the 30-year-old chemistry professor who helped synthesize quinine when he was only 27, and his assistant, Charles H. Schramm, have come close to making real protein—and may have done it. They have produced a thin, flexible sheet that looks like cellophane but is chemically similar to natural skin, and they have created a long fiber that is apparently identical to silk.

Chemists have long known that proteins are amino acids, linked chain-fashion into extremely big molecules. They also know how the amino acids “join hands” to become such big molecules. Amino acids are compounds containing carbon, oxygen, nitrogen and hydrogen (some also include another



Schramm demonstrates for PSM's camera the method that may lead to artificial fur, meat, textiles and other proteins. Here he weighs one of starting compounds, an amino-acid anhydride.

element like sulphur or iodine). When they join together to make the long chain of a protein molecule, a nitrogen atom of one amino acid is held jointly by a carbon atom and an oxygen atom of the neighboring amino acid. This connection, called a peptide bond, is one of the distinctive traits of proteins.

23 Found in Nature

The first amino acid discovered was cystine, in 1810; 22 others have since been found in plant and animal protein, and many others that do not occur in nature have been made in the laboratory. Food researchers recently learned that eight of the 23 natural amino acids are a vital part of the diet—if the food you eat every day did not contain enough of each, you would lose weight, eventually die—and these eight now are used to enrich cereals and other foods and to prepare special diets for hospital patients. One amino-acid compound, monosodium glutamate, or MSG, is also employed as a seasoning. With these exceptions, few amino acids are manufactured commercially, although the raw materials are widely available and cheap. Amino acids can be built up chemically or obtained from natural proteins such as the wastes from canning factories and slaughterhouses.

Although proteins could be broken down

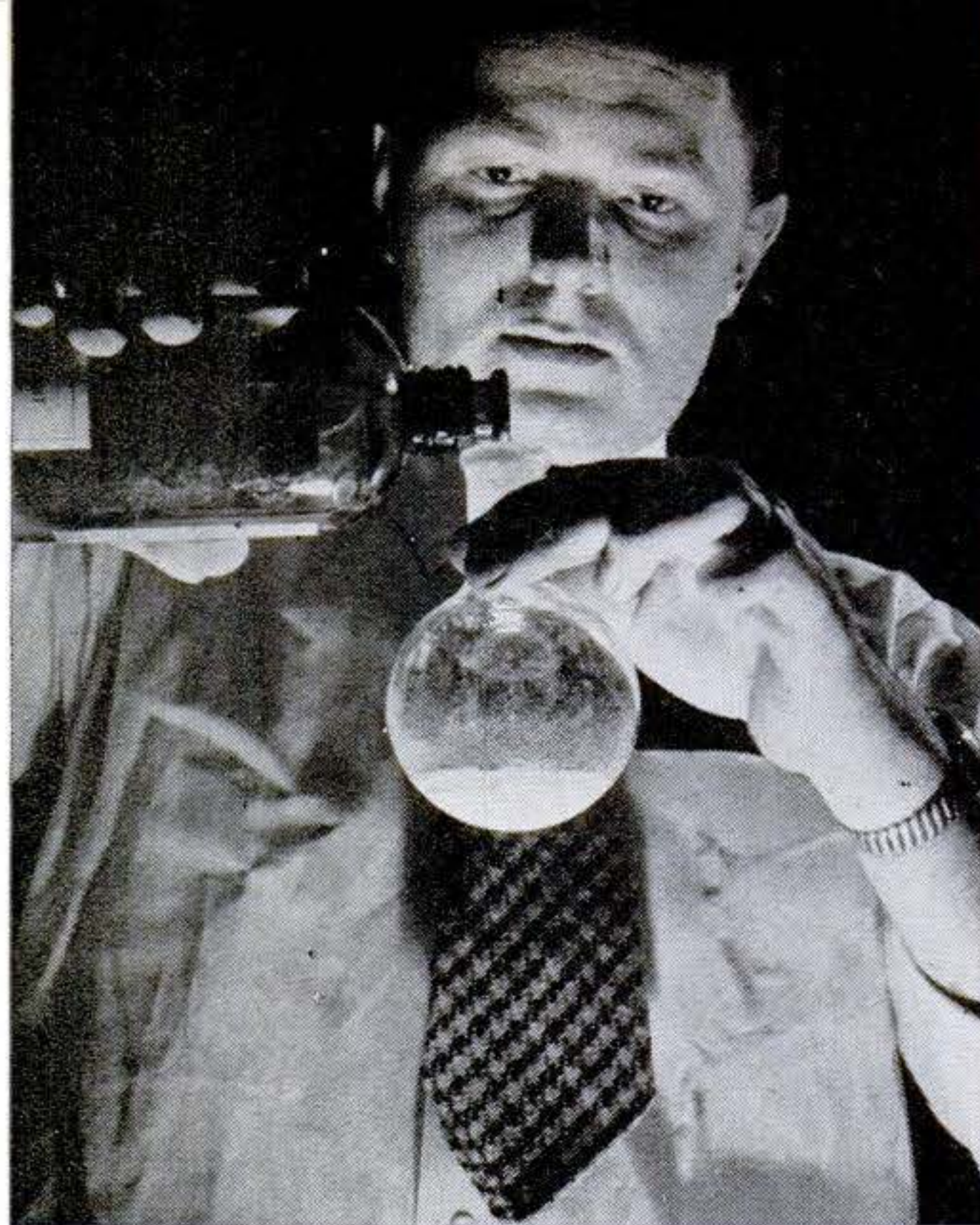

Two or more different amino-acid anhydrides are dissolved in benzene to make the solution that becomes a "protein analogue." A tiny amount of water in benzene starts the reaction.

into amino acids, no one could reverse the process and put amino acids back together again into proteins. The amino acids just would not polymerize, or join in a very long chain. Emil Fischer, the great German chemist who did much of the early work on proteins, tried it in 1907. In a complex series of reactions, he got 18 amino-acid groups to hook up into a chainlike molecule. His student, Abderhalden, raised him one and made a chain molecule of 19 amino-acid groups. But these 18- and 19-group molecules were not big enough to be proteins; the shortest real protein molecule contains about 100 groups, and others extend beyond 10,000 groups.

That was the best anyone had done until Dr. Woodward, during a railroad trip from Boston to St. Louis, thought of a way to get the reluctant amino acids to polymerize. A check on the work of other men revealed that the process itself had been used previously for different purposes. It had been discovered independently by three different research teams, starting with the German chemists Leuchs and Geiger in 1908.

Others Missed the Point

All these scientists, however, had missed the importance of the reaction: that it might produce very long amino-acid chains, or proteins. Realizing this, Dr. Woodward and

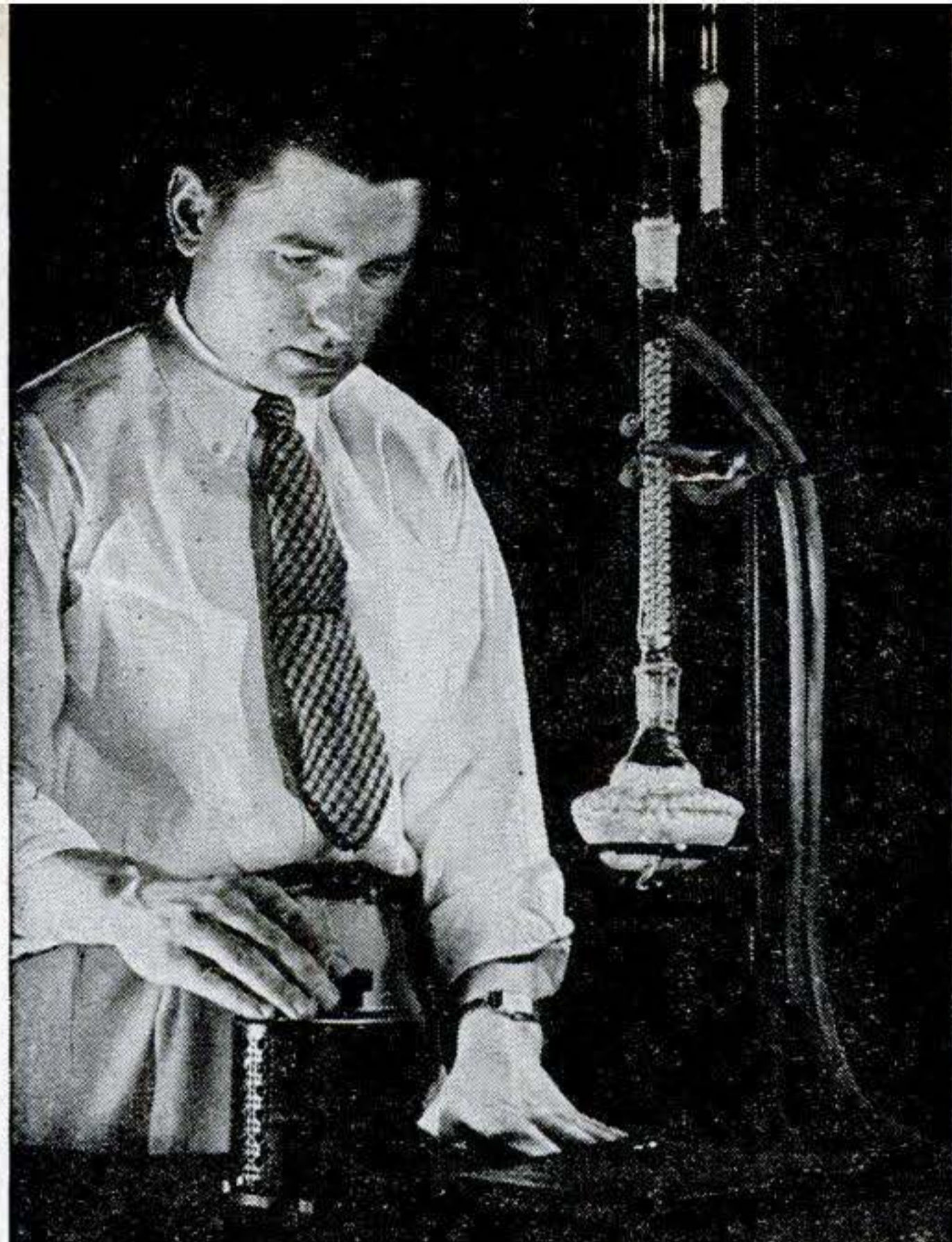

Heating the solution makes the anhydrides join together into long proteinlike molecules in 10 hours. Without heat, the process works just as well, but takes longer—about two weeks.

Schramm went to work; by last June, they had produced several man-made substances that seem to be proteins.

Their process is simple. They treat amino acids to remove oxygen and hydrogen from their molecules (the oxygen and hydrogen come out in the form of water— H_2O). Two or more of these treated amino acids, called anhydrides, are then mixed in benzene (not benzine), and the solution is permitted to stand until it thickens—from a few days to two weeks. This thick solution dries quickly when exposed to air, giving the proteinlike material.

20,000 to the Inch

Squirted out of a hypodermic needle, the solution becomes a fine thread very similar to real silk. Poured on a glass plate, the same solution dries to a transparent, stretchy sheet that looks like cellophane, but chemically is more like natural skin. The sheets already made have been extremely thin—some so filmy that 20,000 of them would have to be piled up to get a stack one inch high. However, thick blocks of the same stuff could be made just as easily.

Dr. Woodward explains that water (a tiny amount present as an impurity in the benzene) starts things going by combining with the anhydride to form an intermediate compound. The intermediate compound quick-

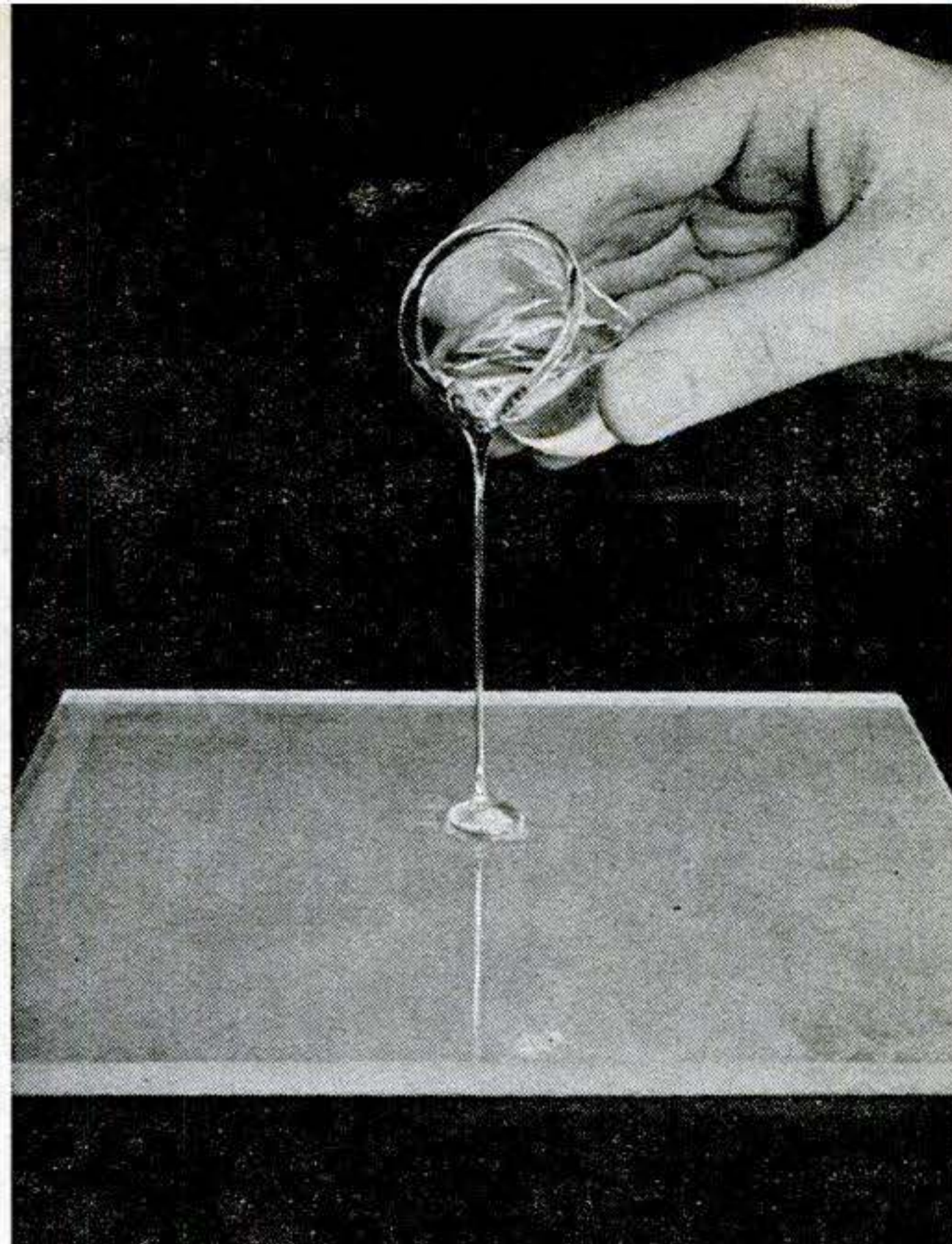

The result is a molasses-thick fluid that dries in air to a synthetic apparently identical with real protein. In the photo above, a film of it is being made by pouring the fluid on a plate.

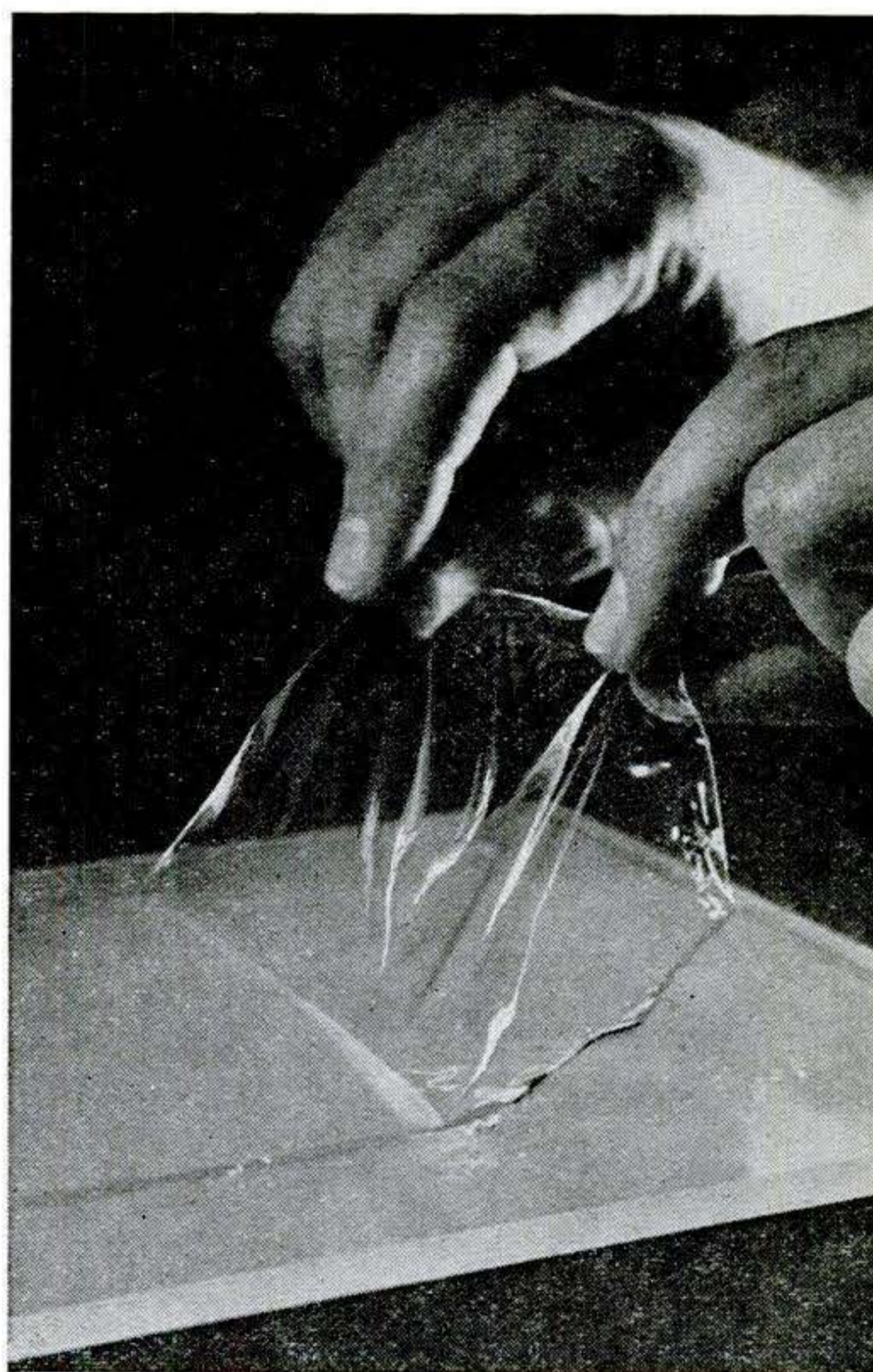

This is the finished "protein analogue"—a thin film that looks like cellophane but actually is more like natural skin. Thicker sheets or even solid blocks could be made in the same way.

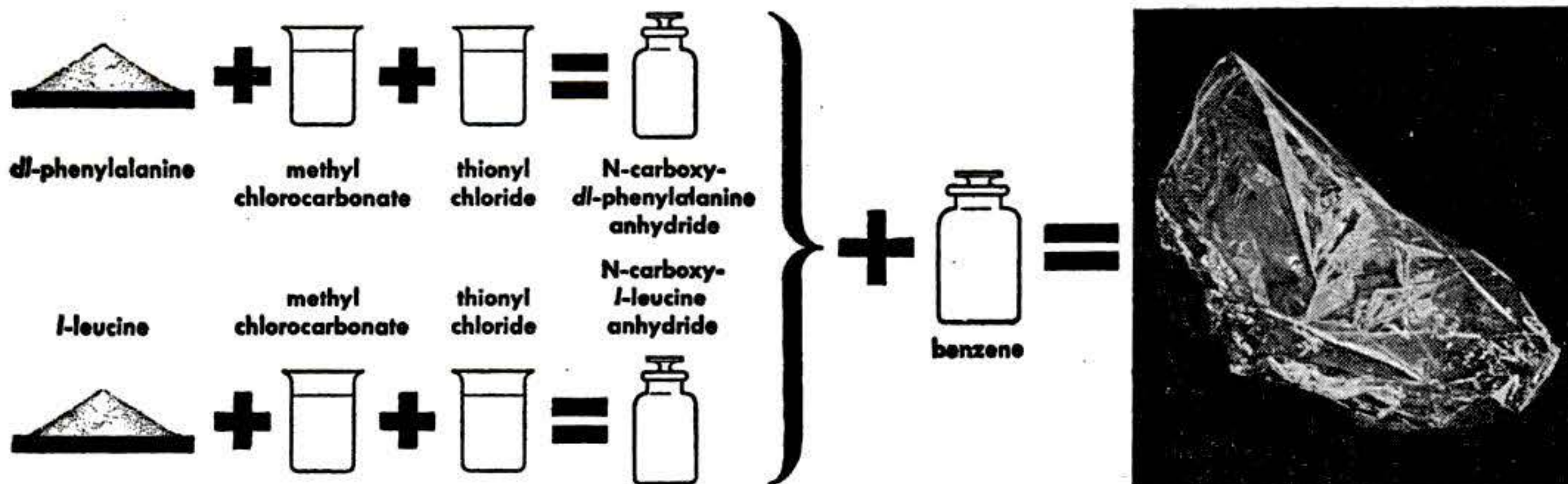

The simplicity of the process for creating protein is illustrated in this chart. Amino acids (obtainable from plant or animal materials or built up from chemicals) are treated to remove

oxygen and hydrogen atoms, giving the amino acid anhydrides (two bottles in center). These anhydrides are then mixed with benzene to yield synthetics rivaling nature's own proteins.

ly breaks up into carbon dioxide and an amino acid. This amino acid has an "active center"—sort of an outstretched hand reaching for another anhydride. When it catches another anhydride, it hooks on with a peptide link, and at the same time changes its newly acquired neighbor into the intermediate compound that loses carbon dioxide and develops an active center. This process continues until no more anhydrides are left to catch. Molecules made up of more than 10,000 amino-acid groups have already been made in this fashion, and Dr. Woodward believes any size molecule is possible if enough anhydride is used.

Length Indicates Likeness

That these synthetic molecules are extremely long indicates that they are at least reasonable facsimiles of true proteins, for protein molecules are the only ones known to be so large. The synthetics also meet other requirements for a protein: They are made of the same raw materials (amino acids) joined together in the same way (through peptide bonds).

Still, Dr. Woodward cannot be positive he has a true protein, for he doesn't know how the amino acids are arranged inside the molecule. Suppose he starts with three amino acids—call them A, B and C. They might join up in the order AAABBBCCCAA. . . etc., or perhaps ABCABCABC . . . etc., or any of countless other combinations. Since the arrangement makes the difference between an exact duplicate of a natural protein and a good imitation of one, Dr. Woodward cautiously refers to the synthetics as "protein analogues."

If the arrangement of the amino acids inside the molecule can be controlled (and Dr. Woodward believes it possible), then

many of the proteins that we use every day can be manufactured. This would mean the birth of an entirely new industry, as did Perkin's discovery of synthetic dye in 1856, for the list of things that might be made cheaper and better than natural products is almost endless.

Luxurious furs could be "grown" in chemical factories. Would you like mink, sable or fabulous chinchilla?

A true synthetic silk (rayon is entirely different chemically) could be spun from the test tube. Already the Harvard chemists have made a fiber that seems to be the same as silk.

Wool, however, would be more difficult to duplicate, since its fiber possesses peculiar scales. The scales might be synthesized, Dr. Woodward thinks, but attaching them to the fiber as nature does would be quite a tricky problem.

Much more must be learned about protein analogues, Dr. Woodward emphasizes, before any of these miracles will become commonplace. Textile experts, for example, wonder if synthetic fibers would be as strong as natural fibers. Could they be washed? Would they take dyes? How long would they wear? And what would they cost? These and many more such questions remain to be answered.

A Clue for Biologists

To biologists, a process for making real protein would have revolutionary importance, for it might reveal how the human body produces its own proteins. The human chemical factory is continually changing amino acids into the special proteins needed for muscles, tissues, hormones and various other parts of the body. That much is known. But how this building-up process

works has always been a mystery. An explanation of it would answer many questions in medicine.

A method for duplicating natural protein would be extremely valuable to medical scientists, yet it would not satisfy organic chemists. They are never content to imitate nature's handiwork, but try to make something better, preferring to design an artificial molecule that will do a particular job more effectively than any natural molecule. Nylon is an example of a custom-built synthetic molecule. Chemically it bears only a slight resemblance to natural silk, yet it makes better stockings than real silk.

Reshaping Nature's "Bricks"

The method discovered by Dr. Woodward and Schramm may facilitate this sort of molecular architecture. Chemists may produce molecules similar to natural protein, but different enough in composition or shape to be more useful. Merely changing the length of a natural molecule, for example, might result in leathers and silks possessing all the advantages and none of the disadvantages of the natural product.

Slight differences in the structure of a wool-like molecule could give synthetic wool that would never shrink, no matter how many times it was washed. It may even be possible, one chemist thinks, to make a wool molecule with a built-in DDT group; the foolhardy moth attacking a synthetic wool suit would die after the first bite!

Tools for War on Germs

Some of the new germ-killers, such as gramicidin, bring swift death to bacteria; unfortunately they are just as poisonous to men. For that reason they can now be used only for surface cuts, never internally. But, suggests Dr. Woodward, a synthetic gramicidin with molecules longer than the natural ones might turn out to be harmless to man yet just as deadly to bacteria. He has already synthesized one possible germ-killer, which is now undergoing tests in medical laboratories.

A similar technique could be used on viruses. The chemists might be able to make a virus similar to the one that produces infantile paralysis, yet different enough so that it would only cause a mild case of the disease. This weak virus would then serve as a vaccine to protect against infantile paralysis—the way mild cowpox serum protects against smallpox. **END**

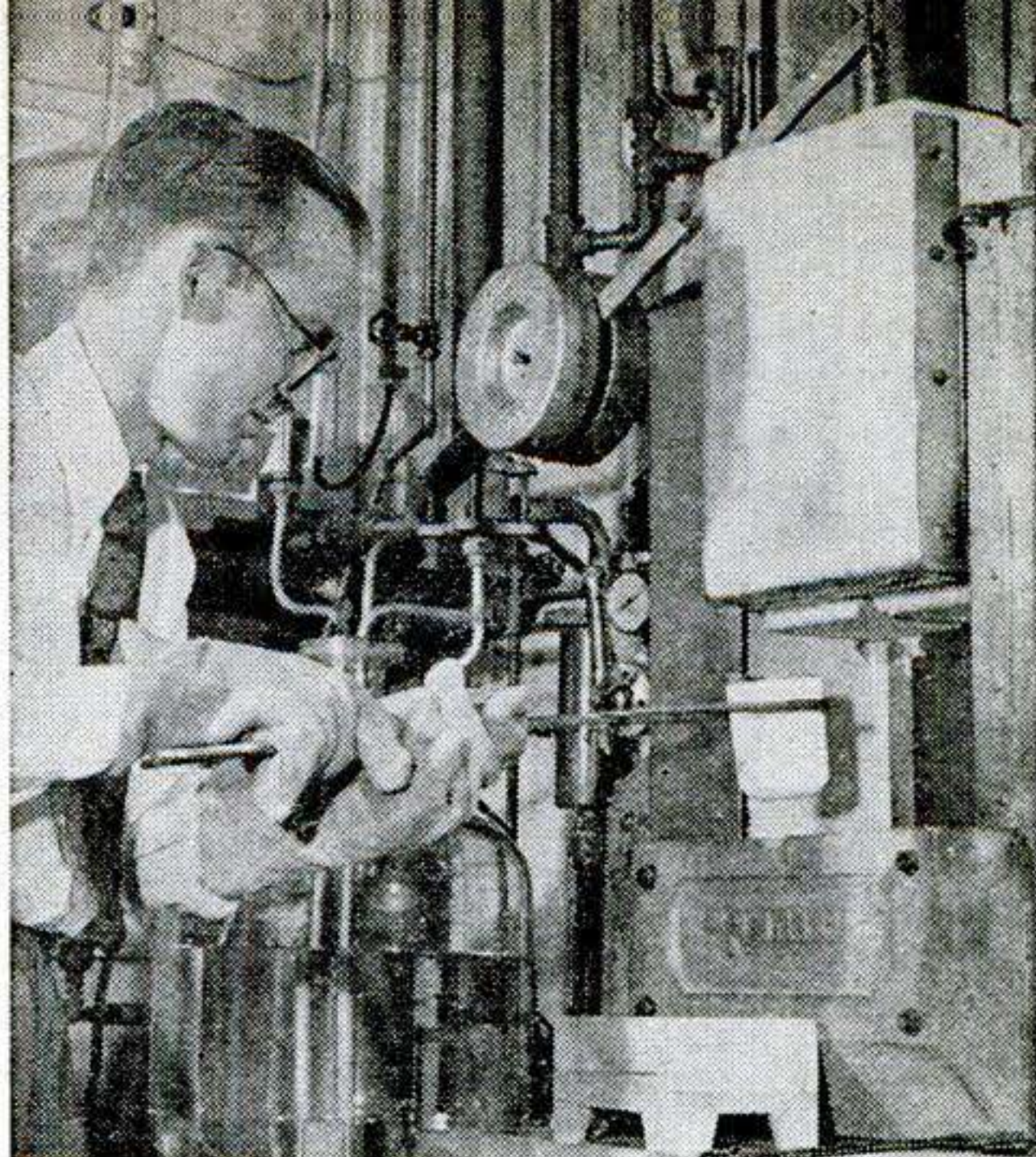

Putting a crucible into first electric furnace for commercial small-batch glass making.

Smallest Glass Factory

THIS tiny factory turns out glass in one-pound lots—and does it commercially. The product is used in making minute bulbs, weighing only 1/10 gram and only .0045 inch thick, for electrodes required in measuring acidity. The glass, made by Leeds and Northrup, of Philadelphia, has a high conductivity in the presence of extremely small voltages.

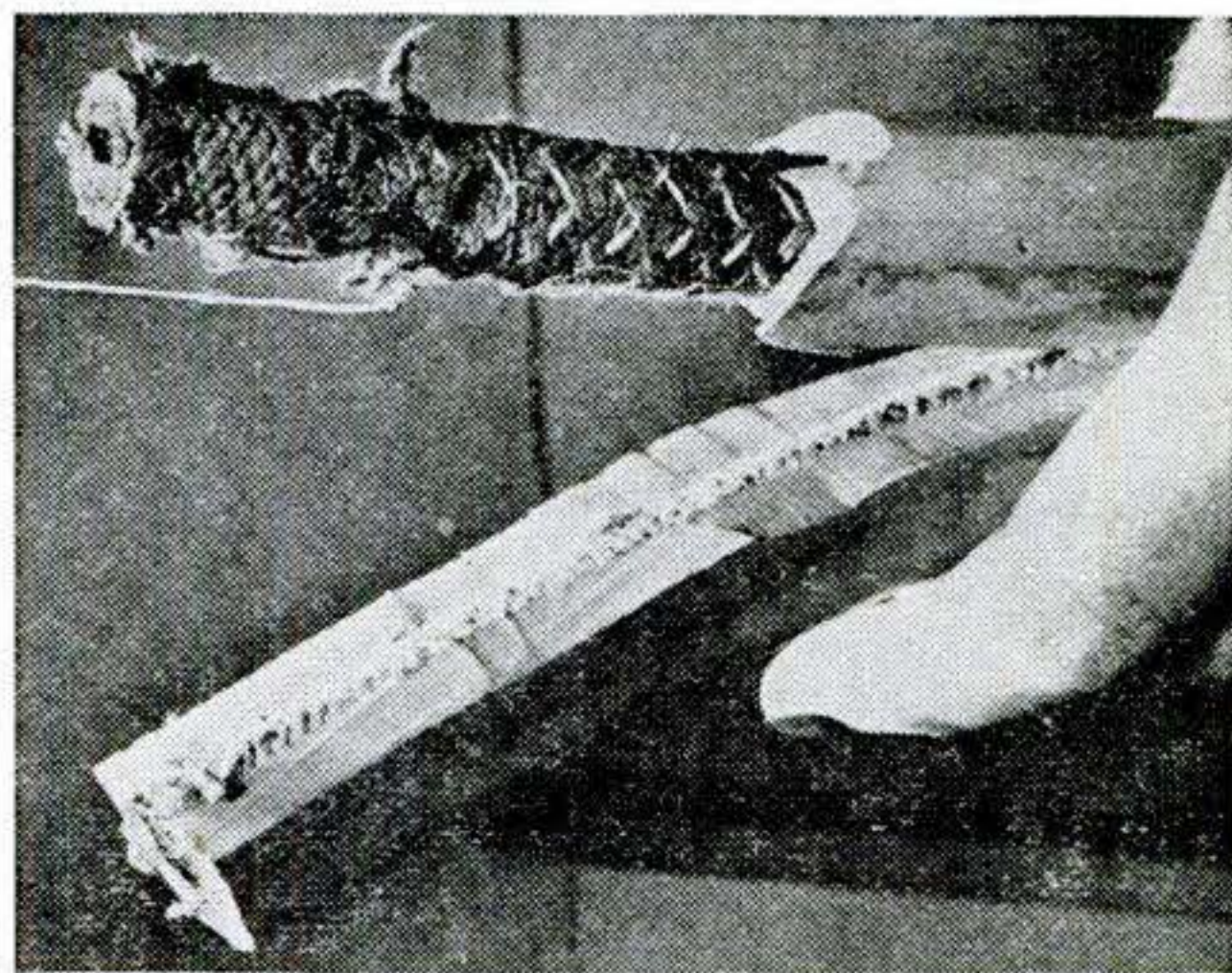

Cutaway cable shows copper braid over the line's inner core, within rubber jacket.

Braid Bans Sparks

EVEN if this cable shorts, there will be no dangerous shower of sparks. A copper braid between insulation and jacket picks up any current leakage and carries it back to a circuit breaker. Made by the United States Rubber Co., of Salt Lake City, it is designed for power lines to mine machines, where arcs from leaky cables sometimes explode dust and gas.

Sway-Backed Bus Cuts Corners

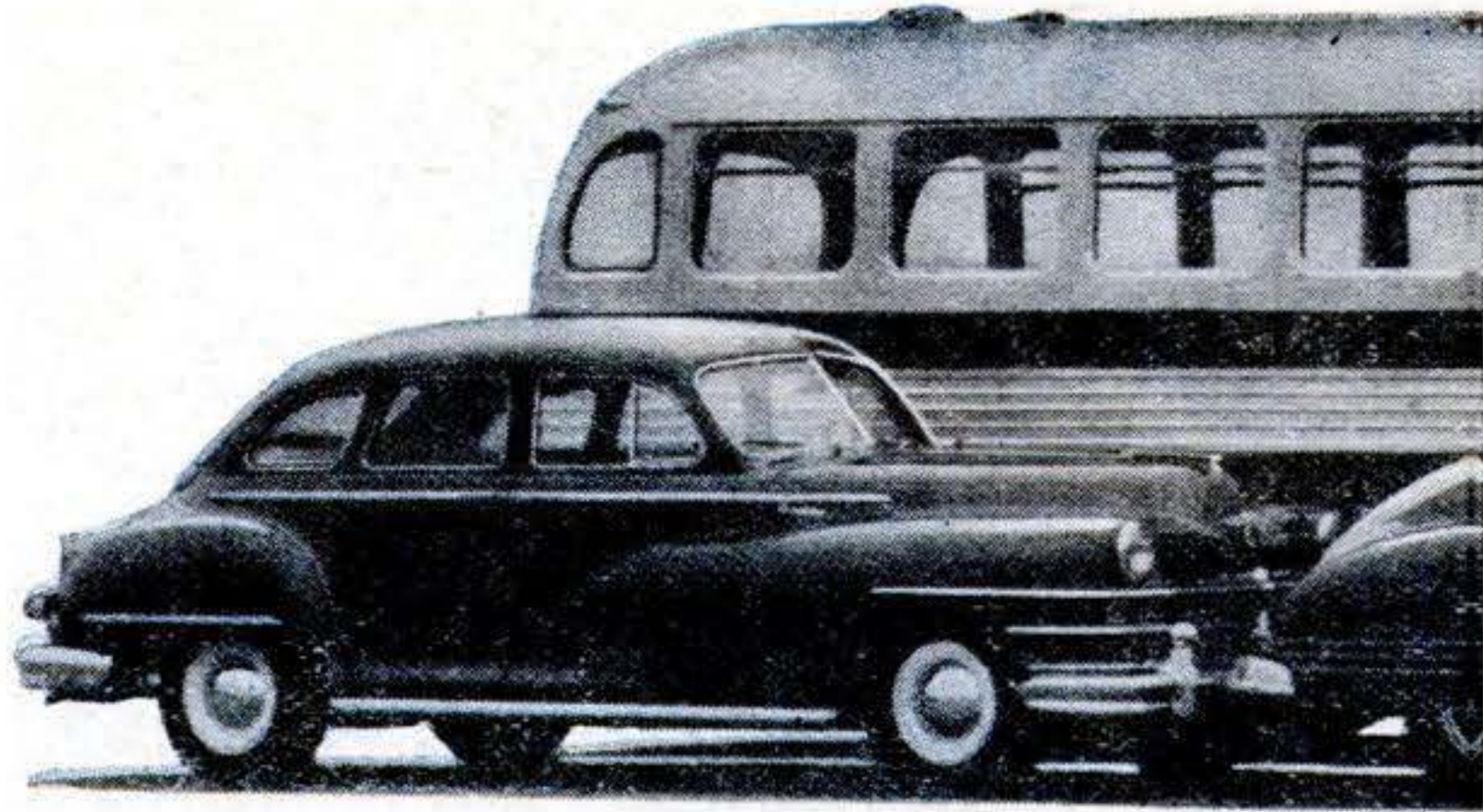

As long as three cars, bus seats 58 persons,

EQUIPPED with steerable wheels both front and rear, a two-section bus produced by the Twin Coach Co., of Kent, Ohio, turns corners with greater ease than any conventional bus now traveling city streets, although it is a dozen feet longer than most.

When the driver steers, a connecting shaft turns the rear wheels simultaneously with those in front, the rear ones turning outward and swinging the back of the bus around

the corner. In effect, therefore, the vehicle pivots on its driving wheels in the center. By virtue of this double steering, the 47-foot bus can turn in less space than an ordinary 35-foot bus.

A hydraulic booster system, actuated by two buttons under the driver's left foot, provides power to steer the four wheels whenever it is desired. One button operates the left-turn booster; the other, the right-turn booster, making the bus as easy

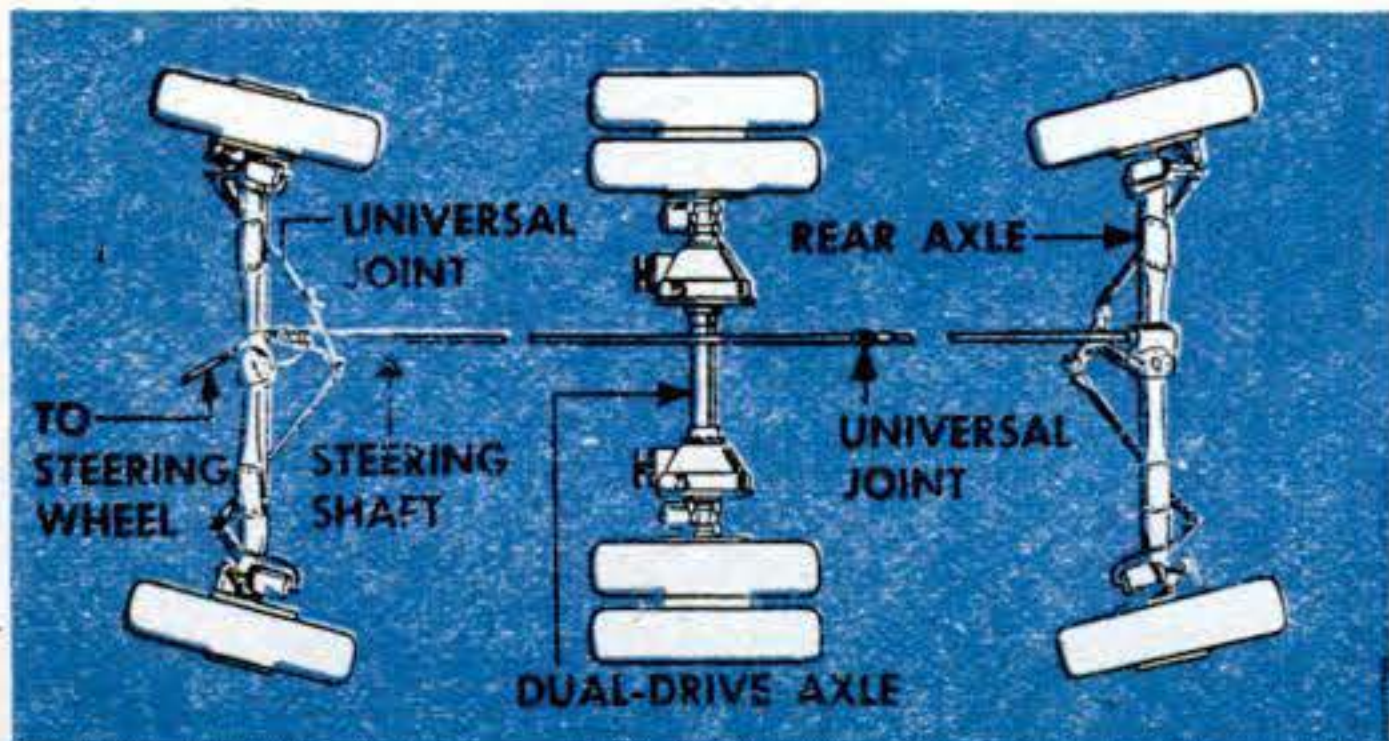

On turns, the rear wheels follow the path of those at the front. This has the effect of pivoting the vehicle on the center driving wheels, allowing it to turn in a radius of 35 feet 10 inches, including overhang at both ends.

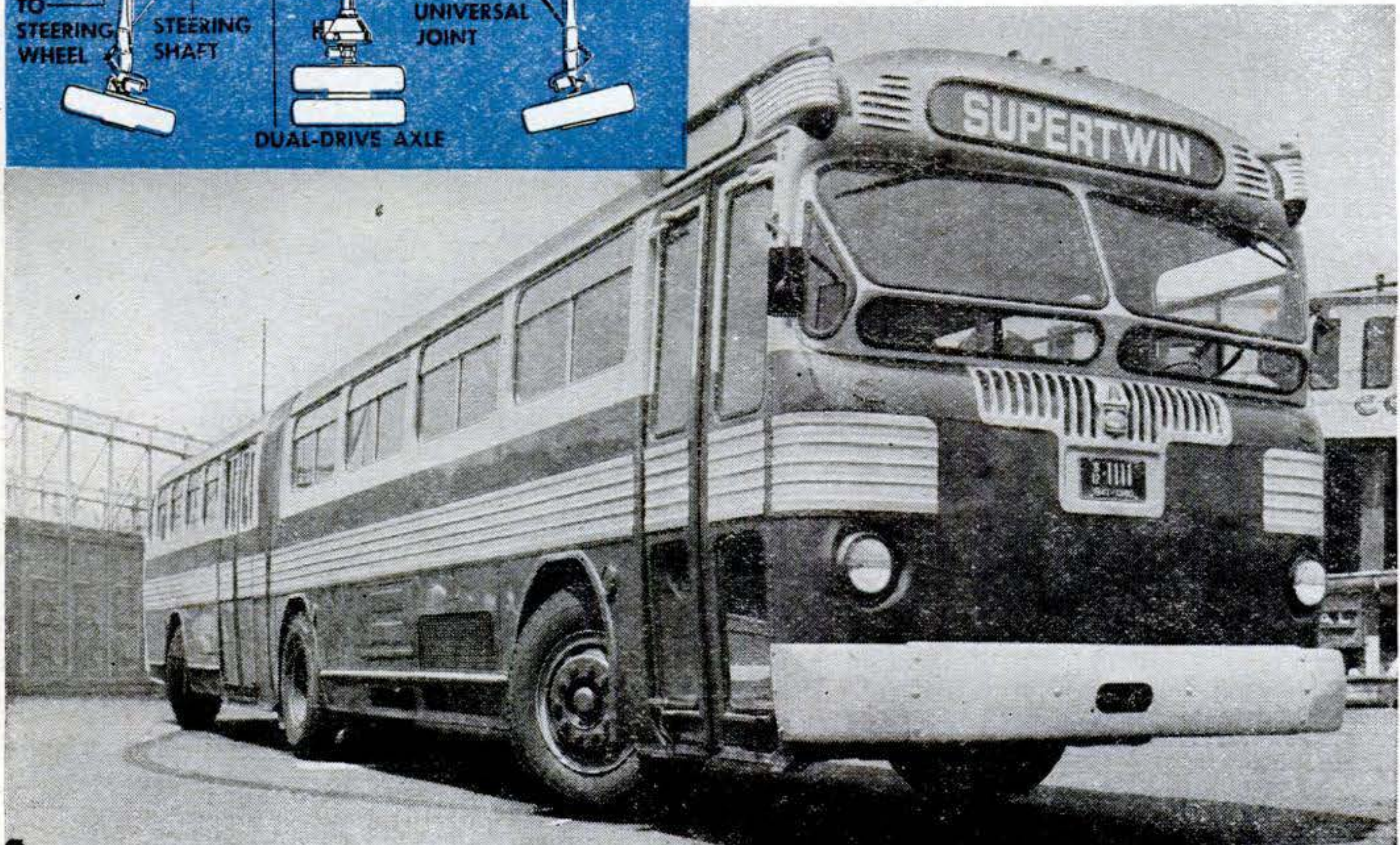

When the driver steers, both the front and rear wheels turn—but toward opposite sides.

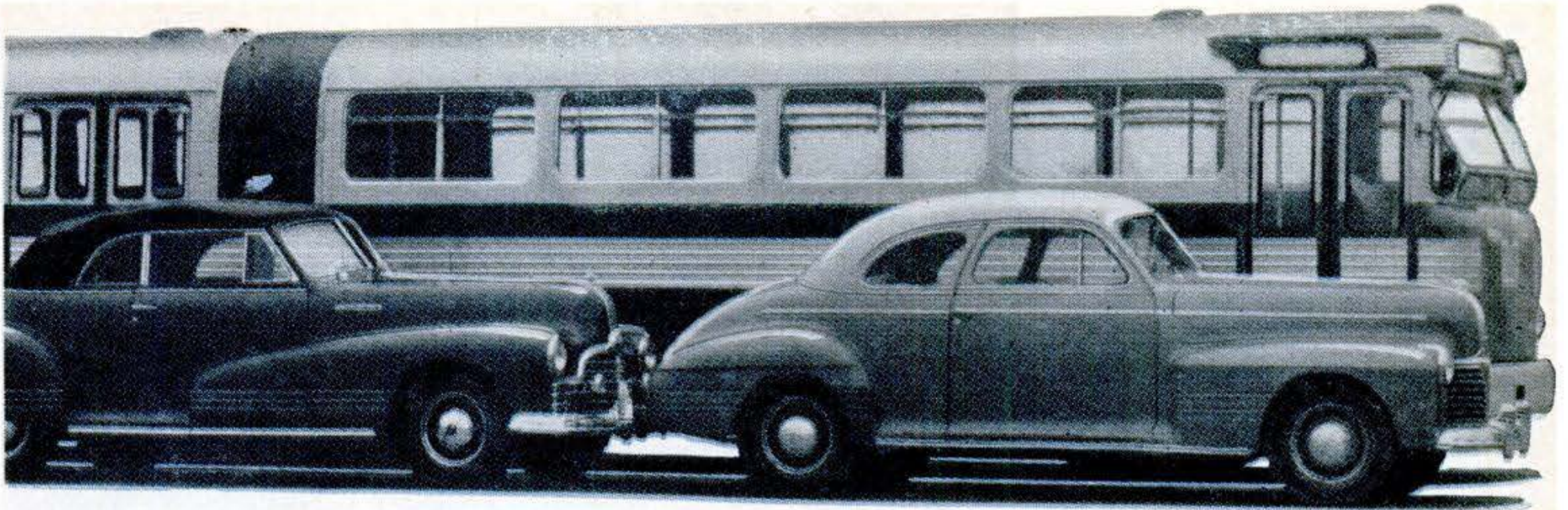

but the total capacity of its two sections—120, including standees—rivals a streetcar.

to handle as a much smaller one. The driver has no clutch pedal, since torque converters eliminate gear shifting.

Joined just behind the center axle by two Torsilastic rubber hinges, developed by the B. F. Goodrich Co., the two sections of the bus undulate when they hit a hump or dip in the road. Similar in construction to the springs employed on all three axles, the hinges consist of rubber bonded between an inner steel tube and an outer shell, the rub-

ber absorbing the twist when force is applied to either tube or shell. Sheets of rubber connect the top, sides and floor of the two sections. This rubber flexes as the center of the bus rises and falls.

Powered by two 180-hp. Fageol gas engines, under the rear of the front section, the bus can travel 75 m.p.h., although normally it would never have to operate at that speed. Built chiefly of aluminum, it weighs about 22,800 lb. END

Rubber hinges join the two sections. Placed transversely under the flooring, these allow the bus to bend up and down in crossing bumps in the street. The rubber is bonded between a steel center shaft and an outer shell.

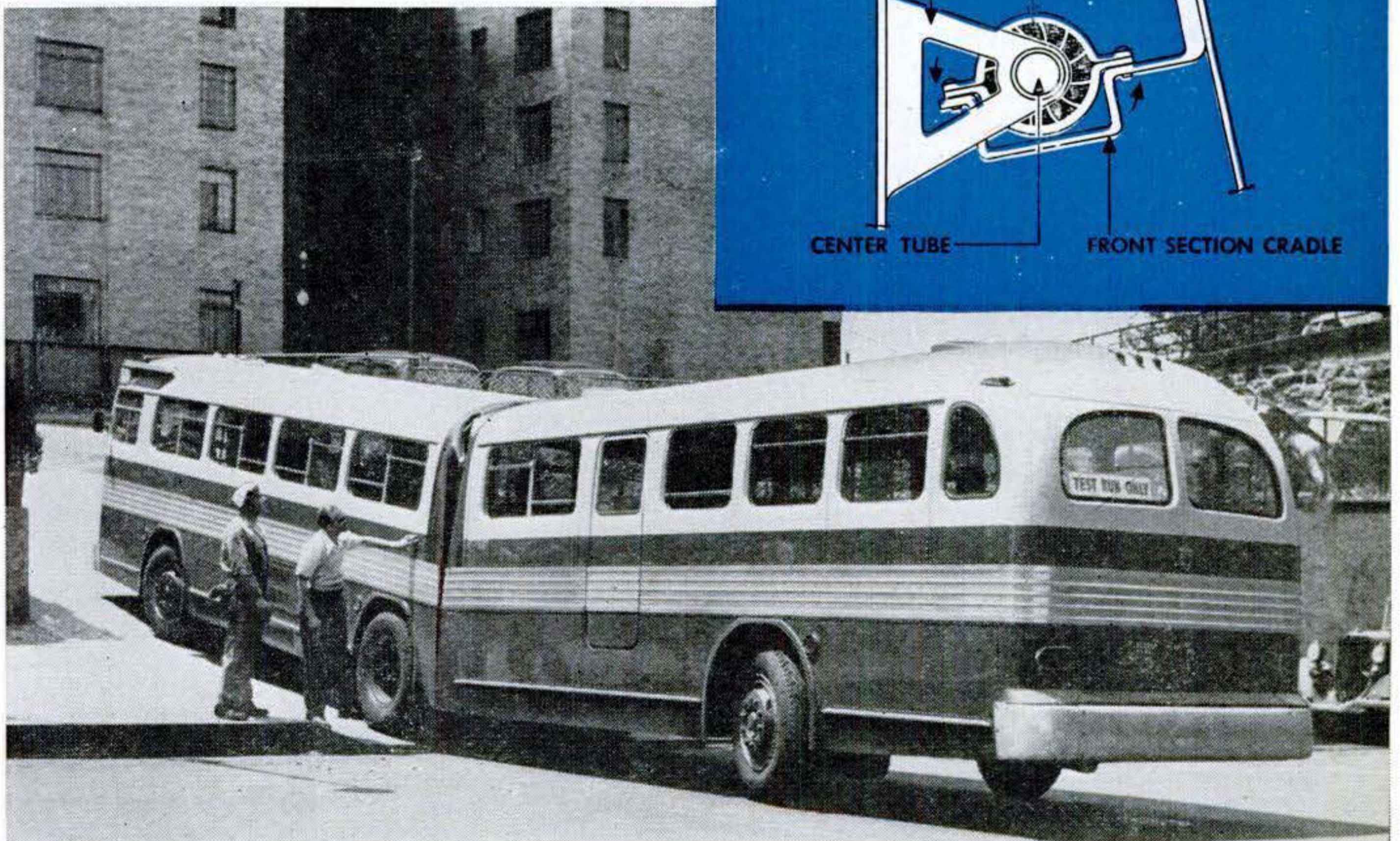
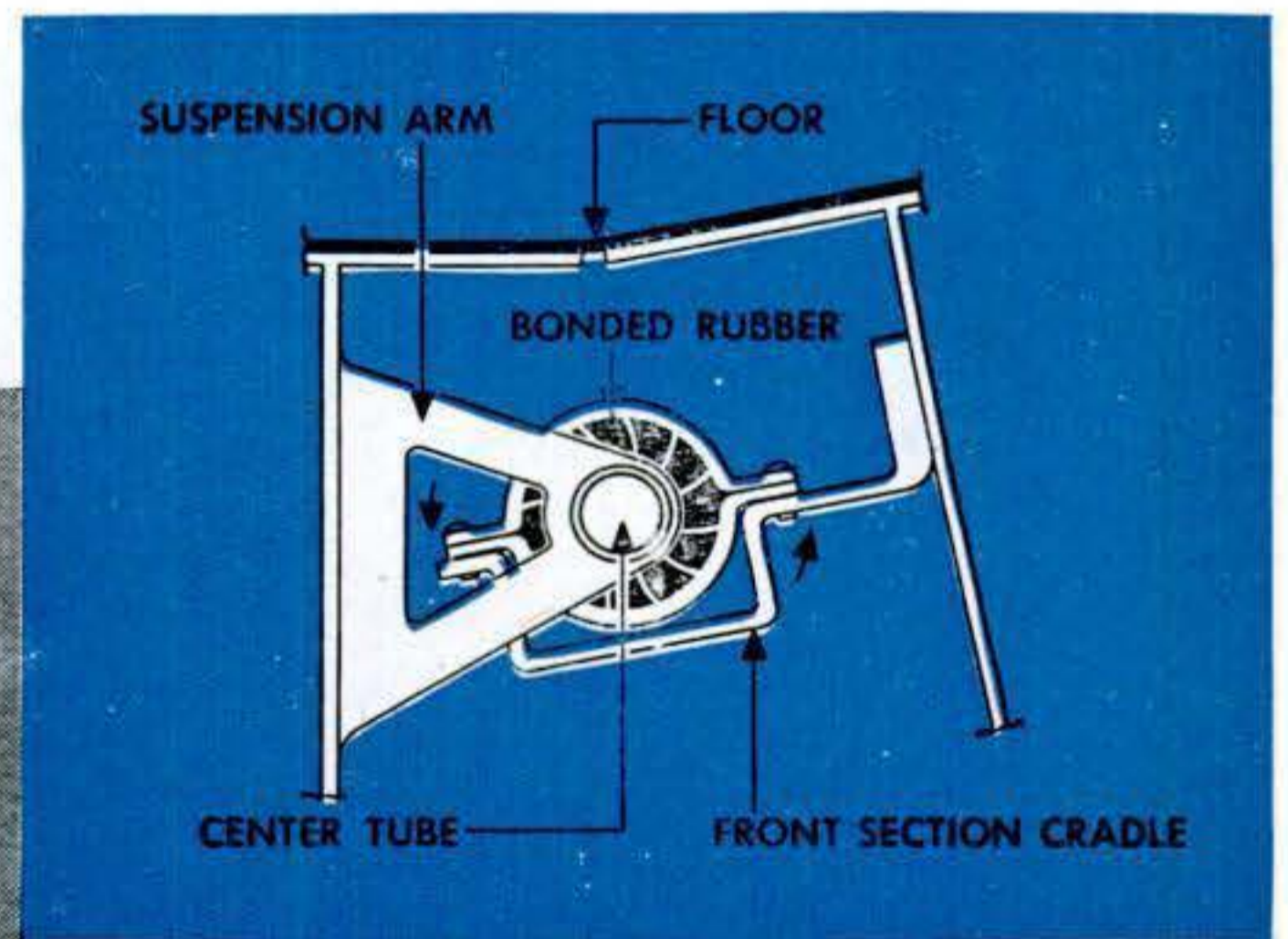

Bending of the bus keeps the center driving wheels always in firm contact with roadway.

5,000 Acres of Sudden Death

DEATH—potentially—for thousands lies close to populous Long Beach, Calif. Yet so tightly is it leashed by safety precautions that danger of major disaster is at a

minimum. The thousands of tons of munitions at the 5,000-acre Seal Beach Naval Ammunition Depot are scattered in small lots in "igloos." Employees are highly trained in safety; to prevent sparks they use bronze tools and wear shoes with no metal in them. Greatest danger is from above: civilian pilots who fly low over the area, never suspecting what it contains.



These safety-minded workers are inspecting and checking the gauges of three-inch AA shells.

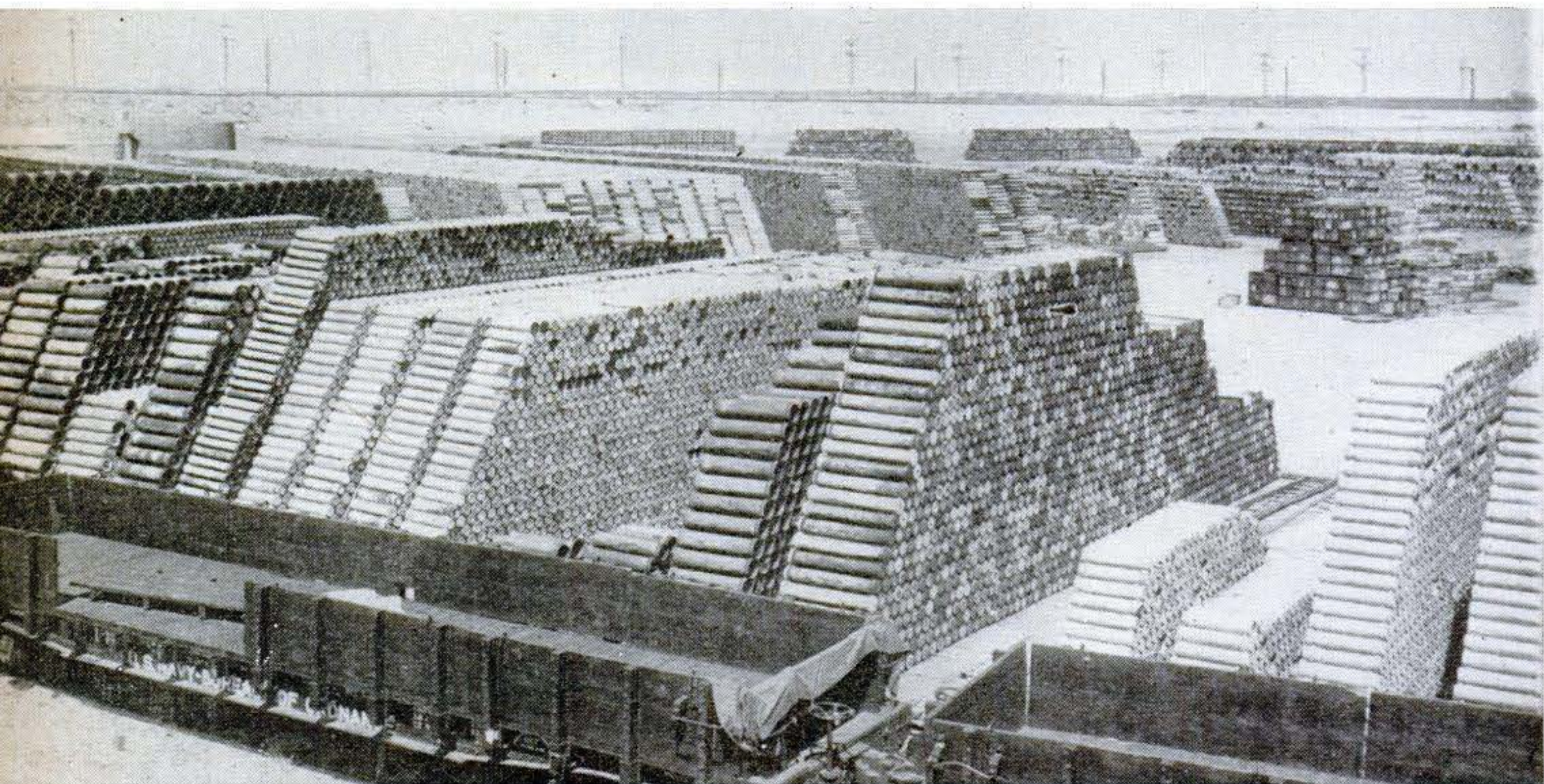

These vast piles are empty shell containers of all sizes, from rifle to 16-inch ammunition.



Farm Jeep Again Offers Four-Wheel Drive

HERE'S the latest member of the growing jeep family: a farm truck with the four-wheel drive of the wartime model. With a full 2,000-lb. load it can climb a 48 percent grade. It is designed for farmers who must drive to market over bad roads in all kinds of weather. The driver can shift to ordinary two-wheel drive whenever he wants to.

Other than the front axle and transfer box, most engineering and body details of the Willys 4WD are identical with those of the two-wheel drive model. Appearance is the same except for distinctive colors. There are seven body styles. Optional features include power take-off, shown in action above, and variable-speed governor for towing.

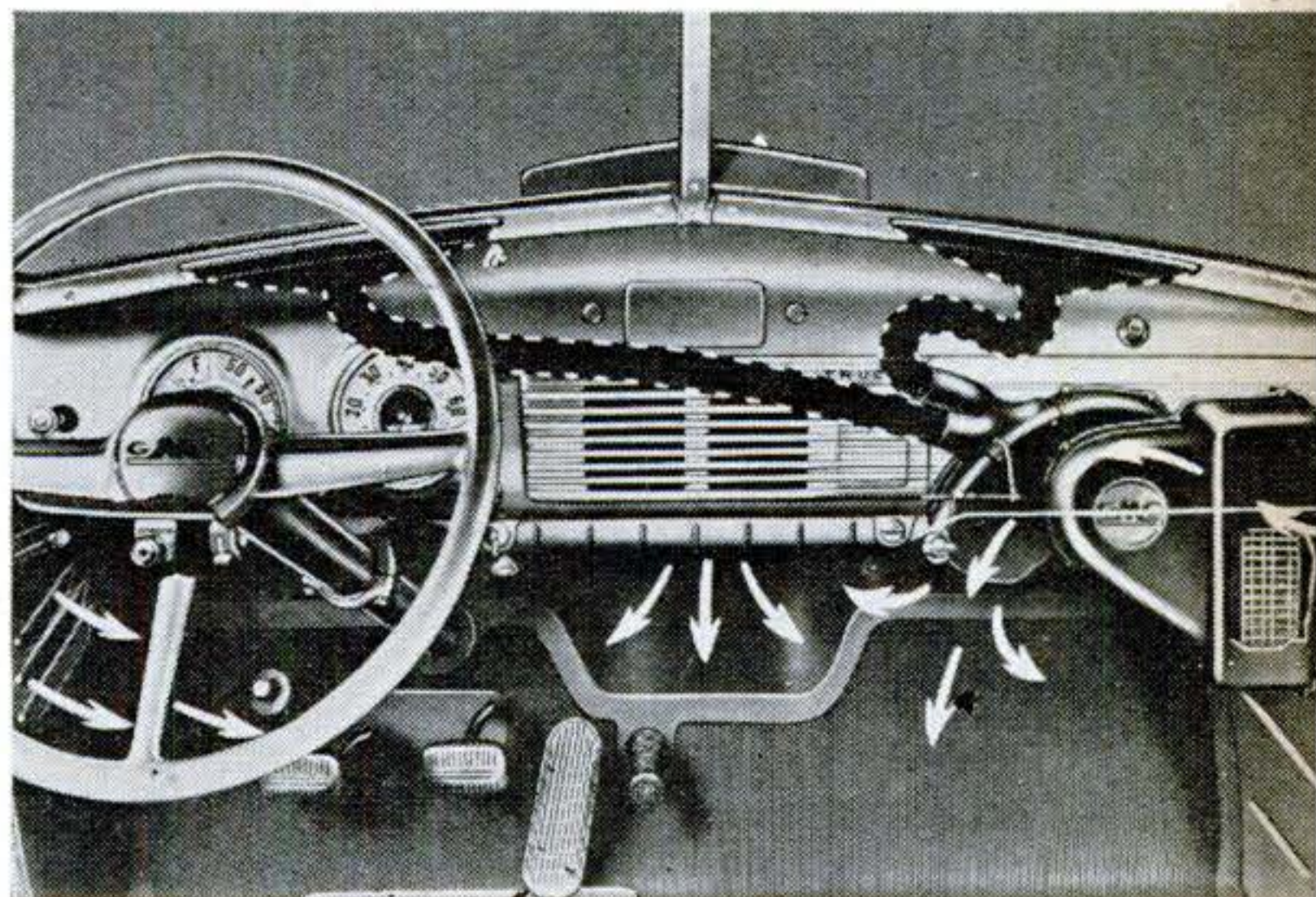
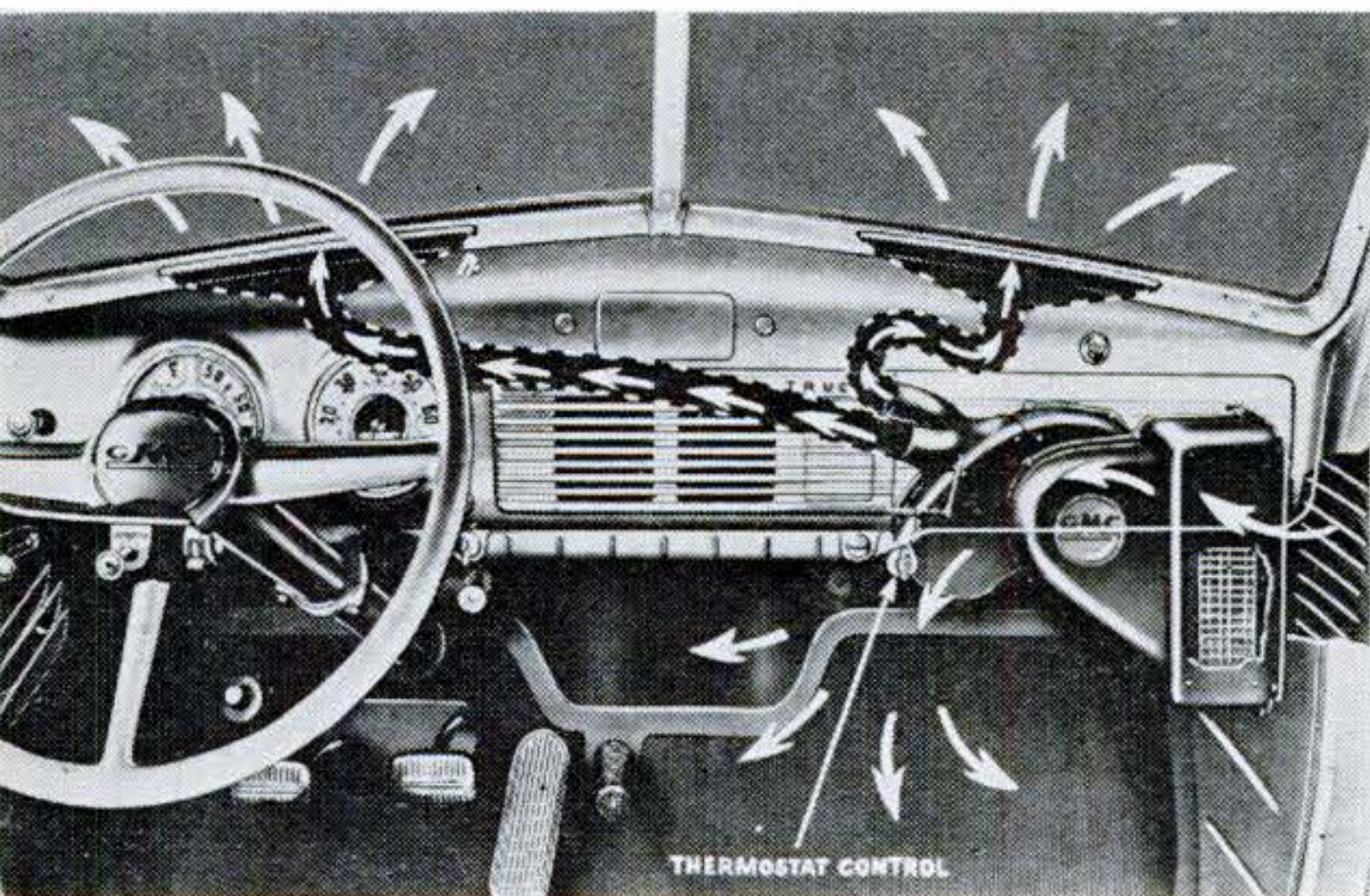

New Trucks Built for Driver Comfort

THE driver gets a break in the new GMC light- and medium-duty trucks. Cabs have been redesigned to provide more room, a more comfortable seat, increased visibility and improved ventilation. The pictures above show how the ventilating system works. In winter (at left) the system draws in fresh air, heats and distributes it. Con-

nections with vents under the windshield provide a defrosting system. Stale air is expelled through openings in the floor of the cab behind the driver's seat. In the summer setup (at right), a steady stream of cool, outside air is sucked into the cab. Other improvements have been made in the engine and chassis of the trucks.

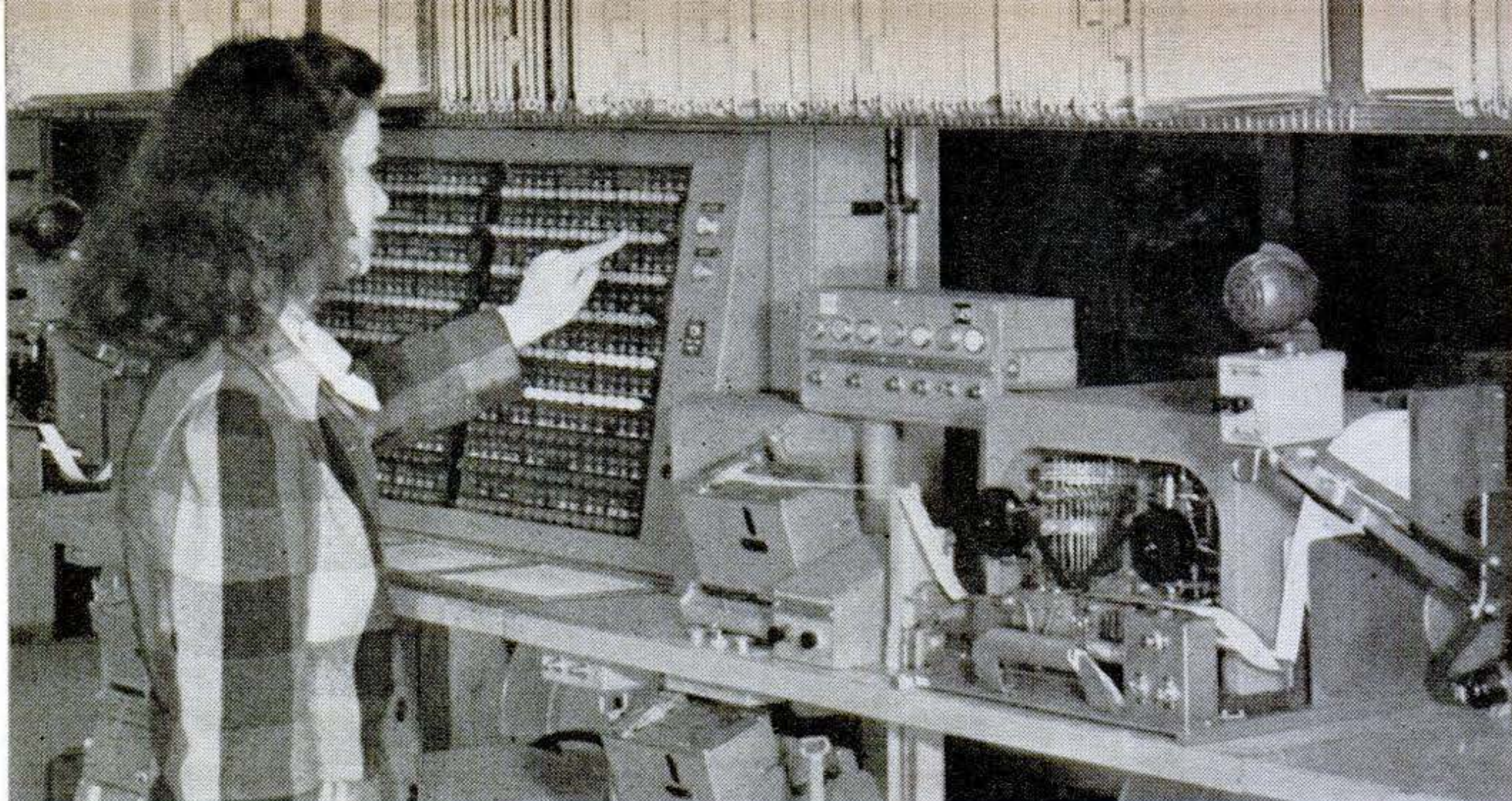

Pushing the right button now relays a telegram through switching centers to its destination.

Buttons Relay Telegrams Faster

YOUR telegrams will soon get there nearly twice as fast, hastened by a new system of push-button switching that speeds messages through Western Union's big central offices. The five minutes or more formerly required to relay a telegram are being cut to seconds, while the number of messages an office can handle is being boosted.

Relay points have always been a major bottleneck in telegraph service. Until now, a message from a branch office was sent to the nearest switching center, where it was printed out on paper tape, pasted on the usual yellow blank, and routed by conveyer belt and messenger to an operator at an outgoing transmitter that was connected to the message's destination (or perhaps only to another switching center near the final destination). The operator manually re-typed the message, and, if another relay point was involved, the same telegram was typed there for the third time. Many attempts had been made to streamline this method—even to equipping the relay mes-

senger girls with roller skates—but it remained slow and inefficient.

Now push buttons will do the job. The message from the branch office is received at the switching center in the form of a perforated paper tape (the holes in the tape make up a letter code, much as the holes in a player-piano roll make up a music code). Above the punched holes, the message is also printed out. A clerk at the receiver reads the address on the tape, then pushes a button that connects an automatic transmitter to an outgoing transmitter connected to the destination. The tape runs through the first transmitter and is relayed without manual retyping.

Conversion of the Philadelphia switching center, biggest in the country, to push-button operation will be finished this month, with other offices scheduled to change over to the new system by 1950. Already in use are similar installations in St. Louis, Richmond, Dallas, Atlanta and Oakland, Calif.

Completely automatic switching—eliminating the need for an operator to push the switching button—is now being developed. With this equipment, certain code letters in the address would trip relays switching the message through to its destination,

This Month's Pin-up

REPUBLIC'S P-84 Thunderjet, a contender for top speed honors in the AAF, is powered by an axial-flow TG-180 jet that has blasted it up to 619 m.p.h. in unofficial tests. The

sleek, midwing fighter has a range of more than 1,000 miles, a service ceiling above 40,000 feet. It is 37 feet 5 inches long, with a span of 36 feet 3 inches.



NEW IDEAS
from the
INVENTORS

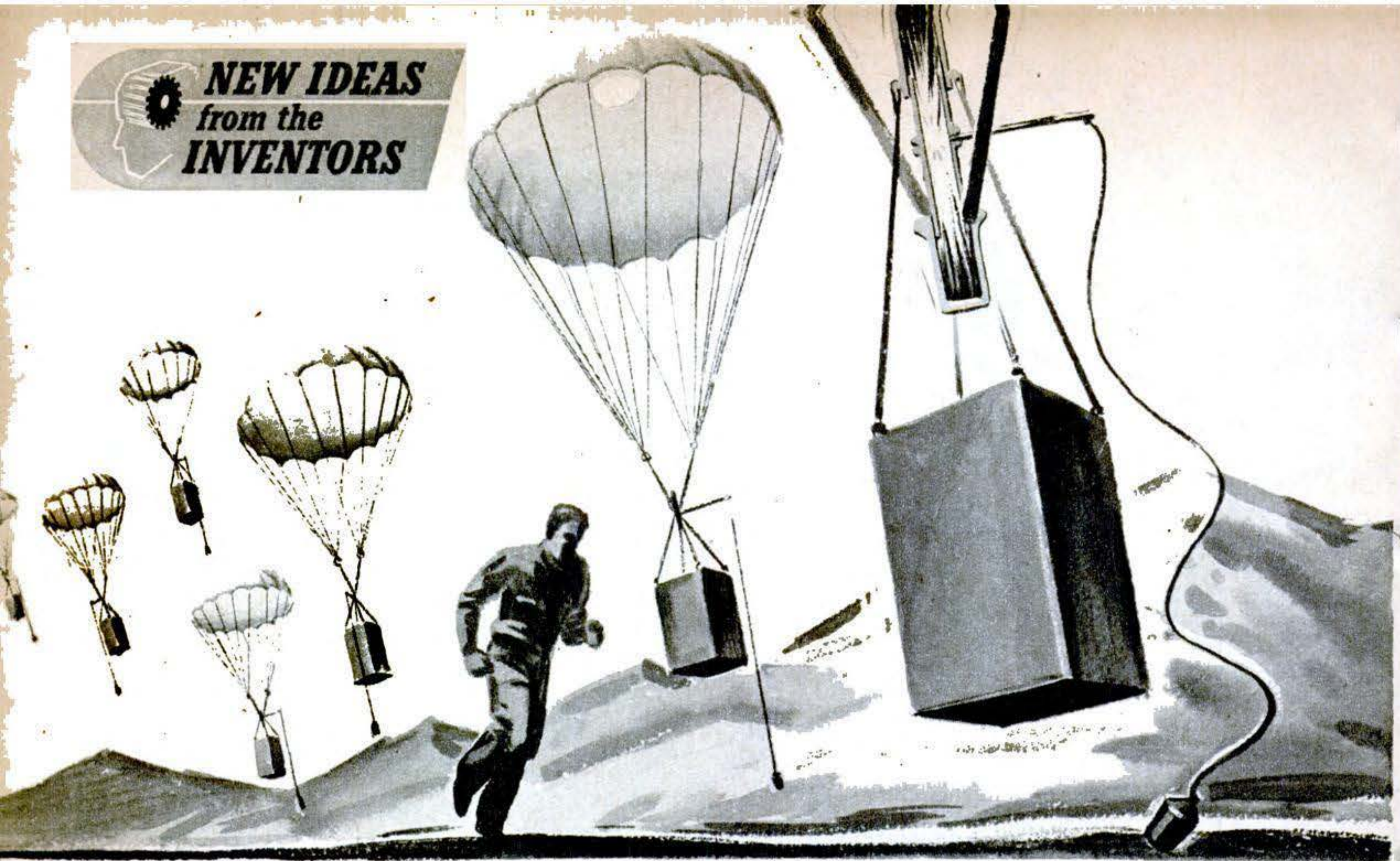

Blast Breaks 'Chute's Fall. The force of an explosion is used to soften parachute landings in this invention of Henry S. Bacon, of West Roxbury, Mass. Set off by a weighted release cord just before the 'chute's

load strikes the ground, the explosion expands a telescoping chamber. This jerks the canopy and load abruptly toward each other, increasing the air resistance to the canopy and momentarily imparting lift to the load.



Phone Keys Speed Calls. To call a number on this novel phone, you simply tap it out on the keys indicating the appropriate numerals and letters. Invented by Charles D. Richard, of West New Brighton, N. Y., the push-button system is similar in principle to that of dial phones but eliminates the time the dial takes to spring back to its starting position after each turn.

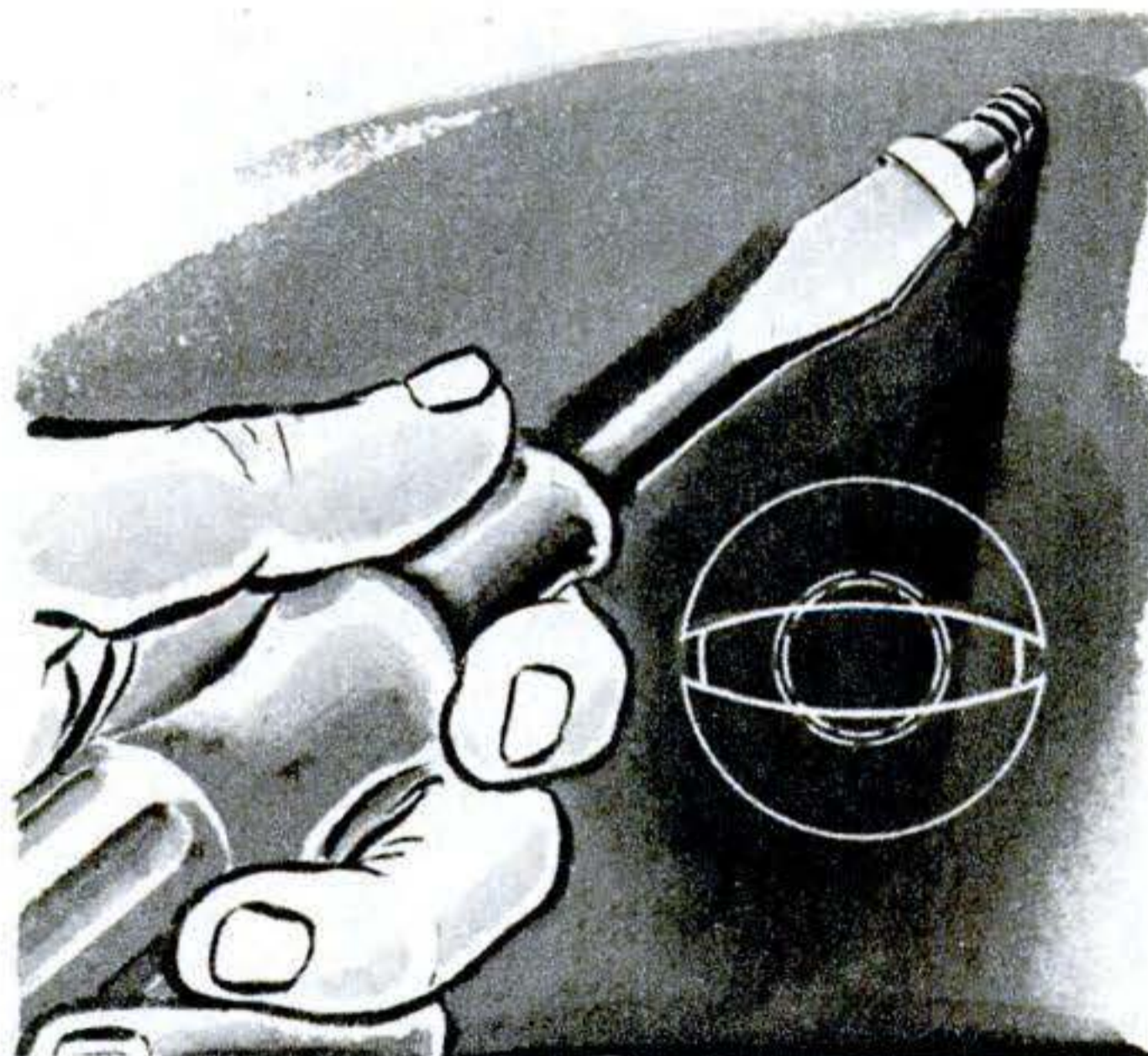

Screw Slot Stops Sideslip. Safe and simple screwdriving is the object of a screw head patented by William L. Todd, of Fort Thomas, Ky. Narrowing at each side, its groove tends to center the screwdriver and keep it from shooting off into a nearby finger or the surrounding woodwork. The best results are obtained with a screwdriver whose blade exactly matches the groove.

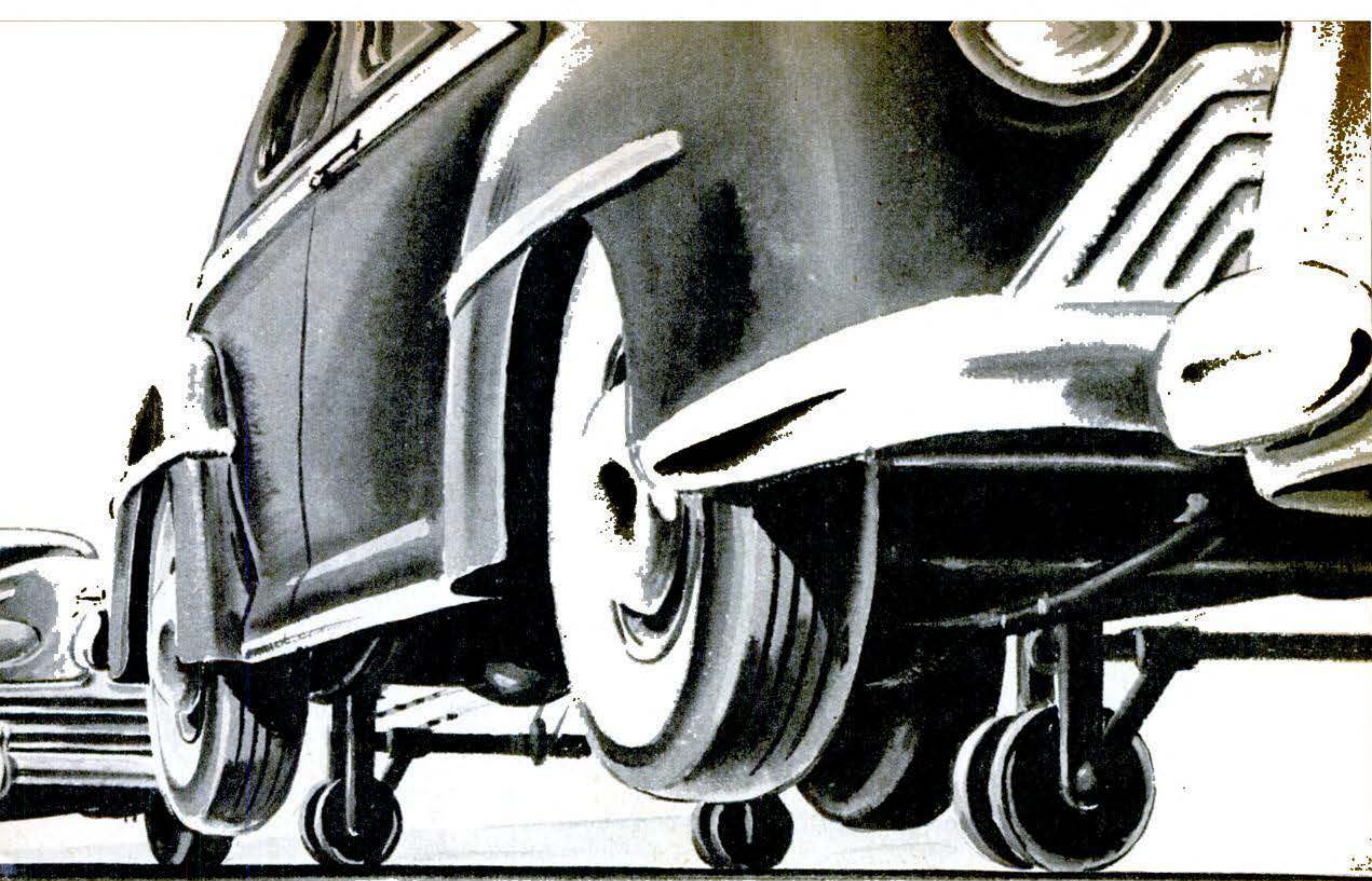

Extra Wheels Park Car. You'd have no trouble slipping your car into a tight spot with the parking wheels invented by Abba Miller, of Cleveland, Ohio. Lowered into position by automatic jack units and

chain-driven by a separate motor, the tiny transverse, retractable wheels permit the car to move sideways in either direction. (Readers may remember seeing this idea in "I'd Like to See Them Make" last January.)

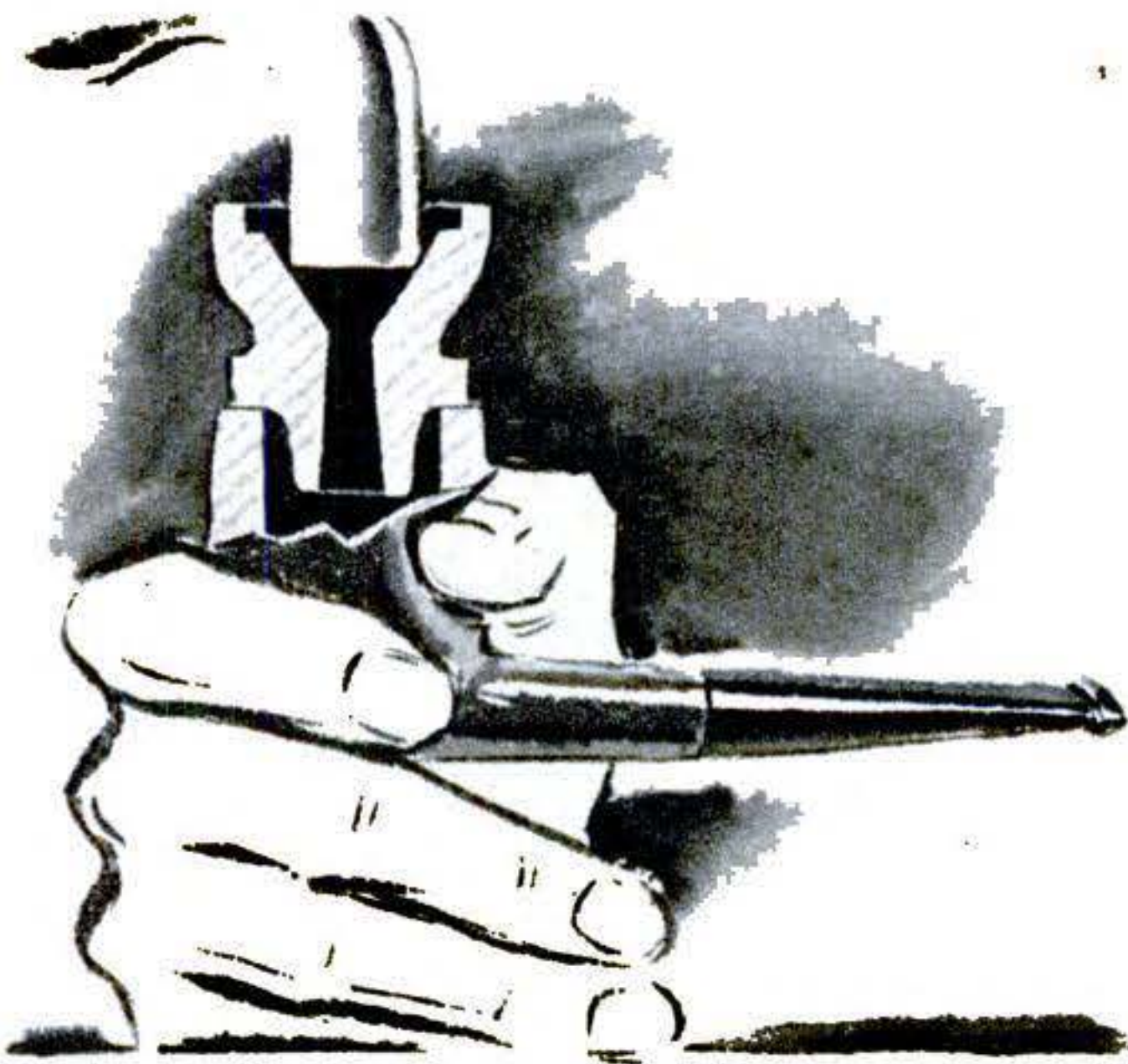

Pipe-Washer Fits Faucet. A simple pipe-rinsing device that fits over the faucet and directs a stream of water into the pipe's bowl has been patented by Bruno L. Pape, of New Braunfels, Tex. Made of rubber, it has a conical opening at the top that accommodates a variety of faucet sizes. The bottom fits into a pipe bowl, but also fits pipe stems and cigarette holders.

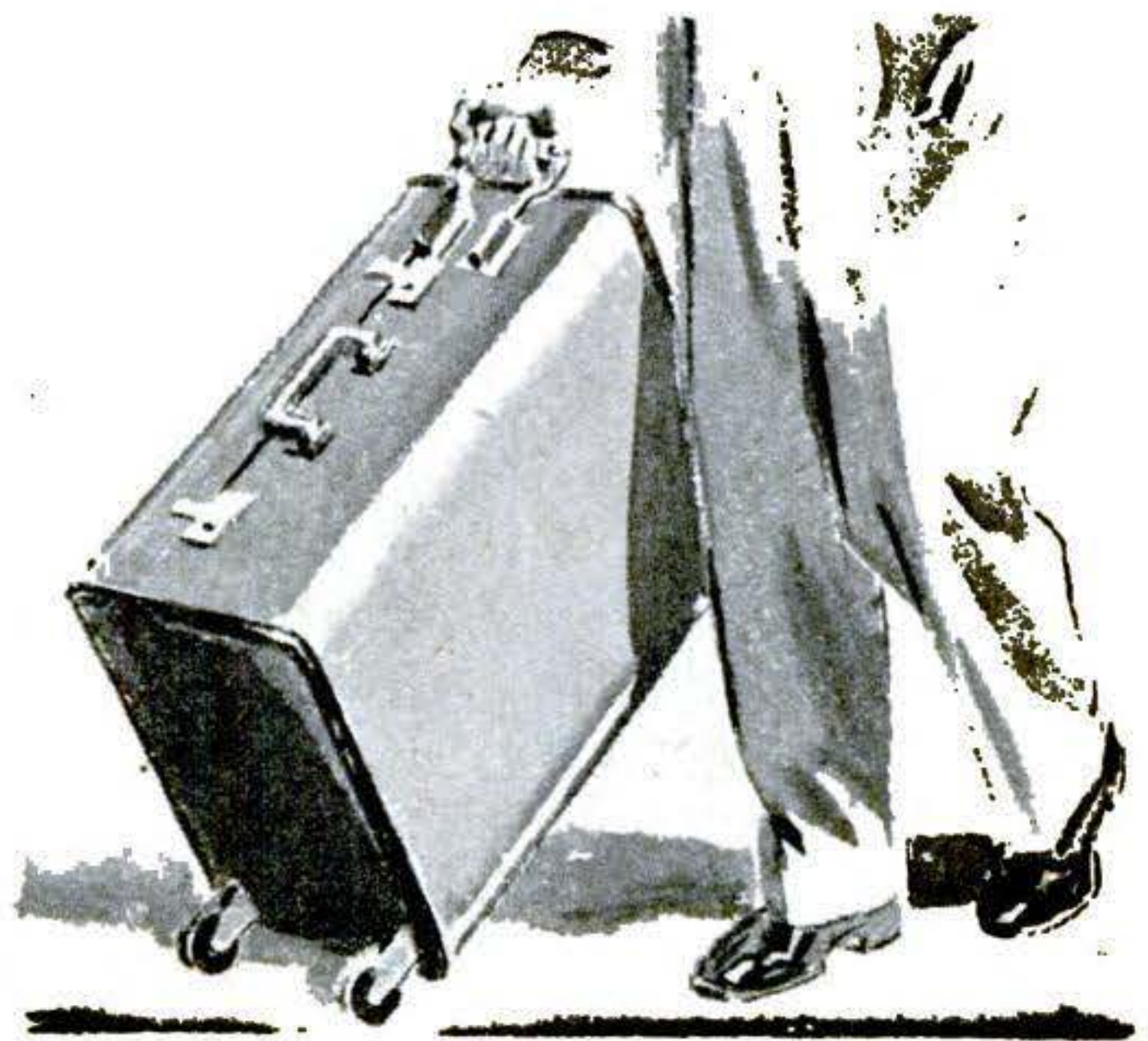

Suitcase Rolls On Wheels. You can roll your suitcase along like a wheelbarrow, instead of having to carry it, with the attachments patented by John M. Hendrick, of Burbank, Calif. The two small wheels near the bottom at one end do not touch the ground until the suitcase is tilted upward. The handle on top at the other end slides out of the way when not in use.

X-Rays Paint Gems

WANT to change the color of the stone in your ring? Or how about one that glows in the dark? Such effects may result from electronic changes temporarily produced in certain precious and semiprecious gems by exposure to X-ray irradiation.

Under the bombardment of special tubes whose rays are several hundred times more intense than those of old-style, conventional types, the electronic arrangements of many gems undergo slight but significant changes. Electrons, separated from their ions, wander free until trapped by structural defects, producing new electronic patterns. These, in turn, cause striking color changes and in some cases even luminescence, found to be valuable in mineralogical studies.

Highly unstable, however, these new arrangements soon revert to their original ones, some without stimulation, others upon exposure to heat or sunlight. Thus, cautious buyers can protect themselves by testing stones with heat and light to see if their colors fade. Diamonds and emeralds are unaffected by the X-ray tubes now in use.

PSM photos by Robert F. Smith

Changes in sapphires lasted longer than those in other stones used in recent tests. These stones were shown at the American Museum of Natural History. The two almost colorless ones in the lower right-hand corner above are untreated; the deep shades of the other four were induced by X-rays.

Before exposure: A large 35-carat cut kunzite with (l. to r.) cat's eye, yellow scapolite and white sapphire.



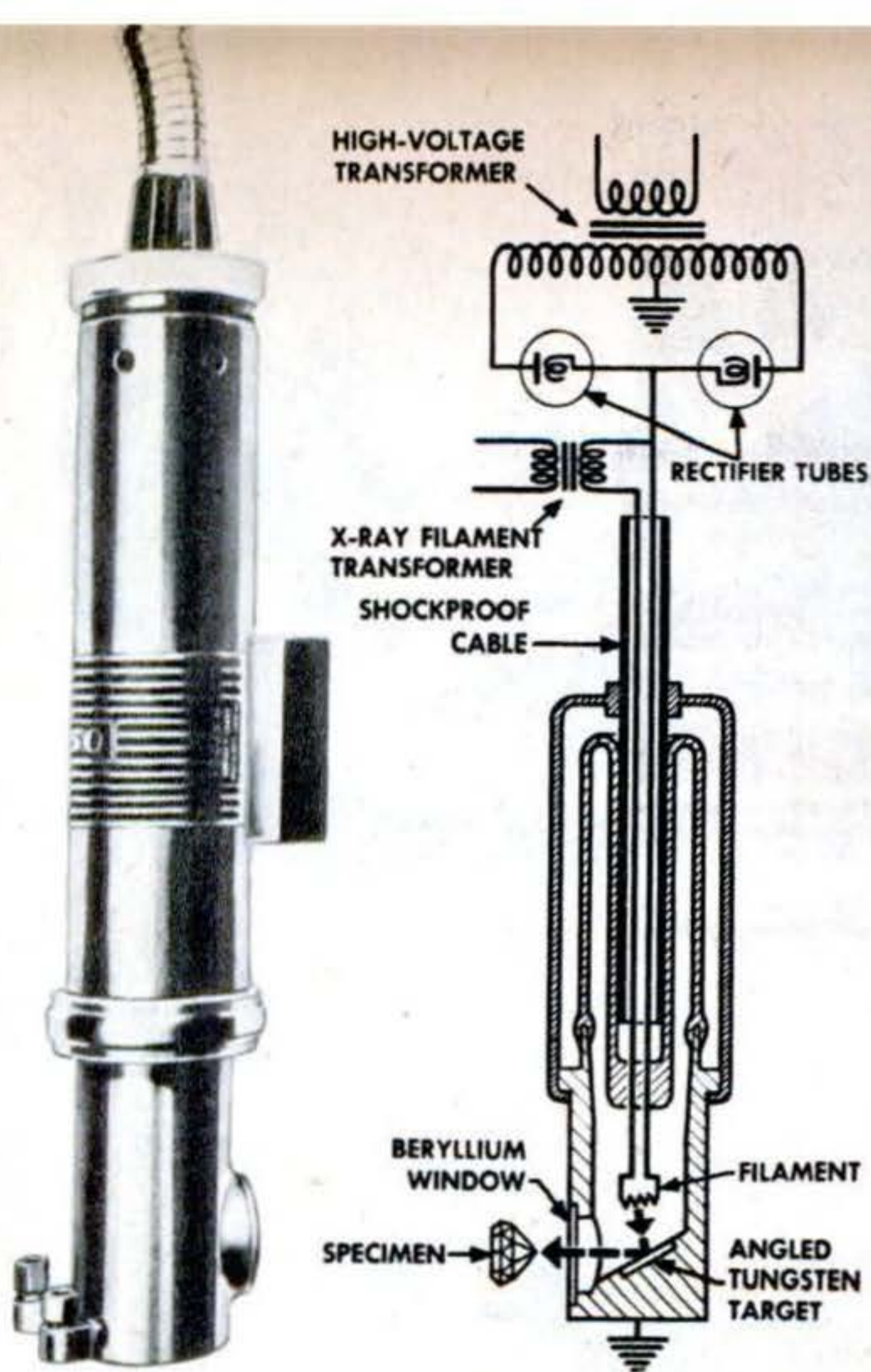

With high-intensity tubes like the one above, radiation effects requiring several hours with ordinary apparatus can be obtained in as little as one minute. Developed by Machlett Laboratories, this 50,000-volt tube uses an angled tungsten target to reflect the rays through a special beryllium window.

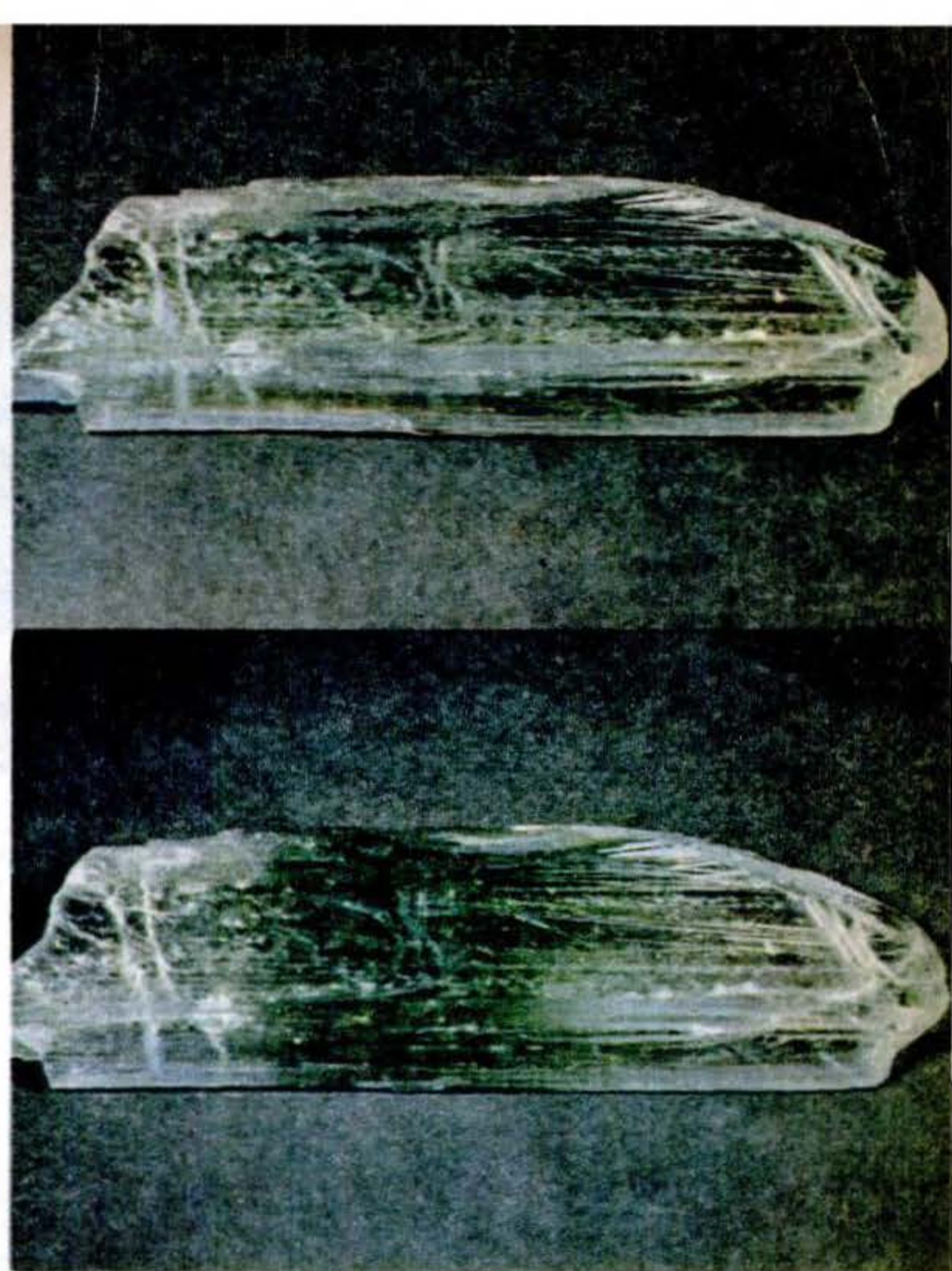

Most spectacular change occurred when a virtually colorless piece of untreated spodumene (top photo, above) was exposed to the irradiation. Becoming brightly phosphorescent, it glowed like a burning coal for an hour. Later, a band of vivid green (bottom photo, above) became visible.

After exposure: Color changes are startling but brief, would raise value from \$500 to \$2,000 if permanent.



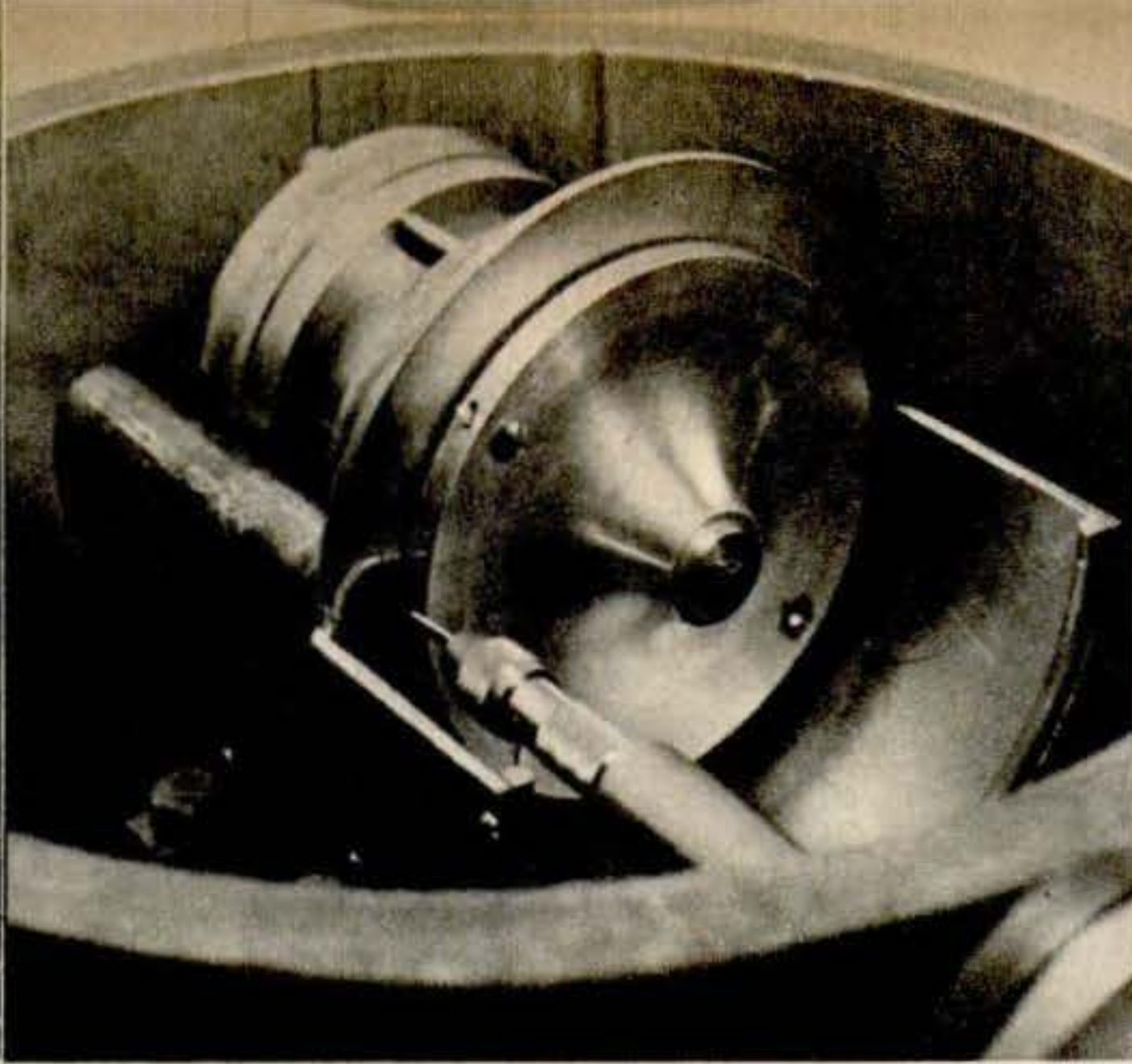
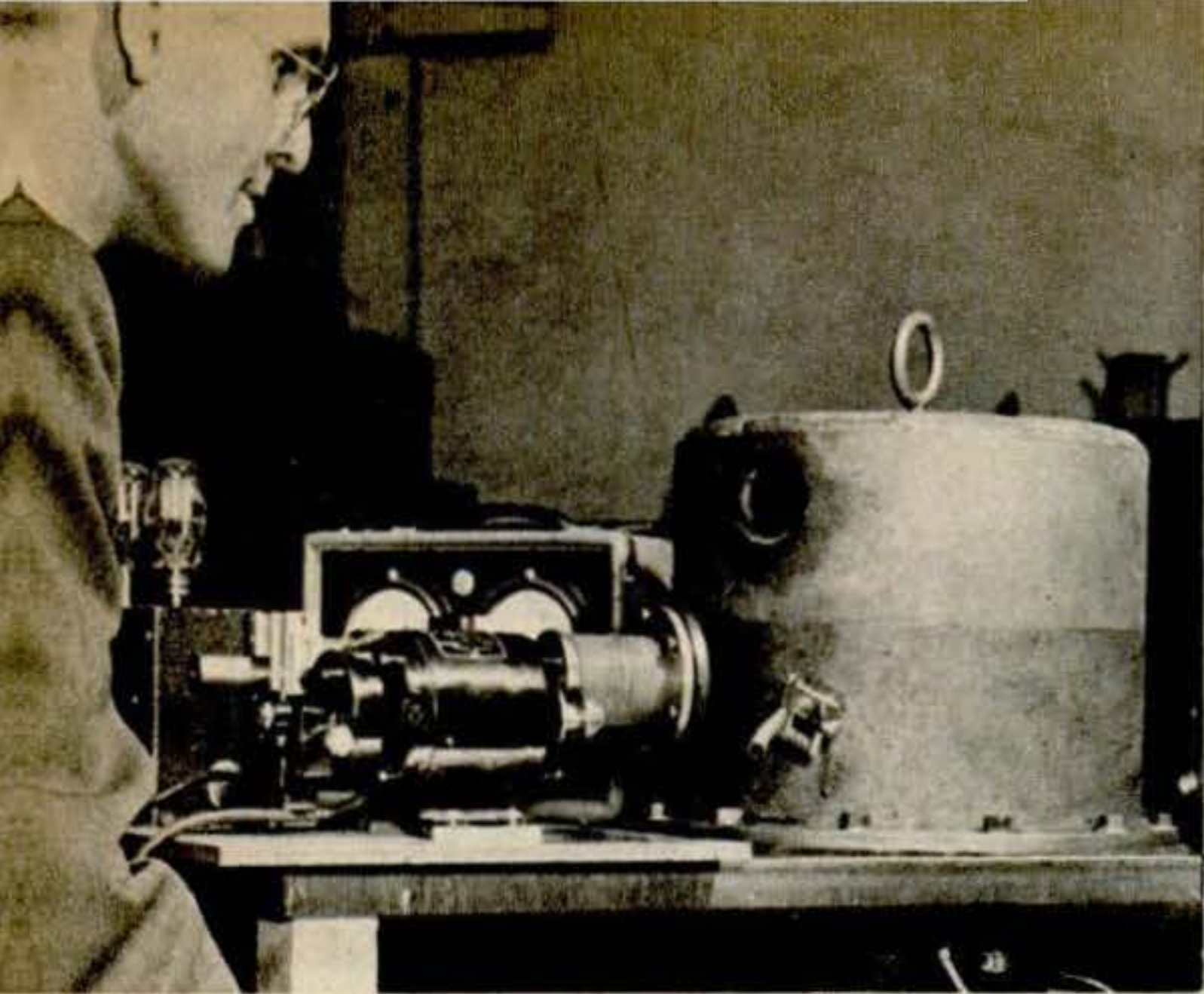

123,000 R.P.M.

A WHEEL that spins at 123,000 r.p.m., nearly double the previous world's record for rigid-shaft rotation, has been developed in General Electric's laboratories. Shown above with its designer, Dr. E. F. Fullam,

the device is a microtome used to slice the fantastically thin specimens required for electron microscopes. A tiny knife projects from the rim of the electrically driven, 3½-inch wheel (right). Spinning in a vacuum, it cuts samples only a fraction of a micron (1/25,400 inch) thick.



Coffee Under Pressure

USING the pressure-cooker principle in a coffee pot, this electrically heated machine turns out the morning brew by forcing superheated water through coffee specially prepared in porous, podlike containers, each

of which makes only a single cup. A container is placed in a small pan (at left, above) that locks to a fixture just above cup-rim height. Moving the handle (at right) allows the water to flow through the container and into a cup. A gauge and relief valve guard against excessive pressure.

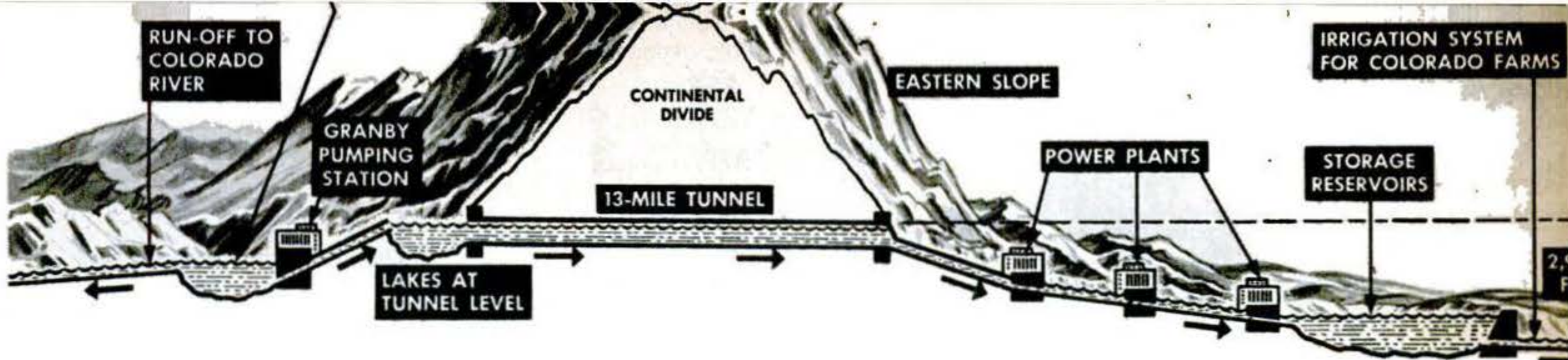

Man-Made River Pierces the Great Divide

PIPED through the Rockies, an artificial river is available now to refresh thirsty farm lands of eastern Colorado with completion of the Big Thompson project, world's biggest transmountain diversion feat. Cascading through electric generating plants and canals, the torrent will develop 176,000 kilowatts of electricity and boost crops on 615,000 acres.

On the western side of the continental divide, where Granby Reservoir collects rainfall that formerly spilled to waste in the Pacific Ocean, pumps raise the water 179 feet to Shadow Mountain and Grand Lakes. Thence, up to 247,000 gallons a minute course through the \$12,400,000 Alva

B. Adams Tunnel, a 9 $\frac{3}{4}$ -foot bore piercing 13 miles of solid granite. Having spun the turbines of hydroelectric plants, the life-giving flow is released through the Big Thompson and Poudre Rivers and a system of canals into territory where, tree rings show, soil has been parched for at least 300 years.

Engineers estimate that the quantity of water should be sufficient to supply a city as large as Philadelphia and Boston combined, and that as much electricity will be generated as a metropolis with the population of Newark, N. J., would consume. Augmented production from farms will amount to \$20,000,000 yearly.

At top capacity, 247,000 gallons of water a minute will flow into this portal of 13-mile bore, one of the world's longest tunnels, emerging 107 feet lower at eastern end.

Crews drove eight miles of tunnel, more than half of length, from east portal, below. On best day they advanced 74 feet. Shafts from opposite sides met only $\frac{3}{4}$ inch out of line.

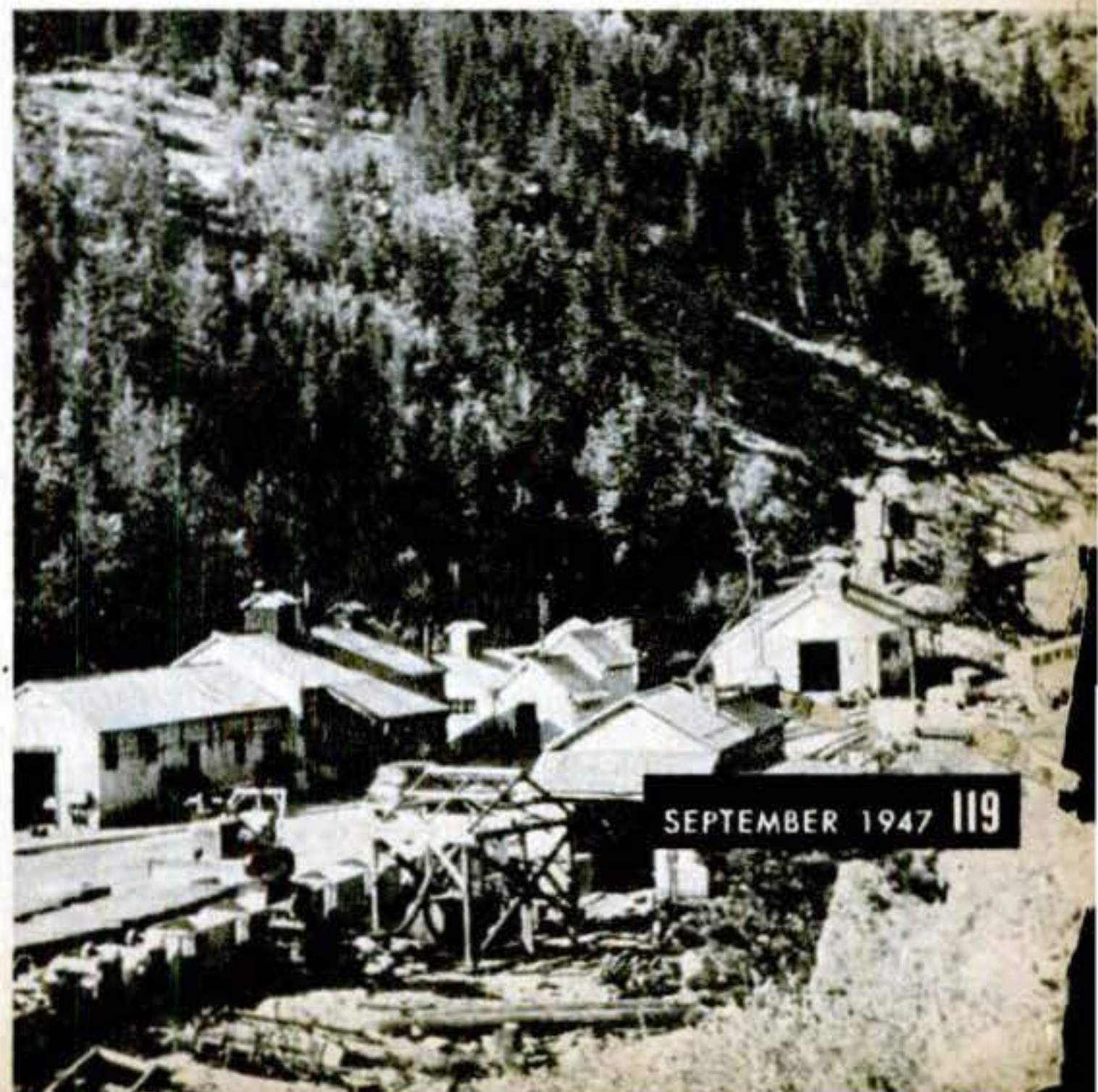
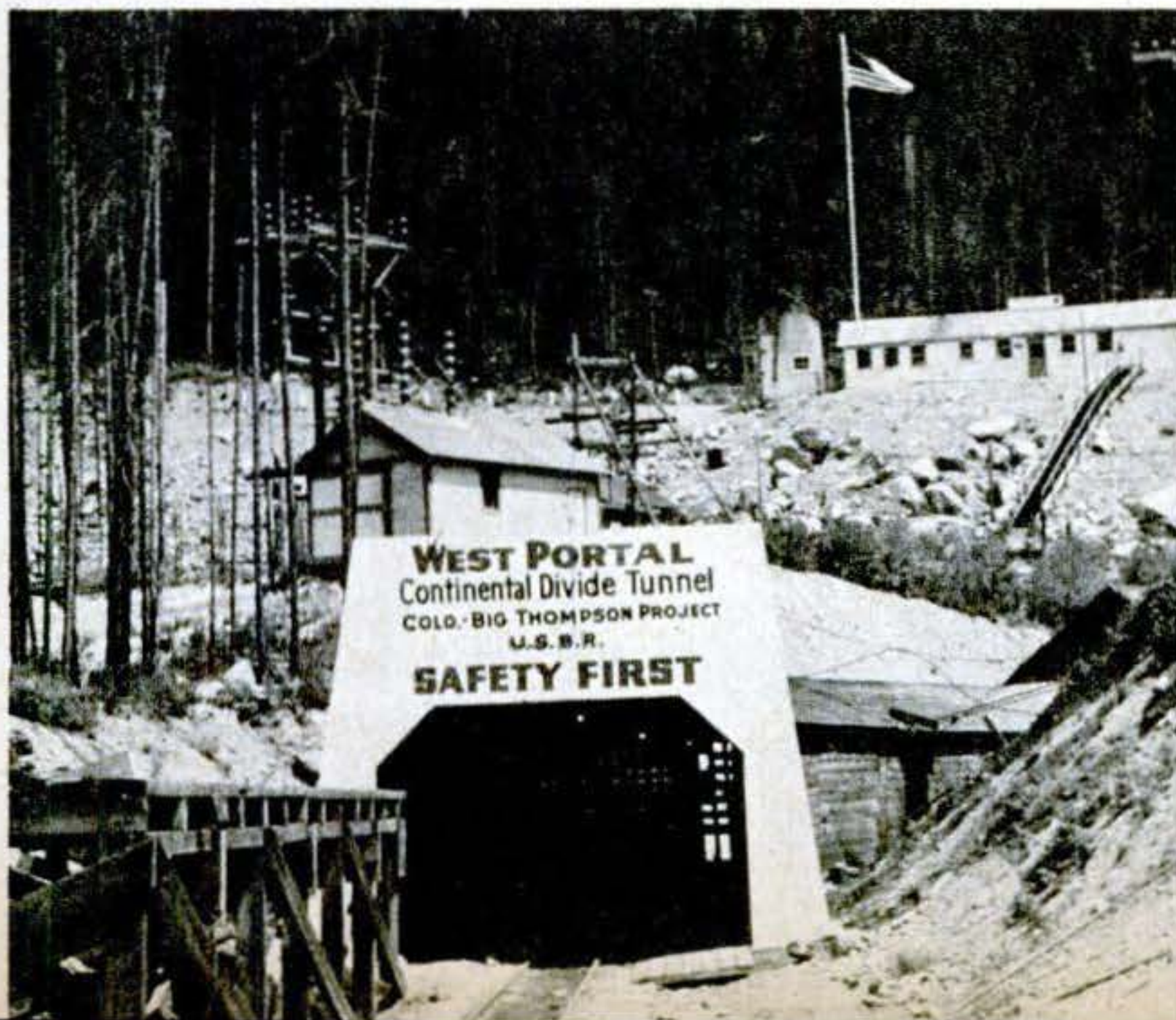



Tunnel-building train. To give the 9¾-foot shaft a waterproof lining, the odd machine above, resembling a locomotive, pumped concrete into hollow space between rock

walls and temporary steel sections assembled to make a cylindrical form. Behind it, apparatus on flatcars kept it supplied with a continuous stream of materials.

Where artificial river starts flow. This scene shows construction of dam creating Shadow Mountain Lake, one of the two reservoirs to which surplus rainfall will be pumped from

the Colorado River by way of the Granby collecting basin. From this point on, water runs by gravity to generating plants and farms on opposite side of continental divide.

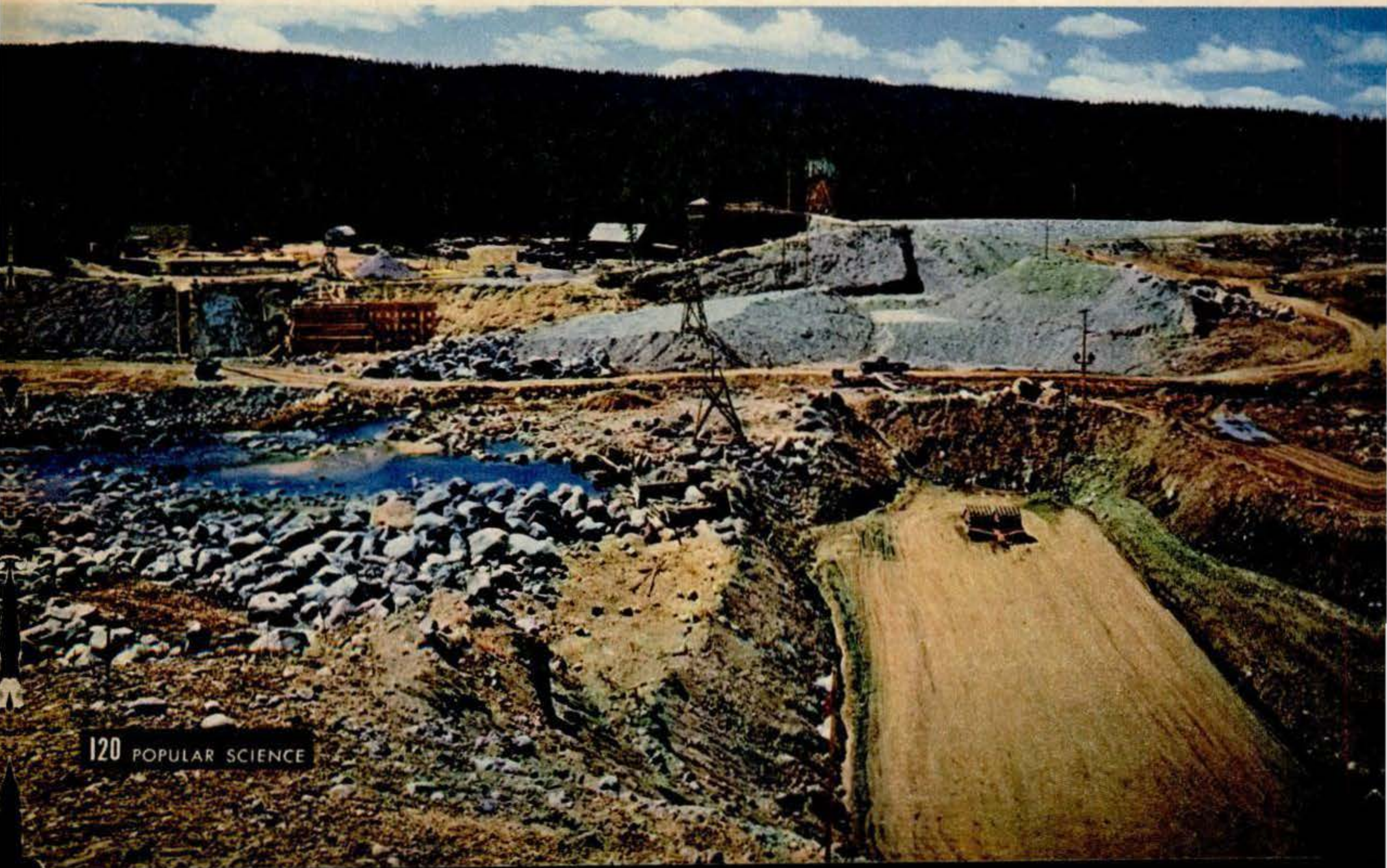

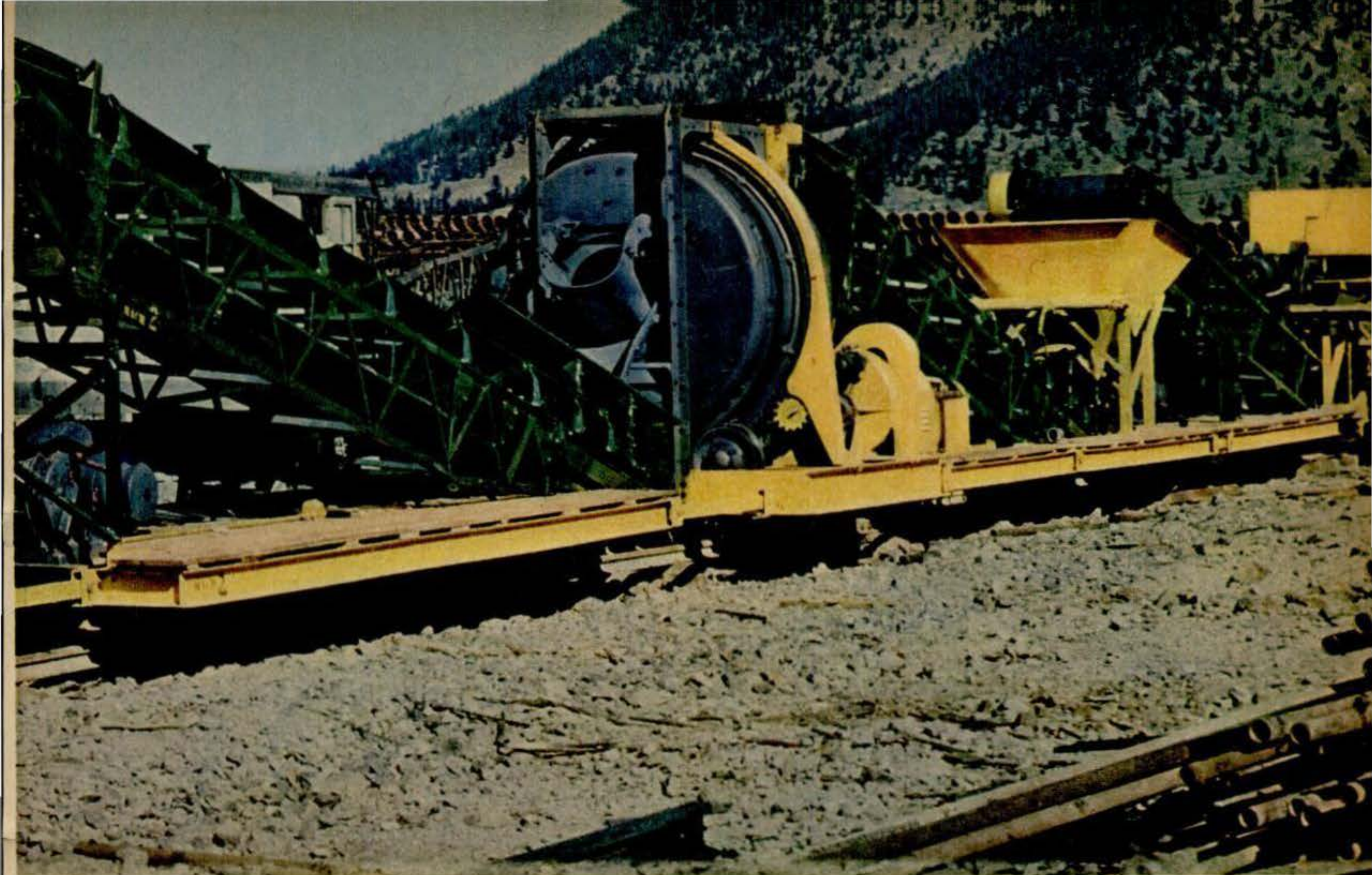

An inclined conveyer to pumping machine received concrete from mixer, center, to which second conveyer delivered crushed stone and cement from hopper at right of it.

Third conveyer filled hopper from compartmented mine car at extreme right, loaded at stock piles. Harnessing labor-saving machinery to job made the project feasible.

Moving mountains. Enough rock to make several respectable foothills came out of the \$12,400,000 Alva B. Adams Tunnel—and much of it, after being crushed and piled

as below, went back into the concrete lining. In addition, some parts of tunnel had to be permanently braced with steel to prevent cave-in under the terrific overhead weight.

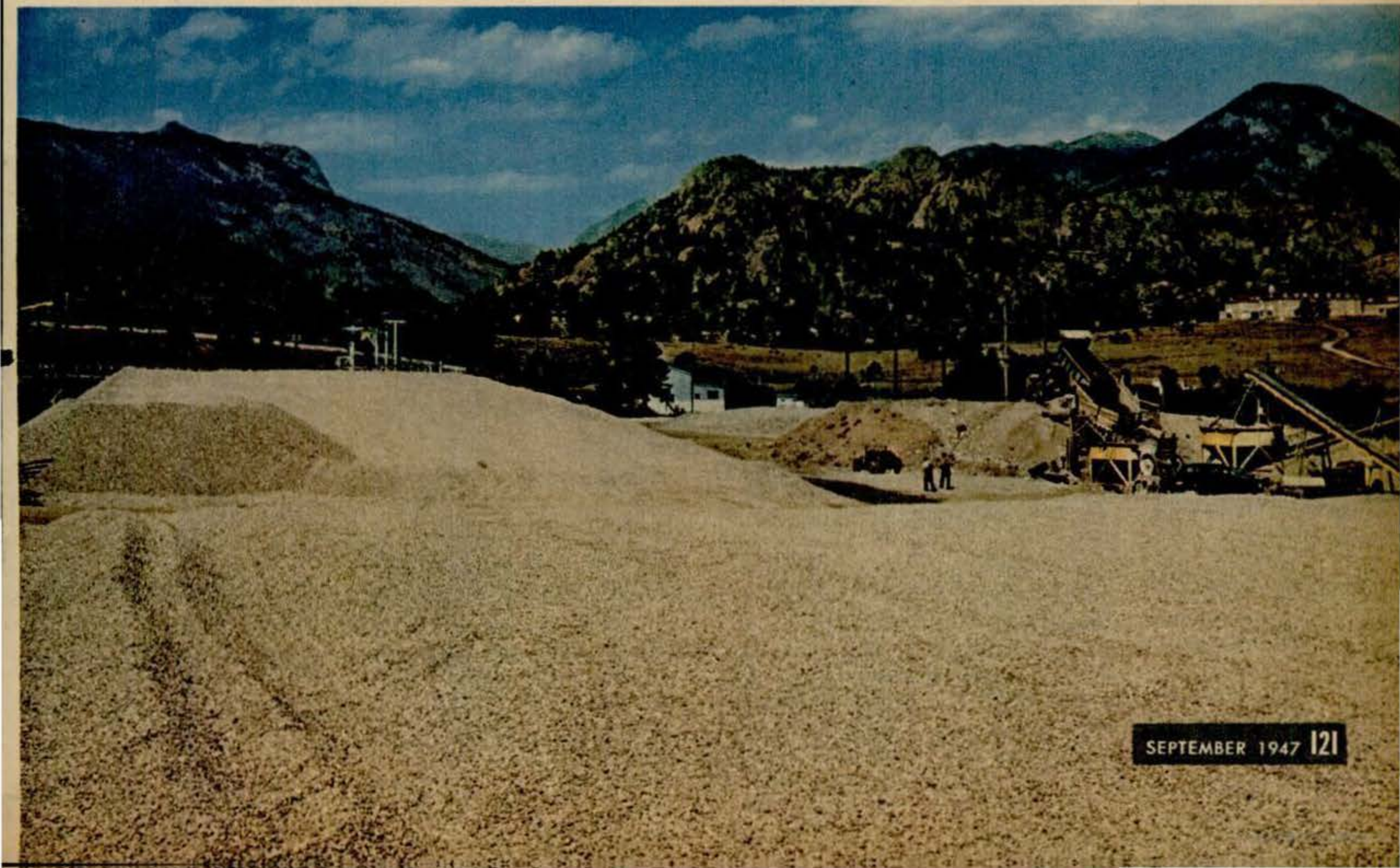

Laboratories Match Men and Machines

Research program strives to simplify equipment that has grown too complex for ordinary humans to handle.

EVEN the scientists now realize that some of the machines of modern life are too complicated for ordinary humans.

So psychologists and engineers at Johns Hopkins University, working under a contract with the Office of Naval Research, are trying to find the best way for men and machines to work together. At the Johns Hopkins Homewood campus in Baltimore, Md., and a field laboratory at Jamestown, R. I., scientists are conducting a basic investigation of how humans react to signals—through sight, hearing, and touch; how they interpret these signals; and how they use that interpretation to send new signals to another machine or man. The investigation covers every question from what is the most crankable crank to how fast a man can copy numbers read over the phone.

With the answers to those questions, the scientists hope to design simpler, more fool-

proof equipment. They anticipate the end of engineering nightmares like the control system of a big airplane, now so complex that pilots sometimes pull the wrong lever.

Already the search for the most crankable crank has produced results that might be applied to such everyday gadgets as lathe controls or automobile window handles. Dr. Clifford T. Morgan, who directs the entire research program and also supervises the crank-turning project, says that the shortest cranks are the best, unless there is considerable resistance. In that case, the crank should be a certain minimum length for easiest turning.

Knobs, too, may no longer be just any old knobs. By using different sizes for different controls, a radio operator might pick out the right one in the dark by feeling its size. Experiments conducted so far indicate that it is easiest to distinguish size differences by feel if the knobs are fairly large—two to five inches in diameter. The possibility of telling knobs by shape is being investigated by a group at the AAF's Aeromedical Laboratory, Wright Field, O.

What about telling time? Yes, they're working on easier ways of doing that, too.



Inside the "padded cell," a specially built soundproof room, Dr. W. R. Garner shows how ear response is tested in research aimed at a blind-flying system using sound signals.



Curved toy train track (hidden behind black paper) and cars bearing tiny lights measure ability to estimate angles—important for operators of complex control panels.

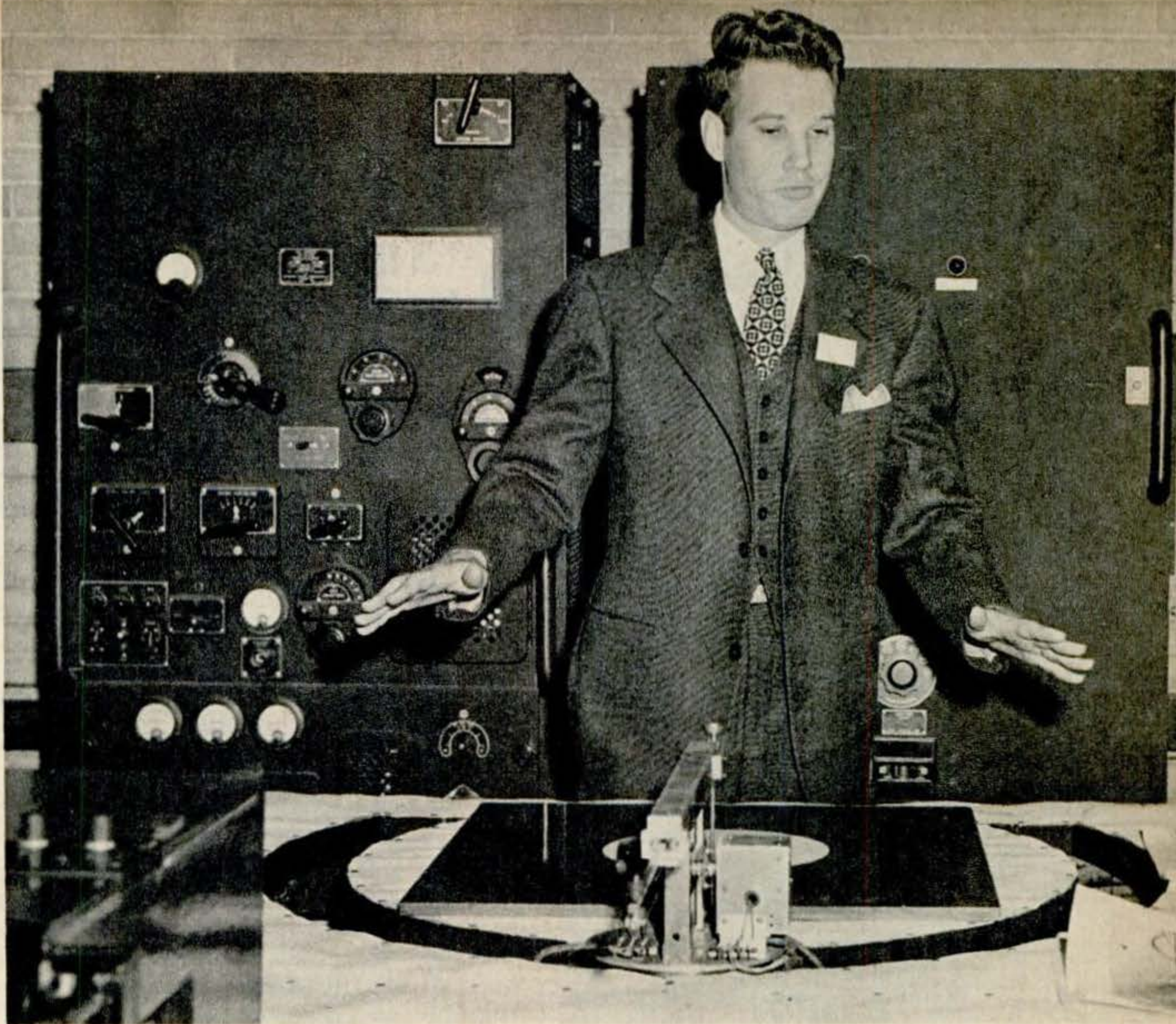

A Johns Hopkins engineer describes testing device expected to lead to improved radar air-traffic-control equipment. It measures

how fast an operator can move a stylus (center of apparatus on table) along a given path on a paper or screen.

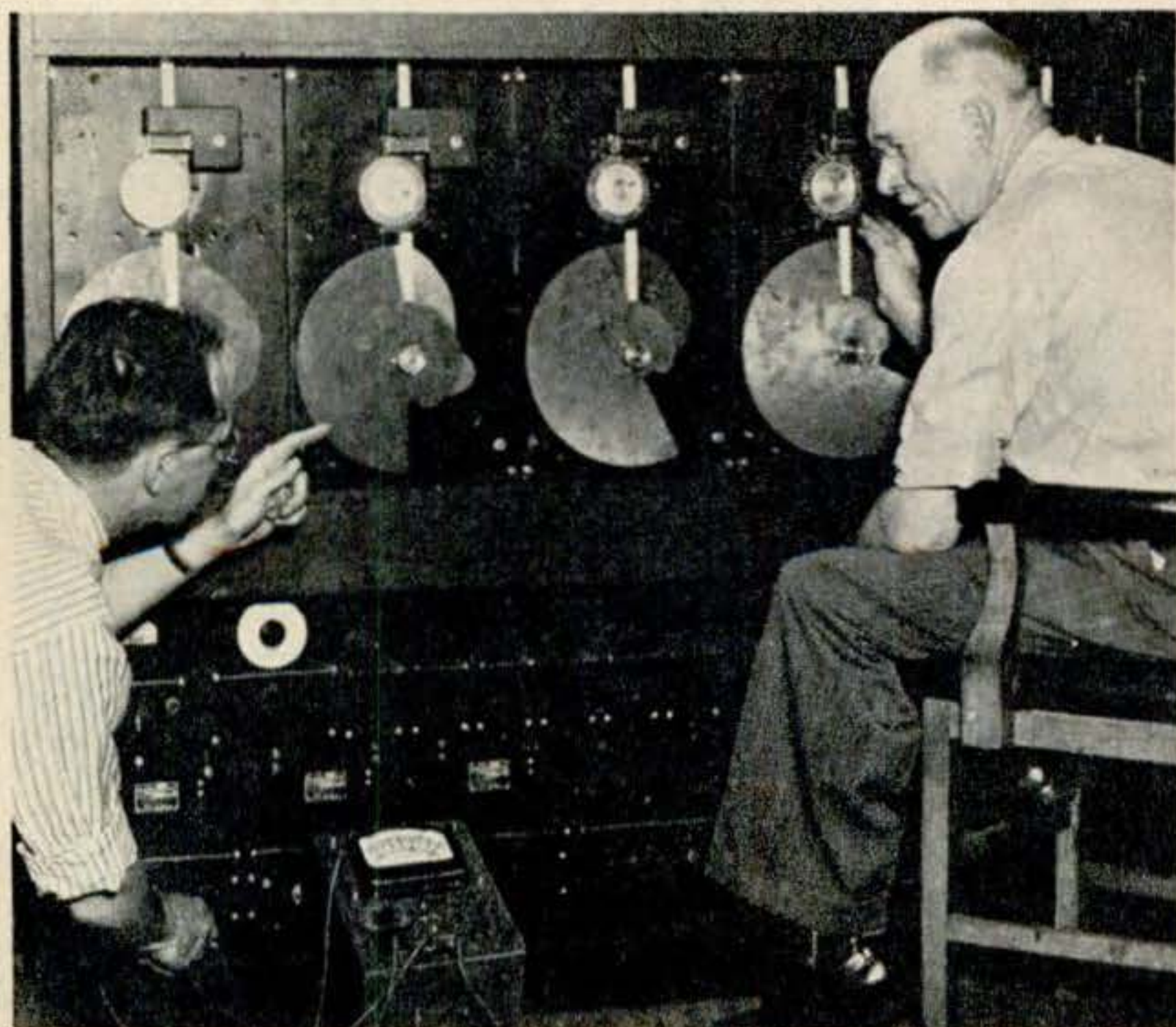

Automatic electronic equipment, governed by cams, produces imitation target "pips" on radar screens for scientifically controlled experiments with radar observation methods.



Technicians operate manual equipment also used to control radar images. Real planes are not used as targets, since pilots could not fly same course again to repeat tests.

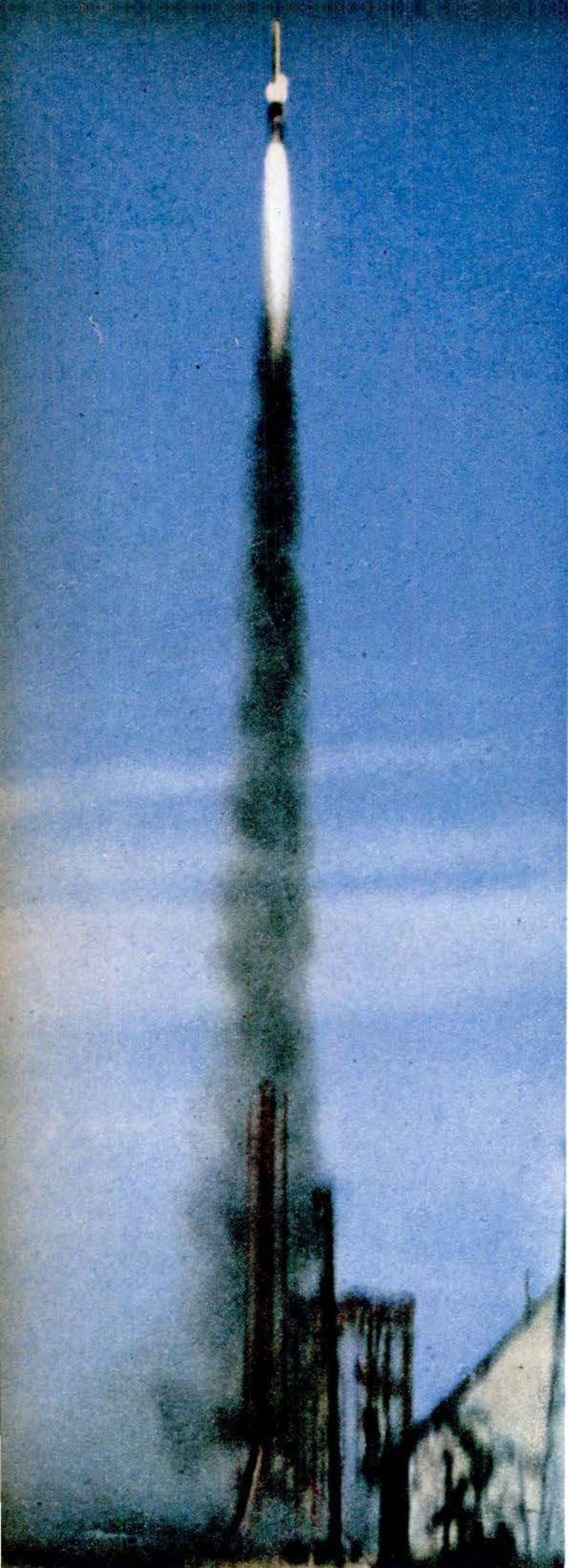

'Chutes Save Rocket Secrets

Instruments fired from soaring V-2s in Blossom project float down safely with vital records of the upper air.

By Stephen L. Freeland

QUEER things can happen to rockets once they are in flight. Some spin like a rifle bullet, some wobble like a top running down, some turn end over end, some change direction, and some misbehave all four ways. The whole story can not be told yet, but means of explaining such erratic behavior have been developed by the AAF's parachute, electronics and photographic experts and scientists of Philadelphia's Franklin Institute Research Laboratories, working together on "Blossom" projects.

Last Feb. 20, some 68 miles above the White Sands Proving Grounds, a small aluminum canister—15 inches in diameter, 30 inches long, weighing 75 lb. loaded—looking much like two little ashcans fitted together, was shot out of the side of a V-2

Test equipment packed in this ashcan-like container, shot from V-2 warhead by mortar, floated safely to earth on ribbon parachute.



A V-2 space laboratory takes off skyward. Blossom project's new instrument-recovery method promises more results from tests.



Ribbon parachute's ability to "bring 'em back alive" was demonstrated when one

landed an entire Wac Corporal from 40-mile altitude with no damage to the rocket.

warhead. About 44 minutes later, swaying gently beneath the canopy of its ribbon 'chute, that canister touched the ground as gently as a feather. It bounced once, lightly, and came to rest. When it was opened, its contents—two cameras, a tensiometer, telemetering equipment, radar, a box of fruit flies—were intact. This was "Blossom I." For the first time, man had brought back a record of a rocket in flight made within the rocket itself.

The scientists then prepared to repeat the experiment, this time using a wedge-

shaped quarter of the control section of a V-2 that will carry 200 pounds of gear including, in addition to the equipment of the first canister, pressure gauges, acceleration recorders and a complete data-recording unit that will operate while the rocket is in flight. There will be at least two such wedges sent up; one of aluminum, the other, designed for special magnetic studies, made of wood. (Heat-sensitive paint on the outer side of the Blossom I canister *showed no signs of excessive temperatures* generated by skin friction.) Ultimately, although

Instrument-carrying canister is in two sections. In this view are seen camera (upper right) and parachute strap spool (center).

Other end of canister holds second camera (top), tensiometer (center), and wheat germ and fruit flies in glass flasks (bottom).

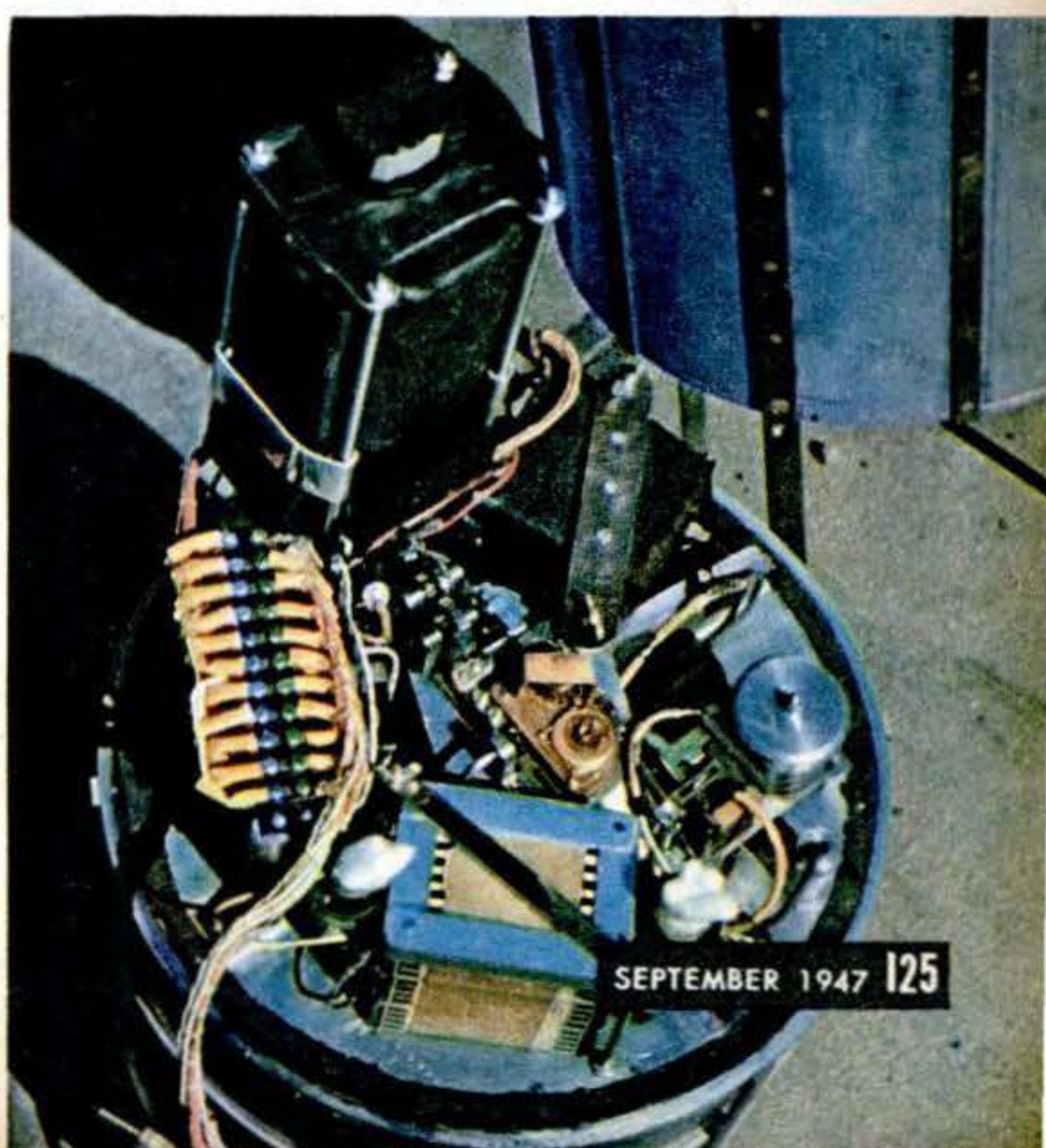

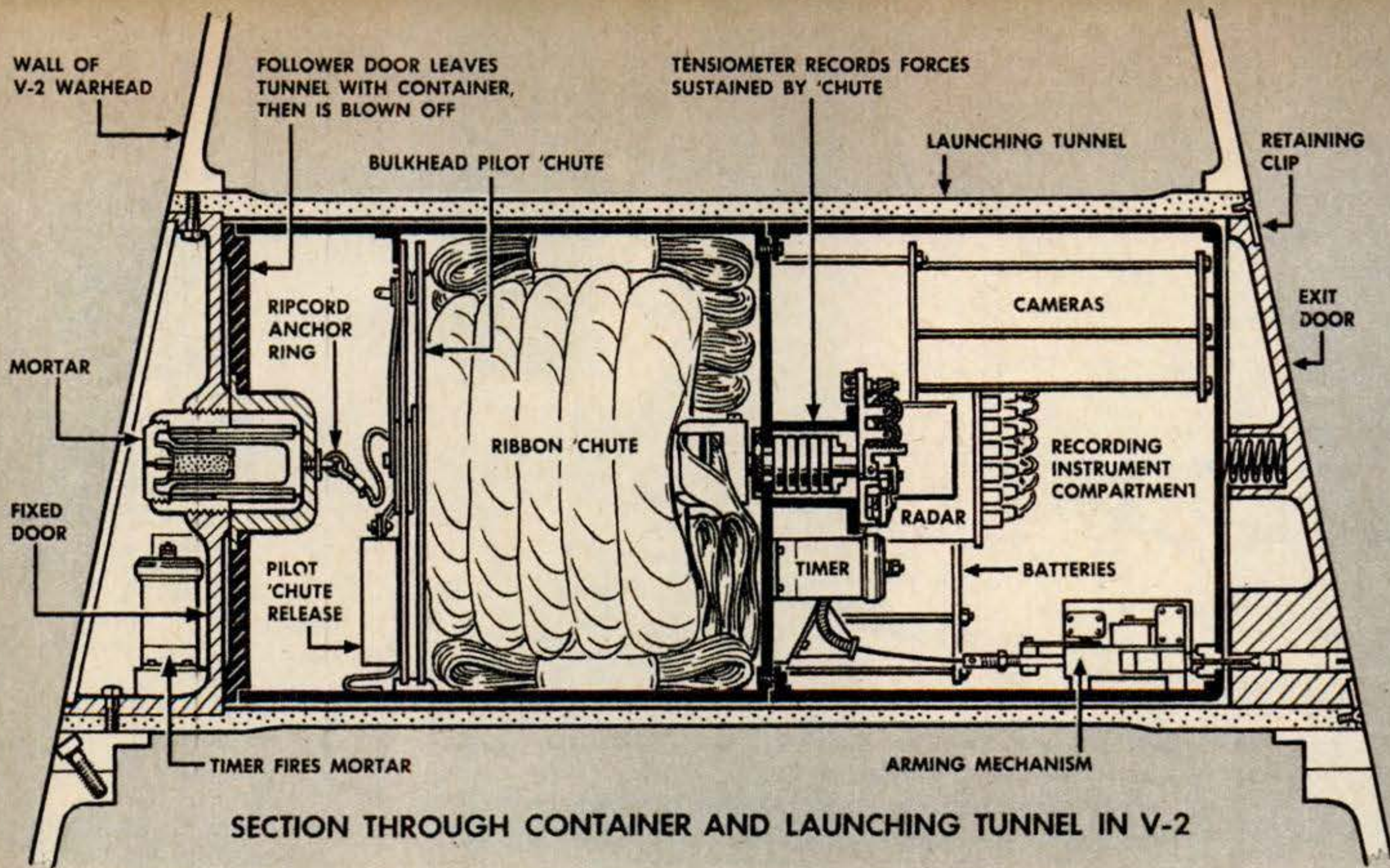

SECTION THROUGH CONTAINER AND LAUNCHING TUNNEL IN V-2

Drawing of a typical container indicates position of equipment and operating mechanisms.

plans for future Blossom projects are iron-curtained by secrecy, it will probably be feasible and desirable to send up and bring back entire warheads containing a ton of equipment—a complete sky laboratory.

When that happens, sometime within the next two years, the dream of scientific conquest of the upper air will be a reality. It's the bringing back that is important.

Offhand, the problem seems simple to the layman, who recalls the old saying that "whatever goes up must come down." Actually, the matter is not quite so easy. As

yet, no one can tell whether any specific rocket is going to soar 60 miles or fizzle out at six. This in itself poses serious questions of pressure and release time. For Blossom I the instrument case was pressurized and sealed at ground level (4,000 feet). In Blossom II, however, an installation of relief valves will permit a decrease from ground pressure to six lb. per square inch during upward flight and an increase from that to ground pressure during descent.

Release of data-bearing containers is more like a shotgun divorce than anything

On the way up, the canister rides in a hole drilled all the way through the V-2 warhead (photo at left, below). Carefully ma-

chined aluminum liner (right) holds canister in place until mortar automatically shoots it out for long trip back to earth.

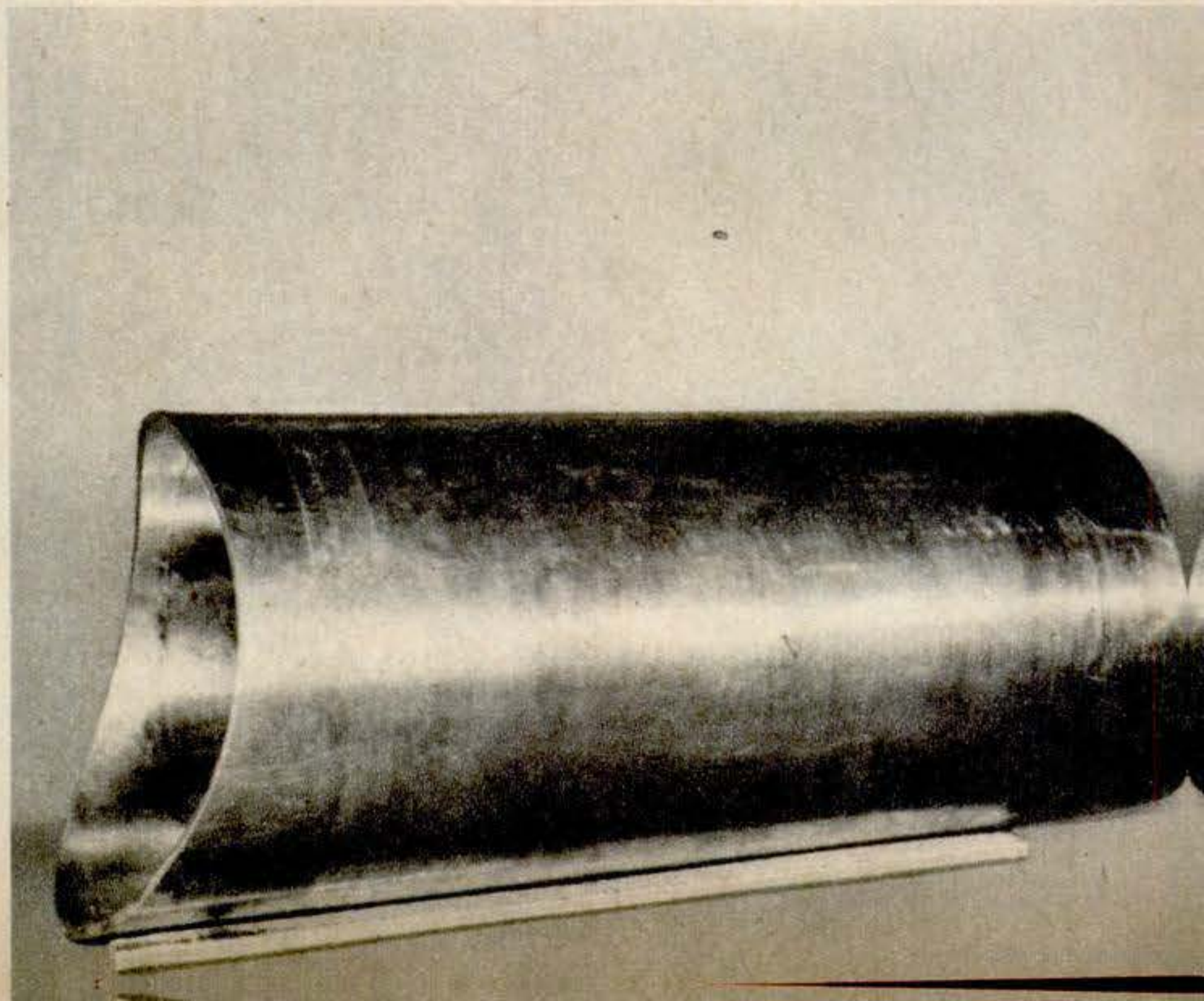
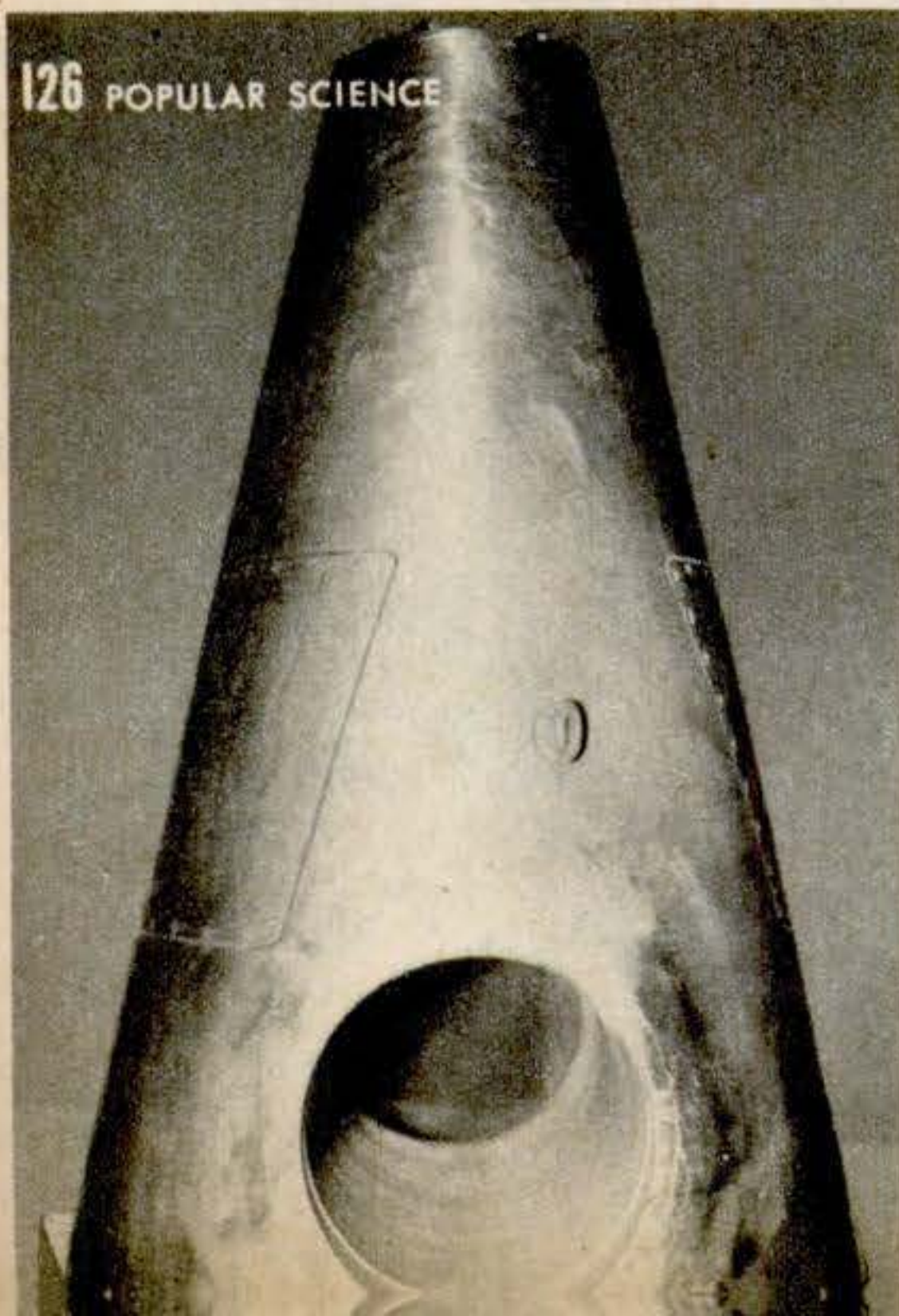

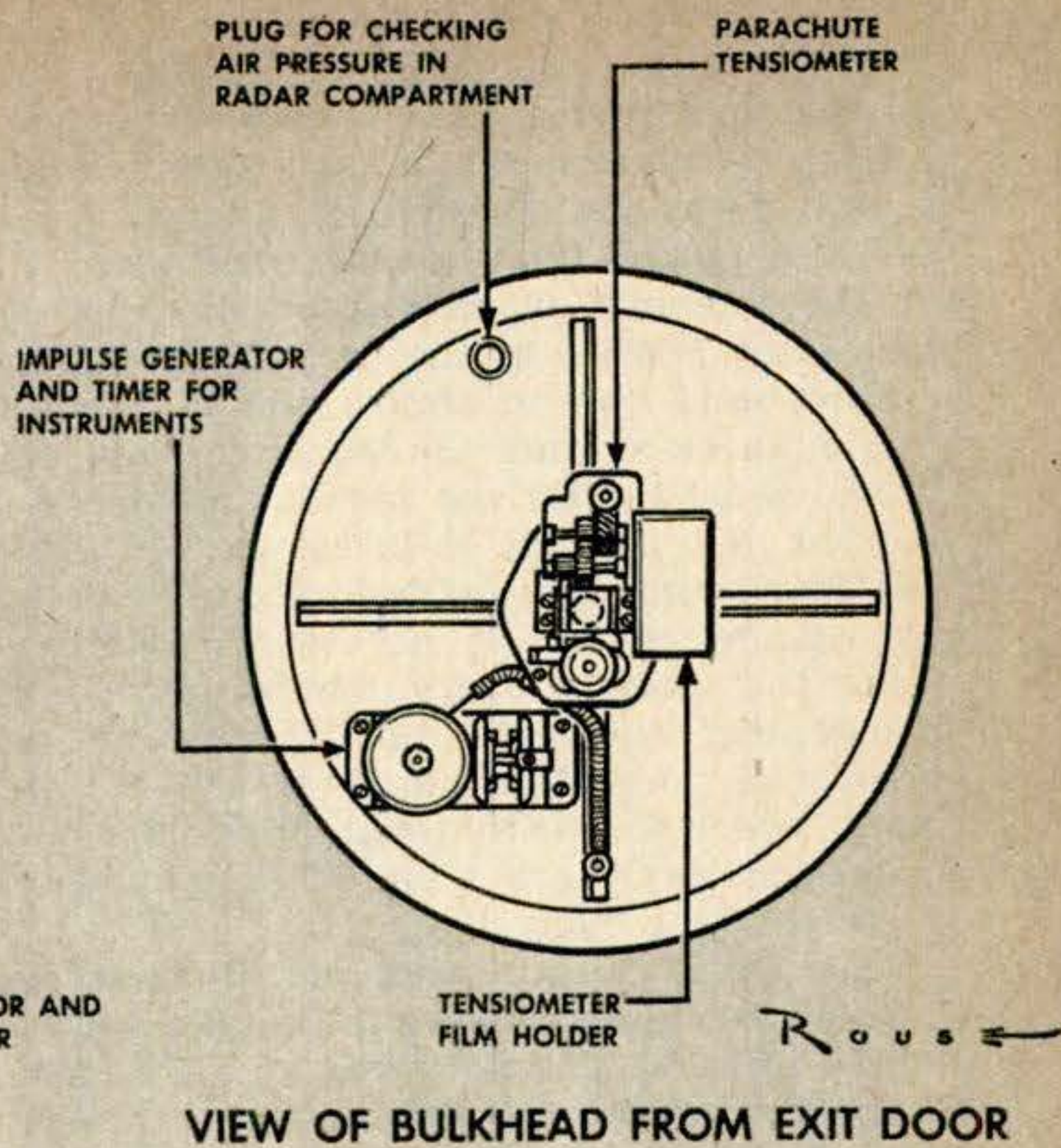
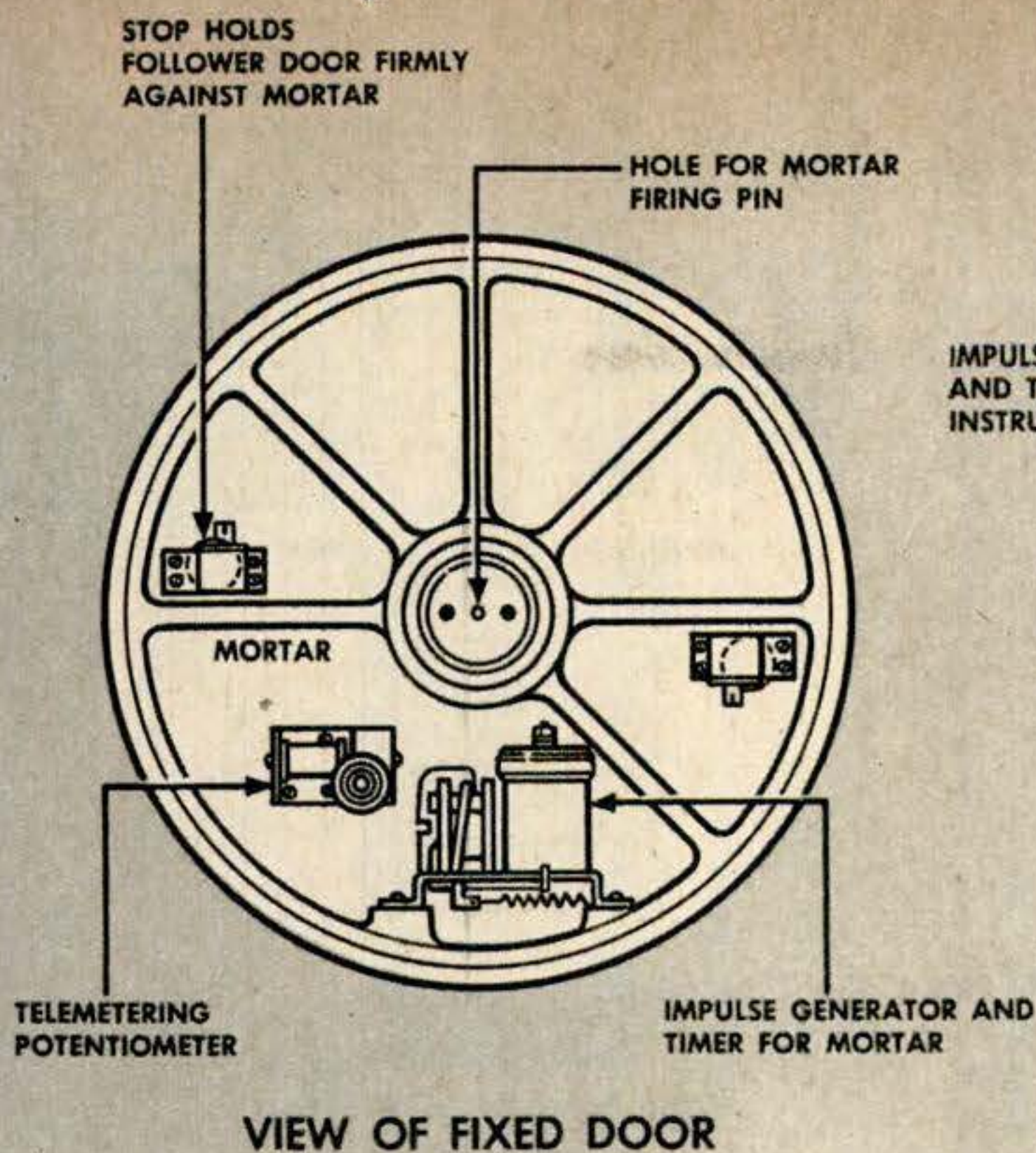

Fixed cover plate and the container's center bulkhead illustrate details of construction.

else. The container with the material to be returned to earth is ejected from the rocket by a small mortar charge (40 grains, or about 1/3 the charge of an 81-mm. mortar) that is fired by a clockwork fuse, similar in principle to the timers that set off anti-aircraft shells. The base of this mortar shell rests against a plate bolted flush with the outer skin of the warhead in Blossom I. In future projects it will rest against some other expendable part of the rocket.

The explosive thrust is exerted through a series of telescoped tubes against a plate

behind which the pilot 'chute is packed. The pilot 'chute opens by mechanical drag as it clears the rocket, while the actual explosion sets off a timer—clockwork in Blossom I—which opens the main 'chute. A small bellows, operated explosively by the same sort of jack-in-the-box arrangement used to pull rip cords of cargo 'chutes, serves to clear the pilot 'chute from the main 'chute at the proper time. The strength of the original mortar blast, incidentally, may be estimated from the fact that the movable end of the canister is held

Operation of main 'chute release gear (solid cylinder, left) was telemetered to the ground by device in cup at right.

Mortar that kicks canister out is in small cylinder (right), with time fuse dials on top. Control (left) releases main 'chute.

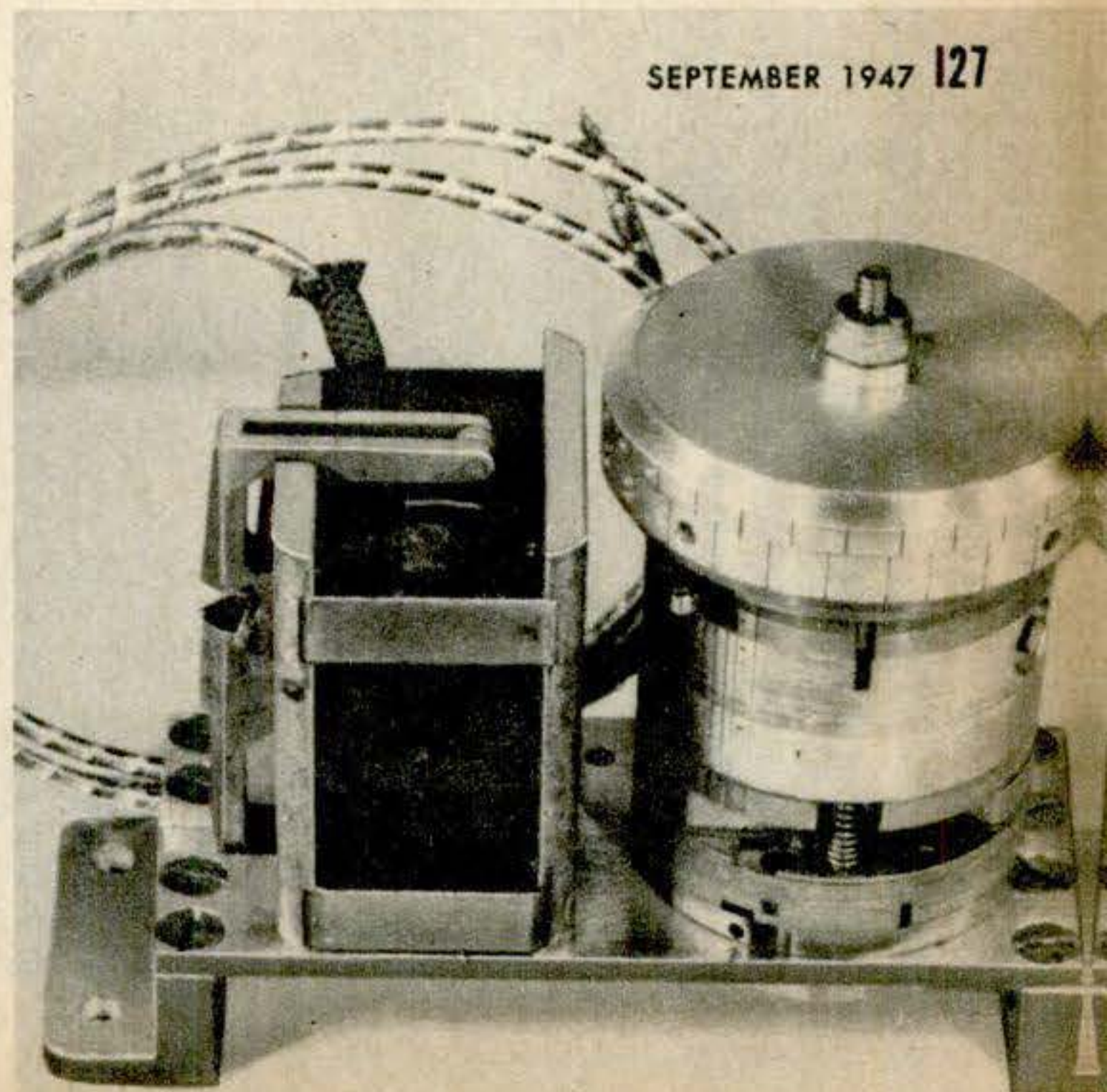
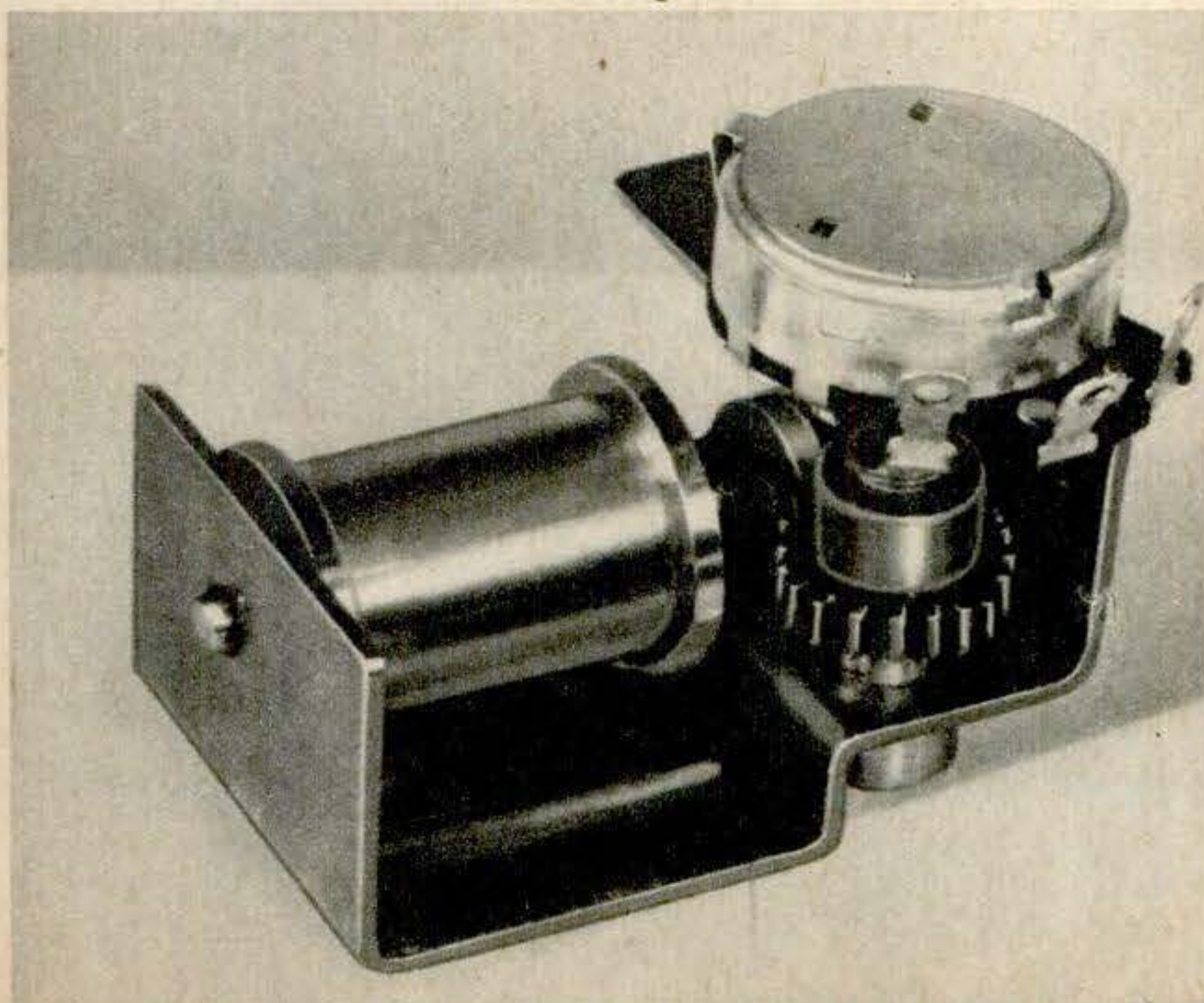

in place by four clips tested to break at 200 lb. Equipment like the cameras—standard AAF gun cameras set to shoot four frames a second—and subminiature radar beacons are also put in operation by timers started at the moment of release by an impulse generator hooked to the mortar firing pin.

Blossom I was an almost complete automatic success, and the canister was released shortly after the rocket fuel was expended, but possible failures were allowed for. Provisions were made to fire the mortar by remote control if necessary. Furthermore, the action of every item of the release mechanism and most of the data-taking gear was telemetered back to the release point, which meant that failure or improper operation anywhere along the line would register right away.

One small setback marred Blossom I. The earth-trained camera taking black-and-white pictures did not function. The sky-trained color camera worked fine, however, and, during the first moments of free fall, while the canister tumbled over and over, it got some earth pictures too. To the earthbound layman these last are naturally the most interesting, but to the scientists of Blossom project, whose eyes are fixed on greater and yet greater heights, they are trivial. Their interest lies in the operation of the ribbon 'chute—a solid 'chute would rip to tatters before it found dense enough air to open—and the safe return of information.

So far, more than a thousand people have volunteered to be shot skyward in a V-2. No one has taken these suicidal offers

This is how canister looks installed in V-2, but before attachment of the cover plate. Base of the mortar can be seen in center.

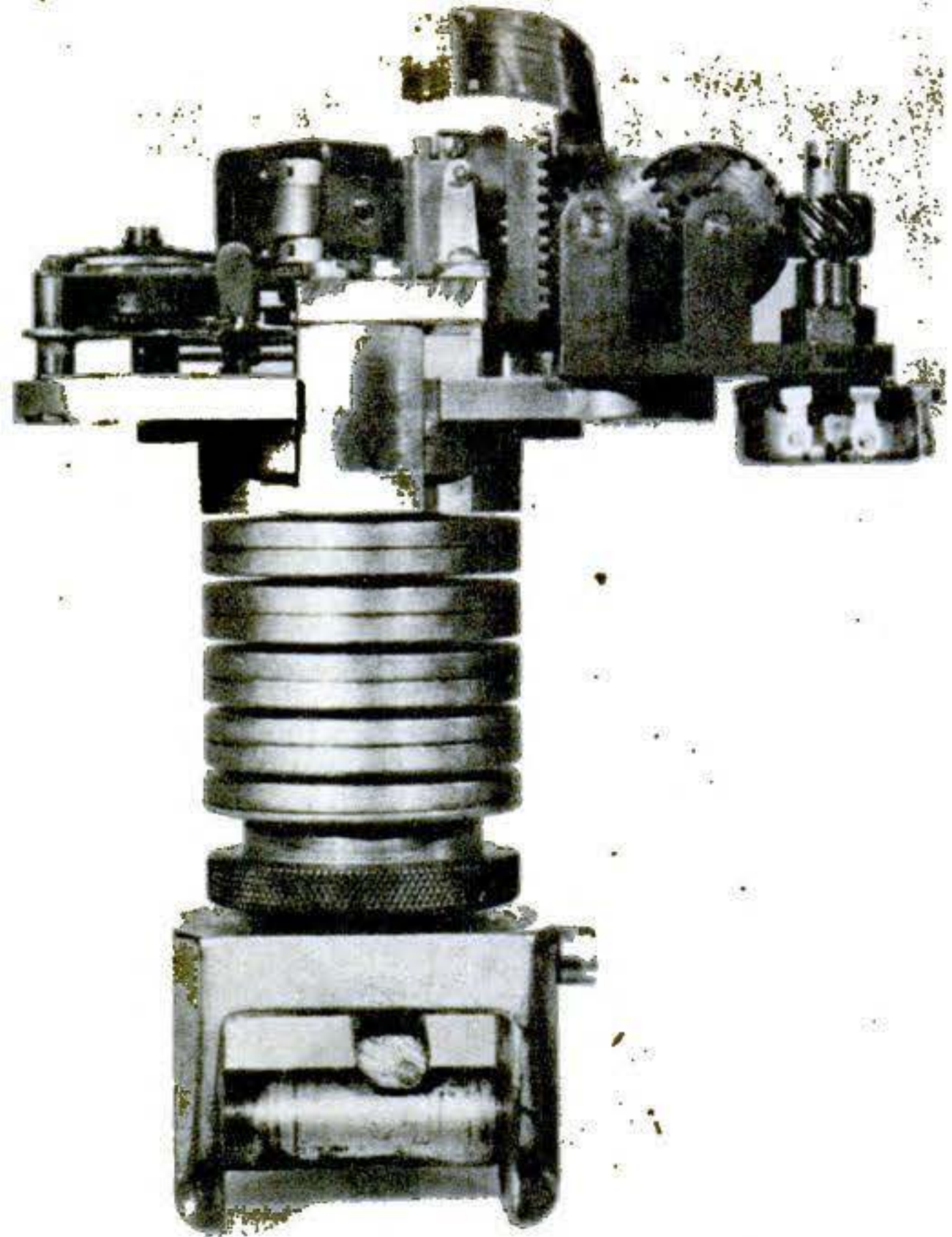
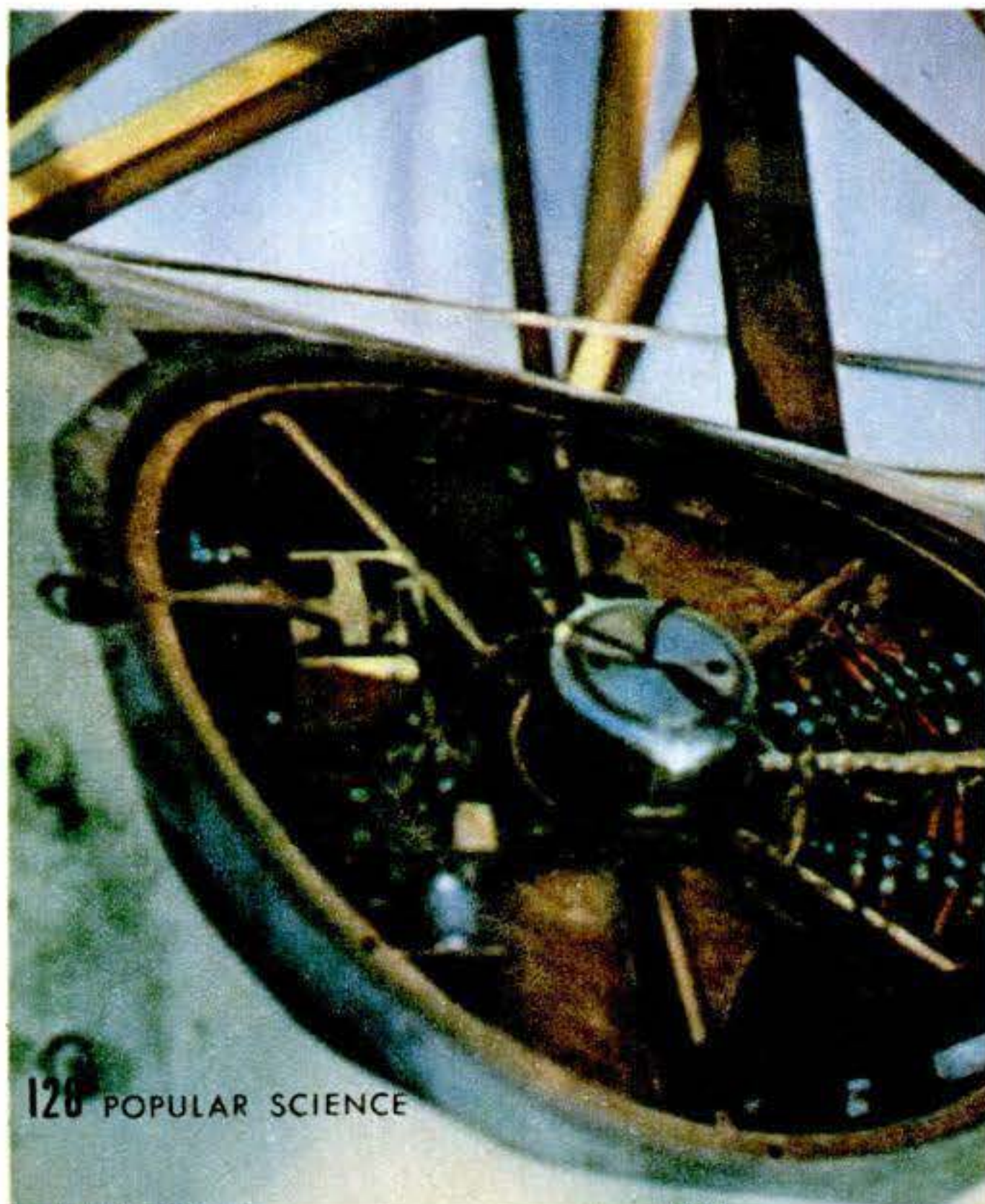

Tensiometer measures parachute pull. Strap, fastened to bar (bottom), tugs on spring to drive film recorder's gears and needle.

seriously because a lot of work and study remains before the dawn of the day of human rocket travel. Meanwhile, the Blossom project is one of the most important ways of hastening that dawn. **END**

Close-up of parachute shows how ribbons are fixed to cords in pairs. This type of 'chute was a wartime German development.

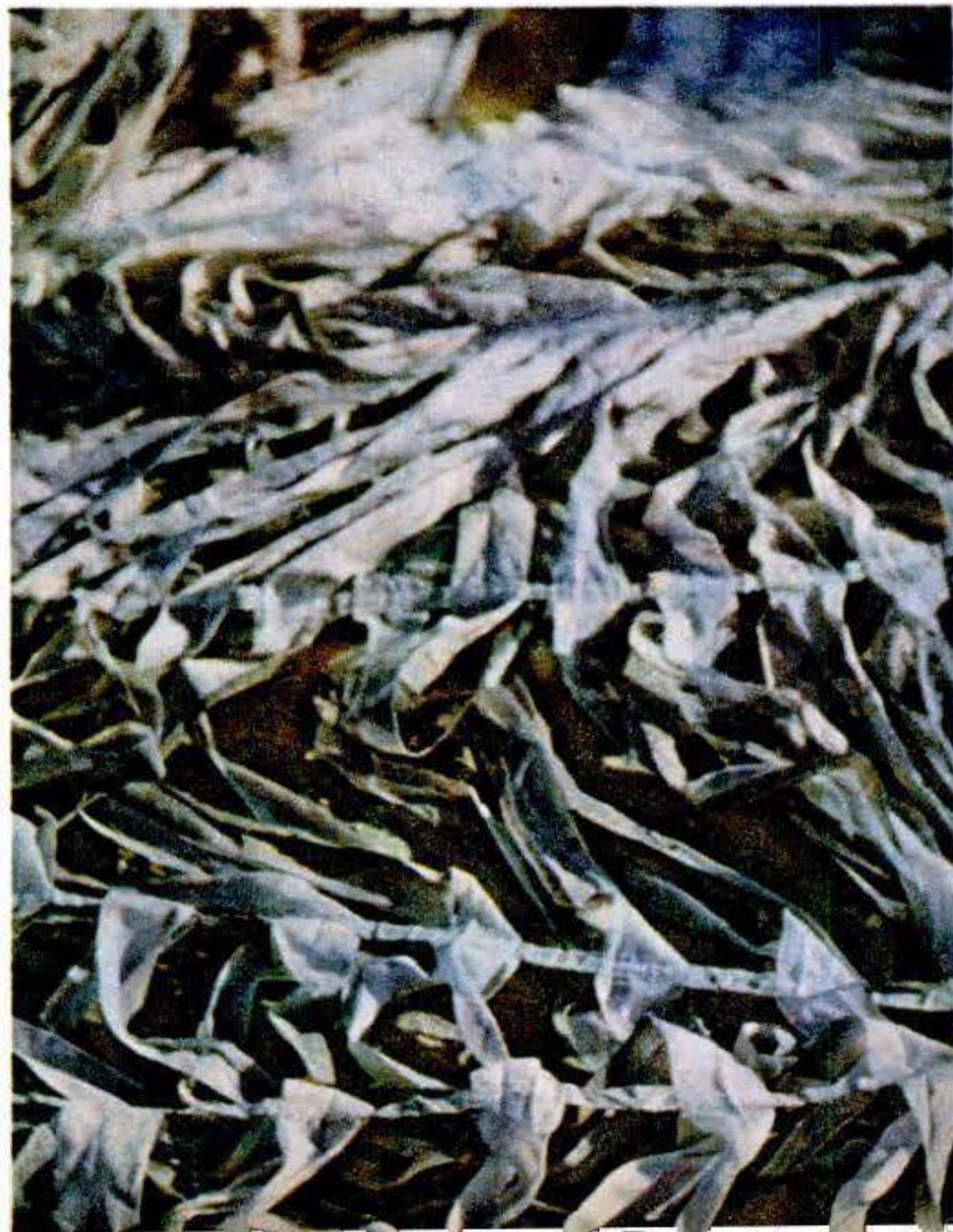

U. S. Tests Russia's Colored Cotton

The natural-tinted varieties developed by Soviet experimenters don't fare so well when they are grown in Dixie.

THE growth of naturally colored cottons suitable for commercial manufacture, long a goal of agricultural experimenters, has taken its place among international rivalries—with Russian and U. S. experts in scientific competition.

In Russia, where extensive research is being carried on, the director of the All-Union Cotton Research Institute has stated that "experiments indicate natural colored cotton produces a greater length of better quality yarn to the mass of raw cotton," adding that blue, green, pink and smoke-colored shades are being developed. Brown fiber is also being tested, but requires the use of copper and chromium salts to prevent fading.

American agriculturists have experimented with green and brown cotton (PSM, Dec. '44, p. 102) but it proved poor for manufacturing purposes; the lints lacked luster and had a tendency to fade. Puzzled by Russian reports of success, U. S. experts tried to obtain samples of the Soviet seeds and of manufactured cloth. They did not get the cloth, but did get the seeds, which were planted last season at a few places in the South, including the U. S. Cotton Field Station, Stoneville, Miss.

The tests, however, indicated that the seeds grow one way in Russia and another way in Dixie. Of the eight stocks tested, six were Asiatic types, which have never done well in this country. The other two were New World types, but even the best—*Gossypium hirsutum*, the equivalent of our ordinary Upland type—did not match the performance of U. S. commercial varieties. So, even though some natural colored cotton is believed to have been used since Colonial times in home manufacture of clothes and household goods, the vision of a Dixie full of varicolored cotton fields remains a dream of the future.

The Kodachromes at the left illustrate some of the results obtained in the comparative plantings: Top one shows U. S.-grown cotton from the Russian-evolved seeds; the bottom one, cotton obtained from this country's Upland-type seeds.



RUSSIAN

AMERICAN





How Navy Keeps Jets On the Job

A NAVY jet pilot who sees the insignie shown at the top of this page doesn't have to worry about the performance of his engine. It has been given the works at the Alameda (Calif.) Naval Air Station by highly skilled mechanics who know jet power plants from the ground up. They have taken the engine apart, piece by piece, adjusted alignments to a ten-thousandth of an inch, balanced the rotor so that it whirls with less vibration than that of a smoothly spinning top.

The rotor, heart of a jet engine and the mechanism that develops a jet fighter's tremendous thrust, strains every fiber of its alloy metal. Not only are the scooplike buckets of the rotor subjected to a continuous searing heat, but the tips whirl at a speed of 1,200 miles an hour, better than one-and-a-half times the speed of sound.

When the Alameda boys reassemble a rotor after overhaul, they know it is right—ready for another go at the grueling grind of jet flight.

The all-important rotor, however, must have the proper co-operation of fuel pumps, fuel pressure control units, barometric valves, lubricating pumps, fuel spray nozzles, and the overspeed governor. Special flow and test benches do the job on these. One check even duplicates the effects of various altitudes in testing the barometric fuel valve.

If the strain on a part has been too much, the evidence will out when placed in a dark room and subjected to violet (black) light. The part under examination glows with a ghostly, greenish light, while the cracks or imperfections appear as black lines or splotches.

To keep Alameda's experts on their toes, weekly classes are held on jet history, theory, performance characteristics and the problems of high-speed flight.

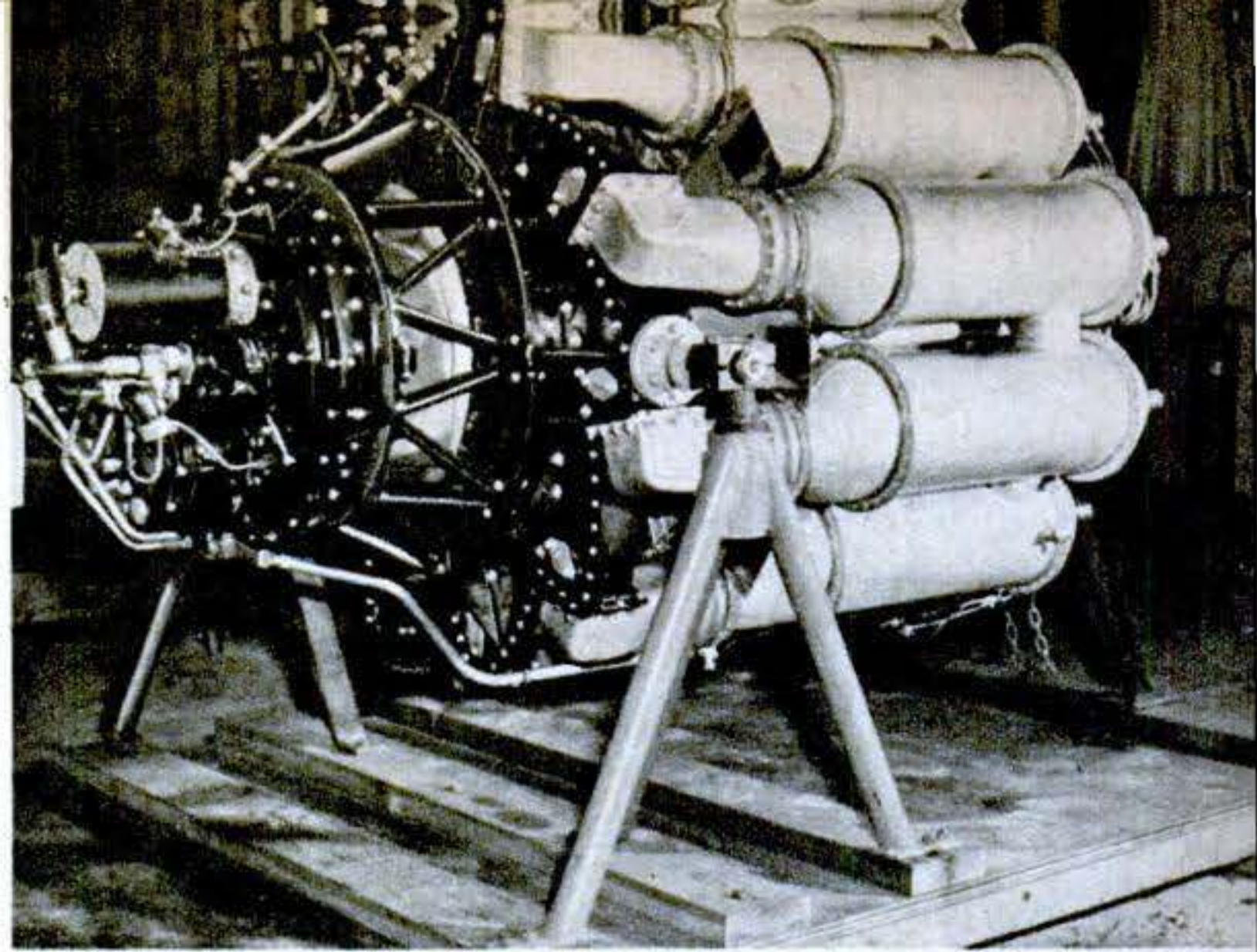

1. Jet jobs, like other engines, need periodic checks. Above, a GE I-16 is delivered at Alameda Naval Air Station for overhaul.

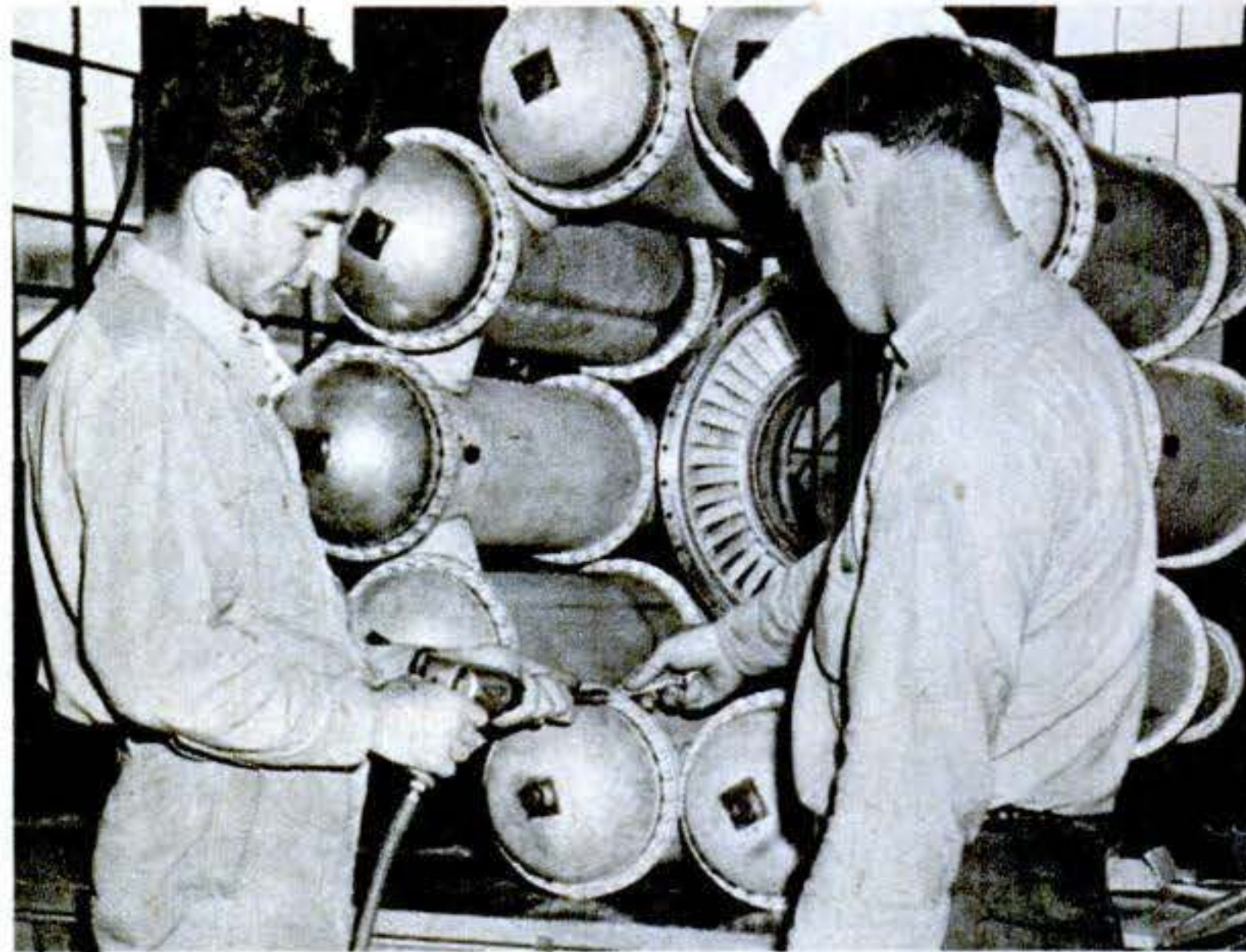

4. Power spinner is used to extract bolts, releasing combustion chamber domes. Rotor vanes are visible in the center.

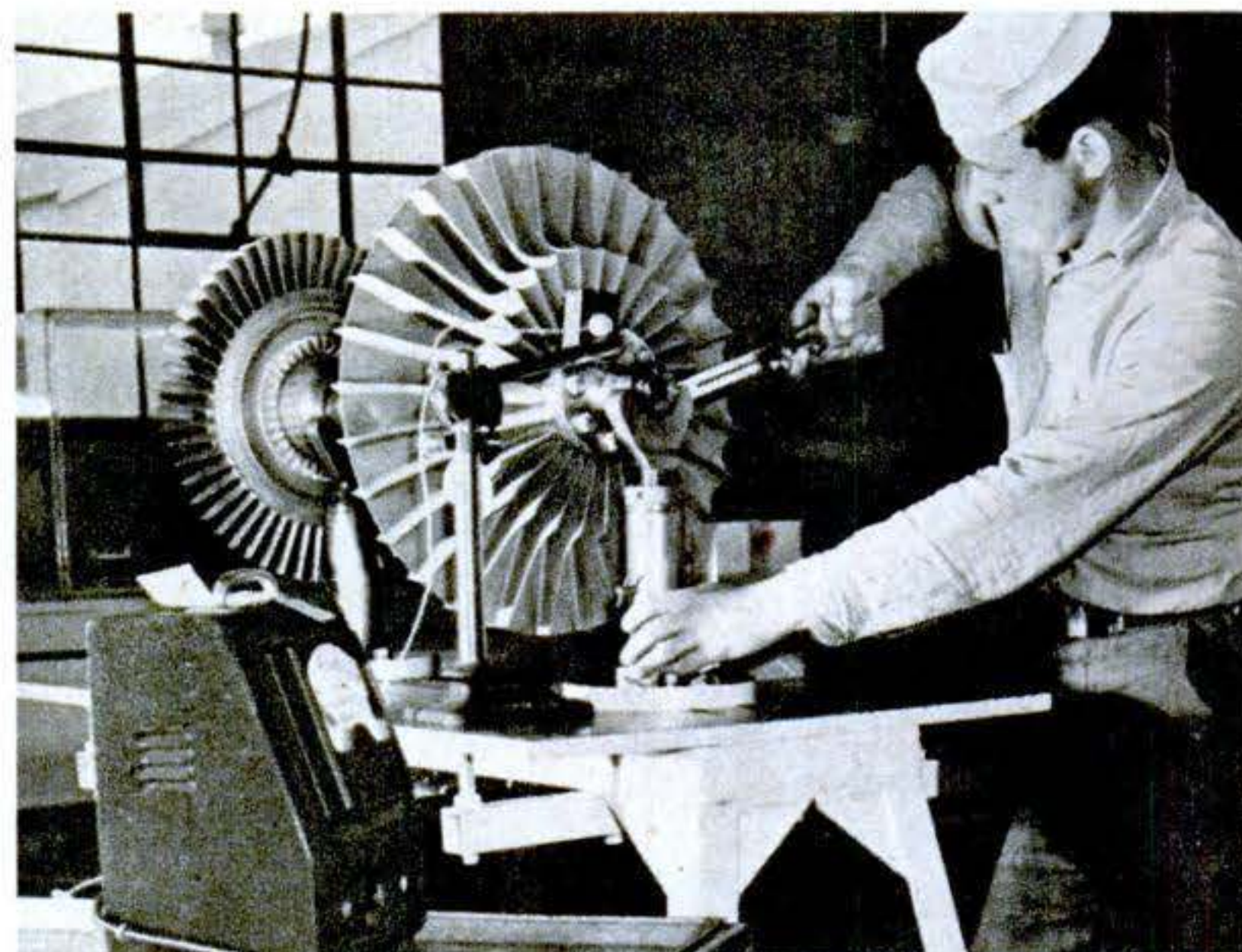

7. The rotor, only major moving part of jet engine, is placed on a testing stand. Here the assembly shaft is being checked.

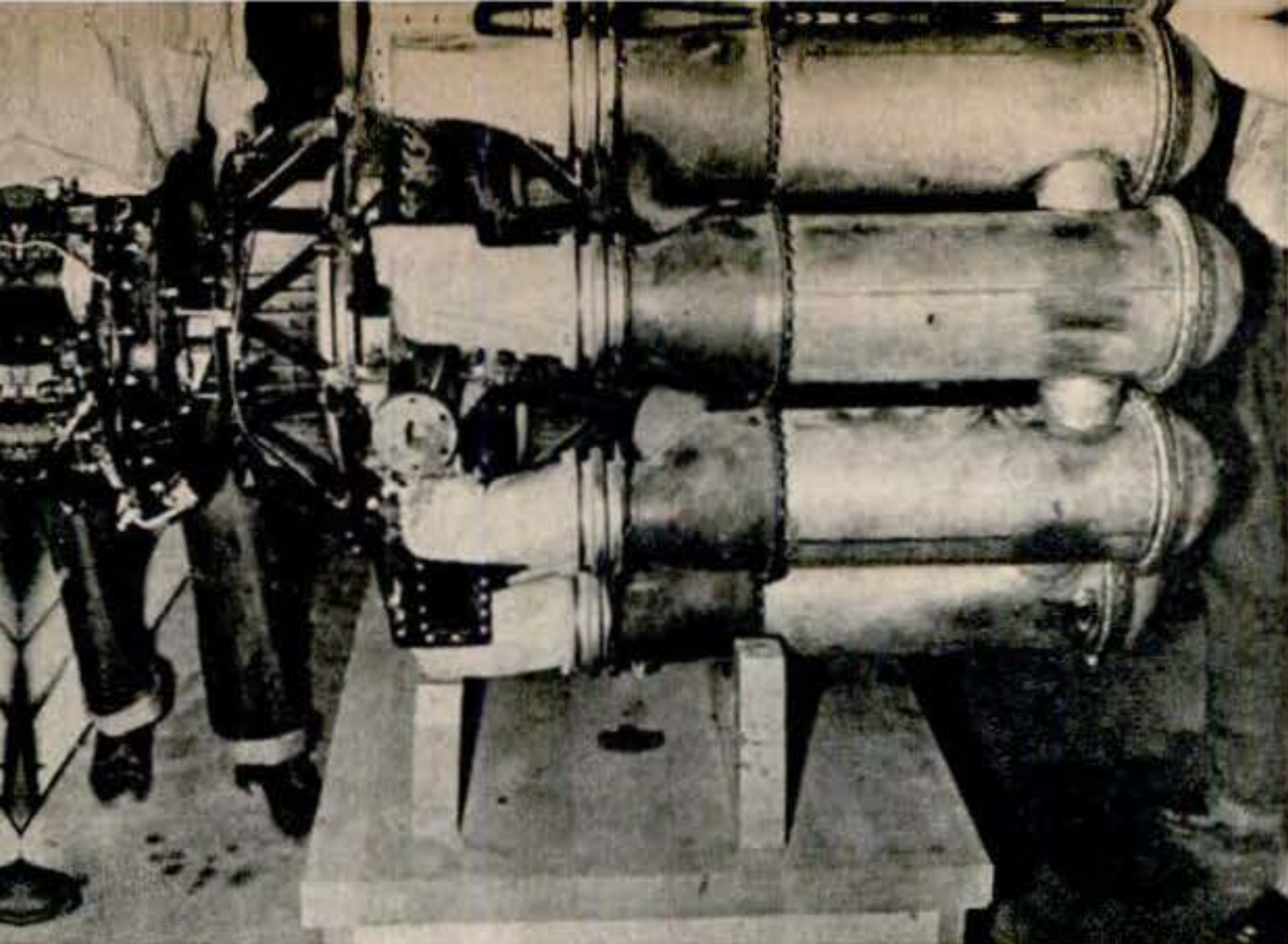

2. For first step in disassembly, engine is placed on horizontal stand and accessory case (left) removed before tear-down begins.

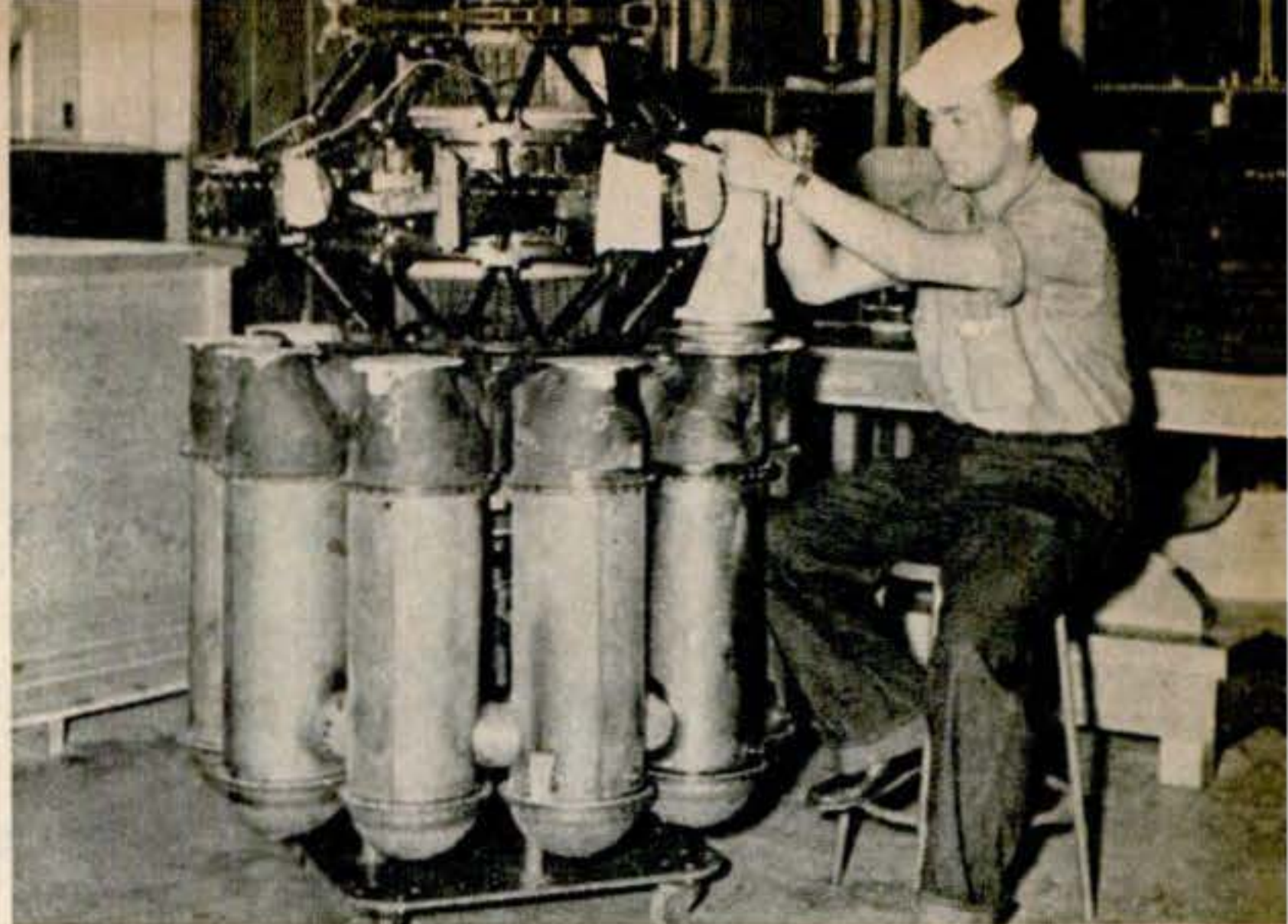

3. Engine shifted to vertical position, Navy mechanic removes the elbows. All types of Navy jet engines are handled at Alameda.



5. Assembly line in reverse moves along as the combustion chamber, ring, and elbow casing are removed from the turbine wheel.



6. Compressor chamber is split and compressor removed. This is final step in tear-down; components are now ready for testing.

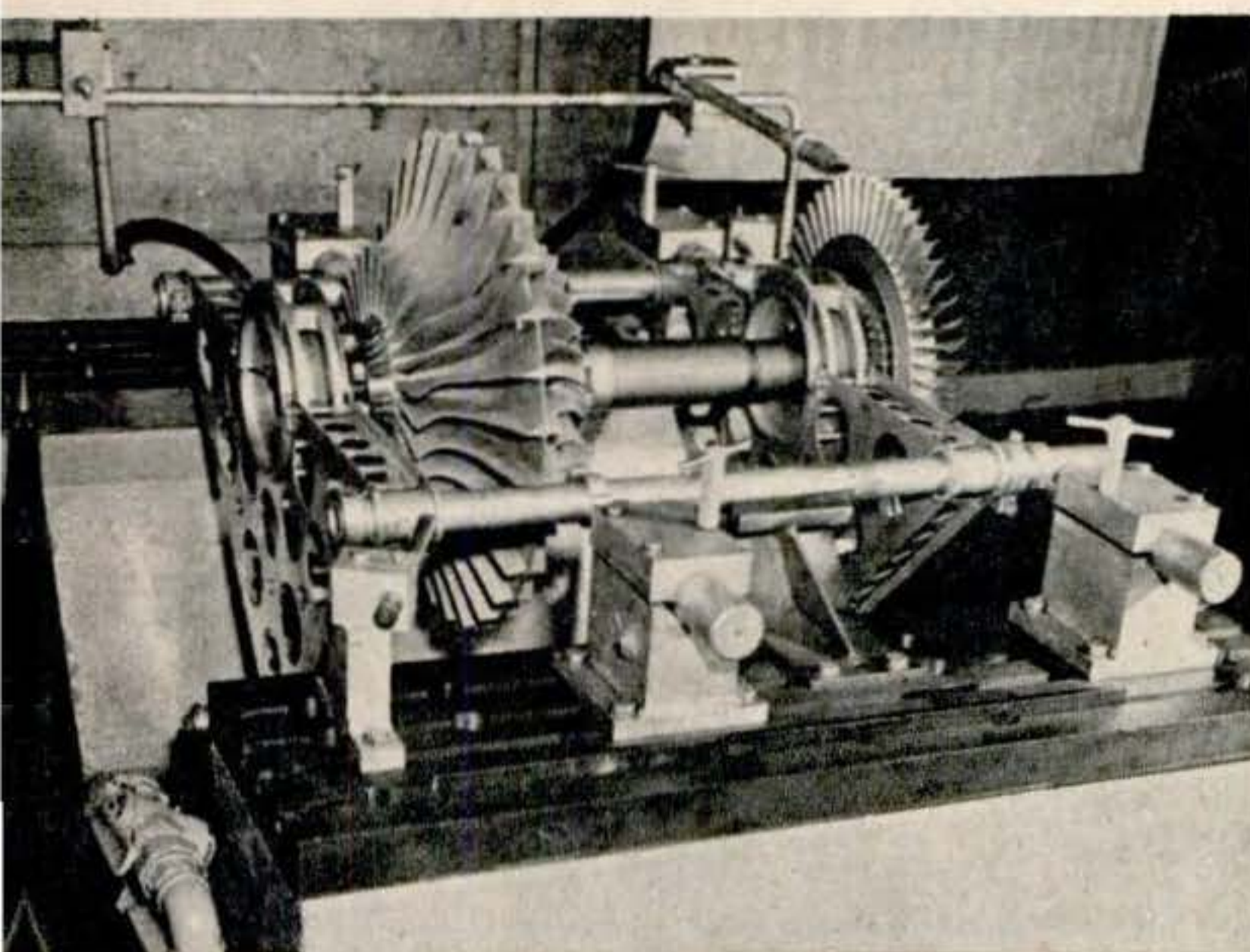

8. Balance of rotor assembly is under test. Rotor spins up to 16,000 r.p.m., and any unevenness could rip the engine to bits.

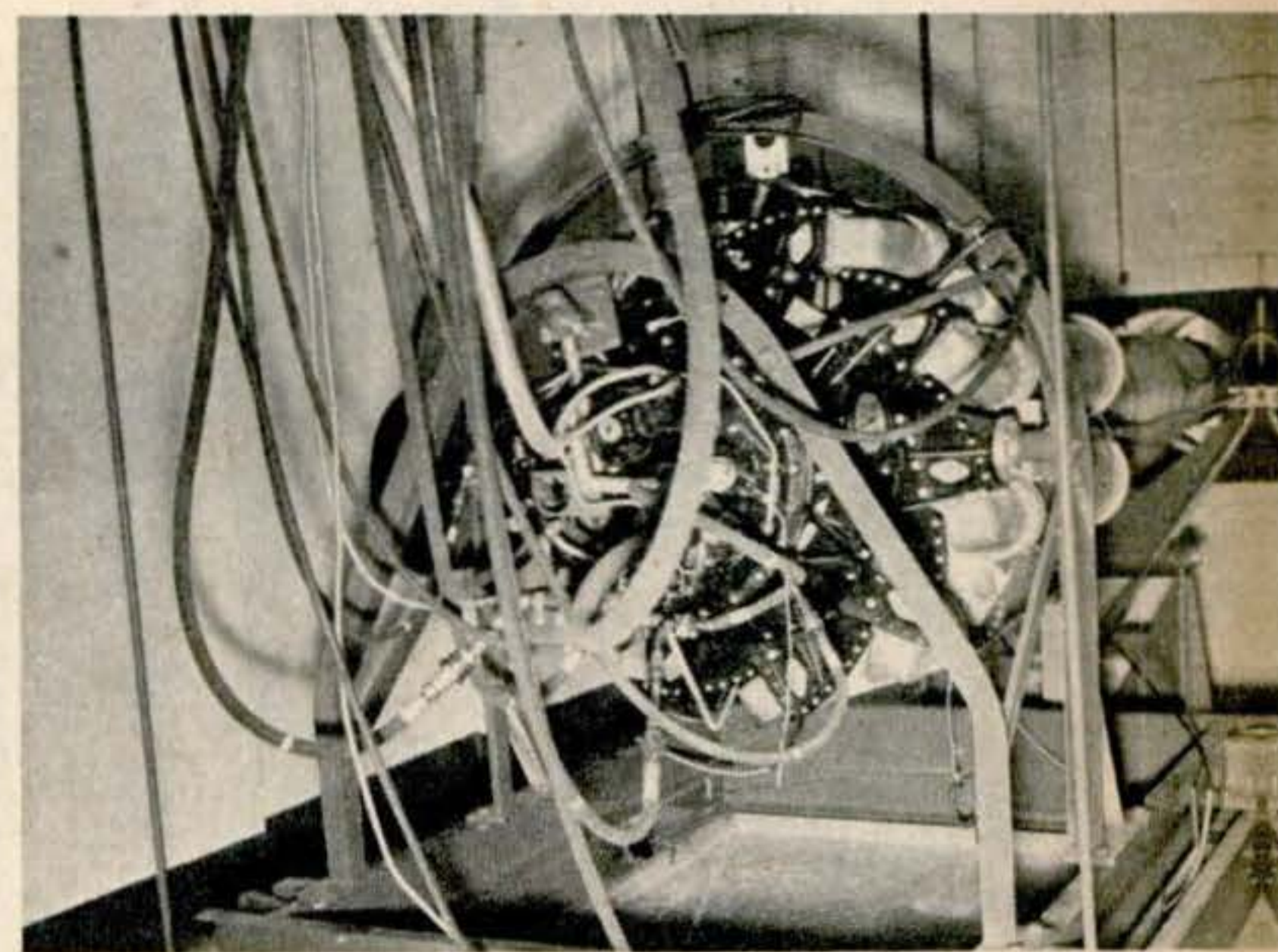

9. Reassembled engine, under power, gets final check. Run from adjoining room, jet blasts against deflector outside test cell.

These Stairs Block Fires

THE Number One fire problem—how to stop stairwells from sucking flames and smoke throughout a tall building—has been solved by a new system of exhaust ducts and water sprays. A test installation has kept upper floors and the vital exit stairway clear and cool while flames raged below.

Developed co-operatively by Otis Elevator Co., Westinghouse Electric Corp., and Grinnell Co., the exhaust-spray system is intended to protect department-store escalators.

The installation automatically goes into action when a fire sets off any sprinkler in the building. It opens the dampers in an exhaust duct circling the escalator on the burning floor, starts a blower sucking smoke up through the duct, and opens a fresh-air intake over the escalator well.

The blower creates a vacuum in the escalator well, pulling fresh air from the roof intake down the well. This downward stream of air completely blocks the usual chimney action of a stairway and prevents upward spread of the fire. Should flame reach the escalator, nozzles opening automatically around the escalator curtain it with a sheet of water, while a separate nozzle inside the escalator well starts if any flame gets past the water curtain.

*PSM photos by W. W. Morris
and Robert F. Smith*

J. Richard Hill, the Rhode Island deputy fire marshal, lights a pan of alcohol to create fire for demonstration of the new system.

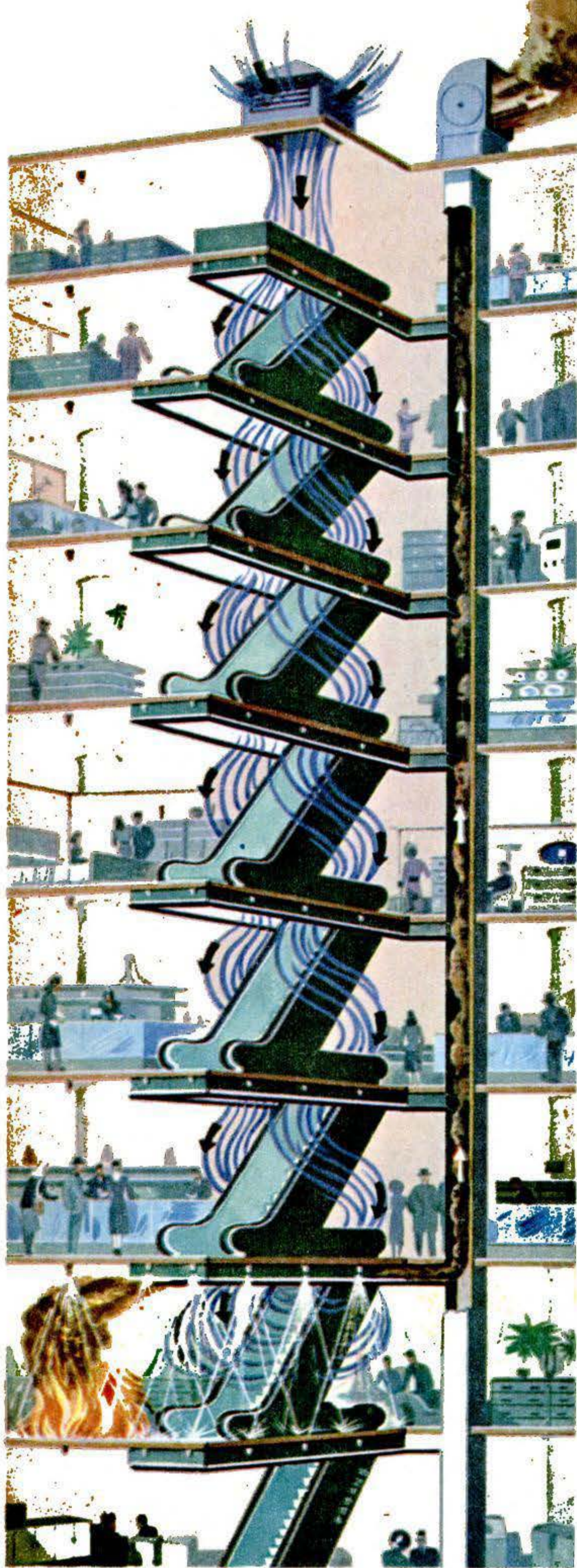
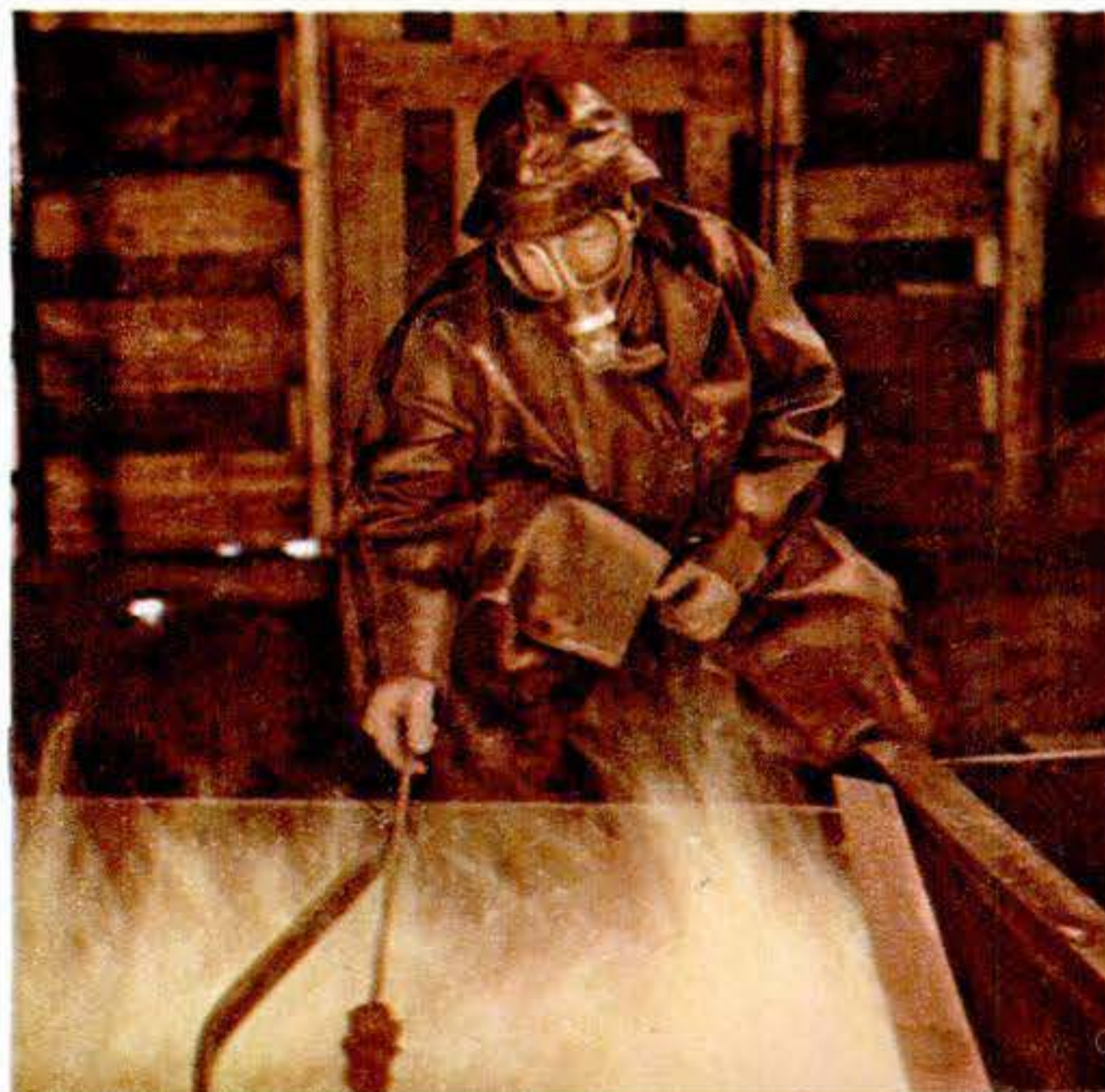

In a typical department-store fire, illustrated above, exhaust-water-spray system prevents mushrooming of smoke and flame to the upper floors. Curtain of water keeps fire out of escalator well, while fan removes smoke and creates draft to pull fresh air down well.



In a vivid demonstration of the installation's effectiveness, a technician measures down-

ward flow of air as flames roar below. Without this system, fire would envelop him.

SEPTEMBER 1947 133

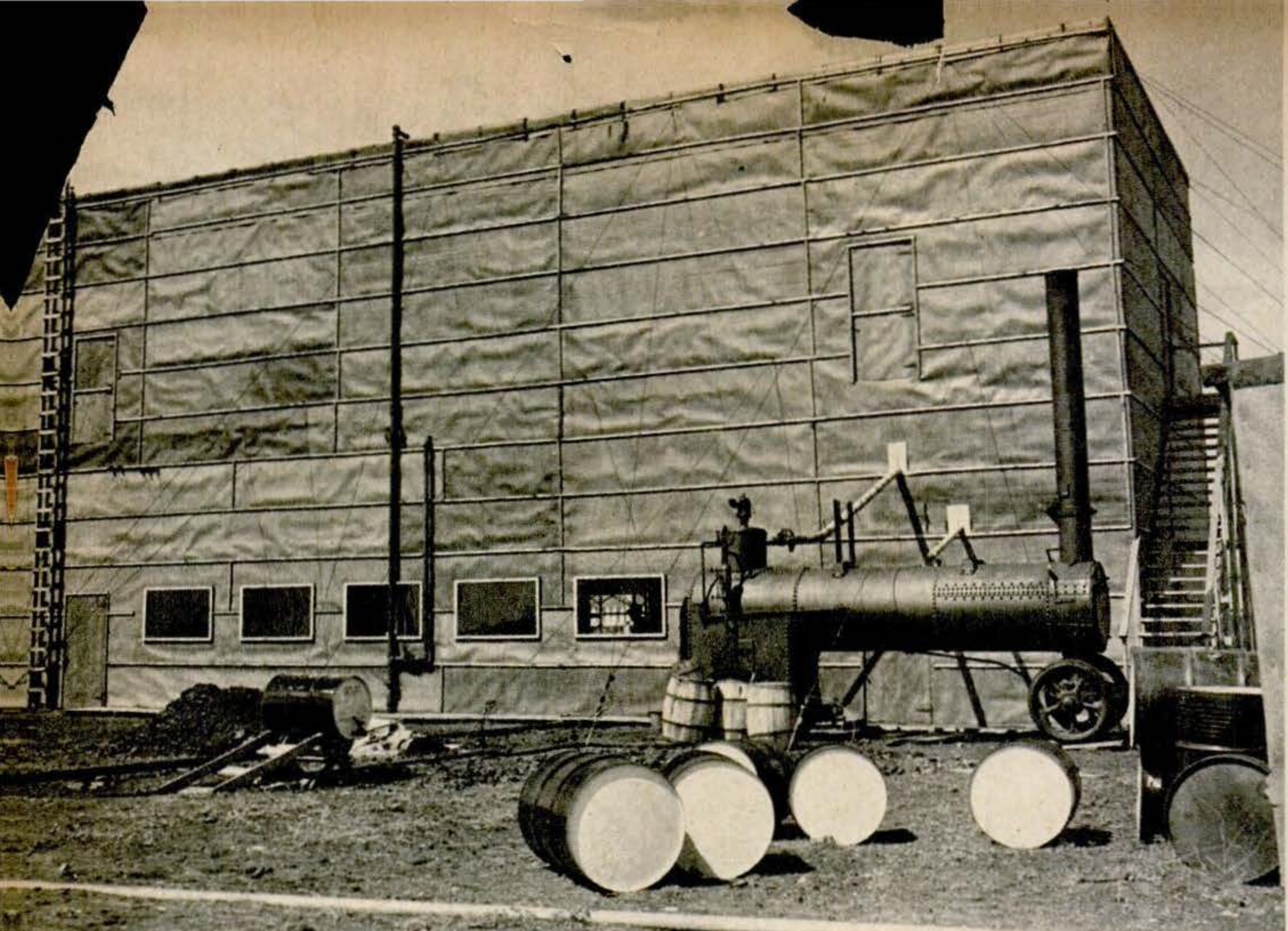

This two-story building, largely tarpaper on a tubular steel framework, was erected for tests of the new system. It contains a

mockup escalator fitted with exhaust ducts and sprinklers. Boiler at right furnishes heat in winter—when test fires are out.

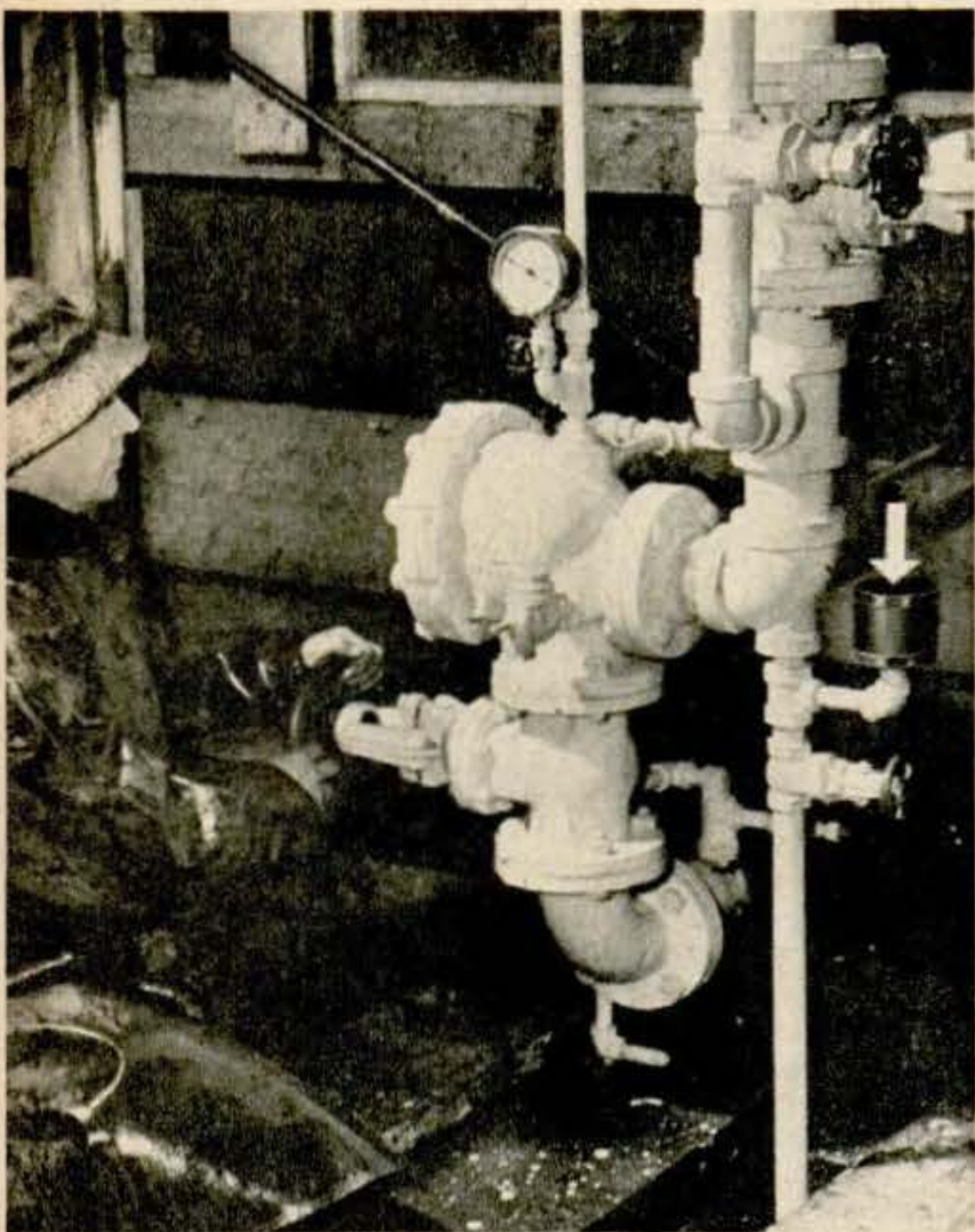

Automatic control (arrow) works by water pressure when first sprinkler is set off. It sounds alarm, stops escalators and air conditioning, starts exhaust fan, and opens dampers in exhaust duct and air intake.

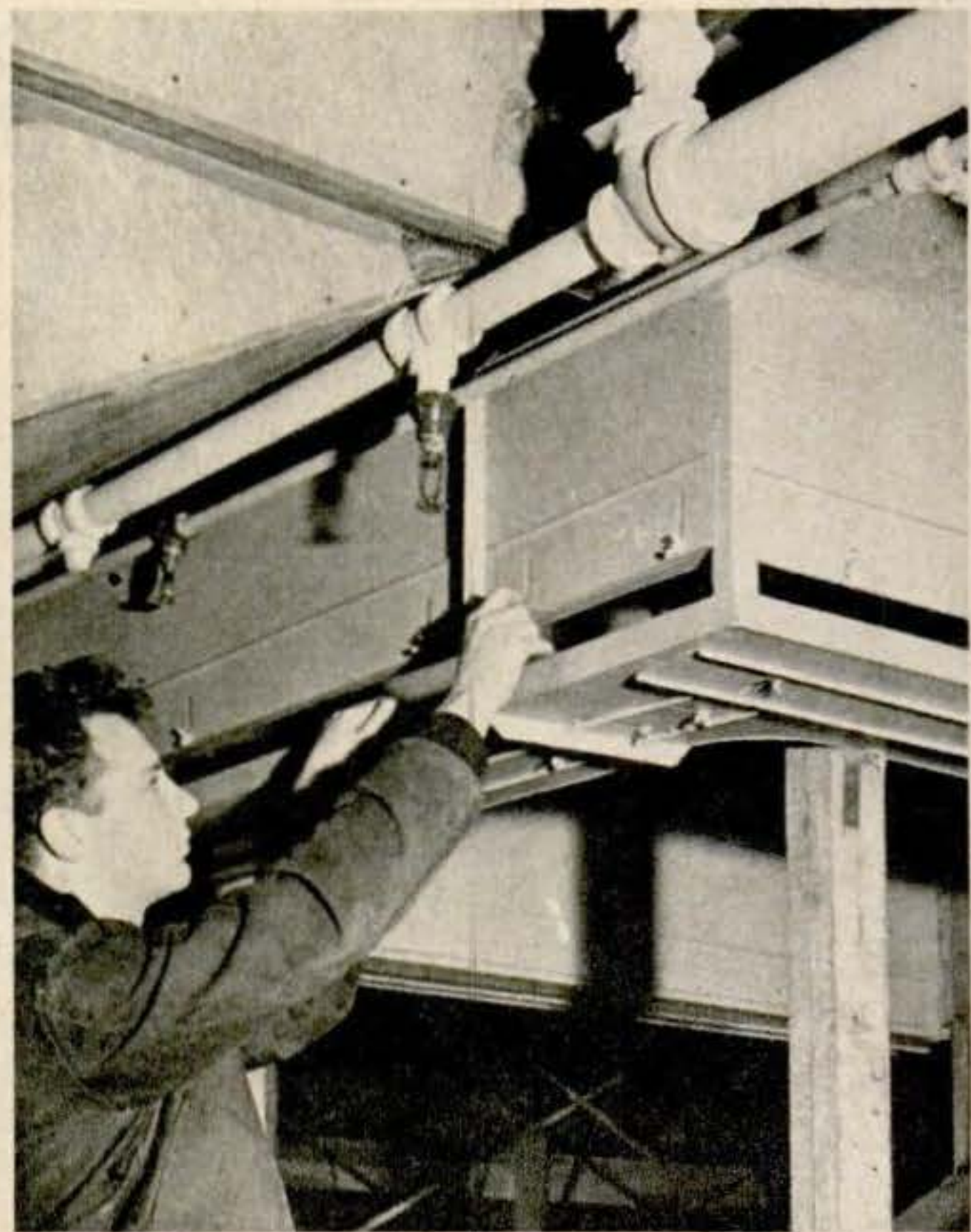

Technician examines damper in exhaust duct that circles escalator well. Through this duct smoke and fumes from fire are sucked outside building by fan, creating downward draft that blocks chimney effect of stairs.

Everybody has his own pet idea of some gadget he would like to see in general use. What is YOURS? *Popular Science Monthly* will pay five dollars for every such suggestion that its editors decide to publish. Suggestions cannot be acknowledged or returned.

I'd like to see them make

Cartoons by SYD LANDI



Roadside Phone Sockets. Connections along the road for portable, plug-in phones would let motorists make emergency calls, says E. Wasilewski, Orwigsburg, Pa.

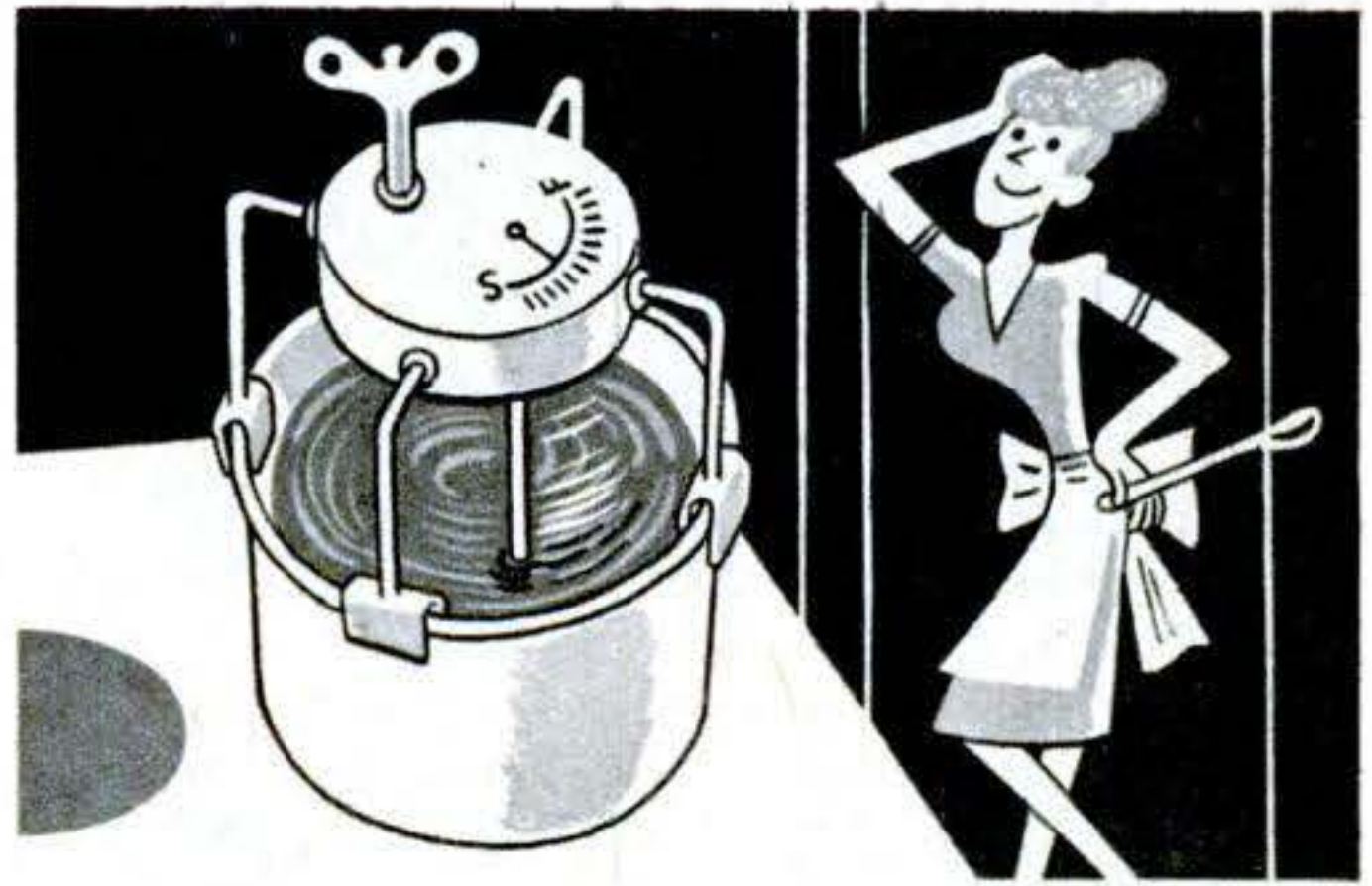

Self-Stirring Pots. Spring-driven stirring arms that could be clamped to pots would be a boon to housewives, thinks Josephine Bourquin, of Conneaut, O.

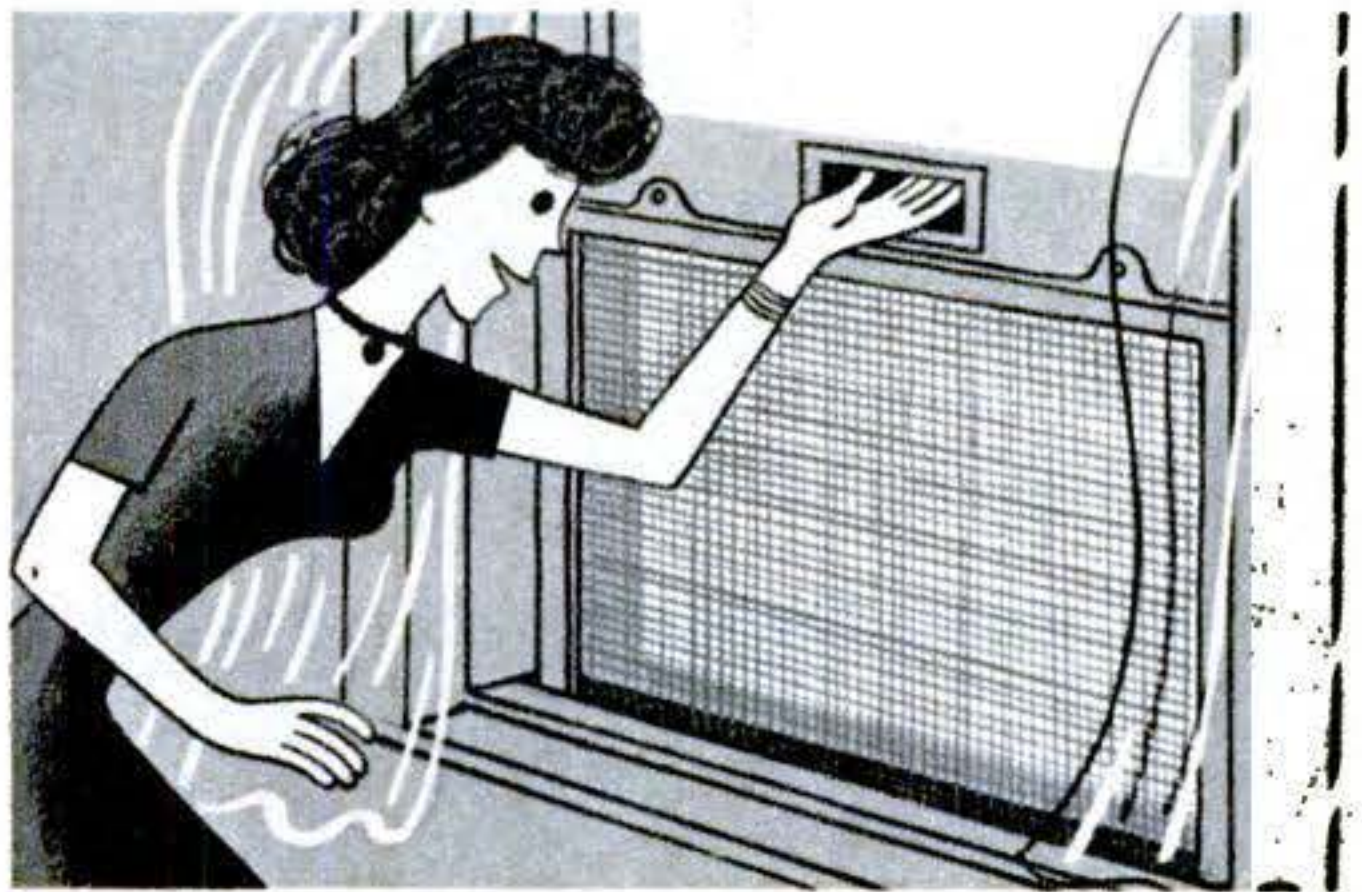

Wind-Up Window Screens. Plastic screens that wind on rollers and pull up from the sill when the window is raised are the dream of Leighton Harris, Natick, Mass.



Waiter Catcher. To attract the waiter's wandering eye, E. V. Wilson, of Lexington, Ky., suggests table buttons that sound a buzzer and flash his section number.



Wrap-Around Warming Aid. For easier heat-treating of head, neck, arms and legs, Paul Carlstedt, of Edmonds, Wash., wants heating pads made in long strips.



Earphones for Pianos. Worn only by the player, they would save others' nerves while the children are practicing, claims E. Aileen Foster, of Albuquerque, N. M.



Copper By Candlelight. What material is more appropriate to these hand-fashioned candlesticks than the warm-hued metal that has been the craftsman's choice for centuries? Many find coppersmithing a

source of fun and fascination even today. An article beginning on page 168 describes tools, working methods, and how to finish your handiwork either to a high luster (left above), or to an antique sheen as at right.

CRAFTWORK

PROJECTS OF THE MONTH

Phono Amplifier.

There's more music on modern, high-fidelity records that meets most ears because only the finest phonographs are capable of reproducing a full frequency range. This amplifier, the second part of PSM's high-quality sound system, can help you get the musical richness that record makers put into their better disks. It's also a perfect companion for a radio tuner, microphone, or combination of any of these. Details start on page 202.

Photos by Hubert Lockett

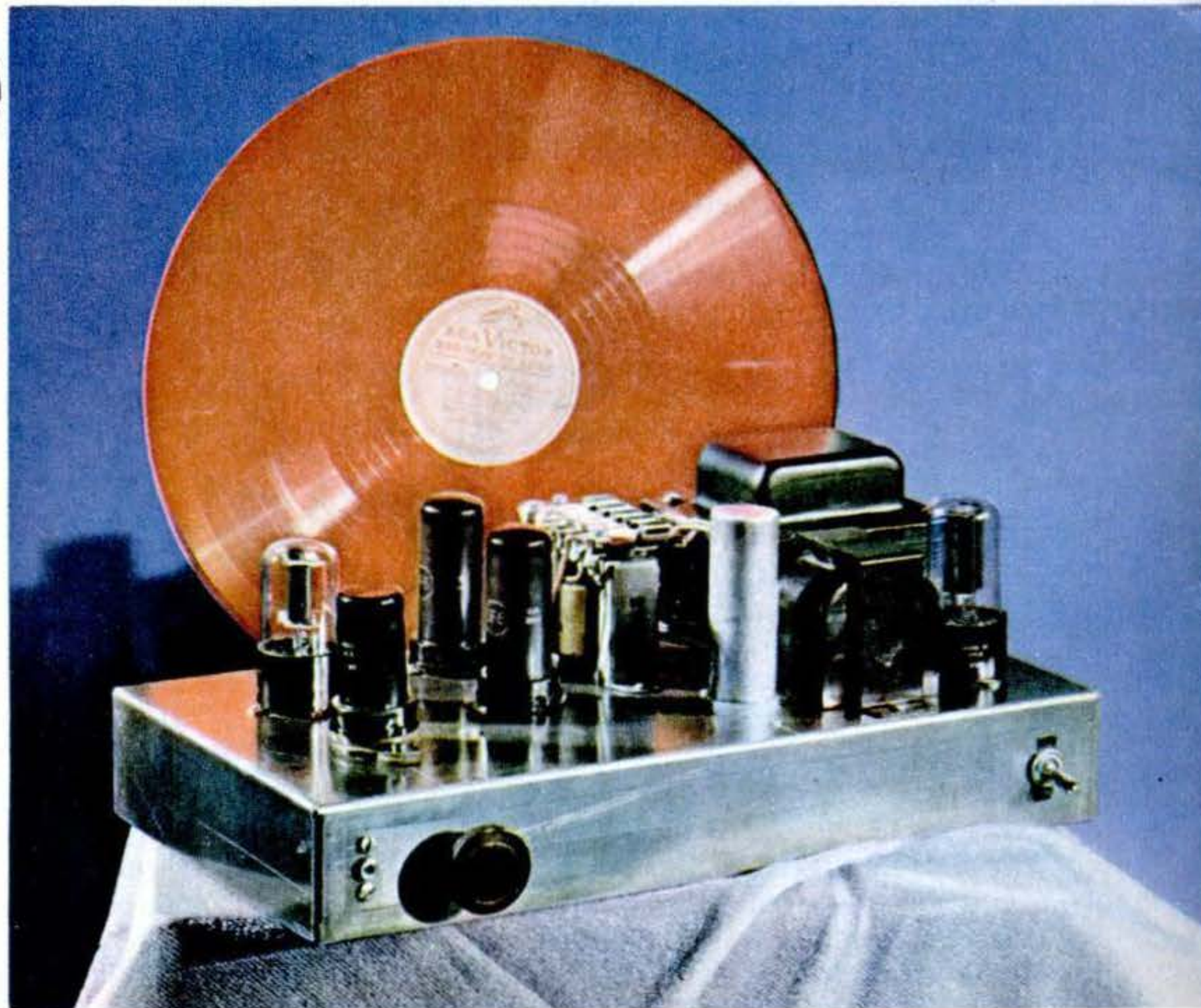

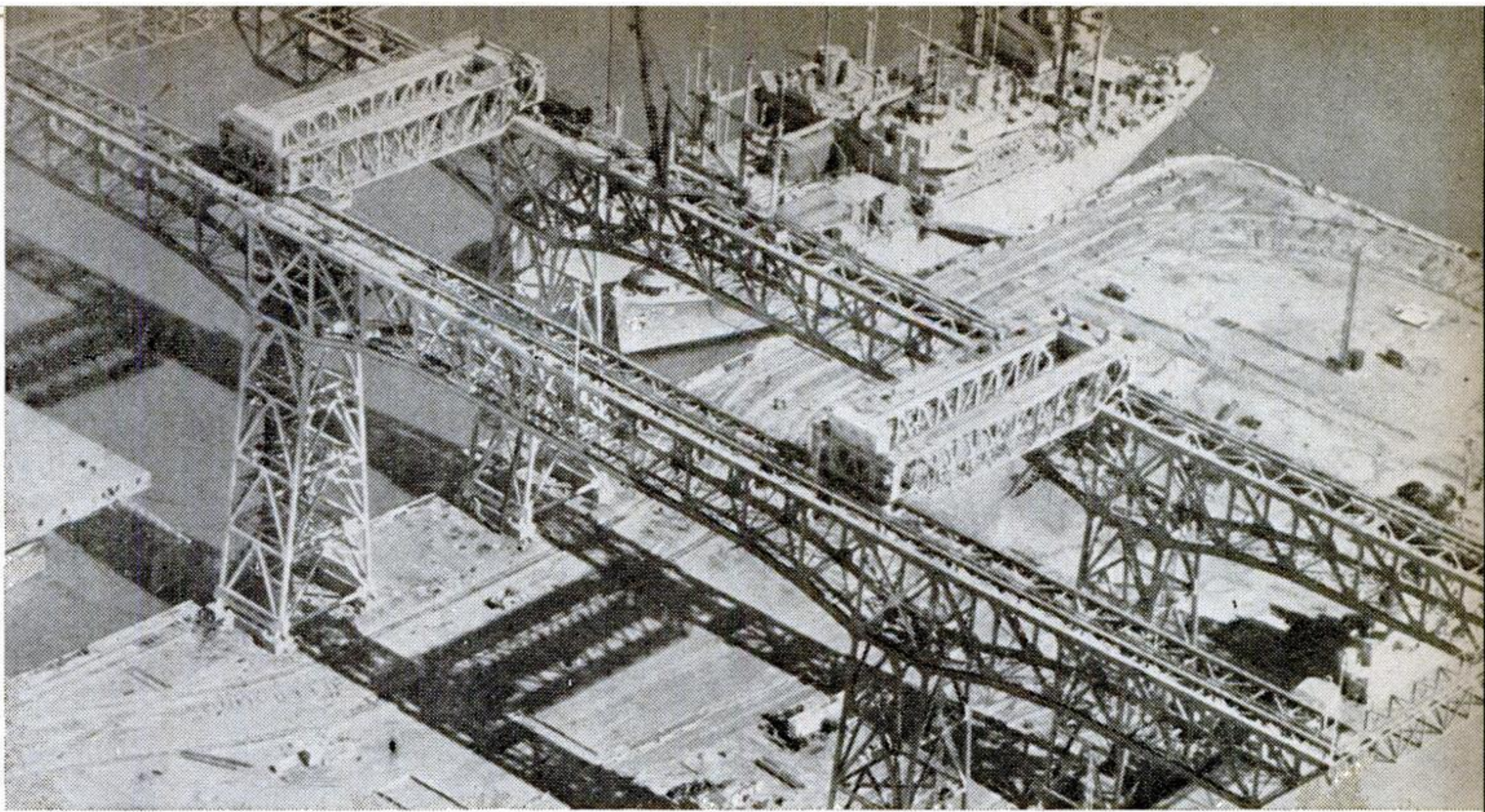

Navy Raises the Limit

TOWERING 182 feet in the air and operating on a 730-foot overhead runway, this

450-ton crane is the largest in the world—by a 100-ton margin. It is being built by the U. S. Navy at San Francisco to speed repair of major fleet units.

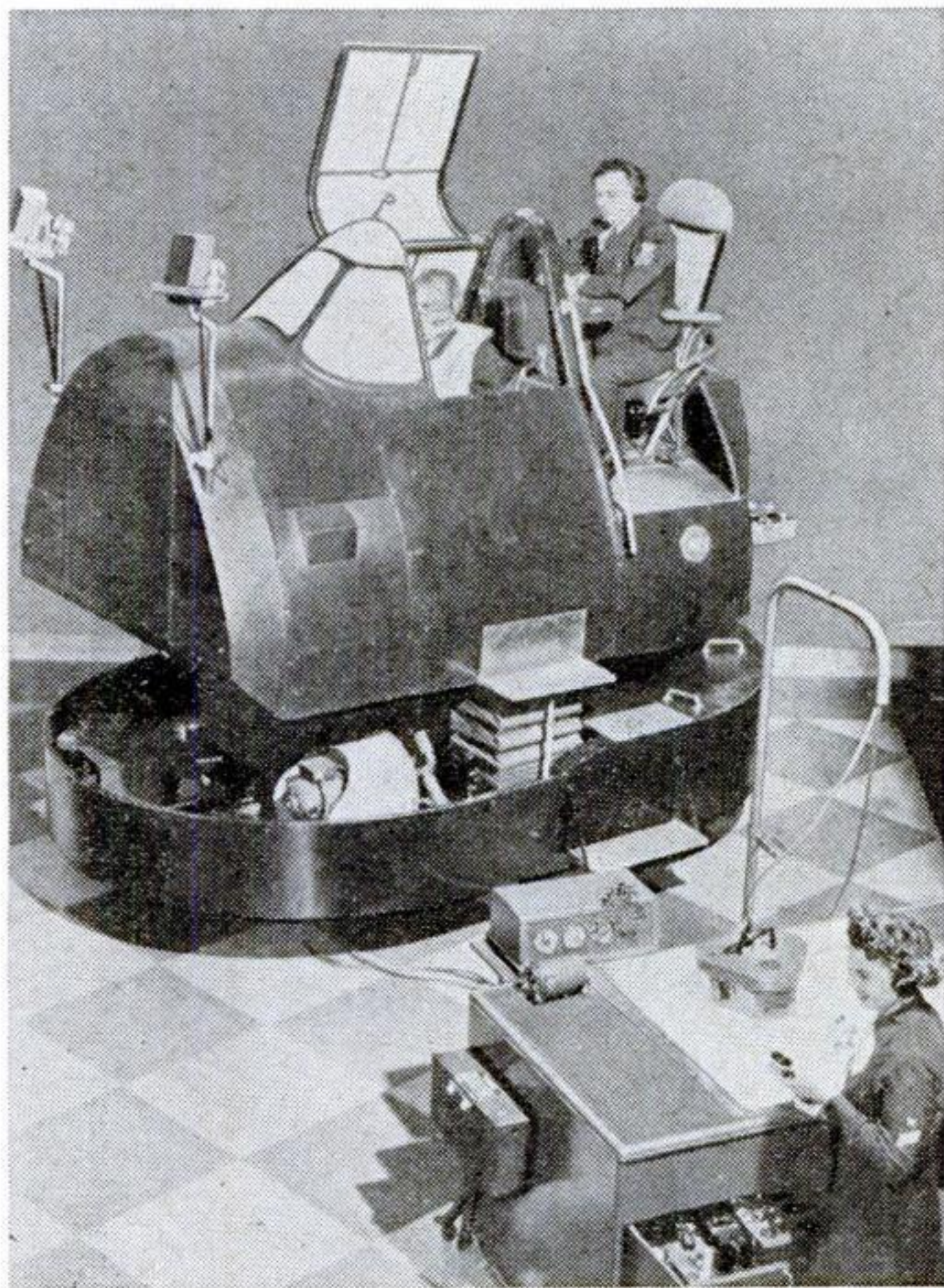

Last Word in Illusion

CLOUD shadows over the cockpit, the roar of an engine, and the screech of tires during "landings" are only a few of the realistic touches in a new Navy instrument-flight trainer. A model of the Bearcat fighter, it even simulates rocket- and gunfire.



Outsize Kite Takes Off

KITE-FLYING contests, resumed in Japan after a 10-year suspension, brought out this 12- by 15-foot job, probably the biggest ever flown. Inset shows take-off of the bamboo-framed monster, which, with control ropes, weighed 1,430 pounds.

All the World's Weather

IT TAKES exactly 10 paces to travel from the jungle to the Arctic in the Army Air Forces' new Climatic Hangar at Eglin Field, Florida. A few steps more transport you to the dry heat of the Sahara, to the salt-laden sea air of New Guinea, or to regions explored so far only by unmanned balloons

and rockets, 100,000 feet above the earth.

By providing all the world's weather under one roof, the Climatic Hangar enables the Air Proving Ground Command to determine the performance of men and machines anywhere upon the earth that they may be required to fight. Formerly, in such

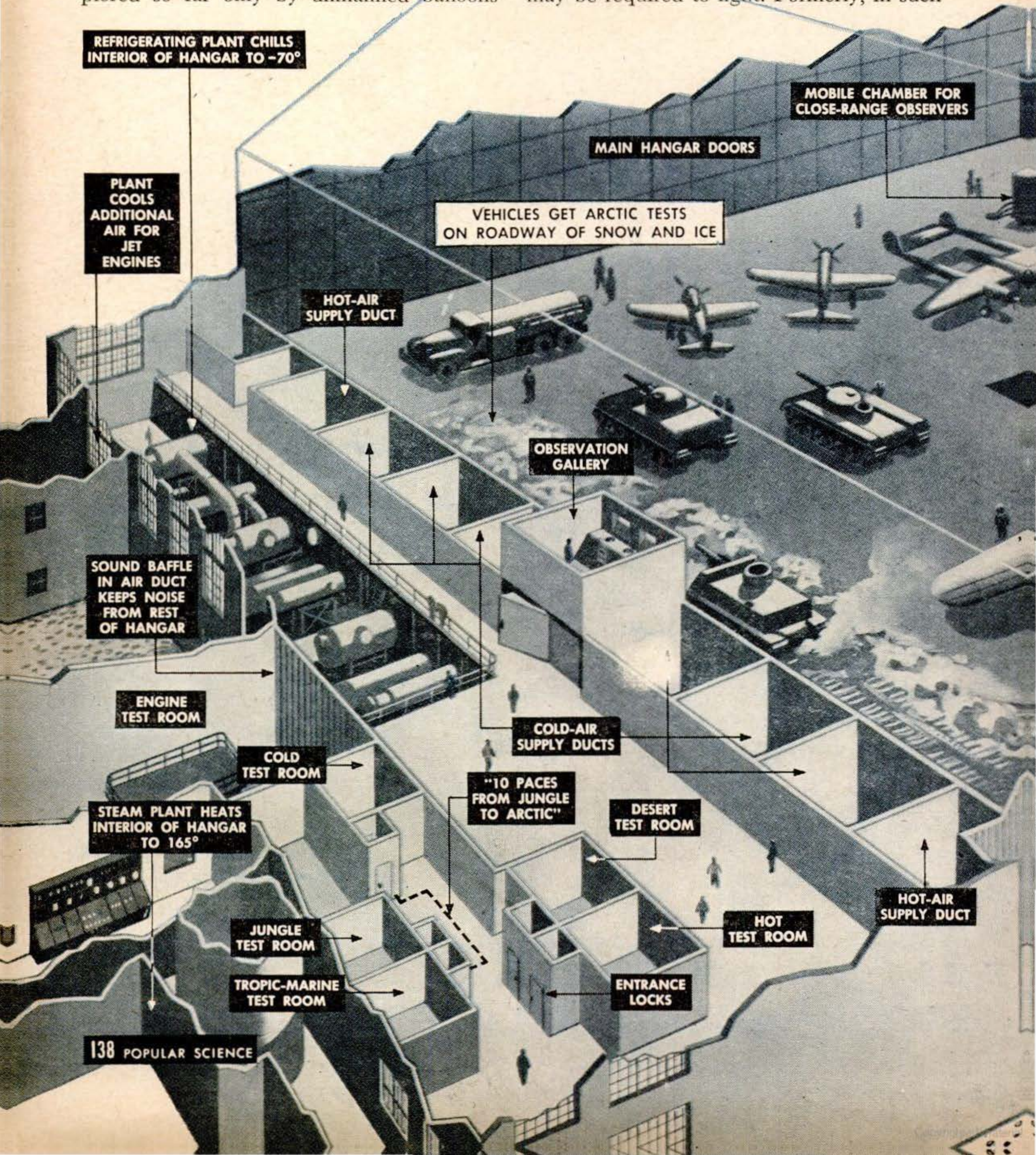

Packed Under One Roof

elaborate and picturesquely named maneuvers as Operation Frigid, Operation Wiliwaw and Operation Furnace, expeditions have had to travel thousands of miles to try out Arctic and tropical gear—taking the fickle weather as they found it, or waiting another year. Now the Army's latest

weapons and tactics can be tested, improved, retested and OK'd at the accelerating tempo that preparations for tomorrow's style of warfare demand. Heading the program are guided missiles, gun turrets, bomb-release gear, storage batteries and lubricants suited to the newly important polar regions, 

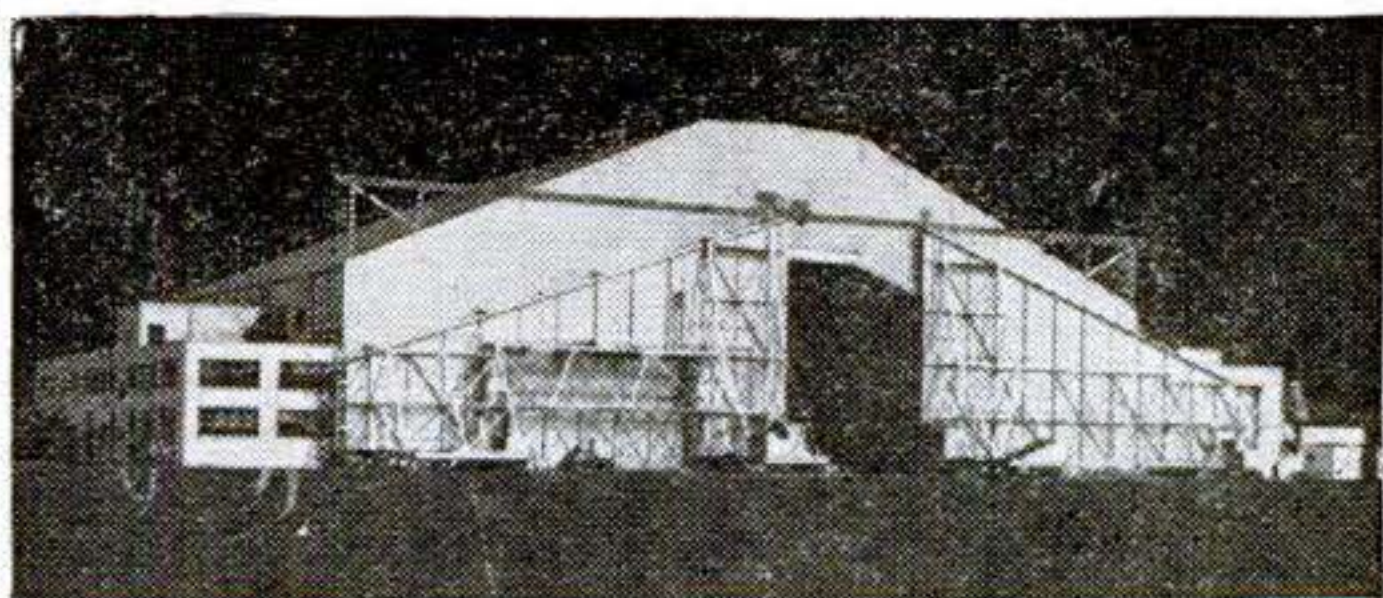
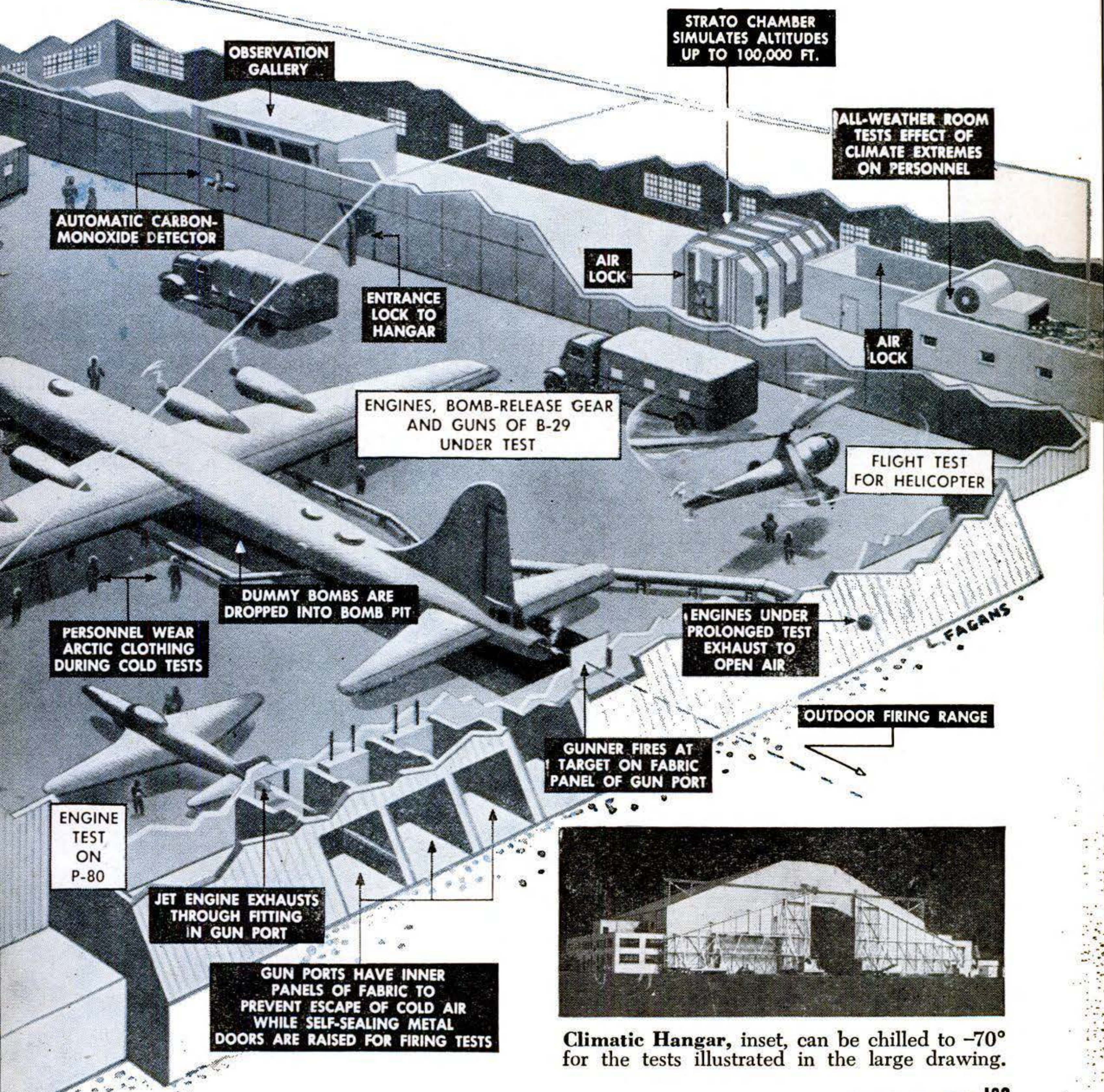

Climatic Hangar, inset, can be chilled to -70° for the tests illustrated in the large drawing.

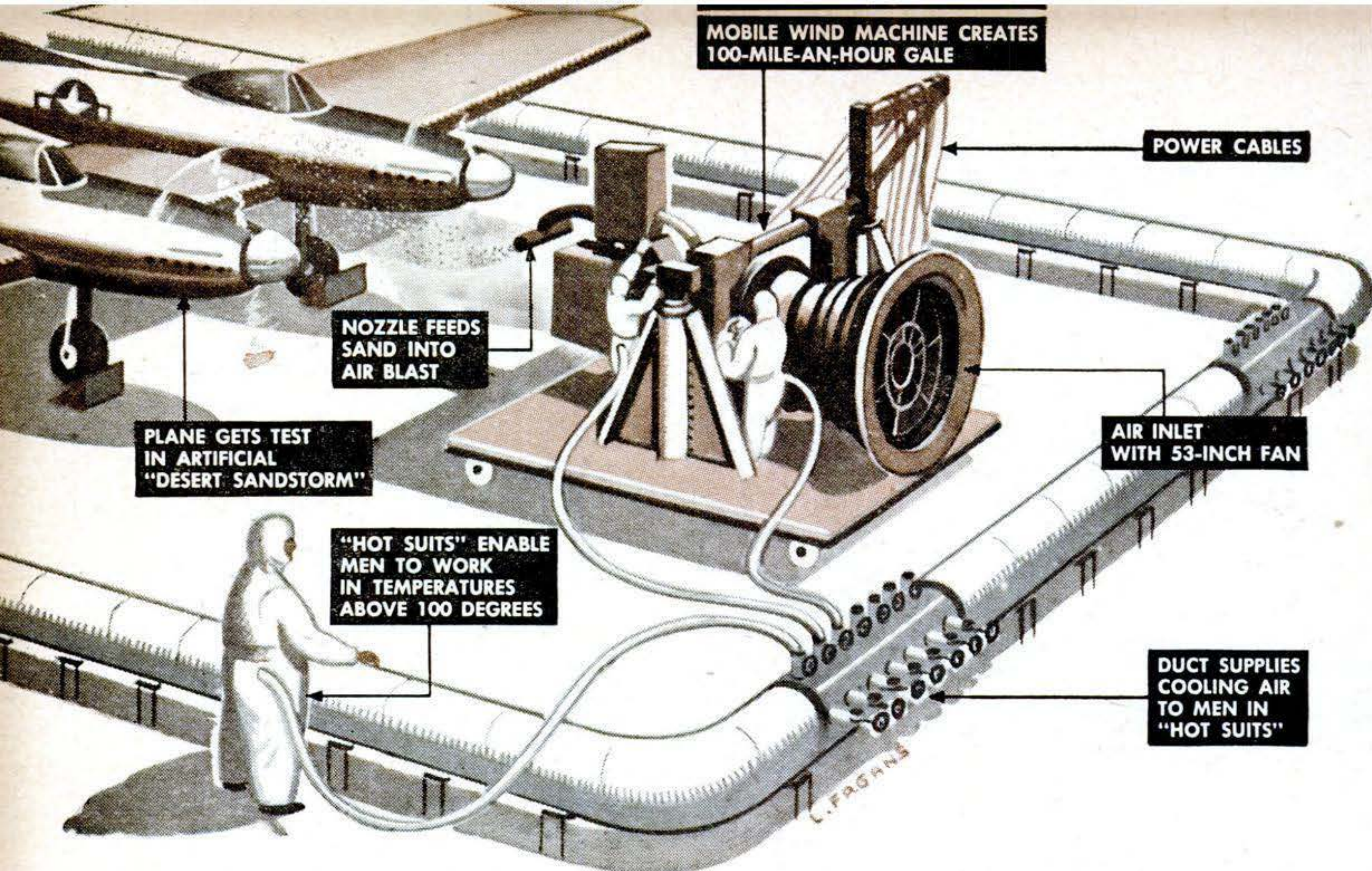

Equator's heat can be reproduced in hangar with temperatures up to 165°. Above, 100-mile-an-hour blast from mobile wind machine hurls a "desert sandstorm" at spinning propellers

of P-82 under test. So men can work in heat, duct in foreground supplies cooling air to "hot suits," below, fitted with slide-fastened inserts of tubing that can be detached for cleaning.

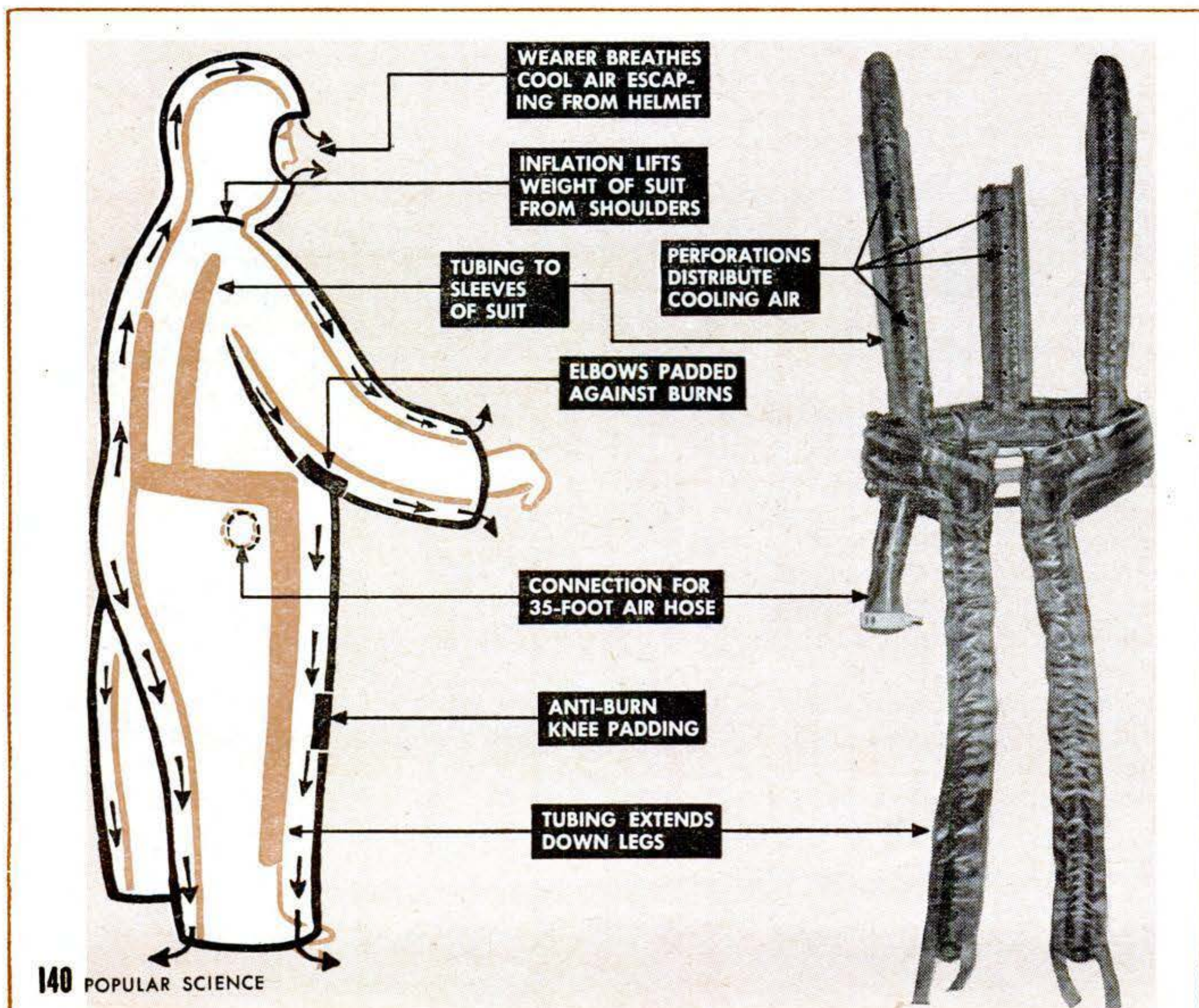

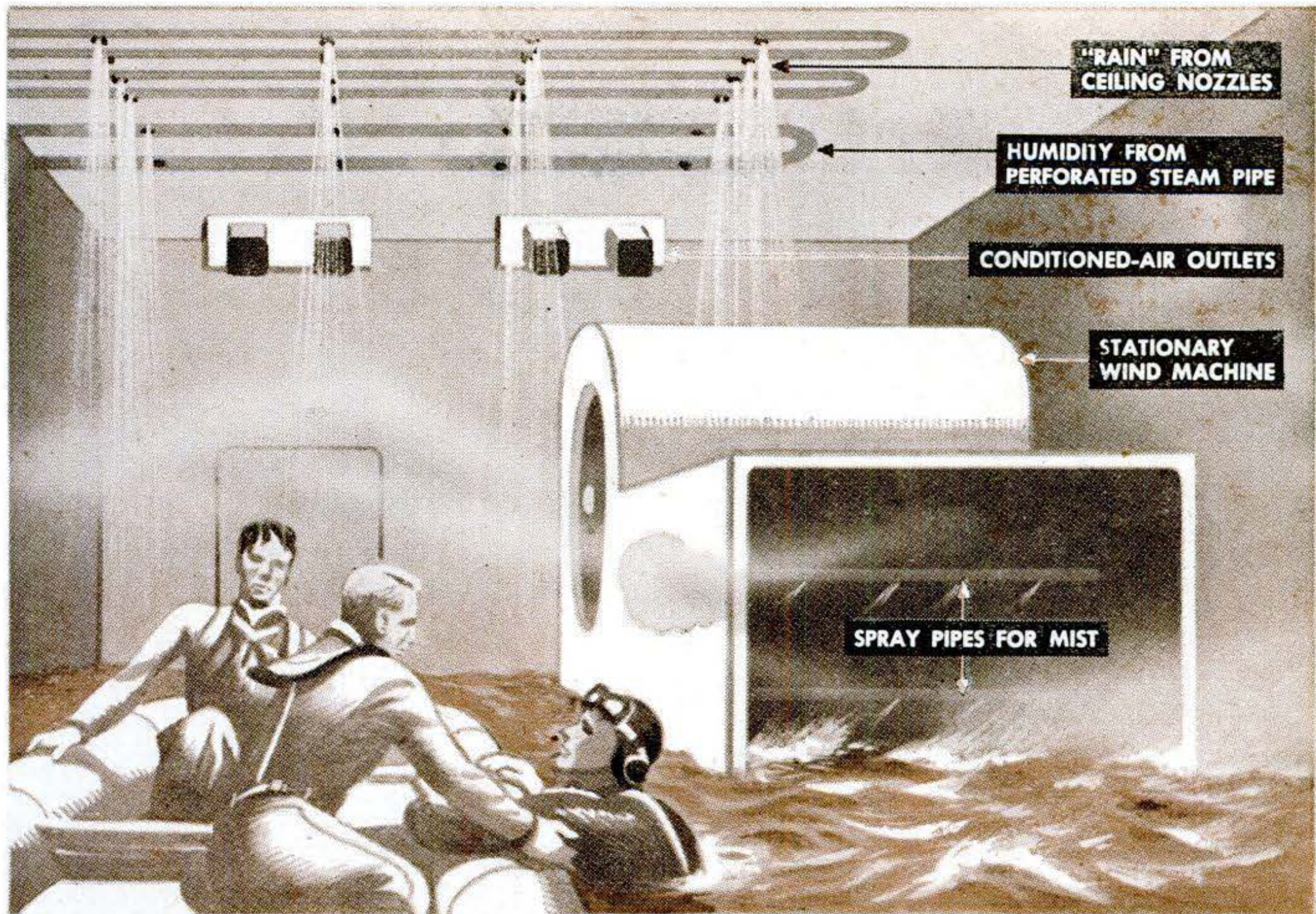

All-weather room tests men and equipment in action under hot or cold blasts and artificial rain from overhead pipes. Stationary wind machine in background creates gale to which mist, sleet

or snow can be added. Room can be flooded, as shown, to try out life-saving rafts and immersion suits that would be used by fliers forced down at sea and exposed to the elements.

and clothing and food packaging for all climates.

A hangar-shaped test room measuring 200 by 250 feet, with a ceiling up to 70 feet high, realizes the dream of the Air Proving Ground Command: an all-climate chamber large enough to hold the Army's biggest fighting machines in existence or on the drawing boards.

Chilling this enclosure of nearly 3,000,000 cubic feet to -70° , so cold that mercury thermometers have long since frozen solid and men in fur-lined Arctic suits can work only an hour and a half at a time, represents a feat unprecedented in the annals of air conditioning. The three-story, 9,000-hp. York Corporation refrigerating plant that does it, through ceiling air inlets and wall outlets, ranks as one of the engineering wonders of the world.

At the opposite end of the temperature scale, steam coils raise the hangar to the oven-like heat of 165° . It can be held at either temperature during tests lasting for weeks. A similarly conditioned engine test room accommodates the biggest aircraft power plants, while equipment for personnel

and other non-bulky items may be exposed to made-to-order climate in an all-weather room, a strato chamber and five smaller, specialized testing cubicles kept permanently at climatic extremes.

Artificial hurricanes, sandstorms or snowstorms are unleashed in the main hangar and engine test room by a mobile wind machine. Its 53-inch, 250-hp. fan creates a 100-mile-an-hour gale.

So that hangar workers can endure temperatures exceeding 100° , they wear "hot suits" through which a current of cooling air constantly flows from a U-shaped duct and 35-foot hoses supplying up to 20 men. The strange clothing may some day appear in combat, for trials suggest its use in tanks—and perhaps in future supersonic planes, whose cabins may be excessively heated by air friction at ultrahigh velocities.

Even when the Climatic Hangar is sealed airtight, its vast size permits engines to be run and helicopters flown as in the open air. If carbon monoxide approaches the danger point, automatic detectors flash lights and ring alarm bells, warning that tests should be suspended until the ventilating system

flushes out the gas. For extended trials and tests on jet engines, special fittings discharge exhaust gas out of doors.

Closing the main doors of the hangar is an engineering feat in itself. First a built-in motor rolls each 200-ton door along railway tracks to a point at which T-shaped hooks along its upper edge engage wall cleats. Then motors retract the hooks, while other motors exert inward pressure along the bottom; under the combination of pull and push, the whole door moves six inches sideways on rollers, to seal against top and side gaskets of rubber. Finally, cams depress a pivoted rubber gasket on the bottom edge of the door, completing the seal. Electric strip heaters around all hangar doors keep them from freezing shut. END



Hot test room provides temperature up to 165° and humidity as high as 95 percent for small-scale trials, as of plastic aircraft parts and food packaging for torrid climes.

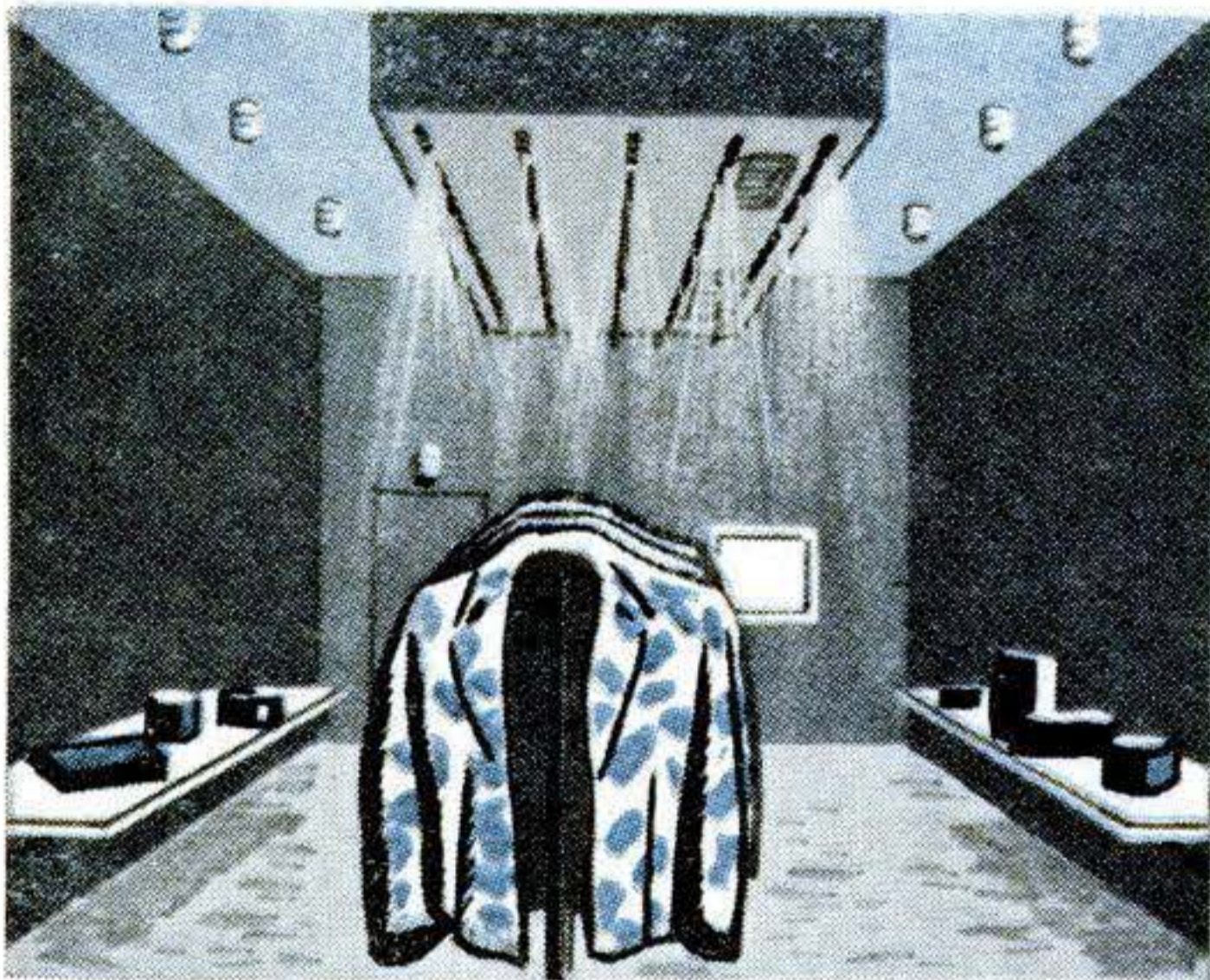

Jungle test room simulates actual day-and-night cycle of tropics' humid heat, with torrential "rainfall" from ceiling nozzles, to develop mold- and mildew-proof fabrics

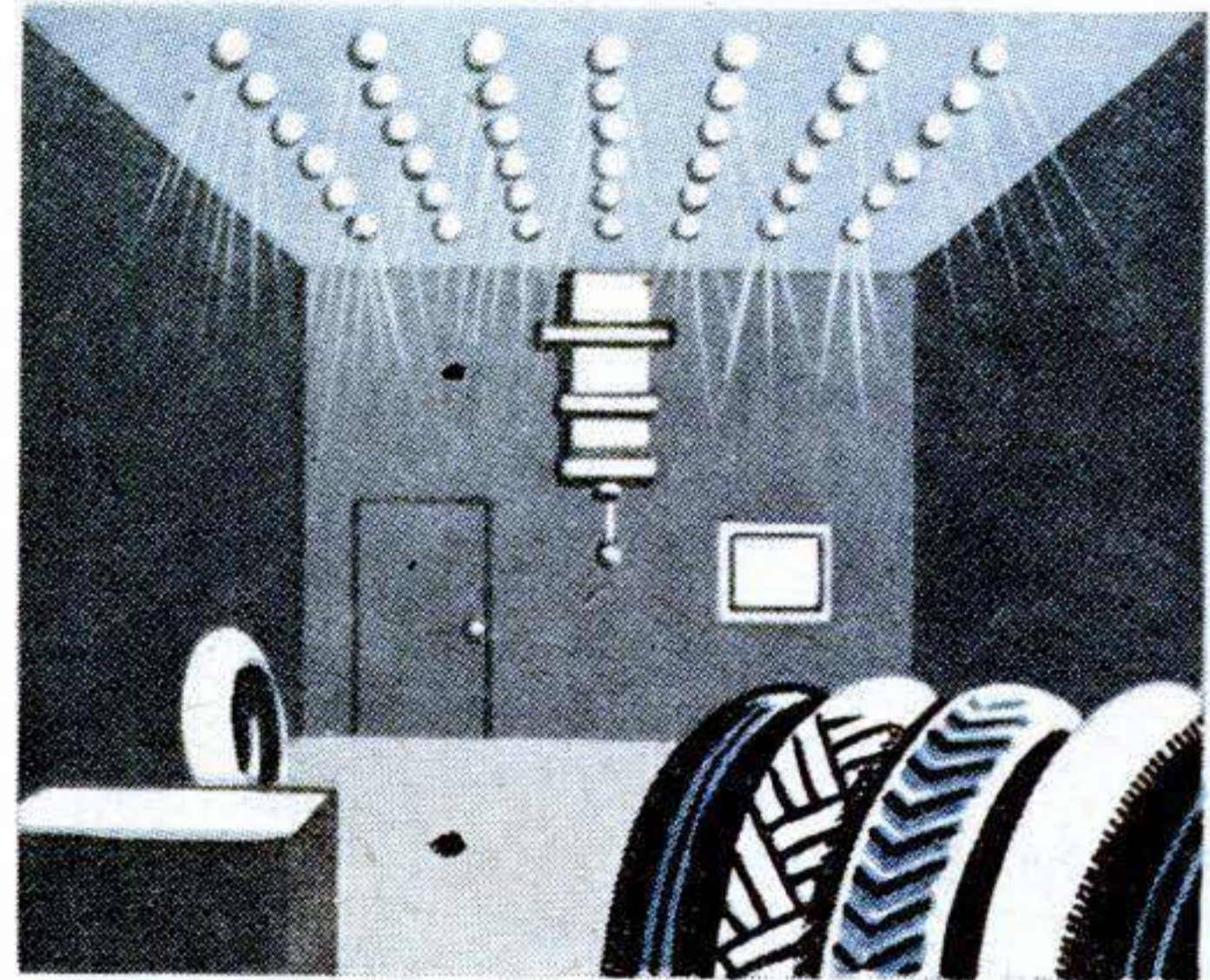

Desert test room employs 144 ultraviolet sun lamps in ceiling, providing equivalent of noon-day sun over Sahara, to learn effect of dry heat on such items as rubber tires.

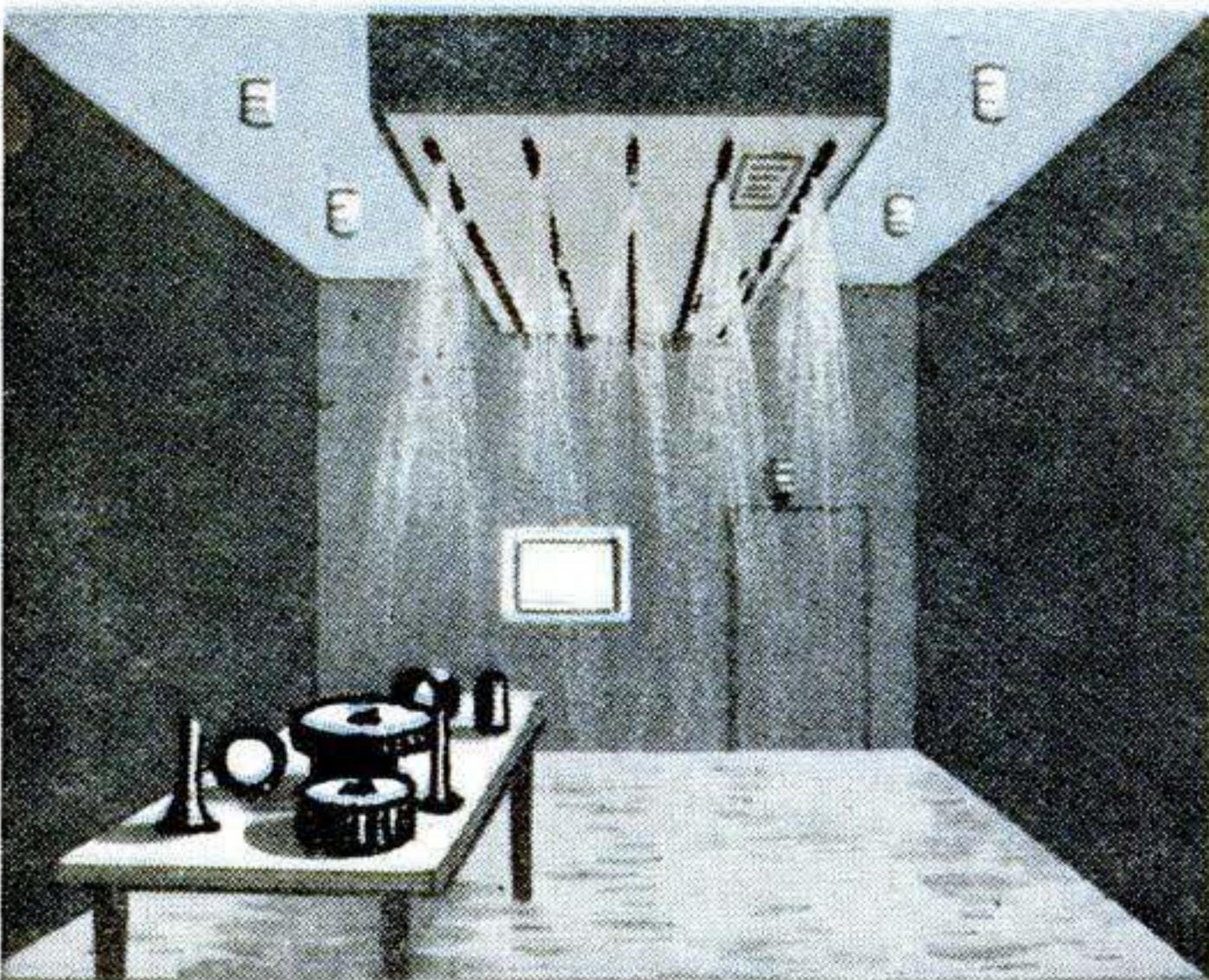

Tropic-marine test room adds salt spray to jungle climate for trials of ways to keep metal objects from corroding in climate like that found on tropical islands of Pacific.

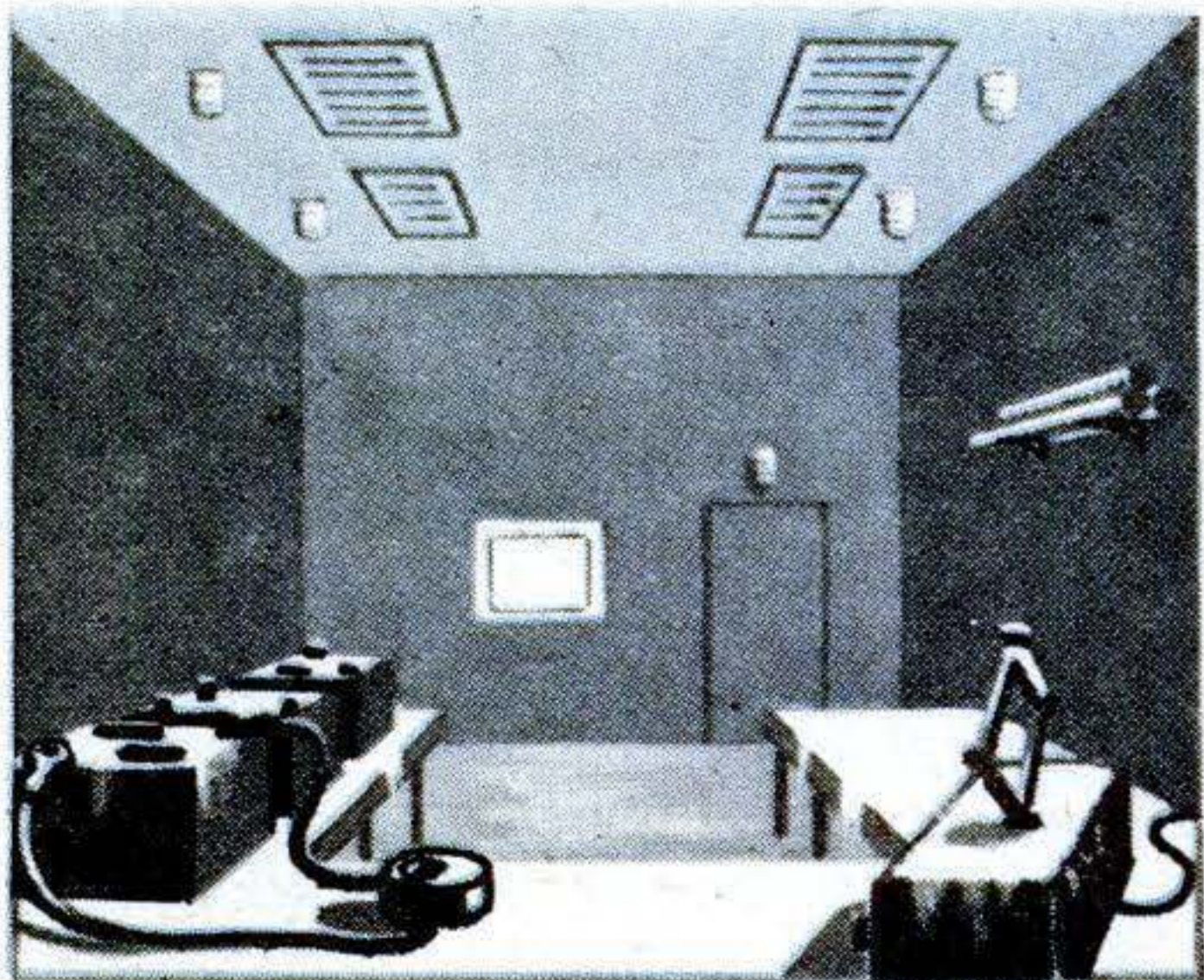

Cold test room reaches -70°. It tries out batteries, cameras, radios and lubricants, determines what effect long exposure to Arctic cold has on ammunition and rockets.

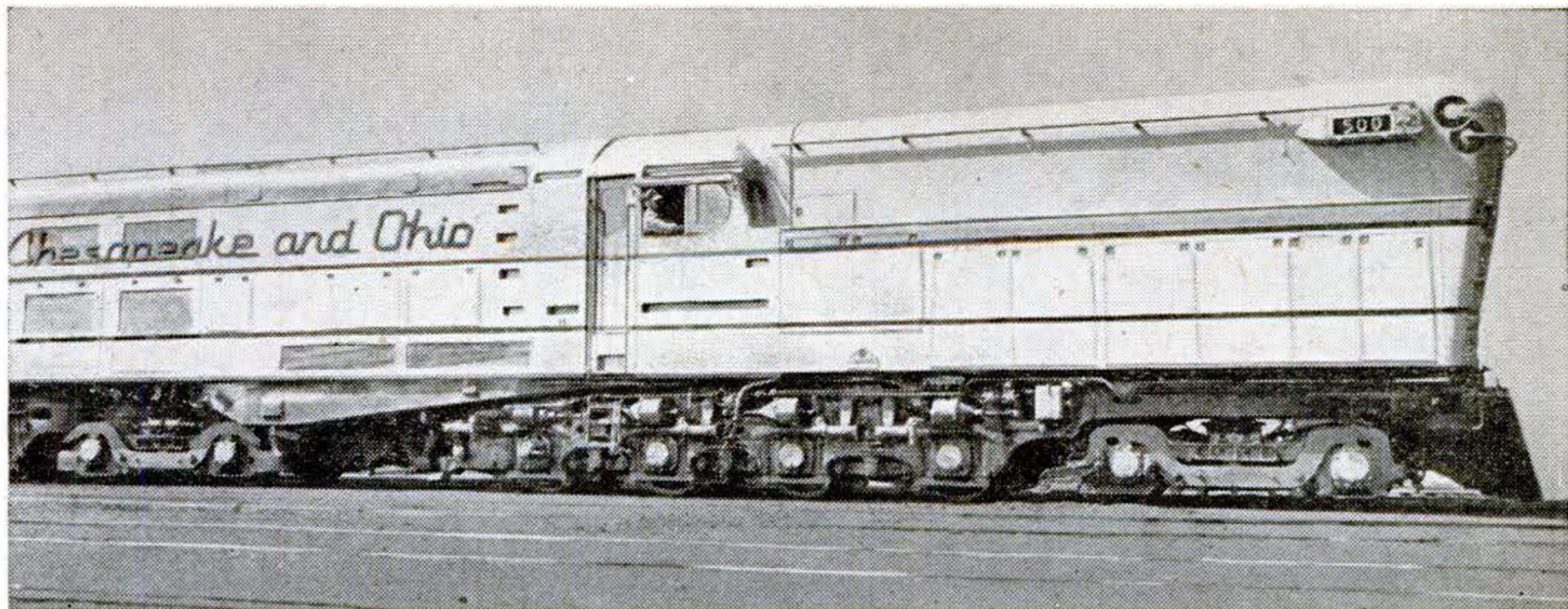

Biggest Ever Built

THE first steam turbine-electric locomotive ever built and the largest passenger hauler in the world, the Chesapeake and Ohio's No. 500 (above) starts service this

fall. One of three coal-burning electrics being built for the line, No. 500 is more than 140 feet long, making it the biggest single-unit engine of any type. Its 6,000-hp. turbine, two generators and eight driving motors give it a top speed of 100 m.p.h.

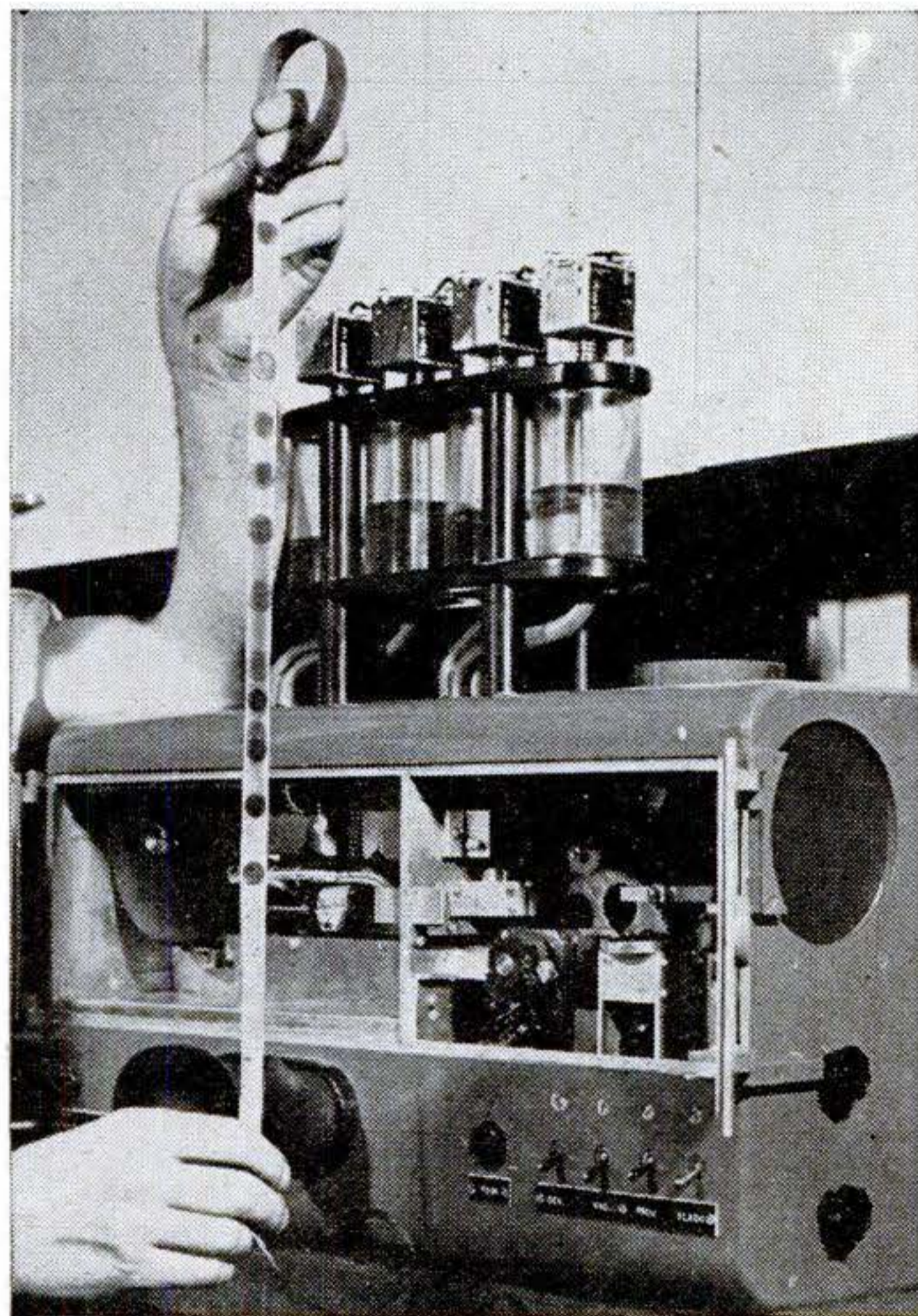

Camera Speeds Testing

THIS machine will take a picture in a millionth of a second, automatically develop it in 25 seconds, then project it on a circular, built-in screen. A strip of exposed film is shown in front of the machine, which was developed by General Electric for testing electrical devices.

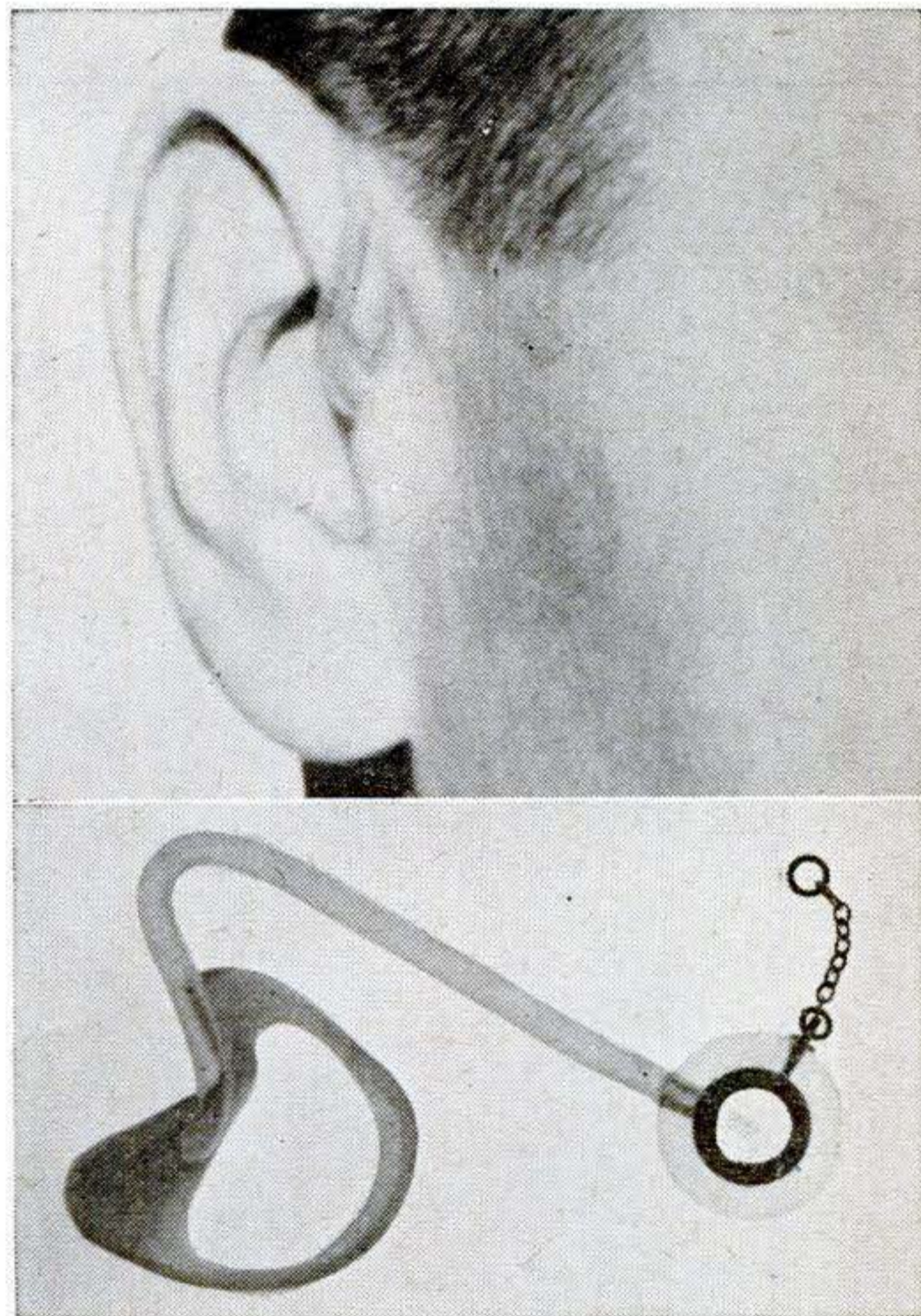

Hiding a Hearing Aid

ANOTHER step toward making hearing aids inconspicuous: A shell-like rim of flesh-colored plastic, a product of the Maico Co., of Minneapolis, fits into the ear and is hidden by its folds. A transparent lucite tube carries the sound from a tiny receiver, hidden under the hair or a collar.

Clever Farmer Makes Water Run His Pump

Harnesses sunken lake with handle a quarter of a mile long that never—well, hardly ever—stops working.

PAUL BUNYAN may never have visited the South, but down near Winston-Salem, N. C., there's a pump he should have seen. It has a handle a quarter of a mile long, and it makes water pump itself.

The pump was built by L. M. Craver, whose house is on a hilltop above a sunken lake. He got tired of lugging water and decided to make the lake do the work. Water from the lake flows through two pipes into a washtub on a weighted beam. When the tub fills, it thwacks down its end of the beam; a dump valve empties the tub and the beam rises again. From an upright atop the beam, a cable runs up hill to a lever that transmits a shorter, more powerful impulse along another, longer cable to a second weighted beam. As the tub goes endlessly up and down at the bottom of the hill, this second beam does too, operating a deep-well pump.

For 13 years, except when infrequent sleet storms ice up the homemade timbers, the pump has been filling a tank in the attic of the house for gravity distribution, with overflow pipes supplying a chicken house, a backyard drinking fountain and a horse trough. What's left over goes for irrigation, then runs back down to the lake to do some more work for Mr. Craver.

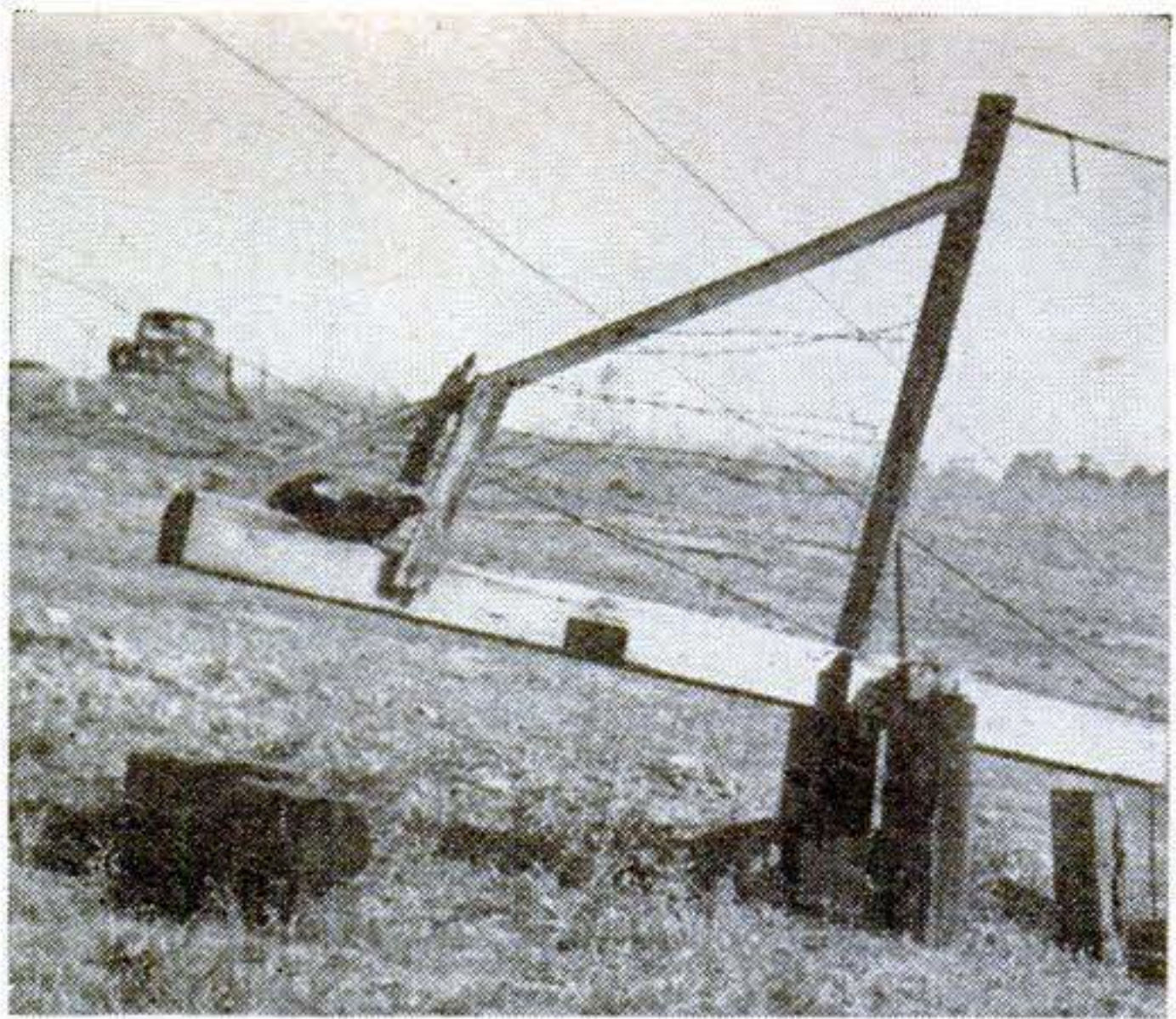

Pump rod, at extreme right, has only a short throw, but each upstroke sends a quart of water to tank, 400 feet away and 30 feet higher.



Washtub's dump valve is tripped at bottom of its fall. Runoff isn't wasted—it goes on to operate a waterwheel-powered machine shop.

Sketch shows beginning (black) and end (white) of power stroke, made every two minutes.

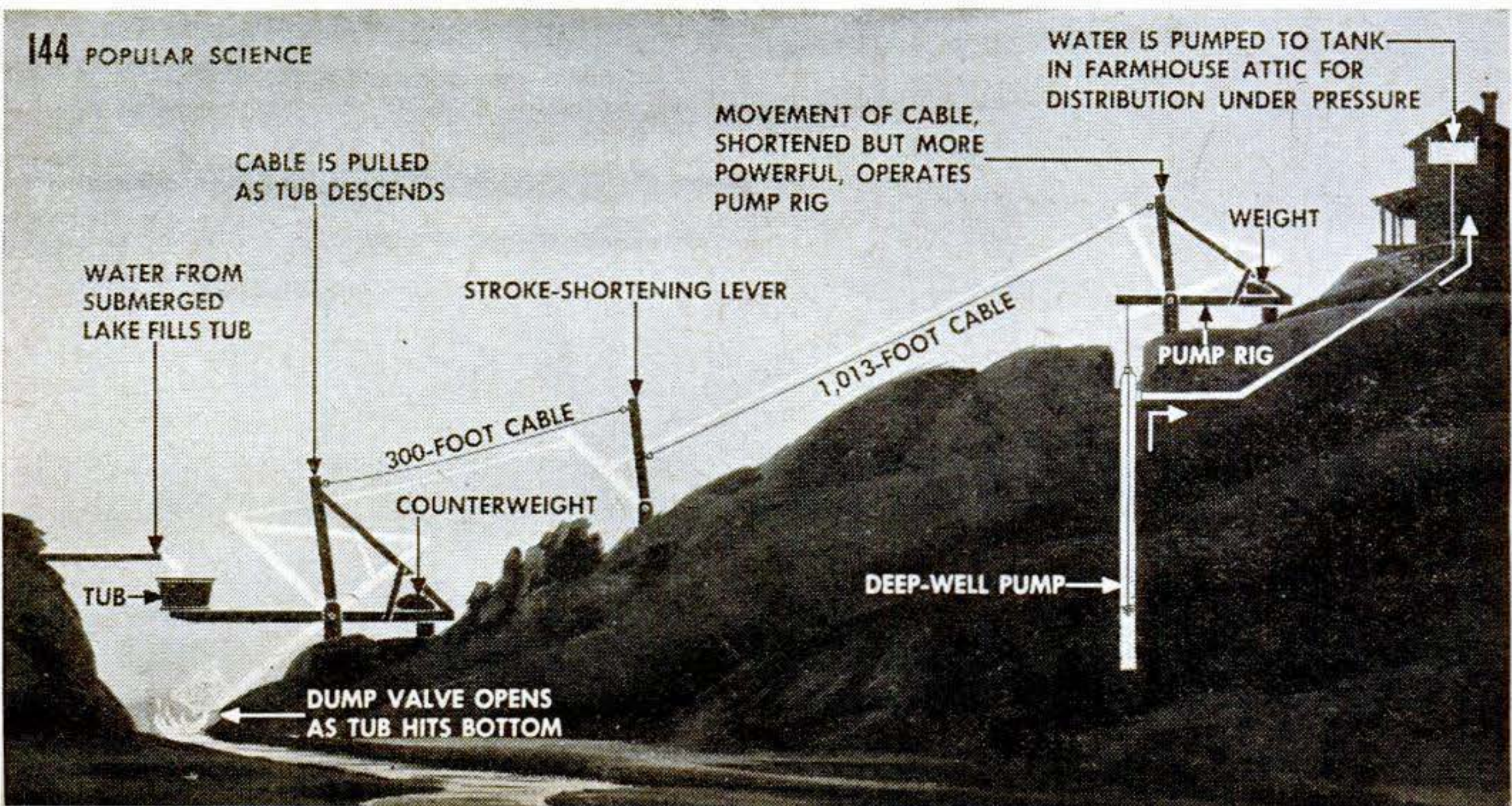

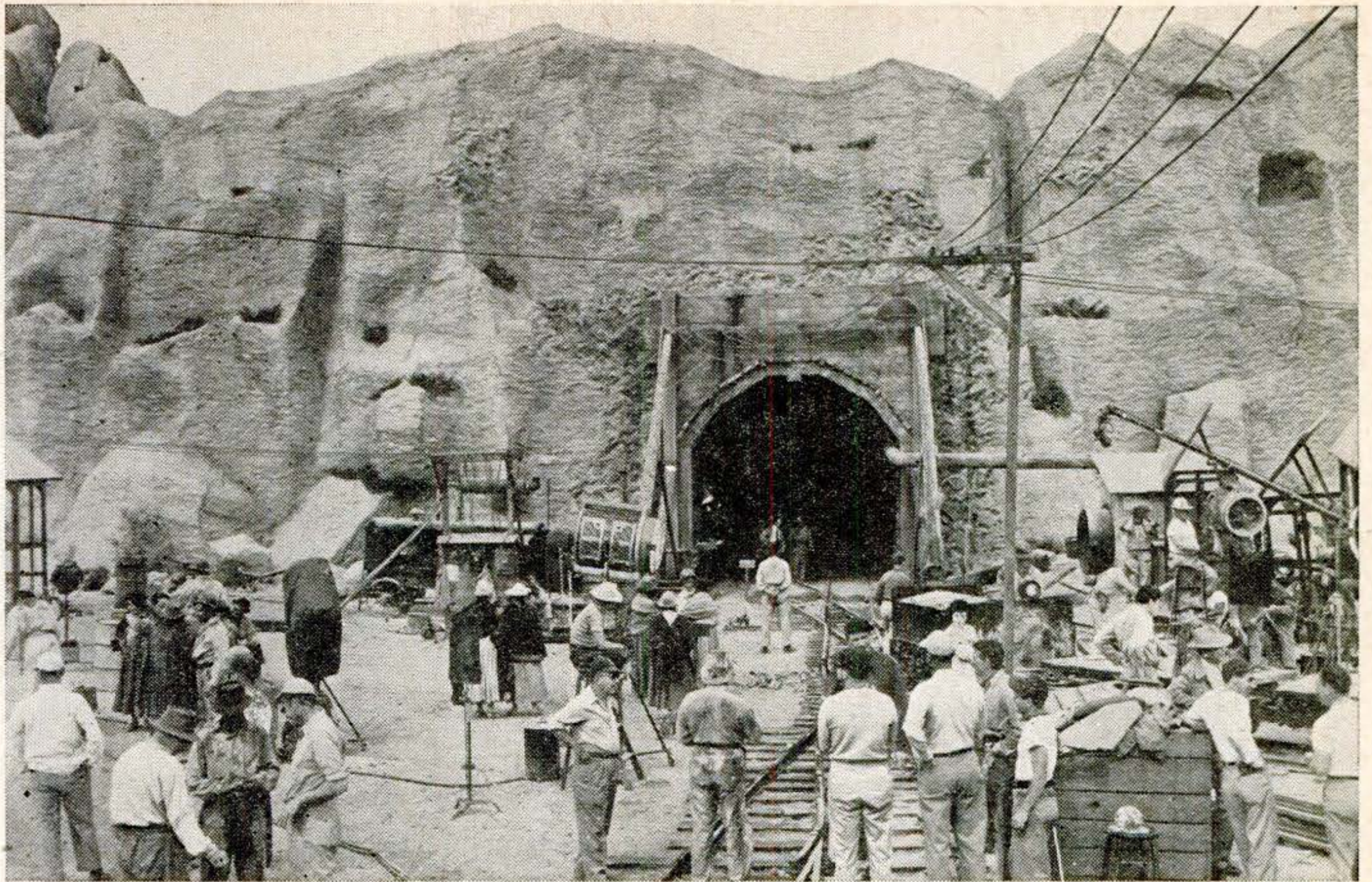

Mountain ‘Moved’ to Camera

WHEN Hollywood wants an Andean mountain, like the one called for in the script of RKO's *Tycoon*, it's easier to build one than to go to the real thing. The rugged chunk of real estate shown above, complete to tunnel mouth and railroad

tracks, was constructed in a ravine at Lone Pine, Calif., and to the camera it looks like the McCoy. But the movie camera doesn't go behind the scenes, as in the view below, where the cliff looks like what it is—a blend of wood, plaster and ingenuity.

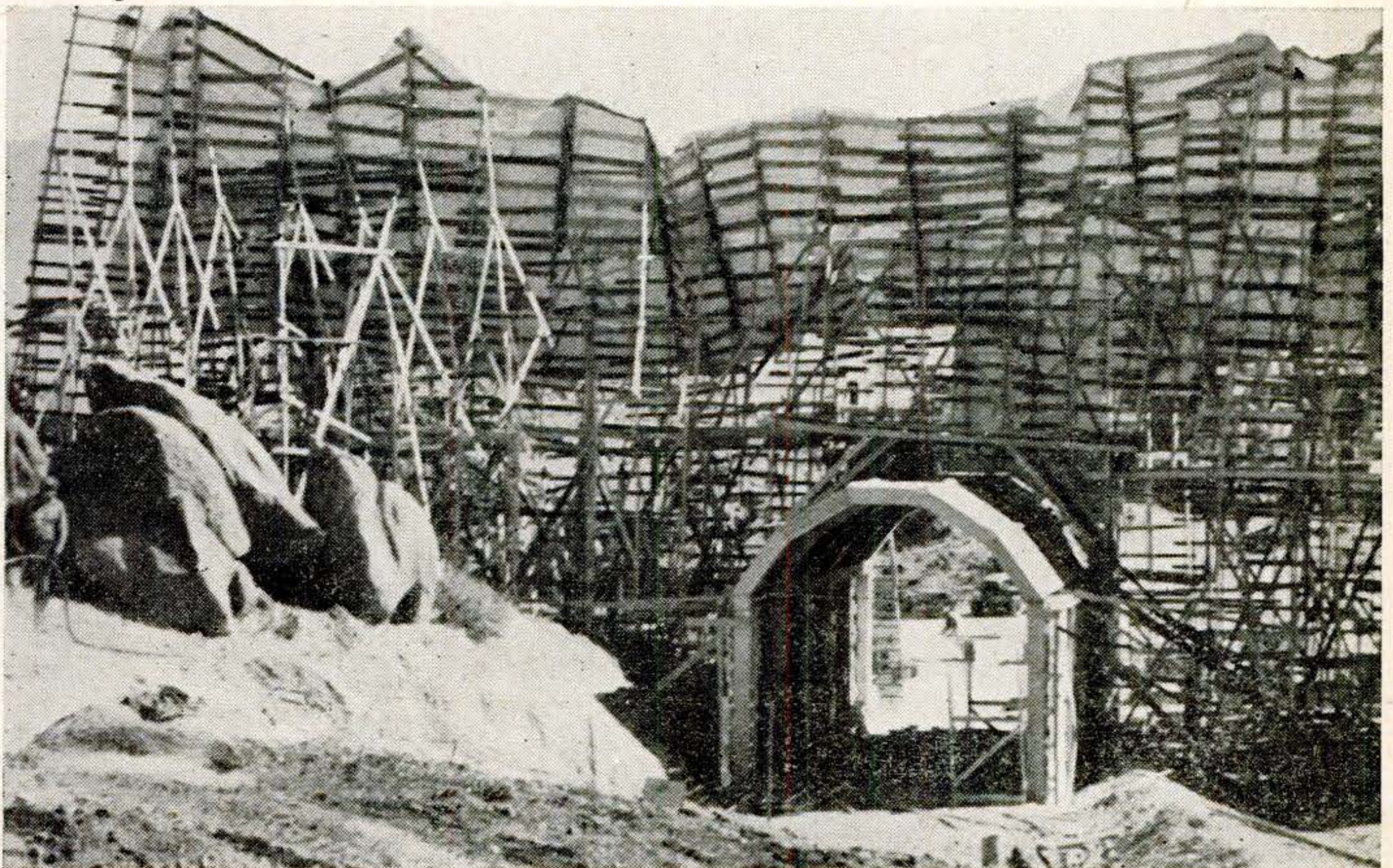

MARCH OF SCIENCE



Split Atom Photographed. A uranium atom was at the center of the white streak shown above; a neutron split it into two particles, which flew apart to form the line. Photo was made on Eastman's new nuclear-track plates, which are supersensitive to atomic electrical charges.

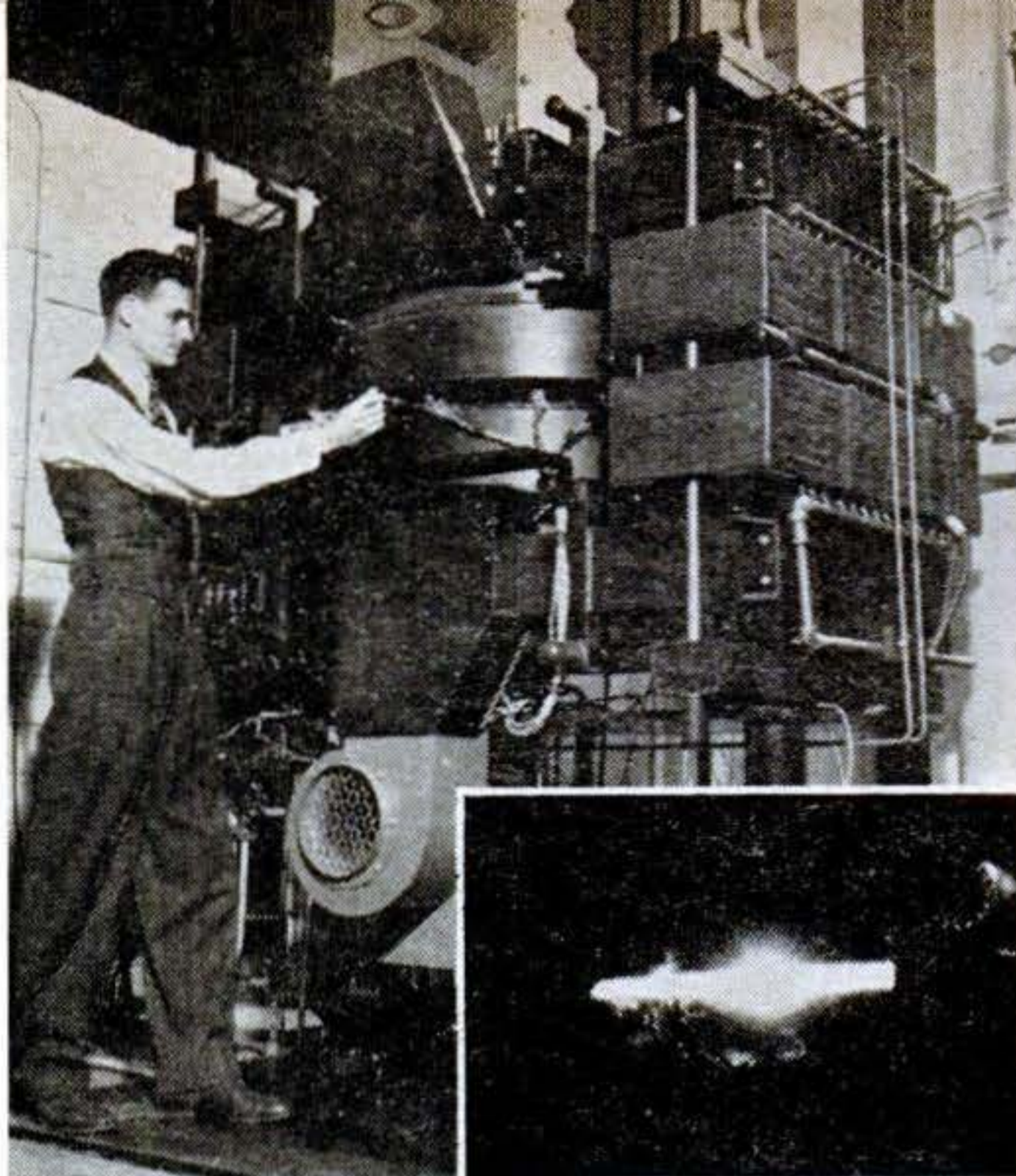

Electrons Light Own Path. Light from moving electrons is seen for first time in the 70-million-electron-volt GE synchrotron, shown above. The beam (inset) is emitted as electrons circle inside "doughnut," can only be seen head-on. Light spot in center is electron light; line is reflection.

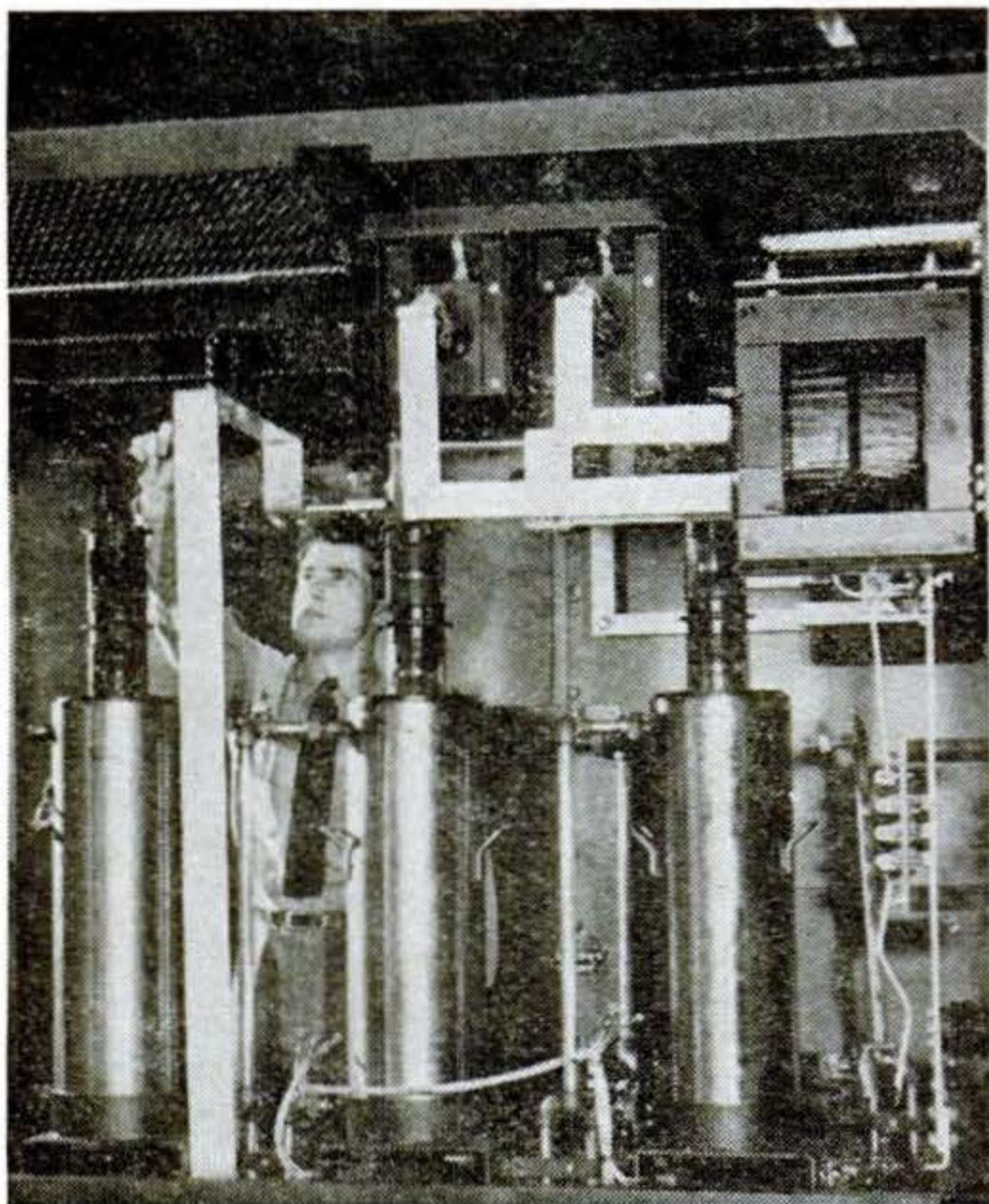

Tubes Guide Atom Smashers. These metal tubes are ignitrons, being assembled into controls for two new 300-million-electron-volt GE synchrotrons. Electronic switches, they control size and timing of current pulses in the magnets that hold electrons in orbit during speed-up.



Ray-Traps on Display. Westinghouse scientist holds a detector of radioactive atoms in liquids. Glass-tower counter at left of assortment on table does same in humans. In foreground is gamma-ray counter, plastic-masked against beta rays. Receiver at rear meters trapped rays.

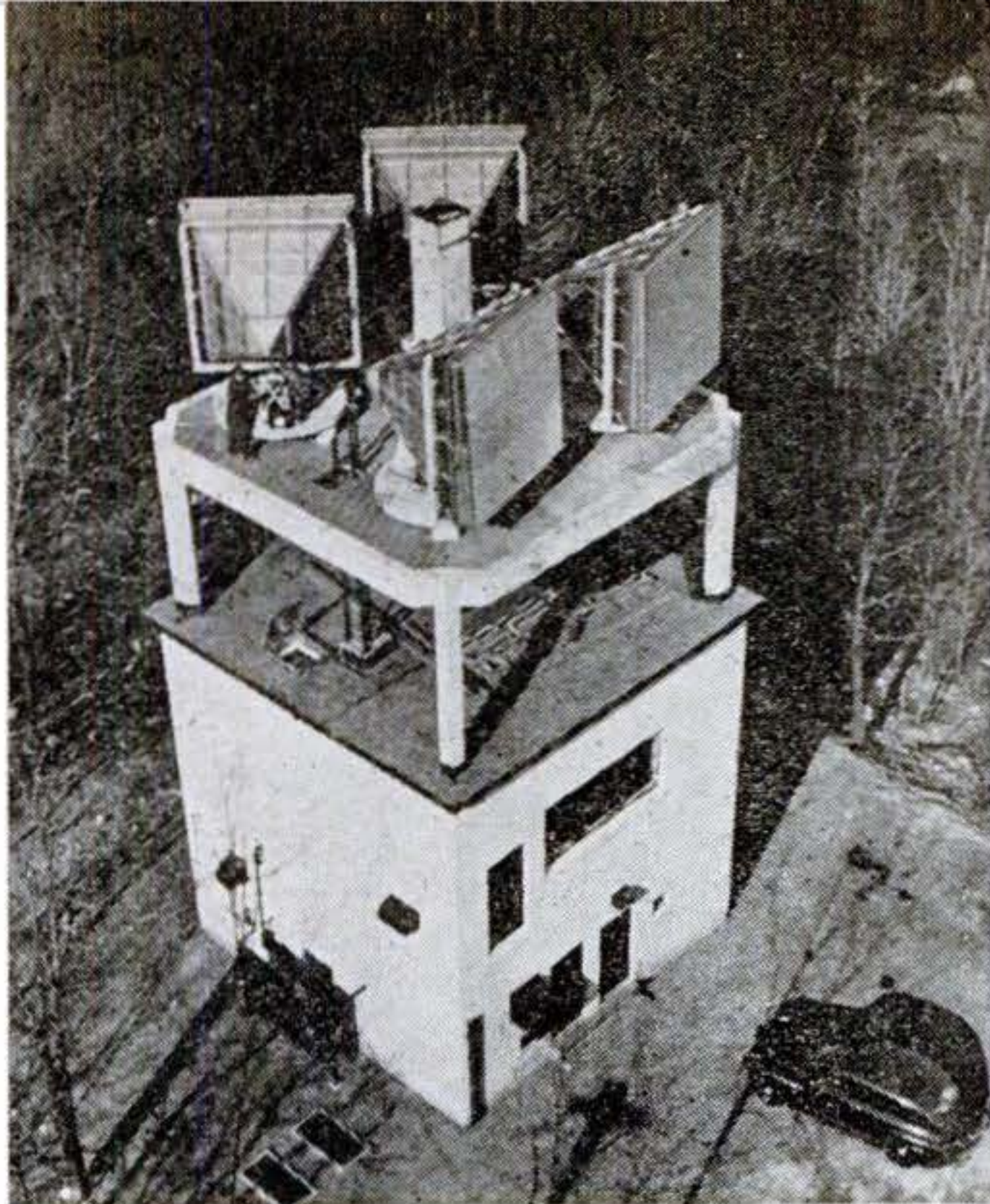

Hilltop Tower Relays Radio.

This is one of seven Bell stations that relay microwaves between New York and Boston. Since the very short radio waves fly off into space, they must be beamed straight at next relay point. Four square metal "lenses" atop tower focus the microwaves.

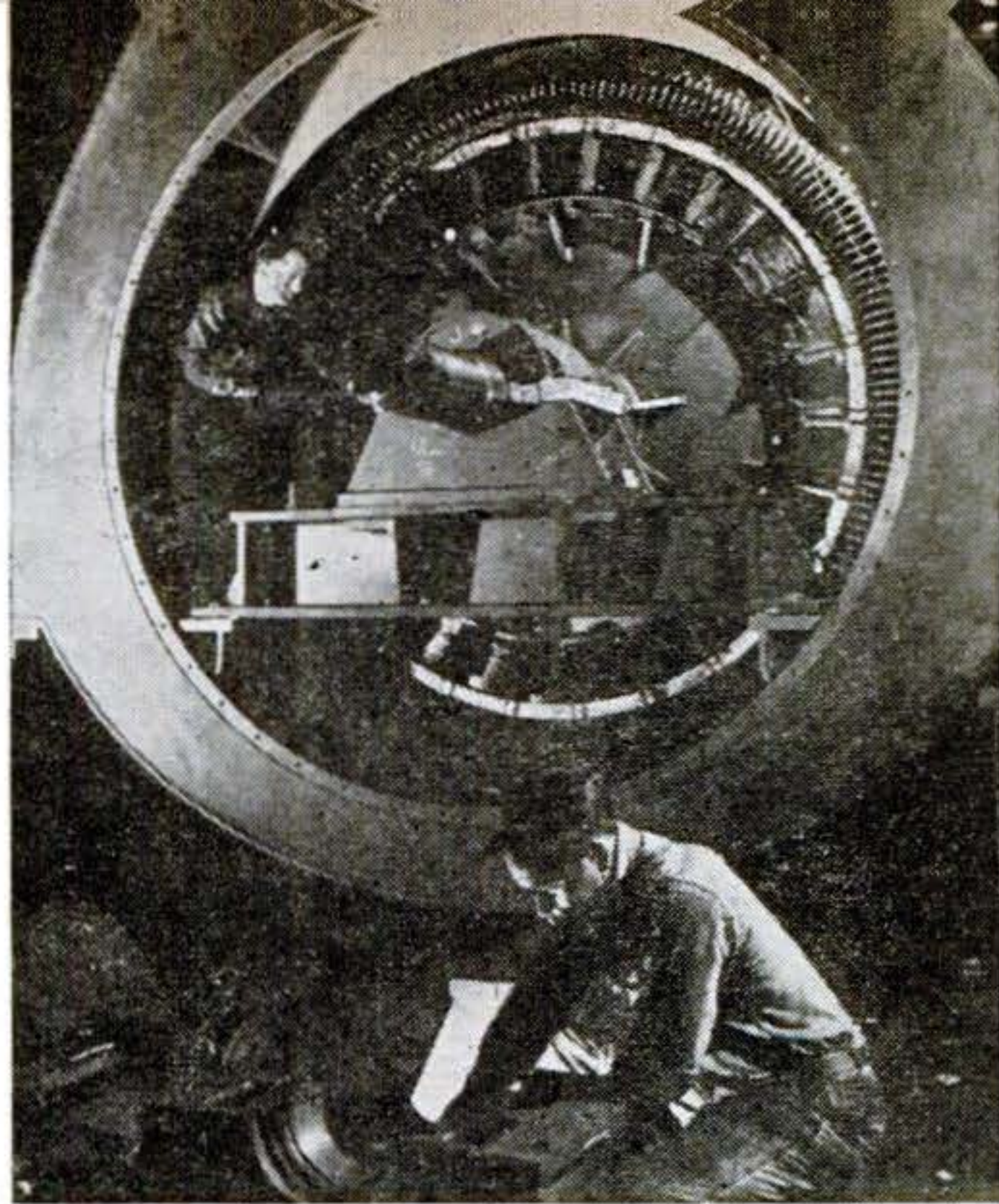

Motors Hold Their Noses.

This 2,300-hp. GE electric motor will be undamaged if waters close over it. One of six for Oregon paper mill flooded by 40-foot spring rises of Willamette River, its bearings and their pedestals are enclosed with stator and rotor in a watertight frame.

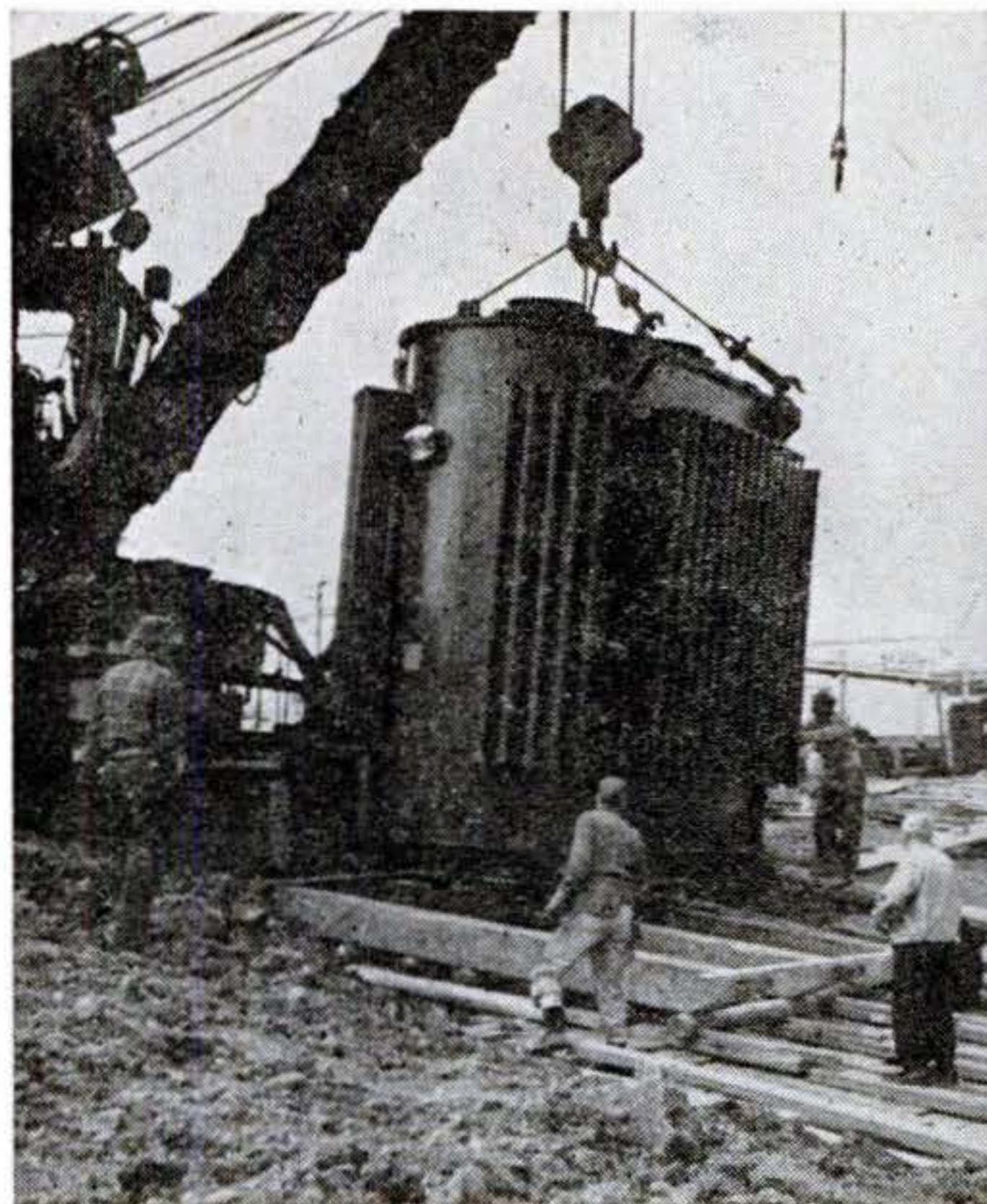

52-Ton Transformer. One of the largest electrical transformers in private industry is shown being installed in a new B. F. Goodrich plastics plant at Marietta, O. Nitrogen and 25 tons of oil insulate the 14-foot monster as it steps 132,000-volt AC down to 2,300 volts at 5,000 kw. output.

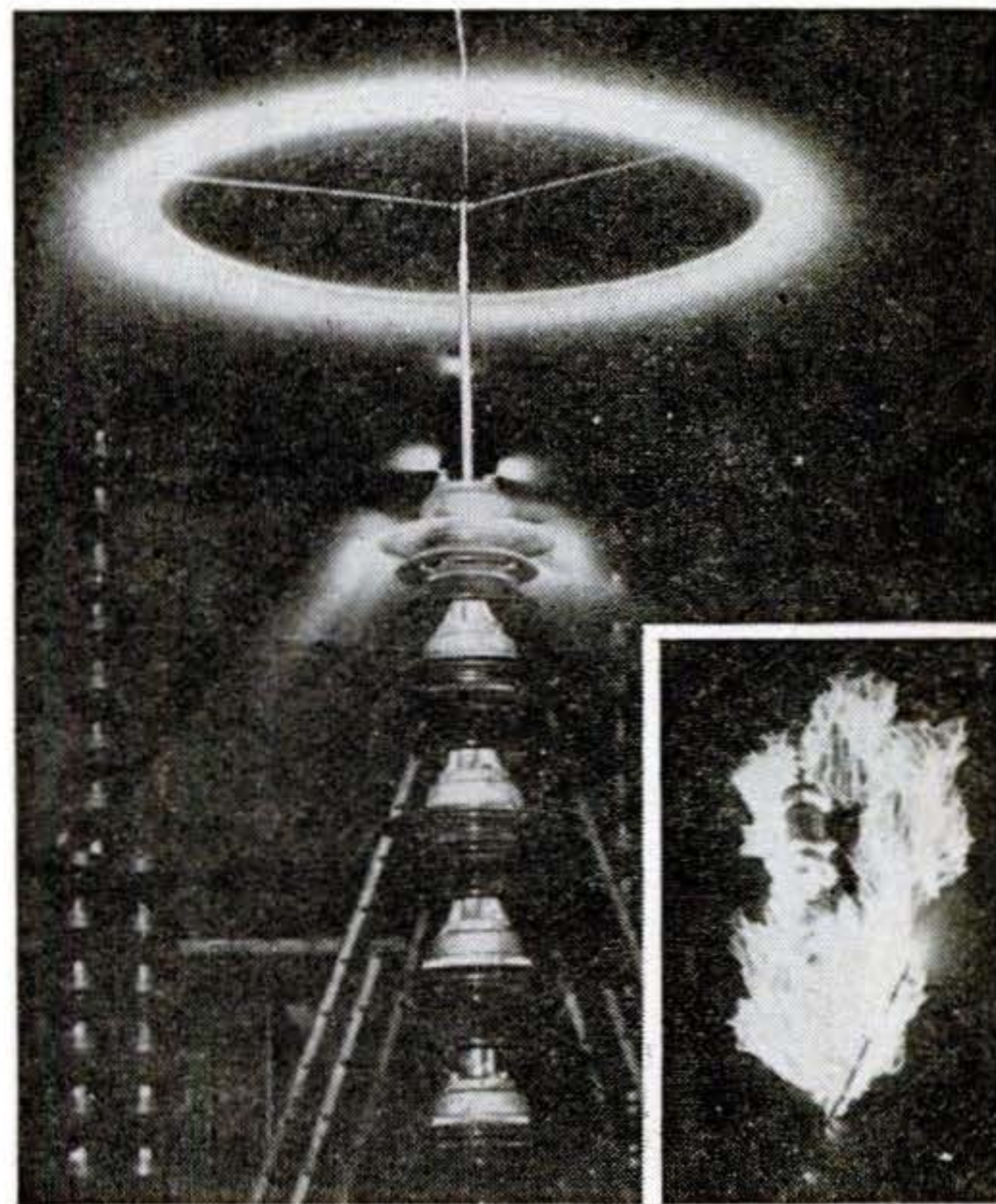

"Fireworks" Aid Lab Studies.

Fiery pinwheel, a "corona motor," shows how high-voltage lines lose electricity through air. A million-volt charge spins rod like a water sprinkler. Torch (inset) is million volts crackling over insulators. Tests help Westinghouse design lightning guards.

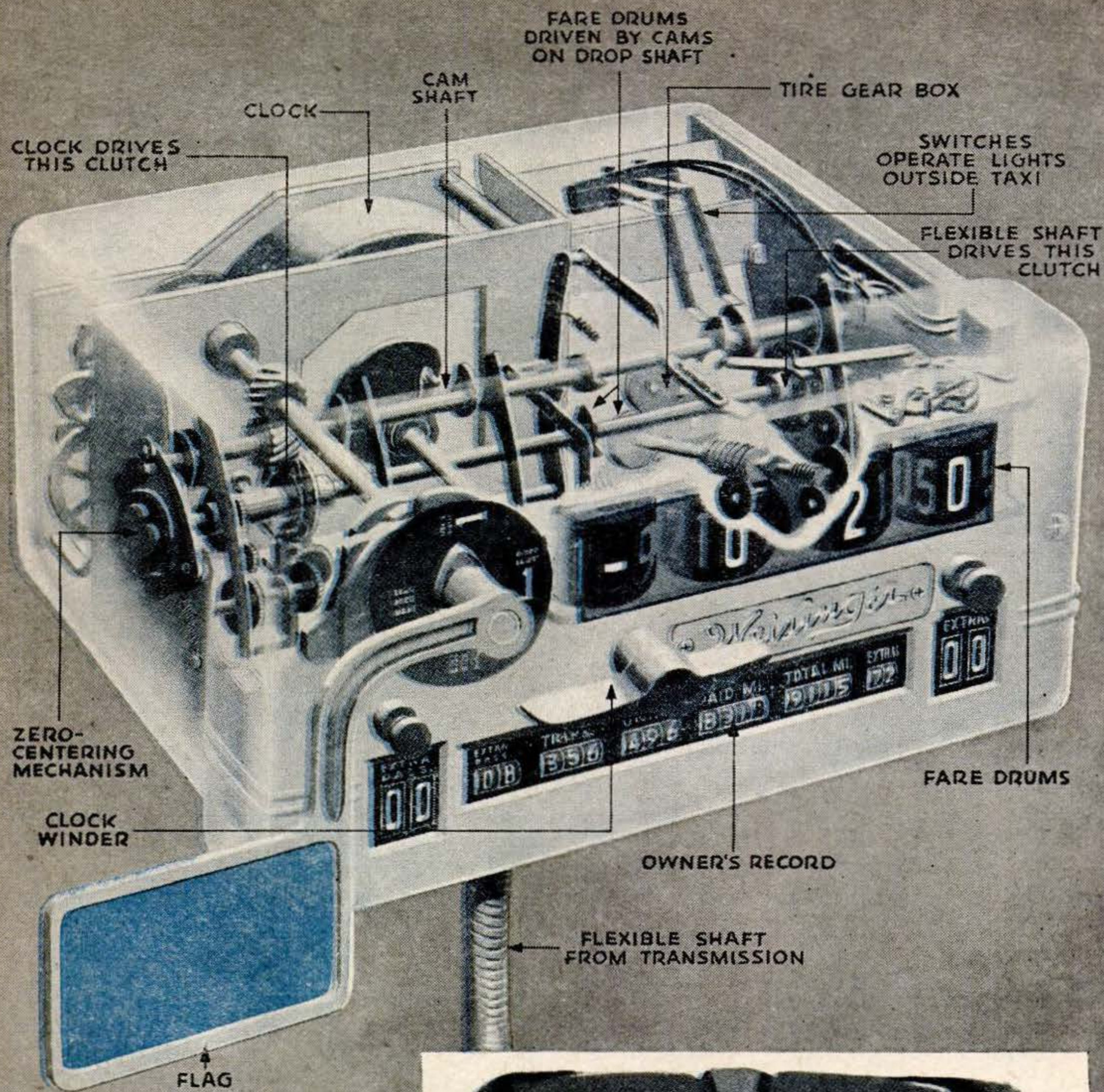

MECHANICS OF LIVING

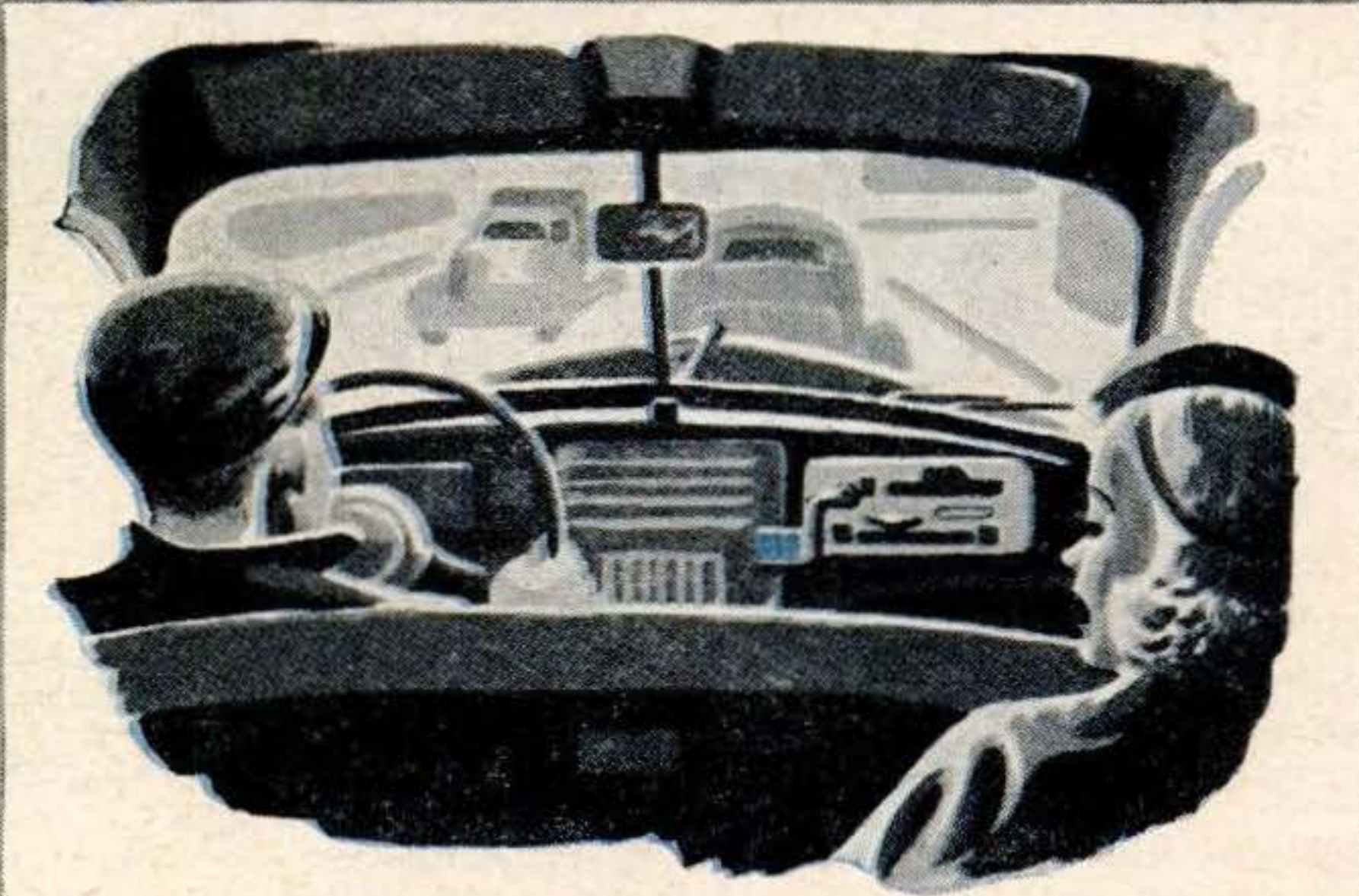

The new Weisinger meter can go in the glove compartment or in the usual place on the cab partition.

Retrum

How the New Taximeter Works

Night Light for Idle Cabs. The latest taximeters are streamlined like little radios—and their simplified construction cuts in half the usual 800 to 1,200 parts. The U. S. Taximeter Co., of New York, asserts that the Weisinger meter is the most important development in taximeters in 35 years. The new machine makes it easy to find a cab at night: Roof lights go on when the flag is in the upright, or vacant, position.

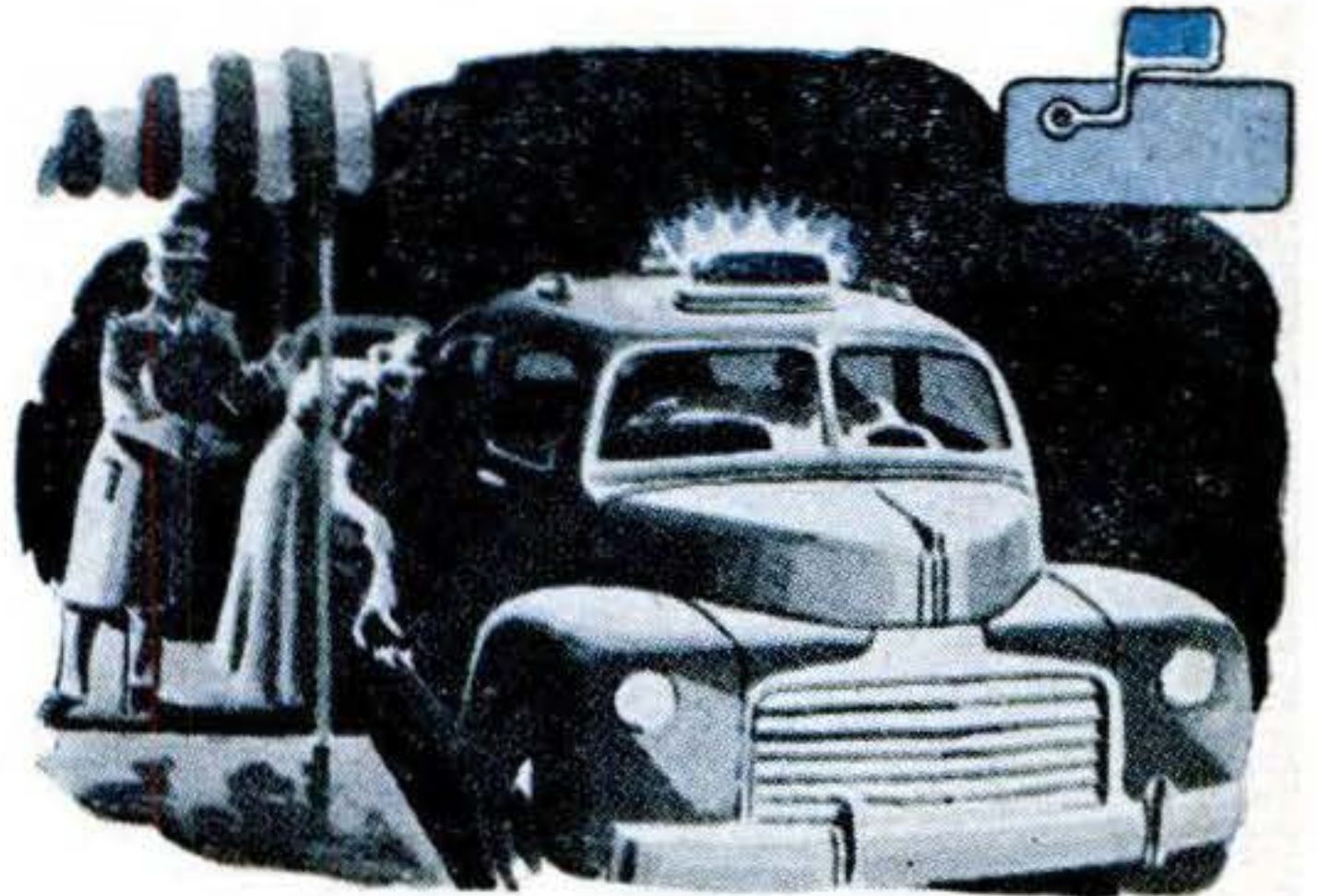

R.P.M.=\$\$\$. Cutaway at the left shows the simplified mechanism. A flexible shaft connects the meter to the cab's transmission. Each revolution of the rear wheels is registered, and the meter can be adjusted for various tire sizes before it is installed. The tire gear box in the meter automatically compensates for tire wear or change in size. City authorities make both periodic and spot checks of the meter's accuracy. On test stands, meters are run up to \$99 twice, at 450 m.p.h.



Minutes Mean Money, Too. When the taxi stops for a red light or travels at slow speed, a clutch allows the flexible shaft to slip. Waiting time is then registered in the fare section, at a preset rate per minute, by a hand-wound clock. Mileage and waiting-time charges are automatically totaled by the fare drums. Cams return all gears and drums to zero when the flag goes up at the end of the ride. The 85,000 taximeters in the United States last year ticked off more than \$2,000,000,000.



Not Registering. If a tire blows out during the ride you will not be charged for the time required to fix it. The hackie swings the flag down, stopping the clock while you wait. Later, at the end of your trip, he lowers the flag again and the meter locks to give you time to read the total fare. The driver then unlocks the meter by pulling the flag slightly to the left before raising it. A fourth flag position is provided for "double tariff" in cities where such fares are authorized for unusual trips.

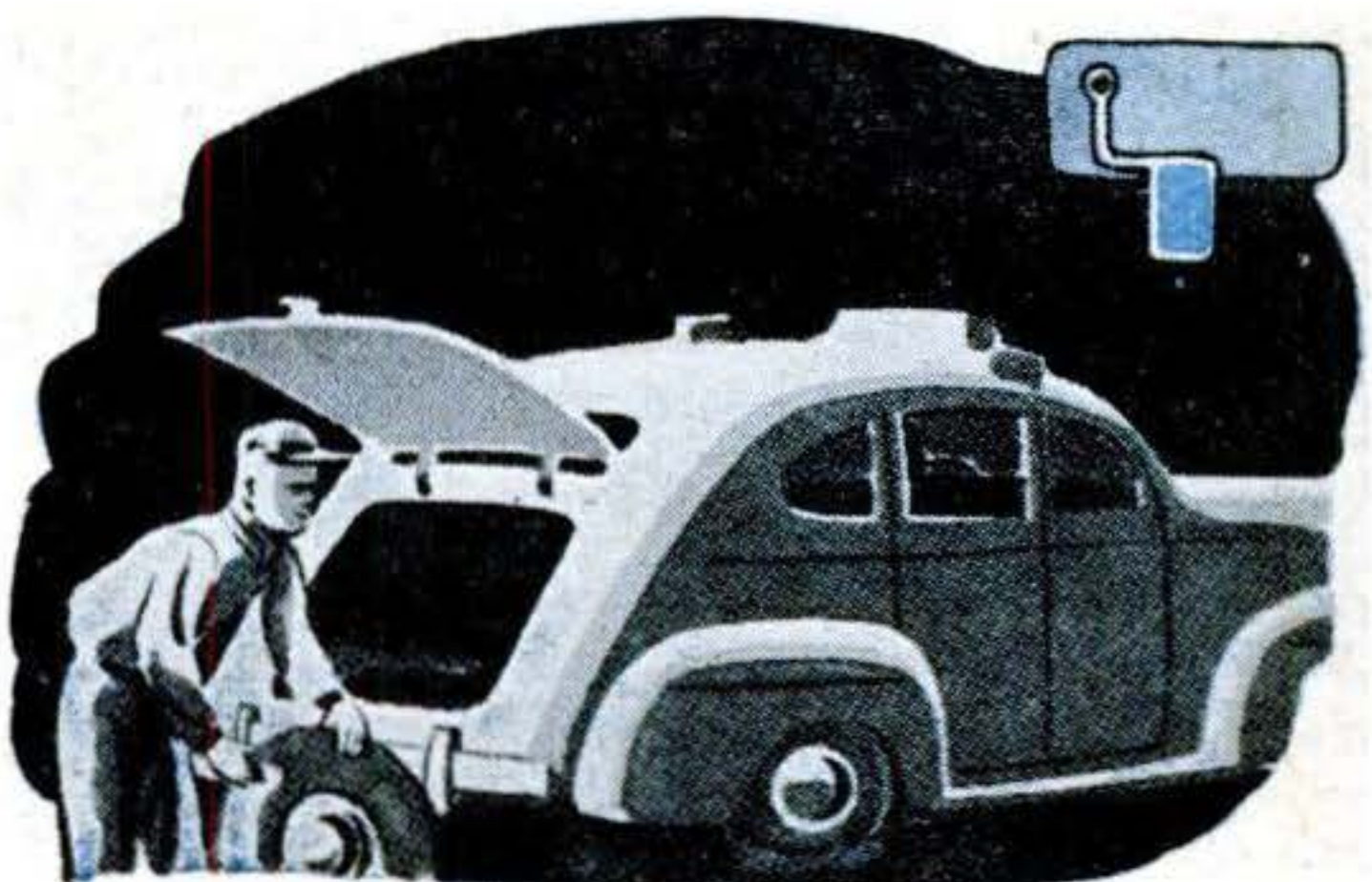

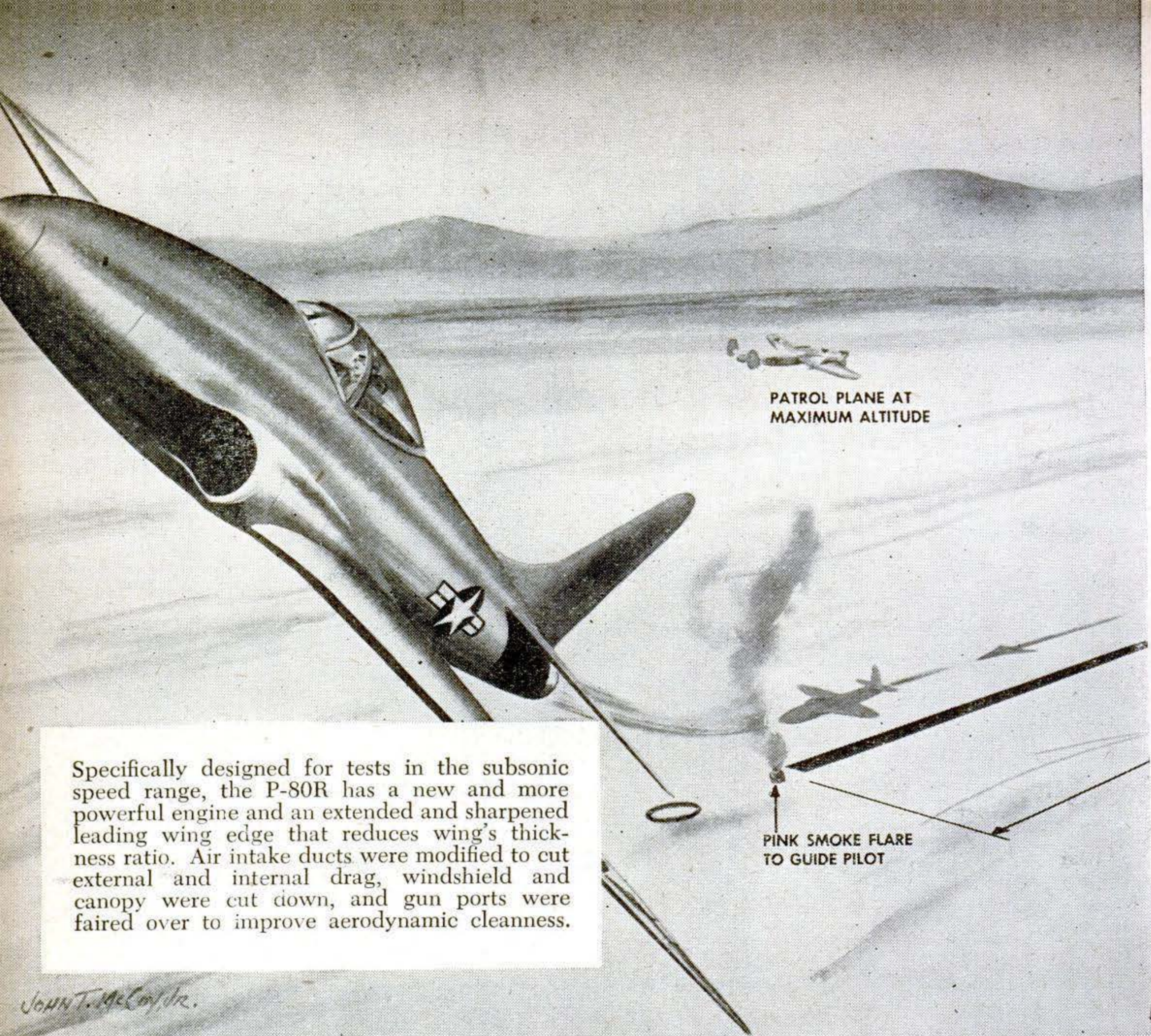

Specifically designed for tests in the subsonic speed range, the P-80R has a new and more powerful engine and an extended and sharpened leading wing edge that reduces wing's thickness ratio. Air intake ducts were modified to cut external and internal drag, windshield and canopy were cut down, and gun ports were faired over to improve aerodynamic cleanness.

PATROL PLANE AT
MAXIMUM ALTITUDE

PINK SMOKE FLARE
TO GUIDE PILOT

Artist's conception of conditions under which P-80R, nicknamed "Racey," set speed-mark.

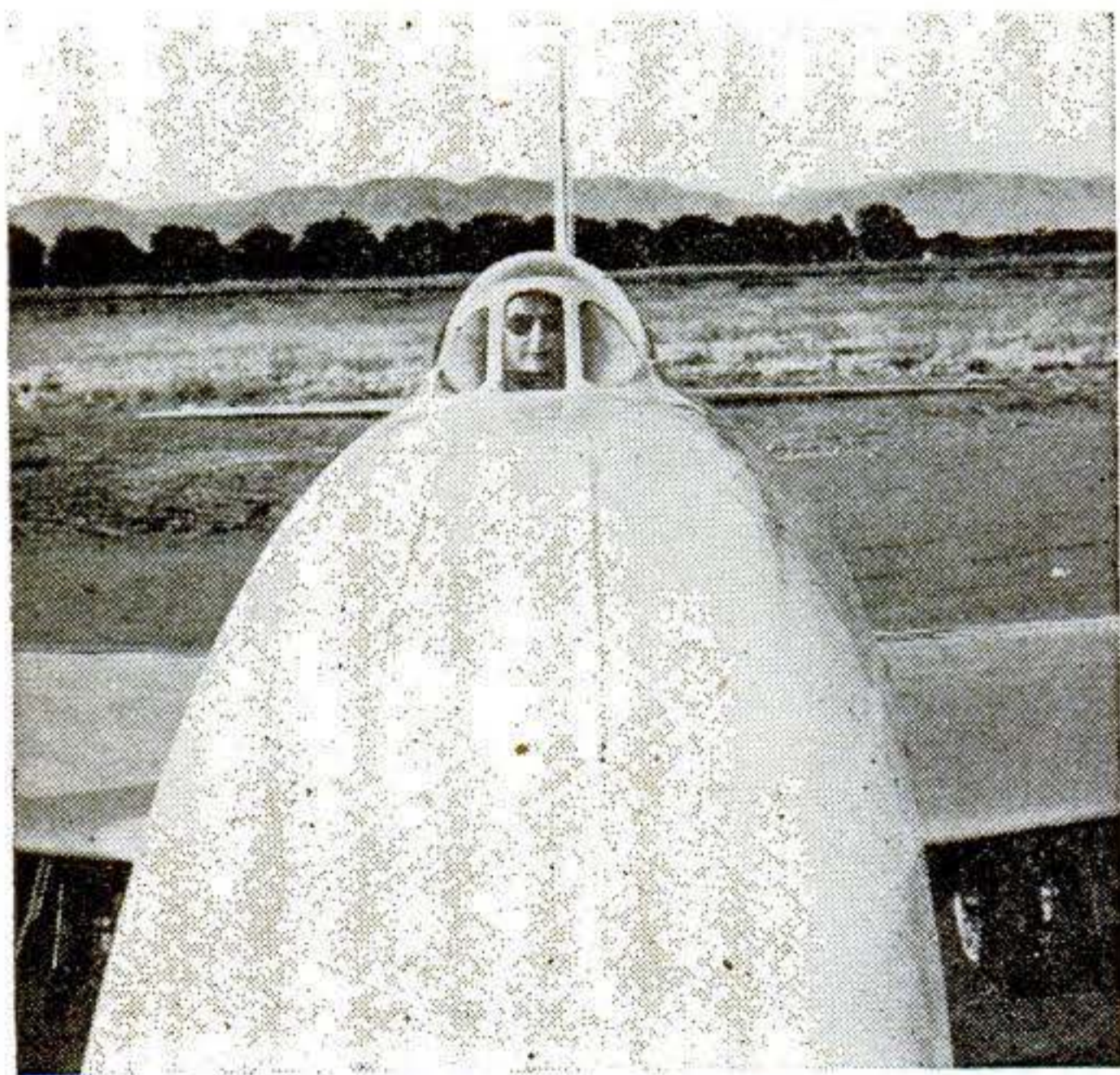

Cockpit view of Col. Albert Boyd, the new speed champ. His plane has a GE-designed Allison 400 jet, rated at 7,500 hp. at 600 m.p.h.

Souped-Up P-80 Double-Checked On Record Run

WHEN a super P-80 flashed over Muroc Dry Lake last June 19 at an average speed of 623.8 m.p.h., electronics and high-speed photography teamed up to make doubly sure that the AAF's new world air speed record became official.

The primary timing system, so accurate

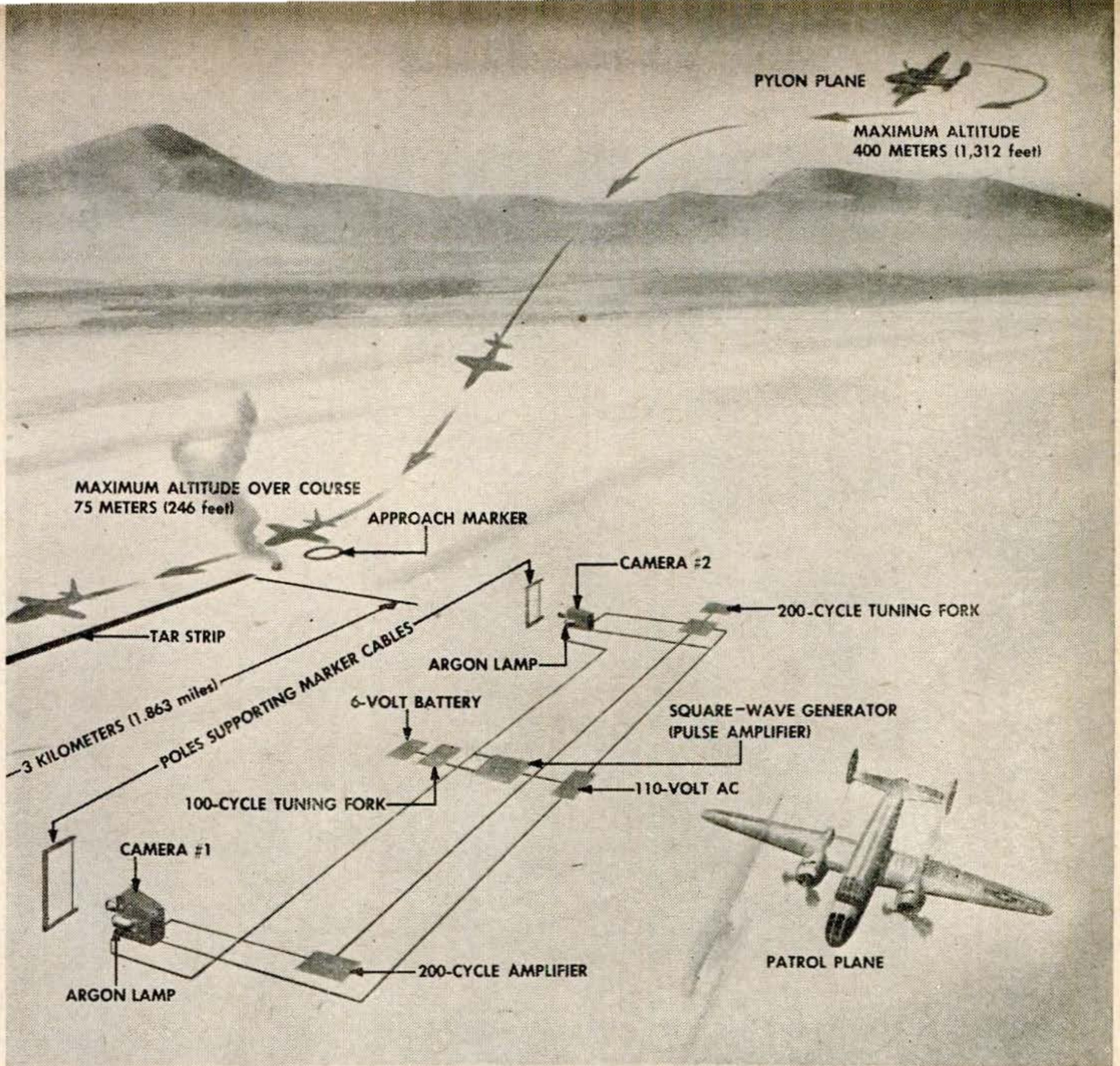

Making four passes "on the deck," at 50-foot altitude, plane flew one run at 632.5 m.p.h.

that it determined the plane's position to within three inches, depended upon the "heartbeat" of a 100-cycle tuning fork. Impulses from this fork, amplified through a square-wave generator, operated argon lamps to flash a synchronized series of light impressions on the edges of motion-picture film racing through twin cameras at 500 frames a second. One camera "shot" the plane during the first half of each of its runs, and the other pictured the second half; light impressions linked the two films in a complete record.

A secondary timing system was provided by clocks mounted in the base of the cameras and synchronized by the pulses of a 200-cycle tuning fork. Showing intervals of 1/1,000 second, the clock faces were photographed every time a frame of the motion-picture film was exposed.

END

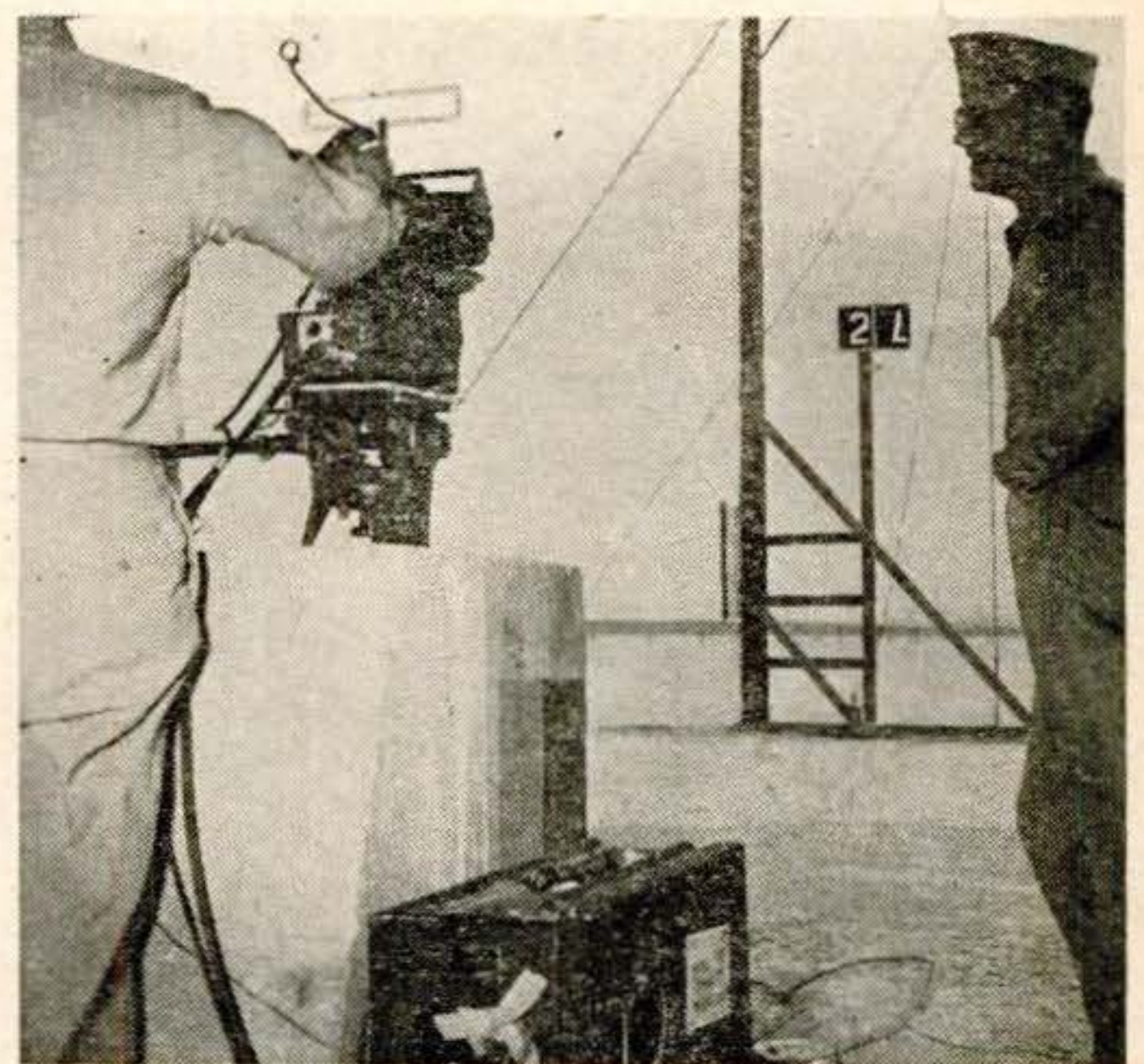

One of twin cameras, its lens exactly centered on a vertical marker cable accurate to 20 seconds of arc, perches on a special concrete base.

**AIDS TO
MODERN LIVING**

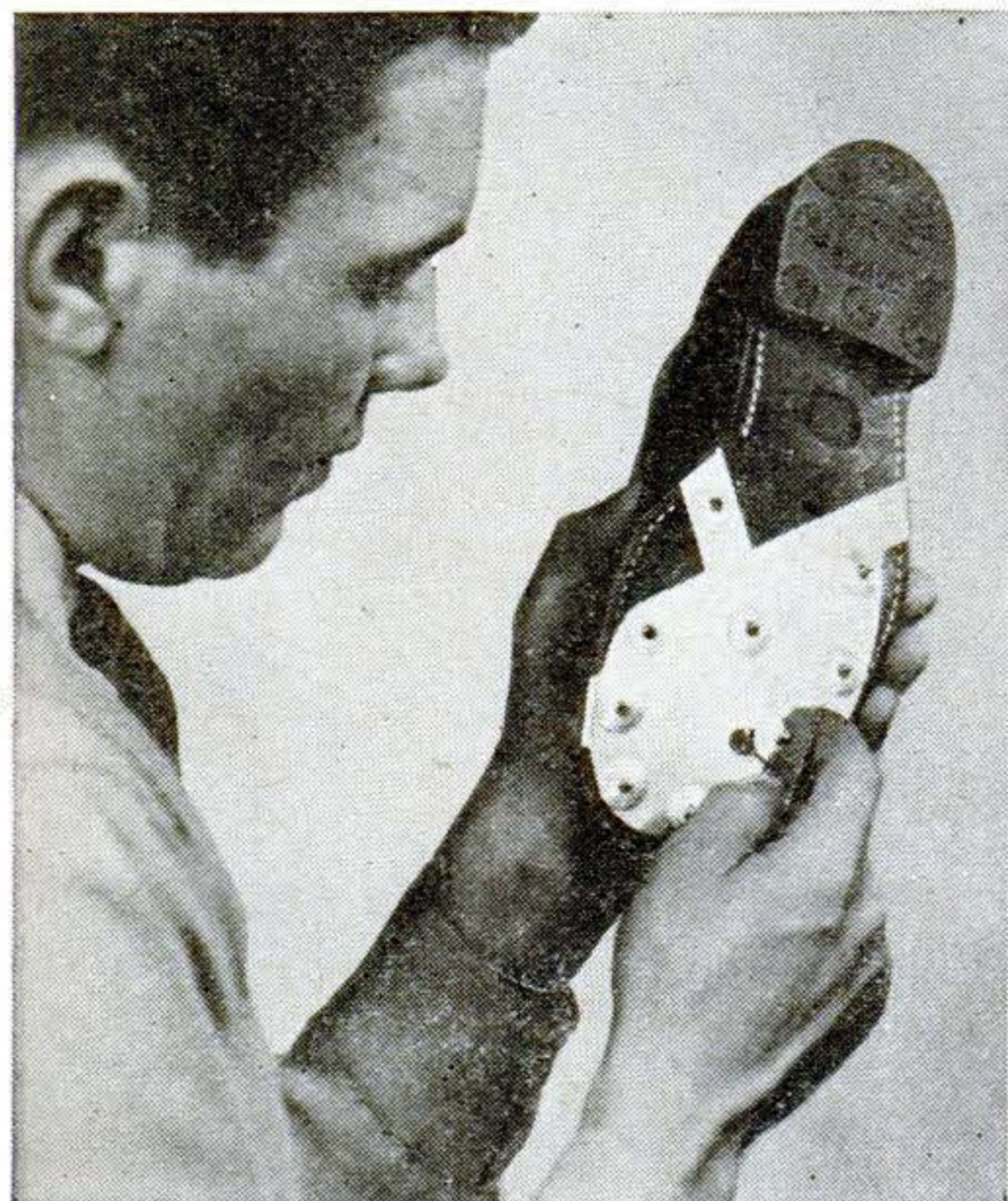

Cleats Are Detachable. Any shoes become golf shoes with the addition of these cleat-studded sole plates. Fitting any shoes from size 7 to 12, the rustproof plates can be quickly put on or removed by the turn of a key. They are made by the ParCleit Company, of Washington, D. C., and sell for less than \$3.

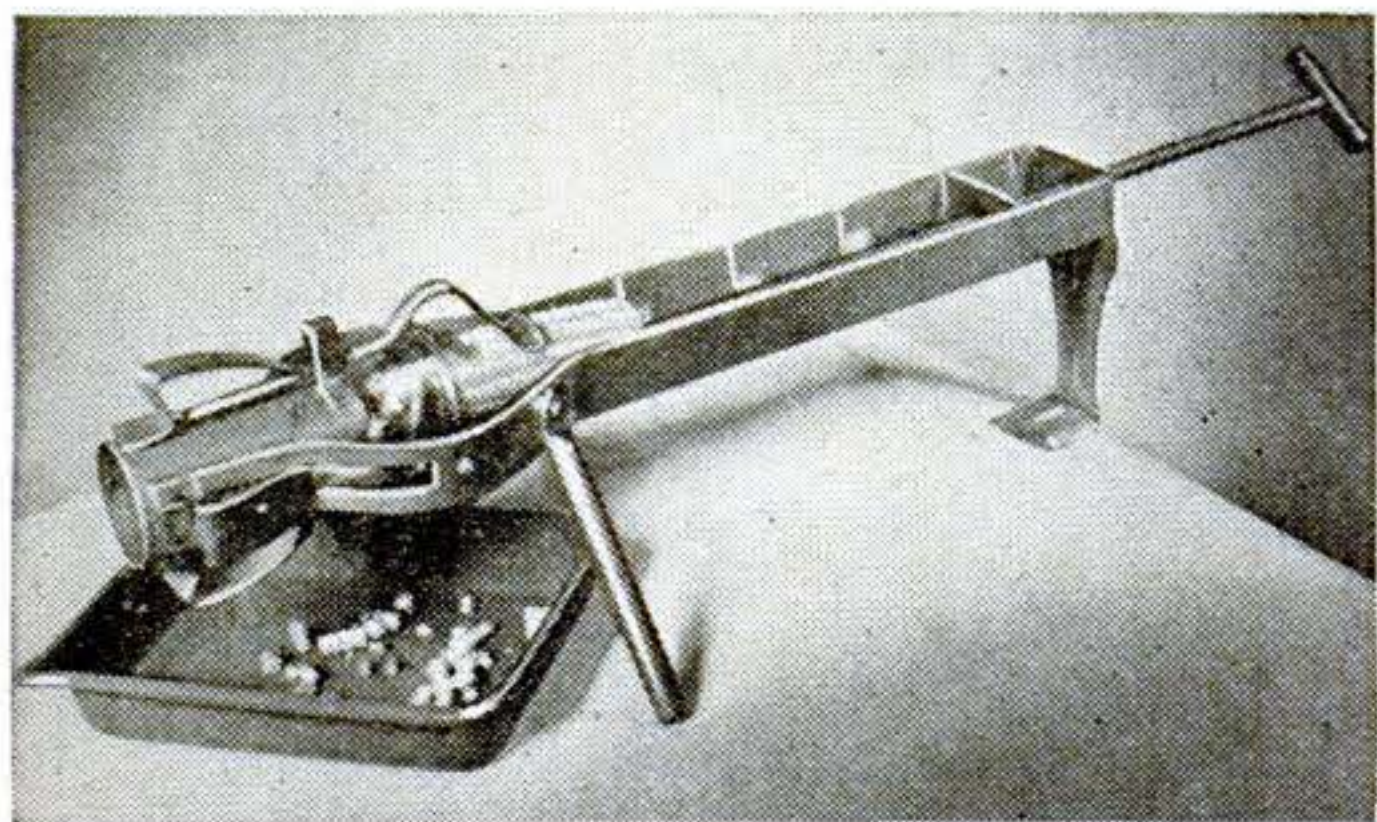

Corn Clippers Cut Kernels. Whole kernels are sheared off for canning by four semicircular knives in this tubular device. Guides gliding over the tops of the kernels adjust the cut as the ear is pushed through. The manufacturer is the Jiffy Products Company, of Hiawatha, Kans.

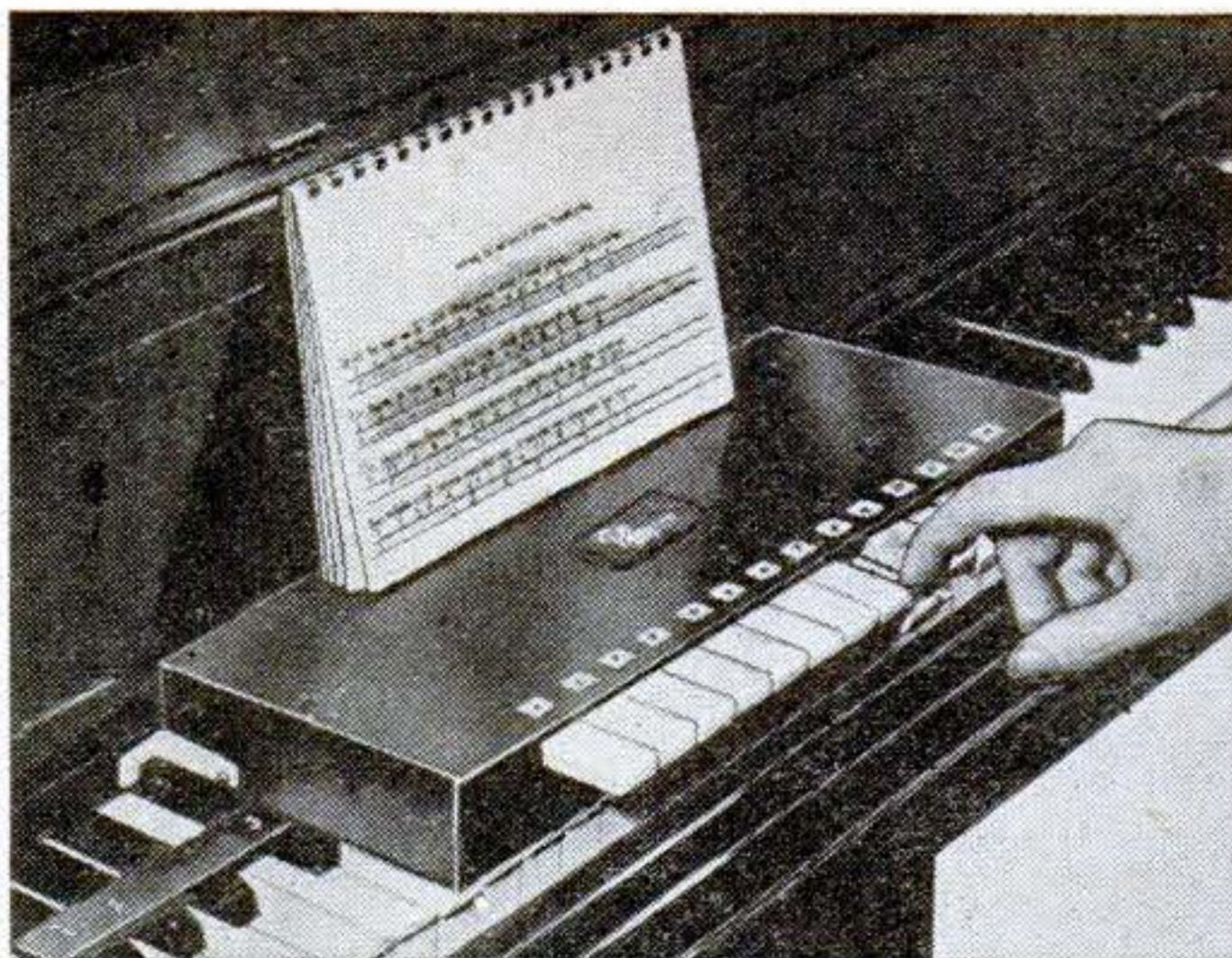

One Finger Plays Piano. An attachment that can be used on any piano will strike a chord of three keys each time a single key on the device is depressed. It enables the one-finger virtuoso to play without long practice. No musical knowledge is needed; notes are translated into numbered keys in an accompanying book. Ayer, Davis & Co., of New York, makes it.

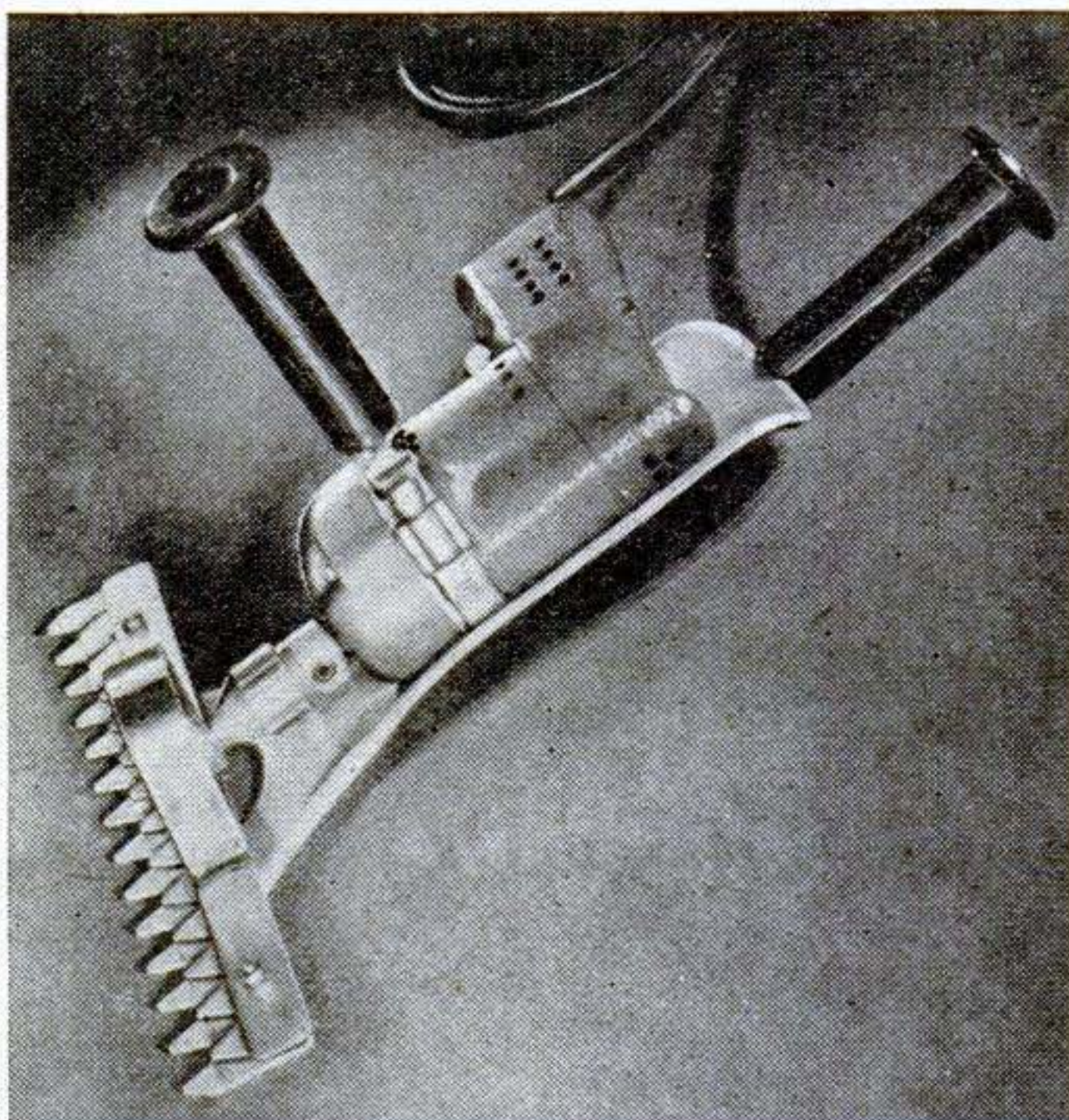

Drill Runs Hedge Trimmer. Fast hedge clipping and shrub pruning are possible with this 3½-lb. cutter fastened by one bolt to an ordinary ¼" electric drill. Trimit, as the attachment is called, is made by the Woodland Products Company, of Pittsburgh. It is priced at about \$15.

Soaking Cleans Paintbrush. A liquid put out by the Savogran Company, of Boston, makes old brushes usable if soaked overnight. It costs \$1 a quart.



Modernizing Washbasin. A pop-up drain that operates like the modern built-in type is now available for installation in old plumbing. No special tools are required. At left the stopper is shown closed, at center open, and at right removed by a twist for cleaning. The drain is all metal—chromium-plated brass. It is made by the Stellar Products Co., of Chicago.

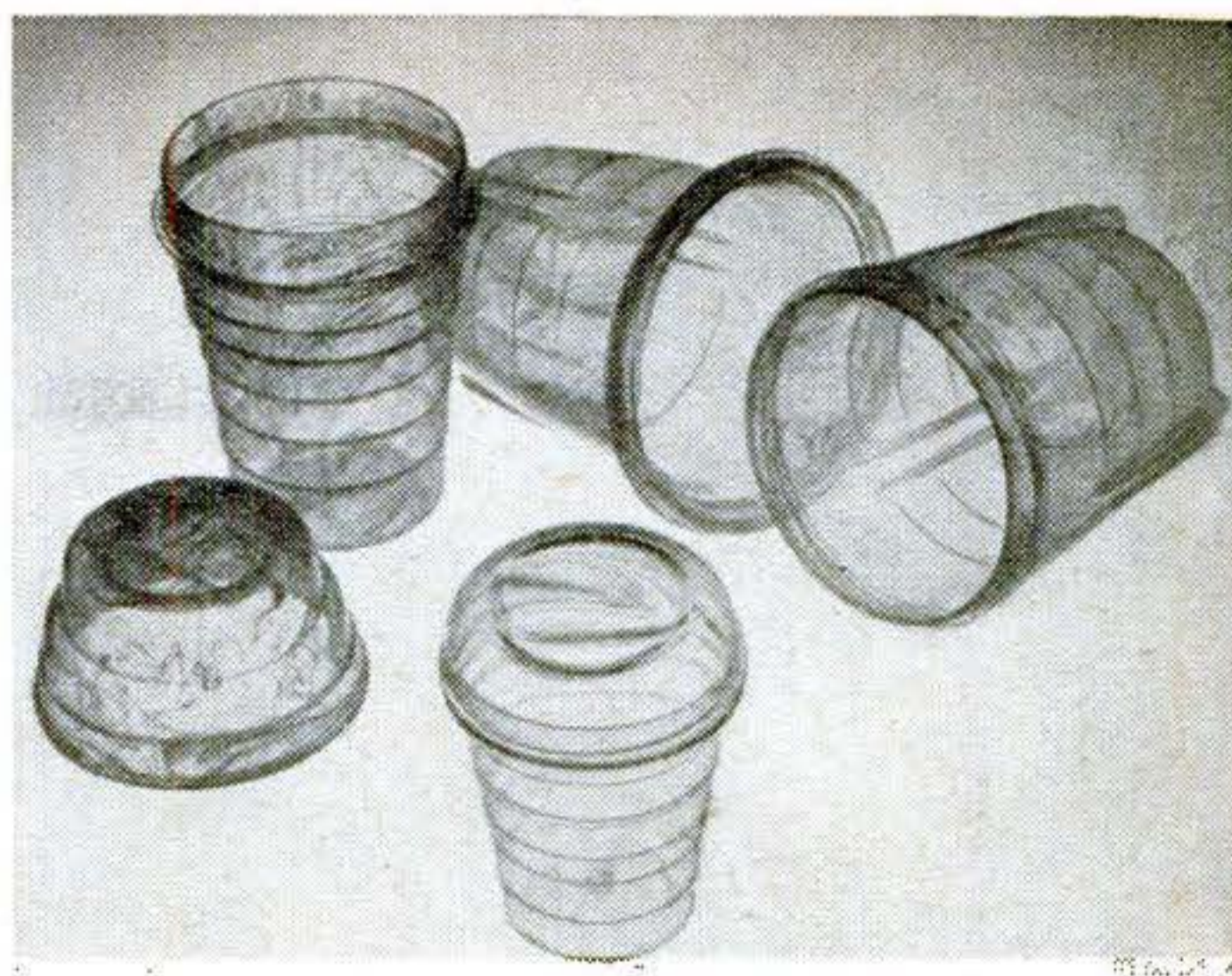

Wash Done in a Shaker. Socks, stockings, and shorts can be washed in a hotel or bathroom with the large-size plastic swirl mixer shown at right above. The others in the photo are one- and two-cup sizes for mixing gravy, sauce, waffle batter, salad dressing, and cocktails, also by swirling. The manufacturer is the Rochow Swirl Mixer Company, of Rochester, N. Y.

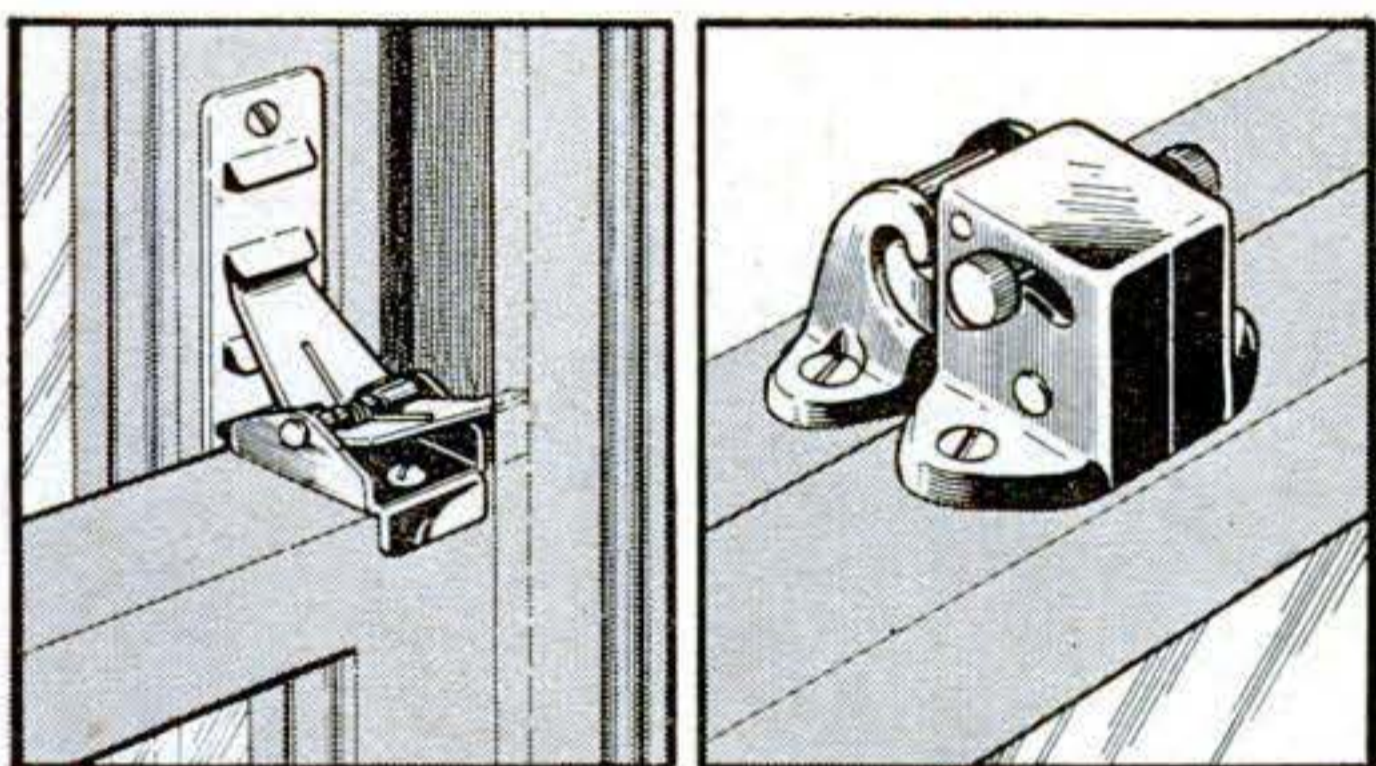

Windows Lock Automatically. Two new latches for double-hung windows are safety devices that lock themselves when the window is closed. At left, the lock of the Perfect Manufacturing Co., of Seattle, has the additional feature of locking a window against prowlers while still providing up to 5" ventilation. The lock shown at the right, made by the New Products Co., of New York, has a spring bolt operating like those of spring door locks. Either may be released easily from inside.

Electricity Plays Accordion. Somewhat larger than the standard instrument, a piano accordion invented by Louis De Fonso plugs in on either AC or DC. It has the regulation button arrangement for left hand and piano keyboard for right, and is portable despite its size. The Accordionola Mfg. Co., of Chicago, makes it.

Fluorescent Trouble Light. With a 25' rubber-covered cord, a fluorescent lamp made by Sylvania is handy for lighting dark corners in attics, cellars, shops, and garages. It uses a 6-watt tube mounted in a reflector guard so small that it will go through an opening 2" square. A ballast is located in the line 3' from the plug, whereas starting and off buttons are on the reflector. The lamp has a hook on the end and provision for mounting as a permanent bench or wall fixture. About \$8.50.

Sport Smokers. Ash trays installed on stands in the shape of familiar pieces of athletic equipment are a new accessory on the market for sport lovers. Now available are "sport model" smoking stands designed in the form of tennis rackets, golf clubs, and bowling pins. They are being offered by the Funderburk Engineering Company, of Waltham, Mass., for use in playrooms, studies, and the like.



AUTO IDEAS

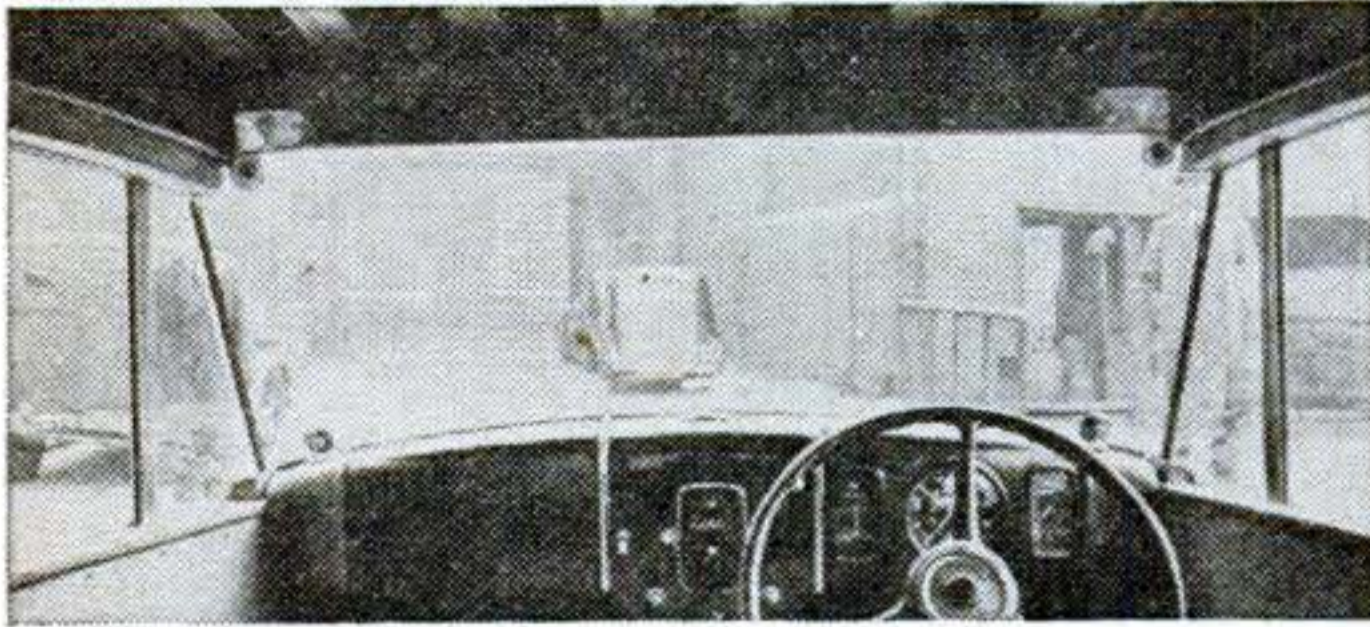
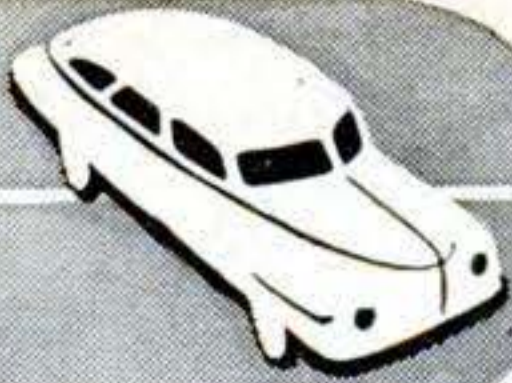

Windshield Posts Narrowed.

Fuller vision is provided the driver by cutting to a minimum the thickness of the windshield posts on this English station wagon. The body is built by Queensway Motors, of London, and is fitted on a Ford chassis. It's said no loss of structural strength results, as the car top is fully supported by other body posts.

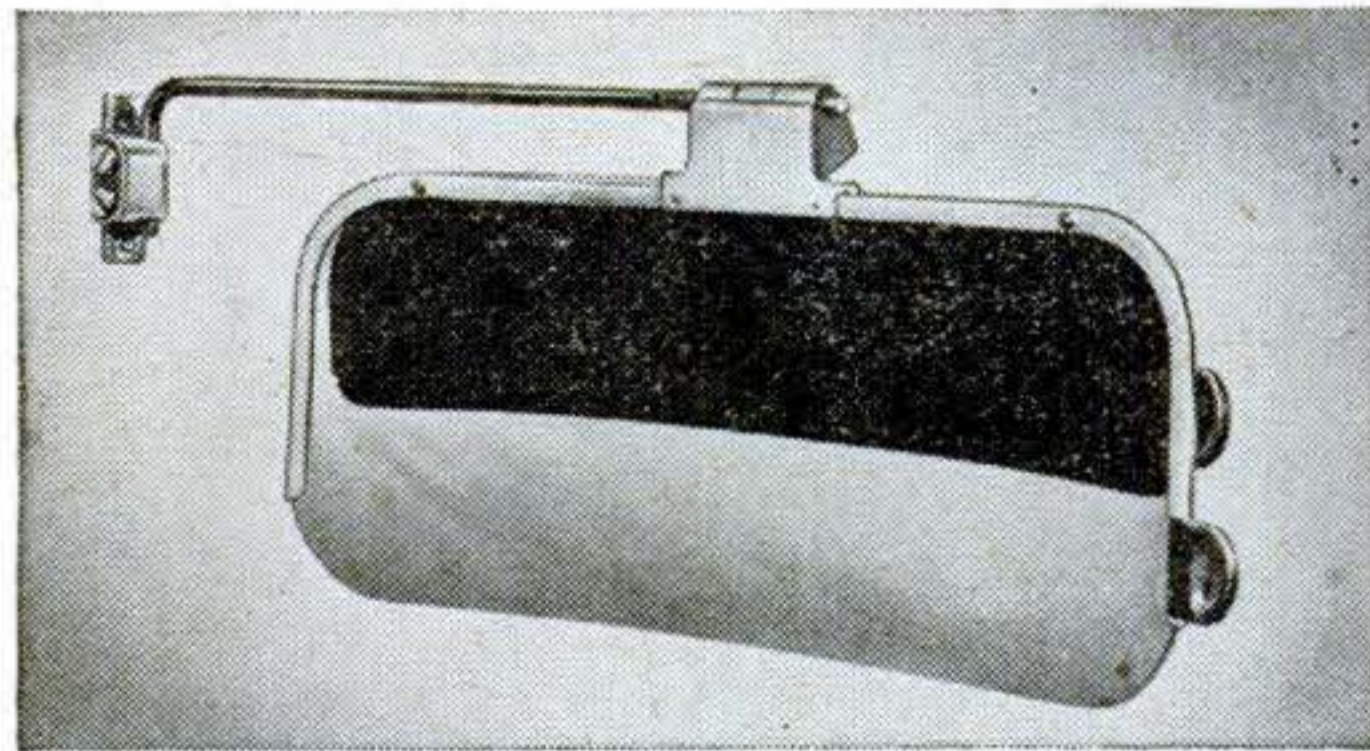
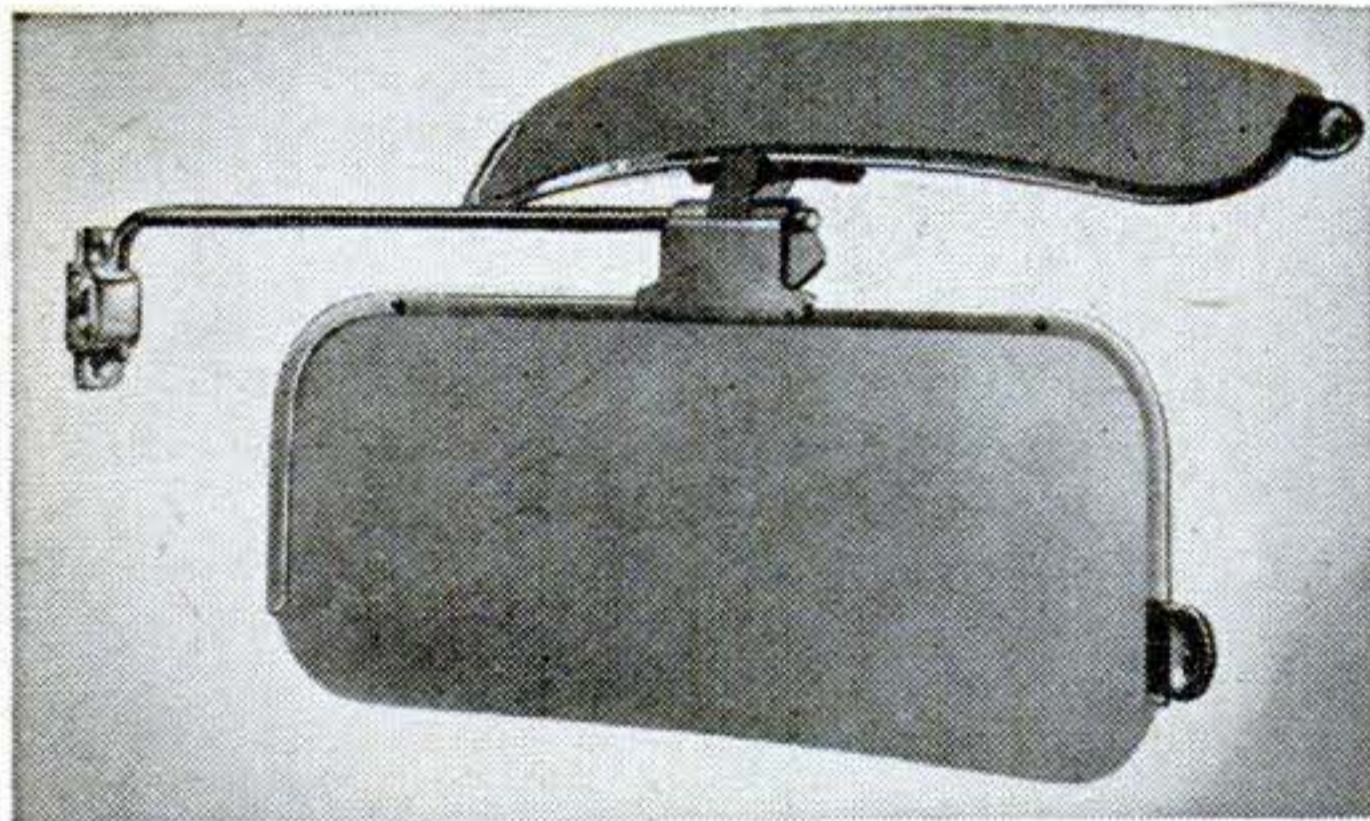

Visor Is Cross-Polarized. This sun shield for buses and trucks employs a polarized film between clear plastic sheets to furnish glare-free vision. An attached smaller visor has its polarized axis at right angles to the first and can be brought into use to control brightness when driving into the sun. Samuel Moore & Company, of Kent, Ohio, is the distributor.

154 POPULAR SCIENCE

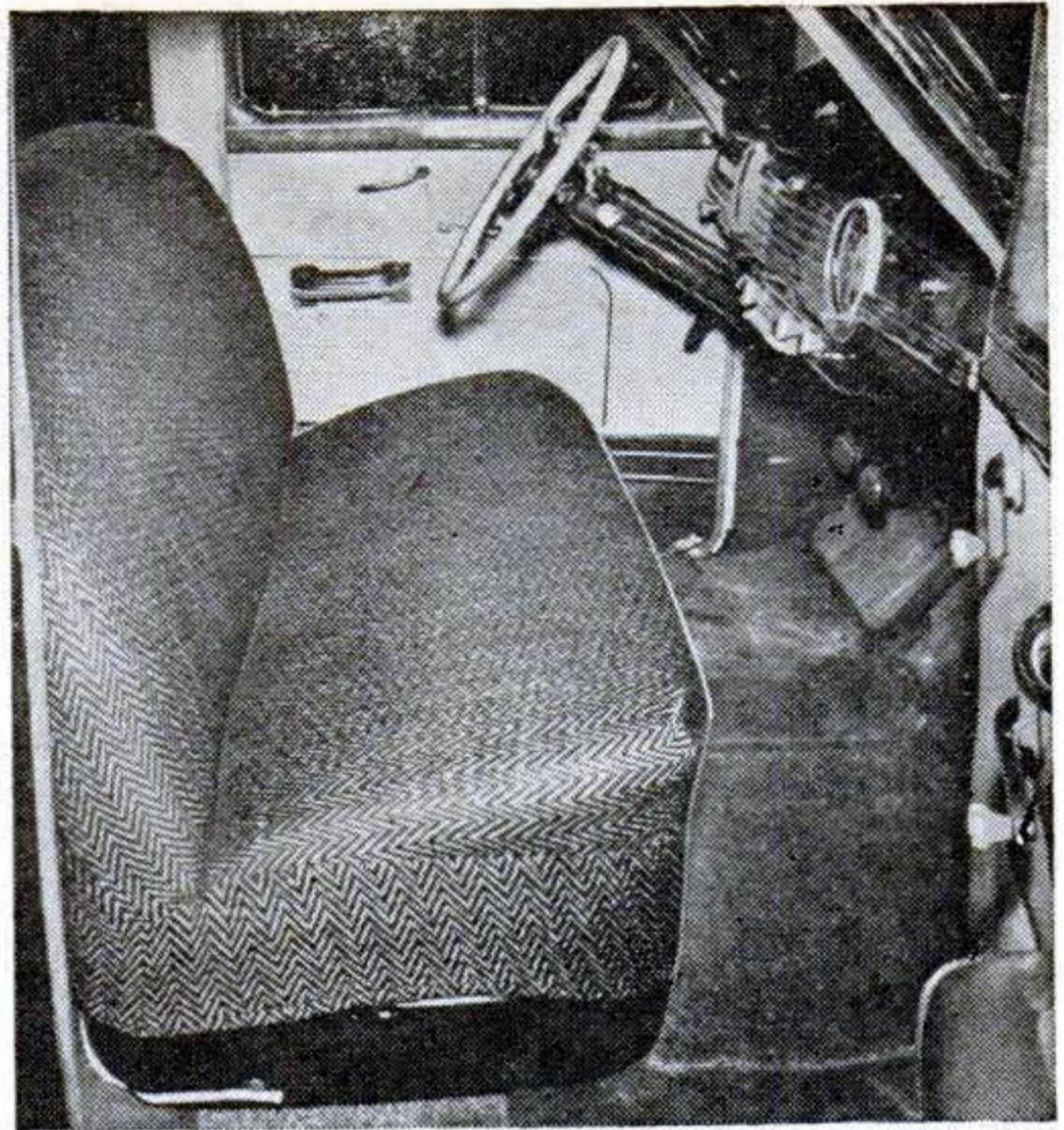

Covers Fit All Seats. Three styles of a new one-piece slip cover care for all standard automobile seats. The fabric stretches to size and shape as it is pulled on and is held snug by a drawstring in the hem. A product of the makers of furniture slip covers, Kwik-Fit car-seat covers sell for less than \$5 a unit.

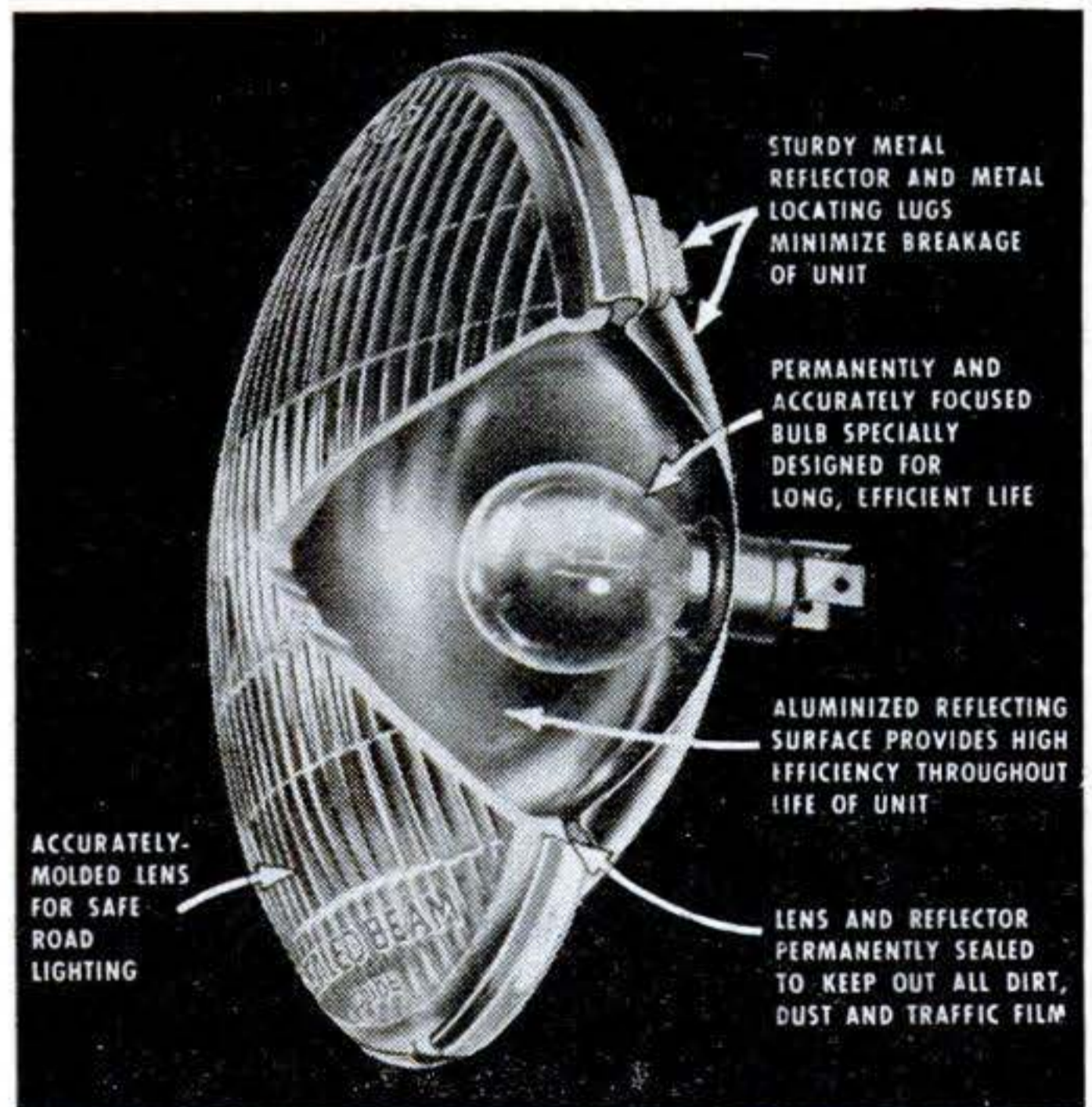

Sealed Beam Stays Lit. Unlike the filament in vacuum-type sealed-beam headlights, a separate bulb in this unit remains operative when the lens is cracked and provides illumination until the damage can be repaired. The light shown is made by the Guide Lamp Division of General Motors Corporation. Several other companies make them on the same principle.

AUTO HINTS



1 Boxes Hold Garage Shelf. A sturdy shelf may be quickly put up in the garage by nailing two boxes of equal size to the wall and then nailing a wide board across them. The boxes themselves also provide storage space.—W. H. McCCLAY.

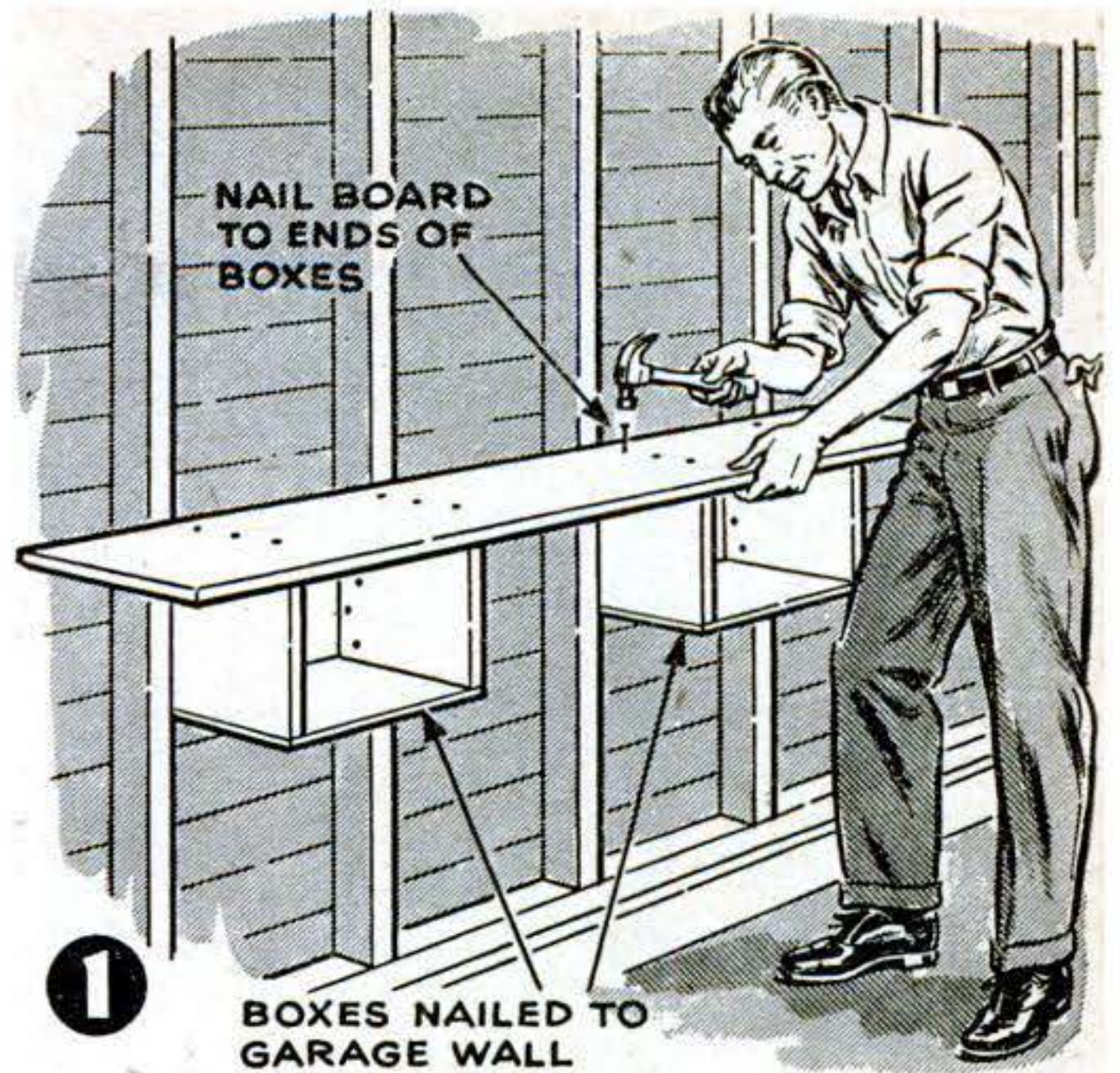

2 How to Patch Upholstery. To repair small holes in car upholstery, cut a piece of matching material about twice the size of the hole, place this over a piece of cardboard $\frac{1}{2}$ " larger than the hole, turn under the edges, and sew or cement them fast. If the inside padding of the cushion has been damaged, fill the cavity with cotton. Then work the patch into the hole, turn the edges of the burned area under, and stitch to the patch to give a snug fit.

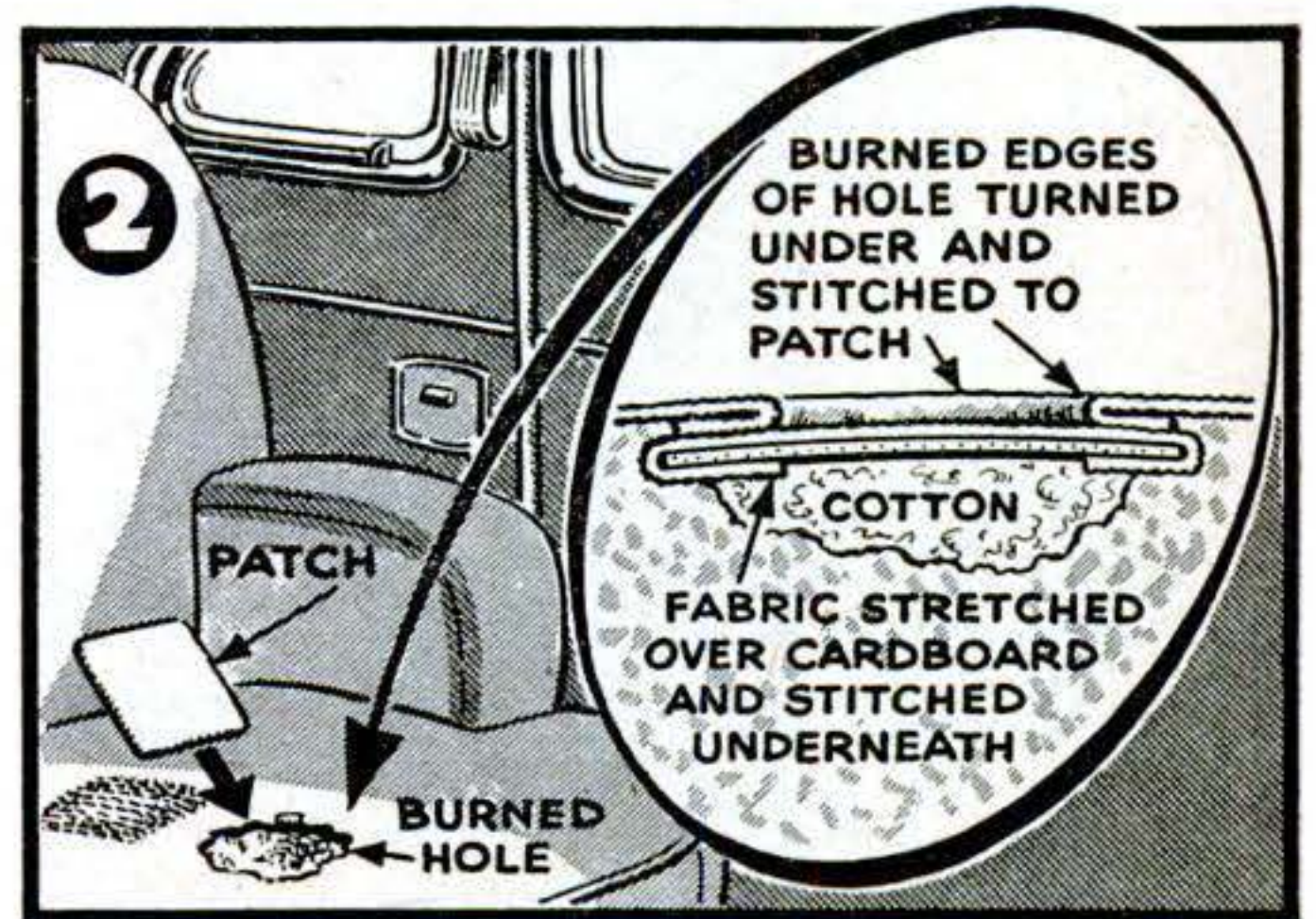

3 Pin Removes Broken Key. A bobby pin, straightened and then bent to give it a small hook on the end, can be used to pull a broken key from a car lock. The pin holds the tumblers out of the way, letting the key be withdrawn.—S. WOOLER.

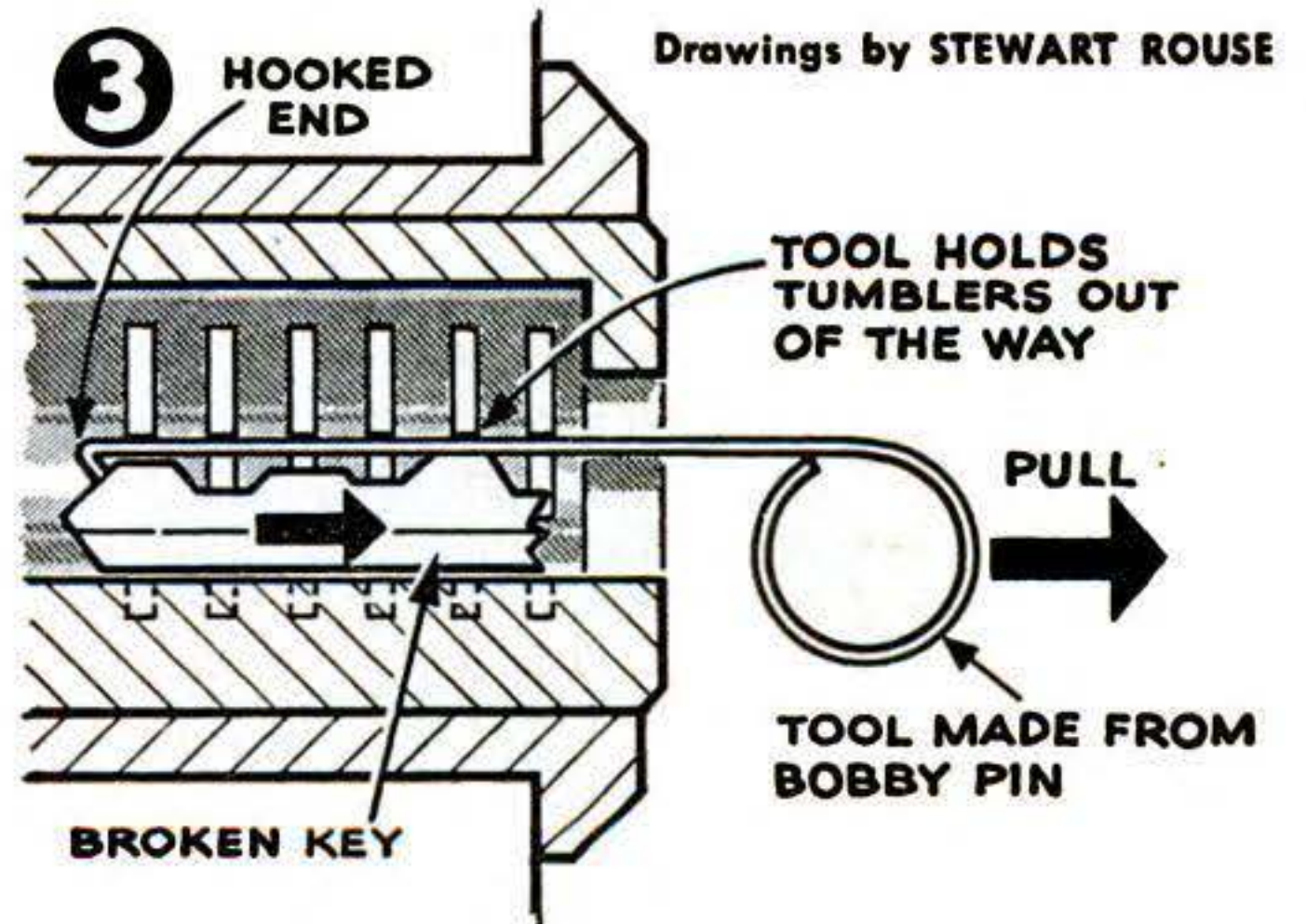

4 Screw Unlocks Starter. If a starter has a habit of jamming, a $\frac{5}{16}$ " cap screw placed permanently in a hole drilled and tapped in the end of the armature shaft will enable you to loosen the jam quickly. In a starter of the type illustrated, turning the screw clockwise will pull the jammed pinion free from the ring gear. Remove the starting motor to drill the hole. It will also be necessary to drill a clearance hole in the dust cap.—N. W. GOODWIN.

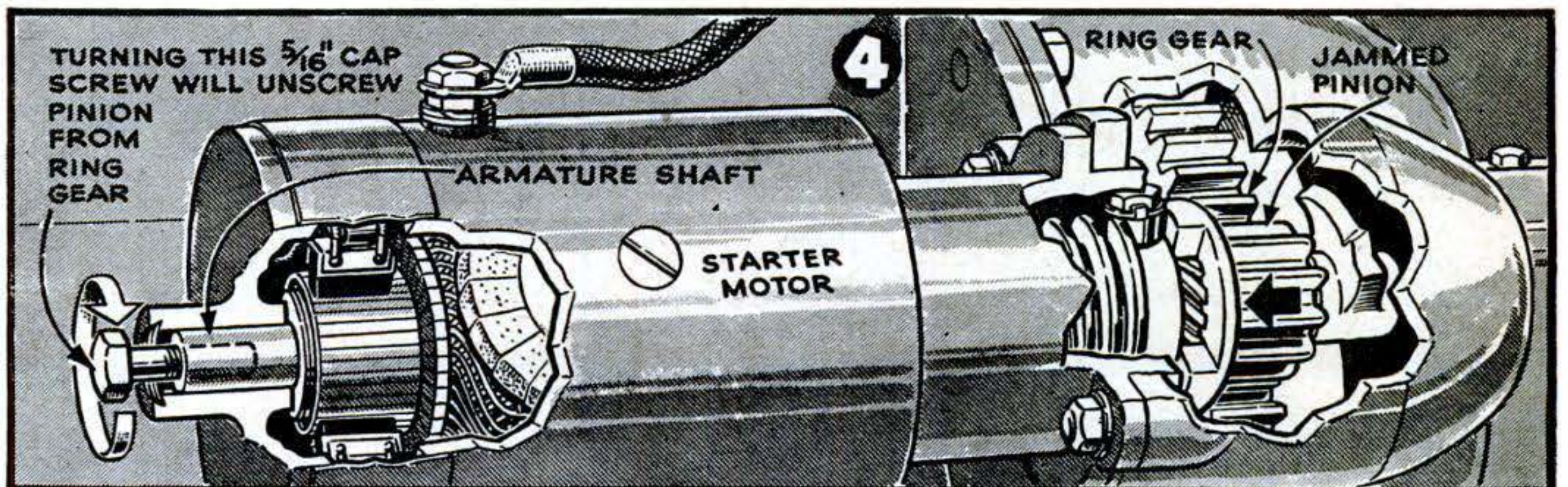

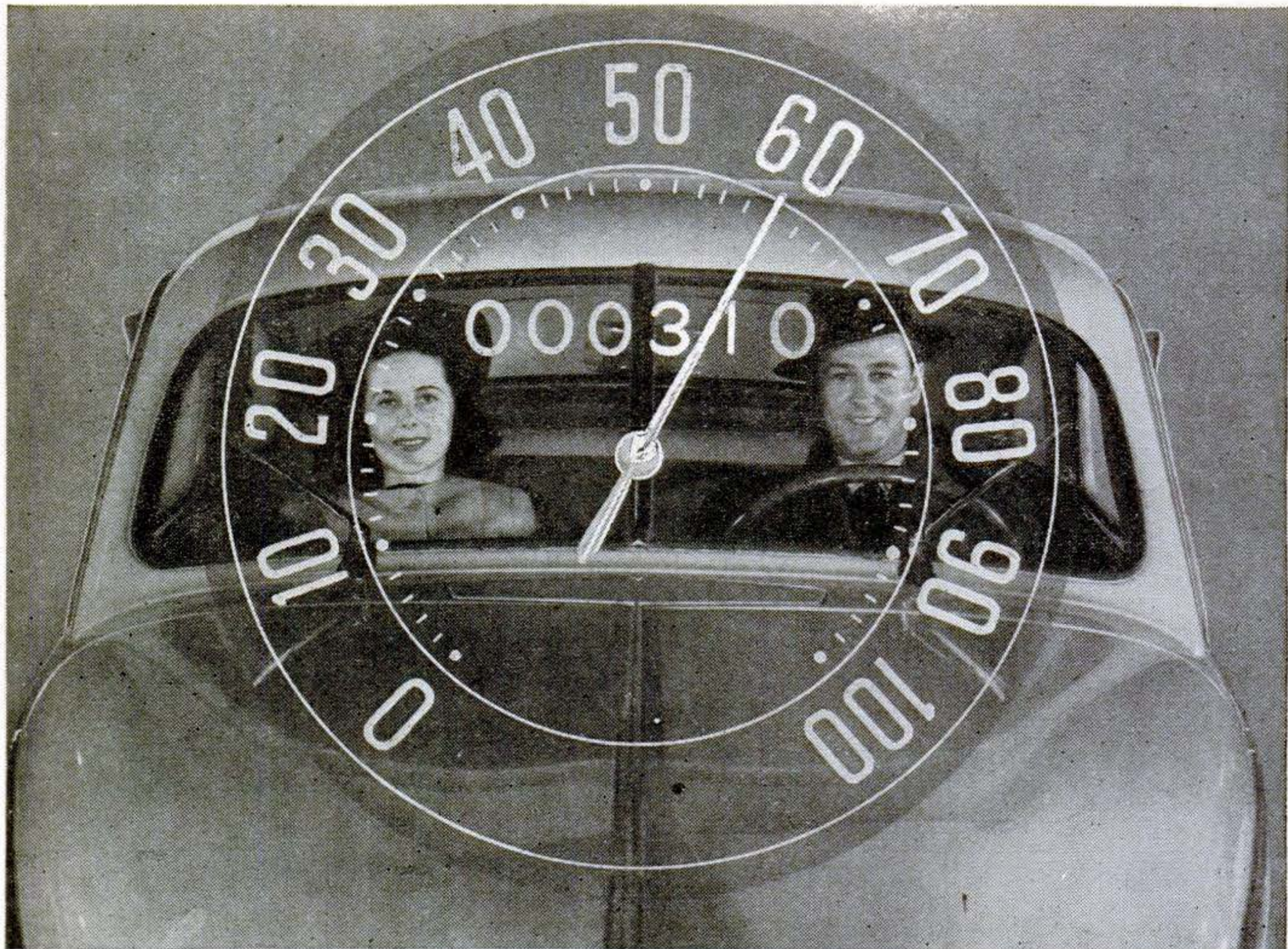

Driving at 60 with only a few miles "on the clock" isn't as harmful for a brand-new car as it once was.

Must You Break In a New Car?

Fast speeds at lower mileages are now all right, but the answer still is "yes" if you want the best ultimate results.

By R. P. Stevenson

BREAKING in a car no longer demands the crawling speeds of a decade ago. Improvements in design and manufacture, and in lubricants, have contributed to outmoding the old, slow break-in process. Since the war, virtually all manufacturers have issued revised recommendations for operation of their cars during the first few thousand miles, most of them now approving faster speeds at lower mileages. Going even farther, several have dropped the subject of break-in entirely from the instruction booklet they furnish with a new car.

Consequently, you may hear it said that a break-in period no longer is necessary. If you do, it would be well to raise a skeptical eyebrow—particularly if you are interested in getting the most from the investment a new car represents.

The fact is that, although you may safely drive fast sooner, you still are dealing with a piece of machinery that is not yet capable of its ultimate performance at the time it reaches you, however perfect it may seem in comparison with the standards of some years ago.

A new car these days has many so-called frictionless bearings (that is, ball and roller), but it also has many friction-producing metal-to-metal movements—rotating contacts, as in the crankshaft and wristpin bearings; and sliding contacts, as in the cylinders and rings. On how these surfaces wear in, a great deal depends—including the eventual

power of the engine, its silence or noisiness, and its oil economy.

As any machinist knows, a properly sized bearing at first is a bare running fit, with a tendency to be stiff, to run hot, and to seize or score if not babied. As it runs, the exceedingly small (millionths of an inch) protuberances on the facing surfaces are worn away, leaving a bearing that is free running but in no way loose.

Improvements in the finish of mating parts are given a big share of the credit for cutting down run-in time. By modern techniques, they are sized within a few ten-thousandths of an inch and given a smoothness of millionths of an inch. As a result, they are ready for their best work sooner.

In the field of metal finishing, a process that is a comparative newcomer has been as-

suming a position of increasing importance. This is honing, a method by which a bonded abrasive is worked over an area. If the customary finishing methods were to be ranked in an ascending order of nicety, honing should be given a place above the other three—machining, which at best gives a comparatively rough surface; grinding, always useful but by no means perfect; and lapping, which has production disadvantages.

Honing finds perhaps its greatest usefulness in the finishing of cylinder bores, but it also now helps give an ultrafinish to many other auto parts. A great increase in mileage between ring jobs in the last two decades may be traced mainly to this process. Without enlarging the diameter of the bore to any extent, honing knocks down the peaks

Watch These Points During the Break-In



LUBRICATION. Metal-to-metal contacts need plenty of oil while wearing in. So check the oil often.



ENGINE HEAT. Allowing a new engine to overheat is an invitation to all kinds of expensive repairs.

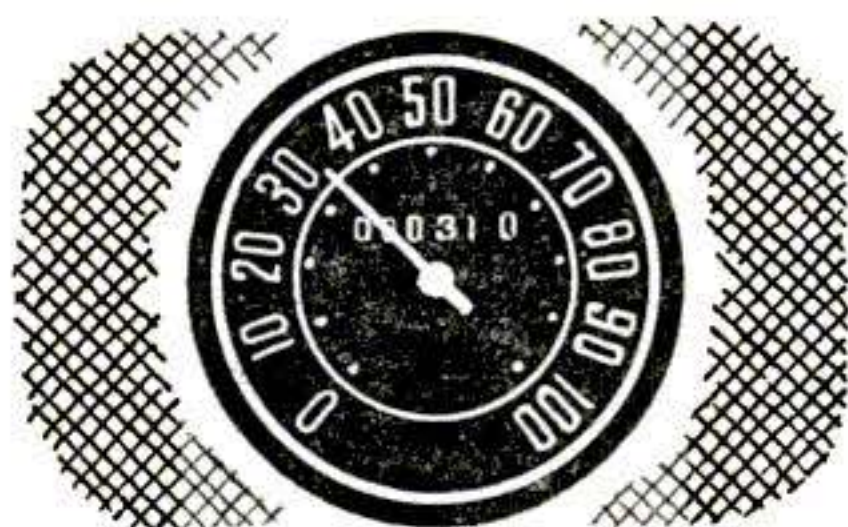

WATCH SPEED. Gradually push the car up to higher road speeds. Crawling along won't break it in.

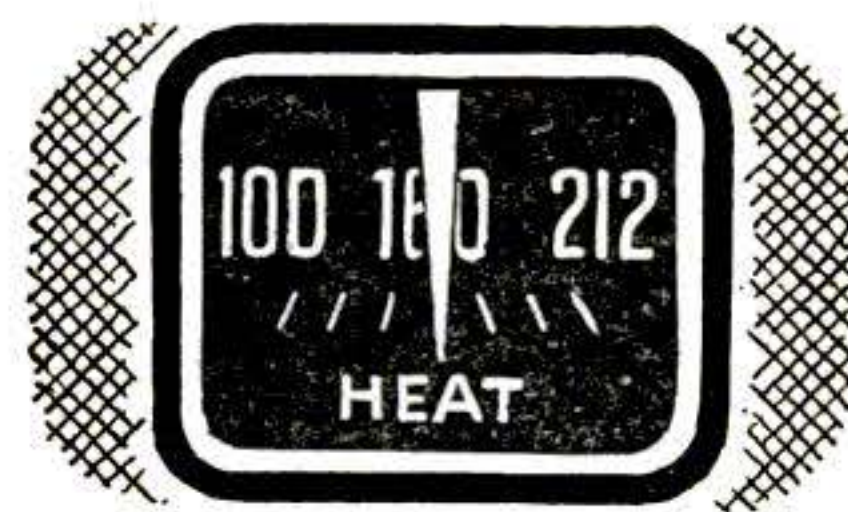

WARM UP FIRST. Allow the engine to run a bit before driving so the oil will be warm and flowing.

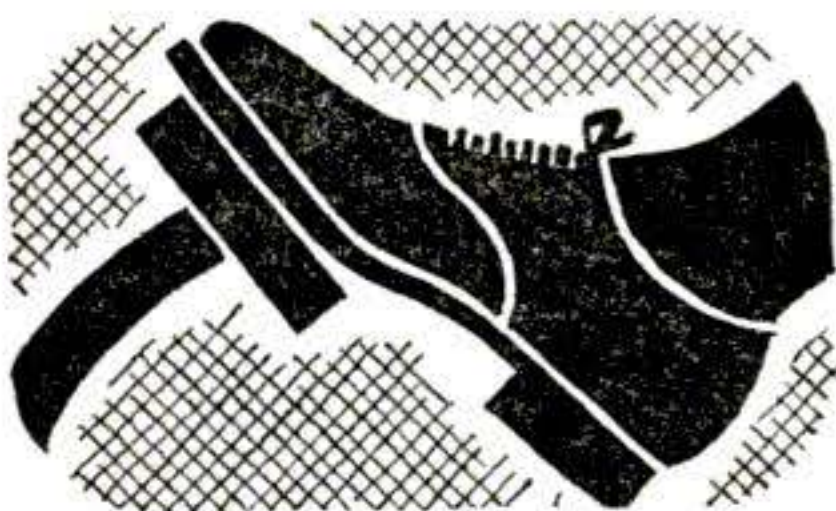

BABY THE BRAKES. Go easy on the brakes for a few hundred miles until the linings are broken in.



SERVICE CHECKUP. Most new-car service policies entitle you to these. Don't fail to have them.

and jagged tips of surface irregularities that are apt to wear out the rings.

Until a bearing has run in, it will operate at a higher temperature than ordinarily. For that reason proper lubrication is never more important than during the break-in period, if scoring or seizing are to be prevented. Motor oil has a dual function—to cool the moving parts and to reduce friction. New processes by which protective metal platings are applied to bearing surfaces in some new cars offer a safeguard against temporary oil starvation.

Always Warm Up the Engine

Temperature is an all-important tipoff while an engine is new. Like the temperature of your own body the engine temperature quickly reflects any abnormal condition. Never allow a tight engine to run too hot. If you do, your nose probably will let you know, since an engine running on the hot side has a distinctive smell—a hot metal and varnish odor. So keep an eye on the heat indicator—after the engine has had time to warm up.

Proper warmup is essential whether an engine is old or new. Engineers have found that the greatest amount of damage occurs during the first three or four miles of driving, when the lubricants have not yet thinned out sufficiently to coat all the moving parts. Before leaving the garage, let the engine idle for about five minutes. If you must set out immediately, drive slowly for the first dozen miles or so.

During the break-in period, some new cars may require what appears to be an unusual amount of oil. This should cause no worry. Until the piston rings are properly seated, oil may get past the rings and into the combustion chamber. This often is helpful, for the extra lubrication allows the rings and pistons to wear more gradually and form a good seal. After the car has been driven 2,000 or 3,000 miles, the oil consumption should drop to normal.

Faster Speeds Make Better Cars

A memorandum distributed by Plymouth to its dealers explains that some new owners who report using more oil than expected may be keeping the oil level at the "full" mark rather than the "running level" mark on the dip stick. When the level is too high, the excess is vaporized and escapes through the crankcase ventilator. Plymouth advises that in checking the oil when the engine is

warm the level should be kept up to but not above the "running level" mark.

When many new cars are delivered, the crankcase oil is S.A.E. 10-W, no matter what the season. This should remain in until the first checkup—at 1,000 miles, or whatever your service policy stipulates. If oil must be added before then, the manufacturer usually recommends use of the same grade. A careful owner will of course not neglect to take in his car for these checkups.

There is now a fairly general feeling among automotive engineers that faster break-in speeds produce a better final result. The slow speeds of the past sometimes failed to accomplish the purpose for which they were intended. Although the driver may have complied with all instructions, his car would sometimes not be broken in by the time the specified mileage figure had been reached. Consequently, when the driver speeded up, thinking it was safe to do so, the bearings often were scored or other damage caused.

One prominent Detroit engineer believes that limited break-in speeds are not needed by a man with good engine sense—an expert who knows and understands his car and can make it a part of himself. Such a driver can feel when a new car is tightening up and not responding as it should. When that occurs, he will ease off to a slower rate. Unfortunately, not all drivers can classify as expert.

Break In the Brakes Too

One rule on which there is agreement is that a new car should never be held at any speed the first time it is pushed to that figure. For example, the first time you reach 50 m.p.h., keep the car there only a brief time before dropping back. Then, after it has been raised to 50 on several occasions, push it to another slightly higher point. Keep repeating this procedure until you have reached the peak performance of the car. If a car never has been driven over 40, don't raise it suddenly to 70 or 80. Work it up gradually.

In addition to the engine components, the rear axle, gears, and brakes also require time and use to wear in properly. Rear ends used to be especially subject to damage, but the high-pressure hypoid lubricants now used in many cars help reduce this. In the case of the brakes, fast stops should be avoided for the first few hundred miles until the linings acquire a smooth finish. **END**

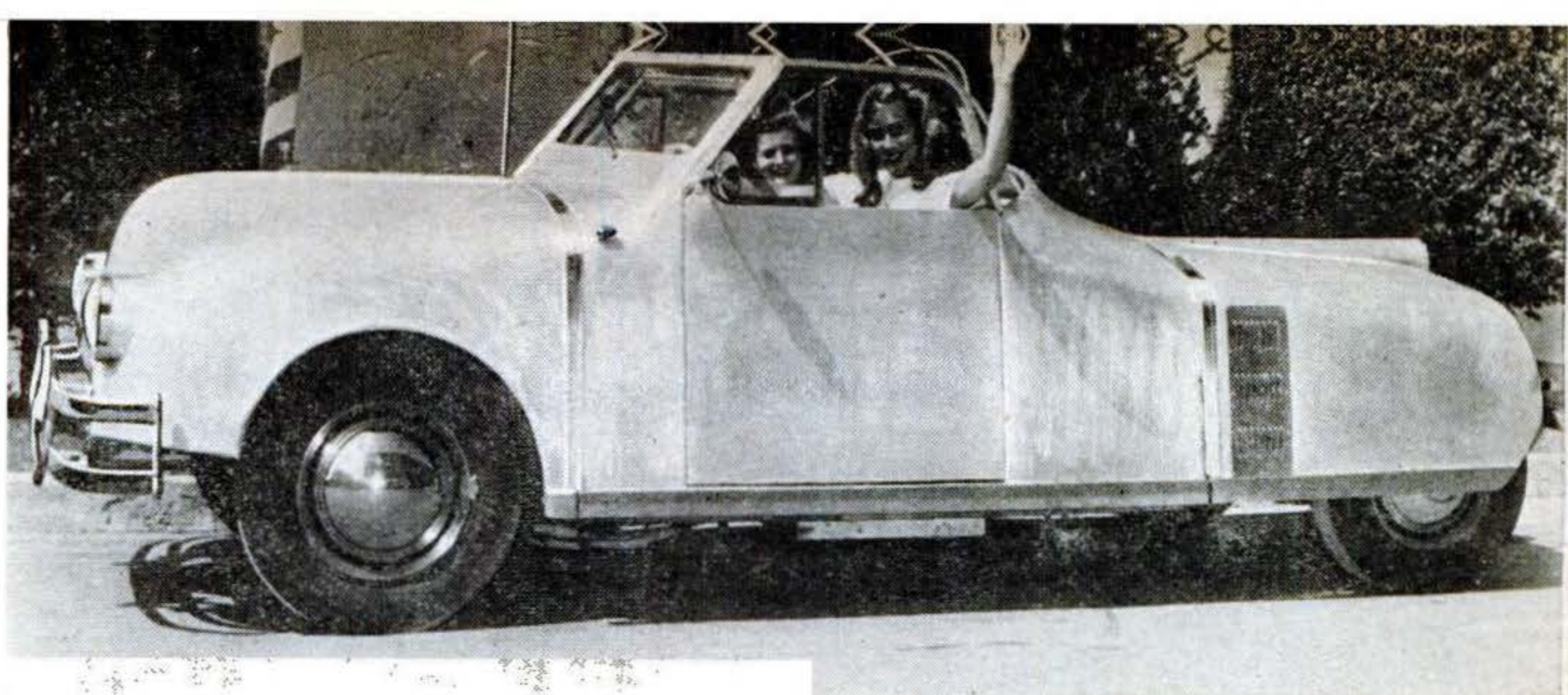

Sheet-aluminum on 1" chrome-molybdenum steel tubing forms a light body for this home-for-two on wheels.

Rear-Engine Car Boasts Kitchen

WHEN Roy Hunt, Hollywood cameraman, decided stock automobiles weren't ideal for camping, he rolled out his own. Except for a four-cylinder, 90-hp. air-cooled Franklin engine from a war-surplus plane, and a Ford Model-A transmission, Hunt built the car from stock materials. He mounted the engine in back, placed a kitchen and dining equipment under the front hood, and made seats convertible into beds.

Motor and transmission are suspended by a ball-and-socket joint in front and hinged to the rear axle; there is no universal joint or drive shaft. Undoing two clips and one bolt permits rolling out the power unit.

Flat doors only 1" thick increase the inside width of the sheet-aluminum body. The car is 4' 8" high, 16' long on a 114" wheelbase, and weighs 2,045 lb.

Hidden under the front hood is a complete kitchen and dinette, including icebox, sink, GI gasoline stove, folding table, and dishes.

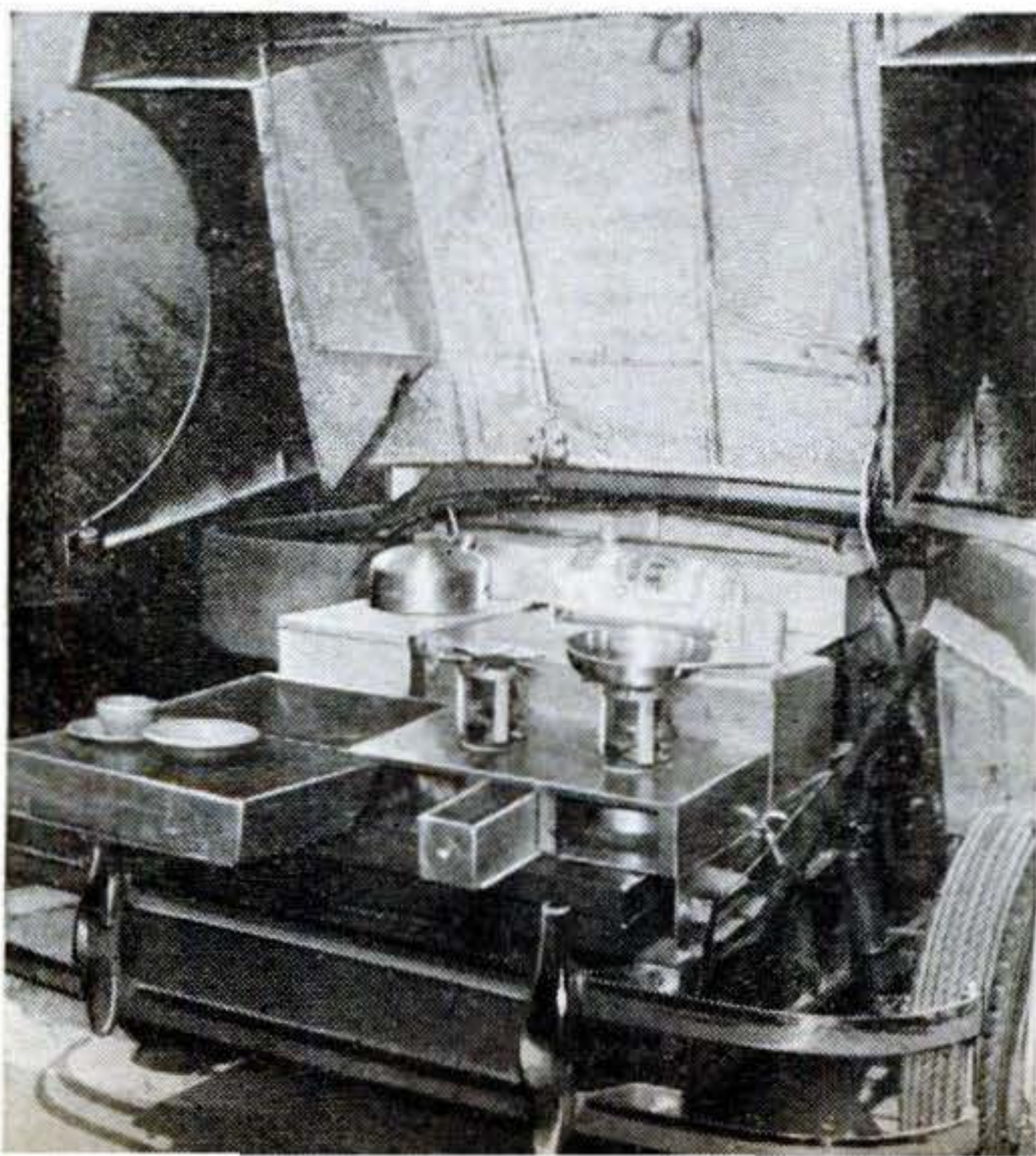

Roy Hunt, the builder, stretches the canvas top over the frame. Vents are provided at the sides and back of the rear-engine compartment.



Gail Davis rests on a full-length bed while Regan Callais, another movie starlet, is at the wheel. A second bed extends from the driver's seat.

Gus Comes Home to Trouble

By Martin Bunn

GUS WILSON was in such a hurry to get back to the Model Garage that, instead of waiting five minutes for the bus that passes it, he took a taxi from the railroad station.

He had had a grand time visiting his sister out in Colorado, but now that he was almost home, the two weeks he had been away seemed like two years. In the course of the 10-minute ride, so many misgivings about what might have gone wrong in his absence chased each other through his mind that he was almost surprised to see the familiar garage still standing.

His partner, Joe Clark, grinned a welcome from the office door, and Stan Hicks, the grease monkey, leaning against the gas pump as he slow-motioned through his morning chore of hosing off the concrete driveway, called out breezily, "Hi, boss!"

"Hi, kid!" Gus returned just as breezily, and started for the office. "How're things?" he asked, unable to hide his anxiety.

"Swell, just swell," Stan assured him in a matter-of-fact tone.

Joe Clark was just as placid. His eyes twinkled delightedly from behind his horn-rimmed glasses, but all he said was, "Have a good time?"

"Fine!" Gus told him. "It's good to be back, though. I've been sort of worried about things."

"You needn't have been," Joe assured him. "Everything's gone O.K. Plenty of work, but all of it routine stuff that Stan and that Mike Cawthorne you hired could handle without any headaches. I let Mike go yesterday, knowing you'd be back today."

Gus grunted. He was relieved—and a little deflated at the same time. "There's no indispensable man even in a garage," he told himself with a rueful mental grin. Aloud he remarked that he had his best suit on and had better go home for a change before getting to work.

As he started for the office door it was opened violently ahead of him, and a tall, thin, glum man he didn't know stomped his way in. His thin lips mouthed an unlighted cigar as the visitor looked the partners over,

an expression of bitter dissatisfaction on his lean, dark face.

"There never has been a time," he declared solemnly, "when automobile mechanics charged so many so much for doing so little. Maybe Winston Churchill didn't say that—but he would have, by gum, if he'd had any work done on his car!"

Joe bristled. "Why, Mr. Downunder . . ."

"Underdown, if it's all the same to you," the sour man corrected acidly.

Joe reddened. "Yes, of course—Mr. Underdown," he amended. "What I was going to say—I mean, what's the matter?"

Underdown dexterously rolled his cigar from one corner of his mouth to the other.

"You remind me of a doctor I had a couple of years ago," he said slowly. "Sold me an operation—said if I had it I'd cut six strokes off my golf score. That would have brought me down under 90, so I had the operation—cost me a thousand before I got through with it. It didn't do what the doctor said. I've never broken 90."

"That's—that's too bad," Joe said uncertainly. "But what's it got to do with your car?"

"Same sort of deal," Underdown went on. "You sold me a motor tune-up, didn't you? You claimed it would give my old bus more power and a quicker pickup, didn't you? You claimed—"

"Well?" Joe broke in.

"Well," Underdown mocked. "It's just like my operation. The motor runs O.K., but not the way the doctor claimed it would. It hasn't got any more power, and its pickup isn't any faster than it was before the operation. I'm not satisfied I got my money's worth—that's flat!"

Joe gave Gus a get-me-out-of-this look, and Gus went to his assistance. "If you've got your car outside, Mr. Underdown," he suggested, "suppose you and I take a little ride in it? Maybe I'll be able—"

"You're Gus Wilson, I suppose," Underdown said. "Feller told me you're a whiz. That's why I brought my car here."

They went out to a 1939 sedan. Gus slid behind the wheel. The engine ran smoothly enough, but when they got on the highway and Gus pressed his foot suddenly on the

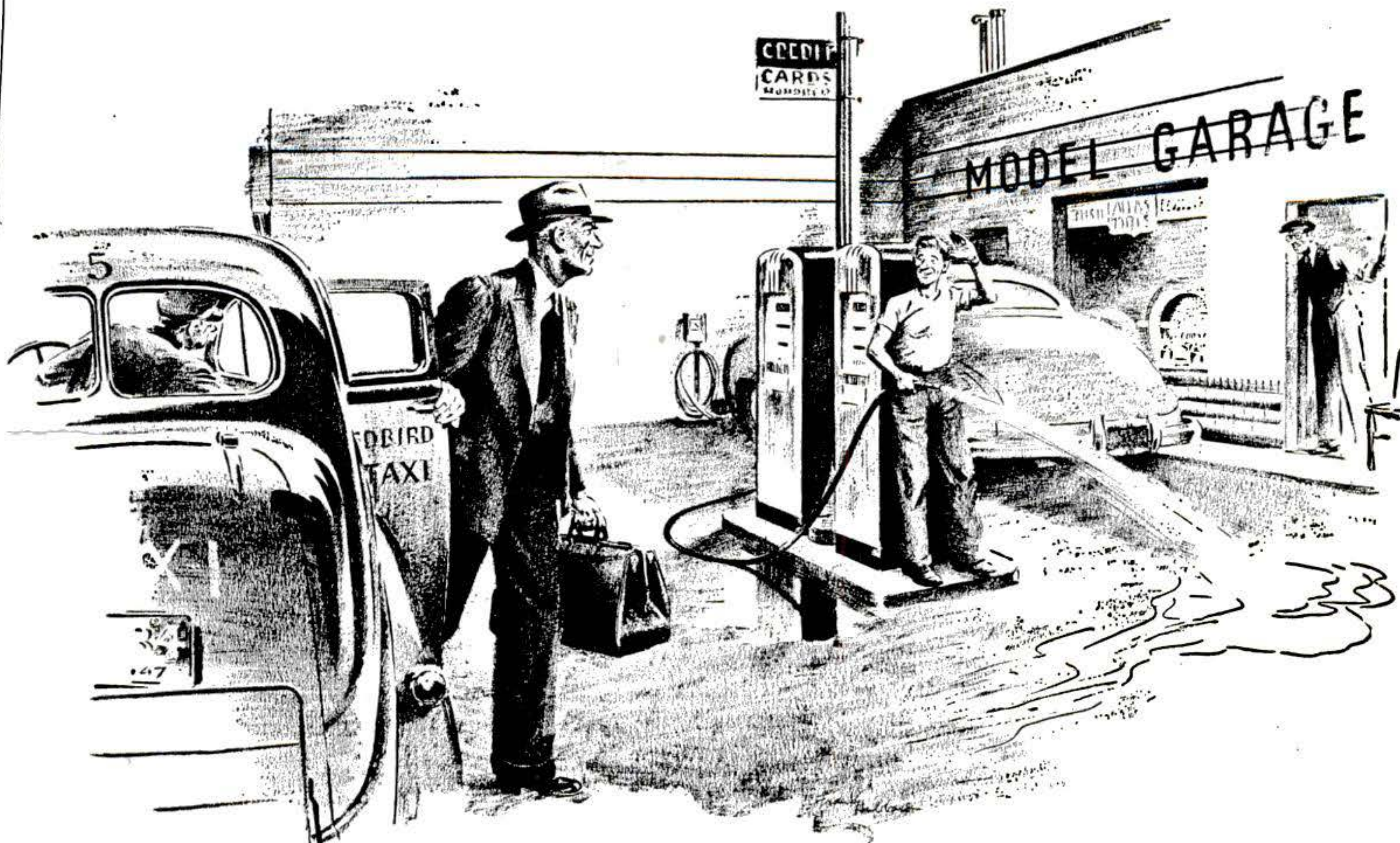

Joe grinned a welcome from the door, and Stan, in slow-motion at the morning hosing, called, "Hi, boss!"

accelerator pedal, the power plant's response indicated that Underdown had a real kick coming. Noticeably lacking was the flashy acceleration to be expected from a job just out of the shop with a good tuning. And when they climbed a fairly steep grade, there wasn't any power to spare.

"You win," Gus told the customer. "She isn't as good as she ought to be. If you want to leave her until quitting time this afternoon, I'll see what can be done."

AFTER Gus had driven the sedan into the shop, Stan came over to him. He looked embarrassed. "Say, boss," he began, "I've got to talk to you."

"Go ahead and talk," Gus told him.

Stan had turned red, and his greas-smearred face showed drops of perspiration.

"You've heard about the high cost of living and everything," he blurted out.

"I've more than heard about it," Gus assured the youngster.

Stan hesitated, looking miserable. Finally he stuttered, "I—I ought to get a—a raise."

"Why?" Gus asked.

Stan turned still redder. "Oh, I dunno," he muttered.

Gus laughed and gave him a friendly poke in the ribs. "You certainly don't rate a raise

for being a good salesman for yourself," he said. "I'll think it over and see what Joe says about it." He indicated the sedan. "Remember this job?"

Stan nodded. "It was in for an engine tune-up a couple of days after you left."

"Who did the work, you or Mike Cawthorne?" Gus asked.

"Mike did, mostly," Stan told him. "I helped, but he wouldn't let me do much. He's the sort of guy who thinks he's the only one who knows anything."

"Either of you road-test it after it was finished?" Gus wanted to know.

Stan shook his head. "No. Mr. Clark did. He said it was O.K."

Gus tried not to grin. "It's not O.K. now," he said. "There's not enough pep. Let's check the engine."

It ran smoothly. The vacuum tester didn't indicate that there was anything the matter. But, just as had been the case on the road, when Gus stepped on the accelerator pedal the engine didn't answer instantly. He checked the carburetor, and found that it was working normally. Then, after some silent thinking, he had Stan remove the manifolds from the block and examined them.

The inside of the intake manifold was covered with a brown varnishlike coating, and

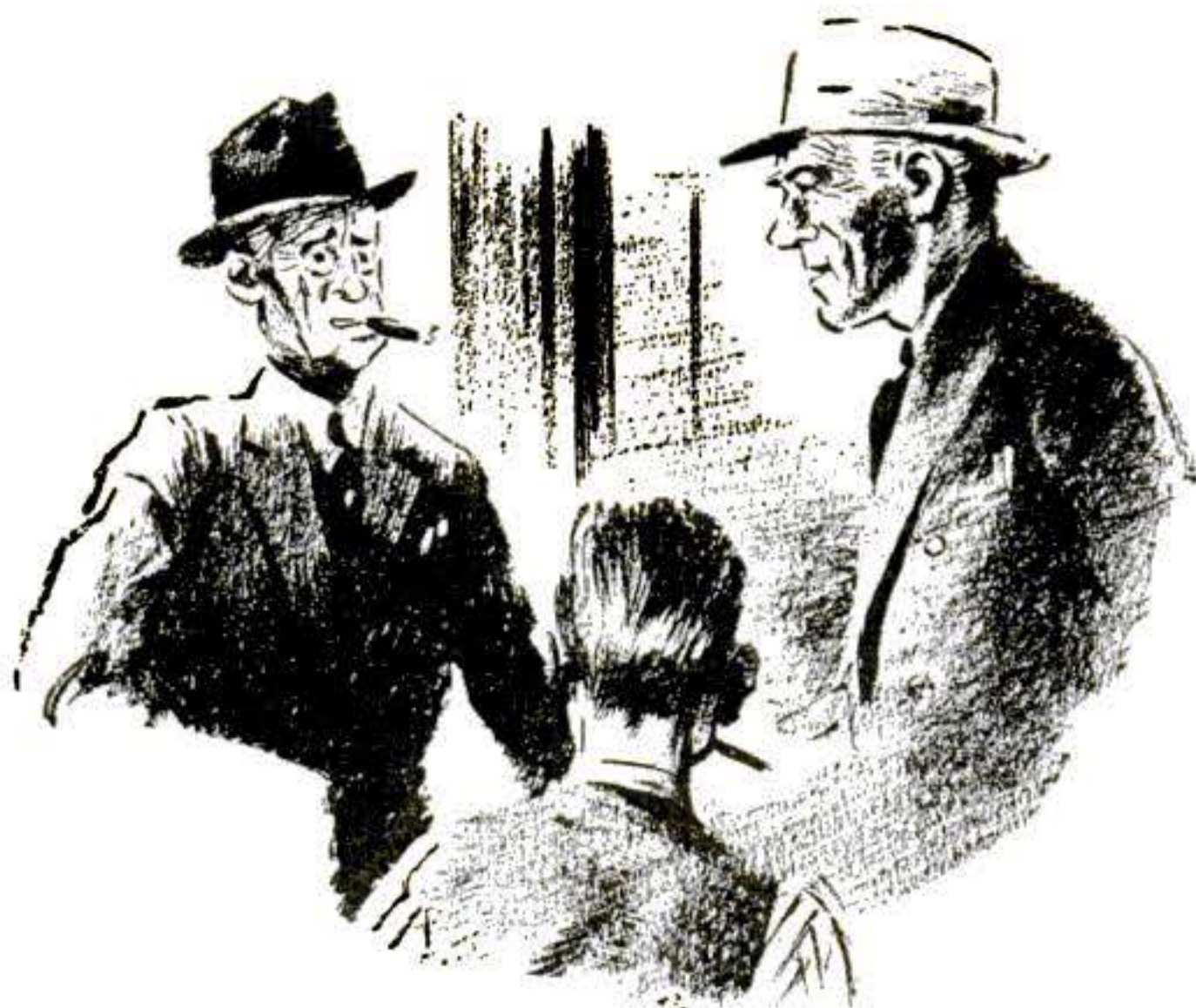

His thin lips mouthed an unlighted cigar as the visitor looked the partners over, an expression of bitter dissatisfaction on his face.

the inside of the exhaust manifold had an uneven but generally thick carbon deposit.

Gus shook his head sadly. "Sloppy work," he commented. "I thought better than that of Mike Cawthorne. He probably cleaned out the inside of the manifolds, but he didn't do a thorough job. He left some of the old deposit of varnish binder in the intake and some spots of carbon in the exhaust, and new deposits built up quickly."

Stan's face got red again. He looked as if he wanted to say something, but for a long moment he was silent. Then he blurted: "That wasn't Mike's fault, boss. He gave me the job of cleaning the manifolds. I was sore because he wouldn't let me do anything more important, and I guess—I guess I wasn't careful enough."

Deep gloom shrouded his usually cheerful face, and he spoke aloud his gravest thought: "Now what chance have I got for a raise?"

Gus managed to smother a grin. He looked at his young assistant and shrugged his shoulders. "Well," he said, "you'd better get back at them with a wire brush. And make sure this time you get them thoroughly clean. It would be easier to soak them overnight in a gum solvent—ethyl acetate or something like that—to loosen the deposits and then clean them off with an air jet, but I promised Mr. Underdown I'd have his car ready this afternoon."

Stan went to work, and when he brought the manifolds to Gus an hour later the inner passages of both had been polished clean and smooth.

"O.K.," Gus approved after an inspection.

"That's the kind of job you should have done the first time. And here's something to remember. If you ever use a gum solvent to get the varnish binder off inside an intake manifold, be very careful to remove all the loosened matter afterwards. That stuff can cause real grief if it gets carried into an engine."

When Stan had reinstalled the manifolds, they took the car out for a road test. Gus pressed his foot down, and the old sedan leaped ahead. Its acceleration was really flashy. And when they climbed a hill, there was plenty of power and then some.

Stan shook his head in bewilderment. "I don't get it, boss," he said. "I know I did a bum job cleaning those manifolds the first time, but I don't see how the little carbon and stuff I missed could make all that difference."

"Ever see the manifolds of a racing car?" Gus asked. "Their inside passages are plated—or well polished, at least—to improve the volumetric flow of the mixture and of the exhaust. To get the most out of an automobile engine, those passages must present the least possible friction so the pistons can suck in the largest possible charges of mixture and expel the largest possible volume of exhaust gases.

"You don't find plated manifolds on anything but real hot-rod jobs; but whatever kind you have, they must be clean and smooth to get top performance out of the car. The deposits that built up quickly on the rough spots you didn't get rid of interfered with the easy flow of mixture and exhaust in this engine, so it had a sluggish pickup and couldn't deliver full power. Get it?"

Stan thought it over. "Yes," he said finally, "I get it. Say, auto engines are sort of funny, ain't they?"

"You're telling me!" Gus agreed grimly. "By the way, I spoke to Joe about your wanting a raise."

Once more Stan's face got red from embarrassment. "I guess I haven't got it coming to me now—after that punk job on Mr. Underdown's manifolds," he muttered gloomily.

Gus laughed good-humoredly.

"We all have to learn the hard way sometimes," he said after a moment. "And you didn't let me think that it was Mike's fault. Your pay envelope will be five bucks fatter this Friday, son. O.K.?"

"O.K., boss," Stan grinned.

MECHANICS AND HANDICRAFT

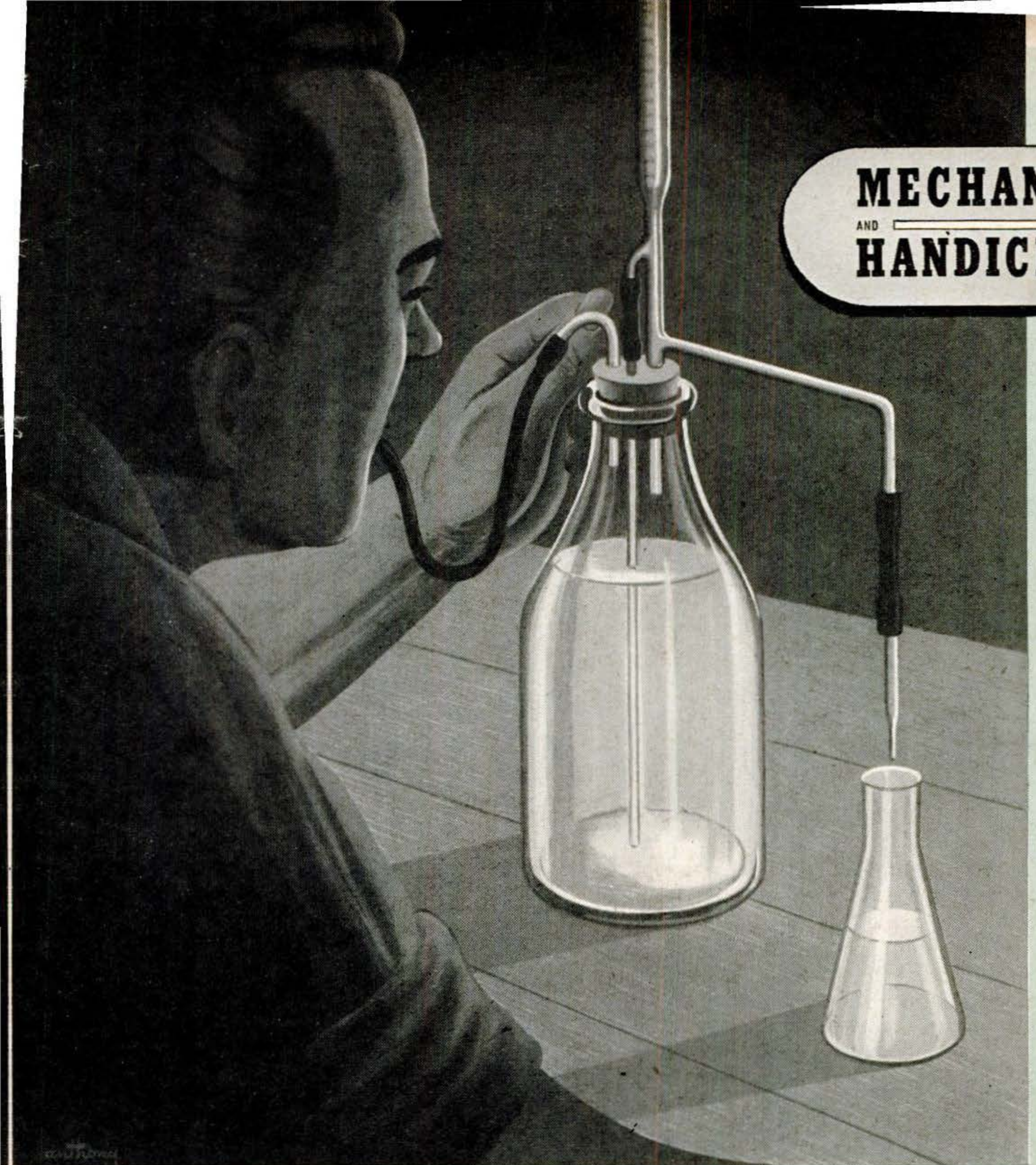

- **Homemade Lab Equipment**
- **Flexible Couplings**
- **Sports Photography**
- **Quality Audio Amplifier**
- **Servicing Gas Stoves**



All fastenings must be tight to make a steady table. Nuts on the machine screws holding the legs are put on the inside. The stretcher goes only part way into the outer legs. Wax or varnish completes the job.

Coffee Table Has Ax-Handle Legs

UTILITARIAN good looks, associated with the first furniture of our American forefathers, who used whatever material there was at hand, is captured in this coffee table assembled from a breadboard and four ax handles. The pieces may be old or new. A 15" length of $\frac{3}{8}$ " dowel is needed for the stretcher, and four 2" angle braces to join the legs and top.

Prepare the breadboard by rounding the corners and edges and sanding smooth. Be sure to sand only with the grain, masking the strips running crosswise at the ends when working lengthwise on the main boards.

Take care also in sawing the ax handles

to length. They are pretty well standard, but the bevel on the handle ends may vary and the saw cuts must be made parallel to this bevel so the cut ends will fit flat against the top while the bevels rest flat on the floor. Lay each out separately with a carpenter's square, providing for a 17" or 18" table height and taking into account the thickness of the breadboard.

Flatten slightly the surfaces where the legs cross and those on which the angle braces will fit; then drill for the stretcher and the machine screws that hold each brace. Assemble on the stretcher with glue, and screw to the top.—ROLAND CUEVA.

Desk Name Stand Bent from Sheet of Plastic



A SINGLE sheet of $\frac{1}{16}$ " clear plastic can be formed into a crystal-like desk stand to hold your name on a 1" by 7" strip of cardboard. The plastic is bent at two places over a $\frac{1}{8}$ " thick strip of wood.

Sand the edges smooth and remove the masking paper. Heating may be done in the oven at 250 deg. or, perhaps easier, it may be only along a strip $\frac{1}{2}$ " wide where the plastic is to be bent. This can be accomplished by masking with asbestos and using a heat lamp.—FRANK SHORE.

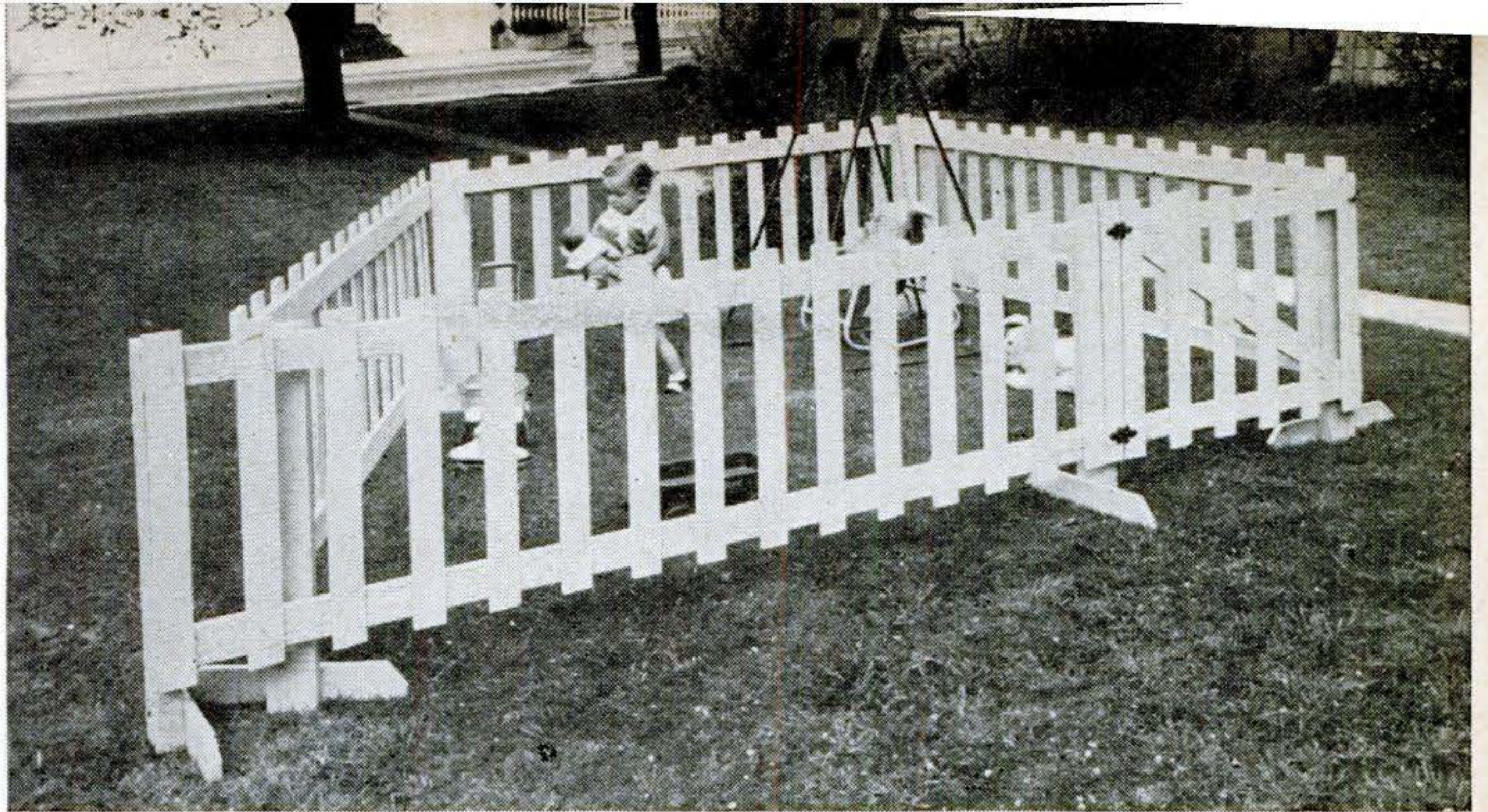

Set up as a pen, four fence sections and gate form an area in which a young child can play with safety.

Portable Fence Grows with Baby

FOR a child that is learning to walk and has outgrown the regulation folding pen, a portable enclosure can be set up on the lawn. This one, resembling a picket fence, is built in sections and is easily taken down and stored when not in use. Unlike the indoor pen, it can be enlarged as the child requires more play space by adding sections or sometimes even by rearranging those on hand to join the property fence and house.

The posts are two-by-fours with cross-pieces nailed to the bottoms so each section will stand alone. Top and bottom rails are lengths of 1" by 3". Pickets are cut from $\frac{1}{2}$ " stock. They are spaced wider than usual so the baby can see out and will not feel boxed in. If the bottom hinge eyes are cut off, the gate can be lifted off readily to facilitate moving. By extending the pickets to the ground, the fence can be used for a puppy's run.—DICK HUTCHINSON.

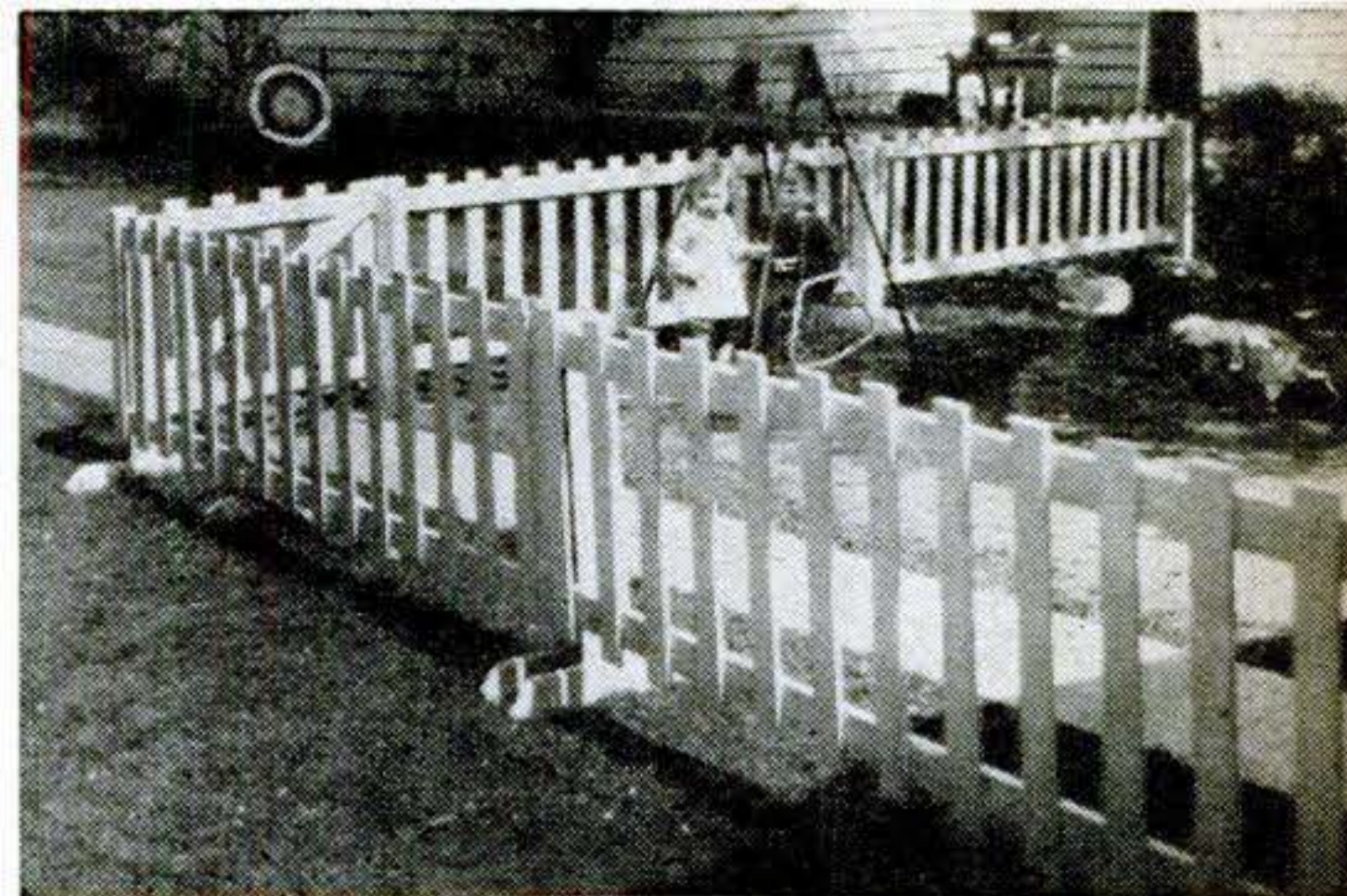
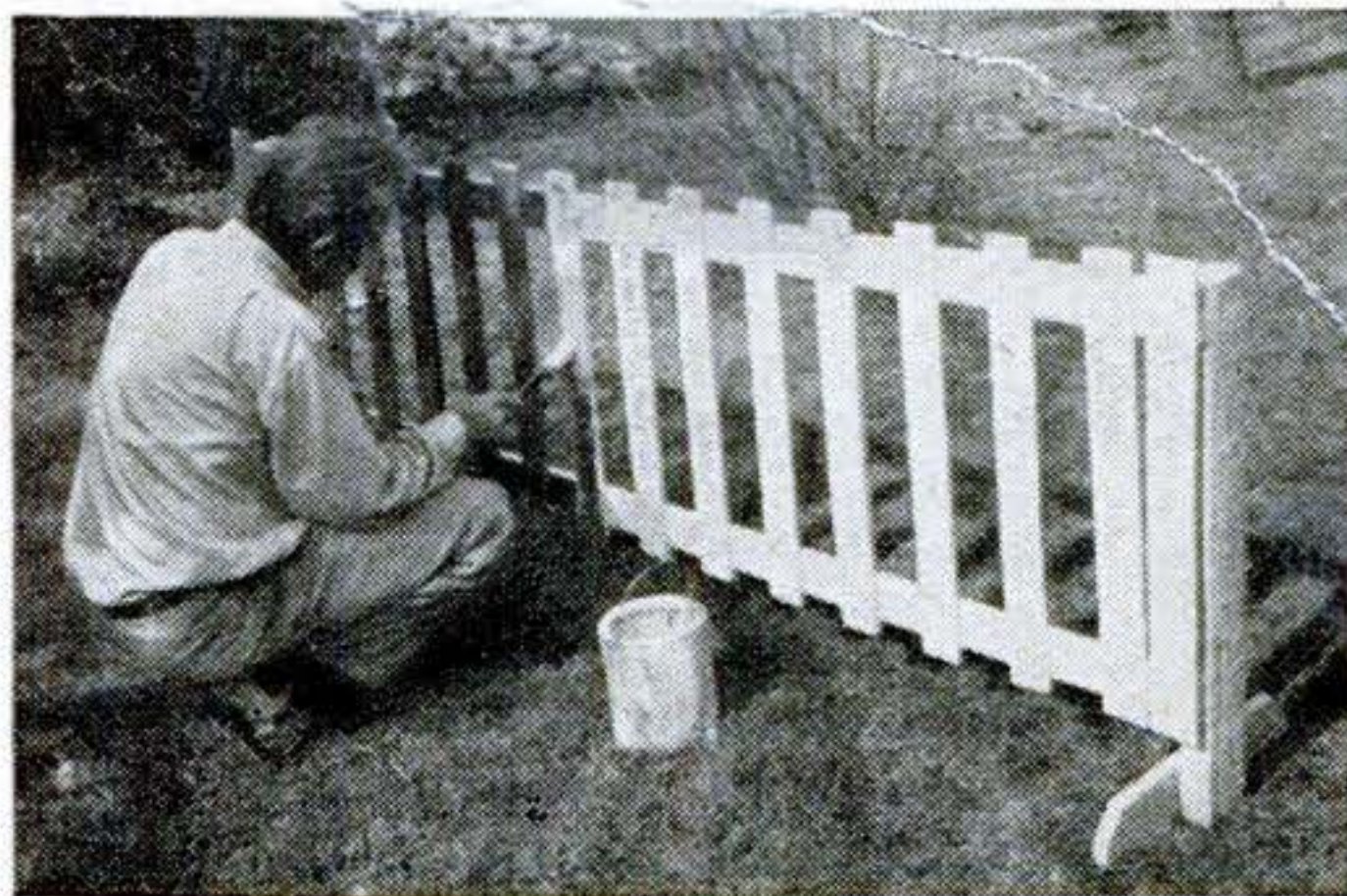

As the baby grows, the sections can be rearranged or others added to provide more room for activity.

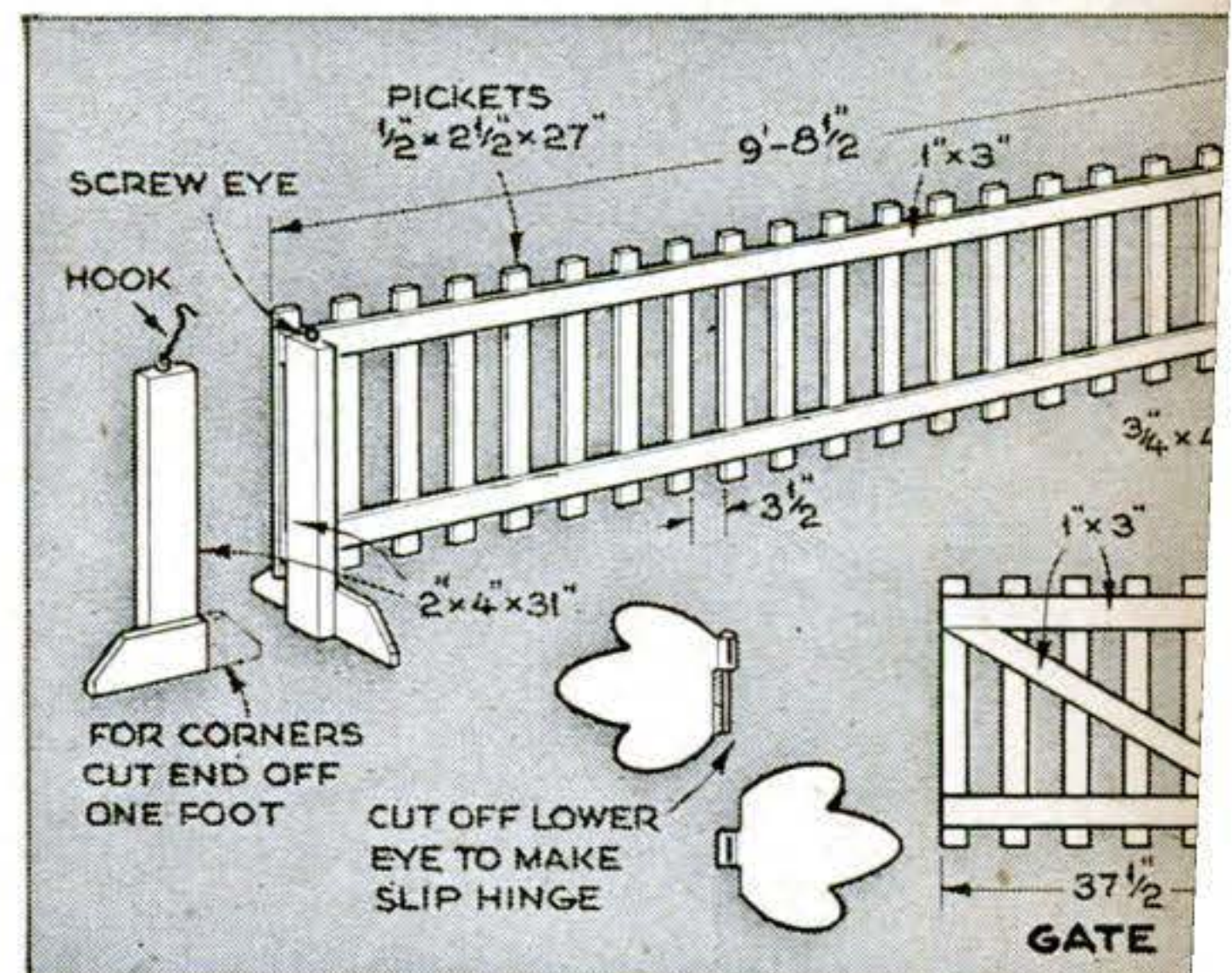

Fence sections are all built alike and are joined with a hook and eye at each corner. The feet are crosspieces. If a perfect square is desired, one section may be shortened the width of the gate.

White paint is usually acceptable for fences, but children enjoy bright colors. Sand smooth before painting to avoid the danger of splinters.

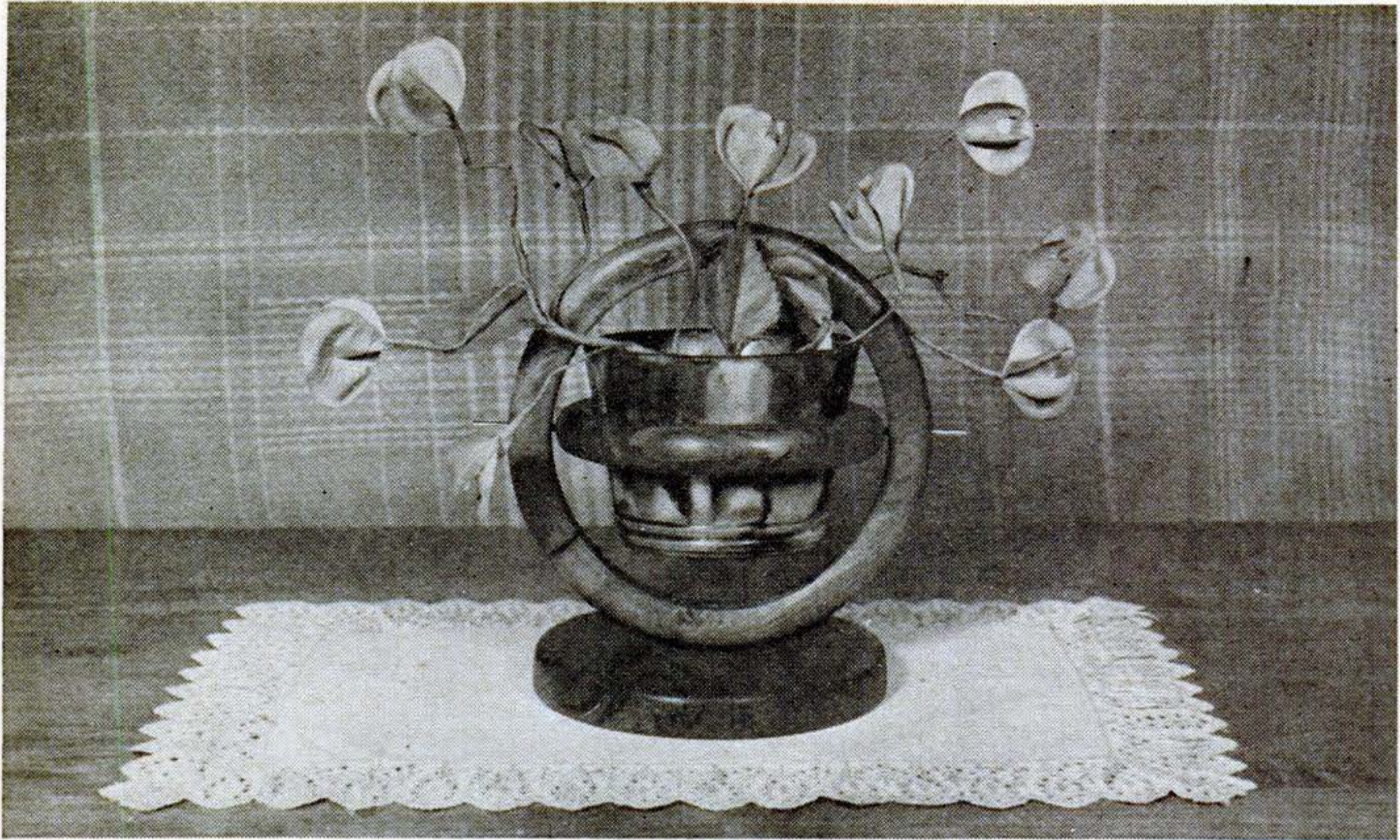

Circle Within Circle Is Stand for Flowerpot

Two wooden rings and a disk, turned in the lathe or cut with a coping saw, form the parts for a stand that frames a flowerpot while also serving as its support.

In the stand shown, the disk base is 6", the ring for the standard 7" o.d. and 5½" i.d., and the pot holder 5¾" o.d., the inside fitting the taper of the flowerpot. The rings are turned with a square edge inside and a ⅜" radius on the outside, a form that permits turning and finishing before cutting off. Likewise, the top arris of the base is turned to a ⅜" radius. If the work is done by hand,

a rasp and sandpaper will finish the edges quite neatly. Be sure to measure the outside diameter of the flowerpot just below the lip, and change the dimensions, if necessary, to suit.

Allow 1/16" clearance between the rings so the inner one can be swiveled for removing the flowerpot. Drill for copper or brass pivot rods, with temporary wedges between the rings to maintain the 1/16" spacing. Flatten the bottom of the outer circle and screw the base to it. Finish with oil stain and wax.—R. J. DE CRISTOFORO.

Pie Tins Used As Wall Plaques Display Decals

PAINTED pie tins decorated with interesting decals make attractive wall plaques. As craftwork projects, they're just the thing for children who want to work alongside Dad on something of their own. The plaques shown here were ordinary tins from a dime store.

Drill a hanging hole near each rim if the tins don't already have them; then paint inside and out to avoid rust even though the inside will be against the wall. White or a pastel shade is best on the bottoms to serve as a background for the decals. Borders may be a contrasting color to harmonize with both the decals and the room. Take care to apply the decals so they will hang straight.—WILLIAM E. DANNEMAN.

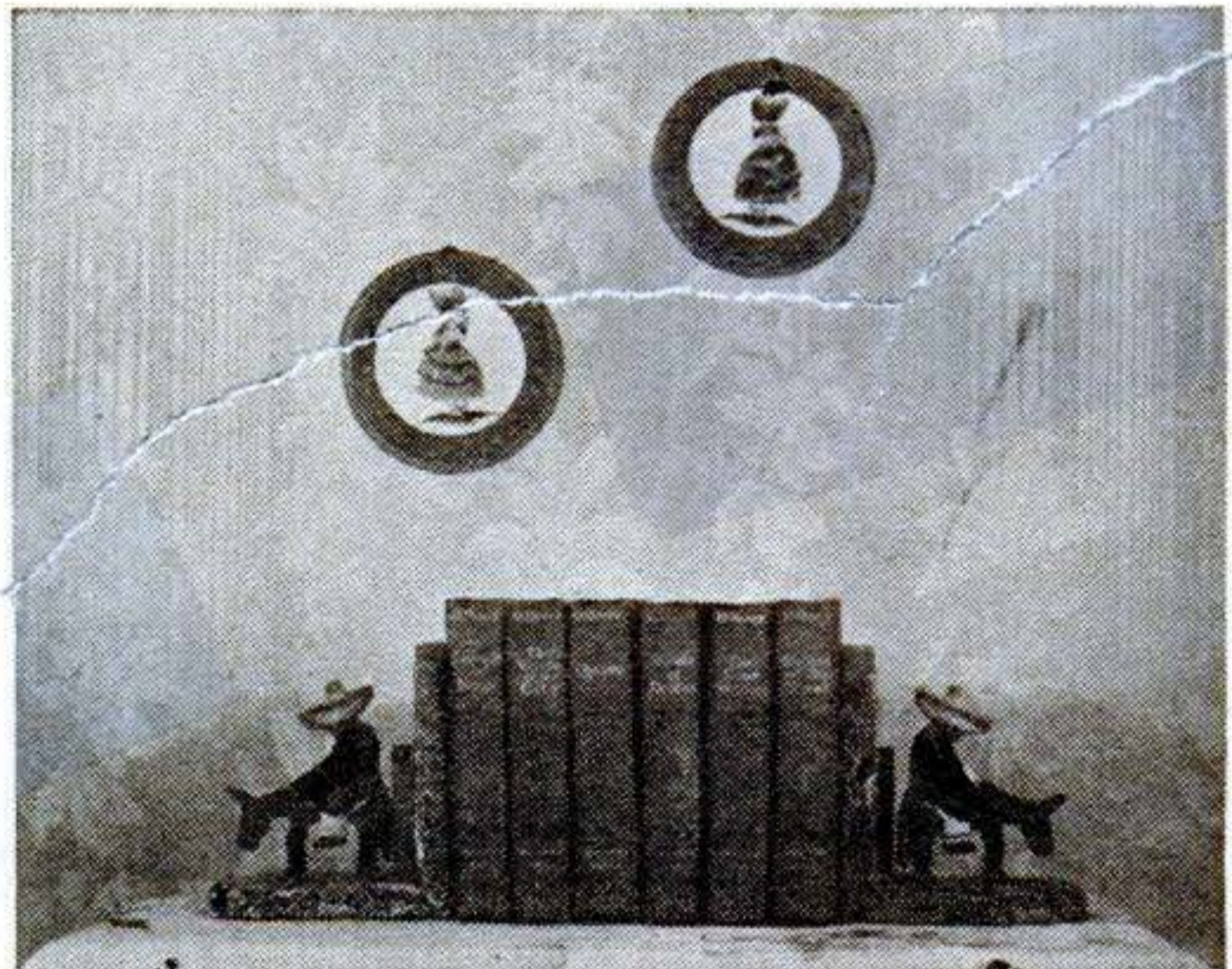

Clever wall decorations at a cost of a few cents. These plaques are common pie tins well disguised with a coat of paint and a pair of decals.

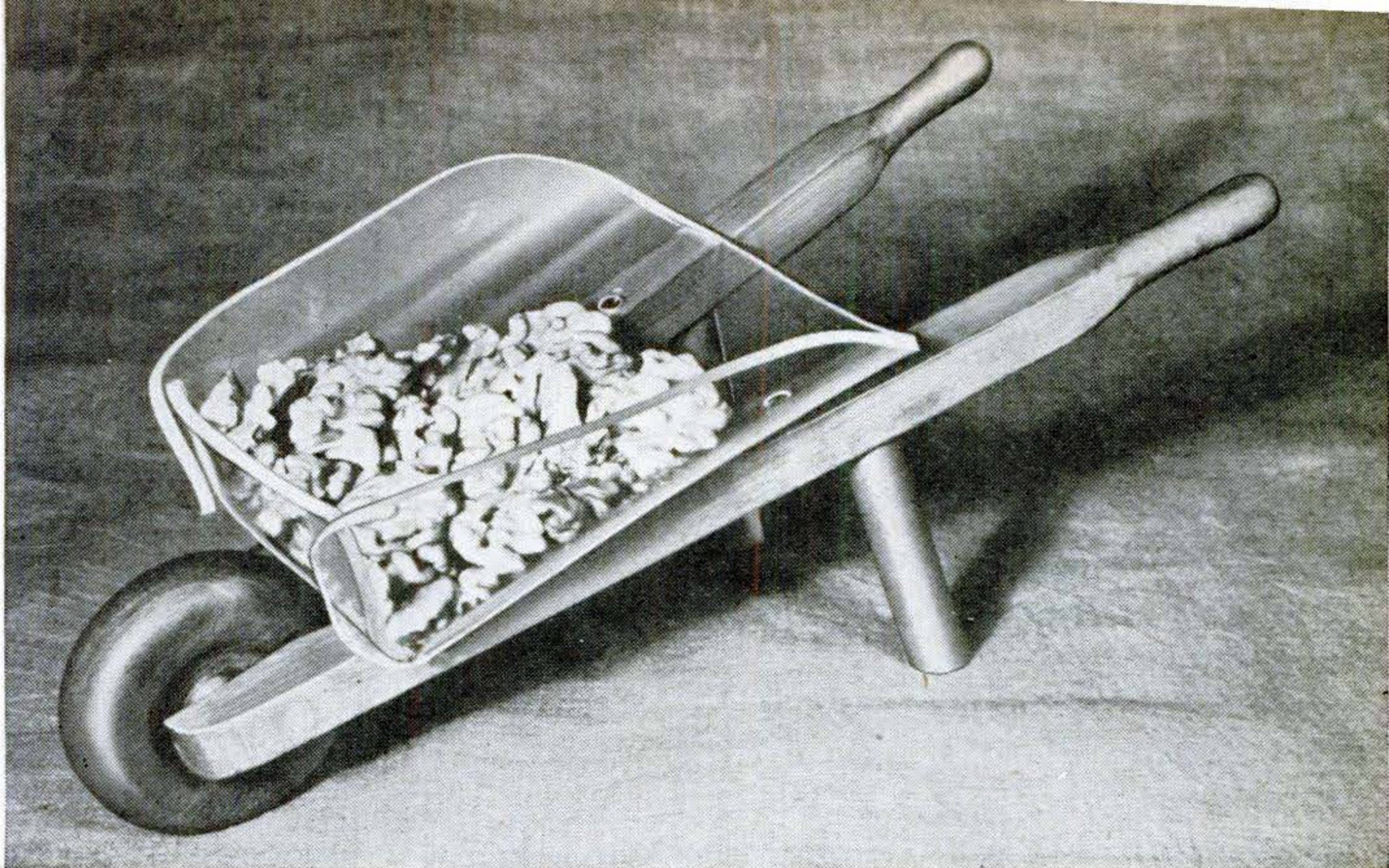

Snacks, candy, or salted nuts are offered attractively in a plastic dish mounted on a midget wheelbarrow.

Wheelbarrow Serves Tidbits

SHAPED from a sawed blank of thin plastic, this crystal-clear wheelbarrow body attractively serves bonbons or nut meats. The project can be a one-evening job.

Heat the plastic blank to 250 deg. in an ordinary oven, and bend up first the front, then the sides, and finally the rounded flaps around the front end. Hold for a few moments until the plastic retains its shape.

Hold the shaped body on the barrow frame and with a scribe spot the mounting holes on the plastic to overlie the shafts. Drill and countersink the plastic for tiny brass or nickeled screws.—ELMA WALTNER.

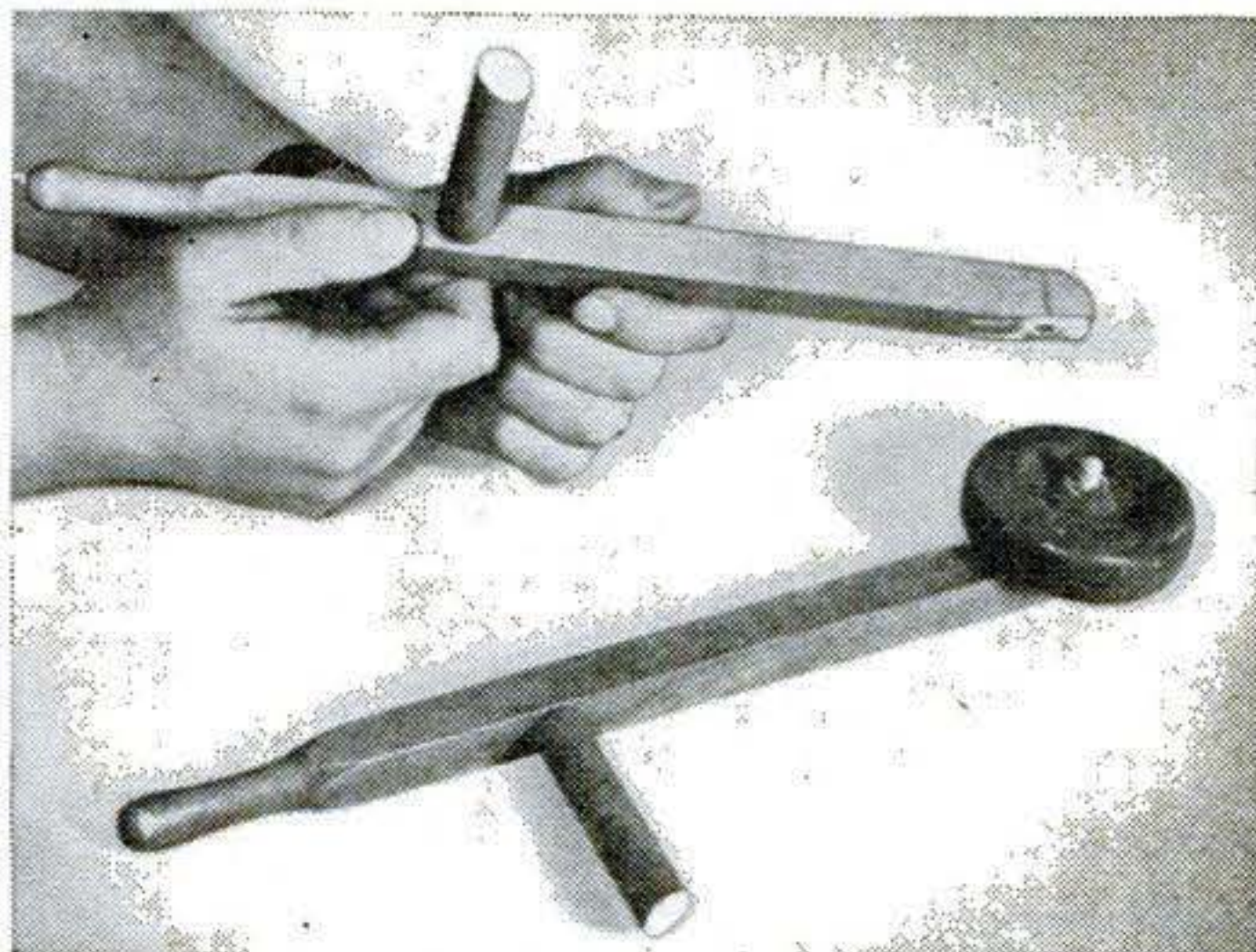

Dowel legs are glued into shafts having turned or carved handles. The axle is also a short dowel.

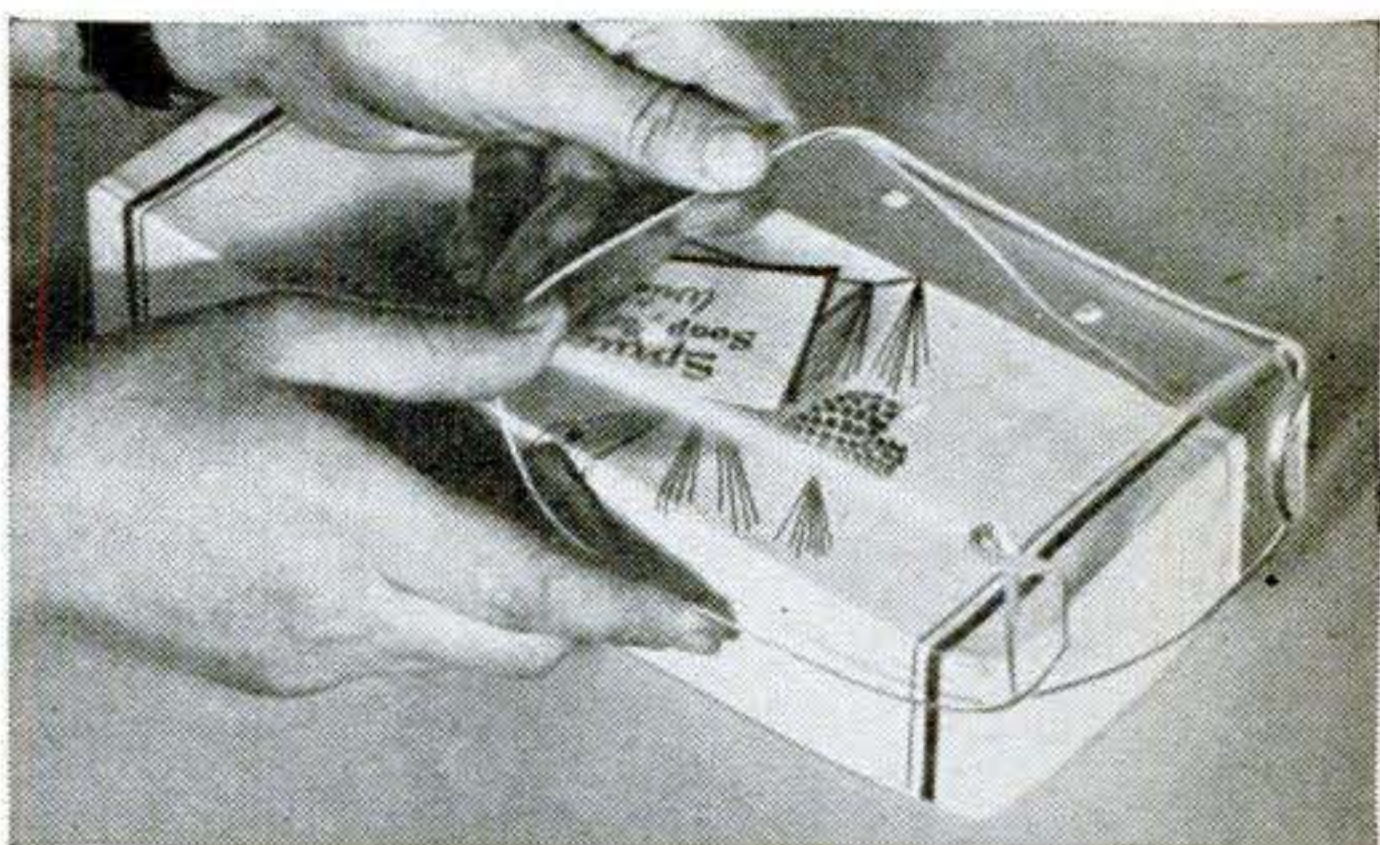

Bend the body from heated plastic over a stiff cardboard box or on a block with rounded corners.

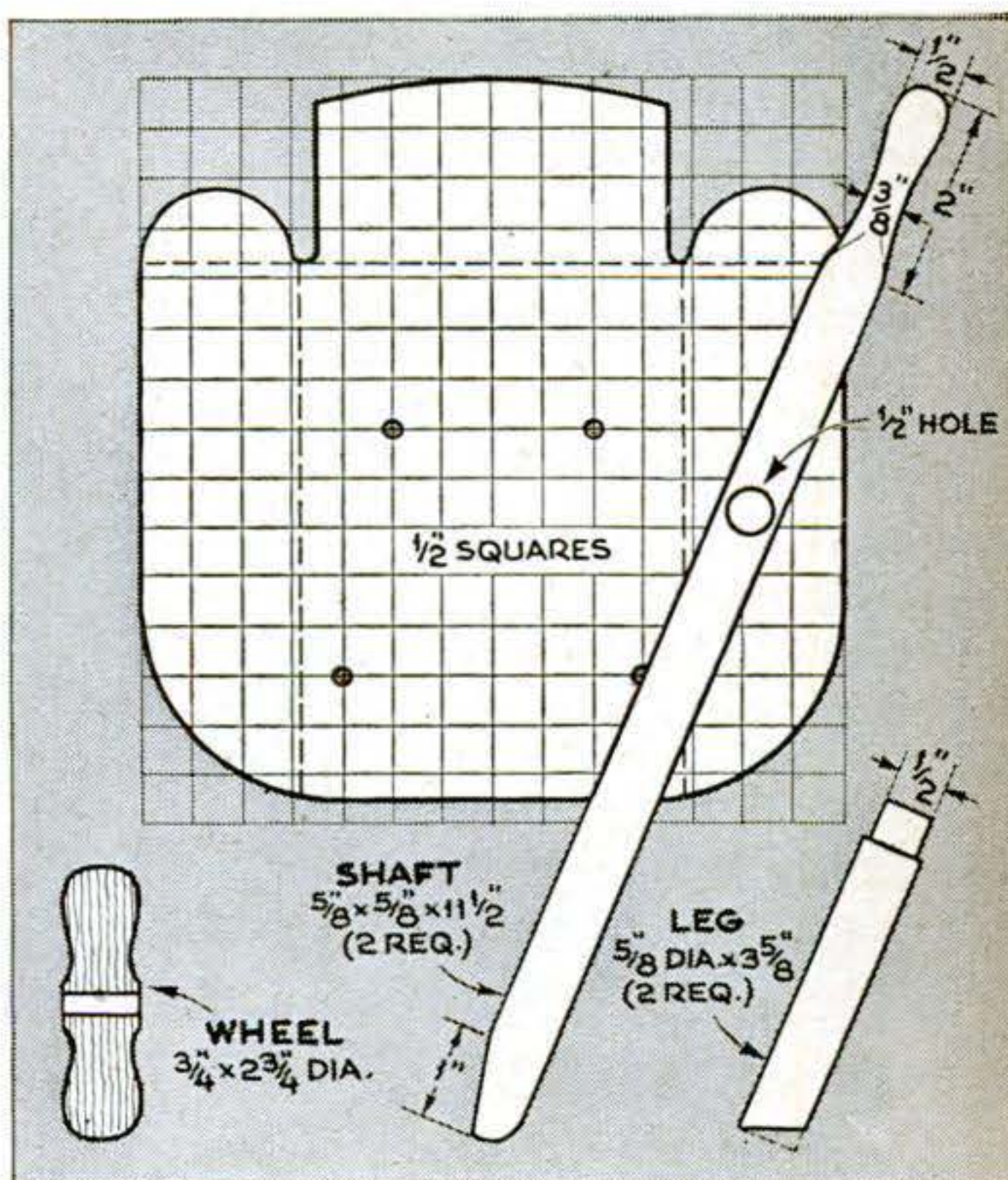

It's Copper for Candlelight

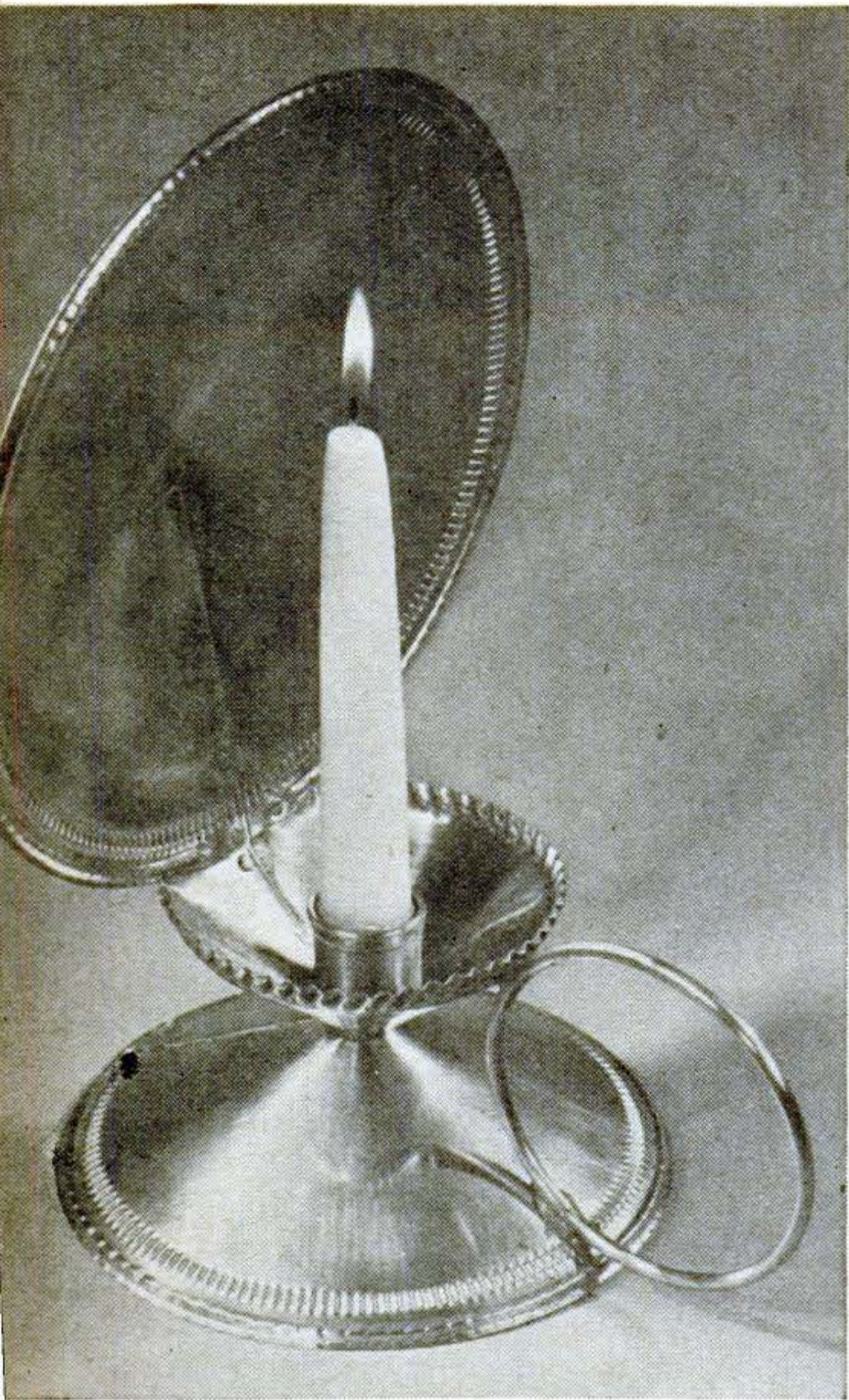

Gleaming candlelight is reflected in the burnished finish of this copper holder designed and executed for PSM by Morton Bartlett and James Harris.

FEW metals are as easy to work as copper sheet and still so suitable for display pieces in the home. It is ideal for candlesticks. The two shown here and in full color on page 136 consist of cones, crimped and otherwise decorated on the edges and soldered together. They have a subdued richness that catches the soft glow of candlelight and reflects it with reddish overtones.

Soft 16-oz. (24-gauge) copper was used for both projects. It is stiff enough to give good body to the cones, and yet it is sufficiently pliable to be worked without resorting to bending jigs. The metal transmits heat rapidly, so a fairly heavy iron or a small torch must be used, especially on the longer joints. It is wise also to clamp the parts with a rivet or two where convenient before running in solder.

Decorations are put on while the cone-shaped pieces are still flat. Though the markings can be applied with regulation chasing tools and the like if they are at hand, simple homemade tools were used for the two pieces shown. A set of gears mounted on a sturdy steel block will be found excellent for crimping, a pair of pliers filed or ground for a bead on one face and a mating slot on the other is a first-rate chasing tool. Such ornamentation as the scalloped cup of the candlestick on the facing page is done by filing notches, further indenting with a dull chisel, and finally peening.

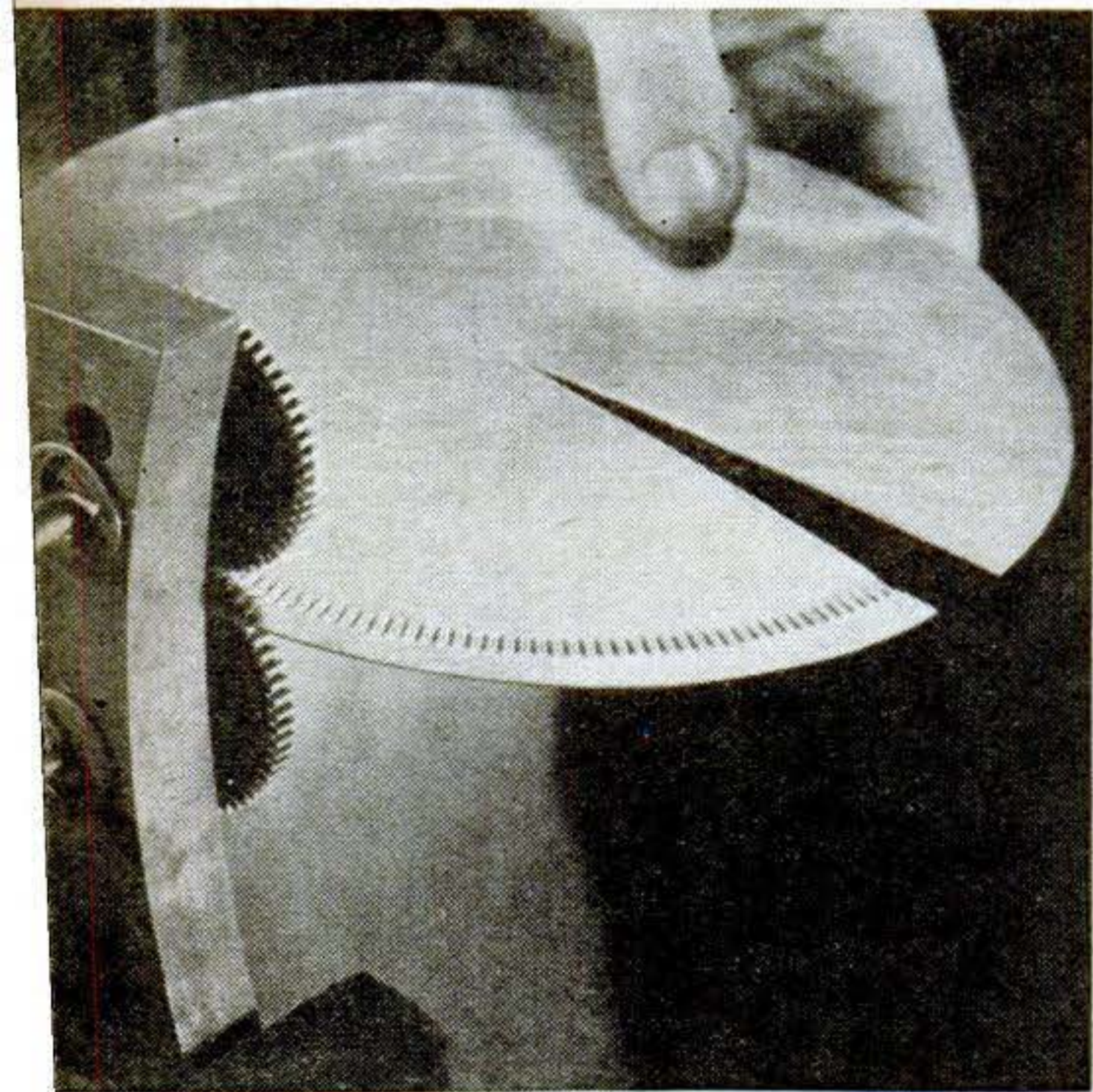

Decorative edging is put on with a crimper made of two gears on a steel bar. Complete directions for assembling such a tool are on page 170.

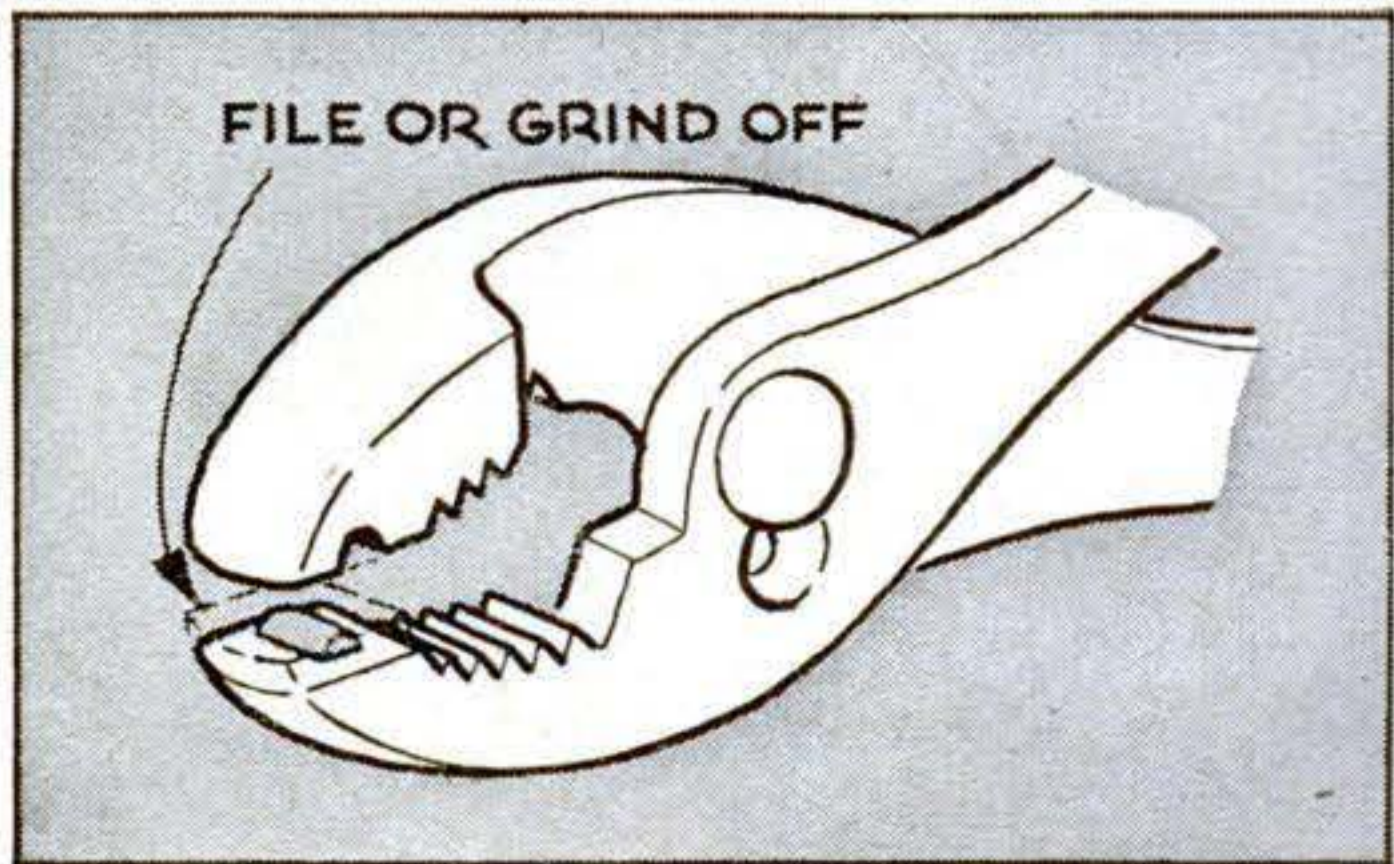

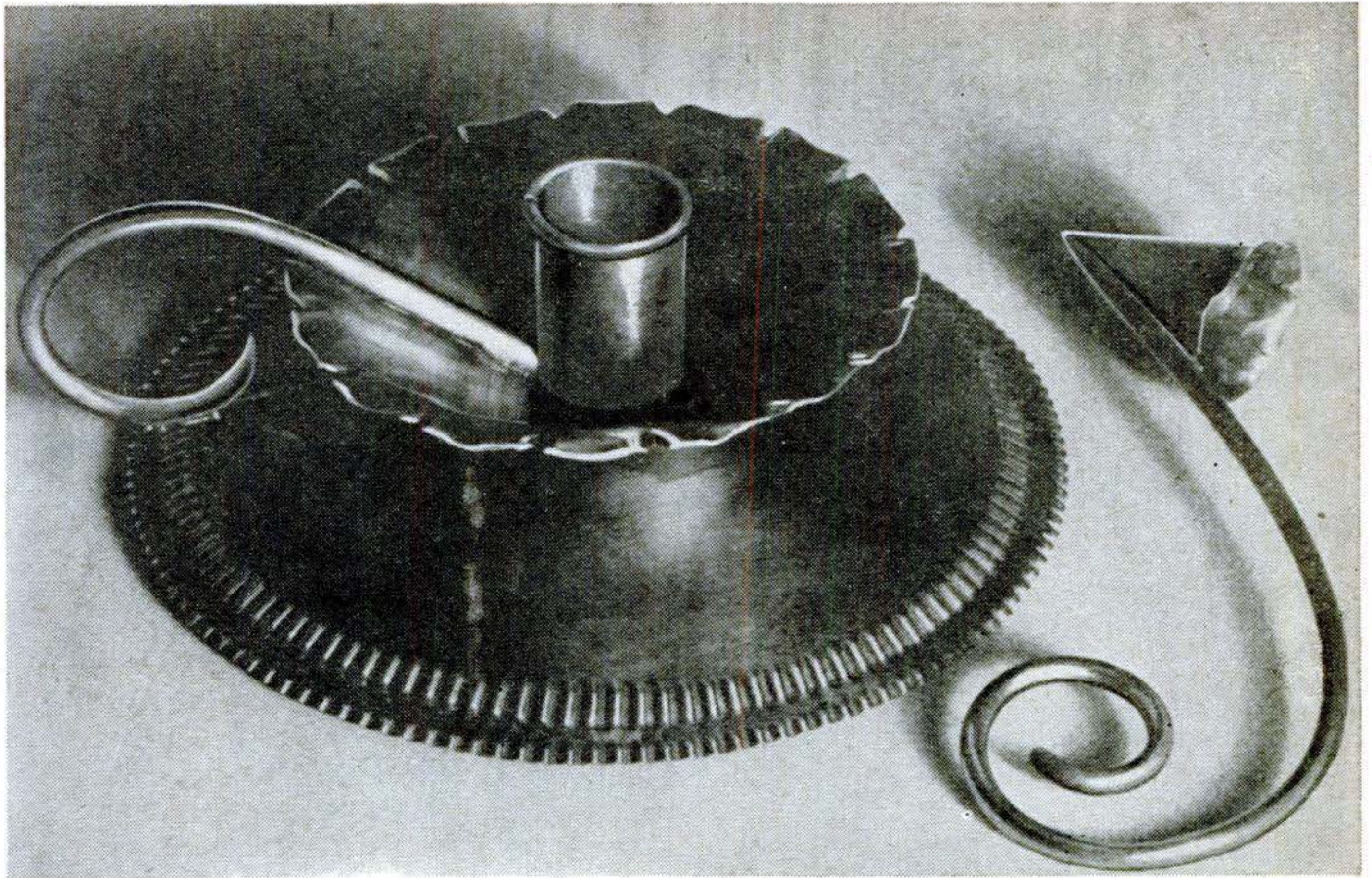

Copper lends itself to antiquing as well as a bright finish. How to antique it is explained on page 171.

The drawing below gives dimensions for this holder. Lay out the radiuses for the cut sectors and indicate the overlapping tabs. Cut the sector and inside circle out of the base, after which the decorative edges can be worked and the piece rolled and soldered into a cone. Solder the cup into the base cone with the seams aligned. Next, bend the handle from $\frac{3}{16}$ " copper rod or tubing. The scroll end is hammered flat and filed smooth; the other is cut to a bevel against the socket.

Cut a piece of copper for the candle socket, and bend one edge back on itself. Then, with the fingers, shape the strip around a $\frac{7}{8}$ " rod, pipe, or dowel. The bent

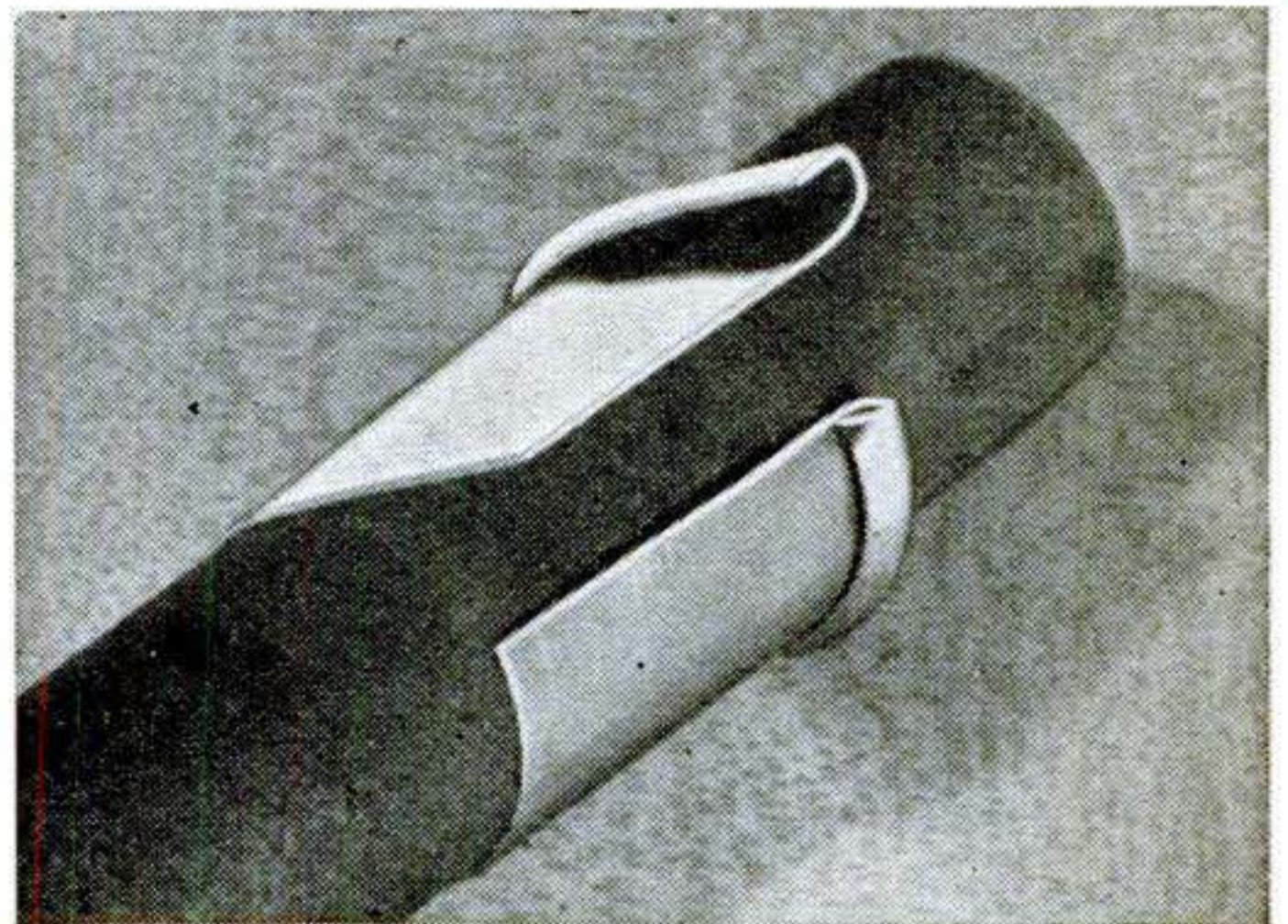

Candle sockets are easily bent around a length of rod of candle diameter. The folded edge closes to form a neat roll during the process.

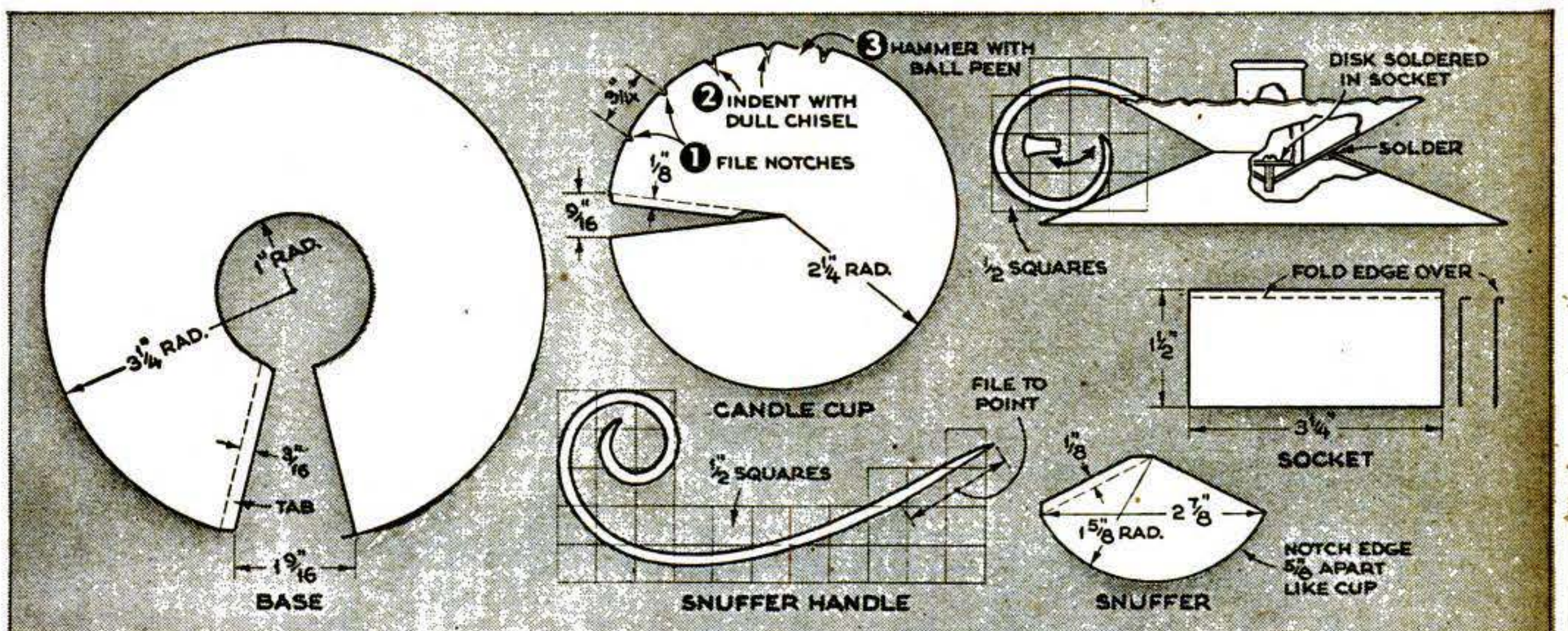

edge will close further, forming a neat roll, and only the ends may have to be helped with round-nose pliers. Cut the ends to size and solder them; then solder in a washer or disk drilled for a machine bolt. Center the socket in the cup and drill through with an undersized drill for the machine bolt, which will cut its own threads in the soldered copper joint.

Mark around the socket, remove it, and solder the handle on just behind the socket line and along the cup seam, which it will conceal. A touch of solder secures it to the base. Polish or antique the parts, and assemble the socket with the bolt.

The snuffer involves no extra problems, but the scroll handle should be of 1/8"

stock. It, too, is soldered to the cap along the seam and filed to a tapered end.

Except for dimensions, the candlestick on page 168 is made up just as the other. The base is from a disk having a 3 1/4" radius with a 2" sector, measured on a chord, cut out. Its center hole is only 1/2" in diameter. For the candle cup, use a 2 3/8" disk with a 2 1/4" sector cut out. Crimp and turn the edge up with the pliers shown. The reflector is a disk of 4" radius with an 11/16" sector.

A ring handle can be cut easily from 1/8" copper rod or wire wound on a 2 1/2" diameter wood form. If several are to be made, wind the required number of turns, let the wire open up into a natural spring, and saw across the turns. Solder to the base at the joint.

You can make a crimper from two steel gears, not necessarily of the same size but of the same pitch (3/32" to 5/32") and preferably case-hardened. The body may be bar steel or an old railroad spike. One gear is pinned to a shaft that is a free-turning fit in a hole in the body. It carries the handle. The other is left free to turn on a stud, which may be a push fit in the body. If the gear shaft on this stud is turned off center, some adjustment will be provided for work of various thicknesses. The stud will then be held in the body by a removable pin. Two slotted guides vary the distance of the crimp from the edge.

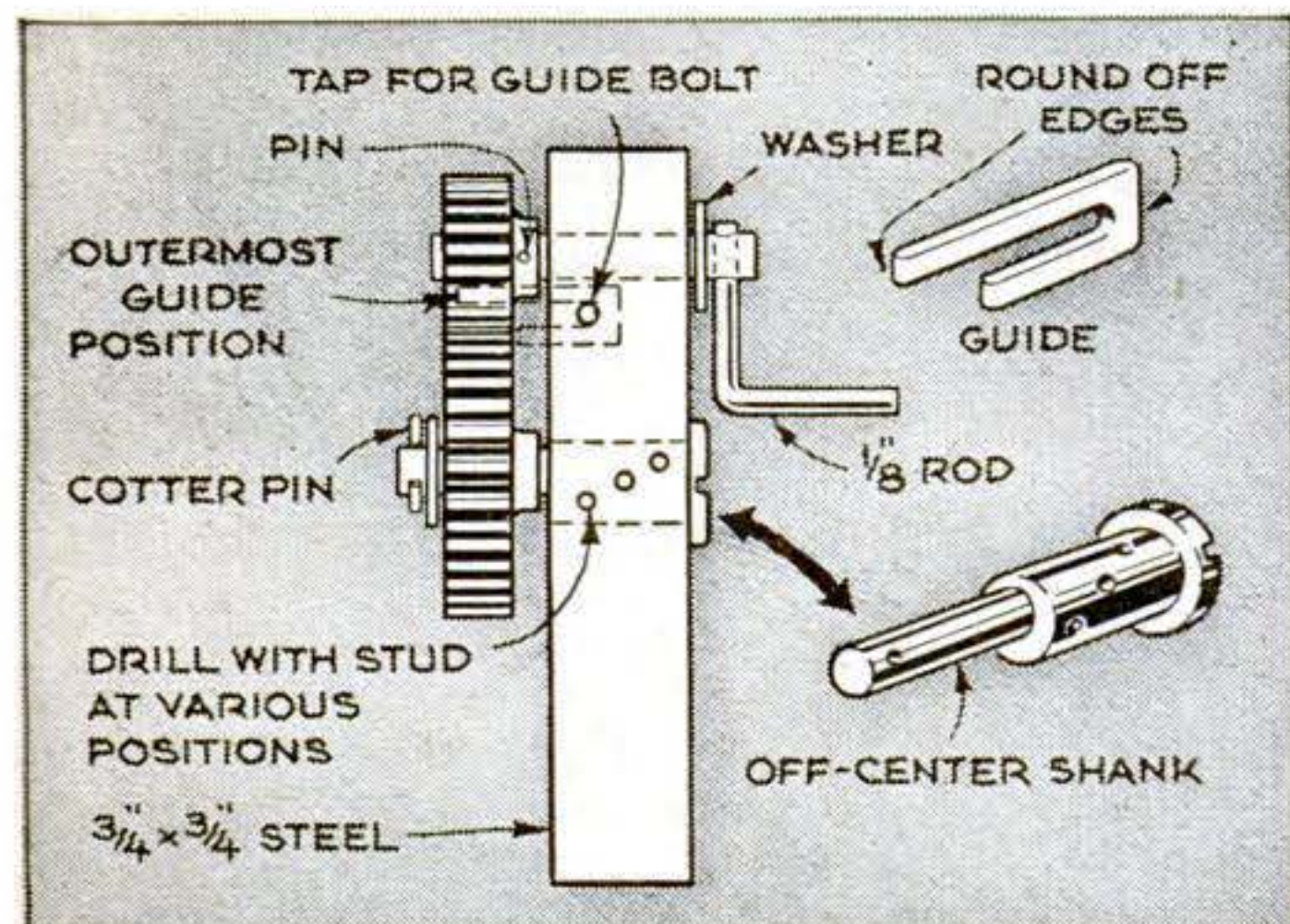

This is one way a homemade tool can be built for applying neat, uniformly spaced edge crimping.

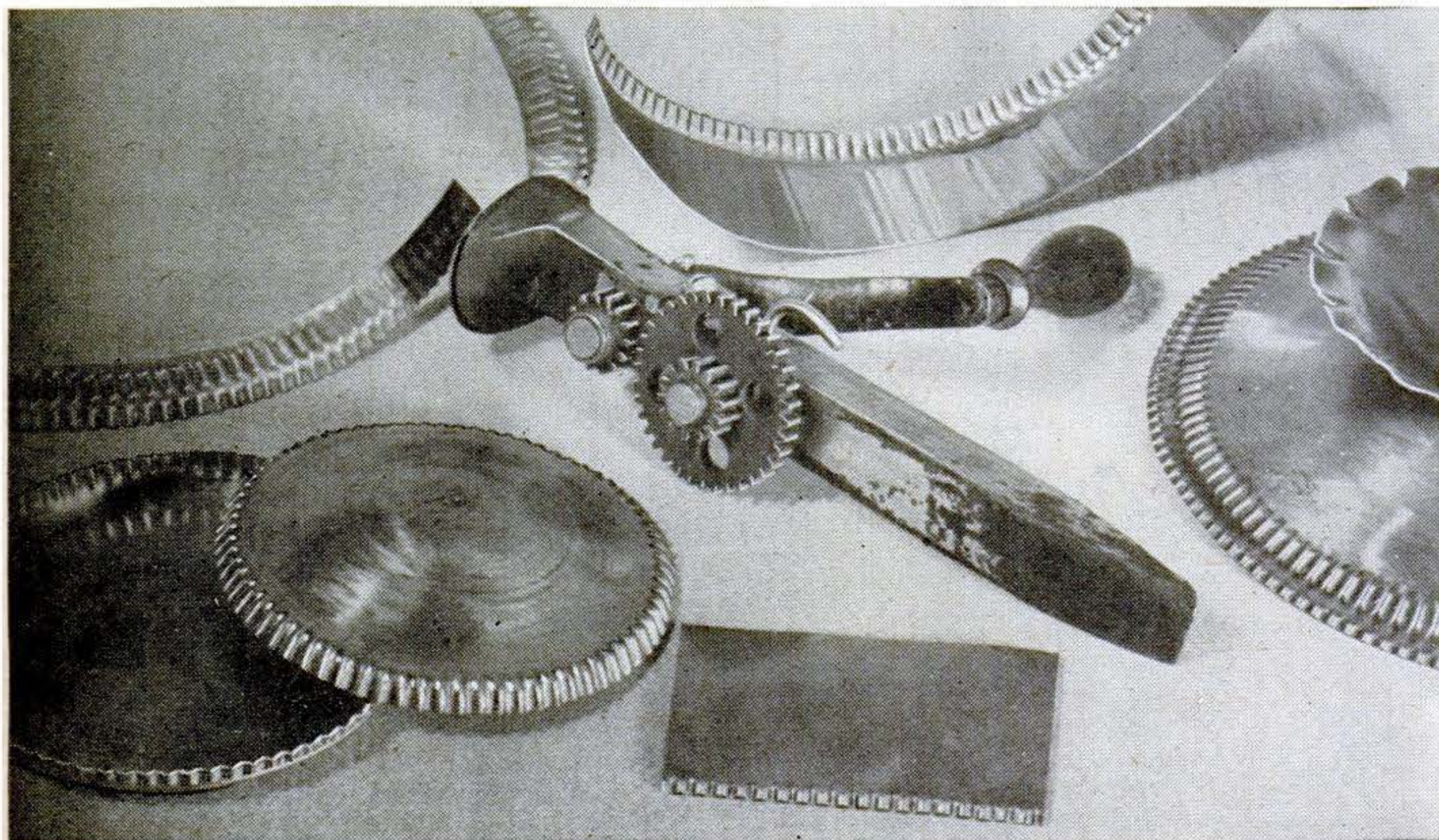

A crimper mounted on a railroad spike and some edges it makes. The handle is from a pencil sharpener.

Ball Toy Teaches Colors to Child

WITH this educational toy, a young child will have a lot of fun and also quickly learn to identify the five colors—red, blue, yellow, green, and orange—represented by the keys and bouncing balls. A plastic shield confines the balls.

The base, two end pieces, and five keys are cut from hardwood. Suitable balls and a mallet for striking the keys may be turned or salvaged from another toy.

When the wooden parts have been cut, assembled, and stained or painted, draw a pencil line across the base block from the front face of the rabbet of one end support to the other. Then center the keys in the grooves and fasten with escutcheon nails

about $1/16$ " outside this line, making them loose so the keys work freely. Where the pencil line crosses the partition between the grooves, cut shallow channels and cement in the front edge of a $7\frac{1}{4}$ " by 11" sheet of $1/32$ " cellulose acetate. After putting in the balls, tack the plastic to the rabbet and back of the base.—JOHN P. ARNOLD.

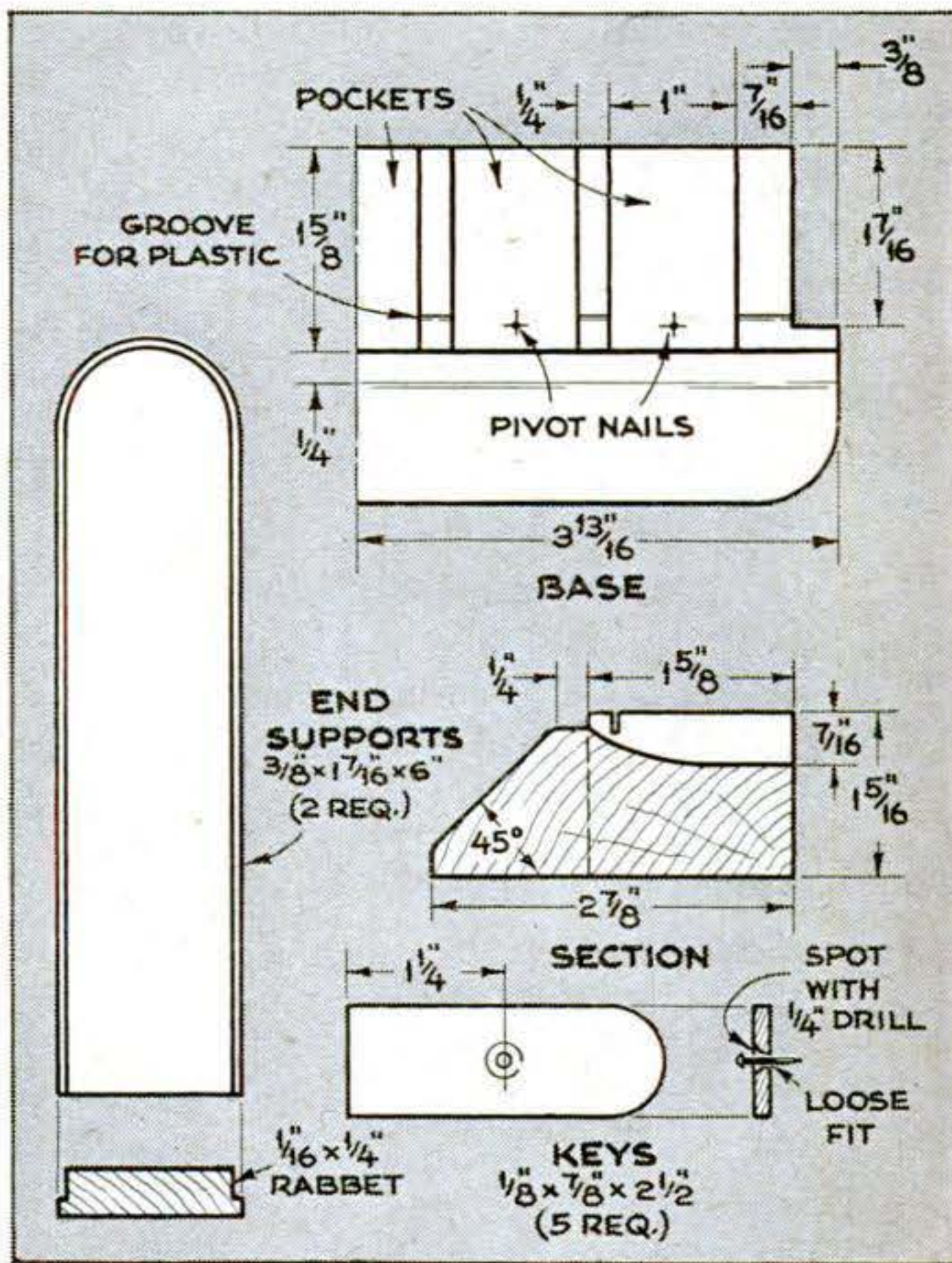
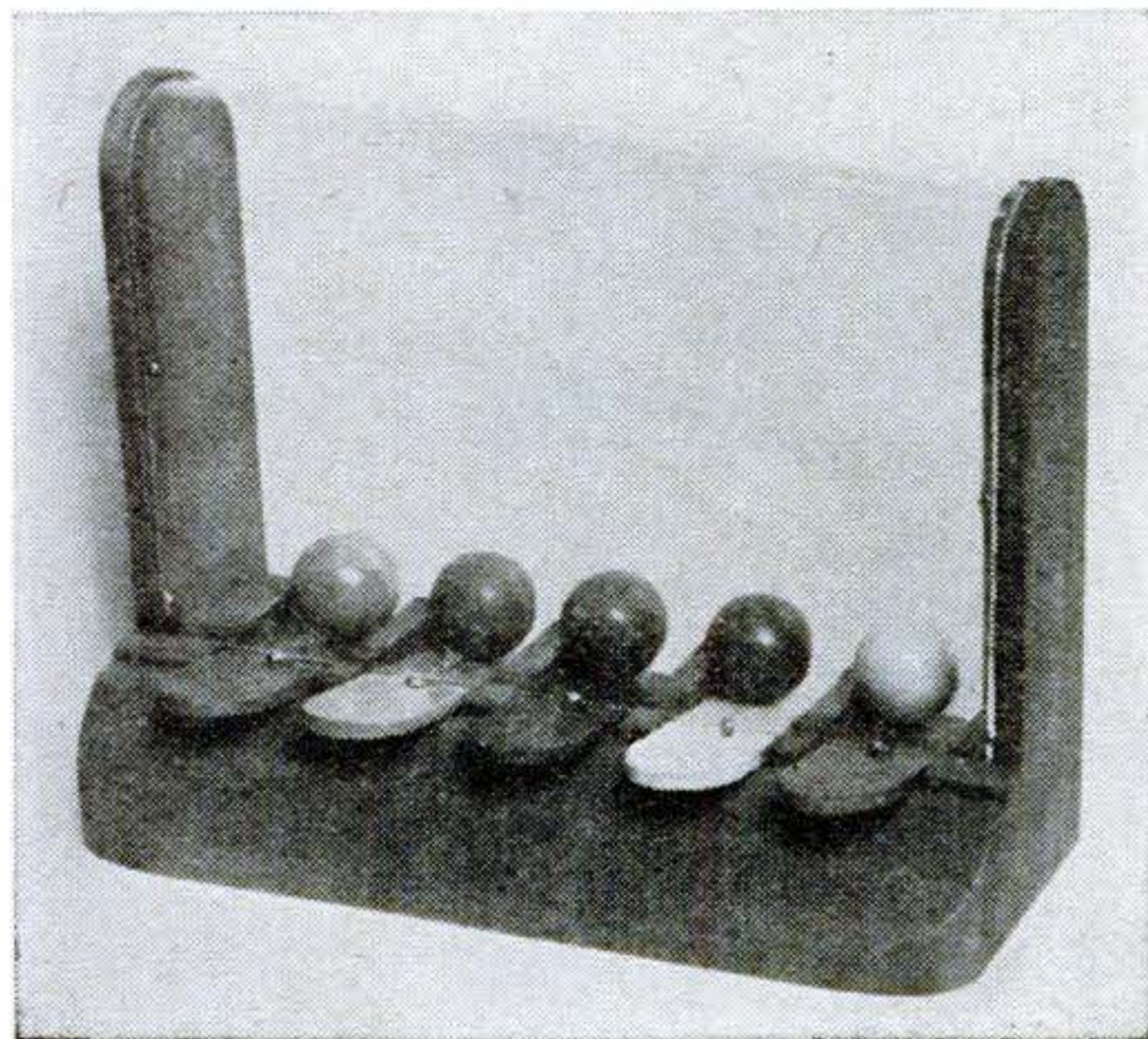

ANTIQUING COPPER

[SHOP METHODS]

When the natural color of copper or a highly polished finish is inappropriate, it is a simple matter to give it a more subdued "antique" or French finish. Such a finish ranges from coppery red with a brownish cast to a blue-black. Accents for purposes of texture or ornamentation are easily achieved by embossing or engraving some parts in low relief. Dark tones will remain in such portions while higher parts are highlighted to varying degrees.

Dissolve about 1 cu. in. of potassium sulphide (liver of sulphur) in a pint of water. Add six drops of ammonia. Clean the copper thoroughly or dip in an acid pickle to remove all dirt and grease, and rapidly swab on the solution. The metal will gradually darken to black. With a cloth or toothbrush, and clear water, rub off the outer black deposit immediately. If the metal is not then a deep brown-black, clean thoroughly and repeat the process. Wash well and dry off.

With very fine steel wool, rub to bring out the tone desired. The less rubbing, the deeper the tone. Excessive rubbing will restore the copper to its natural color. It is at this point that recessed parts can be left dark, while high parts are brightened to a lesser or greater degree. A smooth surface can be given an attractive mottled appearance by judicious use of the steel wool, some spots being left darker in tone than others.

The finish should be protected either with clear metal-finishing lacquer or by several coats of good-quality wax, each left to harden and then polished.

Aside from embossing, peening, crimping, and other worked effects that are set off by the treatment, considerable variation in the effect on a smooth surface is possible by polishing, scratch-brushing, sandpapering, or rubbing with coarse steel wool before treatment. The deeper the scratches left, the more dark tones will tend to remain, and the more "grain" and deeper the tone the finish will have.

For the same reason, work should be free from undesirable scratches, scoring, gouge marks, and the like, as all these will be emphasized by antiquing. The exception, of course, is work that is to simulate the battered appearance of use and age.

POPULAR SCIENCE MONTHLY SHOP DATA

Hinged Model-Train Table Folds Up



By H. A. Machlan

WHERE lack of room will not permit the permanent installation of a model-railway layout, this table will fill the bill. The tracks can be attached to it permanently, and yet it can be folded compactly and stored out of the way when not in use.

Dimensions of the table top will depend upon the track layout. The best way to decide is to make the layout on the floor and measure its length and width. Then cut two panels of $\frac{1}{2}$ " plywood which together will be 3" larger all around than the layout.

Nail a $\frac{3}{4}$ " by $2\frac{1}{2}$ " rim on three sides of each half, and join the two with hinges on top of the rim. Make up three pairs of $\frac{3}{4}$ "

by 2" legs, joining each pair with a $1\frac{1}{2}$ " by 3" lapped crosspiece, and hinge them to the table. The center pair should be narrow enough to fold inside one end pair. They are hinged $\frac{3}{4}$ " from the table joint so the $1\frac{1}{2}$ " crosspiece will cover the joint and act as a support there.

One way to finish the table is with a heavy coat of grass-green paint on the layout surface. Sprinkle lightly with dyed sawdust for a close approximation of grass. Slate-gray asphalt roofing shingles are then cut into strips and attached with roofing cement as a roadbed. Lay the tracks so a joint will come exactly at the table joint, remove the pins at this joint, and solder jumper wires across, making them long enough to allow the table to be folded.

Some controls can be mounted permanently on the table since a 5" headroom is provided by the rims when it is folded. The transformer, since it is heavy, is best used on a separate small table or stool and stored separately. It can be connected to the rails by means of a pair of Fahnestock clips permanently mounted on the table.

As the railroad trackage grows, additional tables can be set up and joined at the rims with bolts and wing nuts. Have track joints come at the table edge. A method of cutting the table joint for a diagonal crossing is shown in a drawing. Soldered jumper wires are also used there.

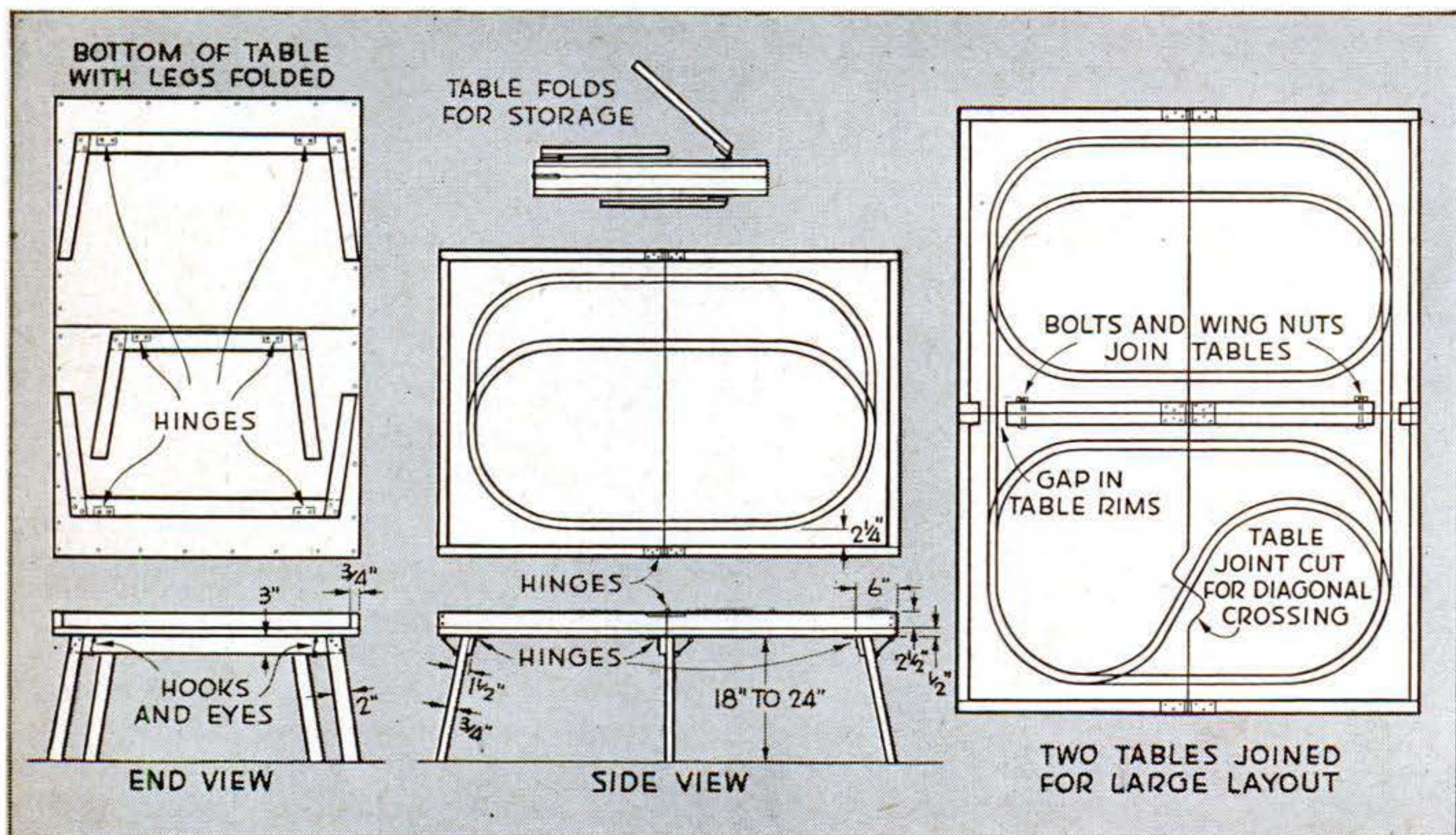

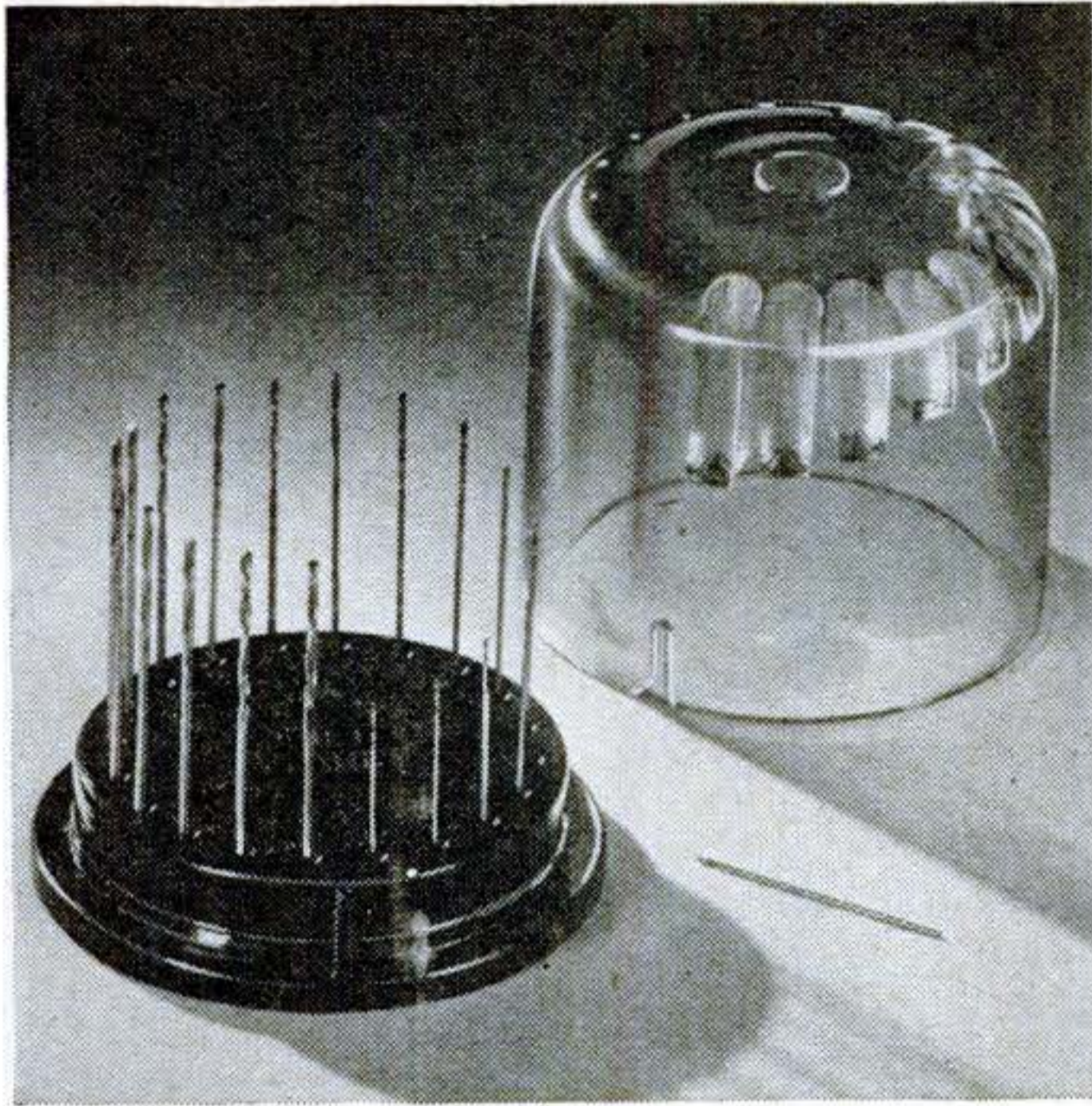

Safeguards Drill Set. Fine drills from No. 61 to 80 are protected and kept in order by this plastic stand and case. Each hole in the stand is just large enough to accept a drill of a given size, that of each hole being marked on the face of the stand. The product is manufactured by V. F. Rogers, of Denver, Colo.

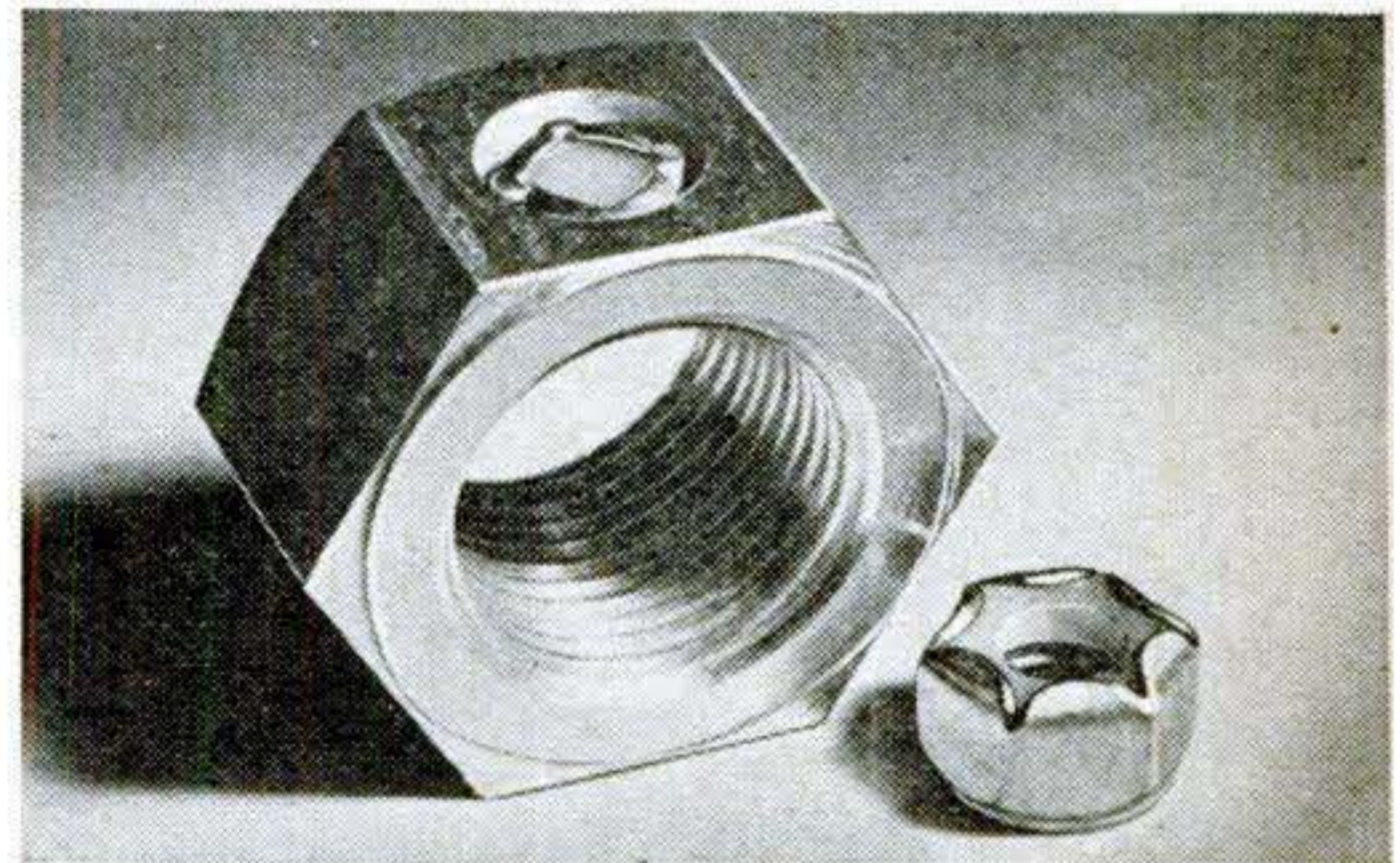
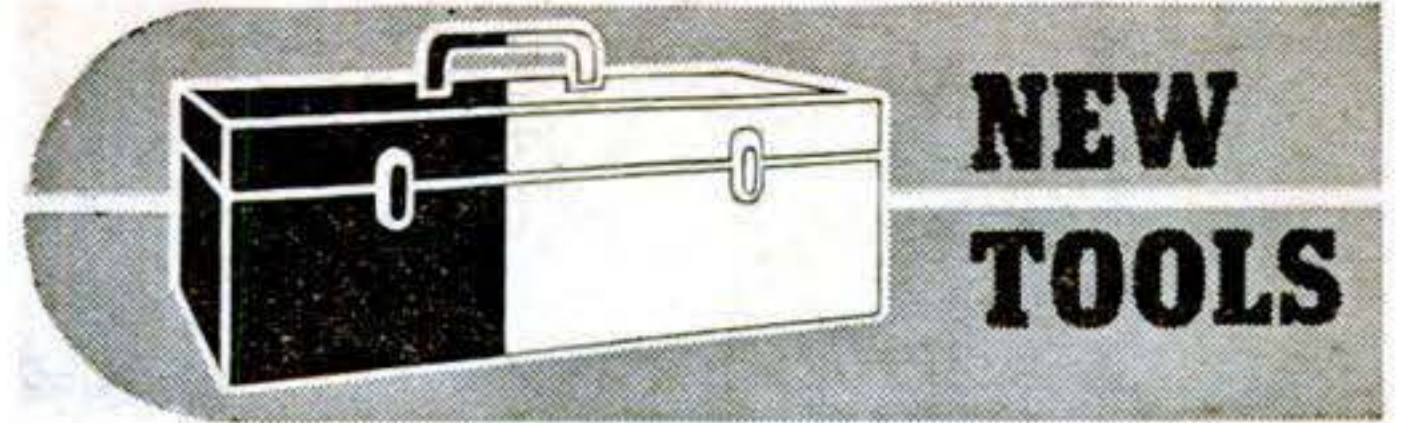

Lock Nuts Use Nylon. In lock nuts made by the Nylok Corporation, New York, nylon inserts serve as the locking medium. In the larger, thrust exerted by a nylon plug in a hole on one side gives a wedging action. In the smaller, metal is crimped over a hexagonal nylon washer. Another company makes a wing nut with a nylon locking collar.

Stand Protects Iron. A soldering-iron stand made by the Beyer Manufacturing Company, Omaha, Neb., serves two purposes. It provides a handy place to put down a hot iron, and the aluminum radiation fins draw off excess heat while the iron is at rest, preventing oxidation and burning of the tip and prolonging the life of the heating element. The stand is priced at \$3.75.

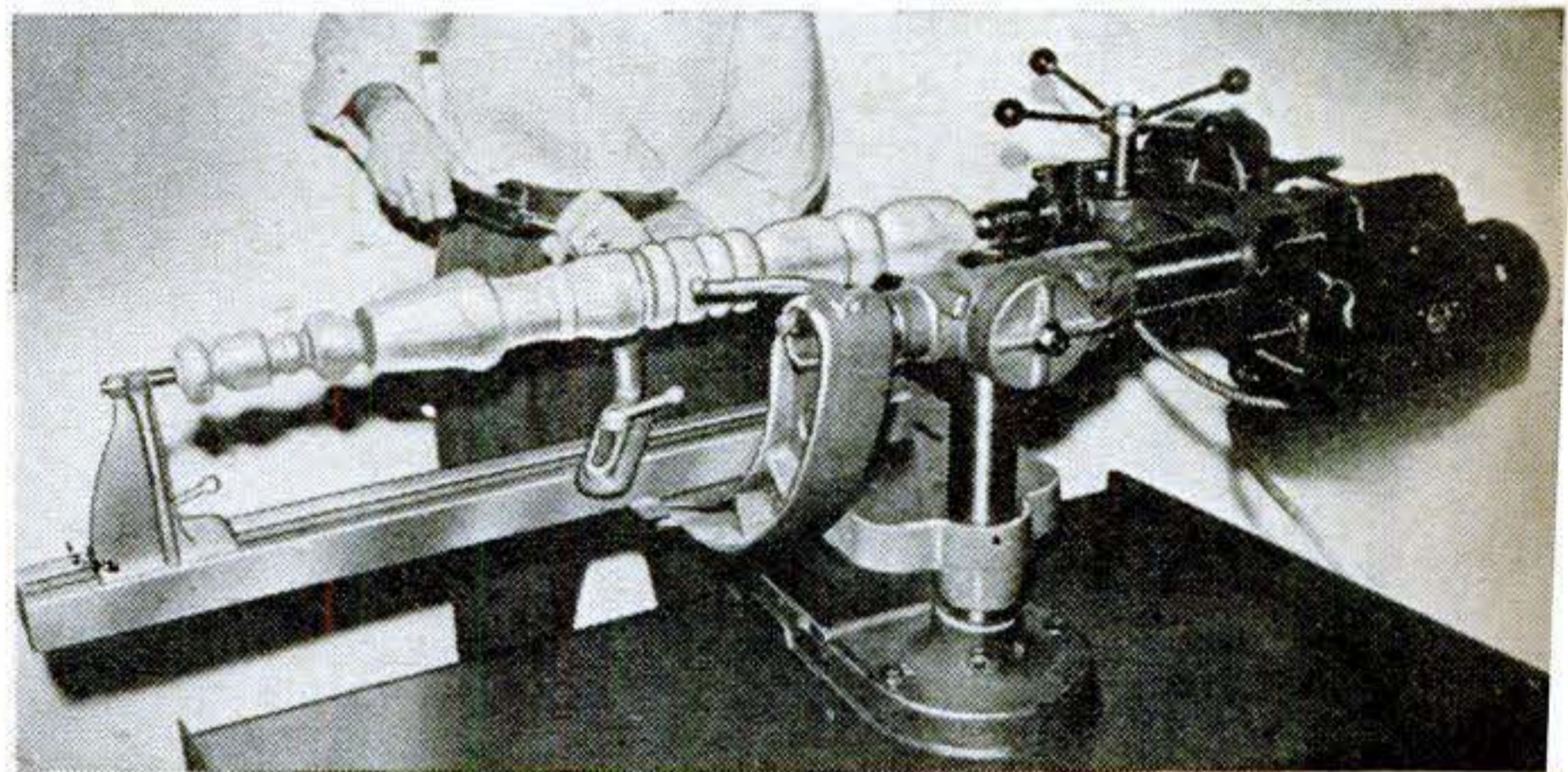
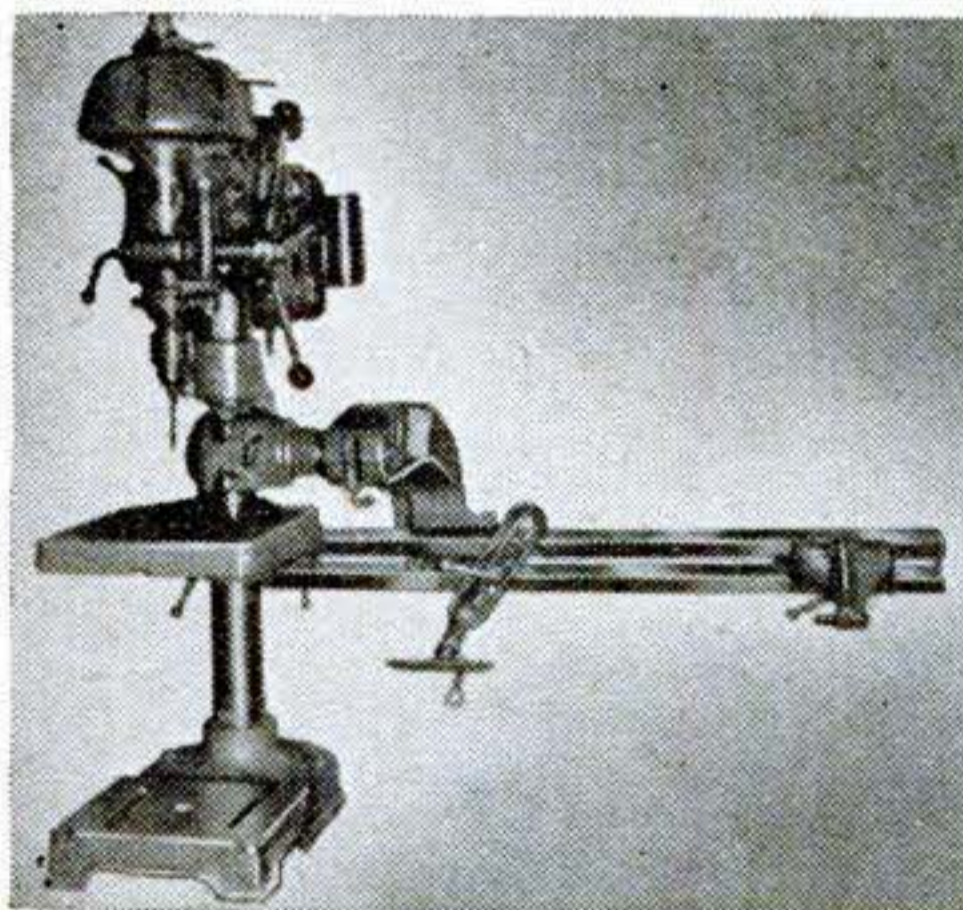
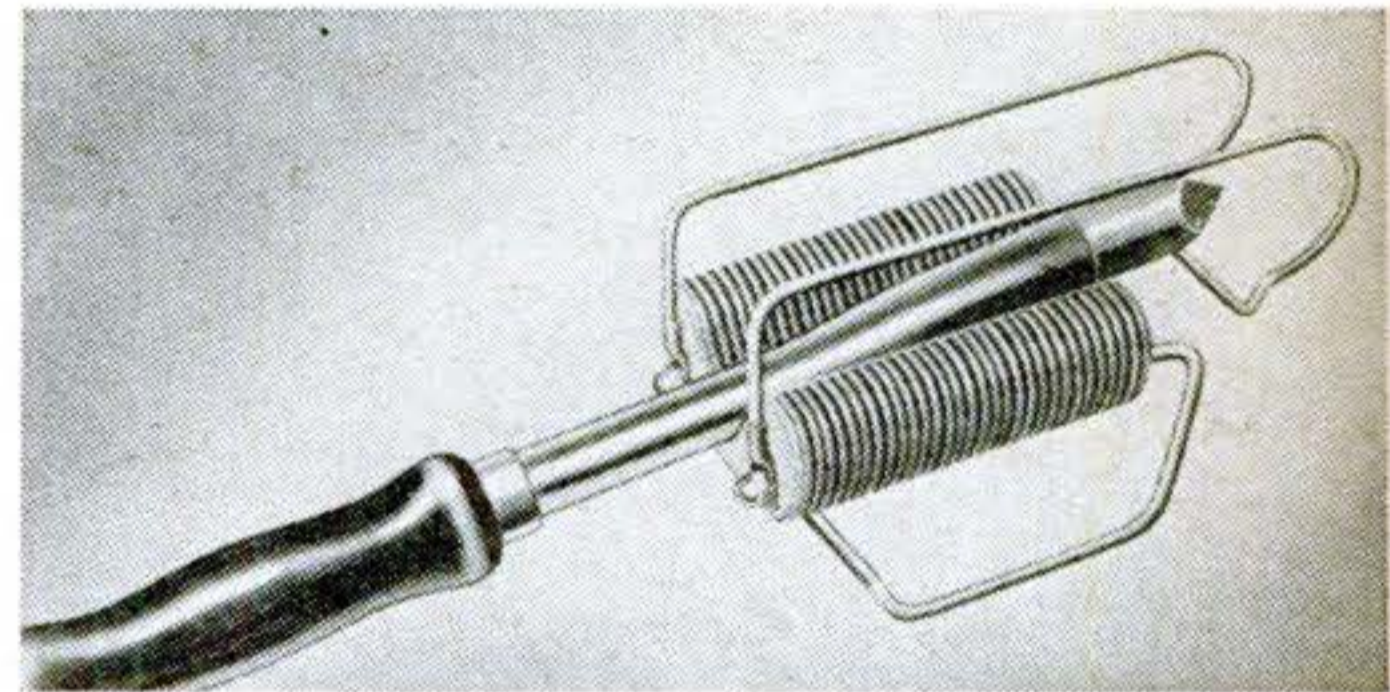

Drill Press Used as Lathe. With an attachment made by the Nobur Mfg. Co., of Los Angeles, a drill press having a 2½" or 2¾" column may be changed back and forth in a few seconds for use either as a wood lathe or a drill press. Installation requires

only substitution of a two-piece column with a swivel joint for the regular column. When a lathe is needed, the drill press is turned horizontal and the lathe bed is locked to the table. Work up to 36" long is accommodated by the lathe.

KEEPING the HOME SHIPSHAPE

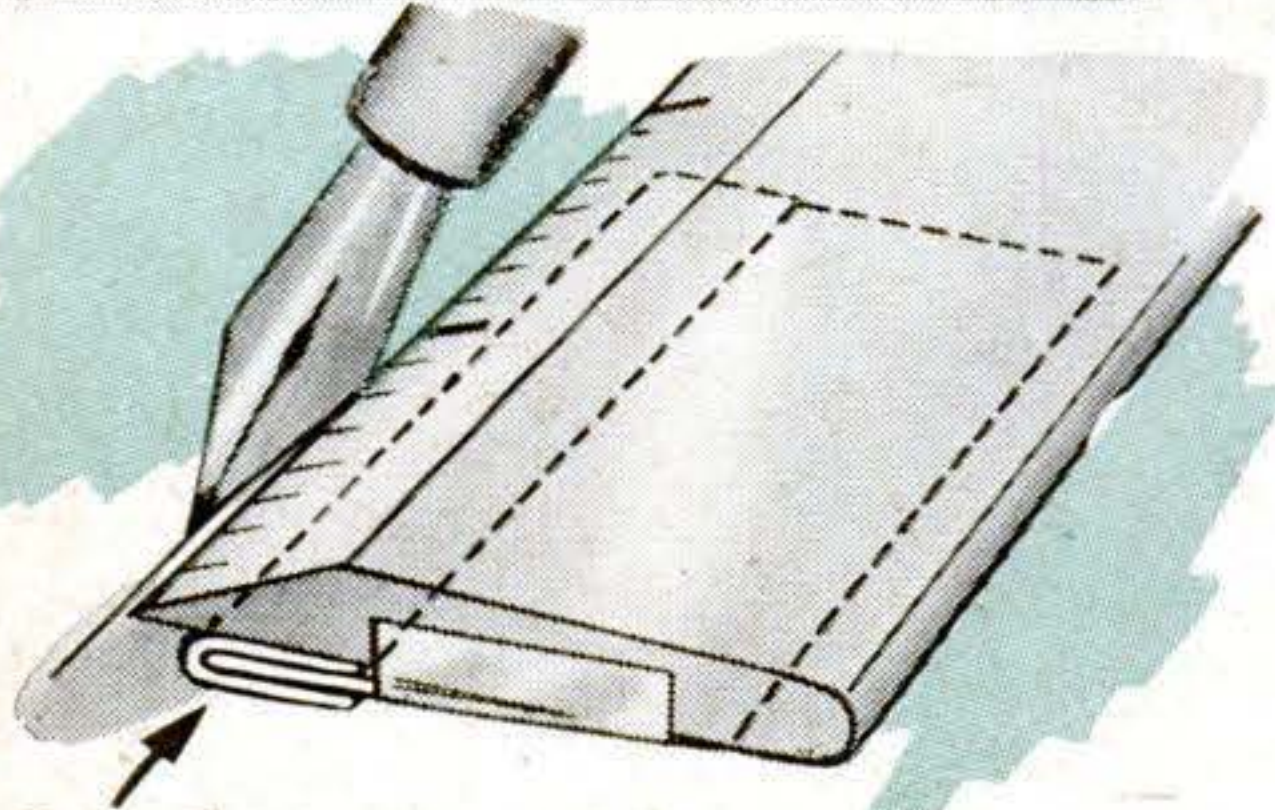

SINGLE-EDGE BLADE

A ruler will be less likely to blot inked lines if you tape a single-edge razor blade under each end. This raises the ruler enough to clear the paper.

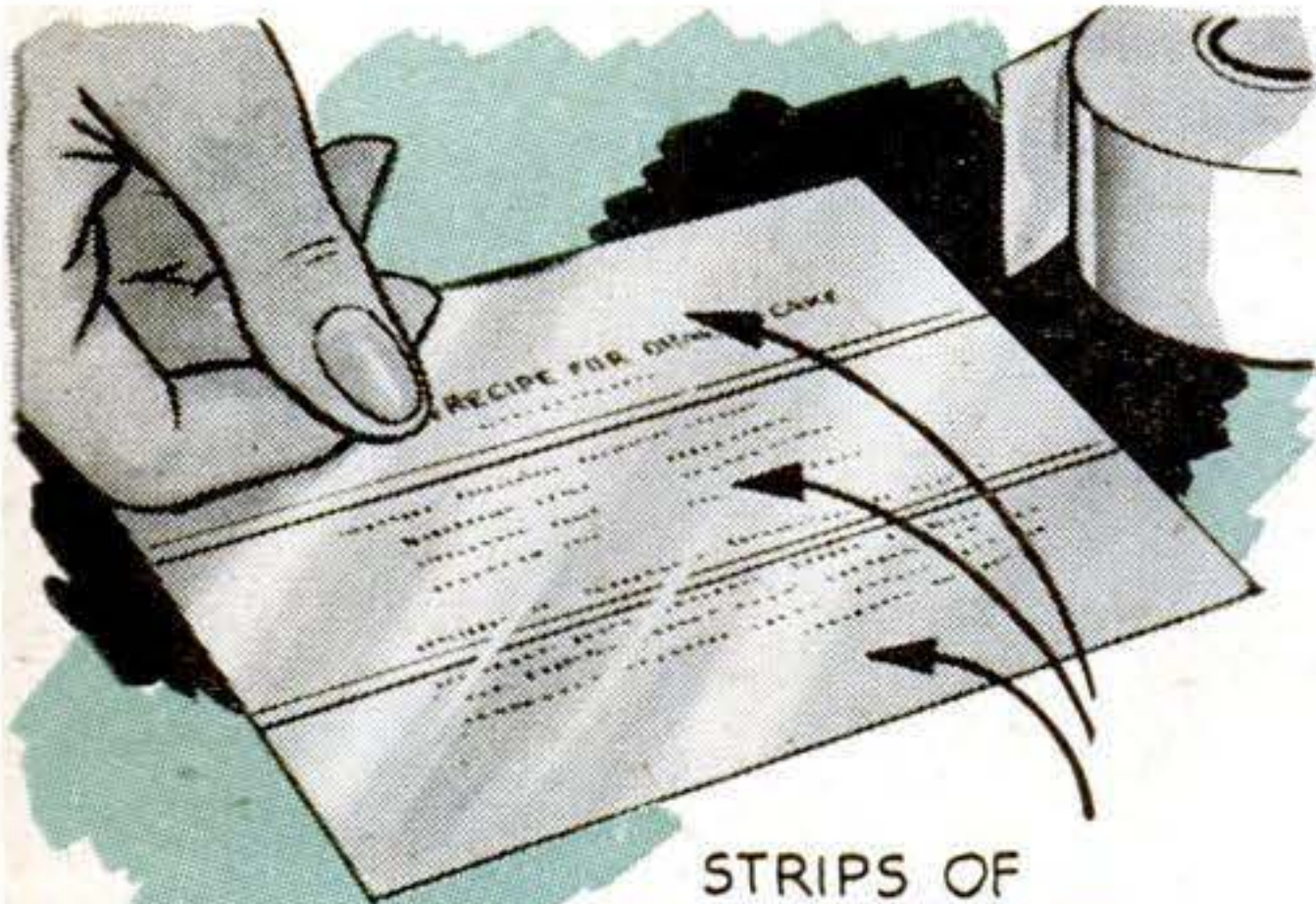

STRIPS OF CELLULOSE TAPE

Frequently used recipe cards from your file box will withstand kitchen wear better if you protect the print with strips of cellulose tape. Lap the tape and press it tight to make it water-resistant. You can then wipe off any spots with a damp cloth.



Empty waxed-cardboard milk containers have many household uses. Cut down and used as containers for leftover foods, they make fine refrigerator-space savers. They are also excellent for soaking paint brushes, as molds for homemade soap, or, cut lengthwise, as disposable dishes for feeding pets.



Grapefruit can be used up twice, the first time in the eating, and the second by using the rinds as handy cleansing pads for copper and copper-clad utensils. Sprinkle some salt on the pulp and rub the copper surface. Salt and acid remove tarnish.

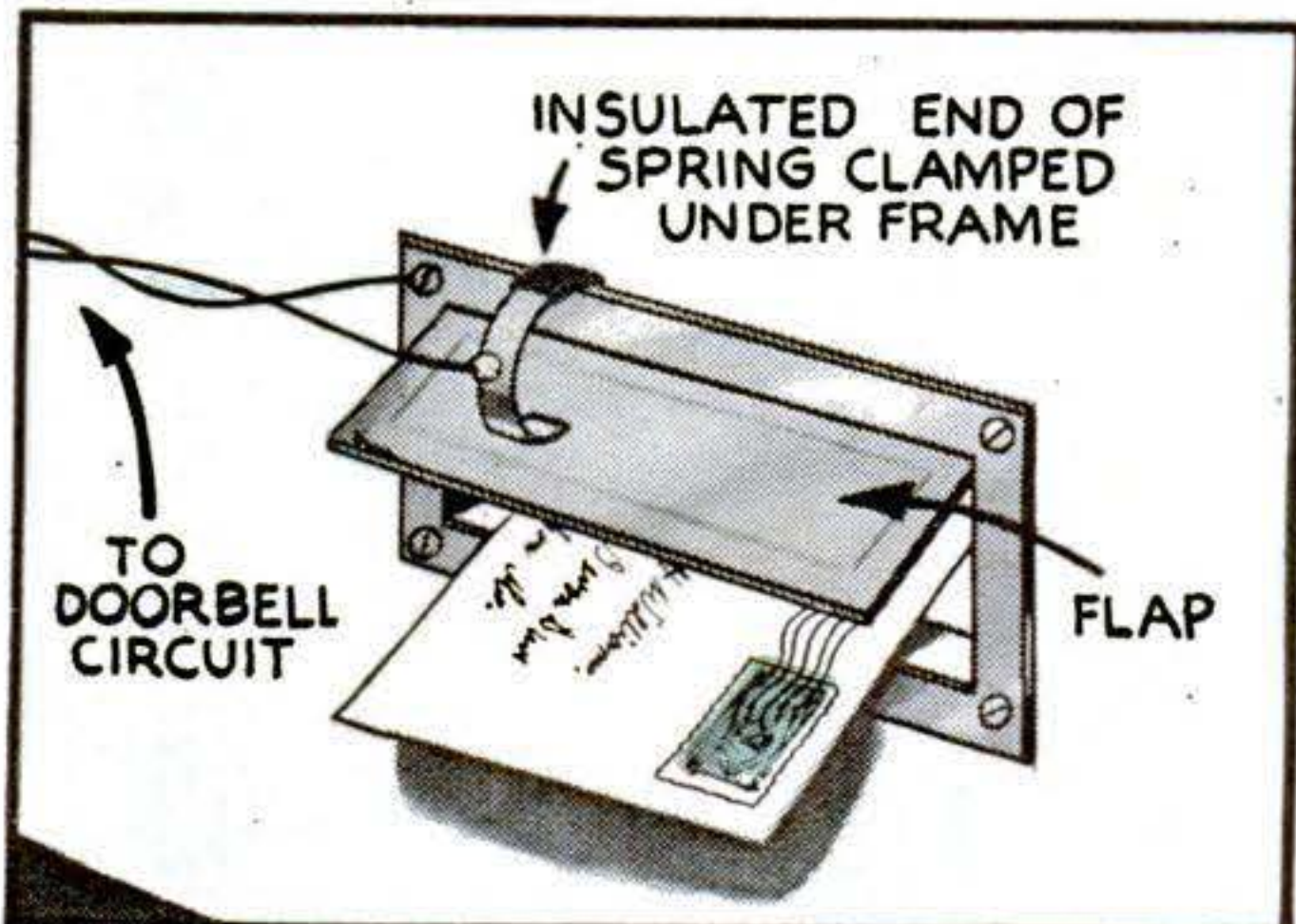

The postman sometimes rings twice, and sometimes not at all. But you can always tell when mail is dropped through your letter slot if you use the bell-ring circuit shown above. The flap forms one contact, and a bent spring-metal strip the other.



Throwing light exactly where you need it is a cinch with the mirror and gooseneck rig shown above. It's especially good in jobs where an extension-cord lamp isn't available or else can't be plugged in. The mirror is also valuable in letting you look behind obstructions when working in cramped quarters.

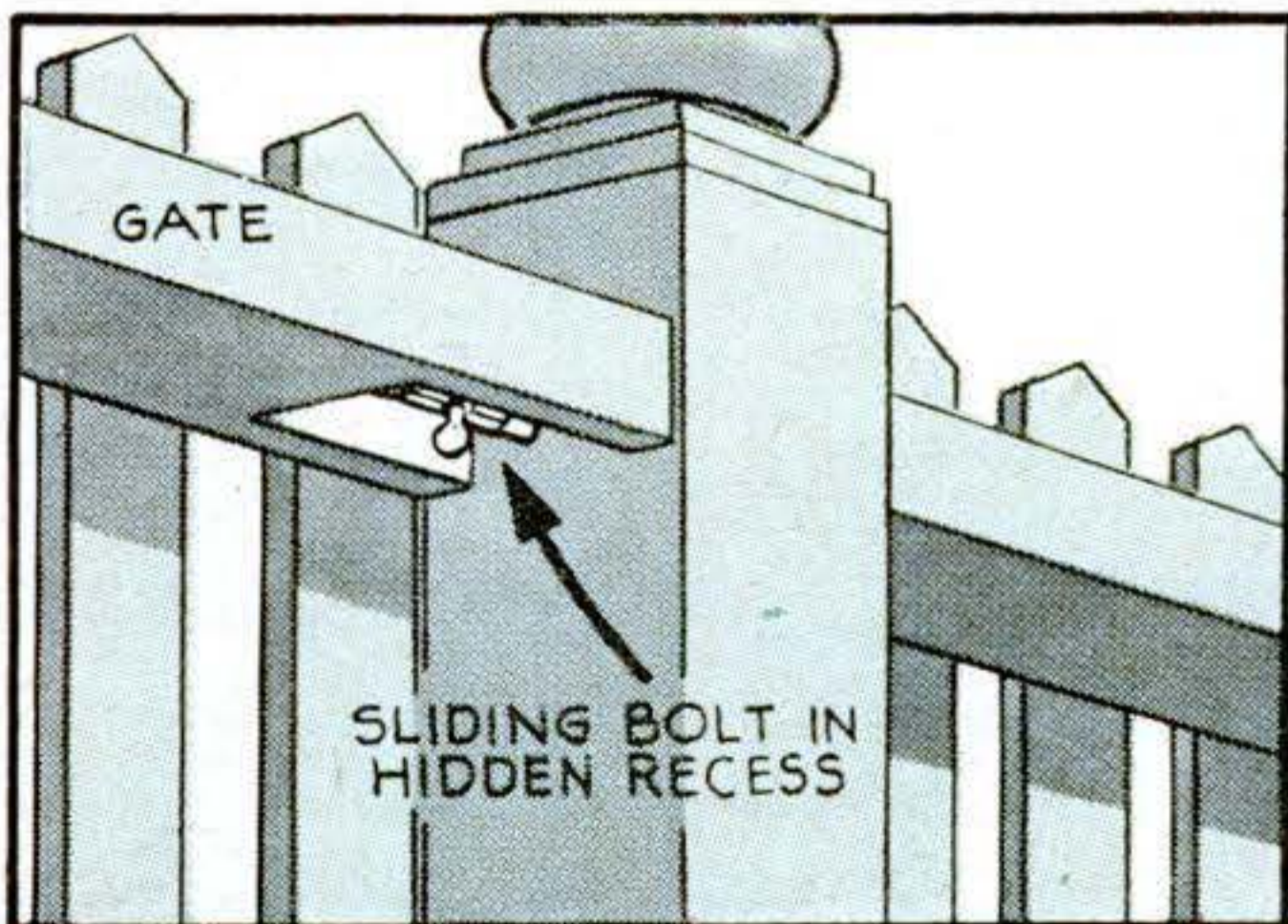

If your house is so situated that the yard is used as a public thoroughfare by people in search of a short cut, here's a device for reducing traffic. A lock concealed in the upper stile lets friends in but keeps out strangers who aren't in the know.

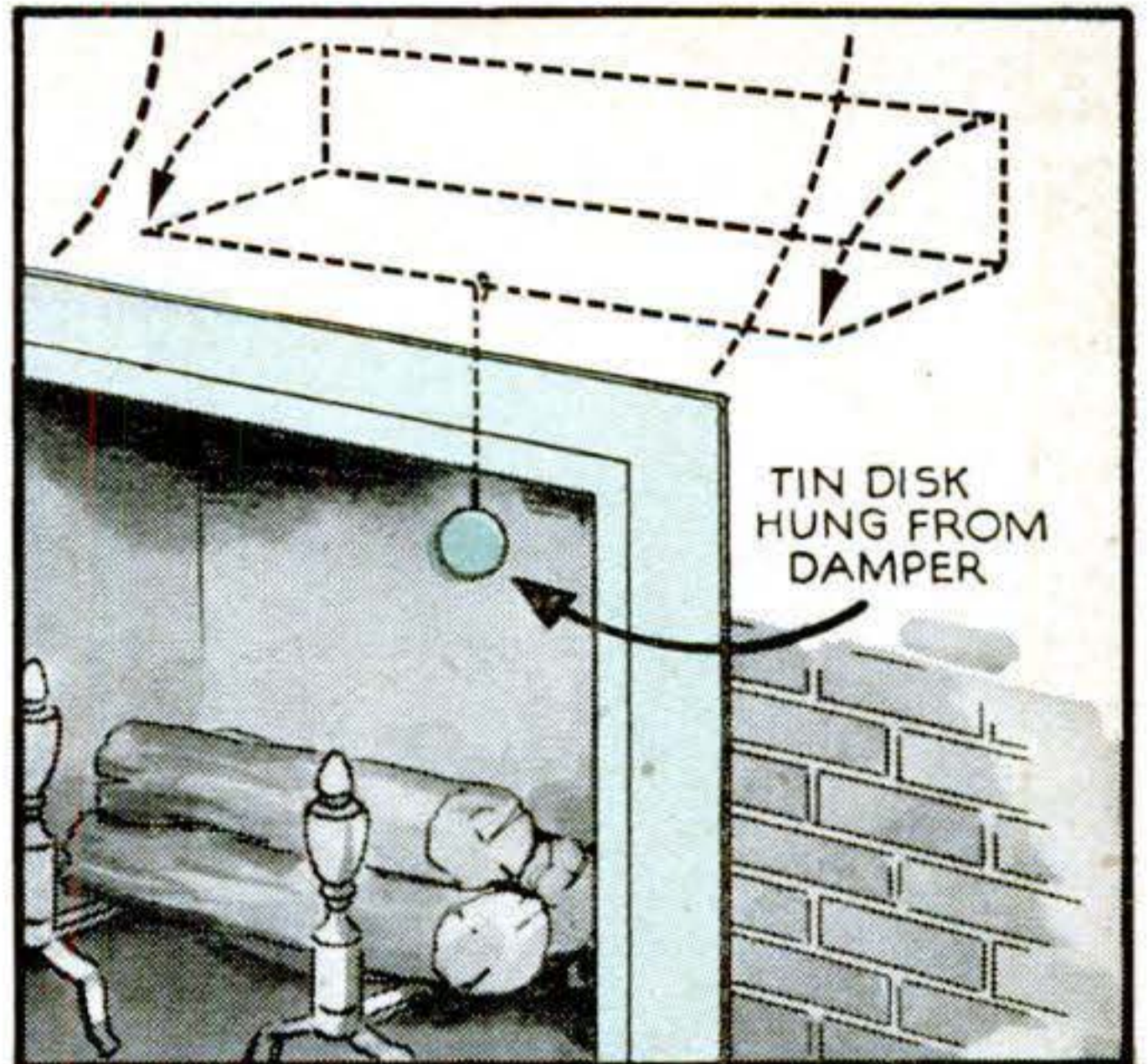

There's no need to forget the damper and light a fire in a closed fireplace when a metal disk suspended by a wire makes the damper position clear.

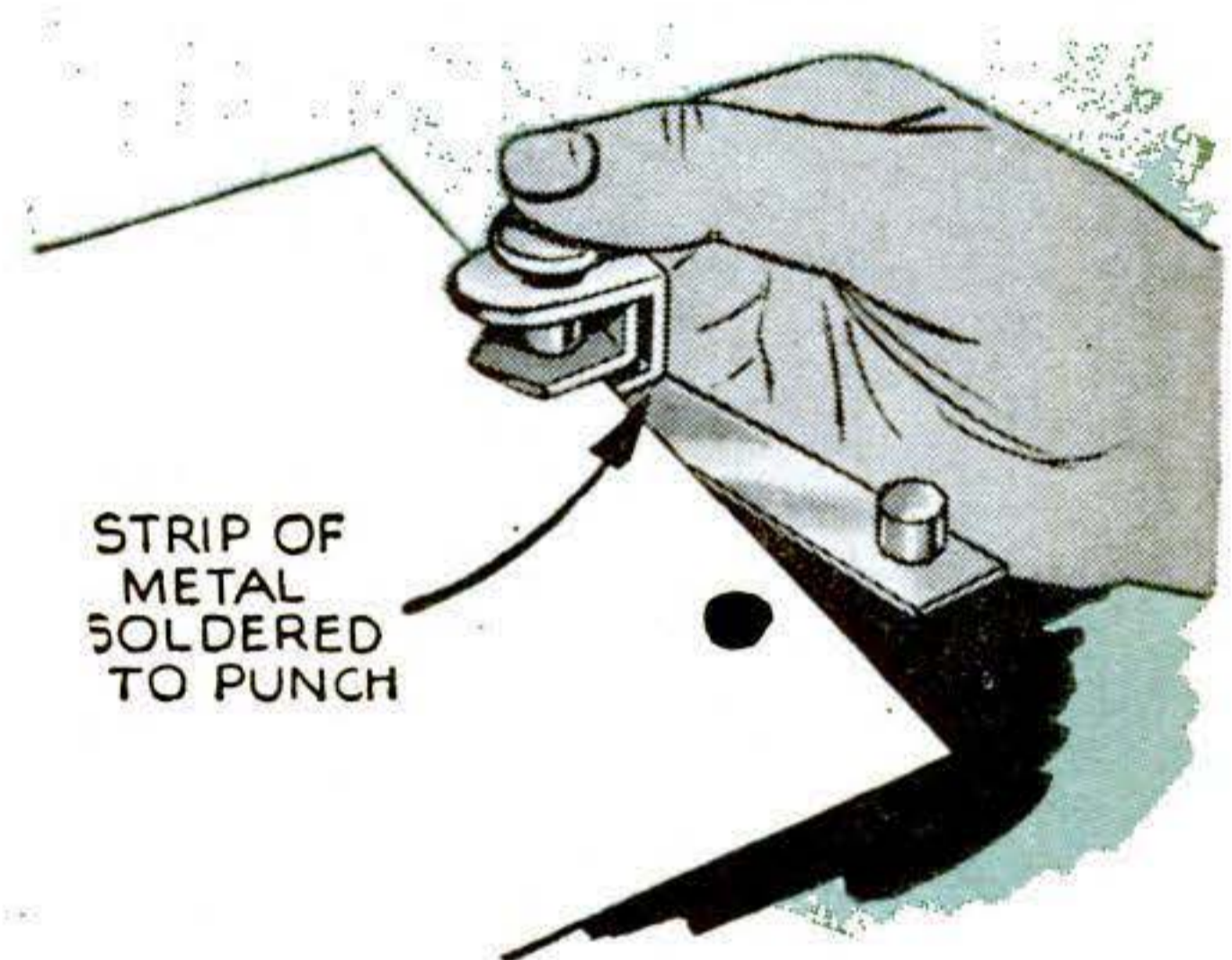

If you have a punch of the type shown and find it difficult to space holes properly, try this spacing jig. Solder a metal strip to the base of the punch, and solder in a pin at the right distance.

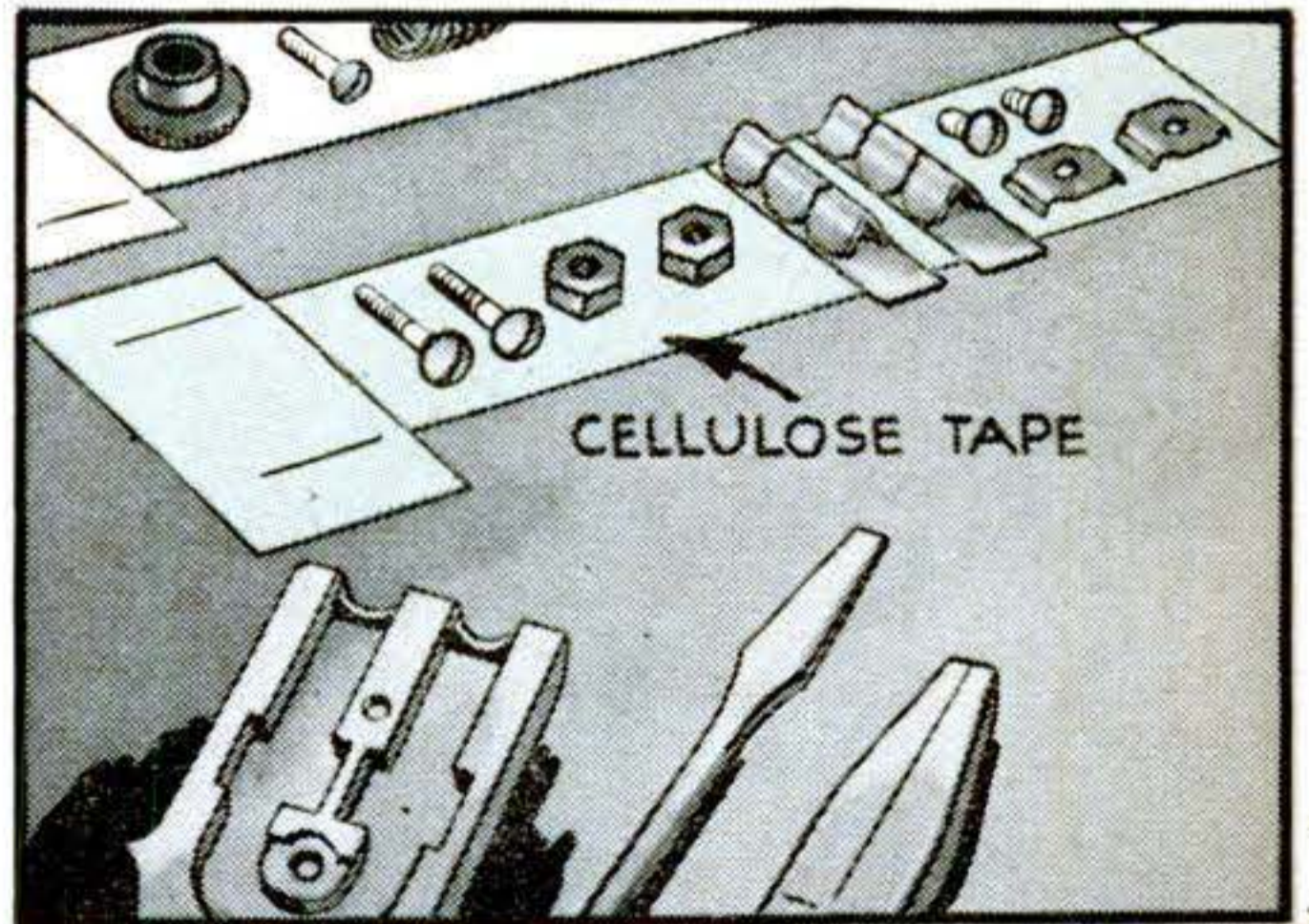

When disassembling locks, cameras, or other small mechanisms, parts that are easily misplaced may be kept under control by placing a strip of cellulose tape on the workbench, sticky side up. Parts will adhere lightly and remain in order for reassembly.

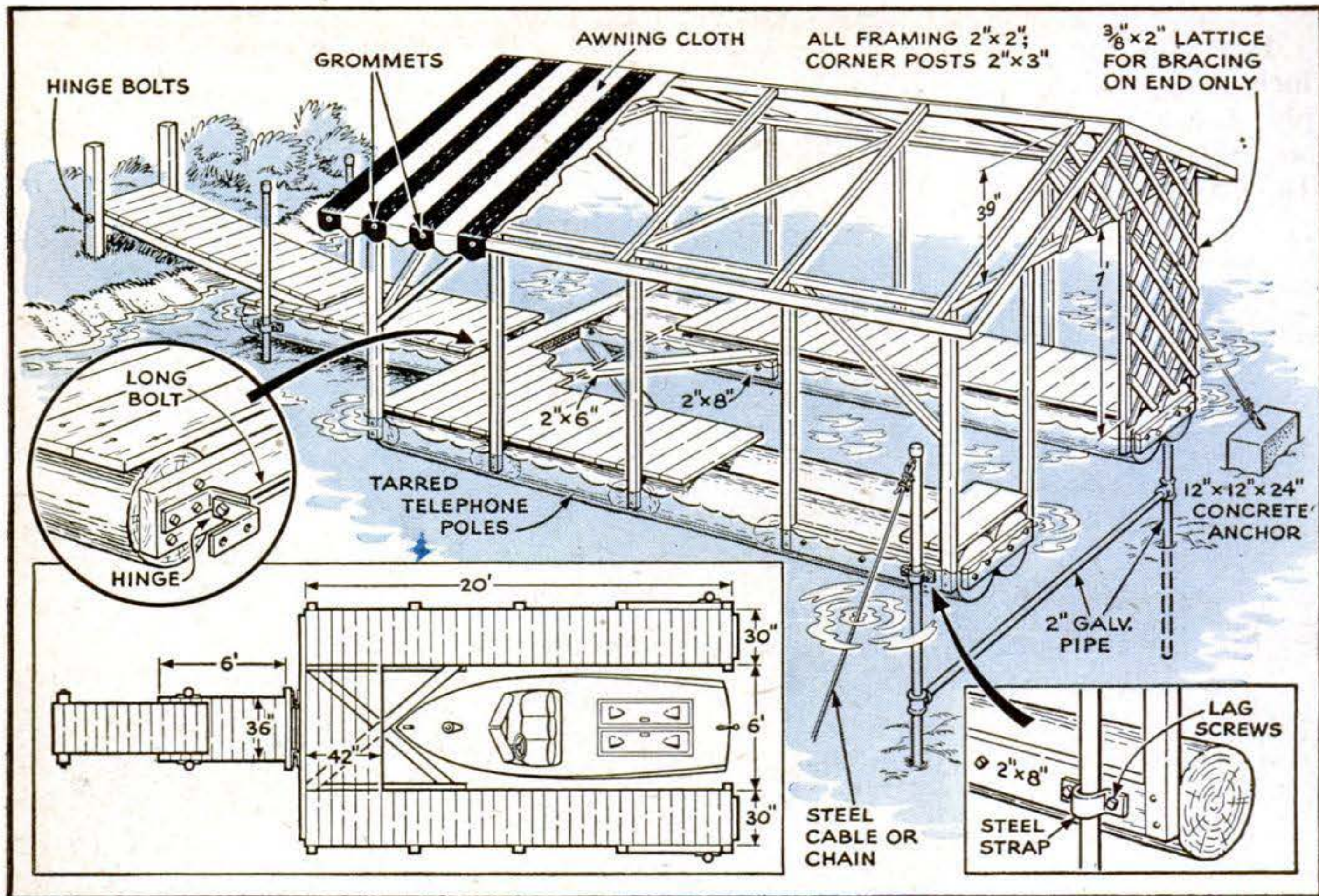

Floating Boathouse Has Picnic Terrace

FRAMWORK construction and a canvas roof will provide protection for your boat from sun and rain. In addition, the boathouse shown floats on the surface of the water, rising and falling with the tide, and has an ample boardwalk for picnicking.

The framework floats on discarded telephone poles in the drawing, but logs, empty oil drums, or the like would do as well. Boats up to 5½' beam and 16' length can be accommodated with the dimensions given. Tarred all over, the telephone poles will remain buoyant for a long time. If only short lengths are available, the joints should be staggered. Wooden saddles are easily made for holding oil drums to the framework. A log boom out a short distance from the entrance will be a protection if open water is faced.

Side drift is prevented by two galvanized pipe pilings guyed to concrete-block anchors. The open end of the structure is braced with lattice work. If this is painted white, it will also serve as a guide in bringing the boat to port in the dark.

Use two poles or four oil drums under each side deck. Lag-screwed crosspieces hold them together. Studs and posts are lag-screwed also to flats trimmed in the logs, and the structure is braced at all corners. The awning should be fitted with grommets so it can be removed in winter. While the open framework offers little protection against the wind, the shelter will generally keep rain out of the boat.

Assemble the pipe piling with tees in the shape of an *H* and drive it into the bottom with a sledge hammer. Give a few taps on one side and then on the other. Or better still, if you have a helper, drive simultaneously while using the float itself as a platform. The unit should be driven in deep enough for the crossbar to be 6" below your boat at low water.

Jockey the concrete anchors into position with the cables handled from a boat. The guys should not be drawn so tight that they pull the tops of the pipes out of the vertical.

Hinge the ramp at the shore end to compensate for varying water level.—HI SIBLEY.

Two-Way Rack Holds Dishes Aboard Boat

IN THE cabin of a small boat, where every inch counts, a side rack will care for a supply of dishes, glasses, and silverware. This one holds a table setting for four persons. The glass carrier can be lifted off and passed

around. It could be enlarged to hold still more tableware, including saucers for coffee cups kept on cup hooks screwed to the bottom.

Lightly nail together $\frac{3}{4}$ " mahogany or other stock to cut both ends to shape at once, and notch for the front rails; then separate and rabbet the pieces for the back. Cut the rails, partition, and bottom from $\frac{3}{8}$ " solid stock. Assemble with waterproof glue.

Cut holes for tapered glasses in the detachable glass holder that hangs on the top rail. Then glue on the triangular pieces to brace it against the front of the dish rack.

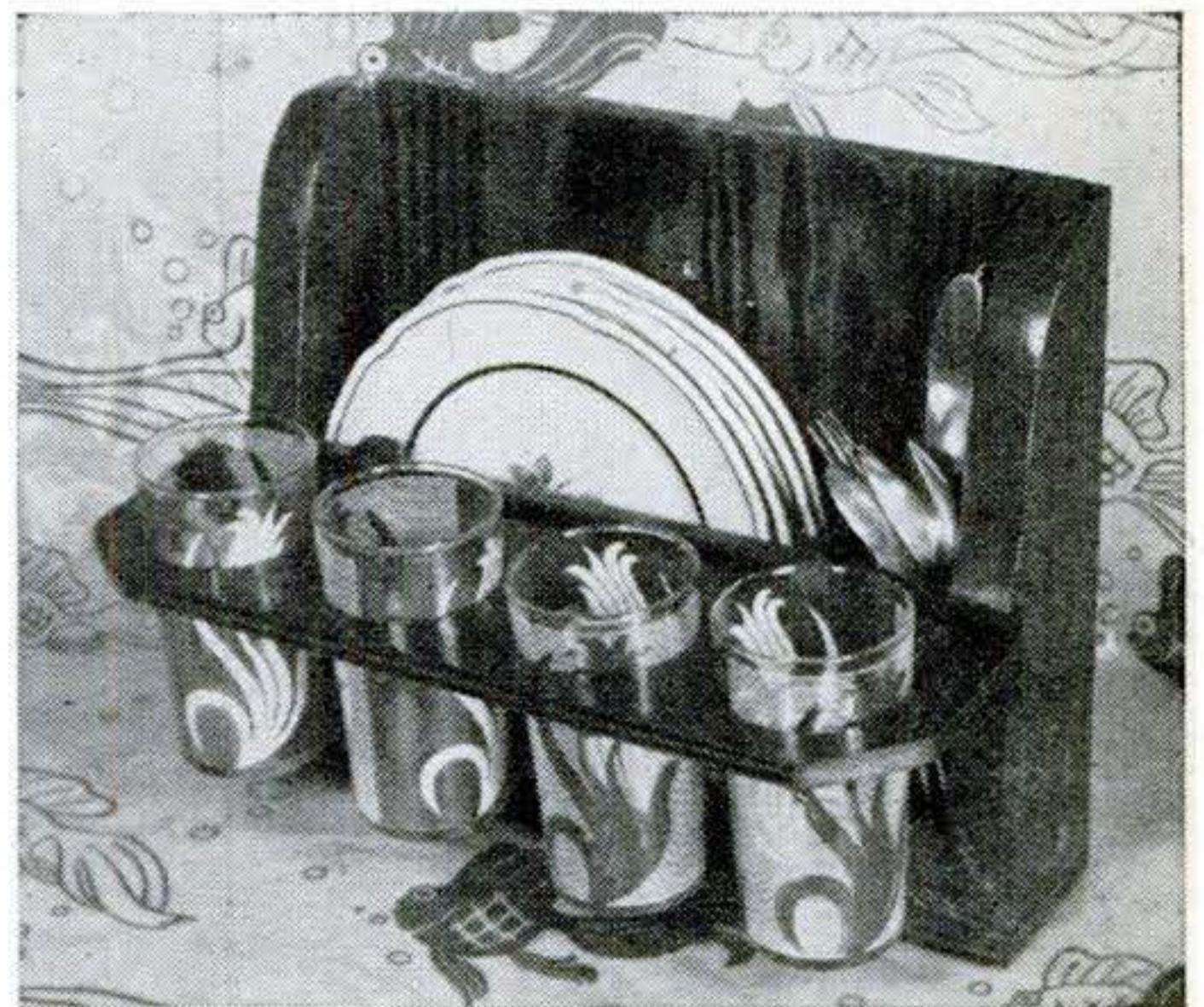
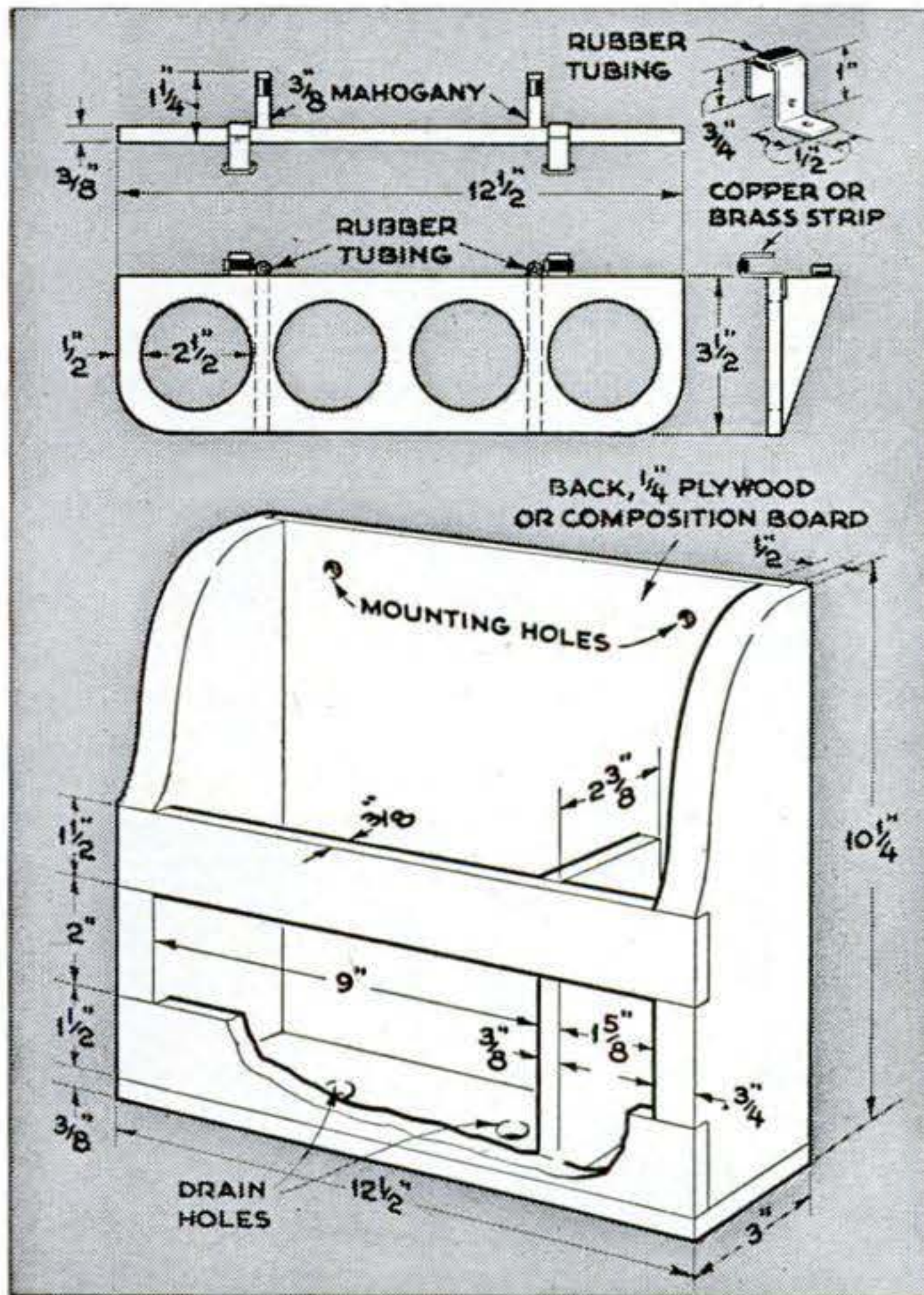

Adjustable Socket Handles Trolling Rod

HOURS and miles of holding a trolling rod against motor and tide can become tiring to even the most ardent fisherman. Sportsmen on Buzzards Bay, Mass., have rigged up a gadget for their boats that relieves the strain and permits them to relax completely when they wish.

The device consists of two blocks of $\frac{3}{4}$ " oak or other sturdy wood carrying a rod socket adjustable to various angles. One of the blocks is slotted for a clamping bolt and attached rigidly to such parts as the thwart seat and a rib or cleat. The other is held to it with a fixed pivot bolt and the clamping bolt. Cut the socket from automobile radiator hose, which is soft enough not to scratch the rod and stiff enough to give it adequate support, and mount with the pivot bolt and a pipe clamp. All parts should be given two or three coats of good boat paint.—BRUCE MACINTOSH.

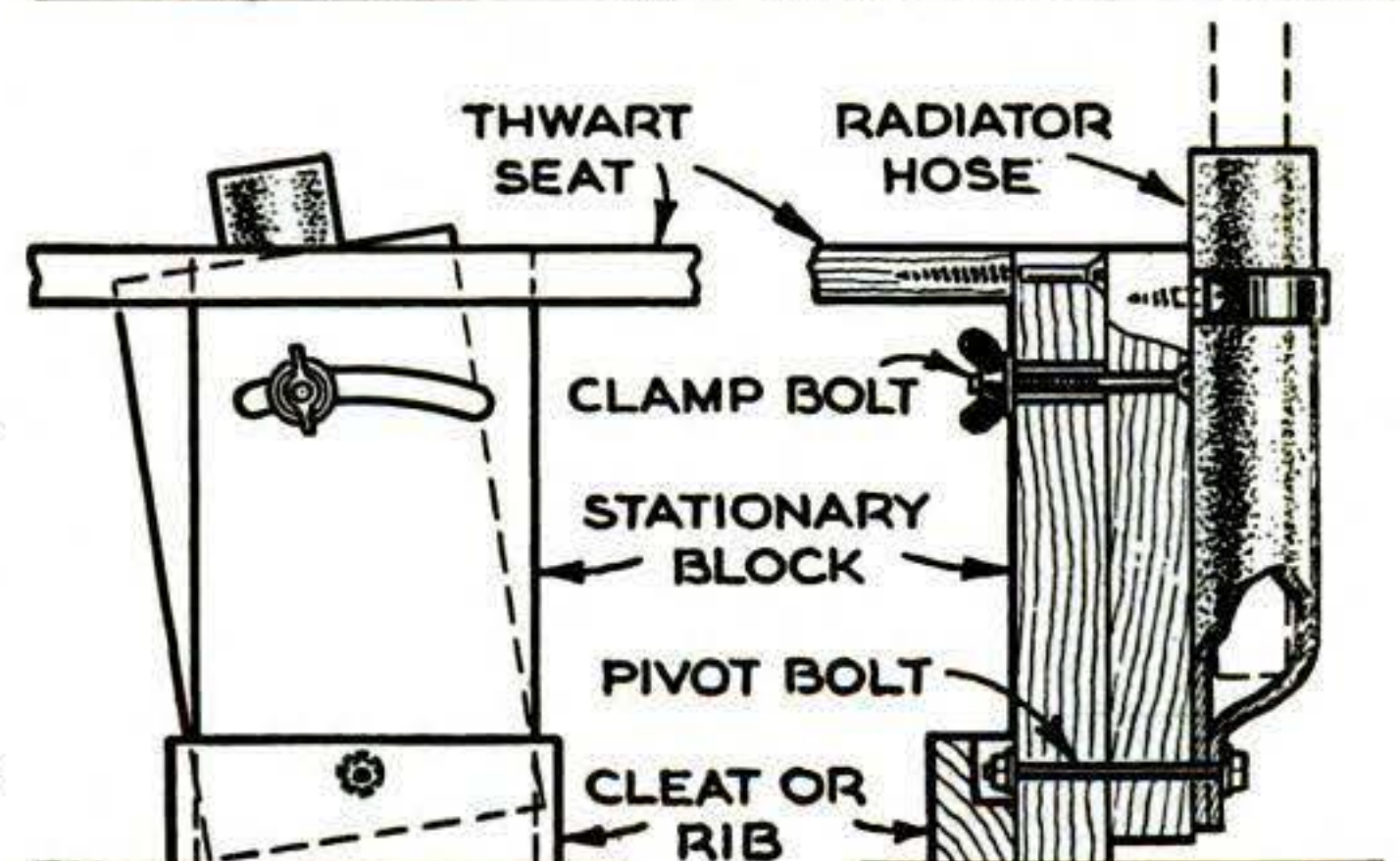

**WHAT'S YOUR
INGENUITY QUOTIENT?**

IQ



Chimney Crickets! No, the sounds that come from my chimney aren't caused by insects. When I removed the stove pipe, instead of using an ordinary flue stop, I stuffed the gaping hole with an extra loudspeaker and covered it with a decorative grille. The loudspeaker, of course, is connected to the main radio in another part of the house.—CHARLES FARNSWORTH.



Having Trouble, Jack? Or jack trouble? In my case it was the latter. I had a flat on a lonely stretch of dirt road and no jack with which to lift the baggy tire off the ground. So I put a rock solidly under the axle and dug a hole 6" deep under the tire. That left plenty of room to wiggle the old wheel off and to wiggle on the pumped-up spare.—CHARLES STARNES.



It Keeps Me In Stitches. Even up in our vacation cabin, where electricity hasn't yet arrived, I can still get a sharp seam out of my electric sewing machine with the aid of my husband's grindstone. A belt drive from it to the machine pulley gives plenty of speed and control, since the grinding wheel turns nine times for each swish of the handle.—MRS. A. R. GREEN.



Hang It All! I've always found it annoying to have my coat draped around me during a long train ride, but it used to happen whenever I hit a train that had no coat hooks. Then I discovered that the luggage racks overhead were really clothing hangers in disguise. All that's needed is a pencil slipped through the loop or label in the neck of the garment. The pencil is then placed crosswise so as to rest on two parallel bars of the rack.—THOMAS P. RUSSELL.

Have you pulled off a smart one lately? We will pay for acceptable contributions showing ingenious solutions of problems in the home, shop, garage, or camp. It doesn't matter if it's wacky—if it works.

Vanishing Towel Rack

WHEN an old-fashioned kitchen sink is to be modernized by enclosure in a cabinet, it is a good idea to add a built-in towel rack. The one shown is conveniently placed at the right-hand side of the sink to be within easy reach when dishes are to be dried. It rolls out for access either by a gentle pull on the handle or by a nudge with the foot under the raised front. A slight push is sufficient to roll it back out of sight until a towel is needed again.

Ease in operation is provided by three ball-bearing skate wheels. Two of these roll in grooves in inclined guides at top and bottom. The third is fixed in the lower

cabinet rail, and the grooved bottom of the rack unit rolls over it. A stop cord attached to a spring halts outward motion before the two lower wheels touch. The raised head of a roundhead screw in the lower groove at the back anchors the wheel there. Be sure not to have the screw head so high that it interferes with easy starting.

The towel bar is set into two bored blocks. It may be a regulation chromium-plated bar, an enameled length of pipe, or a hardwood dowel. If the cabinet frame is left open at the side of the sink and the drawers, air will circulate to aid the drying of damp towels.—BENJAMIN NIELSEN.



Toe operation saves time when the hands are full. The rubber guard prevents scratches on your shoe.

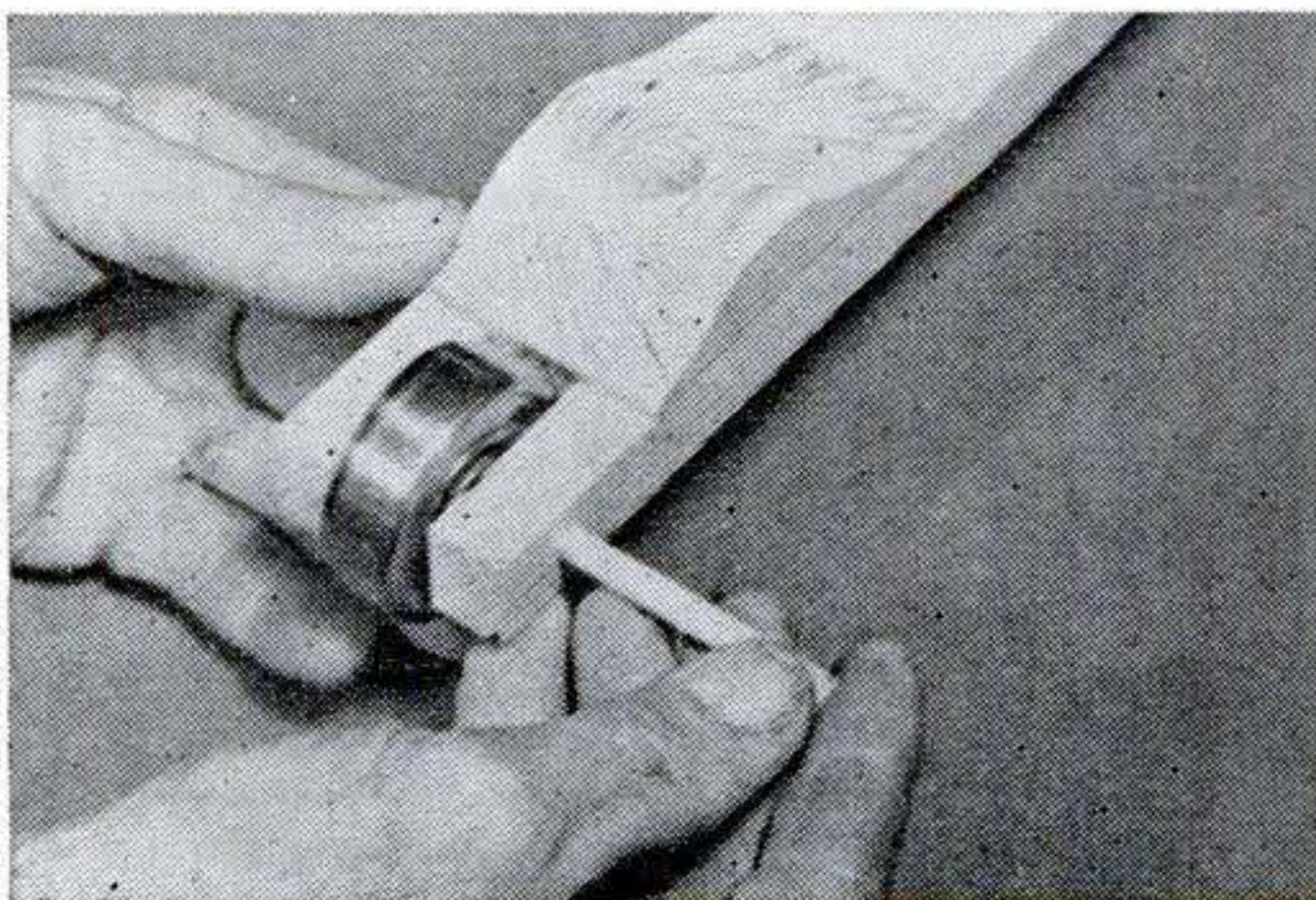
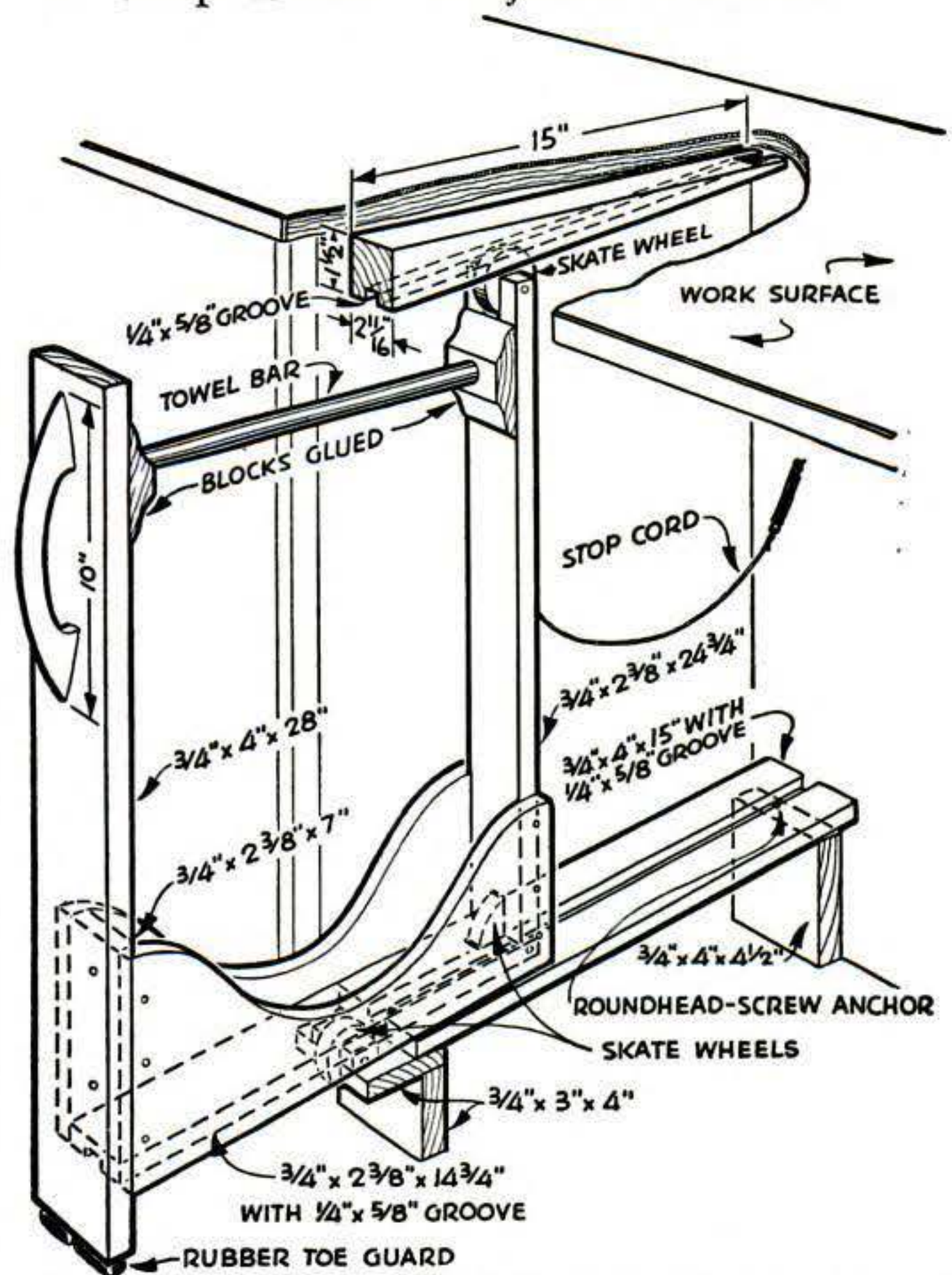

Skate wheels turn on axles cut from a hardwood dowel. Drill rod or bolts are also suitable. This wheel is set in the top of the back upright.

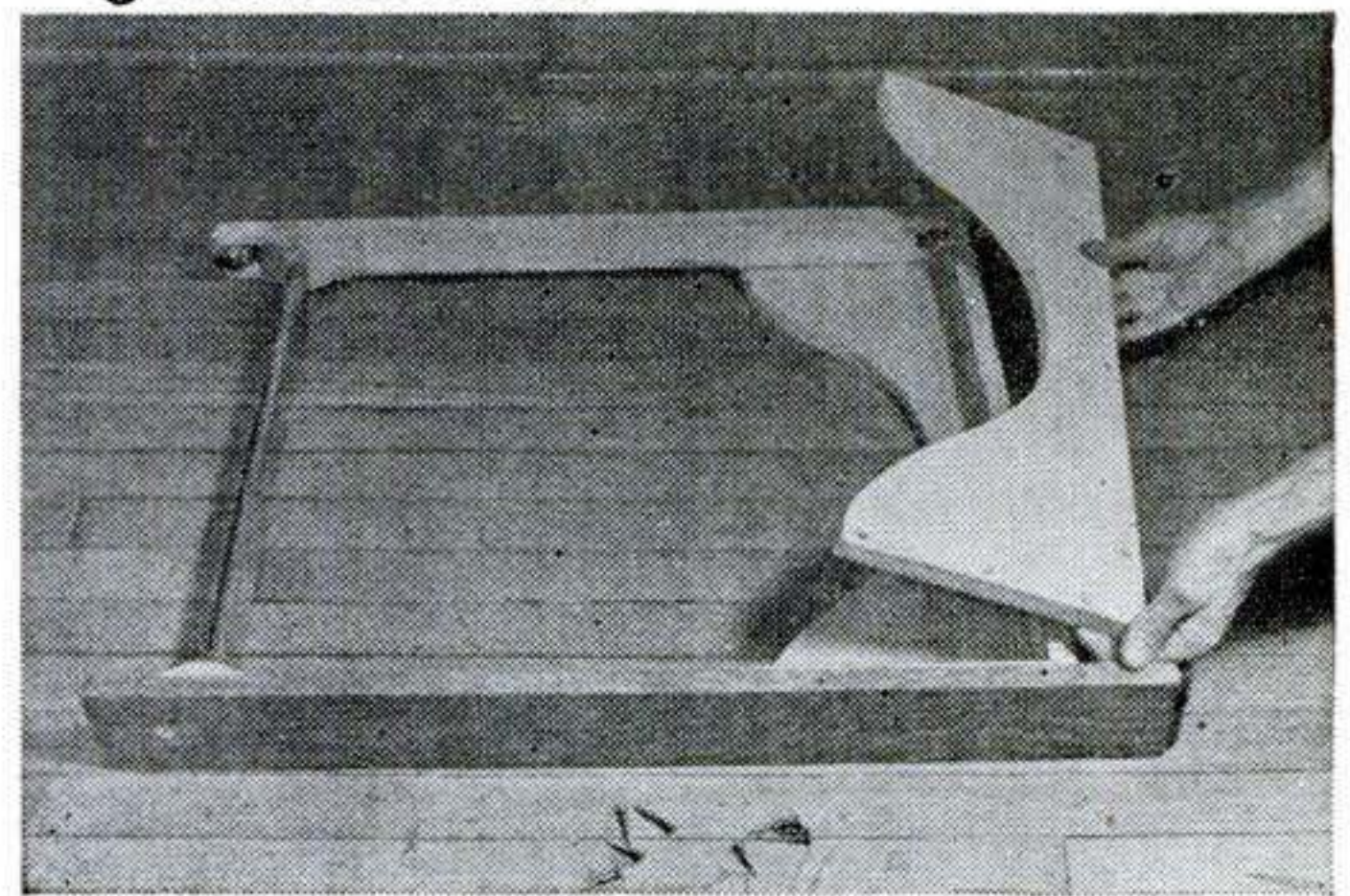

Curved braces nailed into the rack assembly at the bottom hold the unit square. The trough could be utilized for storing boxes and bars of soap.

Paper Handles Give Hacksaw Blades Many Uses

WHILE worn or broken hacksaw blades can be made into high-grade knives, you may have found that trying to punch or drill holes for the handle rivets is a difficult task. However, rolled wrapping-paper handles, varnished or glued on, are an easy and long-lasting substitute.

Grind the teeth off the old blade first and cut to length, allowing $3\frac{1}{2}$ " to $4\frac{1}{4}$ " for the handle end. Then grind the blade to shape (some suggested forms are shown at right). Take care in grinding to do the work slowly and cool often, especially at the edge and point.

Cut ordinary brown paper to the width and length required. The latter governs the thickness of the finished handle. Then coat the paper with plastic resin glue and roll tightly on the blade shank. If it is to be a paring knife, which will be washed frequently, use plastic-base varnish instead of

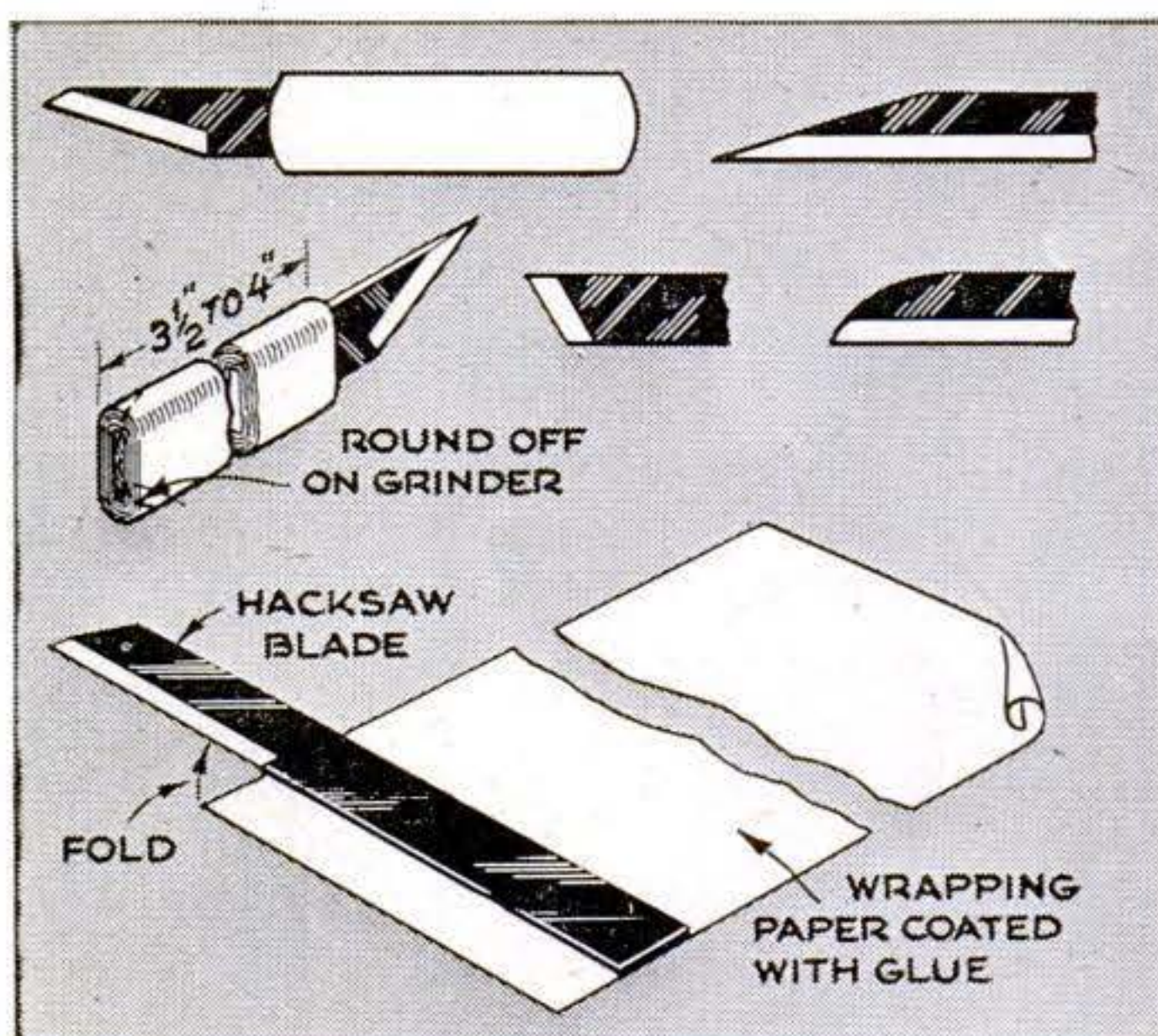

glue. Clamp firmly and let it set for about a week, after which it may be shaped to suit your taste on a sander. Finish with a coat or two of varnish.—E. C. LYNCH.

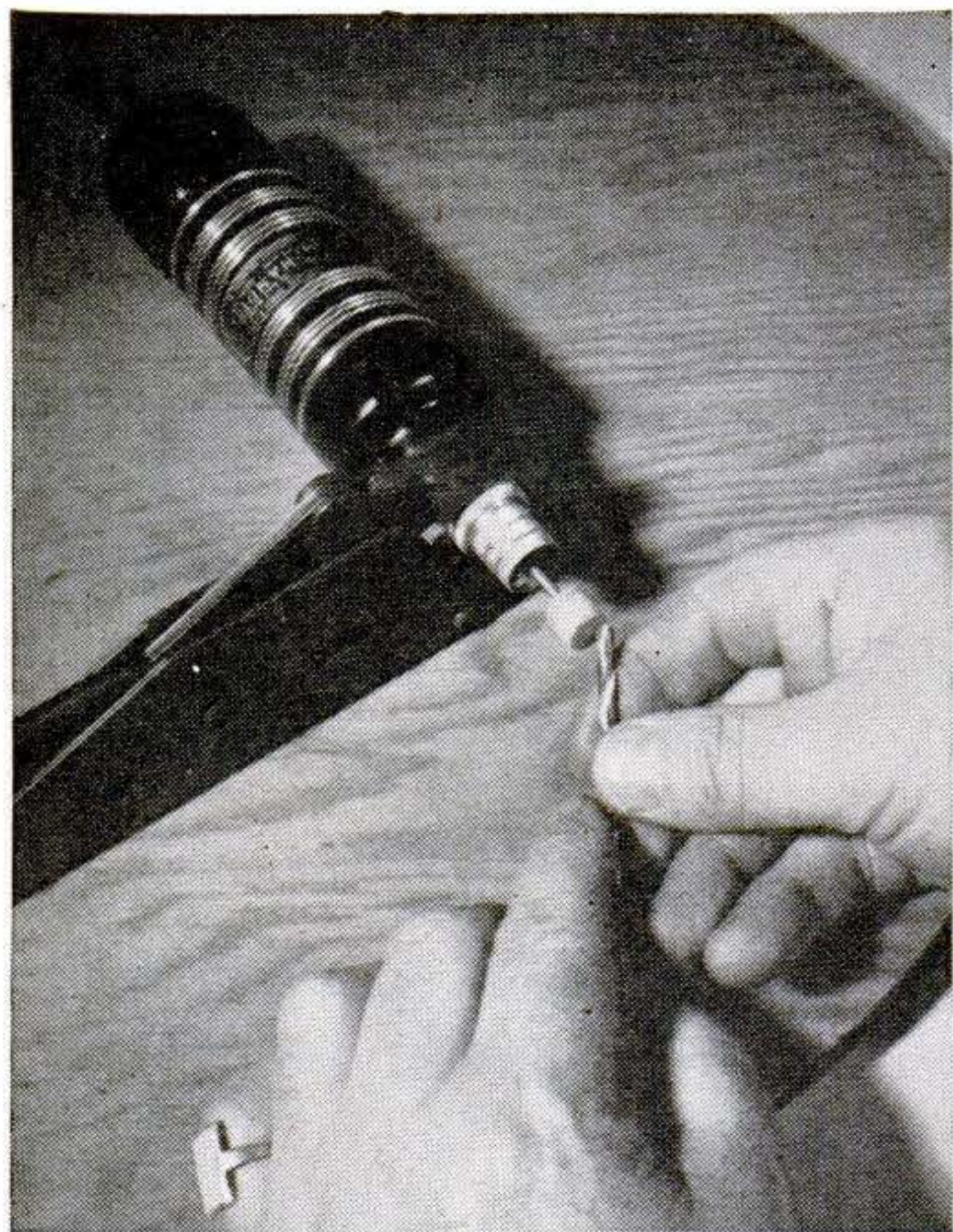

Wrench Grips Hand Grinder

WHEN drill bits and the like are to be sharpened on the wheel of a hand grinder, some means must be found to support the tool so both hands will be left free. One of the new toggle-type wrenches is excellent for the purpose. With the jaws drawn up and locked on the tool neck, it will hold the grinder against light pressure.

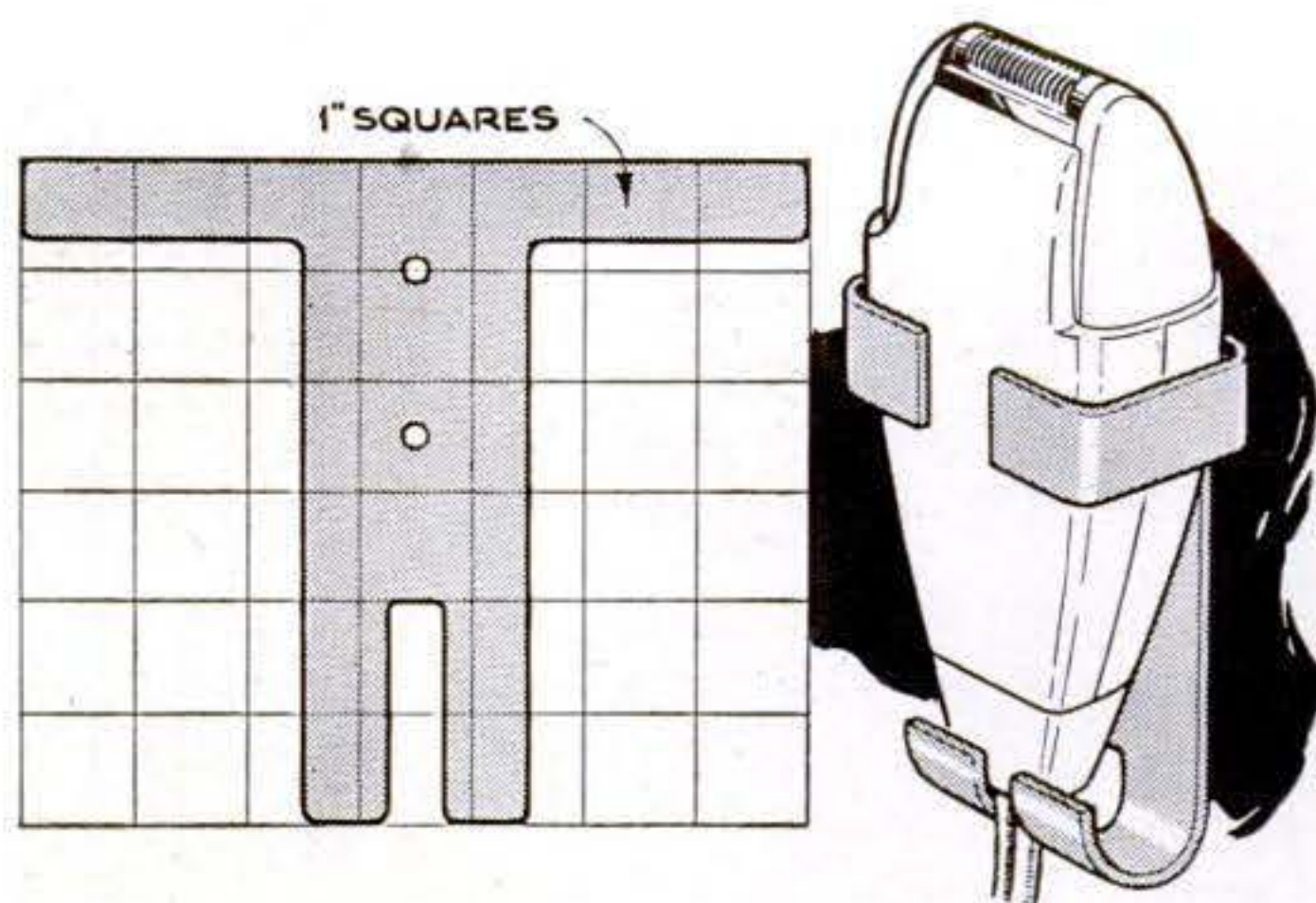

Plastic Bracket Holds Shaver

A WALL bracket near the electric outlet and shaving mirror is a convenient holder for an electric shaver. Such a bracket can be made without cemented joints from $\frac{1}{8}$ " sheet plastic, which can be softened sufficiently for bending in hot water. Be careful to dry the plastic before shaping the arms around the shaver, however, to avoid getting water on the wiring inside. Two holes drilled in the body of the bracket provide for screwing it to the wall.—RONALD EYRICH.

Sticking Metal to Wood

A TRICK that's useful for modelmakers who wish to join metal to wood or celluloid with household cement is to soak the metal in acetone first. Don't touch the cleaned area of metal before cementing.



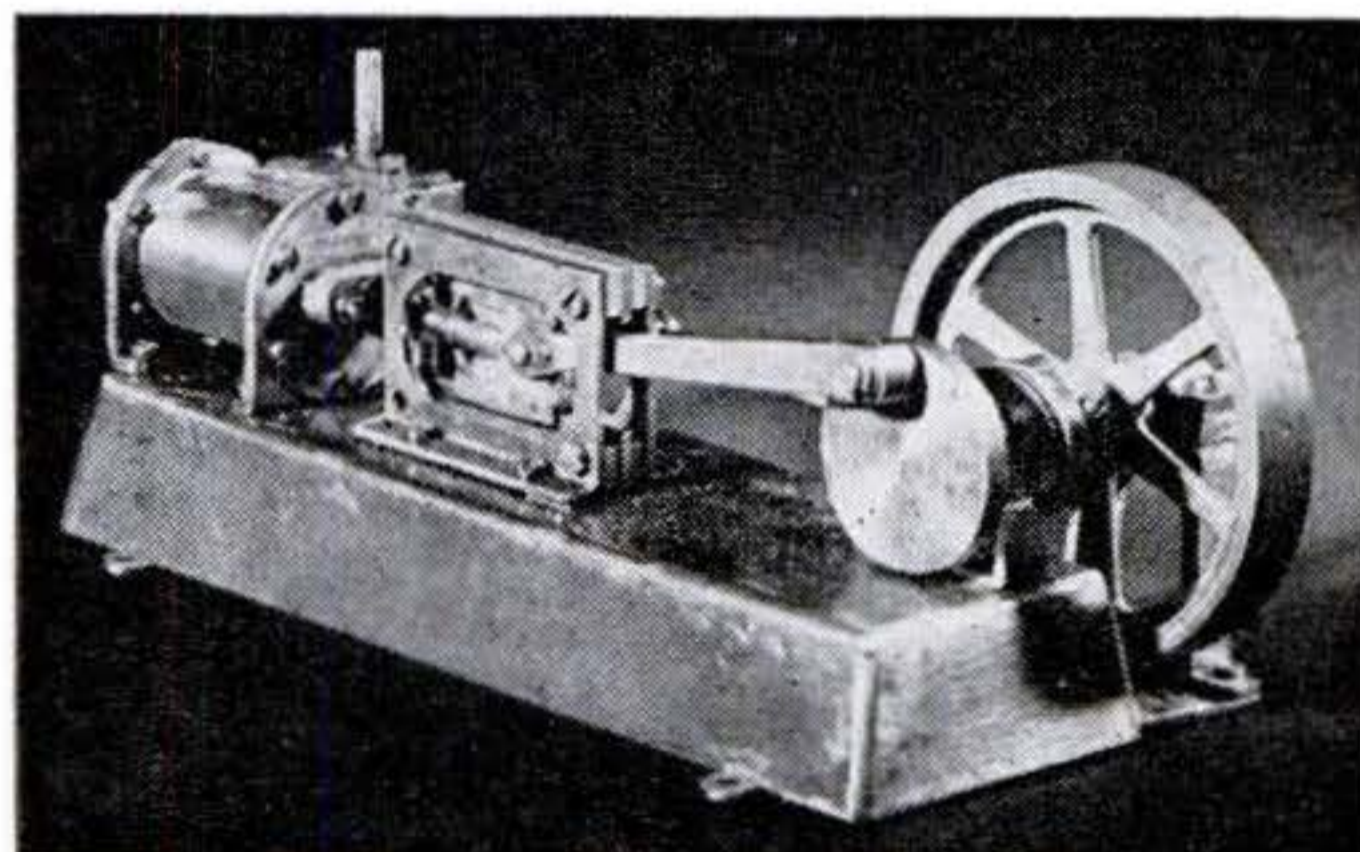

CRAFTSMEN at WORK

Back-Yard Thrill Ride. Kids—and grownups, too—can get as much or as little shaking around as they like in this caper-cutting carnival ride. The Aerobat, as it is called, rotates end over end or side to side, always under full control of its occupant. Commercial models are to roll along a track as well. Inventor B. B. Pewett, of Oak Ridge, Tenn., is shown taking local youngsters for a ride in a pilot model made of pipe and scrap metal. It is powered by a $\frac{1}{2}$ -hp. motor.

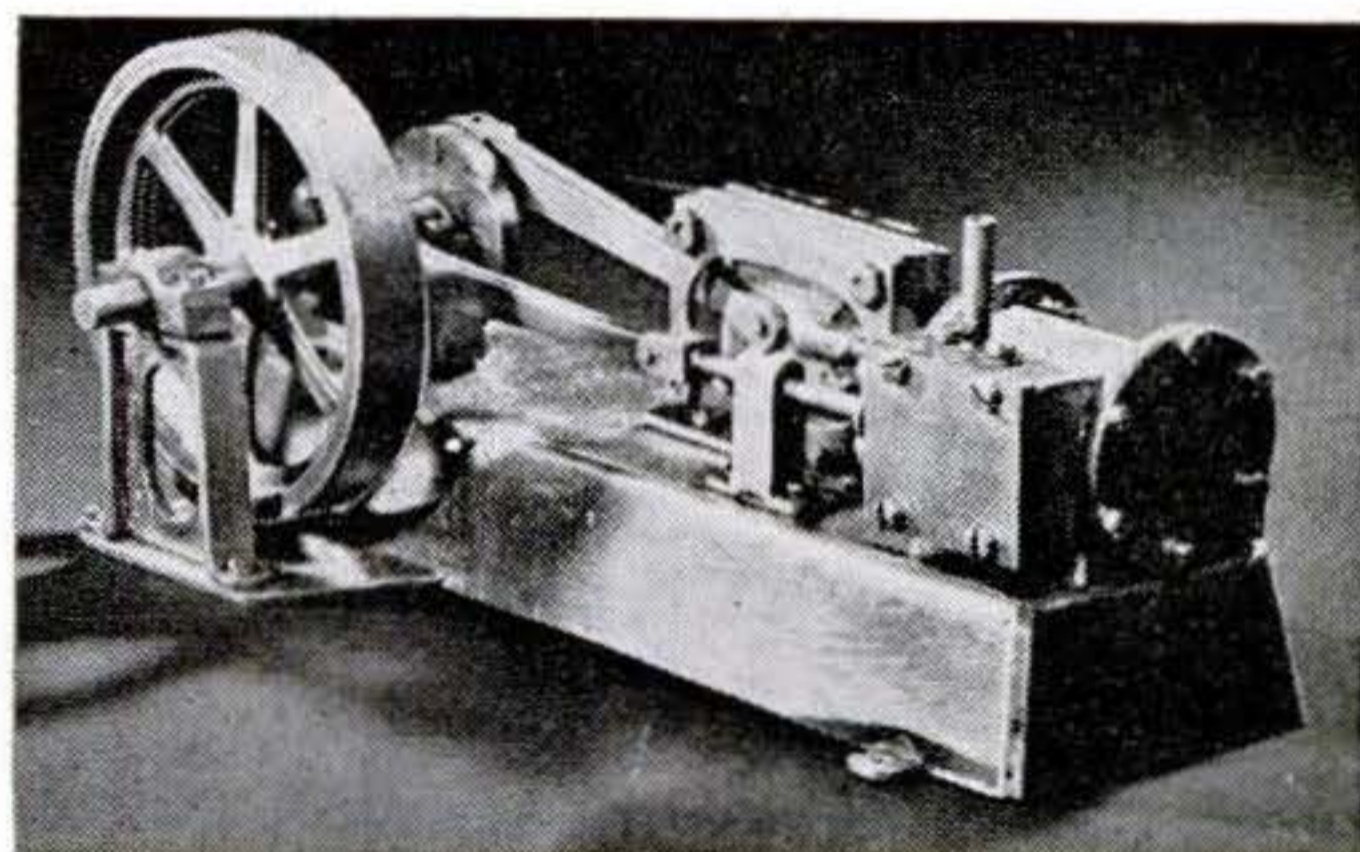

Engine Made of Stock Parts. Neither castings nor a lathe was used by Gordon D. Carlson in the construction of this horizontal, double-acting, slide-valve steam engine. In fact, his only power tool was a homemade drill press used to turn shoulders



on the crankshaft and piston rod. Stock sheet, tubing, and rod were used throughout. The model measures $2\frac{1}{2}$ " by $3\frac{1}{2}$ " by 6". It is the builder's own design, and, while it resembles many big engines, has no actual prototype.

One-Motor Shop.

Only a single $\frac{1}{3}$ -hp. motor is used in W. J. Barr's shop to drive an assortment of power tools. Discarded bed rails, braced and bolted at the corners, make up the bench frame. The motor is directly coupled to a $\frac{1}{2}$ " line shaft, which is mounted in hangers made from Ford Model T connecting rods. Minor adjustments of belt tension are made by moving the board on which the jackshaft and driving motor are mounted.

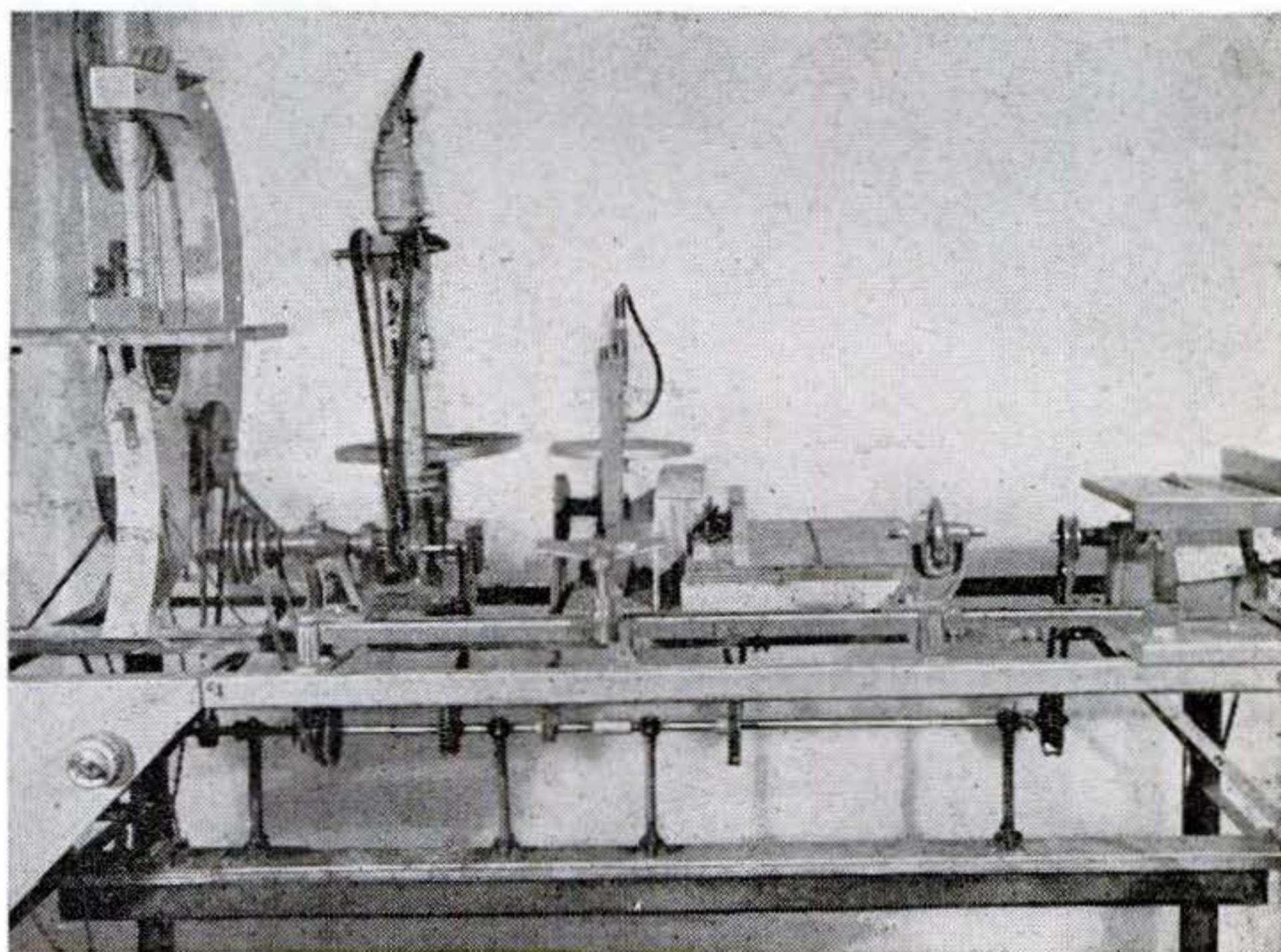

Good Layout Starts the Job Right

UPON proper as well as accurate marking depends much of the success of the finished project. Layout may be scrupulously accurate and yet so sloppily done that the piece will be defaced though the parts fit perfectly. This is particularly true of wood where pencil marks may be so deep that they cannot be removed, but it is also possible on metal where deep scratches cannot be taken out even by persistent polishing.

Marking a large number of small parts with the care required by craftsmanship may appear to be a needlessly tedious job; but in the end it will pay by speeding up the work that follows and adding to the project an unmistakable professional look.

If the nature of the work permits, sit down to it. Steadiness is more likely when the wrists and elbows are supported as you sit at the workbench or table.

Have all marking implements in good condition and in easy reach. It is a good habit to put the ruler, square, scratch awl, pencils, gauge, punch, patterns, compass, and other instruments in individual slots or stands. Then, after each is used, it is returned to its

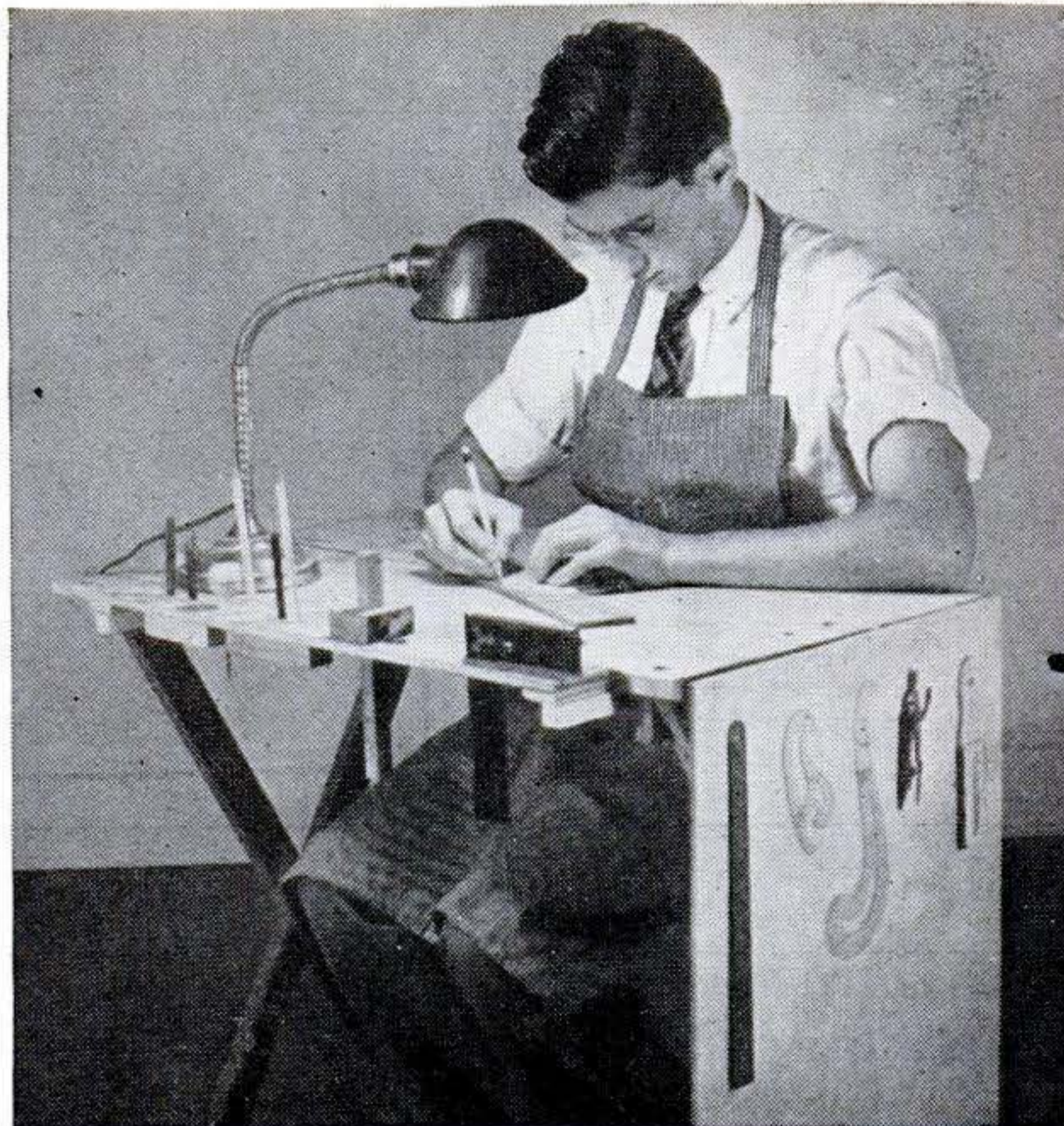

proper place. In this way there will be no groping for the implement as the layout progresses.

Always work in good light so the marking can be done without eye strain. The lamp should be in such a position that your hand will cast no shadow on the work.

Erase pencil marks before applying finish. Always rub with the grain. If the pencil mark is in a groove, cut the eraser to an edge.—CHARLES and BERTRAM BROWNOLD.

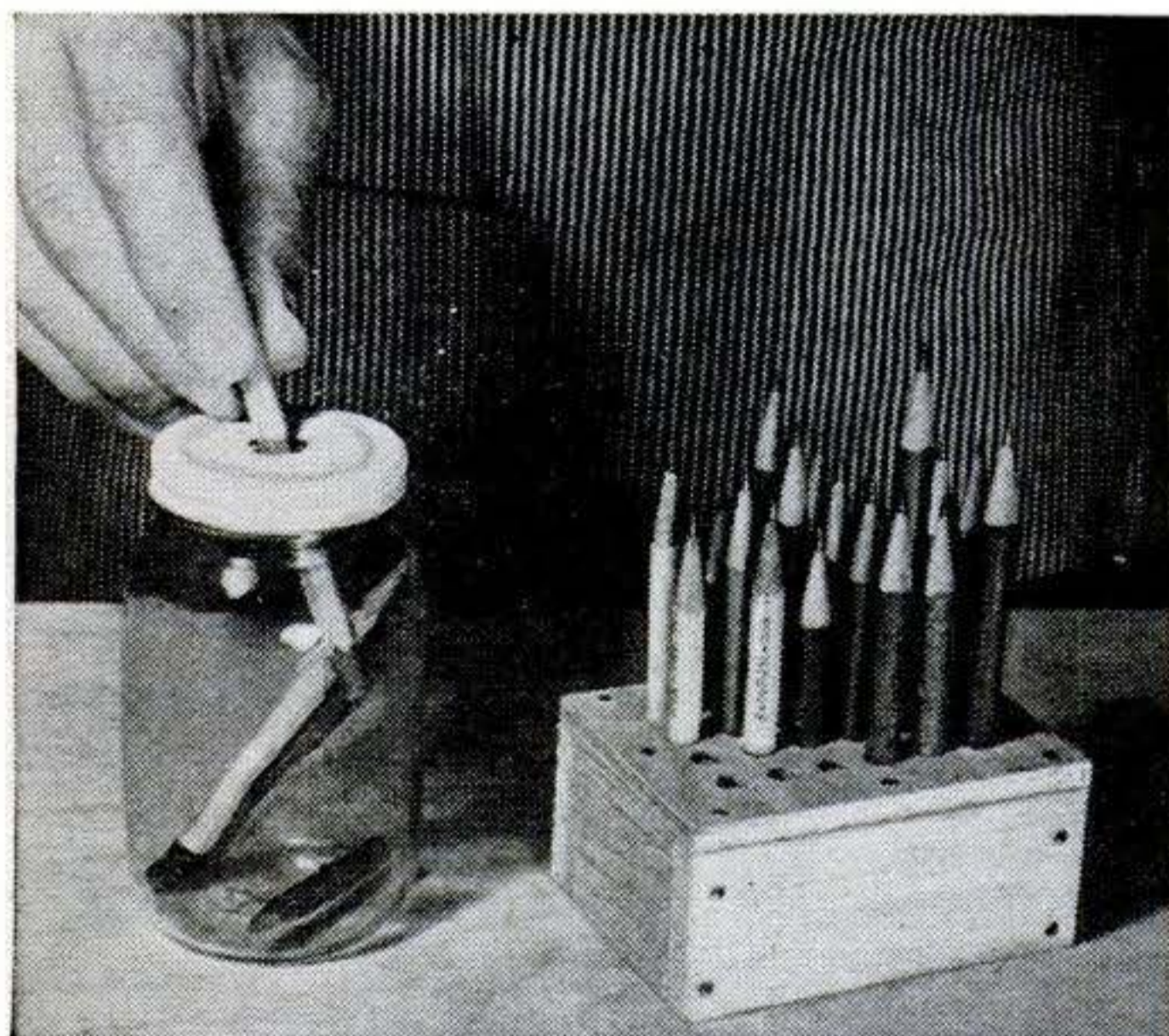

USE PENCILS WITH SHARP POINTS. Put extra sharp points on the pencils you use, and have plenty of them handy. When one becomes dulled, place it in a jar with a hole in the lid to get it out of the way, and then sharpen them over in some spare moment. Use an awl in marking metal.

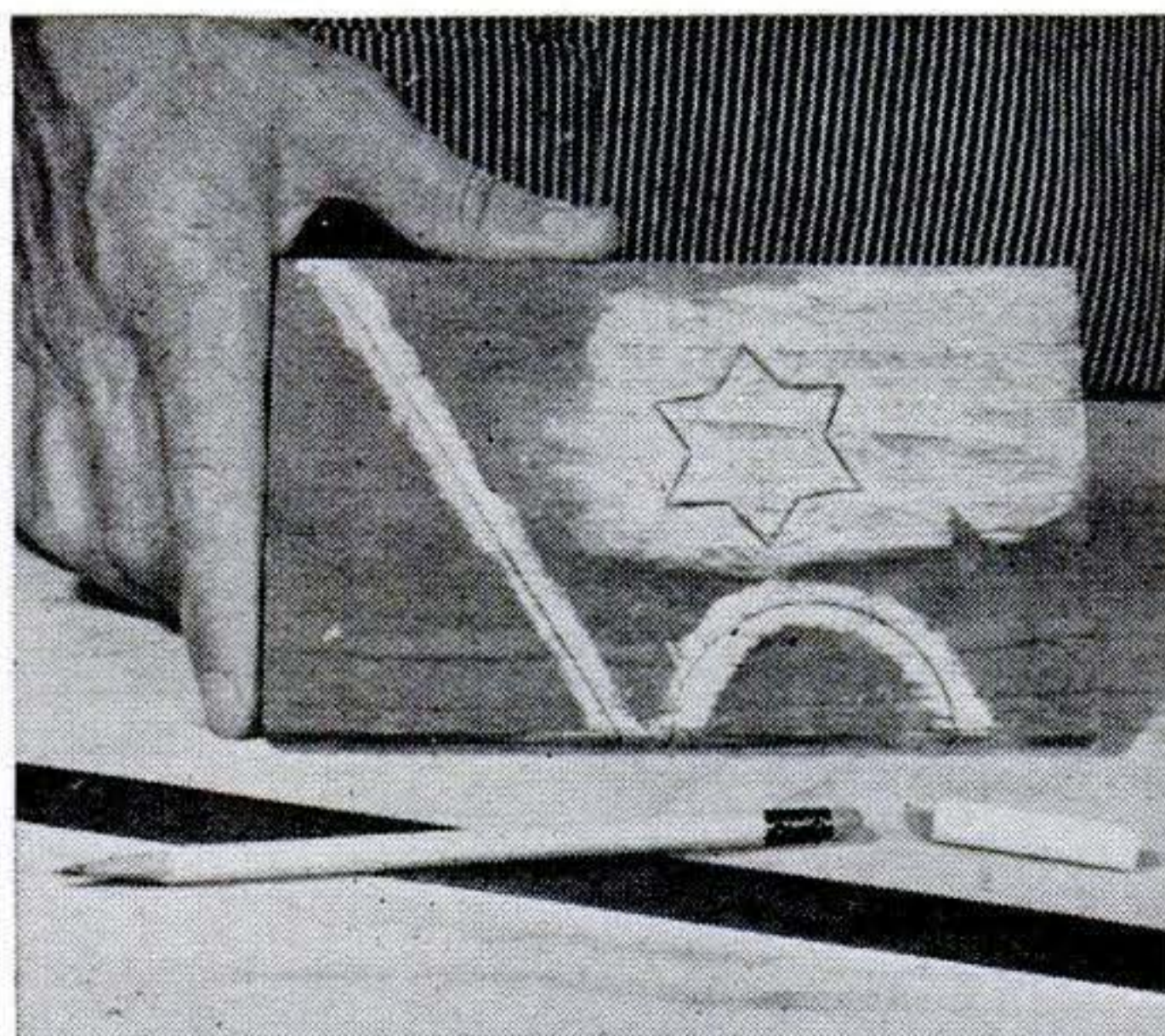

CHALK BACKGROUNDS ON DARK WOOD. Pencil marks are hard to see on walnut and other dark woods. A useful kink is to chalk the surface to be marked so the lines will stand out clearly. Never make the lines too long on any wood; it only makes more to rub out after cutting.

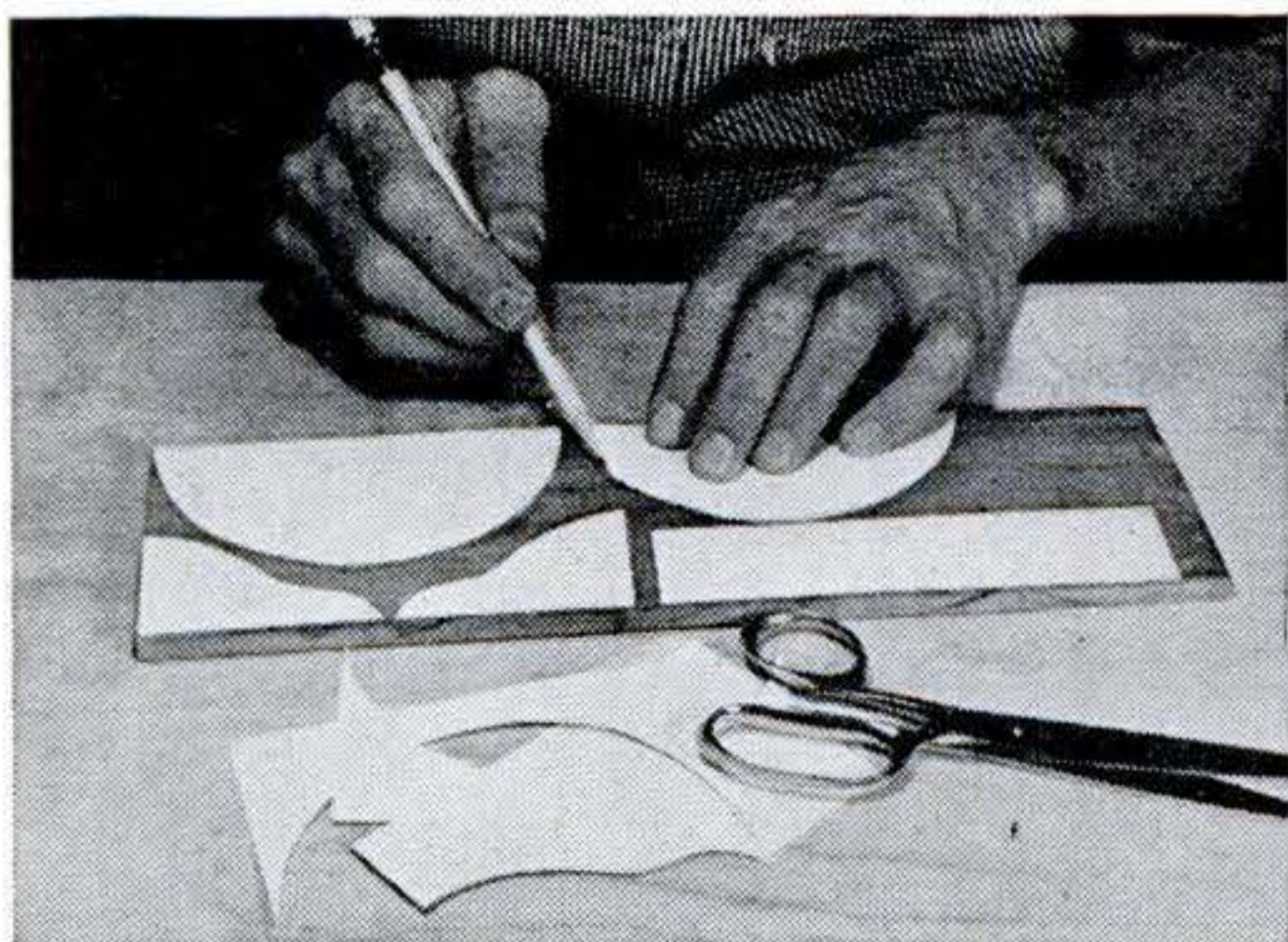

PATTERNS AID ACCURACY. Except for layouts that can be made with a straightedge or compass, don't make them directly on the work. It is far better to try them first on paper, and then to transfer them to stiff cardboard or even light metal. Such patterns are a help also in figuring how to get the most out of a given piece.

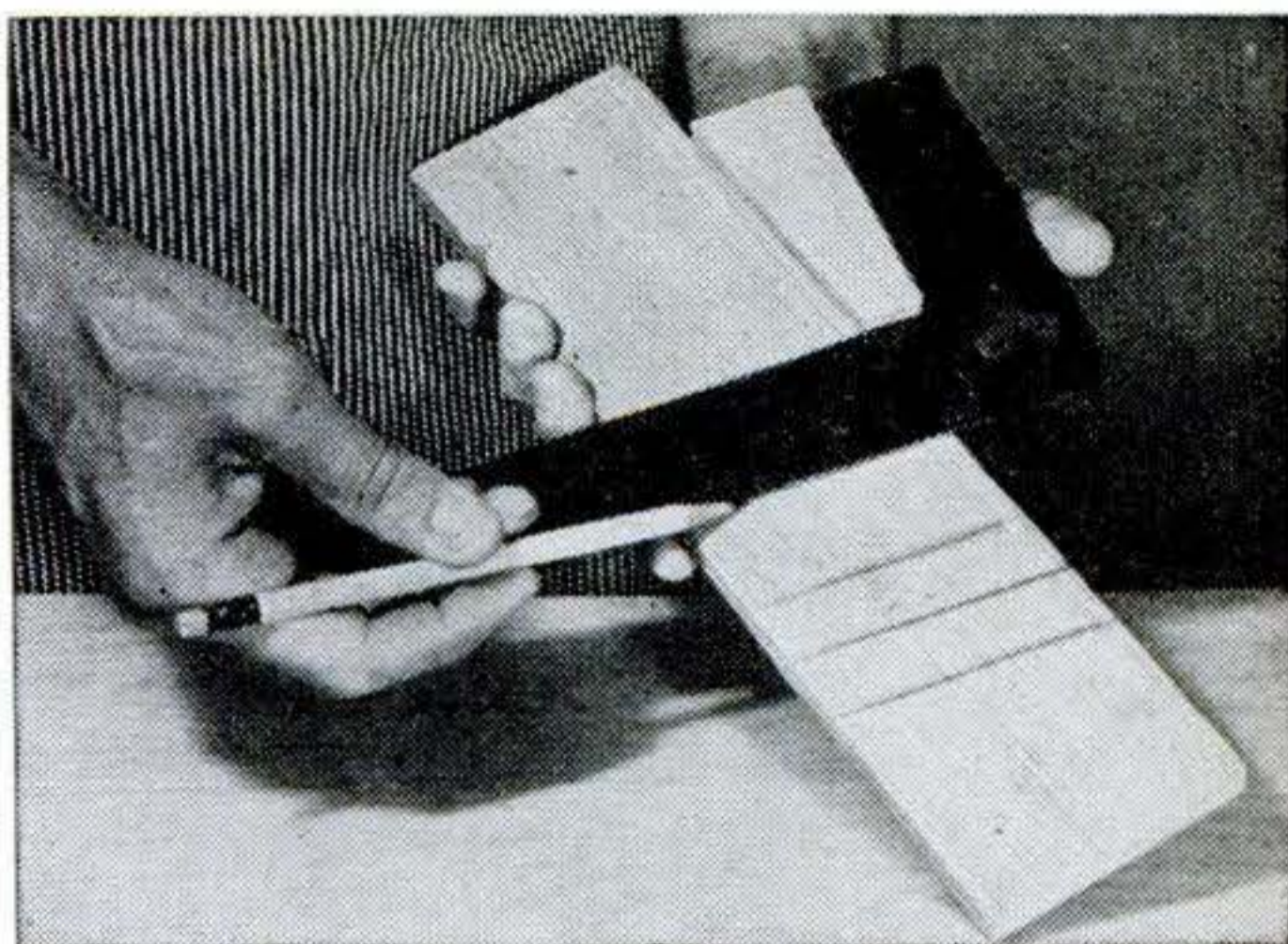

HOW TO REPEAT AN ANGLE. If an angle has to be made a number of times on work, make a wedge of the required taper and hold it between the work and the square when marking. For 30-, 45-, and 60-deg. angles, artist's triangles can be used. Marks can be made close to the square if the pencil point is long and tapered.

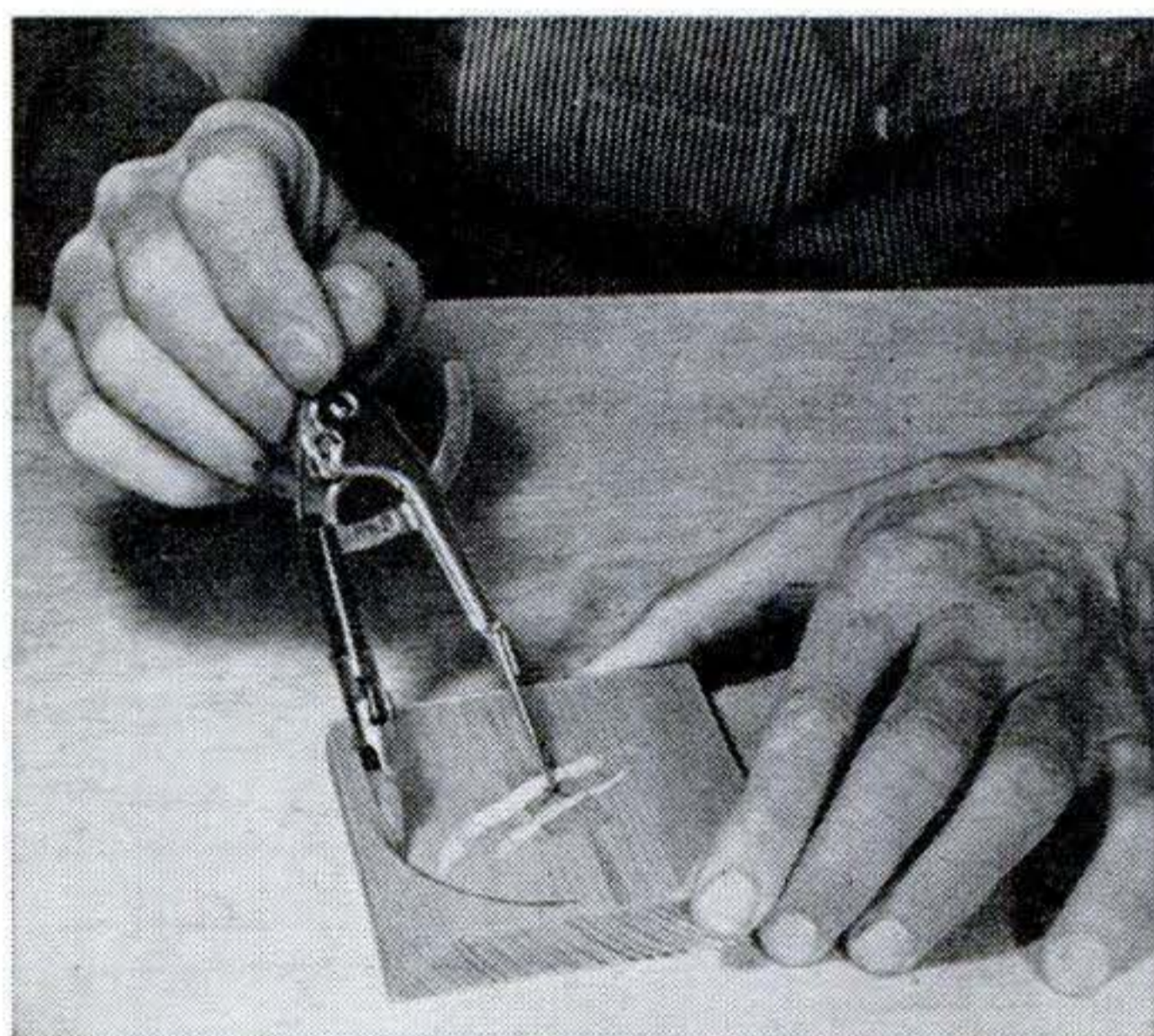

PREVENTING COMPASS-POINT DIG. A sliver of wood taped on the work under the compass point will keep it from making a deep hole.

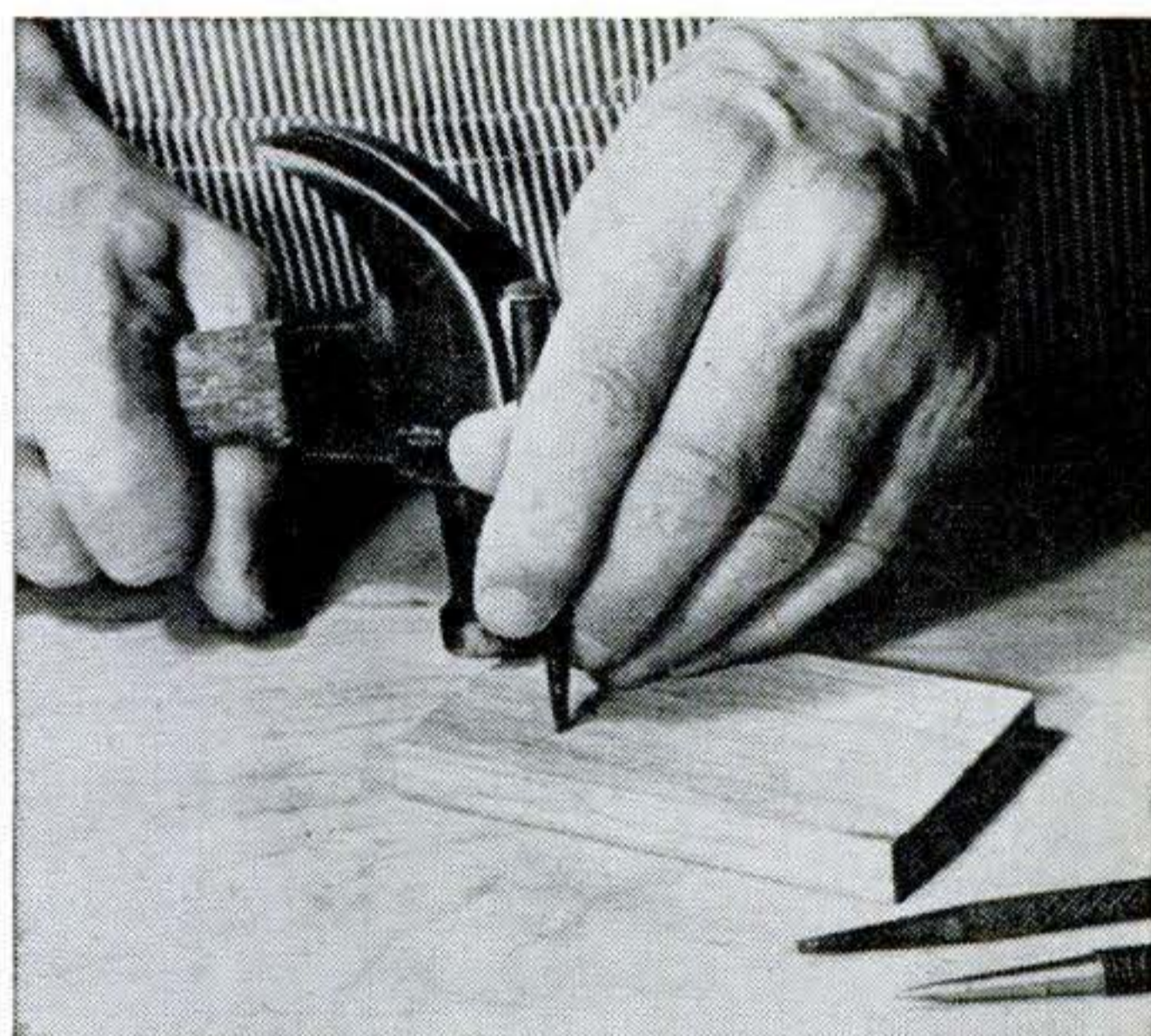

BLUNT CENTERPUNCH WON'T SPLIT WOOD. If you use a blunt punch it straddles the fibers and locates a mark more precisely than a sharp punch.

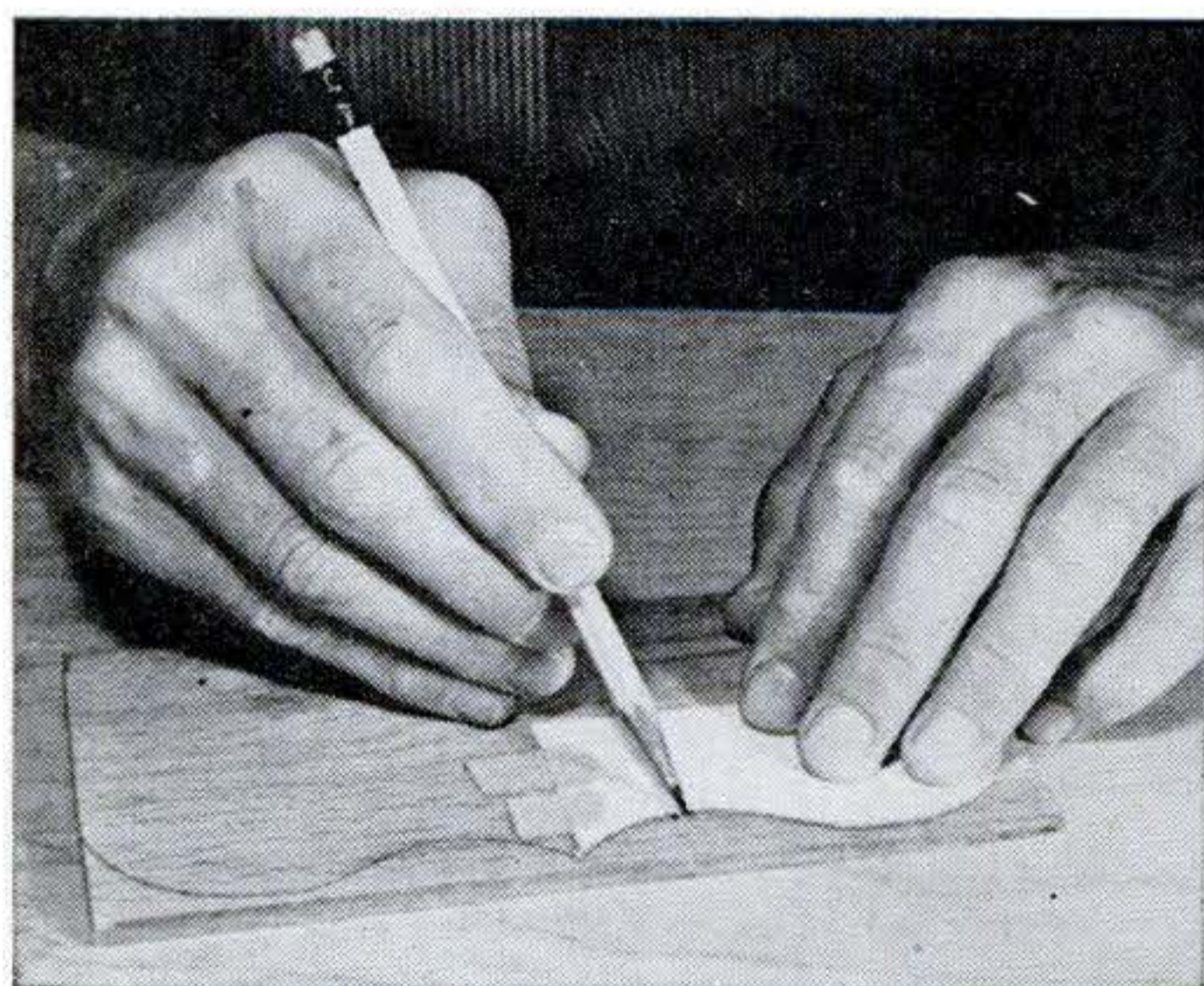

HOLD PATTERNS WITH ADHESIVE. To prevent the slipping of a template while marking, hold it to the work with bits of adhesive tape.

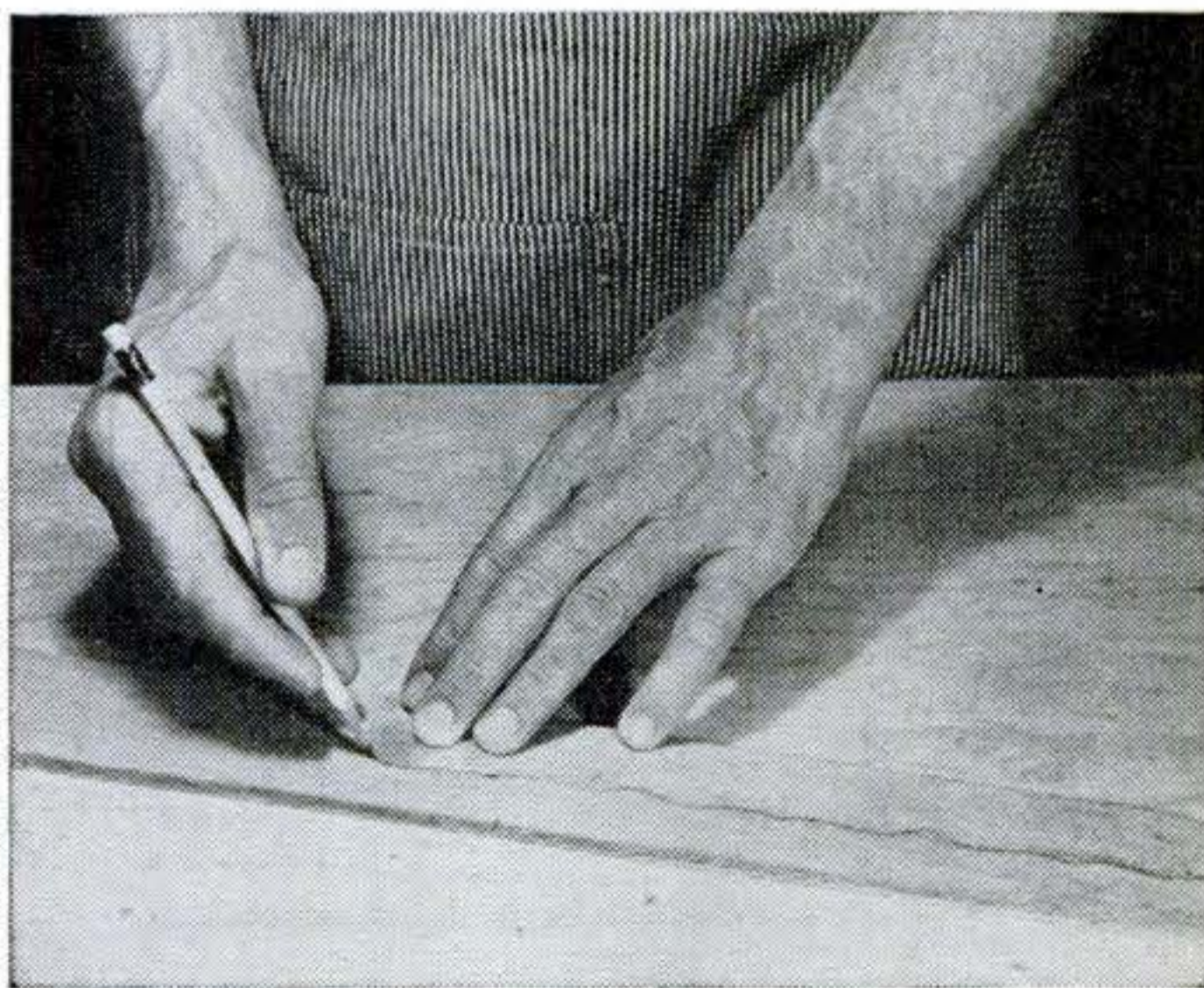

MAKING A REPEATING PATTERN. Cut a template to the shape of one repeat part of the pattern and move it along as often as necessary.

Power Oilstone Ends Sharpening Chores

THIS may seem like a luxury for the home workshop, but once you've tried a power whetstone that works while you do some other job, you'll never be without one. Because its patience is inexhaustible, it will continue sharpening a chisel or plane iron long after you would have given up, and it will produce an edge the like of which you've probably never used before. In fact, the edge will be so keen you better watch your fingers the first time you try it.

The stone is moved back and forth under the chisel by a motor-driven pulley operating two gears. A ball bearing mounted on the second gear travels in a slotted brass yoke screwed to the oilstone table, which is held on two drill-rod slides by two drilled brass guides. With a 1" pulley on a 1,750 r.p.m. motor and a 4" pulley on the sharp-

ener, the speed will be about right. If the yoke bearing is bolted near the edge of the large gear, travel of the oilstone table will be about $2\frac{3}{4}$ ". Experiment by relocating the bearing nearer the center if vibration is troublesome.

Make the table of a $\frac{3}{8}$ " aluminum plate and the stops, clamps, and stand of hardwood. The base, ends, and front cover may be $\frac{3}{4}$ " stock, but the bearing block should be $1\frac{3}{4}$ ". Bore it $\frac{5}{16}$ " for $\frac{1}{4}$ " drill-rod shafts, and counterbore both sides for a press fit for the four $\frac{3}{4}$ " o.d. ball bearings.

Make up the tool holder as shown in the drawing, and assemble on the pivoted brass arms by means of the end-threaded rod and wing nuts. The two springs should be strong enough to hold the chisel evenly against the oilstone. Pack the five ball bear-

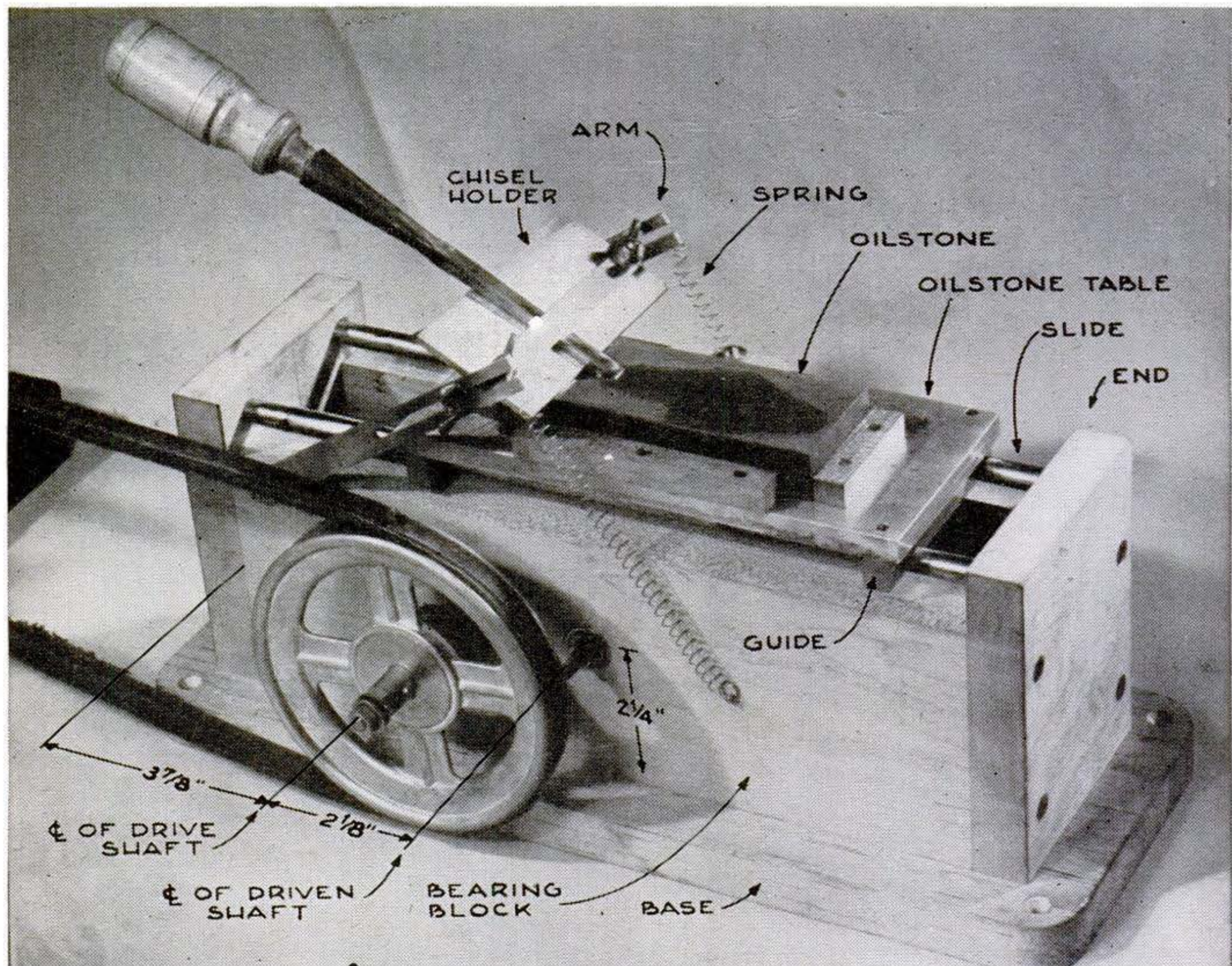

Drill the shaft hole for the $3\frac{1}{4}$ " gear at the center of the block. Check gear mesh and lay out the other.

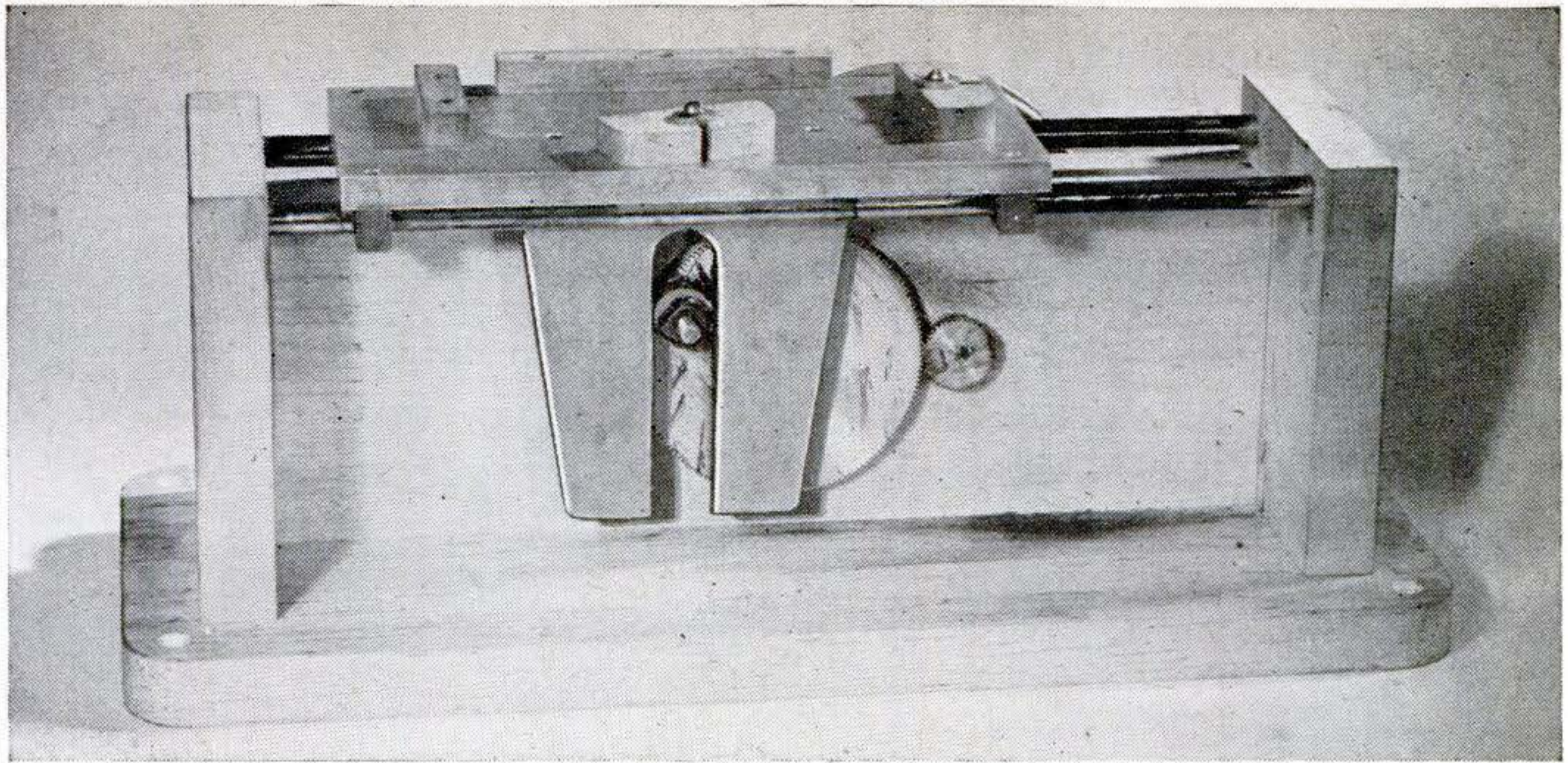

Movement of a ball bearing in a yoke operates the stone table. The bearing fits the slot without play.

ings with cup grease and spread a tough, fibrous grease in the yoke slot.

A badly nicked chisel must be ground first on a wheel in the usual manner. It is then clamped in the holder carefully to get the bevel flat, and the machine is started.

Use a medium oilstone first and finish by setting a hard Arkansas stone on the table and readjusting the chisel. After a perfect edge has been put on the bevel, a few strokes are taken by hand on the flat side to remove the feather edge.—HERBERT PFISTER.

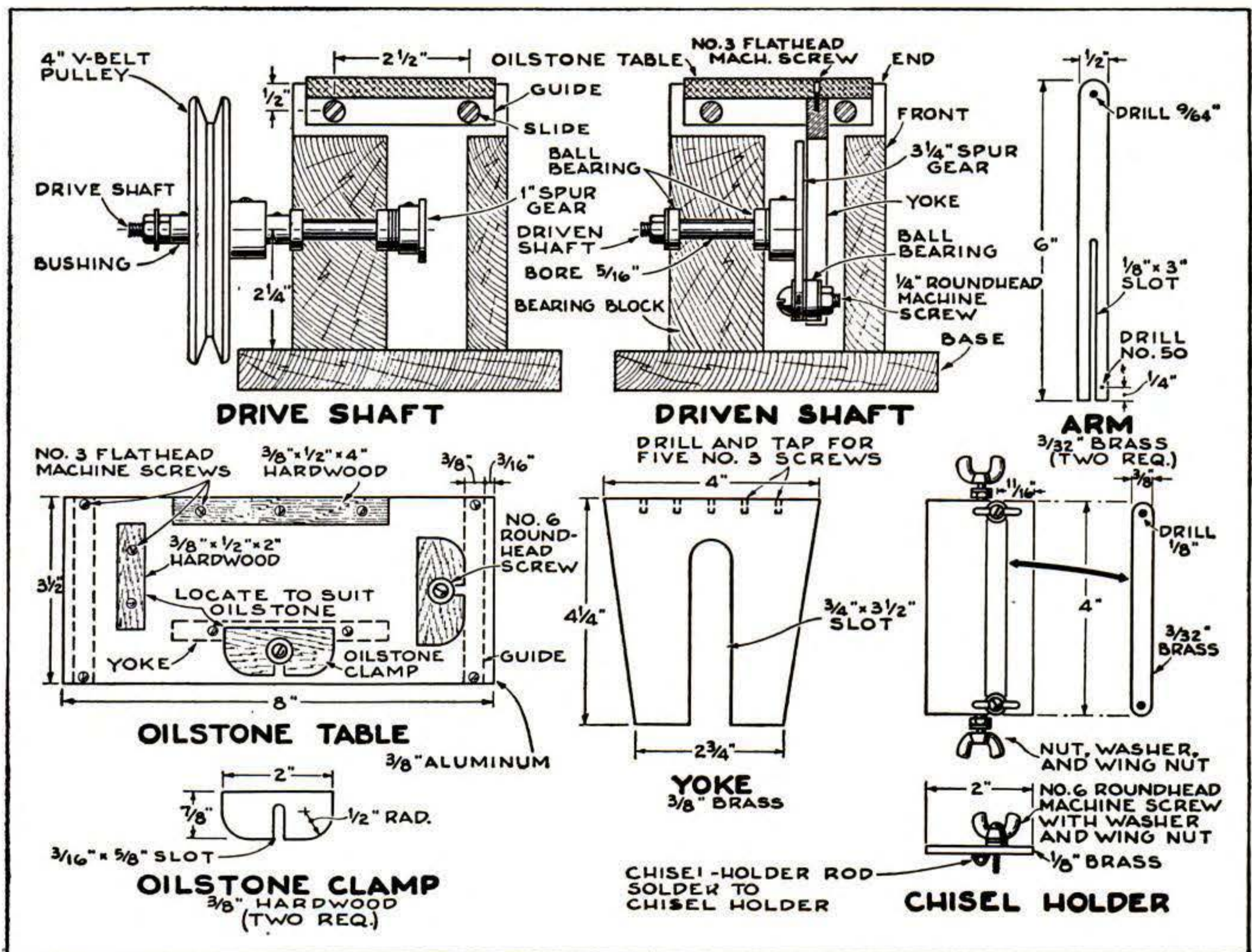

Few dimensions are critical. Adaptations may be made in most parts if substitute materials are on hand.

HOBBY SHOPPING

Dart Game Uses Blowgun. With a new dart game invented and put on the market by William L. Kline, of New York City, you use a blowgun instead of your arm to send the dart into the target. The 28" gun is made of aluminum alloy and the darts of aluminum with steel tips. Fair accuracy up to 50' is said to be obtained with the gun. Selling for \$2, the game consists of two blowguns, two removable plastic mouthpieces, four darts, and a 14" by 14" cork target, all packaged in a carrying case.

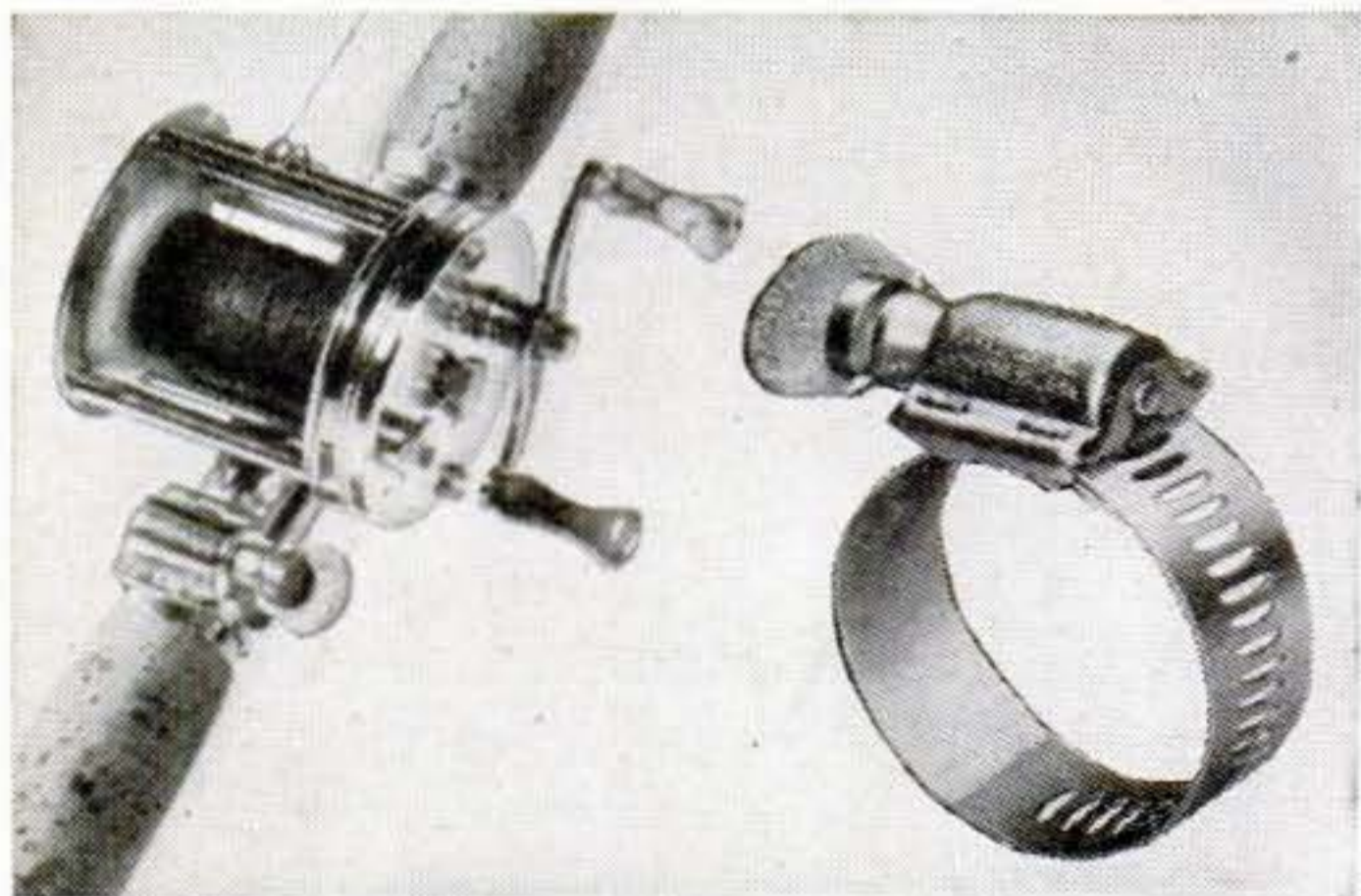
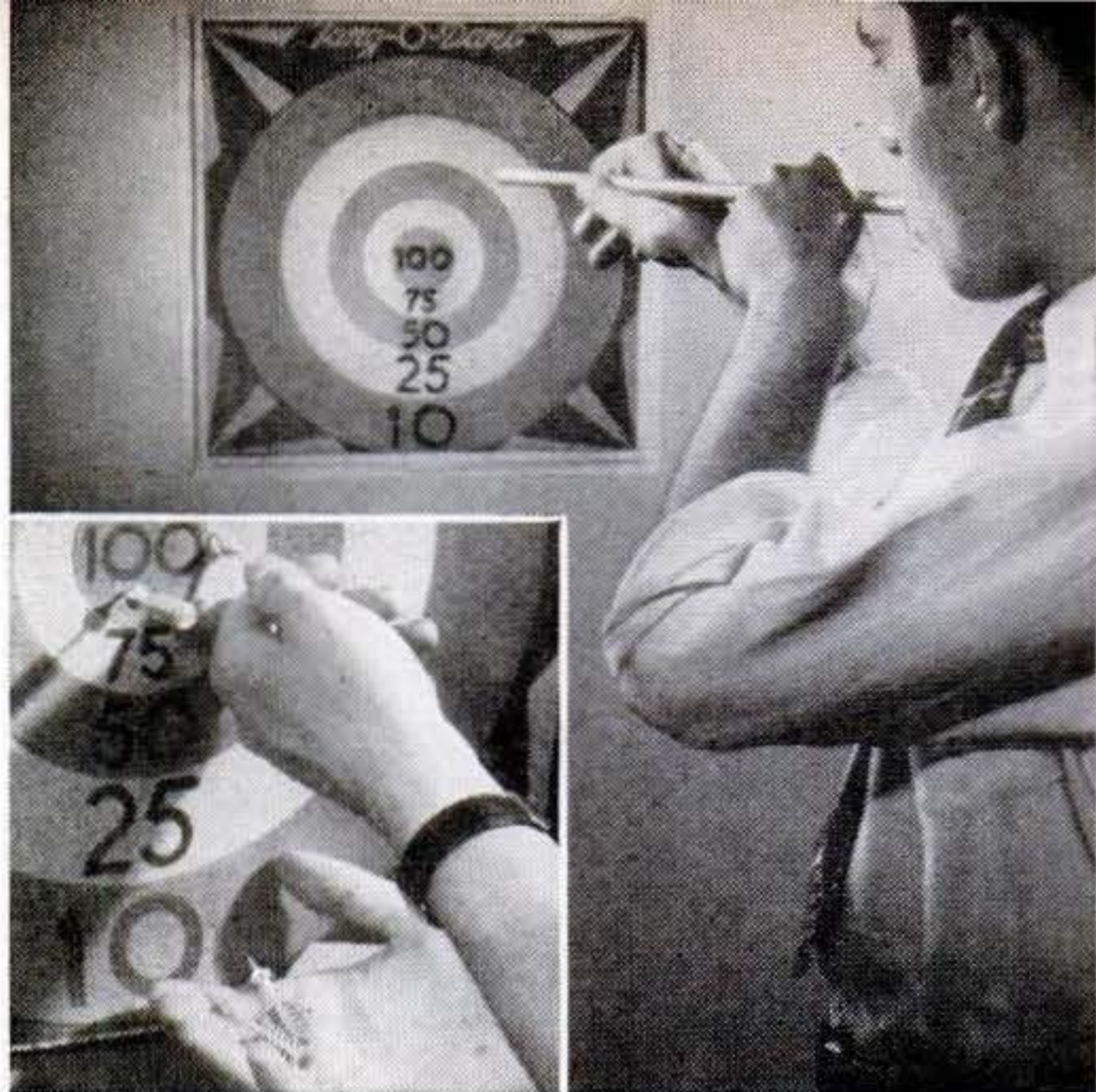

Reel Clamped to Any Rod. Originally designed during the war for various military uses, the Aero-Seal clamp produced by the Aircraft Standard Parts Company, Inc., of Rockford, Ill., now has been adapted for use of fishermen. Easily tightened with a thumbscrew, the stainless-steel clamp may be used to fasten a reel to any rod.

Radial Engine. A model five-cylinder airplane engine that is a scale replica of the LeBlond engine is being produced by the Burgess Battery Company, of Chicago. The parent engine is 33 $\frac{1}{4}$ " in diameter, weighs 219 lb., and develops 85 hp. The model is 5 $\frac{3}{8}$ " in diameter, weighs 22 oz., and develops $\frac{1}{2}$ hp.

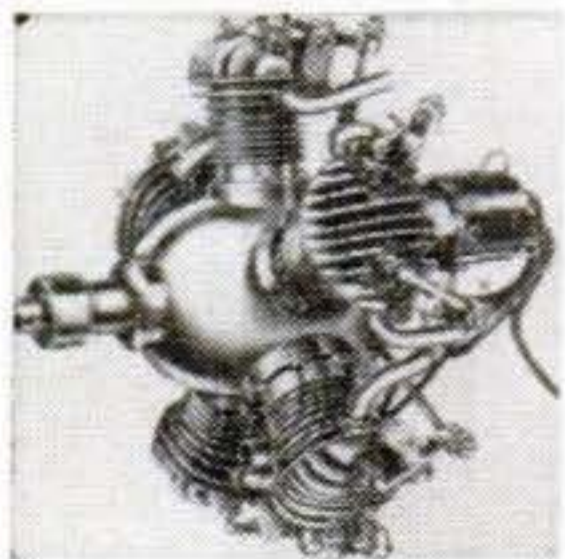

Fishing Bob Lights Up. A plastic fishing bob made by the S & H Mfg. Co., Russell, Kan., contains a small battery and bulb, both of which are replaceable. When a fish bites, a mercury switch flashes the bulb.



Model Car Is Light. Designed for either cable or track racing, a new 17" model car produced by Reuhl Products, Inc., of Madison, Wis., has a fibreglas body and weighs only 3 lb., 14 oz. without engine and accessories. It features a front drive with 2-to-1 bevel gears in oil. Packaged in a kit, it sells for about \$25.

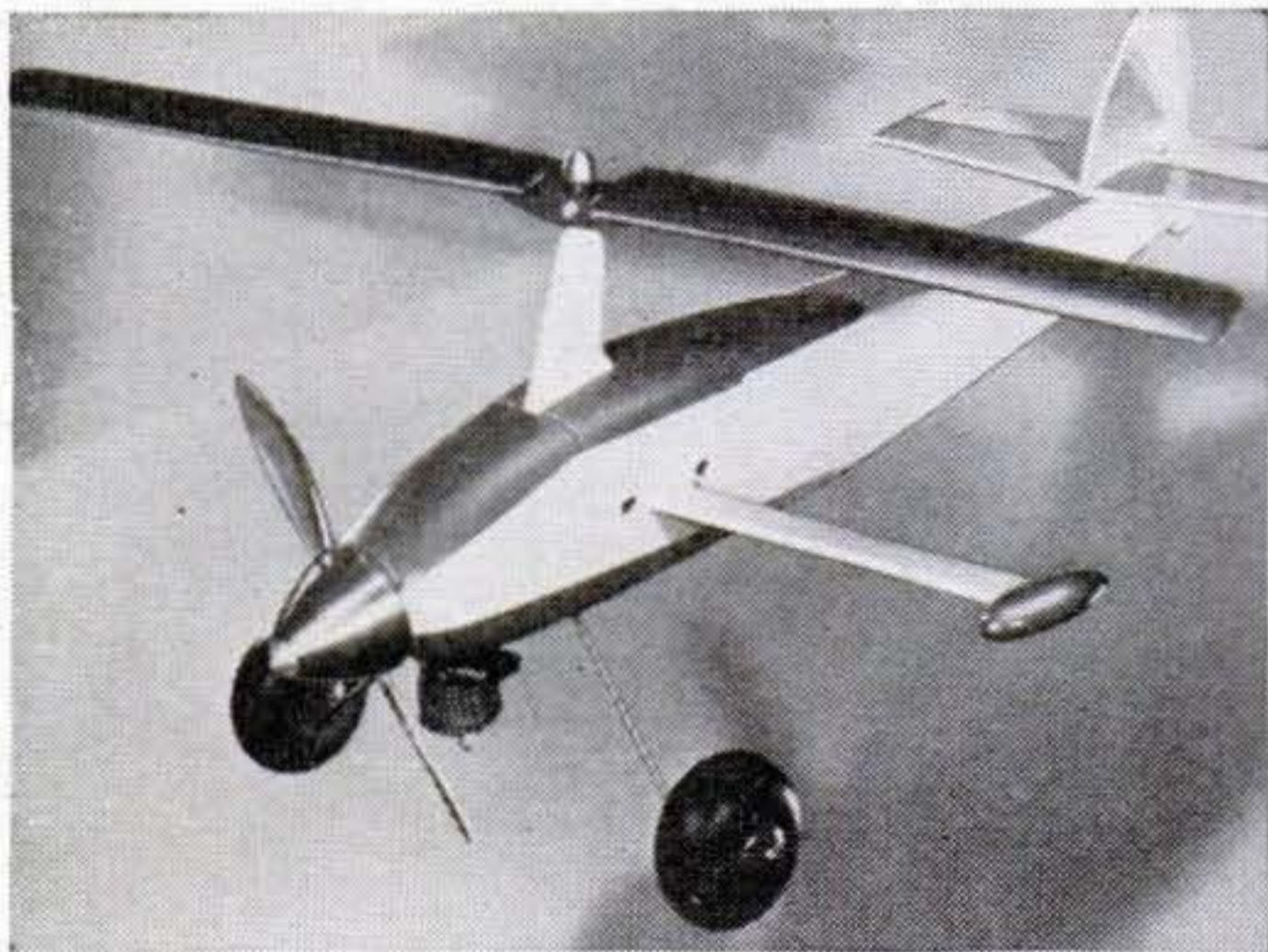

Control-Line Autogiro. A model Autogiro produced by the Engineering Development Company, Del Mar, Calif., is designed for control-line flying. Built for any engine from .232 to .600 cu.in. displacement, it descends gently when the motor is cut, like the real thing. The plane is 27" long, with 25" rotor blades.



The canopy is the base, plastic tubing raises the glass body, and a brass tube carries the socket.

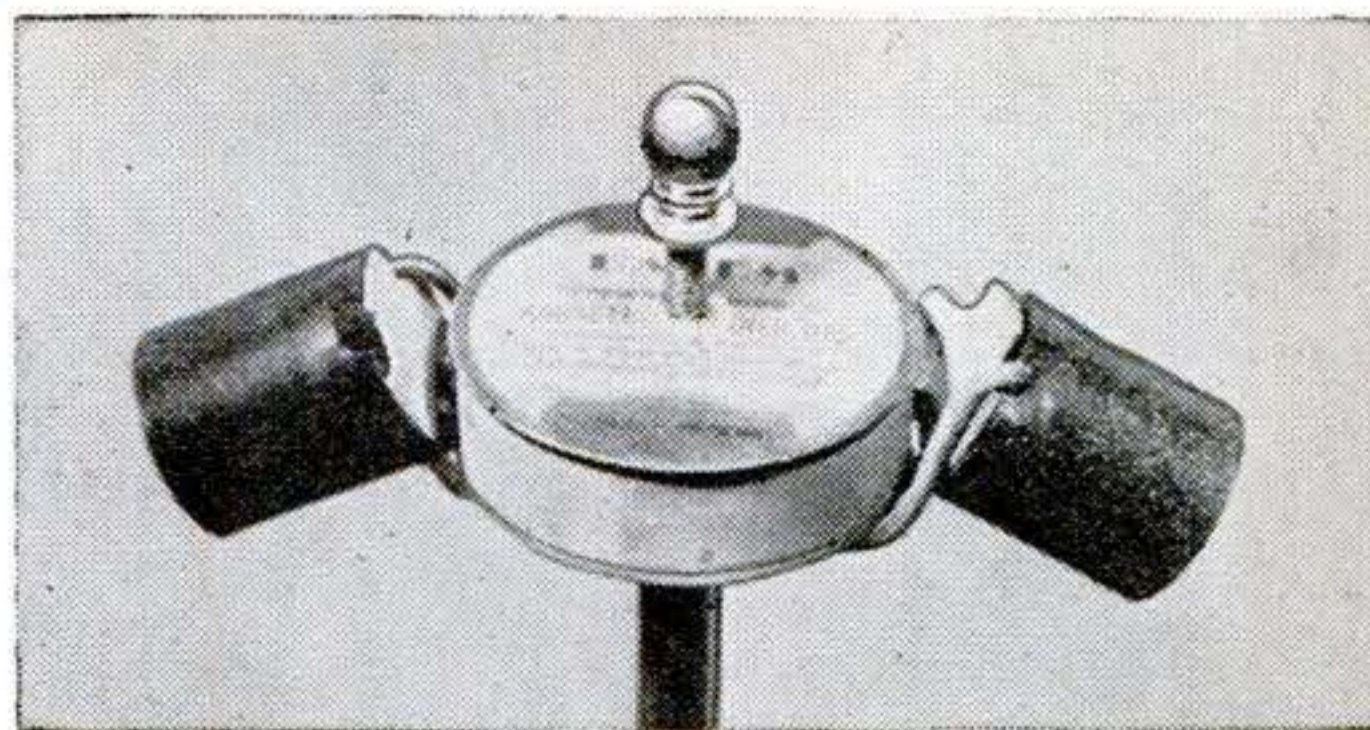

Common lock nuts secure the typewriter-ribbon can to the stem. A bolt takes the shade and finial.

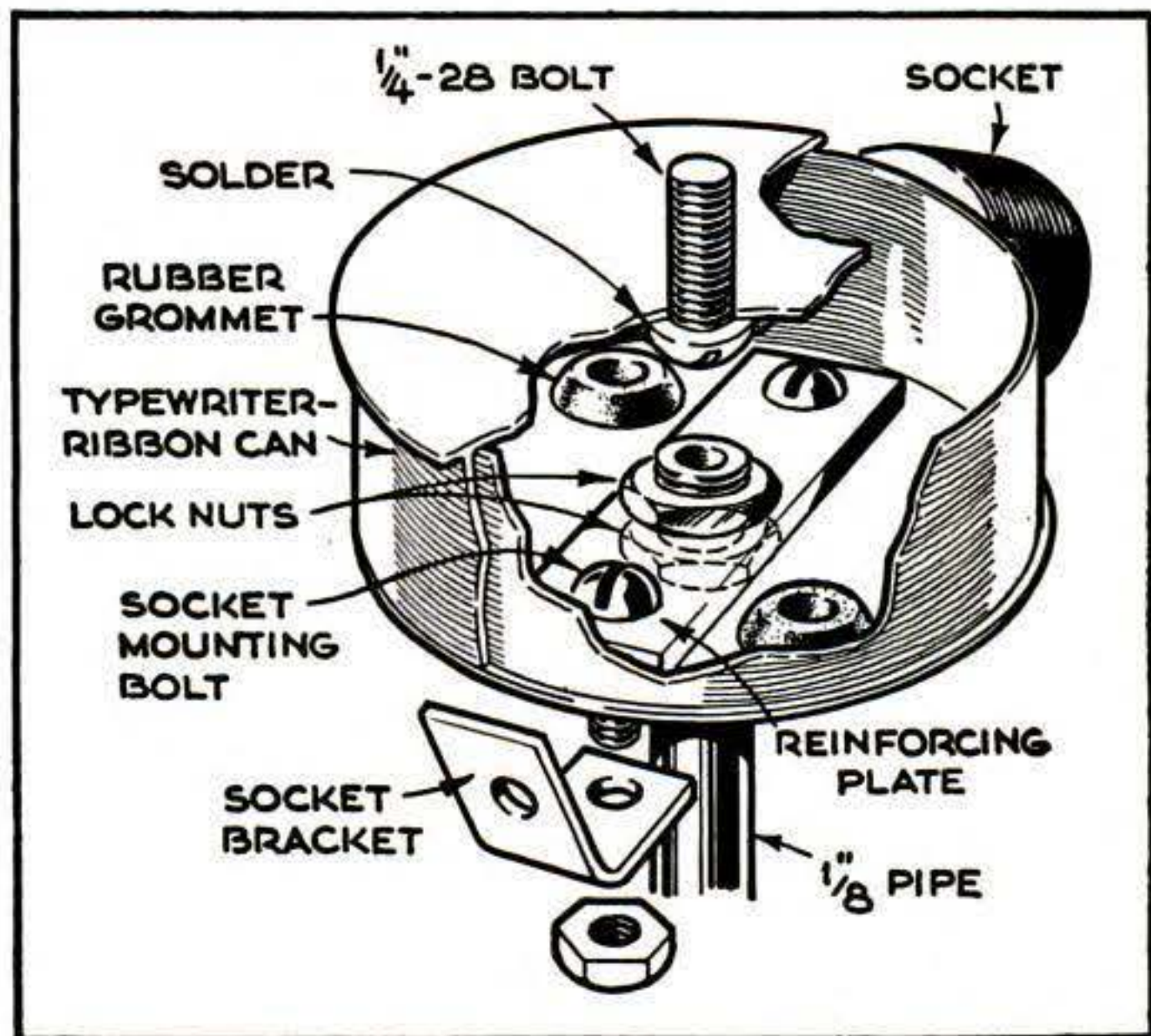

Junked Lighting Fixture Provides Lamp Parts

AN OLD overhead lighting fixture may yield numerous items of value to the craftsman who likes to build floor and table lamps. In addition to running-thread pipe (there was a 14" length in the old fixture used here) he may find a spun or stamped canopy, sockets, tubing, and perhaps an ornamental glass body drilled for a pipe.

Such a body, plus the canopy, a 3½" length of 1¼" plastic tubing, a length of ⅛"

pipe, and a short piece of brass tubing, comprises the lamp shown. What was the canopy of the fixture (placed against the ceiling) forms the base of the lamp.

The sockets were switchless, but each had a small angle bracket by which it could be mounted in a two-bulb cluster on a typewriter-ribbon can. Leads were run through grommets into the can, and control was provided by a switch set in the lamp base.



Snap Fasteners Make Hinges

CONCEALED pivot hinges for doors on small craftwork projects may be simply a pair of snap fasteners. Align carefully, and then recess and cement half of each fastener in the frame and half in the door before final assembly is made.

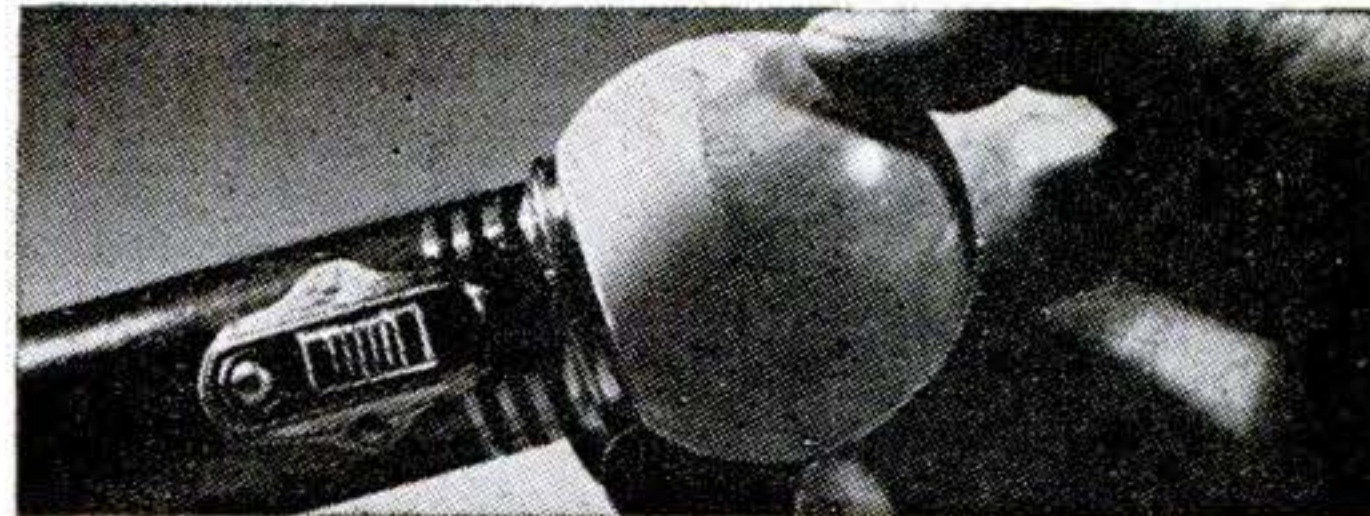

Ball Protects Flashlight Lens

KEPT in a serviceman's or handy man's tool chest, a flashlight won't be damaged if the lens is protected by a hollow rubber ball. A circular section cut from the ball with scissors should be just large enough for the ball to fit the barrel snugly.

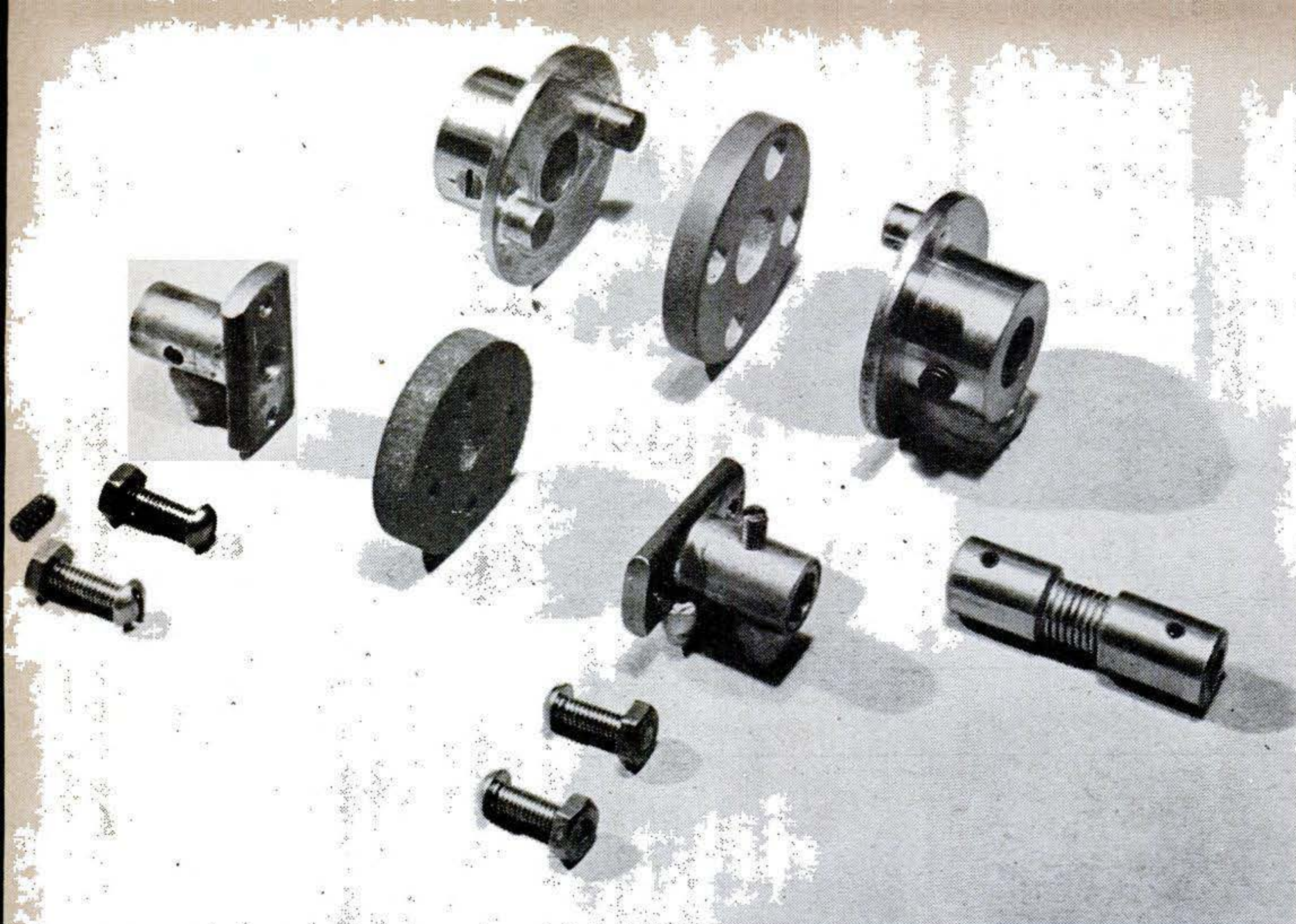

Three types of flexible coupling are seen here. Two use a flexible disk, the third (right) a coil spring.

Flexible Couplings Smooth Power Flow

WHEN two shafts meet end to end, a flexible coupling of some sort usually is needed to compensate for unavoidable misalignment. By bending or giving a little, such a coupling will transmit rotary power smoothly from one shaft to the other. Furthermore, a flexible coupling absorbs much of the starting shock when power is applied, thereby protecting the parts of the mechanism. It also lessens noise and prevents vibration from passing between the shafts. Sometimes a coupling of this type is used as an insulator in electrical control equipment, or it may perform the functions of a universal joint, the misalignment of the shafts being intentional.

Flexible couplings of many types are successfully used. A few are described here to suggest possible designs that may fit your shop requirements or mechanisms that you may want to build.

Perhaps one of the simplest is a crude type of universal joint often encountered on

toy boats. Paradoxically, this coupling involves no actual linkage between the shafts. The end of each shaft is simply bent to about 35 deg., the bent ends touching to transmit rotation and sliding on each other to take up any unevenness.

Figure 1 shows another simple arrangement that is useful where you want some flexibility and also a cushioning action in starting and stopping. A short coil spring is soft-soldered into two collars secured to the shafts with setscrews. For light drives, the spring can be soldered right on the shafts. Since there are no moving parts other than the turns of the spring, there is nothing to wear or require lubrication, but a steel spring should be oiled to prevent rust. It is usually possible, of course, to make this and other types of couplings to join shafts of different diameters.

A coupling arrangement that is frequently used consists of a disk of rubber, leather, fiber, or some similar material mounted be-

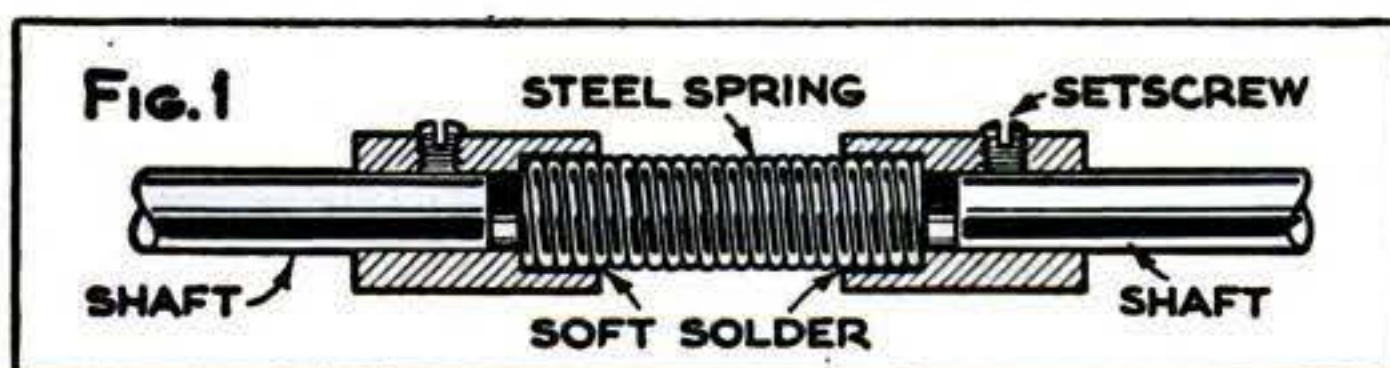
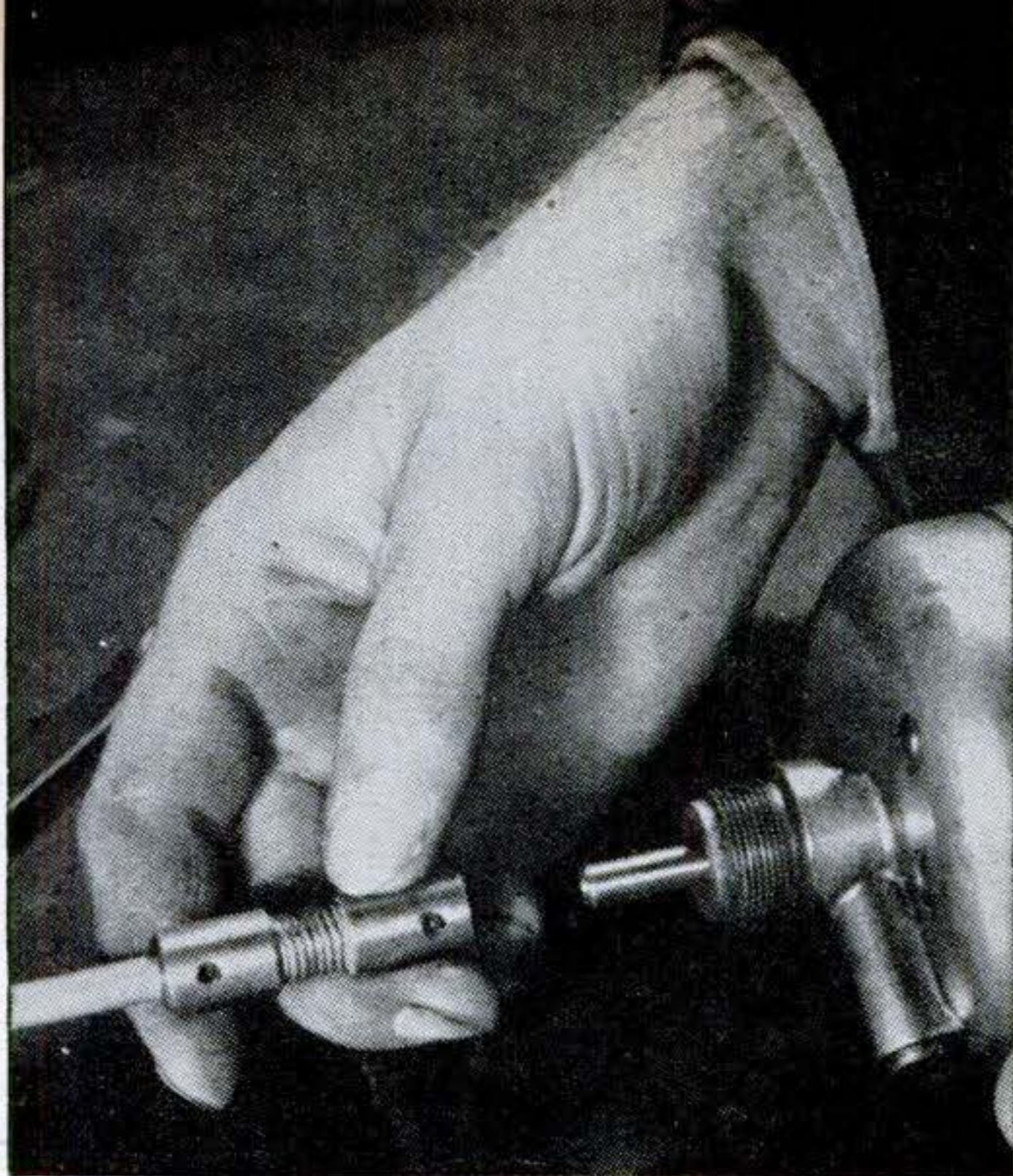

Closely wound springs are good for absorbing shock as power starts or stops. In the photo above, one is being installed between a motor and shaft.

tween two plates fastened to the shaft ends, the disk having four or six holes to receive pins attached to the plates. Figure 2 shows how you may build up the end plate for such a coupling from a large washer, a piece of steel machined to fit the shaft end and the washer bore, and two short steel pins. The parts are brazed or silver-soldered.

If you want considerable cushioning action, the disk should be cut from resilient rubber, preferably reinforced with fabric. A piece of rubber belting will serve nicely. If less cushioning is needed, the disk may be made from some material such as leather, formica, or fiber. It must be thick enough so that the pins from one plate do not extend through to touch the other plate.

A popular variation of the disk idea makes use of a flexible member and two metal "spiders" attached to it and the shafts. A coupling of this type may be seen in the pull-apart photo on the facing page and also in the photo at the top of page 190.

Each end piece, or spider, consists of a flat, rectangular piece of steel brazed to a sleeve to form a T. Near each end of the flat strip is a hole for bolting or riveting it to the disk. The two spiders are positioned so their flat T-heads are 90 deg. apart. There should be no metal-to-metal contact.

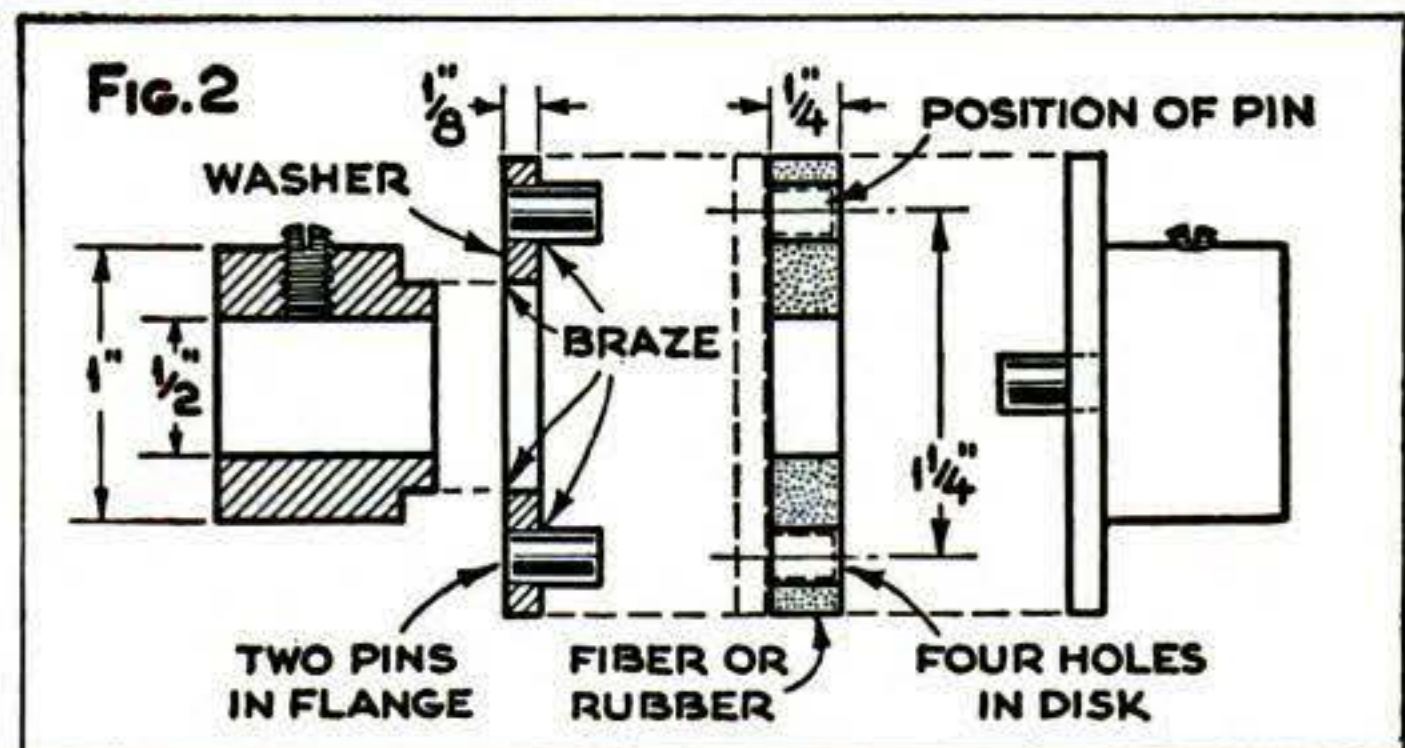
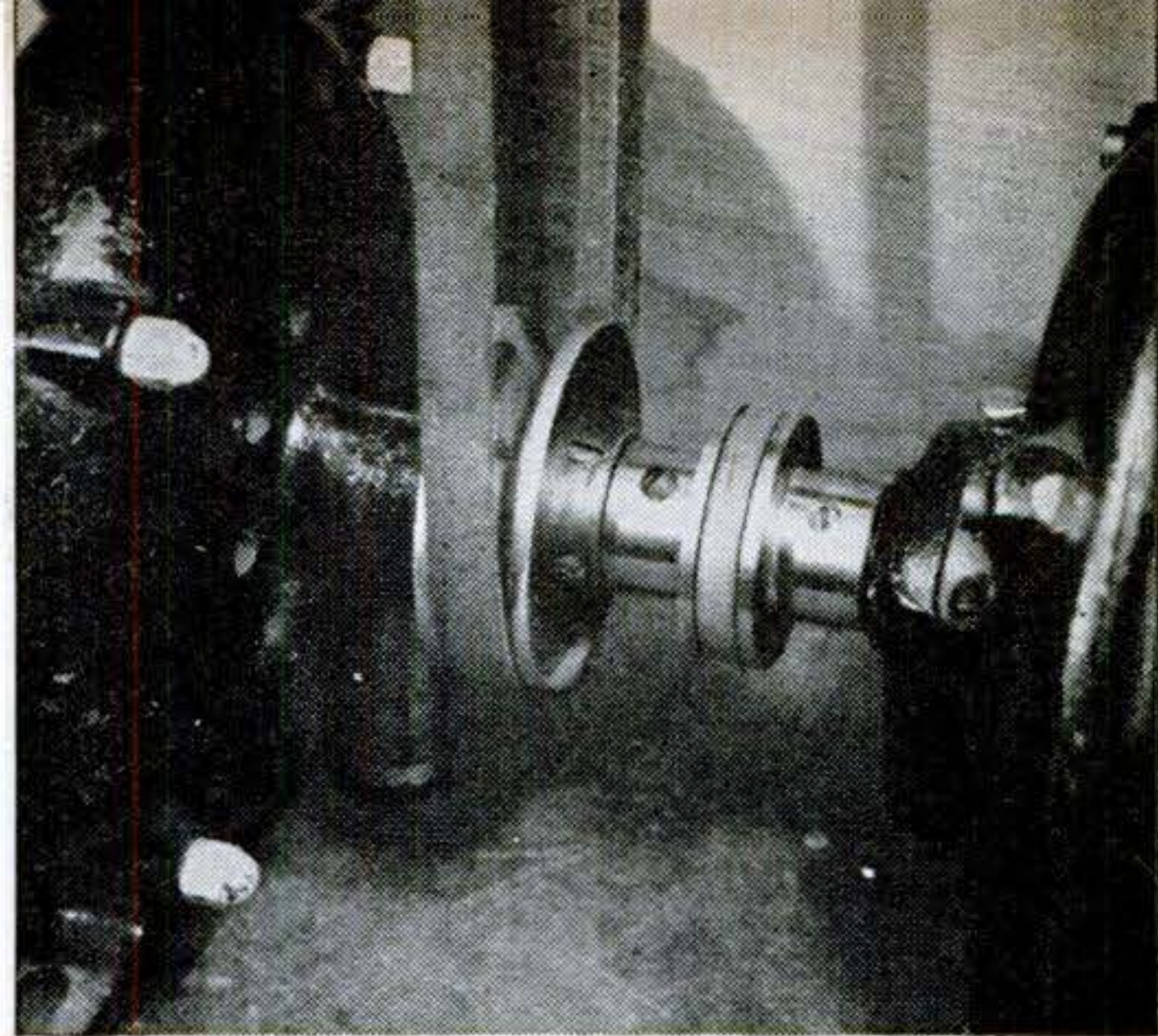

Joined by a disk coupling, two $\frac{1}{4}$ -hp. motors in the photo above deliver nearly $\frac{1}{2}$ hp. The drawing gives dimensions for a disk coupling to fit a $\frac{1}{2}$ " shaft.

Instead of the flat strips, curved U-shaped yokes might be used for the end pieces, especially if the coupling is large or subjected to considerable angular deflection. Disks may be cut from flat rubber belting, leather, or similar material.

When the disk is a nonconductor, such a coupling will serve as an insulating unit in the shafts of radio or other electrical equipment. Couplings with flexible members made of resin-impregnated fabric or other insulating material are available at many radio supply stores. These are designed for ganging condensers.

Interlocking castellated members form the coupling illustrated in Fig. 3. The two sections may be machined from steel, brass, fiber, or plastic—depending on the strength desired—or one might be of metal and the other of fiber or plastic. The notches should be machined so there is slight clearance between them and the matching fingers; the more clearance, the more flexible the coupling. Graphited grease applied as a lubricant will reduce noise. This may be retained by placing a short tube of oil-resisting synthetic rubber or similar flexible material around the coupling.

If the shafts are mounted with negligible end play, the sections will remain inter-

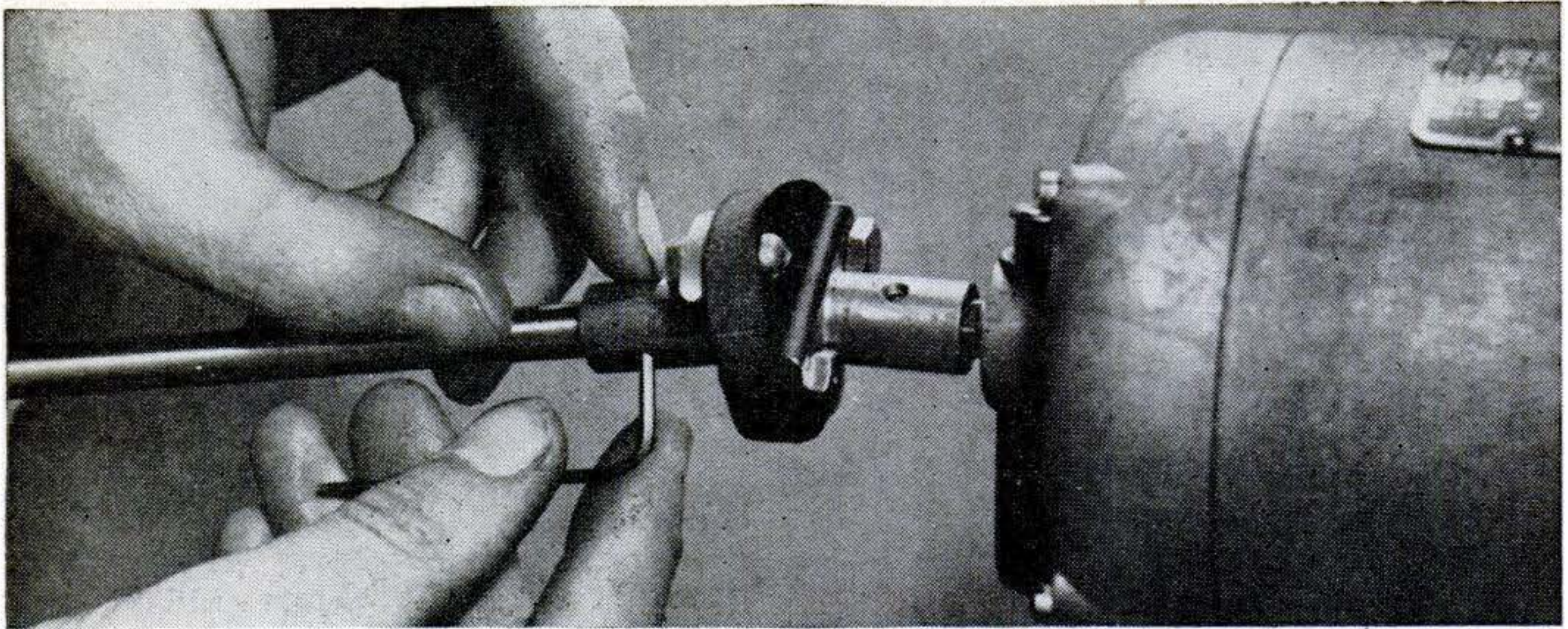

In this coupling, each end consists of a sleeve with a piece of flat stock brazed on in the form of a T.

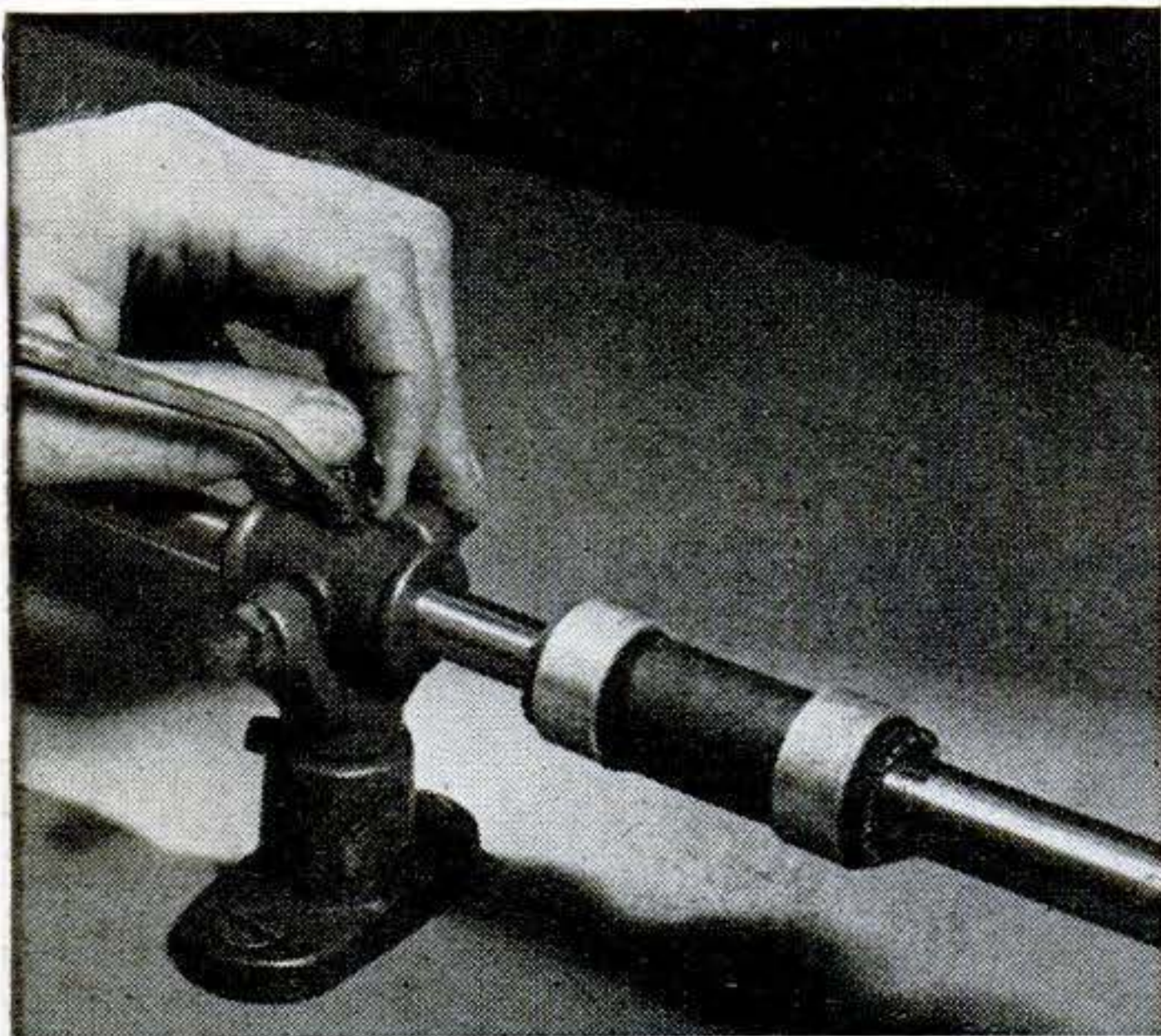

One of the simplest couplings is a piece of rubber hose clamped to the shafts. Here such a coupling is used to join two shafts of different diameters.

locked without any special fastener. The drawing, however, shows a wire ring resting in a shallow groove cut around the interlocking fingers, the groove being wider than the ring to permit slight angular movement of the coupling.

A coupling of similar type sometimes is improvised from two bevel gears, the gears being mounted so their teeth interlock to transmit the power.

Another common type of coupling—and one of the simplest—is merely a short length of rubber hose clamped over the ends of the shafts. Figure 4 shows just two possible ways of anchoring such a coupling positively. One involves drilling small holes through a metal band, the hose, and shaft to receive a bolt or rivet. The other is simply a conventional hose clamp. These clamps are satisfactory if there is no danger

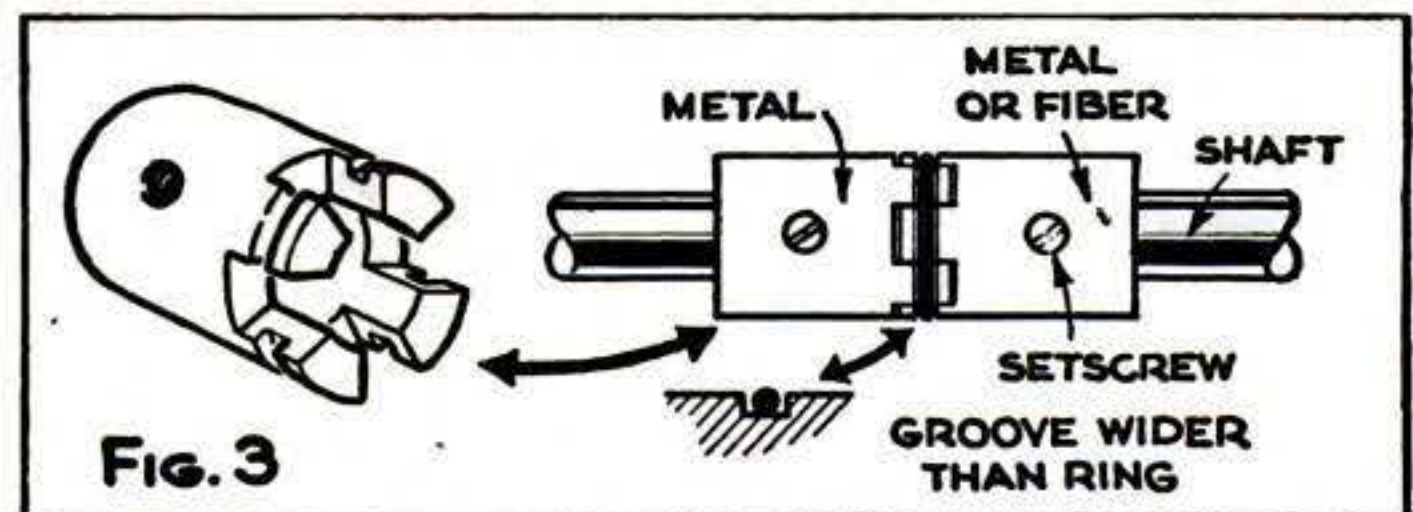

Interlocking teeth transmit power from one shaft to the other in this coupling. Clearance between the interlocking members provides flexibility.

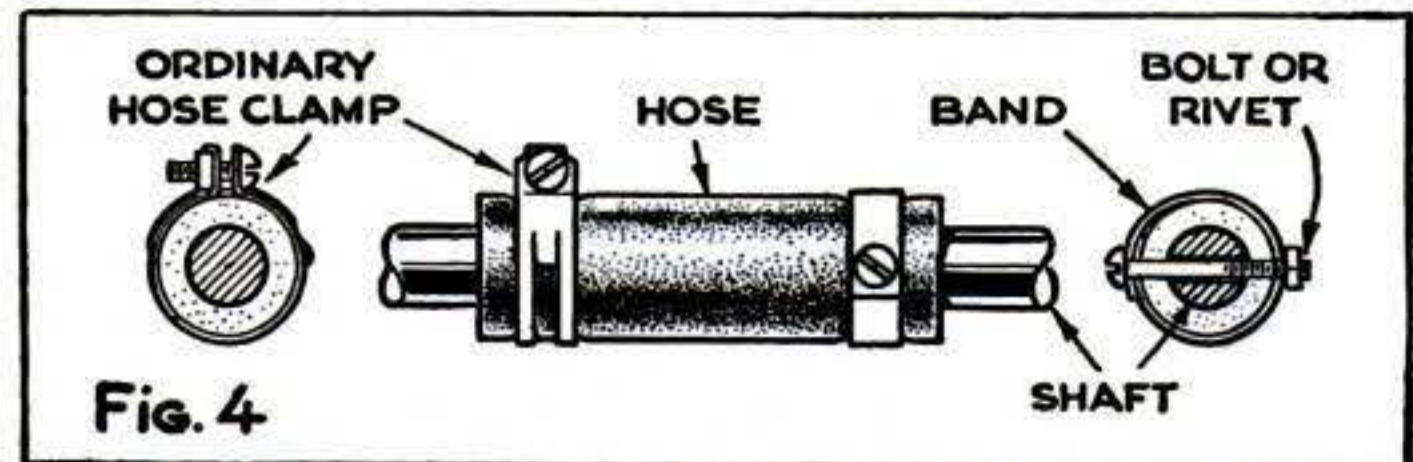

Two methods of attaching a hose coupling are shown here. With an ordinary hose clamp, the hose may be bonded to the shaft with cement to avoid slippage.

that projecting parts of the clamps will strike something, and if friction alone between the rubber and shafts is sufficient to prevent slipping. If you wish, the hose may be cemented to the shafts or to two metal sleeves that in turn are fastened to the shafts. Commercial couplings of this type come equipped with setscrews that do not project above the surface of the metal ends.

No matter what type of coupling you use, or where you use it, every effort should be made to line up the coupled sections as closely as possible, for the less work the coupling has to do the quieter it will run, and the less heat developed in its flexible or friction members the longer the coupling will last. Rubber coupling parts should be protected from oil and grease unless they are made of oil-resisting synthetic rubber.—
W. A. CONWAY AND W. E. BURTON.

How to Make Rotary Files

THESE little tools, so much like dental burrs in appearance and operation, are as easy to make in the home workshop as they are handy to use on metal, wood, and plastics. They can be driven by a hand grinder, electric drill, drill press, lathe, or milling machine.

Turn the blanks to shape for a set such as shown below, and file and sand smooth. A is a ball point. The cone B can be used as a countersink if the angle is suitable. C is for undercutting. One of the handiest shapes is the cylindrical D. For cleaning out grooves and the like, E will be found excellent. F may be used for both concave and convex cuts.

Perhaps the most useful shank is $\frac{1}{4}$ " in diameter, suitable for both drill press and electric drill. A $\frac{1}{8}$ " shank will fit many small hand grinders, while a $\frac{1}{2}$ " shank is good for large files and rasps and for countersinks, edging cutters, and the like used in a collet or setscrew chuck in a drill press or milling machine.

Clamp the blank to cut the teeth. A wood- or metal-block backing covered with lead, aluminum, copper, or fiber will prevent bending the shank while cutting. Use a slender, sharp chisel and a hammer. Some file cutters grind the chisel to taper to a very sharp edge with no distinct bevel. A magnifying glass is needed when making the smallest files.

The blanks may be of drill rod or tool steel. After cutting the teeth, heat cherry red and quench in water or oil. Tempering isn't necessary, though you may wish to anneal the shank.—W. E. BURTON.

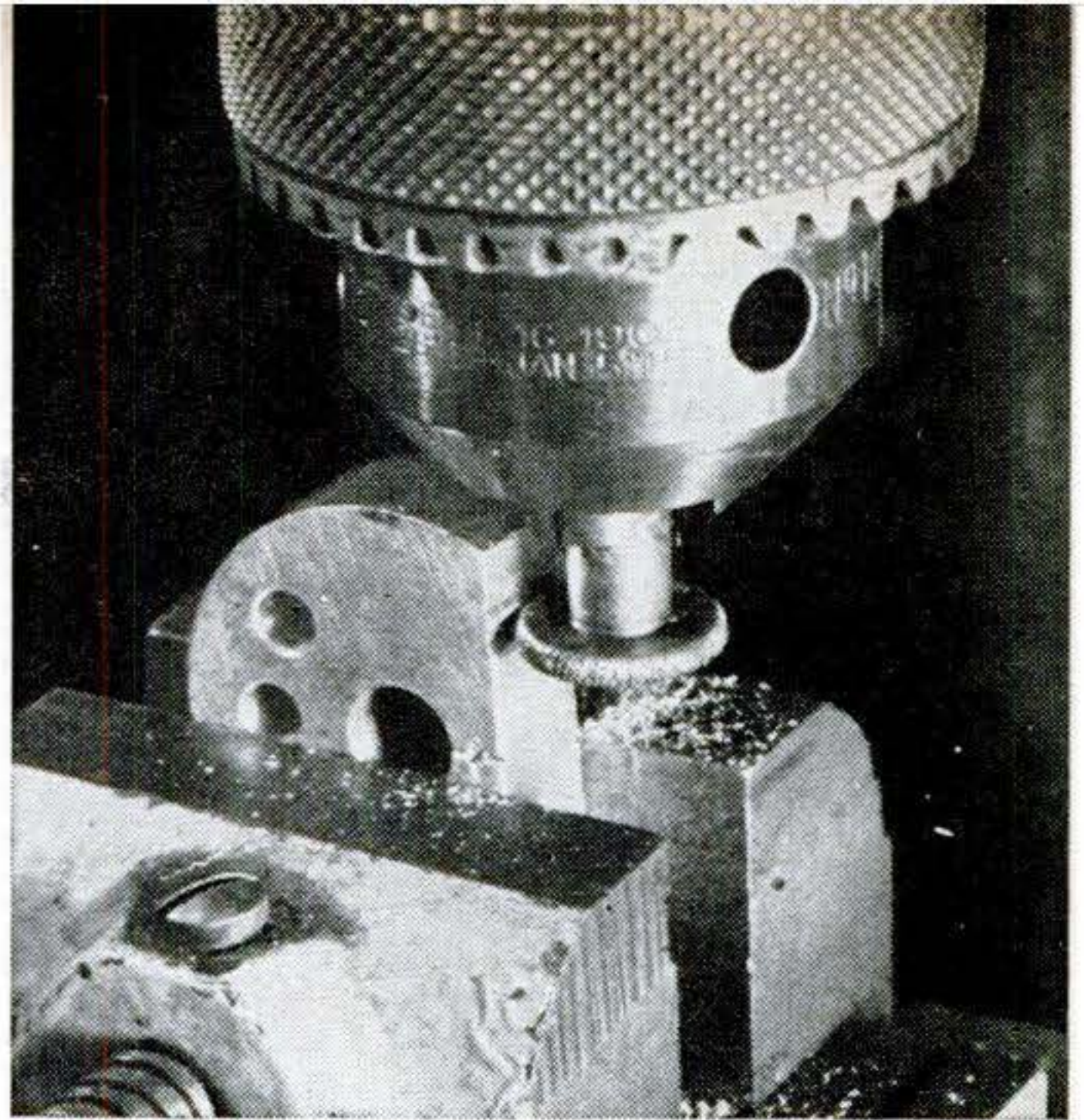

In a drill press, rotary files will shape cavities, burr or enlarge holes, and do many smoothing jobs.

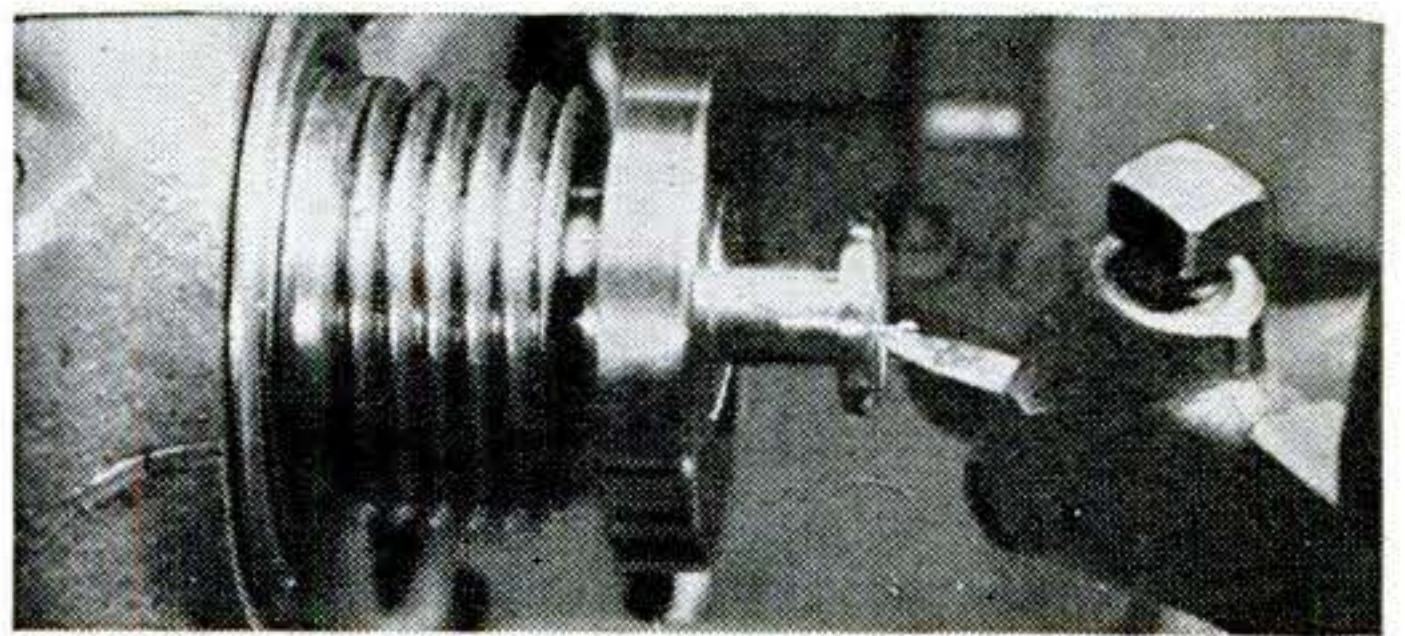

Blanks are shaped with the heads slightly smaller than required for the finished "working" diameter.



Cutting teeth enlarges the blank. If some sizes must be exact, experiment by making others first.

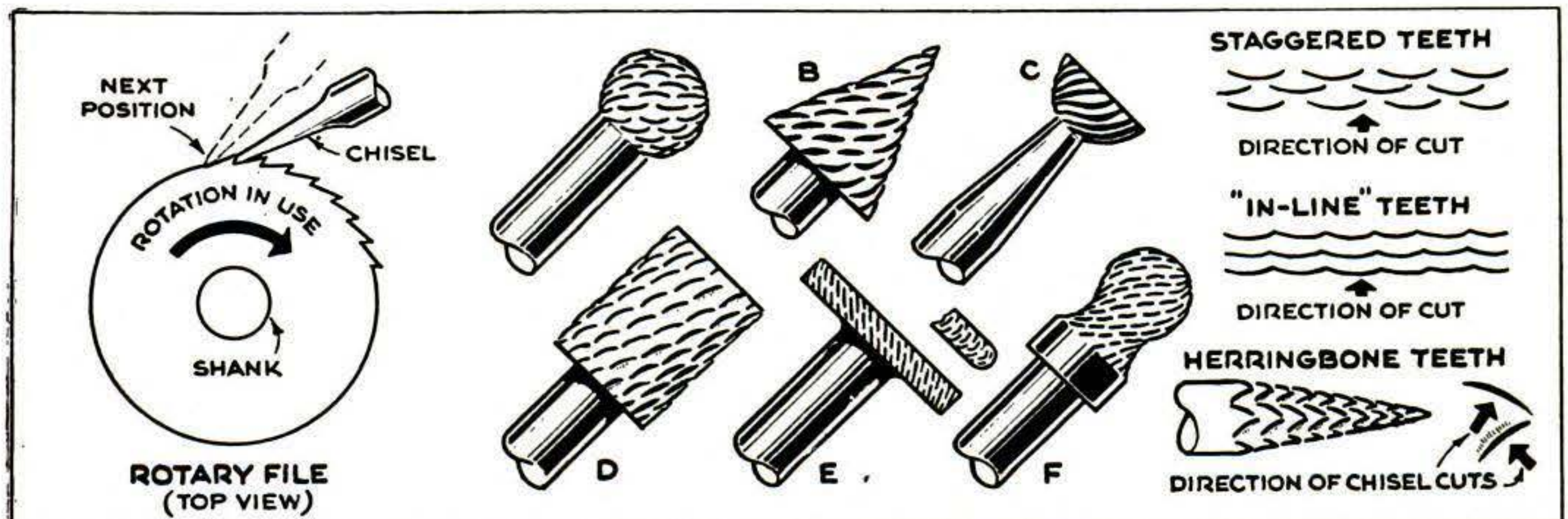

Space each tooth by resting the chisel on the back of the preceding one. Above, three tooth arrangements.

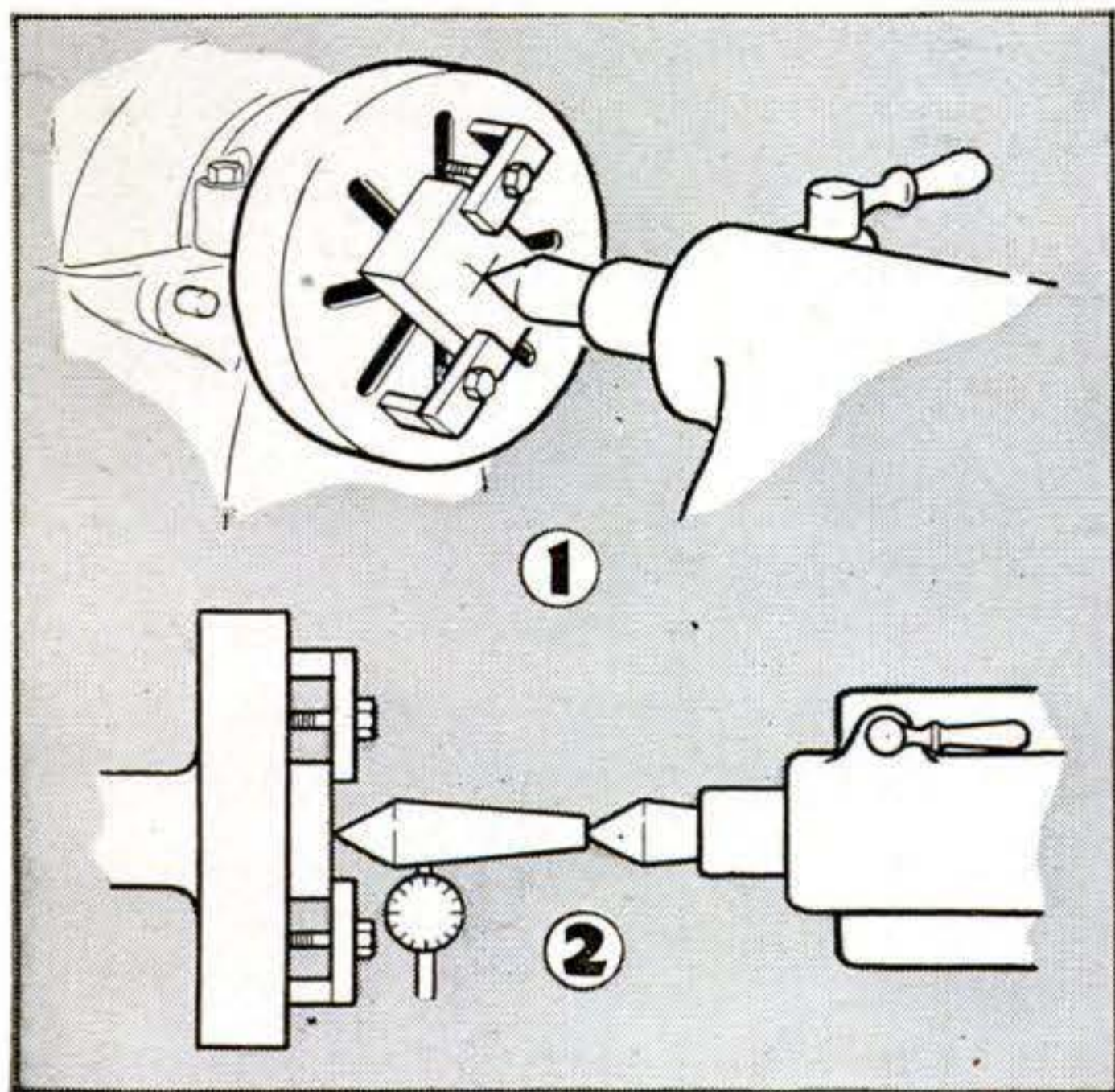

Centering a Faceplate Job. By this method, a faceplate job may be set up to a center punch mark without a wobbler. The work is first held against the faceplate with the dead center, Fig. 1, in approximate position for clamping. For truing, slide back the tailstock and use the live center and an indicator, Fig. 2. In a pinch, a paper feeler between the tool holder and center will substitute for an indicator.

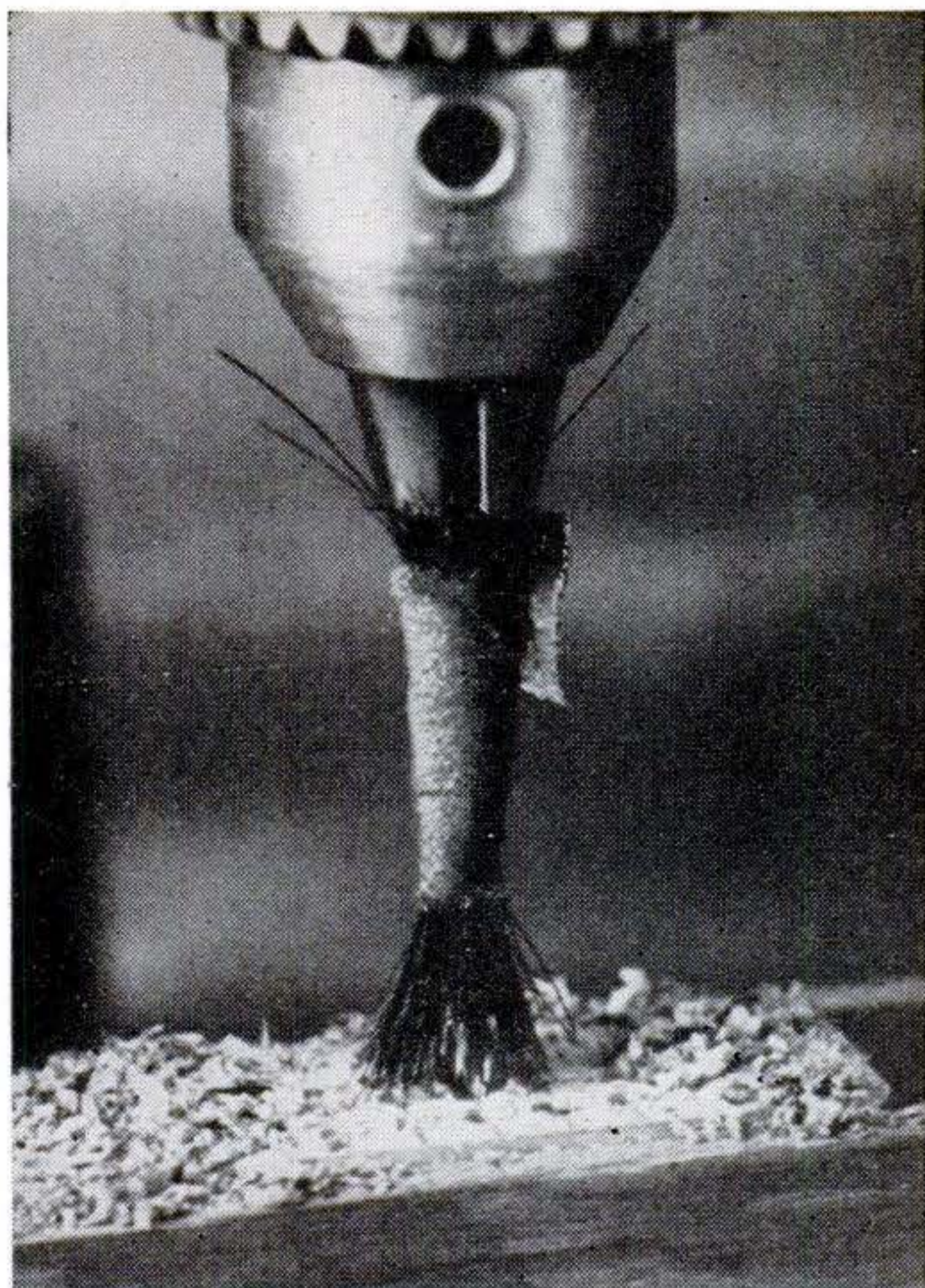

Brush Keeps Drill Clear. There is no need to waste time blowing away chips while drilling several holes close together in a single piece of work if you wire or tape a few bristles from an old floor or paint brush on the drill. Place the bristles a little above the end of the drill, as in the photo above, to prevent obstructing the view when centering the drill for the next hole to be drilled.—WILBER H. FULKER.

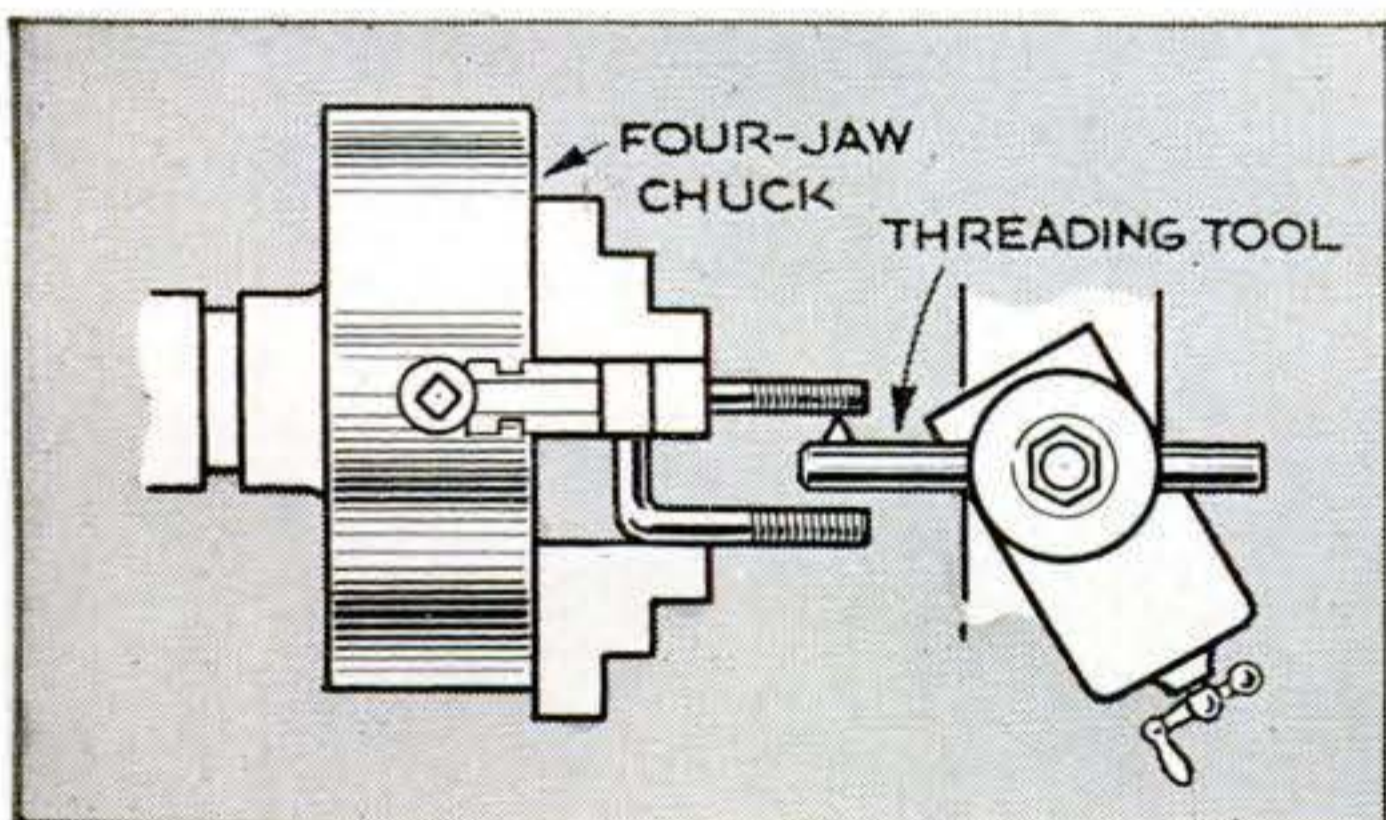

How to Thread a U-Bolt. When the problem came up of rethreading a U-bolt for which no die was available, the job was done as illustrated here. The U-bolt was clamped in a four-jaw chuck while the threading tool was held in a boring bar. Threading then was carried out in the usual manner. For lack of space, a regular tool holder could not be used.—R. M. DYKE.

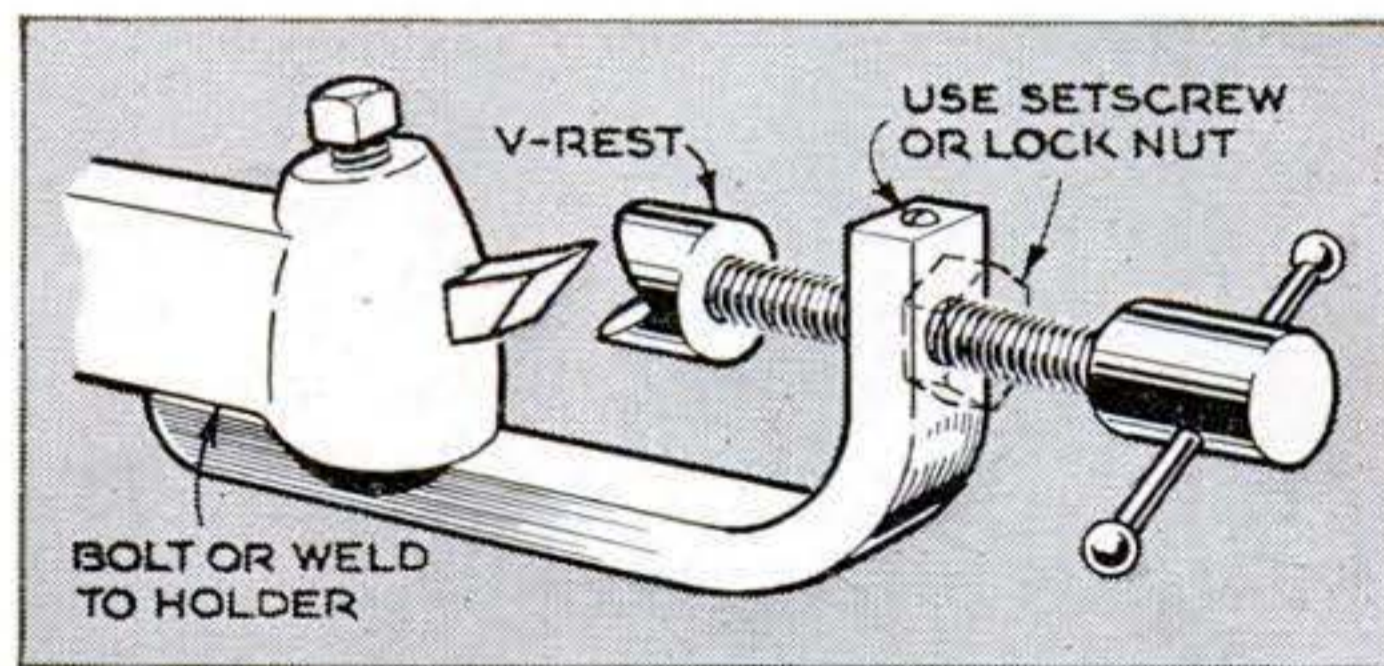

V-Rest Keeps Work Rigid. Attached permanently to a standard tool holder, this improvised follower rest will keep long, spindly work in proper contact with the cutting tool. The center of the screw, the bottom of the V-notch, and the cutting edge of the tool should all be aligned at lathe center height. The V-rest, which is free to pivot, is machined from brass. If made sufficiently large, one rest will accommodate most sizes of work.—D. BISCEGLIA.

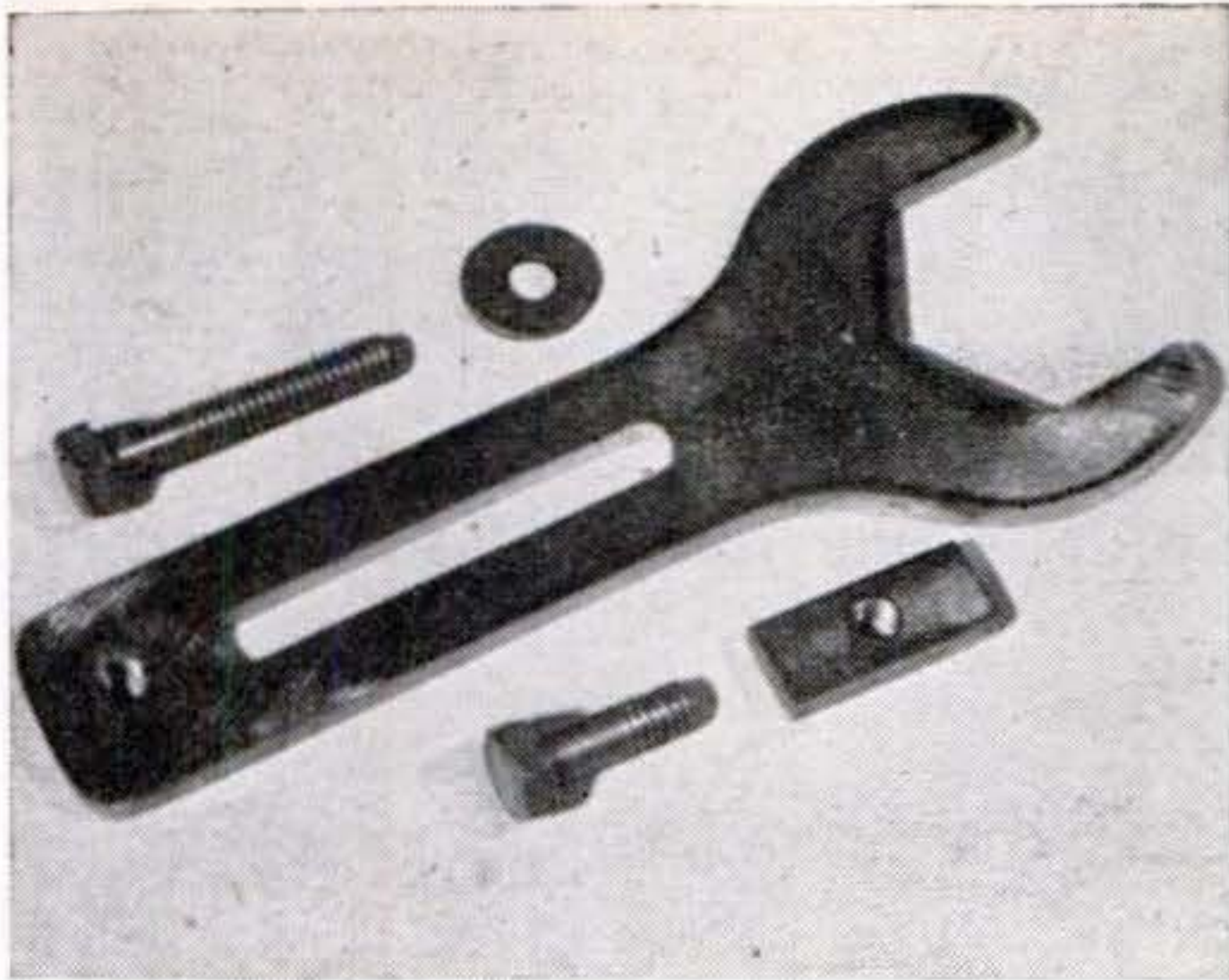

Work Holder Aids Drilling. An open-end wrench about 6" long and 3/16" thick may be quickly converted into a drill-press hold-down that will be particularly handy for thin, flat work. Drill and file a 9/32" slot for the hold-down bolt, and drill

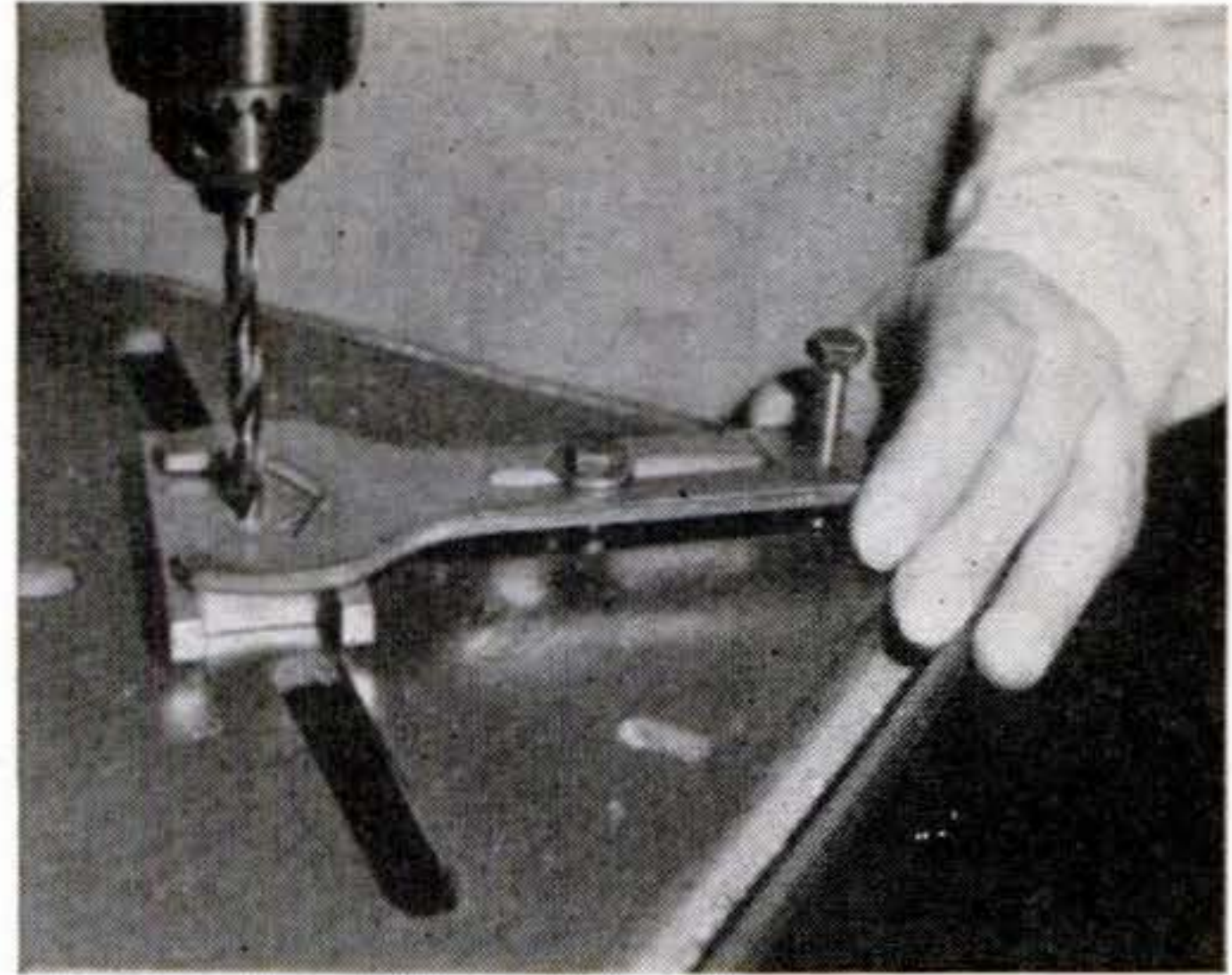

and tap a hole 1/4"-20 for an elevating bolt. The hold-down bolt is fitted with a special rectangular nut made of 1/4" stock and also drilled and tapped 1/4"-20. This nut is slipped through one of the table slots, turned cross-wise, and then tightened.—WILL THOMAS.

Soldering Tip Fits Torch. You may extend the usefulness of a small acetylene or gas torch by equipping it with a tip for heavy soldering. Copper is best for such a tip, but iron or steel also may be used if properly tinned. Drilled so that it is hollow almost to the point, the tip slips over the torch head and is held in place by six set-screws. Angled to keep escaping flame away from the tip, three exhaust ports are drilled into the flame chamber just ahead of the end of the torch. The tip is quickly removed when a flame is wanted.—H. L. PHILLIPS.

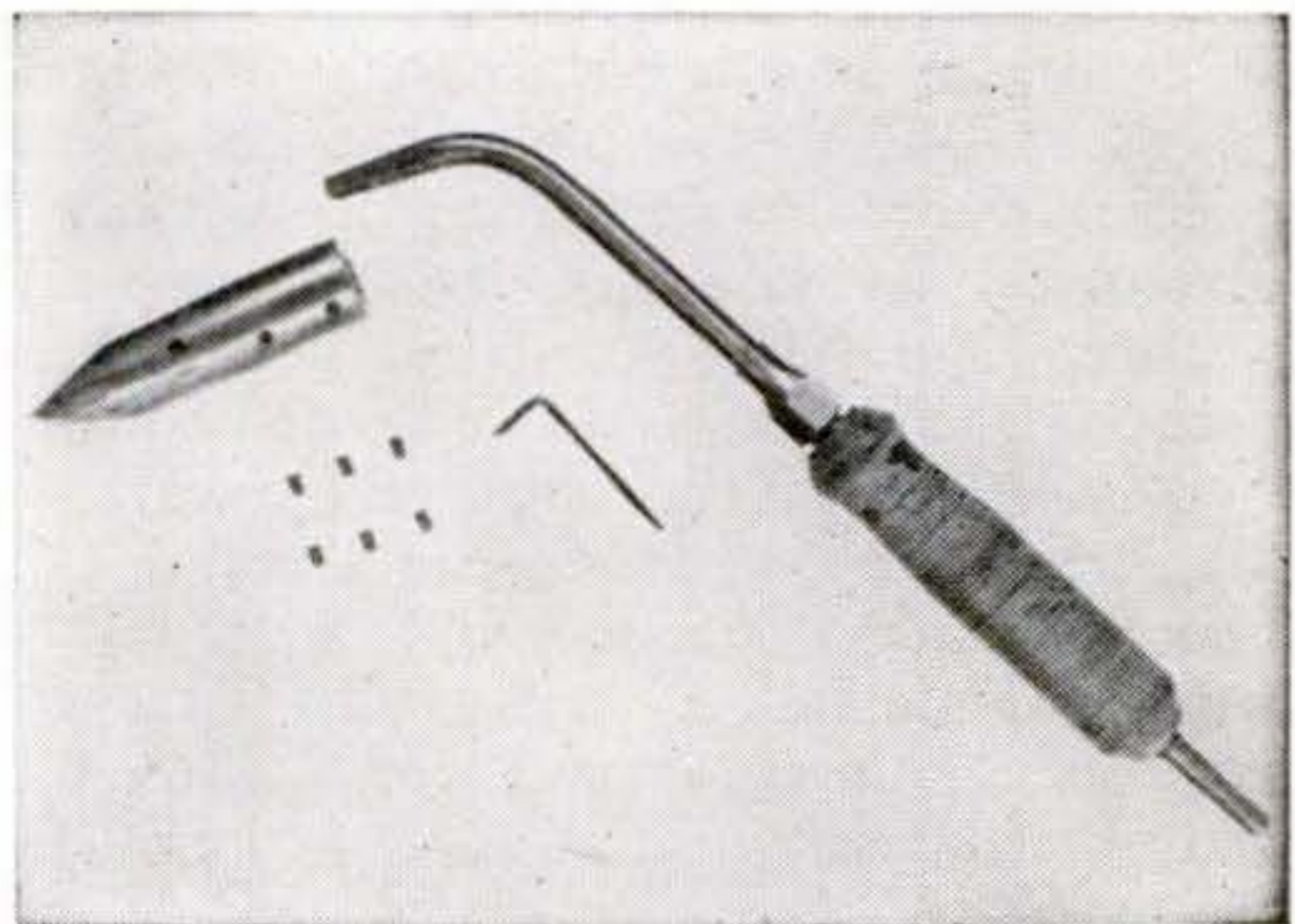

COATED ABRASIVES, II

[SHOP METHODS]

Abrasive	Work	Properties	Grades	Form
Aluminum oxide	General metal working and finishing, hardwoods, floors	Sharp, tough, nonmagnetic—good for burnishing when dulled	400 (10/0) to 12 (4½)	Belts, rolls, disks, sheets
Silicon carbide	Soft metals, paint, plastics, glass, leather, wood, floors	Hard, fragile, nonmagnetic—stays sharp when crystals break off	400 (10/0) to 12 (4½)	Belts, rolls, disks, sheets
Garnet	Woodworking, plastics	Sharp, fragile	8/0 to 3½	Drum covers, belts, rolls, disks, sheets
Flint	Household use, paint, carpenter work, sanding commutators	Not so sharp as garnet	5/0 to 3	Rolls, sheets
Emery	Metal polishing	Medium hard, medium sharp, magnetic	3/0 to 3	Rolls, sheets
Crocus	Fine metal polishing	Extrafine grit		Sheets

Some common trade names:

Aluminum oxide—Abrasive, Adalox, Adamite, Alabrase, Alorix, Al-Ox, Aloxite, Alundum, Ansandum, Ansolox, A-O-66, Baco, Boxite, Carbalox, Durexalo, Durexite, Durundum, Electric-Abrasive, Garalun, Jewelox, Luminox, Lumnite, Metalite, New Process, Production, Three-M-ite, Usalox, Wausite, Yellow-Stripe.

Silicon carbide—Amunite, Ansilicon, Armourite, Blue-Stripe, Carbicon, Carbonite, Carborix, Carborundum, Crystolon, Crystox, Durexil, Durite, Herculundum, Jewelite, Sil-Carb, Tri-M-ite, Vulcanite.

POPULAR SCIENCE MONTHLY SHOP DATA

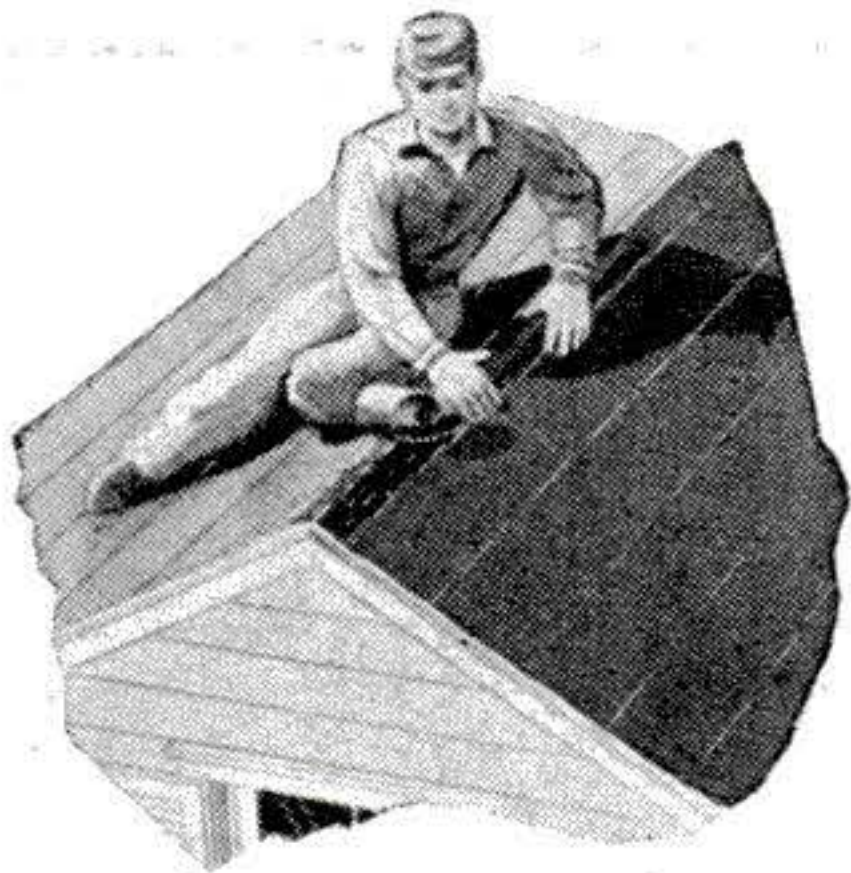

How to Paper a Roof

Tackle the work before a leak actually shows up; then, if properly done, the job will last for years.

By Harold R. Terpeny

WHEN a tar-papered roof begins to leak, that's one definite sign it needs immediate repapering. If allowed to go on, leaks will stain ceilings and wallpaper and in time will soften plaster, weaken the clinch, and cause the ceiling to crack, sag, and perhaps fall. Continued dampness also eventually rots the sheathing under the roofing material and may even damage the rafters.

But you don't need to wait until a leak actually occurs to tell that repapering is in order. If the smooth surface looks flaky and fuzzy, the life of the paper has gone and it should be replaced. This happens earlier than necessary in many cases because of neglect. The third year after a roof has been laid, it should be coated with asphalt, and then recoated each succeeding year.

If the old paper is still solid and fairly smooth, you may repaper over it, but this is not recommended. It is really better to strip off the old paper and take out the old nails first. Many expert roofers prefer to use paper 18" wide. When the paper gives with the alternate expansion and shrinkage of the wood sheathing to which it is attached, there is a great deal of wrinkling. These wrinkles can't harm the roof, but they are much smaller on 18" paper than on 36" widths and are less noticeable from the ground. Figure 1 shows a simple method of cutting 36" paper if the narrower width is not available. The line is gauged with a nail driven in a homemade T-square and is cut with a linoleum knife.

Lay the paper from the lower edge of the roof up, overlapping each piece 2". Start flush with the bottom and gable edges, as in Fig. 2, and nail (at 6" intervals) only in the upper margin, which will be covered. (Direct sun heats the paper tremendously, expanding it and causing exposed nails to loosen a little each season.) Cement the paper flush with both edges of the roof, using good roofing cement along a 3" band, and cement also the overlap of each suc-

ceeding piece. Some roofers bend paper over the edges instead of trimming it flush, but in such cases the stiff paper frequently pulls away before the cement can set, the edge of the wood can't be completely coated with paint, and moisture creeps in. Cement itself is a good waterproofer and produces a tight joint when paper is trimmed flush.

When flashing is reached, as at the upper edge of a porch roof (Fig. 3), trim the strip if necessary to required width; then turn up the flashing, nail the paper down, apply cement, and press the flashing onto the cement. Take care not to smear the cement here or at the overlaps, where it will show. Flashing should be sheet copper or lead, but failing these the roofing paper itself can be used.

At a hip, cut the paper flush and nail it along the hip. Then gauge a line on each side, as indicated in Fig. 4, and cement on a 9" wide covering strip of paper. No nails and no covering strips are used in valleys (Fig. 5). Instead, the paper is brought up to the center of the valley, trimmed, and fastened to the flashing with a thick coating of cement. If new flashing is needed, apply a 12" wide strip.

Finishing at the ridge is similar to that at hips, as shown in Fig. 6. Trim the last strip of roofing paper on each side flush with the top, gauge a line on each side 3" down, and nail within the margin. Then apply cement, and press a 6" wide covering strip firmly into it.

Have no qualms about the sticking qualities of good roofing cement. It will hold, if the job is otherwise done properly, even in the strongest winds. In using the cement, fasten a 6' length of the paper at a time, press the paper down, and then do another 6' length. Complete one piece of paper before starting on the next. Covering strips at the ridge and hips are cemented similarly. Finish one complete side of the ridge first, and then do the other.

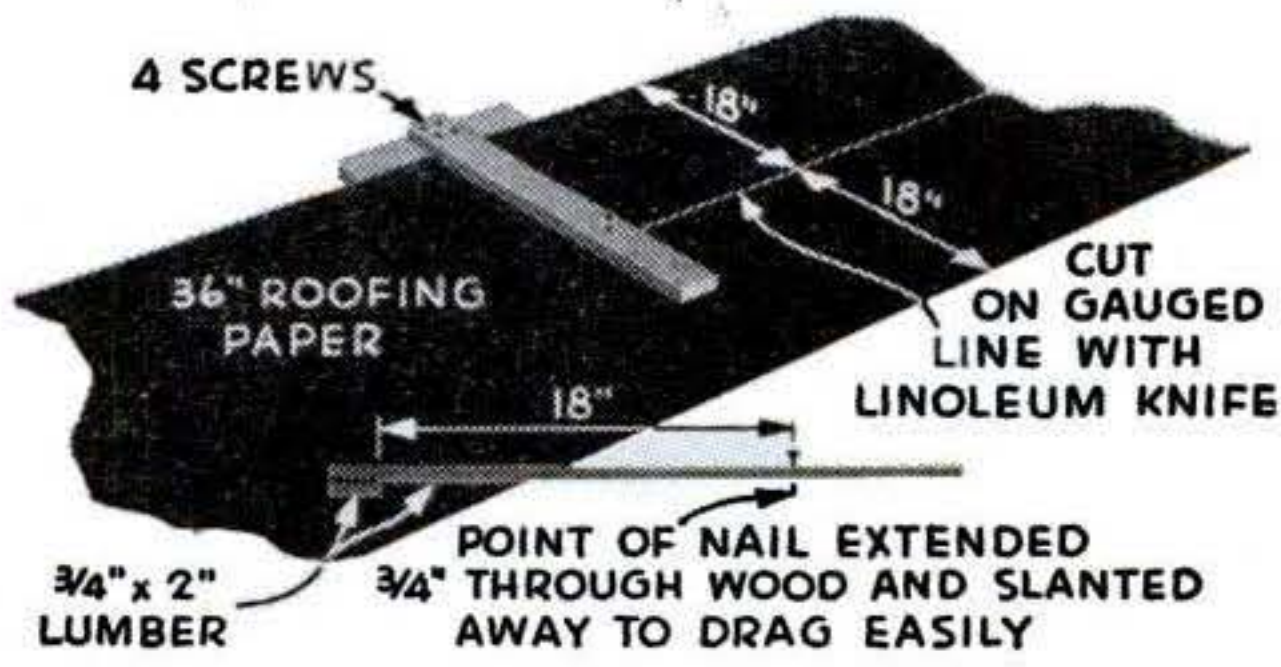

Fig. 1

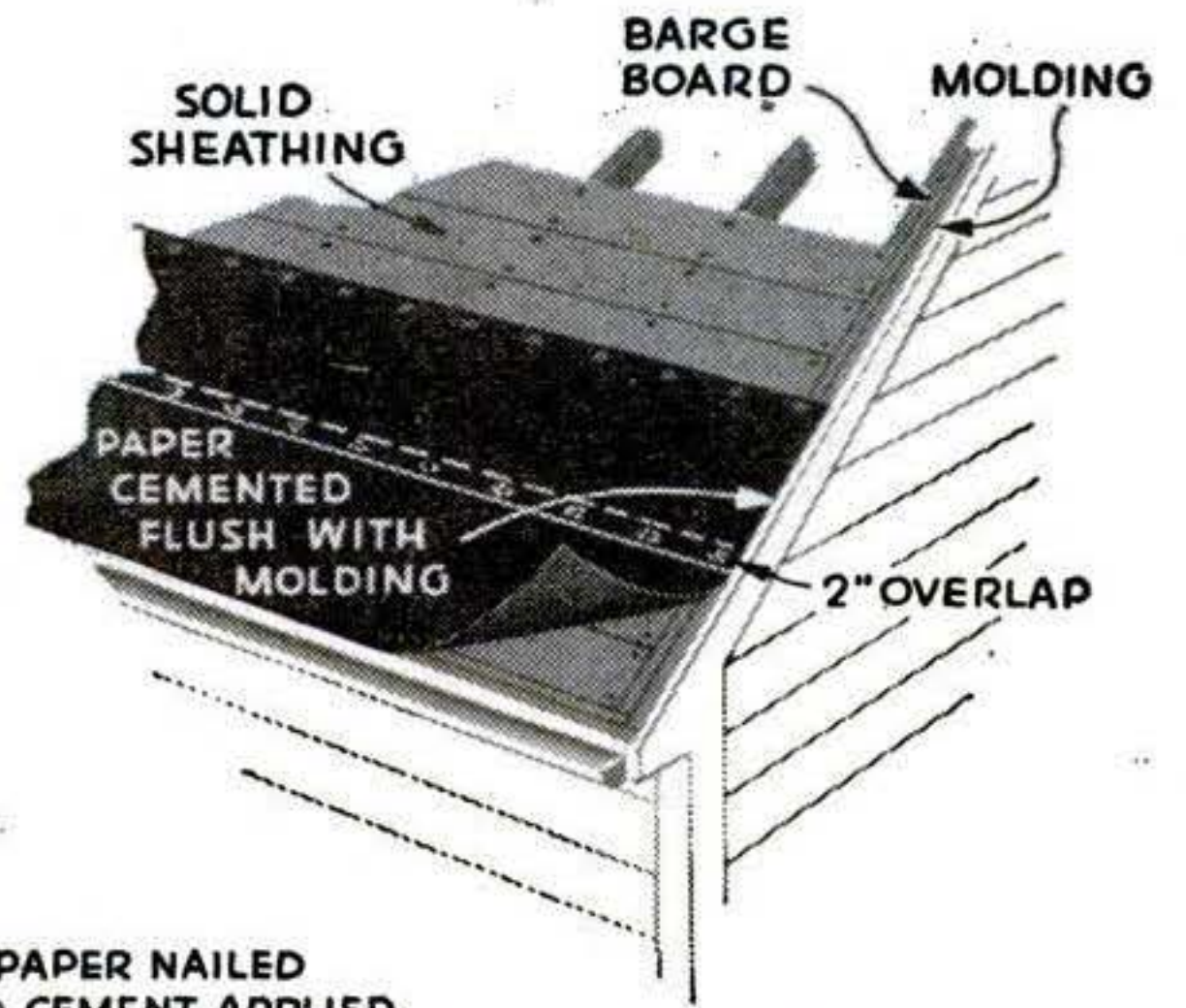

Fig. 2

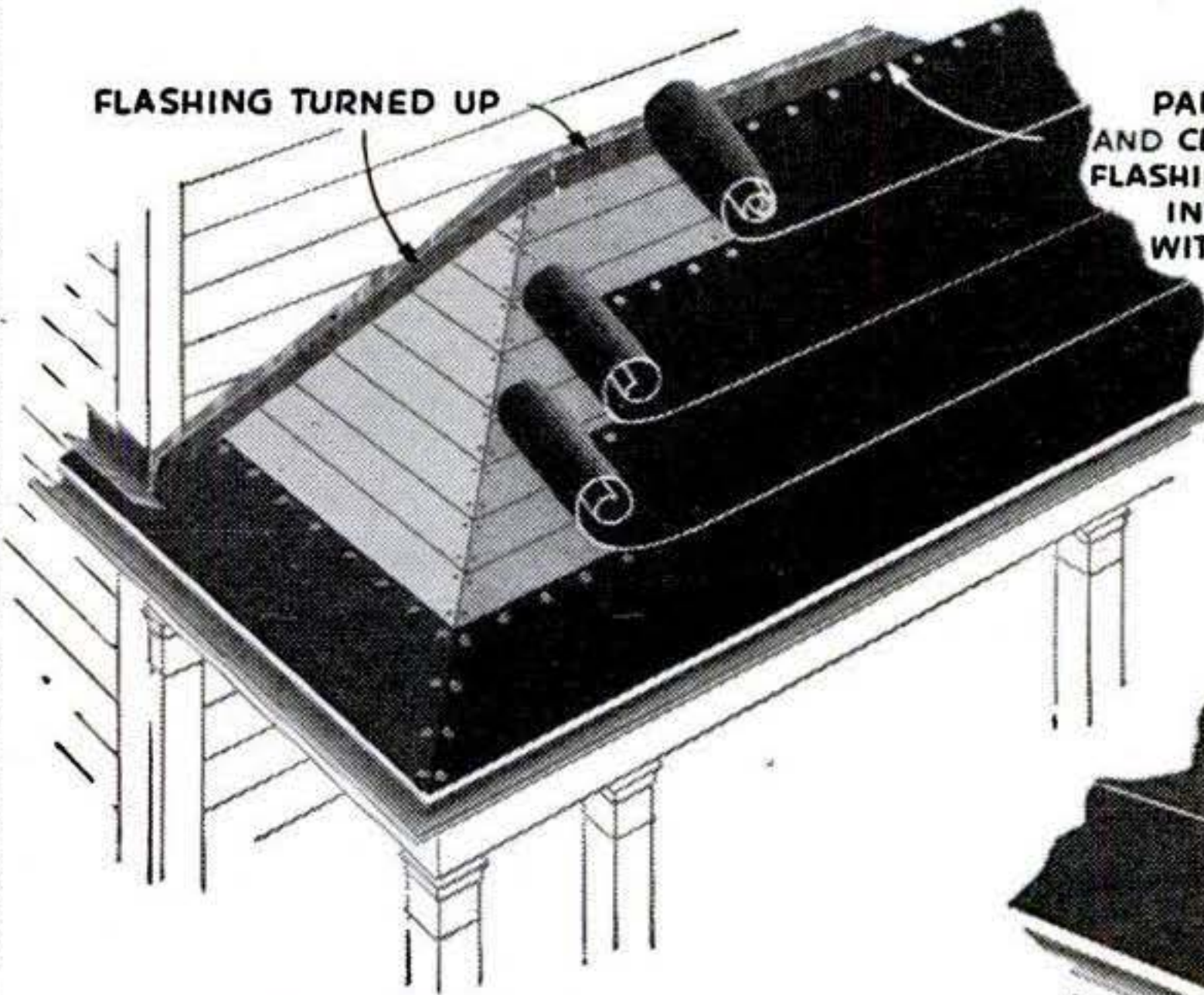

Fig. 3

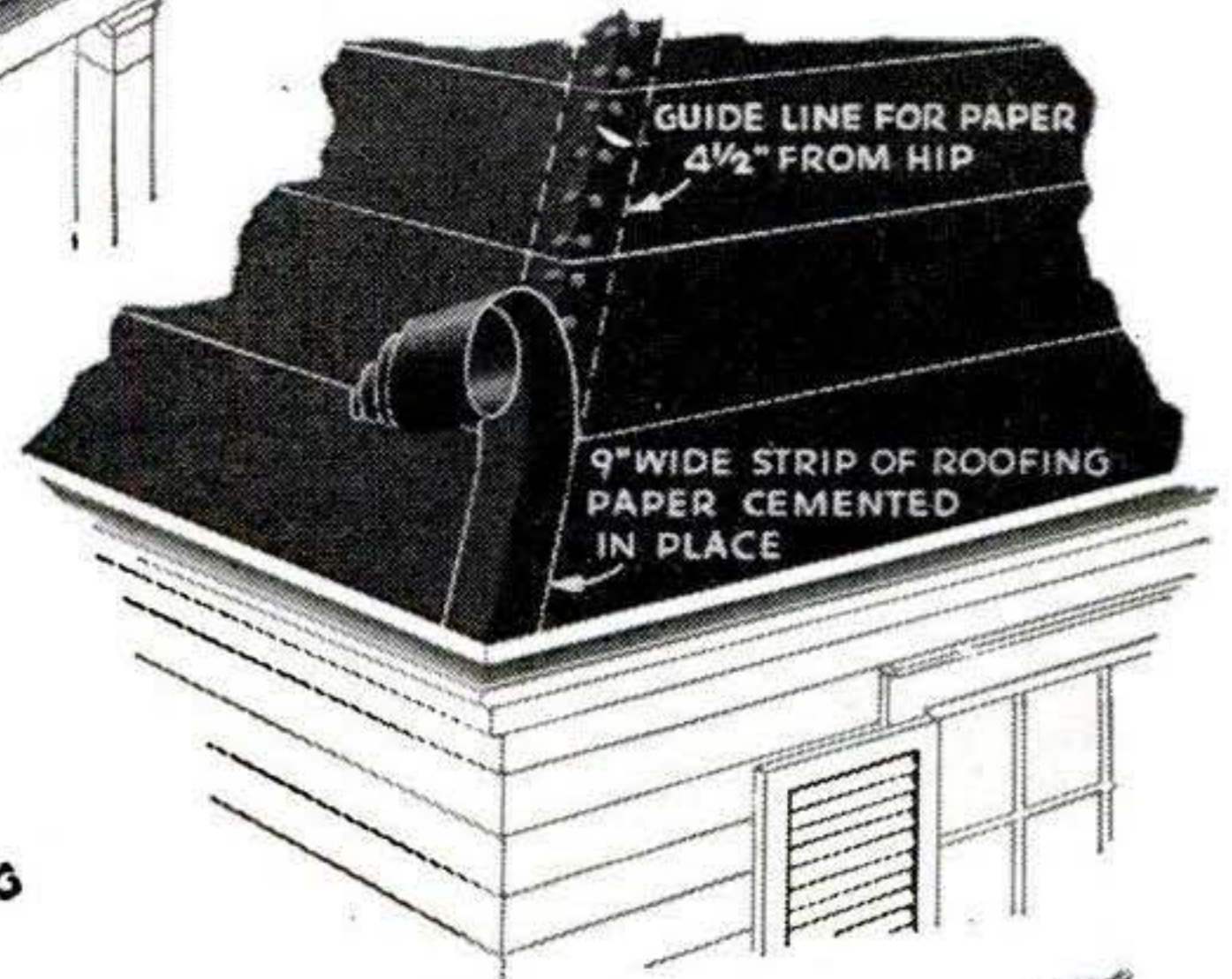

Fig. 4

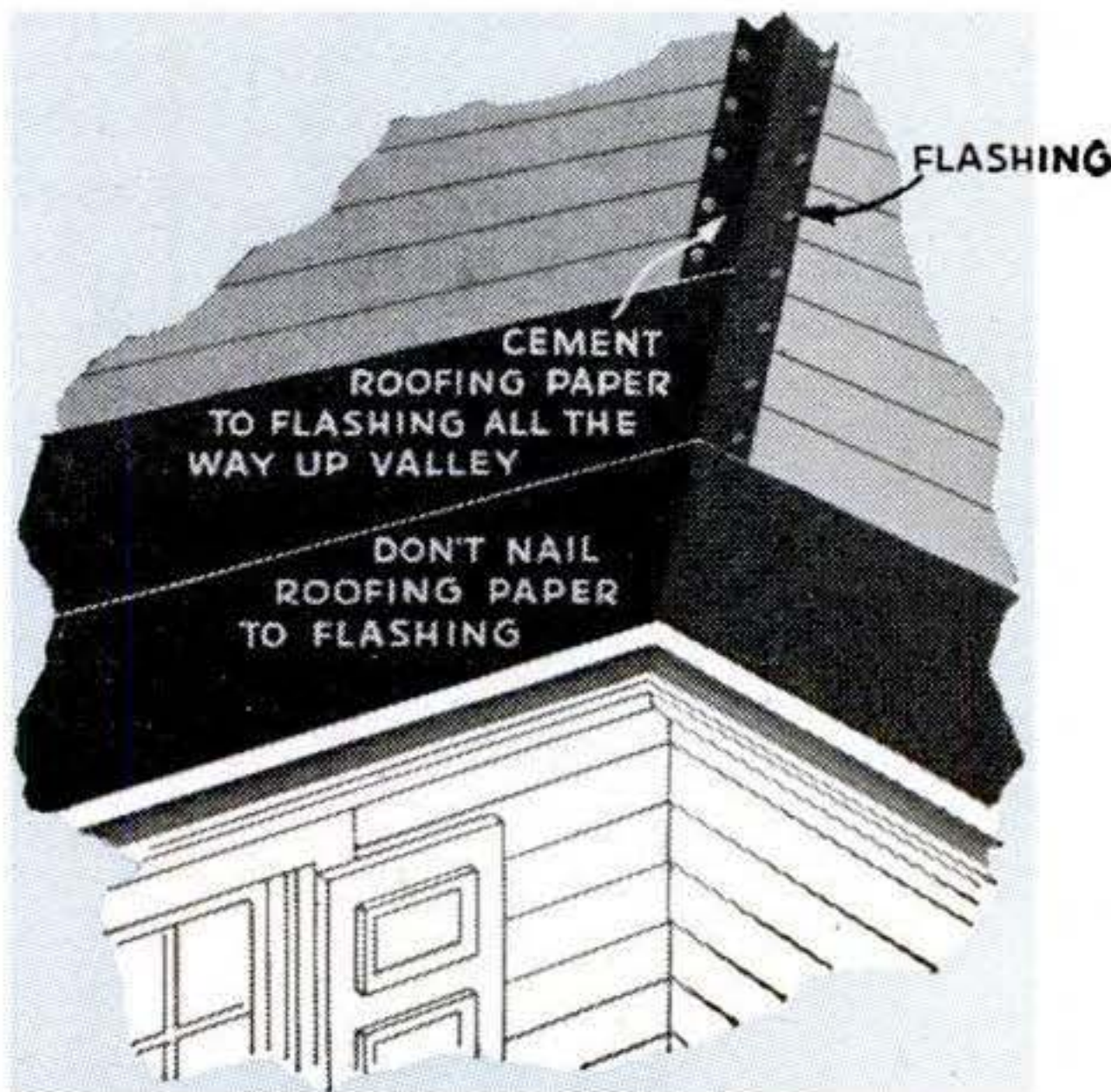

Fig. 5

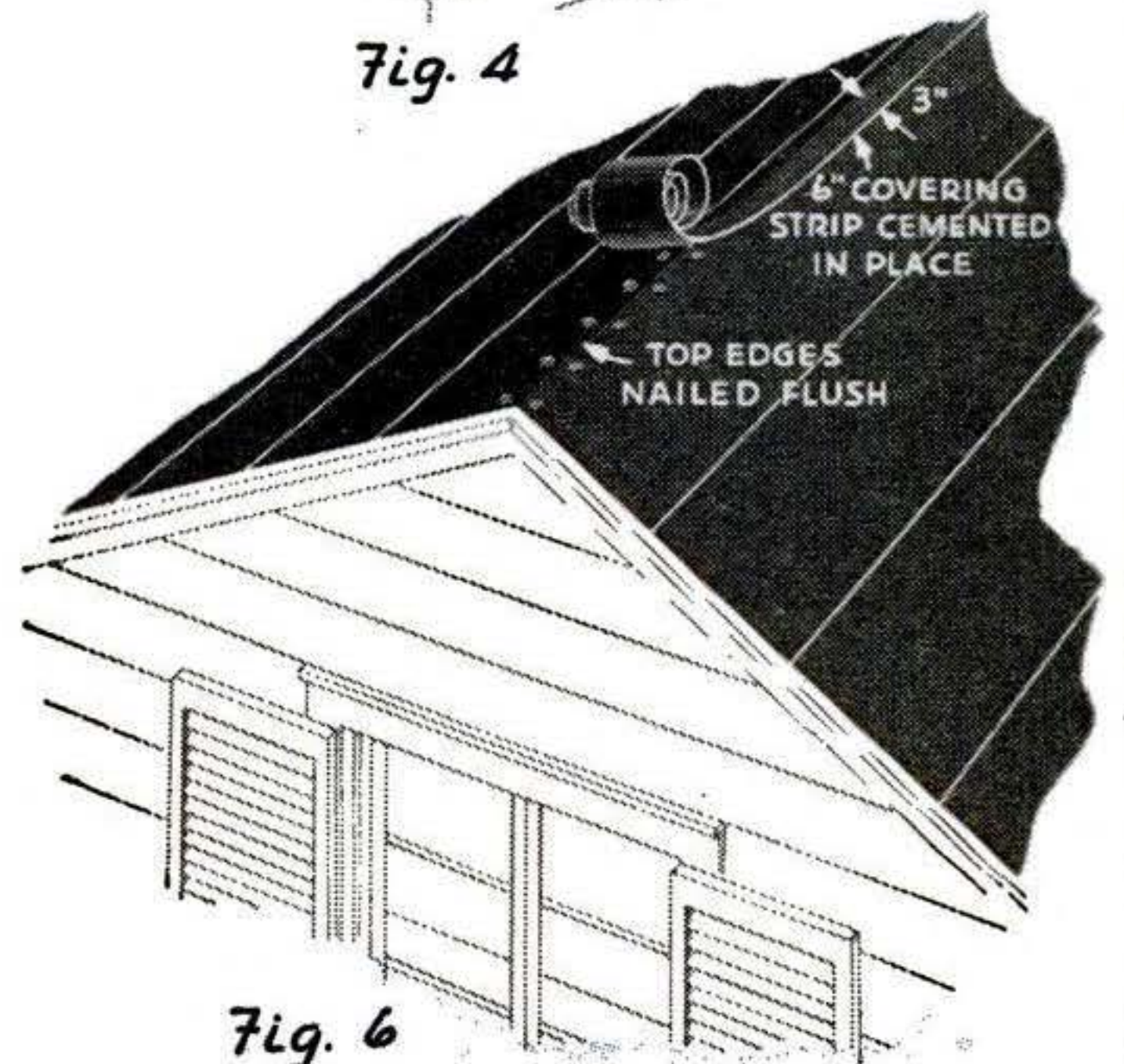
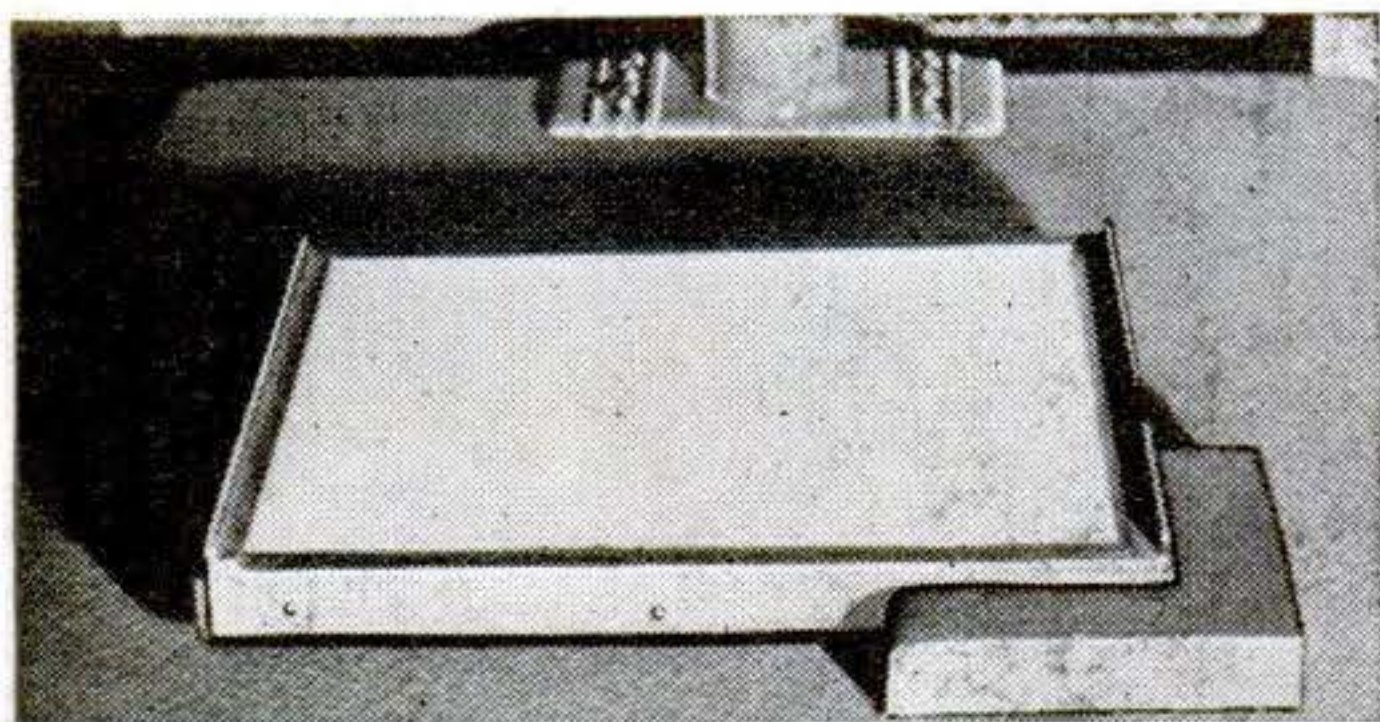
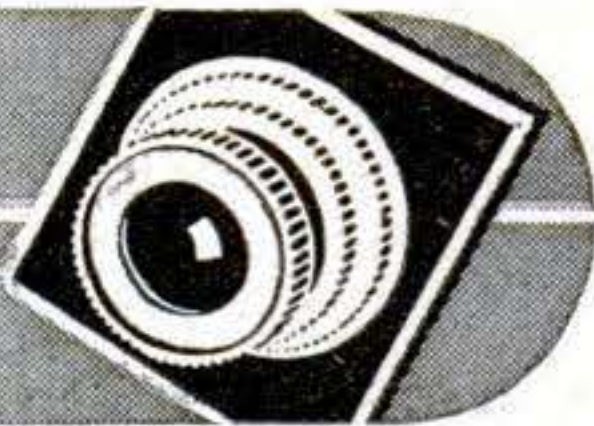

Fig. 6

PHOTO IDEAS and EQUIPMENT



Block Locates Easel. In enlarging, this weighted angle block is almost as good as an extra hand. After spotting the easel and pushing the block against a corner, you can remove the easel to load it with paper,



Cleaner Dries Reel. The reel of a roll-film developing tank may be quickly dried with a vacuum cleaner of the type that has a blower connection. Just attach the hose to the blowing end and let the air do the job.—R. F. DONOVAN.

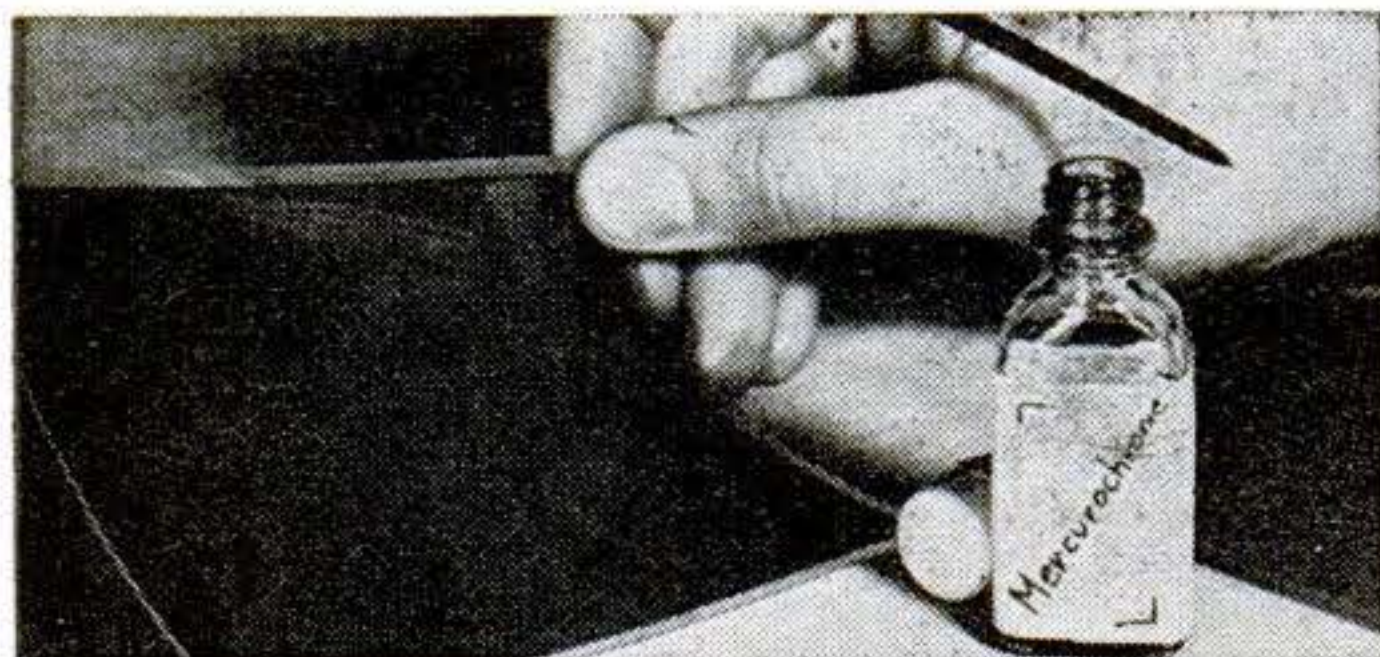

Doctoring a Negative. If a bottle of opaquing solution is not at hand when you want to cover a pinhole or other blemish in a negative, a little Mercurchrome may be used in its place. Apply it to the spot with a small soft brush drawn to a point.

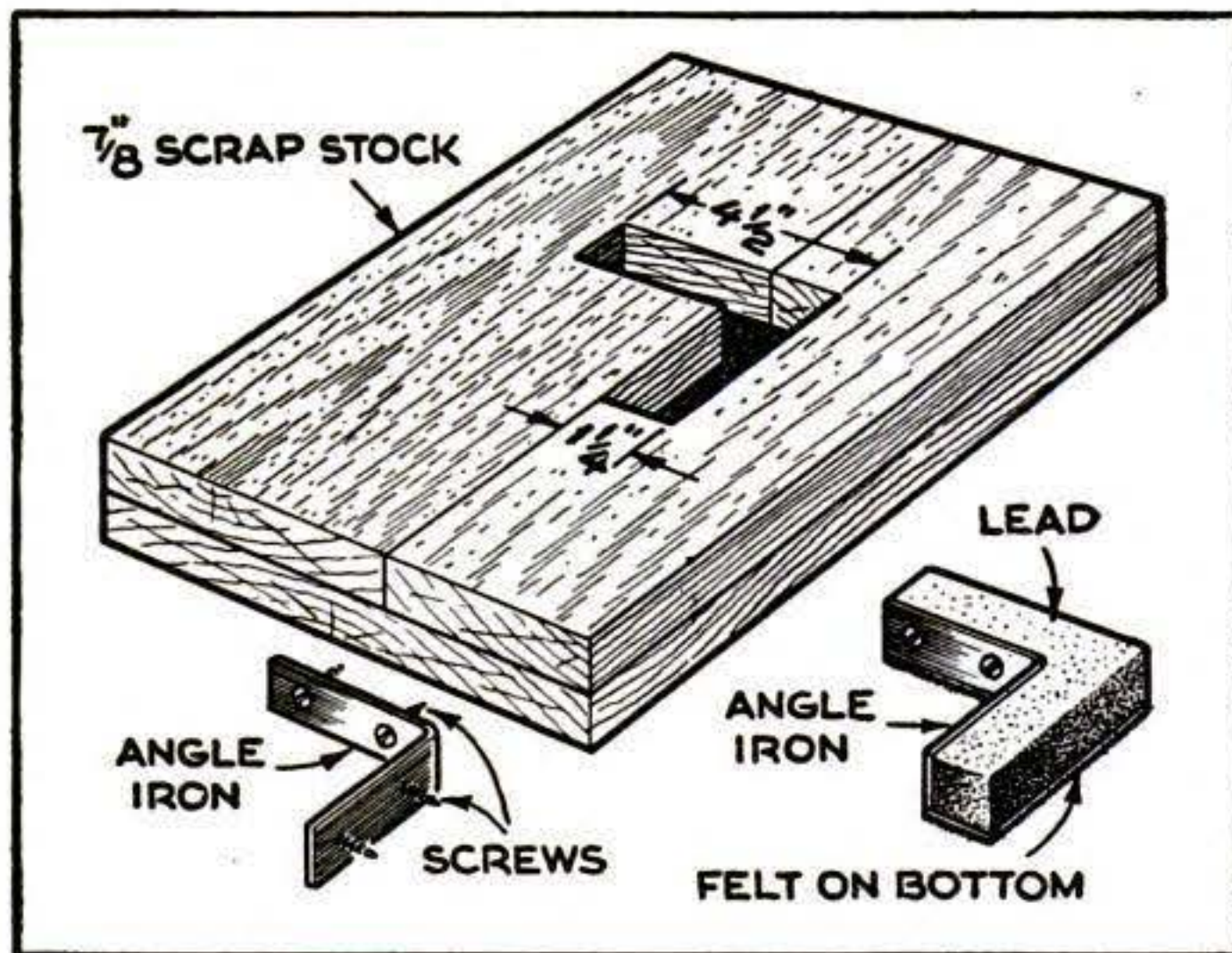

Place the angle iron and screws in a form made of three pieces of wood, and pour in molten lead. Glue felt to the bottom of the finished weight.

and put it back in the original place. The weight is made by placing screws in a metal corner angle, setting this in a wood form, and pouring in molten lead. Paint it dull black.—JAMES A. RICHARDS.

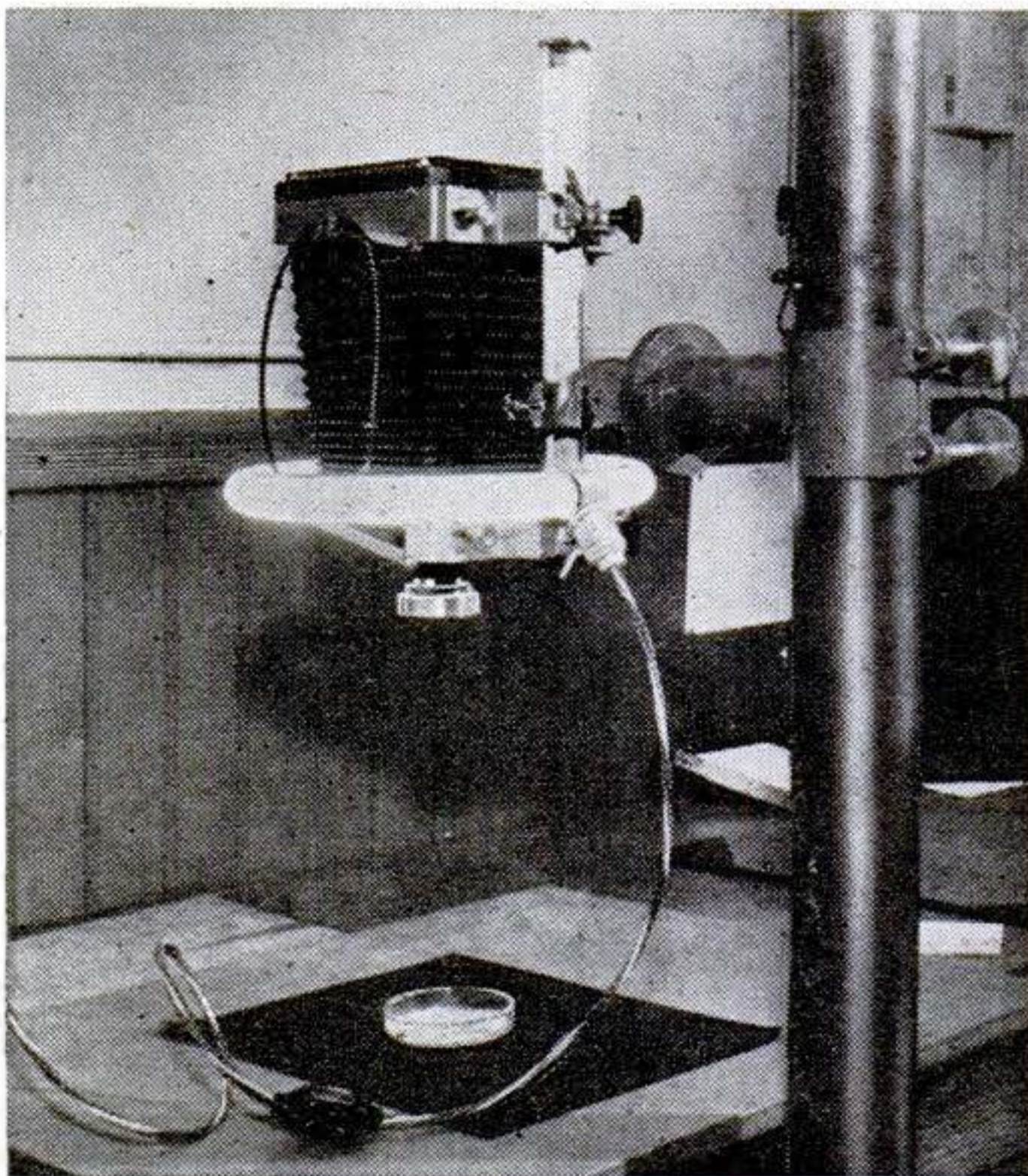

Fluorescent Lighting. A 12" circular fluorescent lamp provides flat, even lighting for photographing small objects or copying work. In addition, its high actinic value keeps exposures short. With most 4" by 5" cameras, no special clamp is required to hold the lamp while the camera is in a vertical position. By compressing the extended bellows slightly, the lamp may be slipped over the front. For other cameras, tape or wire clips might be used to keep the lamp in place.—G. DEXTER HERNDON.



Lights Move with Camera. An attachment made by A. L. Bensen & Co., of Staten Island, N. Y., provides easy portability of both camera and lighting for indoor movie making. In addition to a metal arm that supports two reflector photofloods above the camera, the attachment includes a handle with a threaded stem that passes through the arm into the camera tripod hole. It also may be used with still cameras.

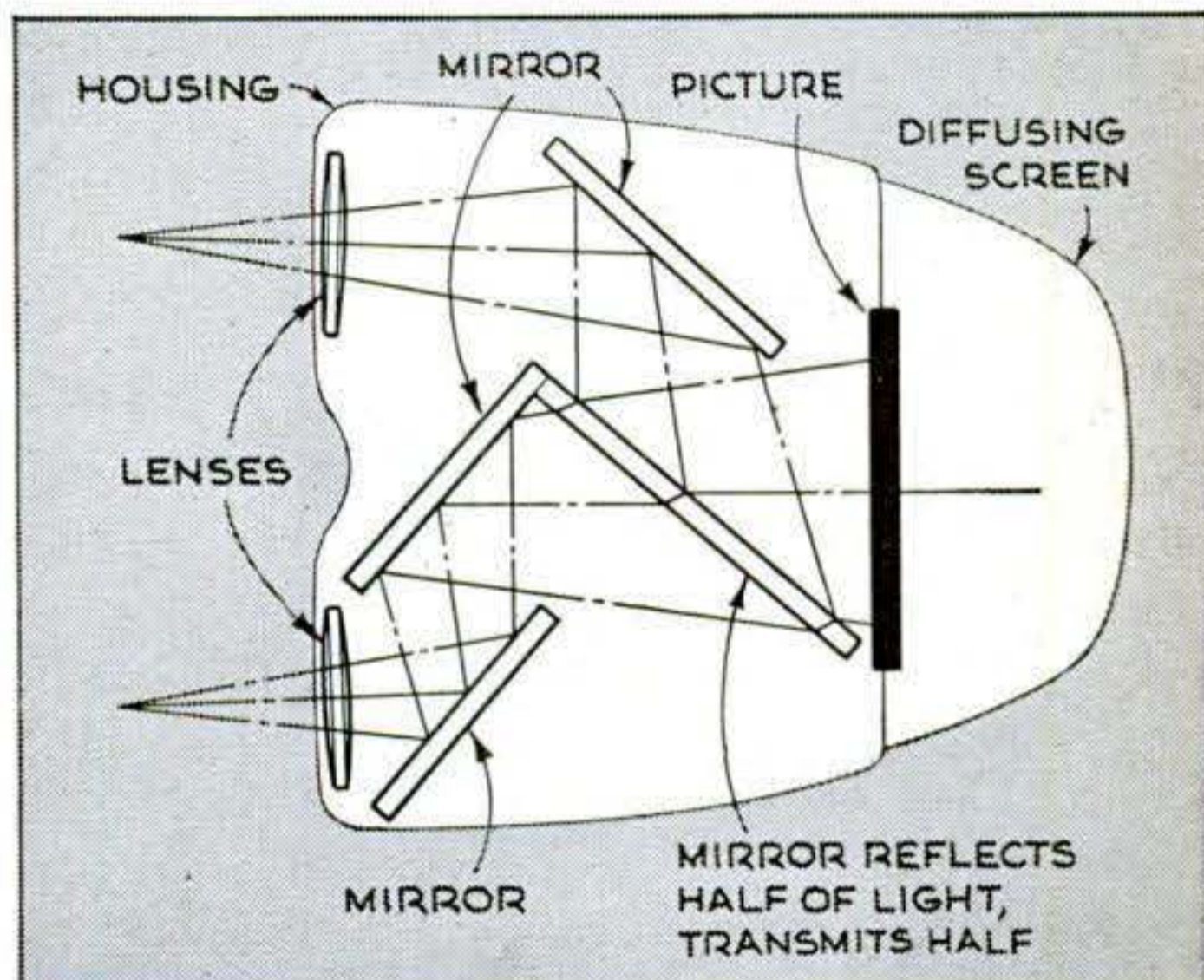
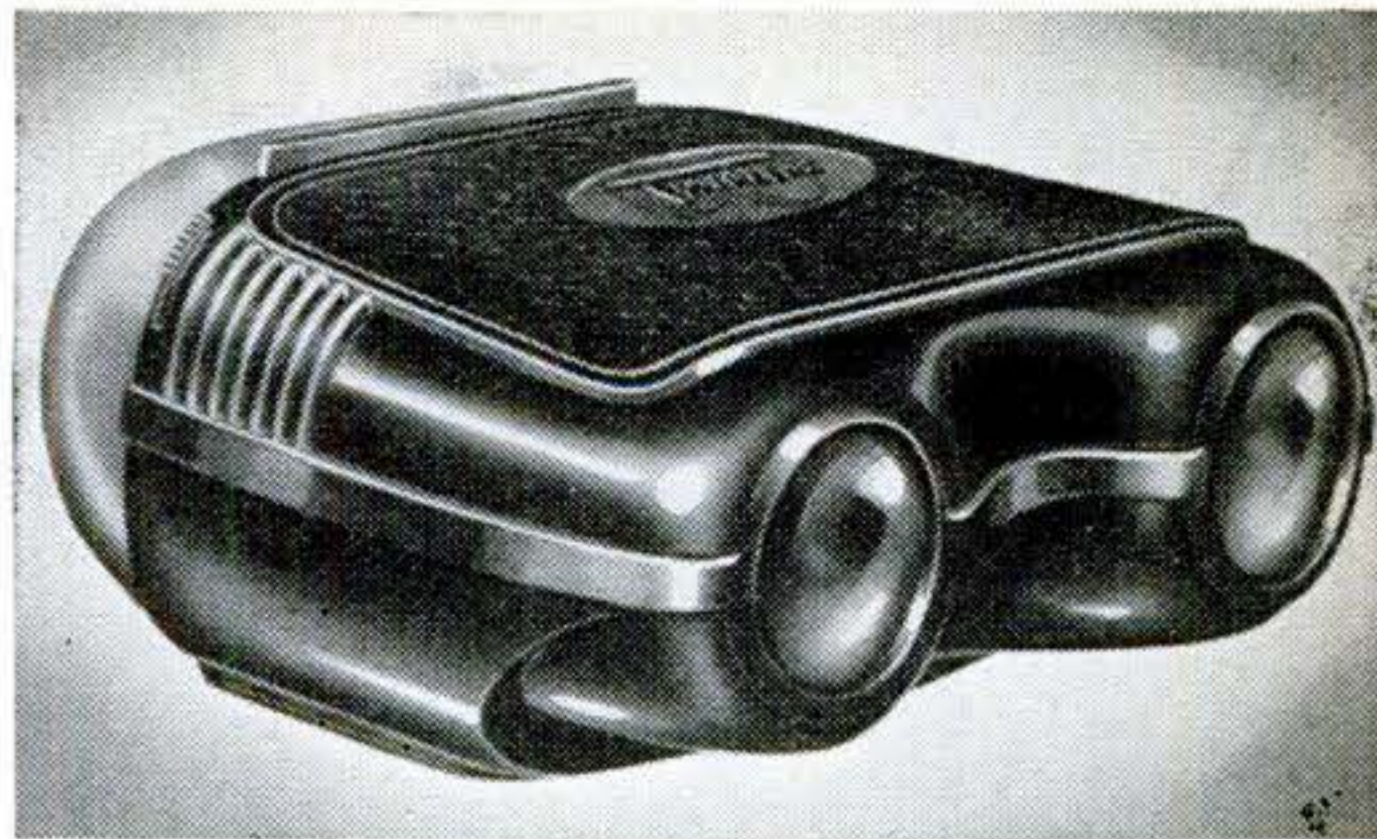

Gives Third Dimension. A new viewer for 2" by 2" transparencies produces the effect of a third dimension with only one picture. This is accomplished by use of an optical system that carries the image to both eyes, making it unnecessary for the user to close one eye as with most viewers. Selling for about \$12.50, this viewer is manufactured by the Craftsmen's Guild, of Hollywood, Calif.

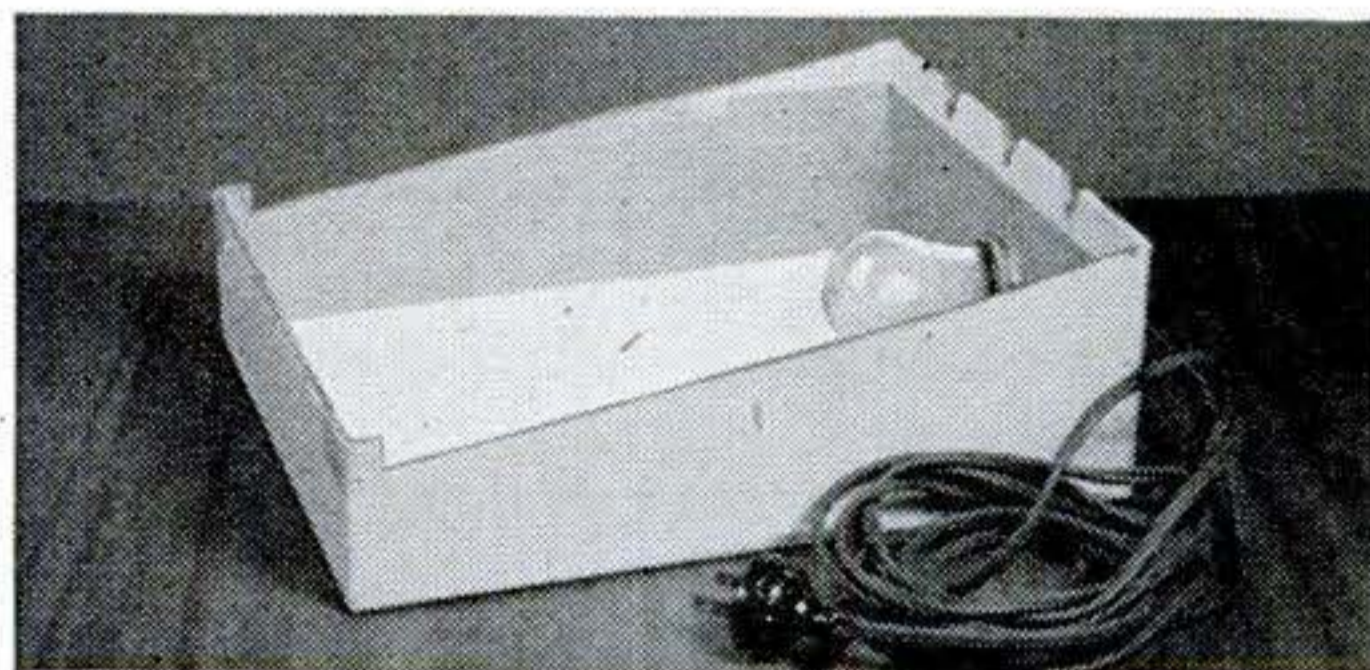

Retouching Stand. A strong cardboard box cut as above provides the base for an inexpensive retouching stand and viewer. Place white paper on the inside bottom surface to reflect light, and a sheet of ground or opal glass on top. A 15-watt lamp will do for retouching, but a 50-watt bulb is better for viewing. Cut masks to exclude light from all but the working or viewing area of the glass.—KENNETH S. JOHNSON.

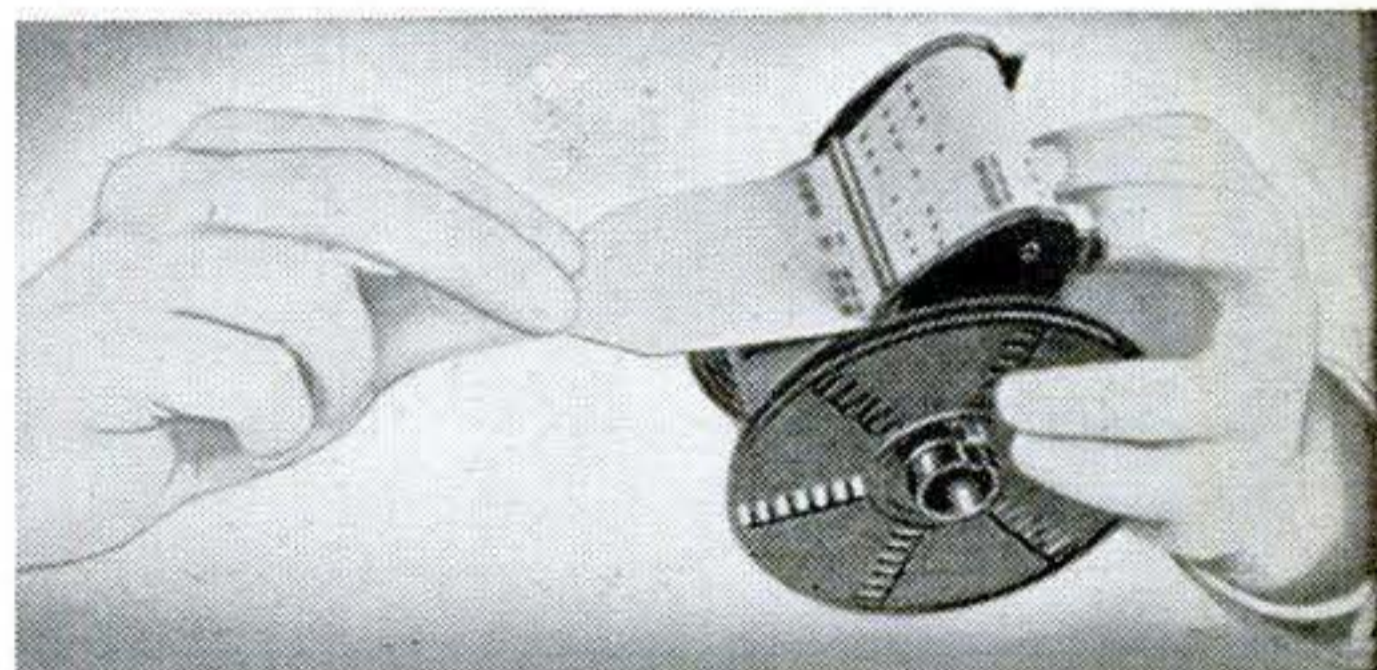

Film Loaded with Ease. A loading device made by the Airequipt Mfg. Co., Inc., of Mount Vernon, N. Y., makes it possible to thread a roll of exposed film on a developing-tank reel without touching the film. The roll of film is inserted in the loader, the latter is placed at the proper position on the reel, and as the protective paper covering is pulled, the film automatically slides into the grooves of the reel.



"Old School Try" by Jack Frank of the New York Herald Tribune shows the action you can find in sand-lot and school baseball. First prize winner in a New York show, it was taken from 20' at 1/1,000 sec. at f/8.

Focus on Sports

By Murray L. Becker

Chief Photographer, The Associated Press

EVER wonder whether you could make sports action photos like those in your newspapers? With average amateur equipment, there's no reason you can't. Besides adding some interesting pictures to your own collection, you may find your local editor willing to buy a few of the best.

While covering sports, press photographers ordinarily use cameras with a shutter speed of 1/1,000 sec., but the lack of such equipment need not deter you. Even if

your top is only 1/150 or 1/200 sec., you can freeze a lot of movement by shooting head-on or at a 45-deg. angle—or you can pan with the action as it sweeps by. The professionals who produce the photos you see on the sports pages use both methods.

An eye-level camera is best for most sports, for you can see what is going on around you while keeping the area of probable action within the finder. Fast film should be used, and a lens shade is an excellent idea. You can avoid missing a lot of shots by using a focusing footage scale instead of a rangefinder. If your camera does not have a footage scale, make one by placing permanent markers on the camera bed (if it is that type) for various common distances. This will permit a quick change of focus for any desired shot.

Sports action never waits. Because of this,

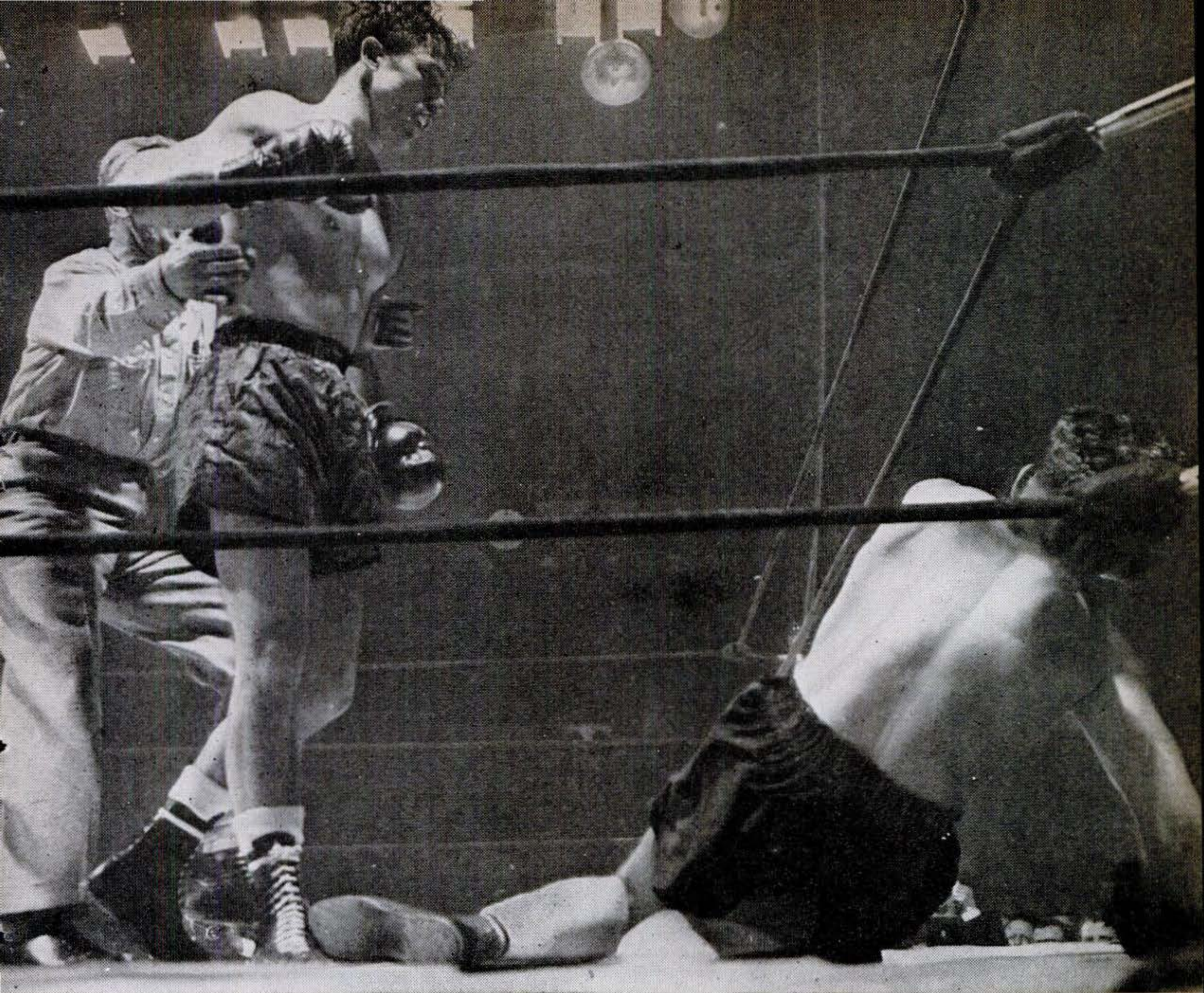

Ring lights make it possible to shoot fights without flash. At the ringside, 1/150 sec. at f/4.5 on fast film will give excellent results. Good shots also can sometimes be made from a close-in spectator's seat.

you should know your camera so well that you almost could operate it in your sleep. You also must know the game you are covering. In fact, a topnotch sports photographer practically plays the game, anticipating what the next play will be and getting set to catch it exactly the right split second.

In this connection, it should be noted that in some sports there are split seconds where the fast action hesitates. For instance, a pole vaulter shooting up over the bar hangs suspended for the merest fraction of a second before starting his fall. Even a slow shutter speed at exactly that moment would keep your vaulter there for eternity—in a photograph. Another point to remember in stopping action is that the closer you are the faster shutter speed you must use to avoid a blurry result.

Before setting out for the ball game with

camera in hand, there are a few other points you should consider. At many of the larger sports events, photographers must get special credentials and abide by certain rules. Because of this, major league baseball offers little opportunity for the amateur. At such games, press photographers generally work from the press box, shooting with a "Big Bertha" (28" to 40" lens) for closeup action. Even if the amateur could afford such equipment, it is doubtful whether he could get permission to work in the already overcrowded press box. The same situation goes for work down on the field.

At sand-lot and most amateur contests, however, you can shoot right from the side lines, and the pictures that result often will equal anything that might be taken at the pro game. Football, basketball, the fights, tennis, horse races, and various winter sports



Synchronized flash brings basketball shots within the range of the amateur. This well-lighted flash picture was taken from a spectator's seat in the front row. At a distance of about 30', one peanut bulb usually will yield a well exposed negative.

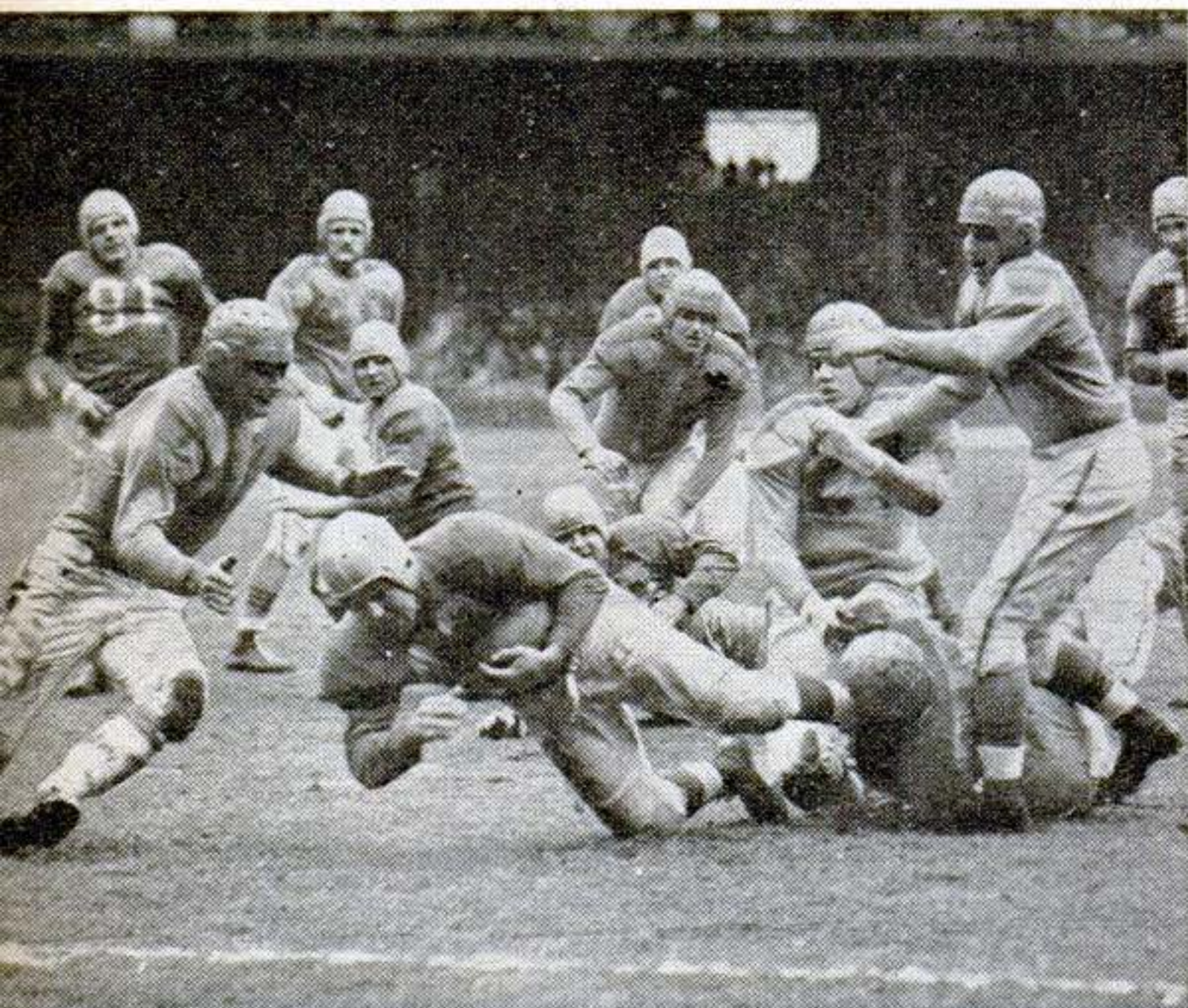

In football, the photographer must anticipate the play so that he can shoot at precisely the right moment. Here, as in most other sports, a footage focusing scale will help you get many pictures.

also abound in good action that the amateur can get.

In photographing baseball from the side lines, the eye-level camera is especially desirable. One trick I learned when trying to catch a runner attempting to beat the throw-in is to shoot a fraction of a second before he completes his slide. In other words, shoot while he is still in the air. The camera shutter is fast, but there is always a lag in its operation. That time lag makes the difference in what the eye sees and the camera registers. Thus we get a split-second action shot that shows the runner either safe or out.

When shooting from the side lines, remember the cash customers. If you jump up at critical moments, they won't like it. Squat down, out of the way. Besides keeping you from becoming unpopular, the low angle probably will give a more dramatic picture.

At almost all fight arenas, the normal ring lights make it possible to take pictures, without flash, at 1/150 and 1/200 sec. at f/4.5 if fast film is used and development is correct. With that speed, one can catch all the good action without a blurry result. In fight pictures, you develop a second sense. You actually outguess the fighters. You learn to feel the punch coming and shoot the instant it lands.

With synchronized flash available for most cameras, I believe an amateur also might well try basketball. Some excellent shots have been taken from a front-row seat. From a distance of 30' from the basket you could get a well exposed negative with one peanut bulb. I have seen good results made with roll-film reflex-type cameras.

In photographing the finish of a horse race, you may find it difficult to concentrate on getting the picture while the horse you are betting on is coming up from behind. But it can be done. Keep your right eye glued on the camera finder while watching (if you must!) your own horse with the left. Never keep the camera rigid and wait for the horses to appear in the finder. Pan with the horses, keeping the leader always in view and shooting just ahead of the finish pole. In this manner, you never will lose the winner.

On the occasions when the leader is so far out in front that a one-horse finish is certain, a quick change of focus will permit shooting back down the track to show the winner lengths in front, with the place and show horses also in the picture. A one-horse finish never tells the story

END

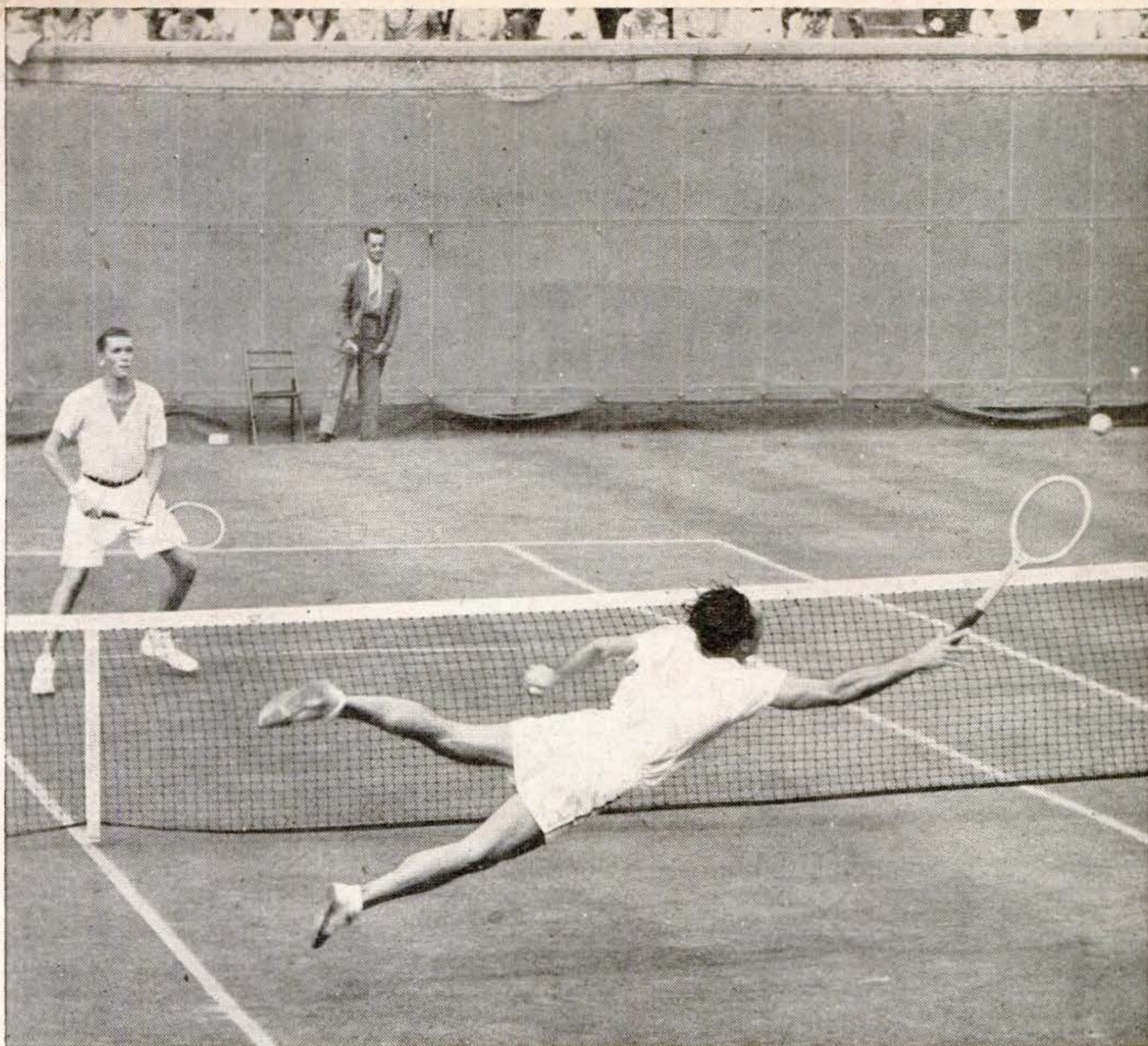

First prize winner in the sports division of the New York Press Photographers Show in 1946, this tennis shot was made by Photographer John Lindsay of the AP with a Speed Graphic. He shot at 1/500 sec. at f/8.



Panning makes the background fuzzy, but at the races it will enable you to use a slower shutter speed. Keep the lead horse in the finder while you pan, or you may shoot the finish—and not get the winner.

Hi-Fi Amplifier Gets ALL the Music

It has power and quality, and will faithfully reproduce the output of pickup, mike, or radio tuner.

By Harry R. Hyder

MANY amplifiers claim the flattering title of high fidelity, but relatively few satisfy the major requirements of accurate record reproduction. It is true, of course, that there is a good deal of argument as to just what is meant by the term, but all definitions agree on at least two things.

Minimum Distortion

The first requirement is low distortion. This means that each stage must have a reserve of gain so that it is worked well within its maximum ratings at all volume levels. Tubes and other components tend to distort a signal when driven at or near their theoretical limits. While the reserve is important for all parts of an amplifier, it is particularly needed in the power-output stage. For good volume in an average room, only one watt of power is required, but occasional sound peaks may call for several times as much, and the amplifier should be able to deliver these peaks faithfully and without overloading. A high-fidelity amplifier, then, needs at least five watts of undistorted output power.

Frequency Coverage

Wide frequency range is the second important requirement. Practically all fundamental musical notes are below 5,000 cycles per second, but the overtones—the harmonics or multiples of the fundamental—that give musical instruments their characteristic sounds extend beyond the range of the human ear to about 15,000 cycles. At the present state of the recording art, the highest audio frequencies cannot be put on commercial disks, but the best new records exceed 10,000 cycles, and your amplifier should be capable of reaching this level without any falling off in output. At the lower end, the

limit is set at about 50 cycles. Good bass reproduction, however, is easier to achieve than good treble.

Test Results

How does this amplifier meet high-fidelity requirements? Actual tests were made on several units built from the same plans with similar but not identical parts. In each case the output was measured at 9 watts or more before distortion became audible; at 5 watts distortion read less than 2 percent. Frequency response proved virtually flat from 50 to 10,000 cycles—that is, all notes between these limits were amplified about equally.

Because the amplifier has power as well as quality, it can be used not only with a radio tuner and record player as a complete radio-phonograph combination, but also with a microphone to make a public-address system.

Construction Notes

The first, or phono-input terminal, I1, is followed by an equalizing network, R1 and C1, and then by a 6SJ7 input amplifier. When this tube is wired as a pentode, the gain of the stage is more than 100. Since this is much greater than will normally be needed, an alternative circuit is given in the drawing. Tying screen and suppressor grids to the plate changes the tube to triode operation, and makes it possible to omit several components. As a rule, triodes give lower output than pentodes, but also have less tendency to produce distortion. Unless you intend to use the amplifier for public address, you will find the triode circuit completely satisfactory. To find where the wires go, simply lay the shaded portion of the diagram over that part of the original which is drawn inside the broken-line box, so that the connections V, Y, and Z coincide.

For the second stage a 6N7 is used as a phase inverter in a self-balancing degenerative circuit. Part of the output of the first triode inside the tube envelope is fed back to the grid of the second triode in opposite phase to the original signal. This produces the out-of-phase signals that are fed to the



These three units and a carrying case in which the speaker is baffled make a complete portable PA system.

push-pull grids of the 6F6s. Strong signals from a microphone or tuner may be fed directly to the 6N7 through input terminal I2, thus by-passing the equalizing network and first amplifier as well as the volume (R2) and tone (R7) controls. Since microphones and tuners vary, try both inputs and use the one that gives best results.

Tone control, in itself, is usually a compromise with high fidelity. A condenser and variable resistor silence upper-frequency noise merely by shunting these frequencies to ground. But while this gets rid of the noise, it also loses the notes with which it is mingled. Many high-fidelity enthusiasts feel that a small amount of noise is preferable to tone-controlled music. To satisfy both sides of the argument, R7 has been connected directly to switch S1, making it possible to cut it out of the circuit entirely.

Two 6F6s in push-pull form the heart of the power-output stage. They are connected as triodes in the interest of low distortion and high speaker damping. A 5Y3-GT is used as the full-wave rectifier in the power-supply circuit.

The entire amplifier is mounted on a standard 2" by 7" by 13" metal chassis. As can be seen in the photographs, the space is not used tightly and a smaller chassis may be substituted if cabinet dimensions demand it. Power-supply components are placed at one end and the input stage at the other, while the phase inverter, output tubes, and output transformer occupy the center of the chassis. The principal precaution to be observed in wiring is to keep the AC filament leads spaced as far as possible from the grid leads, especially in the sensitive input stage. It is also suggested that the 6SJ7 socket be

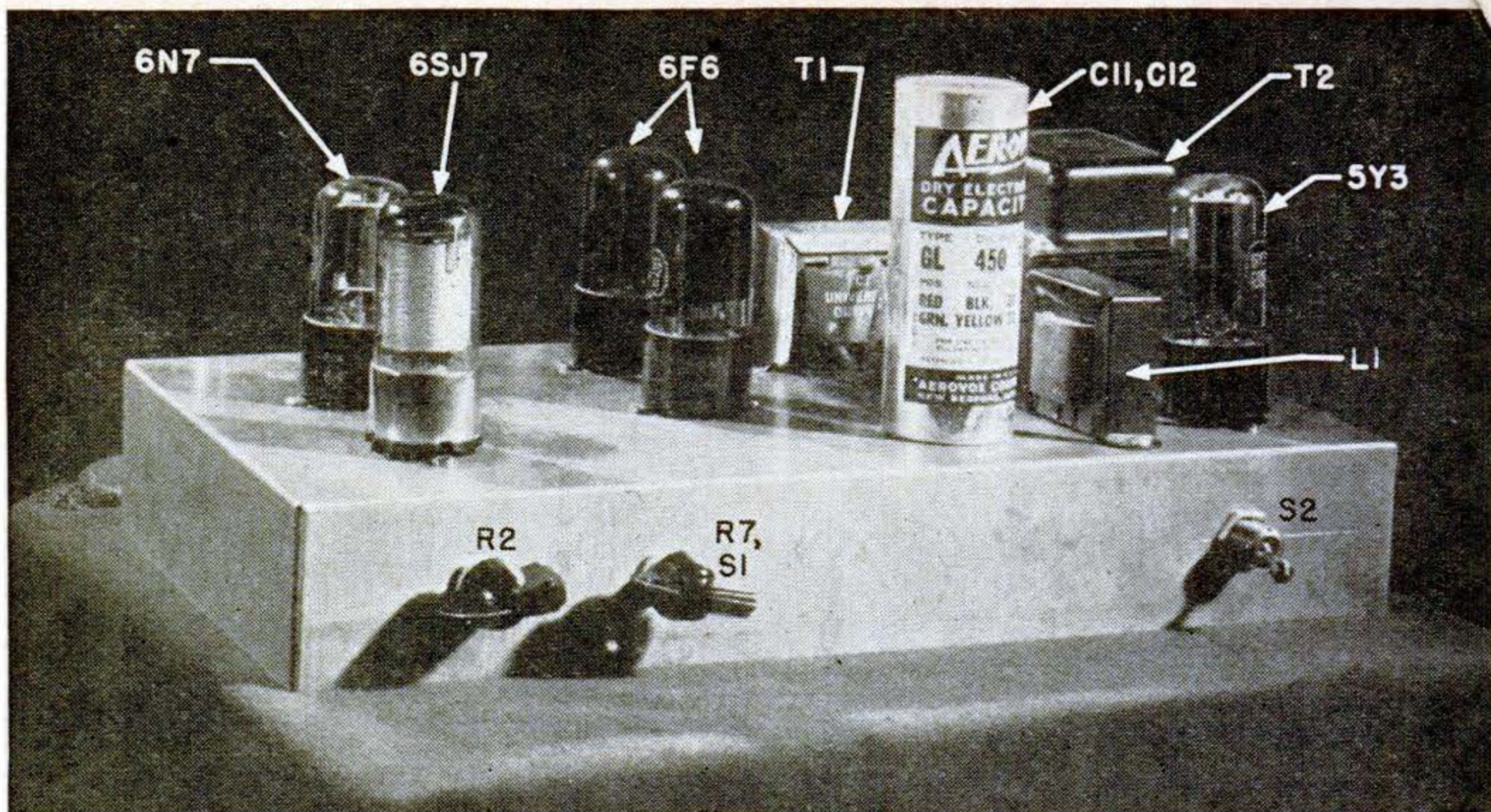

The input stage at one end of the chassis is isolated from the heavy-duty power and filter components.

mounted on live-rubber grommets to reduce any tendency toward microphonics.

Pickup and Speaker

So far as actual sound quality is concerned, a high-fidelity phonograph amplifier is no better than its pickup and speaker, so a few words on these may be in order. Crystal pickups are used almost universally today because of their low cost, high output, and generally good performance. As a rule, pickups of low output voltage have slightly better quality than the high-output types. Since this amplifier has such an abundance of power, the choice of a pickup should be made for quality rather than output. Better pickups are also noted for light weight; many different ones are now available with a needle pressure of about 1 oz. With most records, crystal pickups have higher output at low frequencies than at high. Therefore some form of equalization is needed to boost the treble. In this amplifier it is accomplished by R1 and C1. Note that these are in the circuit only if the pickup is connected at I1.

The speaker selected should be capable of handling the full power of the amplifier without overloading and distorting. Mount it in a solid baffle of adequate size. For best bass reproduction, a speaker of at least 12" diameter is recommended. Speakers of the coaxial type, consisting of a small high-frequency cone, a large low-frequency unit, and a dividing network, give maximum coverage but are quite costly. The better permanent-mag-

net speakers now on the market give very satisfactory response and are priced much lower. For public-address work, two or even three speakers may be used. If they are identical, connect similar terminals together; if they are not, experiment with the connections until you get the speakers in proper phase. See that the units are at least five feet from the mike, pickup, and amplifier. When they are grouped too closely, acoustic feedback or "howls" may occur at high volume levels.

END

LIST OF PARTS

R1: 2.2 meg., ½ watt.	volts, dry electro-
R2: 1-meg. volume control.	lytic.
R3: 1,500 ohms, ½ watt.	C5, C8, C9: .1 mfd., 400 volts, paper.
R4: 1 meg., ½ watt.	C6: .005 mfd., 400 volts, paper (if 6SJ7 is pentode), or .01 mfd. (if used as triode).
R5, R14: 270,000 ohms, ½ watt.	C7: .02 mfd., 400 volts, paper.
R6: 47,000 ohms, ½ watt.	C11, C12: 20-20 mfd., 450 volts, can type, dual electrolytic.
R7: 100,000-ohm potentiometer.	T1: 10-watt universal output transformer.
R8, R12, R13: 470,000 ohms, ½ watt.	T2: Power transformer, 350-0-350 volts, 100 ma.; 6.3 volts, 3 amp.; 5 volts, 2 amp.
R9: 3,300 ohms, ½ watt.	L1: 10-hy, 100-ma. filter choke.
R10, R11: 100,000 ohms, ½ watt.	S1: SPST on R7.
R15: 800 ohms, 5 watts.	S2: SPST toggle.
R16: 2,000 ohms, 5 watts.	Speaker, chassis, tubes, sockets, misc. hardware.
C1: 750 mmf., mica.	
C2: 25 mfd., 25 volts, dry electrolytic.	
C3: .05 mfd., 400 volts, paper.	
C4, C10: 8 mfd., 450	

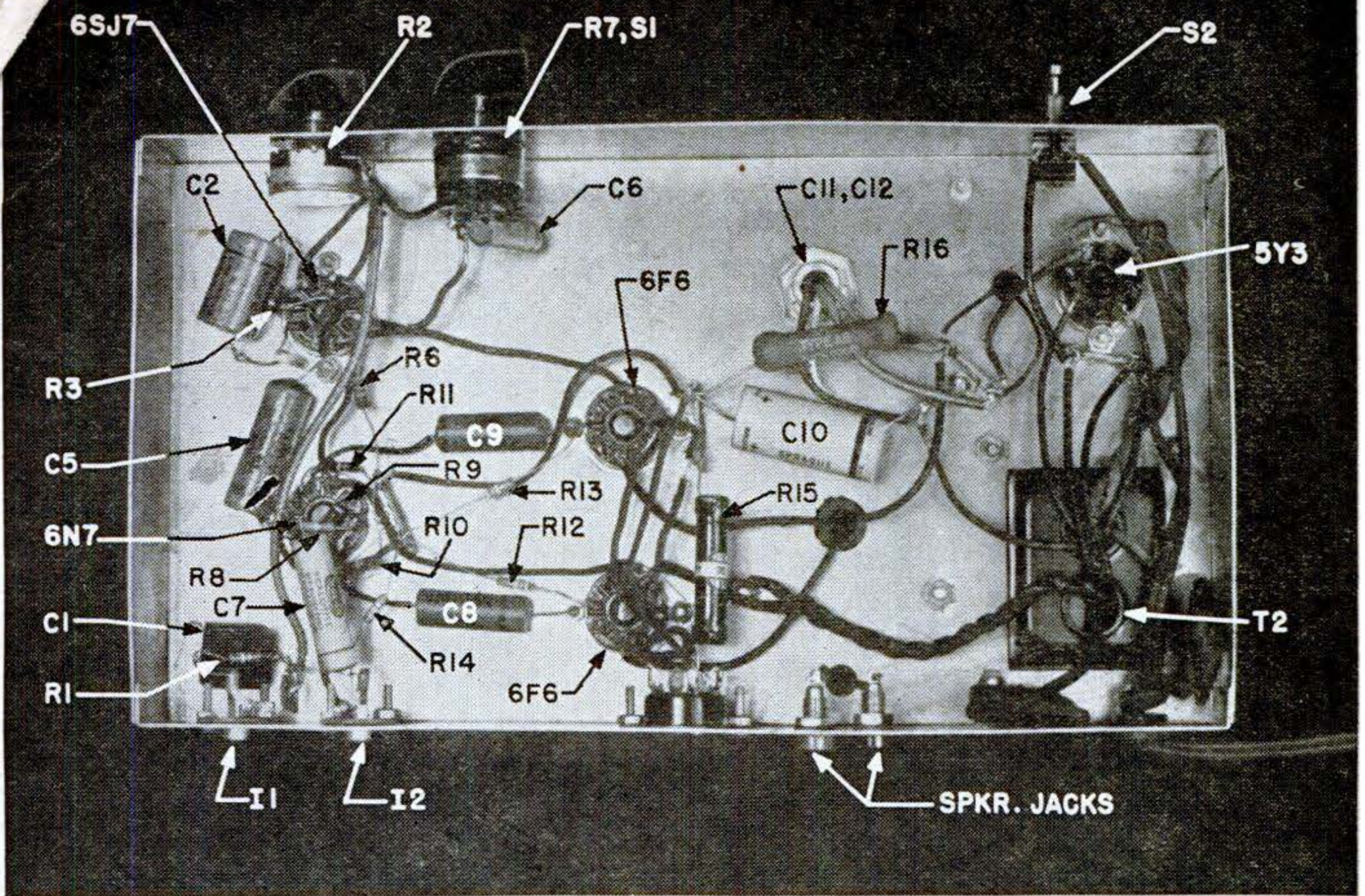

Above, the 6SJ7 amplifier is wired as a triode, and C3, C4, R4, and R5 have been omitted from the circuit.

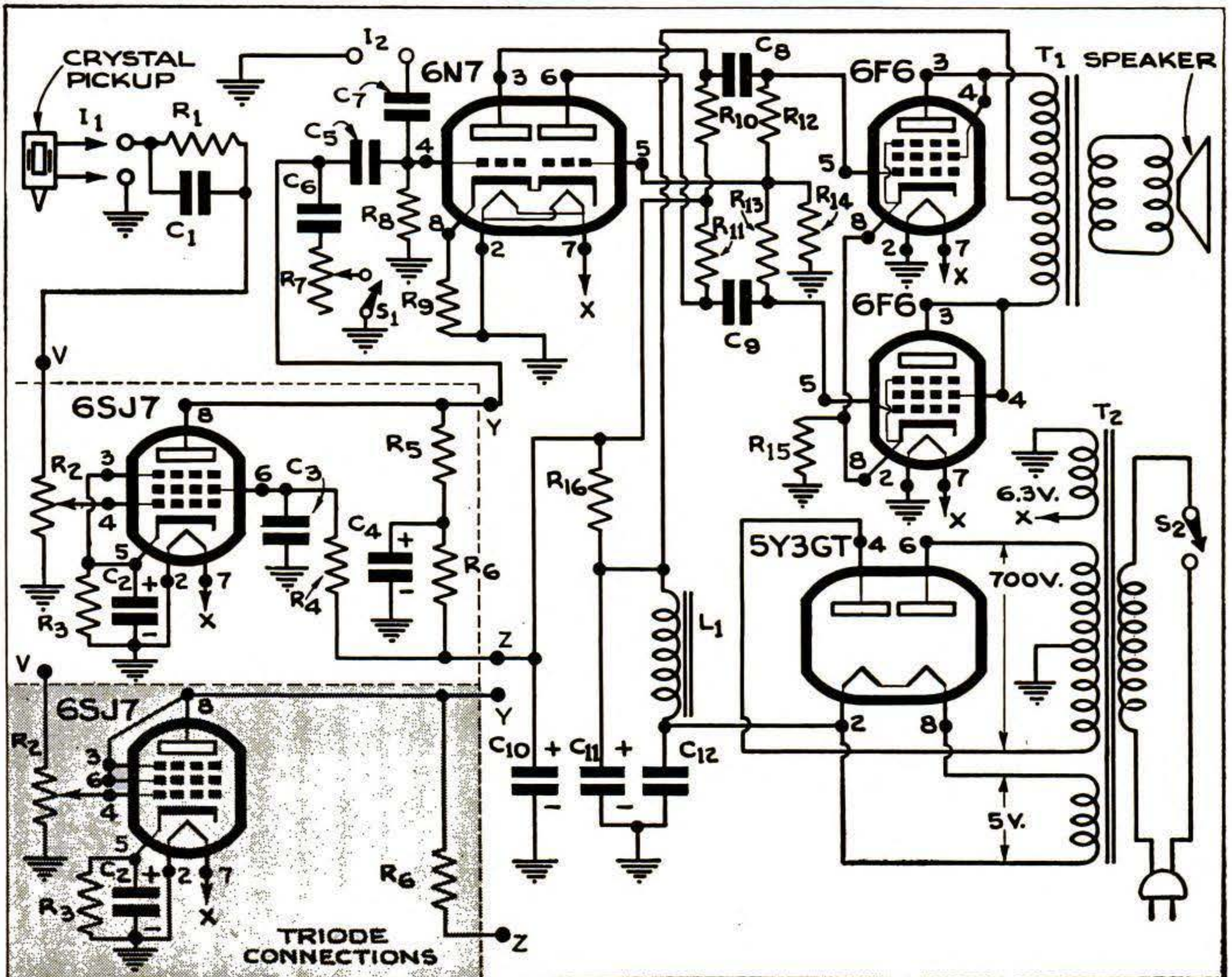

Two input circuits make it possible to leave both pickup and tuner permanently connected to the amplifier.

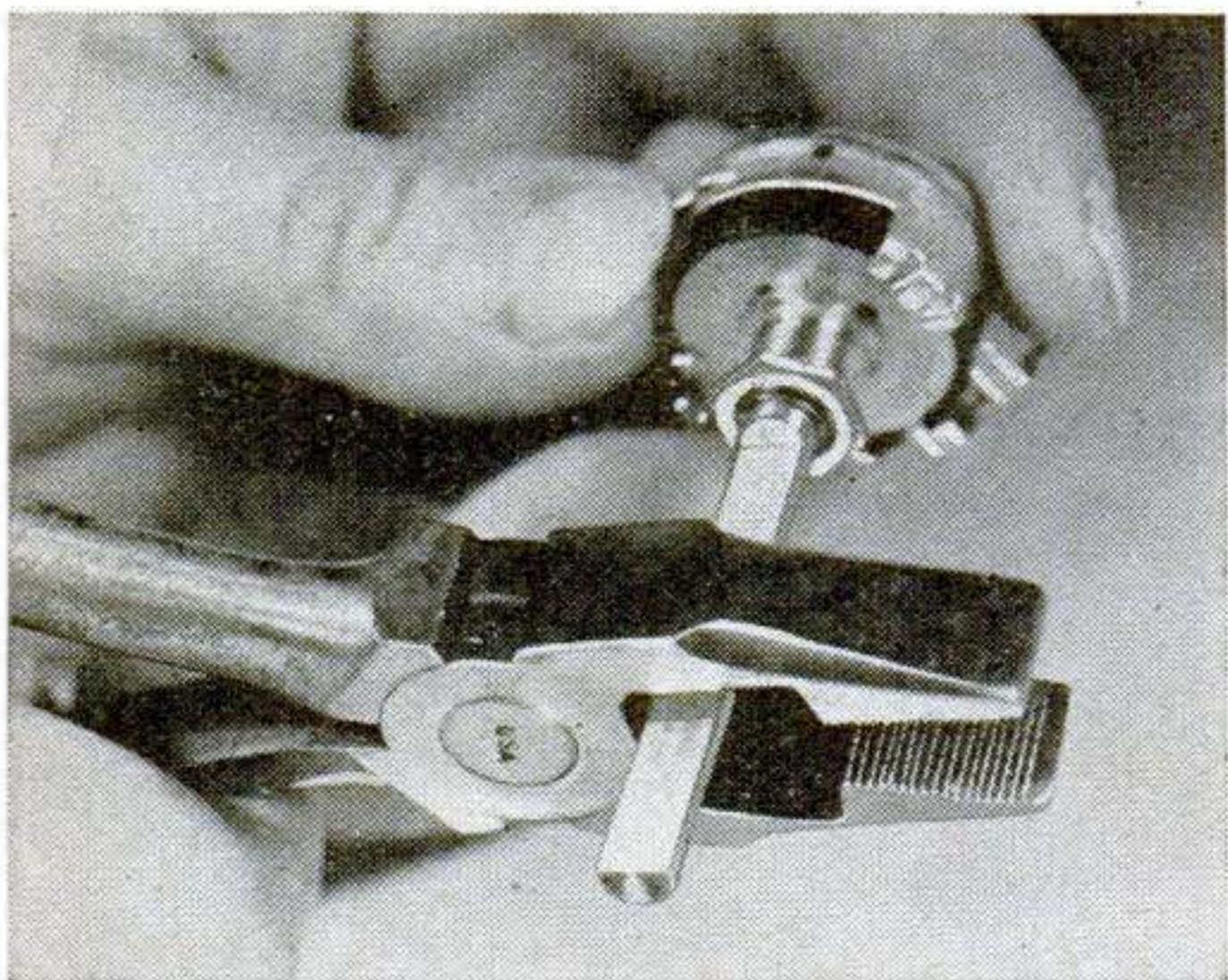

Shaft Can Be Clipped. Aluminum shafts are now used on Clarostat controls in place of the usual steel rod. Instead of sawing it to length, the serviceman can simply clip off the excess with a pair of heavy-duty wire cutters.



Control Tunes Four Circuits. A new ham transmitter, first to be manufactured by the Hammarlund Manufacturing Company, features a device that tunes an oscillator and three multiplier stages with one control. It is said to be the first time this has been done without loss of efficiency. The 20-watt transmitter is shown above (right) with a companion modulator; the two units make a complete phone rig.

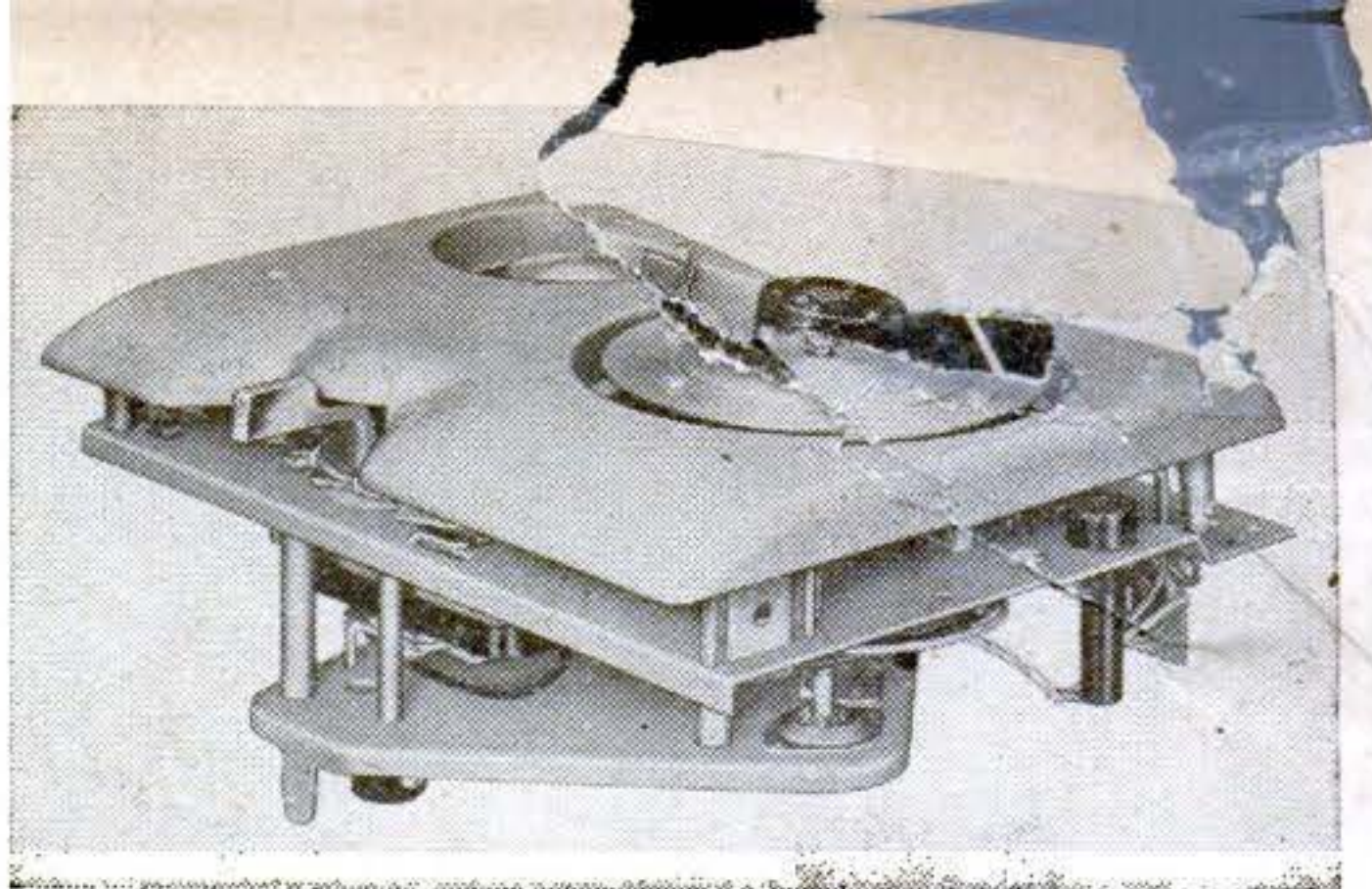

Wire-Recorder Foundation. Experimenters who have put off building their own wire recorders because of the difficulty of making the magnetic head and wire-transporting mechanism will now be able to buy a foundation unit including these essentials. It is made by the Webster-Chicago Corporation, and has a constant-speed motor geared to record at 2' per second and rewind at seven times that speed.

Germanium Varistor. For telephone or telegraph modulation, full-wave meter rectification, or other applications where four matched and balanced diodes are needed, Sylvania offers the plug-in unit shown at the right. It contains four germanium crystals similar to the 1N34. Forward resistance of the diodes is matched to within 2.5 percent. Point contact reduces capacitance and extends the useful frequency range.



Resistors Are Ribbon-Wound. A new type of noncarbon resistor with the accuracy of wire-wound ones is being manufactured by Continental Carbon Inc. of Cleveland. It is made by winding metal resistance film around a low-loss ceramic base, and is said to remain accurate within 2 to 5 percent despite overload and temperature or humidity changes. Ratings are from ½ to 5 watts and values from 1 ohm to 100 megohms.

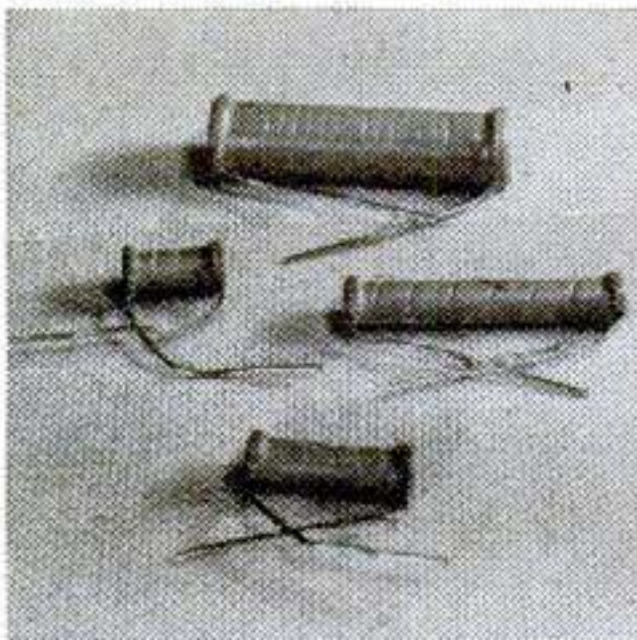

Contact Mike Boosts Music

PRACTICALLY any radio can be used as an electronic booster for your violin, guitar, piano, or similar instrument. A contact microphone feeds the music into the amplifier section of the radio. If the set has a high-gain audio system, the electrical connections may be made directly; a typical installation is shown in the drawing at the lower right.

Radios that don't give all the amplification you want can be pepped up with another audio stage as shown in the diagram below. Tube V1 is the detector-amplifier already in the receiver—probably a 6SQ7, 12SQ7, 6SR7, or the like. Break the grid circuit at the point marked X, and wire in a switching jack as shown. For AC-DC sets using 150 ma. tubes such as 12SA7, 12SK7, 50L6, or 35Z5, the extra tube and associated parts values are given in column A below. Other AC-DC sets with 300 ma. tubes (6SA7, etc.) take the values in column B. Column C applies to straight AC sets with such tubes as the 6SJ7, 6SA7, and 6SK7.

For sets of the last type, connect the heater of V2 in parallel with those already in the circuit; in the case of all AC-DC sets, wire it in series with the other tubes at the ground side of the line.—WILLARD MOODY.

TABLE OF VALUES

	A	B	C
R1:	.5 meg.	.5 meg.	.5 meg.
R2:	2.4 meg.	2.4 meg.	2.5 meg.
R3:	2,400 ohms.	2,400 ohms.	1,500 ohms.
C1:	.0015 mfd.	.0015 mfd.	.0015 mfd.
C2:	5 mfd., 25 v.	5 mfd., 25 v.	10 mfd., 25 v.
C3:	.05 mfd.	.05 mfd.	.05 mfd.
V2:	12SJ7	6SJ7	6SJ7

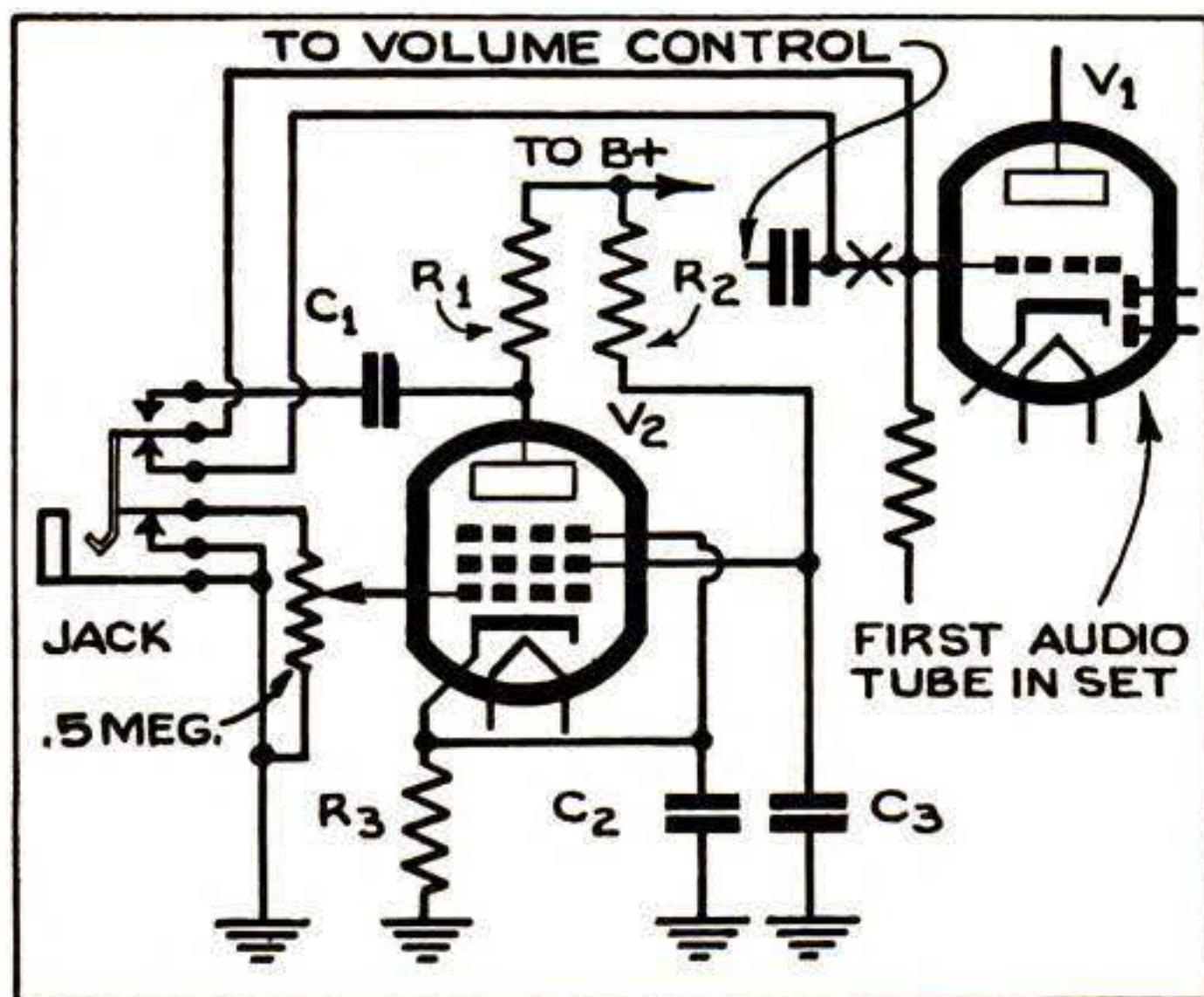

A little rubber cement was used to attach the contact microphone to this flat-top guitar. You can find the best place for the mike by actual trial.

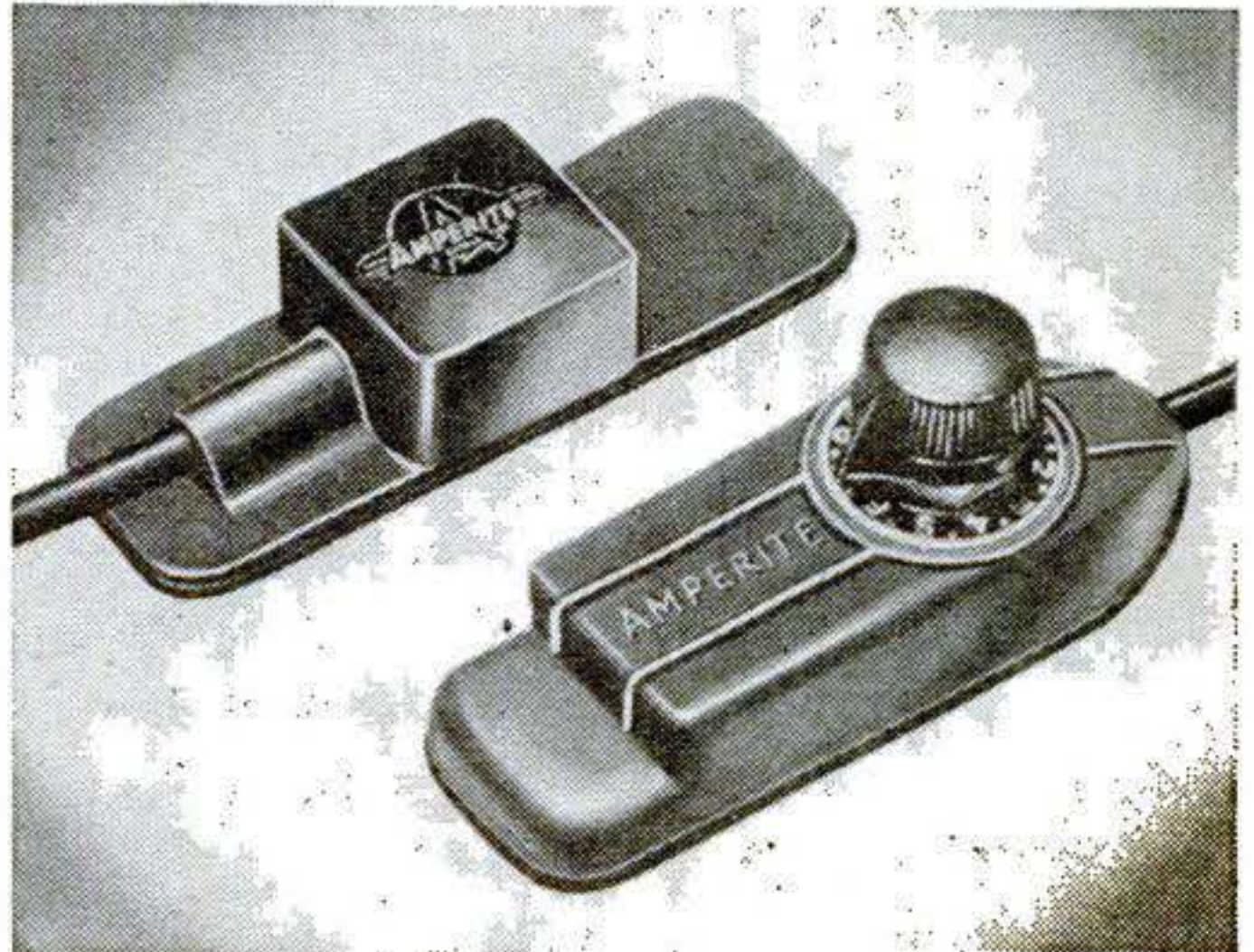

Contact microphones come in a variety of styles, with hand and foot controls. The two models shown above are made by Amperite Company, of New York.

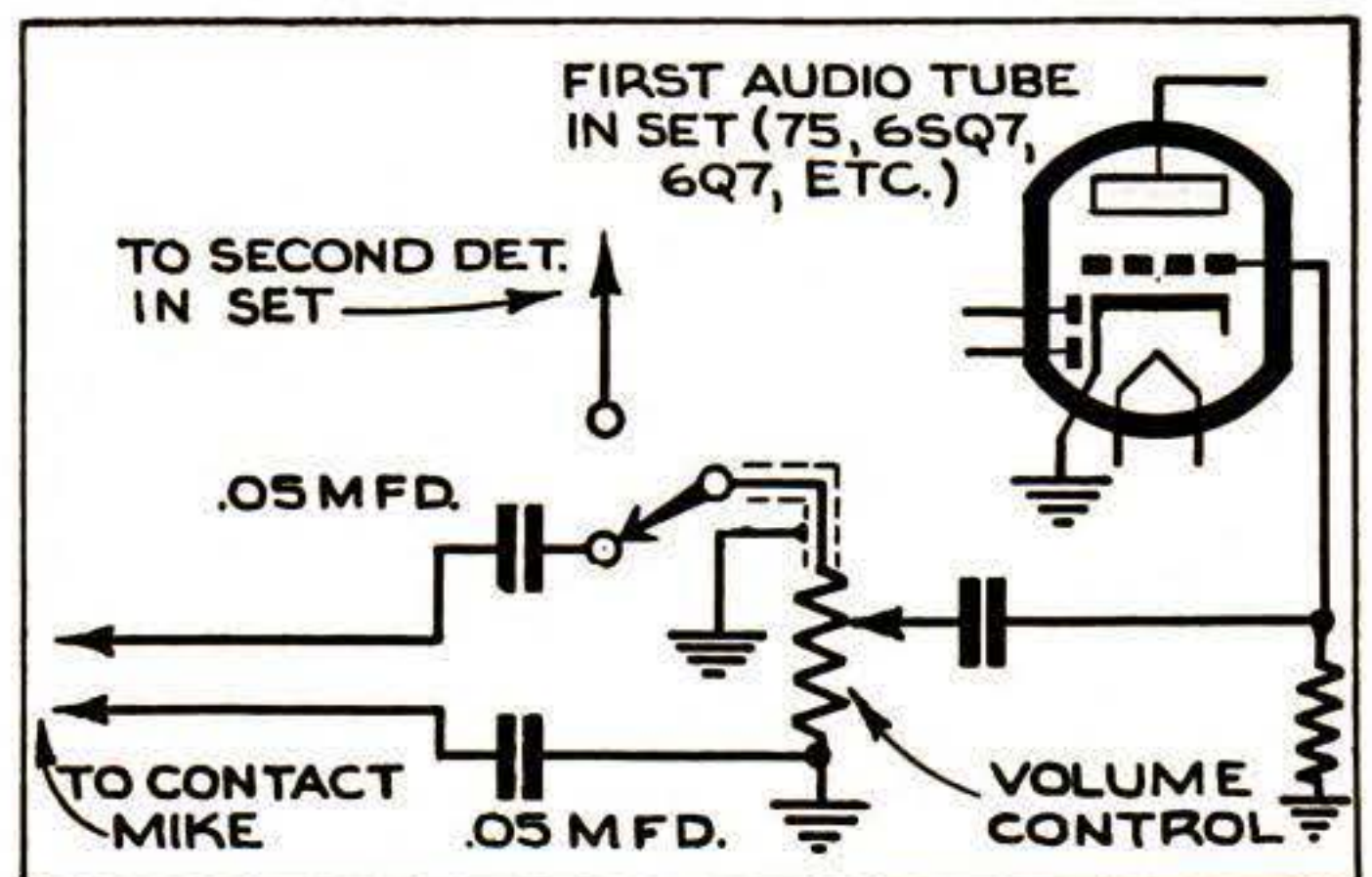

The diagram above shows a simple installation between the detector-audio stages; at left, a more elaborate method, using an extra amplifier tube.

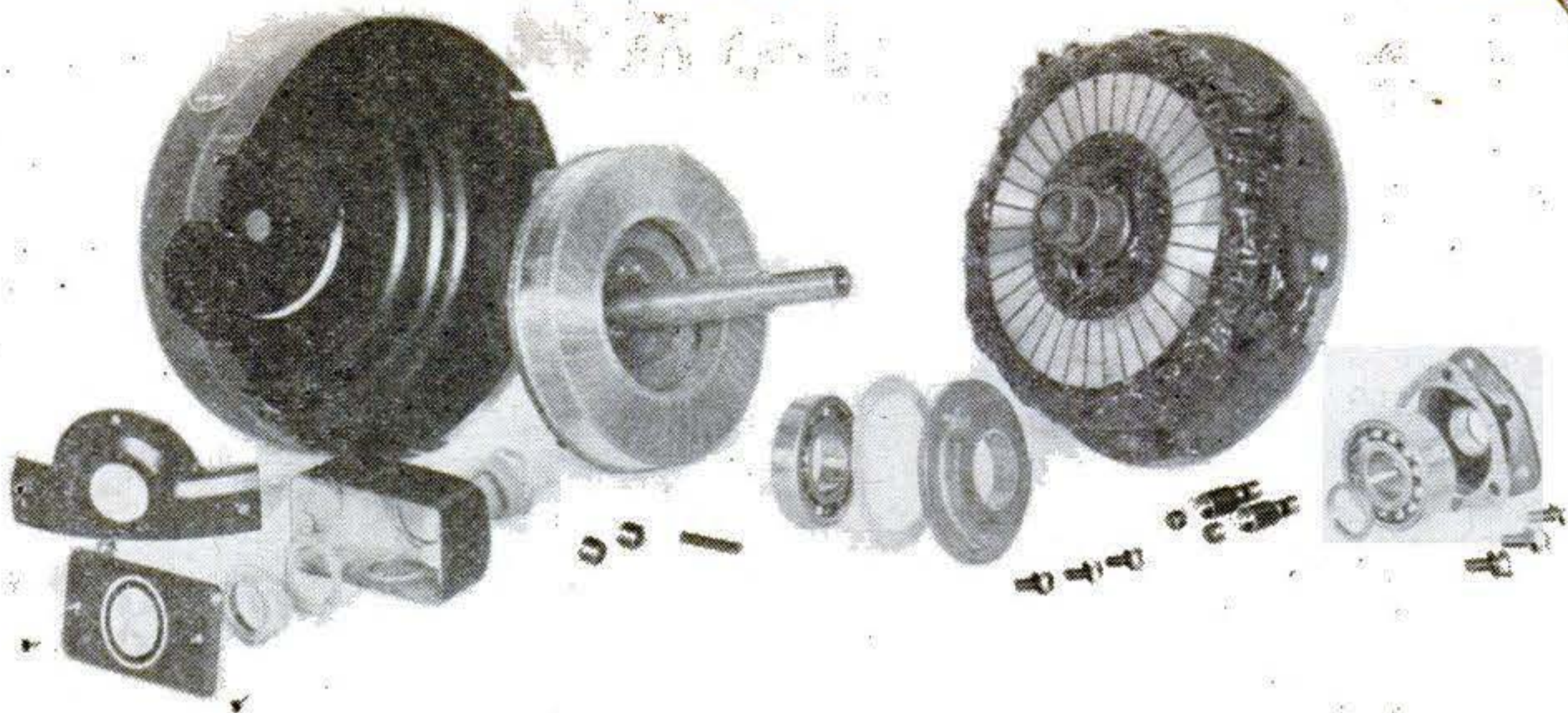

Pancake Motor Saves Space

RECENT developments in manufacturing technique have made it possible for Fairbanks, Morse & Co. to put into commercial production a line of axial air-gap motors that are both smaller and lighter than conventional motors of the same power. Stator and rotor cores are constructed as relatively flat disks, and the rotor turns in a plane parallel to the field faces. The new motors are especially suited for flange mounting on power tools. They may be used in direct-drive or belt application; for the latter, a special base is provided in which the entire motor can be quickly pivoted in order to obtain proper belt tension.



A compact air-gap motor, right, is shown with a conventional unit of equal power. The new motors are being produced in sizes from 1/3 to 10 hp.

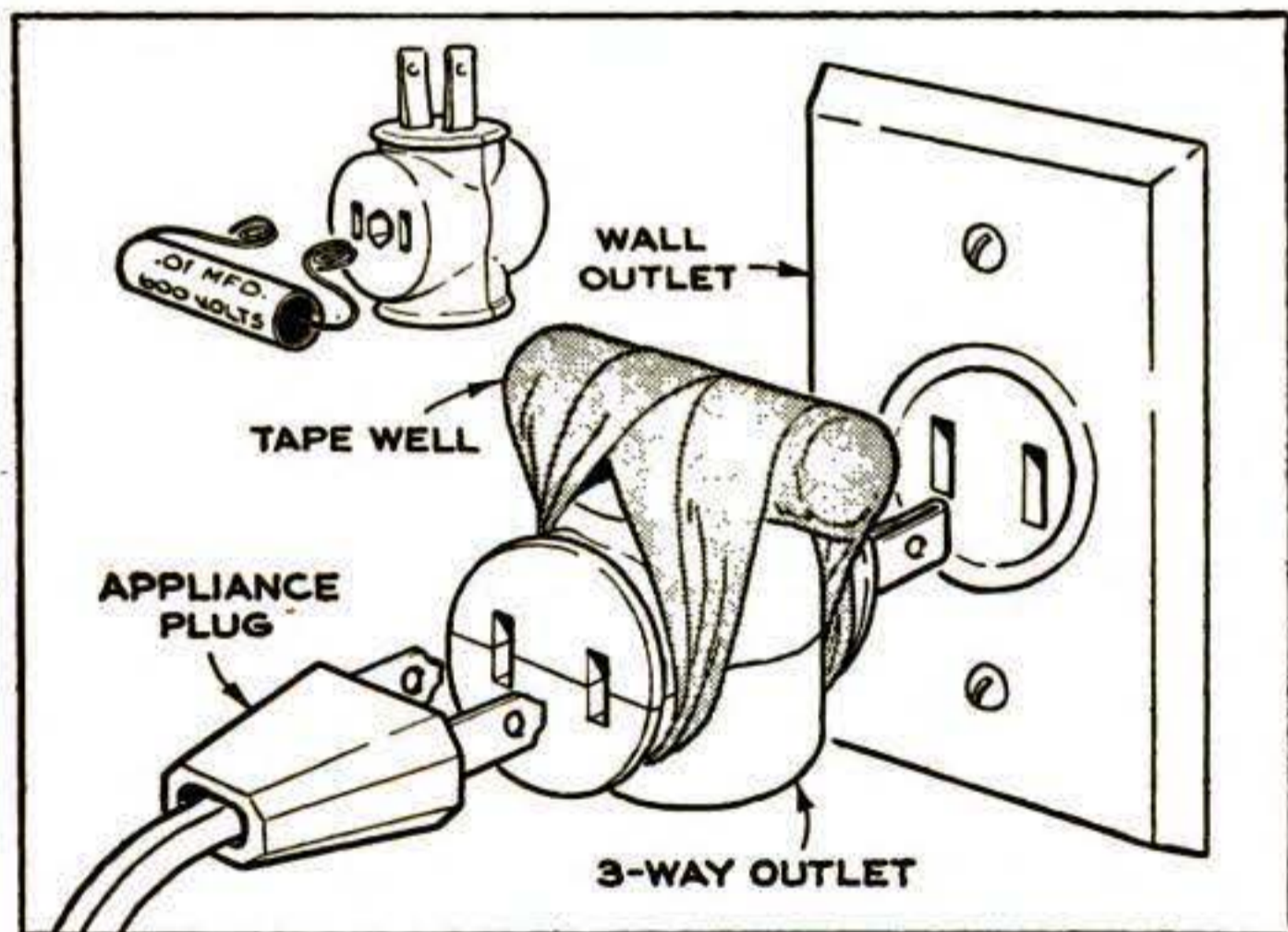

Condenser Cuts Interference

AT LEAST part of the radio interference caused by electric shavers, vibrating tools, and similar appliances can be eliminated by placing a condenser across the line at the noise source. Tape a .01-mfd. 600-volt capacitor into one side of a three-way outlet and plug the appliance into another side of the same outlet.—RALPH S. WILKES.

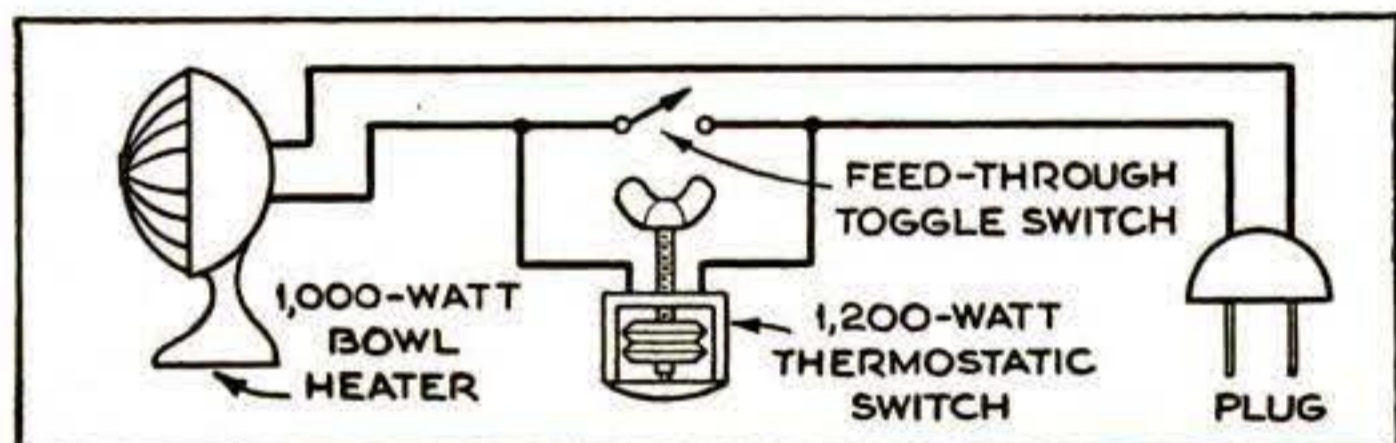

Thermostat Warms Nursery

BECAUSE of uneven heat distribution in my home, bringing the second-floor nursery to a comfortable temperature resulted in overheating the living quarters on the lower floor. To obtain proper regulation, I rigged up a nursery-heating system that is both independent and inexpensive. It consists of a 1,000-watt bowl heater and a bellows-type, screw-adjusted thermostat such as is used for poultry incubators. Trial and error determined the screw setting that kept the room at the desired temperature. An extra feed-through switch across the thermostat allows the current to be kept on when extra heat is needed, as at bath time or when dressing the children.—JOHN S. PARSONS.

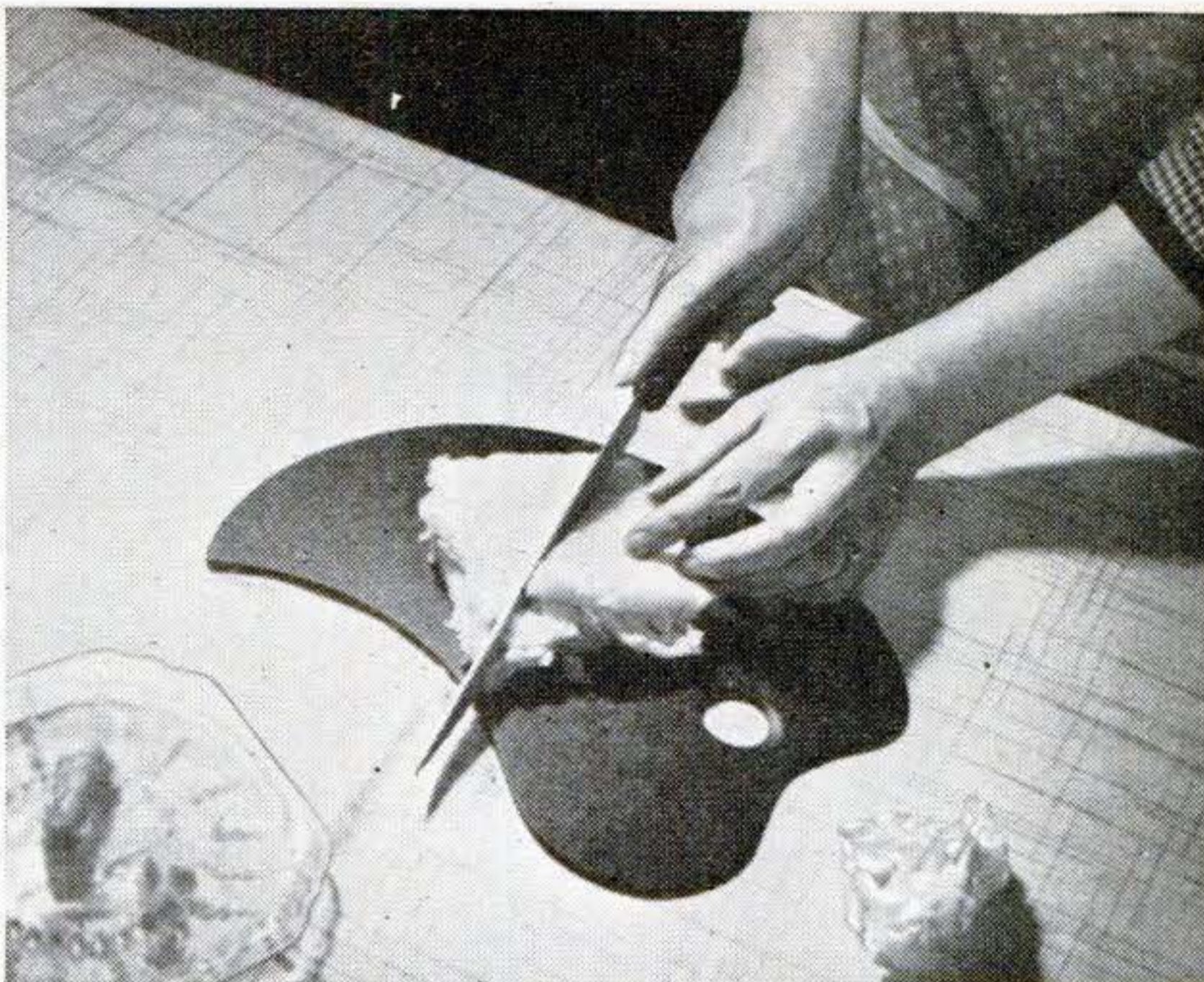
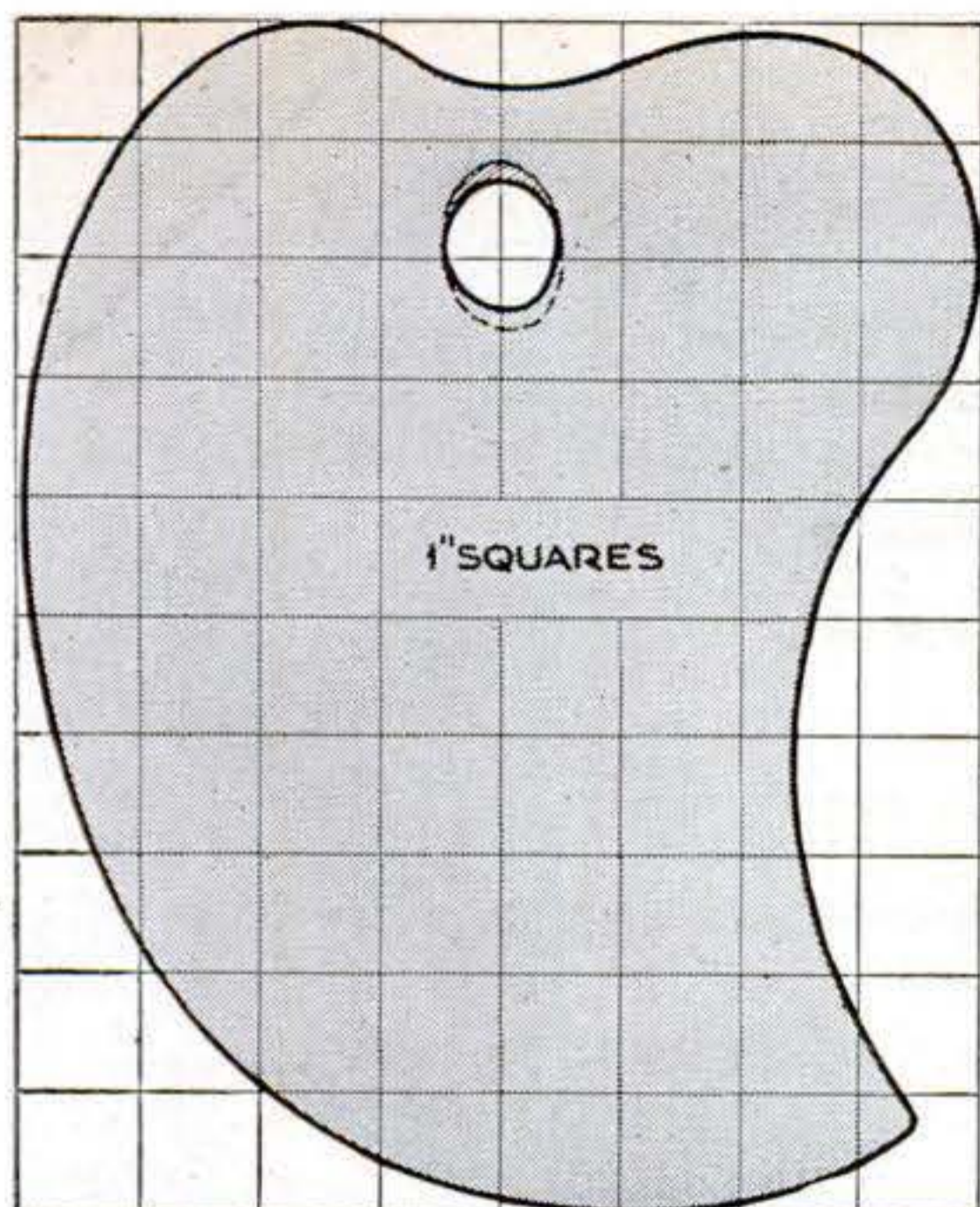

Buffet Sandwich Board Is Shaped Like Palette

FOR making and serving sandwiches at informal parties, or preparing vegetables in the kitchen, a cutting board of $\frac{3}{16}$ " or $\frac{1}{4}$ " hard composition board adds a decorative touch if sawed out in the shape of an artist's palette. The material is waterproof,

needs only a coat of linseed oil for a finish, and will stand repeated washing.

A set of different sizes may be made and will take no more space than one wood board when hung on a wall peg. Merely vary the size of the squares.—W. A. CONWAY.

Marking Your Garden Rows



SMALL glass jars with screw tops make good waterproof and wind-proof markers for the rows in a vegetable garden. Nail the lid to a stake and insert the empty seed package before putting the lid back on. The date of the planting may be written on the package also, if desired, to provide a record of growth.—W. H. FULKER.

Lacquer Polished by Buffing

HIGH glosses like that on plastic can be obtained by buffing many hard lacquers on a muslin wheel. Use a soft wheel with one to three cardboard disks between the cloths.

Fine finishes are possible on metal and close-grained hardwoods. Round sharp edges and apply three coats of lacquer, letting the last dry overnight. Run the wheel at 3,500 r.p.m. Use a cake lacquer-buffing compound, and polish finally with lime composition. Sponge off any film with benzine.

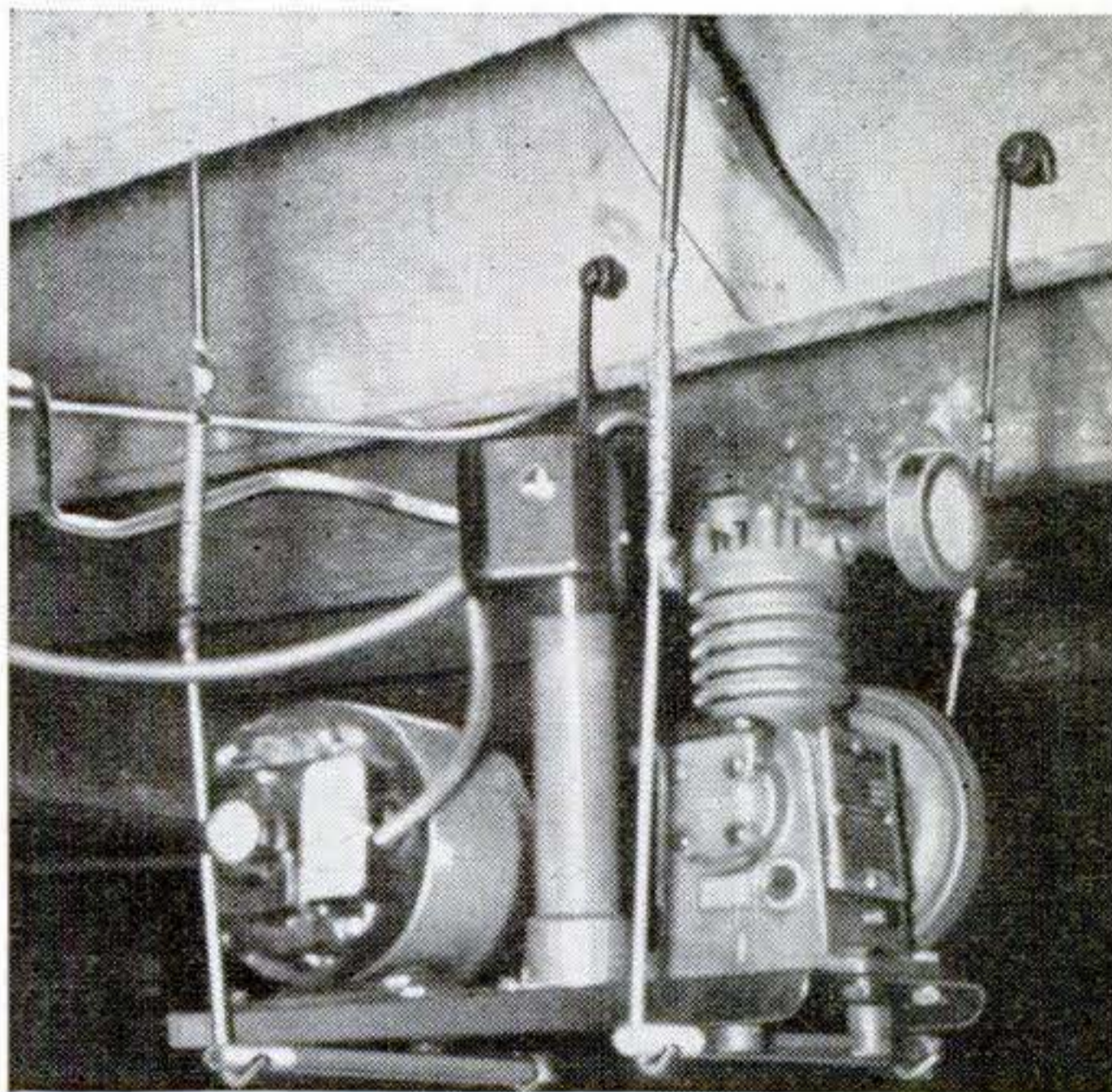

Mounting Quiets Compressor

NOISE and vibration of an air compressor hung from the joists to save space proved excessive in the house above. To quiet it, I made hooks of $\frac{1}{4}$ " welding rod and brazed them to both ends of lengths of $\frac{7}{16}$ " door spring. Hanging the upper hooks on lag screws inserted through rubber bushings, I hooked the lower on $\frac{3}{8}$ " by 10" bolts on which the unit is set. No other platform was found necessary.—JOHN G. LOWNSBERY.

Servicing the Gas Range

By **Frank McCarty**

IF THEY are to do efficient heating, the burners of a kitchen gas range must be kept clean and regulated. Degreasing compounds are available for cleansing both removable parts and the oven to eliminate one cause of kitchen odors. In stubborn cases,

use a solution of 1 cup ammonia in 2 qt. hot water, or treat the oven with ammonia fumes. Rinse degreasing solution from burners with hot water and dry them thoroughly—a few minutes in the heated oven will do—before putting them back in place.

Repairs such as those required by broken door springs and loose handles can be made easily by the average handy man. He should also be able to patch or replace a burned-out oven lining and install new insulation if necessary. Both soft and hard asbestos are suitable insulating materials, but fire-proof rock-wool blankets like the original ones are available cheaply at most building-supply houses and lumberyards.

Steps in cleaning, adjusting, and repairing typical gas ranges are illustrated on this and the following two pages.



Burners are easily lifted out of the top of the range for cleaning. A commercial degreaser or a hot solution of household ammonia followed with rinsing in hot water clears the orifices.

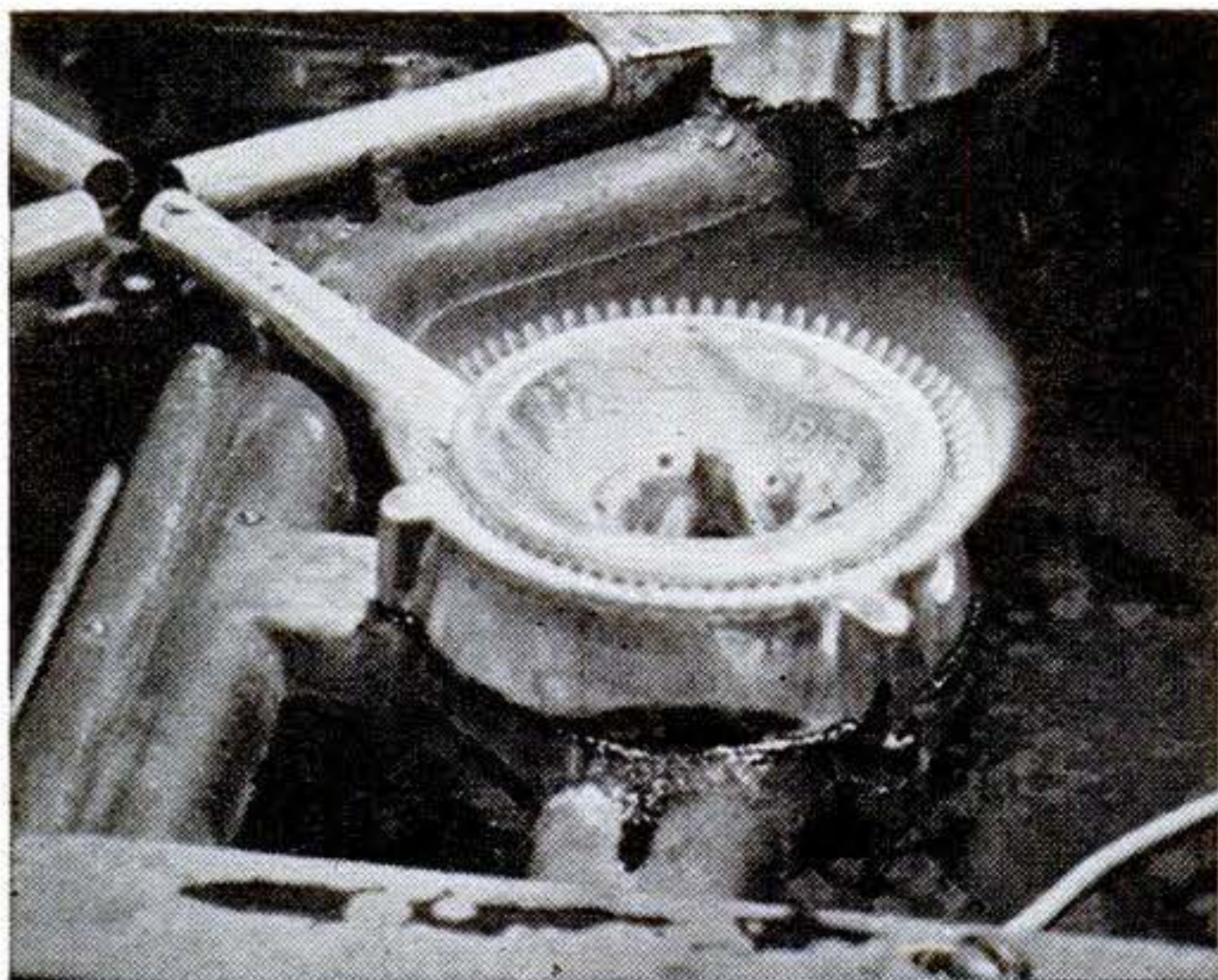

When the burners are put back in place, the air and gas should be adjusted. The most efficient flame is pale blue and noiseless and $\frac{3}{8}$ " to $\frac{1}{2}$ " high. Too much air causes hissing.

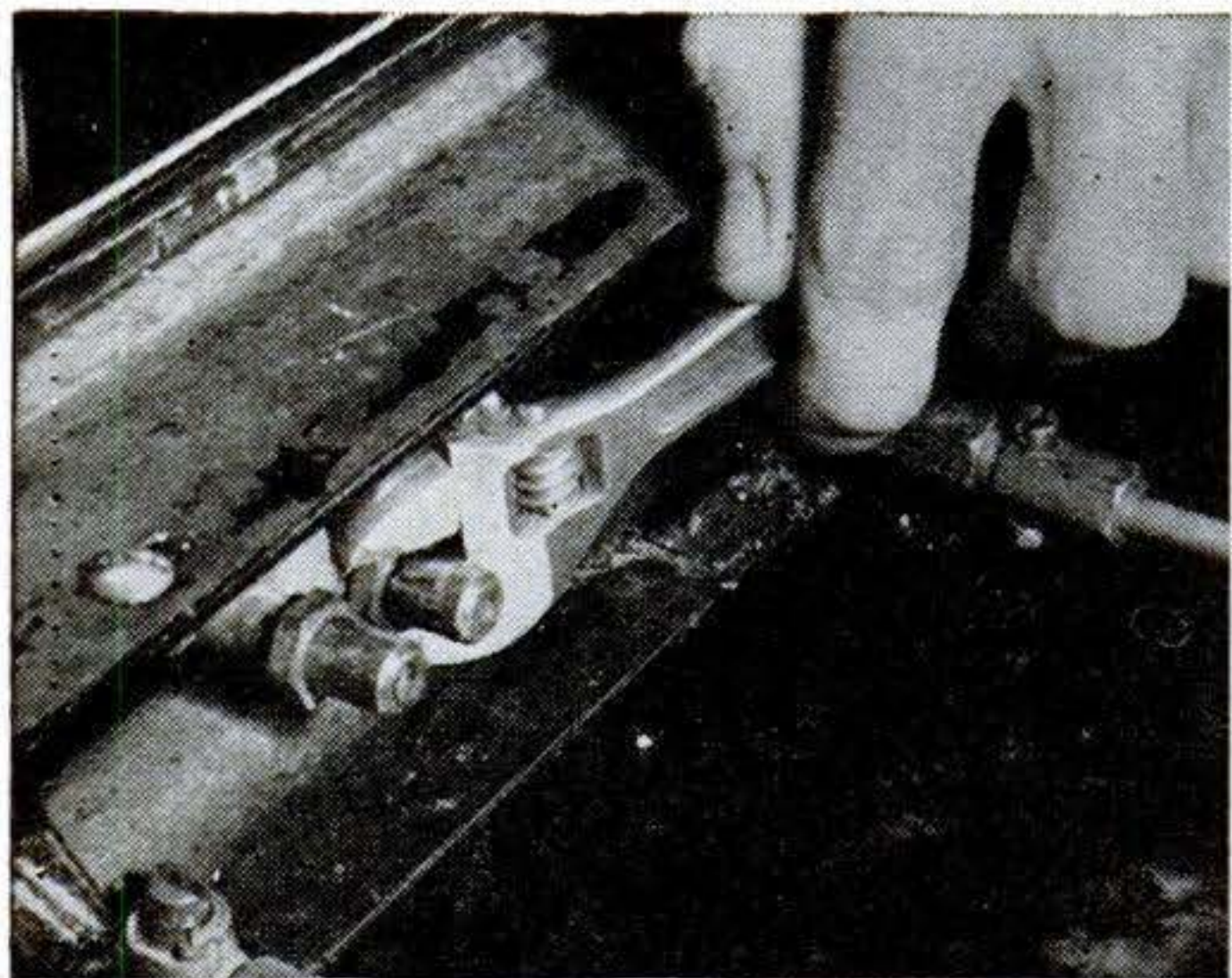

Gas admission on the double-duty type of burners is also controlled by two valves. Unscrewing admits more gas. With the handle half on, the low flame burns; full on puts both in use.

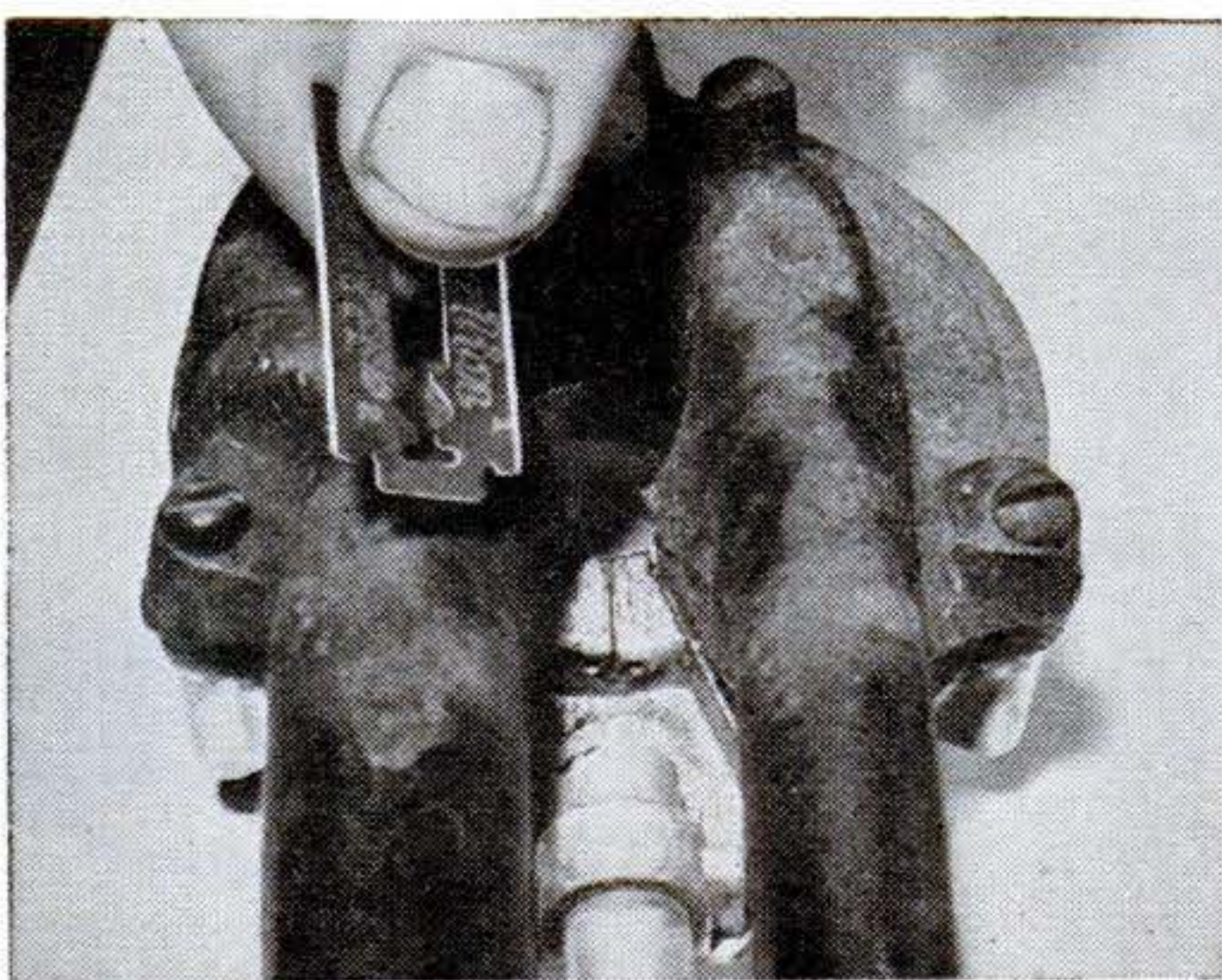

With an automatic pilot, a little gas escapes from a slit or holes in the burner, flows up a tube, and is lit by the pilot flame; flashing back, it lights the burner. A razor blade cleans the burner slit.

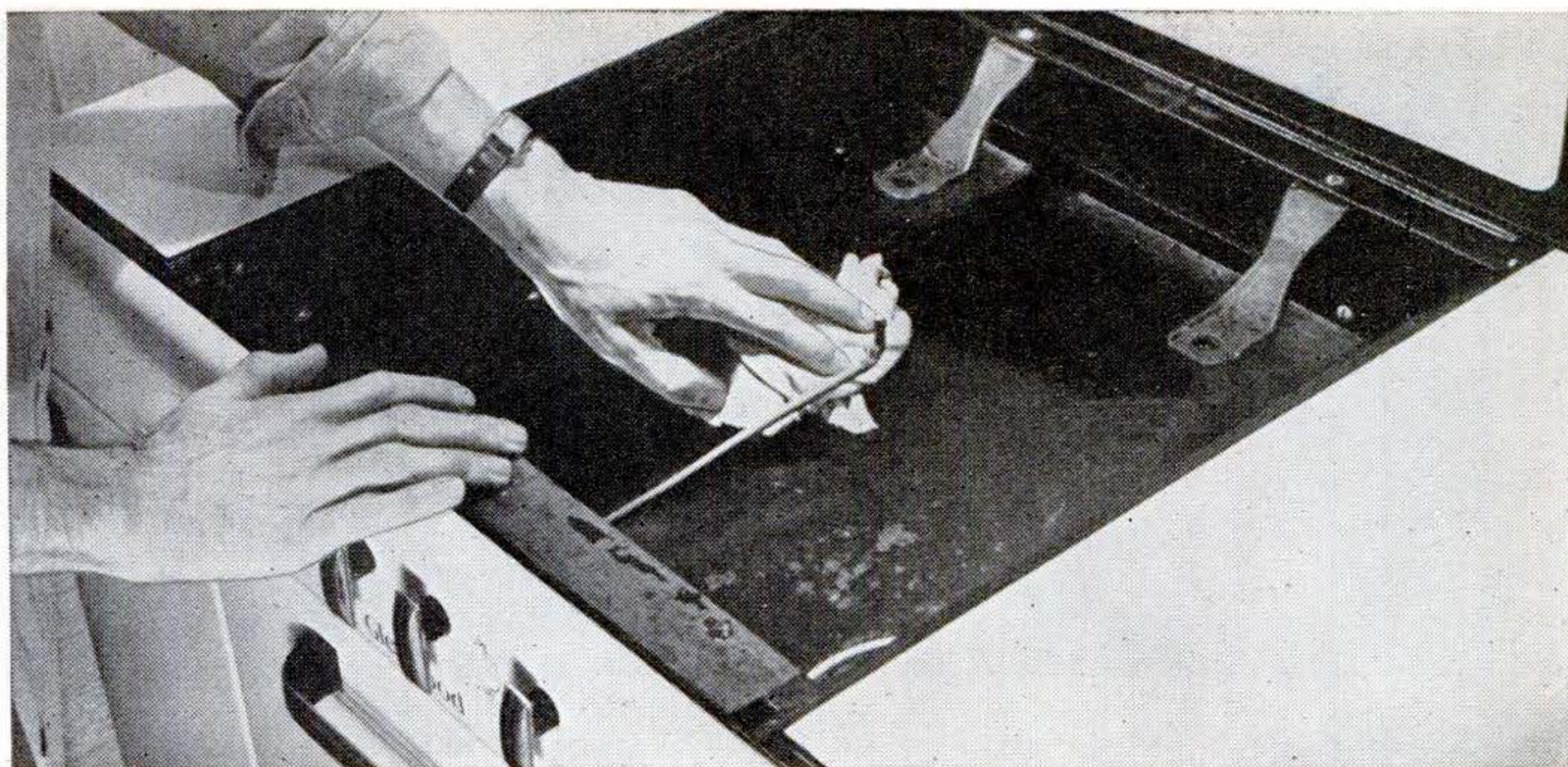

Frequent wiping of the drip pan under the burners saves trouble. Use a degreasing compound if necessary.



One simple, common type of burner has a rotating shutter to admit air. It can be adjusted when a screw is loosened. After the correct setting has been made, retighten the screw carefully.



Another type of burner has an air adjustment in the form of a shutter on the end of the base and also requires loosening a screw. The one shown has a high- and low-flame valve for each burner.

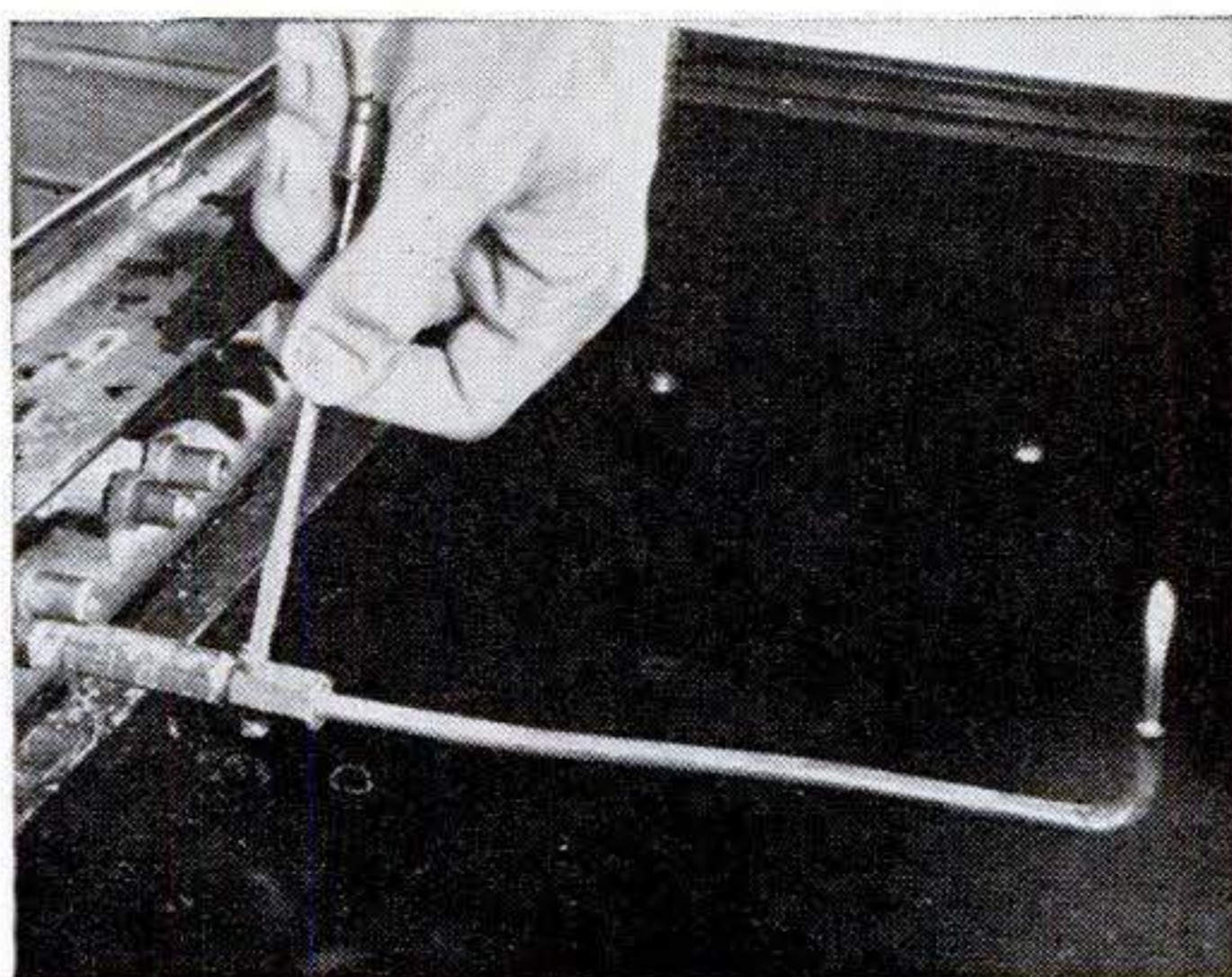

Most pilots have a yellow flame and no adjustment for air. Turn a valve or screw as shown or under the jet end for a small, steady flame. A clogged opening can be cleaned with a wire or needle.



With the bottom, broiler pan, and racks removed, an oven can be scraped of batter and grease. The burner, being inverted, rarely requires cleaning. Adjust it like the top burners. [Turn the page.]

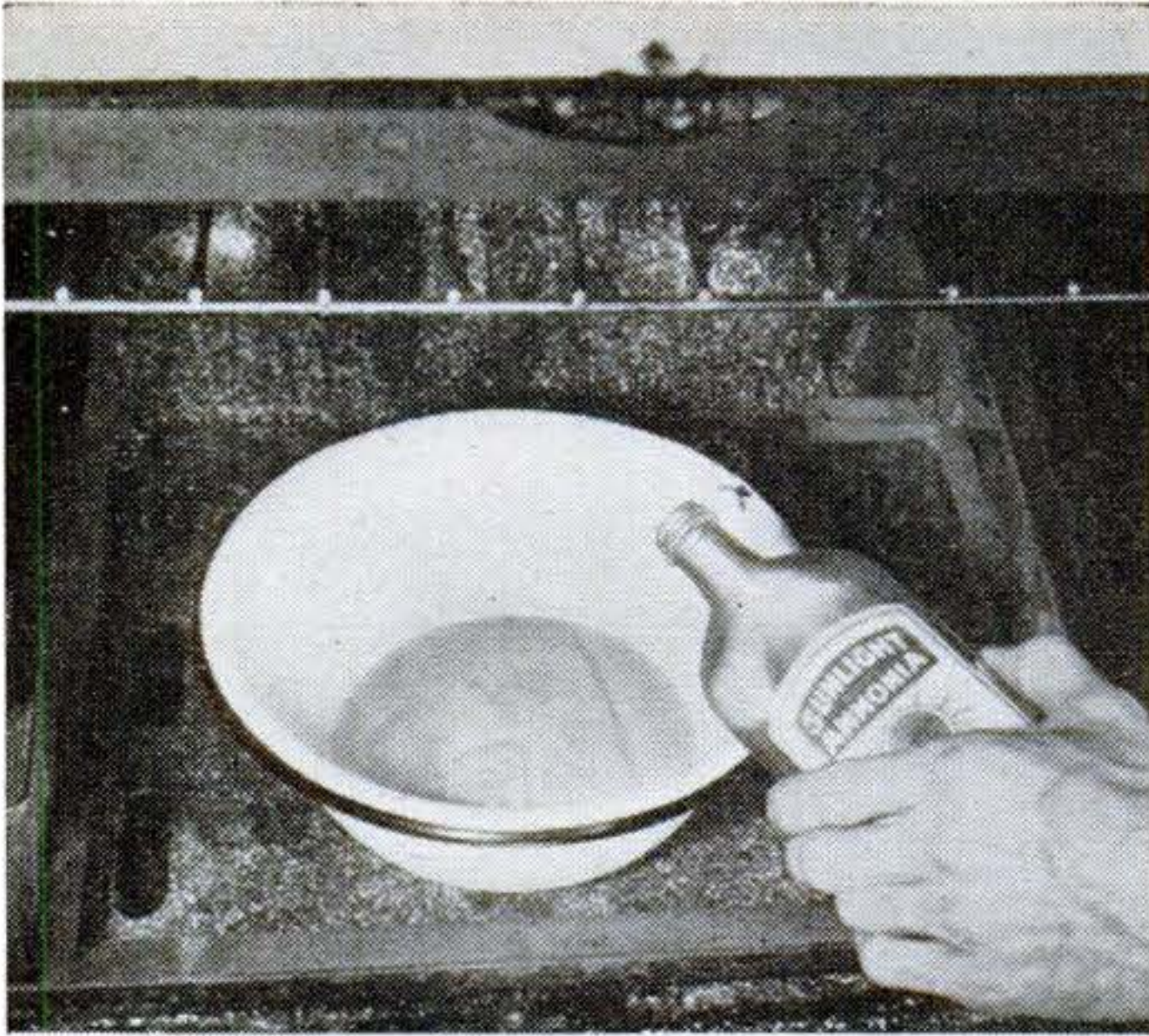

To soften baked-on grease, pour $\frac{1}{2}$ " of ammonia in a pan and lay in a cloth pad to act as a vaporizer. Plug the back flue and close the door; then after 12 hours wash thoroughly with soap and water.



This type of oven burner has all the adjustments exposed and is handled as any other. At right is an automatic oven pilot similar to the pilot for the burners on the top of the range.

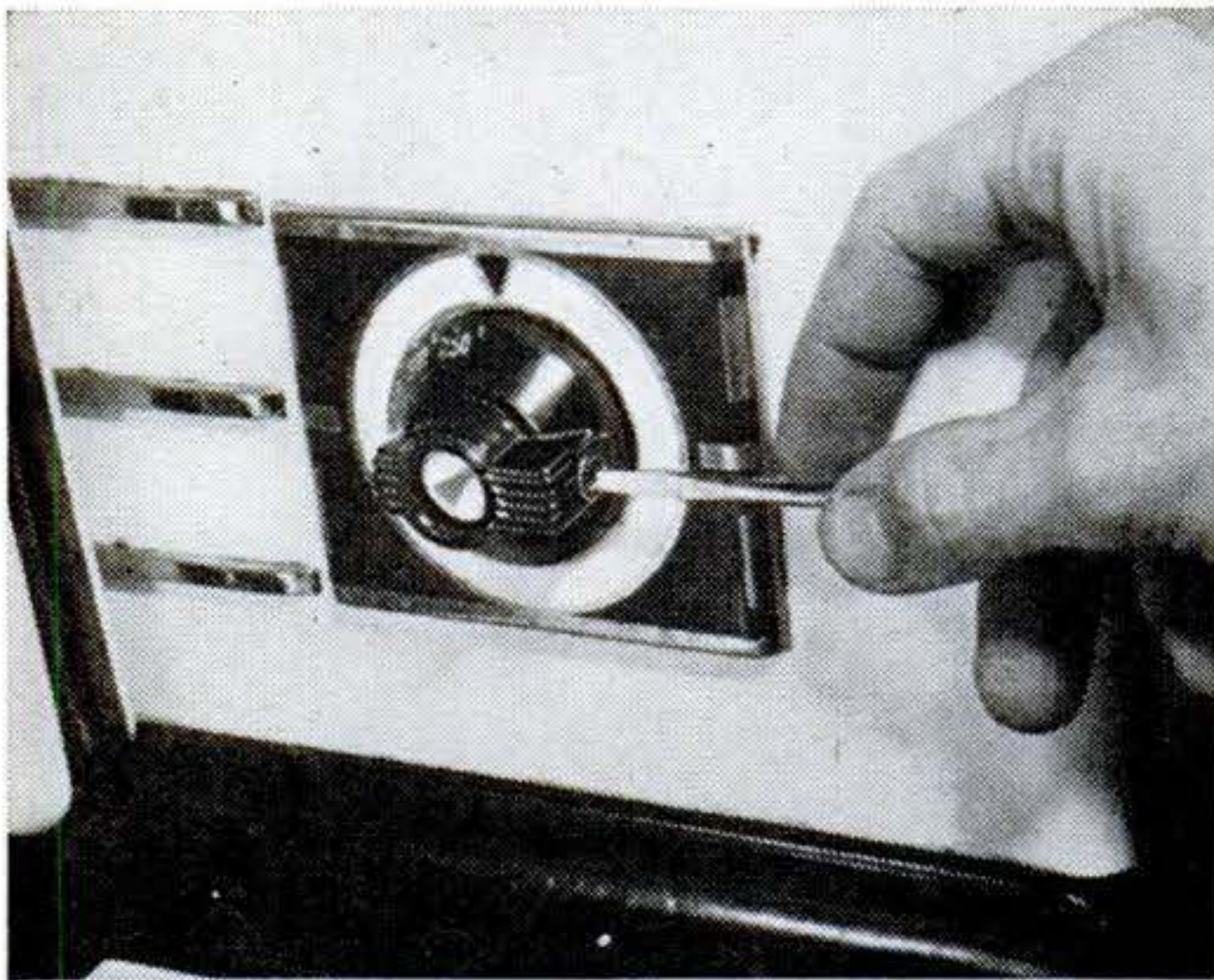

Actual oven temperatures can be checked against those indicated on the control dial by comparison with an oven thermometer. Correct any difference by loosening a setscrew and resetting the dial.

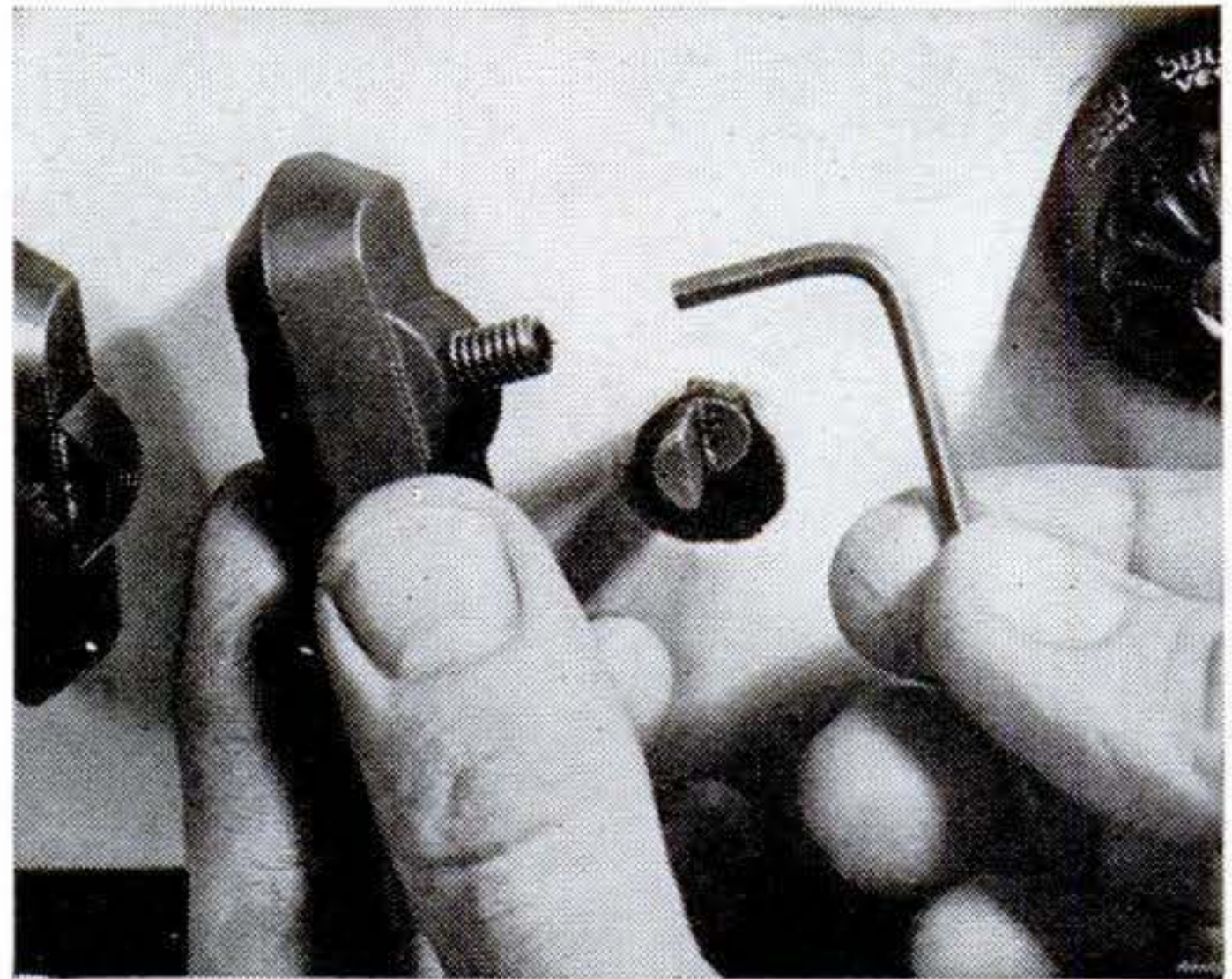

Plastic burner handles loosen when the spring in them breaks or wears. They can be held tight by a socket-type setscrew put flush in a drilled and tapped hole. It will be practically invisible.

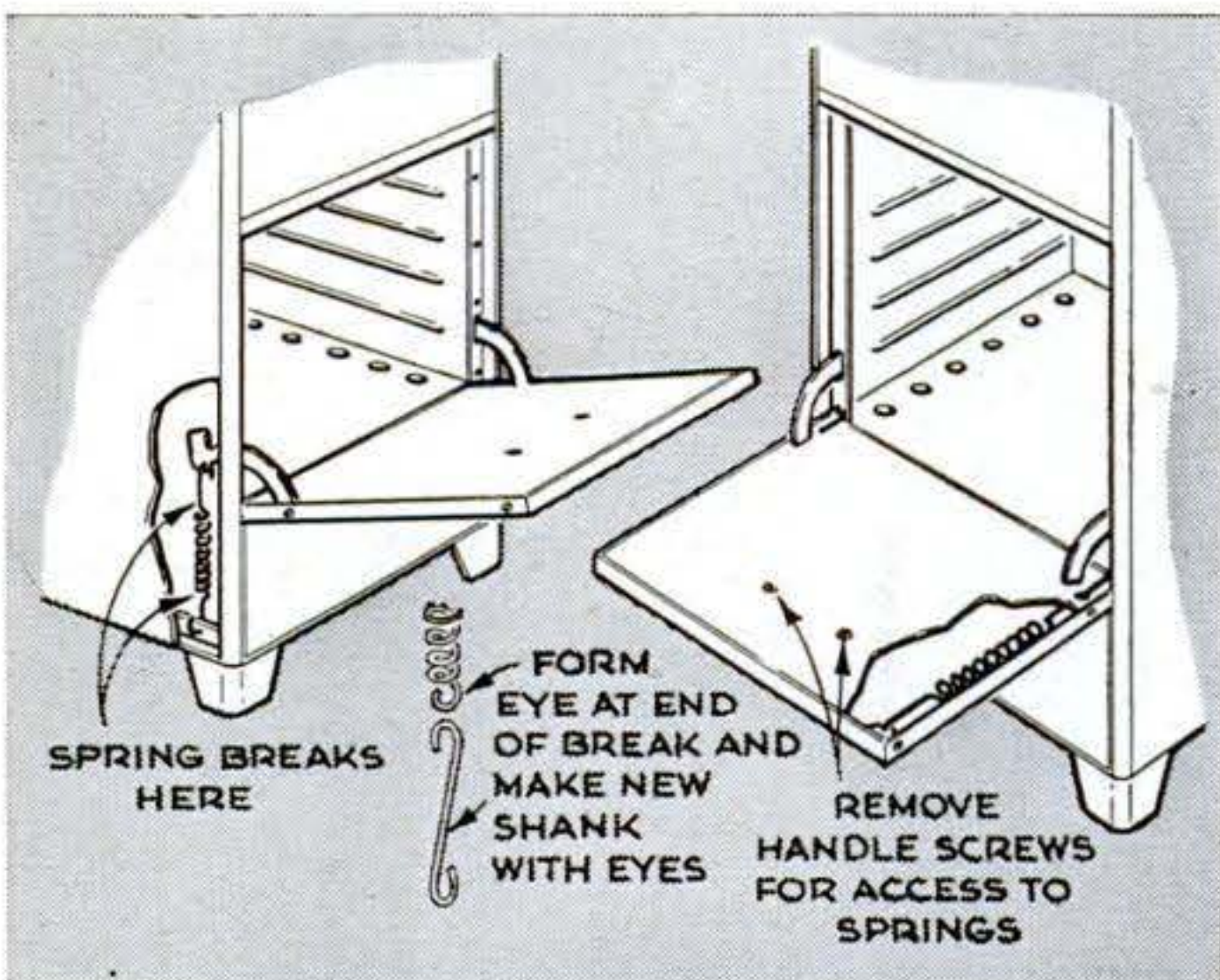

Oven-door springs are either in the body of the stove or behind the lining of the door. Breaks are usually at either end of the shank. The old spring can be salvaged by adding a new shank.

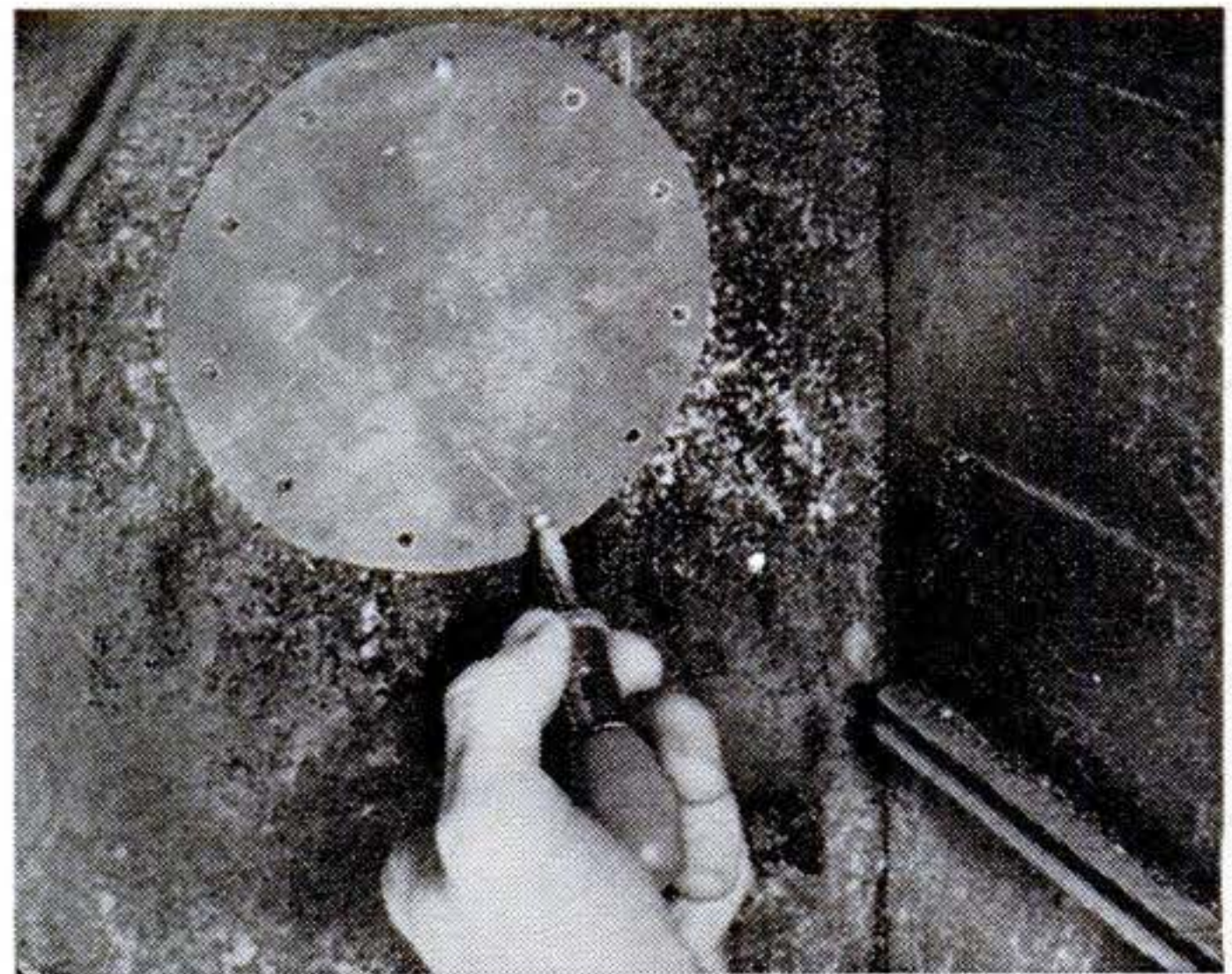

A burned-out oven lining can be repaired with a sheet-iron patch held by self-tapping screws if the hole is small. An entire new lining can be bent from black sheet iron and bolted in place.

Welded Pipe Forms Removable Footbridge

WHERE it is occasionally necessary to re-open a drainage ditch or burn off weeds, a footbridge like this may be swung aside as a unit simply by hooking the line of a winch truck around it.

The base consists of two lengths of 2½" pipe welded 26" apart on centers by means of transverse ties of ¾" rod at 36" intervals. Endpieces of 2½" pipe have two 6"-long nipples of 2" pipe welded on at right angles to enter the open ends of the long pipes. Handrails of ¾" rod are welded to the long pipes. Flooring is made from two 2" by 12" planks held in position by cleats nailed below the supporting pipes.—ELTON STERRETT.

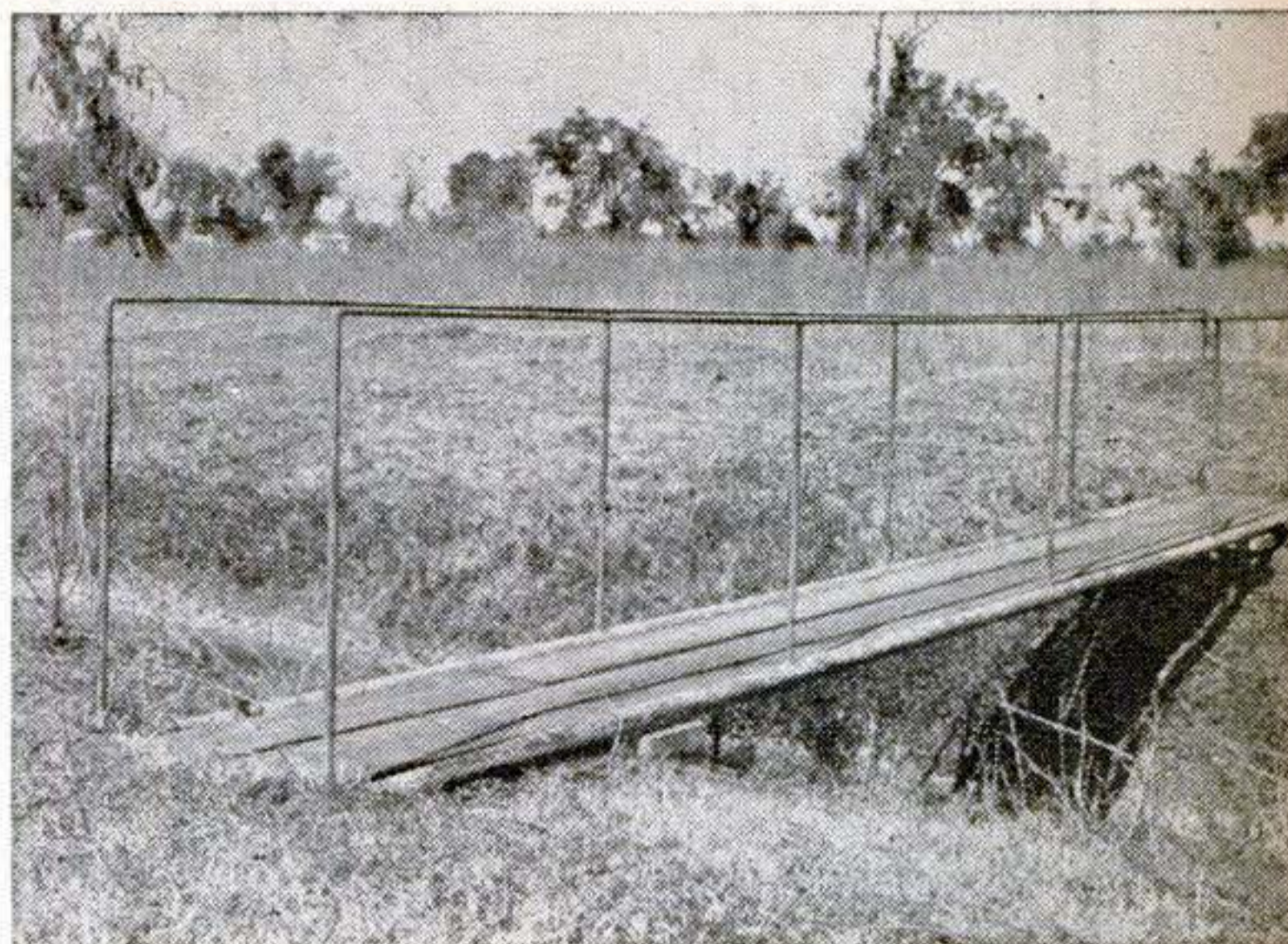

Buffer Posts Guard Sliding Shop Doors

IF THE sliding doors of a shop are apt to be damaged by vehicles driving in or out, two posts of 6" pipe set into the concrete at either side of the driveway will give them protection. The photo at the right shows how it was done at one plant.

After the pipe had been installed in the driveway, four ¾" reinforcing rods were placed inside and the pipe poured full of grout. When this had set, the pipe therefore had several times the rigidity of a simple pipe post and also was protected against internal rust. The outside was coated with aluminum paint to correspond to the building.

Located at the extreme end of door travel, the posts also serve as a mounting base for the guide rollers that keep the doors in their track at floor level. This prevents banging of the doors by the wind and reduces wear on the overhead track.

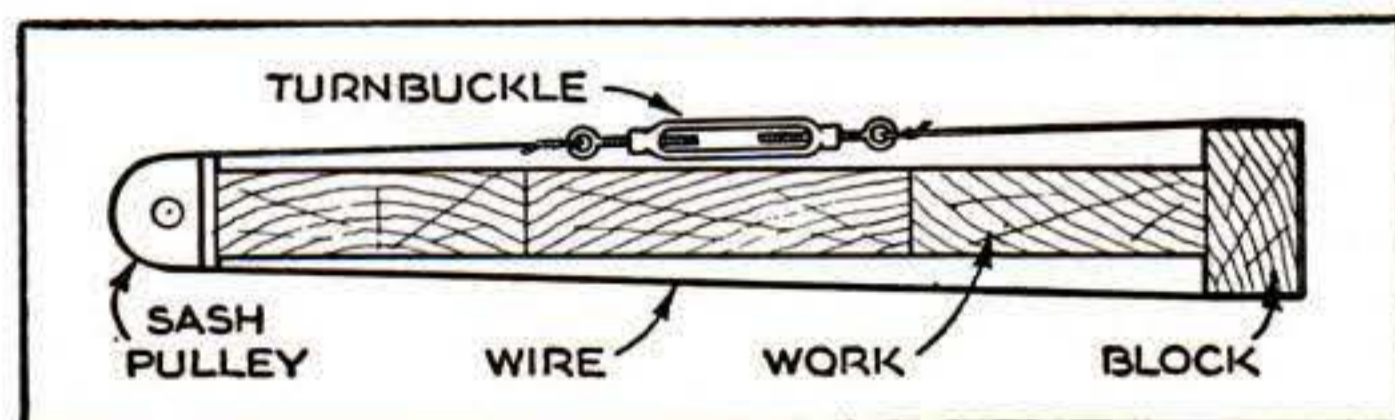

Turnbuckle Adapted as Clamp

WHEN wide boards are to be edge glued, clamps can be improvised from turnbuckles, sash pulleys, and picture-frame wire. Mounted on one edge of the boards, the sash pulley assures uniform tension of the wire on each side of the work. A block of wood on the opposite edge prevents the wire from cutting.—F. E. AVERILL.

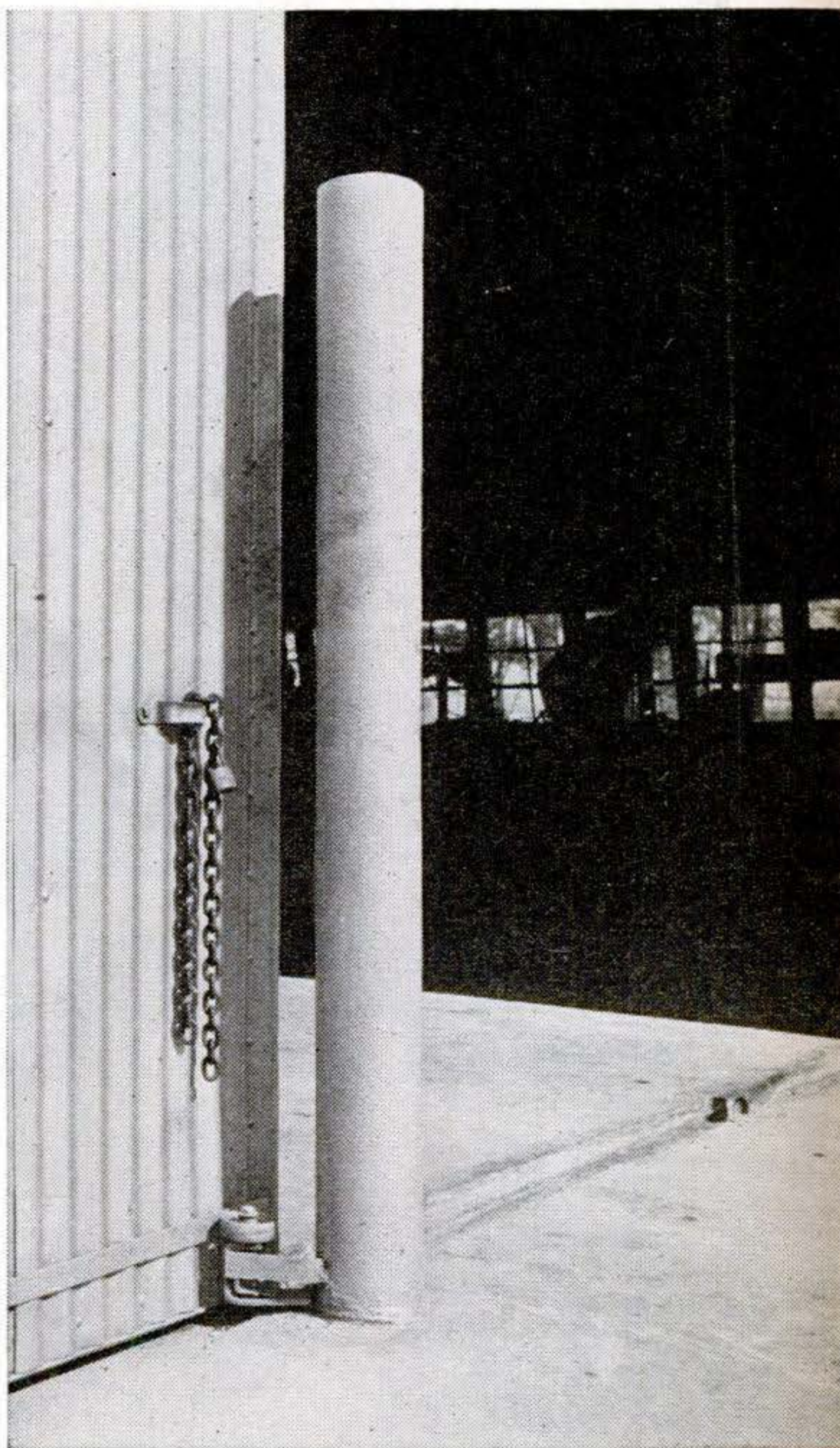

If a driver should turn too short, a post set in the concrete on either side of the driveway like this will prevent shop doors from being damaged.

Vacuum Pump Does

WITH a simple aspirator-type vacuum pump, it is possible to perform many interesting experiments with air at reduced pressures. Available at low cost from scientific supply houses, such pumps produce suction when used on a water faucet. They work on the principle that water rushing through a long tube drags in air through a shorter side tube, or to put it more scientifically, water passing through a venturi tube reduces atmospheric pressure in a tube entering the venturi. For use in the lab, this suction may be harnesses by attaching a length of rubber tubing to the side tube.

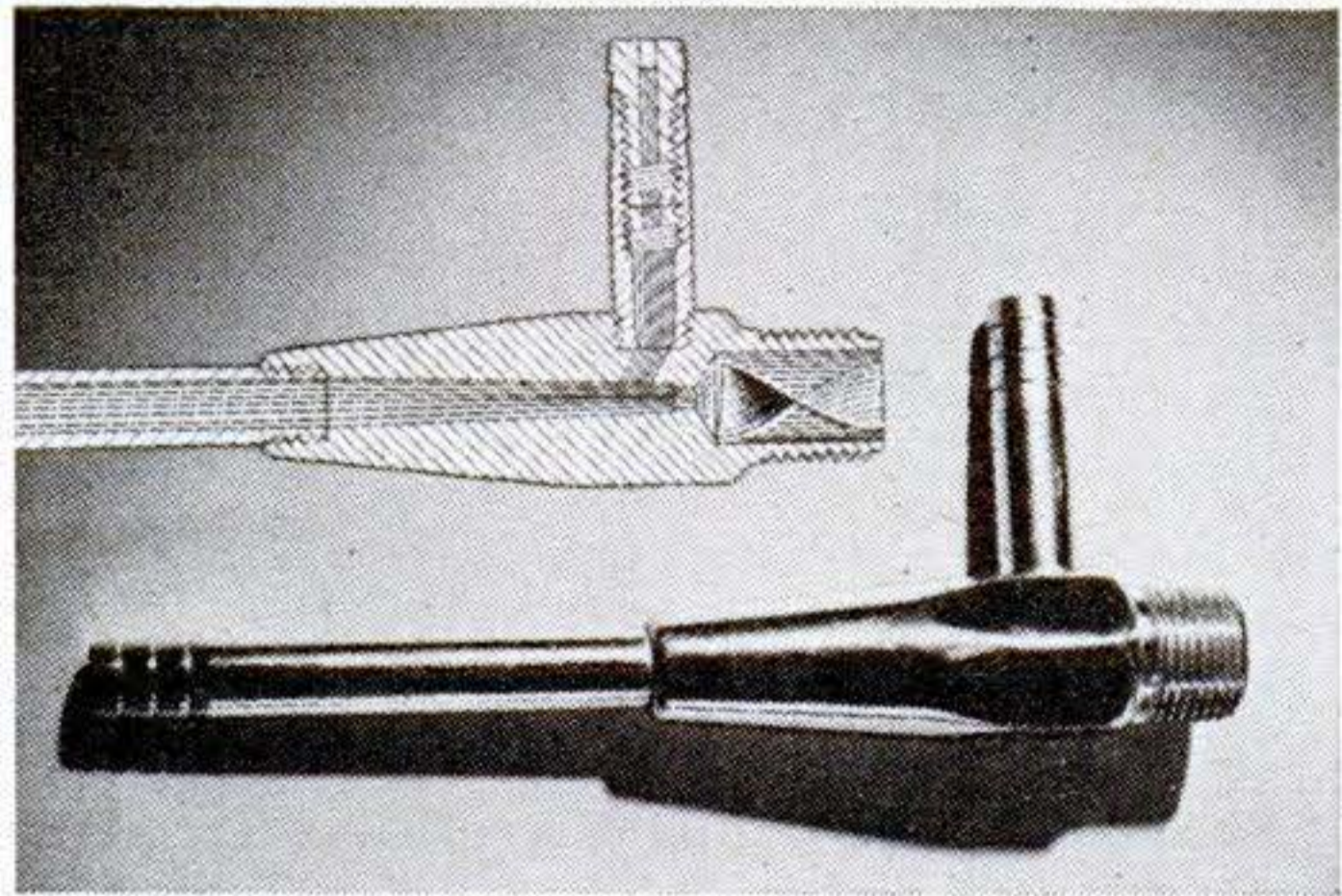

Screw the threaded end of the pump, right, into a faucet, and press rubber tubing on the short tube.



Feather Falls Like Coin. With a vacuum pump, you can duplicate a classical experiment that proves a feather and coin fall at the same rate in a vacuum. Place a tight stopper in one end of a glass tube that is at least 24" long and an inch or two in diameter. In the other, place a one-hole stopper with a glass tube connected to the pump tubing. Using a scrap of paper and a nail, try the experiment first with normal air pressure, inverting the tube quickly to start both objects falling together. Then evacuate the tube and see the difference.

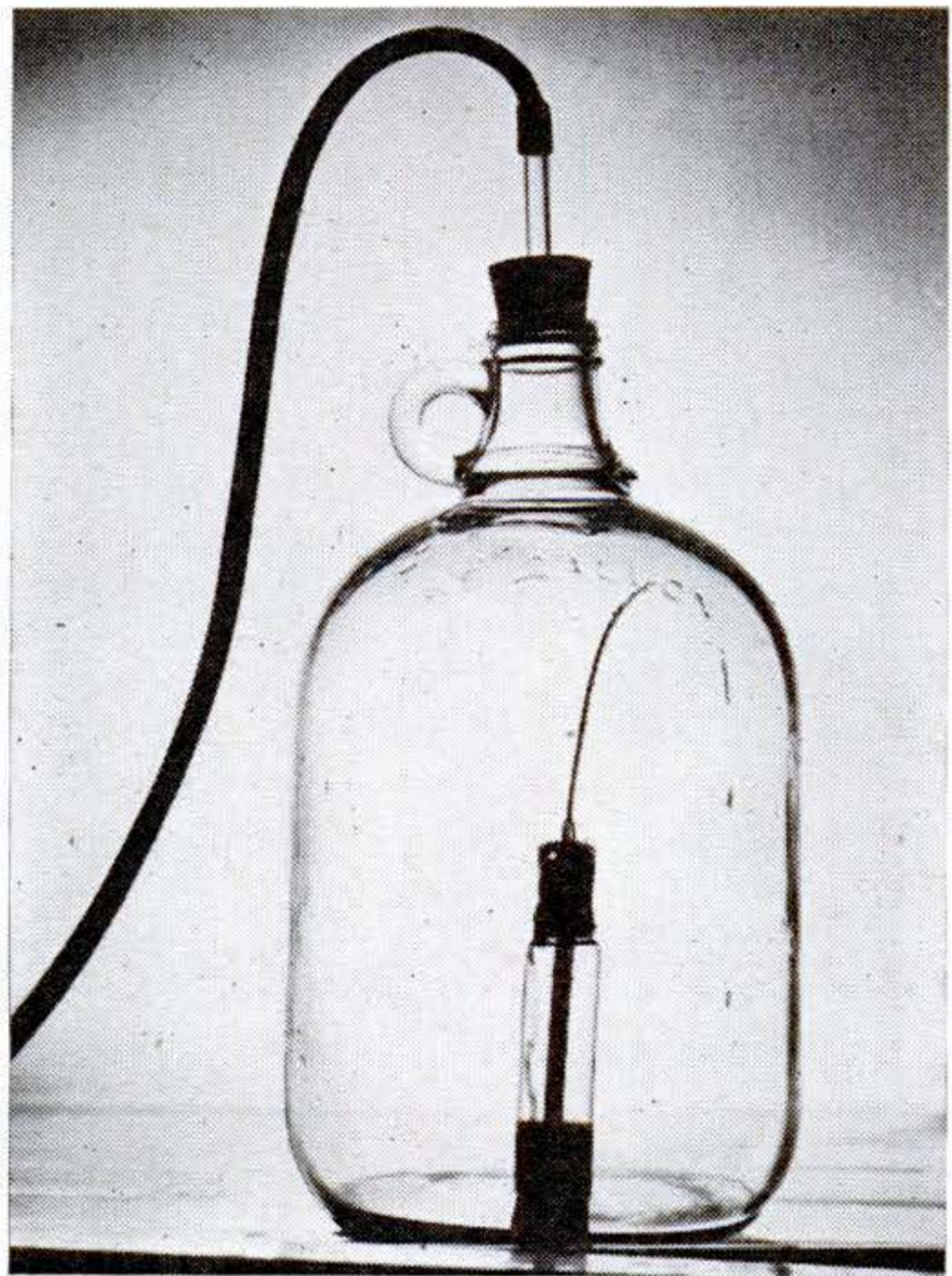

Fountain Flows Inside Jug. A novel fountain may be produced with the setup illustrated here. Get a large glass jug and a bottle that is small enough to go through its neck, and one-hole stoppers to fit both. After filling the bottle half full of colored water, thrust to the bottom a glass tube that has been drawn to a fine jet at the upper end. Lower the bottle to the bottom of the jug, attach the vacuum pump, and apply suction. As the air pressure in the jug is lowered, the greater pressure in the bottle forces water out the jet.

Strange Stunts

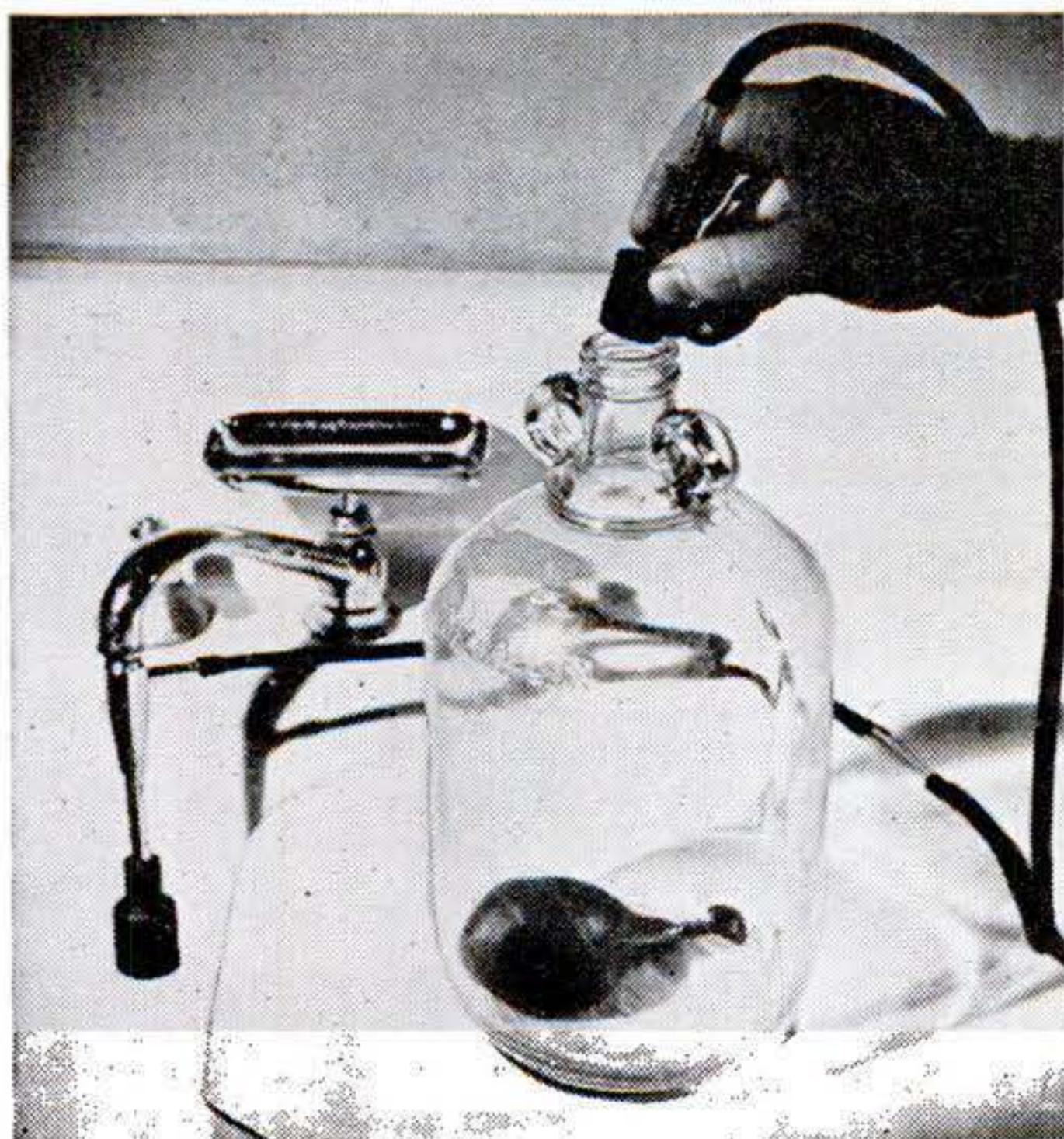

Balloon Blows Itself Up. Ordinarily, you expand a toy balloon by increasing the pressure inside, but here is a method that accomplishes the same result by reducing the pressure—outside. Inflate a balloon with just a little air, squeeze it into a gallon jug, connect the jug to the vacuum



pump, and start the pump. As air is drawn from the jug, the greater pressure inside the balloon will cause it to expand. This illustrates why man-carrying balloons have safety valves to relieve excess pressure at high altitudes and why they are not completely filled on leaving the ground.

Boiling Point Reduced. A liquid boils at the point where its own vapor pressure equals the pressure of the atmosphere pressing down on it. Hence, if the atmospheric pressure is reduced, the boiling point is likewise reduced. You can demonstrate this by placing some lukewarm water in a 2-oz. bottle and reducing the pressure in the bottle with your vacuum pump. The water inside will boil violently until it cools to a temperature just slightly above that of the water flowing through the pump.

Boiling Produces Ice. While boiling, any liquid extracts heat from its surroundings. In the experiment at the left, the boiling water gets heat from the bottle and surrounding air. Consequently, these are cooled. This cooling effect may be carried to an ice-producing stage by substituting for the water a low-boiling-point liquid such as acetone. Moisten the outside of the bottle with water and stand it on a cardboard box or other insulation. As pressure is reduced, the moisture on the bottle will freeze.



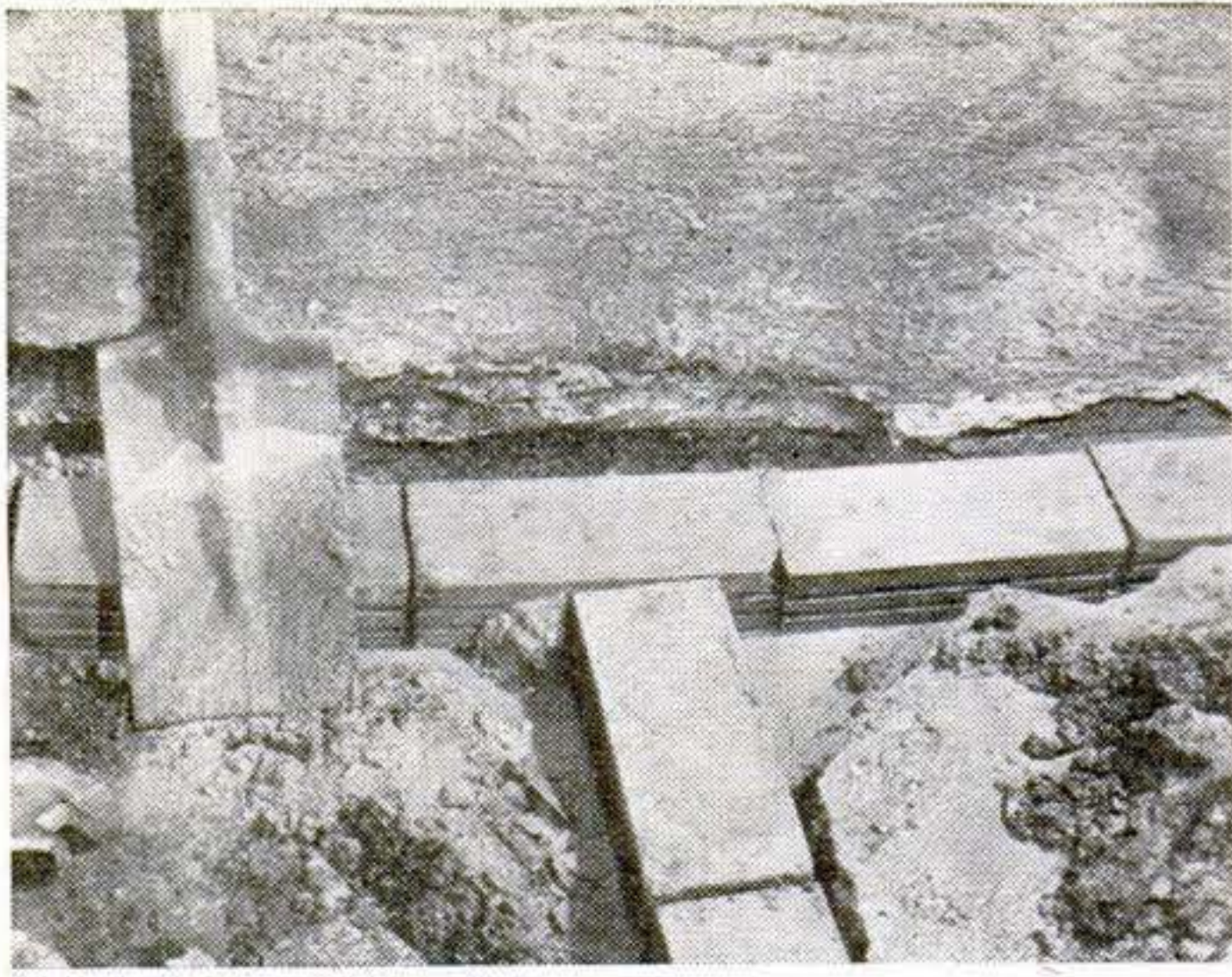

Building Tile Used as Drain

WHEN regular drain tile is unavailable, square or rectangular building tile will make a good substitute. It is sometimes even superior because of its shape.

Used, as in the photo, for draining a basement into which water was seeping, rectangular tile fitted easily into a ditch cut in the floor near the leaking wall. The cost was the same as that of drainage tile.

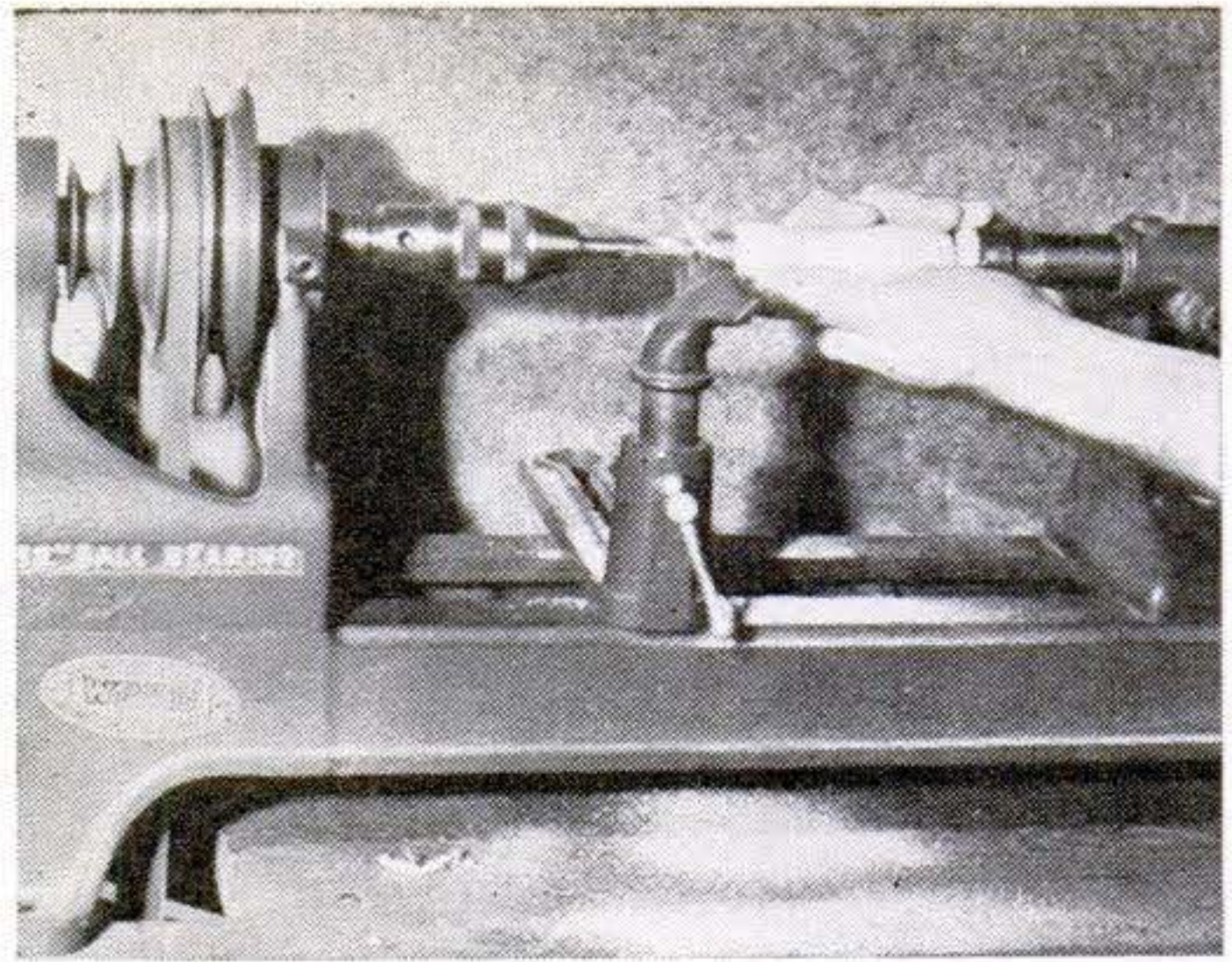

Tool Rest Gauges Depth

SWUNG across the bed of a woodworking lathe, the tool rest serves as an excellent stop when holes of the same depth must be bored in pieces of different length. The sharp edge of the tool rest is turned toward the tailstock. It will then stop the work at the same spot each time, the pieces to be drilled being fed against a bit chucked in the headstock.—GLENN A. WAGNER.

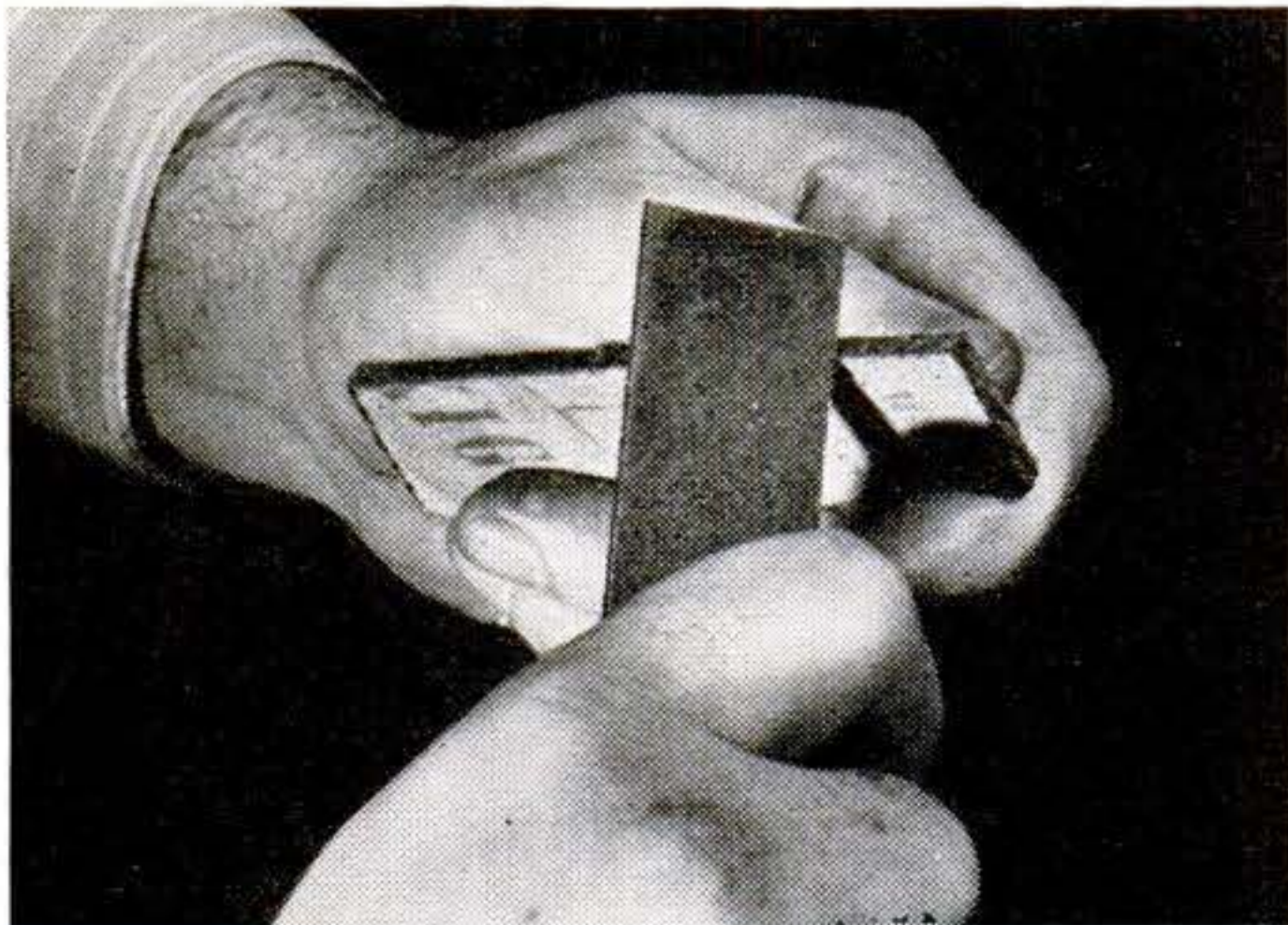

Polishing Plastic Edges

SCRAPING the edge of clear plastic to a dull finish before final polishing will save much time. A scraper for the work can be made from a length of steel such as an old power-hacksaw blade or a good wood scraper. Grind the cutting edge square, and then sharpen with the square edge flat on a carborundum stone. Touch up with an India stone or other fine-grit stone, and hone to a mirrorlike finish on a leather strop.

To use, hold the scraper at a slight angle and draw its edge along the edge of the plastic. When a smooth, dull finish is obtained, polish with compound. If the plastic is very rough, sand with 3/0 sandpaper before scraping.—ELI S. EISENHARD.

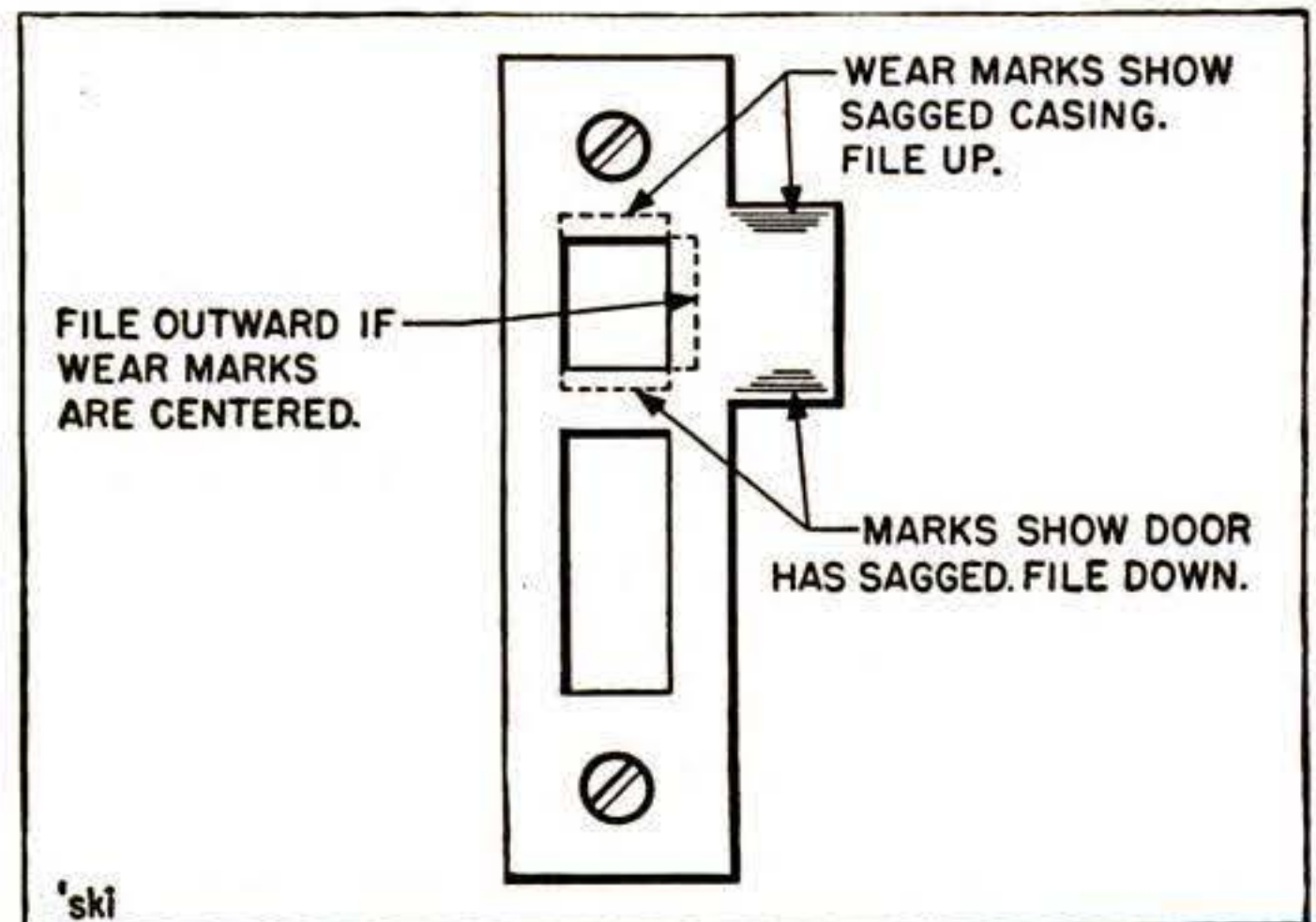

Making a Door Stay Shut

MUCH easier than resetting an offending strike, when the latch of a door lock will not catch properly, is the alternative of filing the slot a little larger. Don't try to do this on the jamb, but remove the strike and clamp it in a vise for the job. It can then be replaced and the screws put in the same holes without plugging and respotting them, or enlarging the mortise.

Wear marks on the strike usually show whether it was too high or too low for the latch. If these are lacking, the latch has not been passing far enough inward, in which case the outer edge of the slot needs to be enlarged. Frequently no more than 1/16" of metal need be filed off.

WHAT'S WRONG

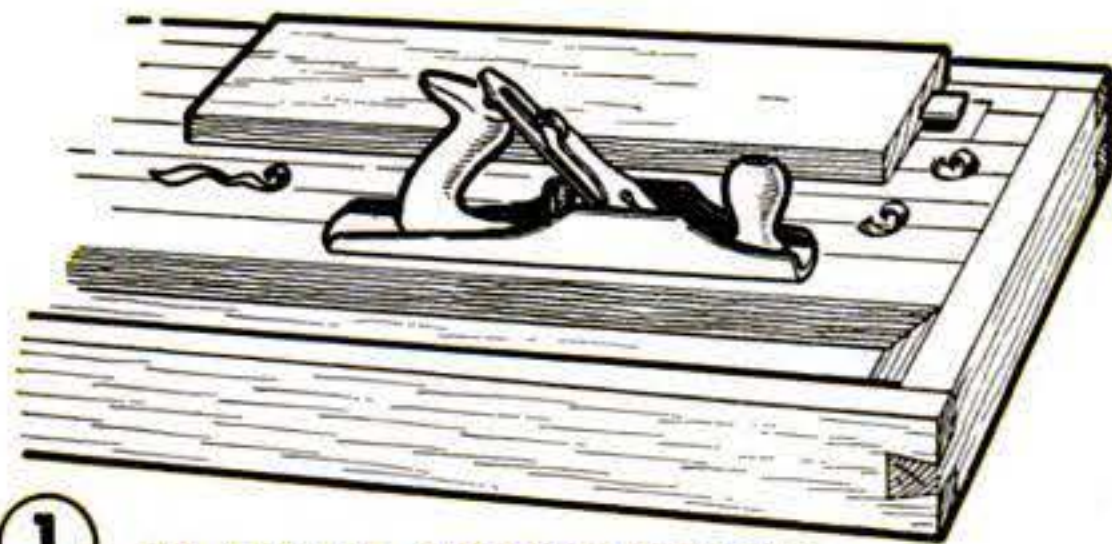

1 PLANING AT THE BENCH



2 DRAWING A STUBBORN NAIL

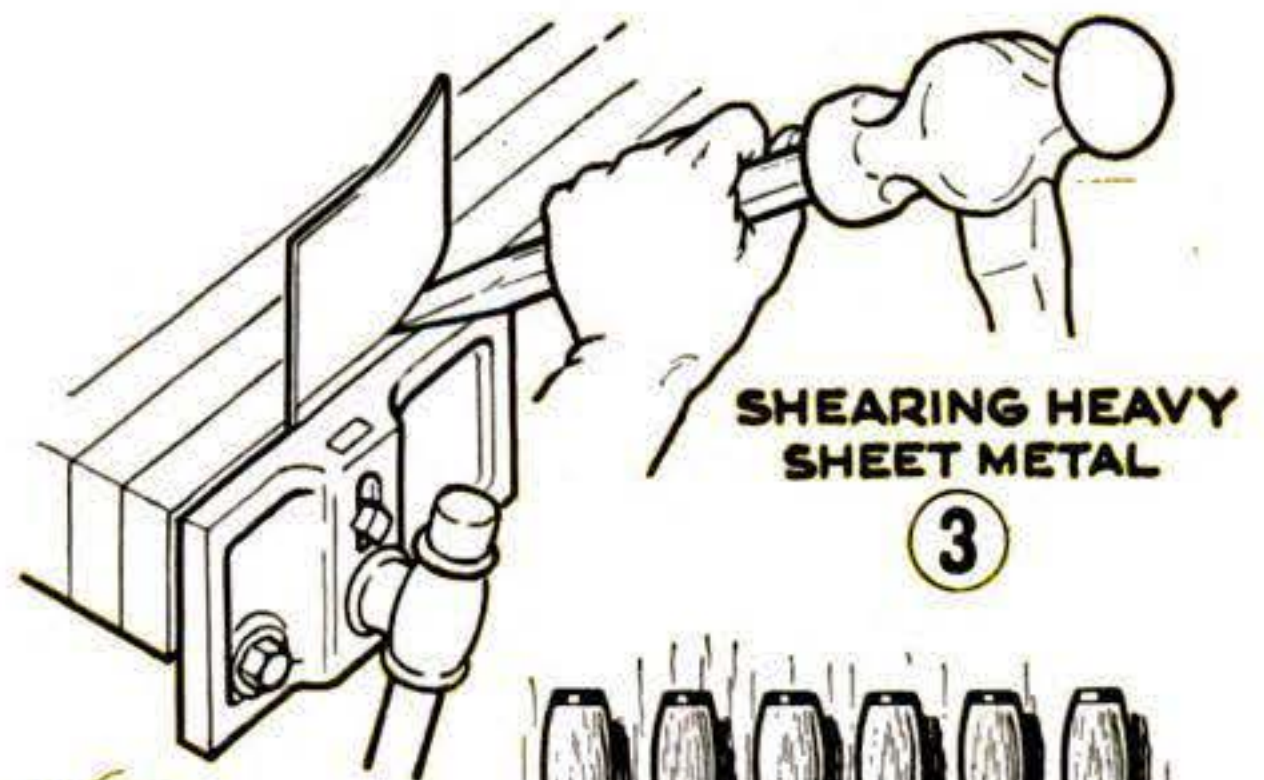

3 SHEARING HEAVY SHEET METAL

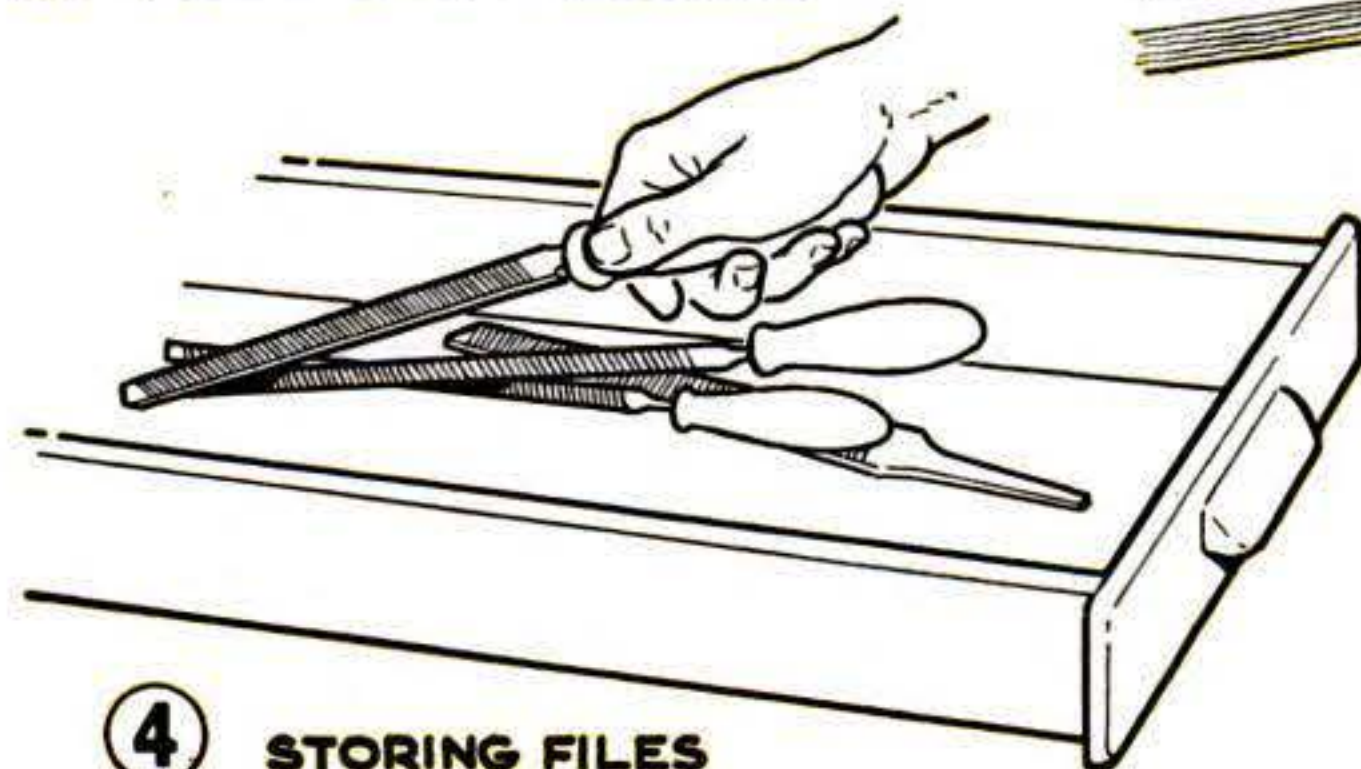

4 STORING FILES



5 WALL TOOL RACKS

HERE are five errors in handling wood-working tools, some of them common. How many can you spot? Compare your answers with those printed upside down.

1. After using a plane, lay it on its side or set it in the tray with the toe resting on the frame end of the bench. This prevents dulling of the plane iron by gritty dirt.
 2. Driving the hammer claws against a headless nail is often an effective means of getting a grip, but there is also risk of breaking a claw.
 3. A woodworker's vise is not built strong enough for heavy metal work.
 4. Piling files together in a drawer dulls them. A separate groove or compartment is needed for each.
 5. This arrangement invites cut fingers when you remove the brace, which is too near the chisel edges. A cleat is needed under them as a guard.

ANSWERS: 1. After using a plane, lay it on its side or set it in the tray with the toe resting on the frame end of the bench. This prevents dulling of the plane iron by gritty dirt.
 2. Driving the hammer claws against a headless nail is often an effective means of getting a grip, but there is also risk of breaking a claw.
 3. A woodworker's vise is not built strong enough for heavy metal work.
 4. Piling files together in a drawer dulls them. A separate groove or compartment is needed for each.
 5. This arrangement invites cut fingers when you remove the brace, which is too near the chisel edges. A cleat is needed under them as a guard.

Kitchen-Match Rail Fence Is Unusual Pipe Rack

A FEW minutes with a handful of wooden matches, a razor blade, and some good glue will provide you with an interesting pipe rack. Two or more pipes can be supported simply by varying the length of the fence.

The base is $\frac{1}{4}$ " plywood or other thin stock cut to required size. Cut the matches off just behind the heads, and cut also some short match lengths to separate the rails at the two outer ends. A drop of glue should be sufficient for each joint. The zigzag design gives considerable strength.

Finish with paint or varnish when the glue is dry. Use a camel's-hair brush for coating the rails.—CLIFTON MORRIS.

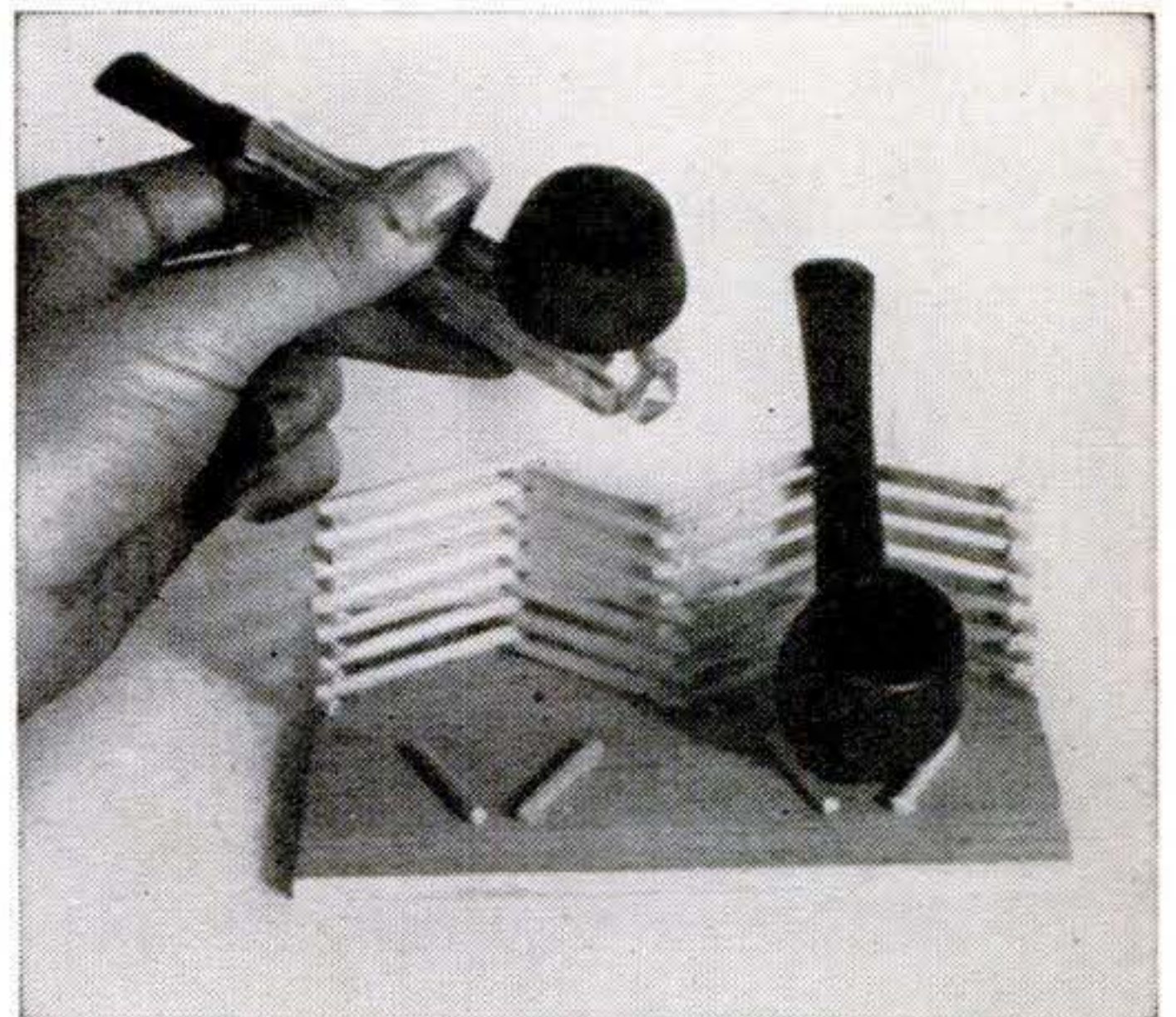

Two headless matches glued onto the base in front of each rail section are stops for the pipe bowls.



Count the drops of soap solution needed to produce stable suds on the surface of distilled water and on an equal amount of hard water. You then will have an indication of the relative hardness of the latter.

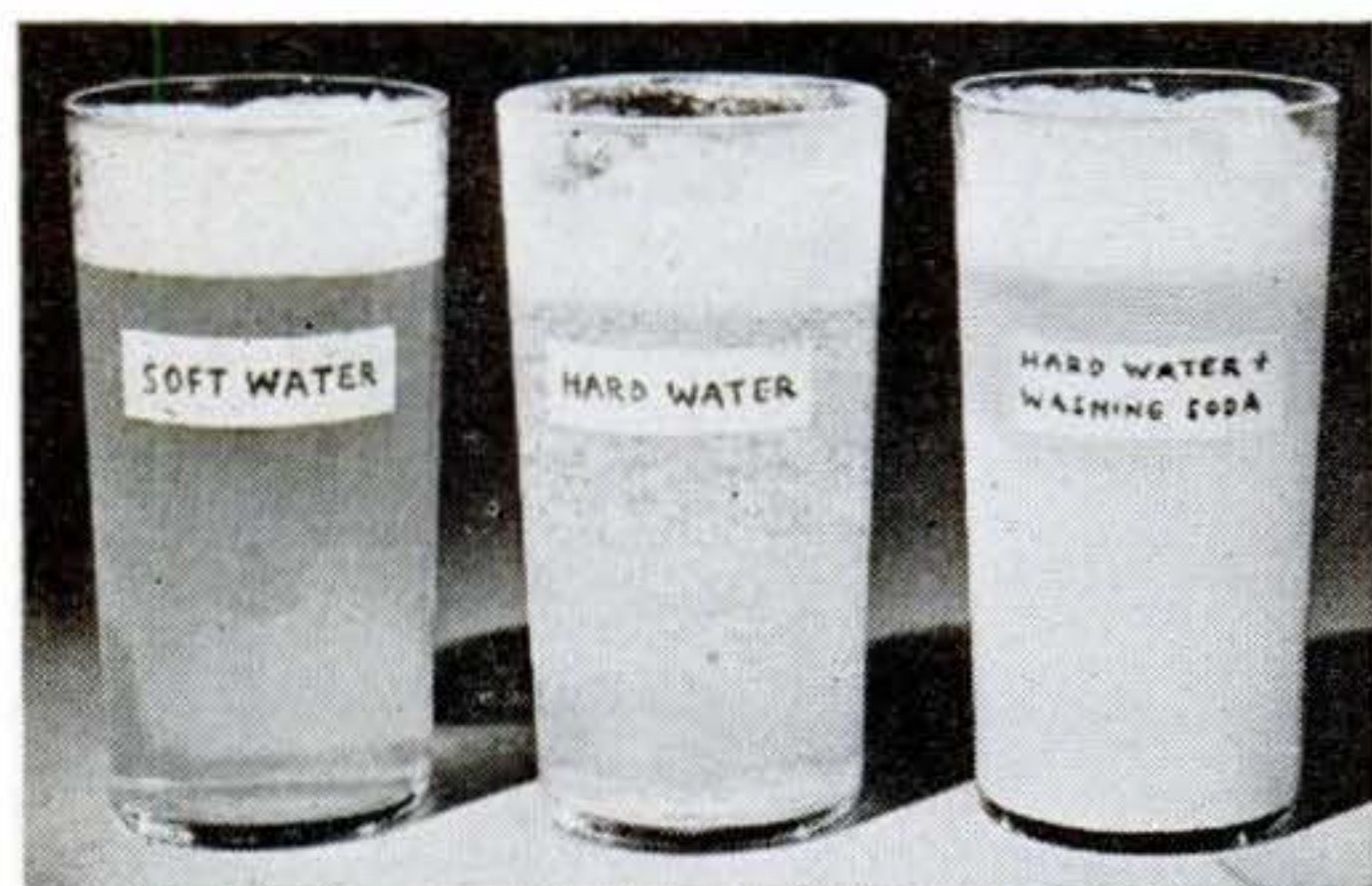

Until recent years, ordinary washing soda was the agent most frequently used for home softening of water. Soap added to water softened in this way produces suds about as freely as in soft water.

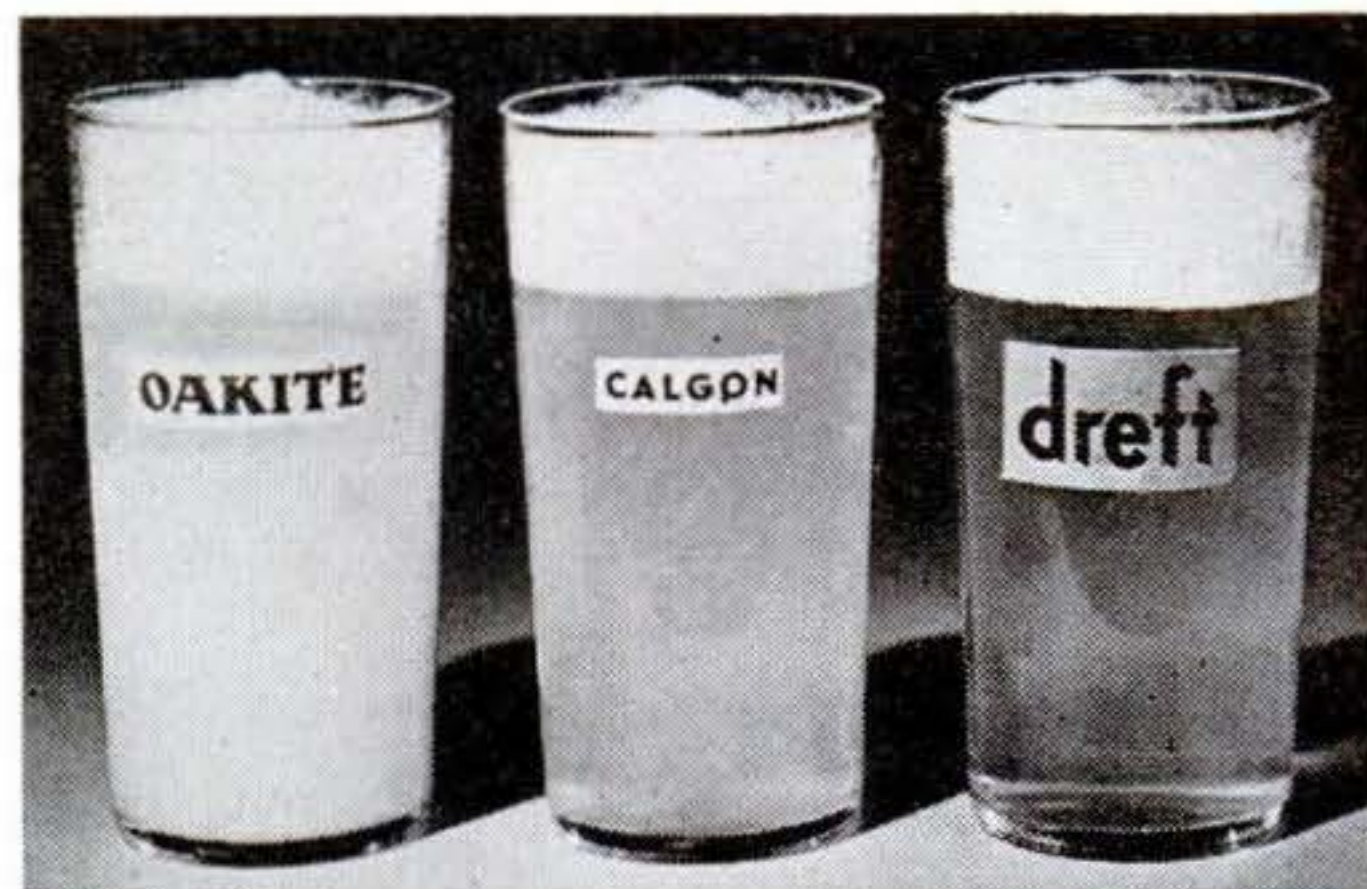

Now, however, you have a choice of such agents as these. Oakite precipitates the hardness, Calgon ties it up in complex compounds, while Dreft, one of the new synthetic detergents, just ignores it.

How Chemistry Softens Water

By **Kenneth M. Swezey**

BECAUSE water is such a good solvent, it is never found absolutely pure in nature. Even while falling as rain, it takes oxygen, nitrogen, and carbon dioxide from the air. As it runs over rocks and through soil, it dissolves salts of calcium, magnesium, and other elements. If it reaches you with less than 100 ppm (parts per million) of such mineral salts, it is said to be soft. If there are more, it is called hard.

Since mineral salts form scum in wash water and crusts inside boilers and pipes, hard water has long caused a lot of inconvenience and costly damage. Thanks, however, to better methods of removing the offending chemicals, new compounds that render them inactive, and synthetic detergents that do not react with them, both inconvenience and cost are now less.

Hard water is a costly nuisance chiefly in the processes of cleaning and heating. Soap usually consists of a salt of sodium with some organic acid, such as stearic or oleic. Dissolved in water containing calcium or magnesium, soap reacts by a double decomposition process, forming insoluble, sticky, and curdy stearates or oleates of these metals. Until enough soap is added to react with all the hardness, the soap has no power to clean. Furthermore, when cleaning finally becomes possible, the sticky and insoluble salts make it more difficult.

In heating systems, the effects of hard

water may be still more serious. When water containing carbonate hardness is heated, an insoluble scale is deposited inside the pipes and boilers. Even in a thin layer, this scale reduces the transfer of heat to such an extent that the boiler metal may become overheated and corrode excessively or crack. Layers sometimes become so thick

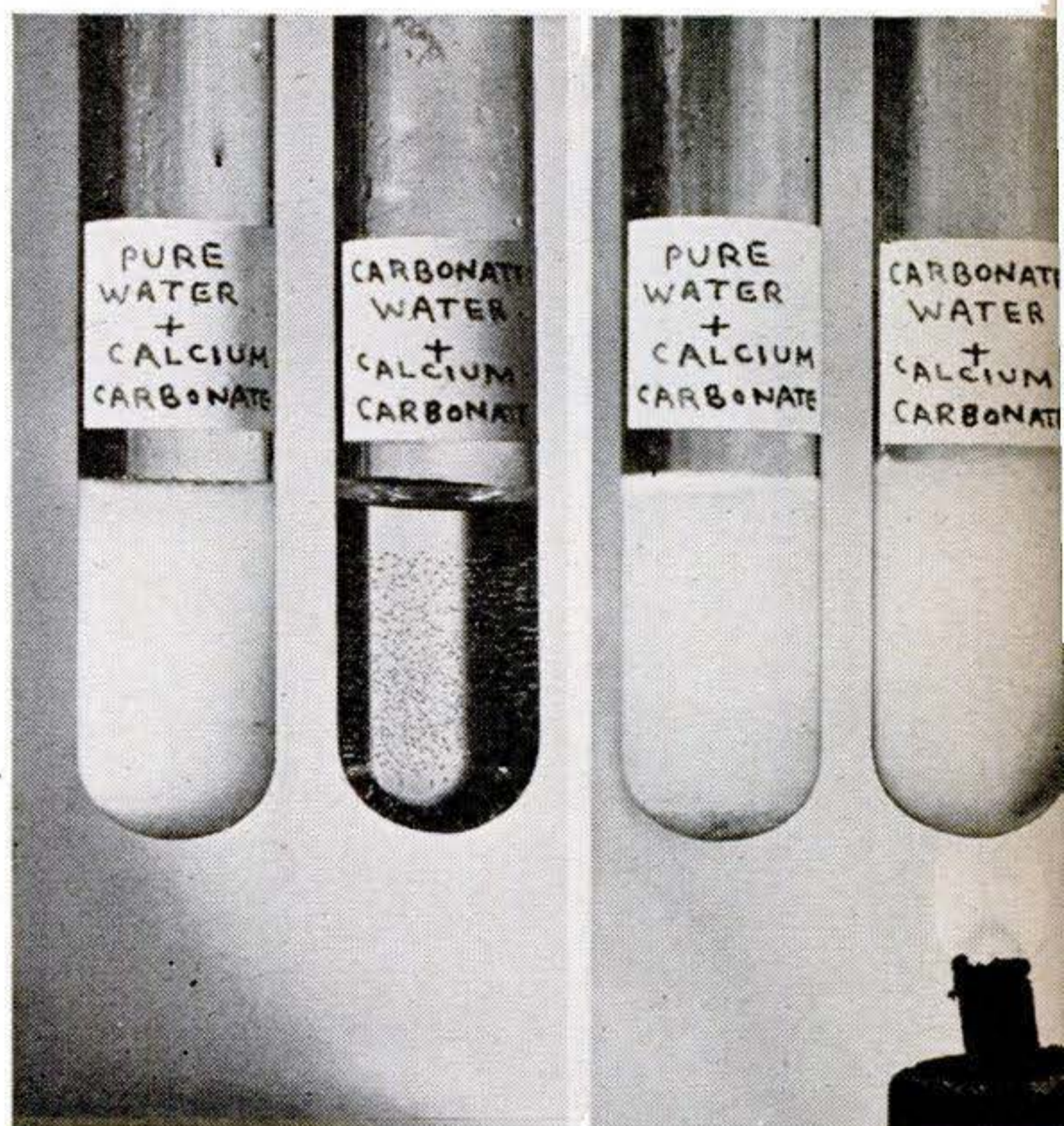

Various carbonates dissolve much more readily in water containing carbon dioxide, as at left. Such water is said to have temporary hardness because boiling, as at right, precipitates the carbonates.



In water containing a little iron, soap produces a pale precipitate. If washing soda is added, this looks even worse. That it actually is not may be shown by placing a strip of white cloth in each.

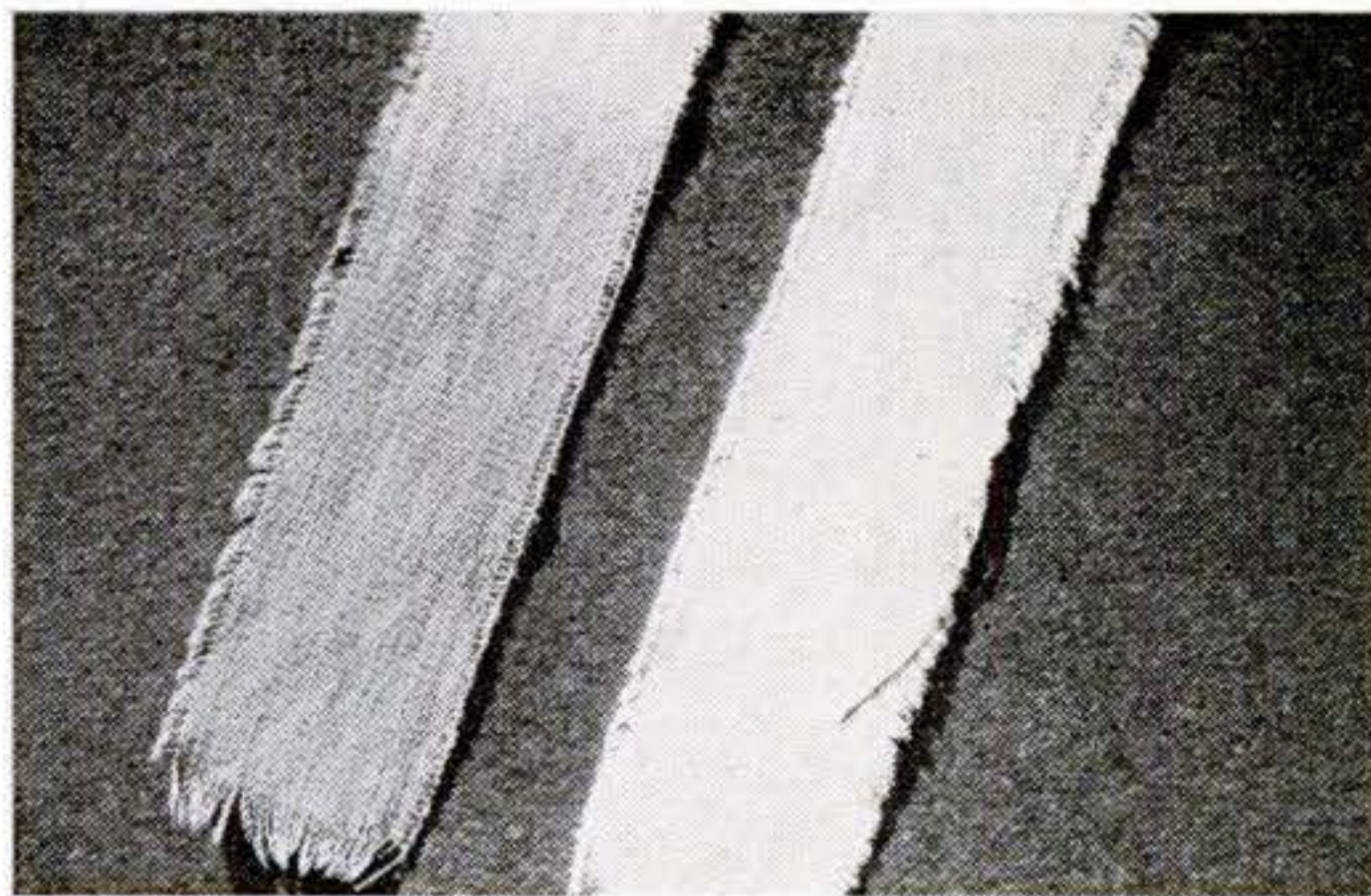

After the strips have been rinsed and dried, the one from the hard water turns a rusty brown. The second precipitate, however, rinses out easily and the strip of cloth will dry to a pure white.

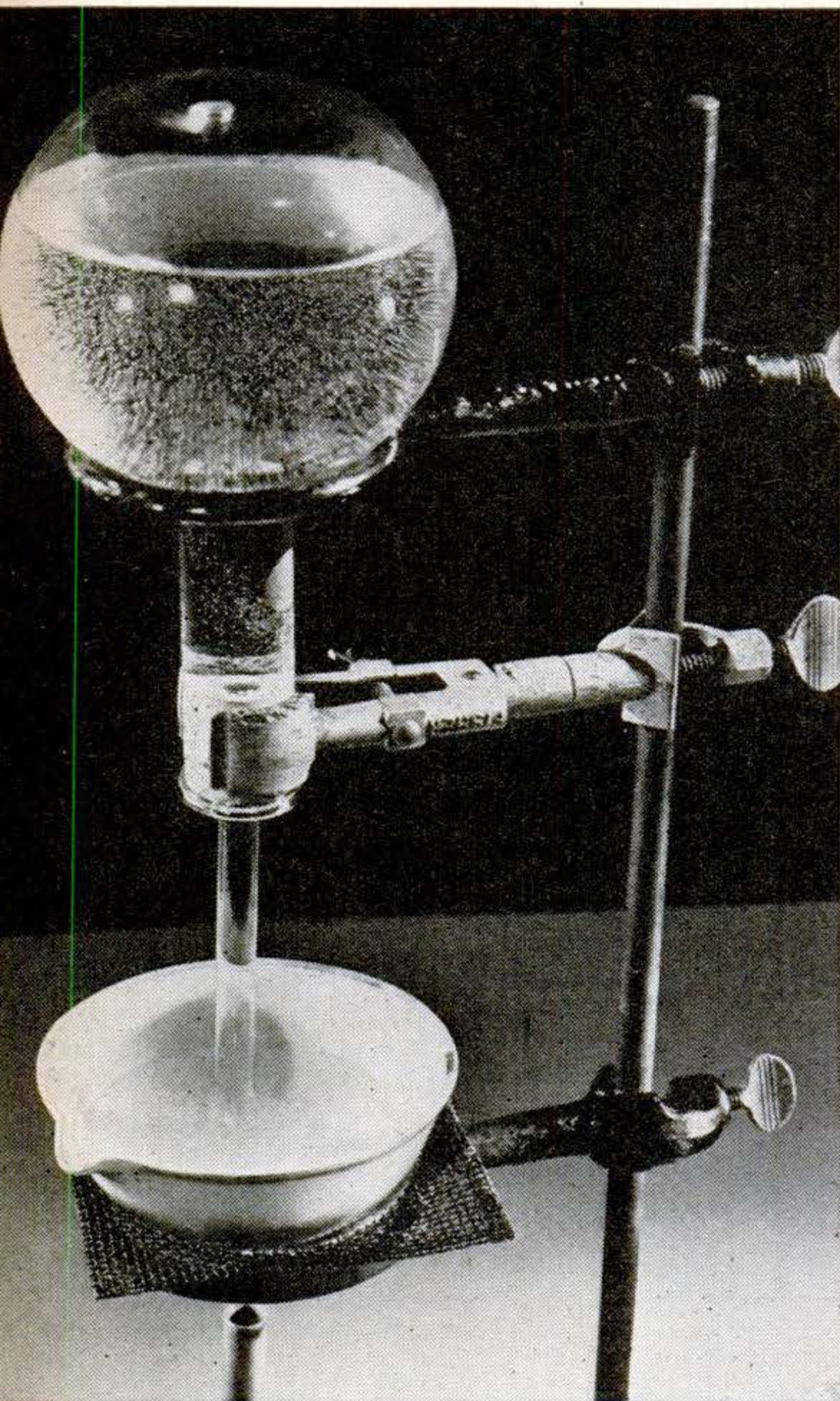

By evaporating some hard water, you can solidify the salts that make it hard. Push tubing through a one-hole stopper in a 500-ml. flask, adjust so the tube is $\frac{1}{2}$ " above the dish bottom, and water will rise in the dish only to the end of the tube.



As the water boils away, more will descend, and finally only solids will remain. Magnesium and calcium salts are white, those of iron are brown.

in pipes that the water flow is seriously impeded—or even stopped. Noncarbonate hardness also forms scale in steam boilers as the water boils away.

To combat the effects of hard water, modern chemists have devised three methods: 1, precipitation of the hardness by boiling or chemical action; 2, treatment of the water with chemicals that prevent curd formation and boiler scale; 3, where cleaning only is important, the use of detergents (other than soap) that clean but do not react with hard water.

Water containing carbonate hardness is sometimes referred to as "temporary" hard water, because mere boiling is sufficient to soften it. Such water owes its hardness to dissolved calcium bicarbonate and occasionally smaller amounts of the bicarbonates of magnesium and iron. These are produced by the reaction of water containing carbon dioxide with the normal carbonates of these metals. When such hard water is boiled, the bicarbonates are decomposed, forming insoluble calcium carbonate, iron carbonate, and magnesium hydroxide. These settle out, leaving the water soft.

The reactions that cause the formation and destruction of carbonate hardness are easily demonstrated. Shake a few specks of precipitated chalk (calcium carbonate) in about 10 ml. of distilled water in a test tube. Like pure water flowing over limestone rock in nature, this water dissolves virtually none of the chalk, but forms with it a milky suspension that settles out.

In a second test tube, shake an equal amount of chalk in water that contains carbon dioxide—carbonated water, or distilled water through which carbon dioxide has been bubbled for several minutes. This time the chalk dissolves and a clear solution results, duplicating what happens in nature when rain water charged with carbon dioxide flows over limestone. The water in this tube now has carbonate hardness.

As a demonstration of how such hardness may be removed, heat the water in this tube to the boiling point. The excess carbon dioxide will be quickly driven off and the clear water will be whitened by a precipitate of the original normal calcium carbonate, which will settle to the bottom.

Although boiling offers an easy method of softening small quantities of such water for purposes of washing, water with carbonate hardness is softened on a large scale and for boiler use by treatment with lime and soda

ash (sodium carbonate). Unfortunately, the use of lime is not feasible for the average homeowner because it must be added in exact amounts that vary with changes in the carbonate content of the water. A slight excess would actually harden the water.

A second type of hardness produces what is known as "permanent" hard water. This hardness usually consists of the sulphates of calcium and magnesium, with sometimes smaller amounts of the chlorides of these metals. Boiling does not alter these salts. They must be removed chemically.

In the past, the chemical most frequently used for home softening of this type of hard water has been common washing soda (hydrated sodium carbonate). This reacts with the hardness and forms a precipitate of calcium, magnesium, or ferrous carbonates. It is far cheaper than the extra soap that otherwise would be needed.

Trisodium phosphate, abbreviated as TSP and the basis of several proprietary products (for instance, Oakite), is another household water softener that has become popular in recent years. It precipitates tricalcium phosphate, magnesium phosphate, and iron phosphate. Although TSP is more expensive than washing soda, the resulting precipitates are finer than those of the cheaper material and consequently easier to wash away.

Sodium hexametaphosphate, sold under the trade name of Calgon, is an excellent softening agent that works on a principle entirely different from the two first mentioned. It forms complex compounds with the hardening elements in the water, preventing them from reacting with soap or producing boiler scale. Since the compounds remain in solution and no precipitate is formed, the water stays as free from sludge as does soft water.

Comparative tests will show the differences between soft water, hard water, and hard water that has been softened by various methods. If you have no hard water for the experiment, some can be made by adding a few grains of calcium chloride, calcium sulphate (plaster of Paris), or magnesium sulphate (Epsom salts) to a glass of water.

For the experiment, set up a series of tumblers—one containing soft water, a second containing hard water, and others containing hard water softened with washing soda, TSP, and Calgon, if you have all of these. Add a small and equal amount of pure soap flakes or granules to each glass and shake

it. You should be able to observe all the differences previously described.

To witness the newest method of conquering hard water without even bothering to soften it, add a little Dreft or Vel to another glass. These new synthetic detergents contain no soap at all, but they produce copious suds and clean well because they do not react with the hardness.

You may determine the amount of softening agent that must be added to any particular hard water by means of a simple suds test. Prepare a standard soap solution by dissolving 5 grams of castile soap in 100 ml. of warm 80-percent alcohol and then filtering. After placing a measured amount of distilled water in a clean bottle, add the soap solution drop by drop with shaking between each drop. Add soap until a foam covers the surface of the water and remains for half a minute.

Now replace the distilled water with an equal amount of hard water and add soap as before, noting the difference in the number of drops required to produce the same foamy condition. Keeping the amount of water constant, make a series of separate additional tests, adding different measured quantities of the softener to the water and emptying and refilling the bottle for each trial. Always add the softener before the soap or the latter will react with the hardness and spoil the result.

Your quest is ended when, on one trial, the amount of soap needed to form stable suds about equals that required for distilled water. The amount of softener used for this trial is the quantity needed for the particular hard water under test.

Even extremely small amounts of iron in hard water may discolor clothes and plumbing fixtures. When soap is added, a pale rust-colored precipitate is formed. This sticks to cloth and turns to iron rust when exposed to the air. If sodium carbonate is added to such water, the resulting green-brown precipitate looks much worse than the original brown. Actually, however, it is better—as you can show.

Stir a few grains of ferrous sulphate into each of two glasses of water. To one, add a pinch of washing soda. A dirty looking precipitate will form. Now add a little soap to each glass, wash a strip of white cloth in each, rinse in plain water, and allow to dry. You will find that the strip washed in the glass containing the precipitate will be white, the other stained with rust. **END**

Laboratory Equipment You Can Make

Burette Is Automatic. The home chemist who performs an occasional analysis can make this self-filling burette from a broken one provided at least 30 cc. of graduation remain. Heat the tube about 5 cc. above the lowest mark, rotating it in the Bunsen flame, and pull the ends to constrict the diameter to 10 mm. Scratch and break midway at the constriction. Cork the top.

Rotate and heat yellow one end of an 8" length of 10-mm. soft-glass tube (A) and the cut end of the burette. Gently press together and then pull slightly apart to thin the joint. With a blowpipe and the yellow flame, reheat a little of the joint to shrink the glass. Remove from the flame and blow gently into the open end to round the area. Repeat all around to remove all lumps.

Side tubes B and C, each 7 mm. in diameter, are set into A at right angles to each other. B is 1" below the joint, and C is 2" below B. Holes to receive them are made by alternate heating and blowing into A until the bulging glass is so thin it can be filed off. Join the side tubes in the same way A was joined to the burette. Heat and bend B $\frac{1}{2}$ " from A, and bend C at a distance equal to half the diameter of the bottle plus 2". Finally, seal off A at a point 2" below C. Rubber tubing connected to D and F form valves, either by use of $\frac{1}{4}$ " lengths of glass rod (as in the drawing) or of pinchcocks.

To fill the burette, blow into G and open valve B. When the level falls back to zero, close B. Titration may then be carried on through F. With alkaline solutions, an atomizer bulb used as an air pump will exclude carbon dioxide. A carbon dioxide absorber can also be inserted in the top of the burette.—ALBERT C. NUESSELE.

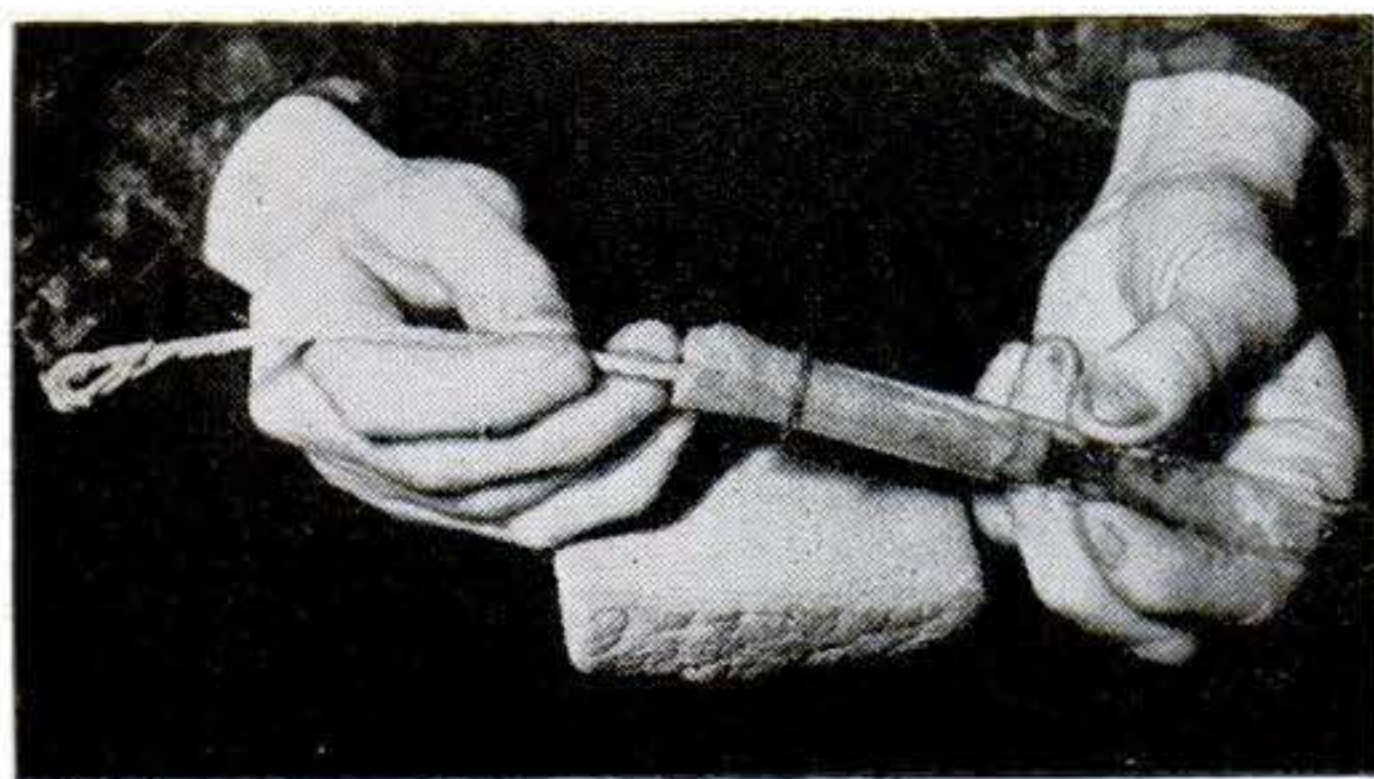
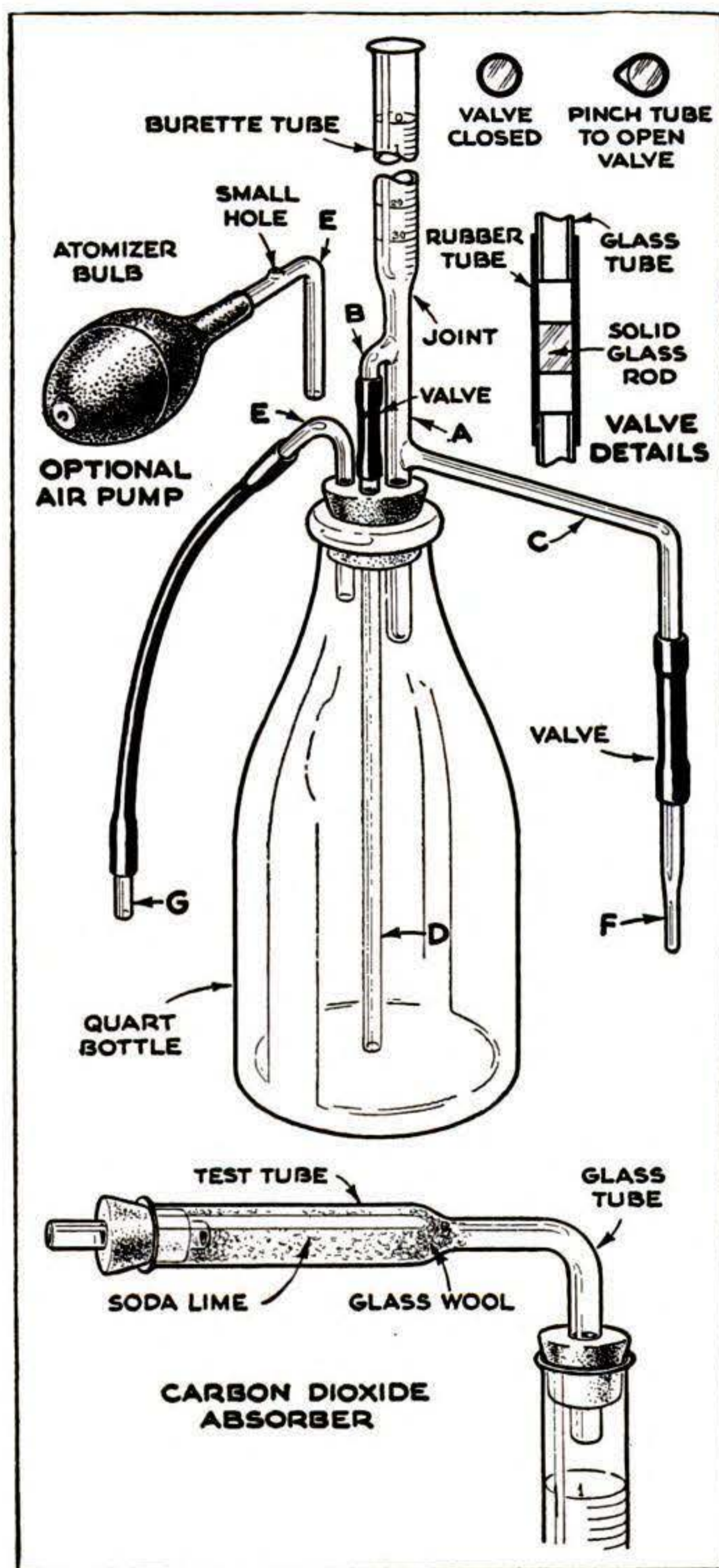

Sponge Swabs Test Tube. One way to clean test tubes quickly and thoroughly is with a piece of cellulose or rubber sponge attached to a length of stiff wire. The sponge should fit snugly in the test tube when it has absorbed maximum water. With a sharp instrument work a hole lengthwise through the sponge, insert the wire, and bend back about $\frac{1}{4}$ " at the end so it won't pull through when the sponge is in the tube.—H. KLEIN.

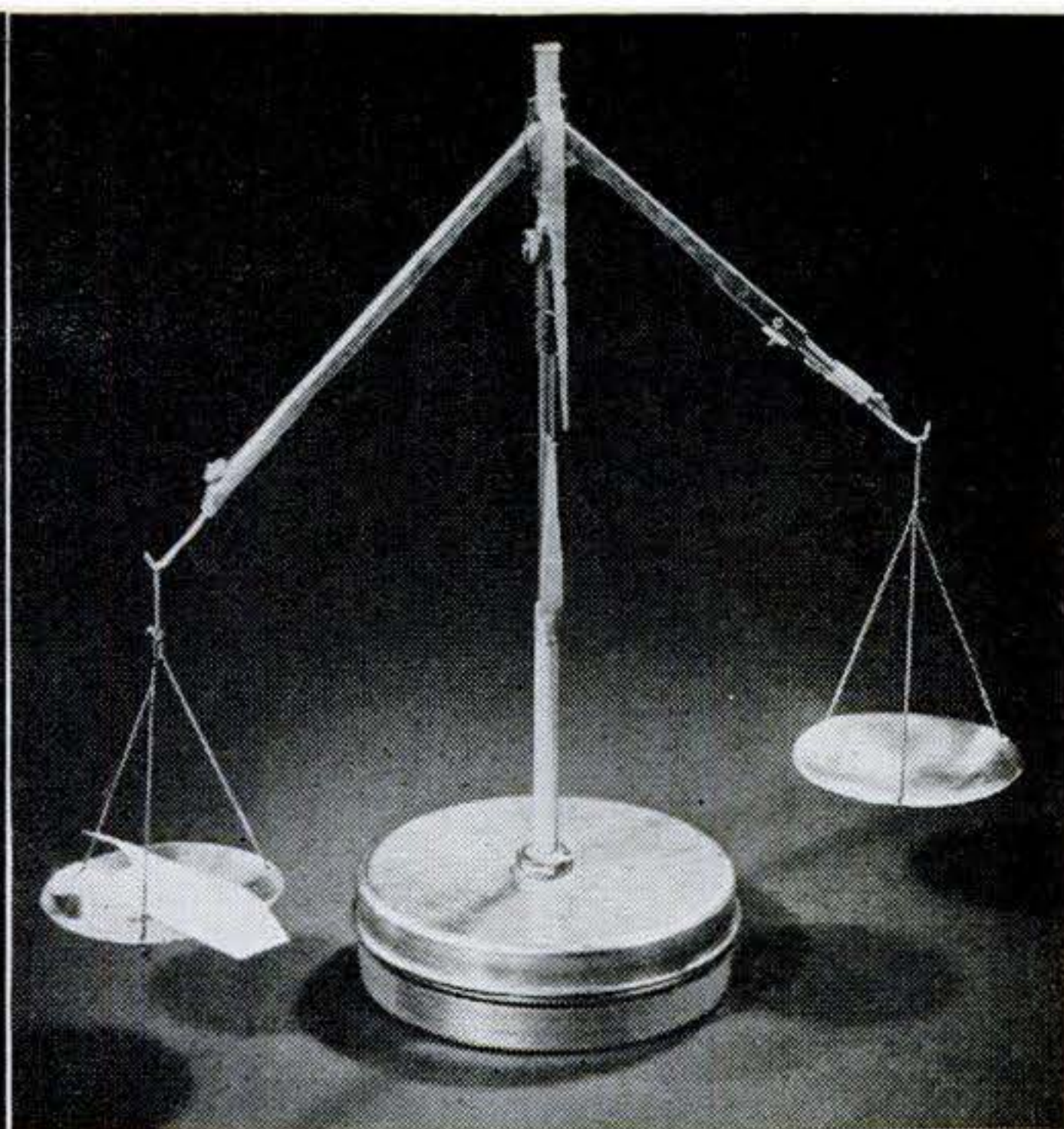
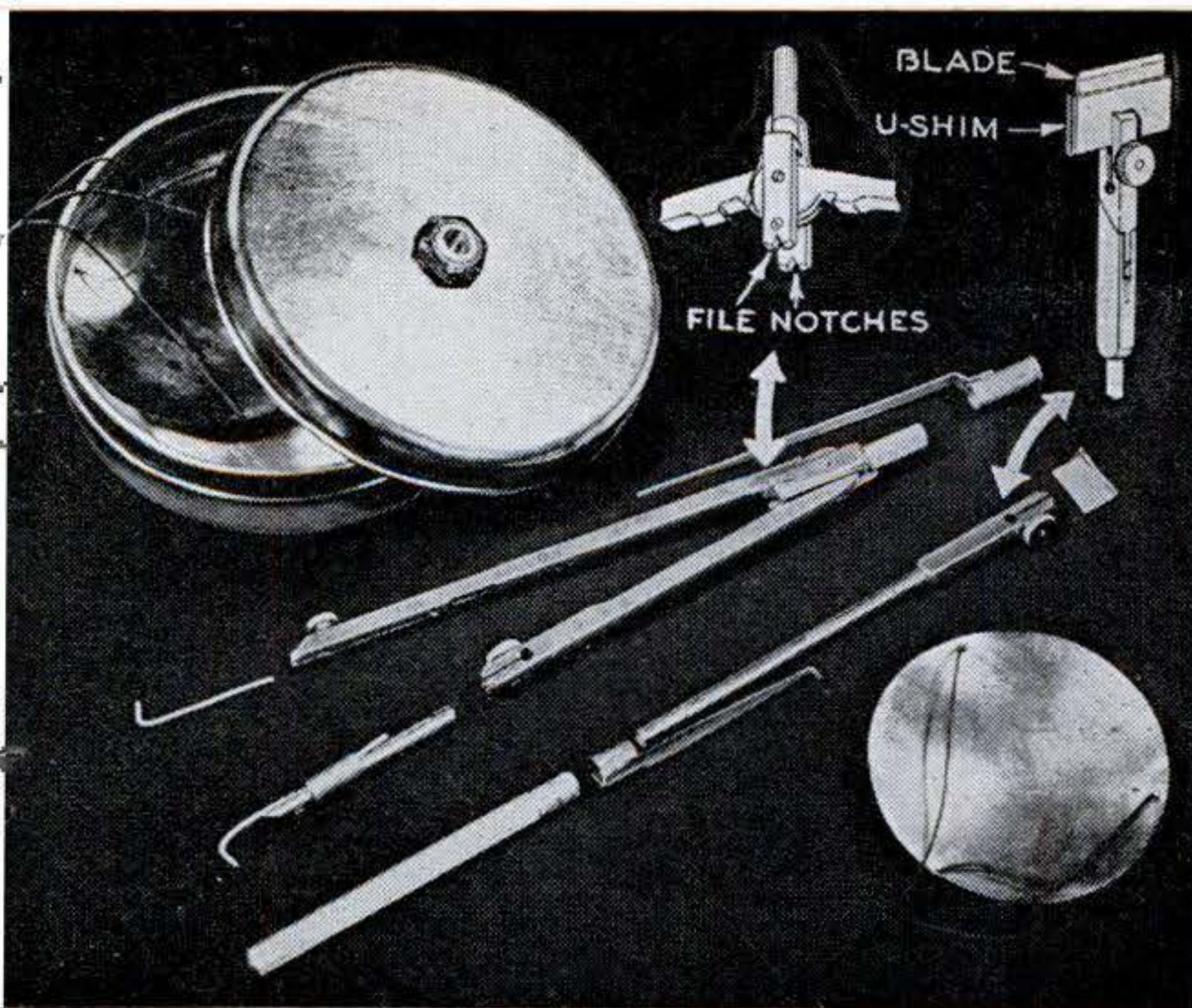

Drafting Tools Form Scales. An accurate balance for weighing chemicals and other small amounts up to several ounces can be assembled quickly from a drafting compass, pen handle, and extension bar. It is sensitive enough to weigh a cigarette paper. There is so little friction that, when set in motion without pans, the compass will oscillate 10 minutes.

The only alterations required are tiny, almost invisible notches at the bottom of the fork to which the compass legs are pivoted. These must be accurately centered and aligned. Make them shallow at first, and deepen if necessary. The knife-edge fulcrum

is a piece of razor blade slightly dulled on a whetstone and clamped in a tin U-shim by the extension-bar setscrew. Bent-wire hooks replace the points in the compass legs to suspend pans made from the bottoms of small cans. Counterbalance the lighter leg with wrappings of foil, wire, or the like. Two pointers to show balance fit on the pen handle and the knurled compass grip.

Make a base by drilling a shoe-polish can and soldering on a nut. Slip the pen handle in the nut, assemble, and the scales are ready for use. For storage keep the accessories in the can and return the instruments to their case.—G. E. HARRINGTON.

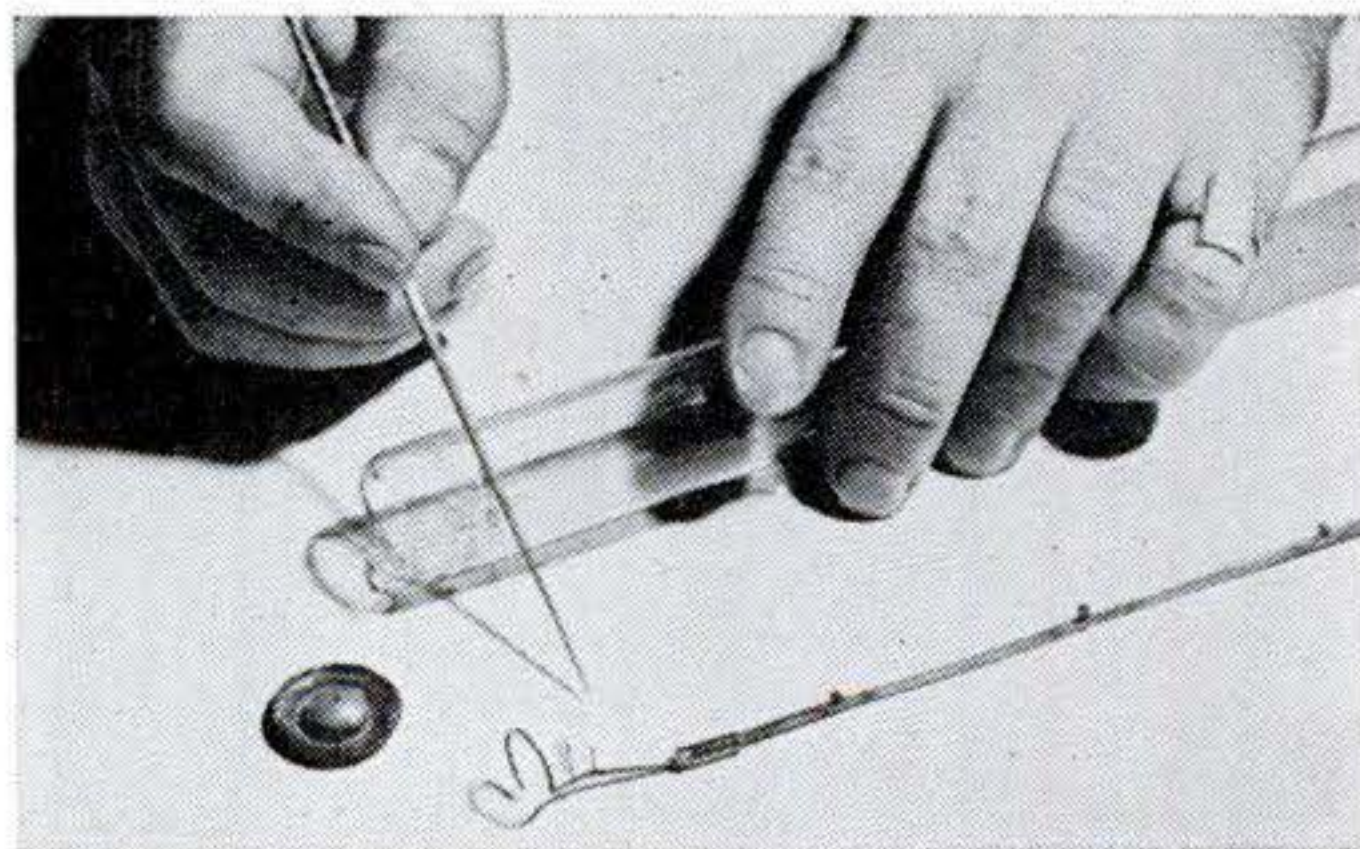

Tubing Cut from Lamps. Burned-out tubular incandescent bulbs make excellent large glass tubing. They can be worked with a Bunsen burner as readily as regular laboratory glass. Break the glass tip at one end to admit air; then file and break off cleanly and clear out the inside. After that the tubing can be broken accurately into desired lengths at file marks made to circumscribe it.—KENNETH MURRAY.

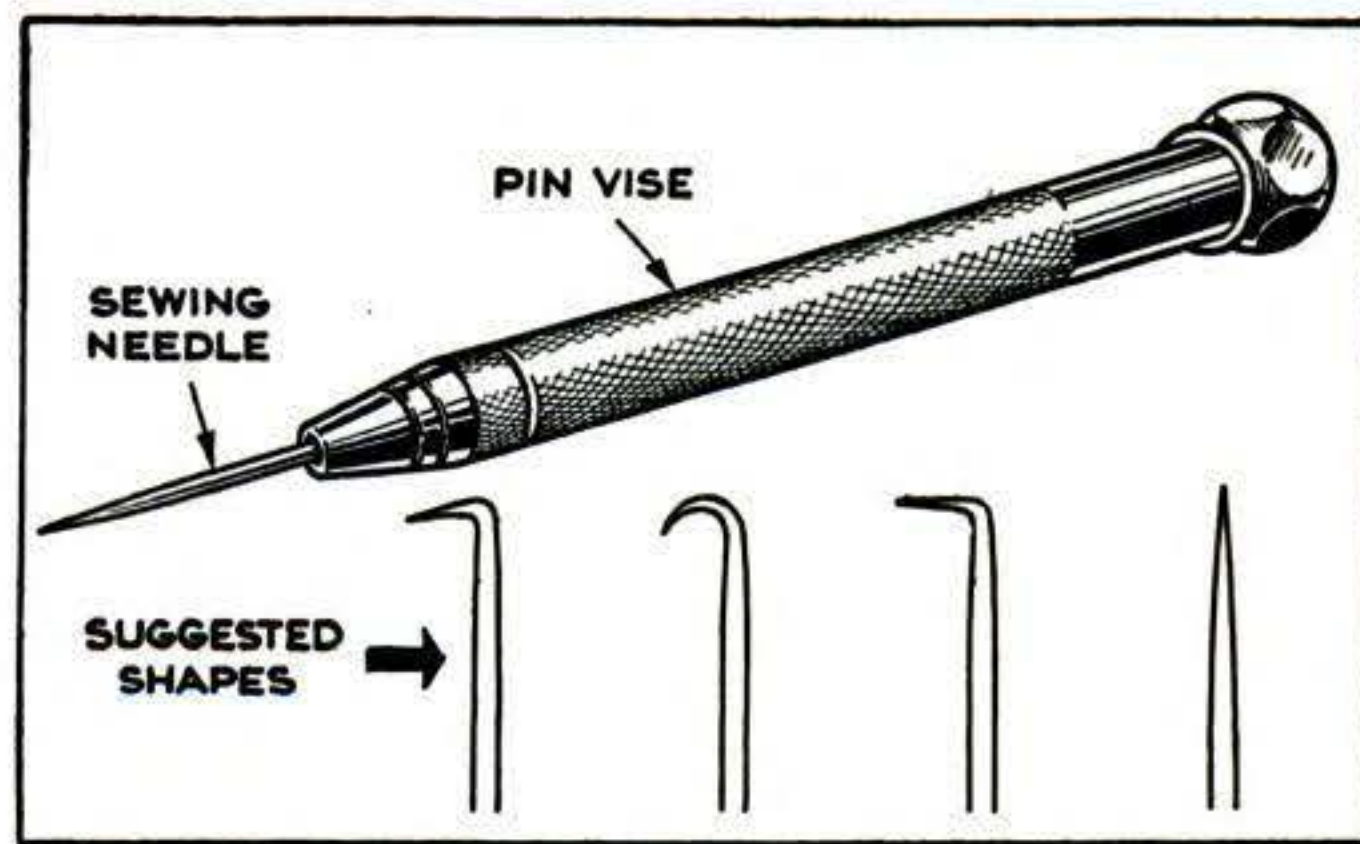

Pin Vise Holds "Scalpel." Dissecting and examining biological specimens can be facilitated with an ordinary sewing needle held in a pin vise, such as the small size selling for about 15 cents and sometimes listed as a scratch awl. Points of various shapes can be bent by heating the needle. Advantages are easy replacement of a corroded needle and the firm grip provided by the knurl.—ALFRED BLAKER.

FOR EASIER FARMING



Terracer Aids Contouring. A new weapon in the fight against soil erosion, this terracer corrects drainage outlets and conserves moisture. The combination plow and whirling screw conveyor is pulled by a tractor and can move 650 cubic yards of soil per mile. It throws it accurately to a distance of 20', pulverizing it and eliminating the need for harrowing and disking. The terracer is marketed by the International Harvester Company.

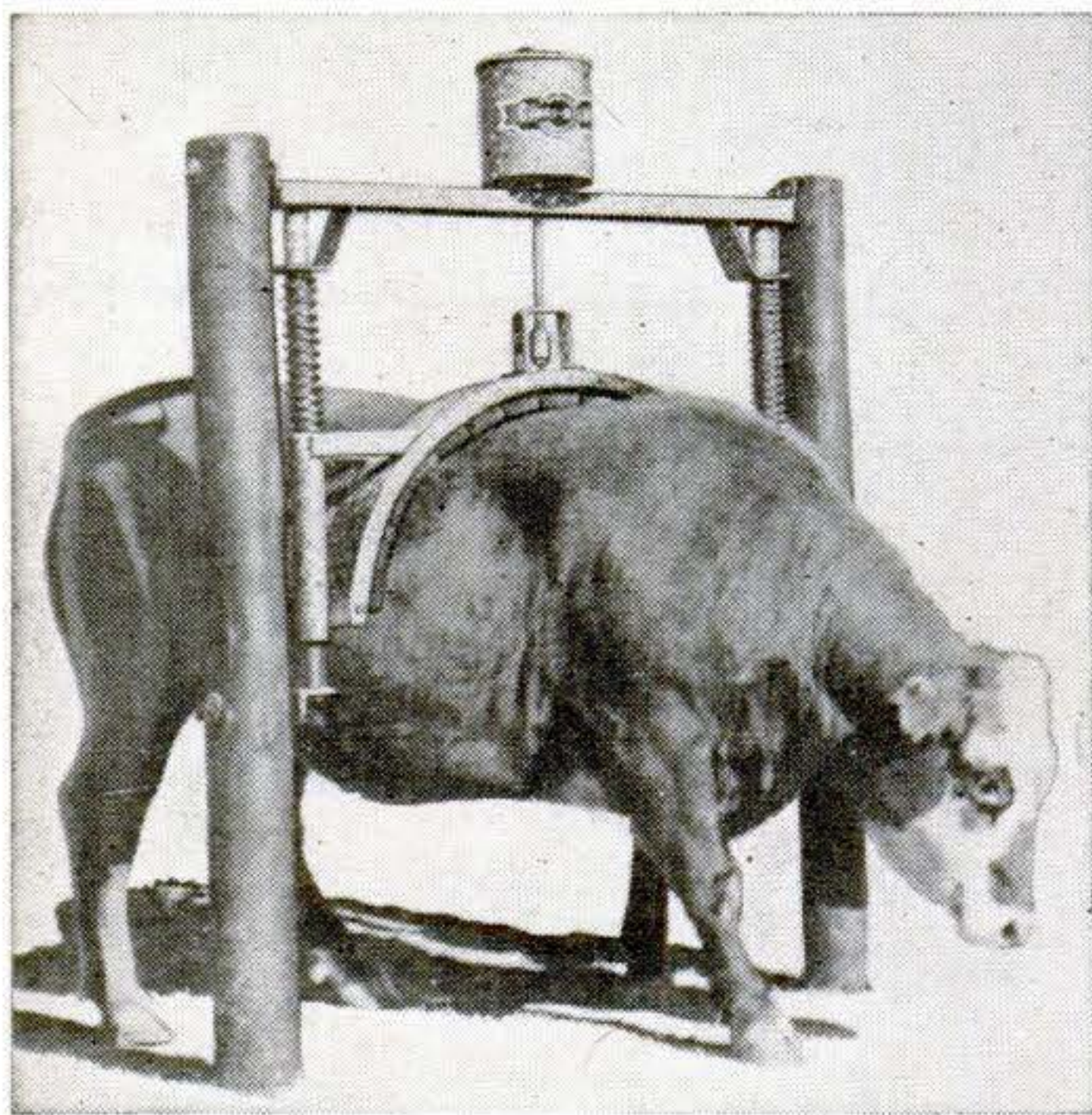

Oiler Curries Cattle. For the greater comfort of cattle, the Farnam Company, of Omaha, produces the automatic currying and oiling equipment pictured above. A 5-gal. insecticide reservoir is mounted solidly on the frame of the device and moving parts are machined for leakproof action. Oil is distributed evenly over the brushes in the spring-mounted steel arch which accommodates itself to the animal's back.

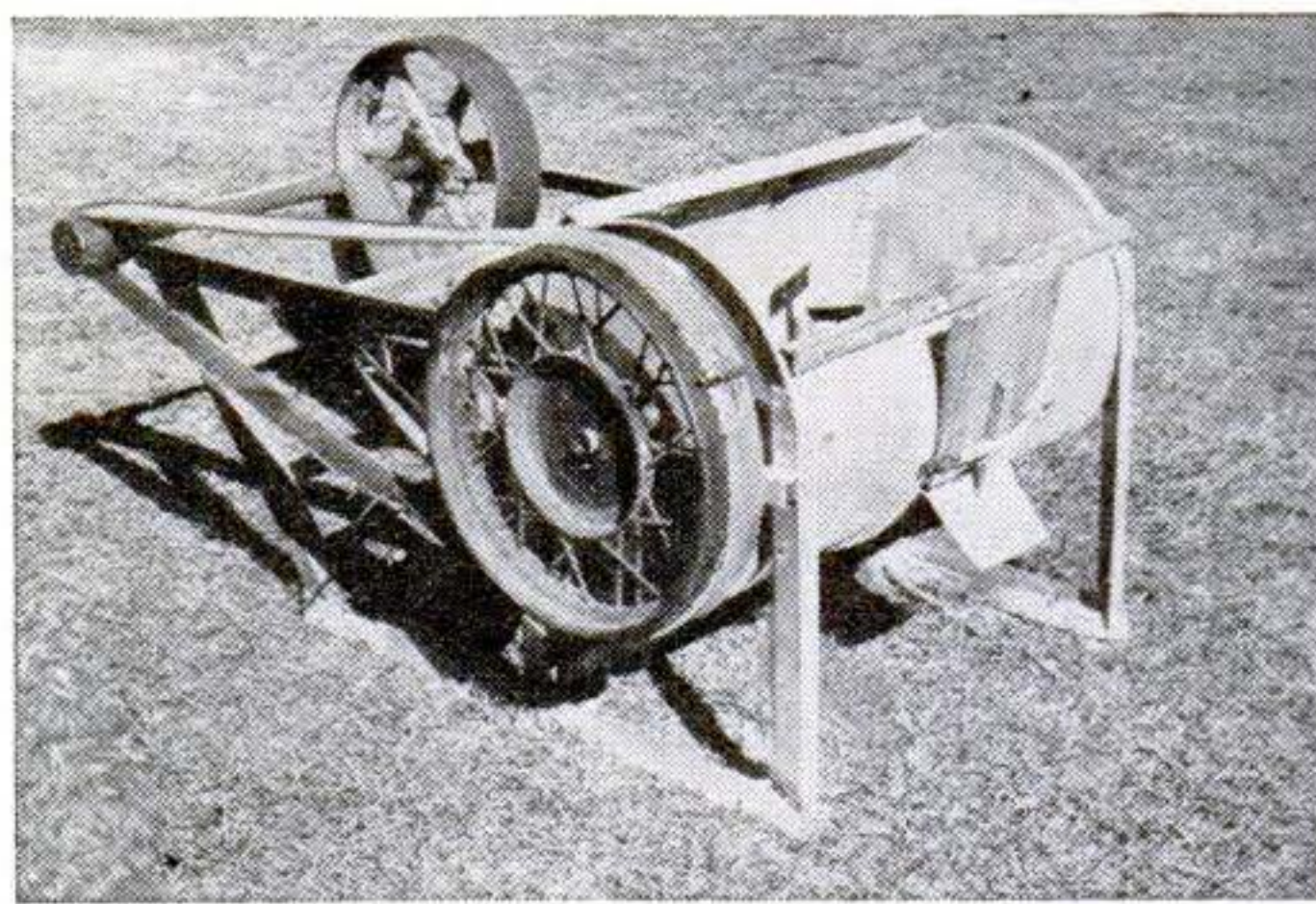

Portable Concrete Mixer. An oil company welder who needed a small-batch concrete mixer for setting fence posts and equipment bases converted a salvaged auto wheel, a steel drum, and some pieces of angle iron to his purpose. The unit is light enough to be loaded on a truck, and it can be powered by the same truck through a belt that connects the drive pulley and a jacked-up rear wheel.

Better pictures are simpler with

**the smart, competent
KODAK REFLEX
camera**

black-and-white . . . color . . . flash

- quick, expert composing of subject with extra-bright ground-glass finder . . . shows image details in full picture size
- sharp focusing—“punchy” pictures—with 4-element $f/3.5$ twin lenses . . . both *Lumenized* (ultrahard coated)
- fast shooting with shutter speeds up to $1/200$. . . built-in synchronization for flash with accessory Kodak Flashholder

See it at your Kodak dealer's



**WRATTEN
FILTERS**



use gelatin



for “pure color”



Famed for thirty years, *Wratten Filters* use gelatin sheets with pure organic dyes, between two pieces of matched optical glass . . . all sealed into one tight unit with the new cement, butyl-methacrylate.

Advantages: *Colors*—wide variety, each precisely adjusted for its particular

purpose. *Sealing*—moisture-resistant, prevents deterioration of filter. *Strength*—metal ring and new cement provide a more rugged unit than a single-glass filter. *Optically flat glass*—especially designed for use with quality lenses. *Cost* is moderate. Consult your nearest Kodak dealer.

Kodak

Eastman Kodak Co., Rochester 4, N. Y.

they're back!



...MASTER NEEDLE FILES BY MASTER FILE MAKERS FOR MASTER CRAFTSMEN

WHERE is the craftsman—professional or amateur—who doesn't rate himself entitled to fine tools? Back in full civilian production, Nicholson X.F. (Extra Fine) Swiss Pattern Needle Files are reappearing in hardware and hobby-tool shops everywhere. They're widely regarded as tops in precision files; and they come in the handsome orange-and-black plastic case shown above, with stand-up base holding a dozen assorted shapes. Tiny files like these need precision manufacture to assure best results. Demand *Nicholson X.F.* and get the finest! A popular size for the hobbyist is 5½-inch in No. 2 cut.



FREE BOOK, "FILE PHILOSOPHY," on kinds, use, and care of files; 48 highly informative, illustrated pages.



NICHOLSON FILE CO.
19 Acorn St., Providence 1, R. I.
(In Canada, Port Hope, Ont.)



NICHOLSON FILES FOR EVERY PURPOSE

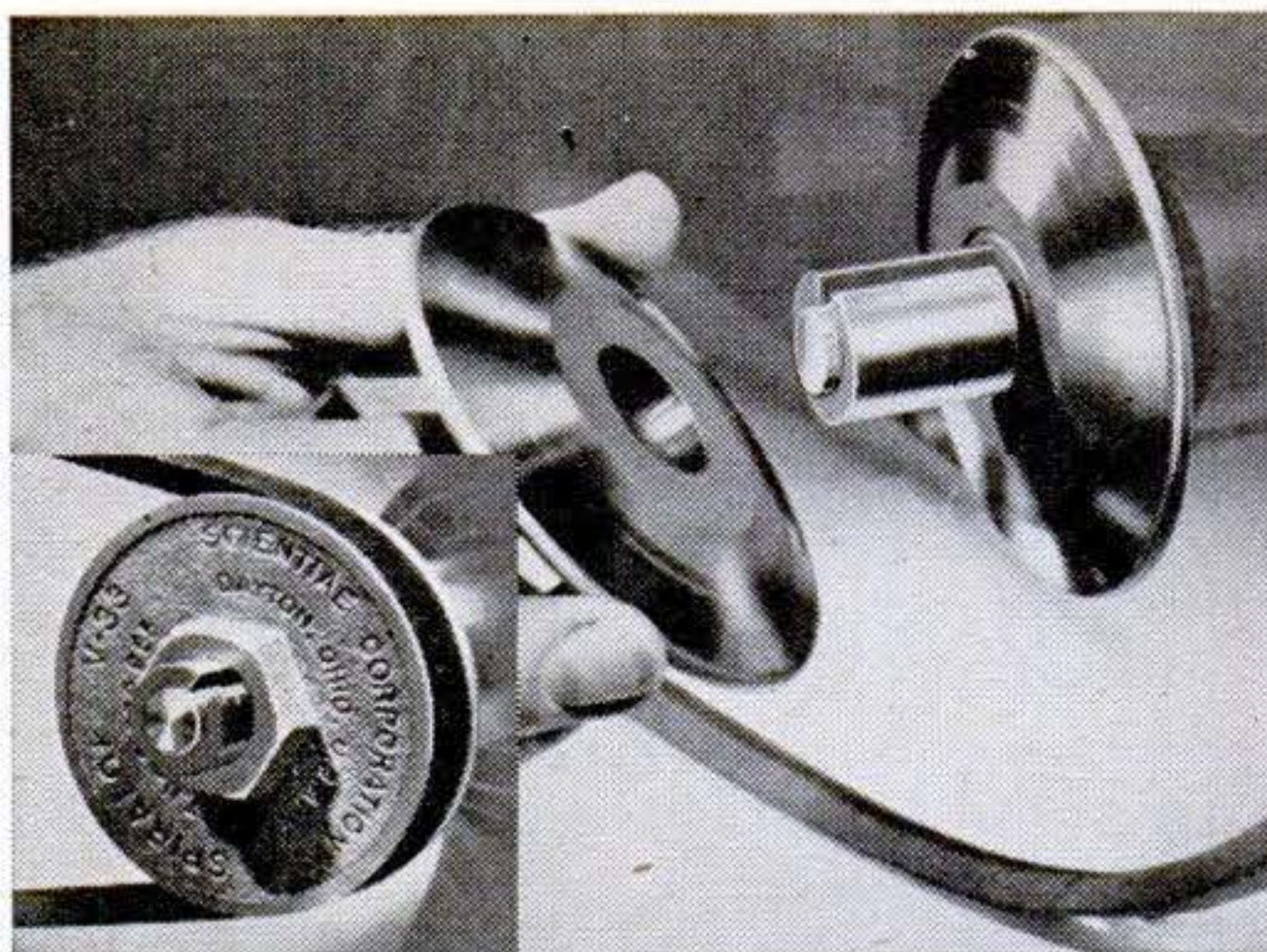

Pulley Is Adjustable

SEPARABLE halves of a new V-belt pulley, named the Spiralok, may be fixed at any desired spacing, providing an infinite range of variable-pitch adjustment. Spiral wedging action locks the disks in place, without need of keys or setscrews. The pulleys are said to be especially suited for home-workshop use, refrigerators and pumps.



Tripod Needs No Locking

AN IMPROVED tripod head, which dispenses with unlocking to tilt or swing a home-movie camera, has been introduced by the Eastman Kodak Company. Once adjusted to balance the weight of the camera, special clutches with multiple disks of felt and polished metal permit moving it with exceptional smoothness, according to the maker. The camera stays put in any position without locking.

NEW

EVEREADY

TRADE-MARK

FLASHLIGHT BATTERIES

*Now last 93% longer!**

Enough Energy to Hurl This Daring Miss Over 100 FEET!

Imagine!—the girl weighs 110 pounds! Yet the total energy in one tiny "Eveready" flashlight cell—properly expended—is equal to the charge that sends her flying up—up—over the gasping audience, to land over 100 feet away.

PACKED with new dynamic power... dazzling in performance... durable beyond any flashlight cells you've ever known, "Eveready" flashlight batteries give you the year's greatest energy value. That's a 93% increase over the great record made by pre-war "Eveready" cells... nearly double the life of light. Yet you pay no more.



The registered trade-mark "Eveready" distinguishes products of

NATIONAL CARBON COMPANY, INC.

30 East 42nd Street, New York 17, N. Y.

Unit of Union Carbide **UCC** and Carbon Corporation



High Energy

MEANS BRIGHTER LIGHT, LONGER LIFE

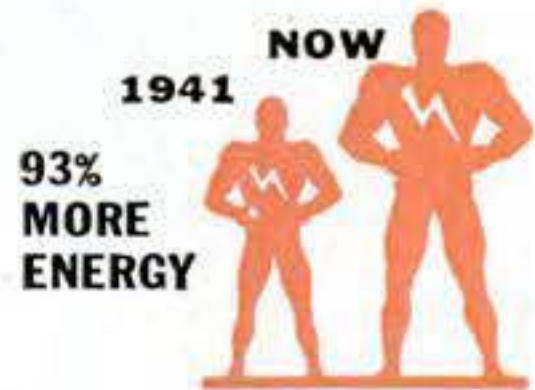

* To you, this means nearly twice the energy... almost two times longer life of bright white light. And it's yours for the pre-war price... still only 10¢!

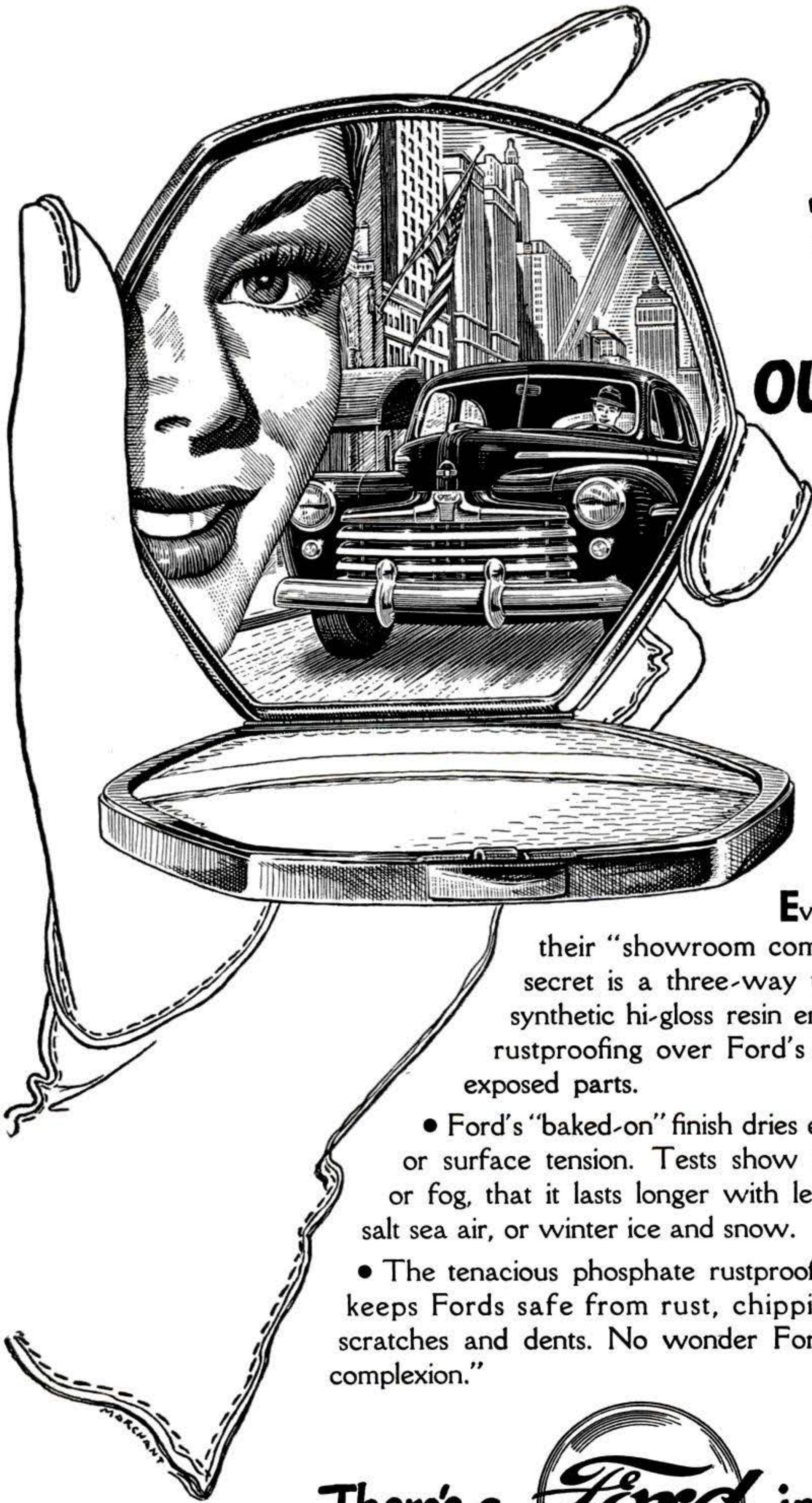

Ford's out Front with "Baked-on" beauty

Ever notice how Fords keep their "showroom complexion"? Ford's beauty secret is a three-way treatment... with special synthetic hi-gloss resin enamel... with a chemical rustproofing over Ford's "Lifeguard" bodies and exposed parts.

- Ford's "baked-on" finish dries evenly, with no "bubbling" or surface tension. Tests show Ford's luster doesn't dim or fog, that it lasts longer with less polishing in tropic sun, salt sea air, or winter ice and snow.
- The tenacious phosphate rustproof coating under the finish keeps Fords safe from rust, chipping, and peeling around scratches and dents. No wonder Fords keep that "showroom complexion."

There's a *Ford* in your future



Wake up your Horsepower

Your car *wakes up*, with a Casite tune-up. No more sputters, no more jerks—just a smooth surge of power. It's hard to believe that anything could improve performance so quickly, so easily. It's been proved in millions of motors.

and keep it wide awake

Casite cleans your motor . . . speeds lubrication . . . retards formation of sludge and gum. A pint of Casite through the air intake every three months and a pint in the crankcase every oil change, keeps your car free-running and full of pep.

the Guaranteed Way!

Double-Your-Money-Back if your car doesn't run better and smoother with Casite. And Casite makes this famous guarantee no matter what kind of motor oil you're using. Give it a try. Casite is sold by service stations, garages and car dealers everywhere. The Casite Corporation, Hastings, Michigan, and the Casite Division, Hastings Ltd., Toronto.



Cleans Motors
Keeps Motors Clean

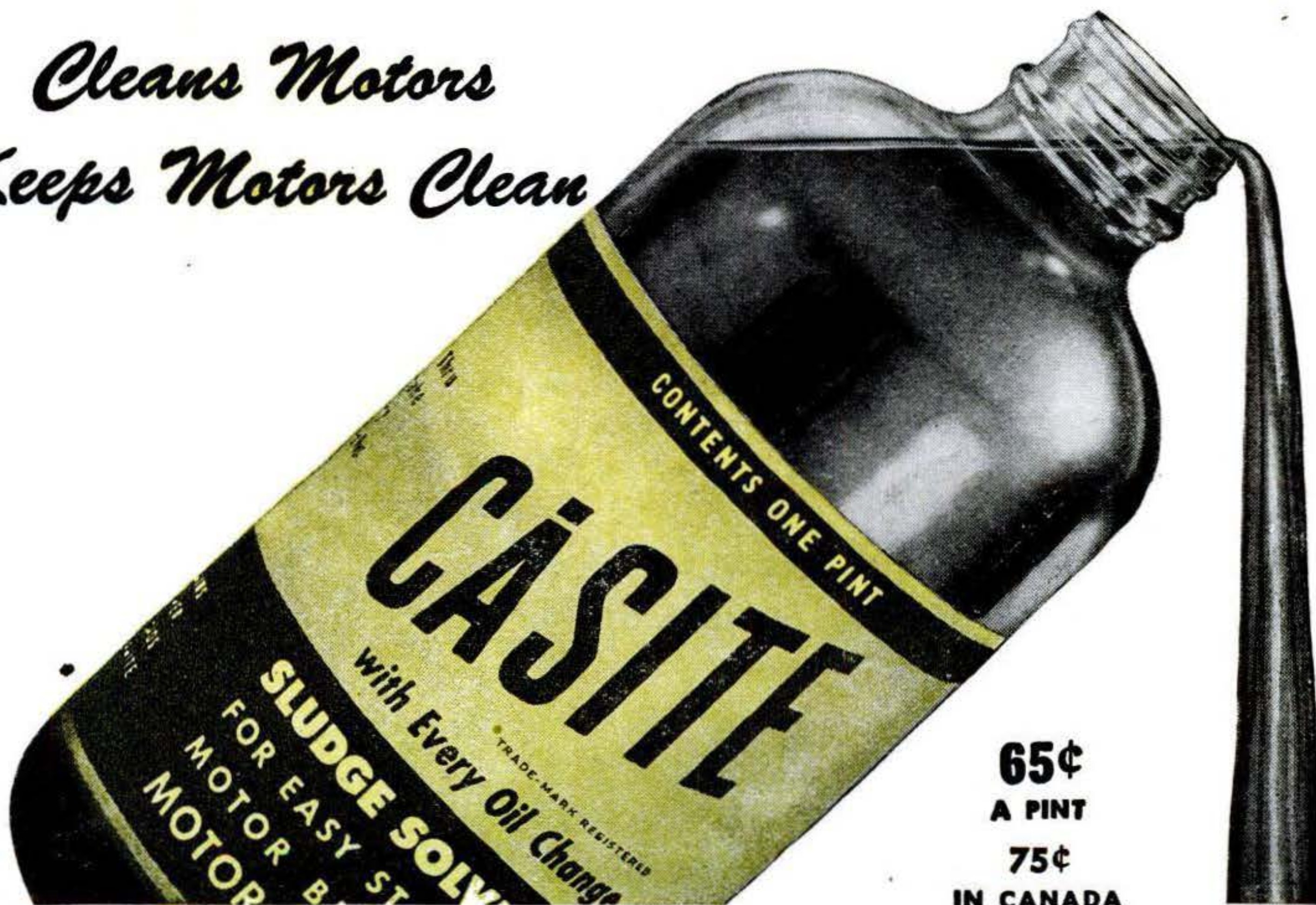

65¢
A PINT
75¢
IN CANADA

Big date tonight



But car is grimy



It'll shine up quick



If you just try me

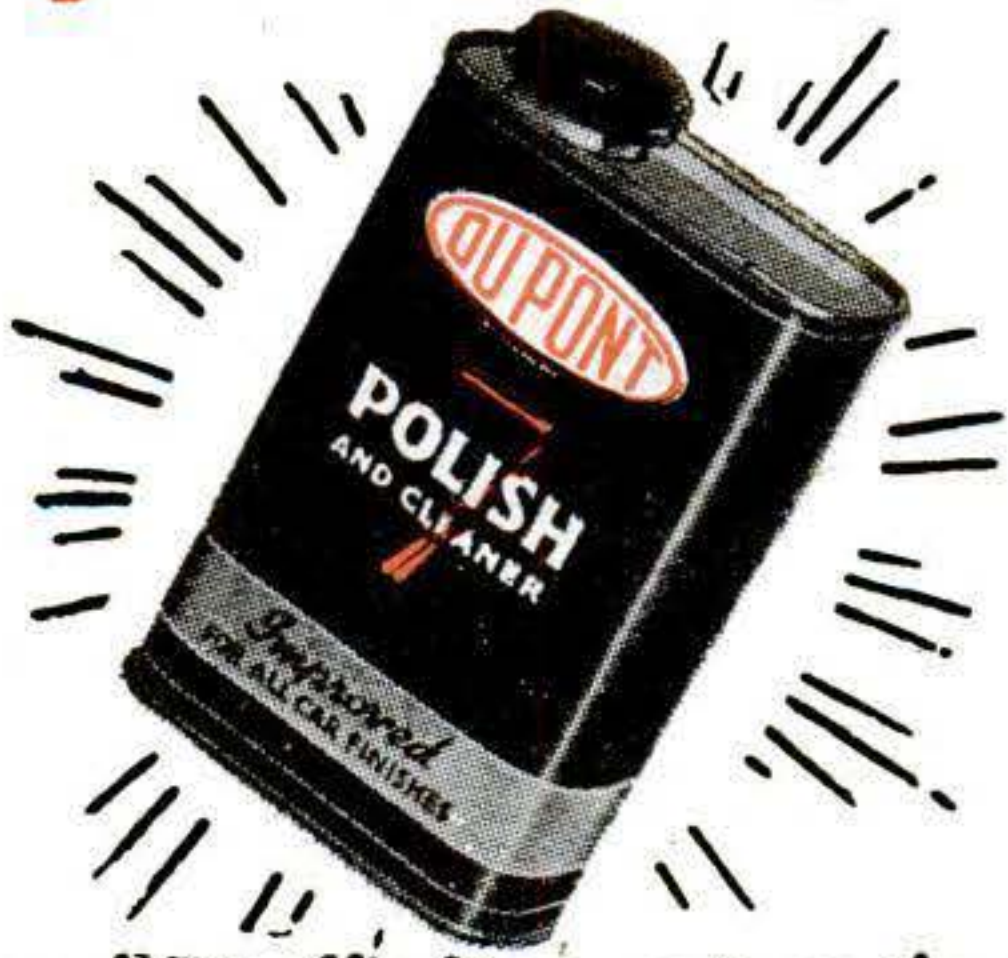

Removes dull traffic film—restores the original color and lustre—quickly, easily and safely.

DU PONT
REG. U. S. PAT. OFF.

Nº 7 POLISH

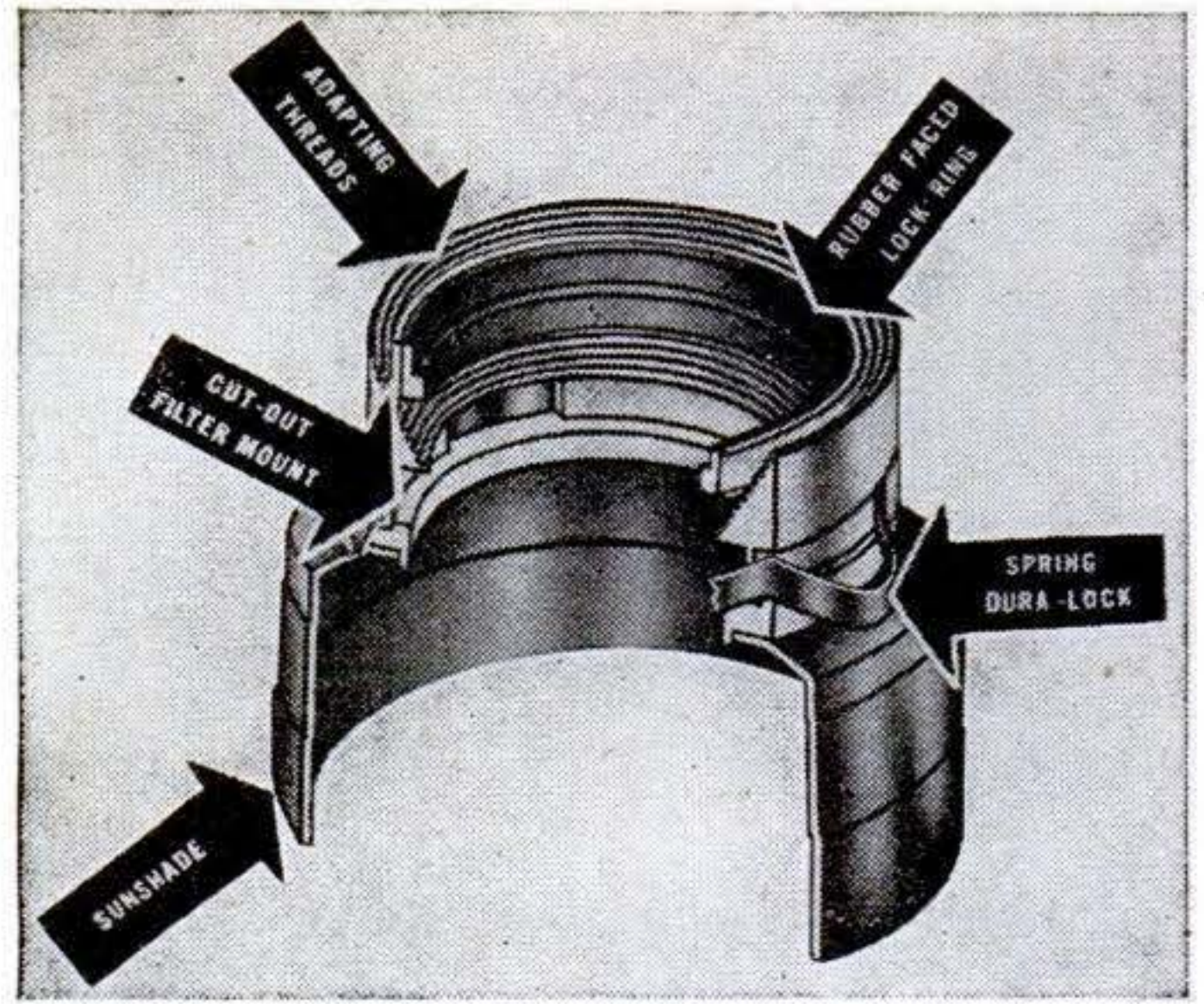

Adjustable Filter Mount

AVAILABLE in five sizes, this filter mount and sunshade fits camera lens barrels ranging from $\frac{1}{2}$ to $2\frac{1}{2}$ inches. A rubber lock ring protects the lens barrel from scratching. The Harrison Adjustable Mount is made of aluminum, duralite and clock-spring steel, and has cutout sides for easy insertion of filters without fingerprint smearing.



Clamps Speed Repairs

BROKEN posts, beams and handles can be easily repaired, and hoses or pipes can be quickly clamped or banded, with the new kit manufactured by the Punch-Lok Co., of Chicago. It consists of flat-strip steel clamps of assorted sizes and a tensioning tool that reaches confined places. Repairs can be made in a few minutes on round, square or oblong items that measure anywhere from $\frac{1}{2}$ to 10 inches in diameter.

Dependable

CHAMPION

AMERICA'S FAVORITE SPARK PLUG



The roaring midgets are in full cry again, dispensing their spine tingling thrills to enormous crowds nightly, on race tracks all over the nation. Tremendous acceleration, and keen driving skill are their stock in trade as they race literally hub to hub. Neither car nor driver can falter for a split second, and that's precisely why dependable spark plugs are of paramount importance. The overwhelming majority of midget car pilots use dependable Champion Spark Plugs. Here is testimony by experts that Champions make every engine a better performing, more dependable engine. Champion Spark Plug Company, Toledo 1, Ohio.

FOLLOW THE EXPERTS

**DEMAND NEW
DEPENDABLE CHAMPIONS.**

FOR YOUR CAR

Listen to the CHAMPION ROLL CALL . . . Harry Wismer's fast sportscast every Friday night, over the ABC network

SEPTEMBER 1947 **231**

Tank blows its top

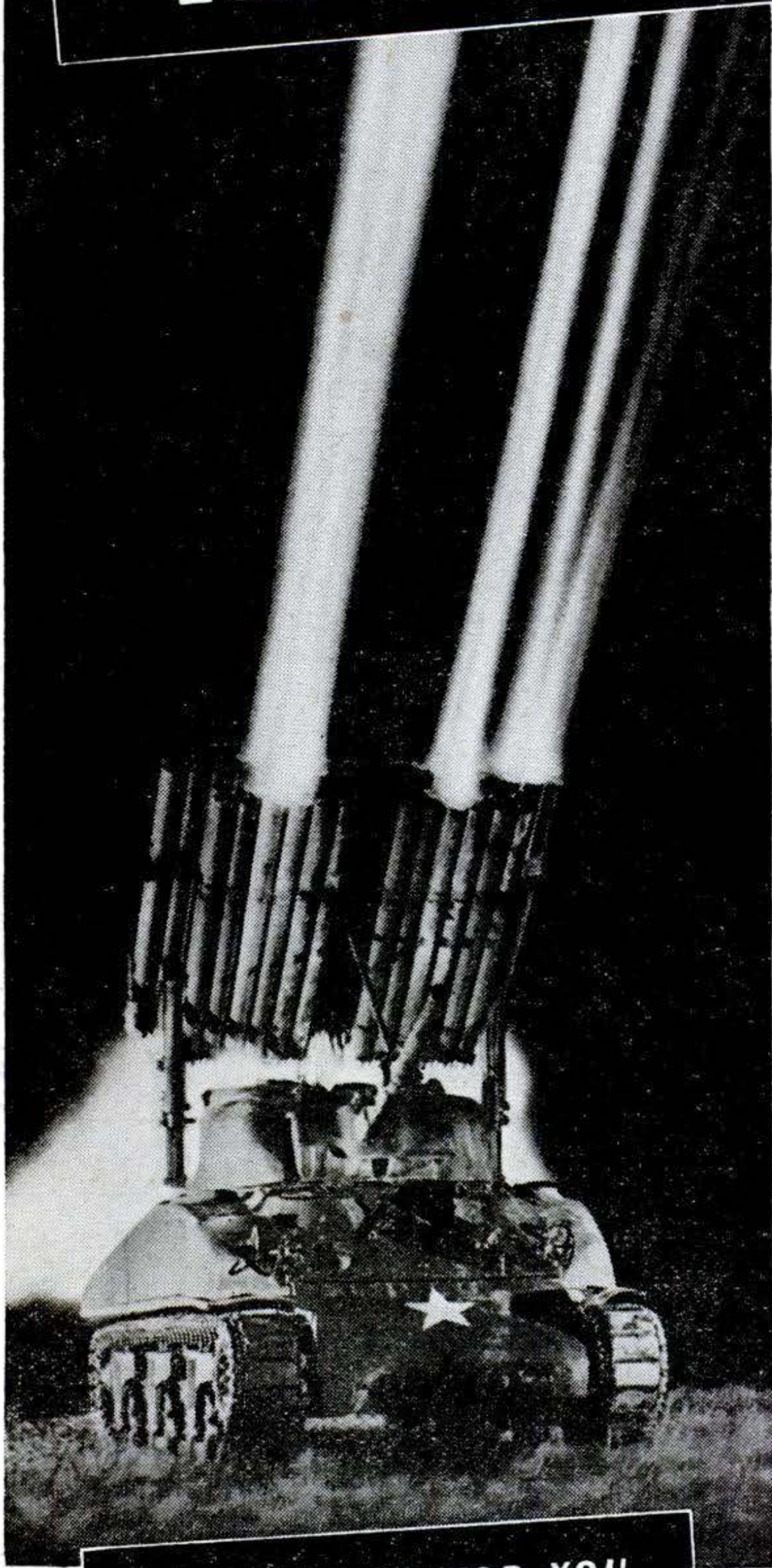

A GOOD JOB FOR YOU
U. S. Army
CHOOSE THIS
FINE PROFESSION NOW!

MEET "Calliope," a medium tank, "souped-up" with a 60-rocket launcher developed for the U. S. Army Ground Forces. "Calliope" can perform like any other tank. Then, at a moment's notice, it can take a fixed position and let fly with a rocket barrage equal to 60 artillery pieces.

"Calliope" is an all-steel model of the enormous strides which the Ground Forces have made in the field of mechanization. At much less danger to itself, one crew can perform missions which would formerly have taken many times the number of men.

Then, too, "Calliope" shows the interesting research and development being carried on by the Army. Any young man with any kind of mechanical bent will find the U. S. Army Ground Forces a fascinating workshop in which to learn skills and trades and give his new-found knowledge the practical application it needs.

There are other advantages, too, to a Ground Forces career. Good pay, steady work, living essentials provided without charge, travel, adventure, and the thrill of doing a worth-while job for your country. Get the facts at your nearest U. S. Army Recruiting Station.

★

Listen to "Warriors of Peace," "Voice of the Army," "Sound Off" and "Proudly We Hail" on your radio.

U. S. ARMY RECRUITING SERVICE

YOUR REGULAR ARMY SERVES THE NATION AND MANKIND IN WAR AND PEACE

Ingenious New Technical Methods

To Help You
Simplify Production

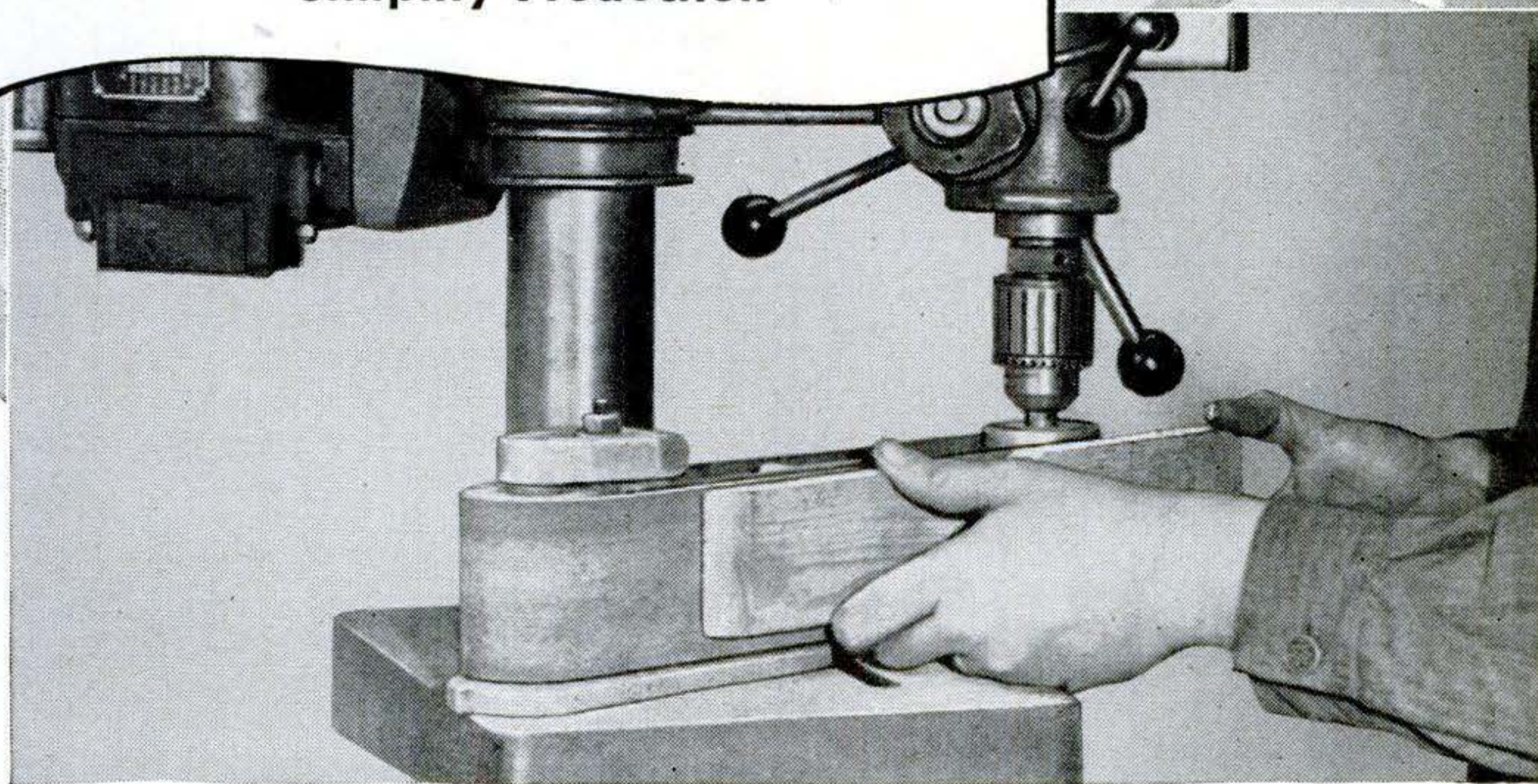

NEW BELT SANDER FOR DRILL PRESS Does Finishing Jobs Faster, Better

A new, simple, faster method for many surface finishing jobs on wood, metal, plastic and other materials has been announced by the OK Specialty Company of Chicago. The new finishing method takes the form of the OK Belt Sander, a drill press attachment.

The new sanding device weighs less than 5 pounds. It is made up of an aluminum base with backing plate or platen, a driven pulley mounted on ground steel shaft and running on precision ground ball bearings, and cast aluminum driver pulley mounted on $\frac{1}{2}$ " ground steel shaft to fit into the drill press chuck.

The base of the sander is bolted to a drill press table. Merely by moving the drill press table, the attachment can be adjusted to handle sanding belts from 26" to 36" in length.

The sander takes belts from $\frac{1}{2}$ " to 3" in width. Two sanding belts, one coarse grit and one fine grit, are furnished with each attachment. The device comes assembled ready for use with any drill press. Most efficient performance is achieved at 3500 to 5000 RPM. The sander stands 5" high, and the base measures $10\frac{1}{2}$ " long by $3\frac{1}{4}$ " wide.

Another time-saver on the job is chewing gum. Chewing gum may be used even when hands are busy; and under dust conditions helps to keep the throat moist—prevents "false thirst." For these reasons many plant owners make Wrigley's Spearmint Gum available to everyone.

*You can get complete information from OK Specialty Company
4655 N. Clark St., Chicago, Ill.*

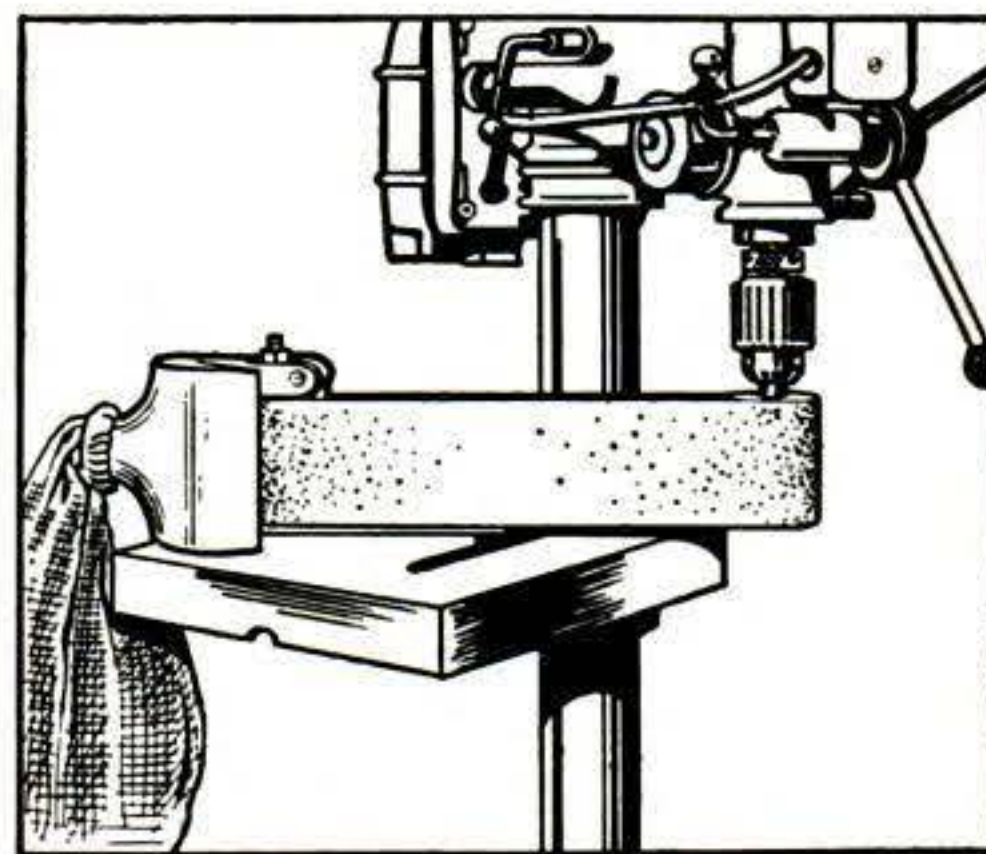

OK Belt Sander
Assembled, Ready for Action



AB-73

THE FAITHFUL
HEART
OF YOUR FUEL
SYSTEM



AC

FUEL PUMPS

Pulsing steadily, hundreds of times a mile, your AC Fuel Pump is the strong, reliable heart of your fuel system. It has given you long, faithful service because of its inbuilt quality and scientific design.

You can prolong that faithful service indefinitely, if you insist upon an AC when you replace your present pump with a new or rebuilt one.

AC SPARK PLUG DIVISION • GENERAL MOTORS CORPORATION



Tubes Dress Up Lights

ATTRACTIVE lighting effects for restaurants, hotels and stores can be achieved by slipping colored Tenite tubing over fluorescent lamps. Light is diffused by longitudinal prisms on the tubing's inner wall. Because the tubing is transparent, little light is lost in transmission, and glare is said to be reduced by 50 percent. Spacer splines hold the device on the lamp. Made by Extruded Plastics, Inc., of Norwalk, Conn., the tubing is shatterproof and comes in seven colors. It requires no special fixtures.

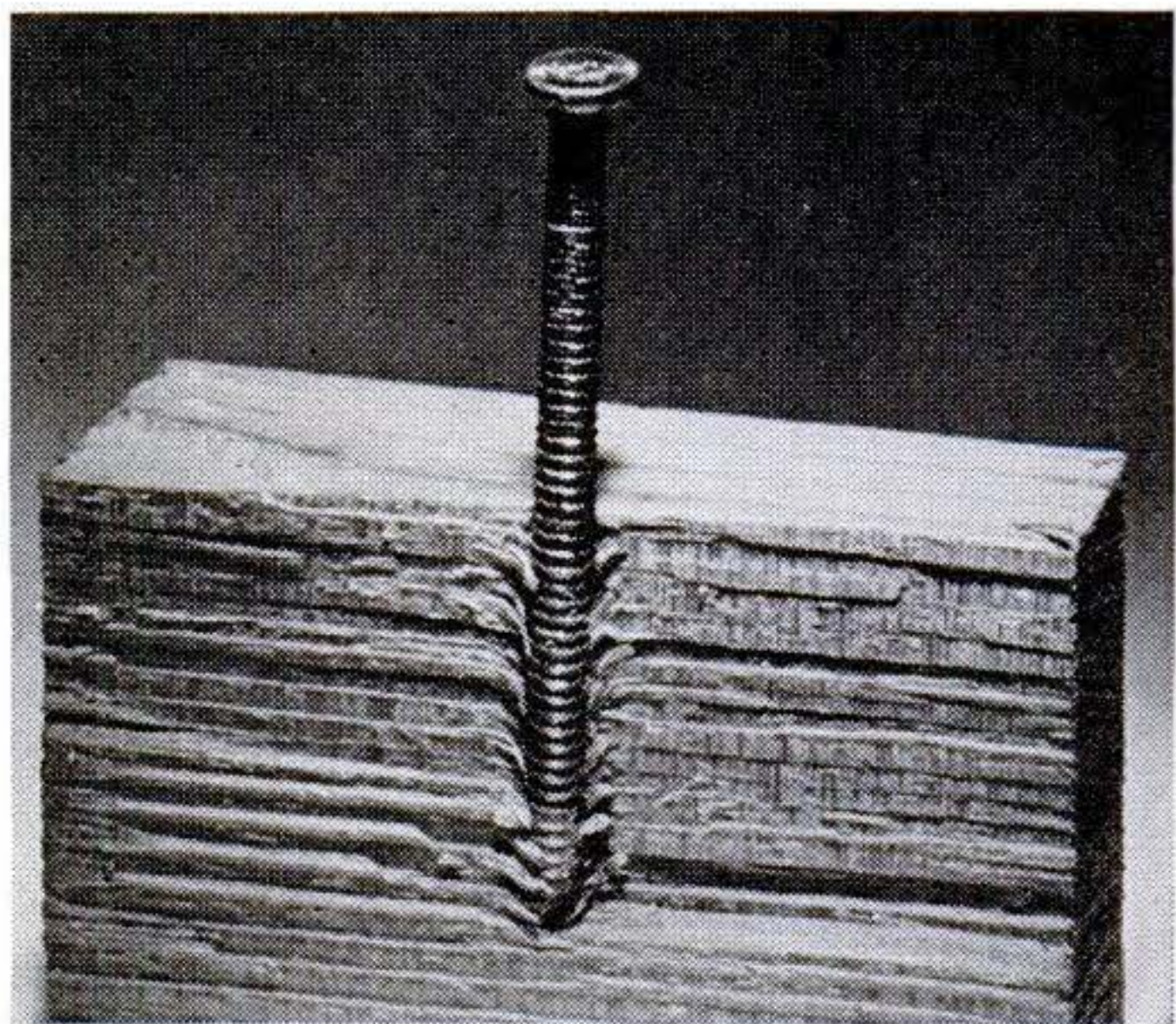

Nail Grips Like a Screw

WOOD fibers wedge themselves tightly into the ring-shaped grooves in this nail, which can also be driven through sheet metal. Made by the Independent Nail and Packing Co., of Bridgewater, Mass., the nails come in a variety of rustproof metals.

All you want in Modern Heating!

Perfection stands at the top in providing all the things you want in oil heating comfort. Since 1888, the highest standards of engineering and workmanship have produced dependable heaters for American homes . . . for *your* better living.

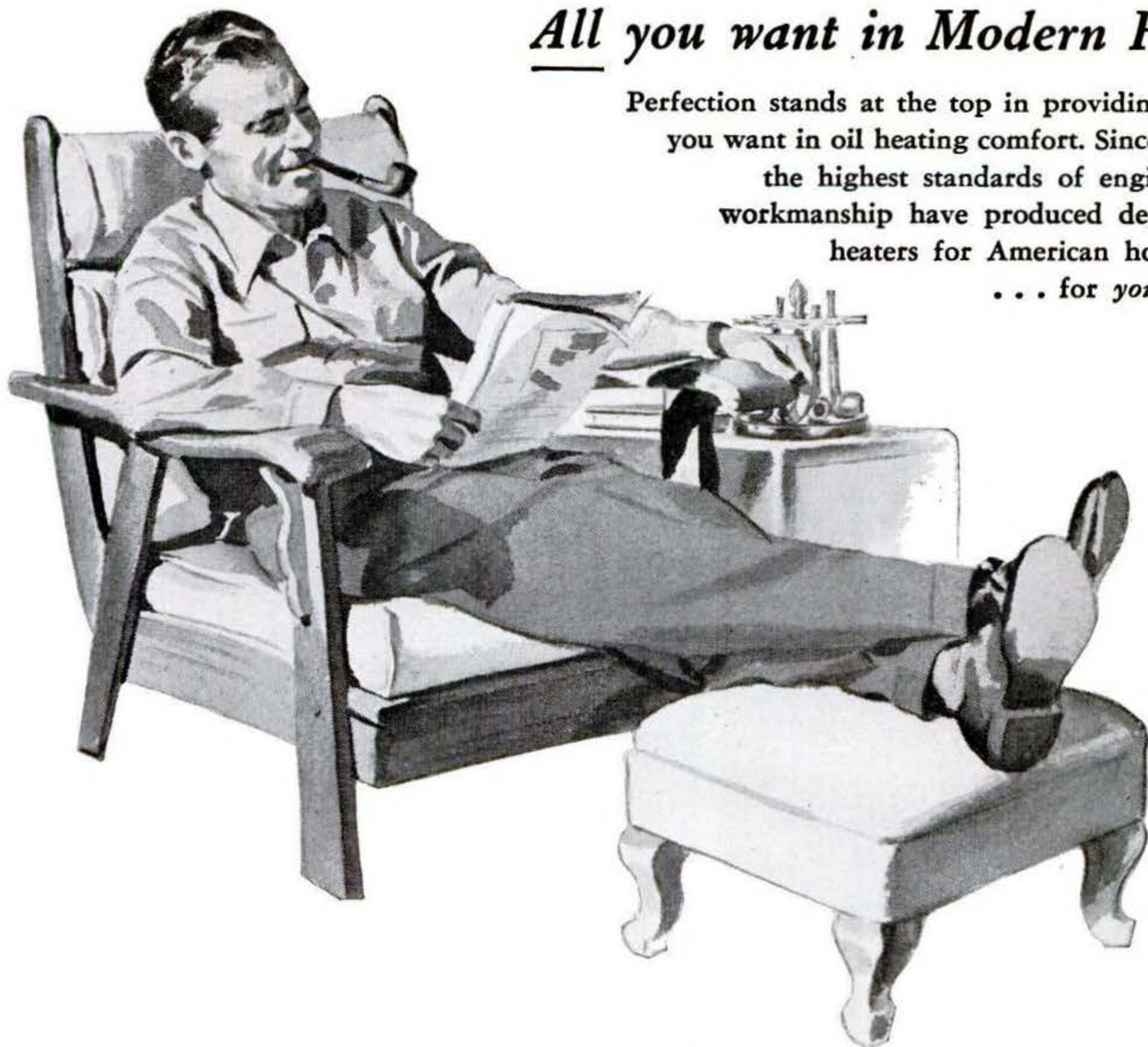

Enjoy the clean, comfortable warmth of Modern PERFECTION Oil Heat!

Uniform Heat—quick radiating and circulating warmth always there, day or night, when and where you want it.

Automatic Control—you can have fully automatic operation with an outside fuel supply tank and Accessory No. 12.

Clean Burning—soot-free, smoke-free, odor-free, result

of advanced Perfection engineering over the years.

Blower—addition of Blower No. 24 will carry heat to far corners and other rooms.

Quiet Operation—a silent servant producing the quick, clean comfort of better living.

and—no coal to carry, no fires to build, no ashes to empty, no soot-streaked walls to clean!



*Ivanhoe Model 2205
Space Heater, other sizes
available*

PERFECTION

*The World's Largest Manufacturers of
Oil Burning Appliances for the Home*

PERFECTION STOVE COMPANY, 7898-A PLATT AVE., CLEVELAND 4, OHIO



*Firelight Portable
Model 750 for "spot"
heating anywhere*

*The greatest invention
since the face!*



ACTUAL SIZE

VESTPOK*
dry shaver by WARD



USE VESTPOK ANY TIME and any place to whisk away "between-shaves" stubble. Small as a match folder, this scientifically designed, precision instrument supplements, but does not replace, a man's regular razor. Can't cut, scrape, nick or burn. \$3.00 with 10 blades of the finest razor steel. At your favorite store or write to us direct: Vestpok Division, Ward Machine Co., Inc., Dept. S-9, Brockton 64, Massachusetts.

*Needs no soap, water, brush,
mirror or electricity*

*Reg. U. S. Pat. Off. Patented & Patents Applied For.

236 POPULAR SCIENCE

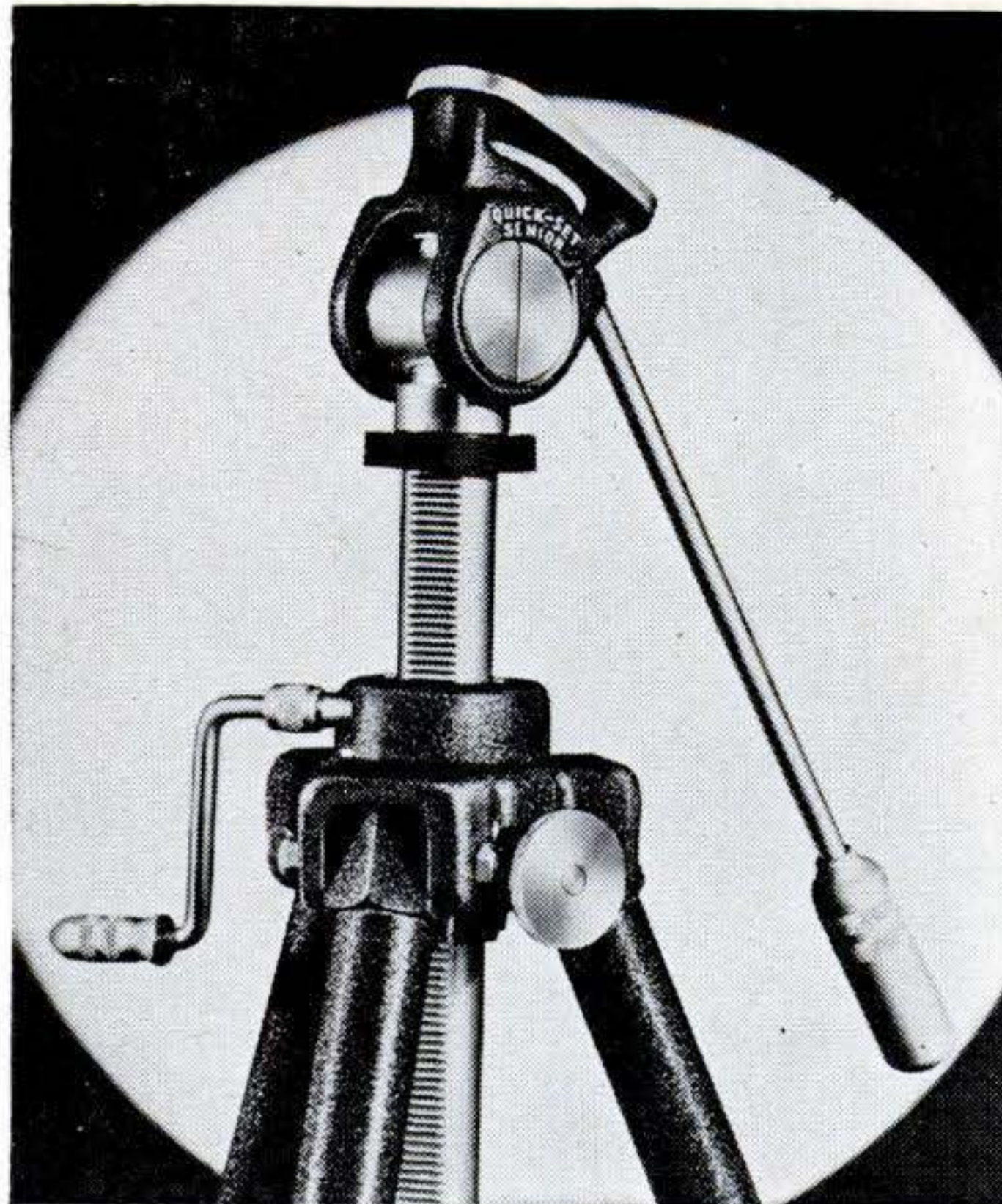

Tripod Has an Elevator

HERE'S a tripod on which you can adjust the height of the camera without fiddling with the tripod legs. The secret is a central column that can be raised or lowered with a fold-away crank handle. A nonslip, set-screw brake locks it into place. Called the Quick-Set Elevator Tripod, the device has a maximum elevation of from 15 to 17 inches, according to the model. It is made by Quick-Set, Inc., of Chicago.

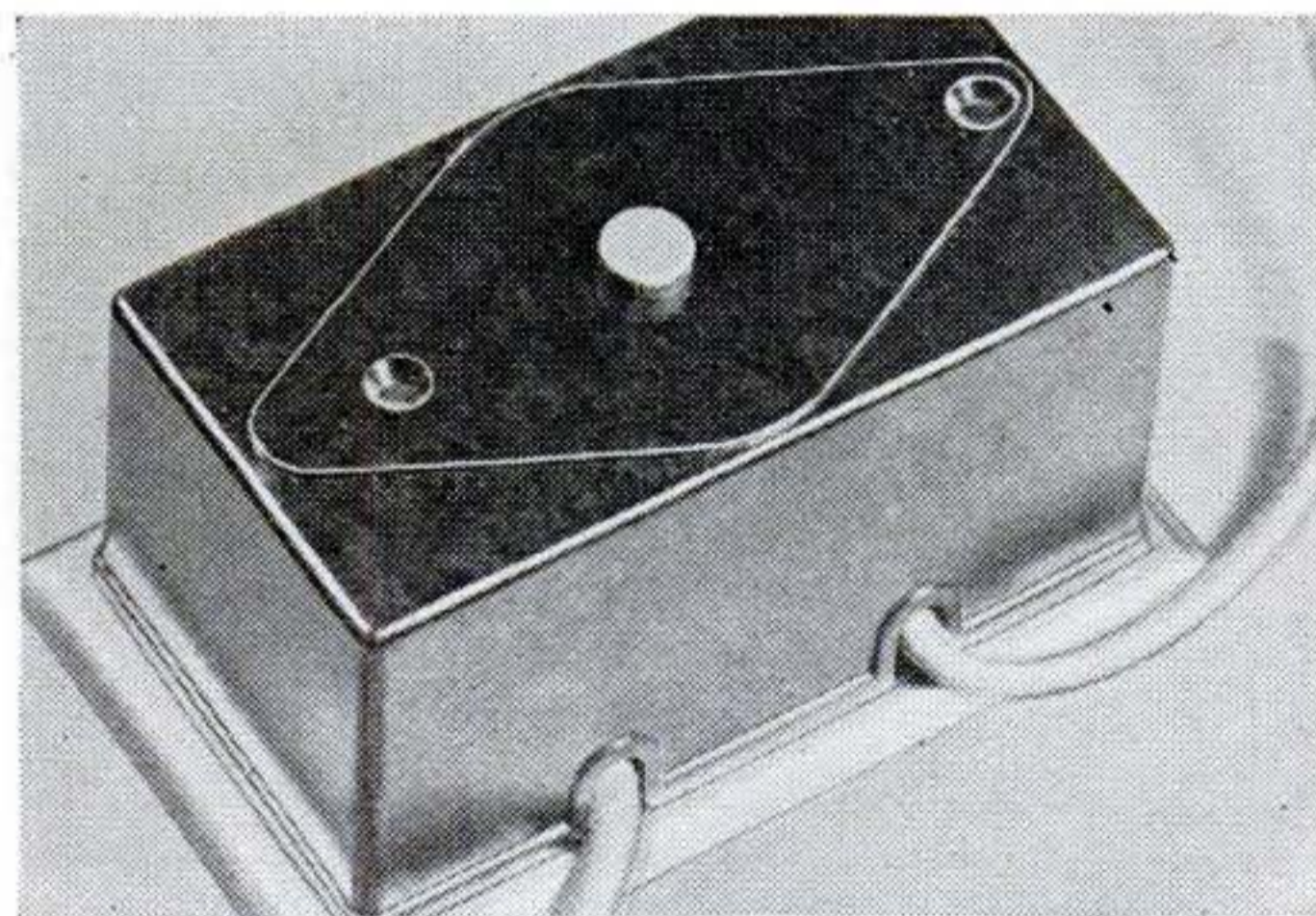

Guard Shields Outlets

PARENTS of small children may be interested in the Save-A-Shock electric outlet guard. It fits over a wall outlet so that nothing can be pushed into it nor the plug pulled out. The plastic guard can be installed in less than a minute.

argus 21 *Markfinder*

does it
with
Mirrors..

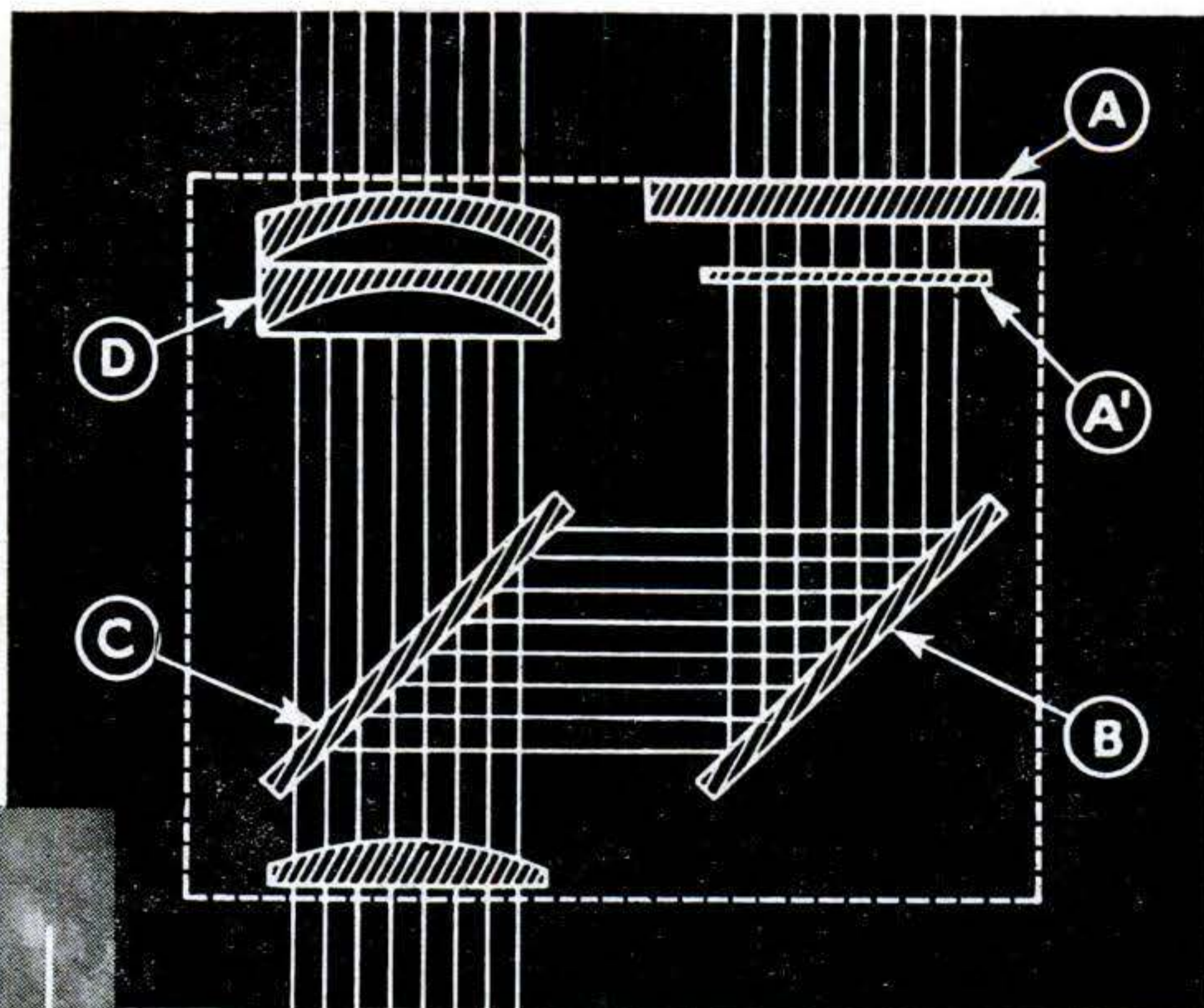

The cross-section above shows the "Markfinder" principle. Light passing through ground glass (A) and the reticle (A') is reflected by mirrors (B) and (C) and is projected into the field of view through distortionless doublet finder objective (D). You see the picture area outlined with a white line... always the same whatever your eye position.

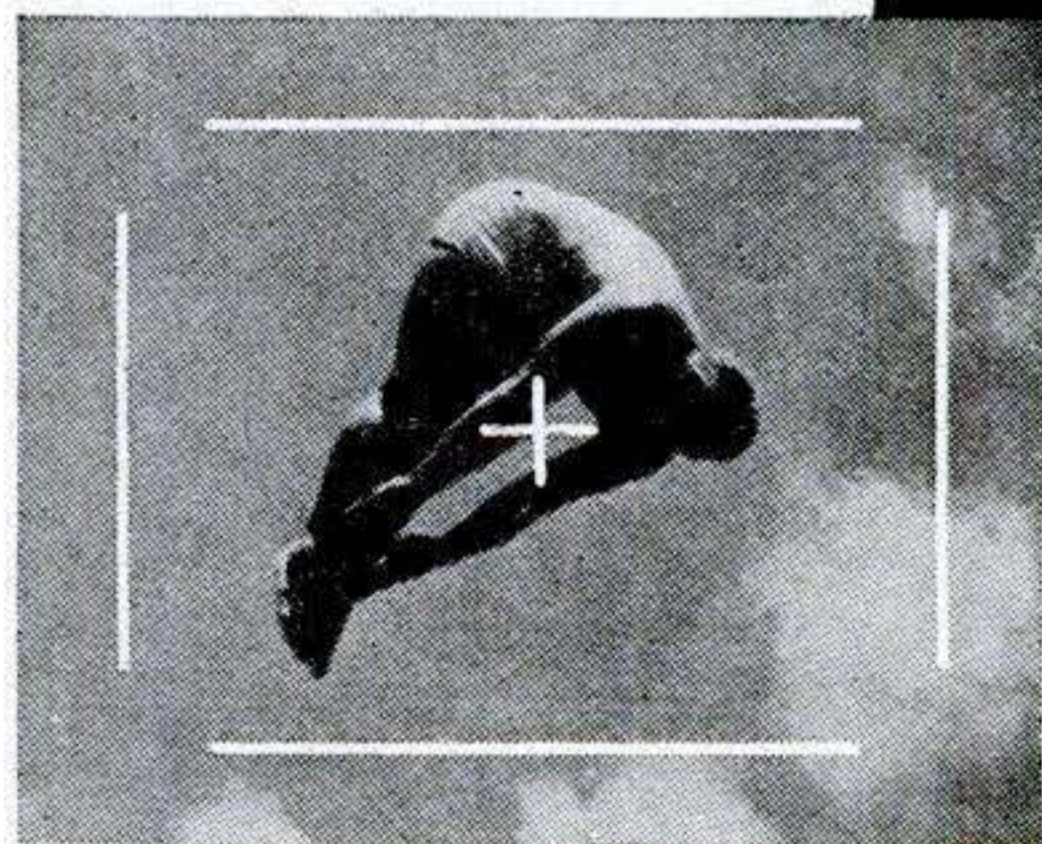

Only Argus 21 has "Markfinder"—Photography's newest camera sight incorporating war-born gunsight secrets.

"Markfinder" consists of one doublet lens, one single lens and two mirrors. It shows you a center cross-mark and a guideline frame projected *right on your subject*. You can't miss!

Aiming with "Markfinder" is quicker. Fol-

lowing action is smoother—more accurate. *And*—you always get exactly what you see. That means ever-improved composition, a critical factor when you use color.

For a real photo treat, ask your dealer to show you Argus 21 with "Markfinder" today. You'll admit there's never been anything like it for speed, simplicity, accuracy.

ARGUS, INCORPORATED • ANN ARBOR, MICH.

Added Argus Features

- F 3.5 Anastigmat, coated lens corrected for exceptionally true color.
- Double exposure guard.
- Accurate shutter speeds from 1/10 to 1/200.
- New, built-in flash synchronization.
- Removable lens for use on enlarger
- Automatic film stop... PLUS — new, exclusive "Markfinder".

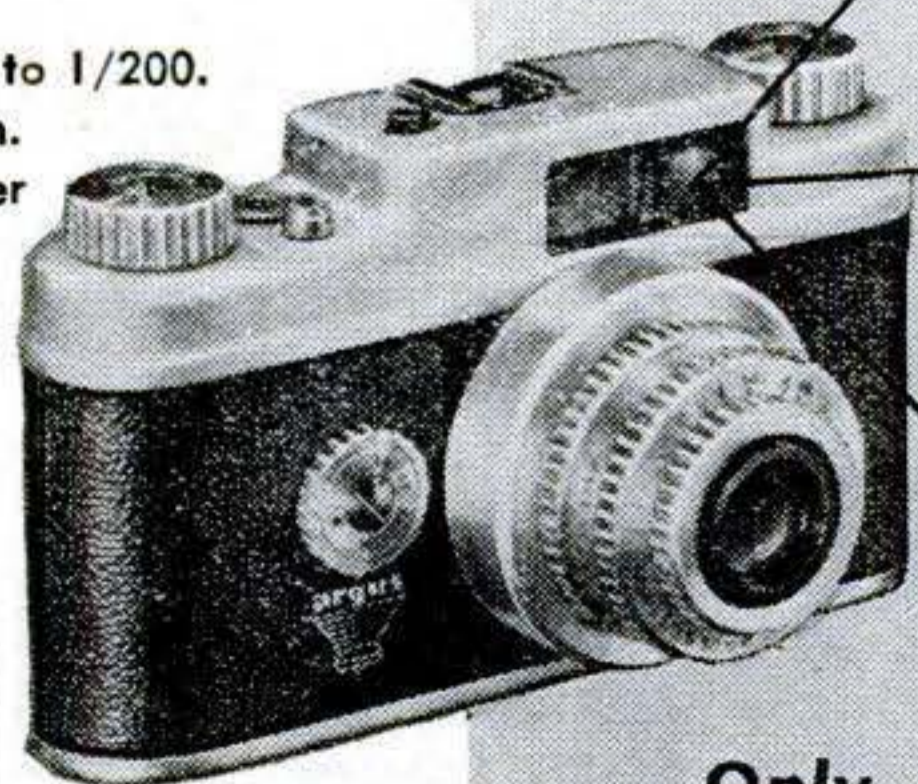

FASTER!—"Markfinder's" center cross-mark lines up subject fast and keeps you with it for better action shots.

MORE!—You see more with "Markfinder", because area covered is 25% more than appears on film. Improves composition.

EXACTLY!—You see exactly what your lens sees when you use Model 21 with "Markfinder", so you know you always get it.

Only Argus has "Markfinder"

Why Wait?

**QUALITY TOOLS ARE
A GOOD BUY NOW**



One of Plomb's popular $\frac{3}{8}$ " Drive Socket Sets for efficient nut turning.

Great volume enables Plomb to give you higher quality tools—at prices close to pre-war levels. That's why it will pay you to buy the tools you need *now*—to make your set complete and up-to-date. Get them from your Plomb dealer today. Write for catalog to Plomb Tool Company, 2257 H Santa Fe Avenue, Los Angeles 54, California.

PLOMB
streamlined
TOOLS

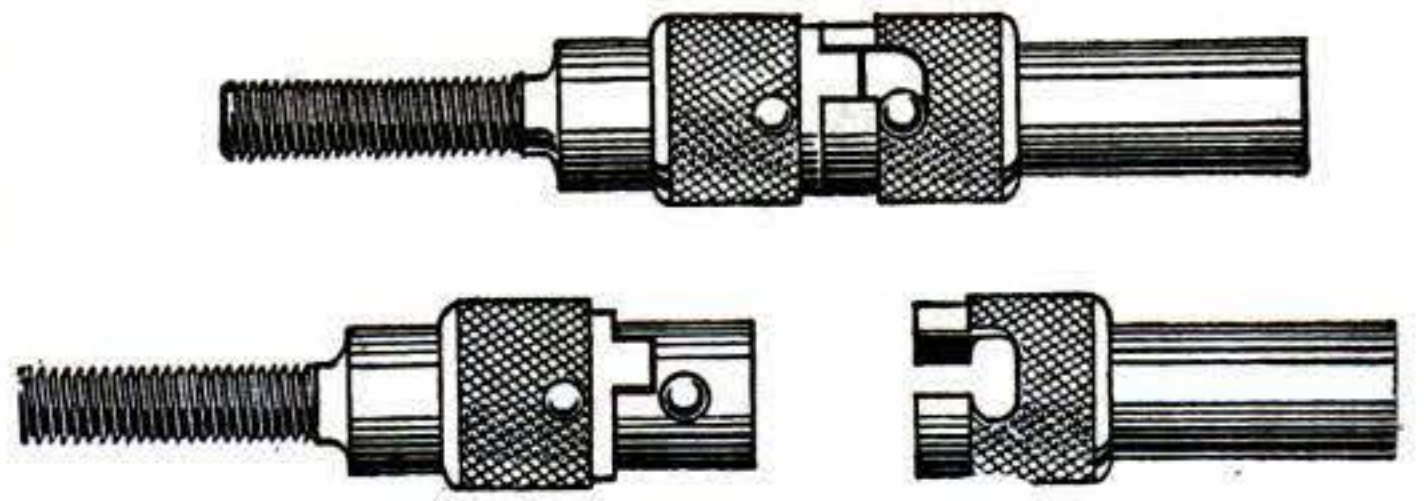

Quick Disconnect Unit

THESE little gadgets speed the installation and removal of aircraft engines. Called Purdy Quick Disconnects, they replace clevis pins, bolts, nuts and locking wire. A slight twist opens or closes the locking collar. Distributed by Durham Aircraft Service, they have CAA acceptance for use on civilian planes.

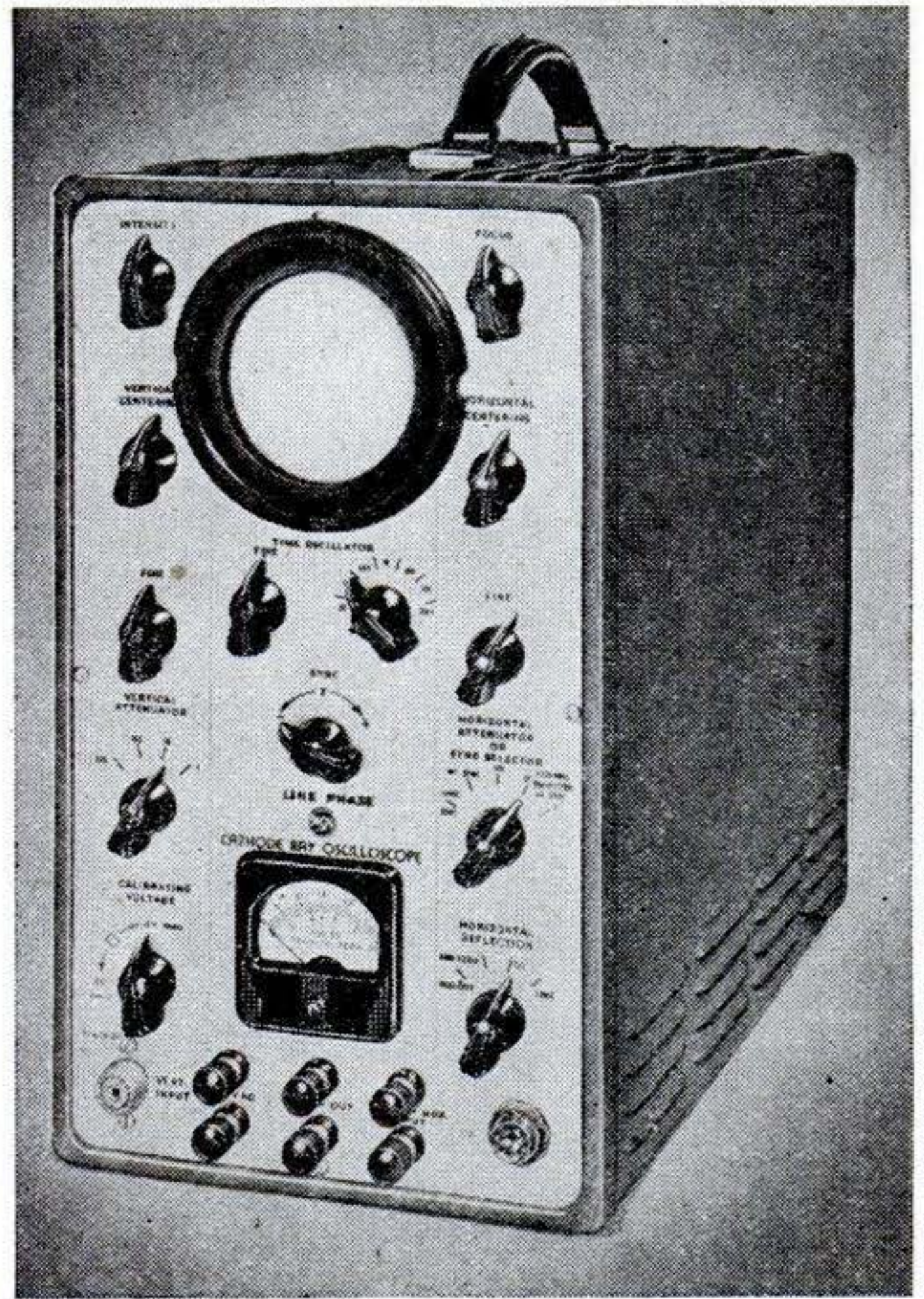

Portable Oscilloscope

RCA's new portable oscilloscope is said to be the first three-inch type to meet laboratory accuracy requirements. Incorporating many advantages of expensive research instruments, it is designed for detailed observation and accurate measurement of the extremely short, sharp-fronted pulses produced by television circuits, ignition systems, pulse generators and the like. The unit shown, model WO-79A, weighs 42 lb.

AUTO-LITE "Plug Tips"

Have you ever checked the Heat Range of your Spark Plugs?

THE HEAT range of a spark plug can be varied through such design factors as length of firing tip, insulator material, volume distribution in the firing end of the plug and material used in electrodes. Make sure your spark plugs are of the correct heat range for your engine. Auto-Lite spark plugs operate for any throttle range and load. Spark Plugs of correct heat range and a "Plug-Chek" at regular intervals using the Auto-Lite "Plug-Chek" Kit, will help stop power loss, gas waste and spark plug trouble. Mail the coupon today for the Auto-Lite "Plug-Chek" Kit which quickly helps you find spark plugs that are causing trouble or are of incorrect heat range. All you do is match plugs with pictures on the "Plug-Chek" Indicator—each example refers to a page in the "Plug-Chek" Data Book that shows you what needs to be done.

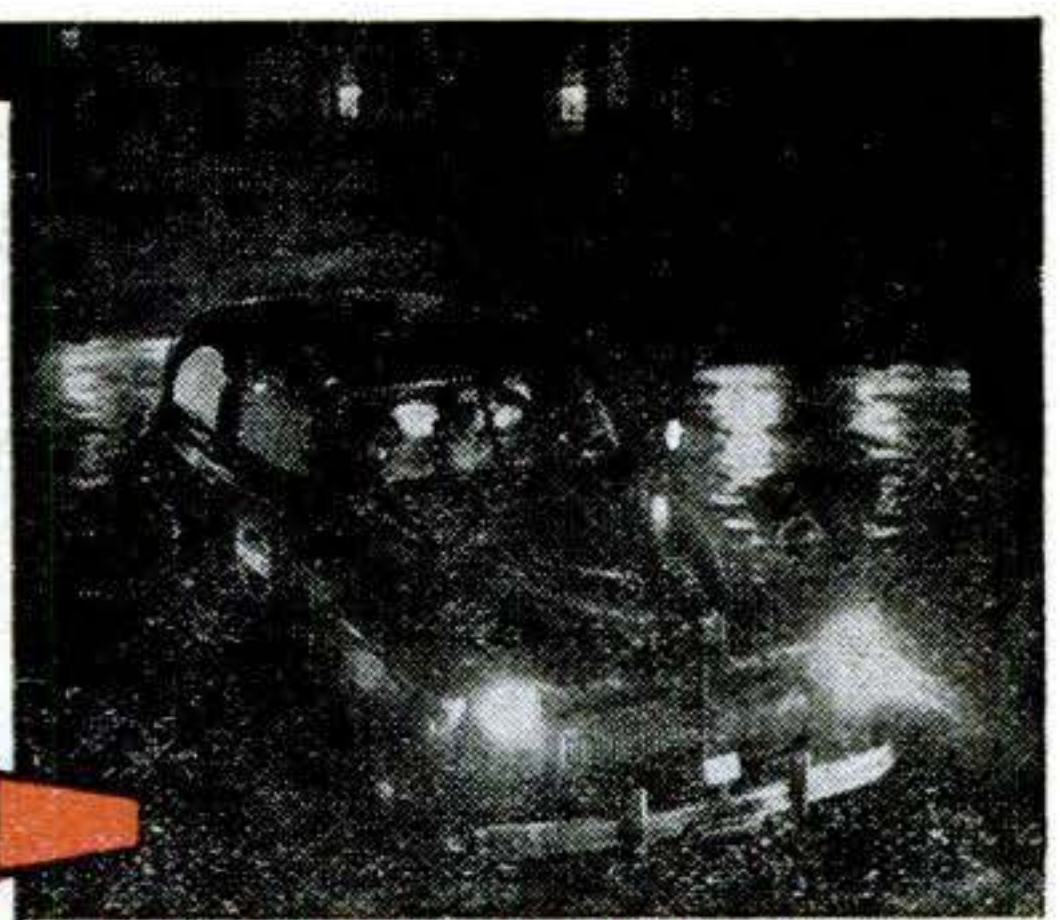
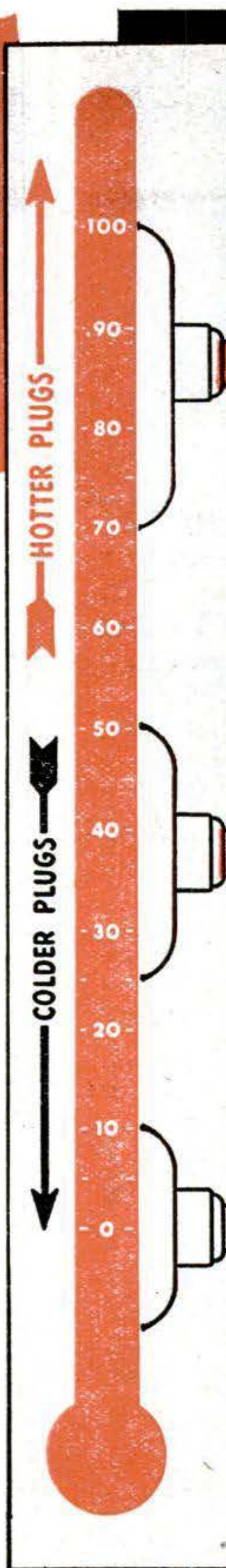

STOP-AND-CREEP DRIVING—Police cars, hearses, door-to-door delivery vehicles, etc. that have long periods of idling usually require a hot plug to prevent fouling.

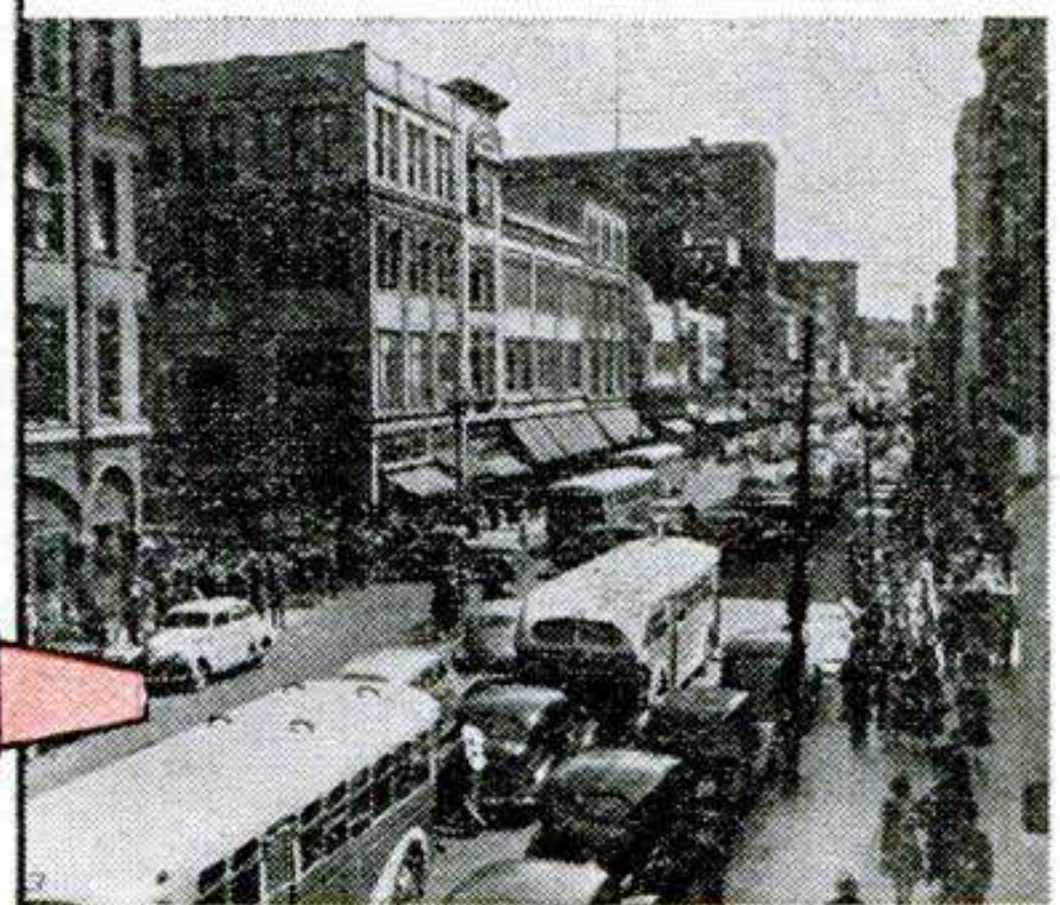

AVERAGE DRIVING—The plug normally specified is of the proper heat range to handle all requirements under average driving conditions where the car is in reasonably good condition.



CONSTANT HIGH SPEED—Cars required to operate for long periods at high speed usually use colder plugs than normally specified, for best results.

Send for Auto-Lite "Plug-Chek" kit...only 10¢!

THE ELECTRIC AUTO-LITE COMPANY, Department PS4, Toledo 1, Ohio
Enclosed find ten cents for the Auto-Lite "Plug-Chek" Kit that includes both the "Plug-Chek" Indicator and Data Book.

Name _____

Address _____

City _____

Switch to
AUTO-LITE
SPARK PLUGS

Ta-pat-co Brings You



New Outdoor Comfort IT TOOK **TA-PAT-CO** "KNOW-HOW"

—to bring you this handsome, all wool, full-cut sports shirt with roomy man-size pockets. The soft, comfortable collar is worn open or snugged down. See it in your favorite color at your sporting goods store—you'll agree it's every inch a man's shirt.

It took Ta-pat-co *know-how* to design this hunting coat, with full width game pocket, and quick easy access for removing game, cleaning and airing the blood proofed lining. Pockets galore—flap-protected shell loops—special water proofing across shoulders, cut bi-swing for freedom of action.

New Ta-pat-co Game Bag

—one big pocket across the back holds your limit—two roomy flap covered side pockets hold shells, lunch, etc. Wide comfortable adjustable shoulder straps evenly distribute the weight. Snap fasteners on back pocket and in front hold the bulk down, make it fit snugly. Tough and snag resistant—it slips easily through the brush. You can't beat it for field shooting or hiking. See it at your dealers.



DON'T MISS IT—GET YOUR COPY OF THIS BOOK
How to call ducks without a call... how to kill a rabbit without a gun... how to boil water in a wooden bucket... get the answers to these and hundreds of other questions that make outdoor sports more pleasant and successful. Printing limited—be sure to get your copy—send 10c in coin or stamps now to—

THE AMERICAN PAD & TEXTILE CO.
Dept. _____ Greenfield, Ohio
CANADIAN BRANCH—CHATHAM, ONTARIO

NEW **WHIZZER** "STATION WAGON" DOUBLES YOUR BIKE'S USEFULNESS

Only
\$14.95

F.O.B. PONTIAC, MICH.

SPECIFICATIONS—Rated over 200 pounds capacity. Strong steel undercarriage, natural finish wood "station wagon" sides. Semi-pneumatic 10-in. tires, 24" long, 18" wide, 20" deep.

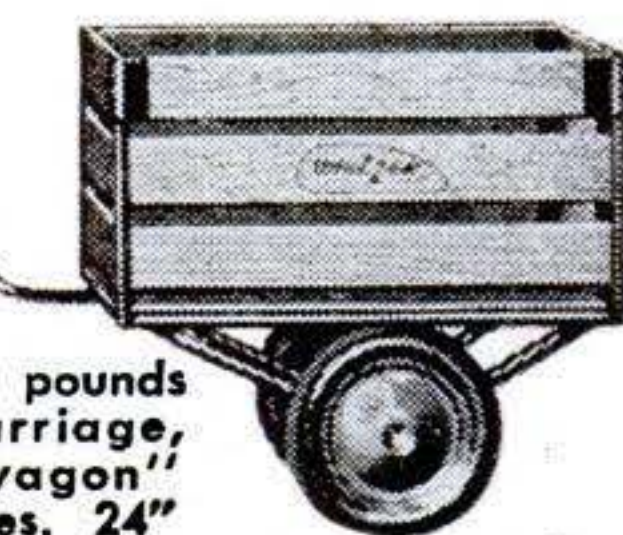

Here's a great new bike trailer that's built to last. What's more, the extra-light, extra-strong **WHIZZER "Station Wagon"** fits *any* bike. Full swivel hitch. Quickly attached and detached... makes an ideal hand cart around the yard and for shopping in stores. Carries bulky loads easily, safely... does not affect balance or control of bike. For low-cost delivery... drug stores and groceries... paper routes... personal shopping—get a **WHIZZER "Station Wagon"** today! Ideal for week-end trips and summer camping. Comes in knock-down package form.

See your local bike dealer or order from
WHIZZER MOTOR SALES CO.
PONTIAC, MICHIGAN

MAKE DOWELED DOORS



on your shaper with our high speed steel—pattern ground—shaper knives 1 1/8", 1 3/8", and 1 3/4" for O. G. Cove and bead doors. 4 knives: 2 coping and 2 sticking, priced at \$19.44. 2 1/4" over all length. Prompt shipments—also other knives. Send 10c for Catalog.

WOODWORKERS TOOL WORKS
QUINCY & JEFFERSON CHICAGO, ILLINOIS

\$2.95



TORNADO GAS TORCH

The Modern Way of Soldering

Ideal for hard and soft soldering. Will heat quickly; solder will flow freely and smoothly. No compressed air required. Self-adjusting. Safe. Economical. Can be used for annealing small parts and bending metal parts. Generates a heat of 1700° F. Simply connect to any illuminating gas jet with a rubber hose and operate. Tornado Torch No. 119 comes

with three tips, (1/8", 1/4", 3/8" blast).
Tornado Gas Torch No. 119—Complete with 2 tips, for Natural Gas or Bottled Gas; with 3 tips for Manufactured Gas. \$2.95 per set. See your dealer or order direct. Send check or money order—post paid.

Robco Corporation, 204 E. 44th Street, New York 17, N. Y.



See and Hear

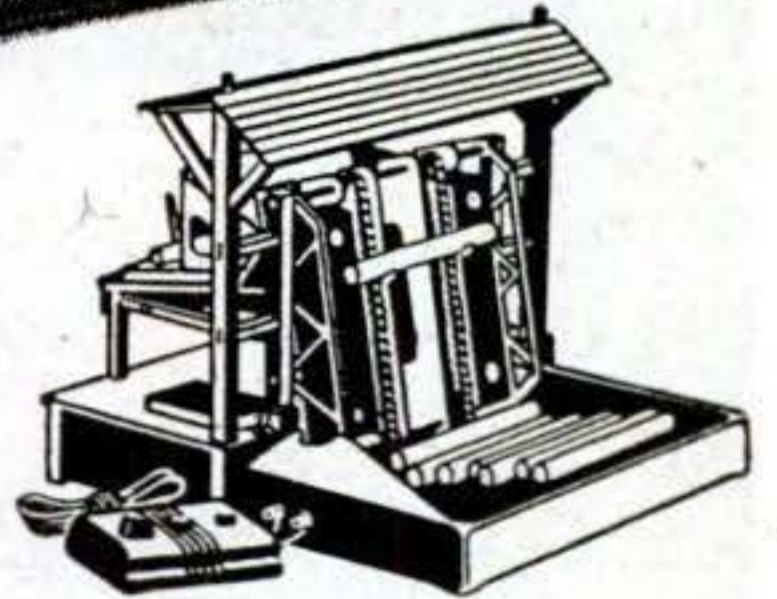

LIONEL TRAINS in Action

This year not alone do we offer you the 32-page full color catalog, but we have provided a Sound Effects Record as well so you can HEAR LIONEL Trains whistle, and thrill to the excitement of LIONEL model railroading. The new LIONELs are simply out of this world. See them! Hear them!



SPECIAL OFFER —

For 25c we'll send you the 32-page full color catalog, the sound effects record with narration by Bill Stern, famous Sports Commentator, also a 32-page "FUN With LIONEL" book, a R.R. Guide Wall Chart, and an ideal layout Blue Print. It's a grand package!

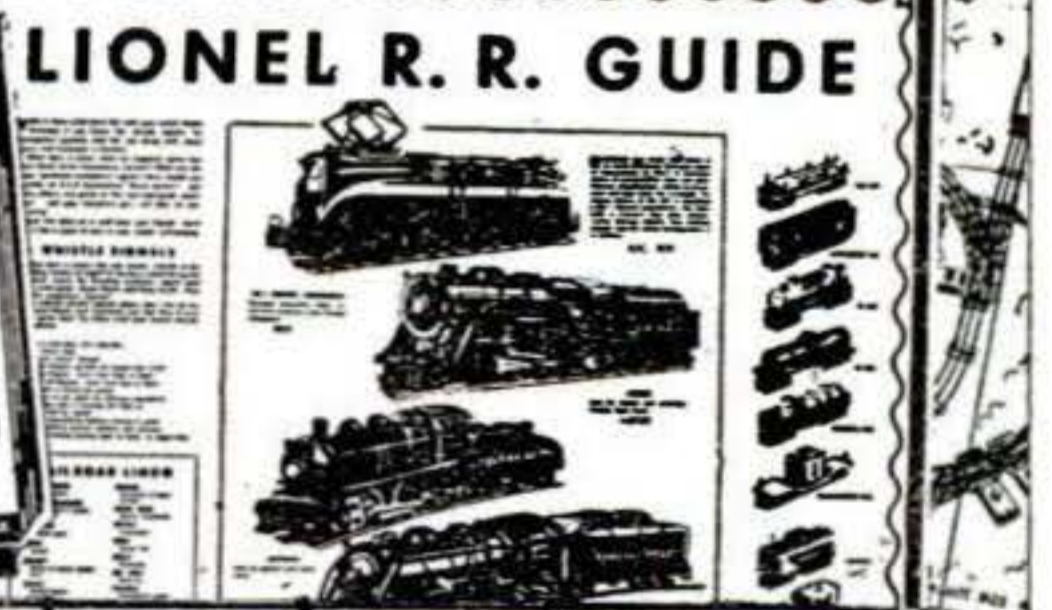

HEAR THEM —

Not alone can you see the LIONEL Trains in the catalog, but you can HEAR them in action on the 4-inch record.

LIONEL TRAINS
Box No. 419, Madison Square Station, New York 10, N. Y.

Please send me offer checked below. Complete special offer of Catalog, Sound Effects Record, Fun Book, Wall Chart, and Ideal Layout—all for 25c.

I enclose 25c for Special Offer.

I enclose 10c for catalog only.

NAME _____

CITY _____ ZONE _____

STATE _____

LIONEL

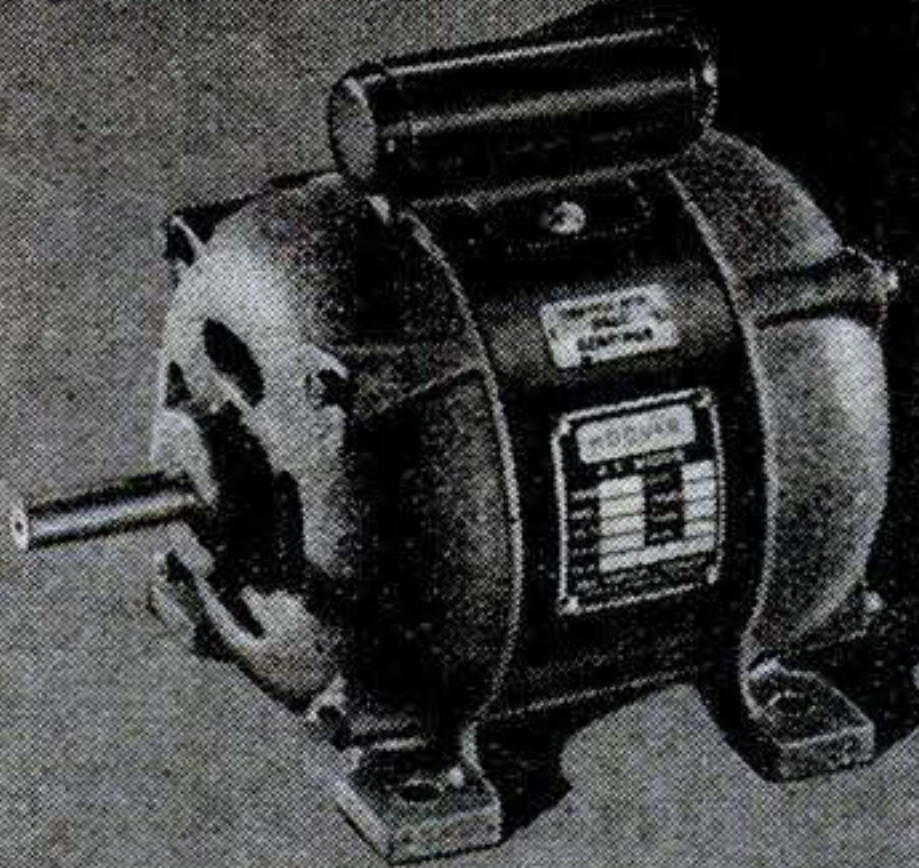

The New **HOOVER**
Fractional Horsepower Motors

Compact, power-packed
watch-like precision,
work-horse stamina.
Made by the manu-
facturers of the
world-famous
Hoover Cleaner.



The Hoover name on the new Hoover Motors is your assurance of the finest in fractional horsepower motors.

The new Hoover Motors are designed with the same electrical engineering skill and know-how that have produced more than 6 million Hoover Cleaners.

FEATURES OF THE HOOVER MOTOR

Induction run . . . single phase . . . 60 cycles . . . 1725 R.P.M. . . . heavy duty . . . built for continuous operation.

Capacitor start . . . more than 300% full load starting torque with minimum current flow.

No vibration or "shift" . . . integral feet, carefully machined to give solid mounting and quiet operation.

Low temperature . . . electrical and mechanical design for low-temperature operation. Ventilated open type. 40° C. Rise.

Laminated steel rotor . . . carefully ground and balanced for maximum efficiency.

Centrifugal starting switch . . . built for trouble-free operation.

High-grade ball bearings . . . sealed against dust and grit, give smooth performance and long wear.

Rotation . . . clock or counterclockwise.

POPULAR USES OF HOOVER MOTORS

Lathes . . . 

Jig saws . . . 

Drill presses . . . 

Bench saws . . . 

Sanders 

Planers 

Hobby shops

Garage tools

THE HOOVER COMPANY

Electric Motor Division, North Canton, Ohio

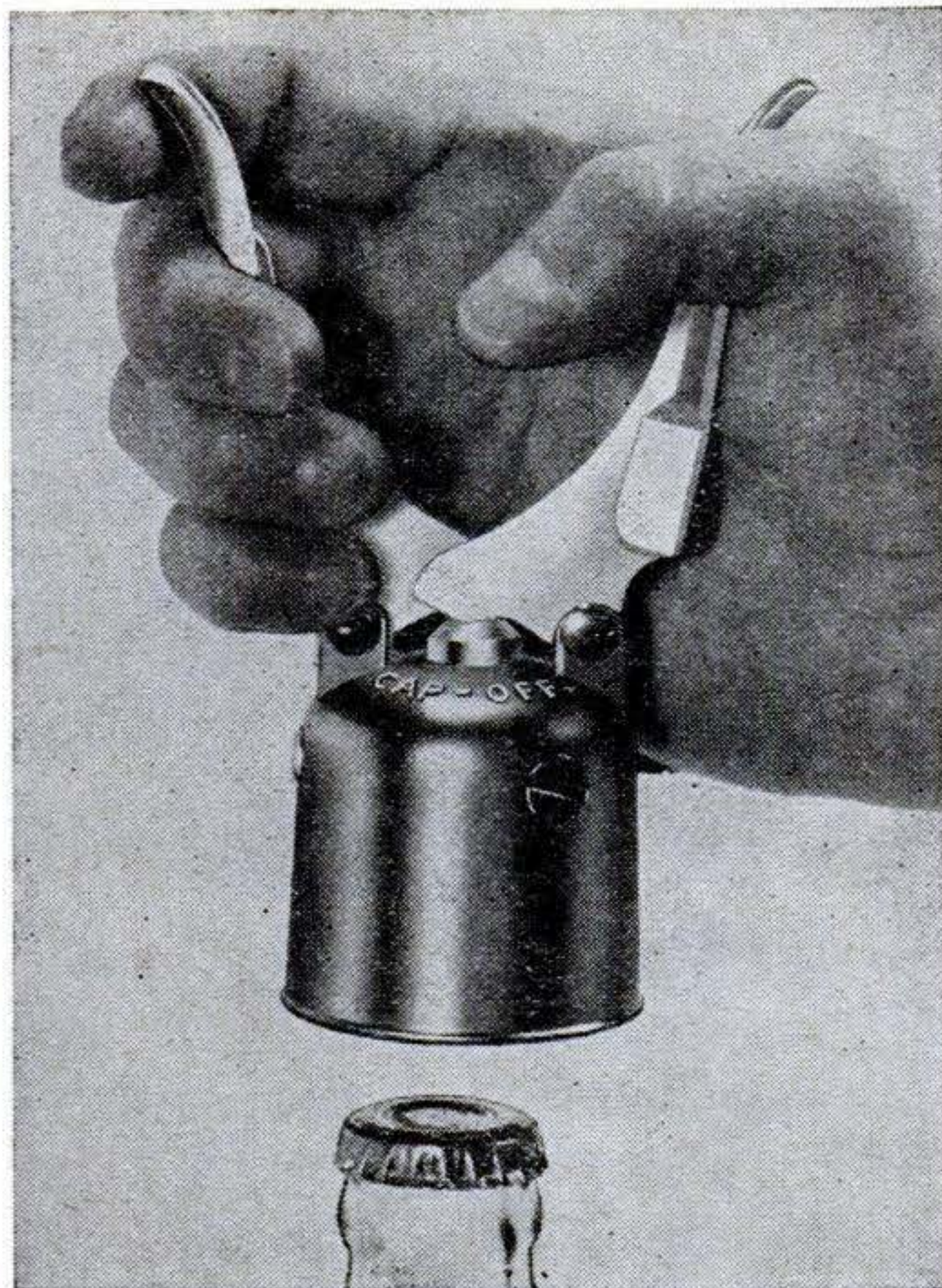

"Squeeze" Bottle Opener

DEPARTING from the "pry" principle of getting caps off bottles, the Eagle Lock Co., of Chicago, has devised an opener that fits down over a cap and levers it off when pressure is applied to upright handles. The opener grips the cap until shaken free.

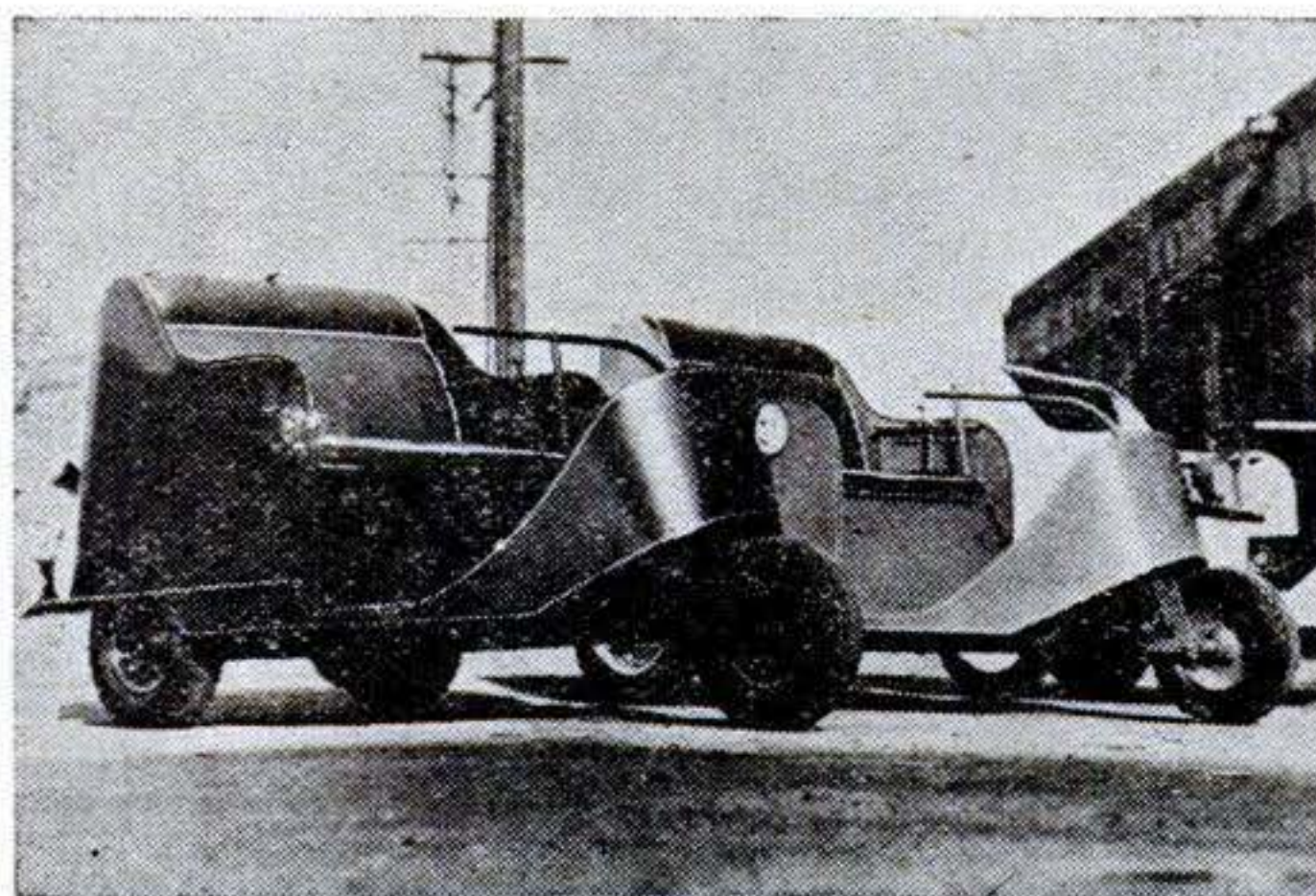

Laminated-Plastic Body

A ONE-PIECE body section of laminated plastic has recently replaced the original all-steel frame of the "Autoette," an electric runabout used in industrial plants during the war and later converted for personal use. The body, constructed of Fiberglas and Laminac resin, is molded into its curved shape over an inexpensive form.

You change blades in a flash with the modern

Gillette

ONE-PIECE RAZOR

SHAVING is mighty quick and easy when you use a modern Gillette One-Piece Razor. There's nothing to take apart or put together. You change blades in jig time. Twist . . . the razor opens. Twist again . . . your blade's locked in position. For cleaning both razor and blade just loosen the holder, rinse and shake.

Enjoy utmost shaving comfort and convenience. Get a superb Gillette Aristocrat or Gillette Milord One-Piece Razor. They're the finest shaving instruments money can buy!

Gillette Safety Razor Co.
Boston 6, Mass.

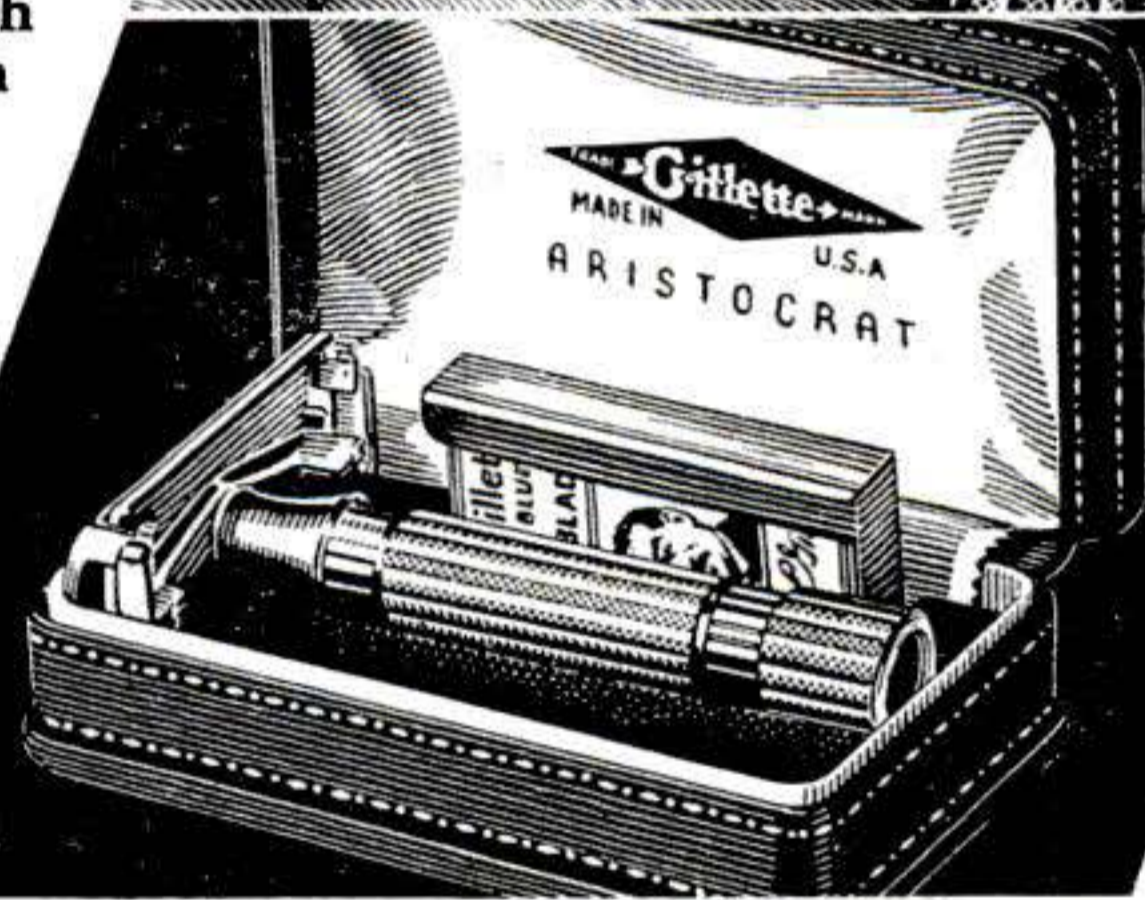

Gillette Aristocrat One-Piece Razor, gold plated, \$379
with case and ten Gillette Blue Blades

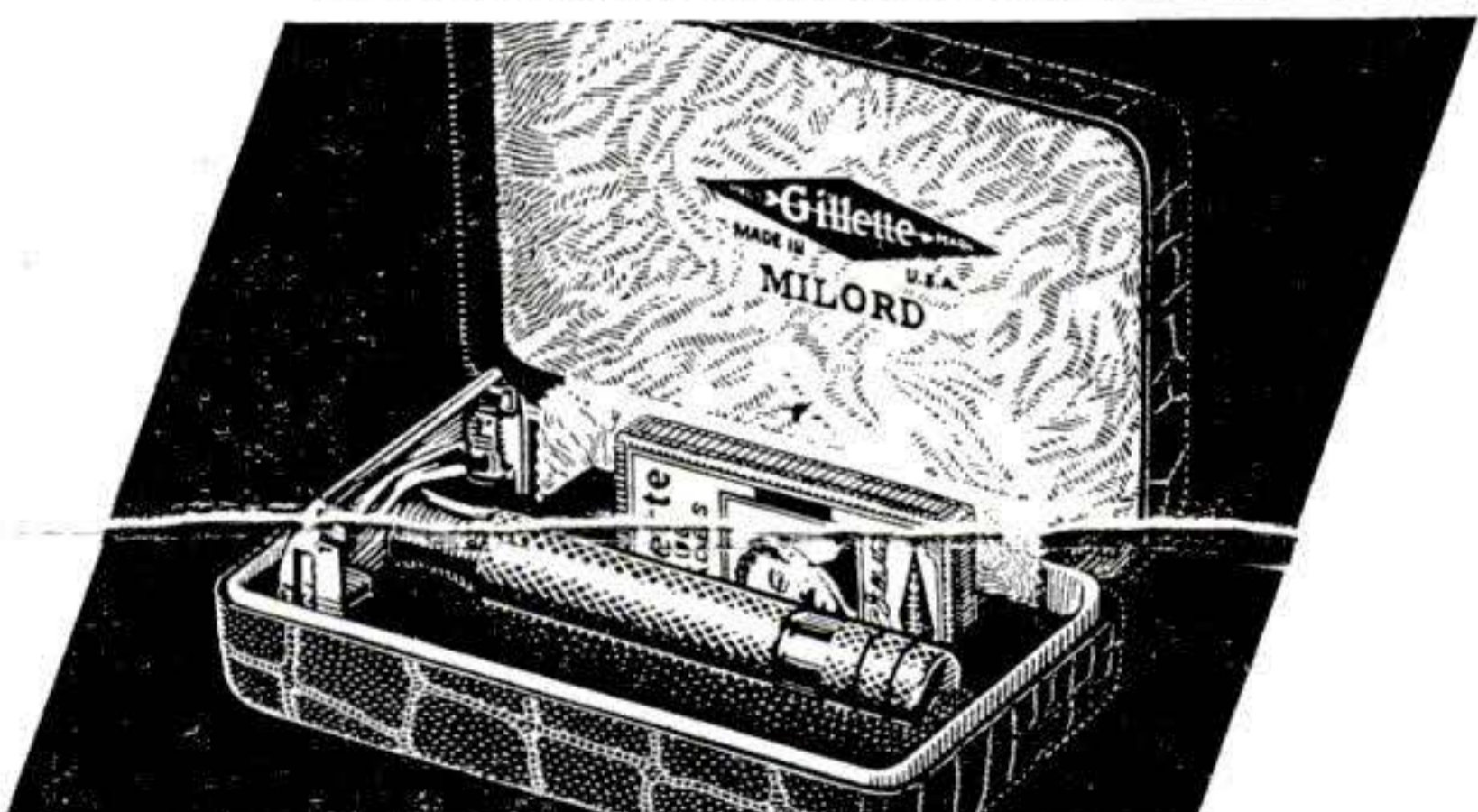

Gillette Milord One-Piece Razor, gold plated, \$250
with case and five Gillette Blue Blades

Copyright, 1947, by Gillette Safety Razor Company

look SHARP! feel SHARP! be SHARP! use Gillette Blue Blades

WITH THE SHARPEST EDGES EVER HONED



Put Skill In Your Hands with **STANLEY CHISELS**

● A few cents extra for Stanley quality in chisels is the biggest tool bargain you can buy. It gives you a blade forged from the finest high carbon chisel steel. Keen cutting edge even after many sharpenings . . . all the way back to the shank. The whole blade is heat treated and tempered to hold a keen edge. Individually tested for temper. Available in a wide variety of types, with hickory handles leather capped or with composition handles. They're a lot of chisel for the money.



Two books that increase your pleasure in tools

The first one's free . . . "The Joy of Accomplishment," an introduction to tools with many helpful suggestions. The other, the famous Stanley textbook, "How To Work with Tools and Wood," clothbound and plentifully illustrated, costs just \$1.00.

STANLEY THE TOOL BOX OF THE WORLD

Stanley Tools, 297 Elm St., New Britain, Conn.
Please send by return mail —

- The **FREE** booklet: "The Joy of Accomplishment."
 188-page book: "How To Work with Tools and Wood."
 \$1.00 enclosed plus state or city sales tax.
 (In Canada: Send order to Stanley Tool Co. of Canada, Ltd., Roxton Pond, Quebec.)

Name

Address

City State

No other tool like it!
BURGESS
vibro-tool
Trade Mark Reg. U. S. Pat. Off.

Writes on . . .

Watches	Costume Jewelry
Glassware	Pots and Pans
Tools	Sporting Equipment
Leather	
Plastics	

\$7.50

Engrave your name . . . etch letters or designs . . . place permanent identification marks on anything with this unique hand tool. Carves wood and linoleum, cuts cardboard and balsa, tools leather. Just plug in on any 110 volt AC line. No home shop is complete without a Burgess Vibro-Tool. See your dealer or write for information.



DELUXE KIT

Vibro-Tool complete with 22 attachments in handsome, polished wood chest. . . . \$16.50

BURGESS BATTERY COMPANY
 HANDICRAFT DIVISION
 LAKE ZURICH, ILLINOIS

\$\$\$ if trained in arc welding

Big income jobs await you. Learn quickly and thoroughly. Enroll under G. I. Bill. Write today.
 Hobart Trade School, Inc., Box P-563, Troy, O.

148 PAGE **WOODWORKERS** CATALOG

ONLY 15 CENTS-REBATED ON FIRST ORDER

SHOWS IN NATURAL COLOR

- 22 inlay and overlay insets
- 32 veneer bandings—matched woods
- 30 kinds of world's finest woods in character grains and color
- 31 mouldings, rosettes, ornaments and home wood working labor-saving tools and hard-to-find hardware.

LISTS OVER 300 PIECES OF ARTISTIC FURNITURE SHOWN including cost of plans, lumber, hardware and finishing material. Choice of MAHOGANY, WALNUT, BIRCH or MAPLE LUMBER—PLYWOOD—VENEERS. UN-EQUALLED BARGAINS.

CRAFTSMAN WOOD SERVICE CO.
 2729 S. Mary St., Dept. B-85, Chicago 8, Ill.

Make beautiful furniture at only 20% store prices.

Get an Electric **FREE** SOLDERING IRON and assemble your own . . .

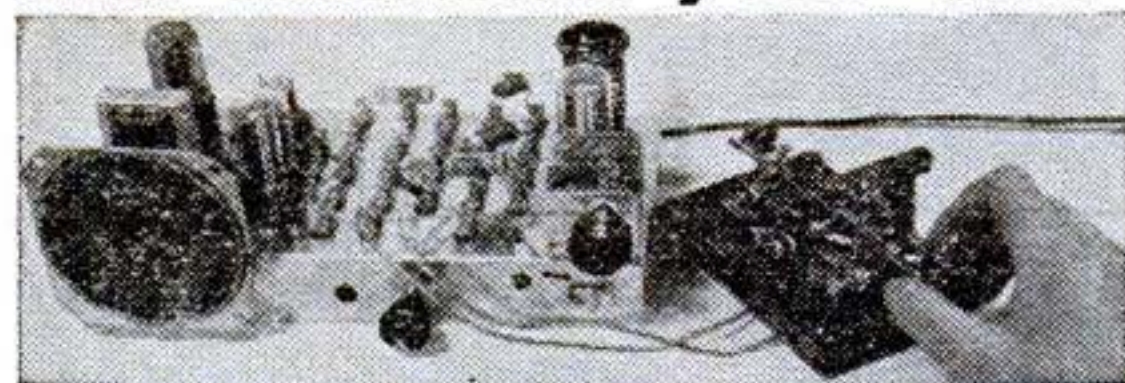

Magi-Klips Kit

This is the same MAGI-KLIPS Radio & Electronic Experimenter's Kit—complete with all parts—that we sell ready assembled for \$29.75.

In knocked-down form with full instruction for assembly, it is now offered at the new low price . . . **\$19.75** complete with an Ungar Electric Soldering Iron—ideal for wiring your unassembled MAGI-KLIPS Kit.

Send for your copy of **FREE** booklet, "Electronics Made Easy."

DEER & TAYLOR COMPANY
 Dept. M, 1340 Milvia St. Berkeley 9, California



No. 69 \$11.80
1/4" Drill

Light in weight, convenient and handy, this improved drill has a special aligning grip that makes straight drilling natural. Backed by 35 years of electric drill manufacturing, produced in great quantities by modern methods, this is today's best drill buy. For every day farm, garage, construction and maintenance use, you can't get a better drill at any price. Specially wound, long life, high torque, fan-cooled motor.

Cut steel gears, self-lubricating bearings, sturdy die cast case and a full sized snap action chuck (no key to lose). With a No. 209 Drill Stand, the 89 Drill makes a capable lever operated drill press. Order from your local Speedway dealer.



No. 229
Drill Stand
(Less Drill)
\$5.25

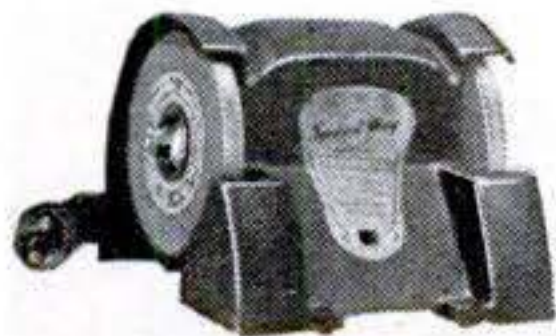

No. 117
Grinder
\$14.95

SPEEDWAY MANUFACTURING CO.
1864 S. 52nd Ave., Cicero, Ill.

NEW! EASIER, FASTER, STRONGER OUTDOOR PROJECTS



with Easi-Bild* Patterns and
CASCOPHEN Resin Glue

"Easi-Bild Full-Size Patterns" take the mystery out of making things.

Just trace the pattern on the wood, saw it out and glue it together. There are 94 projects for furniture, toys, gifts, buildings, home needs.

And the designers of Easi-Bild Patterns recommend CASCOPHEN Resorcin Resin Glue for assembly of all outdoor projects. CASCOPHEN makes permanent waterproof, heatproof, mold-proof bonds. The *only* completely durable glue for home use!

Prove it yourself. See how easy it is to make better projects this new way. Start with the "Project of the Month," No. 32 Lawn Chair, shown above. Mail this coupon now!

*Trade-mark © 1947, Easi-Bild Pattern Co.

CASCO Pattern Dept. PS9
P. O. Box 215, Pleasantville, New York
Enclosed is 25¢ for full-size Easi-Bild Pattern No. 32 and folder describing over 100 Easi-Bild Projects.

Name _____

Street _____

City _____ Zone _____ State _____

Casein Company of America
(Division of The Borden Company)

DUAL TAIL PIPE EXTENSION FOR YOUR CAR. \$2.95
DEEP TONE,
PRODUCED BY 2 1/2 IN. OUTLETS
Chrome Plated -- Fits All Cars
Postage Free on Money Order, Check or Cash
PAT. PEND. LYONS PRODUCTS Co. 2319 Ridgeley Dr. Los Angeles 16, Cal.

Portable Paint Sprayers

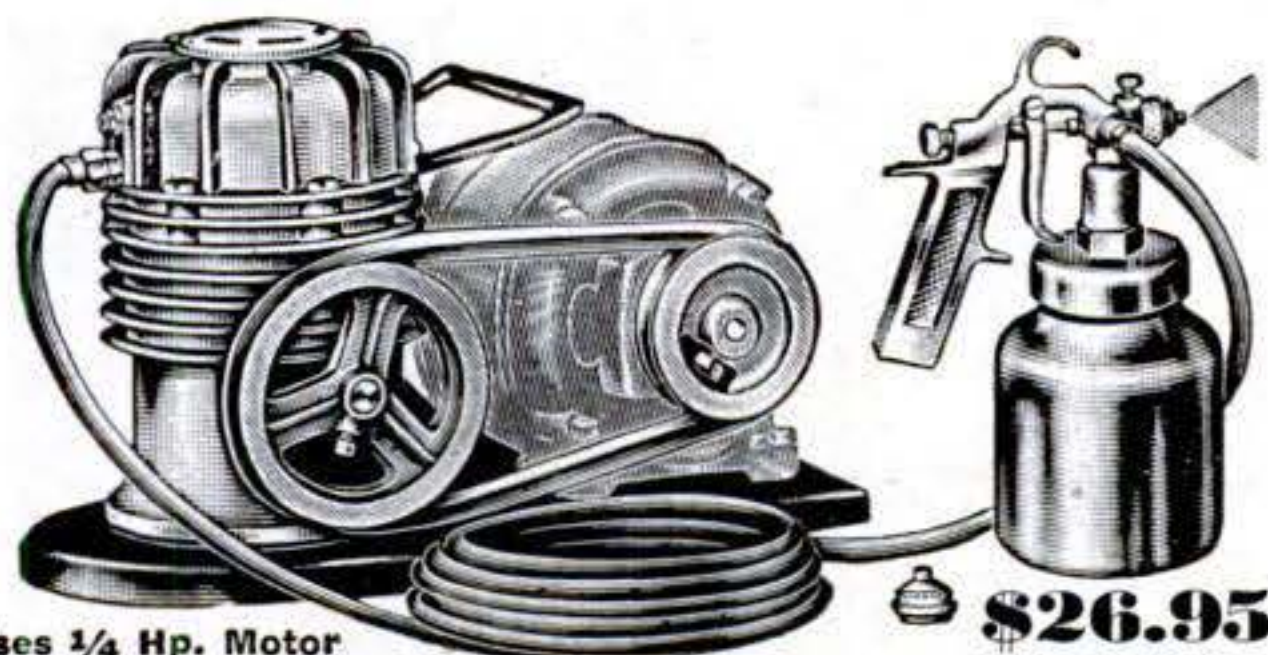

Uses 1/4 Hp. Motor

\$26.95

Complete as illustrated, less motor. Sprays all kinds of paint, lacquer, varnish, etc.... Oil-less ball bearing compressor, 2 cu. ft. air per minute. 15 to 50# pressure. Sprays paint 5 times faster than hand brushing.

No. 890. Outfit complete as shown with "V" Belt, motor pulley, 15 ft. high test air hose and No. 112 gun, but \$26.95 without motor.

No. 444. Outfit, Twin cyl. 4 cu. ft. production type gun, 15 ft. air hose, reg. and gauge. "V" belt and motor pulley. \$47.50 Uses 1/2 hp. motor. Complete less motor.

IMMEDIATE DELIVERY—Check or M.O. with order, shipped prepaid. Or we will ship C.O.D., plus charges.

Write for FREE Catalog today!

INDIANA APPLIANCE CO.

20 E. Sycamore Dept. PS-120 Evansville, Indiana

Have

Lovelier Floors...

with Less Care!

You'll enjoy new freedom with Self-Polishing SIMONIZ on your floors. The same durable long-lasting brilliance that makes SIMONIZ so famous for cars saves you lots of work . . . your floors clean up sparkling beautiful with a damp cloth.

Shines
as it
Dries



Self-Polishing SIMONIZ For Floors

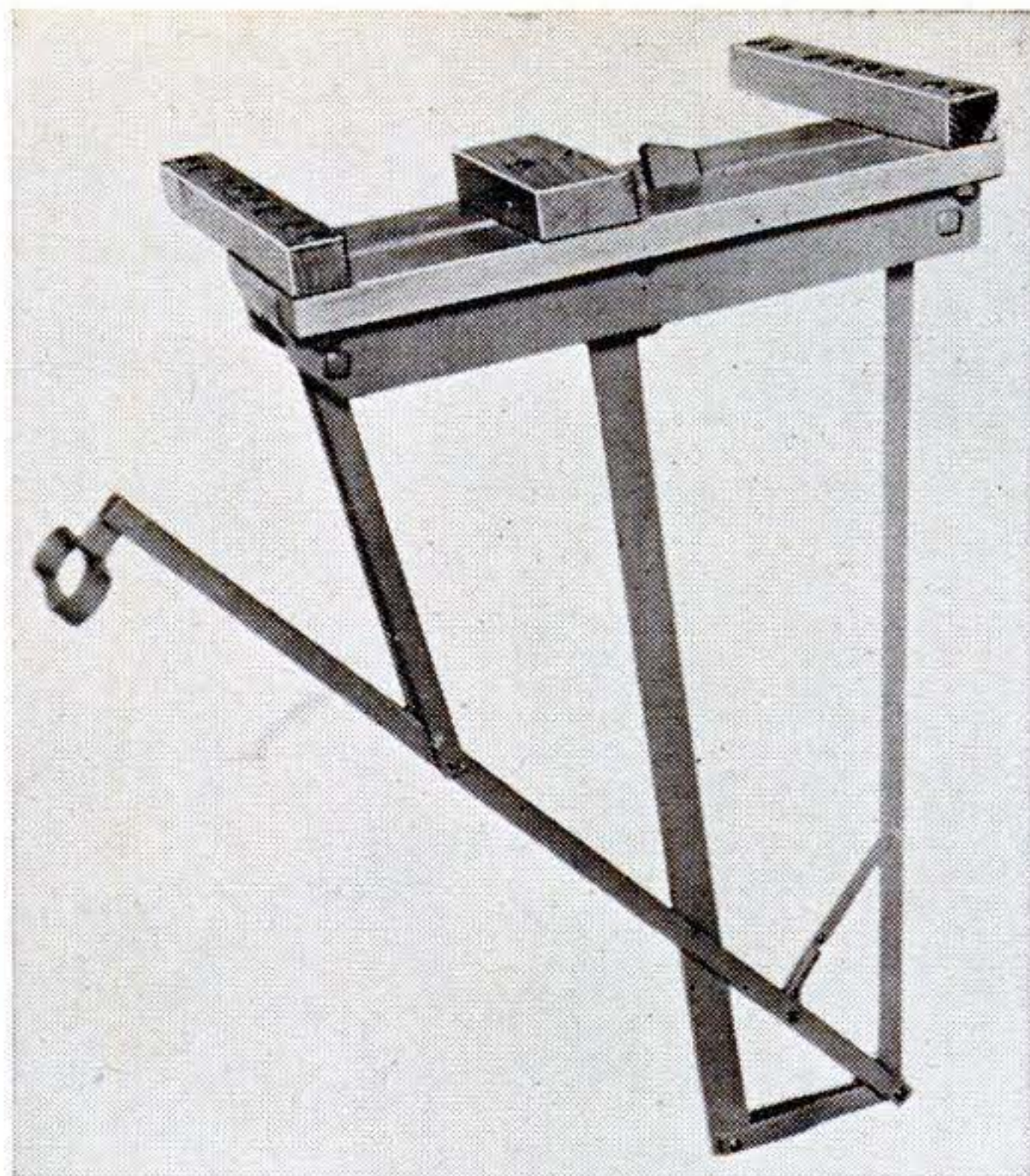

Lever Locks Vise

KNEE action closes and locks a lever-type vise, leaving hands free for adjusting material. Produced by P. A. Fleury & Sons, of Baltimore, Md., the vise is capable of holding stock up to 10 inches.

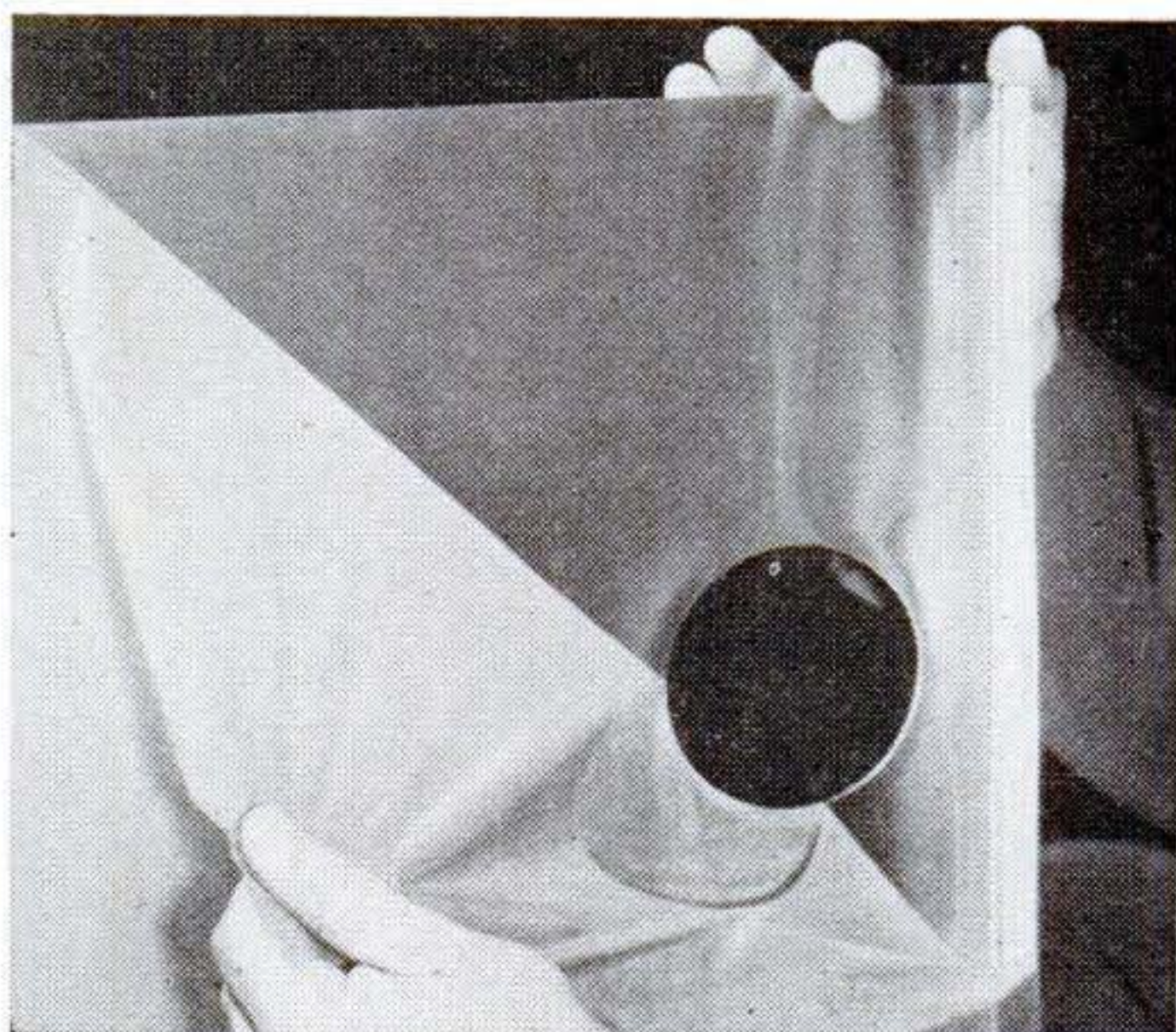

Plastic Guards Metals

A STRIPPABLE, plastic coating—the kind used during the war to protect machinery during shipment overseas—is helping metal industries to prevent corrosion. Brushed or sprayed on a surface, the coating dries quickly to a rubbery film that peels off easily. Developed by Eronel Industries, of Los Angeles, Calif., the protective finish resists abrasion, alkalies, acids and all atmospheric temperatures.

**NOW ADD
PRECISION
DRILL PRESS
OPERATIONS
TO YOUR SHOP'S
WORK RANGE**

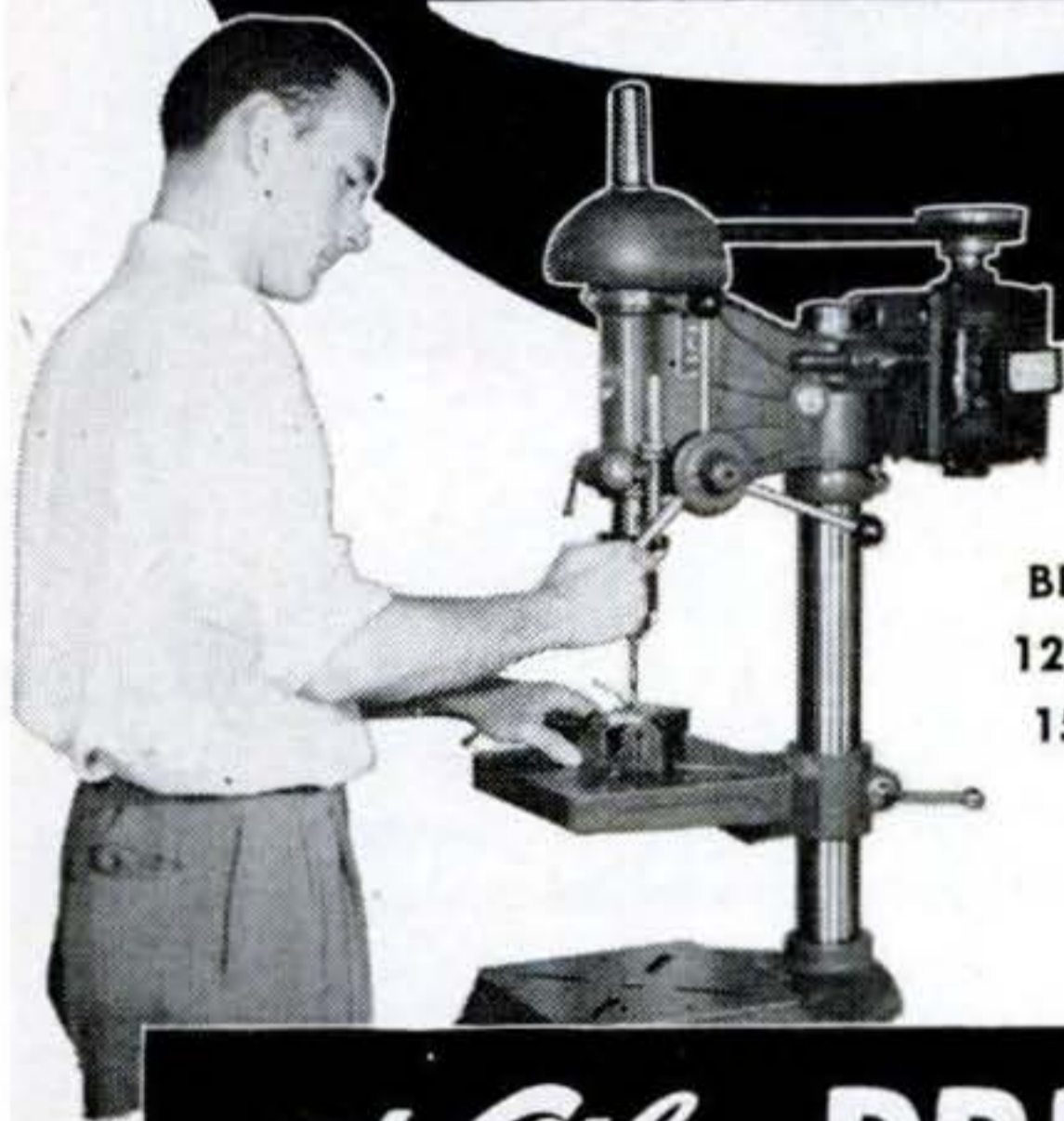

BENCH MODEL
12¾" — \$53.50*
15" — \$65.00*



FLOOR MODEL
15" — \$75.00*

**with Atlas DRILL PRESSES
AT LOWER PRICES!**

Now you can equip for the most productive winter you've ever had in your shop! Atlas drill presses are again available at your distributors — at prices near pre-war levels!

**Amazingly Versatile — Give You
10 Different Types of Work**

Here are some of the operations you can handle easily and quickly with any Atlas drill press and its low cost accessories: precision drilling, tapping, reaming, and routing in metal and plastics; mortise and tenon joints for tables, chairs, doors, book-cases, cabinets, storm windows, screens; inlaying carving, dovetailing, shaping, and drum sanding — *all important additions to the practical "capacity" of any shop.*

Industrial Precision for Your Home Shop

From its finely balanced pulleys to its solid base an Atlas drill press is built to give you rigidity, smoothness, and life-time accuracy. Head, column, table and base are extra heavy. Precision-ground table tilts 90° right or left. The exclusive Atlas "floating-drive" spindle design — with deep-grooved ball bearings — keeps the precision-ground spindle accurately aligned for smooth operation. Ask your Atlas distributor to show you the bench and floor types in his display room, or send for latest literature. Atlas Press Co., 955 N. Pitcher St., Kalamazoo 13D, Mich.

* Prices, less motor, F.O.B. Kalamazoo.

Atlas 4 TOOL TEAM



LATHES



MILLING MACHINES



SHAPERS



DRILL PRESSES

Now! tests prove-

BRIGHT

STAR

BATTERIES



give more
bright light
longer

Here is your proof!

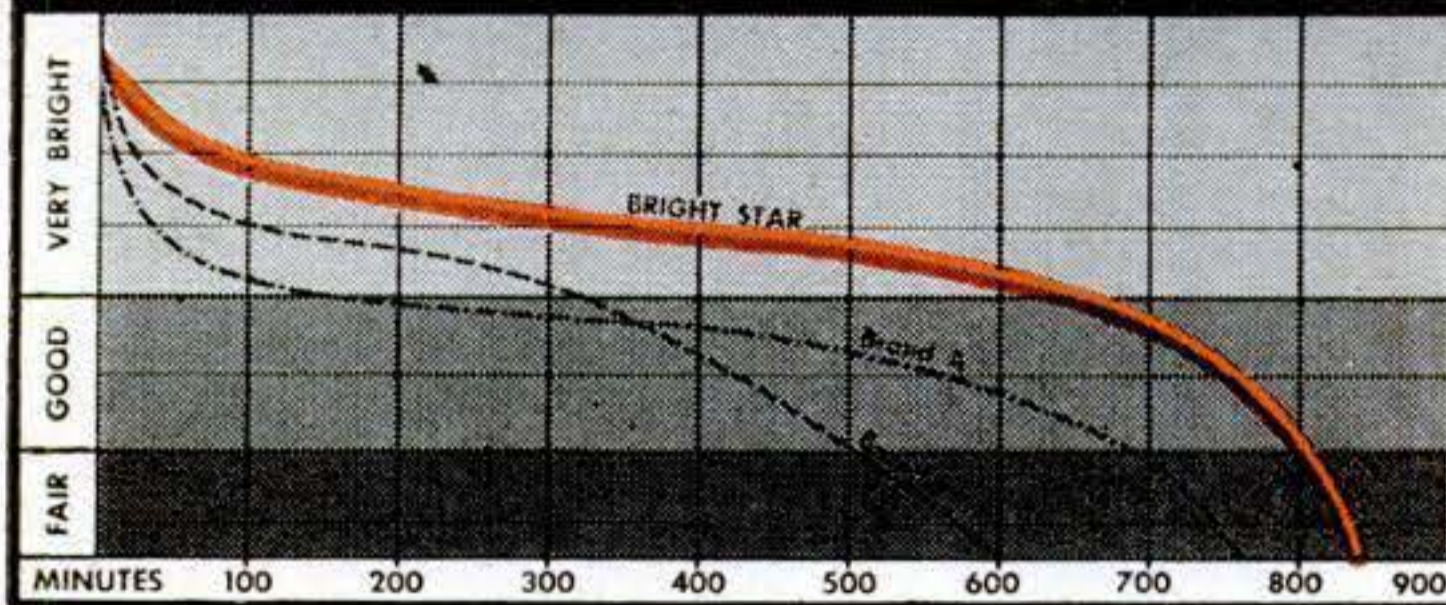

These results of vital service tests* prove that Bright Star batteries give you more *bright light* longer than two other leading brands tested. Insist on the best—it's Bright Star by test!

**Chart based on laboratory tests conducted in accordance with government standards.*

Ask for popular Bright Star model batteries.

BRIGHT STAR BATTERY CO., CLIFTON, N. J.

Fill Holes, cracks, dents, gouges...

These BETTER FILLERS

- HARDEN FASTER
- SHRINK LESS
- STAY IN!

FILLS HOLES IN ONLY 1 APPLICATION

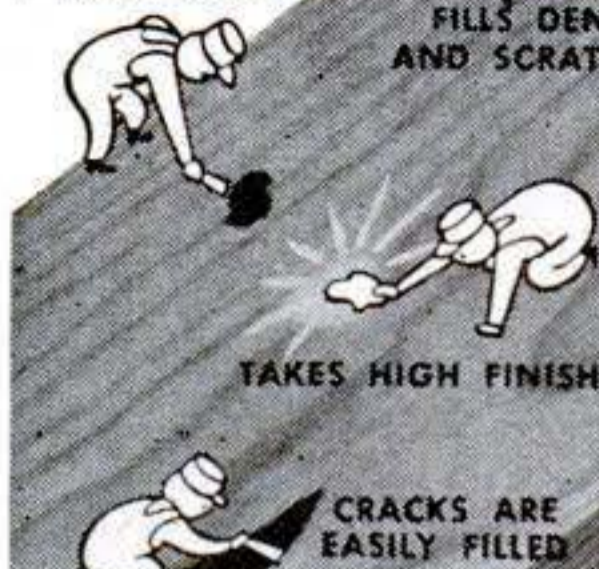

WEATHERPROOF WATERPROOF

SAW OR CUT IT

SAND OR POLISH IT

CRACKS ARE EASILY FILLED

Duratite Wood Dough will fill rough or irregular cavities in wood, metal, plastic or plaster in *one* application. (Duratite Surfacing Putty for shallow cavities). Can be sawed, cut, milled, sanded; are waterproof, fire resistant. Seven wood colors, in tubes or cans, at Hardware and Paint stores.

Only 25c for large tube of Wood Dough and interesting booklet. Write

LARGE TUBE 25c Postpaid

WEBB PRODUCTS CO.

232 South G Street, San Bernardino, California or Webb Company - Dept. S - Norcross, Georgia.



WOOD DOUGH AND SURFACING PUTTY

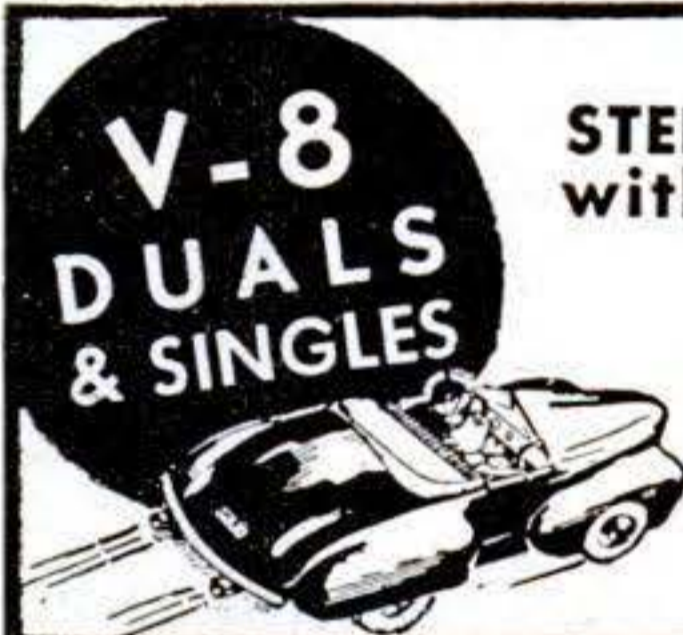

MUFFLERS

STEELS and ALUMINUMS with a motorboat tone

SINGLES, Chev, V-8, Plymouth, Steels \$5.50, Aluminum \$6.50. Chry., Olds., Buicks, etc., Steels \$7.50, Aluminum \$8.50. V-8 and MERCURY DUALS, Steel \$17.50, Aluminum \$20.00. Aluminums are guaranteed for life of your car.

DEALERS WANTED

SANDEE MUFFLER CO.

7523 S. WESTERN AVE., LOS ANGELES 44, CALIF.

Save Time and Money with this Press

Ten-ton press, ideal for all kinds of pressing, separating, straightening, and bending jobs. Ample capacity for home shops. Easily adjustable table takes work up to 18 inches wide and 11½ inches high. Roller-bearing ram for long life. Send for free bulletin showing press and wide variety of accessories.

UT-10A Press f.o.b. factory \$28.25



DAKE ENGINE COMPANY

622 Seventh Street, Grand Haven, Michigan

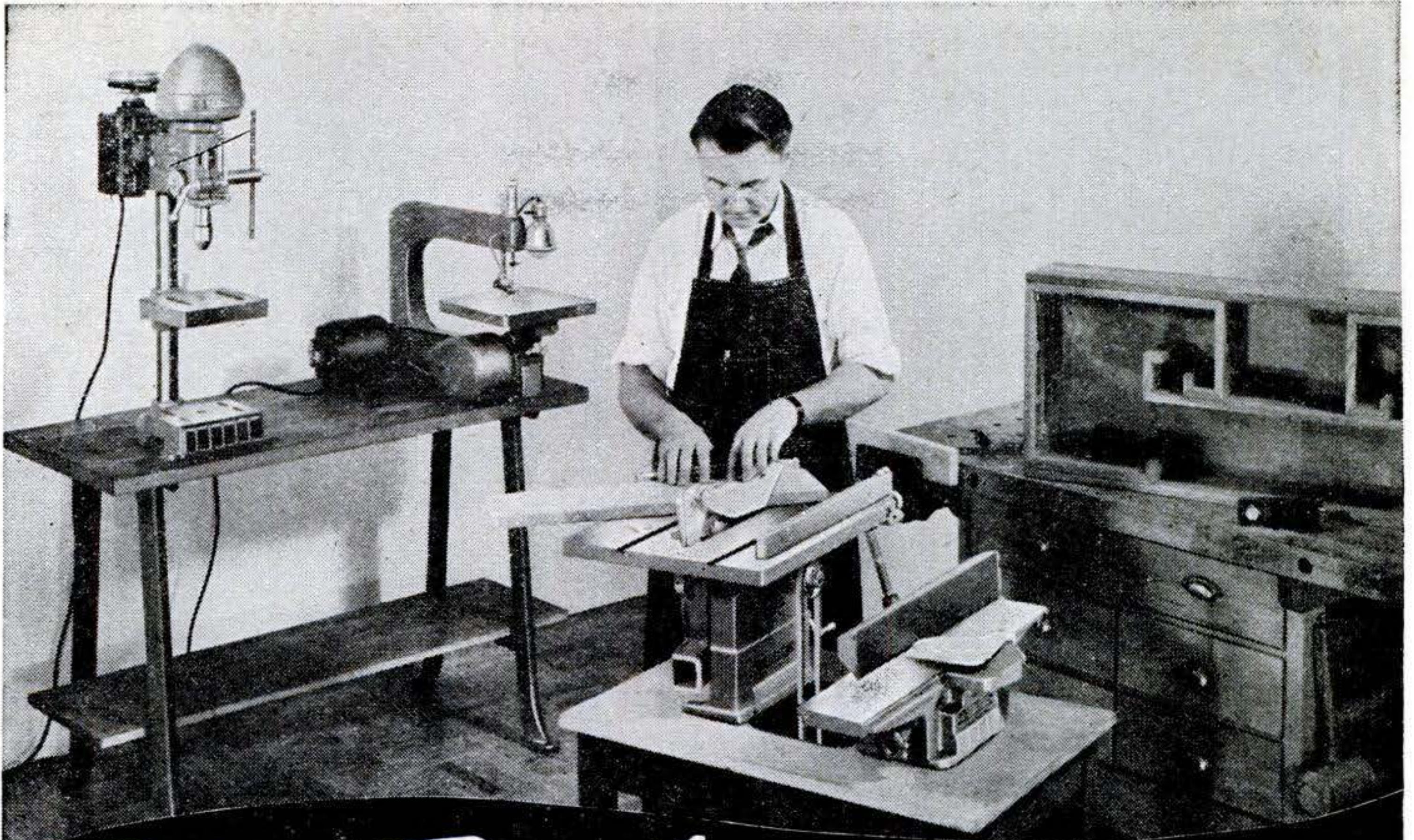

Enjoy This Happiness NOW

... in your own woodworking shop — with Delta-made
Homecraft® Power Tools

A whole new world of fun and healthful relaxation opens up when you follow this fascinating hobby. And now your dealer has popular-priced Homecraft Power Tools that bring this happiness within easy reach.

Homecraft tools are a product of Delta—maker of Delta Power Tools and Delta Machine Tools, long famous for safety, accuracy, and dependability in schools, factories, and home shops.

Made expressly for the hobbyist, Homecraft Power Tools take the work out of wood-

working. They make it possible — even for the beginner — to turn out attractive, useful projects and do it quickly and easily. With these sturdy tools in your shop, you can make toys, small pieces of furniture, and many other things you're proud to use and share. Fun for the whole family.

Visit your Homecraft dealer now. He'll be glad to advise you on starting or improving your shop. Inspect the tools he has on display, and notice how much you get for your money when you buy Homecraft Power Tools. Do it today.



General Sales Office — Chicago 2, Illinois

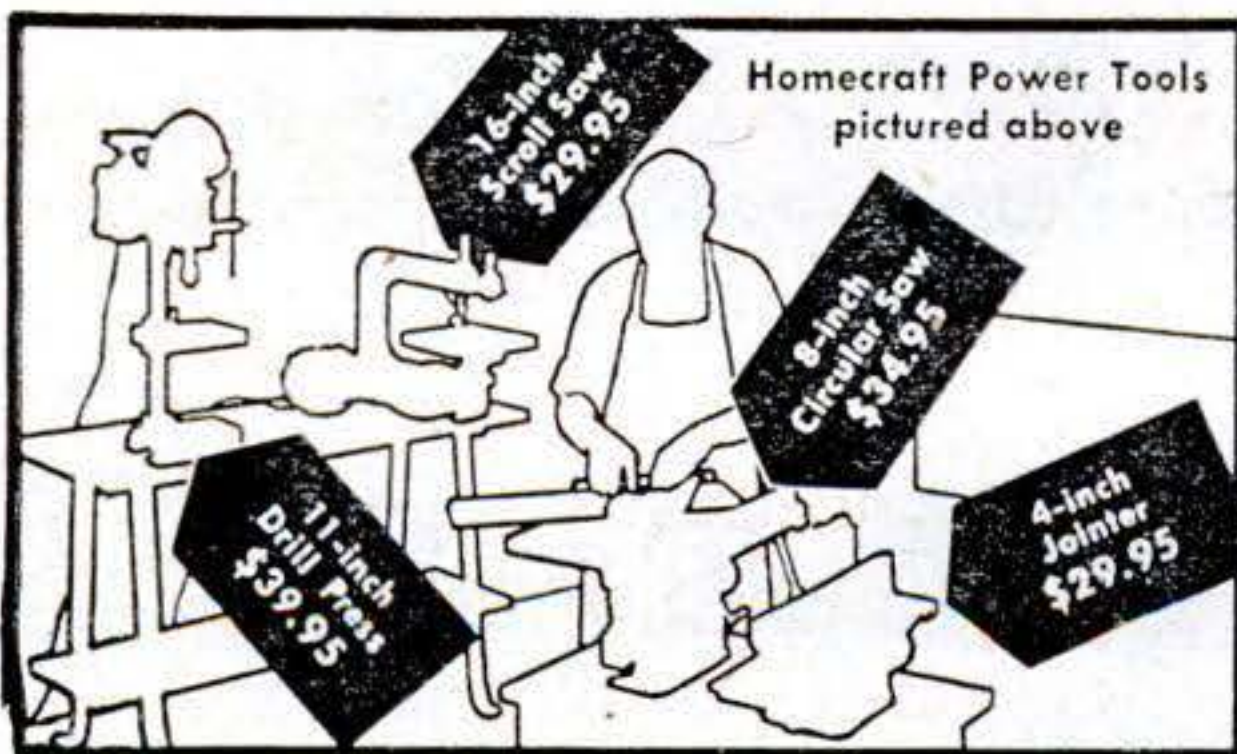

New Catalog

Big 32-page catalog shows all Homecraft Power Tools and accessories. Send 10¢ in coin or stamps to cover mailing and handling. "Happiness Herald," illustrated guide to woodworking, sent free.

Tear out coupon and mail today

DELTA MANUFACTURING DIVISION
 Rockwell Manufacturing Company
 682K E. Vienna Ave., Milwaukee 1, Wis.

Please send your new catalog on Homecraft Power Tools. I am enclosing 10¢ to cover cost of mailing and handling. Also send free "Happiness Herald."

Name.....

Address.....

City.....(.....) State.....

HM-51A

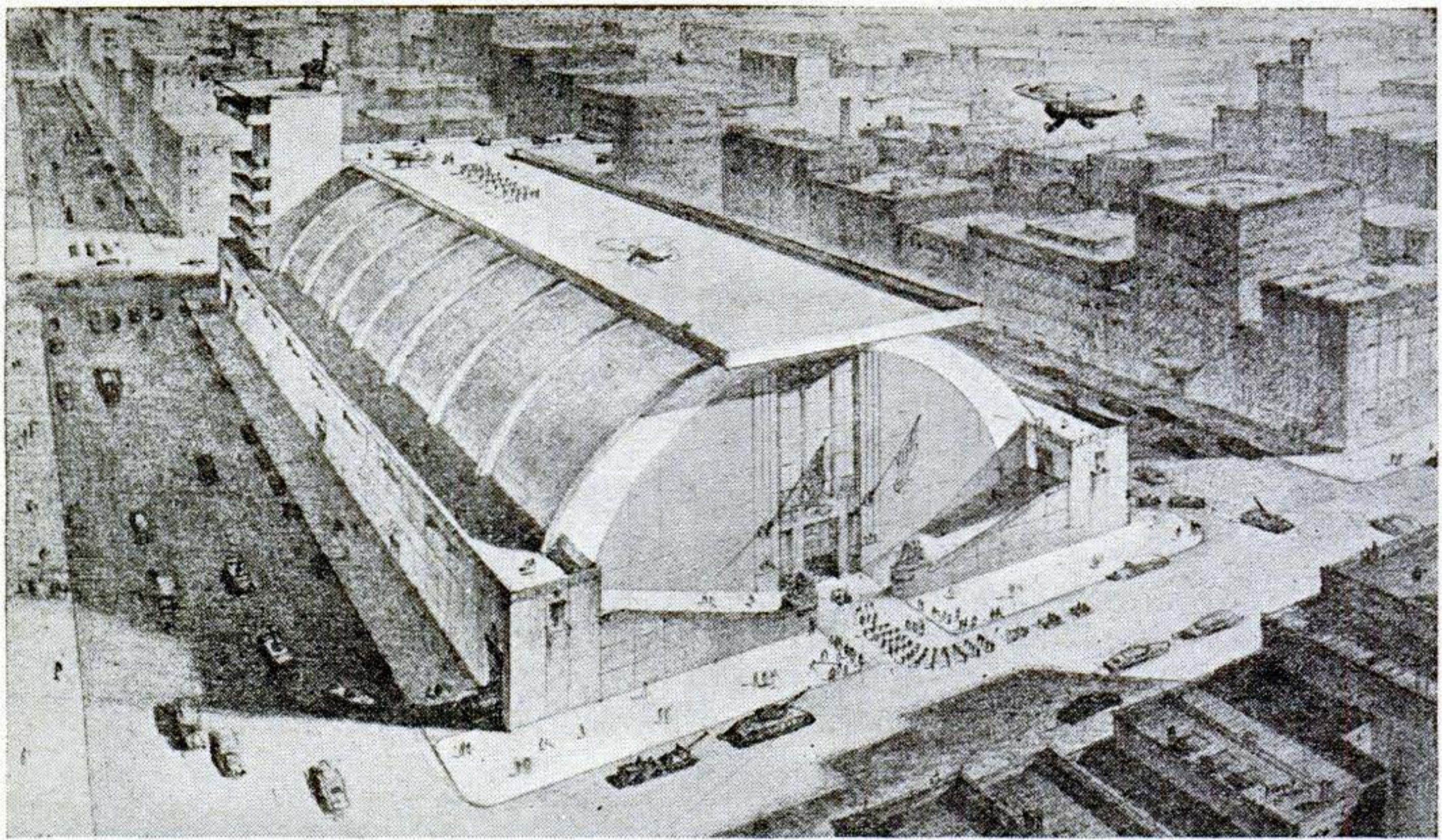

Armory for the Air Age

WITH a huge roof to permit helicopter operations and a thick concrete drill floor covering an underground base for troops and equipment, the building pictured above has

been proposed as a model for National Guard armories. Designed by James C. Mackenzie, New York architect, to meet modern military needs, the massive, air-conditioned structure would also serve as an air-raid shelter—or, in peacetime, a community center.

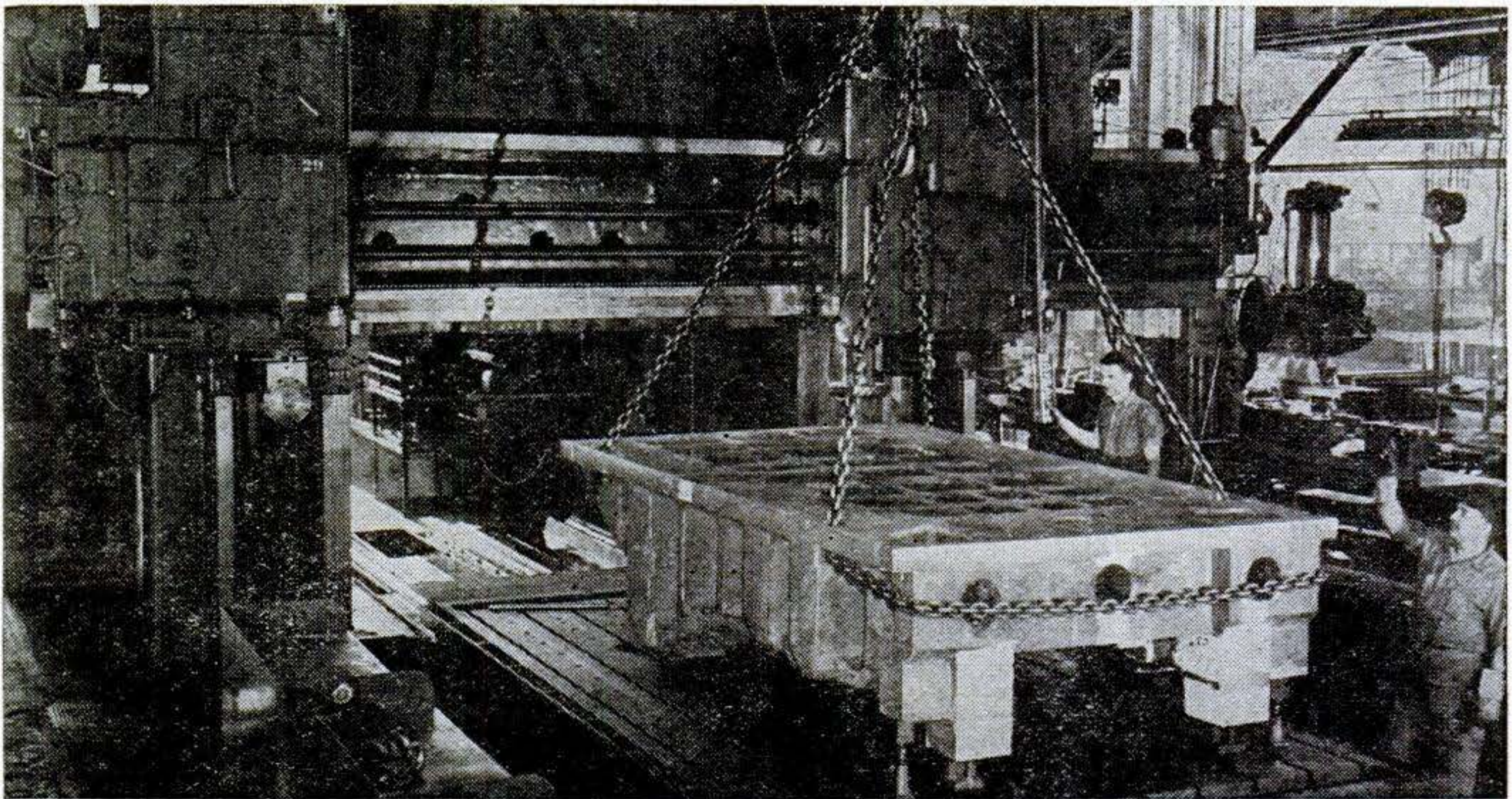

185-Ton Milling Machine

WAITING for a new car? This gigantic machine, believed the largest of its kind in the auto industry, may help you to get one quicker. A two-head milling machine, it weighs 370,000 lb., has a 38-foot bed and an 18-foot table, and requires 178 hp. for its

operation. Five flatcars were used to carry it to Detroit for installation at the die and machine plant of the Fisher Body Division of General Motors, and 300 cubic feet of cement went into its foundations. Here it is pictured just as a tremendous die for forming automobile parts is lowered into position on the machine bed.

Motorcycling is **TOPS**
for **FUN** and **THRILLS!**

Own a **HARLEY- DAVIDSON**

No wonder motorcycling is the favorite sport of so many fun-loving, vigorous, red-blooded young men and women! There's a thrill to riding a new 1947 Harley-Davidson that beats anything else on wheels. Owners have grand times — they belong to clubs—make new friends — compete in endurance runs, race meets and hillclimbs. They get out on the open road and tour the country — even tour other lands. Don't merely *wish* for good times — when you can roll up so many pleasure-filled miles on your own Harley-Davidson! Get set for the happiest evenings, weekends and vacations of your life — see your Harley-Davidson dealer **NOW** — and mail the coupon today.



**HARLEY-
DAVIDSON**
Motorcycles

HARLEY-DAVIDSON MOTOR CO.

Department PS, Milwaukee 1, Wisconsin

Please send free copy of 24-page "ENTHUSIAST" Magazine, filled with motorcycle action pictures and thrilling stories.

Name.....

Address.....

City..... State.....

Within the reach of ALL . . .

No.
325

NEW

hi-power

RIFLE



*"For the shooter who buys a
rifle for more than sport"*

Here's a brand new rifle—a sturdy, dependable, hi-power bolt action ".30-.30" carbine—selling at an *astonishingly low price*. Built for years of the hardest kind of all-round service, it fills a long-felt need for a low-priced, well-built rifle.

SAVAGE ARMS CORPORATION
Firearms Division
CHICOPEE FALLS, MASS.

STEVENS Bolt Action Cal. .30-.30 Carbine Type Repeating Rifle

CALIBER—Chambered for the dependable ".30-.30."
BARREL—"Hi-Pressure" smokeless steel, length 21".
ACTION—Short throw bolt action. Cocks on opening stroke. New design of bolt, sear and trigger mechanism . . . lightning-fast ignition, positive, trouble-free operation . . . clean, crisp, trigger pull. Streamlined bolt handle.
SAFETY—Independent, thumb-operated . . . locks sear and bolt. Conveniently located.
MAGAZINE—Detachable 3-cartridge clip. One cartridge in chamber—4-shot capacity.
SIGHTS—Ramp front—adjustable sporting rear.
STOCK—Stock and fore-end one piece with semi-pistol grip corrugated butt plate. Built to stand up under hard service.
WEIGHT—About 6½ lbs. Overall length 40 inches.

STEVENS

PIONEERING BETTER GUNS
AND GREATER VALUES SINCE 1864

SAVAGE

WORLD FAMOUS FOR DEPENDABILITY
AND ACCURACY

Sheppard Diesel GENERATED ELECTRICITY

costs less... is more dependable

This 2,000 watt Sheppard generating set operates on low-cost furnace oil. Rugged diesel construction assures long life! Simple to service... easy to operate. Write for detailed information.

DIESEL'S
THE
POWER
Sheppard's
THE DIESEL

R. H. SHEPPARD COMPANY, INC.
68 Middle St., Hanover, Pa.

AIRCOOLED FOR MINIMUM MAINTENANCE

Generating sets to 36,000 watts. Power units to 62 H. P.

SAVE MONEY

build your own

SMITH COMPRESSOR

Now, use the world-famous Smith Air Compressor to operate rock drills, paving breakers, spray guns, sandblasting, etc., at low cost! Just order the Smith Compressor Head and Accessories with complete instructions for assembling. All you need is a Ford Motor and shop facilities. Capacity 60 cu. ft.—ample power for most compressor jobs. Pressure up to 100 lbs. per square inch. Head equipped with high speed compressor valves; automatic unloading and idling.

WRITE **GORDON SMITH & CO., Inc.**
TODAY! 405 College Street Bowling Green, Ky.



What holds with
firmness, "peels"
with ease;

What mounts rare
stamps from Celebes?

Dennison STAMP HINGES

At Stationery Departments Everywhere



U. S. GOVERNMENT SURPLUS TRIPODS

Strong Wooden Tripods with adjustable legs. 5½ foot extension. Used by Government for engineers levels and transits. Can be used for holding Telescopes, Cameras, etc.

Value \$4.95
24.50

WHEATSTONE BRIDGES

Used, in excellent condition. Mfg. by Thompson Lever Mfg. Co., Philadelphia. Value \$150.00 **SPECIAL \$49.50**

Engineers All Metal Army Type Hand-Sighting

LEVELS

\$2.00 PRECISION QUALITY



PUBLIC SPORT SHOPS

13 S. 16th St., Phila. 2, Pa.

No COD's

SMALL PRECISION LATHE

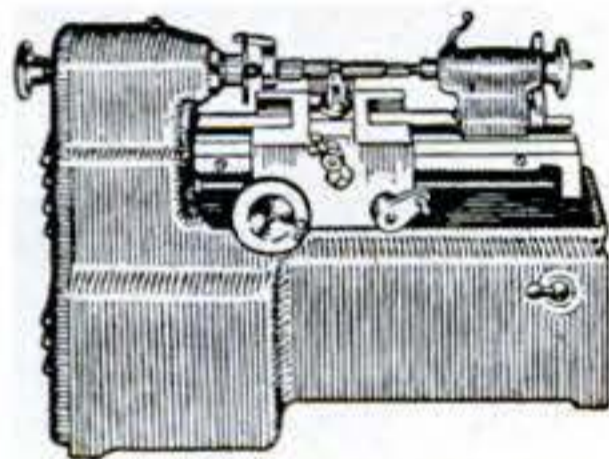

WITH AUTOMATIC FEED AND 110 VOLT A. C. MOTOR

Designed for precision work where accuracy is essential for small parts and tools. Ideal for Home Workshop, Laboratory, Model Builder, Jeweler, Dentist, etc.,

LIST PRICE \$60.75

SMALL • COMPACT • LOW COST

SIZE: 9 3/16" x 3 1/16" x 6 3/4" Wgt. 12 lbs. SEND 20% DEPOSIT. BALANCE C. O. D.

110-Volt A.C. Motor Included Without Extra Cost.

Write For Free Pamphlet. Dealer Inquiries Solicited.

OFFENBACH & REIMUS CO. 372 ELLIS ST. - SAN FRANCISCO 2, CALIF. Telephone ORdway 3-8551

New 4-in-1 SCREWDRIVER with a 1000 and 1 uses

Here's the handiest Screwdriver ever designed. The perfect tool for all-purpose home or shop use. Four different sizes in 1 self-contained unit. 4-in-1 Screwdriver varies from standard 6 in. length to thumb-nail size for precision work. So cleverly made the screw part of 1 size acts as handle grip for the other. So compact it can be carried in vest pocket. Guaranteed to perform perfectly, or your money returned.

ONLY...

98¢

POSTPAID

Mail this
Coupon
NOW!

NAME _____

ADDRESS _____

CITY _____

STATE _____

**CRAFTSMAN SALES CO., Dept. PS-2,
847 W. Jackson Blvd., Chicago 7, Ill.**

I enclose 98c. Rush 4-in-1 Screwdriver postpaid on money-back guarantee.

**Made of Solid
Brass with Hardened
Tool Steel Blade!**

Takes up minimum space! Saves time! Offers type and size screwdriver for virtually every use. A splendid gift . . . Order yours today.

AMAZING NEW MAGNETIC SAW

READY for PROMPT DELIVERY!



SYNGRO
DELUXE JIG SAW

WORLD'S
SAFEST
SAW!

MODEL 2000
ONLY
\$17.50

FOB FACTORY
Shpg. Wt. 18 Lbs.
Prices slightly
higher in foreign
countries

Complete
with Cord
3 Blades

**No Motor Needed . . . Just Plug In! Portable!
Safe! Cuts Clean, Smooth . . . Needs No Sanding!**

This new, remarkable, patented magnetic jig saw needs no belts, no motor, no gears, no oiling! Just plug into any 50 or 60 cycle A.C. 110-130 volt outlet—and saw! Portable. Use anywhere . . . kitchen, basement, attic. Ideal for apartments! Cuts clean, smooth . . . no sanding necessary. Perfect for models, displays, inlays, silhouettes, etc. Special magnetic Safety Stroke feature permits whole family—even small children—to use. Cuts intricate designs on 5/8" soft wood, 1/2" medium hard plywood and thinner hard woods, plastics, thin metals. Leaves NO ragged undersides on plywood, heavy cardboard. Cuts center of 27" circle. Specially finished table top with 1/2" cross sectional engraved lines to assist in accurate cutting! This rugged power tool is NOT for ordinary lumber cutting but is unsurpassed for intricate, fancy scroll work. Nothing else like it. Get yours quickly. Order now. Limited supply. Prompt shipment.

WHY SYNGRO IS THE SAFEST:

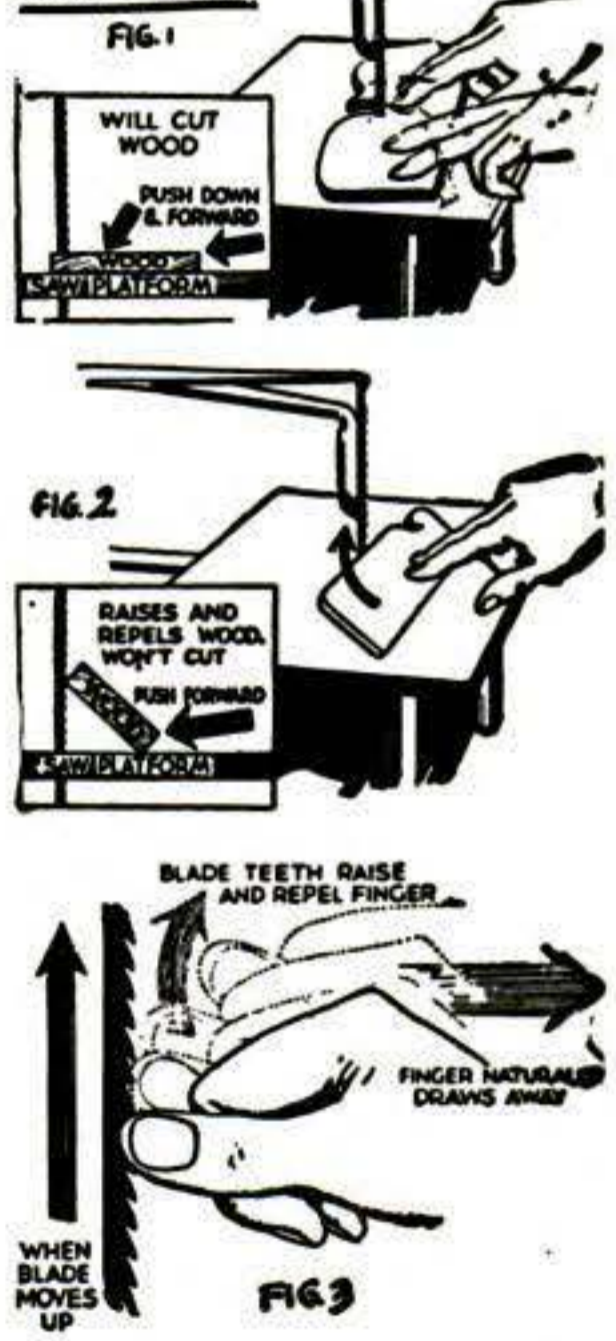

ORDER ON 10 DAYS' TRIAL!

Order today on this liberal Trial Offer: When you get your SYNGRO, plug into any 50 or 60 cycle AC 110-130 volt outlet and saw according to instructions. Then, if it does not satisfy you perfectly, return it postpaid within 10 days of delivery date—we'll refund your \$17.50 promptly without questioning. Order on Coupon below now!

SEND COUPON

SYNGRO SAW CORP., DEPT. B-97, ROCHESTER, MICHIGAN
Export Address: 120 Wall St., N. Y. City

Gentlemen: Here's my order for one SYNGRO MAGNETIC JIG SAW, Model 2000, shpg. wt. packed, 18 lbs., \$17.50 FOB Factory. Please send it complete with electric cable, plug, 3 blades, on your 10 Days' Money Back Trial. I enclose \$17.50 as payment. Please ship saw:

Express charges collect or Parcel Post charges collect.

Express, for which I enclose an extra \$.....

Parcel Post, for which I enclose an extra \$.....

I enclose no money—send FREE SYNGRO CIRCULAR.

WRITE NAME, ADDRESS ON MARGIN BELOW!

Amazing PATENTED INTERIOR

WARM MORNING COAL HEATER

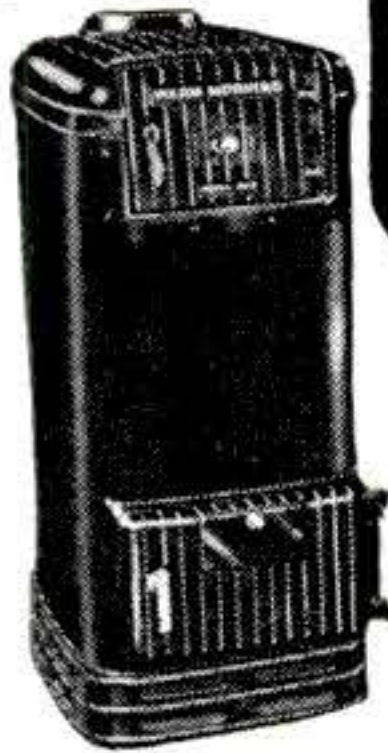

Model 616
60-lb. Coal Cap.

● Look inside... then you'll see the difference. WARM MORNING is the heater with exclusive, patented interior construction that results in abundant heat at low cost.

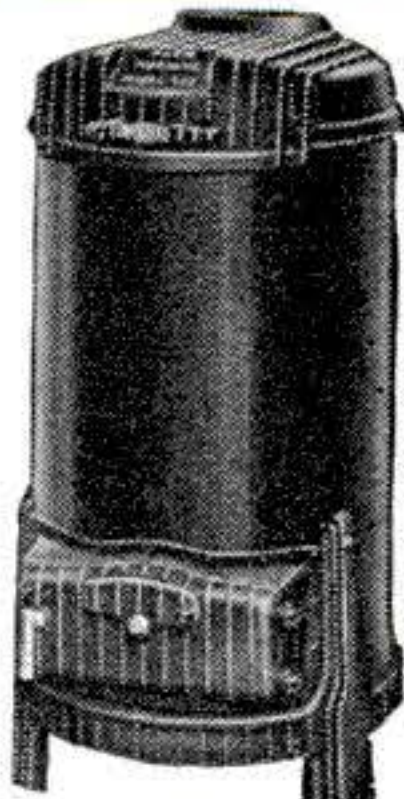

Model 520-B
100-lb. Coal Cap.
Also Model 524-B
200-lb. Coal Cap.

Heats all day and night without refueling. Holds fire several days on closed draft. Burns any kind of coal, coke or briquets. Start a fire but once a year. Four models, 60 to 200-lb. coal capacity. Sold by Furniture, Hardware, Appliance, Lumber and Coal dealers throughout the nation.

Get This BIG BOOK of HOMES PLANS



● A beautiful 16-page book in colors containing floor plans and elevations for 12 distinctive, low-cost homes designed by nationally-known architect. A regular 50c book for only 25c. Send a quarter for your copy... NOW!

(4-B)

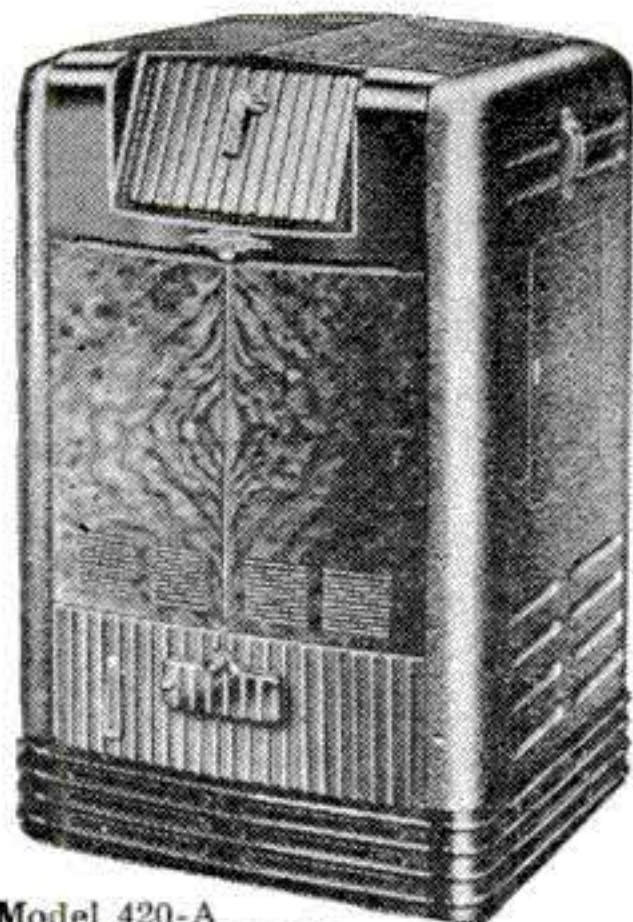

Model 420-A
With Built-in Automatic Draft Regulator.
100-lb. Coal Cap.

LOCKE STOVE CO.
Dept. N, 114 West 11th St., Kansas City 6, Mo.

NEW!

HOBBY HANDBOOK



A GOLD MINE of INFORMATION on NEWEST EQUIPMENT, TOOLS for HOME CRAFTSMEN & MECHANICS

If you work in metals, wood, plastics or glass you need this Giant NEW Book of equipment, tools, parts and materials... including dozens of hard-to-get items you can't find in stores. Many things you must have for your home hobby or shop.

- HELPS YOU GET MORE PLEASURE, MORE PROFIT in
- HOME CRAFTS
 - METAL CRAFTS
 - WOODWORKING
 - PLASTIC CRAFTS
 - HOME REPAIRS

A WAREHOUSE OF THINGS YOU NEED AND WANT

Over 100 items including Spray Guns; Power Bench Tools; Lathe; Drill Press; Drills; Grinders; Tank and Brush Electroplaters; Telephone System; Tool Chest; Model Tools; "Pin Money" Makers for your sparetime fun and profit! **SEND NAME and ADDRESS and 10c TODAY!** Price of Handbook refunded on first order.

WARNER ELECTRIC CO., Dept. N-21
1512 JARVIS AVENUE, CHICAGO 26, ILLINOIS

Freedom PRESTO-FLEX



←YOUR MOTOR
NOW! For Only \$5.95 You can have an Amazing New FLEXIBLE SHAFT TOOL

with PENCIL-SIZE HANDPIECE

Grinds, Polishes, Sharpens, Cleans, Mills, Carves, Engraves, Etches on Metal, Wood, Glass, and Plastic

Now you can turn your old motor, drill press, or electric drill into a Flexible Shaft Tool. Amazing new Presto-flex, latest addition to the Foredom flexible shaft family. Simply attach to your electric drill, drill press or motor. **Presto**—a flexible shaft machine! Pencil-size handpiece gives you finger-tip control. Gets into tight places you can't reach with any other tool. Handy 35" overall length. And—only \$5.95 complete! Order NOW.

SEND NO MONEY

Just send your name and address. We will rush your Presto-flex COD. Pay postman \$5.95 plus postage or send \$5.95 now and WE pay postage. Money back if not delighted! If you order Presto-flex for use on motor, specify motor shaft diameter. Add 50c for special motor coupling. (Available for 1/4", 5/16", 3/8" and 1/2" shafts.) 50 piece accessory set available \$1.50 extra. Order TODAY from.

FOREDOM ELECTRIC CO. Dept. 114

Manufacturers of Flexible Shaft Equipment for Home and Industry For a Quarter-Century.

27 PARK PLACE • NEW YORK 7, N. Y.

RUST! RUST! RUST!

WHAT a headache! Here's the answer! A new liquid RUST REMOVER—quickly dissolves rust on iron or steel, hardware, machinery, etc. NO RUBBING or hard work. Brush, swab, spray or dip. Put ON—let SET—wipe off—RUST GONE! On sale at all Sears Retail Stores in HARDWARE DEPTS. 50c and \$1.00 in Mid-West (slightly higher elsewhere). Valuable manual of rust control FREE with each bottle.

SEARS, ROEBUCK and CO.

For further information, write ALLIED PRODUCTS COMPANY, Dept. H-2, 1133 Newport Ave., Chicago, Ill. Manufacturers of CorOdex.



CORODEX Liquid RUST REMOVER

\$1 PER QT.

First Choice

Hand and power grinders to fit all needs. Sold at leading hardware stores.

LUTHER GRINDER & TOOL CO.
Sheboygan, Wis.

Luther
HAND AND POWER GRINDERS

Est. 1896



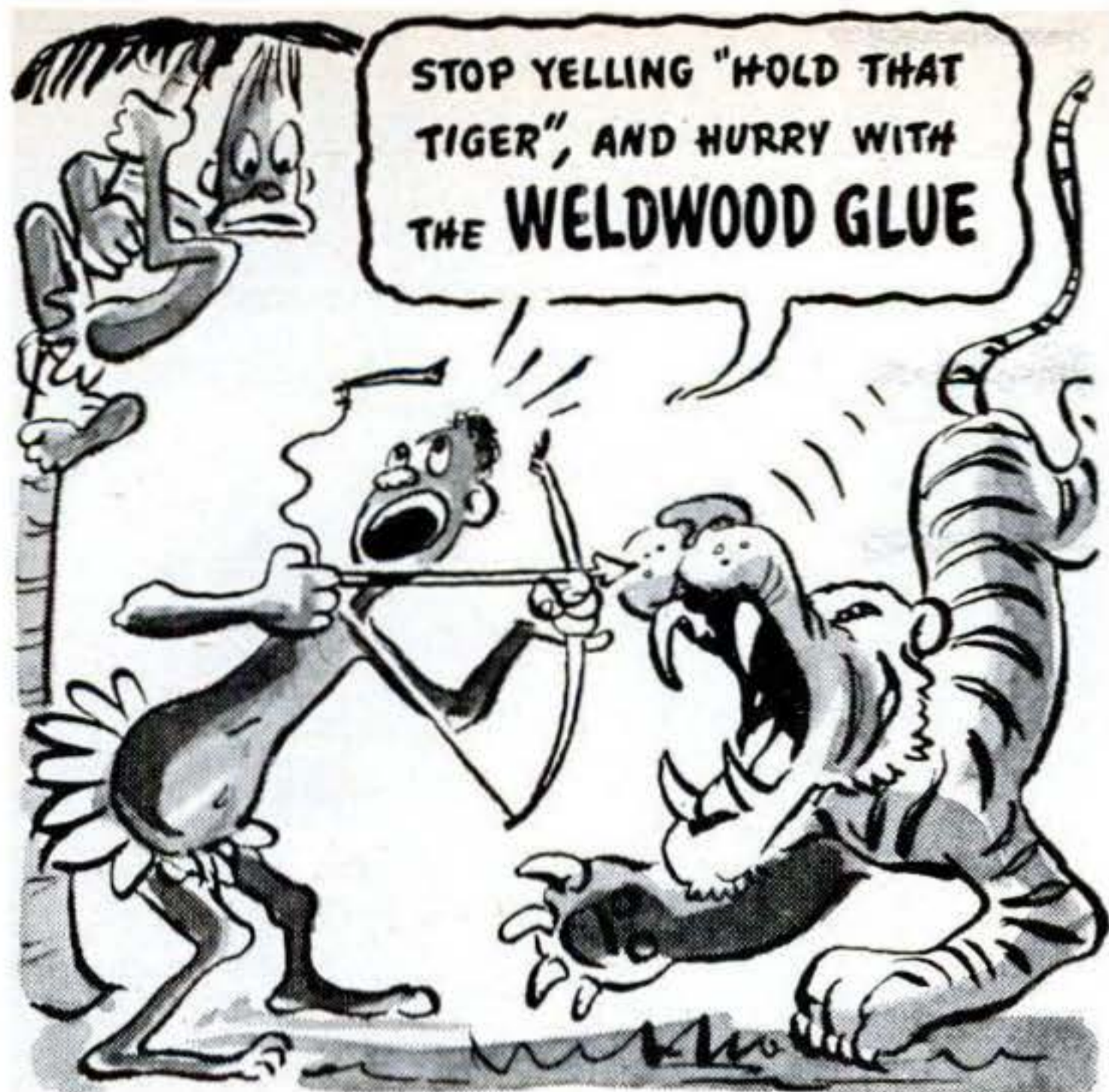

When you want to fix things fast . . . remember Weldwood Glue. It's quick to mix . . . easy to use . . . tremendously strong . . . stain-free . . . rot-proof . . . and permanent. At hardware stores, lumber yards, chain stores.



WELDWOOD PLASTIC RESIN WATERPROOF GLUE

United States Plywood Corporation, New York 18, N. Y.



POCKET TOOL

Handy, useful, easy to carry, needed many times during the day. Regardless of where you work, on the farm, in the factory, around the home, this patented "Lucky 7" pocket tool will be worth its small cost many times over. Made of case-hardened steel, nickel plated, 1/8" thick, 1" wide and 3 1/2" long. Screw driver, rule, square, wrench, wire splicer, tack puller, bottle opener, friction top can opener, wire insulation stripper and other uses. Send only 30c in coin. Mailed postpaid. Satisfaction guaranteed. YATES MFG. CO., 611K—Main St., Lake Geneva, Wis.

ONLY
30¢

CODE SPEED SHORT CUT

Be an expert. Learn to be a Telegraph or Radio Operator. Thousands of men needed. Intensely interesting work—good pay. Learn at home or wherever you are, quickly, easily with the famous Candler Speed System. Book of particulars free. CANDLER SYSTEM CO., Dept. 6-K, Box 928, Denver 1, Colo. U. S. A.

OLD SAWS MADE NEW

With FOLEY

You don't even remove the handle—just put saw in machine and in 3 minutes you have a perfect set of new teeth.

Handsaw Retoother

Accurate—positive—easy to use. Cuts 20 sizes of teeth from 4 to 16 points per inch on any handsaw. Saves filing time,—no eye-strain. Send for circular.



FOLEY MFG. CO., 991-7 Foley Bldg., Minneapolis 18, Minn. Send full details on Foley Retoother

Name.....
Address.....

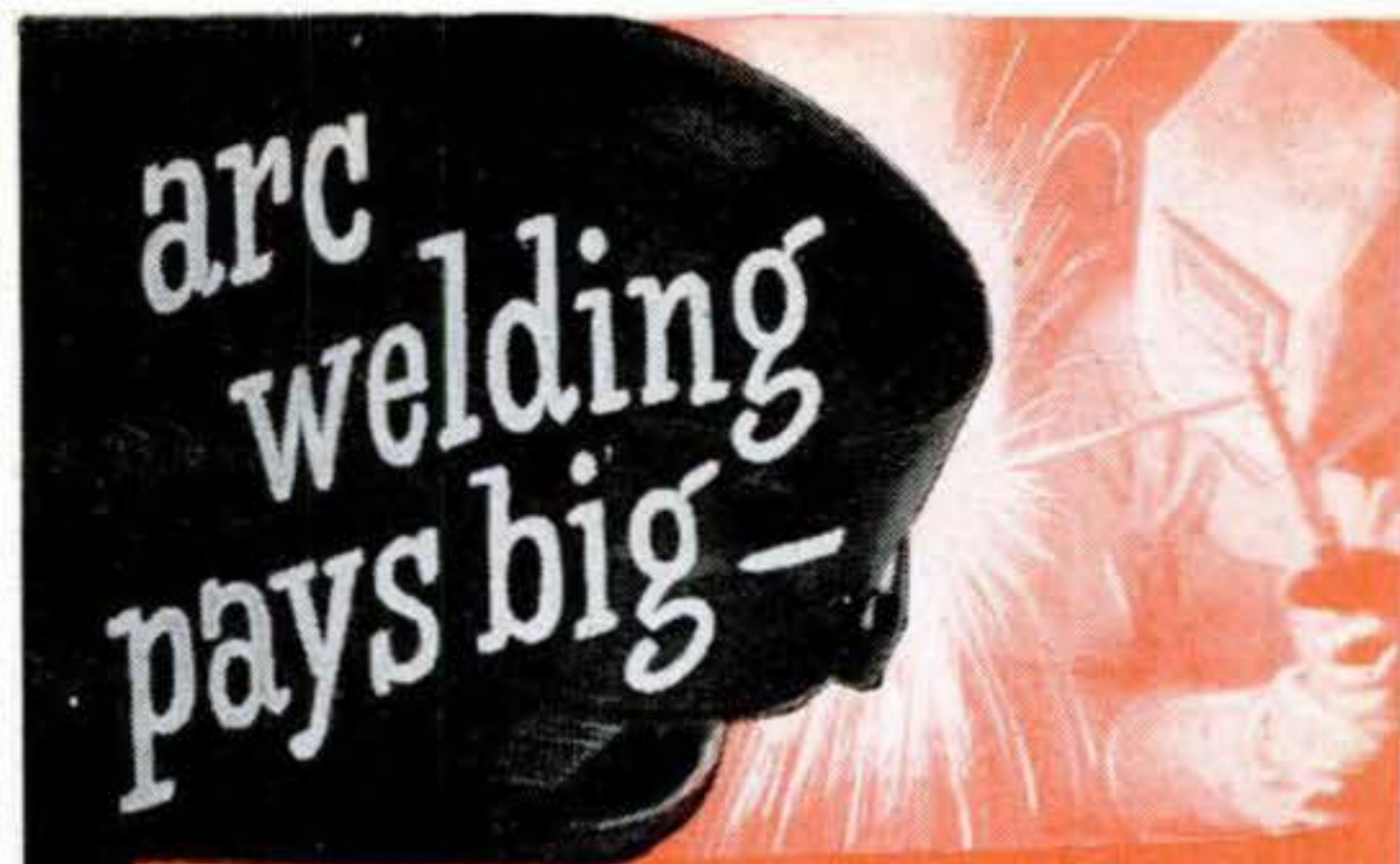

start your own business with this **HOBART** simplified welder



QUICKLY PAYS FOR ITSELF!

Many of the large welding fabricators of today got their start with a single Hobart Electric Drive Arc Welder and they paid for it with a small percentage of their monthly earnings.

MULTI-RANGE CONTROL . . .

gives you the correct welding heat for each job, assuring you of the kind of work that brings customers back.

REMOTE CONTROL . . .

will save you time and enable you to work faster, and turn out more profitable jobs each day.

BUILD YOUR OWN.

You can even build up your own gas drive welder with a Hobart generator and go after the more profitable jobs in the field.

AC WELDER FOR SINGLE PHASE.

If you have only single phase current available, you can still start a profitable welding business with the Hobart 220 volt, single phase AC arc welder.

BE AN EXPERT WELDER.

If you lack confidence, attend the Hobart Trade School and you'll never worry about your ability to turn out good welding work. We have helped thousands to get started in the profitable welding business and we're ready to help you. Return coupon for particulars.

HOBART BROS. CO.,
Box P-97, Troy, Ohio
"One of the world's largest builders of Arc Welders"

Get more information on
Hobart
arc welders
free!

HOBART BROTHERS CO., BOX P-97, TROY, OHIO
Without obligation, please send me information on items checked below.

- Electric Drive Welder. Build Your Own Welder.
- AC Transformer Type Welder.
- Hobart Trade School Booklet.
- Also, please send me information on how to start a Job Welding Shop, so that I can earn some of the big money in welding.

NAME.....

ADDRESS.....

CITY..... STATE.....

RADIO BARGAINS! SAVE AT NEWARK



TELEGRAPH KEY

What a buy! A professional quality Signal Corps key. Bakelite base 4 3/4" x 3", 2 sets of binding posts, circuit closing switch. Solid silver contacts. Don't miss it at only... **49c**

switch. Solid silver contacts. Don't miss it at only... **49c**

Scoop! Army-Navy Phones

Amazing Bargain! BRAND NEW — GUARANTEED! Super quality phones. 8000 ohms impedance. Rubber covered throughout. Ear cushions, cord, and PL-54 plug. Adjustable headband. While they last! Special

99c

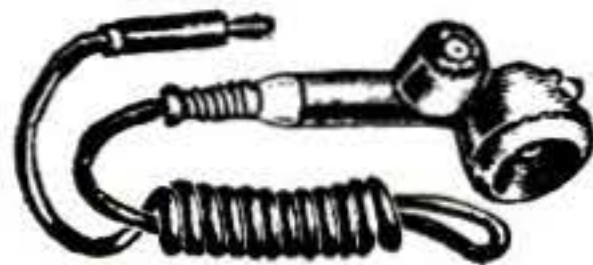

T-17B MICROPHONE

All Brand New — Perfect Carbon Hand Mikes. Light Weight, 200 ohms. Single button, press-to-talk switch. 5 ft. rubber cord, plug, dust cover. Terrific at **99c**

switch. 5 ft. rubber cord, plug, dust cover. Terrific at **99c**

F.O.B. N. Y. or Chicago • Send for Bargain Bulletins

NEW YORK
Offices & Warehouse
242 W. 55th St., N.Y. 19

NEWARK

ELECTRIC COMPANY, INC.

CHICAGO
323 W. Madison St.
Chicago 6, Ill.

New York City Stores: 115-17 W. 45th St. & 212 Fulton St.

**"I saved \$150.00
BY INSTALLING MY OWN
DELTA OIL BURNER"**

"Yes, sir! I saved \$150.00 when I installed my Delta Oil Burner myself in a few hours. I shopped around but couldn't get a burner installed for less than \$350.00. The work was easy because of the Delta Photo-Installation Manual . . ."



MADE BY THE WORLD'S LARGEST MANUFACTURER OF OIL BURNERS

Now you can enjoy fully automatic heat in your home by installing it yourself simply and quickly with a few tools. You can save at least \$150.00 in your spare time! The Delta Automatic Oil Burner comes completely assembled along with everything necessary for the complete installation by you for the low price of only \$195.00. Includes the famous copyrighted DELTA PHOTO-INSTALLATION MANUAL showing step-by-step photographs of an actual installation. **PAY AS LITTLE AS \$6.26 A MONTH!** And—you need not pay a single penny to get the Delta Automatic Oil Burner because a simple deferred payment plan is available. Just send the coupon below for full information and free brochure in color describing how you can install and enjoy fully automatic heat in your home with the Delta Automatic Oil Burner, Delta Automatic Floor Furnace, and other Delta Heating products. *Mail coupon today!*

—PASTE COUPON ON PENNY POSTCARD—

DELTA HEATING CORPORATION
85-07 Northern Blvd., Jackson Heights, New York City
Please send FREE Color Brochure and full information about Delta Heating products.

NAME.....

ADDRESS.....CITY.....

(Please Print Clearly)

PS-9

MARGIE

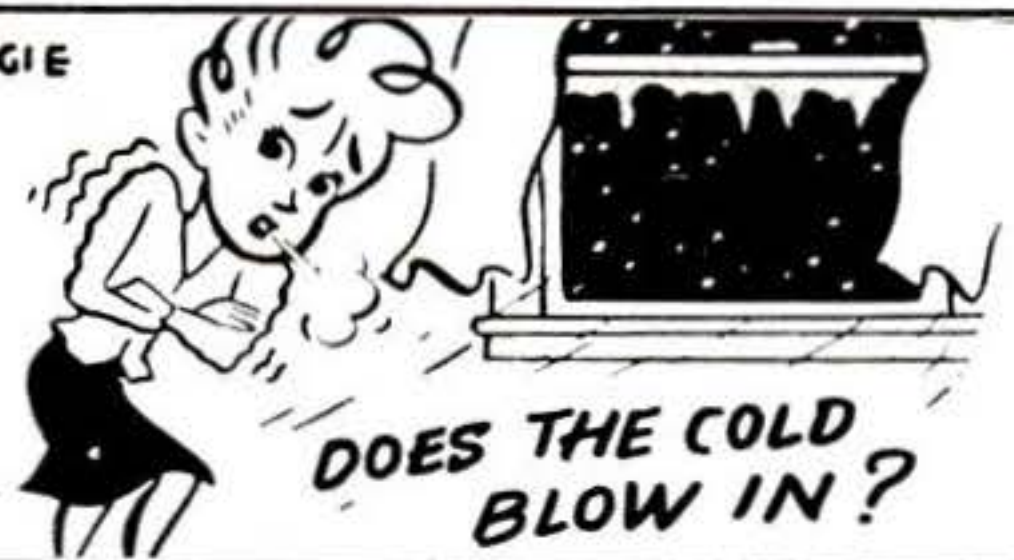

IT'S TIME TO
WEATHER-
STRIP
WITH
Mortite



KEEP WARM—SAVE FUEL

Don't put up with dangerous, drafty zones in your home when it's so easy and inexpensive to weatherstrip with Mortite. Simply press pliable Mortite around windows, doors, baseboards, etc. It keeps cold out, keeps heat in, shuts out dust and dirt, too! Mortite adheres to any clean, dry surface. No tools, no tacking needed. Anyone can apply it.

3 Sizes: 29c - 98c - \$1.25

Higher west of the Rockies and Canada.

Get at stores or write for free circular

J. W. MORTELL CO., 534 Burch St., Kankakee, Ill.

Learn NOVELTY MANUFACTURING!!



Today's best bet for a business of your own starting with little money is the Casting of Wall Plaques, Book Ends and other Novelties. Large orders and profits waiting. Start in garage or basement, quickly learned. **NO EXPENSIVE MOLDS TO BUY.** Our system has started many on the road to a splendid financial future. Some report orders ranging from \$500.00 to \$5,000.00 within reasonable time after starting. Write today.

PLASTEX PRODUCTS, 711 Laguna St., San Francisco 2, Calif.

LAW

STUDY AT HOME for PERSONAL SUCCESS and LARGER EARNINGS. 39 years expert instruction — over 108,000 students enrolled. LL.B. Degree awarded. All texts furnished. Easy payments. G.I. Approved. Send for FREE BOOK.

AMERICAN EXTENSION SCHOOL OF LAW
Dept. 81-S, 646 N. Michigan Ave., Chicago 11, Ill.

New MILLING ATTACHMENT



Sizes for 8" to 16" metal lathes
BUILD IT YOURSELF from our sets of semi-machined castings and save \$\$\$. Can be finished on your lathe alone. Complete working drawings and step-by-step instructions furnished.

Mill keyways, slots, splines, dove-tails, flutes in reamers, taps, hobs, and special cutters; produce spur, bevel, mitre and worm gears, ratchets and racks; mill flat surfaces, square shafts, mill hexes, spot face, drill spaced holes, bore, etc. on your lathe with this precision attachment. It has a T-slotted table, a vise which swivels for angular milling, a gear cutting fixture and dividing centers.

FREE! Illustrated folder and price list. Includes milling cutters, keyway cutters, drill rod, slitting saws and many hard to get shop items. Mention your lathe. Write today.

HURON MACHINE AND TOOL CO.
YALE 2, MICHIGAN

NO. 78 **X-acto**
COMPLETE
CARVING SET

NEW!



20 different blades

Here's everything you need for a super-slick job, from toothpicks to totem poles. Super-sharp blades, firm-grip handles for light and heavy work. Ideal for wood, linoleum, plastics, etc. Contains: 6 different gouges, 4 routers, 2 punches, 6 regular blades, 2 three-inch blades, one No. 1 knife, one No. 5 knife. On wooden block, complete.....only **\$5.00**

*Reg. U. S. Pat. Off.

Other X-acto Knives, Blades, Tools and Sets, 50¢ to \$50
Prices slightly higher in Canada

At hobby, gift, hardware and department stores

X-acto Crescent Prod. Co., Inc., 440—4th Ave., N. Y. 16
In Canada: Handicraft Tools, Ltd., Hermant Bldg., Toronto

New THOR "B" ENGINE—\$6.95

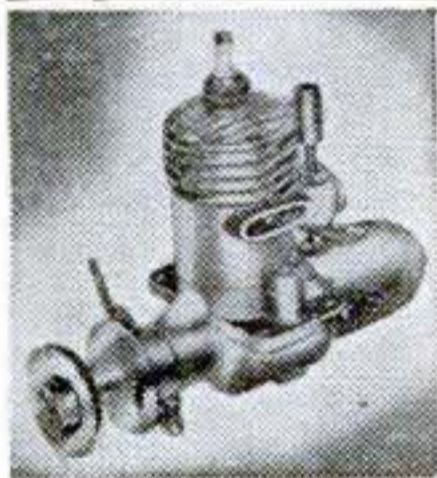

The new THOR "B"—Sensational miniature gasoline engine that really works. Super-power performance. Smooth, velvety power that roars into action with a "twist of the wrist." Over 25,000 already sold. 1/6 H.P. Complete with coil and condenser. Ready to run, only \$9.95. In KIT form, fully machined, 5 minutes to assemble, \$6.95, without coil and condenser. Powers all models. Fully illustrated instructions. Send \$1.00—shipped collect same day C.O.D. FREE—Send for 24-page illustrated hobby catalog.

AMERICA'S HOBBY CENTER

DEPT. S-97, 156 WEST 22nd STREET, NEW YORK 11, NEW YORK

FINE TOOLS
NEED
FINE OIL!



• Lubricates



• Prevents Rust

• Cleans • Polishes

SOLD EVERYWHERE

3-IN-ONE Oil

NOW TRY
Dustless
SWEEPING



Reduce Germ
Laden Dust
Eliminate
Sweeping Compound

Dustless brushes used with Arbitrin sweeping fluid eliminate up to 97% of germ laden dust and reduce sweeping costs 20%. Arbitrin fluid, poured into a metal reservoir in the brush back, filters through the tufts and keeps dust down as you sweep. Dustless brushes are used in thousands of schools, factories, offices, stores, and institutions. There is a Dustless brush to fit your needs. Write for sizes, styles and prices today.



Milwaukee Dustless Brush Co.
530 N. 22nd St., Milwaukee 3, Wis.
Please send complete facts about Dustless Brushes.

Name _____

Street Address _____

City, State _____

**RIDE IT...
AND
YOU'LL
BUY IT!**



\$97⁵⁵ PLUS TAX

F. O. B. Pontiac,
Michigan

WHIZZER

Whizzer Motor Company, Dept. 539, Pontiac, Michigan.

I enclose \$99.97, which includes \$2.42 Federal Excise Tax () check or () money order. Send me one Whizzer Motor complete, ready for installation. If descriptive literature only is desired, check here ().

Name _____ City _____

Street _____ State _____

HERE'S WHY! A Whizzer Bike Motor takes you 125 miles on a gallon of gas! It's precision-engineered! Fits any man's balloon tire bike! Complete with all attachments necessary to motorize your bike! See your local Whizzer Dealer!



CROSMAN Silent RIFLE

Most Amazing Gun Ever Invented for Target and Small Game Shooting

The ideal rifle for year 'round shooting indoors or out. Shoots low-cost SUPER PELLETS without noise, odor or recoil. Requires no cleaning. At your dealer or write direct.

Adjustable power—rifled barrel for accuracy. .177 and .22 caliber models. Write for information.

CROSMAN ARMS CO., INC.
9 B HENRIETTA ST., ROCHESTER 7, N. Y.

Shoot CROSMAN SuperPells

The BETTER Ammunition for ALL .177 and .22 caliber Air Pistols and Rifles.

.177 cal. . . \$2.50 per M
.22 cal. . . \$3.00 per M

POSTAGE PREPAID

At your dealer or order direct

**FOR
GREATER
ACCURACY
MAXIMUM
POWER**

CROSMAN ARMS CO. HENRIETTA ST., ROCHESTER 7, N. Y.

MACHINE SHOP EQUIPMENT



Just off the press!—Every man who owns a workshop should have a copy of our new, up-to-the-minute, 200 page catalog of Machine Shop Equipment—the latest tools made by the biggest manufacturers in the U. S. Replete with illustrations, descriptions, prices. Prompt delivery on most tools listed in this book. Available at cost of printing—50c a copy—get yours today! **Price of Catalog Refunded on First Order over \$5.00.** Send Check or Money Order to

CENTER TOOL CO., 153 Centre St., Dept. D, N. Y. C. 13

\$13⁵⁰ Value for Only \$2.49

8000 ohm impedance Head Phones, produced to Air and Signal Corps specs. Extremely sensitive, lightweight (only 9 oz.). With 5 1/2 ft. cord, plug, jack and ear cushions. Every One **BRAND NEW.**

No. 17A37, Special Per Pair..... **\$2.49**
Plus 25c each for Postage.



Burstein-Applebee Co. 1012 McGee, Kansas City 6, Mo.

NONE BETTER! SUPER DRILL GRINDER



Sharpens round shank drills from 3/32" to 1 1/16" in diameter, up to 11" long. Grinds old drills like new in 4 different point angles, using hand or power grinding wheels. Money-back guarantee.

Price only \$2.95
At Dealers or Postpaid

Crandall Mfg. Co. 1512 W. Slauson, Dept. FB-21 Los Angeles 44, Calif.

Arc Welded Design "Know-How"

Only \$3.50 each Each volume contains over 3 different volumes 100 welding designs. Write \$10.00 postpaid **Hobart Bros. Co. Box P-561, Troy, O.**

WOODWORKERS ... Get this CONSTANTINE MASTER MANUAL

Get the Most Fun From Your Hobby Indispensable to woodworkers. Newest, biggest edition, more pages, more color, helpful how-to-do-it articles, pre-war and new items, more bargains. Send 25c today and we will include **FREE! FULL YRS. SUBSCRIPTION** to Chips and Chats, published bi-monthly. Keeps you up-to-date on everything in woodworking, offers big money-saving bargains. Send now. **ALBERT CONSTANTINE & SON, Inc. 793-J 135th Street, New York 54, N. Y.**



This is the way to Make Money!

MACHINE SAW FILING with the Foley Automatic Saw filer is the modern way to recondition saws. Anyone can do the work—no experience needed—no eye-strain. Start in spare time. Foley-filed saws cut so smooth and fast, they will advertise for you, bring you new customers and a steady repeat cash business.

The Foley is the **ONLY** machine that files all hand saws, also band and cross-cut circular saws,—enables you to handle work from schools, shops and factories as well as farmers, carpenters, etc.

Send for **FREE PLAN**

Shows how to start—no canvassing. Send coupon today.

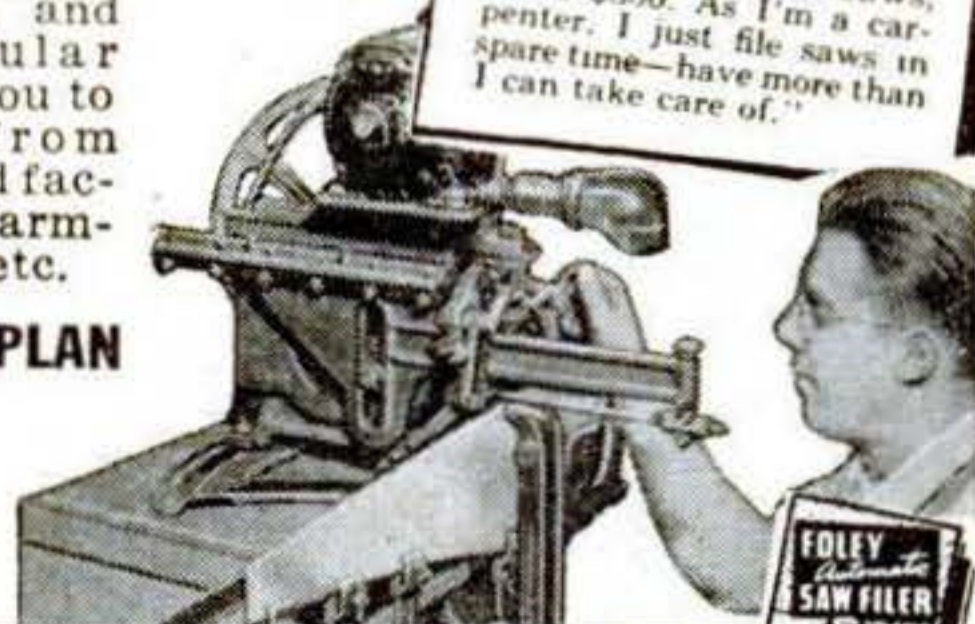

"I bought a Foley Saw Filer, one year later had all debts paid and also \$400 on a new home. Many days I earn as much as \$16," says **J. H. Kellogg**

W. L. Tarrant writes "I left my old job last September and in 10 months have filed 2,159 saws. We have a lovely business worked up and cannot keep up with the work"

Thor Nedricke, Iowa, says, "I have filed 550 saws, made \$350. As I'm a carpenter, I just file saws in spare time—have more than I can take care of."

FOLEY Automatic SAW FILER

FOLEY MANUFACTURING CO.
919-7 Foley Bldg., Minneapolis 18, Minn.
Send Free Plan on Saw Filing business, no obligation

Name _____

Address _____

The Pipeline

PIPES COAL IN! PIPES ASHES OUT!

WARMTH WITHOUT WORK

All the work of furnace tending is done automatically by *The Pipeline* Coal Burner. Pipes bituminous coal from any bin to your present furnace, burns it smokelessly and efficiently, and even pipes ashes to dust-proof containers! Modulated warmth regulated by automatic controls.

Conversion models and complete winter air conditioners. Field-tested since 1934. Write for free 20-page booklet.

FITS ANY
COAL BIN

FITS ANY
FURNACE

DUSTPROOF
ASH CONTAINER



POCAHONTAS FUEL COMPANY INCORPORATED
Stoker Division • 341 East 131st Street • Cleveland 8, Ohio

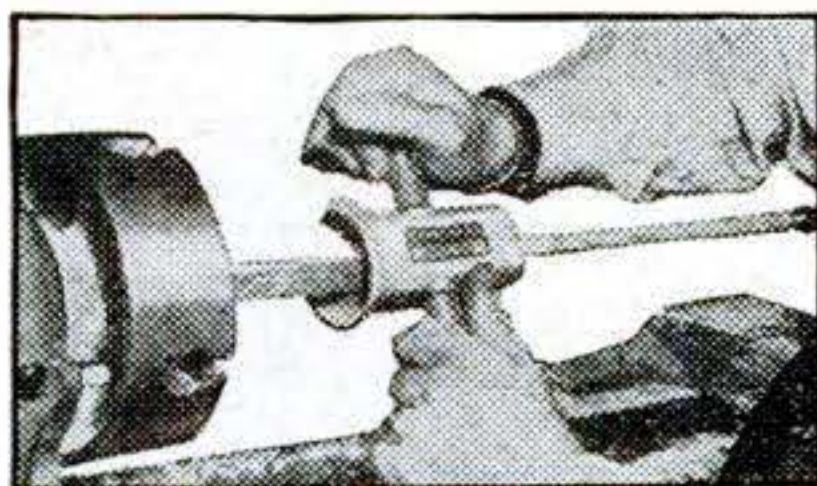

DOWELS Make Your Own and SAVE

No wanting or waiting for mahogany, cherry, for any dowel with **SPEE-DOWL**. Let this amazing tool start saving its cost now.

Model 8 (not shown). 2, 3, 4, 5, 6, 7 & 8/16" Only \$1 each size.
SPECIAL: 4—\$3.50; 7—\$6.
Model 20 (shown) \$2.54 each size—9 to 20/16". All 12—\$25.
Guaranteed. Postpaid in North America.

FREE LITERATURE
on this and new never-dull carbide tipped wood-turning tools.

JOHNS MFG. CORP.

Dept. B-12,
Dunellen, N. J.



SHAW DU-ALL GARDEN TRACTORS and MOWERS

Get FREE FOLDER NOW!

Get details on 1 to 9 H. P. walking and riding tractors. Do 1000 jobs on small farms, estates, orchards, gardens. Low-priced. Send postcard!

SHAW MFG. CO.

5709 Front St., Galesburg, Kans. 668PS N. 4th St., Columbus, Ohio

IF **GLUE** WILL FIX IT

FRANKLIN LIQUID HIDE GLUE

will do it better, faster, easier!

Ready-to-use Franklin makes joints stronger than the wood itself. Saves time — no mixing, no heating. Banish unpleasant odors, avoid chilled joints with Franklin Liquid Hide Glue.

The FRANKLIN GLUE CO., COLUMBUS 15, O

AT YOUR HARDWARE DEALER



ONE TON "BITE"

BERNARD Parallel Action Pliers—with the "ONE TON BITE"—have the cutters on the outside of the head, easy and convenient to use. Jaws close parallel, like a vise, hold tight, won't slip. Average grip exerts one ton of pressure!

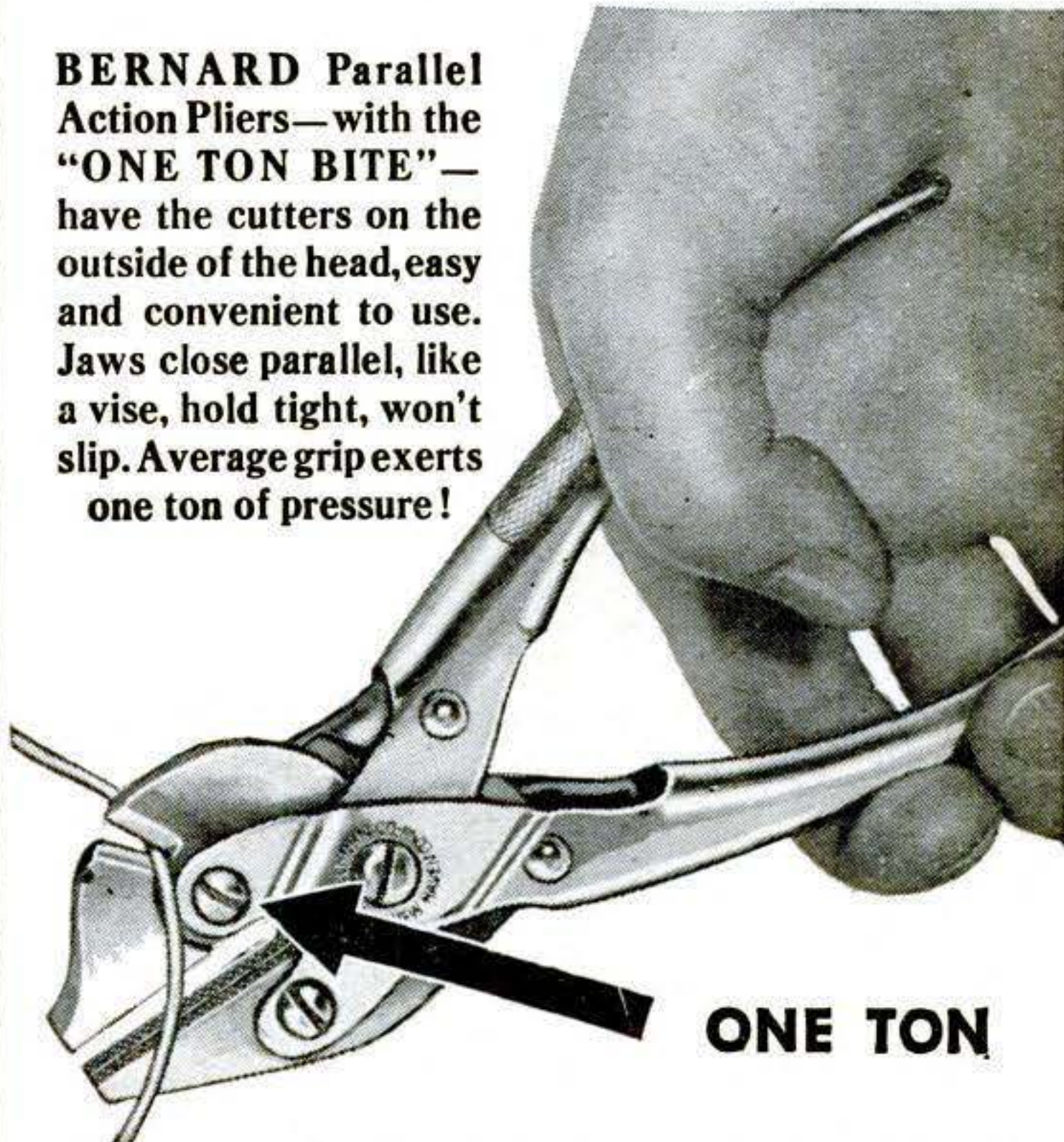

ONE TON

<p>BERNARDS</p>	<p>ORDINARY PLIERS</p>	
<p>BERNARDS work like a wrench. Parallel jaws fit snug on nut.</p>		<p>Cutters on outside of head. Easily cuts baling wire.</p>
<p>Compound leverage doubles gripping power. 6 1/2" size cuts 8-penny nail.</p>		<p>Breaks glass perfectly. Jaws close flat against glass.</p>

At your local hardware store... Send for complete catalog

FAITHFUL  QUALITY SINCE 1870

BERNARD

TRADE MARK REGISTERED

WM. SCHOLLHORN CO.
7009 Chapel Street, New Haven 9, Conn.



A SOLDERING IRON FOR THE HOME CRAFTSMAN

The new G-E Handy iron is designed specifically for home and hobby shop work. With the Handy iron, you can do a professional soldering job. The same kind of heater used in G-E industrial irons assures quick, constant heat. And a brazed-on tip flows the heat to your work faster. Built for a wide variety of home soldering jobs, the Handy iron is a tool you'll use often. Only \$3.95. Ask to see it at your dealer's. Or write to Dept. 667-3, Apparatus Dept., General Electric Co., Schenectady 5, N. Y.

FREE: A "how to solder" manual with every iron

GENERAL ELECTRIC

667-3

**GOOD WEAR FOR WORK
GOOD LOOKS FOR PLAY**



REEVES Army Twill is a double duty fabric that's right for work and play. It's highly resistant to wear and tear, and its wide variety of vat dyed colors are fast to sun, water and perspiration. Being Sanforized*, it can take repeated washings and still come up fresh and new. For better looks and longer wear—demand Reeves Army Twill.

*Residual shrinkage less than 1%

REEVES BROTHERS, INC.
54 Worth Street, New York 13, N. Y.



PAINTERS' STRIPING TOOL

A TOOL... NOT A BRUSH

NEW, IMPROVED

Modern—streamlined—fits the hand like a fountain pen! Easy to use as a pencil. Draws parallel lines—straight, curve or circular. Does expert job on autos, furniture, toys, bikes, model planes, signs, bulletins, linoleum. (Makes wall board look like tile.) Every painter and craftsman needs one! Type "M" MASTER Painters' Striping Tool complete with tip for 1/16" stripe, \$1.00. Extra tips 1/64", 1/32", 3/64", 1/16", 5/64", 3/32", 1/8"—75c each. Tool with complete set of 7 tips \$5.00. (C.O.D. orders 25c extra.) Paint dealers, write!

EASY AS USING A PENCIL!

\$1.00 POST PAID

WENDELL MFG. CO.

4234-A Lincoln Ave., Chicago 18, Illinois



**Sand Casting—Forging—Heat Treating—Case Hardening
BRONZE FOUNDRY**



is again available in limited quantity without priority. Orders filled in sequence as received. INVENTORS-SCHOOLS-CRAFTSMEN use FOUNDRYETTE for making castings quickly for new inventions, for instruction, and general purpose. Order now for early delivery. Three sizes are available capable of making bronze castings of 1½, 3, and 6 pounds weight, aluminum, copper, brass, etc. Domestic gas supply and 110 volt AC or DC energy required for operation. Write for circular.

KANSAS CITY SPECIALTIES CO.

Box 6022, Dept. S-12

Kansas City, Mo.

BUILD YOUR OWN MACHINE TOOLS!
Blueprints \$1.00 - Catalog FREE

We supply quality Foundry Castings for Lewis Shapers, Milling Machines, Drill Presses, 8" Circular Saws, 6" Jointers, etc. Construction Blueprints for above 6 tools postpaid \$1.00. Illustrated 32 page Catalog sent free with Blueprint Order—describes 23 Lewis Tools. Write today!

LEWIS MACHINE TOOL CO.

P. O. Box 7446, Sta. L, Dept. S, Los Angeles 23, Calif.



Everything in Radio!

Make Radolek your buying headquarters for Radio-Electronic repair and replacement needs. Large stocks assure finest, most complete selections of all available items at lowest prices. Your orders receive special attention for fastest delivery. Send today for FREE Radolek Buying Guide.

RADOLEK CO., Dept. A-130, 601 W. Randolph St., Chicago 6, Ill.

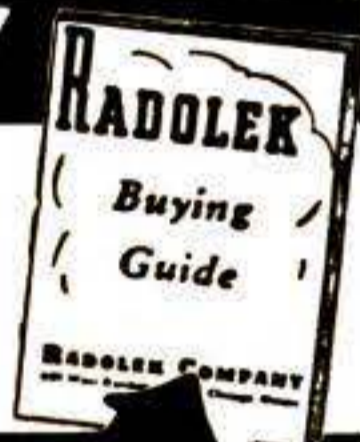

FREE RADIO BUYING GUIDE

WATCHES WANTED

BROKEN OR USABLE

All kinds. Highest Prices paid for jewelry, rings, spectacles, gold teeth, diamonds, Sterling Silver, etc. Cash mailed promptly. Write for free shipping container.

LOWE'S, Dept. PS, Holland Bldg.,

St. Louis 1, Missouri

Say You Saw

It In Popular Science

FREE!
FAMOUS
BLUE BOOK
CATALOG

GAME SUPPLIES

Club Furniture - Courier Games - Punchboards - Magic Cards Readers, Read the backs - Inks - Daubs - Poker Chips - Tops Flats - Layouts - Game Boxes.



K.C. CARD CO., 238 South Wabash Ave., Chicago 5, Ill.

Electrically Welded Endless

Paramount

**BAND
SAW
BLADES**



Made in widths from 1/8" to 1-3/4"

Make your band saw do more work for you. The proper width of blade will extend the scope of this important machine. Burrill's Paramount Blades are made from tough Nickel Alloy Steel properly tempered. Teeth accurately set and filed, and all saws carefully straightened. Send order and check today. Delivery will be made as promptly as conditions permit, from a few days to a week or two. You can obtain these saws at the following prices:

1/8"-3/16"-1/4"-3/8" wide, 5'6" long.....\$.90 each
1/8"-3/16"-1/4"-3/8" wide, 6'6" long..... .95 each
1/8"-3/16"-1/4"-3/8" wide, 7'6" long..... 1.10 each

Other sizes at proportional prices

NO C.O.D. SHIPMENTS ACCEPTED
State Make of Machine

Your satisfaction is guaranteed

BURRILL SAW & TOOL WORKS
405 E. Main St., Ilion, N.Y.

Stop PIPE JOINT LEAKS

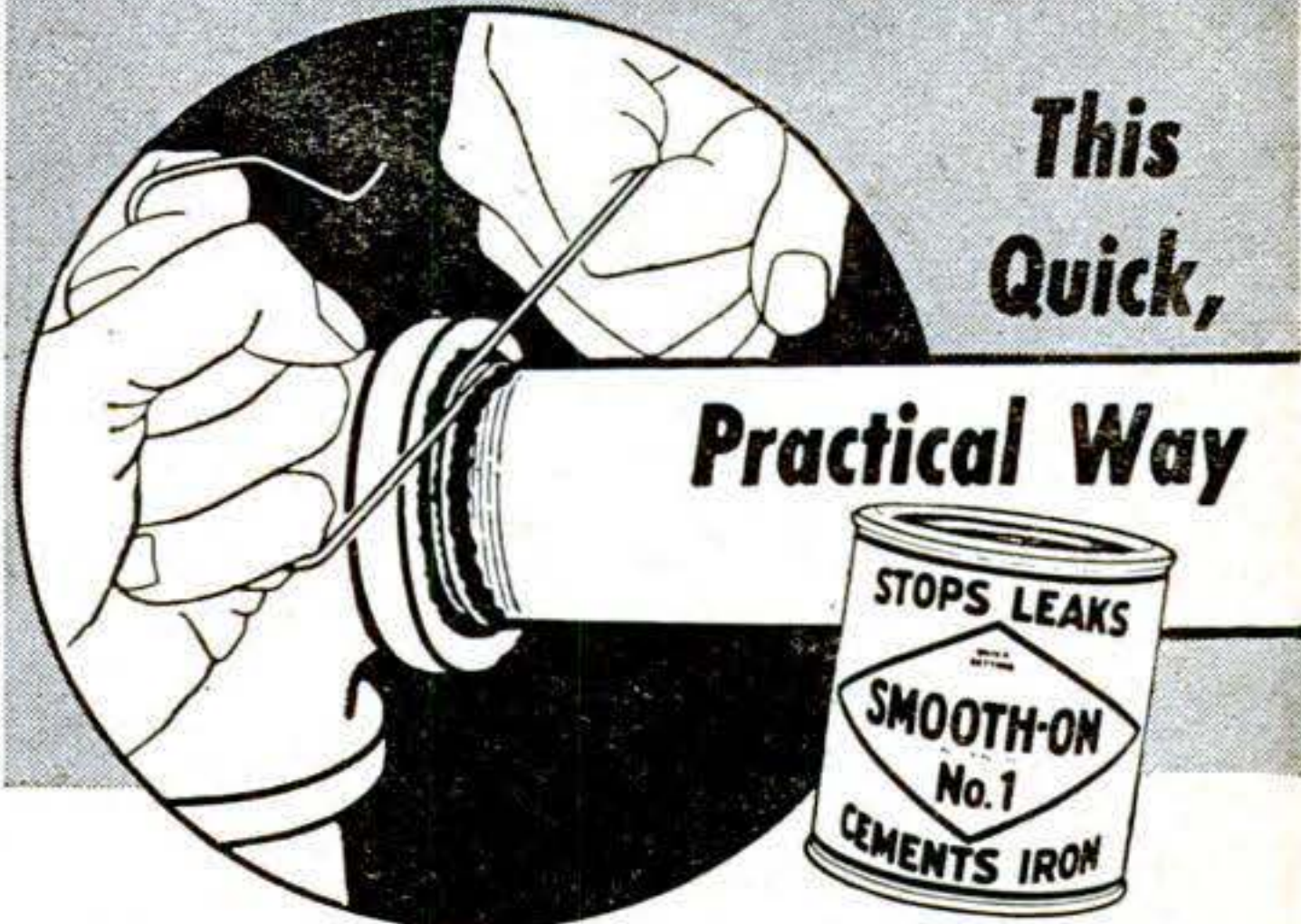

This
Quick,

Practical Way

If it isn't possible or convenient to take the joint apart, shut off the water and apply Smooth-On No. 1 Iron Cement to the pipe threads where they enter the fitting.

Force the cement into the leak by winding soft iron wire around it. Twist ends of the wire together and let the cement harden before turning on the water.

You'll find you've stopped the leak surely and inexpensively.

To apply Smooth-On, you simply mix it with water—no heat necessary. It hardens like metal, expands slightly as it sets and stays tight.

Keep Smooth-On No. 1 handy for stopping leaks, sealing cracks, tightening loose parts, bolts, screws, handles, knobs, casters, etc. Buy it in economical 1 3/4-oz. or 7-oz. size at your hardware store. If they haven't it, write us.

GET THIS REPAIR HANDBOOK **FREE**

This 40-page, pocket size book shows many other time-saving, money-saving metal repairs you can make around the house, on the car, etc. Clear directions. 170 diagrams. Just send the coupon.



SO-208 Sign and Send NOW

Smooth-On Mfg. Co., Dept. 58J
570 Communipaw Ave., Jersey City 4, N. J.
Please send me my free Smooth-On Handbook

Name.....

Address.....

9-47.....

Do it with **SMOOTH-ON**
THE IRON CEMENT OF 1 000 USES

**FOR SAFER DRIVING IN STORMS AHEAD
ASK YOUR GAS PUMP MAN TO PUT ON FOR YOU**

New "DEAD-LOCKER" Models

ANCO RAIN-MASTER

Windshield Wiper Arms and Blades

Made in U. S. A. by

THE ANDERSON COMPANY GARY, INDIANA

WHEELS AT BARGAIN PRICES



- ...4" wheel & tire, 5/16" sleeve bearing & hub cap\$0.45 ea.
- ...5" wheel 5/8" solid tire 5/16" shaft hole.... 0.65 ea.
- ...6" wheel 5/8" solid tire 5/16" shaft hole.... 0.75 ea.
- ...7" wheel 3/4" solid tire 3/8" shaft hole..... 0.85 ea.
- ...8" wheel 1" solid tire 1/2" sleeve bearing.. 1.25 ea.
- ...8x2" wheel, semi-pneumatic tire
7/16" ball bearing..... 2.50 ea.
- ...10x1.75 wheel semi-pneumatic tire
7/16" ball bearing..... 3.25 ea.
- ...12x1.75 wheel semi-pneumatic tire
7/16" ball bearing..... 3.50 ea.
- ...x2.75 wheel semi-pneumatic
5/8" ball bearing..... 5.75 ea.
- ...6x2" wheel 5/8" ball bearing, solid tires... 3.95 ea.

BUILD YOUR OWN Wagons, Scooters, Soap Box Racers, Welding Carts, Baby Pens, etc.

To order above wheels write number wheels wanted in space provided, tear out and mail this ad with check or money order and your name and address. If other sizes are wanted write for FREE LIST. **TRULSON MFG. CO., 811 E. 31 St., Dept. P-5, Kansas City, Mo.**

Shoots Light 800 Ft!

A genuine Delta for home and away. Spotlight and floodlight. 80-100 hrs. on a 6-volt battery. At hardware, sport, electrical stores. Less battery **\$3.95**



Delta ELECTRIC CO.
MARION, INDIANA

POWERlite 2-LITE ELECTRIC LANTERN

PRESSURE QUEEN

FOUR CYLINDER
PORTABLE AIR COMPRESSOR
SPRAY PAINTING OUTFIT

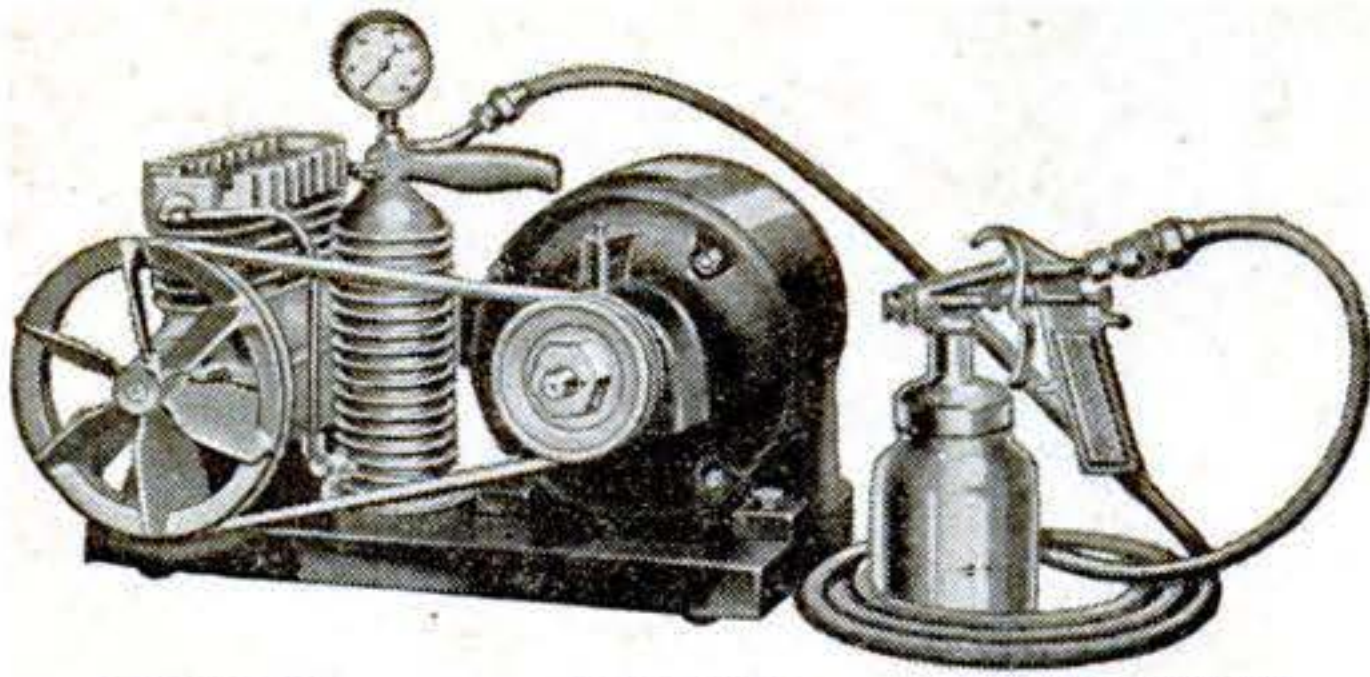

COMPACT • RUGGED • POWERFUL

The ideal air supply for home and farm workshop, machine shop, garage and contracting painter; for product finishing, inflating tires, painting automobiles, trucks, machinery, etc. Indispensable for building maintenance, interior and exterior. Handles any paint, insecticide or disinfectant.

This 4 cylinder compressor has drop forged crankshaft, stainless steel, heat treated valves; bronze bearings and positive forced feed lubrication. Maximum pressure 50-60 lbs., free from pulsation. Standard equipment includes the compressor mounted on steel base with carrying handle, belt, compressor pulley, air chamber, air gauge, 15-ft. hose, spray gun. Requires 1/2 or 1/3 h.p. motor or gas engine.

If your dealer does not sell Pressure Queen write direct

THE CAMPBELL-HAUSFELD CO.

151 RAILROAD AVE.,

HARRISON, OHIO

Now
for EVERY WORK SHOP!
NEW
Invention

Electroplates by BRUSH



Easy to Plate CHROMIUM
GOLD, SILVER, NICKEL, COPPER
... For Pleasure and Profit!

If you have a workshop—at home or in business—you need this new Warner Electroplater. At the stroke of an electrified brush, you can electroplate models and projects—you can replat worn articles, faucets, tools, fixtures, silverware, etc. with a durable, sparkling coat of metal... Gold, Silver, Chromium, Nickel, Copper or Cadmium. Method is easy, simple, quick. Everything furnished—equipment complete, ready for use. *By doing a bit of work for others, your machine can pay for itself within a week.* So make your shop complete by getting a Warner Electroplater right away. Send today for FREE SAMPLE and illustrated literature. ACT AT ONCE! Mail Coupon.
WARNER ELECTRIC CO., DEPT. N-6
1512 Jarvis Avenue, Chicago 26, Ill.

FREE Details & Sample!

WARNER ELECTRIC CO., 1512 Jarvis Avenue, Chicago 26, Dept. N-6

Gentlemen: Send Free Sample and Details to:

Name _____

Address _____

City _____

State _____

CHANGE BLADES IN 10 SECONDS

Without opening the case



QUICK-CHANGE BLADES are featured on all Carlson Rules. CHIEF is available in 6-, 8- and 10-foot lengths; WHITE CHIEF and HOBBY in 6- and 8-foot lengths. Keep a "spare" replacement blade on hand.



CHIEF



HOBBY



WHITE CHIEF

SOLD BY LEADING HARDWARE DEALERS

CARLSON STEEL TAPE RULES

60 POWER TELESCOPE \$2.95

VARIABLE EYEPIECE 20X-40X-60X

NEW! Three telescopes in one, 3 different magnifications. 20 power for ultra-bright images with 40 and 60 power for extra long range. Guaranteed to bring distant objects, people, sports events, ships, moon, stars, etc., 60 times as close.



Most powerful for anywhere near the money. 5 sections. Closes to 1 ft. long. Contains 4 ground and polished lenses. Also used as a powerful compound microscope. Directions included. Mass production enables us to offer this high-powered instrument at the amazing price of only \$2.95. We pay the postage. Get yours immediately.
BROWSCOPE CO. Dept. 9P 24 West 45 St.
New York 19, N. Y.

ATTENTION HOMECRAFTSMEN!

PLANS For Dutch Windmills, Lighthouses, Bird Houses, Lawn Chairs, Arbors, Trellises, many kinds of fine furniture, also a great variety of Lawn Figure patterns. SEND 10c FOR CATALOG ILLUSTRATING OVER 100 PRACTICAL PROJECTS.
Craftsman's Model Co., 2030 N. 41st St., Dept. K21, Milwaukee, Wis.

OWN A Printing Business

Cards, Tickets, Stationery, etc. Good profit in spare time. PRINT YOUR OWN greeting cards, movie titles, church work, etc. Save money. Easy rules supplied. Raised printing like engraving too. Have home shop. Sold direct from factory only. Send dime for supply book, suggested outfits, all details and advice on your needs. No obligation. **KELSEY, INC. C-33, MERIDEN, CONN.**

arc welding manual and text book...\$2.00
Teaches you how to become an arc welding operator - one of highest paid trades today. Write today!
Hobart Bros. Co., Box P-562, Troy, Ohio

EXHAUST BLOWERS \$15.85

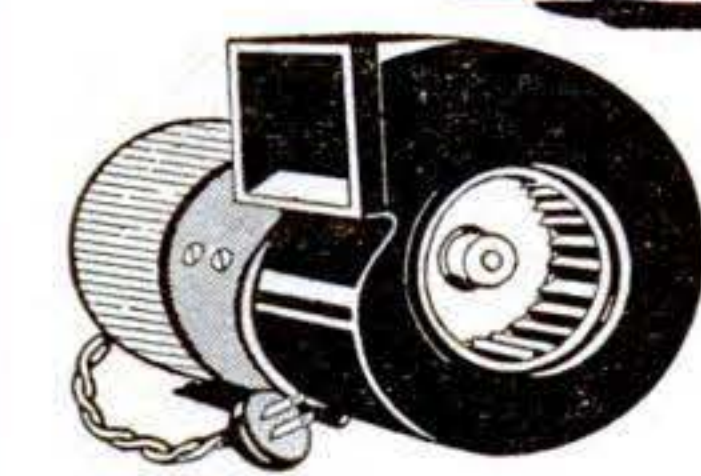

For PHOTOGRAPHERS • HOSPITALS • LABORATORIES • WORK SHOPS • LAUNDRIES • OFFICES • RESTAURANTS • PRINTERS • PLAYROOMS

100 CU. FEET FRESH AIR EVERY MINUTE!
Solve your ventilation problems with this NEW, durable, built-for-service blower and exhaust. Quick and simple to install. Anyone can do it with ordinary household tools. Continuous duty. BALL BEARING motor assures quiet, trouble free operation. Rugged housing insures long life. 110 Volt, A.C., 50-60 cycles. Send Check, Money Order. No C.O.D.'s. West of Mississippi add \$1.00 for mailing, handling.

Immediate Delivery!
UNIVERSAL YONKERS CORP.,
(Dept. S-9) 41 Locust St. Yonkers 2, N. Y.

Keep Brushes like New

BEFORE



AFTER



● 5c
● 10c
● 25c

**DICADOO
PAINT
BRUSH
BATH**

*Clean and Restores
PAINT BRUSHES*

Copyright
HELPS BRUSHES SPRING AND CLEAN
NET WEIGHT

At Paint, Hardware, Dept., and 5 & 10c Stores
Patent Cereals Co. Geneva, N. Y.

DIE-LESS DUPLICATING

Many small parts can be formed without dies, to duplicated accuracy of .001" with DI-ACRO Precision Machines. — Benders, Brakes, Shears. Save die expense and time delay. Ideal for experimental and research work, making samples, models, etc. as well as regular production runs. Write for descriptive literature.

O'NEIL-IRWIN MFG. COMPANY
342 8th Ave., Lake City, Minn.

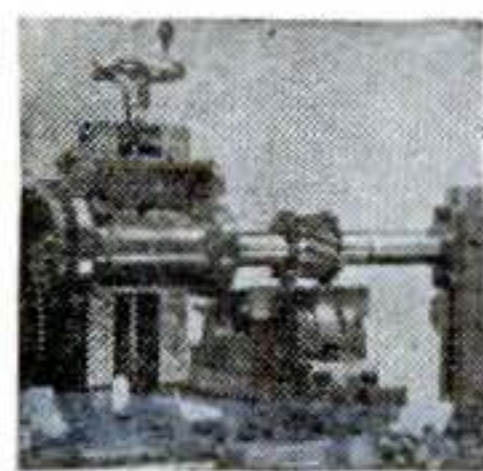

GLOBE MILLER

Installed on your lathe
in three minutes

DOES ALL TYPES OF MILLING . . . The Globe Miller does plain and angular milling, slotting, slitting, keyway cutting, dovetailing, spur gear cutting, rack cutting and many other types of work. *Increases swing of 10" lathe to over 16".*

CONTACT YOUR DEALER OR

WRITE FOR DETAILED INFORMATION

Give make, model and swing of lathe when ordering or requesting prices

GLOBE PRODUCTS MANUFACTURING CO.

Dept. 10, 3380 Robertson Blvd., Los Angeles 34, Calif.



1775

*On the night of
April 18th, Paul
Revere summoned
the Minute Men of
Lexington to arms.*

Sterling Hall's superb smoking
qualities were also "in the making"

Among the aged imported briar burls used for Sterling Hall pipes are many that were part of the Mediterranean landscape when Paul Revere made his famous midnight ride. For only the most mature, flavor-rich burls are used in fashioning this fine pipe.

Each bowl is skillfully turned to accentuate the beauty of its grain . . . then hand-polished to a lustrous, lasting finish . . . and further enriched by an *inlaid* Sterling Silver band, which strengthens the shank and maintains a perfect fit for the stem.

At leading tobacconists;
in all authentic shapes.

Sterling Hall, Standard, \$3.50
Sterling Hall, Hand Made, \$5.00
Sterling Hall, Highest Grade, \$7.50

Briarcraft, Inc.,
347 Fifth Avenue,
New York 16, N.Y.



Sterling Hall

BY BRIARCRAFT

ELECTRICITY *Anywhere*

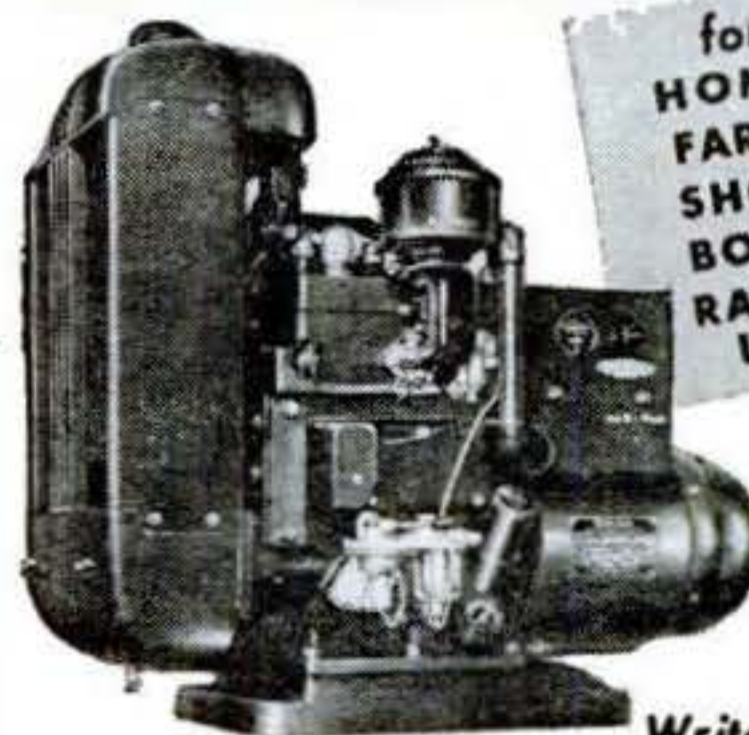

for
**HOMES
FARMS
SHOPS
BOATS
RADIO
USE**

● Onan gasoline-engine-driven Electric Plants supply reliable, economical electric service for any use. Portable, stationary or stand-by models. Water or air-cooled, compact and rugged.

A.C.: 350 to 35,000 watts in all standard voltages and frequencies. D.C.: 600 to 10,000 watts, 115 and 230 volts. **BATTERY CHARGERS:** 500 to 3,500 watts; 6, 12, 24, 32 volts.

Write for folder

D. W. ONAN & SONS INC.
2775 Royalston Ave., Minneapolis 5, Minn.



SEPTEMBER 1947 263

The easy way to paint!

Speedy Sprayer



ONLY \$26.95 LESS MOTOR

Favorite of home owners and craftsmen for 20 years! SPEEDY SPRAYER gives your work that professional paint finish everyone admires. Sprays paint, enamel, varnish, lacquer, etc. . . . 4 to 7 times faster than hand brushing! Lightweight, portable, uses any 1/4 H.P. motor. Improved diaphragm principle assures clean, oil-free air. You'll find dozens of time and money saving uses for SPEEDY SPRAYER, including spraying insecticides 2-4-D and DDT. Complete outfit, without motor, only \$26.95.

At leading hardware, lumber, and auto supply dealers. **FREE**—write for handy booklet "How to Spray."

W. R. BROWN CORPORATION
5718 Armitage Ave. • Chicago 39, Ill.

Completely New and COMPLETE

Federal's Low Price INCLUDES A Highly Corrected Enlarging Lens



When you examine the price tags of the new Federal Enlargers remember that the price on the tag is for a complete enlarger . . . LENS AND TAX INCLUDED.

For Federal's low prices are not arrived at by stripping off important enlarger parts and listing them as separate items in order to give the impression of low price.

Federal's prices are low! . . . the result of years of specialized experience in designing and building "America's Fastest Selling Enlargers" . . . undeniably America's greatest enlarger values.

MODEL 312. For miniature to 2 1/4" x 3 1/4" negatives. Fedar: 3 1/2" F:6.3 Anastigmat with Iris Diaphragm. Complete with lens **\$53.00**

Model 315 (as illustrated) \$89.50

FEDERAL MANUFACTURING & ENGINEERING CORP.
Makers of Photographic & Electronic Devices
213 STEUBEN STREET • BROOKLYN 5, N. Y.

Ask For the *Genuine* **ZIPPO** Windproof **LIGHTER**



\$2.50
\$1.00 extra with signature or initials

LIFETIME GUARANTEED BY ZIPPO MFG. CO., BRADFORD, PA.

A.C. CURRENT ANYWHERE!

WITH **Katolight Plants and Generators**



Furnish the same kind of Current as the highlines. Sizes 500 watts to 100 KW. Also Manufacturers of Rotary Converters, Frequency Changers, 32 and 110 Volt D.C. Motors in 1/4, 1/3, & 1/2 H.P. A.C. Motors (high line) in 1 1/2 and 2 H.P. only.

KATOLIGHT 1401 First Avenue MANKATO, MINN.

ONE-MAN SAWMILL LESS THAN \$200.00

Easy To Turn Trees Into Money



Makes Lumber (jes, shingles, crates, lath, studding, siding).

BELSAW MODELS in 10 to 24 foot sawing lengths. **MECHANICAL FEED.** accurate set works and positive dogs. Use tractor or old auto engine for low cost power. Thousands used for commercial sawing. Pays for itself quickly. Send post card today for **FREE** booklet, "How To Make Lumber" and Catalog of Woodworking Equipment.

BELSAW MACHINERY COMPANY
2846A Field Bldg., 315 Westport Rd., Kansas City 2, Mo.

Evinrude Catalog Free



Completely describes 1947 line of Evinrude outboard motors — light "singles", smooth "twins" and 3 thrilling four-cylinder models. Gives helpful information on boats, speeds, etc. Profusely illustrated. Address, **EVINRUDE MOTORS**, 5603 N. 27th St., Milwaukee 9, Wis.

EVINRUDE

PLASTIC SUPPLIES

Plexiglas, Lucite, Sheets, Rods, Tubes, Cement Dyes, Buffs, Equipment, Etc. Lowest prices. Send 3c stamp for catalog. **PLASTICS MFG. & SUPPLY CORP.**, Dept. S-9, 4707 Euclid Ave., Cleveland 3, Ohio.

L*AM CARBIDE SCRIBER NON-MAGNETIC



Tungsten Carbide — carefully ground on diamond laps, brazed into stainless steel 6" handle for marking steel and other metals — for etching, marking, cutting glass. In plastic case with pocket clip.

PRICK PUNCH Tungsten carbide tip, silver brazed into 3 1/2" heat treated steel body. with Carbide Tip . . . **\$1.50** Price Post Paid

LUCAS-MILHAUPT ENGINEERING CO.
5051 SOUTH LAKE DRIVE • CUDAHY, WISCONSIN

IMMEDIATE DELIVERY!

Complete
as shown

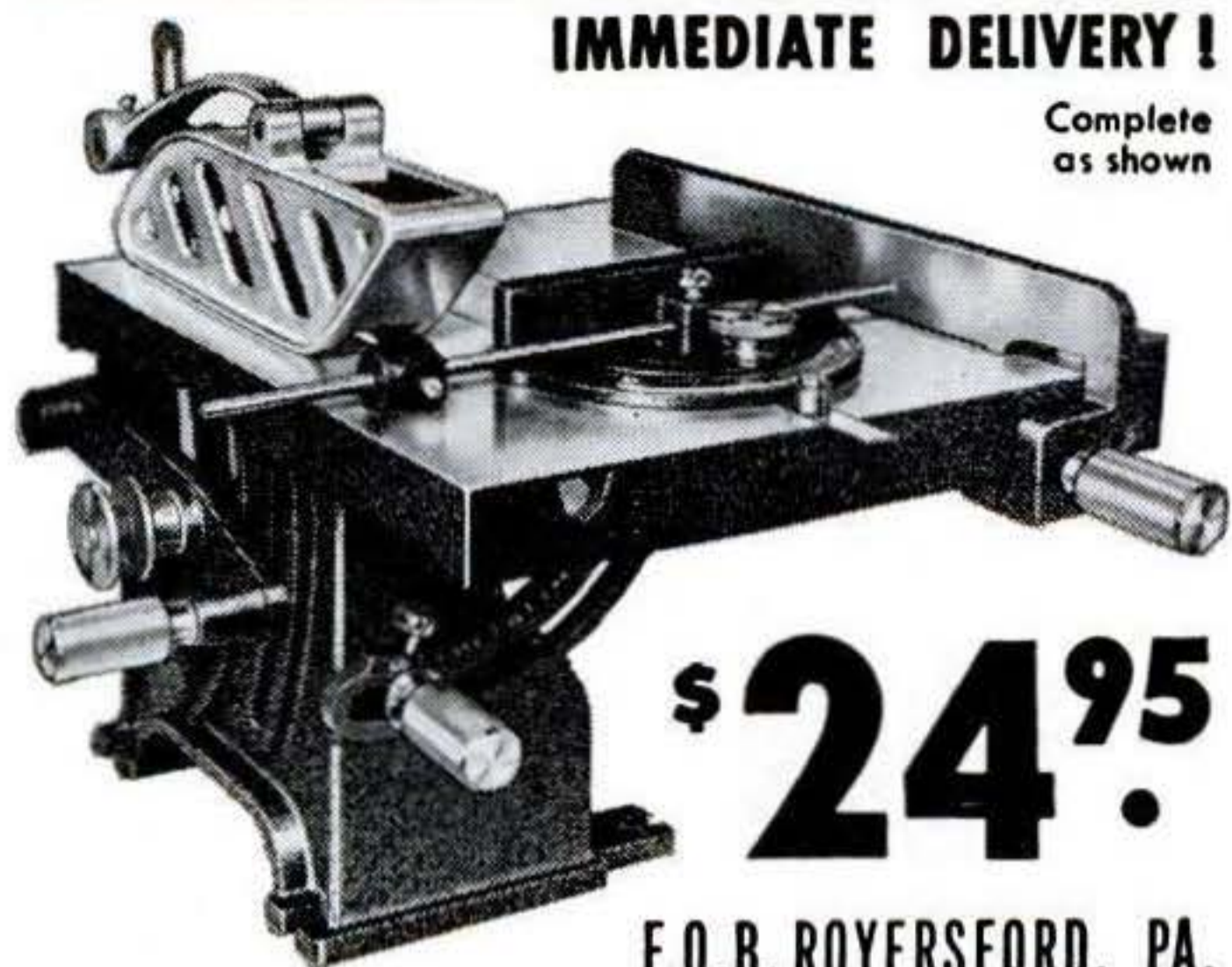

\$24⁹⁵

F.O.B. ROYERSFORD, PA.

QUALITY 8" BENCH SAW

CUTS THROUGH 2⁵/₁₆"

UNCONDITIONALLY GUARANTEED ONE YEAR

(Write for Free Booklet and Guarantee Bond)

Comes complete with Floating motor mount—miter gauge with adjustable stop—aluminum guard—soft aluminum insert—spring steel splitter—heavy gray iron fence—(no motor—no blade). Table 12" x 14". Tilts to 45°—Oilite bearings. Shipping Wt. 50 lbs.

AMERICAN MACHINE & TOOL CO. Inc.

DEPT. 200

ROYERSFORD, PA.

FREE

value packed

RADIO CATALOG

write for it today!

Lafayette Radio

DEPT. K17, 100 SIXTH AVE. • NEW YORK 13

USE AC's FOR

UTMOST RELIABILITY

Dairies and milk producers use factory-recommended AC Spark Plugs to assure utmost reliability in milk delivery. Your AC dealer can supply you with factory-recommended AC's for your car, truck or tractor, designed for today's fuels and driving conditions.



Look for this sign



Spark Plugs cleaned and adjusted "By the AC Method" may save as much gas as 1 gallon in 10

AC SPARK PLUGS

AC SPARK PLUG DIVISION • GENERAL MOTORS CORPORATION

GENERATOR and BATTERY CHARGER

Economical! Portable! Many Uses!



Continental Motors' **TINY TIM** is back! This sturdy, reliable unit generates enough current to light a six-room house. Genuine **Red Seal** 3/4 h.p. engine drives generator delivering 240 to 300 watts — 6, 12, 32 volts. Write for free folder!

EXCLUSIVE TINY TIM FEATURES

Push-button self starter. Pulley for power take-off. Gas tank in base. Built-in ammeter. Simple output control. Handle for easy carrying.



HOMES



GAS STATIONS



CAMPS

WRITE FOR FREE FOLDER

Colorful folder gives complete details on Tiny Tim. Send for it today. Dealer inquiries invited.

Continental Motors Corporation
Muskegon, Michigan



TRAILERS



COTTAGES

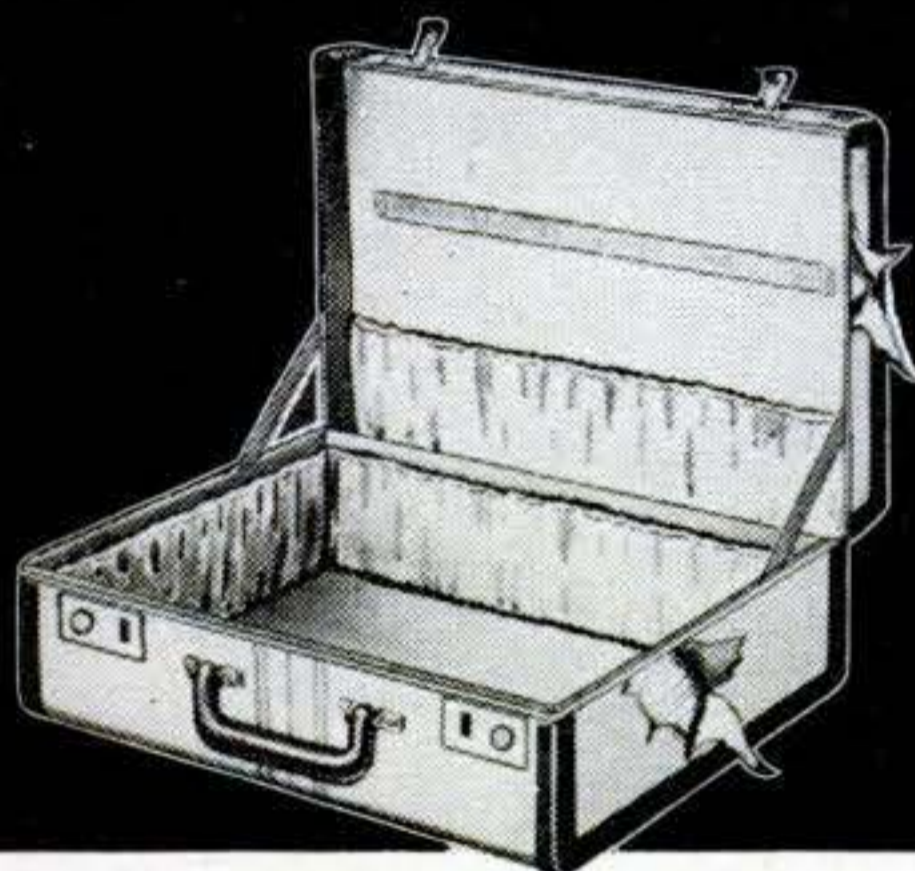

FIXES

LUGGAGE, FURNITURE,
DISHES, TOYS,
AND BOOKS

It's transparent, water-proof, flexible and durable. Get a tube today.

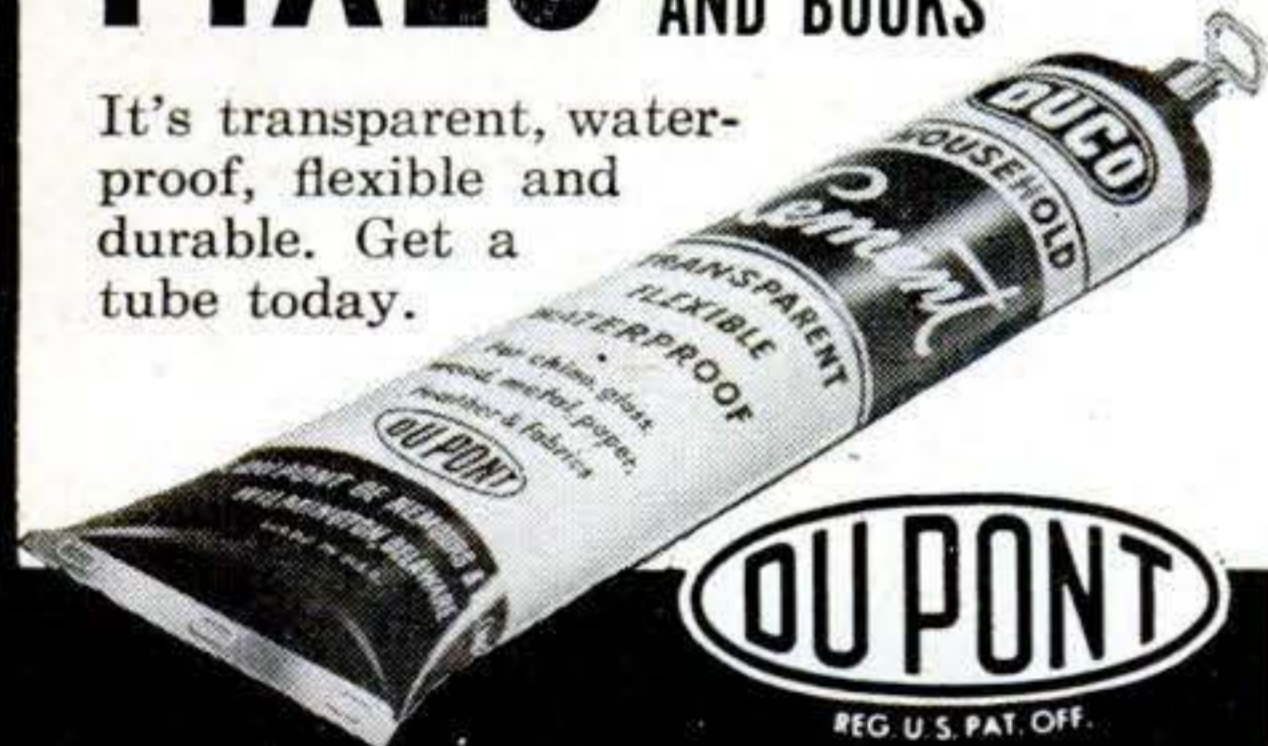

DUCO CEMENT

REG. U. S. PAT. OFF.

BUILD IT YOURSELF

COMBINATION WORK-BENCH AND DRAWING BOARD

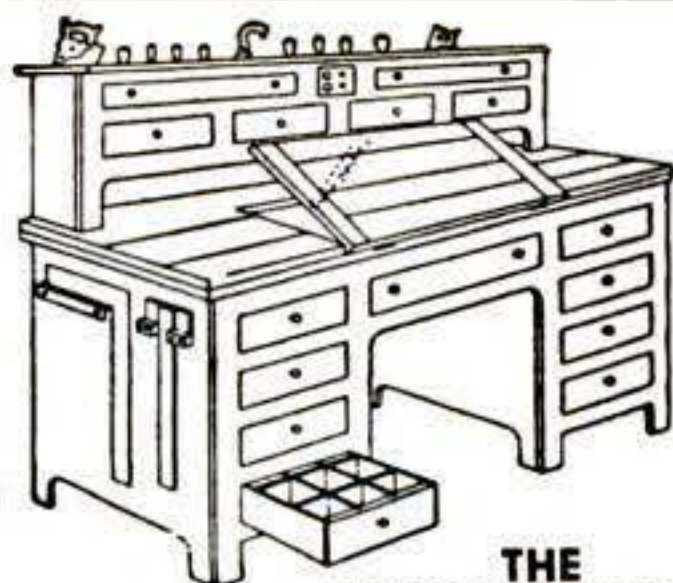

THE HANDY MAN'S FRIEND

This combination is entirely new and just what you need to help you build everything you want. There are drawers for everything—room to draw—room to work. Blueprint simplifies every step. Size can be regulated to your requirements—60" or larger, or smaller. Anyone handy with tools can make it. Start with this item, and be prepared to make anything you want. It's the first step to Big Profits—or an enjoyable hobby. Complete set of drawings and booklet "Let's Make It"—showing numerous new useful and beautiful pieces for home or office—things you'll be proud to own. Send check, money-order, or cash today.

ALL FOR
\$ 1.00

Post Paid

I. C. SHALKOP DEPT. B
1216 RIDGE AVE., PHILA. 23, PA.

5 DAYS TRIAL on NEW WONDER TOOL

Try the remarkable Bandsander—Economy Home-shop Model—5 days in your own workshop! It's again available to hobbyists, craftsmen, model-makers, etc. Quickly shapes, sands, carves, profiles, grinds, bevels, smooths, polishes and cleans wood, metal, plastics! Works equally well on inside cutout openings or irregular outside edges, on intricate scrolls, curves. Gets at places no other can. Patented. Table top tilts. Rust-and-sweat proof top. Self-oiling sleeve bearings. Normal band speed 1600 ft. per min. gives fast, smooth, clean cuts. 1/4 hp 1725 rpm motor recommended. Rush only \$14.95 with Bandsander order—or \$5. balance COD. **Immediate shipment!** 5 Days Trial. Money Back Guarantee. Limited supply so order NOW or send postal for free, lavishly illustrated Circular!



(Dealers write!)

MEAD SPECIALTIES

4114 N. Knox Av. Dept. 297 Chicago 41, Illinois

FREE TRAILER PARTS CATALOG

"Safety Engineered"



BULL DOG Hitches & Parking Jacks.

TORQ-LESS Axles,

Drop a card to Dept. D-16
HAMMER BLOW TOOL CO., WAUSAU, WIS.

How to PROSPECT For ATOMIC MINERALS

The world-wide search for radioactive minerals is on! New deposits are being found constantly in the U.S. Find out how to detect Carnotite, Pitchblende, and other atomic minerals. Send 25c for booklet now! Tells:

How To Operate a GEIGER COUNTER

New radioactive deposits may be found in any state. There may be atomic minerals on your mining properties. Write today for full details on three models available:

TX-5, Prospector's Model
TX-7, Mine Inspection Unit
TX-9, Mine Laboratory Unit

Ask About IMMEDIATE DELIVERY!!

Manufacturing Division OMAHA SCIENTIFIC SUPPLY
3623 Lake Street Dept. PS-3 Omaha 3, Nebr.



A Real Sensation!

Here's something needed in every shop

the New

L-W Medium Duty 4-Jaw Independent CHUCKS for Small Lathes

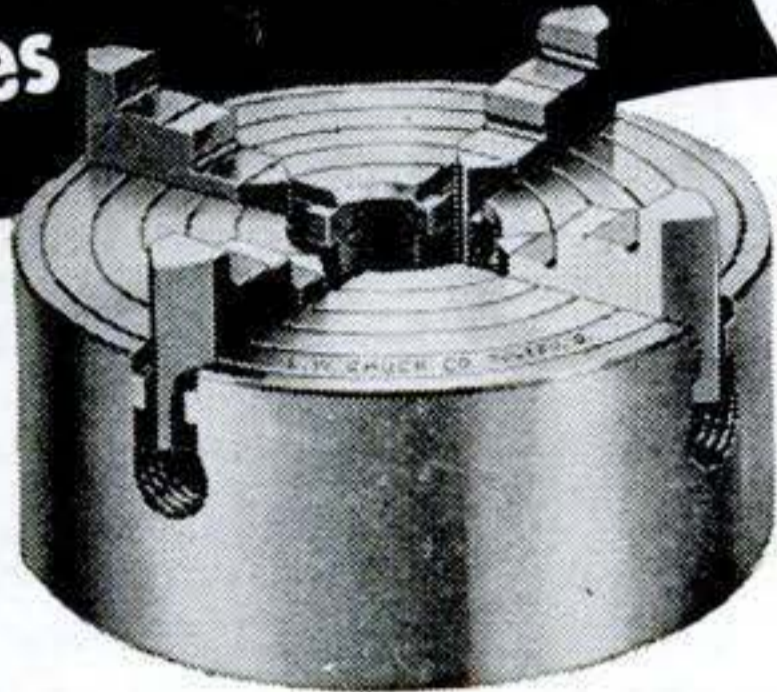

They will save you a lot of time and labor and permit much more accurate work.

PRICED WITHIN THE REACH OF ALL!

Semi-steel bodies. Face and outer edge surfaces ground. Steel jaws. Hardened and ground steps. Heat-treated steel screws. Complete with wrench.

Finished adapter back plates are suitable for some models of Atlas, Clausing, South Bend and Logan lathes.

6" HEAVY DUTY \$16.95

Semi-finished, ready to mount adapter back plate, 1 1/2"—8 thread \$3.00. Rough adapter back plate casting, \$1.25.

RUGGED 8" MEDIUM DUTY \$21.

Semi-finished, ready to mount adapter back plates, 1 1/2"—8 thread \$3.60. Rough adapter back plate casting, \$1.50.

ORDER TODAY or write for complete catalog

MFGRS. UNIVERSAL AND INDEPENDENT LATHE CHUCKS • MILLING MACHINE VISES • POWER HACK SAWS • DIVIDING HEADS • MAGNETIC CHUCKS • RECTIFIERS • DEMAGNETIZERS

L.W. CHUCK CO., 32 So. St. Clair St., Toledo 4, Ohio



"LITTLE WONDER" Crystal Radio

NO ELECTRIC—NO BATTERIES—NO TUBES

One of the smallest genuine crystal radio sets in the world. Slider-contact tuning, binding posts for aerial and ground. Extra long range. **SEND NO MONEY.** Just send your name and address and when your "Little Wonder" arrives simply pay the postman \$1.99 plus a few cents postage. Sent prepaid if you inclose check or money order with your order.

MART DISTRIBUTORS

Box 3472 Merchandise Mart, Chicago 54, Illinois, Dept. S-1



MACHINISTS — TOOLMAKERS

Gerstner Tool Chests in modern designs for your good tools. Free Catalog.

GERSTNER TOOL CHESTS
547 Columbia St., Dayton 7, Ohio

AUTOMATIC RETOOTHER

MAKES NEW PROFITS

Cuts new teeth in 50 seconds! Any size tooth 4 to 16 points. Old teeth fall off as chips. Simple to operate. A perfect job.

IMMEDIATE DELIVERY

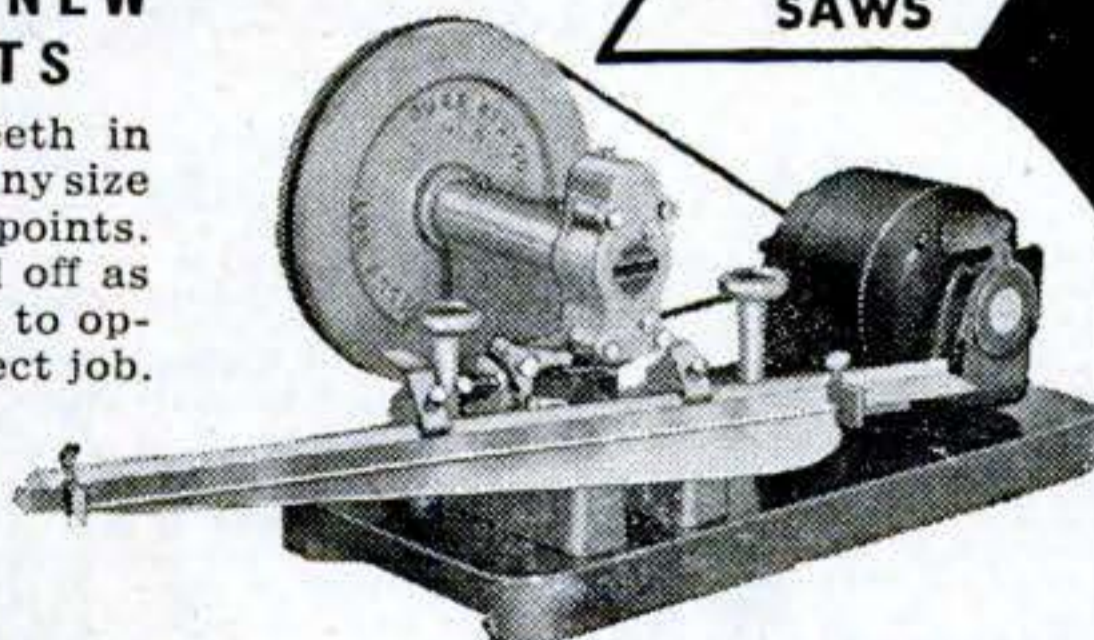

FOR HAND SAWS

SET SAW TEETH — 400 PER MINUTE WITH THE NEW AUTOMATIC SAW SET
PERFECT HAMMER AND ANVIL ACTION SETS TEETH UNIFORMLY — TENSIONS METAL — NO TOOTH BREAKAGE.
BURR MFG. COMPANY 8931-H Venice Blvd., Los Angeles 34, Calif.



Carve Real Gifts for fun and profit

Pleasure and profit are yours when you work with a Millers Falls Carving Tool Set. With these high-quality tools you can carve wood and linoleum blocks into a variety of useful or fun-provoking objects. Their fine quality, heat-treated steel blades take and hold a razor-keen edge.

You're your own gift-maker with a carving tool set — so get ready for Christmas by carving animals, toys, model airplanes and ships the children will love. Print your own colorful greeting cards from linoleum blocks you can cut yourself. And remember Millers Falls carving sets make fine gifts themselves — for fellow craftsmen.

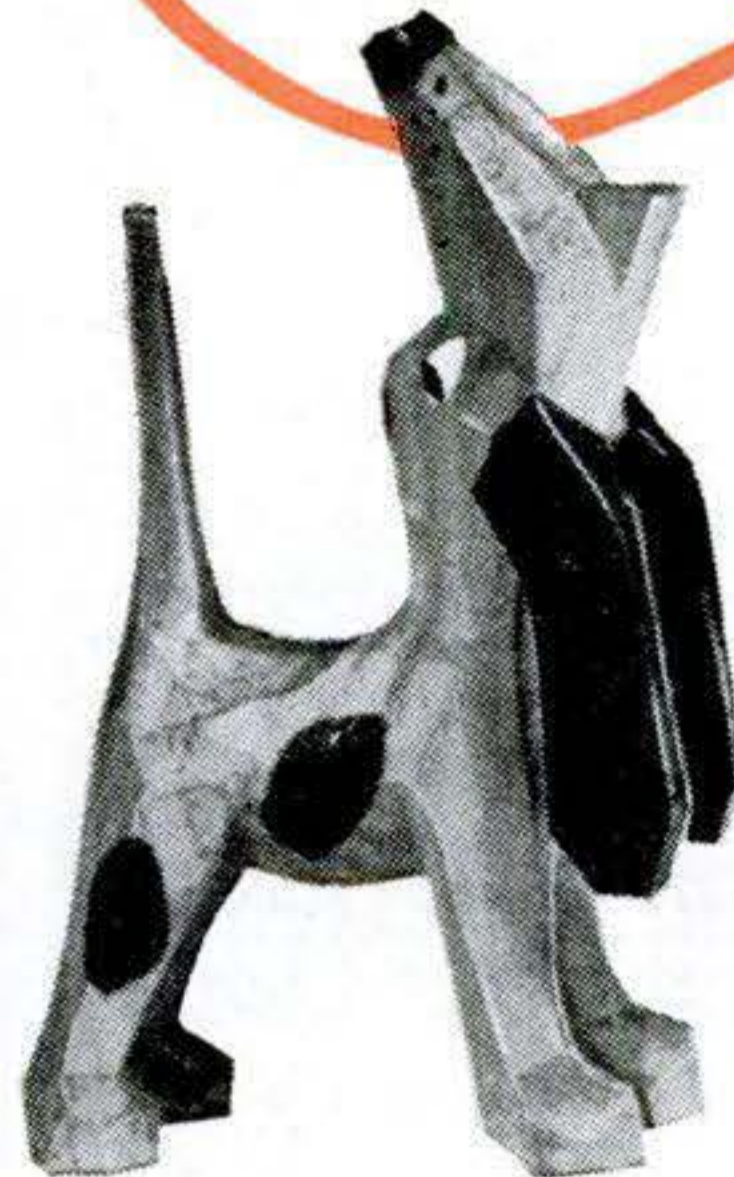

See Millers Falls carving tool sets at your hardware dealers.

MILLERS FALLS TOOLS

SINCE 1868

MILLERS FALLS COMPANY
GREENFIELD • MASSACHUSETTS

SEPTEMBER 1947 267

MASTER DRAFTING MACHINE

Mounted on
20" x 24"
Masonite

for Beginners • for
Professionals

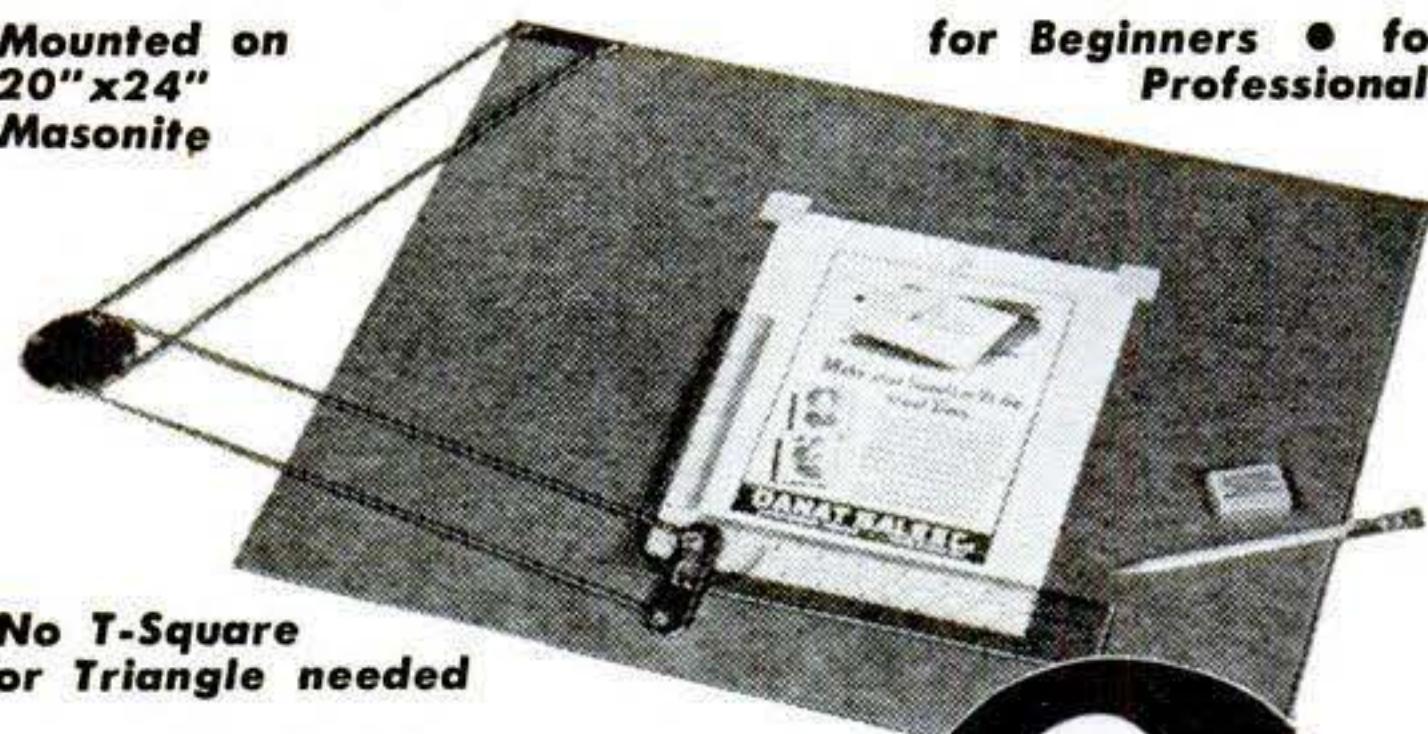

No T-Square
or Triangle needed

Make
FASTER-BETTER
Drawings-Layouts!

\$2.95

Yes!—the Master Drawing Machine not only is an advanced aid for faster and better mechanical drawing—it is a Time Saver. Professional users praise its dual-purpose features which eliminate countless unnecessary movements.

Advertising men have found the Master Drawing Machine to be a short cut to quicker results and better work. This mechanical drawing board adds Speed to valuable time.

The unique, fixed mechanical guide operates with finger-tip ease. Its swivel action allows diagonal paneling at any angle.

DANAT COMPANY, Dept. PS-9, 624 S. Michigan Ave., Chicago 5, Ill.

Please ship
Quantity.....Master Drafting Machine @ \$2.95 ea. \$.....

Name.....

Address.....

City.....State.....

Send check or Money Order

Danat Company, 624 S. Michigan Ave., Chicago 5, Ill.

In Canada \$3.95 F.O.B. Write to: 1055 Eglinton Av. W., Toronto 10, Ont.

The Torco utility combination bench and pipe vise is so carefully designed and ruggedly constructed that it will give years of satisfaction without side wear or dead motion. Precisely threaded spindle and replaceable hardened steel jaws.

See Your Dealer
as low as **\$7.20**
With 3 1/2" Jaws

Free Folder Explains Features To Look For In A Good Vise
Wilton Tool Mfg. Co., 936-F Wrightwood Ave., Chicago 14

WILTON VISES
Built by Wilton—They Must Be Good

NOW YOU TOO CAN BUILD 15 RADIOS

COMPLETE KIT \$14.75

Absolutely no Knowledge of Radio Necessary
You Need NO Additional Parts

The PROGRESSIVE RADIO KIT is THE ONLY COMPLETE KIT. Contains everything you need. Instruction Book, Metal Chassis, Tubes, Condensers, Resistors and all Radio parts. The 36-Page Book written by Expert Radio Instructor teaches you to build radios in a Professional Manner. You start with a 1-tube receiver. Before you are done with this kit, you will have built 11 Receivers, 1 Public Address System and 3 Transmitters.

SPECIAL FREE OFFER!
Electrical and Radio Tester sent absolutely FREE with each Progressive Radio Kit. PLUS FREE membership in Progressive Radio Club. Entitles you to free expert advice and consultation service with licensed radio technicians.

Write for further information, or **ORDER your KIT NOW! ONLY \$14.75**
(Postage not prepaid with C.O.D. orders)

PROGRESSIVE ELECTRONICS CO., Dept. 88
22 Havemeyer Street Brooklyn 11, N. Y.

**FOR AN INTERESTING HOBBY
FOR A PROSPEROUS BUSINESS**

BUY A PORT-O-TOOL
THE TOOL OF A THOUSAND USES
for PLASTICS • WOOD • LEATHER • METAL

A FEW OF ITS THOUSAND USES
Cutting and carving plastics (internal or external) • Engraving or stamping • Embossing • Welding • Heat sealing • Soldering • Etching • Wood burning • Sawing

PORT-O-TOOL will make many beautiful items from plastics, leather, wood. Easy to operate. **NO SKILL REQUIRED.** A natural for hobbyists, home craftsmen or for commercial use. PORT-O-TOOL is economical to operate—light in weight—guaranteed against defective parts for one year. Illustrated instruction book with each model suggests many items to make. If your dealer cannot supply you, order direct, giving his name. Free descriptive literature on request. **2 MODELS TO CHOOSE FROM:**

PORT-O-TOOL MASTER: Large, heavy duty—for hobbyists or commercial use. Complete with carving tools and saw. Retail \$22.50 • PORT-O-TOOL JUNIOR: Small, compact—for hobbyist. Equipped with carving tools. Retail \$15.75.

We carry a complete line of plastic supplies and materials for the Plastic-craft hobbyist. Send for our free catalog.

BARNETT SPECIALTY CO 5104 HOLLYWOOD BLVD. HOLLYWOOD 27, CALIF.

NEW 7 3/4" DISC SANDER - NO GLUING \$5.95

Designed on an exclusive "Snap off—Snap on" principle, sandpaper can be changed in a few seconds. No messy gluing. No special discs. Uses 7" square sandpaper. Precision-machined aluminum head. Specify 1/2", 5/8", 3/4" bore. Tremendous saving time and material. Also drill press planer and sander. Literature available.

MASTERCRAFT, 60 South, Boston, Mass.

Ottawa Self-Propelled Buzz Master

CLEARs LAND FAST! Powerful 7-HP motor with friction clutch for safe operation. Cuts down timber, brush and hedge; turn blade vertically and saw logs to length. Also furnished with post hole diggers. Has clutch pulley for belt work.

OTTAWA MFG. CO., 1-701 Brush Ave., Ottawa, Kansas

No Other Like It!

Learn LANDSCAPE GARDENING

A thorough, interesting, home study course for those who wish to become Landscapers, Gardeners, Designers, etc., for profit or pleasure. Write today for Free Book to

APPROVED NATIONAL LANDSCAPE INSTITUTE
FOR VETERANS Dept. PS-9, 310 So. Robertson, Los Angeles 36

BUILD YOUR OWN FAST FREEZER

PLANS \$1.00

It's easy to build this household appliance and profitable to use. Save up to 75%. Operates on 110 or 32 volts. Plans show 5 sizes and are easy to follow. **ENJOY MAKING ONE OF** these freezers from new or used parts. No expert knowledge needed. Mail \$1.00 bill or check for complete plans and catalog.

LE JAY MFG. Co., 123 Le Jay Bldg., Minneapolis 8, Minn.

5 sizes
8 to 40 cu. ft.



Night write?

Inkograph's a light writer any time... less tiring when you write a lot—never cramps your hand. The point is a rounded, fine cylindrical shaft of extra-hard 14kt. gold that writes easily on any kind of paper, in anybody's hand—even left hands!

Rules lines, makes carbon copies, takes hard wear, gives years of service...

In five colors and black. At all good stores. Priced lightly...

only \$2

INKOGRAPH

Inkograph Co., Inc., 200 Hudson St.,
New York City 13, N. Y.



A TOOLSHOP IN YOUR HAND!

- GRIND • DRILL • ROUT
- POLISH • ENGRAVE
- CUT • SAND • SAW • etc.

MAKE THINGS FROM WOOD
PLASTICS—METALS—GLASS
LINOLEUM—LEATHER
ALLOYS—HORN—STONE
BONE, etc.

HANDEE TOOL OF 1001 USES

THE ORIGINAL TOOL OF THIS TYPE AND TODAY'S FINEST! Smooth, steady power at your fingertips! Perform precision operations not possible with any other portable tool! With a Handee you can turn out professional looking projects for pleasure or profit—ship, plane and train models, delicate, internally carved costume jewelry, wood carvings, puppets, initialed tumblers, etc. AC or DC. 25,000 r.p.m. Wt. 12 oz. Over 500 accessories made especially for the Handee!



A GOOD START—THE HANDEE KIT

HANDEE Tool and 40 most popular accessories packed in compact steel carrying case. You'll be amazed at what you can accomplish! Complete, \$27.50
Handee only, with 7 accessories, \$20.50

FOR YOURSELF OR A FRIEND...
THE GIFT OF A LIFETIME!

NEW PRECISION ATTACHMENTS

Fit Handee only, enable novice or craftsman to do perfect work. Magically, easily, your offhand carving, routing, shaping will be exact as to depth of cut, accuracy of line. Set of 6 attachments with instructions, \$7.95

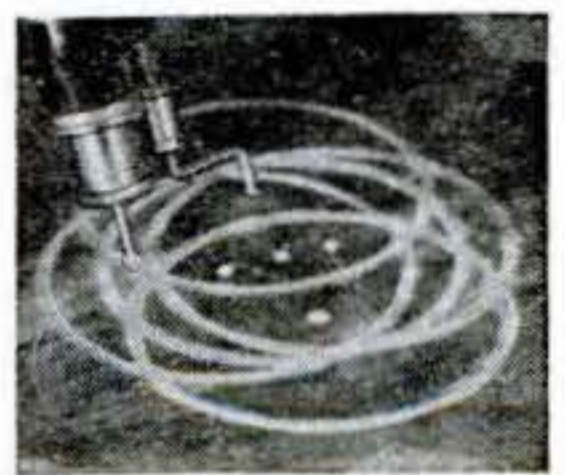

GET A HANDEE at stores everywhere. If they can't supply you we'll send it postpaid. Satisfaction guaranteed. Free 52-page Manual on request.

CHICAGO WHEEL & MFG. CO.
1101 W. Monroe St. Dept. PO, Chicago 7, Ill.

Send Handee Kit Handee Tool Precision Attachments C.O.D. Remittance enclosed Send Manual

Name.....
Address.....
.....

USE YOUR BENCH SAW

FOR JOINTING & CUTTING MOULDINGS

With our six inch tool steel cutters make mouldings, casings, drop-leaf tables, grooves beading and jointing. Moulding cutters, A 1 in. wide \$1.50, 1 1/2 in. \$2.00. Jointing cutters, B 1 in. \$1.50, 1 1/2 in. \$2.00. E 1 in. for drop-leaf tables, \$1.50, E 1 1/2 in. Makes 3/4 in. cove & Quarter. \$2.00. Postpaid. Guaranteed. State size hole. List & Folder free.
JOHN A. SANDSTROM
Rt. 1-P. Clearwater, Fla.

41 HANDICRAFT KITS for the workshop and the home



• Woodcarving, leatherwork, veneer and plastic packets, metalcraft and many other complete kits. Each with full instructions for making attractive articles and gifts. Kits for all ages. Send dime for illustrated catalog-handbook describing all kits in detail.

BEAVER CRAFTS, Inc. DEPT. 11

11558 S. Wentworth Ave., Chicago 28

CUSTOM-MADE QUALITY AUTO SEAT COVERS

Of Genuine Plas-Ti-Text Fibre

2 for 1
Because You Buy DIRECT FROM FACTORY

18 Month Unconditional Money Back Guarantee

PLAS-TI-TEXT Auto Seat covers are water repellent, fibre-plaid sturdy & trimmed with harmonizing piping, leatherette to match.

In Maroon, Blue, Green
Get This Amazing Value
SAVE UP TO 50% \$7.49 All Standard Coupes Reg. \$12
\$11.49 All Standard Coaches & Sedans. Reg. \$21
Add \$3 for Center Arm Rest Models.

Save Money! We pay postage if full payment is enclosed. Same money back guarantee.
Distributors Invited

REPUBLIC MFG. CO., Dept. R-22
1040 Findlay Ave., N.Y. 56, N.Y.

Print clearly (On separate piece of paper) your Name, Address, State, Make of Car, Year, Series No. and type of front seat. Pay postman.

BRAND New
6 Tube Superheterodyne
**AIRCRAFT
RADIOS**

3 gang condenser, RF stage, 2 IF stages, tunes 6 to 9.1 Mc. built by Western Electric complete with tubes in original carton. Easily converted to home use. Shipping Weight 8 lbs.

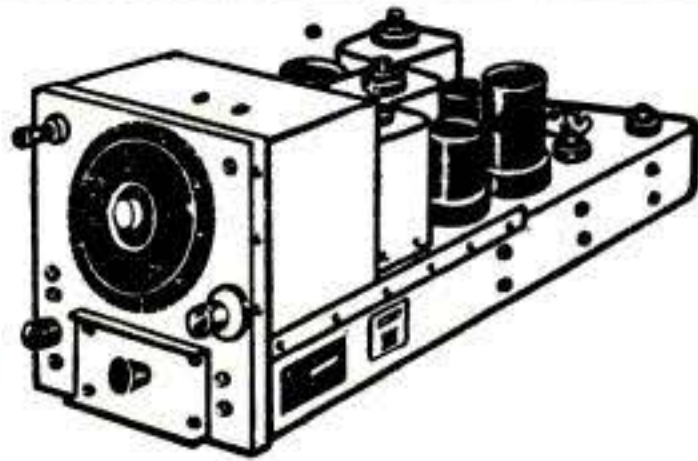

Only **\$4.95**

NEW DYNAMOTORS

built by Western Electric for Army. Consists of 6 to 24 volt electric motor operating 220 volt generator on same shaft. Hundreds of uses, motor alone worth \$5.00. Can be converted to 110 AC for fans, movie projectors. Shipped in original carton. Shipping Weight 6 lbs.

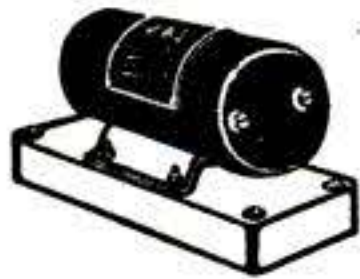

\$1.50

TUNING UNIT

The heart of the Army Walkie-Talkie BC745. Contains transmitter crystal and tank coil, receiver coil, tuning condenser and crystal, ideal foundation for small amateur set or walkie-talkie's. Brand new. Shipping Weight 1 lb.

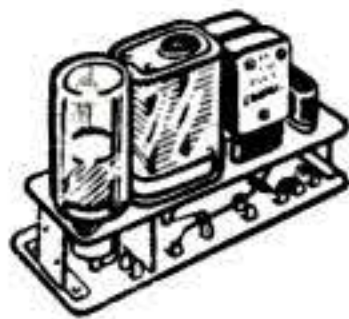

\$1.

**BRAND NEW ARMY T-30
THROAT MICROPHONES**

Used in aircraft, tanks, etc. Use to broadcast through your radio, in noisy factories, for home telephone systems, hundreds of applications. Shipping Weight 1 lb.



\$1.

THE HEATH COMPANY
BENTON HARBOR, MICHIGAN

BUILD YOUR POWER TOOLS

WITH OUR
BALL BEARING ARBORS

New Departure Self Lubricating Bearings 10,000 rpm

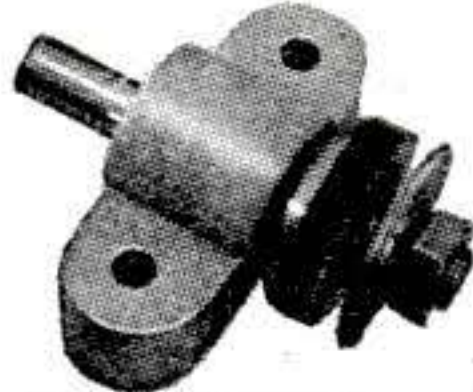

B33—\$4.95 PP
5/8x4 1/2 Spindle
B15 Plain Spindle
\$3.45

(No extra charge for left hand threads)
C4-1 1/2x12 1/2 Spindle, Housing 2x8 \$8.25 PP.
C5-5/8x12 1/2 spindle, housing 2x8 \$8.25 PP.
C6-3/4x12 1/2 spindle, housing 2 1/4x8 \$9.25 PP.
D8-1x17 1/2 spindle, housing 2 5/8x11 \$16.95 PP.
1 INCH BETWEEN WASHER AND COLLAR

SPECIAL SAW ARBORS MADE

Shaper Arbors, C4, C5, C6 or D8, 3 inches between collars, add \$6.00. Plain Spindle Models less threads and collars C4—\$8.00, C5—\$8.00, C6—\$9.00, D8—\$16.00. All P.P.

SANDING DISCS, 8"—\$3.50 PP., 10"—\$5.00 PP. Center Hole 1/2, 5/8 or 3/4. State hole size.

PILLOW BLOCKS, Ball Bearing, Heavy Duty, Self Aligning, 1/2—\$3.90 ea., 5/8—\$3.90 ea., 3/4—\$4.25 ea., 1"—\$4.95 ea. P.P.

V BELTS 2 cents per inch.

PULLEYS 2"—\$33, 2 1/4"—\$35 P.P. State hole size.

DEALERS WANTED. We Guarantee Complete Satisfaction.

POLY PRODUCTS, 406 S. Chester, Ct. 1b, Pasadena 5, Calif.

A BONANZA FOR THE HOME WORKSHOP
ACTUALLY \$50.00 WORTH OF
GRINDING WHEELS

Abrasive discs, felt and buffing wheels, mandrels, rotary files, sheets, etc.

327 PIECES

ASS'T. SIZES
FOB CHICAGO

\$6.95

ALL FOR ONLY

The buy of a lifetime! 327 pieces including 35 ass't. Grinding and Cut-off wheels up to 10 inches diameter, 1/16 to 1 1/4 in. face, 1/8 to 3 in. holes. Assorted grits—all brand new—made by Norton, Carborundum, Macklin, Bay State, etc. Also included are 100 slotted disc cloths; 100 paper discs; 3 round wire brushes on handles; 2 felt bobs; 2 felt wheels; 1 4" rag buff; 3 honing stones; 10 abrasive sleeves; 10 mounted stones, 1/8 and 1/4 shank; 2 mandrels; 2 rotary files, 1/4 shank; 50 abrasive discs; 2 72" abrasive belts; 5 9x11 abrasive sheets. Satisfaction guaranteed. Order today. It's better than a \$50.00 value for only.....

\$6.95

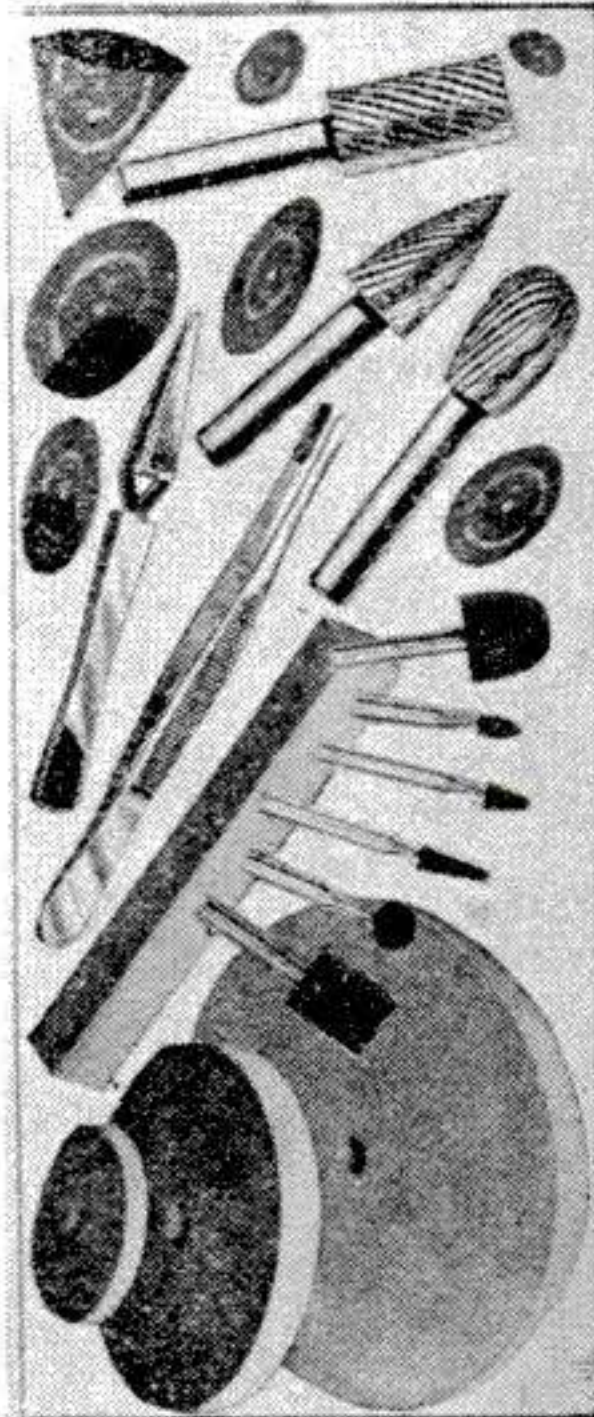

GROBAN SUPPLY CO. 1522 SO. MICHIGAN AVENUE
DEPT. PS 9, CHICAGO 5, ILL.

HANLAN APPLIANCE TESTER

AC ammeter range 0-15 Amp. Serves as wattmeter with conversion chart. High sensitivity neon tube. Checks thermostats. Tells instant it cuts in or out. Only \$14.50 complete, postpaid. Money Back Guarantee.

FREE with each tester. Complete course in practical appliance repairing. Write for circular.

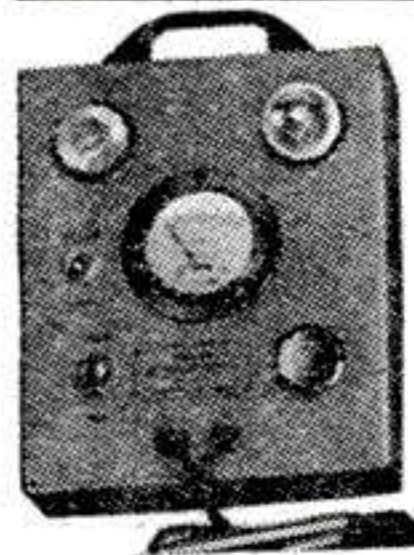

HANLAN CO.

1419-B, West Jefferson, Los Angeles 7, Calif.

**HIGH SPEED
ROTARY FILES**

Set of 5 Assorted.....\$2.00
Set of 10 Assorted.....\$3.75
Set of 20 Assorted.....\$7.25
Set of 30 Assorted.....\$10.00
1/4" shank

Send for circular on High Speed DRILLS & TAPS. Enclose 3c stamp for mailing.

SID TOOL CO.
MACHINE SHOP SUPPLIES
183 Grand St., New York 13, N.Y.

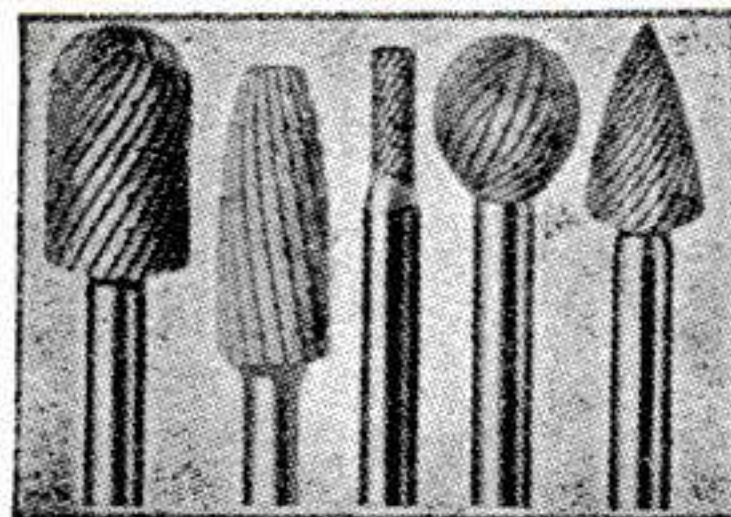

Say You Saw

It In Popular Science

LAW

STUDY AT HOME for PERSONAL SUCCESS and LARGER EARNINGS. 39 years expert instruction—over 108,000 students enrolled. LL.B. Degree awarded. All texts furnished. Easy payments. G.I. Approved. Send for FREE BOOK.

AMERICAN EXTENSION SCHOOL OF LAW
Dept. 81-S, 646 N. Michigan Ave., Chicago 11, Ill.

Floor Model, \$79.50,
Shipping Wt.,
156 Lbs.

QUALITY 8" TABLE MODEL TILT-ARBOR SAW

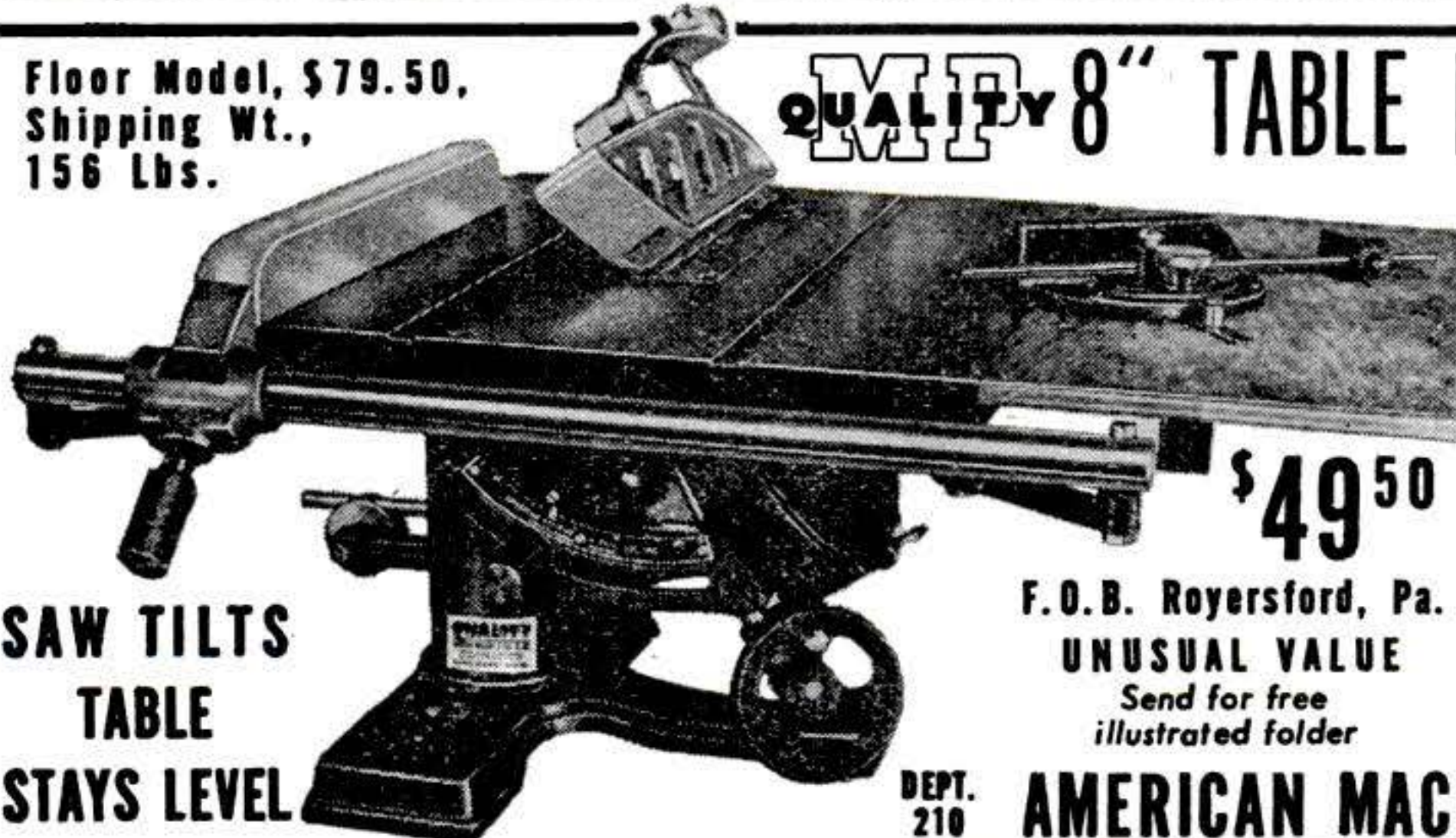

**SAW TILTS
TABLE
STAYS LEVEL**

\$49.50

F.O.B. Royersford, Pa.

UNUSUAL VALUE

Send for free
illustrated folder

DEPT.
210

AMERICAN MACHINE & TOOL CO., INC.

Royersford,
Pa.

UNCONDITIONALLY GUARANTEED 1 YEAR

Complete as shown with Trans-axial Ball Bearing Motor Drive, Ball Bearing Saw Arbor, Table including extension 18" x 25", Aluminum Fence & Saw Insert, Complete Mitre Gauge, Precision Segments on Mitre Gauge and Cradle. • Cast Iron table extension bracket furnished. Will support plywood top much larger than 9" x 18". Motor pulley and belt furnished. Blade and motor not included. SHIPPING WEIGHT 118 LBS.

IMMEDIATE DELIVERY

Royersford,
Pa.

MORE PROFITS

with

MODERN LAWN MOWER SHARPENER



SHARPEN ANY LAWN MOWER from 5-inch Edger to 36-inch Power Mower in ten to twenty minutes with a MODERN LAWN MOWER SHARPENER because dismantling is unnecessary — neither handle, roller, wheels nor motor need be removed when sharpening any mower. . . . the MODERN SHARPENER eliminates all hand filing; it precision grinds to the extreme ends of both left or right reel blades. Bottom knife is held in same brackets for sharpening. NO EXTRA ATTACHMENTS! Order today! Price \$241.50 (less motor) f.o.b. Pasadena (1/3 or 1/4 H.P. single phase motor recommended.)

Modern Mfg. Co., 160 N. Fair Oaks, Pasadena 1, Calif.

for smooth smart men

Vibra-Shav ELECTRIC RAZOR

TAKES ANY DOUBLE EDGE BLADE
SHAVE WET . . . CLEAN . . . FAST

WHISKER SLICING ACTION

ONLY \$6.95 post paid



Write to VIBRA Corporation

6651 ENRIGHT AVENUE — ST. LOUIS 5, MISSOURI

HOUSE PLAN TEMPLATE

Simplifies Home Planning

Made of clear sheet plastic, with accurate cut-outs for drawing door-swings, plumbing and electric fixtures, fireplace, stairs, molding, roof-pitch, etc. Standard 1/4" = 1'-0" scale.

\$1.50 POSTPAID
TIMELY PRODUCTS CO.
Box 206L, Columbus 9, Ohio

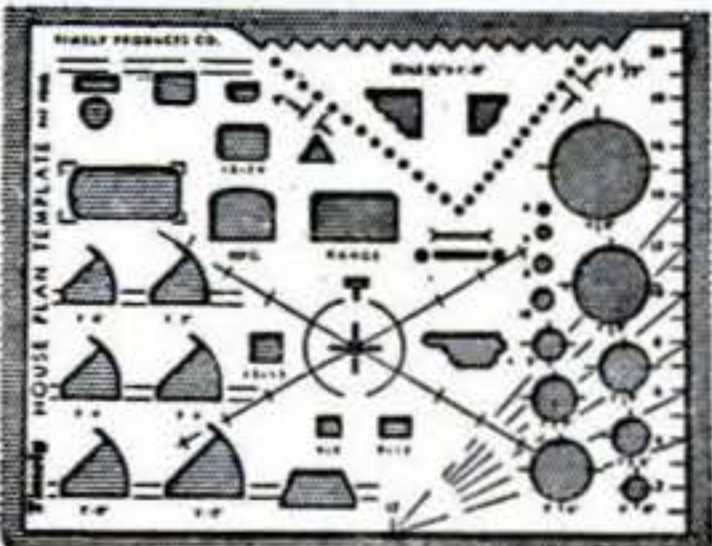

NEW "THERMO-SAW"

MAKE THINGS FOR THE HOME or FOR SALE

● ANY CHILD CAN USE IT ●

No Noise—No Vibration—No Sawdust
Boys and Mechanics thrill over the many interesting things that can be made with this NEW ALL-STEEL THERMO-SAW . . . You can cut out any pattern or design in 1/2 the time . . . Difficult patterns are made QUICK and EASY . . . No turning of work . . . Cuts in every direction! . . . Cuts plywood 1/8" or 1/4" . . . Cuts 14" x 36" board. Will cut 1/8" Plexiglas very well . . . A special transformer produces high frequency current in a tough steel wire "blade" from ordinary Alternating (AC) Current . . . IMMEDIATE DELIVERY!
Extra Blades Machine Measures 11" x ONLY 30c 4" x 3 1/2" High, Throat per dozen. 7" Deep. **PATTERN ORDER TODAY INCLUDED FREE.**

Manufactured by THE KING COMPANY, 6 No. Batavia Ave., Dept. PS-9, Batavia, Ill.

(cuts with heat)

CUTS RAPIDLY AND CLEANLY THROUGH WOOD AND OTHER MATERIALS

A FEW OF THE MANY INTERESTING THINGS YOU CAN MAKE

Pat. No. 2,272,931
D-87-072

AN IDEAL GIFT

NOTE: Operates on 110 volt Alternating Current: 50 to 60 cycle.
\$6.23 in Canada & Mexico. \$6.48 elsewhere. On C.O.D. Orders Mail \$1 Deposit.



DEALERS WANTED EVERYWHERE

ONLY \$5.98 Postpaid

COMPLETE SAW outfit as illustrated with transformer and 12 spare blades. Ready to use.

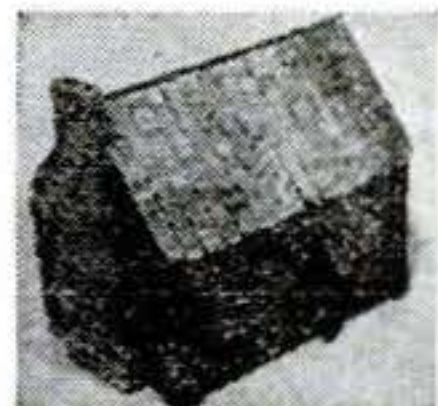
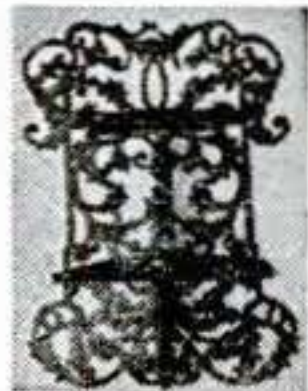

Before you shoot color—

. . . remember that the secret of true, life-like color is in the exposure. With a WESTON Exposure Meter to guide you, you'll know when to shoot and, better yet, when not to. Ask your dealer for a demonstration today, or write Weston Electrical Instrument Corp., 622 Frelinghuysen Ave., Newark 5, N. J.

WESTON
Master II
EXPOSURE METER



"THE METER MOST PHOTOGRAPHERS USE!"

LOW-PRICED LARGE-IMAGE TELEVISION IS HERE!

Transvision's Brand
New 12" Tube Kit, only **\$289.50**

**Gives You Larger Image Than
Sets Selling at \$500**

● Here is your chance to get low-priced, large-image television with an easy-to-assemble Transvision Television Kit. After only 20 working hours you'll have a ringside seat at fights and ball games with a "big-as-life" television set.

Nothing extra to buy! Price includes specially designed folded dipole antenna, 22 tubes, R. F. unit pre-assembled and pre-tuned for all stations, true F. M. sound (besides 12" picture tube large enough for 60 people!). Even solder is supplied!

If you can read a roadmap you can put a Transvision kit together! Complete novices have done it by following the simple step-by-step directions. All you need is a screwdriver and soldering iron to finish off the assembly. Factory guarantees high quality, clear, sharp reproduction as good as sets selling at twice the price.

So, join over 10,000 satisfied people who have saved money by putting an easy-to-assemble Transvision Television Kit together. *Beat high-priced finished set costs!* Order today. A \$25 deposit will assure early delivery. (Beautifully turned walnut cabinet available, for those who wish it, at low cost.)

MAIL THIS FOR FREE DETAILS

Beacon Television, Inc., Dept. E
143 E. 49th Street, New York 17, N. Y.

Gentlemen:

Please send me more information about Transvision's new easy-to-assemble, large image 12" tube television kit.

Name

Address.....City.....State.....

FURNACES

Gas
Oil

Floor furnaces, RANGE burners, GAS burners for natural, mixed and liquid petroleum gases. GUNTYPE oil burners with controls. PRE-CAST fire boxes. BLOWERS, blower wheels, Bearings, etc. Exhaust fans. Wholesale and retail.

PEERLESS SALES, 4320 SHERIDAN BLVD., LINCOLN 6, NEBR.

MAKE \$ MORE MONEY

Applying or Selling

CORKSTONE

A General Purpose Magnesium Oxychloride Flooring

THE MODERN PLASTIC FLOORING

EASY TO APPLY
Here's your opportunity to get into business for yourself applying or selling Corkstone, the economical, top-grade plastic flooring. Plenty of profit. Act without delay!

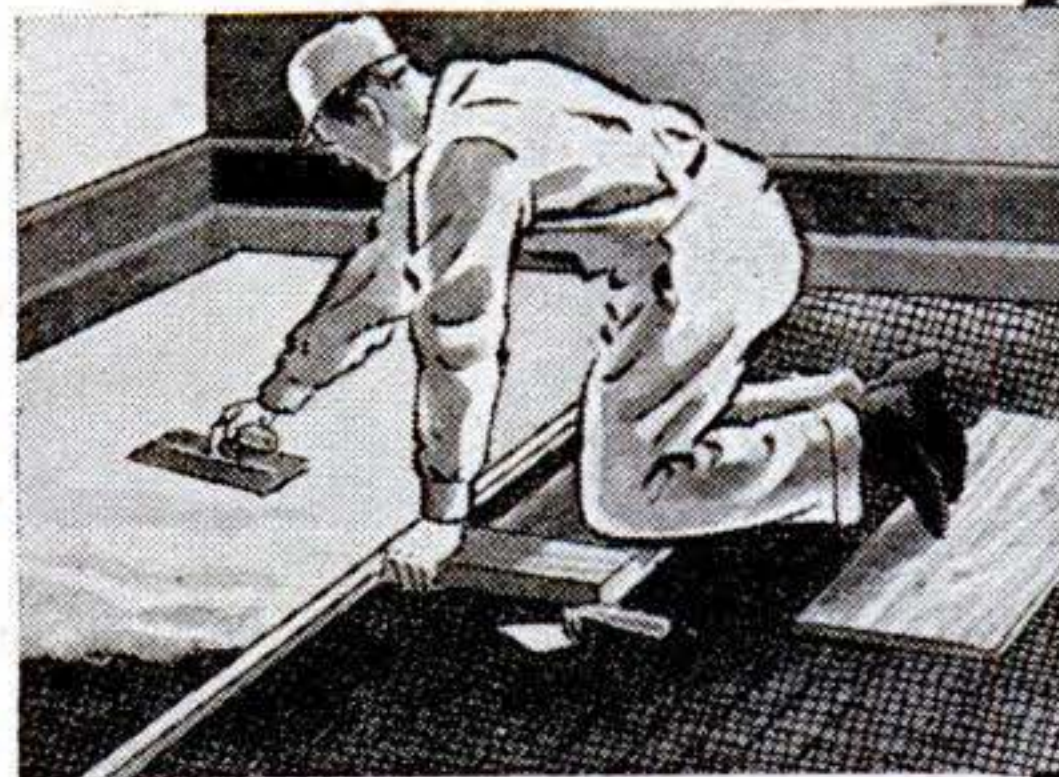

Dealers & Agents Wanted

WRITE FOR DETAILS

LASTING PRODUCTS COMPANY

200 Block S. Franklinton Rd., Baltimore 23, Md.



**U. S. SURPLUS
BARGAIN**

**New NAVY
GOGGLES**

Brand new! In original packing. Each with three interchangeable lenses.

SHOCK PROOF FRAME—SHATTERPROOF LENSES

Use them for all outdoors sports, beach, motoring, boating—anything. Heavy wind-proof sponge rubber ventilated frame with chamomile sweat lining! Adj. elastic head band. Red, green, amber flexible shatterproof lenses, all instantly interchangeable. They won't last long at this price—it's smart to buy an extra. Post paid in U.S.A.

GROBAN SUPPLY CO., Dept. PS 9
1522 S. Michigan Ave., Chicago 5, Ill.

\$1.00
POST PAID

WRITE FOR YOUR **FREE** COPY OF THE NEW
KRW HYDRAULIC PRESS BOOK

Describes all manner of Production and Shop Work on KRW Hydraulic and Bench Type Arbor Presses. 32 pages illustrating the new KRW Hand-operated, Electric-operated and Air-operated Hydraulic Presses.

Write for your copy today.

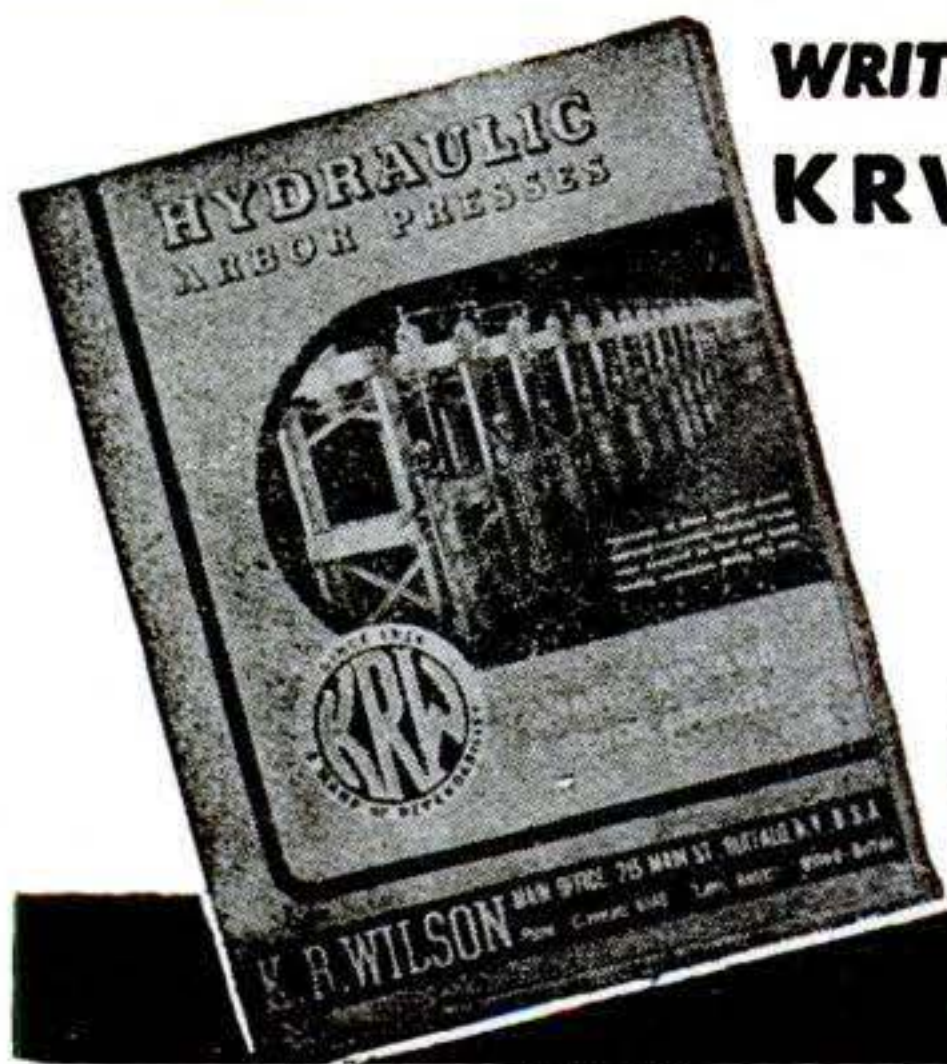

K. R. WILSON, DEPT. 54, 215 MAIN ST., BUFFALO 3, N. Y.

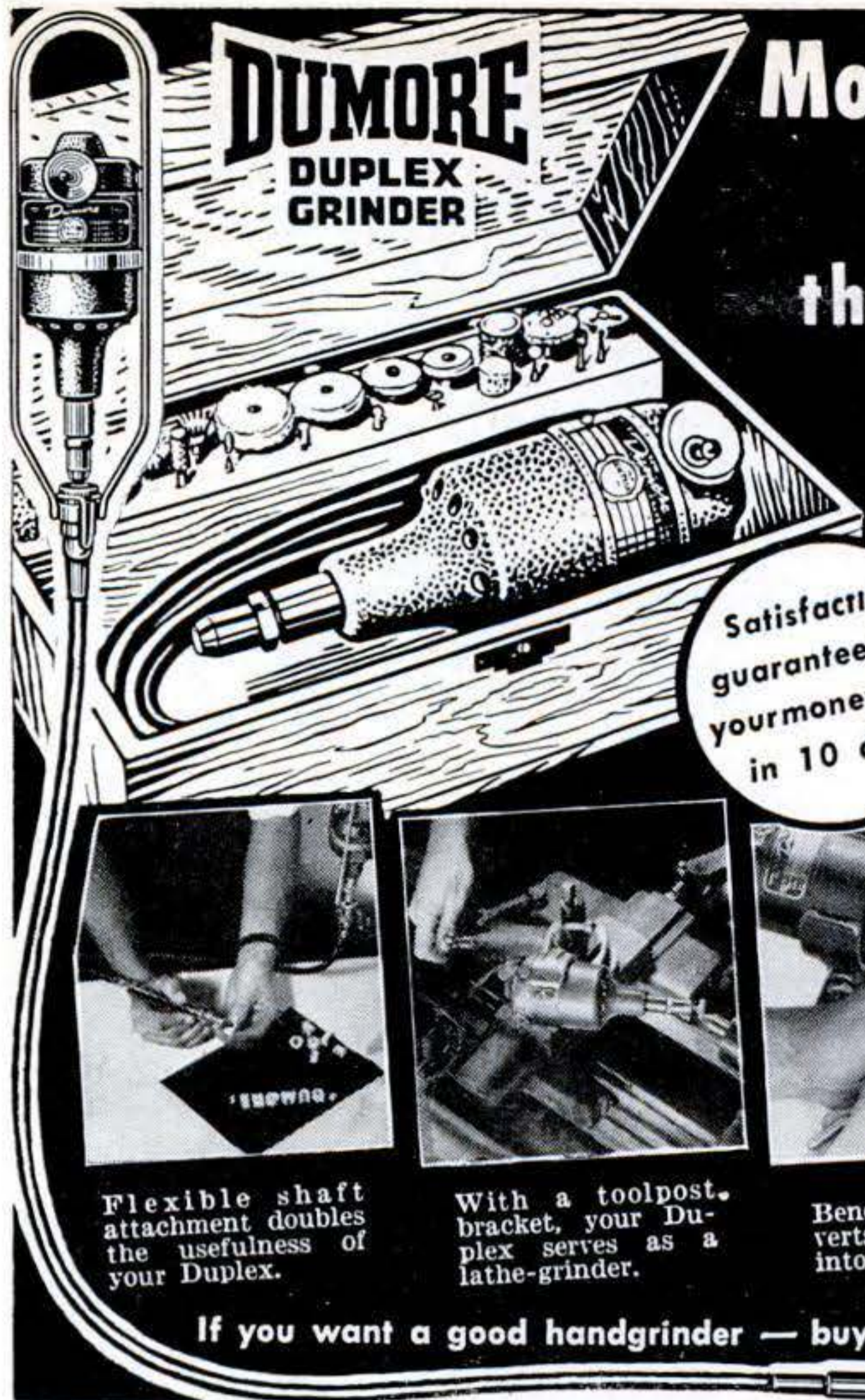

**DUMORE
DUPLIX
GRINDER**

**More Power, More Capacity,
and More Versatility —
than any other handgrinder!**

Makes your work easier, faster, twice the fun!

Here's the handgrinder you've always wanted for your workshop — the tool that gives you more of everything you want, than any other handgrinder. Its full 1/4 HP motor has the extra power for "heavy" jobs. Its extra-capacity chuck takes all 3 tool sizes—1/4", 1/8", 3/32". With a simple, easy-to-use attachment, your Duplex becomes a flexible-shaft tool. Other attachments convert it in-

stantly for bench or lathe work.

Think what you can do with the extra power, capacity, and versatility of the Dumore Duplex! Work in wood, metal, and plastics is faster, easier — and twice the fun!

The powerful Duplex is the perfect gift for any hobby-minded man or boy. See it in your local hardware store today — or send in the coupon below!

**Satisfaction
guaranteed or
your money back
in 10 days!**



Flexible shaft attachment doubles the usefulness of your Duplex.



With a toolpost bracket, your Duplex serves as a lathe-grinder.



Bench stand converts your Duplex into a third tool.

If you want a good handgrinder — buy a Dumore!

Tear out this coupon and mail today!

The Dumore Company, Dept. J-52, Racine, Wis.

- Please send complete information on Duplex Grinder.
- Send me DeLuxe Duplex Kit (27 accessories as illustrated); \$27.50 enclosed.
- Send me Standard Duplex Kit (9 accessories); \$19.75 enclosed. Shipping charges C.O.D.

Name.....

Address.....

City..... State.....

**NEW! TWIN CARBURETION FOR V8 FORDS
MERCURYS
CHEVROLET
PLYMOUTH
PONTIAC 6
OLDS 6**

Test-O-Lite the MODERN TROUBLE SHOOTER



THE NEON GLOW

... LOCATES TROUBLE INSTANTLY in electric circuits, fuses, cut-outs, motors, radios, appliances. Tests everything electrical from 100 to 550 volts. Indicates hot or grounded wires. Tells AC from DC. Engineers prefer it because it has patented safety features.

PUTS "FINGER" ON THE TROUBLE SPOT - - QUICKLY

Far superior to ordinary clumsy test bulb. Saves precious time. Indispensable in shop or home. Vest pocket size. Lifetime guarantee. (Pat. No. 1,778,883) Purchase through regular electrical dealers.



FUSES



MOTORS



OUTLETS

L. S. BRACH MFG. CORP.

200 Central Ave. Newark, N.J.

CRANDALL TILTING TABLE SAW

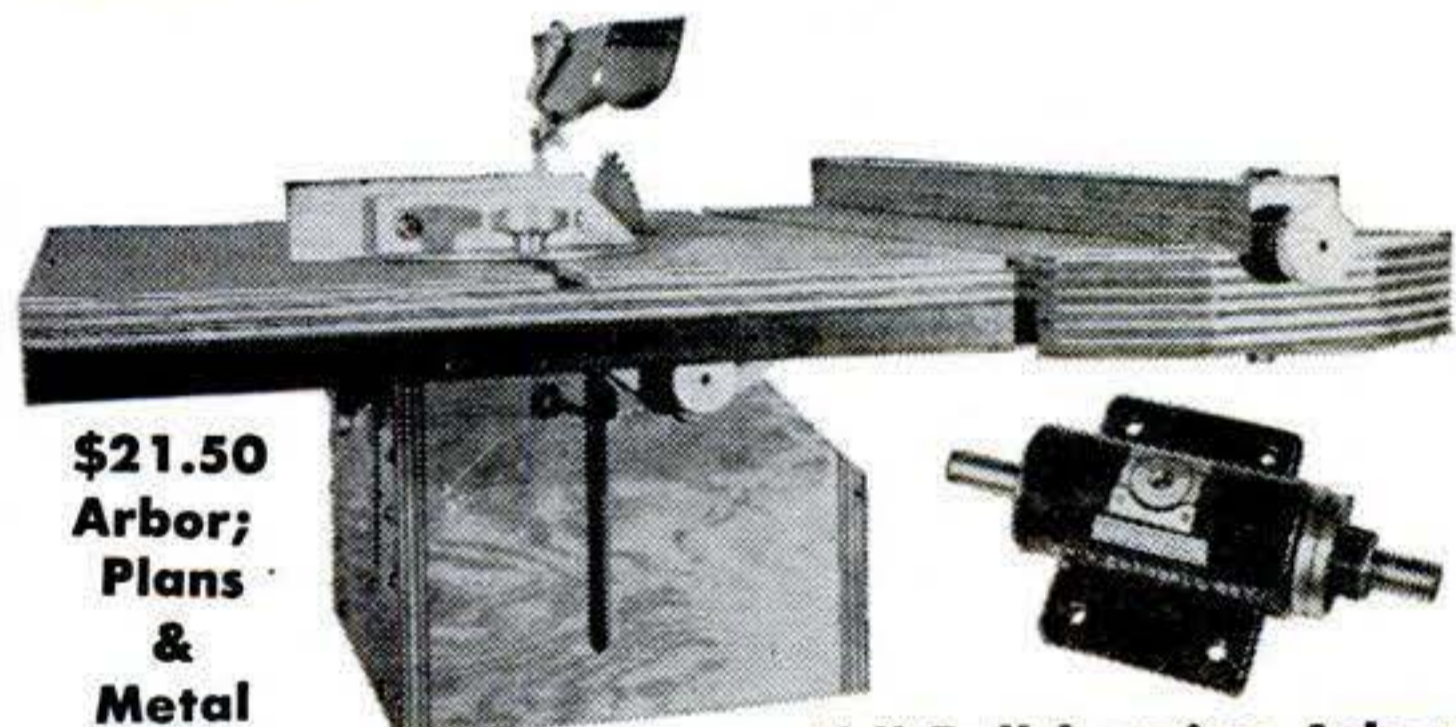

**\$21.50
Arbor;
Plans
&
Metal
Parts**

5/8" Ball-bearing Arbor

Build it yourself—with our Ball-bearing Arbor, Plans and Metal Parts. Here's the saw you've been wanting for your shop!

With our easy to follow step-by-step plans and instructions, you can build it with ordinary hand tools for a fraction the cost of all metal saws of comparable size and capacity. Sturdy wood, steel and aluminum construction.

FEATURES—

Big roomy top 27" x 32" with 13 1/2" clearance ahead of saw. Tilts to 45°.

Precision built ball-bearing arbor lubricated and sealed. No further lubrication required.

Self aligning, full length rip fence. Indexed mitre gauge. Indexed table tilting quadrant. Adjustable saw arm—cuts from 0" to 2 1/4".

Complete Kit—includes Ball-bearing Arbor with Saw Plans and instructions, and all metal parts, bolts, washers and screws (less saw blade) **\$21.50**

5/8" Ball-bearing Arbor only—with Saw Plans and instructions **\$ 6.95**

Metal Parts only—less Arbor **\$14.95**

If your dealer cannot supply you, send check or money order—we will ship promptly postpaid in U.S.A. or possessions.

WILLIAM H. CRANDALL COMPANY, Dept. S

1009 Fruitvale Avenue,

Oakland 1, California

For BEGINNERS
(4 yrs. and up)

\$16⁷⁵

JUNIOR BIKE

Adjustable Handle-Bars and Seat

Comes in Glistening RED or BLUE Enamel

"Danny Boy"

Not a toy — a Real Bike

STURDY ENOUGH—EVEN FOR DAD

- Double Bar—Steel Tubing
- Disc Wheels with Ball Bearings
- Wheel Base 32 Inches
- Sturdy Fork — Bronze Bushings
- Adjustable High Grade Seat
- Adjustable Handle Bars, Rubber Grips
- Danny-Boy bikes have the adjustable take-up feature on the rear wheel to take up any slack which might appear in the belt drive.
- Welded Frame
- Large Semi-pneumatic Rubber Tires
- V-Belt Drive—Safe—Quiet
- Full Bearing Pedal Crank
- Rubber Pedals—Streamlined
- Baked Enamel Finish

Shipped Express Collect—Send Check or Money Order

Danat Company, 624 S. Michigan Ave., Chicago 5, Ill.

In Canada \$19.75 F.O.B. Write, 1055 Eglinton Ave. W. Toronto, 10

MILL IT...ON YOUR LATHE!

PALMGREN

MILLING ATTACHMENT

3 SIZES
No. 250 Illustrated

2 1/2" JAW Only

\$24⁷⁵

CONVERT LATHE IN 10 SECONDS

Now you can Mill, Slot, Grind, Groove, Square Shafts, Saw at Angles, Recess and many other important jobs. **SAVE TIME and MONEY!** Why send work out or use costly methods when a **PALMGREN MILLING ATTACHMENT** will solve your problem. Precision built, it has accurate graduations for rotary angle adjustments, also graduated vertical feed screw. Fits South Bend, Atlas, Craftsman, Logan, Sheldon and all other lathes. Thousands now in use in small and large machine shops, repair shops, railroads, schools, home work shops, etc. **ORDER SIZE NEEDED TODAY!**—it will quickly pay for itself.

IMMEDIATE DELIVERY

Nos.	Width Jaws	Depth Jaws	Jaws Open	Weight Pounds	Fits Tool Post	Price F.O.B. Factory
150	1 1/2"	1"	1 5/8"	6 1/2	1" Dia.	\$18.75
250	2 1/2"	1 7/16"	2 1/2"	11	1 1/4" Dia.	24.75
400	4"	1 1/2"	4"	25	2" Dia.	39.75

Order From Your Dealer or Jobber: Write for Circular No. 351
Mfrs. of **PALMGREN PRODUCTS**
Since 1915

8396 South Chicago Ave.
Chicago 17, Ill.

CHICAGO TOOL and ENGINEERING CO.

JUST A FEW OPERATIONS YOU CAN DO ON YOUR LATHE!

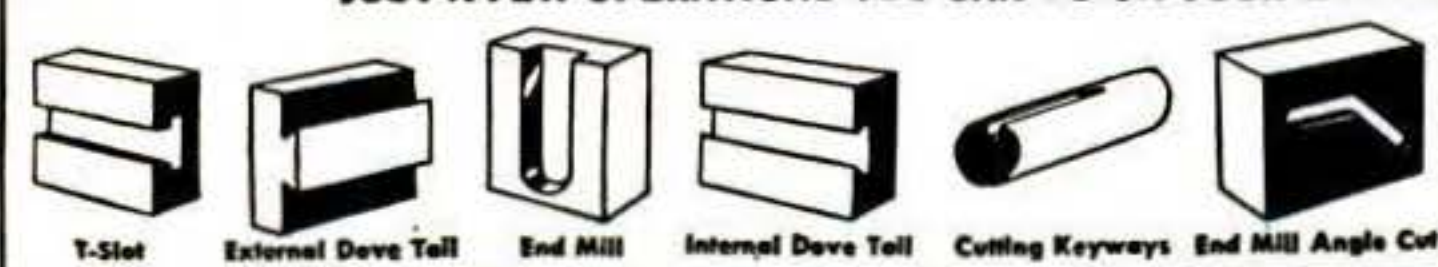

GLOWS in the DARK

FREE Sample!

Be the first to sell luminous house numbers, light switch plates, wall protectors, pull cords. Also luminous pictures, statues, decals, and a host of religious, nursery and other objects that glow in the dark. Get into this new and growing industry. Enormous demand... no competition... sensational demonstration... big profits. Represent a large manufacturer, established over 34 years. Write today for liberal money-making offer and free sample to show how they glow in the dark.

MADISON MILLS 303 Fourth Ave., New York 10, N.Y.

5

!! SPECIAL!!—GIANT "GRAB-BAG" RADIO PARTS KIT

- A real buy for the Radio Serviceman, Amateur or Experimenter.
- 15 FULL POUNDS of resistors, condensers, transformers, wire, speaker repair parts, hardware, etc., etc. An amazing value at \$1.95
- Telegraph Key & 6V. Buzzer (Western Electric). Gap & tension adjust. All on 1/4" bakelite base.....1.25. Key only......39
- HEADPHONES (Army P-23) 8000 ohms impedance. Leather covered, adjustable. With 5 ft. cord & PL-55 plug.....1.49
- Rubber Phone Cushions. Per pair......20
- EXPERIMENTAL TUBES. 20 asstd. receiving types for testing, research, etc. All filament tested.....1.00
- Brand new R.C.A. UX-200 tubes in sealed cartons. Ideal triode detector.....8 for 1.00
- Kit of 10 asstd. R.F. Antenna & Oscillator Coils......98
- RADIO HARDWARE TREASURE. An indispensable assortment of approx. 1000 screws, nuts, washers, lugs, etc......49
- RESISTOR ASSORTMENT. 20 carbon & wire-wound. 1/3 to 3 watts......49

Min. Order \$1.00 — Please Add Sufficient Postage
WRITE FOR LATEST BARGAIN BULLETINS

LEOTONE RADIO CO., 67 Dey St., New York 7, N. Y.

NEW Liquid Plastic

Special Castolite Kit

- Cast without heat or pressure.
- Crystal clear or dye brilliantly to any color — transparent, opaque, phosphorescent, fluorescent.
- Can be sawed, drilled, carved, turned.
- Embed real flowers, butterflies, photos, advertising novelties.
- Make figurines, statuettes, other beautiful objects in New Flexible CASTO-MOLD.
- Easy, fascinating to use. Illustrated manual tells how.
- Send \$3.35 for kit prepaid, or order COD. For manual alone, send 25c.
- Write: **THE CASTOLITE COMPANY**
Dept. K-4, Box 211, Kenilworth, Illinois

20-Project KIT \$3³⁵

NOW READY! Floyd Clymer's Newest and Best Motor Scrapbook of Historical Cars . . No 4.

Illustrates, describes 200 early cars, motorcycles. Entirely different from books 1, 2, 3 (also available). \$1.50 each postpaid; \$2.50 for De Luxe edition.

CLYMER, Dept B-9, 2125 W. Pico, Los Angeles 6, Calif.

AT HOME • Your Own Manufacturing Business

Making popular \$1 Novelties. Costs you 3c to 15c. We supply everything. Write today!

SO-LO WORKS, Dept. A-801, Loveland, Ohio

MAKE MONEY IN SPARE TIME

Dealers wanted: Sell high quality line of athletic footwear and top grade of cowboy boots. Build your own business in spare time. For full particulars, write to

SPORT-PRO
426 East 4th St., Dept. P-2, Cincinnati 2, Ohio

NEW MIDGET ELECTRIC ARC WELDER



Plugs into Light Socket AC or DC

It's new! It's handy! It's efficient! Use the Midget Electric Arc Welder for hundreds of light-metal jobs. Does comparable welding work with a 1/16 inch welding rod on thin metal as that of larger and higher priced welders. Operates on 15 ampere fuse, 110 volt 60 cycle A.C. or D.C. current, by use of our special standard-coated 1/16-inch welding rods. Generous supply of rods supplied with machine. Recommended for all light welding like automobile fenders, etc. Take the Midget Arc anywhere to the job. Sturdily built and fully guaranteed. Comes complete—ready to use. Nothing else to buy. No previous welding experience needed to strike an arc. In a short time,

anyone mechanically inclined can learn to weld with this machine.

You'll find hundreds of money-saving, time-saving uses for the Midget Arc around your home, garage, or workshop. Also in garages, factories, repair shops, tin shops, mechanics, farmers, inventors, etc. Order a Midget Electric Arc Welder now! SEND NO MONEY. We'll rush one to you, complete with rods and helmet (equipped with APPROVED welding glass). Pay postman only \$3.95 plus postage charges. If not satisfied, return Midget Arc in 5 days from receipt and we'll refund your money immediately. RUSH YOUR ORDER NOW.

MIDGET ARC WELDER CO., Strader Ave., Dept. C-205, Cincinnati 26, Ohio

RETAILS ONLY
\$3.95

FULLY GUARANTEED

SURPLUS BARGAINS

ASSEMBLE YOUR OWN BINOCULARS!

Complete Optics! Complete Metal Parts!
Save More Than 1/2 Regular Cost



GOVERNMENT'S 7x50 BINOCULARS

Complete Optics, new and ready for assembly. We supply full instructions. Limit—1 Set of Metal Parts and 1 Set of Optics to a customer.

METAL PARTS—Set includes all Metal Parts—completely finished—for assembly of 7 X 50 Binoculars. No machining required. Bodies have been factory hinged and covered. A sturdy Binocular Carrying Case is optional with each set of Metal Parts.

Stock #842-N \$39.40
Postpaid, plus \$4.80 for Case—Total \$44.20

OPTICS—Set includes all Lenses and Prisms you need for assembling 7 X 50 Binoculars. These are in excellent condition—perfect or near-perfect—and have new low reflection coating.

Stock #5102-N \$25.00 Postpaid
NOTICE! If you buy both Binocular Optics and Binocular Metal Parts, add 20% Federal Excise Tax to above prices.

ARMY'S 6 X 30 BINOCULARS—Complete Optics and Metal Parts for Waterproof Model. Would retail \$102 to \$120. All Optics coated, perfect or near-perfect; Metal Parts new and perfect. Assembly instructions included.

Stock #830-N \$40.00 Postpaid,
plus \$8.00 tax—Total—\$48.00

NEVER HAS THERE BEEN SUCH A SENSATIONAL BARGAIN AS THIS!
BUBBLE SEXTANT—TYPE A-10

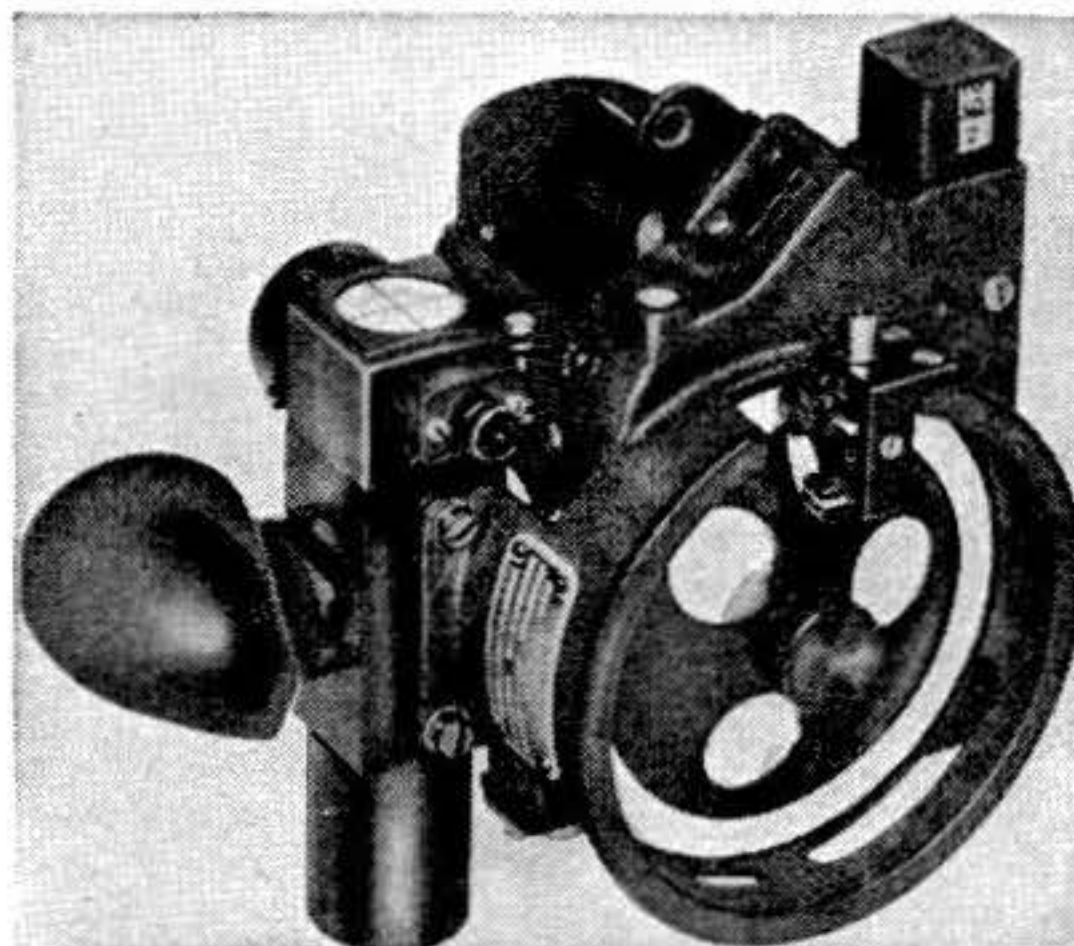

These Army Air Forces Bubble Sextants cost the Govt. about \$200 each. A real bargain at our price of \$12.50! Included with Bubble Sextant shipment is wooden Carrying Case, 5 spare waxed paper discs, flashlight with rheostat for night use (uses ordinary flashlight cells—not furnished) aux. 2-power Galilean Telescope, Allen wrench, 1 spare marking point. Wartime used, but where necessary completely repaired, collimated and put in good working order. If not satisfied that Sextant is exactly as represented, return within 10 days and money will be refunded. Full directions for use accompany each shipment.

Stock #924-N \$12.50 Postpaid

BATTERY COMMANDER'S PERISCOPE With Tripod 6 Power Instrument. Excellent condition. Length 27 1/2 inches—diam. 1 1/2 inches. Cost U. S. Govt. approximately \$175.00.

Stock #717-N \$20.00 F.O.B. Audubon

MOUNTED KELLNER TELESCOPE EYE PIECE—Perfect coated, in Ordnance sealed boxes. F.L. 1 3/4 inches. Outside dia. of steel mount 40 mm.

Stock #6198-N \$3.15 Postpaid

35 MM KODACHROME PROJECTING LENS SET—Consists of Achromatic Lens for projecting, plus a Condensing Lens and piece of Heat Absorbing Glass with directions.

Stock #4025-N \$1.95 Postpaid

CONDENSING LENSES—6 1/2" dia., 9" F.L. Seconds, but suitable for Enlargers and Spotlights.

Stock #1061-N \$2.50 Postpaid

We Have a Limited Quantity of Condensing Lenses—seconds—ranging from 4 1/2" to 8 1/2" in dia. with various focal lengths. Send for Free Bulletin titled "MISCELLANEOUS CONDENSING LENSES—N".

MOUNTED PROJECTING LENS SYSTEM. F.L. 91.44 mm (just right for 35 mm. Projectors). Speed of F 1.9. Outside dia. of mount at one end 60 mm. Length of mount 64 mm.

Stock #4033-N \$3.00 Postpaid

We have literally millions of war surplus lenses and prisms for sale at bargain prices. Write for Catalog "N"—Sent Free!

Satisfaction Guaranteed • Order by Stock No.

EDMUND SALVAGE COMPANY

P. O. AUDUBON NEW JERSEY

STARLIGHT LOW COST

PRECISION ENLARGER

LENS AND ALL ACCESSORIES

1 PIECE OF EQUIPMENT DESIGNED FOR ENLARGING, REDUCING, COPY WORK, CONTACT PRINTING. Comes with a fine Ilex Anastigmat 3 1/2 inch f6.3 lens and Iris diaphragm. Takes any size negative up to 3 1/4 x 4 1/4. Easy to operate, no complicated gadgets.

Write for free folder S-9 and start making money.

PHOTO-SPHERE CO., Inc. 115 E. 23 ST. N. Y. 10, N. Y.

\$24 INCL. TAX



RAISE PROFITABLE CHIN-CHINS



No experience needed. A few minutes daily, a few feet of backyard space. Several females and a male starts a large, money making herd. WE FURNISH ALL INSTRUCTIONS.

Free booklet explains tremendous demand for live youngsters, delicious meat, gorgeous fur. Write today.

WILLOW BROOK FARM, R-45B, SELLERSVILLE, PENNA.

DRAIN YOUR CELLAR, POOL, WASH TRAYS, ETC.

LABAWCO Type P Pump keeps garden pools fresh. Circulates oil or refrigerant etc. DOES NOT CLOG! 1500 Gals. per hr.—300 Gals. at 30'. Uses 1/8 to 1/3 H.P. motor.

PUMP ONLY

\$6.50 POSTPAID

Pump alone \$6.50.

Pump with complete self-priming unit \$13.95. POSTPAID if cash with order. West of Mississippi, add 50c.

Send Order Today

LABAWCO Pumps

Belle Mead 3, N. J.

\$13.95 Postpaid

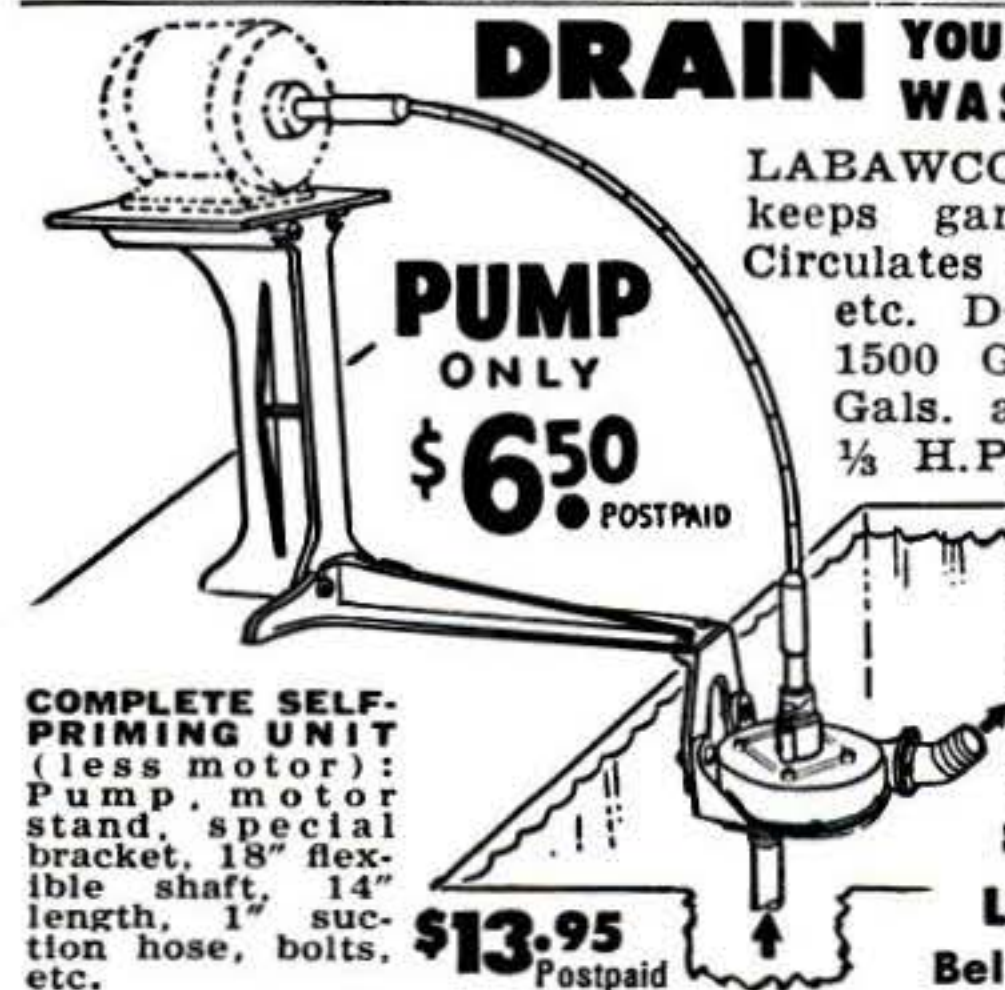

COMPLETE SELF-PRIMING UNIT (less motor): Pump, motor stand, special bracket, 18" flexible shaft, 14" length, 1" suction hose, bolts, etc.

Authenticast
Exclusive!



FAMED USS MISSOURI
Full-hull official scale model
with replica of surrender plaque



Kit plaque is size
of a quarter ready
for mounting.

A DREAM OF A MODEL . . . you'll have hours of fun building it! And you'll enjoy owning this fine model for years to come.

Authenticast assembly kit includes easy directions, diagram, tools, over 100 cast-metal precision-perfect parts. Scale: 1 inch to 500 inches, finished model is 21 inches long. Priced \$12.95 complete at hobby shops.



Send 35c in coin for colorful 32-page Authenticast catalog.



132-01 91st Avenue, Richmond Hill 18, L. I., N. Y.

HOW TO BUILD YOUR OWN CABIN!

Here's an amazing new book that shows you complete detailed plans for building your own log cabin, bungalow, hunting lodge, etc.! 256 big pages, 180 diagrams give step-by-step directions for laying foundation and floors—building fireplaces, chimneys, porches, garages—shingling roofs—cutting doors, windows, shutters—yes, even for installing plumbing and electricity without expensive hired help! A big money-saving bargain at ONLY \$1.98!

YOURS FOR 7-DAY FREE TRIAL!



Order this astonishing 256-page book now for 7 days' FREE trial! On delivery pay postman only \$1.98 plus postage—then use it for a whole week FREE! If not delighted, return for full refund. Address:

OUTDOOR LIFE, Dept. 97

353 Fourth Avenue, New York 10, N. Y.

ARMY FIELD TELEPHONES EE8



Canvas Case Illu.

Battlefield proven! Worth many times this low selling price! Includes leather or canvas case, telephone handset, transmitter, receiver, and ringer. Two telephones comprise set. Will give lots of service. Uses regular flashlight type battery. Lasts for months. Hooks up with any type standard wire. Will work on barbed wire fence. Ideal for farmers, barn to house, warehouses, lumber camps, camps, garages, nurseries, etc. Several phones can be hooked up on one line for multiple communication system. Good for miles. The kids love them; anybody can install. New, complete, per pair (2 telephones) and canvas case

\$29.50 (with leather case \$32.50). Used, complete, per pair \$19.50. Switchboards will handle 12 phones. Used, excellent \$45.00. New telephone wire, 500 ft. \$3.50; 1/2 mile reels \$12.50; 1 mile reels \$18.50. F.O.B. warehouse.

Send check or money order.

LORIS, BOX 2414 SACRAMENTO, CALIF.

DO YOUR OWN PROFESSIONAL FELT FLOCK FINISHING

with Complete Spray Outfit

Now you can apply a professional, colorful, felt flock finish on unfinished furniture, art objects, novelties, hobby crafts, toys, etc. Velvety, durable, easy-to-apply finish. Available in 10 brilliant colors. Complete outfit (as pictured) includes undercoat, brown and ivory flock, solvent, brush, patented spray gun and instructions. Complete price \$9.25 post paid. Write for FREE circular and color sample card.



BEROTT-ROSS • Dept. 9B • 411 N. Foothill Rd., Beverly Hills, Calif.

CRAFTSMEN . . .

We offer you hundreds of craft materials, supplies and accessories:

- PLASTICS • POWER TOOLS • PLYWOODS
- PLASTIC LEATHERS • JEWELRY FINDINGS
- MARINE PLYWOOD • BOAT KITS

Send 10¢ today

for latest big 64-page illustrated catalog.

CARMEN-BRONSON CORP.

Dept. DS-1,

162 So. Fulton Avenue,

Mount Vernon, N. Y.



One Spot
Flea Killer

KILLS Lice
Ants
Fleas
Aphids
Bedbugs
Crab Lice
Potato Bugs
Cabbage Worms

• DUST ON ONE SPOT • Mex. Bean Beetles
35c AT YOUR STORE OR THE
ONE-SPOT CO., JESSUP, MD.



'QUICK-CHANGE' GEAR BOX

CUT THREADS — 4 TO 224 PER INCH

Approximately .003 feed, for fine turning. New reverse furnished with box for Atlas. Bronze bearings throughout entire unit. Aluminum casting—All steel gears. Maintained accuracy. Speeds up production. Easy to install. Simple to set. Immediate delivery.

Only \$75⁰⁰

F.O.B. Chicago Guaranteed

FOR— Atlas, Logan, Craftsman
and Power-Kraft Lathes

Write for information or order direct. Full instructions with shipment. WHEN ORDERING, PLEASE MENTION NAME OF LATHE GEAR BOX IS TO BE USED ON O'Brien Machine Co., Sales Dept. PS-9, 1620 Highland Ave., Chicago, Ill.

THE WORLD'S FINEST SURPLUS BARGAIN

**BRAND NEW
U. S. ARMY AIR FORCE
ASTROGRAPHS**

Original Cost
\$125.00

**Now ONLY
\$3.95**

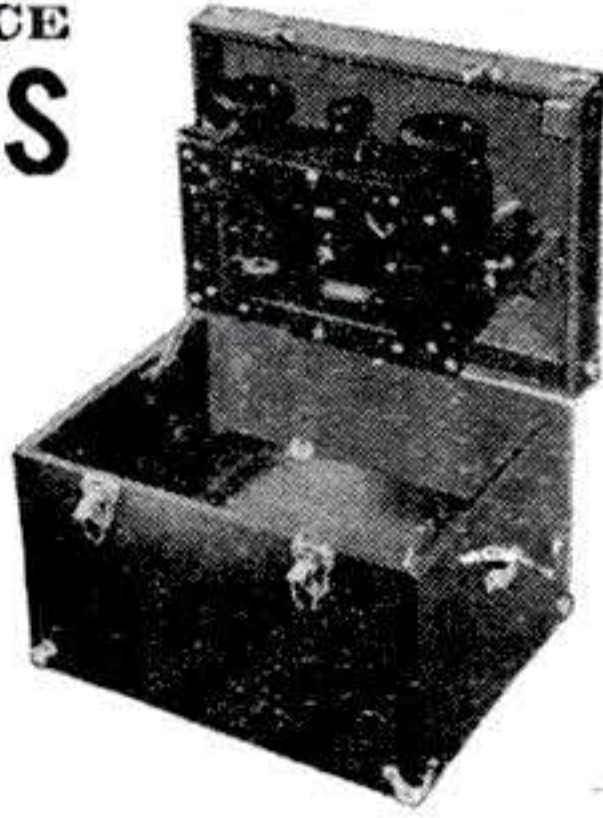

Thousands of uses. An ideal navigation instrument for boats, yachts, etc. A wonderful unit for home construction to build cameras, enlargers, large slide viewers and strip map holders. Excellent foundation for microfilm reader. A beautiful precision instrument consisting of machined aluminum housing with optical glass view plate, two large ratchet film drive knobs and shafts, one film spool, variable light source slide and holder, illumination control rheostat, resistor, power plug and tools. All housed in beautiful plywood case measuring 14 1/2 x 11 x 10" high. Case has leather handle, steel reinforced corners, hinged lid with stop, lower compartment divided into eight sections. Case is ideal for fishing kit, picnic set case, tool kit, portable radio case, make-up kit, travel case. Case alone worth twice the giveaway price we are asking for both. Shipping weight, 30 lbs., F.O.B. Benton Harbor.

HEATH COMPANY 4th and Territorial
BENTON HARBOR, MICH.



**LABORATORY
MICROSCOPE
600 POWER \$22.50**

3 Objectives—75X, 300X, 600X
A professional type microscope priced within the reach of the amateur. For school, laboratory, physician, and student. Color corrected achromatic lenses. Professional size eyepiece and objective interchangeable with all standard professional makes. Height 14 inches. Weight 5 1/4 lbs. Stage 4"x4". 2 wheel focusing. Body tilts any angle. Microscope complete with 3 objectives, prepared specimen slide, and 96 page book on microscopy, only \$22.50.

We pay the postage. Immediate delivery. Money back guarantee.

BROWNSCOPE CO.

Dept. 9 P, 24 West 45th St., New York 19, N. Y.

**SUPER-MITE RADIO
PACKS AMAZING POWER!**

Not much larger than a pack of cigarettes and using War-Born midget tubes, this powerful little set gets Coast-to-Coast reception! Power is supplied by cheap hearing aid battery. Brilliant red chassis and streamlined bakelite knobs. Not available anywhere else at 3 times this price! Complete kit ready to wire as shown Only \$3.99 Post Paid. Tubes 95c each.

ELECTRONIC RESEARCH

199 Contentnea St., Greenville, North Carolina



\$3.99

BAUSCH AND LOMB

7x50 NAVY

**BINOCULARS
\$110.00**

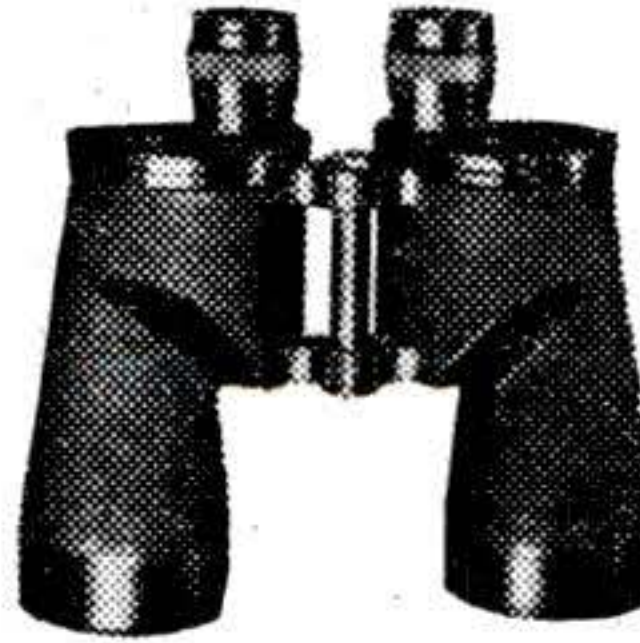

• Mfrd. to U. S. Navy Standards! (Alignment guaranteed to .001") Dust proof! Climate proof! Individual eye adjustment. Instant focusing. Ideal for long range hunting, yachting, watching planes, etc. This magnificent 7 power 50 mm. Navy Binocular gives better detail, heightening image contrast. Used in **NEW-LIKE condition!** Complete with carrying case only \$110.00 plus 20% Federal tax (with Coated Optics \$125.00 plus tax).

6x30 ARMY

**BINOCULARS
\$55.00**

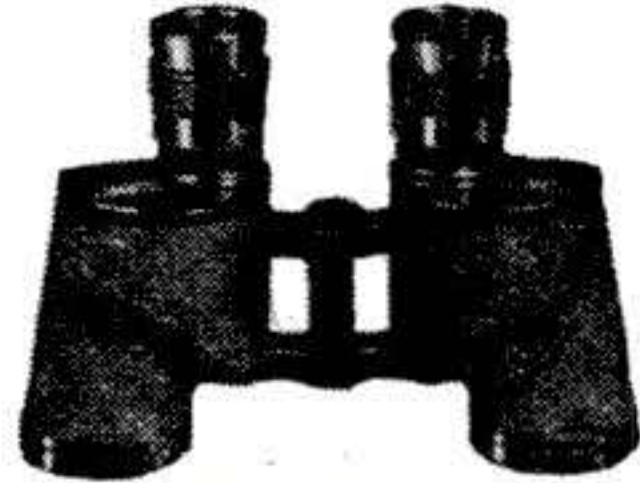

• Brand new! Lightweight! **MODEL-M3** Made to rigid Army specifications. Individual focusing eye pieces. Compact glasses made to withstand rough usage. Come complete with case and straps ready to use. **WHILE THEY LAST!** \$55.00 plus 20% tax.

OTHER BINOCULARS (4 to 16 POWER!)

16x50 Carl Zeiss. Used.....	\$225.00
16x40 Weerasport. Used.....	125.00
16x45 French Monte Carlo. New.....	135.00
12x30 Carl Zeiss. Like new.....	200.00
12x38 French Monte Carlo. New.....	100.00
10x32 French Monte Carlo. New.....	79.00
10x50 German Dienstglass. Used.....	130.00
9x50 Sportscope. Monocular. Not taxable.....	77.00
8x56 German Hensoldt. New.....	155.00
8x34 French Monte Carlo. New.....	67.00
8x30 French Monte Carlo. New.....	62.00
8x30 Carl Zeiss. Used.....	85.00
8x25 French Monte Carlo. New.....	57.00
8x25 French Monte Carlo. Used.....	45.00
7x50 Carl Zeiss. Used.....	150.00
7x50 Barr-Stroud. British Admiralty. Lens Shades. Used.....	90.00
7x50 Same as above, but Coated.....	110.00
7x50 German Dienstglass. Used.....	120.00
7x35 Bausch & Lomb. Used.....	125.00
6x30 Army Signal Corps. Used.....	37.50
6x30 Carl Zeiss. Used.....	70.00
6x30 Bausch & Lomb. Used.....	47.50
6x30 German Dienstglass. Used.....	60.00
6x30 Ross, London. Used.....	50.00
6x30 Naval Gun Factory. Used.....	37.50
6x30 Navy. Navigation. Coated. Used.....	45.00
6x30 Universal. Navy. Lightweight. Coated. Used.....	49.50
6x30 Universal. Navy. Lightweight. Coated. New.....	62.50
6x30 Universal. Navy. Lightweight. Used.....	42.50
6x30 Bausch & Lomb. Lightweight! Navy. Used.....	85.00
6x30 Spencer. Navy. Lightweight. Used.....	42.50
6x24 USN. Turner Reich. Lightweight. Used.....	50.00
5x40 Nat'l. Field Glass. Coated optics. New.....	29.75
4x50 Conestoga Field Glass. New.....	12.50
4x40 Airguide Field Glass. New.....	20.00
5x40 Airguide Field Glass. New.....	22.00
4x40 Wollensack Field Glass. New.....	16.25
10x, 20x, 30x, 40x, Variable Telescope. Not Taxable. New.....	42.50
20x40 French Telescope. New. Not taxable.....	34.50

Add 20% For Federal Excise Tax. Carrying case and straps included. Supply limited. Give second choice.

5 TO 15 POWER VARIABLE TELESCOPE



Simply twist dial to change power! Sturdily made of durable Aluminum! Weighs only 6 ounces. Closes to only 9 1/4 inches. Opens to 11 inches! Six Achromatic Lens. Compact! **BRAND NEW.** \$34.50 not taxable.

MONEY BACK GUARANTEE

Use for 20 days at our risk and expense. If not fully satisfied, return for full refund of your money. **ORDER TODAY!** Send \$2.00 deposit and we will ship C.O.D. for balance. Cash orders sent postpaid.

UNITED PRODUCTS CO.

7941 S. Halsted Dept. ARF-316 Chicago 20, Ill.
(Reference Dun & Bradstreet)

AN ENTIRELY NEW WAY OF SHAVING

Now comes Pneumatic Automatic Shaving, the biggest major improvement in safety razors in a generation. The Patented double action coil spring in the handle permits the razor to follow the curves of your face entirely automatically. Your shave is now cushioned. Shave now in half the time.

It's sensational, it revolutionizes shaving. Fits all standard double edge blades. Comes to you with 5 extra blades free, for only \$1.00 Post Paid. Guaranteed for a lifetime. This is the Razor you have been waiting for. Agents and Dealers write for quantity prices.



FLEXO RAZOR CO. INC., 528 West St., Amherst 5, Ohio

Be a NEON Expert

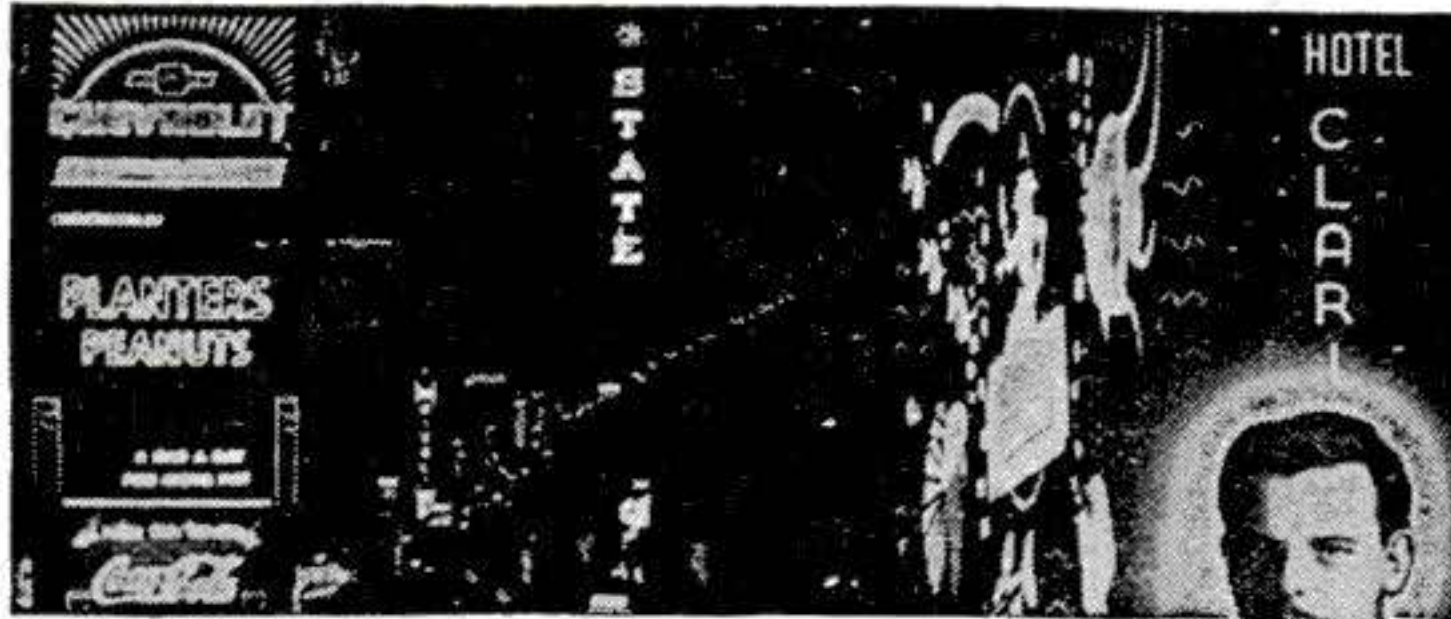

I'll show YOU how to make
\$100 a week and UP
in NEON

C. C. Blakely, Executive Director
Acme Neon Institute

Today's wide open field for ambitious men who want to make \$100, \$150 and more per week is the colorful, exciting business of Neon. I'll train you for a highly paid place in America's most fascinating industry. At Acme you become a Master Neon Technician. Learn Neon Tube Bending, Color Gassing, Neon Glass Blowing, Cold Cathode, Lighting, Bombarding, other important skills.

Coast-to-Coast Opportunities

Demand for Acme Trained Men is greater than we can supply. We're getting calls from coast-to-coast. Today beginners have a once-in-a-lifetime chance to master an art and learn a profession that will pay big dividends for life. Our practical, intensive 500 hour course prepares you for thousands of BIG MONEY opportunities. Get a fine job, or go into business. Other Acme Trained Men are succeeding. So can you. Room Assistance for out-of-town students. Acme Training Approved under the G.I. Bill of Rights. Rush coupon today.

FREE FACTS

ACME NEON INSTITUTE
Dept. L-4, 1648 West Van Buren Street
Chicago 12, Illinois

Send me the FREE FOLDER, "Your Big Opportunity" plus facts about training me for a highly paid job in Neon.

Name _____

Street _____

City _____ State _____



AVIATION SURPLUS

- Radio Headphones, Army type.....\$ 1.95
- Radio Hand Microphone T17..... 2.95
- Radio Throat Microphone, 3 for \$2.00, each..... .95
- Airplane Generator, 200 amps, 28 volts (for welders) 22.50
- Gas Mask Bags, ideal for school, with strap, two for 1.00
- Helmet, flying A-9, OD cloth, two for only..... 1.00
- Helmet, flying, B-6, leather, sherling lined, used..... 1.50
- Sun Glasses, gold rimmed, regular \$10, now..... 4.95
- Hand Lantern, stainless steel, streamlined, 6 volt.... 2.95
- Flying Goggles, clear lens, Type AN6530..... 4.95
- Boots, flying, A-6, leather, sherling lined, reclaimed, (sizes 9 and above only), with zipper..... 5.95
- Gauntlets, A-9 (long gloves), leather, fleece lined, new 5.95
- Jacket, pilot's A-2 (not surplus). Genuine dark pony leather, elastic cuffs, etc. Cloth lined. New..... 24.50
- Jacket, flying, leather, sherling lining, used, has some patches, but redyed, reclaimed, has zipper..... 4.95
- Pants, leather, for above jacket, as described..... 4.95
- Coveralls, white, no pockets, new, sizes 40 to 50 only 4.95
- Cap, leather, fleece lined, type B-2, square visor, (pilot's)..... 2.50
- Cap, cloth, baseball style pilot's, long bill..... 1.00
- Grease Gun, push type, for autos, planes, cycles, etc. New..... 1.00

(Deposit required on all COD orders)

AERO PARTS SUPPLY

Municipal Airport

Houston 12, Texas

Do You STILL CHANGE MOTOR OIL??

If so—you can END this needless waste and expense forever, with "RECLAIMO"

America's Foremost Oil Re-Refining Filter. Continuously re-refines crankcase oil through an ingenious use of motor heat while driving!

1. Removes solids by filtration
2. Removes water-fuel dilution by heat and distillation
3. Prevents acid-sludge formation
4. Maintains stable viscosity
5. ELIMINATES ALL OIL CHANGES!

CAR—TRUCK—TRACTOR and DIESEL OWNERS!
U. S. Bu. of Stds. Bul. 86 states: "Oil Does Not Wear Out Mechanically"—"Reclamo's" re-refining action has fully confirmed that statement. This great oil-saving feature is indeed important, BUT of far greater importance are the savings resulting from "Reclamo's" tremendous reduction of costly motor wear! Again available—also to dealers. Complete details in FREE Book "Oil Facts". Write now!

New 90-Day No Risk Trial Offer!

Reclamo is now offered to responsible motor owners for 90 Days Trial—ABSOLUTELY FREE!

RECLAIMO MFG. CO., 5081 Elston Ave., Dept. 52, Chicago, 30, Ill.

GET THE FACTS!



FREE 40 PAGE BOOK

THE Improved 16mm Battery Drive-Magazine Load LECTRO Jr. MOVIE CAMERA

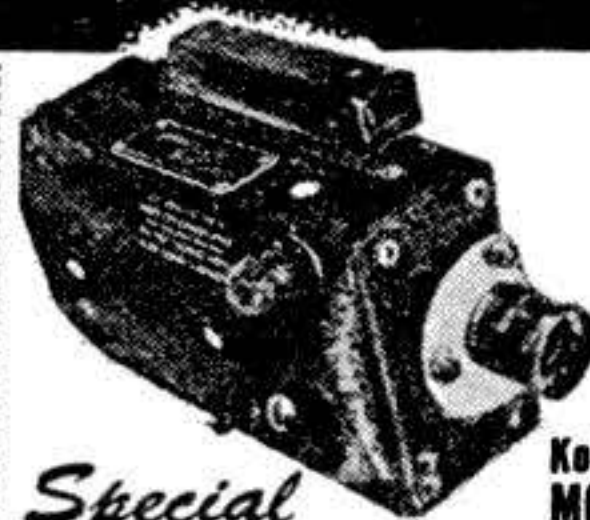

Simple to Operate—Easy to Load—Standard Kodak film magazine. Economical. Complete—Battery, Cord, Tripod Socket. Original Value over \$200. Never needs winding or film threading.

\$59⁵⁰
case add'l

50 ft. Magazine—16mm Gov't stock Panchromatic Weston 32 Tested Guaranteed. Price includes processing.

Dept. PO, 18 E. 42nd St. 136 W. 32nd St., N.Y.C.

Special Kodak Super-X MOVIE FILM

FOTOSHOP



IMPORTED SWISS WATCH

7 DAY MONEY BACK GUARANTEE NOW ONLY \$4.98 PLUS 50c Fed. Tax

A beauty—for dress, sports, outdoor wear. Precision made. Streamlined, chrome-plated case. Smart modern dial (glows in dark), handsome watchband. Supply limited. Order now!

SEND NO MONEY! We mail C.O.D. plus postage or send money order. Save postage.

THE JEWELBOX, 2-A Stone St., N. Y. 4, N.Y.

Table Top MODEL RAILROAD!



Imagine a roaring locomotive in the palm of your hand... cars not much bigger than this ad... all exact scale models that operate electrically on 15/32" track. You can have a whole layout on a card table or desk. Equipment easy to build from kits, or may be obtained ready-to-run, including freight and passenger cars, steam and diesel engines, track etc. See your Hobby Dealer or send dime for illustrated circular and price lists.

LOCOMOTIVES \$12.50 to \$27.00
FREIGHT & PASGR. CARS \$1.50 to \$5.50

H. P. PRODUCTS CO., Hartford City, Indiana

LIGHT PLANTS

Used Gov't Surplus—Lowest Price Ever Offered—3,000 watt, 110 volts.

Powered by Briggs-Stratton or Wisconsin 6 H.P. air-cooled engine. For stationary or portable use. REBUILT-GUARANTEED, good mechanical and operating condition. Our price \$14950

Limited Supply—Immediate Delivery—Order Now Write for Illustrated Circular

MIDWEST SURPLUS SALES 1520 LOCUST ST. KANSAS CITY, MO.



EASY with one hand
and a

"YANKEE"

Quick-Return Spiral Screw Driver

Got to drive screws where it's hard to use both hands? Easy with a "Yankee" 130A Spiral Driver. "Quick-return" spring in handle keeps bit in slot, returns handle after each push.

Write for the "Yankee" Tool Book.

YANKEE TOOLS NOW A PART OF

STANLEY

THE TOOL BOX OF THE WORLD

NORTH BROS. MFG. CO.

Philadelphia 33, Pa.



BOYS-IT'S FREE!

Exciting, new book tells about
"ATOMIC ENERGY"
and **"THE WONDERS OF CHEMISTRY"**

Also shows how to amaze friends with Chemcraft magic and do many exciting home experiments. Free. Send today!



THE PORTER CHEMICAL CO., 20 Prospect Ave., Hagerstown, Md.

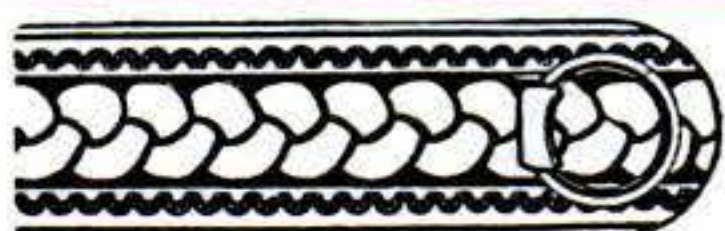

Now! MAKE YOUR OWN

LEATHER BELTS & HANDBAGS

10 different, full size, easy to follow, handbag patterns, transferring, tooling. No. 332 only \$1.30
47 NEW belt designs for carving or embossing. Full directions. Catalog free with first order. No. 397 only 75¢

We carry a full stock of quality leather craft materials.

OSBORN BROS., 225 W. Jackson Blvd., Chicago 6, Ill.



Bar Bells

Buy Direct From Factory

Write for free booklet
and price list

\$8.95
up

INDEPENDENT IRON WORKS
2416 East 23rd Street, Dept. C
Los Angeles 11, Calif.

SELL SHOES DESIGNED BY Dr. R. M. KIEL D. S. C.



Every man or woman in your territory needs the supreme comfort and good looks of these fine shoes, made by leading company of its kind... and sold thru well-paid Direct Salesmen.

FREE SAMPLE OUTFIT!...

Learn how you can earn liberal Cash Profits Daily with 200 styles of Shoes, Leather Jackets, Raincoats, etc. We show you how to fit each customer perfectly, and furnish you FREE with everything you need. Send name, address on a post-card now!

VICTOR THOMAS SHOE CO., Dept. V-820
610 W. VAN BUREN ST., CHICAGO 7, ILL.



GET
SPECIAL
OFFER
NOW!



Time & Date
AT A GLANCE

BELL
GUARANTEED
**CALENDAR
WATCH**

Tells time, name of day and date.
Day name changes automatically.

No. HY 382—Calendar watch, 17 jewels water-shock resistant, anti-magnetic, radium dial and hands, stainless steel back. **\$49.75**

No. HY 383—Same features as above. ALL STAINLESS STEEL CASE..... **\$55.00**

OTHER SPORT WATCHES WATER-SHOCK RESISTANT

Precision tested, 17 jewels, anti-magnetic, radium dial and hands, unbreakable crystal, sweep second hand.

No. HY 196—Stainless Steel Back..... **\$24.75**

No. HY 220—ALL STAINLESS STEEL CASE.. **\$29.95**

ORDER BY MAIL: Send check, money order or pay postman C.O.D. Prices Incl. Fed. Tax and Postage. Write for FREE Booklet "HY".

Repair
Service

All types and makes of quality watches repaired expertly and promptly. Free estimate on request.

BELL WATCH COMPANY, INC.

Time and Life Bldg., Rockefeller Center, New York 20, N. Y.



5 POWER TOOLS IN 1

\$34.95



COMPLETE HOME WORKSHOP

Here is power tool pleasure and profit in a ruggedly built, HEAVY steel unit—the Emrick Universal Woodworker. Handles big work. Drill press pulls 1/2" drill in steel. Saw takes 6" to 8" blade. Lathe 10" swing, 30" centers, spindle dia. 3/4". Takes all standard accessories. Sander 8" dia. Emery wheel 5". Bronze bearings, replaceable throughout.

10
DAY
TRIAL

Price does not include motor and saw blade. Order today.

1759 CLINTON STREET
EMRICK, Inc. KALAMAZOO 24, MICH.

Ship on 10 Days Trial. I am enclosing \$17.50, balance C.O.D. Send free literature.

Name _____
Address _____ City _____

**GOVERNMENT PAID \$15,000
FOR COMPLETE UNIT
Portable Power Plant**

Mobile tow bar—72" wheel base—5 ft. high—600x16 tires—Tail light—hand brake—Ford V 8 axle—30 gal. gas tank—All steel frame and chassis—Ideal for hundreds of industrial uses—Also suitable as electric welder with small adjustments

HERCULES 6 cyl. gas engine—Model JXD 4x4½—air cleaner—self starter

WESTINGHOUSE ¾ HP fan motor—6-blade fan—24" diameter

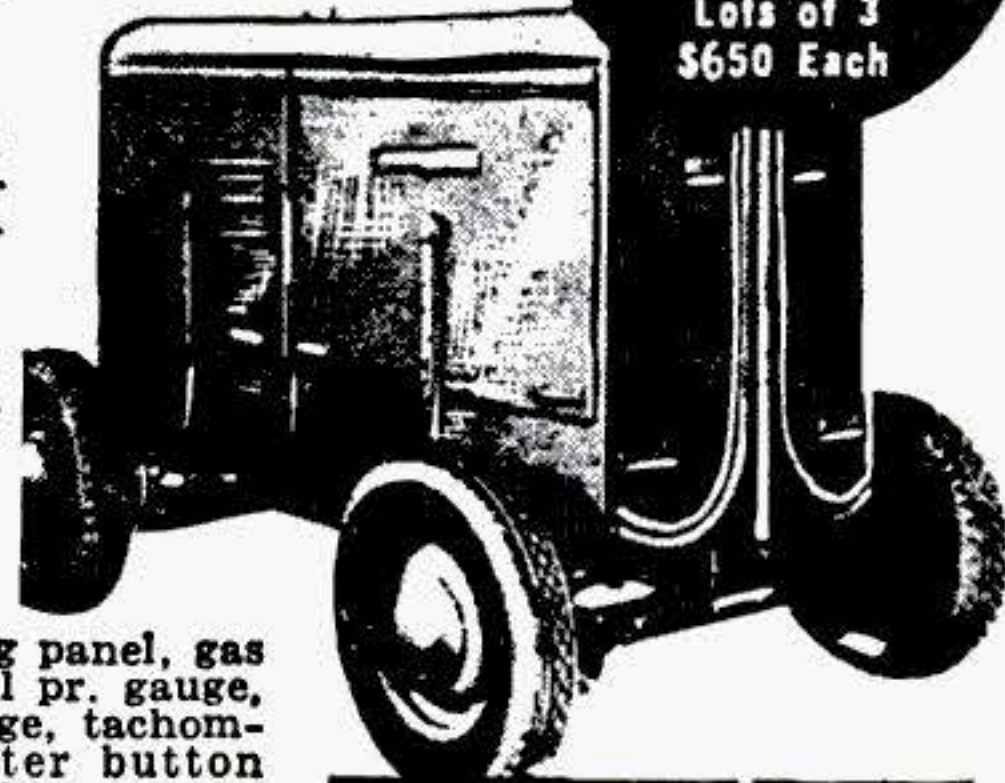

\$695
EACH
Lots of 3
\$650 Each

Complete operating panel, gas gauge, ammeter oil pr. gauge, temperature gauge, tachometer. Choke starter button throttle—115V plug—115V switch—Fan switch, winter, summer—Ignition switch—6V plug—Voltmeter—115V Ampmeter—300 A-rheostat—Main switch

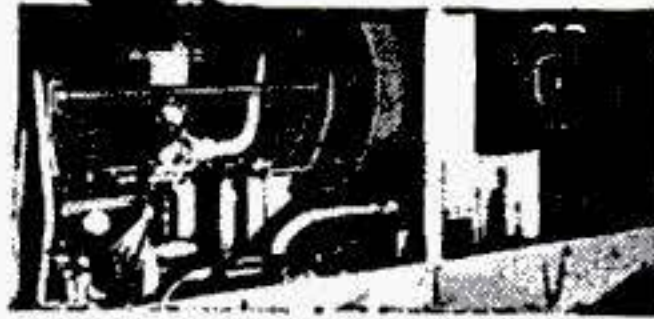

Westinghouse marine generator, type SK—direct current—Style 1B7494—1100 RPM, 16.2 KW, 162 Amp., 100 volts—1400 RPM, 24.8 KW, 210 Amp., 118 volts



**800 MILLION CANDLE
POWER SEARCHLIGHTS**
Complete with remote control station

(\$300 ea. in lots of 3)

\$349
EACH

Mobile unit has four 600x16 tires. Performs perfectly with power plant. Ideal for carnivals, outdoor games, advertising purposes, hundreds of other uses.

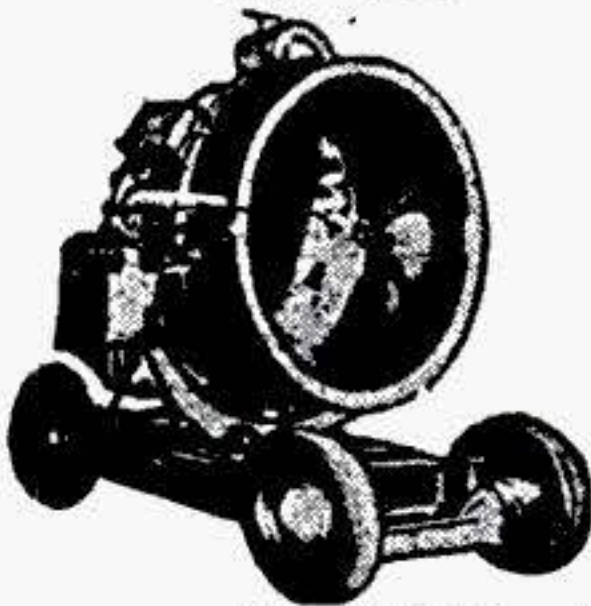

(Send 25% with order, balance C.O.D.)

CHICAGO SURPLUS CO.

THE MOTOR TRUCK BROKER

4545 W. Madison St. Dept. P59 Chicago 24, Ill.

NEWEST OTTAWA SAWS

Goes anywhere on its Own Power



World's fastest Log Saw. Propels itself anywhere. Powerful 6 H-P air-cooled motor.

Attachments for felling large trees, buzzing limbs, post hole digging and pulley for belt work. Five machines in one. Same engine does all. Big demand for wood, pulp and posts. Make big money in wood business this easy way. Low factory-to-user prices. Send today for FREE details.

OTTAWA MFG. CO., 8-701 Pine St., Ottawa, Kansas

**MAGIC LIQUID CASTS
PLASTICS**



THE GREATEST THING IN PLASTICS! A new liquid Plastic. Pour PLASTICAST into any kind of mold (rubber, metal, glass, plaster, etc.) and it hardens in a few minutes into a solid clear-as-glass plastic! No machinery or tools required. PLASTICAST has unlimited possibilities . . . novelties, toys, jewelry, knick-knacks; fascinating, brilliant, clear or colored plastic articles, including sparkling GOLD and SILVER! Being transparent it is ideal for imbedding flowers, coins, photos, souvenirs—an endless variety of useful things. Can also be cast into rods, sheets, blocks, ANY SHAPE! No experience required; start casting 10 minutes after you receive your outfit. Full instructions, molds, dye and accessories provided. COMPLETE MASTER OUTFIT, will make over 200 articles \$3.00 ppd.

FREE Valuable book on MOLD MAKING and CASTING of plastics, rubber, plaster, wax, metal and every known substance used for casting! Sent free for 3c stamp.

PLASTICAST CO., (Dept. A)

(Send order to nearest office)

5961 Madison St., Chicago 44, Ill.

P. O. Box 987, Palo Alto, Calif.

BUILD YOUR OWN TILTING TABLE SAW!

Performance of \$60 Saw at 1/6 the Cost!



• 21x27 in. table tilts full 45 degrees
• 8 in. blade cuts from 0 to 2½ inches

• Precision ball bearing mandrel
• Self-aligning and indexed rip fence and mitre gauge

• Sturdy wood, steel, and aluminum construction
• No machining—build easily with hand tools
• Ability to read blue prints not necessary
• All metal parts (less blade) as low as \$8.95

Send \$1.00 NOW for easy step-by-step Plans!

GIL-BILT, P. O. Box 1-G, Lambert Field, St. Louis 21, Mo.

SAVE \$50 OR MORE

COMPLETE PLANS only \$1.00

Like Putting New Skills Into Your Hands!

AUTOMATIC BENCH STOP



A new piece of equipment your workshop needs. Easy to mount. Only 11" long. Holds firm grip on pieces up to 2½" No vise marks. When mounted on board, ideal for hanging or repairing windows, doors and screens. Finger-flip release. Money back guarantee.

Now \$2.00 Postpaid

BILBAX PRODUCTS

5533 Pleasant Ave. S.

Minneapolis 9, Minn.

BUILD YOUR OWN ARC-WELDER

For Light or Heavy Work

We show you how to build this powerful machine. Produces 75-200 amps. Easy to build. Mail 35c for complete Plans, valuable Catalog today.

LEJAY MFG., 1323 Lejay Bldg., Minneapolis, Minn.

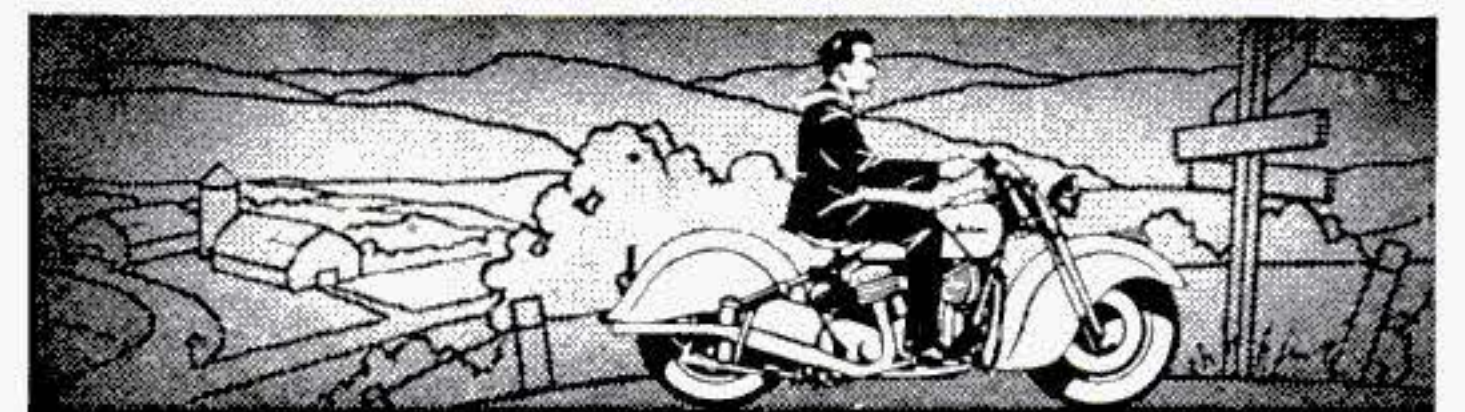

Indian
WORLD'S FINEST
MOTORCYCLE
SPRINGFIELD, MASSACHUSETTS

STOPS LEAKS PERMANENTLY

Cut your fixture replacement, water and fuel bills with Economy Renewable Seats. Make economical, permanent repairs quickly and easily with the Junior Kit (illus.). Repair bathroom, kitchen and laundry fixtures. Everything you need included in steel box. This is a natural for the "Fixit" shops—get extra income from making permanent repairs on your customers' faucets.

Senior Master Kit also available—repairs faucets and valves up to 1" pipe. At better Jobbers and Hardware Stores . . . or Write Direct.

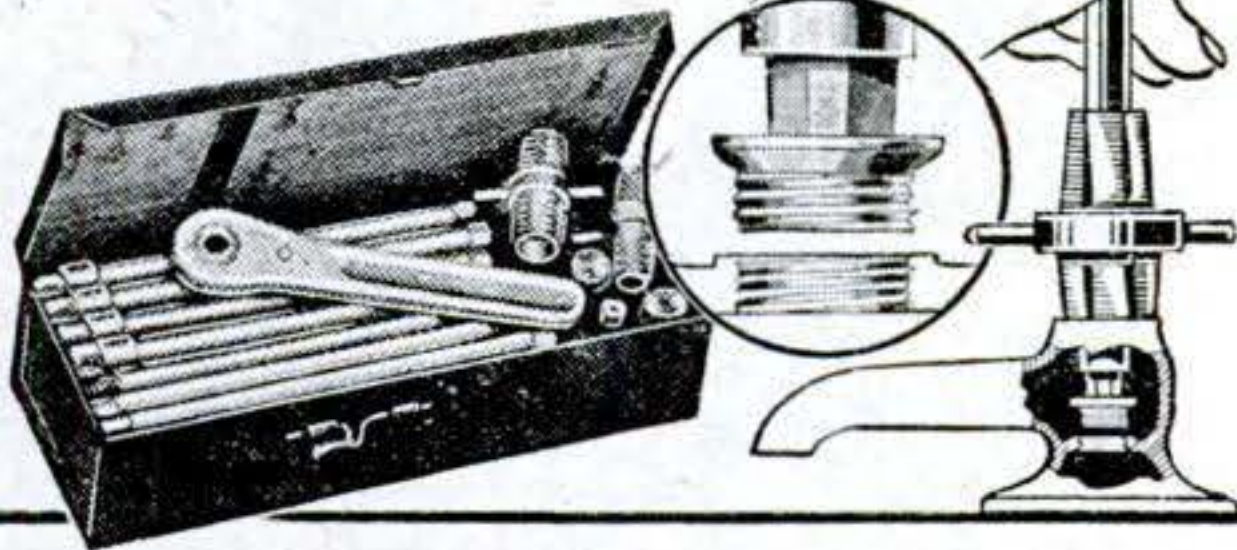

ECONOMY VALVE SEAT CO.

2811 W. Fletcher Street Chicago 18, Ill.

12 lbs. SURPLUS RADIO PARTS \$2.00

A gold mine of parts for repairmen, amateurs, and experimenters . . . sockets, condensers, resistors, transformers, coils, hardware, wire, etc., etc. An outstanding bargain in usable parts! Send \$2.00 cash, check or M.O. today! (Pay small express charges on receipt.)

HEAVY DUTY POWER TRANSFORMER

Thordarson T70R62. 115V. 60 Cycle primary. Secondary 700 V.C.T. @ 145ma., 6.3V. winding @ 4.5 amps; 5V. winding @ 3 amps. Special price while limited quantity lasts (F.O.B. Chicago)..... **\$3.95**

ELECTRONIC DISTRIBUTORS, Inc. Dept. S9, 620 W. Randolph St., Chicago 6, Ill.

Assemble KING MIDGET



Practical highway racer runabout. New model. We supply all parts. Just bolt together. Low cost. Ready for delivery NOW. One or two cylinder, 40 m.p.h., up to 100 miles per gallon. Send 25c for complete new literature with large picture, 4-view drawings, price of parts, or send \$1 (refunded with first order) for the above, plus 24-page assembly book with 42 photographs and drawings.

MIDGET MOTORS Athens, Ohio

ALUMINUM-BRASS BRONZE-COPPER

Stainless Monel & steel, in sheets, strip rod, wire tubing, pipe angles, molding, various sizes, gauges, shapes. Min. sale \$2. F.O.B. warehouse. Prices on request.

ANGLO SAXON SUPPLY CO., Inc. 458 Broome St. N. Y. 13

? CAN YOU INVENT A NEW FASTENING

A successful midwest fastening manufacturer would like to hear from you if you have an idea for a new fastening product. It can be a metal, plastic, rubber or chemical product to be used either in industry or by the general public.

Your information should be in the form of an issued patent or—in the interest of your own protection—should contain information from your pending application for letters patent. Those whose ideas are selected for further study will be contacted direct by our client. Product ideas judged worthy of purchase will be offered either a cash or royalty plan of payment.

Business Research Corporation

79 West Monroe Street
Chicago 3, Illinois

TOOL STEEL DRILL ROD

\$1.95
POSTPAID
in Continental U.S.
C.O.D.'S ACCEPTED

25 Rods — **SAMPLER KIT** — 25 sizes
1001 uses for CRAFTSMEN, HOBBYISTS, MECHANICS, Etc.

For Making
Punches
Chisels
Engraving
Tools
Shafts, Etc.

Free machining, easily worked, yet can be made file hard. Hardening instructions included!

ORDER TODAY.

FREE

With Every Kit or first order 6" Steel comb. rule & depth gage with pocket clip.

SUPER SPEED TOOL BITS

Longer Life. Faster Cutting. Smoother Finish.

Dynacut—1/4" ground bits.....10 for \$4.00

Dynacut Supreme—1/4" ground bits.....10 for \$5.00

Include 25c postage on orders under \$5.00.

We can supply all your Tool Steel Needs.

BESSEMER STEEL COMPANY OF AMERICA, Dept. CA-10
Small Shops Division, 1958 W. 59th St., Chicago 36, Illinois

BSA and "Sunbeam" shaft drive motorcycles

NOW AVAILABLE FOR IMMEDIATE DELIVERY AS ILLUSTRATED AND DESCRIBED IN AUGUST ISSUE OF POPULAR SCIENCE

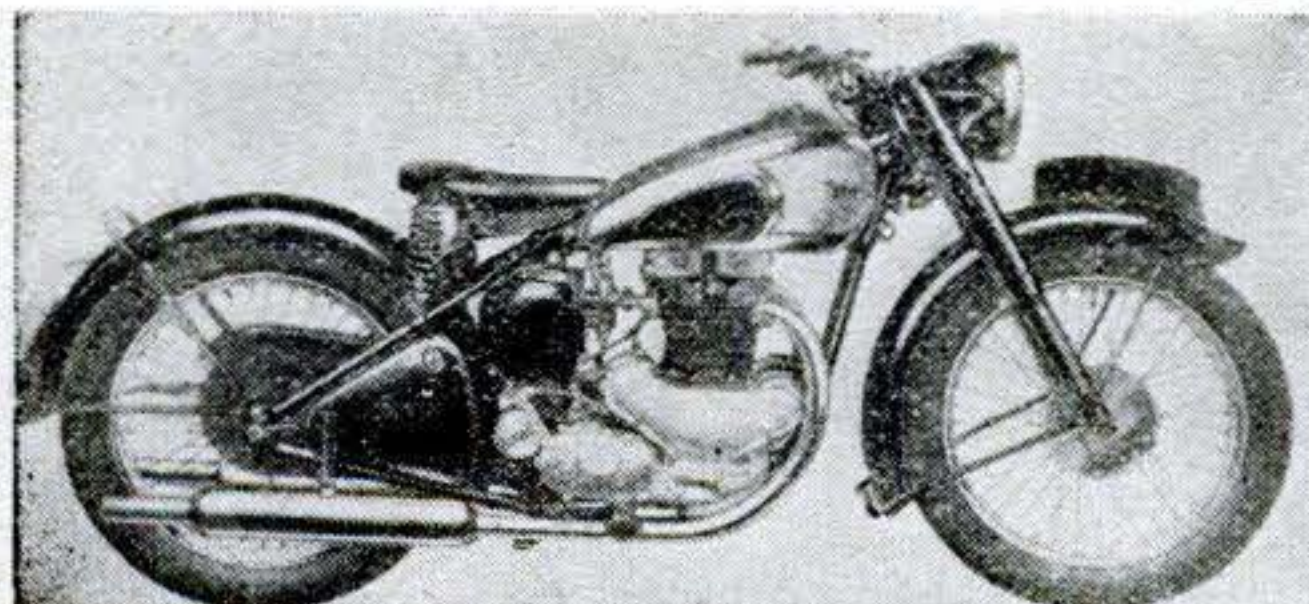

SEND FOR
FREE
ILLUSTRATED
LITERATURE
AND
REAL PHOTOS

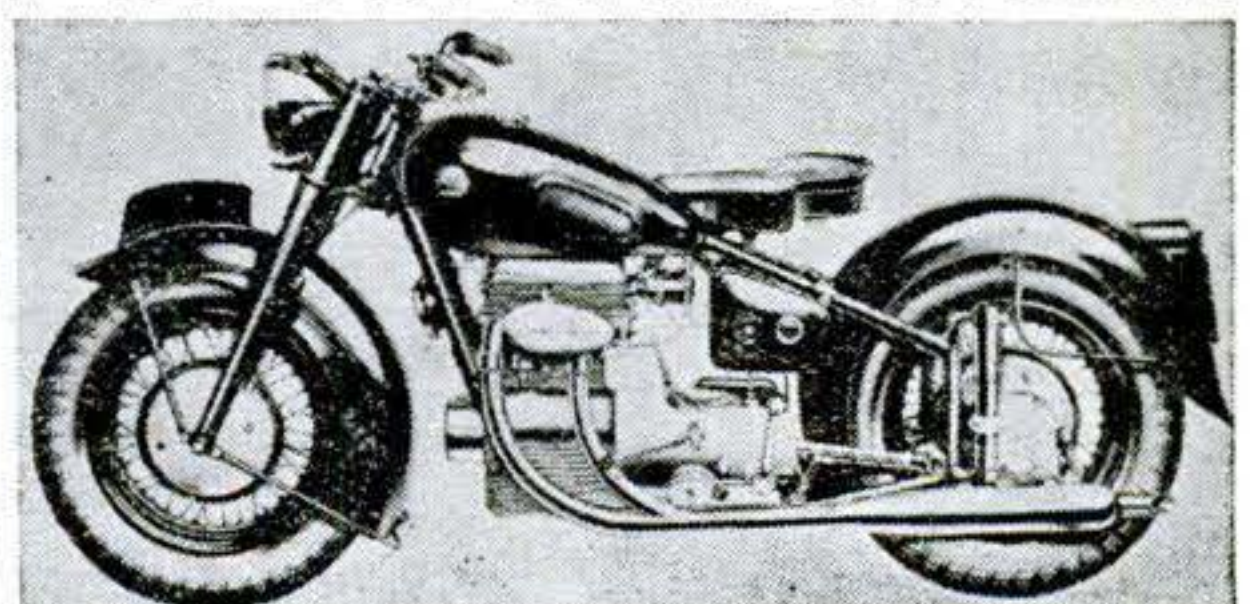

SOLE U.S.A. IMPORTERS: RICH CHILD CYCLE CO. INC. Dept. PS, 94 Madison Ave., N.Y.C.
We also import the World Famous BSA Cadet Air Rifle



Permission Peter Arno
 © The New Yorker
 Magazine, Inc.

PUZZLE: *Station Scene, 1957. Find the man who is getting a steady income from U. S. Savings Bonds. He was smart enough to start buying, back in 1947.*

Of all the ways of saving up a tidy sum of money, one of the *easiest* and *safest* ways is to invest your money in U. S. Bonds.

You can buy Bonds either through the Payroll Savings Plan at your place of business—or if the Payroll Plan is not available to you,

but you *do* have a checking account, through the Bond-a-Month Plan at your local bank.

Both ways repay you \$4 for every \$3 you save, by the time your Bonds mature. Choose the sum you can afford—and start saving today!

**Save the easy, automatic way
 — with U.S. Savings Bonds**

*Contributed by this magazine in co-operation
 with the Magazine Publishers of America as a public service.*



TOOL BARGAINS

2 Great Hand Grinder Assortments

A Super Value

Get this superb assortment of top quality grinding, cutting and polishing wheels and other useful tools, and be money ahead. Save \$35.25. Have JUST THE RIGHT ATTACHMENT for every job. Order today. Send check or send \$2.00 deposit with C.O.D. order.

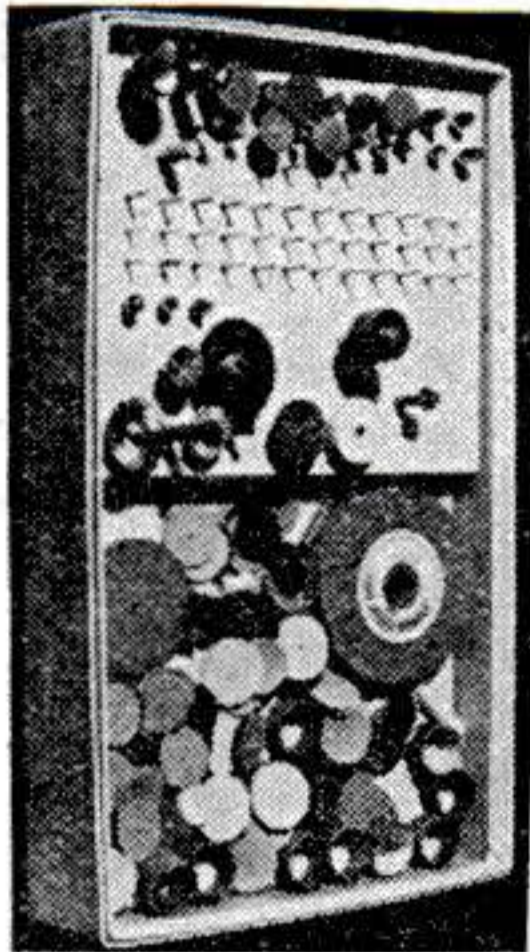

Kit comes in compact container with special rack for drills. Over 250 tools and items in this deal.

MASTER KIT
Now Only **\$9.75** A \$45 Value
FOB Chicago

- 102 Grinding, Cutting, and Polishing WHEELS PLUS 150 assorted items for Home or Shop.**
- 2 Grinding Wheels 3" and 2" dia.
 - 2 Rotary Files, High Speed Steel.
 - 6 Rotary Cutters 1/8" Shank.
 - 3 Rotary Cutters 3/32" Shank.
 - 6 Mounted Grinding Wheels 1/8" Shank.
 - 6 Mounted Grinding Wheels 3/32" and 1/4" Shank.
 - 4 Speed Drills 3/32" Shank.
 - 30 Rotary Cutting Burs 3/32" Shank.
 - 2 Mandrels 3/32" Shank.
 - 1 Mandrel 1/8" Shank.
 - 1 Screw Type Mandrel 3/32" Shank.
 - 3 Rotary Bristle Brushes 3/32" Shank.
 - 1 Rotary Wire Brush 3/32" Shank.
 - 1 Circular Saw 1 1/2" dia.
 - 1 Mandrel for Circular Saw 1/8" Shank.
 - 2 Rubber Cylinders and Mandrel 3/32" Shank.
 - 1 Rotary Drum Sander 1/8" Shank.
 - 15 Bands for Rotary Drum Sander.
 - 15 Rotary Felt Wheels 1" dia.

D. SCHUPACK, 2256 E. 75th. St., Dept. Q-6, Chicago 49, Ill.

PLASTICS

WORK IN A FASCINATING AND PROFITABLE HOBBY
We carry a complete line of plastic supplies and accessories. Send 10c today for our latest catalog and fabricating manual.

HOUSE OF PLASTICS

8648 Linwood MO Dept. -Detroit 6., Michigan

BECOME A MANUFACTURER'S AGENT

Be your own boss and earn big profits with little or no capital investment. Send today for the VIMAR PLAN which provides you in detail with soundly-tested methods on how to become a representative for prominent manufacturers. Learn how to contact concerns, select products and build a successful business for yourself. \$2.00 postpaid.

VIMAR CO.

210 LOEB ARCADE, Dept. B-21
MINNEAPOLIS 2, MINN.

WAR SURPLUS

For the Sportsmen—Young or Old
All Year 'Round Use



Perfect all wool
Olive Drab

SLEEPING BAG

Comes in handy for fishing trips, hunting, camping, boating, just roughing it or use as auto robe and many other purposes. Has warmth of 2 blankets; zipper slide fastener; tie-strap on bottom; approx. Gov't cost \$12.90, our price **\$3.95** Ea.

Outside Cover for Sleeping Bag—Water repellent.....\$2.39

PUP TENTS 2 Man size—Scouting, camping, etc. Without Pole..... **\$2.95**

NEW AIR CORPS SUNGLASSES

Manufactured by Bausch & Lomb for U. S. Air Corps. Quality and Style with bone nose cross bar, individual case. Priced at big savings which includes postage. **\$5.95**

NEW GOGGLES

Set comes complete. Kit with 1 extra interchangeable shatterproof, flexible, cellulose acetate lens. Green and white colors. A rubber flexible goggle frame. Back adjustment head strap. Made for A. A. F. Cost Gov't approx. \$4.50. Ea. **\$1.00**

WE PAY POSTAGE—No COD—Send check or money order
AMERICAN SUPPLY CO., DEPT. P.S., 5TH & BROADWAY
KANSAS CITY, MO.

HEARING

**CORRECTED
INVISIBLY**



**NO ONE KNOWS WHEN YOU WEAR A
MAICO HEARING AID**
WITH

SECRETEER

Now you can enjoy a wonderful new invention, the Maico Secreteer, that prevents even people close to you from noticing you wear a hearing aid. Secreteer and Maico's tiny, single-unit, super-powered Atomeer hearing aid together weigh but 7 oz. People say these two Maico inventions are the most wonderful gifts modern science has brought to the hard of hearing. Learn how to hear better with no one noticing. Maico offices are in all principal cities.

Send for a
SECRETEER
folder today

**MAICO, DEPT. P-9
MAICO BUILDING
MINNEAPOLIS 1, MINN.**

Please send me information on
INVISIBLE hearing correction.

Name.....

Address.....

City..... State.....

KAYAKS

AQUA VIR

Easy to Build

**OUTBOARDS
ROWBOATS**

25¢ COIN FOR ALL THREE

AQUAMOBILE V-18

Designed for Auto Engines. Open or with cab. Length 18 ft.
Fast VEE Bottom Hull.

KAYAK BOAT CO., 152R EAST 129th ST., NEW YORK 35, N. Y.

**BOATS for
Home Assembly**

"U-MAK-IT"

KAYAKS, ROWBOATS, DINGHIES,
INBOARDS, OUTBOARDS, RUNABOUTS

Cut-To-Fit for Quick Assembly. Everything Complete plus Illustrated Instructions. No Experience Necessary. Simple as A. B. C.

SEND 25c POSTAGE (COIN) TODAY FOR 3 MONEY SAVING ILLUS. CATALOGS Showing all '47 Models (marine plywood) and construction details.



FOR PEOPLE WHO LOVE TO PUTTER

MOTO-SAW

The Amazing Electric
SCROLL SAW

Boys from 8 to 80 (and girls, too) have fun with a Moto-Saw . . . it works more like magic than any tool you ever saw! It takes no effort to run, no perceptible pressure to feed. Runs 7,200 strokes a minute . . . easily cuts intricate scroll designs in medium hard wood up to 3/4" thick. Blade holder faces blade 4 ways . . . permits you to saw sideways as well as forward and backward. No limit to length of stock it will cut . . . saws to center of 19" widths. *Moto-Saw is as safe as a hand saw* . . . has only two moving parts . . . never needs oiling. Uses 110-120 V. 50 or 60 cycle A.C. (only). Thousands of satisfied users.

MONEY-BACK GUARANTEE: If your dealer does not yet have Moto-Saw, send only \$5.85 . . . we'll pay postage. Or send \$1, and pay postman balance plus postage. Money back if not delighted after 5 days' trial.

DREMEL MFG. CO., DEPT. S127-J, RACINE, WIS.

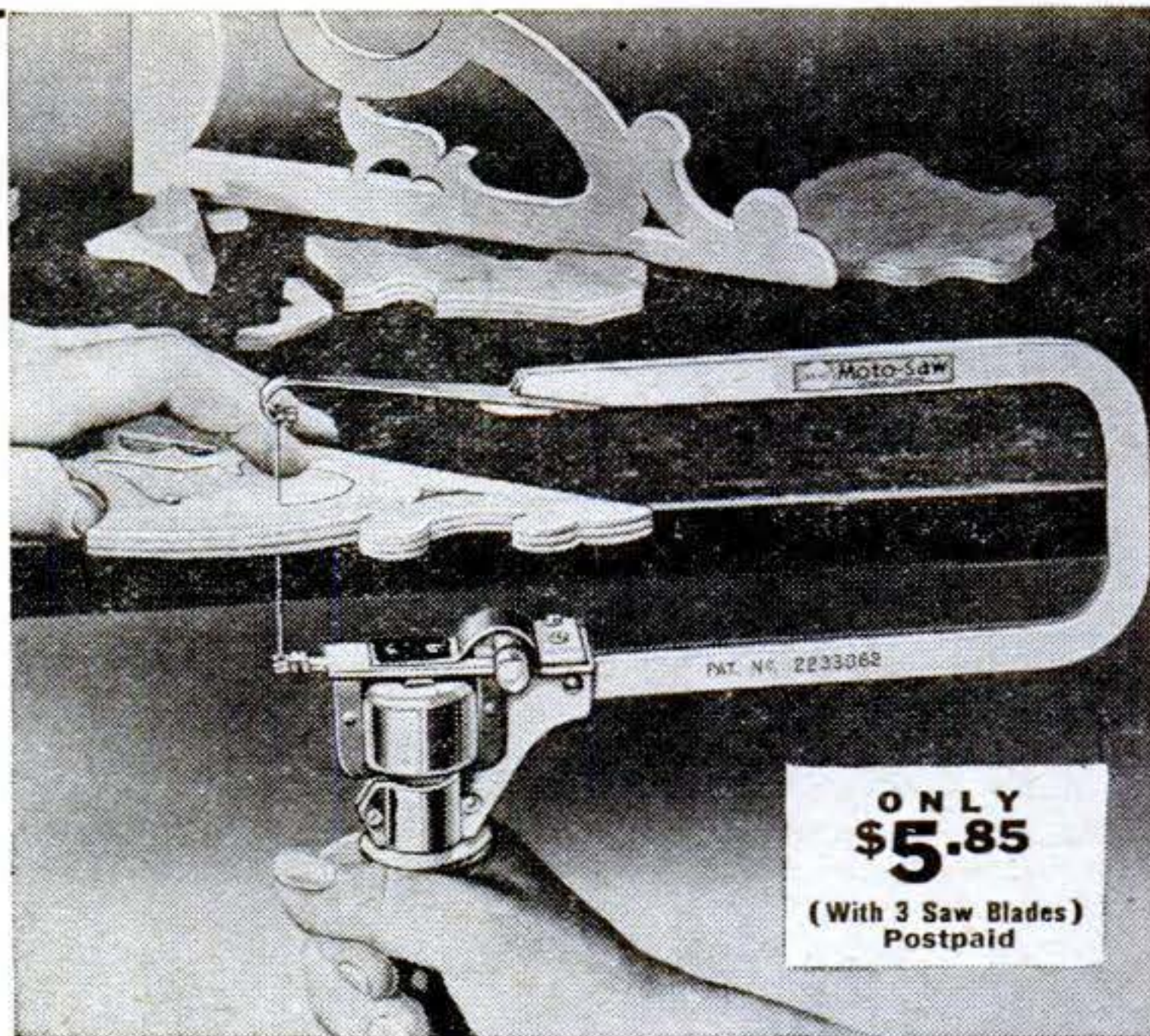

ONLY
\$5.85

(With 3 Saw Blades)
Postpaid

WAR SURPLUS BARGAIN SPECIAL

BELT DRIVEN CENTRIFUGAL PUMP

READY TO
USE ON ANY
LIQUID
PUMPING NEED
NOW ONLY

\$29.75

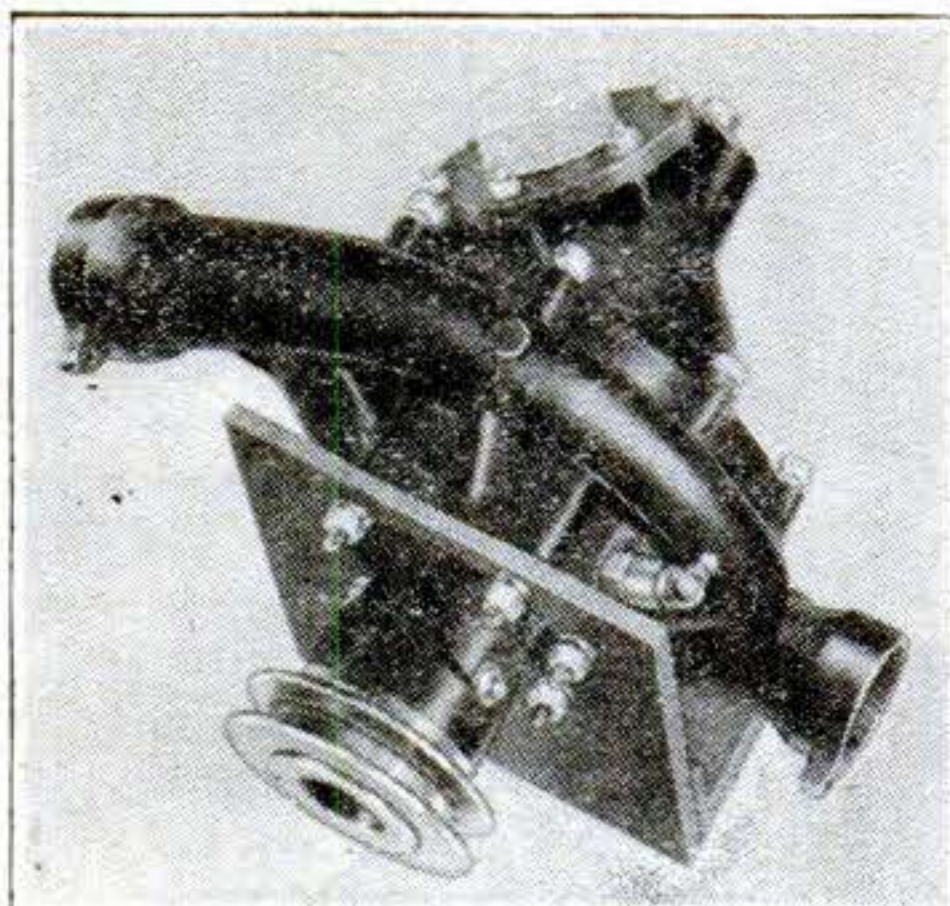

FOR HOME WATER SYSTEMS, IRRIGATION, FIRE PROTECTION, DRAIN BASEMENTS, PONDS, ETC.

● A super value for all types of intermittent service in pumping large volumes of liquid for stock watering, home and shop water systems, irrigation, draining pools, basements, etc. At 1750 RPM on 23 foot head will pump 42 gallons per minute; at 3600 RPM on 52 foot head will move 88 gallons per minute. Cast aluminum housing. Accurately machined bronze impeller vanes. Complete with mounting bracket and 3 1/2 inch V belt pulley. Run with electric motor, gasoline engine, power take-off on tractor, etc. Shaft rotates on sealed ball bearings with grease gun fitting. Has 1 1/2 inch threaded intake flange, two 1 inch outlets. Use one or both as necessary. Made for Packard Motor Car Co. for use in Rolls-Royce Merlin Aircraft engines. Comes complete with pulley and mounting bracket. Original cost approx. \$147.00. Sold F.O.B. Chicago. Shipping weight 23 pounds. Complete engineering reports and operating instructions free with pump. You can't beat this pump value at anywhere near this price. Satisfaction guaranteed.

ORIGINAL COST APPROX. \$147.00
IMMEDIATE DELIVERY FOB CHICAGO
SPECIAL PRICE, WHILE THEY LAST
\$29.75
GROBAN SUPPLY CO. 1522 So. MICHIGAN AVENUE
Dept. PS 8, Chicago 5, ILL.

Craftsmen • Cabinet Shops 6" WOOD JOINTER

"All Aluminum"

\$125⁰⁰ Value—NOW \$75⁰⁰

(SEND
CHECK
OR P.O.
MONEY
ORDER)

- 41" TABLE
 - SEALED WATER BEARINGS
 - APPROX. WT. 70 LBS.
- *Shipped F. O. B. Portland, Ore.

A B Co. P. O. Box 3871 PORTLAND, OREGON

WHY HEAT WATER WHEN YOU SLEEP?

Save Money on your gas bill with a Step Saver Remote Gas Control. Lights heater for kitchen, laundry and bath with easily operated automatic push button thermostat. Gas Pilot. Operates on 10-12 Volts. Two wall switch unit, \$28.50. One switch unit, \$25.50. Cash orders prepaid. C.O.D.'s—plus postage. Immediate delivery.

STEP-SAVER MANUFACTURING CO.
BLOOMINGTON, ILLINOIS

DRILL CASE INDEX THE COMPACT, ALL STEEL LIFE-TIME DRILL CASE



\$3.29

Has easily read fractional or thousandths data permanently attached to front. Can be used as drill gauge. Equipped for hanging on wall or standing on tool box. Drills cannot fall out.

DANAT COMPANY

624 S. Michigan Ave., Chicago 5, Ill.

Independence
EVEN WEALTH,
WITHIN
EASY GRASP

Make & Sell THERMO-SOL Tested Fire-proofer

Right now this fine fire-proofer is being made and profitably sold by hundreds of people like you who started out by answering our ads. And it's but one of our 15 Private Manufacturing Processes.

We tell you ALL—How to Make—Where to Buy simple inexpensive materials—How to Package, Promote, Sell. If you are SINCERE, if you can follow simple directions, here are 15 Roads to Success.

These are factory-tested processes. Big businesses have been built on them. There's still room for you. The public WANTS the products. You, yes you, can Make & Sell them. Lose no time! Write for details.

CHEMICAL RESEARCH CO. 214 West 42nd Street, New York 18, N.Y.

HOW TO GET THE THINGS YOU REALLY WANT!



HOW large a home do you want to own? How popular do you want to be? How much money would you like to have? What are your ambitions in business or profession? Set your goal—and set it high! You can win it, thanks to the proved formula for success dynamically explained in "Think and Grow Rich!"

you want? Time and again the answer is—failure to use the formula by which big money is made! **You can get rich only by using the formula for getting rich.** And the same thing goes for other goals you may have.

That's why "Think and Grow Rich!" can mean so much to you. It reveals in specific detail the very formula necessary for success in gaining whatever goal you're after—the secret of achievement used by Andrew Carnegie in making hundreds of millions of dollars for himself and many more millions for others!

Suppose your goal has been to have \$10,000 or \$25,000 or \$50,000 in the bank. Why have you failed to get the money

HERE IS THE SIMPLE FORMULA THAT HAS BROUGHT WEALTH AND FAME TO THOUSANDS!

Yes, this amazing formula is revealed step by step exactly as told by Carnegie and confirmed by hundreds of other sensationally successful men, in "Think and Grow Rich!" If you are deeply seeking some worthwhile goal get a

copy of "Think and Grow Rich!" right away. Let it show you how to turn failure into success . . . how to get the money you want, the home you'd like to live in, the time to travel, or whatever it is you really want.



GETS AMAZING RESULTS!

Endorsed by America's Richest Men! Scores of famous and wealthy men have enthusiastically endorsed the formula for success as disclosed in "Think and Grow Rich!" You will find reprinted in the book amazing letters of endorsement. Here are two excerpts:—**F. W. WOOLWORTH** wrote, "By applying your philosophy we have built a great chain of stores. The Woolworth Building might properly be called a monument to the soundness of your principles." **WM. WRIGLEY, JR.**, wrote, "Whatever success I have attained I owe, entirely, to the application of your principles of success."

SEND NO MONEY

"**THINK AND GROW RICH!**" is yours on **FREE TRIAL**. In just one hour you can learn enough about the formula for success to start it working for you. In ten days you can know how effectively the formula is working—and whether "Think and Grow Rich!" is worth its small cost of only \$2. You risk nothing. Order a copy on **FREE TRIAL**. Mail coupon **NOW!**

FREE TRIAL COUPON

RALSTON SOCIETY
147 Engineers Bldg., Cleveland, Ohio
Send me a copy of "Think and Grow Rich!" for Free Trial. I will pay postman \$2, plus postage on delivery with the understanding that if I return the book in 10 days you will refund my purchase price.

Name.....

Address.....

City & Zone..... State.....

SAVE POSTAGE. We pay postage if you enclose \$2 now. Same Free Trial and refund privilege.

TELLS WHAT TO DO AND HOW TO DO IT!

PAGE 42—Formula for Transmuting Your Desire for Riches into Real Money

PAGE 74—Formula for Gaining Self-Confidence

PAGE 147—Formula for Building a Practical Plan for Getting What You Want

PAGE 178—Formula for Correcting The 30 Causes for Failure

PAGE 277—5 Ways in which Energy May Be Used to Improve Personality

PAGE 297—The 7 Major Positive Emotions . . . the 7 Major Negative Emotions

PAGE 328—The 6 Basic Fears and How to Overcome Them

PAGE 370—57 Alibis for Failure—and What You Can Do About Them



For Real Driving Convenience—THE NEWEST HULL BEACONLITE or VETERAN STREAMLINE

New illuminated Hull Automobile Compass—**BEACONLITE**, \$5.95; standard model **STREAMLINE**, \$3.95. At your dealer's. Write for literature.

HULL MFG. CO.
P. O. Box 246-E8, Warren, Ohio



Blades of finest custom made steel, **HAND HONED** under oil. Ask your good neighbor, the local hardware or sporting goods dealer. We're doing our best to keep him supplied.

CAMILLUS
has the edge!

Kä-MILL-us

No. 72
3 3/8" closed

CAMILLUS CUTLERY COMPANY, New York 17, N. Y.
Established 1876 . . . Factory at Camillus, N. Y.

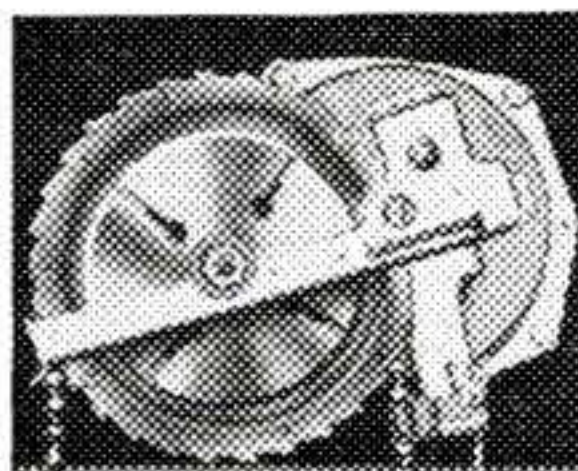

SURPLUS SPUR GEAR HAND HOIST

LIFTS, as a hoist...or pulls, as a winch. Hundreds of uses for this converted bomb hoist. Made by famous manufacturer for Uncle Sam . . . Brand new, unused. Easily lifts or pulls up to 350 pounds. 20 ft. of multi-strand wire rope can be fed out of any one of three drum housing openings. Rig it up yourself on wall, beam, tripod or trolley, wherever you want to lift or pull heavy or bulky loads, such as boats, outboards, stock . . . anything too heavy to handle. Free illustrated "How To Use It" suggestions.

LIMITED QUANTITY
at never-again price of:

\$9.95

Postpaid in U.S.A.

IRELAND & VICE P. O. Box 146-B, Auburn, N. Y.

9 BIG NEW BOOK

EVERY ONE AN UNBEATABLE VALUE!

Prepared by the Editors of POPULAR SCIENCE MONTHLY, these great books are bursting with up-to-the-minute information, pictures and diagrams that will save you both time and money! You need not hesitate to order one or all for your own enjoyment or to use as gifts. We guarantee complete satisfaction or your money back!



NEW HOME WORKSHOP ENCYCLOPEDIA

Here's a giant book that's jam-packed with over 840 thrilling things to make and do in your own home workshop! It's filled with over 1500 pictures and diagrams that show you how to build bookcases, furniture, cabinets, toys, games, gifts . . . how to repair radios, autos, electrical appliances . . . and no end of ideas for keeping the home shipshape! Yes, you'll even find dozens of chemical experiments, hints for the garden, photographic ideas and woodcarving projects. 580 pages! Handsome DeLuxe edition! Printed in 5 colors!

TINKERING WITH TOOLS

\$1.49 It's *easy* to do your own repairing—and lots of fun—if you follow the simple instructions in this big 260-page book! Everything you need to know about carpentry, plastering, plumbing, painting, masonry, shingling, wallpapering, electric wiring, etc. 215 pictures. DeLuxe edition.

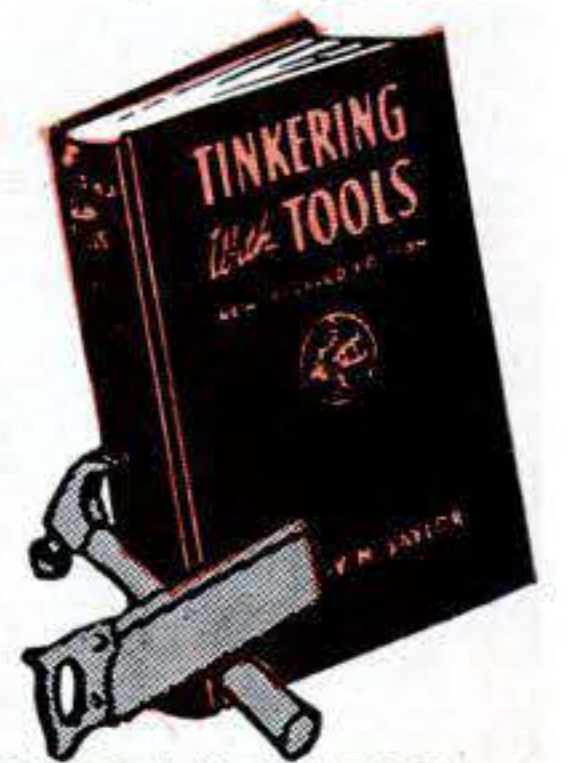

THE HOME CHEMIST

Shows you how to set up an inexpensive lab and perform hundreds of thrilling experiments. How to do amazing chemical tricks, and magic. 192 pages. DeLuxe edition.

\$1.49

BOOK OF FORMULAS

A wealth of formulas, recipes, and secret processes for making soap, ink, insect spray, glue, furniture polish, hundreds of other useful household items! 250 pages. DeLuxe.

\$1.49

WONDERS through the MICROSCOPE

Hundreds of exciting experiments you can do with *any* microscope! How to secure specimens, build apparatus, make slides and photo-micrographs, etc. 192 pages! DeLuxe.

\$1.49

DECORATIVE METAL

How to make useful, attractive articles out of sheet metal, pewter, bronze, steel and precious metals. Directions for bending, shaping, finishing, antiquing, etc. DeLuxe.

\$2.00

BARGAINS FOR YOU

EVERYBODY'S RADIO MANUAL

\$1⁴⁹

How to build and repair your own radios — tiny portables, F-M receivers, radio-phonographs, short-wave sets, recorders, wireless record players, etc! Written in simple, non-technical language with a wealth of drawings, diagrams and wiring circuits that make every step easy to follow! 256 pages. 216 pictures. DeLuxe edition.

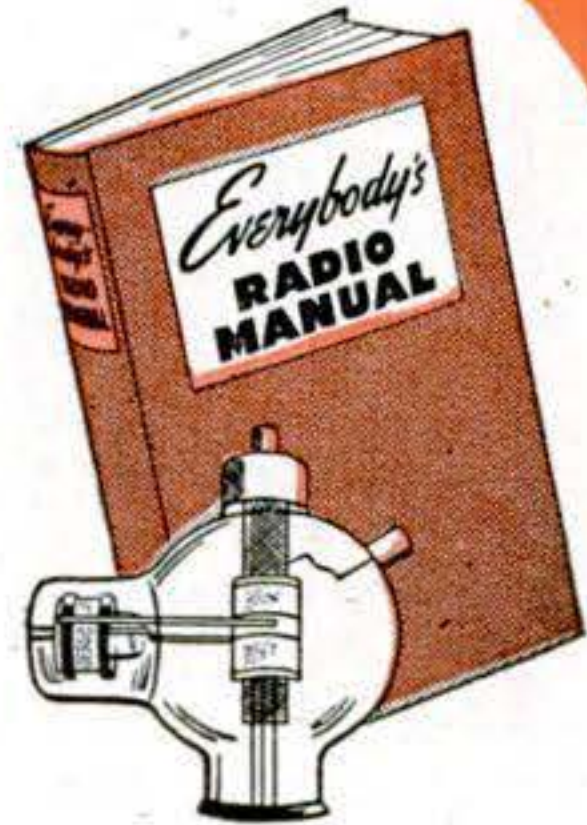

FIX IT YOURSELF

Home repairs made easy. Be your own handy-man! Simple directions and easy-to-understand diagrams show how to fix and repair furniture, electric outlets, windows, doors, leaky pipes, floor boards, chimneys, boilers, weather proofing, apply wallpaper, lay linoleum, and hundreds of other construction and repair jobs around the house. You will be surprised how easily you can do things after reading "Fix It Yourself." 256 pages, 163 helpful illustrations, complete index, DeLuxe edition.

\$1⁴⁹

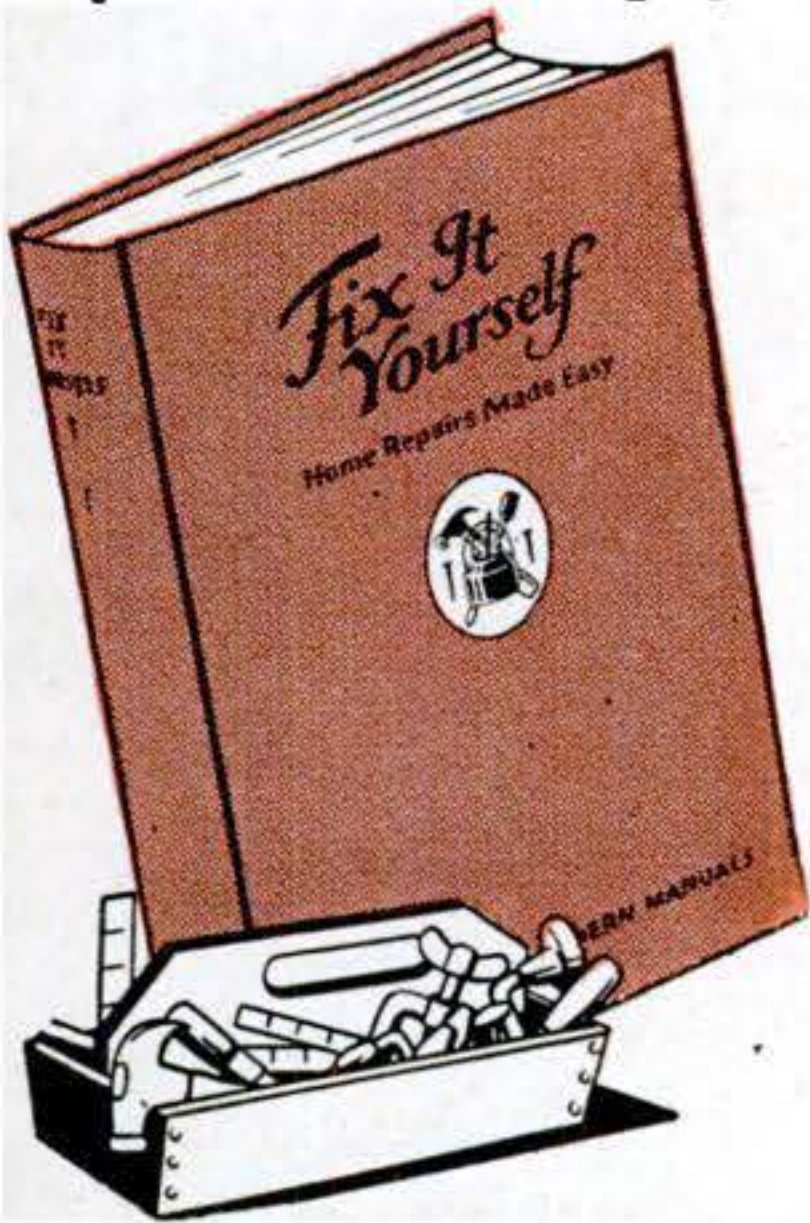

WOODCARVING AND WHITTLING

\$2⁰⁰

Here's a fascinating hobby anyone can learn with this *completely illustrated*, easy-to-follow book! You'll find step-by-step instructions for making scores of ornaments, jewelry cases, furniture of all kinds, treasure chests, trays, chairs . . . and even wooden figures of men and animals! Over 270 pages, with 150 pictures to explain your every move! A gold mine of ideas packed in one big book!



SEE THESE BOOKS AT OUR EXPENSE!

Send no money now—mail this Order Form! When postman delivers books pay listed prices plus few cents postage. Read them 7 days free—if not delighted return for full refund!

**POPULAR SCIENCE, Dept. 97
353 Fourth Avenue, New York 10, N. Y.**

Please send me the book(s) checked below. I will pay postman the price shown, plus few cents postage, on delivery. You guarantee complete satisfaction or I may return books in 7 days for a full refund.

- | | |
|----------------------------------------------------------------------|---------------------------------------------------------|
| <input type="checkbox"/> NEW HOME WORKSHOP . . . \$3.48 | <input type="checkbox"/> RADIO MANUAL \$1.49 |
| <input type="checkbox"/> TINKERING \$1.49 | <input type="checkbox"/> FIX IT YOURSELF \$1.49 |
| <input type="checkbox"/> WOODCARVING \$2.00 | <input type="checkbox"/> HOME CHEMIST \$1.49 |
| <input type="checkbox"/> BOOK OF FORMULAS . . . \$1.49 | <input type="checkbox"/> DECORATIVE METAL . . . \$2.00 |
| <input type="checkbox"/> WONDERS through the MICROSCOPE . . . \$1.49 | |

NAME.....

ADDRESS.....

CITY.....ZONE.....STATE.....

Check here if you remit now, and we will pay postage. Same refund guarantee.

It's Here!

BARRON ALL METAL SHAPER FENCE

Fits ANY Drill Press

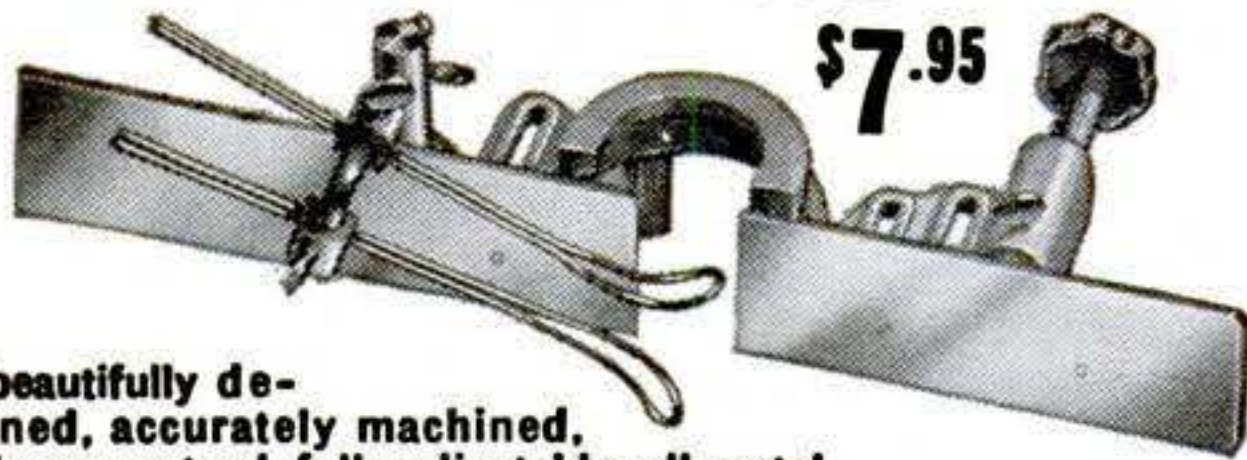

A beautifully designed, accurately machined, fully guaranteed, fully adjustable, all-metal shaper fence. Made throughout of aluminum and non-rusting steel. No cast iron—no wood! Complete with anchor bolts, 2 hold down springs. A real value. See it at your dealer or shipped direct

FAMOUS 5-IN-1 DRILL PRESS PLANER



Planes Rabbets
Panels
Tenons
Grooves

\$7.50

COMPLETE

NEW 2 1/2" DRUM SANDER

Fits All Makes of Drill Presses or Motor Shafts

\$3.95

Includes 5 sanding sleeves



OTHER DRILL PRESS ACCESSORIES

4" ROTARY SURFACE SANDER \$5.95 1/2" DOVETAIL CUTTER \$1.85
ALL-METAL AUXILIARY DRILL PRESS PLANING AND SHAPER TABLE \$9.85
TAPERED AND THREADED SPINDLE ADAPTERS
ROUTER AND ROUND END MORTISING BITS 1/8" TO 1/2" SET OF 6 \$9.50

Liberal 10 Day Money Back Guarantee

Workshop Guide FREE

BARRON TOOL CO.

570 Architects Bldg., Detroit 1, Mich.

BARRON PRECISION WORK SHOP TOOLS

Say You Saw

It In Popular Science

free
CONCORD
Radio
Catalog



RADIO PARTS • RADIO SETS • RECORD CHANGERS —
PLAYERS • KITS • HAM GEAR • AMPLIFIERS • TESTERS

It's here! The big, new 1947 Concord Catalog with a vast, complete selection of everything in Radio and Electronics for building, experimenting, testing, repair and maintenance. Thousands of items—hundreds now available for first time—latest 1947 prices. Now LOWER prices on Radio Sets, Receivers, Kits, Record Changers, Players, Portables, Amplifiers. Latest listing standard items. Complete stocks—IMMEDIATE SHIPMENT. Write for FREE COPY—please address Dept. PS-97.

CONCORD RADIO CORP.

LAFAYETTE RADIO CORPORATION

CHICAGO 7

901 W. Jackson Blvd.

ATLANTA 3

265 Peachtree Street



HOW TO BUILD YOUR OWN LOG CABIN LODGE OR BUNGALOW!

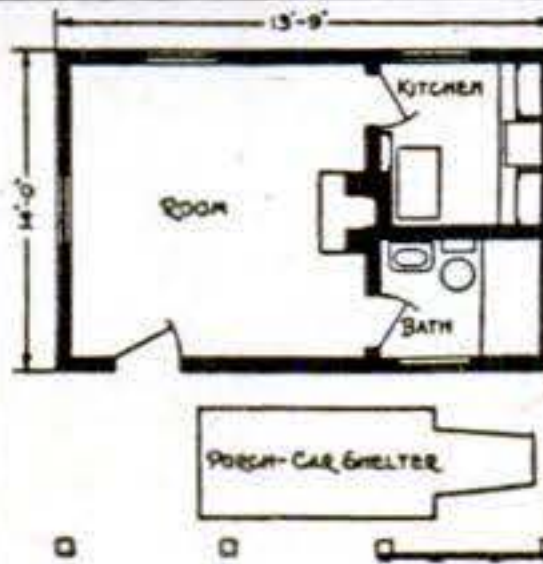

COMPLETE INSTRUCTIONS IN ONE GREAT BOOK!

Countless thousands say this great volume brings them *complete detailed plans* for building their own log cabins and bungalows!

180 PICTURES - 250 PAGES - ONLY \$1.98!

Just take your pick from the scores of cabins, lodges, tourist homes, wayside stands and bungalows jam-packed into this big book, "How to Build Cabins"! You'll learn how to lay a foundation . . . how to build walls . . . how to lay floor boards and roofs. Yes, you'll discover step-by-step details for building porches and garages . . . for cutting doors, windows, and attaching shutters . . . for building fireplaces and chimneys . . . and even for installing plumbing and lighting!

SAVES YOU HUNDREDS OF DOLLARS!

Now you can have a vacation spot of your own—a place where you won't be gouged by sky-high summer rentals—one that you can build yourself and *save hundreds of dollars* on the construction costs! And don't imagine that it's hard for you to build—for you'll find this great how-to-do-it book makes it as easy as pie—shows you every move!

SEND NO MONEY - 7-DAY FREE TRIAL!



Imagine! This big book with 180 pictures and 250 pages costs *only* \$1.98! So fill out the order form below right now! When book arrives pay postman only \$1.98 plus a few cents mailing charge as payment in full. If after 7 days' free trial you aren't delighted, return it for a full refund!

MAIL COUPON TODAY!

POPULAR SCIENCE Publishing Co., Dept. 97
353 Fourth Avenue, New York 10, N. Y.

Send me "How to Build Cabins" in edition checked below. I will pay postman price plus postage. If not delighted I may return it within 7 days for full refund.

- DeLuxe Edition in handsome Buckram binding, only \$2.48
- Regular cloth-bound Edition, only \$1.98

Name.....

Address.....

City.....Zone.....State.....

Check here if you send payment with order, and we will pay shipping costs. Same return privilege.

WANTED MAN WITH CAR

No Time Like Now to Get In McNess Business

It's no trick to make good money when you use your car as a McNess "Store on Wheels." Farmers buy everything they can from McNess Men because McNess Products are tops in quality, represent extra values. Attractive business-getting prizes and premiums; also money-saving deals to customers make selling McNess daily necessities a snap. **We Supply Capital—Start Now!** There's no better work anywhere. Pays well, permanent, need no experience to start, and we supply capital to help you get started quick. You begin making money first day. Write at once for McNess Dealer Book. It's FREE. Tells all—no obligation. (1)



**Use Your
CAR
to Raise
Your
PAY**

THE McNESS CO., 483 Adams St., Freeport, Ill.

Men's Fully Guaranteed NEW \$13.95 PLUS TAX 15-JEWEL WRISTWATCH

ORIGINALLY sold up to \$55
Now sacrificed because they're Gov't surplus.

LOOK AT THESE FEATURES:

Luminous dial . . . sweep second hand . . . waterproof . . . shockproof . . . anti-magnetic . . . imported Swiss precision movement and case. You get them now for a small fraction of original prices. Don't delay! Order now while they last. Send only \$1 down payment with order. Pay balance to postman on arrival, plus postage. Or we pay postage if you enclose \$13.95 plus \$1.39 Fed. Tax. Receive reg. \$2 expansion band FREE with prepaid order. Money back in 5 days if not defighted. Order now.



MARYLAND DISTRIBUTERS, Dept. S-1
501 E. Balto. St. Balto 2, Md.

NEW YORK MACHINE SHOP FACILITIES For Your Own Use

For your use on our premises; many new machines; no minimum; low hourly rates; Q C 10" lathes 75c, millers \$1.25, drill presses 50c, surface grinder \$1, engraver 75c, metal planer \$2, etc; you may use machines for any job they can do; we advise and show you how free; open 9 A M to 11 P M daily and Sat; visitors welcome. Leaflets sent to local addresses.

ZELF TOOL & DIE WORKS
682 6th Ave., New York 10, N.Y. Tel. GR 5-2355

★PRICE REDUCTIONS★EXPANDED STOCKS★

Aluminum flats to 4", squares, rounds, hexagons, angles, tubing. Drill rod in rounds, squares, flats and octagons. Plastic in sheets, rods and tubing, clear and color. Also Decorative Panels. Many other items. Listing (A47) on above 5c. Catalog 1046-D and Listing A47 which lists tools, supplies, equipment, etc. 15c. METPLAS SUPPLY COMPANY, 1420 South 16th, Maywood, Illinois.

DECORATIVE METAL WORK

A new manual for the amateur. Tells in easy to understand language how to make useful metal articles in your home workshop. You'll be surprised how easy and interesting metal work really is. Fully illustrated with diagrams and step-by-step instructions. Sturdy cloth binding. 253 pages. Send only \$2.00 and your copy will be sent postpaid. Popular Science Monthly—Dept. 97, 353 4th Ave., New York 10, N. Y.

FREE!



SEND FOR
**ALLIED'S
BIG 164-PAGE
RADIO
CATALOG**

Everything in Radio at Lowest Prices!

Here is *everything* you want in Radio! New home radios and phono-radios, Ham receivers and gear, new kits, thousands of parts, tubes, tools, complete PA equipment, diagrams, latest radio books. The most complete stocks anywhere—in one *big* book—all at money-saving low prices!

BUILD THIS AMAZING 5 TUBE RADIO

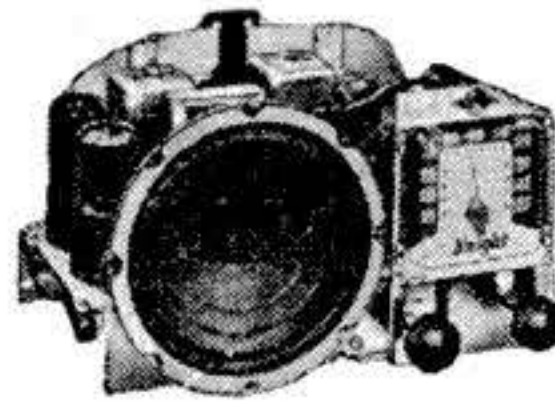
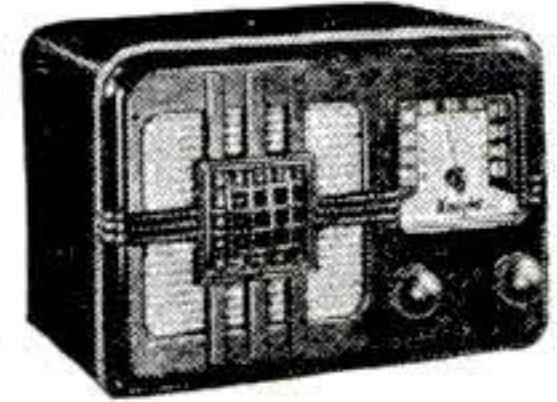

LOW-COST SUPERHET KIT Complete with Plastic Cabinet, Loop Antenna, and Tubes

It's here! The first ultra-modern 5 Tube AC-DC Superhet kit at so low a price! Here's what you get—full broadcast band coverage (550-1600 Kc); built-in loop antenna; latest 5" PM dynamic speaker; handsome walnut plastic cabinet. Unbelievably easy to build; no special tools required. Sockets are riveted in place on chassis base; just assemble, wire and slip into cabinet. Outstanding for power and tone quality. Highest grade components only. Complete with all parts, tubes and full instructions. **ONLY** Nothing like it at the price! Shpg. wt., 10 lbs. **\$14.95** No. 83-275. Complete

GET THESE VALUABLE ALLIED RADIO BOOKS!



- Radio Formulas & Data No. 37-752 . . . 10c
- Dictionary of Radio Terms No. 37-751 . . 15c
- Radio Circuit Handbook No. 37-753 . . . 25c
- Radio Builders' Handbook No. 37-750 . . 15c
- Simplified Radio Servicing No. 37-755 . . 10c
- Radio Data Handbook No. 37-754 25c
- ALL 6 BOOKS above No. 37-799 . . . \$1.00
- Parallel Resistance and Series Capacitance Calculator. No. 37-960 . . . 25c
- R-F Resonance and Coil Winding Calculator. No. 37-955 25c

ALLIED RADIO

ALLIED RADIO CORP.
833 W. Jackson Blvd., Dept. 7-J-7
Chicago 7, Ill.

**FREE
CATALOG**

- Rush FREE 164-page Catalog
 - Send Kit No. 83-275
 - Send 6 Books No. 37-799
 - Send Calculators checked above
- } \$ enclosed

Name
Address
City Zone State

SPECIAL! GOV'T SURPLUS SPECIAL!



Holland Hardware Co., Inc.
24 VESEY ST., New York 7, N. Y.

These Prices for U.S.A. Only — Send Postal or M.O. Only — 25% Deposit on C.O.D. Orders

1/2 H.P. MOTOR



Size 6 1/2" Long—3 3/4" Long
24v D.C. Field—60 v D.C.
Armature Instruction for
conversion to 110v A.C.
or D.C. included. **\$10.00**
Add \$1.00 West of Miss.
9-1 HEAVY DUTY GEAR
HEAD\$2.00 Extra

Fenwall Temperature Switch



Range ad-justable from
40° below to
400° F. length 4x1/2". Specify
normally open or normally
closed\$1.25

MICRO-SWITCH

110-v A.C. Many Uses.
Roller type for nor-
mally open and
closed circuits.

\$1.00



MOTOR



6-12v D.C. approx. 1/20
HP. 3x3" with 1/4" shaft
suitable for auto de-
frosters, fans. **\$3.00**
New.....

1/100 H.P. MOTOR
24v A.C.-D.C.



Size 3" Long—1 3/4" Diam.
7000 RPM'S. Can be run
off 110v A.C.-D.C. with
200 ohm—100w resistor
or 60w light bulb in series. **\$3.00**



AMMETER

24v D.C. 20
plus-20 mi-
nus. C.P. For
Auto, Boats,
small Battery
Tests. **\$1.00**

FLEXIBLE CABLE

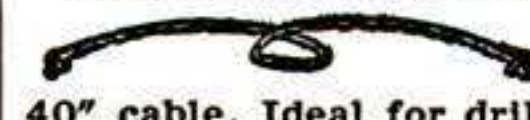

40" cable. Ideal for drill-
ing, buffing, turntables,
light shopwork etc. **\$1.25**

BUILD YOUR OWN SPORTS TRAILER

takes two days . . . saves you \$200

Now—this beautifully streamlined sports trailer—made and sold by Modernistic Trailer Manufacturing Co. for years at a price over \$500, is being shipped in a complete, prefabricated kit. Comes to you ready to assemble. It's easy—all you need is a screwdriver and wrench! Anyone can do it! Complete instructions furnished. Trailer has all-aluminum exterior. Accommodates 2 adults. Overall length, 12'7"; width 6'; height, 5'. Has roomy galley, and plenty of storage space. Total weight slightly over 400 lbs.—hardly noticeable behind your car. Kit comes complete with every part needed, less tires and tubes.

Build this deluxe sports trailer for your own use—or sell it and make money! Order your prefab kit today . . . fit and quality of every section unconditionally guaranteed. Price only \$279.50, plus tax, f.o.b. Los Angeles. Enclose full remittance, or, if you desire C.O.D. shipment, enclose \$50 deposit. If more convenient to you we will ship trailer in two kits—one kit now, the other later when you're ready for it. Price is slightly higher but you pay for each when you order. First kit, containing chassis and outer shell sections, only \$157.50. Second kit, containing balance of trailer, \$139.00. Order today specifying complete kit or first half of kit. Write for free folder.

NATIONAL TRAILER STORES • Dept. 11, • Box 2353, Terminal Annex • Los Angeles 54, California

HOW TO CUT RAFTERS

New vest pocket book gives lengths, Side cuts, Plumb cuts, Deductions. For all rafters for any building from one inch to forty feet wide. Gives numbers to cut on square. Also degrees for same cuts for Radial Saws. All standard pitches from 1/8 to 5/8. Just open book to pitch page and there are your lengths, side cuts, etc. Anyone who knows what a jack rafter is can frame a roof if he has this great book. Price one dollar pre-paid. Builders' Topics, Dept. S, Lock Box 828, Seattle, Wash- ington. Original teachers of the square in five easy lessons by mail. SEND FOR FREE LIST OF TECHNICAL BOOKS. Learn to read blueprints, etc.

TWO WAY ELECTRONIC, SOUND POWER TELEPHONE SET only \$2.49

You can have loads of fun talking from room to room, floor to floor and house to house. Take a set with you on weekend trips, parties. Works anywhere. Complete with 2 electronic microphone receivers and roll of double wire for hooking up. No extras needed. Rush your order today.

BERNARD FINE CO., INC.

501 6th Ave., Dept. P.F. 1, New York 11, N. Y.



ATKINS *Silver Steel* **SAWS**

FOR MEN WHO APPRECIATE THE BEST

- HANDSAWS
 - HACK SAWS
 - CIRCULAR SAWS
 - BAND SAWS
- ALL OTHER TYPES

E. C. ATKINS AND COMPANY, Indianapolis 9, Indiana

Now A DYNAMIC Super-charged WELDER

IDEAL FOR AUTO • HOME APPLIANCE • FARM REPAIRS

DESIGNED TO DO HIGH GRADE WELDING INEXPENSIVELY!

Maintenance Men; Farmers; Mechanics; Machine Shops; Foundries; Auto, General Repair and Job Welding Shops; all using the DYNAMIC find it so indispensable and useful that they cannot afford to be without it. If inexperienced you can easily learn to do a variety of high grade welding jobs by following the practical, simplified operating and welding instructions furnished. Once you see a DYNAMIC in operation, you won't want to be without it. Its simplicity will amaze you. In a year the DYNAMIC only costs you about 6c a day. Helmet, rods, cables, holder and operating instructions, etc., furnished.

SAVES YOU VALUABLE TIME AND MONEY!

This portable industrial transformer type DYNAMIC WELDER easily carried right to the job, can be operated from any convenient, properly wired 110 Volt, 60 Cycle Line—has 8 metallic and carbon arc welding heat stages—does work you would think only possible with a larger more expensive machine. Can also be supplied for 220 volt, 60 cycle operation and other voltages and cycles at slight additional cost. Works on Iron, Steel, Brass, Bronze & other metals.

DYNAMIC WELDER CO., 13 East 23rd St., SM, Chicago 16, Ill.

ONLY \$28.50

COMPLETE Available Now IMMEDIATE DELIVERIES

Write Today for Particulars

GET DETAILS on our 10 day Trial Offer.
Member Chicago Association of Commerce.



WORLD'S LOWEST PRICED ADDING MACHINE

VEST POCKET SIZE
IDEAL FOR BUSINESS OR PERSONAL USE

FREE TRIAL
ONLY \$2.50
TOTAL COST
SEND NO MONEY
FREE!!

Each Baby Calculator in Beautiful, rich-looking Leatherette case—at no extra cost.



Fits vest pocket or purse. Guaranteed accurate. Operated as easily, and as reliable, as machines costing many times as much. Not a toy. Substantially made of 28-gauge steel—guaranteed for life against defects in construction. You positively can't buy a calculator of equal quality for as little money. **ACCEPTED AS THE FINEST LOW PRICED CALCULATOR FOR OVER 30 YEARS!** Operates with a flick of your finger. Adds, subtracts, multiplies, divides—counts up to ten million. Pays for itself over and over in mistakes avoided, and time saved. **MAKES IDEAL GIFT.**

Sold on a positive money back guarantee. Send only \$2.50. Calculator sent postpaid, or send name and address and pay postman \$2.50 plus postage. **MONEY BACK IN 10 DAYS IF NOT DELIGHTED!** (If outside U. S., send \$3.00.) **AGENTS WANTED.**

CALCULATOR MACHINE CO., (Mfrs.)

Dept. 482 P.O. Box 248, Glenview, Illinois

HANDY 1/12 H. P. MOTOR

\$4.95

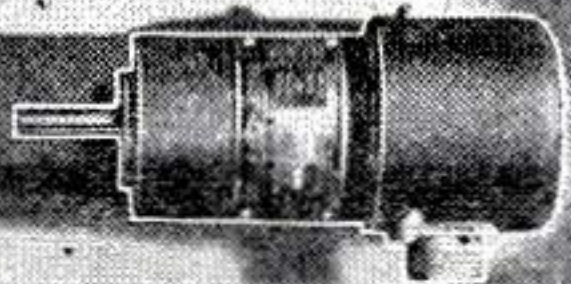

1001 USES FOR HOBBYISTS, CRAFTSMEN

New Emerson 1/12 H.P. D.C. motors. Amazing value for hobbyists, craftsmen, radio hams. Operates buffers, fans and grinders, plus 1001 other uses. 6000 RPM, 24V, D.C. Will operate on 6V current. Sent postpaid for only \$4.95! Send check or M. O.

LEO HORCHOW ASSOC., Dept. 102, 50 W. Broad St., Columbus, Ohio

1612 miles for \$15.42



CONVERTIBLE

Choose any model of CROSLY you wish and you'll get a car that weighs about 1/3 as much and operates for about 1/2 as much as heavier, more cumbersome and expensive automobiles.

J. M. Rachford, 1048 Boone St., Newport, Ky., drove 1612 miles—to Carlisle, Pa., and return, and spent only \$15.42 for gas and oil.

In the Convertible (or Sedan) you get a really modern car with ample room for four husky people (like its 6' 4" producer) plus luggage. Designed to be "the safest car," requires less than your half of the road.

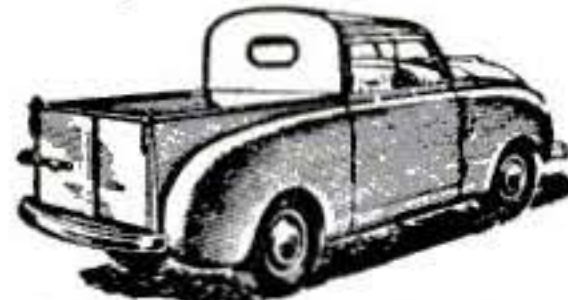

The CROSLY PICKUP (left) offers the most economical transportation for service calls, light deliveries, country

places, farms, etc. Has full quarter-ton capacity; all-steel construction; roomy cab; full drop tailgate.

And every Crosley has the startling COBRA (COpper BRAzed) 4-cylinder, valve-in-head steel engine that weighs only 59 lbs., yet delivers 26.5 horsepower, 35 to 50 miles per gallon, 50 miles per hour cruising speed.

Sedan lists \$888 at factory . . . taxes extra

CROSLY

a FINE car

For information and literature, write: Crosley Motors, 2532-JD Spring Grove Ave., Cincinnati 14, Ohio.

MOTO-TOOL ★ THE "POCKET-SIZE" MACHINE SHOP

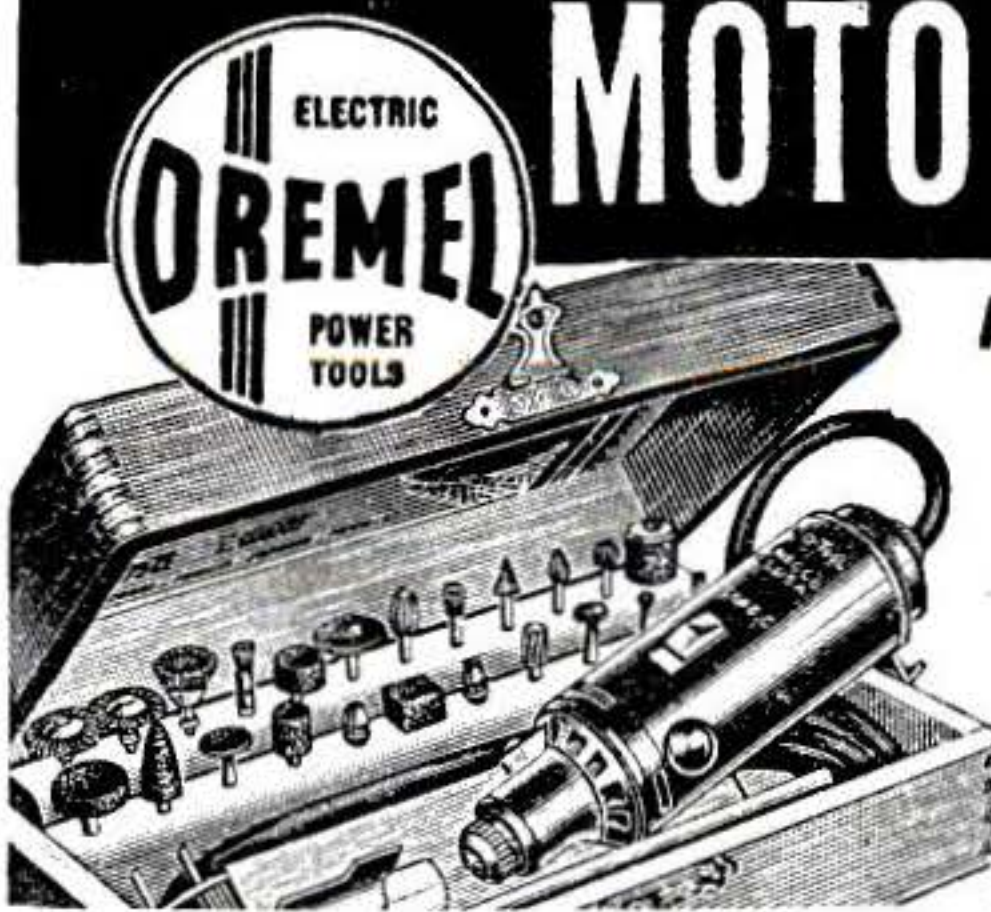

A TOOL THAT PACKS EXTRA YEARS OF PLEASURE

. . . Look At The Rest, Then Buy The Best

Here's a tool to please a man's heart . . . one that holds promise of endless creative hours. Dremel Moto-Tool is a "war veteran" . . . used by all branches of the armed forces in far-flung repair bases . . . helped set production records at General Electric, Westinghouse, Remington Arms, Ford and others. Hobbyist or expert craftsman, first choice is Model 2 Moto-Tool Kit with its handsome felt-lined, highly finished wood case with rows of tools begging to be put to work. Write for FREE catalog of Moto-Tool attachments and accessories.

10 Reasons Why Moto-Tool's a Better Buy

Oil-less, sealed, bearings • Patented automatic chuck lock pin • Oversize armature shaft, hardened, ground, polished • 110 Volt, AC-DC motor • Sliding snap-type switch • Handy hanger hook; cord protector • Shock-proof bakelite housing • Dust-filtered, air-cooling system • Weighs only 13 oz. • Dynamically balanced for vibrationless operation. **MONEY BACK GUARANTEE:** Buy Dremel Moto-Tool from your dealer. If he cannot supply you, order direct from factory on 10 day trial. Shipped postpaid for payment in full (send check or money order); or send only \$2.00, we will ship C.O.D. You pay balance plus postage.

DREMEL MFG. CO.

Dept. 127-J . . . Racine, Wisconsin



Do These Better - Faster

- Drilling
- Routing
- Sanding
- Engraving
- Touching-Up
- Mortising
- Polishing
- Cleaning
- Rasping
- Brushing
- Dressing
- Burring
- Grinding

APPROX.
27,000 R.P.M.

- Finishing
- Sharpening
- Burnishing
- Inlaying
- Sawing
- Scoring
- Carving
- Cutting

PRE-WAR PRICES STILL PREVAIL

Moto-Tool Kit No. 2, with 23 accessories (high speed steel cutters, grinding wheels, polishing accessories) and heavy-duty professional Model 2 Moto-Tool in natural finish, hardwood case . . . \$23.50. (Items purchased separately would cost about \$30.00; you save \$6.50.)
Moto-Tool No. 2 with one emery point \$16.50.
Moto-Tool Kit No. 1 with 34 accessories and Model 1 Moto-Tool in wood case . . . \$17.50.
Model 1 Moto-Tool with one wheel point \$9.85.

15 Jewel Swiss Made WRIST WATCH



Special \$15.95

35c Post.-Insurance

Plus 10%
Fed. Tax

Internationally famous Mentor and other makes. Handsome, accurate timepieces for dress or hard use. 15-jewel Swiss movement, usually found only in watches selling for much more. Gold or stainless steel finish; stainless steel back, shock resistant, waterproof type; luminous dial; sweep second hand. *Money back guarantee.* Precision built throughout. Add \$1.60 Fed. tax, plus 35c for postage and insurance.

Gov't Surplus—Famous STANLEY SUPER-VAC

Lifetime vacuum bottle. Will not break! These famous Stanley bottles sold everywhere before the war for \$7.95. Brand new Navy surplus one-quart size. Stainless steel liner. Handsome black finish. Heavy chrome plated screw cap. Include 25c additional for postage—anywhere in U.S.A.

\$5.95

Qt. size



Many other brand new war surplus items at large savings. Write for new free catalog.

ALLIED SALES CO.

Dept. S, 523 Mission St., San Francisco 5, Calif.

Special!

While they last. Gold finish metal elastic band to match... no extra charge. Please specify metal or leather.

LOOK!

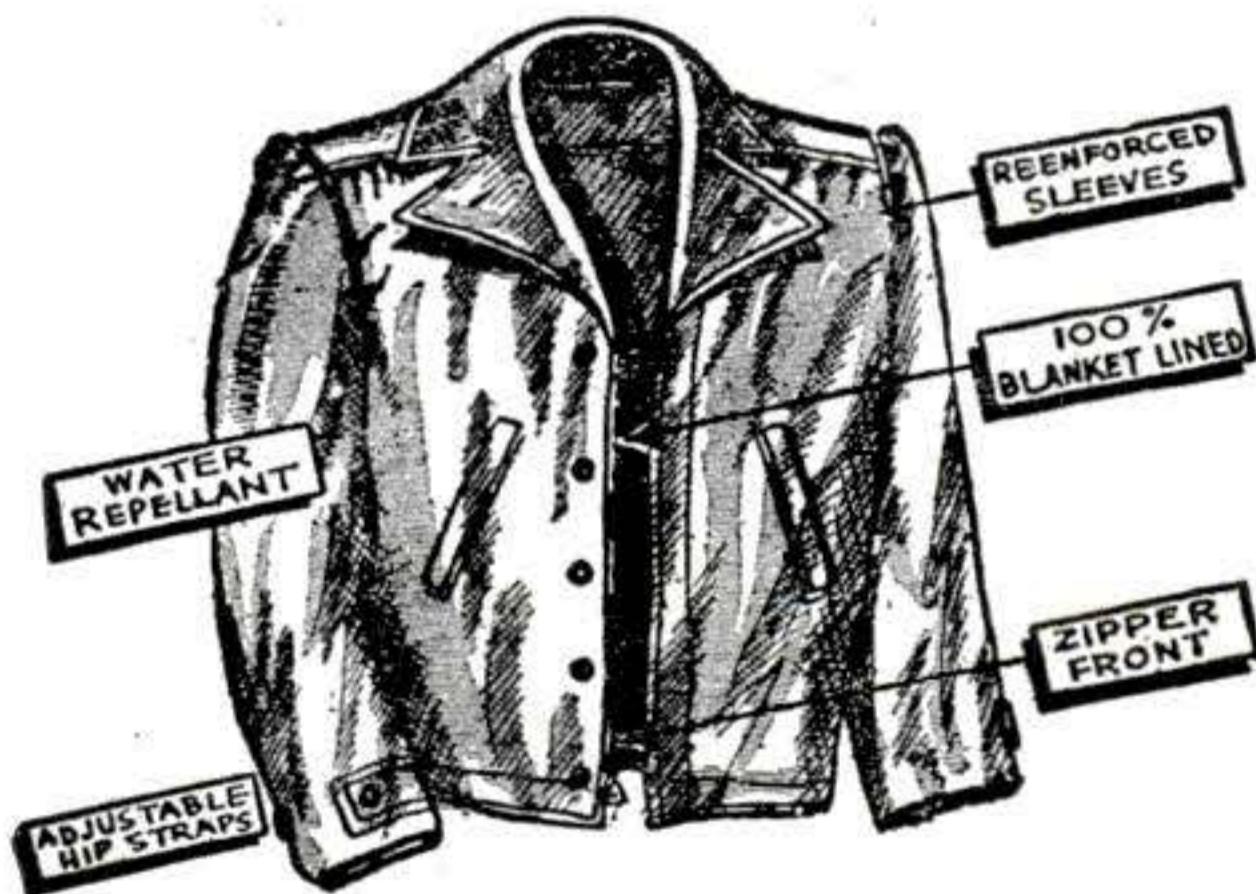

WAR SURPLUS

FIELD JACKETS

Ideal for
Farmers • Lumbermen
Truck Drivers • Laborers
and for
Plain and Fancy Loafing

ONLY
\$1.88
EACH

Nothing like it has ever been
offered at this low price!

This full-zipper front, bi-swing back, fine poplin Army FIELD JACKET is the favorite of G.I.s all over the world. Although used EVERY jacket is guaranteed to be in perfect condition. Sizes 34 to 40. Send name, address and size and on delivery pay postman \$1.88 plus C.O.D. charges, or send \$1.88 with your order and we will pay postage. Order yours today!

S & B SURPLUS SALES CO., Dept. PS
2905 W. Madison St. Chicago 12, Ill.

FASTEST PLANER in the WORLD at this Low Price... \$195.00

Belsaw Multi-Duty Planer



Needed by every saw mill owner and woodworking shop to Speed Up Production—Increase Profits. Belsaw high speed thickness planer provided for single surfacing stock up to 12" wide by 8" thick at the high speed rate of 24 lineal feet per minute for HIGH PRODUCTION. Planes green or dry sawed lumber into higher priced, valuable smooth and worked forms. Machine has welded all STEEL frame... nothing to break. Safety-type all Steel cutterhead runs in heavy duty ball bearings. Three HIGH SPEED Steel knives make 42 cuts per inch for smooth finish. Belsaw Multi-Duty Planer is REALLY ECONOMICAL... adequately powered by any motor developing 2 horsepower—REALLY

PROFITABLE... lowest in investment and operating costs, and takes inexpensive attachments for all common planing mill operations: Jointing, Rabbeting, Grooving, Matching. Produces S4S Finish (surfaced four sides) without the great investment required for S4S Surfacer. Simple accessories provide for SHARPENING and JOINTING its own knives. You get BIG VALUE in Belsaw, and provide for your progressive growth. Write for FREE specifications, illustrations and low prices.

BELSAW MACHINERY CO. 1021 Field Building

315 Westport Rd., Kansas City 2, Mo.

World's largest manufacturer of light sawmill and woodworking equipment



PLYWOOD BOAT KITS

\$49.00
(Freight Included)



Model 50

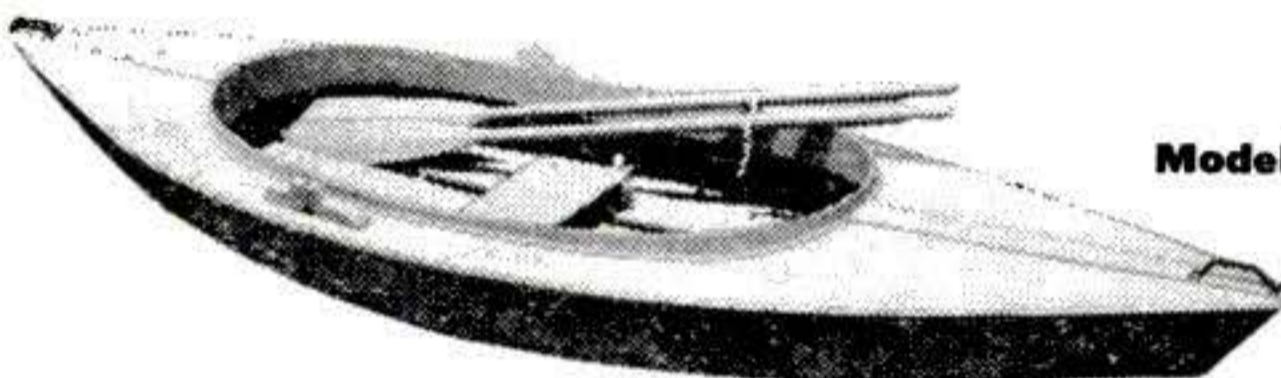

Model 70

These READY-CUT boats can be assembled in 8 hrs. without forms or special tools. Kits are complete including all hardware, paint, etc. Send for free folders.

Taft Marine Woodcraft

Dept. A 636 39th Ave. N.E.

Minneapolis 13, Minn.

Say You Saw

It In Popular Science

FOR STEREO PICTURES, IT'S

STEREO-TACH!

Take Third Dimension Pictures with the
STEREO-TACH and your own camera!

There's nothing in photography so startlingly beautiful and lifelike! You can't reproduce a 3-dimension picture in flat 2-dimension printing!

Outfit No. 101—'Tach and Transparency Viewer (for transparencies, with 35MM cameras) **\$22.50***



Outfit No. 100—'Tach and Print Viewer (for stereo prints, with both 35MM and other size cameras) **\$16.25***
*Plus Tax.

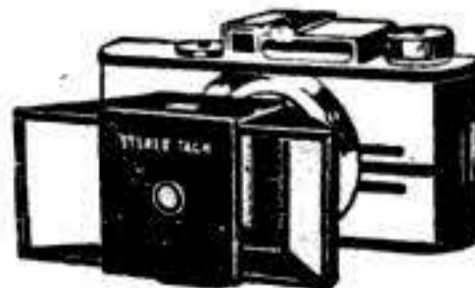

The Stereo-Tach

Transparency Viewer For Third-Dimension Projection, the STEREO-FLECTOR! Just Out! See your dealer or write.
ADVERTISING DISPLAYS, INC. Dept. PS-7 COVINGTON, KENTUCKY

UP TO
SAVE 85%

in WAR SURPLUS...SENSATIONAL VALUES
at "GADGETEER'S HEAVEN"
IN MANY ITEMS WE HAVE THE WORLD'S LARGEST SUPPLY

New Hydraulic Cylinders
VALVES, PUMPS, FITTINGS, HOSE & TANKS
The World's Largest Supply. 1001 Labor Saving Adaptations for pulling, pushing, lifting operations.
Finest precision workmanship and materials. Liquid and or air operation, developing terrific power.
15% OF GOVERNMENT COST!
Write for Catalogue



A Real Buy!
A 1001 USES!
WINCH HOIST
Capacity 2500 lbs. Controlled worm gear drive winch, with 19 ft., 1/4" diam. alloyed steel cable. Ideal for garages, truck loading, machine shops, boat building, etc.
#100A Without handle \$10.75
#100 With handle \$12.50



#516 Dry Cell BATTERIES
NEW! FULL STRENGTH
For portable Radios, Signal Lamps, Boats, Electric Trains, etc.
#515
#516 9 Volt 8 1/2 x 6 x 4 in. 3 run. 24 Volt Motor 79c
#515 90 & 1 1/2 Volt 69c
#517 67 1/2 & 1 1/2 Volt Battery 69c



PNEUMATIC RIVET GUNS
Pistol & Goose-neck Type
101 Uses. Chipping Riveting, Hammering, Breaking cement and Auto body work.
Chicago Pneumatic, Cleco, Ingersoll Rand Makes.
E3, E2, 3X, 2X, OY \$55 Value
#180 Goose-neck \$8.95
#181 Pistol \$8.95
#186 Squeezer PNEUMATIC ALLIGATOR SQUEEZER \$80 Value \$15.95



MESS TRAY
6 COMPARTMENTS
Rustless, Stainless Steel. Can be used for cooking as well Ideal for restaurants. The perfect companion for that vacation trip, barbecue picnical Saves dishwashing.
NEW... 79c ea.



PLEXIGLASS DOMES
15"x19 1/2"x6" deep. 1/4" thick.
Can be used for home hot-house, fish bowl, washbowl, ornamental light. Can be flattened in oven and will make flat sheet, 15"x19 1/2"x1/4". Weight 3 1/4 lbs.
#700 \$1.69
Also 200,000 lbs. of other plexiglass sizes and shapes.



Air Force Pilots Brief Case
Ideal for Business Men and Students. Long-wearing, genuine leather. Two full width compartments, and three smaller pockets. Holder for identification card. Full zipper on three sides.
16 3/4" by 12". \$15.00 VALUE
Only \$2.95!



AIR DRILLS
CLEVELAND THOR CHICAGO PNEUMATIC 1/4" JCB Chuck
Straight \$17.95
Angle Drill \$19.50



WINDSHIELD WIPER KIT
1/6 H. P., 24 volt, D. C. series wound motor, with 30" flexible shaft, switch circuit breaker, 10,000 forward or 5,000 reverse R. P. M.
Wiper & wiper bracket, arm blade & switch.
only \$7.95



PLASTIC CRAFT KIT
Kit contains Lucite & Plexiglass material, 3 colors of dye, cement, and book of projects and easy-to-follow instructions for cutting, fabricating, carving, drilling, etc. \$2.39



OPTICAL GYROSCOPE!
MARK 18 GYRO-SIGHT
An engineering marvel worth hundreds of dollars! - Our Price \$8.35
Airforces Gun-Sight, #103 N8A, with polarizing variable density \$2.95
L3 Type, #102, Triple Lense \$1.95



ELECTRIC DRILLS
CLARK and THOR
110 V. A.C. 50/60 cycle. 1/4 drill bit & JCB Chuck. Both side and trigger handle. High Speed. For commercial or home use. The best there is. Gov't. Cost Approx. \$60.00
A TERRIFIC VALUE \$17.95



COMPASSES
#151 Marching, lensite, with luminous dial \$1.69
#152 Matchbox, both jewel & liquid floating dial 39c
#153 Jeweled Pocket Watch Compass \$1.19
#154 Wrist strap Compass 69c



Hunting Knife
New, 6" Chrome Vanadium Blade, 4" Handle, Leather Grip In Leather Sheath. \$5.95 Value - Only \$1.69



Electric GYRO PILOT Assembly Part
2 solenoids for reverse and forward motor control. 2 solenoids throw clutch to engage drive. With brake assembly. Can be used as boat rudder control, converted for lathe tapping and slow speed motor tool. wt. 29 lbs. Finest precision workmanship
Cost Gov't. Thousands!
Your Cost \$8.95



1/3 to 1/5 Gov't. Cost (approx.)
Air Corp Fleece-lined LEATHER JACKET
To keep you warm in the coldest wind.
• Made to last practically a lifetime.
• Full sheepskin pelt
• Fleece-lined collar.
• Leather taped seams.
• Full length zipper.
• 2 zippered, deep, slash pockets.
• Adjustable strap & buckle at throat.
• Type D-1. Styled for easy, bind-free action.
• Soft, pliant, "aviation tan" leather.
Made to U. S. gov't. specifications - "nul sed!"
Sizes: #401, small; #402, medium; #403 large.
YOU'VE NEVER SEEN THEM AT THESE PRICES. RECONDITIONED, CLEANED AND BRUSHED. PERFECT CONDITION! \$8.95 WHILE THEY LAST!



New! PRESSURE TANKS
Stainless steel, shatter proof. 400 lbs. /sq. in.
G-1 2100 CU. IN. 26 x 12 in #105 \$4.75
D-2 500 cu. #104 \$2.25



Valuable GEARS BARGAINS
8-1 Ratio Spindle Drive #110 \$2.98
4 to 1 with screw Shaft #111 \$4.95
9 to 1 Ratio Gear Reversible #112 \$3.25
85 to 1 (can be used for radio antennae, etc.) #113 \$3.95
2 to 1, Box gear type #114 4.95
1 to 1 #115 3.95
Flexible gear shaft with end drives 30" #115 1.00



All Purpose HAMMER
Ax & hammer combination for wood & metal work. 3 1/2 lbs. 14 1/2" hardwood handle. hard steel cutting edge. 69c.
Compound METAL SNIPS
Action
Hard steel blades. Expansion spring. Locking device.
Now \$2.59



SLEEPING BAG
NEW! 100% wool. Mummy type. Heavy duty 30" zipper.
\$1 extra Gov't. cost \$22.00 for used water repellent cover. \$4.95 #303



ELECTRIC SOLDERING IRON
#198
200 WATT "SOLDER MASTER" \$3.95
105, 110, 120 Volt Nuf-Sed



RUBBER GOODS
24 x 24 in 1/8" thick. \$1.95 Salt & springy. Ideal foot-mat for workers who stand on their feet - Cashiers, Demonstrators, machinists, etc.
NEOPRENE SHEET RUBBER
Thick-ness approx. Width Price per sq. yd.
#323 .015" 1/4 36" \$1.60
#325 .020" 1/4 36" 1.75
#326 .037" 1/2 36" 1.25
#327 .064" 1/2 36" 1.75
#328 .175" 3/16 42" 5.00



COMPRESSOR complete with tank and fittings. G. E. 2-stage, A.C. or D.C. 1/3 h. p. 1000 lbs. sq. in. Spraying, laboratory use, inflating. NOW #506 \$17.95
Compressor and 24 volt motors can be adapted to 110 A.C. with transformers or 4 1000 heating elements. We stock both.
ELECTRIC MOTORS
New 1/2 H. P. 27 Volt D. C. 24 Volt A. C. #500 \$5.45
#500 Can also be easily adapted to 110 A.C. by changing leads. We fur. direct & drawing for \$1. extra.



COMPARE THESE PRICES
#301 CANTEEN, 1 qt., alum., plastic top 29c
#305 GOGGLES, New, Colored Polaroid flexible lens. Shatterproof. 59c
Sponge Rubber Frame
#400 WORK HELMET, Plastic, 12 oz. 59c
#510 & 511 Amp. & Volt Meters ea. \$2.50
GADGET MIX Rivets, spacers, nuts, clamps, bolts, gears, Radio parts, etc. #106 \$1.19
A gold mine 5 lbs. \$1.19

Fire Extinguishers
Kiddie Lux CO2 Type
Built to Gov't Spec. 4 lb. Trig. con. with horn, fully Rechg'd. \$30.00 value = #61 \$10.75
2 LB. CO2 TYPE
\$22.50 value = #62 \$8.75
10 lb. Chgd. CO2 with Horn \$80.00 value = #63 \$29.50
7 1/2 lb. Unchg'd. Nozzle Control \$70.00 value = #64 \$7.50
indispensable for small or large planes, trucks, auto, home, factories, etc.



LEATHER FLEECE-LINED BOOT INSERTS
For hunting or around house as slipper. sizes: medium.
\$7.00 Value
\$1.89 pr. #312

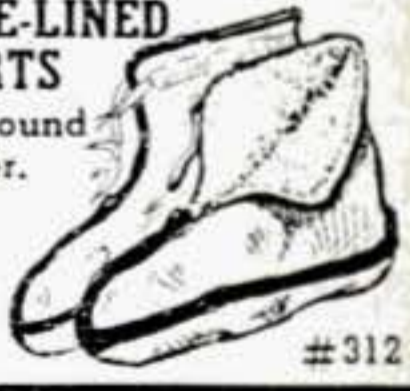

BEARING MIX
Needle, ball and roller bearings in excellent assortment. Sizes from 1/2" to 2".
#170 Introducing this shelf treasure - Assortment of 15 Bearings at \$2.95



#313 BOAT FENDER-21 in. long 5 in. diam. Protection against docks for small boats.
\$6.50 VALUE A STEAL AT \$1.95
9/16" JUTE ROPE
3 Thread Strand, Right Lay, 50 Ft. 79c
7/8 SISAL ROPE
50 Ft. \$3.59
5 lb. Ball 3/16" Hemp Twice Treated \$1.49 #314

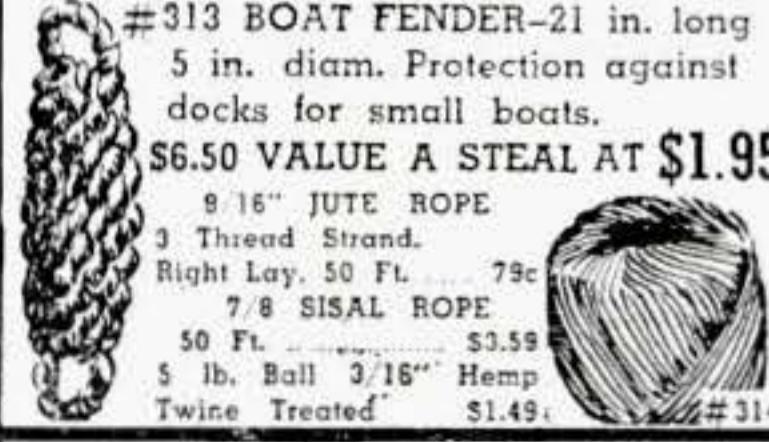

CLAMPS
Adel Aluminum, rubber lined, Mixed. #121 4 dozen 89c
Aero-Seal, Rust Resistant. Slotted with screw gear top. 1/2" to 3". #120 Regular 27c
Now 10c \$1.00 doz.



HORSEHIDE WORK GLOVES
ALL LEATHER GAUNTLET TYPE REINFORCED PALMS & FINGER STITCHING.
LENGTH 13 3/4" #381 \$1.95 pr.
ALL LEATHER WRIST Length 10 1/4" #382 \$1.55 pr.
Barbed wire, welding, all purpose work gloves.
A Steal... Gov't. cost many, many times more.



ORDER DIRECT FROM THIS AD
All sales final. Make remittances by money-order, bank draft or personal check. Purchase orders acceptable from D & B firms. All quotations F.O.B. Los Angeles. **BIG ILLUSTRATED CATALOGUE AVAILABLE**
Also Aircraft Supply Catalogue
Send 25% deposit with C.O.D. orders.

#370 **SAFETY BELT**
New, Original Box, Type B-14 Lap Safety Belt. Adjustable - full length 48", width 3". Forged steel, fool proof safety catch. Ideal for planes, jeeps, fun rides, farm equipment, etc. Try to beat this at 99c



TO:

Reader

FROM:

Editor

It-Might-Come-In-Handy Dept.

EVERY PSM editor has an active curiosity. But there are certain local characters around the shop who are as likely to have a screwdriver as a pencil in their shirt pockets. Referred to without prejudice as the "dirty-hands" editors, they are principally concerned with the back of the book—those pages devoted to automobiles (and the imperishable Gus Wilson) and to the countless gadgets and projects published each month.

A dirty-hands editor is a strange fellow, with values all his own. For him, curiosity has no decent bounds. He has an uncontrollable passion to take the covers off things, to poke and pry behind the panel or cabinet, to admire the shiny little thingummies within, to see how every new device he finds actually works. If on inspection of the innards of a new machine he comes upon a clever cam or a tricky gear train, his delight knows no limit.

Among the other blessings for which PSM's boys in the back room are grateful, the fact that they work in New York City looms large. For New York is one of the world's richest hunting grounds for the bits and pieces so dear to the heart of a dirty-hands editor. With whole blocks of stores devoted to metals, machine tools, motors, cabinet woods, and the like, rare is the week when some staff man doesn't sacrifice a lunch hour to poke happily over the counters and bins in search of that elusive 25B8 tube or 11-mm. O.D. bearing. These easily available riches make him especially sympathetic to the plight of fellow craftsmen in, say, Gap Gulch, Wyoming, who are mainly dependent on the slender resources of a general store. It is for this reason that no workshop project is published until the general availability of materials, in either local outlets or national mail-order houses, has been considered.

The magpie instincts of an editor con-



The desk of a dirty-hands editor.

fronted with an array of hard goods are usually manifested in one of two ways. Home and Workshop Editor Walton heads one group that might be called the Purposeful-Buyer School: He carries little lists containing such notations as "3/16-inch end mill, 1/2-inch drill rod, 18-gauge copper, 5-amp. fuses." When he returns to his office after lunch, the list is missing but his pockets have a perceptible sag, and he clanks as he walks.

The other group, known as the It-Might-Come-In-Handy-Someday School, is made up of those who return to their desks laden with gleaming bombsight components, surplus gun-director subassemblies and other entrancing bits of treasure. Questioned about what he will do with his purchases, such an editor will generally concede that his plans are vague. "What else could I do?" he will inquire defiantly. "Why, the ball bearings alone are worth more than it cost me."

Frank Rowson



**An old horse is old for keeps—
but an old engine can be made young again**

YOU can't look an engine in the teeth, but you can tell its age by its performance—and new Sealed Power Piston Rings can knock years off its age, saving oil, saving gas, and lengthening engine life.

Whatever the make, model, or degree of cylinder wear in your car, truck or tractor, there is a Sealed Power Piston Ring Set specifically engineered to do the best possible job. These sets are made up from twenty-six (26) basic designs of piston rings, proud product of 36 years' use as original equipment by major engine builders. See your Sealed Power Franchise Dealer. Send a postal for illustrated, informative new booklet on 7 ways to save oil. It's free and may save you lots of money. Sealed Power Corporation, Dept. H-9, Muskegon, Mich. In Canada: Stratford, Ontario.

**For better results
26 Basic Ring Designs**

No one piston ring design can meet all replacement needs. Sealed Power Individually Engineered Ring Sets are made up from twenty-six (26) basic ring designs, which permit each set to be specifically engineered to do the best possible job in a particular make of engine.

These ring sets are engineered to save gas without sacrifice of oil economy, to save oil without inducing friction and cylinder wear. Each set gives balanced performance in a particular engine.

In addition to Sealed Power Individually Engineered Piston Ring Sets, ask for Sealed Power Pistons, Cylinder Sleeves, Valves, Water Pumps and Chassis Parts.



KEEP YOUR WAR BONDS! GET \$4 FOR \$3! © 1947, Sealed Power Corp.

SEALED POWER PISTON RINGS

BEST IN NEW CARS! ★ BEST IN OLD CARS!

NOW available On Easy Terms Immediate Delivery

SOUTH BEND 9" LATHES

South Bend 9" Lathes are the answer for men who are not satisfied with mediocre shop equipment. Built for industry's finest toolmaking, experimental, and production work, their use makes it possible to duplicate industrial performance in small shops. Their accuracy, versatility and ease of operation will improve your craftsmanship.

Made in three models
priced from \$145.00



COMPARE THESE FEATURES! 9" Model A Lathe

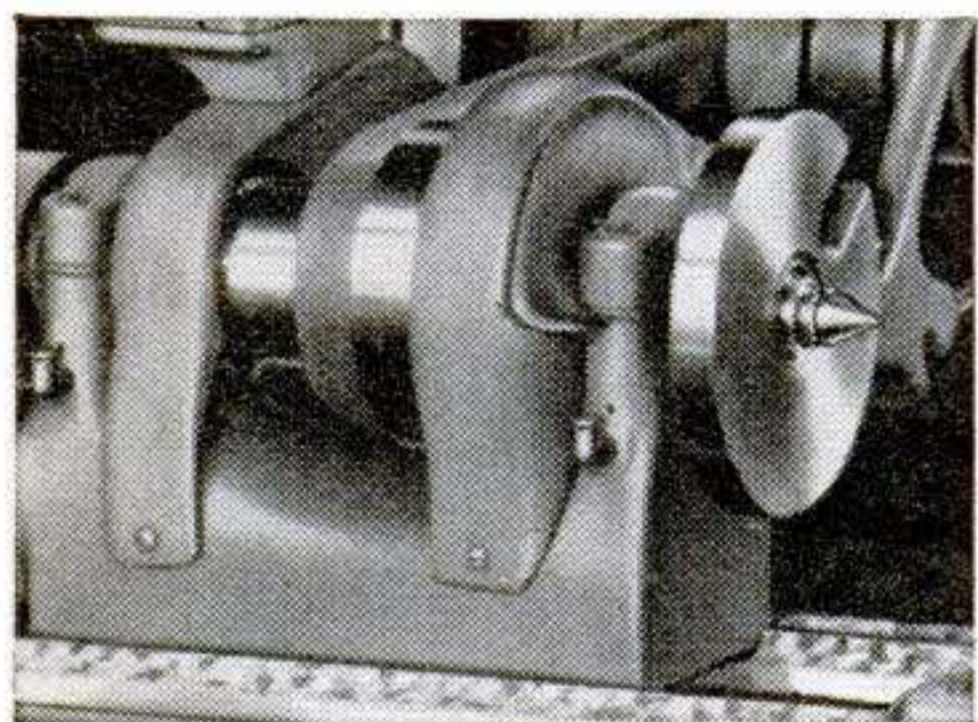

HEADSTOCK

Large diameter heat-treated spindle provides extreme rigidity. Bearing surfaces superfinished to 5 micro-inches rms. (.000005"), adjustable journal bearings, and ball thrust bearing assure precision. Direct belt drive for smooth operation at high speeds. Back gear drive for slow speeds.

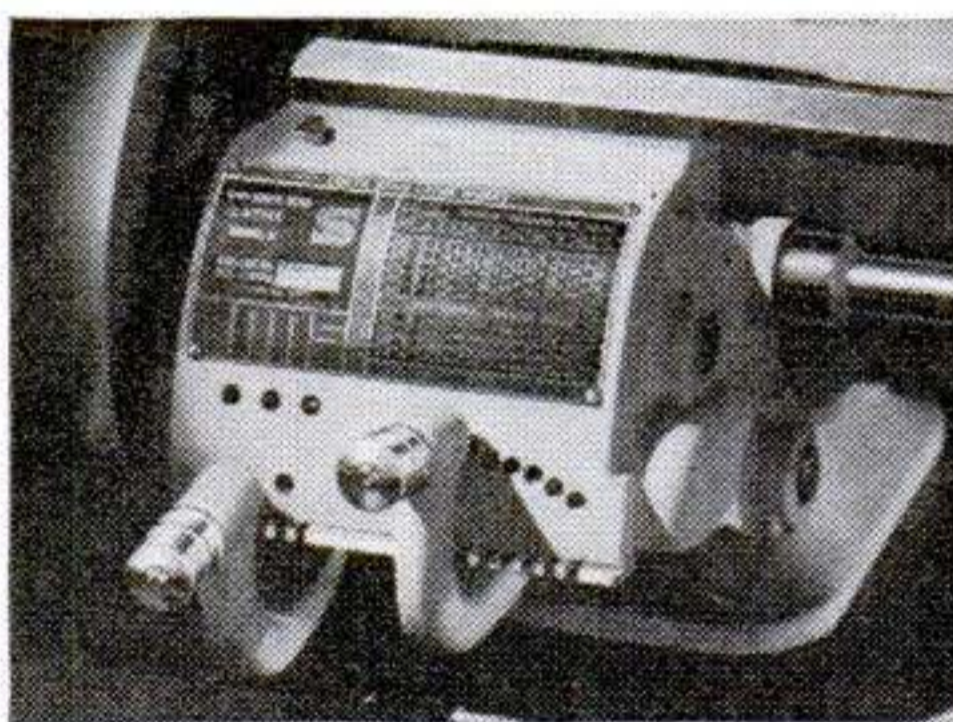

QUICK CHANGE GEAR BOX

Makes available 48 pitches of screw threads—8 to 224 per inch instantly selected by changing two levers, coarse threads from 4 to 7 per inch after changing stud gear. 48 power longitudinal feeds—.0015" to .0853", and 48 power cross feeds—.0004" to .0252" are similarly selected.

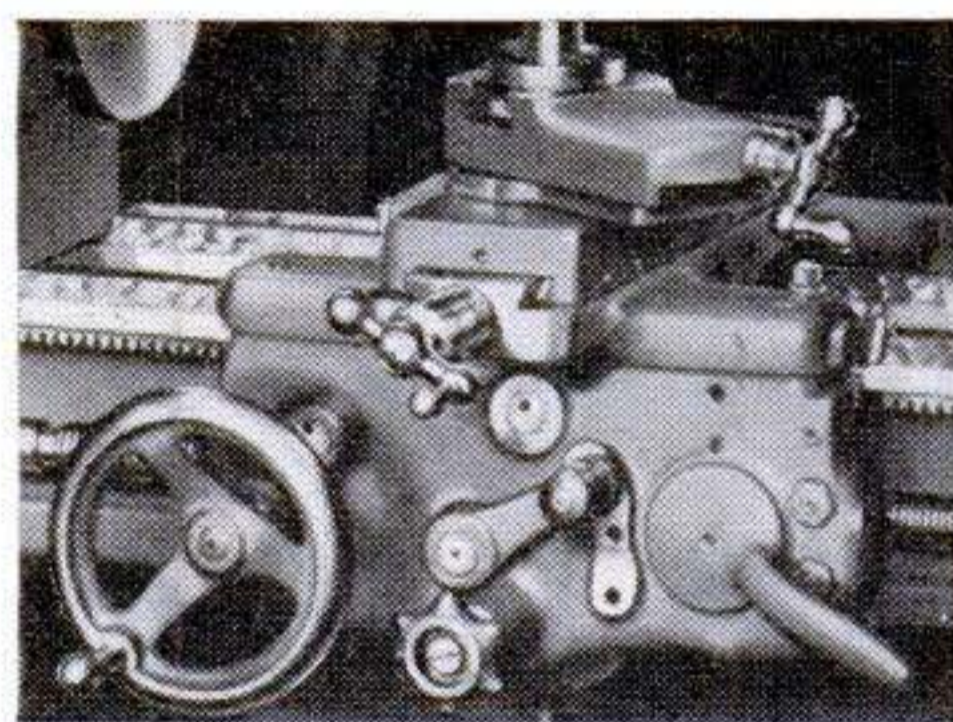

CARRIAGE

Saddle travels on two V-ways. Compound Rest Cross Slide operated by power or hand feed. Compound Rest Swivel adjustable through 180° for machining bevels and short tapers. Apron has worm drive from lead screw through friction clutch for all power feeds and half-nuts for thread cutting.

 Building Better Lathes Since 1906

SOUTH BEND LATHE WORKS

South Bend Lathe Works
456 E. Madison St., South Bend 22, Ind.

Please send items checked:

- Catalog of 9" South Bend Lathes
- Catalog of 10" to 16" Lathes
- Time Payment Plan Outline

Name _____

Street _____

City _____

State _____

296 POPULAR SCIENCE

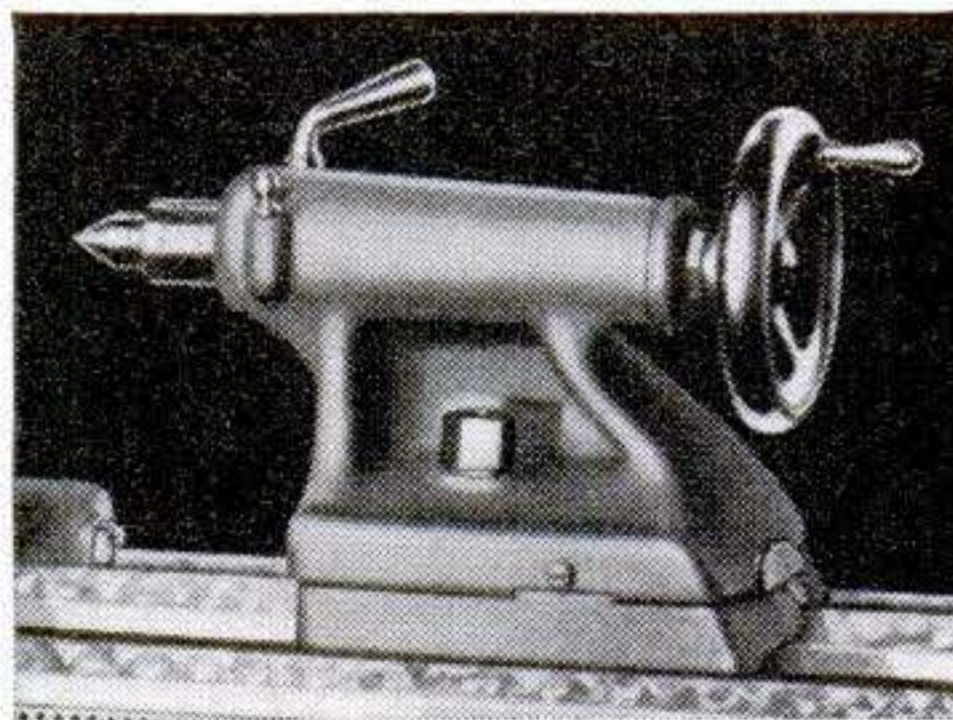

TAILSTOCK

Graduated spindle of special quality spindle steel. Hardened, self-ejecting center. Tailstock off-set top has set-over for taper turning. Long hand-scraped bearing surfaces for flat and V bed ways assure perfect alignment and reduce wear. Positive action spindle lock and tailstock clamp.

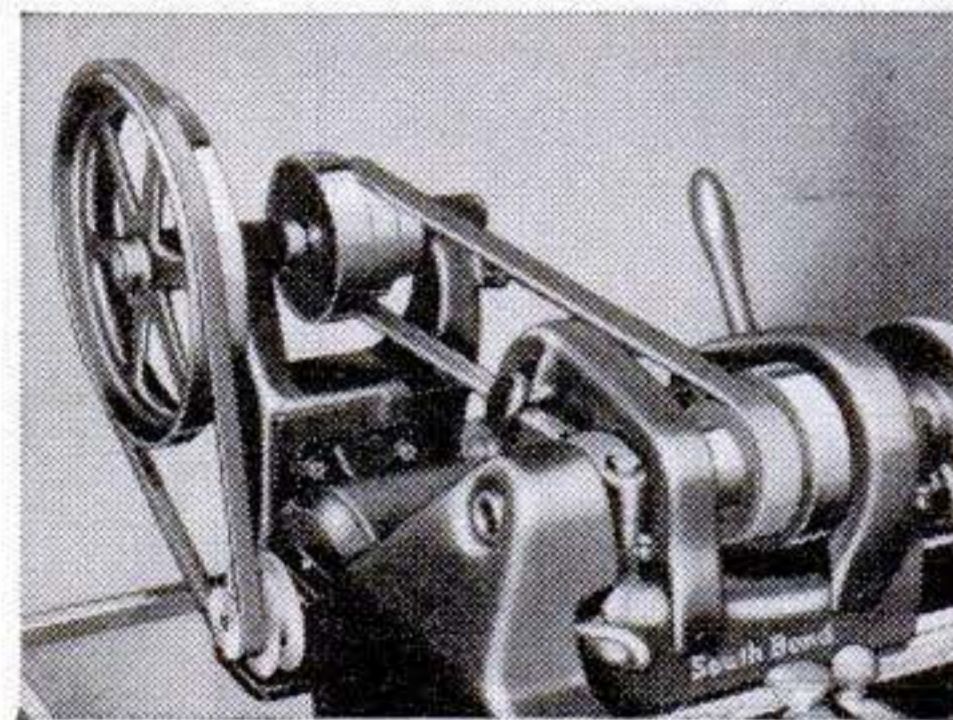

DRIVE

Practical, trouble-free, horizontal motor drives. Vibration-free and exceedingly quiet. Tension release makes selection of spindle speeds fast and simple. Positive belt tension adjustments. TWELVE-SPEED DRIVE provides spindle speeds from 41 to 1270 r.p.m., SIX-SPEED DRIVE from 41 to 658 r.p.m.

NOW

A COMPLETE SCIENCE IN ONE GREAT

VAN NOSTRAND'S

Scientific Encyclopedia

MORE THAN 10,000 SEPARATE SUBJECTS

NOW at last, between the covers of one giant book, has been gathered the most useful, complete and authoritative fund of information on science ever published.

More than thirty-six leading scientists and professors have worked for years to put this vast wealth of knowledge at your command. It covers in detail the principles and actual applications of the physical sciences and engineering skills—in countless numbers of interesting articles,

VAN NOSTRAND'S SCIENTIFIC ENCYCLOPEDIA

**19
BOOKS
IN ONE**

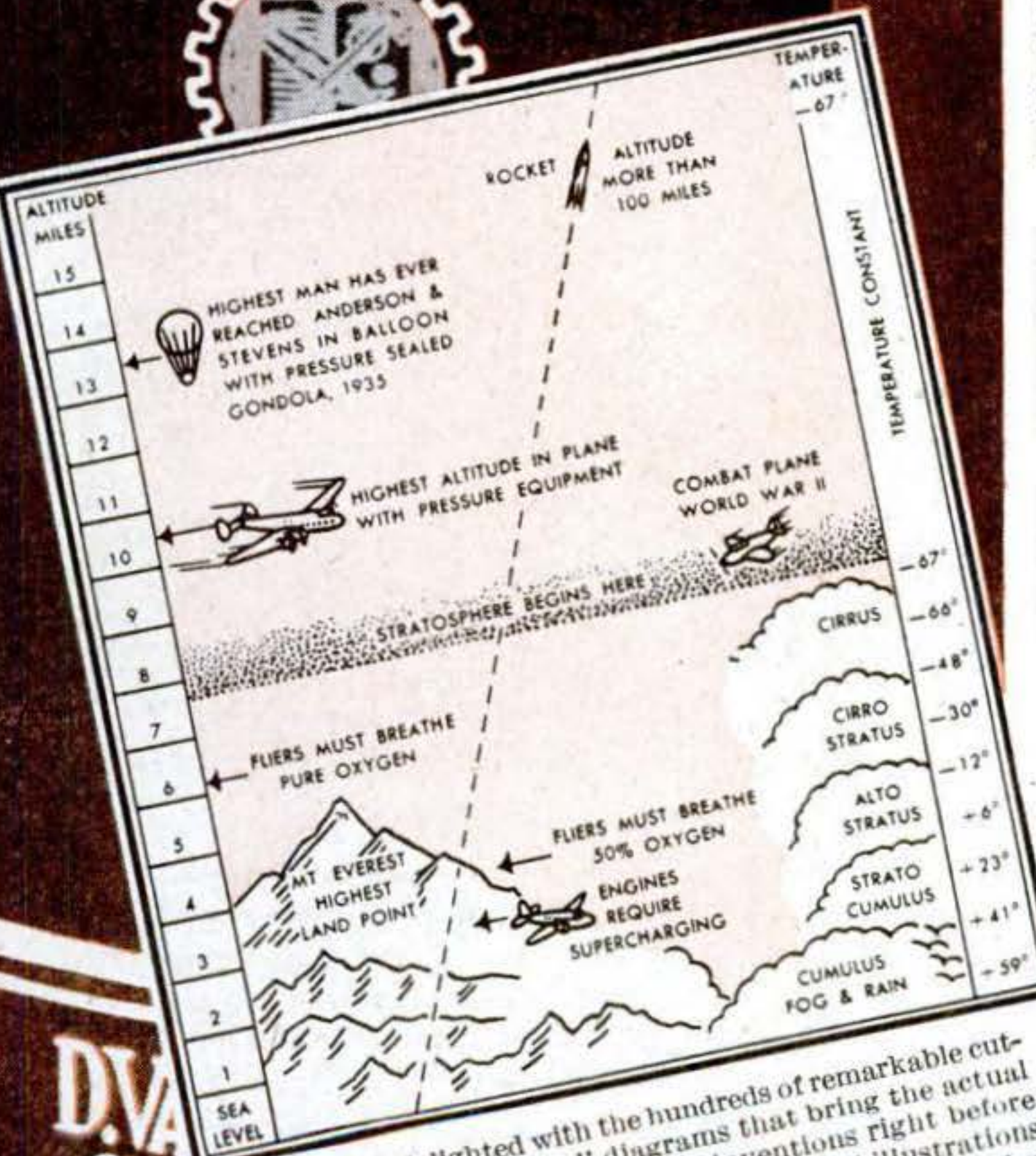

**NEW
2nd
EDITION**

You will be delighted with the hundreds of remarkable cut-away views and "X-ray" diagrams that bring the actual inner workings of machines and inventions right before your eyes... striking photographs and vivid illustrations... comprehensive charts (like the one above) that give you instant answers to countless scientific questions.

PHOTOGRAPHY

From the practical, everyday knowledge of photography needed by the beginner—all the way to darkroom methods, commercial processes, color photography—these articles cover the entire field. They explain everything from basic principles to full practical directions that you require to assure the best results.

AERONAUTICS

Interesting articles and specially drawn diagrams make it easy to understand why and how a plane flies, the forces causing stalling, and the part they play in airplane design. This authentic, complete account of aeronautics explains balloons, dirigibles, all types of airplanes, including jet planes and rockets. It covers engines, instruments, parachutes, etc.

CHEMISTRY

All the fascinating facts about atoms and molecules—the vast array of new materials. Great articles explain chemistry from its simplest beginnings to its countless applications in plastics, drugs, dyes, paints, vitamins, adhesives, detergents, and a host of other substances.

PHYSICS

Direct from the great pioneer experiments that established the laws of gravitation and mechanics, the speed of light, the flow of heat, and the action of the electric current—to X-rays, radioactivity, the electron microscope, and the contributions of Langmuir, Einstein, Millikan, Compton, etc.

BOTANY

Here are the basic and useful facts about plant life, elimination of weeds, the cultivation of fruits and vegetables and flowers, soil-less gardening, etc. The processes of plant growth, the various parts of plants, the recognition of different species, families, etc.

RADIO AND ELECTRONICS

Fundamentals of radio are fully explained in plain words and telling pictures that show clearly what happens in simple circuits and sets. This same clearness of explanation is used to extend your knowledge to radar and loran, to the new FM and television systems.

CHEMICAL ENGINEERING

Fascinating accounts of the methods used to put chemical discoveries into practice, and to transform them from laboratory experiments into vast tonnage production. All the methods and apparatus used in large-scale processes—evaporation, filtration, distillation, crushing and grinding, extraction, drying, gas absorption.

MECHANICAL ENGINEERING

This great group of articles includes: steam engines and turbines, gas and gasoline engines, diesel engines,

water wheels—the machines and tools that use power: pumps, compressors, lathes, grinders, jig borers, planers and shapers—all machine parts: bolts, rivets, cams, gears, etc., and the principles of mechanics and machine design.

CIVIL ENGINEERING

Bridges, dams, aqueducts, highways, skyscrapers, railroads—are among the hundreds of subjects on civil engineering that deal with the principles on which they are built, and their parts and methods of construction. They include locomotives, signal systems, track construction, etc.

ELECTRICAL ENGINEERING

From simple wiring and wire sizes to the construction and operation of the great units that produce, transmit and apply electrical power—the topics in electrical engineering are fully explained: generators, motors, convertors, transformers, circuit-breakers and many others.

ZOOLOGY

The immense variety of animals of land and sea, of field and stream, birds, fish, insects, molluscs, are so clearly described and pictured, that you can recognize them and know their classification and their habits, from the tiniest one-celled organism to Man himself.

GEOLOGY

Each geological process is fully described, the action of the forces that have brought about the rise and fall of land areas, the formation of mountain chains, and the great changes in coast lines. Economic geology—coal, oil, ore minerals, etc., a feature of unusual value.

METEOROLOGY

The science of weather is presented in full scientific accuracy. There are detailed explanations of the how and why of climate and air masses, cold fronts, warm fronts, polar air, tropical air, storms. Included are weather maps, charts, and reports, and their use in forecasting.

METALLURGY

Complete accounts of the properties of all the metals and their alloys. Detailed explanations of the recovery of the metals from their native ores, and of the preparation and treatment of alloys, etc.

STATISTICS

Here are problems in statistics—from correlation of data in medicine and biology to statistical methods in business, insurance, industry and daily life. Engineering statistics, law of averages, consumer's risk, producer's risk, sampling, etc.

MATHEMATICS

Clear, self-teaching articles on the fundamentals of arithmetic, algebra and geometry and the advanced branches of mathematics—masterly accounts of the properties of triangles, trigonometric curves, analytical geometry, calculus and differential equations. Emphasis is placed on the actual use of these methods in science, engineering and other practical fields.

**"EXPERIENCE IS THE
BEST TEACHER!**

**...in bronc riding
...in smoking too,"**

says bronc-riding star

Jerry Ambler

EXPERIENCE? 18 years of rodeo.
Most recent crown is the saddle
bronc championship
of the world



I HAD PLENTY OF
EXPERIENCE WITH
DIFFERENT CIGARETTES
DURING THE WAR...
IT'S **CAMELS**
WITH ME!

More people are smoking CAMELS than ever before!

The wartime cigarette shortage was an experience
that switched millions of critical smokers to Camels

BRONC-RIDING champion Jerry Ambler
is just one of millions, but his *experience*
during the wartime cigarette shortage is typical:

"I took any brand I could get. I couldn't help
comparing. Camels suit me best in every way.
It's swell to get Camels again regularly."

Yes, those choice Camel quality tobaccos
are available again in sufficient quantity
to insure all the Camels you want.

According to a recent Nationwide survey:

**MORE DOCTORS
SMOKE CAMELS**
than any other cigarette

When 113,597 doctors were asked by three independent
research organizations to name the cigarette they smoked,
more doctors named Camel than any other brand!



YOUR "T-ZONE" WILL TELL YOU
... **T** for Taste... **T** for Throat...
that's your proving ground
for any cigarette.
See if Camels don't suit your
"T-Zone" to a "T."

R. J. Reynolds Tob. Co., Winston-Salem, N. C.