

# POPULAR SCIENCE

April 1948 • 25c



*10 Easy Ways to  
Get "that Extra Room"*

PAGE 98



HERE IT IS

THE MOST USEFUL

# THE HOME MECHANIC'S HANDBOOK

- PAINTING
- DECORATING
- WOODWORKING
- METALWORKING
- PLUMBING
- MASONRY
- ELECTRICAL WORK

Here, in one great, brand-new volume is **EVERYTHING** you need to know to do **ANY** job in or around your home — repairs, alterations, improvements, and new projects.

## JUST A FEW OF THE HUNDREDS OF PRACTICAL JOBS FULLY DESCRIBED

- How to choose the right paint for every job
- Figure the quantity of paint needed
- Mix paint
- Paint a house—inside and outside
- Choose room color schemes that harmonize
- Apply stain, shellac, varnish
- Care for brushes
- Apply wallpaper
- Touch up or refinish an automobile
- Make the various wood joints
- Put glass into a window
- Replace a sash cord
- Fix a tight window, door, drawer
- Tighten a loose chair, floor-board, stair tread or riser
- Fit screen, storm-windows, doors
- Screen in a porch
- Build a chicken house, lawn chair, cupboard, window screen, cold-bed frame, or woodworker's bench
- Cut, drill, grind, solder, temper, and forge metal
- Make a spring
- Measure, cut, thread, join and assemble pipe
- Install a hot-water heater
- Join copper tubes with flared tube fittings
- Connect cast-iron pipe
- Repair a bad section of pipe
- Install plumbing fixtures
- Repair a radiator
- Thaw frozen pipes
- Take care of a heating unit
- Waterproof concrete.

**HERE'S AN AMAZING OFFER!**  
 We are going to give you a copy of "The Roof Over Your Head" absolutely **FREE!** This up-to-the-minute book on home building and home planning contains hundreds of facts, figures, photos, sketches, and scores of valuable suggestions by experienced architects—plus eight basic home plans, and a comprehensive cost chart that permits you to select the home and payment plan best suited to your wants, your needs, and your pocketbook. Accepted this practical, down-to-earth guide now—it is especially designed to save you time, money and disappointments—and you get it absolutely **FREE!** Just mail the coupon on the opposite page.

You get this book **FREE**

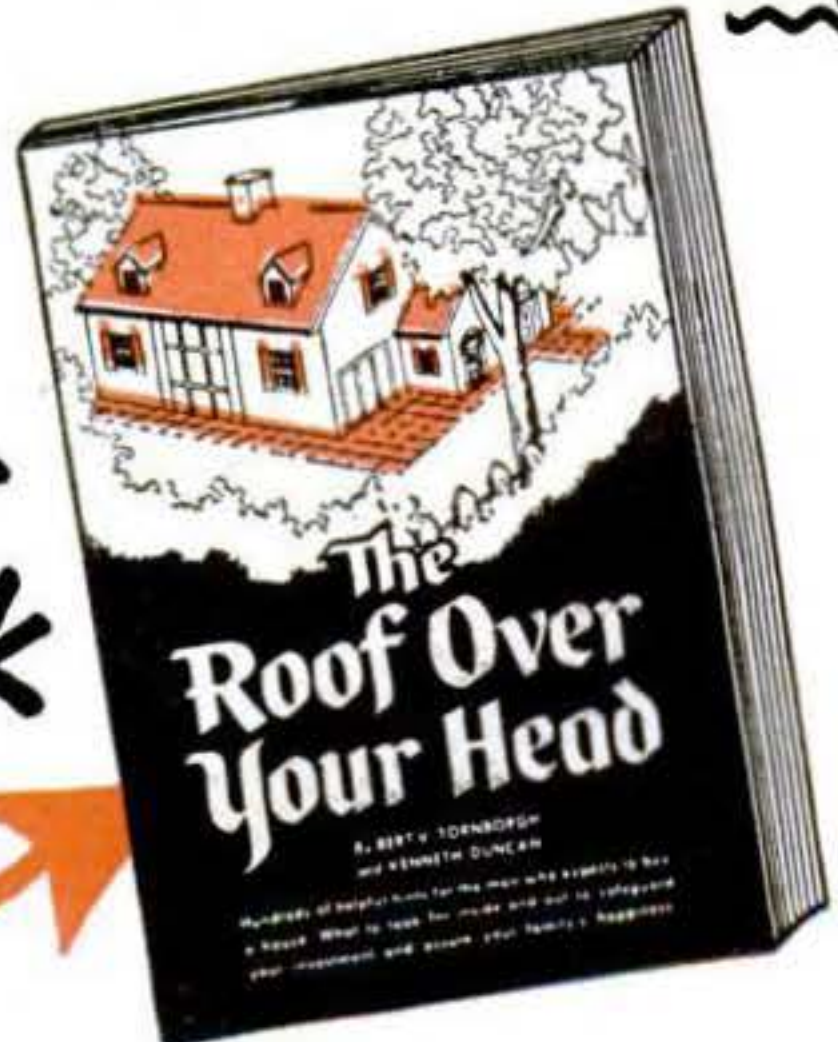

# BOOK YOU'LL EVER OWN!

## COMPLETE INFORMATION ON EVERY PRACTICAL TRADE

Turn to this comprehensive HANDBOOK with confidence. You will find its helpful pages crammed with the latest, most efficient and workmanlike ways of doing every kind of job about the home and in the home workshop. Carpentry, metal work, electrical work, plumbing, masonry, painting and decorating—all explained by master craftsmen. The most detailed information about how to choose, repair, and apply the right materials in the right places.

Every move in the use of tools is shown by vivid hands-at-work photographs. All the important operations, and those "tricks of the trade" that play so great a part in good craftsmanship, are explained and made crystal clear by detailed step-by-step drawings. Complete directions, fully illustrated, for thousands of jobs, small and large—from fixing a broken window to installing a hot-water heater; from varnishing a chair to painting a house.

### PAINTING & DECORATING

Principles of paint mixing, formulas, and how to obtain any desired hue. Full directions for selection and care of brushes and other equipment. How to calculate amount of paint required, and best methods of applying to wood, metal, brick, concrete, stone, stucco, plaster. Exterior house painting—interior house painting—choice of color schemes. Complete directions, fully illustrated, for obtaining decorative effects—stippling, mottling, texturing, stenciling, striping, etc. Methods of finishing with stain, shellac, varnish, and wax. Proper stains for each variety of wood. Detailed step-by-step instructions for wall-papering. How to finish an auto, quickly, easily, and inexpensively.

### WOODWORKING

The many varieties of wood and their relative merits, working qualities, and uses. Plywoods, veneers, and wood substitutes—how to choose the materials best suited for the job. Sizes, types and functions of all carpentry tools—how to use, sharpen, and adjust them. All the basic operations and processes of woodworking—everything from how to avoid warping to full directions for cutting each of the common joints. Wood turning—the different cuts, roughing, facing, sanding and finishing; drilling, boring, morticing, spinning, polishing. Hundreds of repair jobs and new constructions—inside and outside the house—are fully explained with diagrams and every practical fact you need to get the best results.

### METAL WORKING

Complete information about the common metals, and the alloys—wrought iron, cast iron, steel, German silver, pewter, the brasses and bronzes, solders and babbitts—when to use, how to use, and how to work them. Hand tools and machine tools—their specific purposes, sizes, and the most detailed instructions for their use. Hints, ideas, and "tricks of the trade." How to use the engine lathe. Metal jobs and projects for home and shop, complete with bill of material, equipment needed, and a fully illustrated account of every step in the work.

### PLUMBING

The various kinds of pipe, pipe fittings, valves, and fixtures. All the common plumbing tools—types, sizes, functions, and how to use them. How to cut, ream, thread, and assemble iron and brass pipe. How to connect copper tubing and make lead joints. The technique of pipe fitting, and the proper sequence of steps in assembling a piping system. Household plumbing projects—installing a hot-water heater, radiator, and various other units. How to drain a plumbing system when closing the house for the winter. How to fix leaks in faucets and valves, repair a faulty section of pipe. The cleaning, and maintenance of each part of the plumbing system.

### MASONRY

Answers every practical question about concrete, plastering, stucco, brick work, concrete-block and glass-block construction. Describes all tools, and just how to use them. How to specify materials and estimate quantities. How to build forms; mix concrete, color it, make it watertight, finish it off; how to build walls, floors, steps. All the sure methods and special ways of working by which the master mason assures good results. Everything about plastering—from small repairs to doing entire rooms. Complete instructions for stuccoing—reinforcing, methods of applying different coats, and how to obtain various decorative finishes. Kinds of brick—handling and laying. Mixing and coloring mortar. Material charts. Types of construction. Various bonds. Forming cross joints. Fireplace construction. Working with concrete blocks—building the wall, corner construction. Kinds and sizes of glass blocks. Glass-block construction—mortar, full-mortar joints, set-in-wood construction.

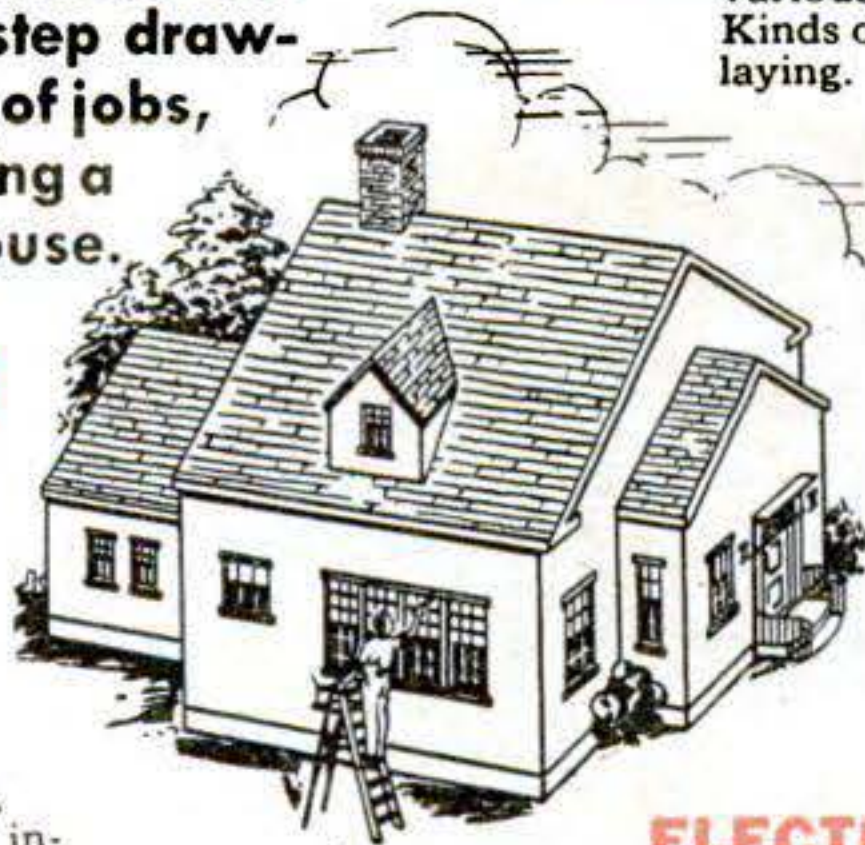

### ELECTRICAL WORK

Practical information about every electrical job the home mechanic may undertake around the house or in the home workshop. Principles of electricity—volts, amperes, ohms. Generation of electricity. Electrical energy and power. Fuses and circuit breakers. Parallel and series circuits. Standard electrical symbols. Tools, materials, and requirements of National Electrical Code. Complete, fully illustrated explanations of every step in various operations of general electrical work—splicing, soldering, taping, testing, etc. Installation of various signalling systems—bells, buzzers, and alarms. Wiring methods for power and lighting circuits. Complete projects for the home, such as BX wiring a room, and wiring a garage in conduit and BX. Portable appliances—fans, mixers, clocks, heaters, radios. Fixed equipment—oil burners, refrigerators, lighting plants, pumps, motors, generators, and control devices; all clearly described, with practical suggestions and hints for trouble shooting and adjustment.

**Send No Money**

### EXAMINE THE HOME MECHANIC'S HANDBOOK AT OUR RISK

Don't send us any money, not a penny, just fill in and mail the coupon at right and you will receive The Home Mechanic's Handbook for 10 days' free examination. Look it over, spend some time with it and decide for yourself whether or not you want to keep it. Unless you are convinced that The Home Mechanic's Handbook is the most useful book you have ever seen, you may return it to us and owe nothing. What's more, if you mail the coupon *right now* you will receive a copy of "The Roof Over Your Head" absolutely free—a gift from us that is yours to keep even if you should decide to return The Home Mechanic's Handbook. So mail the coupon now, today! There is no obligation, no agent will call on you, you have nothing to lose.

### MAIL THIS COUPON

D. Van Nostrand Company, Inc., 250 Fourth Avenue, New York 3, N. Y.

Please send me a copy of "The Home Mechanic's Handbook" and my FREE copy of "The Roof Over Your Head." Within 10 days I will either return "The Home Mechanic's Handbook," or send you \$2.95, plus a few cents postage, and \$2.00 a month for two months until the total price of \$6.95, plus postage, is paid.

*(If you send the entire amount of \$6.95 with this coupon, we will pay the postage. Same return privilege and refund guarantee if not completely satisfied.)*

Name \_\_\_\_\_

(Please print)

Address \_\_\_\_\_

City \_\_\_\_\_ State \_\_\_\_\_

(Zone No., if you know it)

Reference \_\_\_\_\_

Address \_\_\_\_\_

In Canada, Order From: D. VAN NOSTRAND COMPANY (CANADA) LTD.

SA-945

228 Bloor Street West, Toronto, Canada

PopSci.-Apr. 1948

FOUNDED 1872

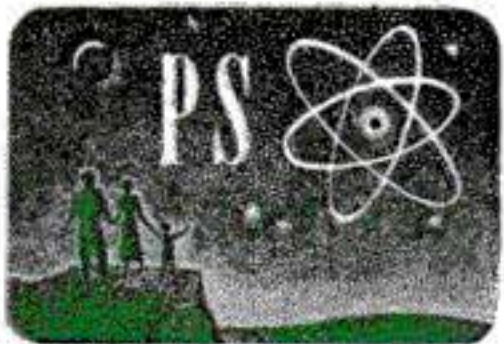

VOL. 152: NO. 4

# POPULAR SCIENCE

MECHANICS AND HANDICRAFT REG. U. S. PAT. OFF.

**EDITOR:** Perry Githens

**MANAGING EDITORS:** Fred O. Newman, Volta Torrey. **ART EDITOR:** Howard C. Jensen.

**MECHANICS & HANDICRAFT EDITOR:** Harry Walton.

**ASSISTANT MANAGING EDITORS:** Hartley E. Howe, Frank Rowsome, Jr.

**ASSOCIATE EDITORS:** Alden P. Armagnac, Devon Francis, Robert Gorman, Sheldon Gallagher, Herbert Johansen, Martin Mann, John F. Stearns, Robert P. Stevenson.

**STAFF PHOTOGRAPHERS:** W. W. Morris (Chief), Hubert Luckett.

**WESTERN EDITOR:** Andrew R. Boone (Los Angeles).

**ART DIRECTOR:** Harry Samuels. **ART ASSOCIATES:** Herbert Anthony, Eric Karminski, Jr., Richard Meyer, Saverio Rada, Frances Cooper (Production).

**EDITORIAL ASSISTANTS:** Mae G. Dyer (Assistant to the Editor), Julia Charnif, Carol Ennis, Charlotte Korch, Georgette Sparks, Ruth Westphal.

**PUBLISHER:** Godfrey Hammond

## CONTENTS FOR APRIL, 1948

*Cover painting by Reynold Brown*

### Science News

Plastic Magnets Do Tricks.....	107
Freeze as You Please.....	109
Apple Flavor Squeezed Into Delicacies..	111
Slapless Trigger Improves Pistol Aim....	121
Heated Rubber Ceiling.....	122
Earth Ripper Digs Deep.....	124
Chow Gear Improved.....	125
Machine Probes Your Personality.....	148

### Science at Work

Picture of the Month.....	97
Oil By-Products Battle Bugs.....	108
Phase Microscope "Sees" the Invisible....	124
How You'll Use the New Silicones.....	130
Steel Samples Studied.....	136
Aerial Spans Canyon.....	144
Sound Without Fury.....	154
Rockets Lay Phone Wires.....	156

### PS Features

10 Ways to Get "that Extra Room".....	98
World's Biggest Model.....	115
Iron Donkeys Can Save Your Back.....	137
K.P. Chores Made Easy.....	155
Rock-A-By Razor.....	157
How English Experts Handle Glass.....	158
Seconds Split a Million Ways.....	162
Hot Dogs Hitch a Ride.....	167
Radiant Heat Packs a Punch.....	234

### Aviation

What's New in Aviation.....	128
How to Talk to an Airplane.....	135

### Automobiles

New Olds Gives Wider View.....	114
Power in Sleek Package.....	125
Pontiac Gets "New Look".....	167
Bump 'Em Out Yourself.....	168
Gus Untangles a Double Cross.....	172
Hints from the Model Garage.....	176
Chevrolet Improves Bearings.....	178
New Scooter Uses Auto Parts.....	178
Trailer Coupler Is Removable.....	228

### Inventions

I'd Like to See Them Make.....	110
New Ideas from the Inventors.....	146

### Photography

Condensers Improve Enlarger.....	218
Movies Shown on Ceiling.....	219
Photo Ideas and Equipment.....	220

### Mechanics & Shopcraft

Mortise Built Up with Shims.....	182
Center Finder Works Quickly.....	186
Tuner Measures Engine Speed.....	186
Squaring Stock with Power Tools.....	192
Taking Inside Measurements.....	203

Ⓢ This mark in text indicates Trade Name.

*Continued on page 4*

Published monthly at 353 Fourth Avenue, New York 10, N. Y., by Popular Science Publishing Co., Inc. Godfrey Hammond, President and Treasurer; R. C. Wilson, Raymond J. Brown, Stephen P. Glennon, Vice-Presidents; F. W. Briggs, Secretary. Entered as second-class matter Dec. 28, 1918, at the Post Office at New York under the act of March 3, 1879; additional entry as second-class matter at Dayton, Ohio. Entered as second-class matter at the Post Office Department, Canada. Printed in U. S. A. Copyright, 1948, by Popular Science Publishing Co., Inc. All rights reserved in the United States, Great Britain, and in all countries participating in the International Copyright Convention and Pan-American Copyright Convention. Yearly subscriptions to United States, its possessions and Canada, \$2.50; foreign countries, \$3.50. Subscribers must notify us of change of address four weeks in advance of the next publication date. Be sure to give both old and new addresses, including zone numbers.

**NEW NEW NEW**

# AUTO-LITE

*Resistor*

## SPARK PLUG

### *Here's what it is*

The many benefits which can be obtained through a wider than standard spark gap setting are well known to the automotive industry. Up to this time the rate of spark gap increase due to electrode erosion has been such that the desired wide setting has not been generally used. Auto-Lite, working with leading car and truck manufacturers, has Ignition Engineered a built-in 10,000 Ohm Resistor which reduces electrode erosion so that Auto-Lite Spark Plugs can now be given this wider gap setting desirable for improved operation and economy.

### *Here's what it does*

**PROMOTES SMOOTHER IDLING**, because the wider spark gaps help eliminate occasional missing.  
**REDUCES MISFIRING** due to lean spots in carburetion.  
**ASSISTS IN BURNING OF LEANER MIXTURES** for improved engine economy at idle and throughout the speed range.  
**REDUCES RING AND CYLINDER WEAR** when lubrication is washed away by gasoline not burned as a result of occasional misses.  
**INCREASES ELECTRODE LIFE** up to 200% and more.  
**SUPPRESSES SPARK PLUG INTERFERENCE** with radio, radio-telephone, radar and television reception.\*

### **Advantages So Significant They Are Expected To Affect The Entire Industry**

A complete line of Auto-Lite Resistor Spark Plugs with the built-in Resistor will soon be available for original equipment and replacement on popular makes of cars, trucks and tractors. The regular line of ignition engineered Auto-Lite Spark Plugs, which has won such an enviable reputation for dependability of performance, will continue to be manufactured. Ask your favorite dealer.

**THE ELECTRIC AUTO-LITE COMPANY**  
Toronto 1, Ontario                      Toledo 1, Ohio

**NEW**

## BUILT-IN RESISTOR

Auto-Lite Ignition Engineers, working with leading automotive manufacturers, have developed the new Auto-Lite Resistor Spark Plug with this built-in resistor. As a result, improved operation and economy will be possible for the owners of cars, trucks and tractors everywhere.

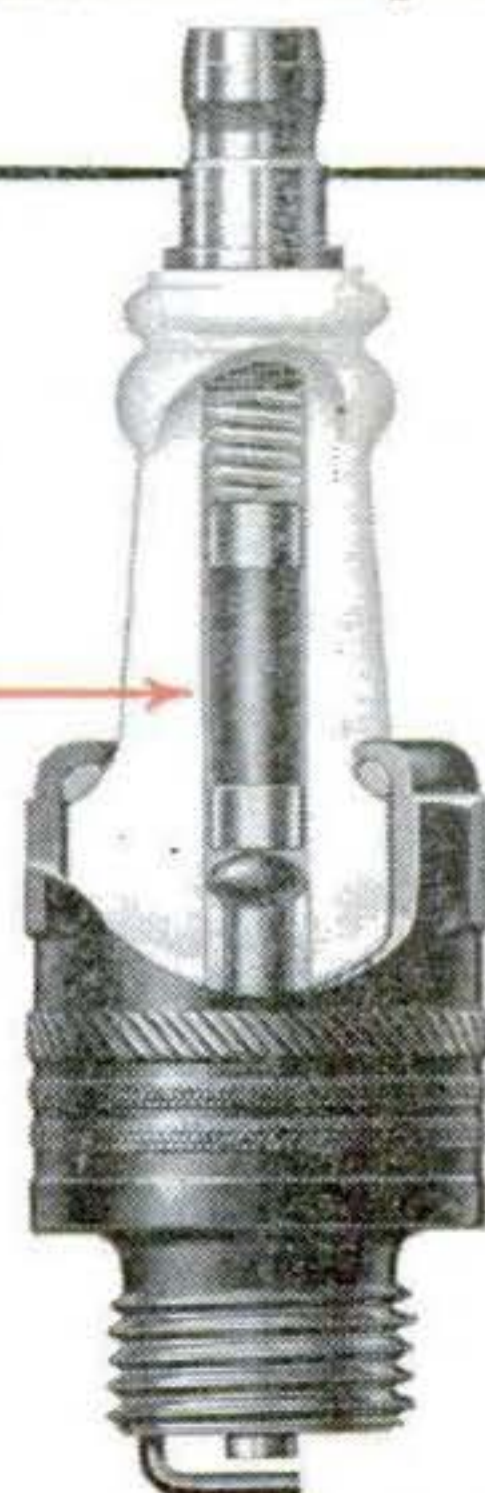

\*Within 35 mv/m from 540 kc. to 150 mc. at 50 ft.

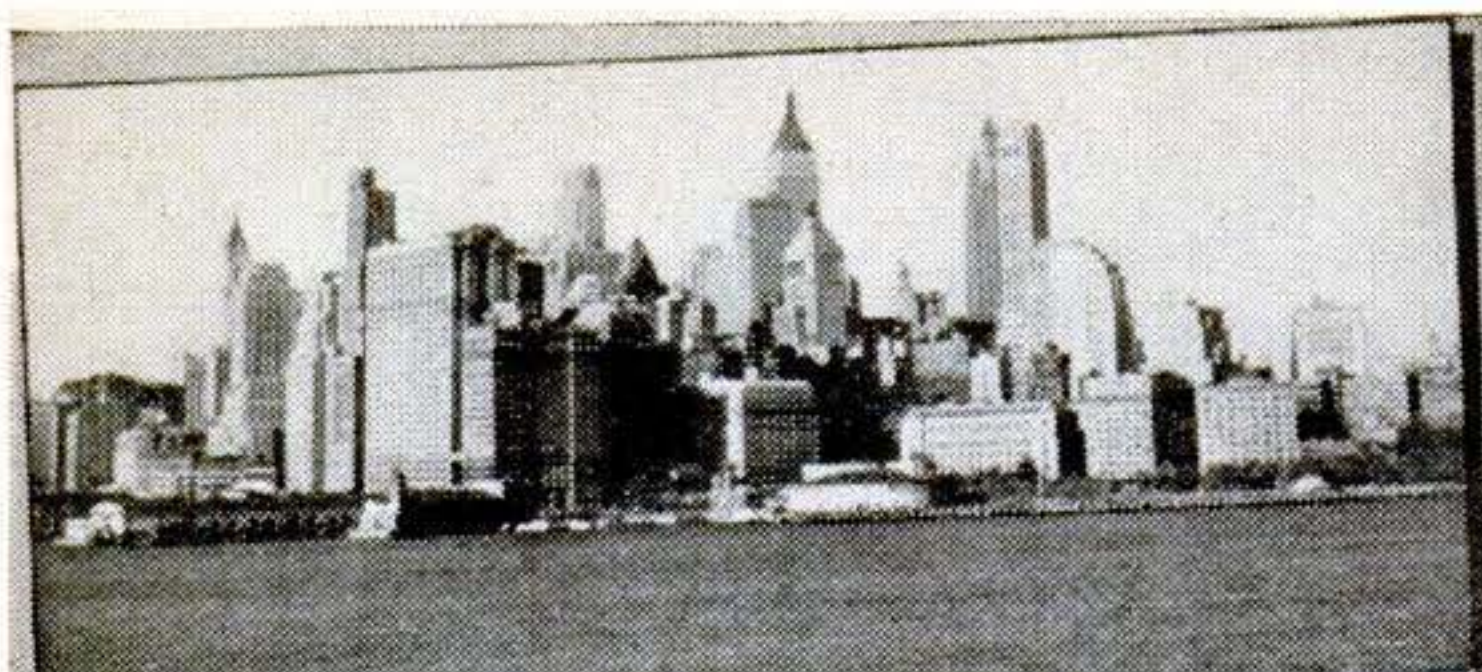

**LOWER MANHATTAN**—a sight that amazes the visitor and is ever a thrill to New Yorkers. This group of huge skyscrapers is the 20th Century wonder of the world, and a symbol of this country's progress.

## New York

...the city that belongs to everybody

...fabulous city of finance, fashion and fun, teeming with life, gleaming with greatness. To the visitor, New York is a maze of excitement and crowds—but to New Yorkers it is home, and enjoyment of all the good things New York has to offer. One of the most popular is...

## Beech-Nut Gum

It has the flavor  
you like



Beech-Nut  
**BEECHIES**  
—good too—  
Peppermint, Spearmint  
and Pepsin.



**STATUE OF LIBERTY**—symbol of hope to all freedom loving people—its light must burn forever.



**FIFTH AVENUE**—looking South towards the Empire State Building tallest structure in the country.



**TIMES SQUARE**—the amusement center—everything from a flea circus to the Metropolitan Opera.



**ROCKEFELLER CENTER**—city within a city, mecca of visitors, radio headquarters.

How I Built a Milling Machine.....	209
Tin Snips Converted to Bench Tool.....	213
Nut Retains End Mill in Spindle.....	213
New Shop Ideas.....	214
Ball-Bearing Support Speeds Work.....	228
Razor Blades Used in Knife.....	233
Holder Aids in Sawing Curves.....	233
Chain Wrench Grips Big Pipe.....	239
Wrench Ground as Screwdriver.....	240
Hooked Steel Rod Is Bucking Bar.....	240

### Home Mechanics & Handicraft

Man's Jewelry Is a Lathe Job.....	180
New Slant on Flowerpot Shelves.....	182
Chest Faced in Matched Veneer.....	183
Binocular Case Is Tackle Box.....	186
Handmade Links Form Necklace.....	187
Soft Stone Readily Carved.....	187
Silent Sam Takes Your Messages.....	188
Old Bottles Cut to Make New Mugs.....	190
Ivy Pot from a Coffee Can.....	191
Outdoor Fireplace Cooks Three Ways....	196
Bedspring Serves as Scraper.....	198
Tubing Supports Fishing Pole.....	198
Snack Server Has Slicing Edge.....	200
Light from a Salt Box.....	202
Plug Removes Faucet Nipple.....	203
Light Shows Coal Impurities.....	203
Whizzer—a Fizz-Powered Speedboat.....	206
Drink Mixer Clips Tie.....	228
Simple Microscope Has Liquid Lens.....	229
Tweezer Jaws Lined with Cork.....	229
How to Bind Your Favorite Magazine....	230
Tape Holds Punch Confetti.....	233
Hinged Rack Supports Motor.....	233
Model Wheels Spin Pioneer Yarns.....	236
Use Those Extra Asbestos Shingles.....	238
Nail Keg Converted to Bucket.....	239

### Radio & Electricity

Unmaking Man-Made Static.....	126
Button-Big Motor Runs.....	145
Radio Robot Squirts Out 3 A Minute.....	160
Superhet a Beginner Can Build.....	222
External Battery Runs Portable.....	226
Gasket Prevents Short Through Meter....	226
Low-Loss Antenna Plug.....	227
Foil Shields Radio Tube.....	227

### Departments

Letters .....	16
The Voice of Science.....	95
What's Your Ingenuity Quotient?.....	199
Keeping the Home Shipshape.....	204
New Tools.....	208
Aids to Modern Living.....	216
Editorial Memo.....	302

All cars have **TIRES**  
but in the lowest-priced field only **PLYMOUTH**  
has **SUPER-CUSHION TIRES** on **SAFETY-RIM WHEELS**

*Bigger, softer-riding Super-Cushion Tires are standard equipment with Plymouth. They reduce chances of tire failure but if trouble occurs you have the added protection of Plymouth's new, wider Safety-Rim Wheels.*

All cars have **SPRINGS**  
but in the lowest-priced field only **PLYMOUTH**  
has **AMOLA STEEL SPRINGS**

*You draw extra dividends of continuing comfort with Plymouth's famous high-tensile Amola Steel Springs. They're tough for long life . . . soft-acting always for front and rear riding ease on all types of roads.*

## It's easy to tell where the Value is!

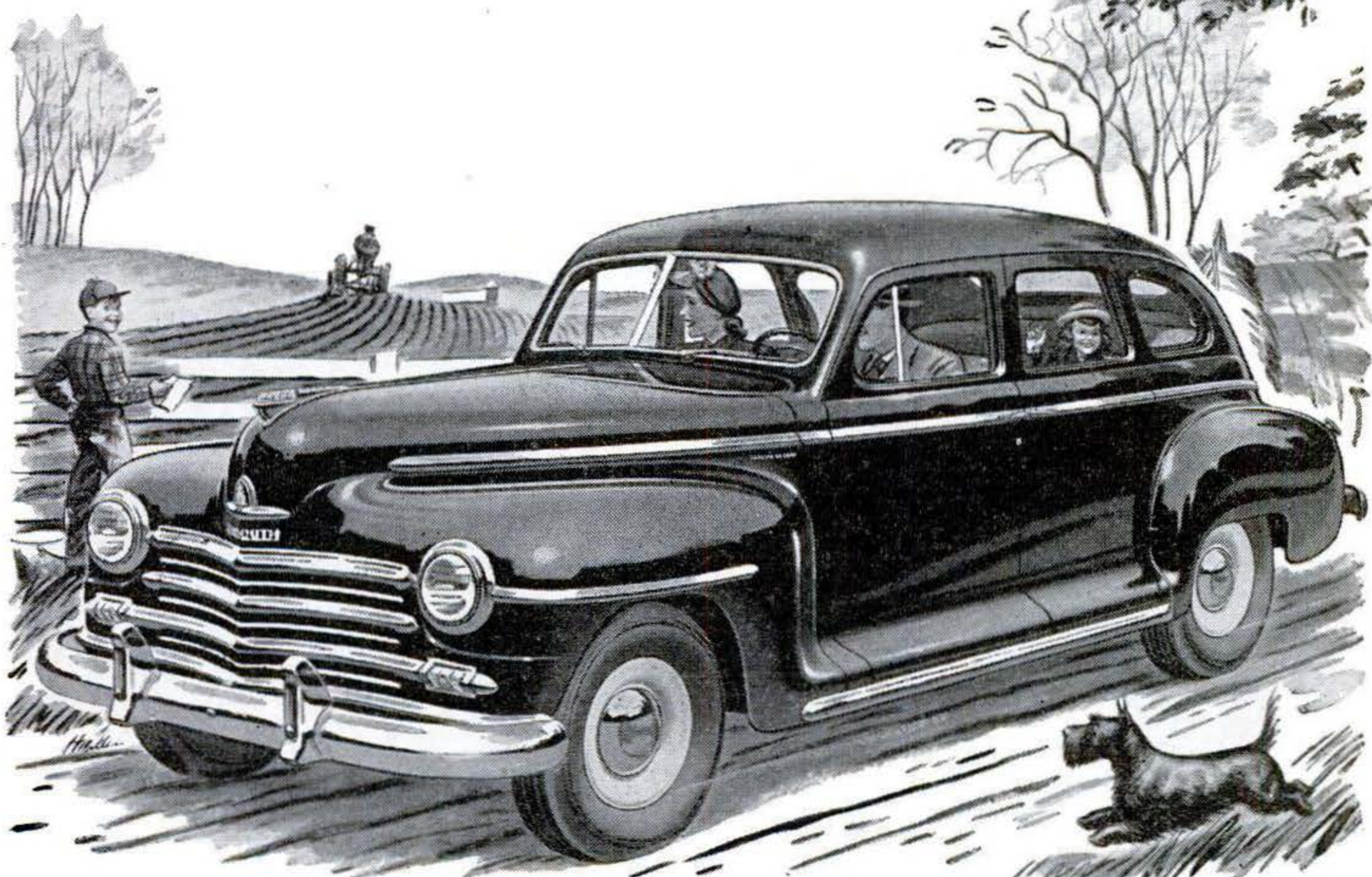

It's easy to tell that low-priced Plymouth leads the field in reduction of tire-failure hazards and increase of riding ease.

It's just as easy to tell that Plymouth stands out for all-around safety, comfort and top performance. A look at the Quality Chart at your Plymouth dealer's will show you that Plymouth has 20 of 21 features common to most high-priced cars.

You can make your own comparison and see for yourself that neither of the other leading low-priced cars has *half* as many of these features. Yes, it's easy to tell where the Value is in the lowest-priced field.

**Plymouth builds great cars . . . good service keeps them great.** Your nearby Plymouth dealer will provide the service and factory-engineered parts to keep your present car in good condition while you're waiting for your new Plymouth. PLYMOUTH Division of CHRYSLER CORPORATION, Detroit 31, Michigan.

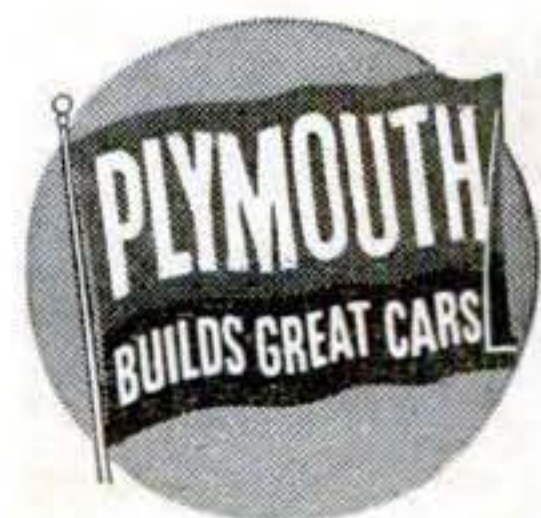

If it's **VALUE** you want—  
it's **PLYMOUTH** you want

# The battle of the atoms

Telephone equipment is constantly at war against invisible forces of nature which seek to take it apart, atom by atom. On all fronts, Bell Laboratories chemists must fight corrosion—an enemy able to make a telephone circuit noisy or perhaps to sever it altogether.

An example: for years lead cable had lain protected in wooden ducts. Then in certain areas something began to eat the sheath, exposing wires to moisture. Corrosion chemists of the Laboratories were called in. The corrosion, they found, came from acetic acid generated in the wood during the preservative treatment then in use. They pumped in neutralizing ammonia. Corrosion stopped. Now telephone duct wood is controlled for acidity.

In a large city, smoke-polluted air was coating the silver surfaces of contacts with sulphide. Noisy circuits resulted. Chemists discovered minute traces of sulphur vapor in the air. They filtered incoming air with activated charcoal. Today, the latest telephone contacts are of palladium—not affected by sulphur.

Corrosion in metals is only one type of deterioration which engages Bell chemists against hostile forces. Plastics, paper, metals, rubber, textiles, coils, waxes and woods all have enemies. But knowledge, and persistence, are steadily winning out—to the benefit of the telephone user.



*A Bell Laboratories corrosion engineer examining samples during an exposure test on corrosion-resistant finishes and alloys.*

**BELL TELEPHONE LABORATORIES**



**EXPLORING AND INVENTING, DEVISING AND PERFECTING FOR CONTINUED IMPROVEMENTS AND ECONOMIES IN TELEPHONE SERVICE**



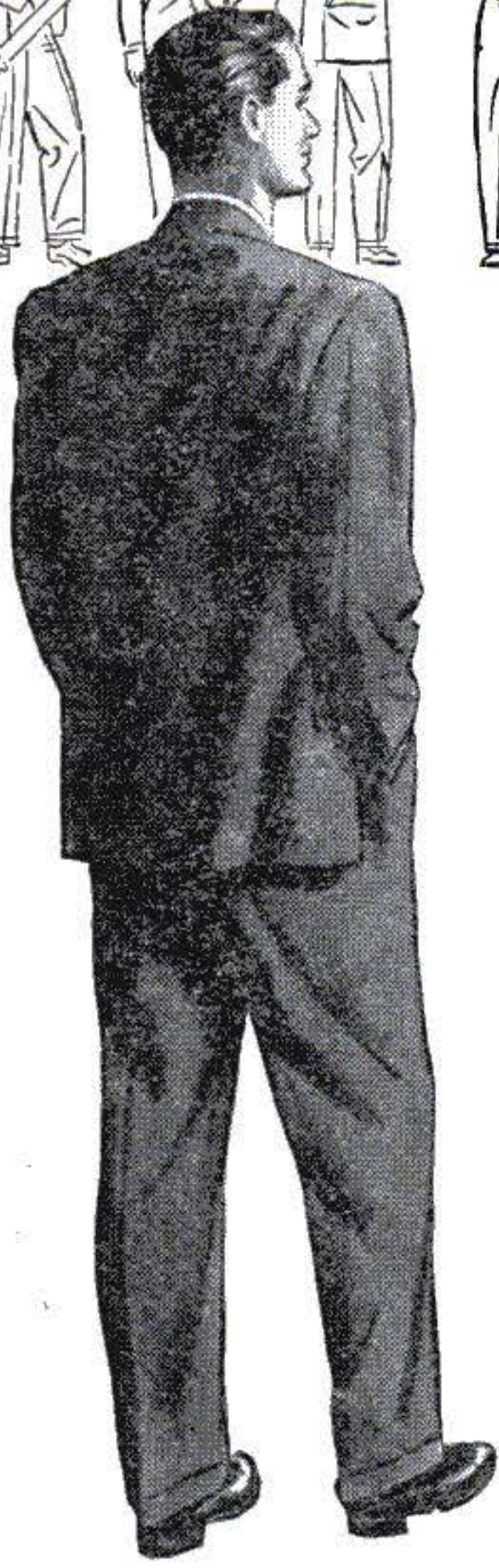

## You've got to compete with trained men!

The untrained man stands a slim chance today. Right now there are 14 million more highly skilled, experienced workers in the country than before the war.

Jam-packed schools and colleges are turning out record classes two and three times a year. The armed services continue to return thousands of technical experts to civilian life every month.

That's why it is so important that you get all the training you can—now, before "the squeeze" begins. Continue your formal

education if you can. If not, investigate the opportunities offered by I. C. S.

For more than 56 years, I. C. S. has been training those determined to make good regardless of the odds. Leaders in nearly every field of business and industry are counted among the men and women who have taken I. C. S. courses. Their records of success prove the worth of sound, practical I. C. S. training. Don't gamble with your future. It may be later than you think. Mark and mail the coupon today!

### INTERNATIONAL CORRESPONDENCE SCHOOLS



BOX 7605-M, SCRANTON 9, PENNA.

Without cost or obligation, please send me full particulars about the course BEFORE which I have marked X:

- |   |   |   |  |
|---|---|---|--|
| <p><b>Air Conditioning and Plumbing Courses</b></p> <p><input type="checkbox"/> Air Conditioning</p> <p><input type="checkbox"/> Heating</p> <p><input type="checkbox"/> Refrigeration</p> <p><b>Chemistry Courses</b></p> <p><input type="checkbox"/> Chemical Engineering</p> <p><input type="checkbox"/> Chemistry, Analytical</p> <p><input type="checkbox"/> Chemistry, Industrial</p> <p><input type="checkbox"/> Chemistry, Mfg. Iron &amp; Steel</p> <p><input type="checkbox"/> Petroleum Refining</p> <p><input type="checkbox"/> Pulp and Paper Making</p> <p><b>Civil Engineering, Architectural and Mining Courses</b></p> <p><input type="checkbox"/> Architecture</p> <p><input type="checkbox"/> Architectural Drafting</p> <p><input type="checkbox"/> Bridge and Building Foreman</p> <p><input type="checkbox"/> Building Estimating</p> <p><input type="checkbox"/> Civil Engineering</p> <p><input type="checkbox"/> Coal Mining</p> <p><input type="checkbox"/> Contracting and Building</p> <p><input type="checkbox"/> Highway Engineering</p> <p><input type="checkbox"/> Lumber Dealer</p> <p><input type="checkbox"/> Reading Structural Blueprints</p> <p><input type="checkbox"/> Sanitary Engineering</p> <p><input type="checkbox"/> Structural Drafting</p> | <p><input type="checkbox"/> Plumbing</p> <p><input type="checkbox"/> Steam Fitting</p> <p><b>Communications Courses</b></p> <p><input type="checkbox"/> Electronics</p> <p><input type="checkbox"/> Practical Telephony</p> <p><input type="checkbox"/> Radio, General</p> <p><input type="checkbox"/> Radio Operating</p> <p><input type="checkbox"/> Radio Servicing</p> <p><input type="checkbox"/> Telegraph Engineering</p> <p><b>Electrical Courses</b></p> <p><input type="checkbox"/> Electrical Drafting</p> <p><input type="checkbox"/> Electrical Engineering</p> <p><input type="checkbox"/> Electric Light and Power</p> <p><input type="checkbox"/> Lighting Technician</p> <p><input type="checkbox"/> Practical Electrician</p> <p><b>Internal Combustion Engines Courses</b></p> <p><input type="checkbox"/> Auto Technician</p> <p><input type="checkbox"/> Diesel-Electric</p> <p><input type="checkbox"/> Diesel Engines</p> <p><b>Mechanical Courses</b></p> <p><input type="checkbox"/> Aeronautical Engineer's, Jr.</p> <p><input type="checkbox"/> Aircraft Drafting</p> <p><input type="checkbox"/> Flight Engineer</p> <p><input type="checkbox"/> Forging</p> <p><input type="checkbox"/> Heat Treatment of Metals</p> | <p><input type="checkbox"/> Structural Engineering</p> <p><input type="checkbox"/> Surveying and Mapping</p> <p><b>Industrial Engineering</b></p> <p><input type="checkbox"/> Industrial Metallurgy</p> <p><input type="checkbox"/> Machine Shop</p> <p><input type="checkbox"/> Mechanical Drafting</p> <p><input type="checkbox"/> Mechanical Engineering</p> <p><input type="checkbox"/> Mold-Loft Work</p> <p><input type="checkbox"/> Patternmaking—Wood, Metal</p> <p><input type="checkbox"/> Reading Shop Blueprints</p> <p><input type="checkbox"/> Sheet-Metal Drafting</p> <p><input type="checkbox"/> Sheet-Metal Worker</p> <p><input type="checkbox"/> Ship Drafting</p> <p><input type="checkbox"/> Tool Designing</p> <p><input type="checkbox"/> Toolmaking</p> <p><input type="checkbox"/> Welding—Gas and Electric</p> <p><b>Railroad Courses</b></p> <p><input type="checkbox"/> Air Brake</p> <p><input type="checkbox"/> Diesel Locomotive</p> <p><input type="checkbox"/> Locomotive Engineer</p> <p><input type="checkbox"/> Locomotive Fireman</p> <p><input type="checkbox"/> Railroad Section Foreman</p> <p><b>Steam Engineering Courses</b></p> <p><input type="checkbox"/> Boilermaking</p> <p><input type="checkbox"/> Combustion Engineering</p> <p><input type="checkbox"/> Engine Running</p> <p><input type="checkbox"/> Marine Engineering</p> <p><input type="checkbox"/> Steam Electric</p> | <p><input type="checkbox"/> Ship Fitting</p> <p><input type="checkbox"/> Car Inspector</p> <p><input type="checkbox"/> Gas Engines</p> <p><input type="checkbox"/> Steam Engines</p> <p><b>Textile Courses</b></p> <p><input type="checkbox"/> Cotton Manufacturing</p> <p><input type="checkbox"/> Rayon Weaving</p> <p><input type="checkbox"/> Textile Designing</p> <p><input type="checkbox"/> Woolen Manufacturing</p> <p><b>Business and Academic Courses</b></p> <p><input type="checkbox"/> Accounting</p> <p><input type="checkbox"/> Arithmetic</p> <p><input type="checkbox"/> Business Administration</p> <p><input type="checkbox"/> Business Correspondence</p> <p><input type="checkbox"/> Certified Public Accounting</p> <p><input type="checkbox"/> Commercial</p> <p><input type="checkbox"/> Commercial Art</p> <p><input type="checkbox"/> Cost Accounting</p> <p><input type="checkbox"/> Federal Tax</p> <p><input type="checkbox"/> First Year College</p> <p><input type="checkbox"/> Foremanship</p> <p><input type="checkbox"/> Good English</p> <p><input type="checkbox"/> Higher Mathematics</p> <p><input type="checkbox"/> Motor Traffic</p> <p><input type="checkbox"/> Salesmanship</p> <p><input type="checkbox"/> Sign Lettering</p> <p><input type="checkbox"/> Spanish</p> <p><input type="checkbox"/> Traffic Management</p> <p><input type="checkbox"/> Advertising</p> <p><input type="checkbox"/> Bookkeeping</p> <p><input type="checkbox"/> Bookkeeping</p> <p><input type="checkbox"/> French</p> <p><input type="checkbox"/> High School</p> <p><input type="checkbox"/> Postal Service</p> <p><input type="checkbox"/> Secretarial</p> <p><input type="checkbox"/> Stenography</p> |
|---|---|---|--|

Name \_\_\_\_\_ Home Address \_\_\_\_\_

City \_\_\_\_\_ State \_\_\_\_\_

Age \_\_\_\_\_ Present Position \_\_\_\_\_ Working Hours \_\_\_\_\_ A.M. to \_\_\_\_\_ P.M.

Special tuition rates to members of the Armed Forces. Special discount to World War II Veterans.  
Canadian residents send coupon to International Correspondence Schools Canadian, Ltd., Montreal, Canada.

# WAR SURPLUS OPTICAL BARGAINS

## ASSEMBLE YOUR OWN BINOCULARS!

Complete Optics! Complete Metal Parts!  
Save More Than 1/2 Regular Cost



### GOVERNMENT'S 7x50 BINOCULARS

Complete Optics, new and ready for assembly. We supply full instructions. Limit—1 Set of Metal Parts and 1 Set of Optics to a customer.

**METAL PARTS**—Set includes all Metal Parts—completely finished—for assembly of 7 X 50 Binoculars. No machining required. Bodies have been factory hinged and covered. A sturdy Binocular Carrying Case is optional with each set of Metal Parts.

Stock #842-N ..... \$39.40

Postpaid, plus \$4.80 for Case—Total.....\$44.20

**OPTICS**—Set includes all Lenses and Prisms you need for assembling 7 X 50 Binoculars. These are in excellent condition—perfect or near-perfect—and have new low reflection coating.

Stock #5102-N.....\$25.00 Postpaid

**NOTICE!** If you buy both Binocular Optics and Binocular Metal Parts, add 20% Federal Excise Tax to above prices.

## ARMY'S 6x30 BINOCULARS

**COMPLETE OPTICS & METAL PARTS**—Model M-13A1, 6 x 30 Binoculars (waterproof model). Everything you need—ready for assembly. When finished will look like a regular factory job costing \$102 to \$120. The Optics are new, in perfect or near-perfect condition. Have new low reflection coating. Metal Parts are new and perfect, all completely finished. No machining required. Bodies factory hinged and covered. Complete assembly instructions included.

Stock #830-N.....\$40.00 Postpaid,  
plus \$8.00 tax—Total—\$48.00

**METAL PARTS ONLY**—Model M-13A1, 6 x 30 Binoculars. No Optics. Same Metal Parts as described for Stock #830-N.  
Stock #832-N—6 x 30 Metal Parts.....\$25.00 Postpaid

**OPTICS FOR 6 x 30 BINOCULARS** (No Metal Parts.) Perfect, and low reflection coated. Stock #5130-N..\$15.00 Postpaid

**SAME OPTICS AS ABOVE** (6 x 30) Coated—but slight seconds.  
Stock #5124-N.....\$12.75 Postpaid

If you buy both Binocular Optics and Binocular Metal Parts, add 20% Federal Excise Tax to above prices.

Optics and Metal Parts are Available for Monoculars (1/2 a Binocular). For Complete Details, Write for Bulletin #14-N.

**SIMPLE LENS KIT**—Some gov't surplus, some commercial surplus, some chipped rejects, some perfect, few coated... in any event an excellent bargain. Containing Plano Convex, Double Convex, Concave, Miniscus Lenses. Dia. range 5mm to 40mm. Assorted focal lengths.

Stock #5-N.....45 lenses.....\$ 5.00 Postpaid

Stock #10-N.....80 lenses.....\$10.00 Postpaid

## 6 POWER GALILEAN TELESCOPE

(Commercial Surplus) 28mm dia. Achromatic Objective Lens. Sturdily constructed of Aluminum. 7" long, extends to 9". Complete with carrying case.

Stock #941-N.....\$3.00 Postpaid

**HASTINGS TRIPLET 10 Power Magnifier** (Cemented but not Mounted). Dia. 15mms. Focal length 1". Gov't used these for magnifying image on tube screen of Snooperscope. Worth \$12.00.

Stock #6203-N.....\$3.00 Postpaid

## 8 POWER ELBOW TELESCOPE

Gov't Cost \$200.00! Our Price \$17.50!  
Big 2" diameter objective. All lenses Achromatic. Amici prism erects the image. 4 built-in filters—clear, amber, neutral and red. New to slightly used condition but all guaranteed for perfect working order. Weight 5 lbs. Can be carried but a trifle bulky.



Stock #943-N.....\$17.50 Postpaid

## TERRIFIC BARGAIN—BUBBLE SEXTANT

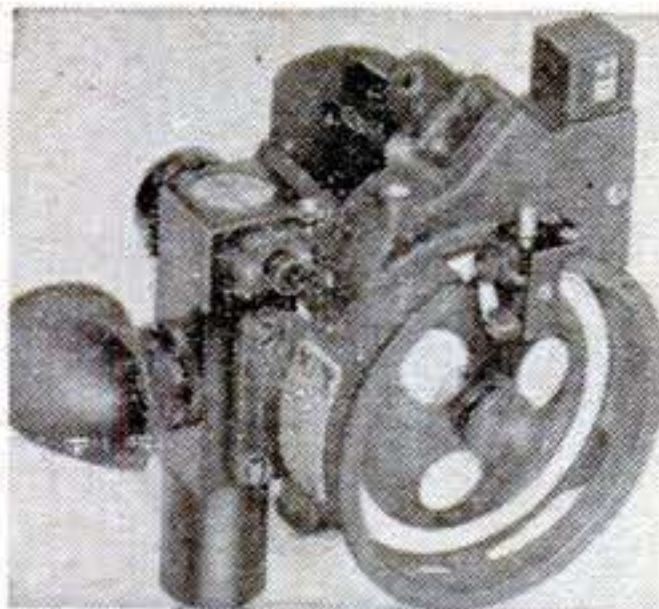

These Army Air Forces Bubble Sextants cost the Govt. about \$125.00 each. A real bargain at our price of \$12.50! Included with Bubble Sextant shipment is wooden Carrying Case, 5 spare waxed paper discs, flashlight with rheostat for night use (uses ordinary flashlight cells—not furnished) aux. 2-power Galilean Telescope, Allen wrench, 1 spare marking point. Wartime used, **BUT COMPLETELY REPAIRED, COLLIMATED AND PUT IN GOOD WORKING ORDER.** If not satisfied that Sextant is exactly as

represented, return within 10 days and money will be refunded. Full directions for use accompany each shipment.  
Stock #924-N.....\$12.50 Postpaid

Same Sextant as above, but **BRAND NEW** and with Automatic Electric Averaging Device and Illuminated Averaging Disc for nighttime use. Govt. cost \$217. Though brand new we have re-checked Bubble and Collimation and **GUARANTEE** perfect working order.

Stock #933-N.....\$22.50 Postpaid

**CONDENSING LENSES**—Seconds, but suitable for Enlargers and Spotlights.

Stock #1061-N.....6 1/2" dia., 9" F.L.....\$2.50 Postpaid

Stock #1082-N.....4 1/2" dia., 5 1/2" F.L.....70¢ Postpaid

We have a Limited Quantity of Condensing Lenses—seconds—ranging from 4 1/2" to 8 1/2" in dia. with various focal lengths. Send for Free Bulletin titled "MISCELLANEOUS CONDENSING LENSES—N"

## \$200.00 DRIFT METER for \$5.60

These were used for determination of drift and true air speed. You can adapt to other uses or take apart to get 2 mounted Achromatic Lenses—Mirrors—Field Lens—Pantograph—Engraved Scales—Sponge Rubber Discs—metal parts and other components. Instrument weighs 4 lbs.  
Stock #942-N.....\$5.60 Postpaid



**LENS CLEANING TISSUE**—1st quality, sheet size 11" x 7 1/2". Made to Govt. specs. Free of abrasives and lint. High wet strength.

Stock #721-N.....500 sheets.....\$1.00 Postpaid

**AIR FORCES GUN SIGHT**—With Polarizing Variable Density Attachment. (Polarizing attachment alone is worth many times the price of entire unit.)

Stock #908-N.....\$5.00 Postpaid

Same Unit Without Polarizing Attachment

Stock #916-N.....\$2.50 Postpaid

**35 MM KODACHROME PROJECTING LENS SET**—Consists of Achromatic Lens for projecting, plus a Condensing Lens and piece of Heat Absorbing Glass with directions.

Stock #4025-N.....\$1.95 Postpaid

## MOUNTED PROJECTING LENS SYSTEM



F.L. 91.44 mm. (just right for 35 mm. Projectors). Speed of F 1.9. Outside dia. of mount at one end 60 mm. Length of mount 64 mm.

Stock #4033-N.....\$3.00 Postpaid

**THREADED OUTSIDE MOUNT FOR FOCUSING ABOVE SYSTEM (Not illus.)**—

Stock #715-N.....\$1.00 Postpaid

**CONDENSING LENS SET**—Consists of 2 Condensing Lenses with diameter of 2". Used for making 35mm projectors or many other purposes.

Stock 4034-N.....75¢ Postpaid

**POLARIZING VARIABLE DENSITY ATTACHMENT FOR BINOCULARS**

An amazingly effective unit for controlling amount of light reaching your eyes. Cuts down glare in sky and overwater observations. Easily snapped on and off over the eye cups of American made 7x50 Binoculars Govt. cost \$8.30 each.

Stock #20,000-N.....\$2.00 Postpaid

Above Polarizing Attachment also adaptable to Govt. 6 x 30 Binoculars with substitution of special Eye-cups.

Stock #20,010-N....6 x 30 Eye-cups....75¢ pr. Postpaid

We have literally millions of war surplus lenses and prisms for sale at bargain prices. Write for Catalog "N"—Sent Free!

SATISFACTION GUARANTEED

Order by Stock No.

**EDMUND SALVAGE CO., P. O. Audubon, New Jersey**

# MORE MONEY \$\$\$ a BETTER JOB

Your Competition is Keen



**YOU'RE** in the biggest competition—yes, the biggest battle in the world—that of making a living. You have to work for a living—so does everyone else.

Competition for promotion is keen—people all around you are looking for more money—a better job—and so are you.

*You can get a head start.* Other men have—and in a short time you should be able to outdistance those who have no progress plan, make more money—have a better job—a more certain future.

Few people prepare themselves for that promotion—that better job and more money. Not many are making any special effort to learn outside of the time they put in each day on their work. They're taking the long, hard road to success. *How about you?* Are you, too, taking that same old, winding road—with its many disappointments and heartbreaks?

Here at LaSalle we have been training ambitious men and women for success for 40 years—enrolled hundreds of thousands of students—and our files overflow with grateful letters from students who have attained success and earnings far beyond their fondest dreams.

Perhaps we can help you—at any rate it will be well worth a three cent stamp to mail the coupon below. **DO IT NOW!** Just check the field of your choice and we'll send you full information on that field without obligation. It may be the turning point in your life to a successful career, and more money.

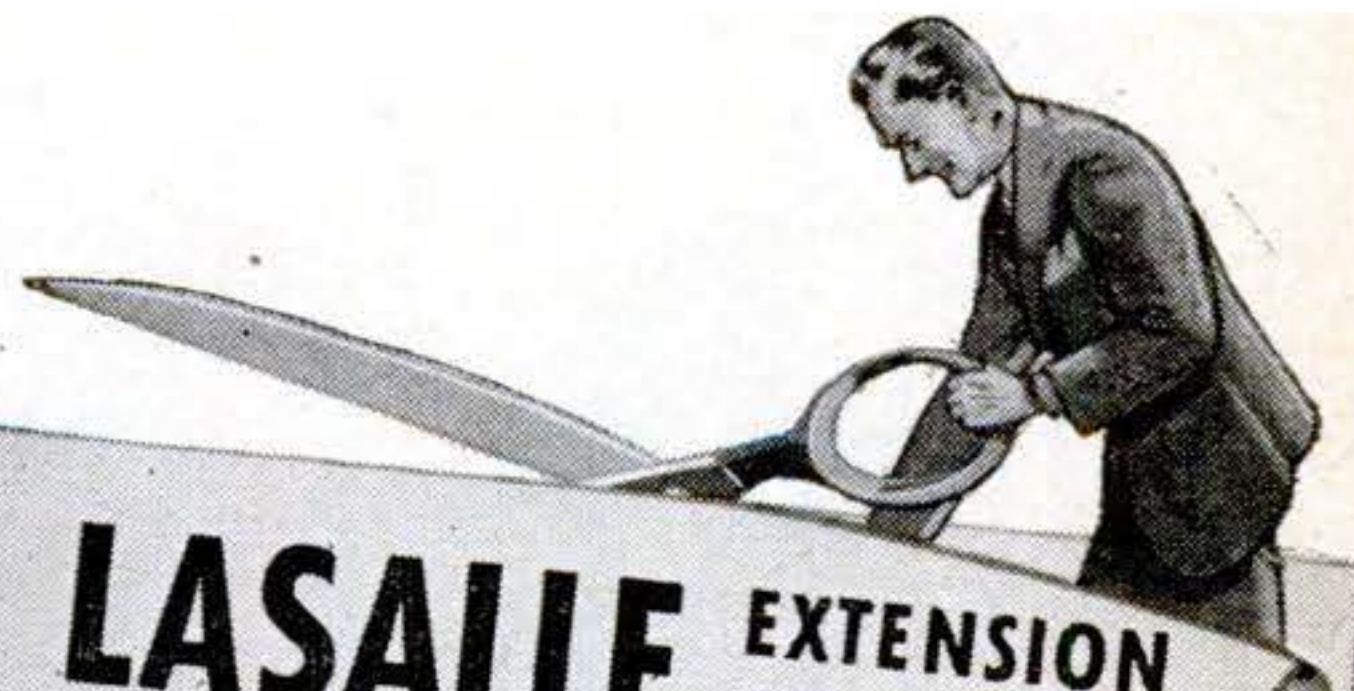

**LASALLE** EXTENSION UNIVERSITY  
A Correspondence Institution

417 SO. DEARBORN ST.

DEPT. 483-R

CHICAGO 5, ILL.

I am interested in preparing myself for a better job and more money. Please send me your free 48-page booklet on the training course I have checked below.



- |  |  |
|--|--|
| <input type="checkbox"/> Accounting              | <input type="checkbox"/> Industrial Management       |
| <input type="checkbox"/> Bookkeeping             | <input type="checkbox"/> Business Management         |
| <input type="checkbox"/> Business Correspondence | <input type="checkbox"/> Traffic Management          |
| <input type="checkbox"/> Sales Training          | <input type="checkbox"/> Stenotypy Machine Shorthand |
| <input type="checkbox"/> Law: LL.B. Degree       |  |
| <input type="checkbox"/> Foremanship             |  |
| <input type="checkbox"/> C. P. A. Coaching       |  |

Name \_\_\_\_\_

Age \_\_\_\_\_

Present Position \_\_\_\_\_

Street Address \_\_\_\_\_

City, Zone and State \_\_\_\_\_

**CLIP AND MAIL THIS COUPON TODAY!**

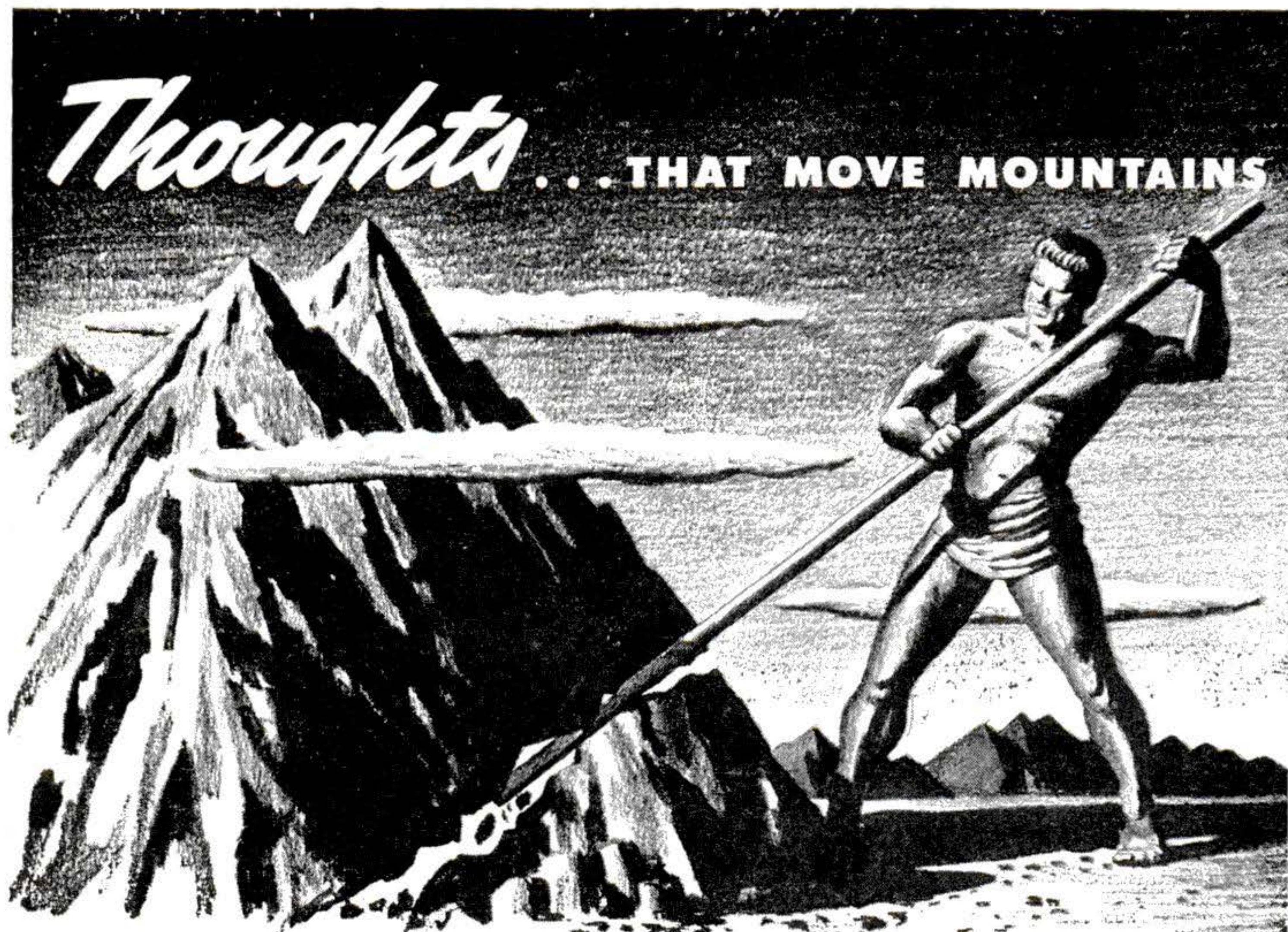

## ... IS MIND POWER REAL?

**H**AVE YOU READ volumes on the power of thought? Perhaps you have listened to lengthy theoretical addresses on the forces of mind. You may have wondered if these same writers and lecturers on mind power know how to use it. How many mountains of personal obstacles—everyday trials and tribulations—have *they* moved? What are these subtle principles whereby man can skillfully remove the barriers that impede his progress? How can *you* displace the obstructions and hindrances to *your* goal... the mountains in *your* life? Can practical information about inner power be reduced to mere words... words for public dissemination? Or, is there a secret method especially and uniquely preserved for the worthy seeker.. practicable only under ideal circumstances? If so, who has the secret method? Where can it be found?

*The*

**ROSICRUCIANS (AMORC) San Jose, California**

Investigate the Rosicrucians (NOT a religion), the oldest *practical* philosophical fraternity on earth. See if they cannot show you a method for attainment such as you may not have dreamed. Thousands of men and women today are enjoying mental mastery... realization of ideals... the attainment of their objectives. They *know* the secret methods for converting mountains of personal problems into green valleys of achievement.

### ACCEPT THIS OFFER

A FREE book, *The Mastery of Life*, is yours for the asking. It explains how easily you may enter upon the path of attainment. Fill in and send coupon *today!*

SCRIBE G. K. W.  
THE ROSICRUCIANS (AMORC)  
San Jose, California

Please send me the book, *The Mastery of Life*, which explains how I may learn to use my faculties and powers of mind.

Name \_\_\_\_\_

Address \_\_\_\_\_

City \_\_\_\_\_

Zone Number \_\_\_\_\_ State \_\_\_\_\_

# Learn **ELECTRICITY** in the **GREAT SHOPS OF COYNE**

**ACTUAL SHOP SCENES AT COYNE**

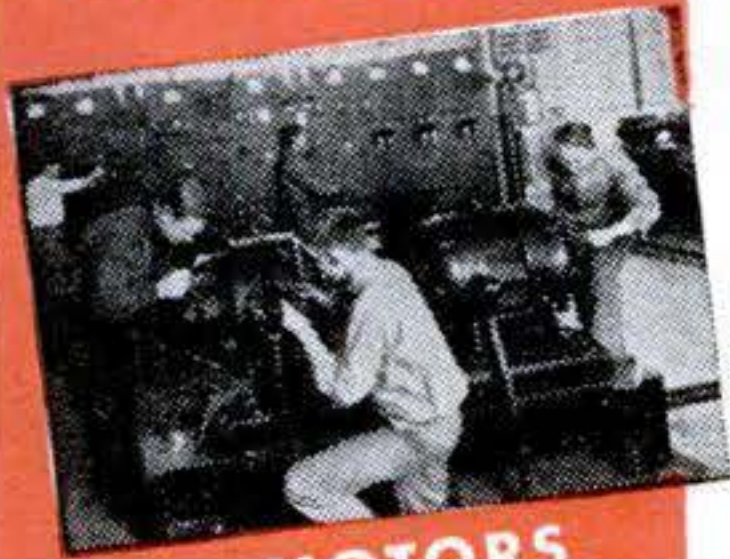

**MOTORS**



**ARMATURES**



**REFRIGERATION**



**LIGHTING**

**COYNE**  
ELECTRICAL AND  
RADIO SCHOOL  
500 S. Paulina St.,  
Dept. 48-73  
Chicago 12, Illinois



**ESTABLISHED 1899**

## **NOT A "HOME-STUDY COURSE"**

For nearly 50 years, the Great Shops of COYNE in Chicago have been training men to step into the better-paying jobs in ELECTRICITY. Here in the World's Greatest Electrical Center YOU can quickly prepare for amazing opportunities.



**B. W. COOKE**

As a Coyne student you work on real equipment — just like you'll use later on the job. We do not teach by mail. You get actual shop work plus necessary theory. Coyne training is practical. You make rapid progress at COYNE because it's a shop course.

## **GET ALL-AROUND TRAINING QUICKLY**

Why be satisfied with a "one-operation" job? At Coyne you learn Motors, Armature Winding, House and Factory Wiring, Appliances, Power Plant Work, Illumination, Electrical Maintenance—plus the fast-growing branch of Industrial Electronics. Whether you're experienced or not, we train you for a good job, then help you get it! Coyne graduates may use our Lifetime Employment Service as often as they wish.

## **INDUSTRIAL ELECTRONICS and REFRIGERATION Included**

Added training in Electric Refrigeration—principles, testing, repairing—is included with this course. Industrial Electronics given as part of our "all-around" Electrical Training.

**VETERANS!** Coyne is authorized to accept veterans for G. I. Training. Coupon brings special G. I. Bulletin.

**NON-VETERANS** who are short of cash can finance most of their tuition and pay it in easy monthly payments after graduation.

## **MAIL COUPON for Big FREE Book**

Find out NOW what Coyne offers in training for your future. Coupon brings big book filled with fascinating pictures of our great shops and our plans to help YOU. Get your copy FREE. No cost or obligation, and no salesman will call. Rush the coupon TODAY.



**B. W. Cooke, President,  
COYNE ELECTRICAL and RADIO SCHOOL,  
Dept. 48-73, 500 S. Paulina St., Chicago 12, Ill.**

Send me your Free Book and tell me about your Student Finance Plan; also details of Training in Industrial Electronics and Electric Refrigeration that is now included.

NAME.....

ADDRESS.....

CITY.....STATE.....

# I will teach you... ELECTRICAL APPLIANCE REPAIRING

**LEARN IN  
YOUR OWN HOME BY  
BUILDING, TESTING, REPAIRING**

• Learn this fascinating, big money-making business. Repair all kinds of electrical appliances. Millions now in daily use will eventually require repair. Thousands of new appliances sold daily in all parts of the country! These unlimited prospects mean you will always have places to do profitable jobs. If you are mechanically inclined (can hold and use tools), you can qualify for this big steady-paying field. It is not at all unusual for appliance repairmen to charge on the basis of \$5.00 to \$6.00 an hour! **WE TEACH YOU EVERYTHING!** What trouble to look for, how to detect it, and how to quickly repair the appliance! Our course is written in simple, easy-to-understand language, is profusely illustrated with photographs and drawings and shows you each and every step! Also shows you how to build the power tools you need. Our **FREE** advisory service is yours for **LIFE!** Should intricate technical problems arise or the need for a special repair part, simply call on us! We teach you how to solicit business and how to keep it coming to you! Not a theory course but a practical, honest-to-goodness course written by and used by repairmen the country over. Price of course is so low the repairs on your own appliances should pay for it many times over.



**S. T. CHRISTENSEN**  
President & Founder

## New Electronic Kit Does All!

**AND BEST OF ALL I'LL SEND IT TO YOU**

• Knowing how valuable Practical Shop Training Experience is, particularly in the Electrical Field, I will send to you the **CHRISTY ELECTRONIC KIT**. It will be sent to you completely unassembled, together with detailed instructions on how to assemble this portable all-purpose, electric trouble finder! Read the partial list of its multiple uses listed below and realize how valuable and helpful such a kit will be to you! Every part is sent to you including the lightweight case, precision meter, jacks, etc., etc., even down to the very last screw! In addition to the practical electrical experience just assembling this kit will provide, we also include complete instructions as to the many, many ways this delicate instrument can be used by you. It took us years of academic training and years of hard work to obtain the knowledge this kit will give you. The combination of our Course and Electronic Kit will go a long way towards **ASSURING YOUR SUCCESS.**

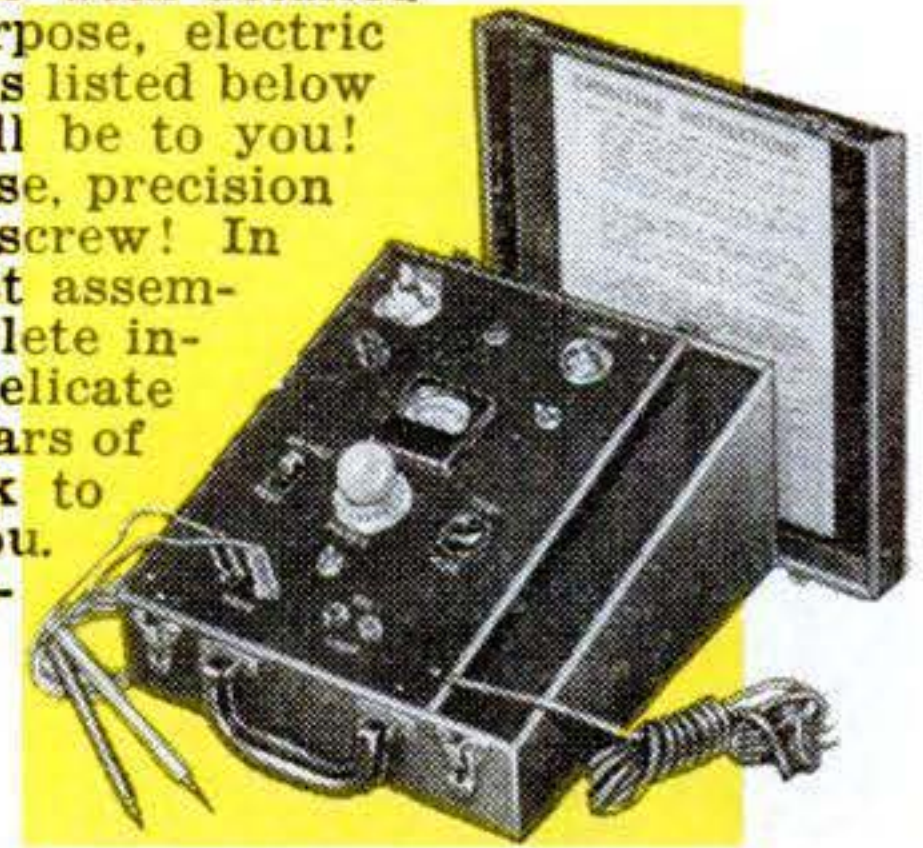

### MODEL 390 TESTS

- Current Consumption
- Heat Controls
- Electrical Circuits
- Motor Windings
- Shorts
- Refrigerators, Radios
- Irons, Fans
- Washing Machines
- Motors
- House Wiring, etc.

**RUSH COUPON NOW!**

**CHRISTY SUPPLY CO.**  
2835 N. Central Ave., Dept. D-6301  
Chicago 34, Illinois  
Please send me free illustrated literature about America's Fastest Growing Industry—ELECTRICAL APPLIANCE REPAIRING.

Name.....

Address.....

City..... State.....

**AUDELS REFRIGERATION & AIR CONDITIONING GUIDE.....\$4**

New from Cover to Cover—1280 Pages, Fully Illus. Covering basic principles, servicing, operation & repair of household, commercial & industrial refrigeration & air conditioning. A gold mine of essential important facts for engineers, servicemen, users.

**AUDELS CARPENTERS & BUILDERS GUIDES—4 Vols. ....\$6**

A practical illustrated trade assistant on modern construction for carpenters, joiners, builders, mechanics and all woodworkers. 4 vols., 1600 pages, 3700 illustrations, flexible covers. Pocket size. Each volume sold separately \$1.50 a vol.

**AUDELS AUTOMOBILE GUIDE.....\$4**

A practical quick ready reference book for auto mechanics, service men, operators & owners. Explains theory, construction & servicing of modern motor cars, trucks, buses & auto type Diesel engines. 1700 pages, fully illustrated. 55 chapters. Indexed. A standard book for mechanics. New fluid drive covered.

**AUDELS DIESEL ENGINE MANUAL..\$2**

A practical, concise treatise with questions and answers on the theory, operation and maintenance of modern diesel engines including General Motors 2 cycle Diesel. 384 pages, fully illus., flexible binding, pocket size. All details plainly brought out, this book is of extreme value to engineers, operators & students.

**AUDELS WIRING DIAGRAMS.....\$1**

210 Pages, Illustrated. Gives practical facts on wiring of electrical apparatus. It shows clearly how to wire apparatus for practically all fields of electricity. Each diagram is complete & self-explanatory. Highly Endorsed Pocket Companion.

**AUDELS PLUMBERS & STEAMFITTERS GUIDES—4 Vols. ....\$6**

A Practical Trade Assistant & Ready Reference. Explains in plain language & by clear illustrations, diagrams, charts, graphs, pictures principles of modern plumbing practice including Marine Pipe Fitting and Air Conditioning. 4 Vols.—1670 Pages—3642 Diagrams. Pocket size. Each Vol. Sold Separately \$1.50 a Vol.

**AUDELS SHEETMETAL WORKERS HANDY BOOK.....\$1**

Practical inside information. Fundamentals of Sheet Metal Work. 388 pages. Illustrated. 11 sections. Clearly written. Essential & important facts, figures, pointers in everyday language. Ref. Index.

**AUDELS SHEETMETAL PATTERN LAYOUTS.....\$4**

Developed by Experts for Sheet Metal Workers, Layout Men & Mechanics. A Practical Encyclopedia in 10 Sections, size 7 x 10 x 2—1125 Pages—350 Layouts—1600 Illustrations. 1001 Key Facts. Fully indexed for ready reference in answering your layout problems. Covers all phases of sheet metal work including Pattern Cutting, Pattern Development & Shop Procedure.

**AUDELS ANSWERS ON BLUE PRINT READING.....\$2**

For Mechanics & Builders. Covers all types of blue print reading including ship & airplane. 416 pages, fully illustrated.

**AUDELS NEW MACHINIST & TOOLMAKERS HANDY BOOK.....\$4**

Covers modern machine shop practice in all its branches. 5 practical books in 1. New from cover to cover. Tells how to set up & operate lathes, screw and milling machines, shapers, drill presses and all other machine tools. 1600 pages, fully illustrated, 5 x 6 1/2 x 2. Indexed. 5 sections. 1—Modern Machine Shop Practice. 2—Blue Print Reading & How to Draw. 3—Calculations & Mathematics for Machinists. 4—Shop Physics. 5—How to Use the Slide Rule. 60 chapters. Easy to read and understand. A shop companion that answers your questions.

**AUDELS MATHEMATICS & CALCULATIONS FOR MECHANICS \$2**

Mathematics for home study or reference. 700 pages, 550 illus. Practical mathematics from beginning. How to figure correctly. Easy, correct methods covering complete review. Illus. & Indexed.

**AUDELS HANDY BOOK OF PRACTICAL ELECTRICITY.....\$4**

For maintenance engineers, electricians & all electrical workers. 1440 Pages, 2600 Illus. Covers important electrical information in handy form—including Marine Wiring, Radio Principles, Welding. Indexed. A Key to a practical understanding of electricity.

**AUDELS RADIOMANS GUIDE.....\$4**

A key to the practical understanding of radio including Frequency Modulation, Television, etc., Aircraft & Marine Radio. For radio engineers, servicemen, amateurs, 914 Pages, 633 Illustrations & Diagrams. Photos. Review Questions & Answers, Reference Index. Authentic, clear, concise.

**AUDELS ELECTRONIC DEVICES.....\$2**

Tells What You Want to Know About Electric Eye. Easily Understood. Covers photo-electric cells & their applications. Amplifiers, illumination, frequencies, voltage, photocell, tubes, Ohm's Law, wiring diagrams, etc.

**AUDELS WELDERS GUIDE.....\$1**

A concise, practical text on operation & maintenance of all welding machines for all mechanics. Over 400 pages, illustrated. Covers all methods of electric and acetylene welding including airplane work.

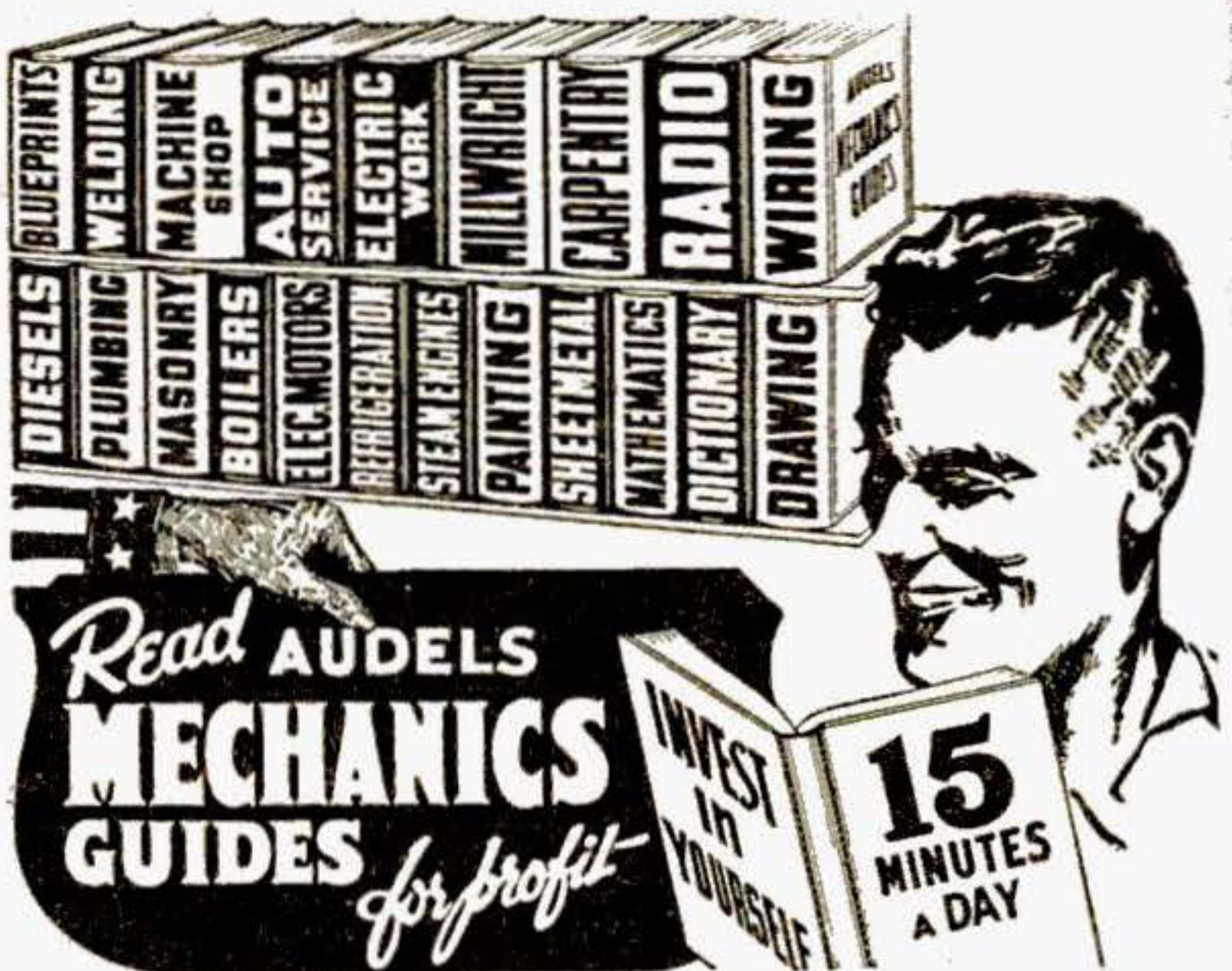

**AN AUDEL GUIDE IS A GOOD FRIEND!**

Step Up Your Own Skill with the Practical Facts and Figures of Your Trade. Save time and money with right methods, short cuts, labor saving ideas. CHECK NOW! You can look over any Audel Guide in your home. Start the Easy Payments if satisfied.

**CUT HERE MAIL ORDER**

THEO. AUDEL & CO., 49 W. 23 St., New York 10, N. Y.

Please mail me for 7 days' free examination the books marked (X) below. I agree to mail \$1 in 7 days on each book or set ordered, and to further mail \$1 a month on each book or set ordered until I have paid purchase price.

If I am not satisfied with Guides I will return them.

- Audels ELECTRIC MOTOR GUIDE . . . . . \$4.
- Audels OIL BURNER GUIDE . . . . . 1.
- Audels REFRIGERATION & Air Conditioning Guide . . . . . 4.
- Audels POWER PLANT ENGINEERS GUIDE . . . . . 4.
- Audels PUMPS, HYDRAULICS & AIR COMPRESSORS . . . . . 4.
- Audels WELDERS GUIDE . . . . . 1.
- Audels BLUE PRINT READING . . . . . 2.
- Audels SHEET METAL WORKERS Handy Book . . . . . 1.
- Audels SHEET METAL PATTERN LAYOUTS . . . . . 4.
- Audels AIRCRAFT WORKER . . . . . 1.
- Audels MATHEMATICS and CALCULATIONS . . . . . 2.
- Audels MACHINISTS & TOOLMAKERS Handy Book . . . . . 4.
- Audels MECHANICAL Dictionary . . . . . 4.
- Audels AUTOMOBILE GUIDE . . . . . 4.
- Audels DIESEL ENGINE MANUAL . . . . . 2.
- Audels MARINE ENGINEERS Handy Book . . . . . 4.
- Audels MECHANICAL DRAWING GUIDE . . . . . 1.
- Rogers MECHANICAL DRAWING and DESIGN . . . . . 2.
- Audels MILLWRIGHTS and Mechanics Guide . . . . . 4.
- Audels CARPENTERS and Builders Guides (4 vols.) . . . . . 6.
- Audels PLUMBERS and Steamfitters Guides (4 vols.) . . . . . 6.
- Audels MASONS and Builders Guides (4 vols.) . . . . . 6.
- Master PAINTER and DECORATOR . . . . . 2.
- Audels GARDENERS & GROWERS GUIDES (4 vols.) . . . . . 6.
- Audels ENGINEERS & FIREMANS EXAMINATIONS . . . . . 1.
- Audels ENGINEERS and Mechanics Guides . . . . . 1.
- Nos. 1, 2, 3, 4, 5, 6, 7 and 8 complete . . . . . 12.
- Audels Answers on Practical ENGINEERING . . . . . 1.
- Audels ELECTRICIANS EXAMINATIONS . . . . . 1.
- Audels WIRING DIAGRAMS . . . . . 1.
- Audels Handy Book of PRACTICAL ELECTRICITY . . . . . 4.
- Audels ELECTRICAL POWER CALCULATIONS . . . . . 2.
- Audels ELECTRONIC DEVICES . . . . . 2.
- Audels ELECTRIC Dictionary . . . . . 2.
- Audels RADIOMANS GUIDE . . . . . 4.
- Audels NEW ELECTRIC LIBRARY at \$1.50 a Volume . . . . .

Name \_\_\_\_\_

Address \_\_\_\_\_

Occupation \_\_\_\_\_

Employed by \_\_\_\_\_ PSM

**AUDEL, Publishers, 49 W. 23 St., N. Y. 10**



**I'll Send You 8 Big Kits of Training Equipment**  
*including*  
**TWO-BAND 6 TUBE SUPER RECEIVER**  
**AND 16 RANGE METER SET-UP**  
*for Testing*

**Learn Fast . . . Earn Fast**  
**HOME TRAINING**  
**Planned For Your Needs**  
*You Build All These*  
**TESTERS . . . and MORE!**



I give you a fine, moving-coil type Meter Instrument on Jewel Bearings—with parts for a complete Analyzer Circuit Continuity Tester. You learn how to check and correct Receiver defects with professional speed and accuracy.

**Practice Does It!**  
 Soldering, wiring, connecting Radio Parts . . . building circuits with your own hands—you can't beat this method of learning. When you construct this Rectifier and Filter Resistor and Condenser Tester, etc., you get a really practical slant on Radio that leads to a money-making future.

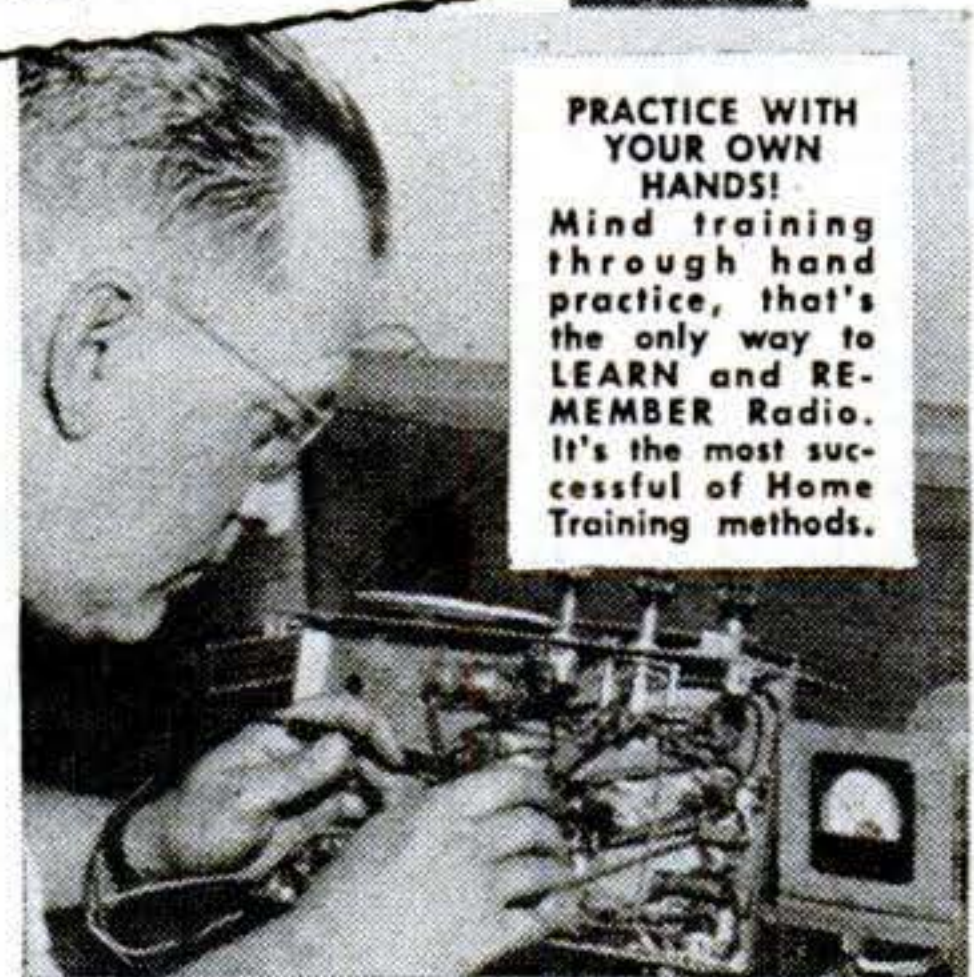
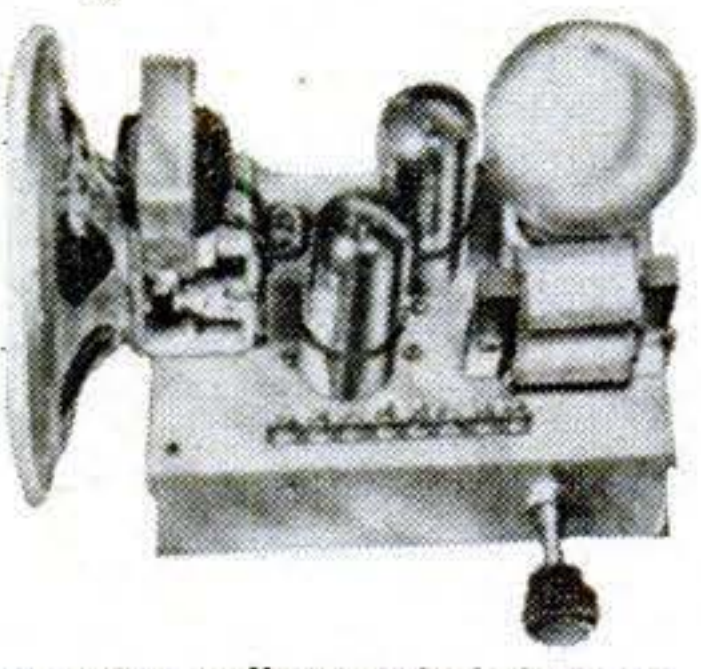

**PRACTICE WITH YOUR OWN HANDS!**  
 Mind training through hand practice, that's the only way to LEARN and REMEMBER Radio. It's the most successful of Home Training methods.

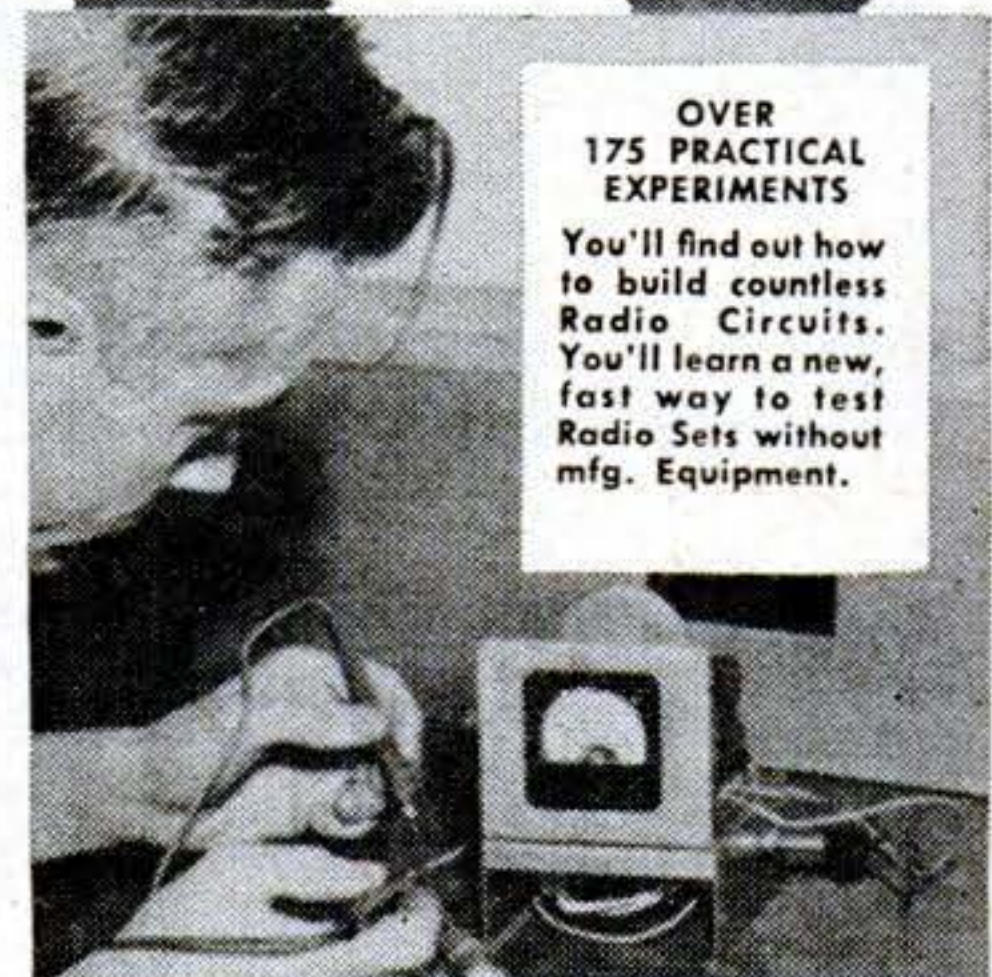

**OVER 175 PRACTICAL EXPERIMENTS**  
 You'll find out how to build countless Radio Circuits. You'll learn a new, fast way to test Radio Sets without mfg. Equipment.

**LOW COST HOME RADIO TRAINING!**  
**Easy Monthly Payments!**

My perfected Radio Training prepares you to start your own Radio Service Shop—or to land a big pay Radio job. With my help you get neighborhood Radio jobs while learning—for extra cash and rich experience. I train you RIGHT by putting you to work with your hands in your own home during spare hours. You get 8 big kits of real professional Radio Parts and Equipment—and use them to build, test and trouble-shoot a powerful 6 tube superhet receiver, a 16 range test meter set-up and over 175 fascinating, instructive Radio experiments. My Training is down-to-earth, really PRACTICAL—it's the Training

you need to make money in Radio. Theory is cut to the bone—you don't need any previous schooling or experience. Sprayberry Training starts you out at the very beginning of Radio—the lessons are completely illustrated, simply written and easy to understand. Get the facts about Sprayberry Training NOW. Find out what it can do for you—prepare for amazing opportunities in Radio Servicing, Television, FM, Radar and Industrial Electronics. Fill out and mail coupon for my two big Books—FREE. No obligation—and no salesman will call. Mail coupon TODAY!

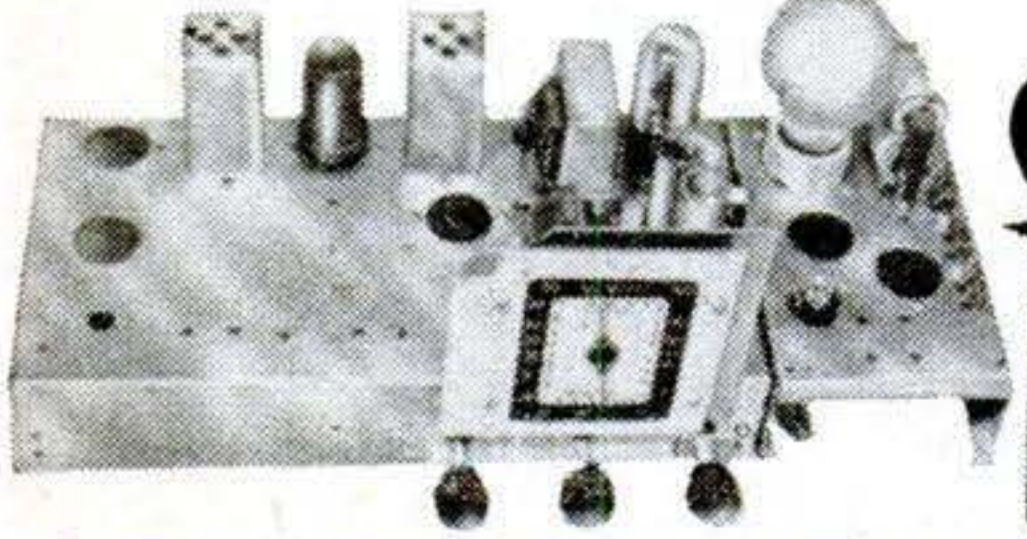

Building this Signal Generator and multi-purpose Tester will give you the kind of valuable experience and practice that is so important as a foundation for making good money in Radio. It makes a breeze out of fixing Radios, and you don't have to spend money on ready-made Equipment.

**VETERANS**  
 Approved for G. I. Training  
 Under Public Laws 16 and 346.

**MAIL COUPON FOR THESE 2 BOOKS!**



"How to Read Radio Diagrams and Symbols" and "How to Make Money in Radio, Electronics and Television." Immense, practical value to you — and they're yours FREE!

**SPRAYBERRY ACADEMY OF RADIO**  
 F. L. Sprayberry, President  
 5548 Sprayberry Bldg., Pueblo, Colo.

Please rush my FREE copies of "How to MAKE MONEY in RADIO, ELECTRONICS and TELEVISION" and "How to READ RADIO DIAGRAMS and SYMBOLS."

Check here if a Veteran.

Name \_\_\_\_\_ Age \_\_\_\_\_

Address \_\_\_\_\_

City \_\_\_\_\_ State \_\_\_\_\_

(Mail in envelope or paste on penny postcard)





# INVENTORS



Learn how to protect your invention. The U. S. Patent Laws provide that any new and useful art, machine, article of manufacture, or composition of matter, or any new and useful improvement thereof, may be patented if the act of invention is involved. Therefore, every inventor with a valuable invention should take advantage of the Patent Laws and proceed for patent protection in order to safeguard his rights.

A patent gives the inventor the exclusive right to prevent others from making, using, or selling the invention claimed in the patent for a period of seventeen years.

The Patent Laws were enacted for the benefit of the inventor to give him protection for the features of his invention which are patentable. These features must be properly and concisely set forth and claimed in a formal application for patent, in order to comply with the requirements of the U. S. Patent Office. For that reason, the Patent Office advises the inventor, unless he is familiar with such matters, to engage a competent registered patent attorney or agent to represent him. We maintain a staff of registered patent attorneys ready to serve you in the handling of your patent matters.

A specially prepared booklet entitled "Patent Guide for the Inventor", containing detailed information with respect to patent protection and procedure, together with a "Record of Invention" form will be promptly forwarded to you without obligation upon request.

**Registered  
Patent  
Attorneys**

**CLARENCE A. O'BRIEN & HARVEY B. JACOBSON**  
Registered Patent Attorneys  
82-D District National Bldg., Washington 5, D. C.

Please send me copy of "Patent Guide for the Inventor" and also "Record of Invention" form. This request does not obligate me.

Name \_\_\_\_\_

Address \_\_\_\_\_

City \_\_\_\_\_ State \_\_\_\_\_

(Please write or print plainly.)

**CLARENCE A. O'BRIEN  
& HARVEY B. JACOBSON**

82-D District National Building + Washington 5, D. C.

# You're running on **OIL** with **PYROIL**

Pyroil in your gasoline and crankcase means your car is running smoothly *on oil*. Metal to metal contact in cylinders causes undue wear—dry cylinder surfaces corrode and rust. *Pyroil gives oil the property of clinging to metal surfaces*. It means ready lubrication the moment you step on your starter. It means a protective coating against rust when your car is not running. To add miles to your car—ask your gas station attendant to add Pyroil.

## PYROIL For Aircraft Engines

Use Aircraft Pyroil B for lubricating oil, Aircraft Pyroil A for gasoline.

**GIVEN!** An attractive PYROIL metal savings bank—takes coins up to 50c pieces—is yours for the asking—sent postage paid.

Manufactured and Guaranteed by Pyroil Company, 307 Main Street, La Crosse, Wisconsin.

Canadian Distributors: Central Purchasing Agencies, Ltd., Toronto, Ontario, Canada

**PYROIL COMPANY**  
307 Main Street,  
La Crosse, Wisconsin

I want my car to last and run properly. Please tell me more about Pyroil and how it can accomplish this for me.

Name.....

Address.....

City or Town..... State.....

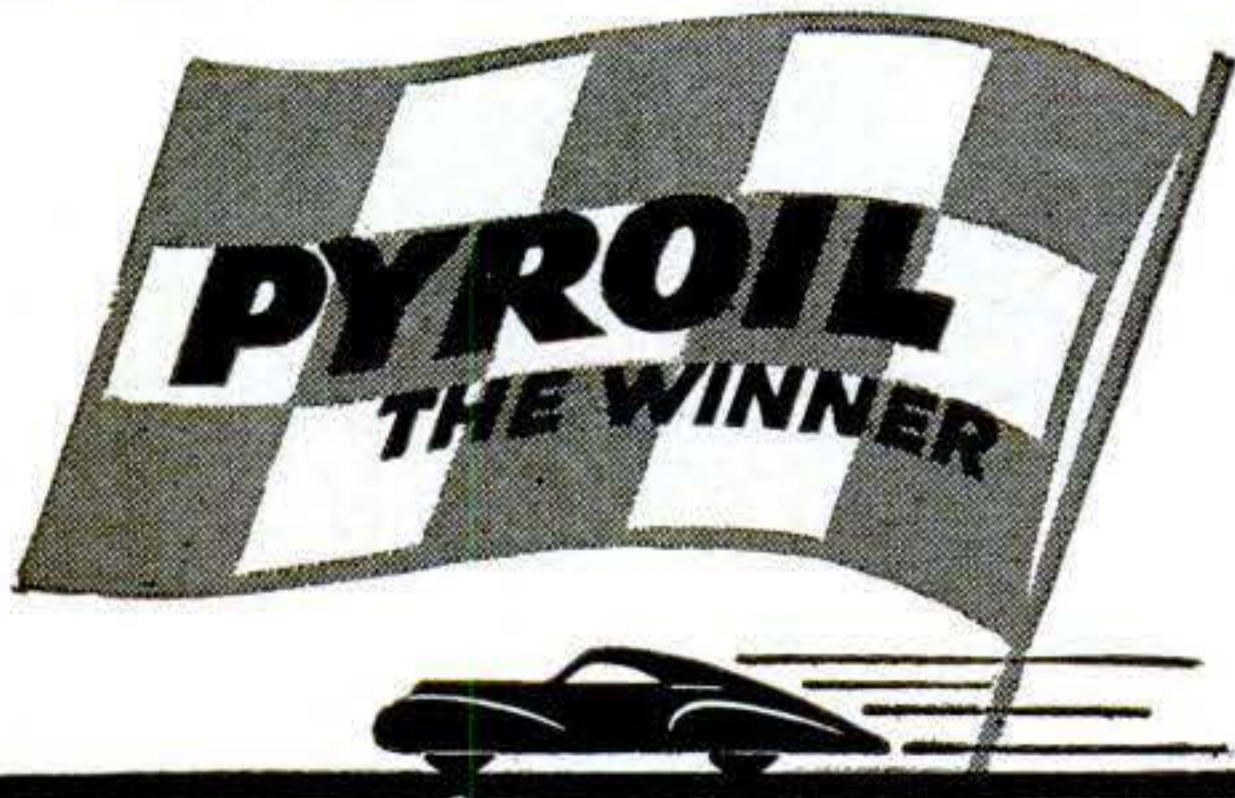

## Letters

### One Mailbox Made the Grade

Sir:

The letter about rural mailboxes on page 20 of the January issue recalls an experience I had some time ago. The New York Central has a crack train running between Cincinnati and Chicago known as the "James Whitcomb Riley."

My friend Mr. Wollums was an engineer on this train and lived on a rural mail route out of Indianapolis. While waiting at the depot one day to see him the "Riley" came in and at a distance the engine looked to me just like a rural mailbox on wheels. It gave me an idea. I went to building a "Riley" mailbox and presented it to Mr. Wollums for a Christmas gift.

As you will note from the photo (below), engine, tank, and right-of-way were made from a conventional rural mailbox, the rear end of the tank being the mailbox door. I constructed a trunnion under the box with two ball-and-socket stops at 180° apart, so that when the engine was turned toward the country road the carrier would have to turn it half way around to insert the mail. This way, the folks could see from a distance whether any mail had been left in the box.

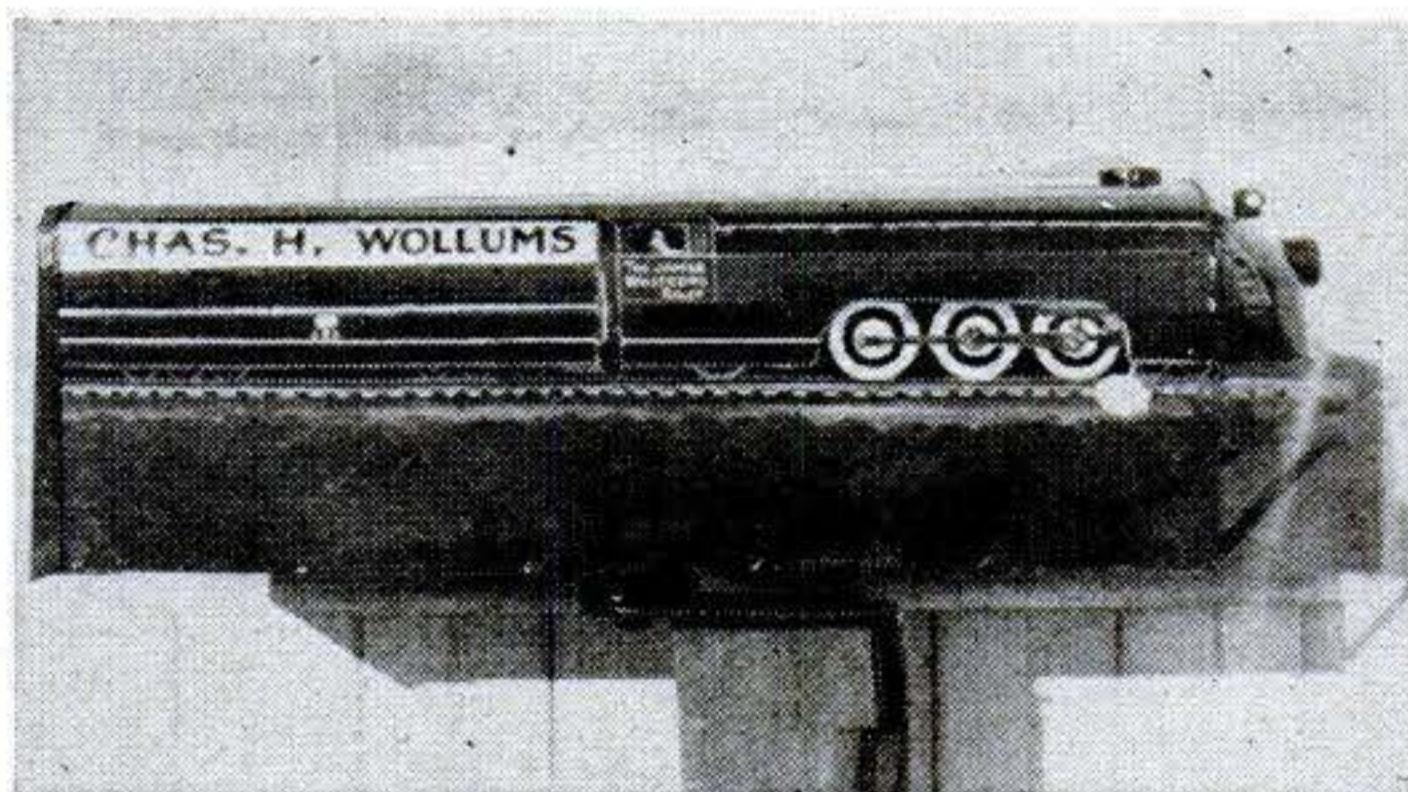

After completing the box, I found out to my sorrow that only white or aluminum boxes were permissible. On account of this box being such a novelty, however, the postal authorities gave my friend permission to put it on the post.

O. C. THOMPSON

West Lafayette, Ind.

*Oddly enough, the Post Office Department now permits the use of paint but is*

# INVENTORS

## Patent Laws Encourage The Development of Inventions

The Rules of Practice of the U. S. Patent Office advise—unless an inventor is familiar with such matters—that he employ a competent registered attorney or registered agent, as the value of patents depends largely upon the skillful preparation of the specifications and claims.

The firm of McMorrow, Berman and Davidson is registered to practice before the U. S. Patent Office. Additionally, it maintains a staff of attorneys able to readily understand inventors' disclosures, to advise concerning patentability, and to prepare appropriate specifications and claims for filing with the Patent Office.

If an inventor believes he has an invention, a search of the most pertinent prior U. S. patents should be made and a report obtained relative to its patentability. Where such report indicates that the invention appears patentable, in order to secure protection, diligence should be exercised in making application for a patent.

## McMORROW, BERMAN & DAVIDSON

*Registered Patent Attorneys*

PATENTS • TRADE MARKS • COPYRIGHTS

142-F VICTOR BUILDING, WASHINGTON 1, D. C.

### McMORROW, BERMAN & DAVIDSON

*Registered Patent Attorneys*

142-F Victor Building, Washington 1, D. C.

Send me further particulars as to patent protection and procedure and "Invention Record" form at once. I understand that this request does not obligate me.

Name \_\_\_\_\_

Address \_\_\_\_\_

City \_\_\_\_\_ State \_\_\_\_\_

(WRITE OR PRINT NAME CLEARLY)

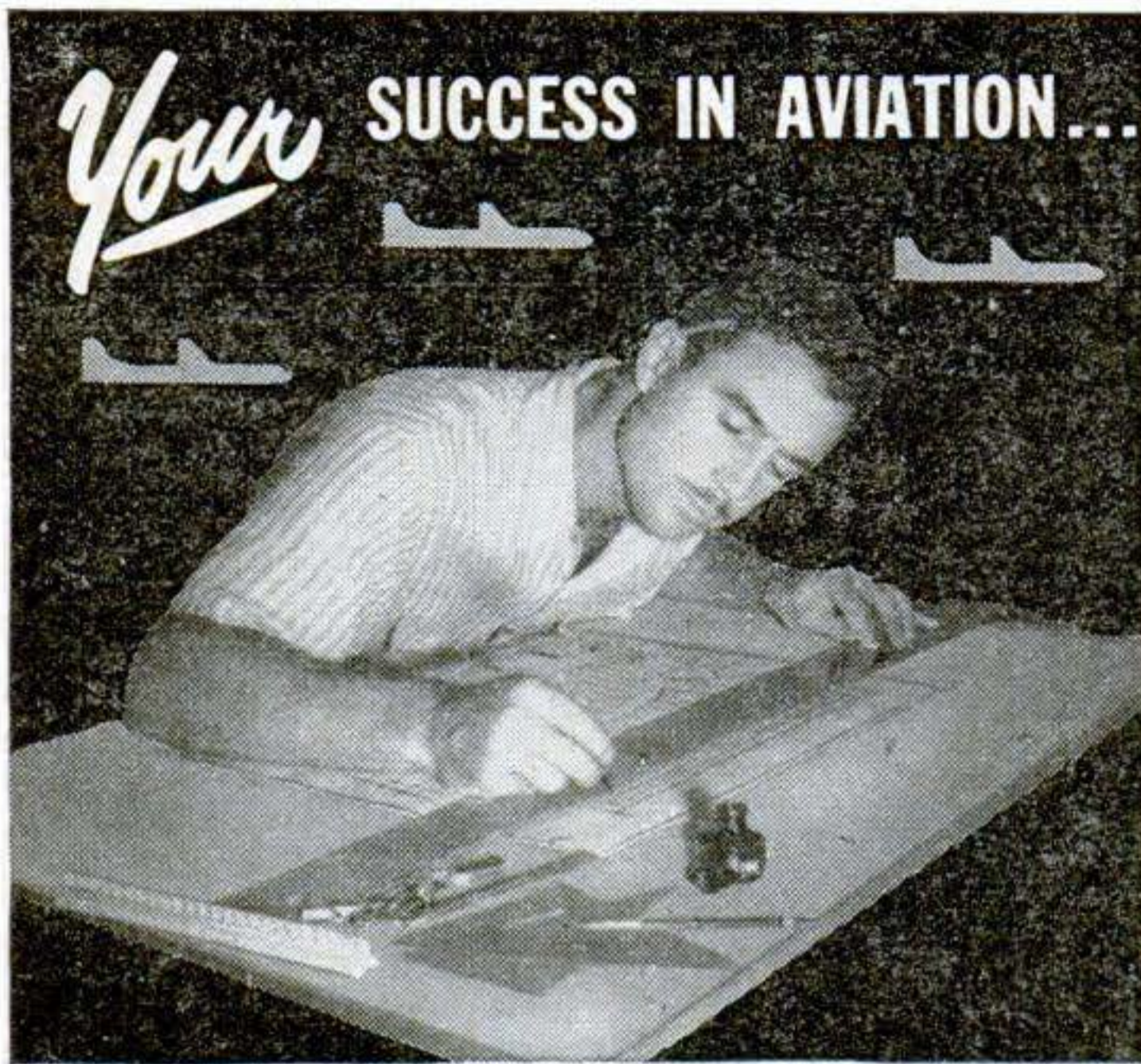

## Embry-Riddle trained **DESIGN ENGINEERS** Rate Best Jobs...Everywhere

Embry-Riddle courses in design engineering lead to your success in aviation as a flight, project or maintenance engineer and to all types of drafting and design. In 26 years Embry-Riddle has trained almost 40,000 civilian and military students... and has always found good jobs for its technical school graduates.

Aviation needs thousands of skilled men. Embry-Riddle's expert staff trains you in fully equipped classrooms and laboratories for all standard ground and flight positions including radio and electronics. Features include daily work on live aircraft.

Excellent dormitories provide bachelor housing at Embry-Riddle. Live, work and play in beautiful Miami, where your training in aviation is complete with 365 flying days a year... and modern airliners fill the sky. Send coupon today for full information at no obligation to you!

### Authorized G. I. Training

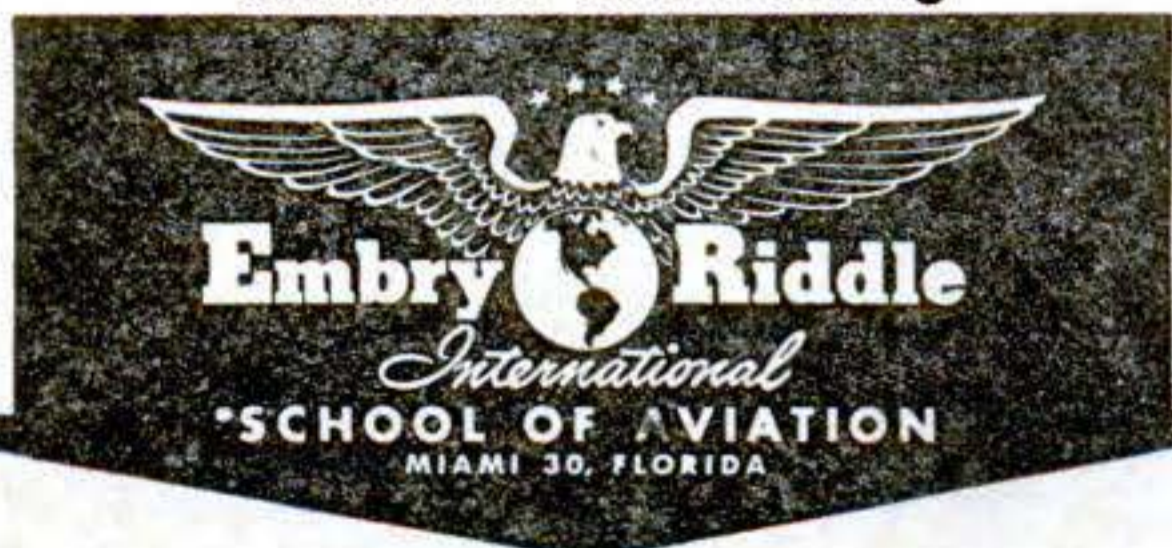

Dean of Enrollments -- Dept. 61  
PLEASE PRINT

Embry Riddle School of Aviation  
Miami 30, Florida

Name \_\_\_\_\_ Age \_\_\_\_\_

Address \_\_\_\_\_

City \_\_\_\_\_ State \_\_\_\_\_

I am  
interested in

- Airplane and Engine Mechanics (A & E)
- Design Engineering & Maintenance
- Aeronautical Drafting & Design
- Flying Mechanic
- Airplane Operation & Maintenance
- Flight Training  Radio and Electronics

Check One  
Veteran   
Non Veteran

**TRAIN IN MIAMI -- AIR CAPITAL OF THE WORLD**

adamant on refusing to permit the use of any boxes other than the two standard sizes and shapes it approves.

### Up-to-Date Science

Sir:

This is my first letter of this nature to congratulate you on first-hand information. I am somewhat of a science reader, and I happened to be glancing through a section of the Sunday paper and there was an article on the lowly fly and his method of producing inertia, or stability, as in the spinning gyroscope. Being interested in such, I knew I had read the same explanation before somewhere. Well, being a hoarder of PS, out come my back issues and lo and behold there in the August 1946 issue was the same story of the fly's inertia secret. The up-to-date science that appears in PS is O.K. with me, so keep up the good scooping.

MICHAEL W. SCOW

Wilkes-Barre, Pa.

### Library for the Layman

Sir:

I enjoy PS so much that there are few suggestions I could make to improve it. Except for politics, economics, etc., it is a very good way to "keep up with the world."

The color photos of the XB-45 and XB-46 were first-rate. The only thing that could make them better is heavier paper. PS is a modern age library for the layman.

FRED C. MASSA

Phila., Pa.

### Not So Dumb

Sir:

After reading the article "Box Reflectors for Flood Lamps Increase Light," I am more than convinced that either the editors are not thorough in investigation of articles submitted to them or that they think their readers are awful dumb.

I have never been able to use more than 3 No. 2 photo flood lamps on a single house circuit that was fused at 20 amperes. The writer of the article suggests using his box reflectors with 6 No. 2 photo flood lamps, which may be all right anywhere but on an ordinary house circuit.

Will you tell Mr. Jack Mellinger that 3 single clamp-on reflectors of the usual \$1.75 variety will give more than ample lighting



ABOVE: TELEVISION offers YOU one of today's thrilling, newer fields with possibilities for a bright and promising future. The above scene shows some of the modern equipment at D.T.I. used in preparing men for TELEVISION.

# • Television

## • RADIO

## • Industrial ELECTRONICS

### Get **FREE** Facts About YOUR Future in These Fields

SEE HOW YOU MAY MAKE REAL MONEY, HAVE A GOOD JOB, OR A BUSINESS OF YOUR OWN . . .

Mail the coupon below and you will receive, absolutely FREE, facts showing how you may get started toward a good job or a business of your own in RADIO or ELECTRONICS. See how readily you may begin to realize your life-long ambition for a REAL FUTURE. See how you may make your start toward a field that also includes such interesting branches as F-M Radio, Broadcast Radio, Aviation Radio, 2-Way Train Radio, Police-Cab-Truck Radio, Sound Recording.

#### NO ADVANCED EDUCATION, NO EXPERIENCE NECESSARY

Our Chicago Laboratory and Home Training have been designed to prepare you and to get you started in Radio and Electronics — whether or not you have a higher education or previous experience. Don't delay . . . mail the coupon below today!



With our HOME TRAINING you receive actual radio parts from which you make 133 experiments and build 7 radio receivers . . . plus loose-leaf lessons with fold-out diagrams . . . plus HOME MOVIES to help you learn easier, faster.

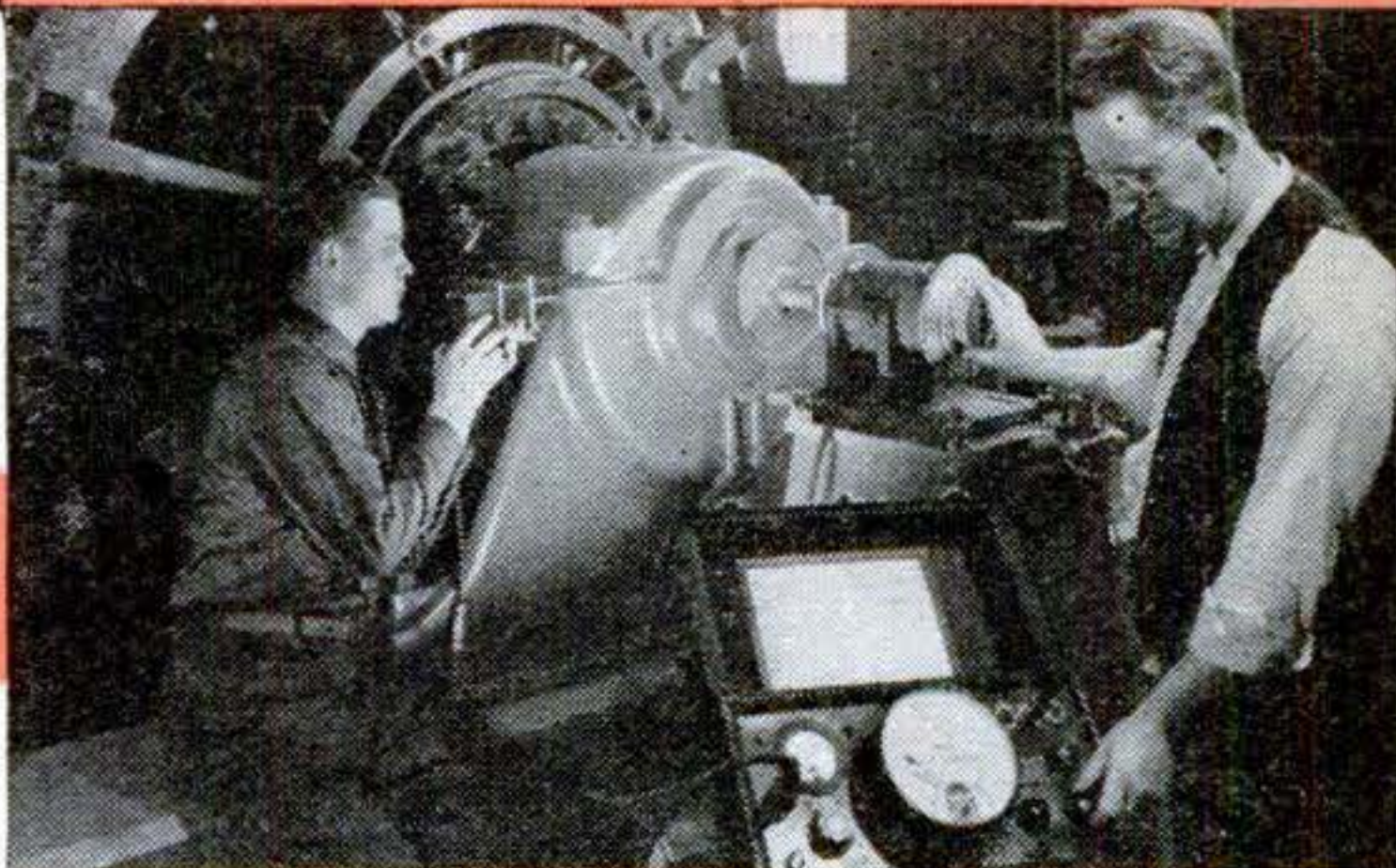

One of today's most promising fields is INDUSTRIAL ELECTRONICS. D.T.I. can prepare you for this field — either at home or in our modern Chicago laboratories. See HOW you may get started toward this fascinating work now. Fill in — mail the coupon below today!

#### 2 TRAINING PLANS — TAKE YOUR CHOICE

1. You may come to our modern, Chicago laboratories, where you train with the aid of capable instructors and some of the finest Radio-Electronic equipment. We will find comfortable living quarters for you
2. Or, if you prefer, you may STUDY AT HOME — using modern, commercial-type radio equipment, well illustrated lessons and HOME MOVIES. You can do this in your SPARE TIME, without interfering with your present job.

#### VALUABLE EMPLOYMENT SERVICE

When you complete either training, our effective Employment Service goes to work for you, to help you get started toward a real future in Radio-Electronics. Don't delay!

#### MAIL THIS OPPORTUNITY COUPON NOW.

■ Mr. E. B. DeVRY, President  
 ■ DeForest's Training, Inc.  
 ■ 2533 N. Ashland Ave., Dept. PS-E4  
 ■ Chicago 14, Illinois

**ACCEPTED FOR G.I. TRAINING**

■ Please show me how I may get started toward a good job or a business of my own in Radio-Electronics.

■ Name \_\_\_\_\_ Age \_\_\_\_\_

■ Address \_\_\_\_\_ Apt. \_\_\_\_\_

■ City \_\_\_\_\_ Zone \_\_\_\_\_ State \_\_\_\_\_

■  If under 16, check here for special information.  If a discharged Veteran of World War II, check here.

**DeForest's Training, Inc.**  
 CHICAGO, ILLINOIS

Associated with the DeVry Corporation  
 Builders of Electronic & Movie Equipment

# IDEAS KNOWLEDGE SKILL

are top money-makers for any man

**YOU** can buy these top-value assets in these books

**1. Plastic Craft.** *By DeWick & Cooper.* Scores of original ideas and designs for making useful, saleable things out of plastics, with complete, detailed, illustrated directions. All necessary information about tools and materials. No expensive equipment needed. \$5

**2. Making Patent Drawings.** *By Radzinsky.* If you know drafting this book will help you make big extra money. Patent draftsmen are always in demand, and this book teaches you every detail of the special techniques required by the U. S. Pat. Off. Much expert advice from an experienced patent lawyer. \$3

*Introduction to*  
**3. Practical Radio.** *By Tucker.* Very clear, thorough instruction in all fundamentals needed for any kind of radio work. Hundreds of problems show just how principles are used in the construction of radio apparatus. All necessary math explained at the points where it is used. \$3

**4. Machine Shop Operations.** *By King.* Shows how each major machine tool and its attachments work, with complete clearly illustrated directions and all technical data needed to perform each operation skillfully. All calculations explained. Ready now: Lathe Operations; Milling Machine Operations, \$1.75 each; Shaper Operations, \$1. Bench, Grinder Operations preparing.

**5. Aircraft Drafting.** *By Katz.* Easy to learn. 1000 large clear drawings show you just how it is done. No previous knowledge of drafting needed. Teaches aircraft drafting as it is done in the big plants today and includes a wealth of valuable information on production and engineering procedures; design data, etc. \$5

*Introduction to*  
**6. Electronics.** *By Hudson.* If you want a clear understanding of the science and potentialities of electronics, get this book. A masterly explanation in non-technical language of the theories, construction of basic devices and their innumerable uses. \$3.30

**7. The Blueprint Language.** *By Spencer & Grant.* Called by leading teachers and industrialists the best book on this subject. Teaches you to read blueprints in the clearest, most thorough, most practical way. All illustrations reproduced from actual drawings and blueprints from files of over 100 leading industrial concerns. \$5

*Pick the ones most profitable to you and*  
**SEE THEM WITHOUT COST**

The Macmillan Company, 60 Fifth Ave., New York 11  
Send me the books checked by number below  
ON APPROVAL, with the privilege of returning  
them at the end of ten days free of charge. If I  
decide to keep them I will pay the price quoted  
above plus a few cents postage. (Postage prepaid  
on cash orders.)

1. 2. 3. 4. 5. 6. 7.

Signed.....

Address.....

City.....Zone No.....State.....

for any sort of a photograph that even a box camera can take with medium-type film.

JOHN F. SLAVINSKY

Rochelle Park, N. J.

No reader familiar with flood lamps is likely to connect six to a single outlet, and the article did not suggest that this be done. Since the No. 2 lamp draws 4.4 amperes, three will take 13.2 amp., well within the capacity of the 15-amp. house fuse. (If Mr. Slavinsky uses 20 amp. fuses, he is over-fusing.) The two three-lamp units should be plugged into separate house circuits. As for finding three lamps "more than ample," PS wonders if reader Slavinsky has ever tried taking color pictures with such a setup.

## From Worksheet to Wagon

Sir:

Here's a picture [below] of my son with the wagon I have built from the plans in your magazine ["Bantam-Size Farm Wagon," July '47 p. 158]. The wagon's underpart is made from white oak and brass. The wheels are made from mahogany, teak, and birch, with steel rims and brass bushings. The woodwork is varnished and striped with light blue paint.

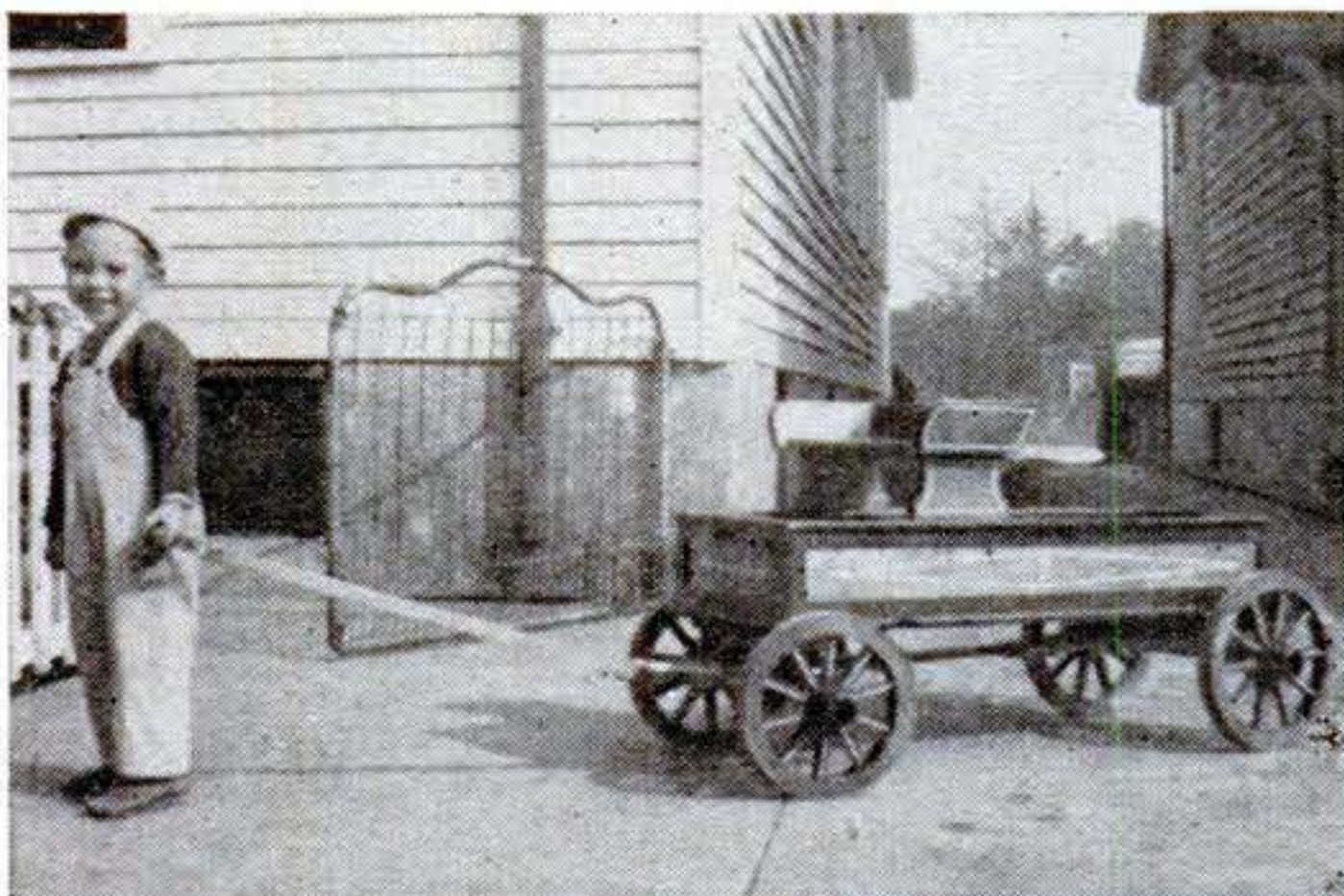

The wagon sure makes a hit with the kids. I am now working on an electric jeep, aluminum-covered, with brake and clutch.

JOSEPH JOHNSEN

South Ozone Park, N. Y.

## PS Gets Around

Sir:

... I think more of PS than any magazine I could get over here because it explains and gives details of metal-work, wood-work, toys, etc., so any chap with a little knowl-

# PATENT PROTECTION *for* INVENTORS

## A PATENT IS A VALUABLE RIGHT

On the basis of a constitutional provision Congress has established a system under which inventors may secure the exclusive right to prevent the unauthorized use, manufacture and sale of their inventions for periods of seventeen years. The inventor secures this protection by obtaining a patent from the United States Patent Office.

THE United States Patent Office recommends in its Rules of Practice that "an applicant is advised, unless familiar with such matters to employ a competent registered patent attorney or registered patent agent, as the value of patents depends largely upon the skillful preparation of the specifications and claims."

WE recommend that you authorize us to conduct a search through the U. S. Patents pertinent to your invention and submit a report setting forth our opinion regarding its patentability.

*Victor J. Evans & Co.* has a staff of experienced registered patent attorneys, available to represent inventors in the preparation and prosecution of their cases before the Patent Office. Detailed information and the steps to be taken in obtaining patent protection will be furnished upon request.

FORM BELOW FOR MAILING CONVENIENCE

VICTOR J.  
**EVANS & CO.**

*Merlin M. Evans*

REGISTERED PATENT ATTORNEY

340-D Merlin Building, Washington 6, D. C.

Please forward to me detailed information regarding procedure to obtain Patent Protection, together with your convenient "Evidence of Invention" form.

Name.....

Address.....

City and State.....

PATENTS . . . . TRADEMARKS . . . . COPYRIGHTS

# Aviation Training Opportunities Open at Northrop School

FOR a limited number of properly qualified men there are openings in the next starting classes of the Aeronautical Institute division of Northrop Aircraft, Inc., according to an announcement by the Institute director. Aeronautical Engineering and Aircraft Mechanics courses are given in the Northrop training program.

The technical institute conducted by this famous builder of the spectacular Flying Wings and war-renowned Black Widow is located in the midst of Northrop's busy center of aircraft manufacturing and aeronautical research and development. The students were among the first to see the great 8-jet Flying Wing and viewed its first take-off - from the Northrop Field runway at the Institute's "back door."

## Engineering and Mechanics Training

Over 1000 students from every state and many foreign countries are being trained by Northrop. Many are former servicemen, all courses being approved for veterans. The courses are open to non-veterans, also. A 2-year Aeronautical Engineering course and a 1-year Aircraft and Engine Mechanics course are given, also a Pre-Engineering "refresher" and "prep" course.

The Northrop school is one of the few technical institutes offering an Aeronautical Engineering curriculum approved by the Engineers' Council for Professional Development. The Mechanics course is approved by the Civil Aeronautics Administration.

Besides being employed in Northrop's own plants, Northrop graduates hold important positions with leading aircraft and airline companies throughout the world.

Information on qualifications for enrollment, and on opportunities with Northrop training, may be obtained from the Registrar, Northrop Aeronautical Institute, 1525 East Broadway, Hawthorne, Los Angeles County, Calif.

*This coupon may be used for convenience in inquiring.*

NORTHROP AERONAUTICAL INSTITUTE,  
1525 E. Broadway, Hawthorne, Los Angeles County, Calif.

Please send me the Institute catalog and complete information, including starting dates of classes. I am interested in

Aeronautical Engineering

Aircraft and Aircraft Engine Mechanics (A&E)

Name \_\_\_\_\_

Address \_\_\_\_\_

Age \_\_\_\_\_

City \_\_\_\_\_

Zone \_\_\_\_\_

State \_\_\_\_\_

Check one:  Veteran     In Service     Civilian

Advertisement

edge of what he is doing can carry on and do the job satisfactorily. I have made quite a number of household cabinets and gadgets out of PS, which I could never have made from one of our magazines. . . .

R. M. HILLOCKS

Dundee, Angus, Scotland.

## Switch the Switches

Sir:

Your article "Switches Act as Door Lock" in your January '48 issue, page 219, describes a method of connecting 12 SPDT switches in series to act as a combination door lock. But with the type of switches shown, the caps could be easily removed, and the binding-screws could be connected by a temporary jumper wire, causing the device to open the door. . . .

ROBERT HEILMAN

Clinton, N. J.

*Radio toggle switches, whose terminals would be inaccessible from the front, would be better, but the switches shown can be fairly foolproofed by simply running dummy wires to the dead terminals. Also, the external leads, shown connected to the first and last switches for clarity, should be wired up in some less obvious combination.*

## Doppler Was No Dope

Sir:

In your article "Rocket's Flight Kept in Sight," page 130 of the January issue, you make the statement: "This same thing (change in frequency caused by movement of the transmitter) happens to all kinds of waves—light and sound as well as radio."

I have always been under the impression that light waves were not influenced by movement of either the transmitter or the receiver; in other words, that light waves have no Doppler effect. . . .

M. M. McLEOD

New York, N. Y.

*The speed of light does remain constant, but the Doppler effect is caused by a change, not in the velocity of the waves, but in their frequency, or number of vibrations per second. Some stars, for example, are moving away so fast that the resulting change in the frequency of their light makes them appear red. The amount of this "red shift" tells astronomers their speed.*





You receive all parts, including tubes, for building this fine, modern Superheterodyne Receiver. This and other valuable standard equipment becomes your property.

# Learn RADIO TELEVISION, ELECTRONICS *by* SHOP METHOD HOME TRAINING

Let NATIONAL SCHOOLS, of Los Angeles, a practical Technical Resident Trade School for over 40 years, train you for today's unlimited opportunities in Radio

*these two FREE books will tell you how*

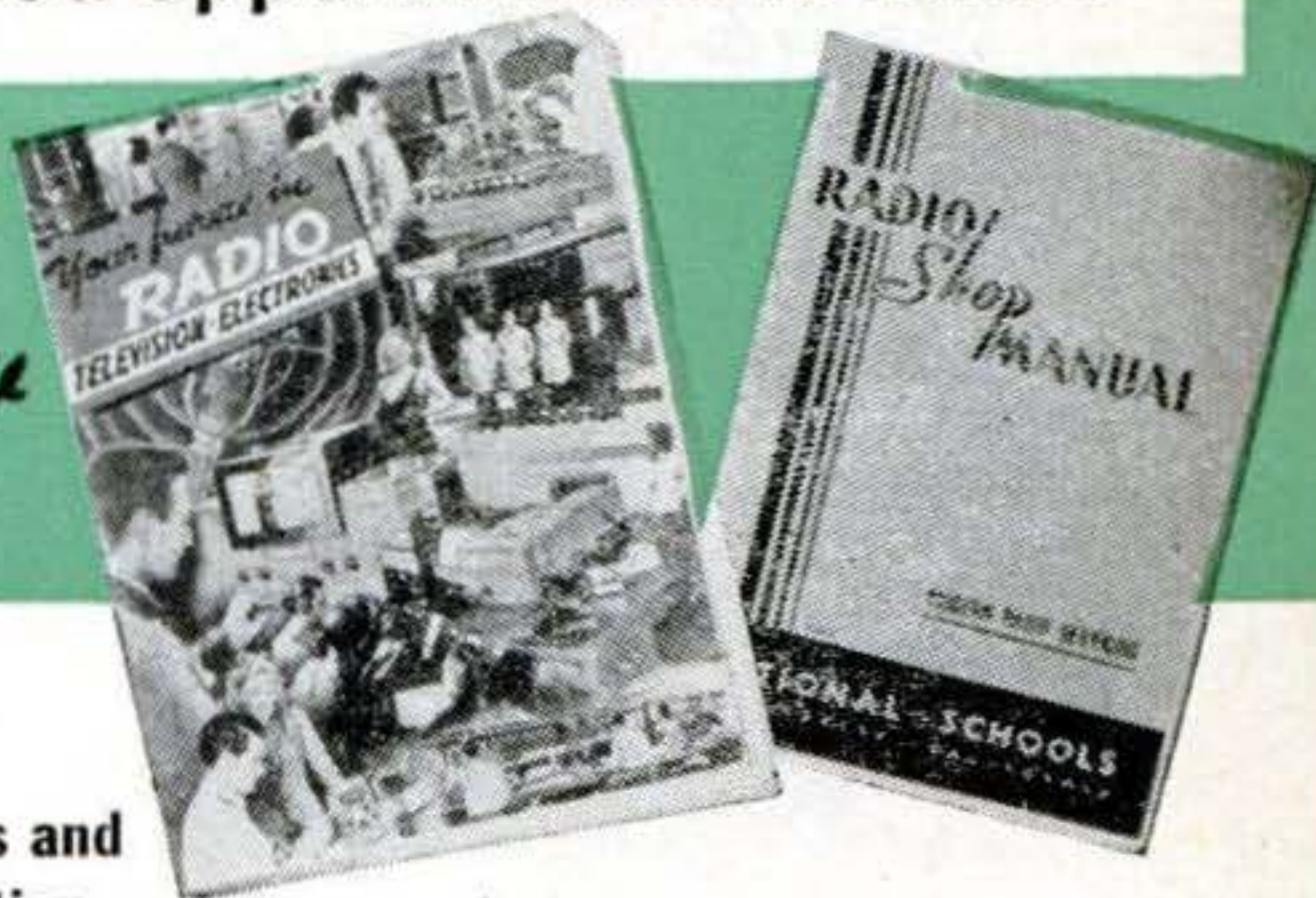

## GOOD JOBS AWAIT THE TRAINED RADIO TECHNICIAN

You are needed in the great, modern Radio, Television and Electronics industry! Trained Radio technicians are in constant and growing demand at excellent pay—in Broadcasting, Communications, Television, Radar, Research Laboratories, Home Radio Service, etc. National Schools Master Shop Method Home Study Course, with newly added lessons and equipment, can train you in your spare time, right in your own home, for these exciting opportunities. Our method has been proved by the remarkable success of National Schools-trained men all over the world.

### You Learn by Building Equipment with Standard Radio Parts We Send You

Your National Schools Course includes not only basic theory, but practical training as well—you learn by doing. We send you complete standard equipment of professional quality for building various experimental and test units. You advance step by step until you are able to build the modern superheterodyne receiver shown above, which is yours to keep and enjoy.

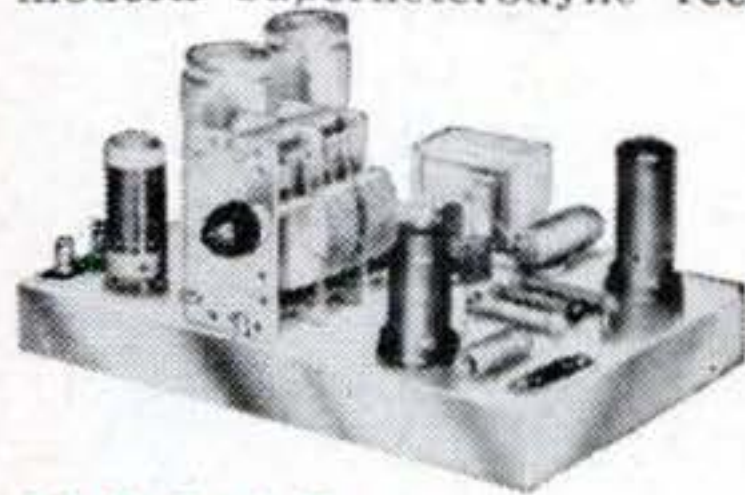

You perform more than 100 experiments—build many types of circuits, signal generator, low power radio transmitter, audio oscillator, and other units. The Free Books shown above tell you more about it—send for them today!

## NOW! NEW PROFESSIONAL MULTITESTER INCLUDED



This versatile testing instrument is portable and complete with test leads and batteries. Simple to operate, accurate and dependable. You will be able to quickly locate trouble and adjust the most delicate circuits. You can use the Multitester at home or on service calls. It is designed to measure AC and DC volts, current, resistance and decibels. You will be proud to own and use this valuable professional instrument.

### Lessons and Instruction

#### Material Are Up-to-date, Practical, Interesting

National Schools Master Shop Method Home Training gives you basic and advanced instruction in all phases of Radio, Television and Electronics. Each lesson is made easy to understand by numerous illustrations and diagrams. All instruction material has been developed and tested in our own shops and laboratories, under the supervision of our own engineers and instructors. A free sample lesson is yours upon request—use the coupon below.

Here's Just a Few of the Interesting Facts you Learn with the

#### FREE MANUAL

1. Routine for diagnosing Radio Troubles.
2. Preliminary inspection of Receivers.
3. How to Test and Measure Voltages.
4. How to Test Speaker in Audio Stages.
5. How to Trace the Circuit and Prepare Skeleton Diagram.
6. Complete Reference Table for Quickly Locating Receiver Troubles.



## VETERANS

If you are a veteran, qualified for training under the G.I. Bill, check the coupon for a Special Bulletin.

G. I. APPROVED

## NATIONAL SCHOOLS

LOS ANGELES 37, CALIFORNIA EST. 1905



### MAIL OPPORTUNITY COUPON FOR QUICK ACTION

National Schools, Dept. PS-4  
4000 South Figueroa Street  
Los Angeles 37, California

(Mail in envelope or paste on penny postcard.)

Mail me FREE the books mentioned in your ad including a sample lesson of your course. I understand no salesman will call on me.

NAME.....AGE.....

ADDRESS.....

CITY.....ZONE.....STATE.....

Check here if veteran of World War II

GET THE DETAILS—SEND THE COUPON

Copyrighted material

# LEARN WATCH REPAIRING

# 4 CAREER FIELDS

Here is a career field which offers opportunity at every "tick" of a watch or a clock. Millions of watches and clocks need fixing—millions more will continue to need repairs. Here is an interesting, top-bracket opportunity to start an independent business of your own, or work for good pay in a factory, repair shop or store. AMERICAN SCHOOL OF WATCHMAKING has trained many men who are now making good. At A. S. W. you get proven, practical training under QUALIFIED, patient instructors who delight in the success of their students and graduates. MAIL THE COUPON BELOW for illustrated booklet. It is FREE—and will give you a fine picture of our complete facilities.



### STUDY IN LOS ANGELES, CALIFORNIA

Enroll at American School of Watchmaking and study in Southern California, the glamor spot of the country. Beach and mountains, Catalina and Hollywood, the Hollywood Bowl and the Rose Bowl—yes, indeed, here is much to interest the student in off hours and over weekends. DECIDE NOW to investigate the field of Watchmaking for your future.

### APPROVED FOR VETERANS

American School of Watchmaking  
Dept. PS 4-4-8, 5145 W. San Fernando Rd.  
Los Angeles 26, Calif.  
Gentlemen: Please send me free booklet and information on your training.

Name (Print) .....

Street .....

City .....

Veteran .....



## TECHNICAL

## TRAINING

# LEARN TO BE — — — — AN AIRCRAFT

## INSTRUMENT TECHNICIAN

Do you like Aviation? Do you like airplanes? Do you like to take things apart and see what makes them tick? THEN YOU WILL LIKE AIRCRAFT INSTRUMENTS. Here is a vital part of the great aviation industry—and necessary part. As long as planes fly there must be trained men to service, repair, and maintain the instruments that make flight possible. AMERICAN SCHOOLS OF AIRCRAFT INSTRUMENTS teaches men to perform this important, interesting and well-paid work.

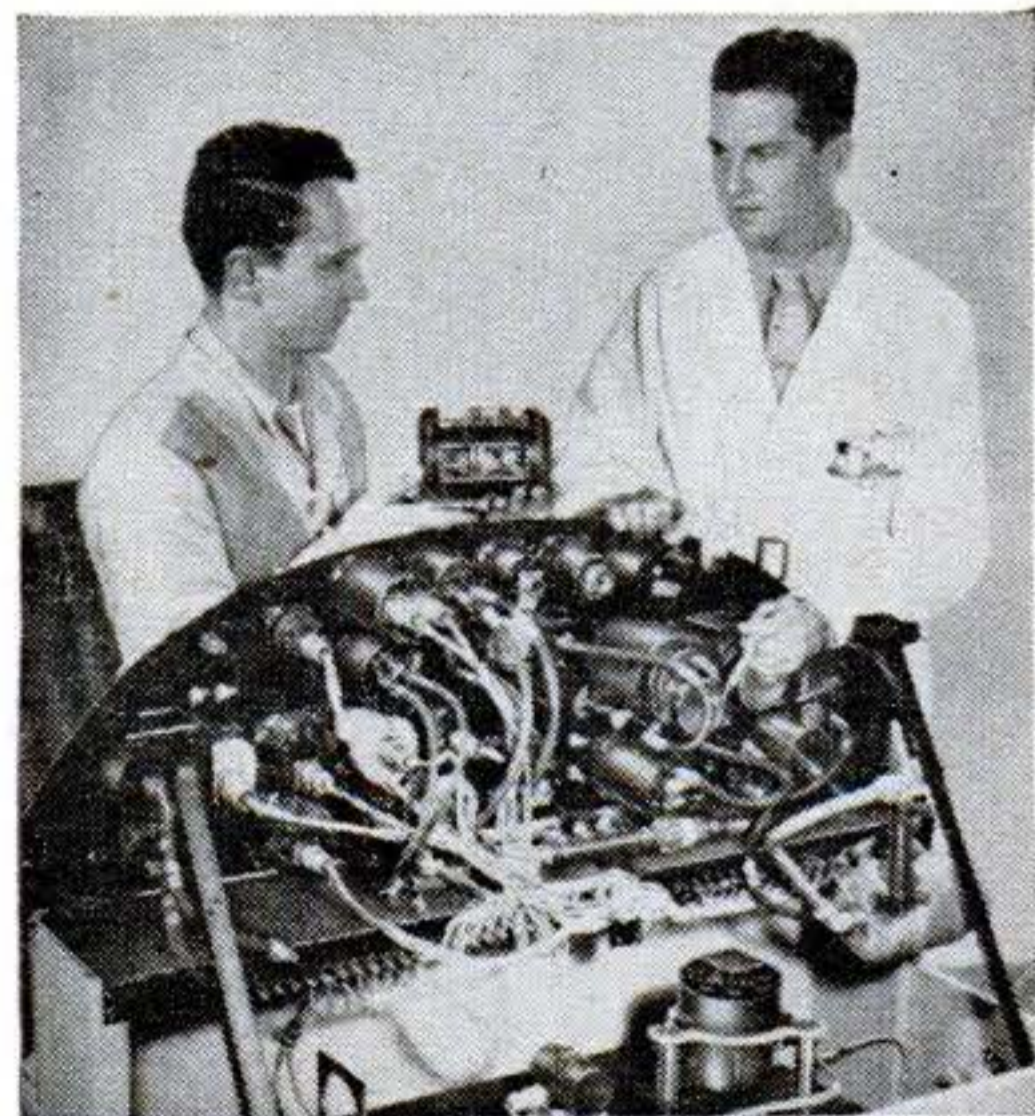

**DO YOU WANT A SPECIALIZED CAREER IN AVIATION?**  
Then be an Aircraft Instrument Technician and get your training NOW. 34 Weeks intensive course. Hundreds of A.S.A.I. graduates employed in the industry or have own business. Mail coupon below TODAY for free booklet and complete information.

### APPROVED FOR VETERANS

American Schools of Aircraft Instruments  
Dept. PS 4-4-8, 5145 W. San Fernando Rd.  
Los Angeles 26, Calif.  
Gentlemen: Please send me FREE and WITHOUT OBLIGATION, illustrated booklet describing Aircraft Instrument field.

Name (Print) .....

Street .....

City .....

Veteran .....

### INSTRUMENT TRAINING VALUABLE

A sound training in Aircraft Instruments is also applicable to many industrial fields. Many large, important industries use delicate instruments at some point in their operation—and trained instrument men are needed to install, service and maintain them. Here, then is further opportunity for you as an Expert Instrument Technician.

# ... CHOOSE YOURS

# LEARN PLASTICS

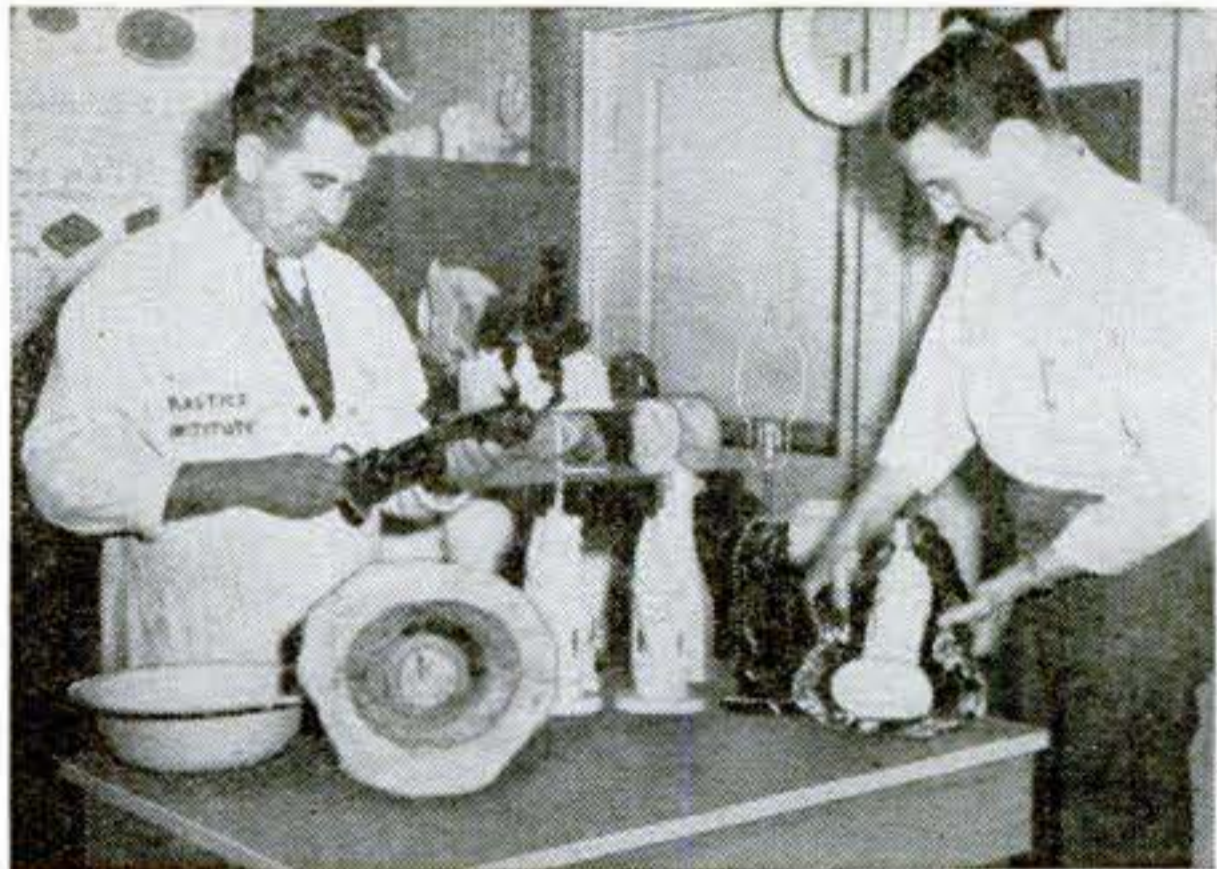

### LEARN BY DOING

You get practical experience making useful, attractive articles from plastic materials which we supply. Many students have earned extra money selling articles of their own manufacture.

Consider the growing, important field of Plastics for your future. Many have compared the Plastics Industry with the Radio and the Automobile industries before their great and rapid growth. Today such a comparison seems warranted because more products are being manufactured from various types of plastic materials than ever before—requiring **TRAINED MEN** to develop, design, and fabricate them. Mail the coupon below for complete information and free literature which show, in actual photographs, the many uses of plastics and what trained men must know to get the better paying positions in this field. This literature tells you about Plastics Institute, the oldest and largest exclusively plastics training school in the United States. Read what graduates say about Plastics Institute training and the progress they have made since graduating.

### LEARN BY MAIL OR COME TO CALIFORNIA (IMMEDIATE ENROLLMENT)

You can study at home, in your spare time, without interfering with your present employment—or, if you prefer, you can attend Plastics Institute's large, modern school in Los Angeles, the city that "has everything." Please check the coupon to indicate your choice and **MAIL TODAY**.

### APPROVED FOR VETERANS

Plastics Industries Technical Institute  
Dept. PS 4-4-8, 1601 S. Western Ave., Los Angeles 6, Calif.  
Gentlemen: Please send me free literature and information on your practical courses. I am interested in Home Training  attending school in Los Angeles .

Name (Print).....  
Street..... Age.....  
City..... Zone..... State.....  
I am a Veteran..... Non-Veteran.....

## FOR



## SUCCESS

# LEARN TO BE A — — — DIESEL SPECIALIST

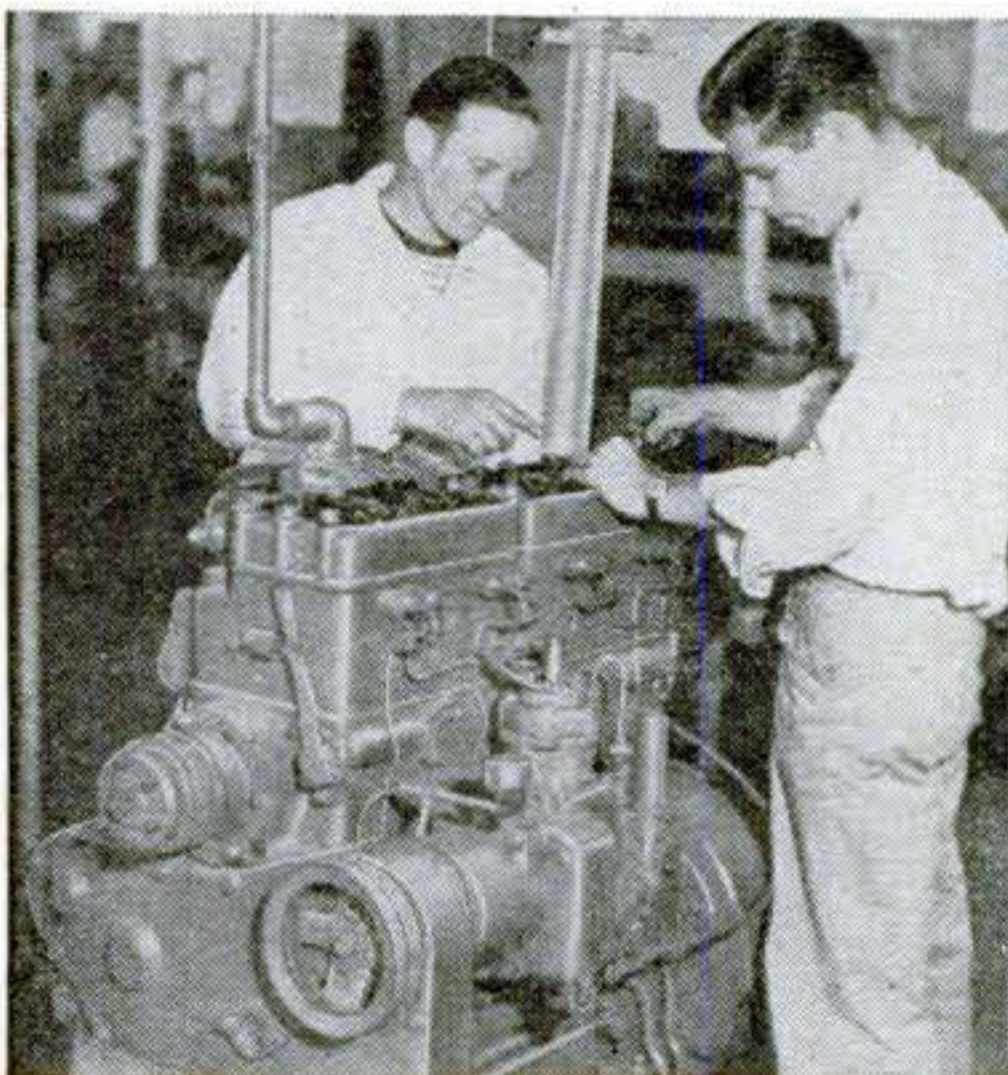

### YOU CAN LEARN DIESEL AT HOME

Study in your spare time, without interfering with your present activity—or attend one of the resident training schools listed below:

**NEW YORK**      **LOS ANGELES**      **MEMPHIS**  
31-28 Queens Blvd.    1601 S. Western Ave.    311 S. Main St.  
Long Island 1, N. Y.    Los Angeles 6, Calif.    Memphis 3, Tenn.

Practical shop training on a wide range of Diesel engines available at all three schools. Check coupon if interested in this type training.

YOU can "go places" in Diesel because Diesel Power is being used more widely than ever before. From tiny Diesel engines in model planes to giant Diesels in locomotives, power generating plants, ships, trucks, drilling rigs, logging machinery and mines, construction machinery and farm equipment—it's Diesel **DIESEL, DIESEL!** **PREPARE YOURSELF NOW FOR THIS GREAT SWING TO DIESEL.**

### LEARN DIESEL THE FAMOUS HEMPHILL WAY

Hemphill is the oldest training school in the world specializing in Diesel. Graduates are successfully engaged in all branches of the Diesel Industry—manufacture, installation, maintenance and operation. Why not take your place beside these Hemphill-trained men.

### APPROVED FOR VETERANS

Hemphill Diesel and Automotive Schools  
Administrative Office: 1601 South Western Ave.  
Dept. PS 4-4-8, Los Angeles 6, California  
Gentlemen: Please send me **FREE BOOKLET** and information on your Diesel Courses. I am interested in Home Study  Resident School  at New York  Memphis  Los Angeles  (Check school desired)

Name..... Age.....  
Street..... Zone.....  
City..... State.....  
Veteran..... Non-Veteran.....

EQUIPMENT SOLD AS USED UNLESS OTHERWISE SPECIFIED!



FOR THE BEST WAR SURPLUS BARGAINS — LOOK TO AMERICAN SURPLUS!

**Brand New  
SCR-625 MINE DETECTOR**

If you are looking for metal buried in logs, pipes in the ground, ore bearing rocks, underground cables, metallic fragments in scrap materials, metallic money buried or hidden in undetermined places this Mine Detector will probably surpass anything that was ever built. The United States Forestry Service has recommended procedure for using this detector to find concealed metal and tree logs and other timber products. They originally were sold by War Assets to jobbers for \$166.00. Unit consists of a balanced inductance bridge, a two tube amplifier and a 1000 cycle oscillator. The presence of metal disturbs the bridge balance resulting in a volume change of the 1000 cycle tone. Tubes used are low battery drain types such as 1G6 and 1M5. The circuit may be modified for control of warning signals, stopping of machinery, etc., when metal is detected. Operates from two flashlight batteries and 103 v (B). However a power supply operating for 100 v may be used. This unit is brand new and comes complete with spare tubes, spare resonator and instruction manual—in wooden chest 8 1/4 inches x 28 1/4 inches x 16 inches. Weight in operation is 15 pounds. Packed in original overseas container.

**\$79.50 Shipping Weight, 125 pounds.**

Note: Batteries not furnished—we can supply for \$4.50 extra



**New  
WILLARD  
Rechargeable  
STORAGE  
BATTERIES**

New 6 volt battery in spill-proof clear plastic case, housed in metal case, foreasy-mounting. Applicable for a wide range of uses where battery power is needed. Shipped dry. Uses standard battery electrolyte available everywhere.

Price, ea. ....\$4.00  
Lots of Ten .....\$3.35  
Without Metal Cases, ea.....\$3.00  
Lots of Ten .....\$2.85

**AMERICAN SURPLUS  
BARGAIN LIST**

- New Navy Hospital Tents. New, fire-resistant heavy canvas, 16' wide, 50' long, 12' apex, 4' side walls—complete except poles. Specially priced—**\$150.00**
  - Landing Lights (Aircraft), 24-V., 600 watts, retractable. Only—**\$3.95**
  - Dynamotor. Modulator Unit. 28-V., 3 tubes. **\$2.75**
  - Bendix Magnetic Compasses—**\$6.00.**
  - Interphone Amplifiers, RLS.—**\$1.95.**
- Prices F.O.B. Indianapolis.

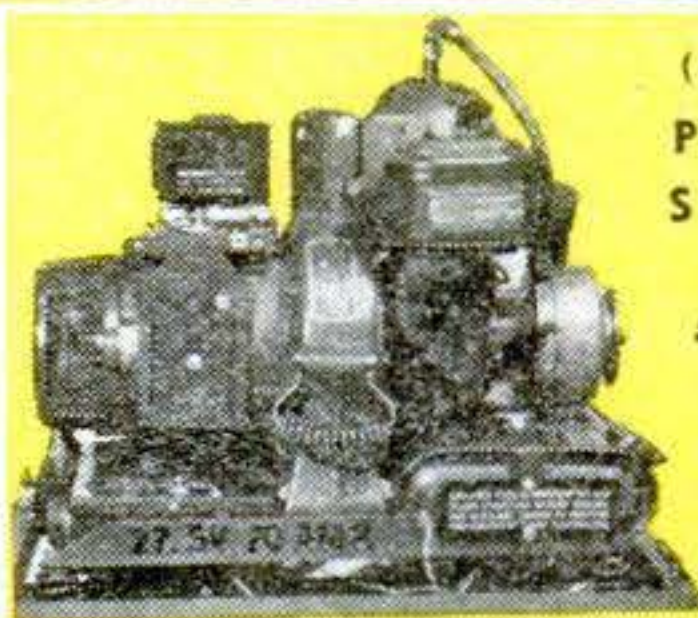

(HRU)—DC  
**POWER  
SUPPLY**  
24-28 V.  
at 70 Amp.  
Electric  
Starter

Priced at  
**\$72.50**

24-28 V. at 70 amp. 2000 W. gasoline engine generator with electric starter. Power supply which can be used to operate 24-28 V. equipment, to start airplane engines, to charge batteries, as a welding machine, lighting system, or for an amateur radio station. Height, 21 1/2"; Width, 17 1/2"; Length, 24 3/4" and weight, 115 lbs.

**OXYGEN TANKS — In Excellent Condition**

These oxygen tanks, removed from surplus aircraft have a capacity of 500 lbs. pressure. Type D2, with complete regulator assembly. Size of tank 22"x5". Weighs only 7 lbs.

Specially Priced .....**\$5.95**



TERMS: CASH WITH ORDER — ALL PRICES F. O. B. INDIANAPOLIS, INDIANA

ORDER EARLY — WHILE THE SUPPLY LASTS — IMMEDIATE DELIVERY

**New BRUSH  
Electroplater**

**ESPECIALLY BUILT FOR  
MECHANICS, MODEL MAKERS  
HOME CRAFTSMEN**



**Easy to Plate GOLD, SILVER, NICKEL,  
COPPER, etc... For Pleasure and Profit!**

If you have a workshop—at home or in business—you need this new Warner Electroplater. At the stroke of an electrified brush, you can electroplate models and projects—you can replate worn articles, faucets, tools, fixtures, silverware, etc. with a durable, sparkling coat of metal... Gold, Silver, Nickel, Copper, Cadmium, and after a bit of practice, even Chromium! Everything furnished—equipment complete, ready for use. By doing a bit of work for others, your machine can soon pay for itself. So make your shop complete by getting a Warner Electroplater right away. Send today for FREE PLATING SAMPLE and illustrated literature. ACT AT ONCE.

**WARNER ELECTRIC CO., Inc., Dept. S18  
1512 Jarvis Ave., Chicago 26, Illinois**

**FREE Details & Sample!**

WARNER ELECTRIC CO., Inc., 1512 Jarvis Ave., Chicago 26, Illinois, Dept. S18  
Gentlemen: Send Free Sample and Details to:

Name \_\_\_\_\_  
Address \_\_\_\_\_  
City \_\_\_\_\_ State \_\_\_\_\_

*Save Money*  
**FREE**  
RADIO CATALOG  
AND SUPPLEMENT

KITS for  
Amateurs  
and  
Experimenters

Build it yourself.

Thousands of radio values in this big book — Radios and radio phonographs, F.M., P.A., Ham Xmitters, receivers, kits, thousands of parts — whatever the job calls for Lafayette has it. And every item priced way down, to save you money!

RADIOS  
KITS  
HAM  
P. A.

*Lafayette Radio*  
RADIO WIRE TELEVISION, INC.  
100 Sixth Ave., N. Y. 13 • 542 E. Fordham Rd., Bronx 58  
110 Federal St., Boston 10 • 24 Central Ave., Newark 2, N. J.

LAFAYETTE RADIO, Dept. KD-8  
100 Sixth Ave., New York 13, N. Y.  
Rush catalog #88  Flyer #C42

Name.....  
Address.....  
City.....Zone.....State.....

To Help You Get Ahead in

# ELECTRICITY OR RADIO

A COYNE BOOK OF DIAGRAMS IS YOURS

# Free

FREE TO MEN INTERESTED IN RADIO

FREE TO MEN INTERESTED IN ELECTRICITY



Just for Asking to See THESE GREAT NEW

## ELECTRICAL OR RADIO BOOKS

Get a valuable electrical or radio diagram book ABSOLUTELY FREE! If you are interested in ELECTRICITY, Coyne will give you their "150 ELECTRICAL SHOP PRINTS" Book, of large size, easy-to-read prints for which electrical workmen have paid 10c to 25c apiece. It's yours free for merely looking over their great set, "APPLIED PRACTICAL ELECTRICITY." If RADIO is your choice, your free "get acquainted" gift is the brand new "150 NEW RADIO AND TELEVISION DIAGRAMS EXPLAINED," showing latest circuits, including FM and Television, and full instructions on reading and using diagrams. You get this FREE book for merely examining Coyne's new 5 vol. set APPLIED PRACTICAL RADIO.

### EASY WAY TO BIGGER PAY

Get the "know how" you need to "go places" in Electricity or Radio with these easy-to-understand, practical sets of Electrical or Radio books. They have been prepared out of 48 years of Coyne training experience to help the man who wants to get ahead in these two big money, big opportunity trades. They are written in easy-to-understand language, loaded with hundreds of interesting examples, pictures and diagrams that "sink in" at once. All the facts you need are "boiled down." They have the answers to thousands of questions that come up in electrical or radio work to help you earn more pay and even own your own profitable full time or part time business.

### USE BOOKS 7 DAYS FREE!

SEND NO MONEY! Ask to see the set you prefer—at our risk—and receive the FREE book described above. Use the books for 7 days. Then if you do not want to keep them, send them back at Coyne's expense and you don't owe a penny! If you keep the set you can use the liberal payment plan explained at the right. If you can pay cash after 7 days you save money. But remember, you keep the FREE BOOK even if you return the set! But you must act promptly—this offer is limited.

SEND COUPON TODAY — IT COSTS NOTHING. Coupon is merely a request to examine the set free and get the Free Book.

**MAIL TODAY!**

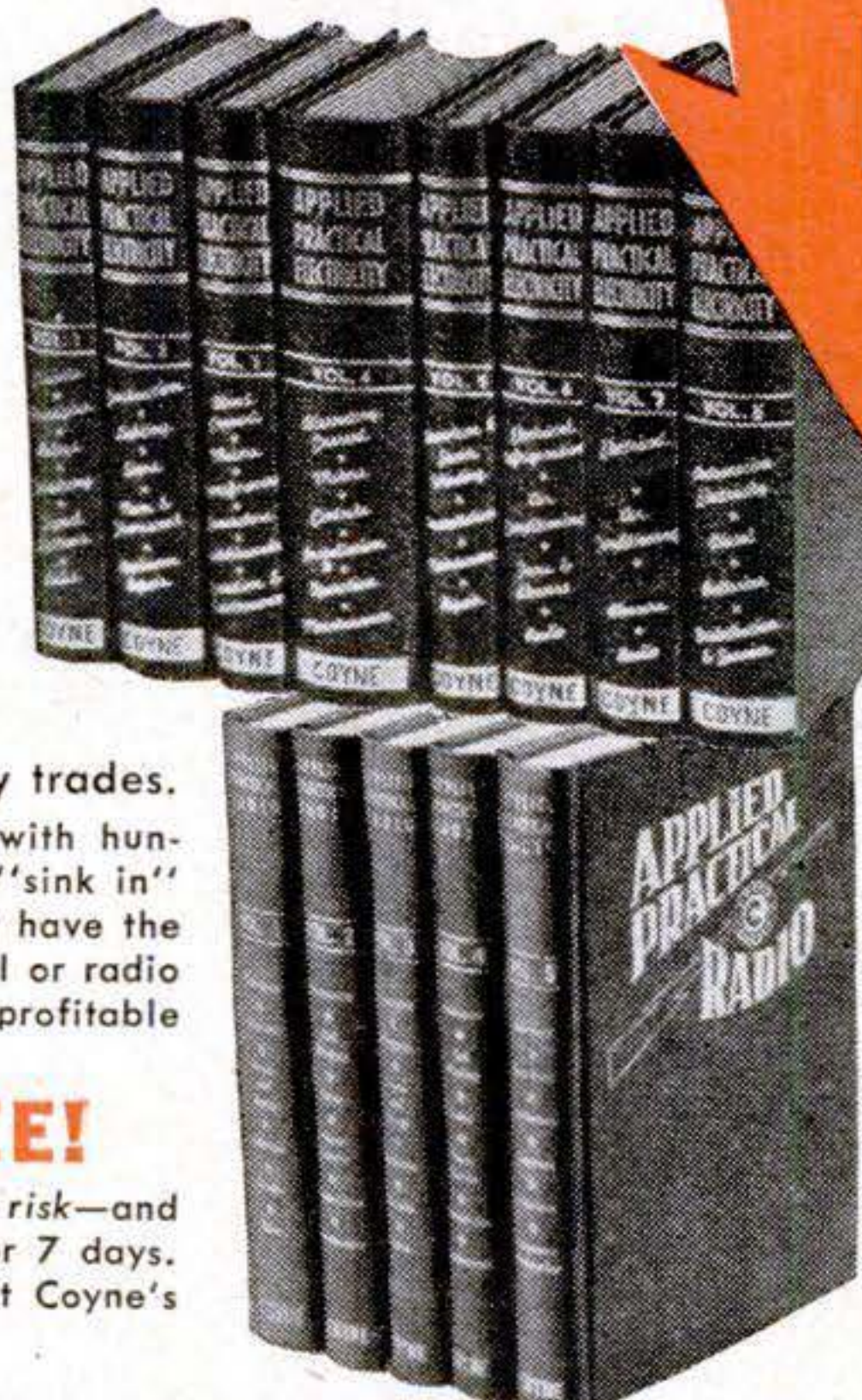

#### "APPLIED PRACTICAL ELECTRICITY"—8 volumes

11,500 electrical facts—3,400 subjects—hundreds of diagrams, photos, charts, tables, etc. Covers electricity, automotive, diesel, refrigeration, air conditioning, electronics, etc. Price \$24.00 on time—at \$3.00 in 7 days and \$3.00 per month—\$22.75 cash (you save \$1.25).

#### "APPLIED PRACTICAL RADIO"—5 volumes

Just out. Up-to-the-minute information, from basic principles to High Frequency, Short-Wave, Multi-Bands, FM and Television, etc. Radio testing instruments and service short cuts, phototubes, etc., etc. Price complete \$16.75 on time—\$3.00 in 7 days and \$3.00 per month—\$15.00 cash (you save \$1.75).

### FREE BOOK—FREE TRIAL COUPON

Educational Book Publishing Division  
COYNE Electrical & Radio School  
500 S. Paulina St., Dept. 48-R8, Chicago 12, Ill.

O.K.! Send me postpaid the set checked below for 7 days examination, and FREE BOOK, as per your ad.

- APPLIED PRACTICAL ELECTRICITY (8 vols.) and FREE Shop Prints Book
- APPLIED PRACTICAL RADIO (5 vols.) and FREE Radio Diagram Book

NAME..... AGE.....

ADDRESS.....

CITY..... ZONE..... STATE.....

Check here if you want the books sent C.O.D. You pay cash price shown in the ad when books are delivered. Same 7-day Money Back Guarantee.

EDUCATIONAL BOOK PUBLISHING DIVISION  
**COYNE** ELECTRICAL AND RADIO SCHOOL  
500 S. PAULINA ST., DEPT. 48-R8, CHICAGO 12, ILL.

# And to think they used to call me SKINNY!

**Give Me 15 Minutes A Day And I'll Give You A NEW BODY**

PEOPLE used to laugh at my skinny 97 lb. body. I was ashamed to strip for sports or for a swim. Girls made fun of me behind my back. THEN I discovered my muscle-building system—"Dynamic Tension." It turned me into such a complete specimen of MANHOOD that today I hold the title "THE WORLD'S MOST PERFECTLY DEVELOPED MAN."

That's how I traded in my "bag of bones" for a barrel of muscle! And I felt so much on top of the world in my big new, husky body that I decided to devote my life to helping other fellows change themselves into "perfectly developed men."

## What's My Secret?

When you look in the mirror and see a healthy, husky, strapping fellow smiling back at you—then you'll be astonished at how short a time it takes "Dynamic Tension" to GET RESULTS! "Dynamic Tension" is the easy, NATURAL method and you can practice in the privacy of your own room—JUST 15 MINUTES EACH DAY—while your scrawny shoulder muscles begin to swell... those spindly arms and legs of yours bulge... and your whole body starts to feel "alive," full of zip and go!

Thousands are becoming marvelous physical specimens—my way. I give you no gadgets or contraptions to fool with. With "Dynamic Tension" you simply utilize the dormant muscle-power in your own body—watch it increase and multiply into real, solid LIVE MUSCLE.

### FREE Book

Mail coupon right now for my illustrated book, "Everlasting Health and Strength." Tells all about my "Dynamic Tension" method. Shows actual photos of men I've made into Atlas Champions. It's a valuable book—and it's FREE. Mail coupon to me personally. CHARLES ATLAS, Dept. 1D, 115 East 23rd St., New York 10, N. Y.



CHARLES ATLAS, Dept. 1D,  
115 East 23rd Street, New York 10, N. Y.

I want the proof that "Dynamic Tension" will help make a new man of me—give me a healthy, husky body and big muscle development. Send me your free book, "Everlasting Health and Strength."

Name \_\_\_\_\_ Age \_\_\_\_\_  
(Please print or write plainly)

Address \_\_\_\_\_

City \_\_\_\_\_ State \_\_\_\_\_

*Learn to Write*

*How to Become an Expert Penman*

**GOOD PENMANSHIP** makes favorable impressions and helps you win success. Poor penmanship contributes to failure. It makes no difference how poor you now write, you can quickly and easily learn **Business Writing**, and you can learn **Shaded Writing** also right in your own home during spare time by my Simplified Method, without cost of going away to school. Easy Lessons, Diploma.

**BEGIN NOW!** write for my FREE BOOK, "How to Become an Expert Penman," which contains valuable information and many specimens that show what others have learned by taking my Courses. Send 10 cents for special penpoint and your name with a beautiful flourished bird written on a card.

T. M. TEVIS, BOX 25R, CHILLICOTHE, MO.

Send for this FREE Book

**LEARN TO WRITE**

*a Good Hand!*

**FOR BUSINESS AND SOCIAL SUCCESS!**

Improve your handwriting at home quickly with my new instruction books just off the press. Master all the secrets of better penmanship. Simple and easy, fully illustrated, highly endorsed. Begin today. Write for:  New Free Book, "How to Become a Good Penman", or check books wanted, \$1.00 each.  Business Writing  Artistic Writing  Card Writing  Engrossing Alphabets  Bird and Design Flourishing  Complete Set \$4.50  Enclose 10c for your name beautifully written and shading penpoint.

S. A. Ziller, President, **TAMBLYN SCHOOL OF PENMANSHIP**  
439 Ridge Bldg. In Business Over 52 Years Kansas City, Mo., U.S.A.

**THERE'S MONEY IN CARTOONS!**

RAYE BURNS will teach you HOW to CREATE ORIGINAL CARTOONS at home that you may SELL! Course contains 26 lessons and over 600 illustrations. All for Only.. **\$2.85**

Send name and address for free details.

RAYE BURNS SCHOOL, Dept. 8, Box 3583, CLEVELAND, OHIO

**ANALYZE Handwriting**

Uncrowded, fascinating field. Gratifying earnings reported by graduates in Employment, Credit, Social Service, Police and Entertainment fields. Others have developed profitable private practice, full or spare time, as Personal Problem and Vocational Counselors. Send for 3000 word TEST LESSON and Grapho Analyst FREE.

A. I. G. A. Inc., Wilholt Bldg., Dept. 126, Springfield, Mo.

**FREE BOOK and LESSON**

**STAY HOME AND MAKE MONEY!**

—Men! Women! Get into profitable, uncrowded profession you can operate from your home or small office after short home training course. No capital required. No goods to buy. No age limit. Others earn \$50.00 to \$100.00 per week making famous Stephenson corrective foot devices to order. Foot sufferers everywhere pay gladly for relief. Send today for FREE BOOKLET. STEPHENSON METHOD, Established 1894, 12-62 South Market St., Boston, Mass.

**Learn BAKING At Home**

Baking is one of America's high industries in wages. Nearly depression-proof. Thorough basic home course lays sound foundation. If you have aptitude, write for FREE BOOKLET, "Opportunities in Commercial Baking."

National Baking School, 1315 Mich. Ave., Dept. 1364, Chicago 5

**Fit-Rite** makes False Teeth TIGHT

Makes loose dental plates fit snugly and comfortably. **LASTS for MONTHS!**

Simply squeeze on dental plate and put it in your mouth. Hardens and becomes part of plate. Money-back guarantee.

**FREE** Generous package of Dental Plate Cleanser with each order. Send \$1.00 or mailed parcel post collect.

Fit-Rite Co., 1573 Milwaukee Ave.  
Dept. 4-42 Chicago, Ill.

**BIG MONEY FOR YOU!**

Just Telling Property Owners About **ZONE HEAVY-DUTY ROOF COATING**

Sensational product cuts essential building repair cost up to 75%. Amazing demonstration gets orders in a hurry. Only six average orders a week can pay you well over \$190.00!! Complete FREE selling outfit includes everything you need to make big money right from the start. If 30 or over, this may be the opportunity of your life. Tell about yourself. Write, Jack Canning, Vice Pres. P. O. BOX 789, DEPT. D-13

**ZONE Company** FORT WORTH 1, TEXAS

# BE A BUILDING CONTRACTOR

## Big Earning Opportunities



### DO YOU WANT TO BE ON THE INSIDE IN THE BUILDING BOOM AHEAD?

Big years right ahead in Building. Right now eighteen million Americans who do not own homes are being educated to advantages to them in home ownership! Do you want to be on the inside in the building boom—where big money is made? This is your chance now. Learn about opportunities for Building Contractors whether or not you have previous experience in this field. Millions of dollars are going to be made in home and farm buildings, in construction of stores, garages, small industrial buildings.

### BUILDING INDUSTRY NEEDS MEN WITH ORGANIZING ABILITY

The Building Industry uses men with organizing ability by the thousands in construction, supervision, management, sales. Properly trained men needed in production, distribution, finance, installation, marketing. Government estimates housing demand at 40 billion dollars!

### PRACTICAL HOME STUDY TRAINING—EASY TO LEARN BY THIS PLAN

Home Builders Training Institute has developed a training program that makes rapid progress possible. Gives you the all around training you want to prepare you for your advancement. Modern methods making use of visual aid illustrations make it easy to learn. From very first lesson assignments the type of information provided is the kind that can be useful to a man taking part in building.

#### GET FREE INFORMATION NOW MAIL COUPON—NO OBLIGATION

Others are preparing to get in now! Act immediately! To delay preparing yourself is certainly to put yourself at a disadvantage. The building industry is going forward rapidly. Fill out, mail coupon today. No obligation.

Home Builders Training Institute, Dept. D1-4

**Billions for Housing Needs**  
According to a report called "America's Needs and Resources" made available by the Twentieth Century Fund, a capital expenditure of \$85,000,000,000 to \$87,000,000,000 would be needed to fulfill America's housing needs in the next few years.

### BUILDING CONTRACTING FREE...

Important Information Telling How To Get Started.

### LEARN ABOUT the HOME BUILDERS TRAINING INSTITUTE PLAN...

Essential facts whether you are a tradesman in the building field or whether you have no previous experience.

Action Going On Now in the Building Industry.

**MAIL COUPON TODAY FOR FREE ILLUSTRATED BROCHURE**

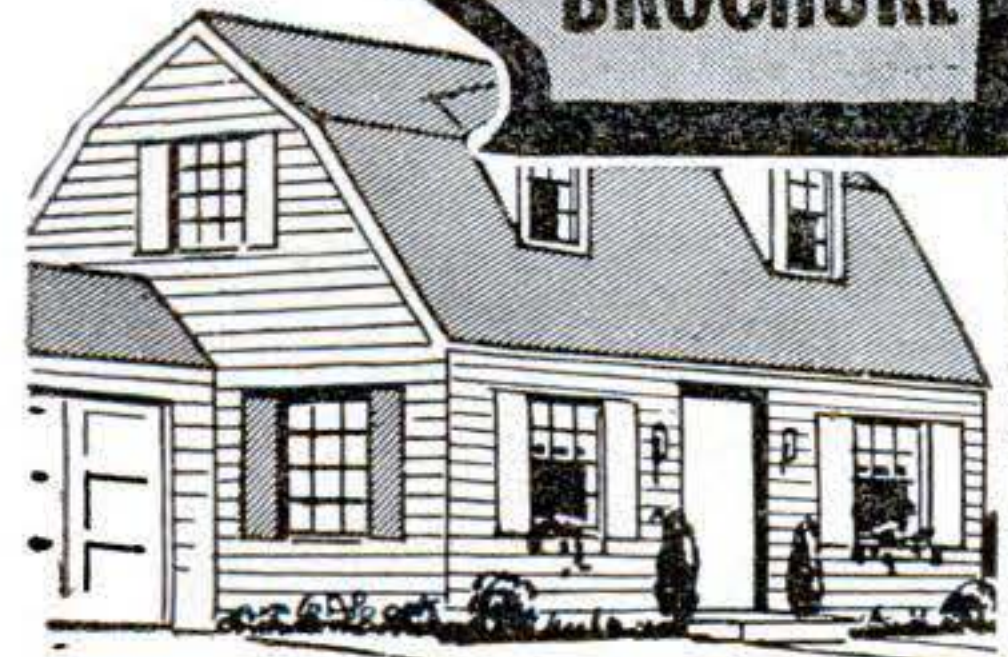

The building boom will last for many years. Prompt action now will get you started now—will put you in line for a big-paying job or a business of your own.

### → FILL OUT—CUT OUT—MAIL TODAY ←

#### FACTS FREE for Men Who Want to Get Ahead

Home Builders Training Institute, Dept. D1-4  
7050 N. Glenwood Ave., Chicago 26, Illinois

Send free illustrated Brochure and other information about Building Contracting.

VETERAN  NON-VETERAN

Name .....

Address .....

City ..... State .....

Less than **50¢** A week buys as much as **\$1746.**  
of Old Line Legal Reserve  
**LIFE INSURANCE**

**YOU ACTUALLY PAY**  
only \*\$2.00 a month at all ages for the amounts shown below.  
\*THIS IS HALF THE PERMANENT RATE WHICH TAKES EFFECT THE 6TH YEAR.

AT AGE	FOR MONTHLY PREMIUM OF	YOU GET A POLICY FOR
20	\$2.00	\$1746.
25	2.00	1582.
30	2.00	1408.
35	2.00	1250.
40	2.00	1086.

Proportionate amounts at all other ages, 15-55. Mail coupon now for full facts and amounts at your age.

Here is a unique plan that lets you budget your Life Insurance like rent. The rate is the same no matter what your age! The amounts vary but, even at 40 you can get \$1086 of this Solid, Old Line, Legal Reserve Life Insurance protection!

And not only that—but your policy will be

**FULLY PAID-UP IN 30 YEARS**

with no more premiums to pay, yet your

insurance continues in force the rest of your life.

**POSTAL LIFE** operating under the rigid New York State Insurance laws has sold Life Insurance by mail and over the counter for 43 years and has satisfied policyholders everywhere. Over \$14,000,000 in assets! More than \$60,000,000 paid out in benefits!

Postal Policies are participating! Mail Coupon today!

**Get the FACTS by mail!**

Postal Life Insurance Company  
511 Fifth Avenue, Dept. D-793  
New York 17, N. Y.

Mail me complete information about your new "\$2.00-per-month", 30-payment Modified 5 Whole Life Policy at my age.

NAME.....

OCCUPATION.....

DATE OF BIRTH.....

ADDRESS.....

Include Postal Zone, if any.

**NEW EASY WAY TO MAKE MONEY at HOME**

**YOUR COST ONLY 5c YOU GET \$5.00, FULL OR SPARE TIME.**

It's easy to Bronze Baby Shoes. Business still in infancy. Get in on ground floor and skim cream of profit from rich and never-ending market. No experience needed. Learn in one week. Income up to \$1,000 a month full time—\$50 to \$75 weekly in spare time. We furnish complete kit and full instructions. Simple as A B C to become an expert.



**FREE FACTS.** Write today. Don't send a penny. Just name and address in letter or postcard. Be the first in your territory to reap rewards waiting. Costs only 5c to bronze shoes. Sell for \$5.00! This is too good to miss. Get facts today. Write to

**KIKTAVI COMPANY, Dept. 22**

8620 So. Ruthelen

Los Angeles 44, California

*Great*  
**PROFITS**  
**CASTING**  
**ATHOME**  
*Free*  
**FACTS SENT**

**X.L. RUBBER MOLDS**

**—EARN GREAT PROFITS QUICKLY!**

Cast thousands of perfect plaques, book ends, ash trays, figurines, etc. Start in basement or garage. **X.L. RUBBER**, Pts. \$2.00; Qts. \$3.50; Gallons \$8.95—Models and enough rubber for 3 molds \$1.00—Foreign \$1.50. **FREE FACTS SENT!**



**PLASTIC ARTS STUDIO • Route 2 • Dept. 2 • Muncie Ind.**

**Now You Can Lick ANY AUTO REPAIR JOB!**

Look up make, model, job in MoToR's **AUTO REPAIR MANUAL**—and go to work! Complete guide for every model built since 1935. 700 pages; 1700 illustrations; 200 charts; 200,000 repair facts. After 7 days' Free Examination, send \$1 plus 35c postage; then \$2 monthly for 2 months; 95c one month later. If not satisfied, return book, pay nothing. MoToR Book Dept., Desk 2D, 572 Madison Ave., New York 22, N. Y.

**"YOU ARE UNDER ARREST!"**



**Help Bring Crooks to Justice Through Scientific CRIME DETECTION!**

We have taught thousands this exciting, profitable, pleasant profession. Let us teach you in your own home. Learn Finger Printing, Firearms Identification, Police Photography, Secret Service Methods thoroughly, quickly, at small cost. Over 800 of all American Bureaus of Identification employ I. A. S. students or graduates. We can prepare you for this fascinating work during spare time. Write today, stating age, for "Blue Book of Crime."

**INSTITUTE OF APPLIED SCIENCE, 1920 Sunnyside Ave., Dept. 1364, Chicago 40, Ill.**

**LAW**

**STUDY AT HOME for PERSONAL SUCCESS and LARGER EARNINGS.** 39 years expert instruction—over 108,000 students enrolled. LL.B. Degree awarded. All texts furnished. Easy payments. Send for **FREE BOOK.**

**AMERICAN EXTENSION SCHOOL OF LAW**  
Dept. 88-S, 646 N. Michigan Ave., Chicago, Ill.

**Photography for**



**PLEASURE or PROFIT**

Learn at home. Spare time. Practical basic training. Long-established school. Many have earned while learning. Send coupon below for free booklet, "Opportunities in Modern Photography" and full particulars.

**AMERICAN SCHOOL OF PHOTOGRAPHY**

1315 Michigan Avenue Dept. 1364 Chicago 5, Illinois  
Send booklet, "Opportunities in Modern Photography," full particulars and requirements. No salesman will call.

Name.....Age.....

Address.....

City.....Zone.....State.....



**WIN \$2500<sup>00</sup> CASH! \$5,000 CASH PRIZES IN ALL**

**READ FULL DETAILS in COLUMN AT RIGHT BELOW**

**Paint Your Car** for **\$3<sup>95</sup>** **ONE QUART DOES ENTIRE JOB**  
**WITH WYPE** **TRADE MARK REG.** **2 FULL COATS**  
**NO SPRAYING · NO MASKING · NO BRUSHING**

**AMAZING NEW BRUSHLESS AUTO ENAMEL**  
**You JUST WIPE ON**  
**with a POWDER PUFF**  
**instead of Brushing or Spraying**



**Dries Dust Free One Hour · No Streaks or Lapmarks**

**You're SURE You Are SAFE when You Paint with WYPE HERE'S WHY!**

**TESTED BY U. S. Testing Co., Inc.**

**Leading Scientific Testing Laboratory**

Report No. 87496  
Jan. 5, 1948

**and found to conform to the claims and guarantee of the Wype Corporation.**

No higher or more rigid standards are set by any Testing Laboratory. United States Testing Company conducts scientific tests for the world's foremost organizations and is accepted as a leading authority on such tests.

**For Your Protection**  
 With cars so expensive, it's a satisfaction to find ONE product you can TRUST to renew and protect the beauty of your car—especially when it's so easy to do!

**2-YEAR GUARANTEE**  
 We Guarantee WYPE against cracking, peeling, fading or chipping for two years after application, if applied according to directions furnished. Your money cheerfully refunded if WYPE does not live up to this Guarantee.

COPYRIGHT 1948; WYPE CORP



**APPLY in ONE HOUR — DRIES to GLISTENING PROFESSIONAL FINISH**

WYPE is a new Miracle Enamel for Autos. It is NOT a wax or polish but a hard high lustre ENAMEL finish! With WYPE, ANYONE can do a beautiful job! Order a quart to paint your car or to get started in this BIG-MONEY Business!

**NO STREAKS OR LAPMARKS LOOKS LIKE SPRAY JOB**

**ANYONE MAY WIN**

Yes, YOU may win \$2500 in cash by writing the best letter telling your experience with Wype; how easily and quickly Wype can be applied, what a beautiful job it does; how it compares to a professional spray job.

**Just 3 Easy Steps**

1. Write a letter on the subject: "My Experience with Wype."
2. Enclose with this letter any one of the following—not all—just one: Either the sales check or receipt you got when purchasing Wype, or the powder puff you used to paint your car, or a reasonable facsimile of the Wype can. Send only one of the above with your letter, not all three. (When you order direct, we send official entry blank—our dealers also have blanks.)
3. Mail to Wype Corporation, 2214 Dolman St., St. Louis 4, Mo.

**\$5,000 CASH PRIZES!**

1st Prize... \$2,500 Cash!  
 2nd Prize... \$500 Cash!  
 3rd Prize... \$250 Cash!

Five Prizes—  
 Each \$50 in Cash!

One Hundred Prizes,  
 Each Ten Dollars Cash!

One Hundred Prizes,  
 Each Five Dollars Cash!

**Total Cash Prize List,  
 Five Thousand Dollars Altogether!**

Two Hundred & Eight Prizes—Two Hundred and Eight Chances to Win!

**HURRY! Act Now!**

Your letter can be any length. The letters considered best by the judges get the cash prizes! Decision of judges on all points final. Duplicate awards in case of ties. No entries returned.

**All entries must be postmarked before Midnight, June 30, 1948, and received before July 14, 1948.**

**Get Beautiful Mirror Like Finish That Looks Like Spray Job!**

At last! Practically anyone can now paint his car with WYPE! No previous car-painting experience necessary. You get a beautiful high-gloss job that gives you an expensive finish such as is sprayed on by Professional Auto Painters—at a fraction of regular cost! With WYPE you need **NO BRUSH, NO SPRAY, NO MASKING!** Just **WIPE ON** with Powder Puff—which we furnish at no extra charge. You get a brilliant, glossy finish that is truly "factory-like." No streaks. No lap-marks. Guaranteed for **TWO** years not to crack, peel, chip or fade, if simple directions are followed. Takes about an hour to apply. Dries dust-free in an hour. WYPE comes in eight most popular shades including those on newest model cars. Goes over any other color, lacquer or enamel.

**MOST POPULAR COLORS**  
 Black Brewster (dark) Green  
 Maroon Jewel (light) Green  
 Red Washington (dark) Blue  
 Gray Monticello (light) Blue  
**\$3<sup>95</sup> Per Quart**

**SEE YOUR DEALER or ORDER DIRECT SEND NO MONEY · Get WYPE Today!**

If your dealer can't supply you, just send us a postcard. We'll ship C.O.D. Just pay mailman for Wype, plus postal charges. Or send remittance with order and WE pay postage.

**Some of the FAMOUS DEPARTMENT STORES that Sell WYPE**

- |  |  |  |  |
|--|--|--|--|
| <b>VISIT OR PHONE THE STORE IN YOUR CITY</b>   | <b>AKRON:</b> M. O'Neil Co.  | <b>FT. WAYNE:</b> Wolf-Dessauer Co.            | <b>NEW ORLEANS:</b> Maison Blanche Co.   |
| If you live in one of the cities shown here, it will be more convenient to buy from your favorite department store. Ask your dealer! Leading merchants everywhere sell WYPE. | <b>BALTIMORE:</b> May Co.  | <b>FT. WORTH:</b> W. C. Stripling Co.          | <b>PHILADELPHIA:</b> Lit Brothers  |
|  | <b>BATON ROUGE, LA.:</b> D. G. Rosenfield Co.  | <b>KANSAS CITY, MO.:</b> Jones Store Co.       | <b>RICHMOND, VA.:</b> Miller & Rhoads, Inc.  |
|  | <b>CHICAGO:</b> Goldblatt's 15 Department Stores (Goldblatt's Department Stores, also, at Joliet, Ill., Hammond, Ind., Gary, Ind., South Bend, Ind.) | <b>LOS ANGELES:</b> May Co.                    | <b>ST. LOUIS:</b> Famous-Barr Co.  |
|  | <b>CINCINNATI:</b> Fair Store Co.  | <b>LOUISVILLE:</b> Kaufman-Straus Co.          | <b>ST. PAUL, MINN.:</b> The Golden Rule  |
|  | <b>CLEVELAND:</b> May Co.  | <b>MEMPHIS:</b> B. Lowenstein & Bros.          | <b>SAN ANTONIO:</b> Joske's of Texas   |
|  | <b>DALLAS:</b> Sanger Bros., Inc.  | <b>MILWAUKEE:</b> Ed. Schustgr & Co., Inc.     | <b>SAN DIEGO:</b> Whitney's  |
|  | <b>DENVER:</b> May Co.   | <b>MONTGOMERY, ALA.:</b> Montgomery Fair Store | <b>TOLEDO:</b> Lion Dry Goods Co.  |
|  |  |  | <b>YOUNGSTOWN, O.:</b> Strouss-Hirshberg Co. and many other leading merchants. Phone or visit your favorite today! |

**WYPE CORP. Dept. 17D 2214 DOLMAN ST. ST. LOUIS 4, MO.**

Copyrighted material

# AUDELS Carpenters and Builders Guides

## 4 vols. \$6

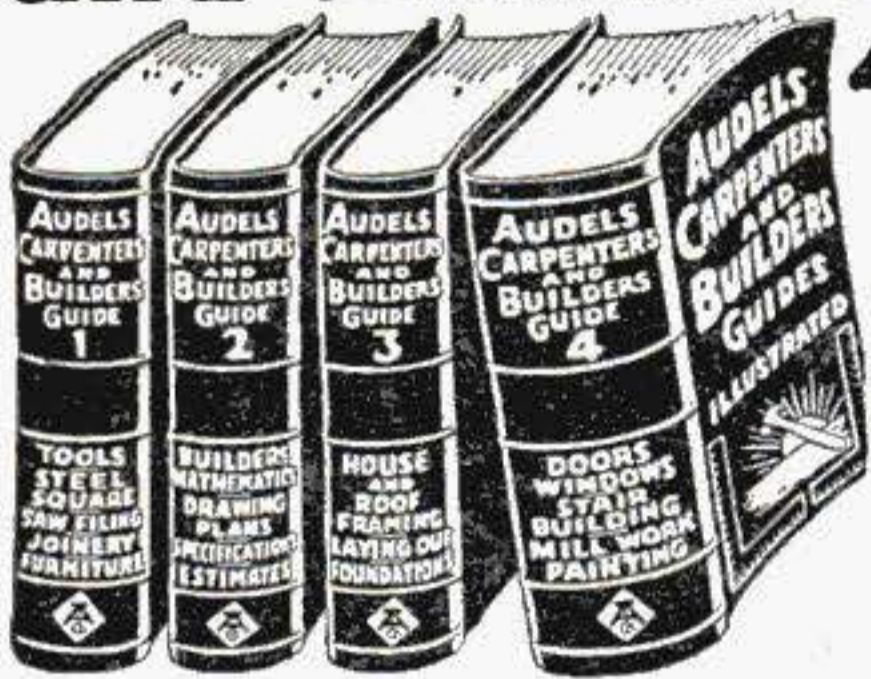

**Inside Trade Information** for Carpenters, Builders, Joiners, Building Mechanics and all Woodworkers. These Guides give you the short-cut instructions that you want—including new methods, ideas, solutions, plans, systems and money saving suggestions. An easy progressive course for the apprentice and student. A practical daily helper and Quick Reference for the master worker. Carpenters everywhere are using these Guides as a Helping Hand to Easier Work, Better Work and Better Pay. To get this assistance for yourself, simply fill in and mail **FREE COUPON** below.

### Inside Trade Information On:

How to use the steel square—How to file and set saws—How to build furniture—How to use a mitre box—How to use the chalk line—How to use rules and scales—How to make joints—Carpenters arithmetic—Solving mensuration problems—Estimating strength of timbers—How to set girders and sills—How to frame houses and roofs—How to estimate costs—How to build houses, barns, garages, bungalows, etc.—How to read and draw plans—Drawing up specifications—How to excavate—How to use settings 12, 13 and 17 on the steel square—How to build hoists and scaffolds—skylights—How to build stairs—How to put on interior trim—How to hang doors—How to lath—lay floors—How to paint.



**AUDEL, Publishers, 49 W. 23rd St., New York 10, N. Y.** Mail Audel's Carpenters and Builders Guides, 4 vols., on 7 days' free trial. If OK I will remit \$1 in 7 days and \$1 monthly until \$6 is paid. —Otherwise I will return them. No obligation unless I am satisfied.

Name \_\_\_\_\_

Address \_\_\_\_\_

Occupation \_\_\_\_\_

Employed by \_\_\_\_\_ P. S. M.

## OPPORTUNITIES AHEAD

For Men Who are Trained in

## AUTO BODY & FENDER WORK

Men 18 to 60. Want a future with good pay, perhaps a business of your own later? If you are mechanically inclined, start now to learn to become an auto body mechanic and fender repair man. This fast growing field has great possibilities for trained men with experience. U. E. I. spare time, home-study training combined with actual shop practice gives you sound, basic knowledge of latest, best methods so you may get the experience which may bring you big pay. Capable instructors supervise your studies and actual practice. Course includes acetylene welding, spray painting, use of hand and power tools, etc.

### THOROUGH, RELIABLE TRAINING

U. E. I. has trained men for new opportunity fields since 1927 and many students are now making good. Auto body and fender repairing is one of the best profit-makers in any garage or service station. Little capital required. . . . placement service, or we will show you how to start your own shop. Get the facts **FREE**, without obligation. Write today.

Training approved under G. I. Bill

## UTILITIES ENGINEERING INSTITUTE

AUTO-CRAFTS DIVISION

2523 Sheffield Ave., Dept. 348-X, Chicago 14, Ill.

Gentlemen: — YES! I want to get into profitable Auto Body and Fender Repair Work. Please send me **FREE FACTS** at once.

Name \_\_\_\_\_ Age \_\_\_\_\_

Address \_\_\_\_\_

City \_\_\_\_\_ Zone or County \_\_\_\_\_ State \_\_\_\_\_

Check here for Special Information if under 17.

## Be A MASTER PLUMBER

Earn \$15 To \$50 A Day

DON'T ENVY THE PLUMBER—BE ONE

Every skilled workman will tell you that Plumbers have the best of it. WINTER and SUMMER the Plumber is busy at top wages. No skilled Plumber is ever out of a job—compare his opportunities with any trade, plus the opportunities of having your own shop. We teach you Plumbing with **TOOLS** (not books) under Licensed Master PLUMBERS in one of the finest equipped schools in America. We make you a Plumber, every branch is taught thoroughly—Lead Work—Blueprint for plan reading—all other tricks.

### LEARN IN 32 WEEKS WITHOUT PREVIOUS EXPERIENCE

If you like to work with tools you owe it to yourself to investigate. No need to ever work as an apprentice. Get free bulletin. Write now! G. I. APPROVED. Our 24th year.

**UNIVERSAL PLUMBING SCHOOL**  
819 HOLMES STREET KANSAS CITY, MO.

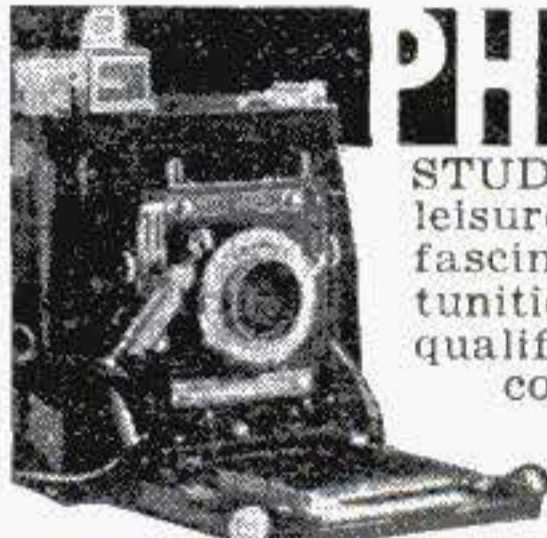

## PHOTOGRAPHY

**STUDY AT HOME.** Photography offers leisure time enjoyment and well-paid, fascinating career. Ever-increasing opportunities! Success-proved N. Y. I. training qualifies you at home. Also resident courses. Details **FREE!**

**NEW YORK INSTITUTE OF PHOTOGRAPHY**

Dept. 5, 10 West 33 St., New York 1, N. Y., (37th Year)

## BE A REAL ESTATE BROKER PAYS BIG!

**EASY TO LEARN**—Start and run your own business quickly. Many graduates report making up to \$1000 a month. Course of study covers Sales, Property Management, Appraising, Loans, Mortgages and hundreds of related subjects. Course offered in home study or residential classrooms.

**FREE** Big new illustrated catalog from this nationally known school. Send Post Card Today. G. I. Approved.

**WEAVER SCHOOL OF REAL ESTATE**  
Dept. PS, 15 E. Pershing Road Kansas City, Mo.



## IMPROVE YOUR PENMANSHIP

*Write Like This*

YOUR penmanship can be improved in 3 hours or corrected to your satisfaction in 10 hours' practice with my **DEFINITE HAND CONTROLS**. New way!

WRITE **OZMENT 35-D ST. LOUIS, MISSOURI**

Complete OUTLINE FREE!

## ARTISTS MAKE MONEY

Do you like to draw? Send name, address, age and occupation for **FREE ART TEST**, to find out your ability.

**ART INSTRUCTION, INC.**

4148 Art Instruction Bldg., Minneapolis 15, Minn.



**CORRESPONDENCE COURSES IN RADIO and ELECTRICAL ENGINEERING**

Tuition \$25

**ELECTRICAL ENGINEERING.** Get good grasp of wide electrical field. Modern. Very understandable. Theory made easy.  
**RADIO ENGINEERING.** Extra fine course in radio, public address, photo-electric work. Trains you to be super-service man, real vacuum tube technician. Tuition ONLY \$25. either course. Deferred payment plan. Servicemen needed badly.

**FREE** Write for free copies of school catalogs, student magazines, etc.  
**LINCOLN ENGINEERING SCHOOL, Box 931-S-112 LINCOLN, NEBR.**



## LEARN MEAT CUTTING At Home — In Spare Time

Get into the vital meat industry. Concise, practical Home Training based on 25 years proven instruction methods used at National's famous resident school. Prepares you for bigger pay as Meat Cutter, supervision, market manager or more money in your own store. Go as rapidly as your spare time permits. Diploma. Start NOW to turn your spare hours into money. Send for **FREE** bulletin today. No obligation.

National School of Meat Cutting Inc., Div. O-65, Toledo 4, Ohio



GET INTO  
**DRAFTING**  
 The Draftsman Plays a most  
 Important Part in INDUSTRY

**DRAWING OUTFIT INCLUDED**  
 with Drafting courses.

All the tools you need including folding drawing table. With them you can put your ideas on paper quickly and with accuracy. With training you are all set to master Drafting in months,—not years—at home.

**Learn in Spare Time—At Home!**  
 (or at the College in Chicago)

A few hours of pleasant home study every week—that's all. With Chicago Tech's help, you train yourself step by step. This tested method—developed over 44 years of C.T.C. progress—prepares men for good positions in industry.



**CHICAGO TECHNICAL COLLEGE**  
 D-225 Tech Building, 2000 South Michigan Ave.  
 Chicago 16, Illinois

Practically everything that's built or manufactured these days is constructed from blue print drawings prepared by the draftsman. He is the KEY man in industry. No new machines can be built, no bridges erected, no buildings constructed until the draftsman has completed his work.

Drafting is clean, interesting, professional-type work. The draftsman is paid well to start. And he has real opportunities for advancement to high-pay jobs in Engineering. The tremendous production programs ahead in industry will require more draftsmen than ever before.

Send today for free information. See what this training has done for others, what it can do for you. Simply MAIL COUPON TODAY in an envelope or use a penny postcard.

**MAIL COUPON NOW**

**CHICAGO TECHNICAL COLLEGE**  
 D-225 Tech Bldg., 2000 So. Michigan Ave., Chicago 16, Ill.  
 Mail me FREE Drafting Lesson with information about big opportunities in DRAFTING and how I can train at home.

Architectural Drafting       Electrical Drafting  
 Machine Drafting         Structural Drafting  
 Builders' Course

Name.....Age.....  
 Address.....  
 City.....Zone...State.....

**EVEN IF YOU DON'T KNOW  
 A NOTE OF MUSIC NOW...**

**You Can Learn Your Favorite  
 Instrument This Easy A-B-C Way**

No special talent, no previous musical training needed. This remarkable U. S. School home-study method is so successful because you learn to play by playing real tunes by note, right from the very start.

Once you start a U. S. School Course you look forward to the time you spend on your lessons. No tiresome exercises. No long-winded explanations. Instead of hard work, learning to play becomes a happy pastime. You begin with simple



**EASY AS A-B-C**



melodies. As you improve, you take up more advanced tunes. Sooner than you ever dared hope you're thrilled to find yourself playing many popular numbers by note. And no matter which instrument you take up, the cost is only a few pennies a day.

If you honestly want to learn music, to be invited everywhere, and get lots more fun out of life, send in the coupon

below for our FREE 36-page Booklet and Print and Picture Sample. They give full details. (Instruments supplied when needed, cash or credit.)

**U. S. SCHOOL OF MUSIC**  
 84 Brunswick Bldg., New York 10, N. Y.  
 (50th Successful Year)



**FREE! Print and Picture Sample**

U. S. School of Music, 84 Brunswick Bldg., New York 10, N. Y. Please send me free booklet and Print and Picture Sample. I would like to play instrument checked below.

- |  |  |  |
|--|--|--|
| <input type="checkbox"/> Piano           | <input type="checkbox"/> Saxophone       | <input type="checkbox"/> Modern Elementary |
| <input type="checkbox"/> Guitar          | <input type="checkbox"/> Trumpet, Cornet | <input type="checkbox"/> Harmony           |
| <input type="checkbox"/> Violin          | <input type="checkbox"/> Reed Organ      | <input type="checkbox"/> Clarinet          |
| <input type="checkbox"/> Piano Accordion | <input type="checkbox"/> Tenor Banjo     | <input type="checkbox"/> Other Instrument  |

Name.....  
 Street.....  
 City.....State.....

(PLEASE PRINT)

# HOW TO Fight! Wrestle! Jiu-Jitsu!

**FREE**

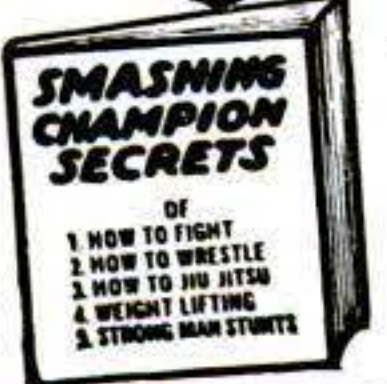

## Plus Weight Lifting! Strong Man Stunts!

Be prepared to protect your family, friends, yourself in any emergency! Be admired! George F. Jowett, Champion of Champions, gives you free his "SMASHING CHAMPION SECRETS." Contains many "HOW-TO-DO-IT" pictures that quickly and simply show you how to powerfully deliver a knockout, how to break any hold, how to overpower any opponent plus weight lifting and strong man stunts! Inside professional

**YOU NEED  
HE MAN  
FITNESS  
TO HANDLE  
ANY TOUGH  
SITUATION!**

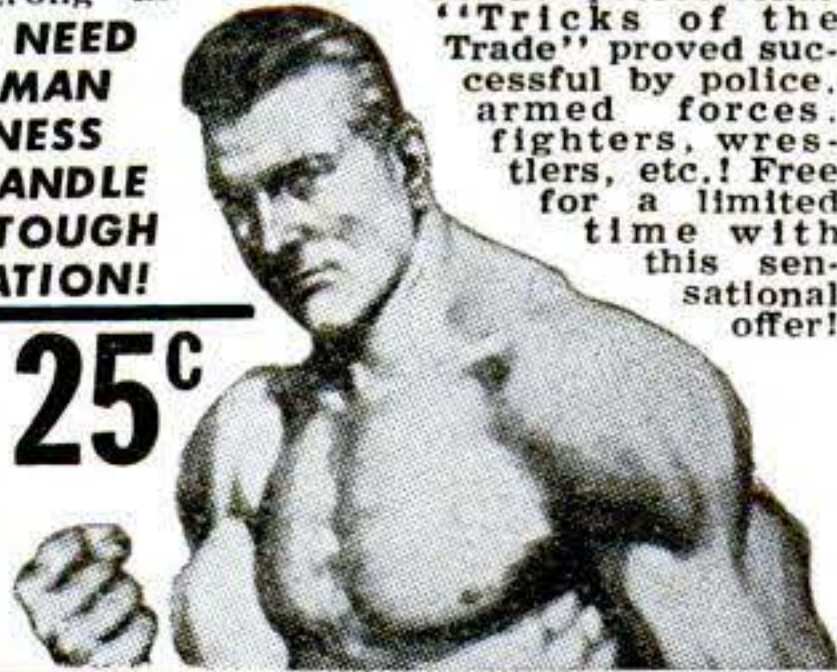

"Tricks of the Trade" proved successful by police, armed forces, fighters, wrestlers, etc.! Free for a limited time with this sensational offer!

**NOW! All 5 Famous  
JOWETT COURSES  
in 1 Complete  
Muscle Building  
Volume!**

**25c**

**LET ME PROVE  
I CAN MAKE YOU—**

## COMMANDO-TOUGH OR IT WON'T COST YOU A CENT!

says *George F. Jowett* WORLD'S GREATEST BODY BUILDER

### Give Me 10 Minutes A Day Learn My Time Tested Secrets of Strength

I'll teach you the "Progressive Power Method" that rebuilt me from a physical wreck condemned to die at 15, to the holder of more strength records than any other living athlete or teacher! Has proven it builds the strongest, handsomest men in the world. Let me prove on a money back basis—that no matter how flabby or puny you are that I can add inches to your arms, broaden your shoulders, give you a man-sized chest, powerful legs and a rock-like back—in fact power pack your whole body so quickly it will amaze you—right in your own home! I'll bring to life new power in you inside and out, until YOU are satisfied you are the man you want to be.

### PROVE IT TO YOURSELF IN ONE NIGHT

Send only 25c for my 5 easy-to-follow, picture-packed courses now in 1 complete volume "How to Become a Muscular He-Man." Try it for one night! Experience the thrilling strength that surges through your muscles.

### 10 DAY TRIAL!

Think of it—all five of these famous courses now in one picture-packed volume for only 25c. If you're not delighted with this famous muscle-building guide—if you don't actually FEEL results within ONE WEEK, send it back and your money will be promptly refunded!

### PHOTO BOOK OF FAMOUS STRONG MEN!

**FREE!**

Photos that inspire you to might and muscle. Free with order.

I am making a drive for thousands of new friends fast—REGARDLESS OF COST!  
**SO GET NOW MY 5 Muscle Building COURSES**  
(Valued at \$5 each)

**All in 1 Great Complete Volume  
Packed With How-To-Do-It Pictures!**

Now, this "get-acquainted," extremely low price of only 25c is your chance to build a body you'll be proud of! Follow Jowett's easy method of muscle building NOW!

**For Only 25c**

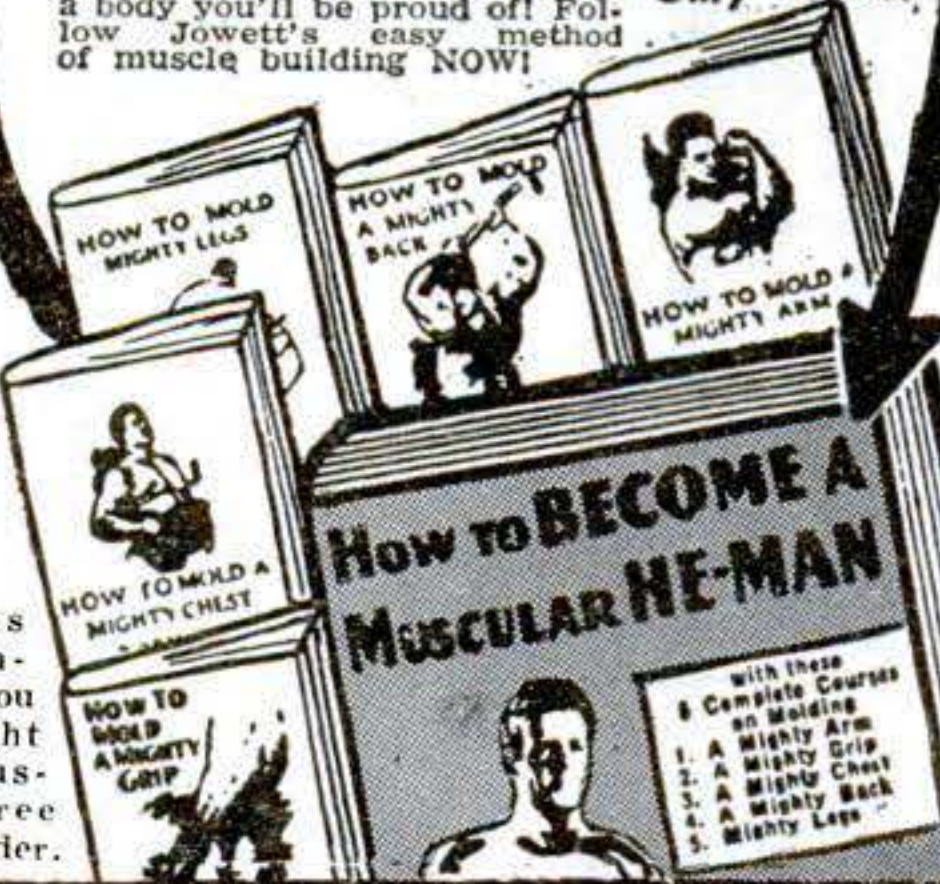

## 2 FREE GIFTS!

Jowett Institute of Physical Culture Dept. PS-84  
230 Fifth Avenue, New York 1, N. Y.

George F. Jowett:—Please send by return mail, postpaid, FREE "Smashing Champion Secrets" and FREE Jowett's Photo Book of Strong Men, along with all 5 Muscle Building Courses. 1. Molding a Mighty Chest. 2. Molding a Mighty Arm. 3. Molding a Mighty Grip. 4. Molding a Mighty Back. 5. Molding Mighty Legs—Now all in One Volume "How to Become a Muscular He-Man." Enclosed find 25c. NO C.O.D.'S.

**George F.  
Jowett  
Champion of  
Champions**

NAME.....AGE.....  
(Please Print Plainly, Include Zone Number)

ADDRESS.....

## Practical Shop Training

in

**REFRIGERATION  
AIR CONDITIONING**

and/or

**PRACTICAL ELECTRICITY  
MAJOR APPLIANCES  
Service, Maintenance, Installation**

Write for Details

**COMMERCIAL TRADES INSTITUTE**

202 SO. 20TH ST., BIRMINGHAM, ALA.

Veterans Inquire About GI Training

Train in  
the Magic  
City of  
the South

## LAW FREE BOOK



Write today for FREE 48-page book, "THE LAW-TRAINED MAN," which shows how to learn law easily in spare time at home through the Blackstone course prepared by 60 well-known law authorities. We furnish all material including 18-volume Modern American Law library. Many successful attorneys among our graduates. LL.B. degree. Moderate cost; easy terms; Money-Back Agreement.

### BLACKSTONE COLLEGE OF LAW

225 N. Michigan Ave., Dept. 124, Chicago 1, Ill.

A Correspondence Institution Founded in 1890

## Learn LANDSCAPE GARDENING

A thorough, interesting constructive home training, covering your regional conditions, for those who wish to become LANDSCAPERS, DESIGNERS, GARDENERS, etc., for profit or pleasure. Write today for FREE INFORMATION without obligation.

Approved for Veterans—in all States

**NATIONAL LANDSCAPE INSTITUTE**

Dept. PS-4, 310 So. Robertson, Los Angeles 36, Cal.

### TURN YOUR LONGHAND INTO

## SHORTHAND in 6 Weeks at Home

Famous Speedwriting system. No signs; no symbols; no machines; uses ABC's. Easy to learn; easy to write and transcribe. Fast preparation for a job. Surprisingly low cost. 100,000 taught by mail. Used in leading offices and Civil Service. Write for free booklet. Speedwriting, Dept. 2604-8, 55 W. 42 St., N. Y. 18, N. Y.

## LEARN TRIG QUICKLY—EASILY

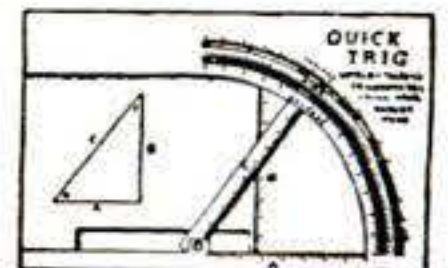

WITH QUICK TRIG, by competitive tests, it was found that QUICK TRIG gave answers faster to one with a slight knowledge of trig than to an expert on trig with a slide rule. Let it solve your trig. problems. You need no previous training. Entirely automatic. Easy instructions included FREE. We mail C.O.D. plus postage or send \$1.00. the full price, and we mail postpaid.

REED MFG. CO., 11350-X Burbank Blvd., N. Hollywood, Calif.

### New Designs in

## FRANZITE GRIPS



### Modernize Your Gun! Improve Your Score!

Most durable grips made. Positively unbreakable! For Colt, Smith & Wesson, Hi-Standard. Ortgies, Luger & Mausers in a wide choice of beautiful designs in ivory, pearl, walnut, onyx, etc. Low prices. FREE CATALOG. Dealers Wanted.

SPORTS, INC., (Mfrs.) 5501 Broadway, Dept. S-4, Chicago 40, Ill.

# Yes, Stanley Piaskowski made an Important Decision

• Mr. Piaskowski is not the president of a bank or a railroad. He is just an ambitious young man who faced a problem that may be very similar to the one you are facing today. He wasn't kidding himself and he didn't want others to kid him. All he wanted was a really worthwhile job—one that paid a good salary, offered him reasonable security, and a chance to advance to higher pay.

He decided to enroll for C.T.I. training. Now, a graduate, he writes as follows: "I have worked myself up to chief body man of this organization and I like my work very much . . . my average salary is now close to \$80.00 a week."

We believe the same opportunities that were within the reach of this C.T.I. man are within the reach of other ambitious men. We can give you the same help we gave him. We invite you to send for our FREE booklet and other information. The request for information does not obligate you in any way. MAIL THE COUPON TODAY.

**VETERANS**—C.T.I. Courses are approved under the G.I. Bill. Just mail coupon, we will handle all details.

**NON-VETERANS**—Don't let the lack of ready cash prevent you from taking this training now. Investigate our Low Easy Payment Plan and our Pay After Graduation Plan.



**Mail Coupon for FREE Booklet**

**Train at Home or in Big C. T. I. Shops**



*Home of C.T.I.*

Large, modern, well equipped shops. Located in excellent residential district only 1 block from Lake Michigan.

**COMMERCIAL TRADES INSTITUTE, Dept. E1-4**  
1400 W. Greenleaf Avenue, Chicago 26, Illinois

**FILL OUT · CUT OUT · MAIL TODAY!**

**FACTS FREE FOR MEN WHO WANT TO GET AHEAD**  
**COMMERCIAL TRADES INSTITUTE, Dept. E1-4**  
1400 W. Greenleaf, Chicago 26, Ill.

Send free illustrated Brochures and other information about the field I have checked below.

- |   |   |
|---|---|
| <input type="checkbox"/> Refrigeration and Air Conditioning | <input type="checkbox"/> Automotive Mechanics     |
| <input type="checkbox"/> Electricity                        | <input type="checkbox"/> Diesel Mechanics         |
| <input type="checkbox"/> Radio Servicing                    | <input type="checkbox"/> Body & Fender Rebuilding |
|   | <input type="checkbox"/> Building Construction    |

Name .....

Address .....

City ..... State .....

Veteran  Non-Veteran



**YOU CAN LEARN TO BE AN ARTIST**

Start **DRAWING** At Home in Your **SPARE TIME!**

**Draw for Money! Trained Artists are capable of earning \$60, \$75 and more a WEEK!**

Your future is in your own hands. Prepare yourself now in **COMMERCIAL ART, DESIGNING and CARTOONING**—all in ONE complete home study course. No previous art experience necessary—we teach you step-by-step for a fascinating hobby and a profitable career. For 34 years WSA graduates have been "making good"—**WHY NOT YOU? FREE BOOK.** "Art for Pleasure & Profit" fully describes course. service and commercial opportunities. **TWO ART OUTFITS** included with training. Mail coupon today.

**(VETERANS! Course approved under G.I. Bill.)**

**FREE BOOK gives details!**

**WASHINGTON SCHOOL OF ART,**  
Studio 134M, 1115 15th St., N. W., Washington 5, D. C.

NAME ..... AGE .....

Address .....

City ..... Zone ( ) State .....

I am entitled to training under the "G.I." Bill

**GADGETEERS!!**

**JOIN THE FASTEST GROWING CLUB in the WORLD**

**NEW • DIFFERENT • EXCITING**

*Gadget-of-the-Month Club, Inc.*

TRIAL MEMBERSHIP

YOU'VE read about it in the newspapers—heard it on the radio! Here's your chance to join the greatest club in the world!

Created especially for you "gadget lovers," the Gadget-of-the-Month Club sends you each month a new patented practical gadget, **before** it is marketed anywhere! Members get an exclusive preview of tomorrow's gadgets.

More than 600,000 gadget-minded men and women are already enjoying this exclusive privilege. One dollar and this coupon brings you a trial membership; a gadget every month for six months! Get in on the fun NOW. Preview new gadgets before public sale. Send your dollar in today for six-months membership in the most exciting club in America—The Gadget-of-the-Month Club! (This offer is for a limited time only and may be revoked without notice.)

**GUARANTEE**

The total retail price of the six gadgets you will receive must be far greater than the cost of your membership or your money will be cheerfully refunded.

**NEW GADGETS FOR \$1.00**

**MEMBERS SAY:**  
"Received my first gadget today and would like to order five more for gifts . . . P.K.M."  
"Was thrilled today when I found the postman had delivered my first gadget. My wife insists that I order a membership for her dad, and one dollar is enclosed . . . R. B. H."  
"My secretary has swiped the gadget you sent me yesterday to start my membership. Please enroll her so I can enjoy them myself . . . P.O.W."

**JOIN NOW!**

**GADGET-OF-THE-MONTH CLUB, INC.**  
P. O. Box 2000, Los Angeles 54, California

Name .....

Street .....

City .....

Occupation ..... Age .....

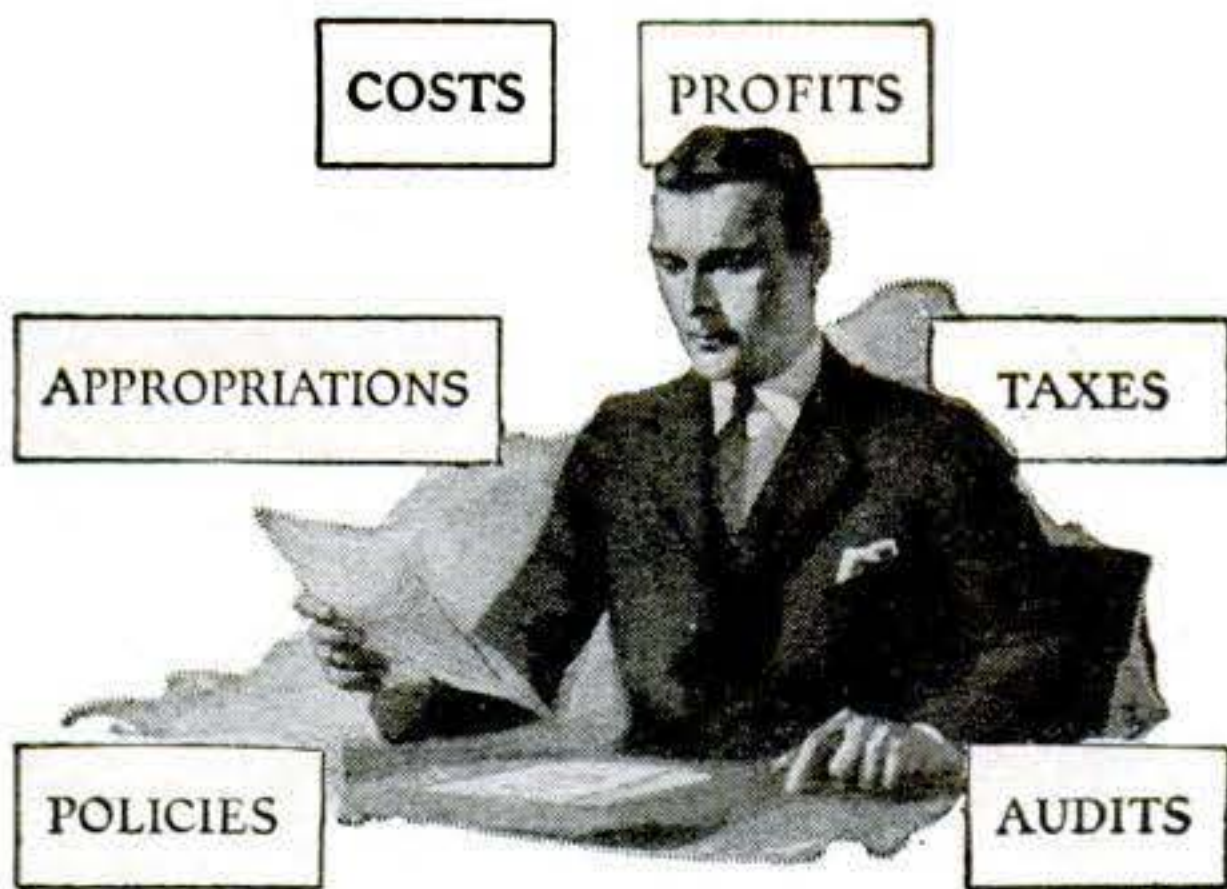

## Become an Expert Accountant

*The Profession That Pays*

The demand for skilled accountants—*men who really know their business*—is increasing. National and state legislation is requiring of business—both big and small—much more in matters relating to Auditing, Cost Accounting, Business Law, Organization, Management, Finance. Men who prove their qualifications in this important field are promoted to responsible executive positions—given an opportunity to earn real salaries. The range is from \$3,000 to \$10,000 a year, even to higher income figures.

Send for Free Book—

**“Accountancy, the Profession That Pays”**

Why let the other fellow walk away with the better job, when thru home-study you can equip yourself for a splendid future in this profitable profession?

Knowledge of bookkeeping unnecessary. We train you from ground up, or according to your individual needs. Low cost; easy terms.

Send for free 48-page book describing the LaSalle accountancy training and the opportunities in this highly profitable field.

If you have the urge, the will to increase your income, mail the coupon NOW.

### LASALLE EXTENSION UNIVERSITY A CORRESPONDENCE INSTITUTION

Dept. 483-HR, 417 S. Dearborn St., Chicago 5, Ill.

Please send my copy of “Accountancy, the Profession That Pays,” without obligation.

Higher Accountancy

**Other LaSalle Opportunities:**

If interested in the fields below, check and mail now.

- |  |   |
|--|---|
| <input type="checkbox"/> Business Management     | <input type="checkbox"/> Sales Training     |
| <input type="checkbox"/> Business Correspondence | <input type="checkbox"/> Law—LL.B. Degree   |
| <input type="checkbox"/> Expert Bookkeeping      | <input type="checkbox"/> Business English   |
| <input type="checkbox"/> C. P. A. Coaching       | <input type="checkbox"/> Effective Speaking |

Name.....

Street.....

City, Zone & State.....

## TRAIN NOW FOR AN AVIATION CAREER IN SUNNY SOUTHERN CALIFORNIA

### MAXIMUM TRAINING IN MINIMUM TIME

Specializing in AERONAUTICAL ENGINEERING and MASTER AVIATION MECHANICS since 1929... America's Finest Aeronautical Institute... 7000 successful graduates... MAKE MORE MONEY... MAIL COUPON TODAY. APPROVED FOR VETERANS. Board and Room now available.

Without obligation, send free catalogue with full information.

NAME..... AGE..... PS-4

ADDRESS.....

CITY..... ZONE..... STATE.....

**CAL-AERO TECHNICAL INSTITUTE**  
GRAND CENTRAL AIR TERMINAL • GLENDALE 1, CALIFORNIA



# FUN!

## MAKE THIS SquirrelLamp

Yes sir, out of a real squirrel! Also make ash-trays, book-ends, etc., using rabbits, frogs, etc. LEARN AT HOME TO MOUNT BIRDS, ANIMALS & FISH: Tax skins and make fur rugs, buckskin and leather.

It's FUN! BIG profits in spare time!

Free book tells how.

**FREE BOOK!** Write TODAY for beautiful free book telling how to learn this fine hobby. Book is free. Contains many fine pictures. STATE YOUR AGE.



N. W. SCHOOL OF TAXIDERMY, Dept. 3394 Omaha, Neb.

The American Institute of Specialized Watch Repair  
270-276 East Building GRAND RAPIDS 6, MICHIGAN  
A Fully Accredited School

You can learn this highly fascinating and profitable trade through this Institute, either at home by correspondence or at the resident school.  
**Earn While You Learn**

Write for Free Circular



## Learn WATCH REPAIRING

## TRI-STATE COLLEGE

B.S. Degree in 27 months in Engineering (7 branches), Bus. Admin., Acctg. and Sec. Science. Graduates successful. 64th year. Enter Sept., Jan., March, June. Write for catalog. 548 College Ave., Angola, Ind.

## RADIO

ENGINEERING Television, FM, Broadcasting, Servicing, Electronics, Aviation, Marine & Police Radio taught thoroughly. 72 weeks' Engineering course equivalent to 3 years' college radio work. Approved Veteran Training. Catalog upon request. Valparaiso Technical Institute, Dept. 503, Valparaiso, Ind.



**Thrilling Work COLORING PHOTOS**

Fascinating vocation learned at home by those with aptitude. Thrilling pastime. National method brings out life-like colors. Free booklet.

**NATIONAL PHOTO COLORING SCHOOL**  
1315 S. Michigan, Dept. 1364, Chicago 5

**EASY TO LEARN**

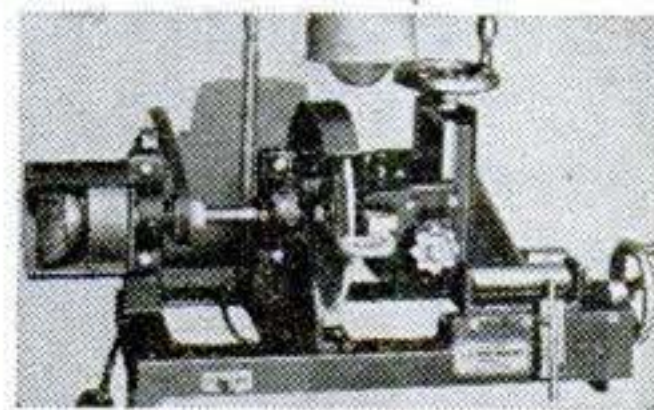

Pat. applied for

**J. C. MOORE INDUSTRIES** P.O. Drawer 276 FREDONIA, PA.

**Start a NEW BUSINESS**  
Or Add to Your Present Repair Business  
Sharpen Dull Pipe Wrenches  
Pipe Taps & Dies  
“Gum” Circular Saws

Write for information.

## SHOE REPAIR OFFERS BIG INCOME

LEARN IN 12 WEEKS TIME

In 12 weeks time you can own your own shop or earn big income as skilled shoe repairman. Growing demand everywhere at top wages for men who know how. We teach you quickly by actually working on shoes and modern machines. Costs nothing under G.I. Bill of Rights. We help you get big pay job or start your own shop in 12 short weeks. School open to all from 18 to 60 years of age. FREE BIG 16 PAGE BOOK explains everything. Send for your copy today.

**MODERN SHOE REBUILDING SCHOOL, Established 1927**  
2937 Belmont Ave., Chicago, Ill. RUSH POSTCARD TODAY!

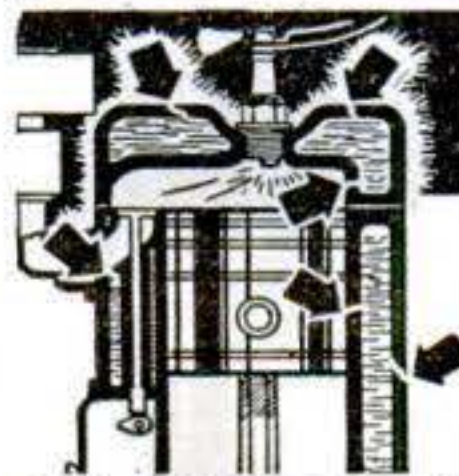

## REPAIR CRACKED BLOCKS AND HEADS—

External and internal leaks in blocks, cylinders and valve ports quickly and easily with LUSCO PLASTIC SEAL.  
**90 day Service Guaranteed** or your money back. Send money order or check for full pint—more than sufficient for average repair... **\$3.00** Postpaid

**C. F. LUSK CO., 5916 Bonna Ave., Cleveland 3, Ohio**

# THESE 5 TRADES ASSURE YOU HIGH PAY • Future Security

- **PLUMBING** Every phase of plumbing Pipe-Cutting and Installations, Completed Installations of entire plumbing systems Threading, Lead-Wiping, Rough-in Projects on Blueprint reading. Estimating
- **DRAFTING** College-level courses in General Machine and Architectural Drafting, with fundamentals in Drafting Mathematics—all under graduate engineers
- **SHOE REPAIRING** From simplest repairs on boots and shoes to the finest details of reconditioning and rebuilding, under expert craftsmen.
- **ELECTRICAL** Technical and shop training include Basic Electricity, Residential Wiring, Industrial Wiring, General Testing and Trouble Shooting, and Appliance Repair
- **AUTOMOTIVE & TRACTOR** Applied training on latest model automobiles and tractors, including engine overhaul, transmission and differentials, carburetion, generator and ignition systems, engine tune up, Hydramatic and Vacumatic Transmissions, and general service

*"There's Always a Demand for the Man who KNOWS!"*

**CHOOSE ONE OF THESE 5 LEADING TRADES**

Get Out of that Rut... Be a Skilled Tradesman! Have a Lifetime Career... Own Your Own Business and Be Secure in Your Old Age

**NOW** while Enrollment is still open, send for FREE information.

## THE 5 DIVISIONS OF NATIONAL TRADE SCHOOL

Dept. C 2610 Grand, Kansas City 8, Mo.

- Plumbing                       Drafting  
 Shoe Repairing                   Electrical  
 Automotive & Tractor

NAME \_\_\_\_\_

ADDRESS \_\_\_\_\_

CITY \_\_\_\_\_ STATE \_\_\_\_\_

VETERAN \_\_\_\_\_ OCCUPATION \_\_\_\_\_

### Choose One of these 5 Essential Trades

Our complete courses of thorough training prepare you to go right into the field as a Qualified Tradesman at High Pay in only 34 weeks (39 in Shoe Repair). All courses under especially trained instructors with practical experience. 6 Hour Classes 5 Days a Week. Our Employment Department helps you.

**VETERANS** "Approved for veterans' training by the State Department of Education under Public Law 346."  
"Approved for veterans' training by the Veterans' Administration under Law 16."

*Send Coupon for Free Information Now*

# BLISS ELECTRICAL TRAINING

Intensive 32 weeks' residence course in fundamentals of industrial electrical engineering, including radio, electronics. Prepares for technician, engineering aides. Approved for veteran training. 54th year. Enter July 26, Nov. 22. Catalog.

7606 TAKOMA AVENUE, WASHINGTON 12, D. C.



## THE LIBRARY OF ELECTRICAL MAINTENANCE AND REPAIR

5 vols., 1826 pages, 1724 illustrations

**HERE'S WHAT YOU GET:**—The "know-how" to tackle any wiring or motor job big or small—practical, easy-to-understand information on how to install, inspect, and repair all types of motors, generators, starters, transformers, regulators, etc.—how to diagnose troubles quickly—how to figure new windings.—Gives you step-by-step procedure for every wiring and repair job you may run up against. One book is full of trouble shooting charts to show you symptoms, causes, specific remedies, etc. A gold-mine of electrical knowledge—Send for free-trial set today.

**SEND NO MONEY**

**SEE THESE BOOKS  
10 DAYS  
FREE**

**Prepare NOW! —FOR JOB SECURITY  
—AND BIG MONEY IN**

## ELECTRICAL REPAIR

**NOW—this minute—you can take the first step toward a high-pay position in electrical repair and maintenance... a fast-growing field that's crying for men—trained men to fill top-notch jobs! Right now hundreds of men are getting the solid background needed to advance quickly in electrical repair work from this up-to-date library. You can too—IF YOU ACT PROMPTLY.**

*Don't delay—take advantage of this free-trial offer*

**MAIL THIS COUPON TODAY**

McGraw-Hill Book Co., Inc., 330 W. 42 St., New York 18, N. Y.  
Send me for ten days' free examination the Electrical Maintenance and Repair Library. If satisfactory I will send you only \$2.50 in 10 days and \$3.00 monthly until the price of \$17.50 is paid. If not wanted I will return books postpaid.

Name.....

Home Address.....

City and State.....

Company.....

Position..... PSM-4-48

# WANT A GOVERNMENT JOB?



**START  
as high as  
\$3,021 Year**

**Prepare NOW For  
Next Examinations**

**VETERANS GET  
SPECIAL PREFERENCE**  
Many Early  
Appointments Expected  
City Mail Carriers  
City Postoffice Clerks  
Ass't Statistical Clerks  
Stenographers-Typists  
Storekeeper—  
Gaugers, Etc.

**32-Page Civil  
Service Book  
FREE**

**Mail  
Coupon  
today—  
SURE**

★

**FRANKLIN  
INSTITUTE**  
Dept. A81  
Rochester 4, N. Y.

COUPON

Rush to me, entirely free of charge, 32 page book with:  
(1) A full description of U. S. Government jobs; (2) A list of U. S. Government jobs; (3) Tell me how to qualify for a job.

Name.....

Address.....

..... Vet?.....

*The Merriam-Webster Book of*

# Synonyms

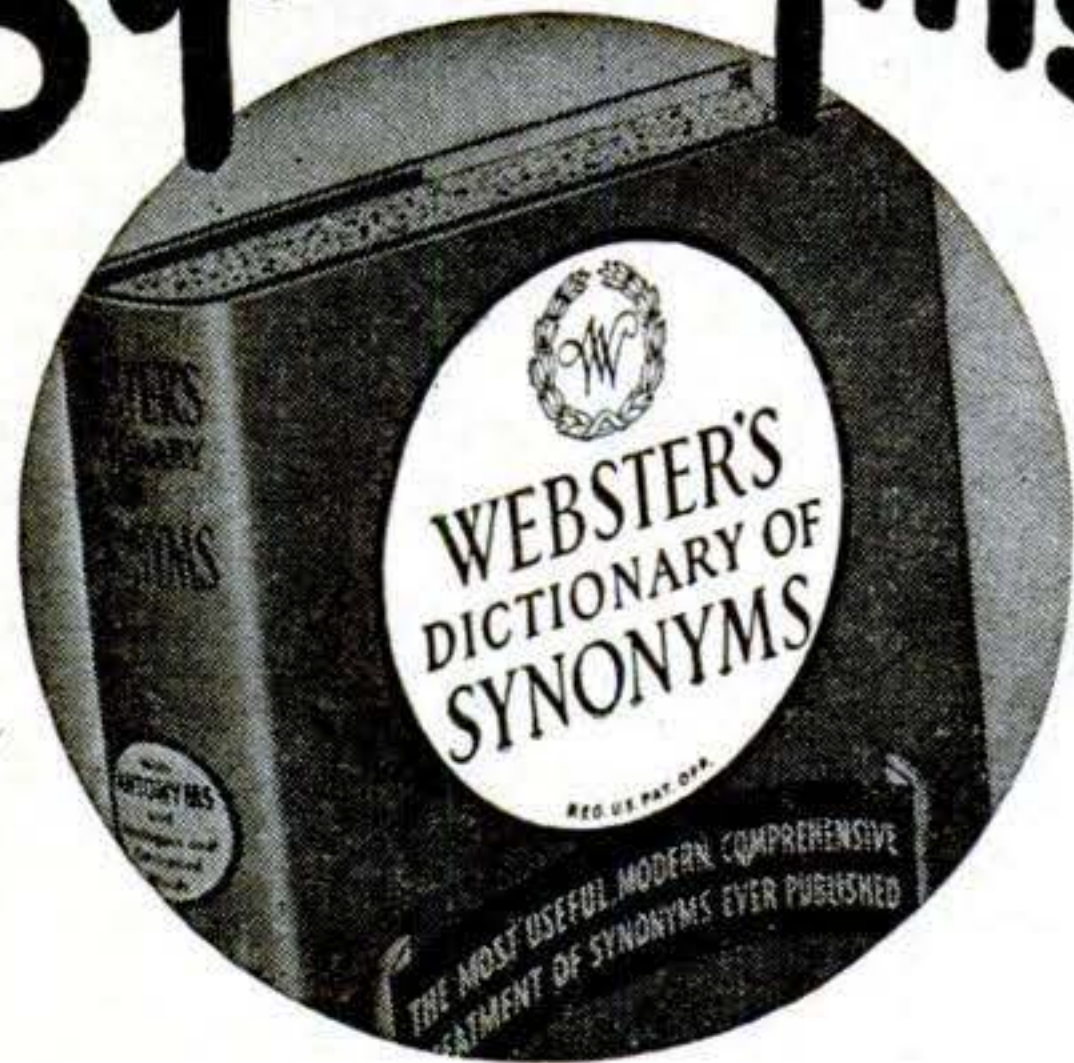

**helps you use the right word in the right place**

**WEBSTER'S DICTIONARY OF SYNONYMS** clarifies distinctions between Synonyms, giving their Antonyms and Analogous and Contrasted Words, explains differences in their shades of meaning, and illustrates usage. Prepared by the famous Merriam-Webster editorial staff. Alphabetical listing and cross-indexing of every entry. Over 900 pages, thumb index, \$5.00. At your bookdealer, or from the publishers, G. & C. MERRIAM Co., 745 Federal St., Springfield 2, Mass.

Buy Give-a-Book Certificates at Your Bookseller

**\$10,000 a year is easy—SELL the charger that is safe FOR FAST BATTERY CHARGING**



**FAST CHARGER & COMPRESSOR**  
GUARANTEED not to harm batteries. Users all over the world say "Wouldn't be without it!" SIMPLE—FAST and SAFE TOO!  
Starts motors and inflates tires QUICKLY. Charges in 30-45 min. Model GKN gas powered for farm use. Model SN, charger only. Write direct to factory. VALUABLE TERRITORY OPEN FOR SPECIALTY SALESMEN AND DISTRIBUTORS. WRITE NOW. Manufactured and GUARANTEED by

**H-H PRODUCTS MFG. CO.**  
SUCCESSORS TO PLASTIFORM MFG. CO.  
DEPT. PS-2, 306 BOYD STREET • LOS ANGELES 13, CALIFORNIA

# CHEMISTRY

**LEARN AT HOME...**Chemical knowledge is essential for thousands of good jobs in industry, business, science. IPC enables you to master practical chemistry. It's the ONLY home study chemistry course which enables you to learn by performing actual experiments—using chemicals and apparatus supplied with the course—in addition to your IPC textbook studies. Compares with recognized college courses in General Chemistry. Write today for free descriptive booklet.

**INSTITUTE OF PRACTICAL CHEMISTRY**  
2 PROSPECT AVENUE, HAGERSTOWN, MD.

## LEARN WATCH and CLOCK REPAIRING

Start training now for a better paying job or your own profitable business. Qualified Watch Makers are in demand . . . Unlimited opportunities. Intensive practical training by experienced watch makers. Approved for veterans. Write for full details. Indicate if Veteran.

**SCIENTIFIC SCHOOL OF WATCH MAKING, Dept. PS-4**  
3923 San Fernando Road Glendale 4, Calif.

**GET INTO CARTOONING!**  
Let Hartman teach you cartooning, gag writing at home. Learn by mail from a professional! Send Name, Address for **FREE DETAILS**.  
Hartman Studios, 2776 California Court, Lincoln 8, Nebr.

## OLD GOLD JEWELRY WANTED

Dental gold teeth, plates and bridges with metal attached. Any broken pieces of gold jewelry. Immediate payment and free mailing container to you or your friends upon request.

**LOWES, DEPT. PS** Holland Bldg., St. Louis 1, Mo.

## DETECTIVES

Home Study in Detective Training—Professionally Modernized—Recognized Instructors—Easy Payments—Write

**INTERNATIONAL DETECTIVE TRAINING SCHOOL**  
1701-P Monroe St. N. E. Washington 18, D. C.

**\$1.98** For Laughs **DAFFY DILLY**  
For Fun The Wonder Drinking Clown



**THE GREATEST ACROBAT OF ALL TIME**  
Complete with stand. No springs, no gadgets, no wires, not mechanical. Sensational "Daffy Dilly" somersaults through the air into a glass of water. It's "eye-stounding." Young and old go wild over him. A wonderful gift. **SEND NO MONEY**. Start laughing at the antics of Daffy Dilly today. Pay postman \$1.98 plus postage and C.O.D. charges when delivered or send \$2.00 and we pay postage.

**Special Price to Dealers**  
**BERNARD FINE CO. INC.**  
501 6th Ave. Dept. PS-11 N. Y. 11, N. Y.

**MONEY for MEN ALL DATA FREE**

THE PLASTEX Industry needs manufacturers on small scale and for big production of Lamp and Clock Stands. Art Goods and Novelties in Plastex and Marble imitation. Experience unnecessary. 1/2c material makes regular 10c store sellers. Rubber moulds furnished for speed production. Small investment brings good returns. Big chain store orders now being placed. Ambitious men have chance for real prosperity. Our Free booklet will interest and benefit you.

**PLASTEX INDUSTRIES, Dept. 2, 3400 Third Ave., New York 56, N. Y.**



**GENERAL ELECTRIC  
BC 645  
TRANSCEIVER**

**TWO-WAY COMMUNICATION  
For EVERYBODY!!**

10 times as powerful as a walkie talkie



**\$14.95 for \$27.**

A brand new two-way communication set which cost the Army over \$400.00 and is ideal for two way communication between house and cars, office, service trucks, ambulances, boats, etc. Range up to 15 miles in the 450 to 500 Megacycle band. Operates in the new citizens band. Supplied complete with 15 tubes and conversion instructions to operate from 110 V A.C. Add postage for 25 pounds.

**ACCESSORIES NEEDED**

- PE101C Dynamotor for 12 or 24 Volt storage battery operation .....\$3.95
- 110 V A.C. Power Supply to operate BC 645 from house current .....\$11.95
- T-32 Table Microphone.....\$2.95
- Microphone Transformer.....\$1.00
- 5" PM Speaker for BC 645 \$2.80

**HEATHKIT 3-TUBE ALL-WAVE RADIO**

110-volt AC-DC operation

**\$5.95**

An ideal way to learn radio. This kit is complete ready to assemble, with tubes and all other parts. Operates from AC or DC. Simple, clear detailed instructions make this a good radio training course. Covers regular broadcasts and short wave bands. Plug-in coils. Regenerative circuit. Operates loud speaker. Battery model for use where no AC house current is available. Add postage for 3 lbs.

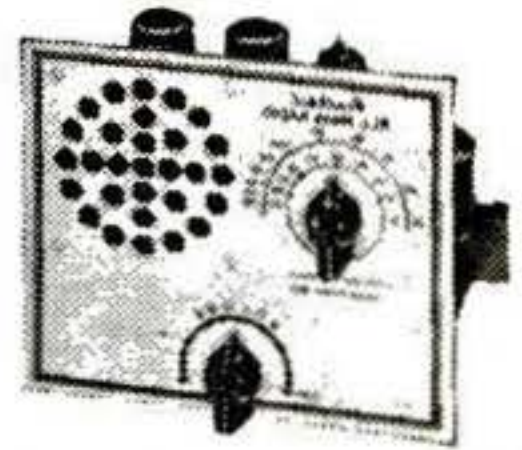

- Heathkit Beginners' Radio 110-volt type .....\$5.95
- Heathkit Beginners' Radio, battery type (2 tubes, no rectifiers).....\$5.95
- Headphones for either type HS 30 per set.....\$1.00
- 2 1/2" permanent magnet loudspeaker for either type.....\$1.95
- Batteries, complete kit for battery type set.....\$3.25

**GN58 GENERATOR**

Makes excellent home lighting plant, operated by wind propeller, waterfall, gas engine, or hand crank. Reduction gear allows full output at slow speed; supplies 6 volts at 2.45 amp., 425 volts at .115 amp. New. Add postage for 28 lbs. ....**\$7.95**

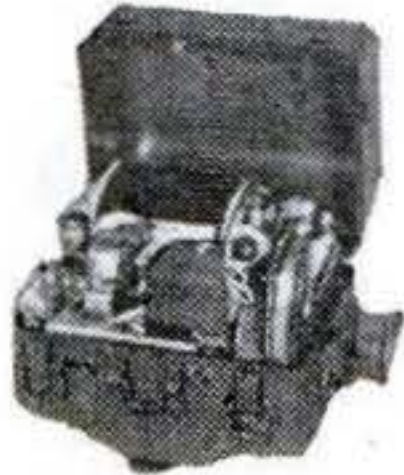

**DYNAMOTORS**

An electric motor operating a generator on same shaft—hundreds of uses—gives high voltage from storage battery.



**\$1.95**  
**\$5.95**  
**\$5.95**

- Dynamotor C—Input 28 volts, output 220 volts at 60 MA. Add postage for 6 lbs.
- Dynamotor A—Input 12 volts, output 1000 volts at 350 MA. Shipping weight, 72 lbs.
- Dynamotor B—Input 6 or 12 volts, output 500 volts at 160 MA. Shipping weight, 30 lbs.

**BRAND NEW ARMY AIR FORCE ASTROGRAPHS With Case**

New B29 navigation instrument which can easily be used to make a good contact printer, strip map holder, etc. The plywood case 14 1/2"x11"x10" high is perfect as a tool kit, camera, projector case or for building a portable phonograph, picnic kit, make up case, etc., has leather handle reinforced covers, 8 covered compartments in bottom. Cost Gov't \$125.00. Add postage for 20 lbs.

Only **\$3.95**



**G.E. BC375 TUNING UNIT**

A beautifully constructed tuner containing the best in variable condensers, coils, vernier dials, etc., at least \$30.00 worth of parts, complete with conversion instructions to transmitter and receiver. Add postage for 20 lbs.....**\$2.49**

**MIDGET TRANSMITTER KIT**

Complete kit to assemble a 1 Watt battery operated amateur 80 meter transmitter, including tube and crystal. Range up to 500 miles. Only accessories needed are sending key and batteries. Complete instructions supplied. Add postage for 2 lbs.

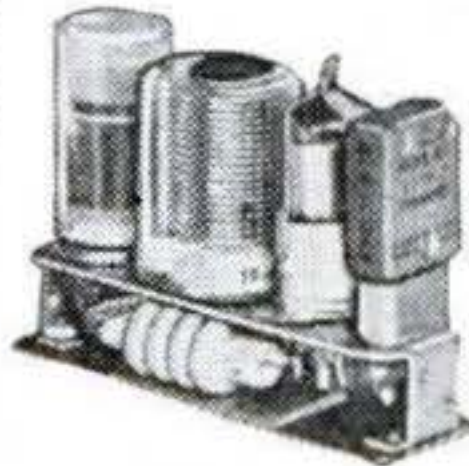

**\$3.95**

- Key—add postage for 2 lbs.....\$1.00
- Batteries—add postage for 4 lbs. ....\$3.25

**THE NEW 1948 HEATHKIT 5" OSCILLOSCOPE KIT**

Complete kit to build a beautiful 5" oscilloscope. Ideal for studying and servicing television and FM radio. 6 tubes including 5BP1 cathode ray tube. 1500-volt power supply operates from 110-V 60 cy A.C. Has compensated vertical and horizontal amplifiers and 15 cy to 30 KC sweep generator. Detailed instructions make assembly easy. Shipping weight, 35 lbs. Nothing else to buy .....**\$39.50**



**MINIATURE HEADPHONES**

**\$1.00**

Hearing aid type, comfortable, keeps out outside noise, one of the army's best types. Add postage for 2 lbs.



**T32 TABLE MICROPHONE**

One of the army's finest built by Kellogg. Ideal for public address, transmitters, etc. Add postage for 5 lbs.....**\$2.95**



**G. E. CIRCUIT BREAKER**

**\$2.95**

Protect your electrical equipment, eliminate fuses. 50 AMP 220 Volt rating. Add postage for 4 lbs.



**THROAT MICROPHONE**

Used by army in noisy applications in aircraft, tanks, etc. Many interesting home uses. Add postage for 1 lb.....**\$1.00**



**No Orders Under \$2.00**  
Add postage for weight shown. Write for Flyers listing hundreds of other electronic bargains



**The HEATH COMPANY**

**DEPT. S . . BENTON HARBOR, MICH.**

## PRACTICAL TECHNICAL TRAINING FOR YOU

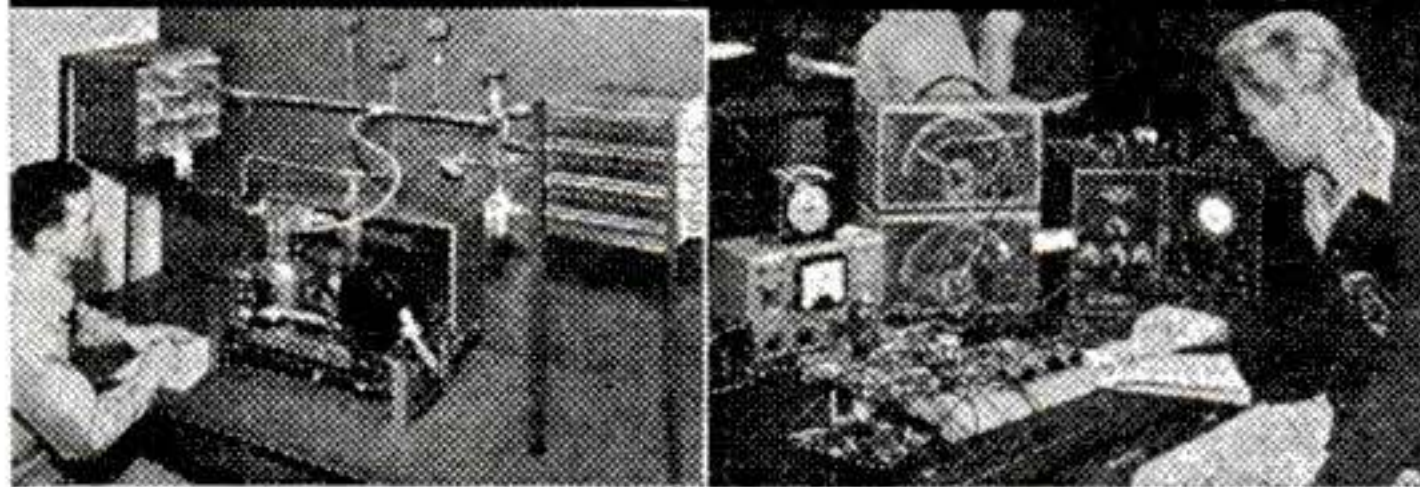

**SPECIALIZE in 6 months to 3 years**

OUR time-tested CONCENTRIC SYSTEM enables you to build your career step by step. Each 6-month course is complete in itself yet prepares you for advanced courses. You train as long as circumstances permit—until you reach the "top step" in your desired occupational objective. More than 35,000 former students in industries the world over.

### COURSES

**SERVICE — 6 to 12 months**  
 Practical Electricity  
 Practical Welding  
 Refrigerator Service  
 Heating Service

**TECHNICIAN — 1 to 2 years**  
 Electro Technician  
 Radio Technician  
 Electronics Technician  
 Refrigeration, Heating and Air Conditioning Technician

**PROFESSIONAL — 3 years**  
 Electrical Engineering  
 Bachelor of Science Degree  
 Major in Machinery or Electronics

## MILWAUKEE SCHOOL of ENGINEERING

A Technical Institute

Terms Start April, July, September  
**MAIL COUPON TODAY!**

Milwaukee School of Engineering,  
 Dept. PS-448, N. Broadway & E. State, Milwaukee, Wis.  
 Without obligation, send me free booklet "Career Building" and more details on course in.....

Name.....Age.....  
 Address.....  
 City.....State.....

## LEARN ACCOUNTING SALESMANSHIP SECRETARIAL WORK

### Assure Your Future Now!

Hill's, one of America's outstanding Business Schools, offers you the opportunity to enter one of the three fields acknowledged to hold substantial earnings and a secure future. Our FREE book, "Through Hill's to Success," tells how and where the best positions are found and how you can qualify for them by study at home or in our resident school. We have thousands of successful graduates and maintain nationwide employment service. G. I. Approved.

**FREE WRITE TODAY**

### USE THIS HANDY COUPON

HILL'S EXTENSION SCHOOL Dept. PS-4  
 AND BUSINESS UNIVERSITY,  
 619 W. Main St., Oklahoma City 2, Okla.  
 Please send me your Free book, "Through Hill's to Success."

NAME.....  
 ADDRESS.....  
 CITY.....STATE.....

## STEP INTO THE AUTOMOTIVE INDUSTRY—A TRAINED MAN! PRACTICAL SHOP TRAINING

IN  
**AUTOMOTIVE MECHANICS BODY and FENDER REBUILDING**

If interested write or wire

**ATLANTA MOTIVE TRADES INSTITUTE** Dept. C, 254 IVY St., N.E.  
 Atlanta, Georgia

Veterans ask about G I Training

## Have an OFFICE of YOUR OWN!

**LEARN NEW PROFITABLE PROFESSION**  
 At Home in 60 Days, Men & Women, 18 to 70!

Be Your Own Boss and the Boss of Others. Be Respected. Meet Interesting People.

Earnings of men and women in this profession run as high as \$5,000-\$15,000 yearly. Others make good money in spare time. Little money needed to start. A business where your earnings begin sooner. Easy to learn. No selling or goods to buy. No experience necessary. A depression-proof business. A course of action to guide you step by step as you earn. All 53 lessons sent at once to use as operating manuals. Easy terms. Diploma. Money-back agreement. Write for FREE BULLETIN.



**FRANKLIN CREDIT SCHOOL**  
 Dept. 71-D ROANOKE 7, VIRGINIA

**BY MAIL in Easy Lessons**

## STAMMER?

This new 128-page book, "Stammering, Its Cause and Correction," describes the Bogue Unit Method for scientific correction of stammering and stuttering—successful for 47 years. Benj. N. Bogue, Dept. 4826, Circle Tower, Indianapolis 4, Ind.

GET THIS FREE BOOK!



LOOK! It actually Flies—this NEW model

## HELICOPTER

Jet model—soars up 100 ft.—a string operates it. Aluminum, with 12-inch rotor, only \$1.69 complete. Send \$1 with name and address. Pay postman balance of 69c plus postage. Order now. ROBERT SALES, Dept. K-3, 727 Hennepin Ave. Minneapolis, Minn.



## HUNTING KNIFE

Made For U. S. Marine Corps

Used by HUNTERS - FISHERMEN - CAMPERS  
 7 1/2" Single Edge Blade—12" Overall Length  
 Dressed Leather Handle—Saddle Leather Sheath

A \$4.00 Value—Send \$1.25

No C.O.D. We Pay Postage

**ZIMM'S SURPLUS STORE**  
 2310-C Broadway, Oakland 12, Calif.

## INVENTIONS WANTED AT ONCE

Patented or unpatented inventions, all types needed by manufacturers. Write for free booklet "MARKETING YOUR INVENTION" and Protective Disclosure Form. We have a tremendous list of firms who may pay cash or royalties for good inventions. For full particulars, write today.

**NATIONAL INVENTION SERVICE**

1404 Mitchell Street, Dept. A

Oakland 1, Calif.



## MECHANICAL DENTISTRY

A profession offering unlimited opportunities. Most modern and complete course embracing every branch from Plate to Porcelain Work, which prepares you to work for Dentists or start your own business. Individual instruction—practical training in day or night school. No books—no classes. Catalog upon request.

McCARRIE SCHOOL of Mechanical Dentistry, 207 N. Broad St., Dept. 873, Philadelphia, Pa.

## SIGNS EASILY AND EXPERTLY PAINTED WITH LETTER PATTERNS AND SHOWCARDS

MANY SIZES & STYLES WRITE FOR FOLDER!

**JOHN F. RAHN**  
 1330-33 N. CENTRAL AVE.  
 CHICAGO 51, ILL.

# AMERICA'S GREATEST ELECTRICAL SCHOOL OFFERS YOU

**MORE EQUIPMENT!**

**MORE SPACE!**

**MORE TRAINING!**

OVER

**1000**

PIECES OF ACTUAL ELECTRICAL EQUIPMENT TO WORK ON!



## Learn **ELECTRICITY**

It's Easy - "LEARN-BY-SEEING" MOVIES  
It's Fast - "LEARN-BY-DOING" METHODS

and its THOROUGH! . . . There is *no other place*—no other way to get the same all-around training you get at M.T.I. NOT A HOME STUDY COURSE! . . . You get actual "hands-on-equipment" training in great MODERN SHOPS in Detroit. No previous experience necessary. Learn HOUSE WIRING, A.C., D.C. MOTORS, ARMATURE WINDING, POWER PLANT WORK, etc. New classes start every few weeks. Part time work available. Living arrangements made.

In  
**NATION'S  
LARGEST  
EXCLUSIVE  
ELECTRICAL  
SCHOOL**



**MAIL TODAY  
FOR QUICK  
ACTION!**

MICHIGAN TECHNICAL INSTITUTE, Dept PS-4  
2281 W. Fort St., Detroit 16, Michigan

Send me catalog and complete information.

I am a GI. Send special information.

Married.  Single

NAME \_\_\_\_\_

ADDRESS \_\_\_\_\_

CITY \_\_\_\_\_ ZONE \_\_\_\_\_ STATE \_\_\_\_\_

### **MICHIGAN TECHNICAL INSTITUTE**

Department PS-4 2281 West Fort Street, Detroit 16, Michigan

# WHICH OF THESE *Opportunities* INTERESTS *You* MOST?

● *Today*, choose the job you want—and prepare for it. Or if you are already engaged in the work you like best, start training *now* for quicker promotion. Acquire the knowledge that will help you to get ahead faster, make more money and have greater security.

American School, founded in 1897 as an educational institution *not for profit*, can

help you to reach your goal just as it has helped others during the past fifty-one years. Check the coupon at right, add your name and address and mail it at once. The school will send you details on its training plan and outline of study prepared by specialists. There is no charge, no obligation, so send the coupon immediately.

### CHECK, CLIP AND MAIL COUPON NOW

AMERICAN SCHOOL, Dept. G446, Drexel at 58th, Chicago 37, Ill.  
*Without obligation. Please send FREE and postpaid, bulletin and details of the Subjects checked:*

- |  |   |  |
|--|---|--|
| <input type="checkbox"/> PLASTICS ENG'R            | <input type="checkbox"/> Accounting                   | <input type="checkbox"/> Drafting and Design for Men and Women |
| <input type="checkbox"/> Refrigeration             | <input type="checkbox"/> Electrical Engr.             | <input type="checkbox"/> Radio                                 |
| <input type="checkbox"/> Architecture and Building | <input type="checkbox"/> Electricity-Pract.           | <input type="checkbox"/> High School                           |
| <input type="checkbox"/> Contracting               | <input type="checkbox"/> Electronics. Industrial      | <input type="checkbox"/> Air Conditioning                      |
| <input type="checkbox"/> Practical Plumbing        | <input type="checkbox"/> Bookkeeping                  | <input type="checkbox"/> Mechanical Eng.                       |
| <input type="checkbox"/> Automotive Engr.          | <input type="checkbox"/> Private Secretary            | <input type="checkbox"/> Shop Management                       |
| <input type="checkbox"/> Aviation Drafting         | <input type="checkbox"/> Diesel Engineering           | <input type="checkbox"/> Tool Making                           |
| <input type="checkbox"/> Aviation                  | <input type="checkbox"/> Sheet Metal Pattern Drafting | <input type="checkbox"/> Better Foremanship                    |
| <input type="checkbox"/> Business Management       | <input type="checkbox"/> Railway Training             | <input type="checkbox"/> Machine Shop Operations               |

Name..... Occupation.....  
Address..... Age.....  
City..... State.....

### AMERICAN SCHOOL

Dept. G-446, Drexel at 58th Street, Chicago 37



**YOU  
can  
acquire**

## **LAW NIGHTS AT HOME! L.L.B. DEGREE**

LaSalle's famous Law Library—used as reference in many Law libraries and Law offices—has enabled thousands to master Law surprisingly fast, in spare hours at home, for business and professional advancement.

These 14 remarkable volumes, compiled by leading professors and lawyers, cover the whole basic field of Law in condensed, orderly, simplified manner.

You advance rapidly with this great library, plus special lectures furnished. We guide you step-by-step with personalized Problem Method of instruction . . . you *learn by doing*—handling legal problems—not by memorizing rules.

Send for two FREE 48-page booklets, "Law Training for Leadership," and "Evidence," answering questions about Law and its value to you, and telling how LaSalle Law graduates are winning rapid advancement in business and public life. Mail coupon below. No obligation.

### **LA SALLE EXTENSION UNIVERSITY A Correspondence Institution**

417 S. Dearborn St. Dept. 483-L Chicago 5, ILL.

Send me your two FREE booklets described above, without obligation.

Name \_\_\_\_\_ Age \_\_\_\_\_

Street \_\_\_\_\_

City, Zone & State \_\_\_\_\_

# EARN BIG MONEY

## IN YOUR OWN BUSINESS

### Sharpening Lawn Mowers

### **BUILD A BUSINESS OF YOUR OWN WITH A UNIVERSAL GRINDER**

In your basement or garage and earn \$150 a month. Mr. Felber of Ind., writes, "My UNIVERSAL GRINDER is faster and more accurate than any other grinder. Its efficiency enabled me to sharpen 450 mowers in 4½ months. More than paid for itself the first month. Every customer satisfied." Mr. Hardy of Mississippi writes, "Received my Universal Grinder the first part of May and by August 18 had sharpened over 1000 mowers." Mr. Bacon of California writes, "The lawn mower business, with my Universal Grinder, has been a gold mine these last two years."

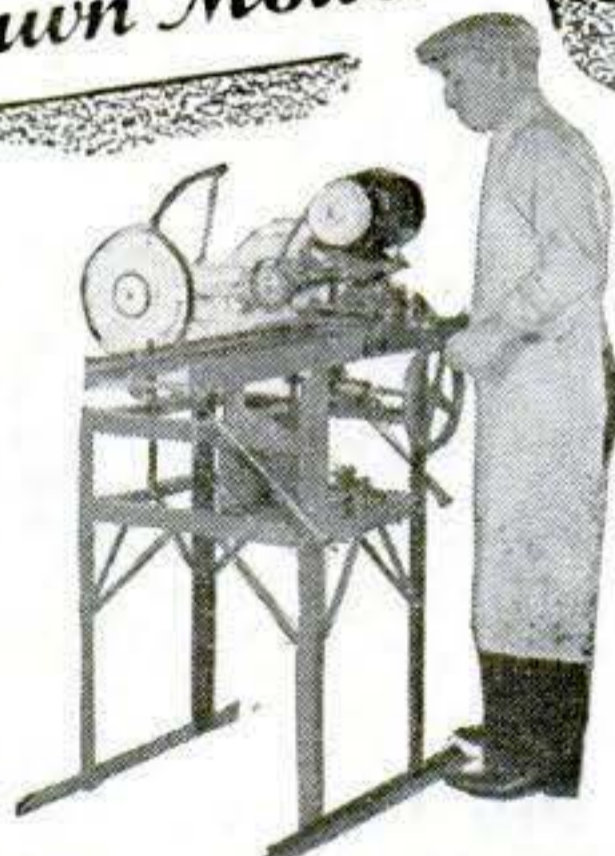

**Only on the UNIVERSAL GRINDER can the inside face and edge of the stationary blade, as well as the reel blades, be ground to proper clearance**

### **ALL IN ONE SET-UP**

**WITHOUT REMOVING ANY BLADE FROM THE MOWER**

**Write for Free Folder TODAY!**

**Rogers Mfg. Co., Dept. P-48, Lindsey, Ohio**

## GLOWS in the DARK FREE Sample!

Be the first to sell luminous house numbers, light switch plates, wall protectors, pull cords. Also luminous pictures, statues, decals, and a host of religious, nursery and other objects that glow in the dark. Get into this *new and growing* industry. Enormous demand... no competition... sensational demonstration... big profits. Represent a large manufacturer, established over 34 years. Write today for liberal money-making offer and free sample to show how they glow in the dark.

**MADISON MILLS, 303 Fourth Ave. Dept. D-5 NEW YORK 10, N. Y.**

Free Book



## **RAISE HAMSTERS**

The new wonder animals from Syria. Often called Toy Bears. Delightful pets. Everyone wants them. Laboratories need thousands. Clean, odorless. Raise anywhere. A profitable and interesting hobby or business. We furnish breeders and instructions. Write today for free book.

**GULF HAMSTERY, 1540 BASIL ST., MOBILE, ALA.**



### **Burn-Rite Wood Burning Detachable Pen**

Approved by Underwriters  
Only one of its kind. Write for complete list of casting and wood burning sets.

**\$1.50**

EACH

**RAPAPORT BROS. INC. POST PAID**

Dept. PS-4, 1830 S. Washtenaw Avenue

Chicago, Illinois

### **EYE-GLASSES by MAIL NEW**

Send No Money!

16-Day Trial Offer  
NEWEST STYLES



**LOW PRICES**

FREE Scientific Sight Test Chart and Catalog. Write today.  
**U.S. EYE-GLASSES CO. 1557 MILWAUKEE AVENUE Dept. 4-42, CHICAGO, ILL.**



### **AMAZING BENCH KNIFE CUTS ANYTHING**

Even Cuts Bolts With  
Out Hurting Blade

3½" blade, 7" overall. Finest lucite handle in black, red, blue or green. Rugged saddle leather sheath included.

My famous handmade Buck knife has a blade that's tempered by a secret process to last a lifetime. The edge is ground to razor sharpness—cuts anything. Handiest tool on your work bench. Ideal for small game. Send check or money order. Satisfaction guaranteed or your money back. \$5 postpaid.

**H. H. BUCK & SON**  
1272 Morena, San Diego, California

## **If Ruptured**



Do What Others Now Do—  
**Wear a Form Fitting  
MILLER Truss**

which provides natural freedom and comfort in working, walking, playing, horse back riding, dancing, swimming or sleeping. You just cannot afford to be without this protection and convenience.

**Wear two weeks** then consult your physician before deciding to keep it.

Write me today for **FREE** descriptive circular. Sent in plain, sealed envelope.

**FRED B. MILLER Manufacturer**  
Dept. P.S. Hagerstown, Maryland.



**THEY'RE OFF!**

**HAVE THRILLING RACES AT HOME!**

Great fun for every occasion!! Start this record on any phonograph and NO ONE CAN TELL THE WINNING HORSE—Not Even the Owner! Has all the thrills and sound effects of BIGTIME racing! Comes complete with scoring sheet. Send TODAY sure... Safe Delivery Guaranteed. (Write for wholesale prices.)

**ONLY \$1.49**  
Postpaid (Tax Incl.)  
2 for \$2.50

**STAR SPECIALTY CO.**  
DEPT. P5-2 BUTLER, PENNA.

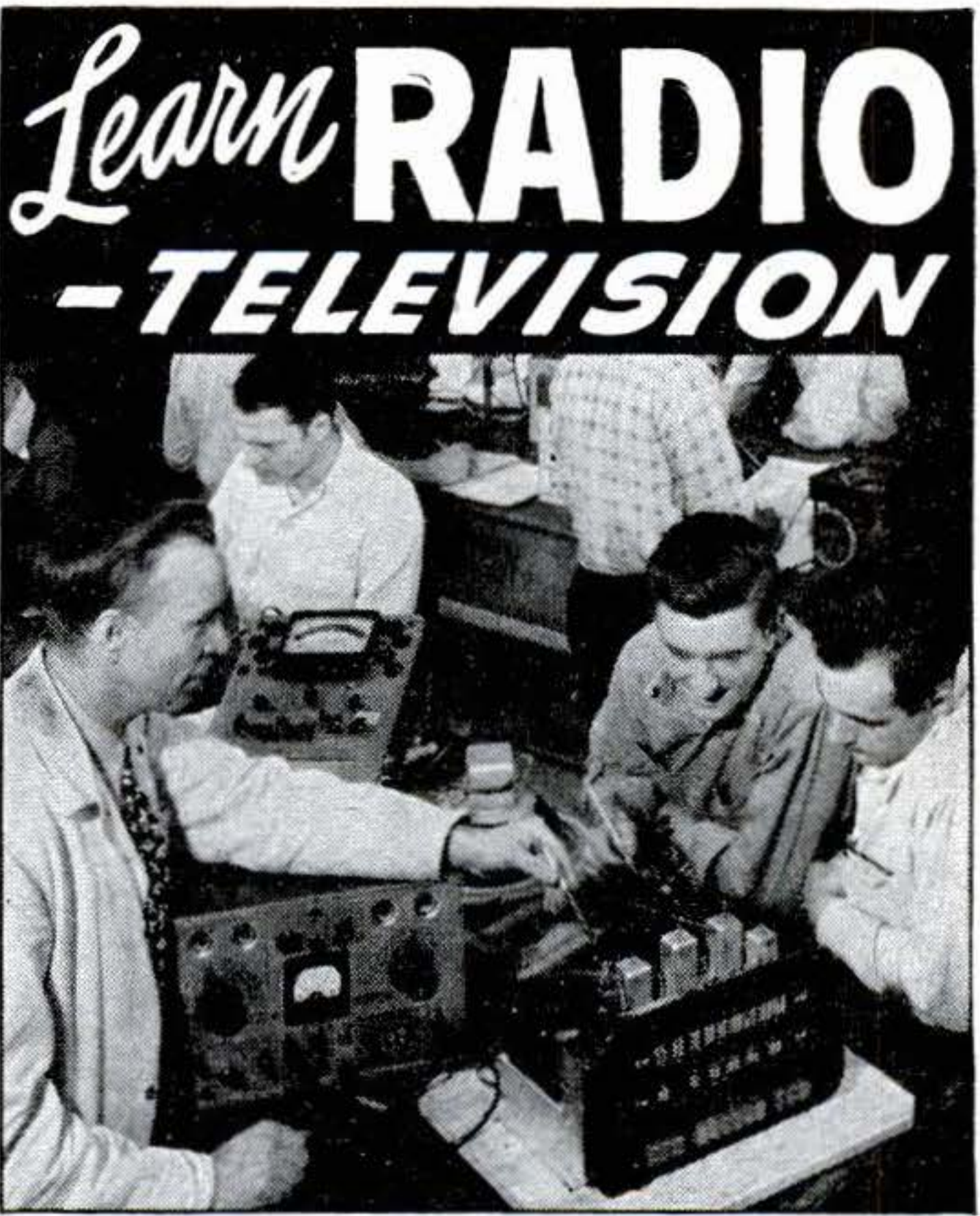

in the GREAT **SHOPS OF COYNE**

Get ready for a better job, bigger pay NOW in Radio. Cash in with "All-around" knowledge of Radio—Television. Train on actual equipment. You learn easily at COYNE because it's real shop training. Thousands of graduates in Industry.

**Not a "Home-Study" Course!**

You get actual shop work on full-size equipment plus necessary theory. Whether you had previous experience or not makes no difference at Coyne.

**Easy To Start Own Shop**

Right along with our course, we include special training on how to operate your own Radio Shop.

**GI Approved—Finance Plan for Non-Vets EARN WHILE LEARNING**

If you need part-time work to help out with living expenses while at Coyne we'll help you get it. Don't be held back by lack of money. Free employment service to graduates.

**SEND FOR FREE BOOK**

Get the facts! BIG FREE BOOK tells about your future in Radio and Television and how you can prepare at Coyne. Dozens of pictures. No obligation—no salesmen will call.

Established 1899

**MAIL COUPON TODAY!**

B.W. COOKE, President  
COYNE Electrical and Radio School  
500 S. Paulina St., Dept. 48-4H, Chicago 12, Ill.

Please send me your Big Free Radio and Television Book and all the facts.

NAME.....  
STREET.....  
CITY..... STATE.....



**3 In 1 AIR PISTOL**

**SPORTSMAN JR.**—Sensational, low-priced air pistol. Ruggedly built, full size target gun shoots either standard BBs, pellets or steel darts. Fast, single-action compression chamber. Single shot, silent shooting. Use indoors or outdoors. Modeled after famous target pistol Economical to operate. Die cast all metal non-slip moulded grip; machined steel chamber and barrel. 8-in. long; 4 1/2-in. deep; full size, weighs 15 oz. **EACH \$3.49**

BBs, 3 pkgs. 25c; .177 pellets, 500 for \$1.50; steel darts, 35c package. (Holster 50c) Order Plenty.

**No C.O.D. JOHNSON SMITH & COMPANY, Dept. B-75, Detroit 7, Michigan**



**\$3.49**

Shoots BBs Darts Pellets

Add Sales Taxes

**HOW TO CUT RAFTERS**

New vest pocket book gives lengths, side cuts, plumb cuts, deductions. For all rafters for any building from one inch to forty feet wide. Gives numbers to cut on square. Also degrees for same cuts for Radial Saws. All standard pitches from 1/8 to 5/8. Just open book to pitch page and there are your lengths, side cuts, etc. Anyone who knows what a Jack rafter is can frame a roof if he has this great book. Price one dollar, (\$1.25 in Canada). **Builders' Topics, Dept. S, Lock Box 828, Seattle, Washington.** CARPENTERS, PLUMBERS, PLASTERERS, ELECTRICIANS, ETC. subscribe for Builders' Topics, the monthly magazine for HE-MAN CONSTRUCTION WORKERS. Only \$1.00 per year, (In Canada—\$1.25). Sample copies 25c.

**make your own Gems 29.50 F.O.B.**

All necessary lapidary equipment is furnished, including a super-charged diamond blade for sawing, and all wheels for grinding, shaping and polishing; also complete instructions. The complete equipment as shown, less motor and belt, for only \$29.50, f.o.b., Burlington, Wisconsin. Write today for information and literature.

**B&I MANUFACTURING CO.**  
Dept. M — Burlington, Wis.



**AGENTS WANTED**

SELL Certified Fever Thermometers to the home. Big demand, huge profits. Meets U. S. Bureau of Standards specifications. Buy direct from manufacturer. Thermometer and case retails for \$1.25, costs you 50c. Write for area agency on this and our other products such as chemical indicator kits, pipette and test tube racks, portable chemistry units, etc. **CERTIFIED INSTRUMENT COMPANY, 5 Beekman Street, New York 7, N. Y.**

**GARDEN TRACTORS**

**\$146.50 F.O.B. RAVENNA**

**Latest Model C SPEEDEX**

1 1/2 Horsepower with cultivator, 500-12 pneumatic tires, powered with Briggs and Stratton engine, and many other features. Deliveries being made now. Prices slightly higher West of the Rockies.

**WRITE FOR FREE BOOKLET**



P-248-33

**POND GARDEN TRACTOR**  
BOX 216 RAVENNA, OHIO  
5821 First Ave., South Seattle, Wash.



**Had Never Written a Line  
Sells Article Before Completing Course**  
"Before completing the N.I.A. course, I sold a feature to Screenland Magazine for \$50. That resulted in an immediate assignment to do another. After successive feature stories, I am now working into the fiction field. Previous to enrolling, I had never written a line for publication."—Gene E. Levant, 116 West Ave., 28, Los Angeles, Cal.

## How Do You Know You Can't Write?

**HAVE** you ever tried? Have you ever attempted even the least bit of training, under competent guidance? Or have you been sitting back waiting for the day to come when you will awaken all of a sudden to the discovery, "I am a writer?" If the latter course is the one of your choosing, you probably never will write. Lawyers must be law clerks. Doctors must be internes. Engineers must be draftsmen. That is why the Newspaper Institute of America bases its writing instruction on Journalism—continuous writing—the training that has produced so many successful authors.

### Learn to write by writing

Newspaper Institute's New York Copy Desk Method starts and keeps you writing in your own home. You receive actual assignments, just as if you were at work on a great metropolitan daily. Your writing is individually corrected and constructively criticized. Under such sympathetic guidance, you will find that (instead of vainly trying to copy some one else's writing tricks) you are rapidly creating your own distinctive, self-flavored style.

Many potential writers become awestruck by fabulous stories about millionaire authors and, therefore, give little thought to the \$25, \$50 and \$100 or more that can often be earned for material that takes little time to write—stories, articles on business, shop crafts, sports, hobbies, travel—things that can easily be turned out in leisure moments.

### A chance to test yourself—FREE!

Our unique Writing Aptitude Test tells whether you possess the fundamental qualities necessary to successful writing—acute observation, dramatic instinct, creative imagination, etc. You'll enjoy taking this test. The coupon will bring it free, without obligation. Newspaper Institute of America, One Park Ave., New York 16, N. Y. (Founded 1925.)

**VETERANS: This course approved for Veterans' training.**

**FREE** NEWSPAPER INSTITUTE OF AMERICA  
One Park Avenue, New York 16, N. Y.

Send me without cost or obligation, your Free Writing Aptitude Test and further information about writing for profit as promised in Popular Science, April.

Mr. \_\_\_\_\_  
Mrs. \_\_\_\_\_  
Miss \_\_\_\_\_

Address \_\_\_\_\_  
 Check here if eligible under the G.I. Bill of Rights. 34-D-808  
(All correspondence confidential. No salesman will call on you.)

Copyright 1948 Newspaper Institute of America

**NOW! Build Your Future On**



**DIESEL Opportunities**

LOOK around you. See the way tractors, trucks, buses, railroads, ships, power plants and equipment of many kinds are "going Diesel." Every day new opportunities are opening—in industrial and farming communities—for trained men who can install, maintain, operate and repair Diesel engines. Plan now to build your future in this growing field.

**Diesel Knowledge is Earning Power**

You don't have to give up your present job. Now, you can begin learning DIESEL in spare time at home. UEI practical training teaches you, step by step, how Diesel engines operate, how fuel systems work, repairs, accessories and auxiliary equipment; a world of Diesel "know how." Includes actual practice on Diesel equipment in our shop under expert guidance. UEI training methods are successful. For 20 years they have helped mechanically inclined men better themselves.

**NOW IT'S UP TO YOU!**

Coupon below brings you all the facts without cost or obligation. Get going today! MAIL COUPON NOW.

**UTILITIES ENGINEERING INSTITUTE Diesel Division**  
Founded 1927



2521 Sheffield, Dept. 348-D, Chicago 14, Ill.

UTILITIES ENGINEERING INSTITUTE, Diesel Division  
2521 Sheffield, Dept. 348-D, Chicago 14, Ill.  
Please send me Free Facts about Diesel opportunities and training.

NAME \_\_\_\_\_ Age \_\_\_\_\_

ADDRESS \_\_\_\_\_

CITY \_\_\_\_\_ Zone or County \_\_\_\_\_ STATE \_\_\_\_\_

Check here for special information if you are under 17.

# FIREWORKS

## CHINESE FIRE CRACKERS

1 Bundle or 1280—1 1/2" Crackers..... \$4.50  
1 Bundle or 1600—1 1/2" Crackers..... 5.35

## BALLOONS—LATEX RUBBER

No. K 10, per gross..... \$1.50  
No. K 20, per gross..... 3.00

Write Dept. R for Wholesale Quotations.  
Send Remittance with Order.

**UNITED FIREWORKS MFG. CO., INC.**  
Dayton 7, Ohio



# COMBAT JUDO

Fiercest fighting technique known. Learn trick knock-outs, police tactics, and the art of Defense and Attack. Expert instructions in THREE volumes with 200 photographs and illustrations. Complete. . only \$2.25

**VARIETY HOUSE**  
Box 46-AC Wall St. Sta., New York 5, N. Y.

# HELP FOR INVENTORS

Hundreds of manufacturers have requested our assistance in locating marketable new products.

Complete information, free.

**INSTITUTE of AMERICAN INVENTORS**  
Dept. 3, 1926 Eye St. N.W., Washington 6, D. C.

# INVENTORS

Whether an invention is patentable can be substantially determined by a search of the U. S. Patent records. Without obligation, write for information explaining the steps you should take to secure a patent.

**JOHN N. RANDOLPH**

Registered Patent Attorney  
205 Columbian Building, Washington 1, D. C.



**PATENTS AND TRADE MARKS**  
**C.A. SNOW & CO.**  
REGISTERED PATENT ATTORNEYS  
WRITE FOR INFORMATION TO  
246 SNOW BUILDING, WASHINGTON 1, D. C.



# INVENTORS

IF YOU WISH TO PROTECT YOUR INVENTION, You should take steps to protect it by a U. S. Patent. Write me for "Record of Invention" form.

**CARL MILLER**  
REGISTERED PATENT ATTORNEY

Woolworth Bldg., 35th Floor, Dept. 48-C, New York City  
Please send me "Record of Invention" form.

NAME.....  
ADDRESS.....

# STUDY AT HOME

With An Educational Institution

Men with specialized training win higher positions, insure larger earnings, and are bigger successes in business and public life. Opportunities NOW greater than ever before. Send for our Catalog.

## ARTS and SCIENCES

Courses in Philosophy; Education; Letters; Public Health; Medical Jurisprudence; Psychology; Sociology; Physics; Chemistry; Plastics; Geology; Political Science; Theology; Business and Commerce; Accounting; Mathematics; Statistics; Agriculture.

## ENGINEERING

Courses in Electrical, Civil, Mechanical, Drafting, Architectural, Steam, Aeronautical, Radio, Structural, Mining, Industrial, Petroleum, Marine, Chemical, Diesel, Automobile, Refrigeration, and Air Conditioning Engineering.

## LAW

Complete Professional Law Course includes 18 Hornbrook Series college grade textbooks. Courses also in Commercial Law, Patent Law and Medical Jurisprudence. McKinley-Roosevelt Incorporated, 4610-AB, Sheridan Rd., Chicago 40, Ill.

## ENGINEERING DEGREE IN 27 MONTHS

**INDIANA  
TECHNICAL  
COLLEGE**

Aeronautical, Chemical, Civil, Electrical, Mechanical, and Radio Engineering (inc. television). Drafting, 1-yr. Gov't approved for G.I.'s. Low rate. Earn board. Large industrial center. Students from 48 states, 18 countries. Demand for graduates. Enter June, Sept., Dec., March. Catalog. 648 E. Washington Blvd., Ft. Wayne 2, Ind.

## LEARN MONEY-MAKING CARTOONING

**IN SPARE TIME — by Easy Picture Chart Method**  
Same Simplified Method that has helped train creators of "Terry & Pirates," "Freckles," "Out Our Way," "Winnie Winkle," "Reg'lar Fellers," "Strange As It Seems," "The Neighbors," and many others. Earn while learning. Send 10c for Picture Chart (to test your ability). Samples of successful students, and full details. (State age.)  
The Landon School, 4824 Cleveland Transit Bldg., Cleveland, O.



ELMER WHEELER shows you

### HOW TO SELL YOURSELF TO OTHERS

A noted sales expert shows you the tried and tested way to success and happiness. From "Don't Make 'em Drink — Make 'em Thirsty" to the "Secret Ingredient" of your personality, this 320-page book is packed with pertinent advice on selling that most precious commodity — you. Be a success — send this with your name and address and \$3.50 for your copy to PRENTICE-HALL, Inc., 70 5th Ave., N. Y. 11, Dept. 40.

## LEARN TO WRITE

The Magazine Institute, a private school owned, operated, and staffed by successful writers and editors, offers an up-to-the-minute course in writing for magazines, which makes it easy for beginners to get started in this rich field. You work in spare time at home. You may concentrate on either fiction or non-fiction. Send today for the FREE CATALOG describing the Magazine Institute method. **VETERANS: THIS COURSE APPROVED FOR VETERANS' TRAINING.**

The Magazine Institute, Inc.  
Dept. 464, 50 Rockefeller Plaza,  
Rockefeller Center, New York 20, N. Y.  
Please send free catalog, without obligation, to:

Name.....  
Address.....

Check here if eligible under G. I. Bill  
(Inquiries confidential. No salesman will call)

**ACE Hollywood Experts  
WILL TRAIN YOU AT HOME...  
NOW YOU CAN MAKE GOOD IN**

# RADIO

## TELEVISION ELECTRONICS

Through Practical  
Experiments With

# 10

**BIG KITS  
R.T.A.  
Gives you!**

**You Do  
Scores of  
Practical  
Experiments**

Illustrated above are only a few of the many job-exercises you do, through RTA's "shop-type" home training method. You build a TRF Receiver, a High-Frequency Converter, a 6-tube AC-DC Superhet Receiver, plus dozens of other interesting jobs.

These jobs give you actual SHOP EXPERIENCE necessary to your success.

**FILL OUT  
COUPON  
AND MAIL  
TODAY!**

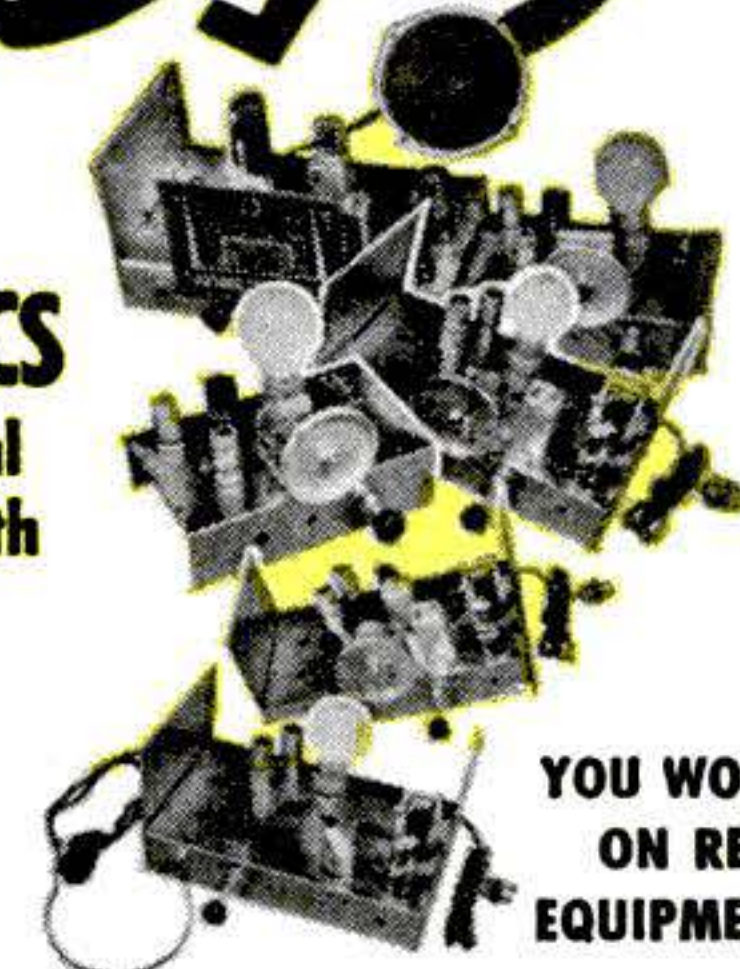

**YOU WORK  
ON REAL  
EQUIPMENT**

### Opportunities Wide Open

400 MILLION new radio and television sets will be built within ten years. 72 MILLION dollars are being spent RIGHT NOW for radio repairs alone! When you are trained by RTA's Hollywood Experts, you too can qualify for big, interesting GOOD-PAYING technicians jobs, or YOUR OWN profitable radio-television repair business.

### Extra Cash in Spare Time

RTA's Hollywood Experts show you how to earn welcome EXTRA CASH, while you learn. In fact, like many RTA students, you may actually get MORE spare time work than you can handle.

### 25 Years of Success

RTA's long years of experience assure you quickest progress. If you are at all mechanically inclined, RTA can teach YOU to MAKE GOOD in Radio-Television.

**SO GET THE FACTS!  
SEND FOR FREE  
30-PAGE BOOK  
TODAY!**



### APPROVED FOR VETERANS

**RADIO TRAINING ASSOC. OF AMERICA, DEPT. PSD  
5620 Hollywood Blvd., Hollywood 28, Calif.**

Send FREE BOOK showing how to make good in Radio-Television through training by Hollywood experts.

NAME \_\_\_\_\_ AGE \_\_\_\_\_

ADDRESS \_\_\_\_\_

CITY \_\_\_\_\_ ZONE \_\_\_\_\_ STATE \_\_\_\_\_

Check box if VETERAN of World War II

Don't Gamble with your Savings  
**PROTECT YOURSELF**  
 in case you enter a hospital on account of  
**SICKNESS or ACCIDENT**



The New Family Mutual Hospitalization Plan Protects your entire family. Costs only 3¢ a day for adults, 1½¢ a day for children.

**FOR SICKNESS OR ACCIDENT**

Hospital Room and Board up to . . . . .	\$6.00
Operating Room up to . . . . .	\$10.00
X-Ray Examinations up to . . . . .	\$10.00
Laboratory Examinations up to . . . . .	\$10.00
<b>FOR ACCIDENT</b>	
Ambulance up to . . . . .	\$10.00
Emergency Accident—Dispensary up to . . . . .	\$6.00
Loss of Limbs, sight, etc., or loss of life up to . . . . .	\$500.00
Maternity Indemnity up to . . . . .	\$35.00
Identification Service up to . . . . .	\$100.00

Don't let hospital bills wipe out your life savings in a few weeks. Be protected against hospital bills in case sickness or accident strikes you. Under this new Family Mutual plan, you will be able to pay your hospital bills resulting from sickness and disease or bodily injury. You may choose any hospital in the United States. Benefits for children are one-half those paid to adults.

**DON'T DELAY—MAIL THE COUPON TODAY**

**FAMILY MUTUAL LIFE INSURANCE CO., WILMINGTON 99, DEL.**

Family Mutual Life Insurance Co. Dept. N-1  
 601 Shipley St., Wilmington 99, Del.  
 Please send me, without obligation, complete information on your Economical Hospitalization Plan.

NAME \_\_\_\_\_  
 ADDRESS \_\_\_\_\_  
 CITY \_\_\_\_\_ STATE \_\_\_\_\_

**SMART  
 NEW**



**POWERBIKE**

**gets you there safely and economically**

The motor is in the rear, mounted low to aid balance and handling. No grease to rub off on your legs, no hot fumes blowing in your face. 100 miles per gallon, 30 MPH.

1½ HP fan cooled engine, kick starter, automatic clutch, fits any man's or woman's balloon-tire bike. See your dealer or write direct.

**TERRITORIES AVAILABLE.**

**SAGINAW PRODUCTS CORP. • SAGINAW, MICHIGAN**



**WAKE UP YOUR SCALP** Want better looking hair? Embarrassed by falling dandruff, itching scalp? Then try VITABRUSH, new electric driven scalp brush that gives your scalp a vigorous and invigorating "workout" in just three minutes of fun. Cleans scalp. Stimulates blood supply. Restful. Pleasant. Write today for complete information and satisfaction-guaranteed offer. Hershey Mfg., 3768 Field Bldg., Chicago 3

**BEARINGS** Fafnir, S.K.F., N.D. & Torrington

Bore	O.D.	Type	Price
.250	.750	Ball	.15
.1575	.6299	Ball	.15
.1895	.500	Needle	.15
.1895	.625	Needle	.15
.2495	.625	Needle	.15
1.000	1.250	Needle	.28

Minimum order 10 bearings. Add 10c postage per order.

**JAY-CEE SALES CO.**

4554 Grand River Ave. Detroit 8, Mich.

**BUILD THIS CONCRETE BLOCK MACHINE**

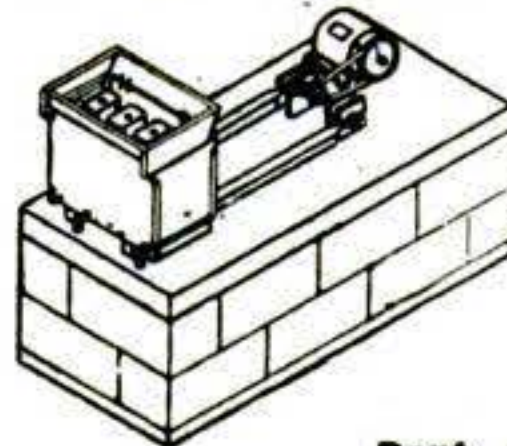

Sell blocks; or build your home, garage, barn, or filling station at 1/3 cost by making and laying your own blocks.

This simple machine which you can build yourself at a cost of \$15 (excluding motor) will make a block in 30 seconds using only one form. Mass production can be achieved by a new simple method of removing blocks which allows two to four forms to one vibrator. Power driven concrete mixer plans also. Send dime for details and "How to Make and Lay Blocks" folder.

**U-BUILD-IT SERVICE**

Dept. 4-A, 206 West Wilder St., Tampa 3, Florida



*For Your Class or Club*

Pins, rings and emblems. Over 300 designs. Finest quality. Reasonable prices. Pins, 30c up. Write today for free catalog. Dept. O, Metal Arts Co., Rochester, N. Y.



**TALK-SING** thru your own radio with **RADIO MICROPHONE**

Be the life of the party. Put on your own broadcasts at home. Talk-Sing, make announcements from any room. Wonderful voice practice. Microphone easily attached to any radio. Follow enclosed instructions. SEND NO MONEY—pay Postman \$2.25 plus postage. Send Money Order or check and save postage.



**EMPIRE RADIO & TELEVISION CO.** (Dept. S.I.) 1521 Bedford Ave., Brooklyn 16, N. Y.

**Refit and Tighten**



**FALSE  
 TEETH**

With **AMAZING PLASTI-LINER**

If your plates are loose and slip or hurt; reline them better than new, with this pliable, non-porous strip. Just lay on plate, bite and it molds perfectly, hardens for lasting fit and comfort. Ends forever the mess, bother and expense of temporary applications that last only a few hours or few months. Will not injure plates, and guaranteed to give satisfaction or your money back. Write for Plasti-Liner today. Pay postman \$1.25 for one reliner, \$2.25 for both upper and lower—or send money, save C.O.D. charges. **PLASTI-LINER CO., Dept. 41-C Buffalo 2, N. Y.**





# Learn BUILDING

AT HOME • All Blue Print Building Plans, Specifications, Lessons Furnished

## FIND OUT ABOUT TRAINING AND OPPORTUNITIES FOR YOU IN BUILDING

Established in 1904, Chicago Technical College offers you thorough, practical training in Building, by home-study. Mail coupon for free information. See what this Course has done for others, what it can do for you. Read what Chicago Tech graduates say about their work, earnings, success. Learn the rewards awaiting you as a trained builder—and how quickly, easily you can get started. Simply MAIL COUPON TODAY in an envelope or paste on a penny postcard.



Earn more money as a building tradesman. Prepare for advancement and increased pay as a building foreman, superintendent, inspector, estimator, material buyer or salesman. Train to be a building contractor, have your own money-making business in this busy, prosperous building field.

More than 19 million new homes needed in U.S., say experts. New building now at rate of one million homes a year, plus 200,000 commercial buildings, plus expanding farm building construction.

Mail coupon today. FREE book tells how you learn Building Construction—How to Read Blue Prints, and Estimate Building Costs—at home in your spare time. Learn modern construction methods and materials, how to lay out work and direct all building operations. This is the training needed for rapid advancement to higher-paid jobs, or your own successful building business.

## MAIL COUPON NOW

**CHICAGO TECHNICAL COLLEGE**  
D-158 Tech Bldg., 2000 S. Michigan Ave.,  
Chicago 16, Illinois

Mail me FREE building Lesson with information about big opportunities in BUILDING and how I can train at home.

Name.....Age.....

Address.....

City.....Zone.....State.....

**CHICAGO TECHNICAL COLLEGE**  
D-158, Tech Building, 2000 South Michigan Ave.  
Chicago 16, Illinois

## Learn to Repair ELECTRIC APPLIANCES

AT HOME in your SPARE TIME

Prepare now for a permanent future, independence and security with a business of your own. Our practical, easy-to-learn home course teaches you, during your spare time, how to repair washing machines, vacuum cleaners, electric ranges, lamps, motors, irons, etc., REFRIGERATION and HOUSE WIRING.

### OPEN YOUR OWN SHOP

For the man who is handy with tools, and likes to work with his hands as well as his head, there is a WIDE OPEN OPPORTUNITY today, in this great growing field. If you own your own shop you can depend on making more money in good times . . . and not losing your job in a depression. You can start a business of your own in your garage or basement with the tools we send you. One good repair job can pay for the cost of the entire course. Write today for our FREE BOOKLET.

I Send You a BIG KIT of Special TOOLS at NO EXTRA COST!

WRITE TODAY for FREE BOOK



**PACIFIC TRAINING SCHOOL**  
7217 So. Broadway, Dept. S-84, Los Angeles 3, Calif.

Dear Sirs: Please send me, without obligation, your free booklet and complete details.

Name .....

Address .....

City..... State.....

## Keep that "TICKING" Car



1588 PAGES  
1500 ILLUSTRATIONS

Every operator and mechanic needs AUDELS AUTO GUIDE.

This book saves time, money and worry. Highly endorsed. It presents the whole subject of auto mechanics:

- 1—Basic principles
  - 2—Construction
  - 3—Operation
  - 4—Service
  - 5—Repair
- Handy Size. Easily understood.

### NEW FLUID DRIVE, HYDRAULIC SHIFT AND DIESEL ENGINES FULLY COVERED

Over 1500 pages—1540 illustrations showing inside views of modern cars, trucks and buses with instructions for all service jobs.

ASK TO SEE IT!—To Get This Assistance for Yourself Simply Fill in and Mail Coupon Today.

**\$4 COMPLETE • PAY ONLY \$1. A MONTH** ←

**AUDEL Publishers, 49 West 23rd St., New York**  
MAIL AUDELS NEW AUTO GUIDE for free examination. If O. K. I will send you \$1 in 7 days; then remit \$1 monthly until price of \$4 is paid. Otherwise I will return it.

Name.....

Address.....

Occupation.....

Employed by..... P.S.M.

# FALSE TEETH FIT TIGHT FOR LIFE OF PLATE



With One Application  
of **YOUR MONEY BACK**  
Professionally Developed **AMAZING**  
**LINO-DENT**  
Patented

**REAL COMFORT INSTANTLY  
FOR ALL PLATE WEARERS**

At last — with no fuss or  
bother—looseness and slipping  
vanish—gum soreness  
heals and disappears—forever.

## NOT MESSY • NOT STICKY

Not a paste—not a powder—Lino-Dent is an amazing  
development in the field of plastics. It is the same  
material modern dentures are made of. That's why we  
can guarantee perfect plate comfort not for just a  
month but permanently with one application.

## ABSOLUTELY SAFE

Lino-Dent is pure, non-toxic,  
non-irritating, harmless, odorless,  
tasteless, pleasant, simple to use.  
Needs no heat.

It's professionally developed  
**YOUR MONEY BACK IF NOT  
COMPLETELY SATISFIED**

We guarantee perfect plate comfort permanently with  
only one application.

**SEND NO MONEY** Full size package only \$1 plus  
postage. Specify upper or lower.  
Or send \$1 and we will pay postage.

**LINO-DENT, Inc.** 1199 Broadway  
New York 1, N. Y.

LINO-DENT, Inc. Dept. A-2  
1199 Broadway New York 1, N. Y.

Send LINO-DENT for:

Upper

Lower

\$1

Both — \$2

I will pay postman  \$1 . . .  \$2 plus postage. My money  
will be cheerfully refunded if I am not satisfied.

NAME \_\_\_\_\_

ADDRESS \_\_\_\_\_

CITY \_\_\_\_\_

STATE \_\_\_\_\_

Enclose payment and you save postage!

# \$9.95 TAKES ALL THREE BIG BARGAINS

**1. AUDIO AMPLIFIER.** Undreamed of value.  
Uses 6V6's. Has 4  
microphone inputs brought to jacks at rear panel. Various  
output impedances available at rear panel connections.  
Steel case with chrome handles. 9" long x 9" high x 6"  
deep. Tubes included. New in original carton. Shipping  
weight 15 lb. SUPER SPECIAL—\$4.95 while supply lasts.

**2. RADIO HEADSETS.** Latest supersensitive  
type with rubber ear-  
pieces. Every pair guaranteed perfect. \$.59 per pair OR  
3 PAIRS FOR \$1.00.

**3. HOME WORKSHOP AT BARGAIN  
PRICE.** Accurate and precise 2 speed guaranteed hobby  
lathe, the essential machine for the home work-  
shop. Sturdy enough for light production work or factory  
standby service. Supplied with 56" of belting for connect-  
ing to any available electric motor or power take-off, such  
as on a jeep or tractor. Also included in this unbelievable  
offer are such accessories as a 1/2" drill chuck with specially  
hardened tool steel jaws, a 4" electric furnace high  
speed grinding wheel, a cotton buffing wheel with a large  
supply of buffing compound, and a 4" steel wire scratch  
brush. Your cost \$6.00. Sole export agent. Distributor  
inquiries invited.

ORDER NOW—DON'T DELAY—NO C.O.D.s

**BUFFALO RADIO SUPPLY**

Dept. 4M  
219 Genesee St.  
Buffalo 3, N. Y.

# Hollywood WOLF WHISTLE



GIVE THE  
WOLF CALL

CAR HORN

— imitate BARKING DOGS and make other weird noises.  
You, too, can become a Hollywood Wolf. Have lots of harmless fun.  
Install a Hollywood Wolf Whistle on your car. Beautiful Hammertone  
finish. Self lubricating bearings. Works off of the intake manifold.  
Simple to install in 15 minutes. Full instructions with every box. For  
cars, trucks, motorcycles, motor boats, outboard motors. Money back  
guarantee. If your dealer can't supply you, order today.  
Be the first to have this attention-getting horn. ONLY  
\$4.00 postpaid — Cash, Check, or Money Order.  
QUITE A DEAL.

**YODER MFG. COMPANY**

2403-B East 103rd Street Los Angeles 2, California

DESCRIPTIVE  
LITERATURE  
ON  
REQUEST

# PRICES SLASHED! ALUMINUM PIPES

\$4.50 pipe for \$1.00.  
Imported briar bowl,  
hard rubber stem, air  
cooled aluminum shank.  
No filters required.  
Check or money order, we pay  
postage. C. O. D. orders filled  
on request. Write for FREE  
catalog of pipes and cigars.

SATISFACTION GUARANTEED OR  
YOUR MONEY BACK

**Eddie THE CIGAR MAN**

Dept. P-1, 1094 Bedford Ave., Brooklyn 5, N. Y.



# GUNS-SWORDS FIREARMS

Your treasure hunt ends in our new 156 page catalog  
listing 2500 authentic items, including old pistols, swords,  
knives, armor, etc. To get your illustrated catalog of over  
156 pages, send 50c to cover postage and handling to **ROBERT  
ABELS, Box PS, 860 Lexington Avenue, New York 21, N. Y.**

# RUPTURE!

An amazing Air-Cushion  
Invention allows body  
freedom at work or play.  
Light, neat, cool, sanitary.  
Durable, cheap. Day and night protection helps  
Nature support weakened muscles gently but surely.  
No risk. **Sent on Trial!** Write NOW for free Booklet and  
**Proof of Results.** All correspondence confidential.

**Brooks Company, 163-A State St., Marshall, Mich.**

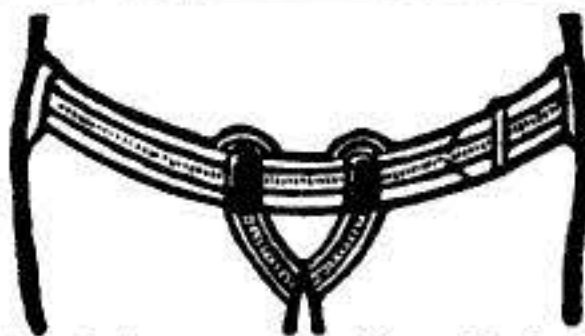

# ★ PSORIASIS ★

PSORIASIS SUFFERERS: Has everything failed to bring even  
temporary relief from scales, lesions and itching? Then write  
today for FREE important information. You needn't invest one  
cent!

**PIXACOL CO., Dept. S-4, Box 3583, Cleveland, Ohio**

**CANVAS COVERS** Waterproof tarpaulins, war  
surplus (Used), perfect  
condition. Originally made for tents. Approx. 5'x8'. Two buttoned  
together make approx. 80 sq. ft. Complete with buttons at-  
tached. Suitable for use as canvas dams, hay covers, truck  
covers, machinery and equipment covers, etc. Packed in bales  
40 each, priced 40 covers, \$1.00 ea; 15 covers, \$1.50 ea. Less  
than 15, \$1.75 ea. All FOB, Kansas City.

329 W. 5th

**AMERICAN SUPPLY CO.**  
Dept. P. S.

Kansas City, Mo.



# EXCITING FILMS

Extraordinary and unusual 8-16mm. Silent and  
Sound Films to thrill your Home Movie Audiences.

For Sample Film and Special List send only 10c to...

**EXCITING FILMS** 1071 EL CENTRO  
HOLLYWOOD 38, CAL.

# WAR SURPLUS BARGAINS

## CONTINUOUS PIANO HINGE



Length 72"-thick, 0.040-width 1 1/4"-operating radius 275°-material A1. Alloy-AN 251-6 Ft.-\$1.14-6' lengths only. Each only **\$1.14**

## STAINLESS STEEL PRESSURE TANKS

These pressure tanks suitable for compressors, pneumatic units, hydraulic, and liquids. 1/4" pipe thread at each end.

Vol. (Cu. In.)	Pressure (PSI)	Cap. (Cu. Ft.)	Pr.
104	50 to 400	1.4	\$1.25
280	50 to 400	3.8	2.00
500*	50 to 400	6.9	2.50
1000*	50 to 400	13.8	4.50
2100*	50 to 400	29.0	5.50

## PARACHUTE SEAT CUSHIONS

These seat cushions can be used for working around the house and garden, and baseball games, all types of sports events. Color is O.D. Used, size 2 x 14x14, in excellent condition. Each only **.75**

## FOAMEX SEAT CUSHIONS

These air foam rubber cushions, excellent pads for scrubbing, working in the garden, seats at football or baseball games. This rubber is oil and gasoline resistant. Sizes 14 x 16 x 1 inches. Each only **\$1.14**

## WHEELS FOR TRAILERS

These wheels and tires can be used on trailers, trucks, adapted to tractors, etc.

Tire and tube size 5:00 x 4-split wheel complete with bearings 5/8" axle hole, wheel-width at axle 2"-overall height 13.1", width 4.8". Brand new tire tube and wheel assy. Complete 660 pounds capacity -airplane-tailwheel smooth tread tire. Each only **\$14.50**

56" Stands 56" overall tire width 19"-complete tire, tube, wheel bearings, and axle used but in good condition-load capacity 29,000 pounds. Each only **\$94.00**

36" Stands 36" overall tire width 12 1/2"-complete tire, tube, wheel, bearings, and axle stub, used but in good condition. Each only **\$62.50**

27" Stands 27" overall tire width 9"-complete tire, tube, wheel, bearings, and axle used but in good condition. Each only **\$49.50**

Extra tires 56"-New tire and tube **\$47.00**

Extra tires 27"-New tire and tube **\$14.95**

30x7 equal to 7:00x16 tires-8 Ply Nylon and Rayon Cord. Each only **\$14.95**

## SWITCH KITS

### 5 Toggle Switches

- (1) SP-ST; 5A, 125V; C.H. 35A, 24V-On-Off-Flush Mounting
- (2) SP-DT; 5A, 125V or 35A-24V; Mom. On-Off-Mom. On; Flush Mounting
- (3) SP-ST; CA-125V or 3A-250V-On-Off, One hole 1/2"
- (4) C.H. 8816k2; DP-ST; 5A, 125V; On-On; One Hole 1/2"
- (5) SW 15; TP-ST, 5A, 125V or 3A 250A, On-On; One Hole 1/2" (1 Boot & PANAL) Complete kit. Each only **\$1.24**

## AIRCRAFT BATTERY

Aircraft Battery-12V 35 Amp. Hrs., D.C. non spill, Dry Charge. These are new Exide batteries, 35 Amp. at 5 hour rate, size 10-5/32 x 11-3/4 x 8 1/2. Excellent for home power units as storage batteries. These batteries are shipped dry charged. **\$15.95** Each only

## SPRAY GUN

Excellent for any home use. Works from any pail or bottle. These are new De Vilbiss Type GDZ. Series 510 Spray Gun, complete with hose. **\$5.25** Each only

## MOTOR GENERATORS

### 5-Speed-5 Drive

Input 18 volts-4.5 AMPS-Output 450 Volts-0.060 AMPS. Speeds from 4,000 R.P.M. **\$6.95** Each only

## GOOSE NECK FLASHLIGHT

Handiest tool for any mechanic-comes complete with extra bulb, less batteries at only **\$1.65**

Send 25% Deposit on C. O. D. Orders

Rush order today

U A S CORPORATION, Dept. P.S.  
5643 W. 63rd Pl.

Chicago,

Illinois

## DUMMY TRAINING RIFLE



Authentic, raised sight-ADJ for range, carrying strap, bolt action. (CLICK!) Each only **\$3.95**

## FLEXIBLE CONTROL CABLE

Arens flexible control cable. Length-8.0'2 1/2" pull, can be mounted thru 3/8" hole, has brass knobs. Something that has been hard to obtain in auto shops, only **\$1.98**

## HEATING ELEMENTS

Can be used for chicken brooders or chicken houses during cold weather. Come complete inset of four, with wiring diagram. **\$96**

## MECHANICAL FINGERS

Rigid Mechanical Finger for reaching hard to get places, a tool that every mechanic can use. Only **.95**

Flexible Mechanical Finger for reaching hard to get places where a flexible shaft is needed to pick up lost items. Each only **\$1.05**

## RUBBER CEMENT

Comes in two size cans, pint and 4 ounce. Used for cementing rubber, leather, etc., and many other household uses. Pint, **.89** 4 ounce can **.24**

## GENERAL ALL PURPOSE PUMP

Can be used for vacuum-air hydraulic, can be used on oil burners, spray machines, milking machines, compressors, vacuum pumps, hydraulic systems, manure loaders, presses, etc. Original cost \$45. Now only **\$9.95**

## LIFE RAFTS

Life raft, comes complete with rain canopy, sail and mast, repair kit, ball bucket, anchor, mirror, etc. Excellent for duck hunters, fishermen, and excellent beach accessory. Only **\$17.95**

## PARACHUTE HARNESS

Parachute Harness Seat **\$1.75** Pilot Chute, toys Only **.75**  
Chest and back parachute harness **\$1.50**  
Buckles worth more than the cost.

Say You Saw It In Popular Science

# LEARN AT HOME A PROFITABLE, LIFETIME TRADE

Many Start Own Business While Learning!

Learn SCREEN PROCESS, the modern machineless method of printing. Uncrowded, profitable field where trained men are always in demand. 2 BIG KITS OF SUPPLIES we send start many of our students making money even before finishing home

study course. Many we have trained now have own successful businesses or spare time earnings. Write today for FREE BOOK giving full details. You owe it to yourself to find out about this profitable field NOW.

CALIFORNIA SCHOOL OF SCREEN PROCESS • 3740 Overland Boulevard, Dept. S48, Los Angeles 34

FREE BOOK



APPROVED FOR VETERANS

# How to Write

Short Stories, Mysteries, Novels, Articles—at home in spare time

The demand for writers is creating great new opportunities for people with an urge to write. It's not as hard to succeed as you may imagine. Most famous authors come from ordinary walks of life. At home, you too may learn fiction writing, the best basis for all fields—short stories, novels, features, articles, radio scripts. Palmer Institute's Home Study Training (Established 1917) is endorsed by Rupert

Hughes, Ruth Comfort Mitchell, Gertrude Atherton, Katharine Newlin Burt and other famous authors and by scores of successful graduates. Complete instruction material, professional coaching develop your own style. FREE book and lesson show how you may enjoy an ideal part time or full time career. Write today (no salesman will call). Veterans: advise us if you are eligible for G.I. Training.

PALMER INSTITUTE OF AUTHORSHIP • Desk U-48 • 1680 N. Sycamore • Hollywood 28, Calif.

# PROFITS AND SPEED

## THE MODERN LAWN MOWER SHARPENER

PRICE  
**\$241<sup>50</sup>**  
LESS  
MOTOR

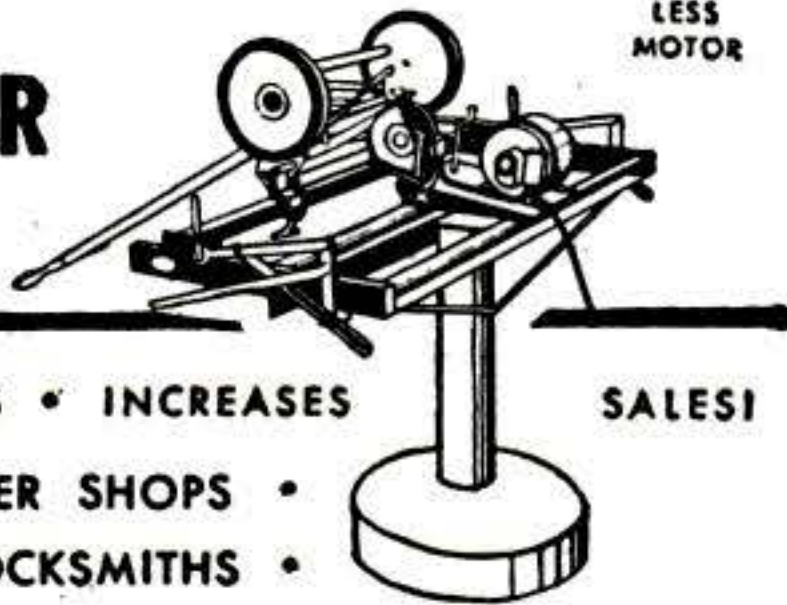

INCREASES PROFITS • INCREASES SALES!  
FOR LAWN MOWER SHOPS •  
FIXIT SHOPS • LOCKSMITHS •  
HARDWARE STORES • GOLF COURSES • SCHOOLS  
PARKS • PLAYGROUNDS • INSTITUTIONS •  
CEMETERIES • AND ALERT INDIVIDUALS!

*Sharpens All Reel Type Mowers • Hand, Power or  
Gang • 10 to 20 Minutes • No Dismantling  
No Extra Attachments Needed*

All reel type mowers, from 5-inch edgers to 36-inch power mowers, are quickly sharpened to extreme ends of both left and right twist reel blades. Handle, wheels, roller and motor remain in place when sharpening is in process. Bed knife is sharpened in same brackets that hold mower in grinding position. No extra attachments required. One lever puts mower or bed knife in grinding position. 100% steel construction. Grinding head rides on five ball bearing races. Small, compact, easy to operate. Sharpens wood chisels, joiner knives and planer blades without extra attachments.

**ORDER  
NOW**  
Immediate  
Delivery

*Skate Sharpener Attachment Available  
Send For Free Bulletin No. IIB*

**MODERN MFG. CO.** 160 N. FAIR OAKS AVE  
PASADENA 1, CALIFORNIA

## COMPLETE OUTFIT TO DRILL THROUGH CHINA, GLASS OR POTTERY \$1.00—Postpaid. Guaranteed.

Lang Lamp Company, Dept. PS, 1245 Bellevue Ave., Eau Claire, Wisconsin

Say You Saw  
It In Popular Science



### Make This Amazing Astronomical Telescope For As Little As \$6.00

Now you can afford to own the telescope you always wanted. A fine dependable scientific instrument which will give endless pleasure and education to you and your friends.

Positively no special tools or skills required . . . Built in four hours as described in a recent national scientific magazine (reprint of this article upon request for 6¢).

5 lenses accurately ground and polished with flat and mirror hard-aluminized. All ready for you to assemble into an achromatic (color-free) distortionless instrument.

This wonderful 'scope guarantees success for the beginner. Without rainbow effects or fuzziness, gives hard, sharp, clear images. Easy to make; material for tube and the few other parts can be found around every home or may be purchased for a few cents.

**\$6.00 for the 3" diameter kit and instructions.**

*If you need more information send 6¢*

Telescopes — Microscopes — Scientific & Laboratory Apparatus  
**HARRY ROSS, 68 West Broadway, Sect. M., N. Y. 7, N. Y.**

50 POPULAR SCIENCE

## Men's Fully Guaranteed NEW \$13.95 PLUS TAX 15-JEWEL WRIST WATCH

ORIGINALLY sold up to \$55  
Sacrificed because they're post-war surplus

### LOOK AT THESE FEATURES:

Luminous dial . . . sweep second hand . . . waterproof . . . shockproof . . . anti-magnetic . . . imported Swiss precision movement and case. You get them now for a small fraction of original prices. Don't delay! Order now while they last. Send only \$1 down payment with order. Pay balance to postman on arrival, plus postage. Or we pay postage if you enclose \$13.95 plus \$1.39 Fed. Tax.

Receive Reg. \$2 expansion band FREE with prepaid order. Money back in 5 days if not delighted. Order now.



MARYLAND DISTRIBUTORS, Dept. 57  
501 E. Balto. St. Balto. 2, Md.

### V-8 DUALS & SINGLES

DEALERS WANTED

### MUFFLERS STEELS and ALUMINUMS with a motorboat tone

SINGLES, Chev., V-8, Plymouth, Steels \$5.50, Aluminum \$7.00. Chry., Olds., Buicks, etc., Steels \$7.50, Aluminum \$9.00. V-8 and MERCURY DUALS, Steel \$17.50, Aluminum \$21.00. Split Manifold Sets, Steels \$35.00, Aluminum \$45.00. Aluminums are guaranteed for life of your car.

**SANDEE MUFFLER CO.**  
BOX 296 LA TIJ., LOS ANGELES 43, CALIF  
2624 W. SLAUSON AVE., LOS ANGELES, CALIF.

### DUAL TAIL PIPE EXTENSION

*Fits all cars—chrome plated*  
**DEEP TONE**  
produced by 2 1/2 inch outlets  
Postage free on prepaid orders  
DEALER INQUIRIES INVITED

**\$2.95**

**LYONS PRODUCTS COMPANY**  
Pat. Pend. 2319 Ridgeley Drive, Dept. PS4, Los Angeles 16, Calif.

### BURIED TREASURE, MINERALS AMAZING NEW GOLDAK LOCATORS

**SENSATIONAL NEW MODEL!**  
ONLY 11 pounds weight! One hand operation! Money-Back Guarantee of Superiority. Write for full details.

**THE GOLDAK CO.**  
1544 WEST GLENOAKS BLVD.  
GLENDALE 1, CALIFORNIA

World's largest maker of fine locators.

### AGENTS 300% Profit

### SIGN LETTERS

For Store Fronts and Office Windows. Anyone can put them on. Free Samples. Liberal Offer to general agents.  
**METALLIC LETTER CO., 441 N. Clark, Chicago 10**

### NEW! MINIATURE DUST MASK

Wear when sanding, grinding, paint spraying, sweeping, dusting, furnace cleaning, etc. Handy as a pair of glasses. Just keep mouth closed and breathe through nose is all you do to operate. Protects against nuisance dusts, lint, coal, cement, grain dust, Hay Fever Pollen. Has 9 sq. in. filter.  
For EYE protection against paint spray, dusts, gases, fumes, smoke, order our Fog-Proof Rubber GOGGLES. . . . . \$2.00 p.p.

**JERRY BRYANT, Dept. PS, 919 N. Michigan Ave., Chicago 11, Ill.**

Order Today \$1.00 POST PAID

# SUPER! War Surplus VALUES



## HIP BOOTS

Brand new rubber boots for fishing. Snug fitting. Size 10 only. **\$8.95**



## ELBOW TELESCOPE

3 Power. Achromatic, color corrected lens suitable for photography, microscopes, etc. **\$6.95**



## SUN GLASSES

Air Corps type. Scientific no-glare lenses. Filters 96% of ultra violet rays. **\$2.79**

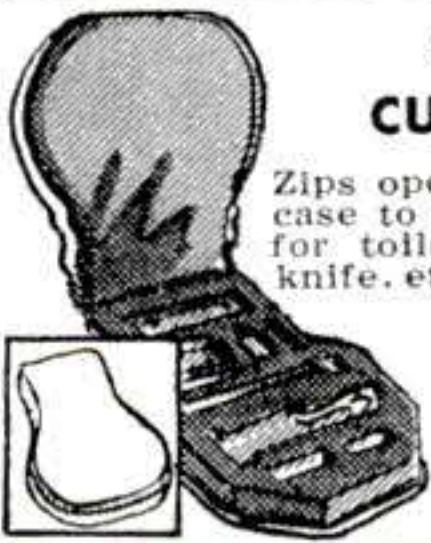

## SEAT CUSHION

Zips open like a brief case to provide space for toiletries, pocket knife, etc. Canvas cover. Full size seat for boat, car, truck. 17" widest point, 2" thick. **\$1.49**

## Utility Zip Case

Sturdy canvas, with carrying handle. Excellent camera case, tool kit, toiletry case, fishing kit or shell case. 7 1/2" long, 3" wide, 4 1/2" deep. **69c**

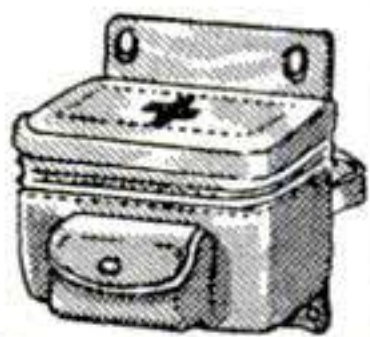

## G. I. CAN OPENER

A must for all outdoor men and scouts. Good for emergencies. 1 1/2" long, 5/8" wide. Will fit vest pocket. **25c**

Knife, fork & spoon sets. **50c**

Army Compasses, wrist type without strap. Made of plastic. **\$1.00**

Shelter halves—2 new halves with poles & pegs. **\$5.00**

Tent pegs—8 pegs & 2 uprights for pup tent— **\$1.00**

Canvas tool bags—Good for tools, etc. 5 1/2 x 16. Drawstring top. **25c**

Sleeping bag liners—used. **\$1.00**

Webbing, 100-in. long, 1 1/2" wide. **50c**

**Radio Transmitter - Receiver** BC-645, 450-500 MC brand. Complete transmitter & modulator system & receiver originally used for identification. Comes with conversion sheets & blue prints. Originally cost gov't over \$300. **\$11.95**

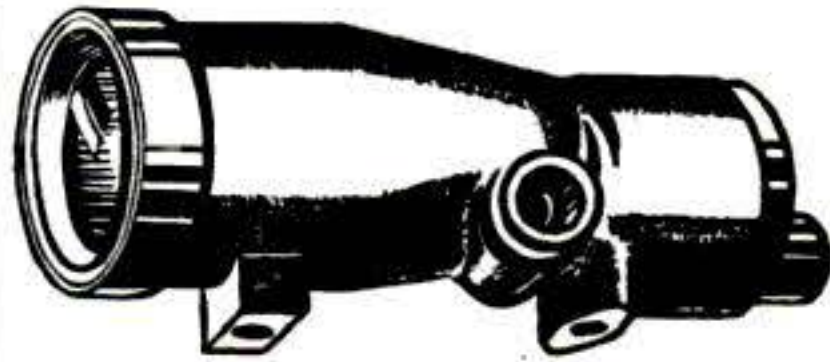

## 2X PERISCOPE SIGHT

A high precision, all bronze gun sight with long eye relief. Color free, wide field of vision 7/8" dia. objective lens. Circle & dot aiming point fine for game or target shooting. Will withstand recoil of heavy caliber rifles. 4 1/2" long. Machined and threaded pads can be used to mount sight on rifle. **\$4.95**

## PRECISION EYE-PIECE



Telescope eyepiece that gives a flat, bright colorless field of vision. A 4-lens system of 1 3/4" focal length. Eye relief is 1 1/2" long. Fine for use as a hand lens in the shop. Could be used for enlarging and projecting photos. A fine eyepiece for astronomical scope. **\$4.95**



## ARMY TELESCOPE SIGHT

3x gun sight. Color corrected lens, 2 1/2" overall. Consists of 6 lenses. For low power microscope or hand lens. **\$4.95**



## Spark Plugs—New

For practically all makes & models. **25c**



## AIR PUMP

Used for inflating rubber boats. Will attach to any size boat inflation valve. **\$4.95**

Use as shovel or pick around the home, cottage or farm. **\$1.00**



## TRENCH SHOVEL



## SLEEPING BAGS

Wool with 30" zipper. Fine for campers, outdoorsmen, etc. Like new. **\$1.50**

## HAMMOCKS

Ideal for camping, or resort use. Waterproof roof, nylon netting. New. **\$6.00**

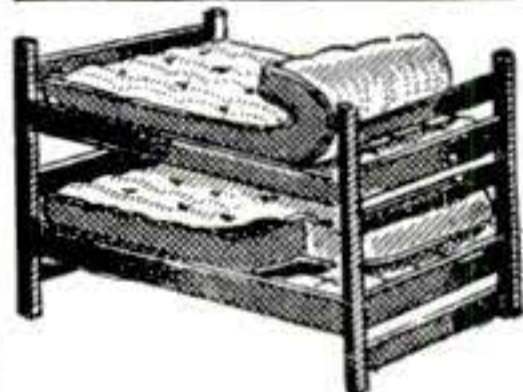

## BUNK BEDS

Sturdy hardwood, O.D. color. In good condition. To be used as a double deck or twin bed combination. Mattresses not included. **\$8.95**

## RUBBER BOATS

Brand new. Rubber & neoprene. Ideal for summer cabins, fishing, water sports, yacht clubs. Holds 10 people. Complete with repair kit, tools, pump, 2 paddles, motor mount. Original cost to gov't approx. \$800. Now **\$50.00**

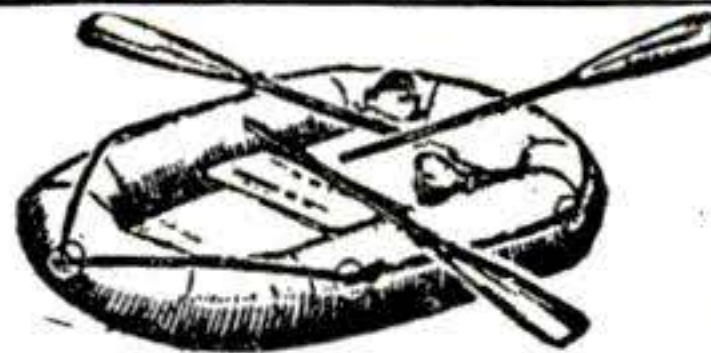

## POLAROID GOGGLES

With one extra amber lens. Rubber frame and adjustable headstrap. For hunters, fishermen, flyers, etc. **50c**



150 lb. test Nylon Cord. 125 feet long. Perfect fishing line. **\$1.50**



## Rubber Balloons

Air Corps target type balloon. Inflates up to 45". **\$1.00**



## RUBBER GLOVES

Heavy duty. One piece seamless. Reinforced cuff. For chemists, carwashers, etc. Brand new. **75c**



## UTILITY DRAWER

Made of sturdy wood. Dark green color. Compartmented with heavy felt section. Perfect for collectors and gadgeteers. **\$1.50**



## MESS KITS

Regulation. Two piece army mess kit. New. For picnics & camping. **69c**



## DISPATCH BAG

9 x 12 x 3 1/2". Shoulder strap. Canvas bag. 4 compartments, 6 pencil holders plus slots for rulers, etc. Perfect campers bag, for hikers, for school. **\$1.00**



## BUTTON SIGNAL MIRROR

Used as a distress signal. Useful for Boy Scouts & outdoorsmen. Original government cost **\$1.37**



## Insect Repellent

For outdoor workers & sportsmen. Easy to apply, vanishes on application. Comfort & protection. Liquid 2-oz. bottle. 4 for **\$1.00**

## PACK BOARD

Used for carrying heavy packs. Ideal for sportsmen, campers, scouts, etc. **\$2.00**



## CANOE PADDLES

5-ft. and 6-ft. length, matched woods, sturdy construction. **ea. \$1.00**



## 3X GUNSIGHT EYEPIECE

3 piece eyepiece which gives a very flat colorless field of vision. 1 1/8" diameter with focal length of 1 3/8". Heavy bronze and brass construction. Can be used "as is" for medium power eyepiece for astronomical or telescope. Individual lens fine for hand magnifier or dissecting microscopes. Worth at least \$25.00. Our price— **\$5.00**

# SURPLUS DISTRIBUTORS

924-B N. Plankinton Ave

Milwaukee 3, Wisconsin

All orders shipped FOB Milwaukee postage collect. Send money order or check. No orders to British pound controlled countries accepted.

On C.O.D. order, enclose 20% deposit, balance plus postage on arrival.

# VETERANS *Learn* WATCHMAKING

## A Lifetime Career

No Age, nor Physical Limitations

**YOUR OPPORTUNITY**  
To Lift Yourself from a  
Futureless Job



Approved  
G. I. Training

## LEARN WATCHMAKING

and earn from the start, higher than average pay . . . easy hours . . . ideal working conditions . . . be prepared to establish your own business.

**WATCH REPAIRING—JEWELRY—ENGRAVING**  
*Always in Demand*

Requests for our Graduates from Everywhere. Permanent positions (no layoffs) \$75.00-\$100 per week for trained men. Write today for latest FREE Catalog.

## KANSAS CITY SCHOOL OF WATCHMAKING

America's Most Progressive Horological School  
619 WYANDOTTE ST. KANSAS CITY 6, MO.

## Operate Your Own Business!

18  
YEARS  
OF  
PROVEN  
SUCCESS



## Clean and Mothproof Rugs and Upholstery

- Nationally Advertised Services
- Big Profits
- Repeat Orders
- No Experience Needed

If you are dependable, honest and willing to work, send today for details on how to become financially independent in a profitable, growing business of your own. Choose an open territory any-

where in United States, Canada or foreign countries. Services rendered in homes, offices, clubs or public buildings.

**DURACLEAN** cleans by absorption. No scrubbing! No soaking or shrinkage. This modern safe cleaning process uses mild solvents. Dirt, grease and many unsightly spots vanish as if by magic. Wool fibers come to life . . . matted pile rises . . . colors revive. Upholstery and floor coverings last longer.

**DURAPROOF** is another year 'round service. Not only kills moths and carpet beetles but makes materials resistant to both. Protects furnishings, clothing and auto interiors. Guards against mildew, too. **DURAPROOF**, to our knowledge, is the only moth proof service backed by a National MONEY BACK, 4 YEAR WARRANTY.

Leading furniture and department stores recommend **DURACLEAN** Dealer's service. Almost every building in your territory houses a potential customer needing one or both these Nationally Advertised services. Even auto dealers buy your service to revive upholstery in used cars.

Easy to learn. No shop needed. Operate from your own home. We furnish enough material to return your TOTAL investment. Gross profits up to \$15 and \$20 a day on EACH of your service men.

Start full or part time. Territories are limited! Write immediately for FREE Booklet explaining details. Easy terms.

**Duraclean Co.** 36-4 Ct.  
DEERFIELD, ILL.

## Glider Model FLAME GUN

with 100 PRACTICAL USES!

KILL WEEDS, crab grass, Canada thistle, — stalks, seeds and roots. Destroy brush, caterpillar nests, diseased trees, grasshoppers, chinch bugs, etc. Clear irrigation ditches, split rocks, burn tree stumps.



Sterilize poultry houses, kennels, barns. Use as portable home forge. Melt ice, thaw pipes. Safe, inexpensive. Burns only 6% kerosene—94% air! Thousands of satisfied users. Write for FREE CATALOG.

HAUCK MFG. CO., 81 Tenth St., Brooklyn 15, N. Y.

## ALL PURPOSE CLUTCH

\$9.95

Collet Type, up to 2 H. P. For industrial uses, for inboard motor boats and Hobby shops. Shipped anywhere in U.S.A. post paid.



**MICHIGAN CLUTCH COMPANY**

756 Oakdale St. S. E., Grand Rapids 7, Mich.



## FIX SEWING MACHINES

BIG MONEY. Spare or full time. Open your own neighborhood shop. Thousands need repairs. Send for complete Repair Manual—only \$1.98 postpaid. Money back guarantee.

SEWING MACHINE SERVICE CO. Hamilton 26-M, Ohio



## ELECTRIC WELDER

AC or DC 110 Volts

Pre-war type—All metal—No chemical—5 year written guarantee. Welds 1/8" thick metal or money back. Repairs tanks, tools, fenders, machine parts, etc. Comes complete with rods, unit directions and eye shield. We also manufacture a set you can

learn with for only \$3.95 complete. On C.O.D. mailing charges extra.

ESSAY MFG. CO., INC., Dept. P.S., Quincy 69, Mass.

\$6.45  
Complete

## BALDING MEN ONLY!



Hair loss has 7 BASIC BENEFITS for YOU! Learn what they are—how they exist—how to use them to bring MORE MONEY, BETTER POSITION, GREATER HAPPINESS and a RICHER SOCIAL LIFE to YOU! Seven books paper bound. Write today—read them FREE for seven days—send only \$3.95 if you decide to keep them. Especially for BALDING MEN! Send no money. Comes in plain wrapper. Write today to—

HARKE & CO. 903 N. LATROBE ST. CHICAGO, ILL.

7  
DAY  
FREE  
OFFER  
SEND NO  
MONEY



## Earl's LEATHERCRAFT TOOLS

Finest precision quality leather working tools. Light weight, durable—professional type for hobbyist or craftsman. Home and School Set contains eight basic tools in attractive plastic case. All you need to get started—just \$5.50 Postpaid. Satisfaction guaranteed. Send for Free Catalog of complete line of leathercraft and coppercraft tools. EARL ENGINEERING CO. 1017 N. Market, Inglewood, Calif.



## YOU CAN BUILD anything on wheels!

**KIT A**—Contains 2 steel wheels (18" x 1 1/4") with moulded rubber tires, 1 steel yoke with welded axle, 2 steel brackets, and plated nuts. Stands up to 1000 lbs. load. \$3.95

**KIT B**—Contains 2 steel wheels (15 1/2" x 3/4"), moulded rubber tires, 1 steel yoke with welded axle, 2 steel brackets, and plated nuts. Stands up to 475 lbs. load. \$2.95

Build your own soapbox racers, wheelbarrows, toy wagons and carts, utility trucks, bike trailers, etc. with the new

## PALMER COMPLETE WHEEL KIT

Everything complete: 2 sturdy, steel, molded rubber tired wheels, bright red baked enamel finish; 2 steel brackets; 1 steel yoke, welded axle; rustproof; plated steel nuts; easy to assemble, complete instructions. Stands up to 1000 lb. load.

Send check or money order. Shipments F.O.B. Cleveland 9, Ohio.

FULL MONEY BACK GUARANTEE

CONNIE-BERT CO. 8115 Clinton Rd., Cleveland 9, Ohio

# ELECTRIFY

Your Sewing Machine With a

## "SEWING MACHINE MOTOR KIT"

The IDEAL GIFT for Mother... Wife... Sister!

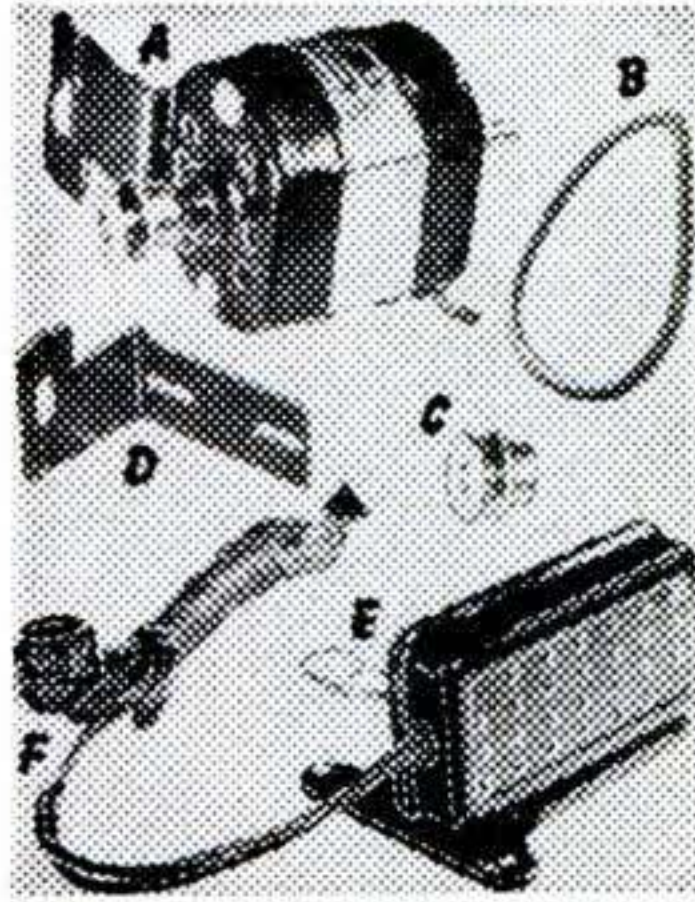
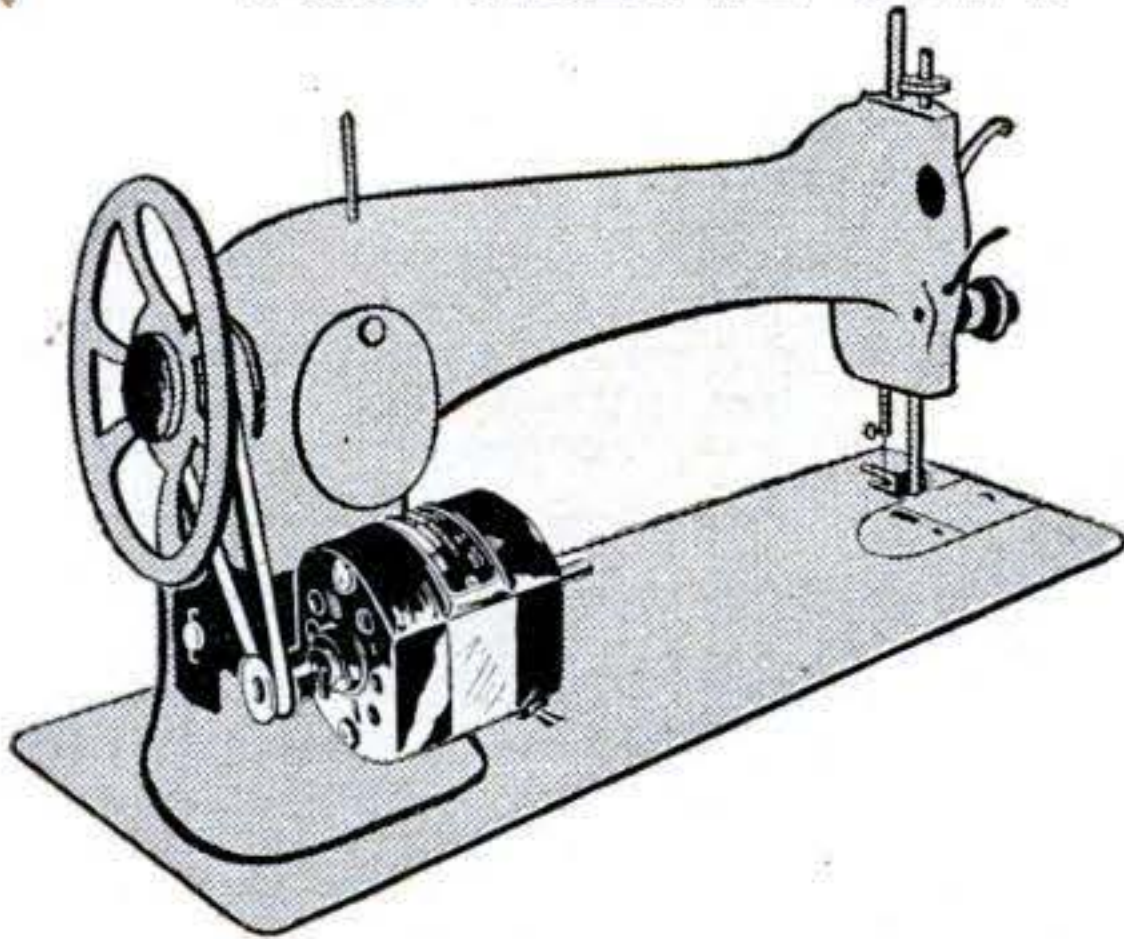

**\$17.75**  
**COMPLETE**

ADJUSTABLE FOR USE WITH ANY TYPE OF SEWING MACHINE

**ANYBODY CAN INSTALL IT!**

Takes but a few seconds

COMPLETE SET CONSISTS OF:

(A) MOTOR & BRACKET—Universal AC or DC, 60 cycle, 115 Volts. (B) BELT—Long Wearing Rubber Belt. (C) PULLEY—Single Grooved Steel Hubbed Pulley. (D) BRACKET—New and Improved. (E) FOOT CONTROL—7 Step Rheostat. (F) CORD SET—Extension Cord fitted with plug and socket. (G) Installation Instruction Sheet.

**SPECIAL NOTE:** This 1/20 H.P. motor with double end shaft and rheostat can be used in all hobby workshops for flexible shaft attachments, grinding, drilling etc.

**Special Offering to DEALERS!**

MAIL THIS COUPON

Dept. PS-3

**BROWNELL DISTRIBUTORS, INC.**

308 Canal St., New York 13, N. Y.

Please rush \_\_\_\_\_ motor kits at \$17.75 each (postage prepaid) in:

money order or  check  
 send C.O.D.—and I'll pay postman \$17.75 plus C.O.D. fees.

Name \_\_\_\_\_

Address \_\_\_\_\_

City \_\_\_\_\_ Zone \_\_\_\_\_ State \_\_\_\_\_

## Learn this Profitable Profession



**IN 90 DAYS AT HOME**

**Money-Making Career Open to Men and Women, 18 to 50**

Hundreds of men and women between 18 and 50 make \$10 to \$20 in a single day giving scientific Swedish Massage and Hydro-Therapy treatments. There is big demand from doctors, hospitals, sanatoriums and clubs. Graduates earn large full time incomes from these or in private practice in their own offices. Others make good money from home treatments given in spare time. Learn this interesting, money-making profession in your own home, through our home study course. Same instructors as in our nationally known resident school. You can win independence and prepare for future security by qualifying for your Diploma. Course can be completed in 3 to 4 months. Many earn while they learn. Begin your training at once.



**Anatomy Charts & Booklet FREE**

Enroll now and we will include, at no extra cost, many needed supplies. Fit yourself to help meet growing demand for Scientific Swedish Massage. Send the coupon at once for complete details, Anatomy Charts and 32-Page Illustrated Booklet, FREE, postpaid.

THE COLLEGE OF SWEDISH MASSAGE  
Dept. 870-D, 100 East Ohio St., Chicago 11, Illinois

Please send me FREE and postpaid, Anatomy Charts, 32-page Booklet and complete details on Home Training.

Name \_\_\_\_\_

Address \_\_\_\_\_

City \_\_\_\_\_ State \_\_\_\_\_

# EARN MORE

\$\$\$



**SEND FOR THIS FREE BOOK NOW!**

● Increase your earning power. Become thoroughly trained in a well-paid profession. Without obligation, find out about the opportunities in Electrical, Mechanical, Plastics, Civil, Mining and other engineering fields. Our free 118-page handbook, lists details of home study courses, compiled by world authorities. See for yourself how you can soon earn more dollars. Write today, to: Canadian Institute of Science and Technology, Ltd., 451 Century Building, 412, 5th Street, N.W., Washington, D.C.

Approved by the Veterans Administration under the GI Bill of Rights.

MAIL THIS COUPON NOW

Canadian Institute of Science & Technology, Ltd.,  
451 Century Building, 412, 5th Street N.W.,  
Washington, D.C.

Please forward free of cost or obligation of any kind your 118-page handbook "Engineering Opportunities".

Name \_\_\_\_\_ Age \_\_\_\_\_

Address \_\_\_\_\_

CANADIAN ENQUIRIES: 219 Bay Street, Toronto 1.

**"I saved \$150.00  
BY INSTALLING MY OWN  
DELTA OIL BURNER"**

"Yes, sir! I saved \$150.00 when I installed my Delta Oil Burner myself in a few hours. I shopped around but couldn't get a burner installed for less than \$350.00. The work was easy because of the Delta Photo-Installation Manual . . ."



**MADE BY THE WORLD'S LARGEST  
MANUFACTURER OF OIL BURNERS**

Now you can enjoy fully automatic heat in your home by installing it yourself simply and quickly with a few tools. You can save at least \$150.00 in your spare time! The Delta Automatic Oil Burner comes completely assembled along with everything necessary for the complete installation by you for the low price of only \$195.00. Includes the famous copyrighted DELTA PHOTO-INSTALLATION MANUAL showing step-by-step photographs of an actual installation. **PAY AS LITTLE AS \$6.26 A MONTH!** And—you need not pay a single penny to get the Delta Automatic Oil Burner because a simple deferred payment plan is available. Just send the coupon below for full information and free brochure in color describing how you can install and enjoy fully automatic heat in your home with the Delta Automatic Oil Burner, Delta Automatic Floor Furnace, and other Delta Heating products. *Mail coupon today!*

**—PASTE COUPON ON PENNY POSTCARD—**

**DELTA HEATING CORPORATION**  
85-03 Northern Blvd., Jackson Heights, New York City  
Please send FREE Color Brochure and full information about Delta Heating products.

NAME.....

ADDRESS.....CITY.....  
(Please Print Clearly) PS-A

**Made to U.S. Army Specifications!**

**16-JEWEL  
ELGIN  
\$19<sup>95</sup>**



Sturdy 16-Jewel ELGIN men's wrist watches. Water repellent. Sweep second hand. Stainless Steel back. Unbreakable crystal. **QUALITY!** American made. Fully reconditioned with **ONE YEAR GUARANTEE!** Made for the U. S. Army Air Corps. They **HAD** to be good. **SEND NO MONEY.** Simply pay postman \$19.95 plus 10% tax and postage on delivery. Cash orders sent postpaid. Limited supply. **UNITED PRODUCTS CO.,** 7941 S. Halsted St., Dept. RES-520, Chicago 20, Ill.



**SEND FOR THIS FREE!**

Make money. Know how to break and train horses. Write today for this book **FREE**, together with special offer of a course in Animal Breeding. If you are interested in Gaiting and Riding the saddle horse, check here ( ) *Do it today—now.*

**BEERY SCHOOL OF HORSEMANSHIP**  
Dept. 584 Pleasant Hill, Ohio



**LEARN TO PLAY AN  
A C C O R D I O N  
"THE PAGANI WAY"**  
WRITE FOR DESCRIPTIVE CIRCULAR

**O. PAGANI & BRO., INC.** 289 Bleecker Street  
New York 14, N. Y. Dept. S

**Learn A Trade NOW!  
PRACTICAL  
SHOP TRAINING!**

**In Our Chicago Shops  
TRADES THAT PAY**

**LEARN BY DOING**

- Auto Mechanics    ■ Machinist
- Diesel Engines    ■ Welding, Gas & Arc
- Refrigeration    ■ Piano Tuning
- Body & Fender Repair

*Above approved for G.I.'s & Civilians*

ESTABLISHED 1902

**VISITORS WELCOME**

**—CALL IN PERSON OR MAIL THIS AD TO—**

**GREER SHOP TRAINING**

(Dept. 118) 460 South State St., Chicago 5, Ill.

Please send without obligation free information regarding trade checked above. (Specify whether you are a Veteran  or Civilian )

Name.....Age.....

Address.....

City.....State.....

**WAR SURPLUS!  
HIGH SPEED DRILL BITS**

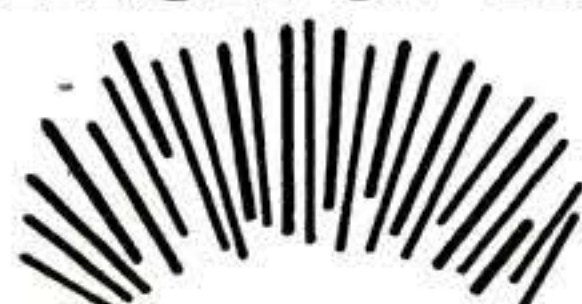

**LIKE NEW!** Original value over \$16.00. 25 assorted sizes and lengths. **\$2.50**

Send check, money order or cash.  
Shipped F.O.B. Culver City. Weight 1 Lb.

**AIRBORNE SALES CO. INC.** DEPT. PSM-4-8  
CULVER CITY, CALIF.

**BACKACHE,  
LEG PAINS MAY  
BE DANGER SIGN  
Of Tired Kidneys**

If backache and leg pains are making you miserable, don't just complain and do nothing about them. Nature may be warning you that your kidneys need attention.

The kidneys are Nature's chief way of taking excess acids and poisonous waste out of the blood. They help most people pass about 3 pints a day.

If the 15 miles of kidney tubes and filters don't work well, poisonous waste matter stays in the blood. These poisons may start nagging backaches, rheumatic pains, leg pains, loss of pep and energy, getting up nights, swelling, puffiness under the eyes, headaches and dizziness.

Don't wait! Ask your druggist for Doan's Pills, a stimulant diuretic, used successfully by millions for over 50 years. Doan's give happy relief and will help the 15 miles of kidney tubes flush out poisonous waste from the blood. Get Doan's Pills.



# WAR!

## Surplus & other BARGAINS!

Startling!



**Surplus DUST MASKS**  
**33¢**

BRAND NEW Here's a mask that will serve many purposes. Insecticide and paint spraying, ideal for milling companies. Reg. \$1.50 value.

### AVIATORS STYLE

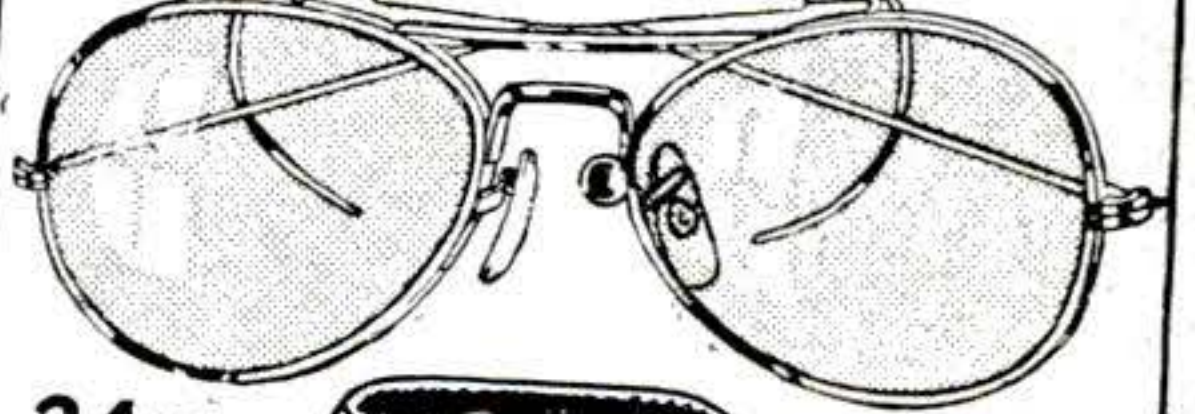

**24 Karat GOLD RIM** **4 BASE CURVE**  
**SUN GLASSES**

BRAND NEW. The type the aviators used. Genuine 24-karat gold-plated rims, ophthalmic ground, 4-base curve. Eliminates 96% of **ULTRA VIOLET RAY** We sold thousands at twice the price.

**2.88**



**BRAND NEW 17 JEWEL Military Style WATCH**  
**19.95**

PLUS 10% FED. TAX

The Greatest Watch Value in the U. S. A. Finest quality 17-jewel precision Swiss movement. **DUST PROOF, WATER REPELLENT, SHOCK PROOF, ANTI-MAGNETIC, SWEEP SECOND HAND, Stainless Steel Case.** Complete with strap. Be sure to include the 10% Federal tax.



**Genuine NYLON PER HANK**  
**59¢**  
**PARACHUTE CORDS**  
3/16-in. diameter. Has a tensile strength of 550 lbs. Ideal for clotheslines, venetian blind and drapery cords. Each hank 50 ft. long.

### Surplus NAVY UNLINED FIELD JACKETS



BRAND NEW. Made of fine quality water-repellent poplin material. Unlined, full zipper front, 2 slash pockets. Here's an ideal utility jacket for all-around wear. Worth twice our price.

**\$3.99**

### O. D. WOOL Serge SHIRTS AND PANTS

These were designated for reissue. Used, Absolute Perfect Condition. All have been cleaned and pressed by the Q. M. Corp. 100% wool serge. Less than the price of the cheapest overall.

**SHIRTS SIZES 13 TO 15** **2.69**  
**PANTS SIZES 28 TO 33** **2.95**



### 69¢ Navy STYLE T SHIRTS

BRAND NEW. Made of fine quality long staple cotton yarn. White only. Sizes: small, medium, and large.



### U.S. NAVY WORK JACKETS

U. S. Navy Regulation  
First Quality  
Brand New  
Full Cut Sizes

Made of 8-oz green herringbone twill. Tailored to Navy specifications. Ideal utility and work jacket.

**1.69**

**FREE SURPLUS Circular**

Send for

Write today for our **FREE WAR SURPLUS CATALOG**. Over 150 war surplus items, also other outstanding values.

### ORDER BY MAIL

Please send remittance with order. **ADD APPROXIMATE POSTAGE.** If desired, merchandise will be shipped C. O. D. plus postage and C. O. D. charges.

**SIoux FALLS SURPLUS STORE**  
**SIoux FALLS, S. DAK.**

### BUILD ARC WELDER PLANS 35¢

We Show You How to build this new powerful welder without rewinding. For light or heavy work. Uses coils taken from old auto generators. Works on 110 or 220 volts A. C. Has 20 different heats. Send 35c for complete **PLANS** and valuable Catalog. Write today. **LEJAY MFG. CO., 1323 LeJay Bldg., Minneapolis 8, Minn.**



### HOME BARS 25 DESIGNS

**HOME BARS** for genial hosts. Fun to make and use. 25 designs... built-in, portable bars; cellophane, only \$1.00. Send currency or check today. Money-back guarantee. **MECRAFT PLANS, Dept. S-113, 7241 Madison, Kansas City 5, Mo.**

### NEW SOLID BRASS 7 FT. PORTABLE RADIO ANTENNAS

## RADIO ANTENNAS

Real \$12 Value Now Only \$3.45 Postpaid FOR HOMES, BOATS or AUTOS

**JUST OUT!** Gov't surplus used on Army tanks. These telescopic rustproof antenna have tremendous pickup eliminate dangerous wiring. Solid Brass throughout practically insuring **NOISE FREE RECEPTION.**



**7 Exceptionally Rugged Sections** compress into 1 ft. 3 in. Handy for Camping Trips, also Useful for Transmitting FM & Television sets. Each antenna comes securely packed with mounting bracket. Easy to install anywhere.

**QUANTITY LIMITED ORDER TODAY.** A real \$12 value for only \$3.45 Postpaid. Mail check or money order now or sent C.O.D. plus postage. Money back in 10 days if not satisfied.

**RADIO HOSPITAL 422 East 86th St., Dept. B16 NEW YORK 28, N. Y.**



**QUICKLY RELIEVES PAIN!**  
**MASSAGE THOSE ACHES with the INFRA-RED**



### HEAT APPLICATOR

Join the thousands who bless the relieving comfort of this remarkable infra-red heat applicator. Use it for colds, stiff neck, muscular pains, toothaches, facial massage, sinus pains... even on feet chilled by poor circulation! Plug into wall socket—A.C. or D.C.—and apply curved plastic head to aching spot. Infra-red rays diffuse comforting, warming heat. Safe, easy to use. In unit small enough to carry in handbag when traveling. **Agent & dealer inquiry invited**

**\$3.45**  
COD or Post Paid

**SIBERT & CO., 41-P RANKIN ST. NEWARK 3, N. J.**

# INVENTORS

When you are satisfied that you have invented a matter of value—write me, without obligation, for full information as to what steps you should take to secure a Patent or Trademark.

The usual first step is to have a search of the prior U.S. Patents conducted, so that I can report to you on the question of Patentability.

**PATRICK D. BEAVERS**  
(Formerly RANDOLPH & BEAVERS)  
Registered Patent Attorney

937 Columbian Building, Washington 1, D. C.

**PATRICK D. BEAVERS, Registered Patent Atty.**  
937 Columbian Bldg., Washington 1, D. C.

Please send me full information on how to secure Patents & Trademarks.

Name.....  
Street.....  
City.....State.....

## Do you want

- .. to go to College?
- .. or to enter a Profession?  
(Such as Accounting, Architecture, Nursing, Dentistry, Teaching, Social Work, Osteopathy, Beauty Culture, Optometry, Embalming, Chiropody, Law, Medicine, etc.)
- .. or get an Office Position?

To get anywhere, you practically MUST finish High School FIRST. You can complete our simplified High School Course in SPARE time at home, as FAST as your time and abilities permit. Equivalent to resident school work—prepares you for college, pre-professional examinations, business, industry. Standard texts furnished. Diploma. Credit for H.S. subjects already completed. Single subjects if desired. Low tuition, easy terms. American School, Chicago, est. 1897—endorsed by educators. Finish your high school education NOW. Write TODAY!

## High School Course at Home Many Finish in 2 Years

American School, Dept. H446, Drexel Ave. at 58th St., Chicago 37

Gentlemen: Send me FREE information covering special training in subjects checked below. No obligation on my part.

- |  |  |
|--|--|
| <input type="checkbox"/> High School Course          | <input type="checkbox"/> Diesel Engineering                    |
| <input type="checkbox"/> Electronics, Industrial     | <input type="checkbox"/> Drafting and Design for Men and Women |
| <input type="checkbox"/> Architecture and Building   | <input type="checkbox"/> Plastics                              |
| <input type="checkbox"/> Automotive Engineering      | <input type="checkbox"/> Private Secretary                     |
| <input type="checkbox"/> Business Management         | <input type="checkbox"/> Mechanical Engineering                |
| <input type="checkbox"/> Electrical Engineering      | <input type="checkbox"/> Aviation                              |
| <input type="checkbox"/> Elec. and Gas Refrigeration | <input type="checkbox"/> Salesmanship                          |
| <input type="checkbox"/> Air Conditioning            | <input type="checkbox"/> Radio                                 |
| <input type="checkbox"/> Railway Training            |  |

Name.....

Address.....

## \$200.00 NAVIGATOR'S SEXTANT \$17.50

GOV'T. SURPLUS



A precision instrument of recognized quality. These Link Sextants are used for navigating by the stars or other celestial bodies, on large and small boats—for all types of aircraft—anywhere on the face of the earth. The Sextant is to the mariner what the transit is to the surveyor.

### FINEST PRECISION CONSTRUCTION

These fine Link Sextants are the product of a famous name manufacturer. Original procurement cost was approximately \$200.00. Now, as war surplus, you can buy one at a fraction of original cost. Instrument is equipped with easy-reading vernier type scale. Bubbles are checked for accuracy. Although slightly used, they are in perfect operating condition. Furnished complete with operating instructions and protective wood carrying case 8x12x4 inches. These are guaranteed to be the genuine Link A12 Sextants. Sold FOB Houston. Send check or money order. Rush your order.

**\$17.50**

**AERO PARTS SUPPLY, Dept. PS4**  
Municipal Airport HOUSTON 12, TEXAS



## CRONOGRAPHS SEND NO MONEY

• 17 Jewel-2 push buttons-Wrist watch-Telemeter-Stop watch-Tachometer. Incabloc shock resistant. Features: Sweep second hand, Anti-magnetic, Unbreakable crystal, Stainless steel back. Every watch guaranteed brand new.

MAIL ORDERS PROMPTLY FILLED Formerly \$71.50  
Order C.O.D. Just pay postman \$29.75 plus C.O.D. charge. Send check or money order we pay postage. Money refunded in 10 days if not completely satisfied.

**\$29.75**  
add 10% tax

LIBERTY JEWELRY SHOP 678 8th Ave. N.Y. 18, N.Y.

## DEVELOP RUGGED STRENGTH!



**Strong Men's Club of America offers FREE Membership!**

Send for your personal membership card and Strength Secrets. No dues! No obligations! Many valuable privileges! Send name, address, age, on penny postcard.

JOE BONOMO Strong Men's Club of America Director (Dept. P.S.-4B) 1841 Broadway, N. Y. 23, N. Y.



## BAR BELLS

Buy Direct From Factory Save 20% to 30% **\$8.95**  
**8 up**

Write for Free Booklet and Price List

INDEPENDENT IRON WORKS

2440 EAST 23RD STREET, DEPT. C LOS ANGELES, CALIFORNIA

## RUPTURED?

Get Relief This Proven Way

Why try to worry along with trusses that gouge your flesh—press heavily on hips and spine—enlarge opening—fail to hold rupture? You need the Cluthe. No leg-straps or cutting belts. Automatic adjustable pad holds at real opening—follows every body movement with instant increased support in case of strain. Cannot slip whether at work or play. Light. Waterproof. Can be worn in bath. Send for amazing FREE book, "Advice To Ruptured," and details of liberal truthful 60-day trial offer. Also endorsements from grateful users in your neighborhood. Write:

Cluthe Sons, Dept. 14, Bloomfield, New Jersey

# BE YOUR OWN BOSS! LEARN ELECTROPLATING HIGHLY PAID FIELD



UNCROWDED, interesting business. Part or full time. Common school education sufficient. Chromium, Nickel, Silver, Gold, etc., money making trade secrets Learn at home in spare time. Send postcard today for **FREE** electroplating idea booklet.

**PLATER HYDE**  
432 F Street Room 522  
San Diego 1, California



## MAKE JEWELRY AND NOVELTIES AT HOME!

Work right on your kitchen table! No tools or experience necessary. Learn—earn within a week. Complete home instruction course, beautifully photographed, shows how to make 115 different designs of earrings, pins, sprays, brooches, hair ornaments, bracelets, candy dishes, ash trays, wall plaques, etc. Illustrates also 55 kinds of Sea Shells and Fish Scales often used. Explains fully home methods of dyeing, pearlizing, golding and glow-in-the-dark processes. Lists hundreds of raw materials with wholesale prices. Complete course only \$1. Beginner's Kit, \$3 (\$3.50 in Canada), postpaid.

**HOUSE of GIFTS, Box 4550-SP1, Coral Gables, Fla.**

## KINKADE GARDEN TRACTOR

and Power Lawnmower

A Practical Power Plow and Cultivator for Gardeners, Suburbanites, Florists, Truckers, Nurserymen, Fruit Growers.

Easy Terms - Write Today

**American Farm Machine Co.**  
1072 33rd Ave. S. E. Minneapolis, Minn.



Catalog Free

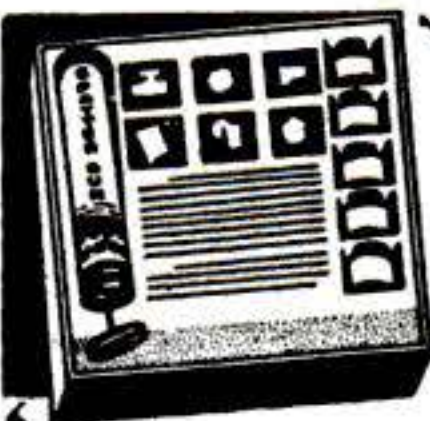

## SPATTER CRAFT

• Learn for fun & profit! Produce color effects on wood, cloth, or paper impossible any other way. Sunfast, wash-proof, too. Kit has GUN; 5 BOTTLES of COLORED INK; STENCIL PAPER; many PATTERNS & DESIGNS; and 22-page TEXTBOOK in full color. Just \$2.50 postpaid. CRAFT CATALOG FREE with order. (If W. Va. add 5c Sales Tax)

**DWINNELL CRAFT SHOP, Dept. PS84, Elm Grove, Wheeling, W. Va.**

# 22 Big Money-Makers in a Single Line! Amazing New Fluorescent Lights with **CIRCULAR TUBES**

THE HOMELITER

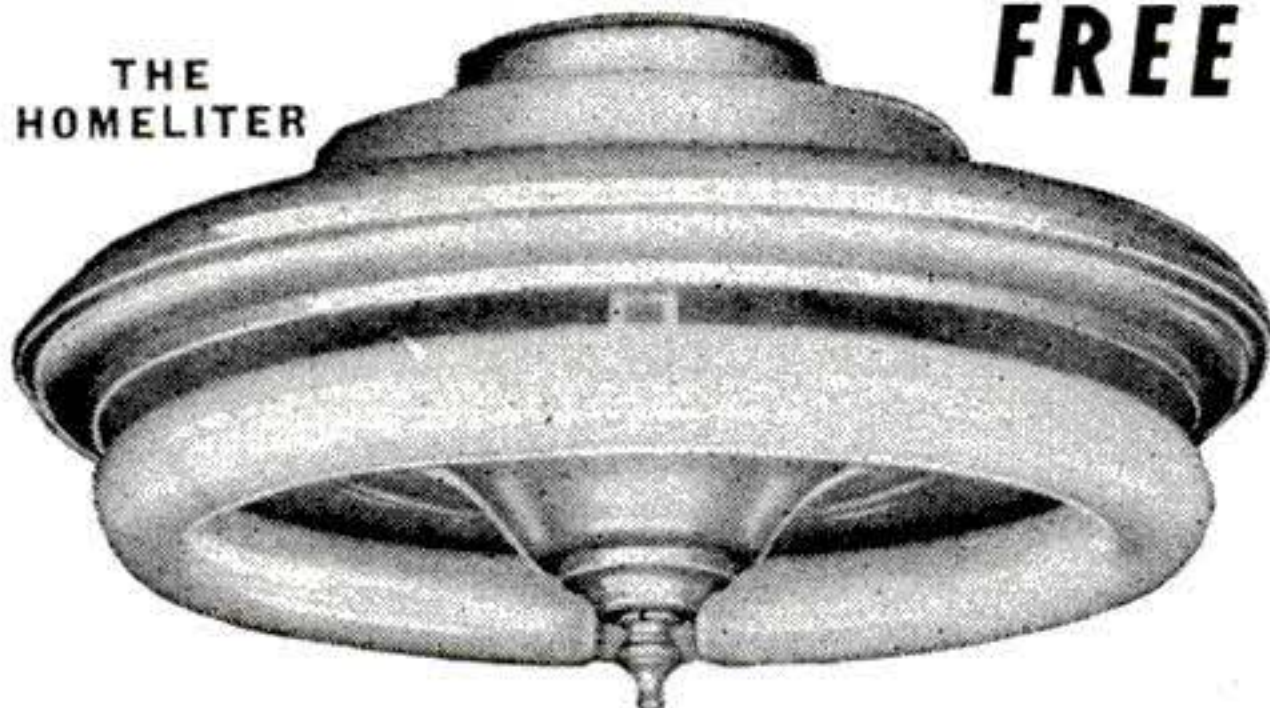

## FREE SALES OUTFIT

• Don't send a penny. Sample Outfit is **FREE**. Rush name on penny post card for money-making facts about sensational new "CIRCLINE"

Fluorescents. Latest scientific development gives you 22 new type circular tube fixtures for kitchens, dinettes, halls, and play rooms. Also Floor and Table lamp for living rooms and pin-ups for shaving and vanity tables. Sells on sight to homes, restaurants, stores, offices. No other fluorescents like CIRCLINE. Salesmen who order samples quickly reorder in large quantities. **All fixtures complete with tubes.** No waiting. Also **immediate delivery** on all standard type Fluorescent Fixtures. This is too good to miss. Big, quick profits waiting. Rush name on post card today for **FREE** Sales Outfit.

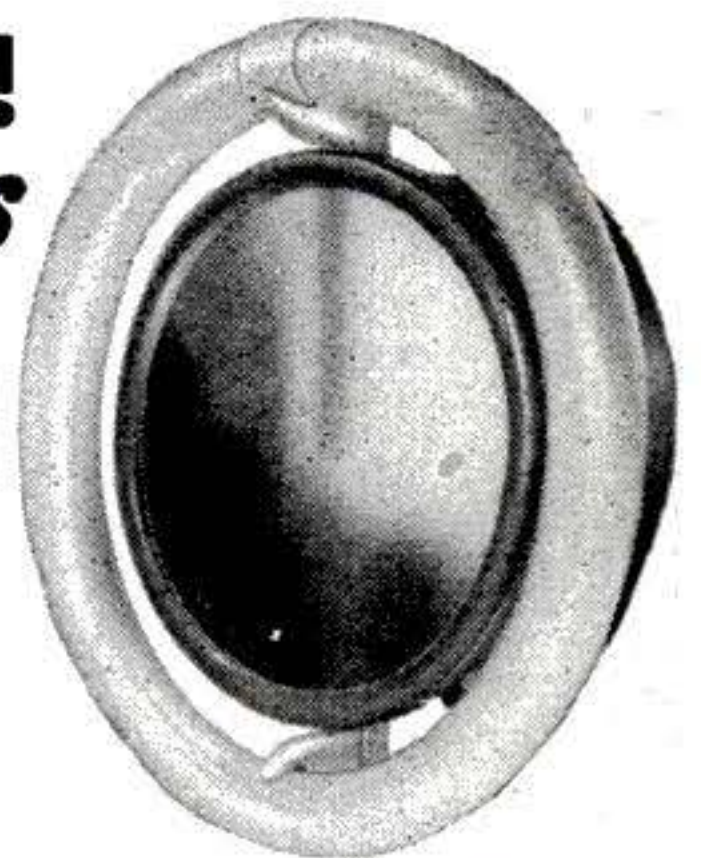

**NEW MAXILUME  
PIN-UP  
MIRROR LIGHT**

**MAXILUME COMPANY • 125 W. Hubbard • Dept. 94 • Chicago 10, Illinois**

## NEW SERIES 16 IMPROVED NO-DRIFT FM



5  
WAVE  
BANDS

in the Sensational 1948

# MIDWEST RADIO PHONOS.

Separate Chassis Like the Powerful Series 16 AM-FM Above, or Beautiful Radio-Phono Consoles Available

## The SYMPHONY GRAND RADIO-PHONOGRAPH AM-FM CONSOLE



A truly magnificent instrument that offers new, improved No-Drift FM, 5 Wave Bands, Automatic Intermix Record Changer that handles both 10" and 12" records, 14 1/2" Panasonic Speaker, and exclusive Midwest Tri-Magnadyne Coil System and Color-Ray Tone Selection. Luxurious Cabinets. Other Console and Table Models with Series 16, 12, and 8 Chassis.

EASY  
TERMS

30  
DAYS  
TRIAL

SEND FOR  
FREE  
Catalog

**BUY DIRECT FROM FACTORY AND SAVE**

FILL IN COUPON AND MAIL TODAY OR JUST  
SEND YOUR NAME AND ADDRESS ON 1c. POSTCARD

### MIDWEST RADIO CORPORATION

Dept. 24-W, 909 Broadway, Cincinnati 2, Ohio

Please send me your new **FREE** 1948 Catalog.

NAME .....

STREET .....

CITY.....ZONE....STATE .....



**MAKE HOLLYWOOD STYLE CEMENT POTTERY,** birdbaths, benches, coffee tables, stucco-rock, rustic garden walks, etc. Many more. Color concrete with chemicals. Start with small capital. 10c brings sample, pictures, details.

**HOLLYWOOD CEMENTCRAFT**  
8527-B Wonderland Ave. Hollywood 46, Calif.



APPLIES LIKE PUTTY  
HARDENS LIKE METAL

**Repairs**

- BODY AND FENDERS
- RADIATOR & GAS TANKS
- CRANK CASES • BATTERIES
- KITCHENWARE • TOYS
- WATER PIPES & TANKS
- PLUMBING • WIRING

Fills holes, dents, cracks and rust spots. Sand or file, and paint when dry. Send \$1 for generous half pint can. (Includes Postage) Money back guarantee.

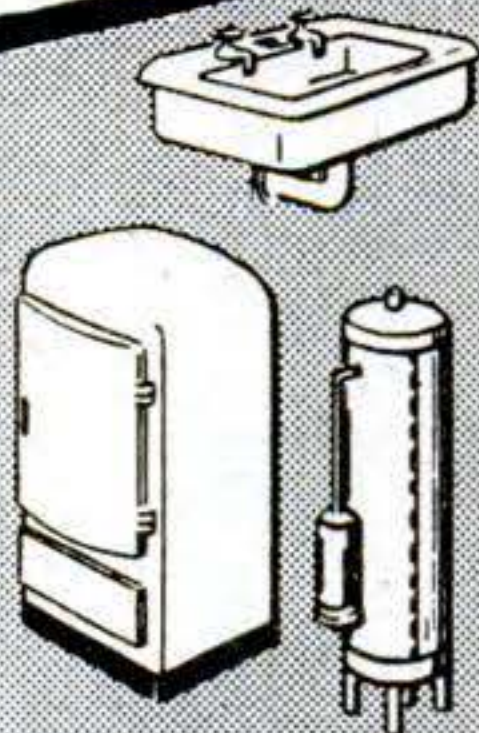

**PLASTI-KOTE, INC.** CLEVELAND 13, OHIO  
LOS ANGELES 16, CAL.

Enclosed find \$1 for half pint can Plasti-Kote Plastic Metal

NAME \_\_\_\_\_

ADDRESS \_\_\_\_\_

CITY \_\_\_\_\_ ZONE \_\_\_\_\_ STATE \_\_\_\_\_



**You Can Make Up to \$5.00 Per Hour with the IDEAL**

THERE are hundreds of lawnmowers in your neighborhood that will need sharpening at least once or twice each season. You can build up a profitable business with the Ideal Lawnmower Sharpener, and earn up to \$5.00 an hour while doing it.

You need no experience to operate the Ideal Lawnmower Sharpener. Just place the lawnmower in the Ideal, make a few simple adjustments, and in a few minutes you have a smooth-running, perfect-cutting lawnmower. The Ideal is not a "make-shift" sharpener, it has 45 years of engineering design behind it,

... is sturdily built, and grinds both straight blade and reel knives to a precision-cutting edge. Write today and learn what the Ideal Lawnmower Sharpener can do for you.

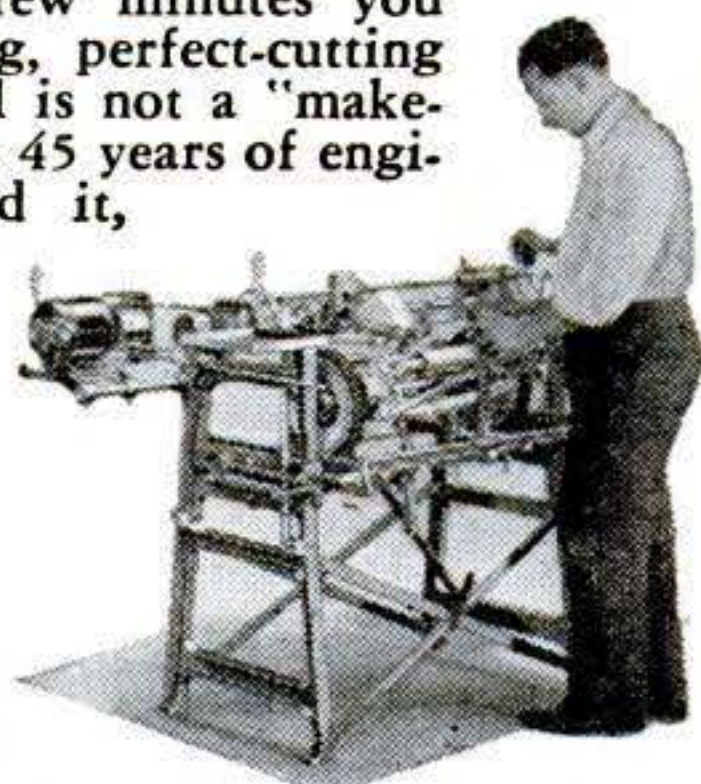

**DON'T DELAY**

**Send For FREE Book**

**The FATE-ROOT-HEATH CO.**

DEPT. D-4, PLYMOUTH, OHIO

**Famous BAILEY DIESEL SCHOOLS**

**Now Accepting CIVILIAN STUDENTS!**

Bailey has a national reputation for "finest training methods." Bailey teaches you fundamentals, plus the practical application of theory in plenty of actual shop work. Bailey is approved by industry. Bailey graduates get the jobs!

Civilian men and boys over 17 who are ambitious to get ahead will act now. Send for FREE catalog. No salesman will call.

**BAILEY TECHNICAL SCHOOLS**

1656 So. Grand Blvd., St. Louis, Mo.

**Easy Self-Instruction In All 25 Branches Of MATHEMATICS**

Brought To You By Experts From Leading Colleges

In the 4 volumes of the PRACTICAL MATHEMATICS LIBRARY. Helps you qualify for the better jobs in industry. 1300 pages, 600 illustrations. Sent for free examination. Only \$2.00 down, \$2.00 a month; total \$9.80 plus postage. (Cash price \$9.50, postage free. Money-back guarantee.) 160-page 6-Place Logarithm book free with order. National Educational Alliance, Inc., Dept. 804, 37 West 47th St., New York 19, N. Y.

**HYPNOTIZE**

Learn to hypnotize. Self-hypnosis. Secrets revealed. Exciting experiments. Overcome inferiority complexes, excessive smoking, alcoholism, stuttering, nailbiting, phobias, insomnia, fear, manias, stagefright. Improve your memory and concentration. Private and class instruction available at Institute. Complete practical home-study course... \$2



**FOR RENT at**

**4¢ PER DAY**

HUNDREDS of NEW 5-cent Nut Vending Machines. No risk. No capital necessary. Nothing to buy. 500% PROFIT

NEMEC-RANKIN Box 767, MILWAUKEE 1, WISC.

**AUXILIARY POWER PLANTS**

Govt. cost \$300. Our Price \$40

Description available. No C.O.D.

NEW YORK OUTLET & SALES CORP., 144 Chambers St. N.Y. 7, N.Y.

**Piles May Lead to Chronic Ailments**

**FREE BOOK — Explains the Causes and Effects**

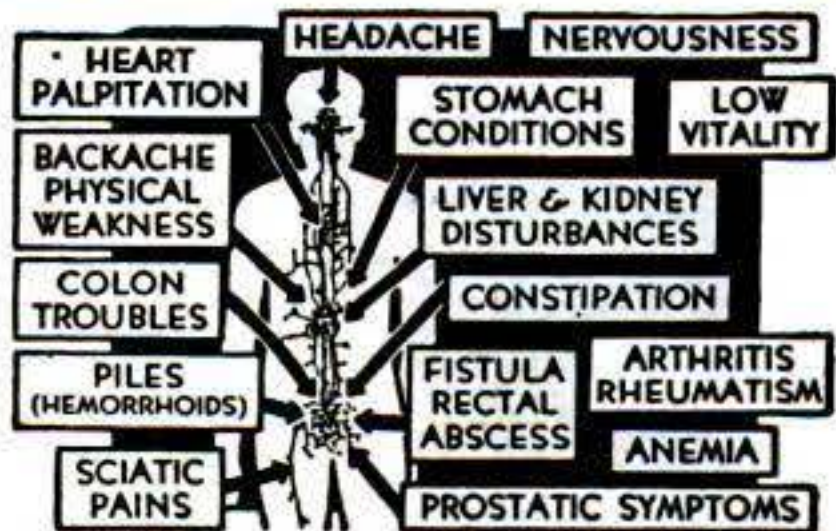

No obligation. Write to Thornton & Minor Clinic, Suite 449, 926 McGee St., Kansas City, Mo.

## BUILD YOUR OWN CAR WITH A WAR SURPLUS HYDRAULIC TRANSMISSION



ONLY \$15.00 each

The plans for a really slick midget car, made with a Surplus Hydraulic Transmission used for controls on Bomber turrets, for control, can be found in the January issue of Popular Mechanics.

These transmissions will operate with a minimum loss of power on any motor up to 2 HP, and provide an excellent means of keeping your Midget cars speeds down for safe driving by youngsters. Each transmission is completely self contained and offers a variable speed in either direction from neutral.

This transmission also has an unlimited number of other uses on power tools, display tables, scooters, and any other job requiring controlled speed or instant reverses.

(Single units shipped Express Collect, Larger quantities shipped per Instructions).

Write for Information

**N. SILVERSTINE CO.**

6532 EAST McNICHOLS ROAD DETROIT 12, MICHIGAN

Seven Acres of Surplus!



## Torpedo Director

only \$3.25

This instrument was used to direct the launching of torpedoes from aircraft. It is brand new and comes packed in a nicely finished plywood box.

Instrument contains an achromat lens diameter 37 mms., and focal length 80 mms. in a threaded mount. The reflector plate is optically flat glass in the shape of an ellipse 45 mms. wide and 65 mms. long. Has a 28 volt light bulb in a white surfaced reflector housing and a glass reticle with the aiming pattern engraved on it.

## N-C-3 Gunsight



Now Only \$1.00 Each

This sight contains 2 3/16" condensing lens with a 6" focal length. This lens works out nicely in projection work and exceptionally well suited for a 35 mm. slide projector. Combined with the lens system of an N6A Gunsight, it gives you a complete projection lens setup.

Price - NC3 ----- \$1.00 ea.

## N 6 A Gunsight Only \$1.00

This gunsight contains an F 1.9 lens system, a fine optical mirror, a 24 volt reflector type bulb, and many other valuable parts.

Price - N6A ----- \$1.00 ea.

## SPECIAL OFFER! SAVE 1/2 PORTABLE AIR COMPRESSOR SPRAY PAINTING OUTFIT

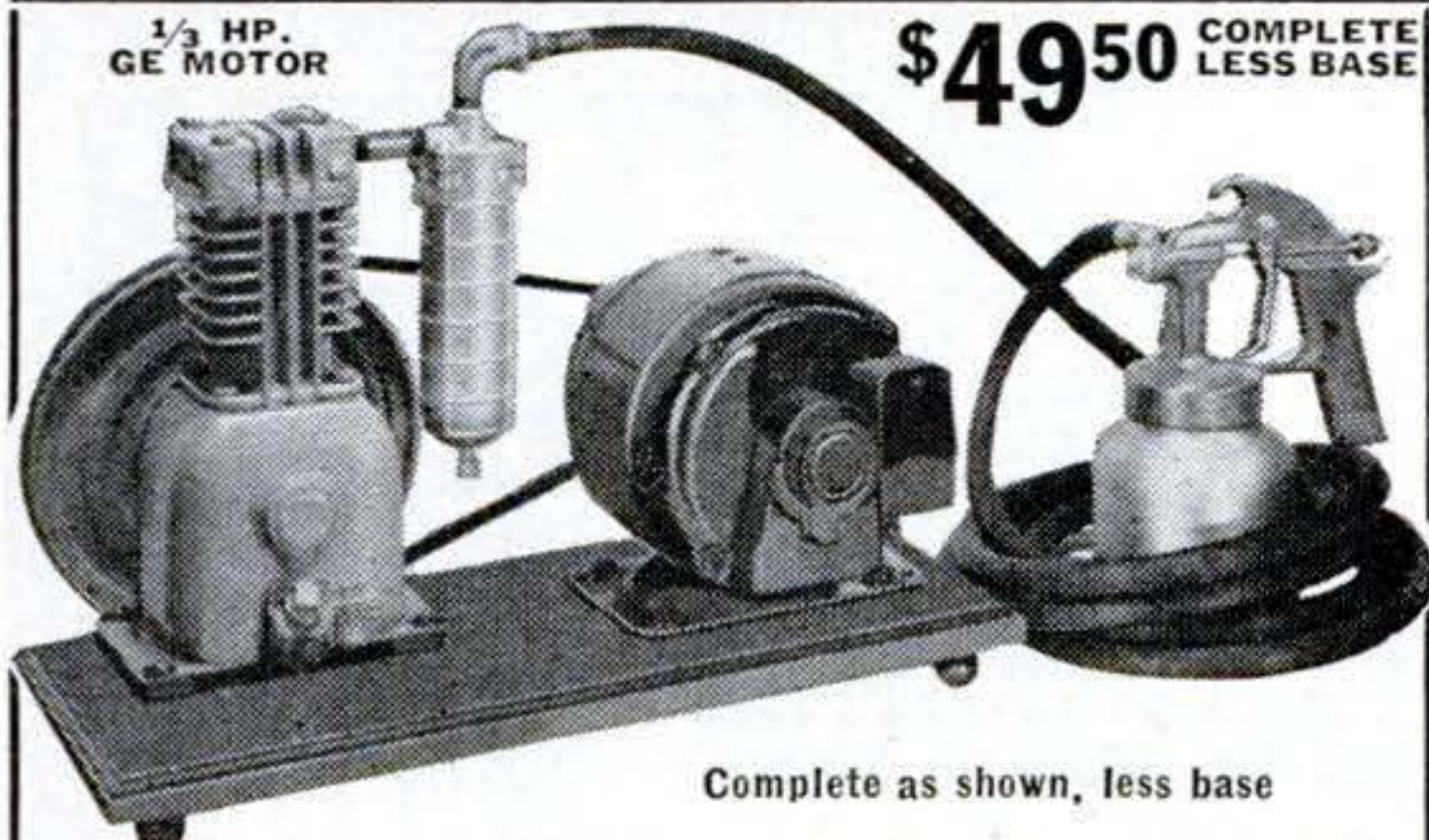

Complete as shown, less base

2.8 C. F. M. DISPLACEMENT COMPACT POWER PLUS

Here is what you get: 1/2 HP. GE motor or equal, 110 volt, 60 cycle, 1 phase, 1750 RPM, with 6 ft. cord and plug; Compressor, 2 x 1 3/4 piston type; Spray gun with qt. cup, 2 nozzles, round-fan spray, air filter, 15 ft. hose and fittings; belt and pulley. All bolts necessary for mounting on base. We pass the big saving in labor on to you. All you have to do is mount on base as shown. Complete operating instructions furnished. Weight 50 lbs.

Special Price \$49.50

SOLD ON MONEY BACK GUARANTEE. Price F.O.B. Chicago. Immediate delivery. Send check or money order today. Dealers write. C & M EQUIPMENT COMPANY 1831 S. State St. Chicago 16, Ill., Dept. B-4

## ARMY FIELD Telephones



### JOB-PROVED

for most practical 2-way communication, indoors or out. Hundreds of uses. Compact . . . rugged . . . portable. Performance equals present-day commercial telephones . . . up to 17 miles!



Anyone can install. Just hook up terminals to any two-strand wire, or single wire and ground; several phones on same line if desired. Operates on standard flashlight batteries—no external power required. **Every phone guaranteed.** Two phones comprise a set—order as many as you need. Each phone complete with hand generator and self-contained ringer.

NEW—Leather case.....\$16.25 ea. Canvas case.....\$15.00 ea. New or Reconditioned—with cases soiled, etc. Performance equals new telephones .....\$10.75 ea. New Field Phone Handsets.....ea. \$3.75 Postpaid Genuine 2-strand W-110 Army Field Wire. New. 500 ft. \$3.50; 1000 ft. \$6.50; 1/2-mile reel \$10.50; 1-mile reel \$16.00

WRITE FOR FREE FOLDER ON TELEPHONES

All Prices FOB Sacramento, No C.O.D. In California, add 2 1/2 % for sales tax. Shipping weights: Phones—12 lbs. ea.; Wire—500 ft., 14 lbs.; 1,000 ft., 28 lbs.; 1/2 mile, 85 lbs.; 1 mile, 164 lbs.

SEND CHECK OR MONEY ORDER

**LORIS SALES**

P. O. Box 1896, Dept. A

Sacramento, Calif.

# BE SMART! BE THRIFTY!

Put a rugged WHIZZER Motor on your bike—your own personal power transportation for pennies a day. 125 miles on a gallon! 2½ horsepower, 4-cycle auto-type engine!

## It's Wise To Go

# WHIZZER

America's Thriftiest Power Transportation

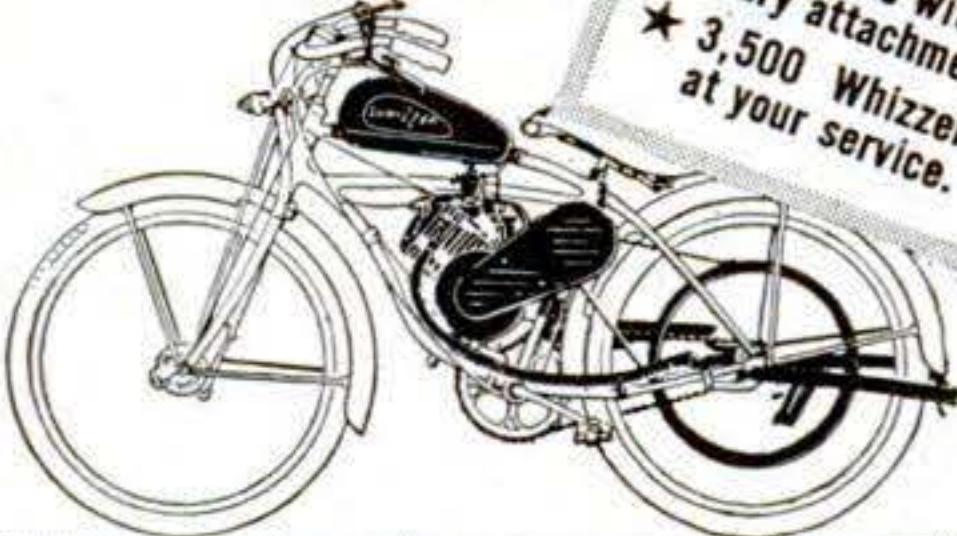

ONLY \$9755 PLUS TAX

F. O. B. Pontiac, Michigan

- ★ Precision engineered for long life.
- ★ Complete with all necessary attachments.
- ★ 3,500 Whizzer Dealers, at your service.

Your Whizzer Dealer is as near as your telephone . . . or write Whizzer Motor Co., Pontiac, Mich.—world's largest bike motor builder.

# LEARN EXPORT



Buy and sell world-wide without capital. Travel abroad if desired. Export men and women in demand. Your own business — profits unlimited. Salaried jobs — up to more than \$10,000 a year. Practical, low cost WORLD TRADE COURSE teaches you quickly at home in spare time. No previous special experience or schooling needed. World Trade Certificate awarded. Write today for FREE DETAILS. No obligation. Please state age. Air-mail reaches us overnight. **THE MELLINGER CO., Exporters-Importers, 1422-F Westwood, Los Angeles 24, Calif.**



### REAL DIESEL ENGINE

For Model Planes, Boats and Race Cars. Now you can own and run a real miniature Diesel engine that operates by the heat of compression. No coil, condenser, wires, or annoying ignition failures. Simply flip the prop or fly-wheel to start. It's the new DEEZIL—a .125 cu. in. displacement, 5 oz. engine that runs at 8000 RPM. Order today; only \$12.95 p.p.. less tank. Every engine fully tested and guaranteed. DEEZILMIX FUEL \$1.00; PROP 50c.

Send For Valuable Free Price List!

**GOTHAM HOBBY**  
New York 35, N.Y. Dep't 5

107 East 126th Street

## TRAIN

# Your VOICE!

## Results GUARANTEED



We build, strengthen the vocal organs—not with singing lessons—but by sound, scientifically correct silent and vocal exercises and absolutely guarantee complete satisfaction with results. Write for Voice Book, FREE. Sent to no one under 17 years old unless signed by parent.

**Perfect Voice Studios, Studio 1364, Kimball Hall Bldg., Chicago 4, Ill.**

### STUDY CHEMISTRY

Portable Analytical Chemistry Kit—\$1.75 postpaid  
APPROVED BY AMERICAN CHEMICAL SOCIETY  
Send for free literature on this and larger portable units suitable for your home science laboratory.

**THE MICROKIT COMPANY**  
P. O. Box 324 Jamaica, N. Y.

## FLOCKING or SANDBLASTING GUN

Works on small air compressor \$16.95



The most Decorative Gun on market. 101 uses. Home Craftsman, Hobbyist, or Refinisher—Spray that velvet Suede Finish on your Radio Cabinet, Lamp, Base, or Shades, Book ends, Statuettes, Jewelry, Boxes, Auto, Dashboard. Make things Snagproof, Marproof, Cushioning. Art or Sign Work, Print Goods. Sand Blast Designs on glass. For frosting glass, putting names on tools, wood or metal. Remove paint or rust from auto bodies. This alone is worth \$16.95. Shipped complete with flock ready to use. 5-day money back guarantee. \$16.95 money with order, postpaid, USA. Aluminum alloy castings, brass fittings, chrome molybdenum heat-treated sand nozzle and air jet. Calif. order send 2½¢ sales tax.

**BLASTO SPRAY GUN MFG.**  
Dept. S4, 7007 Haas Ave., Los Angeles 44, Cal.

## EYE GLASSES BY MAIL

**FREE** ...of extra charge: Eye Glass Case, Wiper, Eye Glass Cleaner with Each Order!

● 30-DAY TRIAL OFFER

NEWEST STYLES. Write today for FREE Catalog, Full Information, Low Prices, Scientific Sight Test Chart!

SEND NO MONEY

POSITIVE MONEY-BACK GUARANTEE



**\$1.95**

AND UP

**LEE EYE GLASSES CO.**  
4148 Easton, Dept. Q-6, St. Louis 13, Missouri

## JUMBO RADIO PARTS ASSORTMENT

An outstanding buy for the RADIO AMATEUR, BUILDER or EXPERIMENTER in new & dismantled radio & electronic parts!—17 FULL POUNDS of COILS, TRANSFORMERS, HARDWARE, RESISTORS, CONDENSERS, WIRE, etc., etc. All these and MORE for \$2.95 only

- T-30 CARBON THROAT MICROPHONE with neck-band, cord & plug. Excludes outside noise; leaves hands free. Requires reg. carbon mike transformer & 4½V. battery. BRAND NEW ea. 39c. 12 for \$2.98
- EXTENSION CORD & SWITCH for T-30 MIKE. 9½ ft. rubber covered with JK-48 jack & PL-68 plug . . . . . ea. .39
- HEADPHONES (Army HS-23) .8000 ohms imp. Leather covered adjustable, with 18" cord & PL-354 plug . . . SPECIAL \$1.25
- Rubber phone cushions. Per pair . . . . . .20
- HEADBANDS—Sturdy fabric covered bronze spring wire. Thumb screw adjust. forks. For standard phones . . . . . .39
- POWERFUL ALNICO MAGNETS in many sizes & shapes always in stock.
- Get On Our Mailing List—Always Something New—Please Add Sufficient Postage
- LEOTONE RADIO CO., 65 Dey St., New York 7, N. Y.

## YOUR OWN PRIVATE TELEPHONE

2-WAY COMPLETE

Speak and hear even a whisper. Ready for communication between any 2 points up to 1 mile. Requires only ordinary wire. Safe in water. Use at home, at work, on farms. Kids love them. Come ready to use. No electricity or battery Complete.....



PRICE INCLUDES SETS FOR BOTH ENDS

**\$2.95**



HEAVY CAST SOLID BRASS

## SHIP'S BELL

An exciting gift item, at a new low price. Weighs 3¼ lbs. Approximately 5" in diameter. Hang outside front door, decorate den, or boys' room, use in barbecue for chow calls. Only . . . . .



**\$6.95**

## SHIP'S LANTERN

A beautiful ornament and a practical lighting fixture. Made of solid, polished brass with red, blue or clear glass lens and socket for house current. Weighs 2 lbs. . . . .



**\$5**

## CHEMISTRY SET

Made for Chemical Warfare Division for testing water, etc. Complete set with chemicals, test tubes, full instructions. Packed in attractive lucite box with cover and dividers. . . . .



**\$1**

Send check or money order. One dollar deposit on all C.O.D.'s. We prepay postage on all items. **15 PIECES**

## WYN CASTLE COMPANY

221 So. Los Angeles T., DEPT. PS-38, Los Angeles 12, Calif.

# Mows and Trims Lawns



In One Simple  
Easy Operation  
8 1/4 Lbs.

Save Time  
and Labor with a

## MONTAMOWER

New model. New type metal handle has special device to adjust cutting height. Drive shaft now mounted on free rolling, factory lubricated, sealed ball bearings. No tired backs or aching arms. 8 1/4 lbs. live precision made mechanism that first gathers, then cuts smoothly a clean 16" swath through grass, dandelions, spike grass, lawn weeds. No noise or clatter. As modern and efficient as your electric razor. Cuts right up to walls, fences, trees or posts; leaves no fringes to be trimmed by hand. Cutters self-sharpening. Built to last many years. Many thousands in use. Sold direct from factory for 26 years. Costs little. Write at once for trial on your own lawn "approval offer," guarantee information and literature.

### MONTAMOWER DISTRIBUTING CO.

830 Keeler Bldg.

GRAND RAPIDS 2, MICHIGAN



### A PENNY POSTCARD MAY CHANGE YOUR FUTURE...

Get full information on the coin-operated vending machine industry. Start with a few machines and build a wonderful future. We'll give you complete advantage of our "know-how." Send for Free Booklet Today—No Routes Sold!

#### PIONEER VENDING SERVICE

ADDRESS ALL MAIL TO DEPT. PS

461 SACKMAN ST. • BROOKLYN 12, N. Y.

### \$ \$ \$ profits with FURNACES

REALE HEAT furnaces. FULL Line. Gas & Oil Circulating heaters & floor furnaces. Burners & Blowers. Of interest to Contractors & Builders. Dealers Franchises. Write for free details. PEERLESS SALES, 4318 Sheridan Blvd., Lincoln 6, Nebr.

**Famous BANNER**

# FIREWORKS

**OH-BOY!** Don't be disappointed. Get the best for your money. Famous Banner Fireworks have all the ZIP, BOOM, BANG you expect of fireworks. This year several new creations have been added. You'll thrill to every last piece in this BIG BARGAIN ASSORTMENT.

**BIG SPECIAL DEAL—Only \$4.95**

Retail value over \$10.00. Cannon Salutes—Sky-screamers—Whistling Devils—Battle in the Clouds—Sky Rockets—10 ball Roman Candles—Chinese Firecrackers—Sparklers and many others. Over 200 pieces in all. Rush order today. Supply limited. Send money order bank draft or currency. No C.O.D.'s. Catalog FREE.

**BANNER FIREWORKS MFG. CO., INC., DEPT. 145**  
446 Capistrano Toledo 12, Ohio

# FREE

get it now

## ALLIED'S NEW 1948 RADIO CATALOG!

172  
Value-Packed  
Pages



EVERYTHING  
IN RADIO AT  
LOWEST PRICES



TELEVISION AND  
NEW HOME RADIOS



SERVICE SUPPLIES  
BUILDERS' SUPPLIES

### Radio's Great Buying Guide

Send today for your FREE copy of Radio's Leading Catalog! It's the preferred Buying Guide for Servicemen, Dealers, Engineers, Soundmen, Amateurs, Builders and Experimenters. Shows everything you want in Radio and Electronic equipment—all the newest releases—complete, highest quality stocks at low, low prices that save you money on every purchase!

### World's Largest Stocks!

You'll find *everything* in the new 172-page ALLIED Catalog—television receivers, latest home radios and radio-phonos, Ham receivers and station equipment, test instruments, public address equipment, new builders' kits, thousands of parts, tubes, tools, radio books, diagrams. Get the speedy, reliable service and expert help you want from ALLIED—Radio's Largest Supply House! Be sure to send today for your FREE copy of ALLIED'S new 1948 Buying Guide!



AMATEUR GEAR



SOUND SYSTEMS

## ALLIED RADIO

ALLIED RADIO CORP.  
833 W. Jackson Blvd., Dept. 7-D-8  
Chicago 7, Illinois

Rush FREE 1948 ALLIED Catalog

Name .....

Address .....

City.....Zone.....State.....

FREE  
CATALOG

# AVIATION NEEDS YOU

... if you have the training and **EXPERIENCE ALLEN** gives you!

Yes, Allen not only gives you mechanical training, but **ACTUAL MECHANICAL EXPERIENCE** on operational equipment as well. Look at these requests to our Vocational Director from nationally known aviation concerns. "We are enclosing ten of our regular employment application forms which we would like to have completed and returned to us." ... "We have employment opportunities for qualified, licensed Aircraft and Engine Mechanics WHO HAVE HAD PREVIOUS EXPERIENCE." \* Employers want men with **EXPERIENCE!** You get that experience at Allen where more than 25% of your time is spent working on *operational, commercial, aircraft*. You graduate from Allen as a fully **LICENSED** and **EXPERIENCED** Aircraft and Engine Mechanic in a minimum time of one year.

**VETERANS** - ALL costs covered under GI Bill. Immediate enrollment possible. Act now.

\*Name and address on request.

**ALLEN Airways & School**  
Founded 1930

**FREE**  
BIG, ILLUSTRATED CATALOGUE

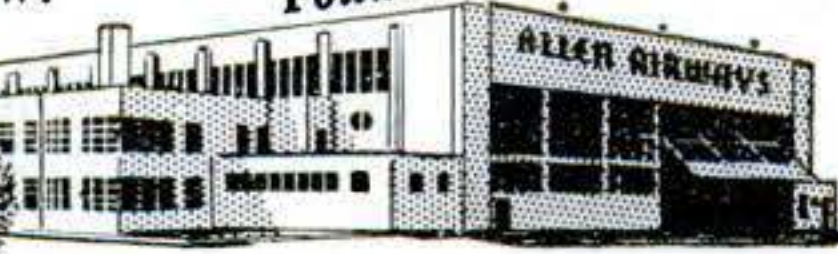

Allen Airways, State Airport, Hillsgrove, R. I.  
Please send me your free catalogue

Name..... Age.....

Street.....

City..... State.....

Learn.....

## WATCH REPAIRING

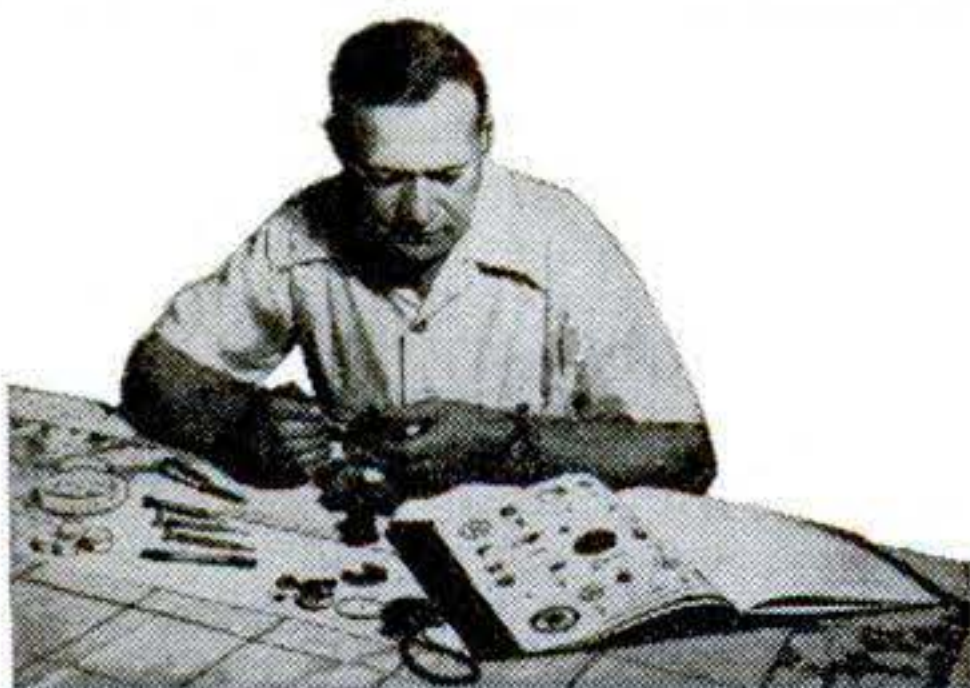

From The Largest Approved School Of Its Kind

### HOME TRAINING WITH TOOLS

With **FREE WATCH** Included AS Part of Your Course

**EARN AS YOU LEARN IN YOUR SPARE TIME FOR A BIG PAY FUTURE**

The demand for skilled Watch Makers is increasing with the step-up in the manufacture of watches because more and more watches need repairing. Now is the time to prepare yourself in the fascinating art of Watch Repairing with the aid of our **HOME TRAINING SPARE TIME COURSE WITH ACTUAL TOOLS**. No loss from your present work! No previous mechanical experience needed! Our **Earn-As-You-Learn-Plan** helps you to pay for your course, like student C. Fuller of Texas: "I have repaired 63 watches and have more than paid for Course."

**WRITE TODAY** -for free, interesting facts and low cost Enrollment Plan.

### ILLINOIS SCHOOL of WATCH REPAIRING

2870BP Elston Ave.,

Chicago 18, Ill.

## Stucco Spraying

Today's Outstanding Business Opportunity



Beauty and protection are sprayed on old and new buildings exterior and interior surfaces... by **COLORCRETE**. It's a plastic, water-resistant material, spread evenly over surfaces and forced into cracks by air pressure. Fuses to masonry with enduring tenacity. Many textures. Range of 30 smart colors. Fully proven by 20 years of actual use under all conditions.



### BIG EARNINGS FOR COLORCRETORS

Colorcrete ties in with today's huge building program. Renews old buildings. Makes new construction more attractive and enduring. Large waiting market, because building owners get long lasting beauty and protective values at low price. Yet your selling price can be several times your basic cost. Machine is easy to operate. Moderate investment. Write or wire for complete information.

**COLORCRETE INDUSTRIES, INC.**  
572 Ottawa Avenue Holland, Michigan

## COLORCRETE

COLOR AT A PRICE YOU CAN AFFORD TO PAY

"PHOT-O-CHROME" 2 1/2 x 3 1/2

"SPARKLING COLOR PRINTS"

Made From Any Ansco, Ektachrome or Kodachrome Transparencies

**50c**

5 x 7... 2.50 8 x 10... 4.00 (unmounted)

**CLEVELAND COLOR SERVICE**

3974 EAST 131st STREET CLEVELAND 5, OHIO

Get Ready for Big Opportunities!

*Engineer Dobe*

### TOOLS AND EQUIPMENT SENT WHEN YOU START

Get a better job with more pay and pleasant working conditions. Get into Drafting—where all products start. I will train you at home—give you experience—on the same kind of jobs you will do with the best paying firms. I furnish instruments and all equipment when you start. Write today for vital facts and **FREE** book. Give age.

I Will Train You at Home Until You Get a

### GOOD PAY JOB in DRAFTING

**ENGINEER DOBE • Div. 24, Libertyville, Ill.**

### No Wood-working Shop Complete Without the Electric WONDER PEN

Costs so little, yet enables you to put magic-like professional finishing touches, borders, decorations, etc. on whatever you make. Six interchangeable points for etching (woodburning), embossing, cutting, shading, hole cutting. Simply plug in and use. Guaranteed. Pays for itself the first time used. Complete professional kit in wood chest. Only \$2.25, postpaid.

**AMERICAN T. & F. CO. 6130 N. Clark St. Dept. 238 Chicago, 26, Ill.**

### NEW ELECTRICIANS CABLE REPAIR KITS

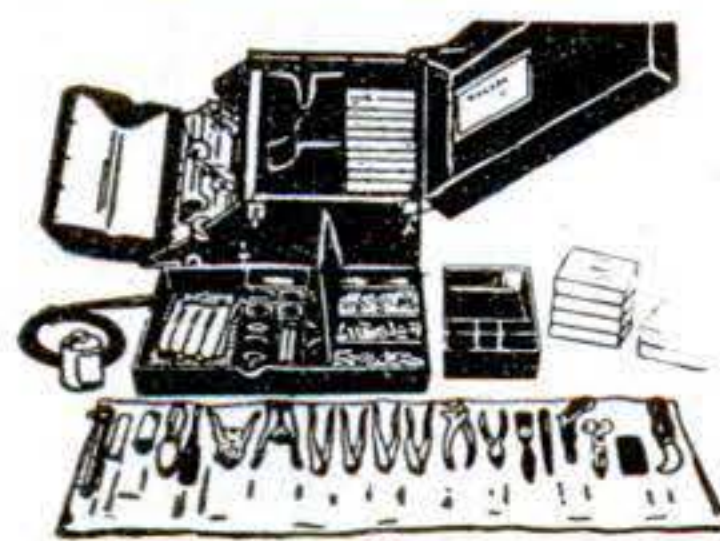

Made of 1/16" steel, welded construction, 15 1/2" wide, 21 1/4" long and 13" high; has 2 trays which are divided into several compartments. Kit has a built-in 1500 watt 110 V vulcanizer. Kit contains the following tools: (1) Wire Stripper, (1) Pair Leather Palm Gloves, (1) 200 W. Elec. Soldering Iron 110 V., (1) Pair Diagonals (side cutting pliers), (1) pair adjustable pliers, (3) crimping pliers, 8-10-12, (2) 1-lb. rolls rosin solder, (1) screwdriver, (1) 6-ft. extension cord,

(1) wire knife, (1) sharpener (Hone), (1) pt. can Carbon Tetrachloride, (3) cans Goo Gum (for vulcanizing), (20) 1-lb. rolls vulcanizing tape. May be used to patch tubes, (2) balls twine, (1) wire gauge, (1) 6" rule, Govt. cost over \$200.00. **\$34.50**

**NATIONAL SURPLUS SALES CO.**  
723 East 18th St. Kansas City, Mo.



- ★ WRIST WATCH
- ★ STOP WATCH
- ★ TELEMETER
- ★ TACHOMETER

**Phenomenal Value!**  
**17 JEWEL • 2 PUSH BUTTON**  
**CHRONOGRAPH**



ONLY \$29<sup>75</sup> PLUS 10% TAX

**INCABLOC SHOCK RESISTANT FEATURE**  
 • Sweep Second Hand  
 • Radium Dial • Anti-Magnetic • Unbreakable Crystal. (formerly \$71.50)  
**IDEAL FOR**  
 • Physicians • Engineers  
 • Radio Men • Sportsmen  
 • Photographers • Aviators

**OUR GUARANTEE**  
**MONEY BACK IN 10 DAYS**  
 If not satisfied for any reason

**ADLEW JEWELERS**

117 W. 42nd St., N. Y. C. 18  
 Mail Orders Promptly Filled • Shipped C. O. D. or send check or money order.  
 Address mail-orders to: **ADLEW JEWELERS** (Dept. PS-4), 152 West 42nd St., N.Y.C. 18.

Also available in 18-k Gold Case. \$64.50 (plus 10% tax), formerly \$125.

Read Below An Important Announcement to the Hard-of-Hearing... their Friends, Relatives, or Employers...

**DEAF NOW HEAR**

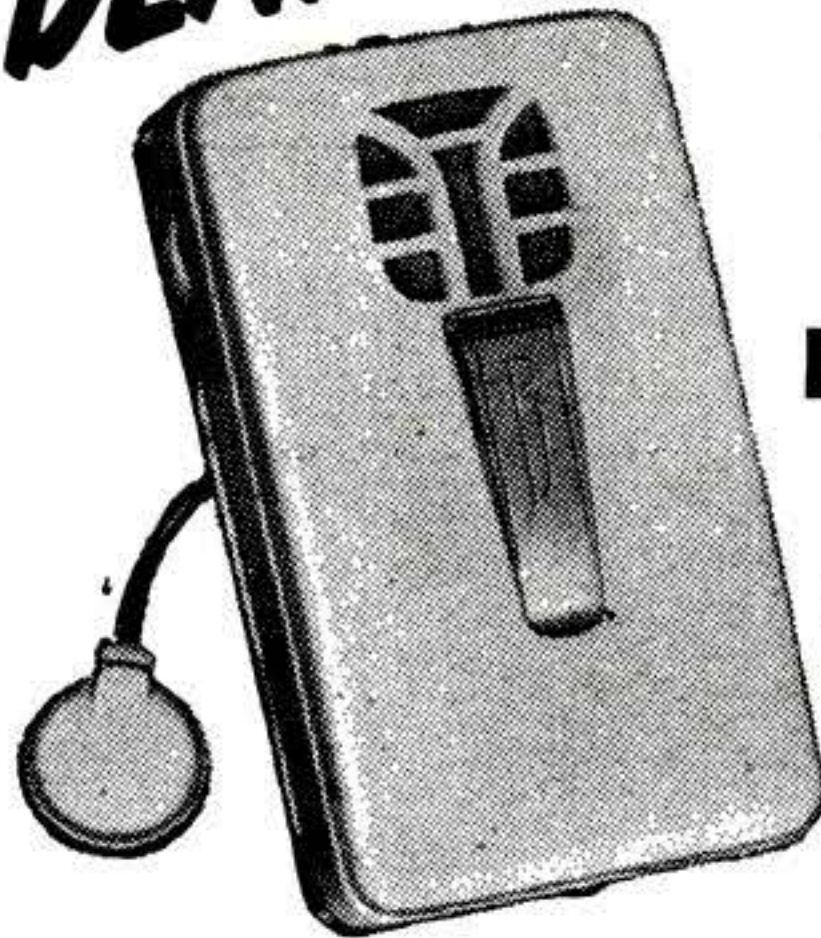

with **WORLD'S Smallest HEARING AID**

**JUST OUT!**  
 NEW 1948 MODEL

**With The Amazing "MAGIC SILVER CIRCUIT"**

• Sensational tiny size—so small the entire unit can slip into the watch pocket of a man's trousers—yet, with a special receiver so powerful, it transmits 2 to 6 times more sound intensity than any other aids! Midget size made possible at last by great war-discovered secret—"The Magic Silver Circuit!" Try it, and you'll agree... *there's no finer hearing aid!*



**FREE BOOKLET—Just off the Press!**  
 Write today for Free booklet containing latest scientific information on Deafness and how it can be overcome. Write for yourself, or friend, relative, or employee.

Beltone Hearing Aid Co., Dept. PS-4  
 1450 West 19th Street, Chicago 8, Ill.

The New 1948  
**Beltone** MONO-PAC HEARING AID

Say You Saw  
 It In Popular Science

**ELECTRIC SHEAR SHARPENER**

OVER 35,000 SOLD—IT MUST BE GOOD!

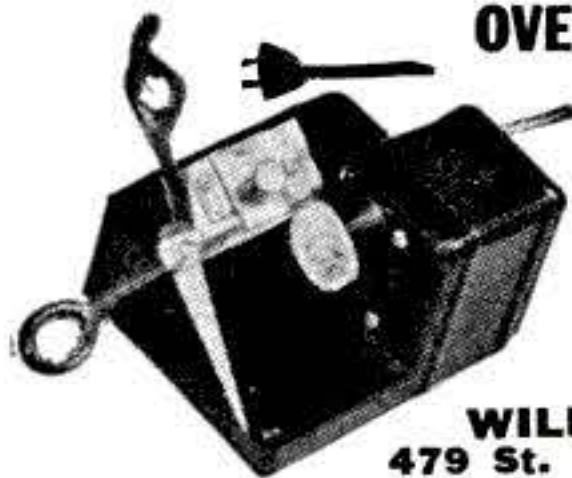

Genuine Carborundum wheel ideal for shop or home use. Send remittance with order and shipment will be made at once, prepaid to your door, complete with electrical goods catalogue.  
**\$9.75** complete with vise and A.C. 115 Volt Motor

**WILLIAM MARVY COMPANY, Dept. 6**  
 479 St. Peter Street St. Paul 2, Minn.

**DRAINS CELLARS, WASH TRAYS CIRCULATES OIL**



1800 GPH 300 gal. 30' high, use 1/8 to 1/3 HP motor. Will not clog. **\$6.50**

Postpaid if cash with order. (Add 50c for west of the Mississippi.)  
 Thousands in use since 1936

**LABAWCO PUMPS, BELLE MEAD 3, N. J.**

**MAGNETS** OF ALL TYPES—10c UP AMAZINGLY POWERFUL!!  
 4 oz. Alnico Magnet, lifts 10 lbs. \$1.00. Our Leader, 15 oz. Magnet, lifts 40 lbs. \$1.95. New alloy—will not weaken! Useful for lifting valuables from tanks, lakes, or rivers easily! 7 small magnets \$1.00 with list of many shop and home uses. Satisfaction guaranteed.  
**R. L. EYRICH, 2566 N. 49TH ST., MILWAUKEE 10., WIS.**

**TRAVEL—for 'UNCLE SAM'**

**ARE YOU JOB-SATISFIED?**

GET A U. S. JOB

**MANY GOVERNMENT JOBS TO BE FILLED**

Postoffice Clerks—Mail Carriers—Stenographers—Typists, Statistical Clerks—Storekeeper—Gauger, etc. 32 Page Civil Service Book—FREE.

**MEN—WOMEN**

**Veterans Get Preference**

Mail Coupon immediately—today sure.

As high as \$3,021  
**FIRST YEAR**



**COUPON**

**FRANKLIN INST., Dept. A80, Rochester 4, N. Y.**

Gentlemen: Rush to me, without charge, 32 page book with list of U. S. Government big paid positions. Advise me also regarding salaries, hours, work, vacation, etc. Tell me how to qualify for a position.

Name.....

Address..... Vet?.....

Everything you want for outdoor pleasure when you ride a . . .



**Royal Enfield**

**FAMOUS ENGLISH LIGHTWEIGHT MOTORCYCLE RUNS 100 MILES ON A GALLON OF GAS**

Up and go—with the rugged new Royal Enfield popular Model R.E. Style, safety, flexibility, 125 c.c. 2-stroke, single cylinder engine, 3-speed gears; 45 m.p.h. Write today for folder "S", for complete details. Also 350 c.c. and 500 c.c. models are immediately available.

Dealer inquiries given prompt attention.

**WHITEHALL DISTRIBUTORS, Inc.**  
1385 Commerce Avenue, New York 61, N. Y.

**35MM FILM FOR LEICA, KODAK, RETINA**

and other similar cameras available in

**ANSCO** AnSCO Super-Pan Supreme, AnSCO Ultra Speed & AnSCO Fino-Pan  
**KODAK** Kodak Plus X, Kodak Super XX & Kodak Background X  
**DUPONT** DuPont Supreme #2 & DuPont Supreme #3

**ONLY \$1.40 per 100 ft. ROLLS**

each roll of film contains 18 strips of 36 exposures each —properly notched.

**SUPPLIED ON REELS IN METAL CANS GUARANTEED IMMEDIATE DELIVERY**

Send \$1.40 for each 100 ft. roll and we will ship your film immediately. We pay postage.

Eight-Sixteen Films, Inc., 630 Ninth Ave. N. Y. 9, N. Y.



**ART STUDENTS**

**SHOW YOUR OWN MOVIES AT HOME OF BEAUTIFUL HOLLYWOOD MODELS**

Films Suitable for Study of Effective Lighting & Composition.

50' 8mm. . . . . \$1.25 | 100' 16mm. . . . . \$5.00  
200' 8mm. . . . . \$5.00 | 400' 16mm. . . . . \$10.00

Send No Money—Pay Postman—We Ship C.O.D.  
Eight-Sixteen Films Inc., 630 Ninth Ave. N. Y. 19, N. Y.



**DELCO MOTORS**

1/75 H.P. Delco Motor—For cooling, ventilating and heating purposes. All are factory tested and guaranteed. Quiet operation. Triple rubber mountings. Horseshoe stand. 110 V.A.C., 60 Cy., 1000 C.F.M. 6 blade fan 7 1/2"—stand 6 1/4", 4 1/2" wide. Complete as shown. Shp. Wt. 5 lbs.

No. 7014 Suction Type **\$5.25**  
No. 9272 Blower Type...EACH

Lots of 10.....Each \$4.90 Plus Postage  
Lots of 50.....Each \$4.75

FREE CATALOG—Send for new G. & E. Appliance & Parts Catalog  
**G. & E. EQUIPMENT SUPPLY CO.**  
Dept. P.S.2, Ogden Ave. at Fulton, Chicago 7, Illinois

**ROOSEVELT AVIATION SCHOOL**

HANGAR 38 MINEOLA, L. I., N. Y.

Qualify for Airplane or Engine Mechanic's license in 24 weeks (both in 48 wks.). Every CAA-approved maintenance station must have a licensed mechanic. GI-approved. Begin April 26, May 24, June 21.

**HOTTER GAS TORCH**

**100% PRIMARY AIR KELLER GAS TORCH \$3.45**

Burns Regular House Gas (Natural Gas Only)—No Compressed Air, No Adjusting Needed—Develops 2100° F. Guaranteed to silver solder, light brazes, solders, removes paint rapidly. Precision-engineered. 1500 B.T.U. per hour.

ORDER TODAY C.O.D. FROM  
**KELLER GAS APPLIANCES**  
P. O. Box 261 Monrovia, California



**SAVE! OUT OF PAWN Genuine Diamonds**

Write for FREE ILLUSTRATED CATALOG of other Unredeemed Diamond Pledges from \$5.00 to \$5,000. References; Dun & Bradstreet, Equitable Trust Co., of Baltimore, Md., or your own local bank.

1/5 CARAT \$49  
\$125 Value Tax incl.  
1/2 CARAT \$79  
\$200 Value Tax incl.

**BERMAN'S COLLATERAL LOAN BANK**  
Dept. PS-6, 636-38 W. Baltimore St. Baltimore 1, Md.

**THIS IS THE BUSINESS YOU DREAM ABOUT**

QUICK STEADY PROFITS

**CORADIO**

The Coin Operated Radio

IT'S the new, fast-growing, depression-proof business. Coin operated radios are

placed in hotels, tourist courts, clubs, hospitals, etc. on a commission basis—play 1 or 2 hours for 25c and produce immediate profits. The best coin operated radio is CORADIO

**ACT NOW**

Start your own lifetime business, full or part time. Limited capital required.

Send for further information.

**WRITE TODAY Dept. P.S.**



**CORADIO**

COIN OPERATED RADIO  
108 W. 31st ST. N.Y. 1, N.Y. WISCONSIN 7-5902

**SALESMEN WANTED**  
YOUR PASSPORT TO A  
**BIG INCOME FUTURE**



*Write Today!*

If you devote most of your time to selling, write today. Selling experience helpful but not necessary. Send us full details including experience, age, etc.

Start a business of your own. Fyr-Fyter offers you an outstanding sales opportunity—explained in this free booklet. Send for it! Learn about the tremendous market for Fyr-Fyter Underwriters' approved fire extinguishers—how you can build a steady, permanent income without capital or inventory by selling direct from factory to customer. Any person owning anything that will burn is a prospect. No store room or office necessary. No collecting or delivering. We bill and collect—mail commission checks weekly.

**Fyr-Fyter**

Dept. 92-40, Dayton 1, Ohio

**DEVELOP RUGGED STRENGTH!**



**Strong Men's Club of America offers FREE Membership!**

Send for your personal membership card and Strength Secrets. No dues! No obligations! Many valuable privileges! Send name, address, age, on penny postcard.

**JOE BONOMO** Strong Men's Club of America  
Director, (Dept. PS-4A) 1841 Broadway, N. Y. 23, N. Y.

*Learn* **MASONRY CARPENTRY**



Make big money in the building trades. Learn now while opportunities are greatest. Train in our well equipped shops. Approved for Veterans, **MIDWEST SCHOOL OF BUILDING TRADES**, Dept. A-24 411 N. Center Street Bloomington, Ill.

**POWER LAWN MOWERS**

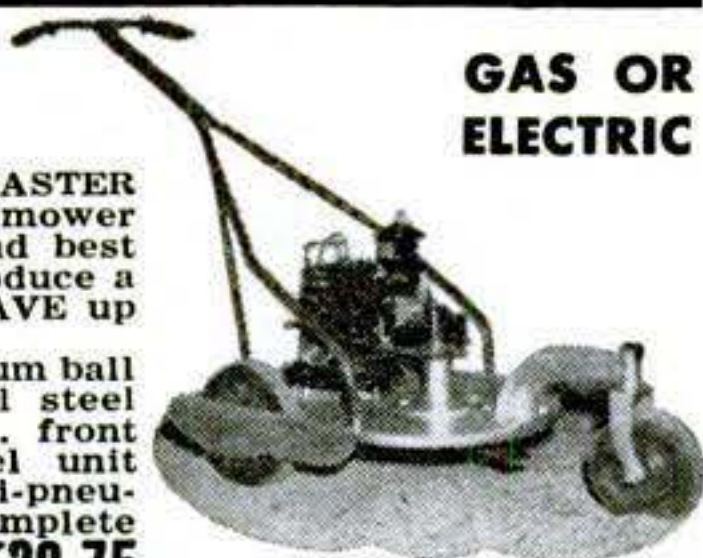

**GAS OR ELECTRIC**

Assemble **TRIANGLE'S 1948 MASTER KIT** and you have the finest lawn mower that money can buy. The latest and best ideas have been incorporated to produce a truly "dream mower." And you **SAVE** up to 75% in cost.

Kit consists of heavy cast aluminum ball bearing center post with 18" tool steel blade; one 8" semi-pneumatic B.B. front wheel with cast aluminum swivel unit complete; two 10" heavy duty semi-pneumatic B.B. rear wheels and axle; complete plans and instructions included. **\$28.75**  
**SPECIAL PRICE ONLY**

**EARN MONEY IN YOUR SPARE TIME**

Build and sell power lawn mowers. Send only 25c for complete plans and instructions on how to make **TRIANGLE'S MASTER LAWN MOWER**.

**WHEELS for LAWN MOWERS, WHEELBARROWS, and etc.**  
Semi-pneumatic tires, 1/2" ball bearings, "Seamless Tube Hub" 8X2.00...\$2.45 ea. 10X2.00...\$2.75 ea. 10X2.50...\$4.95 ea. 4.00X8 3/8 or 3/4" roller bearings...\$5.00 ea. with 4-ply heavy duty tire and tube...\$12.95 ea.

We also have complete lawn mowers, garden tractors, gasoline engines, and other items.

For prepaid shipment add 10%. Your money refunded if not satisfied.

**TRIANGLE MANUFACTURING CO., Dept. 4B**  
BOX 185 FORT SCOTT, KANSAS

THE NEW "400" *Precise*  
**fully automatic ADDING MACHINE**



Light-weight—less than 5 lbs. Compact—4 3/4" high, 4 1/2" x 7" base.

**Fully Guaranteed**

*Only*  
**\$19.95**

Money Back if not satisfied

**SEND NO MONEY**

Mail coupon today. We will ship by return mail. You pay postman \$19.95 plus postage. If you prefer to save postage send \$19.95 with order.

A godsend to anyone who cannot afford a high priced adding machine. The new "400" does work of machines costing \$100 and more—yet costs only \$19.95. Will delight anyone who does figuring. Fills an urgent need for men and women in every walk of life . . . students, clerks, salesmen, farmers, accountants, bookkeepers, dentists, doctors, contractors, housewives. Easy to tuck away for use while traveling. Most remarkable adding machine ever developed. Adds and subtracts automatically—always shows magnified cumulative totals. 7 columns—counts up to 99,999.99. Clears with a touch of the handle. Accurate, speedy, easy to use. Operated with stylus. Precision built, sturdy, durable, handsome. Non-skid protective rubber feet. Fully guaranteed for one year. Liberal factory service policy thereafter. If not fully satisfied, return it within 10 days for full refund.

**NATIONWIDE ADDING MACHINE CO., Dept. 84**  
2518 Montrose Ave., Chicago 18, Ill.

**NATIONWIDE ADDING MACHINE CO., Dept. 84**  
2518 Montrose Ave., Chicago 18, Ill.

Please ship . . . . . Precise Adding Machines at \$19.95 each.

- Ship C.O.D. plus shipping charges.
- Ship postpaid. Check or Money order enclosed.

Name . . . . .

Address . . . . .

City . . . . . Zone . . . . . State . . . . .

Inquiries invited from recognized dealers

**Press the Button!**  
**Watch the wheels spin!**  
**and "BINGO!"**



**The Family's Favorite Winning Game!**  
 Fun Galore can be had for the first time at home with all the thrills, fascination and close calls of a real BINGO GAME. Loads of enjoyment at parties, games for the children and grown-ups who get their share of fun. Push the plunger down . . . round and 'round she goes automatically and nobody knows who the next winner is. BINGO is a complete game of chance. Furnished complete with master chart. Good supply of BINGO cards and chips . . . sufficient for 15 players. Buy nothing else! Made of steel and finished with alternate shiny nickel and dull satin stripes. **SEND NO MONEY.** Rush your order today. Remit with order and we pay postage or C. O. D., plus postage.

**\$2.98**  
 complete  
 with Bingo  
 Cards and Chips

**Satisfaction Guaranteed**  
 SPECIAL PRICES TO DEALERS  
**BERNARD FINE CO., Inc.**  
 501 Sixth Ave., New York 11, N. Y. **PSB1**

**NEW!** SENSATIONAL DEVICE  
 ENABLES ANYONE TO  
**TEST OWN EYES** RIGHT AT HOME



**SAVE up to \$15.00  
 ON GLASSES**  
 Big News to the Millions of Spectacle Wearers and Prospects. Means Freedom from Outrageous Prices. Perfect Satisfaction Guaranteed! No Risk!

**MAKE BIG MONEY QUICK  
 with FREE SAMPLE KIT!**

Send for Free Sample at once. Show it to friends and others. Let them use it Free and watch their amazement over this new system of Self Testing. Here is a great new opportunity in a tremendous new field of unlimited possibilities. Spare or full time. No experience or capital needed. Act quick!  
**CLARK OPTICAL CO., Dept. D-504**  
 800 N. Clark St., Chicago 10, Ill.

**THIS MOTOR** **\$2.45**  
 1/30 HP 24 volt DC motor  
 2450 R.P.M. .95 amps 1/4" shaft size overall 3" x 4". Weight 3 lbs. Also operates on 32 volts . . . . . only



**USE AS 6 VOLT GENERATOR**—Generate your own power. Can be operated on your bicycle wheel. Furnishes sufficient power for two 6 volt bulbs. Resistor furnished free with each motor enables you to maintain constant voltage. Special Price \$2.45, or 4 for \$7.50, or 24 for \$36.00.



**REVERSIBLE THOR**  
**218RY Screw Driver**  
 and nut setter 750 RPM. Like new. List \$93.00. Special price \$22.50. Wt. 4 lbs.

**INGERSOLL-RAND**  
**Riveter and Chipping Hammer**  
 Model AVC-11, like new. Takes up to 5/32" rivet. \$73.00 list. Special price \$8.75. Wt. 5 lbs.  
 Prices are F.O.B. Chicago. Immediate delivery. **SOLD ON MONEY BACK GUARANTEE.** Send check or money order today.  
**DEALERS — WRITE . . .**



**\$8.75**

**C & M EQUIPMENT COMPANY** 1831 S. State St., Dept. D-4, Chicago 16, Ill.

**BRIGGS-STRATTON ENGINES**

**1 1/2 Hp Model N—Govt. Surplus**

Special Low  
 "as is" price **\$34.50**  
 Only . . . . .



In good operating condition with **\$44.50**  
 30 day written guarantee . . . . .

Engines will develop almost 2 Hp at 3600 RPM. Hurry, don't wait, buy now while limited supply lasts. Suitable for lawn mowers, garden tractors, motor bicycles and scooters, midget cars, etc. Will power many kinds of machinery.

Write for Descriptive Circular

**MIDWEST SURPLUS SALES CO.** 1520 Locust St. Kansas City, Mo.

**Bar Bells**  
 Buy Direct From Factory **\$8.95**  
 Write for free booklet and price list **up**  
**INDEPENDENT IRON WORKS**  
 2416 East 23rd Street, Dept. C  
 Los Angeles 11, Calif.

**CODE-RECEIVING SPEED**  
 Learn to send and receive Radio Code with greater speed. Stop nervous tension. Have confidence. Be proficient. Same system used by radiotelegraph specialists. Thousands of operators needed. Rush name for FREE book.  
**CANDLER SYSTEM CO.**  
 Dept. 6-D, Box 928, Denver 1, Colo., U. S. A.

**FALSE TEETH**  
**KLUTCH** holds them tighter

KLUTCH forms a comfort cushion; holds dental plates so much firmer and snugger that one can eat and talk with greater comfort and security; in many cases almost as well as with natural teeth. Klutch lessens the constant fear of a dropping, rocking, chafing plate. 25c and 50c at druggists. . . . If your druggist hasn't it, don't waste money on substitutes, but send us 10c and we will mail you a generous trial box. © I. P. Inc.

**KLUTCH CO** Box 4894-D, ELMIRA, N. Y.

**NOW HE HAS**

**WHAT LOOKS ALMOST LIKE**

**A NEW SKIN**

**He Got It Quickly At Home This New Simple Way**

**Read FREE Offer**

Thousands like him, including girls and older men and women, who suffered humiliation and lack of success in business and affairs of the heart, because of a bad looking skin, can now rejoice over this good news. A new way has been found anyone can do at home, for removing that blemished or old looking external layer on the skin called the epidermis, easily, and often in a few days time. And now, a new TREATISE is being sent to all readers of this paper who need it, in plain wrapper, prepaid. Just send post card or letter requesting the FREE TREATISE. Address WILLIAM WITOL, Dept. 18, Valley Stream, N. Y. If pleased, tell friends.

**LOOK!**

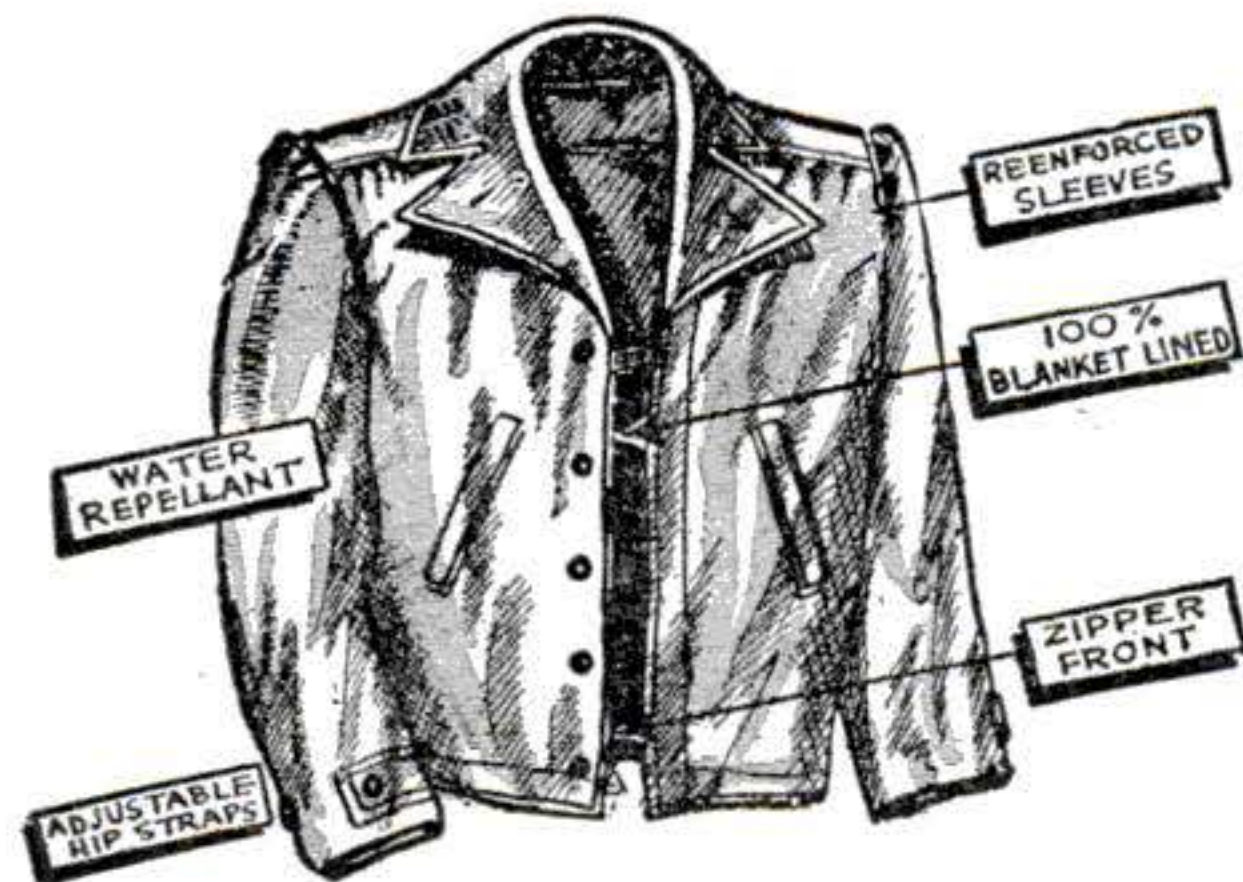

WAR SURPLUS

**FIELD JACKETS**

Ideal for  
Farmers • Lumbermen  
Truck Drivers • Laborers  
and for  
Plain and Fancy Loafing

ONLY  
**\$1.98**  
EACH

Nothing like it has ever been offered at this low price!

This full-zipper front, bi-swing back, fine poplin Army FIELD JACKET is the favorite of G.I.s all over the world. Although used EVERY jacket is guaranteed to be in perfect condition. Sizes 34 to 40. Send name, address and size and on delivery pay postman \$1.98 plus C.O.D. charges, or send \$1.98 with your order and we will pay postage. Order yours today!

**S & B SURPLUS SALES CO., Dept. PS-31**  
3244 W. Roosevelt Rd. Chicago 24, Ill.

**WAR SURPLUS AND OTHER BARGAINS**

**SCOOP!**  
We have been awarded 100,000 genuine briar pipes by Quartermaster Corps. Assorted shapes and sizes. All popular makes. Set of 6, \$3.50



**MICROMETER**  
Chrome plated, precision engineered and carefully tooled to give long life ... all new. 0-1" capacity, \$2.25. 1-2" capacity, \$3.50 Each.



SEND CHECK, MONEY ORDER or CASH



**4 in 1 SCREWDRIVER:** 3 smaller screwdrivers fit compactly into hollow barrel of largest screwdriver. Sizes...6", 3", 1½", and 1" overall. Fine steel bits. Solid brass knurled handles for non-slip grip. Large enough for standard screws, small enough for watches. Will handle all sewing machine screws. A handy all-purpose tool for kitchen, garage, or workshop. All New... \$1.00 per set.

**FISHING AND HUNTING KNIFE**  
Hollow ground 6" blade of bright finish, high quality, tempered steel. Non-slip cowhide handle, with hand finished metal guard and butt. Stitched and riveted genuine leather shield. It's a knife you'll be proud of! All New... \$1.50 Each.



**GEAR PUMP**  
For circulating liquids... oil or water. Will operate on 1/10 H.P. Pumps 3 gals. per minute at 1700 R.P.M. Hardened steel gears, bronze bushings, aluminum housing. 2" diameter, 3¼" long. Wgt. 2 lbs. New... \$3.50 each.



ALL PRICES F.O.B. CULVER CITY, CALIF.

**EMERSON 3 HP MOTOR:**  
AAF Type D50. This motor can also be used as generator when driven by another motor. Ideal for portable welder, etc. 28 Volts, D.C. Compound, 3800 RPM, 115 AMP, windings glass insulated, blower cooled, shaft dimension 5/8". Weight 27 Lbs. New. \$13.95 each

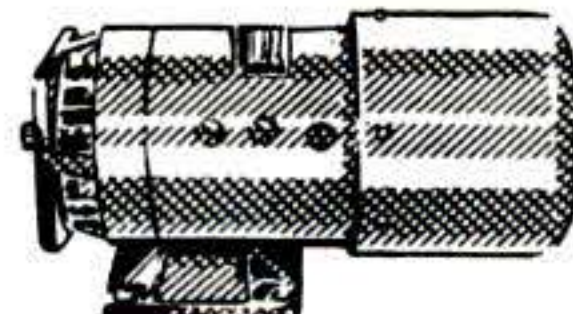

**CLIPS:** Rubber lined, aluminum, hundreds of uses in any shop. Assorted sizes, all new. 5 Doz. \$1. - 500 \$5.

ALL PRICES F.O.B. CULVER CITY, CALIF.

**POWER DRIVEN ANTENNA REEL**  
½ HP, G. E. Motor—12-24V. Removable 6" Reel. Cam worm gears, bevel gear. Solenoid clutch. In gear only when current on. Operates clockwise or counter clockwise. Ideal for power fish line, opening or closing doors, auxiliary power take off. Can be used as buffing machine or for dozen of other uses. New. Weight 6 Lbs. \$4.50 each.

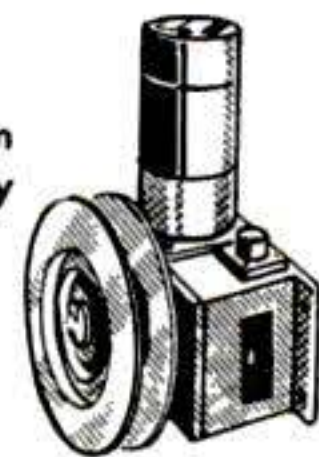

**BLOWER COOLER or HEATER:**  
For trailers, autos, offices, darkrooms, homes. DUMORE Motor, 1/6 cont. HP, Amperage 7.5, RPM 6400, 24 Volts. May also be used as dryer. Simple installation, radiator type, copper coils. Transformer advertised in this ad will operate this unit from house current. Weight 13 Lbs. New, \$15.00

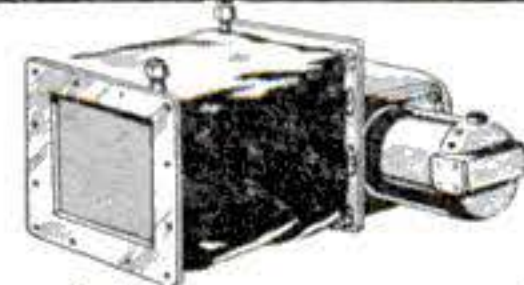

**AIRBORNE SALES CO., INC.** DEPT. PSM 4-8 CULVER CITY, CALIF.

**Smoking PIPES REPAIRED**  
Genuine hard rubber stems fitted \$1.00. Bite-Proof Type & Specials \$2.00. Write for Free Catalog of Pipes and Pipe Makers supplies. C.O.D. orders accepted.  
**BRANDON PIPE HOSPITAL, Dept. P.S. 1**  
3740 Richton Detroit 6, Mich.



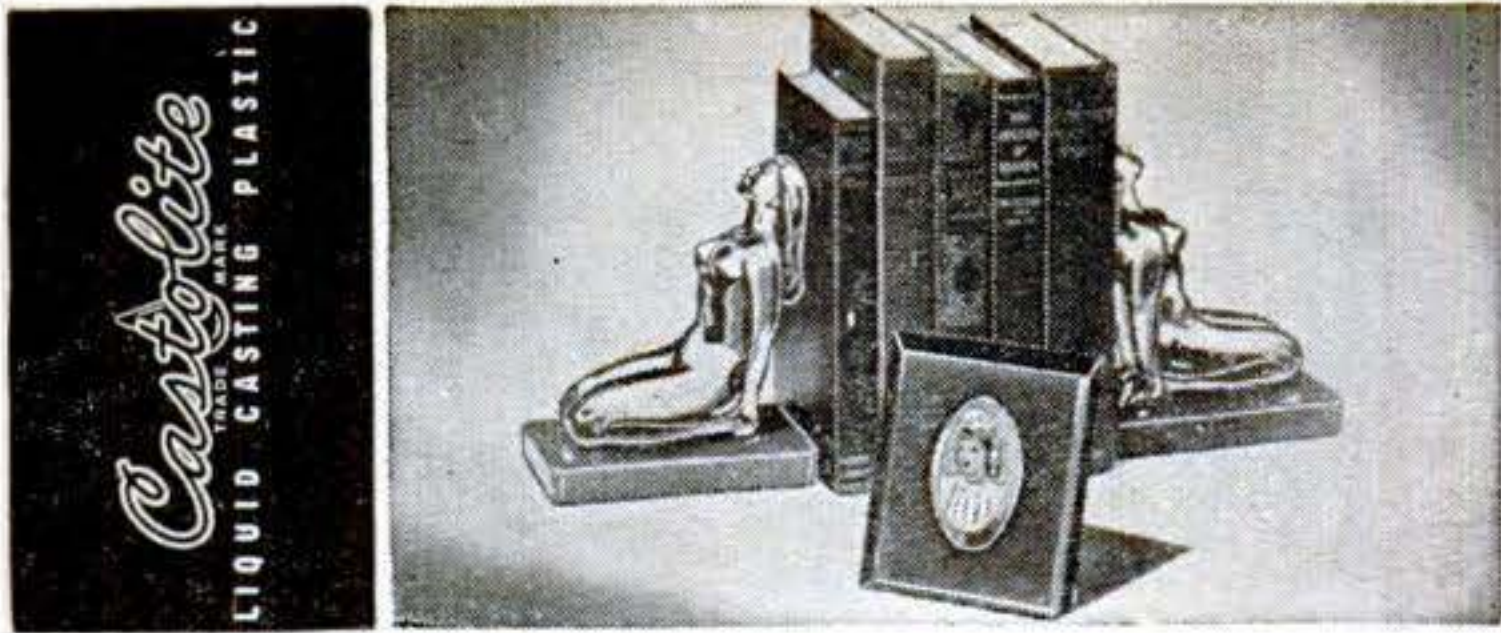

# NEW LIQUID PLASTIC

**MAKES SWELL GIFTS, NOVELTIES, THINGS TO SELL!**

Thousands are having fun, making big extra money, using CASTOLITE, the wonder Liquid Plastic that pours without heat or pressure. Use crystal clear or with brilliant colors. Embed real flowers, butterflies, coins, medals, photos, for plaques, paper weights, novelties. Make useful objects like book ends, trays, picture frames, coasters, jewelry, toys. Also make gears, parts, models. Can be sawed, carved, drilled, turned.

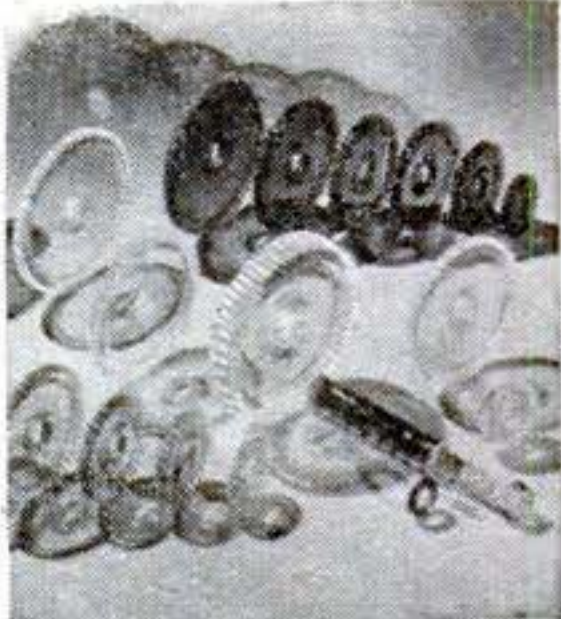

The plastic with 1001 uses. DEALERS—Write for literature and prices.

**20-PROJECT KIT \$3.50**

(West Coast, Canada, Mexico \$3.75)

Special Casto-Kit now ready. Contains materials and instructions to make useful objects at once. Get into this fascinating new field now, and have unusual distinctive gifts or make fine sales. Send \$3.50 (West Coast, Canada and Mexico, \$3.75) for your Casto-Kit, postpaid. Or order C.O.D. No overseas shipments. For instruction manual alone, send 25c. The Castolite Company, Dept. D-2, Box 211, Kenilworth, Ill.

## Flash! Amazing Opportunities NOW Open in these practical money-making trades watch and clock repairing



### LEARN AT HOME—IN YOUR SPARE TIME

Prepare for a happy future of prosperity, security... and get a big-pay job now. Fascinating, high-grade occupation. You can EARN WHILE YOU LEARN. Excellent field for part-time work at home.

#### COMPLETE COURSE in HOROLOGY

Thorough self-instruction training in American and Swiss watches, clocks. Special sections on alarm clock repairs. New, practical LEARN-BY-DOING instruction method. Learn QUICKLY, easily. No previous experience necessary. Watchmaking is basic training for aircraft instrument work, and other scientific precision jobs.

**ONLY \$4.95 COMPLETE • MONEY-BACK GUARANTEE**

Get into this fast-growing field NOW... big opportunities... don't delay. Mail coupon below. Only \$4.95 postpaid, or COD plus postage. NELSON-HALL CO., Dept. D-01, 1139 S. Wabash Ave., Chicago 5, Ill.

## locksmithing and key making

### COMPLETE UP-TO-DATE COURSE

How to pick locks, de-code, make master-keys, repair, install service, etc. New, self-instruction lessons for every handy man, home-owner, carpenter, mechanic, service station operator, fix-it shop, hardware dealer, gunsmith.

**53 EASY ILLUSTRATED LESSONS** \$3.95 Complete! Satisfaction guaranteed or money back. Postpaid, only \$3.95—or C.O.D., plus postage.

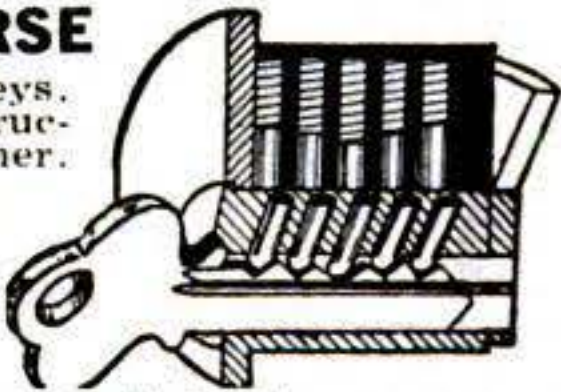

Send No Money—Mail Coupon Today!

NELSON-HALL CO., Dept. D-01, 1139 S. Wabash Ave., Chicago 5, Ill.

On your money-back guarantee please send me the courses checked:

- ( ) Watch & Clock Repairing..... only \$4.95
- ( ) Locksmithing & Key Making..... only \$3.95
- ( ) I enclose \$..... in full payment. Ship postpaid.
- ( ) Send C O D for \$..... plus small postage fees.

NAME.....

ADDRESS.....

CITY..... STATE.....

# Ball-Bearing SPEED WHEELS



Juvenile wheels, solid tire—No Bearings

- 7" wheels.....60c
- 6" wheels.....50c
- 4" wheels.....30c

#### Semi-pneumatic tired wheels

- 12 x 1.75".....\$3.25
- 10 x 1.75".....\$2.75
- 10 x 1.25".....\$2.00
- 8 x 2".....\$2.00

#### Industrial wheels for heavy loads

- 400 x 8. 2 ply tire and tube \$12.50
- 10 x 2.75" Hollow Core.....\$6.75
- 10 x 2.75" Single Tube.....\$7.25
- 12 x 3.00 wheel bolted hub \$9.75
- 8 x 2.50".....\$4.90
- 6 x 2" spot welded.....\$2.80
- 6 x 2" lug base @.....\$3.30

Dealers and Manufacturers inquiries invited

Free blueprints with all wheel orders. Send check with order. Shipments f.o.b. Akron.

## JIM BROWN TOY COMPANY

1093 Home Ave.

Akron 10, Ohio

### FENDER SKIRTS . . . . . \$17.20 PER PAIR

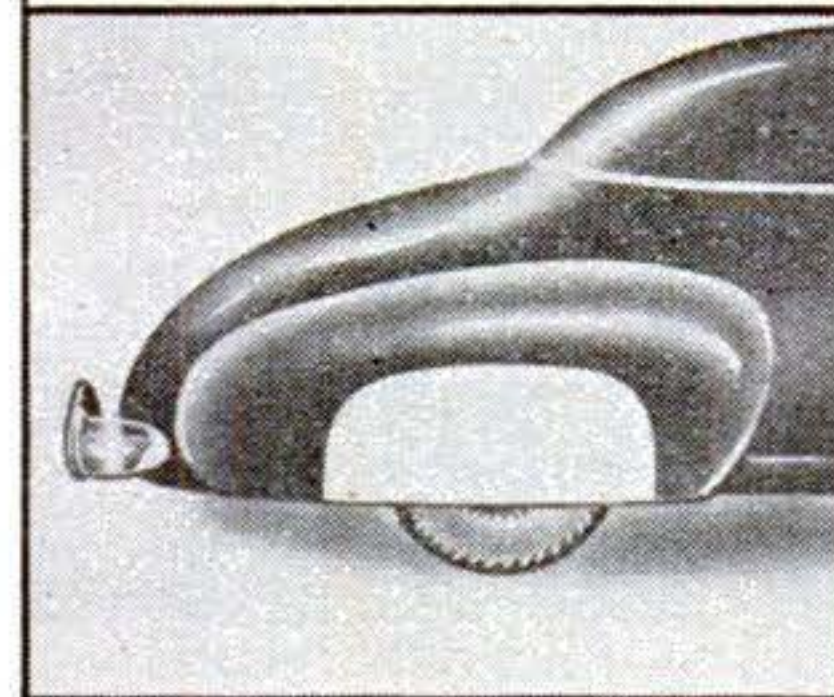

For Ford, Chev., Merc. Plym. DeSoto, Chrv., Dodge, Kaiser-Frazer, and Buick. Beautify your car. Bring out the flowing lines inherently designed there. Sparkling beauty you'll like. Constructed of heavy gauge body steel finished in prime, perfect fit.

SANDEE MUFFLER CO.  
Box 296 La Tijera Sta.,  
Los Angeles 43 Calif.

Gentlemen Please send me one set of Sandee Fender Skirts to fit my.....

- ..... (year and make of car)
- Check for \$17.20 enclosed
- Ship C.O.D.

### PILOTS' JACKETS



(Left) NEW AIR-CORPS B-15 Style. Green poplin. Warm alpaca wool pile lining. Genuine Mouton fur collar. 4 Pockets. 36-46... \$15.50  
(Right) A-2 Style. Brown leather, sturdy rayon lining. Zipper front. Sizes 34-46... \$17.95  
NAVY N-4 JACKET: Water repellent green poplin. All wool flannel lining. Zipper front. Sizes 34-36... \$5.50  
Write for FREE illus. List Army Surplus. Orders sent postpaid except C.O.D.



Satisfaction or Money Back

CONSUMERS CLOTHING CO., Box 5, 26 Greene St., New York 13, N. Y.

## SPECIAL! LOW PRICES ON—Natural Rubber Latex FOR BETTER MOLDS



This new molding compound with 70% natural rubber concentration is easier to use, gives cleaner, sharper, more profitable castings. Order now at these low prices: \$3 Qt., \$5 1/2-Gal., \$8.50 Gal., \$7.50 per Gal. in 5-Gal. Cans. Send check or m.o. New Molding Manual sent with each order.

FRANCIS RUBBER PRODUCTS CO.

Dept. D-2, 1836 E. Fulton Columbus 9, Ohio

HOW to Make ART OBJECTS with RUBBER MOLDS

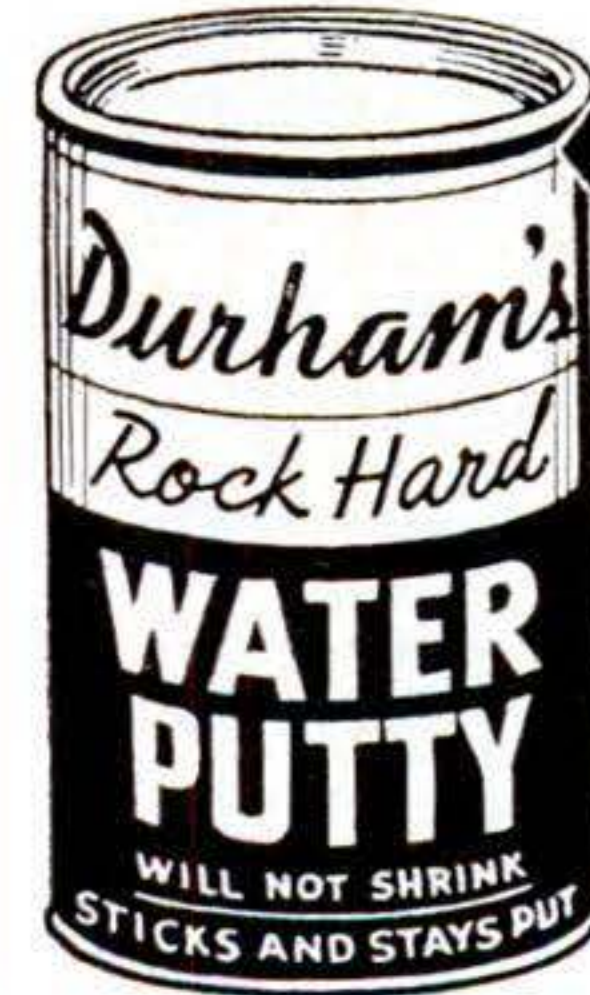

## The Modern PLASTIC for lasting Home Repairs

PERMANENTLY mends cracks or holes in wood, tile, stone or plaster. Sticks and stays put—Does not chip, shrink or fall out. Easy to use. Economical. Mold it, chisel it, polish or paint it. If unobtainable from your lumber, paint or hardware dealer, the big 4-lb. can will be sent you postpaid (in U.S.) for only \$1. Full money-back guarantee, order now.

DONALD DURHAM CO.

Box 804-N, Des Moines, Iowa

## GET THIS COMPLETE GARDEN AND LAWN CART SET

ENDS HEAVY HANDLING AND HAULING



### LAWN AND LEAF CART

Easiest way to haul leaves, grass and trimmings you ever saw. Holds 10 bushels each trip. Light, strong and sturdy frame. Mildew and rot proof bag. Folds flat to hang up when not in use. Sells individually for \$12.95.

### UTILITY TRUCK

No end of uses for this handy, patented truck. Open body carries stones, bricks, plants, soil, fertilizer. Closed body forms platform for baskets, ash cans, barrels, boxes, etc. Husky disc wheels and solid rubber tires insure quiet operation. don't mar lawn. Capacity 500 lbs. Folds flat to hang up when not in use. Sells individually for \$9.75.

### SPRAY TRUCK

Designed to carry 3 gal. spray tank as shown. Has many other uses such as golf bags, cans, etc. Tubular frame, sturdy construction. Heavy disc, rubber tired wheels. Rubber handle grip. Sells individually for \$7.95. (Tank Not Included)

ALL FOR  
**\$25**

Express Collect

Make your garden work easier, lighter, more pleasant with this complete set. Will give years of service.

CONNIE BERT CO., 8115 Clinton Road, Cleveland 9, Ohio

## PRECISION JEWELERS SCREW DRIVERS

Complete Set of 8 for Every "Hobbyist"



At last—a complete set of precision screw drivers to meet the needs of every model builder. Not a miniature but the same type set used by U. S. Navy for precision instruments and watches during the war. Brass knurled handles, hexagon heads, finest tempered steel blades. Sizes 2-9. Never before a set of this quality and precision at such a low price. Your money back if not satisfied. C.O.D. \$2.00 plus postage or send \$2.00 and we pay postage.

PINE WATCH CO., Rm. 40, 29 Eldridge St., New York 2, N. Y.

GIANT

## Astronomical Telescope

100 diameters magnification. (10,000 area magnification) 3 inch diameter steel main tube 50 inches long. Brass focusing tube. Tripod 6 feet high. Equatorial mounting. Ready to set up and use. Full power and clear vision guaranteed. Price \$15.00. 20% deposit on C.O.D. orders.

DEPT. BT, SUFFOLK SCIENCE SERVICE, MANORVILLE, N. Y.  
"NO EXPORT ORDERS ACCEPTED"

## LEARN TO DRAW & PAINT

LANDSCAPES, PORTRAITS, FIGURES, ANIMALS.

No Previous Training Necessary

IF YOU LIKE TO DRAW YOU HAVE TALENT. YOU CAN DEVELOP THAT TALENT THROUGH OUR HOME STUDY COURSE LEARN TO DRAW AND PAINT IN YOUR SPARE TIME. WRITE FOR INFORMATION.

JOHN CLINTON ART INSTITUTE, Inc.  
STUDIO C PALM BEACH FLORIDA



## FOR BIG MEN ONLY!

### QUALITY SHOES IN SIZES 10 TO 16

We specialize in extra large sizes only—sizes 10 to 16; widths AA to EEE. Oxfords, High Tops, Work Shoes, Sox. EXTRA quality — EXTRA comfort. Prompt delivery. Satisfaction guaranteed. FREE catalog.

KING-SIZE, Inc.

P.O. Box 798, Dept. 539  
Brockton 64, Mass.



Write for  
FREE  
Catalog

Carries  
the Same  
90 DAY  
GUARANTEE  
As a New  
Motor Assy.

Our Finest Precision REBUILT

## MOTOR BLOCK ASSEMBLIES

Sold Outright or Exchange

Rebuilt by skilled mechanics. Assembly has Rebored Block with New Pistons, Pins, Rings, Re-ground Crankshaft, and all New Bearings. Guaranteed 90 Days.

Allowance on Old Motor

We ship at outright price. Send your motor prepaid, must be suitable for rebuilding. Send in notarized bill of sale showing title number if any. We refund difference when we receive your motor.

\$5.00  
Crating  
Charge

BUICK	Outrt.	Exch.
34-47 8 cyl.	\$199.00	\$160.00
CHEVROLET	Outrt.	Exch.
29-47 6 cyl.	117.50	87.50
CHRYSLER	Outrt.	Exch.
35-47 8 cyl.	199.00	160.00
DODGE—3 1/4" bore	Outrt.	Exch.
33-47 6 cyl.	144.00	109.00
FORD	Outrt.	Exch.
28-31 4 cyl.	119.00	87.00
32-34 V8	139.00	99.00
35-47 V8	149.00	99.00

HUD.-TERRA	Outrt.	Exch.
35-47 6 cyl.	\$175.00	\$135.00
MERCURY	Outrt.	Exch.
39-47 V8	149.00	99.00
OLDSMOBILE	Outrt.	Exch.
37-47 6 cyl.	175.00	135.00
35-47 8 cyl.	199.00	160.00
PLYMOUTH	Outrt.	Exch.
33-47 6 cyl.	139.00	109.00
PONTIAC	Outrt.	Exch.
37-47 6 cyl.	175.00	135.00
35-47 8 cyl.	199.00	160.00
STUDEBAKER	Outrt.	Exch.
35-47 6 cyl.	175.00	135.00
35-47 8 cyl.	199.00	160.00

We Can Supply REBUILT ENGINES, TRANSMISSIONS, REAR ENDS, etc., for Cars and Trucks. Also JEEP ENGINES. Write for Prices!

## POWER TAKE-OFF for JEEP ENGINE

Bolts to clutch housing on the Jeep engine. Has a spline shaft to engage with clutch and extending from rear is a keyed shaft on

which pulley can be mounted. Hand lever controls clutch.

PF4N-23J—  
Each.....

\$37.50



## NEW 5 Gal. CANS

FOR GAS, OIL OR WATER

Vented for Safety.

Self-locking Safety Cap

Extra Heavy Construction

Will Float When Full

Size of can, 18" high, 6 1/4" thick, 13" wide.

PA35U-60—

Lots of 5, ea. 1.15

Lots of 50, ea. 1.05

Lots of 100, Each 98c



SEND 25% CASH WITH ORDER, BALANCE C.O.D.

## J.C. WHITNEY & Co.

1919 Archer Ave. Chicago 16, Ill.

Say You Saw  
It In Popular Science

## The HAMSTER MANUAL

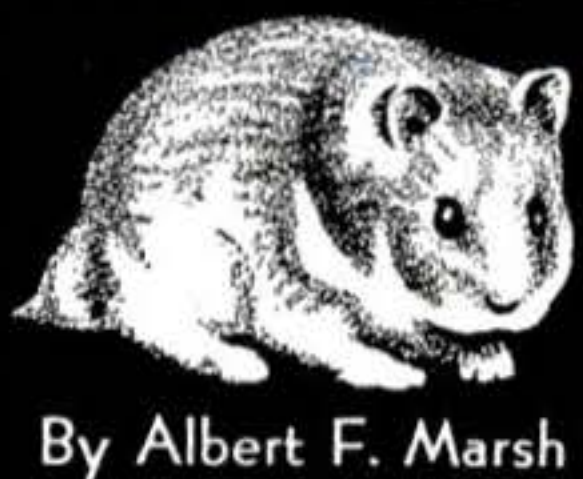

By Albert F. Marsh

## READ THE HAMSTER MANUAL

The most complete guide book on the successful breeding and raising of Syrian Golden Hamsters. Tells all about this new, fast growing, profitable and interesting hobby industry. Reveals all the secrets of the largest breeder of these delightfully profitable pets and laboratory animals. 34 Chapters

chuck-full of information gleaned from actual experience as a breeder. Twenty Pages of illustrations. A few subjects are: history, housing, three methods of breeding, easy to get feeds, sexing, fertility vitamins, handling, educational, scientific projects, crating, profits and selling, where to buy and how to sell hamsters. Sent postpaid for \$1.00.

Albert F. Marsh, 1524 Basil St., Mobile, Alabama

ON THE HILL  
AT THE LIGHT  
IN TRAFFIC

more **POWER**

for your car -

WITH

**WATER INJECTION!**

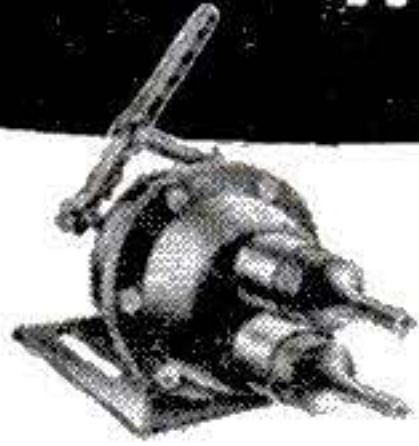

**\$19.95** Complete with water reservoir

Easy to Install

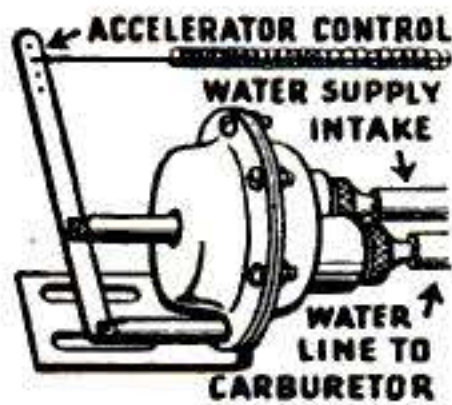

The Sensational, New Hydro-jector Gives Engine More Power... Makes It Smoother Running As In Misty, Rainy Weather!

Originally developed and successfully used by the Air Forces, this water injection system is now available for car-owners!

The **Hydro-jector**

- Lowers Fuel Costs!
- Increases Engine Performance!
- Eliminates Preignition (Ping)!
- Reduces Carbon!
- Makes Engine Operate Smoother!
- Prolongs Engine Life!

See Your Dealer or Mail Coupon Today!

**ASSOCIATED LABORATORIES, Inc.**  
2129 WEST 19th STREET, CLEVELAND 13, OHIO

- Check or M.O. for \$19.95 enclosed. Send Hydro-jector Prepaid  
 Send Hydro-jector C.O.D. plus postage

NAME.....

STREET.....

CITY..... STATE.....

**AIR RIFLES**

**BENJAMIN**

**AIR PISTOLS**

**PIONEERS - LEADERS**

**SEND FOR FREE FOLDER OF LATEST MODELS TODAY**  
If you want a REAL GUN for PRACTICAL USE inside or outdoors get a SAFE - CLEAN - ECONOMICAL - BENJAMIN with Adjustable Power and Amazing Accuracy. For BEST RESULTS use BENJAMIN H-C PELLETS. WRITE AT ONCE. BENJAMIN AIR RIFLE CO., 811 MARION ST., ST. LOUIS 4, MO.

**MAKE BIG MONEY IN**

**FEW DOLLARS STARTS YOUR OWN PROFITABLE BUSINESS!**

**LIQUID SYNTHETIC MARBLE**

Here are 3 amazing, new opportunities to get into your own highly-profitable, dignified business—without previous experience—regardless of your age or sex. 1. **LIQUID SYNTHETIC MARBLE**—Easy to make and install beautiful synthetic Marble Slabs—pouring from liquid state. Big Demand for kitchen and bathroom walls, etc. 2. **FIBRE-TITE FLOORING**—Easy to make and install—in any color or color combination. Many years wear. Dustproof. Soundproof. Verminproof. 3. **FLEXIBLE MOLDS**—for Plaster Casting. \$1.00 in raw materials makes up to \$25 worth finished products. F. B., Iowa, writes: "Am on job that will net me \$150 for 4 days work." Get FREE details. No obligation. Write today!

**COMPOSITION PRODUCTS CO.**

5853 Delmar Blvd.

Dept. 42

St. Louis 12, Mo.

Write for **FREE DETAILS NOW!**

**WHY PAY MORE?  
FREE TUBE  
With Each Order**

**EVERY TIRE GUARANTEED  
98% NON SKID, ORIGINAL TREAD  
TRIPLE INSPECTED DEMONSTRATORS**

**Positively Not Re-caps!**

600-16 . . . . . \$6.35	700-15 . . . . . \$6.55
650-15 . . . . . 5.35	700-16 . . . . . 6.95
650-16 . . . . . 6.45	750-16 . . . . . 7.95
32x6-8 . . . . . \$12.35	8.25-20 . . . . . \$17.45
32x6-10 . . . . . 14.35	9.00-20 . . . . . 17.65
750-20HD . . . . . 14.35	10.00-20 . . . . . 17.95
750-20 8 PLY MILITARY SUPER \$15.95	

1/2 million tires shipped to satisfied customers. Trial will convince you. Mail Orders. Rushed on Receipt of Check or Money Order.

**STANDARD TIRE**

834 N Broad St. Phila. 30, Pa.

**YOUR NAME OR MONOGRAM**

**MATCH BOOKS**

Your name or initials on match books that reflect your good taste. As a business card, they remind your clients of you many times. Sent postpaid.

**AGENTS WANTED**—write for details.

**Dept. PS CALVERT MONOGRAM COMPANY**

No COD's.

2208 Eutaw Place, Baltimore 17, Maryland

**SENSATION ON WHEELS**



the **"SIDEWALK SAILER"**

**HERE'S HOW TO SAIL WITHOUT WATER!**

The SIDEWALK SAILER skims along over any land surface with even the lightest breeze. Sturdily built for seasons of fun, metal body is 12" x 10", with 32" mast, rubber wheels, vinyl plastic sail in rainbow fleet colors. Completely demountable for easy carrying.

SEND NO MONEY. Rush your order today. Remit with order and we pay postage or order C.O.D. plus postage. Satisfaction Guaranteed.

Complete only **\$2.98**

**BERNARD FINE CO. Inc.**  
501 Sixth Avenue New York 11, N. Y.

Dept. S-S-1

**ELECTRIC MOTORS**

**NEW HEAVY DUTY MOTORS**

Nationally known makes. Guaranteed capacitor type, ball bearing heavy duty motors, 110/220 volts, 60 Cycle AC Single Phase. 1725 RPM.

1/4 HP	Wt. 30 lbs.	\$24.00
1/2 HP	Wt. 36 lbs.	\$34.50
3/4 HP	Wt. 50 lbs.	\$44.00
1 HP	Wt. 80 lbs.	\$57.00

These motors also furnished in 3450 R.P.M. at same price. Prices are F.O.B. Chicago. Immediate delivery. **SOLD ON MONEY BACK GUARANTEE.** Send check or money order today.

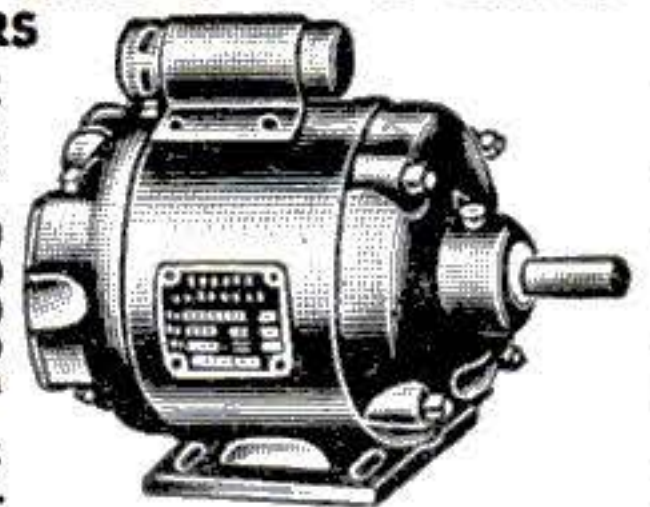

**C & M EQUIPMENT COMPANY**

DEALERS—WRITE  
1831 S. State St.  
Dept. D-4, Chicago 16, Ill.

**CARBURETOR TOO RICH  
MAKES MOTORIST TOO POOR**



Car owners who are wasting money and not getting proper gas mileage due to over-rich mixtures will be pleased to learn how to save gasoline by VACU-MATING over-rich mixtures. VACU-MATIC fits all cars, trucks and tractors. It is automatic and operates on the supercharge principle. Easily installed in a few minutes.

**SALESMEN WANTED!** Big Profits!

Send name, address on penny postcard for free particulars and how to get yours for introducing.

**VACU-MATIC CO., 7617-1315 W. State St., WAUWATOSA, WIS.**



## USEFUL SURPLUS BARGAINS

### FISH LURE and LIGHT



Uses one ordinary flashlight battery. A floating fish lure that brings 'em in. Also can be used as a regular flashlight. Brand new..... **\$1.29**

### A to Z Steel Letter PUNCH SETS

1/4" .....\$6.50  
3/8" .....\$7.95    1/16" .....\$1.95



### New Precision Bilt MICROMETERS

Chrome finished, nationally known makes. Give a lifetime of accurate detailed service. Individually boxed.

1" Central .....\$3.50    2" Reed .....\$5.25  
4" Central .....\$6.25    6" Slocumb .....\$7.50

Prices FOB, Kansas City.    Send 25c for handling & mailing.

## ATLAS SALVAGE & EQUIPMENT CO.

229 SW. Blvd.    Kansas City, Mo.

### USE THE WIND TO CHARGE BATTERIES



## 6 VOLT WIND DRIVEN GENERATOR

Ideal for farm and camp lighting—for boats, motorcycles, autos, farm radios, etc. The wind driving the propeller operates the generator. Produces 6 volts, 12 amps—weighs only 8 1/2 lbs.

### OPERATE WITH PROPELLER OR PULLEY

May be used with 13 inch propeller as illustrated—with homemade propeller or pulley. For farm lighting plants using batteries it may be run direct by windmill. Use pulley for autos, boats, etc. Fitted with break to control charging rate. With 13 inch propeller as shown, each \$22.95. Generator only, less propeller \$14.95. Shp. wgt. approx. 12 lbs. F.O.B. Houston. Send check or money order. Immediate shipment.

AERO PARTS SUPPLY, Dept. PS 4    8242 Travelair Blvd.    Houston 17, Texas

# NOW! EXTRAORDINARY New GOV'T RELEASE!

Shoots A High Pressure Stream Of 30 Feet!

### ALL PURPOSE STIRRUP

## PUMP

ONLY **\$1.49**  
EACH



### The Tool of 100 Uses!

- Just the thing for
- FIRE FIGHTING. A very handy tool to have in your workshop in case of fire.
- Spraying Garden
- Washing Cars
- Bailing Boats and Basements

Finest quality all purpose pump on the market! Never before offered at this ridiculously low price. There are dozens of uses for this versatile sprayer. Approximate height 27" overall. Complete with 10 feet of flexible hose, ready for assembly. **SEND NO MONEY:** Simply send name and address and number of pumps desired and we will promptly mail your order C.O.D. plus 25c for postage. If you prefer send \$1.49 plus 25c for postage with order.

**S & B SURPLUS SALES CO., Dept. PS29**  
3244 W. Roosevelt Rd.    Chicago 24, Ill.

## MEN over 38!

### READ "THE MALE HORMONE"

by Paul de Kruif

ORDER TODAY—ENJOY LIVING!

Free Information

HEALTH BOOKS    Box 1426    Dept. PS-1, Los Angeles 15, Calif.

BARGAIN

**\$1.00**

Postpaid  
In plain  
wrapper

## FENCING World's Finest Sport Exciting Fun—Harmless



Just Out! Two 3 ft. Spring Steel Foils with Safety Rubber Buttons. Complete Outfit 2 foils (swords) with hand guards and Free Instruction Book Now Only \$1.98 Postpaid. A healthful & clean sport, makes you Strong & Alert. Instruction Book teaches Quickly—Easily. Mail check or Money Order for \$1.98 Today. Add 28c for Foreign postage.

LEE PRODUCTS CO., 1613-R First Ave., New York 28, N. Y.

## DO LATHE JOBS ON YOUR DRILL PRESS

WITH DRILLATHE **\$1.98**  
Postpaid



A rugged tool that converts any model drill press into a lathe. Enables you to face, chamfer and groove metals, wood, plastics—to turn diameters, shoulders, pulleys, etc. Precision made of cast aluminum. Comes complete with high speed tool bit. Money back guarantee. Send \$1.98—we pay postage.

BRAEMER PRODUCTS • Box 2636 • Lakewood, Ohio

## Treasure and Mineral LOCATORS

Low priced, unsurpassed in efficiency, lightweight models. Miniature batteries and tubes. Credit plan available. Free literature.



**FISHER RESEARCH LABORATORY Inc.,**  
Palo Alto, Calif.

## THE GREATEST THING

## IN PLASTICS!

# PLASTICAST



**PLASTICAST** is a liquid plastic; can be poured into ANY kind of mold or container. Hardens in a few minutes into a transparent solid, clear-as-glass, tough-as-steel plastic! No tools or machinery required. Ideal for imbedding flowers, butterflies, photos, souvenirs, and for making beautifully brilliant jewelry, gems, displays, fishing lures, magnifiers, lenses, knick-knacks and novelties. Easily cast into sheets, rods or blocks, ANY shape, ANY color. **EVERYTHING FURNISHED**, including 4 molds, for making over 200 attractive articles! Start manufacturing beautiful and useful plastics today—no other equipment required! C.O.D. orders accepted with \$1.00 deposit.

**COMPLETE MASTER OUTFIT** Postpaid U.S.A. & Canada only **\$3.25**

**MULTIPLEX MOLD COMPOUND** . . . simply pour over models to form solid flexible rubber molds in which ANY material may easily be cast! Nothing else like it! Good for thousands of castings; never wears out or spoils . . . may be remelted into new molds over and over again! Easily handles difficult shapes and undercuts. **Pound can, only** **\$2.00**

**FREE** A very attractive and useful novelty made of one of our products given absolutely free with every one of our catalogs! Catalog lists many new materials for making **MOLDS** and **CASTINGS** with Liquid Plastics, Liquid Ivory, Liquid Marble, Wax, Latex, Metal, Castwood, Plaster, etc.; also many molds listed. Price of catalog only 10c coin or stamps.

**PLASTICAST CO. (Dept. A)**  
(Send order to nearest office)

5961 Madison St.  
Chicago 44, Illinois

P. O. Box 987  
Palo Alto, Calif.

**POLISHES!  
SANDS! GRINDS!  
CURVED & FLAT**

**SURFACES - FASTER -  
EASIER!** Works with any  
1/4" Electric  
Power Drill,  
Flexible Shaft.

You Can Use It To:  
Fix Bodies, Fenders;  
Wax, Polish Cars, Floors, Linoleum;  
Refinish Furniture, Wood, Metal  
Surfaces; Smooth, Reduce  
Welds; etc.

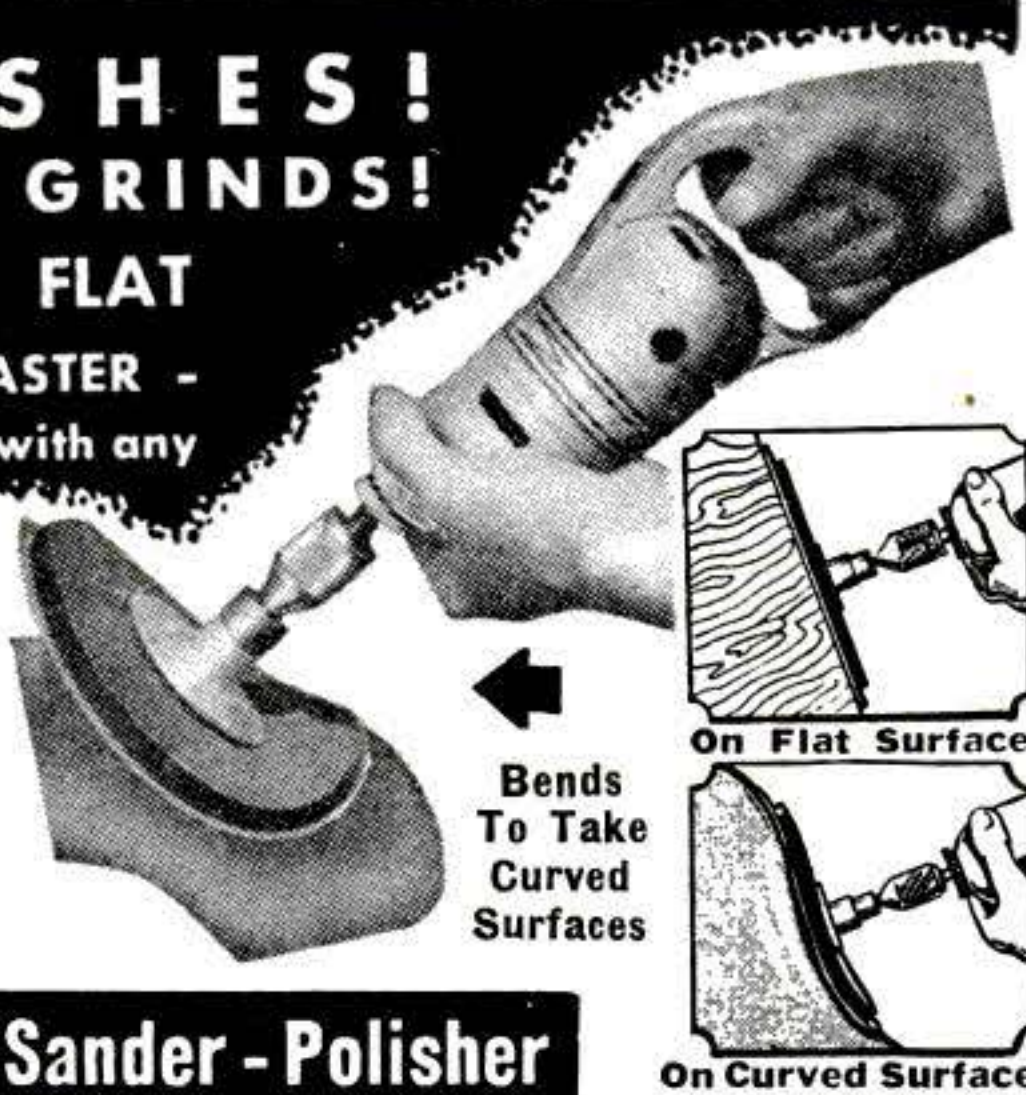

Bends  
To Take  
Curved  
Surfaces

On Flat Surface

On Curved Surface

**NEW FLEX Sander - Polisher**

Works with your electric drill, flexible shaft or chuck equipped motor. Speeds up all grinding, sanding and polishing jobs—fits any 1/4 inch chuck. Rubber face plate flexes into curves for fast, smooth, clean work. Outfit includes 6 1/2 inch rubber disc, with metal flange and shank, fibre backed sanding disc, and heavy sheep's wool polisher. Makes your drill the equal of any \$75.00 grinding or polishing outfit. Satisfaction guaranteed. **\$4.95**  
Order today. Shipping wgt. 2 lbs. F.O.B. Chicago. Only **DEALERS WRITE**

**PREHLER PROVED PRODUCTS**

Division Norbert Prehler & Co. Chicago 47, Ill.  
Dept. PS-4, 1623-5 Milwaukee Ave.

**SURPLUS SALE!**

BRAND NEW

45 X 3.5

**Liko BINOCULARS**

with INTERPUPILLARY ADJUSTMENT and

**COATED OPTICS**

**Only \$6.98**  
**IMMEDIATE DELIVERY**



First Time in America! Now you can get close-ups of all events with these all-purpose heavy duty binoculars. Coated precision lenses, interpupillary adjustment and other features found only in high price binoculars. Carrying case and shoulder straps included. 10 day no risk money back trial. Ideal gift. **SEND NO MONEY!** Pay postman on delivery plus charges. Send payment with order and we mail postpaid. Be sure to add 20% Fed. tax (\$1.40). Act now.

**VETERAN'S EMPORIUM, Dept. B-31**  
1148 W. CHICAGO AVE. CHICAGO 22, ILL.

**BIG PROFITS with BELSAW**

**ALL-PURPOSE SAWMILL**

Make finished, easy-to-sell lumber, ties, shingles, lath, studding, etc. Portable BELSAW uses tractor or auto engine for low cost power, with big profit returns. Start NOW. Turn your trees into money

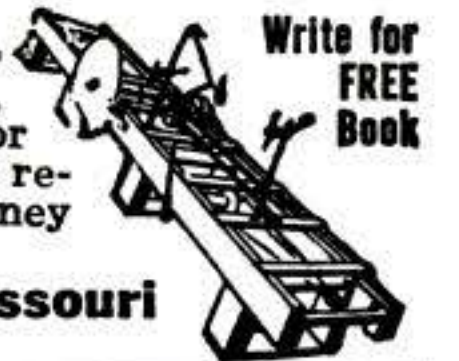

**BELSAW MACHINERY CO**  
2846M Westport Road, Kansas City, Missouri

**HOW TO BE YOUR OWN BOSS!**

Send today for amazing book, "How To Start Your Own Business"! Explains in complete detail:—how much money you need to start . . . how to advertise, add new business . . . fees to charge, pitfalls to avoid. Covers 60 fields including: radio, advertising, publishing, credit agency, travel bureau, retailing, camera exchange! Send no money now! Pay postman \$1.98 when book arrives—or \$2.48 for handsome DeLuxe edition. If not delighted after 7 days' free trial return book for full refund. Write:

**FOREMOST BOOKS, Dept. 48, 104 E. 26 St., New York 10, N.Y.**

**NEW B-M POWER MOWERS**

For Modern Lawn Care. Newest model self-drive, three-wheel, rotary blade mower. Equipped with quick-starting, dependable, trouble-free 1 1/2-2 h.p. Clinton engine. Light. Sturdy. Choose from three models of assembled mowers or Build-it-yourself kit of parts. Guaranteed. FREE literature.

AT  
LOW  
FACTORY  
COST



**B-M MOWER COMPANY**  
Box 66-S Blue Mound, Kansas

**BUILD HEAVY DUTY MACHINES**



**SAVE UP TO 90%** You can build, using our practical, easy-to-read plans, all kinds of machines, for home, farm or shop—scooters, portable sawmills, metal working machines, concrete machinery of all kinds, printing equipment, woodworking machines, midget autos, dish washers, farm equipment, freezers, tractors.

**FREE CATALOG HANDBOOK**  
**183 SETS OF PLANS** **NICHOLS EQUIPMENT COMPANY**  
**VALUABLE INFORMATION** Dept. D-1004, PURVIS, MISS.



**NEW Auto FLASHER**

**For Fast, Snappy Drivers**

Makes your Stop Light Shout. Flashes 115 times a minute. Fully automatic when brake is applied. Approved by leading Safety Engineers. **INSTANT ACTING.** If your dealer can't supply you, send check or M.O. for \$3.00. We pay postage. Dealers and Agents desired.

Patented. **MACCHI and COMPANY**  
Simple to install. Dept. S48, 927 Larkin St. • San Francisco 9, Calif.

**MAKE UP TO \$5.00 AN HOUR  
In Your Own YEAR ROUND Business!**

**ONLY A FEW DOLLARS PUTS YOU IN BUSINESS!**

Many Clearing as High as \$20 to \$30 a Day **NET** Renewing Rugs, Carpets, Upholstery. New Method Now Used for Auto Upholstery. Write for Facts About Quick, Easy Way to Get Started

Here is the chance you've been looking for to step into a pleasant, dignified, big-pay business of your own that offers you a steady, year 'round income. Start on "a shoestring," full or spare time, right from your own home. Equal opportunities for men and women, young or old, in small towns or big cities. **No experience needed.** Many making big money with new Americlean System just cleaning auto upholstery. Easy to learn. We send you complete instructions and quick-cleaning supplies so you can start making money the very first day! Quick method cleans upholstery, rugs and carpets like new without taking off floor! Tremendous demand in homes, apartments, hotels, stores, office and public buildings. Steady repeat business. Territories going fast. Write today for full FREE facts. No cost or obligation. Rush letter or postcard now to **AMERICLEAN CO., Inc.**  
Dept. H-16, 211 North 7 St., St. Louis 1, Mo.

**WRITE FOR FREE DETAILS NOW!**

Say You Saw  
It In Popular Science

**HARLEY-DAVIDSON MOTORS**

**Brand NEW (not used) 1/2 Price!**

For '37 to '48 Motorcycles. Or boats, power plants, saws, midget cars.

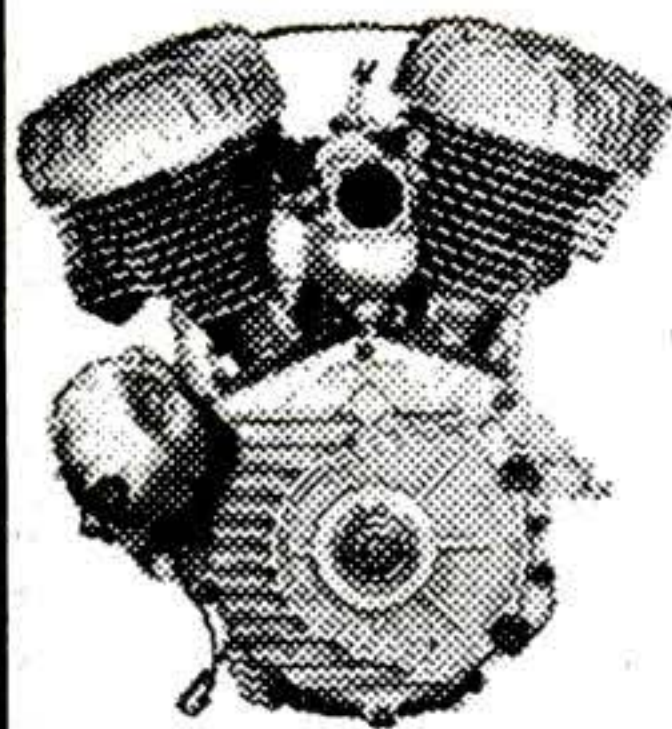

Worth \$265. Complete with new carburetor, new generator, new sprockets. Never uncrated. Positively guaranteed new in perfect condition. Government surplus. These are not rebuilt but **BRAND NEW** regular Harleys. Side valve. L head. 30 HP (N.A.C.C. 6.05). Worth more than our price for new parts! \$122.25 crated. FOB Okla. City. Weight packed 220 pounds. Remit \$25. bal. C.O.D. Shipped immediately. Few left. Guaranteed as advertised or money refunded. You have seen our ads for years.

**FEDERAL IDENTIFICATION CO.**  
1910 Classen Blvd. Dept. S Oklahoma City, Okla.

**FREE**  
7-DAY TRIAL  
JUST MAIL COUPON

# HOW TO BUILD A BETTER HOME

If you Are Undecided Whether You Should Build or Buy—  
If You Are Leery of 'Cheap' Building, Shoddy Work or Poor Design—  
If You Are Fed-Up With DREAMING About Your New House and  
Want to Get STARTED—Then This Will Prove a GOD-SEND to YOU!

HERE is the answer to how to build your own home. Here is the WORKS—how to plan, how to construct, how to supervise—simply, clearly explained step-by-step. Jam-packed with everything you need to know about building your own home yourself, or having a contractor build it for you. Dozens of clear-cut, complete diagrams. You will be able to build a home that will amaze everyone!

**Everything You Need to Know to Get Started**

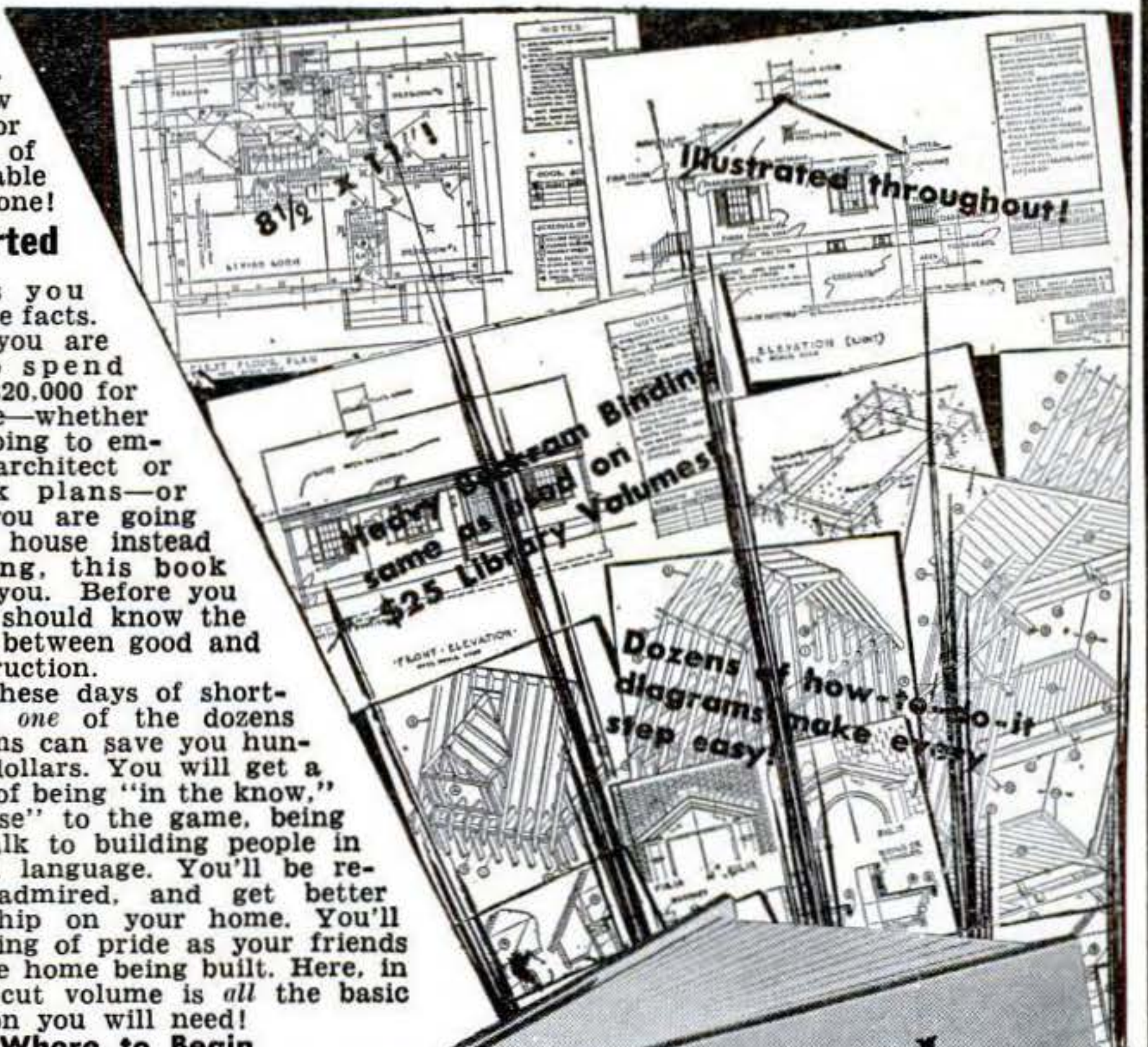

**Some of the Things This Book Explains:**

Here at Your Fingertips, the Secrets that Produce Fine Small Homes—Completely Revealed in this Great-Easy-Reference Book!

How to Get Started; Deciding Upon Home Ownership; How to Select Professional Service; How to Finance Your Home; How to Select a Building Lot; How to Plan the Home; How to Fill Out Contract Documents; How to Obtain Good Construction; How to Prevent Termites; How to Prevent Decay; How to Prevent Corrosion; How to Lay Out Building, Excavate, Grade; Monolithic Concrete Construction; Masonry Construction; Footings for Foundation Walls, Chimneys, Piers; How to Build Piers, Foundation Walls; Basement Construction; How to Waterproof Basements and Foundation Walls; How to Build Chimneys and Fireplaces; How to Select the Proper Species and Grades of Wood; House Framing Methods and Details; Finish Carpentry and Millwork; How to Insulate; Sheet-Metal Work, Roofing, Stucco, Lath and Plaster; How to Paint and Finish; Tile Work, Electrical Work, Plumbing, Heating; List of Publications for the Home Builder (Most of these are free or cost only a few cents); Where to Get Stock Plans; Taxes, Insurance, Interest, Maintenance, Assessments; How to Choose a Bank, Real Estate Dealer, Contractor; Locating Lot, Tax Searches, Comparative Costs, Designs; Prefabricated Houses? Bungalows, List of Usual Mistakes; Architectural "Don'ts" and over 300 additional paragraphs of important information.

**QUICK REFERENCE INDEX TO SPECIAL PAGE-SIZE PLATES (HUNDREDS OF ILLUSTRATIONS)**

Footings—foundation walls—basements; Garage floor, footings, etc. — septic tank—grease trap—area for basement window; Concrete porches, steps, automobile runways and driveways and walks; Brick steps, walks and terraces; Brick, tile and stone wall details—flagstone and stepping stone walks; Masonry dwellings—brick veneer walls; Chimney and fireplace details; Balloon framing details (minimum-shrinkage type); Balloon framing details (box sill type); Roof framing details; Basement columns and girders—framing of openings—bridging; Miscellaneous framing details; Watertables—exterior sidewalls of siding or shingles—cornices—porch columns; Double-hung wood window details; Door frame details—points for millwork—stock doors and windows—sash details; Paneling—stairwork—baseboard details; Termite shields—miscellaneous flashings; Flashing details; Gutters and leaders (downspouts); Roofing details.

**Nothing Like It Before! One Simple Fact May Repay you a HUNDRED Times Its Small Cost. A Book You Will Refer to for Years to Come!**

Provides you with all the facts. Whether you are going to spend \$2,000 or \$20,000 for your home—whether you are going to employ an architect or use stock plans—or whether you are going to buy a house instead of building, this book will help you. Before you build you should know the difference between good and bad construction. Now—in these days of shortages—just one of the dozens of diagrams can save you hundreds of dollars. You will get a thrill out of being "in the know," being "wise" to the game, being able to talk to building people in their own language. You'll be respected, admired, and get better workmanship on your home. You'll get a feeling of pride as your friends admire the home being built. Here, in one clear-cut volume is all the basic information you will need!

**Where to Begin**

No matter what your building problem may be, you will find the answer in this amazing volume. No truth is kept from you. You are told the disadvantages of home ownership as well as the advantages. You are told of the precautions you will need to safeguard your investment. You are shown how to select a lending institution, a lawyer, a real estate dealer, an architect, a contractor. Your questions on methods of buying are fully answered. Just a quick glance at the partial table of contents on this page will show you some of the thousands of facts on building which this complete volume contains. Those who have bought a copy write that they have never seen so thorough a work on this subject for any price, anywhere!

**Hundreds of Construction Details**

Explains all the "mysteries" of permits, contract forms, and construction. Tells you how to build the right kind of home, how to avoid "cheap," cracker-box construction, how to get a house that is suitably located, beautiful to look at and priced within your means—a house you will be proud to call your home.

**How to Build—from Plans to Paint**

Not one important step is missing from this volume. See for yourself. Every conceivable thing you would want to know about building will be found in this wonderful new book!

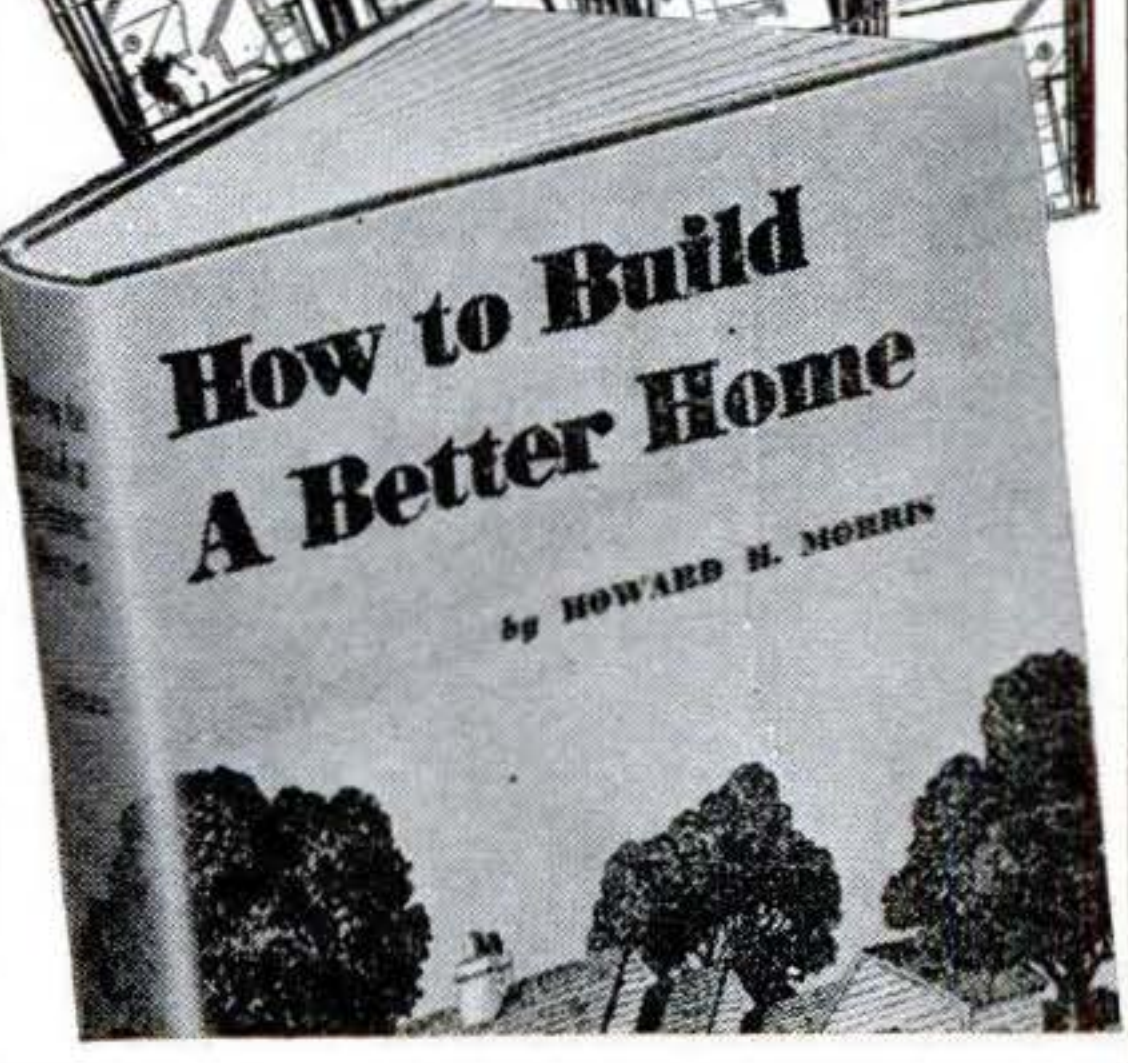

**Read What Great Building Authorities Say About This Amazing Book (names on request)**

Excerpts from typical letters of praise:

"... the best book on the subject that has been published to date." "was thrilled" "valuable information for the new home-builder."

"... an excellent piece of work" "helped us decide our building plans" "well worth price."

"... very much impressed" "an excellent reference book."

"... the writing is clear and compact... complete and unbiased information."

"... most interesting and complete." "You are to be congratulated. Contains more information than any volume seen... Everything you said."

"... One of the best works of its kind I have ever seen. Send me 10 more for presents."

And from an amateur:

"From this book, I did the plans myself! Had never done anything like it before... A neighboring architect said I was an up-and-coming designer and he found not one fault with my plans... The building is now finished and everyone says it's beautiful!... I saved \$1900!"

**SEND NO MONEY**  
Examine It for 7 Days  
**FREE!**

You don't even risk a cent to examine "How to Build a Better Home." Just mail coupon. Study book for a week, FREE! See how easy it is to supervise or build a better home, YOURSELF—even if you know nothing about construction NOW! Then, if you are THRILLED with this amazing volume, send only \$3.98 (plus postage). If you are not thrilled, return book and pay nothing! This is your chance to build not just a house, but a BETTER HOME! Mail FREE EXAMINATION COUPON NOW, to The Westport Publishing Company, Dept. PS, Westport, Conn.

**FREE Examination Coupon—Mail Now**

The Westport Publishing Company, Dept. PS, Westport, Conn.  
Please send me, for one week's FREE EXAMINATION, a copy of "How to Build a Better Home." After 7 days I will either return this book and owe you nothing, or I will keep it and send you \$3.98 (plus shipping charges).

Name.....Age.....  
(please print)

Address.....

City & Zone.....State.....

Save postage. Check here if you enclose full payment of \$3.98 (check or money order) WITH coupon. WE will then pay shipping charges. If not thrilled with book, return it and we will refund your money by AIR MAIL!

**Make More Money in**

# AUTO BODY and FENDER REPAIRS

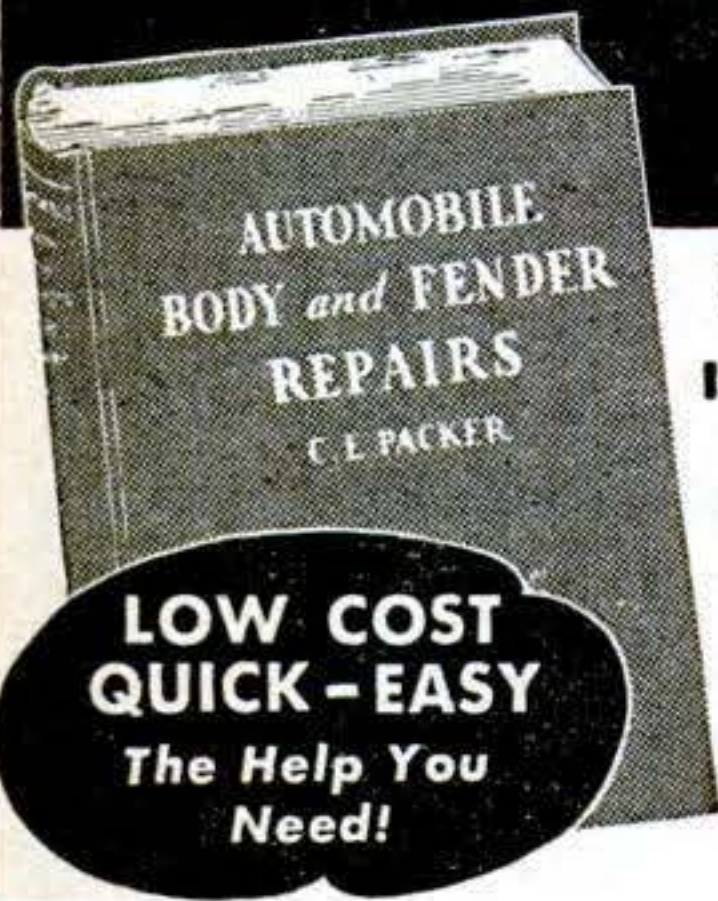

**GET THIS BOOK NOW**  
**In Your Own Home** **FREE TRIAL**  
**Send No Money**

GET YOURSELF a share of the big money car owners are spending to keep their older cars looking good. This practical book will put you right into this profitable business. No experience needed. Get a good job or start a business of your own with little or no capital. Biggest selling book of its kind. Thousands in use. Mail coupon today—money back if not fully satisfied.

**Mail Coupon**

**233 Pictures—Diagrams**  
**325 Pages of Vital Facts**  
*Covers methods, tools, materials—How to get business—How to start your own shop. Latest information and pictures.*

**GOODHEART-WILLCOX CO., Dept. 34**  
**2009 S. Michigan Avenue, Chicago 16, Ill.**  
 Send Auto Body and Fender Repair, \$3.50. If not satisfactory I will return in 5 days and you will refund money paid.  
 Remittance enclosed, sent postpaid.  
 Send C.O.D. Postage extra.

Name.....  
 Address.....  
 City..... State.....

**"TOOK IN \$217 FIRST 10 DAYS"**

Some Make More,  
 Some Less . . .

**We Help You to Start Your Own All-Year Business, Make Big Money!**

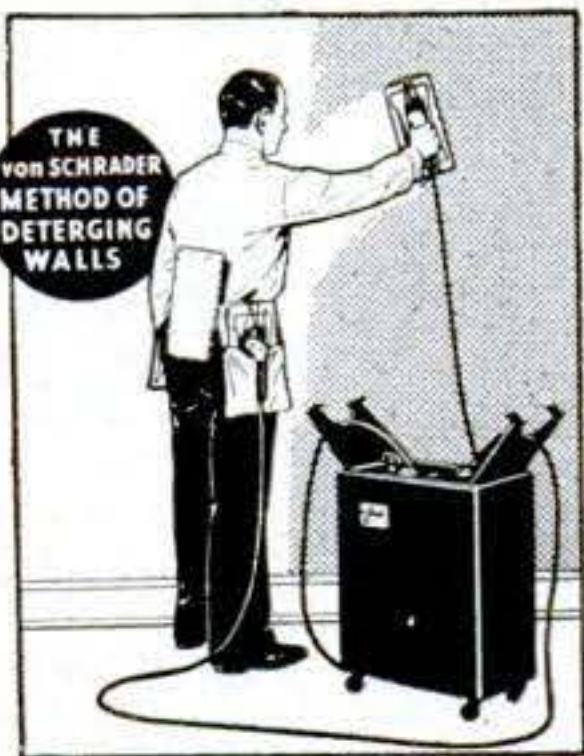

With our easily operated, highly efficient wall washer, Chas. Stelle took in \$217 gross in first ten days. E. L. Goss took in more than \$10,000 in one year. E. C. Taber wrote, "I made \$400 gross in two weeks." And no wonder—this machine washes walls 6 times faster and better than by hand.

**YOUR MONEY-MAKING OPPORTUNITY**

We want more men to go into this profitable business for themselves and enjoy independence. There are customers everywhere—homes, offices, schools, churches, hotels, stores, etc. What you take in is mostly profit, for material costs are low. And there's no need to rent a shop or office. Operate your business from your home.

Lose no time. Get all facts without obligation. **WRITE FOR FREE INFORMATION.** Ask for Wall Washer Details at once.

**VON SCHRADER MFG. CO., C-43, Racine, Wis.**

Motors, fixtures, and appliances are quickly tested for open circuits, dangerous grounds or short circuits. Traces circuits in wiring, radios, airplanes and signal circuits.

**STAR UNIVERSAL NO-LEAK TESTER**

- FOR CONTINUITY testing on your bench or at the job. Simply plug into any outlet — no batteries needed.
- FOR LINE AND POWER testing, the plug is inserted into the insulated frame and circuits of 110-600 volts are positively tested.

**PRICE \$2.50**  
 If unable to obtain from jobber, add 10c postage

Send for free illustrated circular describing uses.  
**STAR FUSE CO., INC.** 235 CANAL STREET NEW YORK 13, N. Y.

**Jiffy Jr. ELECTRIC HEATER** **BOILING HOT WATER IN A JIFFY!!**

Place the Jiffy Electric Water Heater into the water and insert the plug in the nearest electric wall or light plug. You will have hot water in less than five minutes for baby's bath, your washing, shaving and a great many other uses in the home, camping, business, and on the farm. Mailed complete, including six feet of rubber covered wires and plug. One year guarantee. **JIFFY ELECTRIC COMPANY, Dept. W1, 21321 Stephenson Highway, Hazel Park, Mich.**

**Only \$2.95** **HOT WATER IN A JIFFY**  
 plus twenty five cents for postage

**COMB-A-TRIM** **The New Quick Trimmer**

Something New! Trim your hair without any experience. It's easy! The excess hair comes off smoothly and easily by just pulling trimmer through hair like an ordinary comb. Save on hair-cut bills. . . . Trim your own hair or the whole family's. Send 59c and your Comb-A-Trim will be sent at once, postpaid.

**SPECIAL OFFER** Send \$1.00 for 2 Comb-A-Trim. Save 18c **2 for \$1** 5 Extra Blades 25c (Year's Supply)

**COMB-A-TRIM CO., CAREW TOWER, Dept. J-26, Cincinnati, Ohio**

**25 lbs. SURPLUS RADIO PARTS \$5.00**

A gold mine of parts for repairmen, amateurs, and experimenters . . . sockets, condensers, resistors, transformers, coils, hardware, wire, etc., etc. An outstanding bargain in usable parts! Send \$5.00 cash, check or M.O. today! (Pay small express charges on receipt.)

**ELECTRONIC DISTRIBUTORS, Inc.** Dept. S-4 620 W. Randolph St., Chicago 6, Ill.

**LEARN LEATHER CARVING**

Home study course prepares you for this interesting and profitable hobby. Many students earning as much as \$3.00 an hour in spare time carving billfolds, belts, handbags, saddles, etc. Complete with instructions, designs and individual analysis of your work. Send 10c for catalog.

**BAIRD'S SCHOOL OF LEATHER CARVING, 1212-B South Bonnie Brae, Los Angeles 6, Calif.**

**LAW** **STUDY AT HOME for PERSONAL SUCCESS and LARGER EARNINGS.** 39 years expert instruction —over 108,000 students enrolled. LL.B. Degree awarded. All texts furnished. Easy payments. Send for **FREE BOOK.**

**AMERICAN EXTENSION SCHOOL OF LAW**  
 Dept. 88-S, 646 N. Michigan Ave., Chicago, Ill.

**GOVERNMENT SURPLUS BRAND NEW VICKERS CONSTANT DISPLACEMENT PISTON TYPE 1000 P.S.I. HYDRAULIC PUMPS & MOTORS**

**HUNDREDS OF PRACTICAL USES**  
 Build your own Hydraulic Equipment.

(Left) Vickers Hydraulic Pump as shown \$15.00 each F.O.B. Detroit. (Right) Vickers Hydraulic Motor as shown \$15.00 each F.O.B. Detroit.

**JAY-CEE SALES COMPANY**  
 4554 Grand River Ave. Detroit 8, Michigan



**NOW  
HE HAS**

**WHAT LOOKS  
ALMOST LIKE**



**He Got It Quickly At Home  
This New Simple Way**

**Read  
FREE  
Offer**

Thousands like him, including girls and older men and women, who suffered humiliation and lack of success in business and affairs of the heart, because of a bad looking skin, can now rejoice over this good news. A new way has been found anyone can do at home, for removing that blemished or old looking external layer on the skin called the epidermis, easily, and often in a few days time. And now, a new TREATISE is being sent to all readers of this paper who need it, in plain wrapper, prepaid. Just send post card or letter requesting the FREE TREATISE. Address WILLIAM WITOL, Dept. 18, Valley Stream, N. Y. If pleased, tell friends.

**LOOK!**

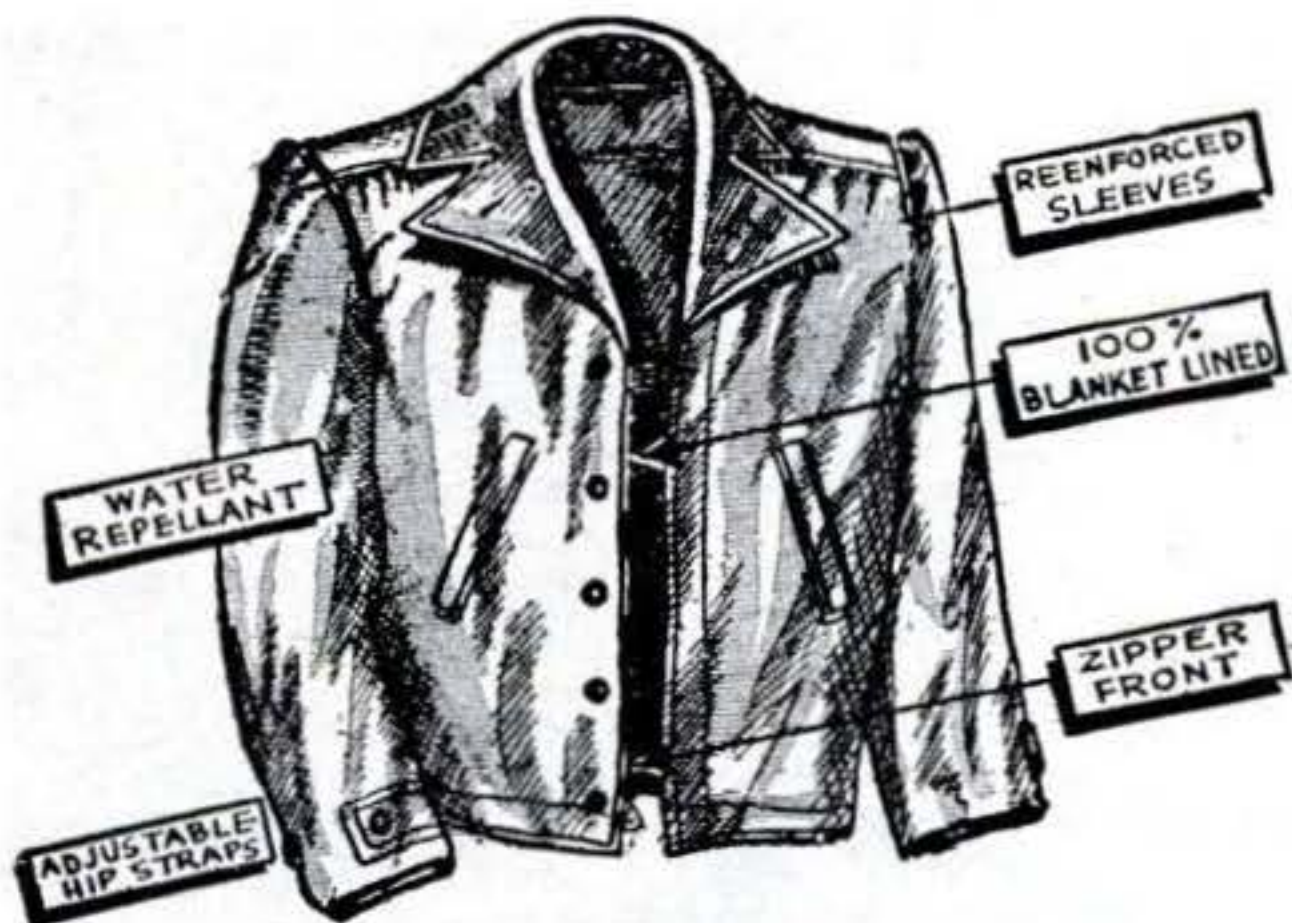

**WAR SURPLUS**

**FIELD JACKETS**

*Ideal for  
Farmers • Lumbermen  
Truck Drivers • Laborers  
and for  
Plain and Fancy Loafing*

**ONLY  
\$1.98  
EACH**

**Nothing like it has ever been  
offered at this low price!**

This full-zipper front, bi-swing back, fine poplin Army FIELD JACKET is the favorite of G.I.s all over the world. Although used EVERY jacket is guaranteed to be in perfect condition. Sizes 34 to 40. Send name, address and size and on delivery pay postman \$1.98 plus C.O.D. charges, or send \$1.98 with your order and we will pay postage. Order yours today!

**S & B SURPLUS SALES CO., Dept. PS-31  
3244 W. Roosevelt Rd. Chicago 24, Ill.**

# NEW REVOLUTION in Hearing Aids!

Single Unit  
\$75 Complete



**NEW** *Zenith "75"*  
**THE HEARING AID THAT NEEDS NO "FITTING"**



THOUSANDS who have hesitated to try a hearing aid are ordering this new type of instrument that needs no "fitting," therefore can be delivered to your home by mail—no embarrassing visits to salesrooms, no salesman to high-pressure you! And you don't risk a penny, because you get this utterly new kind of money-back guarantee:

**Wear the Zenith "75" at home, at work, anywhere. Compare its QUALITY, PERFORMANCE, OPERATING ECONOMY (less than 1c per hour battery cost) with that of ANY other hearing aid. If the Zenith "75" does not excel on ALL counts . . . if it isn't better than you ever dreamed ANY hearing aid could be . . . return it within 10 days of receipt and Zenith will refund your money in full.**

**SAVES YOU OVER \$100, TOO!**

Because it comes to you by mail, the Zenith "75" also saves you over \$100. If its price had to include "fitting," middlemen's profits and high sales commissions, this top quality hearing aid would have to sell for \$195, instead of \$75. So do as tens of thousands have already done. Order your Zenith "75" and find new happiness, new zest for living. You owe it to your family, friends and business associates. Use the convenient coupon below.

**BY THE MAKERS OF THE FAMOUS ZENITH RADIOS**

Look only to your doctor for  
advice on your ears and hearing.



**MAIL THIS COUPON TODAY**

Zenith Radio Corp., Hearing Aid Division, Dept. PS-48  
5801 Dickens Avenue, Chicago 39, Illinois

I enclose check or money order for \$75\* for one Zenith "75" Hearing Aid. If I am not completely delighted, I may return it within ten days after receipt and get my money back in full.

\*Plus tax of \$1.50 for residents of Illinois or New York City; \$1.88 for residents of California, except Los Angeles, \$2.25.

Please send me free descriptive literature about the new Zenith "75".

Name \_\_\_\_\_  
Address \_\_\_\_\_  
City \_\_\_\_\_ State \_\_\_\_\_

# 3 BIG VALUES



## AIR FORCE GENUINE SUN GLASSES

Guaranteed genuine air force issue. Brand new. Spec. No. AN-6531 (none genuine without this spec. no.) 6 base lenses, mfg. by Fischer, Bausch & Lomb and American Optical. Complete with case. \$10.00 value!

**\$5.95**

Air Force "Type" Sun Glasses \$2.49

## Genuine B-7 GOGGLES

Brand New. Air force flying goggles. Metal frames, rubber face piece, chamois lined. Precision ground lenses. Government cost \$7.20.



BRAND NEW

**\$1.98**



## Genuine M-6 COMPASS

Fine precision compass by "Sherrill". Easy to compensate, equipped for nite lite, excellent for planes, cars, boats, trucks, etc. Easily mounted. Instruction manual and calculator included. \$25.00 value. Nite lite and cord 50¢ additional. Mail orders prepaid. COD's add 10%. Write for new circular PS-2C showing hundreds of other govt. surplus bargains!

**\$5.95**

**FISLER SALES CO.** 721 Walnut Kansas City 6, Mo.



## New Invention 1 MINUTE TIRE TOOL

Make big money re-tiring cabs, tricycles, wagon wheels. Easy to operate. For shop or home. Guaranteed satisfaction. Send \$5. Tool shipped prepaid in U.S.A.—Canada.

**\$5.00**  
PREPAID

**O. P. DAVIS MANUFACTURING CO.**  
Waterloo, Iowa

## TOOL STEEL DRILL ROD

**\$1.95**  
POSTPAID  
IN CONTINENTAL U.S.  
C.O.D.'S ACCEPTED

## 25 Rods SAMPLE KIT 25 Sizes

Ground and Polished to a Perfect Finish  
1001 Uses for Craftsmen, Hobbyists, Mechanics, etc.

Ideal for Making  
PUNCHES ENGRAVING SHAFTS,  
CHISELS TOOLS ETC.  
Free machining, easily worked, yet can be made file hard or hardened to spring temper. Hardening instructions included: Entire kit.....\$1.95

## FLAT TOOL STEEL

The Precision ground flat tool steel with the satin-smooth finish. Simple to work, easy to harden, ready to use. Shop Assortment \$4.80. (5 dif. Pieces—1/32" to 1/8" thick, 1/2" wide; 18" long.)

**BOTH KITS.....\$6.50**

Complete range of sizes and shapes in steel, aluminum, brass and stainless steel for every need. NO EXTRA CHARGES for cutting, shipping, warehousing, etc.  
Include 25c postage on orders under \$5.00.

### FREE

With Every Kit or first order 6" Steel comb. rule and depth gage with pocket clip and latest price list.

**BESSEMER STEEL COMPANY of AMERICA**  
Dept. CE-16, 3417-25 27th St. • Chicago 23, Ill.

# Earn BIG PAY Now!

## FREE EMPLOYMENT SERVICE

Learn These Trades  
In the Big Allied Shops

Choose one of these **6** LEADING TRADES

- Machinist Trade
- Tool & Die Making
- Tool & Die Machine Designing
- Mechanical Drafting
- Tool Engineering
- Industrial Product Illustration

## BIG SHOP TRAINING

Largest School of its Kind in the World

## FREE! BIG METAL TRADES ILLUSTRATED BOOK

APPROVED FOR VETERANS  
WRITE TODAY: A 1c Postcard will do.

**ALLIED SCHOOL OF MECHANICAL TRADES**  
1338-1340-1342 So. Michigan Ave.  
444 Allied Bldg.

Est. 1928  
CHICAGO 5, ILL.

## A PROFITABLE TRADE! AN EXCITING HOBBY!

## Learn... PHOTO NEGATIVE RETOUCHING

**\$17.50**

Increase your income... Improve the quality of your own photography. New 5 week home study course—1 lesson each week—will teach you how. Complete course and all necessary equipment only \$17.50. For FREE brochure and complete details write today!

**MARSHALL PHOTOGRAPHERS, Inc. School Division**  
162 N. State St. Dept. PS-4 Chicago 1, Ill.

## BURN WATER IN YOUR CAR



The New OCTA-GANE Water Injecting Carburetor Gives More Power & More Pep More Milage & More Pick-up Cleaner & Cooler Motor Only \$22.25 Complete With Tank Send Today!

Mail postcard for particulars.  
**CONTINENTAL CARBURETION**  
456 Station A, Richmond, Calif.  
DEALERS: Write on your letterhead for information and discount sheets.

## BASEBALL GAME



**NEW** Packs thrill of Big League Ball—strike outs, stolen bases, etc. Play anywhere, any time, any place. Game takes 5 minutes. Fast! Easy to learn; for one or more players. No table needed. Set of complete instructions \$1. postpaid. **FREE** score pad. Order today.

PLAYED WITH CARDS

**D. E. BATES**

2729 Humbolt Ave. So., Minneapolis, Minn.

## POWER Your Lawnmower

Convert Your Mower to a Power Mower. Use old auto generator and car battery or gas engine. Plan also shows how to make an electric rotary-blade mower from easy-to-get materials. Complete PLANS & Catalog 35c.

**LEJAY MANUFACTURING COMPANY**  
823 LeJay Bldg. Minneapolis 8, Minn.

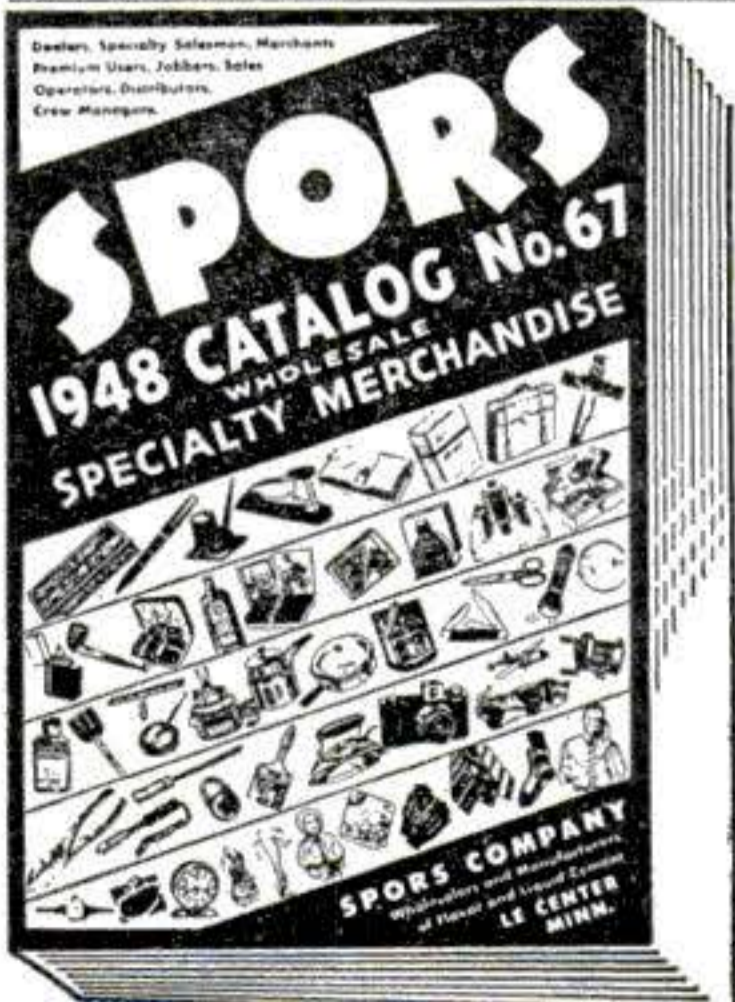
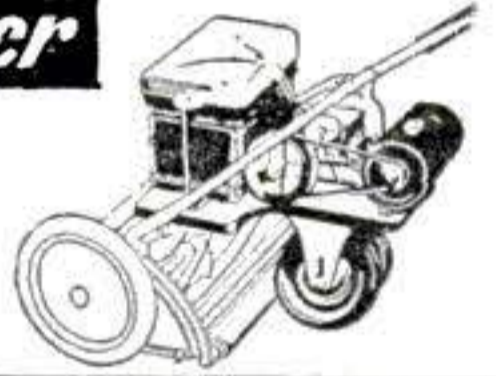

## 6000 SMASH HITS— IN 324 PAGE

## Wholesale Book

Dealers, agents, salesmen and jobbers, you will find this book bulging with Tested Money Makers. Latest catalog shows average price reductions about 21% on many items. A guarantee of satisfaction stands back of every purchase you make from us. 25c brings you this latest 1948 wholesale catalog of Tested Sellers. You may take credit for the 25c on your first order. In that way the Book will not cost you any money. Get your copy now, before supply is depleted.

**SPORS CO.** 2-48 Smith St. Le Center, Minn.

# A NEW ONE-MAN SAW

There is no other like it!

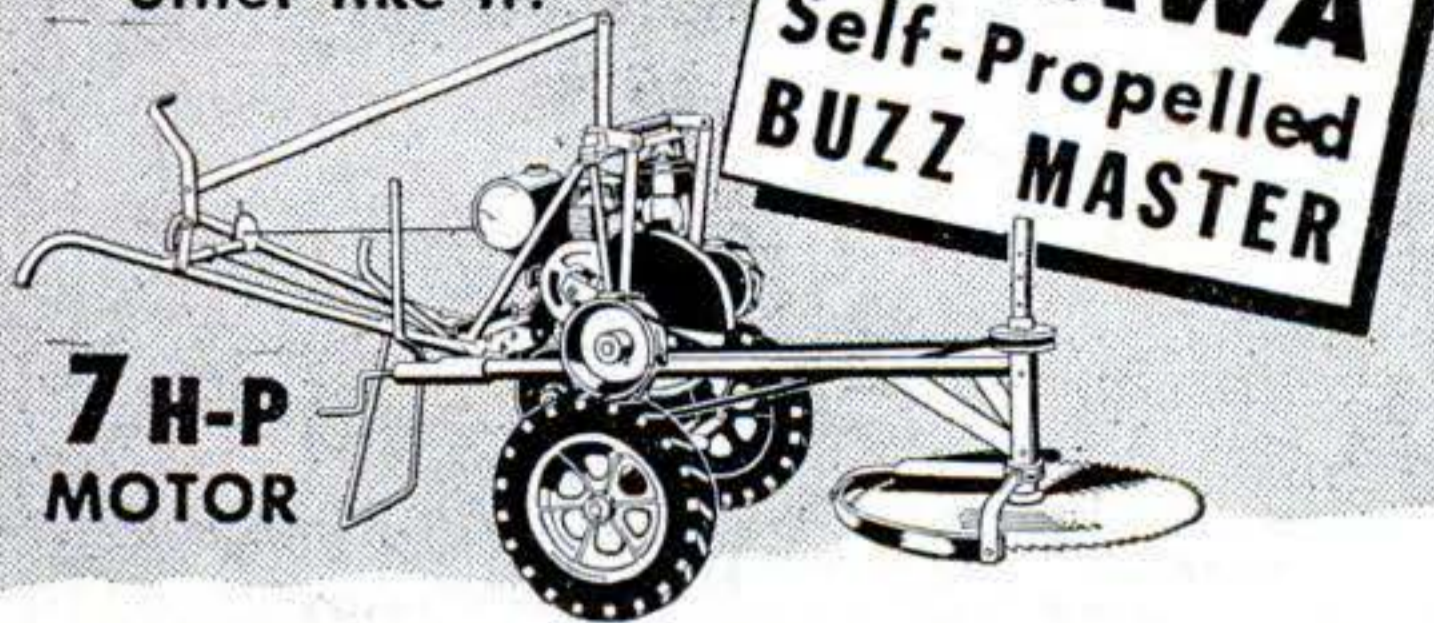

**OTTAWA**  
Self-Propelled  
**BUZZ MASTER**

**7 H-P**  
MOTOR

**Post Hole Digger and Sickle-Bar Attachments Available.** New improved OTTAWA Buzz Master. 2 speeds for cutting heavy brush and for road travel. Clears land of brush, saplings and large trees. Goes anywhere on its own power. Hills no obstacle. Most useful saw ever built. Pulley for belt jobs when not sawing. Reclaim waste land this easy way. Make plenty of money doing custom work. Endorsed by Conservation experts. Ottawa leads for fast, profitable sawing. Strictly a one-man machine. Woman or boy can operate. Write for FREE details.

**OTTAWA MFG. CO., 2-801 Walnut, Ottawa, Kan.**

## SWISS MUSICAL UNITS



Ready to install in your own musical box. Choice of Waltz, Operatic, or Classical Selections.

**\$3.75 EACH**

Postpaid if cash with order. Literature on request.

**A. & R. MUSIC BOX CO.**

582C Third Ave., N.Y.C. 16

(Agents Wanted)

This SPARKRITE ELECTRONIC COIL Gives Your Car

More Miles Per Gallon  
Higher Frequency Spark

More Power and Pep  
Faster Pick Up

ONLY \$5.00  
Post Paid  
SEND TO-DAY!



MONEY  
BACK  
GUARANTEE

Mail Postcard For Particulars - State Make & Year of Car When Ordering  
Knowing that you will recognize the many immense benefits of the SPARKRITE, we offer you a fifteen day trial on your car FREE.

PACIFIC ENGINEERING ENTERPRISES Box 456, Station A, Richmond, Calif.

## The Original NIGHTINGALE SCIENTIFIC BAROMETER

Forecasts the weather  
Instantly 8 to 12 hours  
in advance

At last an accurate barometer at a cost within the reach of everyone. Actually more accurate than dial barometers costing ten times as much. Beautifully designed and made of antiqued metal with graceful crystal clear bulb to beautify any room.

Complete, ready for instant use plus, interesting, historical "Story of the Barometer." Truly a "once-in-a-lifetime" value.

Send only \$1.00, we pay postage. Add postage on C.O.D. orders. Your money back if not satisfied.

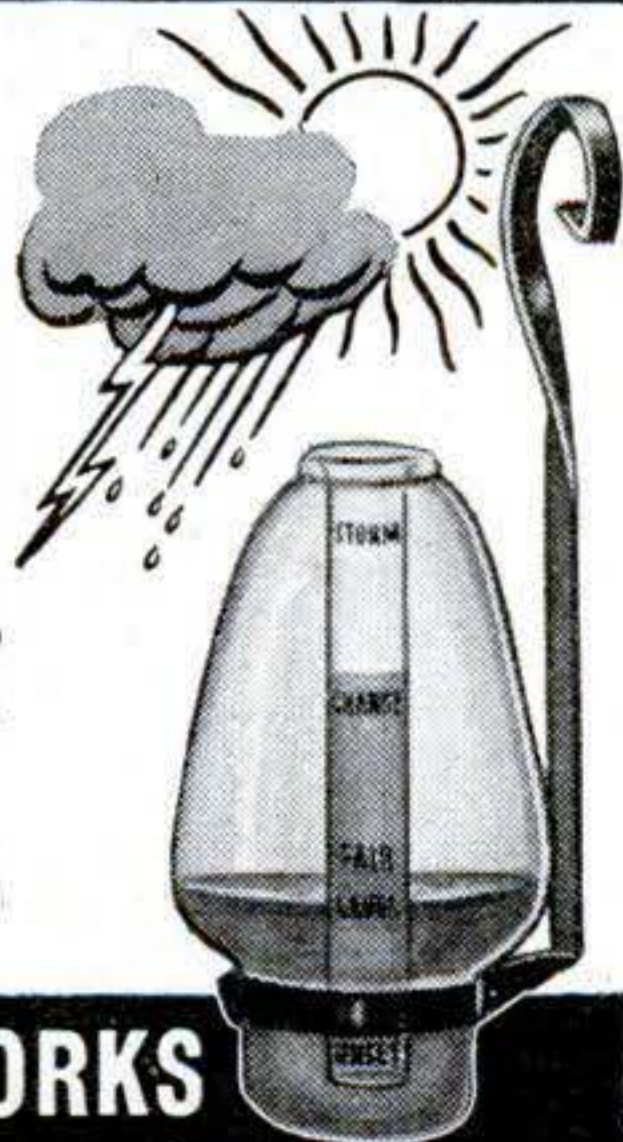

**ELRAM LAMP WORKS**

Dept. P 220 Adams St., Hoboken, N. J.



# BIG MONEY IN TELEVISION

**BUILD TELEVISION SETS for PLEASURE and PROFIT!**

Learn television by building your own television set with the famous TRANSVISION Television Kit. Big future in this growing field.

TRANSVISION KITS save you upward of 50%. Large 12" tube Kit costs you only \$289.50; gives larger image, better sight

and sound reception than many sets selling at

\$500.00. Each Kit is COMPLETE with all tubes, pre-tuned R.F. Unit, antenna, wire, solder, and instructions.

EASY TO ASSEMBLE. No technical knowledge required. Clear step-by-step instruction manual guides you to successful assembly in 24 hours.

TRANSVISION "Service Notes" gives you priceless education in television.

FLASH! Brand new 15" tube Kits now available. Also 7", 10" and 12" tube Kits. Tremendous savings. All Kits backed by factory guarantee. Write today for further details to Dept. P.S.



SEND FOR  
FREE  
CATALOG



**BEACON TELEVISION, INC.**

785-R THIRD AVENUE

NEW YORK 17, N. Y.

## A PROFITABLE BUSINESS OF YOUR OWN?

OF COURSE!  
HERE'S HOW →

THE *Scimitar*  
SELF-POWERED LAWN  
MOWER IS THE ANSWER!

The American Way is the only way! Here is a product that will establish a future for you in a business all your own. The ownership of a Scimitar will make you financially independent. Own the best self-powered lawn mower on the market! It cuts

within 1/2" of trees and buildings, under hedges and shrubs. Adjustable cutting heights from 1/2" to 3", but will cut heavy growth with ease. Trouble free, rapid performance and a money-maker. Remember, it will cut one acre per hour.

WRITE NOW!  
WE WILL SEND  
FULL PARTICULARS



**POWER DEVELOPMENT CORP.**

6719 DENISON AVENUE • CLEVELAND 2, OHIO

**AVIATOR'S OXYGEN OUTFITS**

Bail out type. Consists of all metal tank, release valve, gauge and breather hose, all enclosed in khaki colored cloth bag. These tanks are loaded with oxygen at 1800 pressure. Ideal for use as reserve oxygen supply for all types of emergency use. Shipping weight 4 pounds. All brand new.  
**Stock No. 391—Each... \$4.95**

**MESS KITS**  
 Regulation two-piece Army Mess Kits with folding handle. Used, but perfect. Weight 2 lbs. No. A116—Ea. **69c**

**CANTEENS**  
 Reg. U. S. issue canteens. Plastic screw top chained to body. Slightly used but perfect. Wgt. 1 lb. 117—Metal 118—Plastic—Ea. **69c**

**CANTEEN CUPS**  
 All metal. Folding handle. Wgt. 1 lb. No. A120—Each... **25c**

**CANTEEN COVERS**  
 Heavy canvas. Button fastener. New No. 530—Each... **69c**  
 Used No. 119—Each... **35c**

**WIRE CUTTER**  
 Heavy duty type with compound leverage. Cuts up to 1/4 inch wire. Extended upper jaw acts as feeder to cutting edges. Insulated handles. Ideal for farm fence work and shop use. Shp. wgt. 2 lbs. **Stock No. 392—Each. \$1.95**

**Heavy Duty Rubber Gloves**  
**BRAND NEW**  
 Extra heavy—extra long. Brand new, high quality gum rubber for softness and ease in use. Designed for heavy duty industrial service—protection in handling chemicals, acids, etc. A real bargain at this low price. **Stock No. 295—Per Pair, Only... 79c**

**Shatterproof Goggles**  
 All purpose type. Sponge rubber frame. Red shatterproof flexible lens. Adj. head band. With case. New.  
**Wgt. 1 lb. No. 139—Each... 39c**

**STOP WATCH**  
 Genuine Elgin 15 Jewel movement. Ideal for split second timing in racing, sports, time study, etc. Full sweep split second hand graduated in 1/10th seconds. Stem wind, start, stop and reset. Used but guaranteed perfect. A splendid value. Shp. wgt. 1 lb. **No. 200—Each... \$9.95**

**HIGH PRESSURE SHATTERPROOF TANKS**  
**TYPE D2**  
 A high pressure shatterproof tank of 500 cubic inch capacity—for 50 pound pressure or 6.9 cubic feet. All metal—measures 6 1/2 x 24 inches. Threaded plug end vents. Shp. wgt. 6 lbs. **No. 388—\$2.45**  
**TYPE F1**  
 A high pressure shatterproof tank of 1000 cubic inch capacity—for 50 pound pressure or 13.8 cubic feet. All metal—measures 9 1/2 x 17 inches. Threaded plug end vents. Shp. wgt. 11 1/2 lbs. **No. 389—Each... \$3.75**

# WAR SURPLUS AND HUNDREDS OF OTHER BARGAINS

**POPULAR RECORD ASSORTMENT**  
 Fifty records of modern dance, race, blues and hillbilly selections. No two alike. Famous name bands and artists included. Used in juke boxes, but guar. perfect. Shipped exp. collect only—no exchanges or refunds. Wgt. 28 lbs.  
**No. A300—25 Records. All Dance. Wgt. 14 lbs. \$4.88**  
**No. A301—25 Records. Hillbilly, Race and Blues. Wgt. 14 lbs. Set. \$4.88**  
**No. 302—25 Records. All Hillbilly numbers. Wgt. 14 lbs. Set. \$4.88**

**FLEX. NECK FLASH LIGHT**  
 Ideal trouble shooter's flashlight. Flexible neck lets you direct light around corners and inaccessible spots. Brand new! Plastic case with BX type neck. Uses 2 standard flashlight batteries. (Less batteries) Shp. wgt. 2 lbs.  
**No. 205 Each \$1.39**

**RADIO HEAD- PHONES**  
 Extremely sensitive with 4000 ohms resistance. Brand new and fully guaranteed. With moisture-proof cord and phone plug. A splendid value for the radio serviceman and experimenter.  
**A106—PAIR... \$2.95**  
 New supersensitive phones.  
**A108—Pair... \$5.95**

**PUP TENTS**  
 Regulation Army Pup Tents of durable, brown canvas. Used, but in good condition. Fine for campers, outdoorsmen, Boy Scouts, etc. Wgt. 8 lbs. **A100—Tent only... \$3.95**  
**A110—Tent, new... \$7.95**  
**A101—Ropes, wooden poles and stakes for above. Per set... \$1.00**

**27 LENSES, ALL NEW, PERFECT.**  
 For experimental work in optics. Consists of 27 precision ground and polished prisms and lens elements in assorted diameters and focal lengths. Big variety, positive, negatives, etc. Actual value over \$100.00. **A519—27 PIECES \$7.95**

**ARMY TENTS 16x16 Ft.**  
 A value you can't beat. Big 16x16 ft. pyramid tent with 4 foot drop wall. Used but in excellent condition. Poles not included. Fine for camping out, carnivals, etc. Worth twice this money. Shp. wgt. 100 lbs. **Stock No. 521—Each only... \$35.00**

**STIRRUP PUMP**  
 Works with any pail or bucket. Shoots a high pressure stream up to 30 feet. Use it for spraying garden and trees, for whitewashing, fire fighting, drainage, etc. Complete with 10 foot flexible hose. All brand new. Regular \$3.80 value. **No. 244—\$1.49**

**ORDER DIRECT FROM THIS AD**  
 Values galore! Hundreds of hard-to-find items for home, shop and outdoors. Make remittances by money-order, bank draft or personal check. Send 25% deposit on C.O.D. orders. No C.O.D.'s on orders for less than \$5.00. Include sufficient postage on parcel-post orders—any overage will be promptly refunded. All quotations F.O.B. Chicago. Used items and materials are guaranteed serviceable and as described. Your money back if not more than satisfied.  
**Big Illustrated Catalog Free**  
**WRITE FOR YOUR COPY TODAY**  
**STARK'S** Dept. PS4  
 509 S. State St. CHICAGO 5, ILL.

**FISHING REEL**  
 Exceptional quality for this low price. Has rugged one piece frame. Ratchet drag. Single action. Attractive catalin handles. Brass bearings for smooth operation. Full 100 yard line capacity. Brand new! A splendid value at this low price. **No. F412, Each... 98c**

**BAYONET BLADE**  
 Fine forged steel. Ground but not polished. May be made into throwing or hunting knife or spear. Blade 6 3/4 x 7/8 inches, 1 1/4 inches overall. Will take and hold a fine edge. Shp. wgt. 1 lb. **No. 664-R—Each... 49c**

**AVIATOR'S BREATHING OXYGEN TANK**  
 Loaded with aviator's breathing type oxygen at 1800 pounds pressure. Tank measures 13 1/2 x 5 1/2 inches with rounded ends. Tank is of solid metal fitted with brass release valve at top. Brand new! Loaded—ready for all types of emergency use. Shp. wgt. 13 pounds. A real value! **Stock No. 390—Each, only... \$3.50**

**Officers Watch Compass**  
 Brand new gov't. surplus. Army-Navy model. Single jewel mounted needle. Silver colored dial. A splendid value. Shp. wgt. 1 lb. **A174—Each... 98c**

**McCLELLAN SADDLE**  
 Brand new! Top grade cowhide. 12 inch seat. Hair girth. Has straps for blanket roll and knapsack. Gun boot and sabre loops. A real buy for any horseman. Worth much more. Shipping weight 15 lbs. **Stock No. A145. Each... \$16.95**

**WOOL SLEEPING BAG**  
 G.I. type 100% wool with 30 inch Talon zipper. Used but renovated for reissue. Shp. wgt. 3 lbs. **No. 165. \$3.95**

**AMMUNITION BOX**  
 Used for 50mm ammunition. Heavy, all metal design with latching top and folding handle. Provides safe, fireproof storage for valuables, etc. Measures 12x6x7 1/2 inches. Used but in new condition. Shp. **Wgt. 8 lbs. No. 338—Each 79c**

**RUBBER SUIT**  
 Fits over your regular clothes and shoes. Can be cut apart for waist high waders, hip high or knee high boots, also arm length rubber gloves. Heavy gum rubber over fabric. Fine for those who work in the water, commercial fishermen, sewer diggers, etc. All brand new! **Wgt. 14 lbs. No. 183—Each... \$4.95**  
 Please add 15c for postage.

**WILLARD 1 1/2 VOLT STORAGE BATTERY**  
 A rechargeable, wet plate battery good for years of service. Brand new. Battery is shipped dry but fully charged—any battery station will add acid. Use singly or in multiples for radio sets, bell circuits, alarm systems, etc. Measures 5 1/4 x 4 x 3 inches. Ball floats indicate proper level for filling. Shp. wgt. 4 lbs. **Stock No. 297—Each Only... \$2.95**



Classified Ads only 70c per word per insertion, payable in advance. Minimum ad 10 words. To be included in June issue, copy should be in our office by April 26th. June issue on sale June 1st.  
**POPULAR SCIENCE MONTHLY—351 FOURTH AVE.—NEW YORK CITY 10**

## 1 AUTOMOBILES

**RACING** Car Equipment for all cars. Engines, Racing Heads, Manifolds, Carburetors, Mufflers, etc. Speed instructions and literature \$1.00—refunded first order. Lee Motorcraft Co., 1412-B Great Northern Bldg., Chicago 4, Ill.

**USED-CAR** Buyer's Handbook. Save dollars, grief. Photographs, dealers' tricks, complete tests. \$1 pp. Post Publications, Box 723-TC, Arcadia, California.

**BRITISH** Sports cars. New book. 96 makes described. Fine illustrations, specifications. \$2.00. DeLuxe edition \$3.00 postpaid. Clymer, Dept. B-47, 2125 W. Pico, Los Angeles 6, Calif.

**AUTOMOBILE** Racing, Sixth Edition, 100 illustrations. Working drawings with building instructions for Ford-60 midget, California roadster, Offenhauser racer. Details on racer parts. Sample entrance blank. World's record 158.5 M.P.H. rear engine four-wheel drive car. Interesting information for fans, drivers, mechanics. \$2.00 postpaid; \$2.25 C.O.D. Ray Kuns, Department 62, Cincinnati 27, Ohio.

**IMAGINE**, 250 miles per gallon your car now. Literature 25c. Jet Engine Co., St. Augustine, Fla.

**CLYMERTONE**, Twin muffler sets, beautiful sound, complete with necessary welded pipes, E-Z installation. Ford V-8, \$20.00. Chevrolet set with split manifolds, \$37.50. Specify car model. Clymer, Dept. B-44, 2125 W. Pico, Los Angeles 6, Calif.

**"STREAMLINED Roadster"**—Speedy two passenger automobile! Beautiful! Practical! Sporty! Unbelievably easy construction from scrap parts—small motor! Instruction Kit P-1-u-s Handbook showing Midgets, "Motor-ette." Racer blueprints. Almqvist Engineering, Milford 5, Pennsylvania.

**"CUSTOM Styling"** manual—Easily make car look Hollywoodized, custom, ultra-beautiful by quick inexpensive methods! 100 photographs, instructions on customizing, restyling, streamlining—new and old cars. Also model, sport, conversions; accessories; mufflers, engine "Soup Up" specifications! \$2.00. Almqvist Engineering, Milford 5, Pennsylvania.

**KAISER-Frazer**. Floyd Clymer's new book (no connection with Kaiser) gives uncensored, impartial report 3000-mile test including Pikes Peak, Kansas City—Denver record runs, economy test. Part by part equipment analysis. Good, bad comments, no punches pulled. \$1.50 postpaid. Clymer, Dept. B-41, 2125 W. Pico, Los Angeles 6, Calif.

**"SPEED & Mileage"** manual—Obtain greater speed, mileage racing performance from any automobile! Shows "Simplified Speed Tuning"—Mileage secrets—"Soup-up" tips! Instructions on building speed equipment, economizers, mufflers, "water injectors," manifolds, superchargers, fuels, heads, "hotrods," fast conversions, engines! Also "Hollywood Customizing" information, photographs, parts lists! \$1.98. Almqvist Engineering, Milford 5, Pennsylvania.

**MAKE** your Ford fast! Complete details, photographs. How to construct 120 mph Hotrod. \$1 postpaid. California Bill, Box L-2, Eaglerock, Los Angeles 41, Calif.

**FROM** Speedway to Roadway! Track-proved Hi-speed Heads and Manifolds now available for your passenger car! No special tools needed! Increase horsepower 25%! Astounding getaway! Free illustrated catalog. Speedsport, 5747AB Waveland, Chicago 34.

**HOTROD** and fast car equipment. Heads, camshafts, dual manifolds, mufflers, etc. List 25c. Build up your V8 or Chevrolet for racing, hotrod, or hot stock-car. Specify which make. Instructions \$1.00. Alden Motors, Oakland City, Ind.

**HIGH** Compression heads. V-8. More speed, acceleration, power. Offenhauser or Edlebrock \$75.00 complete set. Dual manifolds, complete with throttle kit, fuel lines. Edlebrock \$49.00. Offenhauser \$55.00. Give make, model V-8. Catalog 10c. Clymer, Dept. B-43, 2125 W. Pico, Los Angeles 6, Calif.

**BUILD** speedy midget track racer from castoff parts! Plans, specifications, construction information, \$1.00. Motor Supply, Box CS-1682, Toledo, Ohio.

**CUSTOM-Car** Photograph Album. Fascinating automobile style classics! Coachcraft. Summers, independents, photo-packed! \$1 pp. Post Publications, Box 723-AC, Arcadia, California.

**NO. 4** Clymer Historical Scrapbook. Entirely new, different. 224 pages, advertisements, photographs 250 early automobiles, motorcycles. \$1.50. DeLuxe edition \$2.50 postpaid. Clymer, Dept. B-48, 2125 W. Pico, Los Angeles 6, Calif.

**"SPEED & Power"** handbook—Very latest methods! Construct your own superchargers, water injectors, compression heads, fuel saving devices—Easily, practically without cost. Get racing speed, acceleration, dynamic power increases from any automobile! Build stock conversions! Fast roadsters! Hotrods. Ingenious formulas! Speed secrets! Fuels. Lubricants. Get "Economy Information"—Tuning techniques! Ignition! Carburetion! Mileage tricks. Literature! Illustrations! Including "Restyling ideas"—Streamlining. Model revising! Customizing! Sport changes. Accessories! Parts lists! Drawings! \$1.98 complete. Newhouse Industries, 5941-A1 Hereford, Los Angeles 22.

**RACE** Driver History. Complete information every driver competing Indianapolis "500," 1911 to present. 313 drivers performance records every year alphabetically arranged. \$1.50 postpaid. Clymer, Dept. B-RD, 2125 W. Pico, Los Angeles 6, Calif.

**DUALTONE** Crystalline packed, California mufflers, single or twin for all automobiles. Carburetor Velocity Stacks. Compression cylinder heads. Dual manifolds. Large double or single chromed tailpipe extensions. Chromed Station Wagon Stacks. Fender Skirts. Request Catalogue. Openings for established dealers. Dualtone Mufflers, 2636B India Street, San Diego 1, Calif.

**BRITISH** Cars. New, unique book illustrates, describes 34 British postwar cars, all makes, models. 67 beautiful photographs. A real catalog. Just out. \$2.00. DeLuxe edition \$3.00 postpaid. Clymer, Dept. B-PW, 2125 W. Pico, Los Angeles 6, Calif.

**CUSTOMIZE** Your automobile! Revised, enlarged book, latest restyling, complete, sharp. 50 photographs! \$1 pp. Post Publications, Box 723-SC, Arcadia, California.

**INSTALL** V-8 engine in your Model A for extreme acceleration, more top speed, smoother performance. Complete details, photographs, \$1 Postpaid. A-V-8, Box L-2, Eaglerock, Los Angeles 41, Calif.

**"VAPO-Steamatic"** Water Injection. Thousands using this famous automatic system. Easily assembled (for less than \$1.00). Saves gasoline. Engineering triumph—up to 33 miles per gallon! Burns 15% water! Reduces wear. Greatly increases horsepower! Speed! Prevents knocking, over-heating. Eliminates carbon. Smoother performance! Copyrighted "Installation Handbook." Also "Injectors"—tractors, lightplanes, trucks, motorcycles. Including "Mileage Secrets"—Gas savers, economizers! Carburetion! Power methods! Tricks! Illustrations! Lists! \$1.98. Newhouse Industries, 5941-A1 Hereford, Los Angeles 22.

**INTERCHANGEABLE** Parts Book. New book tells every automobile part that interchanges with others. Same parts many times vary 100% in price. This book enables garages, mechanics, dealers, owners to buy under cheapest listing. Tremendous savings for users. \$15.50 postpaid. Clymer, Dept. B-IP, 2125 W. Pico, Los Angeles 6, Calif.

**HOT-Rod** manual, fast Fords, photos, instructions \$1.50 air mailed \$1.75. Racing parts list \$.25. Hollywood Hot-Rod Los Feliz, Box 9626 S. Hollywood 27, California.

**MAKE** Your Model "A" do 100 mph. Lightning acceleration, breath-taking top speed. Complete details. Photographs. \$1 Postpaid. Four Barrel, Box L-2, Eaglerock, Los Angeles 41, Calif.

**NEW** Streamlined motorbikes. Send twenty cents for photo. Thomas Fisher, Antigo, Wisconsin.

**SEE** our ad under Motorscooters for midget car bargains. Midget Motors Directory, Athens, Ohio.

## 2 AUTO SUPPLIES & EQUIPMENT

**AUTO** parts. New or rebuilt. Prompt shipment. Write requirements. Save money, buy direct. Factory warehouse, Mechanics Auto Parts, 3807-PS North Ashland Ave., Chicago 13.

**PLATING** Outfits For Autoparts. Connect to a battery. No tanks used. Outfits furnished. Free particulars. Gunmetal Co., Ave. K, Decatur, Ill.

**AUTO** parts for all autos and trucks. Trans. motors, differentials, fenders, carburetors. Also Body Parts. Security Auto and Truck Parts, 1923-PS Grace, Chicago 13.

**FORD-Mercury** owners 1941-1947, operate your dome lights from both front doors. \$2.50 free literature. Danby Manufacturing Company Portland 4, Michigan.

**NEW** and used car and truck parts from 1906 up. When ordering give year, make, model, serial and number on part. Bill's Auto Parts, Valley Falls, R. I.

**FREE** trial in your car; Order Gane air flow needle today. \$1.50 postpaid; Ten day money back guarantee, if not satisfied. For all cars, trucks, tractors, state make of car, truck, tractor, Make of carburetor. Advanced Automotive Products, 563-4 Lake Road, Webster, N. Y.

**"POWERIZE"** Water injector—increase speed, acceleration, mileage to 30%. Easily assemble yourself for few cents! Sensational performance! Reduces wear, knock, oil pumping! "Installation Manual" includes "Hop-up" Tips. \$1.00. Almqvist Engineering, Milford 5, Pennsylvania.

**BATTERY** Cement. "Fixes cracked Batteries"! Saves money! Batteryman, Grand Junction, Colorado.

**TRAILER** hitches for Chevrolets only. models 40 thru 47. Bolts to frame and bumper. With ball \$4.50 Postpaid in U.S.A. Give Model of car. No C.O.D. Strong Mfg. Co., 416 South Second St., Albuquerque, New Mexico.

**WELDERS** for all requirements. Free catalog. Write Hobartweld, Box P-483, Troy, Ohio.

**READY-Made** convertible tops. Easily installed. Reasonable prices. Free literature. Rio Top Company, 1370 Roanoke, Newport News 5, Virginia.

**PISTONS:** Old & New Cars. Discounts. M. Merryman, Lawndale, Calif.

**AUTO** parts—new or rebuilt—for all cars. Starters, generators, carburetors, clutch assemblies, transmission and differential gears. Everything you need. We have large stock—can ship fast. Write us—Grove Auto Supply, Dept. PS, 4854 Cottage Grove, Chicago, Ill.

**SAFETY** rain pad for your windshield. Send 50 cents to Carl Wonner, 603 S.E. 46th Ave., Portland 15, Oregon for a Safety Rain Pad.

**NEW** zip, economy for your car. "Lektron" spark intensifier. State make car. \$1.25 plus C.O.D. Electronic Industries, Box 2733, Cleveland 11, Ohio.

**MOTORISTS** save gasoline by Vacuumating overrich mixtures. Fits all cars. For free particulars write Vacuumatic, Dept. 1317, Wauwatosa, Wis.

**FORD** V-8 owners—EZY-Fill oil filler pipe extension. Not an accessory, a necessity. Saves oil, wiring. Fumes eliminated through air cleaner. No drilling, no bolts. \$1.10 postpaid. Metalart Co., 11374 Tennessee, Los Angeles 25, California.

**WELDING** bodies, repairing fenders pays good profits. Easy with Hobart A.C. Welder. Catalog free. Write Hobart Welders, Box P-482, Troy, Ohio.

## 3 AUTO TRAILERS

**TRAILER** Plan booklet, house, sport, etc. with complete parts, accessory catalog, book Trailer Building—\$1.00. Marine Mart, Buffalo 7A, N. Y.

**BUILD** Your own trailer! Save money! Have every feature you want! Plans for house, sport, camp and utility trailers. Catalog describing 9 models 10c. 15c in Canada and overseas. Jim Dandy, Box 125-B, Wausau, Wisconsin.

#### 4 MOTORCYCLES, BICYCLES, SUPPLIES

**MIDGET** automobile \$15. Cushman motorscooter \$20. Indian motorcycle \$30. tires 75c. Send 25c for Spring catalog #940 listing sensational bargains in motorscooters, Servicycles, midget cars, used motors, parts. Associated, Box CS-1764, Toledo, Ohio.

**MOTOR** Scooters, bicycle engines, 120 miles gallon. Dime for catalog. Clymer, Dept. B-45, 2125 W. Pico, Los Angeles 6, Calif.

**WHEELS!** Build wagons, scooters, mowers, trailers, wheelbarrows, grocery carts, baby carts, play pens, baby carriages. 4" to 16". Free list. Trulsen Mfg. Co., 811 E. 31, Kansas City, Mo.

**WHEELS,** Tires, Tubes for Motor Scooters, Midget Cars, Wheelbarrows, and Industrial equipment. All sizes. Bicycle Parts, accessories. Largest stock in United States. Send dime for list. Cycle Transport Company, 1241 S. Michigan Ave., Dept. C, Chicago 5, Illinois.

**MOTORCYCLISTS,** Chromium accessories. New and reconditioned motors. Complete Indian Parts. Expert motor rebuilding. Indian Motorcycle Sales, Kansas City 1, Missouri.

**FREE!** Illustrated folder custom motorcycle accessories. New seat covers, bright colors, molded cushions, \$6.75. Leather jackets, \$36.95. Chrome muffler-loudspeaker, \$15. Pacific Cycles, Dept. B-5, 1208 Pine, Seattle, Washington.

**MOTORSCOOTERS,** motorbikes, motors. List 25c. Osborne Motors, Box 915, Winston-Salem, North Carolina.

**MIDGET** racer \$40. Cushman motorscooter \$15. motorbike outfit \$15. Harley-Davidson motorcycle \$35. Send 25c for new catalog #12 listing amazing bargains in motorscooters, motorbikes, midget cars, motors, parts. Gail, 538 Erie, Toledo, Ohio.

**ASSEMBLE** sensational, clutch operated motorscooter speedster yourself! We furnish factory finished kits ready to bolt together. Rockbottom prices—Fork \$4.95, etc.! Complete plans, literature, 25c. Zip-scoot, 3839 Drummond, Toledo, Ohio.

**MOTORCYCLE** pistons and parts, new, used. Harley, Indian, Henderson, Super-X. List 10c. Ballak, 811 N. 9th, St. Louis 1, Mo.

**CUSTER** Car \$25. Ner-A Car \$35. other midget cars as low as \$12; motorscooters \$10 up; Briggs Stratton engines \$3 up; motorbike conversion \$5; Whizzers \$30 up. Over 5000 tires \$1 up. Mailorder only. Send 25c for Big War-Bargain catalogue No. 24, just out, listing the above and almost 400 other bargains in new and used motors, motorscooters, midget racers, parts, plans, etc. (35c by First class mail). Midget Motors, Directory, Athens, Ohio.

**FLAT** Rate repair manual for Harley-Davidsons. Gives flat rate charge for every operation. Every dealer, owner, mechanic needs this new book. \$2.00 postpaid. Clymer, Dept. B-FR, 2125 W. Pico, Los Angeles 6, Calif.

**INDIAN** Riders! Equip your "Chief" with Harley jiffy-stand. Special bracket, easily attached—\$3.25. Stand \$4.50 extra. Cycle Specialties Co., Box B, Havana, Fla.

**PROFESSIONAL** Midget racer, motor-scooter, midget roadster, midget motorcycle. Plans, specifications contained in illustrated handbook, 25c. Directory bargain priced used motors, motorscooters, Servicycles, etc., included free! Midwest, 3839 Drummond, Toledo, Ohio.

#### 5 AVIATION

**GIANT** Kites. Only \$20. Fraction government cost, 10x14 ft. Double tier. This monster tows cars, skiers, skaters, canoes. Lifts light persons, antennas, advertising, cameras. Pleasure. Profit. Great-Northern Mart, North Adams, Mass.

**VETERANS:** Flight training under the G.I. Bill. Private, Commercial and Flight Instructor Ratings. Write for information. Gottschalk School of Aeronautics, Adrian, Michigan.

**AIRCRAFT** sketches, any plane, you specify, 12 for \$1.00. Glen Winterscheidt, Seneca, Kansas.

**FLIGHT** Engineers Manual (Zweng) \$4.00; AAF Sextants \$12.50; Aerial cameras \$175.00; Hamilton AAF Master navigation watch \$71.50; (Free folder). Pan American Navigation Service, 12021-D3, Ventura Blvd., N. Hollywood, Calif.

**PROPELLERS**—2 & 3 blade, for snow-ice sleds, boats. Catalog. Standard Aircraft, Box 387, Ft. Worth, Texas.

**JET** Propulsion experiments. New design. Drive bicycle. Circular on plans. Rush name. Maupin, Tipp City 30, Ohio.

#### 7 ELECTRICAL SUPPLIES & EQUIPMENT

**LAMPS**—All parts to build or repair. Illustrated catalog 10c. Gyro Lamps, 5416-B, Chicago 40.

**LELAND** Electric generators, 2.5 KVA, 120 Volt, 60 cycle, single phase with radio filter. Turn at 1800 rpm, producing 2500 watts. \$125.00 freight prepaid. Hopfer & Company, 3124-B East 14th Street, Oakland, California.

**LAMPS**—Build own originals, parts wholesale any amounts. Catalogue 10c. Brown Lamp Co., Box 501 Wellston, St. Louis 12, Mo.

**FREE** Catalog motors, welders, welding supplies, generators, fencers, electric mowers, freezers, other electrical items. LeJay Company, Minneapolis, Minn.

**LAMP** sockets, mogul sockets, three way switches, tumbler switches, receptacles, cordsets, electrical repair parts, lamp parts, etc. Catalog 10c. Gearon Company, 6405H North Oakley, Chicago.

**ELECTRIC** pencil: Engraves all metals. \$1.00 postpaid. Beyer Mfg., 229-C Dixon, Uniontown, Penna.

**NEW** Double voltage generator 115 volt 1200 watt A.C., S.P. & 28.5 volts x 200 Amps. D.C. excellent for welding generators, lighting plants & experimental work. Shp. Wt. 60 lbs. No conversion necessary. results of huge purchase. Your cost only \$19.75 f.o.b. Surplus Sales, 24th St. & Cudaback Ave., Niagara Falls, N. Y.

**SURPLUS** New electric hand drills 1/4 capacity. A.C.-D.C.-60 cycles 110 Volts. Year guarantee. Special \$14.98. Leonard, 1300 Douglas, Los Angeles 26.

1/3 HP GE AC 110v, 1725 RPM, Newest motors. \$15.95. Domestic Electric, 118 E. 28th St., New York City.

#### 8 WELDING, SOLDERING

**WELDER**—New portable champion special Transformer Welder; 110/220 volts. AC. 8 heat stages. Welds, brazes, solder, cuts all metals. Complete with electrode holder, helmet rods, carbons, fluxes, cables. Also special Flame Weld Torch. Easy to use. Full directions. Splendid for shop, farm and home repairs. Guaranteed. Only \$27.50. Money back guarantee. Also resistor model. Now \$14.95. Magic Welder Co., 239 PS Canal St., New York, N. Y.

**ACETYLENE** Welding generator. Build it. Complete Plans \$1.00. P. O. 1325, Brownsville, Texas.

**RUBYFLUID** soldering flux, send \$1.00, get one pint liquid and 1/2-lb. paste flux with pamphlet "How to Solder." Ruby Chemical Corp., Columbus 8, Ohio.

**A.C. WELDERS,** 110 V, welds 1/2" steel \$29. Morris Welding Service, 1850-B State, Schenectady 4, N. Y.

**WELDERS** for all requirements. Free catalog. Write Hobartweld, Box P-485, Troy, Ohio.

**"BUILD-Ur-Own"** Portable Arc Welder. Save \$350. Easy with Hobart Generator plus auto engine. Free instruction book. Write Hobart Welders, Box P-484, Troy, Ohio.

#### 10 MACHINERY, TOOLS, SUPPLIES

**DRILL GRINDER**—Grinds drills to factory accuracy. Calipers with direct reading scales. Circle cutters. New Tool grinder. Lowest prices. Free literature. Factory, 811-A East 31st, Kansas City 3, Mo.

**BARGAINS** in war surplus. Hydraulic Transmissions, switches, motors, geared speed reducers. Aviation instruments, etc. Delta Sales, Dept. S-1, P. O. Box 968, Shreveport, Louisiana.

**POWER** Tools. Build your own with Lewis Castings. Save up to 80%. Complete castings, materials and blueprints supplied for 23 woodworking and metalworking tools. Free catalog. Write today. Lewis Machine Tool Co., 3217 Union Pacific Avenue, Dept. S, Los Angeles 23, California.

**WAR** Surplus special: Big 50 lb. box popular size bolts, nuts, washers, screws, clamps, etc. \$6.85. War Surplus Co., Box 910, New Brunswick, N. J.

**MODERATELY** Priced! Immediate delivery! Nationally known Portable Electric Sander. Woodworking power tools, Shaper, bandsaw, etc. Paint sprayers. Armand grinder. For schools, home workshops, cabinetmakers, farmers, garages, repair shops, others. Postcard brings free illustrated bulletin. H. Saltzman Co., Dept. G, 118-14 83rd Ave., Kew Gardens 15, N. Y.

**SPRING** steel adjustable tool chips. Keeps your tools and parts handy. Send 10c for sample. Baron Products, 20014 Rogge, Detroit 12, Mich.

**BAND SAW**—Bench type for home workshop—Ideal for hobbyists—Cuts wood, metal, plastic, leather, etc. Special \$14.95—Factory to you—Lowest priced band saw on market—Thousands in use. Free circular. Woodcraft Tools, Inc., 147 E. Lake, Minneapolis, Minn.

**CONCRETE** Block machines \$39.50 up. Catalog free. Concrete Mold Company, 5466 Gravois, St. Louis, Missouri.

**CHUCKS,** Independent, Universal, Threaded 1 1/2"-8 for South Bend, Atlas, Logan, Clausing, Craftsman Lathes. Also other chucks to 16". Top value. Free Literature. Westcott Chuck Co., 3700 Walnut, Oneida, N. Y.

**"BUILD-Ur-Own"** Combination AC welder and AC Power plant. Welding, plus power to run tools, lights, motors. Portable. Save \$350. Easy with Hobart Generator plus auto engine. Free instruction book. Write Hobartweld, Box P-486, Troy, Ohio.

**RUST-Free**—Keeps tools, photographic equipment, fishing tackle, etc. from rusting without oily coating. Employs new dehumidifying principle. Satisfaction guaranteed. Order today. Fifty cents. Rust-Free Sales, 1308 Girard, Middletown, Ohio.

**ANGEL** plate 3"x3x4" ribbed precision ground \$3.50. Rough casting 95c. Model Tool Service, Rockfalls, Ill.

**SPEED** Reducer—New variable speed transmissions. 2 Hp., continuous control either direction 0 to 30%. \$14.80. Engineering Research Laboratories, 520 South Boulevard, Norman, Oklahoma.

**SHEBEL** Saw Filer, \$7.50. Files all saws. Free trial. Circular, 730A So. 2nd St., Milwaukee 4, Wis.

**DRILL GRINDER** for twist drills \$2.95. See ad on page 278.

#### 14 BOATS, OUTBOARD MOTORS, ETC.

**FULL** size, cut to shape boat patterns, blueprints, 7 1/2—38 feet. Illustrated "Build a Boat" catalog, 10c (coin). "How to Build Boats" book, \$1.00. Cleveland Boat Blueprint Co., Dept. A-77, Cleveland, Ohio.

**PLYWOOD** Rowboat and Motor Boat K.D. Kits. Assemble and save up to \$57.50. Three popular models. Resin bonded, waterproof plywood construction. Easy to assemble in spare time. Write for free literature and complete specifications. C. R. Dillaugh Boat Co., 7928 N. E. Mallory, Portland 11, Oregon.

**INBOARD** hulls, outboard runabouts, hydroplanes, hunting, fishing boats, boat kits, boat trailers. Huebl Boats, LeSueur, Minn.

**SIGNALLING** Light—New—Gov't surplus. An exceptional value for boats, construction work, scouting, etc. Powerful light with three filters and case. At a fraction of cost. Operates on 27 volts or 110 volts with transformer. While they last, \$7.95, three for \$20. Amazing Bachman's, 25 Herman Street, Rochester 5, New York.

**AIRPLANE** Jettison tanks—streamlined, 10 1/2 foot, tear drop shaped, 165 gallon. Of light weight lead coated steel, weighs 75 pounds. Floats over 12,000 pounds. Ideal for making trim, inexpensive boats, canoes, kayaks, dinghys, duck boats, powered catamarans and runabouts. Prices \$12.50, \$9.75 each for three or more U. S. freight prepaid. General Sales, 205 Market, Grand Rapids 3, Michigan.

**OUTBOARD** motors—good values, used motors. Also used parts for most makes and models. Crandall-Hicks Co., 912 Commonwealth, Boston, Mass.

**LIFE** Rafts, Balsa wood, \$12.00 each. Chataw Trading Company, Jefferson, Tex.

**STREAMLINE** stabilizing Pontoons for canoes, kayaks. Pair \$9.95. Lorenzen Industries, Niles, Michigan.

MARINE conversions for Ford and Jeep engines, Catalog 10c, Lehman Manufacturing Company, Department A, Newark 2, New Jersey.

BOAT plans and patterns A. M. Deering, N.A. 228 North LaSalle, Chicago 1, Illinois.

See display ad page 67; Boat Patterns and Kits, Marine Mart, Buffalo 7A, N. Y.

## 15 ENGINES, MOTORS, ETC.

RANGER Engine—Aircraft—All new in original case, 570 HP, 12 cyl. V type. Air-cooled. Engine Spec. No. 177. Complete with spark plugs. Original Government cost over \$12,000.00 each. Special offer \$200. Crated weight 1200 lbs. No C.O.D. Write for complete description. "Amazing Bachman's", Dept. PS, 23 Herman Street, Rochester 5, N. Y.

WINDING Data, listing 225 motors, single and three phase, \$1.00. Motor Data, Box 7631, Kansas City 3, Mo.

JEEP, Chrysler, Ford, Marine engine conversion parts. Free Pamphlet, Star Marine Engine Works, Oakland 3, California.

ELECTRIC Motors (new) nationally advertised brands. 1/4 HP, 110 V, 60 C, 1725 RPM. Split Phase \$17.50. Condenser start \$20.50. Money back guarantee. Anderson Bros., 326 Meadowbrook Ave., Ridgewood, N. J.

MAGNETO repairing made easy, send for circular. Abbott Electric Co., Quincy, Ill.

MOTOR repair men, get our bulletins on stator winding tester, and A. C. motor winder. Motor Industries, Quincy, Illinois.

MOTORS, generators; any H.P.—voltage; AC or DC; Rebuilt. Year guarantee. Roberts Electric, 7232 Madison, Forest Park, Illinois.

WELDING generator, 150 ampere \$47.50. 1/2 horse 1725 RPM AC Motor \$24.50. Butler, 1885 Milwaukee, Chicago.

MOTORS! 1/2 h.p. d.c. converted to a.c. All new. High speed 110 volt 25 or 60 cycle, single phase, ball bearing motors. Actual value about \$75.00. Now \$15.00 each or 3 for \$40.00. With forward and reverse switch \$19.50. 3 for \$50.00. Can be used in any position. Immediate delivery! No C.O.D. "Amazing Bachman's", 27 Herman St., Rochester 5, N. Y.

## 18 BODY-BUILDING COURSES

ATHLETES, swimmers, tumblers—teenagers—co-operate with amateur photographers. Free information. Hobby Directory, South Orange, N. J.

BARBELLS! 95 pound set \$9.80; extra plates 9c pound. Send for free course and catalog. Bur Barbell Co., Lyndhurst, N. J.

BAR-BELLS, Dumbbells, Exercise equipment, Courses, Free booklet. Good Barbell Co., Reading, Penna.

## 19 SPORTING GOODS, GUNS, FISHING TACKLE, ARCHERY

SKI-TOWS, Portable, Auto-powered, 500 ft. long. Pulls you both ways. Up, level or downhill. Set up in 20 minutes. Only \$125. Send card for particulars. Great-Northern Mart, North Adams, Mass.

SHOTGUNS, Rifles, Revolvers. Over 500 Modern, Obsolete. Also Cartridges. List .10 coin. Ed Howe, 26 Main Street, Coopers Mills, Maine.

5,000 BARGAINS, firearms, binoculars, war relics, catalog 40c, Smith Museum, Rummel, N. J.

WADERS: Gloves, hood all-in-one for one price \$2.95 C.O.D. J. Glass Co., 1634 S. Main St., Los Angeles, Calif.

ANTIQUE-modern pistols, revolvers, swords, daggers, armor, 180-page illustrated catalog 50c. Robert Abels, 860 1/2 Lexington Avenue, New York 21.

SHOTGUNS, Rifles, Revolvers. Over 500 Modern, Obsolete. Also Cartridges. List .10 coin. Ed Howe, 26 Main Street, Coopers Mills, Maine.

CLOSING Out:—435 antique Firearms:—35,000 coins, relics, cartridges, swords, flintlocks, carbines, minerals, antiques.—Illustrated Catalog 25c. Heike, Wenona 2, Ill.

## 20 FIELD GLASSES, TELESCOPES, ETC.

TELESCOPES, Binoculars, Microscopes, —big bargain catalog free. Brownscope Company, 24 West 45th Street, New York.

7x50mm PRISM Binoculars, Zeiss design. New, save 75%. Sacrifice, \$49.50 plus tax. DuMaurier Co., 274 State, Elmira, N.Y.

GOVERNMENT Surplus — Telescopes, binoculars, lenses, prisms. Send stamp for "Bargain" list. Hobbyist lens set—Magnifiers, reducing lenses, positives, negatives. 10 piece set, \$1.00 — G. Jaegers, 123-26 Rockaway Boulevard, South Ozone Park 20, New York.

POWERFUL Astronomical telescopes easily made. Perfect lenses and instructions; 100 power \$3.00, 100 and 200 power \$4.00, 100, 200 and 400 power \$6.00. Clear vision and full power guaranteed. Instructions alone 10c. Suffolk Science Service, Manorville, N. Y.

VARIABLE Density filter for binoculars assures comfortable viewing under all conditions. \$1.50. Ross, Section B, 68 West Broadway, New York.

ASTRONOMICAL Mirrors—Made to order. Herman K. Stump, Winchester, Indiana.

POWERFUL astronomical Refracting telescope, equatorially mounted, all metal, two eyepieces, \$16.50. Bluhm Optical Lab., 1270 E. 83rd, Cleveland 6, Ohio.

ASTRONOMICAL telescope lens kit, 100x—200x—400x powers \$3.00. Microscope lens kit, 100x—200x—400x—800x \$2.00. Plans included. Pfeegor Optical Company, PS-4, Sunbury, Pa.

## 21 OPTICAL

NIGHT-driving bugaboo ended. Amazing new Nite-Lite driving eye-glasses stop blinding headlight glare of oncoming cars. See everything more clearly. Colors look bright and natural. Issued to police of many states and cities. Fulvue lenses with goldplated frames—\$8.50. C.O.D., check or money order. Orders Shipped postpaid anywhere in United States. Nite-Lite Sales Company—Dept. 2, St. Louis, Mo., 315 North Seventh Street.

## 22 BABY CHICKS

BABY Chicks, Champion Mated, 25 varieties, 6 hybrids, licensed inspected, blood-tested. Rush postal, large colored book free, low prices. Berry's Farm, Route 11, Clarinda, Iowa.

## 24 DOGS, BIRDS, PETS, RABBITS

RAISE guaranteed Chinchilla rabbits. Greatest profits from gorgeous furs, delicious meat, valuable breeders. Experience unnecessary. Fascinating hobby. Year-round money-making business. Write world's largest breeder today. Willow Farm, R-18, Sellersville, Penna.

\$5,000 YEARLY possible raising Angora rabbits our Co-operative marketing plan. Iowa Angora Association, Cedar Rapids, Iowa.

\$250 MONTHLY, Raising Angora Rabbits. Particulars free. White's Rabbitry, Newark, Ohio.

GOLDEN Hamsters, money-makers, trio \$7.00. Probert, Box 315, Valdosta, Ga.

REPTILE Catalogue 10c, current bulletin 5c. Biological Hobby Catalogue 10c. Chameleon 25c. Quivira Specialties, Topeka, Kan.

RAISE Guinea pigs. Make money at home. Big demand. Booklet free. Taylor, Box 426B, Hapeville, Georgia.

SEE "Golden Hamster" ad on page 42, and "Hamster Manual" ad on page 69. Each ad shows picture of Hamster.

ANGORAS, Giant Chinchillas, white giants—World's most profitable rabbits. Finest pedigree, heavy producing, prize-winners. Literature free. Grinsteads, Edwardsville, Illinois.

## 25 FROG RAISING

"FROG Raising." New book teaches how. Marlborough, 1035 Marlborough, Detroit 15, Michigan.

FROGS, Crayfish, fishing canes hardware. Lists 10c. Vol Brashears, Berryville, Arkansas.

## 26 FUR FARMING

KARAKUL sheep breeders for sale. Write Addis Kelly, Maywood, California.

## 27 MILK GOATS

RAISE Dairy Goats. All about goats and goat milk in big, illustrated monthly magazine. Sample copy 25c. Special Introductory year subscription only \$1 (regular \$2 a year). Booklet, "Primer for Goatkeepers", Free on request. Dairy Goat Journal, Dept. 868, Columbia, Mo.

## 30 FARMS, OTHER REAL ESTATE

FARMS, Ranches. All kinds, sizes. Choice of location, climate, production. Information on irrigation projects Columbia and Missouri River Basins. Resorts, summer homes. Milwaukee Railroad territory: Washington, Idaho, Montana, Dakotas, Wisconsin, Upper Michigan, Central Corn Belt. Free folders, price lists. L. H. Robbins, 613 Union Station, Chicago 6, Illinois.

STROUT'S Big Farm Catalog—Mailed Free. Describes over 2,800 outstanding Bargains. Coast to Coast. Time-Money Saver. Write Today. Strout Realty, 255-ZB 4th Avenue, New York 10, N. Y., 20 W. 9th St., Kansas City 6, Mo., 453 S. Spring, Los Angeles 13, Calif.

OZARK Lands for All purposes. Actual river frontages, 5 acres \$90.00 and upwards. Free list and literature. Hubbard, 424-L, Minnesota Ave., Kansas City 4, Kans.

GOOD FARMS—Ranches, Washington, Minnesota, Montana, Idaho, Oregon, North Dakota. Dependable crops, favorable climate. Write for literature, lists describing typical farm opportunities. Specify which state. J. W. Haw, 120 Northern Pacific Ry., St. Paul 1, Minn.

CALIFORNIA'S New oil field—Cuyama-Carrizo-Lots near Oil Seep \$60. Pay Monthly (1/2 oil rights.) Delker, 2219 Venango, Philadelphia, Pennsylvania.

HOMESITES \$450—convenient payments. California's finest garden section. On Morro Bay's scenic shores. Wonderful fishing, hunting, boating, bathing. Fertile soil, softest water, temperate climate, congenial community. Free literature. Richard Otto, 6560-Z, Hollywood Blvd., Hollywood 28, California.

CHEAP Homes; Stock, dairy, garden, fruit, poultry farms, for retiring, strong, sick folks. For hunting, fishing, long livity, health, happiness in Scenic mild Ozones. Write G. W. Starr, Ozone, Ark.

LOTS \$60.00. Acreage, desert land \$200. Cuyama-Carrizo San Luis Obispo county, California. Near-by newly discovered oil field 20% down balance monthly. Buyer gets half the mineral and oil-rights. Lucky Delker, 2219 Venango, Phila. 40, Penna.

FLORIDA — Hunting, Fishing, Fruit Growing, 5 Acres, \$245.00, \$10.00 Down, \$10.00 a month. G. B. Potterfield, Route #1, Brooksville, Florida.

## 31 POULTRY AND SUPPLIES

RAISE turkeys the new way, write for free information explaining how to make up to \$3,000.00 in your own backyard, address National Turkey Institute, Dept. 57, Columbus, Kansas.

## 32 PROFITABLE OCCUPATIONS

ANNOUNCING home study course in commercial baking. Practical basic training. Good field for those with aptitude. Nearly depression proof. Send for Free booklet, "Opportunities in the Baking Industry." National Baking School, 1315 Michigan Ave., Dept. 1723, Chicago 5, Ill.

\$5000. from half acre growing Ginseng, seed supplied. Crop bought. Particulars 10c. Associated Growers, 1169 Corydon Ave., Winnipeg, Canada.

DETECTIVES Earn Big Money. Excellent opportunity. Detective Particulars free. Write, Wagoner, P-125 West 86th, N. Y.

EXTRA money? Free Details. Trable, 1018 1/2 Elm Street, Dallas, Texas

YOUR own business painting flagpoles and smokestacks. Particulars free. Skyline Co., 1601-A, Uniontown, Pa.

MAKE beautiful costume jewelry at home for large profits, hobby or therapy. Free illustrated wholesale catalogue of sea shell, metal and plastic parts contains detailed instructions. Florida Supply House, Bradenton, Florida.

RAISE Rabbits. Easy to start. Very profitable. We teach you details free. Harder Farms, Rt. 1, Box 186, Campbell, Calif.

START lamp factory. Profitable, fascinating, easy to learn. Illustrated course teaches you. General instructions, wholesale catalog \$1.00. Gearon Company, 6405H North Oakley, Chicago.

\$40.00 WEEKLY. Made growing mushrooms. Fresh, Dried, Dominion Patent 331,583, free spawn. North American, 169Y Yonge, Toronto, Canada.

RAISING Muskrats in hutches—\$1.00. Cowan, Box 561, Berkeley, Calif.

**MUSHROOMS** Grown. Boxes, barrels. Instruction 50c. Spawn \$1.00. Gordons, 553 William, Winnipeg, Manitoba.

**METALLIZE** anything. Instructions \$3.00. Evans, 2217 South Cedar, Little Rock, Ark.

**INSTRUCTIONS** how to make Rubber stamps — luminous paints — money from sawdust — resilver mirrors — raise earthworms. 25c each, all for \$1.00. Davies, Box 1087-PS, Kingston, Pa.

**COMPLETE** flock finishing outfit. Spray gun, adhesive, two colors flock, brush, instructions—\$7.50. Parvin Manufacturing Co., 1155 So. San Pedro, Los Angeles 15, California.

**MAKE** beautiful mirrors from ordinary window glass. No expensive equipment required. Details free. Tesco, Box 189-SE, Wilkes-Barre, Pa.

**\$150 PROFIT** in 4 days made by Floyd Brown, Iowa. You, too, make Big Money in your own profitable business with amazing Liquid Imitation Marble, Fibre-Tite Flooring and Flexible Molds. Full or spare time. Experience unnecessary. Work from your own home. Write for Free Catalog, full information, today! Composition Products Co., Dept. 43, 5853 Delmar, St. Louis, Mo.

**900% PROFIT.** Stamping key-protectors, dog-tags. Arrington's, LaGrange 15, Georgia.

### 33 BOOKS, PERIODICALS, ETC.

**BOOKFINDERS!** (Scarce, out-of-print, unusual books.) Quickly supplied. Send wants. Clifton Company, Box 1377 PS, Beverly Hills, Calif.

**MAGAZINES** (back dated)—foreign, domestic, arts, Books, booklets, subscriptions, pin-ups, etc. Catalog 10c. (refunded). Cicerone's, 863 First Ave., New York 17, New York.

**"ADULT** bookalogues." 25c. Fifteen—\$1.00! Free catalogs! Hirsch, Spring Valley 3, N. Y.

**USED** Correspondence courses and books bought, sold, rented and exchanged. Catalog Free. Lee Mountain, Pisgah, Alabama.

**HORSE** racing books, systems. Free illustrated catalogue. Charles Hall, Sepulveda, Calif.

**1948 CATALOG,** wholesale directory. 10c. Latshaw Sales, Sunnyside-C, Indianapolis 44, Ind.

**TRADE** Magazines—business, vocational, diversion. Choose current copies from more than 1000 publications available through our easy-to-get acquainted plan. All fields. Price list Free. Commercial Engraving Publishing Co., 34S North Ritter, Indianapolis 19, Indiana.

**MEN** Only. Fresh stuff in little Books. 10 for \$1.00. DuLaw Novelties, Box #297, East Chicago, Indiana.

**BOOKFINDERS!** All subjects. Send wants! Jaher Book Service, 620-K East 178 Street, New York 57.

**HOUDINI** Unmasked 50 pages \$1.00. Best American, English and Australian psychic magazines. 2 back issues Psychic Observer 25c. List free. Bobbitt Agency, 1609 Tenth Avenue North, Dept. 39, Nashville 8, Tenn.

**NEW** Book "Inside Los Angeles Chinatown." 207 pages, rare illustrations, shows inside of Chinese life. \$2.00. Garding Lui, Box 6227 Metro. Station, Los Angeles, Calif.

**BACK** issues magazines reasonable. Reedmor, 240 East 9th, New York, N. Y.

### 35 MAGIC TRICKS, PUZZLES, ETC.

**MAGICIANS'** Gamblers' secrets exposed. Cards, Dice, Punchboards, Slot Machine. Catalog 10c. Book Co., Box 671, St. Louis 1, Mo.

**WORLD'S** largest professional magic shop, keeps you in touch with latest tricks. To receive mailings, send 35c for new catalog. Holden's, 220-P West 42nd St., N. Y.

**200** ELECTRIC Stunts, 110 volts, \$1. Cutting Sons, Campbell 3, Calif.

**COIN & Ring** trick. Mystifies, amuses. 35c. Descriptive literature of Fun and Magical items with gift trick included. Powell's, P. O. Box 2155 C, Potomac Station, Alexandria, Virginia.

**HYPNOTISM!** 25 Lesson Course. \$1.00. Monarch, 38-S Jefferson, Auburn, New York.

**FREE!** Large catalog of magical apparatus if you remit 25c for "Magic Is Fun" magazine. Robbins Co., 152-F West 42nd Street, New York.

**REMARKABLY** Inexpensive pocket tricks! Catalogue, 5c. Postways, Box 5325-Y, Philadelphia 42.

**JUGGLE** Four balls easy!!! Great fun, develops unbelievable coordination. Thin dime brings complete instructions. McHargue, 7358 Calvin, St. Louis, Mo.

**MAGIC**—All kinds. Free details. P. Bowling, 224 W. 133rd St., New York City.

**500 TRICKS.** Send only 10c for Douglas' famous 112-page Catalog 500 Tricks. New magic for amateur, professional. America's fastest service for 25 years. Douglas Magicland, Dept. 2, Dallas, Texas.

**VANISHING** Quarter trick and catalog 25c. Sterling Magic Co., Royal Oak, Mich.

**LARGE** 160 page catalog, just published. 35c. We have supplied the best tricks to beginners and professionals for 38 years. Chicago Magic Company, 2300 No. Mason Avenue, Chicago 39.

**MAGICIANS'** Headquarters — 400-Page Professional Catalogue, pocket, parlor, stage tricks. World's finest magic. Send \$1.00 for Catalogue (refunded first \$5.00 order). Kanter's, S-1311 Walnut, Philadelphia 7, Penna.

**LEARN** magic. Ventriloquism, Mind-reading. Write for particulars. Quackenbush, Big Flats, N. Y.

**HEAD?-Tails?** Toss at will! \$1.00. Arro Company, Bridgeport 1, Conn. (961).

**BE** a Magician. Large professional magic catalog of latest tricks, 25c. Ireland, F-109 North Dearborn, Chicago.

**EARN** money in any crowd. Call names of strangers, tell unspoken questions. Professional mind reading course. \$1.00. Magic course, 278 lessons. \$1.00. American Stamp Company, Wilmington MC-4108, Delaware.

**WHOLESALE,** "World's Largest Line", Catalog 25c. Manufacturers, 12 Churchlane, Philadelphia.

**"VENTRILLO"**, Professional voicethrowing instrument, and Illustrated catalog 25c. POB-971, Philadelphia.

**ITCHING,** Sneezing powders, eighteen other tricks. Free with Joker's catalog. 2404N15, Philadelphia.

**DOLLAR** magic set free with Professional catalog 25c. Magex, 4462 Germantown, Philadelphia.

### 36 GAMES, ENTERTAINMENT

**HOME** Model Slot Machines and Coin Operated Games. Write for catalog. Webb Distributing Co., Dept. P4, 6 South Kedzie Ave., Chicago 12, Ill.

**BE** the Life of the party! Wear Electric bow tie. Complete, tie, bulbs, battery all for only \$1.50! No C.O.D.'s. Electric Bow Tie Co., 306 Bowery, New York 12, N. Y.

### 37 COIN COLLECTING

**FREE!** Foreign coin, banknote and Coin Collectors' Illustrated Catalog to approval service applicants. Send 3c postage. Tatham Coin Co., Springfield-D50, Mass.

**OLD** Money wanted. Will pay \$100.00 for 1894 dime, S. mint, \$50.00 for 1913 Liberty head nickel (not Buffalo). Big premiums paid for all rare coins. Send 4c for large coin folder. May mean much profit to you. Numismatic Co., Dept. 30, Fort Worth, Tex.

**START** coin collecting right! Save money, avoid mistakes. Complete beginners' outfit \$3. Deluxe numismatist's kit \$5. Satisfaction guaranteed. Coin bonus if you hurry! Kirkham's, Glens Falls, New York.

**COMMEMORATIVE** \$1½ — Columbus, Washington, Cleveland, Stone Mountain, \$1.50 en. Illustrated Catalogue 25c. Norman Schultz, Salt Lake 9, Utah.

**U.S.** coins lowest prices. Send stamp for lists. Hutchinson, 3463 I Street, Philadelphia 34, Penna.

**\$10.00 EACH** for certain Lincoln pennies; Indianheads \$50.00; Dimes \$100.00. Send dime for catalogue of prices paid. Lincoln Coin Company, 806 East Indiana, Elkhart 4, Indiana.

**VALUABLE** information. U.S. coins from 1652 to present, prices paid by collectors. 254 page book; prices paid by dealers, 48 page book; both handsomely illustrated—the two for \$2.00 (send money order—not stamps). Hobby Helpers, Dept. G2, Box 665, Washington 4, D. C.

**\$10.00 EACH** paid for lots old coins. Rush 25c. Latest 1948 edition illustrated. Coin catalog. Greenstreet, Union, Mo.

**WHITMAN** handbook 75c; Silver dollar folders, all others—Any 4 \$1.00. 20 coins from 20 countries \$1.00. 3-Legged Buffalo nickel \$1.25. 12 Wooden nickels \$1.00. Our large retail catalogue 15c. Bebee Coin Company, 1180 East 63rd, Chicago 37, Illinois.

**FREE** Indianhead penny. Send 25c (refunded) for price list. Coin dealer's instruction booklet \$1.00. Nelson Coin Exchange, Box 346, Rye, N. Y.

**CLOSING** out:—435 antique firearms;—35,000 coins, relics, cartridges, swords, flintlocks, carbines, antiques, minerals. Illustrated Catalog 25c. Heike, Wenona 31, Ill.

### 38 OLD STAMPS WANTED

**I WILL** pay \$100.00 each for 1924 1c green Franklin stamps, rotary perforated eleven (up to \$1,000.00 each unused). Send 10c for large illustrated folders showing Amazing prices paid for old stamps, coins, and collections. Vernon Baker, PS-84, Elyria, Ohio.

### 40 STAMP COLLECTING

**DEALER'S** Wholesale Catalog. Postage 3c. Franksco, 5031 Queensbury, Baltimore, Maryland.

**300 DIFFERENT** given free with approvals. Postage 3c. Windsor Stamps, 1435 E. 67th Place, Chicago 37.

**ZOWIE-E-E!** A Barrel of Fun for only a Dime! 500 United States Stamps—Absolutely unpicked and unsorted, just as received from church missions. Many varieties, including large commemoratives, airmails, high denominations up to \$5.00! Stampdom's biggest package of fun, and you might find something really valuable!! Price only 10c to serious approval service applicants. Money back if not delighted. Illustrated bargain lists with each order. Mystic Stamp Co., Dept. 55, Camden, New York.

**UNITED STATES** approvals complete coverage fine quality, attractive prices. Seminole Stamps, Box 1138-S, Coral Gables, Florida.

**START** your own stamp business. Write for free circular. Donald Shepard, Box 5139, Chicago 80.

**WOW!!** \$10.00 Worth Of Fun—Only 10c! What a treasure hunt! Big package 500 Foreign Stamps from foreign missions, other sources. Includes Stamps from Africa, South America, Free French, Somali, Palestine, etc. Includes airmails, commemoratives and stamps worth up to 50c. This offer sent for 10c to Approval Applicants only. Jamestown Stamp Co., Dept. 5, Jamestown, N. Y.

**128-PAGE** United States Catalog, 1,000 illustrations. 10c. Harris & Co., 204 Transit Bldg., Boston.

**NICARAGUA** "Tin Pan Alley" Diamond, Ecuador showing George Washington, and American Flag in natural colors, Fezzan, Trieste, "American Army" stamp First U.S. Commemorative, \$100.00 Shanghai, Corsica, Anzac, Antique, others all 5c approvals. Capital Stamp Co., Dept. 10, Little Rock, Ark.

**FREE**—Famous Americans set, plus Flag set, plus the National Parks set, plus the Presidential set to the \$5. A total of 90 stamps absolutely free to customers for our unsurpassed United States or Foreign selection. Send 3c postage for 15 of the above mentioned stamps and full particulars. Triboro Stamp Company, 145 Nassau Street, Dept. 204, New York.

**WORLD'S** Largest Stamp (7½ x 14 inches). A real curiosity! Retail for 50c, only 3c to approval applicants. Tatham Stamp Co., Springfield 50, Mass.

**200 DIFFERENT,** including Roosevelt triangle, 5c to approval applicants. S. Avalon Stamp Co., Springfield, Mass.

**CHOICE** of 35c Worth of stamps from our first U. S. selection Free to applicants enclosing 3c postage. Large selection to choose from. Act Now!!! S. D. Engel & Co., 38 Park Row, N. Y.

**"CONFEDERATE-States"** twelve different unused 10c approval applicants only. "Stamps", Box Eighty-Seven, Albany 1, N. Y.

**200 DIFFERENT** Stamps—cataloging up to 15c each—only 3c to approval applicants! Littleton Stamp Co., Littleton 47, N. H.

**200 DIFFERENT** Stamps, 6c to approval service applicants. Nationwide Stamp Company, 1323 E. 16 St., Brooklyn 30, N. Y.

**STAMP** remover 25 cents. Free with approvals. L. White, Box 922, Pittsfield 2, Mass.

**50 DIFFERENT** Hungary stamps and our price list, one silver dime. Stamp sales, Box 1649F, Oakland 4, California.

**COLLECTORS** outfit, Album, Hinges Gauge, Detector, 50 different stamps, 2 mint sets all 10c, Approvals, Carneta, 228 West 25th, N. Y. 1.

**UNITED States** 2c Yorktown unused; 100 mixed U. S. used all 10c with approvals. Hudson Co., Box 229 Whittier, Calif.

**FINE Approvals.** Fast, personal service. What countries do you prefer? I'll send their stamps. Milton Skinner, 438 Locust, Long Beach 12, Calif.

**POSITIVELY** Greatest free offer—Latest Scott's International \$6.00 stamp album—covering entire world, contains 36,000 illustrated descriptive spaces; Scott's 1948 Standard \$6.00 catalogues "Philately's Encyclopedia"—absolutely free to applicants for foreign approvals becoming customers. Approval Service, Box 1700, San Francisco, Calif.

**GIBRALTAR Packet Free**—Nice collection Gibraltar—New Zealand Centennial—British Uganda—French Colonials—Early British Colonial—West Indies—South American—War stamps plus Philatopic Monthly Magazine. All for 5c postage. Empire Stamp Co., Dept. P. R. Toronto 5, Can.

**FREE**—Canadian Sets Royal Visit, George VI, George V, Coronation, Jubilee, others, to approval applicants, Ensign, Box 118-P, So. Orange, N. J.

**25 DIFFERENT India**—3c with approvals. Premiums with purchases. Brandwein Stamp Co., Box 92-P, Bayonne, N. J.

**FREE**, Irish commemorative collection, including Rebellion issue with approvals. Raymax, 123-X William St., NYC 7.

**UNITED STATES Price list**, Send Postage. State Stamp Corp., 1225 Park Bldg., Pittsburgh 22, Penna.

**FREE U. S. Price list** postage 3c. M. Hanna, 335 5th Ave., Pittsburgh 22, Pa.

**FREE Catalog**, Mint sheets U. S. exclusively. Kenda, 82 New Jersey Ave., Brooklyn 7, N. Y.

**FREE!** Negro Triangle; Turks Islands "Cactus"; Dakar; Guinea; Palestine; "Fairy Tale." Pirate Chart, Map, Ship, Sea Lion and Snake stamps; French, British, Portuguese Colonies, etc. Free for 3c postage. Approvals, Potomac Stampco, Washington 10, D. C.

**United States Stamps** on approval. Bargain prices. Metropolitan, 140-A Nassau, New York City 7.

**GET "How To Make Money In Stamps."** Free information. Write George Wentz, San Marcos 18, Texas.

**SCARCE** colorful Japanese National Park souvenir sheet only 50c to serious approval applicants. Makes your collection the envy of all your friends. M. Okin, 915-B Bryant Ave., New York 59, N. Y.

**COVER collectors!** 12 different cachets of philatelic value, only \$1.00. Cottingham, Wilson Center, Box 7, Norman, Okla.

**WORLDWIDE Different:** 200-25c; 500-60c; 1000-\$1.50; 2000-\$4.25. Beacon Sales, Maynard 3, Mass.

**1880-1899 SCARCITIES:** Egyptian, U. S., Persian, Cuban, others; plus 25 different Br. India, 10c (approvals). Gerhardt, 2804 Rio Grande, Austin, Texas.

**FREE**—The Stamp Finder. Big new edition—32 pages profusely illustrated. Identifies all difficult stamps immediately. Given free with 319 different stamps from Vatican City, Palestine, Cyprus, San Marino, etc. All sent to approval applicants for only 10c. Price lists. Garcelon Stamp Company, Box 818, Calais, Maine.

**15 DIFFERENT U. S.** over 40 years old, 10c special to applicants for our bargain U. S. approvals. Will Portney, 1806S East 22 St., Brooklyn 29, N. Y.

**U. S. 797 SPA Sheet** only 5c to applicants for U. S. approvals. M. Haycock, 333-86th St., Brooklyn, N. Y.

**BRITISH, Spanish, French Colonies, Vatican, Hitler heads, and airmail packet,** free with approvals. Pan-American Stampco, Box 145, New York 33, N. Y.

**FLAG Stamp Free** With U.S. Approvals. E. Wenigman, 929 Oakdale, Chicago.

**FREE!** Triangle Roosevelt, Vatican, Ethiopia, Hitler Heads, with Approvals. Florida Stamp Company, Box 807, Miami, Florida.

**5 SETS**—Five countries—Triangle, Orchid, Maps, Animals, With approvals 5c. Arthur Wirth, Norwichtown 2, Conn.

**FREE!!** Mint British Colonies from Solomon Islands, Caymans, Grenada, Dominica, Turks Caicos. Absolutely free to new approval applicants. Viking, 130-P Clinton St., Brooklyn, N. Y.

**118 DIFFERENT** stamps including commemoratives, airmail, surcharges, sets, etc., only 3c to approval buyers. Badger Stamp Co., Dept. "S", Milwaukee 3, Wis.

**25 DIFFERENT Stamps** 10c. Tunis And Carpenter, Wakeman Ave., Newark 4, N. J.

**HISTORICAL Collection!** Cavalry Charge! (Bulgaria)—Flaming Sword! (Ireland)—Big She-Wolf! (Italy)—Fort! (Dominican Republic)—Field Marshal! (New Zealand)—Pitcairn Mutiny Island!—Commemoratives! Pictorials! Only 3c. Approvals, Star Stamp Company, Dept. 1, 11 East 15 Street, Jamestown, N. Y.

**AMAZINGLY** beautiful collection of stamps depicting ships, trains, birds, locomotives, beasts, bridges, as people in foreign lands picture them. Only 3c with our superb approvals. Universal Stamps, Hollis 7, N. Y.

**EXCEPTIONAL** collector values 1c and up Approvals; singles and sets. Miller's Stamps, 81 Clifton Terrace, Weehawken, New Jersey.

**50 DIFFERENT** United States 10c Price list free. Seidenberg, Cassopolis, Mich.

**FREE** Monthly illustrated bulletin showing Recent Issues, Penny Approvals on request. Reed Company, Box 980, Chicago 90, Illinois.

**FREE** illustrated United States price list. Francis, 3926S Jefferson, Norwood 12, Ohio.

**SELECTED** penny approvals. Henry Jay Service, 15 Park Row, New York 10, N. Y.

**POPULAR U. S. stamps,** popular prices—premiums. Jarr, Box 217-a, Madison Sq., New York 10.

**STAMP Magazine!** Copy Free! "Stamp Post," Station A, Pasadena 3, Calif.

**BIG Bargain!** Over 100 different including Norfolk Island, Abyssinia, Burnei, Nigeria, etc. for 10c to approval applicants. Canisius Kevilus, 933 West 34th Place, Chicago 8, Illinois.

**UNITED States** on approval. Fast service. R. Needham, P. O. Box 818, Inglewood, California.

**GENUINE "Goya Nude"** set complete 35c. Approvals. Royal Stamp Company, Tamaqua 2, Penna.

**COLLECTORS** in possession of extra stamps write for particulars. McPherson's Stamp Exchange Club, Branch, Mich.

**ROGUES Gallery Packet.** Hitler-Mussolini, 30 others. 3c. Premium, Hartland 6, Me.

**FREE**—\$25.00 Stamp collector outfit—Finest, most complete outfit ever offered: Large Scott album, valuable collection of 1050 different stamps, Airmails, Odd-shapes, Hi-values, "Stamp finder," Watermarker, magnifier, perf-gauge, tongs, and hinges. Actually over \$25.00 value absolutely free when regular customer. Mail application now for Foreign approvals. Bargain Stamp Service, Dept. A, Santa Ana, Calif.

**SCARCE Zanzibar, Aden, Kenya Coronation, Curacao Air,** plus 75 other good stamps; 3c approval applicants. Earnest Moublow, 740 Hegney, Bronx 56.

**BERLIN Bears.** Complete set of eight and 100 different stamps only 10c to approval applicants. Reich Stamp Co., 4647 Kenmore, Chicago 40, Ill.

**PENNY Approvals** that satisfy. Neil Gronberg, Box 5441S, Philadelphia 43, Pa.

**GIANT** bicoloured royal visits, Malta pictorials, gorgeous Guianas Goose Airmail, Scandinavian packet and illustrated stamp publication 10 cents with approvals. Crown Stamps, Box 331, Toronto, Canada.

**FLAGS! FLAGS! Flags!** Beautiful collection foreign flag stamps—plus perforation gauge—plus packet 25 countries, including big Roosevelt triangle, airmails, scarce Tasmania, Negri Sembilan, old Victoria, etc. Total value \$1.00. Bargain price 10c to approval applicants. Odd Stamps Company, Dept. D-2, 5391 Metropolitan Station, Los Angeles.

**BRAZIL-Truman** commemorative only 10c to approval applicants. Floyd Frederick, 513½ Green Street, Lancaster, Penna.

**FIRST** day covers on approval. Bob Knobel, 1918 S.W. 12th Street, Miami 35, Florida.

**25 RECENT Hungary** to approval applicants. Quality Stamps, Station F, Buffalo 12, N. Y.

**TWELVE** valuable pictorials (cataloging \$3.25) including Luxembourg Centennial, Hurricane disaster, Victory flags—ten cents with approvals. Charles Ernest, 64 Wayne Terrace, West New Brighton 10, N. Y.

**50 SOUTH, Central America**—20c. Box 6618, Northeast, Kansas City, Mo.

**GOOD U. S. approvals,** used or mint. Panther Stamps, Dorchester 24, Mass.

**TRIANGLES! Diamonds! Octagons! Midgets! Roosevelt! Hitler!** \$500.00 stamps. Stamp magazine. Everything 5c. Approvals. Thrifty Stamps, Silver Spring, Maryland.

**NICARAGUA** diamond shaped set, 10c with approvals. Vargo Stamps, 6044 South Fairfield, Chicago 29, Illinois.

**PURCHASE** from purchase! Any country on approval. Elmer Purchase, 74 East Park Street, Newark 5, New Jersey.

**BARGAIN!** 2,000 stamps from all over world \$1.00, 5,000, \$2.00. American Stamp Company, Wilmington A-4108, Delaware.

**FOR** Better U. S. approvals write today—Reasonable—Box 488 A, Minneapolis.

**ROOSEVELT, Churchill, Stalin, Hitler,** Vatican stamps free to approval applicants. Tamiami Stamps, Box 2188, Miami, Fla.

**FINE U.S. foreign approvals.** Rossom, 218 West 59th St., Chicago 21, Ill.

**FREE:** Twenty different foreign commemorative stamps to new approval applicants. Modern Stamp Service, Box 12A Wakefield Station, N. Y.

**CIPEX Sheet,** commemorating 100th Anniversary 1847 issue with 30 different U.S. containing early issues, commemorative, airmail, envelope, revenue. Catalog value exceeds 65c—all for 10c to approval applicants only. Curhan Stamp, Dept. P, Gloucester, Mass.

**AMAZING "Queer Countries"** packet—free with approvals! Saxon, Walden, N. Y.

**FRENCH Col.** 10 different 5c approvals. Earl Fredenburg, Marshall, Mich.

**QUALITY** blended U.S. Mission mixture, 1000 25c, 2 lbs. \$1.10, 5 lbs. \$2.45, 500 assorted Hungary 61c, 600 different Hungary \$2.95. Halay, 132 West 63rd, N. Y. 23.

**OLD scarce U. S. Seconds** on approval. Slightly defective, bargain prices. Hearnfeld, 551 Clinton, Newark 8, N. J.

## 42 HOBBIES, COLLECTIONS

**INVENTING** can be an interesting and profitable hobby. Write for complete particulars. Institute of American Inventors, Dept. 30-E, 2926-Eye St., N. W., Washington 6, D. C.

**HOBBYISTS**—Send 25c for new 1948 illustrated 64 page catalogue of books, tools, kits, and parts for your favorite pastime. Jar Hobby Mart, Dept. C1, Box 137, Iselin, New Jersey.

**UNUSED Match Book Covers,** 100 all different \$1.00. Free catalog. Charles Edelman, 1311 P East 84, Cleveland 3, Ohio.

**HOBBYISTS**—(men, boys) worldwide contacting service. Free information. Hobby Directory, So. Orange, N. J.

**UNUSUAL** hobby. Earn \$10.00 day in home. Full instructions \$1.00 bill and large self addressed envelope. Textcraft, Box 75, Pierson, Iowa.

## 43 POTTERY & CERAMICS

**MONEY-Making** Experimental Farm poultry raising helps only \$1.00 for 24 months. Sixty months \$2.00. Early start increases profits. Order now! Poultry Tribune, Dept. T, Mount Morris, Ill.

## 44 ANTIQUES, RELICS, INDIAN GOODS

**CLOSING** out:—435 antique Firearms:—35,000 coins, relics, cartridges, swords, flintlocks, carbines, antiques, Minerals, Illustrated Catalog 25c—Heike, Wenona 32, Illinois.

## 46 MINERALS & PRECIOUS STONES

**GEMS,** precious and semi-precious, all genuine from world wide sources. Deal direct, no overhead, save money. Catalog 10c. Hill Co., Route 7-K, Salem, Oregon.

**FIVE** assorted slabs high quality gem material one dollar. M & O Gem House, Mesilla Park, N. M.

ZIRCONS, diamond-like, sparkle, ready to set. 2 samples \$1.00. 5 samples \$2.00. Others, Imhusex PS, Box 232, White Plains, N. Y., Agents Wanted.

#### 47 CAMERAS, PHOTO SUPPLIES

OIL coloring photographs can be a fascinating hobby or profitable sideline for those with artistic talent. Learn at home. Easy simplified method. Send for free booklet. National Photo Coloring School, 1315 Michigan, Dept. 1742, Chicago 5, Ill.

BASS says! At the sign of the old "Horse Trader," 38th year. Thousands of satisfied customers everywhere! Finest brands including Kodak, Bell & Howell, Argus, Zeiss, Leitz, etc. Satisfaction always guaranteed or your money back! Bass buys 'em, sells 'em, trades 'em. Write or wire. Bass Camera Company, Dept. AG, 179 W. Madison St., Chicago 2.

UTILITEE Film Adapters use small color film in large cameras. At dealers or 655 North Broadway, Los Angeles 12, Calif.

HAVE you a camera? Improve your hobby of photography and learn how to make better pictures. Write today for our latest book catalog and sample copy of American Photography, containing articles and pictures by the world's foremost writers and photographers. Camera House, 607 353 Newbury St., Boston 15, Mass.

16mm 50' MAGAZINE, Reloads 4 for \$5.25. Free processing. Doan, 18099 Ham-burg, Detroit 5, Michigan.

COLOR Slides: Travel, nature. List, sample 40c. Kelly S. Choda, Los Alamos, New Mexico.

200X TELEPHOTO Camera easily made. Trifling cost. Telephoto lens and instructions \$3.00 postpaid. Instructions alone \$1.00. Suffolk Science Service, Manerville, New York.

BEAUTIFUL Maine kodachrome slides, five for dollar. Maine Photos, Box 1622A, Portland, Maine.

FOR Perfect pictures day or night Spartus Press flash cameras with built in flash reflector. Retail price \$14.95 tax included. Picture size 2 1/4 x 3 1/4. Uses No. 120 film. Complete with extra flash bulbs. James L. Dailey, 1378 East 48th St., Bklyn. 3, N. Y.

COMPLETE developing printing kit \$4.95. Spada, 10 Lexington, Wethersfield 9, Conn.

#### 48 PHOTO FINISHING

THREE prints each 8 exposure roll 40c. Two each 35c. One each 25c. Reprints 3c. Fred A. Eastman, Bode, Iowa.

ENLARGEMENTS 5x7 15c. 8x10 25c. Glossy or dull. Gorgeously oil colored 50c. Rolls developed and printed 25c. L & R, P. O. Box 1476, Milwaukee, Wisconsin.

PROFESSIONAL 8 x 10 enlargement 50c. Three, \$1.00. Rush negative! Mosher Studios, Vineyard Haven, Mass.

ROLL developed, 8 prints and two enlargements 25c. Trial offer. Young Photo Service, 406-C, Albany 2, N. Y.

50 VELOX reprints, \$1. Suburban Studio, 1410-S Bond, Rockford, Ill.

NEW Process developing and printing. 8 exposure rolls 35c. Mayfair Photo Service, Box 261, Toledo, Ohio.

OLD Photos restored. Free estimate. R. Daly, Box 91, Ansonia Station, NYC 23.

FASTEST service. Finest jumbo size enlarged prints. Roll of eight 30c. Over eight 50c. Reprints 4c. Dick's Photo, Louisville, Kentucky.

8 BEAUTIFUL Double Size pictures and roll developed 30c. 8 hour service. Free Mailables. Pacific Photo Service, Box 666, San Francisco, Calif.

DOUBLE Value:—6 or 8 exposure rolls developed and 2 Deckle-edged prints of each negative—30c. 16 exposure rolls (printed 2 on 1)—30c. 12 exposure rolls—40c. Quick service. Free mailing envelope and price list upon request. Snapshots Co., Dept. W.1, General P.O., Box 979, Newark, N. J.

SNAPSHOT prints on metal, wood, cloth, etc. Preparation for over 300 prints \$1.00 postpaid. Complete instructions. No dark-room necessary. "Hannah," Chemical Co., Box 666, Long Beach, Long Island.

PHOTOGRAPHY for pleasure or profit. Learn at home. Practical basic training. Long established school. Write for booklet. American School of Photography, 1315 Michigan, Dept. M22, Chicago 5.

#### 50 PHOTOPRINTS; PHOTOCOPIES

PHOTO Pacific area, 17—\$1.00, 80—\$5.00. native girls 15—\$2.00. Novelty Sales, Wolf-tit Ave., Norwalk, Conn.

#### 51 MOTION PICTURES, SOUND EQUIPMENT

BEAUTIFUL Kodachrome Slide and Lists 25c. Slide Supply Service, 3111 West Tuscarawas, Canton, Ohio.

8—16mm, SILENT—sound art films. International, 2120 Strauss, Brooklyn, N. Y.

8-16MM. Silent-sound films. Complete rental library. All latest subjects. Free catalogue, (sample film 10c). Garden Film, 317 West 50th, New York 19.

HOLLYWOOD films. Color sample, \$1.00 (refunded). Catalogs 10c (refunded). Stone, Lunenburg 10, Mass.

"BASS says! 38 years of leadership means satisfaction to you! Finest equipment, 8 and 16mm, sound cameras, sound projectors. Bass buys 'em, sells 'em, trades 'em. Satisfaction always guaranteed or your money back! Bass Camera Company, Dept. A, 179 W. Madison St., Chicago 2.

CHILD is born by Caesarean delivery. Project outstanding movie production free. Send postal immediately. Movie Films, Hamilton 26, Ohio.

GUARANTEED fresh anti-halo outdoor movie film! Weston 12! Daylight loading! Processing free! Three spools double 8mm, \$3.45! Six single 8mm for Univex, \$4.60! Postpaid! Catalog. Eso-S, 47th Holly, Kansas City 2, Missouri.

SURPLUS laboratory supplies, 8mm—16mm silent; sound recording. Lists free. Fischer Photographic Laboratories, 1729 North Mobile, Chicago 39, Illinois.

FRESH Ansco 20 exposure 35mm Color Film, 3 rolls for \$4.50, plus 15c postage. Gamera's, 3808-C Eastern Avenue, Baltimore 24, Md.

35MM SILENT sound films supplies. Bedner 5300 So. Talman, Chicago.

SAVE \$30.00 yearly. Send stamp for details. Bonnie's Film Club, 422 Haven Avenue, Hamilton, Ohio.

MAGAZINE 16mm 50' E.K. Super X panchromatic. Guaranteed. Processing included \$1.99 postpaid. Circulars Free. Fischer Photo, 1729 N. Mobile, Chicago 39, Illinois.

LEARN movie projection, management. Free Catalog. Theatre School, Elmira, N.Y.

BARGAINS in used 16mm, sound films. Cartoons, sports, musicals, features. Big list for stamp. Blackhawk Films, Davenport, Iowa.

BARGAINS! Free films, equipment catalogue! Towers, 935 North 40th, Philadelphia 4.

16MM SOUND Western features. Money-making roadshow attractions. Top stars. New prints. Low prices. Write! Grand, 2506P—52nd, Kenosha, Wisconsin.

SEND 10c for 8mm, 16mm catalogue. Sterling's, 679 Northampton, Easton, Pa.

FREE movie list. Write Superior Film Service, Box 713, Troy, N. Y.

ART model films 16mm rentals exclusively. adults list. Enclose stamp. Revere Films, Box 1051, Detroit 31, Mich.

PROCESS your own movie film. Literature. Duro Products, 1519 Eggert, Eggertsville 21, N. Y.

EXCLUSIVE Home Homies Select Films. Write for Free List. Home Pix, 1674 Broadway, New York 19, N. Y.

WE Buy, Sell, Rent, Exchange Home Movies. Details for dime. Midland, Box 429, Oak Park 3, Ill.

IMMEDIATE delivery of 16mm Sound projectors. Large stock of Castle, Official, Nu-Art and Pictorial films. Soundies Comedies, 16mm Ansco color film. Used 8mm, 16mm Sound. List Titlers, Splicers, Editors, Rewinders. (Home Movies, 41 South Fourth Street, Allentown, Penna.)

#### 52 MUSIC, MUSICAL INSTRUMENTS

POEMS set to music. Experienced composer. Free folder. Moquin, 5333A La Cresta Ct., Hollywood.

STUDENT trumpet with case, \$49.50. Satisfaction guaranteed. Order today. Harden's Music, Marion, Ohio.

SWISS Musical units \$3.50 Musical Albums, Boxes 131 West 42nd, New York 18.

MUSICAL movements, \$3.00. Free photo. Pevar's, 4218 Viola, Philadelphia 4, Pa.

BE Independent, tune pianos, music unnecessary. Practical Piano Tuning shows you how. \$2.00 Postpaid. Chord-Slide Co., Dept. PS, 3122 Lawrence Drive, Corpus Christi, Texas.

MUSIC printing \$5-100.00 composing, arranging, publishing. Auto-Litho, Jensen, Florida.

ACCORDION students, play better, sooner, with Visuade, \$1.00. Arkay, Box 5772, Cleveland 13, Ohio.

PHONOGRAPH records 20c. Catalogue. Paramount, SK-313 East Market, Wilkes-Barre, Penna.

SWISS Music units from Manufacturer's agent, \$2.75. Assorted tunes. Helax Co., 233 West 72nd Street, New York 23.

#### 53 SONG WRITERS

POEMS Wanted to be set to music. Free examination. Send poems, McNeil, Master of Music, 510-PS, S. Alexandria, Los Angeles, California.

SONGWRITERS, Songs Published Monthly. Advance Royalty. Send your songs or poems today for our exciting offer. Hollywood Tunemasters, Dept. 10F-C, 1537 N. Vine, Hollywood 28, Calif.

SONGWRITERS: Send Poems for Free Examination and Outstanding offer. United Music, 116, Salem, Indiana.

HONEST outstanding music writing offer. Len-Tex Studios, Leonard 3, Texas.

\$1,200.00 PAID Yearly to new songwriters. Opportunity for publication and advance royalty. No charge for melodies. Records, lead sheets furnished. Send song material now for free examination. Get details. Cinema Song Company, Dept. B-56, Beverly Hills, California.

POEMS wanted for musical setting. Send Poem for immediate consideration. Hamann Service, 626 Manhattan Bldg., Milwaukee, Wisc.

SONGWRITERS—Protect your songs. Get the facts first. Free booklet, attractive offer. Song Service, 331-J West 46th, N. Y.

LOUIS Terry's Tune Service, 709 1/2 N. Broadway, Oklahoma City, Okla. References. Write for Free booklet.

POEMS Wanted For Musical Setting. Send poem for free examination. Five Star Music Masters, 646 Beacon Bldg., Boston.

#### 54 RADIOS, SUPPLIES & EQUIPMENT

MAKE Simple, Tubeless, Batteryless, Distance-Getting Crystal Radios. Crystal and illustrated instructions 25c postpaid. Allen, 427-S, Clinton, Mo.

U.S. Signal Corps Featherweight Ear-phones \$1.00. Radio Service men and experimenters send stamp for our giant radio catalogue. Save dollars. United Radio Co., (100-V) Newark 1, N. J.

HALLICRAFTERS, National, other radios wholesale. Terms. Write. Henry Radio, Butler, Missouri.

BARGAINS—Complete crystal kit with headphone, aerial, illustrated instructions, only \$2.95. Free list. Radios, Phonographs, Supplies. Al's Radio Service, Sioux City 7, Iowa.

RECTIFIER: Maximum amps—20, 0—45v. D.C. For low amperage Surplus, charging batteries, electroplating, etc. \$3.50 Postpaid. BP Products, Box 247, Flint, Michigan.

BIG Bargains in radio parts, tubes, electronic equipment! Bantam 1-Watter 24c; Crystal Oscillator Unit \$2.95; miniature Tube Pin Straightener 27c; Permeability Tuner \$1.24; T-17 Microphone 49c; Daco Tube tester \$29.50; FM Transmitter (APN-1) \$34.50; HS-30 headset 36c. All brand-new, unused. All guaranteed. Rush order today! Send 25% deposit, balance C.O.D. Minimum order \$2.50! Write for Free Bargain Bulletins. Mid-America, Dept. CD-11, 2412 S. Michigan Ave., Chicago 16, Ill.

BUILD "Loudest" crystal radio. Instructions, loud crystal, catalog—25c. Amorose's, Route Four, Richmond, Virginia.

MAKE selective, distance getting crystal radios. Also one tube radios. Improved designs. Instructions and crystal 25c. Radio Leader, LaVerne 6, Calif.

IF YOU are really interested in Electronics, send your name, address, and 50c and I will see that you are furnished information on how to become a success, as I have, in this income-building field. Sincerely, Martin Haanen, Ortonville, Minn.

24 PAGE Plans "18 Crystal Sets" (SW record 5800 miles). Catalog. "Radio-builder"—all 25c. Laboratories, Eye-t. San Carlos, California.

26 YEARS Experience radio repairing at your fingertips. I've repaired 45,000 radios. Have perfected simple system you can follow step by step. No calculations or formulas. Total price \$2.00 postpaid or COD. Moneyback guarantee. Ross Radio, 14615-N Grandriver, Detroit 27, Michigan.

RADIO controlled garage door opener. Works from button in car. Complete plans \$1.00. Champman, Box 3236, Birmingham, Alabama.

## 55 TELEVISION

TELEVISION: Telecraft distributes Transvision kits exclusively. Build your own television receiver. Complete simple instructions. Buy from headquarters. Servicemen, dealers, write for wholesale price list. Telecraft Corp., 96 Fifth Ave., N. Y. C.

## 56 BUSINESS OPPORTUNITIES

\$25 WEEKLY working two hours daily. No canvassing. No Manufacturing. Lycke, Box 2471, Cleveland 12, Ohio.

OPERATE profitable home business selling merchandise by mail. Fast sellers. Large profits. Powell Service, 5713 Euclid, Cleveland 3, Ohio.

RECAST old batteries into new. Latest achievements. Battery Laboratories, Minneapolis.

SPECIALTY Manufacturing, the big money business that can be operated anywhere, start on a very small capital; we supply dependable formulas and complete instructions; get interesting Free booklet, "Money-making Opportunities in Specialty Manufacturing." Howard Robinson, Ph. G., 1300-B S. Ohio St., Sedalia, Mo.

137 PLANS to make money local, mail order. Particulars free. Elite Co., 220-A Grand St., N. Y.

GOOD Paying Business Silvering mirrors, plating autoparts, reflectors, bicycles, bathroom fixtures, etc., by late methods. No tanks or shop required, outfit furnished. Free Booklet. Gunmetal Co., Ave. E, Decatur, Illinois.

START home business making statuettes, plaques, artificial marble flooring, liquid marble, flexible molds, metallizing baby shoes. Amazing profits. Folder Free. Creative, 236-M, Winnetka, Illinois.

SELL By Mail! Books And Novelties! 35 different items! Large Profits! Catalog free. Elfco, 432 N. Wells, Chicago 10.

MANUFACTURE Yourself: Cleaners, Polishes, Cosmetics, Formula Catalog free. Kemico, 10, Parkridge, Ill.

TRAVEL anywhere anytime. Earn \$85.00 week up. Be your own boss. No experience necessary. Less than \$5.00 investment required. Literature free. Traveler, La Grange 2, Indiana.

BIG profits and your own business casting new 1948 Metal Toys and Novelties. Latest scale model Autos, Original Ashtrays, Savings Banks, Water Pistols, etc. Enormous wholesale and chain store demand keeps manufacturers busy. No experience or special place necessary. Write for details and illustrations of patterns needed. Metal Cast Products Co., Dept. E, 1696 Boston Road, New York 60, N.Y.

COLORGLAZED Concrete Pottery made without molds. Patented method. Cemetery products, novelties, tiles. Basement leak-sealing. Money-making projects. Booklet, details free. Men only. National Potteries, Grand Rapids, Minn.

YOUR own plastic business at home. Produce costume jewelry, novelties, statuettes, liquid plastic, liquid marble, flexible molds. Write for free book. American Trades, Box 89-B-5, Cincinnati 39, Ohio.

MEN and women wanted to place self-selling coin machines in stores, hotels, filling stations, etc. New machine earns up to \$6.00 weekly—costs only \$10.50. We furnish supplies and machines for nuts, gum, candy, stamps, scales and amusements. Free details of tested selling plan. Write Dept. Z, Parkway Machine Corp., 623 W. North Ave., Baltimore 17, Md.

START Mailorder Bookshop—Everything furnished. 25c brings booklet, samples, exciting ideas. General Publications, Ossining 1, N.Y.

DON'T guess or wonder any longer about what to sell by mail. Sell Names. Right methods, successful ideas bring large profits. Write, Milton T. Clements, Pinellas Park, Florida.

START Your own electroplating business, highly paid, uncrowded field. Learn at home in spare time. Send postcard for free electroplating booklet and proof. Plater-Hyde, Room 523, 432 "F" Street, San Diego 1, California.

MAKE money spare time, write today. American Letter, New Market 1, N. J.

OPERATE profitable mail order business. Write Walter Service, 4159-B East 112th, Cleveland 5, Ohio.

TYPISTS, Profitable business at home. Complete copyrighted information, 50c. Gaunt, 3521-G Broadway, Chicago 13, Ill.

FOR an extremely profitable lifetime business operate a Collection Agency-Credit Bureau. Easily learned. Free folder. Cole & Associates, Syracuse 2, N. Y.

A FACTORY in your home garage! Mfg. and sales rights, mechanics' waterless hand cleaner, \$500—\$800 monthly. No special equipment necessary. Western Aircraft Mfg., Dept. G, Los Angeles 6, Calif.

"MOST everybody likes candy"—Learn to manufacture in a professional manner. (Our 38th year). Ragsdale Candies, #7, East Orange, N. J.

RAISE Earthworms. Instructions \$1.00. W. Huffman, 391 Pleasant Lake, Rives Junction, Mich.

SENSATIONAL new roller skate item. Sells on sight! Field barely scratched. Make big money now! Send \$1.00 for sample and full details. Write today. Pro-Tek-Toe Skate Stop Co., Dept. S-1, 5166-68 Easton Ave., St. Louis, Mo.

WHOLESALE Fireworks! Catalog 10c. Intermountain Fireworks, 5813 Holladay Blvd., Salt Lake City 7, Utah.

METALLIZE baby shoes. Excellent profits. New system assures success. Free details. Treasures Forever, 89-B Henry Ave., Lynn, Mass.

A BUSINESS start on small capital! Write for full information on Manufacturing formulas-analysis consulting services. Fairview Laboratory (Dept. A), Box 455, Tooele, Utah.

BE Your own boss. Have the security of a steady income with minimum capital investment, operating lowest cost penny person weighing scales, 100 scales can easily be operated as a spare time occupation with an average monthly income of well over \$400. No experience necessary. Write Hamilton Scale Company, 216 Oliver Street, Toledo, Ohio.

MAKE big money! You can clear 25 to 50 dollars a day in your own popcorn-candy business. Start now! Write for free literature and prices. All electric candy floss machines, popcorn kettles, candy pullers, other big money makers. Concession Supply Company, 3908 Secor Road, Toledo, Ohio.

4' X 8' OUTDOOR aluminum popcorn stands. Spring delivery. Evans Metal Products, Elkhart, Indiana.

BE A used car dealer. Tested plan \$1.00 or details. Smith, 17E Rockland Ave., Yonkers, New York.

OWN Mirror shop. Resilver mirrors. Glass sign making. Electroplating. John Sprinkle, V90, Marion, Indiana.

GENUINE Natural Latex for rubber molds. Only two coats necessary for thick mold. Make money reproducing statuary, plaques, novelties. Low cost. Write Major Chemical Company, 131 Inman Street, Cambridge, Mass.

BOOKKEEPERS — Accountants develop your own profitable business posting journal entries for small businesses in your locality. Full or spare time. Write National Bookkeeping Service, Midland Building, Kansas City 6, Missouri.

MAKE perfume. Complete outfit \$7.50. Information free. Lawson, 21 Joiner, St. Augustine, Florida.

NO selling, operate vendors, amazing profits, details Free. Factory Silver-King Corp., 622 Diversey, Chicago, Ill.

MECHANICALLY inclined? Resurface butcher blocks. Lifetime business. Roy Crawford, Keyport, New Jersey.

EARTHWORMS—For Soil Building & Better Composting. Write for free booklet. Coolville Earthworm Farm, Coolville, Ohio.

BE Your own boss. Metallize baby shoes. At home spare time. Schwieger, 8404 West Chestnut, Wauwatosa 13, Wis.

"MONEYMAKING opportunities" in mail order. Write immediately. Wayne A. Burger, Baltic, Ohio.

LIQUID Rubber for making flexible molds. Cast novelties. Sample bottle 25c. free literature. Chaney, 1130 E. 16th St., Jacksonville 6, Fla.

LEARN to publicize yourself for increased income in your business or profession. Details free. Publicity Systems (PS), Box 322, Jacksonville, Illinois.

MANUFACTURE costume jewelry at home for profit, hobby, therapy. Free wholesale supply catalogue. Instructions. Florida Supply House, Bradenton, Florida.

SPECIAL Rubber for making molds. Literature and sample free. Universal, Box 1076-B, Peoria, Ill.

FOR more business, operate an individual business office, exclusively under your own name. Rates \$10.00 and \$18.00 yearly. Cooperative Office Service, 126 Lexington Avenue, N. Y. 16.

MAKE Profits in mail order business. Astounding plans describing method sent free. Jimton Service, Lock Box 1373-L, Mobile 8, Alabama.

GET it for them wholesale. Be community buyer nationally advertised merchandise; radios, refrigerators, washers, sweepers, typewriters, etc. Savings to 50%. This pleasant easy work can earn \$5,000 year. Details free. Cox, 14-A Church, Saugus, Mass.

MAKE \$5000 yearly "Cashing-in on Fluorescent lighting." Start profitable maintenance and fixture fix-it business without capital. Make beautiful lights (Complete) for 50c each and less. Hurry for amazing illustrated literature and sensational free-gift offer. Willis Service, 101 York Street, Brooklyn 1, New York, Dept. A.

START mailorder business—Everything explained. 25c brings booklet, literature, exciting ideas. Cox, 14-A, Church, Saugus, Mass.

MAKE money at home in spare time like I do. Write today for details. Business Associates, P. O. Box 263, Port Huron, Mich.

EARN extra money using only your telephone. Easy and very profitable. Complete details \$1.00. J. J. Mills, 126 Lexington Ave., New York City.

RUBBER Molds. Illustrated list Free. Oman, 642-S Broadway, St. Paul 1, Minn.

MONEY Making Master Budget, \$1.00, postpaid. Big mail, 10c. Buchanan, Dept. 2, 16 Lisle Ave., Binghamton, N. Y.

MAKE flexible molds! Few cents each! Cast plaques, novelties, bookends! Free sample! H. Tooker, Hamilton 7, Ohio.

GOODYEAR—Has natural Malaya 75% heavy brushing rubber for molds, trial half pint 50c. Goodyear, Main St., Lake Geneva, Wis.

MAKE Rubber stamps, metallize baby shoes, silver mirrors. Make plaster novelties. Catalogue of "20 ideas" Free. Universal, Box 1076-B, Peoria, Ill.

OPERATE home business that may mean the road to independence. Write, Sunray, 4756-B N. Bernard, Chicago, Illinois.

EARN faster promotions on your job. Exciting new book shows how. Details free. Castle Book Company, 36 Glenwood Road, Baltimore 21, Maryland.

"SUEDE-Tex" kit contains all materials necessary to provide a velvety suede-finish on anything. Male or female. Rush \$7.95 to start a life long profitable business. Literature available. DonJer Products Company, 1115 Sterling Place, Brooklyn 13A, N. Y.

QUICK Money! "Repairing Car Batteries." At home! Easy too! Write, Batterymen, Grand Junction 1, Colorado.

AGENT or exclusive distributor for cigarette lighter mfg. MacGregor, Tahoe Valley 15, Calif.

INCOME from local information. No selling. Details 25c. Neher Co., LaVerne, Calif.

HOME Workers wanted to hand-spin Angora Wool. Either Sex. House of Angora, S4, Springfield, Ill.

RUBACREAM! Natural Rubber Latex! Makes molds quicker! Thicker! Free Sample convinces! Castcraft Studios, 509-S Fifth Avenue, New York 17.

SELL office supplies by mail from home office. Plenty repeat business with good profits. Descriptive literature free. Glenn Snyder, 5-F Spring Street, Beachwood, New Jersey.

PRESERVE baby shoes. Gold, Silver Bronze. Instructions \$1.00. Johnson, 2611 Harriet, Minneapolis 8, Minnesota.

**MANUFACTURE** small electronic device in your home without experience. Demand everywhere. Guaranteed. Plans \$1.00. Electronic Service. 32P Kenmore, Newark 6. N. J.

**SAVE!** Half million articles wholesale. Directory 10c. Publishers. Olinger 1. Va.

**MAIL** order businesses. bought, sold, brokered. Write for Free bulletin of exclusive opportunities. Turnipseed, Inc., Box 681, St. Louis, Mo.

**MAILING** postcards selling repeat merchandise is profitable. Everything supplied. Details free. Gordon Publishers, Box 23, Pawtucket, R. I.

**BIG Money** in "Kitty-Kat" baby shoes. Complete mail plan No-Co-Ro, Oakland GS, California.

**GET** it for them wholesale. Be community buyer nationally-known merchandise: radios, refrigerators, washers, sweepers, typewriters, etc. Savings up to 50%. This pleasant easy work can earn up to \$5000 year. Get details today. Kraft, Aurora 9, Missouri.

**\$126.50 GUARANTEED** weekly. Send \$1.00 deposit. Stannette, 277 Madison Street, New York 2.

**WATCHES**, wholesale. Rebuilt Elgins, Walthams, Bulovas, etc., \$9.75 up; new and used diamond, railroad, 21J wrist. Catalogue free. Brookings, B-X1975, Little Rock, Ark.

**ELECTROPLATING** Power units, deliver 2, 4, 6 & 8 volts D.C. from 115 V. A.C. 4 Amp. unit \$19.95, 8 Amp. unit \$29.95 with plating instructions. Instructions only \$1.50. Kissel Electric Products, 431 Sherman, Galion, Ohio.

**WOULD** you pay 3%—first \$350 made? Color-illustrated book "505 Odd, Successful Enterprises" free! Some offer occasional "day off." Work home. Expect something odd! Pacific, Oceanside, Calif.

**METALLIZING** Baby Shoes makes you money! Learn this simple, profitable business from nationally recognized authority. Little investment—large returns! Get professional "Know-How"! Free details, Joseph B. Kushner, Metal Finishing Engineer, Stroudsburg 33, Penna.

**HANDYMEN**—Earn money home operating Community "Fix-it" Shop. Write Stafford, 708 Rawlings, Carbondale, Ill.

**BUYERS** Wanted for plaster novelties and religious statuary. Painted—unpainted, retail—wholesale. Write today for free information. Bing Products, 88-B4R Broad, Boston 10, Mass.

**WHITE** Liquid Rubber for making flexible molds! Quick drying! Safe! For home, classroom, or industry! Quart \$2.00, Gallon \$5.95. Full instructions! Beginners booklet on molding and plaster casting 25c. Free with order! Plastercraft Supply Company, 1406 East 43rd Street, Cleveland 3, Ohio.

**AT Home**—Your own manufacturing business; making popular \$1.00 novelties. Cost you 3c to 15c. Everything supplied. Write So-Lo Works, Dept. D-601, Loveland, Ohio.

**START** Home plaster novelty business. Amazing course tells how. Literature free. Kemo-Courses, 4862 Catalpa, Chicago 30, Ill.

**\$46 FROM** Square Foot Plywood; Jigsaw necessary. Write; Woodart, Bridgewater, Massachusetts.

**BABY** Shoes preserved. Formulas. Instructions \$1.00. Supplies & Bases. Novelty Bronzing, Box 56, Hyde Park 35, Mass.

**BIG Money** In Vending Machines—Smallest capital start brings immediate profits that build permanent profitable business. Starting instructions free. Becker Vendors, 105-P Dewey, Brillion, Wisc.

**EXTRA** Money in your pockets. Steady profit. Make-sell specialty products. Tested products and sales plans. Complete treatise \$1.00, particulars free. Karamus Products, Dept. 10, Linden, N. J.

**ELECTROPLATING!** Want a money making trade or profitable business of your own? Learn from nationally recognized authority. It's easy when I show you how! Free details. Joseph B. Kushner, Metal Finishing Consultant, Stroudsburg 1, Pennsylvania.

**LEARN** Piano Tuning, Repairing, at home. Tremendous field! Piano parts, tools furnished. Established 1935. Empire School of Piano Tuning, 606-A East University Ave., Champaign, Ill.

**METALLIZE** baby shoes. Excellent profits. New system assures success. Free details. Treasures Forever, 89 Henry Ave., Lynn, Mass.

**"DO IT** with sea shells." Profitable easy homework. Lesson free. C. Werts, Sharp Park, California.

**GET** 400 money making ideas. Formulas. Plans. Schemes. Folio free. Formico Prod., Box 572, Dayton, Ohio.

**RUBBER**—\$1.75 Qt., \$5.50 Gal. Samples. Stone Art Co., Schaghticoke, N. Y.

**MAIL** order business your opportunity. "How To Build Your Own Mail Order Business." Beginner's idea-book tells how. Quarter, postpaid. Satisfaction warranted. Gilchrist, 622-S. Mass. Ave., N.E., Washington 2, D. C.

**METALIZE** baby shoes for pleasant profits. Many methods. Details free. Enterprise, Box 189-SE, Wilkes-Barre, Pa.

**UNPAINTED** ornaments, bookends, plaques, free list. Haverty Products, 1219-S 8th Ave., Altoona, Pa.

**FLEXIBLE** Molds to order, also originals. Professional course manufacturing molds and cast novelties. Latex, lacquers, flocks, flocking equipment, supplies. Plastics, Box 1574, Boston 4, Mass.

**HOW** and Where to obtain capital. Particulars free. Star Service, Wapakoneta, O.

**HOMEWORK:** Addressing envelopes. Details 25c. Siegel, 126 Lexington, N. Y. 16.

**START** Flocking—Spray professional plush finish on everything. Easy, profitable, inexpensive. Free samples, illustrated folder. Coast, 1511 W. Manchester, Los Angeles 44.

**LIQUID** Marble—Colorful, glossy! Molded, brushed, sprayed! Cast novelties, statuary, colored tiles. Flexible molds. Composition floors. Particulars free. Marbleizing Service, Edwardsville, Illinois.

**SELL** by mail. Exceptional profits. Experience unnecessary. Details free. Largentiere Company, 6462 83rd Place, Forrest Hills, New York.

**LEARN** to make sea shell jewelry, novelties. Instruction book free with \$2.00 and \$5.00 kits. Free catalog. Herbert Diamond Co., Box 4619-B, Miami 31, Fla.

## 57 MONEY MAKING OPPORTUNITIES

**ELITE** Collection describes 137 money-making plans; local, mail order. Particulars free. Elite Co., 220-A Grand St., N. Y.

**DETECTIVES** Earn Big Money. Experience unnecessary. Particulars free. Waggoner, P-125, West 86th, N. Y., N. Y.

**SEWING** Machine Repairmen make big money lifetime. Start neighborhood shop. Complete repair manual, covering all makes, \$1.98 postpaid. Money Back Guarantee. Sewmachine Serviceman, Hamilton 10-M, Ohio.

**EXTRA** Money? Free details. Trable, 1018½ Elm Street, Dallas, Texas.

**MECHANICALLY** inclined? Resurface butcher blocks. Life-time business. Roy Crawford, Keyport, New Jersey.

**TECHNICAL** bulletin listing, 24 Opportunities. Free. Public Educational Service, 493 Irving, Bridgeton, N. J.

**LATEST** Money-making opportunities. Variety of choice. Details free. Edward Stevens, 716 W. 4th St., Michigan City, Indiana.

**TURN** your spare time into real money with the latest coin operated amusement counter game. Write for complete details to Clover Distributing Company, 1123 Broadway, New York 10.

**WIN** contest money. General Contest Magazine gives hundreds of tips. Lists current contests and rules. Sample 25c. General Contests, 1609-A East 5th, Duluth, Minn.

**MANUFACTURE** costume jewelry at home for profit, hobby, therapy. Free wholesale supply catalogue. Instructions. Florida Supply House, Bradenton, Florida.

**METALLIZE** baby shoes. Further information—3c stamp. Metal Crafts, Box 125-R5, Tampa 4, Florida.

**BIG** money manufacturing floor tiles. Details free. U-Build-It Service, 206-A West Wilder, Tampa, Florida.

**A \$100-a-Month** hobby at home! No soliciting, no mail order, no meeting people. Easy, enjoyable pastime. Details, 25c. (Refundable.) Laura Dickson, 808-PS Elizabeth St., Anderson, S. C.

**21 POPCORN**, Candy Apple, etc. Formulas. All money-makers, \$1.00. We can supply equipment. Concessions Supply Co., Dept. "B", Box 133 Sta. "B", Toledo, Ohio.

**WOULD** You pay 3%—first \$350 made? Color-illustrated book "505 Odd, Successful Enterprises" free. Expect something odd! Pacific, Oceanside, California.

**GET** 400 Success Plans. Ideas. Amazing formulas. Schemes. Folio free. Formico Crafts, Box 572, Dayton, Ohio.

**UNBELIEVABLE** but true! I am a Preacher, nevertheless made over \$2300 in 30 days, honestly, legitimately. You may do as well. Details \$1.00. F. J. Winder, 4638 N. E. 34th, Portland 11, Oregon.

**100 THINGS**, make and sell at Home. 10c. Holm, 12B Oaklandon, Indiana.

**START** your own business! Big money manufacturing novelties, plaques, statuary. Free catalog. Write Bing Products, 88-B4S Broad Street, Boston 10, Mass.

**BIG** classified directory listing 100 Leading Wholesalers—25c. Lawrence, 280 North McNeil, Memphis 12, Tennessee.

**MAKE** money at home. Easy work. Bava, 3655 East Canfield, Detroit 7, Michigan.

**BIGGEST** 25c value ever offered! Three big issues "Opportunities Preferred," greatest business building magazine published; plus Big, dollar Idea "Reference Directory" book—\$1.75 value, only 25c! Hurry! Coates, Publisher, Box 88, Dorchester, Mass.

**START** Home mail business! Takes only few dollars. No experience—good earnings. "How folder." Free! Shutt, Box 269, New-castle, Indiana.

**SELLS** like mad! Show it once—bang! Sold! No sales talk. Cost \$2.00. Brings \$5.00. Sell 10 daily easily anywhere day or night. Inquire Stampico, Detroit 4, Mich.

**WANTED** home workers: Easy work, children can help. Send 25c deposit. (Credited) for details, and 50c value surprise. Bishop Novelty's, Box 877, Milwaukee 1, Wis.

**WIN** Contest money, send 25c guaranteed instructions for writing winning answers. Winacontest, 22 Westlake Ave., Auburn, New York.

**LEARN** Battery repairing, rebuilding. Engineer offers money making methods. Battery Bureau, 2225 North 44th St., Milwaukee, Wisc.

**UNPAINTED** Plaster Ornaments: Beautiful designs, easily decorated with water colors or oil paints. Profit or Hobby. Illustrated List Free, distributors of New Loxite, A Firestone Product, for Molds, Midwest Novelty Mfgs., 108 Cedar, Anaconda, Montana.

**REPAIR** leaking faucets easily with our repair kit. For details. Great Lakes Metal Specialty Mfg. Co., 1450 W. North Ave., Chicago 22, Ill.

**BARGAIN!** 1,034 ways to make money at home. \$1.00 complete. American Stamp Company, MM-4108, Delaware.

**MAKE** money. Making \$2.00. S. Sumer-ville, Hazel, Butler, Pa.

**PRIZE** Contest Fans Reap Rich Rewards. Enclose 3c stamp. National Contest Bulletin, Box 2685-S, Miami 31, Fla.

**15 GOOD** business plans 50c. Free list. 100 new products, included. Successful Ventures, 1311-M Widener Bldg., Phila. 7.

## 58 FORMULAS, PLANS, ETC.

**137 MONEY**-making plans, also formulas for salable products. Descriptive booklet free. Elite Co., 220-A Grand St., N. Y.

**REAL** manufacturing formulas. Lists free. Cumming Chemist, Gordon Avenue, Syracuse 4, N. Y.

**TRADE** Secrets, 10,000 formulas, 900 pages. \$3.00 Postpaid. Natco Supply, 1090 W. 43rd, Norfolk 8, Va.

**400 MONEY** Making ideas. Formulas. Mfg. secrets. Amazing folio Free. Formico-NA, Box 572, Dayton, Ohio.

**10,000 FORMULAS** and trade secrets. Free literature. Stillmans, 555 Kingston Ave., Brooklyn 3, N. Y.

**TESTED** Formulas—Genuine manufacturing processes. Literature free. Chemical Service, Edwardsville, Illinois.

## 59 PLASTICS

**LUCITE**, Plexiglas. All size sheets. Cost square foot (12 x 12) 1/16" 90c; 1/8" \$1.16; 3/16" \$1.43; 1/4" \$1.68; 5/16" \$2.09. Include 10% postage. Almac Plastics, 230 Fifth Ave., New York 1, N. Y.

**PLASTIC** initials, animals, novelties. Dandy for monograms, decorations, pins, charms. Assorted package 25c. Secor, 131 West 42nd, New York 18, N. Y.



**PLASTIC**—Sheets, Rods, Tubes, etc. Free List, Plastic Supply Co., 2618 St. Louis Avenue, St. Louis 6, Mo.

**LUCITE** and Plexiglas remnants, masked. Generous assortment \$1.00 postpaid. Industrial Manufacturing, Box 5989 Metro Station, Los Angeles 55, Calif.

**INTERNAL** Carved swans, bluebirds, goldfish, butterflies, etc., pins, \$1.50. Rose or Daisy costume jewelry sets, \$1.50 less findings. Also gifts and novelties. Crystal Floral Novelty Co., Somerville, New Jersey.

**INTERNAL** Carved earrings and necklace ready to wear \$1.75 set. Carving drills, dyes, Jewelry finding, tools, Plexiglas, masked sheets 12" x 12" 1/16"—\$1.00, 1/8" \$1.25, 3/16" \$1.55, 1/4" \$1.85. Include 10% postage. Rods, tubes, dyes, cements, buffing compounds, Free listings, Craft Plastics, Somerville, New Jersey.

**PLEXIGLAS**, clear, masked. Prices per square foot. 1/16"—\$1.00, 3/32"—\$1.15, 1/8"—\$1.25, 3/16"—\$1.50, 1/4"—\$1.80, 3/8"—\$2.60, 1/2"—\$3.40, plus 10% postage—all colors 10% additional. Rethel Plastic Co., 15 Walnut St., Steelton, Pa.

**NEW** Liquid plastic. Clear, colors. Cast without heat. Embed flowers, insects, coins. Saw, drill, carve. Manual tells how. Send \$3.50 (West Coast, Canada, Mexico \$3.75) for complete 20 project kit including one pound liquid Castolite. Castolite, Dept. D-42, Box 211, Kenilworth, Ill.

**PLASTICS**—Sheets, rods, tubes, all colors; dyes, supplies; findings. Illustrated fabricating manual, prices, 10c. Lucite sample, 35c. Gem-O'-Lite, Box 686G, North Hollywood, Calif.

## 60 CHEMICALS AND APPARATUS

**CHEMICALS**—Lab. Supplies New Catalog 10c. Mel-Glo Chemical Co., 258 Fourth Avenue, Brooklyn 15, N. Y.

**LUMINOUS** Paints will glow in dark. Six colors. Fairmount Chemical Co., 136 Liberty St., New York City 6.

**LEARN** Chemistry at home, from the House of Winn. Home of Supplies for student Chemists. New idea chemical and apparatus outfits for Home Experimenting. Semi-Professional Microscopes and accessories. Send 10c for retail catalogue. Established 1931. John H. Winn, Dept. 604, 124 West 23rd Street, New York 11, N. Y.

**SINKER** molds for making your own sinkers. Several styles, many sizes. Free illustrated folder. Reading Instrument Co., Box 78, Reading, Pa.

**CHEMICALS** and apparatus for industrial, analytical, and private laboratories. Complete supply service for correspondence school students. Send 10c for catalog. Dept. M-26, Biological Supply Co., 1176 Mt. Hope Ave., Rochester 7, N. Y.

**FREE** catalog: Chemistry, Mineralogy, Biology, Physics, Tracey Laboratories, Evanston, Illinois.

**COMPLETE** Supply Catalog, 10c. Pilgrim Chemical, 348-EE Edith, Salt Lake City 4, Utah.

**CHEMICALS** ounce quantities catalogue 5c. Chemical Sales, 19165 Gallagher, Detroit 12, Mich.

**LABORATORY** supplies, chemicals, glassware, etc., low prices. Large catalog 15c. Microscopic Stain catalogue 20c. Both for 25c. National Scientific Company, Established 1908, 2204 W. North Ave., Chicago 47, Ill.

**CHEMICALS**, ounce quantities, apparatus, catalog 10c. Fleischer's Laboratories, Everett 49, Mass.

**INTERESTING** catalogue, chemicals, rare elements small quantities, etc. J. B. Herron, Vicor Laboratories, Guerneville, Calif.

**CHEMICALS** in all grades and quantities; Cat. \$1.0. Celtic Chemical Co., 2619 Ocosta Ave., Cincinnati, Ohio.

**CHEMICAL** laboratory, used; equipment, chemicals, glassware, books, etc. Sacrifice price. Lacy Boyer, Woodstock, Va.

**BIG** Chemical value! Only \$3.50—24 different chemicals for home experiments—all neatly bottled. Met & Co., 160 Hillside Avenue, Nutley, N. J.

## 61 HELP WANTED

**SALESMEN:** Big money showing building owners sensational product; cuts essential repair cost up to 75%. Six average orders weekly pay you over \$190.00. Age: 30 or over. Get moneymaking facts. Write, Zone Co., Dept. D-8, Box 789, Ft. Worth 1, Texas.

**EARN** Up to \$520 month part or full time keeping books for small firms. Simplified System. Write Tax-Saver System, Dept. I, Ft. Worth, Texas.

**INTERESTED** in Latin American and foreign employment? \$1.00 brings copyrighted Foreign Service Directory with Hot list of concerns interested in oil, mining, aviation, construction, transportation, manufacturing. How-when-where to apply. Global Reports, Dept. PS, P.O. Box 883, Hollywood 28, Calif.

**BOYS** Wanted. Over \$50 week! Sell name plates for front doors. Write National, 214-R Summer, Boston, Mass.

**RELIABLE** man with car wanted to call on farmers. Wonderful opportunity now. \$15—\$20 in a day. No experience or capital required. Permanent. Write today, McNess Co., Dept. 80, Freeport, Illinois.

**"ALASKA—The Last Frontier"** offers thousands of excellent opportunities. \$1.00 brings government map and copyrighted Report with authentic listing of fishing, mining, fur farming, prospecting, aviations, construction, homestead lands. Alaska Opportunist, Dept. PS, Box 883, Hollywood 28, Calif.

**FOREIGN** positions? Now is the time. Latest list including Central & S. America. 200 Firms. \$2.00. Fox Info Service, 2514 W. Broadway, Corpus Christi, Texas.

**FOREIGN** Employment! List of 70 companies with foreign interests \$1.00 or COD. Foreign Service Institute, Box 3934, Miami 24, Fla.

## 62 AGENTS WANTED

**GOOD** Paying Business Silvering mirrors, plating autoparts, reflectors, bicycles, bathroom fixtures, etc., by late method. No tanks or shop required, outfit furnished. Free Booklet, Gunmetal Co., Ave. G, Decatur, Illinois.

**LICK** After-war layoffs; Start own business; home, office. Booklet describing "Collection of 127 Tested Plans" free. Elite Co., 220 Grand St., New York.

**EXCELLENT** Sideline for printing and advertising salesmen. Decalomania name plates in small quantities. Great demand. Also, make money with our line of Automobile Initials and Sign Letters. Free Samples. "Ralco", XL-Roxbury, Boston 19, Mass.

**AGENTS—Big Line** Including Food Products. Fast selling premium and bargain deals. Low prices. Send card for big outfit offer with gift. Ho-Ro-Co., 2726 Dodier, St. Louis 7, Mo.

**SELL** Delicious Candies, Nuts, Gum. Immediate delivery. Write Casterline, 2031-SG Sunnyside, Chicago 25, Ill.

**AGENTS—300%** profit selling genuine gold window letters; stores and offices. Free samples. Metallic Letter Co., 437 N. Clark, Chicago.

**GOLD** lacquered Window Sign Letters. Large Sizes Penny Each. New Foils. Absolutely Beautiful. Free Samples. Atlas, 544 W. 79th, Chicago 20.

**A DRESS** yours with every 3 you order for yourself and family. Amazing new bonus plan. Everything Free. Harford Frock, Dept. L-9129, Cincinnati, Ohio.

**JOBS** Open In Selling! Send name, address for Free copy Opportunity Magazine, listing hundreds of companies who need men now, full or spare time. Experience not essential. Opportunity, 28 E. Jackson, Dept. 15, Chicago 4, Ill.

**FREE** Sample! Big profit opportunity with amazing Glow-In-The-Dark house number, switch plates, pictures, decals, religious articles. Represent large manufacturer, Madison Mills, 303 4th Ave., New York, N. Y.

**AT last!** Something new and sensational in Everyday Cards. New, gorgeous satin and velour designs. Get orders fast. Big profits. Imprinted stationery, 14 assortments for year 'round occasions, retail 60c to \$1. Get samples on approval. Puro Co., 2801 Locust, Dept. 841-D, St. Louis 3, Mo.

**ADVERTISING** book matches—Cash in on Political campaigns—sel' Union Label matches. Cuts for all businesses and political parties—Free powerhouse selling kit—low prices—protection guaranteed on repeat orders—Cash commissions. Superior Match Co., Dept. P 48, 7530 Greenwood, Chicago.

**AMAZING** new zipper shoe sells on sight. Big cash profits for salesmen. Leads line 200 splendid styles. Territory open. Get Free sample outfit. Write Victor Thomas, Dept. V-29, Chippewa Falls, Wis.

**SELL** New—used clothing from home, auto, store. Men's suits \$1.17. Leather jackets 85c. Overcoats 62c. Dresses 17c. Ladies' coats 38c. Other bargains. Catalog free. S & N, 565A, Roosevelt, Chicago.

**DEALERS** Wanted to sell fishing tackle, lawn mowers, electric drills, Teresi Jobbing, 1703 Olson Hiway, Minneapolis 5, Minn.

**MAGIC** Cleaner and laundry soap deal. Hotter than a firecracker. Big Profits. Sample free. Uko, 5007 Irving Park, Chicago.

**WHOLESALE!** Balloons—Novelties—Watches—Jewelry—Premium Goods. Collins Co., Forsyth 2, Georgia.

**MAKE** more money selling personal initialed individualized belts, buckles, cap badges, tie holders, 2,000 emblems to choose. Big profits, whole or part time. Write today—special outfit offer. Hookfast Specialties, Box 1425, Dept. 7, Providence, Rhode Island.

**RESTAURANT** Salesmen—New fast selling sideline that nets 200%. Sample free. Theron Fox, 1024A Carolyn, San Jose 10, Calif.

**DOUBLE** Duty shopping bag. Zips open. Instantly changes from small to large size. Lightning seller. Samples sent on trial. Kristee 121, Akron, Ohio.

**SPRING** Months offer money making opportunities. Easy sales. Unlimited market in your community. Our helps build business. Write for Free Wholesale catalog today! McGregor Magazine Agency, Dept. 13, Mount Morris, Illinois.

**\$1 STARTS** you in business. Sell DeLuxe ties, 100% wool interlining. Costs you only \$7 per dozen, you make \$5.00 dozen. Send \$1.00 for special introductory offer two DeLuxe ties. Catalog complete line Free. Philip's Neckwear, 20 West 22nd St., Dept. P-21, New York 10.

**AMAZING** offer—\$25 is yours for selling fifty \$1.00 boxes of entirely different, new DeLuxe All-Occasion cards. Each box sells for \$1.00, your profit 50c. It costs nothing to try. Write today for samples. Cheerful Card Co., Dept. 298, White Plains, N. Y.

**EVERYBODY'S** feet hurt. Sell guaranteed relief, 100% profit. Excellent repeater. IDI, Quakertown 2, Penna.

**DISTRIBUTORS—**Increase your income! Wholesale supply sources, Moneymaking plans. Write Bowden Service, Box 0673, Toledo, Ohio.

**AMAZING** Profits selling personal initialed individualized buckles, belts, cap badges, tie holders, flexible cap bands, 2,000 emblems to choose from. Repeats. Write today special outfit offer. Hook-Fast Company, Box 480-PS, Roanoke, Virginia.

**SELL** Gold embossed monogram stationery. Sample free. Dunbars, Sanford, Florida.

**MEN'S** Shirts, pajamas, cotton dresses, nylon slips fast-sellers. Free sales kit. Jarod Mfg. Corp., Rockville Centre 22, N. Y.

**DEALERSHIPS**, Sweetline No-Rub Re-finish, revolutionary cleaner-polisher. Instantly cleans, renews, preserves, leaving high gloss finish on hard surfaces without rubbing. A One-Time-Over principle. Dries immediately. For factories, stores, hotels, banks, theatres, restaurants, lobbies, bars, etc. Repeat sales. Utilized by Army, now available generally. H. C. Sweet Co., 3729 Fenkell, Detroit, Michigan.

**EARN** \$200 weekly installing new amazing "Styron" plastic wall tile in home, offices. Easily applied. Tile your own kitchen, bathroom, too. Instructions, everything furnished. Literature free. U. S. Tile Co., 30-A W. Washington St., Chicago 2, Ill.

**FREE** Water and our concentrates make flavors, lotions, shampoos, 72 products. Labels, bottles furnished. Qualco, F-20030 Russell, Detroit.

**SILVER** Cleaning, plating, polishing, liquid (Nu-Silver). Apply with cloth. Re-news silverplated ware, articles, pieces. Silverplates brass, copper, bronze. Female, male, agents wanted, part or full time. NuProcess Products, Aurora, Ill.

**POCKET** Pal: Replaces pocket knives. New, safe, beautiful. Always razor sharp. 50c seller, 231% profit, \$15.00 or more daily. Agents, salesmen, distributors. Sample 10c. Nelson Mfg. Co., 222 W. Kellogg, St. Paul 2, Minn.

**AGENTS** Wanted for our Slot Machines and coin operated amusement games in every town and community. Sell to clubs and homes, or start a route. Webb Distributing Co., Dept. P40, 6 So. Kedzie Ave., Chicago 12, Ill.

**SALESMEN.** Earn \$100.00 weekly, selling only six pair shoes daily. Commission and bonus. Wide variety for men, women, children. No investment. Experience unnecessary. Tanners Shoes, 232 Boston, Mass.

**\$3 FIRE Extinguisher** sells wholesale or direct. "Fire-Killer", 101 Franklin, Syracuse 1, New York.

**FACTORY agents-dealers.** Gas mower (Maytag)—\$99.50. Photos Free. Rotacut, M-2014, Excelsior Springs, Mo.

**AGENTS** wanted for Tiresignal. Fast selling device. Eliminates flat tires on automobiles. Sample \$1.00. Tiresignal, Dept. B, P. O. Box 1667, Los Angeles 28, Cal.

**INFORMATION** — Wholesale supply sources. Moneymaking plans. Increase your income. Write Reynard Station, Smithfield 3, Ohio.

**FREE** nylons given if Kendex hosiery runs or snags! Mere words could not possibly express the almost unbelievable opportunity you now have to make money taking orders for the world's only complete line of women's beautiful hosiery actually guaranteed against everything! Free replacements made regardless whether cause is use or abuse. Not sold in stores. Here is sales dynamite that will blast your earnings to the sky. Even if you never sold a thing in your life, three magic words "Guaranteed Against Everything" are enough to make women eagerly buy. Complete line includes sheer and service nylons, rayons, etc. in different lengths. You need no money or experience. Simply write orders. We deliver and collect. Liberal advance cash earnings plus huge cash bonus. Write orders spare or full time; exclusively or as a side line. Everything you need to start making money furnished free and prepaid. Just send name and address on postcard for Your free outfit. No obligation. Write Dept. 127, Kendex Co., Babylon, N. Y.

**PROFITS** to 100% selling everyday greeting card assortments. Details and assortment on approval. Glorian, Dept. 20, 515 East 45th Street, Brooklyn 3, New York.

**WOULD** you pay 3%—first \$350 made? Color-illustrated book "505 Odd Successful Enterprises" free! Proven! Work at home. office. Expect something odd! Pacific. Oceanside, California.

**SAVE!** Half million articles wholesale. Directory 10c. Publishers, Box 1302-A4, Detroit 31.

**AMAZING** daily profits, big repeat business selling top-quality, lowest priced men's guaranteed hosiery: full, part-time. Experience, investment unnecessary. Free selling outfit. Coltsos, 242-K4 Purchase, Boston 10, Mass.

**SELL!!** Balloons, Combs, Specialty Merchandise, Carleton House, Distributors, Texas City, Texas.

**SELL** Brilliant new Curv-O-Syns, any copy, one price. Callas Company, 2832 Hamilton, Detroit 1, Mich.

**SELL** advertising booklets, service stations, garages, free literature. Ruberts, Carthage, Ill.

**SELL** Beautiful steel bed lamps, Louverlite, direct to user. Retail \$3.95. Wholesale \$2.37. Sample \$2.77. Write for circular. Randolph Manufacturing Company, Kilgore, Texas.

**MAKE** money at home like I do! Write immediately. Duffy (5), Covington, Ky.

**SELL** Ultra blue stock signs to stores. 1000 slogans, comedy, general, religious. 7 x 11, cost 6c, sells 35c. Make money. Sample free. Lowy, 8 West Broadway, Dept. 378, New York City (7).

**MONEY** every day. Take orders for our lifetime Photo-Plaque, they sell on sight, made from any photo, snapshot or negative. Send for free details. Quaker Photo-Plaque Co., 914 Walnut Street, Philadelphia 7, Pa.

### 63 HIGHGRADE SALESMEN

**START** Your own business on our capital. Always your own boss. Hundreds average \$6,000 to \$25,000 annual sales year after year. We supply stocks, equipment on credit, 200 home necessities. Selling experience unnecessary to start. Wonderful opportunity to own pleasant, profitable business backed by world-wide industry. Write Rawleigh's, Dept. D-U-PSC, Freeport, Ill.

**AMAZING** discovery. Master Glaze, puts brilliant glass-like surface on cars. Free sample, information. Big commissions. Master Glaze, Dept. 648, 7720 Harwood, Milwaukee, Wisc.

**\$240.49 IN ONE week**—Unusual? Not at all! Just look at one week's earnings of these representatives. WWS \$290.99. JMH \$229.75. RJR \$262.47. VJM \$275.95. JEA \$240.49. RWF \$231.21. Direct mail campaign brings hot leads right into your home. Remarkable product does part of 10 men's work—a "natural" during these labor problem days. Has perfect sales story—sells year 'round. As modern as Radar! Special demonstrator offer. We extend credit, deliver and collect. No capital required—no experience necessary. You make big profit on first sale and full credit on repeat business. Every business, store, factory, etc., are prospects. Write John Porter, 2433 Indiana, Dept. 330, Chicago 16.

**EARN** \$25 a day and more selling nationally advertised aluminumware, silverware, pressure cookers and jewelry. It is simple. Let us show you how to make big profits with no investment. Write Continental Products, Dept. C4, 30 Ormsbee Avenue, Providence, R. I.

**SALESMEN** will clean up this year selling our Electric fans and Sump Pumps. Write Universal Fan Co., Peru, Indiana.

**AMAZING** daily profits, steady repeat business selling famous Colt Shoes direct. Exclusive features make selling easy. Experience unnecessary. Patented Footograph assures accurate fitting. Free selling outfit. Colt Shoes, 601-K4, Atlantic, Boston 10, Mass.

### 67 EDUCATIONAL AND INSTRUCTION

**HAVE** your own office! Many earn up to \$5,000-\$15,000 Annually. Learn credit-collection agency business by home study course. Experience unnecessary. Write for Free bulletin. No obligation. Franklin Credit School, Dept. 203-D, Roanoke 7, Va.

**LEARN** Elements of radio at home. Ideal course for beginners. \$15.00. Write Waca Radio School, 1421 Sixth Street, S.E., Minneapolis 14, Minn.

**BECOME** a Doctor of Psychology or Metaphysics. Teach secret of contentment, happiness. Win degree of PsD, or MsD. Solve mental worries. Free book, College of Universal Truth, 5153-K N. Clark, Chicago.

**DENTAL** Technician training. Easy home study in spare time. Dental Crafts and Sciences, P. O. Box 1321, Palo Alto, Calif.

**LEARN** Piano Tuning. Prepare for Career in fascinating profession. \$5,000 year easily earned. Real security, pleasant easy work. No profession Paying so well can be mastered so quickly. Natural Aptitude, desire to get ahead chief requirements. Prospectus and full information on request. Harmony School of Piano Tuning, Box 582, Harrisburg, Pa.

**WANT** U. S. Gov't job? Big starting pay. Security. Men-women. Vets get preference. Qualify now for next examinations. Sample lessons—Details free. Apply Franklin Institute, Dept. A-22, Rochester, N. Y.

**SAY** Goodbye to job hunting. Get a lifetime Government Civil Service job. Men-women. Write for free booklet: "How to Get a Government Civil Service Job." Lincoln Institute, Dept. S-2, 7951 Yates Ave., Chicago 17, Ill.

**USED** Correspondence courses and educational books, bought, sold, rented. Catalog free. Educational Exchange, Summer-ville, Georgia.

**WELDING**—a profitable trade. Demand for trained men. Learn quickly at best equipped school in U. S. G.I. approved. Catalog free. Write Hobart Welding School, Box P-487, Troy, Ohio.

**BOOKKEEPERS!** Increase your earnings! Operate your own simplified "Dollar-A-Week"—Bookkeeping and Tax Service. Full or spare time. Details Free. No obligation. Ellis, Box 18-D, Cedar Grove, N. C.

**EXPERT** Bookkeeping, easily learned—15 lesson course \$5—Introductory lesson 35c—Bernard Buchalter, 1280 (SP) Ocean Ave., Bklyn. 30, N. Y.

**CLINICAL** Laboratory Technicians in great demand. We train you in your spare time, in your own home. You can practice while studying. Write for free catalogue. Imperial Technical Institute, Box 973-B, Austin, Texas.

**STEP-Up** your brains, income. Amaze with Super-memory. Facts, figures, faces stick like burrs. Write for free details. Thor Books, CS-4, Box 1210, Chicago.

**SPEAK,** read, write French or Spanish. Complete course, \$2.00. American Stamp Company, Wilmington FS-4108, Delaware.

**3800 LATEST** Used Correspondence courses. Catalog 50c. EG, Elmsford, N. Y.

**HYPNOTISM.** "How I Hypnotize" 25c. Dr. Lonk, D-1618, Palatine, Illinois.

**"HOW** To Become A Professional Letter Writer". Free booklet. Letter Writing Institute, 45 West 29th, New York, N. Y.

### 69 CONTESTS

**\$1,000,000 FREE**—Yearly—Contests. Win fortune. We prepare entries—lowest cost. Write. Research, 13 Earl Street, Red Bank, New Jersey.

### 70 LANGUAGE OUTFITS

**LINGUAPHONE** Makes Languages Easy at home. Learn to speak Spanish, Portuguese, Italian, French, German, Russian, by quick, easy Linguaphone conversational method. Save time, work, money. Linguaphone Correspondence Courses are available to veterans under G.I. Bill of Rights. Send for free book. State if G.I. Linguaphone Institute, 54 RCA Bldg., New York 20, N. Y.

### 72 AUTHORS SERVICE

**NEW** Writers Needed. Nonfiction material demand is booming. Many magazine editors buy features and "fillers" from new writers. Our Earn As You Learn lessons prepare you to meet their requirements. Experience unnecessary. Reasonable price, unexcelled service. Details, sample lesson free on request. Use postcard. No obligation. Comfort Writer's Service, 200 S. 7th St., Dept. 21, St. Louis 2, Mo.

### 73 BUSINESS SERVICE

**MAIL** Forwarding, Confidential, Letter 25c. Monthly \$2.00. Prompt service. Special services performed. Buchanan, Dept. 2, 16 Lisle Ave., Binghamton, N. Y.

**MANUFACTURERS** Names most any item made. \$1.00 brings list. HMG Company, Mecca 1, Indiana.

### 74 CARTOONING, SIGN PAINTING, DRAWING AIDS

**SIGNS** made easily. Instructions and ten sets modern alphabets, numerals, patterns. Sizes up to eight inches. All for \$1.00. Co-operative Business, 7 West Madison, Chicago (2).

**"HOW** To Make Money With Simple Cartoons"—A book everyone who likes to draw should have. It is Free; no obligation. Simply address Cartoonists' Exchange, Dept. 194-C, Pleasant Hill, Ohio.

**TALENT** Test Free. American School Commercial Art, Box 8066, Dallas 5, Texas.

**EARN** money evenings, copying and duplicating comic cartoons for advertisers. Adservice, Argyle (2-B), Wisconsin.

**CARTOONING,** sketching, etc. 31 lessons. 600 illustrations, including drawing paper, pens, pencils. \$1.00 complete. American Stamp Company, Wilmington C-4108, Delaware.

**"CARTOONS** and drawing," 31 lessons. \$1.00 (refunded). Catalogs, 10c. Stone, Luenburg 30, Mass.

### 75 CHALK TALK-STUNTS

**CHALK** Talks, Laugh Producing Program, \$1.00. Illustrated Catalog 10c. Cartoonist Balda, Oshkosh, Wisconsin.

**ENTERTAIN** with a pencil! Amazing new Chalk Talk Course shows how! Includes sensational "animated" stunts! Complete, \$1.00 postpaid. Vane Co., Box 98, Bergenfield, N. J.

### 76 TYPEWRITERS

**RECONDITIONED** Typewriters, Printing Devices, Office Appliances Supplies Dixie-graph, King, N.C.

### 78 RUBBER STAMPS

**3 LINES,** cushioned indexed 50c Pads 35c. Print-Right, Wauwatosa, Wis.

**RUBBER** stamps. Illustrated literature free. Lee-Vall Press, Dept. 4-D, Box 1242, Indianapolis 6, Indiana.

### 79 PRINTING OUTFITS, SUPPLIES

**PRINTING** outfits, type. Send dime for illustrated supply book. Kelsey A-8, Meriden, Connecticut.

**"PRINTOMATIC"** Selffeeding Post Card Stencil Printing Duplicators \$9.50 Up. Office Size Duplicators, Speedoprints, Hllcos, Excellographs \$33.41 Up. Literature Free. Pittsburgh Typewriter Supply, 336 WE Fourth Ave., Pittsburgh 22, Pa.

**INEXPENSIVE** home-made printing press. Details free. Novelty Shop, Downs-ville, Louisiana.

RUBBER Stamps all kinds, catalogue 10c. Print and Stamp Co., Box 172, Boston 1, Mass.

PRINTING Presses, Type Supplies, Lists 3c. Turnbaugh Service, Loysville, Penna.

WANTED, Chandler—Price presses any size anywhere, Levinson, Box 918, New York 8.

MAKE your own printing cuts. Newly invented Plexiplat process. Plexiservice, Argyle 2, Wisconsin.

## 80 PRINTING, MULTIGRAPHING, ETC.

1,000 BUSINESS cards printed prepaid \$2.50. Reliable Print Shop, 901 E. Jefferson, Louisville, Ky.

QUALITY Printing: Business, personal stationery. State requirements. Samples. Mero Products, 99 Morrison, Punxsutawney, Penna.

100 BUSINESS cards, 75c printed. Prepaid. W. M. Davis, 935 Maxwell, Chicago 8.

SEND 10c Now, for our 48 page price-list—Refunded first order. McCall Press (PSM), 1326 South 27th, Omaha 5, Nebr.

MIDGET business cards—100 printed \$1.25, with case. Send for order-blank. Wellworth Printing Co., 265 East 78th Street, New York 21, N. Y.

GAS Stations: Printing receipts. Padded. Samples. Berliner, 3581 Milwaukee, Chicago 41.

100 MIDGET personalized cards in genuine leather case \$1.00. A little card creates a big impression. Micro Card Company, 111-A East 95 Street, Brooklyn 12, N. Y.

## 82 PATENT ATTORNEYS

INVENTORS: Learn how to protect your invention. The United States Patent Office advises the inventor, unless familiar with such matters, to engage a competent registered patent attorney or agent to represent him. We maintain a staff of registered patent attorneys ready to serve you in the handling of your patent matters. Special booklet "Patent Guide for the Inventor" containing detailed information concerning patent procedure with "Record of Invention" form will be forwarded upon request—without obligation. Clarence A. O'Brien & Harvey Jacobson, Registered Patent Attorneys, 82B-D District National Building, Washington, D. C.

INVENTORS—Send today for "Detailed Patent Information" outlining preliminary steps to be taken toward Patent Protection, also convenient "Evidence of Invention" form, Victor J. Evans & Co., 342-D Merlin Building, Washington 6, D. C.

INVENTORS: When you are satisfied that you have invented something of value write me, without obligation, for information as to what steps you should take to secure Patents or Trademarks. Write Patrick D. Beavers (Formerly Randolph & Beavers) Registered Patent Atty., 938 Columbian Bldg., Washington (1), D. C.

INVENTORS—Patent Laws encourage the development of inventions. The Rules of Practice of the U.S. Patent Office advises—unless an inventor is familiar with such matters—that he employ a competent registered attorney or registered agent, as the value of patents depends largely upon the skillful preparation of the specifications and claims. Write for further particulars as to patent protection and procedure and "Invention Record" form at once. No obligation. McMorrow, Berman & Davidson, Registered Patent Attorneys, 143-Z Victor Building, Washington 1, D. C.

PATENT practice before U. S. Patent Office. Validity and infringement investigations and opinions. Booklet and form "Evidence of Conception" forwarded upon request. Lancaster, Allwine & Rommel, Registered Patent Attorneys, Suite 413, 815—15th St. N.W., Washington 5, D. C.

C. A. Snow & Co.—S-427, Snow Building, Washington 1, D. C. Registered Patent Attorneys. Write for information.

INVENTORS: Without obligation, write for information explaining the steps you should take to secure a Patent. John N. Randolph, Registered Patent Attorney, 207 Columbian Bldg., Washington 1, D. C.

INVENTORS. For "Record of Invention" form, contact Carl Miller, Registered Patent Attorney, Woolworth Building, New York.

INVENTORS: Write for free brochure "Evidence of Invention." Labiner, World Building, New York 7.

INVENTOR'S Guide free on request. Frank Ledermann, Registered Patent Attorney, 154 Nassau St., New York 7, N. Y.

PATENTS—Trade marks. Irving L. McCathran, 316 McLachlen Bldg., Washington 1, D. C. Registered Patent Attorney.

## 83 FOR INVENTORS

"INVENTOR'S Guide" free on request. Frank Ledermann, Registered Patent Attorney, 154 Nassau St., New York 7, N. Y.

INVENTORS: Without obligation, write for information explaining the steps you should take to secure a Patent on your invention. John N. Randolph, Registered Patent Attorney, 206 Columbian Bldg., Washington 1, D. C.

MAKE money from your ideas. Write Grayland, 5312 Grace, Chicago 41.

INVENTORS: The usual First Step is to have a search of the U.S. Patents conducted, so I can report on Patentability. Write, without obligation, Patrick D. Beavers (Formerly Randolph & Beavers) Registered Patent Atty., 939 Columbian Bldg., Washington (1), D. C.

INVENTORS: Learn how to protect your invention. The United States Patent Office advises the inventor, unless familiar with such matters, to engage a competent registered patent attorney or agent to represent him. We maintain a staff of registered patent attorneys ready to serve you in the handling of your patent matters. Special booklet "Patent Guide for the Inventor" containing detailed information concerning patent procedure with "Record of Invention" form will be forwarded upon request—without obligation. Clarence A. O'Brien & Harvey Jacobson, Registered Patent Attorneys, 82A-D District National Building, Washington, D. C.

INVENTORS—Patent Laws encourage the development of inventions. The Rules of Practice of the U.S. Patent Office advises—unless an inventor is familiar with such matters—that he employ a competent registered attorney or registered agent, as the value of patents depends largely upon the skillful preparation of the specifications and claims. Write for further particulars as to patent protection and procedure and "Invention Record" form at once. No obligation. McMorrow, Berman & Davidson, Registered Patent Attorneys, 143-Y Victor Building, Washington 1, D. C.

INVENTORS—Victor J. Evans and Co., has a staff of registered patent attorneys, available to assist inventors in the preparation and prosecution of their cases before the U. S. Patent Office. Detailed information and steps to take to obtain patent protection will be sent to you upon request. Victor J. Evans & Co., 342-D Merlin Building, Washington 6, D. C.

FREE Service, U.S. Industrial Research Committee, 23 Nelson Ave., Staten Island 8, N. Y.

INVENTORS—Capitalize on your ideas—write—Natco, 2507 N. 29 St., Philadelphia, Pa.

FILE Patents yourself, inexpensively. Information free. Birsh, 712-A Manhattan Ave., Brooklyn 22.

PATENT searches—reliable, efficient, air mail service—\$6.00. Write for free invention protection form. Patent Research Service, 703 Albee Bldg., Washington 5, D. C.

I HAVE sold several inventions and can show you how to sell yours for a small fee of \$1.00. John Beaudry, 256 Hennipen, Minneapolis, Minn.

SECURE your Patent and working Drawings now. Write Dent Taylor, General Delivery, Washington, D. C.

PATENTED, unpatented inventions promoted. M. Joyce Humphries, 1424 Landtitle, Phila. 10, Penna.

## 84 INVENTIONS WANTED

INVENTORS: Hundreds of manufacturers have requested our assistance in locating marketable new products. Complete information, free. Institute of American Inventors, Dept. 30C, 1926 Eye St., N.W., Washington 6, D. C.

INVENTIONS Promoted, Patented or unpatented. Write Adam Fisher Company, 183-A Enright, St. Louis, Mo.

INVENTORS! Have you good patentable ideas? Write Patent Agent Metzler, 11 West 42nd, New York.

SMALL Inventions wanted by manufacturers, I'll help you sell your invention. Write for circular. S. Hull, 7829 Euclid, Cleveland, Ohio.

HIGHEST Royalties—cash. Free literature. Universal Marketing Co., 126 Lexington Ave., New York 16, N. Y.

PATENTED, unpatented inventions wanted. We have tremendous lists of manufacturers who may pay cash, royalties. Descriptive booklet free. National Invention Service, 1404-B Mitchell Street, Oakland 1, Calif.

## 85 PATENTS

FREE Pamphlet "O" will tell you how we have helped others develop their ideas into worthwhile patented inventions ready for market. Elo Development Co., 29-28 41st Ave., L. I. City, N. Y.

## 88 MANUFACTURING

MODELS small lot manufacturing, metals, plastics, etc., Millburn, Burlington, Ky.

## 89 MODELS, MODEL SUPPLIES

MOST complete Illustrated Catalog—"O-HO OO" Model Railroad Parts ever published. Send 5c for mailing. Selly, 1377 Gates Ave., Dept. 836, Brooklyn, N. Y.

MODEL Ship Builders! Are you looking for authentic, precision ship models? Send for richly illustrated fully descriptive catalogue in full color of famous ships of all kinds. Only 25c. Halesite Yacht Service Inc., Dept. C-40, Halesite, Long Island, N. Y.

SHIP and Yacht model fittings; blueprints. Send 25c for illustrated catalog No. 20—Listing hundreds of items. A. J. Fisher, 1002-2 Etowah Ave., Royal Oak, Mich.

BUILD Model Ships, Railroads, Catalog 10c. Ideal, 21 West 18th Street, New York 11, N. Y.

SHIP model kits and fittings, most complete stock in New England, of Boucher, Fisher, Marine Model, Model Shipways. Fittings, plans, tools, model yacht equipment. Illustrated catalog 25c coin. James Bliss & Co., Inc., Dept. M 220 State Street, Boston, Mass.

SHIP Model and yacht supplies, complete large 64 page catalogue, 30c. Wm. Wild, 510 E. 11th St., New York City.

SOUTHERN Woods: Texas Ebony, Mesquite, Brazil, Catsclaw, Guayacan, Huisache, Many others. Working supply, \$1.00 each prepaid; sample, dime each; details, stamp. StarCraft 2, Edinburg, Texas.

HOBBYIST'S Catalogs! Controlog—engine powered, line control model planes, 100 kit photos, construction, flying instructions—10c. Send large self-addressed stamped envelope for free folder featuring famous English Twin Trix 3-rail trains, 164 page Ship Model Kit-Fittings Catalog—35c. Booklog—hundreds of model, hobby, craft books—10c. Send coin, stamps. Polk's Hobbies, "World's leading hobby house", 314(PS-4) Fifth Avenue, N. Y. 1.

JET Propulsion powers model plane! Kit \$1.79. Herblin, 35-45 79th Street, Jackson Heights, N. Y.

FREE! Big train folder, packed with new Lionel cars, sets and accessories. Madison Hardware Co., 105-B East 23rd, New York 10.

SHIPMODEL kits and fittings of authentic design and detail. Model kits include brigs, fisherman, cutter, clipper. New catalog, 15c. Model Shipways, Folio 40, 476 Main St., Fort Lee, N. J.

POWER Models—steam and gasoline engines, steam traction engine, metals, tools. Catalog 35c. Charles Cole, Ventura, Calif.

RAILWAY models, complete line. Combined HO and O gauge, catalogue, 50c. Walthers, 241 Erie, Milwaukee 2, Wis.

STEAM engines—boilers—castings. Catalog 25c. Anton Bohaboy, 2297 Price, Rahway, New Jersey.

BUILD Your own model homes, garages, doll houses, displays, etc. Strong wood panels milled to faithfully reproduce shingles, lapsiding and brick in three scale sizes. Write postcard for free picture folder. Scale-Built Materials Inc., 4624 Ravenswood Ave., Chicago 40, Ill.

BASSWOOD sheets, select, satin smooth, 1/8" x 3 1/4" x 18" works easily, lightweight, rugged, uniform. Send \$1.00 dozen sheets—6 dozen \$5.00. Whittlerscraft, Box 981-a, Providence, R. I.

## 91 HOME CRAFTSMEN

DO your own professional felt flock finishing. Complete kit includes flock, undercoat, thinner, spray gun and instructions, \$9.25 post paid. Write for free color card and circular. Berott-Ross, Dept. 4 B, 411 N. Foothill Road, Beverly Hills, Calif.

**LEATHER-Crafters:** Free 1948 catalog showing easily completed projects, full line of tools, hides and accessories. Ester Leather Co., 145 St. Paul St., Rochester 4, New York.

**FREE folder**—"Amazing new service." Materials furnished to build projects featured in this magazine. Project Headquarters, 1756B Henderson, Chicago 13, Ill.

**COPPER Strips,** cold rolled, .025 ins. thick. Assortment 5 sizes, 1, 2, 3, 4, and 6 inch widths, 12 inch lengths. \$1.90, 24 inch lengths, \$3.75 Postpaid. Catalog Free. Groundmaster Company, Boulder, Colo.

**PATTERNS:** Five little novelties \$1.00 Postpaid. Tollie's, 309 9th Ave. S.E., Aberdeen, So. D.

**SHELL Jewelry Supplies**—Wholesale only. McFarland Plastic Co., Sarasota, Fla.

**CATALOG:** Many kinds full size patterns, craft books—booklets, decals, tools, picture frame mouldings, etc. Hundreds articles superbly illustrated. 25c. refunded first order. (No stamps please.) Wo-Met Shop, Ashburn, Georgia.

**SPECIAL Offer:** 80 full size toy, novelty and lawn ornament patterns only \$1.00. Lynds, Medway, Mass.

**PATTERNS**—40 Pictures of new jigsaw projects. Illustrated Folder 10c. Joanness, P. O. Box 141, Omaha 7, Nebr.

**FAST selling.** Good profits making lawn chairs, furniture, toys. Illustrated folders of popular items 25c. refundable. Summercraft Studio, 42 Vernon St., Dept. KH, Newton 58, Mass.

**LEATHERCRAFT designs**—Handbags \$1.00. Billfolds \$1.00. Belts \$1.00. All three \$2.50. Lampkin Artcrafts, Box 641-S, Culver City, Calif.

**SPECIAL 77 Full Sized Patterns.** Lawn Ornaments, Toys and Novelties. \$1.00. Modern Woodcraft, Saginaw, Mich.

**LEATHERCRAFT!** Complete stocks of leathers, tools, supplies. Immediate shipment. Free catalog. Kit Kraft, Dept. 3203 W. Washington Blvd., Los Angeles 16, Cal.

**SILK screening simplified.** Instructions for building & operating equipment \$1.00. No stamps or checks. Kessler, 254 Hudson, Nampa, Idaho.

**SCRAP leather,** large sizes, assorted colors. 5 lb. \$3.95. Enterprise, Sheboygan, Wisconsin.

## 92 BLUEPRINTS AND PLANS

**PLANS**—All types Catalog (40 pages) 25c. Refundable. Bowling, 224 W. 133rd, N.Y.C.

## 93 BUILD IT YOURSELF

**BARBECUE Oven**—Build it yourself in your own back yard with parts and instructions furnished. Write for free information. Bar-B-Kit, 4723 Troost, Kansas City, Mo.

**ROTARY type,** power lawn mowers. Complete machines or parts. Modern Mower, Lohrville, Iowa.

**BUILD your own tilting table bench saw.** Plans and instructions \$1.00. Metal parts available. Write for descriptive circular. William H. Crandall Company, 1009 Fruitvale Ave., Oakland 1, California.

**BUILT-In Kitchen cabinets**—\$1.00 brings detailed plans and specifications showing construction methods. Will fit any kitchen. Thombert Co., Box 447, Newton, Iowa.

**BUILD concrete block machine.** Easy. Inexpensive. Motor or hand. Will last lifetime. Write. Clyde Lee, Mountain View 1, Okla.

**PLAYHOUSES & doghouses,** scientifically designed. Plans and material list for 4 sizes of either \$1.00 postpaid. Miller & Wutkee, 254-B Conant Hotel, Omaha, Nebr.

**ZEOLITE water softener.** Original plans for building your own \$1.00. Materials available from us. Lake Region, Box 2732-S, Minneapolis 7, Minnesota.

**MAKE your own 14 pound Modulite concrete blocks.** Build for less. How booklet 25c. Peerless, New Lenox 1, Illinois.

**"CONCRETE Block Homes"**, 32 page booklet: drawings, instructions on how to build. \$1.00. H. C. Lightfoot, Civil Engineer, Richboro, Penna.

## 94 WATCH REPAIRING

**WATCH and clockmakers Handbook**—Britten \$5.79. Free catalog. Engineers' Book Service, 19 W. 44th St., New York City 18.

## 95 OLD GOLD, WATCHES, ETC.

**CASH for Old, Broken Jewelry.** Highest prices paid immediately. Mail gold teeth, watches, rings, silverware, diamonds, spectacles. Satisfaction guaranteed. Information free. Rose Smelting Co., 29-Y East Madison, Chicago.

**WATCHES,** wholesale. Rebuilt Elgins, Walthams, Bulovas, etc., \$9.75 up; new and used diamond, railroad, 21J wrist. Catalogue free. Brookins, B-1975X, Little Rock, Ark.

**BRAND New Swiss Service wristwatch** only \$5.95. Fed. Tax, Insurance, Mail included. Radium dial, sweep second hand, unbreakable crystal. Every watch tested. Send check or money order. Guaranteed as advertised. Gotthard Watch Corp., 40 W. 40th St., New York.

## 96 JEWELRY

**JEWELRY Findings.** Lowest Prices. George Sassen 154 Nassau Street, New York 7.

**CERAMIC Jewelry Supplies.** Bar Pins, ear screws, for ceramic and woodworkers, also glass and sea shell assemblers. Free catalog. Philadelphia Badge Co., 1007 Filbert St., Philadelphia, Pa. Dept. E-1.

**MAKE your own initial tieclasp.** We supply the ready cut gold-filled metal 1/20 14 ct. and instructions for \$3.00—or finished for \$5.50 C.O.D. Men's Jewelry Mfg. Co., 363 Ocean Parkway, Brooklyn 18, N. Y.

**RHINESTONES**—Moonstones—Pearls—Findings. Free literature. Herber, 1360-B Hicks, New York 67.

**MANUFACTURE costume jewelry** at home for profit, hobby, therapy. Free wholesale supply catalogue. Instructions. Florida Supply House, Bradenton, Florida.

**GEMSTONES** available rough or cut. Precious, semi-precious. Custom cutting and polishing. Plummer's, 5068 Brighton, San Diego 7, Calif.

**PRECIOUS, semiprecious stones,** plastic-metal findings, list 10c refundable with first order. Pickwick Findings, Box 780-L, Stamford, Conn.

## 97 TOBACCO & PIPES

**PIPE Carving kits** 75c. Seconds \$5.00 pipes 65c. Literature free. Carvapipe, 2829A Dixie, Hamilton, Ohio.

**YOUR Name** on each of the finest hand made cigars. Box 50—\$3.75. Blount Cigars, 2926 Germantown Ave., Phila. 33.

**PIPE smokers**—Free literature. Latest development in smoking pipes. Flexo pipe is adjustable for comfort. Celano Mfg. Co., Inc., 577 Tenth Ave., N.Y. 18, N.Y.

## 98 RAZOR BLADES, SHAVERS

**100 DOUBLEDGE blades.** Blue Steel. \$1.00 P.P. Cerny, 5006 Dewey, St. Louis 16, Mo.

**SCHICK Injector razor** with 20 blades. Lifetime guarantee. \$1.00 postpaid. Ellis Distributors, Box 149, Chicago 90, Illinois.

**100 DOUBLEDGE \$1.00.** Best quality, tempered bluesteel. Satisfaction guaranteed. Send \$1.00 to: Gotham Distributors, P. O. Box 114-C, New York 28, N. Y. Distributors Wanted.

## 100 MISCELLANEOUS

**BOOKFINDERS!** (Scarce, out-of-print, unusual books). Quickly supplied. Send wants. Clifton Company, Box 1377 PSM, Beverly Hills, Calif.

**CREW manager,** wagon jobbers, agents! Established manufacturer can supply you with top quality floor waxes and polishes, all sizes from pint to drum. Write Windsor Wax Co., Inc., Dept. PS-1, Hoboken, N. J.

**GET \$1.25 guaranteed Fire extinguishers.** Scheall, Box 225-S, Duluth, Minnesota.

**RECEIVE Giant mails,** samples, Money-making Opportunities. Two year listing, \$1.00. Nine months, 50c. Three months, 25c. Stanford, 6220-N 16th, Philadelphia 41.

**INQUIRE Now** about our Home Plan Service for 24' x 26' x 30' one floor, two bed room homes. Write today for particulars. Columbia Small Home Plan Service, Dept. 50, 1570 Hawthorne Park, Columbus 3, Ohio.

**APPLIANCE & building repairs.** Own your own business. Free particulars. C. A. Griffith, 132 Water St., Fredonia, N. Y.

**WEATHER.** Be your local weatherman. Take observations, make forecasts. Join the Amateur Weatherman of America. Franklin Institute, Phila. 3, Pa.

**HULL Automobile compass,** value \$4.95, brand new, \$2.50. Prisms for 6 x 30 or 8 x 30 binoculars, brand new, \$1.50 each. Offset prisms to be attached to 7 x 50 B. & L. Binoculars, gives double the field of the ordinary 7 x 50 binocular. Cost \$98.00, special \$25.00. Green sunshades for binoculars, size 6 x 30 and 7 x 50, snap on type, value \$7.50, special \$1.25 per pair. Forward money order. No C.O.D. shipments. Send coin \$1.50 for Third Annual Edition of Gun Digest together with our complete catalog of new and used guns, ammunition, rifles, binoculars and powder flasks. Our separate catalog 25c. Public Sport Shops, 11 S. 16th Street, Philadelphia, Pa.

**FOR Sale.** Red foxes \$7.00 each. May delivery. Ingemar Peterson, Vergas, Minn.

**GET lots of mail;** Name listed Mail Directory 25c. Harvey Teeple, Decatur, Ind.

**ORCHIDS** in your living room! Complete plans for building "Orchid House", miniature greenhouse for your home, plus construction notes, orchid growing instructions—fifty cents. "Orchid House", Box 501, Glendale, Calif.

**WESTERN and Hillbilly records,** some slightly used—some brand new, 25 assorted \$6.95, cash or C.O.D. No two alike. Blake, 2215 19th, Lubbock, Texas.

**TOY Pistols,** wholesale and retail. Circular free. C. C. Groff, 116 Broad St., Lancaster, Penna.

**ABACUS.** Add with the abacus, world's oldest calculator. Now improved. Adds, subtracts, multiplies, divides quick as a flash. Illustrated instructions show how. Send for Free lessons and details. Loy's Chinese Calculator, Dept. 84S, 1317 R. I. Ave., N.E., Washington 18, D. C. Agents Wanted.

**BECOME a real estate broker.** Write for Free details. Stambough, 901 Cedar, Plainview, Texas.

**ART Photos!** Sample 50c. 3 for \$1.00. Post Office Box 2011, Phoenix, Arizona.

**WEATHER Instruments.** Thermometers, barometers, hygrometers, rain gages, wind instruments. Science Associates, 401 N. Broad St., Phila. 8, Pa.

**NEW combination Flashlight-Key Chain.** Sells on sight. Retail 50c. Your cost \$3.60 dozen. M. Branche, Towanda 2, Pa.

**MIRACLE art fotos,** instantly developed with plain water. 20 different \$1.00. 4 samples 25c. Modern Products, P. O. Box 2, New York 2.

**PANNING Gold**—Two instruction books 25c. Old Prospector, B105, Dutch Flat, Calif.

**HYPNOTIZE!** Control the minds and actions of others! Completely illustrated course \$1.00. Money Back guarantee. Fowler, Box 1284, Boston 4, Mass.

**SEEKING financial independence?** \$1.00 capital can become \$3000 annually. Proven, legitimate opportunity. Explanatory literature. Harmon, P.O. Box 1057A, Newark 1, N. J.

**SEEKING new job,** personal adjustment? Free details. Salaried Professional Job Center, Highland Park, New Jersey.

**STAMPS, stencils, inkpads.** Send for quotations. Royal Ford, Bristol 4, Conn.

**LEAP year man hunting.** License 25c. H. Herman, 220 N. Hamlin, Chicago 24, Ill.

**LET'S Swap neckties!** Send one to six ties you're tired of, and \$1.00. We'll return same number beautifully cleaned, different ties postpaid. Or we'll send C.O.D. Tieshop, Box 499-1, Denison, Texas.

**TIE Exchange** trades those ties you won't wear. Six ties and \$1.00 gives you six others, cleaned and pressed. State color desired. 2730 Taylor, Detroit, Michigan.

**PARACHUTES surplus new 8 Panel 36"** nylon 35c—3 for \$1.00. Textile, 2008 Union Turnpike, No. Bergen, N. J.

## 102 WANTED MISCELLANEOUS

**MERCURY**—Highest prices. Free Containers. Write Mercury Terminal, Norwood, Mass.

## 104 PERSONAL

**RUPTURED?** Positive comfort, no understraps, no steel, no elastic. Write Smith Manufacturing Co., Preston, Ontario.

**MAIL forward service,** confidential, 25c letter \$2.00 month. A. C. Hanks, Box 426 Edmonton, Alberta, Canada.

**HAIR Falling? Dandruff?** Write Trichologist, 139 Lewis Street, Phillipsburg, N. J.

**EXCHANGE** those neckties you Dislike. Send six ties and \$1.00 for six different ones. State color preference. ABC Exchange, Box 1, St. Joe, Arkansas.

**ART**, scenic photo 35c. 4 \$1.00. Color slide 50c. 3 \$1.00. Novelty Supply, 1227 East Van Buren, Phoenix, Arizona, Dept. D.

**BUY** Vitamins Direct. Amazing Savings. Money Back Guarantee. Our 9th year! Postcard, Matoska Products, White Bear Lake, Minn.

**MAIL** forwarded from Los Angeles, California. 25c per letter. Mail Exclusives, Box 7765, Los Angeles 15, California.

**DESCRIBE** self or friend. I'll send clever poem. Rush \$1.00 to John L. Maxwell, 1507 W. 38 St., Davenport, Iowa.

**MAIL** Forwarded from Reno, Nevada. 25c each. P. O. Box 705. Sparks, Nevada.

**HOW** You can find out! Information discreetly developed. Any matter, person, problem, anywhere. Personal-Business assignments, representations undertaken. Nationwide. Officially licensed, bonded service. Established 1922. Reasonable. Confidential. William Herman, 170 Broadway, New York.

**INFORMATION** on any subject, any question, problem solved. \$1.00; Hale, 836 Broadway, Bayonne, N. J.

**LEARN** Amazing Hypnotic powers. Secret instructions. 50c. Lerner, Box 28, Bronx 67, N. Y.

**"HUMAN** Immortality attainable!" 15c Bulletin. Box 87, Cathedral Station, New York 25.

**MAIL** forwarding service, 25c per letter. Box 534, Tallahassee, Florida.

**MAIL** forwarded—Each letter 25c. Confidential. Buchanan, Suite 2, 16 Lisle Ave., Binghamton, N. Y.

**MORE** and better hair for you. All about latest secrets, discoveries. Write immediately. Bruns, 3307-E Fremont, Madison 4, Wisc.

**MEXICAN** law. General Practice Attorney. 1203 Arizona Street, El Paso, Texas.

**106 ADVERTISING**

24 WORDS in 64 Weeklies \$4.96. J. Darnell, 730 Hays, Jackson, Tenn.

**ADVERTISING** Sensation! Reach 2,100,000 families. \$32.90 inch. Display, classified, ratebook (newspapers, magazines, mailing lists), advertising assistance, free. Chicago Advertising Agency, 20-PS, West Jackson, Chicago 4.

**ADVERTISE:** 24 words, 40 newspapers \$3.50. Lists free. Advertising Bureau, 229-P Dixon, Uniontown, Penna.

**MAIL** Order copy written by expert for small fee and commission. John Morris, Box 5411, Phila.

**109 HANDWRITING ANALYSIS**

**ANALYZE** handwriting for profit! Complete outfit \$1.00. Graphologers, POB-971, Philadelphia.

**114 DRAFTING INSTRUMENTS**

**SAVE** on drafting materials. Free catalog. Draftsmen's Supply Co., 32 North Wells, Chicago 6.

**DRAFTING** templates, architectural, mechanical. Free list. Timely, Box 206-N, Columbus 9, Ohio.

**117 TATTOOING SUPPLIES**

**TATTOOING** Outfits, Supplies. Illustrated List Free. Zeis, 728 Lesley, Rockford, Illinois.

**120 CANDY MAKING**

**MEN-Women—"Most** Everybody Likes Candy." Learn to manufacture Professionally at home. (Our 38th year.) Ragsdale Candies, East Orange, N. J.

**125 WOODS**

**BUSINESS** cards of real wood. Write Cards of Wood, Manlius 2, N. Y.

**126 CAMPING**

**ARMY** tents, canvas, clothing, paint. Dept. P, Jarashow, 10-19 Jackson, Long Island City 1, N. Y.

**129 MAGNETS**

**ALNICO** Magnet—Lifts Ten Pounds! \$1.00. Catalog 3c. Ronald Eyrich, Box 849, Milwaukee 1.

**ALNICO** magnets. Free list. Terry Sales Company, 3726 South Detroit Av., Toledo 9, Ohio.

**TWELVE** Alnico Magnets, 100 experiments. \$3.00. Experiments, 25c. Disc Magnet, \$1.00. Eljay, Box 891, Newark 1, N. J.

**131 TREASURE FINDERS**

**METAL** Detectors. The Very Latest Circuit. Free Literature. Hedden Metal Detectors, 538 North Homewood Avenue, Pittsburgh 8, Penna.

**TREASURE** Hunters! Radically new Goldak locators. New featherweight Model 101 weighs only 11 pounds! Revolutionizes location of Gold, Silver and Minerals. Money-back guaranteed superior any other. Write The Goldak Co., 1544 W. Glenoaks, Glendale 1, Calif.

**M-SCOPE** Metal Locator fully guaranteed and unsurpassed in efficiency. New featherweight models. Time payment plan. Free literature. Fisher Research Laboratory, Inc., Palo Alto, Calif.

**SEEK** Buried treasure; Methods, mysteries, devices explained. Circulars free. Century Press, Box 151-D, Glen Ellyn, Ill.

**137 DETECTIVES**

**DETECTIVE** Training. Phillips Secret Service, 1917C, N. Kenneth, Chicago 39, Ill.

**DETECTIVES—Work** home—Travel, Experience unnecessary. Write Wagoner P-125 West 86th, N. Y., N. Y.

**DETECTIVE** Training. Thirty years experience. Free details. Shewbridge System, 216 Valdez Avenue, San Francisco 12, Calif.

**140 HAIR PREPARATIONS**

**MAKE** your own greaseless, soapless shampoo used by French hair specialist. Send \$1.00 for formula. Henriette, Box 52, Peerless, Mont.

**143 NAME LISTS**

**MAILING** lists; most classes, 1000 \$5.00. Free Prospectus, Dixie Service, King, N. C.

**LIVE** listings—1,000 \$3.50. IT-Novelties, P. O. 51, Toledo, Ohio.

**144 MILITARY INSIGNIA**

**FREE—3** Military Emblems, with Catalog 10c. Hobbyguild, X35 West 32, N. Y.

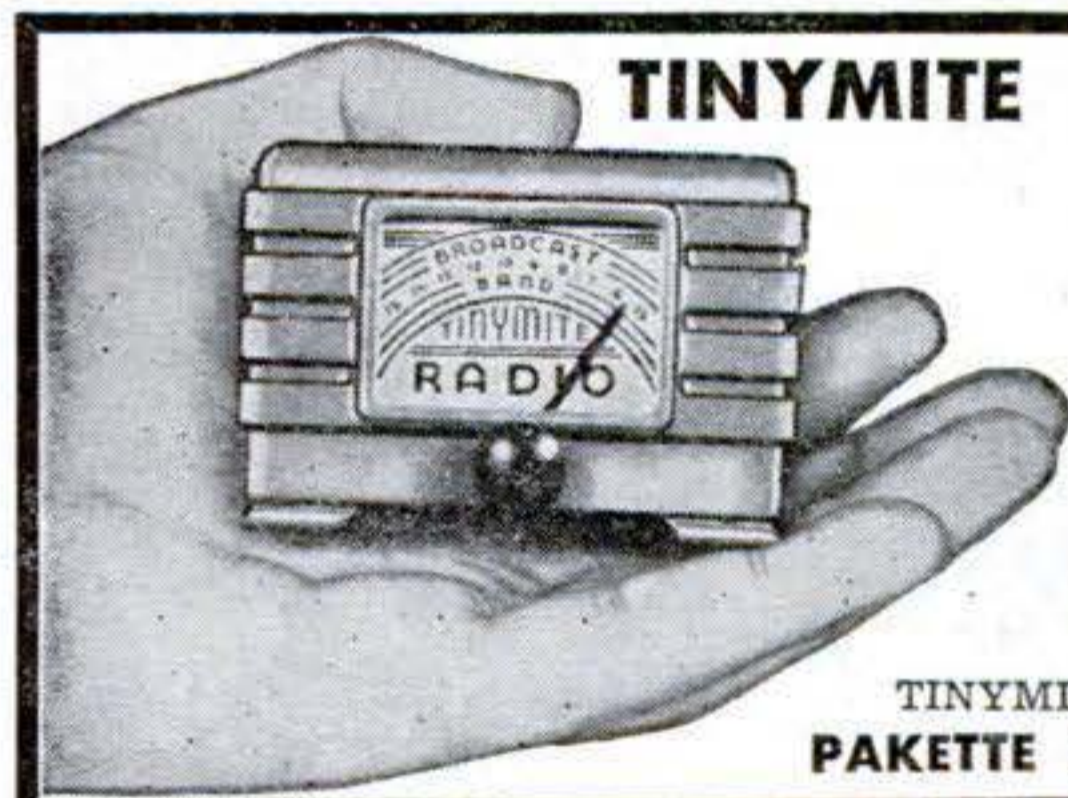

**TINYMITE**

**MIDGET RADIO!**

**FITS IN YOUR HAND! ONLY 1/4 LB.** Beautifully molded red cabinets! No tubes—batteries or electric "plug-ins" needed! Has scale dial—personal phone, new type fixed power crystal diode. One Year Service Guarantee.

**GUARANTEED TO WORK** on local stations if used as directed. **USE MOST ANYWHERE** in bed, hotels, offices, farms, homes, etc.

**SEND ONLY \$1.00**

(bill, money order, check) and pay postman \$2.99 plus C.O.D. fees on arrival or send only \$3.99 for postpaid delivery!

Complete—Ready to play—Excellent gifts for boys and girls. **ORDER YOUR TINYMITE RADIO TODAY AT THIS BARGAIN PRICE!** (Foreign \$5.00 U. S. cash.)

**PAKETTE RADIO COMPANY, INC. Dept. TPS-4 KEARNEY, NEBRASKA**

**AMERICA'S FINEST BUMPER JACK**

Here's an all-around hydraulic utility jack with hundreds of uses where easy lifting or pulling is required. Safest, quickest, easiest to use on any car built. Result of 15 years of advanced precision engineering.

Extra long, heavy duty steel chain with forged steel grab hook picks up loads from 4" BELOW bottom of jack to 22" ABOVE. Base, handle socket, head and chain plate are all tough malleable iron castings. 17" hydraulic lift, 3000 lb. capacity. Order now at your dealer or send money order or check to

© 1948 American Hydraulics, Inc.



**\$15.95**  
Complete with chain, hook and handle.

**American Hydraulics, Inc.**  
SHEBOYGAN, WISCONSIN

**American Hydraulics, Inc.**  
Sheboygan, Wisconsin  
Enclosed find check or money order.

Please send.....American Bumper Jacks.

Name.....

Address.....

# Sensational Values!

## AIR CORPS TYPE Service Precision Watches

### CHRONOGRAPH SWISS MOVEMENT—INCABLOC



**29.95**

Exact type as used by armed forces

\$60.00 VALUE!

#### ATTENTION!

Flyers, Photographers, Yachtsmen, Fishermen, Hunters, Sportsmen, Doctors, Engineers, etc.

#### Check These Features!

- 17 Jewels
- 60 Second Dial
- Stop Watch
- 2 Push Buttons
- 30 Minute Dial
- Telemeter
- Sweep Second Hand
- Radium Dial & Hands

Satisfaction guaranteed or your money back

Add 10% Fed. Tax plus 25c postage and insurance.

### 17 JEWEL WRIST WATCH SWISS MOVEMENT—INCABLOC

A REGULAR \$50.00 VALUE!



- WATERPROOF
- SHOCKPROOF
- SWEEP SECOND HAND
- RADIUM DIAL & HANDS
- STAINLESS STEEL BACK
- LEATHER STRAP

Brand New... Complete satisfaction guaranteed or your money refunded.

**19.95**

Add 10% Fed. Tax plus 25c postage and insurance.

DON'T MISS THIS BUY!

**FREE**  
Send for free illustrated catalog. Has many marvelous WAR SURPLUS BAR-GAINS.

**ALLIED SALES CO.**

DEPT. SA - 88 CLAY STREET - SAN FRANCISCO 11, CALIFORNIA  
Send check or money order. Sorry no C.O.D.s

## PRESTO! ANYONE CAN MASTER GLAZE

- LEAVES HARD GLASS-LIKE FINISH
- EASY TO APPLY
- PROTECTS THE SURFACE
- NO SMEAR OR STREAKS AS WITH WAX
- LASTS SIX MONTHS TO A YEAR
- SEALS THE PORES OF THE SURFACE
- WILL NOT FINGER-MARK
- EASY TO KEEP CLEAR
- NO OILY FILM AS WITH POLISH



SAVE YOU MONEY

Car Owners! Meet Master Glaze—the sensationally different luster for new and used cars! Not a wax—not an oil polish—not a paint!—nothing that “smears” over the surface.

**MASTER GLAZE** is a unique discovery—a creamy liquid—quick and easy to apply! Gives a hard, glass-like surface. Even gasoline cannot dull it! Lasts six months to a year! Amazing luster—beautiful, sparkling clean and brilliant! Doesn't finger-mark—doesn't smear! A match box full glazes an entire car. Seals the pores—protects! **NOTHING LIKE IT!**

#### AGENTS

An unusual opportunity! Quick, flashy demonstrator. Big profits. Good territory. Write today!

#### FREE SAMPLE

Just send your name and address to

MASTER GLAZE CO., 7720-651 W. Harwood Ave., Milwaukee, Wis.

## AIR COMPRESSORS

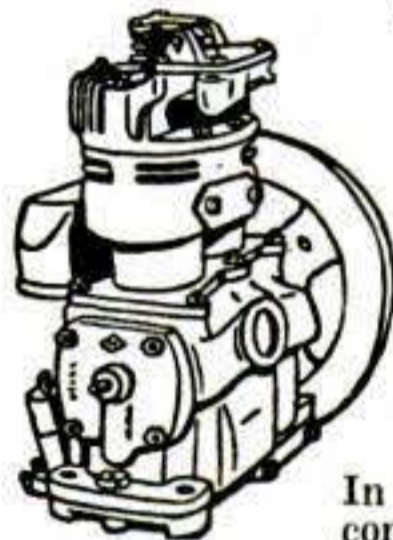

Model 2-V-S-4-V-A Bendix-Westinghouse 4 cu. ft.

Govt. Surplus, 2 cylinder Bus and Truck Type. Ball bearing crank shaft. Pressure feed oil system. Positively one of the finest and most accurately built air compressors on the market.

Original Cost Over \$140.00

In good operating condition with 30 day written guarantee **\$34.50** Special Low “as is” price **\$29.50**

Accessories available for compressors, air regulators, safety valves, air gauges, control governor, misc. fittings, hose, paint guns. Write for Prices and Catalogue.

**MIDWEST SURPLUS SALES CO.** 1520 Locust St. Kansas City, Mo.

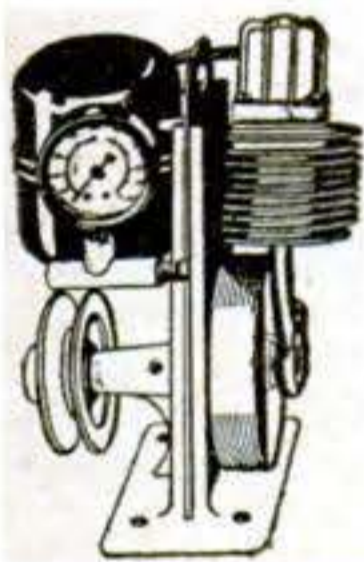

## COMPRESSED AIR INSTANTLY, Anywhere!!

Portable Air Compressor and storage tank. Ruggedly built of best materials using lifetime lubricated ball-bearing on connecting rod and oil impregnated main bearing on shaft. Unusual design forever eliminates valve trouble, the most common fault in air compressors. **PATENTED** unique air intake system increases efficiency tremendously over other compressors so that air output is much greater than that from larger compressors powered by heavier motors. Will deliver approximately 3500 cu. inches of air per minute at maintained pressure of 30 lbs., or will inflate a 90 lb. truck tire in less than one minute. Comes complete with 100 lb.

gauge, although finger-tip adjustment allows setting of output pressure at any value, which will automatically be maintained. Works from any 1/4 H.P. motor. Useful for spraying paints or lacquers, disinfectants, insecticides, annealing or brazing with natural gas, inflating tires, etc. Price \$14.50 postage prepaid anywhere in the U. S. Efficient, completely adjustable syphon type spray gun complete with 12 ft. of 100 lb. tested hose available for only \$7.75 with pint container, also prepaid. 25% required on all C.O.D. orders. Send for free catalogs of radio parts and surplus items.

**BUFFALO RADIO SUPPLY; 219-221 GENESEE ST., DEPT. S-4, BUFFALO, N. Y.**

## NEW DRAWING DEVICE

NOT A TOY

### DRAW ANYTHING YOU CAN SEE WITH LUCY!

No talent needed to draw scenery, objects, profiles, portraits or reduce copy, in perfect undistorted perspective, indoors or outdoors.

Commercial artists, fashion designers, architects, patent attorneys, hobbyists, doctors, children, find many practical uses for LUCY.

#### FINE FOR ART STUDENTS

A student looking thru LUCY draws, let us say, the outline of a building. Then, looking directly at the paper without benefit of LUCY'S magic, he fills in other details. Then a glance into LUCY shows where he drew them and where they should have been **BOTH AT THE SAME TIME.** A perfect art instructor, not a crutch.

#### LUCY IS AMUSING TOO

If you want to liven up a party, mount LUCY on a table so the guests can draw profiles of each other. Forget all other games. They'll play with LUCY by the hour.

#### DURABLY MADE, LOW COST

All metal, life-time construction, nothing else to buy, mounts on drawing board or table, no electricity needed, fully guaranteed. Only \$6.95 postpaid with easy instructions. No COD or open accounts please. One day shipment. A precision instrument you'll be proud to own.

**BRUCE ENTERPRISES**

Dep't GA

North Hollywood, Calif.



Ideal Gift



#### HOW IT WORKS

To the operator at B looking thru eyepiece of LUCY at A, a phantom view of subject to be drawn C appears already on the paper D in full perspective. Drawing becomes simple tracing. LUCY does NOT project view of subject to paper. The magic of LUCY'S clever optical system makes it look that way in eyepiece, and it's just as easy to draw as though it was actually there. Adjustable to vary size of drawing.

**UP TO**  
**SAVE 85%**

**in WAR SURPLUS... SENSATIONAL VALUES**  
at "GADGETEER'S HEAVEN"  
IN MANY ITEMS WE HAVE  
THE WORLD'S LARGEST SUPPLY



**MACKINAW**

Made of heavy water repellent poplin cover. Wool Blanket lined, high length sleeve flap for adjustment. An ideal coat for the outdoor man Truck Driver, Hunter, Farmer.

**\$7.89** each

**NEW DUST RESPIRATORS**

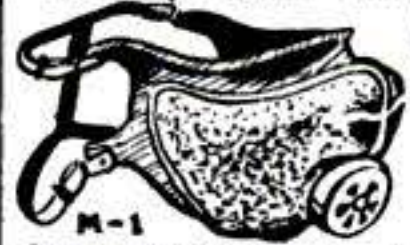

200,000 in 5 different types with adjustable hd. bnds. Bi Valve Type

**29c** each

in lots of 50, 25c ea. 100 or more, 19c ea.

**FOR PNEUMOCOONIOSIS**— producing dusts, road dusts, mists, & chromic acid mist, produced in crushing, mining, road building, abrading, farming, drought, painting, spraying, etc. Ideal for Farm, Mill, Factory, Garage, Foundry.

**COMFO-RESPIRATOR**

dual-disc, Style BM-2101, with 10 extra filters, a \$3.50 value.

**\$1.59** each



WILSON CO., dual disc, type J-750 with 10 extra filters in appearance like BM-2101

**\$1.29** each



**PULMASON RESPIRATOR** with Felt Filter.

**79c** ea.

**AMERICAN OPTICAL CO. RESPIRATOR**

Style R-9100 small & compact especially suited to laboratory & hospital work.

**59c** ea.

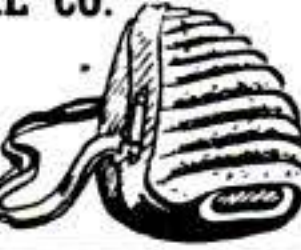

**RADIO HEAD SET**

AN-BH-1 with Leather Sponge Rubber Pad



**\$1.00**

**PLEXIGLASS DOMES**

15"x19 1/2"x6" deep. 1/4" thick. Can be used for home hot-house, fish bowl, wash-bowl, ornamental light. Can be flattened in oven and will make flat sheets. 15" x 19 1/2" x 1/4". Weight 3 1/4 lbs.

**\$1.69**

**TEAR SHAPED PLEXI DOME**

Overall length 21" width at widest point 11" at base 4" 6" deep.

**\$1.39** ea.



**BC 306-A NEW SIGNAL CORPS TUNING UNIT** In heavy alum. case with black crackle finish-16"x10"x8". Velvet vernier dial knob, calibration 0-100, with locking assembly. Switch 5 position with knob. 4 1/2" diam. coil with three others inside, and movable induction tuning coil. WORTH MANY TIMES MORE

**\$1.89** ea.



**16 m.m. MOVIE CAMERA**

Standard Eastman magazine loaded. Battery Driven. Handy, no winding. Has F-3.5 lens. Cost Government \$235.00. Used but perfect. Only

**\$24.95**



**MESS TRAY** 6 compartments, rustless, stainless steel. Barbecue, outdoor cooking, save dish-washing. Hospital, Restaurant, Home, or roughing.

**83c** each

**COMPLETE NAVIGATION SET.** 14 clothbound, 230 page volumes. Embracing tables & graphs from 0-4 degrees, thru 65-69 also American Air Almanac, 2 volumes Air Navigation Line of position manuals, all issued by United States Navy.

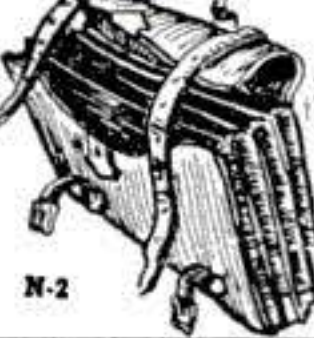

1 Plastic Parallel Straight Edge.  
1 Weems Aircraft Plotter.  
1 Rude's hydrographic star identifier, screw driver and other tools.  
1 Controllable Diamond Navigation Divider Packed in Airplane Luggage Type, compartmentalized with extra roll insert celestial navigation suitcase

A-6 30-12-12. Dim. 10 1/2" wide 8 1/2" deep 23" long & extra outside compartment... N-1

**\$31.25**



**FLYING HELMET**

#407 Fleece-lined winter

**\$1.59** ea.

Ideal for cycle drivers, racers, sportsmen. Used, but in excellent condition.

#407 A—Summer weight

**69c** ea.



**OXYGEN MASK**

A-14 Demand type. Slightly used, but perfect. A terrific deal with "mike."

**\$2.50**

**MICARTA TUBE**

Ideal for Insulation or Bushing Stock. 36" x 1/4" wall x 1" O. D. Original use was for trailing antenna - F 10. Use for towel rack, souvenir displays, shafting spacers, bearings, etc. In original carton.

**59c** ea.

**PILLOWS**

**CURLED CHICKEN FEATHERS** 26" x 17" 99c ea. Blue & white ticking. New, but still Renovated and Sterilized, in accordance with Laws of California.

**NEW HUNTING KNIFE**

6" chrome vanadium blade 4" handle, leather grip. In leather sheath.

**\$5.98 Value For Only \$1.69**

**BROWN LEATHER SHEEP LINED FLYER PANTS**

"KEEP EM WARM" Foot pockets, zippers at side and fly, suspenders. Perfect garment for hunters and outdoor men. Sizes from 40 to 44. Original government cost—\$22.50. Used but perfect.

**\$5.95**

**F-56 CAMERA**

20" focal length. telephoto lens with F-5.6 Bausch and Lomb lens. Complete with spare magazine, filter and film roll in trunk. A \$1000 Value Complete for

**\$395.00**

**KEYSTONE F-8 CAMERA**

F-8, 15" focal length with F-5.6 telephoto lens. Hand operated, complete with carrying case

**\$105.00**

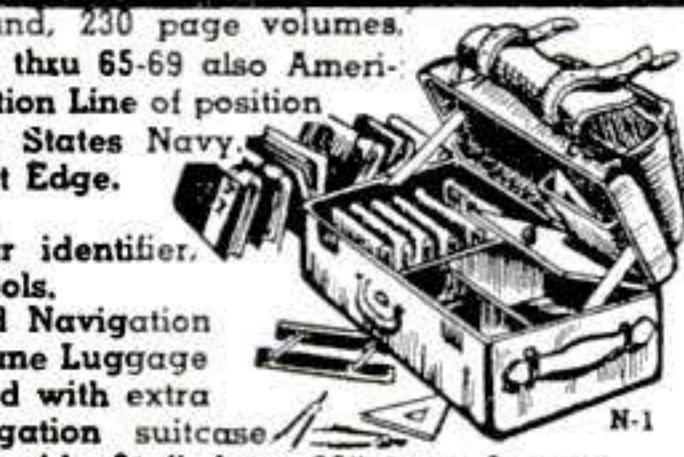

**BED TRAY-TABLE**

adjustable legs, removable tray spreads 33" x 12" high on bed. Made of light weight metal.

**\$4.49**

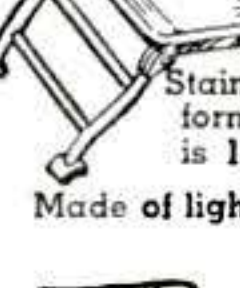

**MUKLUKS**

Knee height, double thickness, leather filled, water repellent body, leather foot with adjustable knee strap and instep lace, also 8" pocket on shank. You'll love 'em in the cold winter sports.

**\$4.29** pr.

**NEW AIRCRAFT ALUMINUM BUCKET SEAT**

Use for boats, jeeps, tractor seats, etc. 17" x 18" seat, 18" x 24" back. Rib enforced. Adjustable height tube mounting. Wide, high back gives excellent support. Easily installed. Shipped in original carton.

**\$4.95**

**CUSHIONS**

New int. leather cushions, yellow pigskin color. Filled with kapok. Will float. Size - 22 1/2" x 17" x 1 1/2" thick.

**\$2.95**

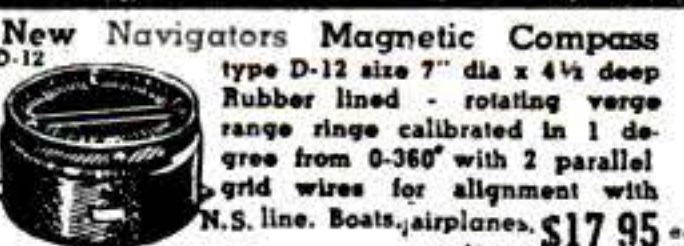

**RUBBER GLOVES**

Neo-Prene. Protective. Impermeable. 1000 Uses. Home Farm, Factory or Laboratory

**79c**

**STOP WATCH**

Elgin 15 Jewel Waltham Pocket style. Shatterproof crystal. Split seconds (1.10ths). Waterproof. Stainless steel, spring suspension Case. NEW

**\$12.95** #300

**WE'RE SCRAPIN' THE BARREL JUST A COUPLE HUNDRED LEFT**



**AIR CORPS FLEECE LINED JACKET**

D-1 TYPE These have been reconditioned, cleaned, and brushed. but they are kinda rough. We do not recommend them for dress wear. However, if you want a warm, rugged, full sheepskin felt, fleece lined collar, zippered front, leather jacket that has lots of outdoor wear left in it that you can't beat for value at this close-out price

**\$7.95** ea.

You'd better write in fast, before they are all gone. Ideal for Hunters, Farmers, Garage Mechanics, etc. Large Size Only

**Rubberized Nylon NEW Tarps, 7' x 11'**

\$6.95 Rubberized Linen 7' x 11' \$5.95

Only 3 lb. light weight yet waterproof. Ideal for outside car storage, etc.

**SLEEPING BAG**

NEW! 100% wool. Mummy type. Heavy duty 30" zipper. \$1 extra Gov't. cost \$22.00 for used water repellent cover.



**\$4.95**

**NEW TARPS - HEAVY CANVAS**

Mildew & Flame Resistant. Cheap Outside Storage. They are Really Moving at These Prices.

5' x 7' \$3.95 8 1/2' x 10' \$8.50 9' x 16' \$11.95

**NEW 100% ALL WOOL BLANKET**

7 x 7 ft. Extra heavy. Also Double warmth. Fits Wood's Robe sleeping bag.

**\$4.65**

**'Twas Made for the Air Forces! THE BEST Loose Leaf BINDER**

You ever saw - 3 metal post. Cylindrical locking heavy duty 3/16" fabricated hinged cover. End identification window. Ideal for price books, salesman catalogues, photo albums, students, publications. Reference books, artist sketch books, etc. Will hold 500 sheets, 8 1/2" x 11". A \$5.00 Value for Only

**59c**

**HORSEHIDE WORK GLOVES**

ALL LEATHER GAUNTLET TYPE REINFORCED PALMS & FINGER STITCHING. LENGTH 13 1/2" \$1.95 pr. ALL LEATHER WRIST Length 10 1/2" \$1.55 pr. Barbed wire, welding, all purpose work gloves. A Steal... Gov't. cost many, many times more.

**COMPASSES**

#151 Marching, lensite, with luminous dial \$1.69 #152 Matchbox, both jewel & liquid floating dial 39c #154 Wrist strap Compass 69c

**ORDER DIRECT FROM THIS AD** All sales final. Make remittances by money-order, bank draft or personal check. Purchase orders acceptable from D & B firms. All quotations F. O. B. Los Angeles. Send 1/3 deposit with C. O. D. orders. Also Complete Aircraft Supplies

**PALLEY SUPPLY CO.** THE LARGEST FIRM OF ITS TYPE IN THE WORLD

DEPT. P. S. 48 — 6321 SAN FERNANDO RD. GLENDALE 1, CALIFORNIA

# How to adjust power tools accurately

● Yes, your modern power tools are marvels of speed and accuracy IF — and it's a big *if* — you are accurate in their use, if you make them do their best work. And that's where your flashlight comes in handy. Better keep it powered with "Eveready" batteries. Powerful, dependable, *they outlast all other brands.\**



← Gauges for power tools are frequently in shadow where they are hard to read. That's where you need your flashlight to make adjustments with a fine degree of accuracy.



A clamp on the side of the table → will keep your "Eveready" flashlight handy, ready for use.



● Brighter light, longer life! That's what you want in a flashlight battery — that's what you get with "Eveready" brand batteries. Laboratory tests prove it. And the best "laboratory" of all — *your own flashlight* — proves it! That's why "Eveready" batteries *outsell* all other brands — because they *outlast* all other brands!\*

\*According to the "General-Purpose 4-Ohm Intermittent Test" devised by the American Standards Association, which most closely approximates average use.

The registered trade-mark "Eveready" distinguishes products of

**NATIONAL CARBON COMPANY, INC.**

30 East 42nd Street, New York 17, N. Y.

Unit of Union Carbide and Carbon Corporation



Proof! . . . in the laboratory . . . in your own flashlight . . .

## "EVEREADY" BATTERIES

### OUTLAST ALL OTHER BRANDS!\*



PS

The Voice of Science

# Edison's Practical Science

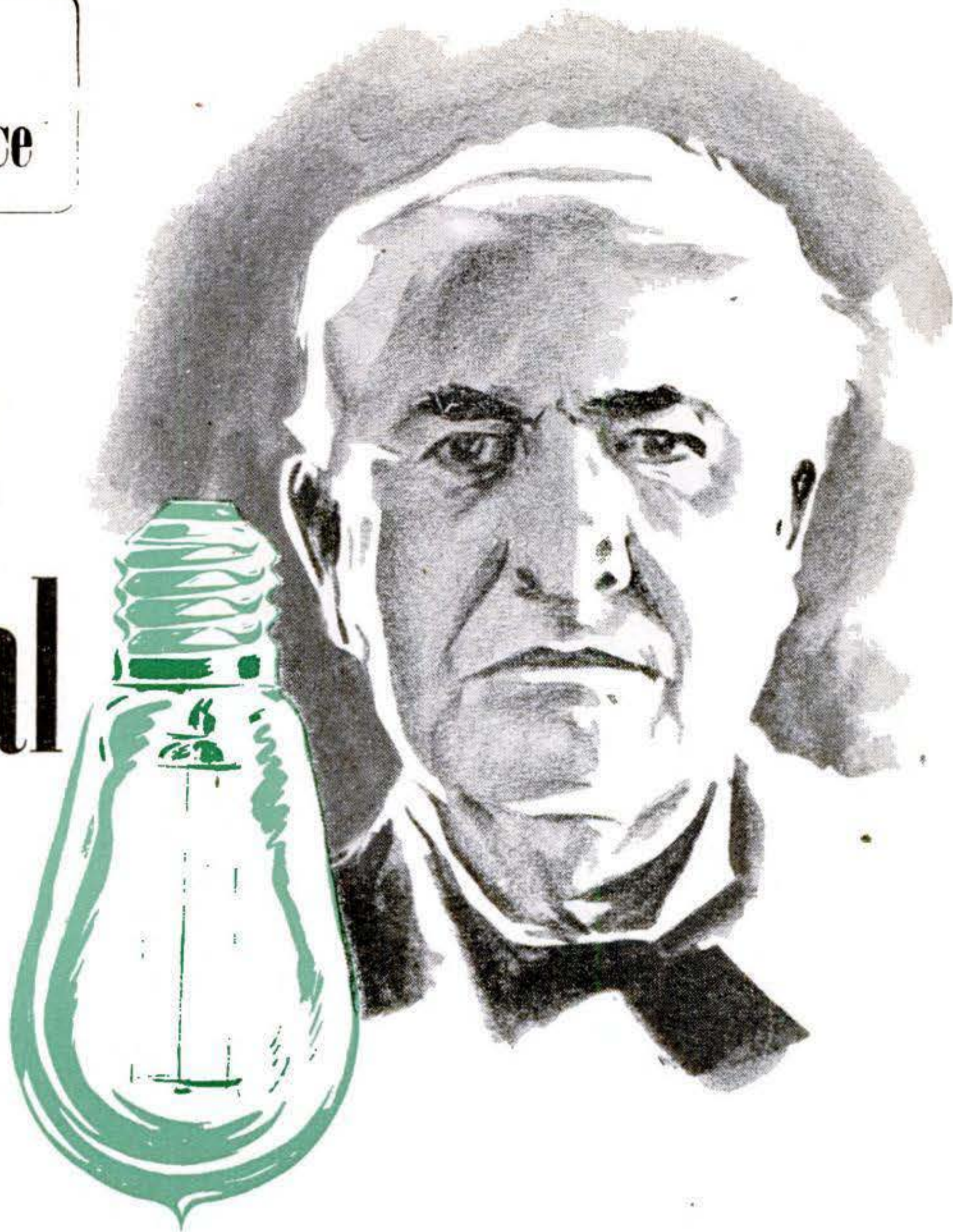

**Y**EARS ago there was a story around about Thomas Edison. This fable illustrates an argument that is still going on. It's the kind of story that ought to be repeated annually anyway.

It seems Edison was interviewing a bright young man who considered himself something of a science hot-shot. He had a head full of figures, some of which were facts. His tool kit bulged with slide rules, calipers, micrometers and the like.

Edison is supposed to have handed the Bright Young Man a then-everyday light bulb, the old kind with the tip. Measure the cubic contents, he told the B.Y.M.

The B.Y.M. calipered the truncated cones and hemisphere of the bulb. Then he broke the glass carefully, and miked the fine wires and their glass support. He dived into solid geometry and came up with an answer carried out well to the east of the decimal point. That, he thought, certainly should

convince Edison—if the old man could follow such complex calculations.

Proudly he returned to Edison and presented the figures. The old man rolled out his lower lip and nodded. Pretty close, let's see how close.

Edison reached into the nearest fixture for another bulb. He filled a glass graduate with water. Then he immersed the tip of the bulb in the water, carefully broke it off with pliers. The water rushed in to fill the vacuum. Edison took a reading on the graduate. Then he proved it out by releasing the water in the bulb into another graduate. The B.Y.M., remembering his hours of measuring and calculating, sighed and grinned.

The moral of this fable is that the obvious, or practical, approach is all the more scientific if it's quicker.

*Perry Witheas*

APRIL 1948 95



**P.A.\*** means **Pipe Appeal**

R. J. Reynolds Tobacco Co.  
Winston-Salem, N. C.

—And Pipe Appeal puts you on the right track with the ladies! With Prince Albert, you're sure of smoking joy and comfort, too!

means **Prince Albert**

FOR THE MAKING OF A GREAT CIGARETTE, YOU CAN'T BEAT P.A.! IT'S CRIMP CUT—ROLLS UP FAST AND EASY!



● Long known as the National Joy Smoke, Prince Albert is America's largest-selling smoking tobacco. Try it —and you'll see why! P.A. is rich tasting, mild, easy on the tongue. That choice tobacco is specially treated to insure against tongue bite. Get Prince Albert—in the red tin—at your dealer's.

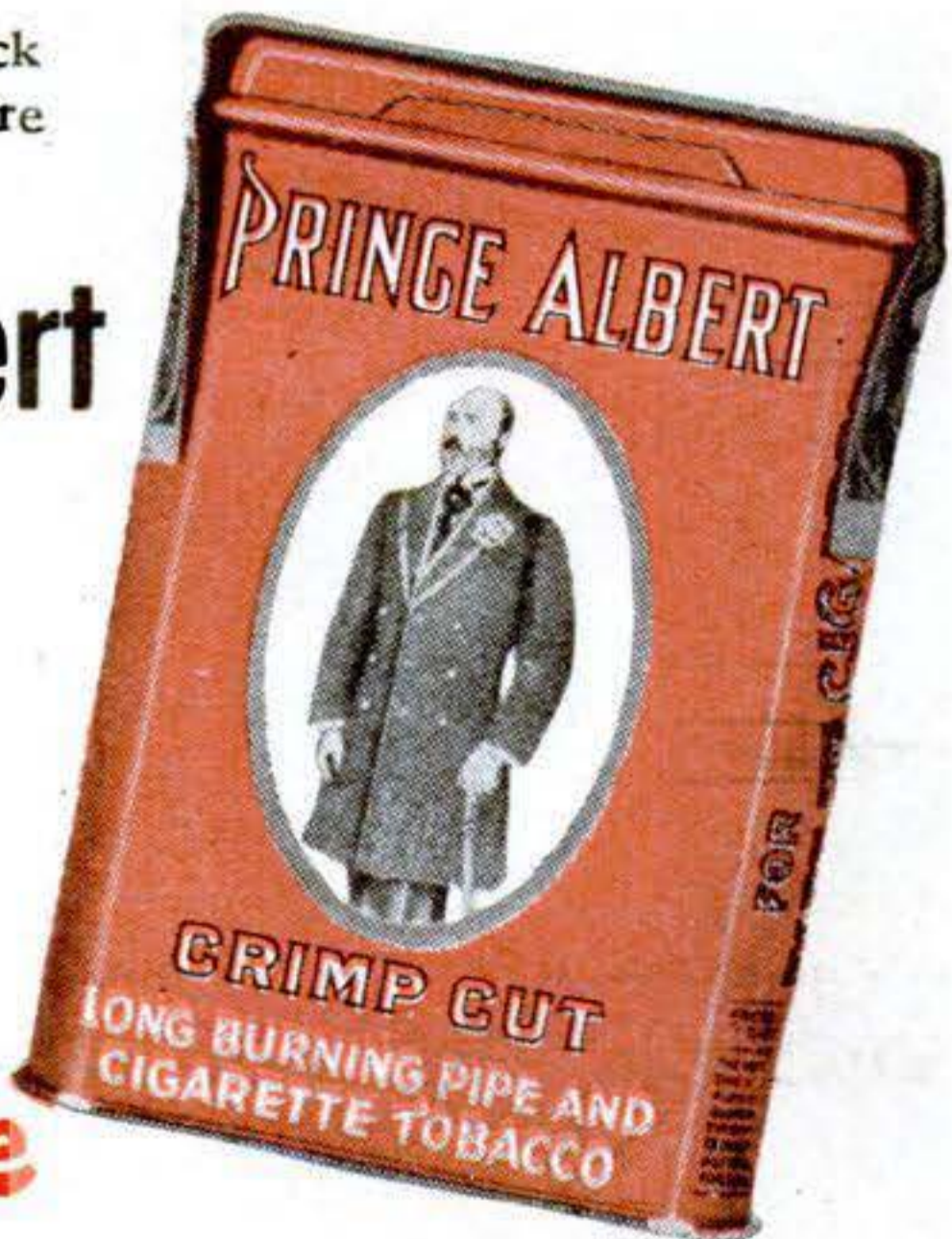

**The National Joy Smoke**

APRIL 1948

## Popular Science



**80,000 r.p.m. Inside Out...** This pocket-sized, 1/10-hp. electric motor not only works up a dizzy 80,000 r.p.m., but it does it "inside out." Unlike conventional motors, its outer shell revolves, while its core remains stationary. Built by GE for the Army Ordnance Proving Ground at Aberdeen, Md., the mighty midget puts the spin on high-velocity projectiles undergoing wind-tunnel tests to determine their behavior at supersonic speeds. Fastened to the inside of the projectiles, it simulates their whirl in actual flight.

APRIL 1948 97

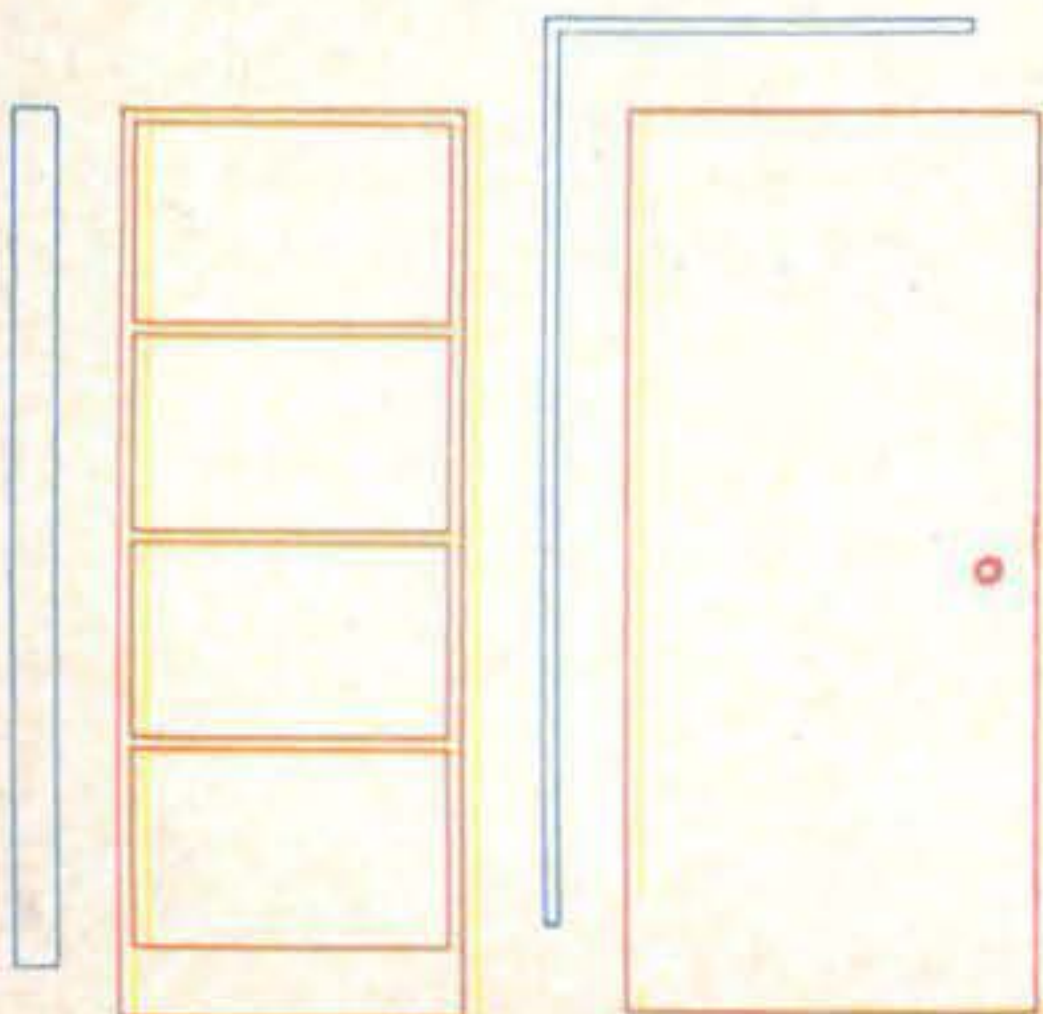
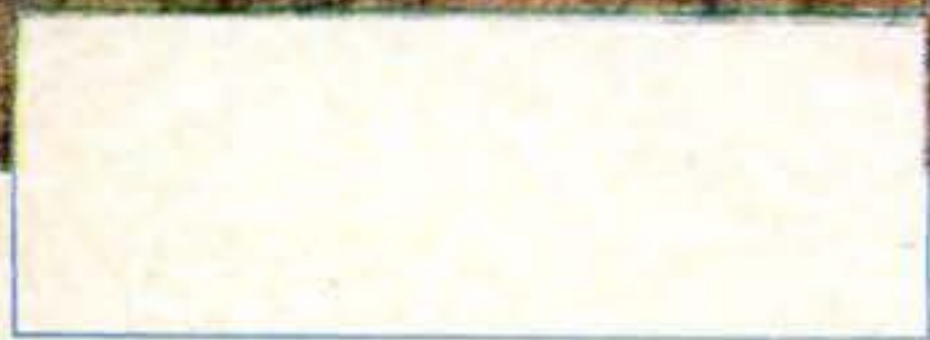

**Without a single nail in the walls,** a bookcase with a door hinged to it blocks up the familiar arch (inset) between living and dining rooms. Basic items, sketched at left, are bookcase and door; trim board, molding, and topping board dress up the job. A lintel board on top of the bookcase will carry a doorstop and latch if you want it. Since bookcase provides support for the entire structure, it must have fairly substantial sides and shelves, but the back can be of the thinnest wallboard. The door need only be strong enough to resist warping and sagging. If the unit is to be temporary, pin-type hinges will simplify dismantling.

**Whether you rent or own,  
whether you can drive a nail or not,  
here are ideas to enlarge your living  
without enlarging house or budget.**

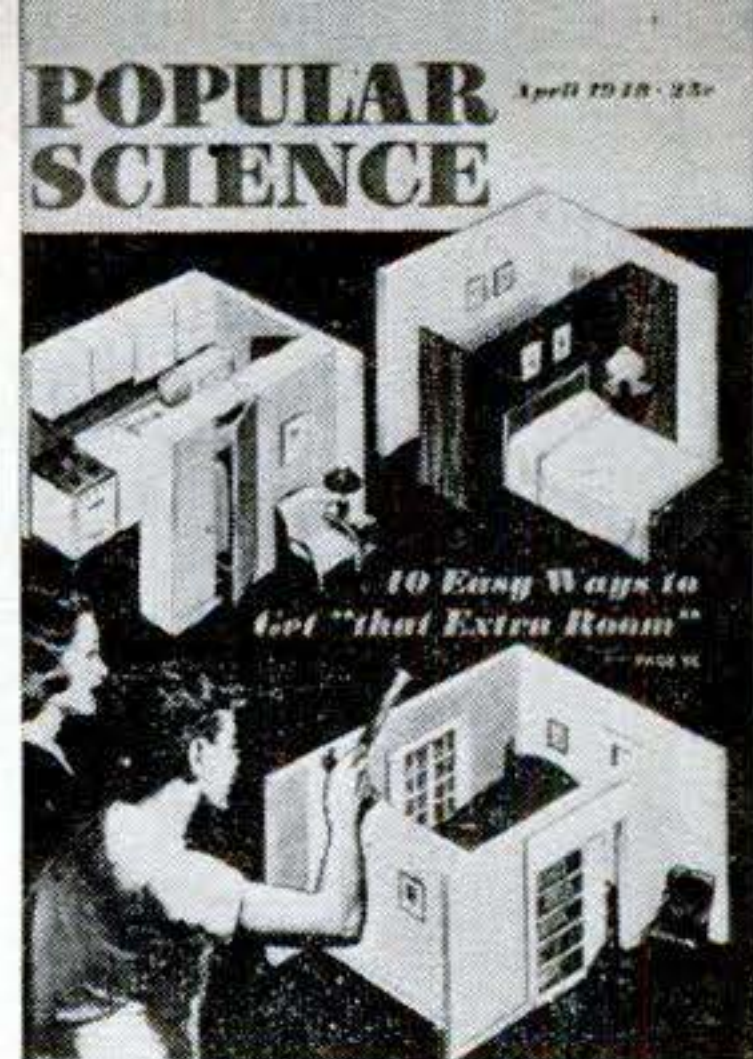

# 10 Easy Ways to Get "that Extra Room"

**By John F. Stearns**

*With the Editors of Popular Science*

JOSEPH ARONSON, *Architectural Consultant*

*PS Staff Photos*

*Drawings by Sigman-Ward*

**H**AVE you a little housing shortage in your home? Has a new baby taken over the "master" bedroom? Have two kids growing up where one grew before turned shared space into a battlefield? Is there an in-law waiting out the bridge game to make camp in the living room?

Most families have some such problem. But few realize that something can be done about it without risking the wrath of the landlord. Or that you can add living space to your own home without building an addition on the house.

## ***The Practical Touch***

To explore the possibilities, POPULAR SCIENCE called in Joseph Aronson, an architect who has specialized in interiors. In his professional work, Joe Aronson has faced all the typical problems in fitting people into places.

And he has come up with practical, workable solutions ranging from a simple, but solid and stable, screen to a ceiling-high storage wall. He says, "the hardest part of any problem is to get people to break with

habit and tradition—and accept the obvious answer."

For example? Well, here's a dining room idle 22 hours a day. There's a kitchen big enough to dance in. Here's a sunroom that is shut off when the leaves fall, simply because it's like Macy's window. There's a living room that could be a fine one-room apartment.

All that is needed in most cases to create living space out of empty air is a wall. If most people shudder at the thought, it's because they think a wall is a minor Boulder Dam, expensively and irrevocably constructed of cement or plaster.

## ***A Wall Is What You Make It***

Actually, a wall need only be a partition fitted to a purpose. Like Lincoln's legs, which were just long enough to reach from the hips to the ground, a partition has only to be high enough to cover the problem.

Modern materials permit a small solution for a small problem. Take the Case of the Quarreling Kids, where a difference in sex or even a slight difference in age makes a big difference in bedtime or living patterns. The quickest, cheapest solution calls only for a chunk of wallboard. Simply swing the beds head-to-head with the wallboard held between them. Buy as big a piece as you can get into the room. Bolt the head-

boards together through the wallboard if you have boys.

Another cheap-and-easy answer to many problems is the king-size screen, a solid citizen compared to the familiar folding screen, which is a shaky and temperamental affair.

The solid Z-screen is one of Aronson's proudest products of obvious thinking. It consists of two stock flush doors, costing

about eleven bucks each, attached at right angles to a panel of wallboard. The doors are light veneer on a honeycomb base, and are used as sold—without hardware. The wallboard is the structurally strong, not the plaster, type.

Such a screen has enough stability to make a practicable partition. A casual bump from a passing shoulder isn't going to knock it over on the new baby or the

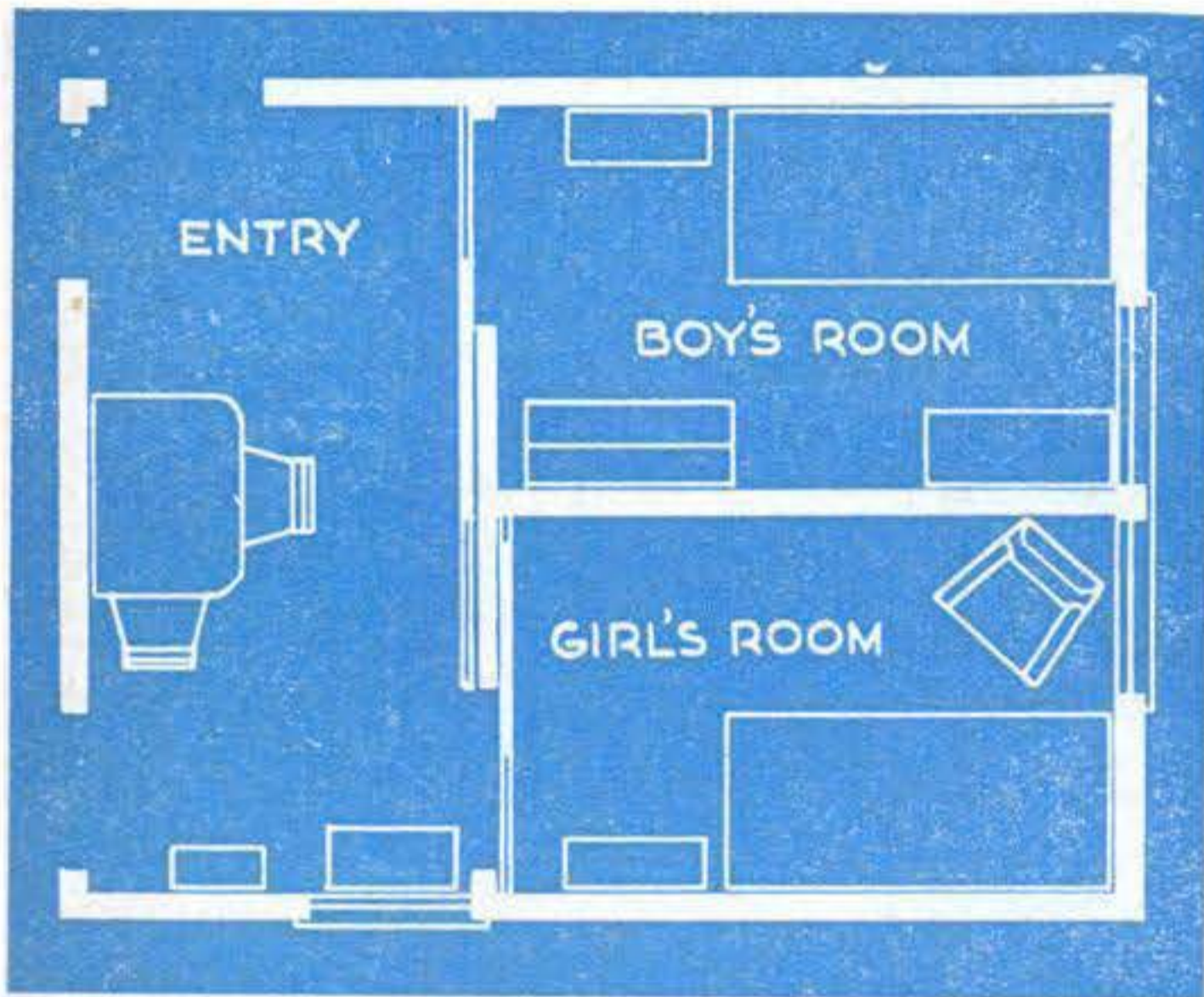

**Floor plan** of a three-room suite for a brother and sister shows what one family did with a single room, about 12 by 15 feet. Dividing wall is of composition board, braced with 1-by 3-inch planks fastened to floor and ceiling. Sliding doors, moving in tracks made of wood strips, give complete privacy in the two bedrooms. For a less expensive project, doors could be omitted or replaced by curtains.

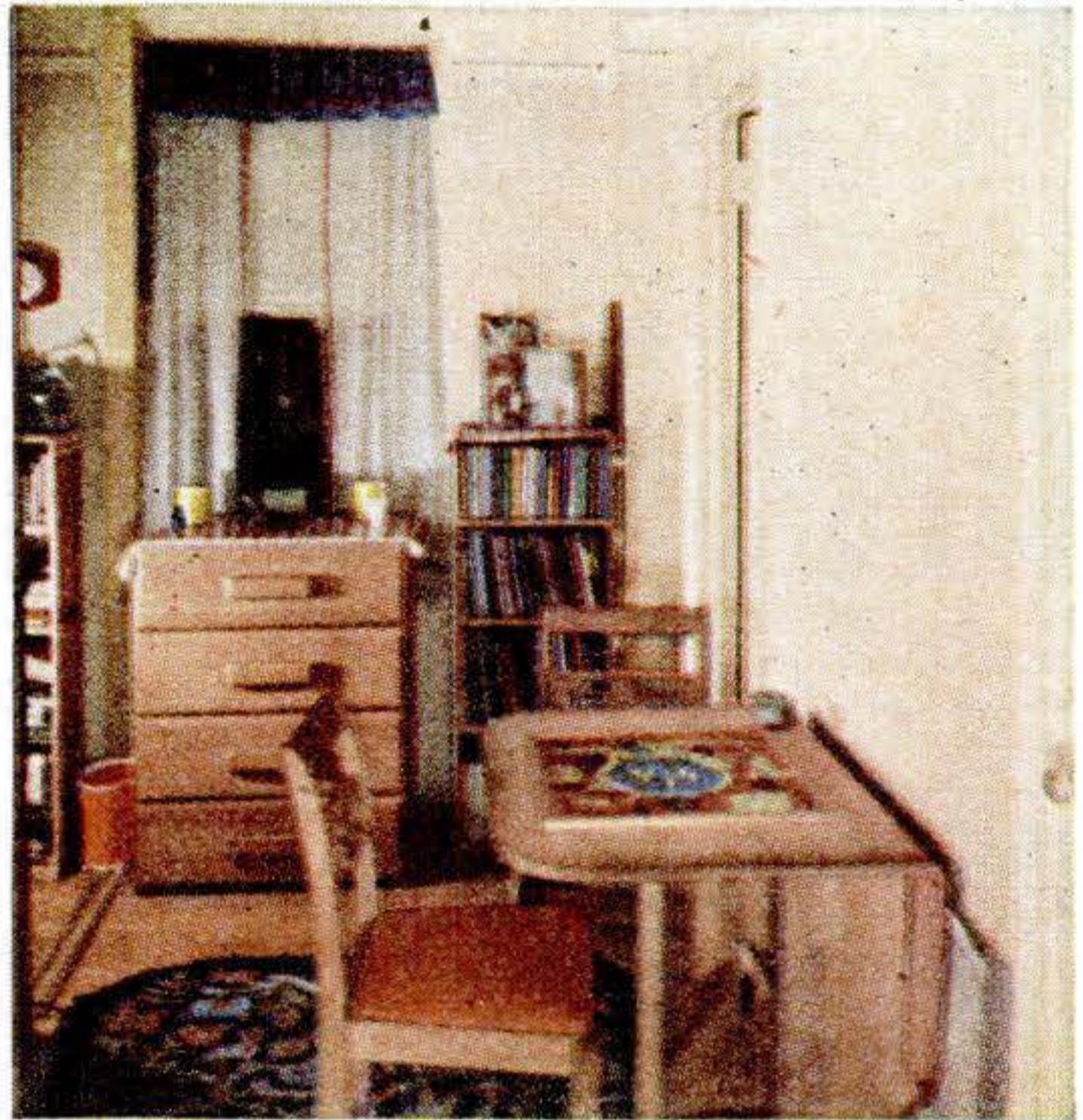

**Entry**, providing playroom and study space, holds game table, bookcases, and bureaus for out-of-season clothing. Track of sliding door is at lower left, forming sill of girl's door.



**Boy's room**, seen from the entry, shows compact arrangement. Panels and braces were left unfinished on this side, since dark panels and natural-wood braces make a good color scheme.

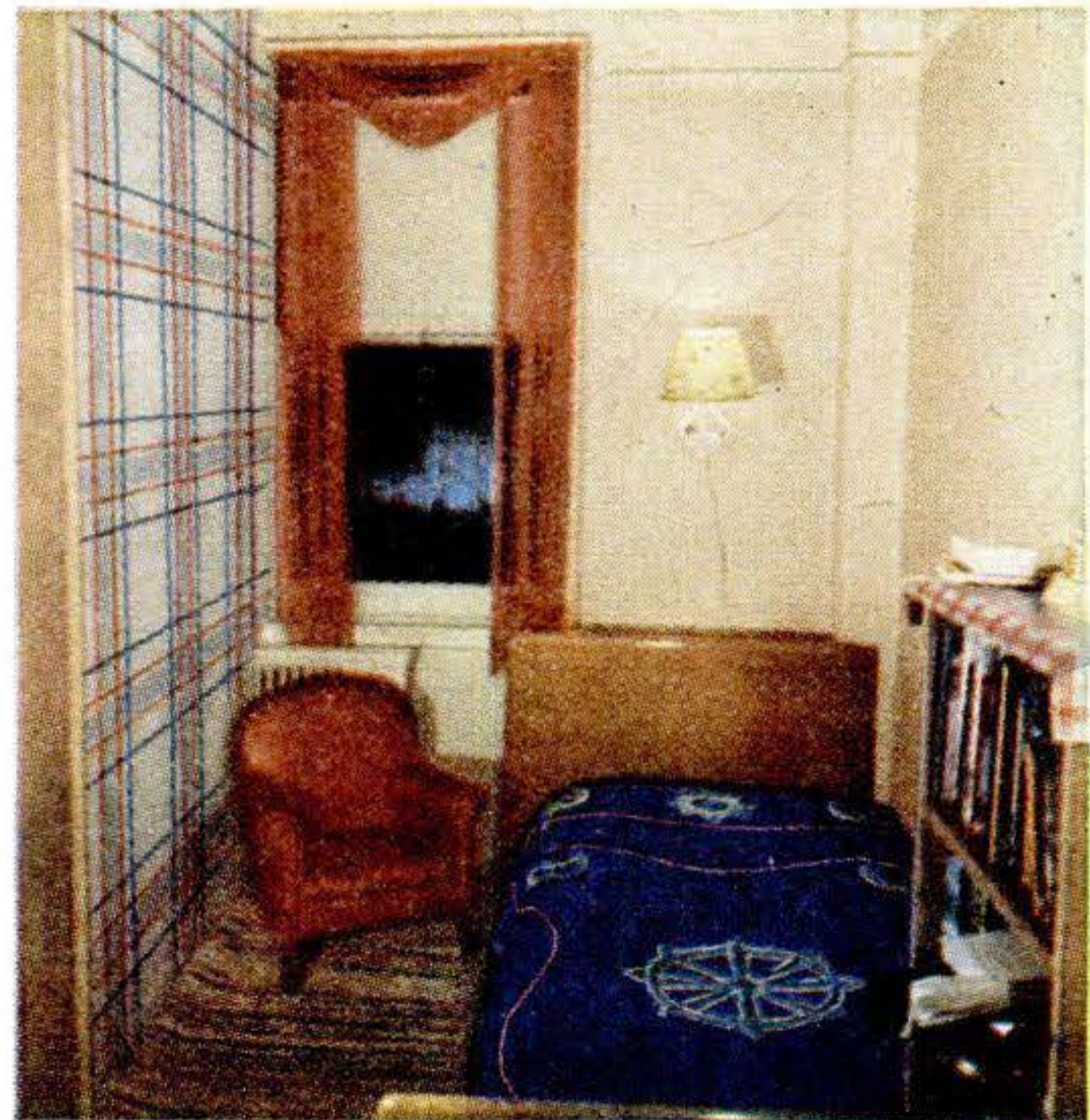

**Girl's room** has wallpaper over the panel, but otherwise is the same. Floor and ceiling fastenings, necessary in this construction, can be avoided with variations shown on next page.

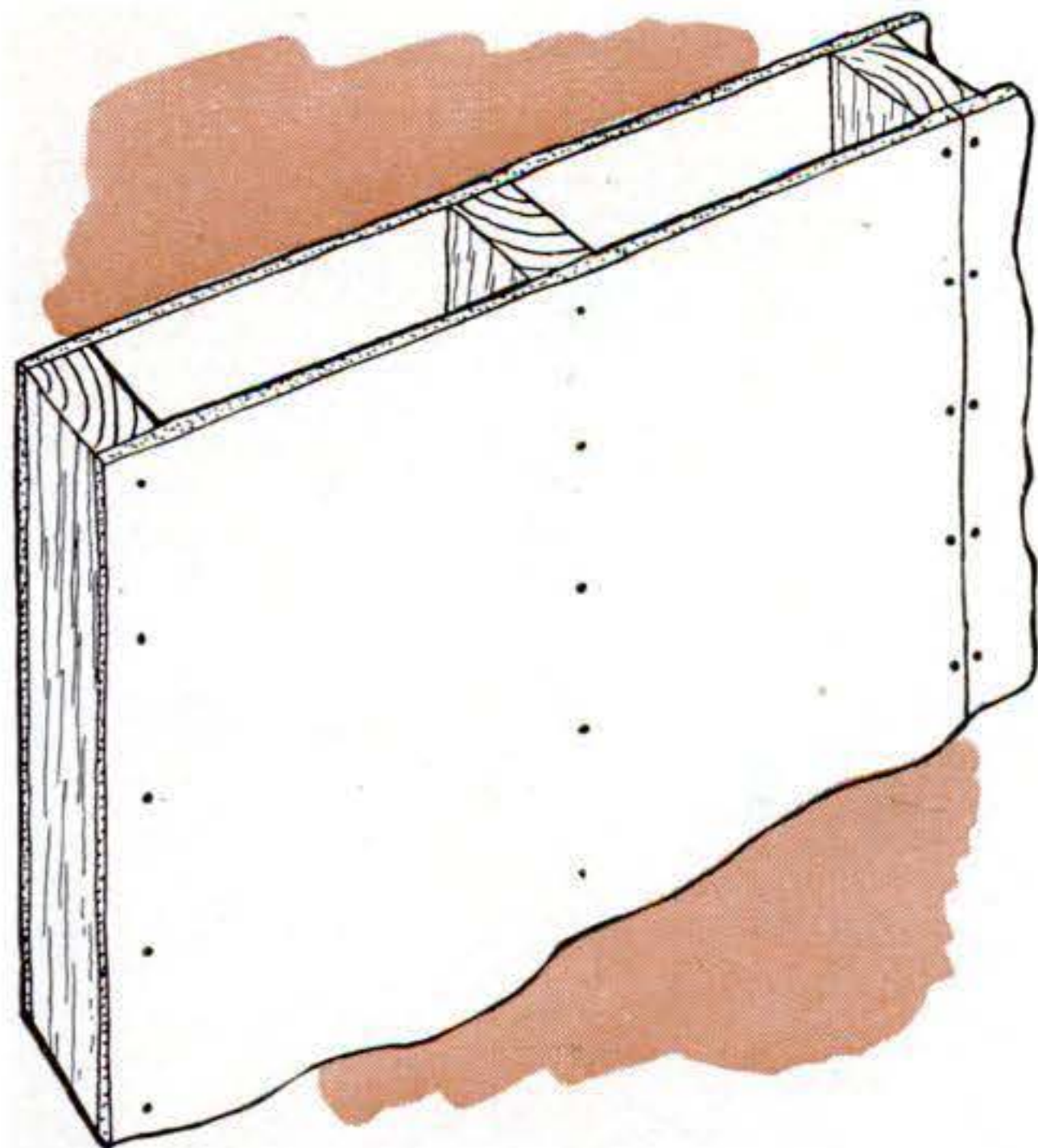

**Double-panel wall**, made by nailing any light sheathing or wallboard on 2- by 4-inch uprights, can be put up with expansion joint. Uprights are cut just short of ceiling height. With a plank

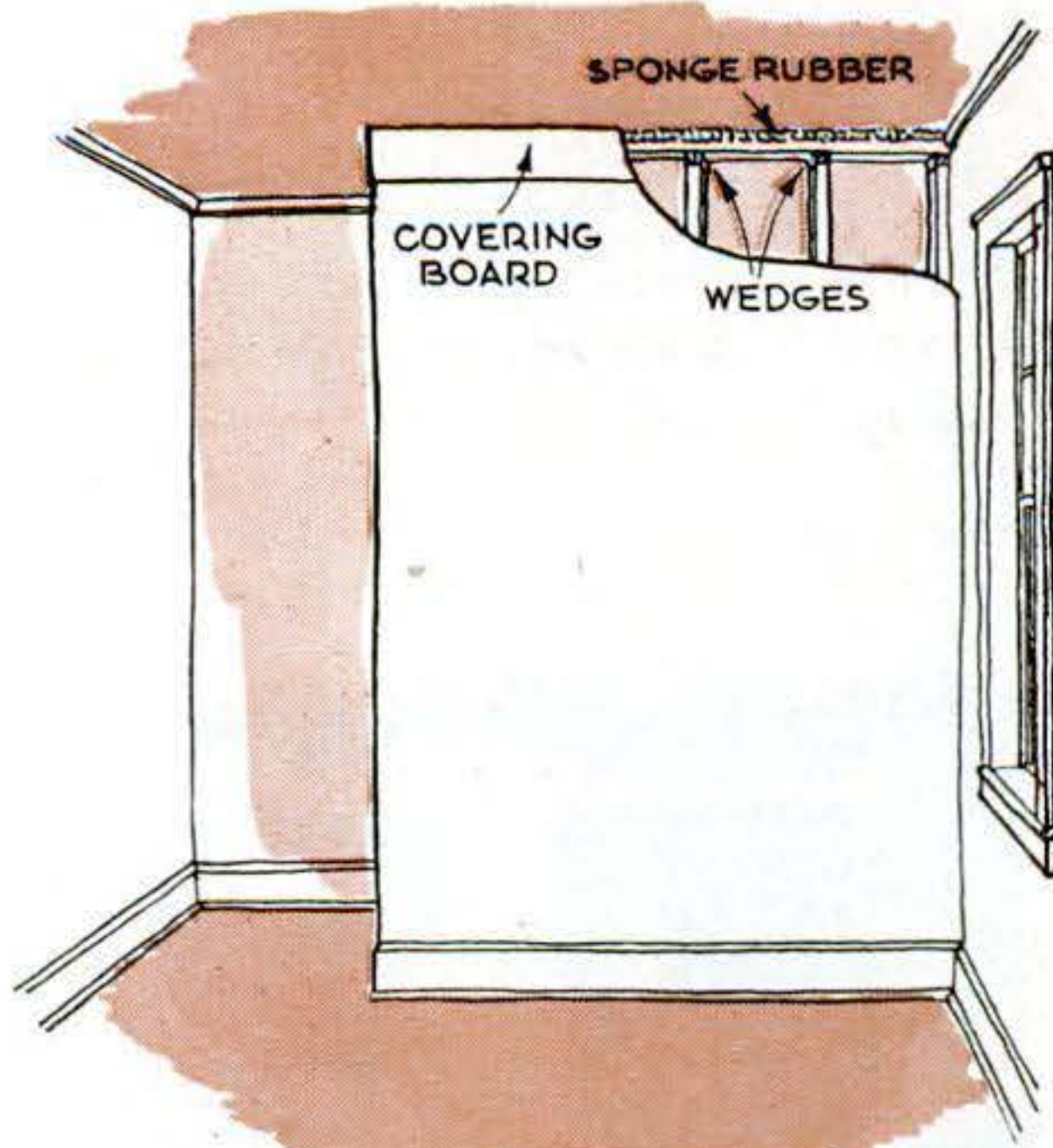

laid above them and topped with foam rubber or fiber insulation to protect ceiling, wedges driven between uprights and plank will lock wall in place. Covering board adds support.

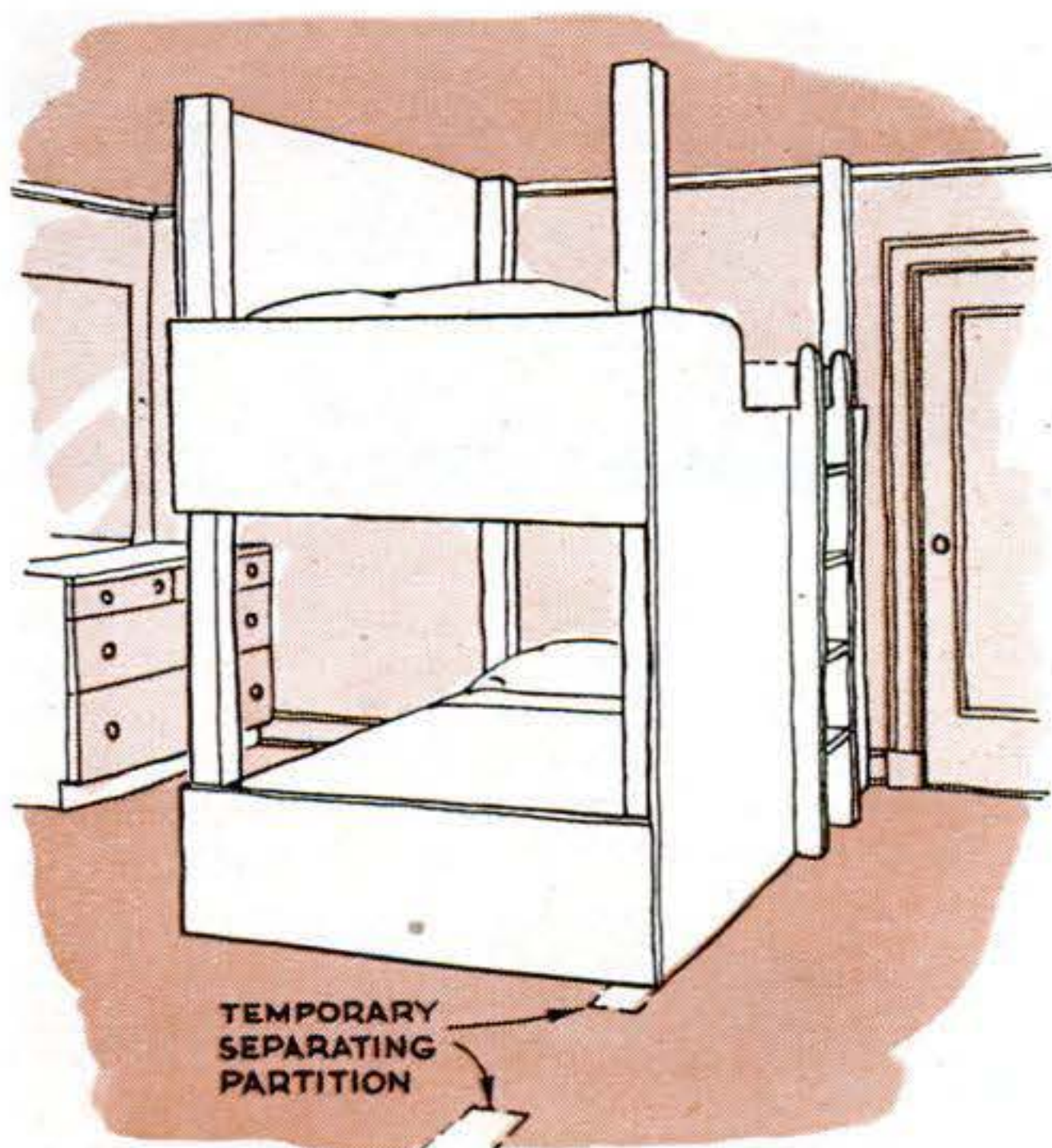

**Double bunks** make a wall, too, with plywood enclosing one side of top bunk and opposite side of bottom bunk. With ends covered, a door hinged to upright will complete the division.

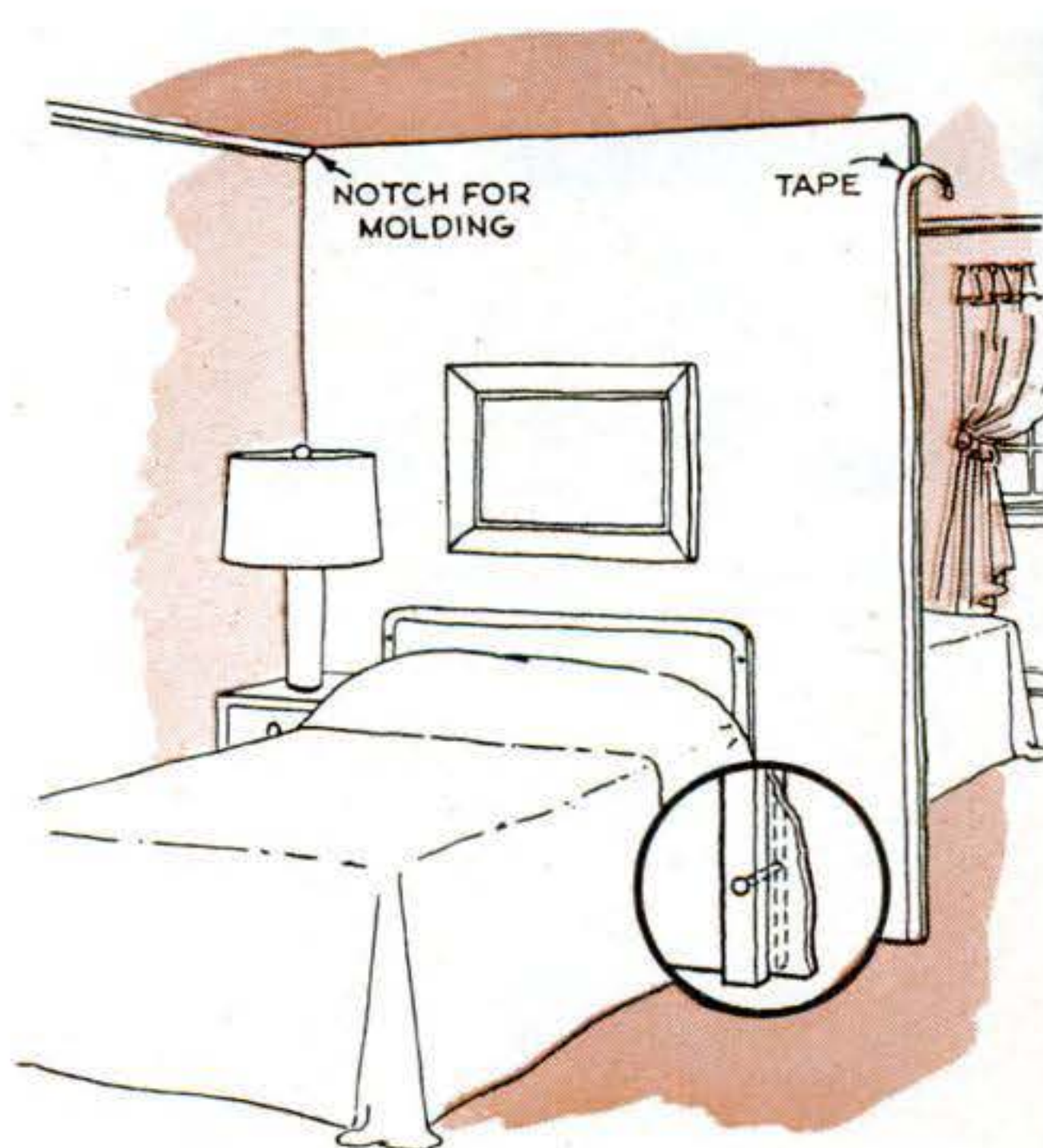

**Two beds**, head to head, support a partition between them. Beds can be bolted together for solidity, but panel itself should be fairly substantial. Decorator's tape finishes edges.

### **Tips on Wall Materials**

A list of wallboards by properties and trade names fills a book, but here are four basic categories (Standard panels are 4' x 8'; larger sizes are often available):

**Plywoods**—Most versatile, but at present hard to get; ¼" to 1½" thick; high structural strength; wide variety of surfaces.

**Plasterboards**—Generally gypsum base, paper faced; various thicknesses; low structural strength; require bracing.

**Hardboards**—Fiber or asbestos composition; various thicknesses and surfaces; strong, but often need bracing.

**Softboards**—Insulation board and sheathing; often rough-surfaced; various thicknesses and strengths; need bracing.

new wife slaving over the new two-burner stove. And it's high enough (a standard flush door is 6 feet 8 inches tall) to provide visual privacy.

Slant a Z-screen across the sink end of the big kitchen, common in old houses, add a lamp and table, a couple of chairs, a few colorful pictures and accessories, and you have acquired a cozy living room. Put the baby behind a Z-screen in the corner of the

bedroom and you'll dare to read in bed again—if you're quiet about it.

These suggestions are all expedients. More money, and more imagination, will permit more permanent solutions. But even the most solid of the partitions presented here can be built without so much as a tack puncturing the landlord's precious woodwork or temper.

Take the gaping arch between the typical

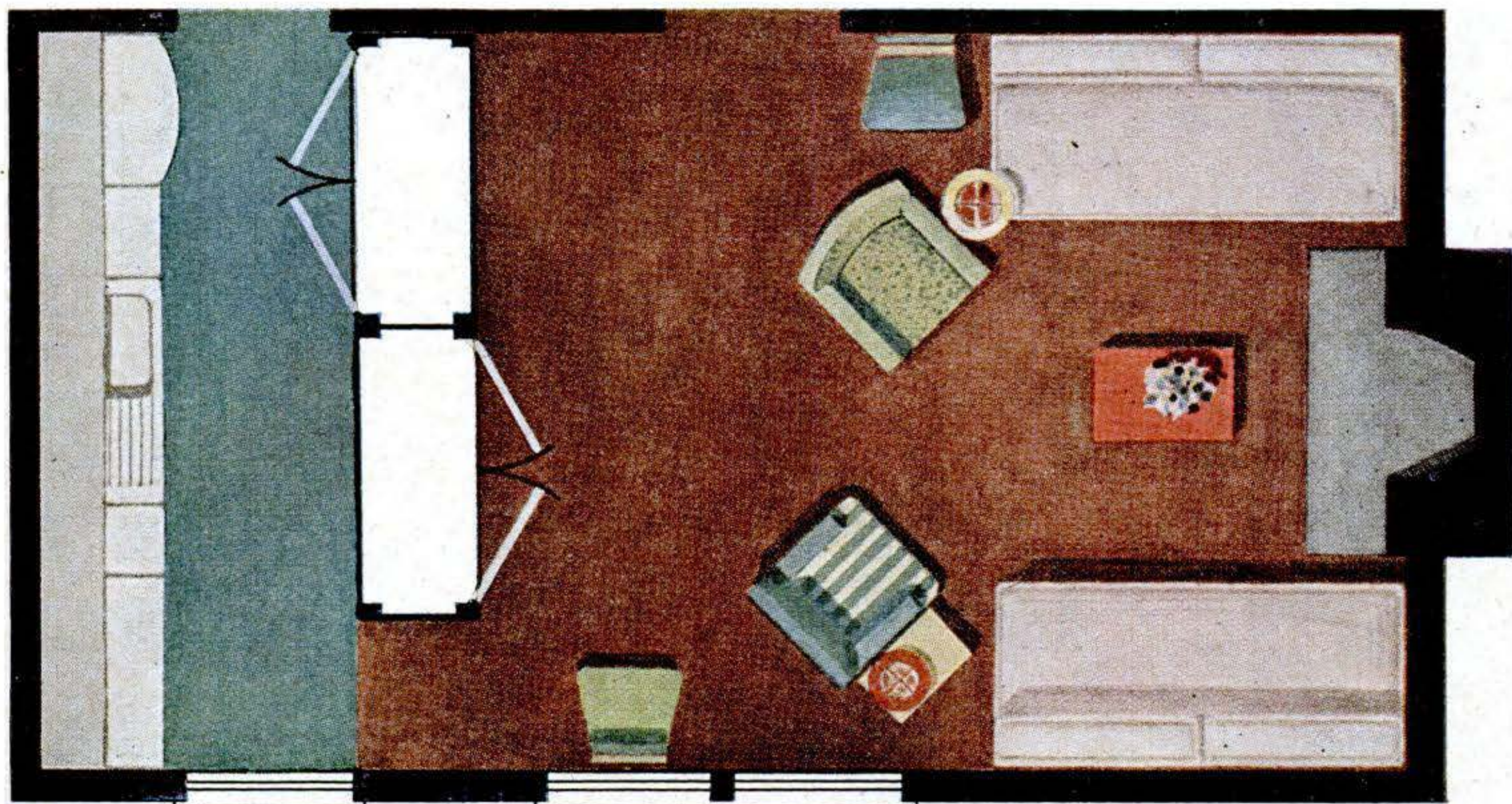

**Put two closets together** and you have a storage wall like the one providing a separate kitchen for this one-room apartment. Closets can be built as a single unit if the desired dimensions permit, or can be made separately for easy handling. Don't make them too big; their diagonal measurement must be less than ceiling

height or you can't tip them into place. If you want a full-height wall, topping boards that reach the ceiling can be fastened to closets once they are in place. If closets are to have shelves, be sure framework is sturdy enough to support the added weight. Strength of paneling helps here by supplementing that of the frame.



**Storage-wall variations** are legion. Here are a wardrobe and cabinet, standard furniture items. Add a top panel, center panel and dressing-table shelf—and there's your complete wall.

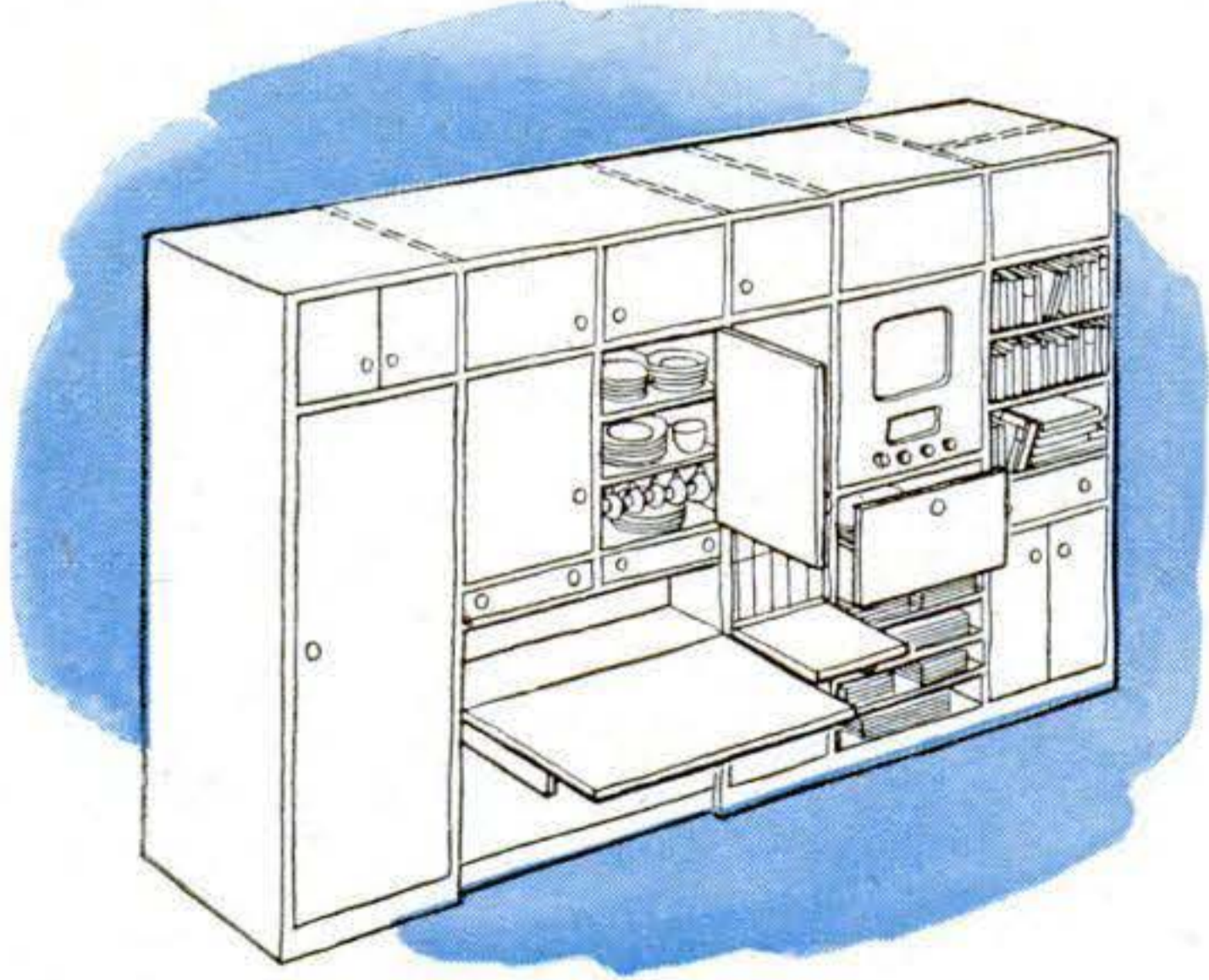

**Sectionalized units** permit such dressed-up versions as this, with closet space, a folding desk-table, room for a television set. Shelves for dishes can have doors on both sides of wall.



living room and dining room. A bookcase with a light door *hung on the bookcase* is all you need. The weight of the books provides the necessary stability.

The bookcase needn't even fit if false boards are used. And the result can look like one of a decorator's better dreams, as the pictures show.

If you know how, you can even have a full-height, extra-thick interior wall without

a scratch on the ceiling or the floor. Such a self-sustaining partition can provide closet space, plus more complete privacy than most original walls. This is the answer for the long-term doubled-up family, or for the people who would like the income from a completely separate one-room apartment.

In this article, we cannot give you blueprints or architectural specifications, but we can supply you with ideas to start you think-

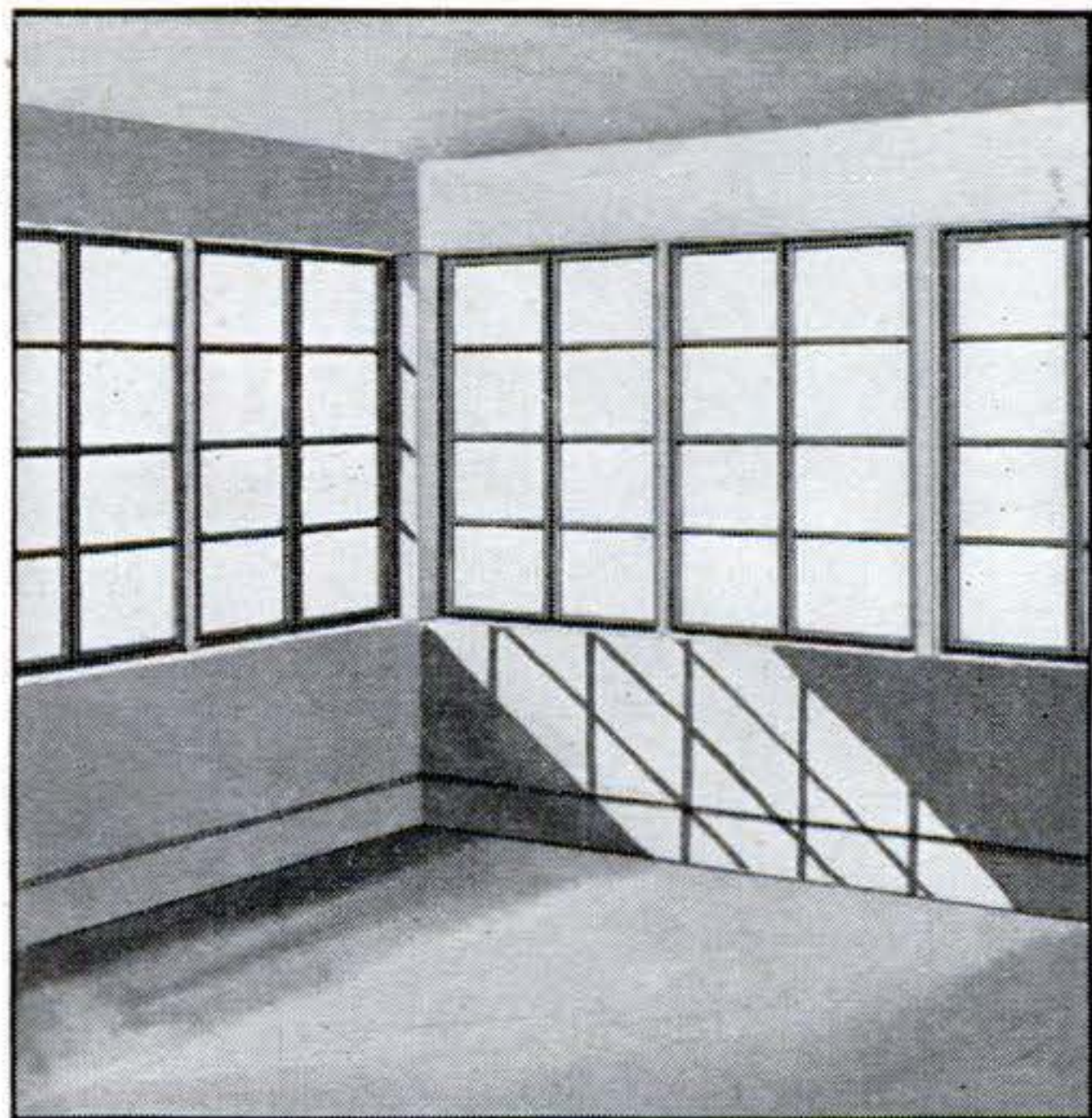

**The sun room** and the glassed-in porch are worth more than just summer-time use these days. Here are two methods of blocking off unneeded windows to make any kind of room.

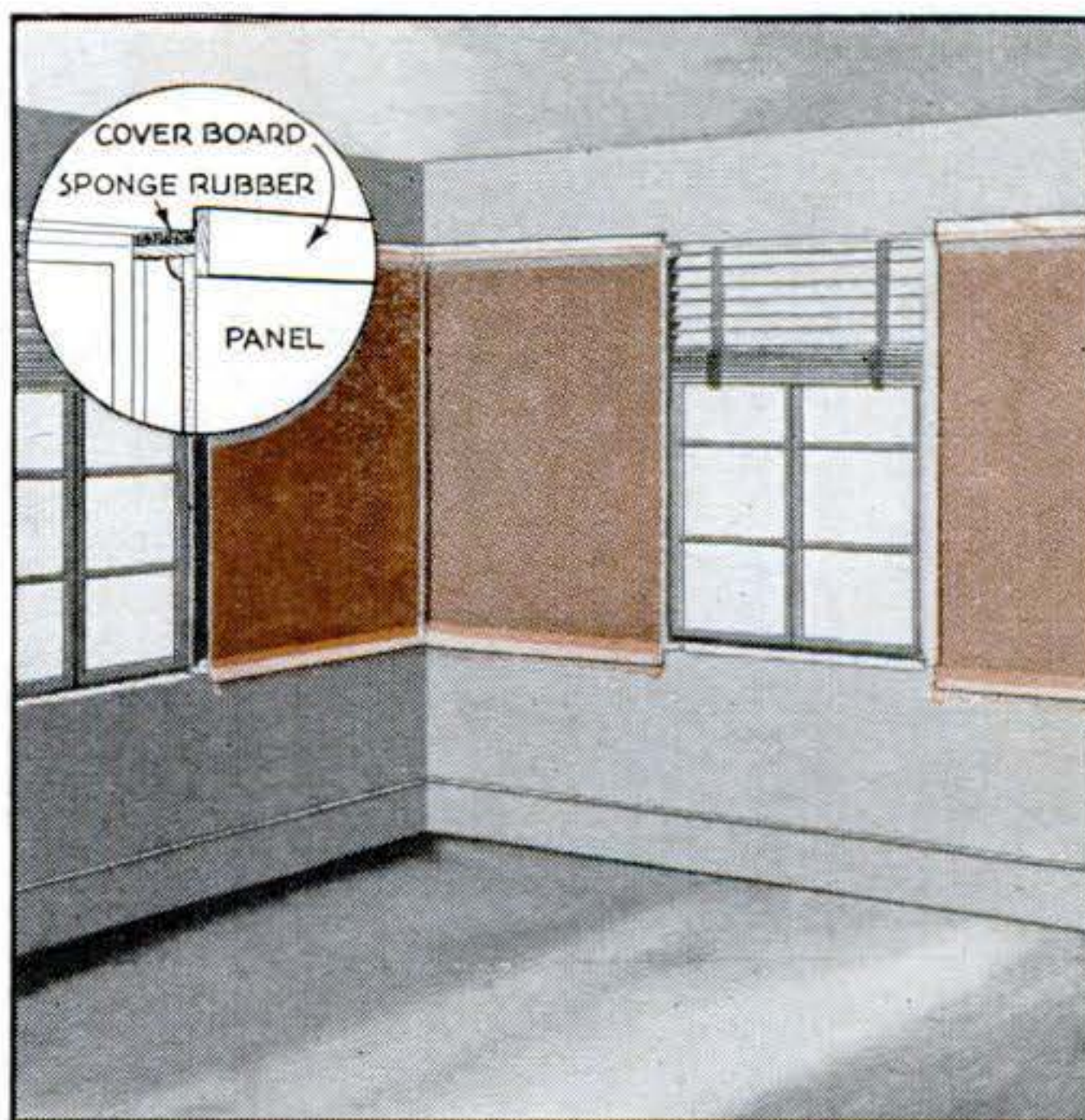

**Padded cleats**, top and bottom, hold lightweight panels over unwanted windows by pressure of padding, which is squeezed into place. Venetian blinds are put over remaining windows.

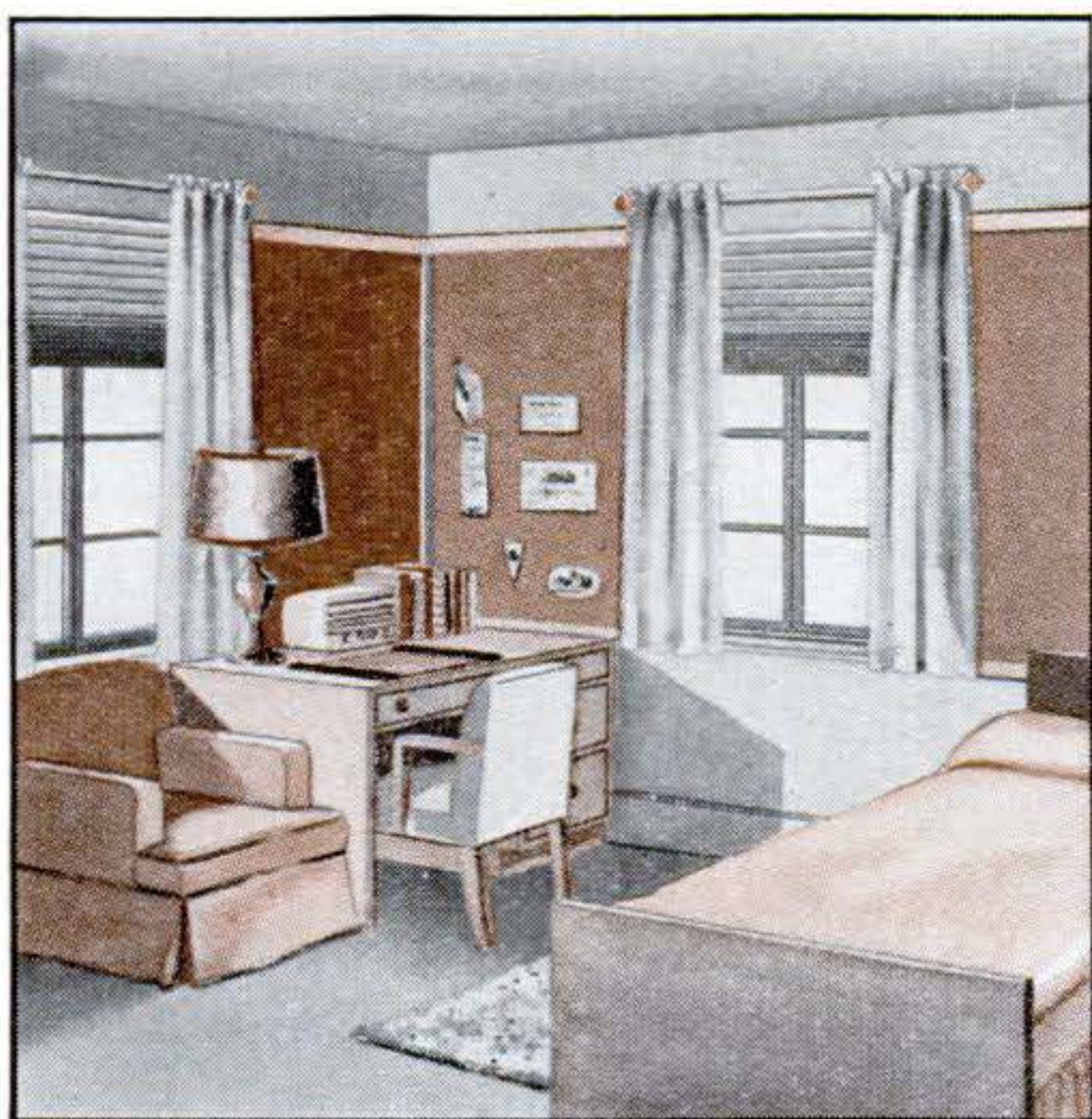

**With drapes and furnishings**, the sun porch becomes a brand new room. Pressure mounting makes panels easy to install or remove and permits variation in arrangement of room's windows.

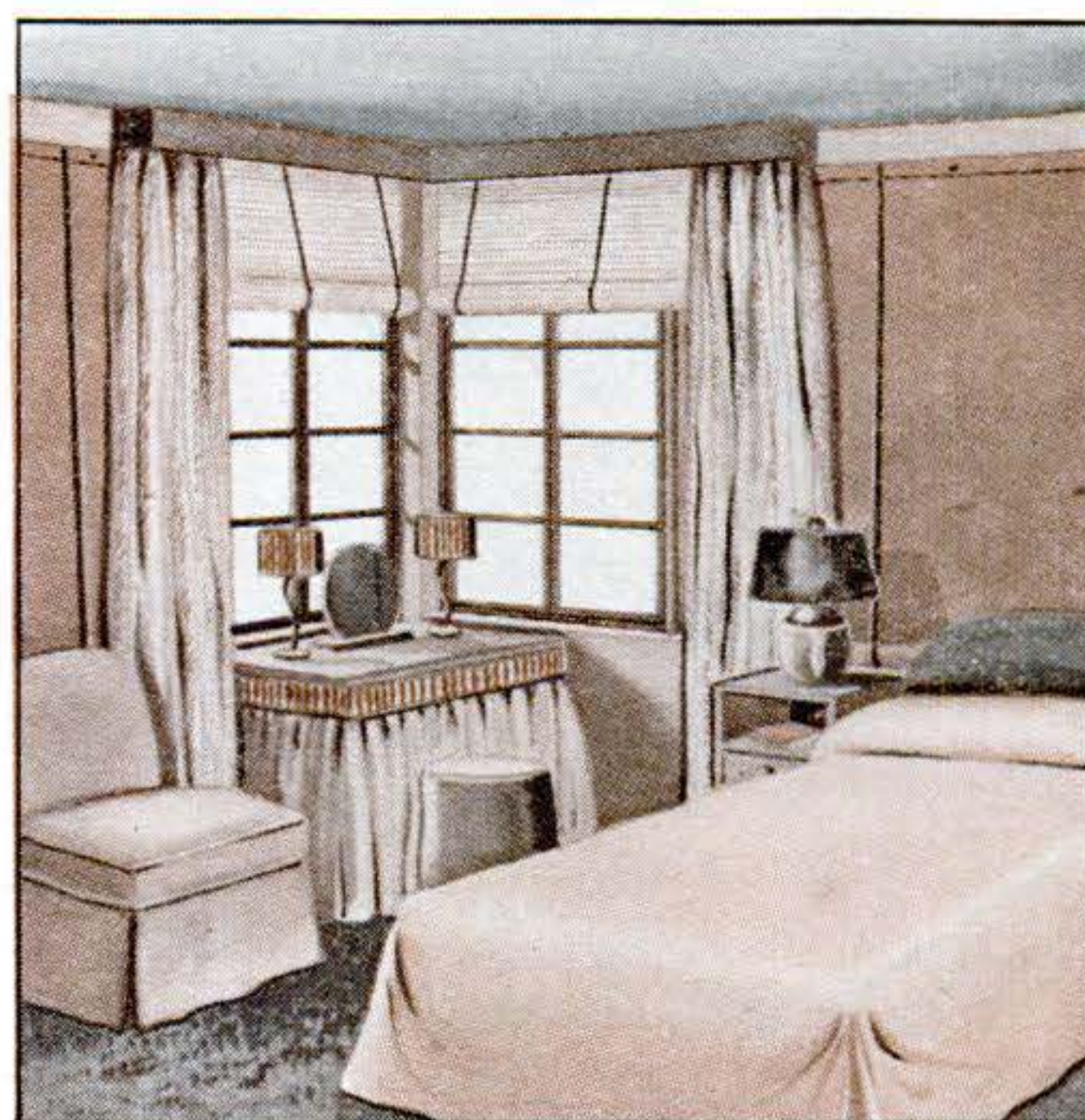

**Second method** is even simpler. Snaps hold roller shades over unused windows, and slatted porch shades replace the venetian blinds. This version can be reconverted in a hurry.



Transforming excess kitchen space into a living room is only one of many jobs for the Z-shaped screen, a wall supported by its own right angles. This one, 6 $\frac{3}{4}$  feet high, is made of two 4-foot-wide panels of  $\frac{3}{4}$ -inch plywood and two

flush-type, mahogany-veneer doors. Any strong, rigid paneling can be used instead of plywood and doors. Here, all four parts of the screen are hinged, but angle braces and cleats make sturdy, fixed joints if they are desired.

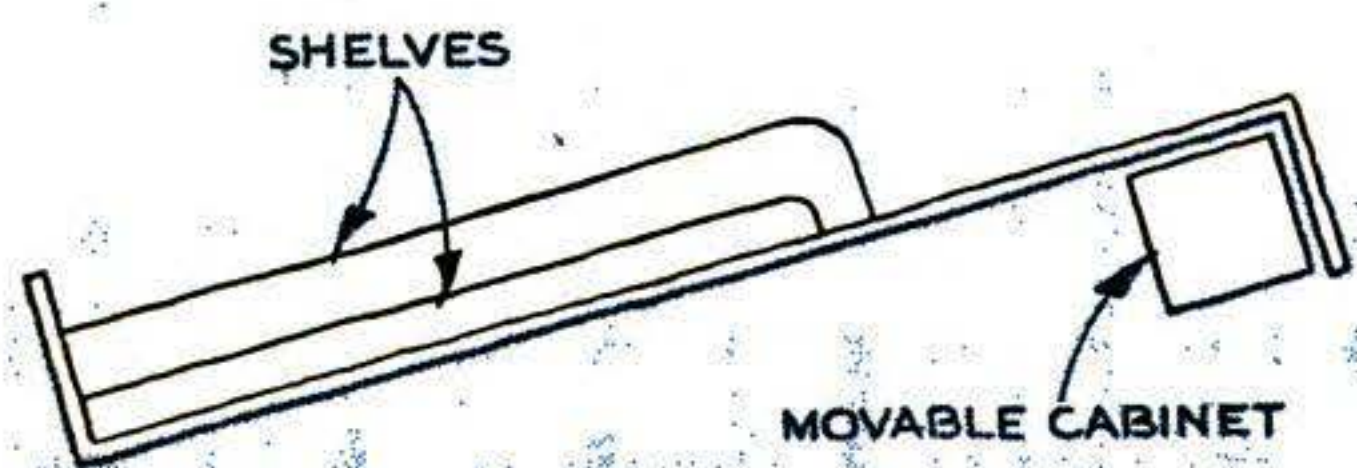

Shelves fastened to kitchen side add strength and convenience; cabinet also helps brace wall.

ing like a professional about your own problem and the possibilities that are usually present.

If you are a regular reader of the Mechanics and Handicrafts section of POPULAR SCIENCE, you will have no trouble adapting some of these ideas to your special situation.

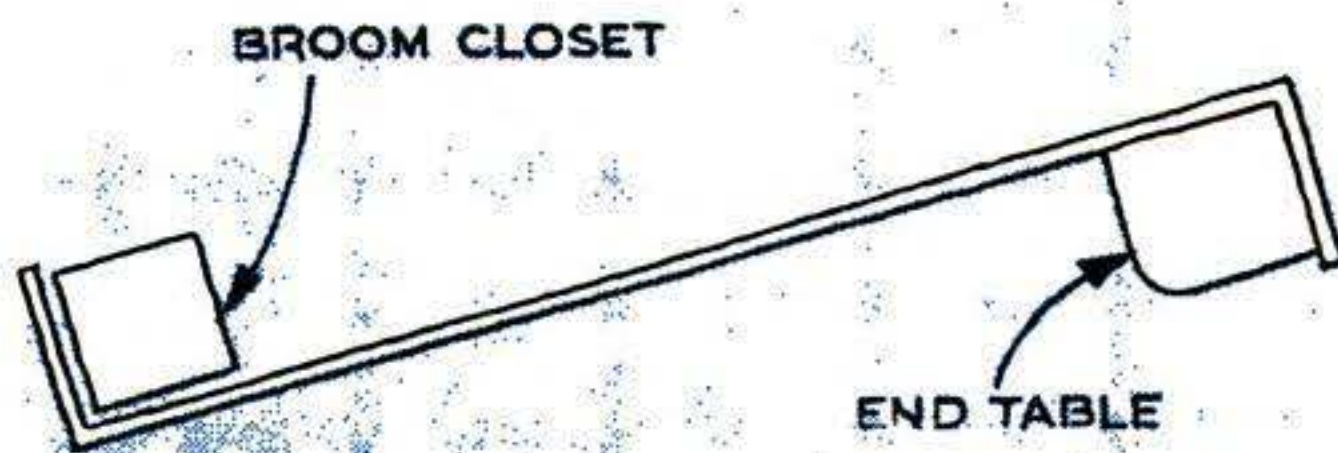

Switching sides, corner shelf serves as a living-room end table; kitchen gets broom closet.

But even if the thought of a hammer makes your thumb sore, you can do plenty about your problem.

The first thing to do is to put on your hat, go outdoors, and come back in as if you had never seen the place before. Leave your hat on, just to remind yourself to for-



**Set up in parents' bedroom.** Z-screen creates a miniature bedroom for the baby. For added sound absorption, nursery side can be padded with rock-wool insulation or quilting batts, then

covered with cloth or oilcloth. Staples or upholstery tacks, driven through covering and padding in regular rows, produce a quilted effect; tape makes a neat finished edge.



**Bedroom side** shows how well the screen cuts off the nursery. Screen need not be set against a wall; it can be angled to isolate a corner, or, if joints are hinged, its panels can be set to take

advantage of any floor plan. The screen is inherently stable enough for most needs, but it can be braced with a bookcase or bureau to provide an additional safeguard.

get old habits and family traditions. Next, sit down with an old envelope and a dull pencil and define your problem.

- You will find that it breaks into two parts:
1. What kind of extra room do you need?
  2. Where can you steal empty air for living space?

One elderly couple I know, in nagging need of an extra bedroom, found that three-quarters of their space was taken up by a big kitchen, a big dining room, and a living room the full width of the house. Closing the usual archway made the dining room into a bigger than average bedroom. Now,

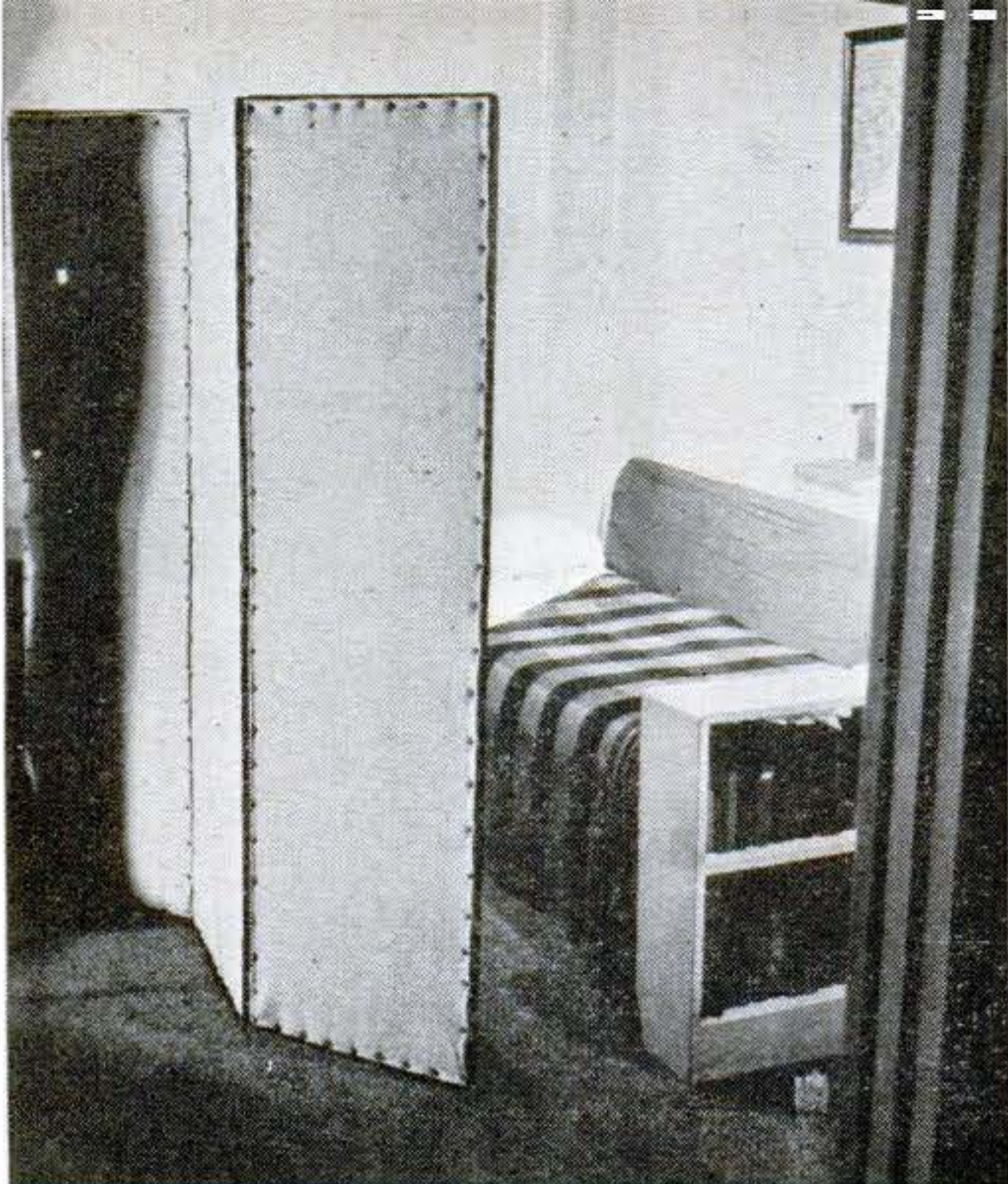

**Shaky though it may be,** the common accordion-type folding screen has shielded thousands of overnight guests, is handy for emergencies.



**Clothes hooks, mirror, and folding shelf** give the guest a break. Shelf can be triangular, fitting between open panels to brace screen.

they eat in the kitchen and like it. An electric ventilator in the window, and a seven-foot Z-screen concealing sink and stove, have made the kitchen the most livable room in the house.

Your problem may be tougher. At first

look, rooms may seem too small, too cluttered. But try visualizing them without furniture, without prejudice of their previous use, as they were when you first moved in. What you see may surprise you—and give you “that extra room.”

END



**Any solid piece of furniture** supports a light panel, and any light panel can be braced to make a firm wall. Half-round or square mold-

ing as a supporting lattice on one or both sides forms a decorative pattern and helps hold nails or screws that fasten panel to furniture.

# Plastic Magnets Do Tricks

**T**HE odd behavior of the little rings pictured on this page is easily explained. They float in the air and perch at queer angles because they are magnets; each one attracts or repels the others, depending on whether like or unlike poles adjoin.

There the real oddity begins: the rings are not metal, but plastic—permanent plastic magnets that weigh half as much as iron, don't conduct electricity, cost a fraction as much as metal magnets, and maintain their magnetic properties just as long.

Called "Dizzy Discs"® by the Norton Trading Co., of New York, which markets them, the toy rings (and other toys to follow) represent only a small phase of a rapidly developing field. Because of their lightness and electrical properties (they act as capacitors, holding but not conducting electric charges), magnetic plastics may replace metal in many electronic devices—loudspeakers, magnetic recorders, lightweight meters and motors for aircraft. Britain already uses them in telephones.

The Norton Co. is reluctant to say just how its magnets are made, but the idea of nonmetallic magnets is an old one. Many materials—even beeswax—can be made magnetic by melting them and allowing them to harden under a strong electric charge. The charge aligns atoms in a neat north-

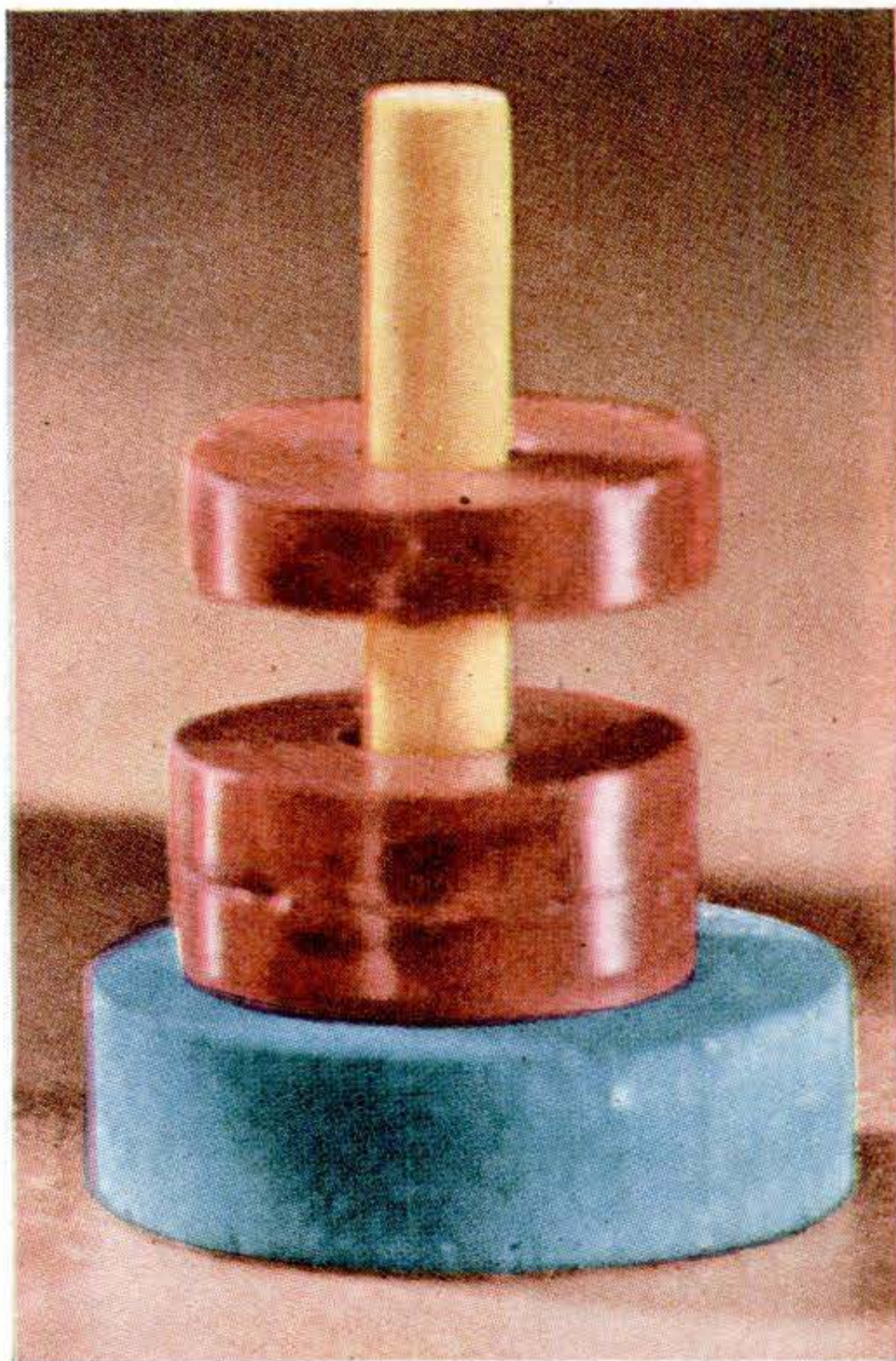

**Upper and lower faces** are rings' north and south poles. Here unlike poles of bottom two attract each other while top ring, repelled, floats in air. Wooden stand comes with the rings.

and-south polarity, and they stay aligned after the material hardens. (The Plastics Research Co., of Alhambra, Calif., which makes plastic magnets this way, calls them "Electrets."®) Another method is to mix certain ferrites (oxides that can be magnetic without being metallic) in a plastic base.

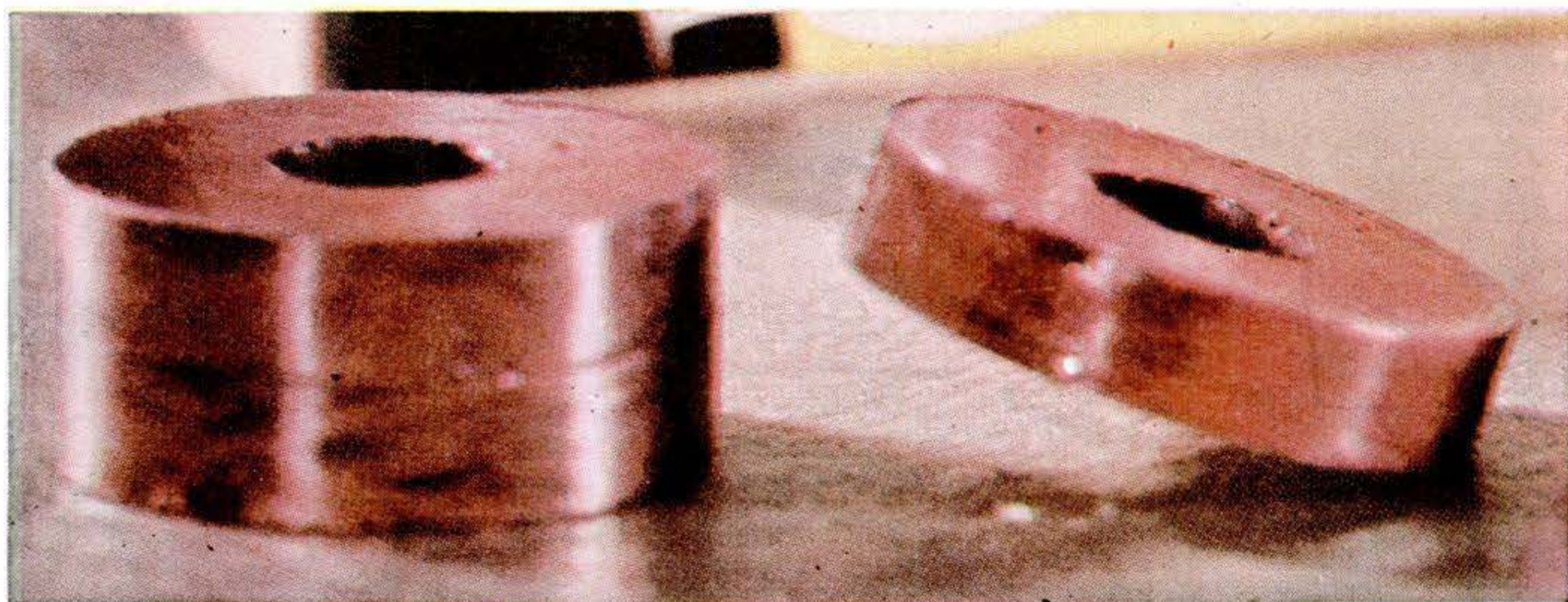

**Balancing act** is only one of many tricks; the three-quarter-inch rings even turn somersaults.

Other proposed toys are plastic-magnet trains and thimble-size, 1/1,000-hp. electric motors.

# Oil By-Products Battle Bugs

**B**Y COMBINING new chemicals with new techniques of application, agricultural experts are winning the battle of the bugs on a 142-acre experimental farm near Modesto, Calif. There, under the direction of the Shell Oil Co., they are injecting Mother Earth with more than 400 petroleum-produced insecticides and fertilizers in an all-out fight against crop-destroying insects.

In one of the new techniques, known as the dry method, the chemicals are literally plowed into the soil. In another, the wet method, they are piped into irrigation water. In addition, crops are showered with clouds of dust insecticide from both ground

and air. With these means, the experts are also battling toxic soil, tree decline, wilts, rots, smuts, cankers, and molds.

One chemical, called D-D, has proved particularly deadly to insects. Produced by fractionating natural gas, it rid Hawaii's pineapple fields of the nematode, which had cost growers there millions of dollars.

Like a woman's work, however, the job of the pest fighters is never done. In time, insects develop immunities to certain chemicals, and new poisons must be found. This and the constant invasions of new insects are keeping the pest experts on the jump to stay ahead of the plant-eating hordes.

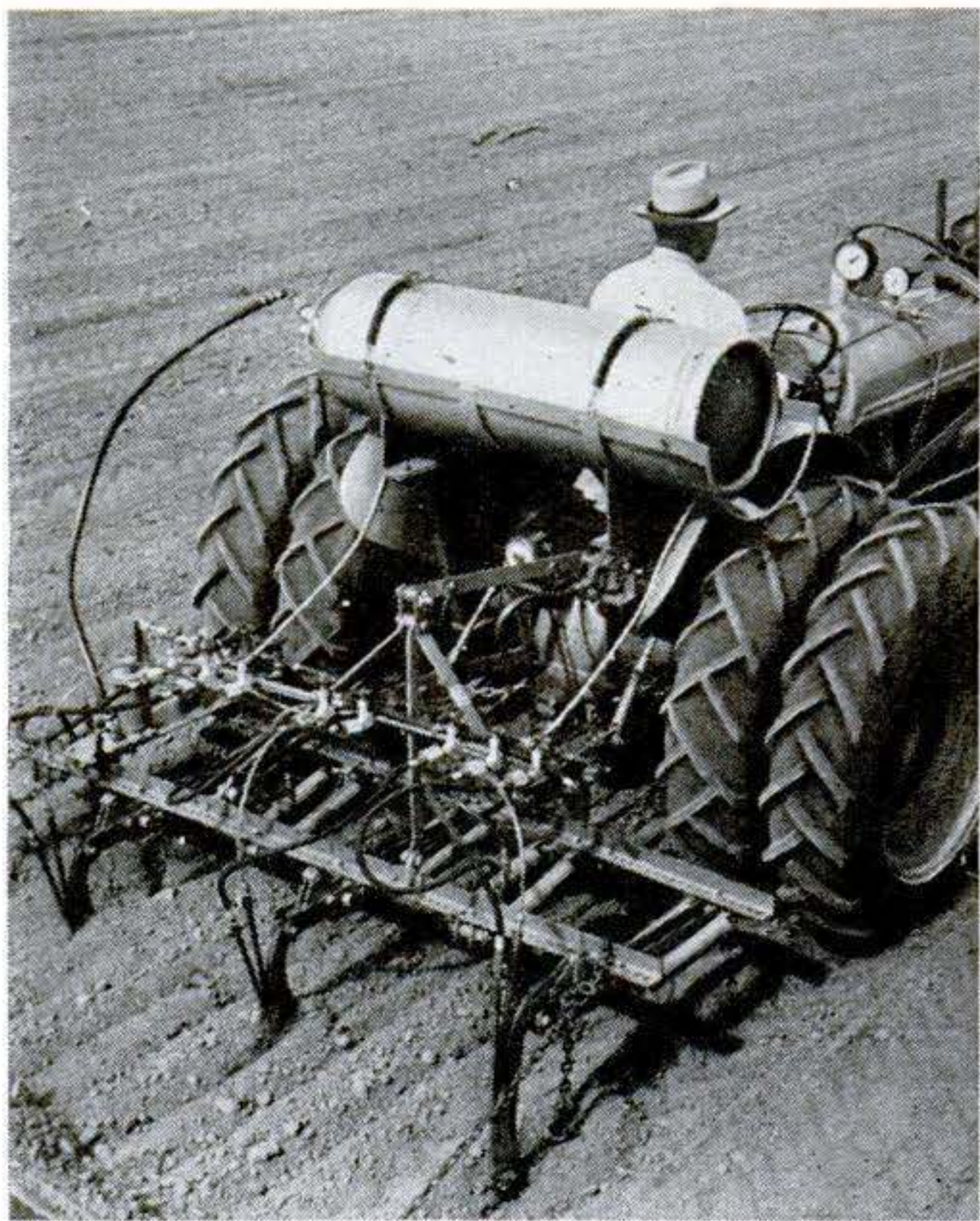

**Dry method:** Ammonia and D-D are piped directly into the soil. Tubes behind the blades of this tractor-drawn harrow direct the chemicals into the ground eight inches below the surface.



**Wet method:** Ammonia, which supplies life-giving nitrogen, is piped into the crop irrigation system. Absorbed by the water, it is carried down to the roots of the growing plants.

Not a tank laying a smoke screen, this mechanized crop duster wages a different kind of war.

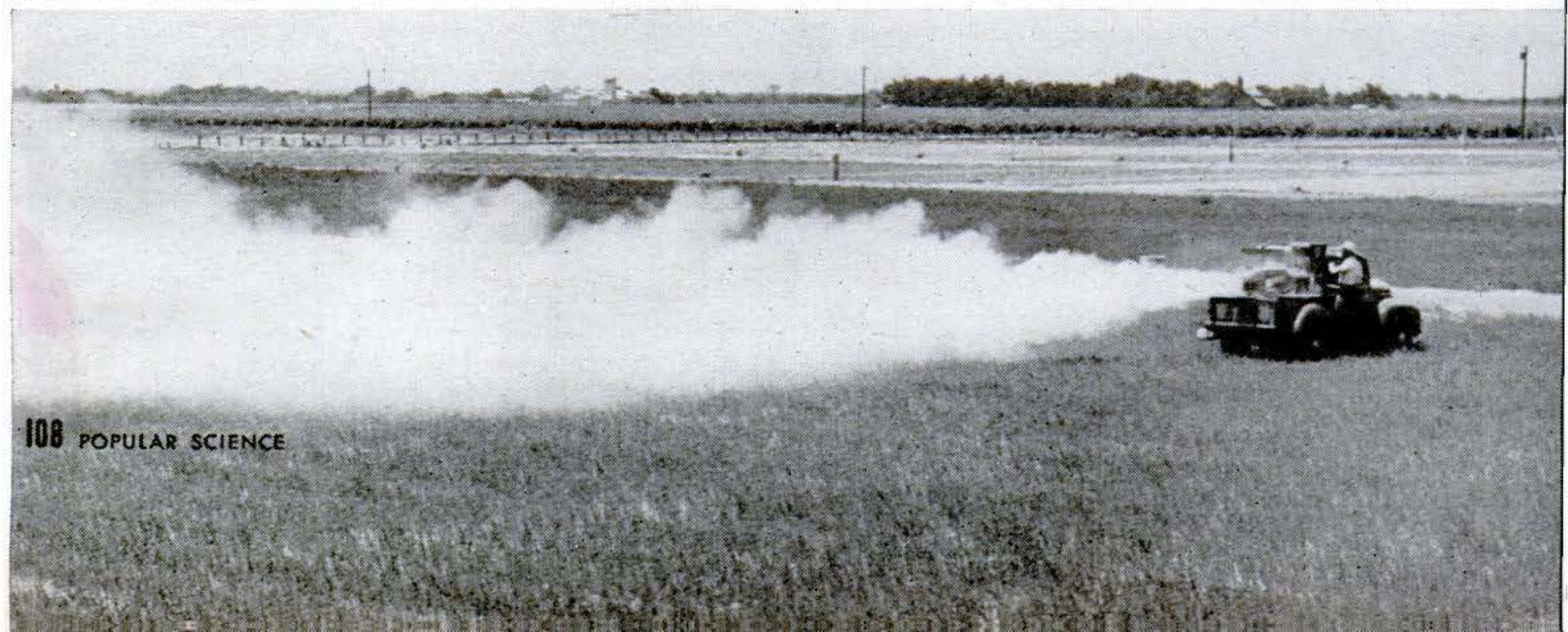



Two-in-one refrigeration depends on separate systems. Compressor operates primary system that keeps freezer section at 0° F. Primary pipes also cool adjoining pipes of secondary system, which works by gravity and vapor pressure. Key of the twin systems is the valve in secondary unit; set manually, it opens and closes automatically to control refrigerator temperature.

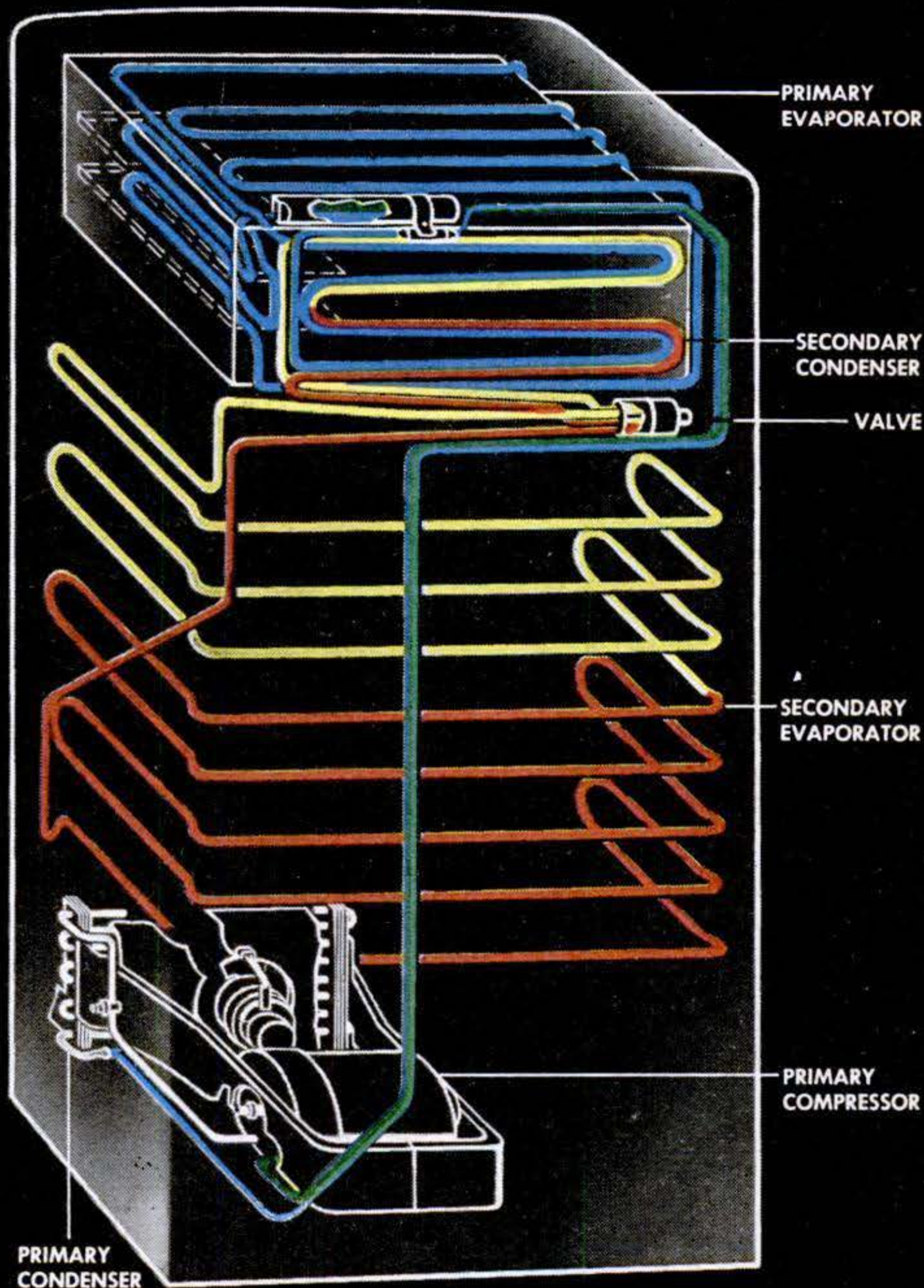
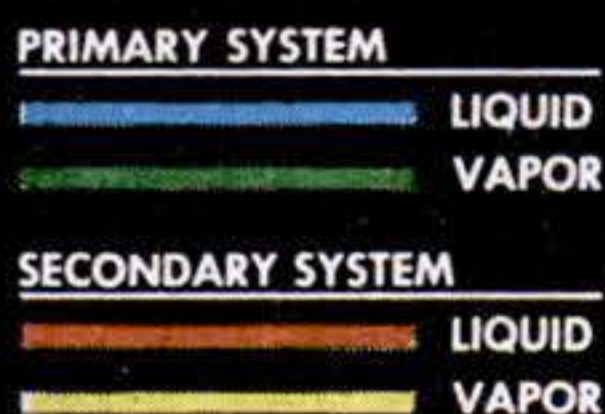

L. F. G. R. S.

## Freeze as You Please

BY FITTING both a home freezer and a refrigerator into one cabinet, and then making one compressor operate two cooling systems, General Electric engineers have put something new on the icebox market.

The combination, labeled Model NH-8, is only 30 inches wide and 63 inches high, but its top section is a 1.5-cubic-foot freezer section, and its refrigerator compartment has a volume of 6.7 cubic feet. Each section has its own door and temperature control, and each works independently. Frequent opening of the refrigerator puts no load on

the freezer, which ordinarily is opened only a few times a day for access to frozen foods or ice cubes.

The sealed secondary cooling system chills the walls of the refrigerator compartment, keeping it at about 38° F. With no exposed freezing unit, defrosting is unnecessary. Moisture condenses on the walls, runs down through a trap into a concealed pan, and evaporates. (The freezer, operating between 0° and 10° F., does require defrosting, but only twice a year.) This system also keeps humidity high in the refrigerator; moist foods need not be covered to keep them from drying out.

Built into the left wall of the NH-8 is its final convenience: a special compartment, warmed by a small heater, that keeps butter just right for spreading.

# I'd like to see them make...

Drawings by Lester Fagans

Everybody has his own pet idea of some gadget he would like to see in general use. What is YOURS? Popular Science will pay \$5.00 for each one published. Use government postcards only. Contributions cannot be acknowledged or returned.



**The World on Balloons.** A rubber balloon with a good map of the world printed on it would serve as an inexpensive reference globe. Every child could have his own.—F. H. Van Benthuisen, Hopewell, Va.



**Target Banks.** I'd like a coin bank that would open automatically when I saved a previously set "target" sum. Once set, it should not open until this amount has been saved.—Stephen Bartlett, Beaumont, Tex.

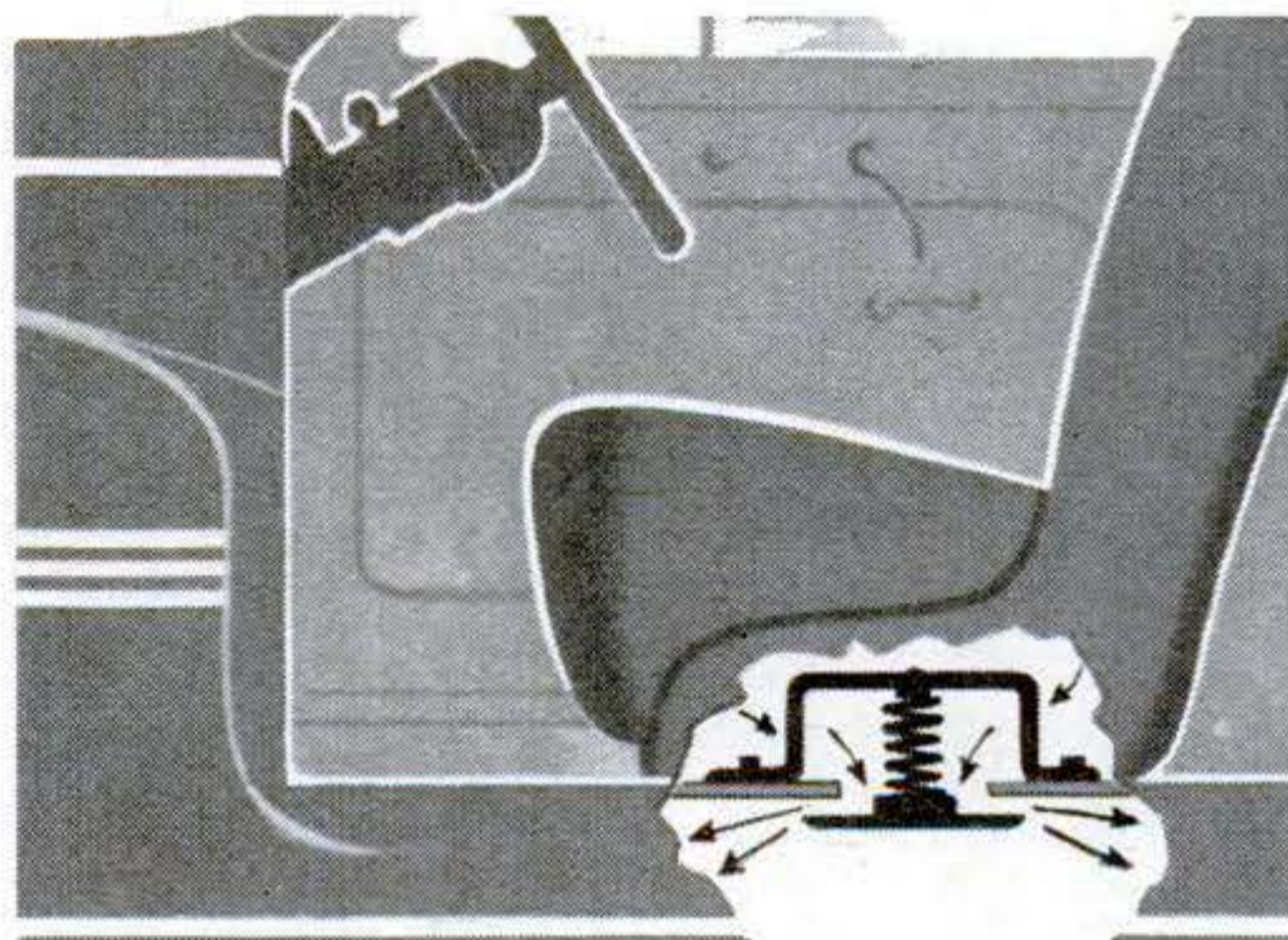

**Door Valves on Cars.** When the windows are up, air pressure often makes it hard to close the door on a new car without slamming it. A simple valve would let air escape.—J. T. Lindley, South Bend, Ind.



**Mustard in Tubes.** Packaged in collapsible tubes like toothpaste, mustard would remain clean and could be spread neatly on hot dogs. Ketchup might come in tubes, too.—E. H. Feck, Tiffin, O.



**A Wall Flour Sifter.** It should be large enough to hold a regular paper flour sack, which would be upended into it. A crank or a push-pull rod would sift flour as needed.—Mrs. D. Roach, Burlingame, Calif.



# Apple's Flavor Squeezed Into New Delicacies



Natural flavor extracted from the apple gives these products the tang of orchard-fresh fruit.

**How scientists solved the problem of the apple's lost flavor and then captured its essence in a bottle.**

**By John P. Arnold**

**I**F YOU must have your apple a day, you can now enjoy it in a variety of forms. A new method of extracting pure apple essence from the fresh fruit has brought the

flavor and aroma of the ripened McIntosh or Red Delicious to candies, ice cream, soda pop, gelatin desserts, and many other home-made and commercial products.

And if current experiments are any indication, you'll soon be able to chew your apple in chewing gum, inhale it in cigarettes, smell it in perfume, or enjoy its taste in apple-flavored medicines.

It all stems from the apple industry's

problem of producing a concentrated apple juice that would keep for year-round sale and still have the flavor of fresh cider, which is perishable. Processors had learned that by adding an enzyme, Pectinol A, they were able to break down the pectin that causes gelling. Thus they produced an apple juice of about 75 percent solids; it had excellent keeping qualities and could be shipped in tank cars without special precautions. But, unfortunately, the processing robbed the

juice of most of its flavor, and it couldn't compete with fresh apple cider.

When the processors tossed their problem into the collective lap of Department of Agriculture scientists, the latter had a theoretical, but wholly logical, answer: extract the flavor from the fresh apple; process the fruit; put the flavor back in again.

"Yeah, brother, but how do that?" was the wail. "Don't know, but let's try," the scientists replied. So an experimental sta-

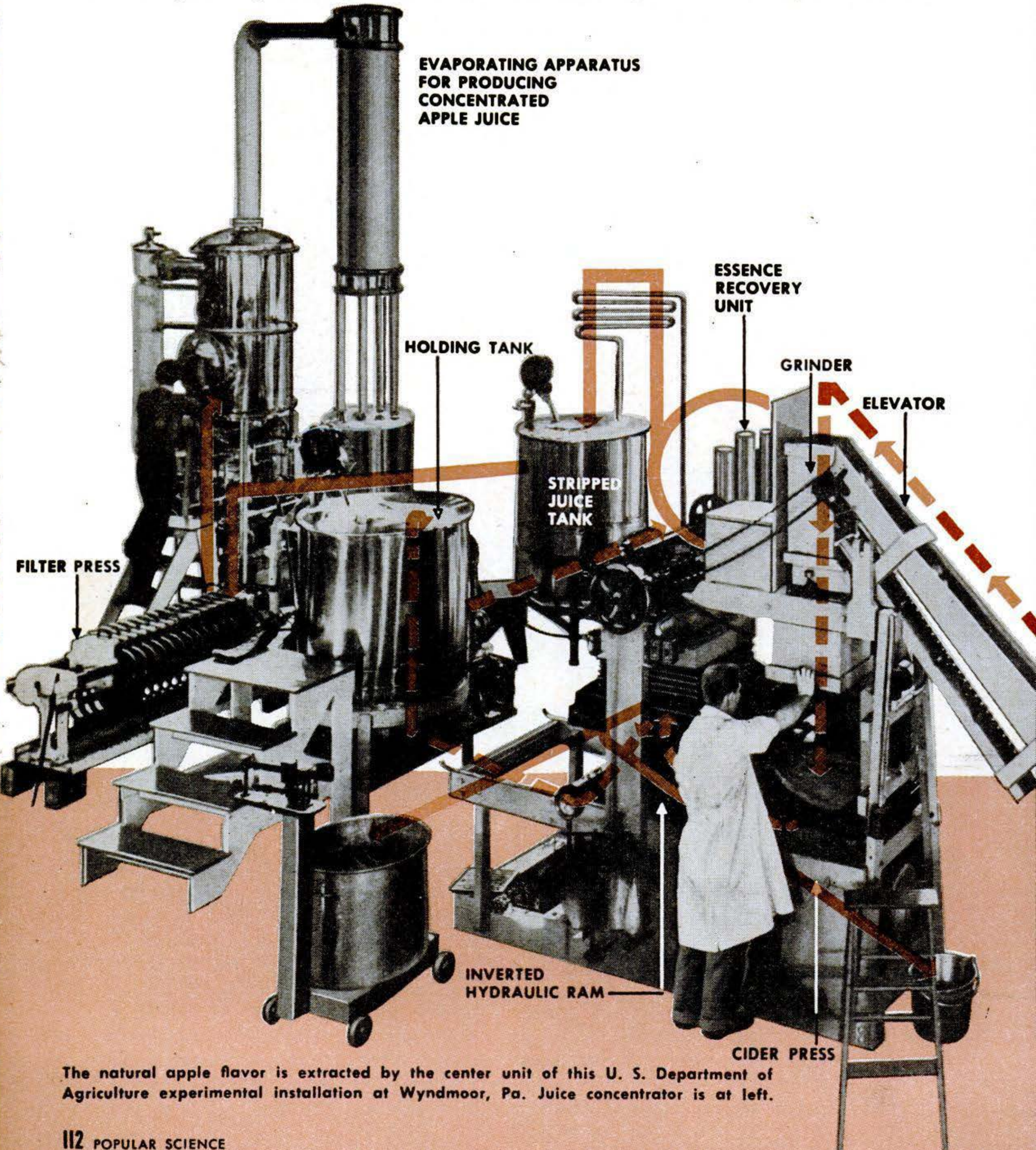

The natural apple flavor is extracted by the center unit of this U. S. Department of Agriculture experimental installation at Wyndmoor, Pa. Juice concentrator is at left.

tion was set up at the department's Eastern Regional Research Laboratories, at Wyndmoor, Pa. There, for several years, the apple has been given such a thorough going over that it has fewer secrets than a presidential candidate.

After much trial and error, the researchers hit on a way of capturing the sources of the natural apple flavor, located for the greater part just under the skin. The process consists of first heating the juice of pressed apples to volatilize the flavoring elements. Then the vapor is mechanically separated from the juice, concentrated by fractional distillation, and condensed.

The result is a clear, colorless liquid, a 150-fold concentration of the juices from which it is extracted. And the stuff is so powerful that a few drops released in a room carry you right back to the old orchard.

This separation of the apple flavor has been a shot in the arm for the apple industry. The essence is first recovered from the fruit. The juices are then concentrated and

re-flavored with the essence, with the result that there is no apparent difference between the processed product and apple cider fresh from the presses. Another advantage is that peelings and other parts of the apple, often waste products, can now be used. Also, apples of inferior flavor can be squeezed for juice-making and then spiked with the essence of the more desirable varieties.

Six companies already are selling the essence, and 60 others are installing the equipment for making their own products. Other fruits and berries are also in line to have the juice knocked out of them.

Since its extraction, the new essence has found many other uses outside the apple industry. Perfume-makers are experimenting with it. Research chemists say it may serve as a bait for insect poisons and as a mask for the nasty taste of castor oil and other medicines. The housewife will soon have a bottle of it on her kitchen shelf to flavor a dish of ice cream or a gelatin mix. Since the day of the Big Apple, this fruit has never had such a big moment. **END**

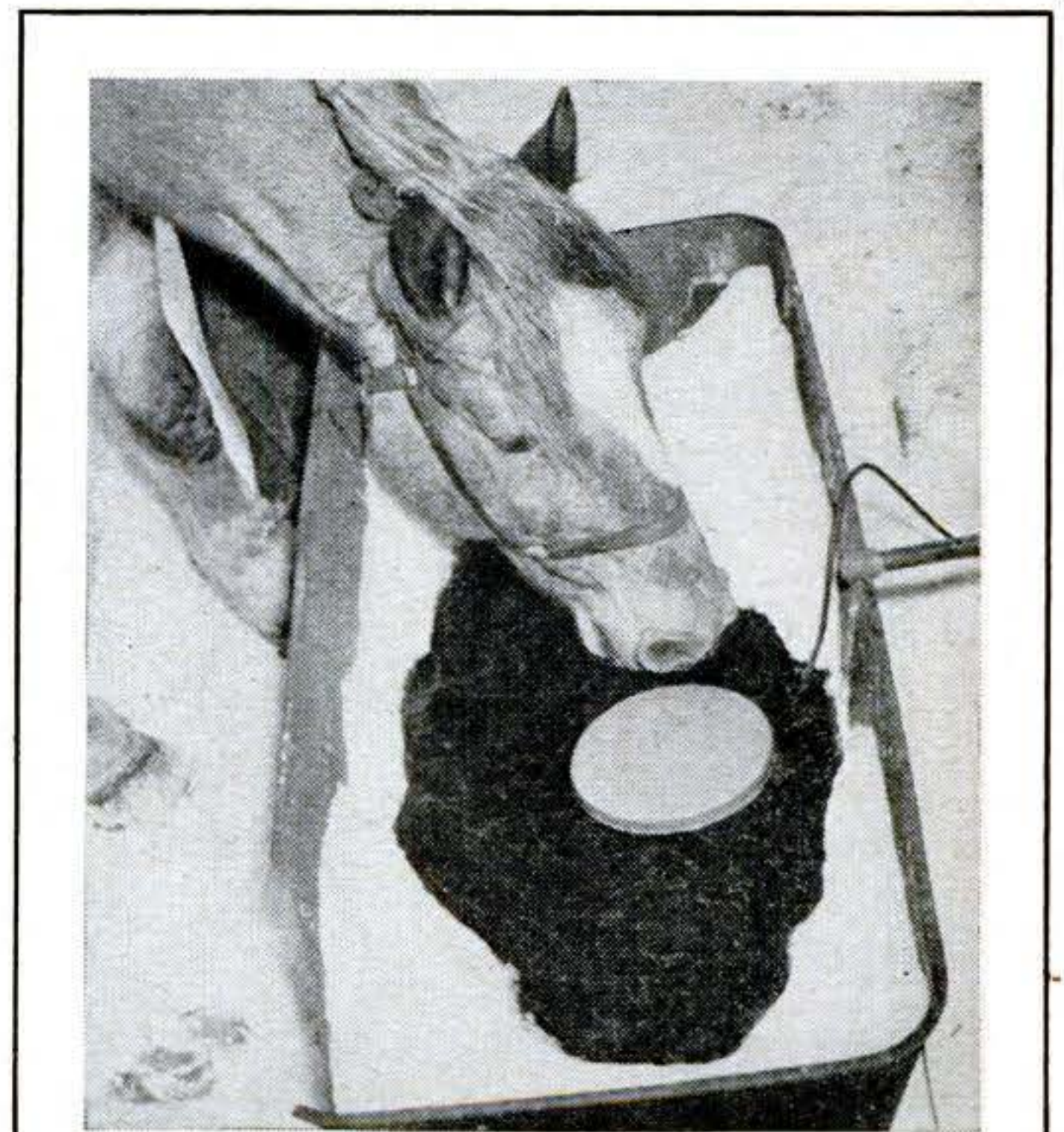
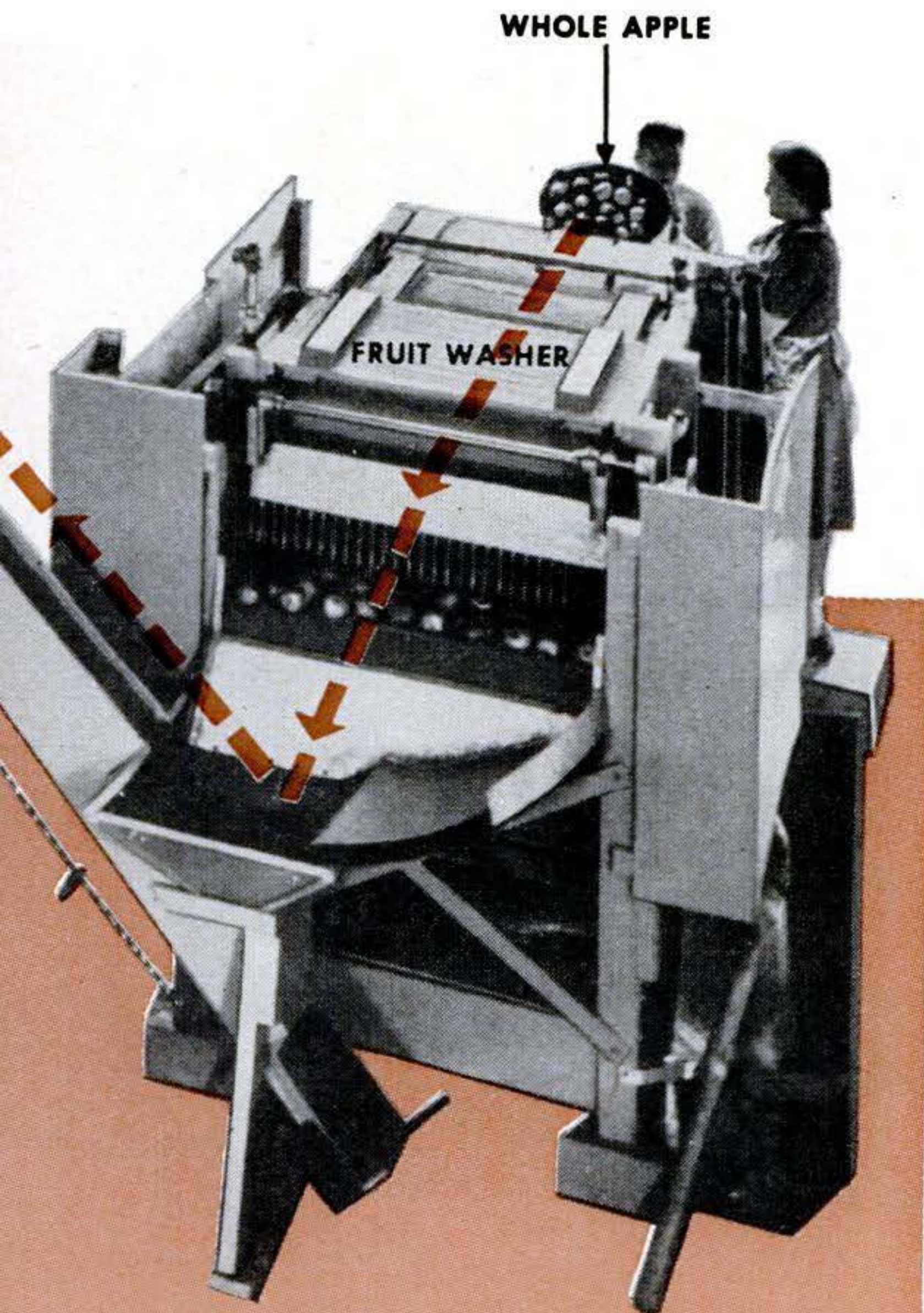

### Horse Laughs at Ice

ICE in his water trough doesn't bother the horse whose master has installed the Westinghouse heating disk shown above. A round piece of metal, it contains a 500-watt heating element giving off enough heat to keep the water ice-free. It costs less than five cents a day to operate.



## ***New Olds Gives Wider View***

**T**HERE'S better vision all around from the striking "Futuramic" Ⓢ body that Oldsmobile is introducing this year for its "98" series. Curved glass is used in both windshield and rear window, the side windows are larger, and the hood is lower.

An advanced example of teardrop design, the new body comes as a convertible, four-door sedan, or two-door club sedan (above). Front fenders and hood flow smoothly into the main shell in streamline tradition, but the rear fenders are distinctively styled, narrow in cross section, and rise well above their junction with the sloping rear deck.

Built on a wheelbase of 125 in., the body is 213 in. long, 78 $\frac{1}{4}$  in. wide, and 64  $\frac{1}{32}$  in. high. Seats are about 2 in. wider.



All models in the "98" series are powered by a 115-hp., 8-cylinder, in-line engine, the horsepower rating having been raised from 110 by adoption of a high-compression head with a 7 to 1 ratio. All "98" series models are equipped with Hydra-Matic Drive Ⓢ. Other models are unchanged from 1947.

**Dash controls are near driver and the new windshield is larger than the old (dotted line).**

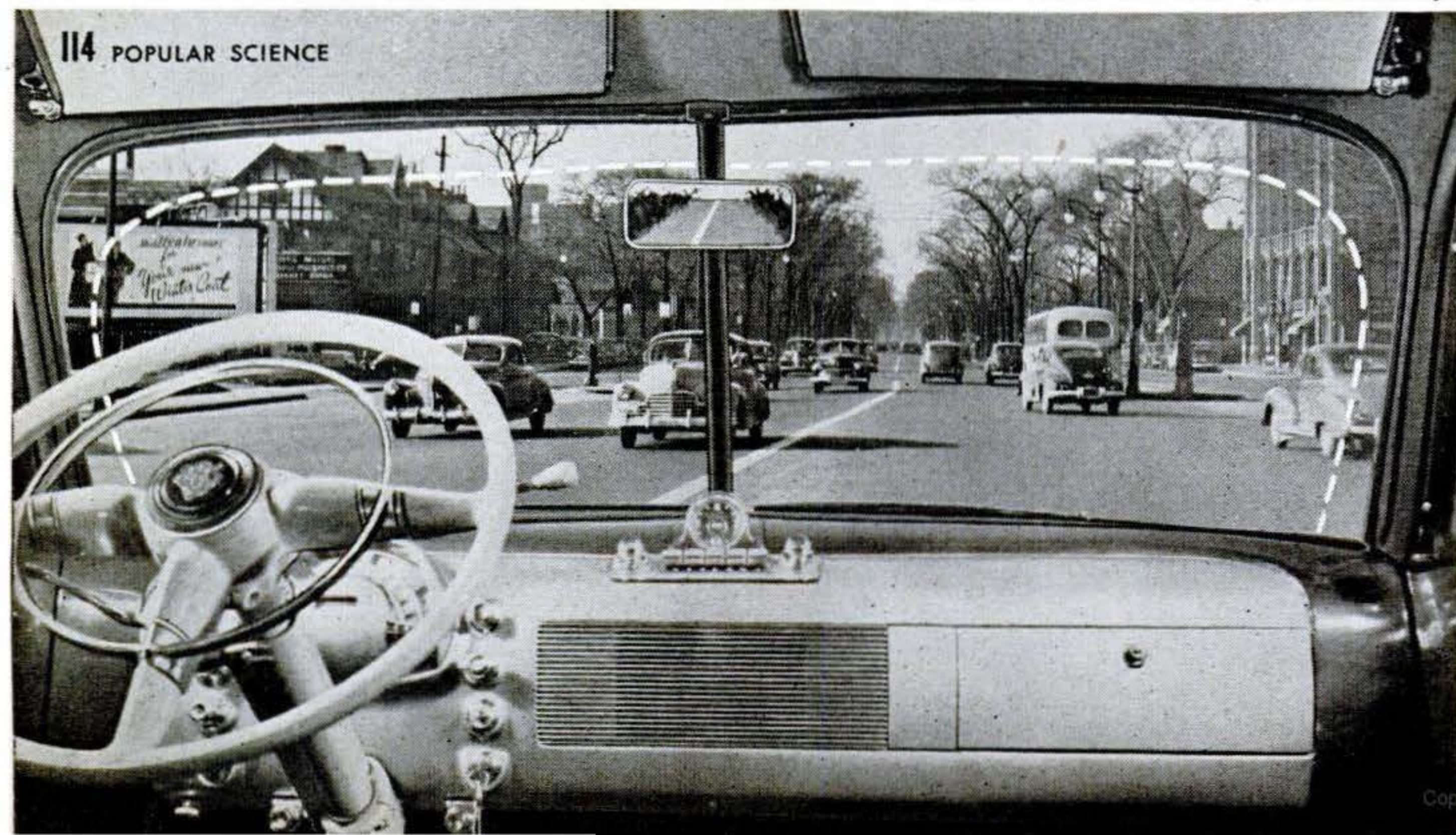



# *The World's Biggest Working Model*

**This colossal effigy of Old Man River will make little floods to help America protect herself against big ones.**

**By Volta Torrey**

VICKSBURG, Miss.—The Colonel will drive around the make-believe Mississippi Basin—from Chicago to Pittsburgh to New Orleans, and back via the Texas panhandle, Montana, and Minnesota—in seven or eight minutes. As the Colonel reckons time, however, this 30-m.p.h. trip will have taken about 24 hours.

“Better send a man with a broom and dustpan over to clean those leaves out of the Missouri River near Omaha,” he may suggest when he returns to the control house.

“Yes, sir, I’ll have it done before March 5,” the engineer may reply. “This is February 27, 1945. How about having lunch now? We can be back in plenty of time to see what the Ohio River does on March 10.”

Such Alice-in-Wonderlandish remarks will be commonplace at Clinton, Miss., in the 1950s. Men will speak of minutes as though they were days, of feet as though they were miles, and of ripples in a test tube as though they were floods. This will be sensible, because the officers and engineers at Clinton actually will have North America’s greatest river system in a concrete test tube. It will be 1,500 yards long, 1,300 yards wide—a working model of the Mississippi and all of its important tributaries.

This model will cover 220 acres. It will

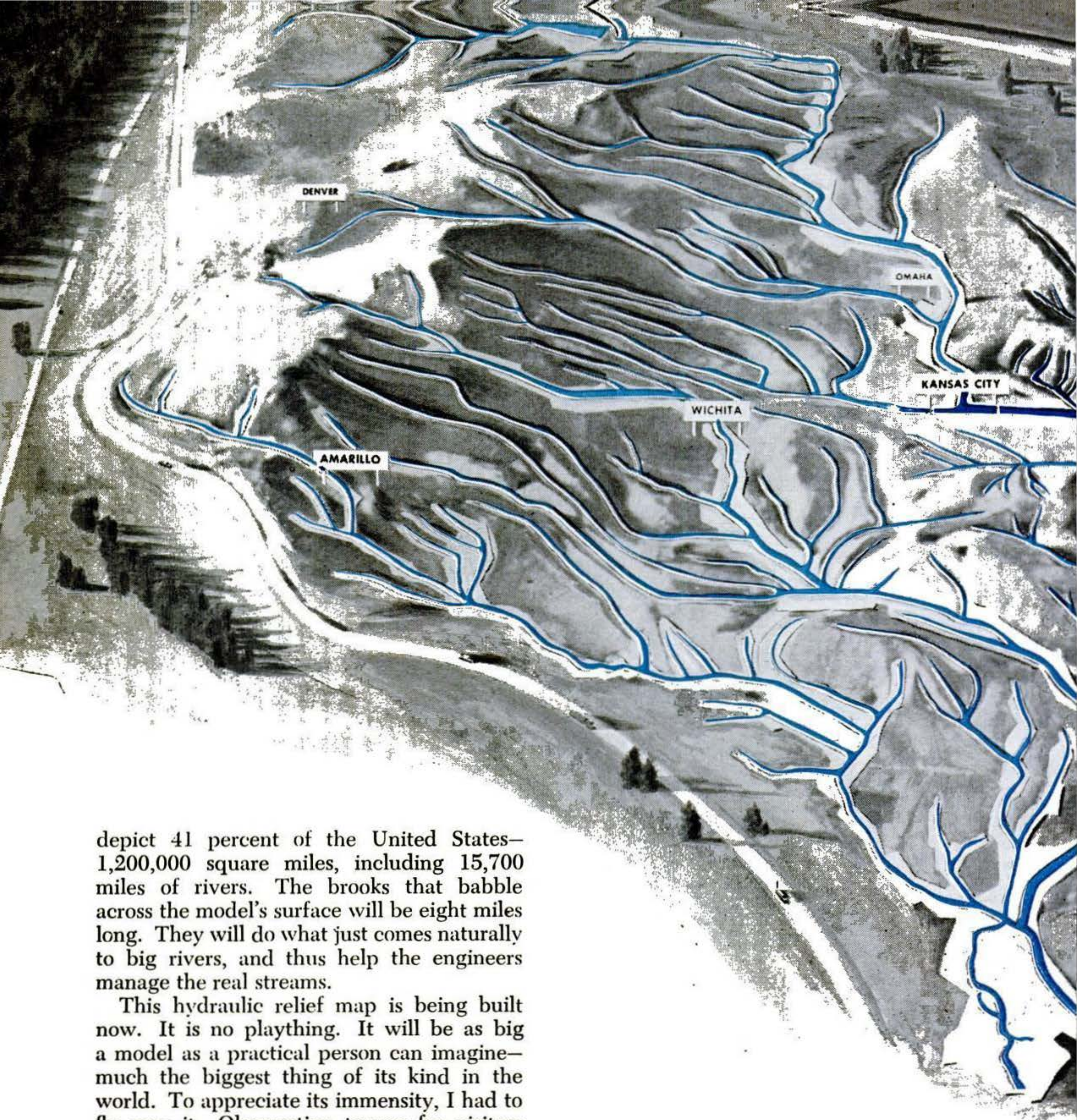

depict 41 percent of the United States—1,200,000 square miles, including 15,700 miles of rivers. The brooks that babble across the model's surface will be eight miles long. They will do what just comes naturally to big rivers, and thus help the engineers manage the real streams.

This hydraulic relief map is being built now. It is no plaything. It will be as big a model as a practical person can imagine—much the biggest thing of its kind in the world. To appreciate its immensity, I had to fly over it. Observation towers for visitors may be built when it is finished, but the hundreds of men now employed on the site are not preparing a mere exhibition for tourists. This effigy of Old Man River is expected to make him behave better.

Authorities on potamology (the science of rivers) believe that floods actually will be warded off by this project of the U. S. Army's Corps of Engineers and the Waterways Experiment Station of the Mississippi River Commission. The model will cost nearly \$6,000,000, but it may turn out to

be a bargain. For it will save money in two distinct ways:

1. On this imitation of the restless Mississippi and its 40 satellites, the great floods of 1912, 1927, 1937, 1945, and 1947 or any other year can be re-enacted. Conditions that may arise in the future also can be simulated. Thus, the model will settle arguments that have raged since the French started building levees at New Orleans in

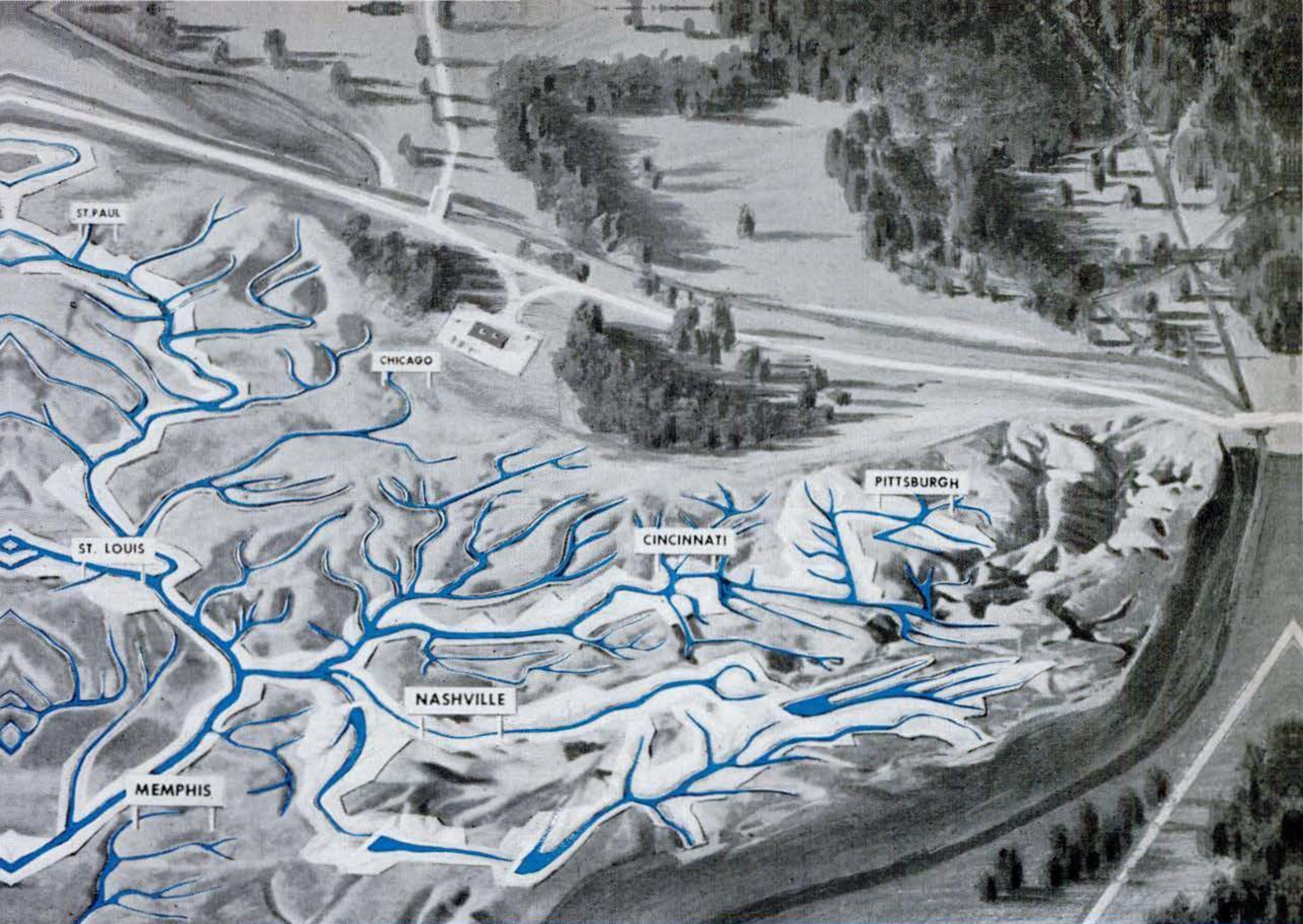

Thirty-one states (area shown in white at right) will be represented by this grassy valley full of midget rivers. Pumps will supply water from sump (at left). After simulating river currents, water will flow back to sump through underground pipelines from 8 to 30 inches in diameter. Entire model will be operated from that little building above "Chicago."



1717 about where more levees, dams, reservoirs, etc., are most needed and the types of structures that will be most useful. That can save Uncle Sam billions. But—

2. The Midwest's rich, green, flat valleys now are threatened by man-made as well as natural floods. There are 200 reservoirs on streams that pour into the Mississippi. More are being built. Still more are contemplated. The danger of floods is increased

every time another such structure is built—unless it is properly operated. This model will show the operators of these dams and reservoirs how to operate them so as to protect their own neighborhoods without creating floods elsewhere.

Suppose, for example, that the men in charge of the 4,100,000-acre-foot\* reservoir in Kentucky, the 3,350,000-acre-foot reser-

\*An acre-foot is the amount of water needed to cover one acre to a depth of one foot.



**Model builders** use hundreds of these metal patterns to make small-scale replicas of main river beds, levees, and spillways. Bottom strips of the templates will be left in the concrete.



**Concrete is poured** and molded to conform to top edges of suspended templates. Rails and supports will be removed after it has set. Minor details are molded in the surface by hand.

voir in Montana, and several others in between were to release water independently. The result might be a catastrophic flood at Memphis.

Suppose, however, that the reservoir operators first wired the scientists in Mississippi. "Reproduce present conditions on the rivers," the director could tell the engineer in charge of the model, "then add water at rates and times corresponding to those at which these reservoir operators say they'll be discharging it."

"Gosh, boss, this looks bad," the engineer might report eight hours later, and lay a sheet of figures on the director's desk.

"Sure does," the director might agree. "But don't worry. I'll phone Hank Johnson up at Fort Peck. He and some of the others can change their schedules enough so that nobody will get wet at Memphis, or anywhere else."

### ***Billion-Dollar Menace***

How many lives, and how much property, can be saved by such fast, sure teamwork? There's no telling, but recent history is enlightening:

Last summer's floods in the Midwest took 16 lives and caused damage estimated at \$1,000,000,000. Very little of that damage was covered by insurance, because the people who live along many of these rivers cannot buy flood insurance the way they buy fire insurance. This estimate, moreover, takes no account of the misery of 48,000 persons whose homes and shops were left caked

with stinking mud, or the sums spent by the Red Cross and other relief agencies. Man-made floods could be equally costly.

This model, in short, is intended not only to save the taxpayers' money by helping the engineers design protective structures, but also to save farmers, merchants, and manufacturers from flood losses that would result from injudicious use of existing structures.

Will it work?

The engineers at the largest hydraulics laboratory in the world, the experiment station in Vicksburg, are sure that it will. They have built dozens of models of rivers and harbors. They have been solving difficult problems with these models for 18 years. They even have a thoroughly tested, 2½-acre model of the lower part of the Mississippi, built on the same scale as the big one now under construction. And it works fine.

Horizontally, one foot on the big model will represent 2,000 feet of the earth's surface. Vertically, however, one foot on the model will represent only 100 feet, because if the vertical scale were the same as the horizontal scale, the rivers would be too shallow and the currents too weak to be measurable. Actually, the currents in the model rivers will be from one-seventh to one-eighth as swift as those you'd have to buck if you were in a rowboat on the real streams, and 1,000 gallons per minute will suffice to portray the 1,500,000,000 gallons per minute of a major Mississippi flood.

The site for the big model, several miles from the Vicksburg laboratory, was chosen





**Engineer checks handwork** on complicated bits of bed. Sections of upper Mississippi, Arkansas, and Missouri rivers are being finished first because of urgency of problems in those areas.

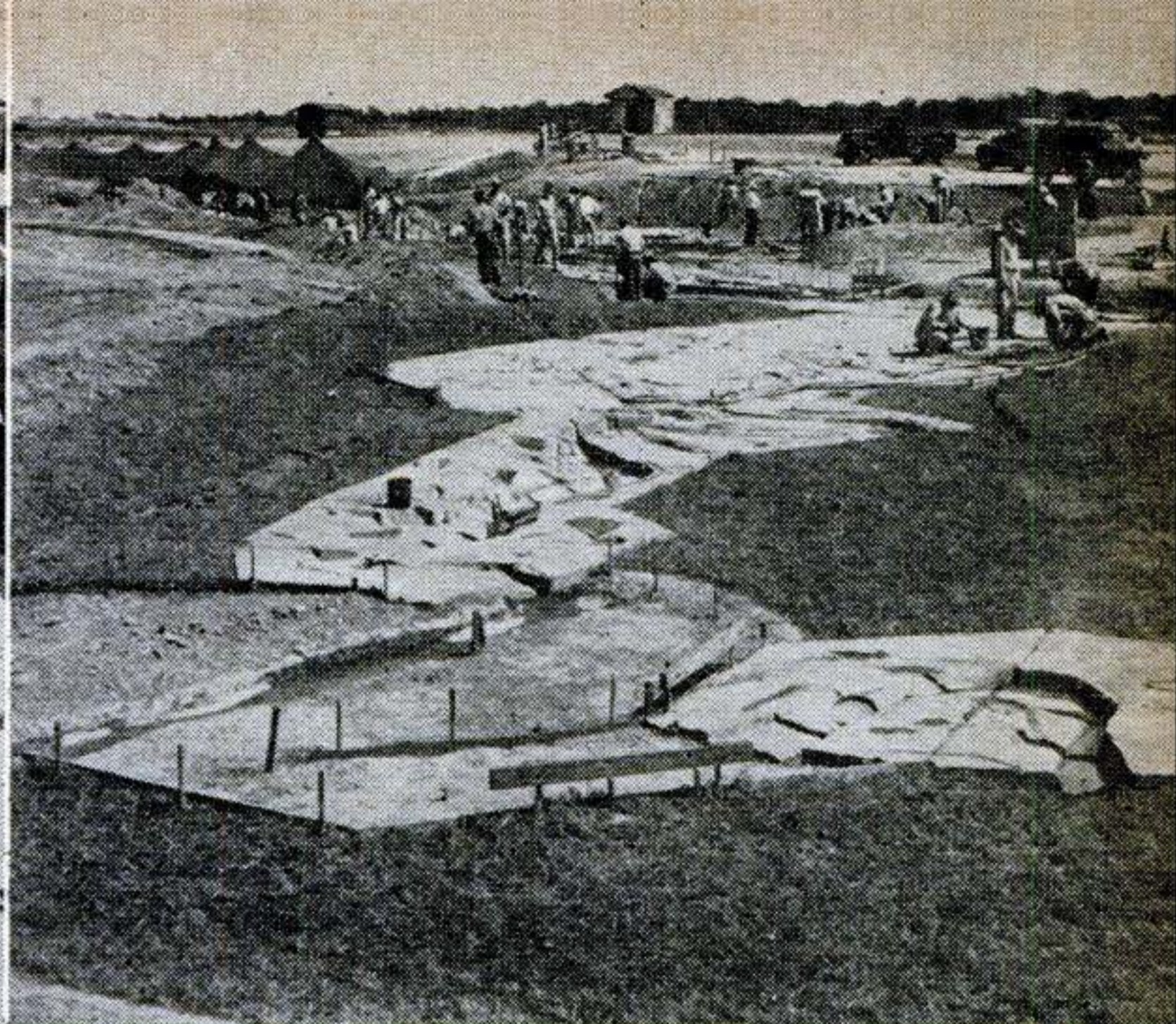

**Completed model** will consist of many strips of concrete like this one representing the Arkansas near Little Rock. Gutters will keep rainfall from draining into working parts.

because of its natural approximation to the desired dimensions. Even so, 1,000,000 cubic yards of earth had to be moved. The knolls that represent the Appalachian slope rise 20 feet now, and those representing the Rockies rise 50 feet above the model's "sea level."

The river beds and valleys will be long, zigzagging strips of concrete, varying in width from a few feet to several yards. These are being built now. The rolling land between these winding waterways will be sodded. Signs will mark the sites of cities, and eventually there will be roads around and through the model.

Like a modern city's utility lines, however, the things that make the model tick will be concealed underground. There will be 15 miles of storm sewers, big water mains, and a maze of wires for electrical instruments below the surface. Water for the midget rivers will come from and return to a deep sump, which will resemble a swimming pool, somewhere near the site of Mobile, Ala., on the model. It will be nice, clean water because the kinds of research that the engineers have in mind can be done without mud. The pumps and instruments all will be operated from a control house "north of Chicago."

The pumps will be capable of delivering 10 times as much water as will be needed to simulate a Mississippi flood. This abundant supply will enable the engineers to operate various parts of the model separately, and study several problems at once.

Like designers of complex industrial plants, the architects of this colossal and intricate device built a "pilot" model first. But these planners bumped into a problem that seldom bothers industrial engineers—the curvature of the earth. To allow for this, Karl A. Dupes devised a method of combining a French mapping system (the Bonne projection) and a rectangular grid system—and thereby won himself a merit award from the Secretary of War.

#### *Robots Will Run It*

The gauges along the concrete channels of the model streams will be delicate electrical instruments. One of the several types now being considered will have a tiny motor suspended from an arm over the water. This motor will spin a set of pins, the points of which will barely touch the water at all times. The arm to which this pin wheel is attached will rise as the crest of a flood approaches and descend when it passes. Although a rise of a tenth of a foot in these creeks will correspond to a 10-foot rise in a genuine river, this instrument will yield as accurate data as can be obtained from human observers on the big streams. There will be from 600 to 800 such gauges.

These and other devices will do just about everything except shout "Mark Twain." They will make it astonishingly easy to conduct experiments. The switchboard in the control house will look like the switchboard of a power plant, and the operator will be able to twiddle his thumbs most of the time



**Existing model** of lower Mississippi shows how big model will look when in use. Note cutoffs in this part of river (near Greenville, Miss.) and levees extending for miles. The "woods"

are strips of wire window screening, a few inches high and pleated like an accordion. When model river overflows, these screens slow the water, just as trees do along a real stream.

because the whole river system will be managed for him by robots.

One of these "programmers" will have a dial about a foot in diameter on its face. A paper record will be placed on this dial. A tiny arm then will follow whatever curve is drawn on the record and send appropriate signals to automatic valves at from 200 to 300 inflow points. Some of these faucets will have fixed orifices of various sizes; others will have single openings that widen or diminish like camera shutters.

Another programmer will control the amount of water flowing out of the model, at from 60 to 70 points, when the operator wants this measured. Some of these outlets will handle only 10 gallons a minute; others will dispose of up to 800 gallons a minute. To change from a simulation of conditions that prevailed in 1947 to those that existed in 1917, the operator will simply change the records on the programmers. It will be no more difficult than putting records on phonographs.

A row of lights will show how the pumps are working and the operator will have a communication system by which he can bark orders to a helper out in the plant whenever

there's a hitch in the proceedings. The results of experiments run on the model will be jotted down, automatically, by a great battery of square-faced instruments.

These instruments will produce a continuous record of the tiny rivers' stages at points corresponding to those at which comparable figures are kept throughout the Midwest. There is no other known way, in many cases, of obtaining such data about floods before they occur. Models of this type are used only to solve problems so complex that they stump the experts' slide rules. And this model will differ from its predecessors in only two ways: it will be bigger, and the instrumentation will be much better.

Construction of this giant was started during the war by Maj. Gen. Eugene Reybold. Three thousand prisoners of war from Germany (where the hydraulic-model technique had originated) were employed on it. Among them were civil engineers, surveyors, and craftsmen of all kinds. They did about a third of the work. Civilians are continuing the job now under the direction of Col. R. D. King, who heads the Waterways Experiment Station. Completing the colossal model will take at least three more years. **END**



## Slapless Trigger Improves Pistol Aim

**A** TARGET pistol with a new type of trigger reached the market a few weeks ago and promptly began hanging up records.

Known as the Tompkins, the .22-cal., single-shot precision pistol is designed to eliminate the errors in accuracy caused by unevenness of trigger tension and "slap." Called "glass-break" action, the trigger's smooth, steady pull, which can be adjusted

to desired tension, remains unchanged by the hammer's release. Move the trigger as little as 1/64 inch and it trips the hammer. It can be dry-snapped without damage.

Made by the Varsity Mfg. Co., the pistol has an 8-inch tapered barrel. The 9 1/4-inch-radius sights have a 1/4-inch-per-20-yard click elevation adjustment and a manual windage setting. The pistol sells for \$88.26.

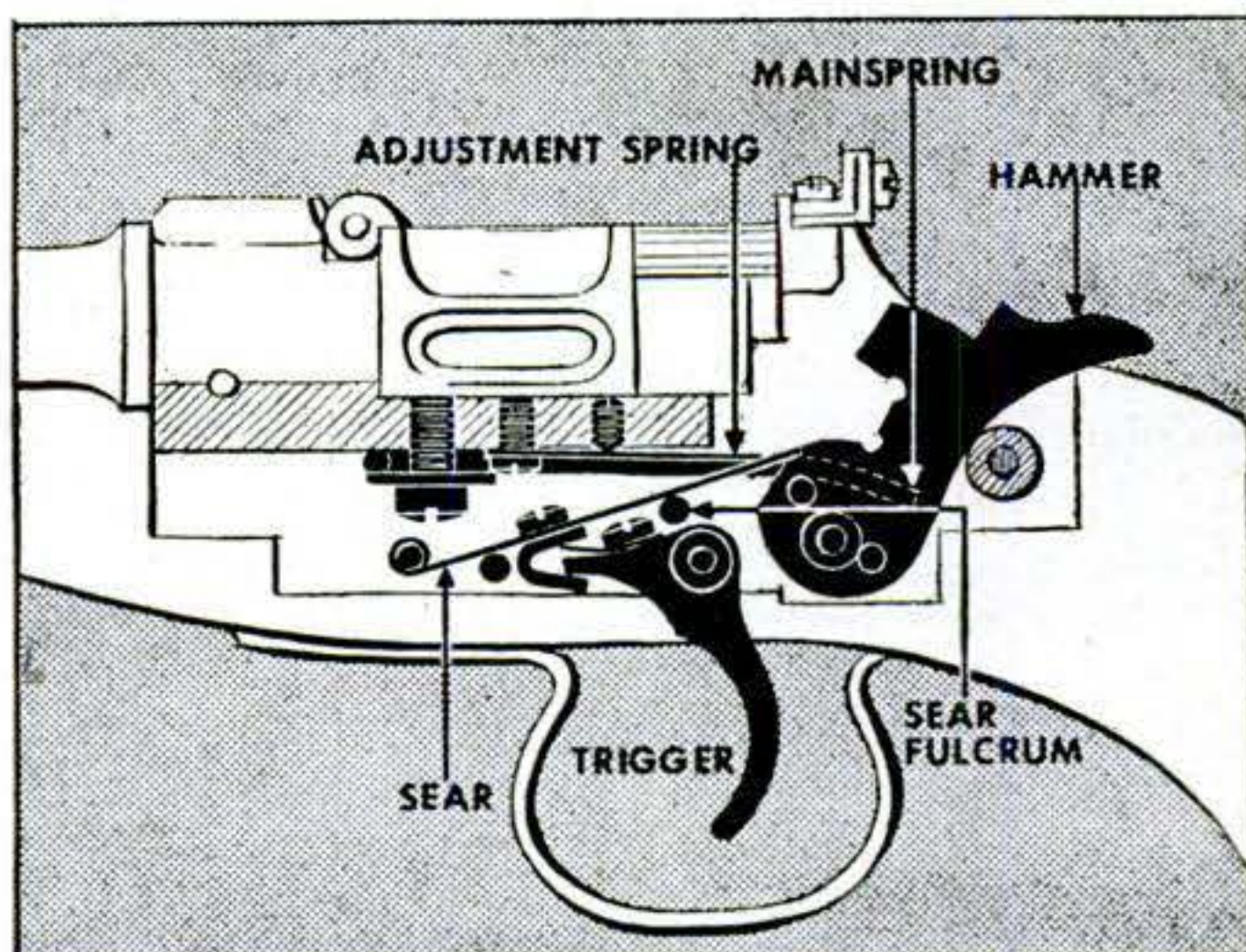

**Smooth trigger pull** is result of special sear spring, which is bent downward against fulcrum by trigger action to release hammer. Spring keeps trigger tension constant as hammer falls.

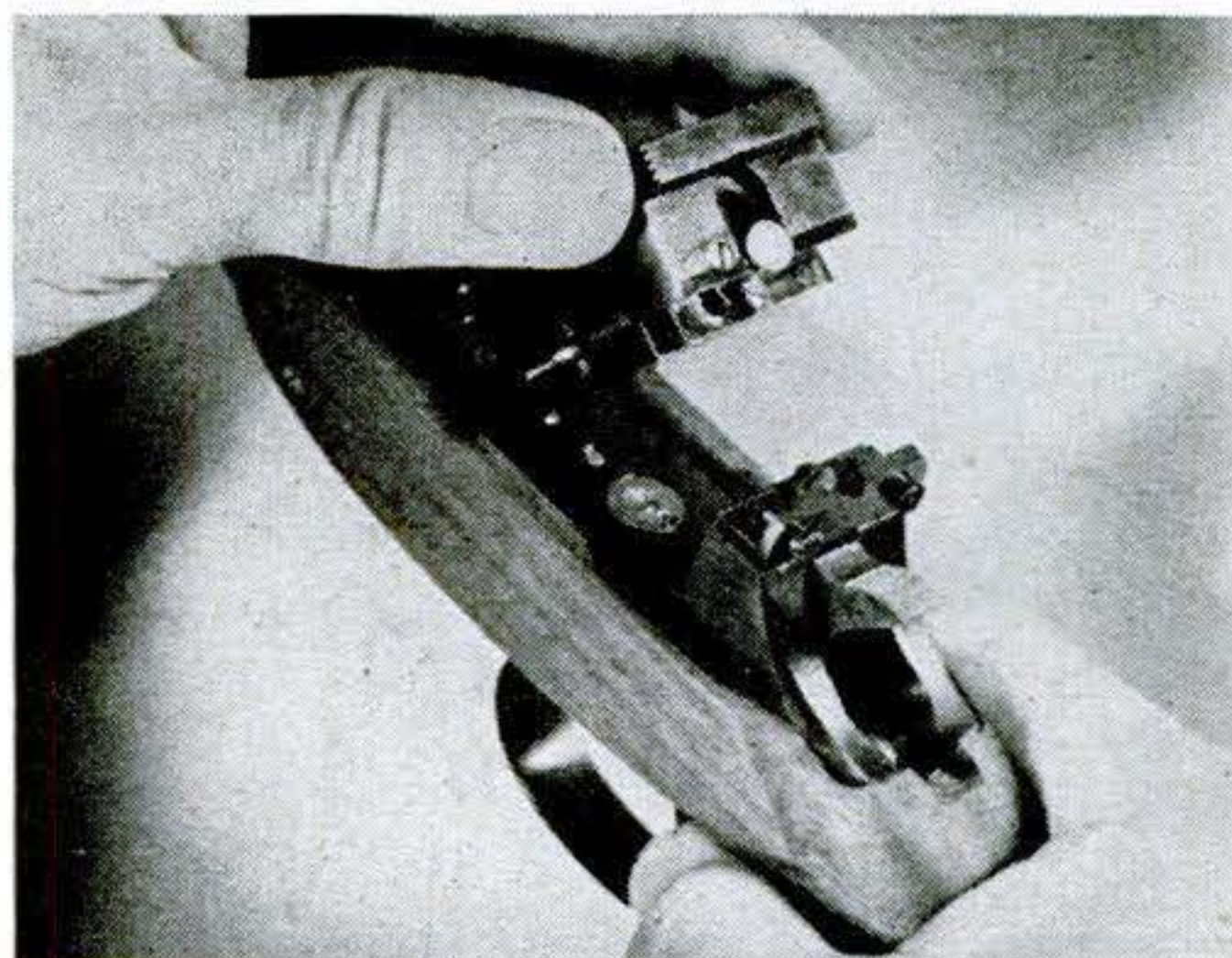

**Entire breechblock** swings up on front hinge when spring-tensioned wedge is lifted. Spring-actuated lock secures it when closed. Note rear end of firing pin in the center of the block.

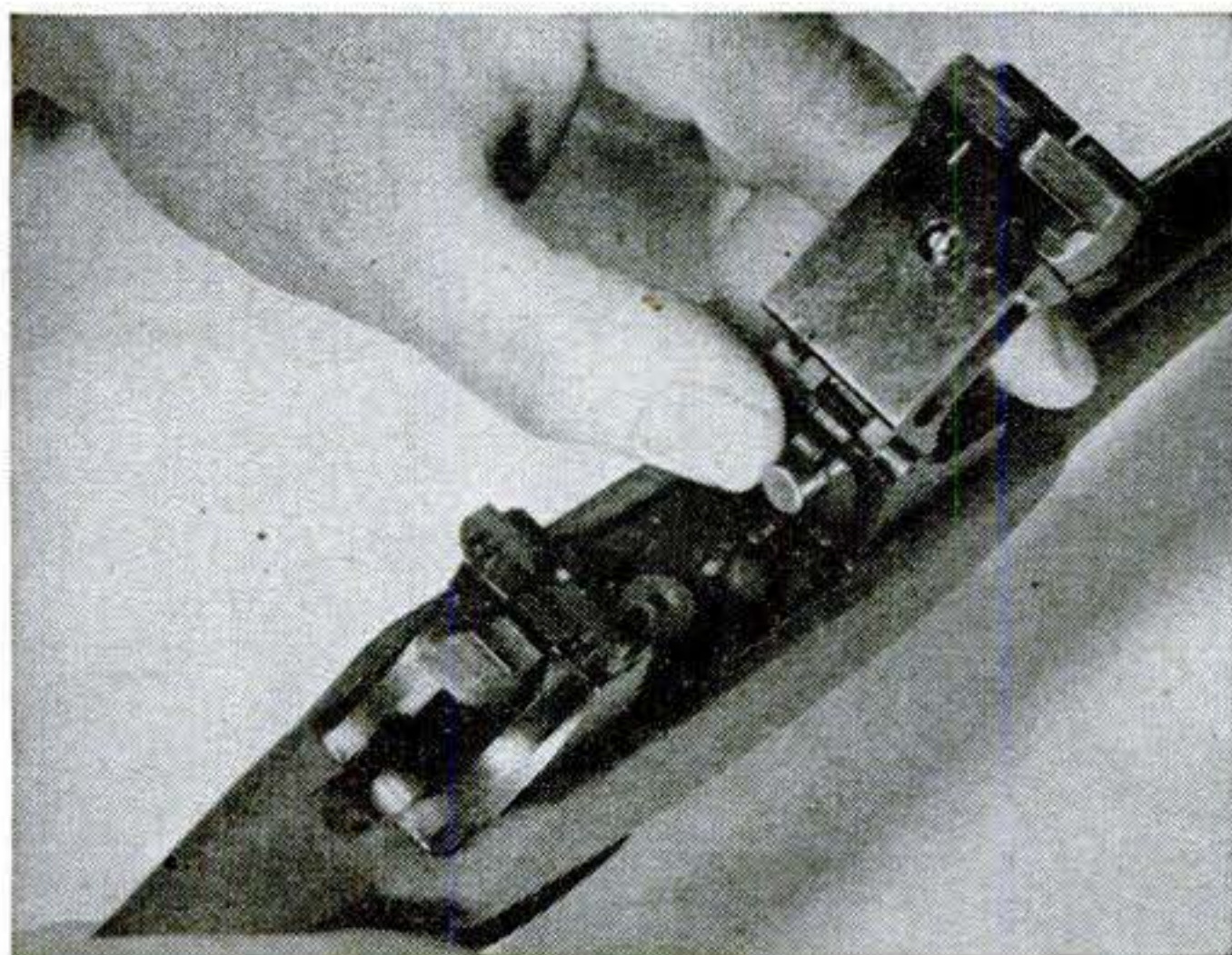

**Lifting breechblock** ejects but does not throw empty cartridge, which is removed with the fingers. Maker stresses ease of loading without bullet damage or risk of premature firing.



**Low line of sight** aids holding and aiming. Walnut stock runs full length of gun, has channel under barrel for addition of balance weight. Cutout portions of breech help lighten the gun.

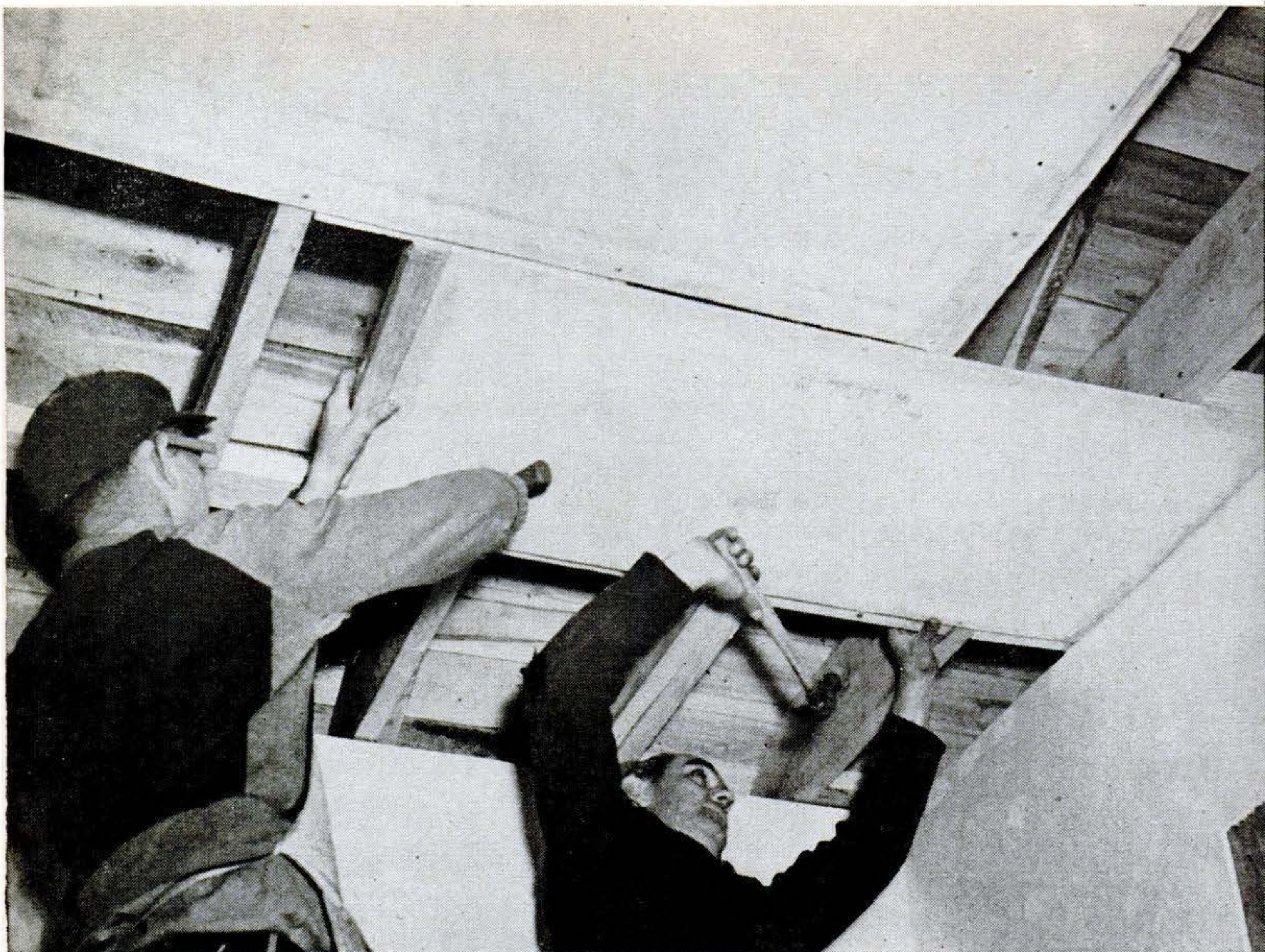

**Radiant heat** from ceiling panels like these may warm your home of the future. Each panel contains a thin sheet of rubber that conducts

electricity, generating heat. The panels look like wallboard and have a 2-in. nonconductive margin around the edge for nailing to joists.

## ***Hide a Rubber 'Furnace' In Your Ceiling***

**S**OMEDAY soon a thermostat on the wall may be the only visible sign that your home has a heating system. Furnace, chimney, pipes, radiators, and fuel storage tanks or bins will have vanished. To get heat, you'll just flip an electric switch.

This exciting forecast is presented for its new radiant heat panels by the United States Rubber Company. For the secret of the new heating is a new kind of rubber whose reaction to electricity is just the opposite of ordinary rubber. Instead of an insulator, it is a conductor of electricity—and as it conducts, it heats.

Resistance elements of the new rubber are sandwiched between layers of insula-

tion—there is no internal wiring except for two aluminum-foil leads. Fifteen minutes after a cold start the surface averages 100° F. Radiant energy from the panels is transformed into heat energy when it strikes any solid object. Like the sun, radiant heat panels warm you directly—in contrast to convection heating systems that first warm the air that warms you.

The four- by four-foot panels are connected in parallel and operate at 220 volts for top efficiency. As with other heating systems, thermostats—one in each room for local control—turn the panels on and off.

Starting at the outer edge, the panels cover about 70 percent of the ceiling area,

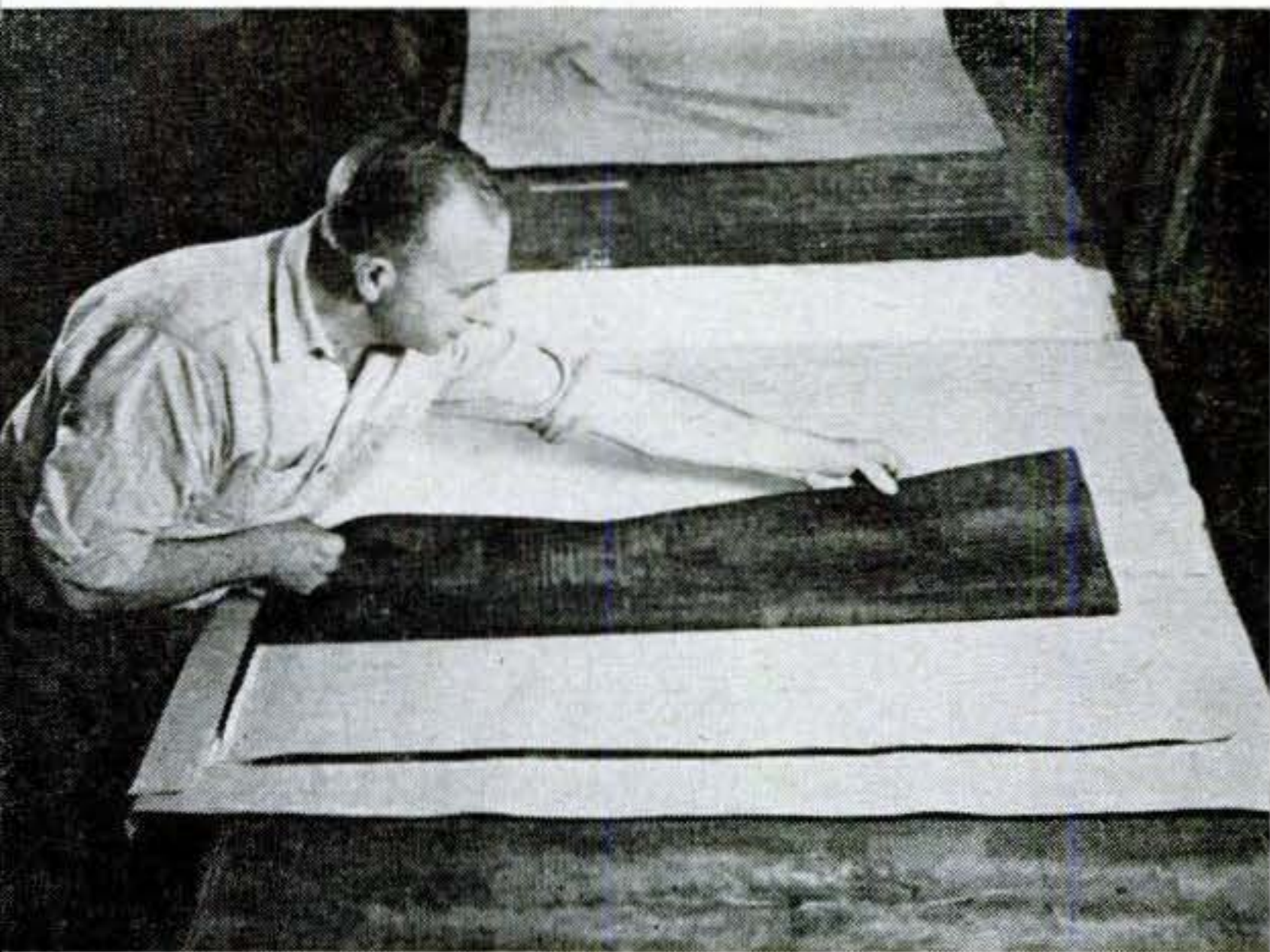

**Conductive rubber** bonded between insulating layers supplies the heat. Called **Uskon**™, this is natural rubber with carbon-black particles added to make it a conductor of electricity.

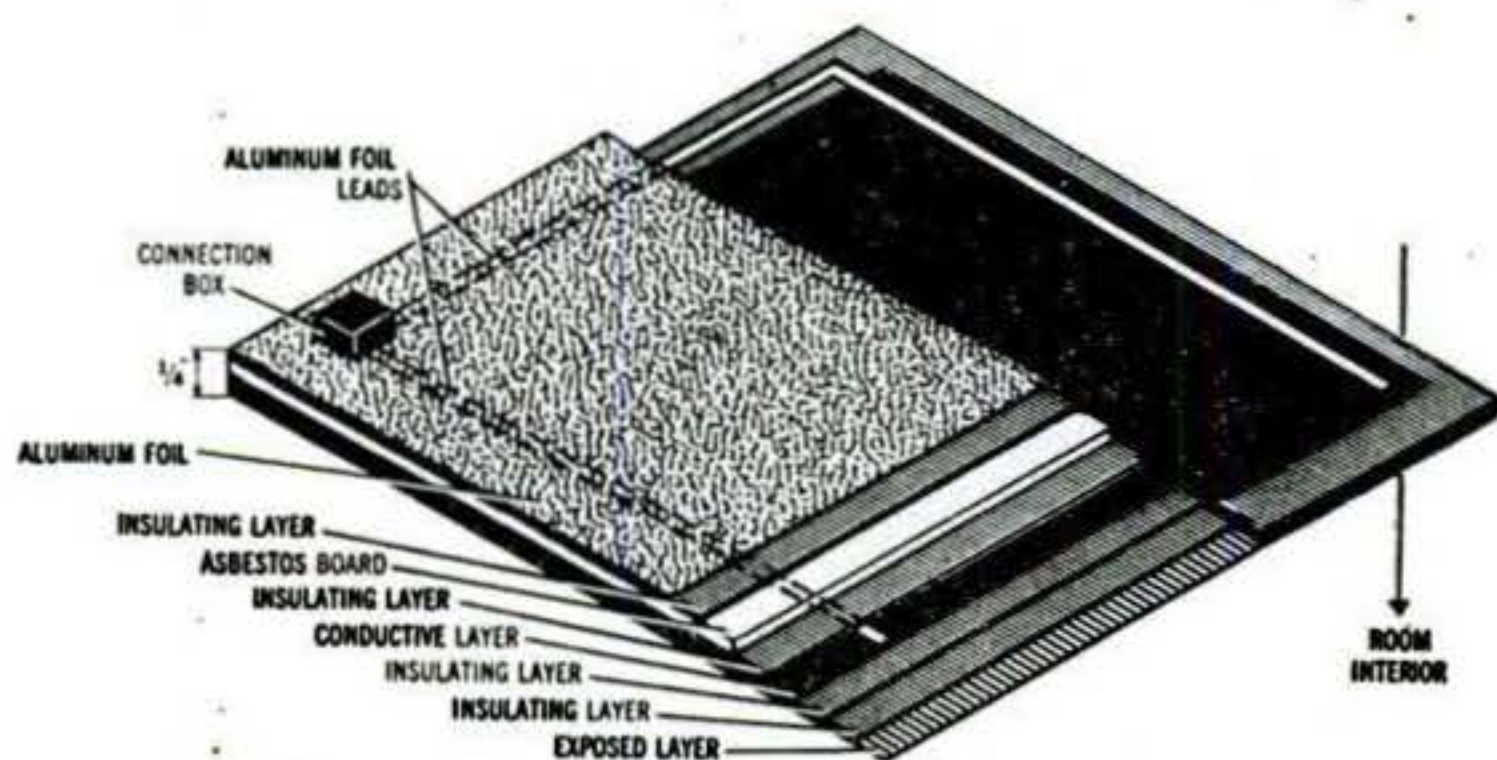

When completed, the panels are ¼-in. thick. Asbestos board makes them rigid and a layer of aluminum foil on top reflects heat down.

the center being covered with ordinary building board. The entire surface can be finished with paint, paper, or a light coating of plaster.

Tested in a number of homes in the past few years, the panels are now in commercial production. Compared with conventional heating systems, original cost is low. But before you rush out and buy, check on your local electric rates. If you pay more than a cent and a half per kilowatt hour, the panels are a luxury.

Engineers of U. S. Rubber have estimated the comparative costs of heating a six-room house in several cities with the radiant panels and with oil. Each is based on a 9,000-cubic-foot house, oil at 13 cents a gallon, and a wind velocity of 15 m.p.h.

The estimates for a full year: New York City, panels, \$299 at minimum electric rate of 2 cents, oil \$190; Buffalo, \$286 at 1½ cents, oil \$258; Atlanta, \$90.80 at 1 1/10

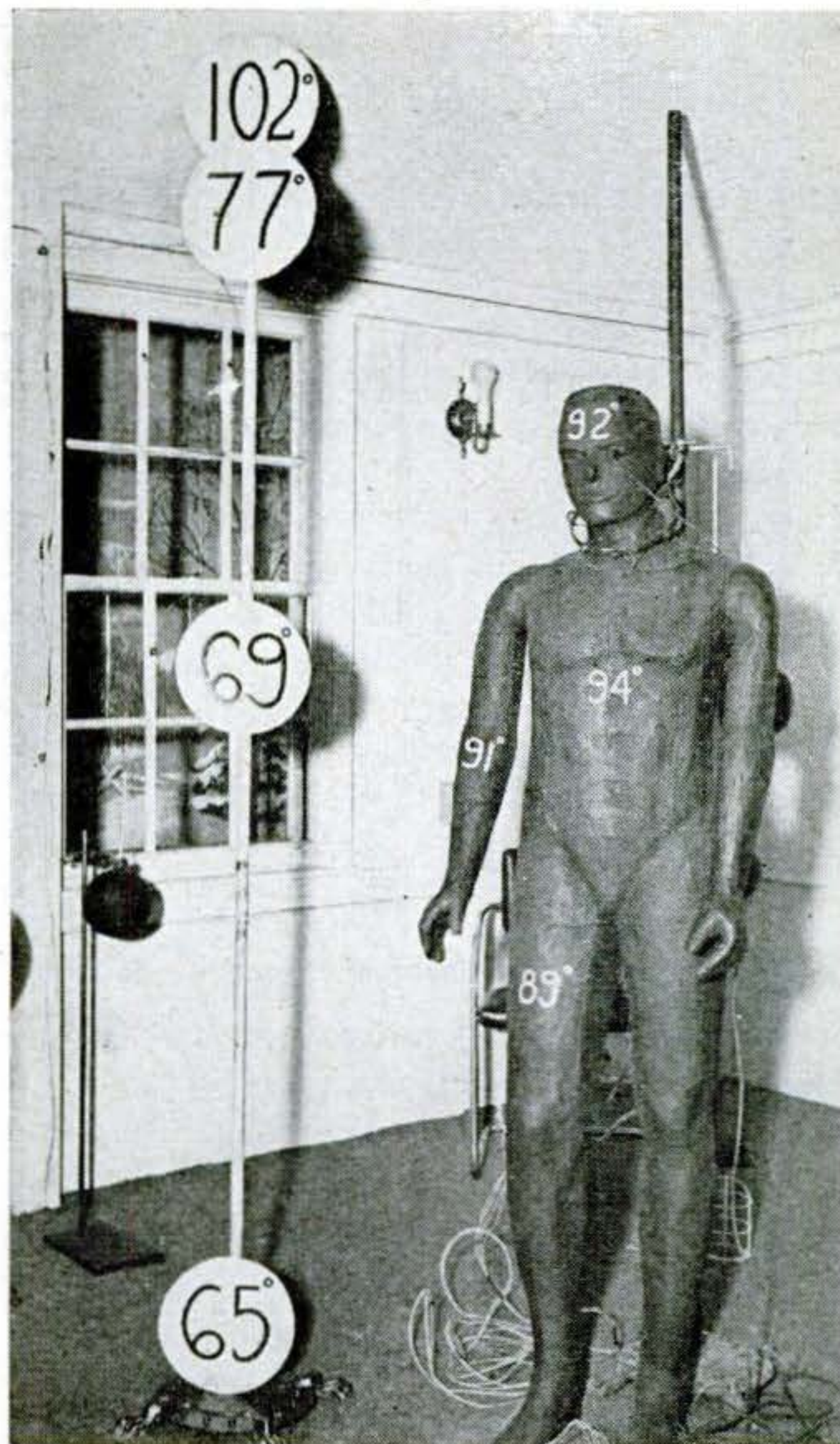

A mannikin in a test home shows that radiant heat warms you more than it does the air. At the left, air temperature at various levels.



Small model home in New York City was used to demonstrate the panels this winter. Its first floor can be heated for around \$200 a year.

cents, oil \$125; Memphis, \$57.30 at 1½ cents, oil \$125; Dubuque, \$355 at 2 cents, oil \$258; Minneapolis, \$307 at 1½ cents, oil \$258; Denver, \$300 at 2 cents, oil \$190; Seattle, \$112.70 at ¾ cents, oil \$190; San Francisco, \$81.80 at 1 cent, oil \$125.

## Earth Ripper Digs Deep

THE long steel tooth of this massive Jugernaut rips its way through hard ground and rocks to a depth of six feet. Called the Giant Ripper  $\text{\textcircled{T}}$ , it is designed to dig up and soften the earth ahead of ditchers on pipeline and cable-laying jobs.

When pulled by three tractors developing 450 hp., the 17-ton machine can handle three of the earth-rendering rooter shanks. Comparison with the man, shown in picture at right, gives an idea of the size of these teeth, which are 10 feet long, 5 inches wide, and measure 18 inches from front to back; the carrier itself is 26 feet long and 13 feet wide. Builders of the device, the Soulé Equipment Co., of Oakland, Calif., have consigned the first unit to Saudi Arabia.

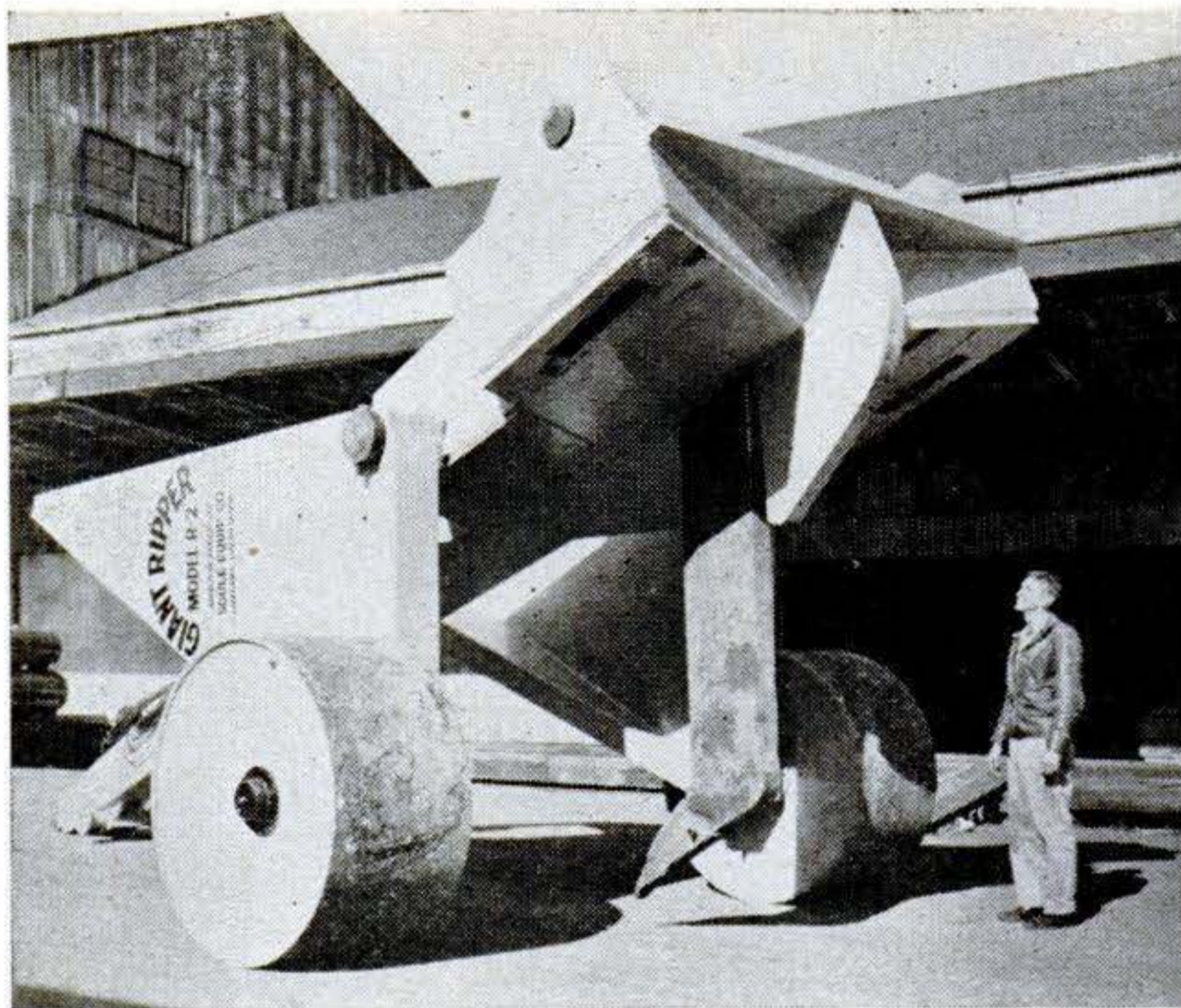

## Phase Microscope "Sees" the Invisible

THINGS that ordinarily seem as transparent as window glass can be seen in all their detail with a new kind of microscope. The phase-contrast microscope, shown below, promises to be a valuable tool in can-

cer research and many scientific fields.

Two simple gadgets in the new instrument do the trick. One of the two plates shown at bottom left, is partly opaque and is mounted under the specimen so that the light illuminating it is limited to a narrow cone. The other plate, which goes inside the lens system, is transparent but has a ring coated with material that slows light waves.

Between them, these plates slow up the light waves passing through a microscopic specimen so much that the light waves going through the invisible detail interfere with the waves going through the rest of the specimen. When this happens, the peaks of one set of waves coincide with the valleys of the other set, so that they cancel out. This forms a dark pattern that is a good image of the detail.

Detail in a microscopic specimen slows up light waves even without the phase-contrast attachments. This effect cannot be seen, however, unless the slowing up is enough to cause interference—as when the attachments are used.

Until the invention of the phase-contrast microscope, the only way to make transparent detail show up was to dye the specimen. This has the disadvantage of killing live specimens—and biologists often want to see their specimens alive.

The invention of a German, Prof. F. Zernike, the phase-contrast microscope has been further developed here by scientists of the American Optical Co., and Bausch and Lomb.

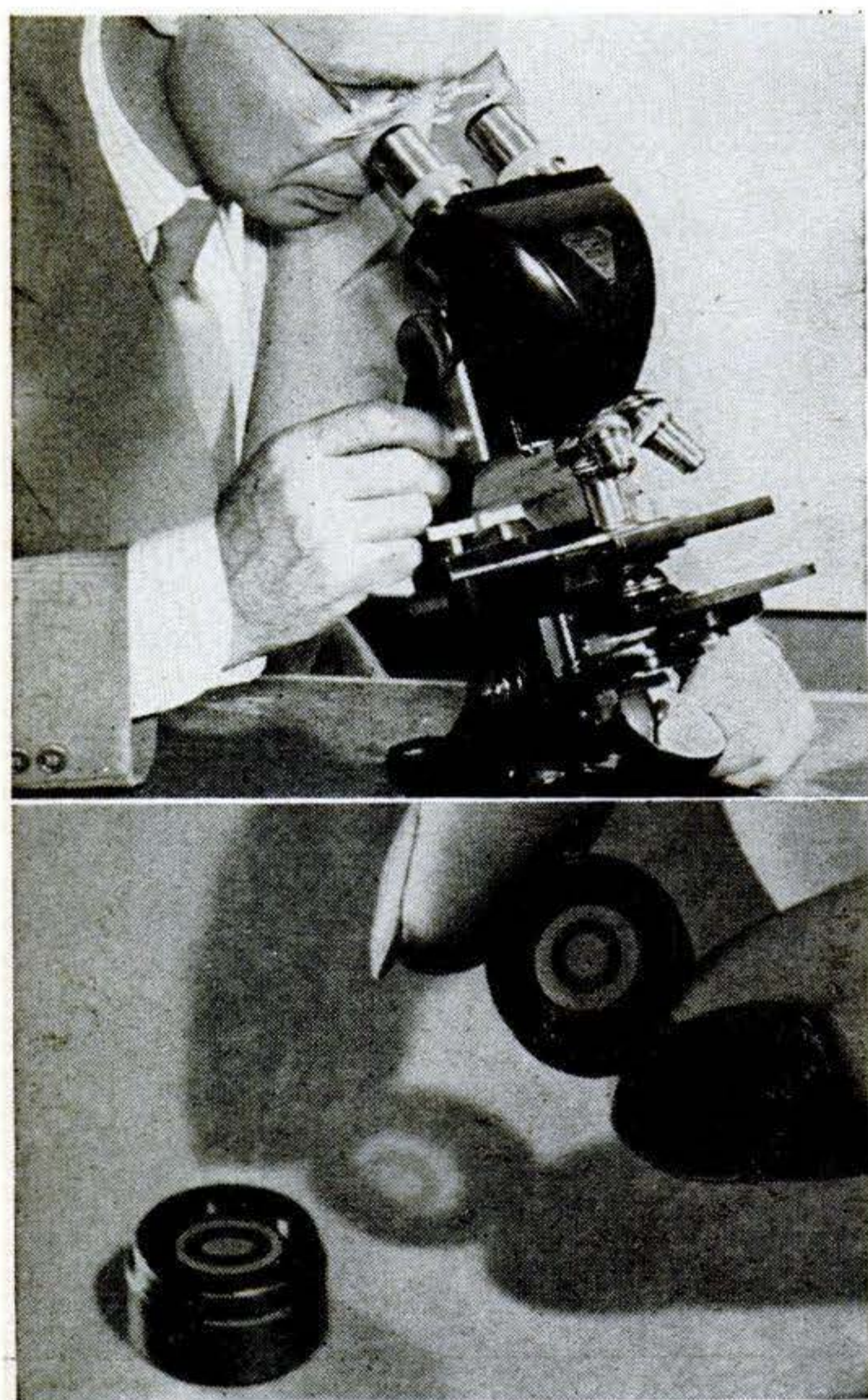

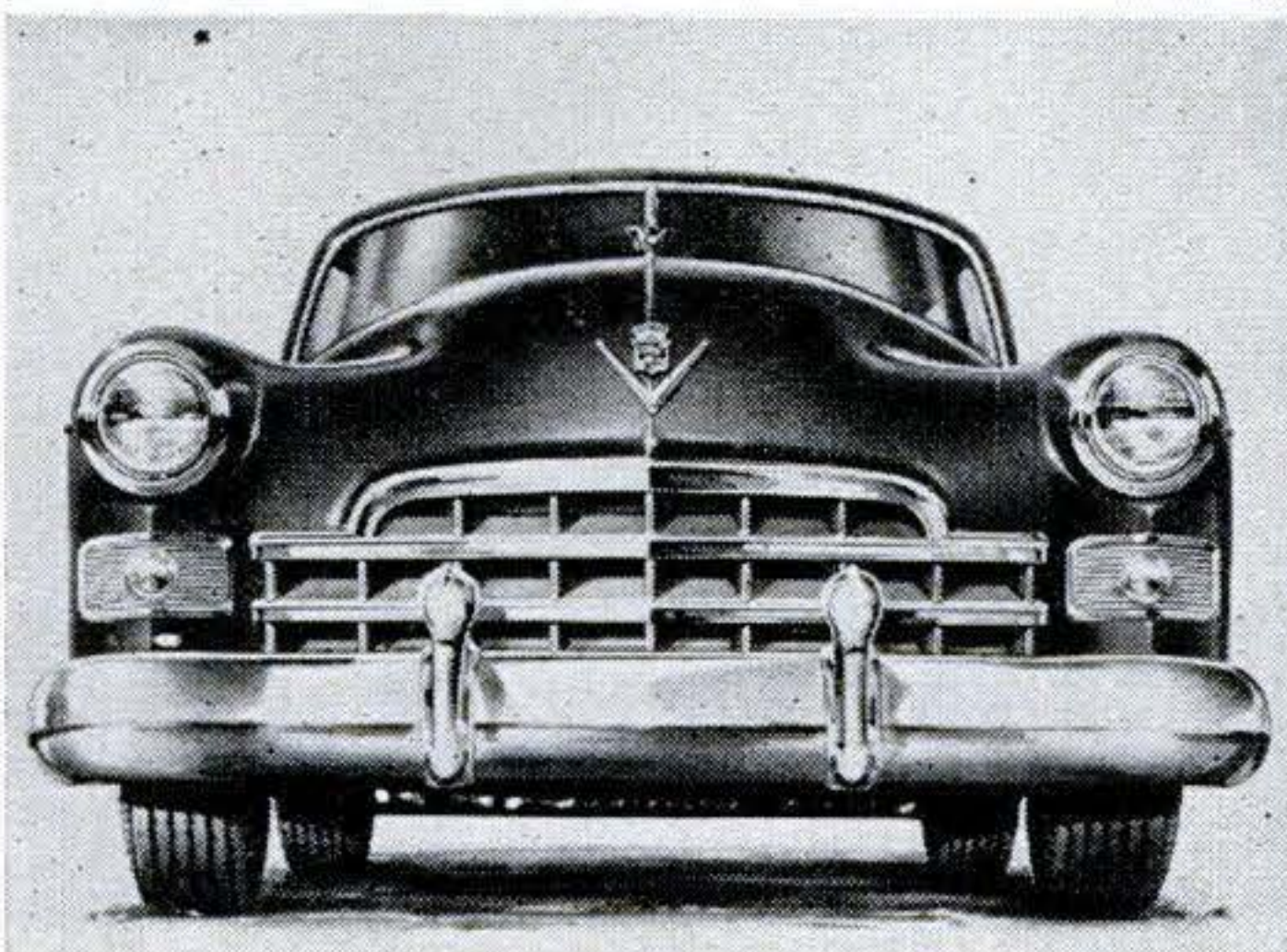
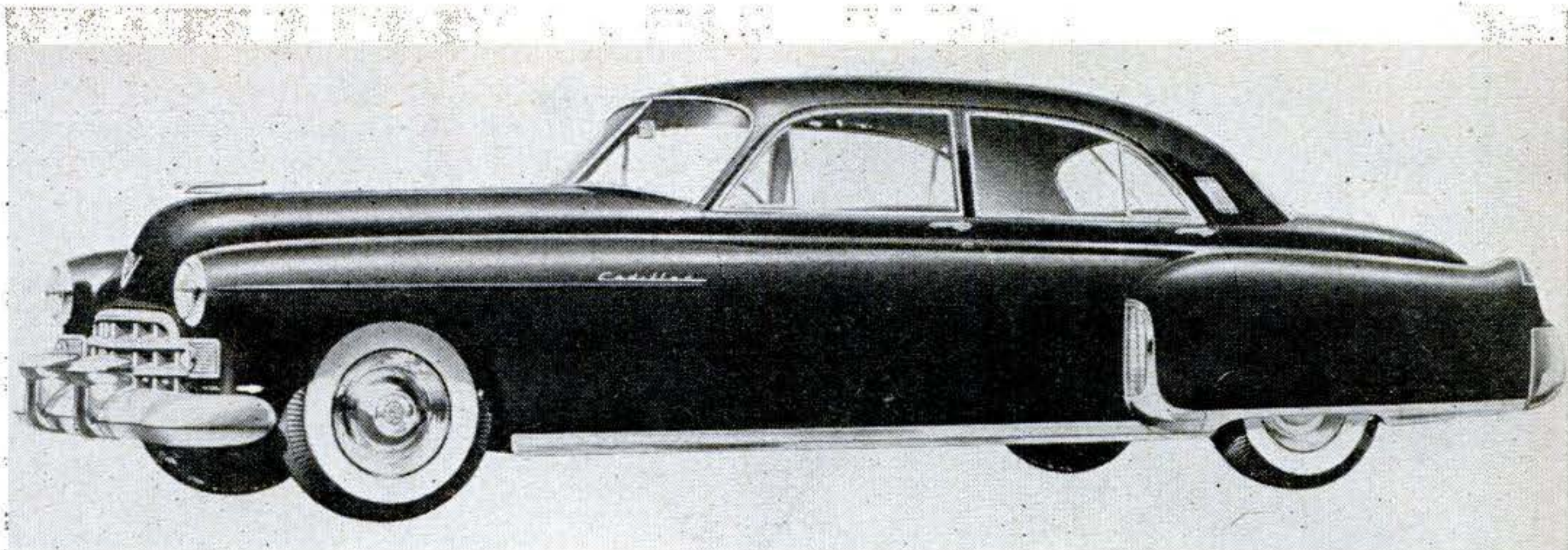

## Power in Sleek Package

NEW note in the 1948 Cadillac is the distinctive rear fender that immediately catches the eye in the Series 50 five-passenger sedan shown above. Taking a leaf from aircraft design, the rear fenders are projected to form vertical fins. Directional lights have been fitted into the trailing edge. Front view, at left, emphasizes the car's traditional road-hugging lowness and massive width. The Cadillac 150-hp. V-8 engine continues to power all new models.

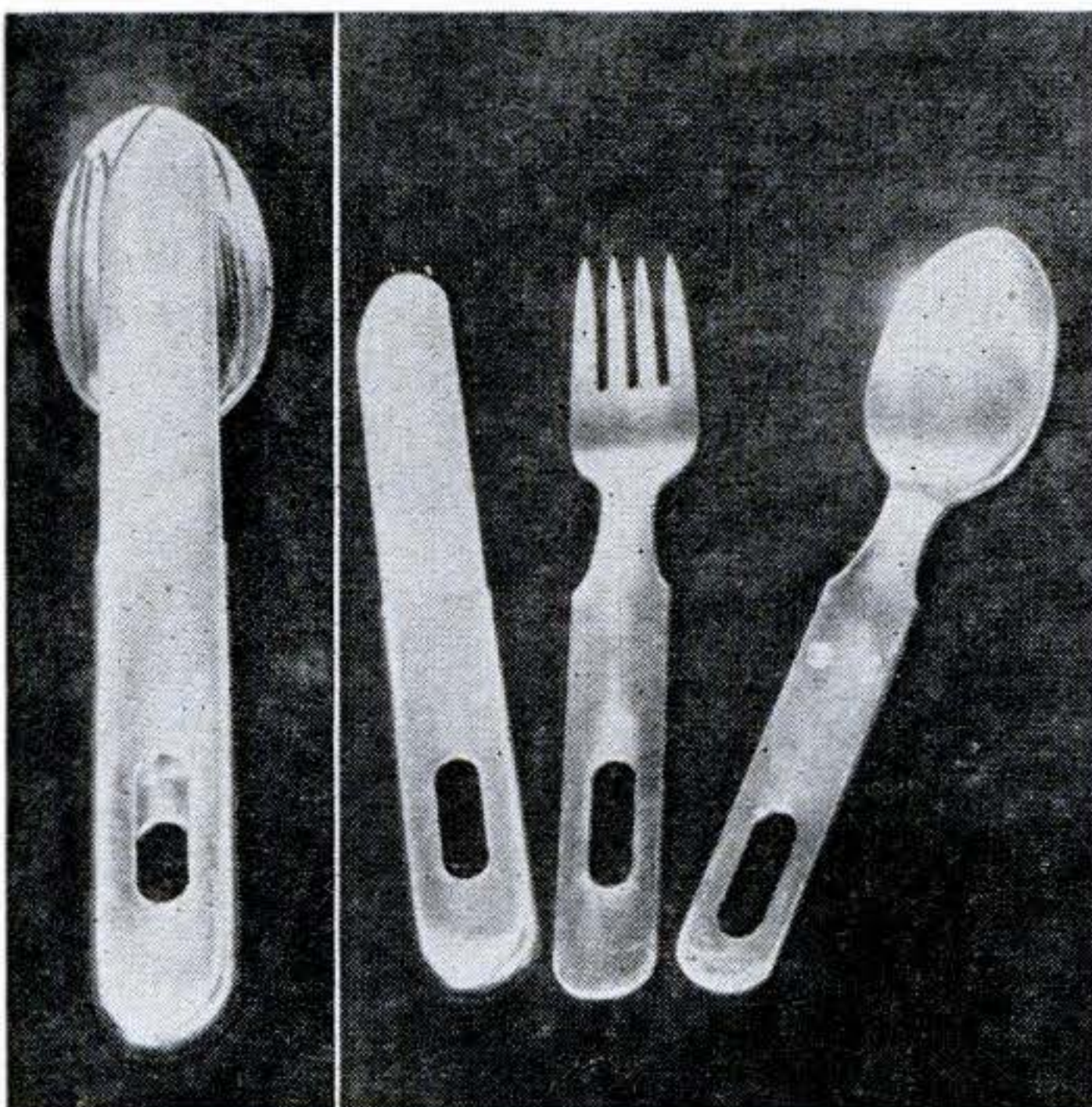

## Chow Gear Improved

RATTLING knives, forks, and spoons can betray a night patrol to the enemy—but not with the new set of eating utensils developed by the Army. The three mess implements, made of stainless steel, nest together (at left), and can be carried in a uniform pocket. Slots in the handles allow them to be slung on the handle of a mess kit for washing. Old type set not only rattled, but was bulky and rusted in the field.

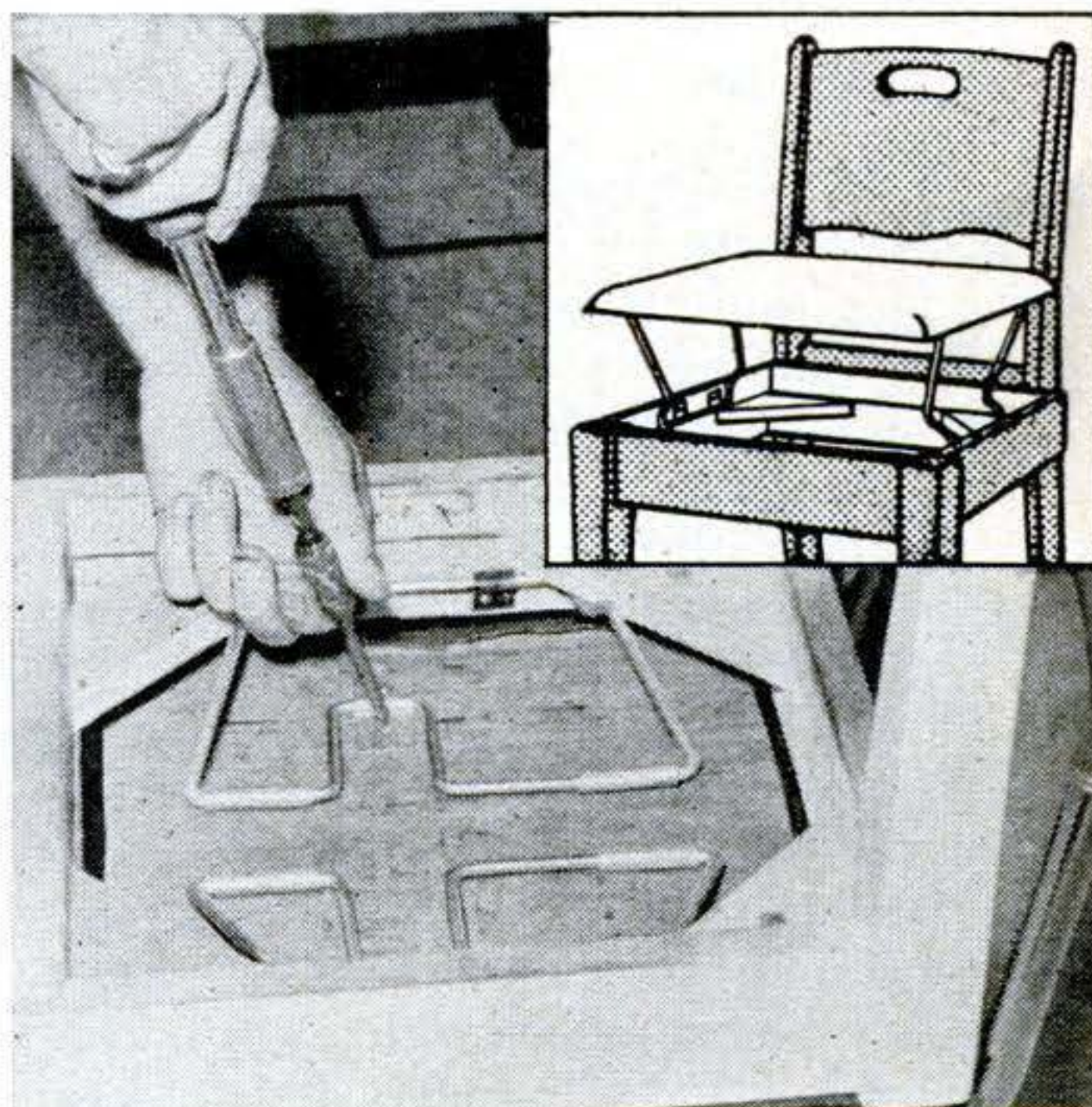

## A Boost for Junior

JUNIOR, or junior miss, can now sit right up there with mom and dad at the dining table in an ordinary chair. But something has been added—a Hi-Lo<sup>®</sup> chair attachment. Consisting of two metal arms, it is easily fastened to the bottom of any chair seat. When screws securing the seat to the chair are removed, the seat lifts up and locks in place. The device is made by the Nu-Way Appliance Co., of Los Angeles, Calif.

Every spark plug, like other parts of ignition systems, is a miniature antenna. Unsuppressed, it covers everything from the broadcast band up, its effect growing worse with higher frequencies. Television (44 to 88 megacycles) gets it in the eye.

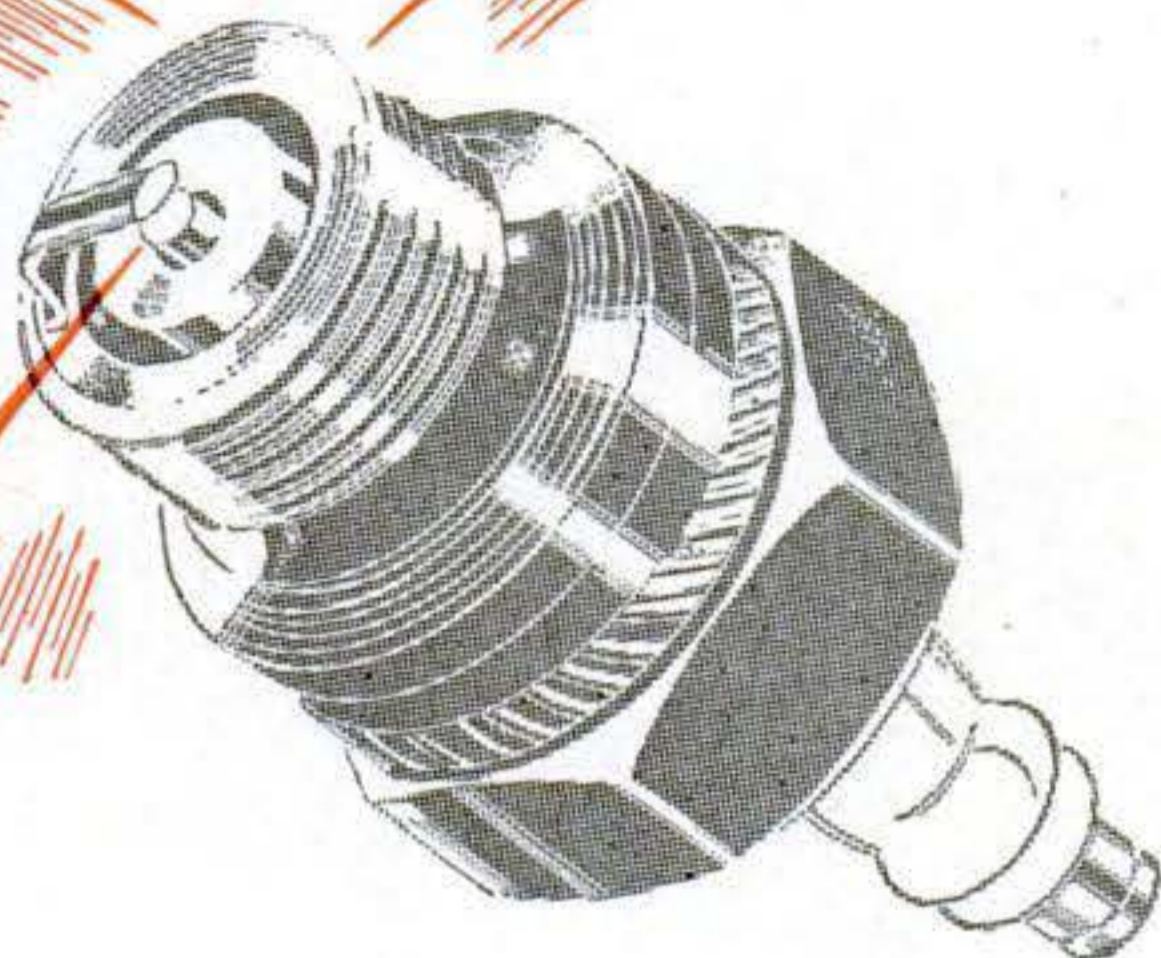
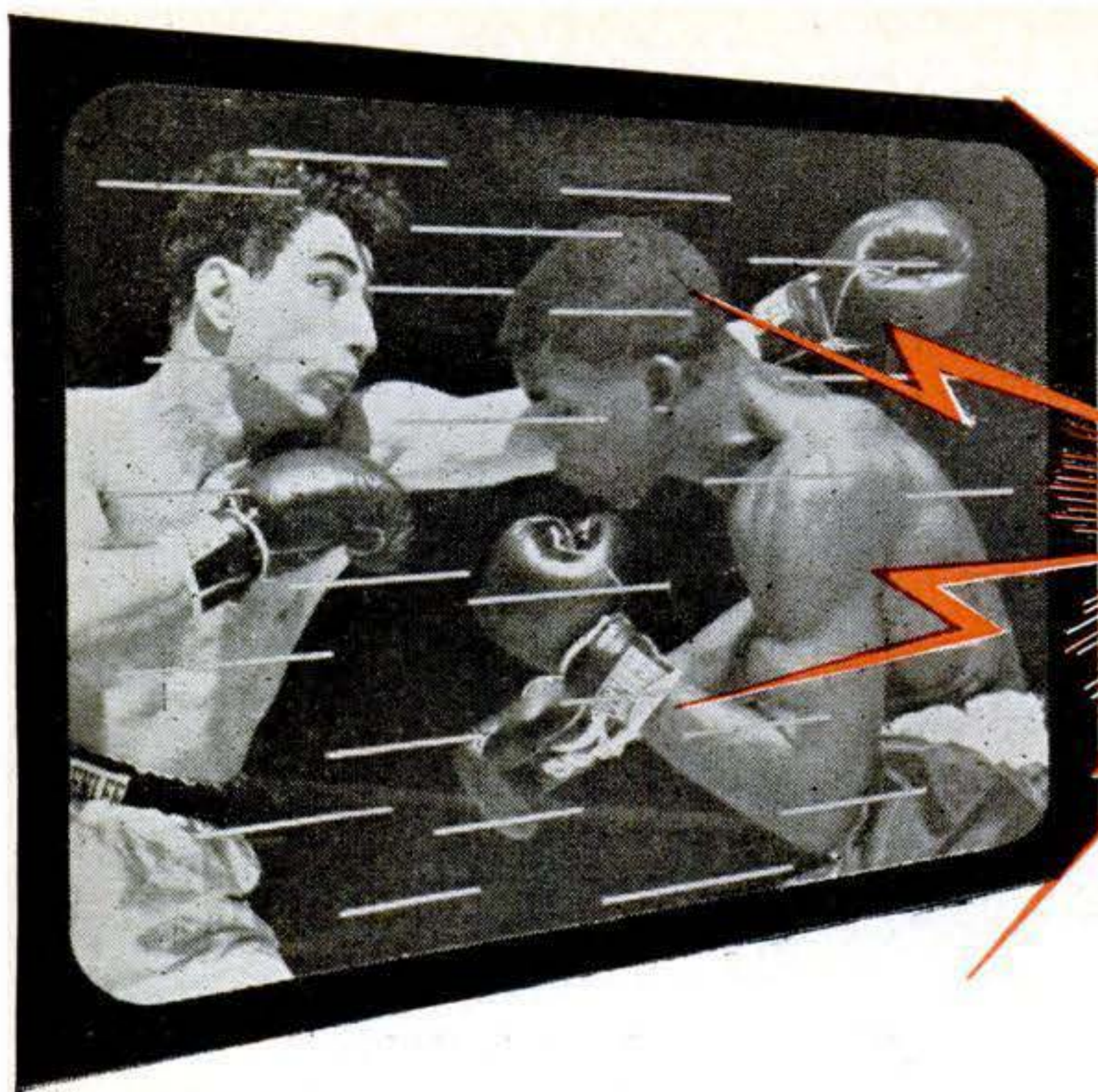

# Unmaking Man-Made Static

**Ignition noise, long a radio nuisance, faces a campaign designed to knock it out of the television picture.**

**A**UTOMOBILE ignition systems have been producing spluttery noises in radios since the days of crystal sets. With television, the noises turned into visible streaks and blotches—and thereby set the stage for a large-scale attack on one of radio's oldest minor headaches.

The attack began during the war, when ignition interference was a major threat to vital military communications. To clear the air, a fleet of mobile Signal Corps test stations toured the country, teaching manufacturers how to build ignition systems that wouldn't sound off through near-by radios.

Static is fundamentally just like any amplitude-modulated (AM) radio signal. Frequency modulation will reject it, but short of using FM for every purpose, the only way to keep interference out of a radio completely is to suppress it at the source.

Eliminating ignition interference is a relatively simple operation, done quickly and easily on any car that carries its own radio. Resistors in spark-plug cables keep electromagnetic impulses from feeding back into the wiring, which would broadcast them; metal shielding around cables and other parts helps trap other impulses, and capaci-

tors channel them to the chassis, which is bonded into a nonbroadcasting ground.

Experts at the Coles Signal Laboratory, at Fort Monmouth, N. J., figured out scores of variations on that basic pattern. Early systems with bulky external shields barred interference only up to 40 megacycles. Research has now progressed to simpler, integrally shielded and suppressed equipment that promises interference-free communications clear up to 4,000 megacycles—and also makes ignition systems waterproof.

By putting the program on a mass-production basis, military experts hurdled the biggest barrier to getting rid of ignition static—the fact that thirty-odd million U. S. cars have to be “suppressed.”

Now the American auto industry has taken over, and cars are being built to a set of anti-interference standards worked out by radio makers and the Society of Automotive Engineers. Accessory makers are also providing war-developed devices to help the program.

As millions of prewar cars go off to junkyards, radio reception will be freed of one source of man-made static. Short-wave operators will say good-bye to a lot of the “garbage” that has plagued them for years. And owners of television sets won't have to fight shy of highways or set up sky-high antennas to avoid spots before their eyes.



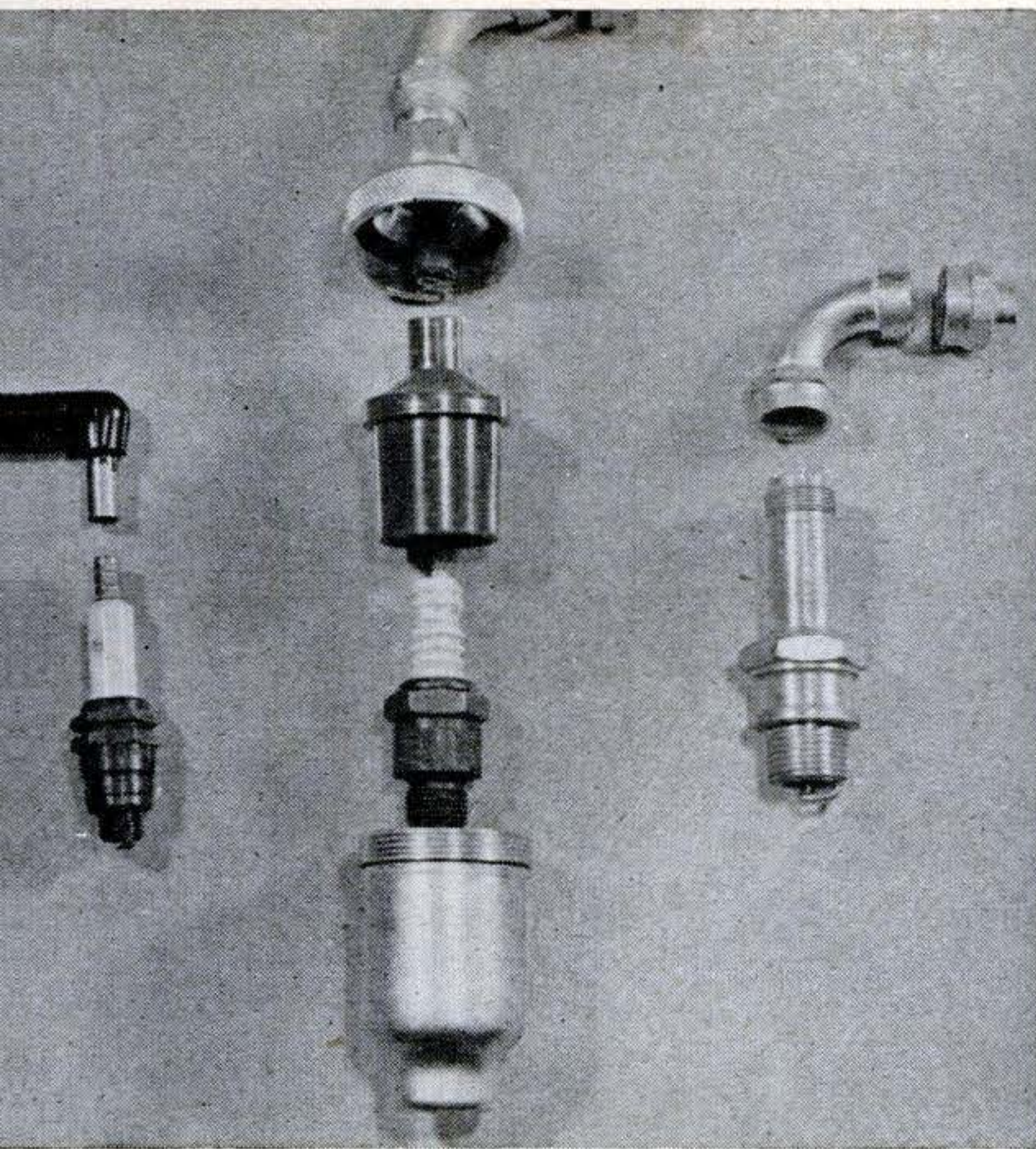

**Three steps** in Signal Corps' program show progress from separate resistor-suppressor cap (on left) through bulky external shield (center), to specially designed, waterproof spark plug with built-in shield and suppressor (right).

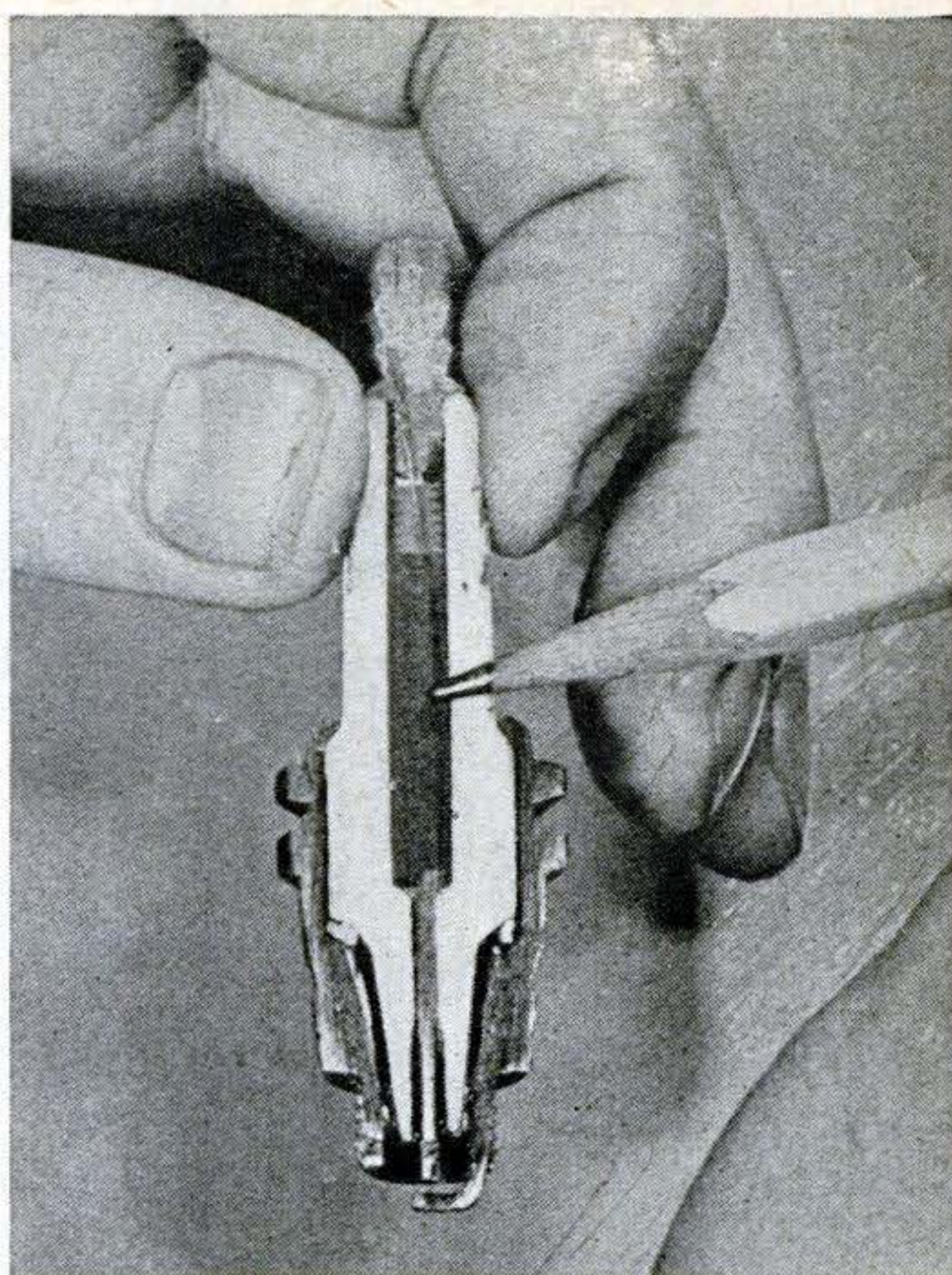

**Plugs that suppress themselves** are now ready for U. S. motorists. Resistor, indicated by pencil point, seals in noisy impulses. According to manufacturers, it also lengthens plug's life and improves its performance.

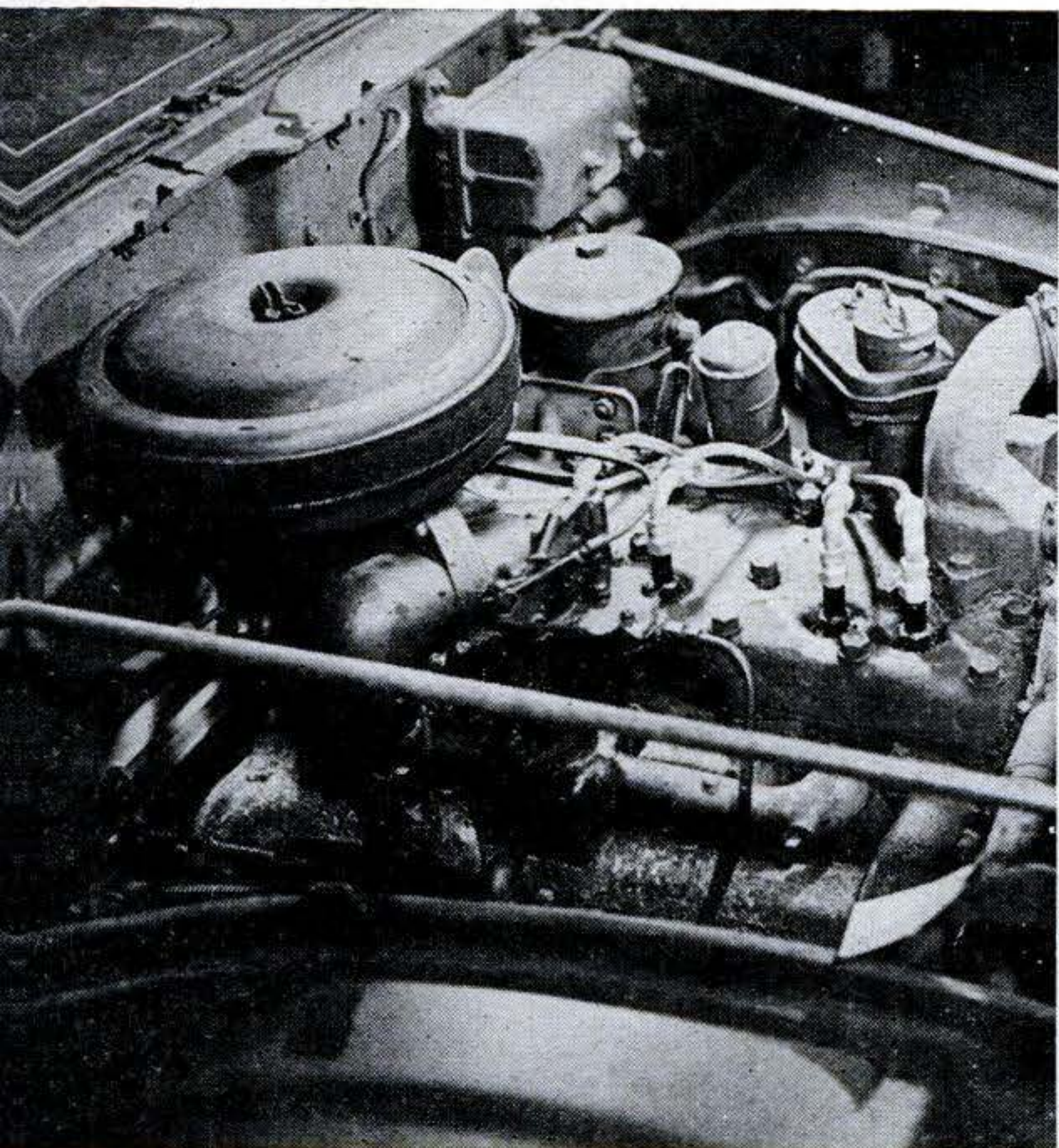

**Full shielding** on plugs and cables of an Army truck illustrates care necessary to block interference at extremely high frequencies. Distributor and coil are also shielded; chassis parts are bonded together; generator and voltage regulator are grounded through capacitors.

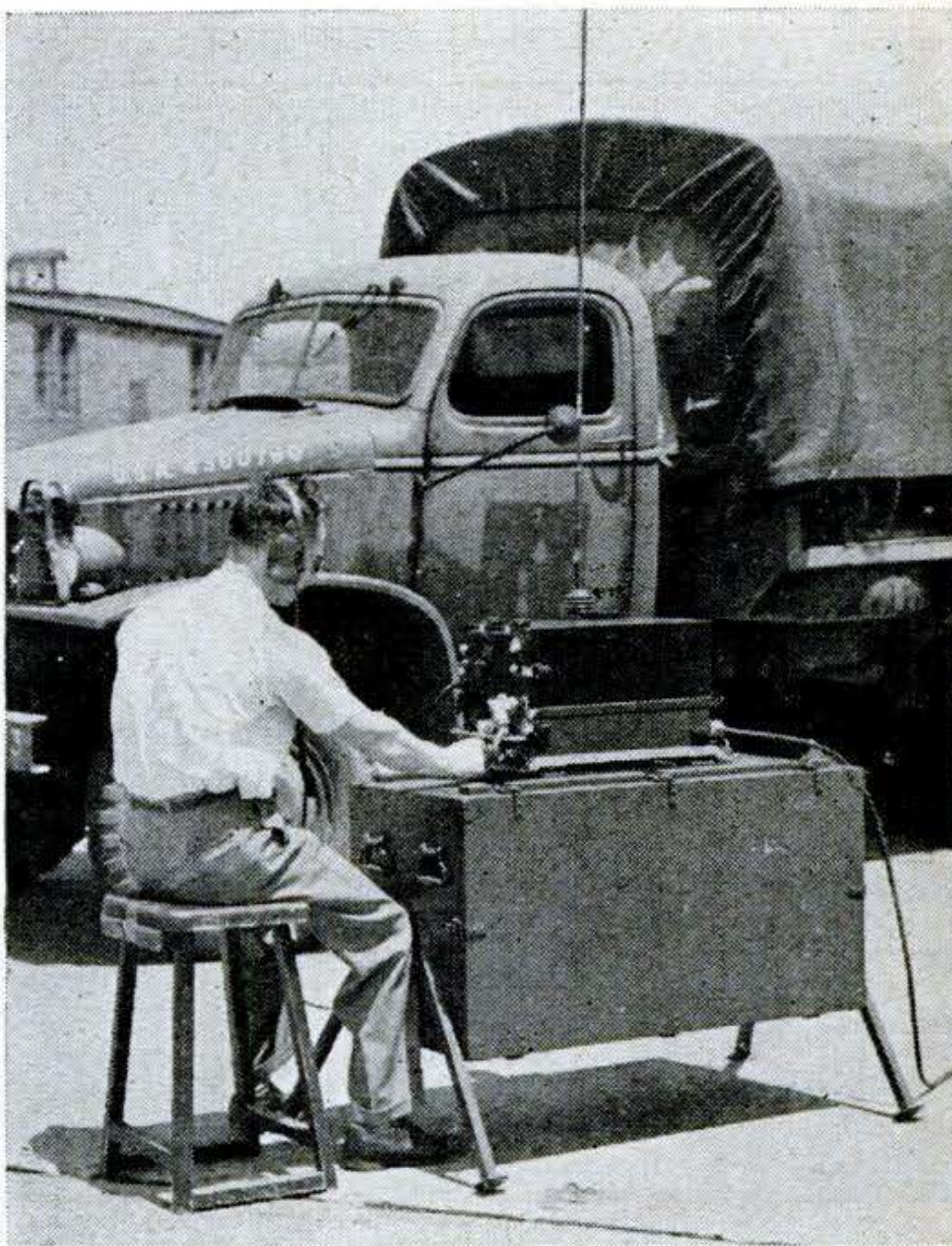

**A radio-noise detector**, this compact test set was developed to check suppression devices on equipment purchased by the Army. Measuring impulse noise from .15 to 40 megacycles, it will also enable repair depots to spot and eliminate interference from older-type equipment.

# What's New in Aviation

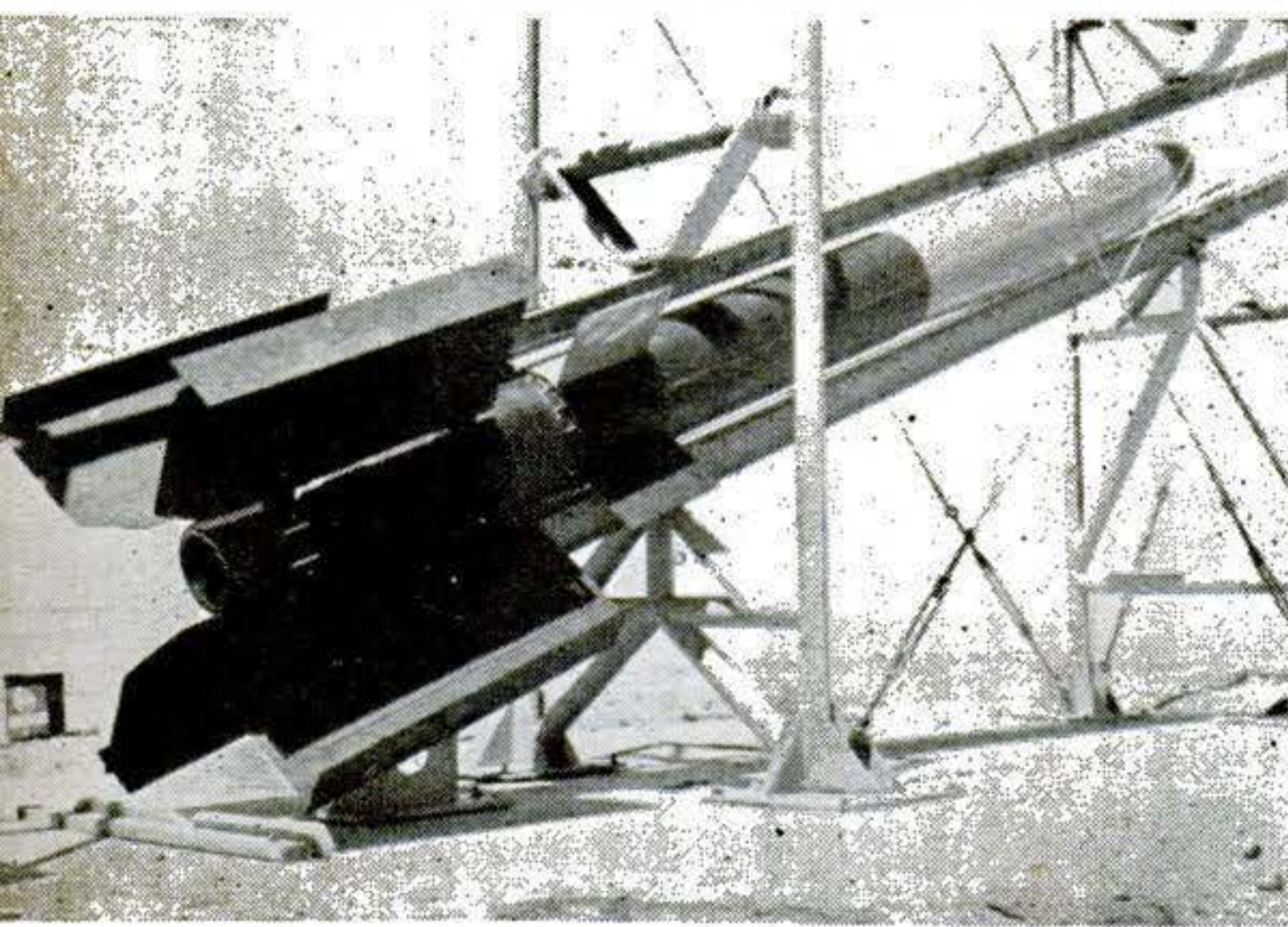
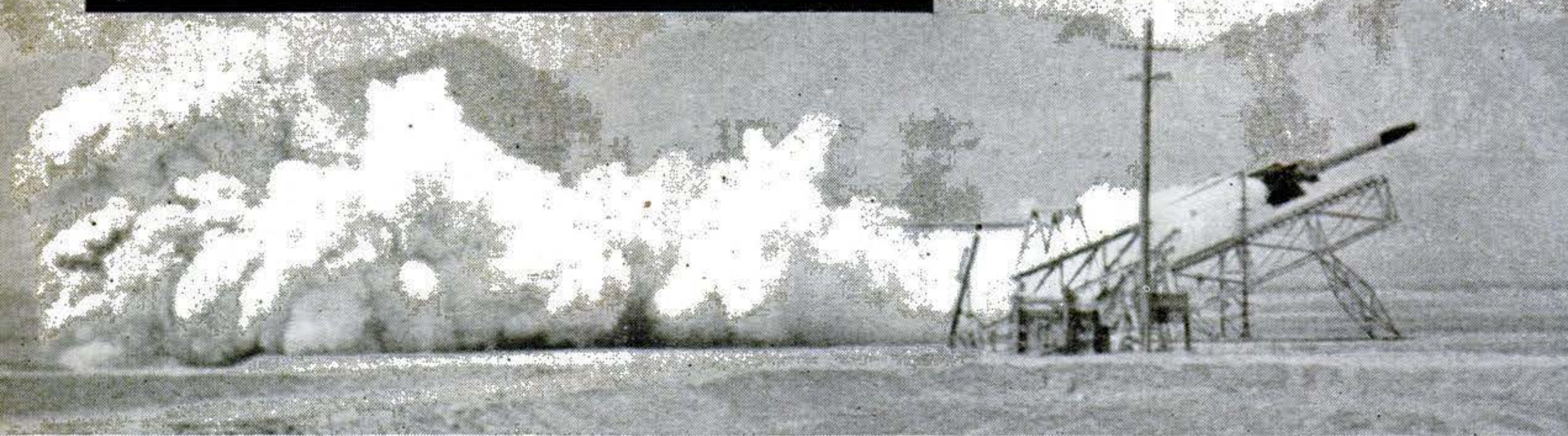

**Biggest Ramjet Goes Up.** Rocketing far above the speed of sound, the biggest "flying stovepipe" ever flown has been successfully tested at the U. S. Naval Ordnance Test Station at Inyokern, Calif. Power for the ramjet's take-off (above) was provided by the big-finned booster rocket shown at left, which drove the ramjet to its operating speed (several hundred miles an hour), then dropped off. The ramjet continued its flight under its own power, which is 25 times as great, pound for pound of engine weight, as the best reciprocating aircraft power plant in use today.

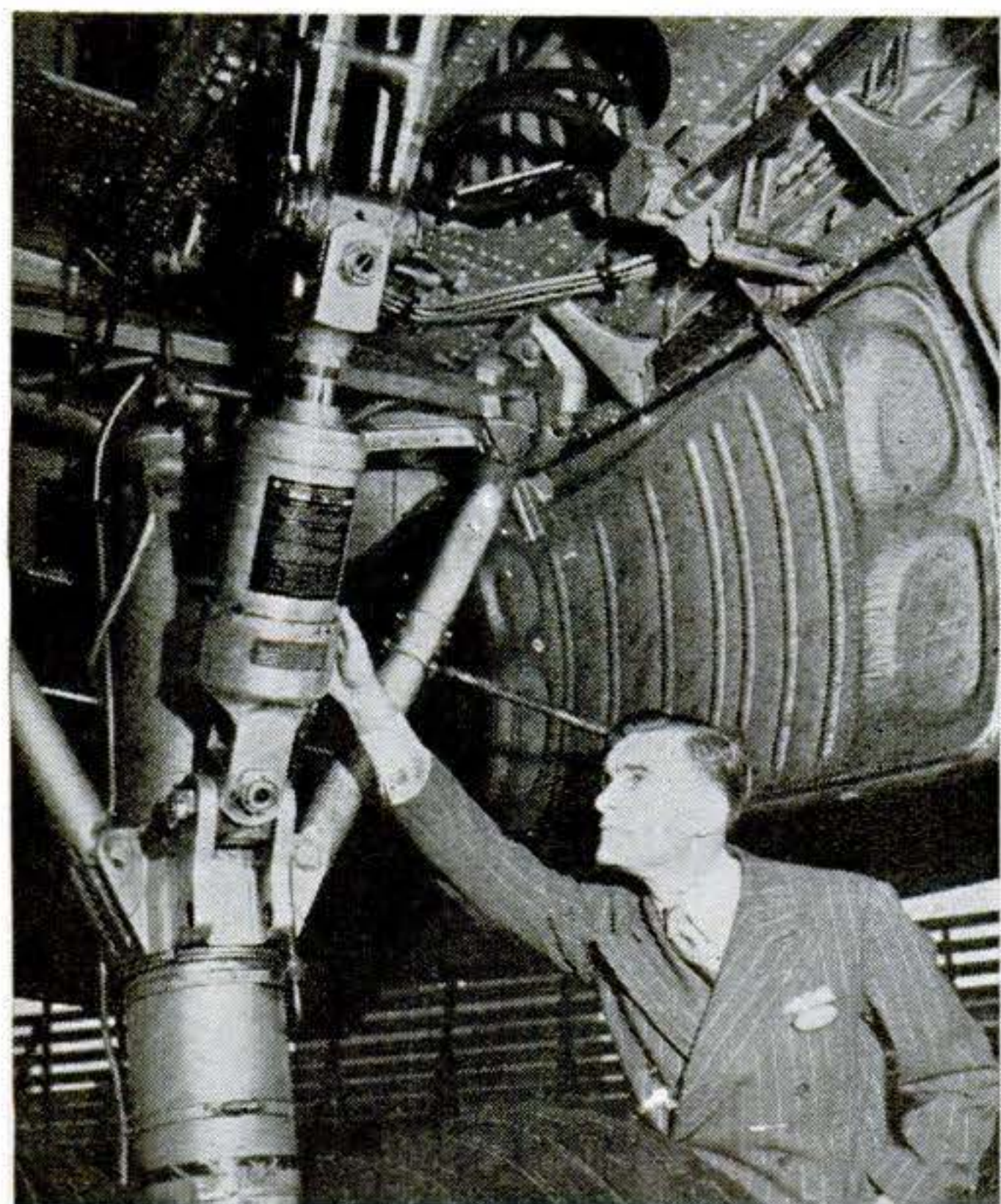

**For Happier Landings.** To cut down landing-gear mishaps, Lockheed devised this hydraulic drag strut, shown in the wheel well of a Constellation. It lets main wheels move six inches to the rear as they touch down, lessening landing shocks.

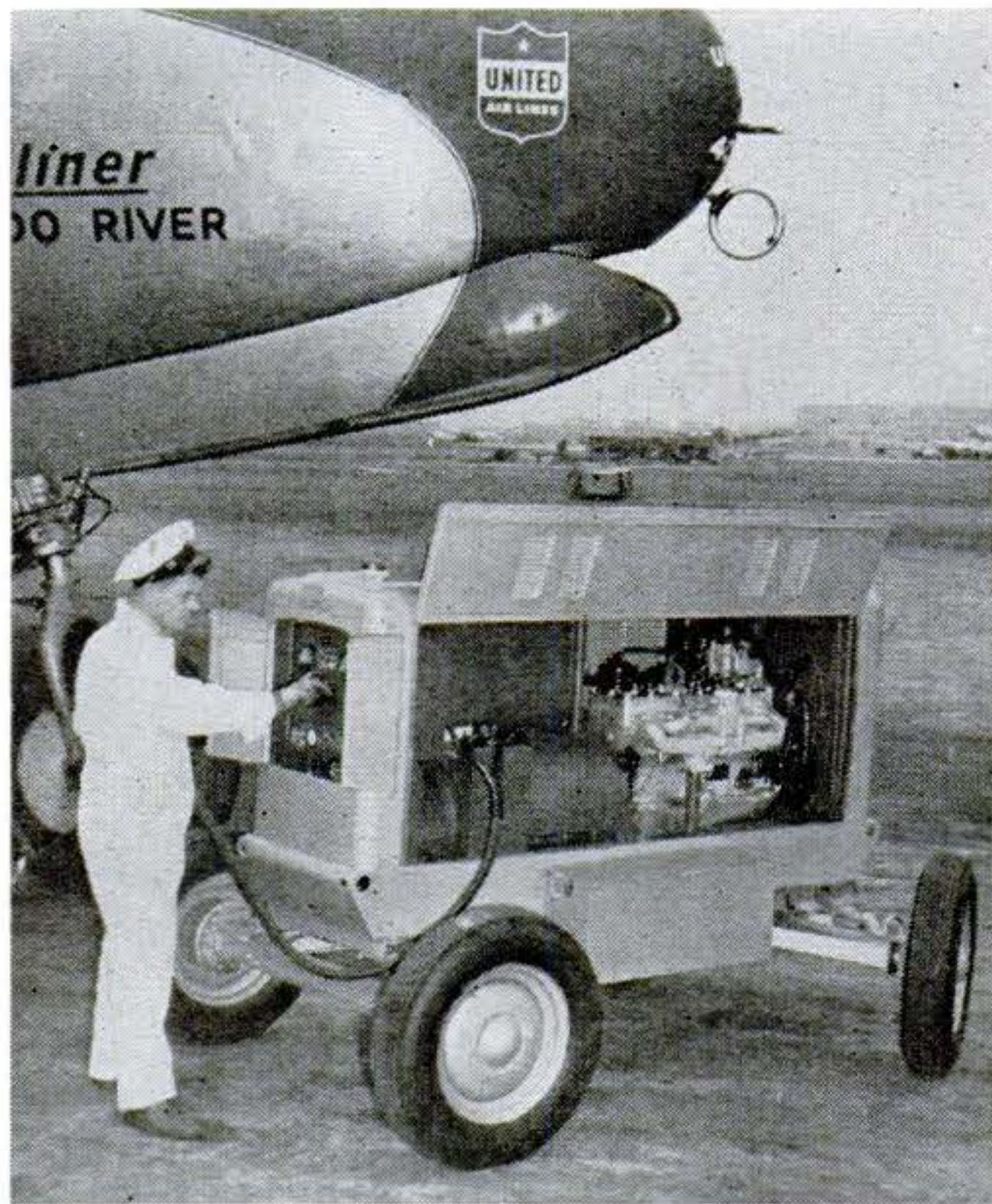

**More Power to Them.** This 800-ampere power truck is one of 40 mobile generators being put in service by United Airlines. Far huskier than previous models, they are required for ground operation of equipment in the new four-engine planes.



### **Seaplane Can Carry Own Dock.**

Nine inflatable nylon float sections and a hinged plywood deck add up to a floating dock (above) that can be stowed aboard Navy patrol bombers for use wherever no other servicing facilities exist. Although it weighs about 5,600 pounds, the dock can be put together or taken apart on the water.

**'Copter Flies Itself.** With nothing but sandbags for a pilot, an experimental helicopter holds itself just clear of the ground—the first time, according to United Helicopters, Inc., that such a craft has hov-

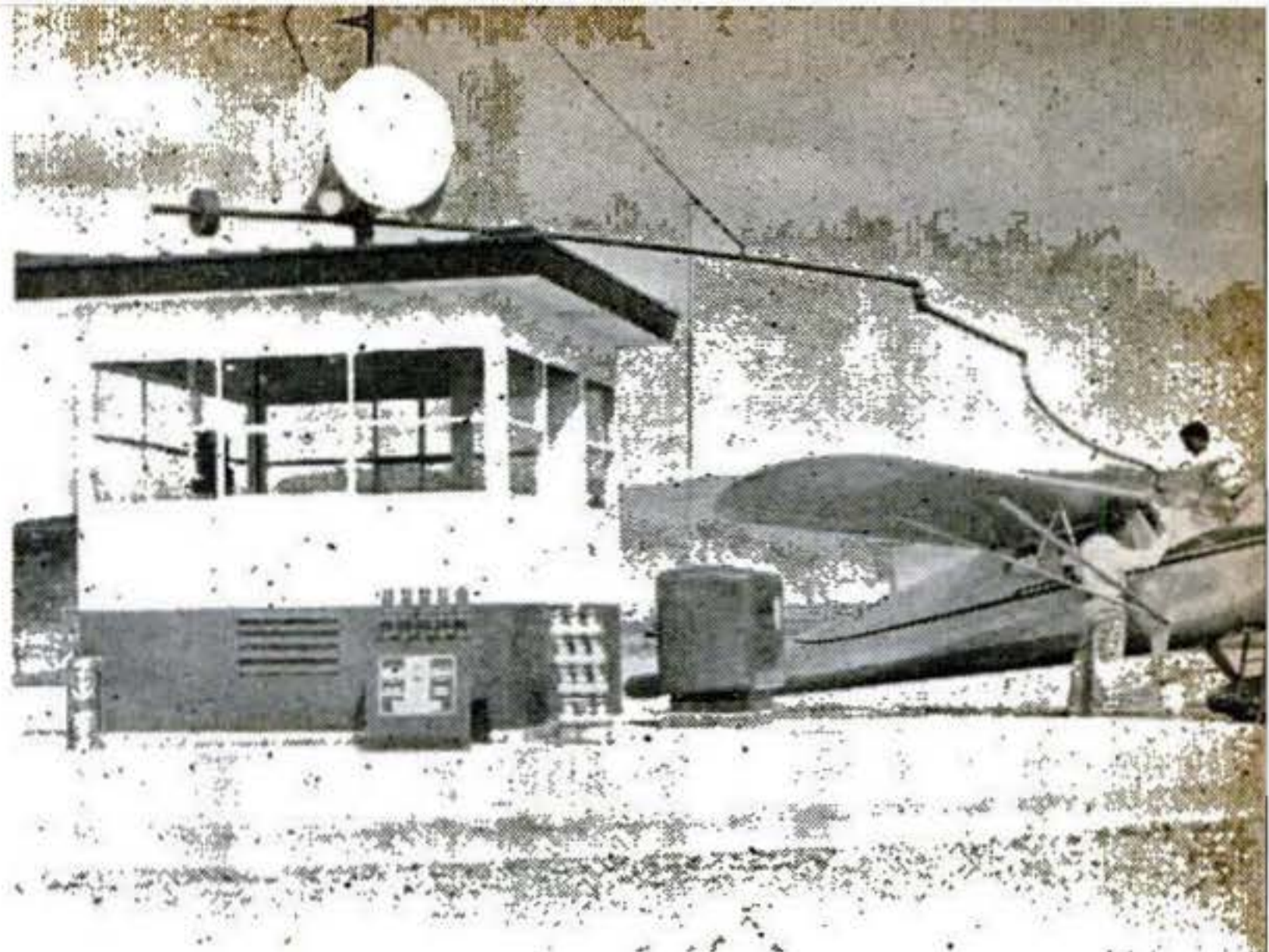

### **Gas Station Makes the Rounds.**

To speed servicing of light planes, Napa County (Calif.) Airport uses this merry-go-round gas station. Overhead line carries gas anywhere around the circular, 40-foot apron, large enough for five planes at a time. Station was developed by an engineer of the Standard Oil Co. of California.

ered without some means of control. The trick was made possible by the stabilizing control rotor used in the same company's Hiller 360 'copter, designed to permit "no-hands" piloting (PS, Feb. '48, p. 125).

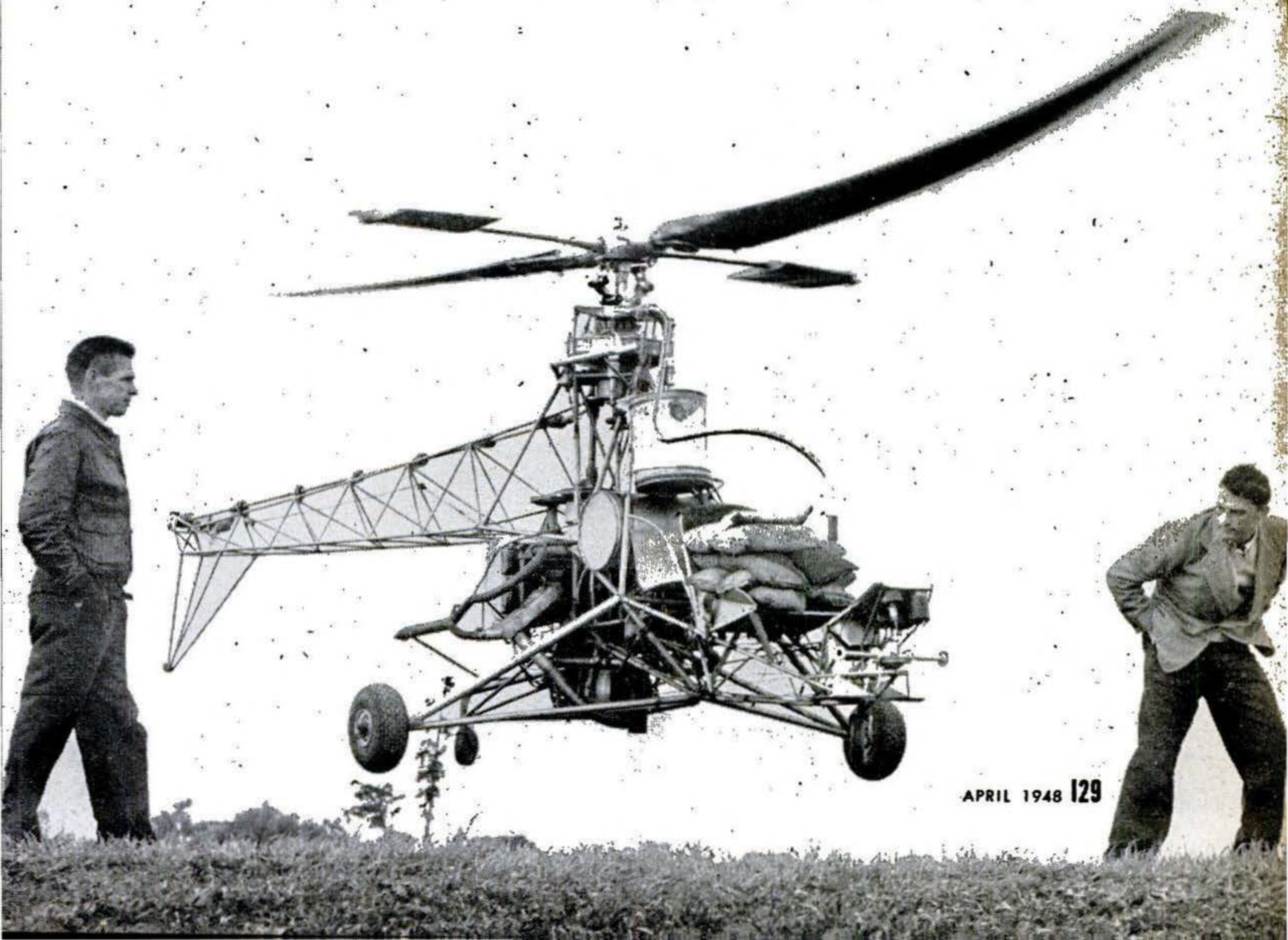



Deluge of water cascades off fabric given Dri-Film treatment, which doesn't alter appearance or "feel" of cloth. In test, GE experimenters successfully applied the same treatment to a suit of clothes. PS photo by W. W. Morris.

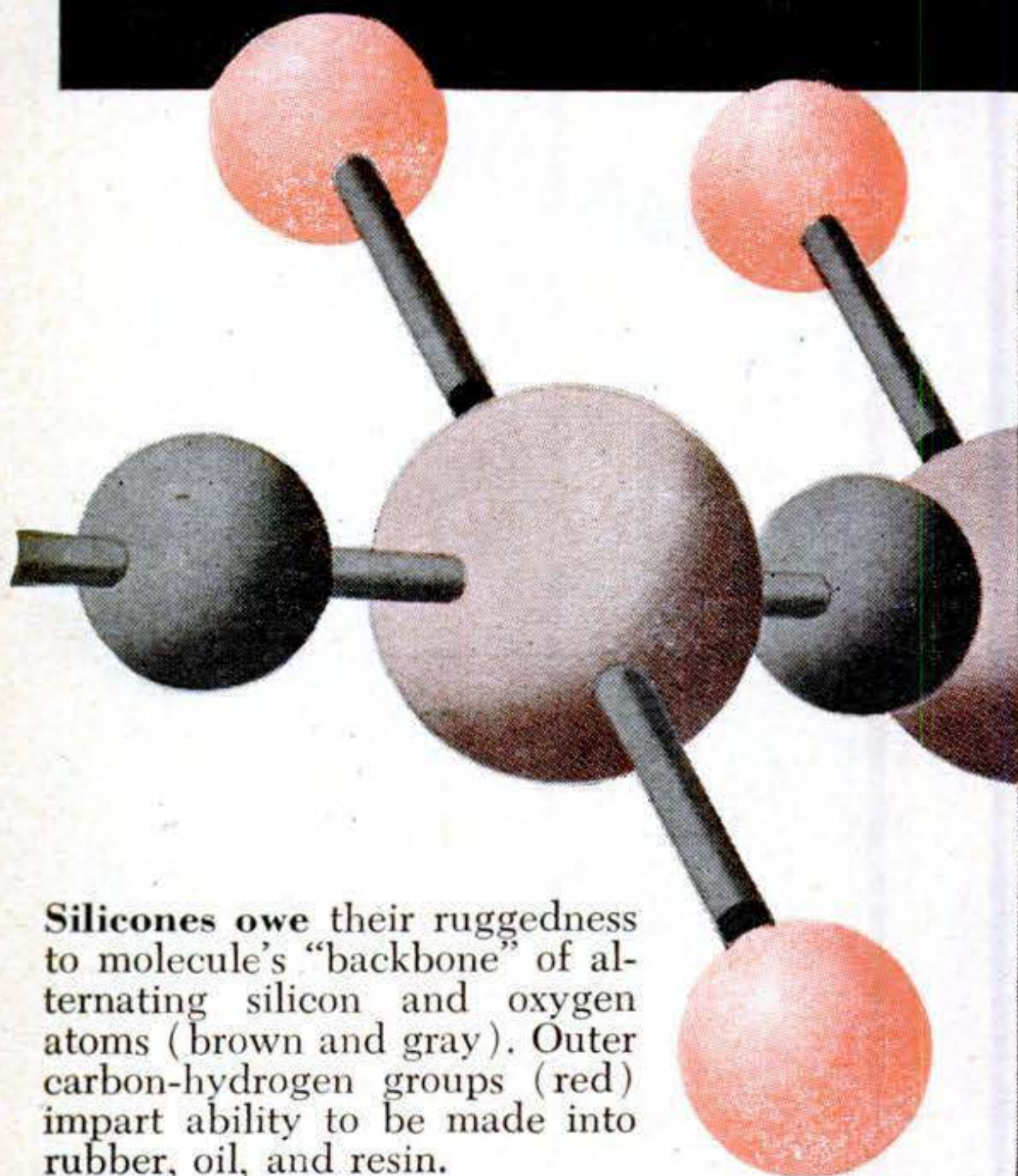

**Silicones** owe their ruggedness to molecule's "backbone" of alternating silicon and oxygen atoms (brown and gray). Outer carbon-hydrogen groups (red) impart ability to be made into rubber, oil, and resin.

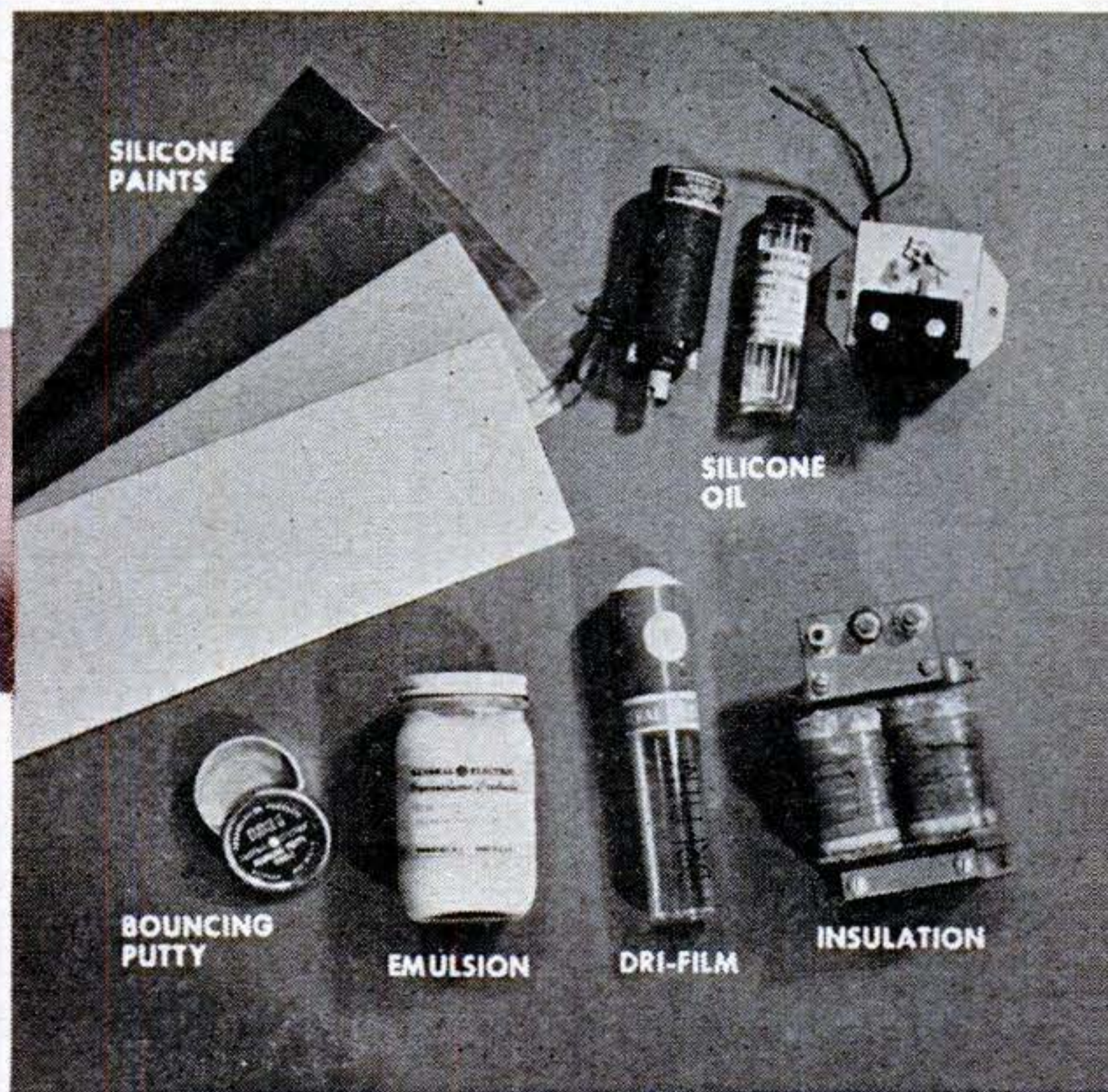

# How You'll Use The New Silicones

Hybrid chemicals that helped win the war now work wonders for golfers and housewives, fliers and motorists.

**By Dr. Dallas T. Hurd**

*Research Laboratory, General Electric Company*  
**and Alden P. Armagnac**

A WHOLE new family of synthetic chemicals, destined to make everyday life more pleasant and comfortable, is now making its debut before the general public. Called the silicones, these ultramodern products can help motorists, sportsmen, and plain John Jones.

Tissues impregnated with one of the new silicone chemicals come in a handy pack for polishing eyeglasses. They leave a transparent, invisible film upon the glass that keeps it magically free of dust and grease.

Golf balls whose cores contain a pellet of another silicone compound have just been placed on the market by a leading maker, the U. S. Rubber Company. Said to give greater distance and to have improved "click" and "feel," they take advantage of the exceptionally high elasticity of "bouncing putty," a laboratory curiosity for which

no use was known until recently. A ball of this white or pinkish substance bounces like rubber, yet can be stretched like taffy, and flattens out like a pancake if left standing on a table.

Bouncing putty's slow-flowing property was applied not long ago (PS, March '48, p. 109) to check any quivering motion of small coil springs embedded in it, in tiny attachments for furniture legs that keep tables and dressers from wobbling on an uneven floor.

Fishing line now is treated with a related compound to make it shed water, keep dry, and last longer. Dry flies for fishermen undergo the same process to make them more realistic.

An oil-like fluid of the silicone family that undergoes remarkably little change in viscosity while the thermometer goes from one extreme to the other serves motorists in a radically new type of vibration damper for the crankshaft of an automobile engine. This innovation is the product of the Houdaille-Hershey Corporation and has been adopted, in some of the latest production models, by Ford, Lincoln, Packard, and Mack International. 

**Examples of GE silicone products** and applications, at left, include "lifetime" paints now under development, all-temperature lubricating oil used in motor and timer shown, bouncing putty, mold-release emulsion, Dri-Film<sup>®</sup> water repellent, aircraft transformer with silicone-varnish insulation, and rubber that resists heat and cold.

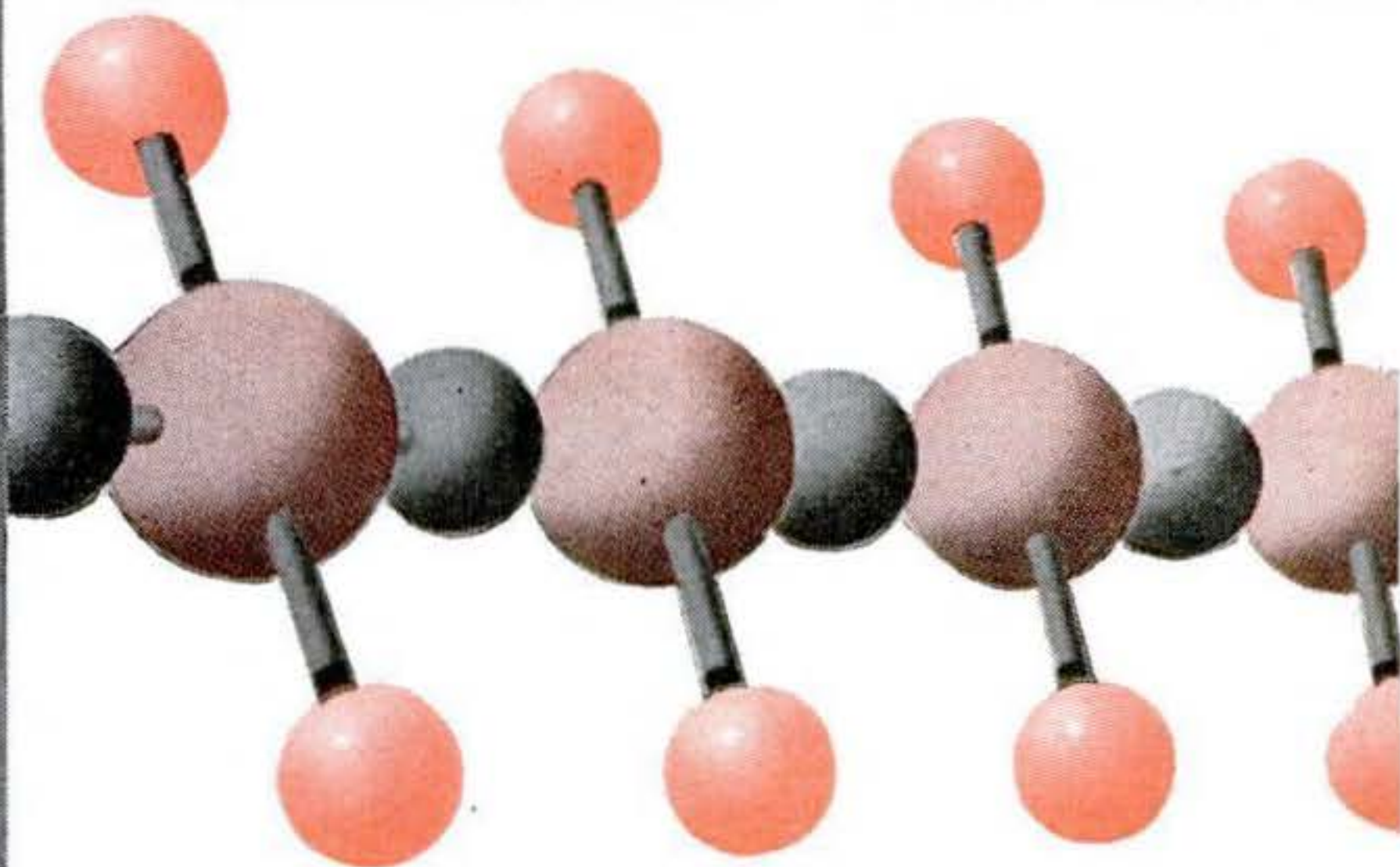
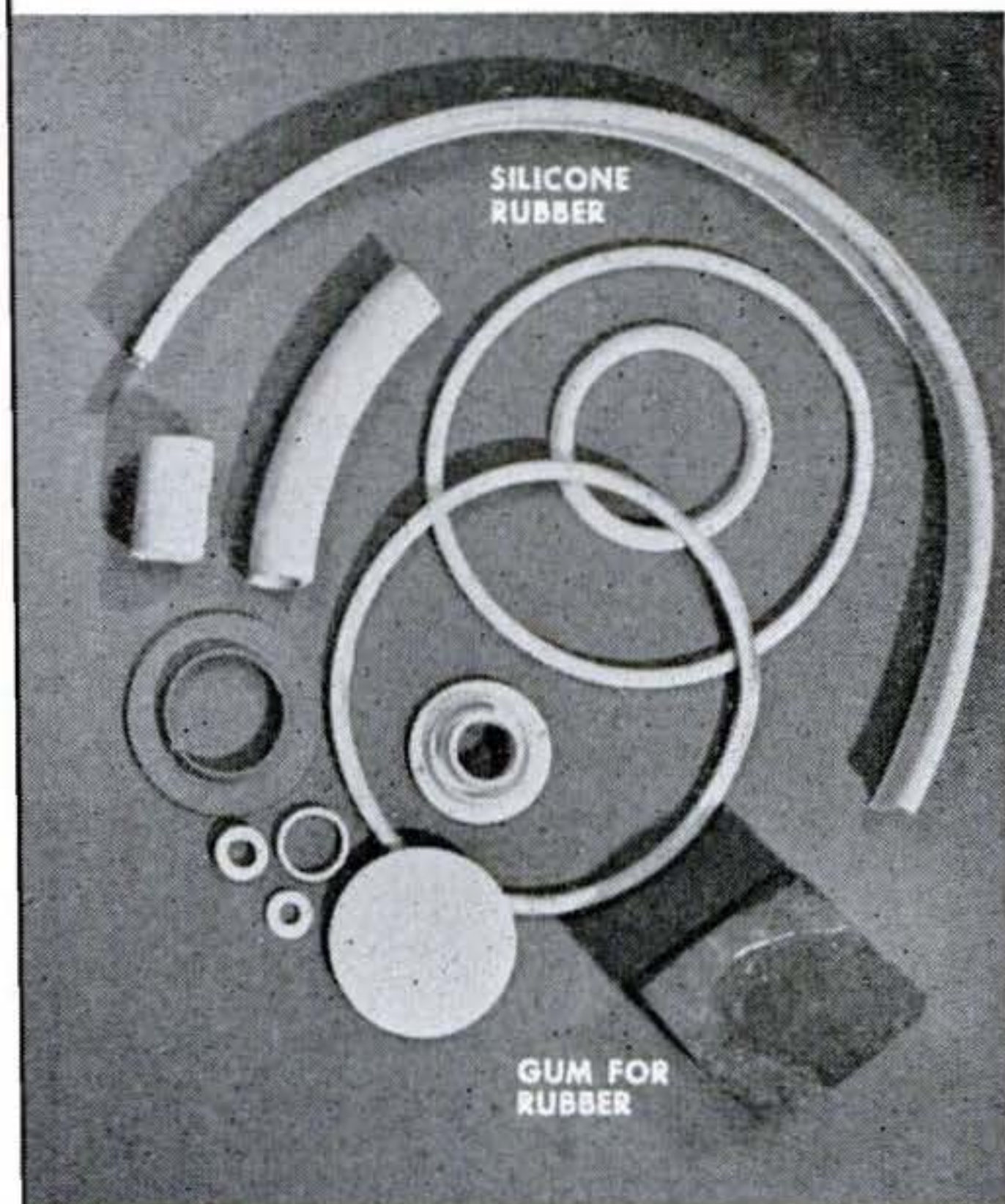

Silicones can be made into rubber, oil, grease, resin, and paint. They are chemical hybrids, made from sand, coke, salt, and petroleum, and they exhibit all the fascinating possibilities that spring from cross-breeding in the other natural kingdoms. They form a man-made link between the "inorganic" mineral compounds of the rocks, earth, and sand, and the "organic" carbon-containing compounds, many of which are commonly associated with vegetable and animal life. Sand is one of the principal raw materials of a silicone. Therefore the skeleton of a silicone molecule consists of the elements of which sand is made, alternating atoms of silicon and oxygen. It is this same silicone-oxygen "backbone" that gives natural silicate minerals, such as asbestos and mica, their heatproof qualities.

Outwardly, silicone molecules resemble those of hydrocarbons — hydrogen-carbon compounds, such as those of petroleum, which are built up on a skeleton composed of a row of carbon atoms. The silicones thus combine such desirable "inorganic" properties as resistance to heat with the characteristic ability of certain "organic" materials to be formed into rubber and plastics.

#### *First Used in World War II*

Long known in the laboratory, silicones first attracted attention during the last war. For lack of a heat-resistant material that would make a resilient gasket, the lenses of searchlights on Navy vessels were often shattered by the concussion of their heavy guns. Gaskets of silicone rubber, produced synthetically for the purpose by General Electric experts, solved the problem. The heat-resistant gaskets filled another vital need in superchargers for B-29 Superfortresses. Until the war ended, military uses monopolized the entire production of the new rubber and other silicone chemicals.

Since then, many of the most useful silicone products developed by the two leaders in the field, the General Electric Company and the Dow Corning Corporation, have been made available commercially. Because they are still relatively high-priced, industrial applications, where their properties are valuable enough to offset their cost, have preceded more general uses.

Supercharged Diesel-electric locomotives and powerful new radial motors for aircraft now make use of the heat-resistant gaskets of silicone rubber. De-icing equipment for plane wings, which uses hot dry air, may

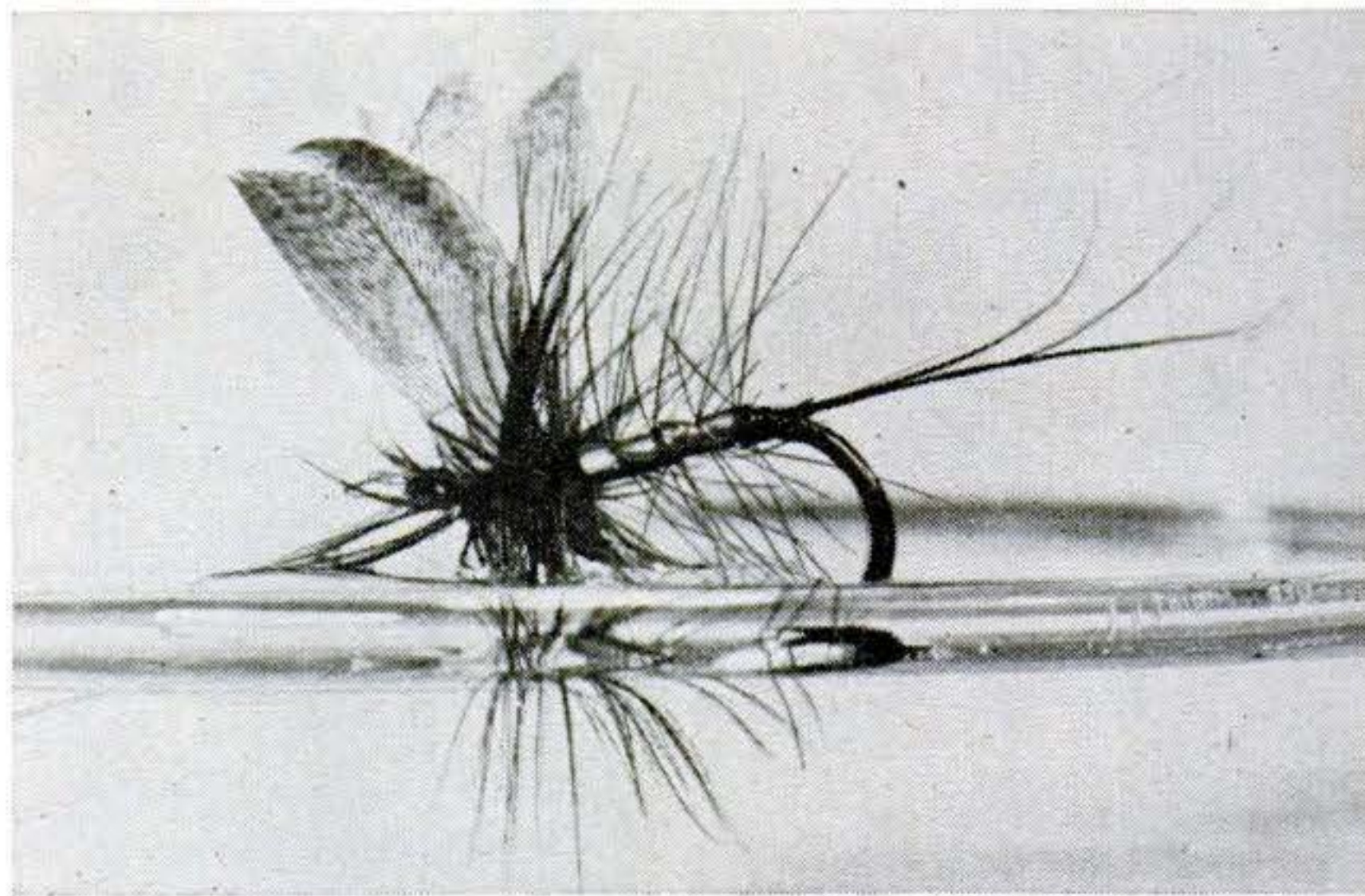

**Fisherman's dry fly** will always stay dry after a single 30-second dip in new water-repellent silicone dressing supplied for purpose, and eight hours' drying. Compound is a colorless liquid.

prove another useful place for the new material. Besides resisting heat, silicone rubber also remains flexible at temperatures so low as to make ordinary rubber stiff and brittle.

Silicone oils are water-white liquids, remarkable for the exceedingly small extent to which temperature changes affect them. A drop in temperature from 100° F. to zero increases the thickness or viscosity of typical petroleum oil 110 times; of a silicone oil, only four times. Functioning perfectly in heat or cold, silicone oils lubricate electric motors exposed to extremes of temperature, and serve in hydraulic airplane-control systems. A new type of landing gear for aircraft, developed in Great Britain, derives its spring action from another extraordinary property of silicone oil — its "give." Compared to water and most liquids, it is highly compressible.

Quite possibly the last tire you bought for your car was made with the help of silicone oil. Mixed with water, it forms an emulsion now widely used by tire makers as a "mold-release agent." In molding a tire, an inflated rubber bag forces the casing against an outer mold of steel. The silicone-oil emulsion lubricates both parts of the mold, preventing the tire from sticking to either when it is removed.

Silicone resin approaches the ideal in electrical insulation. Motors using it can run at high temperature without damage. Fire hazard due to overload is eliminated. Small motors and transformers will deliver as much power as much larger and heavier ones formerly did. A standard five-kilowatt airplane transformer that delivers power for



**Lively golf ball** uses pea-sized pellet of bouncing putty in rubber core (left). Wrapped in rubber thread, core rests in half of balata cover (center). Cover is then vulcanized (right).

landing lights, electrically heated flying suits, and other purposes formerly weighed 110 pounds. Insulated with silicone varnish, the same transformer weighs only 12 pounds.

New applications are being discovered almost daily for a moisture repellent—the GE product has been named Dri-Film<sup>®</sup>—of which one form is a silicone and others are by-products of making silicones. When one of these liquids is applied to ceramics, paper, textiles, plastics, or glass, the surface receives an invisible submicroscopic coating that sheds water completely. One of its first applications was to safeguard the filter paper in gas masks against moisture. Now it repels water from airplane and boat windshields. On insulators and other parts it prevents moisture from interfering with the operation of radio equipment. Fabrics treated with it are unaffected in appearance and “feel.” It does not close their pores, nor is it removed by repeated laundering. Yet, as General Electric experimenters proved in a test, water rolls right off a suit of clothes treated with Dri-Film<sup>®</sup>. They just don’t get wet.

When larger-scale production and improved methods of manufacture lower the cost of silicones so that the general public can share in more of these developments, the results will be far-reaching.

Hats, suits, and dresses may receive the benefit of Dri-Film<sup>®</sup> treatment against rain. Silicone insulation may improve household motors, as in washing machines, and produce better toasters, waffle irons, and electric blankets.



**Eyeglasses stay clean** longer after being polished with one of these silicone-impregnated tissues. Compound leaves a transparent, invisible film that repels dust, grease, and fingerprints.

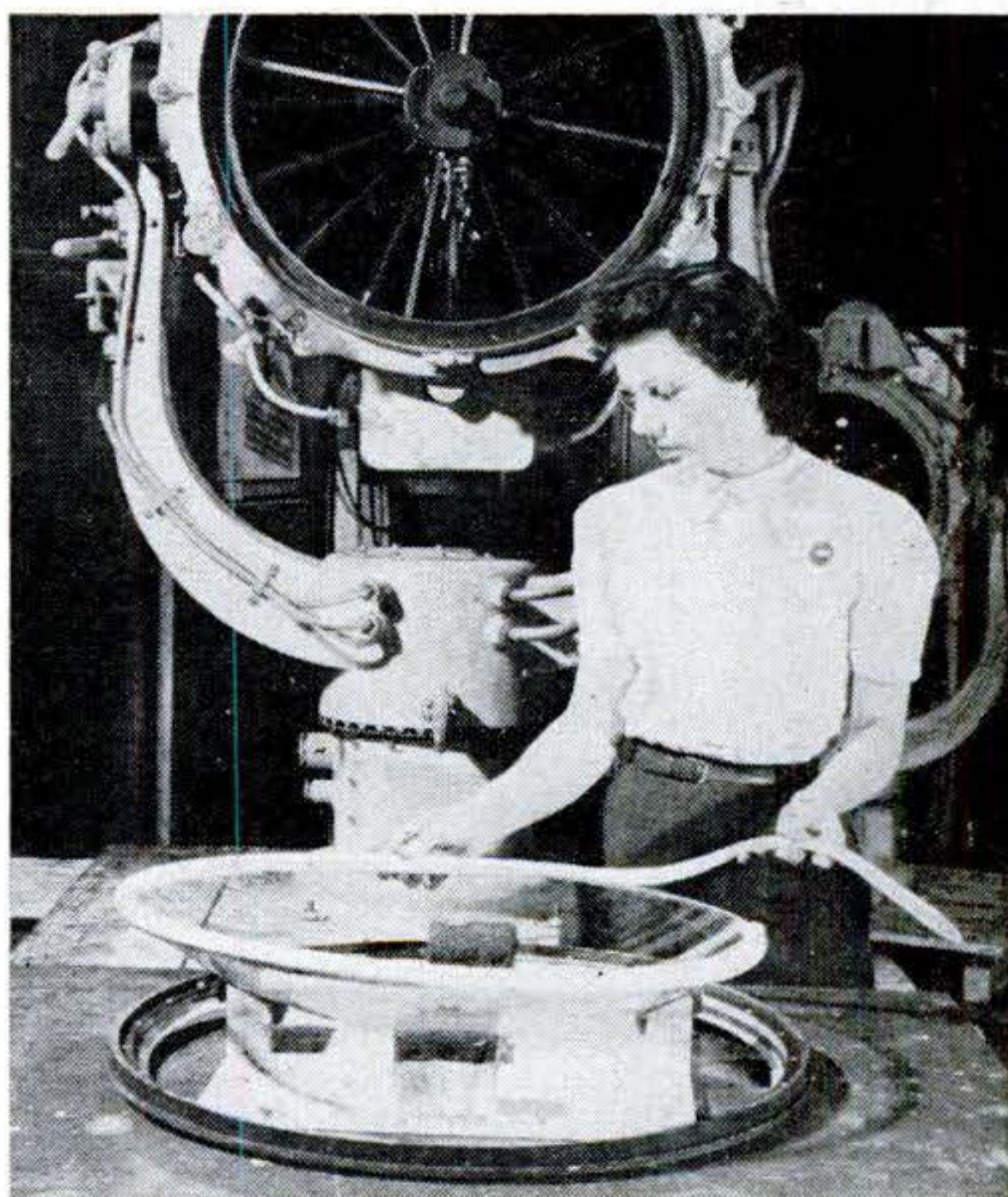

**Navy searchlight** gets gasket of heat-resisting silicone rubber. Entire output of silicones went to armed forces during World War II. Now they have become available to general public.

Another prospect for the near future, now under active development, may prove one of the most interesting of all. Paints and enamels in all the colors of the rainbow, as well as black and white, will be made from silicone resin combined with suitable pigments and solvents. Baked on steel at high temperature, they will yield virtually indestructible coatings.

Given a coat of the new silicone paint at the factory, your car will have a lifetime finish. Even a delicate pastel shade will

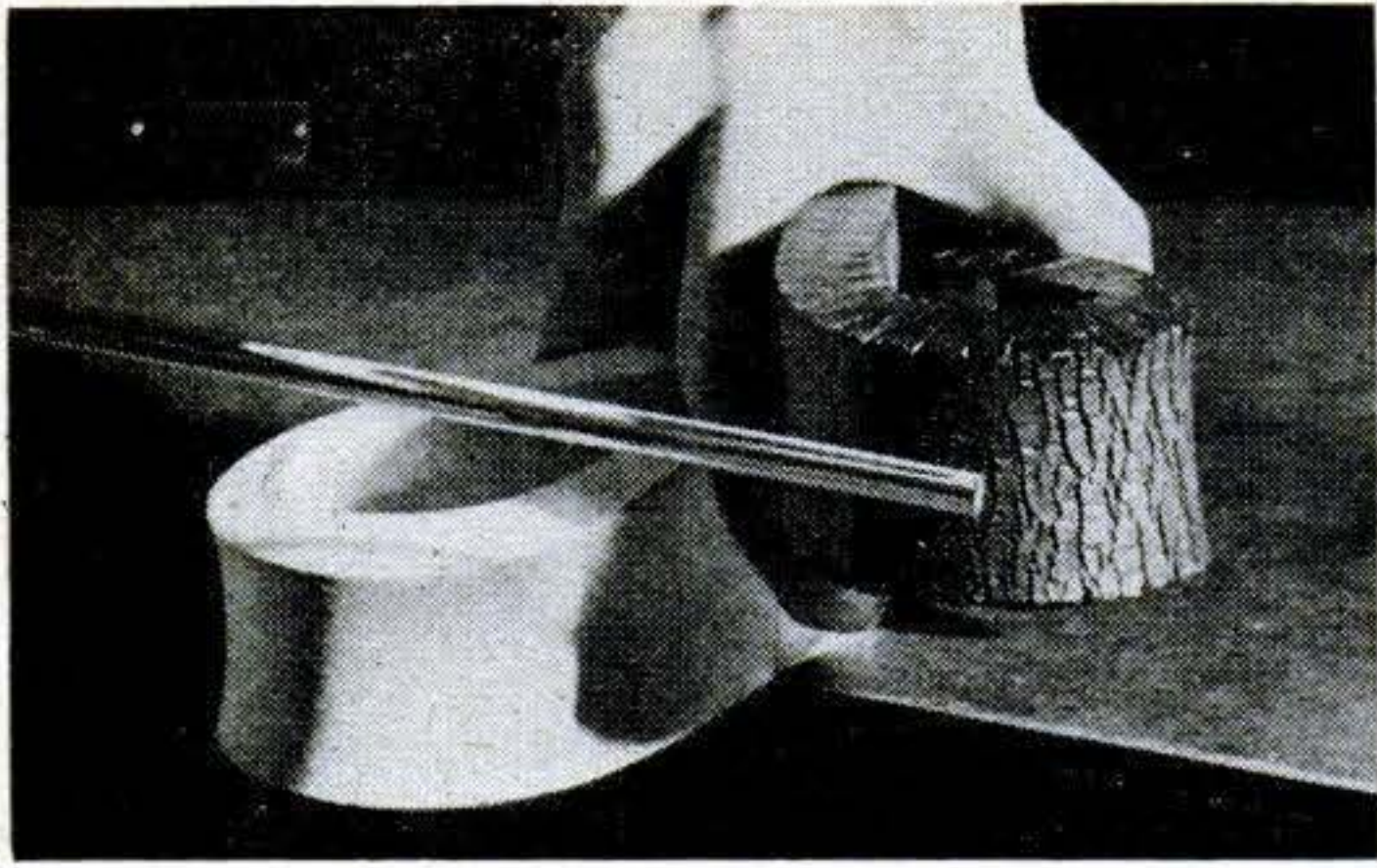

**Heat test** of 24 hours at 350° F. leaves silicone rubber, left, flexible and unaffected. Sample of natural rubber at right, which underwent same test, deteriorated and cracked as shown.

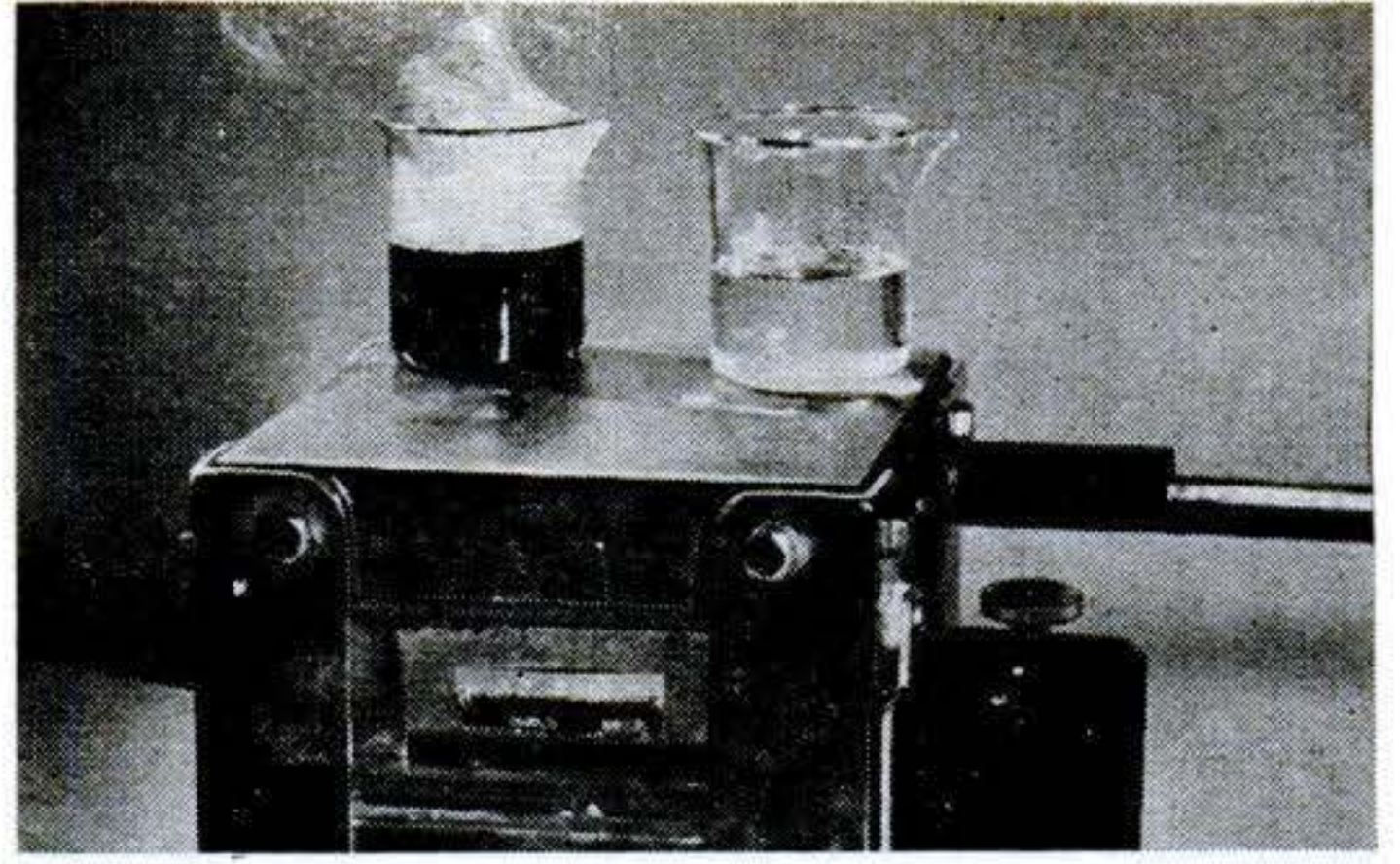

**Silicone oil** at right resists heat and remains clear in comparative test on hot plate. Petroleum oil, left, is decomposing, as shown by darkening and by smoke rising from liquid.

retain its original color and gloss through year after year of exposure to the sun and elements without fading or suffering damage in any way. Since the car will wear out before the paint job does, a wit remarks, we may look forward to beautiful junk yards.

A similar finish for your kitchen range, refrigerator, and washing machine will be superior in many ways to vitreous enamel. It will not crack or flake, and it will resist

discoloration by hot greases, fruit juices, iodine, and other common sources of household stains. In laboratory tests it has proved impervious to some of the most powerful of corrosive chemicals. It also eliminates waste in manufacture due to rejection of products on which vitreous enamel has chipped, an important consideration that may help to offset its higher cost and expedite its introduction to the public. **END**

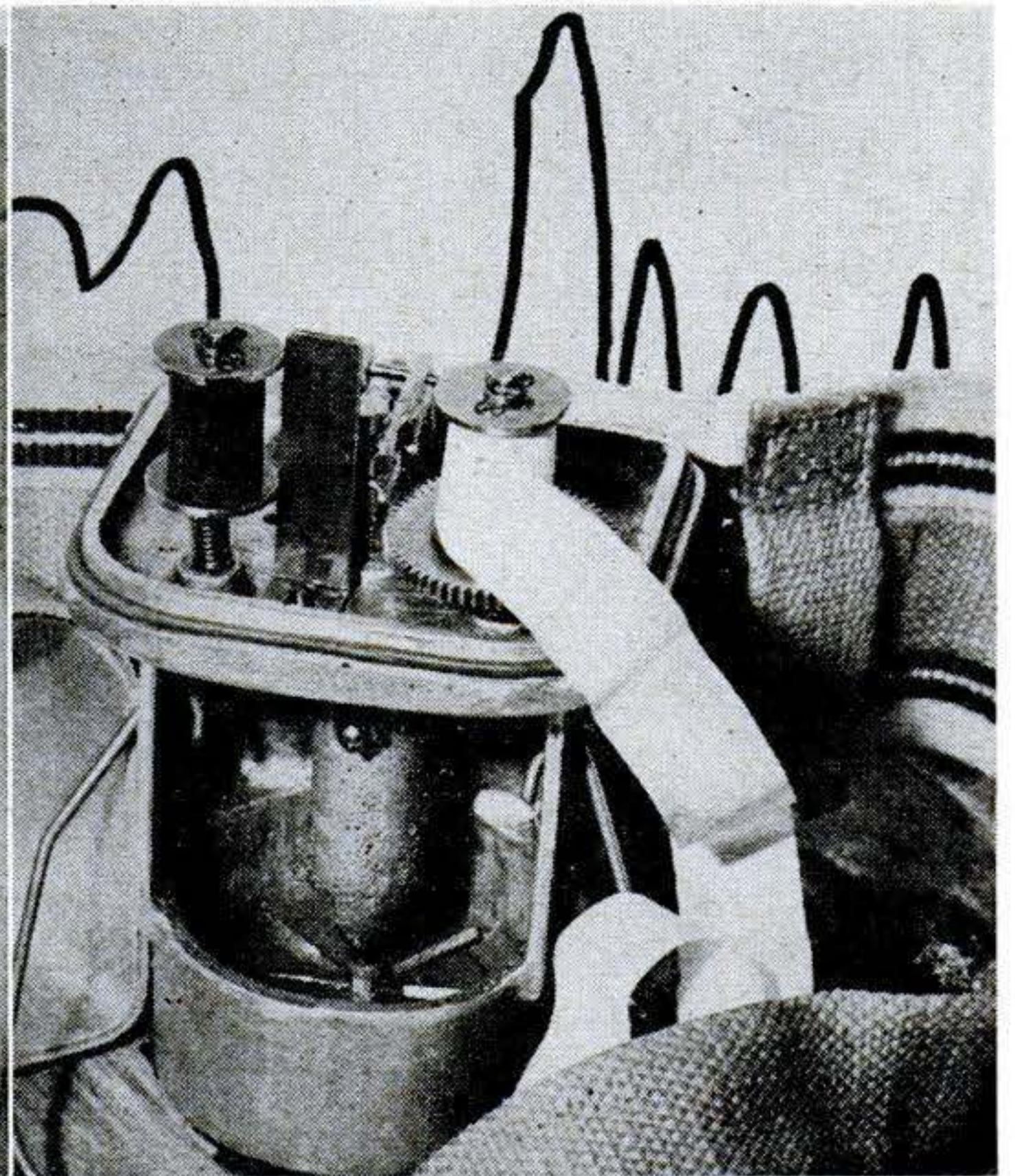
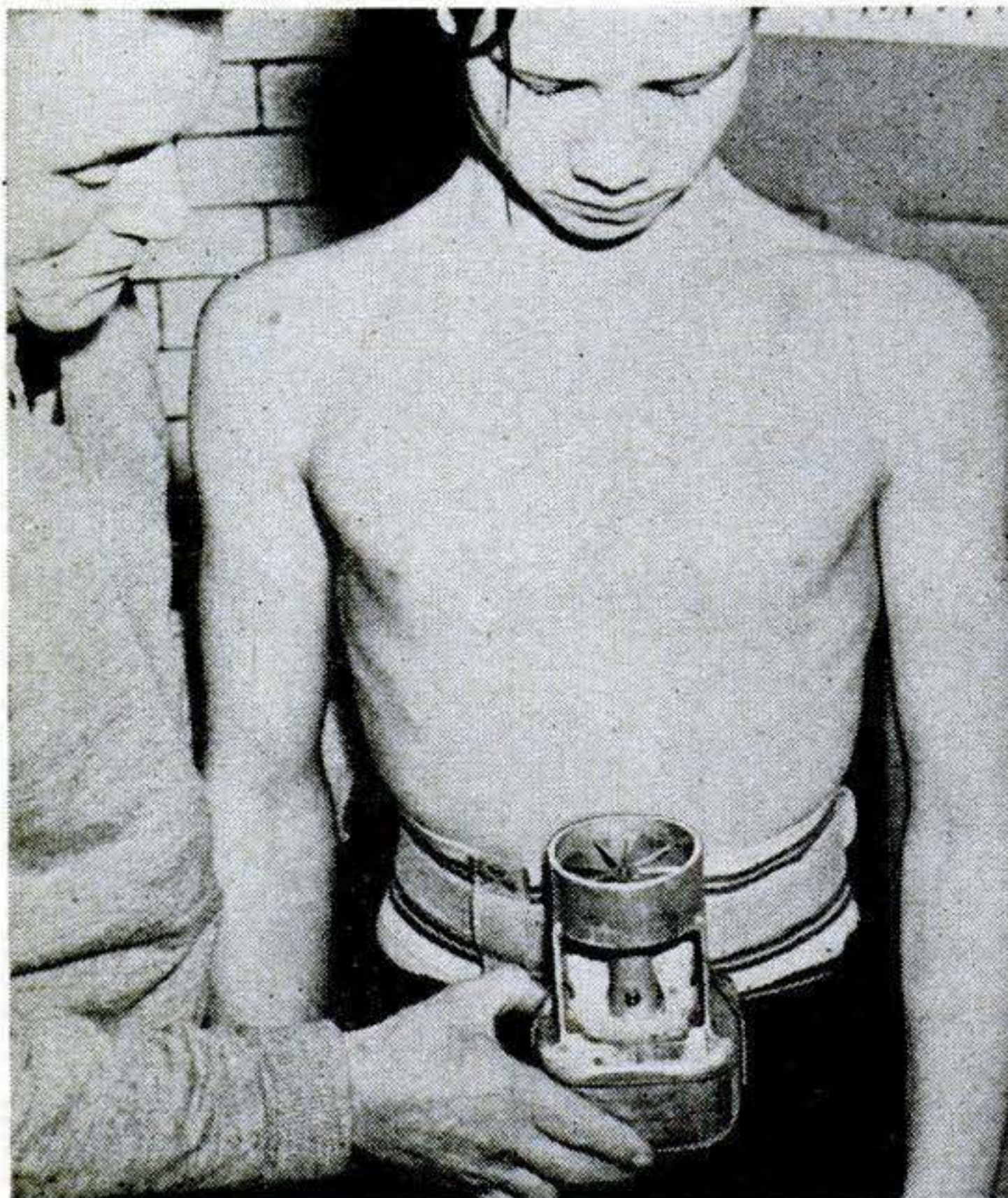

## Meter Aids Swimmers

How well do you swim? Strapped to a bather's waist, the novel recording instrument above graphically tells the story. Rotating as it passes through water, a fanlike

element actuates a pencil that registers the swimmer's speed and the power of his stroke upon a moving paper chart. The device opens as above for inspection of its record, which enables an instructor to detect and correct a novice's faults.



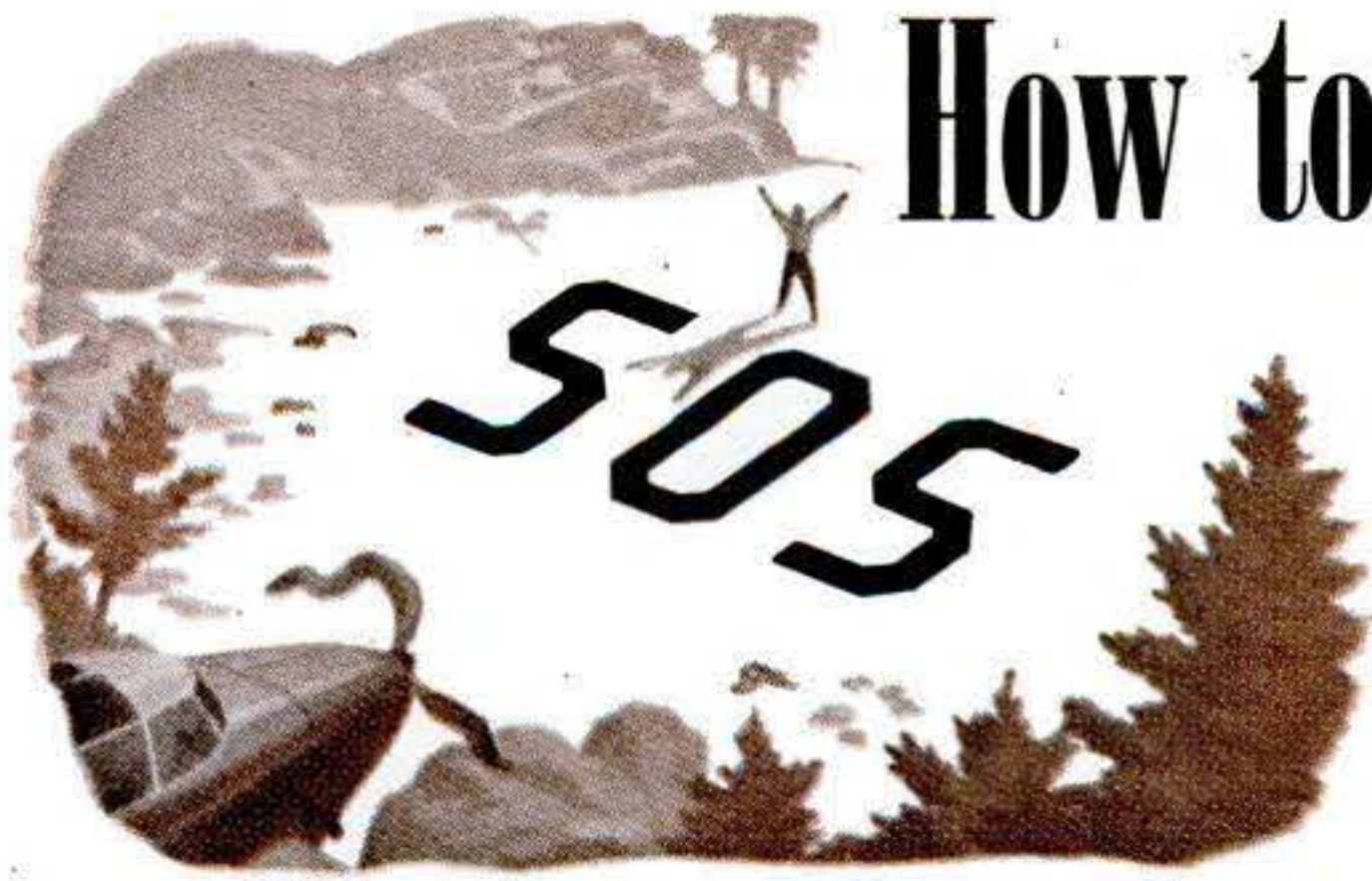

# How to Talk to An Airplane

**D**OWNED airmen, snowbound trappers, isolated communities—anyone in distress can use these 19 symbols to ask a passing plane for help. They are the official ground-to-air emergency code recently adopted by the Civil Aeronautics Administration. Used in wartime signaling, the symbols can be trampled in snow or laid out with cloth, wood, stones, or anything else that gives a clearly visible color contrast.

**Basic signal** is still time-tried SOS. All symbols should be at least 10 feet high, and can be supplemented by flares or smoke to attract notice. Pilot acknowledges by rocking wings.

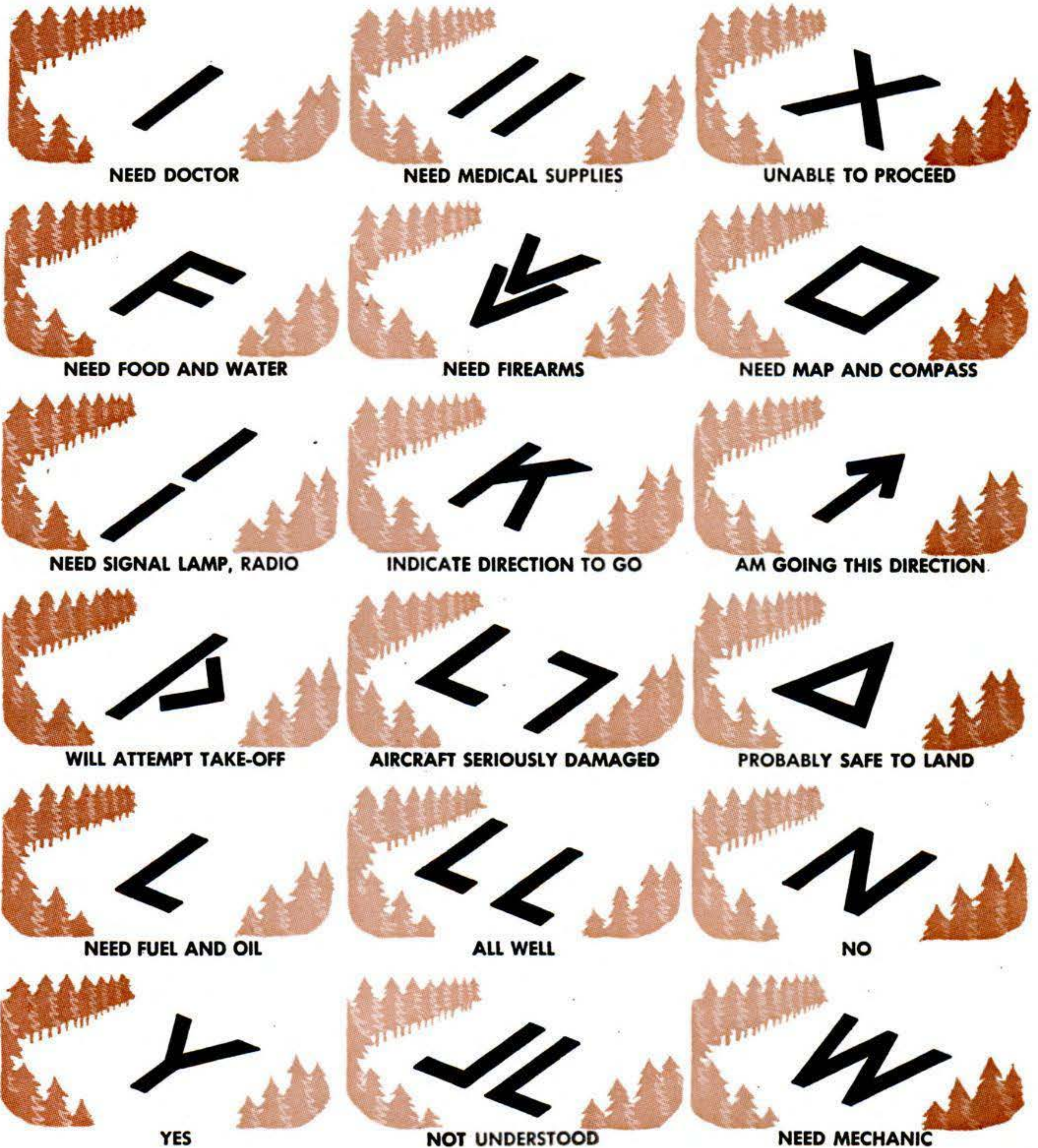

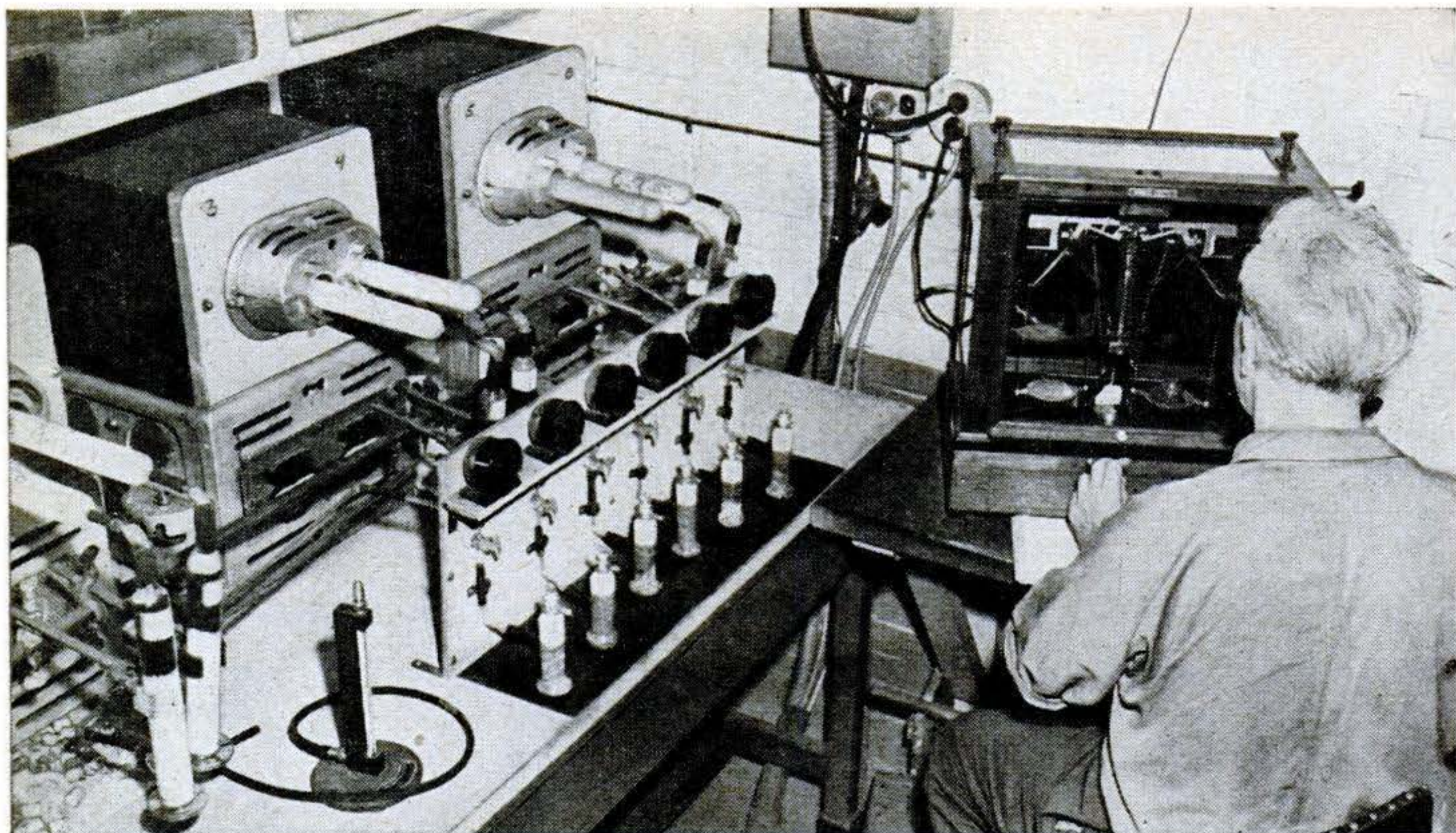

## Steel Samples Studied

A FASTER and better method of checking the carbon content of steel has been developed by the Carnegie-Illinois Steel Corp. Three electric furnaces, shown at left, above, each have two silica tubes so that six samples can be tested at the same time. Placed

in the tubes, the samples are subjected to a heat of 2,012° F. Dry oxygen is injected and combines with the hot steel to form carbon dioxide, which is absorbed by the six small bottles seen in middle foreground. The bottles are then weighed in the scale shown at right, giving a basis for calculating carbon content of the samples.



## Blow, Pedestrian, Blow

MUCH has been written about careless driving and traffic hazards in Los Angeles, but Hilton Tupman, of that city, has done something about it. Carrying his six-pound pedestrian horn, shown above, he honks his way across streets, warning over-eager motorists that even the lowly foot-traveler has some rights. The tank holds air under pressure of 500 lb. A trigger release under the handle sounds it off, good and loud.



## Mask Heats Face

WITH this electric mask you can relax while heat therapy is applied to your face. A product of Progressive Enterprises, of Los Angeles, the mask is intended to relieve sinus pain, and for use where heat is prescribed for head colds, facial neuralgia, and migraine headaches. Made to fit the contours of the face, it weighs only two ounces. Heat is controlled and may be localized to any desired area of the face.



For easy grass cutting, a simple conversion job turns a Bolens garden tractor into a reel-type power mower.

# Iron Donkeys

*can save  
your back*

Lots of people with a little land are shopping for garden tractors.

Here's what these outdoor machine tools will—and won't—do for you.

**By Ladd Haystead**

FROM Tom Sawyer to Victory Gardens, back-yard and suburban farming has been a story of burning blisters and screaming sacroiliacs. Yet from around 1915 garden tractors have been in the country, although in a minor way. Now they're moving into the suburbs.

In bygone years, most of them went to commercial truck gardeners, for amateurs found them too expensive and often unsatisfactory. But the sales of garden tractors jumped from an average of about 8,000 a year before the war to a whopping 165,000

estimated in 1947. And this year may see last year's record passed, with householders the big buyers.

No one has come up with a survey showing precisely why this sudden popularity. But for one thing, many of the "bugs" have been ironed out of the motorized hoes. And for another, their usefulness has been widely expanded by the development of new attachments. Moreover, in this day of high prices for everything the first cost of a garden tractor doesn't seem so far out of line when refrigerators and console radios sell for about the same price.

Today, almost every suburban hardware

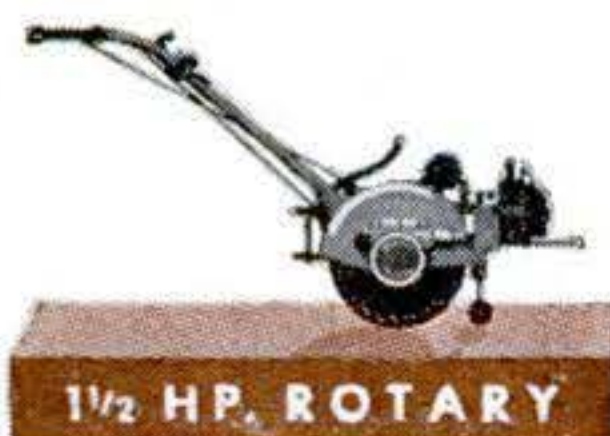
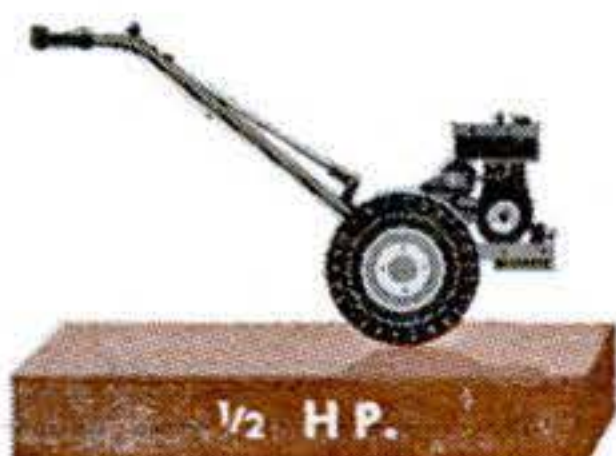

These are the four basic garden-type tractors, starting with the beginner's baby at the left. Next comes the all-purpose rotary, then the larger straight tractor, and finally the smallest

riding tractor. Power units run from around \$150 to well over \$700; attachments, from a simple spade-type cultivator to a power field mower, run from a few dollars to about \$200.



**Bready Garden Tractor**

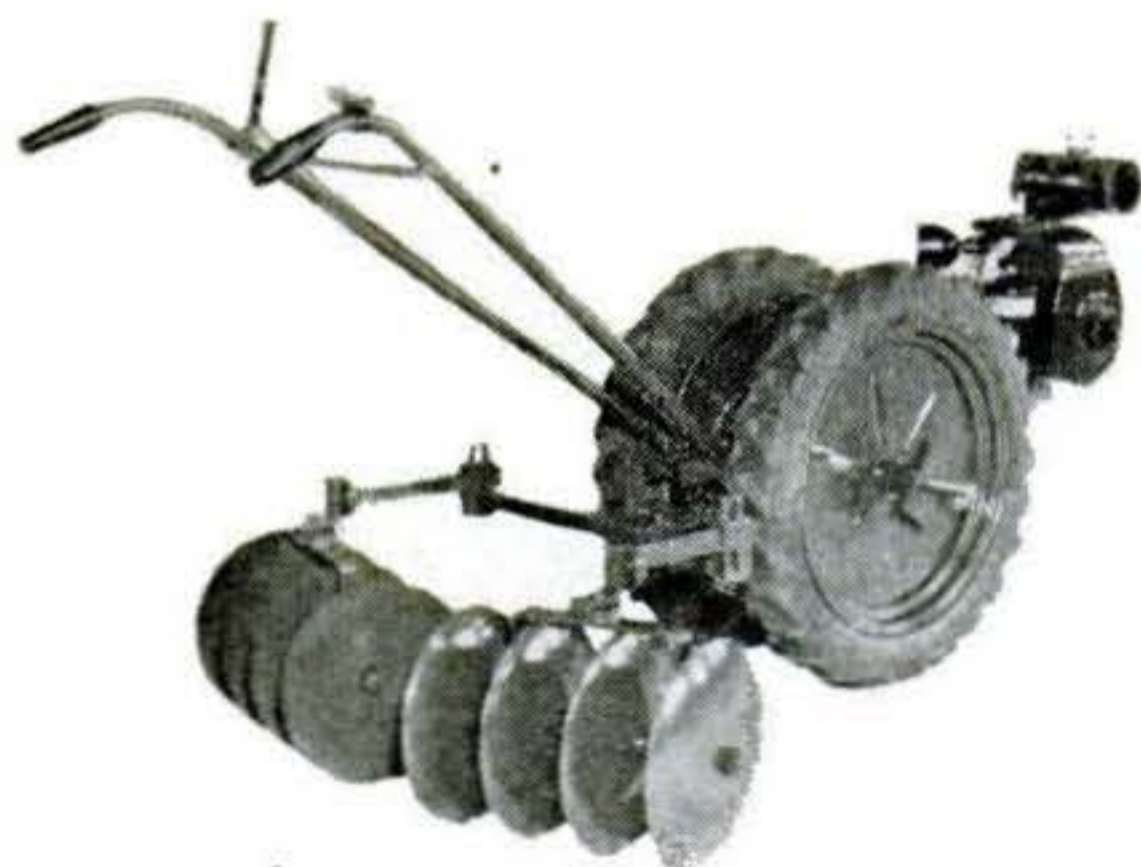

**Cunningham with disk**



**Page Tractor**

**Most 1½-hp. tractors** are similar, but manufacturers try to give extras, such as the lights shown on the Page model above, and the Cunningham's two-gang disk that gives both lateral and swivel adjustment. All types, however, present the same maintenance problems as their big brothers. Working surfaces must be cleaned and rust-proofed before being laid up for the season. The equipment doesn't wear out; it rusts out. Carburetor and gas lines should be drained when the machine is out of use for more than 30 days; otherwise "gum" will form, choking the feed lines. The oil level must be watched closely after the first season, particularly if the machine is operated continuously for several hours. It is easy to consume the entire supply and burn out all the bearings.

**SIX-INCH PLOW . . . \$30.25**

The Planet Jr. Garden Tractor and family of tools. The 1½-hp. tractor (center) with a 6-tooth cultivator, is quoted at \$190.50, f.o.b. Philadelphia. The complete line of priced attachments adds \$251.05 to the cost.

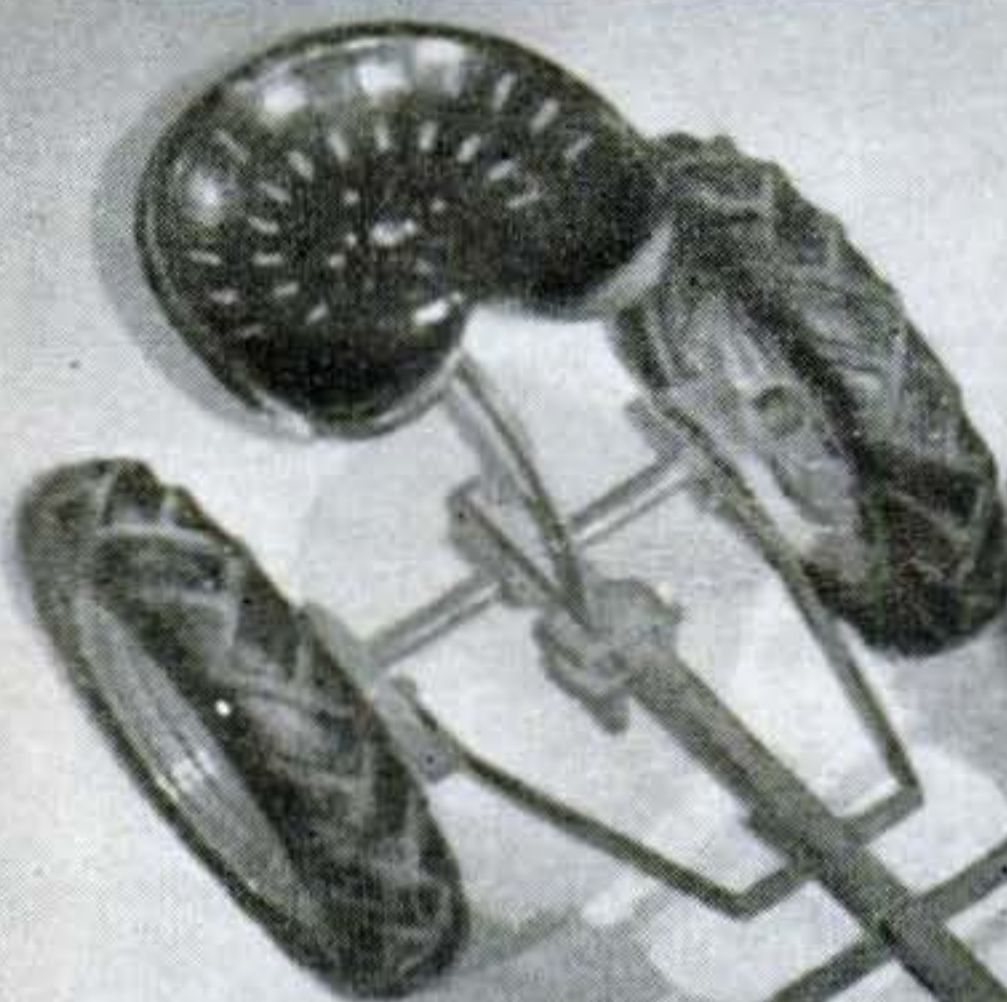

**SULKY . . . UNPRICED**

**HEAVY-DUTY CULTIVATOR . . . \$10.30**

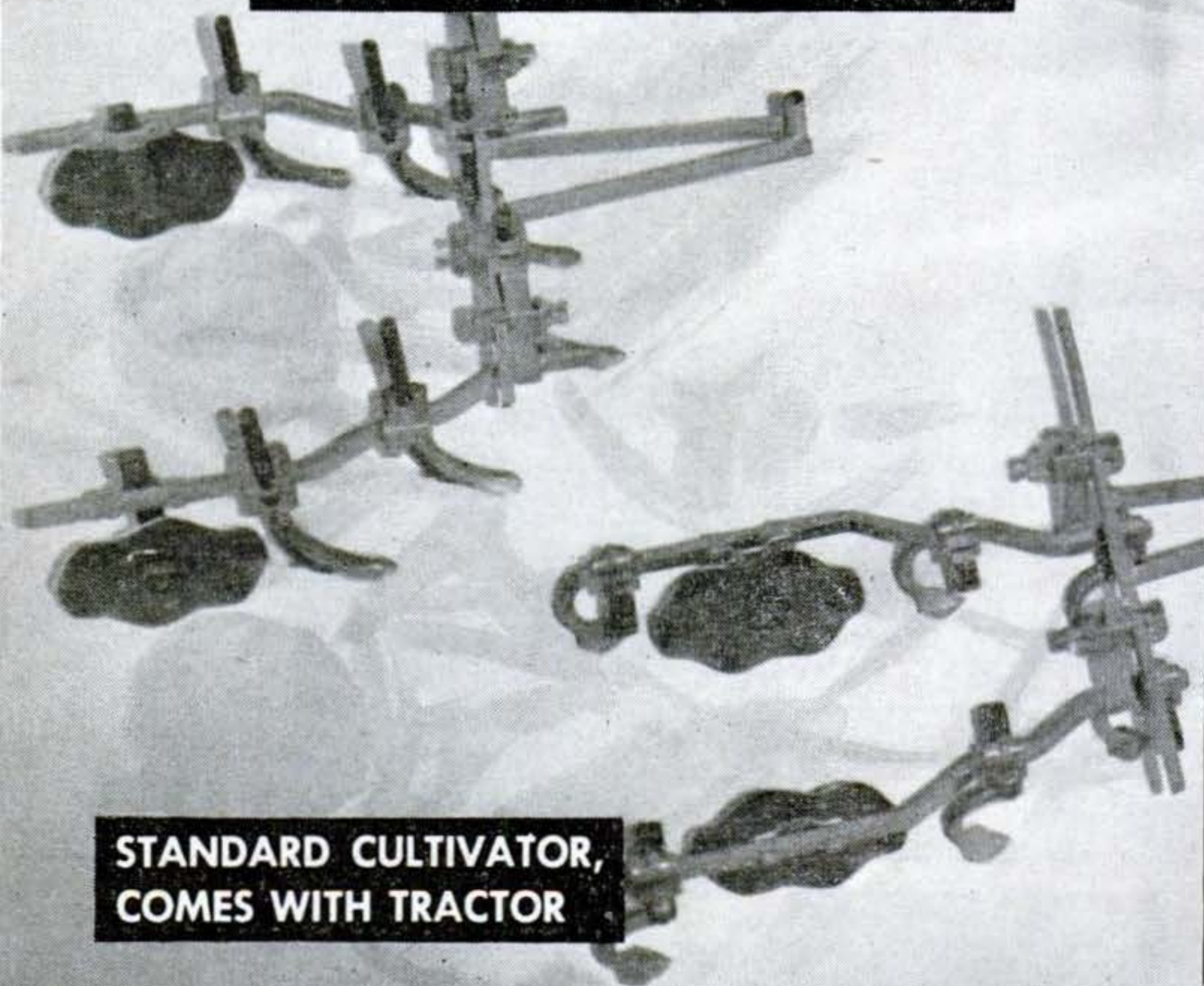

**STANDARD CULTIVATOR, COMES WITH TRACTOR**



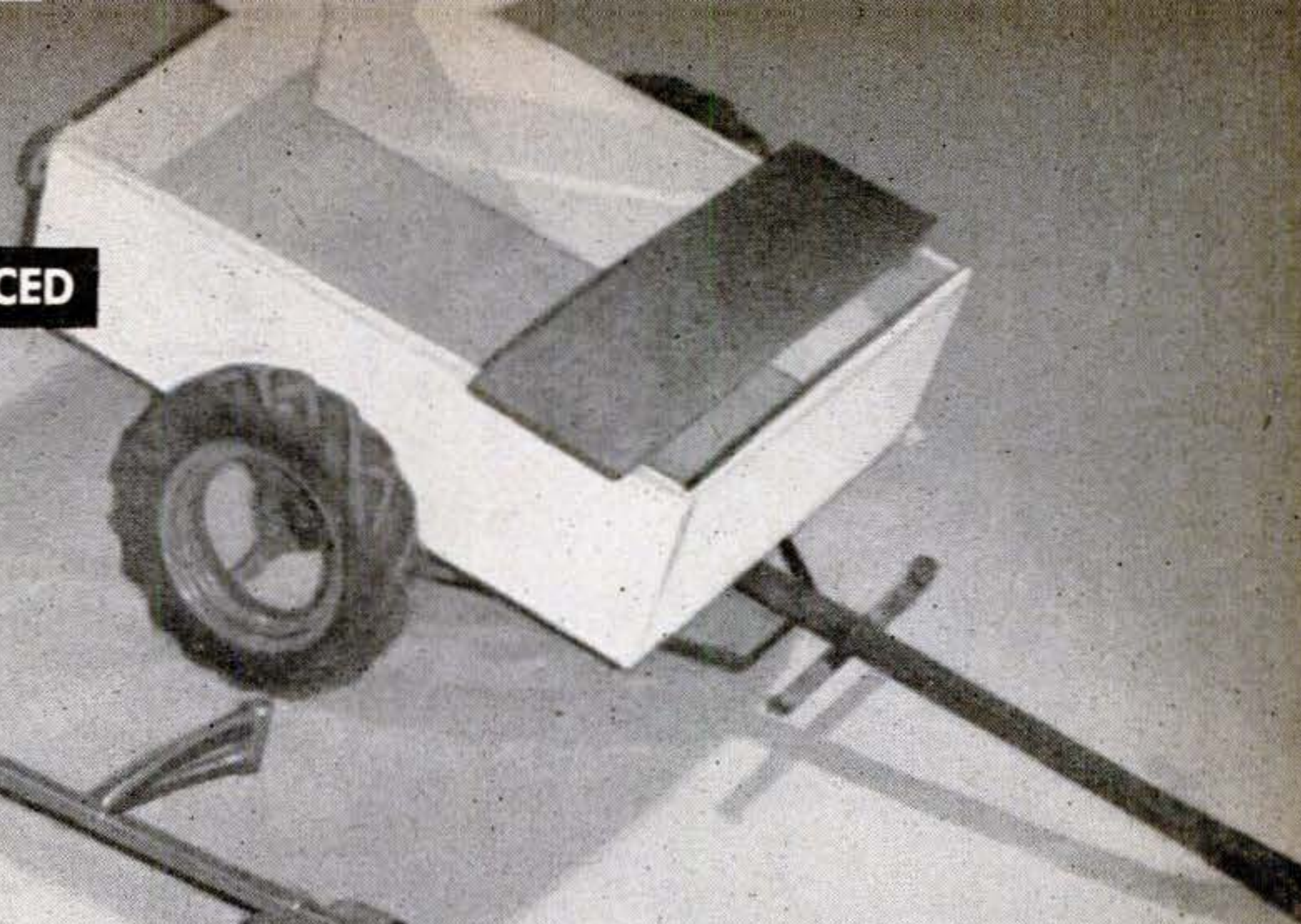

**TRAILER . . . UNPRICED**



**TWO-ROW SEEDER . . . \$64.85**



**SNOWPLOW . . . \$36.00**



**DISK HARROW . . . \$35.80**



**FIELD MOWER . . . \$73.85**

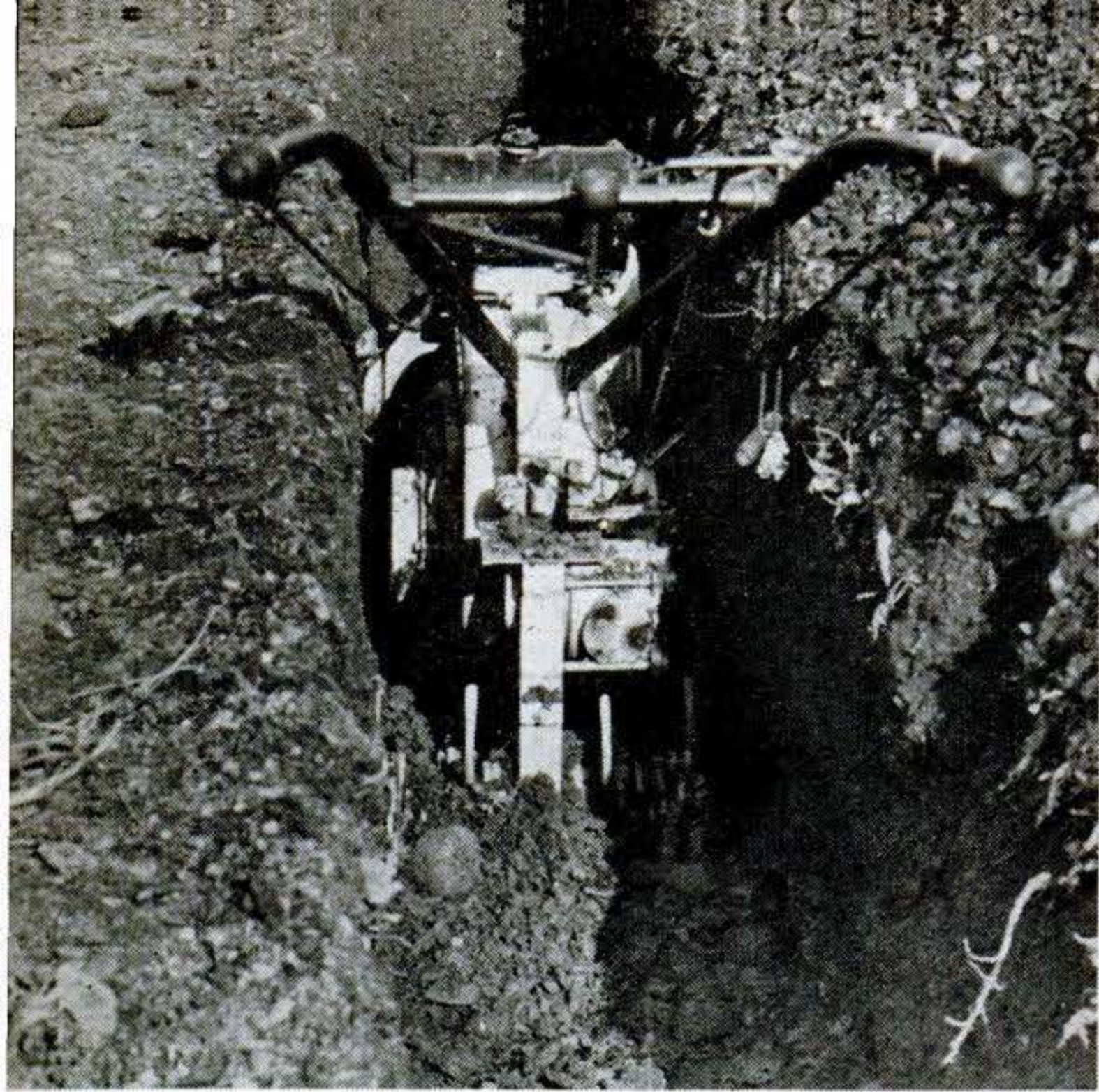

With the Roto-ette<sup>®</sup>, a small rotary tiller, you can dig a 3½-foot trench by running the machine over the ground, shoveling out the soil, and then repeating the process. Price is \$360.



Spinning saws of Roto-ette<sup>®</sup> field mower, shown in foreground above, cut weeds and small trees; the revolving dunce caps throw the cut material out at side. Mower attachment: \$160.

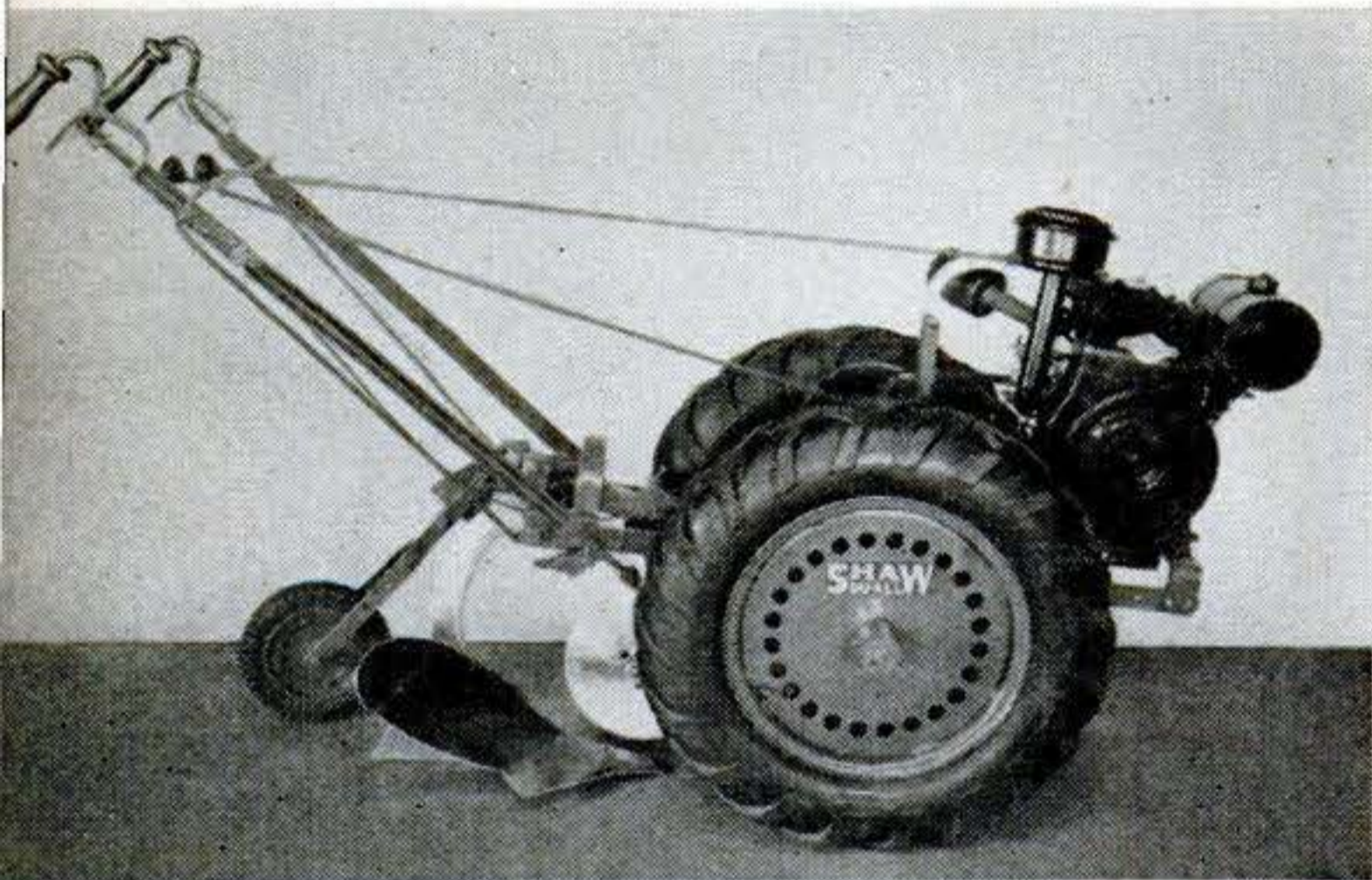

The Shaw Du-All<sup>®</sup>, equipped with light plow, rolling colter (sharp-edged, rotating steel disk), and rubber following wheel, is popular with both commercial gardeners and suburbanites.

Rotary tillers operate at a comfortable walking speed. The Milwaukee Equipment Co. model, shown below, is similar in capacity and operation to other rotary machines in the field.



and implement store displays the little walking machines and the large family of attachments that go with them. Suburbia's twilight calm everywhere is now punctuated with the *put-put* of a "horse-and-half" at work. And if ingenuity has anything to do with it, the manufacturers intend to hold and expand the new interest by finding even more chores for the willing little iron donkeys to perform.

The story of a potential power gardener goes something like this. In the late winter or early spring, he goes to his seed or hardware store to buy some seeds, rotenone, a new hoe and sickle. When he comes to the two last items, he winces with aching memories. Idly, he tells the clerk that he supposes a garden tractor costs a lot. The clerk assures him this isn't so. Only around \$150, he says, and "it will last you a lifetime."

#### Plowing Still a Problem

More questions and answers, more memories of blisters and backaches, and a deal is turned. Only the buyer finds that what with cultivators and a hiller the price is around \$200. But when he gets his purchase home, he remembers it will do him little good until his garden plot is plowed. He returns to the store to buy a plow attachment, but the clerk is not so enthusiastic over this idea. Yes, he will sell a tiny seven-inch plow, but actually the gardener will find it better to hire somebody with a larger

machine to do his basic ground preparation.

The gardener then learns that plow sizes, given in widths, by a rough conversion have a ground penetration of about one half their rating. In other words, the seven-inch plow that a small garden tractor will pull only works the soil three to four inches, while the instructions on the seed packet direct a seedbed six to eight inches deep. Somewhat disappointed, the gardener comforts himself with the thought that the hard job is not the seedbed preparation but the long weeks of cultivation, which his unit will do adequately.

About the time the first cultivation is done, the lawn needs trimming. As long as he has the power unit, why not hitch a mower on it? So he goes back to the store and comes away with either a reel-type or a cutter-bar attachment to take the blisters out of mowing. The ordinary hopper doesn't work so well if the mower is pulled behind. It fills too fast and gets in the operator's way. If the mower is on the front, there is nothing he can do but let the grass fall and rake it afterward.

#### *A Trailer Is Added*

Another trip to the store gives our suburbanite a lawn-sweeper attachment that not only will handle the grass but leaves and other trash as well. Disposing of that trash is a headache, but the last time the gardener passed his store they were showing a little trailer that could be hooked onto the power unit. And adding more persuasion to the argument, the trailer had a board across it so that the operator could sit down as he drove around. The trailer joins the growing family in the garage.

Now winter has come and snowplows to attach to the tractor are featured by the store. Another ache to be avoided—and another purchase is made. By this time, the gardener finds the original \$150 investment has rattled past the \$400 mark and shows no sign of stopping. He feels it is time to sit down and see what he has got for his money.

The cultivator works pretty well. Only trouble is, he finds *he* has to keep up with a machine that doesn't get tired. He wishes he could ride, instead of having the thing drag him all over the place. And he feels that if it is to do a good tilling job and keep down cloddiness, he will have to buy a disk come spring. In a catalogue, he has seen a riding-roller attachment that will enable him to sit down while he works the

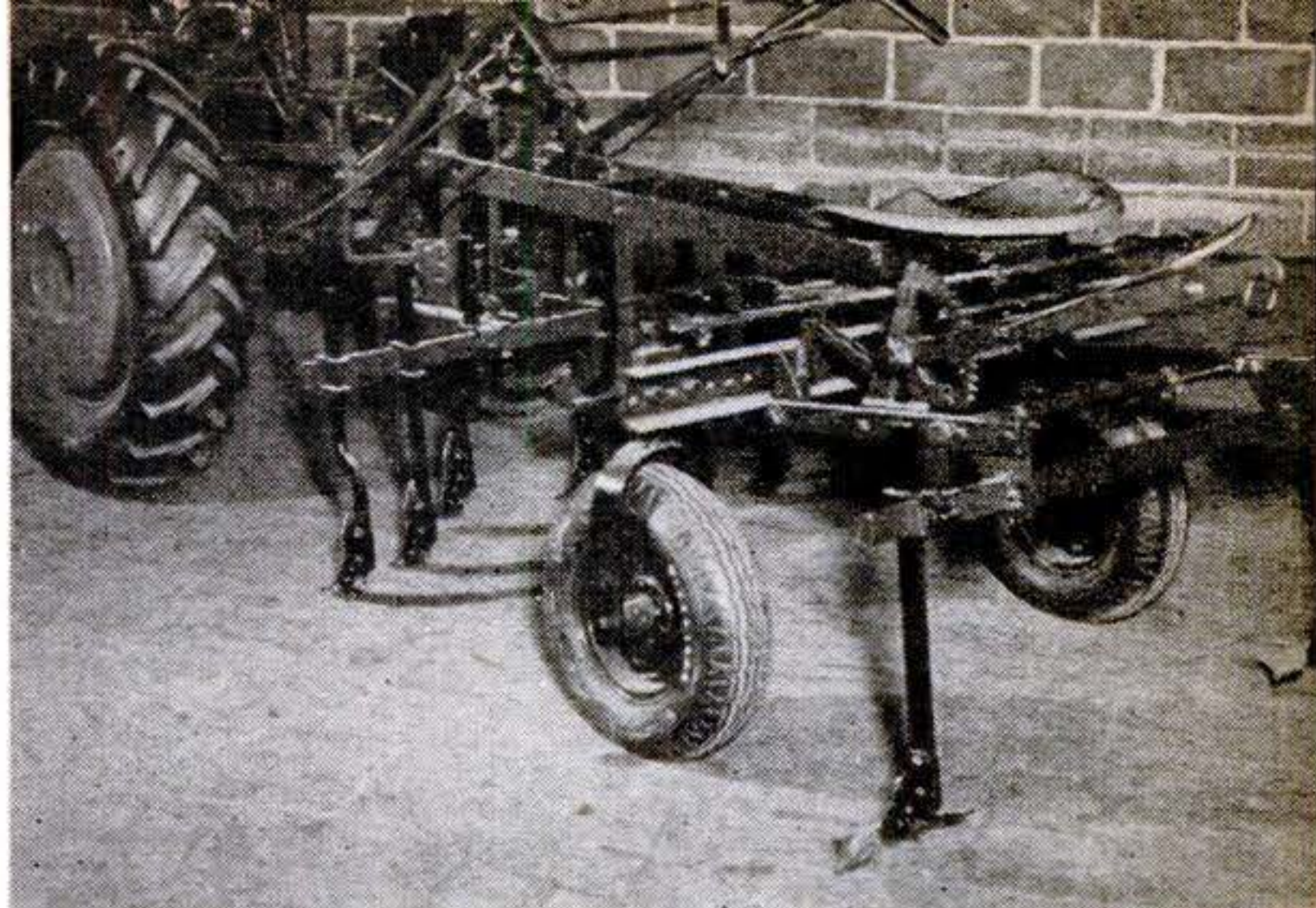

This 5-hp. Standard Twin convertible riding and walking tractor is rarely listed as a power unit alone. Equipped with sulky and cultivator, cost is around \$600; with tools, \$1,000.



Ariens rotary garden tractor (above) is a competitor of the Roto-ette<sup>®</sup>, shown on opposite page. It uses spinning rotor and hooked teeth to plow, disk, and harrow in one operation.



With 42-inch sickle-bar mower attachment, the Gravely 5-hp. tractor works in heavy growth. This machine has plenty of power in terrain where a smaller 1½-hp. job would have trouble.



**The Farmall Cub**® is International Harvester's garden variety entry. It's a regular farm tractor except for its low 8 hp. With attachments, it will handle all field and garden operations.

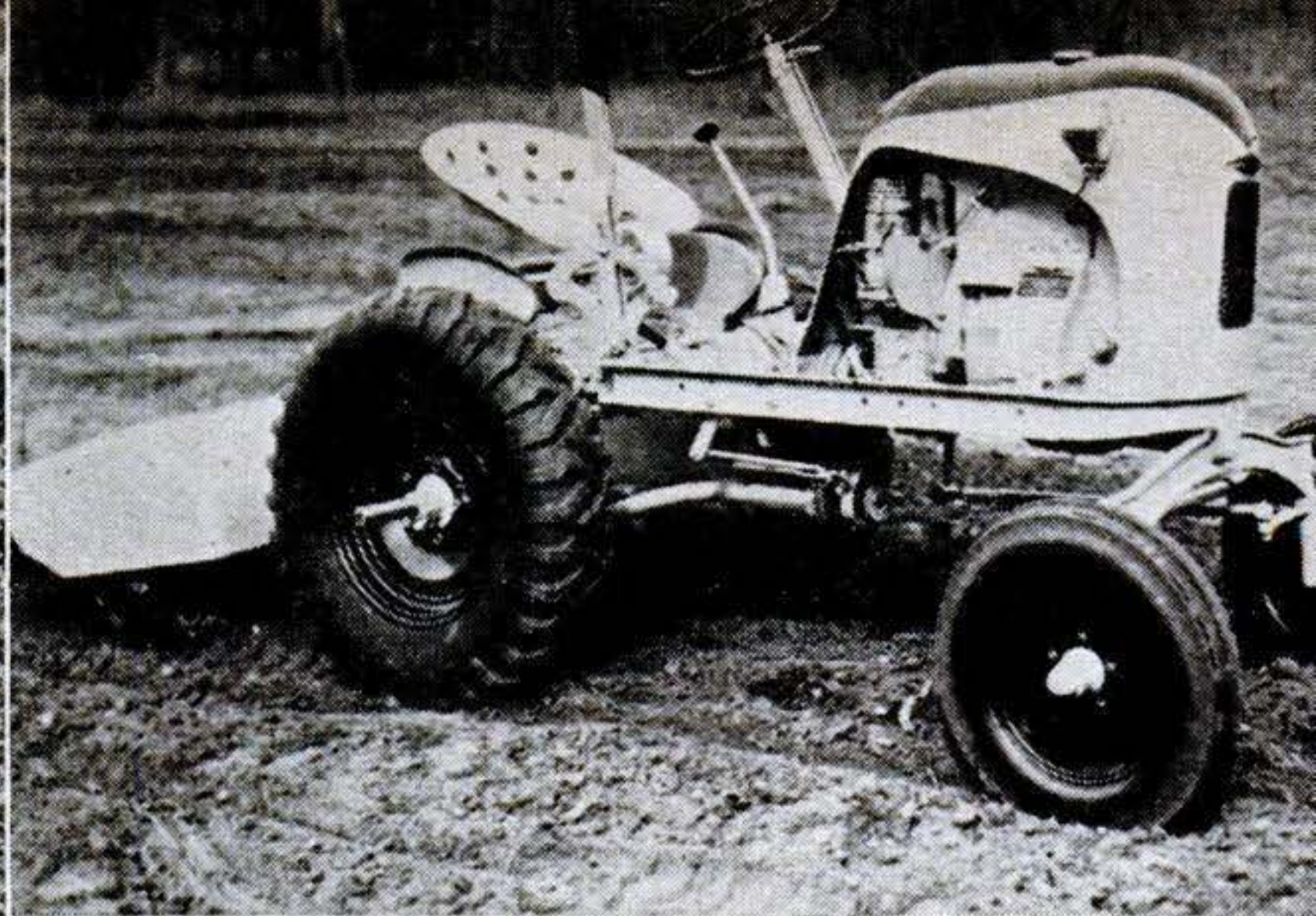

**Newest of the light tractors** is the 6-hp. Jaques-Frazer. With rotary tiller attachment, shown above, it prepares a seedbed in one operation, eliminating disking and harrowing.

lawn, and—he tells himself—his lawn certainly needs rolling. Then, he doesn't like the idea of having to do his seeding the old bending-over way, so he guesses he'd better get a seeding attachment too.

There is still the problem of plowing. And as for snow removal, the 24- or 30-inch snowplow attachment is okay for the front walk when the snow is only a few inches, but it certainly wasn't adequate when the Big Snow came. Nor is it much help in clearing off the 100-foot driveway to the garage. It doesn't have the traction, can't buck the drifts, and there is the problem of what to do with the snow after you have built the pushed-aside snow up a foot or so.

#### ***Rotary Tractor Does Many Jobs***

The man at the store is helpful. If the gardener wants to plow, the thing for him to do is sell his outfit to a neighbor and get a rotary tractor. Of course, that will cost a bit more—\$400 or \$500, depending on size—but it will plow, disk, and harrow in one operation, besides doing his cultivating and hauling around all the attachments. Or, he can get a larger straight tractor, say three to five horsepower, with a sulky attachment for riding to his jobs. It would prepare seedbeds (in mellow soil—not clays), do better snow removal, saw wood, cultivate two rows at once, and various other jobs. How much would it cost? Oh, somewhere from \$600 to \$1,000.

Well, how about the small riding tractors the equipment companies have been advertising? Possibly the clerk is a little unwilling to discuss this unless his firm stocks the equipment, which most garden-tractor deal-

ers don't. However, the prices run from a low of \$345 to around \$600 f.o.b. factory, and with tools will come to about \$1,000.

It takes quite a bit of garden to justify that much power (7 to 12 hp.). But for the part-time farmer who wants to make his garden a semicommercial project, the small riding tractors have much to recommend them. For one thing, if he is selling commercially he can depreciate the equipment on his taxes.

The long-time headache of the walking tractor manufacturers has been, and still is, overselling by salesmen and over-expectation on the owner's part. The little machines will do most of the things claimed for them, but will not do the job of full-sized tractors. In the horse-and-half range, adequate plowing is out. Nor will saw attachments for this power do a job of bucking heavy hardwood logs, although they may be quite satisfactory on small fruit-tree limbs, cured pine, tamarack, etc. From a gardening standpoint, they leave something to be desired in trash burial, although here the more expensive rotary jobs are quite successful.

The rotary machines work on an entirely different principle from the straight drag-through-the-earth technique of the small-wheeled unit, which is the same as the big farm tractors. In the rotary type, curved teeth mounted on a power-operated rotor dig into the earth several inches, completely chopping and burying the surface trash, and make a row from 9 to 30 inches wide. By going over the worked soil several times, sufficient penetration can be secured. The seedbed is ideal, usually, but in some soils is subject to washing or blowing.





**The Farm Imp**®, a stubby, 6-hp. job, can spin around within 5½ ft. A product of the U. S. Tractor and Engineering Co., it is the West Coast's entry in the light riding-tractor class.



**The Haney Bull Terrier**® boasts a 12½-hp. engine. It has three forward speeds, reverse, power take-off, and turns in 7½ feet. A low-price contender, it sells for \$575 at Philadelphia.

Though more expensive, this tool is favored by market gardeners for its high quality and dependability as well as the thorough weed control and the excellent absorptive mulch it gives.

Even as on farm-sized tractors, the catch in the economics of all power garden tools is in the low annual hourly usage if the machine is only to do one or two jobs. The big farm tractors did not begin to reach their wide ownership until many jobs beside plowing and cultivation were found for them.

#### *Advantages of a Riding Tractor*

In the same way, the more jobs the small tractors can do (which means more attachments), the more justifiable their ownership becomes. The beginning power gardener, then, should resign himself to an expected expenditure greatly in excess of the cost of the basic unit. Of course, this has one helpful feature: you don't have to buy all the attachments at one time.

However, if the plot to be worked is more than home garden size, if it is suburban acreage or a part-time farm (of which there are an estimated nearly three-quarters of a million now), it would be wise to inquire into the riding 7- to 12-horsepower tractor. In many cases, it and its string of tools will not cost more than the smaller walking-jobs-with-sulky-attached. Its higher power gives greater versatility and a wider range of possible work. Yet it must be noted that for the most part it will not handle a single 14-inch plow, or seven inches of penetration.

The 12-inch bottom is the one usually recommended. Its wider turning radius means that more land must be wasted in

headlands (unusable area at the end of the row), but it does have a reverse. Most walking tractors do not have this feature, although many of them will in the future. This is becoming more important as attachments get heavier, for it is a man-sized job to haul backward several hundred pounds of tractor and attachment when a heavy rock or buried piece of wood comes up in the row.

Although garden tractors have their limitations they are filling a need. And though they may seem expensive at first glance, consider them in relation to a secondhand car. Do you know where a used-car lot is offering anything worth-while for a few hundred dollars?

END

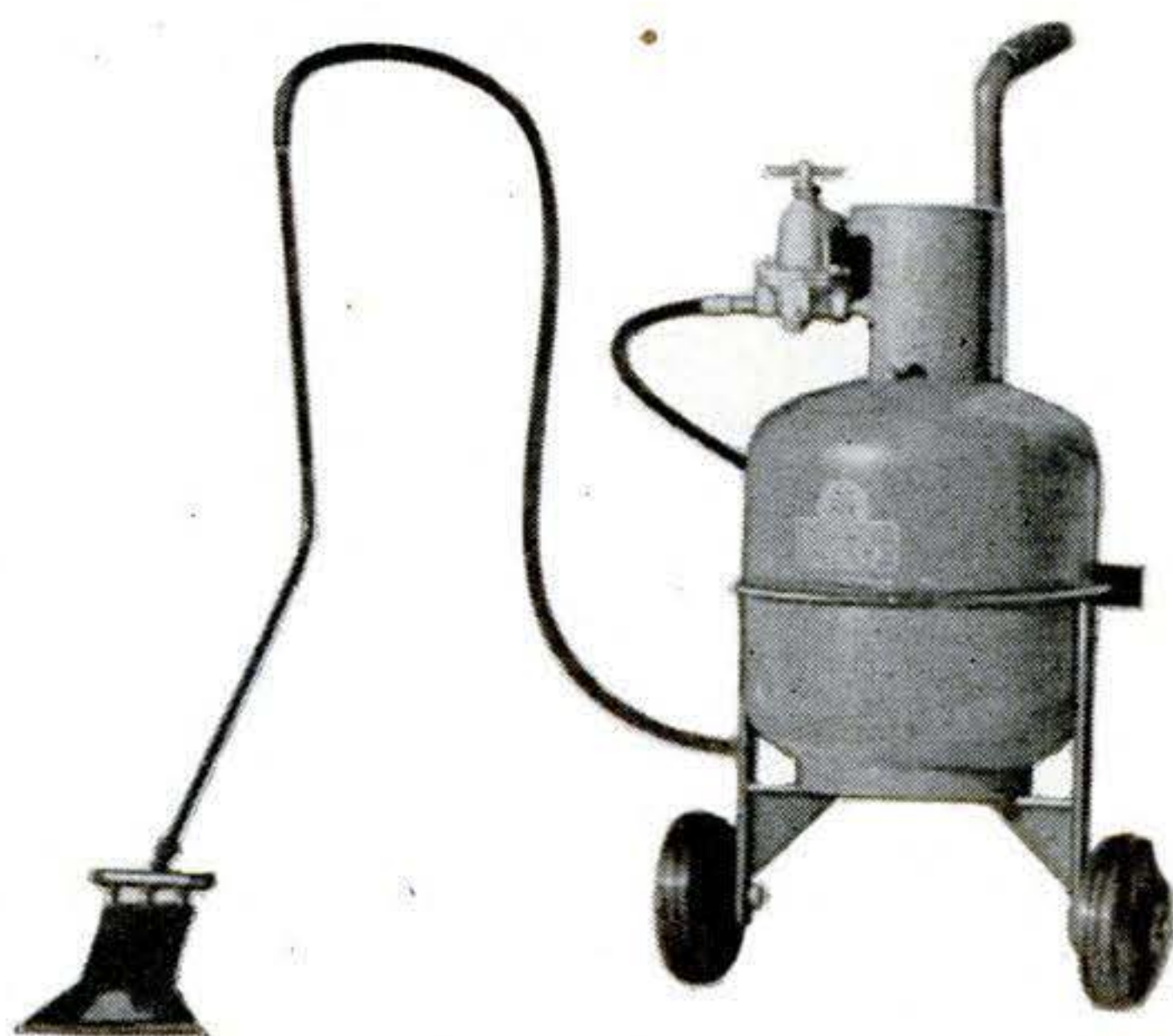

Also handy around the garden is this Holland Sizz-Weeder®. A flame weeder, it works on the same principle as its big brother of the South's cotton fields. This garden model sells for \$35.

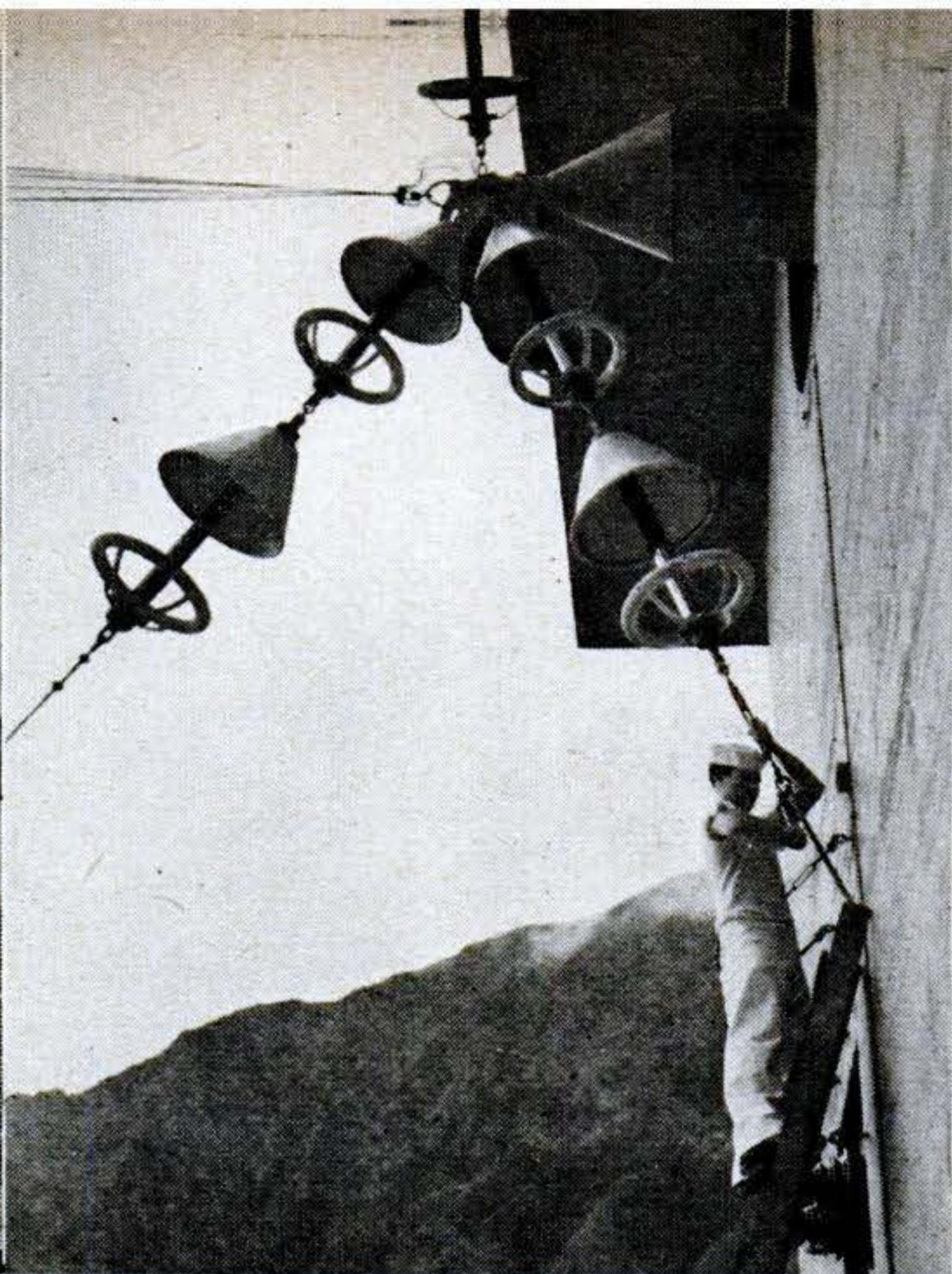

## Aerial Spans Canyon

AN ANTENNA that seems to hang from sky hooks is sending radio messages to Navy submarines in the Pacific. Its five 1½-mile-long cables are strung across the 2,000-foot-high walls of Hawaii's Haiku Canyon. Giant anchors, inspected weekly (above, left), secure the cables at the edges. The aerial

is so high that the lead-in lines, arcing upward from the transmitter on the valley floor (above, right), seem to climb straight into the clouds. The installation has a 200,000-watt alternator transmitter and a 50,000-watt vacuum-tube transmitter, and is one of the Navy's most powerful low-frequency stations. The low frequency can penetrate ocean depths to reach submarines.

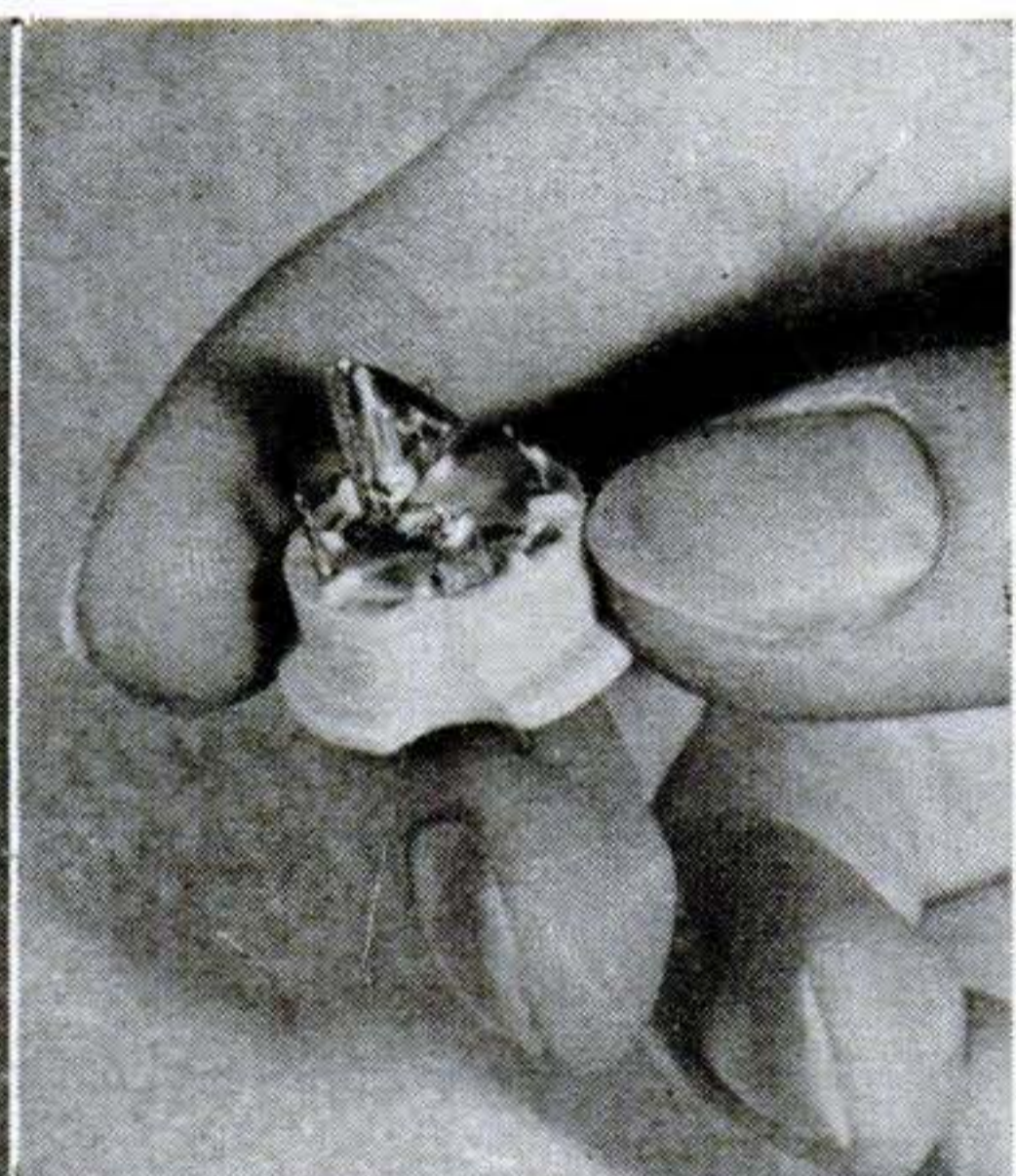

## Diamonds Speak Up

DIAMONDS are being turned into powerful amplifiers—despite the fact that they do not ordinarily conduct electricity. Physicists at the Bell Telephone Laboratories are bombarding snowflake-size diamond chips with millionth-of-a-second bursts of electrons, and inducing currents in the chips as much as

500 times greater than the original current. Gold-plated on two sides to provide electrical connections, the chips are mounted in ceramic sockets (right) and then tested under bombardment (left). A 60-cycle alternating current is applied to the diamond to cancel out "trapped" electrons that would obstruct the amplified current. The method reveals a new field of electronics research.

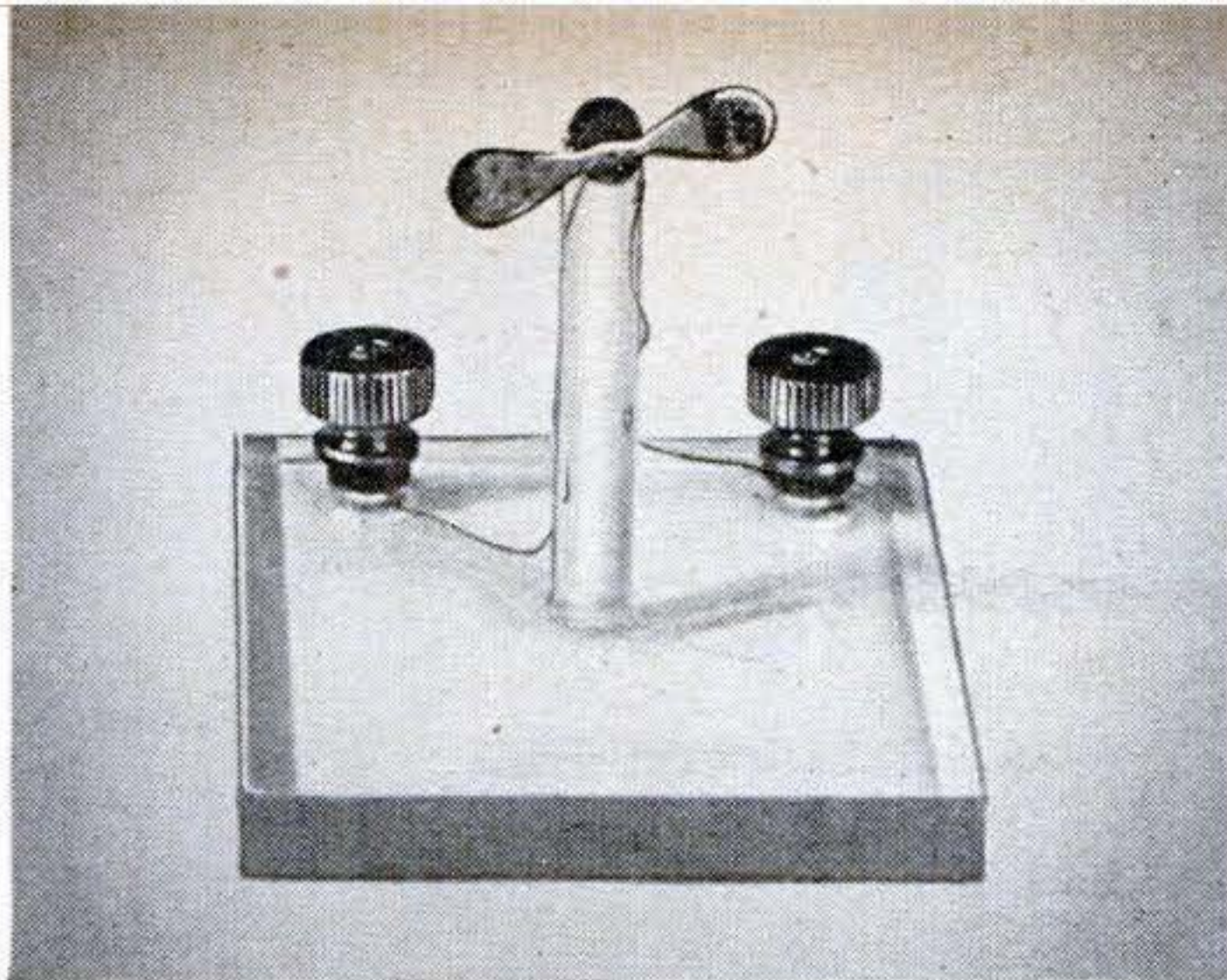

Actual size of world's smallest electric motor is shown in the two photographs above. At left, it spins "fan blades," little larger than a fly's wings. Though dwarfed by comparison with



1.40-carat diamond in girl's ring, at right, it runs efficiently at 7,000 revolutions a minute on current from a flashlight dry cell, and demonstrates practicability of compact, new-style design.

## Button-Big Motor Runs



Larger motors of the new design drive models and toys. Model locomotive uses type measuring  $9/16$ -inch wide and  $7/8$ -inch in diameter. Miniature boat employs the next larger size.

RECENTLY exhibited for the first time in the United States, an electric motor called the smallest in the world measures only  $3/16$  of an inch in length and diameter. It runs with high efficiency on  $1\frac{1}{2}$  volts at 7,000 r.p.m. This pygmy among power plants, of which half a dozen fit in a thimble, is the most diminutive of a series of four subminiature, direct-current motors applying a design invented by J. V. and J. E. G. Eurich of Lancashire, England. They will be manufactured in this country by the U. S. Instrument Co. of Summit, N. J., under the name of Electrotors<sup>®</sup>.

The smallest model is a custom-built motor, intended mainly for demonstration purposes but suitable and available for use in highly sensitive scientific instruments. Popular models to be produced in quantity begin with a  $3/4$ -ounce motor of  $9/16$ -inch width and  $7/8$ -inch diameter for modelmakers, and for use in toys and battery-powered electric razors. It runs on 3 to  $4\frac{1}{2}$  volts and consumes less power than a flashlight bulb. A motor of  $1\frac{1}{2}$ -inch diameter and width may be used in larger models, automatic windshield wipers, movie cameras, and midget air conditioners. A "heavy-duty" motor of twice this size completes the series.

Not scaled-down counterparts of standard types, Electrotors<sup>®</sup> owe their small dimensions to radical departures in design. A "gap-ring" armature—an electromagnet of horseshoe shape—revolves within a permanent ring magnet, picking up its current from contact points without the use of a commutator. The motors are self-starting and instantaneously reversible.

# New Ideas from the Inventors

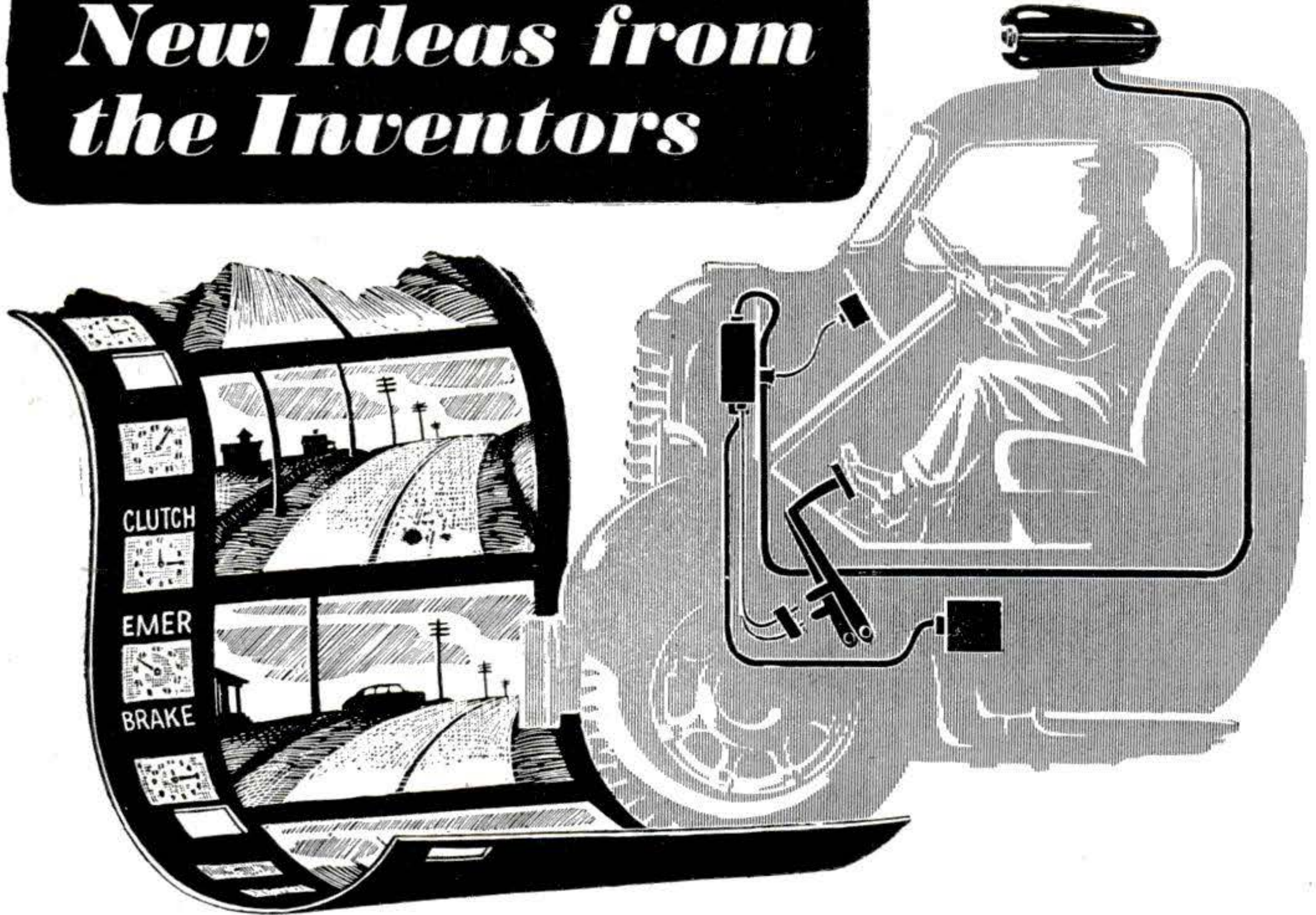

**Camera Records Driving.** This device helps tell who's to blame in an auto accident. Such data as time, car's speed, and brake position are relayed to dials behind a camera atop the car. Reflected into the

wide-angle lens, these are recorded on film's edge as camera automatically snaps the road every few hundred feet. Inventors are G. Finnegan, of Mountain Lakes, N. J., and H. Durham, of Munsey Park, N. Y.

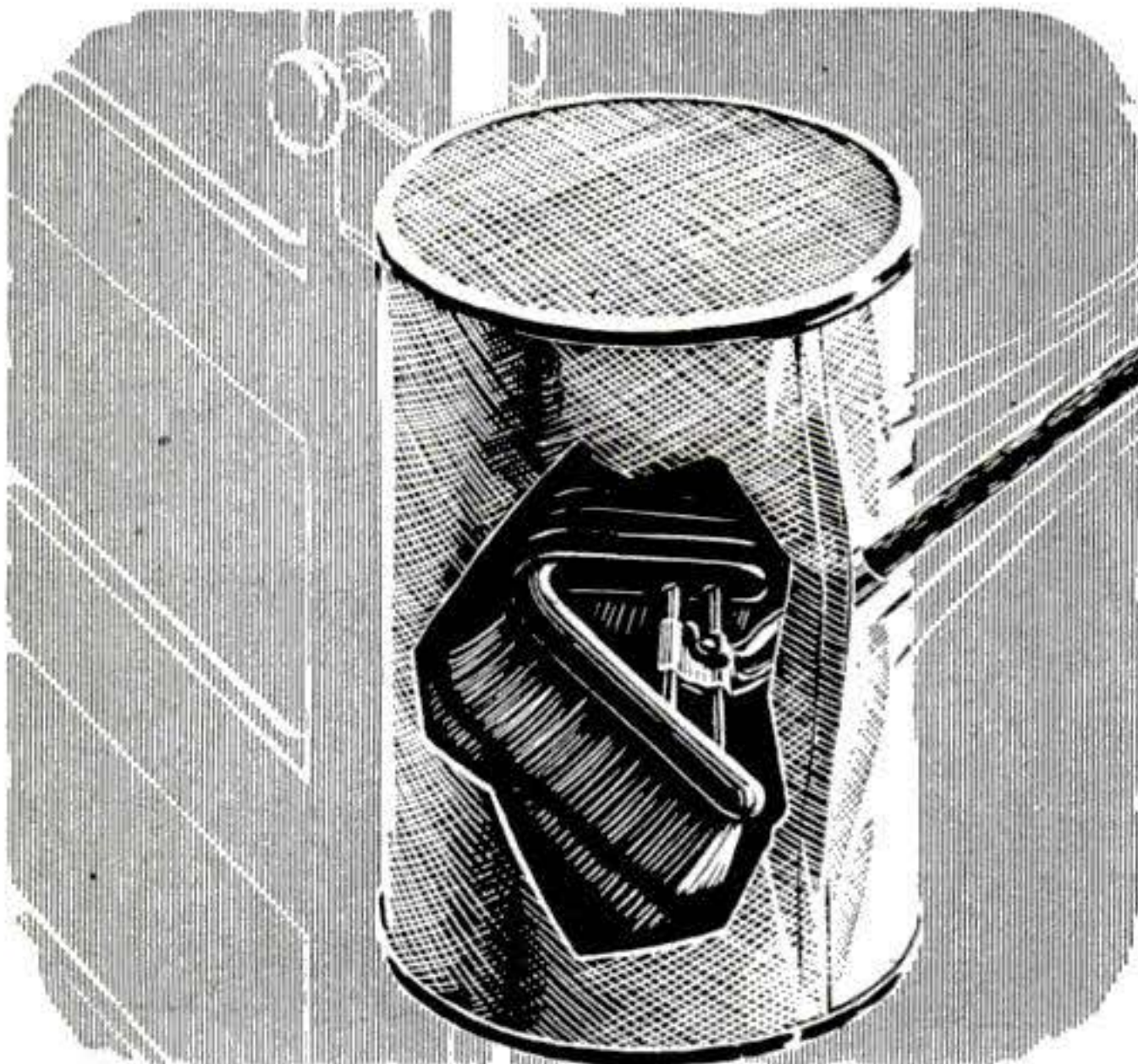

**Dust Can Is Collapsible.** You wouldn't have to shake your mop out the window if you had this flexible dust catcher. Invented by John Barkl, of Washington, D. C., it can be carried from room to room and hung from the doorknobs. It is slit to let in the mop, folds flat for easy storage.

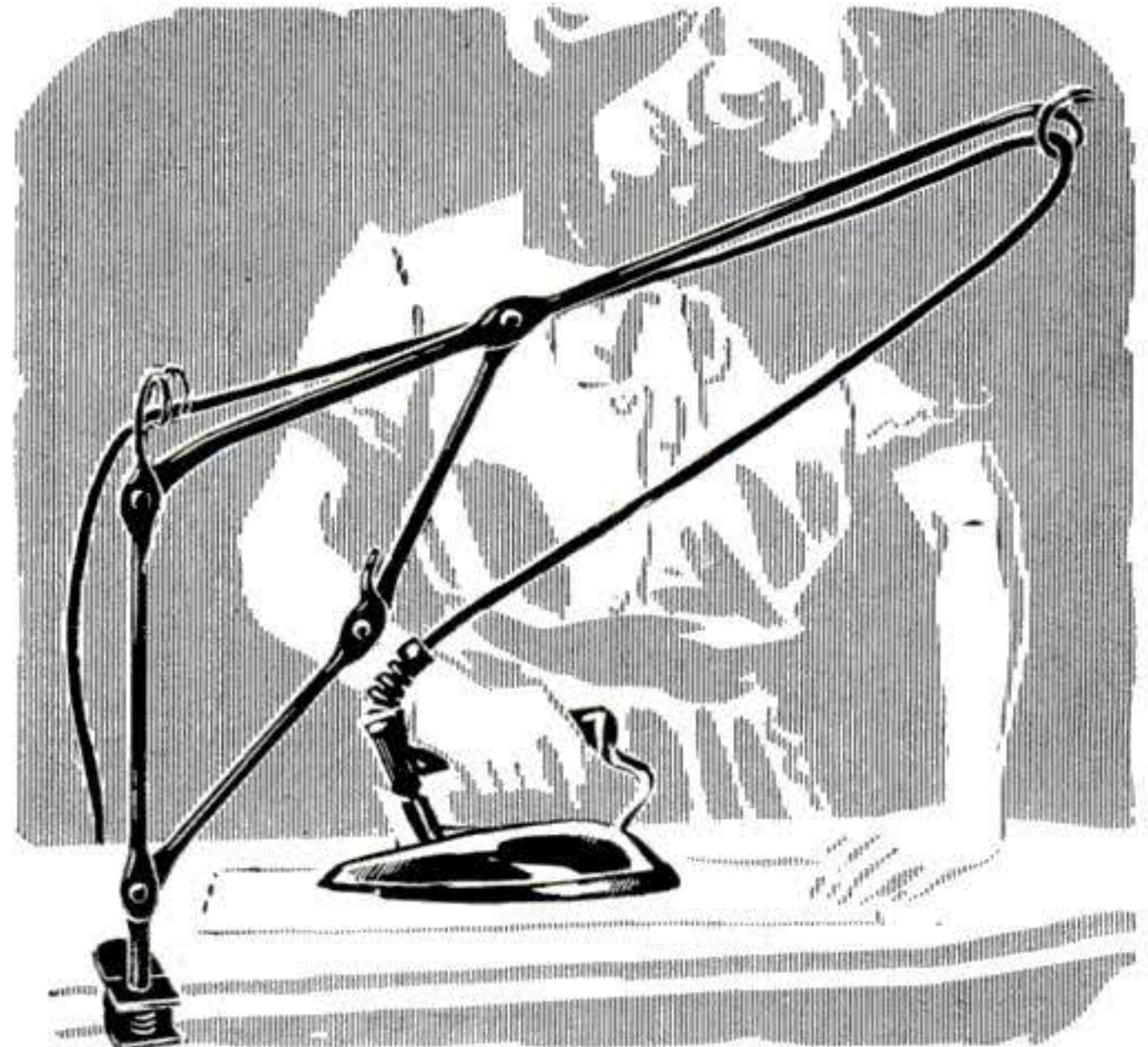

**Cord Holder Clamps On.** To keep your ironing cord out of the way and free of tangles, Charles Borgolte, of Woodside, N. Y., has invented a boomlike arm that holds it high in the air and swings back and forth as you iron. A spring at the pivot point keeps the arm at one side when not in use.

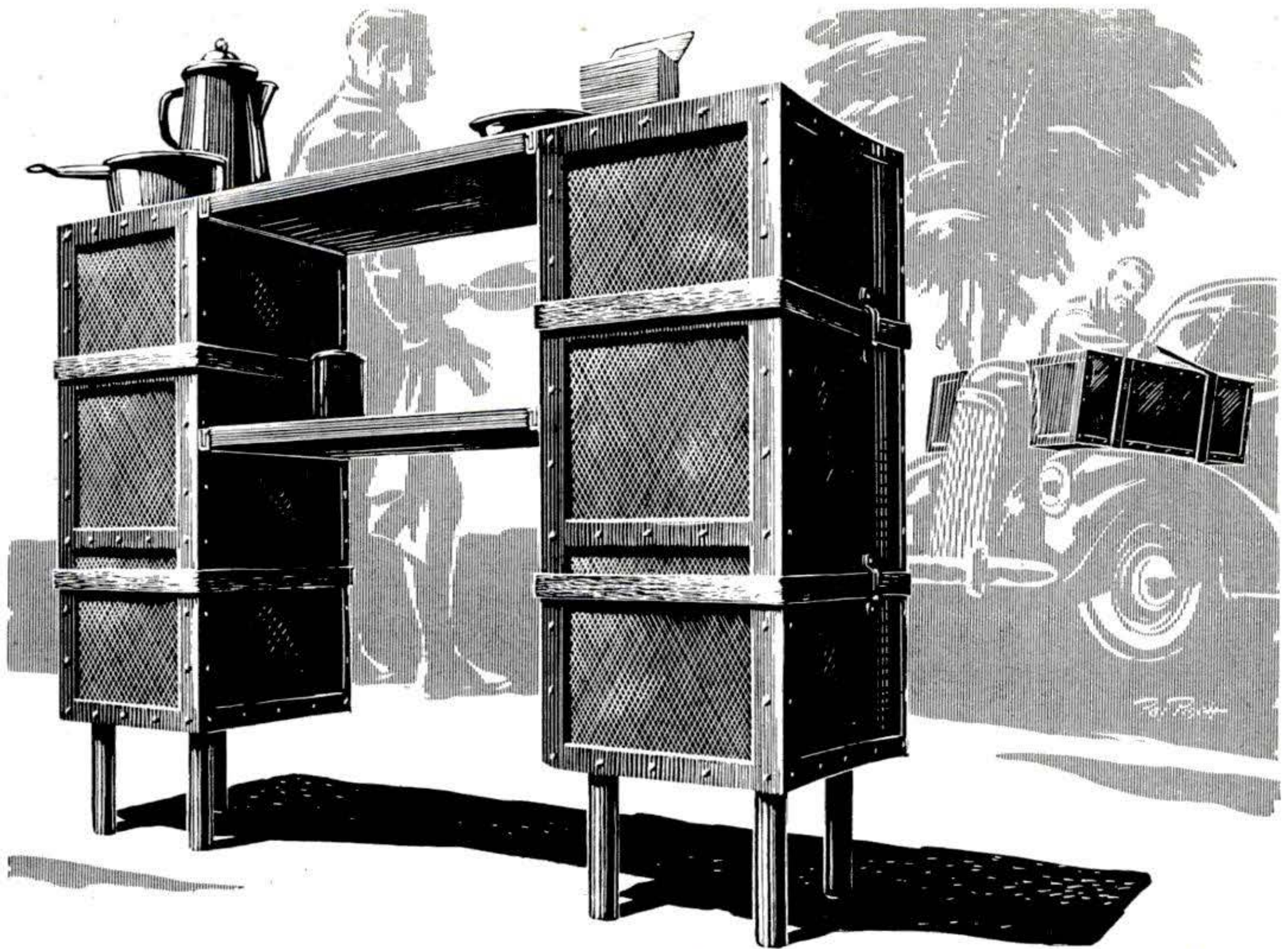

**Boxes Become Desk.** A pair of crates fit together to make this portable table for use as a camp kitchen or field desk. Curved along one side, the boxes can be packed with supplies and carried on either

side of a car's hood, pack-horse style. In use, they are stood on end and joined by shelves that provide work space. Pipelike legs adjust their height. They were patented by Lester Scott, of Wheatridge, Colo.



**Harness Keeps Baby Safe.** This bedsheet baby harness for crib or play pen keeps the little one out of trouble when alone. Fastened to the sheet by two straps that cross each other, the baby can roll over or sit up, but not crawl away. It was invented by Charlotte Krogh, of Compton, Calif.



**Heels Are Interchangeable.** You could quickly replace a worn or broken shoe heel with the detachable one patented by Thomas Gilmour, of Brooklyn. The slotted heel slips on a T-shaped bar on the shoe, and a small latch locks it in place. The device also lets you use various styles of heels.

# Machine Probes Your Personality

**Are you a square peg in a round crowd? The Interaction Chronograph helps choose the best team for you.**

**By Herbert Yahraes**

*PS photos by Hubert Lockett*

**M**ID-JULY and the Bears have finally got going . . . Chances bright for the first pennant in years . . . Pitching staff, though, could stand some jacking up . . . So Bull Smith packs off a pretty good relief hurler and plenty of cash to get the phenomenal Kentucky Kid. "With the Kid," he tells the world, "we can't be stopped." Instead, the whole team slumps, drops out of the first division. "The creepers-jeepers that have struck the Bears," reports a *Morning Sun* analyst, "are due directly to the friction between Roaring Bull and his new pitcher; it's got the whole team down. Too bad the Bull didn't find out beforehand that the Kid was one man he couldn't browbeat."

With a recently perfected personality machine, the Bull could have done just that. For the machine tells, almost automatically, whether or not one person is likely to get along with another. Beyond that, it measures the qualities of personality necessary for certain work and sizes up, with uncanny accuracy, foremen and other bosses.

It has not yet been used to prevent or diagnose the personality troubles of a baseball team—but it could be. Furthermore, it could help a president select a smooth-working cabinet and enable a Leap Year girl to pick the right man.

The machine was devised by Eliot D. Chapple, a Harvard Ph.D. trained in anthropology—the science of man—and some equally learned associates. Early work on it was financed in part by the War Production Board. Some of its results have been reported in half-a-dozen first-rank scholarly

journals. It has been tried on several thousand persons—in industry, a big department store, and a hospital.

Now Chapple has branched into organization engineering, putting on a business basis the scientific know-how of relating people to each other in terms of the job. His personality quizzer is available to any firm that wants to bolster output and morale and fit square pegs into square holes.

Chapple's invention is precisely but rather alarmingly named the Interaction Chronograph, a title somewhat less complex than the machine itself, which is a crinkled gray metal cabinet almost as long as a desk, filled with an orderly jumble of chains, cogs, pulleys, and electric wires.

Its general principle becomes clear when you keep in mind that the whole thing started 10 years ago with just a stop watch and an idea—that perhaps you could tell how a man would get along with others if you *timed* his contacts.

## *Measuring Human Relations*

Industry is filled with skilled interviewers of personnel, but an applicant may know all the answers and still not be fitted for the job. He may say the right things but fail to do them. What was needed, Chapple decided, was a factor that could be measured with the same accuracy as an engineer gauges the strength of steel or a chemist checks the amount of gas in a retort. And in human relationships the only measurable factor he could find was time.

To test his idea, he took a stop watch and some paper ruled off into seconds and traipsed around to factories, shipyards, and stores. He would observe two persons working together and note how often one spoke to the other, and how long, and how much time elapsed between chats or other contacts, like passing a pencil or a wrench. He



**This interview** will really give the low-down when the Interaction Chronograph has analyzed

it. Operator (foreground) sits unobtrusively by control box; machine itself is outside room.

checked also on how quickly each responded to the other's remarks, and how fast a man would shut up or speed up when somebody tried to talk him down.

At first he was adventuring in the dark, but soon he noticed that individuals differed greatly in the frequency, length, and other time elements of their contacts with one another. Bill Jones, for instance, working at a lathe in the machine shop, often got in touch with the foreman but scarcely ever with Tom King, at the next machine; and Tom never spoke unless spoken to. Up in the accounting department it was Alice who usually answered the telephone although Mary sat right beside her. Out in the front office, Brown made many more contacts than White.

Now the problem was to learn whether or not these differences gave an accurate index of personality.



**On control board**, two upper left buttons start machine. *Signal* marks start of interview. Operator then holds down button A whenever subject talks or gestures; button B when interviewer is in action; both, when they talk at once. ➔

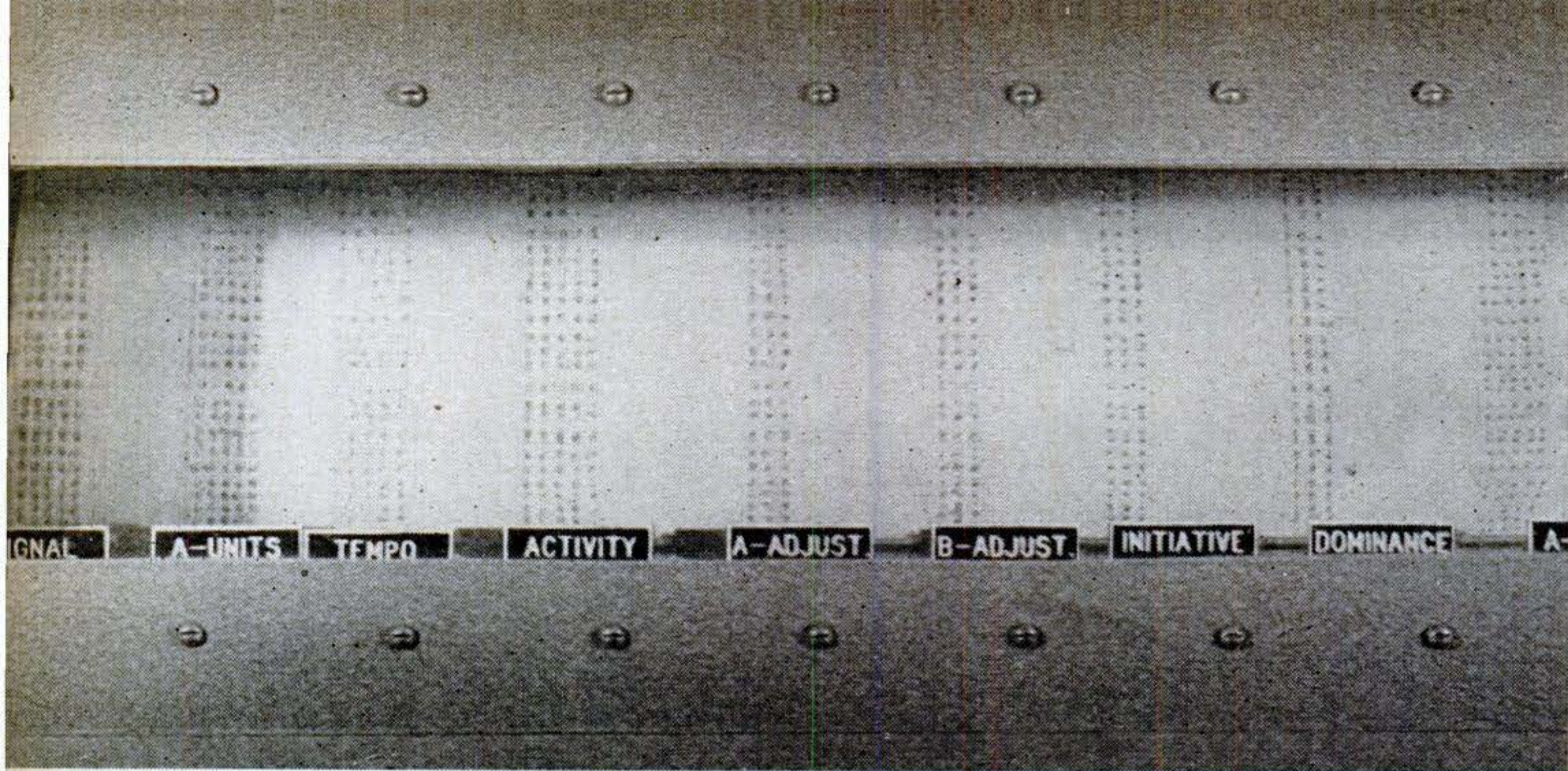

**Gray metal, waist-high cabinet at left holds the works of the Interaction Chronograph. Above at left is view, through the top window, of its columns of figures. In labels, A stands for subject; B for interviewer. Signal marks start of each**

individuals in off-the-job interviews. The quiet machinist let the interviewer carry the ball. The phone-grabbing clerk was quick with her answers. Executive White took longer to restart a conversation than Executive Brown. In other words, the time elements recorded for an individual were much the same one time as another.

After checking hundreds of measurements against known facts about the subjects, Chapple and his associates were certain that time was an important measure of personality. They got other confirming evidence. Chapple's time lines for normal people differed markedly but showed that by and large one individual could adjust himself to another and manage a fairly even give-and-take. What about abnormal individuals? Chapple studied psychiatric patients at Massachusetts General Hospital and recorded wholly new patterns. These people were in the hospital because they could not adjust to other people. The fact that they could not adjust showed up clearly in the graphs calculated by his recorder. Furthermore, different disorders were characterized by different graphs.

Today's personality machine is just a development of the linked-together stop watches. The observer still has only two main buttons to control, but the device uses gears, electrical relays, and printing counters to write down the record not in lines but in figures—10 columns of them.

Here's an actual case of how it works. A

Chapple needed more data. To get it faster and more accurately, he replaced the stop watch with a simple recording machine, a continuously moving roll of paper on which lines were drawn when keys were pressed. When Mr. A spoke, his key was pushed down; when he stopped speaking, it was released. The same for Mr. B. When both spoke, both keys were pressed. In effect, Chapple had hooked up a stop watch for each subject and made them self-recording. The record told not only who talked and for how long but also who interrupted, who was responsible for silences, and who broke them.

With this device, Chapple discovered that recordings of individuals at work usually checked with recordings of these same indi-



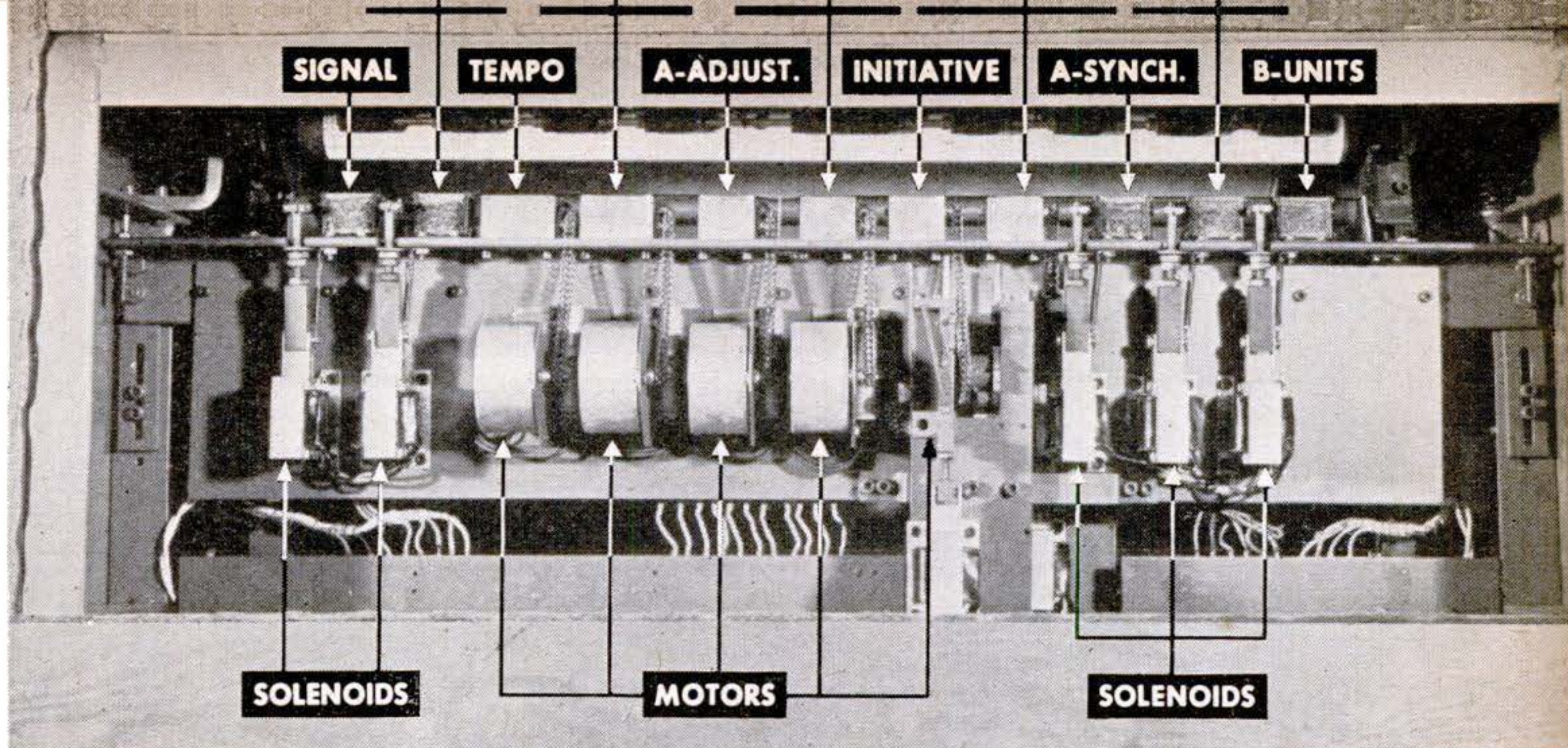

division of interview. *Units* tell how many times each starts to talk—machine totals these at end. *Synch.* (synchronization) gives the total number of times person interrupts or fails to respond—this checks on adjustment. Other labels are

explained in text. Above at right is mechanism: the small metal rectangles at top are printing counters. They are activated by motors when duration of time is measured; by solenoids when frequency is measured.

big Boston department store wants a better line on its salespeople; first to be interviewed is a man from the furniture department. He sits down by the interviewer's desk in the personnel office. In a corner of the room is the observer, with his little black box. The Interaction Chronograph itself is at the end of a cable in another room, although tests have shown that it can be in the same room without disturbing the subject.

#### *The I.C. in Action*

We'll call the salesman Mr. A; the interviewer, Miss B. The session proceeds along lines standardized by Chapple. Miss B opens with a general question, "Well, how have things been going up in the furniture department?" She spends the next 8 or 10 minutes getting Mr. A to talk, limiting her questions to remarks like "Can you give me an example of that?" and "Isn't that interesting?" This is a free-and-easy period.

Then the interviewer slows down; she waits about 15 seconds before answering Mr. A and repeats the process 10 times. Next comes another period like the first, followed by another change of pace. This time Miss B interrupts, picks up what the salesman is saying, tries to talk him down.

Finally, there is another free-and-easy period, and the interview ends. It has lasted 25 minutes, and during the whole time the observer has been pressing buttons to record the interactions of Mr. A and Miss B—one button each time one of them spoke or ges-

tured. And in the next room the Interaction Chronograph has been busily computing the results for each period and the interview as a whole.

A skilled personnel worker might get something from a session like that, but with the I.C., the interviewer need not be skilled, need not ask searching questions, or even questions about the job. What Mr. A says is not important; only how, in terms of time, he says it. And no interviewer could get what the machine gives—a strictly scientific record that can be used to fit the subject to the job, or the job to the subject.

At the end, the observer lifts the hood of the machine, takes out the paper record of the interview, and finds that Mr. A started to talk 85 times, an average of once every 17½ seconds, and that his average talking period was 12 seconds longer than his average period of silence. These figures are basic: they measure what Chapple calls tempo and activity, which in Mr. A are relatively high.

While recording these facts, the machine has been comparing them with similar facts about the interviewer and totting up the results. For Mr. A, they show a good amount of *initiative* (during periods of silence it was often he who started the ball rolling again), and a fair degree of *dominance* (when Miss B tried to talk him down, he interrupted fairly frequently, neither relinquishing the conversational ball completely nor grabbing it all for himself).

Mr. A's *adjustment* was computed in several ways. One was the difference between the length of time he spent interrupting the interviewer and the length of time he failed to respond to her; for the interview as a whole there was very little difference. More important was his variability in activity and tempo—he speeded up or slowed down to meet changes in pace.

Now, what do all these measurements show about Mr. A's qualifications as a furniture salesman? To be able to answer that, Chapple had to set up standards by checking performance records against the I.C.'s findings. He also analyzed the job with a portable recorder and found that furniture selling is a relatively slow process. The average customer asks a great many questions and goes into long, often uninteresting, explanations about decorative schemes and her present furniture. The salesman must stick with her all the way, answering questions and giving her plenty of chance to think out loud, but cutting in if she hesitates too long or grows too long-winded. If she raises a quick series of objections to quality, style, price, he must be able to come back fast lest she walk out on the deal. In other words, his activity rating should be high, but his initiative and dominance only fairly so.

The Interaction Chronograph sized up Mr. A as the best man on the floor, and a study of sales records showed that, in fact, he was. His personality would have fitted him to do well in men's clothing, too, but at some hot-spot bargain counter, where a salesman has to handle two or three customers at once, he probably would have flopped.

### ***Hose Outspeeds Hats***

Store executives had wondered why their best millinery saleswoman, transferred to the hosiery department during a rush, had done a mediocre job. I.C. interviews with dozens of salespeople pointed to the answer: the best salesmen in quick-selling departments, like hosiery, showed a high activity rate in all five phases of the standard interview, while the best salesmen in slower-moving departments, where the customer had to be catered to, began the interview more slowly and were less dominant throughout. Other studies showed that a good department-store buyer has the drive and energy recorded by good salesmen, plus the initiative and dominance of good foremen.

The I.C. picked out similar significant differences among industrial executives. Chap-

ple began this study by interviewing 66 men, ranging from assistant foremen to production managers and supervisors. Then he compared the I.C.'s findings with those of the personnel office. The results surprise anyone who supposes that personality can be studied, sized up, and accounted for but not measured. They showed that *the machine would have selected in advance 92 percent of the men rated best by the company on the basis of long observation*. Time required by the personality tester: 25 minutes a man.

### ***Executives Vs. Non-Executives***

Next, Chapple compared his I.C. records for executives with those for 500 non-executives. As might have been expected, the bosses talked oftener and longer, were quicker on the uptake. Ninety-five percent of them ranked high in initiative and dominance, as against only 14 percent of the others. (Still, 14 percent of 500 is 70—70 potential executives hiding their light under the bushel of a workaday job.)

Finally, the I.C.'s inventor went looking for differences among the executives themselves—and found them. The best supervisors could speed up fastest after being interrupted, or when the interviewer failed to respond; their tempo fluctuated, showing that they could handle different kinds of people. The best production managers, on the other hand, tended to hesitate before answering questions. Foremen in the foundry, where work and personnel had changed little for years, had a stable rate of activity; foremen in the newer munitions division showed greater activity and aggressiveness. High-ranking personnel snapped back faster and took the initiative more often than executives under them. One foreman got a minus in aggressiveness, but all the men under him rated even lower—he had hired them himself.

Up to now, most of Chapple's work with the Interaction Chronograph has been exploratory, but it has solved a number of personnel problems. There was the ambitious young woman, for example, who was making life miserable for the few clerks under her, and for herself. Ranked high in dominance and energy by the I.C., she was given more supervisory work—enough to keep her busy instead of bossy. There was also the bright young production man who, boosted a couple of notches, made a mess of his new job by trying to do everything himself. The I.C. rated him high in activity but low in aggres-

siveness. Placed in a one-man department and given plenty of leeway, he was soon working out for his company valuable time-saving procedures.

These show how the I.C. can be used to tailor a job to fit the man and thus put unsuspected talents to work and prevent or cure personality troubles—which affect both the individual and his co-workers, and may eventually slow down a whole department. Of course, it can also be used to analyze a job—in terms of number, speed, and length of contacts required—and then to find the right man for it.

The I.C. is not the answer to every personnel question. It doesn't measure intelligence, but in most jobs, including executive ones, ability to get along with people is more important than sheer brainpower. It won't measure experience or training, but it will point to persons who, if inexperienced, are *worth* training. And it can tell whether or not a job applicant can meet the standards set by successful people in the same work.

So far, these standards cover a wide range of executive and sales work, and Chapple expects to catalogue others. He is now man-

ufacturing machines for lease, and his company has opened offices both in New York and Boston.

For some jobs it will be almost impossible to find standards. Chapple doubts that he could ever work out the personality traits that make a good baseball pitcher. But right now his machine could tell you in 25 minutes the best kind of manager for the Kentucky Kid.

Could it pick the best presidential candidate? The answer is no—but. It could not pick the man whose policies would be wisest. But it could point to the man with the drive and dominance to make his policies stick, and the flexibility and initiative to handle new associates and new situations.

And how about picking you a wife? Easy. It'll start with you first. Ah, a nice, calm, steady fellow. You don't interrupt; you listen more than you talk; you let a person cut you off. Why, you could marry almost anybody. . . . Wait a minute,—look here what it says about Mabel. Pretty active, Mabel; aggressive, but not too aggressive. . . . Go ahead—Mabel it is. With Mabel, son, you'll go places. END

Miss Ruth Smith

NY 56  
2/4/48

	N	Tempo	Activity	Adjustment		Init.	Dom	Synchron		B-Tempo
				A	B			A	B	
Prelim.	15	41.26	22.66	.33	-2.80	-.20	.73	1.20	1.60	30.95
Sil.	10	44.10	5.80	-1.40	-1.21	.60	0	.90	1.00	49.00
Recov.	11	36.45	23.44	.90	-1.36	.18	.18	.64	1.09	40.10
Inter.	15	13.46	3.26	.40	.33	.07	.47	.80	1.00	11.88
Recov.	13	27.46	12.08	-.53	-1.53	.23	-.15	.69	.92	29.75
Total	64	31.56	13.47	-.50	-3.03	.14	.13	.87	1.14	29.70

Card summarizing I.C. tables (in background) reveals that subject is fairly adaptable (measurements for five periods vary) with fairly good initiative and relatively low dominance. She can listen well (difference between tempo and activity) and talks fairly well (activity). Her

tempo is decidedly slow. Chapple suggested she would make a good assistant to an aggressive executive (she isn't dominant enough to be a good executive herself), or a salesclerk in a leisurely field such as silverware (her tempo is too slow for average sales work).



## Sound Without Fury

THE ridge-helmeted machine gunners at right, above, are "Aggressors." Their army, clad in forest green, is locked in battle with our own. It's all very real—except that they are firing blank ammunition. For these are friendly enemies, whose job is to make maneuvers as much as possible like real battle for the Army's raw recruits.

For their artillery barrage, in fact, this enemy doesn't even need guns. Realistic flashes and bangs come from the 105-mm. gun simulator shown at left, above. Of

British origin, it consists of a bank of metal tubes in which plastic shells containing cellulose nitrate are electrically detonated. An ounce of gasoline in the shell's nose explodes to make more flash. A switchboard controls the firing of the cartridges, either individually or in battery.

The firing of a 90-mm. gun is reproduced by a hopper filled with balls of nitrate. When a switch releases a ball, it rolls into a tube where it is electrically exploded. The advantage of both of these devices is that they can be handled by far fewer men than are required for actual artillery pieces.



## Soil Strength Measured

RESEMBLING a fancy walking stick, this penetrometer, stuck into sand or clay, tells how heavy a load the soil will bear without bogging down a vehicle. A small metal cone on the tip of the stick is pushed into the earth until its top is level with the ground. As the operator presses the cone farther into the ground, the steel spring just under the handle is depressed. The amount the spring is depressed can then be read on the dial, giving an accurate measurement of how much of a load the soil can take.

Designed during the war to determine what equipment could be moved by the Army along beachheads, the penetrometer has been further developed by the U. S. Waterways Experiment Station, Vicksburg, Miss. Tanks, trucks, tractors, and amphibious vehicles are used in the tests.

# ***K. P. Chores Made Easy***

**Y**OU may have only two hands, but with this new British device in your kitchen you will feel like triplets. Called the Electro-hand, it scours, polishes, mixes, whips, and even dries your towels. The driving unit, an electric motor, is seen at top of the picture at right. A heater is built-in for drying dish cloths on rods above, warm air being blown down from under the top. The flexible drive cable seen hanging down is fitted with a universal adapter that plugs into the various attachments on drainboard.

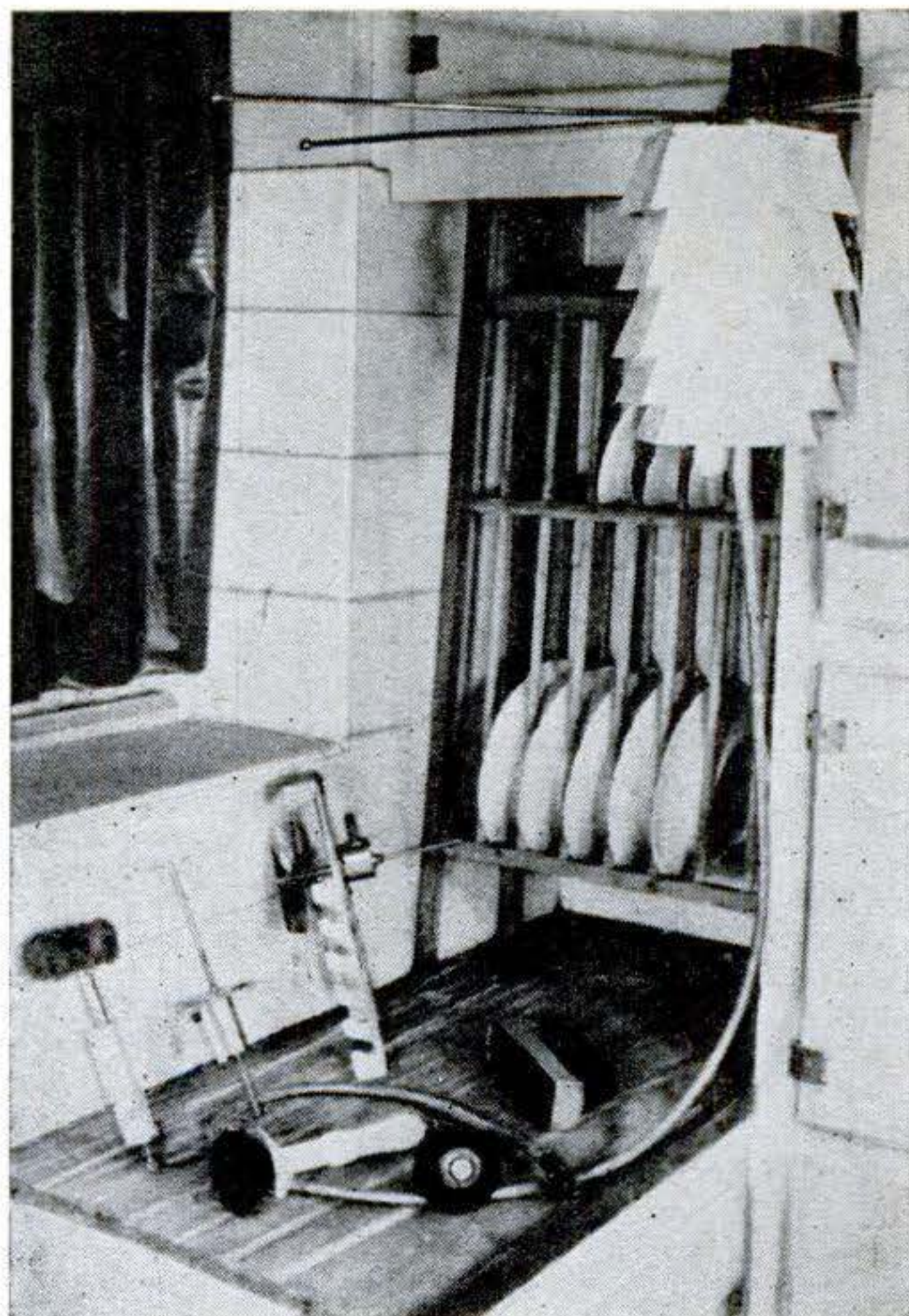

**Resembling an inverted nest of flower pots, the driving unit, shown at top, right, is fixed to the wall with a two-screw bracket. A pilot light fitted under the unit illuminates drain-board working space. The lamp and motor consume 60 watts, the heater, 250 watts.**

**Silver polishing, as at left, is a pleasure with this high-speed, rotating brush that even reaches the hard-to-get-at crevices. Buffer on the table does a high-polish finishing job.**

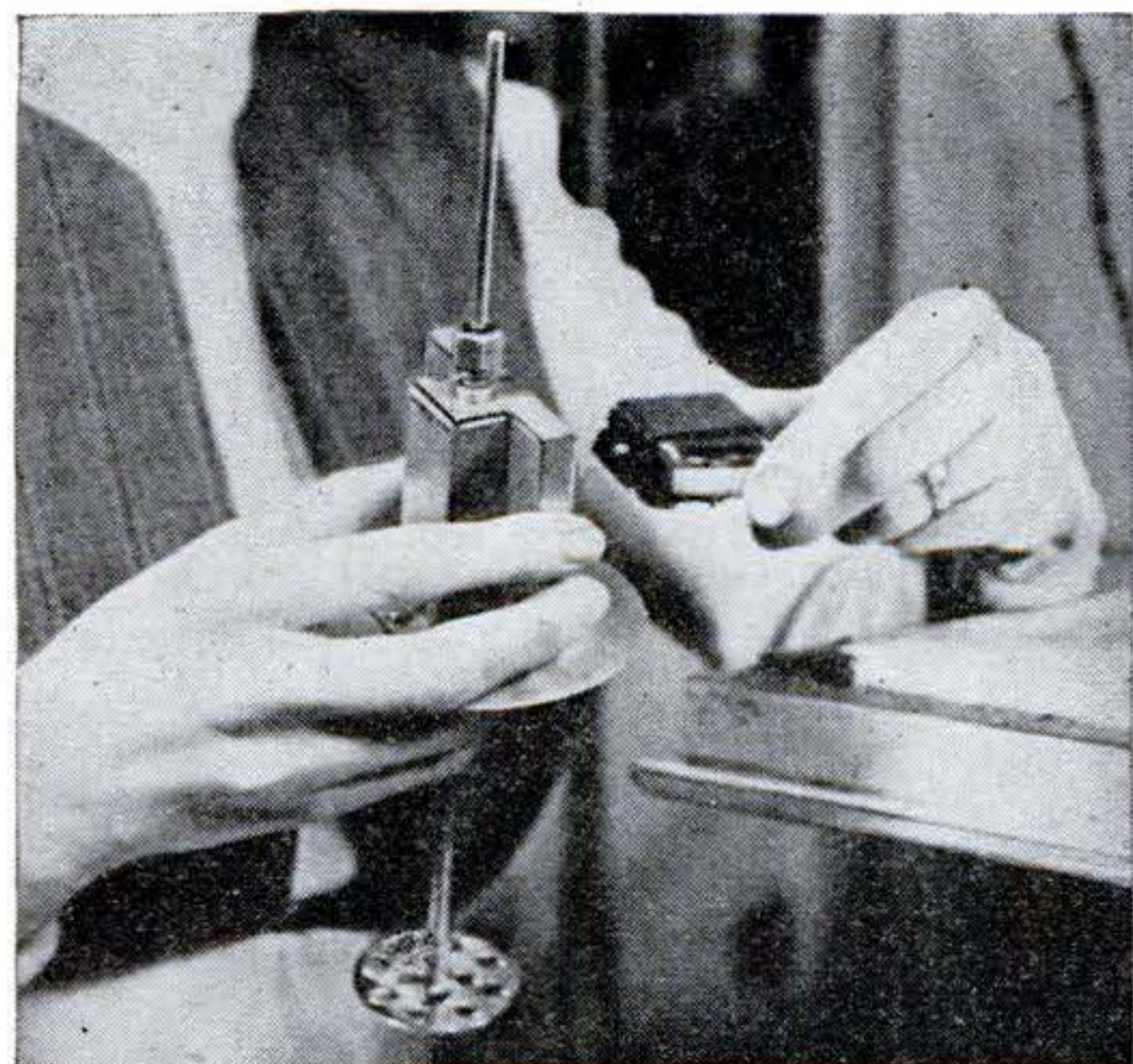

**The universal adapter, about to be plugged into the egg-beater and cream-whipper attachment. The plunger, with a perforated plate at one end, adapts itself to a container of any depth.**



**A polishing pad is used to give shoes that lustrous shine. It is interchangeable with a brush that does the preliminary dirty work, and is ideal for cleaning large surfaces.**

# Rockets Lay Phone Lines

**S**IGNAL Corps linemen are adding rockets to their tool kits. The fiery missiles pull telephone wire from a new type of dispenser across streams, ravines, and other obstacles. One man, equipped with the dispenser, a few rockets, and a field telephone, can now set up communications in rough terrain faster than a large crew using conventional methods.

The new wire dispenser was developed from a model used during the war. With it, the wire-laying rocket may be fired without a launcher. The rocket is set off in the original cardboard packing case, which is placed in a wedge-shaped hole dug in the ground. Even when fired in this manner, the rocket will carry wire as much as 150 yards.

The dispenser itself is intended to aid all kinds of high-speed wire laying. It pays out wire from moving airplanes and trucks, or from a bazooka. Or it can be carried on a soldier's back, laying wire as he walks. Made entirely of noncritical materials, the new dispenser weighs about 28 pounds when full. It holds a half mile of "infantry wire," another recent Signal Corps development that gives a telephone talking range equal to the widely used field-type wire, but weighs only a third as much.



**Signal Corps' new wire dispenser** lays telephone lines from speeding airplanes, trucks, and even rockets. It is shown above mounted under the wing of an L-5 liaison plane.

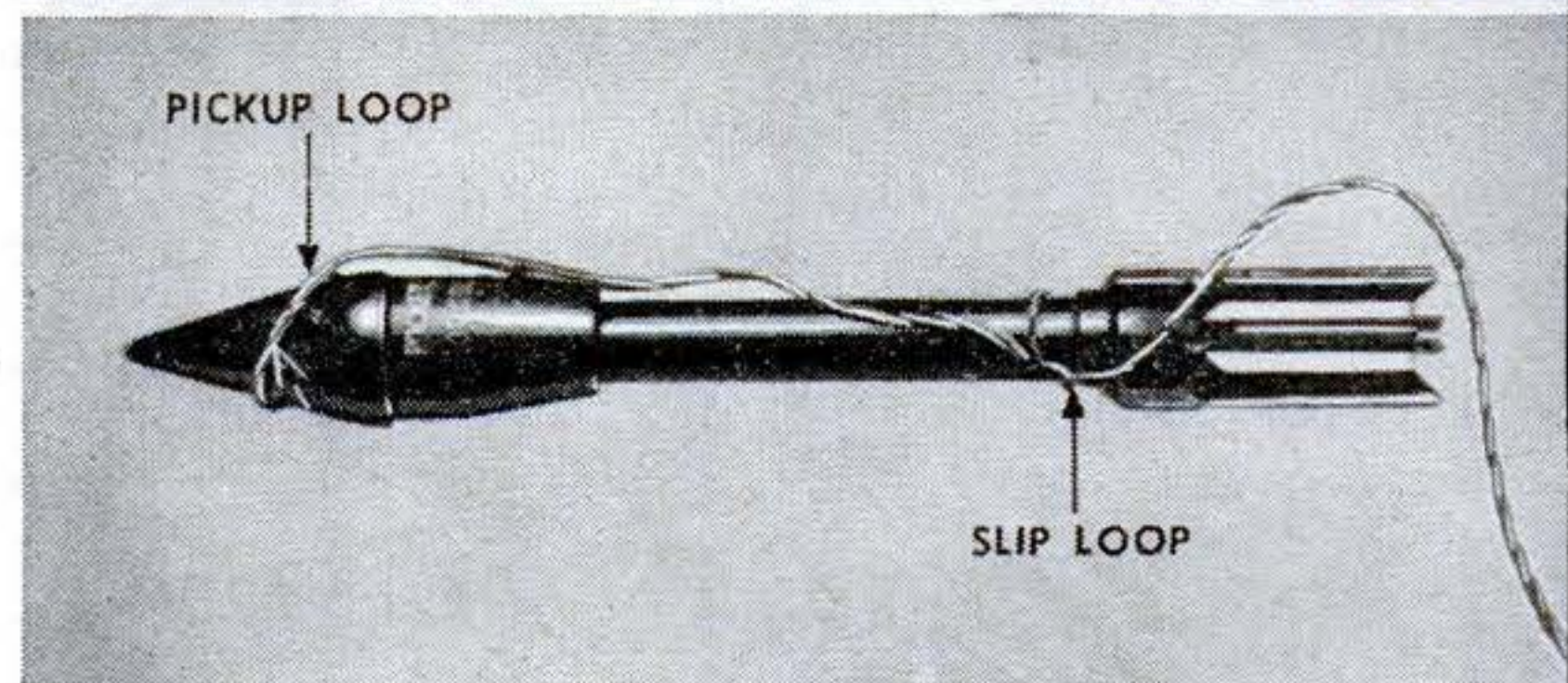

This is the easy way to lay phone wire across a stream—shoot it over with a bazooka (top). Photo below shows how wire is fastened to rocket, which pulls it from reel on ground.

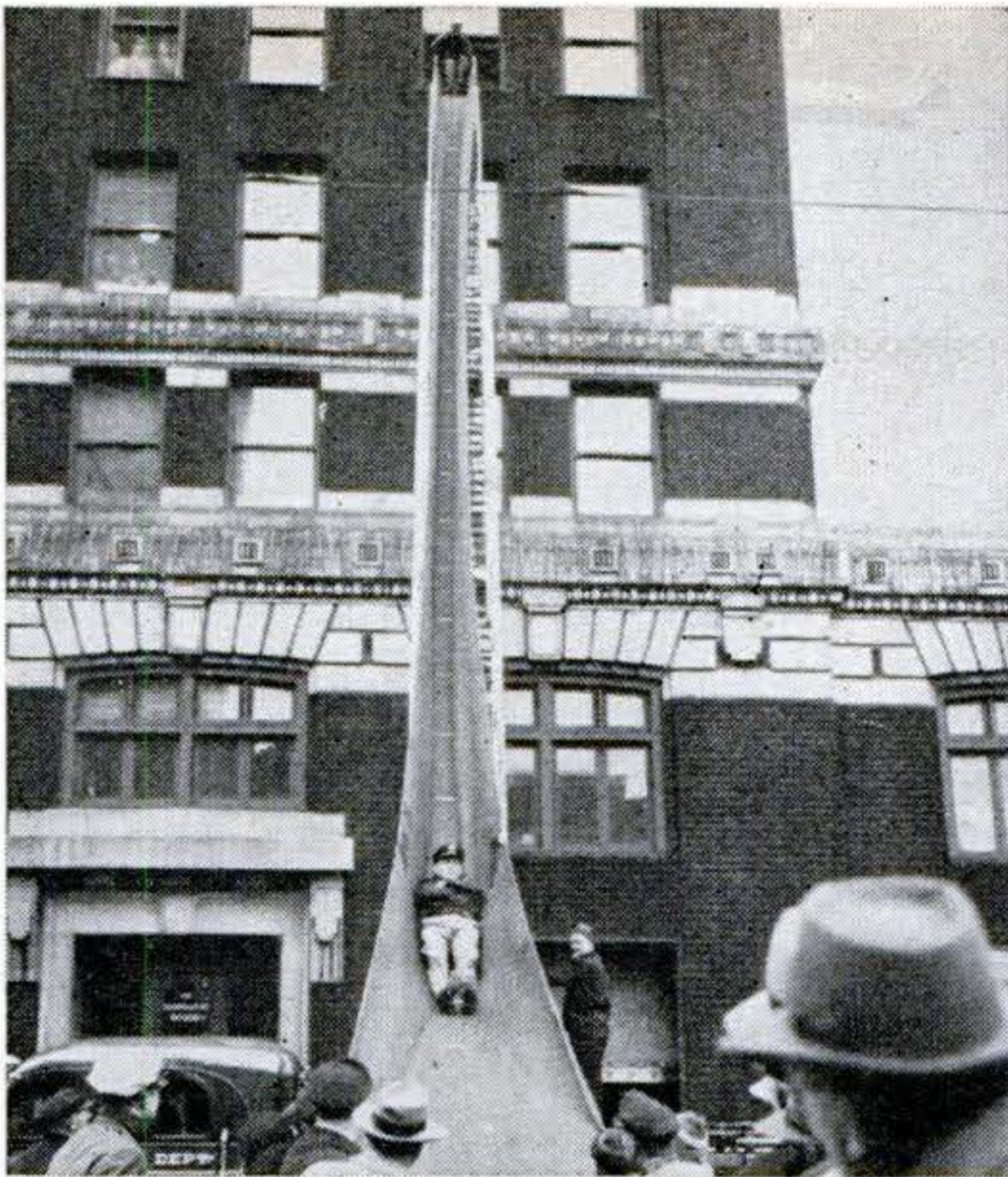

## Slide to Safety

A NEW escape for people trapped in a burning building; the fire chute shown here is made to reach as high as the average tenth floor. Up to the fourth floor, the top end hooks onto the window sill or some object such as a radiator inside the room. For reaching higher floors, it is attached to the end of an aerial ladder and held against the window. The chute is six feet wide, and made of water-repellent, fireproof canvas. The manufacturer, Eastman Evacuator Co., of Detroit, claims the device can evacuate people at the rate of one a second.

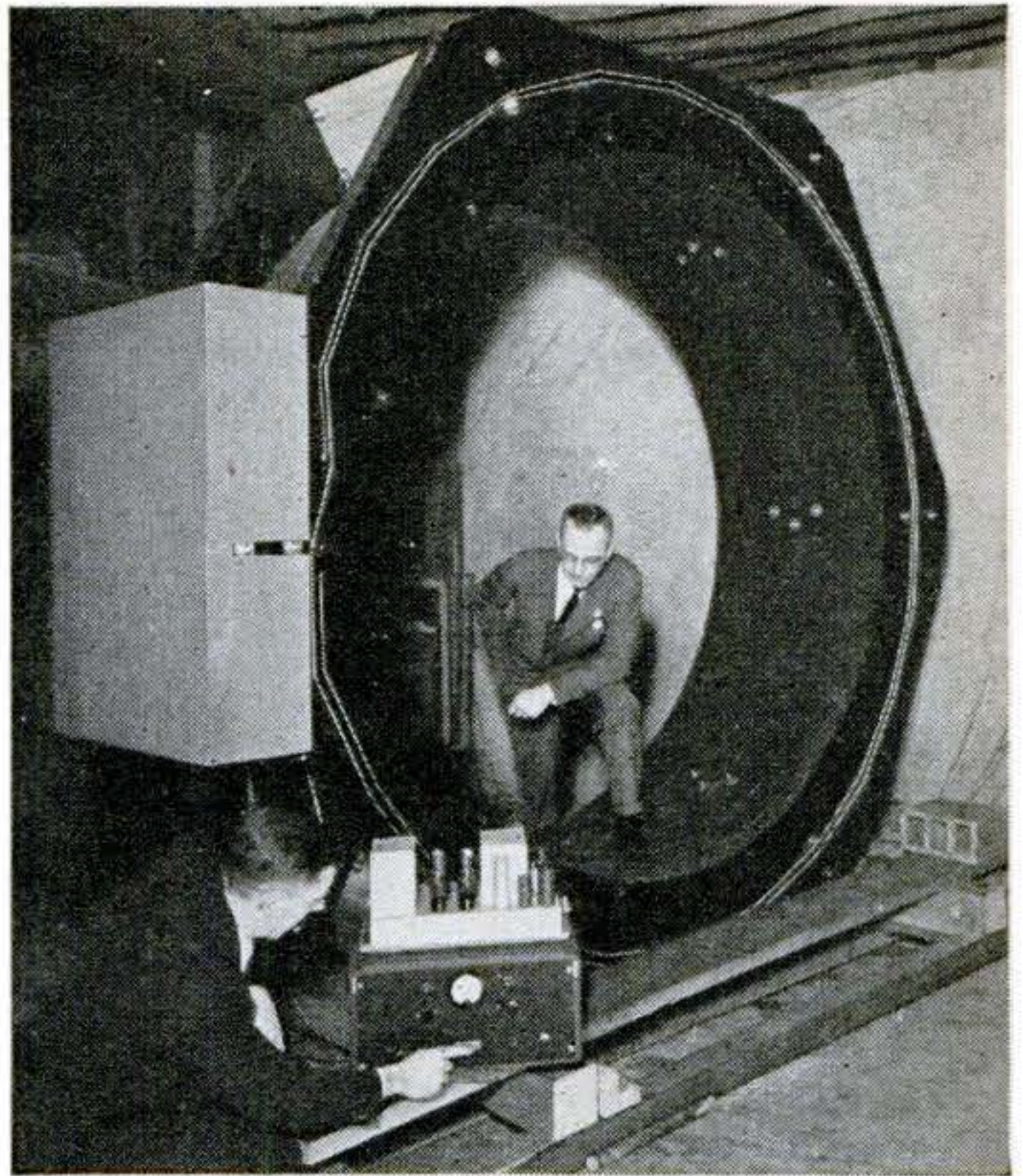

## Lumber Is "Loaded"

HARVESTING of more than 3,700 acres of timber on the Ft. Lewis Military Reservation, Washington, came to a standstill when it was discovered that the trees were not only liberally sprinkled with metal fragments, but that some even contained unexploded shells. When ordinary detectors proved useless in spotting the embedded metal, General Electric came up with the electronic detector shown above. The device is placed in the water; when logs are floated through its magnetic field, the presence of metal is announced by visual and audible alarms.



## Rock-A-By Razor

THIS nonelectric razor gives you a dry shave when you hold it against the skin and rock it gently back and forth. Its two blades, explains the British manufacturer, cut

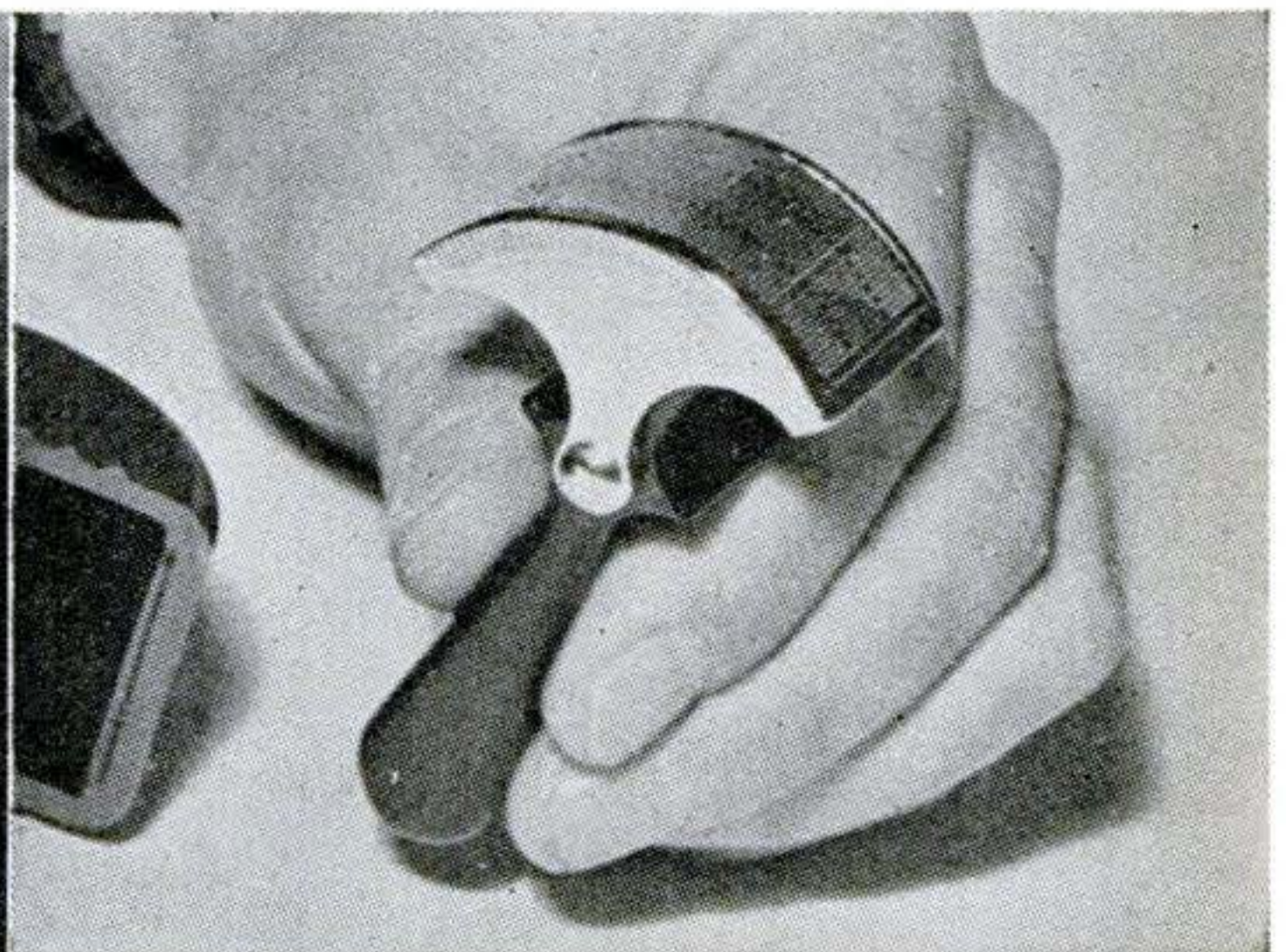

the whiskers by a scissors movement. At the same time the guard sharpens the blades, and is said to give them a life of several years. The blades, moving in a half circle, crop the beard bristles that project through the perforated guard shown above.

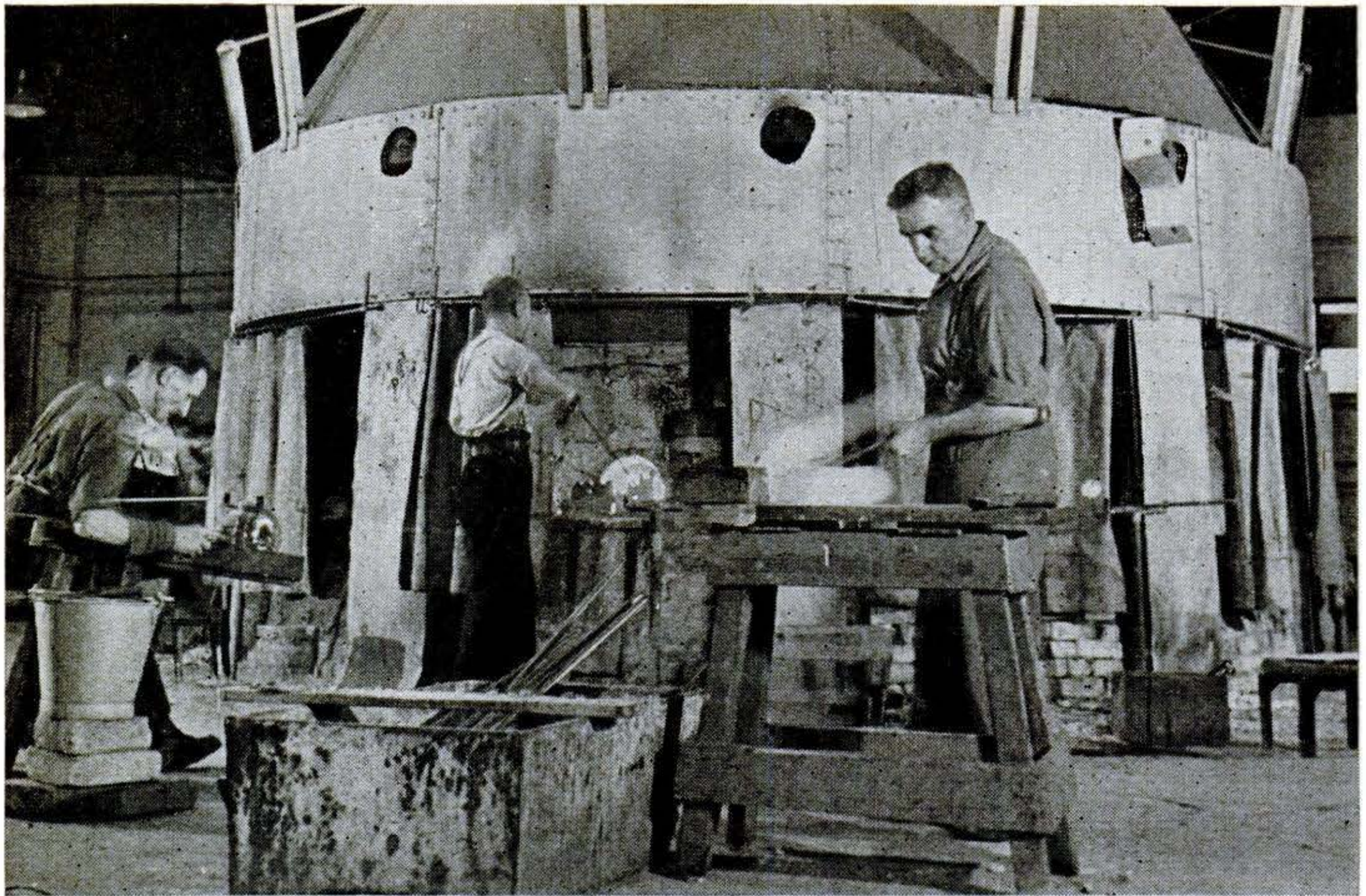

**This modern glasshouse** is scientifically lighted and is cooled by electric fans. Furnaces can be fired with either oil or gas; pot openings are covered with asbestos curtains to keep the heat

in. The workman in center background is "gathering" molten glass from the furnace, while the craftsman at the right is "marvering," or rolling the hot glass to give it shape.

## How English Experts Handle Glass



**A lip is being formed** on a jug by a skilled workman called a "gaffer." Taking over after a "servitor" has shaped the glass, he does such jobs as fitting handles and cutting off waste.

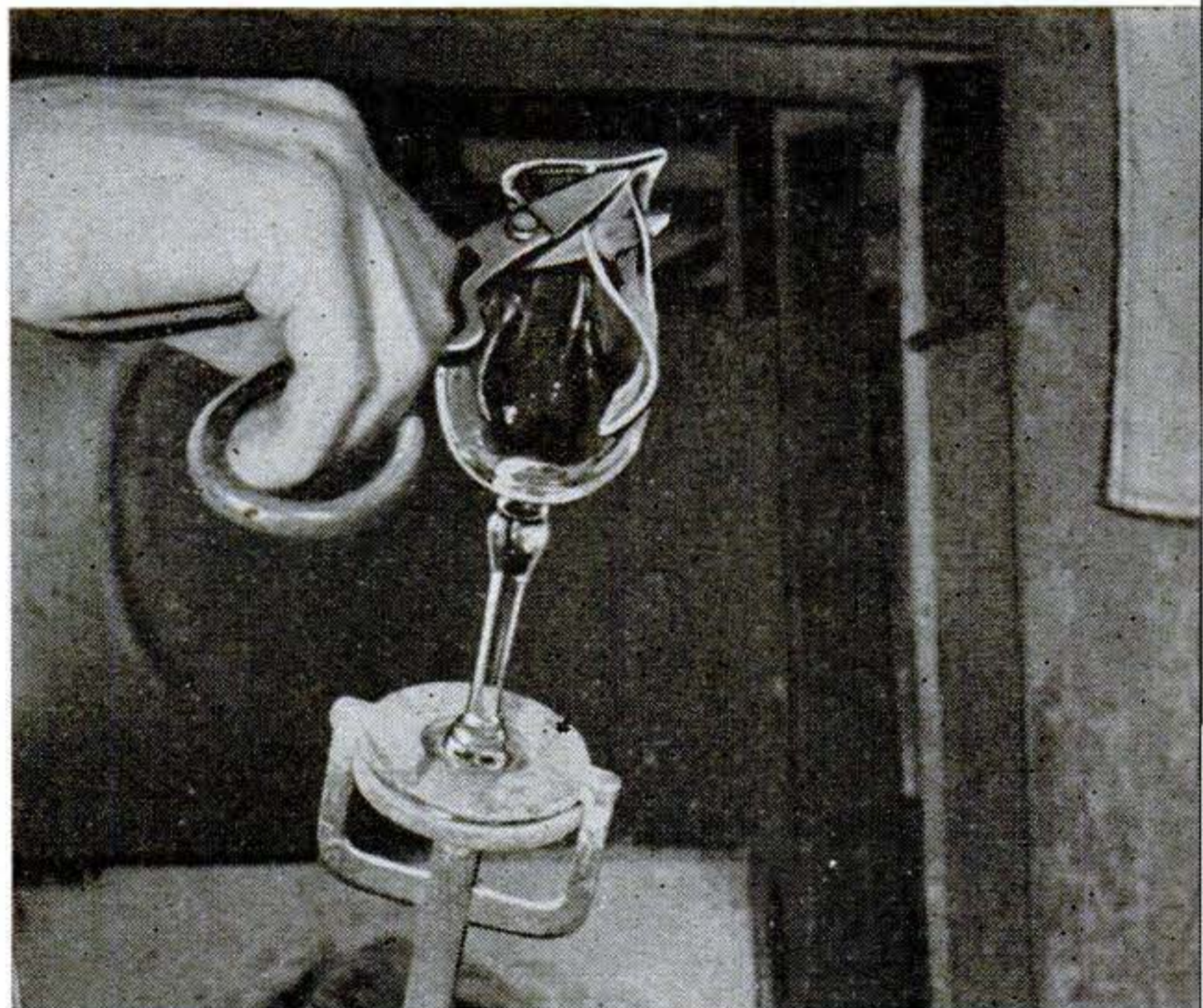

**Here waste glass** is being sheared off the top of a wineglass. Before this step, the open end of the glass has been reheated in a small subsidiary furnace, called the "glory hole."



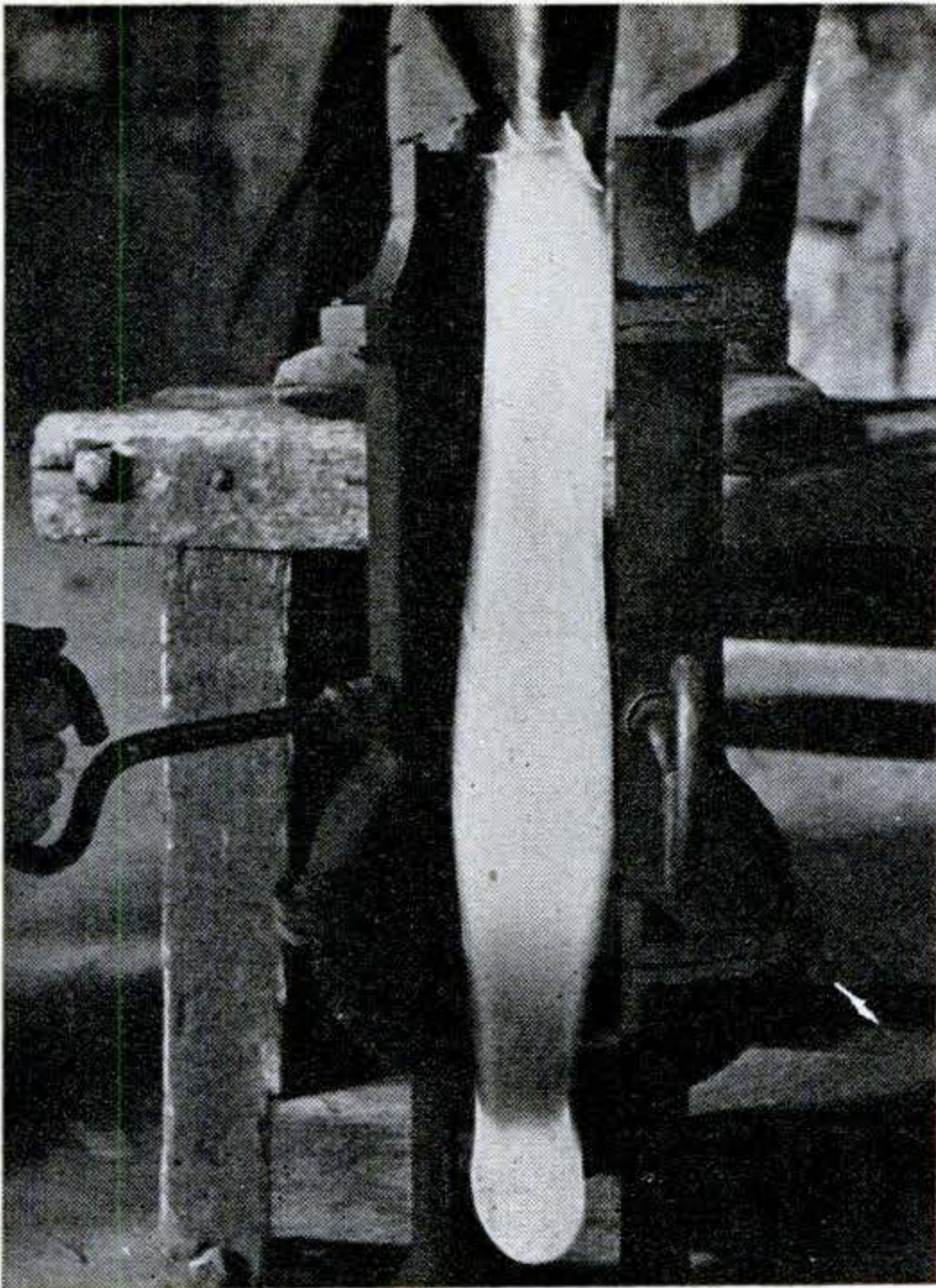

**Glass on a blowing iron** is inserted into a mold coated with a carbon deposit that acts as a lubricant. As the blow pipe is rotated, the article is blown up until it is shaped and set.

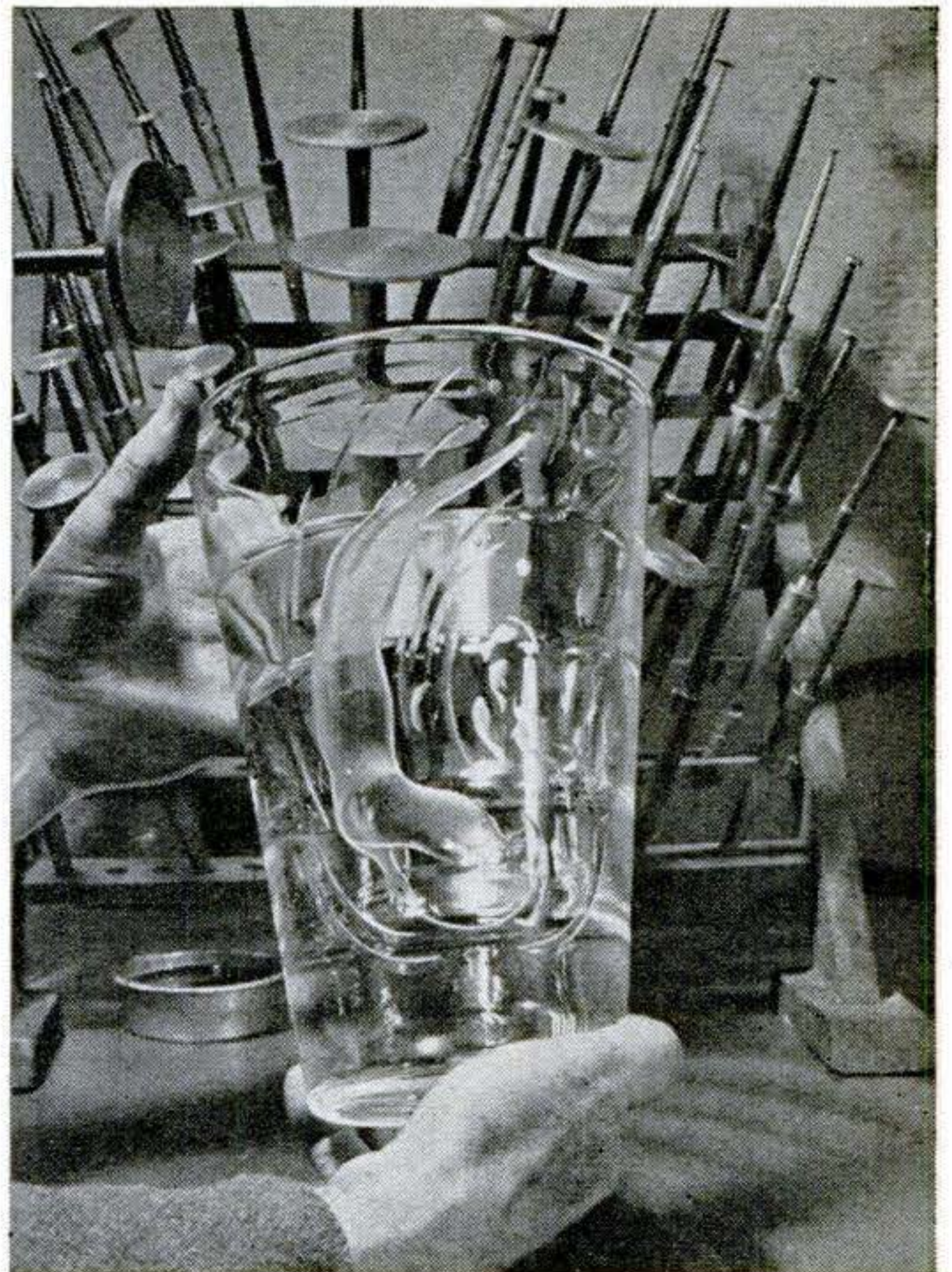

**A beautiful example** of the hand-blown glass-maker's art against a background of the tools required to produce it. Cutters range in size from a pinhead to eight inches in diameter.

**A** THREE-FOLD expansion is planned for Britain's hand-blown glass industry, which has had its center in Stourbridge for almost 400 years. Despite improvements in furnaces and working conditions, as these

photographs reveal, the craftsmen of today still turn out their exquisite lead crystal glassware much the same way their ancestors did. It is an hereditary trade, and a team of glassmakers is still called a "chair."



**A battery of flame guns**, left background, glaze the ground tops of tumblers. While faster than the "off-hand" or handmade method, this newer process produces a less perfect finish.

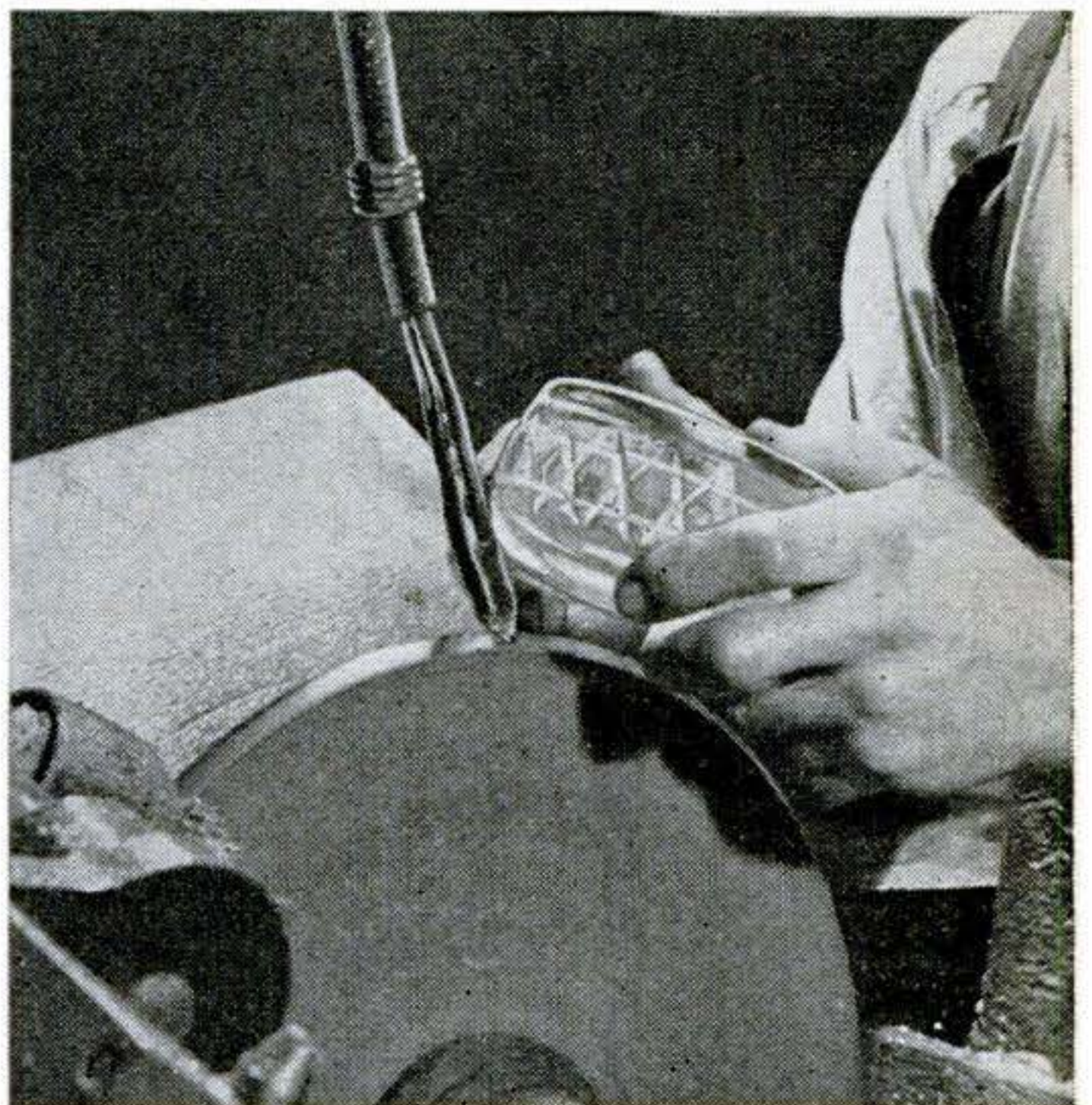

**A glass cutter working** at his wheel. The design to be cut is marked in roughly as a guide, but the highly skilled craftsmen work free hand, and they create many of their own designs.



1. The two rows of robot radio-set makers above form a corridor 70 feet long. Girls seated in the foreground are feeding plastic plates into the device. As these move down the line, a

series of automatic machines, governed by 20 electronic "brains" and "memory units," build up all the necessary circuits in the plates' preformed grooves and depressions.

2. After going through a sand-blasting unit, the plastic plates are sprayed all over with metal, filling in the grooves of the circuit pattern. At right, below, the fully metaled plates

are passing from the spraying unit into the face-milling unit, where surface metal is removed by high-speed diamond tools. At left, an inspector watches the freshly milled plates emerge.

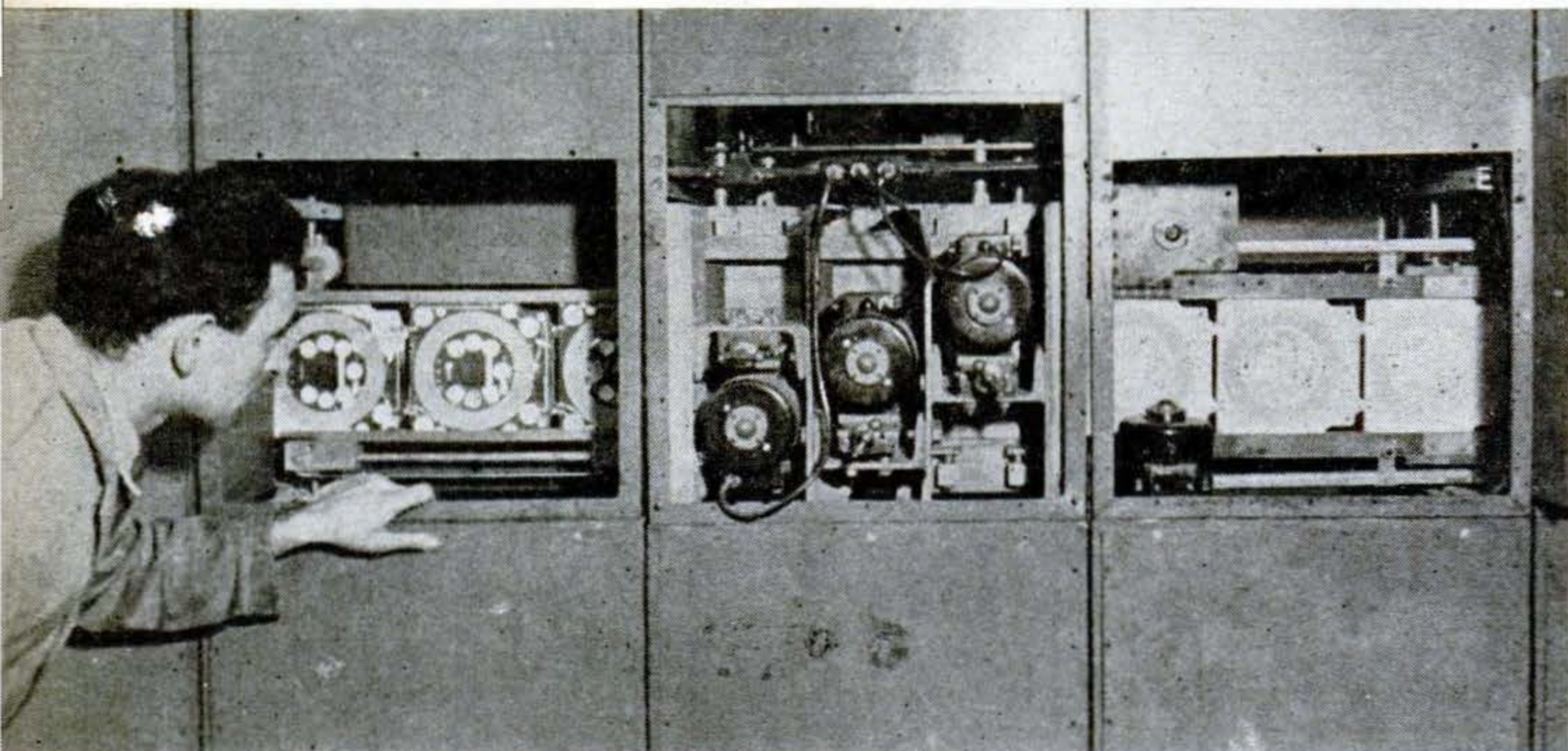

## ***Radio Robot Squirts Out 3 a Minute***

**A** COMPLETE radio set every 20 seconds is the production goal of this new British automatic machine known as ECME (Electronic Circuit Making Equipment). Nearing completion at the research laboratories of Sargrove Electronics, Ltd., this automaton uses the sprayed-circuit technique to do the jobs of a double line of skilled workers. Wiring mistakes are eliminated, and the machine even makes its own tests, signaling the location of any defects in the circuit.

Plastic plates are fed into each end of the two parallel rows of electronic units shown

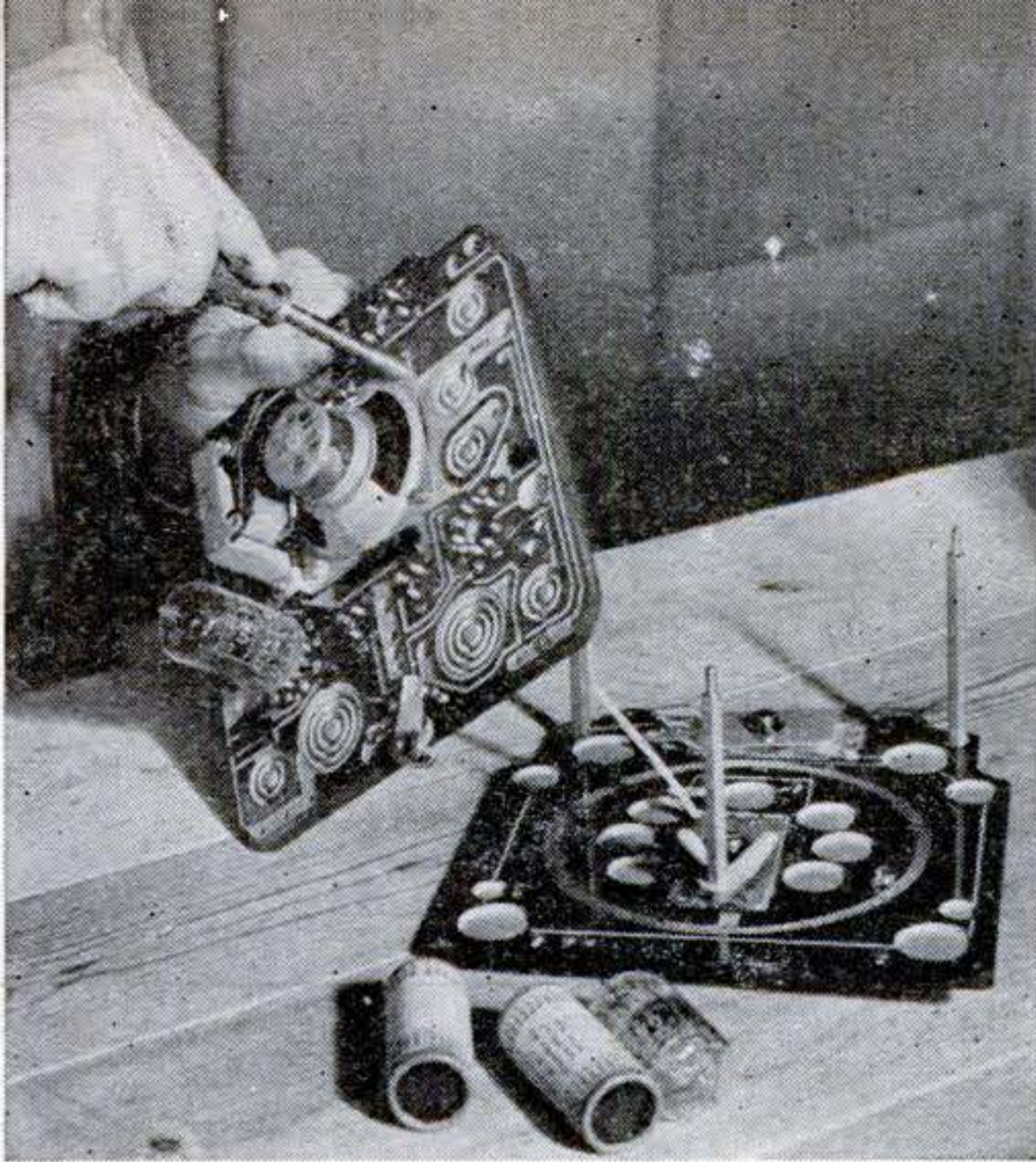

**3. The complete "metal-grown" circuits** can be seen above as a handworker takes over, adding a few finishing touches. At this stage vacuum tubes are fitted and the loudspeaker attached.

**4. The whole assembly, fitted together,** is then slid into a molded cabinet (below). During the 20 seconds it takes to turn out a unit, only three pairs of hands have touched it.

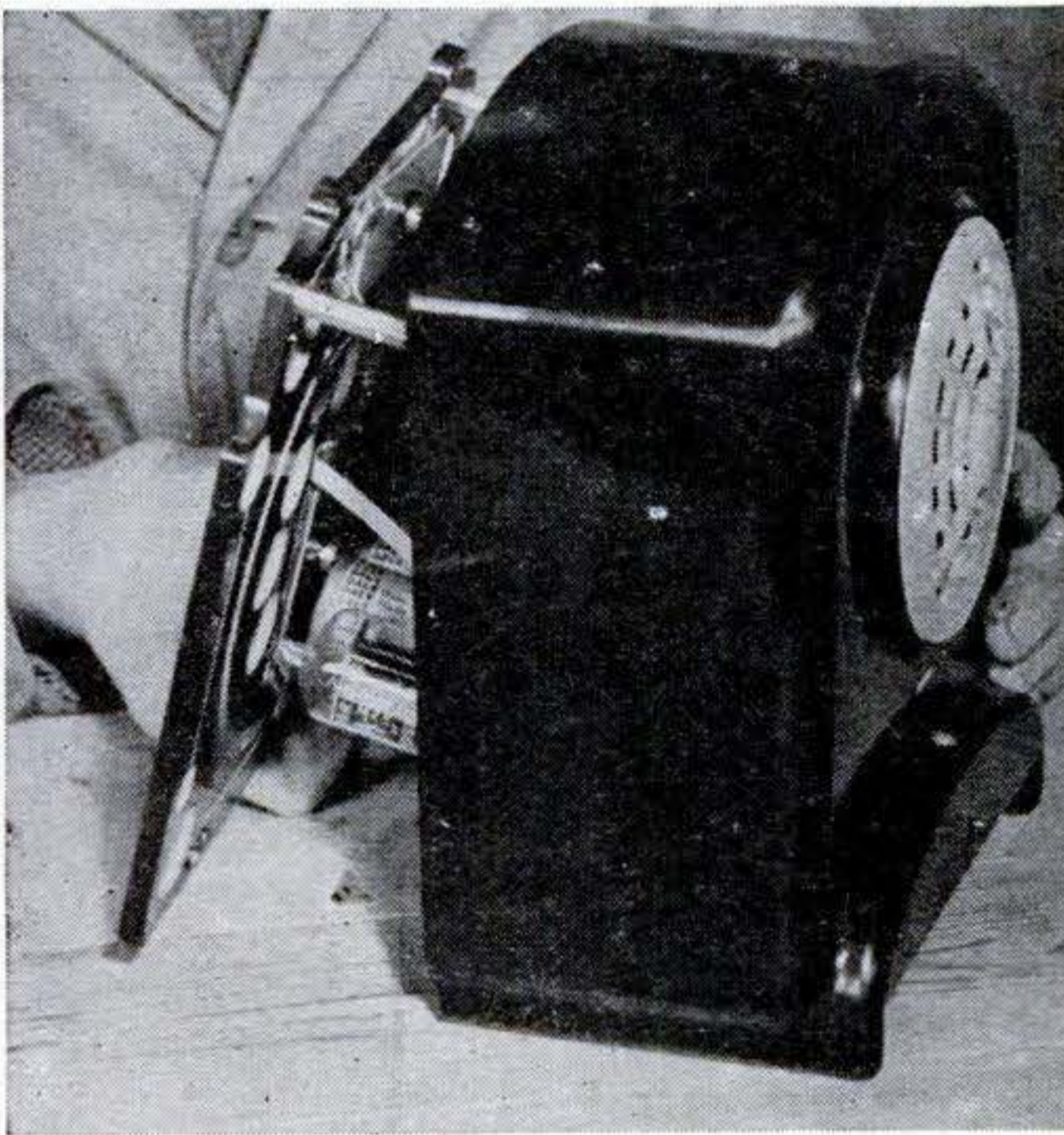

in the photograph at the top of p. 160. As the plates move down the line, all the necessary inductances, capacitors, resistors, and potentiometer tracks are "built up." After lacquering, other units automatically insert rivets, eyelets, and studs. When two plates are joined together at the end of the line, they form a complete radio receiver except for a few parts such as electrolytic condensers, tubes, and loudspeaker, which are added by hand. It is claimed that the sets will be both lighter and sturdier than those made with wired circuits.

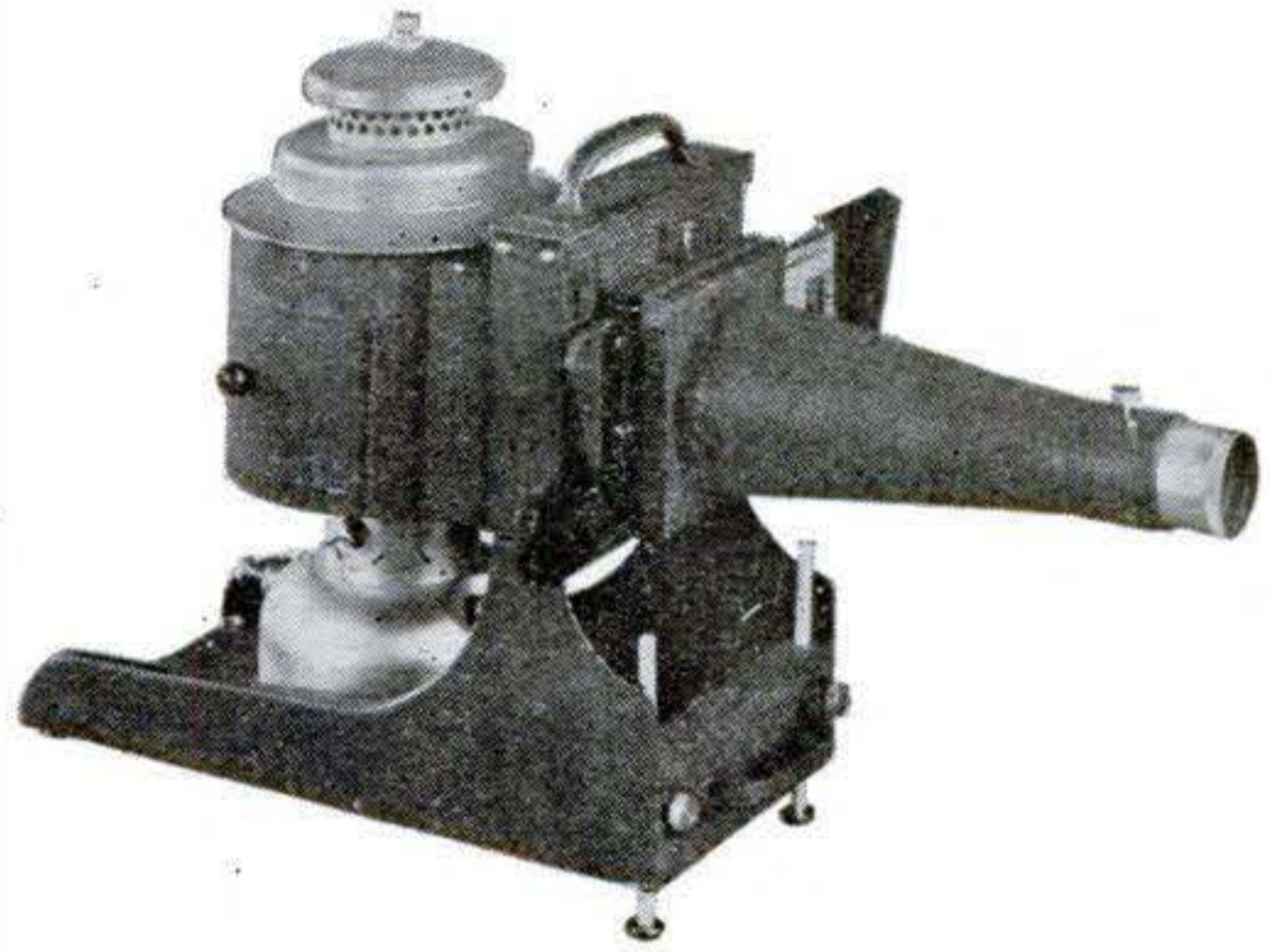

## Projector Uses Gas

This slide projector, operating on gasoline or kerosene, will bring visual education to communities in the United States and foreign countries where electricity is not yet available. Developed by the Charles Beseler Co. at the request of the U. S. Office of Education, it uses a standard Coleman mantle lamp. The projector takes slides and 35-mm. strip film.

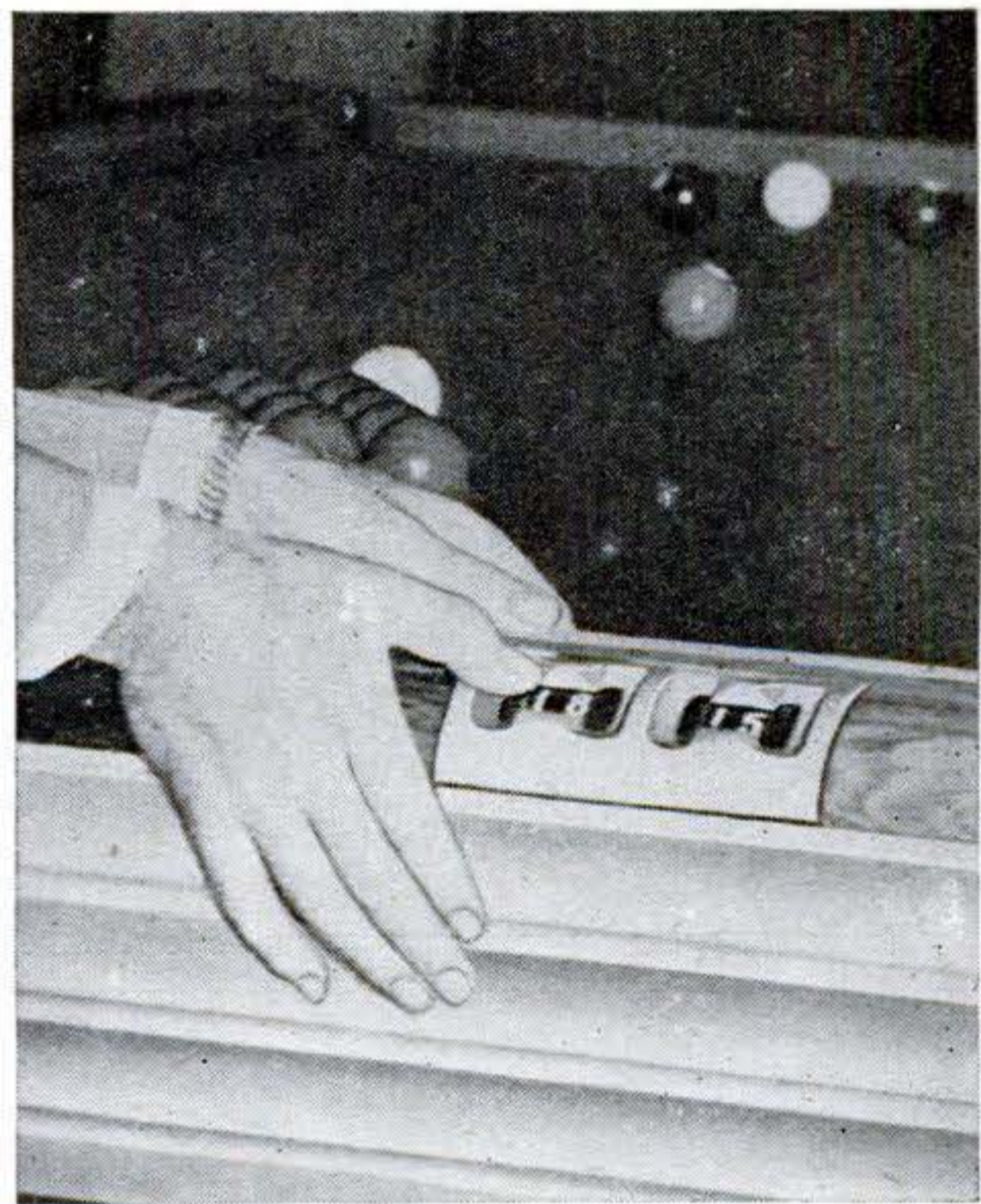

## Dials Keep the Score

BILLIARD rooms need no longer have unsightly string counters hanging overhead. The point-counter dials shown above, a product of the Brunswick-Balke-Collender Co., are built into the billiard table's rail. The device consists simply of numbered dials turned by thumb wheels. There are two dials for each player's score, so he can keep count up to 99.

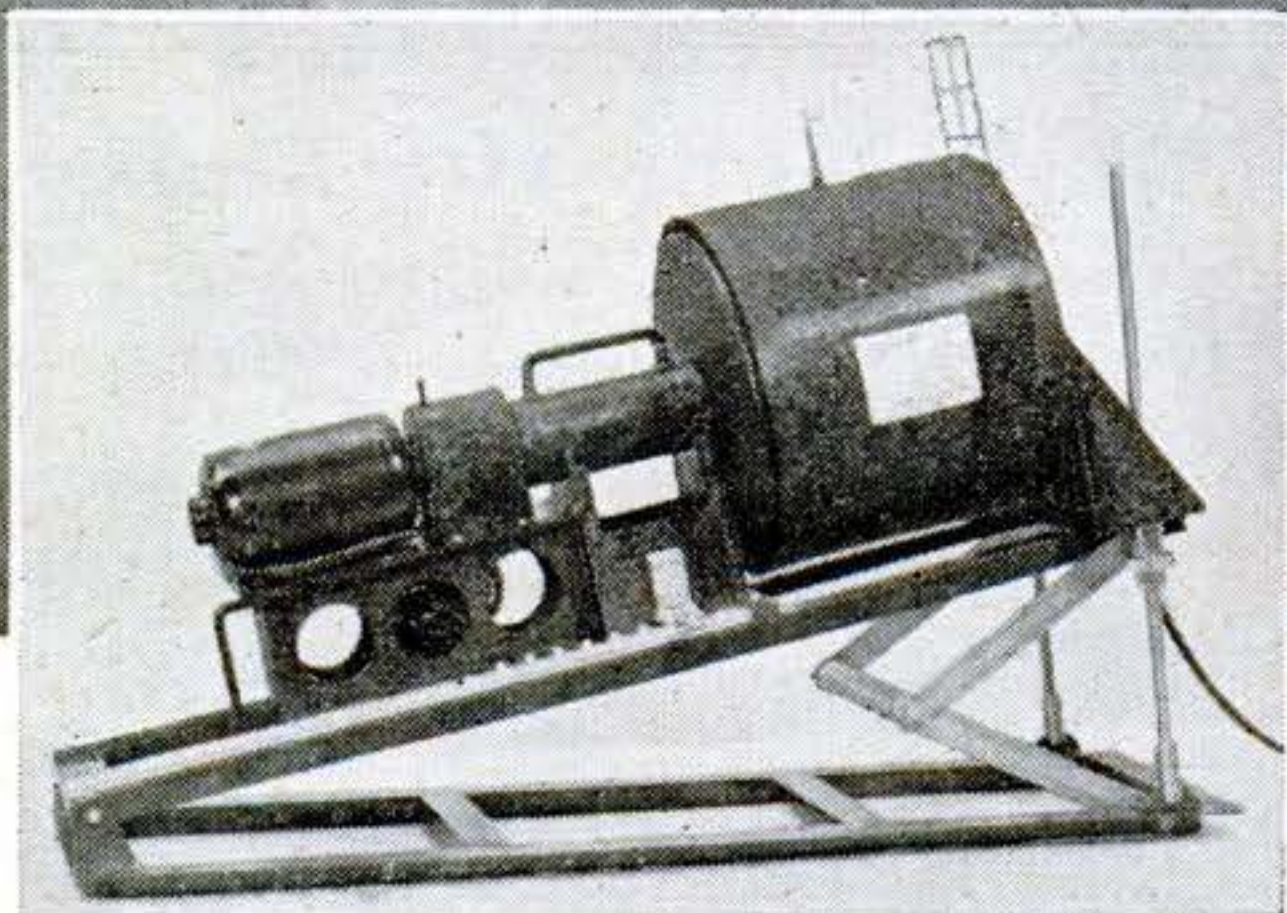
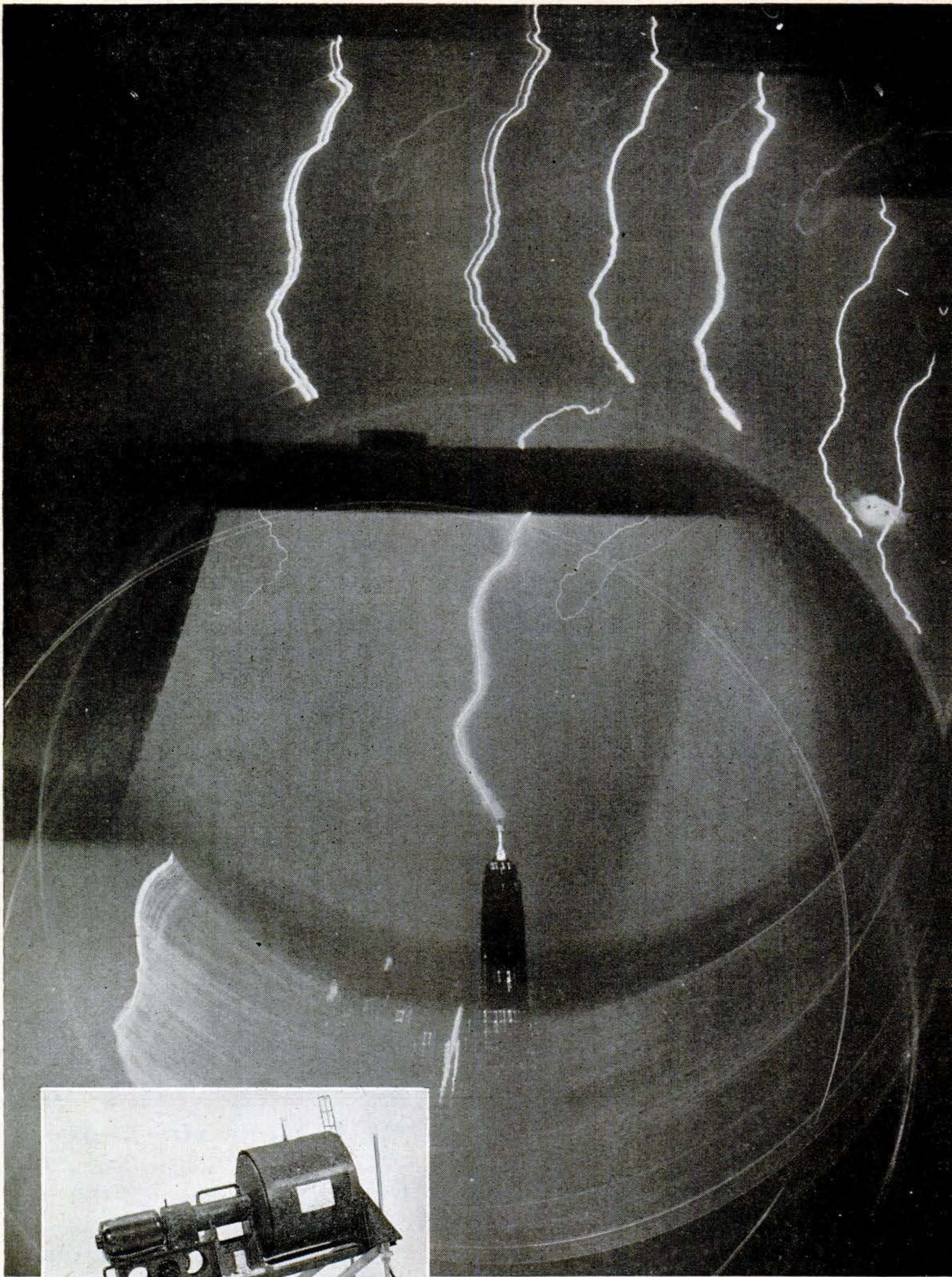

**Microsecond technique** splits a lightning flash. GE's special camera (inset) shows that bolt striking Empire State Building (center of photo) is one slow discharge and six fast ones.

# Seconds Split a Million Ways

Measuring the split flashes of time that are microseconds makes possible many modern miracles of science.

**By Carl Dreher**

**I**T TOOK you about one second, or 1,000,000 microseconds, to read the title of this article. On that basis one microsecond may seem short enough to satisfy everyone, but to the modern electronics engineer it is a fairly long time. Describing a new electronic gadget, its inventor informs us that each dial division corresponds to 0.0132 microseconds; in other words, he is measuring down to a *ten-thousandth* of a *millionth* of a second.

That's slicing it rather fine, but if it is worth a few dollars to you, you can buy a pulse generator that will deliver bursts of power adjustable down to 0.1 microsecond. You can order it from an advertisement—nothing special about it—plug it into a wall socket like an electric iron, and you're a member of the microsecond-splitting fraternity yourself. It's economical to operate, too—consumes only 40 watts.

Is all this just a scientific stunt? Hardly, unless the major part of radio and electronic

development during the last war and between the two wars is to be so regarded. Actually it represents a major technological revolution. If some Rip Van Winkle radio engineer awoke today he would hardly recognize the science he pioneered. Where he figured mainly in kilocycles, he would hear his younger colleagues talking megacycles and thousands of megacycles. Where he was concerned with the production of continuous waves, he would find bursts or pulses of energy playing as important a role.

The technique of producing these pulses would seem especially odd to him, for if he worked with vacuum tubes before his long sleep he would remember that the first rule was to avoid overloading and consequent distortion. Many circuits in use today by their very names—clipping, blocking, slicing, limiting, leveling, square-wave, etc.—show that they are designed to distort wave shapes rather than to preserve them. Finally, he would discover these strange contours manipulated with a split-microsecond accuracy unknown in his time.

The most important practical development of these techniques is radar. We usually think of radar as a system of blind bombing or obstacle detection. Basically radar is

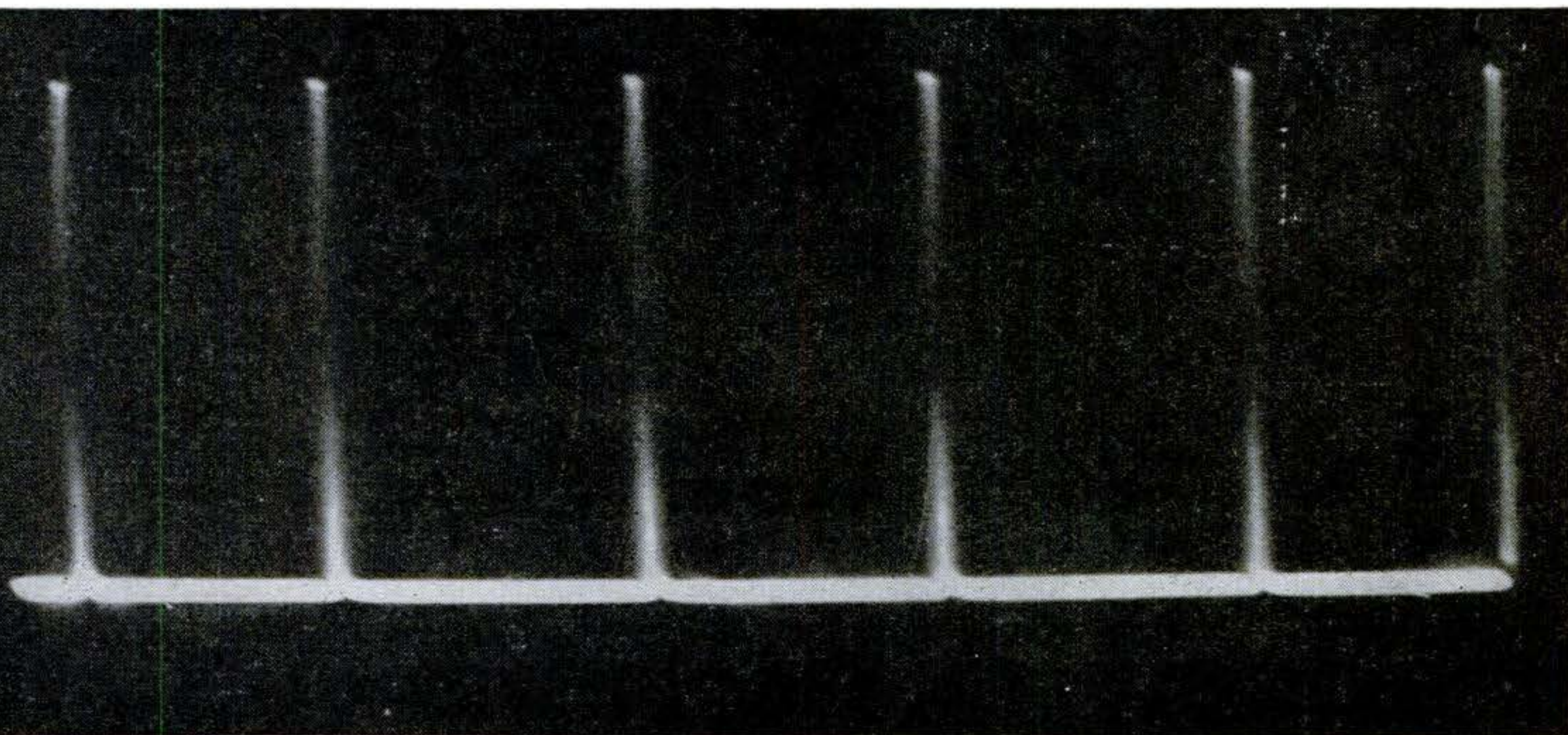

**Microsecond pulses** look like this when viewed on an oscilloscope. Photo above shows six of the ten pulses transmitted in Pulse Time Multiplex radio system developed by Federal Telecom-

munications Laboratories. Each of eight pulses carries different program; others are markers. PTM receiver unscrambles the pulses so that you hear only the program you choose.

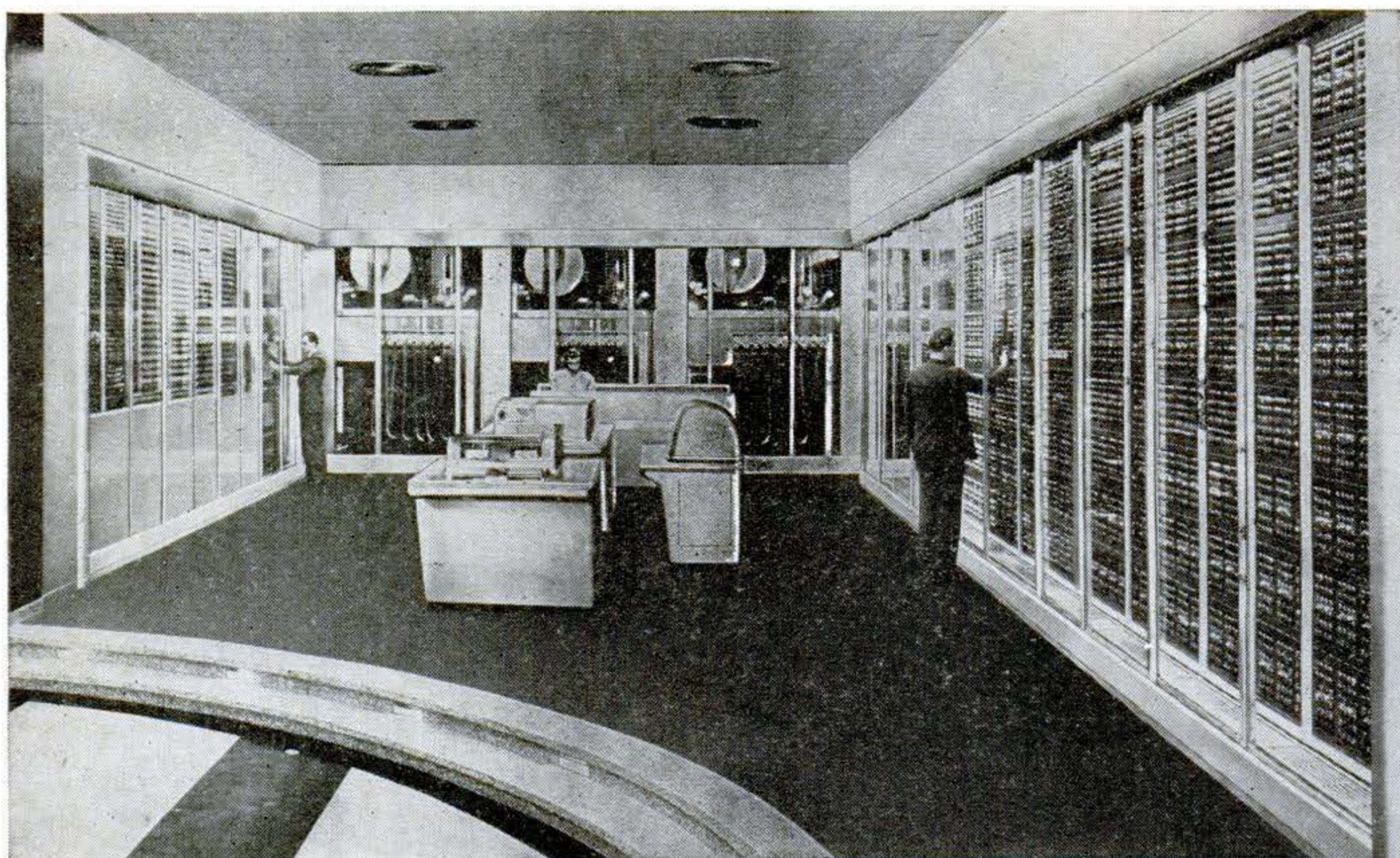

**High-speed computers**, such as the giant just placed in operation by International Business Machines Corp. (above), use electronic pulses

to solve the most difficult mathematical problems. IBM's monster computes the position of the moon—186,260 operations—in seven minutes.

a system of time measurement of exquisite precision, and what we see on the scope is only a derivative of what we measured in microseconds. We send out square-shaped pulses, usually of one microsecond duration, pick up the reflection from a target, measure the elapsed time electronically and automatically, convert it into distance, display the result on a tube, and that's radar.

#### *Used in Navigation Aids*

Another application of microsecond technique is the Loran navigation system (PS, Feb. '46, p. 78). Like radar, it uses rectangular pulses, but they are transmitted on a comparatively long wave length from a number of widely separated locations. Thus they cover a much greater range than radar, which, like television, is limited to the optical horizon. The method is to measure the time of transmission from each transmitter and thus to obtain a fix by triangulation. The individual pulses are relatively long—about 40 microseconds—but it is a split-microsecond technique, for the transmitters are synchronized to within 0.5 microsecond.

Another field for pulse-transmitting devices lies in guided-missile control. The problem here is to feed data to a built-in radio receiver, which will guide the missile to a target. Continuous waves may be used

for this purpose, but pulse control offers the advantage of coding, so that the receiver will respond only to friendly emissions and the enemy will be unable to take over control of the missile for his own ends.

Guided-missile applications are only in the experimental stage, but another field, that of industrial controls, was already highly developed before the war and now stands to benefit by the advances of radar and allied techniques. The devices used are manifold, but their common purpose is to supply self-correcting means in industrial processing in place of imperfect manual controls.

A typical problem is automatic register control in the printing industry. One solution involves the use of a phototube that detects any misregister and promptly triggers a square-wave circuit, which in turn operates a correcting motor. One of these devices will control a large printing press at any speed between 300 and 1,000 feet a minute, and maintain register to within a thousandth of an inch at all times.

High-speed photography is also a field in which microsecond timing is required. One system uses microflash bulbs fired by a control circuit with a period of about two microseconds. This is not the lower limit: the GE General Engineering and Consulting Laboratory is reported to have a fully automatic

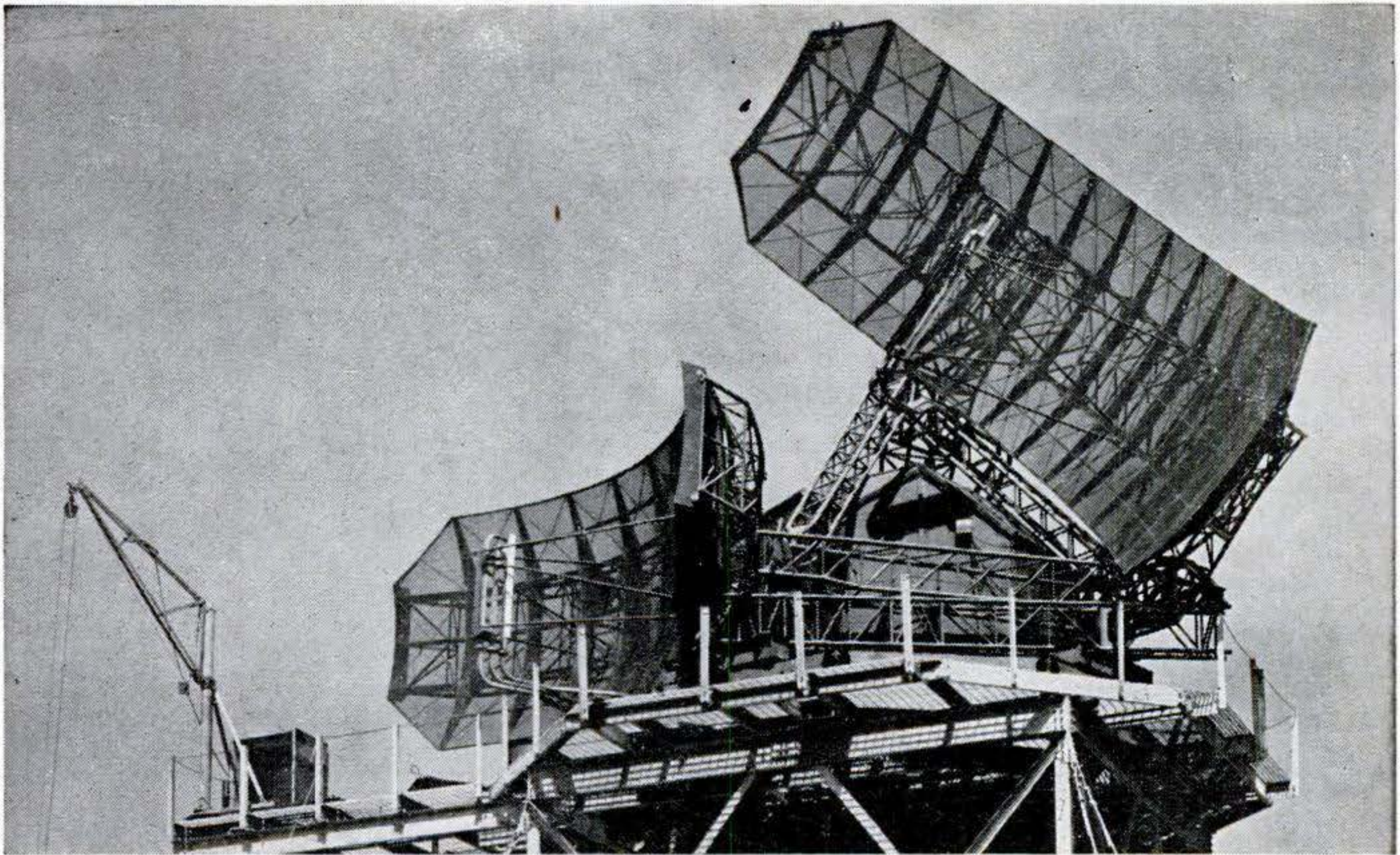

**Radar is really a stop watch**—fantastically accurate—timing the speed-of-light race of a microsecond pulse from antenna to target and

back. Computers then turn travel time into distance to target. The 17-ton antenna above searches thunderstorms over 250-mile range.

camera, with a speed of one microsecond, which produces a finished transparency within 30 seconds; the Navy has another type, utilizing a Kerr cell as the shutter, for which a speed of 0.04 microsecond is claimed.

In the development of the atomic bomb, X-ray photographs were made using high-voltage pulses to create peak currents as high as 2,000 amperes, but lasting only a microsecond or so. These devices are used for observation of machinery in motion, the passage of bullets through gun barrels, and for the study of motion that can be recorded only by microsecond techniques.

Particle accelerators used in atomic research may in one respect be considered microsecond devices. Whether the particles move in linear or closed paths, they must be kicked ahead electrically at the right intervals. At the high speeds at which they move, this normally involves microsecond timing. In the FM cyclotron, for example, the particles circle the chamber at the rate of 0.1 microsecond for a single revolution, and the timing of the accelerating impulses must be of the same order.

A final example takes us back into the field of radio communication. It is the system of multiplexing, or sending several messages simultaneously over a single circuit. Its com-

plexity is one of its advantages. In military use, for which it was originally developed, it affords a high order of security precisely because it involves a complex interlacing of pulses on which it is difficult to eavesdrop.

The underlying principle, however, is simple. Even the shortest single sound of speech or music is comparatively long. It lasts for thousands of microseconds. Why, then, once we have learned how to divide time into microsecond slices, must we send all of a given sound over a circuit on which time represents money?

#### *Sampling Sections of Sound*

All we need to do is to listen to small sections of the sound for a fraction of a microsecond, and all the information in the original wave will be retained. Moreover, by that method we can sample a number of conversations or musical renditions and send them over the same circuit simultaneously.

The military version of this ingenious system was developed by the British, the U. S. Army Signal Corps, RCA, and Bell Telephone Laboratories. It has eight two-way telephone channels that can also serve as telegraph or facsimile channels. Bell is now using this type of equipment in several civilian installations, such as the one linking Catalina Island to the California mainland. 

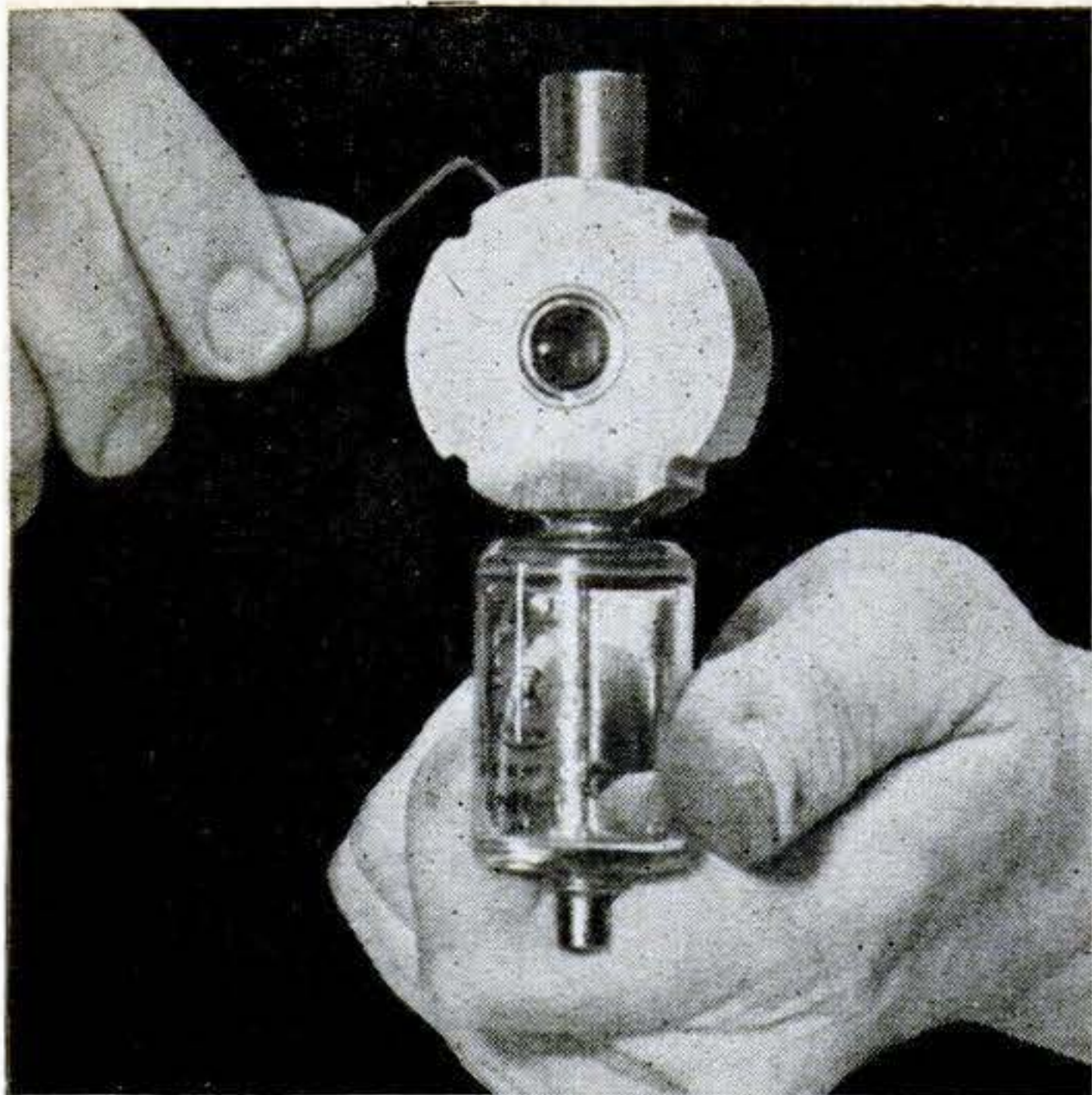

**Radar sets need** only one antenna, thanks to TR switch (above), which changes antenna from "transmit" to "receive" in a few microseconds.

A similar system developed by International Telephone and Telegraph is capable of accommodating eight broadcast channels on a single frequency, with only one transmitting and one receiving antenna. Such microsecond technique may provide economical radio reception in hotels and institutions.

How do they split seconds into a million or more pieces? For transmission and control it is done by means of pulse-generating circuits. Some of these generate square or peaked waves directly, while others start with a standard vacuum-tube oscillator producing the conventional sine wave and distort it into a series of square-shaped pulses. This is done by overloading the tubes, and is called the *brute-force* method. Using crystal-control, such circuits can be stabilized with microsecond accuracy.

For reception and measurement, cathode-ray oscilloscopes are used. In a cathode-ray tube electrons fly out of the cathode and are focused into a beam that makes a spot of light on a fluorescent screen. Deflecting apparatus in the throat bends the beam when a suitable voltage is applied. Amplitude (voltage or current) is represented on the face of the tube by vertical distances, time by horizontal distances. The voltage that produces the horizontal movement is called a *time base* and the circuit that produces the voltage is called a *sweep circuit*. A cathode-ray 'scope may have a sweep of 20 inches per microsecond.

Accuracy depends largely on the fre-

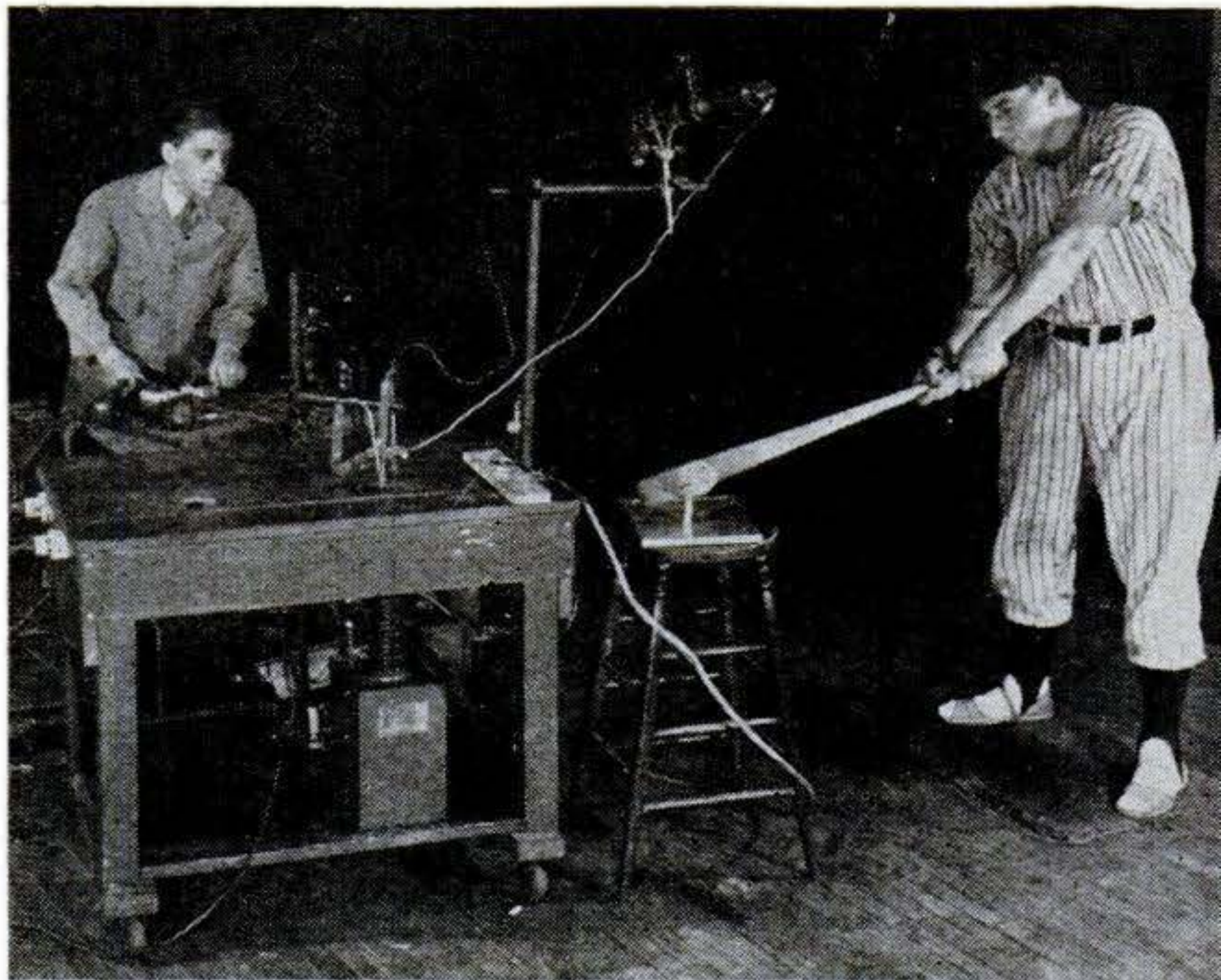

**Fast-action photographs**, such as this one of a baseball being hit, are made with high-speed flashes lasting only about two microseconds.

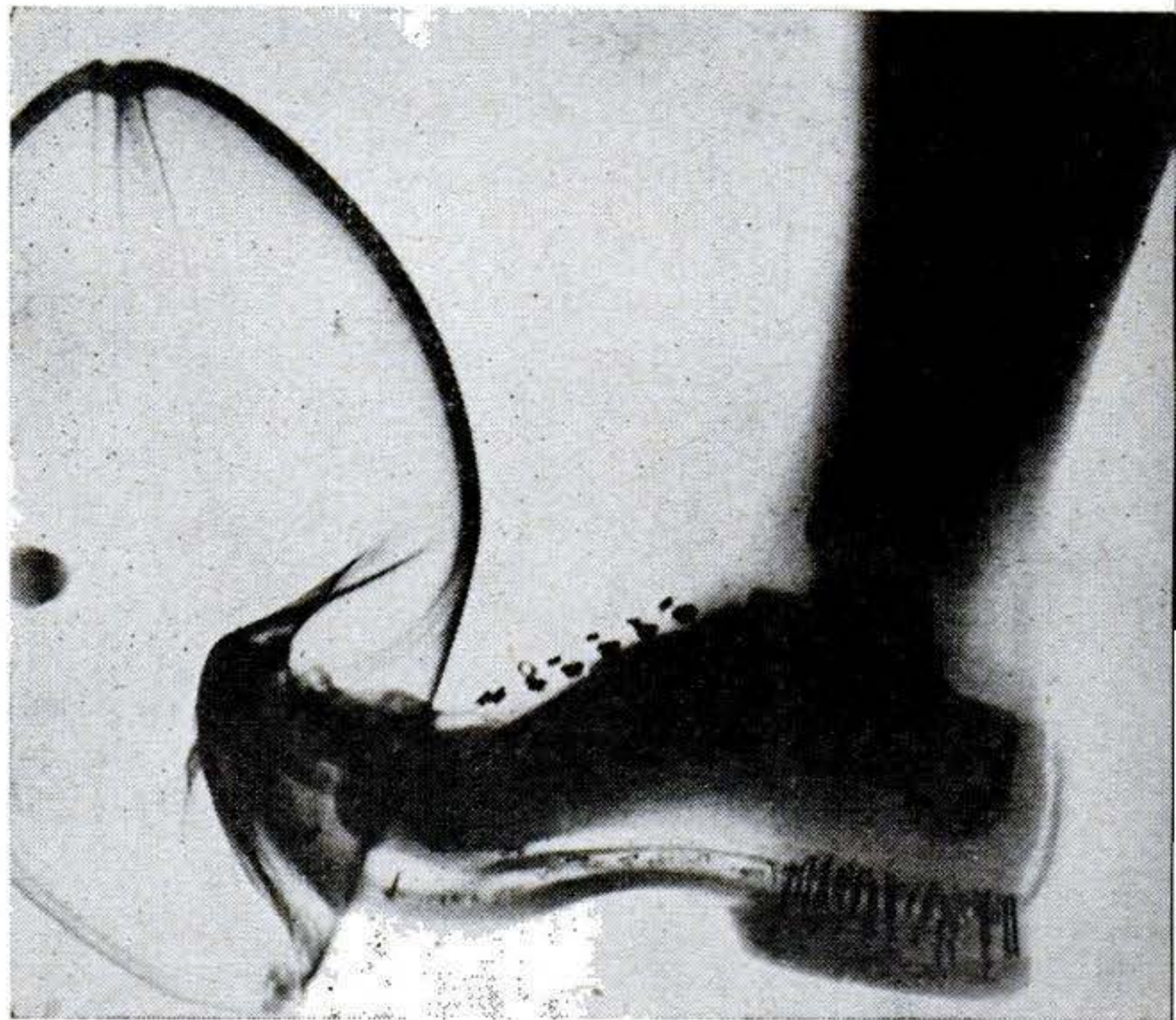

**Microsecond X-rays** have been developed at the Westinghouse Research Laboratories. Notice metal eyelets and nails in the kicker's shoe.

quency standards available. The Bureau of Standards has a number of transmitters constantly on the air to provide a check. Its primary frequency standards are accurate to better than one part in ten million. Its broadcast time signals are constantly compared with absolute time data from the U. S. Naval Observatory. Some of its equipment will measure a rate of change equivalent to one second in 50 years. This remarkable accuracy can be plucked out of the air for nothing. END



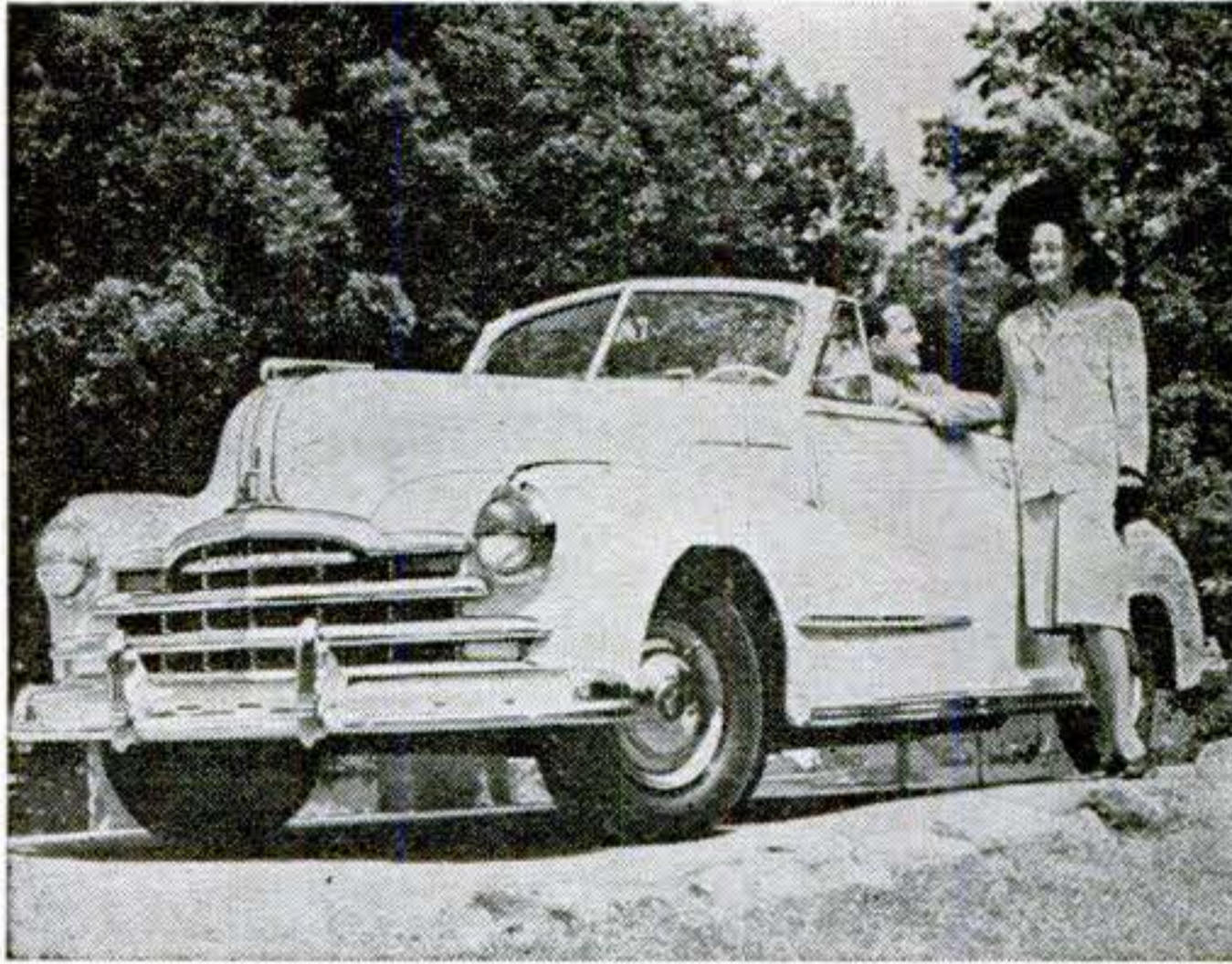

## Pontiac Gets "New Look"

LOOKING longer and lower than its predecessors, the 1948 Pontiac not only rivals its higher-priced cousins in appearance but is the first low-priced car to offer an automatic transmission. Long available only on Oldsmobile and Cadillac, General Motors' Hydra-Matic Ⓢ transmission is now provided as optional equipment. New styling, as shown on the convertible above, creates an appearance of increased length and width.

## Spare Wheel Fits Rim

HERE'S one "fifth wheel" that would always be welcome. If you get a flat tire on some lonely road or in bad weather, just clamp the two half-sections of this emergency spare on the rim of the disabled wheel and bolt them together, as shown at right, and you can be on your way without having to change the tire. Made of heavy aluminum alloy ringed with hard rubber, the device weighs only 8½ pounds, yet is said to permit speeds up to 40 m.p.h. and to support 7,500 pounds. It is made by P. A. Special Merchandise Co., Long Island City, N. Y.

## Pass Light Aids Safety



THIS accessory light for the rear of an auto takes the guesswork out of passing. It flashes "Okay Pass" to the car behind if the road ahead is clear. Operated by a push-button, it can also be used as a warning light for cars preparing to stop. It is made by the Teleoptic Co., Racine, Wis.

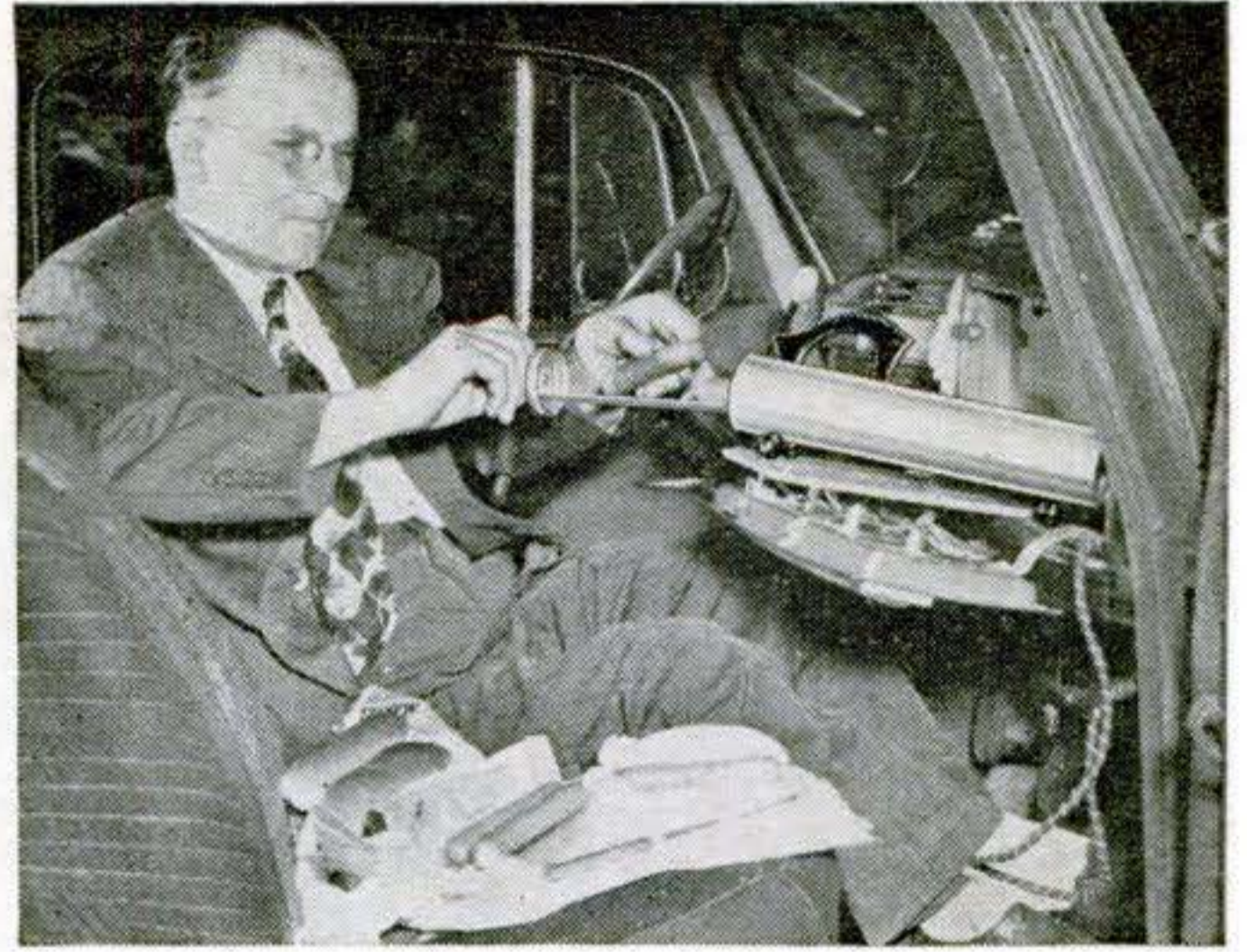

## Hot Dogs Hitch a Ride

IF YOU get hungry on long auto trips, here's an electric hot dog roaster that you can take right along with you. A narrow, aluminum-alloy tube with a loading tray at one end, it operates off the car battery and cooks two frankfurters, laid end to end, in three to five minutes. For home use, a 115-volt AC-DC model is also available. Called the Hot Dog Sizzler, it is made by the Thomas Manufacturing Co., of Chicago.

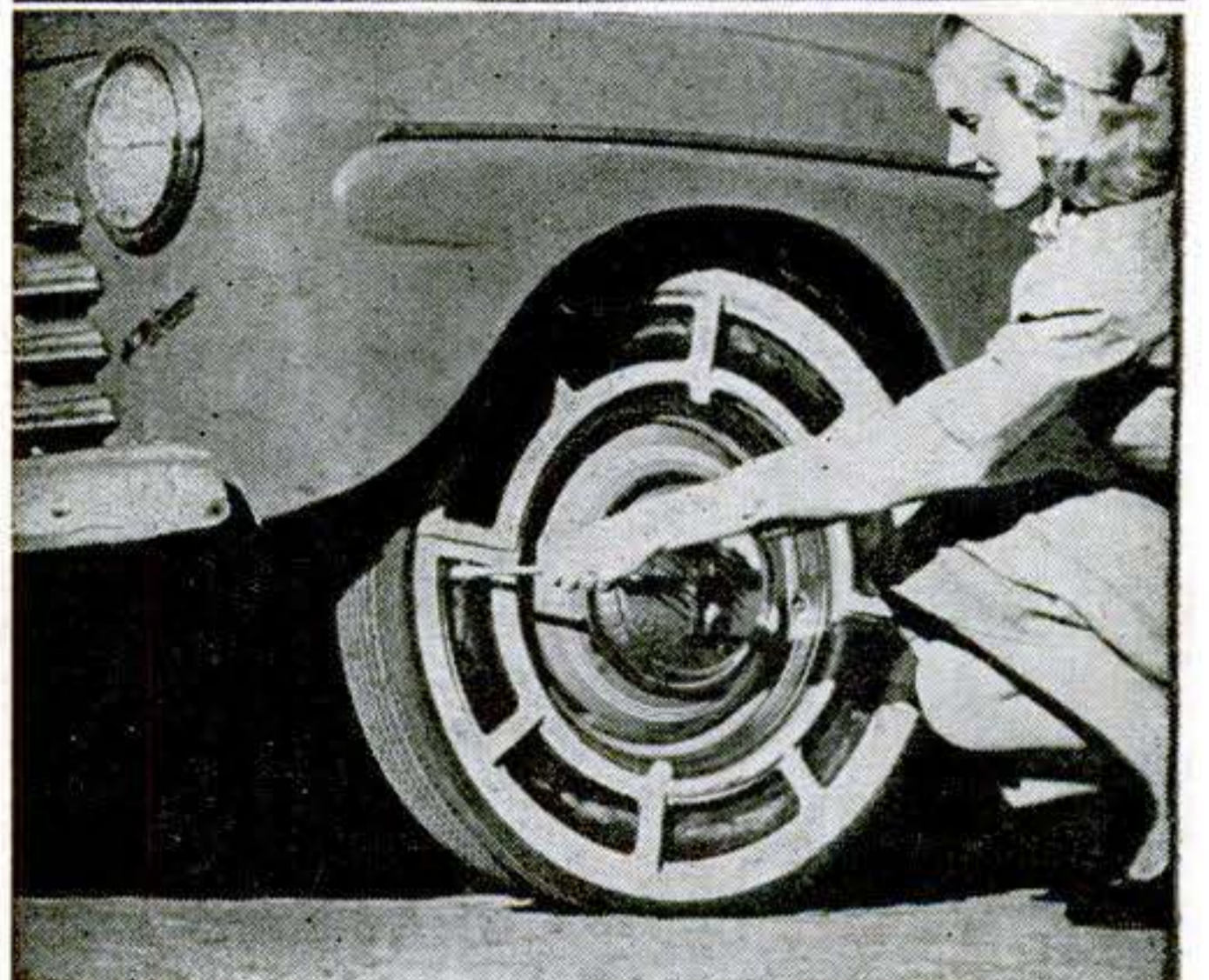
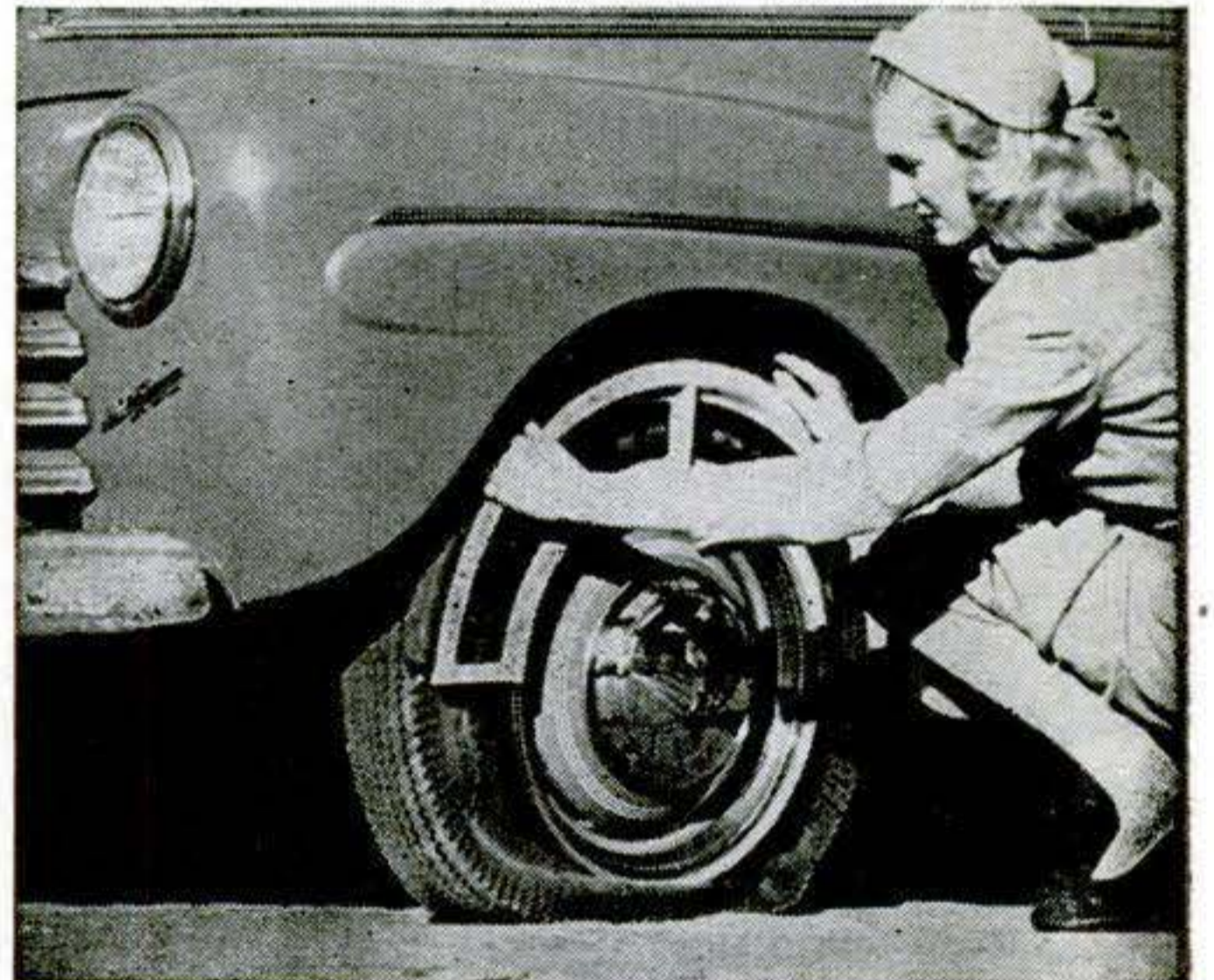

# Bump 'Em Out Yourself

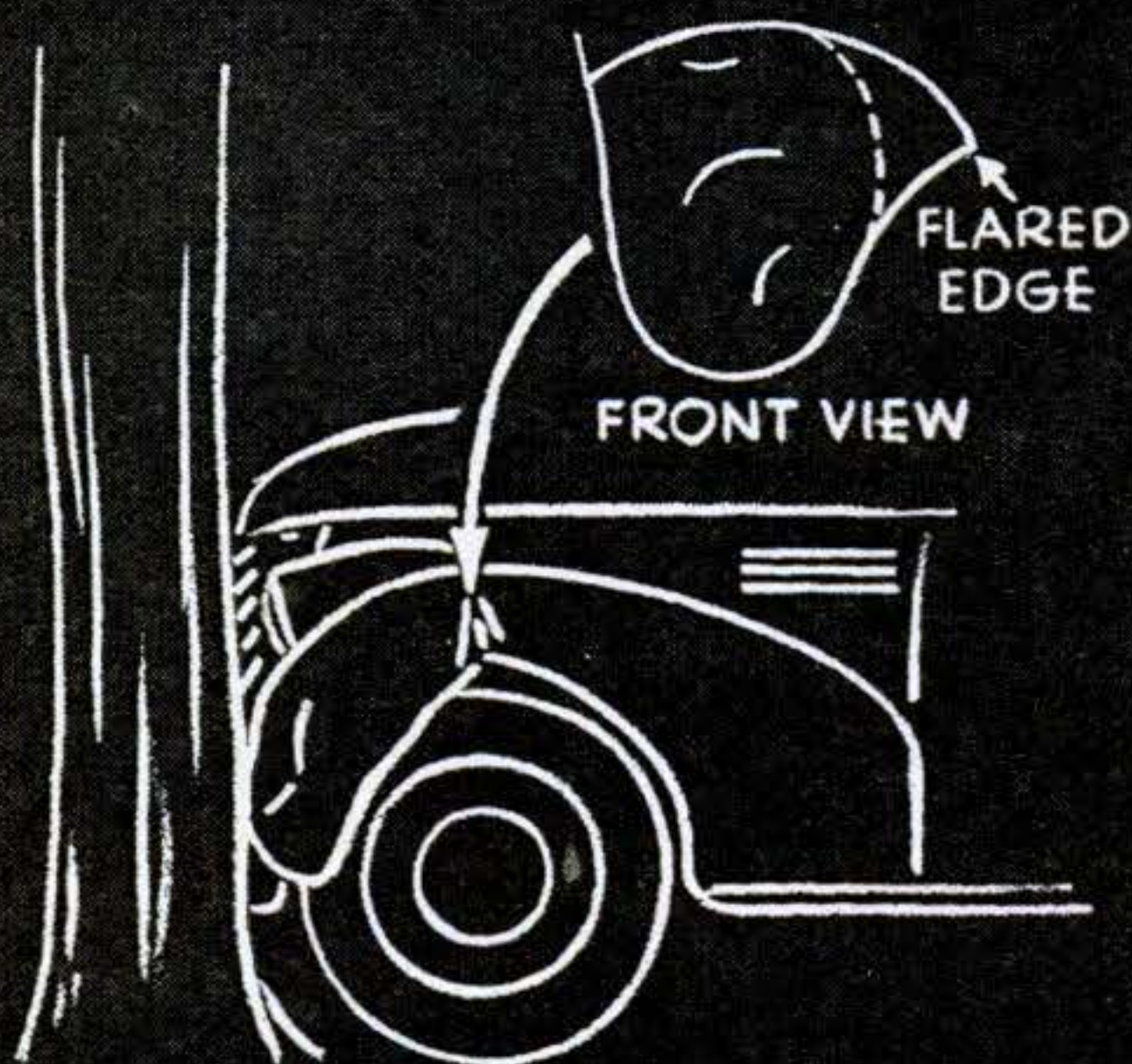

JAM-BACK DAMAGE

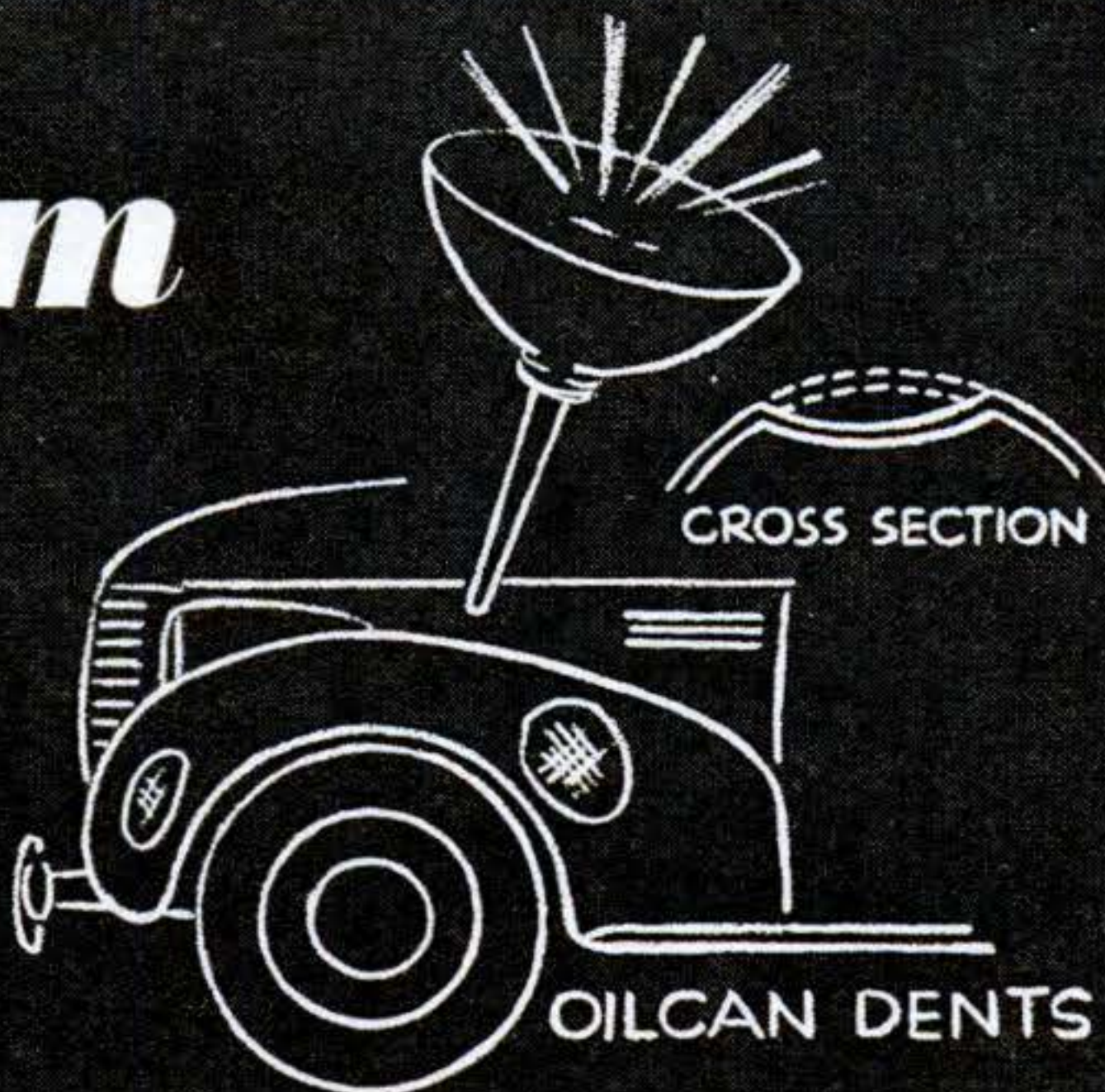

OILCAN DENTS

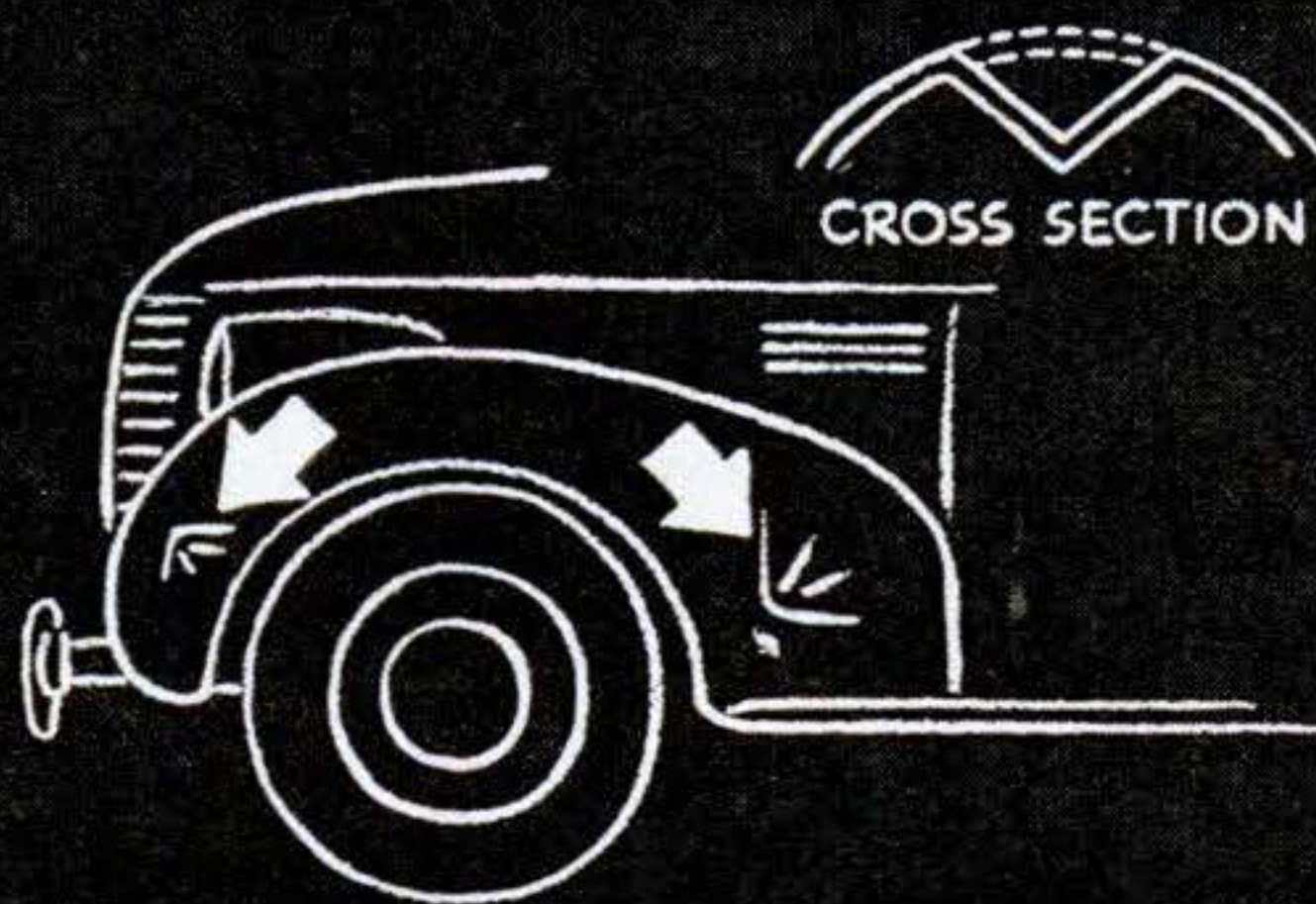

SHORT, TIGHT JAMS

**Are your fenders dog-eared? It's easier to iron out dents than you may think. Just common tools are needed.**

**By E. F. Lindsley**

**T**HERE'S a rule to remember when you're removing a dent from an automobile fender. Even more than you'd like to get rid of the dog-gone thing, the dent itself *wants* to come out. Here's why:

A dent is as out of place in a stamped sheet-metal part as one in a drum head, and built-in strains are constantly trying to force the metal back to its original curvature. It follows that your work should be planned to give these forces a helping hand. Metal that's badly stretched, torn, or cracked is the only exception.

Fender dents fall into three general classifications. First and most common is the oil-can or dish-shape. A type more difficult to remove is the short crease, or jam, stretched into the metal by such unyielding objects as

bumpers and lamp posts. The most troublesome is the jammed-back fender resulting from head-on impact. Here, the rolled edge of the fender shows a definite bellling out and the front part is bent back toward the wheel.

All three conditions also are found in doors, hoods, rear decks, and other locations—but such cases usually require expert attention and special tools. Stick to fenders until you've gained experience.

Step one in removing any dent is careful examination of the edge contours of the fender. Sighting along the rolled bead and comparison with an undamaged member will usually disclose irregularities in the basic alignment. Once these have been spotted, use a jack or timber to force the misalignment back towards its original curve, and use blocks as needed to hold this pressure on the metal while removing the dent. Restoration of the original pressed-in stresses makes dents come out easily. If the rolled bead at the fender edge is buckled, straighten

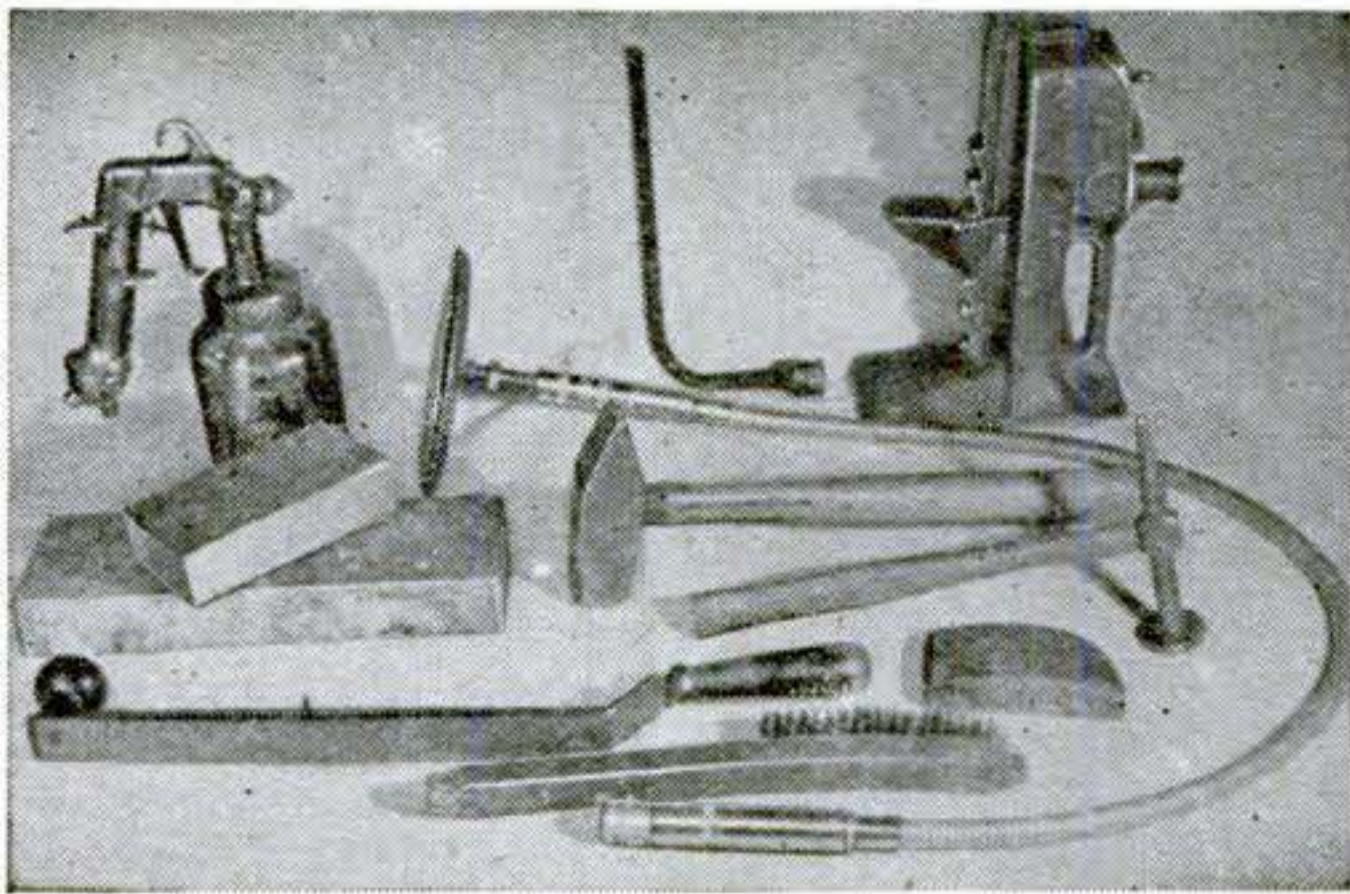

**Few tools are needed** for home fender repairs. The main ones are hammers, a jack, spray gun, vixen file, wire brush, dolly, and wood blocks. A flexible-shaft sander-polisher also is useful.

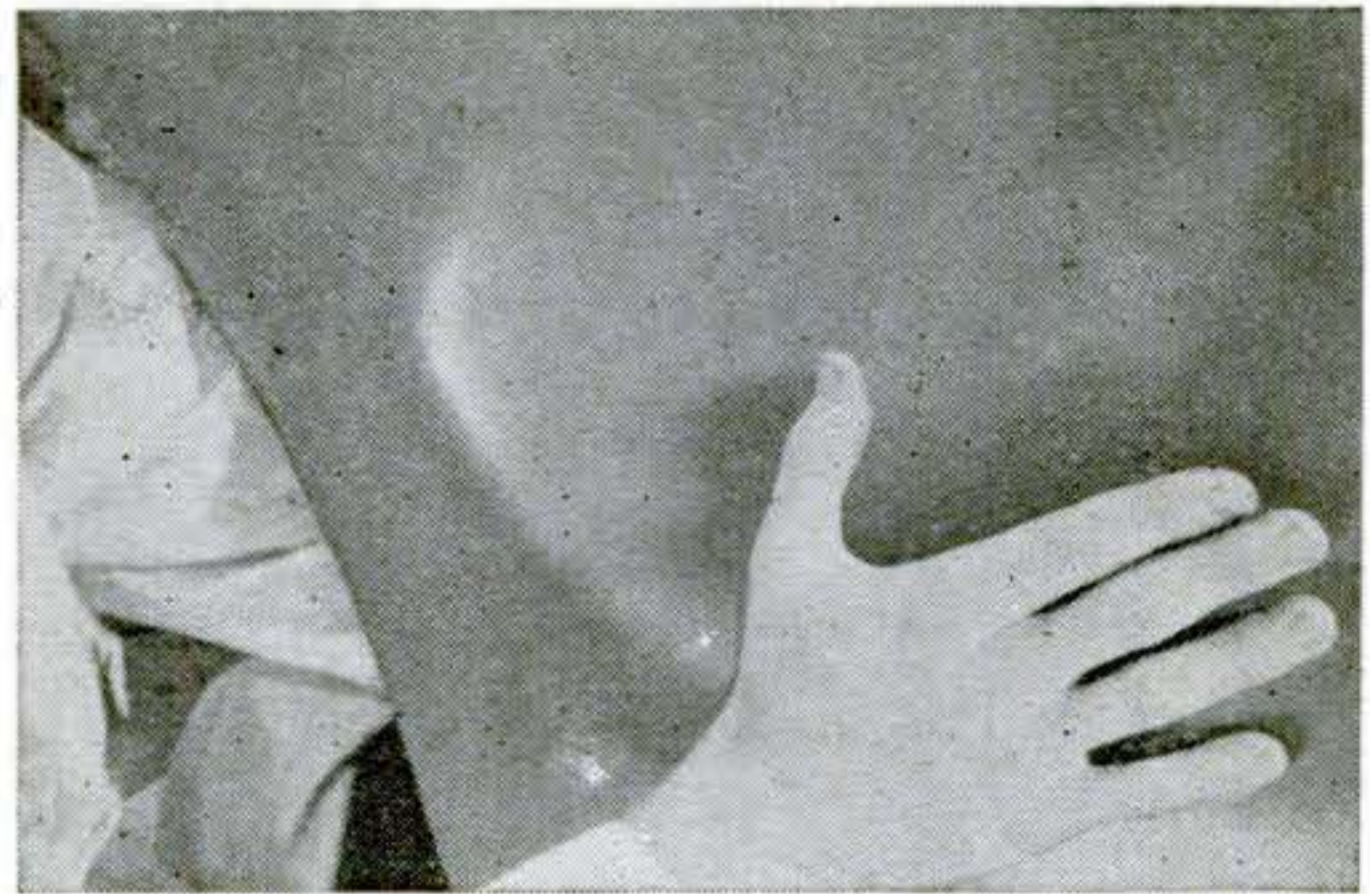

**Oilcan dents** usually are easily removed and often the finish is still good. Sometimes just pressing out with your hand will do the job. Place the other hand on the outside as above.

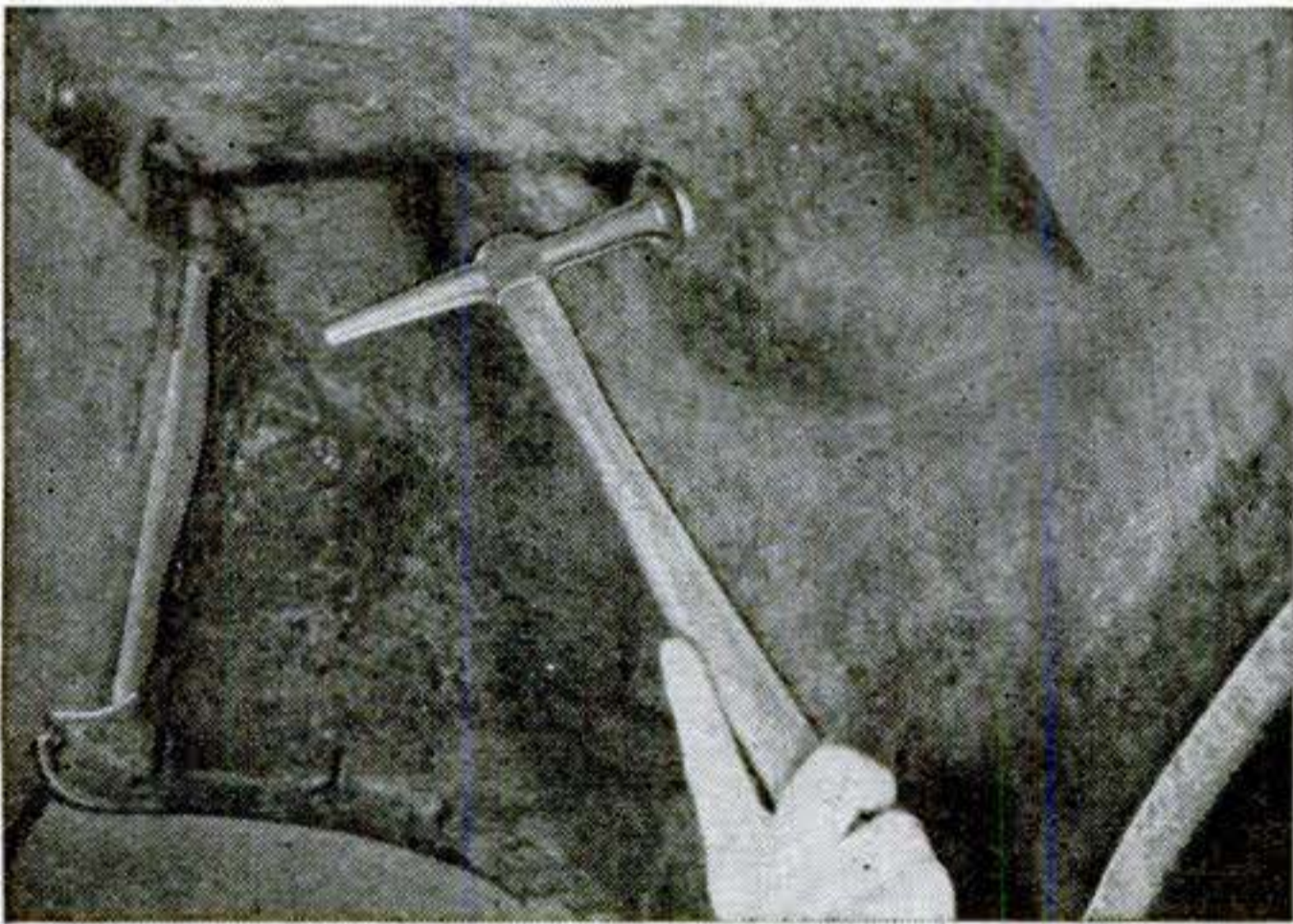

**Gentle tapping** along the edges with a hammer will cause a stubborn oilcan dent to pop out. Avoid heavy blows and never strike the center.

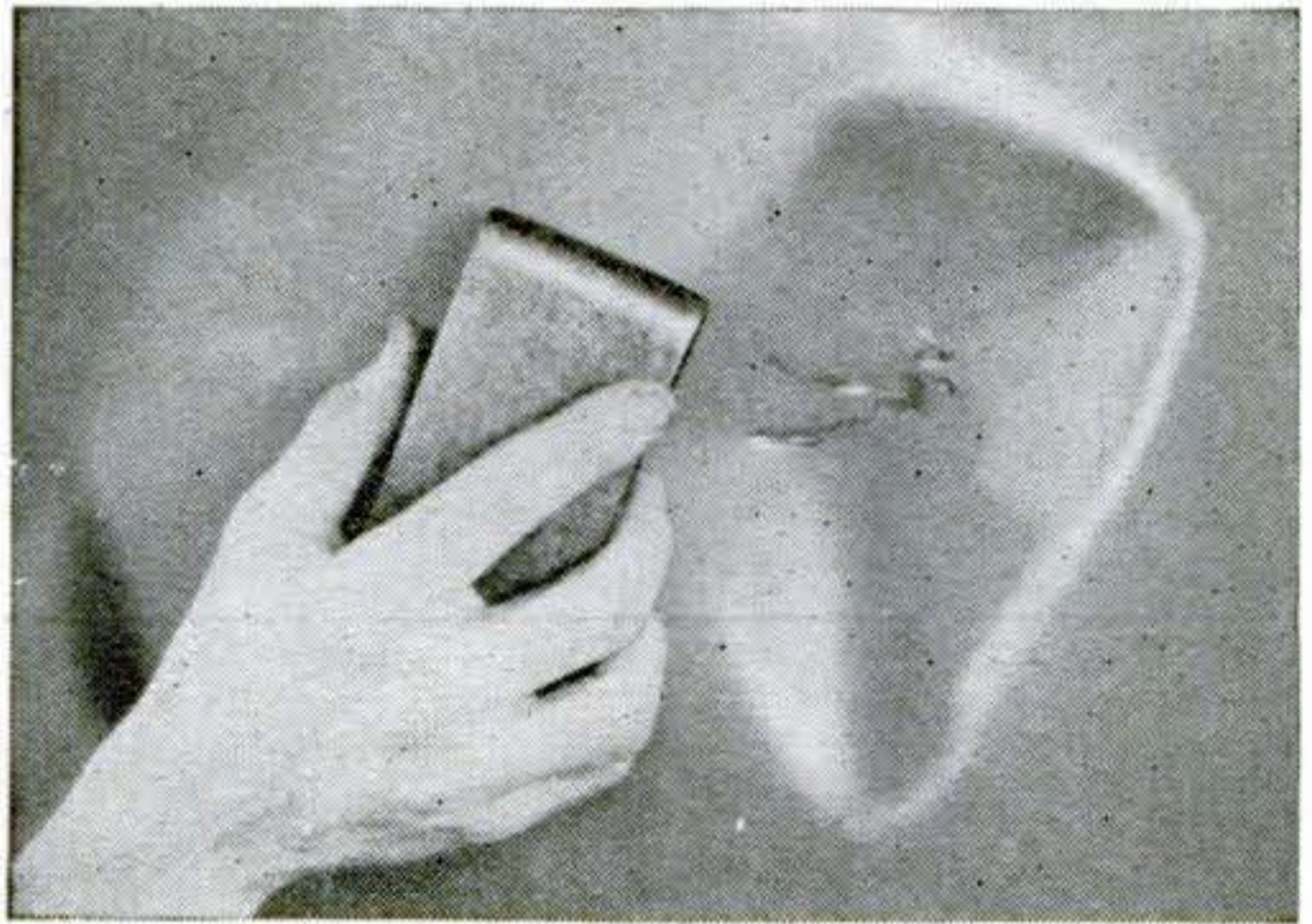

**Short, tight jams** take hammer work from inside and a bumping dolly against the outside. Again confine the blows to the edges.

it at least partially before going further.

At this stage, a clean oilcan dent can often be popped out by a simple push with the hand. This is a satisfying occurrence. If a pop-out seems impossible, sight along the outer fender surface at the edge of the dent. Often a very slight raising of this edge can be detected. If such is the case, tap around this raised area from the outside. In theory, at least, the tapping builds further tension in the dented area. In practice, the theory will commonly prove out by allowing the dent to be popped out.

Should the depression still not yield to hand pressure, start with a light hammer, working from the inside of the fender, and tap gently around the edges of the dent. *Do not strike the dent in the middle.* Although a tempting tactic, the latter almost always results in stretched metal and a bulge in the finished job. The object of edge tapping is to reduce the sharpness of the dent edges. If this tapping is done in easy stages, the dent will either come out suddenly of its

own will, or a push with the hand will spring it back.

Once the main dent has been returned to the natural contours, a few small dimples and a slightly raised area around the edges usually remain. Ordinarily these can be cleaned up with a few well chosen blows from a light hammer. Use the backing dolly here to prevent any tendency for dents to become "warts."

The jammed-back fender usually requires the application of a jack or timber, and over-forcing is necessary to allow for the natural spring-back. The technique is one of working back and forth; force the fender partly into line, straighten edges and remove major dents, bring more pressure on the alignment jack or timber, clean up the dents a bit more, and continue until the fender holds its proper alignment without springing back.

The removal of sharp, stretched depressions is often a real job. Severe metal stretching requires an acetylene torch and

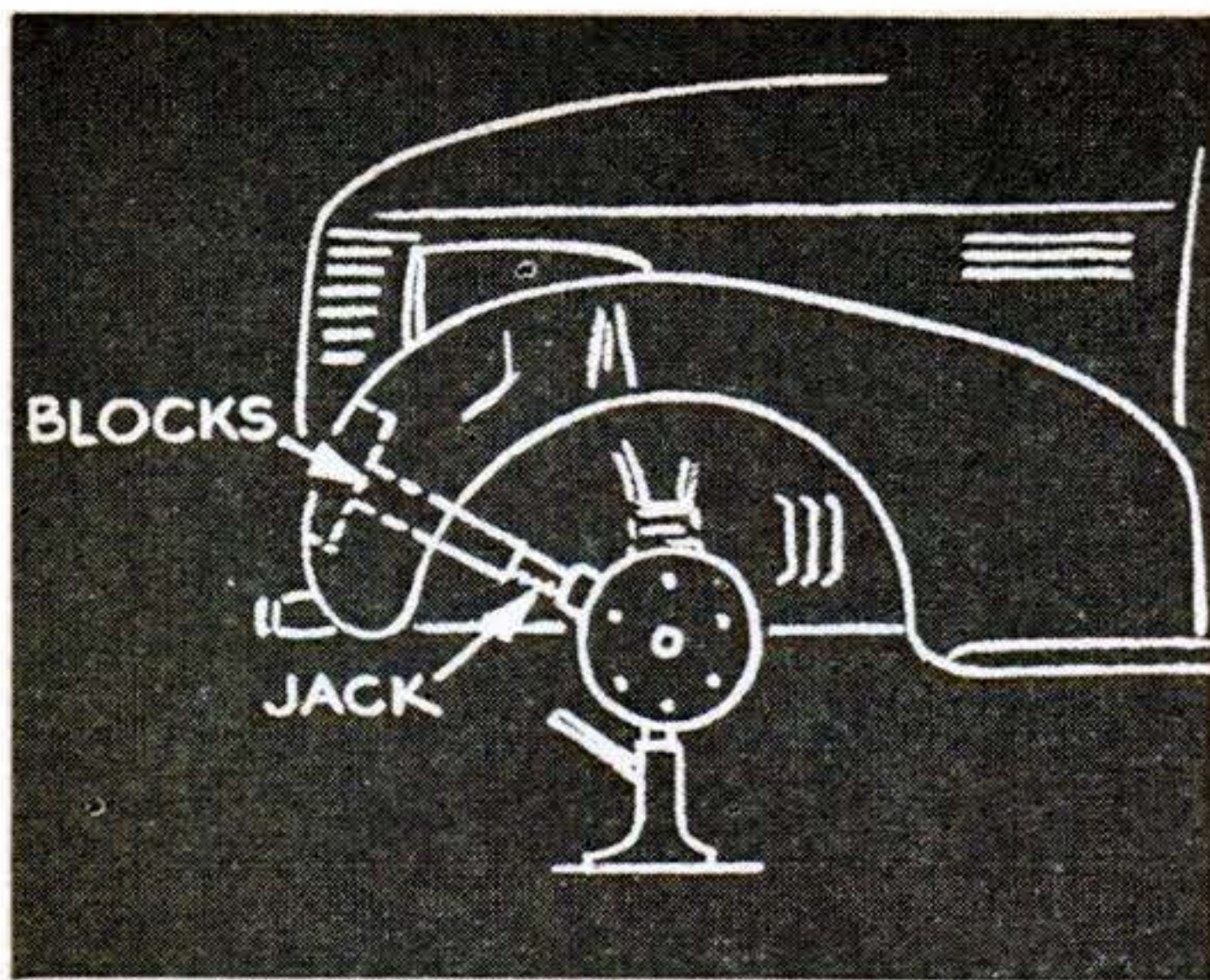

**Jammed fenders** may be returned to position by placing a jack between padded wood blocks and a solid frame member. After normal contours are restored, clean up all minor dents.



**Refinishing** the dent area requires thinner, primer-surfacer, rubbing compound, sandpaper, finishing color, and masking tape. Lacquer is preferable to enamel since it dries quickly.

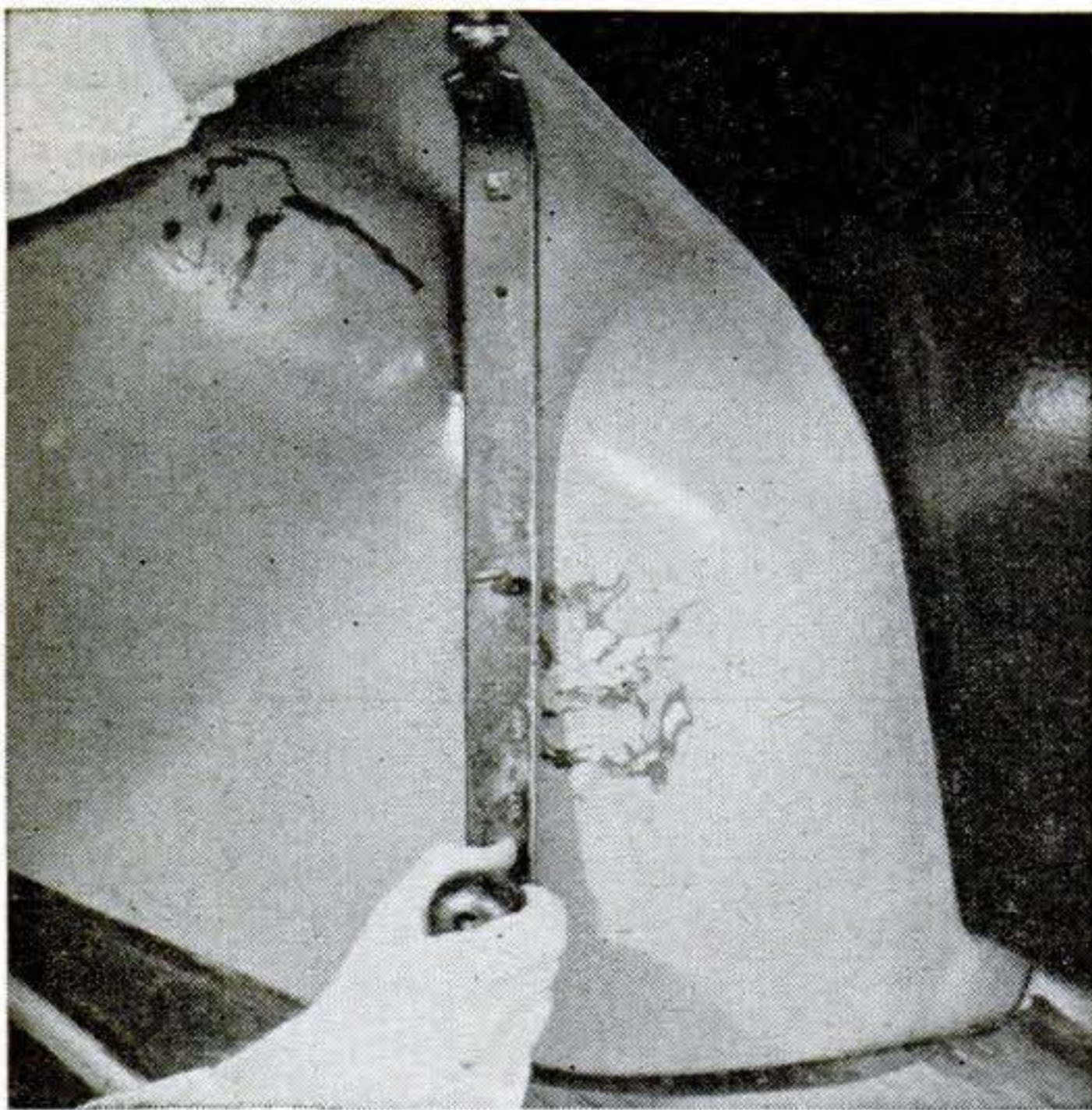

Using a vixen file in long strokes, begin to remove tool marks and feather back the old paint around the damaged area. Also clean all wax, oil, and dirt from the surface.

a metal-shrinking technique to cure it, and a repair shop is the place for such work. However, if the damage is not too serious, treat it the same as you would an oilcan dent. Begin at the edges and gradually level out the entire area to the general contour. Frequent backing of the hammer with the dolly is called for here. When a sharp dent is removed, it should be remembered that the excess, stretched metal must go somewhere. It may compress slightly, but not enough to return to its original form. Hence, it is necessary to distribute, or "blend," the extra metal over a somewhat larger radius of curvature than the original shape. If this blending is skillfully done, the ordinary eye cannot spot it.

Refinishing is essentially the same for all dents. Begin by cutting down the high spots with a vixen file. Excess filing is, of course, to be avoided. When a slight amount of cutting fails to bring the entire surface true, it is a sign that the hammering is not right and more gentle tapping is needed to bring up the low spots the file misses.

When the repaired area reveals no irregularities to the eye or fingertips, a flexible shaft and rubber-backed abrasive disk are useful for removing file marks and feathering back the old paint finish. If such equipment is not available, the worst file marks can be taken out with a mill-cut file.

In home repairs, a better job will result if the entire fender or panel is repainted. The first step is removal of old wax, oil, and

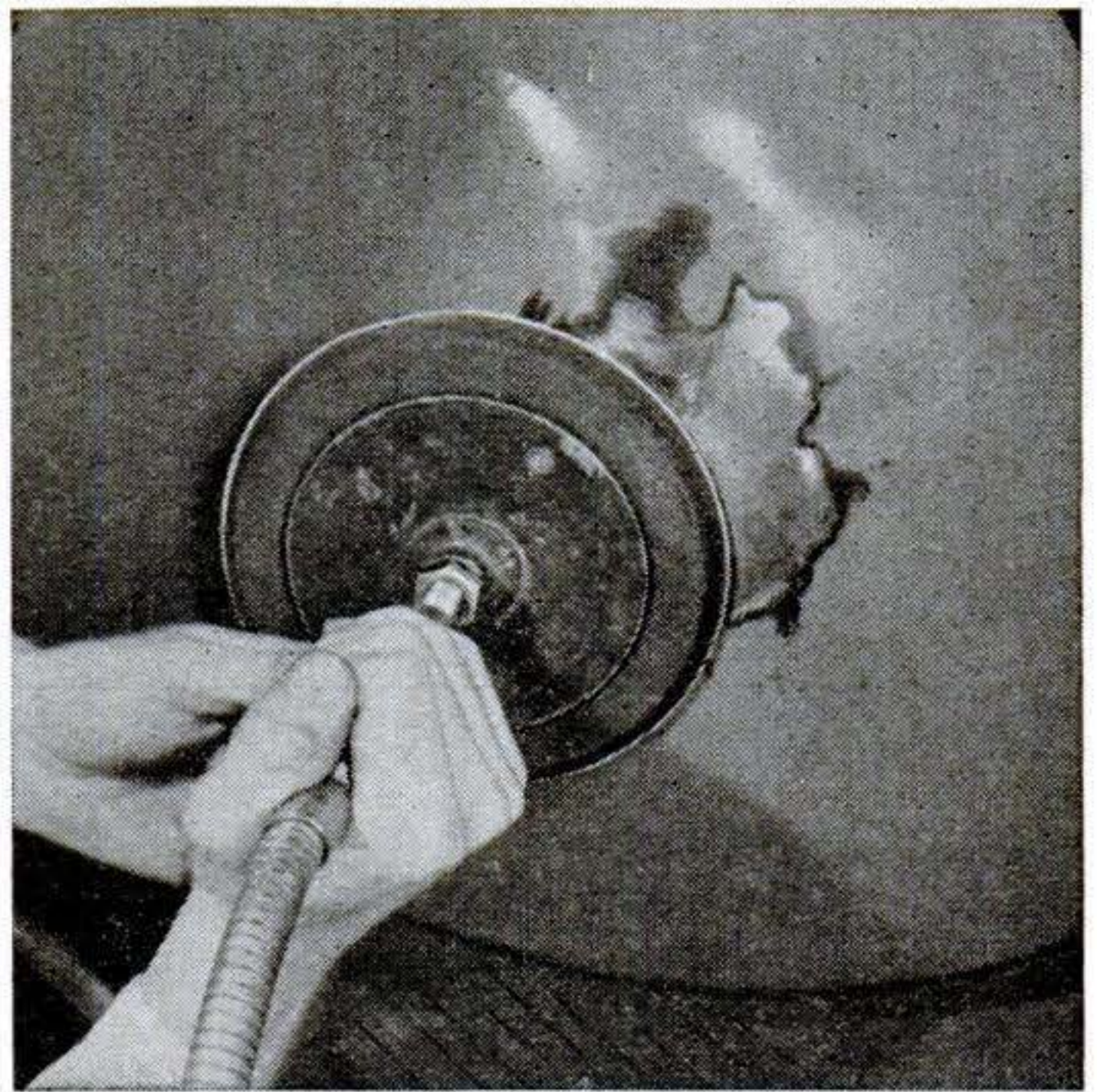

**Clean up the file marks** with abrasive paper and rubber polishing disk on a flexible-shaft tool. Then rub the area with wet sandpaper to get a good priming and painting surface.

dirt. Cleaning preparations made for this particular job by paint manufacturers should be used. Sanding does not remove wax satisfactorily but merely forces it into the old finish. Once the surface is clean, water-sanding with No. 320 paper is in order. Incidental scratches can be leveled down and the old paint surrounding the repair feathered back with 280 paper. Always use the finer paper over the spots sanded with 280; the coarse scratches have a way of coming through.

After sanding, clean the surface once more and avoid touching it from there on. Mask any parts in line with the overspray.

Mix a supply of primer-surfacer and spray it lightly over the repaired area and any areas that were deeply scratched. Build up successive thin layers of surfacer but at no time apply so much that it tends to run or sag. Drying time depends somewhat on the air conditions. For best results, the temperature should be around 70 deg. F. In any case the primer-surfacer should be "hard" dry before you attempt to sand it. Usually an hour or less is adequate for drying and a careful pressure with a finger nail will show if the primer is hard.

Use 320 paper and water to sand the primer to an absolutely smooth surface and to feather out the edges. Clean the surface carefully with water and examine it for imperfections. If any are found, it means that the sanding was inadequate, or, if the sanded primer is thin and bare metal shows through,

insufficient primer was applied. In the latter case, another build-up of primer is indicated.

When the car has a synthetic enamel finish, enamel may be used if a dust-free work place is available. However, lacquer is probably best for amateur finishing. It can be applied outdoors in nearly anything short of a high wind or plague of gnats, and it dries rapidly. If you don't have a spray gun, you can still get excellent results with auto enamel, paintbrush, and patience.

The usual spray procedure with lacquer is a thinned out mist coat—to give the following coats something to "hang" to—followed by several cross-lap coats for build. Don't be afraid to put on enough lacquer, and pay particular attention to the fender edges and projections where subsequent rubbing is likely to cut deep. Once the final spray pass has been made, clean out the gun and forget the job for at least a day.

Then examine the spray job carefully for orange peel, blemishes, runs, and other imperfections. (Orange peel is the term applied to innumerable tiny pits resembling the skin of an orange.) A surface skillfully sprayed with good equipment should need no more than a quick rubbing with compound. An amateur job may require more elbow grease. If done very gently, wet sanding with 400 or 600 paper generally will remove runs, orange peel, small dust motes, bugs, and pipe ashes.

Follow the sanding with rubbing compound, and then wax the fender. **END**



**Lay a smooth surface** for the finish coat by applying the primer with a spray gun. Follow the priming coat with wet sanding. You'll get a better job by refinishing the entire fender.

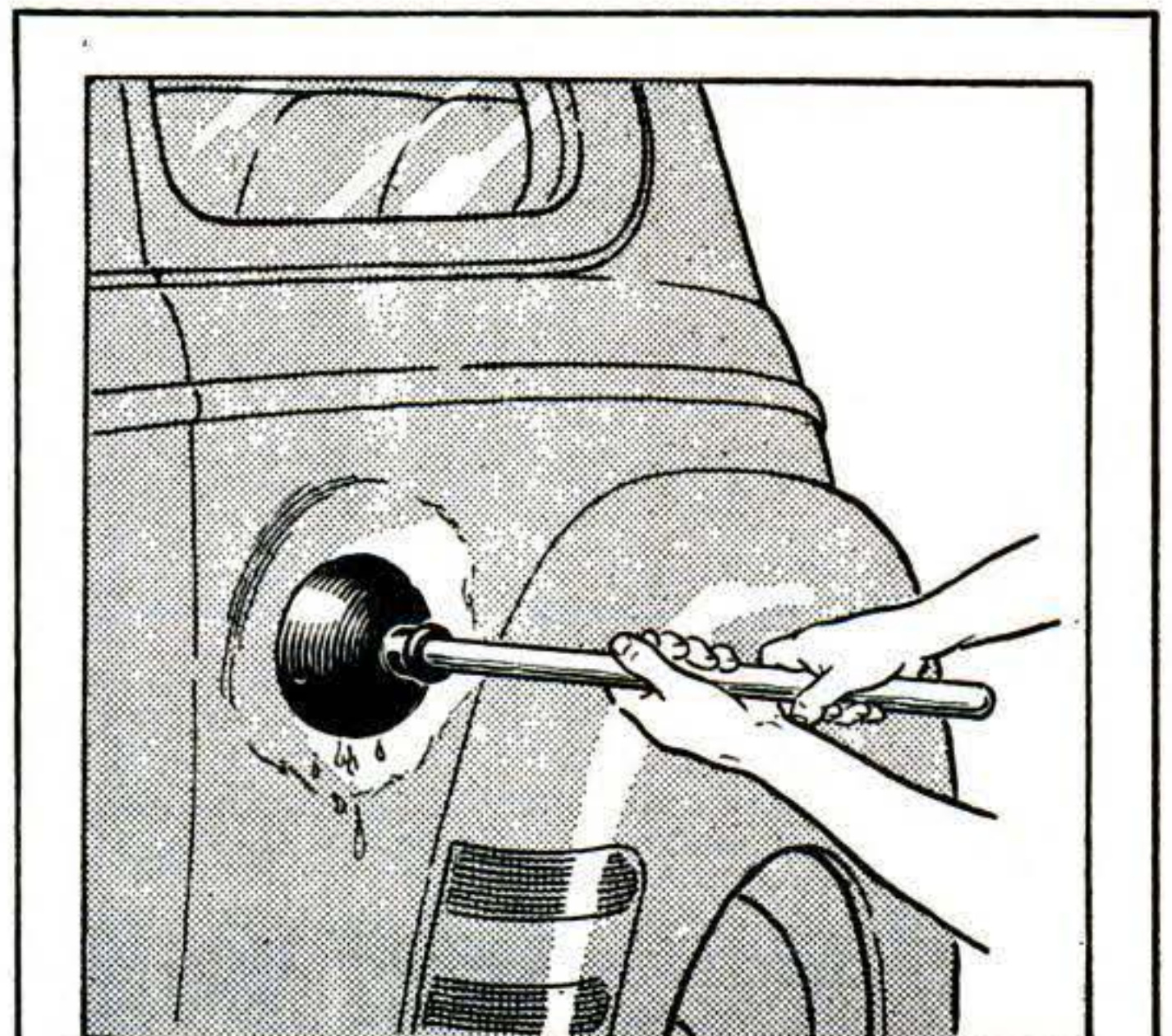

**A sink plunger** often will enable you to pop out a dent that's located in a spot you can't get behind. Dip the plunger in water first. The drawing shows how it's done.—*L. B. Wessel, Madeira, Ohio.*



Something caught Gus's eye. "What sort of mumbo-jumbo is this?" he wondered.

# Gus Untangles a

# Double Cross

By Martin Bunn



When in-law trouble makes an outlaw of a respectable battery, there's a mixup to straighten at the Model Garage.

GUS WILSON was trying to give a finicky little speedometer repair job the 100-percent concentration it demanded, but the horn outside the Model Garage shop hooted and squawked practically continuously. After a full two minutes Gus gave up, slammed his pliers down on the workbench, and pushed the door open.

A man and a woman were getting out of the opposite front doors of a big, expensive car that had slumped into shabby old age. The man was burly, scarlet-faced, and obviously hopping mad; the woman was small, sharp-featured, and even madder.

Neither of them gave him so much as a glance. They were too busy glaring at each other. "It's driving me nuts!" the man yelled. "If that dopey brother of yours—"

"Of course, Harold dear, it's all George's fault," the woman cooed. Then her voice jumped an octave. "That's you all over, you big drip! If it wasn't for George—"

"If it wasn't for George," Harold sneered, "I'd be a lot better off. I ain't sore at him. I'm just sorry for him because he has to try to run a garage when everyone knows he ought to be in a home for the feeble-minded. Why, that—"

His eyes met Gus's, and his voice trailed off. The woman smiled sweetly. "Tell the man what's the matter with the car, Harold dear," she advised.

Harold dear glared at her. "I have the devil's own job getting it started—have to crank it oftener than not," he growled. "Battery must be run down again."

"Had it checked lately?" Gus asked.

"Checked?" Harold smiled balefully. "I

had it recharged two weeks ago—but my brother-in-law who did it must have—"

"I'll check it," Gus broke in. "Drive into the shop, and cut your engine."

Stan Hicks came in, and Gus told him to take up the car's floor boards. Then he got a voltmeter and tested all three of the battery's cells. "It's way down, all right."

Harold grunted. "That's what dopey George said, but this time I had sense enough not to let him monkey with it. Last time after he had recharged it, it wasn't much better than when I took it to him—and now it's next door to dead."

"It could be that you've got a defective switch that has discharged your battery," Gus told him. "Or perhaps your battery is just plain worn out and you need a new one—how long have you had it?"

"Only five months," Harold said, "and it was okay until Mrs. Smith's bright brother went to work on it."

"Never mind my bright brother!" Mrs. Smith snarled. "Tell the man why you had to have the battery recharged—because you came home plastered and forgot to turn the car's lights off after you managed to get it into the garage, and they burned all the rest of the night and half of the next day, and ran the battery down!"

"Me plastered!" Harold said in an outraged voice. "I have a couple drinks just for sociability and you say I was plastered!"

"Plastered—pifflicated—call it anything you want to!" his wife shrilled. "Why, two days later you still were seeing things—after George had recharged the battery you were afraid to drive the car because you

thought the whatd'yacallit—the ammeter—was reading the wrong way!”

“So it was!” Harold howled.

Gus switched on the lights, and watched the ammeter indicator move over to “discharge.” “Well, it’s reading right now.”

“Yes,” Harold admitted, “but that’s because the battery’s in the wrong way.”

“Huh?” Gus grunted.

“The only way George could get the ammeter to read the right way was to put the battery in backside front,” Harold explained.

### *How George Made It Work*

Gus stared at him. Then he checked the cable connecting one of the battery terminals to the car frame. It was a little corroded, but its connections were moderately clean and tight. He put the positive terminal of his voltmeter on the post, the other across the cell, and saw the indicator move in the right direction. “The positive pole of the battery is grounded to the frame,” he told Harold. “That’s right for this model car.” The battery-terminal connections caught his eye. He examined them more closely, and saw that the smaller cable’s lug had been forced over the larger terminal, and that the larger lug had had a shim inserted in it to make it hold on the smaller terminal. “What sort of mumbo jumbo is this?” he wondered out loud.

Harold laughed gratingly. “That’s dopey George’s work,” he said. “When he had to switch the leads to make the ammeter read the right way, he did it to make ’em hold.”

Gus scratched his head. Then he looked at the shop clock and saw that it was close to four. “There’s something screwy about this,” he told Harold. “You’d better leave your car. Maybe your battery is worth recharging—do you want me to do it if I think it is?” Harold nodded assent. “All right, then—come in late tomorrow.”

The Smiths departed, still bickering noisily. Gus went back to the job they had interrupted. By the time he got back to the Smith car it was near quitting time. “Put this battery on the charger, and see what happens,” he told Stan. “It’s probably pretty near done for, but maybe there are a couple of months more service in it.”

### *The Double Cross*

Gus was plenty busy the next day—so busy that it was along toward three o’clock before he thought of the Smith job. “How

about that battery I told you to put on the charger?” he called to Stan.

“It’s okay, I guess,” Stan reported. “It took a charge.”

“Good enough,” Gus said. “Put it back and call me when you’ve got it hooked up.”

Ten minutes later Stan called him. Gus got into the car and pressed the starting button. The starter had a good kick to it, and the engine took off promptly. Gus speeded it up, and watched the ammeter.

The indicator moved over into the “discharge” division of the scale!

“Hey!” Gus yelled. “How the heck did you hook up this battery?”

“Just exactly the same way it was hooked up before I took it out,” Stan told him in an injured voice.

Gus switched off the engine and then switched on the lights.

The indicator moved into the “charge” division of the scale!

Gus turned off the lights, and sat thinking. Then he took up the floor boards and put his voltmeter across the end cell, its positive terminal on the grounded post, just as he had the day before. The indicator jerked below the scale. He put the same meter terminal on the post at the other end cell. The needle moved the right way.

Gus laughed, and rapped the side of his head hard with his knuckles. “The old bean sure is slowing down,” he told his puzzled helper. “Switch the battery around.”

### *When Is a Positive Not a Positive?*

“Okay,” Stan said obediently. “But I don’t get any part of this, boss. Yesterday the ammeter read the right way. I hooked the battery up just the same way today—and now the ammeter reads the wrong way. And yesterday when you checked the battery pole that’s grounded to the frame it was positive—and today it’s negative. But I don’t see what I did wrong.”

Gus gave him a friendly poke in the ribs. “The only thing you did wrong,” he said, “was charge the battery right. . . . I’ll tell you about it afterwards.”

Stan reversed the battery in the car. Then Gus checked the job. With the lights off and the engine on, the ammeter indicator moved into the “charge” division of the scale; with the engine off and the lights on, it moved into the “discharge” division.

“Okay,” Gus said. “And just in time. Here come the Smiths—still scrapping!”

And still scrapping they drove out in the



car. While Gus was washing up later that afternoon he noticed that Stan was very busy making diagrams with a red and black pencil. "Hey, kid," he reminded him, "It's time to go home."

"Yeah," Stan muttered absently. "I've been tryin' to dope out about that battery. You said you'd tell me about it, but—"

### Uncrossing the Double Cross

"Sure I'll tell you about it," Gus said. "It's not so tough if you start at the beginning—which was when our friend Harold got plastered and ran his battery down by leaving his lights on for several hours. Well, he took it over to his brother-in-law George, who put the battery on the charger the wrong way—with the charger's positive lead connected to the battery's negative pole."

"Gosh!" Stan gasped. "What would you do to me if I ever did that, boss?"

"Shoot you, or bash your head in," Gus assured him cheerfully. "A battery treated that way isn't long for this world. . . . Well, George's charger overpowered the battery and gave it a reverse charge, which changed what had been the positive pole to the negative, and the negative pole to the positive. When he put the battery back in the car and connected it the right way, the ammeter read the wrong way. So he turned the battery around—botching up the terminals to do it—and the ammeter read the right way.

"Of course that poor misused battery didn't have much moxie, but with a little help from the hand crank it started the car—for a while. Then it gave up the ghost, and Harold brought it in here. You put it on the charger the right way—and the charger overpowered what was left of the reversed charge, changing the original positive pole back to positive, and the original negative pole back to negative."

"I hooked the positive lead of the charger up to the bigger terminal post on the battery. That's right, isn't it?"

"Sure. But when you put it back and connected it up just the way it was before you took it out, the ammeter read the wrong way again. And then when you reconnected it in the opposite way—the way it always should have been connected—the ammeter read the right way, because the battery polarity was back where it belonged. . . . Got it, kid?"

"All I got," Stan groaned, "is a heck of a headache!"

END

## KEY TO THE MYSTERY OF THE TWO-FACED BATTERY

①

POSITIVE  
POLE  
GROUNDED

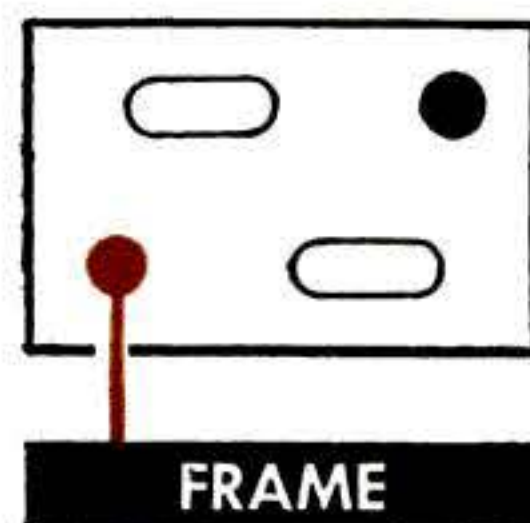

● NEGATIVE  
● POSITIVE

②

BATTERY  
CHARGED  
INCORRECTLY

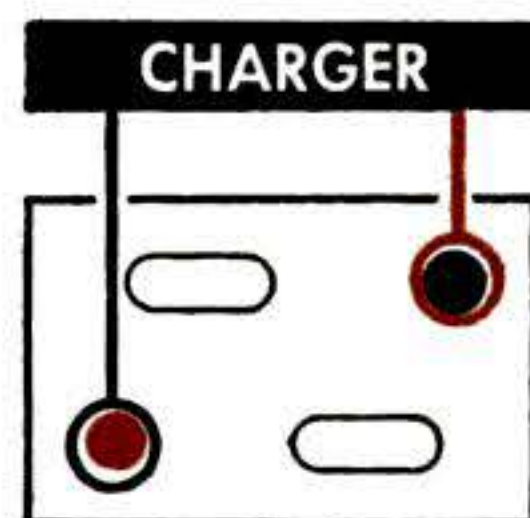

③

BATTERY  
PUT IN CAR  
CORRECTLY

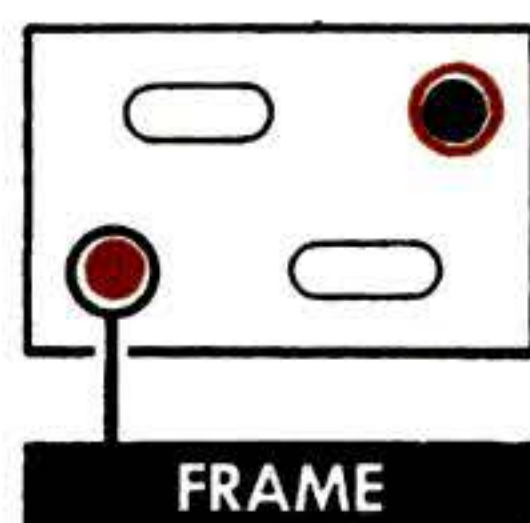

AMMETER  
READS  
BACKWARD

④

BATTERY  
REVERSED  
IN CAR

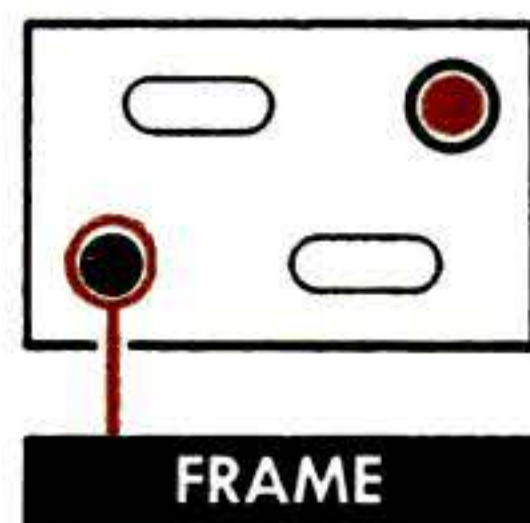

AMMETER  
READS  
CORRECTLY

⑤

BATTERY  
RECHARGED  
PROPERLY

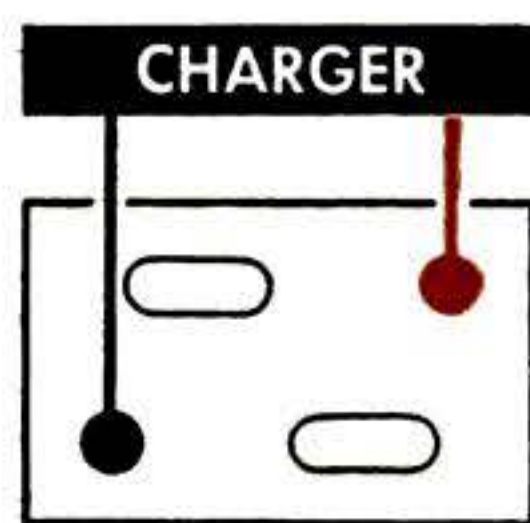

ORIGINAL  
POLARITY  
RESTORED

⑥

BATTERY  
REPLACED  
AS IN FIG. 4

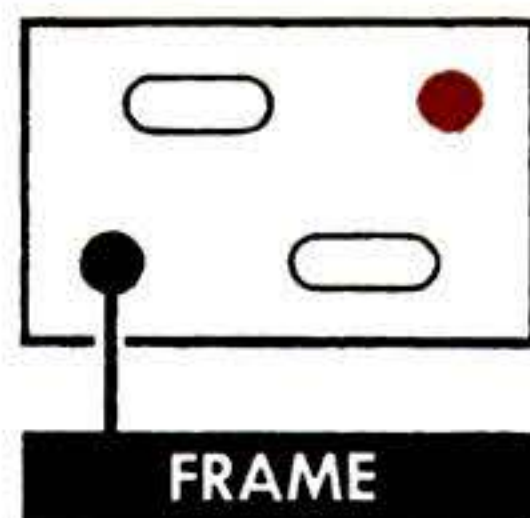

AMMETER  
READS  
BACKWARD

⑦

BATTERY  
PUT IN CAR  
CORRECTLY

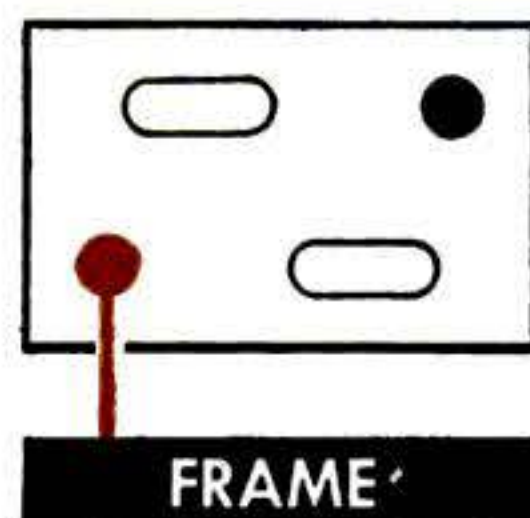

AMMETER  
READS  
CORRECTLY

# Hints From the

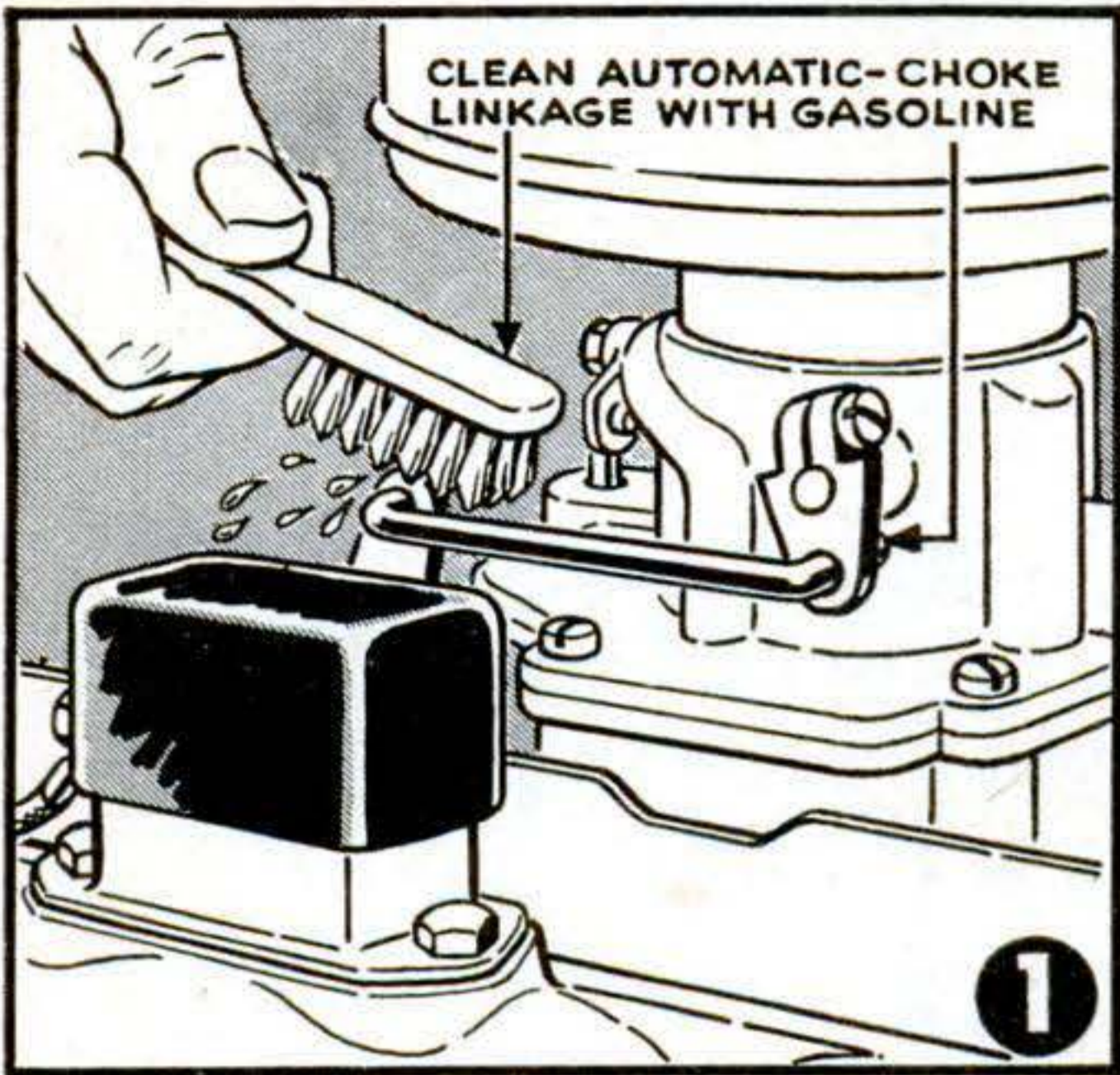

**1. Automatic chokes** sometimes get blamed unfairly. Here at the Model Garage we've learned to look first at the linkage between the carburetor and choke-control mechanism. Oil on the connecting lever will gum it up and make the choke sluggish. A toothbrush dipped in gasoline removes oil and dirt; very often that's all that is needed.

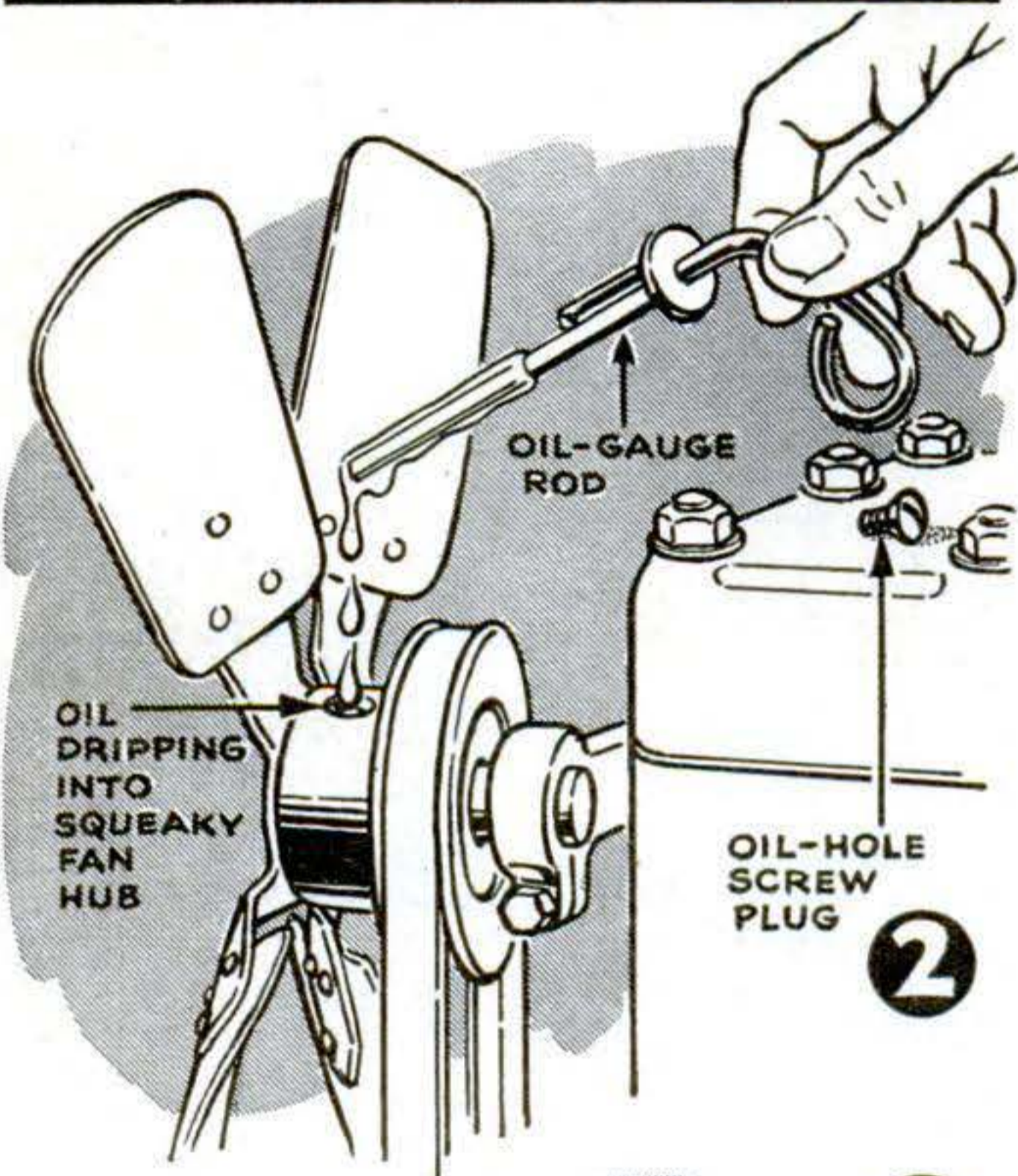

**2. Fan Squeak Gives Warning.** Many fans start to squeak when lubrication is neglected, and a scored shaft is never far behind. Marion L. Rhodes, of Knightstown, Ind., heard the warning noise, but he was on the road, had no oil can, and was miles from a service station. To forestall trouble, he removed the screw plug and held the oil dip stick over the opening.

**3. Freeze a New Insert Ring.** If valve inserts are being replaced and don't come out easily, remove with a drill and chisel, taking care not to damage the recess. Pack new rings in dry ice for at least 15 minutes to shrink them.

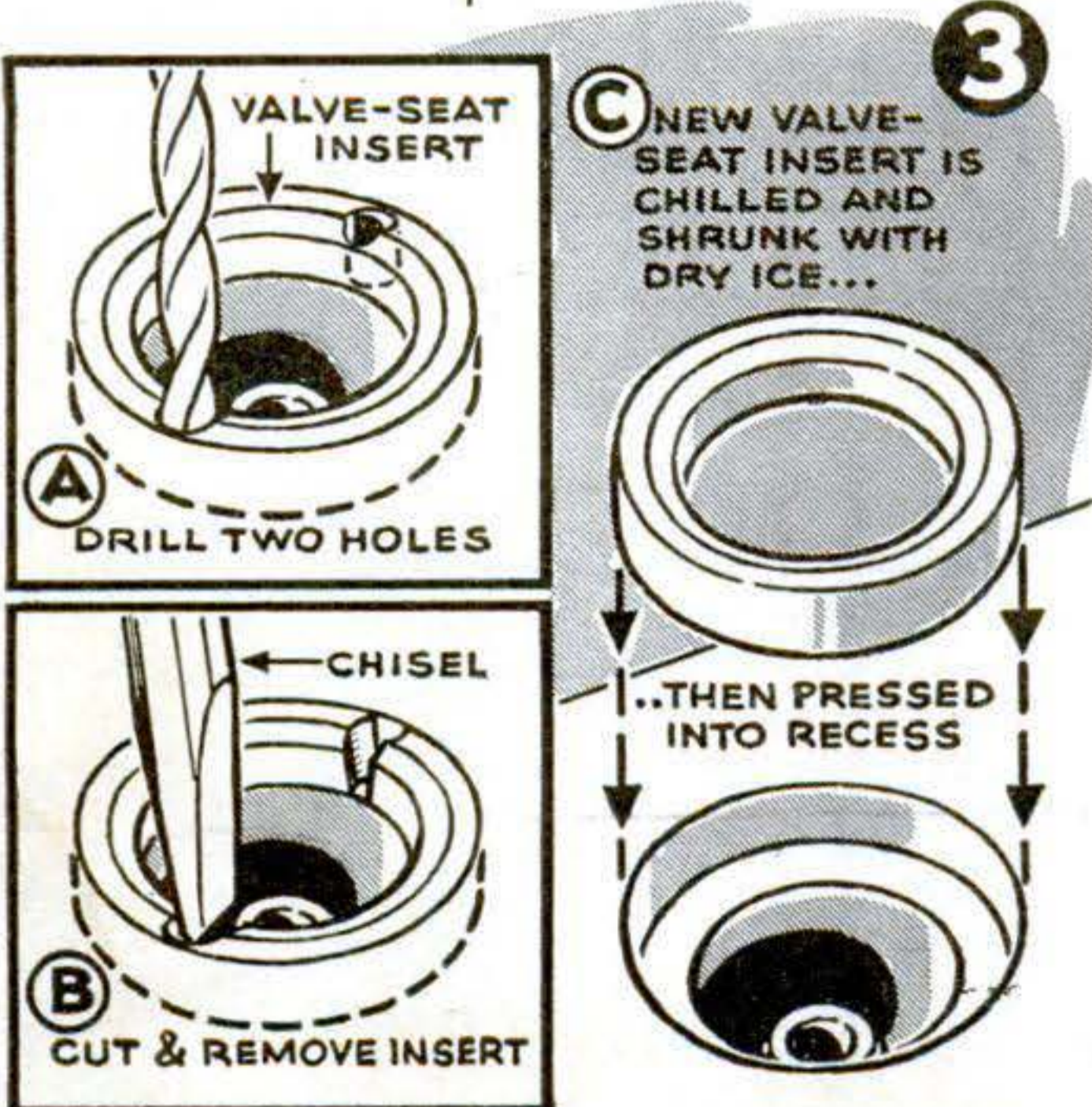

**4. Magnets Peg Things to Dash.** Cigarettes, sun glasses, and the like are always in reach for William G. Hykle, Montreal, who uses magnets to hold them up against the windshield frame on his car's sloping dashboard. Felt glued under each magnet keeps it from scratching.

*Drawings by Stewart Rouse*

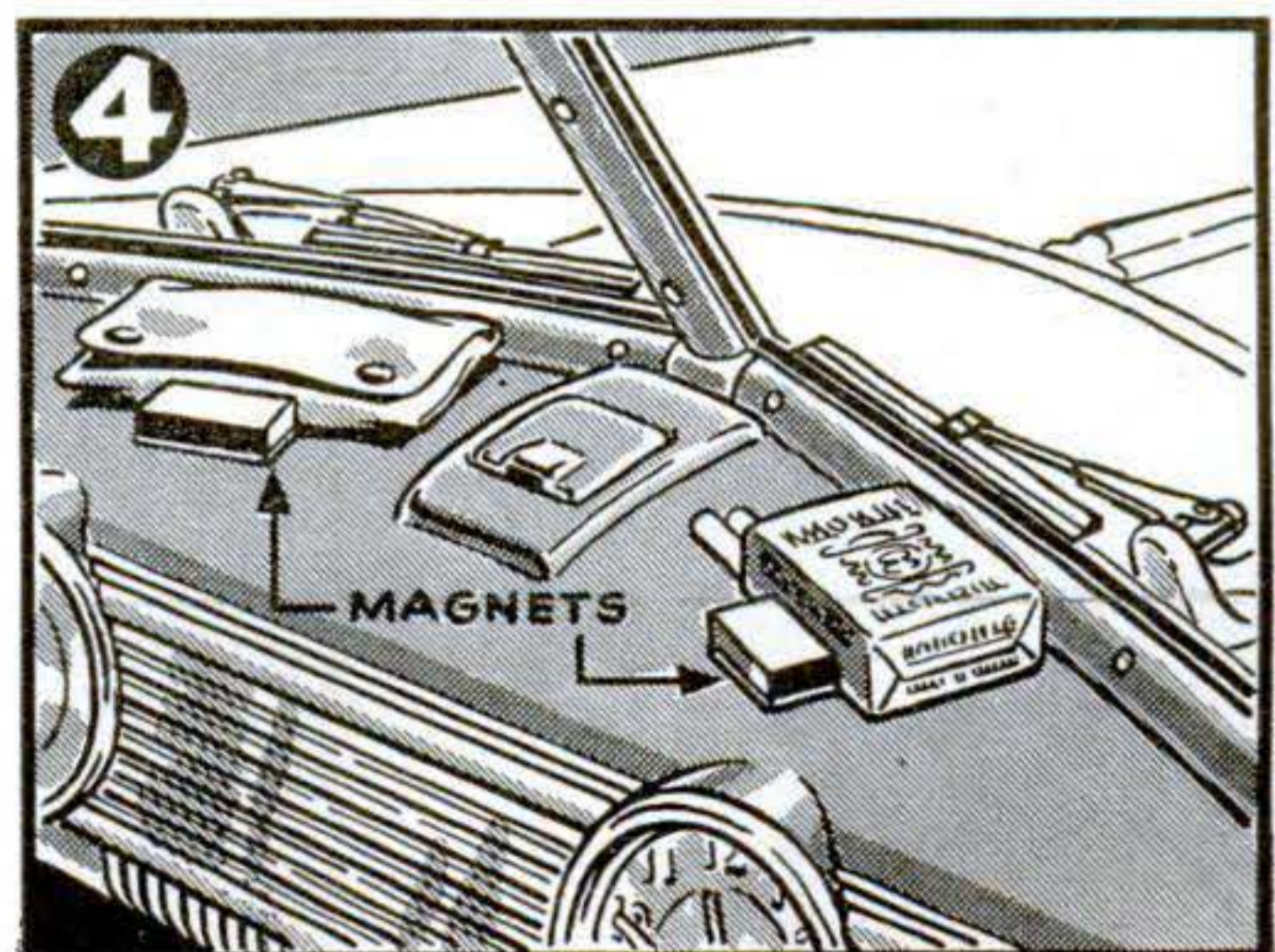

# Model Garage

**5. Grease Stops Squeak.** A persistent squeak when you turn the steering wheel may come from the spring-cushioned end of a drag link that hasn't been lubricated properly because the grease didn't reach the spring. The squeak can be stopped by drilling a tiny hole in the housing and forcing grease directly to the spring.

**6. Gauging Brake-Drum Wear.** John Krill, of North Lima, Ohio, reports that one truck-fleet superintendent uses a straightedge and .010" wire to determine if brake-drum scoring is bad enough to demand machining. If the wire passes through any groove, the surface is considered in need of refinishing.

**7. Blow Out the Dirt.** One thing you'll never see in the Model Garage is a mechanic grab a wrench and remove a plug without preliminaries. Dirt should first be blown from the seat with an air hose—or failing that, a tire pump.

**8. Cycle Footrest Repaired.** If a crack occurs in the rubber casing of a motorcycle footrest bar, cut a disk out of 16-ga. brass, cup with a ballpeen hammer to conform to the casing, and drill the disk and shank for a 3/16" screw. Turning up the screw will close the crack. I. J. Stretten, Detroit, makes the suggestion.

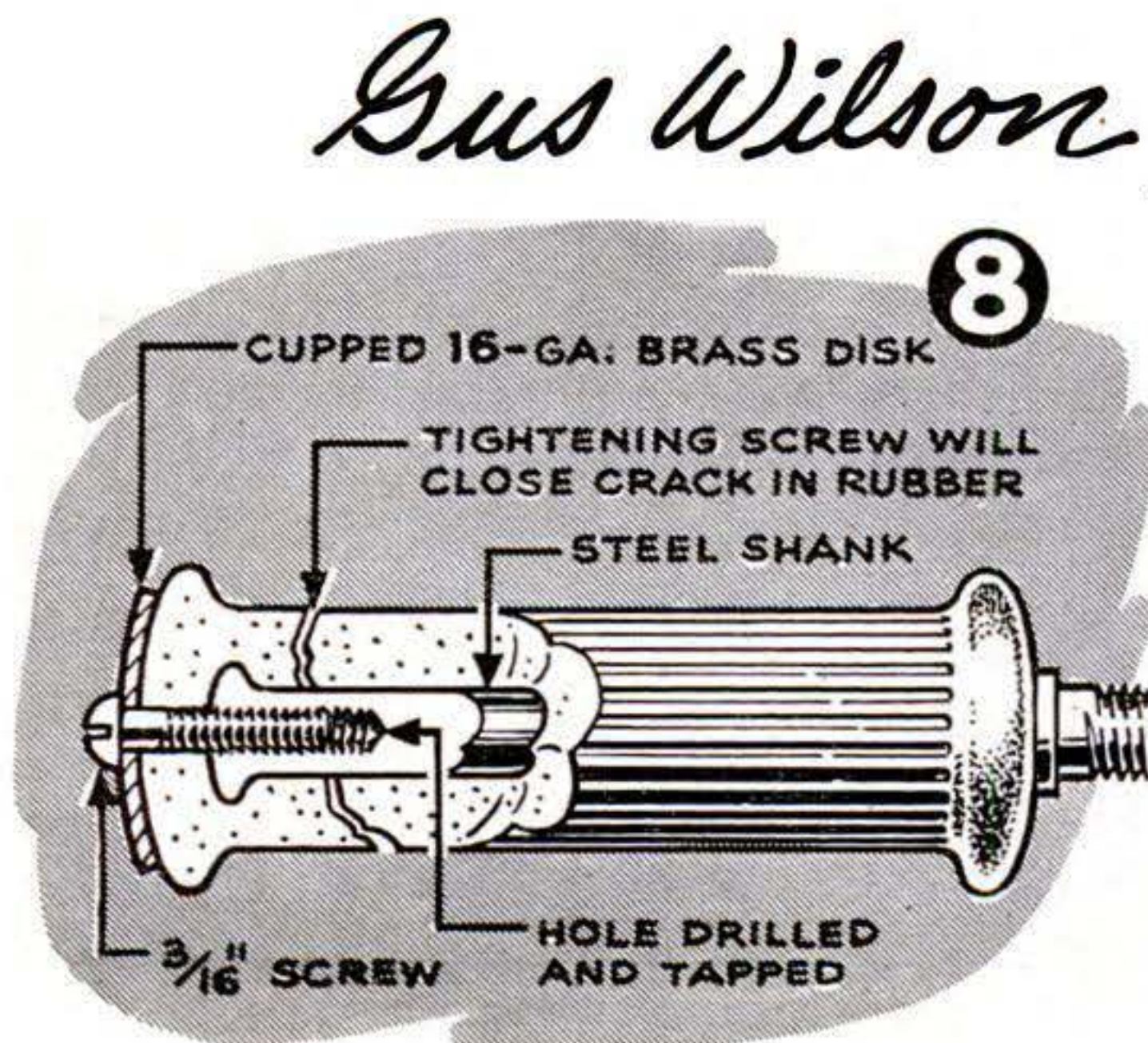
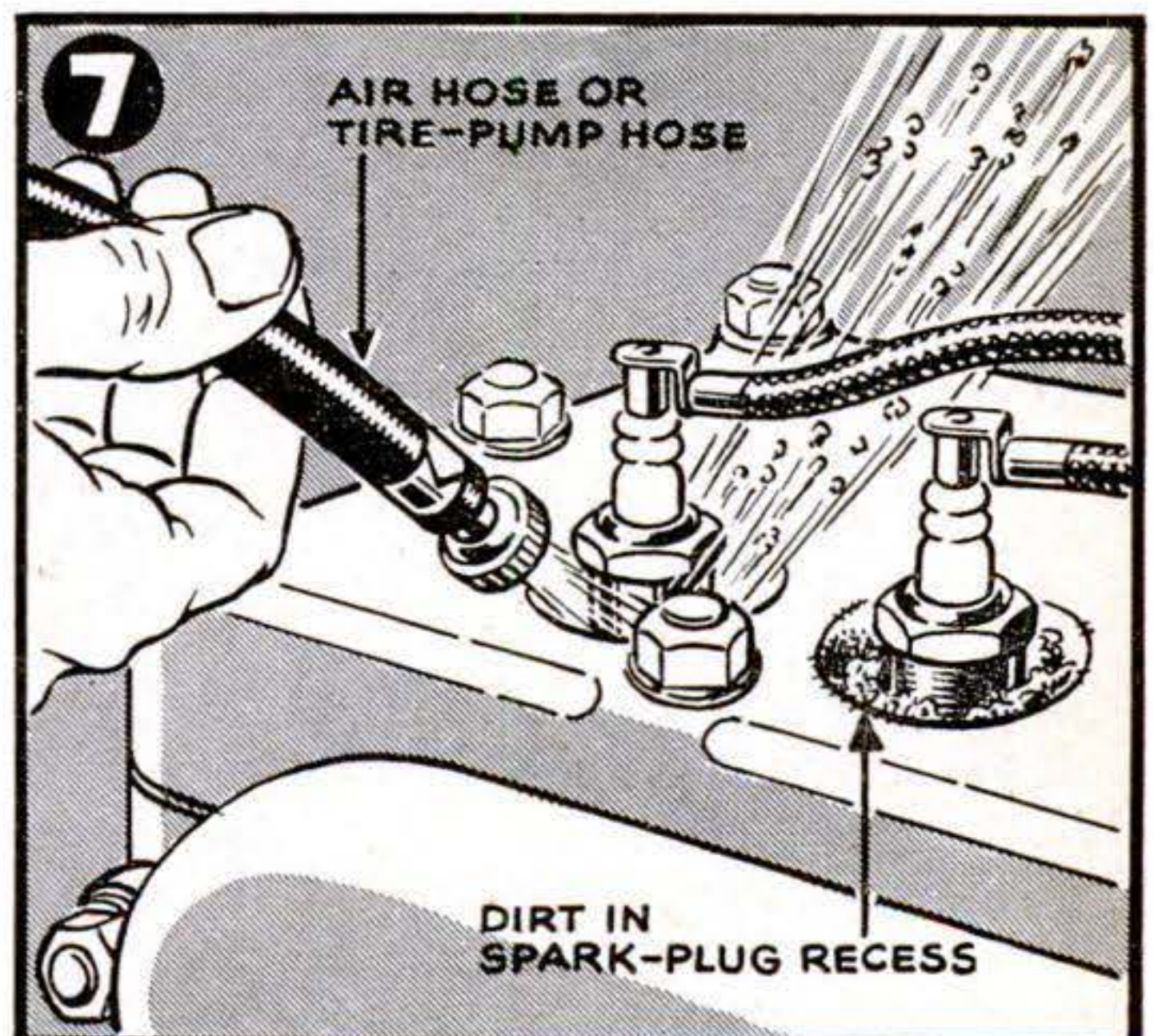
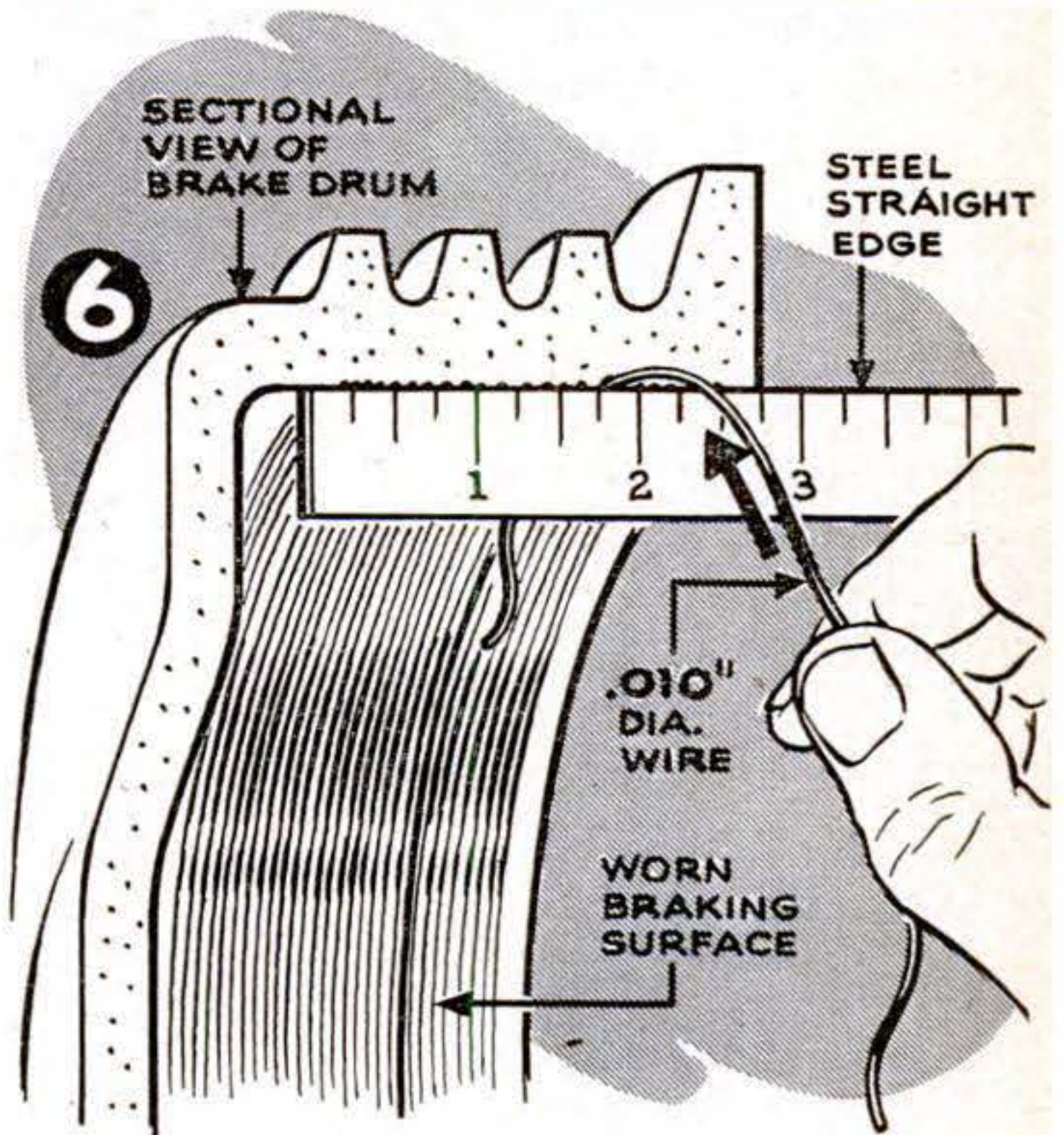
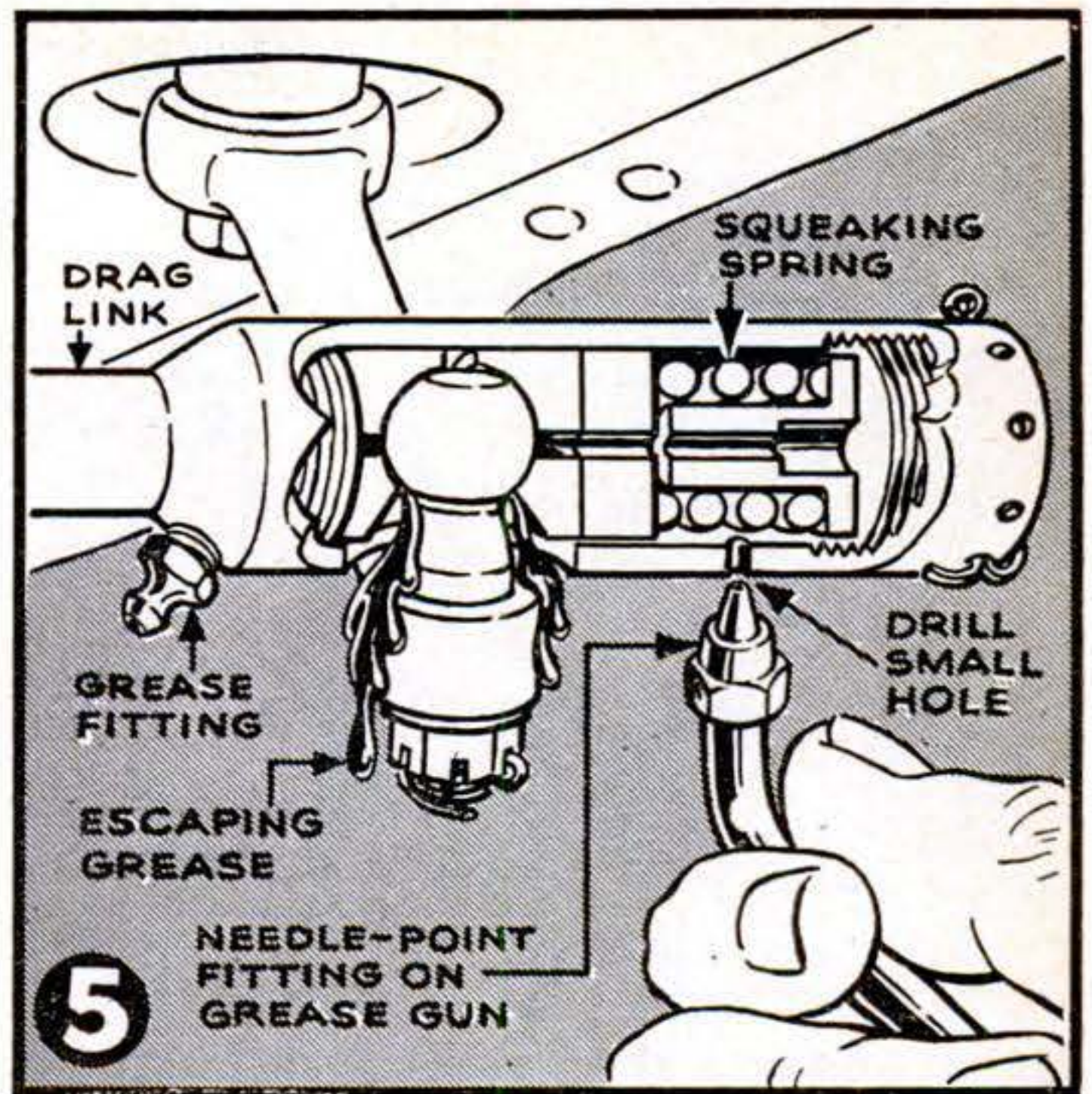

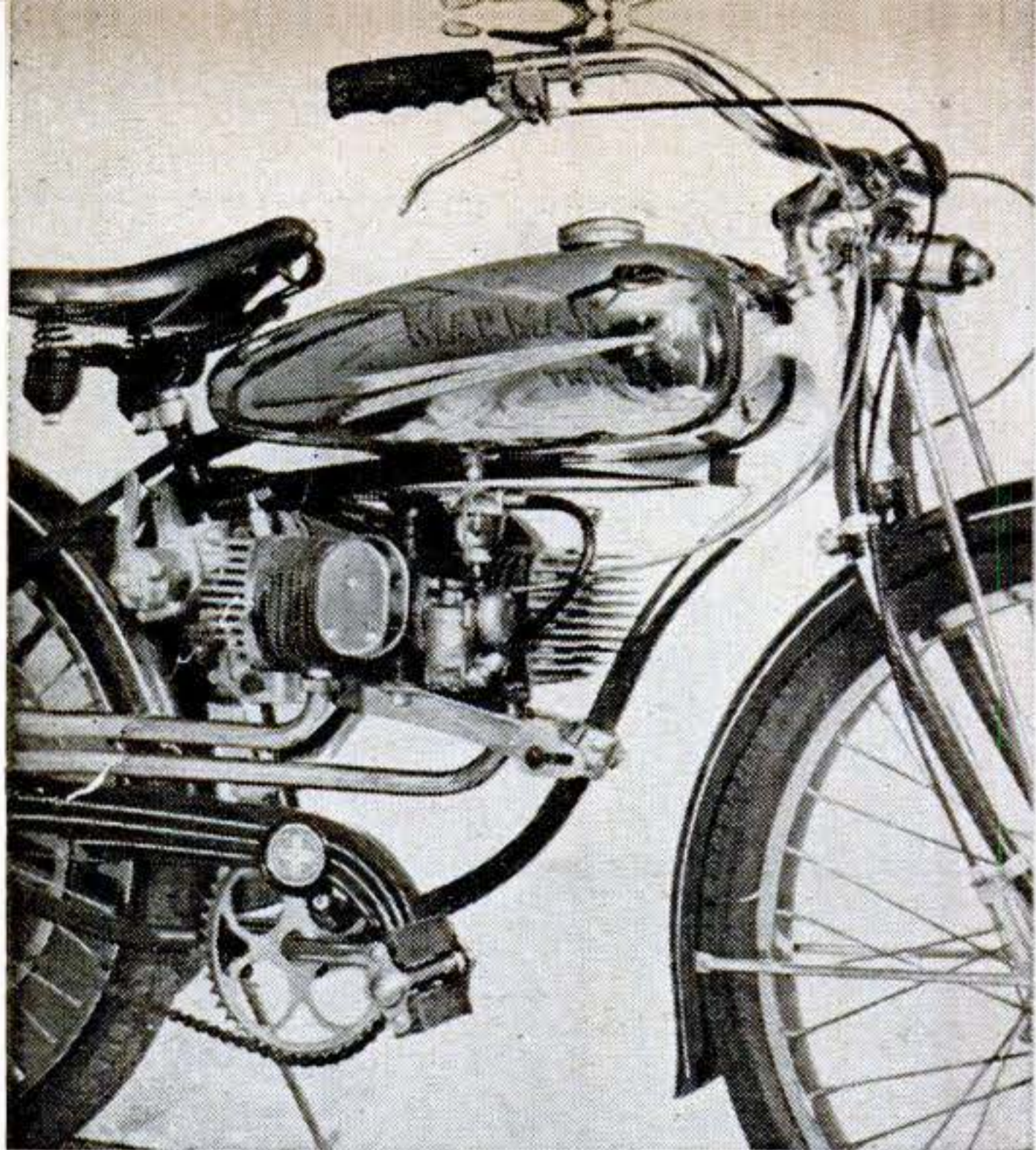

### Bike Motor Has Reserve Power

DEVELOPING  $3\frac{1}{4}$  hp., a new bike motor announced by Marman Products Company, of Inglewood, Calif., provides an easy cruising speed of 35 m.p.h. without strain, leaving ample reserve power and speed for emergencies. Designed for standard balloon tire bicycles, the twin-cylinder, two-cycle engine is of the horizontally opposed type, and a multiple plate dry disk clutch provides smooth starts without belt wear. In tests, it has given more than 100 miles on a gallon of gasoline.

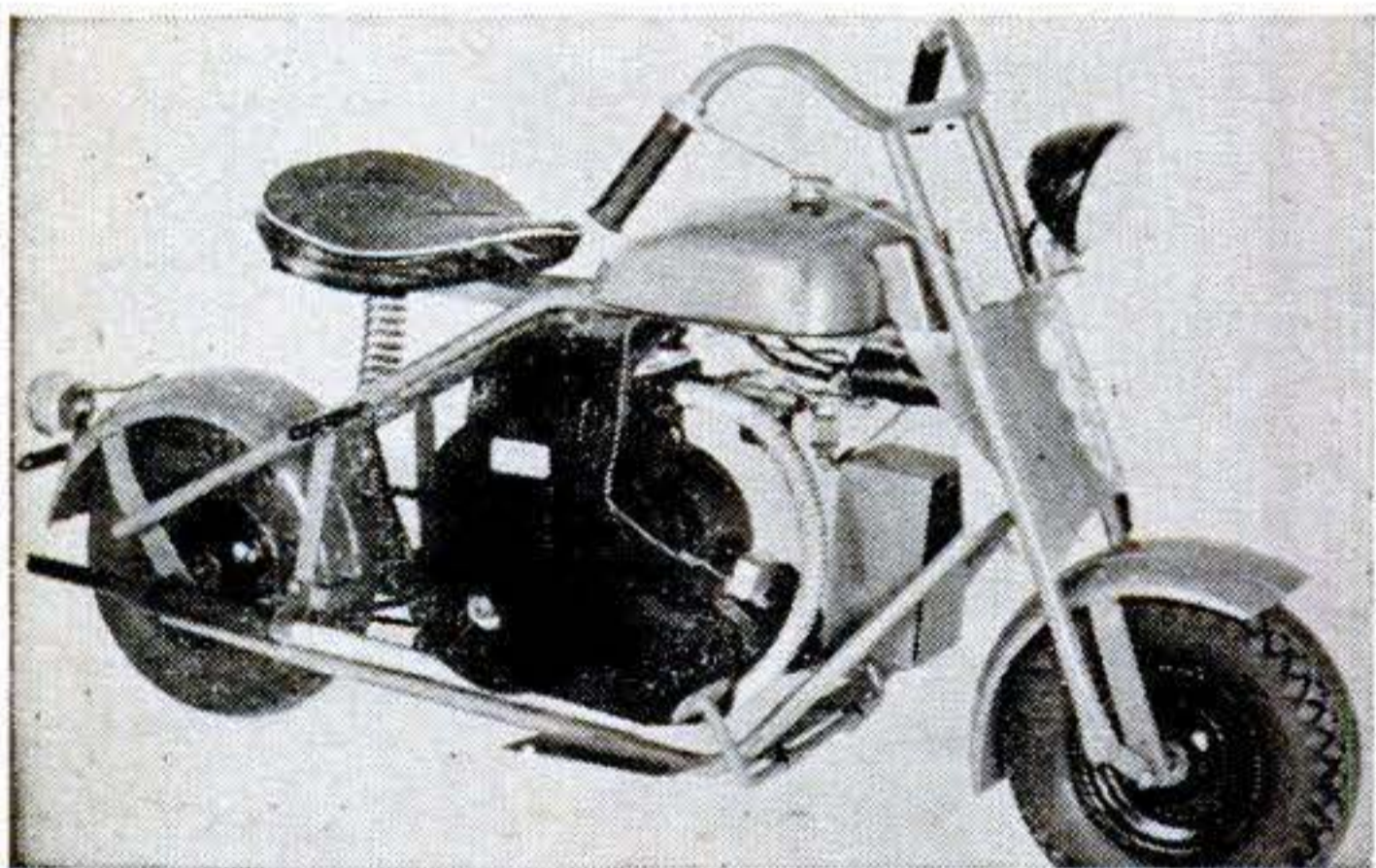

### New Scooter Uses Auto Parts

PROVIDING speeds up to 60 m.p.h., this new 250-lb. scooter is said to give 70 miles per gallon of gasoline. The single-cylinder, four-cycle engine is air cooled, has a piston displacement of 21 cu. in., develops 8 hp., and was designed around automobile parts—pistons, valves, valve keepers, piston rings, coil, generator, etc.—available at automotive supply houses. Built on a 51" wheelbase, the scooter is 70" long with a saddle height of 25". Clark Engineering Co., South Pasadena, Calif., makes it.



### Chevrolet Improves Bearings

CRANK-ARM thickness in the 1948 Chevrolet models has been increased for greater durability, the crankshaft itself has been made more rigid, and new interchangeable main bearings with thin-wall babbitt are expected to have more than double the life span of earlier bearings. Connecting-rod bearings also are of long-life type. Styling changes include a T-shaped, chrome center bar on the grille, as seen above.

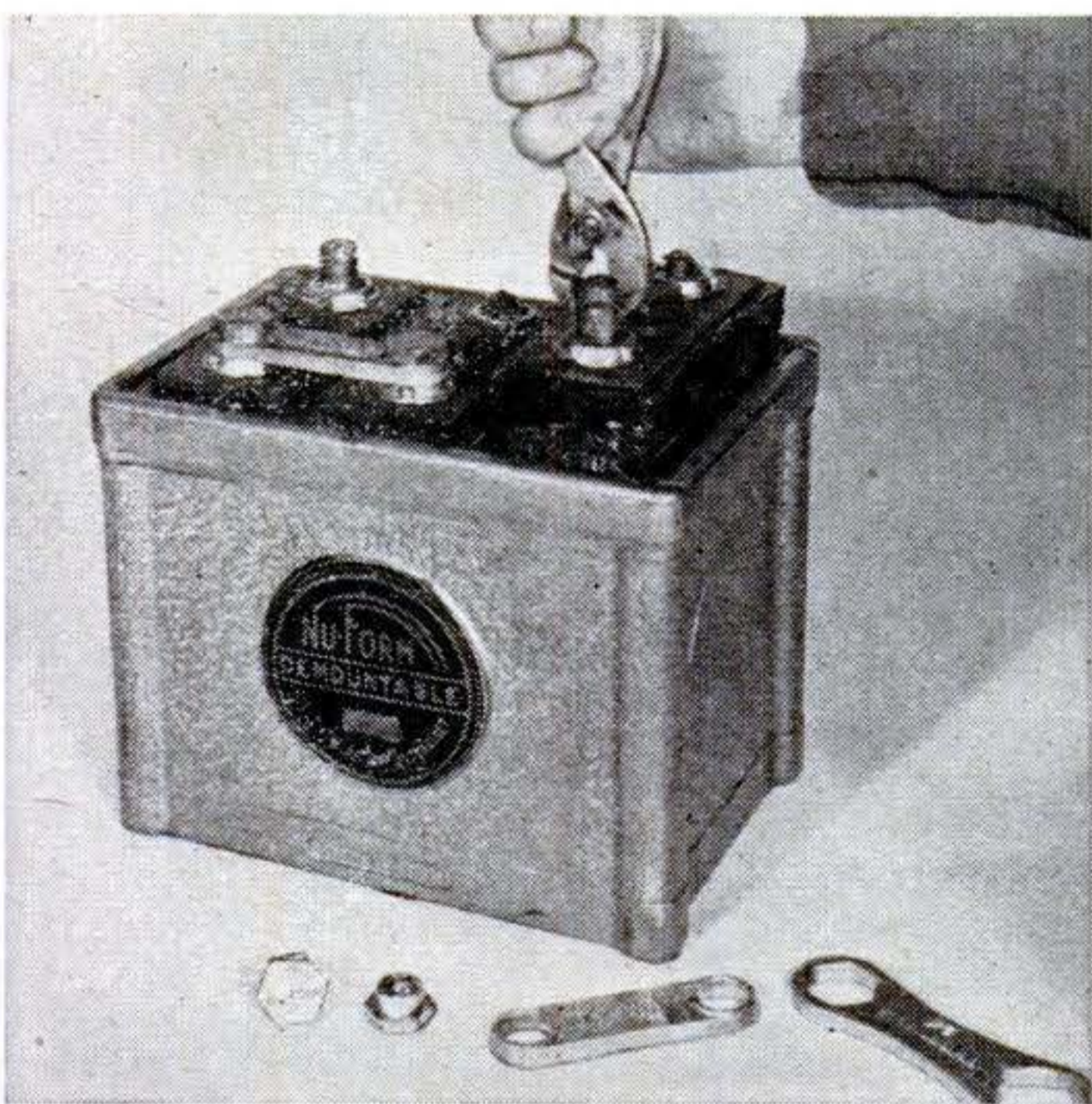

### Battery Easily Taken Apart

SHOULD any of the inner components of this battery wear out, they may be quickly replaced in the home garage, for the battery is designed for easy disassembly with only a pair of pliers. Plates are hung from the covers of the cells, a feature that is said to prevent damage from the shock and vibration that may occur when they rest on the bottom. The manufacturer, the Associated Battery Assemblers, of Los Angeles, also claims that the construction eliminates corrosion around the terminals.

# Mechanics and Handicraft

REG. U. S. PAT. OFF.

- Binding Your Magazines* PAGE 230  
*Squaring Stock with Power Tools* PAGE 192  
*Three-Way Outdoor Fireplace* PAGE 196  
*Small Milling Machine* PAGE 209  
*Superhet a Beginner Can Build* PAGE 222



Simple bookbinding puts your favorite magazines in hard covers. Page 230.



## *Man's Jewelry Is a Lathe Job*

**R**UGGED, attractive cuff links that reflect the personality and craftsmanship of their wearer can be turned on a small lathe from plastic or stainless steel. These materials, which will not mark the skin, also make practical collar buttons.

The links shown on this page (Fig. 1) are actually massive bolts and nuts turned from plastic. Dimensions are not critical and could be copied from a real bolt and nut of appropriate size. To vary the design, the bolthead might be made in square or hexagonal shape, matching the nut.

Square or hexagonal stock, if available, simplifies the work. With it you need only chuck the stock, turn the bolt shank, thread with a die, and part off, forming the chamfer on the head with a file before the piece

is cut free. If round stock is used, chuck a short length and turn and thread the bolt shank. Cut off, leaving enough stock for the head, reverse in the lathe, and form the head. For a square or hex bolt from round stock, remove from the lathe and file the head to shape. If you are copying a real nut or bolt, clamp it in the vise alongside the plastic piece and simply file across the flats until they coincide with those of the metal one.

Cut the screw slot across the bolthead with two hacksaw blades clamped side by side, being careful to cut on a diameter and to keep the sides straight. The threads on the bolt shank should run only  $\frac{1}{4}$ " in from the end. Turn a nut on until it binds, file the shank flush, and polish all over. Stock

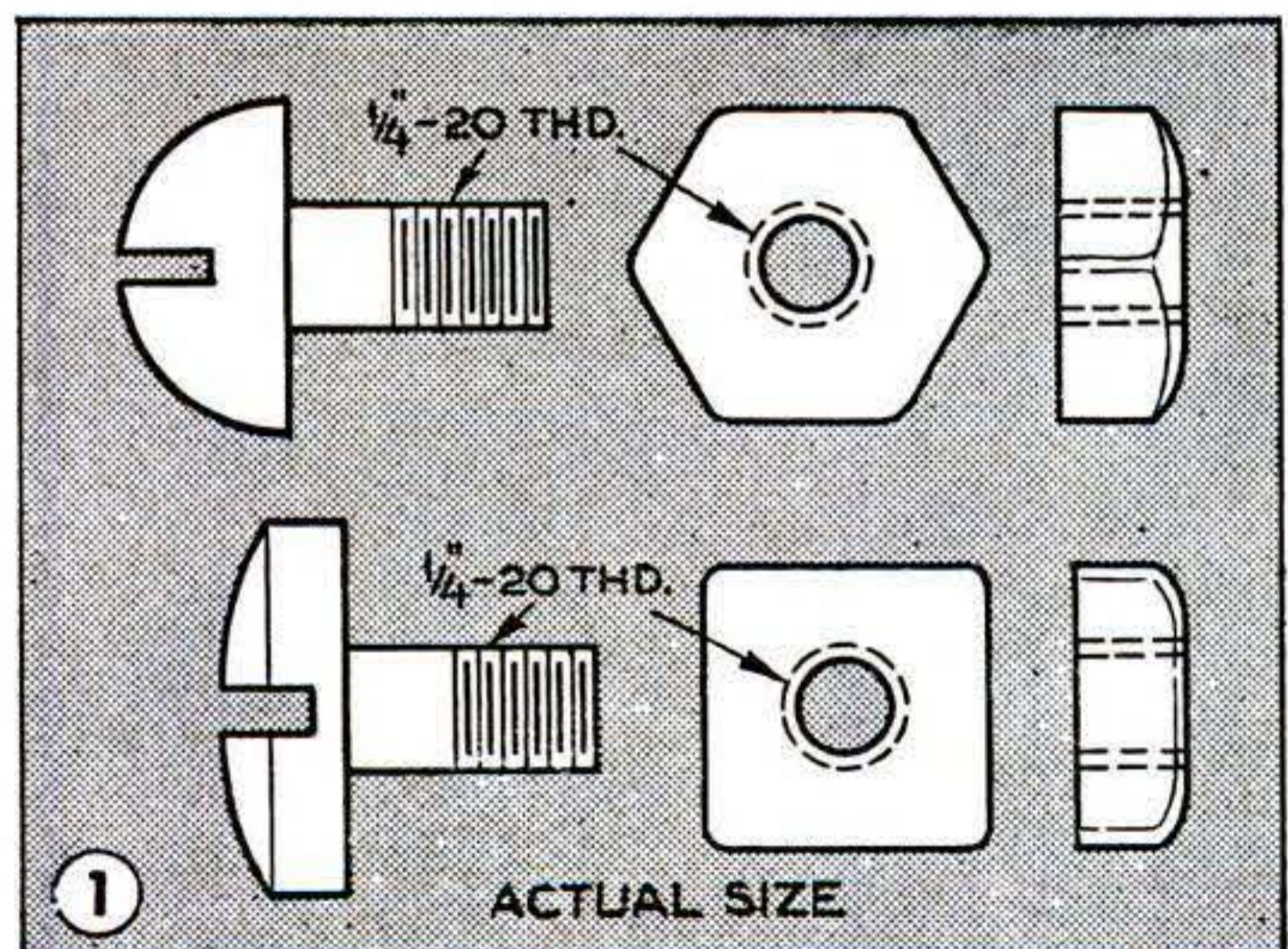
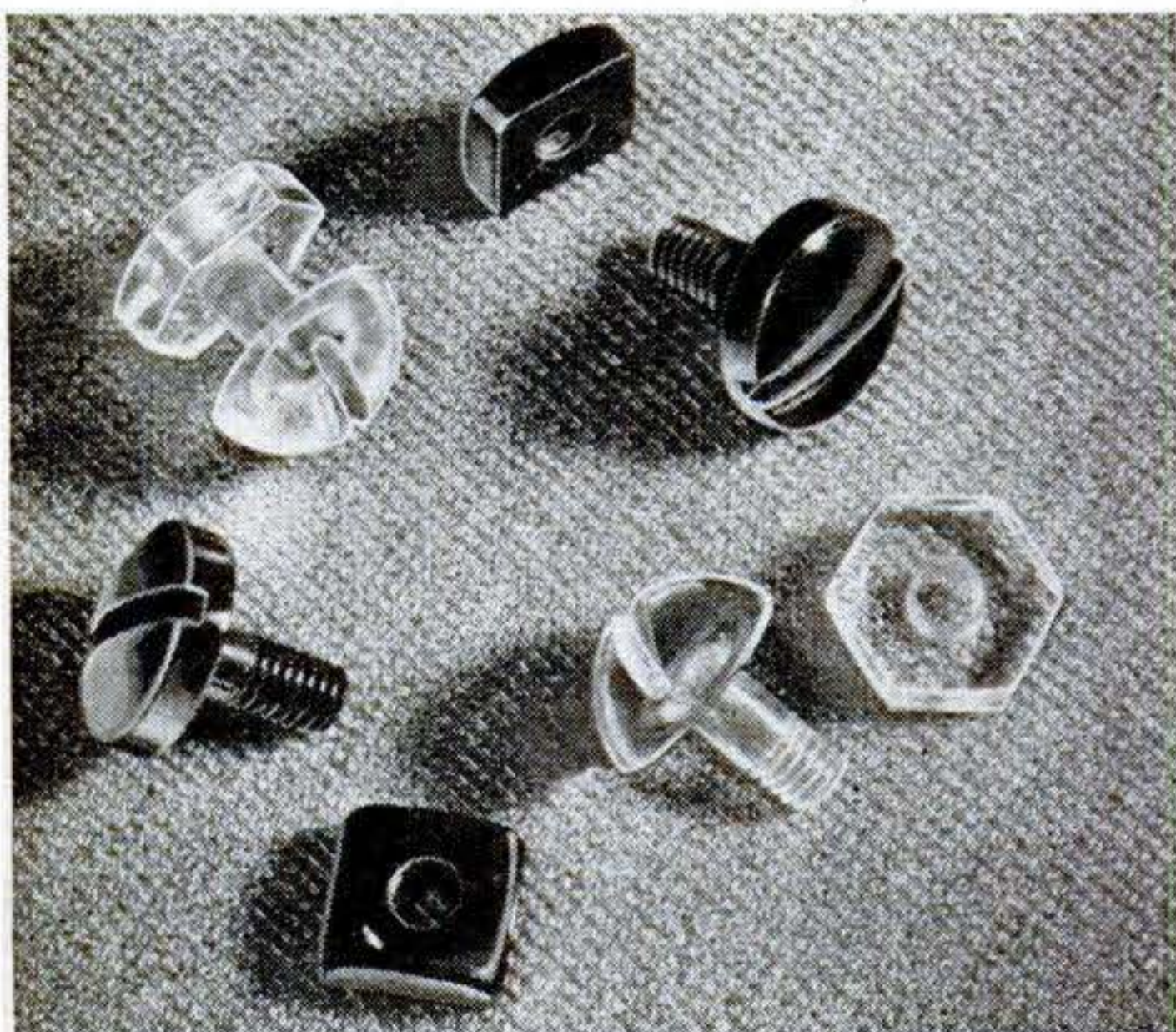

**Jet black or clear plastic, turned on a lathe, produces these unusual nut-and-bolt cuff links.**

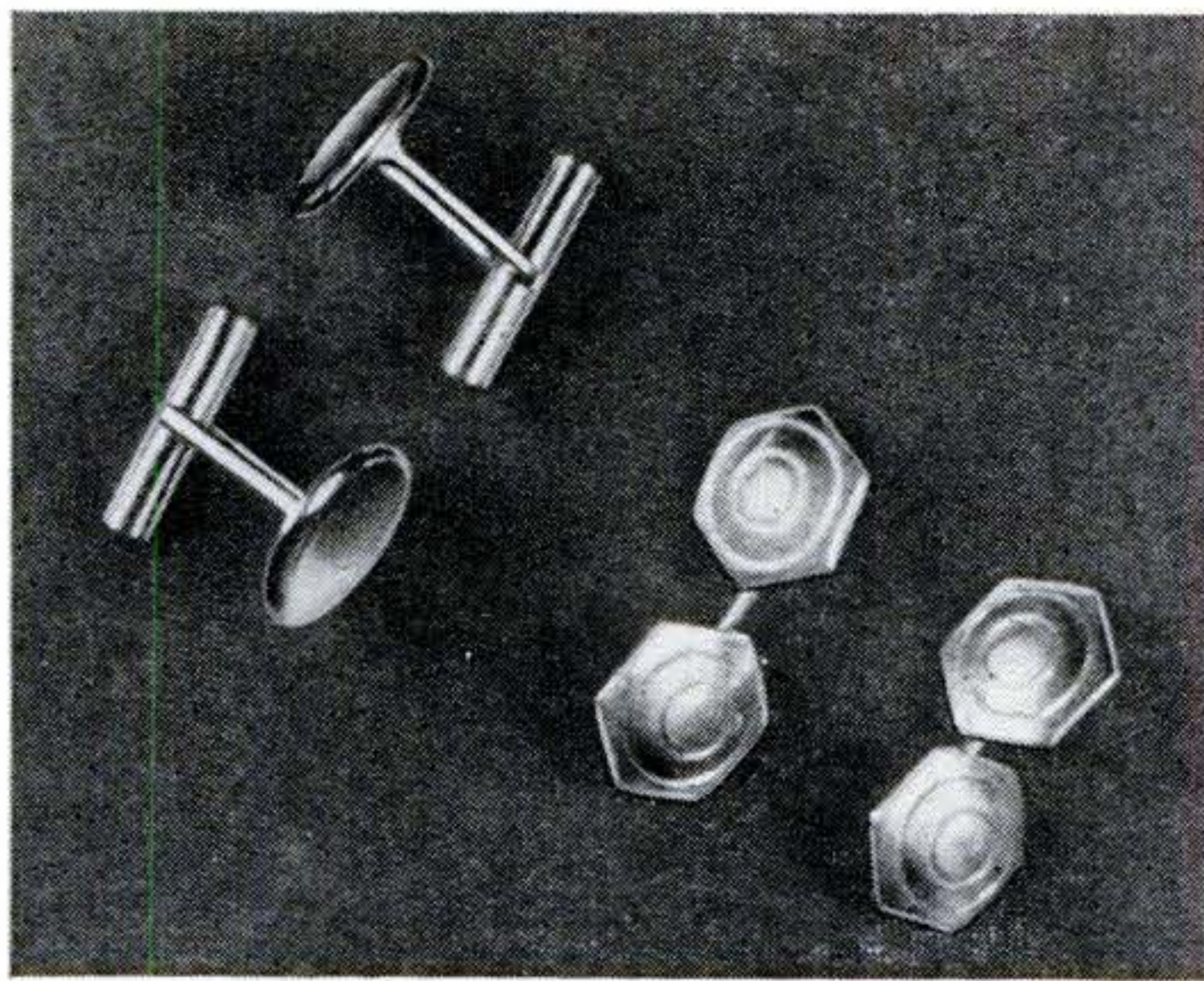

These two link sets, made of stainless steel, were designed by Joseph F. Gréce, of New York.

for the nuts is drilled, tapped, and cut off for filing to shape.

More intricate cuff links can be made of stainless steel, a material increasingly popular with jewelry makers. It polishes to a bright, silvery luster, and resists scratching and corrosion. The design shown in Fig. 2 is turned from  $\frac{1}{2}$ " rod. Turn a  $\frac{1}{4}$ " shank  $\frac{1}{2}$ " long and cut off, leaving a  $\frac{1}{16}$ " head. Reverse the blank in the lathe, round the edges, and smooth the face with a file and emery cloth. Place the shank in a vise and file a flat. Scribe a center line, center punch, and drill three  $\frac{1}{8}$ " holes. Then file the other side of the shank flat. Use needle files to remove the excess material left after drilling, forming an oblong slot in the shank. Slit the end of the shank with a jeweler's saw, and round the corners.

The crosspiece is a short length of  $\frac{1}{8}$ " stainless-steel rod, drilled at the center. To attach it, wedge the sides of the shank apart and slip it into position. Then tap the shank sides gently with a light hammer to lock the crosspiece in place. Finally, buff the flat end surface.

Another style link that uses two "buttons" connected by wire (Fig. 3) is made in much the same way as the links of Fig. 2. It requires twice as many buttons, however, has shanks only  $\frac{1}{8}$ " by  $\frac{1}{8}$ ", and is filed to a greater curve. If desired, the buttons can be decorated with circles by bringing a sharp-pointed lathe tool against the face.

Stainless steel and plastic are both suitable for collar buttons. Chuck a piece of  $\frac{1}{2}$ " rod and reduce it  $\frac{1}{4}$ " for the length of the button height. Then further reduce to form the stem behind the head, and cut off, leaving a thin shoulder or flange to form

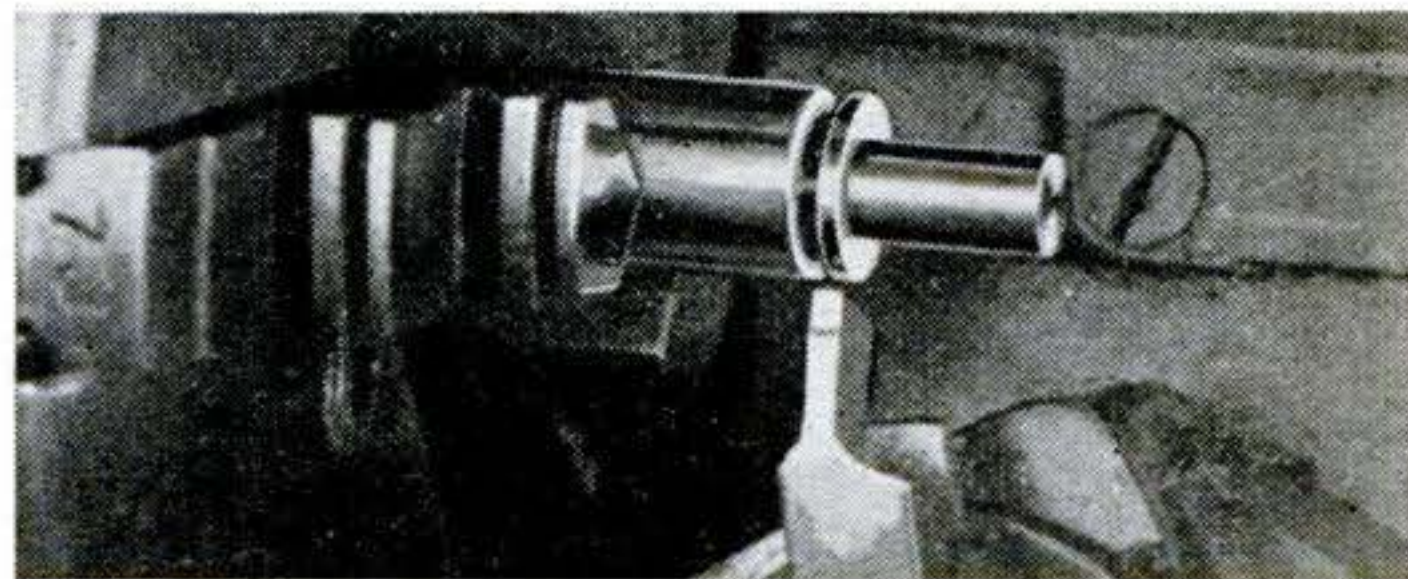
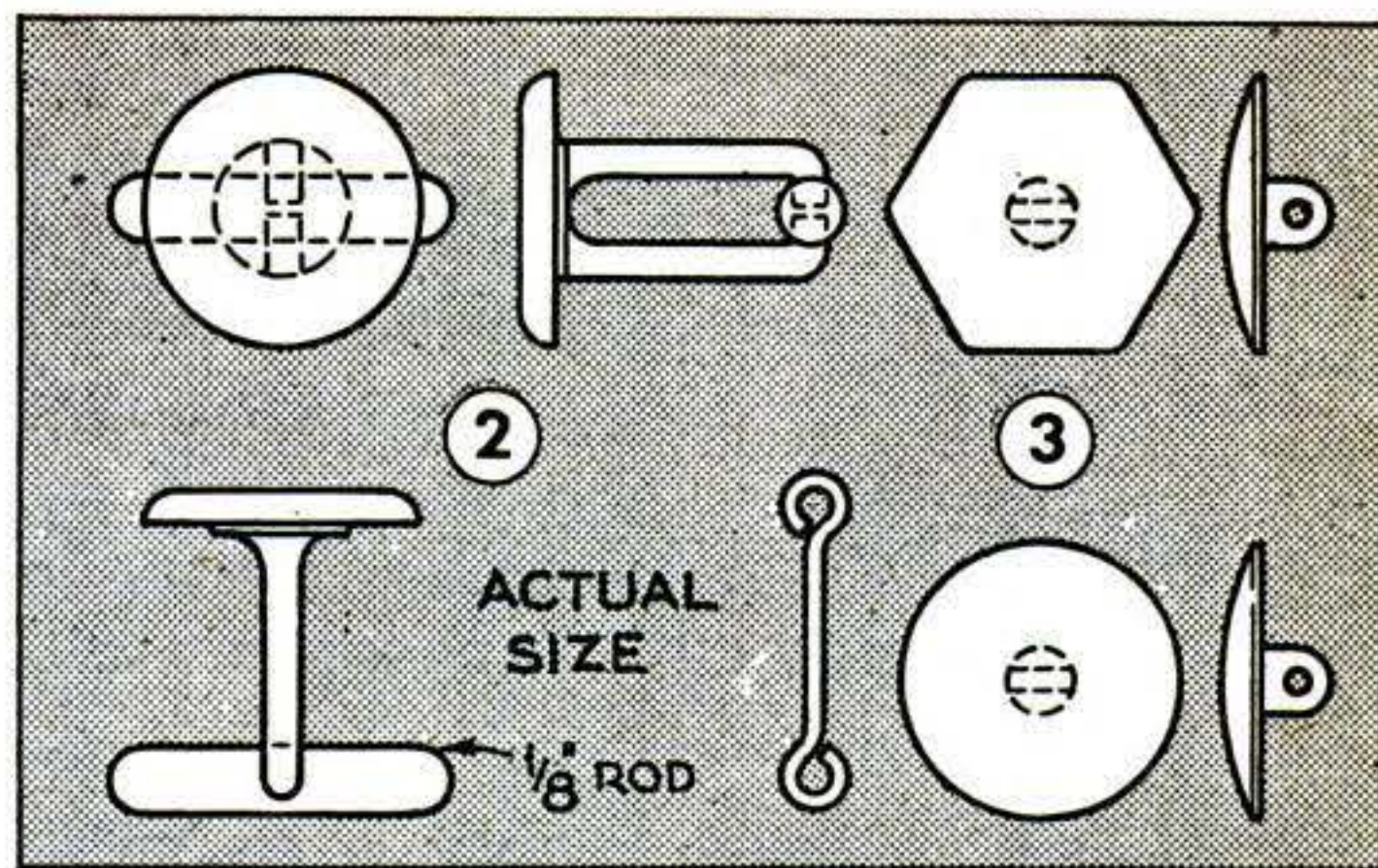

A blank for the link shown in Fig. 2 (top) is cut off after the shank has been reduced to  $\frac{1}{4}$ ".

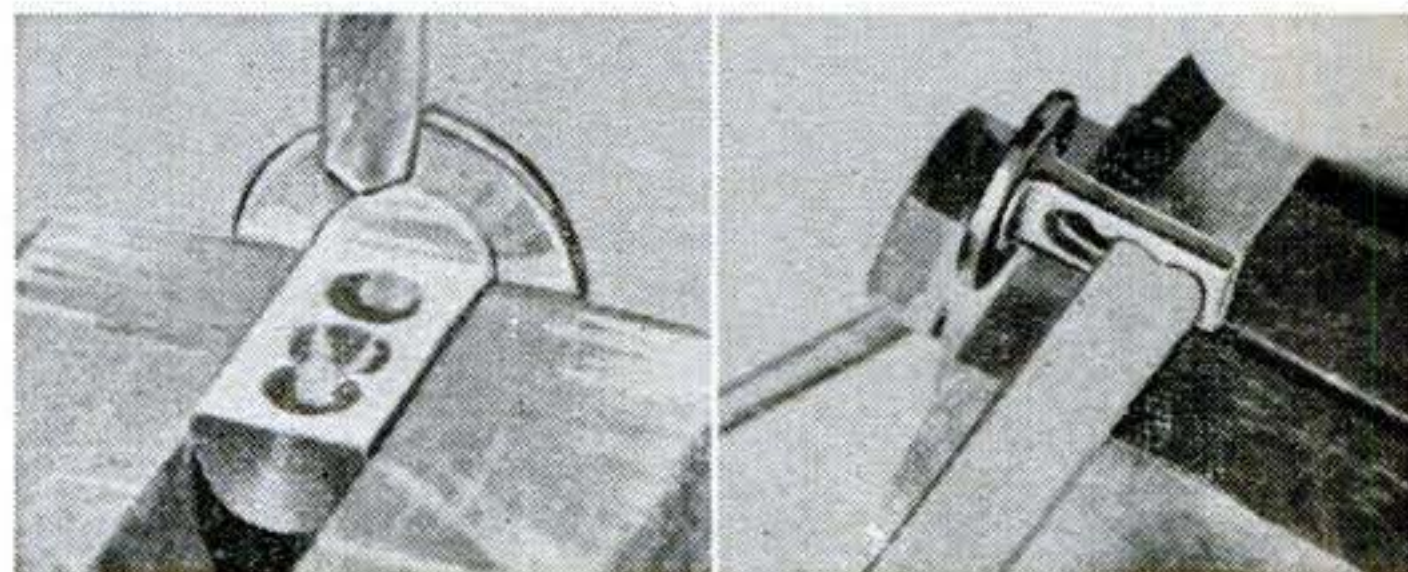

Three holes are drilled through a flat filed on the shank, and the extra metal is removed.

the base. Finish the base by taking it in the fingers and rubbing on a sheet of emery or crocus cloth laid face up on a flat surface.

If you plan to make many of the buttons, it may be worth while to devise a special fixture to hold them in the lathe while facing and polishing the base. It could be a piece of round stock that's bored for the head and slotted for a clamping screw.

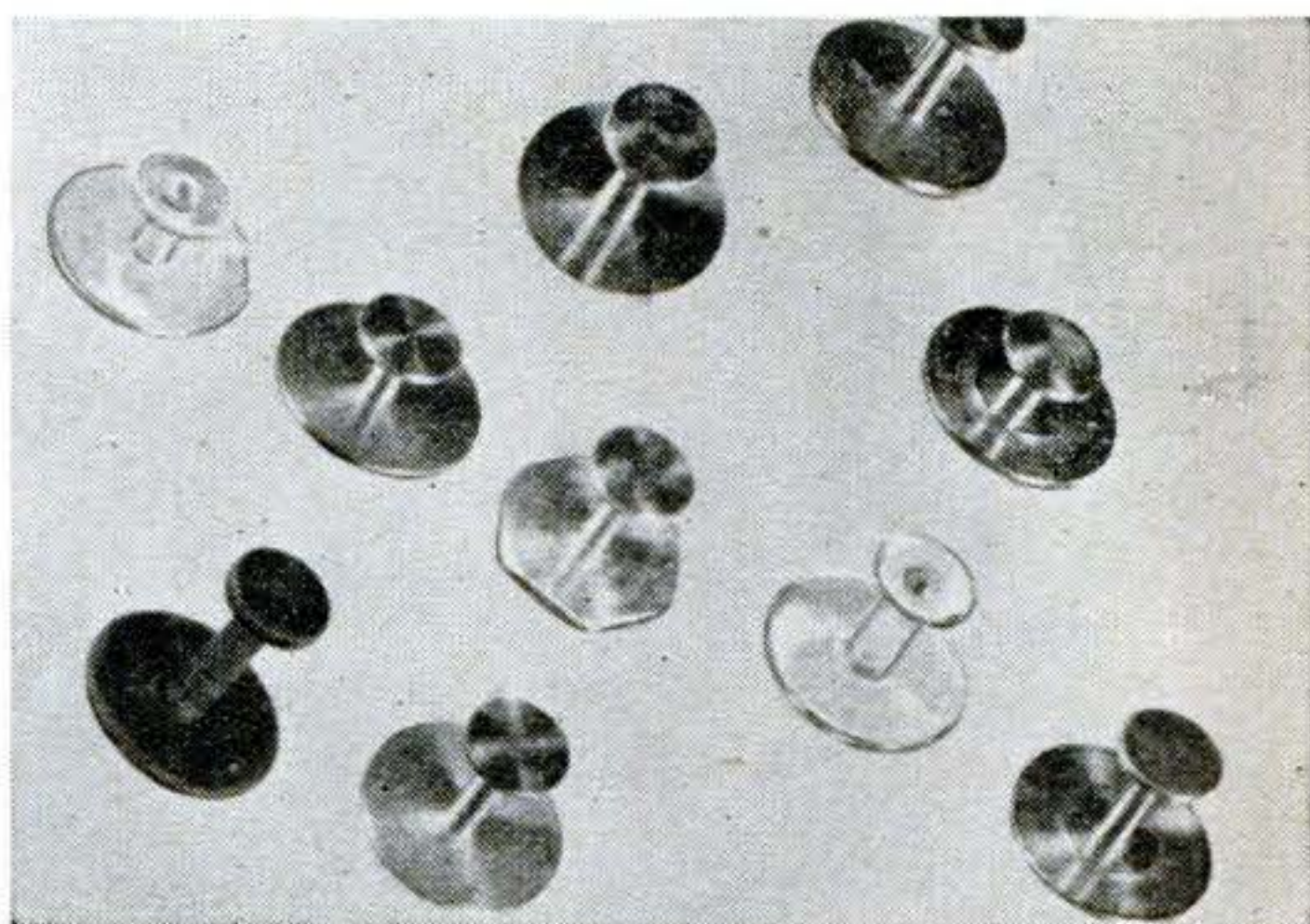

Stainless steel and plastic are good materials for collar buttons, as they do not mark skin.

# A New Slant on Flowerpot Shelves

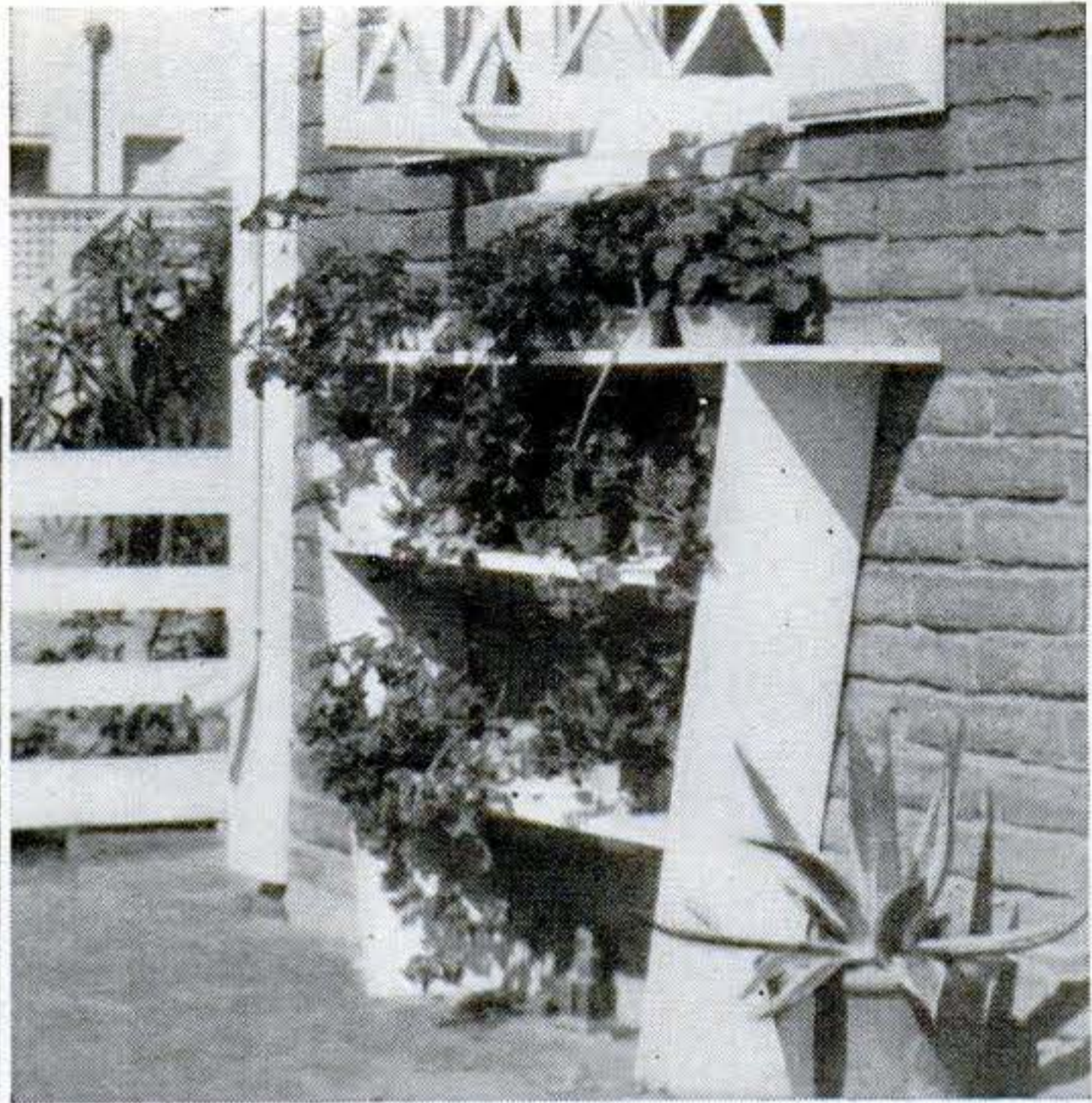
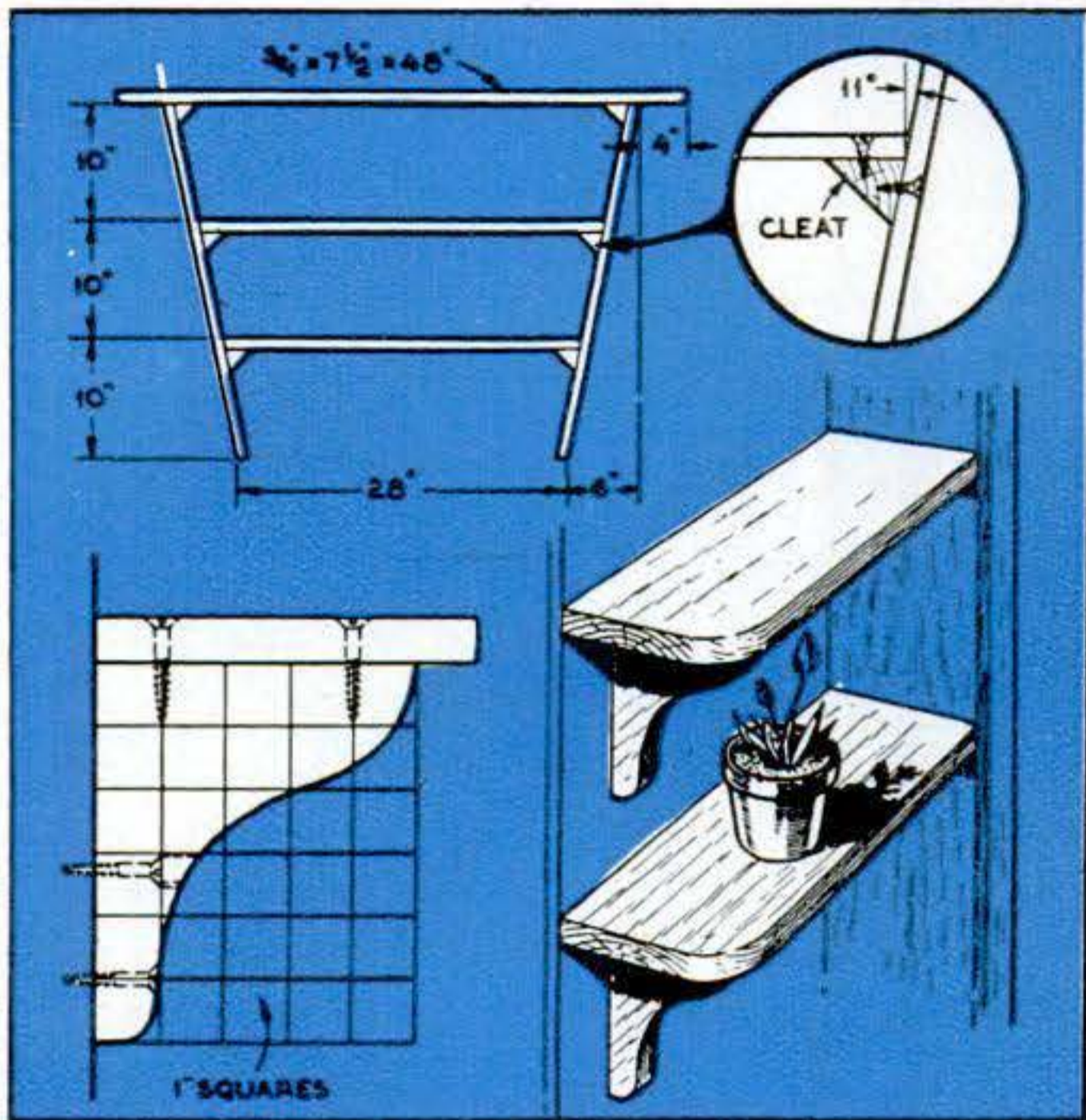

Potted plants on neat shelves add interest to this home. Sketches at the left show how the shelves were made. All are painted white.

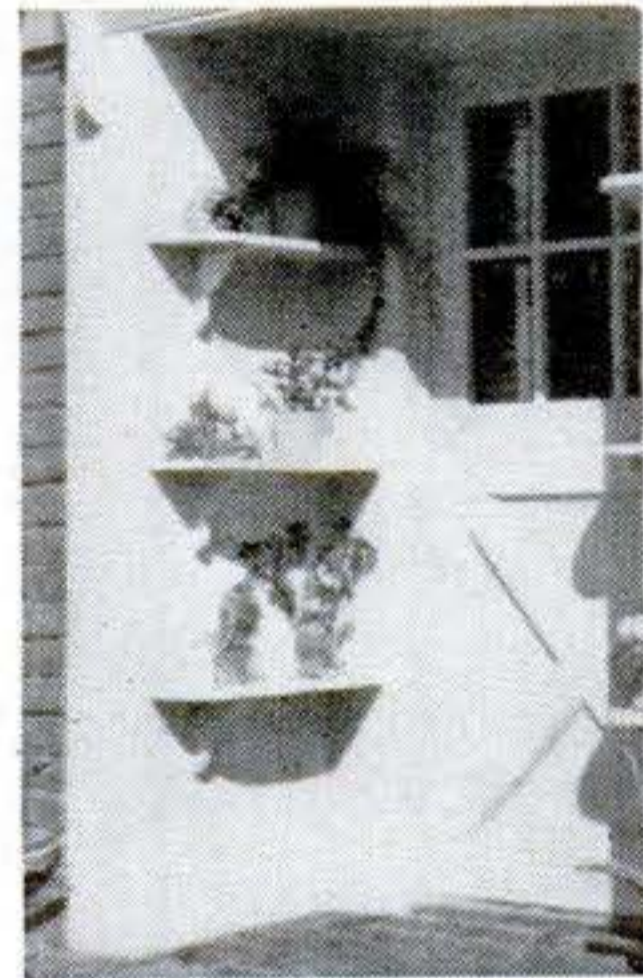

WHEN building a set of flowerpot shelves to go under a casement window on the terrace, the owner of a California beach home gave them a new look by putting the sidepieces at an angle instead of straight. Quickly built of stock material with butt joints as in the drawing, the unit was made rigid by screwing angled cleats under each shelf. At the same home, small shelves are supported by brackets on each side of the entry.—*Hi Sibley, Nuevo, Calif.*

## Mortise Is Built Up with Shims to Strengthen Joint

WHILE reconditioning an old four-poster bed, I found that the mortises in the posts had worn so much that it was impossible to

get a tight joint. The problem was solved by building up the mortises with shims as shown at the left.

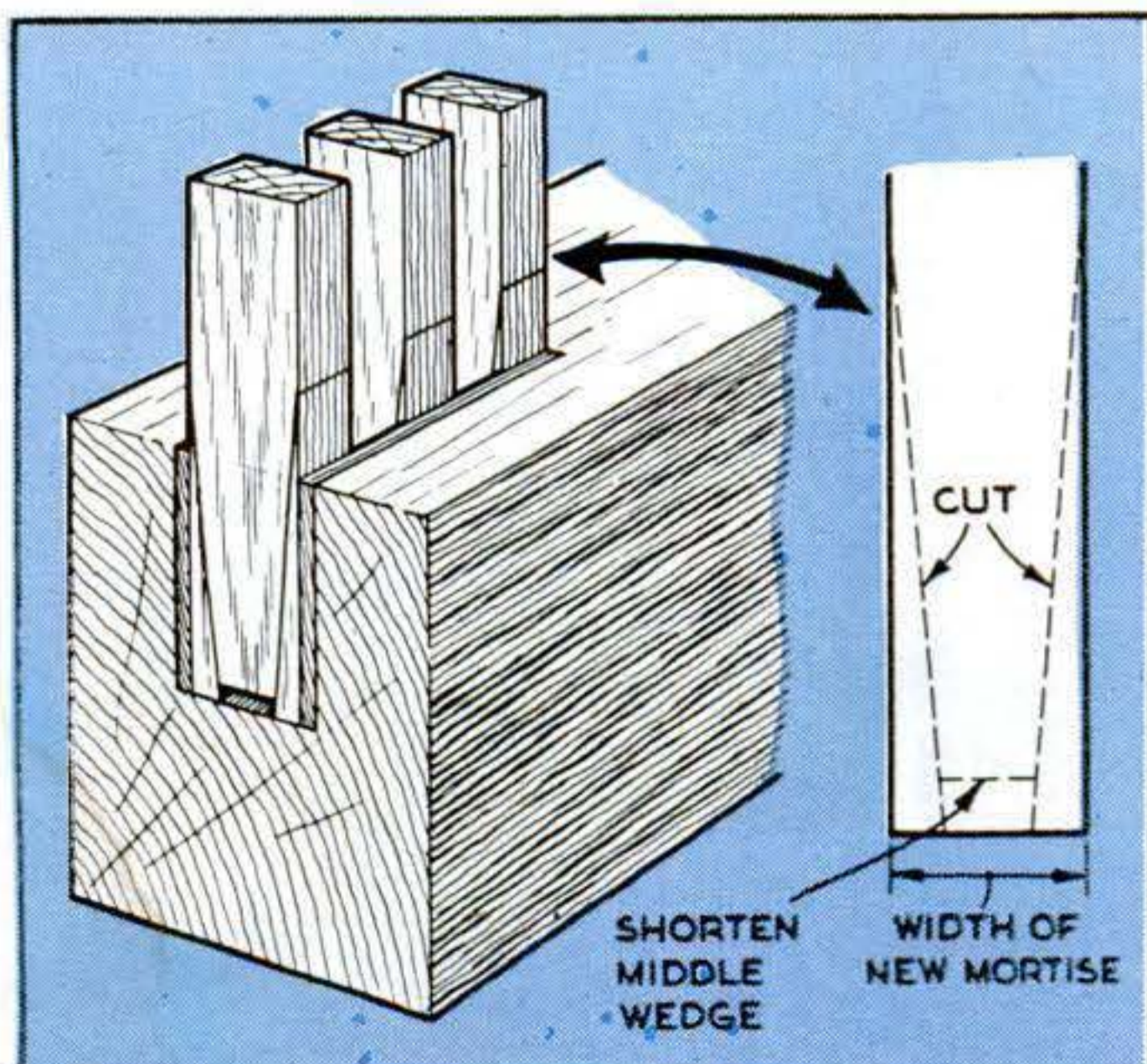

After each old mortise had been cleaned out and enlarged slightly, shims were cut to build up the mortise to suit the existing tenon. The shims then were wedged in place while the glue was drying, the wedges being made by cutting short pieces of stock to the thickness of the finished mortise, taking slanting cuts on each side of one end as illustrated, and marking the mating pieces. The center piece was also shortened slightly so it would clear the bottom of the mortise when driven in.

If the shims have been cut the proper thickness, the mortise will be ready for the tenon as soon as the glue has set and the wedges are removed. The number of wedges required will depend on the length of the mortise.—*H. M. Childs, Mobile, Ala.*



# Chest Faced in Matched Veneer

**By Joseph Aronson**

*An architect whose specialty is interiors (see page 98), Joseph Aronson is also well known for his work in furniture design. He is the author of The Encyclopedia of Furniture and Furniture and Decoration. Here his adaptation of a striking old chest is a challenge to fine woodworking craftsmen.*

**E**XECUTED in the elaborate walnut veneers characteristic of the early 18th Century, this small chest is a close copy of a particularly fine antique originating in England somewhere around 1720.

The date of the original can be set fairly precisely because modification of English importing laws in 1733 encouraged extensive use of mahogany. Previously, the finest work had appeared in complex surface designs of walnut veneers, sometimes so ornate that the fundamental shape of the piece was subordinated to decorative facing.

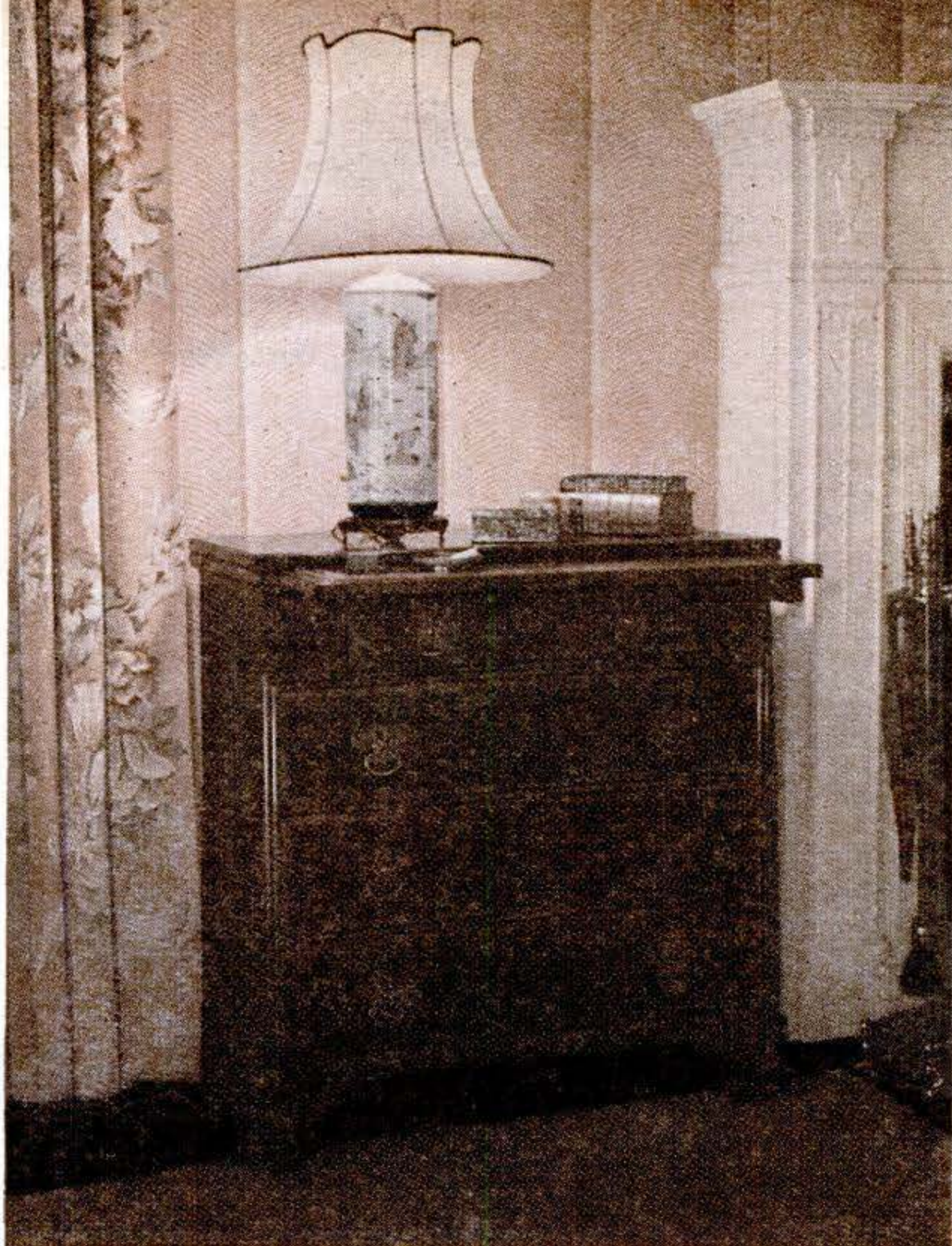

Standing 29½" high, it's known as a bachelor's chest.

A fine copy of the careful handicraft of that period, the illustrated chest demands a degree of craftsmanship equal to that of the cabinetmaker who produced the original. However, to the man possessed of the skill and patience to carry the project through, the result will certainly be a piece of rare beauty and satisfaction.

Although the accompanying drawing spe-

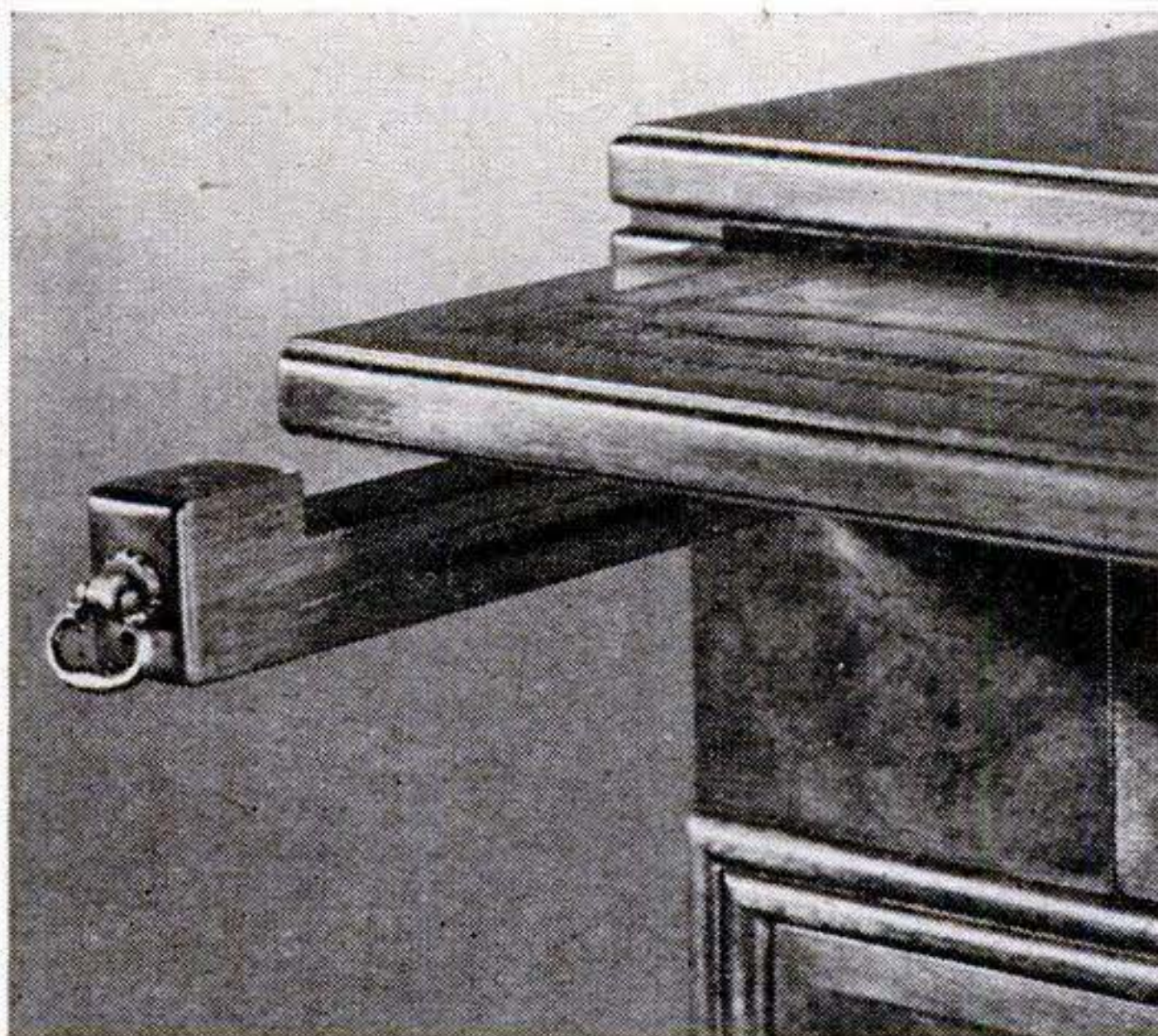

A walnut runner in hammer form supports the pull leaf. The leaf top is faced with leather.

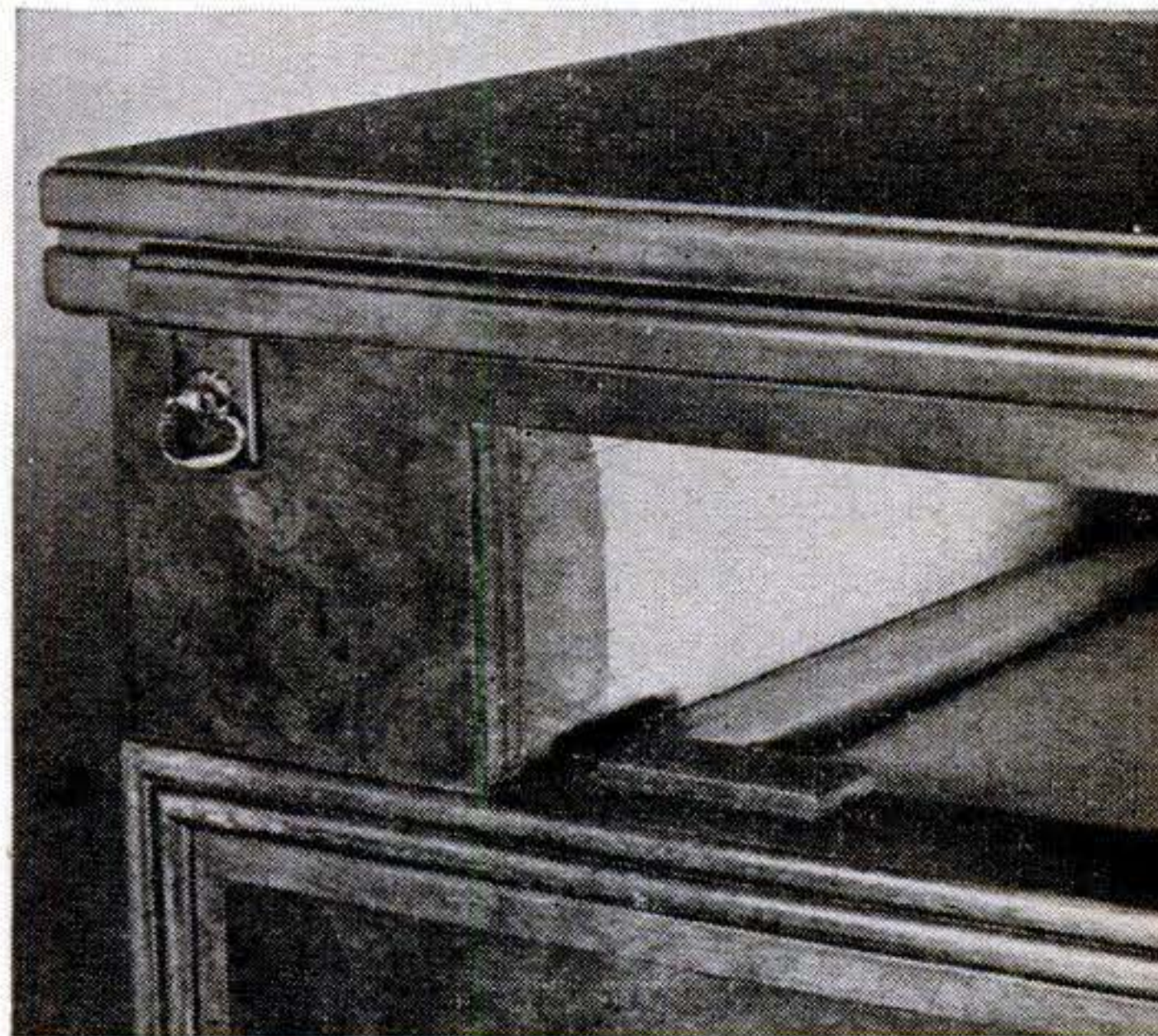

Double half-round molding sets off the lower drawers. Also note the molding around the top.

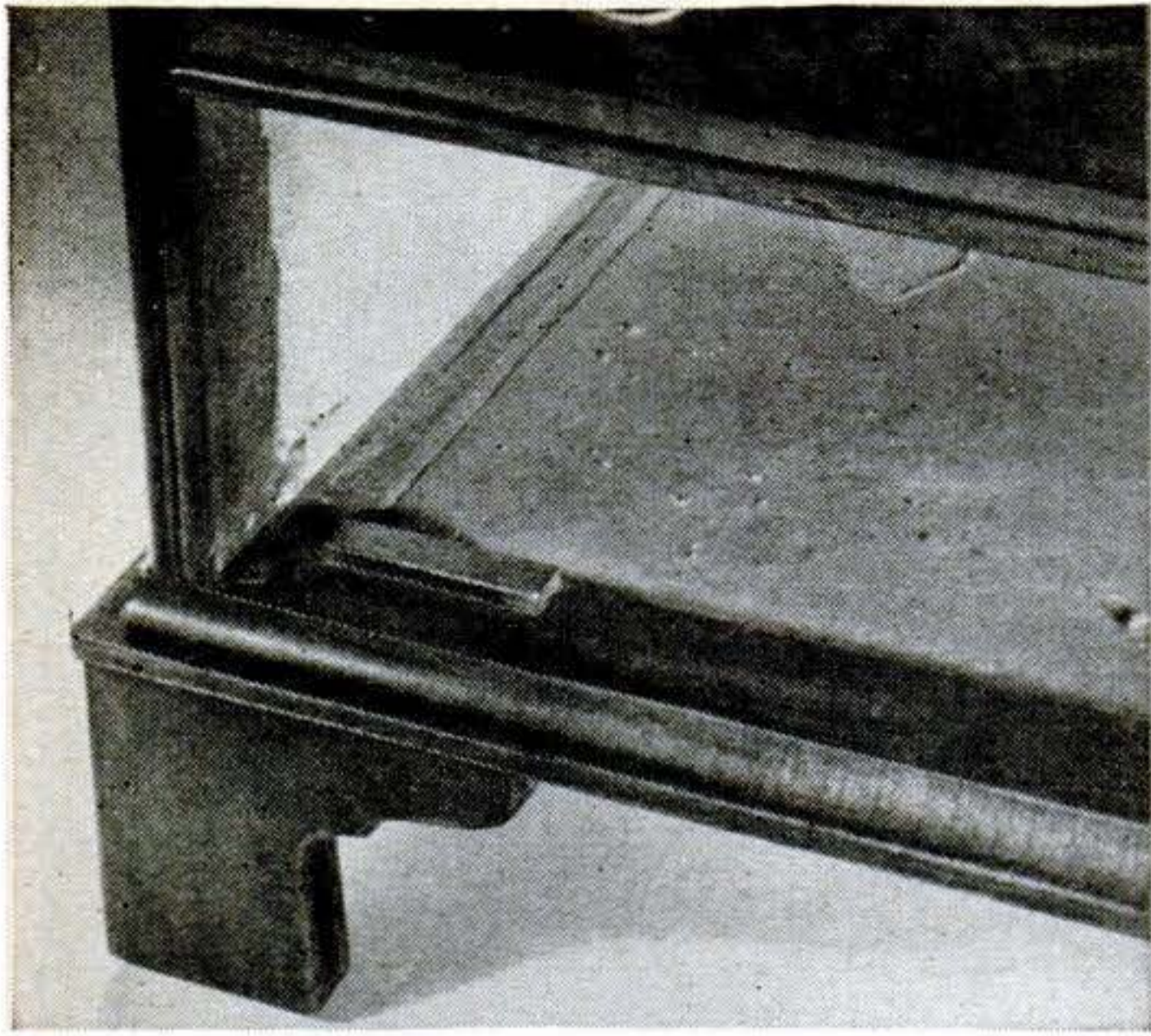

A cross-veneered cavetto around the base is a fine touch, although solid wood can be used.

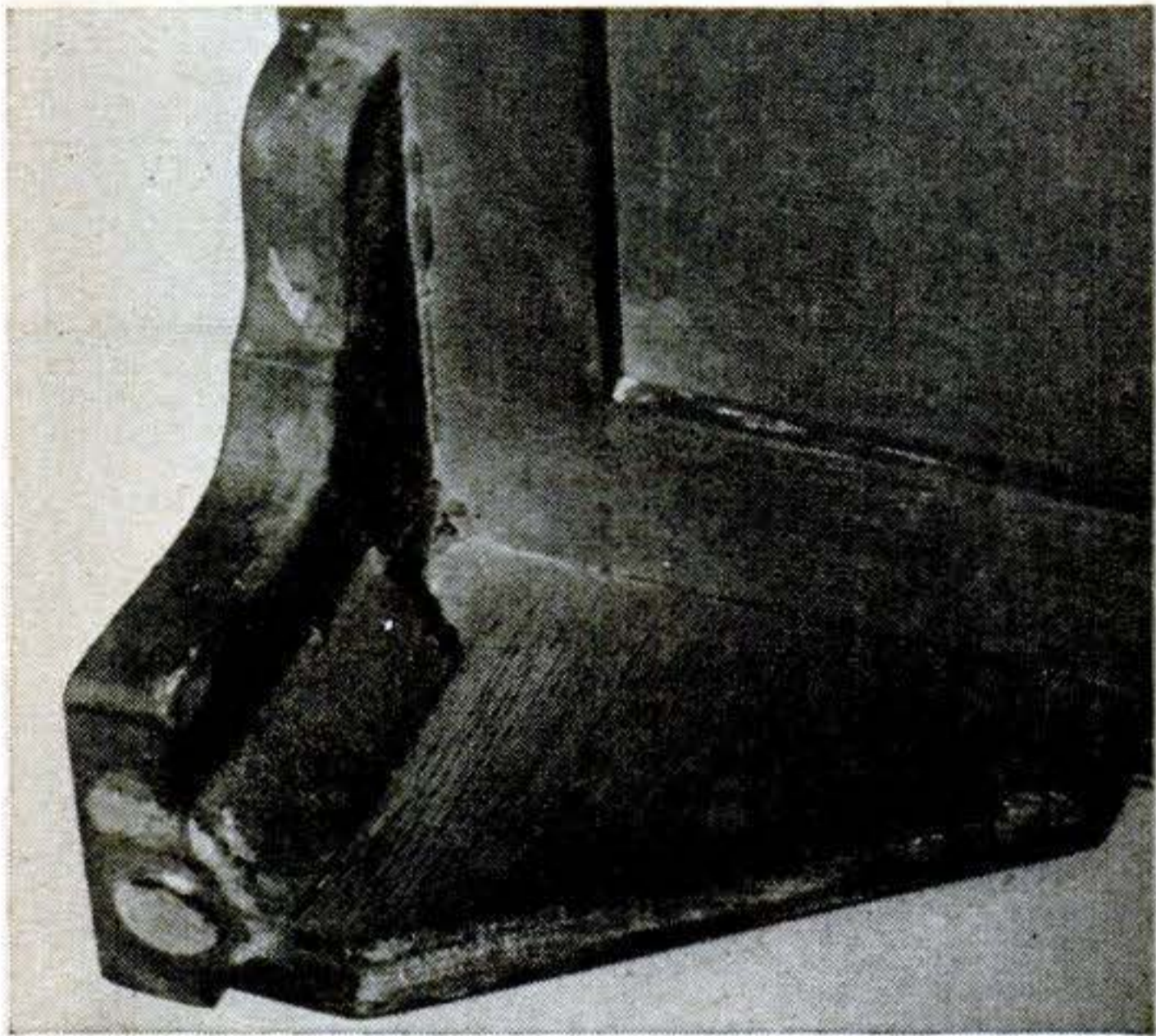

Identical brackets at each corner support the chest. The framing for the case is conventional.

cifies walnut, the design might also be executed in solid mahogany or other wood that will take a fine finish. The pattern in the veneers is formed in the customary way by pasting up cut pieces with tape on a brown-paper ground and applying it as a whole to the surfaces of the chest.

For the two sides and the top, four sheets of burl walnut veneer are quarter matched to form a sort of center star or flower. Each drawer facing consists of two leaves of the same veneer, matched at the center. Solid walnut may be used for the framing faces.

The top has a 7/16" border of a light contrasting veneer, such as English ash or a wood of similar comb-grained character. In the original, as in the replica, the comb grain runs at 45 deg. to the rectangle, with the match occurring at the centers. The same

7/16" border applies to the drawer fronts, but not to the sides.

It is well to stress the fact that the backing should be veneer of approximately the same character as the facing. For example, if you apply a walnut face veneer, say to a birch or gum plywood panel, then the backing veneer should likewise be walnut.

#### *Veneers Must Dry Thoroughly*

Allow the veneers several weeks to dry before cutting the case work. With burl veneers you must always expect a certain amount of checking—fine hair cracks that show through the finish several months after completion. Even many pieces in museums have these characteristic crackings, and ordinary gluing methods will not prevent the action.

All the drawers are of conventional construction, and the case employs dust-panel framework doweled into the sides. Front frame members are solid walnut, the forward edges of the center three being rounded off. The bottom framing member appears as a cavetto along the front and both sides. This is a concave quarter-round molding that the worker in solid wood can run with a shaper or molding plane.

However, if you wish to conform to tradition, you face the problem of applying veneer the short way in the curve. This involves making a reverse mold of identical profile that can be pressed with clamps into the edge mold while the veneers set. Although this is a particularly fine touch, it can of course be omitted. Even if you use veneer facing on the rest of the chest, it wouldn't be out of keeping to make the cavetto in long grain solid walnut.

#### *Pull Leaf Framed in Solid Walnut*

Since the top drawer is shorter than the lower three, space is provided for the walnut leaf runner and the floor on which the leaf slides. The leaf is framed in 7/8" solid walnut mitered at the two front corners, and a 3/8" panel is rabbetted deep enough to bring the leather top flush with the upper surface of the framing. In this example, the leather is a natural finish top-grain steer hide, tooled in gold and lacquered to a polish.

Molding of identical cross section is cut on the edges of the top, the pull leaf, and the framing members for the latter. When gluing the framing members under the top panel, insert a single thickness of walnut veneer to make space for the leaf to run

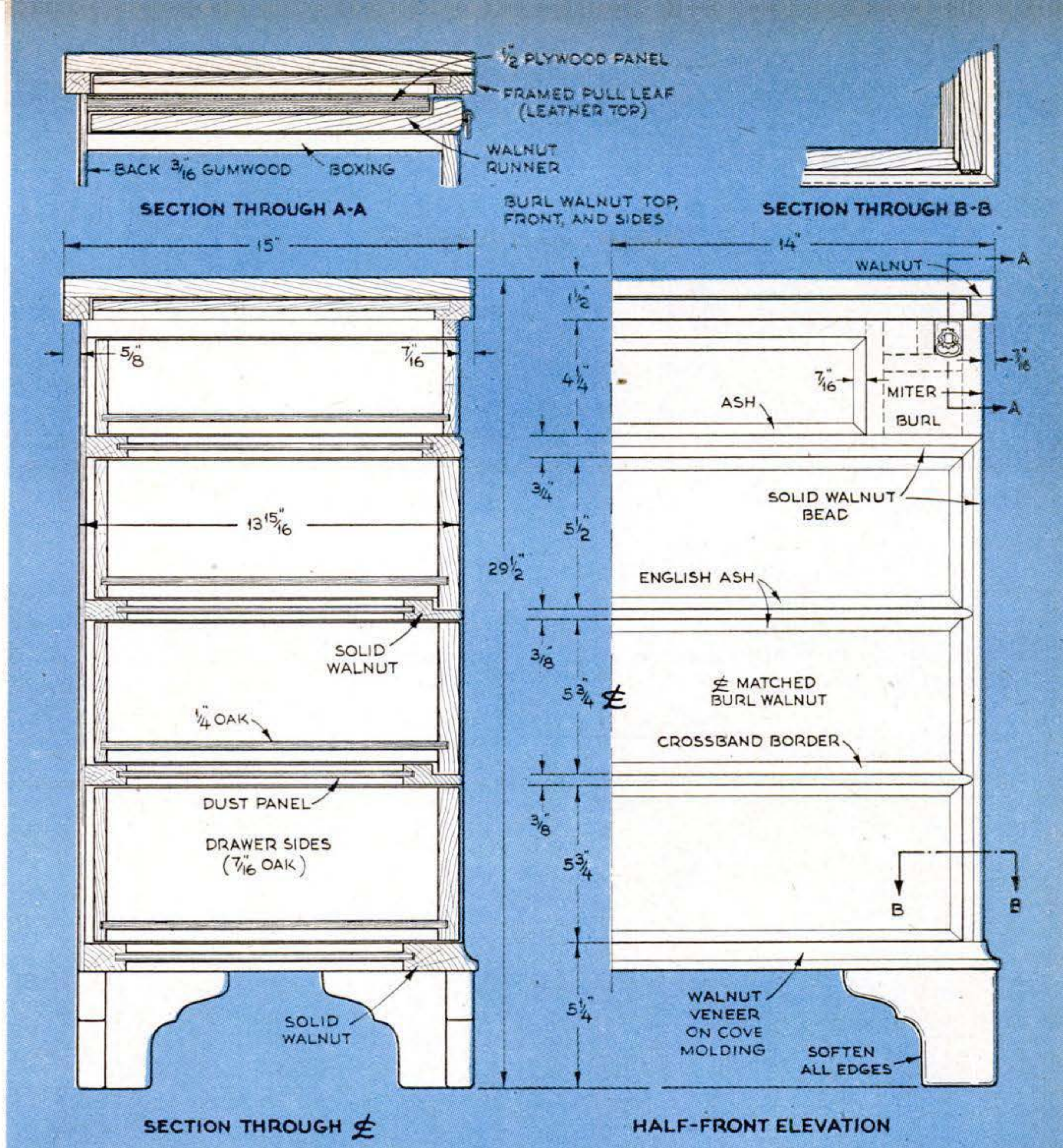

free. As a matter of design, the leaf support is allowed to project from the case about 1/4". Round off its front edges, and apply felt or leather to the top surface of the hammer head.

Each corner of the bracket base consists of two identical pieces mitered together, corner blocked, and doweled and glued to the lowest frame of the case. From the point of view of design, it is preferable to have the grain of these pieces run vertically.

Finishing the veneer surfaces calls for a lot of patience. The characteristic color of such old walnut pieces is a tawny brown with a high satiny texture. Begin by applying an aniline yellow stain irregularly. Then bleach the entire surface lightly and follow with a sealer. Although a fine wash of rabbit-skin glue tends to hold the veneer to-

gether better than any other material, a very thin coat of white shellac will do a fair job. Sand down this coat without mercy and follow with others until the desired fullness is achieved.

Then glaze with a smudge coat of raw umber and burnt sienna, mottling in an occasional dab of Van Dyke brown. The palm of the hand is the only satisfactory tool for this work, and the eye the only judge of how far to go. When you have the glaze you want, apply several coats of dull lacquer or white shellac, sanding down each with 5/0 paper after allowing plenty of time to dry. The final satiny glow comes from a well rubbed coat of hard wax.

To see the job through, you should choose hardware of a quality and style consistent with the chest design. END

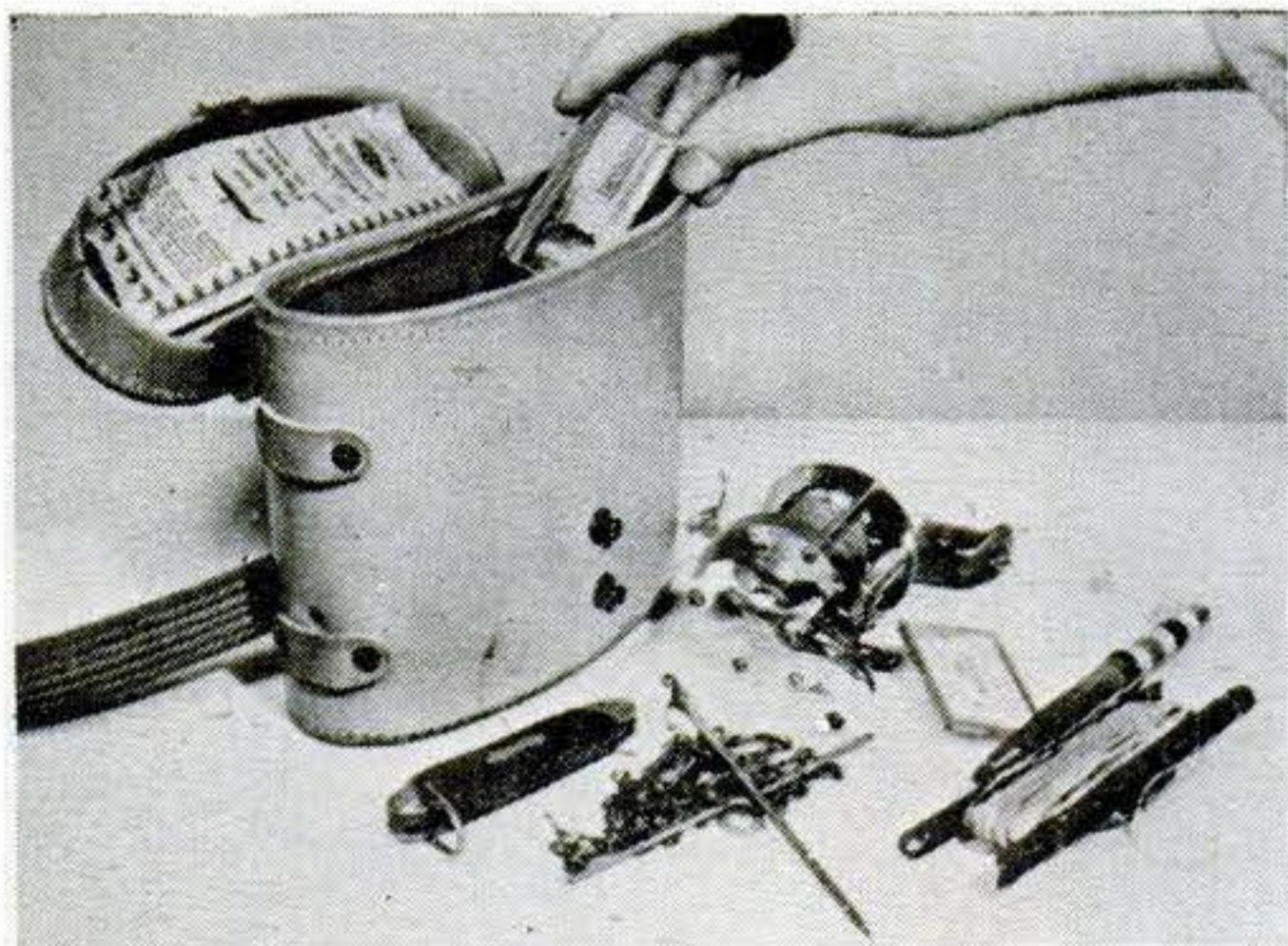

### Binocular Case Is Tackle Box

IF YOU'RE tired of lugging a heavy fishing-tackle box, here's a happy solution. Get one of the surplus binocular cases that are now available at low cost in many localities. The case will usually hold just about everything needed.—H. Leeper, Canton, O.

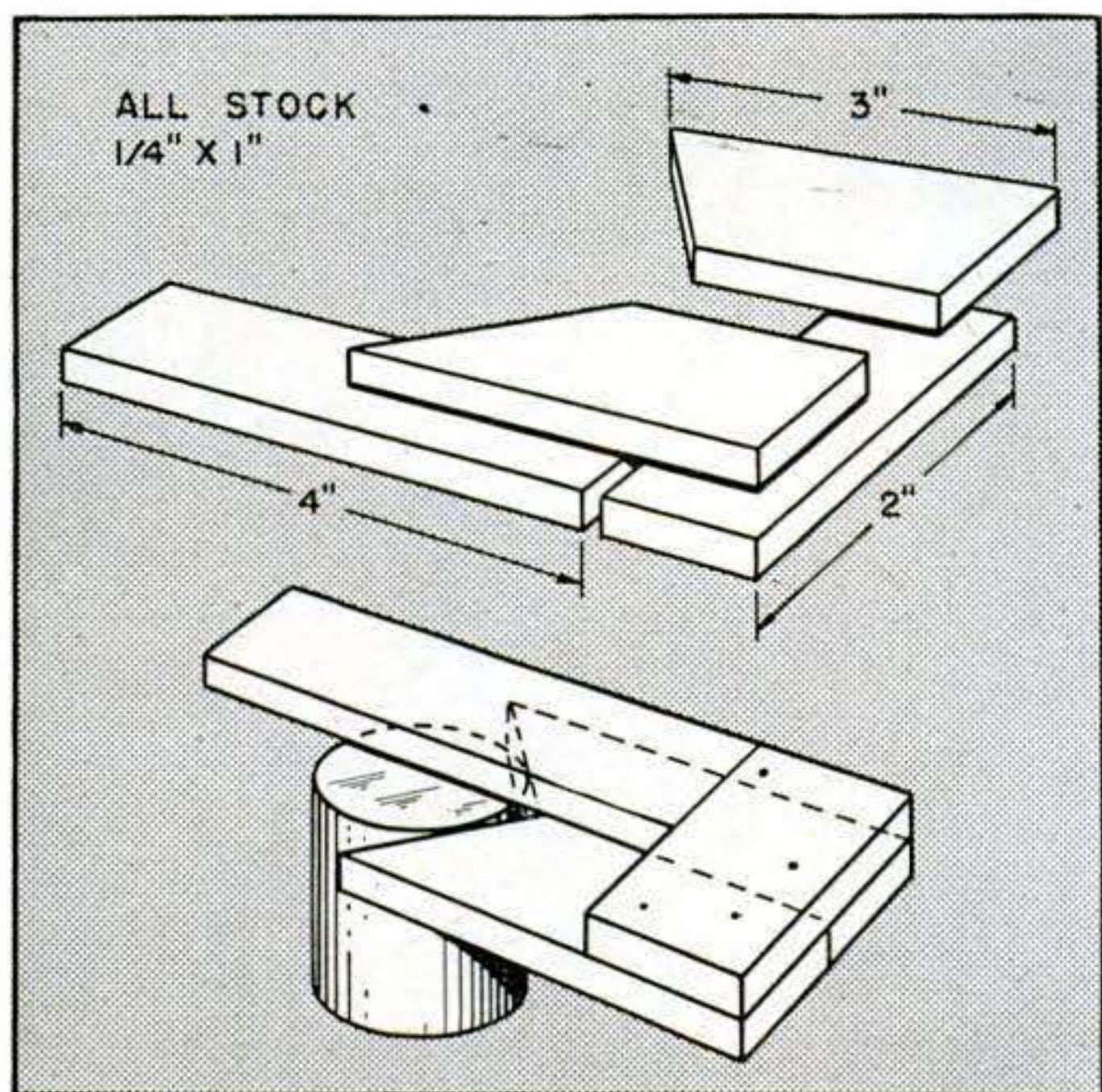

### Center Finder Works Quickly

WHILE making some small turnings, I hit upon this idea for locating the center of round stock. It works like a charm.

Using  $\frac{1}{4}$ " hardwood, rip a strip 1" wide and about 15" long. Then cut off one 4" piece, two 3" pieces, and one 2" piece. Miter each 3" piece to 45 deg. at one end, and assemble all the pieces as above, tacking them together with or without glue.

With the device held on the end of the round stock as above, scribe a line close along the 4" strip. Revolve about 90 deg. and scribe a second line. The lines will always intersect at the exact center of the work.—J. W. Jay, Palmyra, N. J.

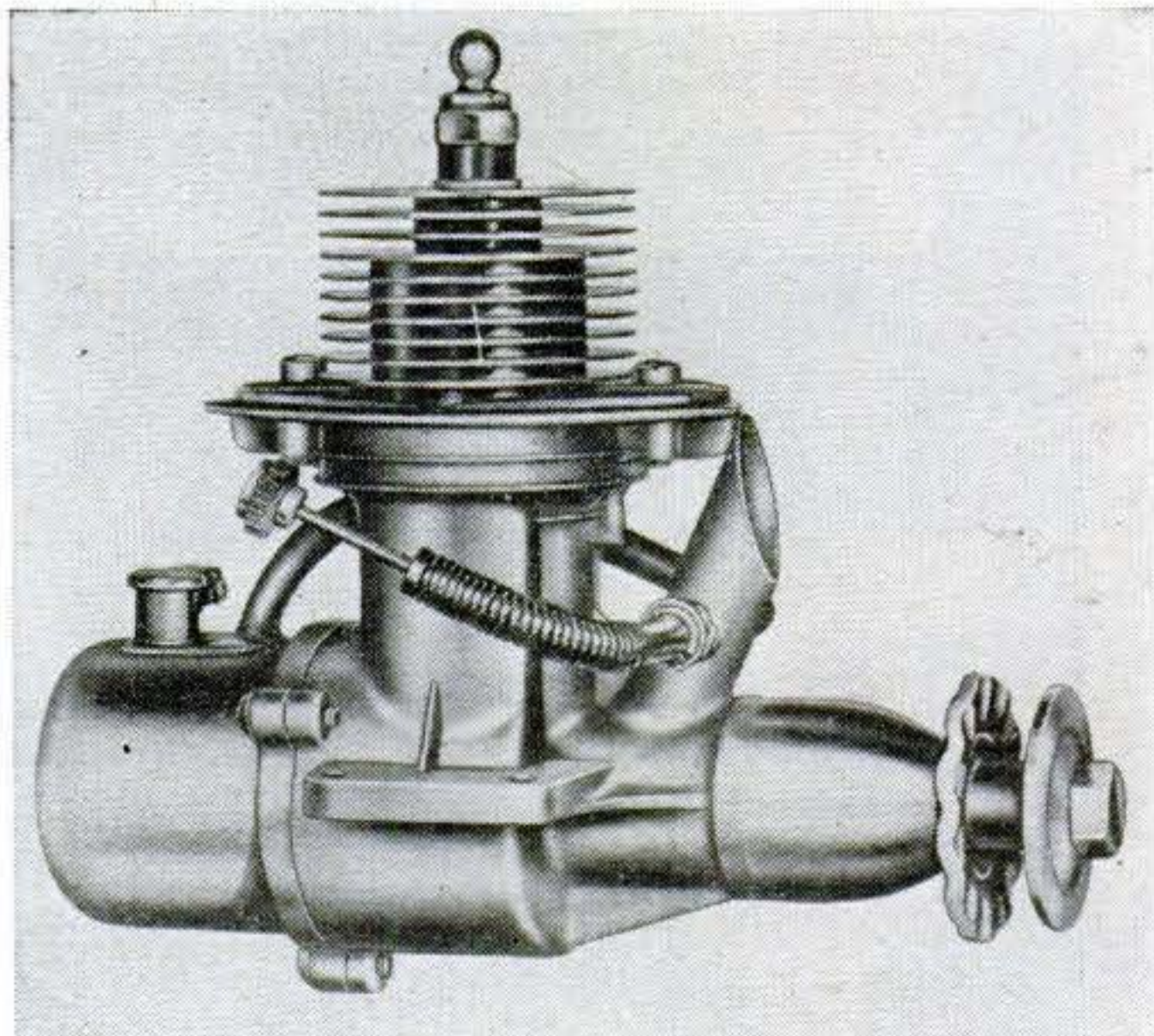

### Engine Designed for Glow Plug

ENGINEERED for glow-plug operation, this new class B model-plane engine features a heavy crankshaft and bronze main bearing that are said to counteract the stresses of pre-ignition firing. Started by connecting a 1½-volt battery to the plug, the engine then runs by pre-ignition, using a special fuel. It's made by the Herkimer Tool and Model Works, Herkimer, N. Y.

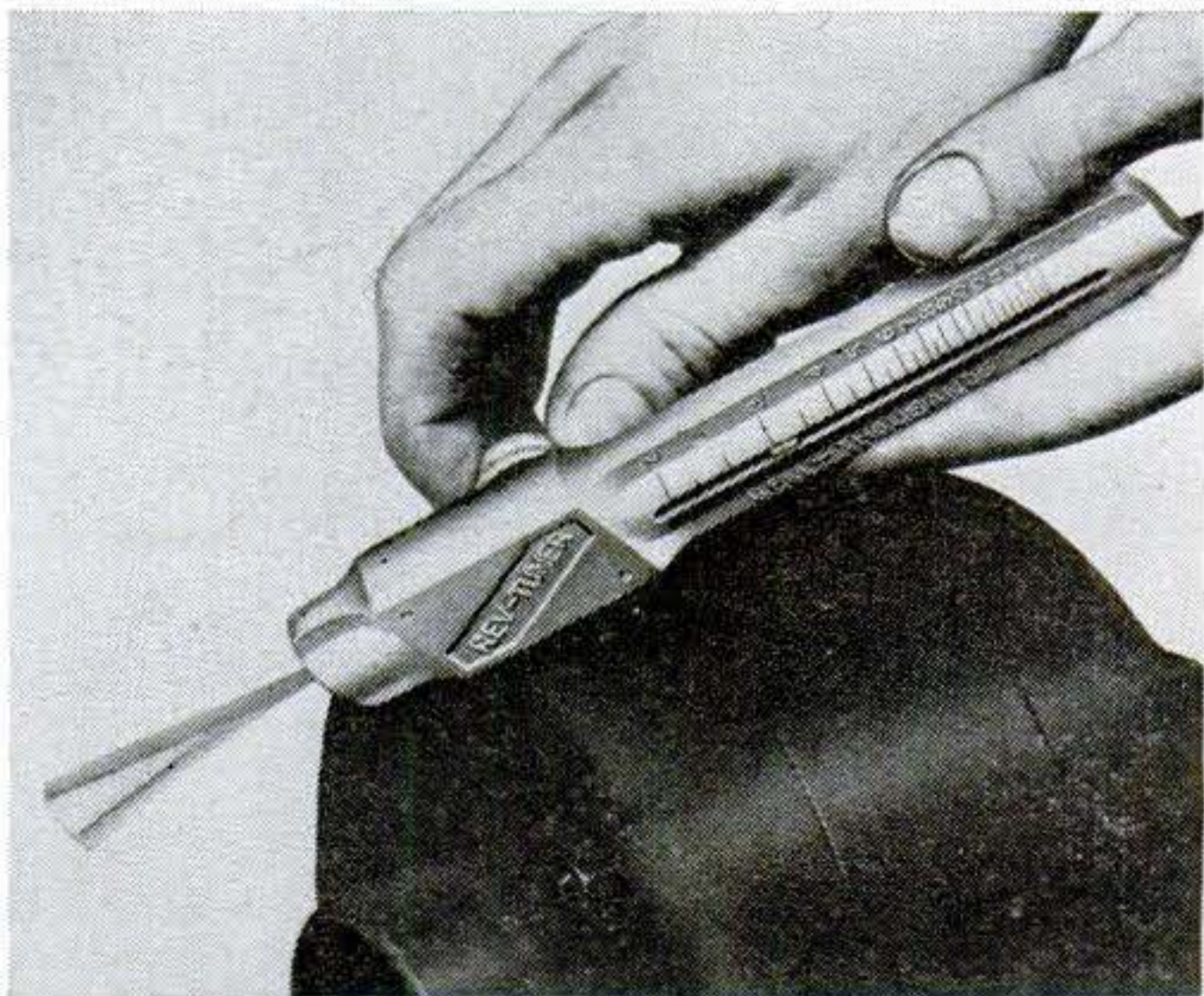

### Tuner Measures Engine Speed

THIS new pocket-size instrument for determining the speed of an engine or motor makes use of the tuning-fork principle. The instrument is held against the motor while a vibrating steel "reed" is adjusted in length by means of a thumb control on the handle until it's in tune with the vibration frequency of the motor. The speed (r.p.m.) of the motor is then shown directly on a scale. Called the Rev-Tuner, the instrument is manufactured by Rev Products Company, Elmira, N. Y., and retails for about \$7.50.

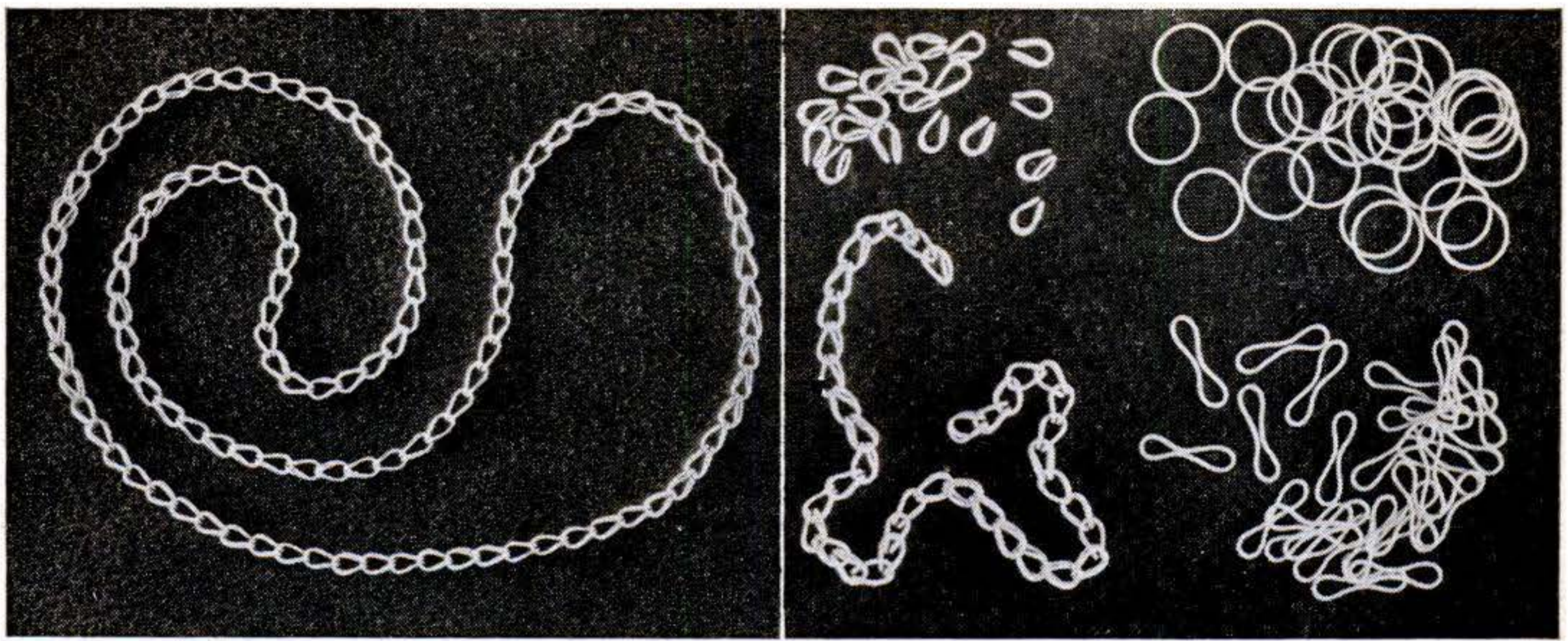

## Handmade Links Form Necklace

CHAIN necklaces like this are a cinch to make and a beauty to behold. The design is probably 6,000 years old, for Egyptian craftsmen turned out some of the same type.

For this particular chain, I used a little over an ounce of annealed 20-gauge sterling-silver wire. The wire was wound on a  $\frac{1}{2}$ " mandrel, yielding circles of  $\frac{9}{16}$ " inner diameter because of the outward spring when removed. These circles were cut apart with shears and filed smooth (a jeweler's saw might have been better). Silver-soldered to form closed rings, they were cleaned by pickling for five minutes in a 20-percent solution of cold sulphuric acid.

Each one was next smoothed out into a perfect circle (A) by lightly hammering with a rawhide mallet onto a tapering mandrel. They were then shaped (B) by finger pressure over a  $\frac{5}{32}$ " drill shank, doubled into links (C), and assembled (D).

To make the chain continuous, one end link was cut, inserted in the other end link,

and soldered. The two loops were cut and soldered separately.

The finished chain contains 115 links. It's 36" long, and weighs approximately one ounce.—L. McFarling, Colorado Springs, Colo.

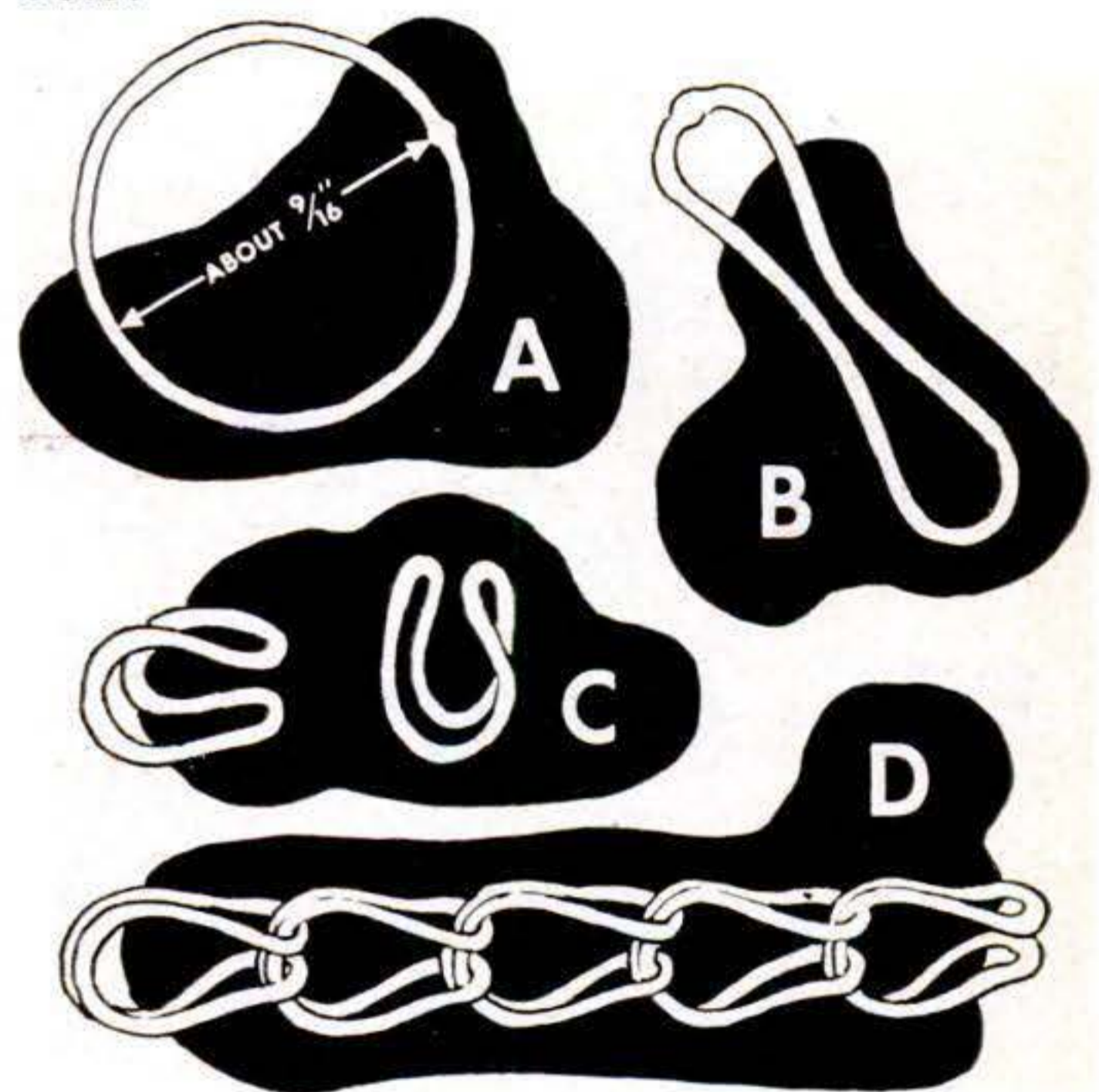

## Soft Stone Is Readily Carved with Hand Tools

HERE are a few examples of what you can do with Sculpsstone  $\text{\textcircled{T}}$ , a commercial form of steatite, a mineral craftsmen have carved since the days of the Pharaohs.

Although the material is easily worked even with a knife, as shown, finished projects may be hardened. The horse's head at the right suggests the novel effects that are possible; an electric bulb inside lights up the translucent green stone. The material is available in several colors from Sculpsstone, Inc., of New York.

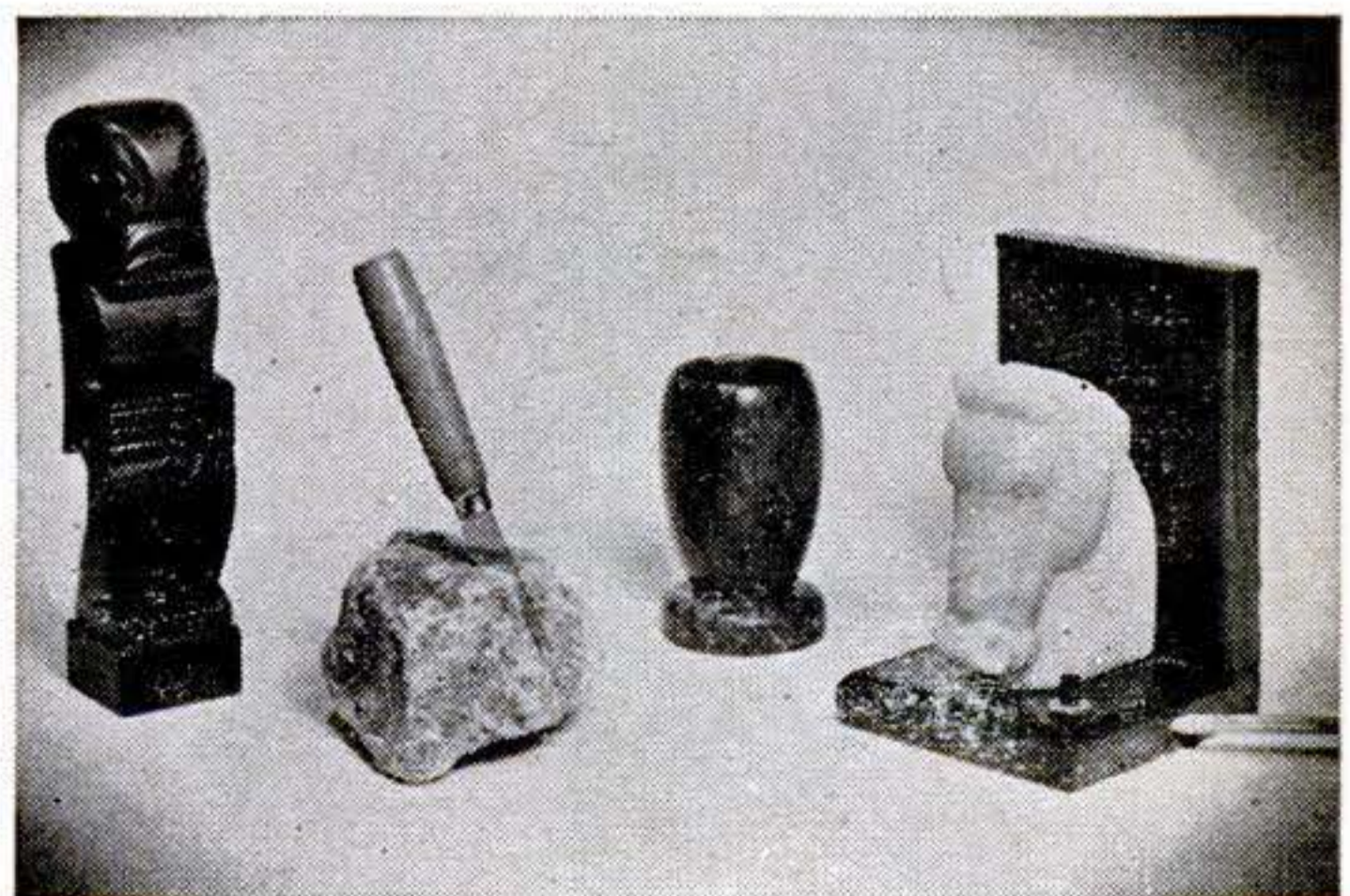



Though he stares at you quizzically, this little man is very obliging about taking messages.

## ***Silent Sam Takes Your Messages***

**P**EOPLE will call on you just for the fun of finding that you're not at home if you have this carved note box at the door to

take messages. A tug at the old fellow's watch fob provides them with pencil, paper, and a writing surface.

Glue the two cheeks to the three back sections, which are just 2 $\frac{3}{8}$ " wide to take adding-machine tape and two roll supports. Don't glue in either front block just yet; the lower one is hinged at the bottom to swing out and down, while the upper one shouldn't be attached until you have formed the meeting bevels and built the catch assembly. The back of the lower should be smooth.

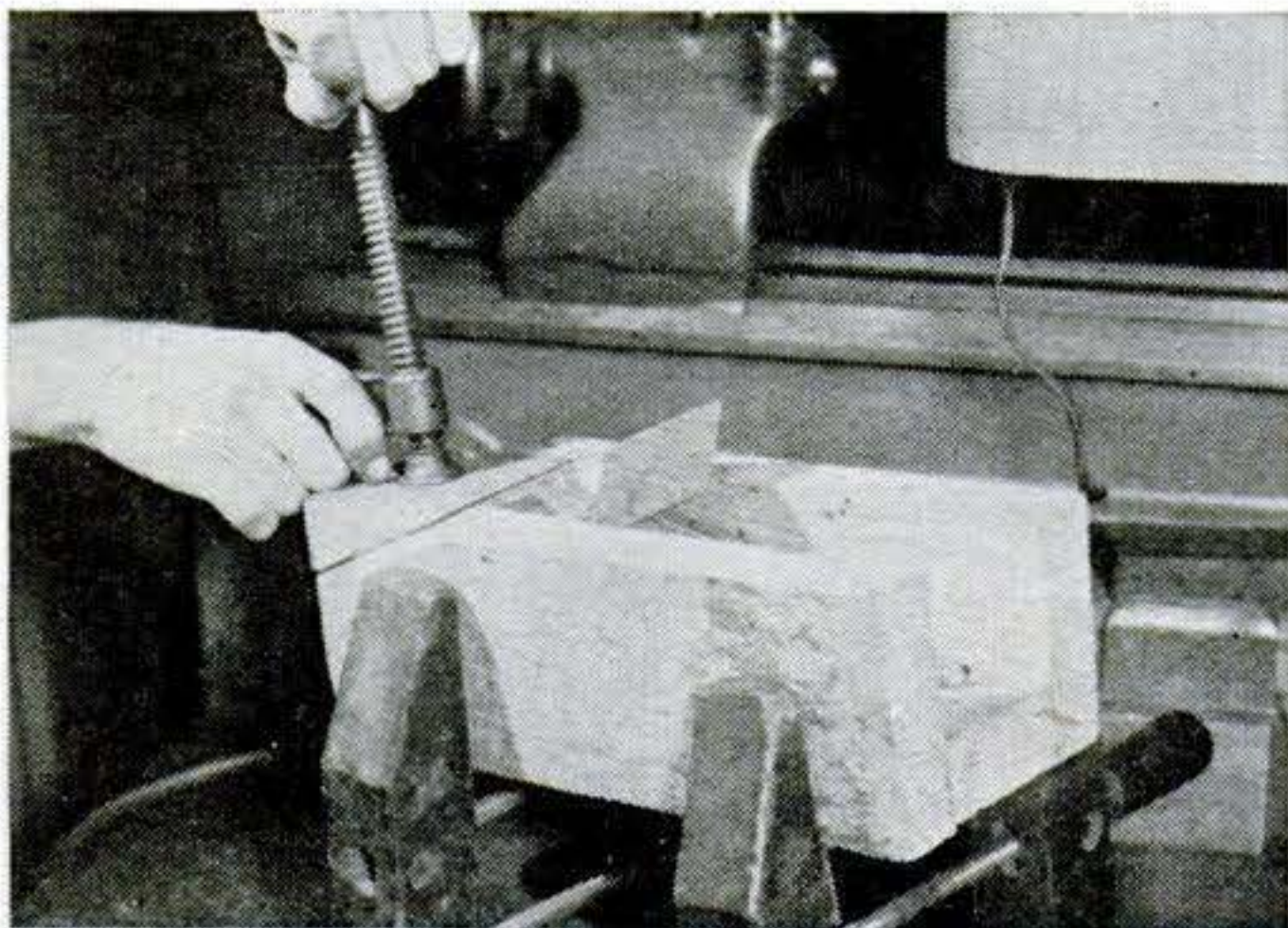

**Glue up pieces of wood to make the carving blank.** Be sure to use a good waterproof glue.

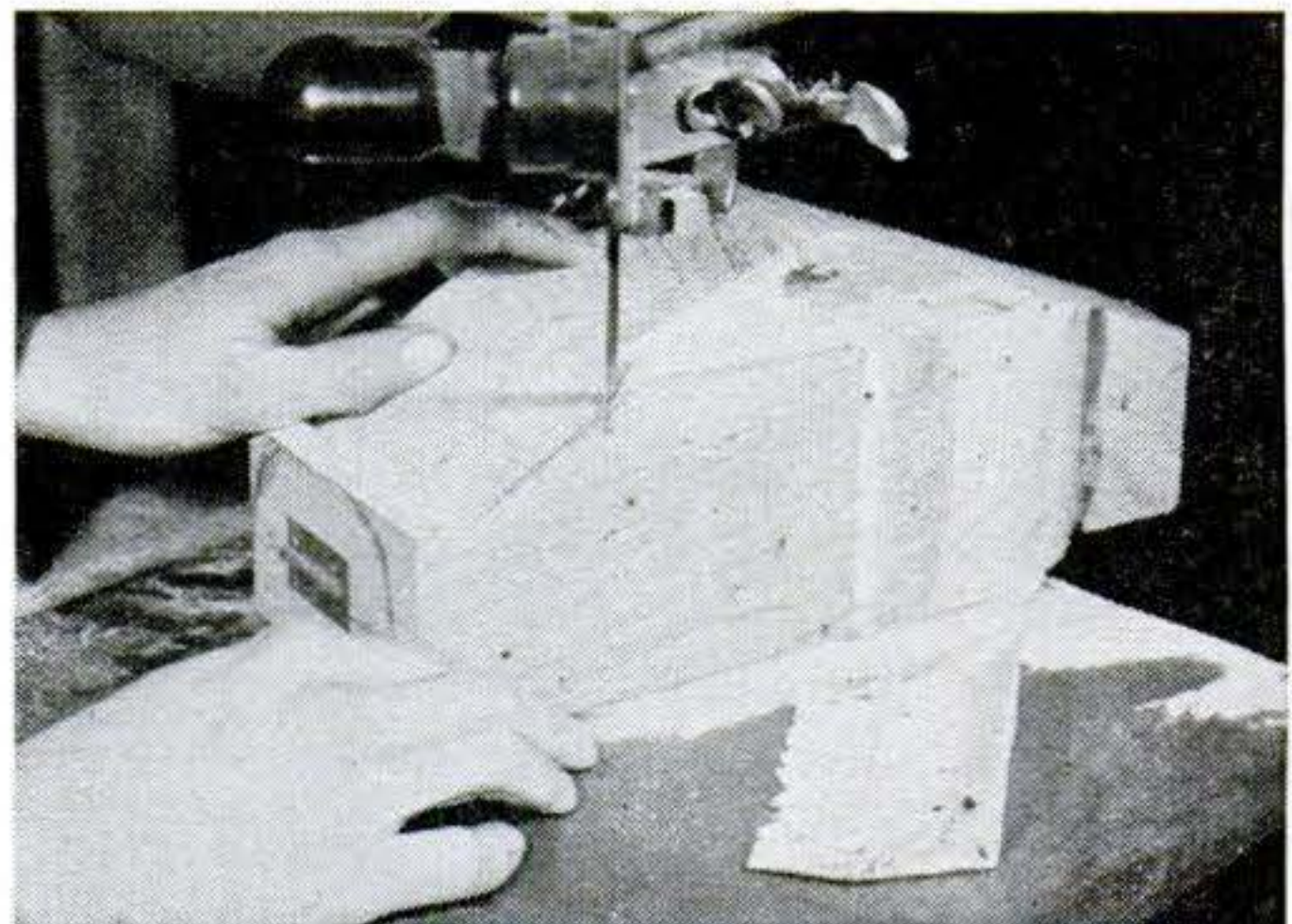

**Draw front and side views on the block and saw around the outline before beginning to carve.**

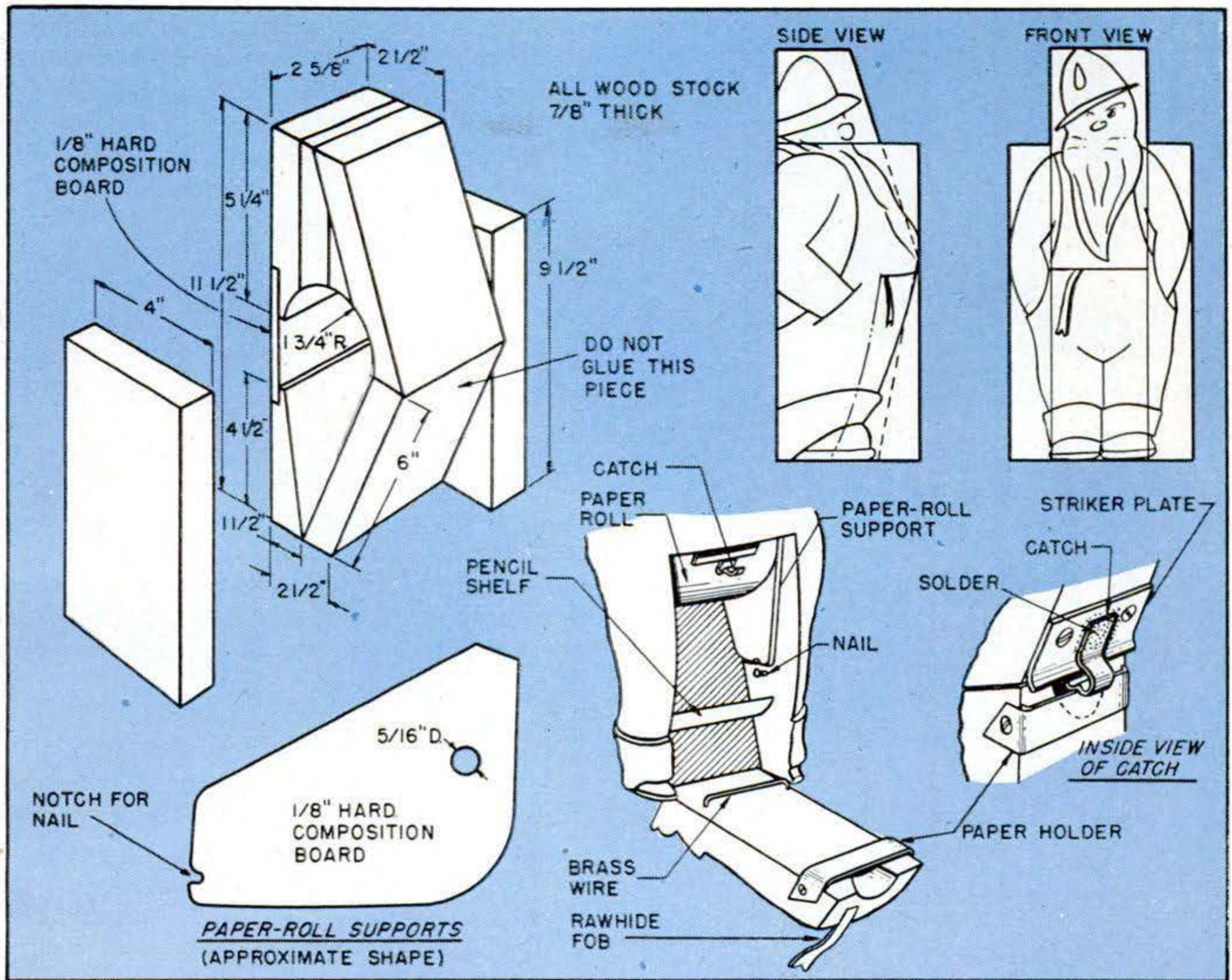

Draw the outlines onto the block and saw and carve it to shape. A small gouge will give texture to the beard; most of the other surfaces can be finished with a flat chisel. Work over the entire figure instead of finishing one part at a time. Cover the overalls with walnut oil stain, use India ink for the shoes and hat, and indigo drawing ink for the shirt. Two coats of linseed oil will complete the finish.

The pencil shelf consists of a slightly hollowed strip of wood bradded from the outside of each leg. Be sure to leave clearance for the paper to slide behind it. A length of string tied to the pencil will serve as a reminder for absent-minded callers. Mount the finished box in as sheltered a spot as possible with two 1½" wood screws driven through the back of the figure behind the roll.—W. A. Conway, Macedonia, O.



**Rough the figure** with a gouge; then work in the full details with a flat chisel or carving tools.

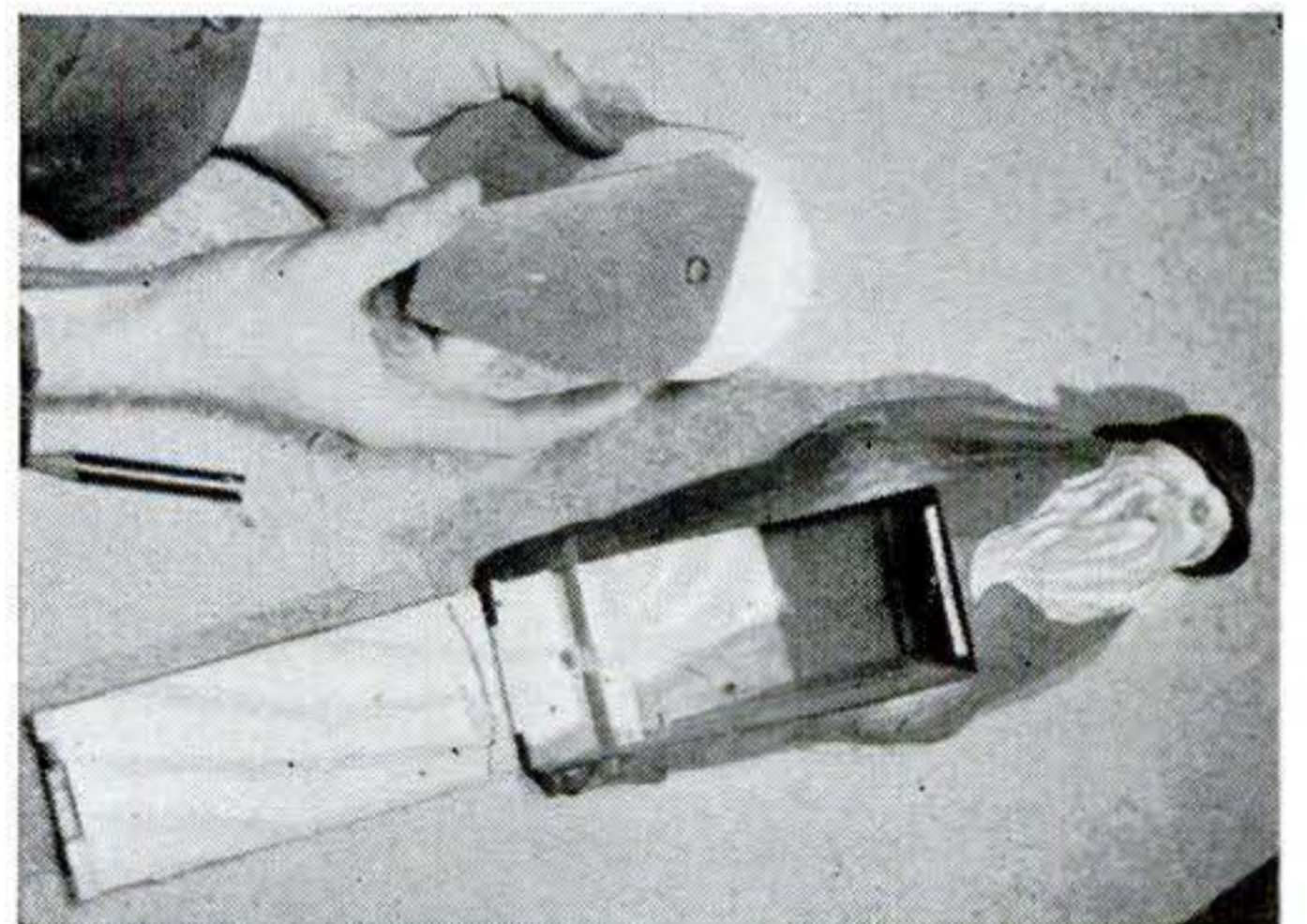

**Paper-roll supports**, notched and drilled for a dowel, hold the roll of adding-machine tape.



# Old Bottles Cut to Make New Mugs

ONCE you know how, cutting bottles into mugs isn't a tough job. You'll find that a matched set of green or amber mugs will make an unusual and attractive gift. If possible, use bottles that have been made fairly recently, since they seem less apt to chip in the cutting.

Although you can do the cutting with

an electrically heated wire (PS, Feb. '45, p. 202), I get good results with an abrasive cutoff wheel. A jig consisting of a trough hinged to swing into the wheel holds the bottle, while a dowel extending from one end of the jig enters the neck of the bottle and steadies it. I mount the wheel in a wood lathe, clamp the jig beneath, and set the belt for a fairly slow speed—about 800 r.p.m. with an 8" wheel. A water can is arranged for a steady drip at the point of contact.

The bottle must be turned constantly while it is in contact with the cutoff wheel, so I press the jig lightly toward the wheel with my body while rotating the bottle with left and right hands. Uneven breakage is likely if you try to cut all the way through; I stop after the wheel has cut through about half way, and then break the upper part off by applying pressure. The cut edge is dressed with an emery wheel under a water drip, and a small bevel ground on the edge with a finer stone.

Handles are jigsawed from  $\frac{3}{4}$ " stock after the finger holes have been bored. The inner edge is shaped to conform to the surface of the bottle by pressing it against a 2" sanding drum. Sheet copper bands  $\frac{5}{8}$ " wide are cut about 1" longer than the mug circumference, the ends drilled, and the bands bent around the mug and secured with  $\frac{3}{8}$ " wood screws. —L. A. Marks, Redwood City, Calif.

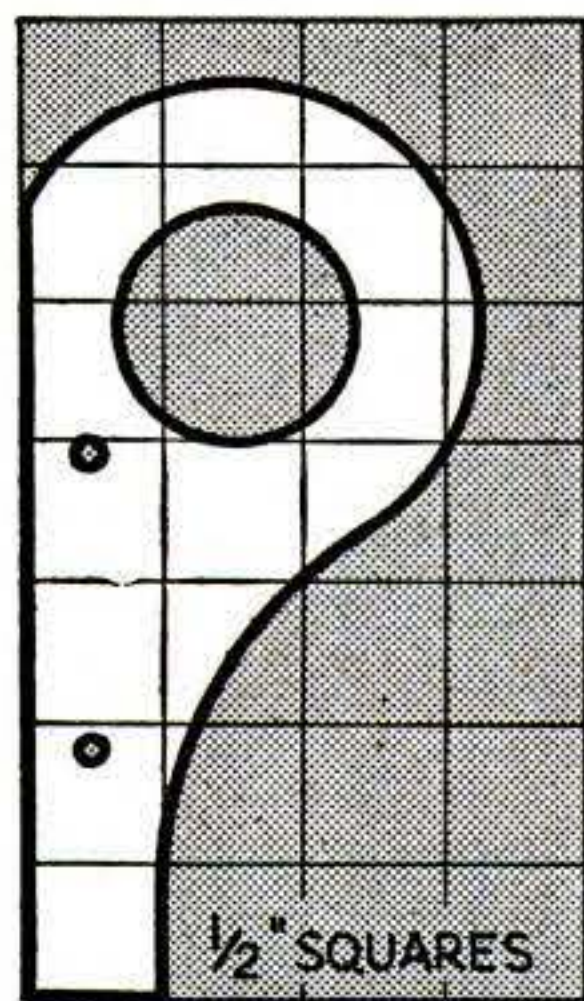
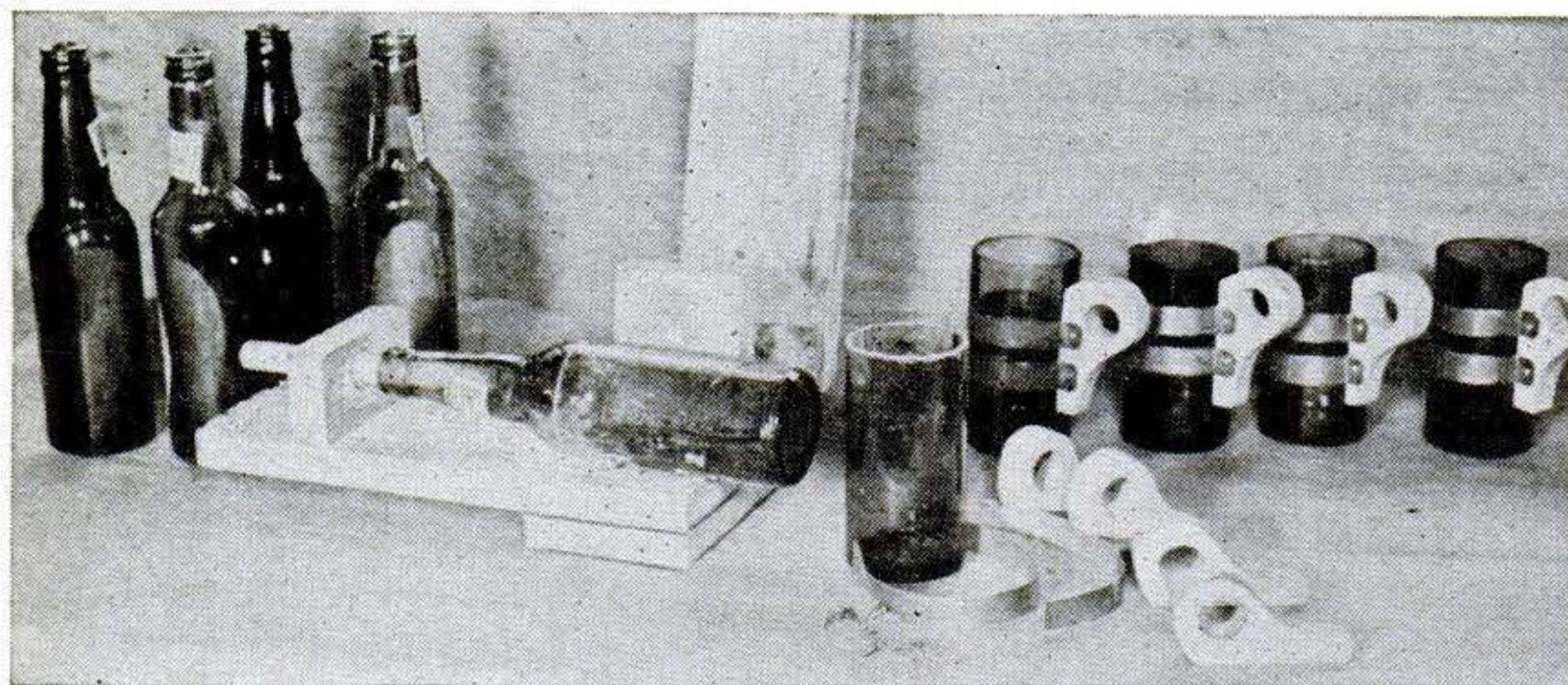

Beer bottles were the raw product from which these mugs were fashioned. Two copper bands

For the circular cut, the bottle is held against the abrasive wheel in a hinged cradle. A dowel projecting from an upright at one end of the

$\frac{5}{8}$ " wide bind the handle to the mug. Cut the handle out of  $\frac{3}{4}$ " stock to the pattern above.

jig fits into the neck and allows the bottle to be rotated as the cut is being made. Grind the edge smooth on an emery wheel, as below.

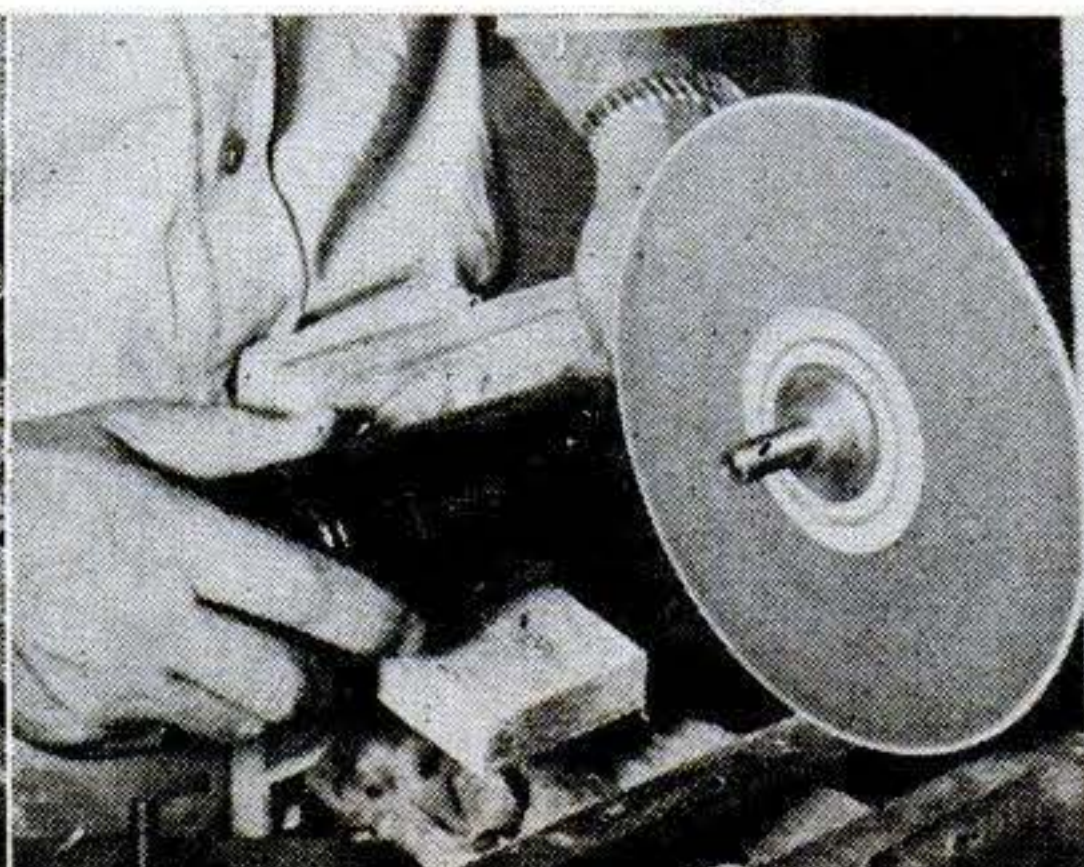
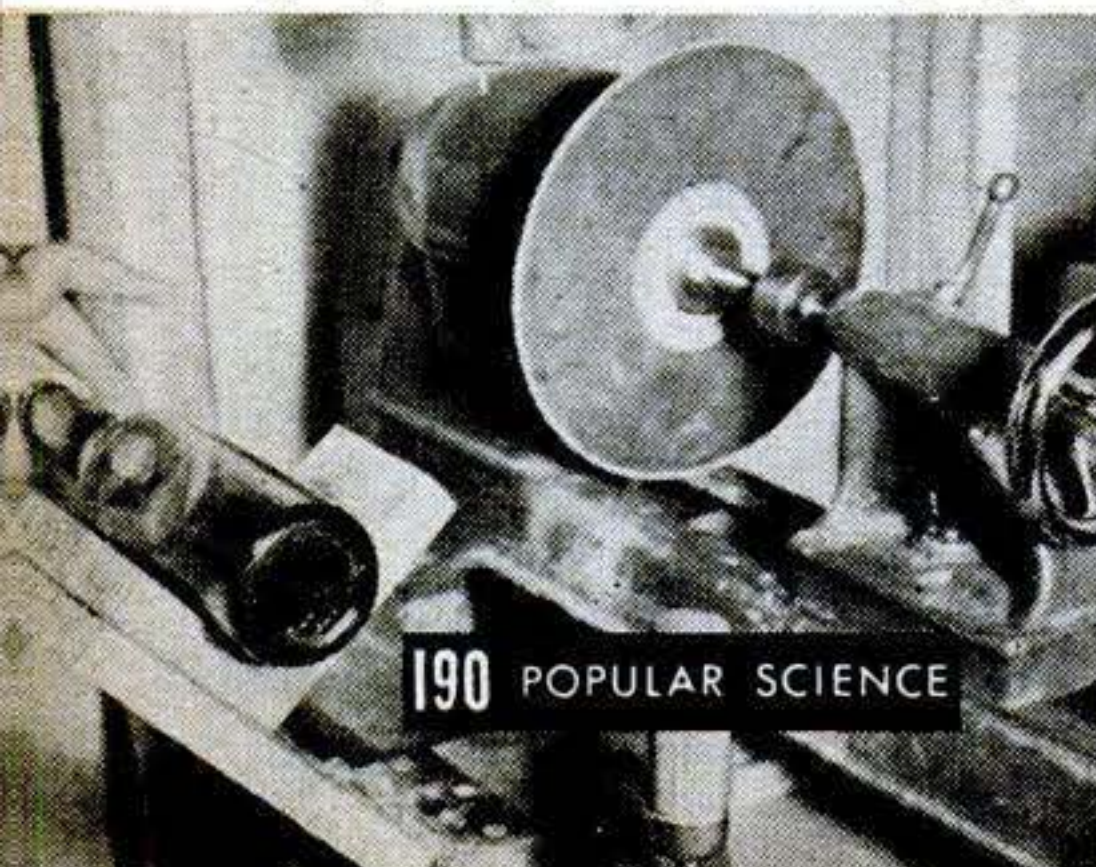



# Ivy Pot from a Coffee Can

**G**LANCING at this wishing-well ivy holder, you might not suspect its base is nothing more than a coffee can. But that's what it is—closely wrapped with brown twine. The uprights are 10" lengths of  $\frac{3}{4}$ " by  $\frac{3}{4}$ " wood nailed to the can, each cut to a point on top to suit the roof slope.

To wrap the can, make a loop in the start of the cord and, with the loop flat against the side as seen in one of the photos, bind it in place with successive turns of the twine. As you go along, keep the strands straight. When you reach the upper edge, cut the twine, stick the end through the loop, draw both under several turns by pulling the loose end of the loop, and cut off the waste ends.

Wrap the uprights from the bottom up, fastening the twine ends with long wire brads. Cut two  $2\frac{3}{8}$ " by  $7\frac{1}{4}$ " roof pieces from cigar-box wood, wrap them in the same way, and nail to the uprights, setting the nailheads flush and then pushing the strands of cord back into place. Put a dab of cellulose cement at each point where the wrapping begins or ends.

Make the bucket from light copper or tinplate, soldering on a wire handle. Suspend by a cord passed through a staple under the roof and tied to a small nail driven into a post.

A decorative surface treatment may be given the wrapped areas by lightly charring with a small torch. Paint the raw wood edges dark brown, and give the bucket and all the wrapped surfaces a light coat of shellac.—*Bill Luther, Los Angeles.*

**Cut the cord** when wrapping is complete, place the end through the loop, and pull both under.

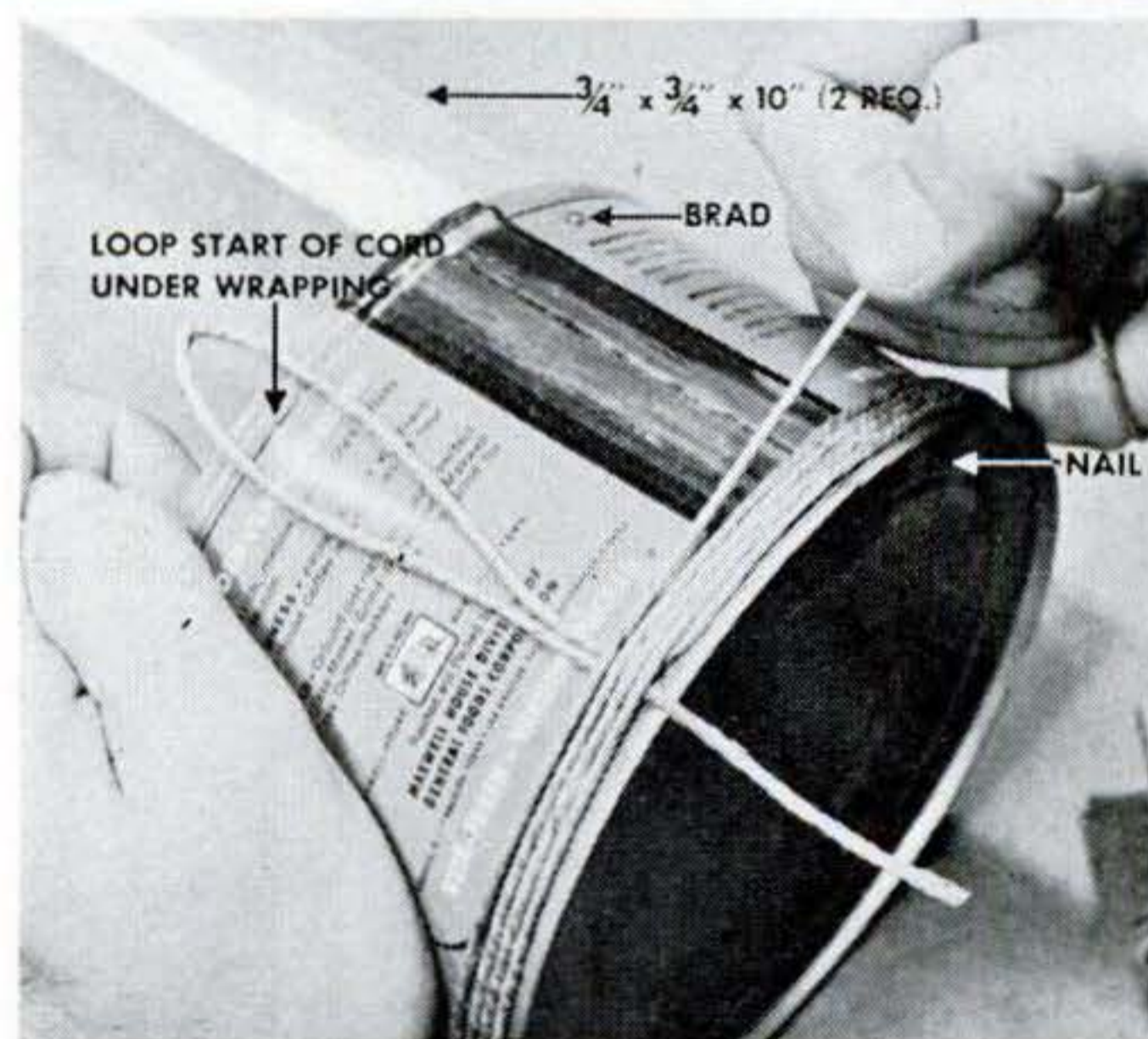
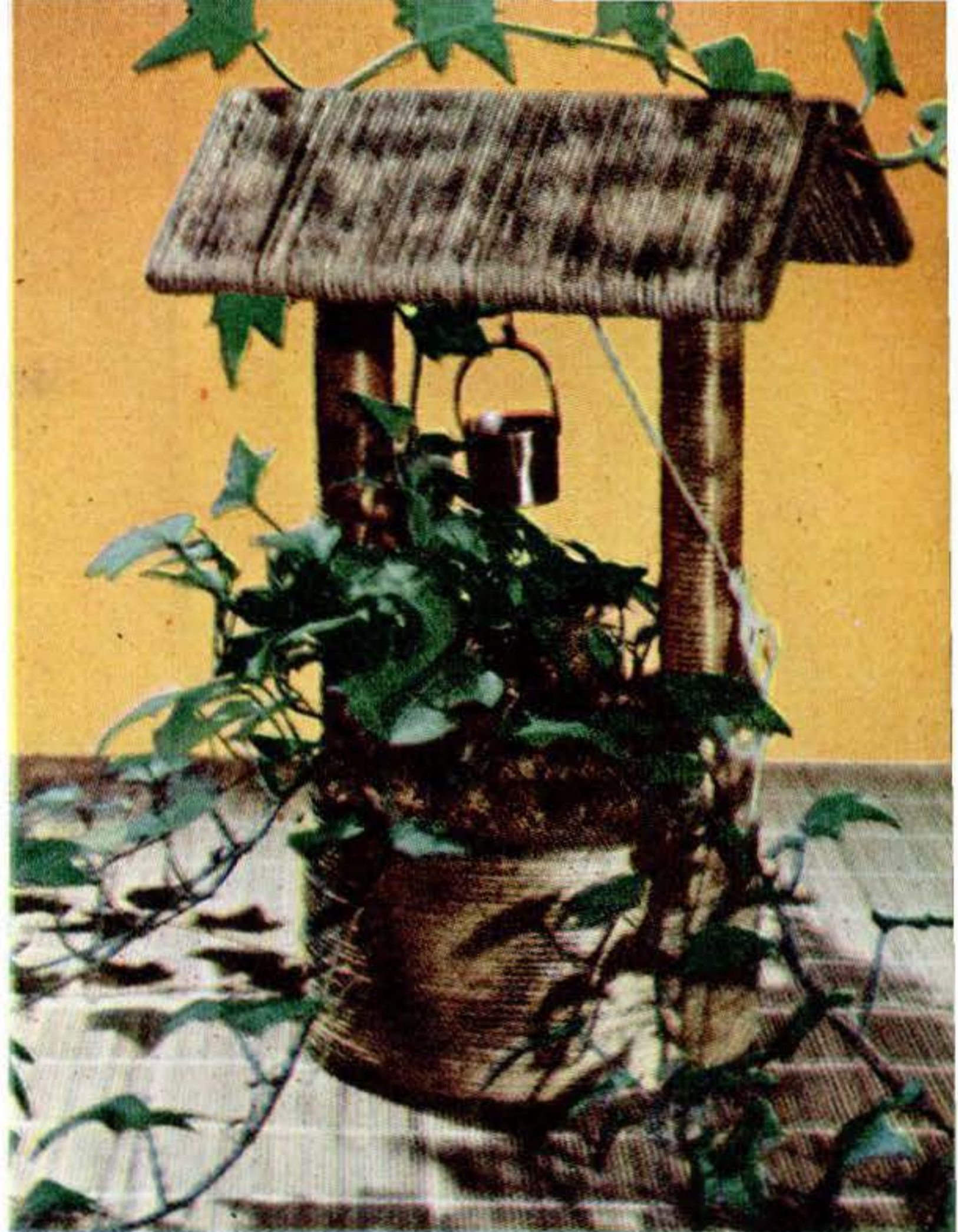
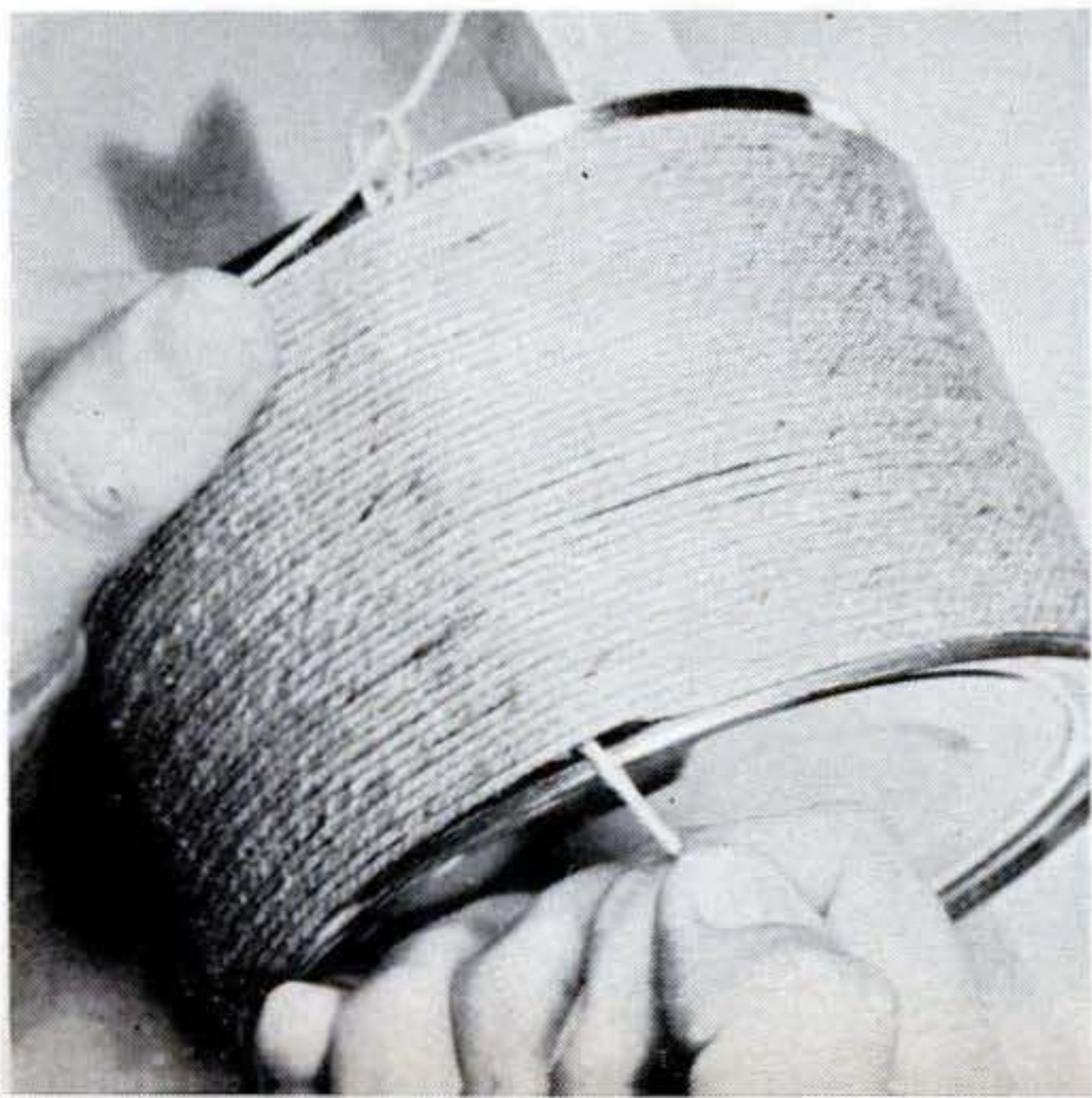

**Loop the start of the cord** and bind it against the side of the 1-lb. coffee can as seen here.

**Decorate the wrapping** by directing the flame of a small torch on it in a random pattern.

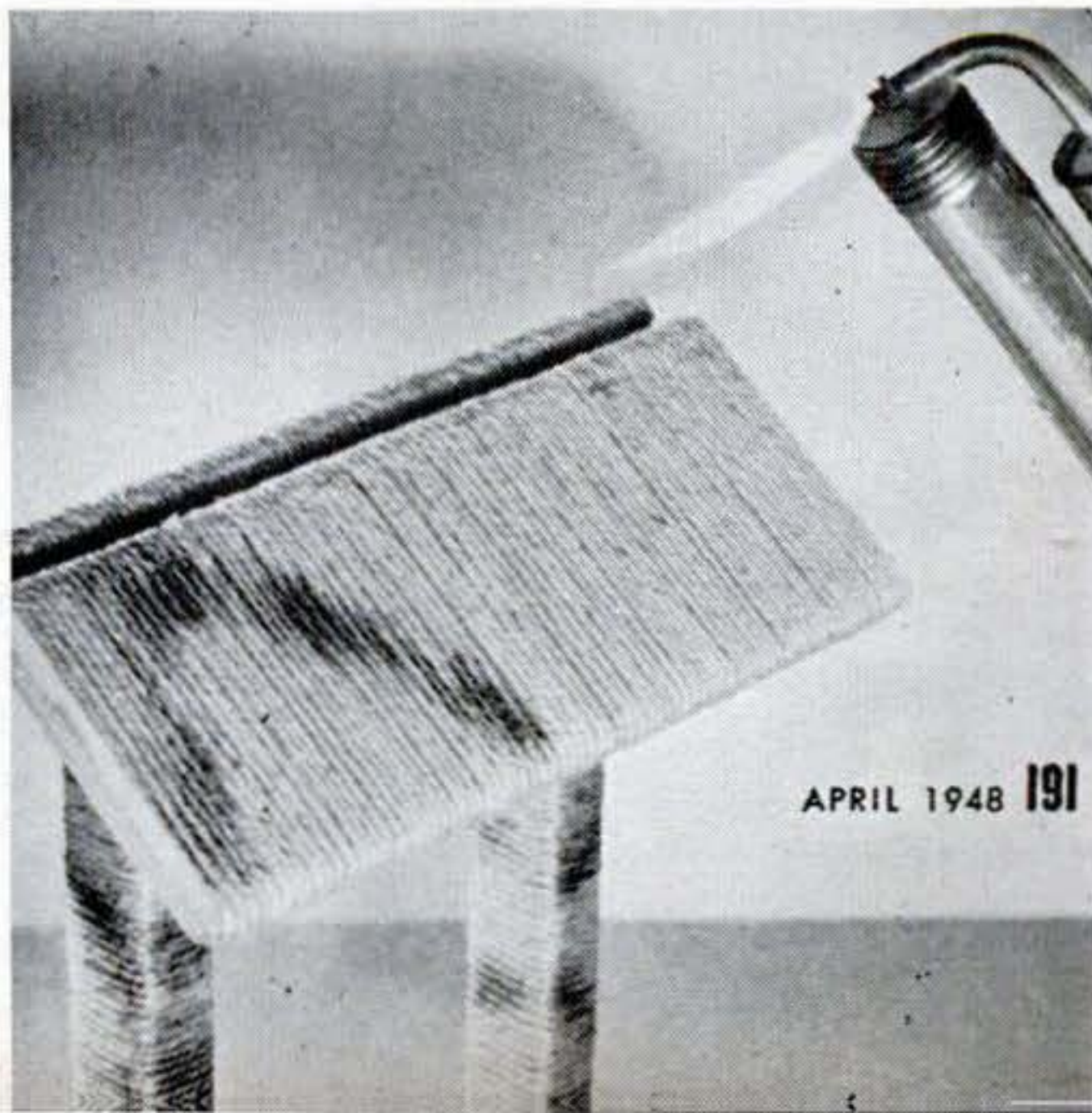

# How to Square Stock with Power Tools

They make woodworking more fun by turning out better work in less time.

By Edwin M. Love

**S**KILL and equipment in woodworking usually grow up together: the longer you've been at the game, the more adept you become at it and—invariably—the more tools you acquire. Perhaps that's as it should be, but the lucky beginner who can start out with one or more power tools will not only find his work made easier but will also be rescued from the apprenticeship needed to gain real mastery over hand tools. You don't *have* to have labor-saving machines, but if you're planning to get them "sooner or later," the quicker you get around to it, the quicker you'll discover how much fun and solid accomplishment you've been missing.

The versatility of most home-workshop machines has been pointed out previously in this series. Just as you can use any of a number of tools for surfacing stock, so can you make almost any machine serve for squaring ends and edges.

A jointer is probably the best bet for establishing a true working edge. If the edge is reasonably square to begin with, set the jointer table as for surfacing, adjust the fence to square position, and with the trued face against the fence (this side will be



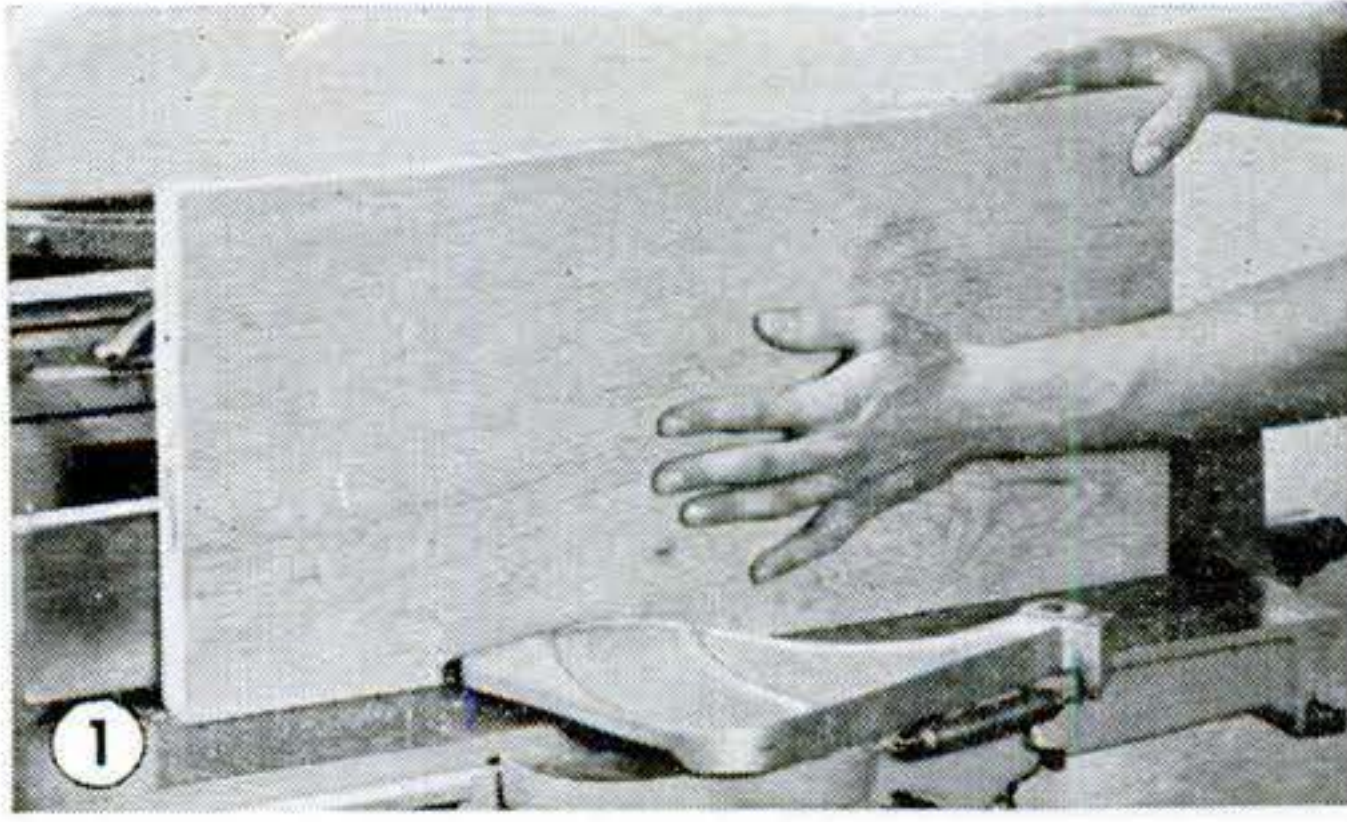

against the fence or table in all cutting operations), pass the board over the cutter as illustrated in Fig. 1. For a very uneven edge, it is best to tack or clamp a straight-edged strip to the face. Locate it exactly parallel to the edge you want and just high enough so that it will ride along the top of the fence. When squaring an end (Fig. 2), remember to chamfer a corner to prevent splitting of the trailing edge.

A circular saw will also do a fine squaring job. To obtain your first working edge it may again be necessary to tack a strip parallel with the edge you wish to produce, and located so that as it rides the table edge, the blade will trim off all irregularities. Adjust the saw depth so that the teeth just project above the top of the board. For difficult cuts you may have to raise the blade somewhat, but the lower setting is safer and should be used whenever possible.

Once you have squared the first edge it is a simple matter to make the remaining cuts. Set a squared miter gauge in one table groove, place the trued edge of the piece against the gauge, and push the board forward to trim the end (Fig. 3). Mark the length, shift the miter gauge to the other table groove, and saw the board to size as in Fig. 4. Even when there is only one groove on the table, you can still keep the face side down and the working edge against the gauge by turning board and gauge end-for-end.

Adjust the fence for ripping to width by measuring from it to the point of a tooth set toward it. Alternatively you can mark the board and use it as a measure. Since the fence-clamping mechanism may shift the fence position a trifle, it is important to check the measurement after locking the fence. The position of a board between fence and blade is illustrated in Fig. 5.

Frequent shifts from ripping to cross-cutting are necessary in the home shop, so a combination blade is usually mounted on

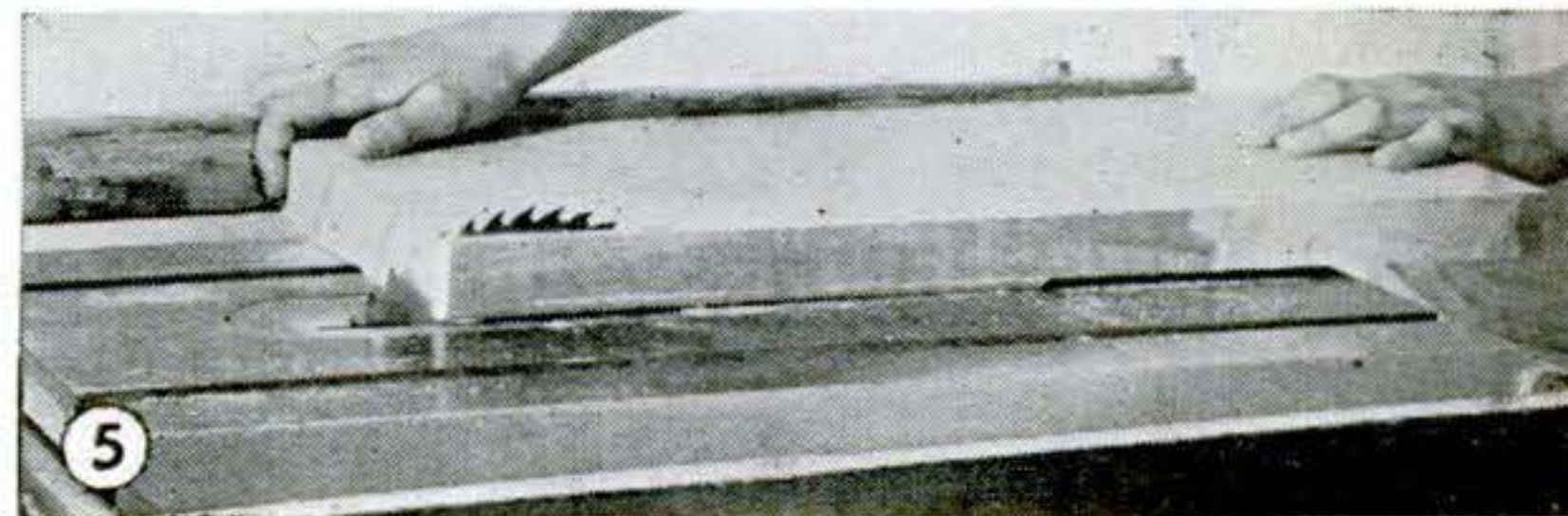
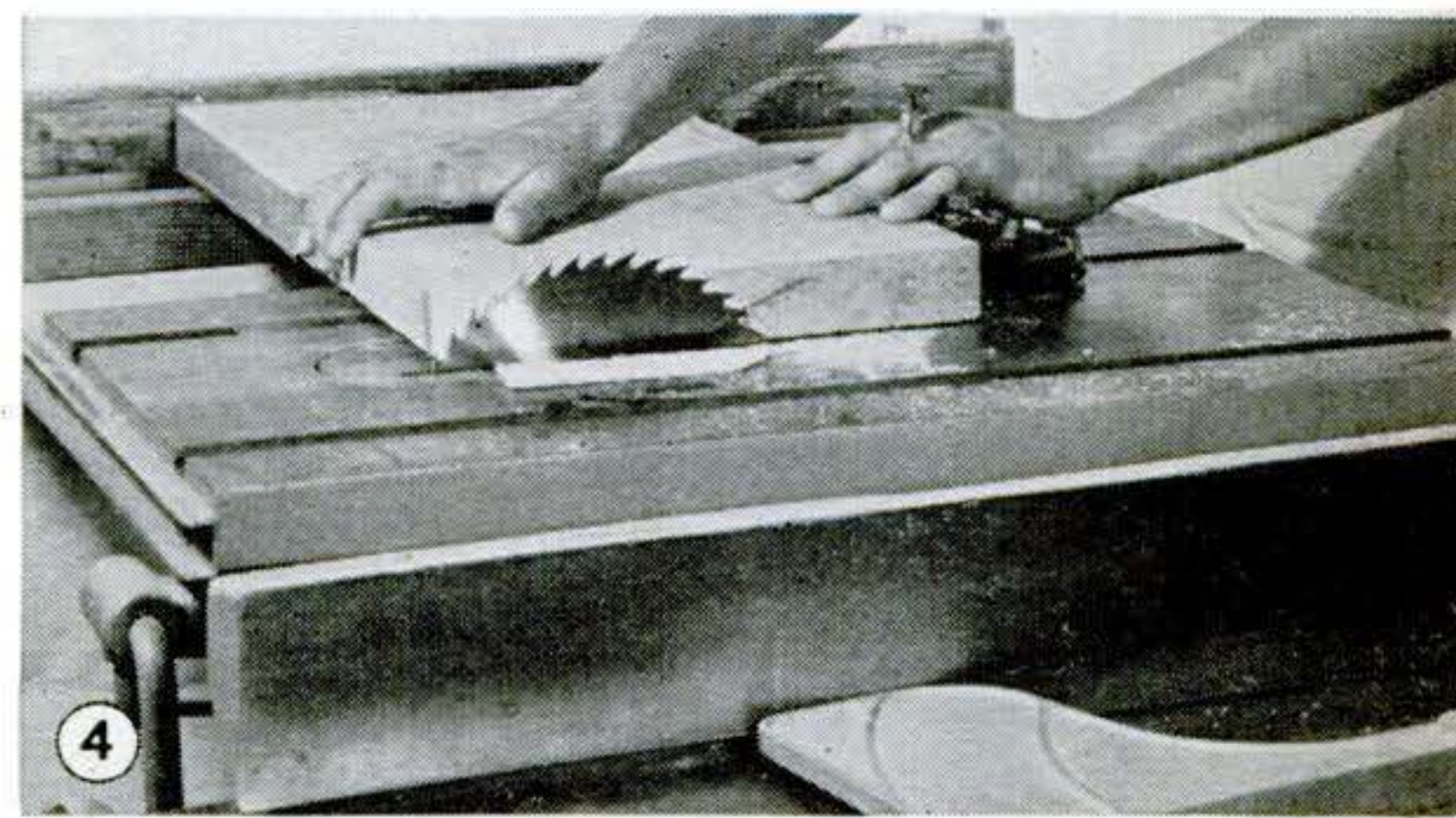
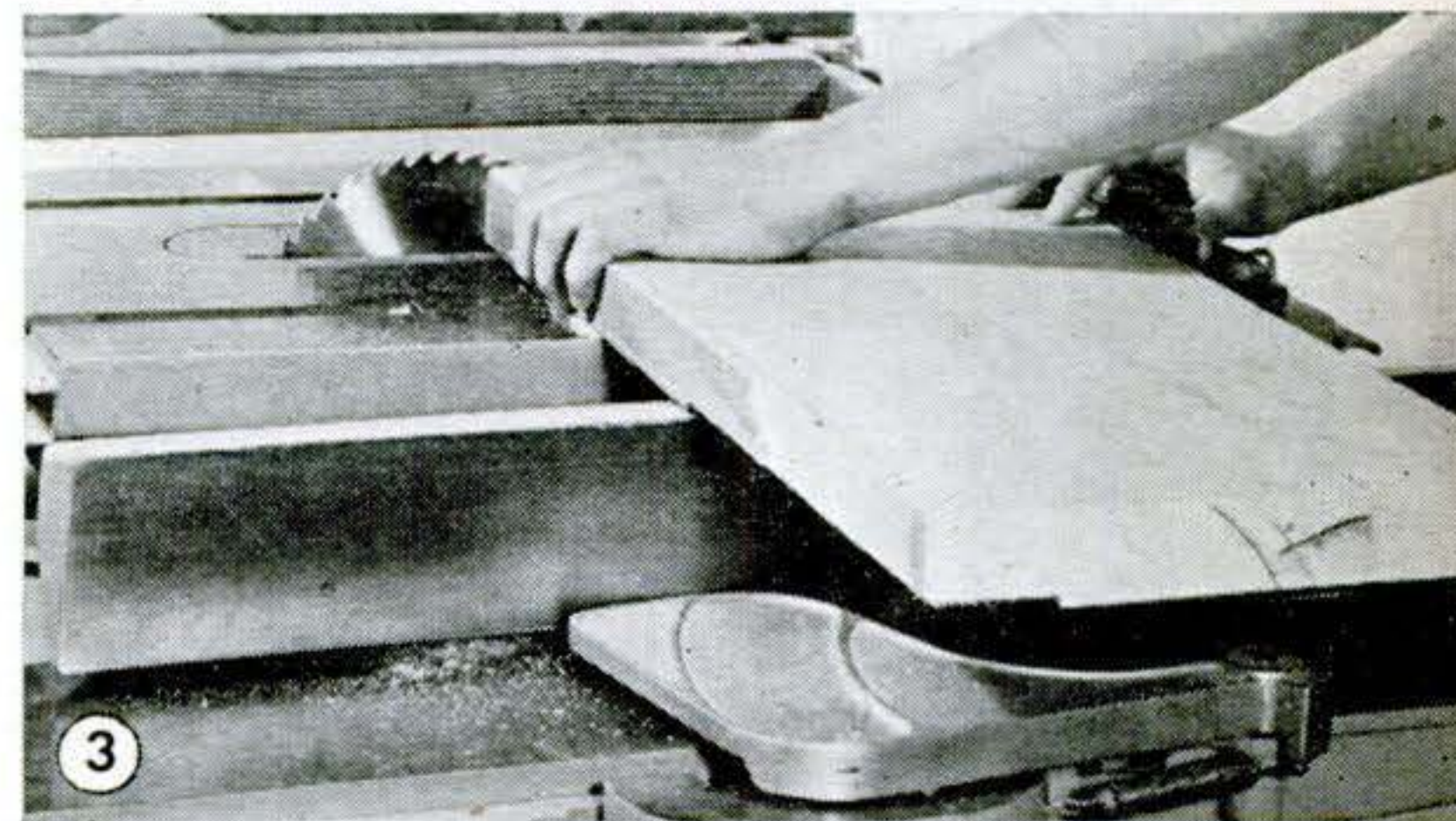
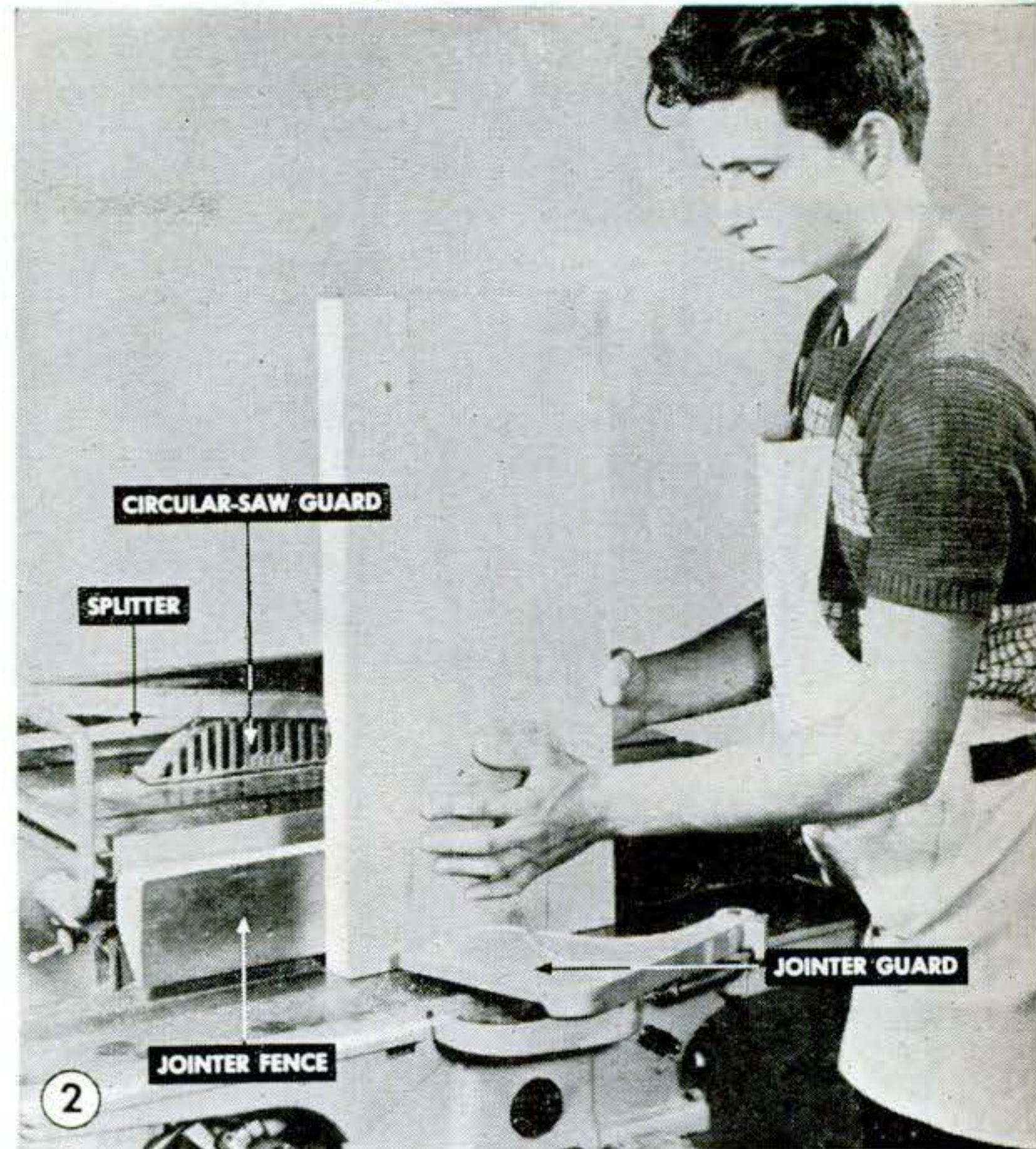

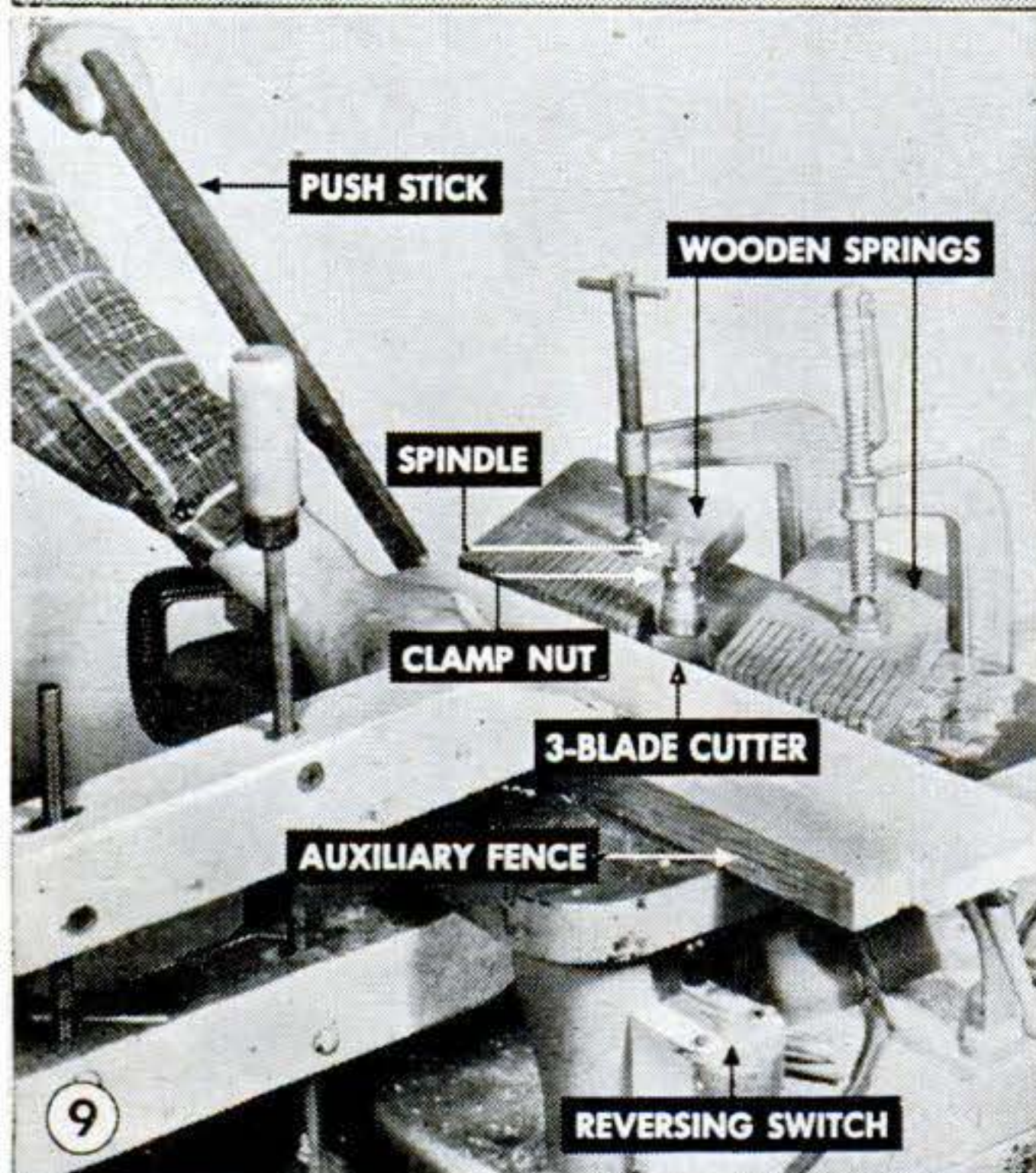
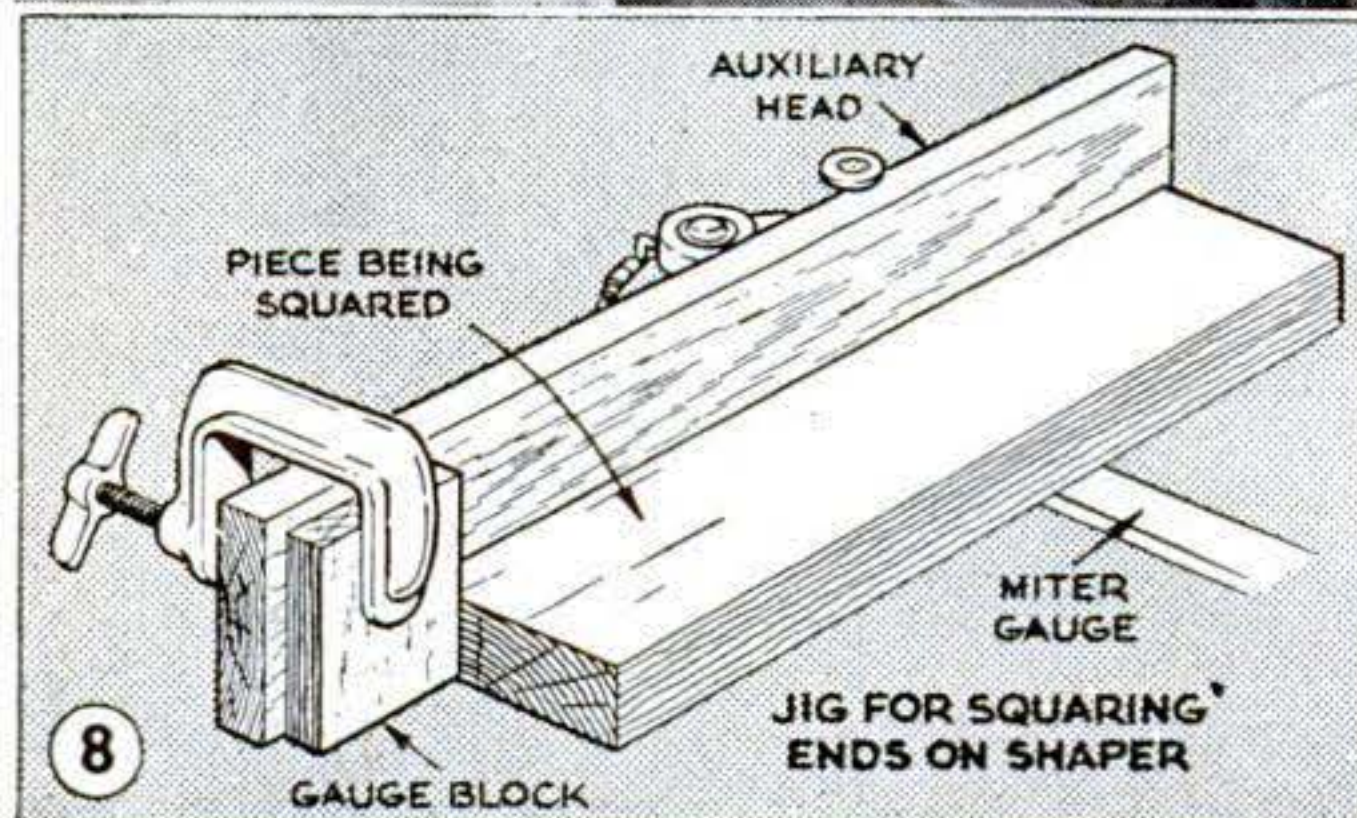
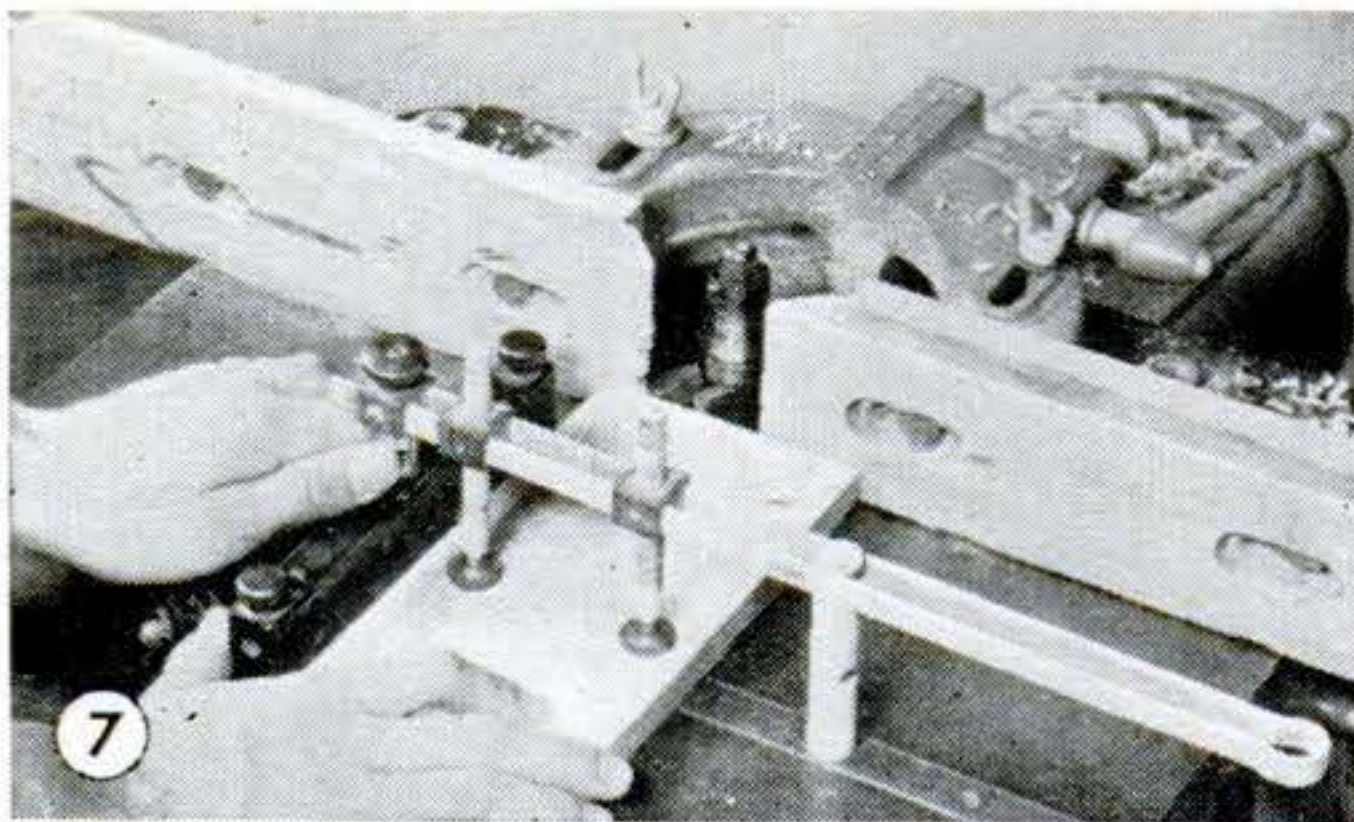
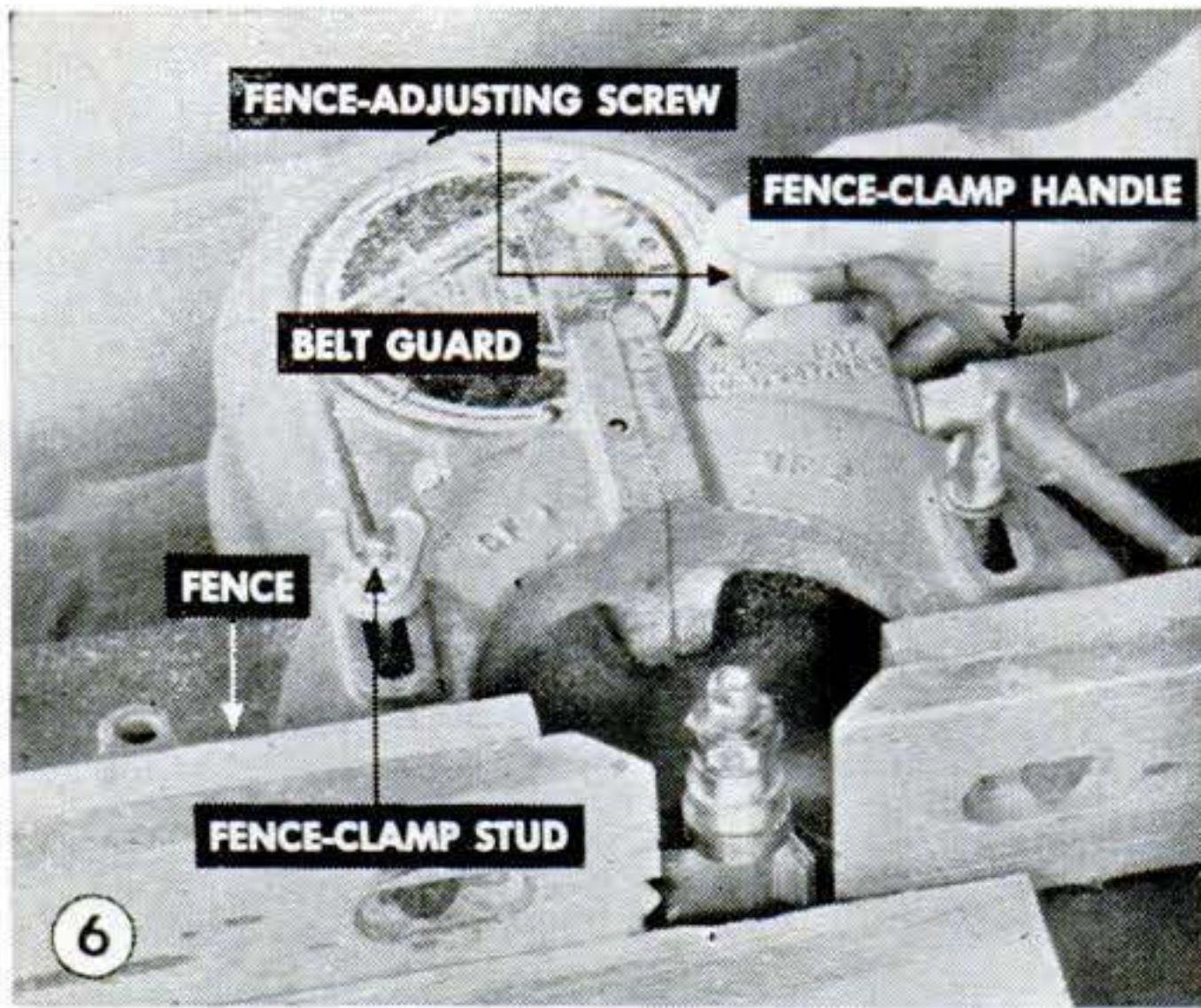

the saw arbor. The blade projects above the table through an opening in a soft-metal insert. When changing blades, tighten the new blade on the arbor with the brand name up. The teeth should of course point in the direction of rotation.

If you turned a jointer over on its back, you'd have a tool that looks pretty much like the standard shaper (Fig. 6). It is used much like a jointer except that the edge being worked bears against the fence and the face is on the table; this gives practically automatic assurance of squareness in edging wide boards. The two sections of a shaper fence are comparable to the infeed and outfeed tables on a jointer in that they are individually adjusted to support the dressed as well as the uncut portion of the edge.

Ends are squared on a shaper in much the same way as on a circular saw. The work must be held tightly against a miter gauge, but since the impact of the blades tends to force the work away, the use of an additional clamping device (Fig. 7) is advisable. If you don't have such a clamp, you can easily construct your own as shown in Fig. 8. The auxiliary head is a wooden bar screwed to the miter gauge; it has a block clamped on to prevent kickback and to permit finishing duplicate pieces to identical length. To determine the correct spacing for the gauge block, measure from the outer position of the cutter edge.

A similar but even simpler setup (Fig. 9) allows sizing a number of boards to the same width. An auxiliary fence is clamped to the table at the proper distance, and the work is passed between it and the cutter.

Small boards can be trimmed square on a sanding disk or belt either freehand or with the aid of a miter gauge. The former method is illustrated in the photo on page 192. The work must be kept moving uniformly along the disk. For greater accuracy use a miter gauge (Fig. 10).

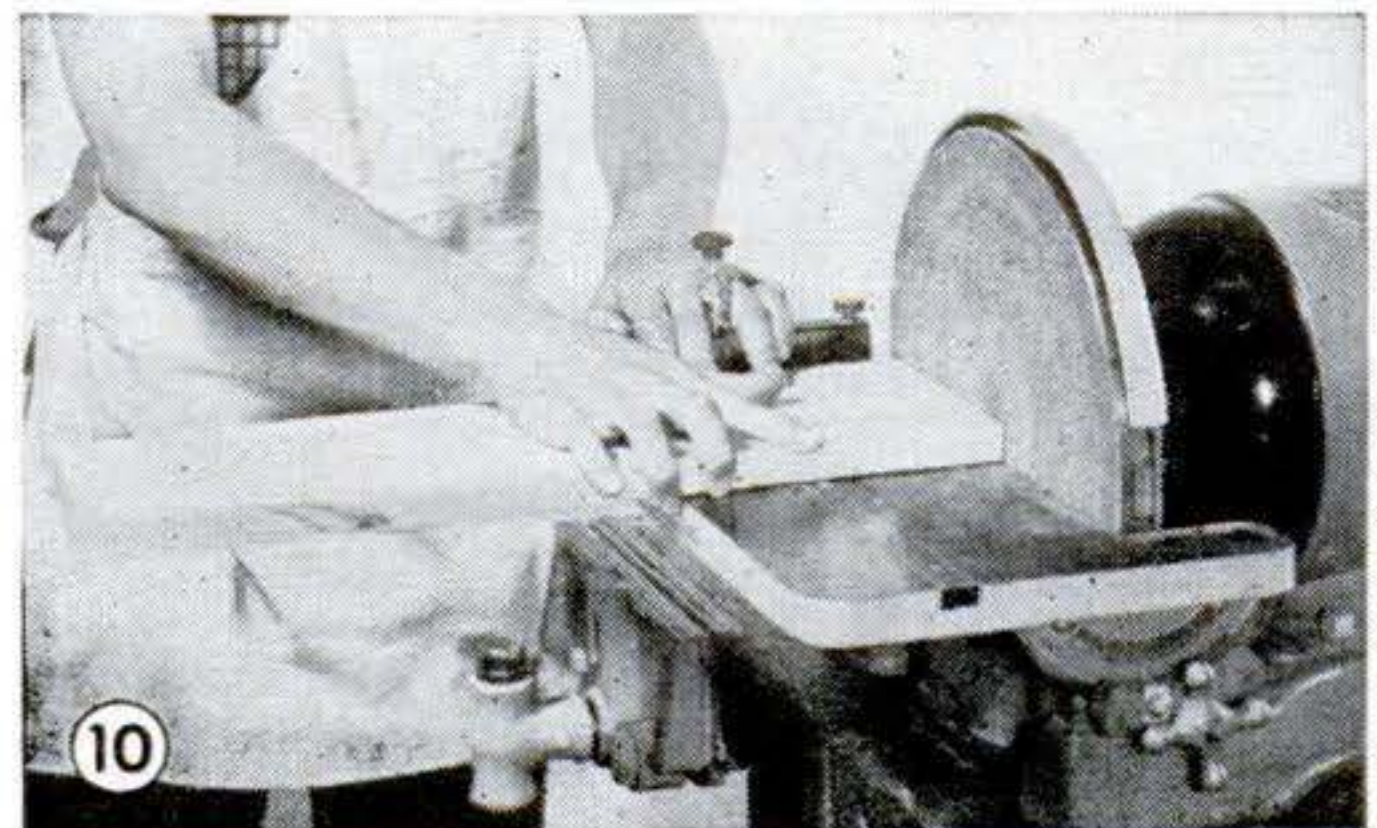

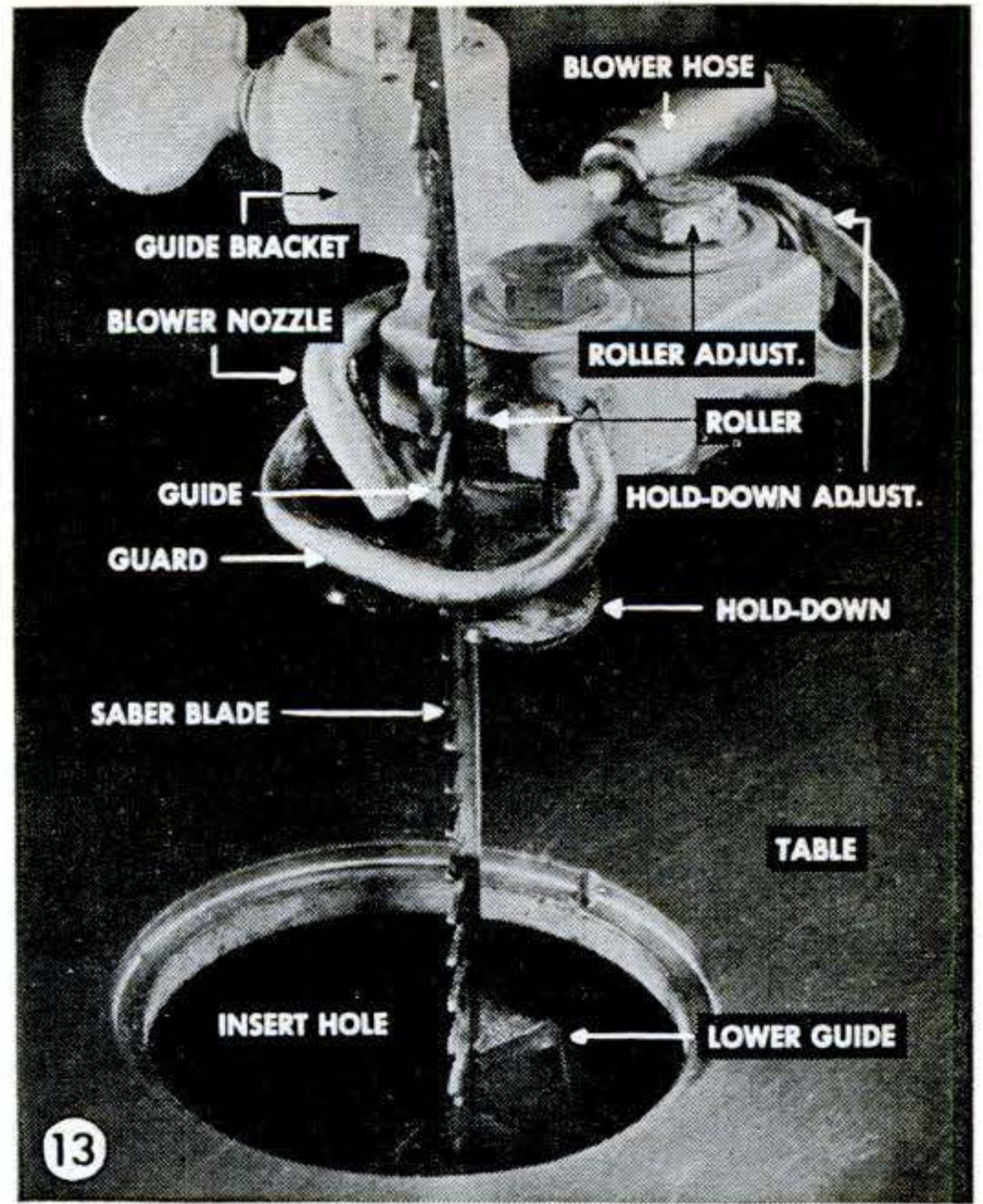
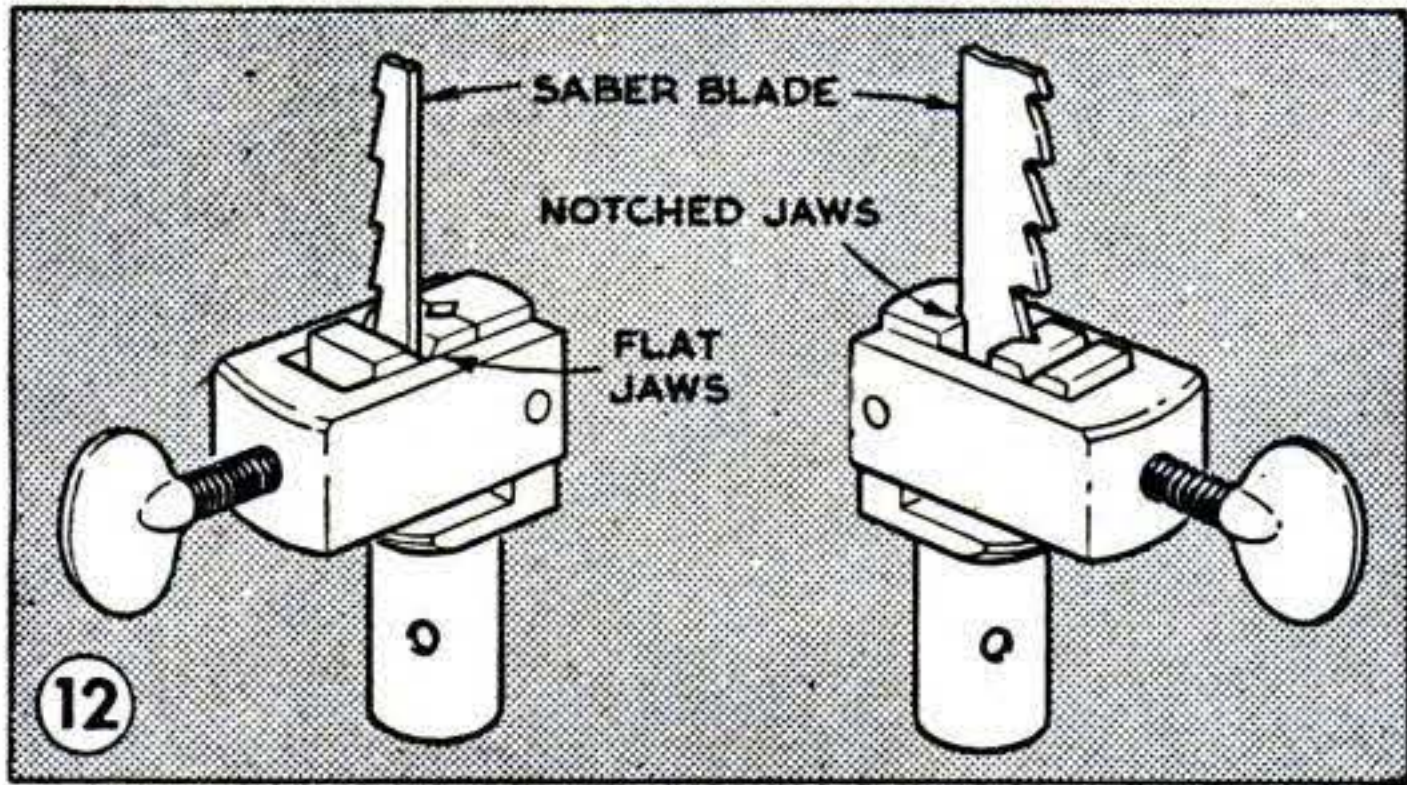
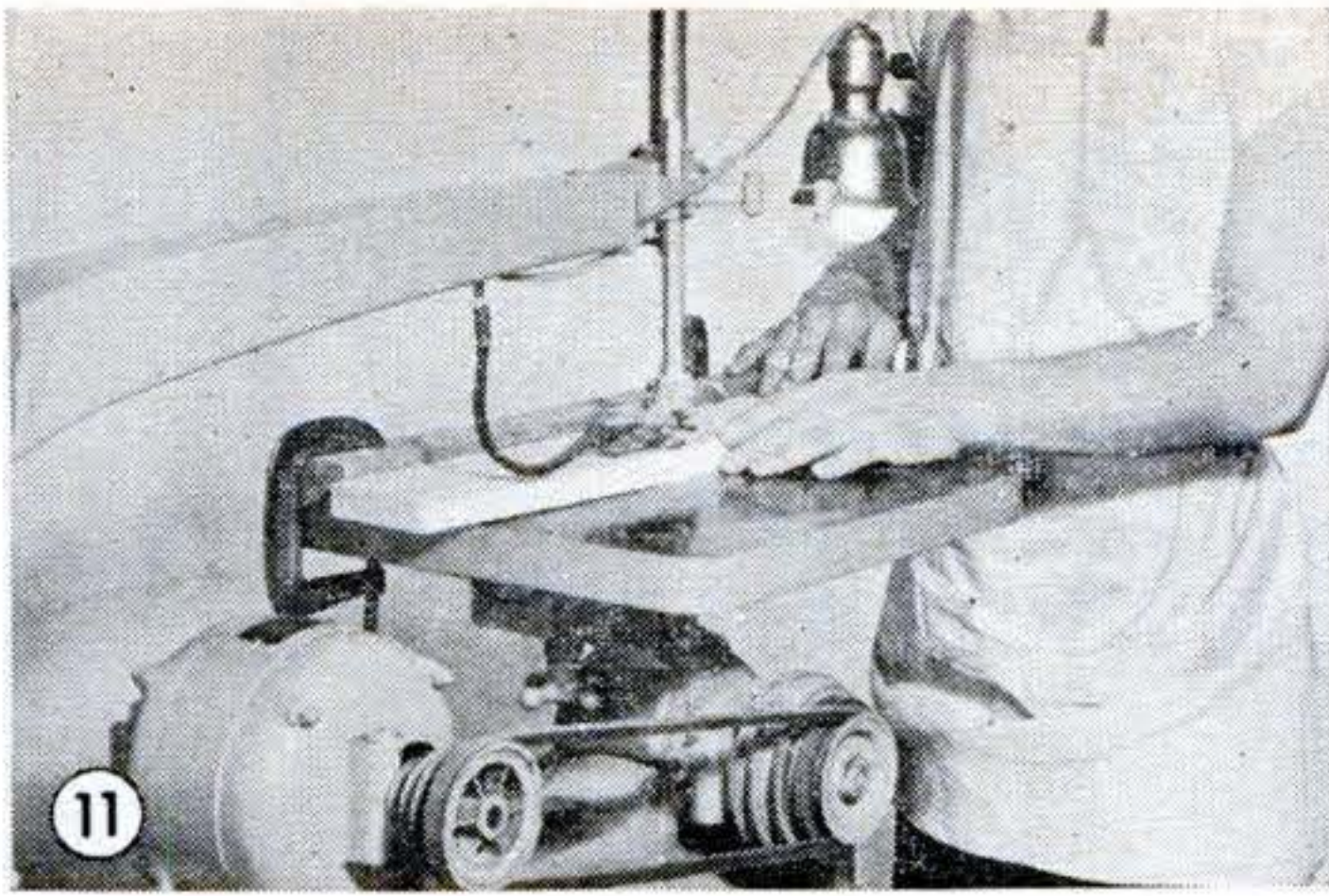

Jigsaws, or scrollsaws, are ordinarily thought of as machines for cutting curved and fretted work, but the heavier home-workshop types will square a board quite well. Straight cutting is made automatic by clamping a wooden fence to the table (Fig. 11) parallel to the line to which you are working. Bear in mind that as a result of blade "lead" the cutting center is frequently slightly to the right or left of the table center. With hardwoods or fairly thick stock you'll wish to use a heavy saber blade chucked below the table only. Teeth are set to cut on the down stroke (Fig. 12). In most cases the highest speed is used, but some tough hardwoods cut better at lower speeds. While the upper chuck is rarely

used with a saber blade, you can sometimes take advantage of the roller (Fig. 13) to support the blade if the going is hard.

A bandsaw can be used in squaring in the same way as a jigsaw; it cuts faster because the teeth travel downward continuously and at a higher speed. The blade is made to track on the wheel by the adjustment screw that regulates upper-wheel tilt (Fig. 14). Set the roller guides (Fig. 15) so that they are clear of the blade except when there is thrust on the blade in actual cutting. Guide blocks are likewise set close but free. Ends and edges cut on either a jigsaw or bandsaw will probably have to be sanded smooth before the piece is ready for use.

TO BE CONTINUED

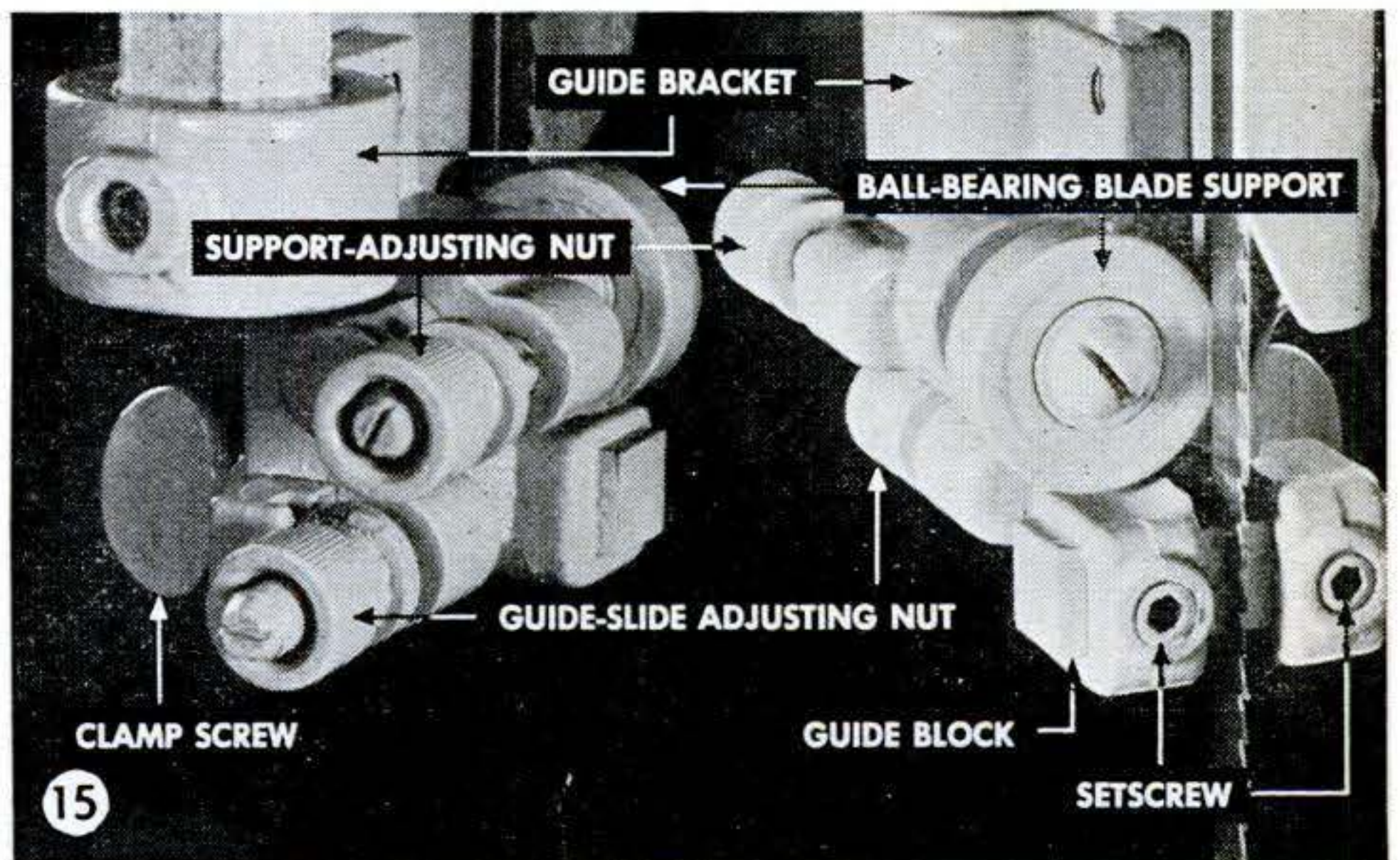
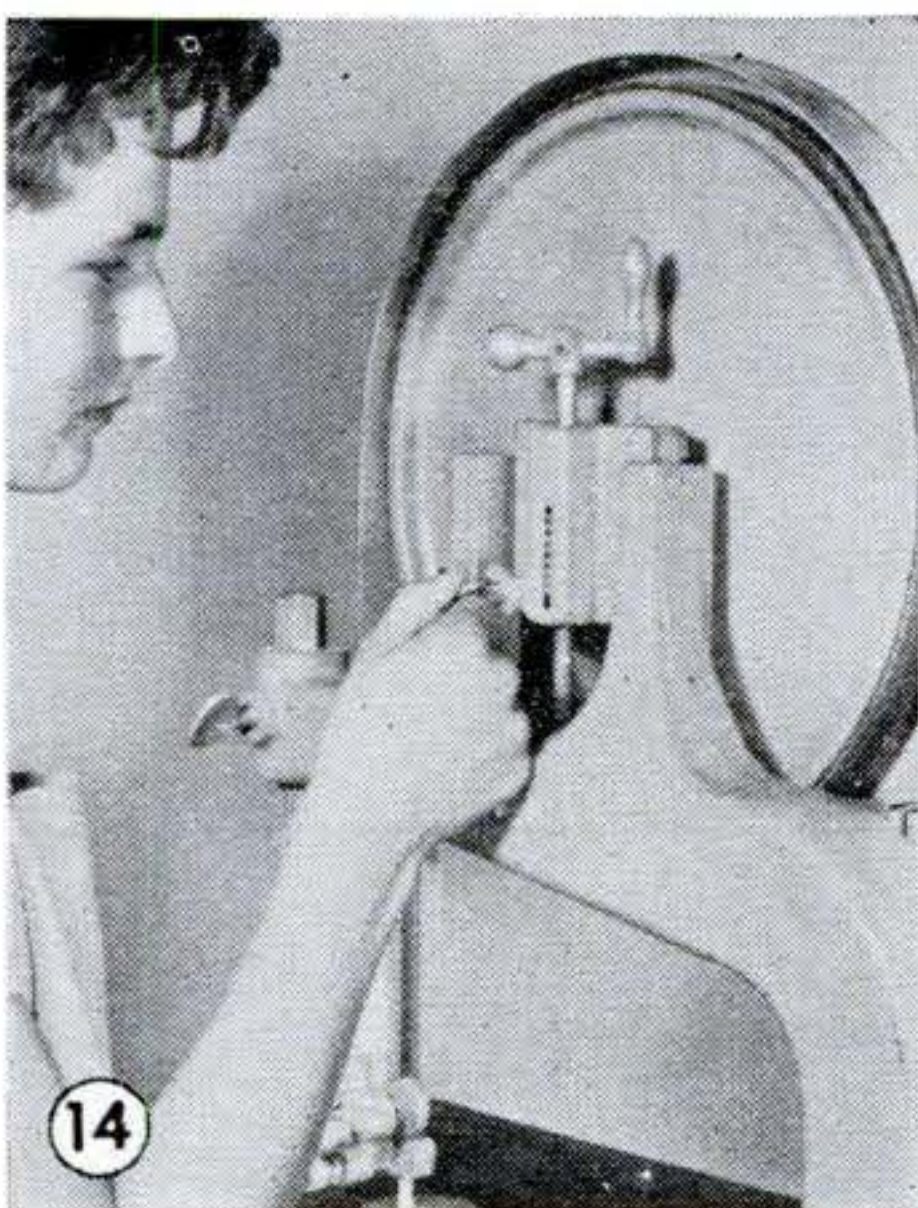



the same time you are grilling the steaks over the open fire. Concrete lids close the holes when they are not needed.

Built against an existing terrace wall, the fireplace has a firebox measuring 17" by 28"—a good average size. Although convenient for a small family supper, the fireplace also will handle the cooking for a really big party—say a barbecue for several score people.

Costing well under \$20, it was completed in about three days of labor, spread out over nearly two weeks of spare time. This permitted careful preparation of the forms and allowed adequate time for the concrete to set between four successive pours. Approximately four bags of cement and a cubic yard of gravel were required.

The ground was excavated and the base slab poured first. Then firebricks were laid for the inner wall of the firebox and the mortar allowed to set. Next came the two side blocks, then the back section around the cooking holes, and finally the encasement of the 8" by 12" tile flue liner that serves as the chimney.

#### *Grill Rests on Rabbet*

A firebrick lining saves most of the form work on the inner face of the firebox, besides adding years of life to the concrete. In laying the bricks, stagger the top row to leave a substantial corner of concrete exposed at the outer end of the firebox. Note that a rabbet along the inner edge of the side blocks allows the iron grill to rest flush with the top of the concrete, making it

easier to skid pots on or off the fire. Although the drawing calls for a 1" rabbet, this dimension should be suited to the thickness of the grill used.

The form for the firebox was built for easy removal after the concrete had set. However, if this strikes you as too much extra effort, you could leave the form in place for a week or two and then burn it out. A few large holes bored in the top under the flue will provide enough draft to burn the form boards with the first fire.

#### *Holes Are of Different Size*

A 6" vitrified tile elbow was used for one of the cooking holes, a 4" cast-iron soil pipe elbow for the other—both being positioned to bring the top edge of the bell flush with the side wings of the fireplace. Such elbows, as well as the chimney liner, usually may be obtained from any building supply house.

Rest the lower ends of the elbows on blocks tacked to the firebox form and support the bells with wires run to the chimney tile. Rigidity is provided by another wire stretched from a hole in the firebox form up through the inside of each elbow to a cross block in the bell. A similar wire and block hold down the chimney tile.

While pouring the concrete around the elbows be sure to drop in plenty of stiff wire or small rod to reinforce the construction. When the cooking-hole section has set, build a rectangular form and also encase the chimney tile in concrete. In finishing off, do not overwork any of the top surfaces of the concrete. Using the edge of a



**Elbows of two sizes** are used for the cooking holes. Support these with wires and blocks.

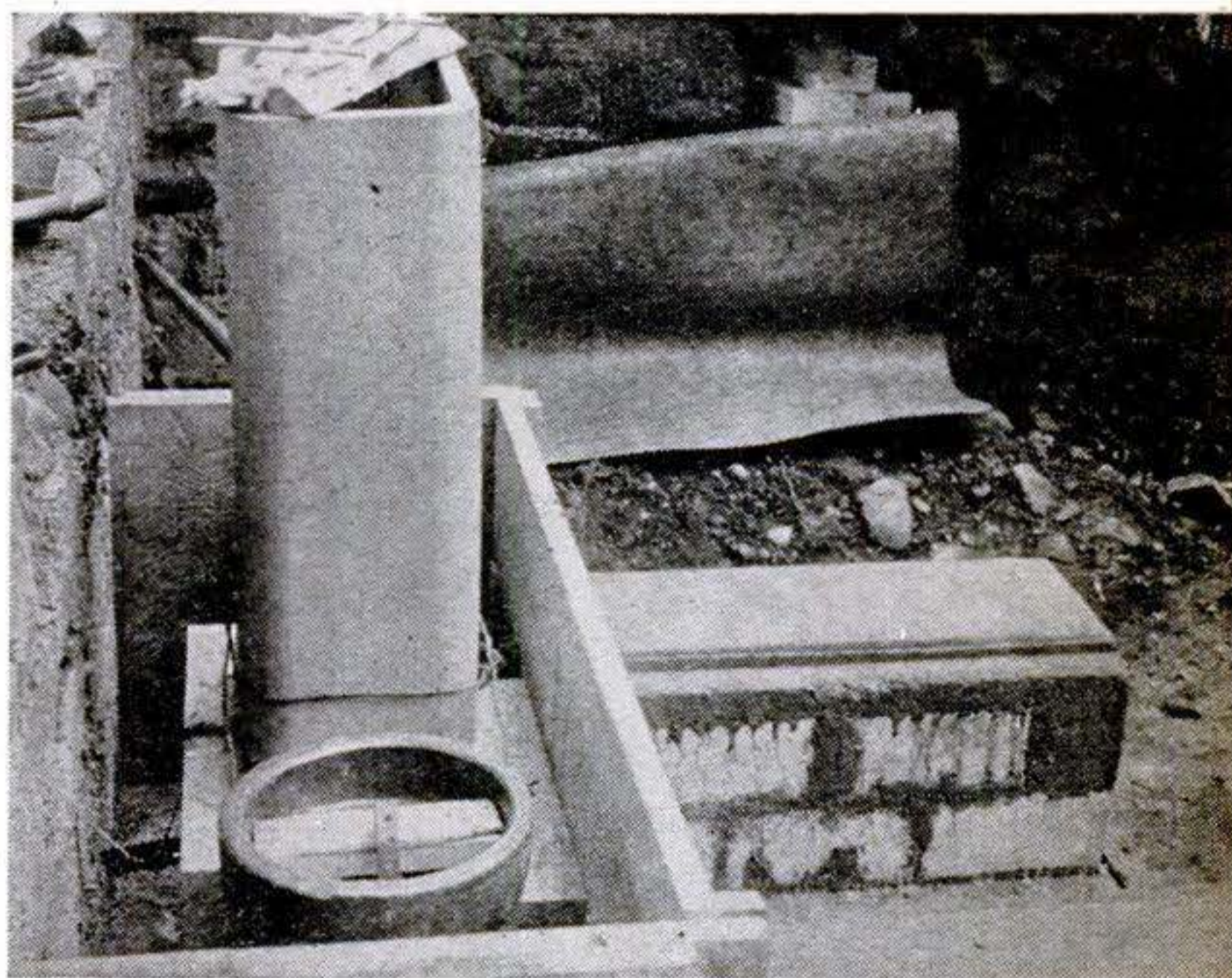

**Ready for concrete**, the form looks like this. Note the cross blocks on the tile and elbow.

board, strike them off flush with the top of the form. Then leave them alone.

To cast concrete lids for the cooking holes, rest a disk of sheet metal on the shoulder of the elbow bell, place a snug disk of tar paper on this, and then line the sides with strips of soft cardboard. This procedure will permit easy removal of the hardened lid. Embed a piece of wire or ring in the lid as a handle.

### Two-Part Grill Is Best

A two-part grill, each piece half the length of the firebox, will give the fireplace more flexibility. For a small party, you then can use only the inner half of the firebox, avoiding the necessity of stoking a small fire far back under the grill. For a big feed, both sections can be used.

Against the day when further refinement may be desired, two steel hooks were embedded in the top of the chimney encasement. To these eventually will be lashed an extension chimney, formed to fit the projecting tile and lead to an 8" diameter smoke-pipe complete with damper and spark cap.

Then the missus can preside over the back cooking holes, well below the smoke floating from the top of the stack. After a little practice the damper may be set, just so, to produce a fluffy omelet that might make any indoor cook shout with pride.

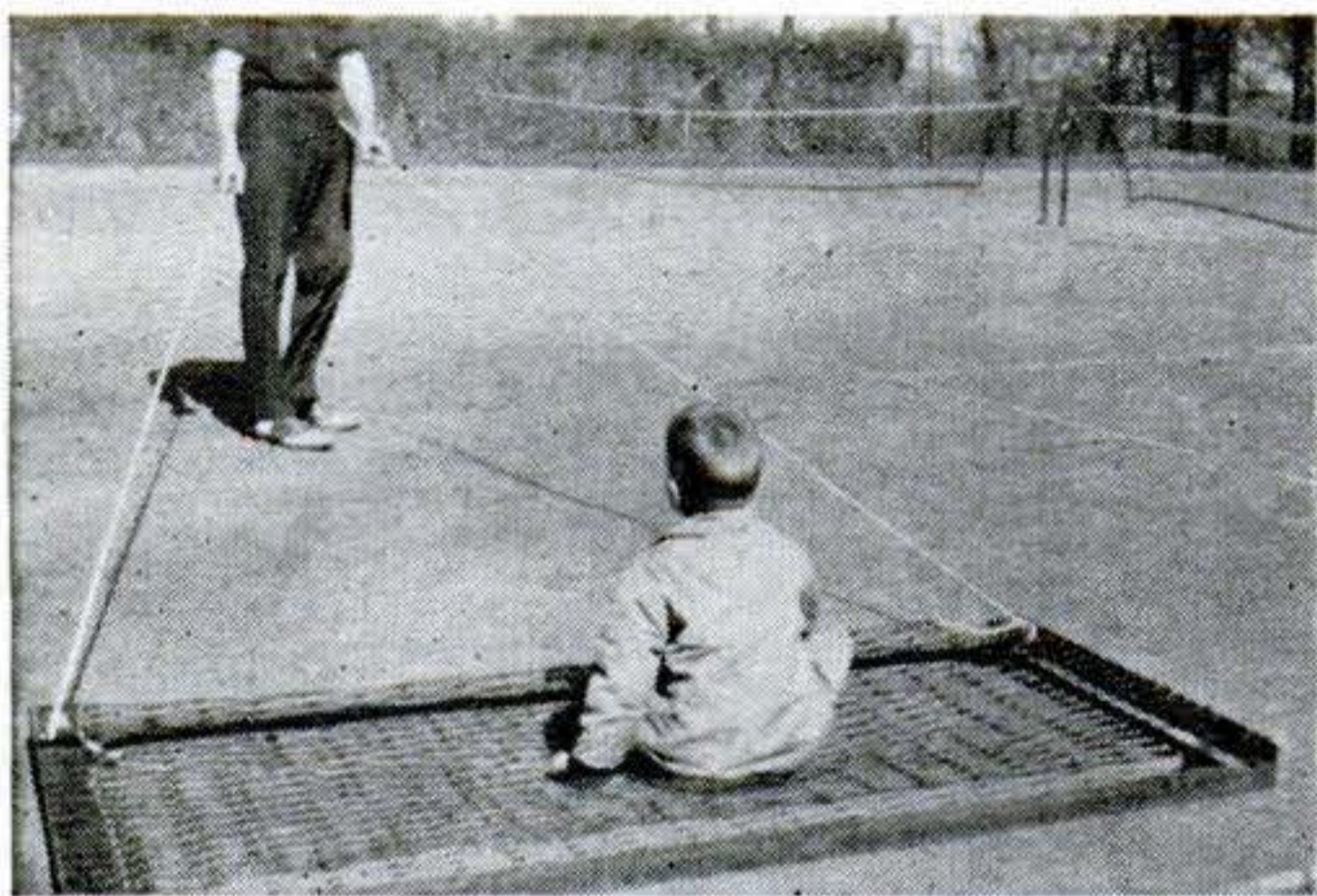

### Bedspring Serves as Scraper

IF YOU'RE looking for a sharp-edged drag to smooth a clay tennis court, nothing can beat an old iron bedspring for the job. Attach ropes to two corners so you can drag it along. The metal edges of the frame will scrape the tops off the bumps and deposit the loose clay in the hollows. Small fry can have a lot of fun riding along to increase the weight of the drag.—Henry K. Fitts, Morristown, N. J.

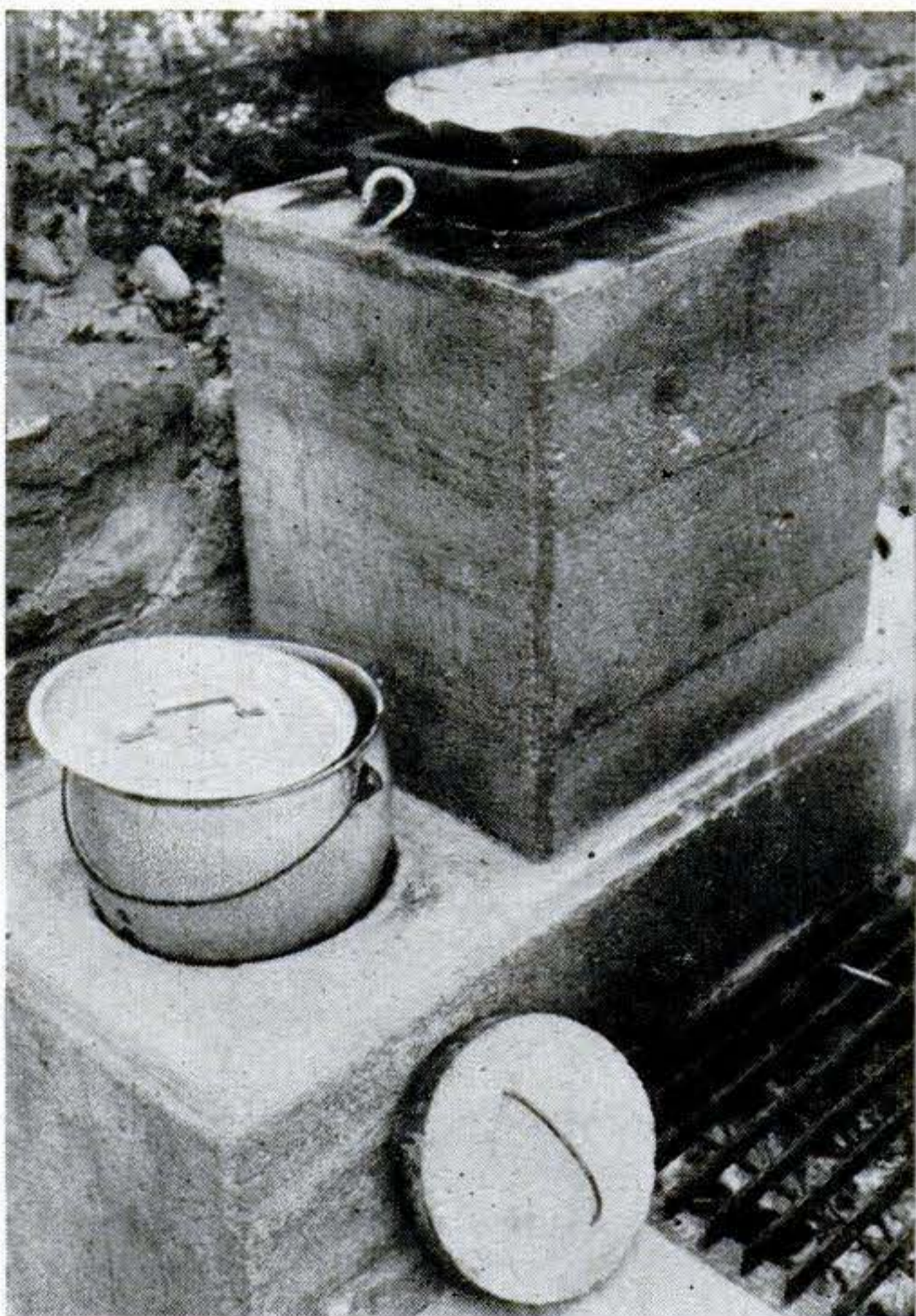

A sheet-iron baffle atop the chimney forces the desired amount of heat to either "burner."

The head man can stoke the fire as clumsily as he will, but no matter. The outdoor supper will be perfect. END

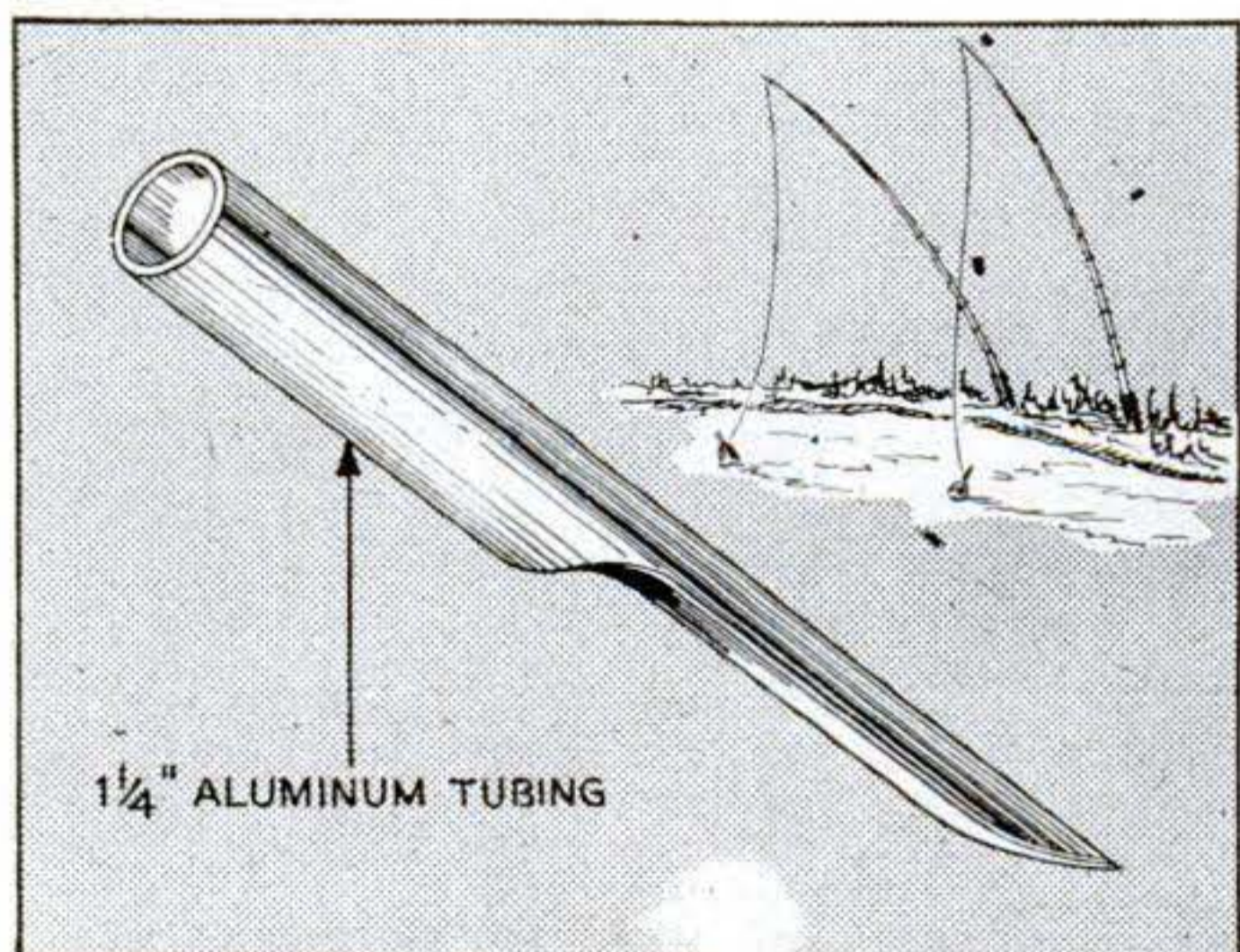

### Tubing Supports Fishing Pole

RATHER than depend on makeshift supports when you want to set up several fishing poles, try carrying along a few of these holders. Saw a 16" length of aluminum tubing down the middle for about 10" and sharpen the end. Driven into the ground, this makes a perfect socket for the fishing pole.—W. C. Hambleton, Louisville, Ky.



# What's Your Ingenuity Quotient?

**Mustachios and playing cards** are an old combination as I recalled when I had trouble trimming my handlebars. A template cut from a card and held in place exposes only ends to be trimmed. It also insures that both my beauties will be balanced.—*W. G. Hykle, Montreal.*



**I'm no sap**, so when I wanted to get some from a stand of maple trees this spring, I fastened an augur on the power takeoff at the rear of our tractor. To bore, I just back the tractor gently up to the tree; to pull the augur out, I drive ahead. It's a matter of seconds to get each tree flowing, and that's a big help when you've got a lot. Using an extra man to drive the spigots, we've mechanized our maples.—*Clarence Breitenfeldt, Marathon, Wis.*

**Singing the blues** didn't soften one landlord's heart. He said no aerial on the roof and meant it. But we can hear the blues and everything else on the air since I fastened a length of bare wire inside the chimney as pictured.—*Arthur Trauffer, Council Bluffs, Ia.*

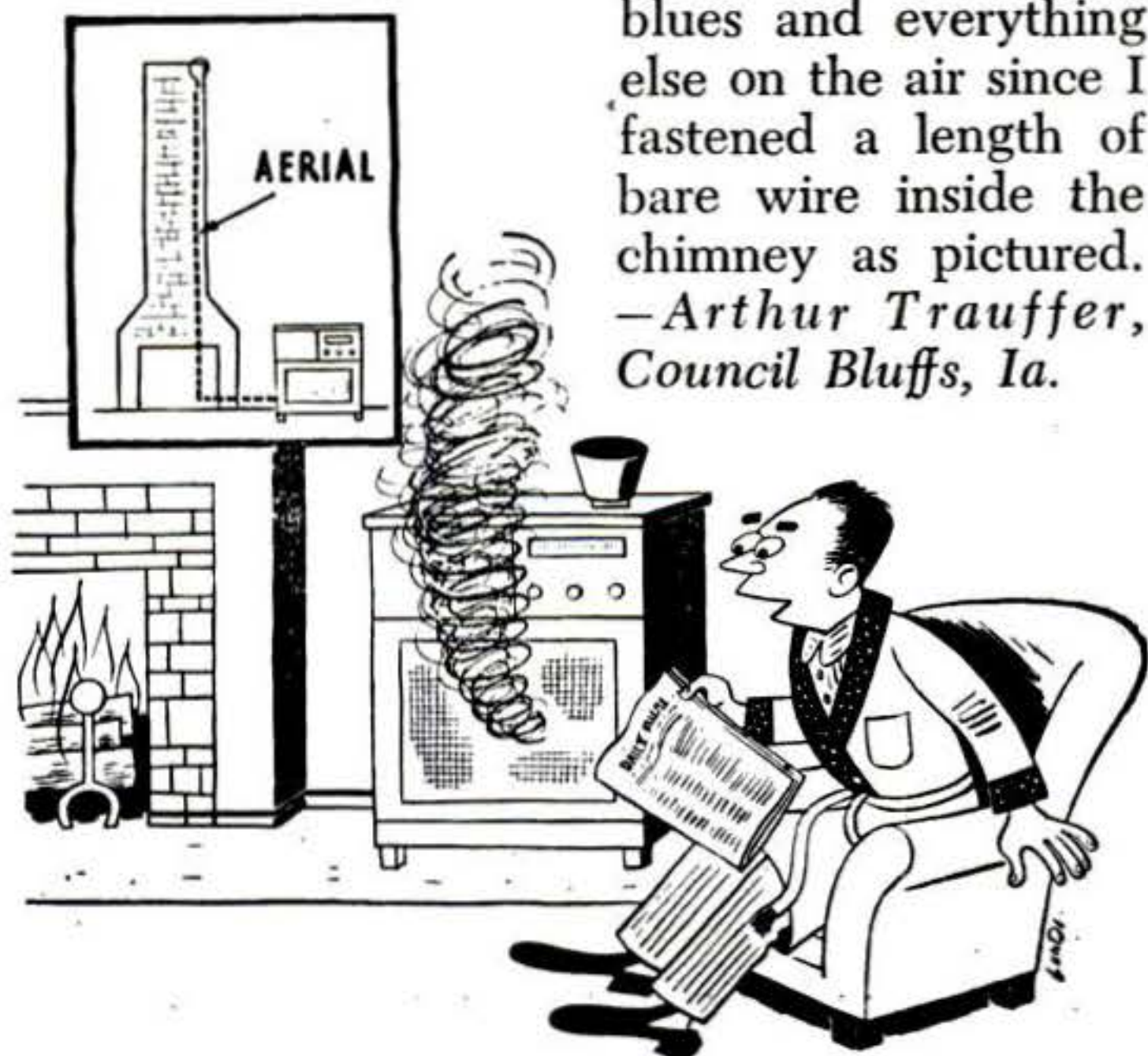

**There's no rule** that says a broken piece of a small hacksaw blade can't be used to cut a groove when the job has to be done and there is no other tool available. To hold it stiff, I extracted the brass edge of a ruler and substituted the blade fragment. The brass edge was later cemented back in place.—*M. C. Everett, Great Neck, N. Y.*



Have you pulled off a smart one lately? We will pay for acceptable contributions showing ingenious solutions of problems in the home, shop, garage, or camp. It doesn't matter if it's wacky—if it works.

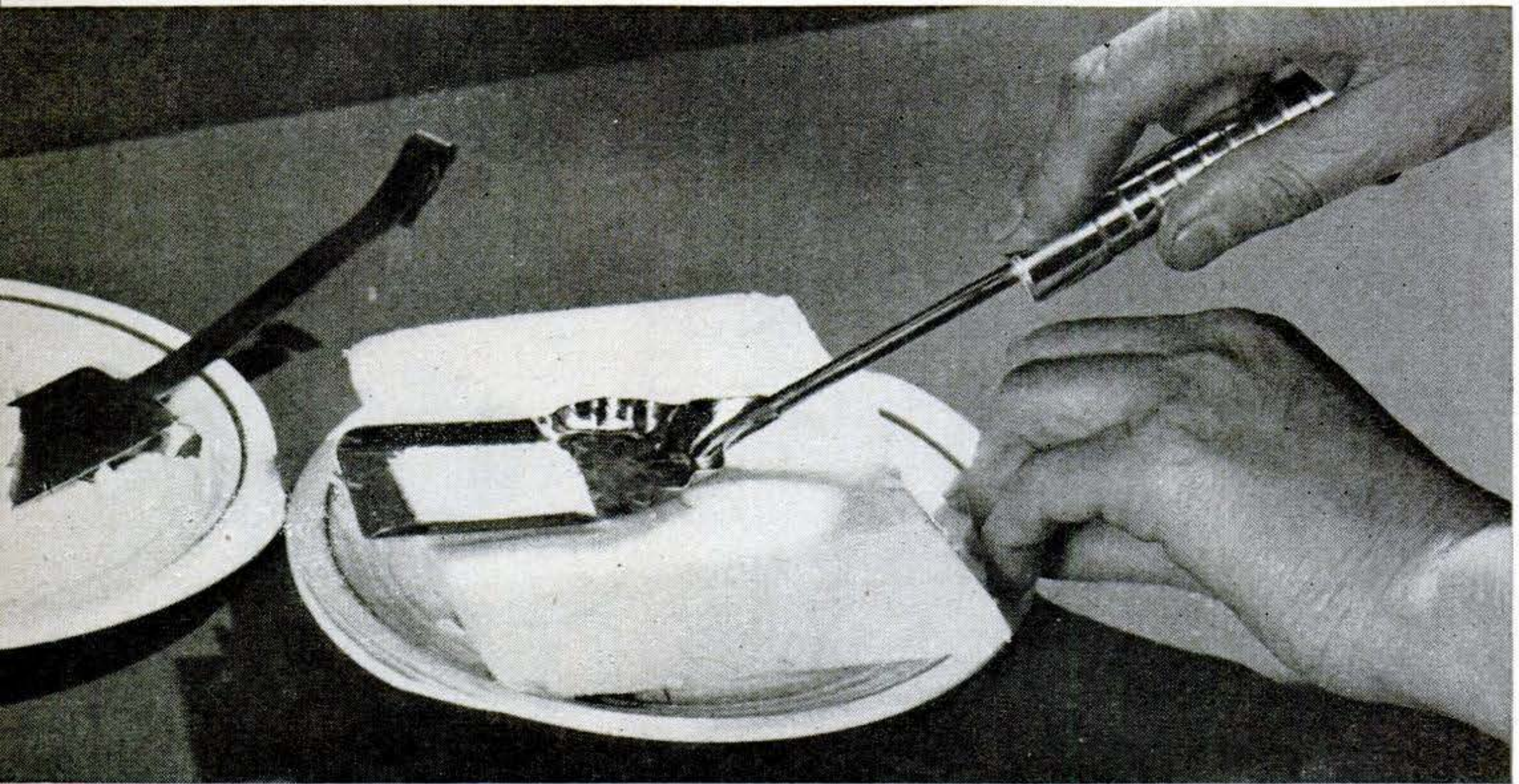

# Snack Server Has Slicing Edge

THE Waldorf never served neater cheese snacks than you can offer your guests with this combination slicer-server. It cuts even, thin slices of cheese, and deftly places them on plates or sandwiches.

This handy gadget is made in two parts that can be used together or separately. You can use common steel for the knife and spatula, though stainless is perhaps the ideal material. The shovel, made of sheet about .025" thick, must be hard enough to hold a good cutting edge. The spatula, of

sheet about .030" thick, must be springy.

To form the shovel-like slicer, trace the pattern (Fig. 1) on sheet metal and cut out. Smooth the edges and cut the slot by drilling end holes with a 3/32" bit and sawing between them with a jeweler's saw. True up the slot with a flat file, but do not sharpen the cutting edge (the forward edge of the slot) until after assembly. If you use hardened stainless steel, anneal the handle end of the blank by heating white hot and quenching in water. Bend up the edges of

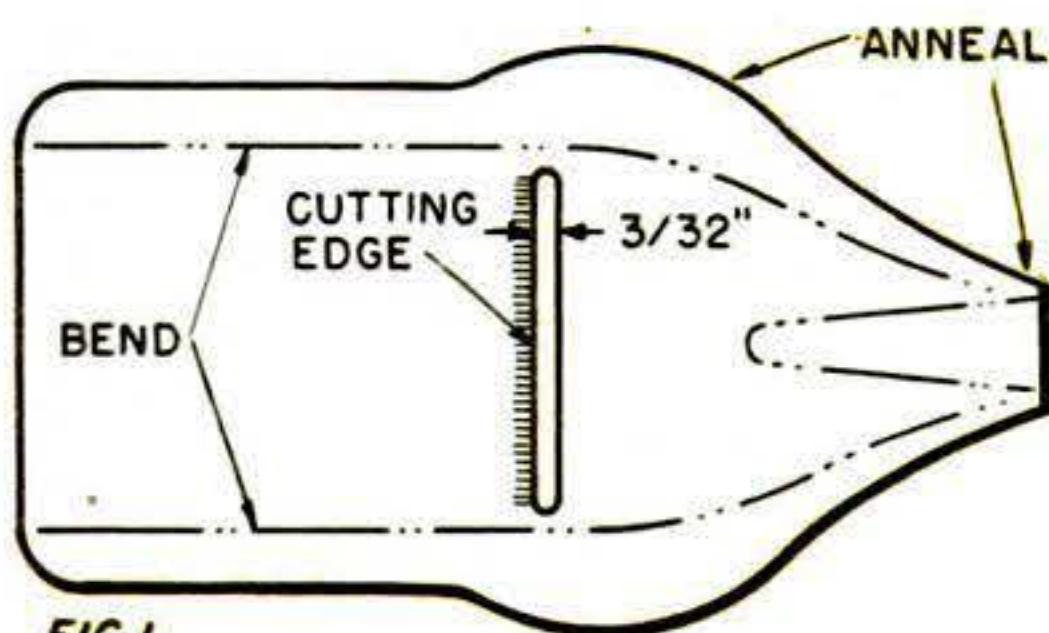

FIG. 1  
KNIFE BLANK

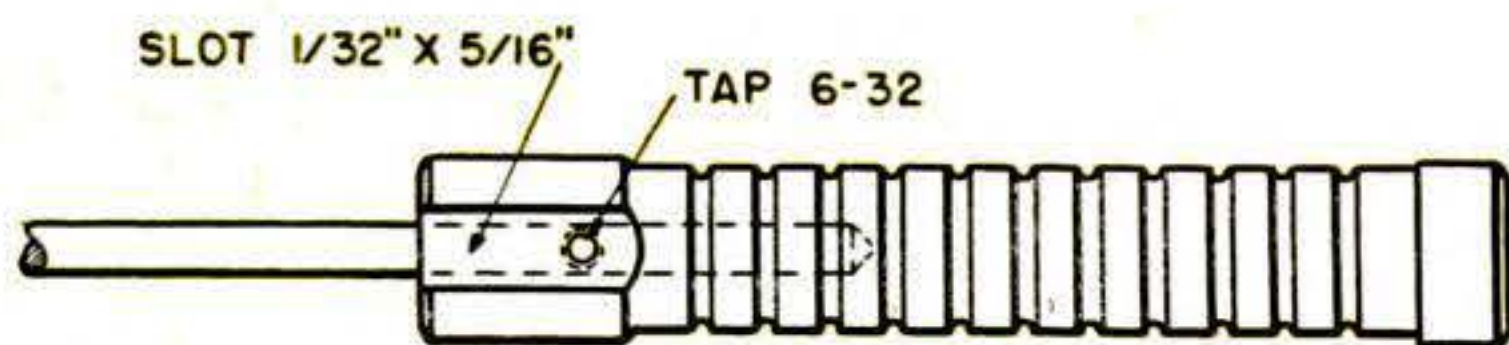

FIG. 2 HANDLE

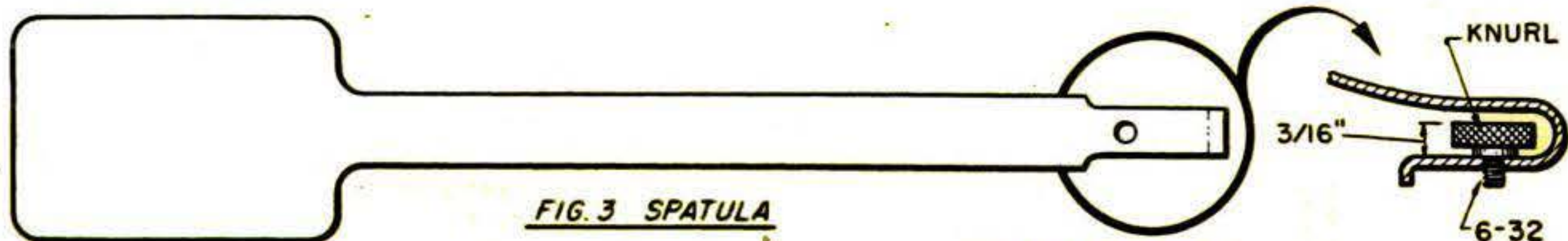
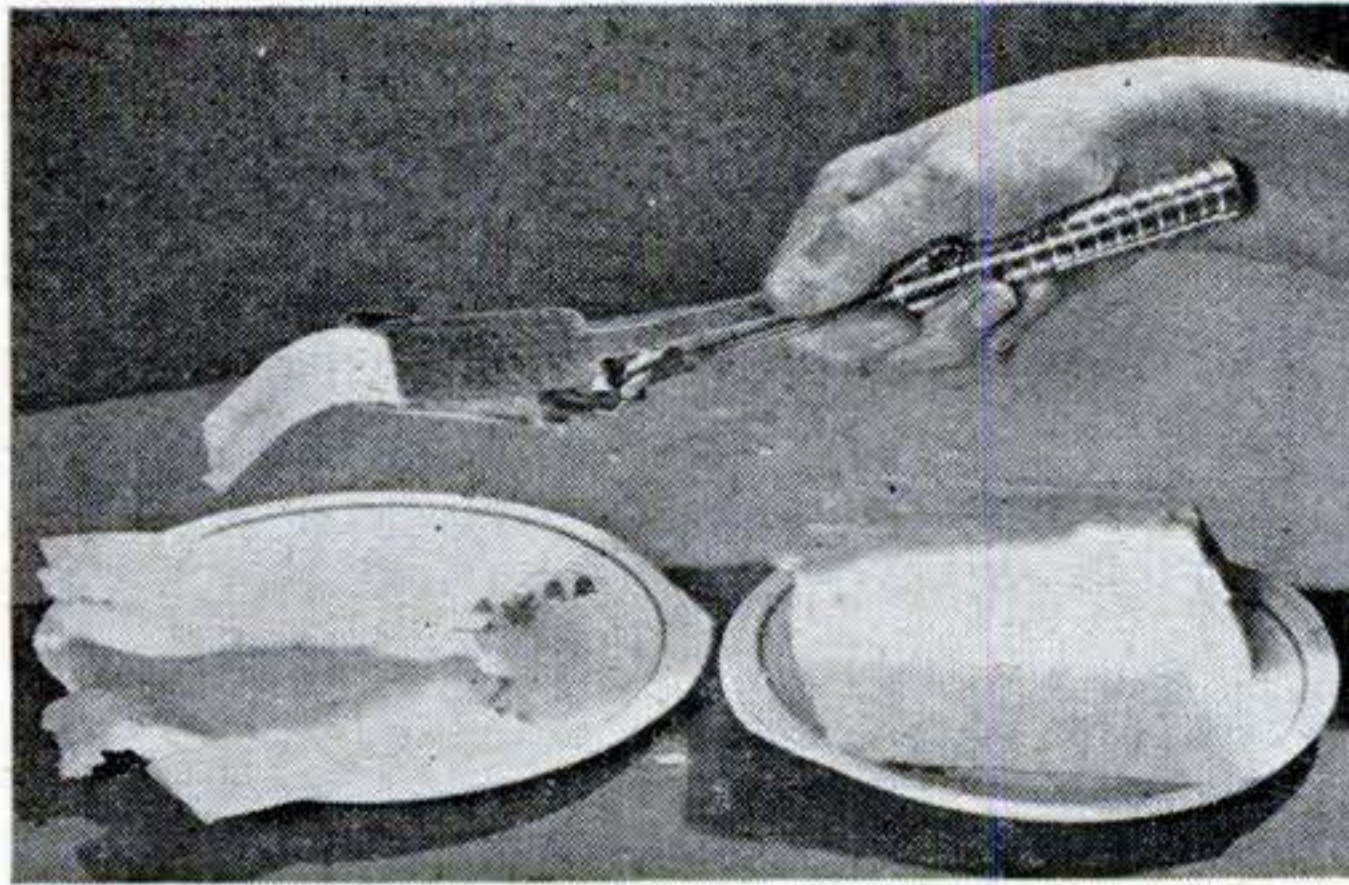
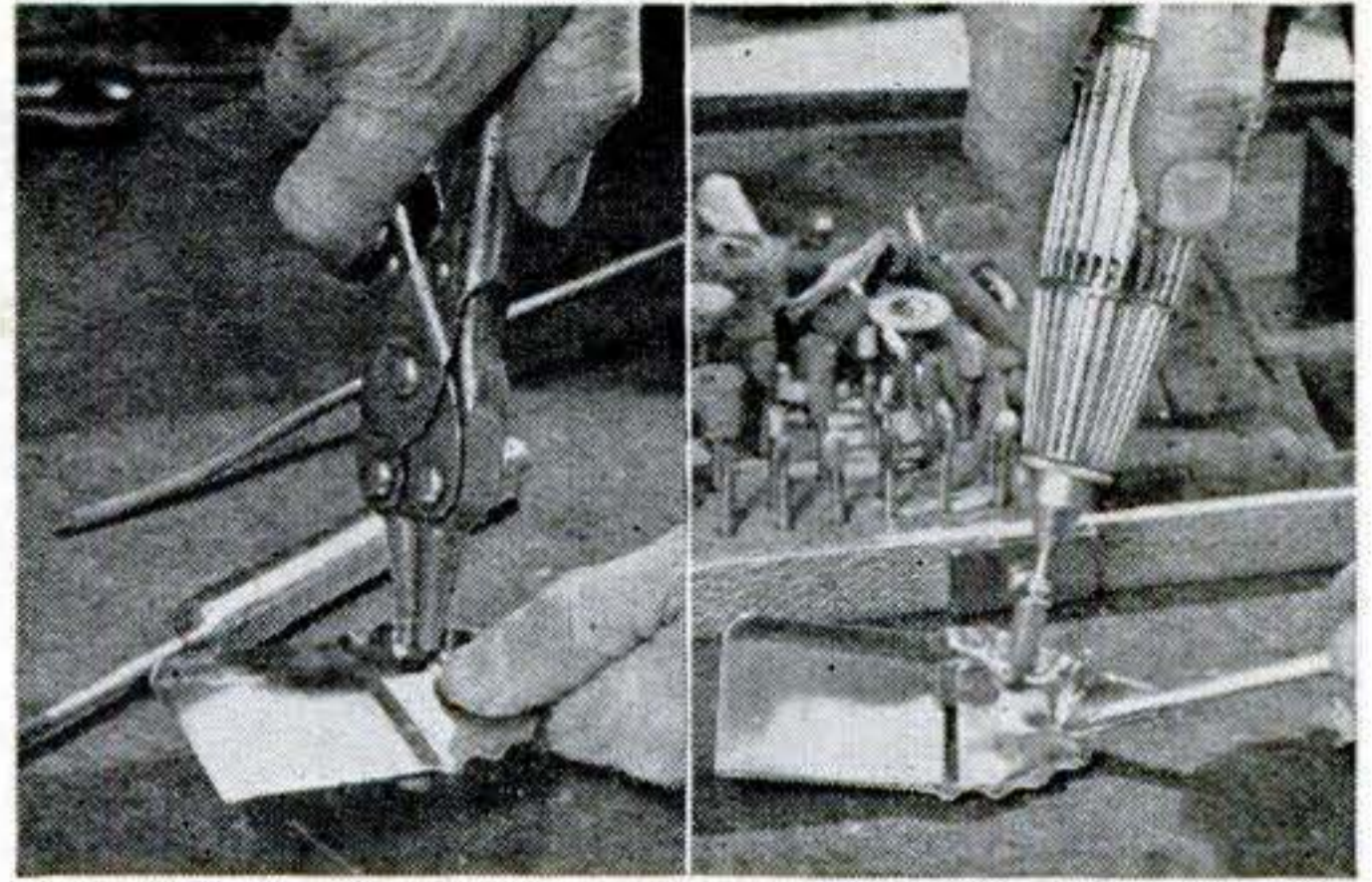

FIG. 3 SPATULA

SCALE: HALF SIZE



The attached spatula helps pick up and serve food that the knife edge has neatly sliced off.



Round-nosed pliers crimp a stove-shovel contour that can be buffed with a hand motor tool.

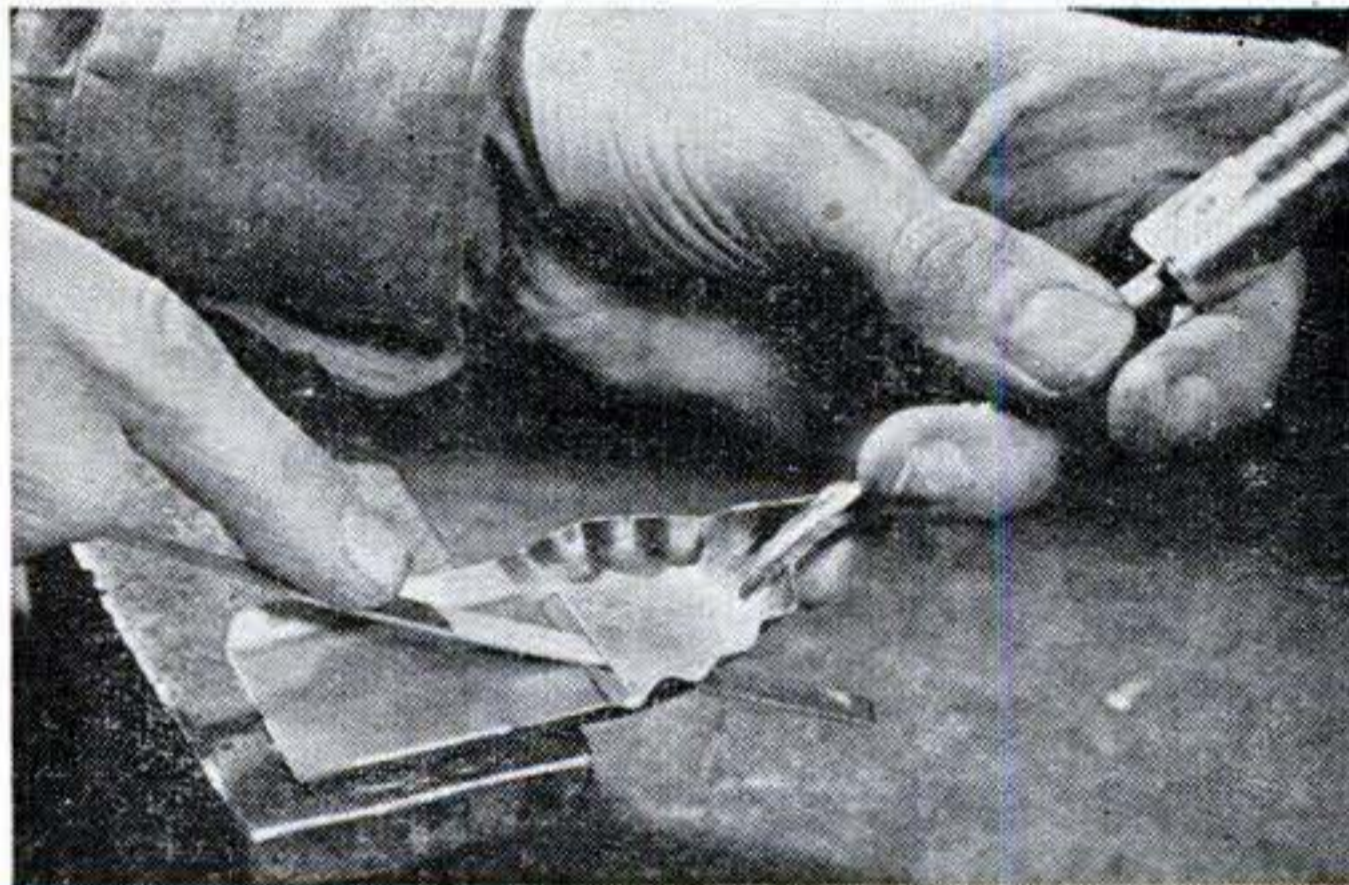

Careful sharpening of forward edge of slot in shovel enables it to slice even, thin portions.



This handle was turned from aluminum rod, but plastic, wood, or other materials can be used.

the shovel forward of the slot in a vise. The curved edges are then crimped piecrust fashion with round-nosed pliers. Shape a recess for the  $3/16$ " stainless handle rod.

After shaping, polish the steel to remove scratches and tool marks. A hand grinder with a rubber-bonded abrasive wheel in it, as shown in one of the photos, does a quick job.

As shown, the handle is  $3/4$ " aluminum

rod with decorative grooves turned in. Of course you could use hardwood, plastic, or even bone instead. Drill the handle hole slightly undersize to  $1\frac{1}{2}$ " depth and ream out  $3/16$ " to  $1\frac{1}{4}$ " depth. Drive the rod, which should be about  $4\frac{1}{2}$ " long, into the reamed hole. Grind or file the end to form a flattened tip and hard-solder to the shovel head. Mill or file a slot for the spatula on the shovel handle (Fig. 2).

Rough out the spatula (Fig. 3) with a narrow chisel and smooth the edges. The spatula handle is  $7/16$ " wide to within about  $7/8$ " of the tip, where it narrows to  $5/16$ " to fit the handle slot. Bend  $1/8$ " of the narrow tip at right angles to hook over the end of the handle. About  $1/2$ " from the bend, drill a hole to clear a 6-32 screw. Drill a matching hole in the shovel handle slot with a No. 36 bit and tap 6-32. Make a  $1/2$ " knurled head, tap it 6-32, and hard-solder it to a screw just long enough to hold the spatula firmly on the shovel. With the screw in place, bend the spatula handle as shown.

File the forward edge of the cutting slot to knife sharpness, and bend up the other edge about  $1/16$ " to expose this knife edge.

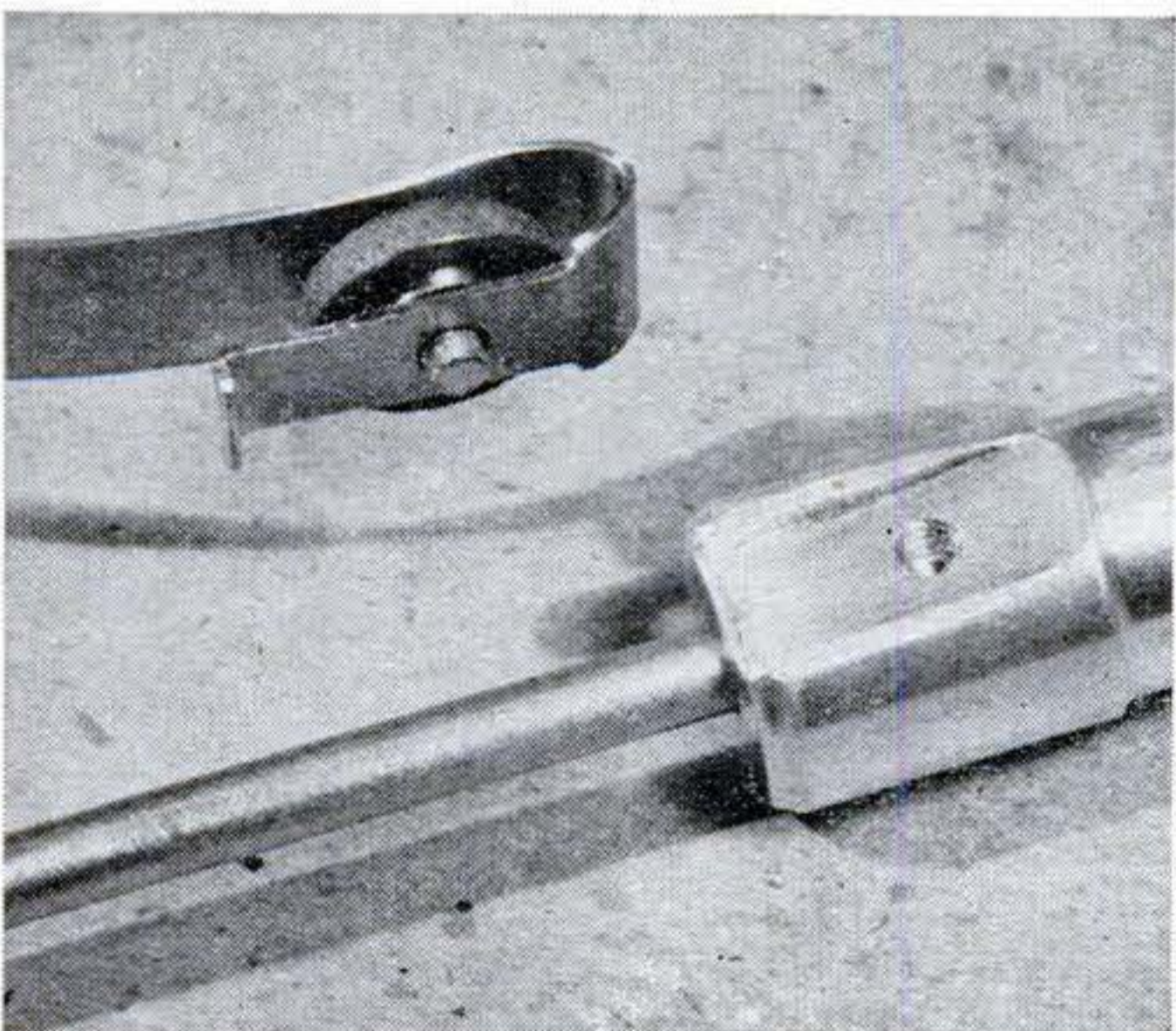

A knurled-head screw in spatula handle quickly attaches it to shovel for deft, no-slip serving.

# Light from a Salt Box

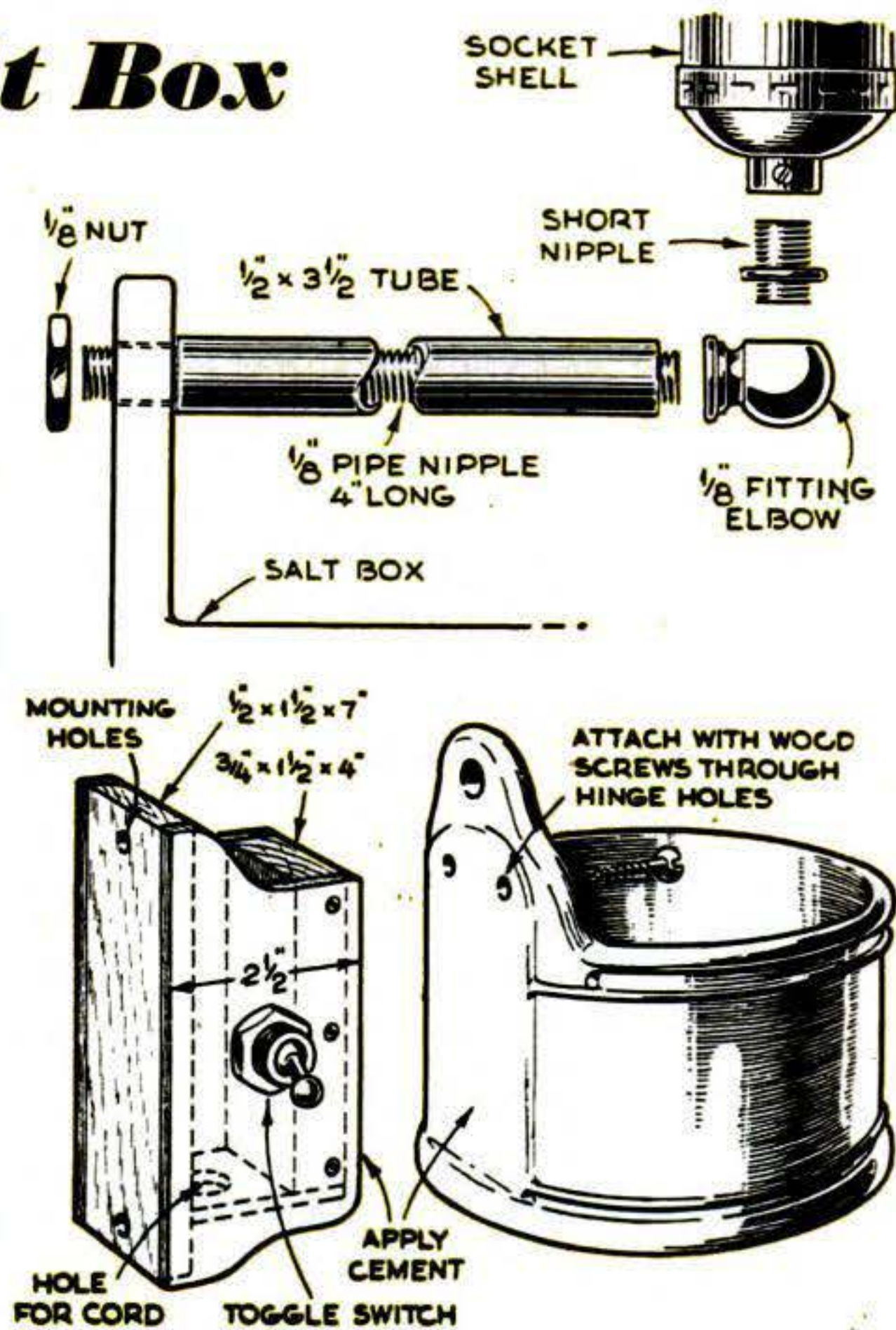

SOME of the old salt boxes available in antique shops and secondhand stores are ideally suited as bases for small lamps—for use on a table or desk or, with an appropriate bracket added, as a pin-up lamp in dining room or breakfast nook.

These old boxes were made of wood or, as in the case above, of glazed and decorated pottery. Except that you'll usually want to remove the hinged lid (if it's still intact), both types are adaptable with little or no change as lamp bases. An elbow fitting to support the light fixture may be clamped in the hole at the back by which

the box originally was hung on the kitchen wall. The holes for the lid hinge, if located at the back as in the example above, may be utilized in attaching a wall bracket.

In the lamp above, clamping action exerted when the  $\frac{1}{8}$ " nut is turned up keeps the fittings in place, and a socket shell with built-in switch was used. When the wall bracket is added, however, it is more convenient to install a toggle switch. A black-trimmed shade was chosen to harmonize with the black-painted fittings and the word "salt." The shade is 10" in diameter at the bottom.—R. P. Stevenson, Manhattan, N. Y.

## Drawing Guide Adjusts to Any Desired Curve

DESIGNED to simplify the work of draftsmen, this new drawing tool can be set to practically any desired curve, including reverse curves. The tool is a product of the Cook Specialty Co., Green Lane, Pa.

It consists of a 12" base plate with a straight slot in one end and a curved slot in the other. Adjustment screws in these slots hold any one of four preformed wire guides. By sliding either or both adjusting knobs along the slots, a guide may be brought to the desired curve. Either a ruling pen or a pencil may be used.

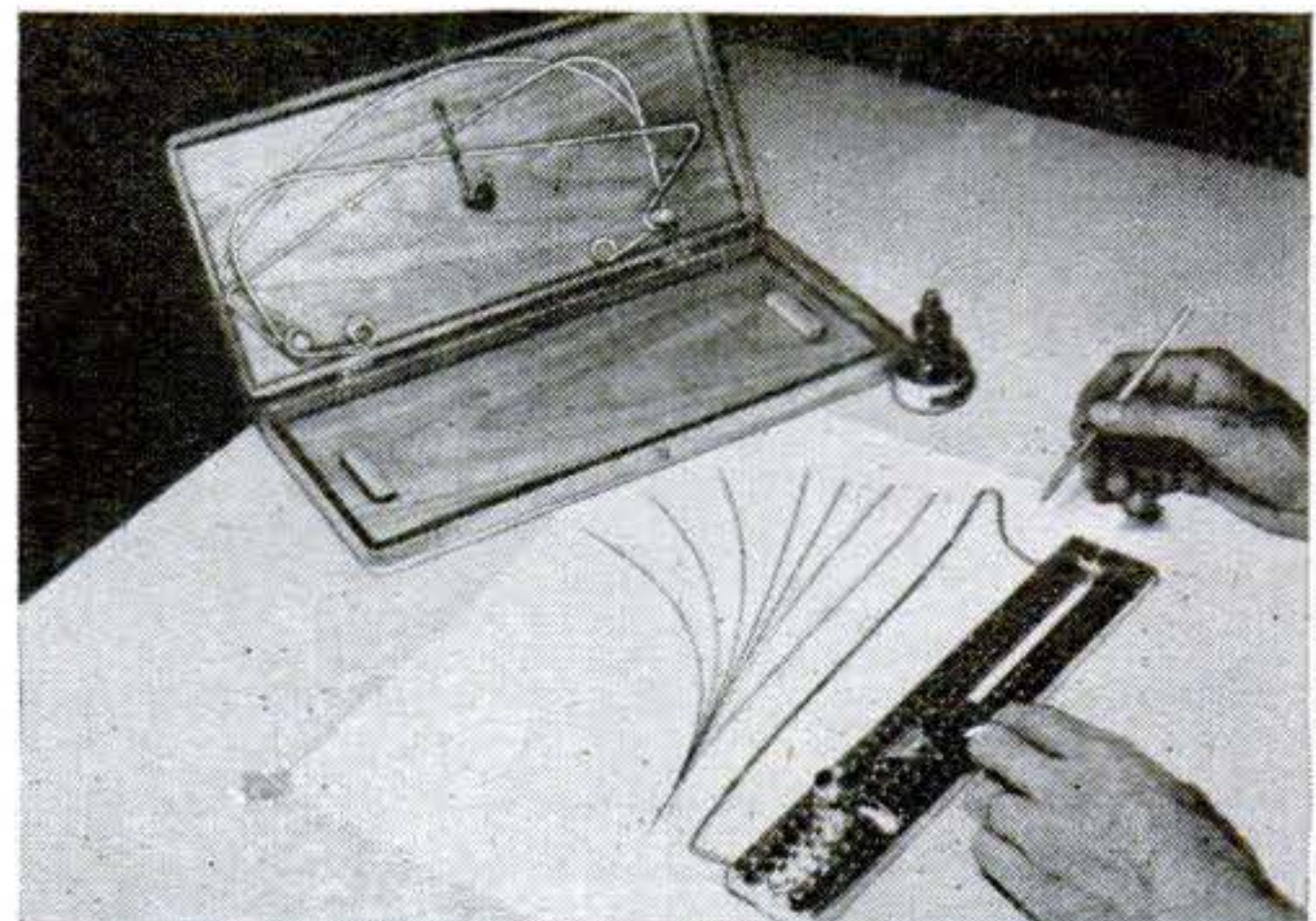

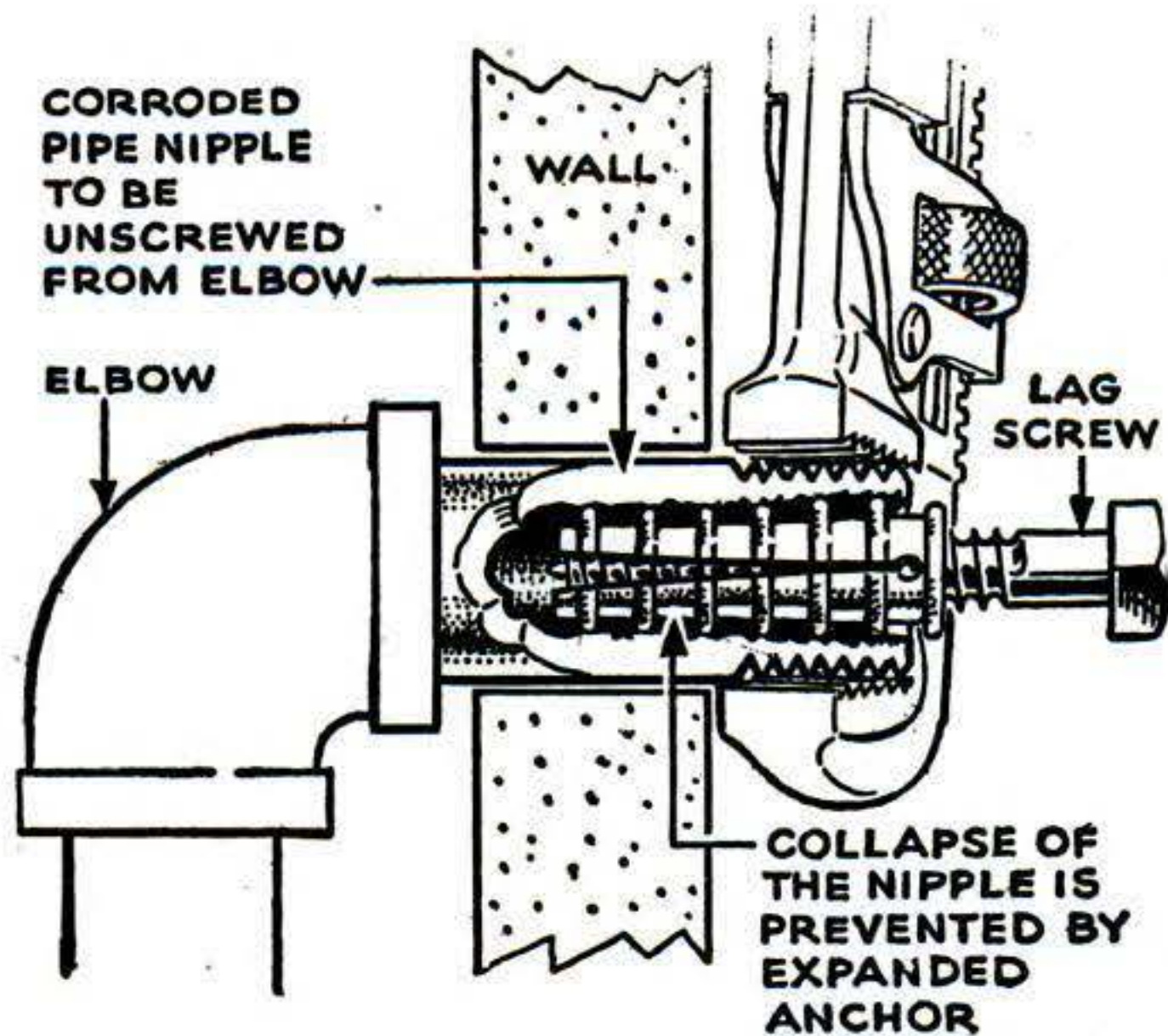

### Plug Helps Remove Nipple

A LAG screw and expansion plug can help you out of what might be a difficult, time-consuming job—replacement of a rusted, leaking faucet nipple that sticks out of the wall only an inch or so and is too weak to stand the pressure of a Stilson <sup>®</sup> wrench. File the plug to fit inside the nipple, insert the lag screw, and turn until the plug has expanded to a firm grip inside the nipple. Even though the nipple wall has rusted thin, you can now use a wrench to back it cautiously out of the elbow. The plug supports the wall.—*Garrett Kemp, Dallas, Tex.*

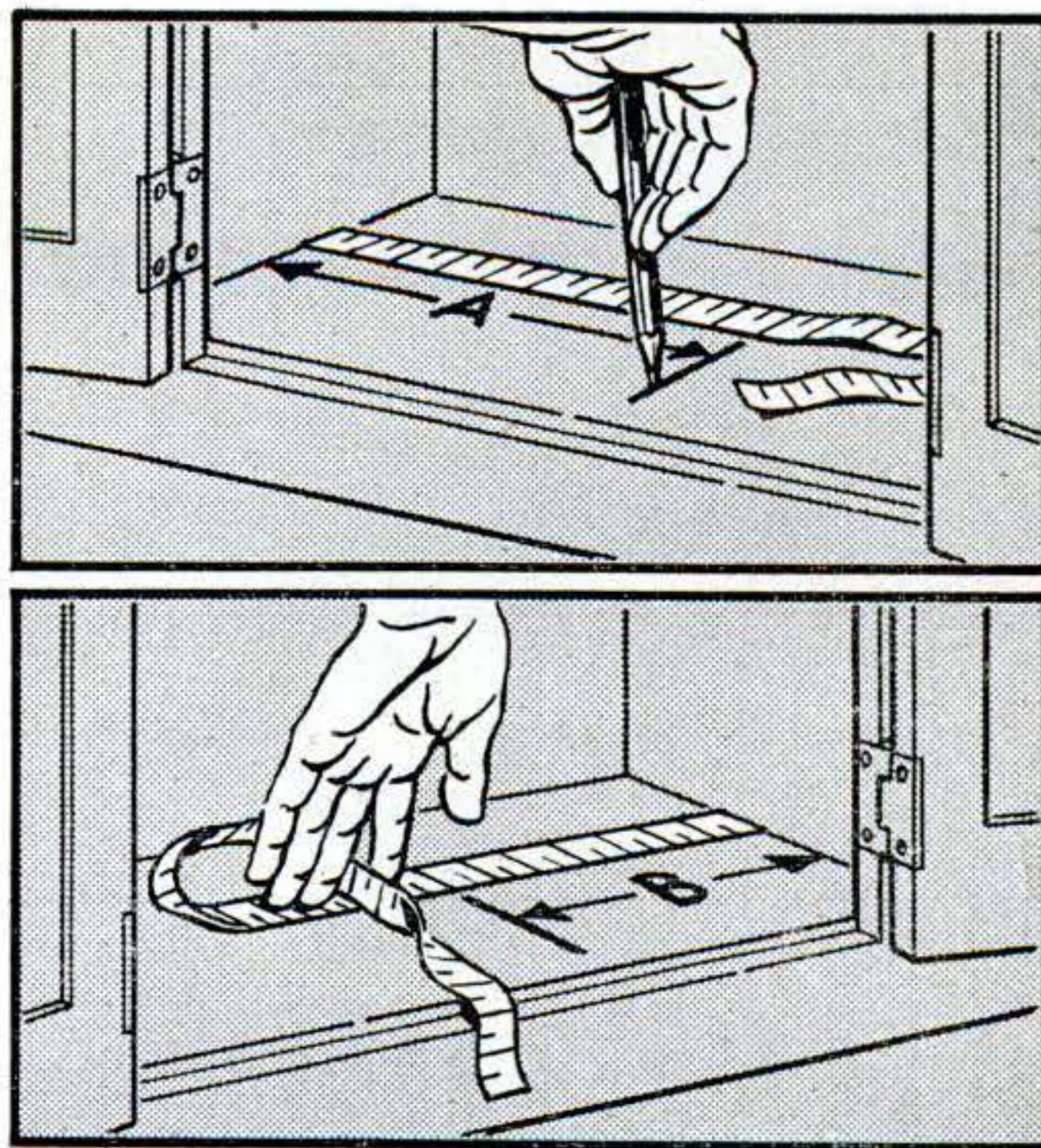

### Taking Inside Measurements

TAKING the exact inside measurements of a cupboard or window is easy, even with a stiff steel rule. Just measure from one side the distance to about the center of the space (A in top sketch) and make a thin pencil mark. Then move the rule over and measure the distance from the other side to the pencil mark (B in lower sketch). The sum of A and B is the total inside dimension.

### Light Over Stoker Hopper Shows Coal Impurities

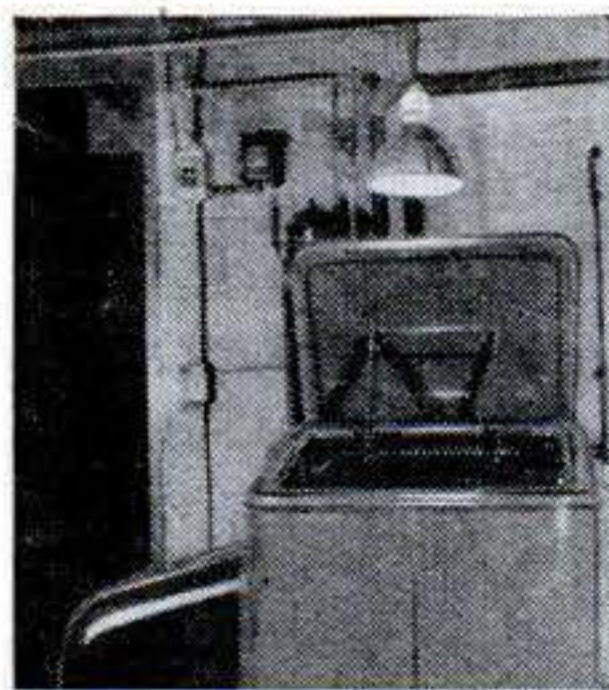

A BRIGHT light over the stoker hopper in the furnace room will repay the trouble of putting it in every time you have to fill the hopper. It will speed that job, and also help you locate rock and slate in the

coal that might jam the stoker worm. I use a porcelain drop socket with a reflector that throws a concentrated beam.

The light should be hung squarely over the hopper opening and low enough so that it will not shine directly in the eyes. It is controlled by a three way switch that also operates the stoker. The switch is wired to turn the stoker on and the light off when the handle is thrown up. With the switch handle down, the light is on and the stoker off. This arrangement serves as an automatic reminder, the light warning if the stoker has not been switched on after the hopper

has been filled. Mark the switch to inform others of the combination control.—*Ernest M. Woerner, Eureka, Ill.*

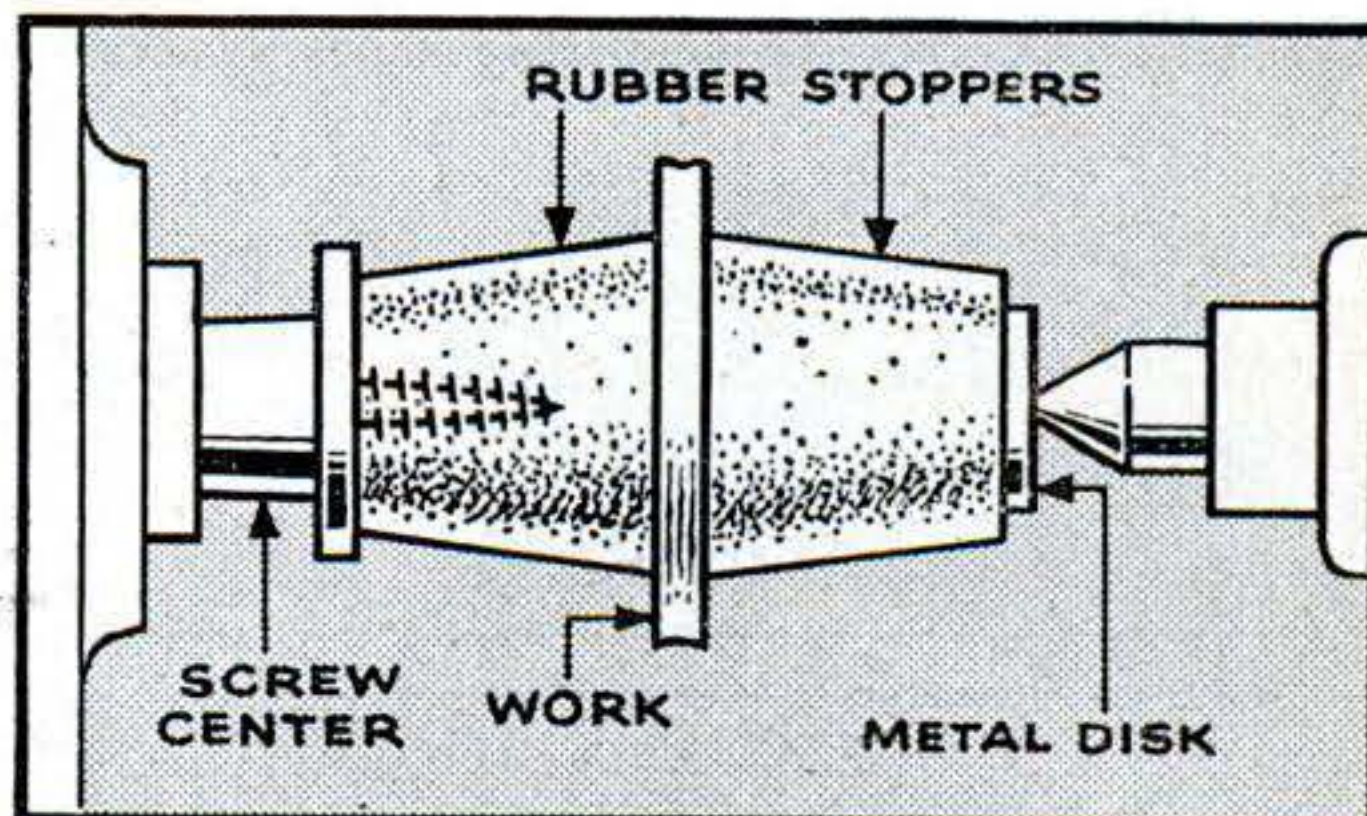

### Rubber Stoppers Hold Disks

DISK edges can be turned easily in a lathe between two laboratory rubber stoppers. Mount a wood-turning screw center, and slip a one-holed stopper over it. The tailstock, acting through a center-punched disk, supplies pressure to a second stopper.—*D. H. Matheson, Hamilton, Ont.*

## Keeping the Home Shipshape

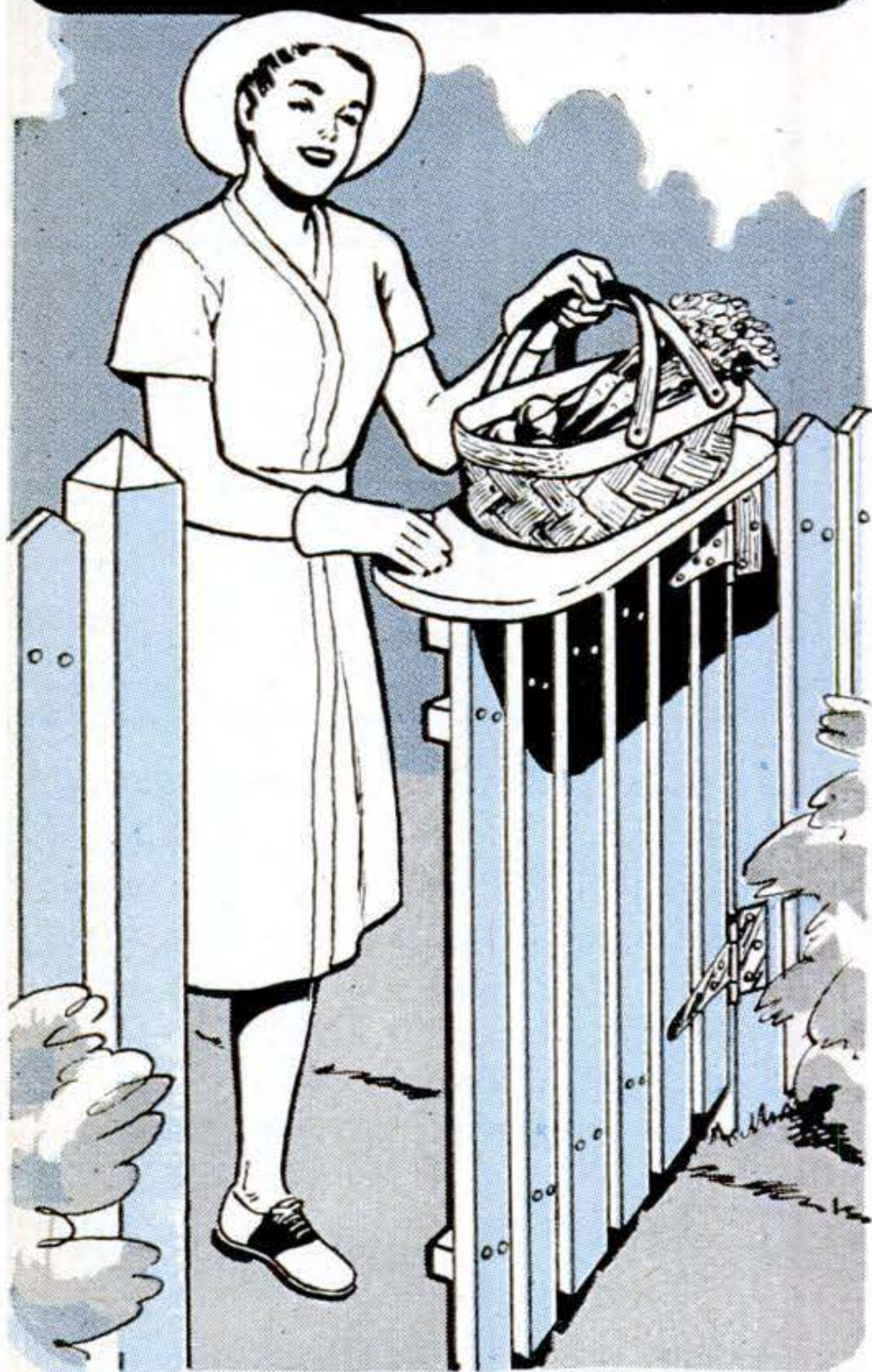

**Fumbling with packages** while you try to open the latch of a gate is unnecessary. Instead, build a shelf or platform on top of the gate to hold them. Brace it with shelf brackets.

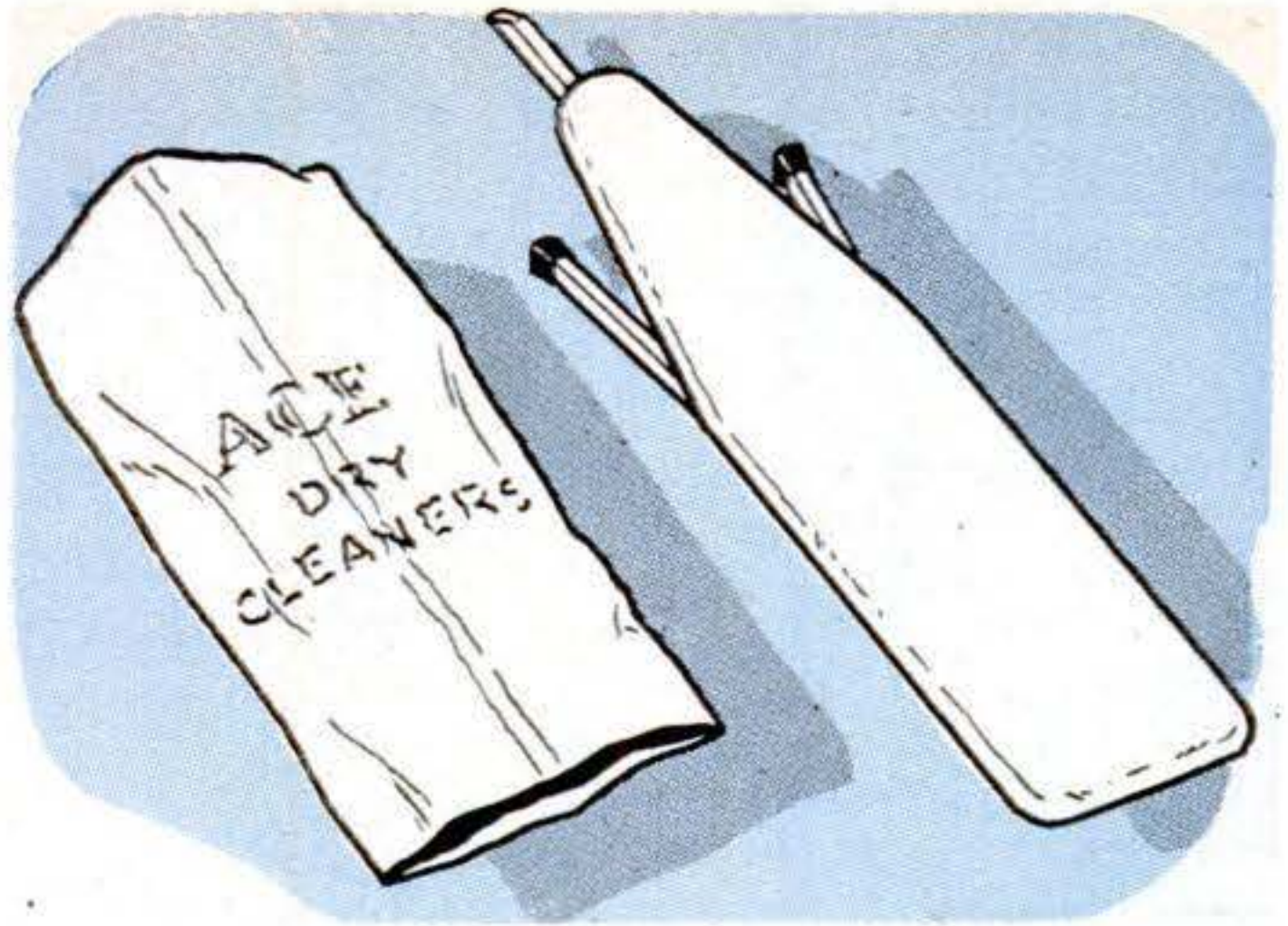

**Dust collects easily** on ironing-board covers, and just as easily gets into the clothes you press. Use the paper garment bags your cleaner sends dresses home in to protect the board.

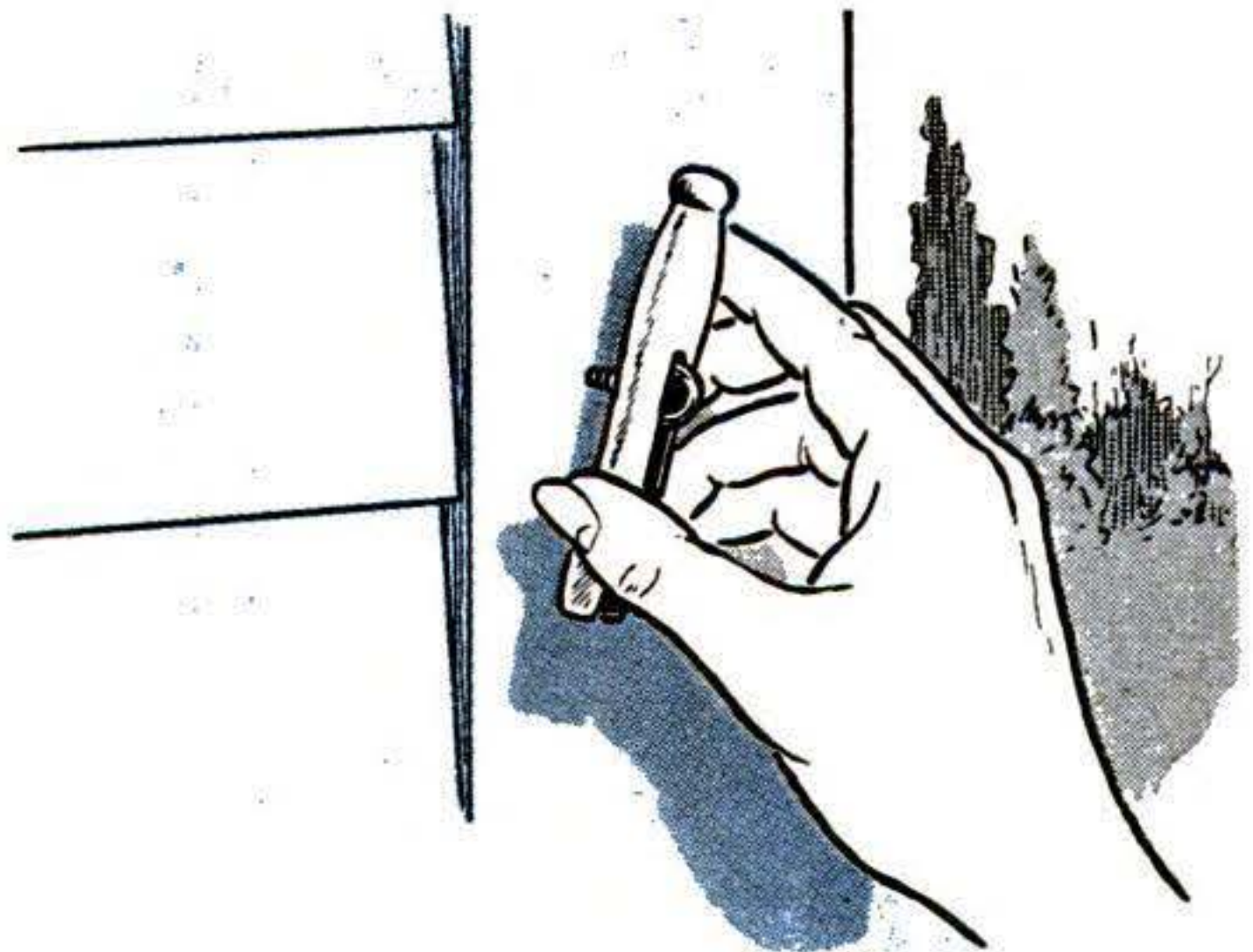

**There's no need** to turn out the tool box when you have to drive or tighten screweyes, cup-hooks, or the like. A wooden clothespin used as shown provides ample leverage for the job.

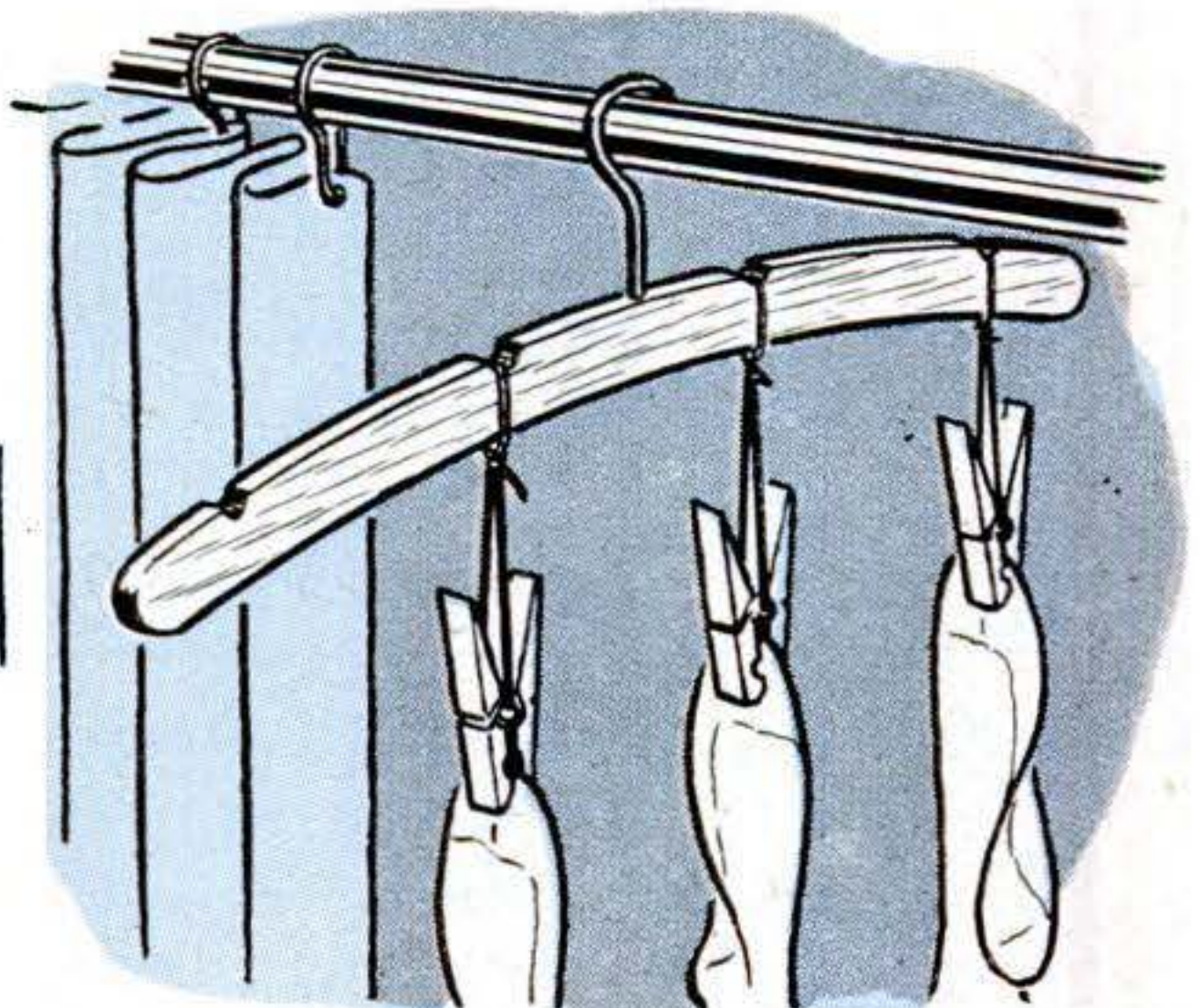

**A stocking drier** can be made from spring-type clothespins and a wooden hanger. File notches in the hanger, run a string through the spring coil of each pin, and tie to the hanger.

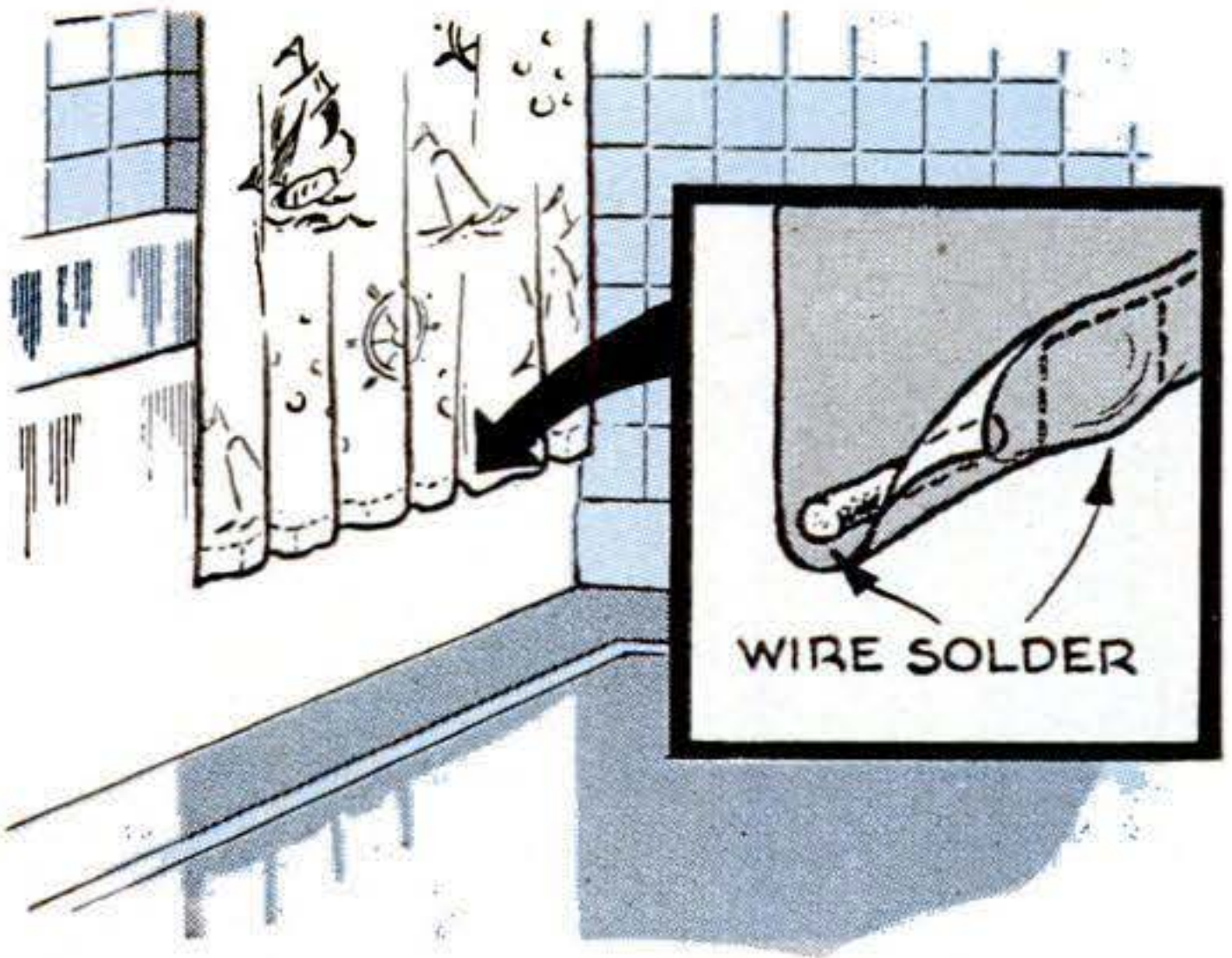

**Shower curtains**, especially the newer plastic type, tend to billow and blow when a window is opened or the water turned on. Tucking small weights into the hem will hold them still.

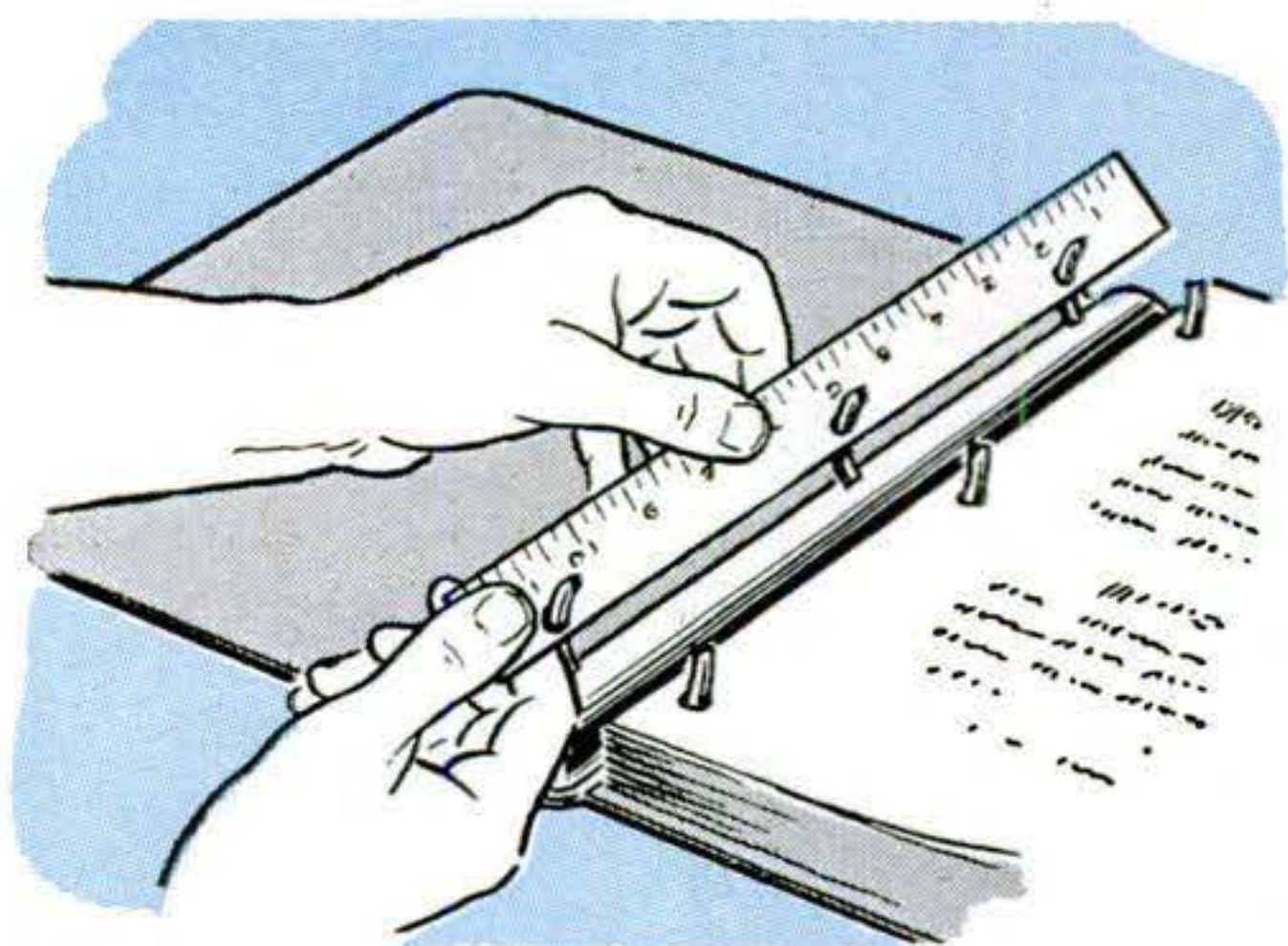

**The student** who occasionally needs a ruler can keep one at hand by drilling holes in a thin plastic, metal, or wooden ruler, and slipping it over the rings of his loose-leaf notebook.

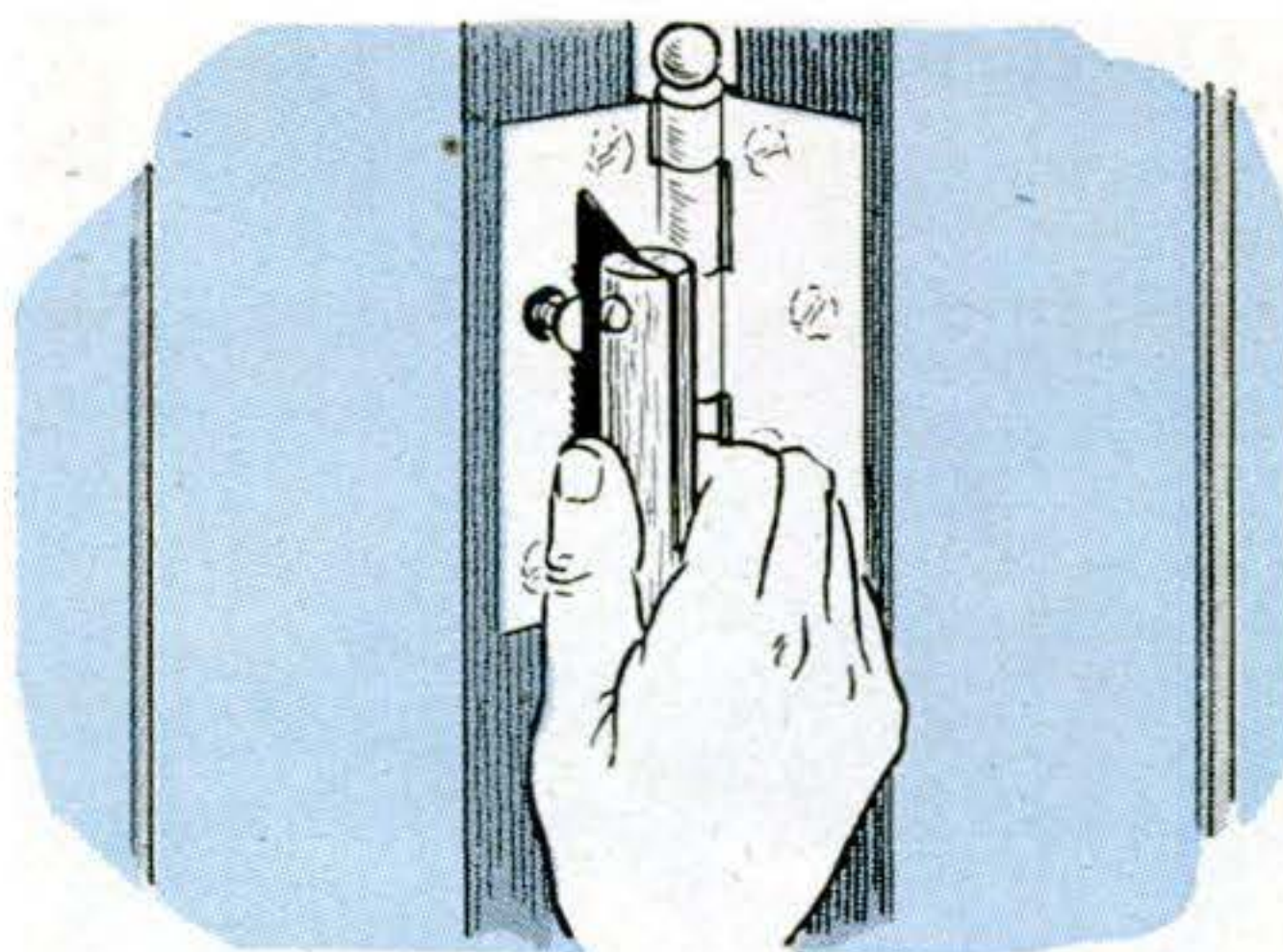

**A piece of hacksaw blade** clamped in a dowel is a good tool for removing paint-covered screws. Use the pointed end to get a start for the screwdriver, and then clean the slot completely.

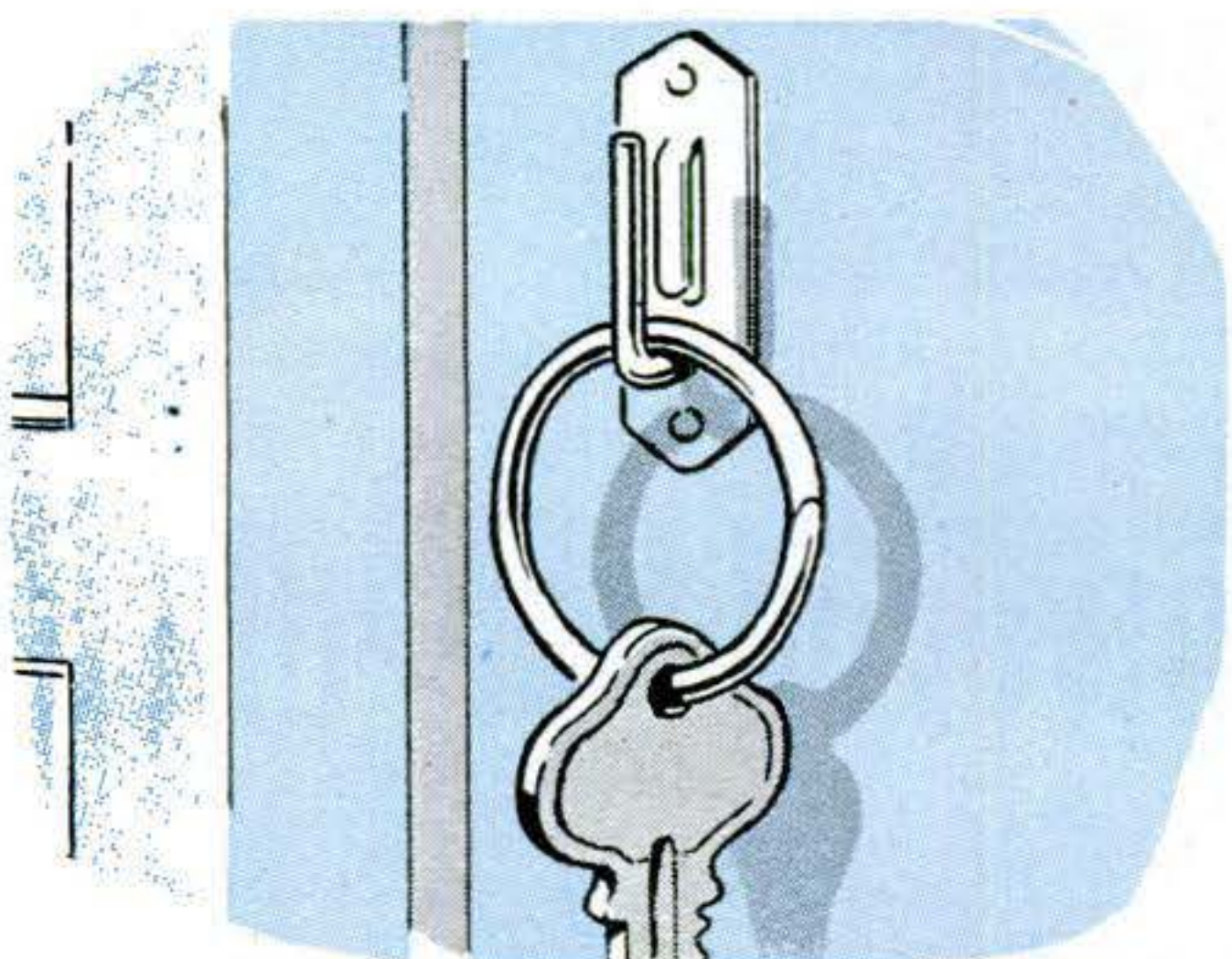

**A curtain-rod holder** of the type shown makes an excellent hook for a key ring. If the friction lug is bent out a trifle, there is little danger that the ring will be dislodged accidentally.



**A worn-out broom** may not sweep out much dirt, but as a shoe scraper it can keep some from getting into the house. Cut the bristles short, and nail the broom to the back step.



**Need more light** for shaving? Cut a mirror to fit inside one frame of a window like that

shown. Attach it securely with clear cellulose tape. Surrounding panes will give ample light.

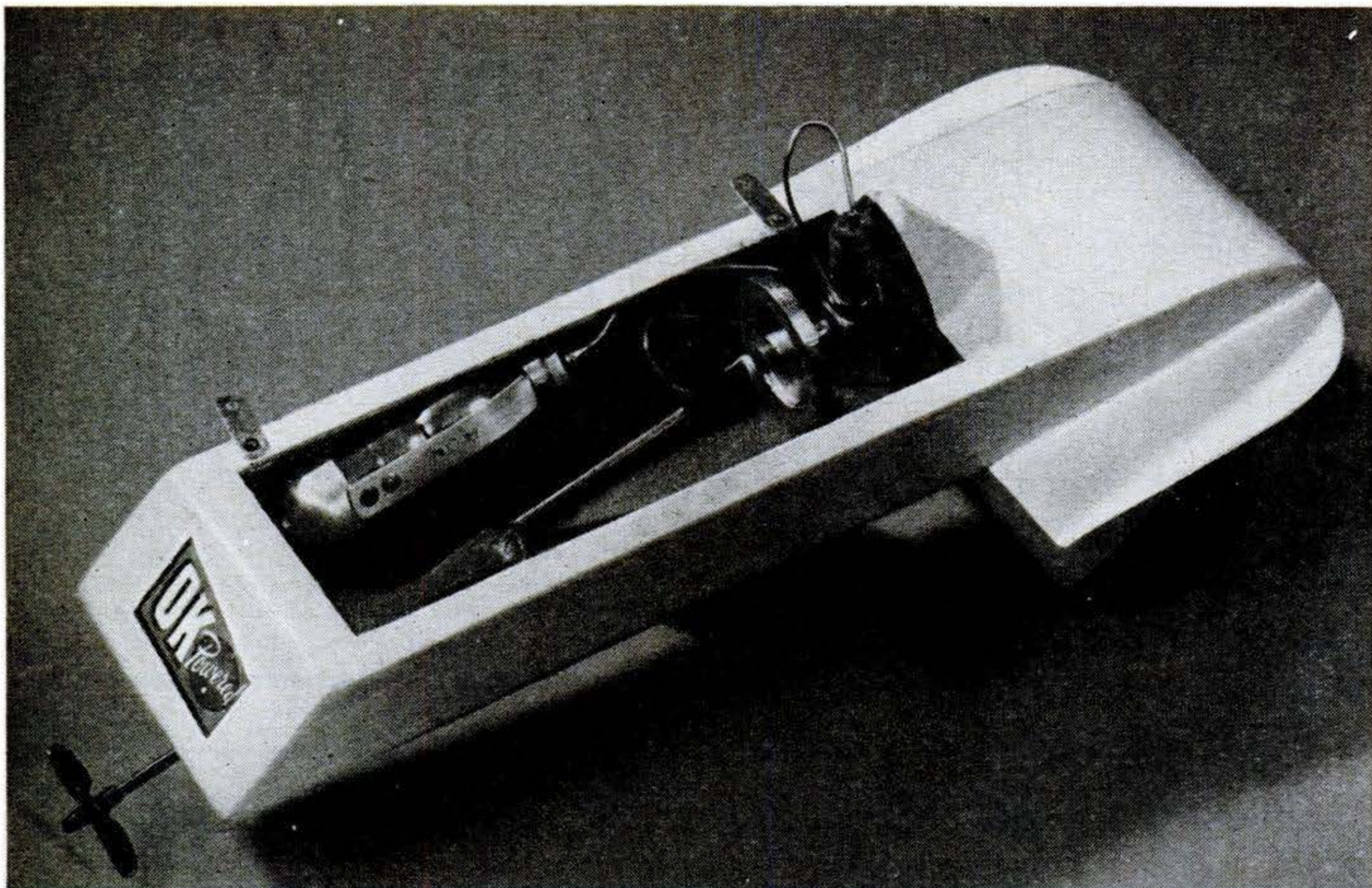

Weighing only a few ounces, this shipshape little craft skims the waves on soda-fizz power.

## Whizzer...A Fizz-Powered Speedboat

**T**HOSE bubbles that put ginger in your soda pop shove this midget speedboat along at a smart clip. Powered by a tiny expansion engine and carbon dioxide cartridges, the model is ideal for the youngster who can't yet deal with a gas job but wants

"a real engine." His father can turn it out in a hurry or supervise Junior at the job.

An adaptation of the Ventnor design, the hull is built in three parts. Begin by cutting the two sides from  $3/32$ " balsa sheet. These are 1" wide, with the point of the bow

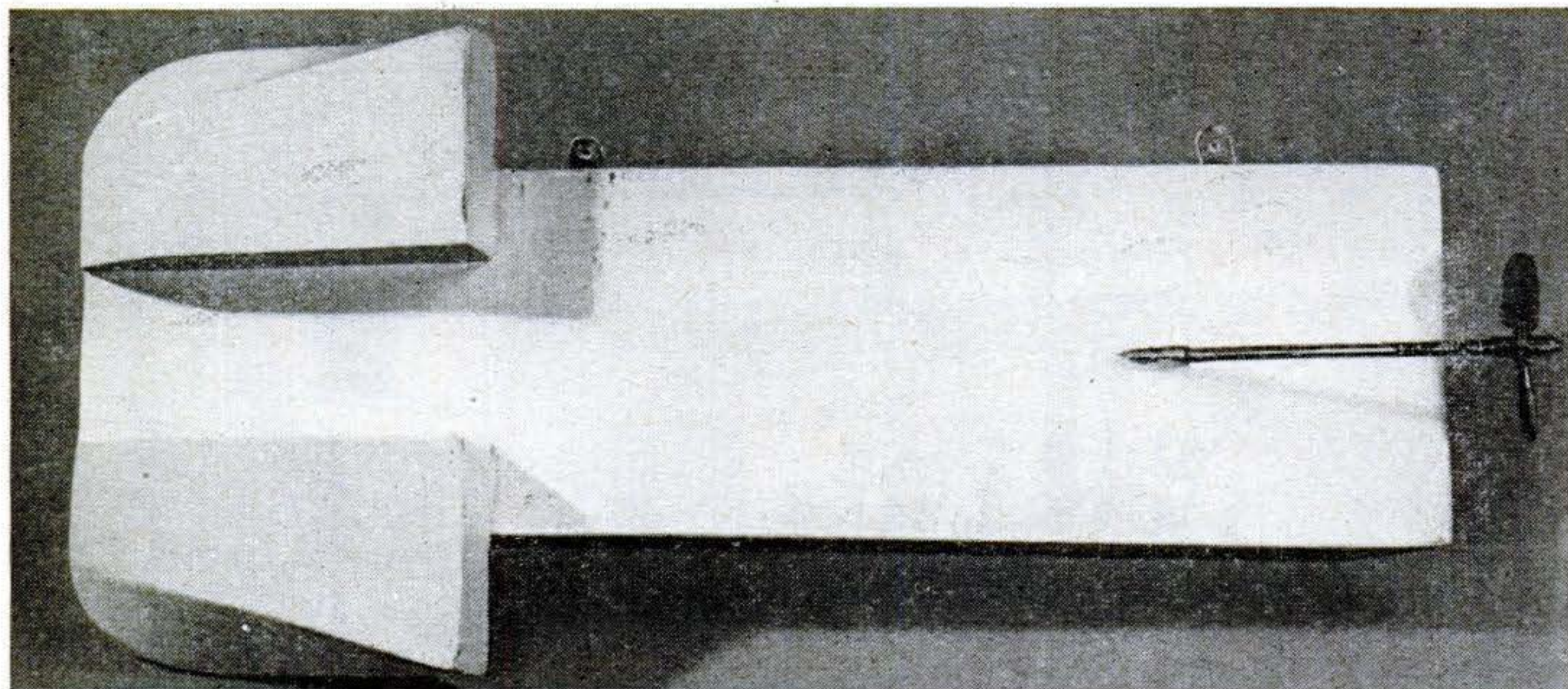

**Turned over,** the hull looks like this. Note the boxlike sponsons with their flared outer sides.

The shaft is aligned with the centerline of the hull. No shaft strut or other brace is required.



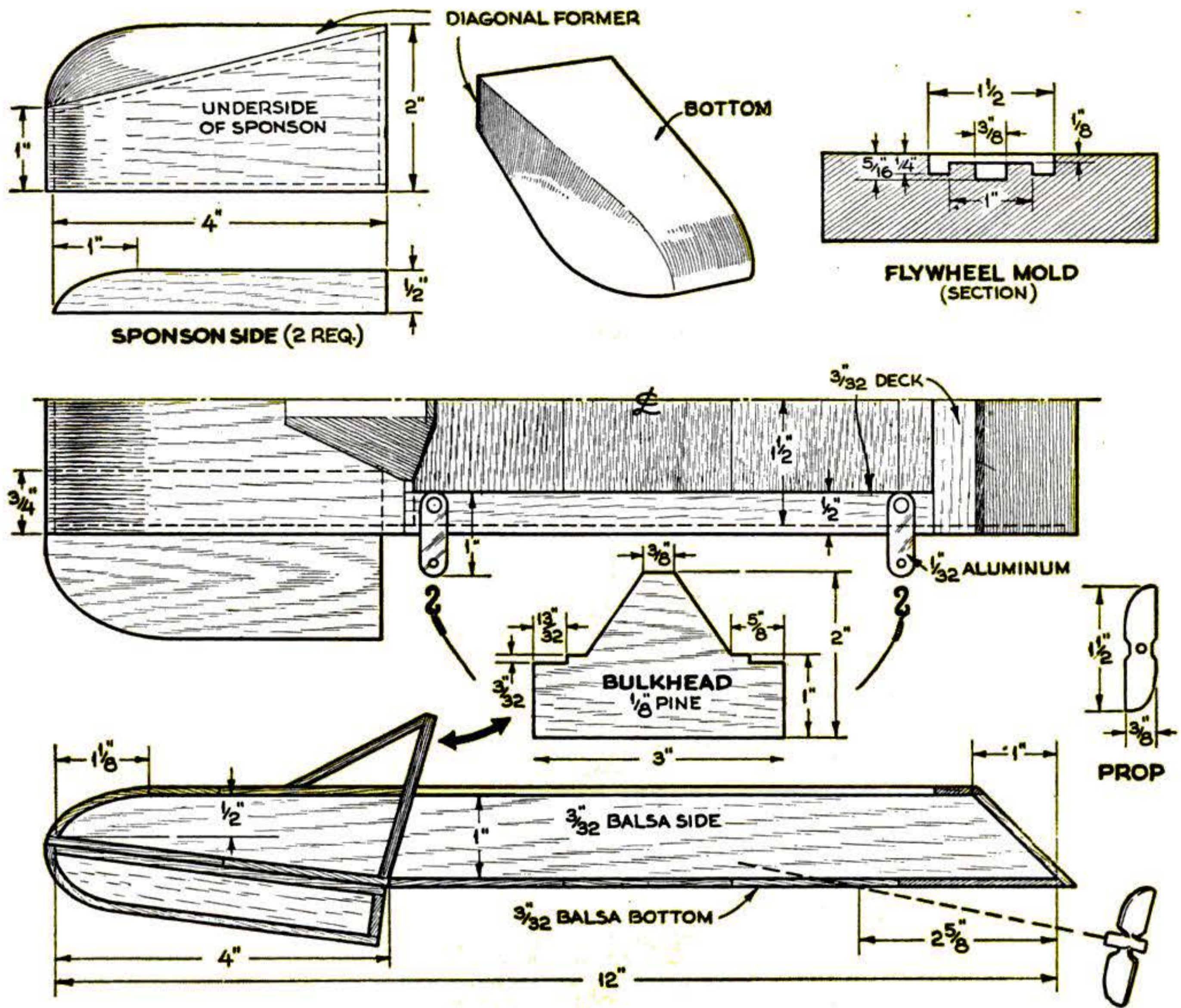

just midway. Cut both at once to be sure they're identical. Shape the bulkhead from  $\frac{1}{8}$ " pine or plywood and cement it and the  $\frac{3}{32}$ " by  $1\frac{7}{16}$ " by 3" balsa transom between the sides. Cement  $\frac{3}{32}$ " sheet balsa over the bow curve back to the bulkhead; then add the strut forward of the bulkhead and cover with sheet on both sides. Cement on the bottom and the gunwales.

For the two secondary hulls or sponsons, cut identical sides, tops, and ends. Cement these into boxlike structures and attach the bottoms, propping these up with tiny struts to maintain a uniform curve forward. Be sure they're square and that you've built one right and one left sponson. Apply cement freely to the edges of the open sides and press on  $\frac{1}{16}$ " sheet balsa so that it takes on the curve necessary. When the cement is dry, trim the edges. Cement the sponsons to the main hull, properly aligned with it and each other. Cover the hull outside with model-plane tissue held on with dope. Finish with four coats of colored dope. Protect the interior with several coats also.

If you can't find a suitable flywheel, turn

a mold in dry wood to the dimensions shown. Remove it from the lathe but not from the faceplate, pour in type metal or solder, and remount in the lathe to face off and drill.

Mount the engine with small wood screws so that the flywheel clears the bottom. Cement a 2" length of  $\frac{1}{8}$ " i.d. brass tube in a hole  $2\frac{5}{8}$ " from the stern and build up composition wood around it; be sure it's lined up with the engine shaft. The propeller shaft is  $\frac{1}{8}$ " brazing rod. Cut the propeller from sheet copper or brass, bend it to shape, and solder it on between bits of tubing.

For a universal joint, cement a bit of Neoprene ① gas-line tubing on the engine and prop shafts after cleaning them with dope thinner. Locate the cartridge holder under the gunwale on the left side (if the prop is to run counterclockwise) to counteract engine torque. Attach tether clips with 2-56 screws and nuts, and use a line 15' long.

At some high-speed valve settings you may have to use a strap around the flywheel to start the engine. Never try to do so by turning the propeller with the fingers.—Roy L. Clough, Jr., Terryville, Conn.



## NEW TOOLS

**Tool Rack Adjusts.** Here's a tool rack consisting of hardwood blocks that slip firmly into an aluminum back strip attached to the wall or bench. Various drilled, counterbored, and slotted for most of the small hand tools you'd commonly use, the blocks may be assembled on the back strip as desired. Priced at about \$2, the rack is a product of Davis Development Company, of Colorado Springs, Colo.

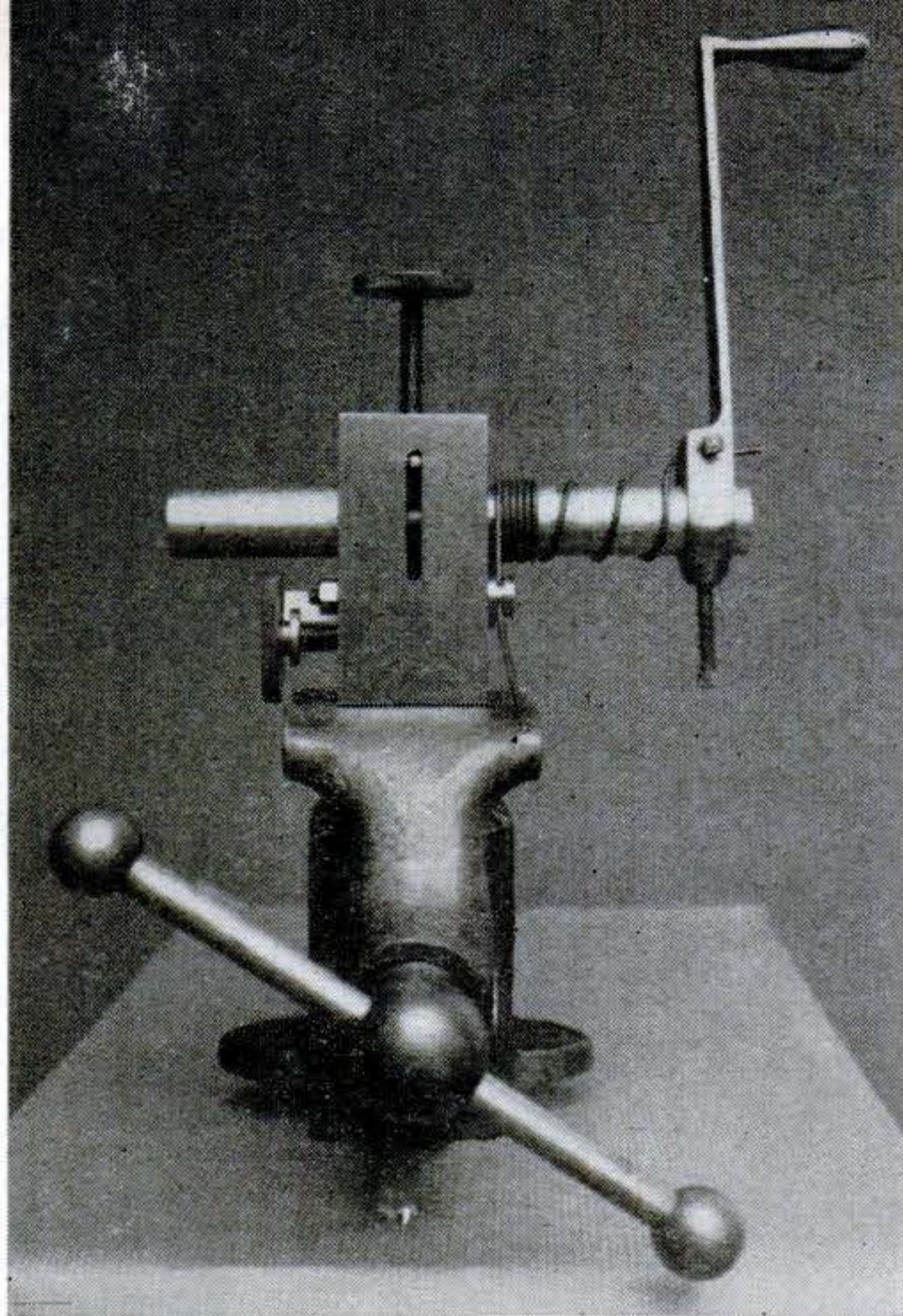

**Winds Springs by Hand.** Short lengths of drill rod are used as mandrels in a hand spring winder produced by the Blaner Manufacturing Co., of Sharon, Pa. Designed with an undercut so that it may be clamped in a bench vise, the tool will produce either close springs or compression springs, depending on whether the crank is set close in or far out on the mandrel. The winder is made in four sizes.

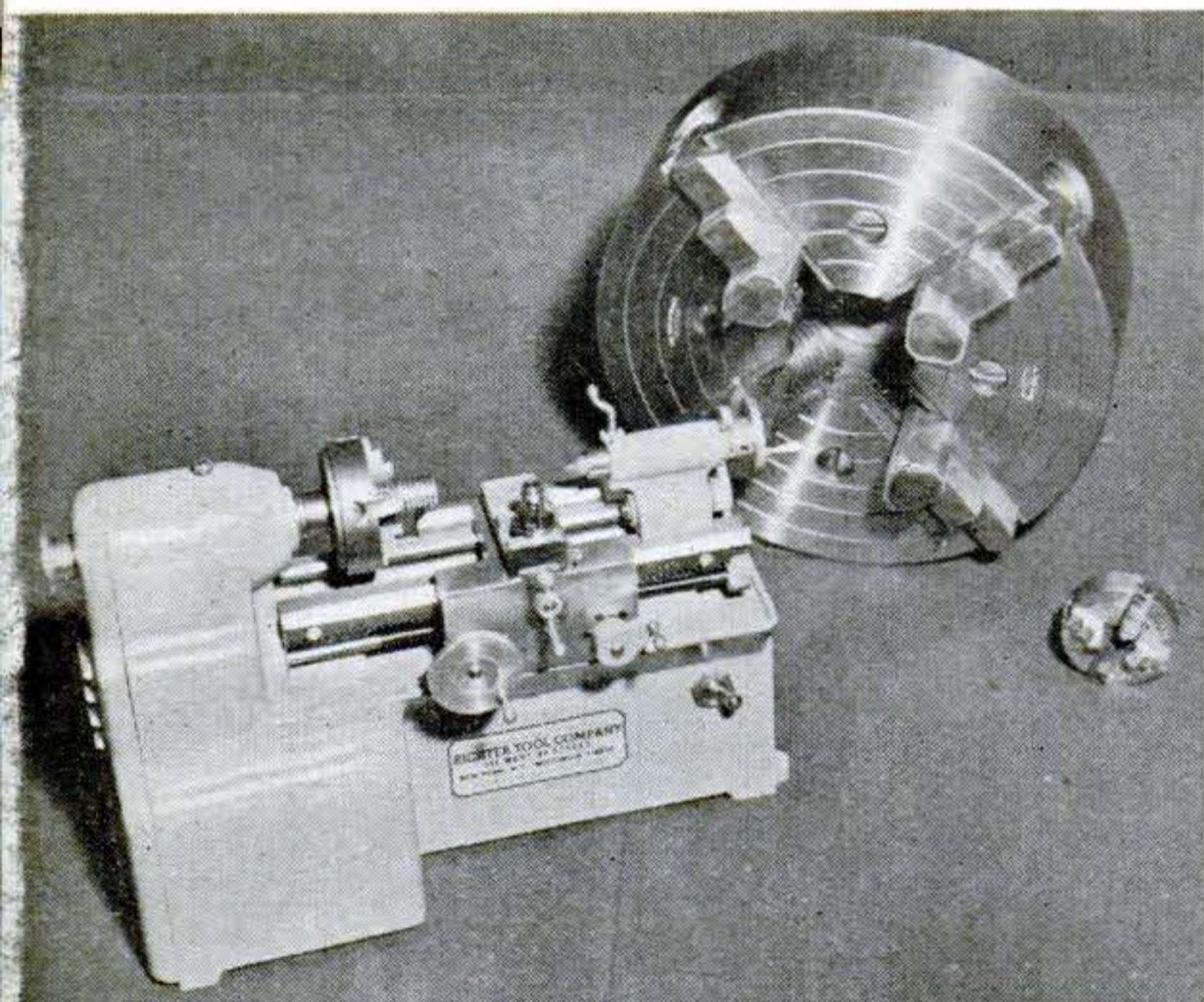

**Lathe Only 9" Long.** Designed for precision work on small parts, this midget lathe is driven by a 115-volt AC motor mounted in the base, and has a spindle with a 3/16" through hole. Maximum swing over the bed is 2" and maximum distance between centers is 3". Power carriage feed, two spindle speeds, and ground V-ways are other features. Small Machines, Inc., of Los Angeles, is the maker.

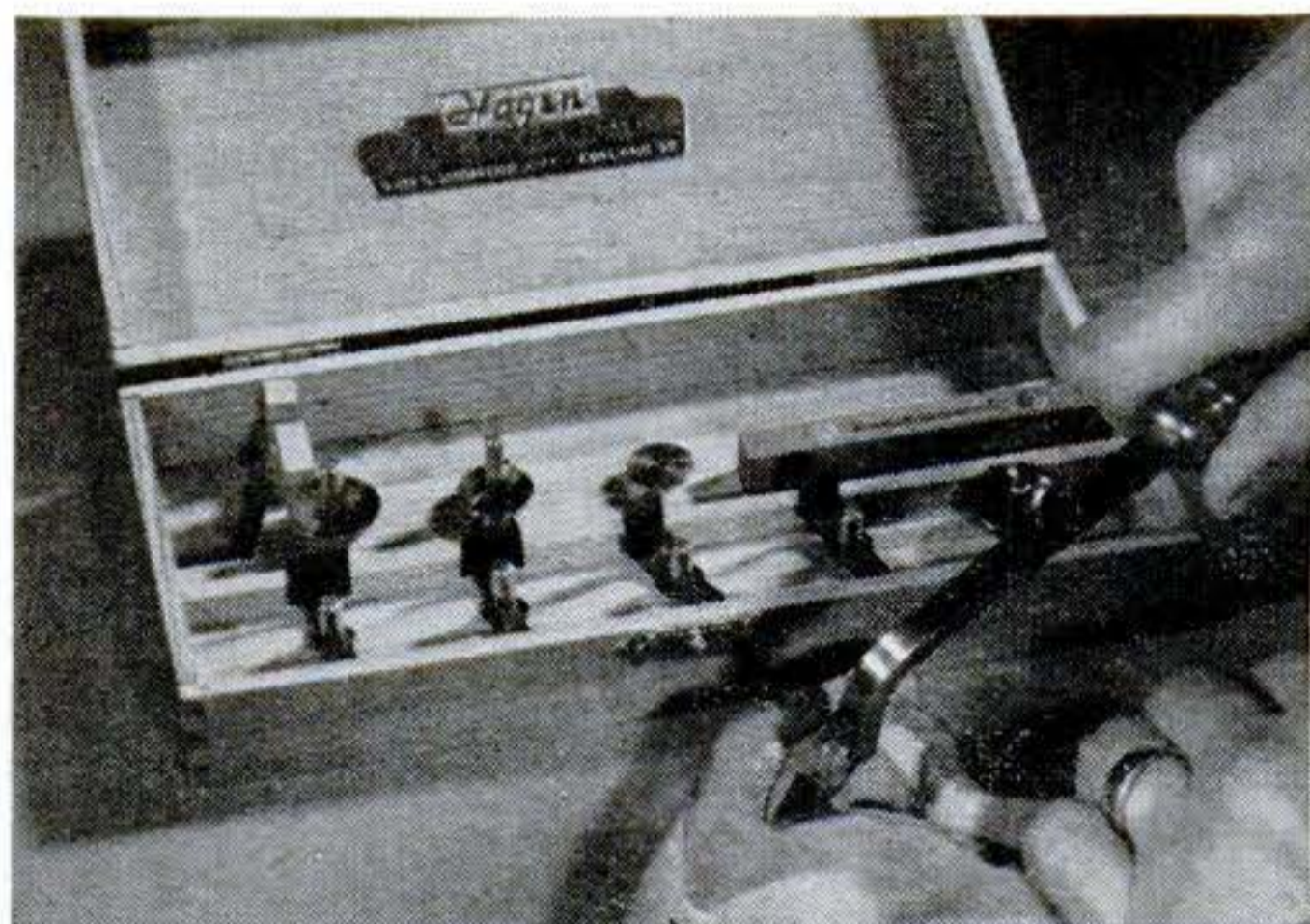

**Carving Set Uses Round Blades.** This new carving set consists of a handle and eight cutters, three of them conical. Since each cutter may be mounted either ahead or behind the curved end of the handle, the tool may be used in the manner of either a chisel or a draw knife. When a circular cutter gets dull in one spot, it may be rotated slightly to a sharp spot. Hagen Engineering, Chicago, makes the set.

# How I Built a Milling Machine

Semifinished castings enable a home machinist to turn out a precision tool, using a lathe and drill press.

By **Walter E. Burton**

**C**AN a craftsman of average ability build himself a milling machine? And if he does, can he expect that it will turn out precision work?

You bet!

In my shop there's a little bench mill that proves both points, at least to my own satisfaction. It also demonstrates that if you start as I did with semifinished castings, the entire job can be handled with just a 9" lathe and drill press.

Of course I could have made up a set of patterns, had them cast at a foundry, and

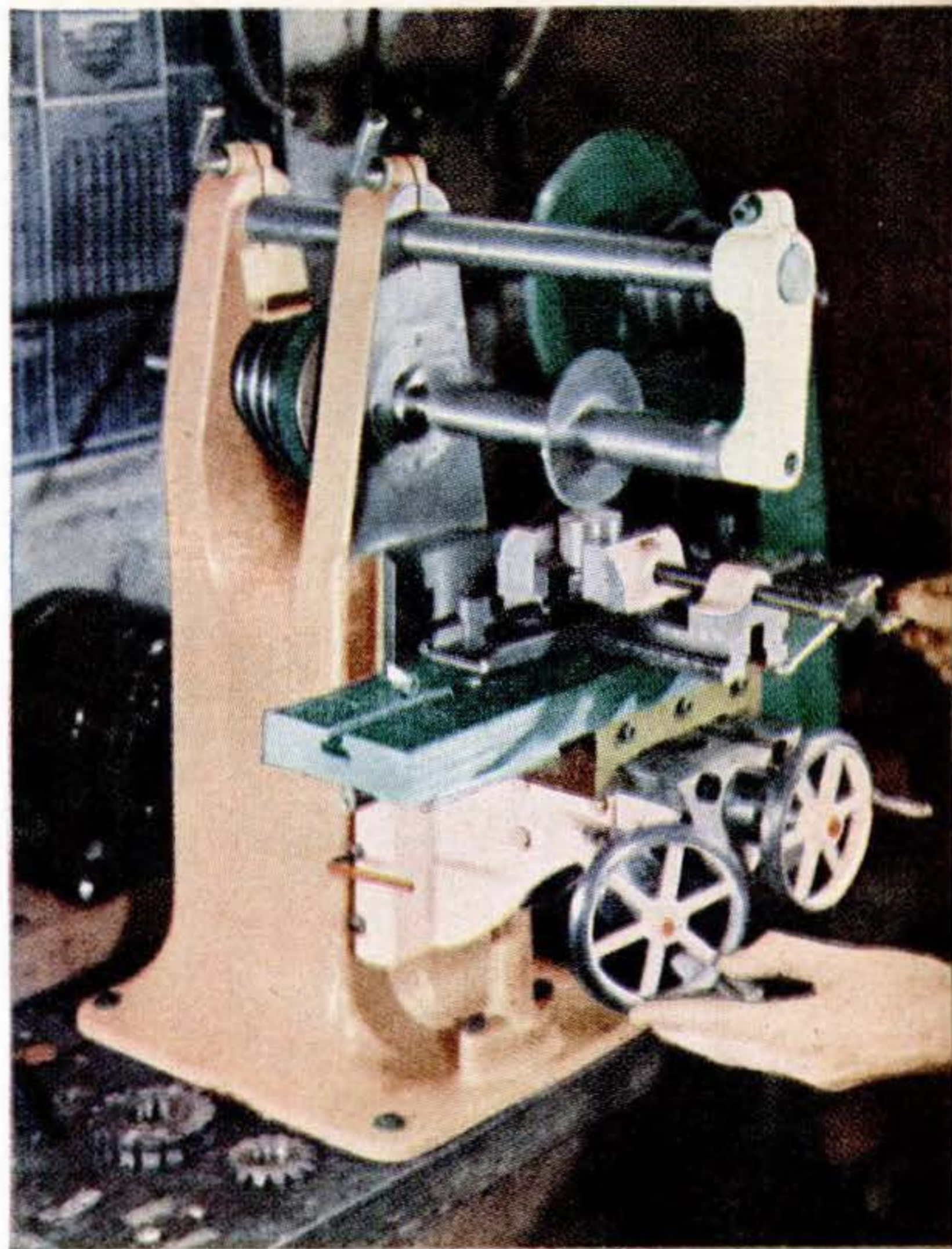

**This is it**—the finished mill at work. Below, an assembly blueprint furnished with castings.

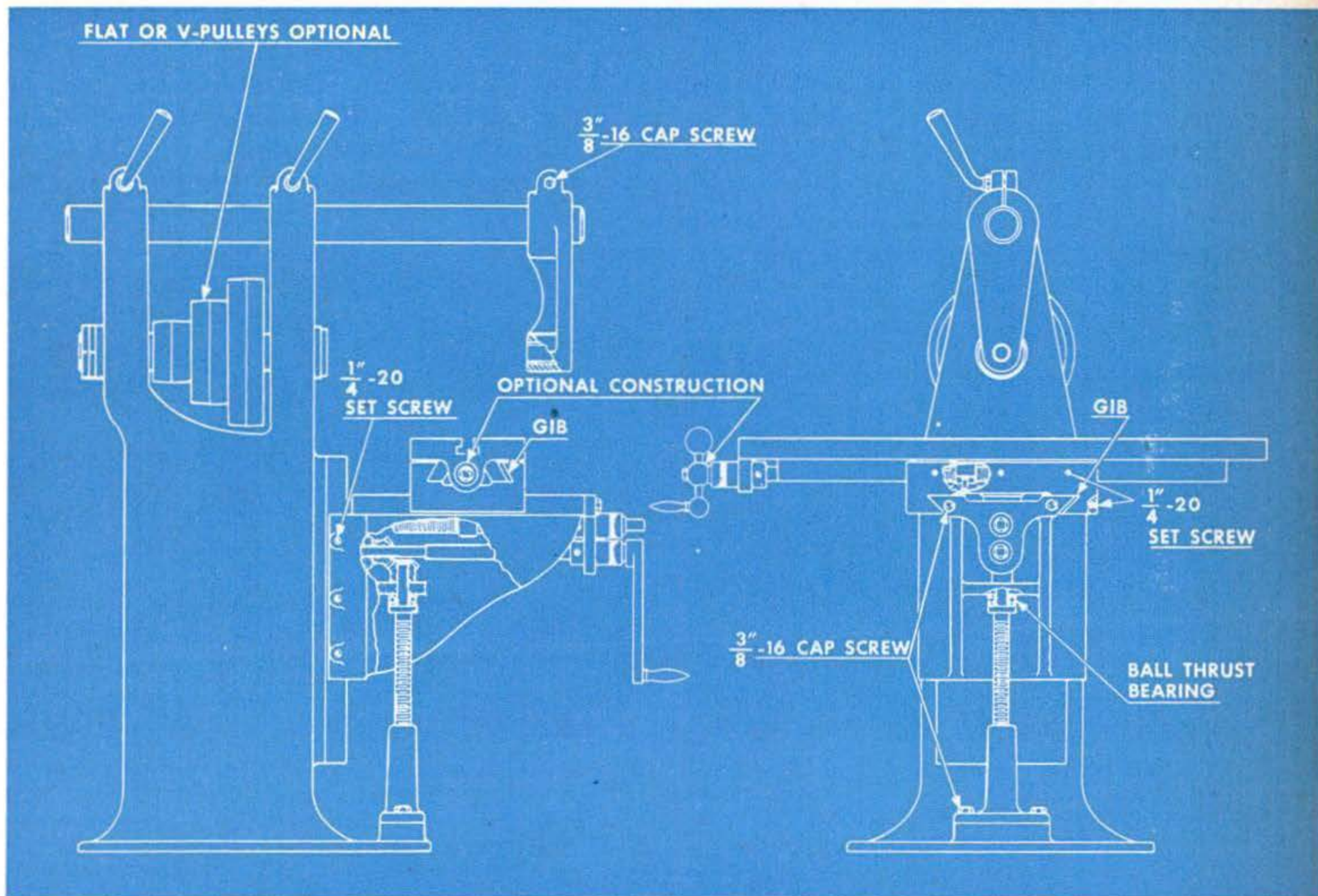

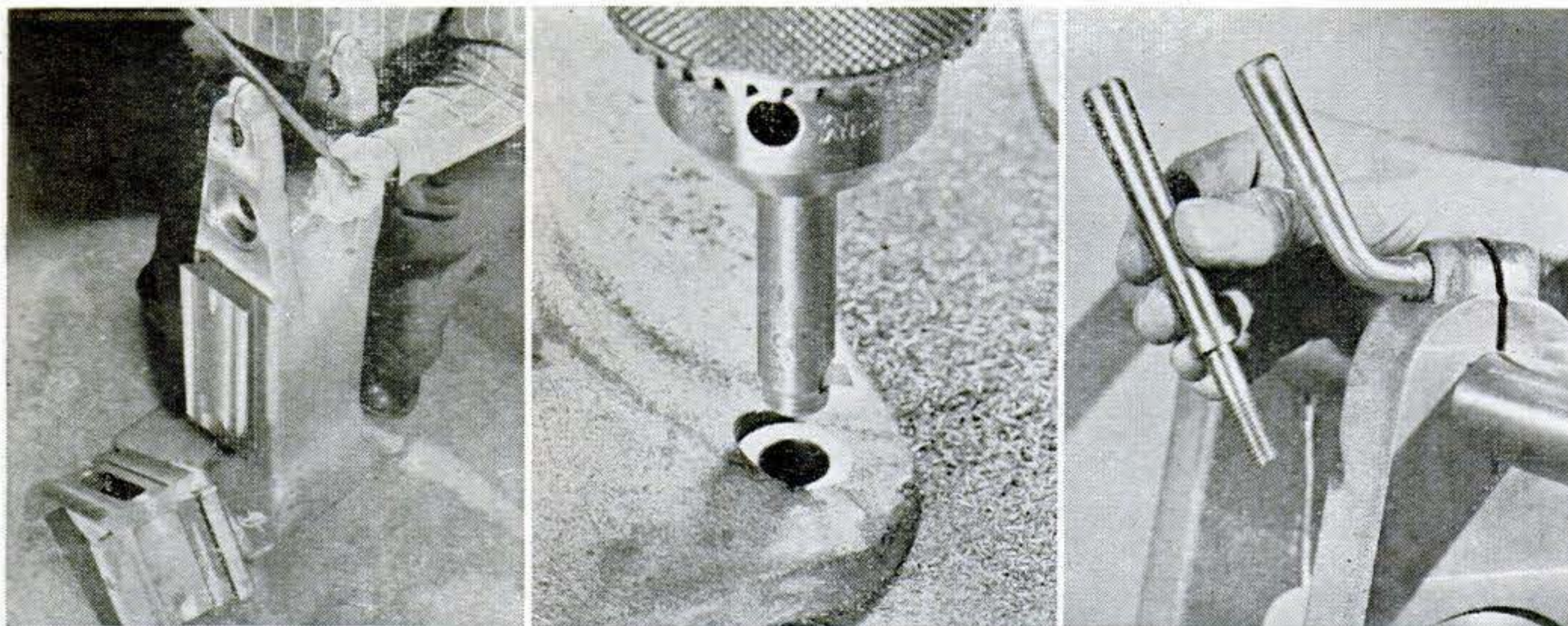

**File all rough spots** from the semimachined castings before starting assembly, and fill blow holes with either auto-body solder or suitable iron cement. Drill each corner of the column base for a  $\frac{3}{8}$ " or  $\frac{1}{2}$ " bolt, spot-facing (center) as necessary to provide a flat area for the head.

Overarm clamp screws are made by turning a handle to the shape shown above, cutting a  $\frac{3}{8}$ "-16 thread on the end, and then bending the handle until it makes an angle of about 110 deg. with the threaded part. Drill and tap the slotted projections for these.

begun from scratch. Apart from the extra labor this would have taken, I'd have needed a shaper, planer, or large milling machine to make the flats, dovetails, and T-slots that are already accurately formed on semifinished castings. As it was, there was plenty of nice, finicky machine work.

When you make your own machine tools, you always have the privilege of modifying the design and trotting out what ingenuity you have. This bench mill, I found, was no exception. Though the maker\* supplied good prints, I departed from them in numerous small ways: micrometer dials were made extra large, permanent handwheels

replaced the crank, and the table-elevating control sprouted out in an entirely new and (I think) better place.

Let's assume you've ordered a set of semifinished castings and the necessary steel bar stock, bronze nut blanks, and bearings. The first step on the main casting is to file down all rough edges and fill any blow holes with solder or iron cement. Drill and spot-face mounting holes in the base, and drill and tap the slotted projections at the top that lock the overarm. Don't forget to open out the left sides of these holes screw-clearance size to get clamping action.

The overarm bracket that forms the out-

\*The Lewis Machine Tool Company, Los Angeles.

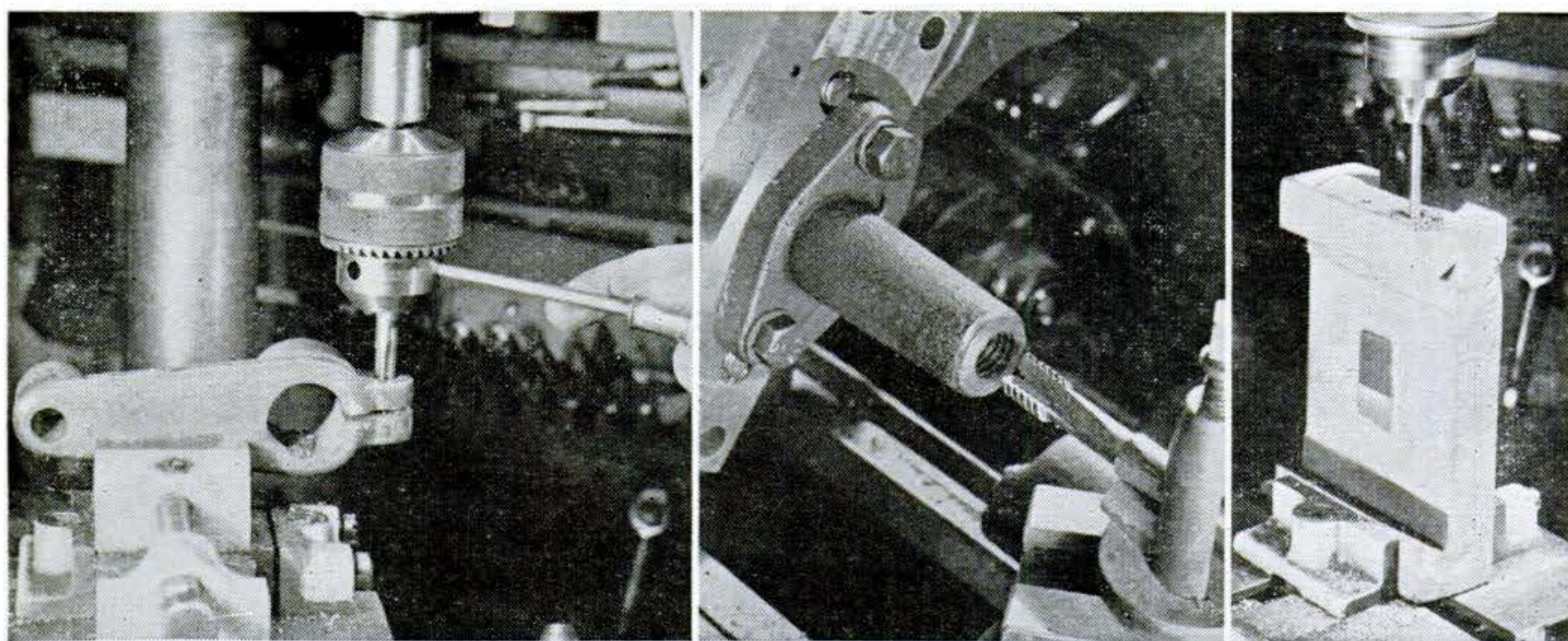

**Bore a  $1\frac{5}{16}$ " hole** in the larger end of the arbor-support casting, slot it, and provide a  $\frac{3}{8}$ "-16 locking bolt. Thread the lock-screw hole as above, turning the tap by inserting a rod or Phillips screwdriver in the chuck. In the smaller end, bore an oversize hole, press in a bronze

bushing, and ream to  $\frac{1}{2}$ ". Acme threads for the elevating screw are roughed out with a single-point tool and finished with a homemade tap (center) cut with the same gear setup. Drill and tap holes in the saddle casting for the gib screws, as at the right.

board arbor support is bored out, slotted, and tapped for a clamping capscrew. (A long locking screw might be a hazard here.) The hole for the arbor bearing should be located carefully; it must have a center-to-center distance with the upper hole that corresponds precisely with the same holes on the main casting. Press in a bronze bushing, but don't ream it yet.

Three lathe-turned screws are required to control table movement, the longitudinal and elevating screws having right-hand threads, and the transverse feed screw being left-hand. They should preferably have standard Acme threads, although V-threads will do. Cut them carefully on the lathe, using a follower rest. While the nuts that fit on these screws may be threaded with single-point tools in the lathe, it is better to make the finish cuts with taps. I made three special taps of cold-rolled steel while the lathe was set up for cutting the screws, case-hardening the cutting edges.

After the two bronze feed nuts have been threaded, drill and tap each for 10-24 mounting bolts and face off their bases. If you use handwheels rather than the crank, the distance between the cross-feed screw and the bottom of the saddle can be greater than the blueprint indicates.

Drill an  $11/16$ " or  $3/4$ " hole in the projection at one end of the table casting for the longitudinal screw. Install a flanged bronze bushing and ream it for the  $1/2$ " screw shank. The thrust in one direction is between the bushing flange and the micrometer collar; in the other direction it is between the inner end of the bushing and a small collar mounted on the screw. You can install the table with the crank at either side.

The vertical-feed screw operates in the threaded post bolted to the base of the main casting. Its upper end extends through a web that forms a part of the knee casting. Drill and ream the web to receive the  $3/8$ " portion of the vertical screw, spot-facing both ends of the hole. The weight of the knee is borne by a ball thrust bearing between the web and the elevating-screw shoulder. On the upper end of the screw one of a pair of steel miter gears is secured by means of a taper pin.

Alternately, the bearing might be arranged in the knee web by drilling an oversize hole and mounting under it a  $3/16$ " by 1" by 1" brass plate with a reamed  $3/8$ " hole and four  $1/4$ " corner holes for 8-32 mounting bolts. The oversize mounting-

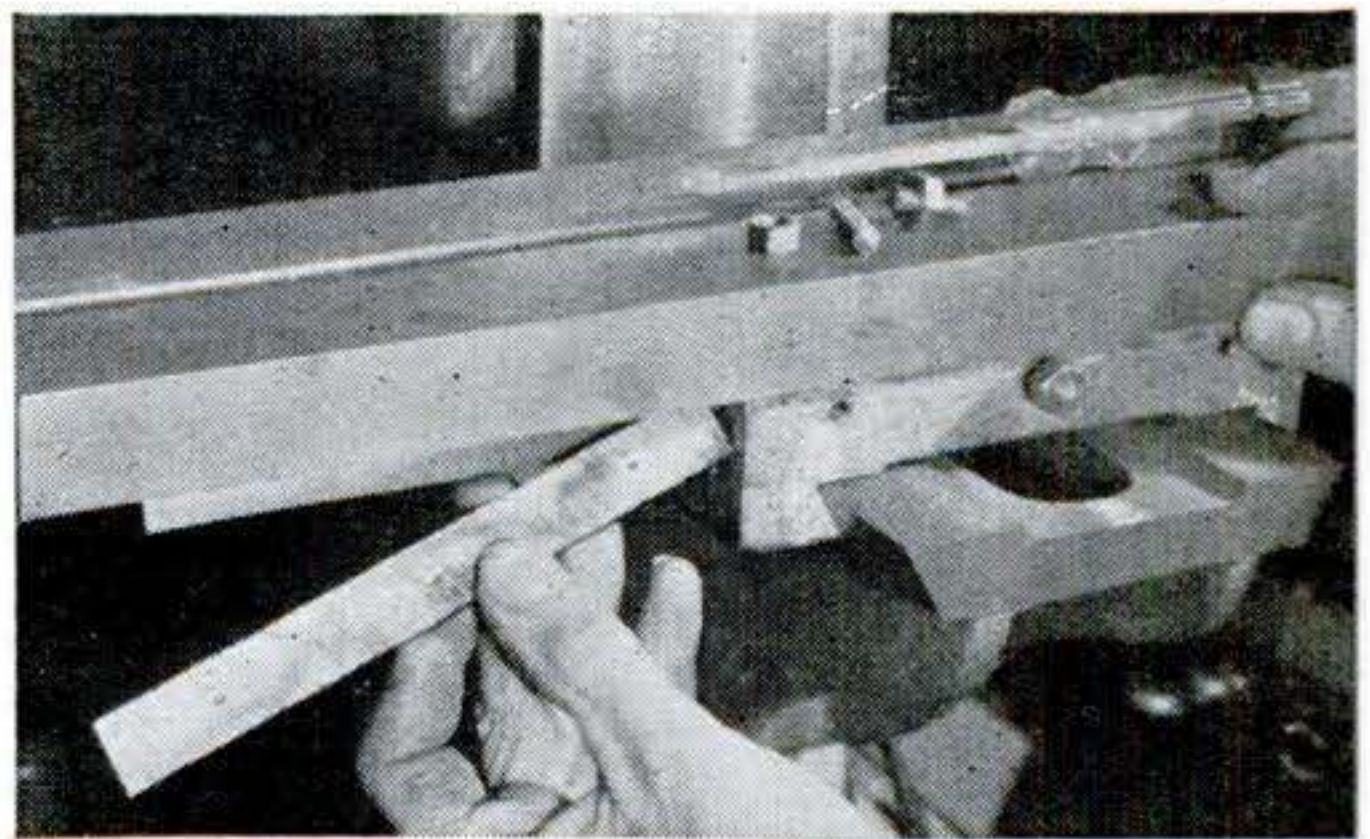

Gibs are cut to length from steel strips and their edges are beveled to match the dovetail angles. After placing the gibs in position, spot-drill each to receive the screw points.

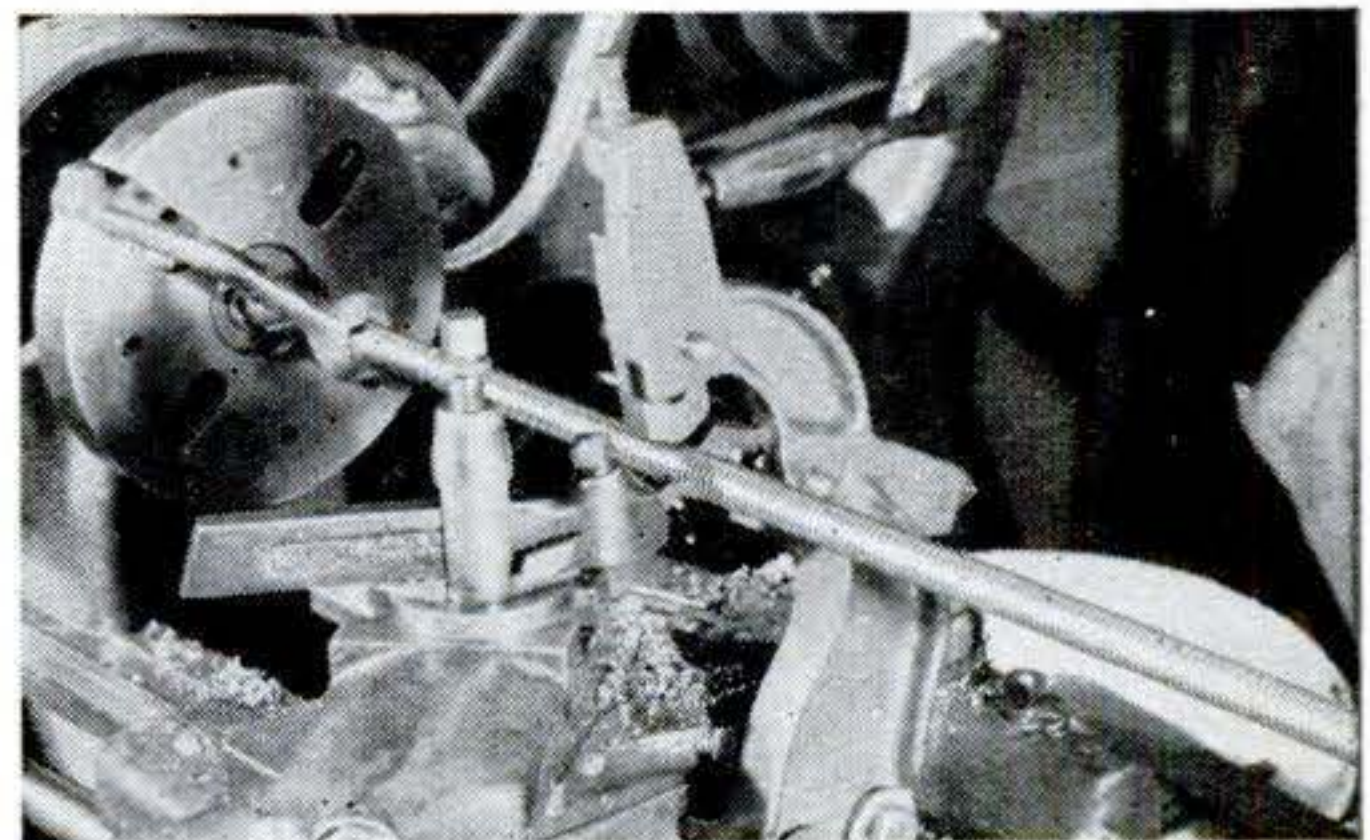

Use a follower rest in cutting threads on the longitudinal feed screw. Standard V-threads will serve for this and the other two table-control screws, but Acme threads are better.

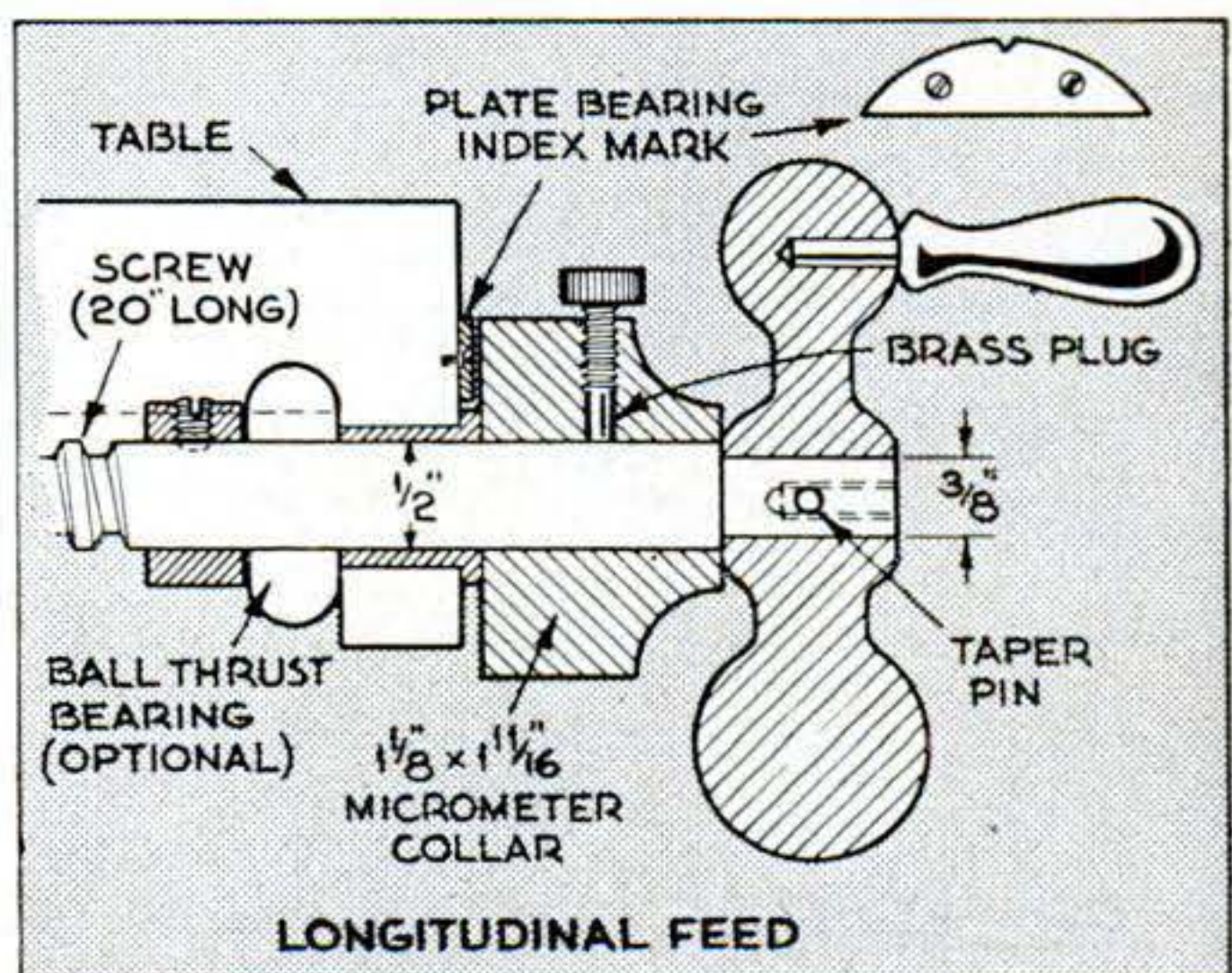

screw holes would permit the plate to be shifted to obtain perfect alignment of hole and elevating screw. Then the plate bolts could be tightened.

The second miter gear is mounted on a  $1/2$ " shaft that extends outward at an angle of about 30 deg. through a  $3/8$ " diagonal hole in the side of the knee casting. This elevating shaft rotates in two bronze bushings in the ends of a  $6 3/8$ " length of  $11/16$ " i.d. tubing. Solder a steel collar with an index

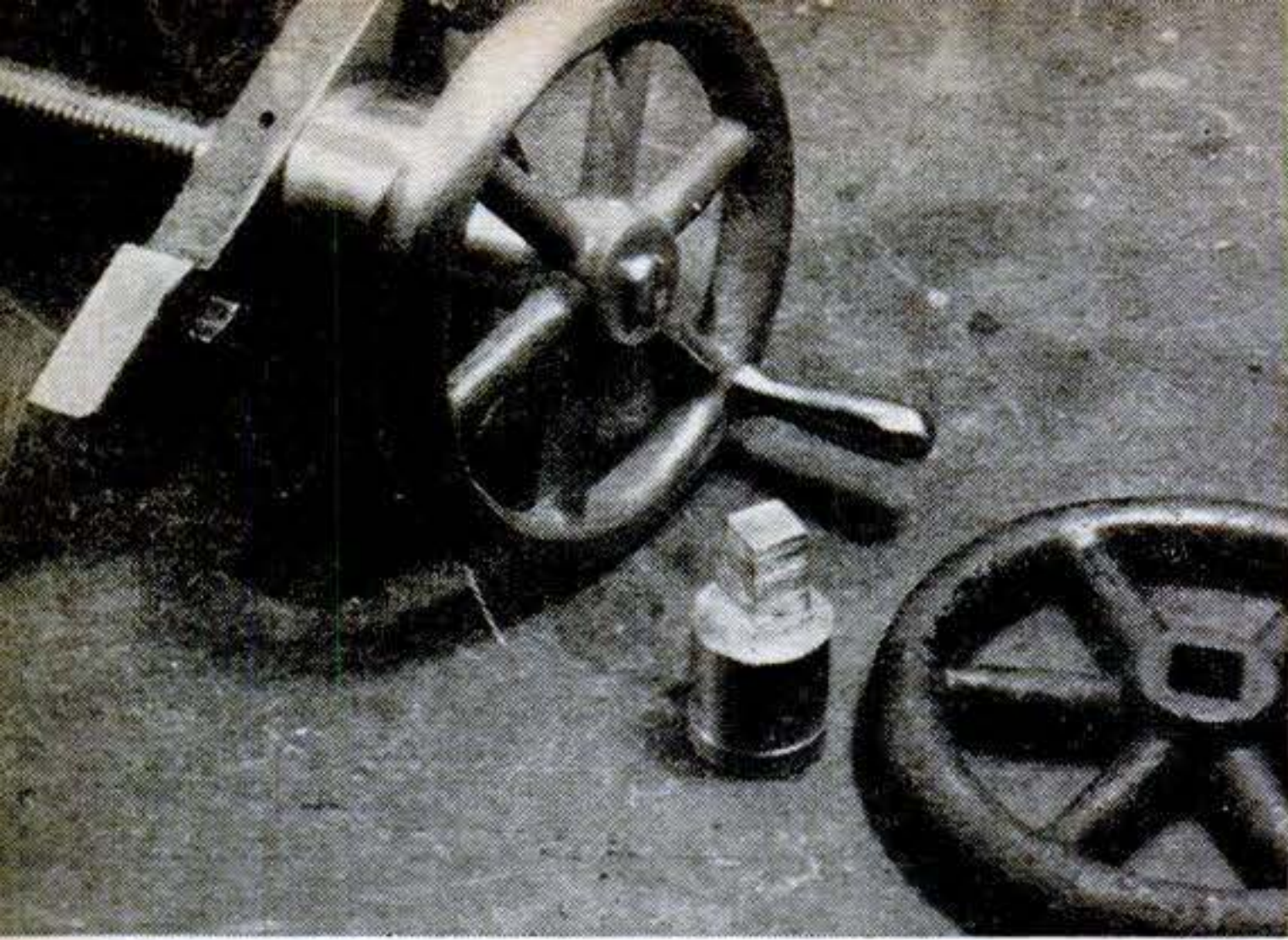

The cross-feed screw is supported at its outer end by a casting attached to the knee dovetail with two  $\frac{3}{8}$ " bolts. A handwheel was machined from a 4" valve wheel like the one at right.

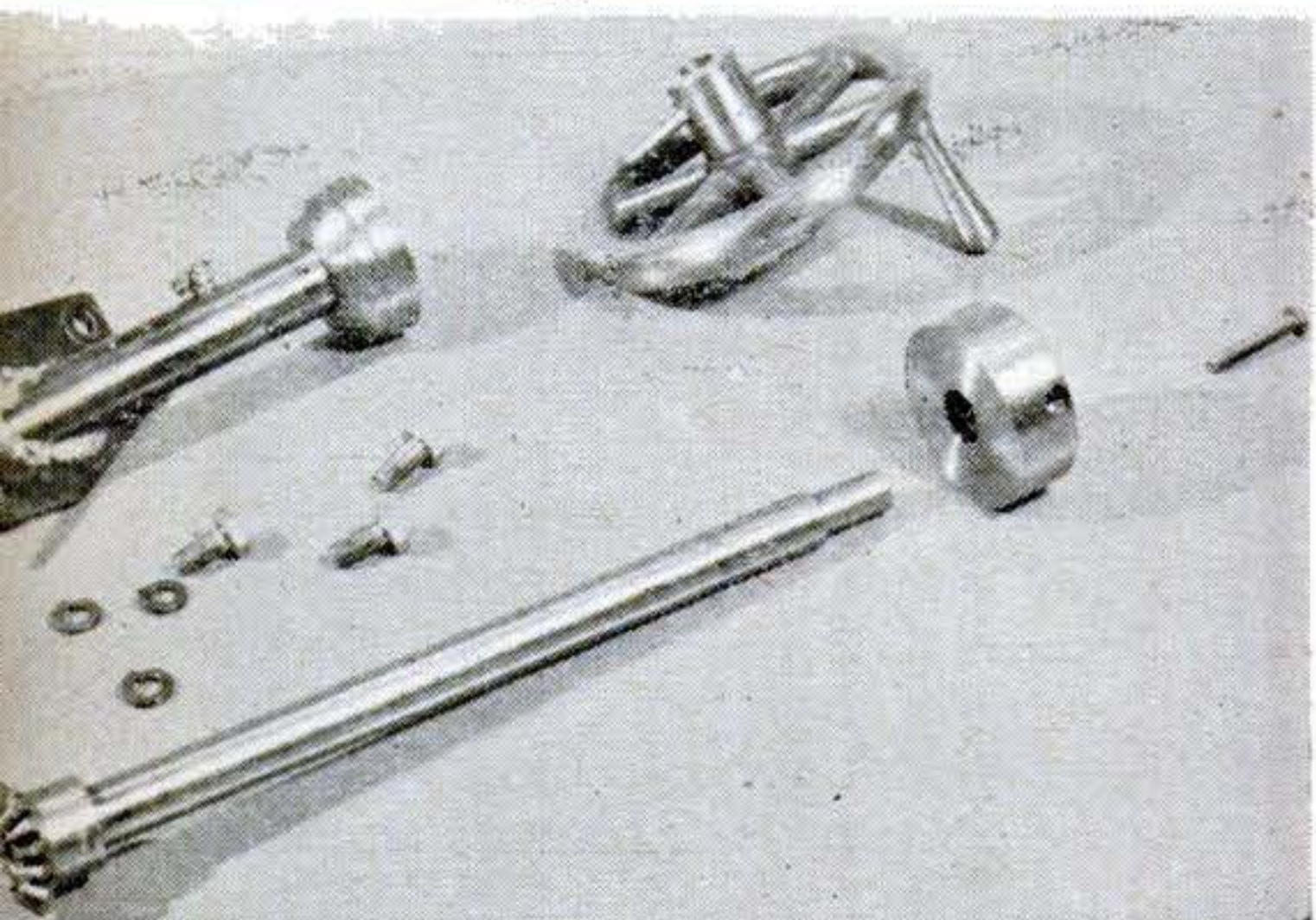
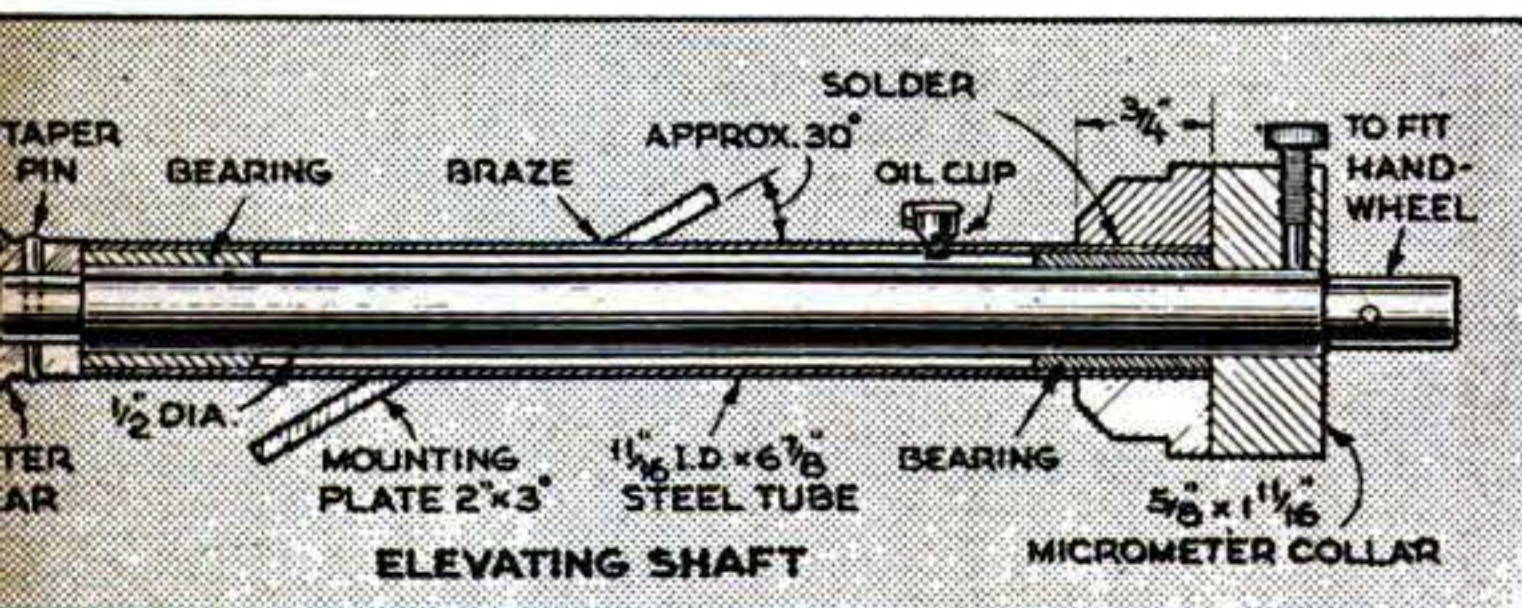
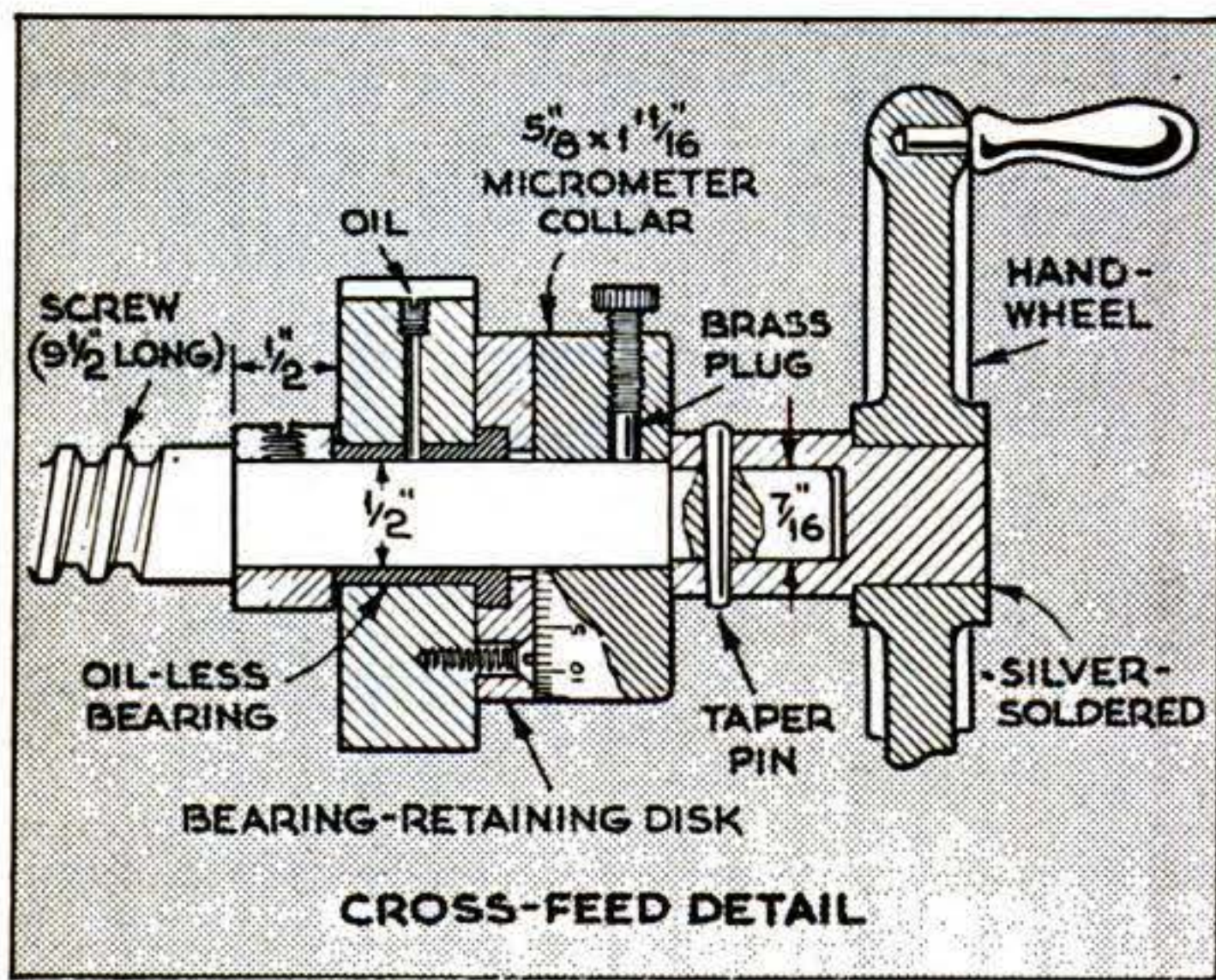

Three  $\frac{5}{16}$ " bolts attach the elevating-shaft mounting plate to the side of the knee casting, a  $\frac{7}{8}$ " diagonal hole being bored through the casting itself for the tubular housing.

mark to the outer end of the tubing.

A ball crank is installed on the longitudinal feed screw. If the elevating shaft is brought out at an angle, permanent handwheels can be used on the vertical and horizontal controls. These might be cast at home, using a lathe tailstock wheel as a pattern, or made from 4" cast-iron valve handles.

For the micrometer collars cut disks from a cold-rolled or stainless-steel rod, drill a center hole, and ream it to  $\frac{1}{2}$ ". About  $\frac{1}{4}$ " from one end of each blank, tap a hole for a  $\frac{1}{4}$ " setscrew. With this screw, lock each blank in turn on a true-running mandrel and machine it to a diameter of approximately  $1 \frac{11}{16}$ " and a suitable length.

Each collar has 100 divisions, every tenth one being numbered. These graduations may be cut by locking the collar with a setscrew on an arbor in the lathe chuck or collet. If your lathe doesn't have provision for indexing, mount a 100-tooth gear wheel between the collar and headstock. Devise a plunger to fit between the gear teeth so it will hold rigidly yet can be backed out as needed.

Mount a tool bit ground to a slightly flattened point, and lock the compound rest parallel to the lathe bed. Set the tool to plow a neat furrow in the collar blank when moved toward the headstock.

Although the micrometer scale on the compound rest may be used to control the lengths of the lines, an easy way is to use pieces of steel rod as stops to limit carriage movement. After the lines are cut, remove the collar from the mandrel and stamp the numerals.

TO BE CONTINUED

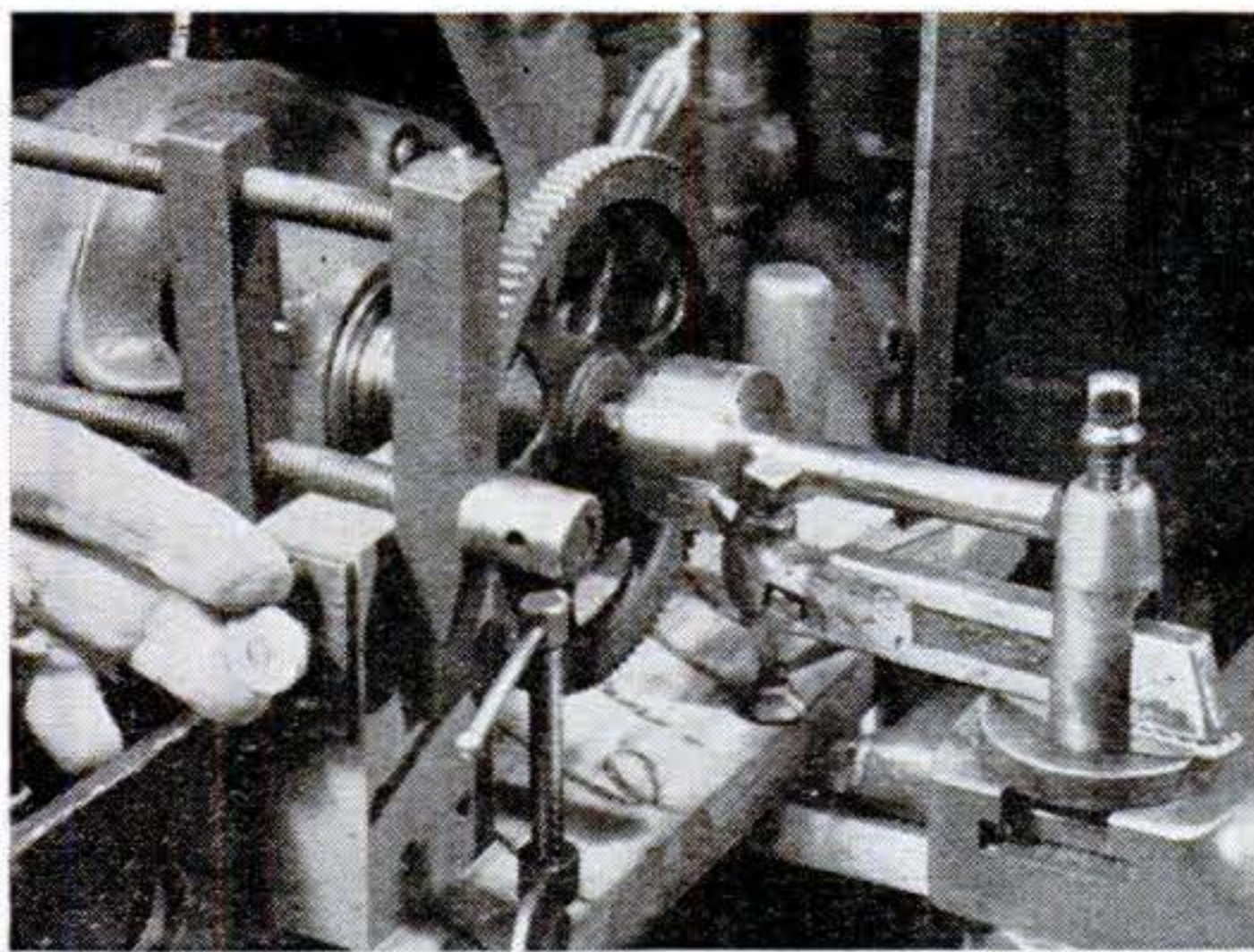

Micrometer collars were graduated with this setup, a 100-tooth gear wheel serving as an indexing guide. Oversize collars are desirable in order to improve visibility of the scales.

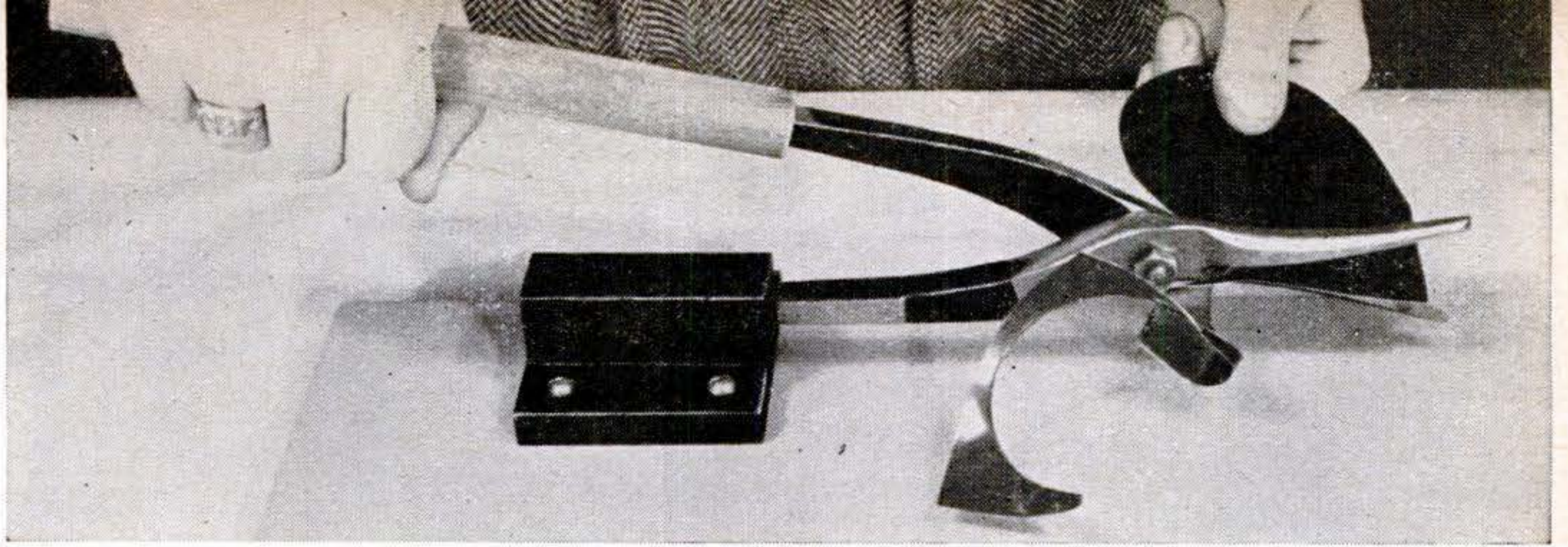

While one hand exerts pressure downward, the other hand can guide the cut with accuracy.

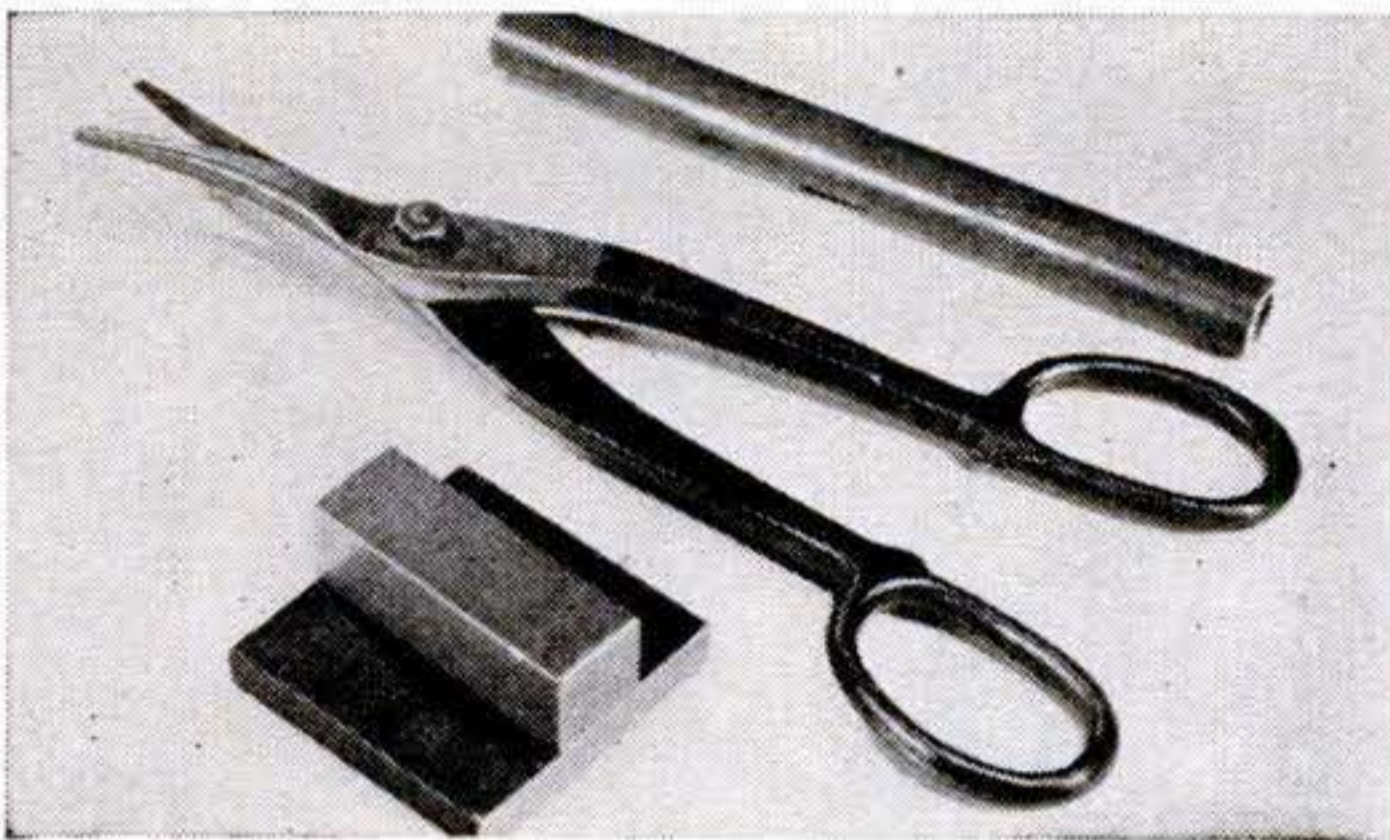

Two steel blocks, a length of pipe, and a pair of good snips are the chief materials needed.

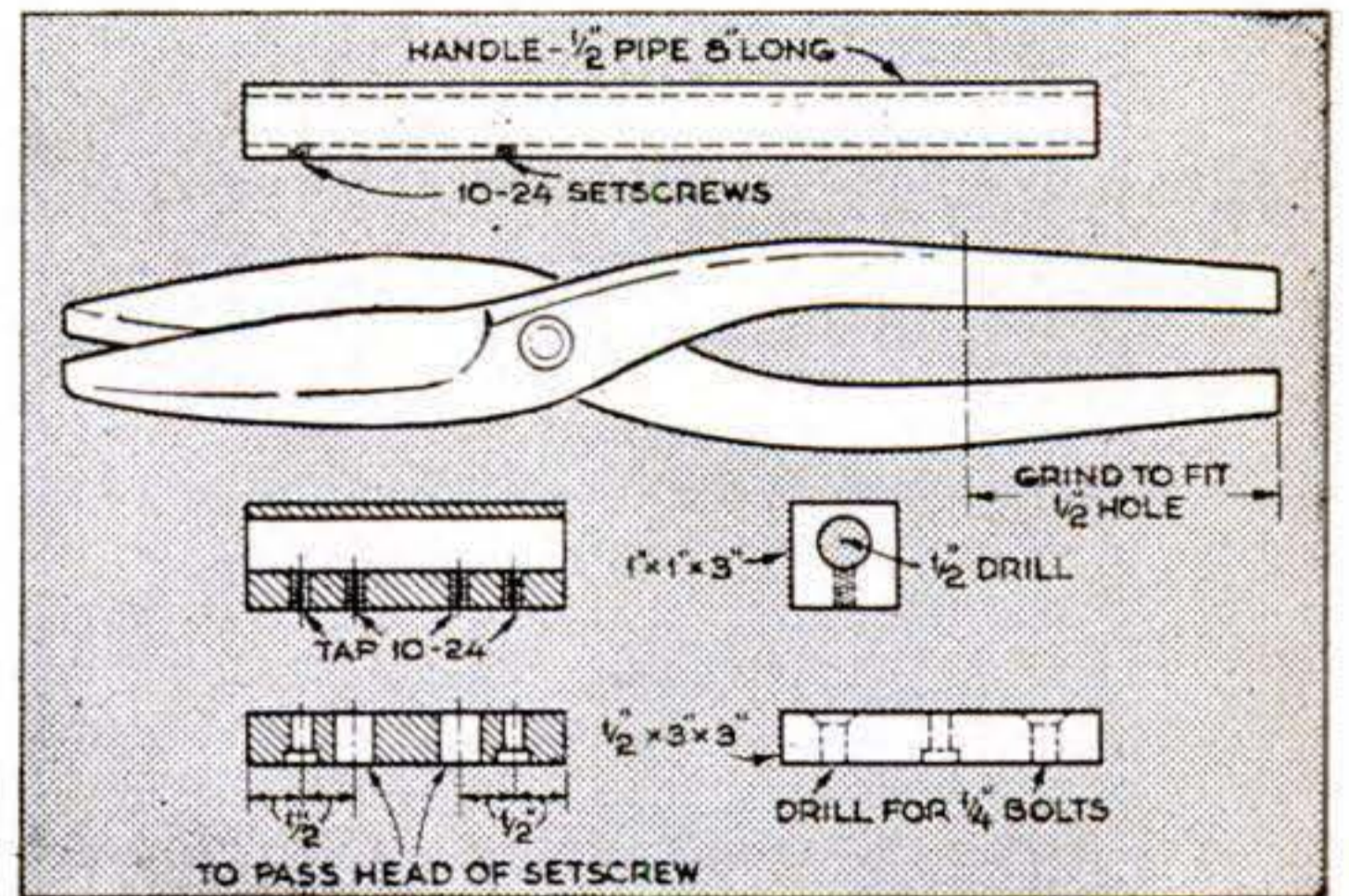

## Tin Snips Converted to Bench Tool

CUTTING sheet metal is a pleasure with these bench snips. Not only can you apply more pressure with less effort, but you can also guide the cut along layout lines with great accuracy. Obtain a good-sized, high-quality pair of tin snips and remove the handle loops (if they're hardened, save your hacksaw blades and use a grindstone or cut-off wheel). Work the ends down to fit a  $\frac{1}{2}$ " hole. Drill a hole of this size through a 1" by 1" by 3" block, locating it a bit off center, and tap the four setscrew holes shown. Drill

four matching holes in a base block, making the two inner holes large enough to clear the setscrews and counterboring the outer holes. Also drill and countersink holes in the base for mounting bolts.

Assemble the blocks with setscrews in the two outer holes, and secure one handle of the snips in the  $\frac{1}{2}$ " hole with setscrews through the inner holes. A piece of  $\frac{1}{2}$ " pipe is driven on the other handle to provide a grip and furnish enough leverage for easy cutting.—*Jack Mellinger, West Orange, N. J.*

## Nut with Collar Retains End Mill in Headstock

END mills with tapered shanks won't work loose in a lathe headstock spindle, even with side thrust, if they are locked on with this collarlike nut. One end of a nut threaded to fit the spindle is covered with a plate about  $\frac{1}{8}$ " thick held on with machine screws. The piece is then turned, faced, knurled, and drilled the size of the largest end mill to be used. When you use smaller end mills that might work through the drilled hole, place a washer over the small mill and then assemble it and the locking collar.—*H. L. Phillips, Watertown, Mass.*

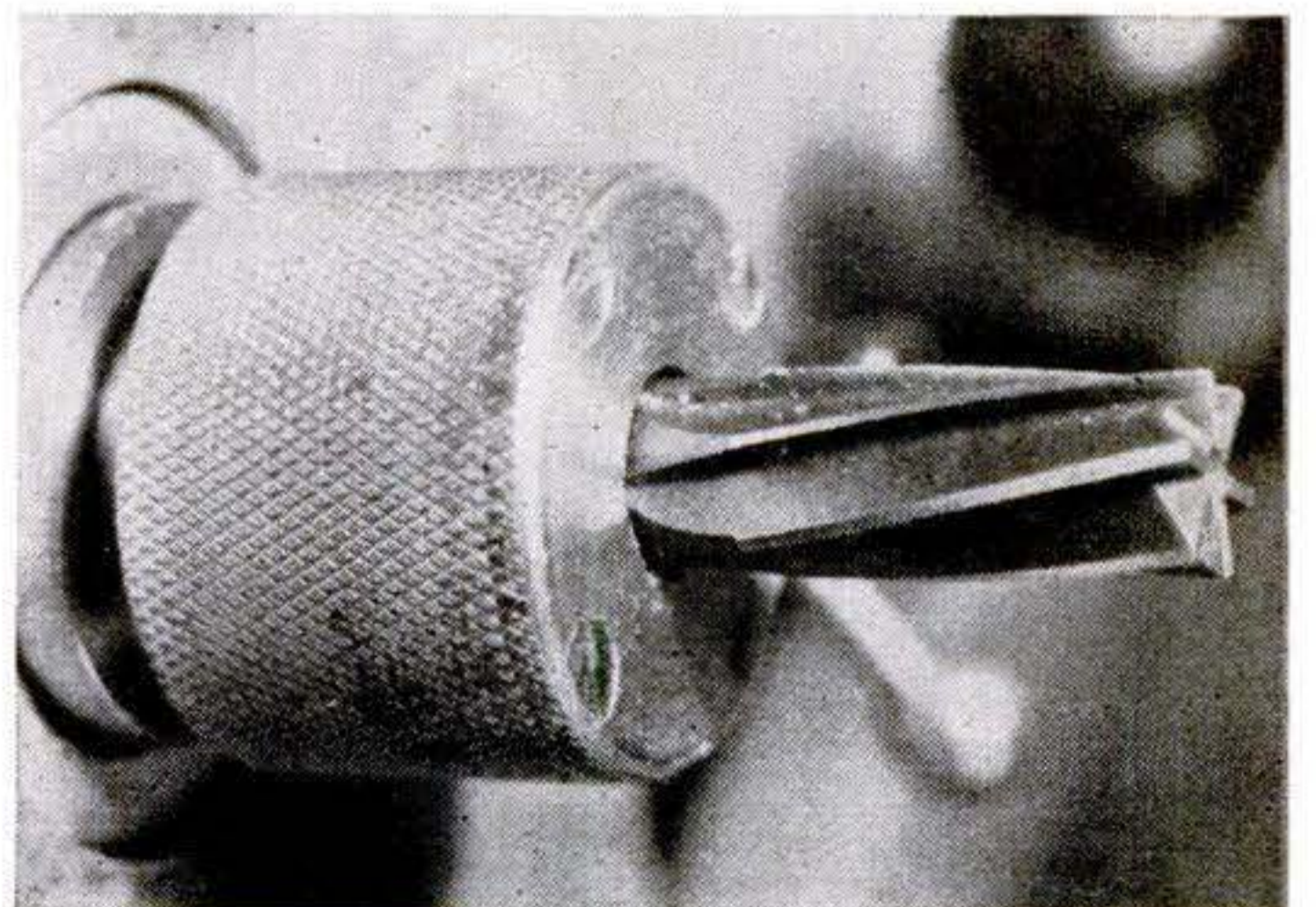



## NEW SHOP IDEAS

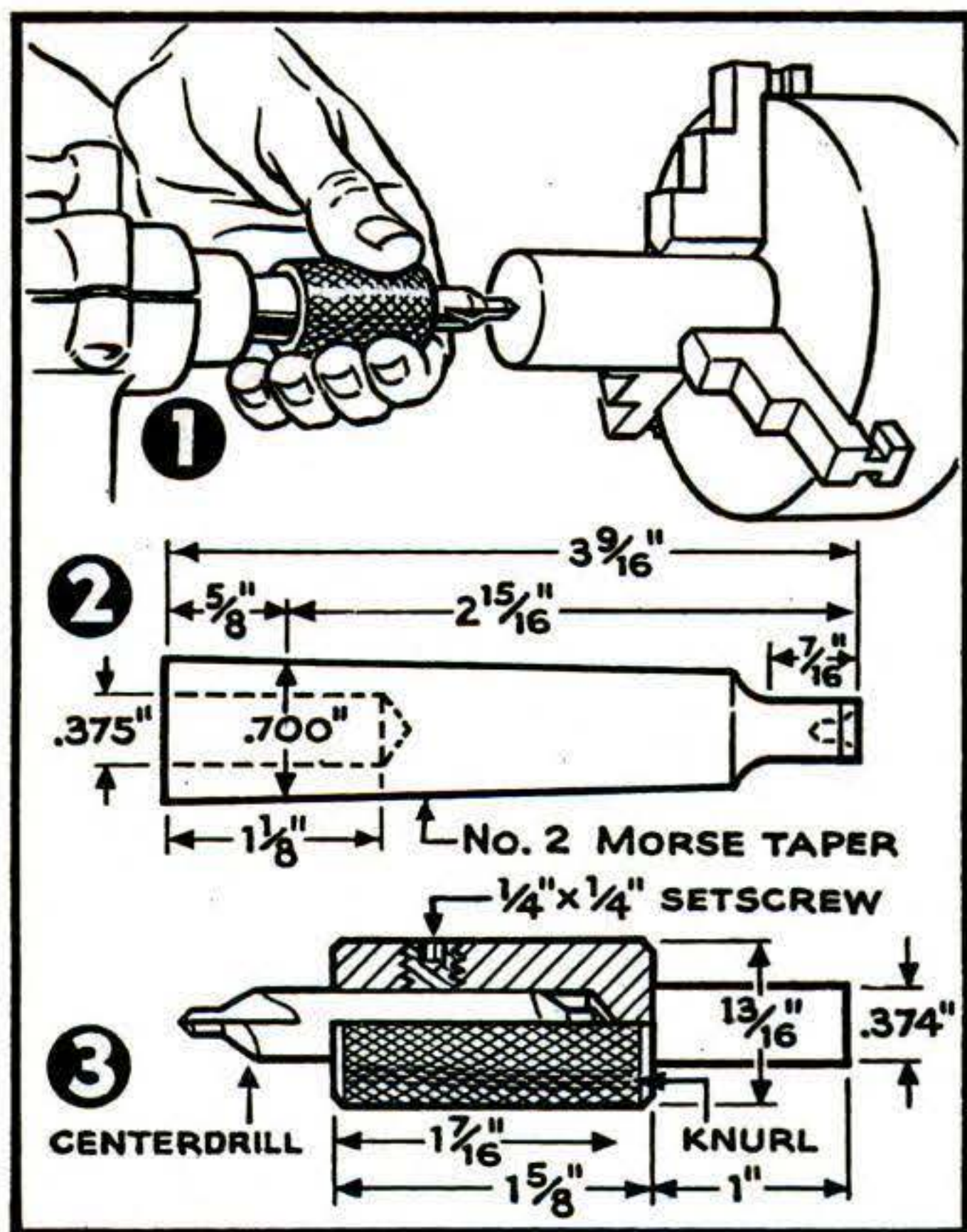

**Centerdrill Holder.** This releasing centerdrill holder, used as in Fig. 1, will cut down drill breakage, because when the going gets tough, the adapter unit will turn in your fingers. It will also serve as a holder for small taps and twist drills.

Turn the taper shank (Fig. 2) on centers, using either the setover-tailstock method or a taper attachment. If you use the former method, leave the smaller end of the taper about .060" oversize on the first cut to permit correcting the amount of setover if necessary. When the piece has no shake in a No. 2 Morse taper socket, it can be brought down to within a few thousandths of finished size by measuring the small end, which is .556" finished. Final fitting is done by filing, polishing, and testing with marking blue. Bore the hole by putting the shank in the headstock with a .375" drill in the (recentered) tailstock. Mill or grind the tang to shape.

The adapter, Fig. 3, can be machined in one chucking with tailstock support at the outboard end. Knurl the work before turning accurate dimensions. The centerdrill hole can be drilled by mounting the tool as for use, with a drill held in the headstock.

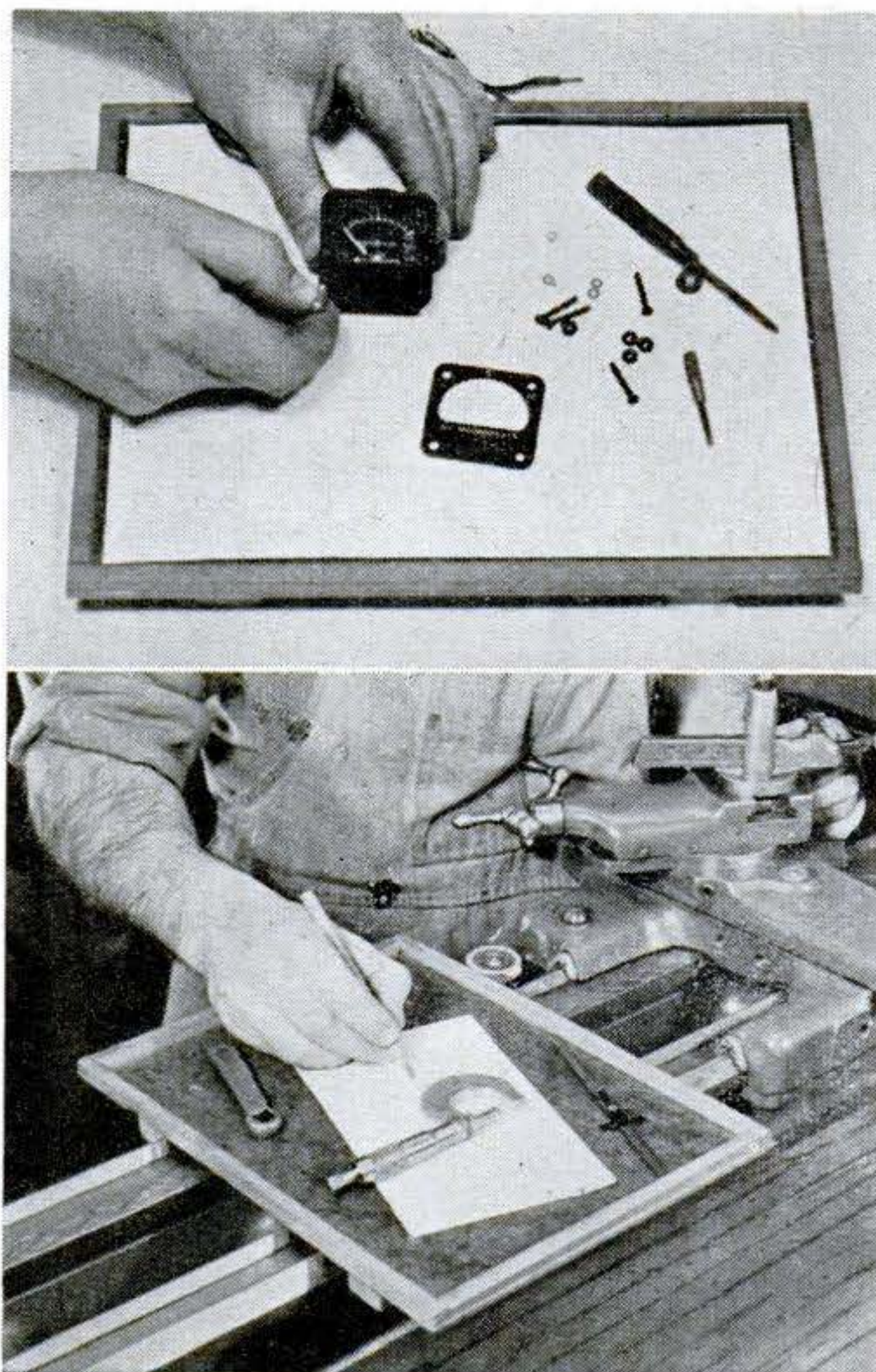

**Tray for Tools or Parts.** Simple trays of the kind shown above have proved time and temper savers for a small shop specializing in instrument work. Each one consists of a piece of hard composition board about 1/8" by 8" by 12", with 3/8" square strips nailed around to form a lip. The underside is cleated to fit the lathe ways.

On the lathe, the tray is convenient for the micrometer, wrenches, drills, and toolbits that would otherwise mix with the chips on the lathe bench. Used on a workbench, the tray is fine for holding tiny nuts, washers, and other parts. A clean sheet of paper on the tray aids visibility.—D. J. Bachner, Jackson Heights, N. Y.

**Improving Aluminum Castings.** While old auto pistons and other aluminum alloys are a valuable source of metal for home castings, trouble is frequently encountered with blow holes, pin holes, or spongy places. A good dodge to eliminate this trouble is to toss in several pieces of sal ammoniac crystals when the metal is ready for pouring; this will bring the dross to the top so it can be skimmed off before pouring.—A. E. Kerswell, San Bernardino, Calif.



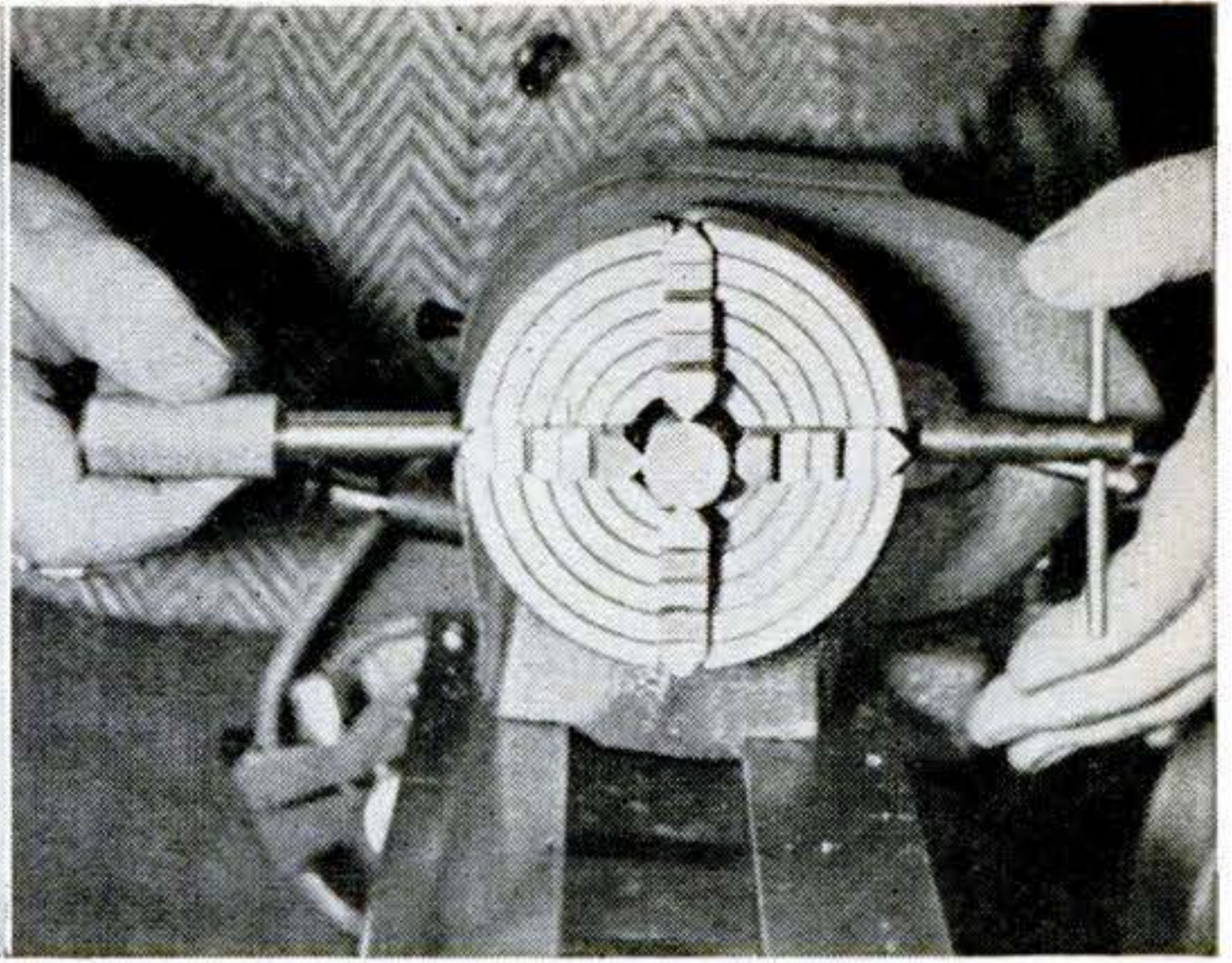
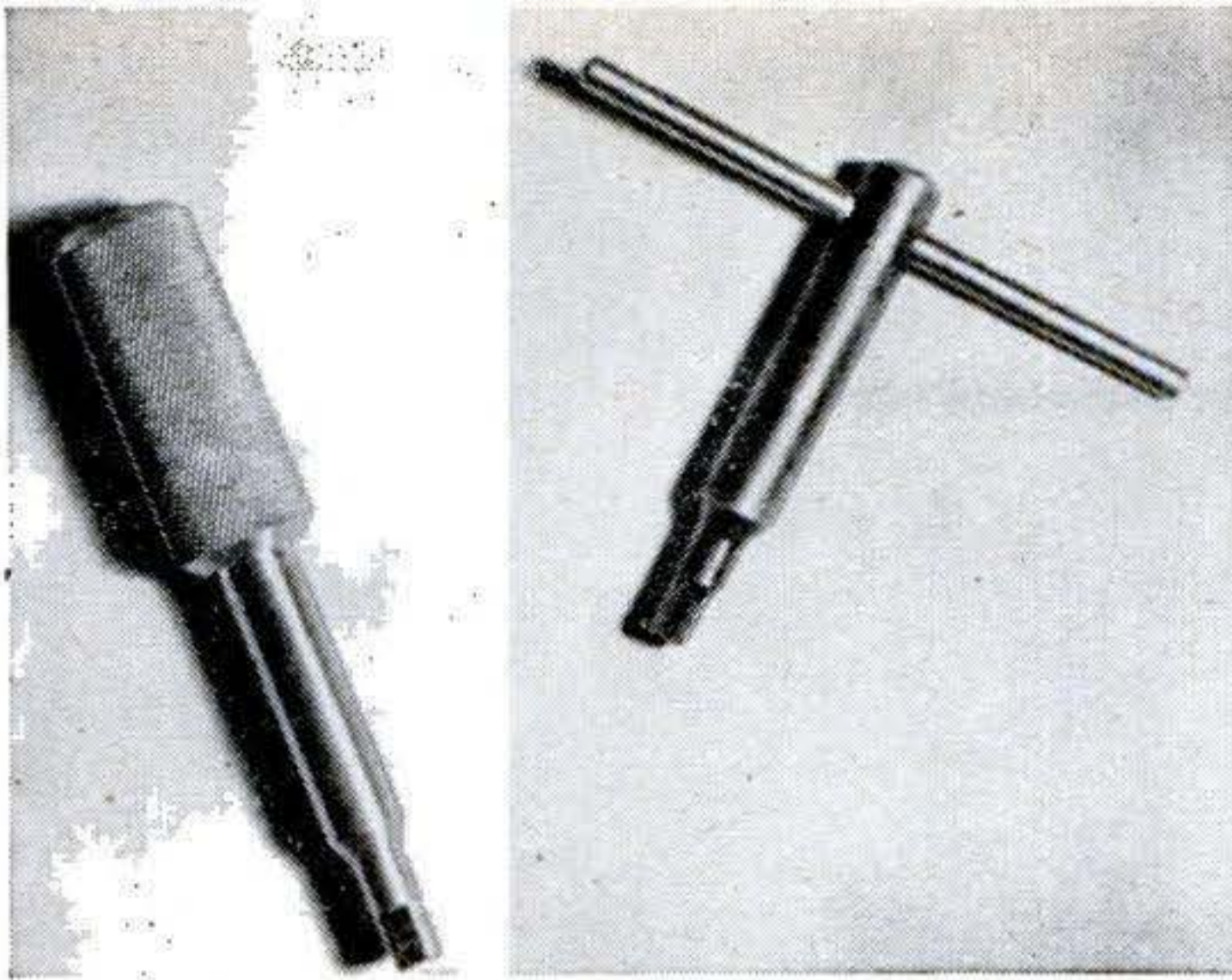

### Speed Wrench for Four-Jaw.

Much of the drudgery of setting up work in a four-jaw chuck is eliminated with a "screwdriver-type" chuck wrench. It will greatly speed up reversing the jaws. Used with the regular wrench in centering work, it eliminates constant switching of a wrench from socket to socket. Its spinner grip gives

a sensitive "feel" ideal for chucking delicate pieces that are easily distorted.

Proportion it to suit the chuck you chiefly use; mine was turned of  $\frac{3}{4}$ " stock for a 4" chuck. While the square shank can be milled, careful freehand grinding finished by filing will do the job nicely.—*John M. Avery, Delhi, N. Y.*

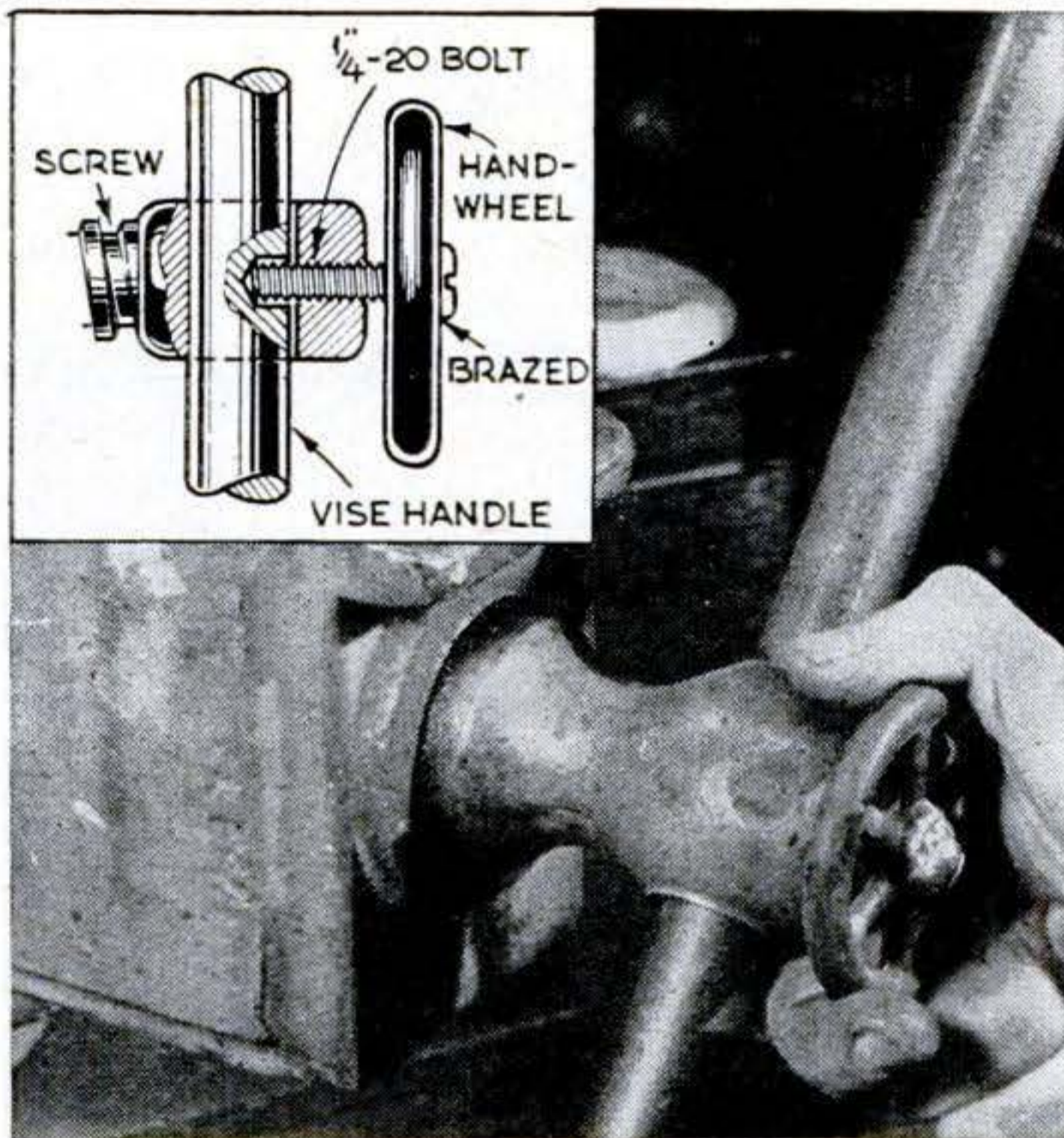

**Wheel Locks Vise Handle.** After the heavy handle on a large vise had dropped through its eye to pinch a mechanic's hand, he devised the simple locking rig shown above. A hole was drilled through the end of the eye and tapped  $\frac{1}{4}$ "-20. In this he turned a bolt that had been brazed to a small valve handwheel. The bolt bears in a dimple drilled in the middle of the handle. Locked centrally in this way, the handle gives plenty of leverage for most needs, but it can be readily loosened and slid out if more force is needed.

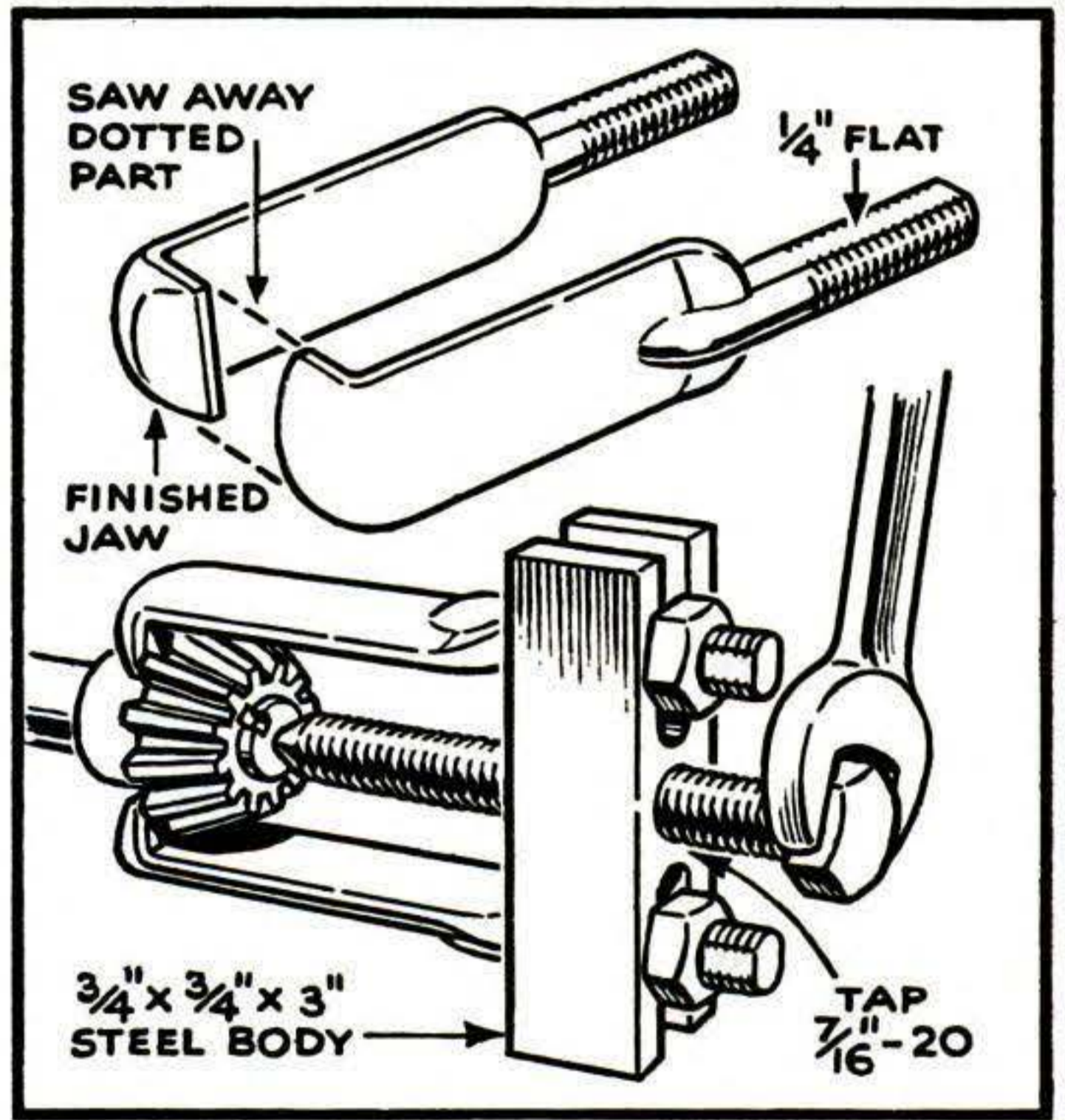

**Puller from Spring Clip.** First sawed and then ground to final shape from an automobile spring clip, this little puller is convenient for removing gears, ball races, collars, and pulleys. The flats on the threaded ends not only prevent rotation in the slots of the bar but also make the puller adjustable for size, which is a useful feature. The cap screw is about  $2\frac{1}{4}$ " long, is threaded full length, and has a 60-deg. rounded point. Parts subject to wear such as the screw point and sidepiece jaws should be case-hardened.



## AIDS TO MODERN LIVING



**Keep Score on Putter.** With a golf putter made by P. M. Connelly, of Oak Park, Ill., you don't have to fumble for score card and pencil after each hole. An 18-hole card slides into grooves on the back of the putter and a pencil clips to it.



**Trigger Releases Wax.** A floor waxer manufactured by New Products, Inc., of St. Louis, Mo., has a container that holds a pint of liquid wax. Pushing a trigger at the top of the 47" handle releases wax through the removable felt applicator.



**Strolling in a High Chair.** Now you can have a high chair and stroller for the baby—both combined in one piece of space-saving equipment. Invented by C. B. Johnson, the chair-stroller above was shown at an inventors' exposition in Los Angeles.



**Drum Glows in the Dark.** Designed especially for use in a child's room or game room, this novelty lamp features a luminescent drum head that glows as a circle of light in the dark, making it easier to locate. Made entirely of plastic, it is a product of the Radio Frequency Laboratories, of Boonton, N. J.



### Tells the Tale.

Here's a gadget that will put an end to those fish that increase in length and weight every time the story's told. Called the "De-Liar," the combination scale and measuring tape will weigh up to 2 lb. and measure up to 24". Small enough to carry in the pocket or pack with your equipment, it is available from Dexter & Co., of New York, for \$2.

### You Squeeze It.

Bottles that you can squeeze are among the latest things to hit the market. But instead of glass, they're made of flexible plastic and won't break. The one shown here was molded by Plax Corporation, of Hartford, Conn., and it's used as a powder container, a hole in the stopper allowing the talcum to be blown out.

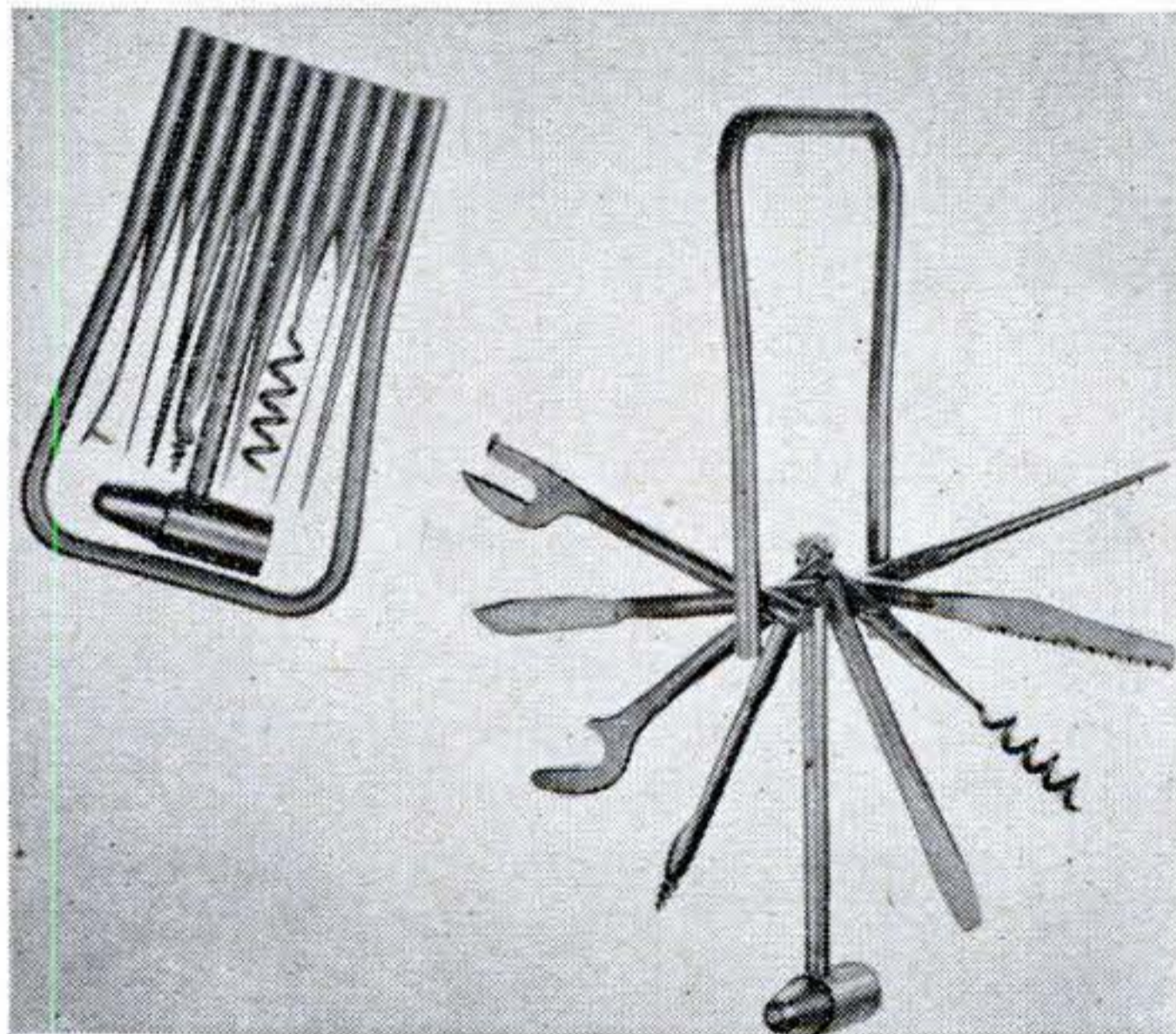

**Tool Kit Fits Pocket.** Here's a collection of handy small tools that you can carry in a pocket, all of them made of high-carbon cutlery steel. A product of Toolmaster, of New York, the kit includes a screwdriver, awl or ice pick, bottle opener, corkscrew, hammer or ice crusher, knife, can opener, auger, and saw.

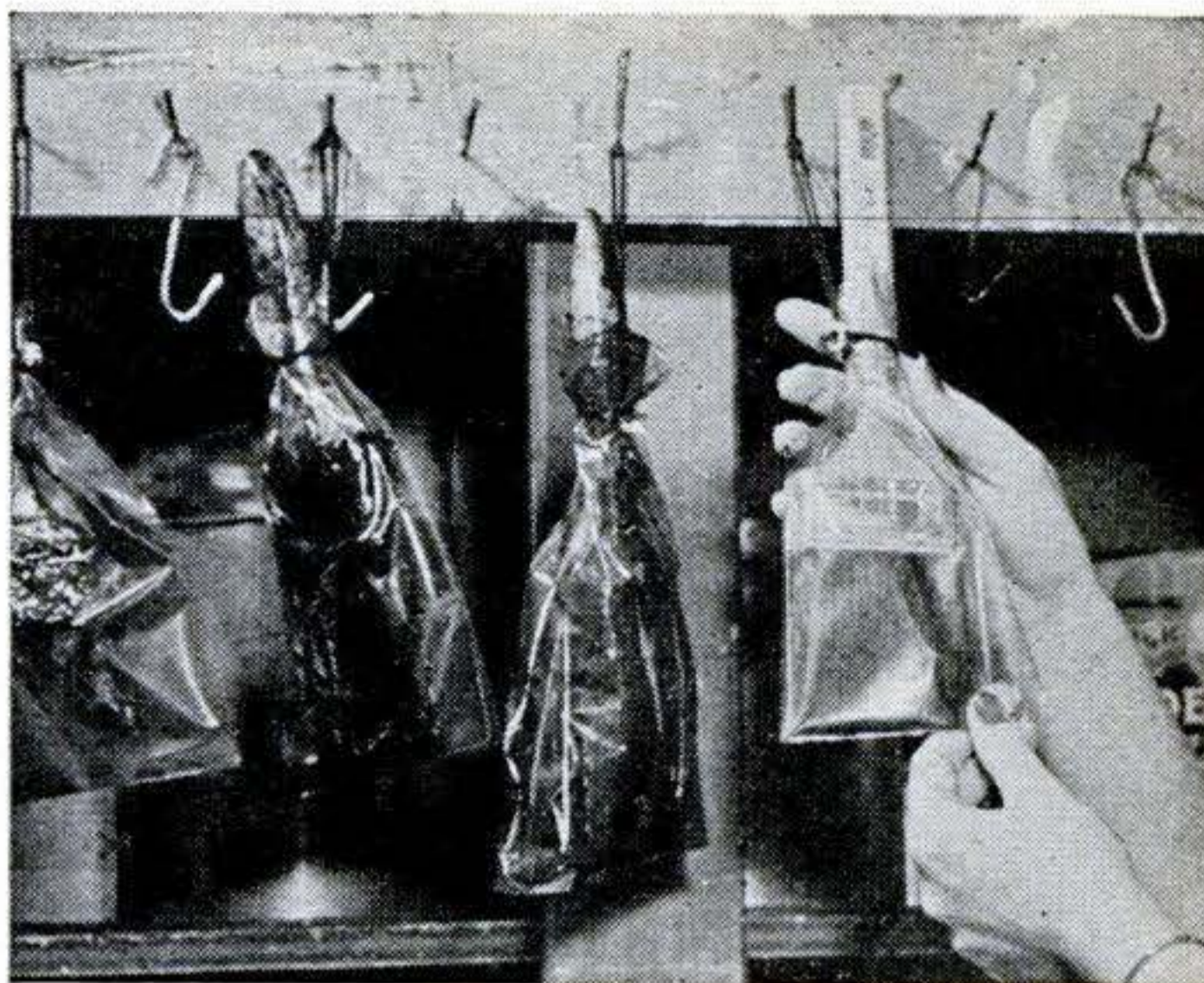

### Brushes Needn't Be Cleaned.

If you're in a hurry, a used paint brush can now be put away without cleaning. Placed in a container made from the Goodyear Tire and Rubber Company's Pliofilm <sup>®</sup>, the brush will remain soft and pliable until the next paint job comes along. The container has an elastic band to seal in the brush and to provide a loop for hanging it up so that the bristles won't spread.

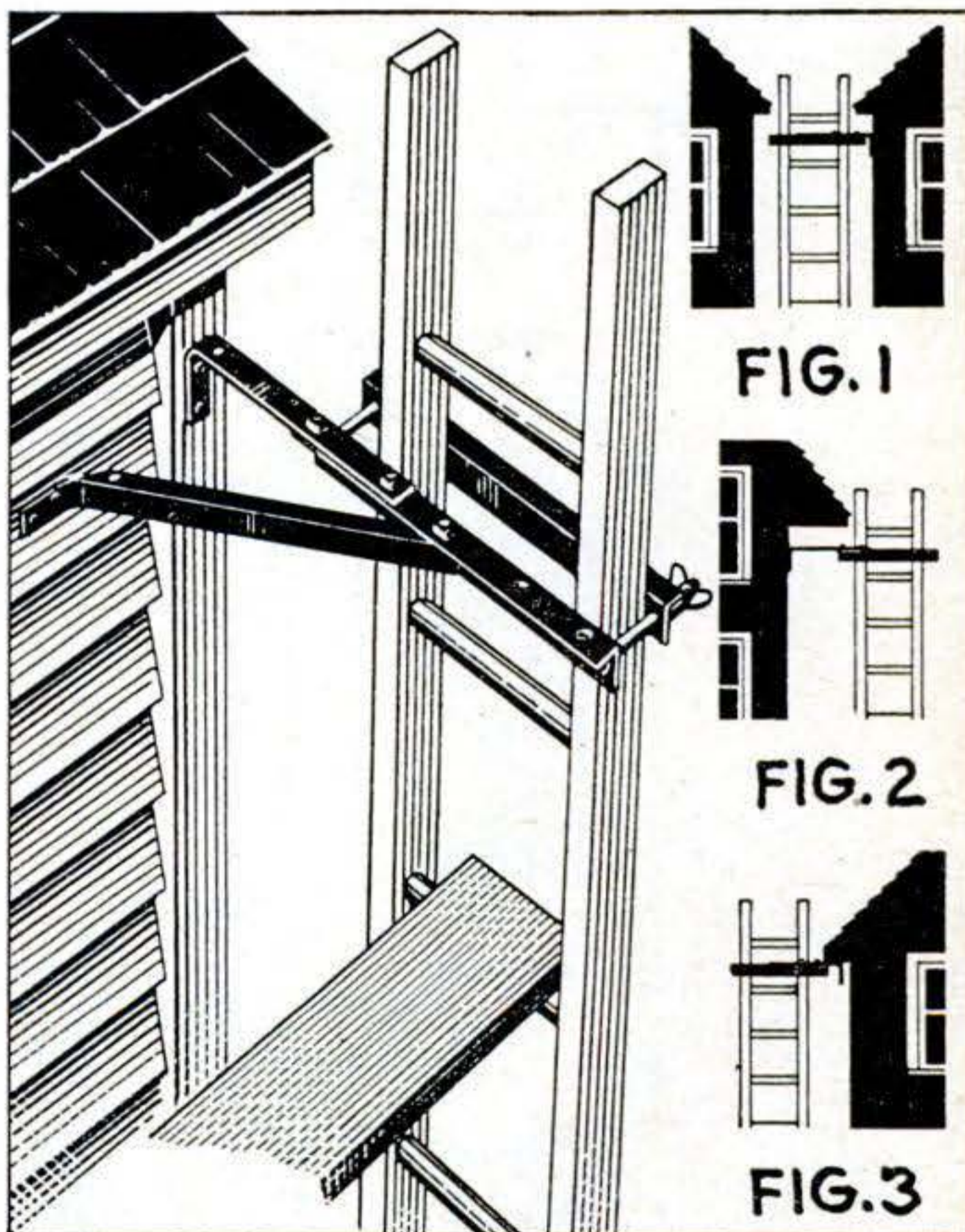

### Brackets Provide Scaffold.

Brackets that may be used with ladders to erect a scaffold are offered by Reimann and Georger, of Buffalo, N. Y. The brackets may be adjusted to keep the ladders close to the building in a narrow passageway (1), to clear the eaves (2), or they may be fastened under the eaves (3).

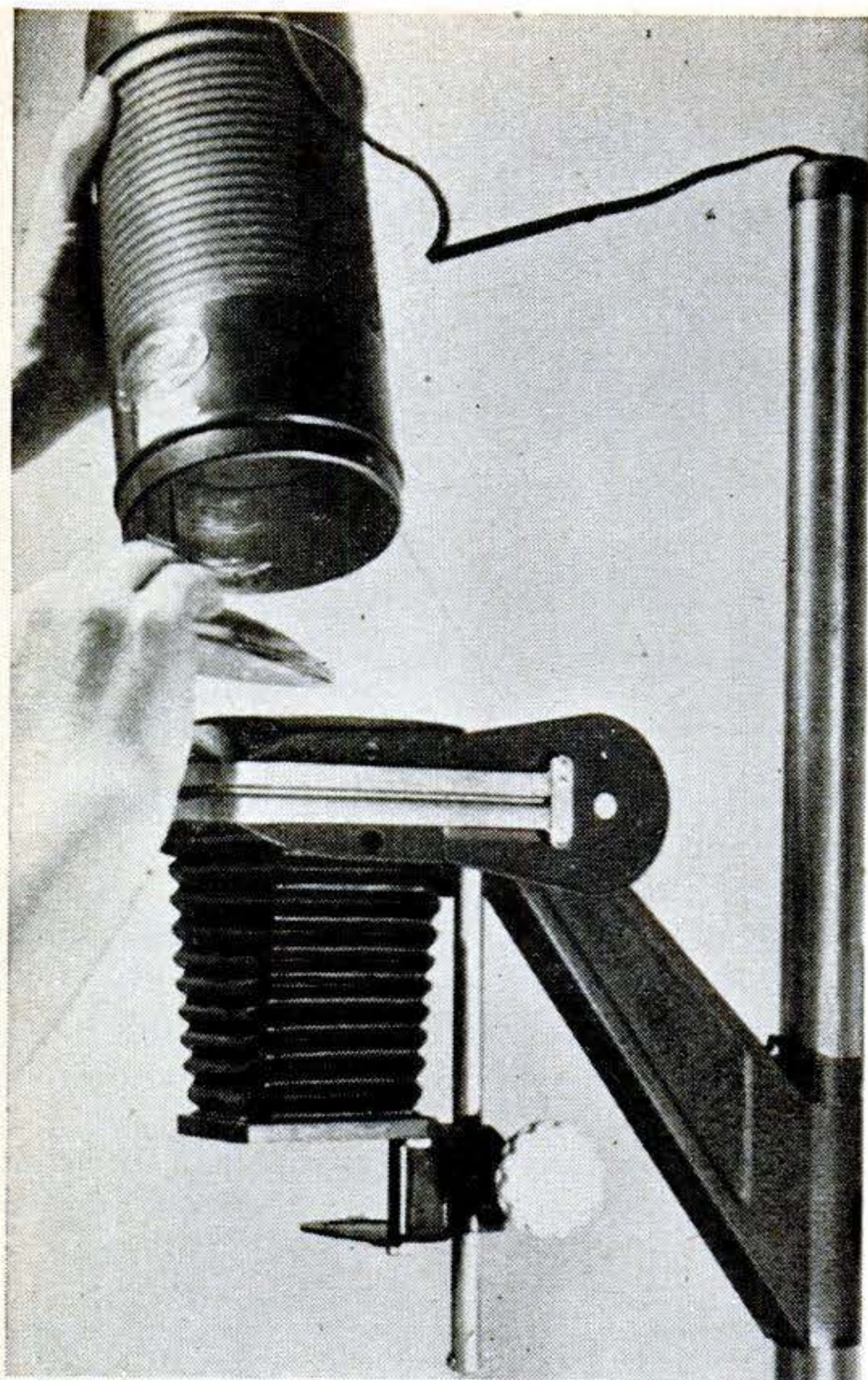

# \$10 Condenser Conversion Better's Enlarger

By Edward Morris

PERHAPS you've thought about converting your diffusion enlarger to a condenser type, and the experts tried to scare you off with lectures on optics, hot spots, and critical lens positions. They tried it on me. But I went ahead just the same and, instead of paying a goodly sum for a new condenser enlarger, accomplished a perfectly satisfactory conversion for about \$10.

Two condenser lenses were picked up at a local photo supply house for \$7. These are  $4\frac{7}{16}$ " in diameter, a size that's a snug fit in my particular enlarger. A  $4\frac{7}{16}$ " disk of heat-absorbent glass, a strip of aluminum  $\frac{1}{32}$ " by  $1\frac{1}{2}$ " by 15", and a 15" piece of No. 8 or 10 copper or galvanized wire complete the list of materials.

Heat-absorbent glass usually may be obtained at a window-glass or photo supply house. There are several makes on the market, but for this purpose get the closest you can to one having a formula of 72-percent transmission of ultraviolet light and 28-percent absorption of infrared. Incidentally, it may be best to let the supply house cut the disk of glass, for it's a difficult job. I broke two pieces trying to do my own cutting.

With the materials at hand, the actual conversion takes only a few minutes. First, remove the diffusion glass from the lamp house. Then position one condenser lens so that it lies above the negative carrier with the flat side down. Next bend the aluminum strip around a  $4\frac{1}{2}$ " form, insert it in the very bottom of the lamp-house tube, and drop in the second condenser from the top, flat side up, so that it rests on the aluminum collar. Return the lamp house to position, making certain the condensers are close together but do not actually touch.

Now bend the wire around a  $4\frac{1}{2}$ " form, squeeze together, and snap it into place in the lamp house midway between the bot-

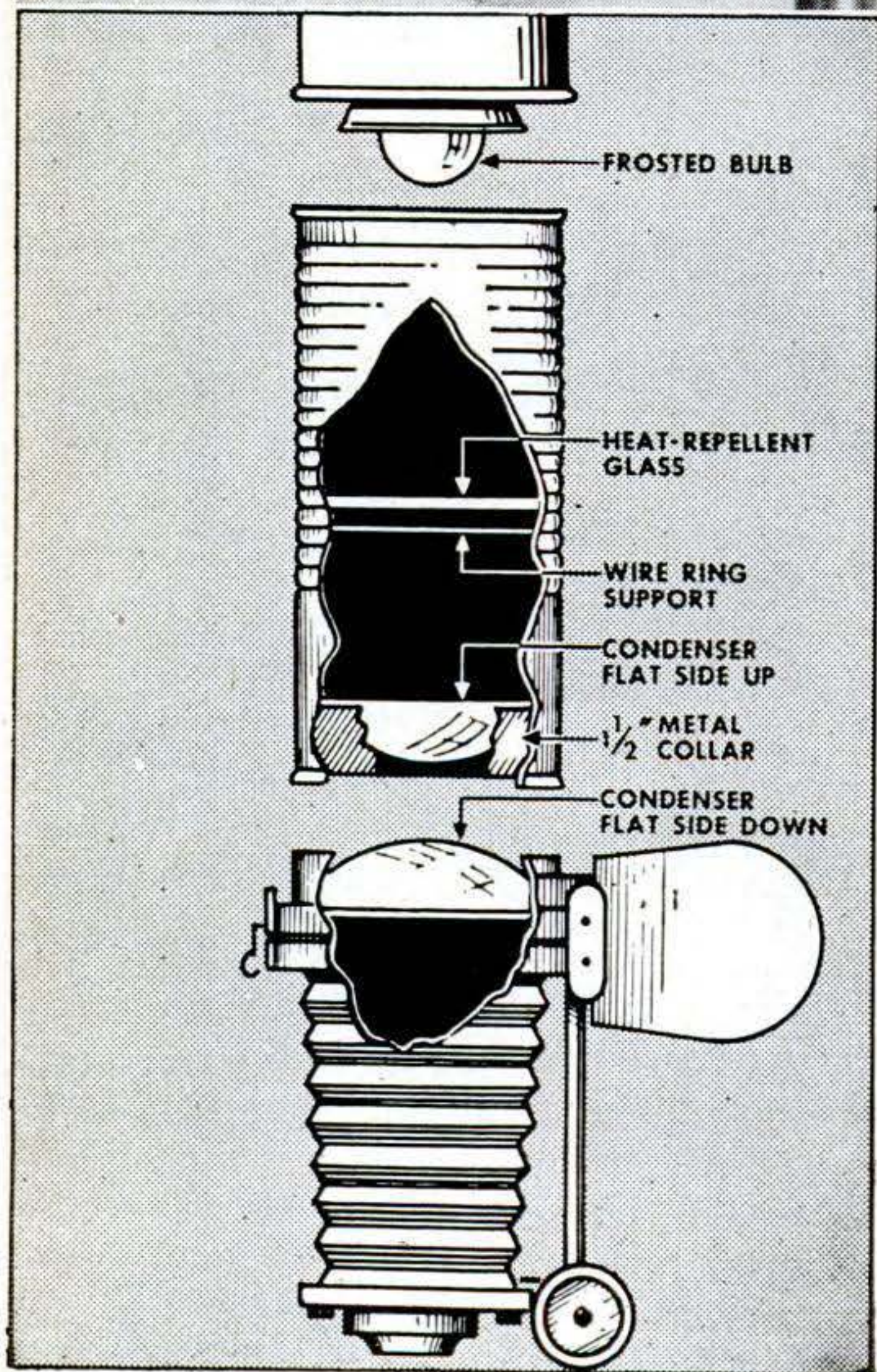

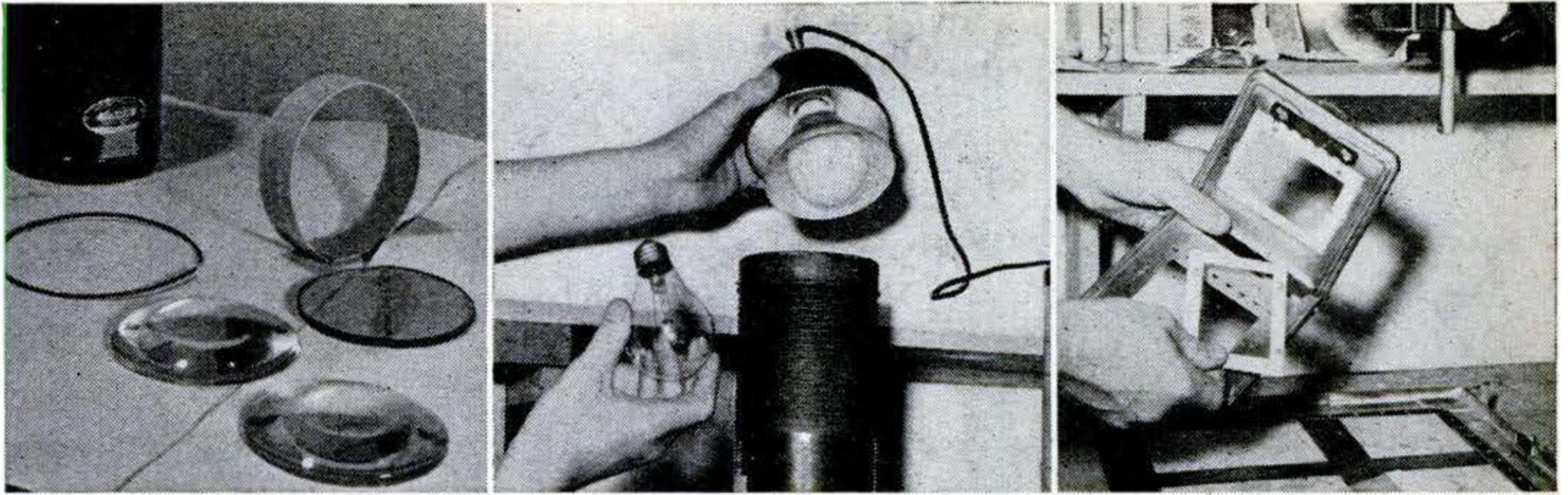

**Materials required** were two condenser lenses, an aluminum collar, a disk of heat-absorbent glass, and a wire retaining ring. A frosted bulb

was also substituted for the clear one. A dustless carrier, right, eliminates the bother of keeping glass plates clean.

tom of the enlarging bulb and the top condenser. Place the heat-absorbent glass on the wire retainer, install a frosted enlarger bulb, and you're ready to go.

verted enlarger covers a 2¼" by 3¼" negative as well as the original did.

You'll find that exposure time is much reduced, and that there's a new world of sharpness and detail in your photos. So far I haven't found any hot spots, and the con-

It didn't take me long to discover that the glass negative carrier would have to be discarded. Dust, lint, and finger marks that were not visible before now stood out clearly. Another trip to the photo supply house for a glassless carrier solved this problem.

## Movies Shown on Ceiling by Double Reflection

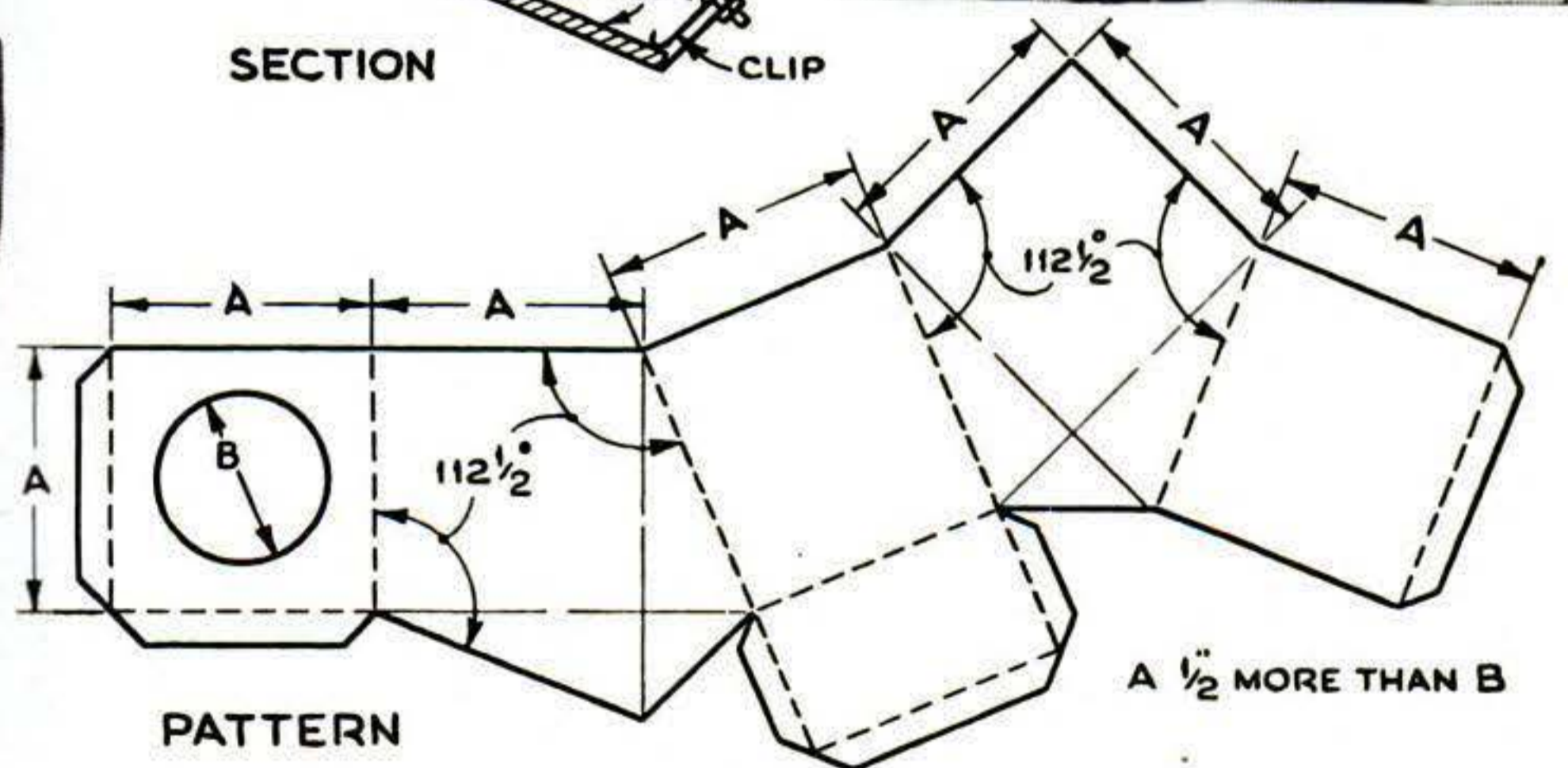
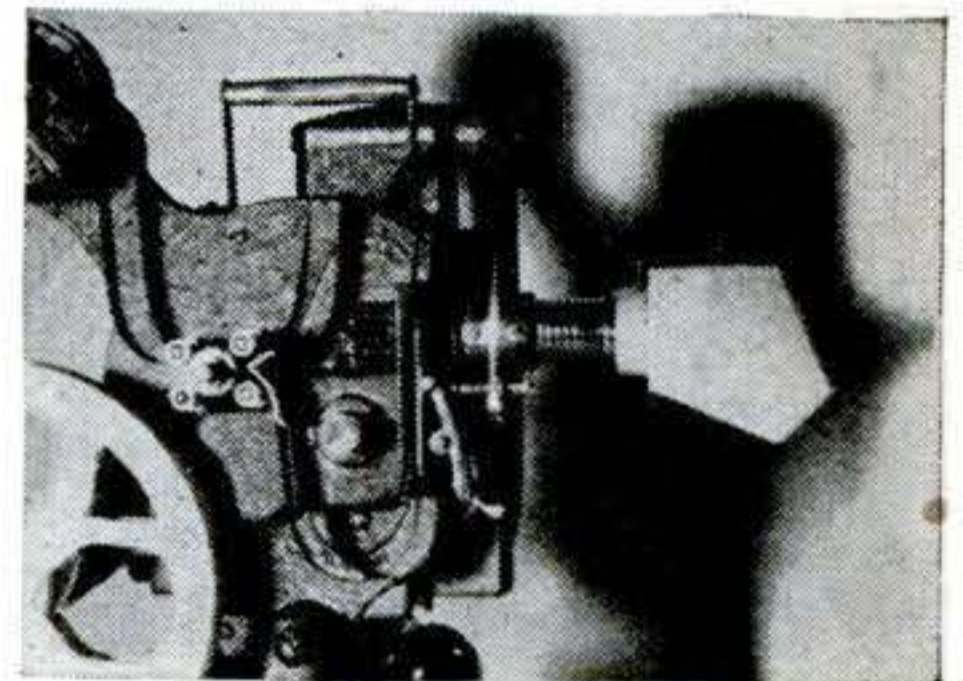
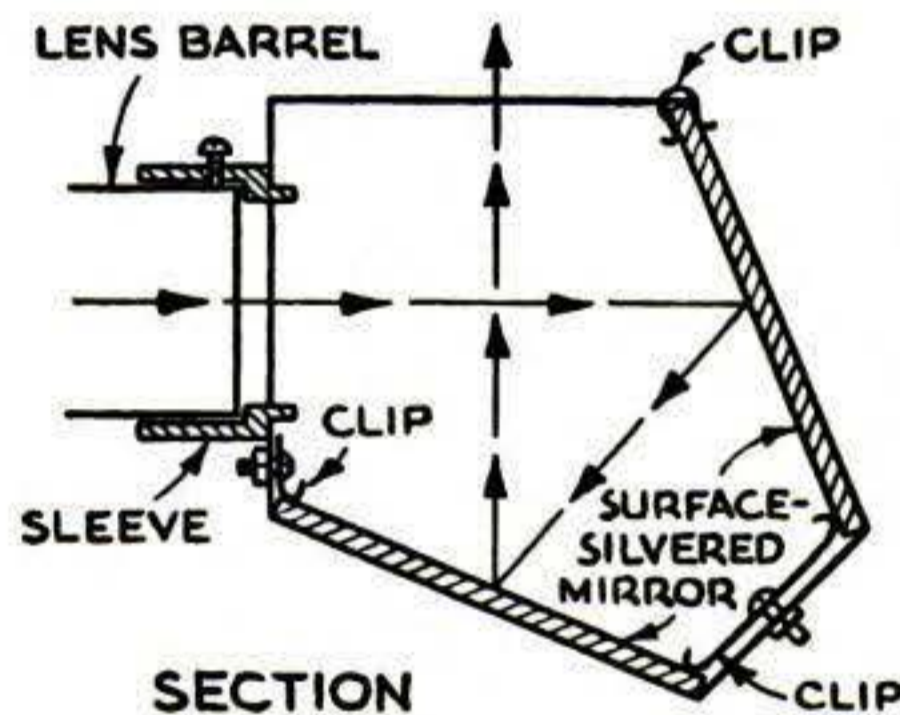
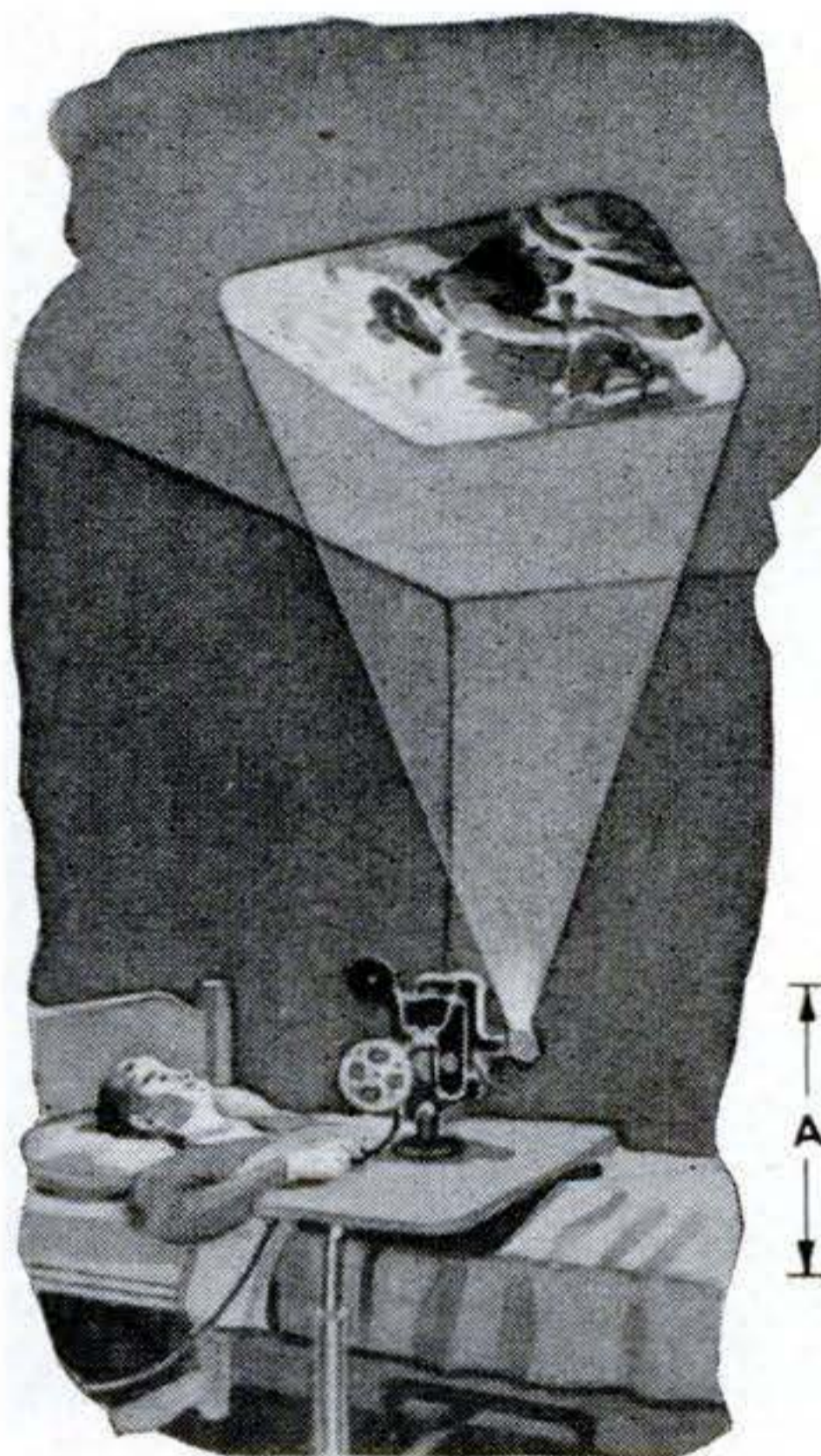

Two mirrors located in a pentagonal metal or cardboard box will enable you to project movies on the ceiling for a bed-ridden person. It's best to use first-surface mirrors, for the glass face of the ordinary type will cast ghost images.

than the diameter of the lens barrel. After bending on the dotted lines, solder or cement the edges, depending on the material. A sleeve to fit the barrel may be turned from metal or built up around a tubular form with successive layers of glued paper. The mirrors may be held in place with clips or an adhesive.—Herbert Dawkins, Baltimore.

Lay out the pattern either on tinplate or cardboard, making the square about ½" more

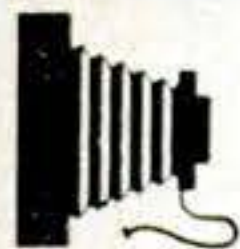

## PHOTO IDEAS AND EQUIPMENT

**Box Camera in Reflex Form.** In the new Kodak Duaflex camera the styling of a  $2\frac{1}{4}$ " by  $2\frac{1}{4}$ " reflex is combined with the operating simplicity of a box camera. Using 620 film, the camera takes 12 exposures on each roll, the fixed-focus lens recording detail sharply from 6' to infinity. On the upper surface is a large reflecting viewfinder for framing the picture. Fitted with built-in synchronization, the camera sells for about \$12 and an accessory flash reflector for about \$2.50.

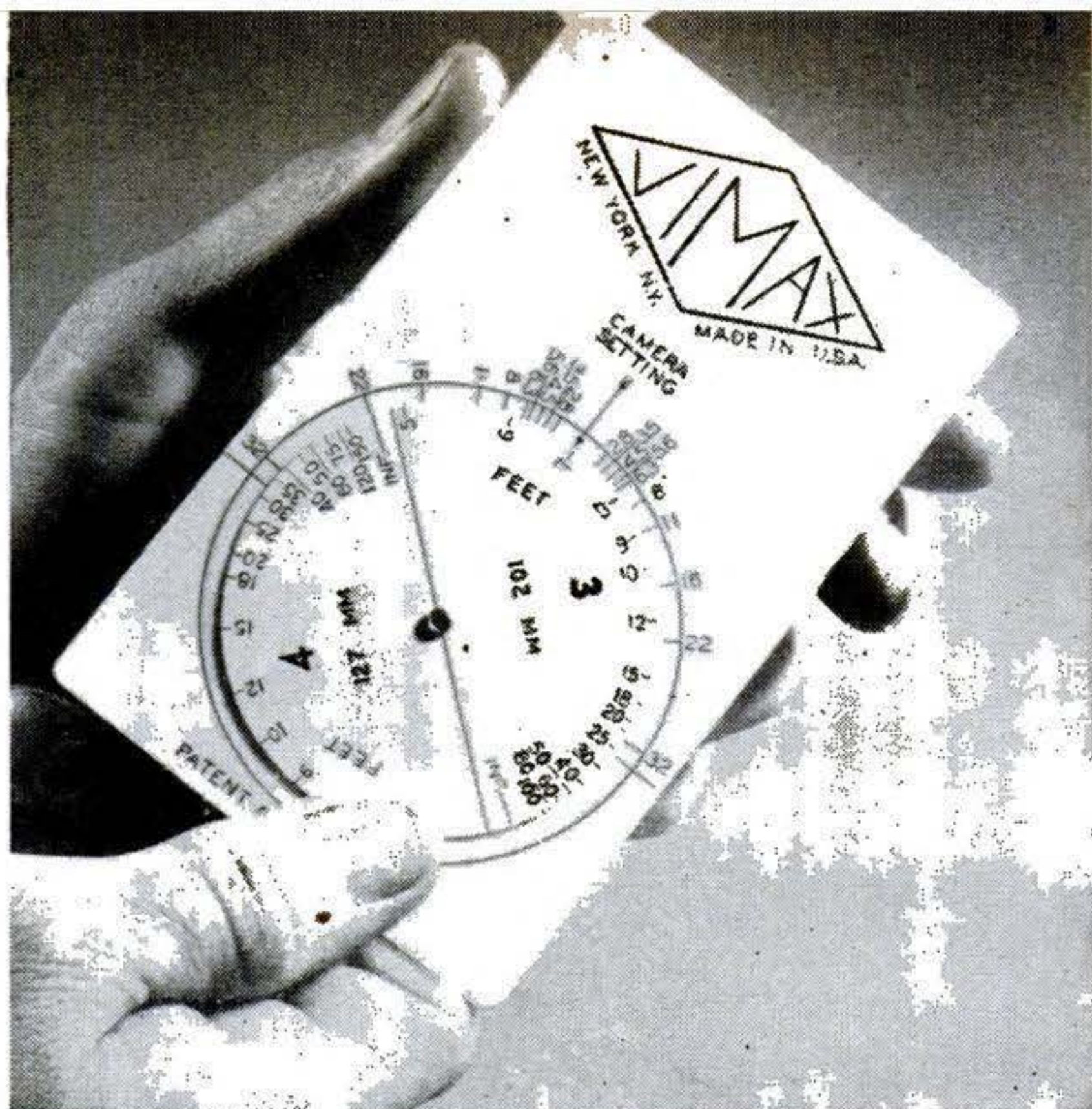

**Guide Shows Depth of Focus.** A pocket guide made by the Vimax Company, of New York, has two scales on either side to show the depth of focus covered by lenses of different focal length. Turn the dial until the distance at which the camera is focused is at the arrow (7' above), and then the distance shown between corresponding "F" stops at the right and left is in focus for the stop selected (for instance, from a little over  $5\frac{1}{2}$ ' to 9' at f/11 above). The guide is suitable for lenses of different focal lengths.

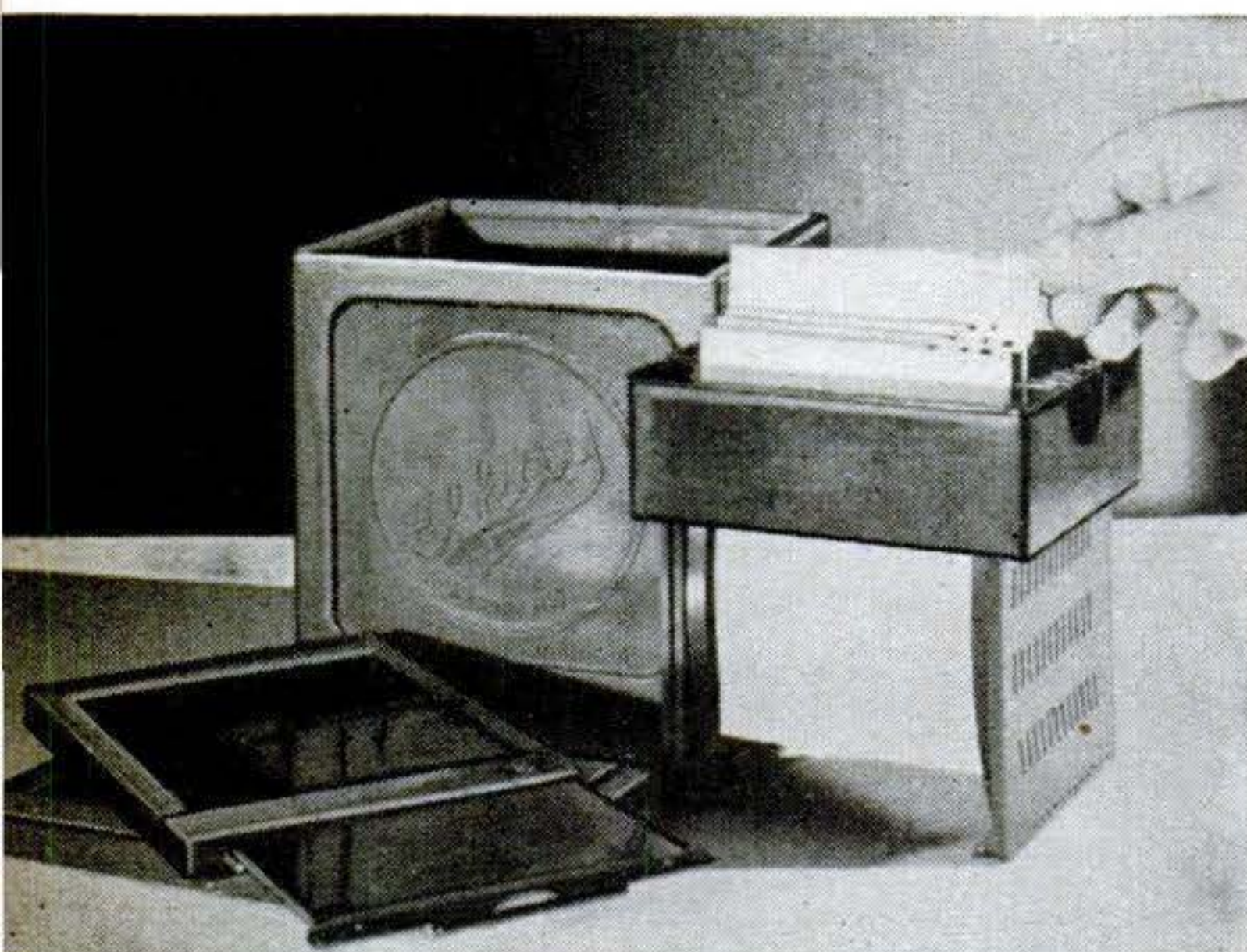

**Film Loaded by Touch.** Tanks with slot guides can be confusing in the dark when you forget how many films you've loaded and don't know which slot to use next. However, if each film is allowed to protrude slightly you can tell by feel where to insert the next. After all are in, you can then push them down to normal position.

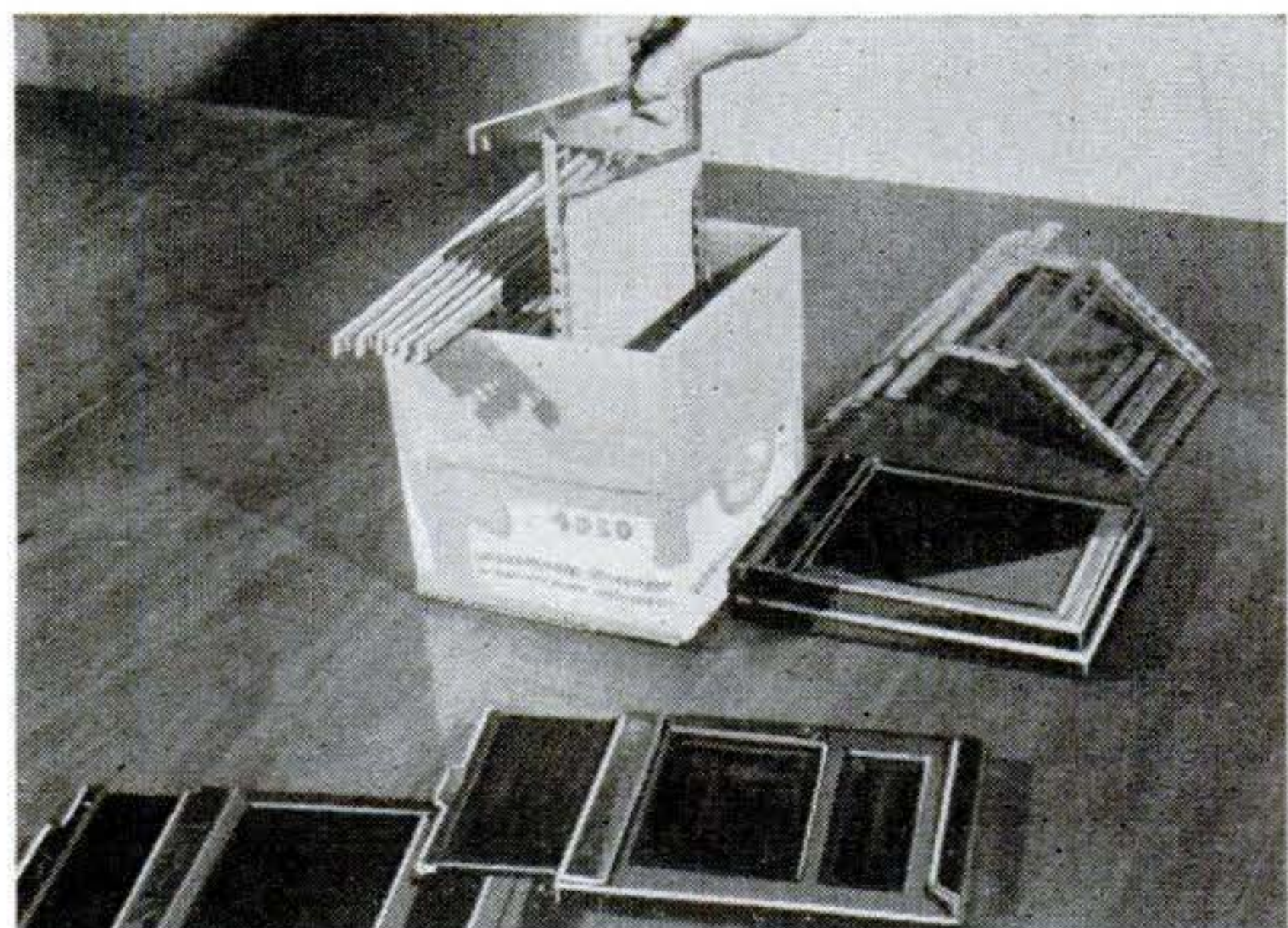

**Box Holds Loaded Hangers.** Where to place cut-film hangers after they're loaded for developing often is a problem. One solution is to have on hand a cardboard carton about the size of the developing tank. As each hanger is loaded, it can be suspended in the box. Then when all have been loaded they can be put in the tank.

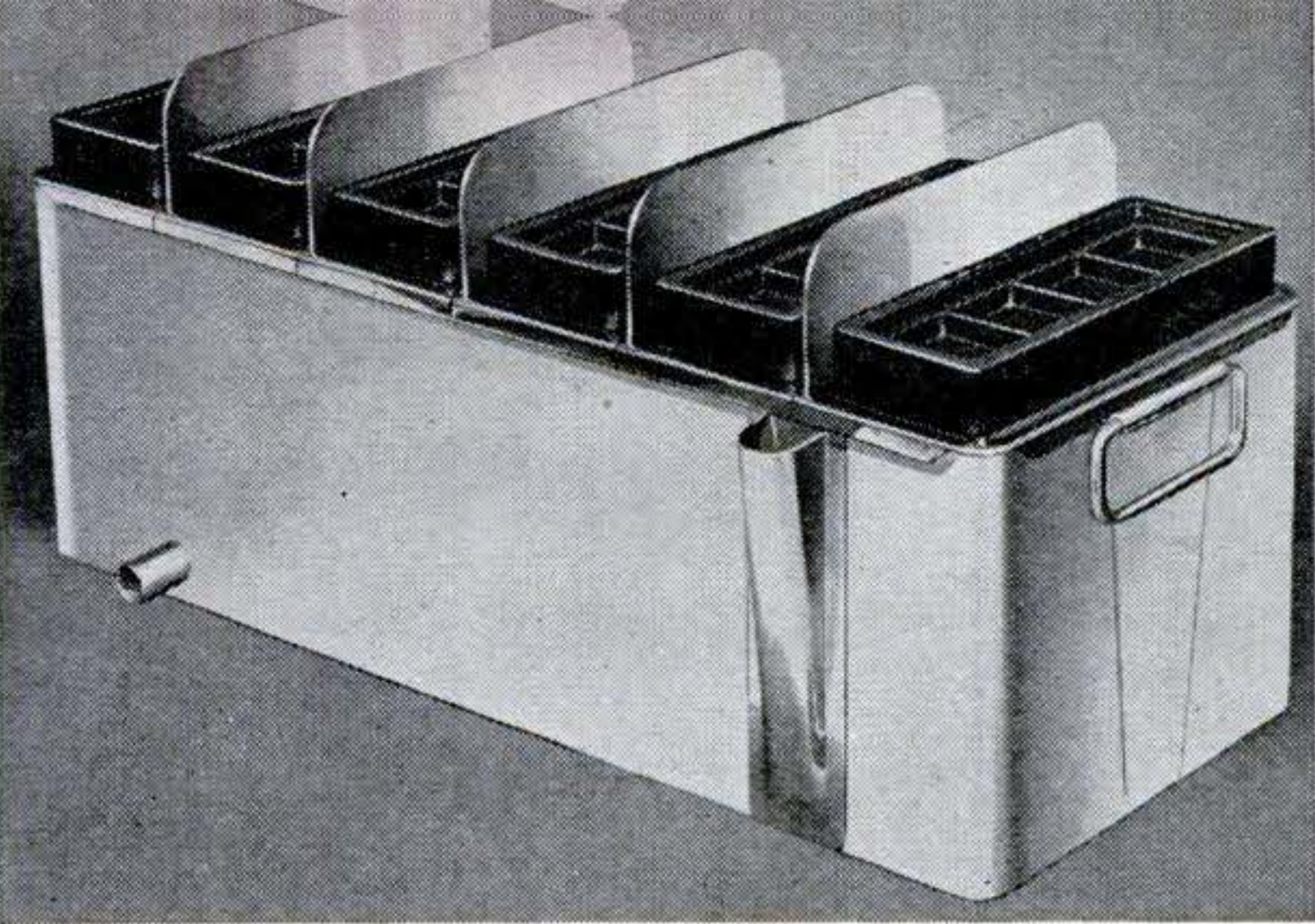

**Color Developed in One Unit.** A developing outfit that meets requirements for home processing of color is offered by the Morse Instrument Co., of Hudson, Ohio. Water heated to the proper temperature circulates around the hard-rubber insert tanks and a thermometer well also serves as an overflow spout. Splash shields are located between each of the tanks.

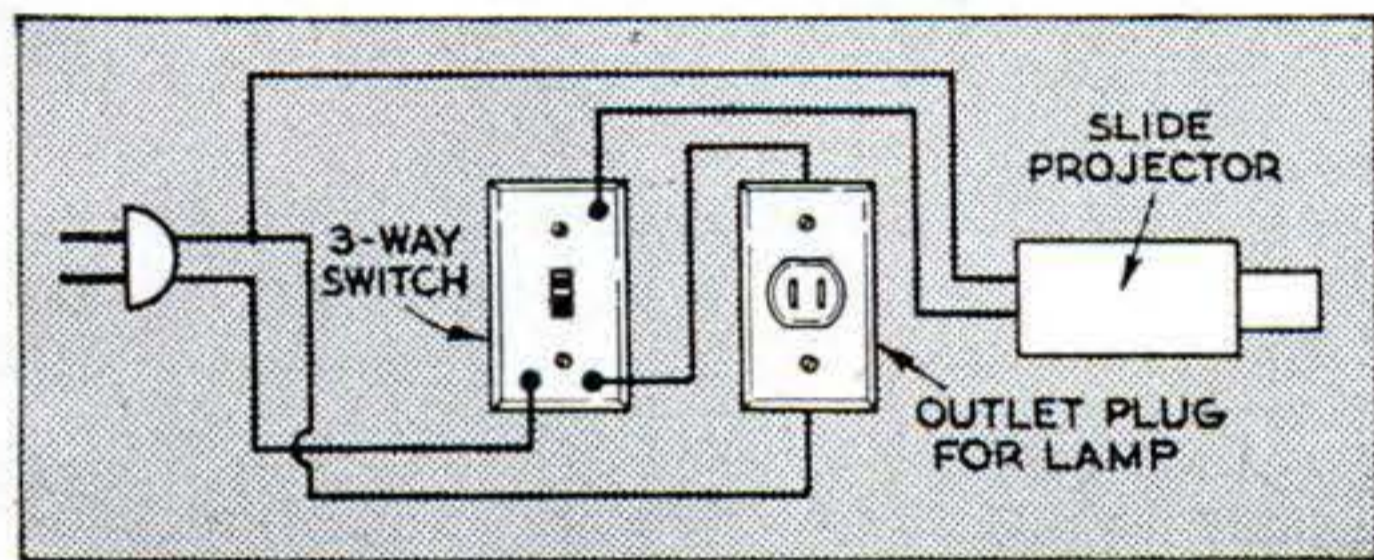

**Lights Off, Projector On.** Tired of stumbling around in the dark hunting for light switches, I wired my slide projector, a light, and a double-throw switch as above. Now when I flip the switch the light is turned off at the same time the projector is turned on, while flipping the switch the other way turns the projector off and light on.—*Thomas R. Osborn, Oakland, Calif.*



**Box Improves Changing Bag.** If a cardboard box of suitable dimensions is thrust into a changing bag, film loading will be a lot easier. The box will keep the bag up out of the way and provide a free, roomy working area for placing the film in the holders. Box, holders, and film should be zipped inside before the arms are inserted.

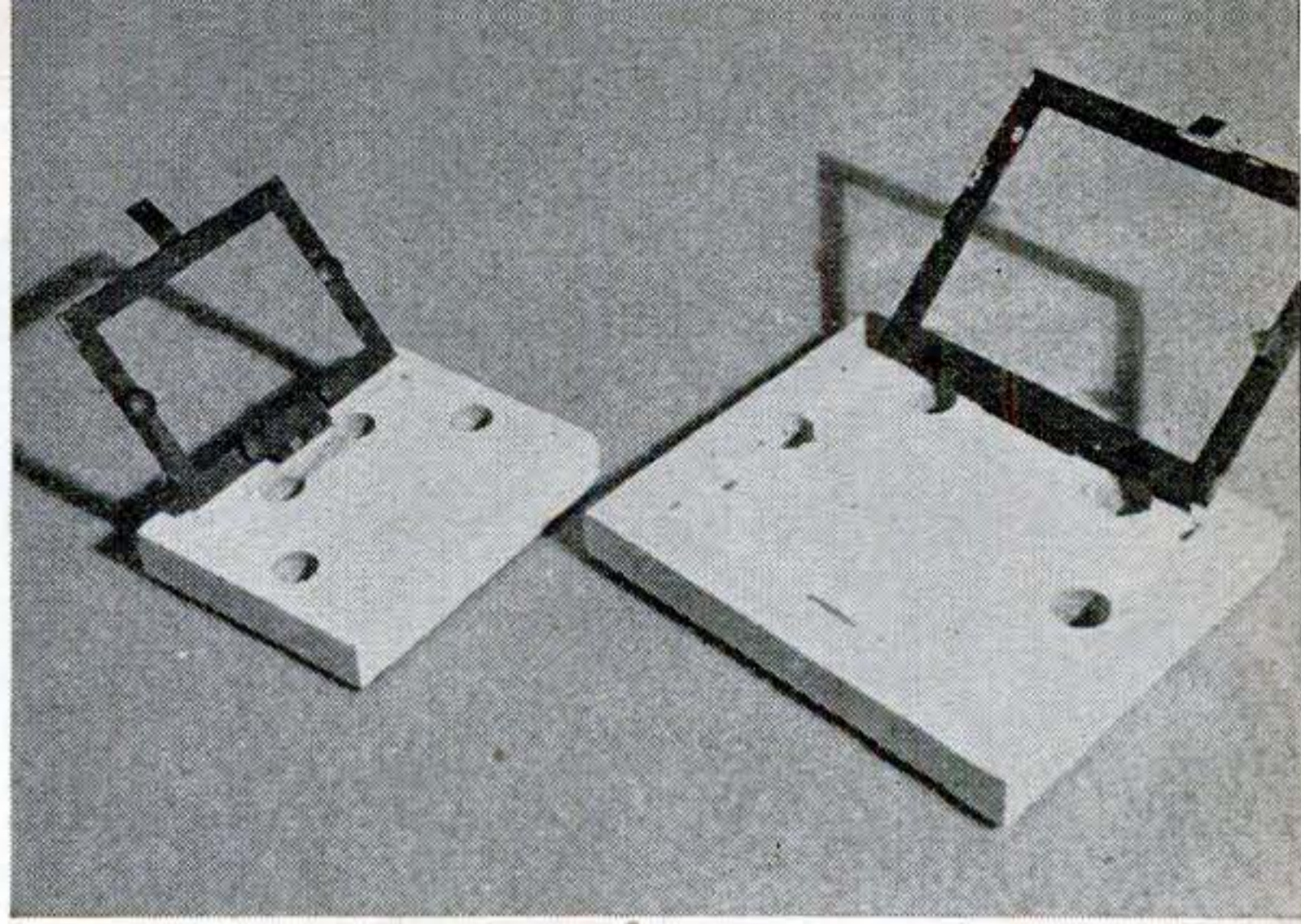

**Easels Give Even Borders.** Here are a couple of easels that provide a quick way of positioning the paper to get even borders when you're making small enlargements. On each, a metal frame with inner dimensions  $\frac{1}{4}$ " less than the finished print is hinged to a white focusing board. One frame has small metal angles soldered underneath to hold the paper loosely; thumb tacks were soldered into tiny holes drilled in the other. After focusing, paper is slipped in and the frame is lowered, the angles or tack heads going into holes drilled in the board.—*D. H. Thompson, Waterbury, Conn.*

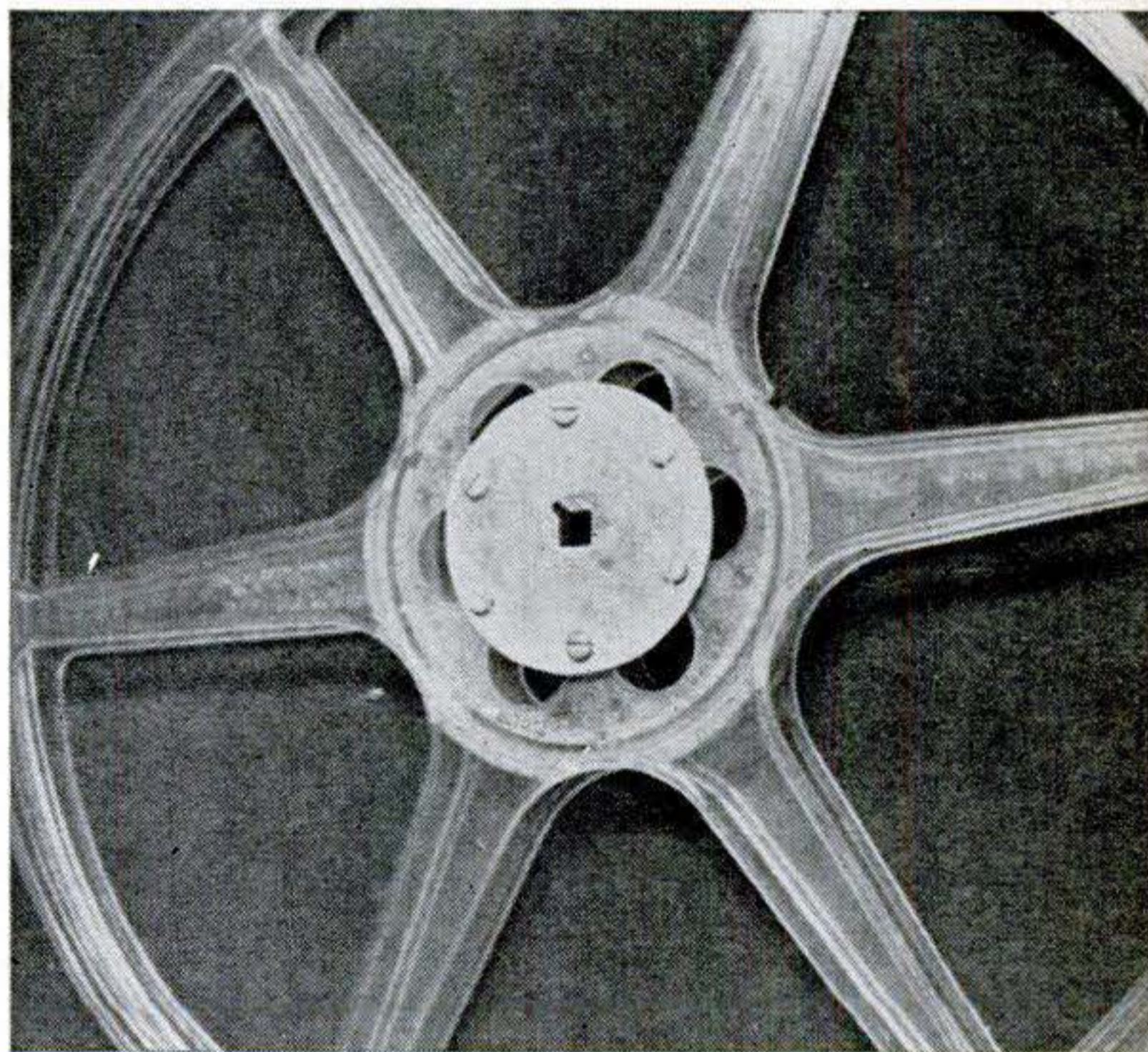

**New Flange Salvages Reel.** The square hubs of 16-mm. movie reels or the slots of 8-mm. reels sometimes become worn by use, especially if made of plastic. Such reels can be repaired by cutting a circular cover flange from scrap aluminum, making it slightly smaller than the inside film roll. In the center, drill a hole and file it square—or make slots, as the case may be. Mount with screws.—*William Jordan, Oil City, Pa.*

# A Superhet the Beginner Can Build

Never built a radio? Tune in on this hobby now with these plans for a five-tuber anyone can make.

**By a High-School  
Shop Teacher**



**D**O VOLTS scare you? Are you *sure* you can't get to first base with radio? Your answer to these questions should be a thumping "No!" If it isn't, someone's kidding you.

I'm not guessing about it. As a shop instructor, I've met hundreds of beginners who were so scared of an ohm they'd hide under a table whenever one crawled out of a circuit. Yet within a few weeks the most timid of them was sporting a receiver he'd built from scratch.

When I say they made receivers, I mean the same 5 tube AC-DC superhet you see here. But isn't it wiser, you may ask, to start off with a simple one-tuber? I don't think so. It's no harder to hook up five tubes than two—you just work a bit longer. And when you've finished, you'll have a sweet little

set with plenty of power and sensitivity. It's even got automatic volume control, something you won't always find on small sets.

The superhet circuit is a highly efficient one used in scores of commercial designs. It has a few more parts than some others, but they're standard and easily obtained. If you're remote from radio shops, the mail-order radio houses have all you'll need. Your parts cost may be as little as \$12, and your time investment will probably run from four to seven evenings.

What this radio—and any other—has to do is to select the signal of a station you want to listen to, separate the audio modulation (electric vibrations at sound frequencies) from the high frequencies that have carried them through space, and then fatten them

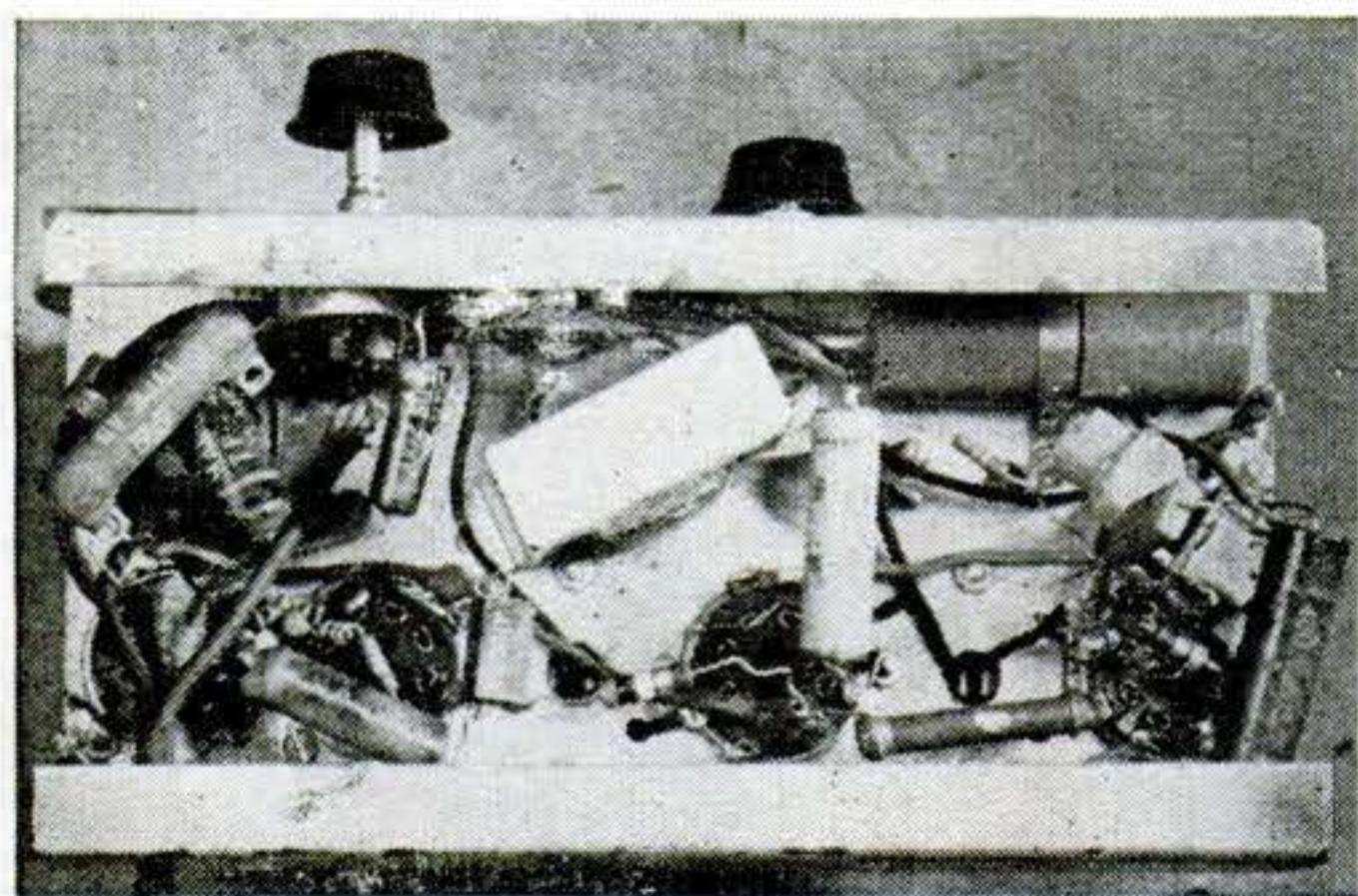

**Bottom of the completed set.** Follow this and the pictorial diagram in laying out the parts.

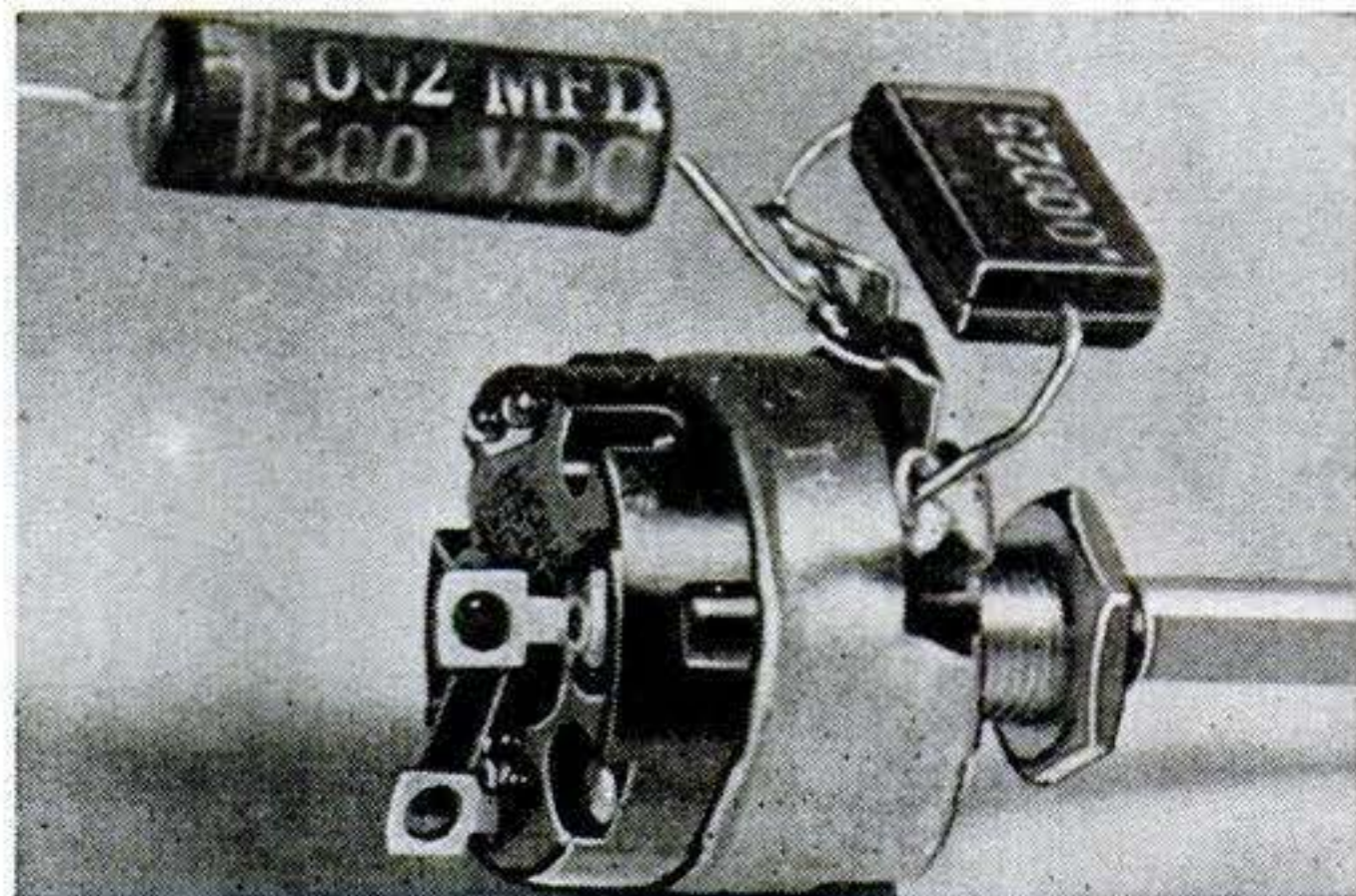

**Soldering can be simplified** by making all convenient connections before mounting parts.



up to loudspeaker volume. A superhet has a baby transmitter of its own, consisting of an oscillator coil and a mixer tube, which generates a radio signal that's used to convert *any* broadcast signal to a standard frequency of 456 kc. This is lower than the broadcast range but not yet in the audible range. It's intermediate, so the transformers and amplifiers that boost it are called intermediate-frequency (IF) transformers and stages. What skims off the low audio frequencies is the detector (part of the 12SQ7 tube in the diagrams), and they are then beefed up by a husky beam-power tube, the 50L6.

Sure, the schematic circuit at the top of page 225 looks complicated. But you've only got to follow one line at a time! Here each part is shown by a symbol—fixed condensers by two thick parallel lines, trimmer condensers by one line and a thick curved arrow, and variable tuning condensers by a straight arrow through a straight and curved line. The letter C refers to condensers that are numbered with the parts list; and R identifies resistors, which are zigzags in the circuit. The springlike symbols are coils or (when paired) transformers.

Those heavy ovals are tube symbols; inside, from the bottom up, are the cathode, one or more grids (thick dotted lines), and the plate. But all you really need to remember is to make the connections to the proper pins on the sockets. Looking at the *bottom* of the socket, these are always numbered clockwise from the little notch or key in the center hole. Connections to the heaters, which make the tubes glow, are separate from other wiring, so they're shown at the bottom of the diagram with just the pin numbers for each of the tubes.

Schematics are drawn in a kind of elec-

tronic shorthand that you'll pick up fast. Meanwhile, a pictorial diagram of the same set may prove a help, since it suggests what the parts look like and where to put them. It's at the bottom of page 225.

In buying parts, be cautious about accepting substitutions, even if a salesman tells you that the exact value of a part isn't important. Don't use paper condensers where mica ones are specified, or resistors of lower wattage rating than called for. Be sure you buy an oscillator coil with four leads. The IF transformers should have trimmer condensers attached inside the can. I recommend Bakelite  $\text{\textcircled{T}}$  octal sockets having a metal frame with ground connections next to prongs 1 and 5, rather than the cheaper wafer sockets.

The tuning condenser is a two-gang cut-plate type; that is, it has one 27-plate section and one 19-plate section. It should also have built-in trimmer condensers—tiny screw-adjusted ones used in aligning later.

Either a permanent-magnet or a dynamic speaker can be used. The latter has an electromagnet, the field coil of which will serve as the filter choke (L3), while with a PM speaker you'll need a separate choke. Some builders use a 1,000-ohm 5-watt resistor in place of the choke, since it costs less and takes less space, but a choke cuts hum and gives better tone.

While we're on the subject of choices, there's another that you may want to consider in building the set. The lower left part of the schematic diagram shows an alternative to the 35Z5 rectifier tube. Selenium rectifiers are gaining popularity as rectifier-tube replacements because they give trouble-free service, don't have to warm up as tubes do, and need no heater supply. Since the heaters in this set are connected in series,

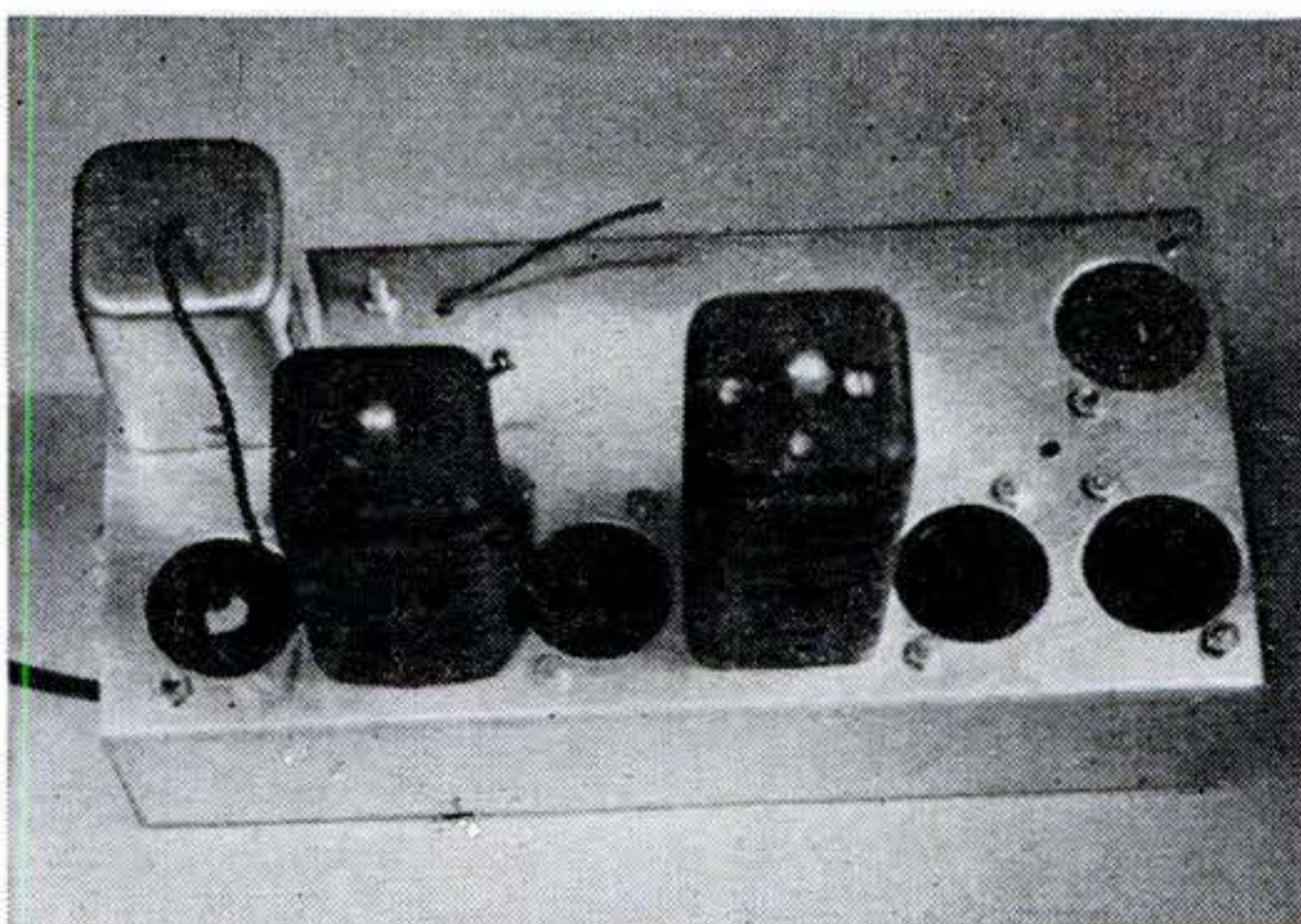

Top of the chassis with sockets and coil cans mounted as called for by the template, right.

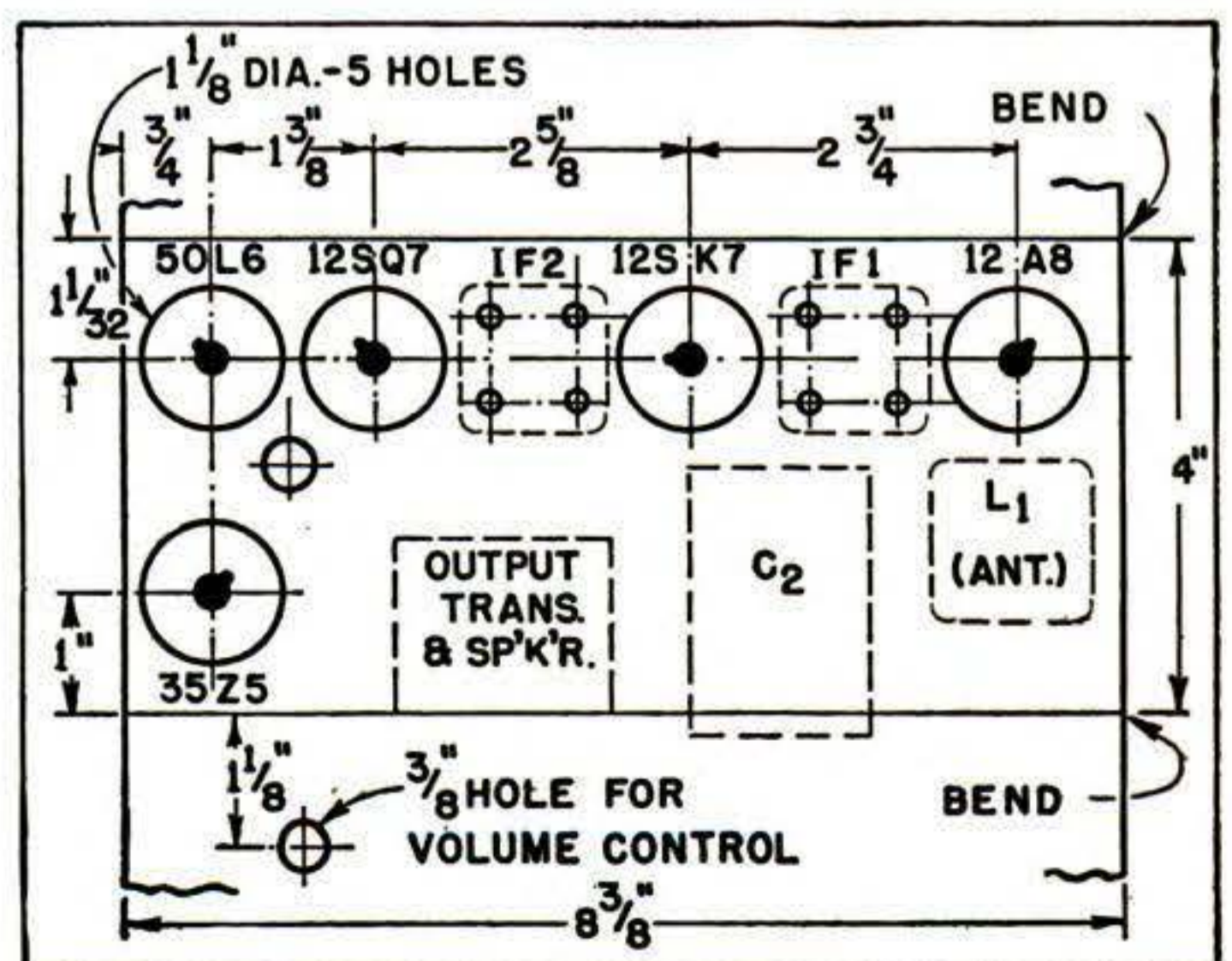

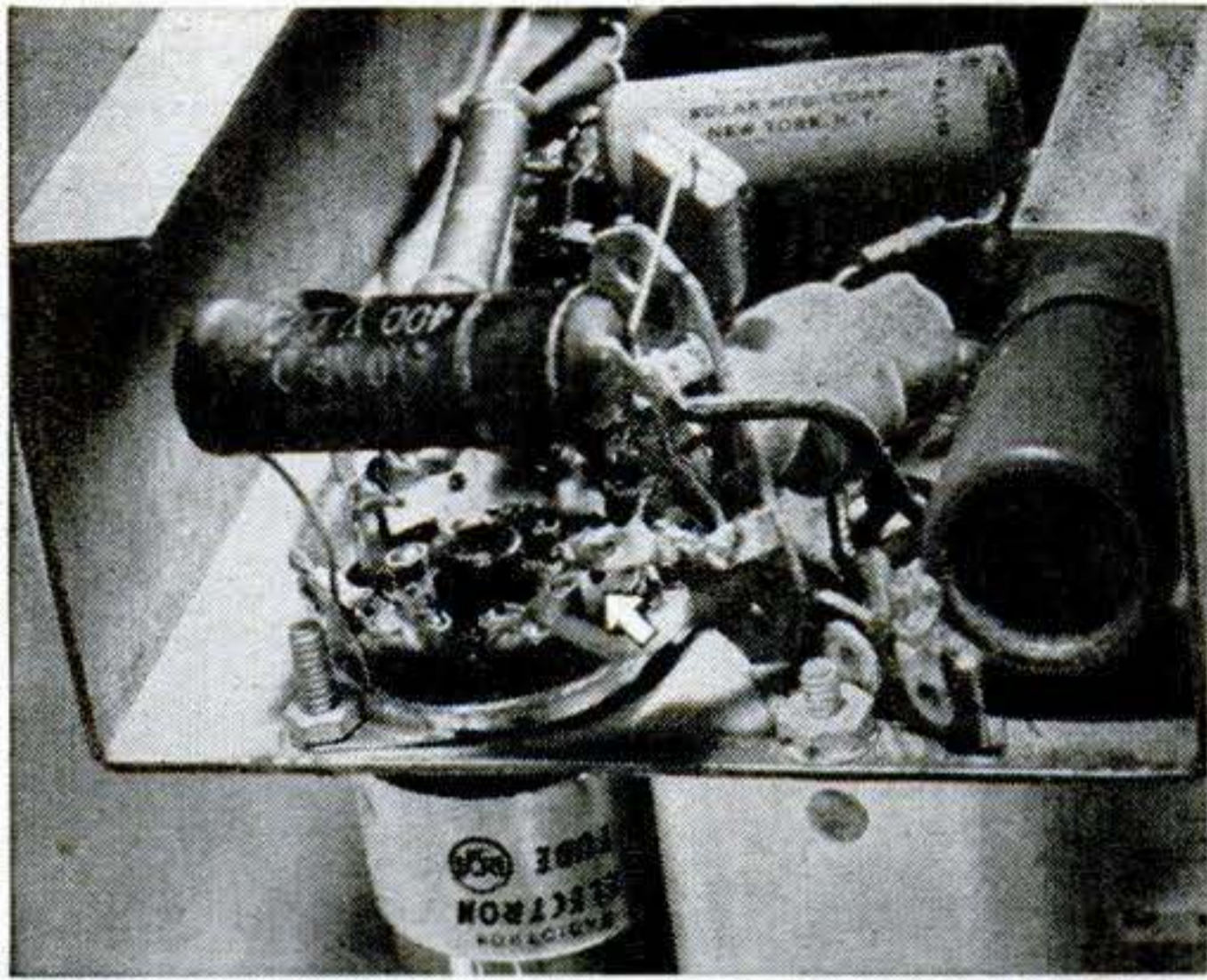

Arrow points to the plate (blue) lead of the oscillator coil, soldered to pin 6 of the 12A8.

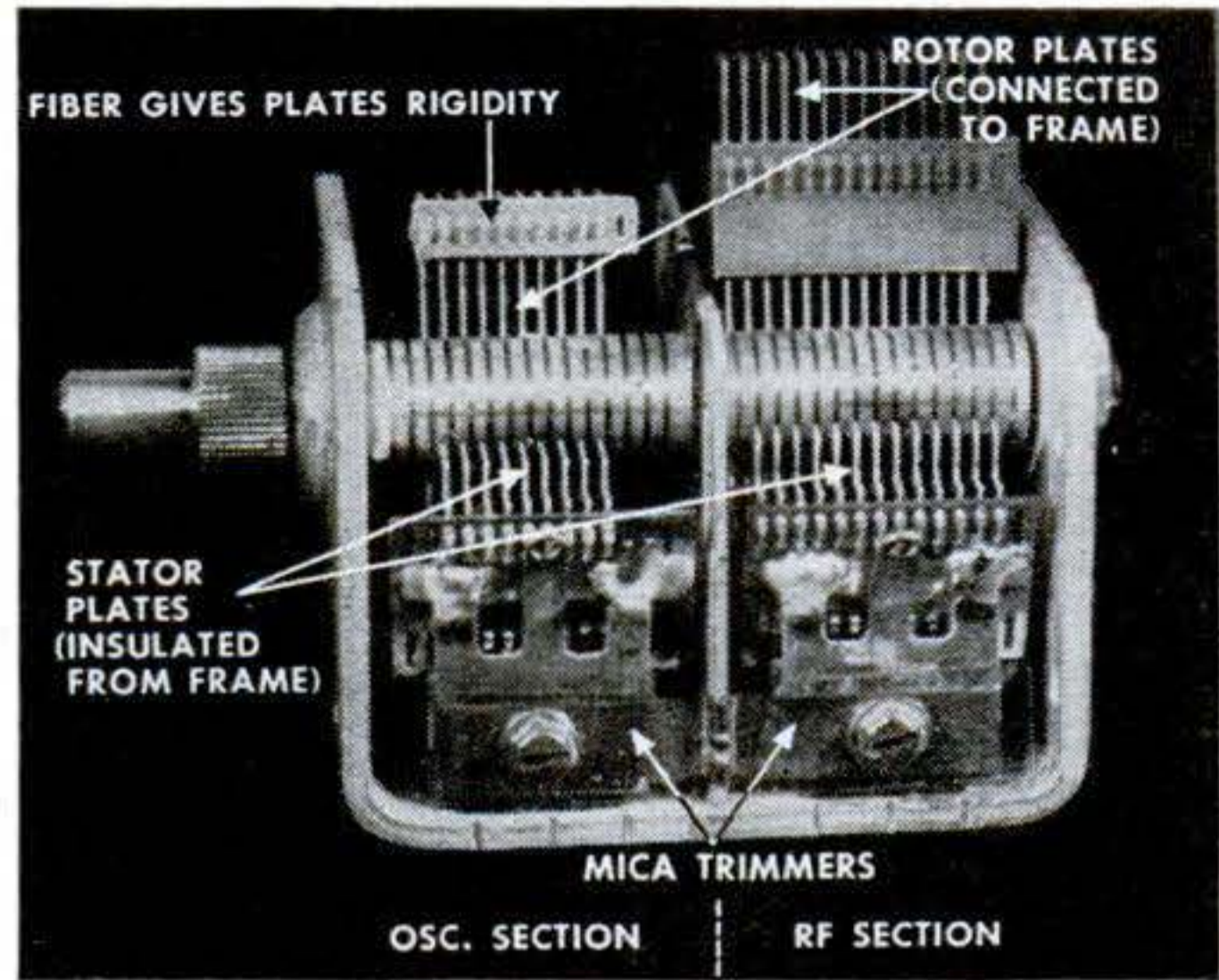

Cut-plate, two-gang tuning condenser, showing basic elements. Make sure yours has trimmers.

you'll have to insert the additional resistors R11 and R12 if you omit the rectifier tube.

And now let's get down to building. For a neat chassis arrangement, draw a full-size chassis template, paste it on a flat piece of aluminum, and punch and drill all holes. A No. 28 drill is right to clear the 6-32 screws used to mount all parts. Take pains in making the holes for the tube sockets, since the big central hole and the two mounting ones must be in line. While the 1 $\frac{1}{8}$ " socket holes can be cut on the drill press with a hole cutter, a chassis punch is much easier. Bend in the sides and letter on the tube numbers for each socket. Many radio supply houses sell prepunched chassis that'll do nicely.

Don't mount the tuning condenser and speaker right away, since they're both fairly delicate and might be damaged during work. Inasmuch as you're using a 12A8 tube in which the signal-grid comes out to a cap at the top, use an antenna coil that has a hole in the top of the shield can for this grid lead. When installing the IF transformers, orient them so that the plate and grid leads are as short as possible. Follow the color coding; the blue one goes to plate, red to B plus, green to grid, and black to the AVC line.

Note the four holes to be drilled through the chassis under each IF can; they allow the leads to be brought out singly for maximum separation. Grid and plate leads of IF transformers must be cut as short as possible, and kept away from each other and close to the chassis. If they *must* cross, see to it that they cross at right angles.

Construction will go most smoothly if you complete all chassis drilling and punching first, and have all parts at hand before you

begin. Many parts can be wired before they're mounted on the chassis. For example, mica condenser C7 is shunted across the outside terminals of the volume control (R5) before the latter is mounted. One end of C6 is similarly attached. Making connections out where you have plenty of room renders assembly easier. Make all leads as short as possible, and don't be afraid to crowd parts together.

It's also a good plan to wire each separate part of the circuit with different colored wire. Circuits are commonly coded like the IF leads—blue for plate, and so on, plus yellow for the filament and brown for cathode circuits. Pushback wire, the kind most convenient to use, comes in these colors. The logical wiring sequence is: heaters, cathodes, screen grids, control grids and diode plates (pins 4 and 5 of the 12SQ7), AVC leads, and the B-plus circuits.

Note the location of the dual electrolytic condenser C11 and C12 in the pictorial diagram—as far as possible from the 35Z5 and the 50L6 tubes. These are the ones that generate most heat, and heat is bad for electrolytics. These condensers must be connected with the correct polarity; they're ruined by reversed polarity. Run the black lead to ground and the red one to the plus side. If the leads aren't colored, the ground lead comes from the end with a heavy black line. The value of this dual electrolytic isn't critical; anything from a 16-16 mfd. to a 40-40 mfd. one will do. With paper condensers, the lead attached to the outer foil is the one to be grounded if either one is. In the case of the tuning condenser, it's the terminals of the rotor section that go to ground.

TO BE CONTINUED

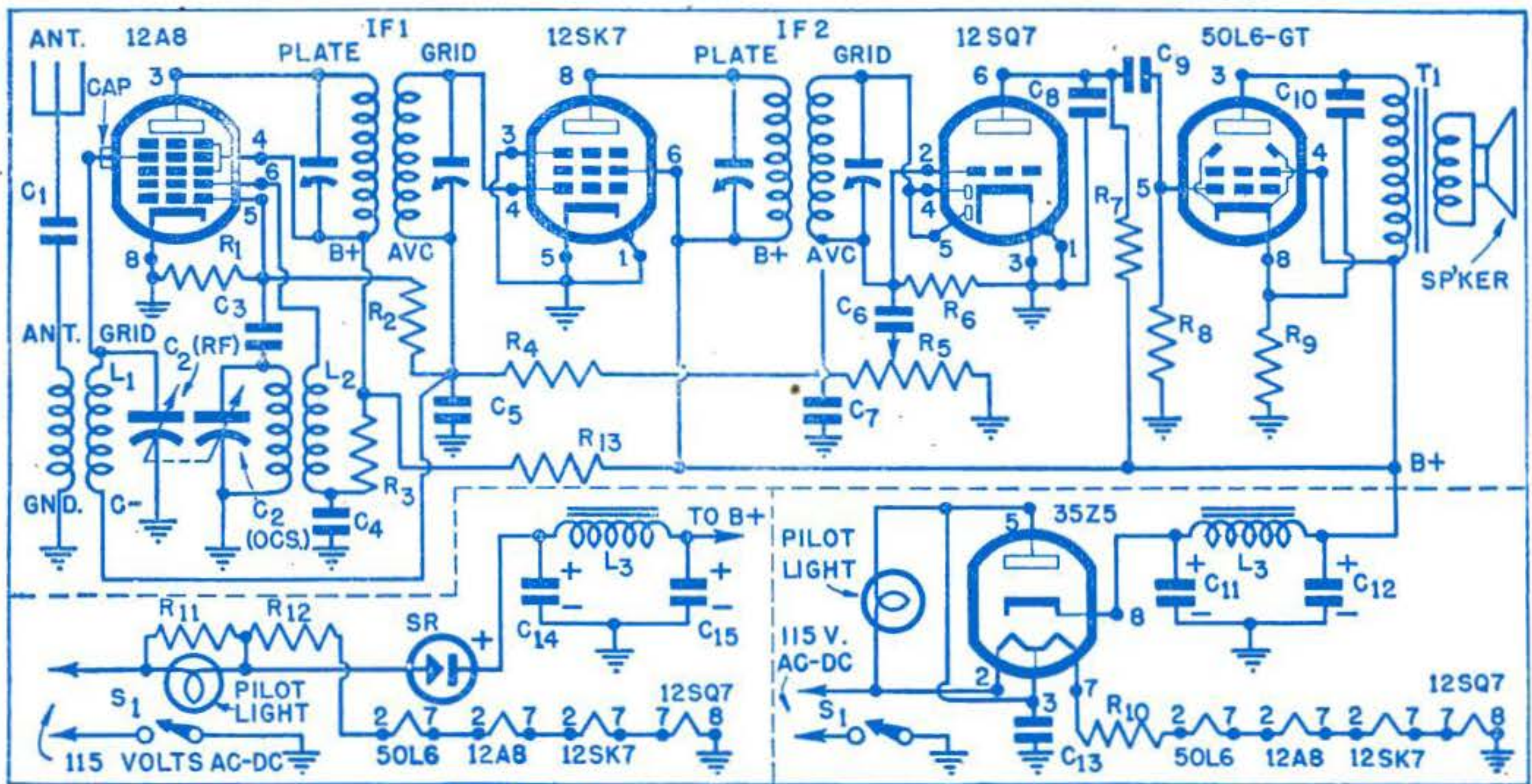

### LIST OF PARTS

All resistors  $\frac{1}{2}$ -watt carbon unless otherwise specified.  
 R1: 50,000-ohm. This is critical.  
 R2, R6: 15-meg.  
 R3: 20,000-ohm.  
 R4: 3-meg.  
 R5: 500,000-ohm pot (with switch).  
 R7, R8: 500,000-ohm.  
 R9: 150-ohm.  
 R10: 30 to 50-ohm, 10-watt wire-wound.  
 R11: 22-ohm, 10-watt wire-wound.  
 R12: 200-ohm, 10-watt wire-wound.  
 R13: 50,000-ohm.  
 All paper condensers 400 volt unless otherwise specified.  
 C1, C7, C8: .00025-mfd, mica.

C2: two-gang, cut-plate variable condenser for broadcast band and 456 kc. IF.  
 C3: .0001-mfd, mica.  
 C4: .1 mfd, paper.  
 C5, C13: .05-mfd, paper.  
 C6: .002-mfd, 600-volt paper.  
 C9, C10: .02-mfd, paper.  
 C11, C12: 20-20-mfd., 150 volt dual electrolytic.  
 C14, C15: 40-40-mfd., 150 volt dual electrolytic.  
 L1: Shielded ant. coil with trans. windings. Grid lead should come out at top of shield can.  
 L2: Four-lead, 455-6 kc. osc. coil.  
 L3: 400-ohm, 15 to 30-henry, 75-ma.

choke coil, or 450-ohm field coil on dynamic spkr.  
 IF 1, IF 2: Input and output shielded intermediate-frequency transformers for 455-6 kc.  
 T1: Output trans. to match 50L6.  
 S1: SPST switch on R5.  
 SR: 100-ma. selenium rectifier.  
 Speaker: 6" PM or dynamic.  
 Pilot light (6-8 volt, .15-amp., No. 47) and bayonet socket; prepunched chassis or 8 $\frac{3}{8}$ " by 9" sheet aluminum; line cord; tubes; octal sockets; nuts; bolts; misc. hardware.  
 Note: With 35Z5 rect., omit R11, R12, C14, C15, SR; with selenium rect., omit R10, C11, C12.

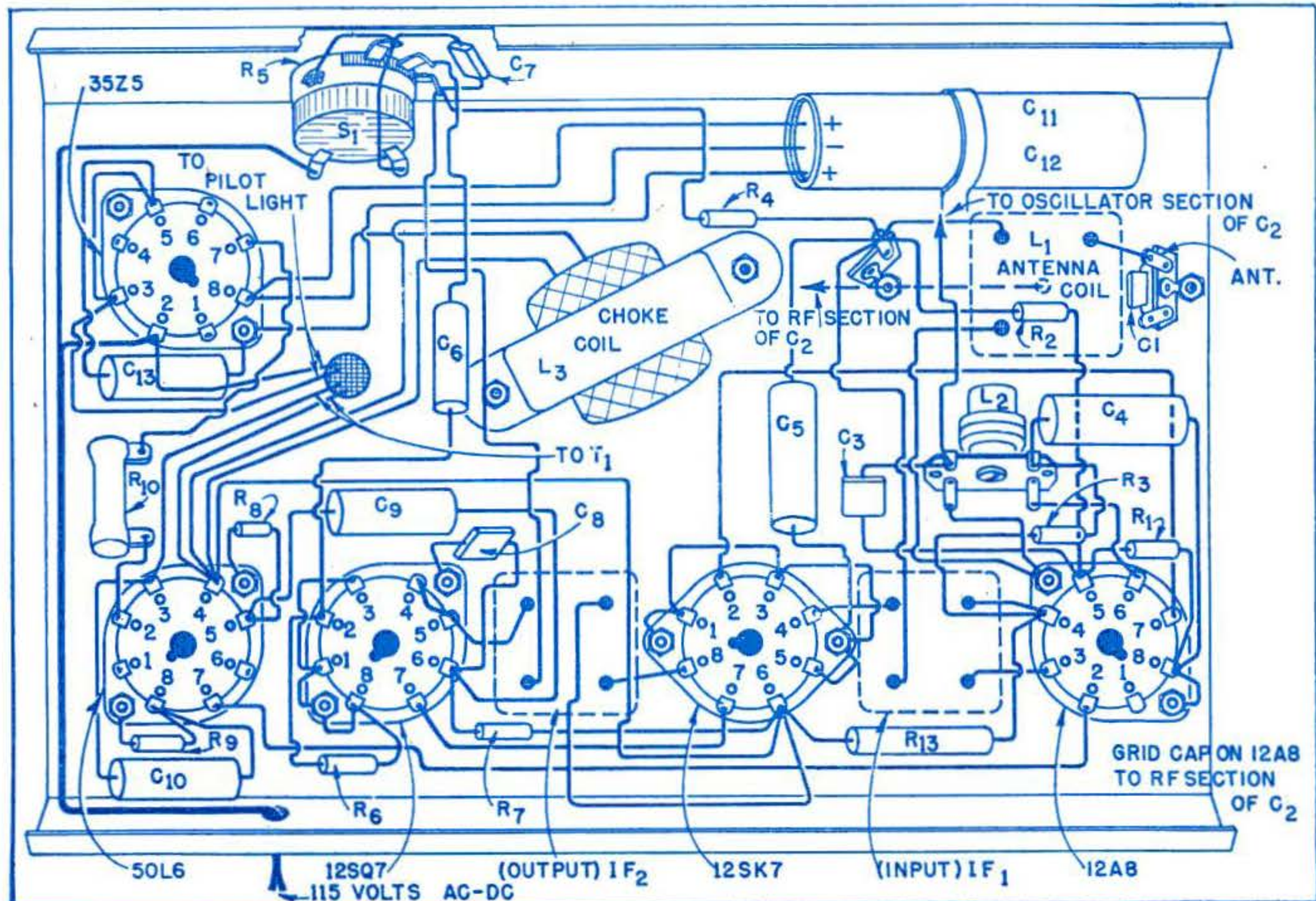

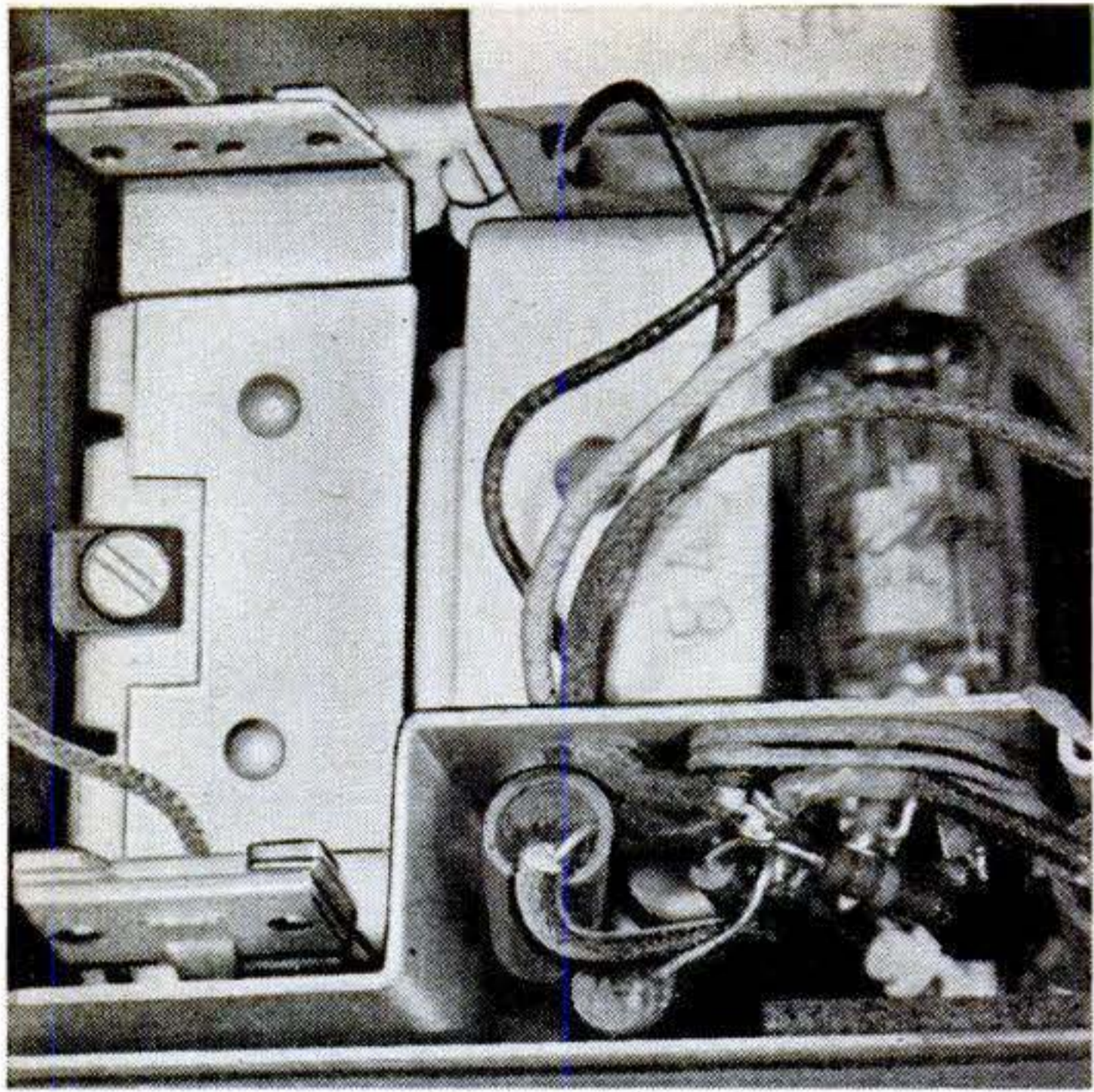

Connect wires to both ends of the A-cell clip shown at the left. One side of it is grounded.

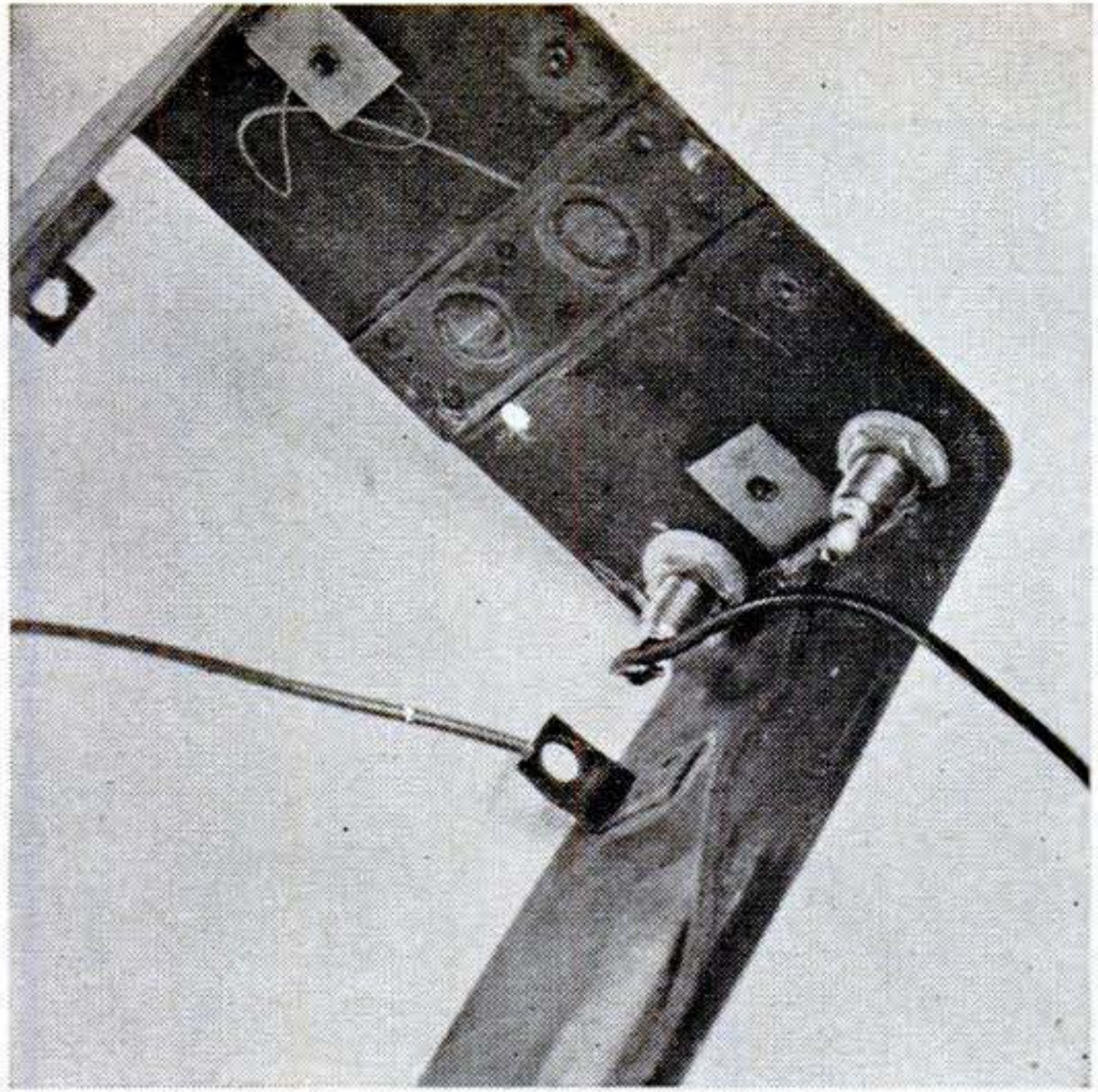

One of the phone jacks must be insulated from the case. This will go to the A-plus terminal.

## External Battery Runs Portable

FLASHLIGHT cells, often used as the filament supply in midget portables, generally become exhausted long before the B batteries. If you have such a set that is mainly used about the home, you can save yourself the nuisance of frequent replacement by plugging in a large No. 6 dry cell. Such cells, commonly used with doorbells and lanterns, have a long shelf life and a high current capacity compared with D-size flashlight cells. For convenient change-over, install a pair of phone-tip jacks in the back of the portable, soldering leads from them to the regular inside cell clip. Be sure to remove flashlight cells when using the external supply, as one might discharge the other.—*Arthur C. Miller, Manhattan, N. Y.*

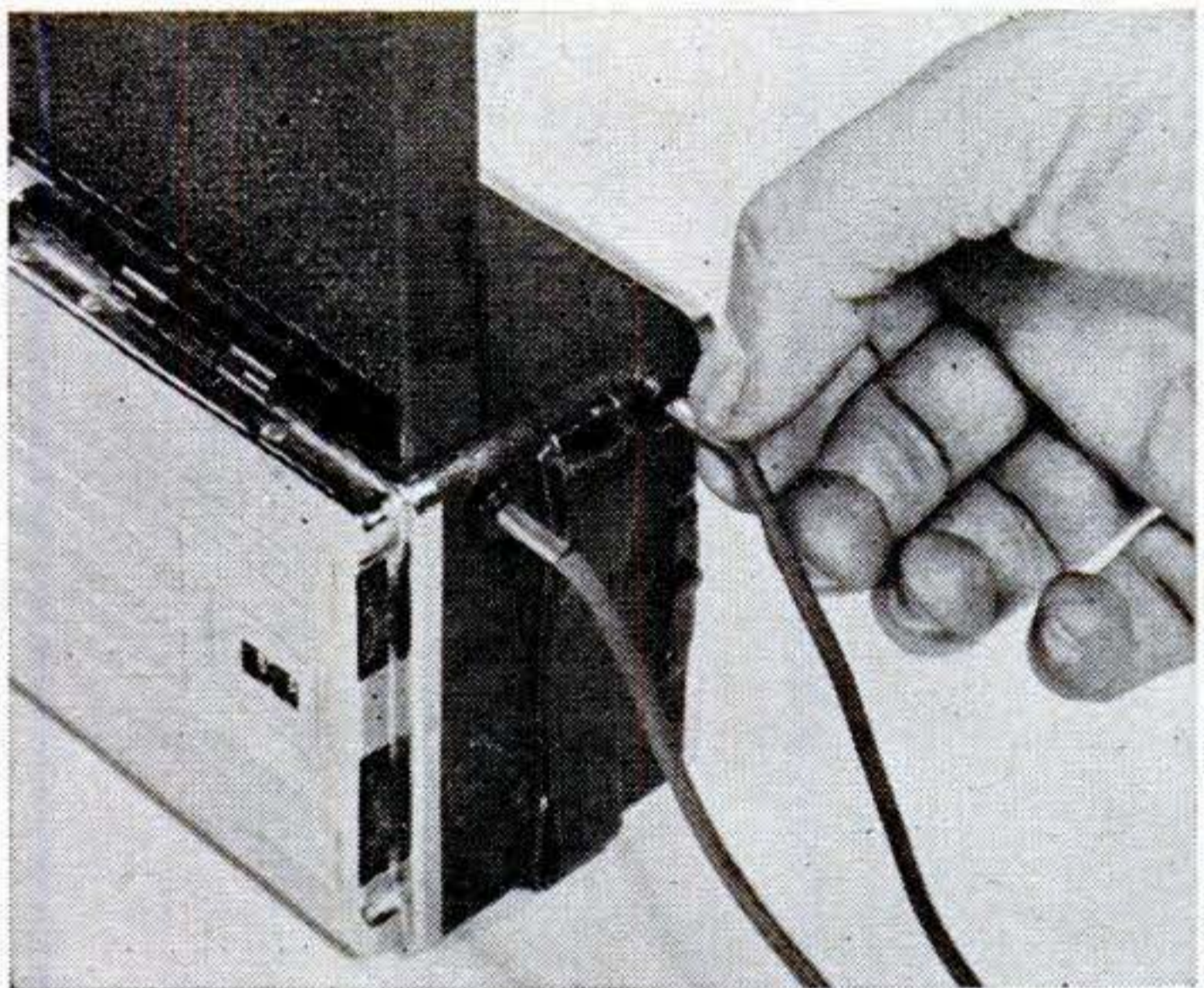

Remove the flashlight cell from its clip and then plug in the external 1½-volt battery leads.

## Gasket Allows Mounting of Grounded Meter

WHEN the rack-mounted meter in the final stage of a transmitter flashed over internally and grounded itself against its case, the meter had to be held off the panel to obtain correct readings. To do this, three layers of cellulose tape were first wrapped around the meter case and shanks of the mounting screws. A cardboard gasket, slightly larger than the flange, was inserted between the panel and the case. Fiber washers were used under screwheads.—*D. J. Bachner, Jackson Heights, N. Y.*

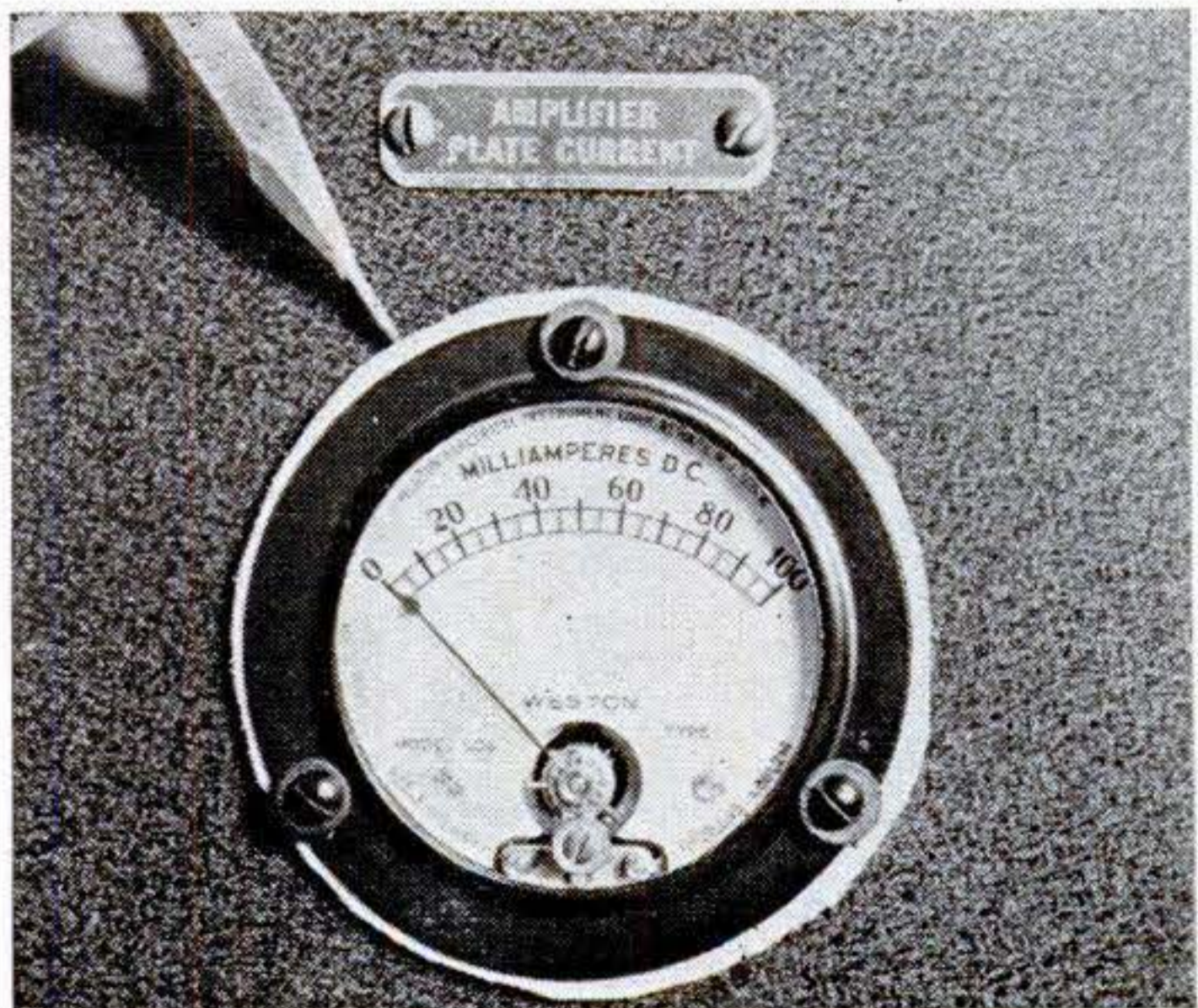

## Low-Loss Antenna Plug Made from Crystal Holder

PARALLEL lead-in line can be connected to an FM or television receiver, without changing the impedance of the lead-in, by means of a discarded crystal holder. Cut and scrape the ends of the 300-ohm line and solder the tips into the holder prongs. Connect a suitable socket to the terminals in the set.—*Myron Bobbe, Bronx, N. Y.*

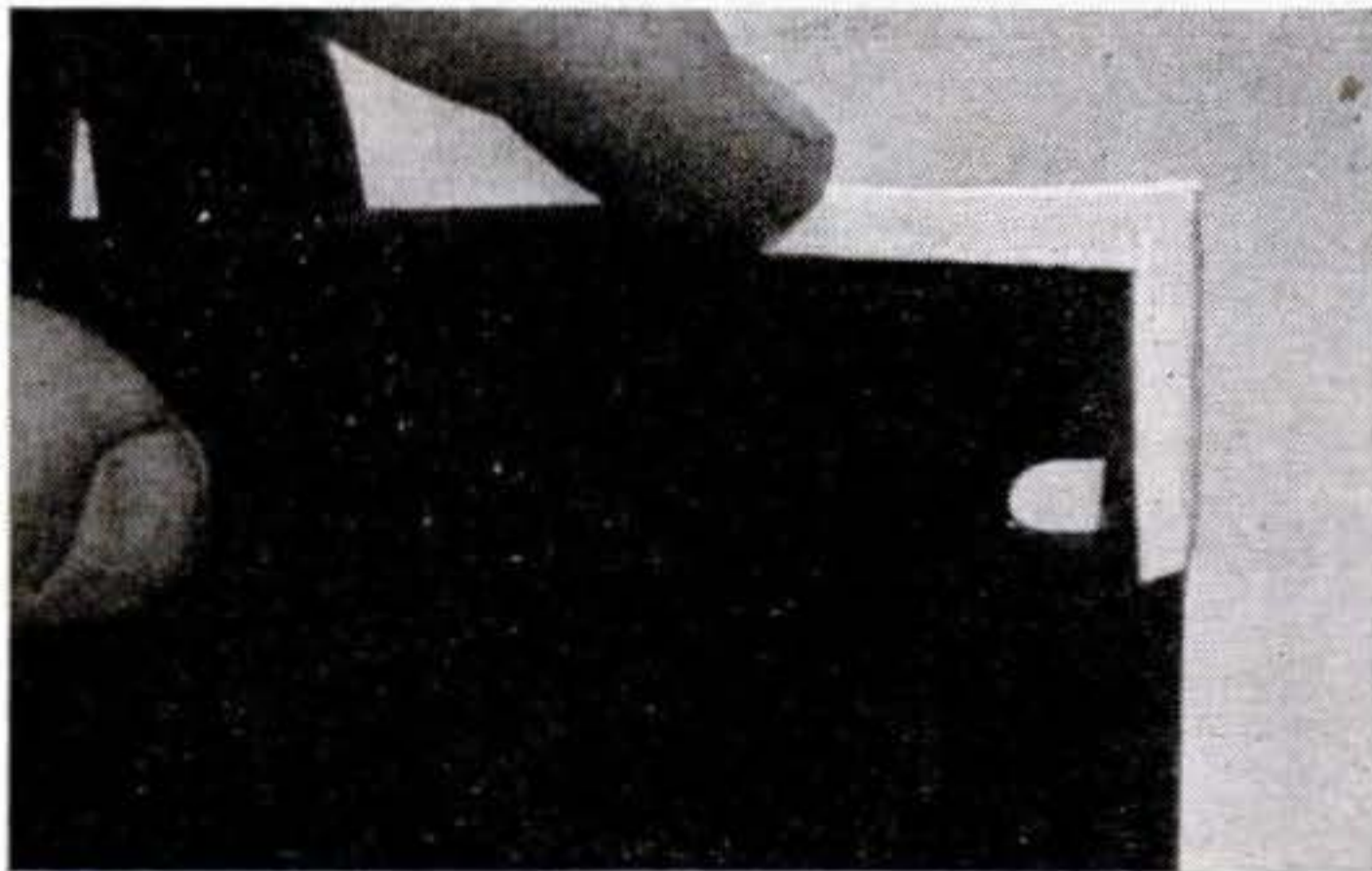
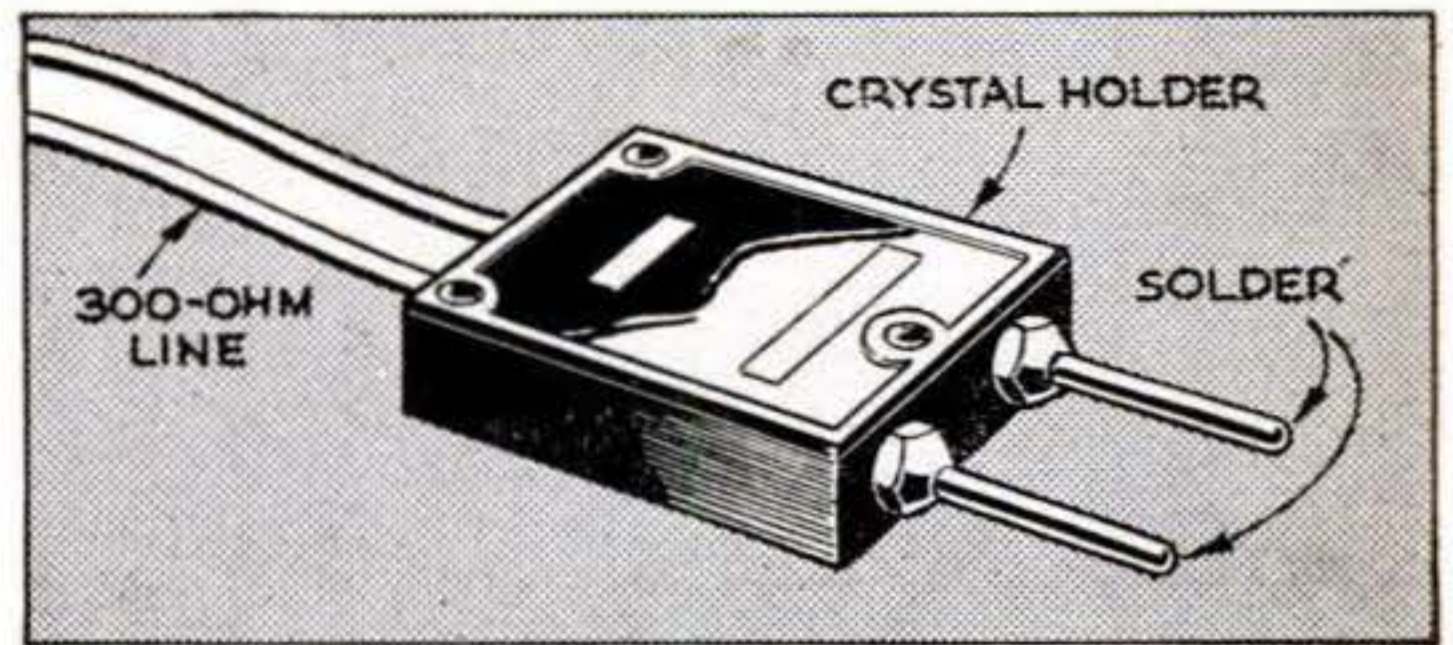

### Tape Makes Corners Safe

AFTER suffering some nasty cuts from the sharp corners on steel radio panels, one experimenter applied adhesive tape as above. Better as a preventive than a treatment, the tape is easily removed when work is done, and leaves no marks.

### Fluid Patches Record Breaks

RECORD cracks that throw the needle back into the same groove can be repaired with mimeograph-stencil correction fluid. Clean the record well with a record brush, apply fluid, let it harden, and play the record with a fresh needle to cut new grooves through the patch. The needle should then track properly, although a click may still be heard as it passes the patch. Repeat patching treatment as needed.—*David Witt, Bronx, N. Y.*

### Foil Shields Radio Tube

NOT having a tube shield of the right size on hand while you are working on a radio need not keep you from finishing the job. It is a simple matter to soak or burn off the metal foil from a package of cigarettes and wrap it around the tube. Fasten it with cellulose tape, and also tape a piece of wire to the foil so that it makes secure contact. Attach the other end of the wire to the chassis so as to ground the shield effectively.—*J. W. Cornell, Utica, N. Y.*

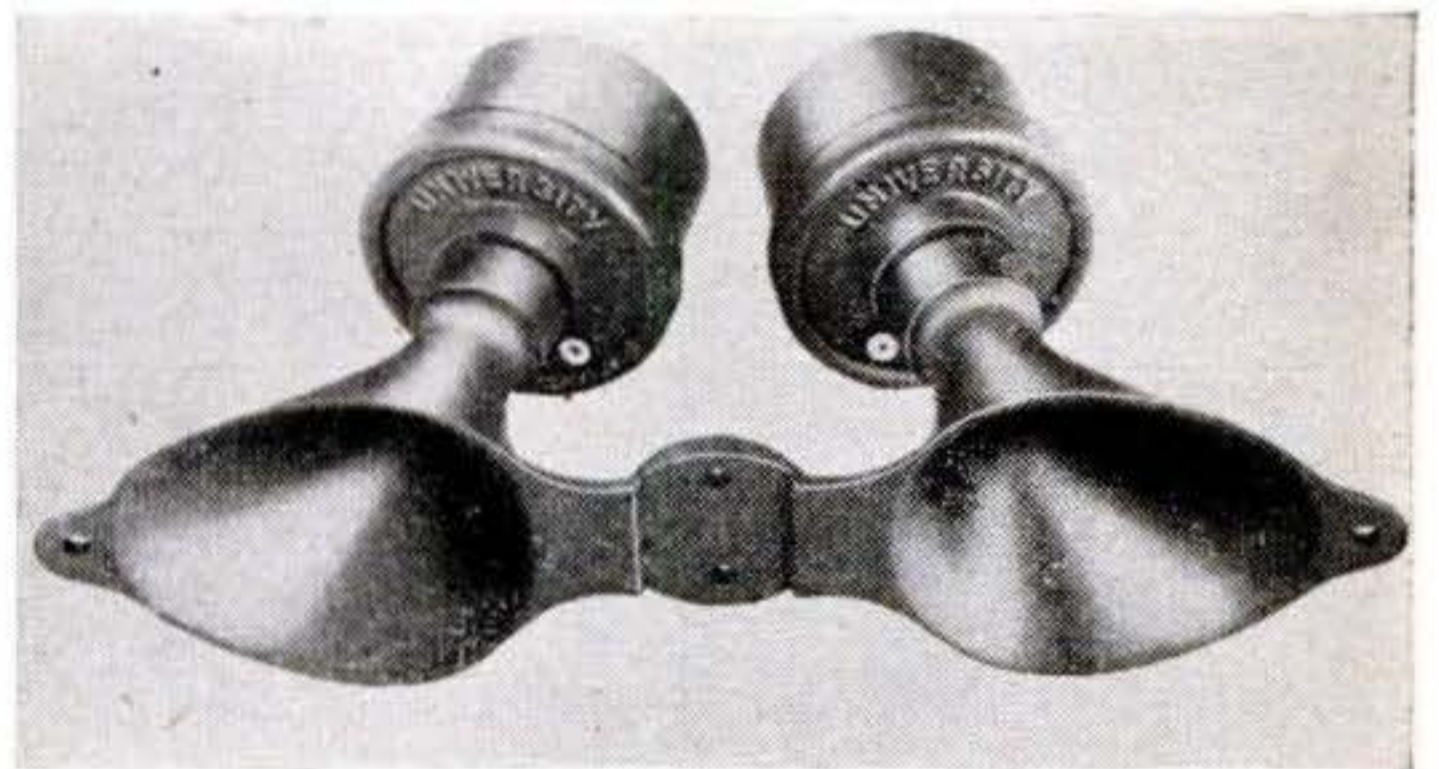

### Tweeter Ups Speaker Response

A HIGH-FREQUENCY speaker said to reproduce the 2 to 15-kc. sound range is made by University Loudspeakers, Inc., New York. It can be attached to an existing 12" speaker merely by connecting two wires, without extra set connections or a dividing network.

## Electronic Circuit Panel Speeds Experiments

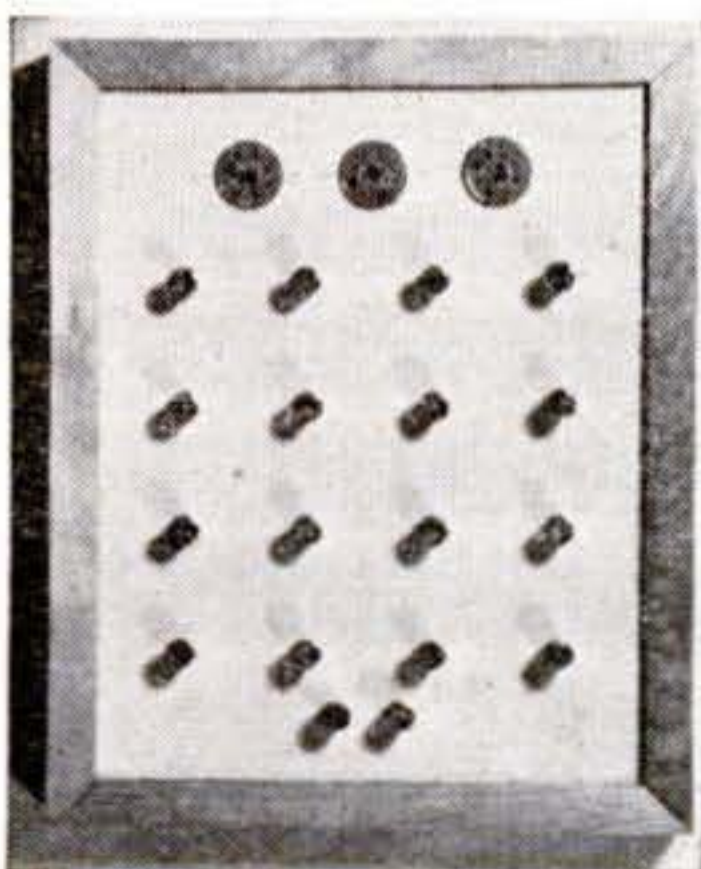

MANY laboratory and school experiments can be performed on this panel containing three wired octal sockets and a variety of interconnected terminals. The board is furnished with 23 keyed diagrams that fit the top of the panel. They are said to cover fundamental experiments in vacuum and gas-filled tubes. Each circuit details the connections that must be completed. Kepco Laboratories, Flushing, New York, is the maker.

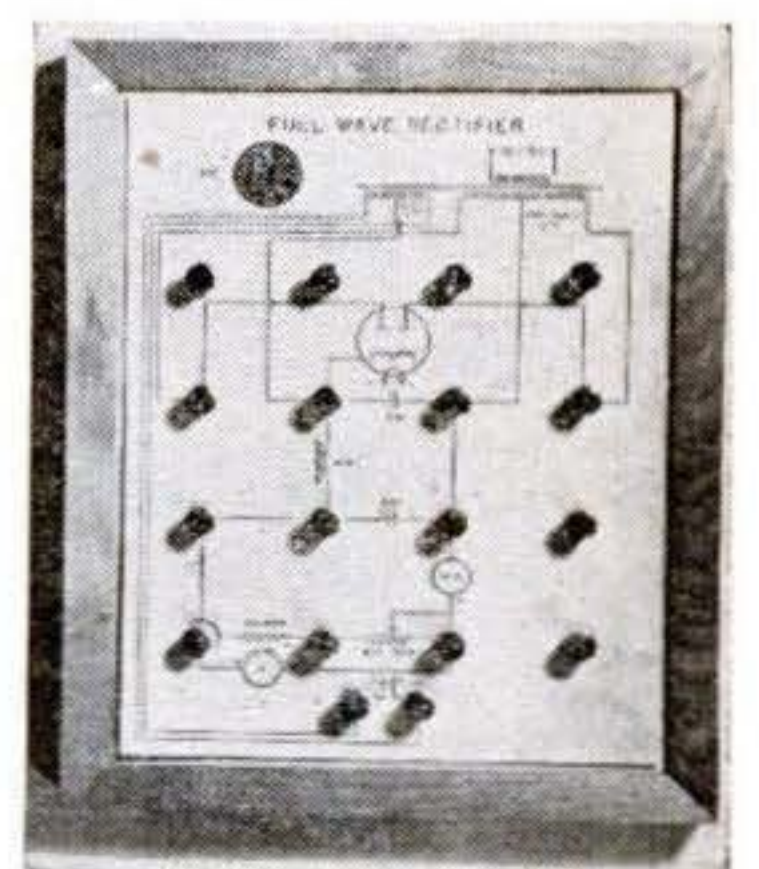

## Ball-Bearing Support Speeds Work on Long Stock

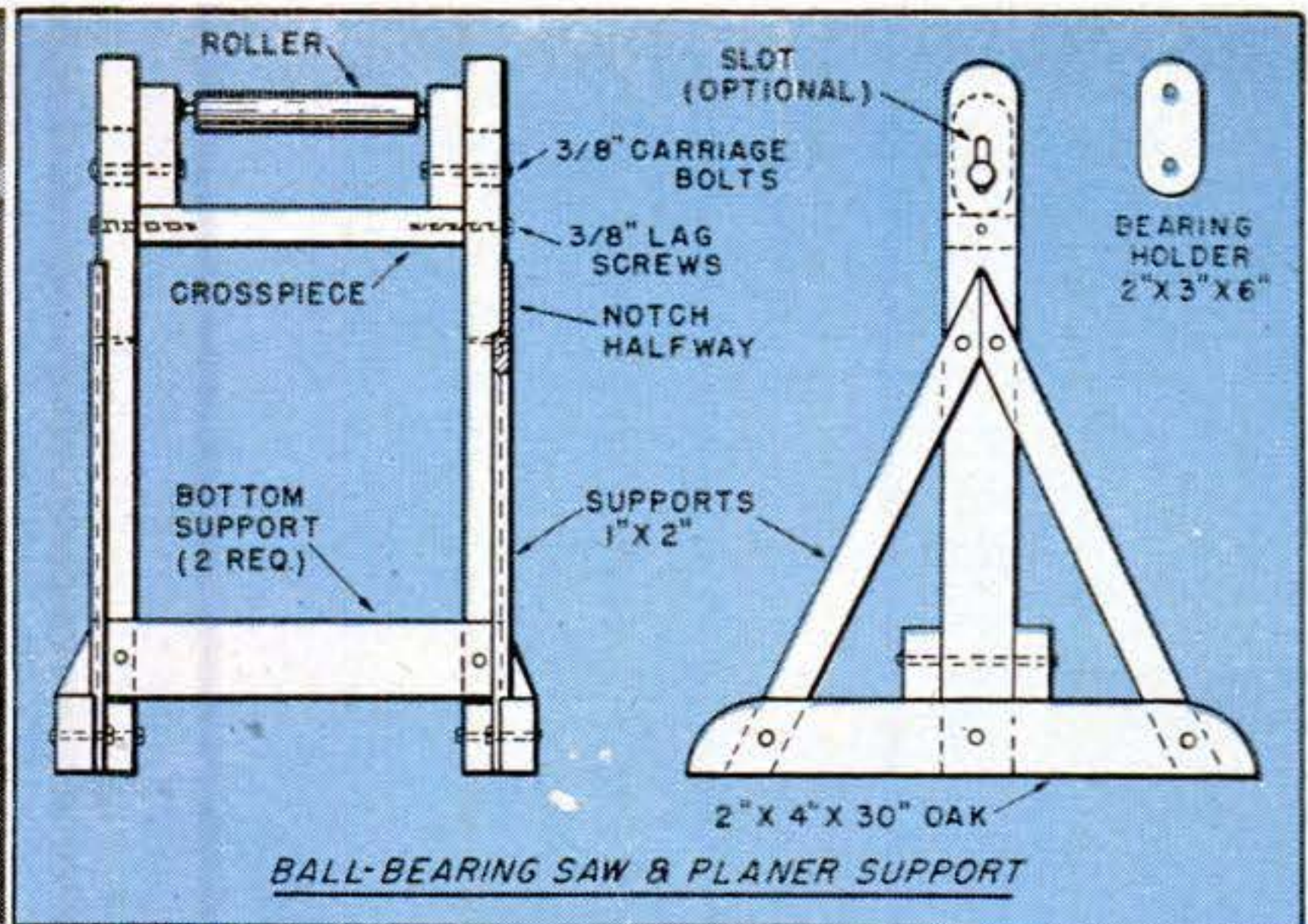
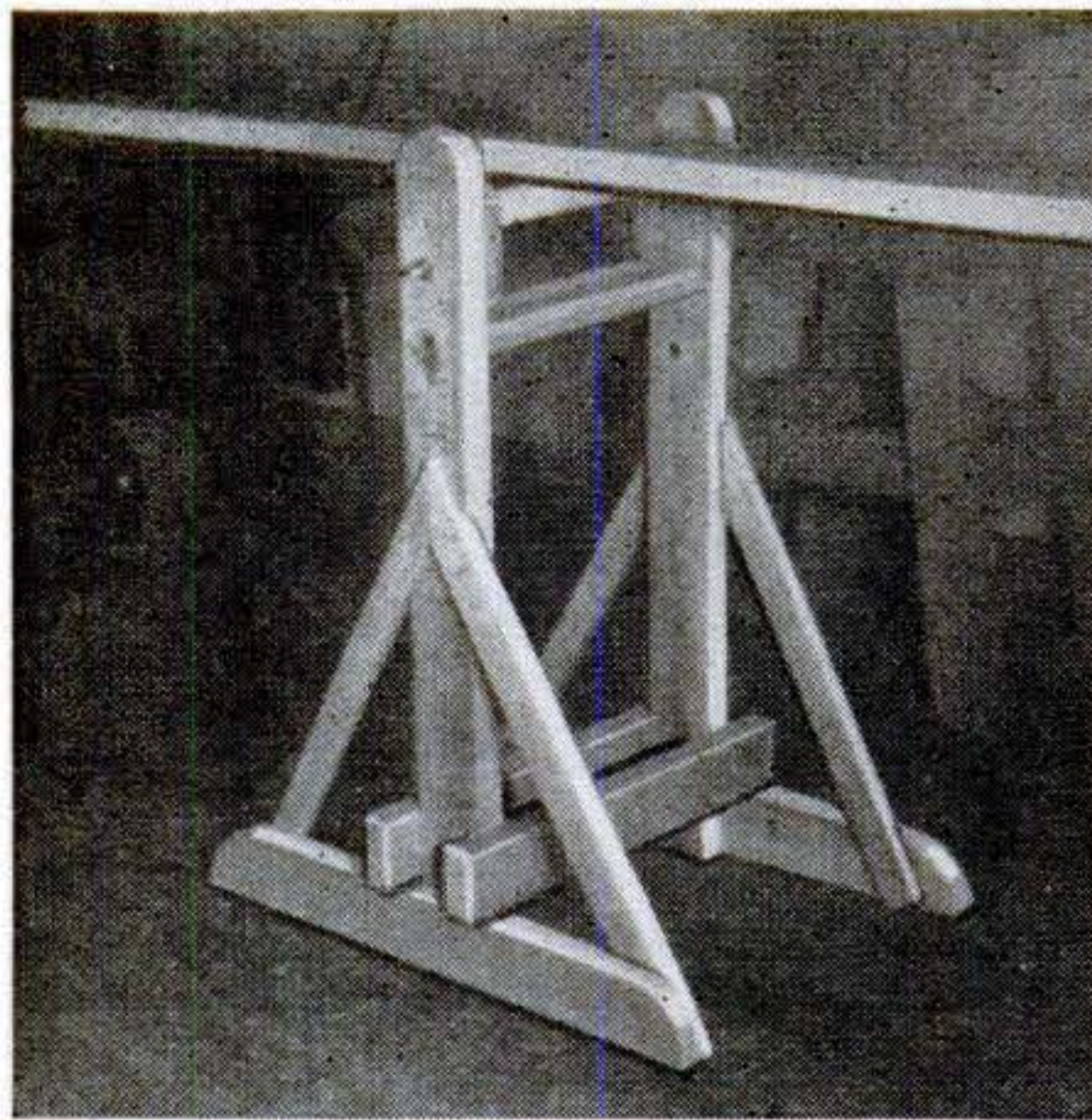

EVER wrestle with a 10' piece of lumber while you tried ripping it on a circular saw? If you have, you must have wished for a third hand (with a mighty long arm) or a roller support just like this. The ball-bearing roller makes even the heaviest work glide on or off the table of the saw, planer, drill press, or other machine on which you use long stock. A washing-machine roller was picked up at a junkyard. Plenty of them are to be found, so select one with its bearings intact and the rubber surfaces in fairly good condition. Make sure you get the bearing retainers, too. Clean the parts and oil sparingly.

Adapt the width of the support to the roller you can get, and its height to that of the machine table. Mortise the bearings in

2" by 3" by 6" holders. Use hardwood for the stand if possible, because the extra weight will be an advantage. Fasten all joints with  $\frac{3}{8}$ " carriage bolts or lag screws as indicated.

Complete the sides first and mount the bearing holders by bolting them in slots. These slots will allow you to vary the roller height according to the adjustment of the table or to suit slightly different machines. —William D. Jackson, Knox, Ind.



## Plastic Drink Mixer Clips Tie

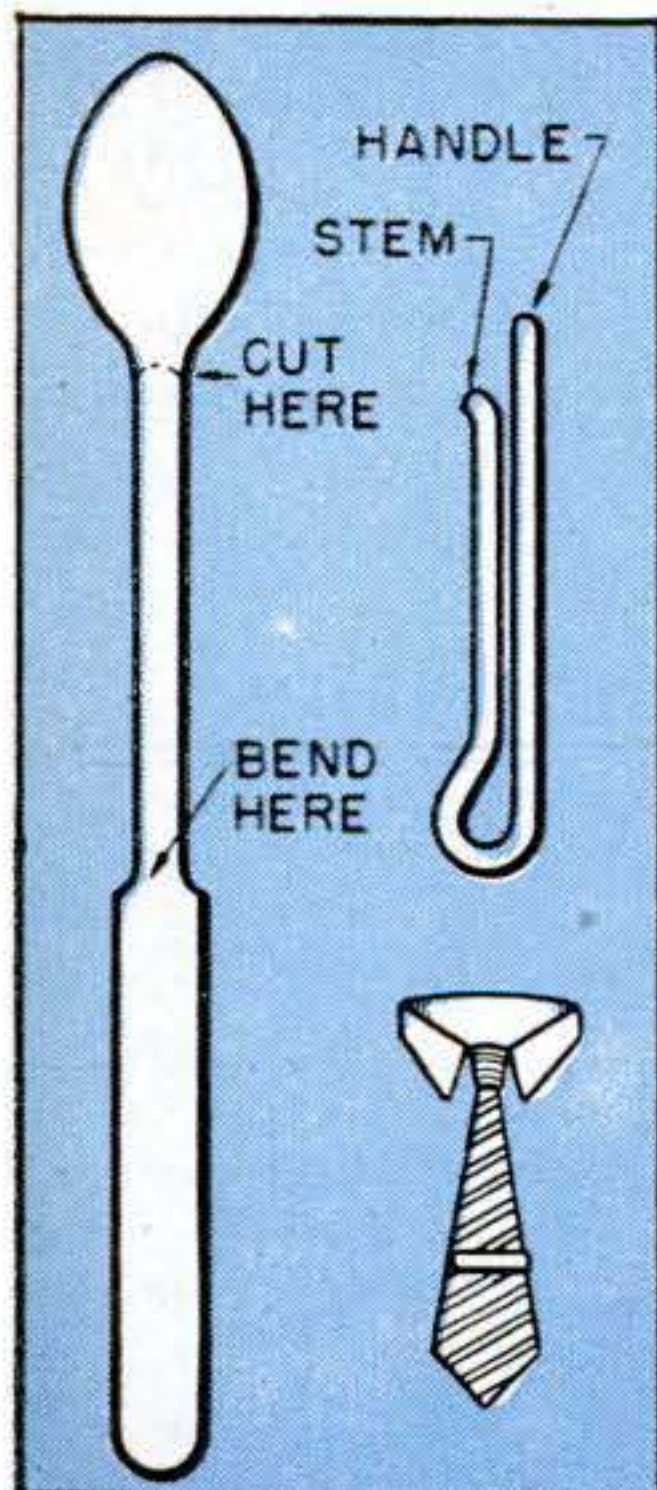

PLASTIC drink stirrers of the spoon or spear type can be readily made into novel tie clasps. Cut off the spoon and bend at the point shown by submerging the plastic into hot water and applying light pressure. Dip the piece into cold water to set the shape. Mixers come in all colors, so you can make a variety of clips to match your best selection of ties.—Donald T. Barry, East Orange, N. J.

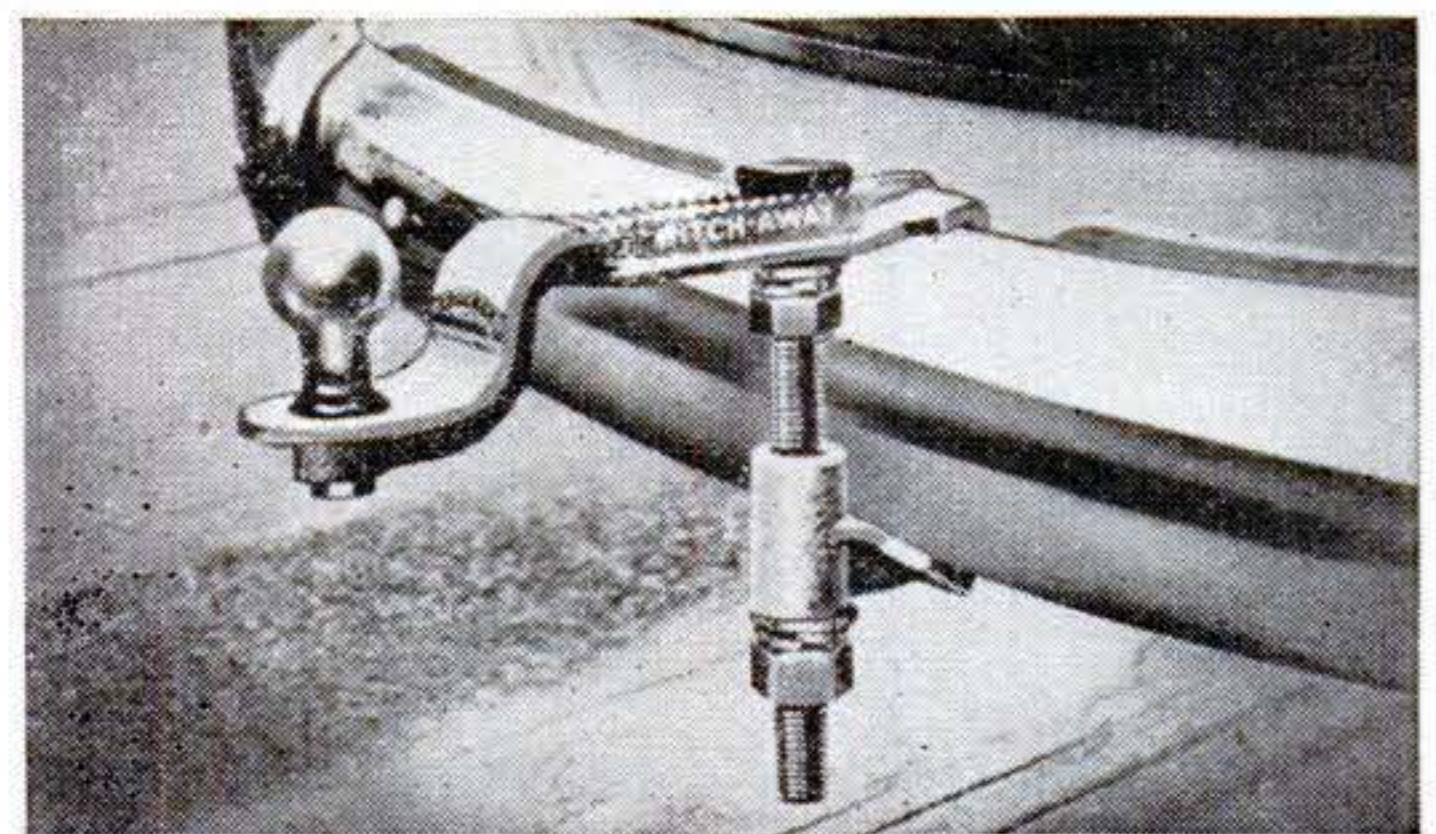

## Trailer Coupler Is Removable

ONCE adjusted to any bumper, this trailer hitch may be taken off or put back on again in a few seconds. The Crocket Manufacturing Co., Culver City, Calif., which makes the device, points out that this eliminates the eyesore of driving with a coupler that isn't being used. This model, rated at 2,000-lb. capacity, retails for about \$6.

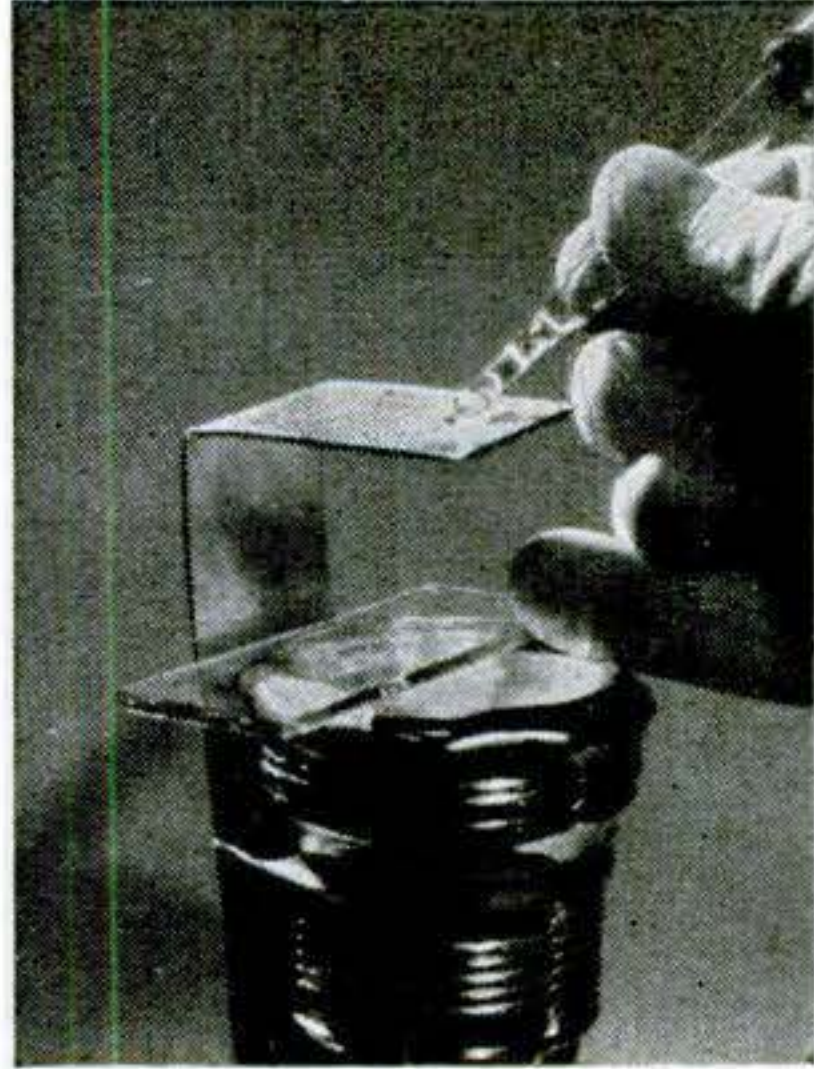
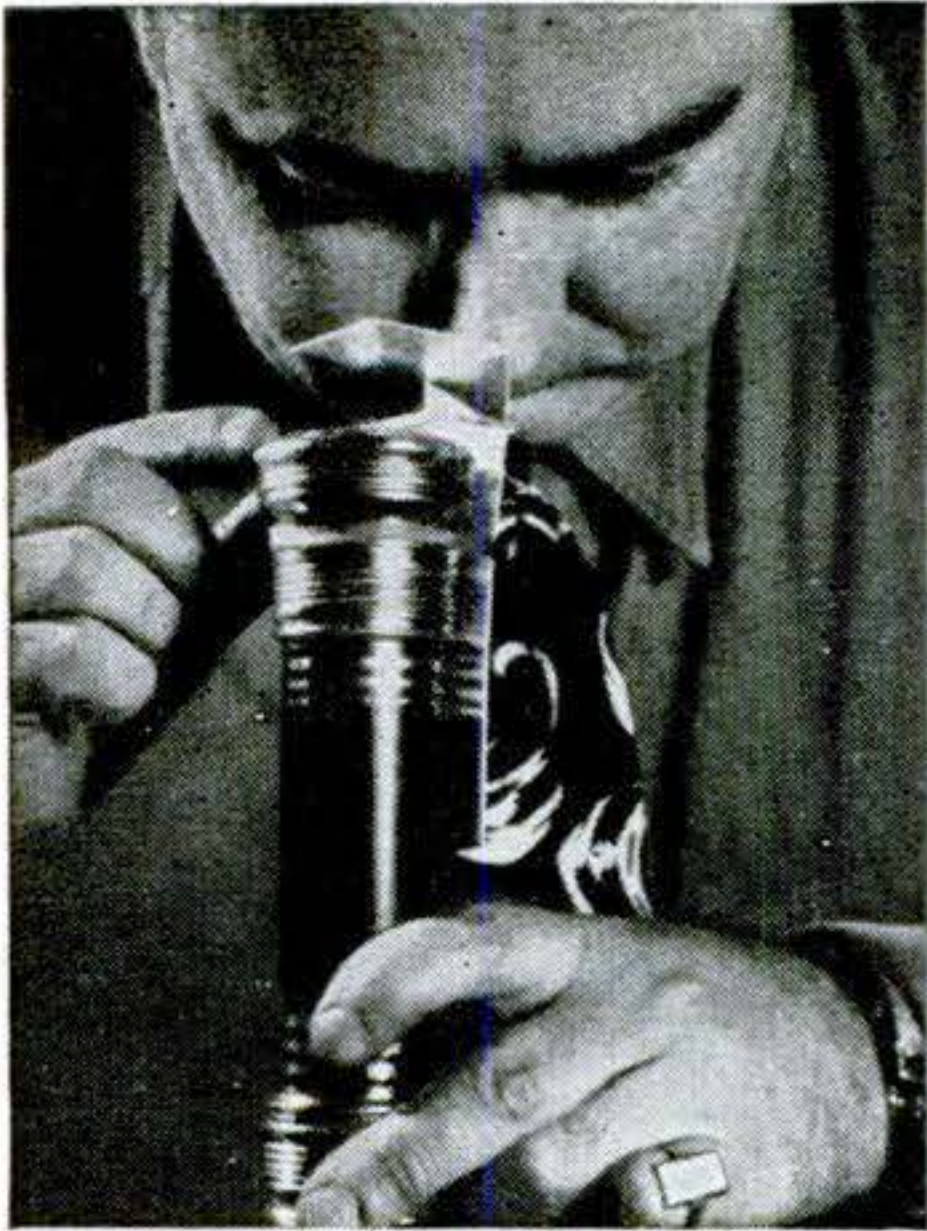

A drop of oil or water is the magnifier in this instrument.

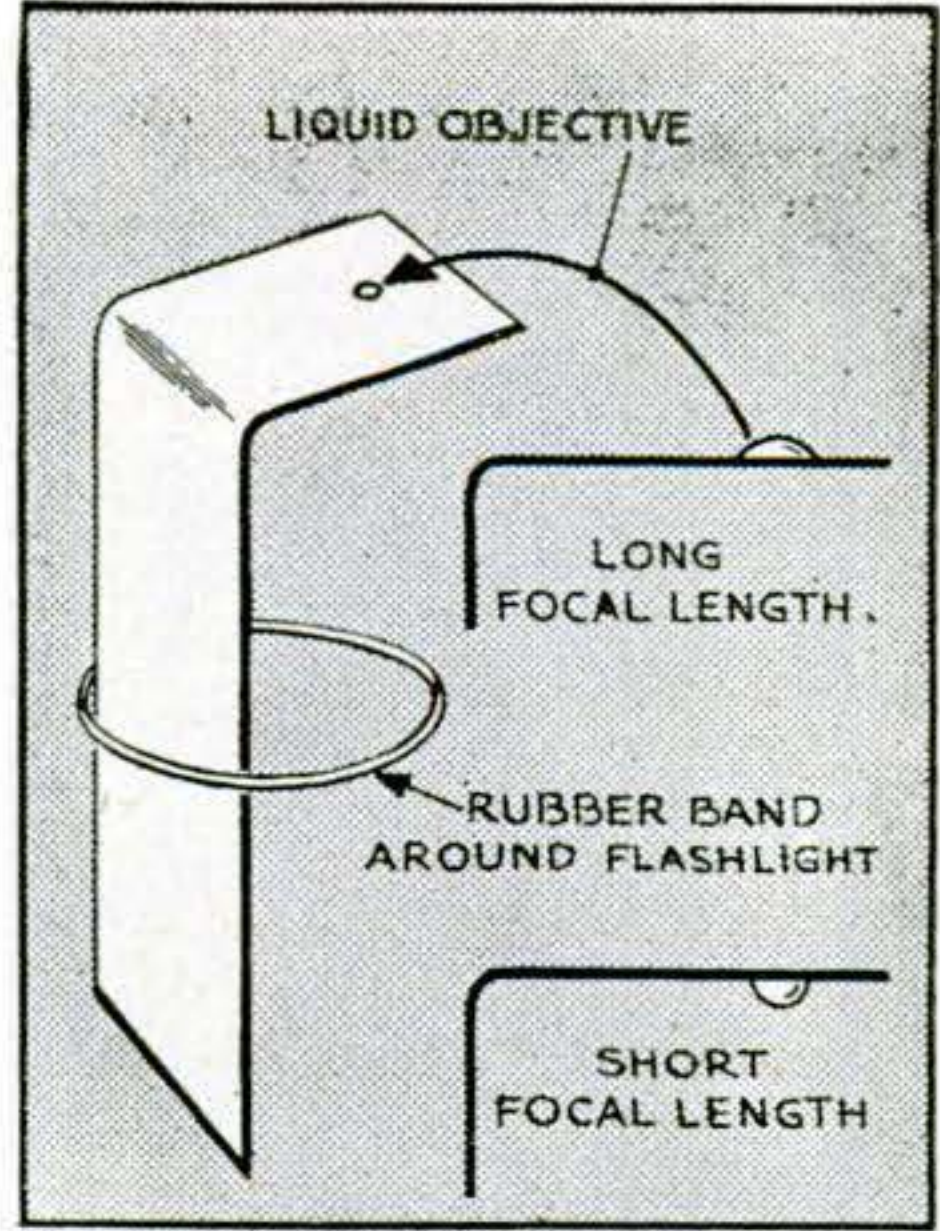

## Simple Flashlight Microscope Employs Liquid Lens

ALTHOUGH you can assemble this flashlight microscope in five minutes and at practically no cost, it is as effective as many low-power microscopes now on the market. An ordinary flashlight bulb supplies the illumination, which is quite intense due to the closeness at which it is used. Other parts consist of a thin brass or tin-plate strip, a rubber band, and a drop of refractory liquid for the lens.

Use a needle to make the lens aperture, removing any burr with a fine file or emery cloth. A large needle will increase image brilliance but reduce definition; experiment with different sizes until you find one that

suits you best. For the liquid lens, a drop of water, glycerine, or white mineral oil can be used. The shape of the droplet determines the power of the lens; a thin drop will have comparatively long focal length, good definition, and medium power. A fat drop will focus closer and have more power. A drop placed above the hole will of course be thinner than one that sags down below it. Focus by gently sliding the metal arm up or down on the flashlight case. Slides under study may be laid directly on the glass. Numerous refinements, such as a stand for the flashlight and a holder for the slides, can be devised.—Ken Murray, Colon, Mich.

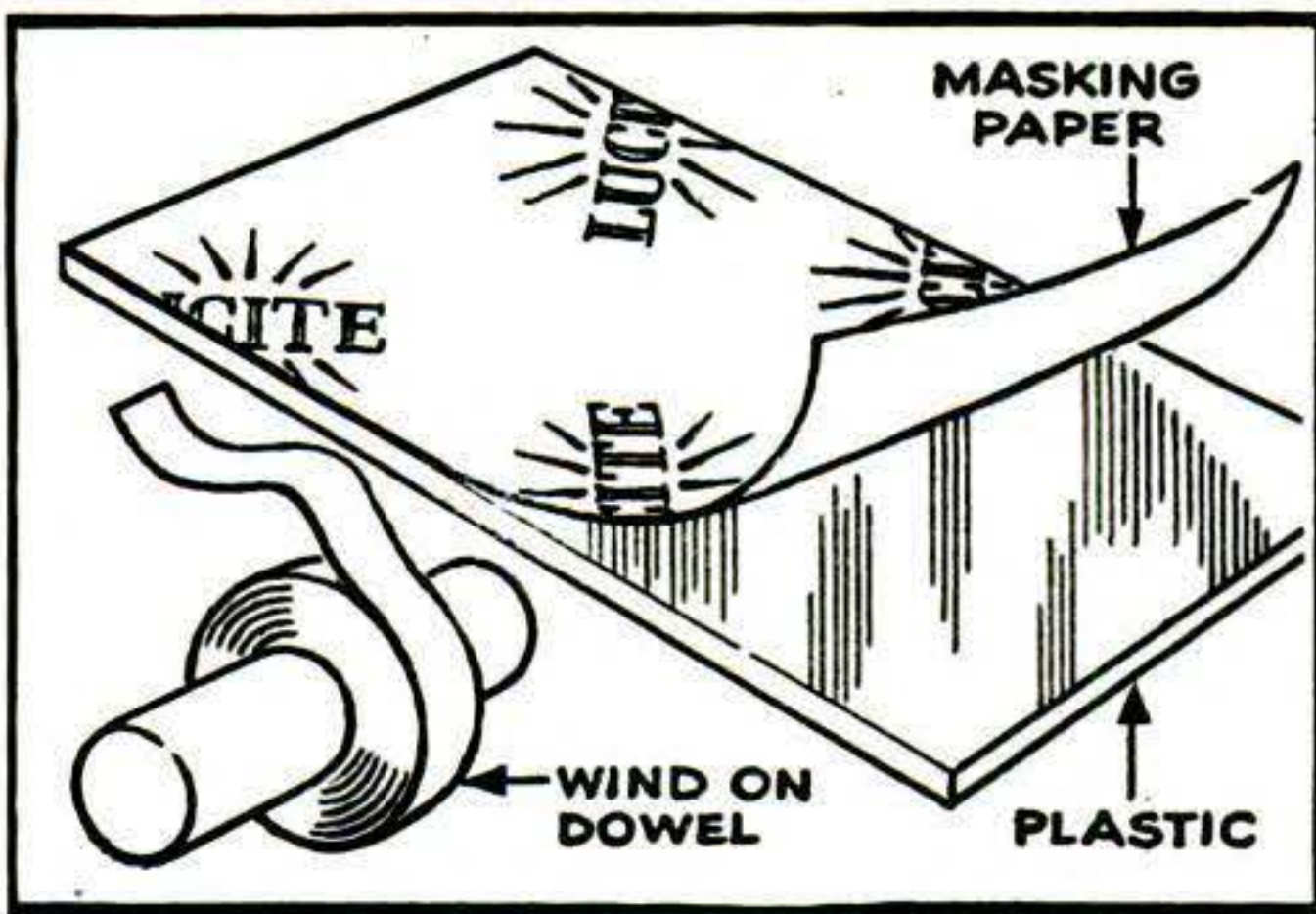

### Masking Paper Reused as Tape

INSTEAD of throwing away the masking paper peeled off plastic sheet, cut it into strips of any desired width and wind them up on dowels. You'll find that the tape will come in handy in many ways, including masking for painting (especially spraying), wrapping parcels, holding inlay veneers, and stenciling.—Frank Shore, Manhattan, N. Y.

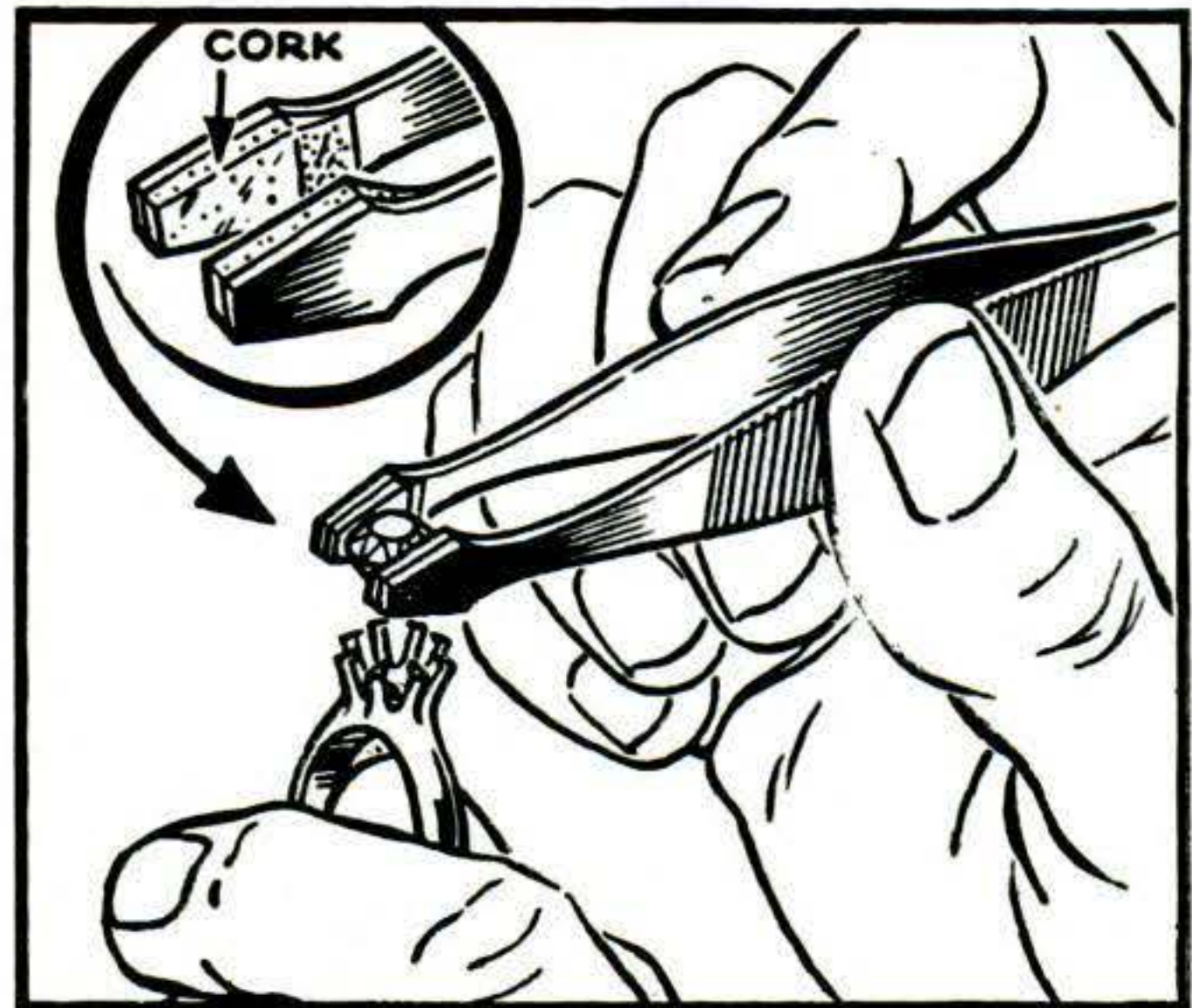

### Tweezer Jaws Lined with Cork

CEMENTED and trimmed flush, cork pads on the jaws of a pair of tweezers will reduce the likelihood of scratching jewels, soft optical-glass lenses, and other highly polished or delicate objects.



Bound copies of magazines look neat, take up less space, and preserve the issues longer.

# How to Bind Your Favorite Magazine

By J. W. Roche and M. C. Anderson

**Q**UITE apart from the fact that they look neater and last longer, bound copies of magazines take up less space and can be referred to more easily. Chances are that

if you tackle the job of binding at home, you'll find it less difficult and more interesting than you've suspected.

Each of the main steps is covered in the accompanying photo sequence. For the clamping press, use fairly heavy plywood,  $\frac{3}{4}$ " or better. Butcher's cord or other tough twine will do nicely as the sewing thread. The method of sewing, known as the "all along" stitch, consists of drawing the needle in from the center fold of the section at one end notch, around the tape, out at the next notch, along to the next one, and so forth.

Each section is sewed individually and the kettle stitch is used to tie together the ends of every three sections. The tape to which the sections are sewed should be a stout cloth tape, such as common gummed cloth mending tape. Don't tie the sections too tightly together, or else difficulty will be experienced in shaping the back. The stitch binder can be cut from a piece of muslin, as are the headbands. Each of the latter should be about  $1\frac{1}{2}$ " wide and long enough to fit the curved back. Fold them around pieces of heavy cord.



**Materials for binding** are generally available and aren't expensive. Rubber cement gives a quick, firm bond without warping the paper. A trip to the scrapbox will probably provide the materials for the press and sewing frame.



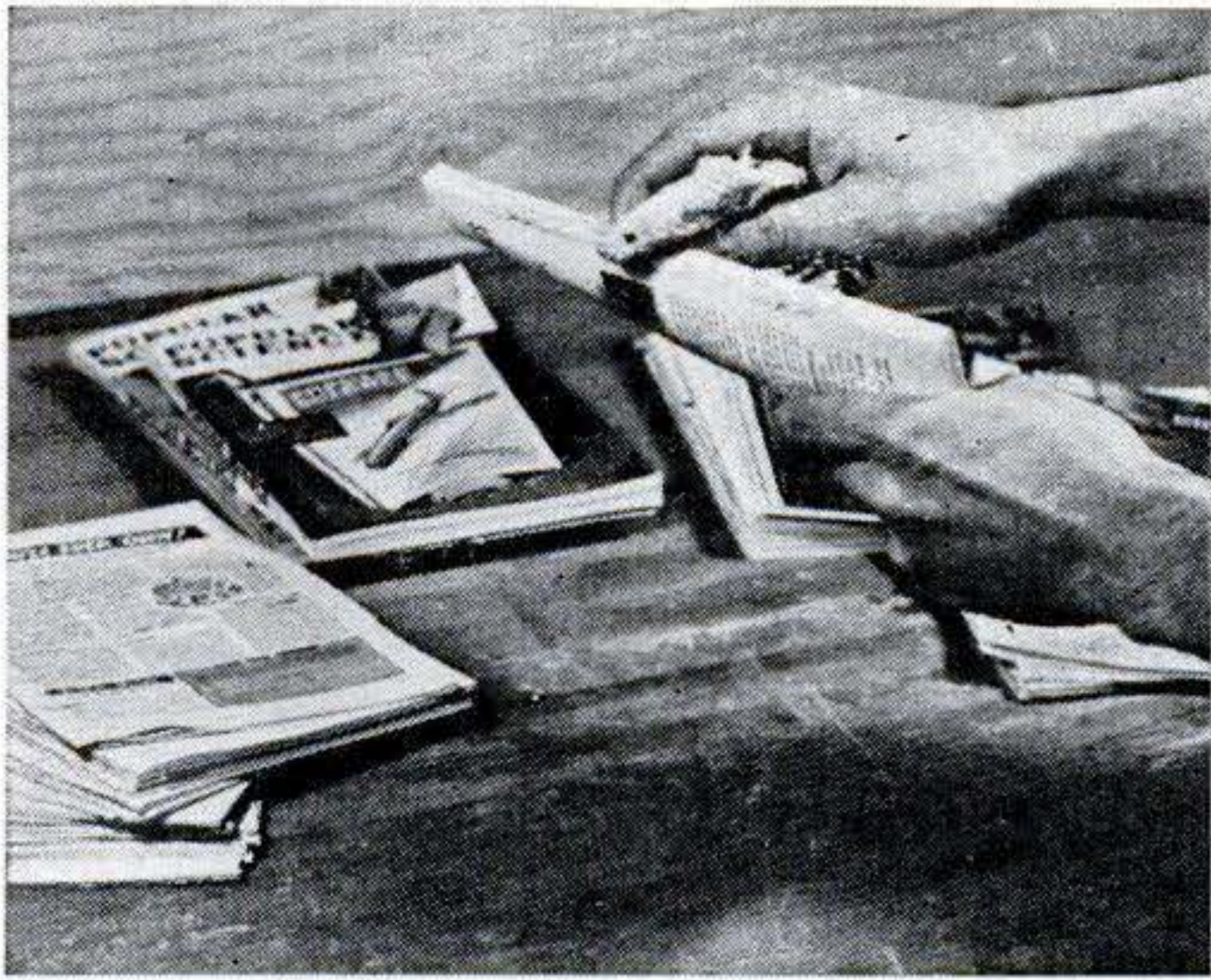

**1. Tear off the cover**, remove the staples, and loosen the glued sections by repeated rubbing with a wet rag. While advertisement sections may be discarded if you wish, save the cover and index pages. Keep the sections in order.

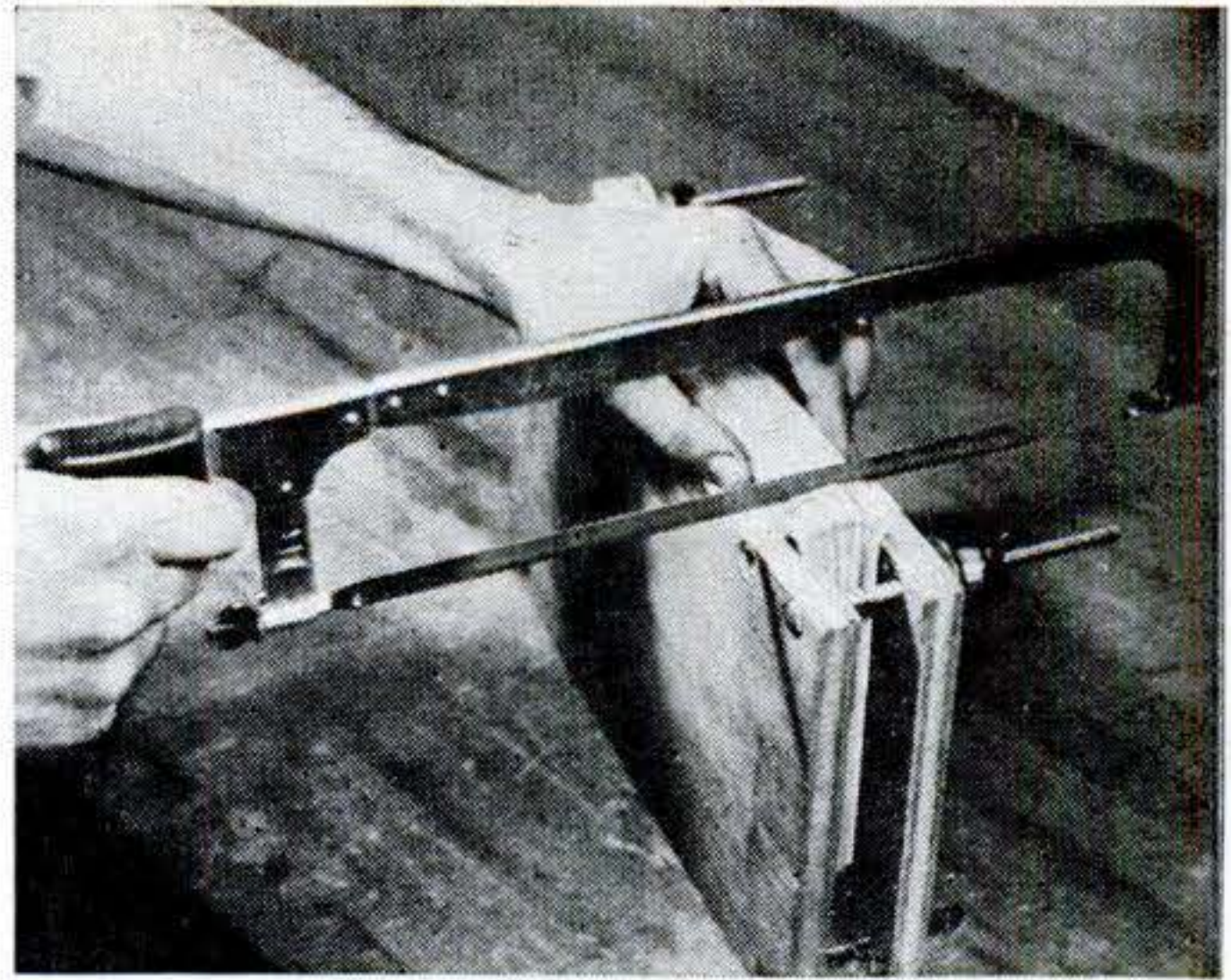

**2. Clamp sections to be bound** in the press, measure in 1" from each end, and make two hacksaw cuts about 1/16" deep. Measure in from each the width of the tape you will use, and make two more similar saw cuts at each end.

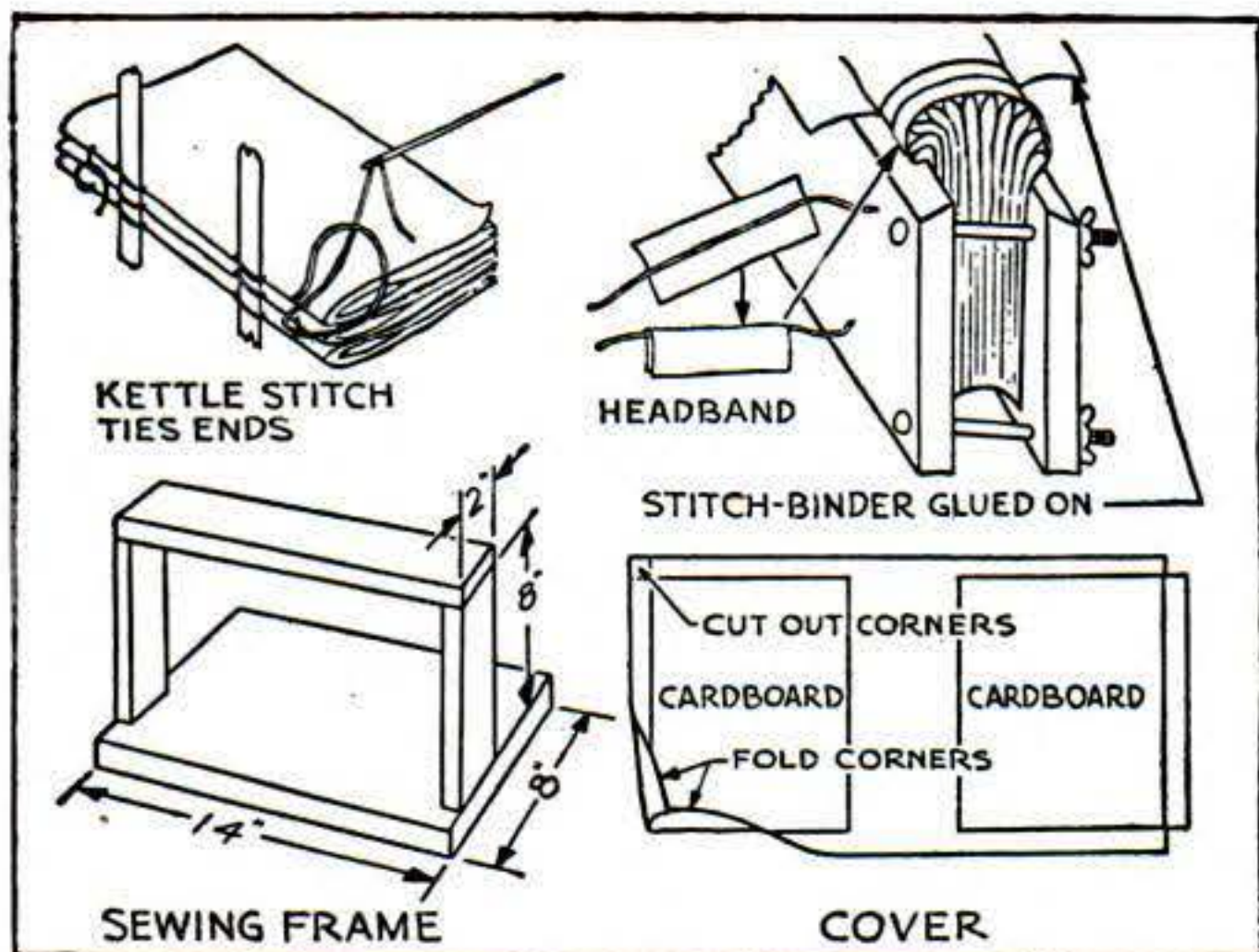

**3. Dimensions** of the sewing frame aren't important so long as it's bigger than the magazine to be bound. Note the details of the kettle stitch that locks the sewing thread, the headband, stitch binder, and cover.

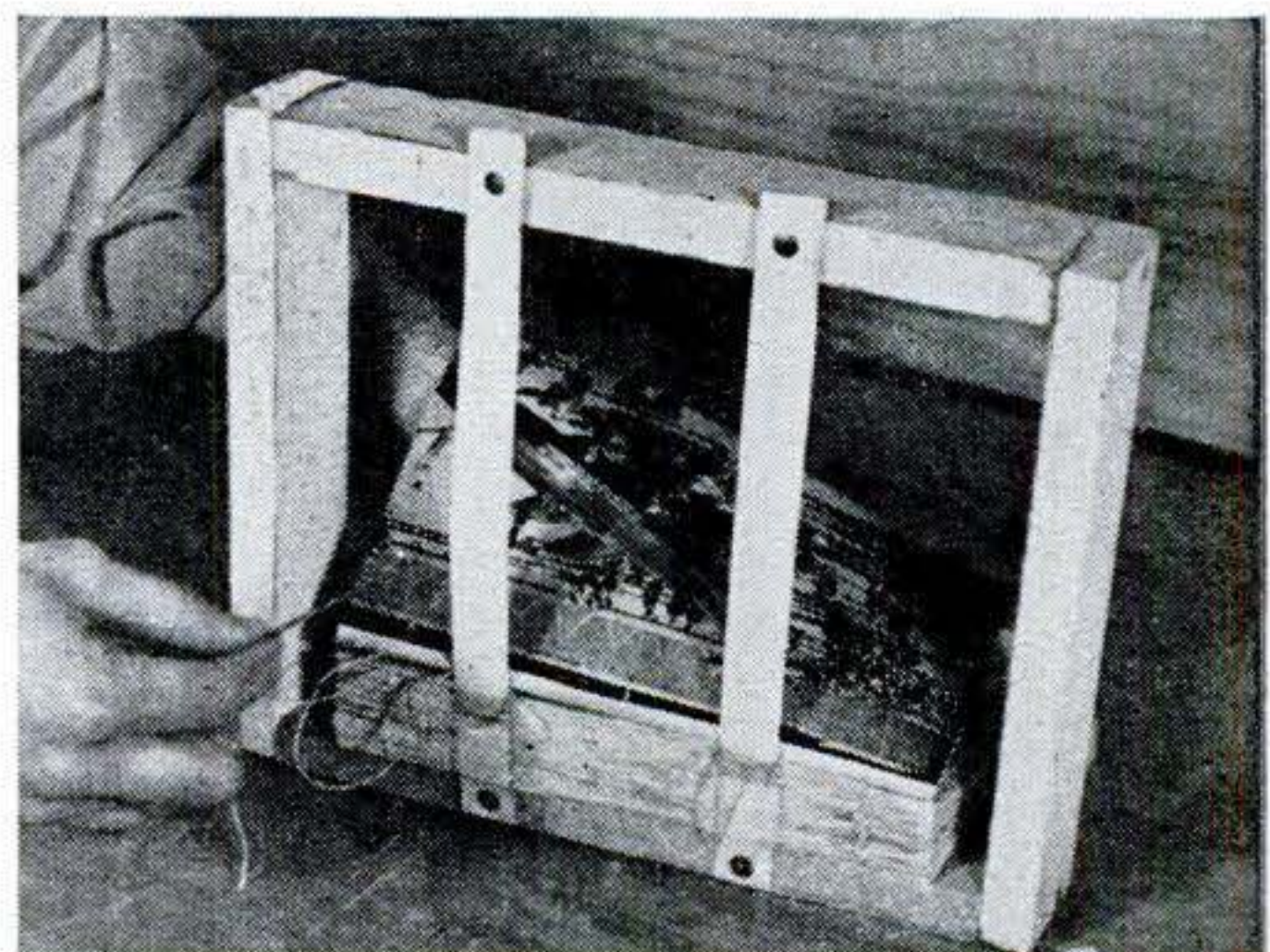

**4. Tack tapes** to the frame according to the spacing of the saw cuts. Place the sections nearby, and insert in the frame first the one that's to be last in the book. Open to the center and stitch through with butcher's cord.

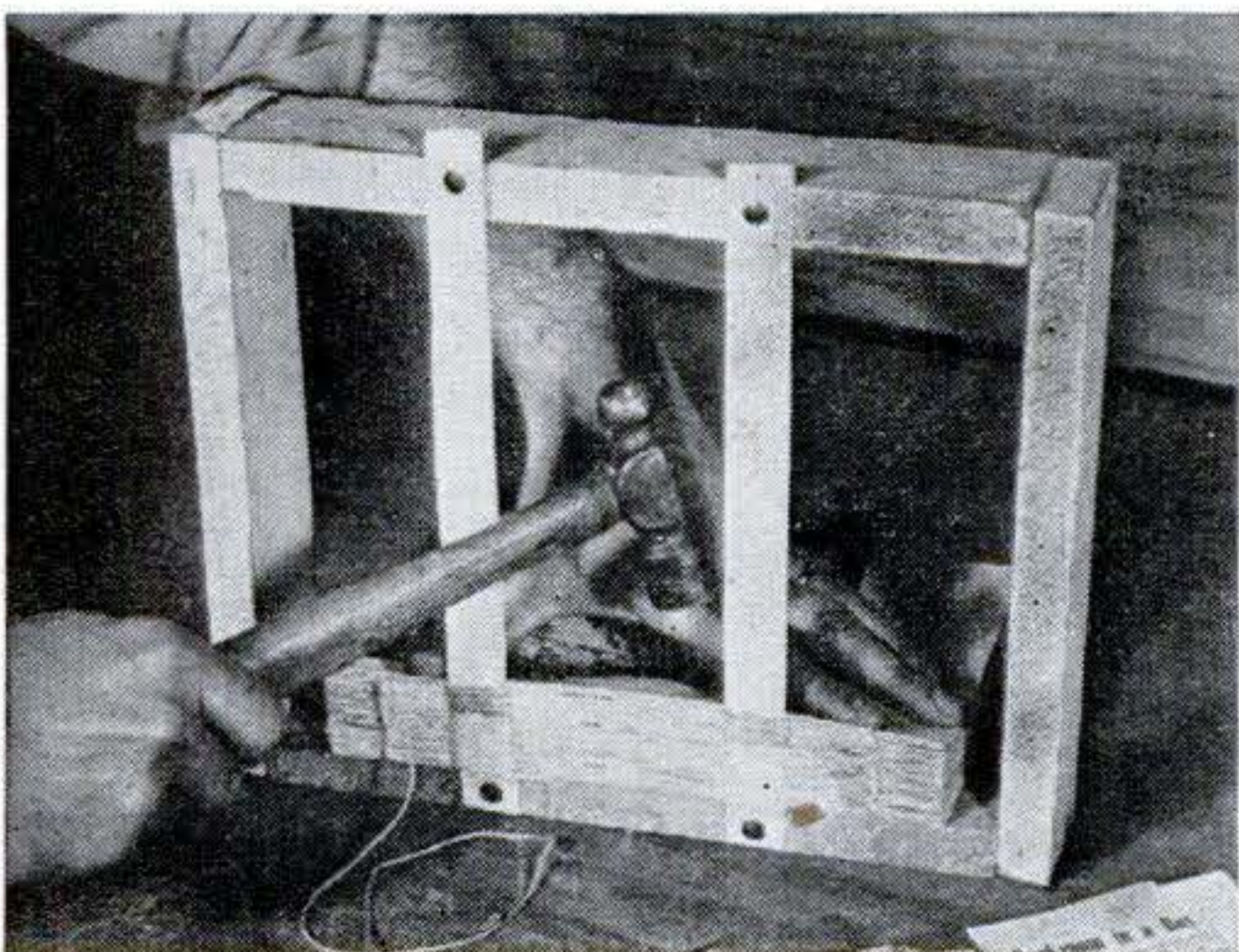

**5. The needle goes in** at the end, around the tape, in again, and along. Tie the cord ends with kettle stitch every three sections. If you pound the sections down lightly as you go, the back will not become too bulky.

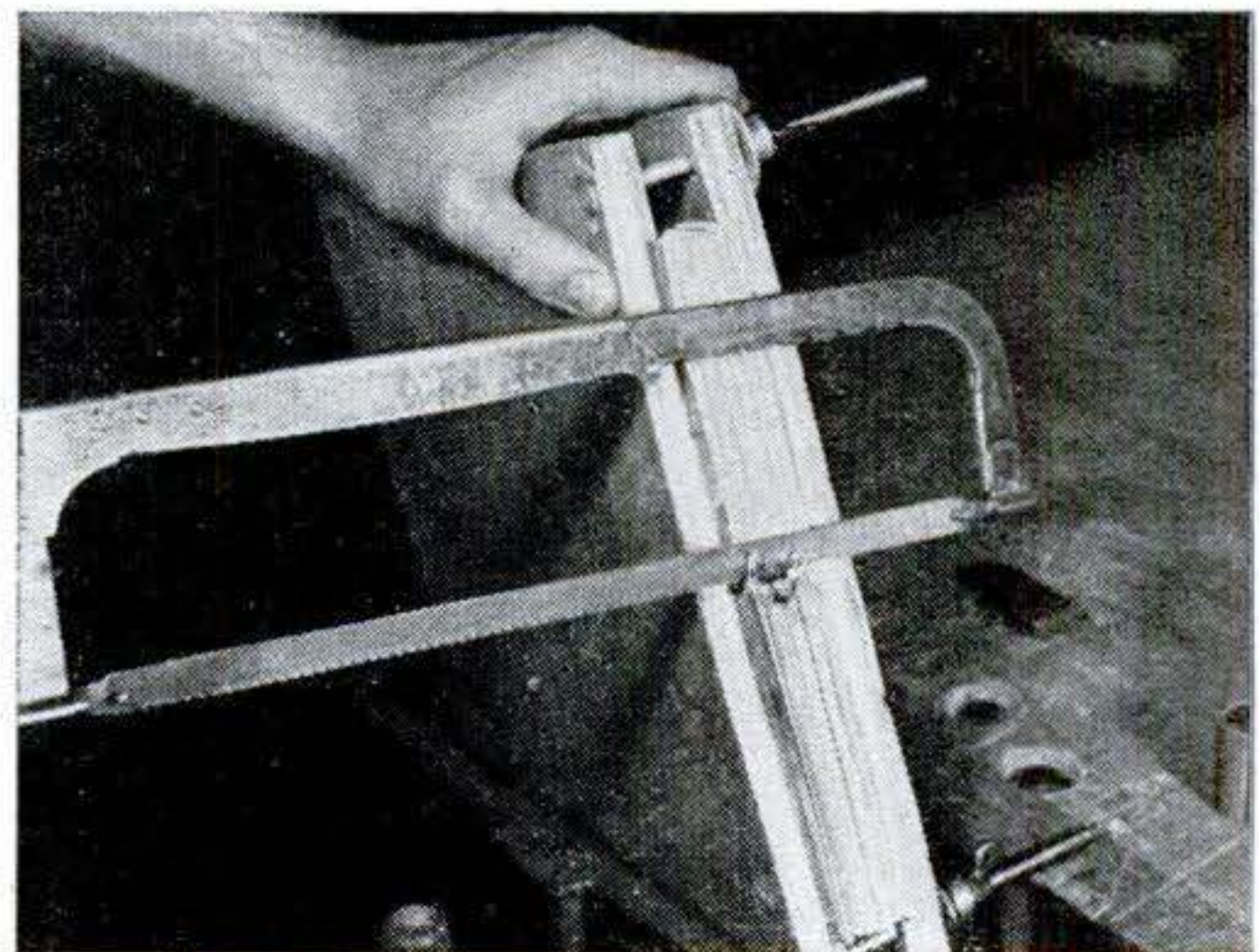

**6. Trim the edges** after sewing, first clamping the sections tightly. Use a hacksaw and cut in far enough to remove all irregularity. Then sand with medium grit paper to remove saw marks. A wood chisel will also trim it.

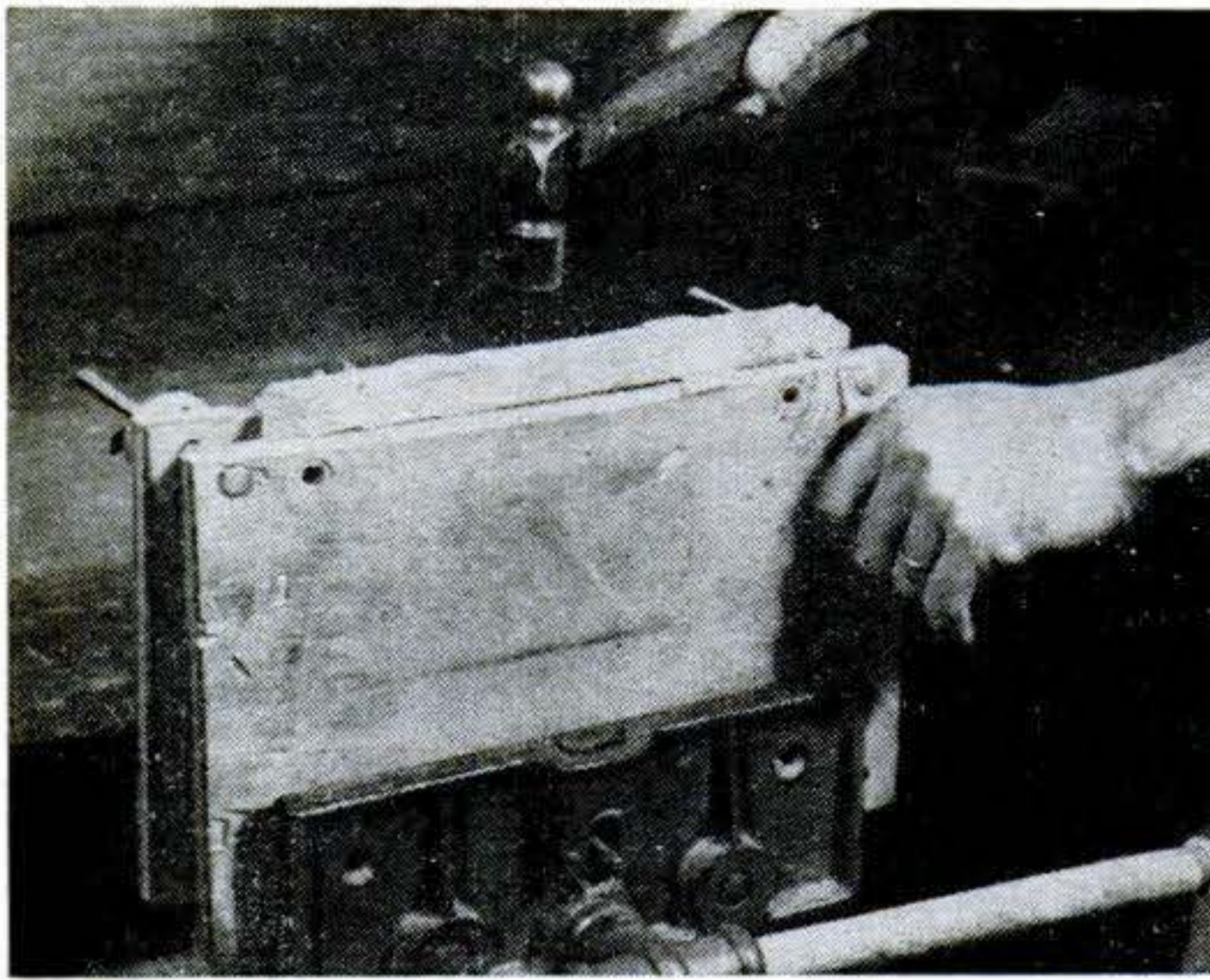

**7. Shape the back** to a rounded form with the clamp frame loose, tighten it with about  $\frac{3}{4}$ " projecting, hammer to form the outer sections over the frame, coat well with glue, and press on the stitch binder and the two headbands.



**8. For the cover**, cement cardboards the size of the page to leatherette or fabric. Allow a space equal to the width of the back plus 1" between the cardboards. Also cement on a paper stiffener that's the width of the back.

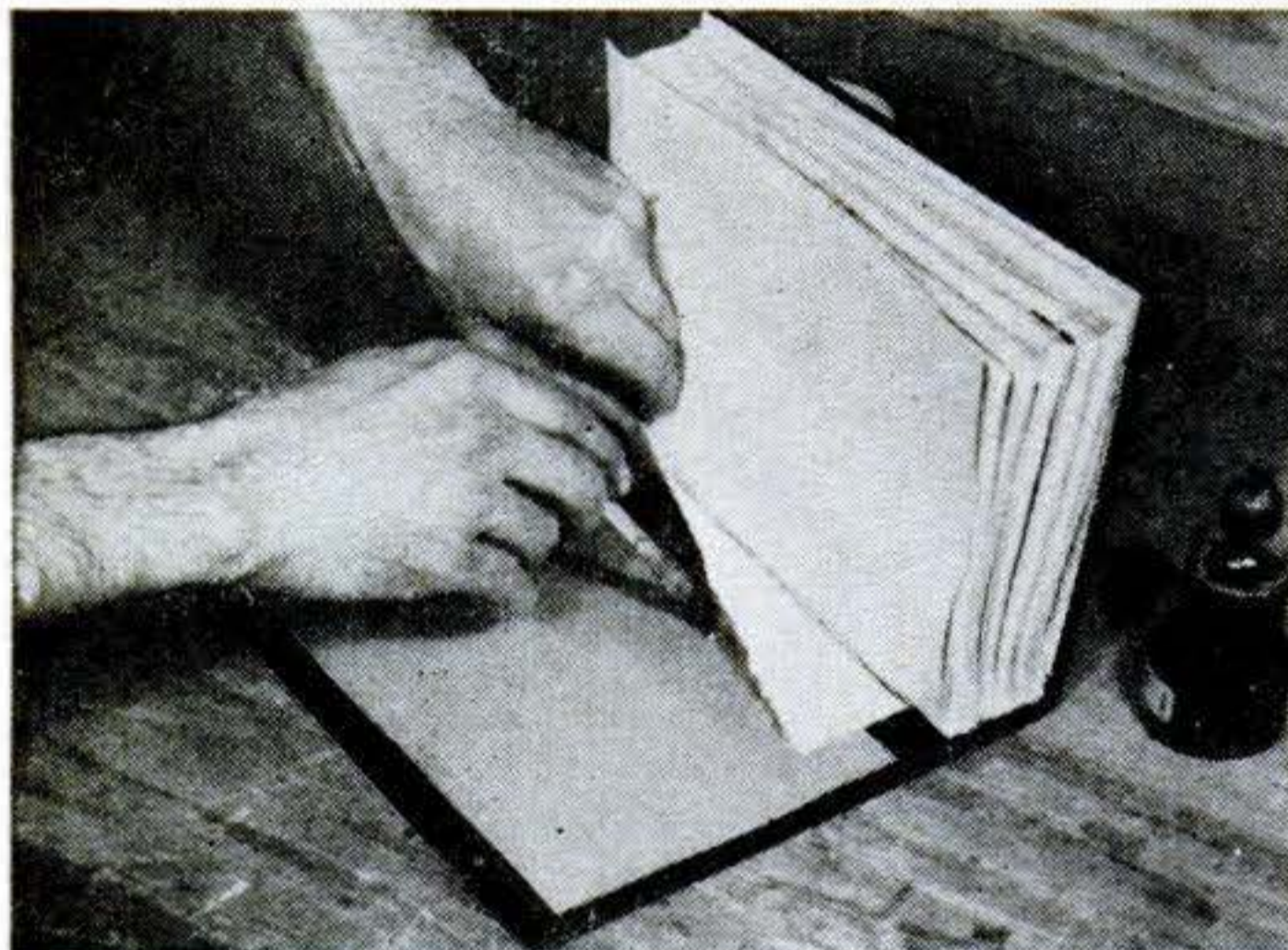

**9. Center the book** in the cover after the glue has dried, and glue the stitch binder to the cover, using wax paper to keep the binder from sticking to the outer pages. Let it dry under pressure with the book closed.

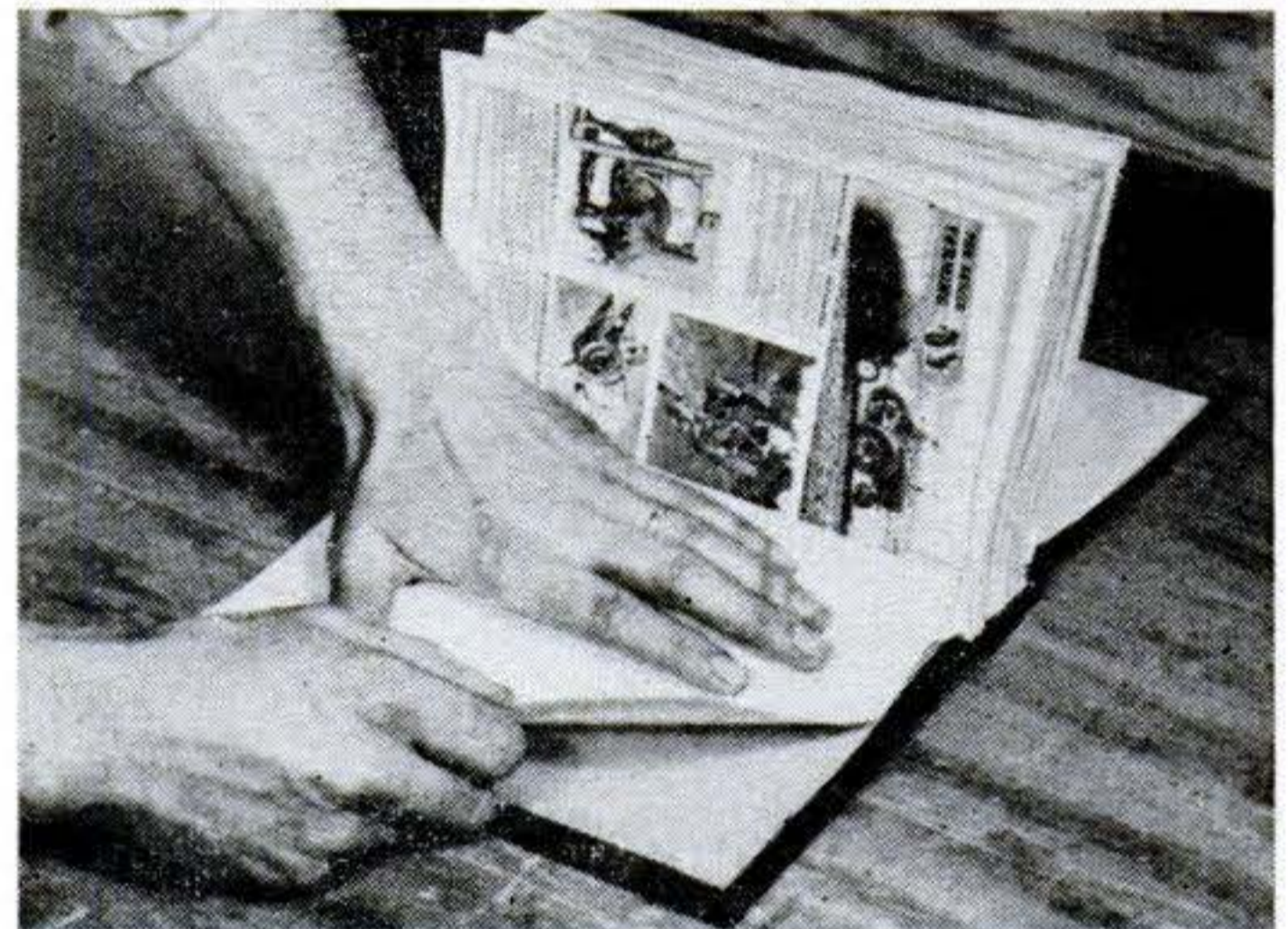

**10. A cover sheet** cemented inside each cover hides both the stitch binder and the lapped corners of the cover material. Either white or colored paper of a good grade should be used, with rubber cement rather than glue.



**11. Flyleaves**, two in front and one in back, give a finished touch to the job. Trim to the same size as the book page plus a  $\frac{1}{4}$ " gluing flap. Magazine contents pages may be cemented to the front flyleaves if you prefer.

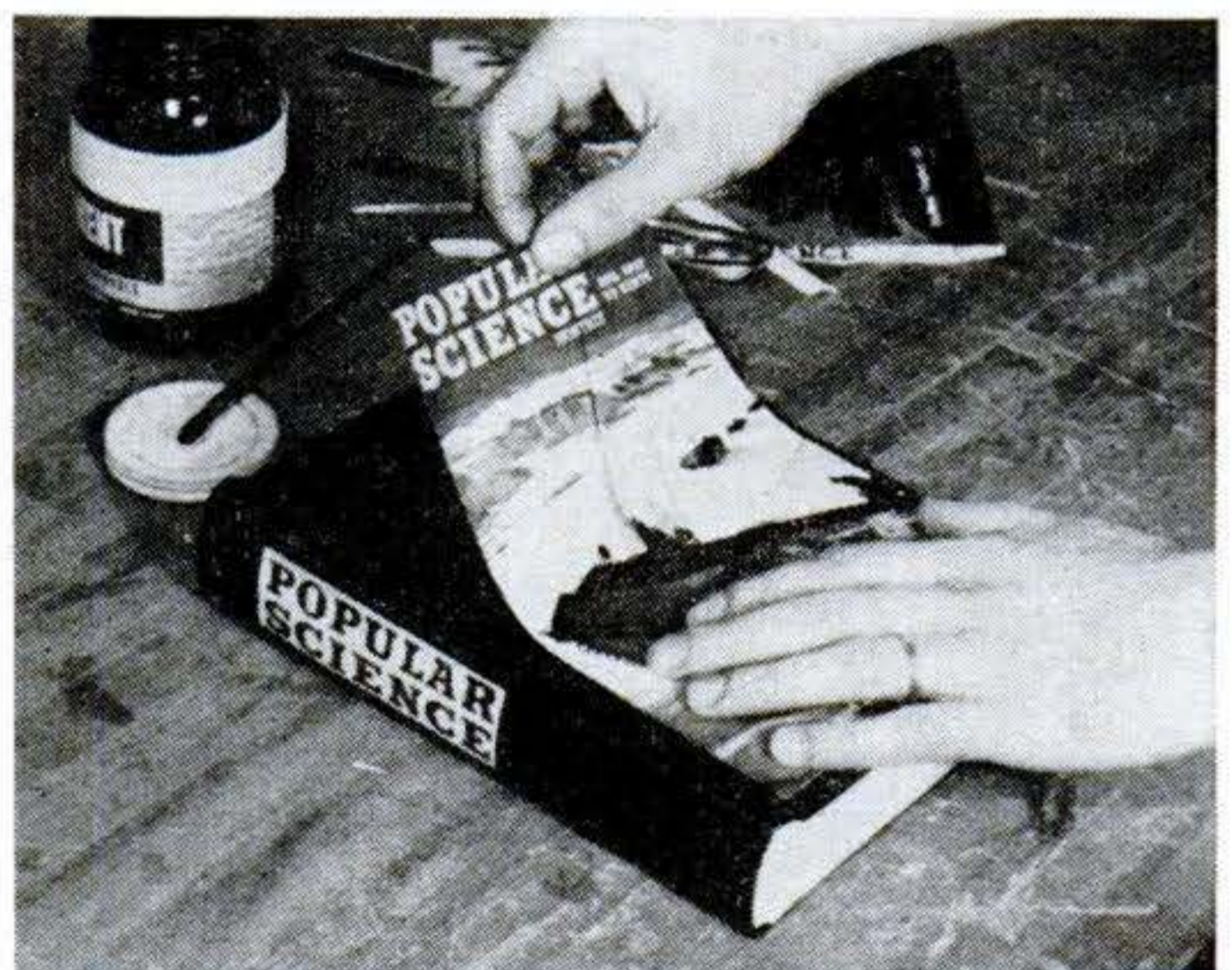

**12. Titling** of the bound volumes can be done with ink or paint, but an attractive cover is obtained if you simply cement on one of the torn-off covers to the front, while the title from another is cemented on the back. **END**

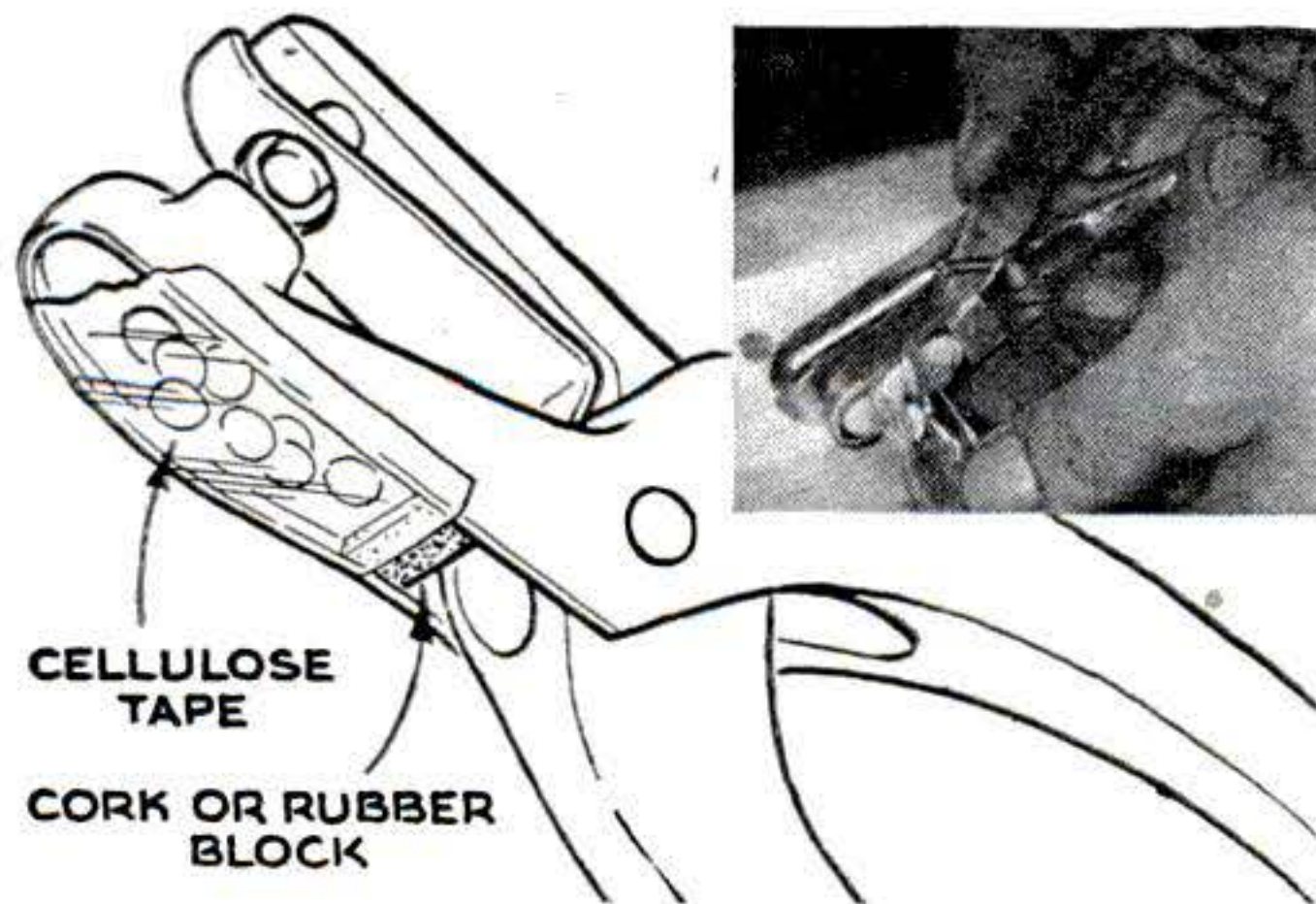

### Tape Holds Punch Confetti

THE nuisance of picking up elusive little paper punchings can be eliminated, even if your punch is not the type that has a built-in "reservoir", by means of a tape receptacle like that shown above. Wedge in a small block cut from an eraser or cork, trim it off flush, and then press on a length of cellulose tape over the hollow portion of the punch. Since the tape is transparent, you can easily see when the chamber has filled with punchings. To empty it, simply peel off the tape, shake out the waste, and apply a new piece of tape to replace the one removed.—*Andrew Vena, Philadelphia.*

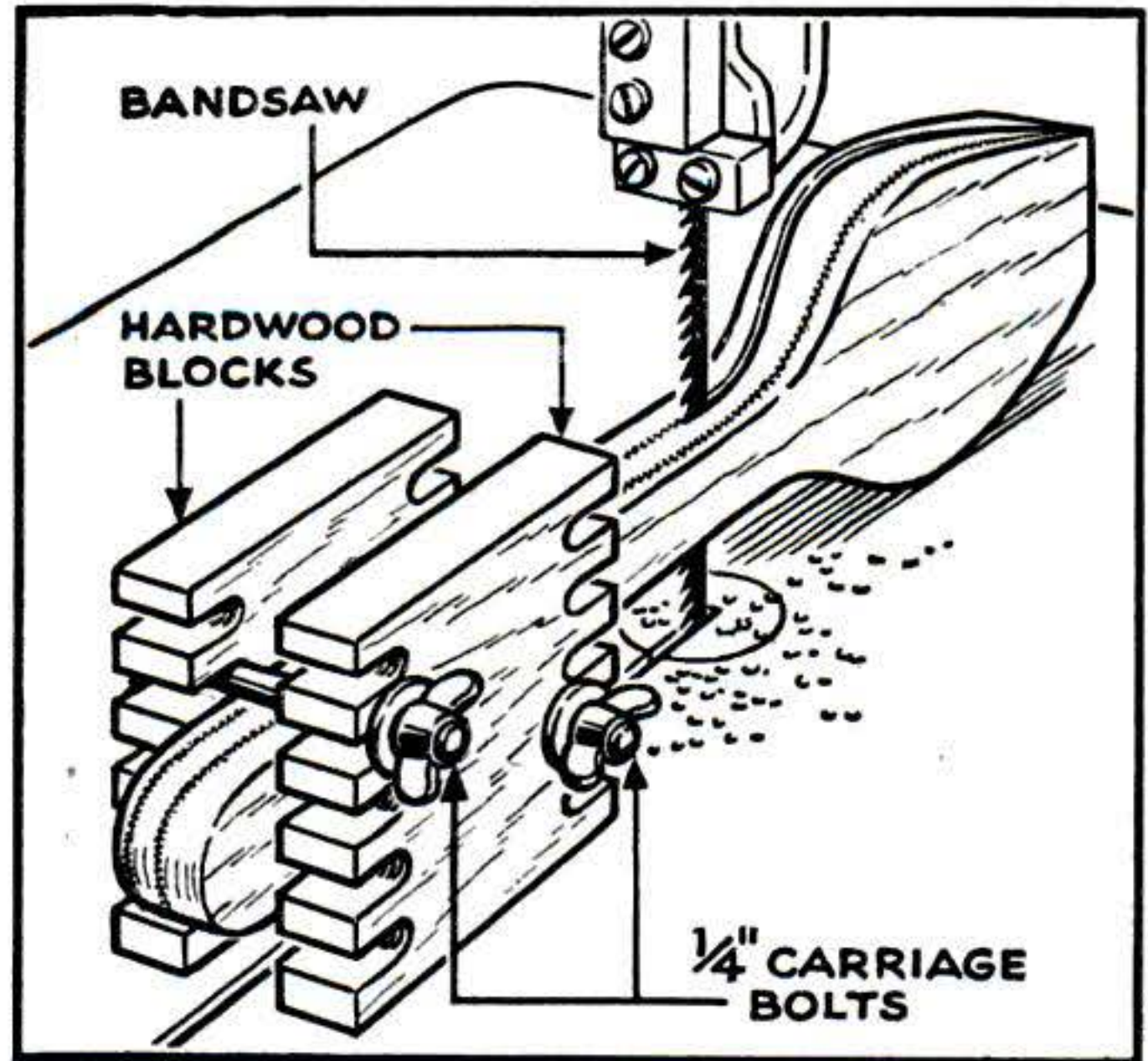

### Holder Aids in Sawing Curves

WHEN sawing compound curves on a bandsaw or jigsaw, it's common practice to tack the waste back on to get a flat surface on the table for subsequent cuts. The extra effort this involves as well as the risk of damaging a saw blade on the nails or brads that hold the waste can be avoided if you make yourself a holding jig like that above. Its disadvantage is that the work must be reclamped when you saw up to the jig, but this can be done quickly. Drill holes near the edges of two hardwood blocks, open them out into slots, and assemble with bolts, washers, and wing nuts.—*Ralph S. Wilkes, Keuka Park, N. Y.*

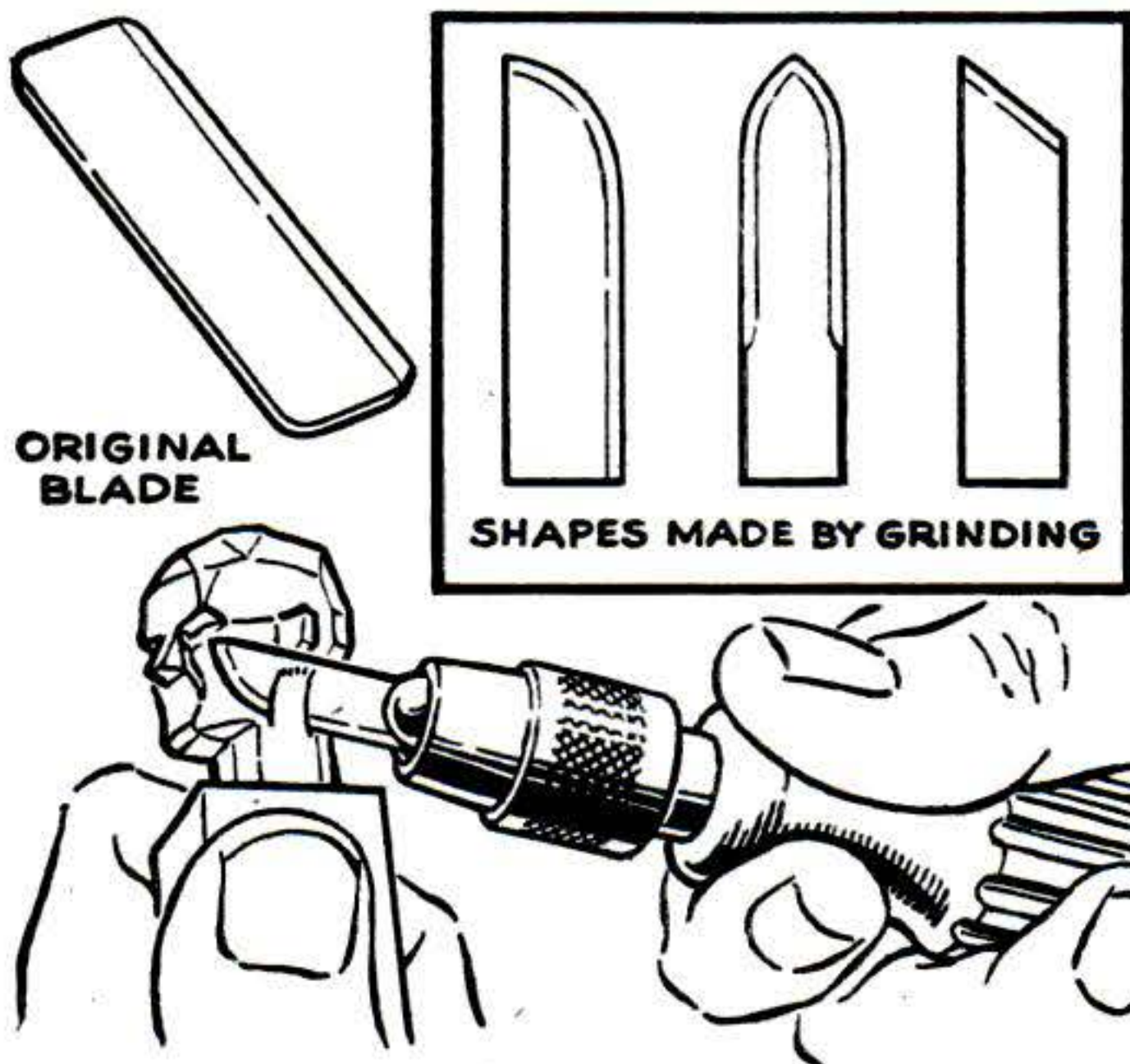

### Razor Blades Used in Knife

EXCELLENT replacement blades for chuck carving tools can be had by grinding old razor blades of the kind used in injector-type razors. Grind on a fine wheel (being careful not to overheat the blade and draw the temper), and then hone on a fine stone. Blades can be ground to a variety of special-purpose shapes to suit particular jobs.—*Raymond F. Ball, Utica, N. Y.*

### Hinged Rack Supports Motor

STOWAGE of a small outboard in a locker crowded with other gear is simplified with this hinged rack of stout wood. When I lift it off the boat, I just clamp it to the rack and then swing it back into a less accessible part of the locker. Use plywood if possible — *Kenneth Buckley, Poulsbo, Wash.*

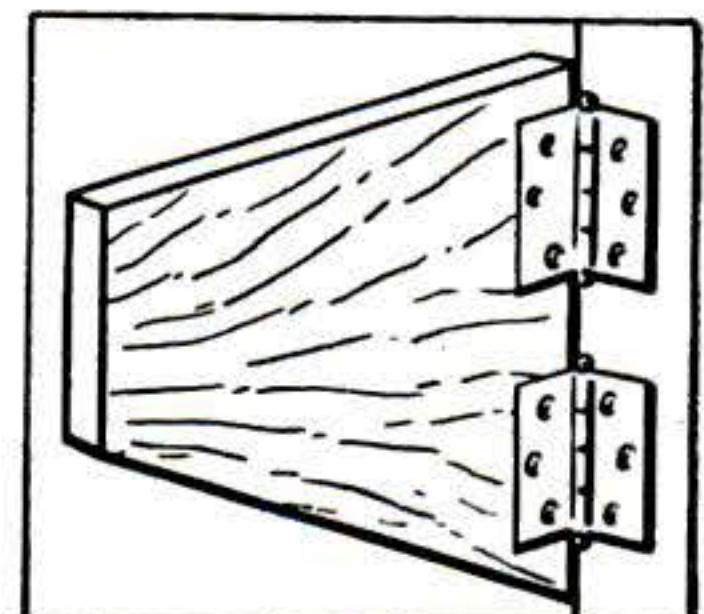
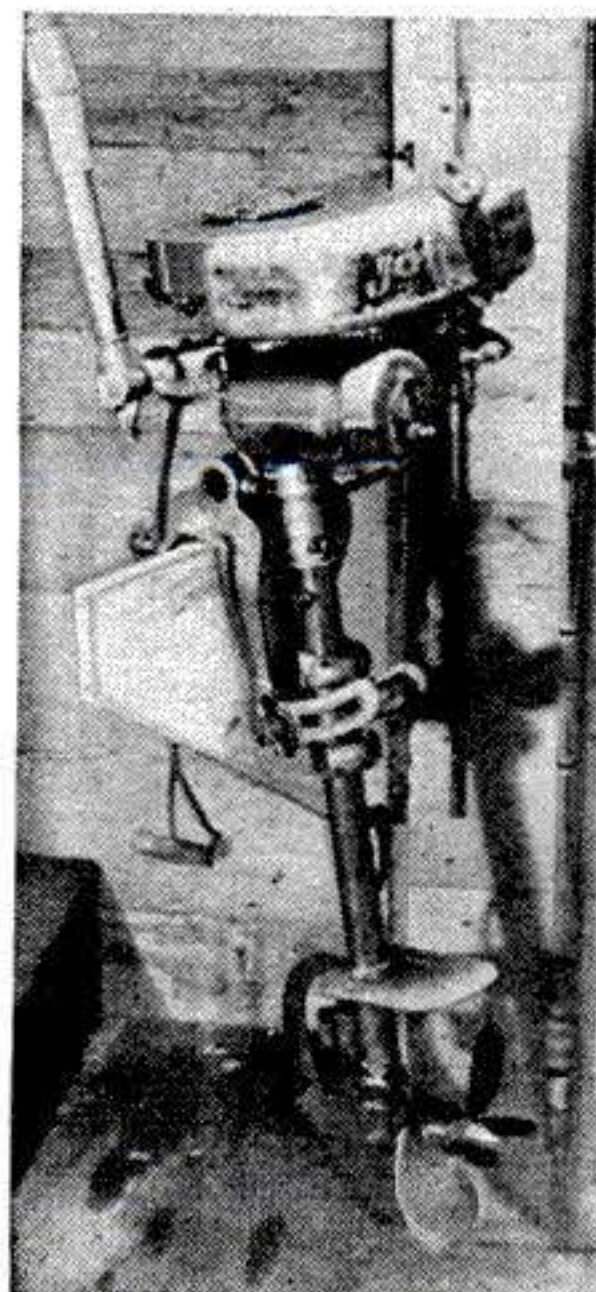

# Radiant Heat Packs a Punch

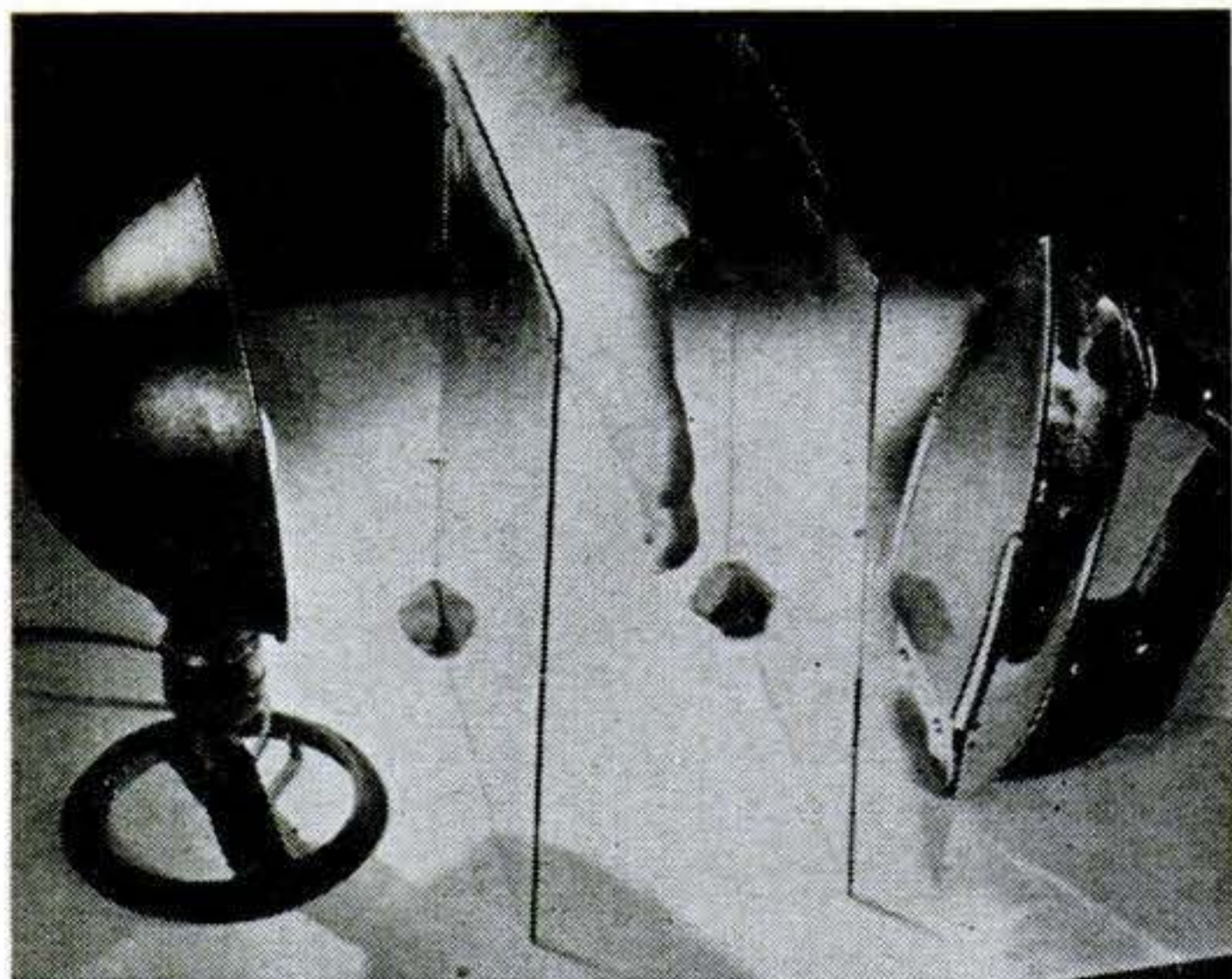

**It Passes Through Glass.** Short heat waves radiated from the sun, electric lights, and other high-temperature sources pass readily through glass, but the longer waves from radiators, electric irons, and other bodies that are not so highly heated do so only with difficulty. This may be demonstrated by setting up two similar sheets of glass, an electric iron, and an electric lamp as above. If you place your hand between the sheets of glass, the side toward the lamp will feel much warmer.

**Lakes Affect Climate.** The fact that radiant heat penetrates deeper into water than it does into soil and rock helps explain why the climate changes less near large bodies of water.

Radiation from the sun is stopped at the soil surface and is changed into heat. Consequently, the surface layers of the earth become quite hot. At night, this heat is lost rapidly. On the other hand, sun radiations heat water to some depth, but nowhere does it become as hot as surface soil. After sundown, water retains heat better.

This may be shown by placing a tumbler of soil and another of water under the rays of a lamp for several minutes. Test the soil and water and note that the surface soil gets hotter but water holds heat longer.

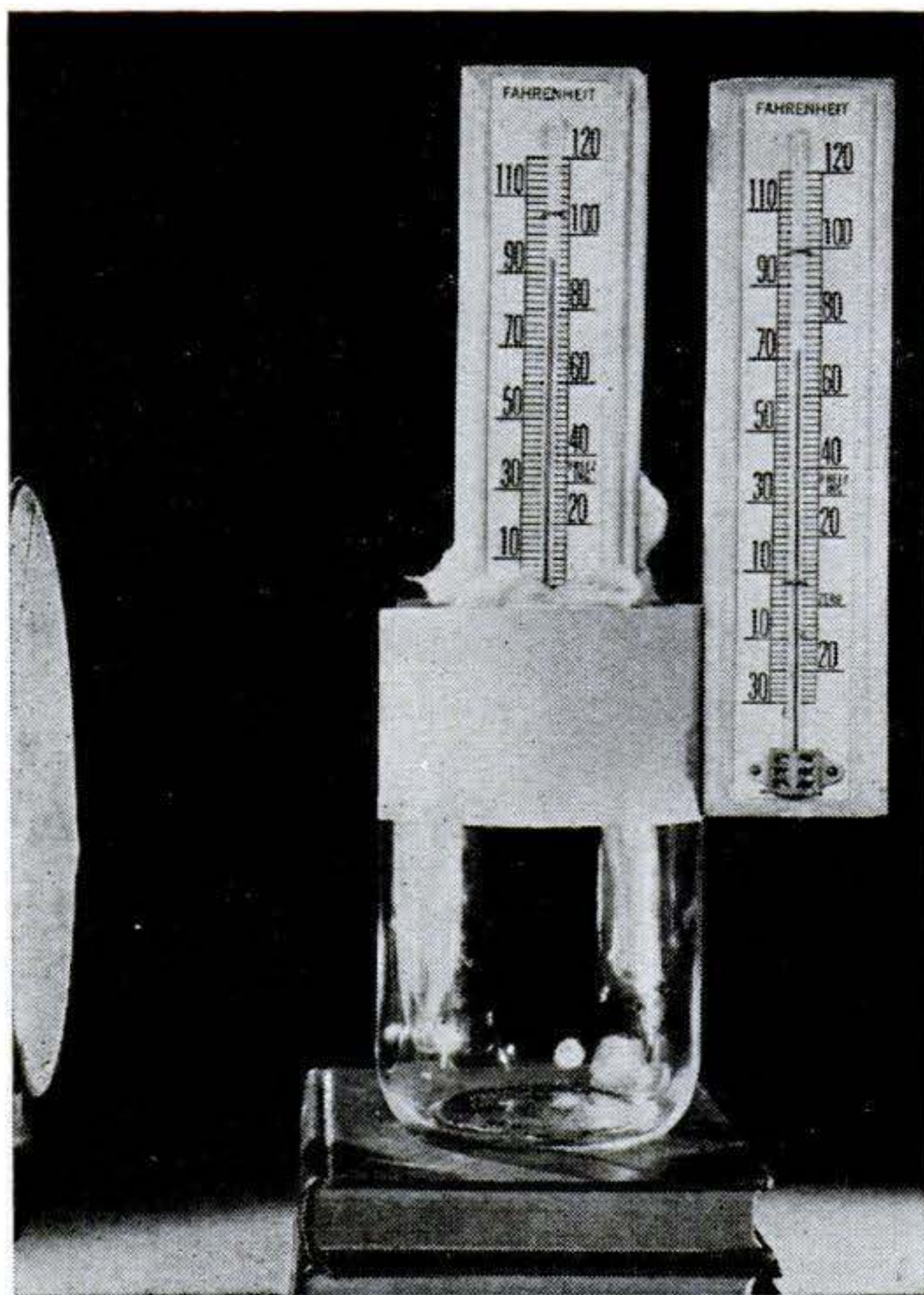

**Glass Traps Long Waves.** In homes and greenhouses, solar warmth is trapped inside by a curious one-way characteristic of glass. The short heat waves of sunlight enter and heat the air inside. But the air is heated to a comparatively low temperature and its longer heat waves can't escape out through the glass. Seal a thermometer in a jar with cotton, protect it from direct light by paper, and face a lamp toward it. The air inside will soon become much warmer than that outside.

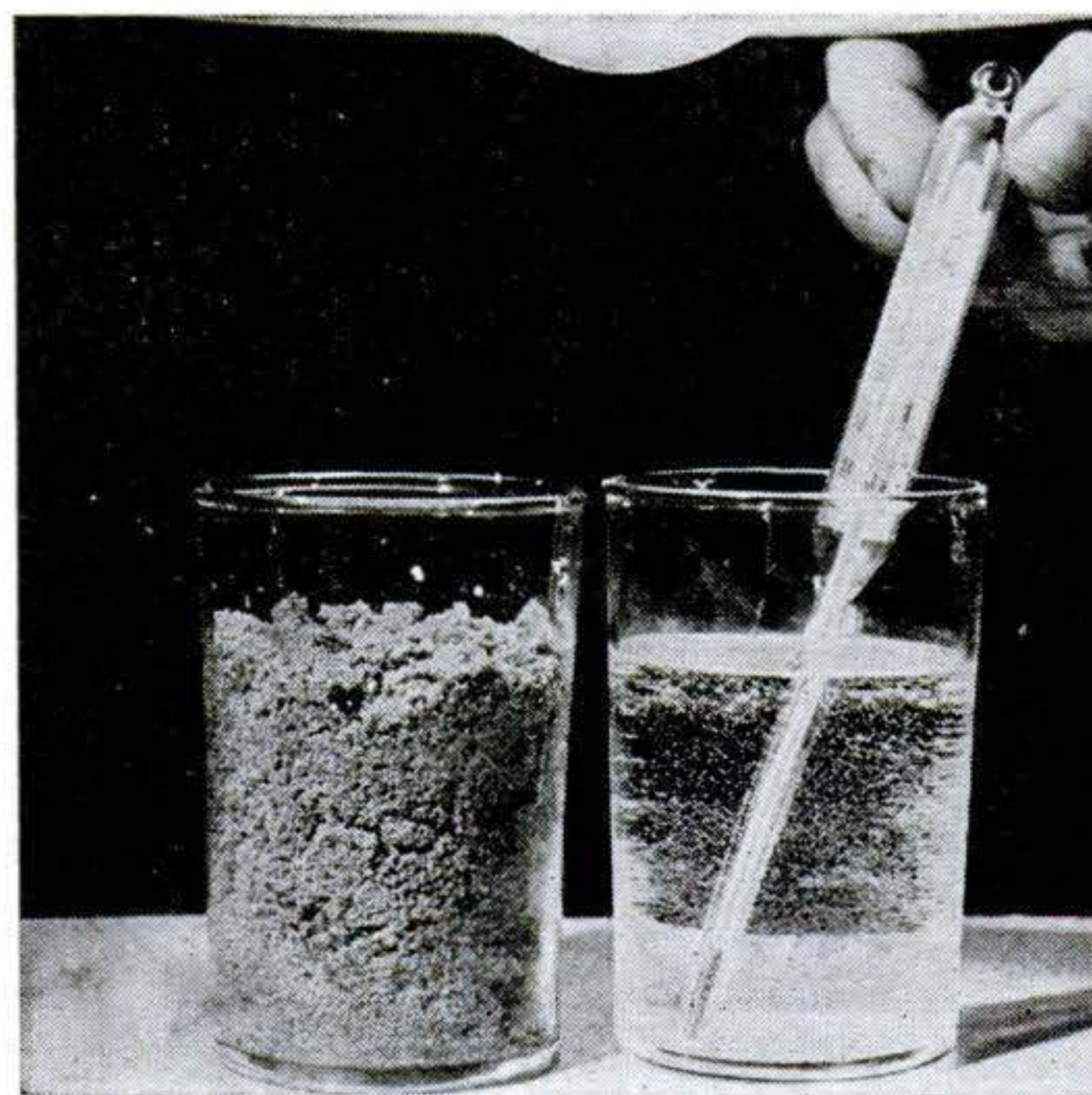

**Air Thermometer Responds Quickly.** With a bottle and glass tube you can make a thermometer that will react quickly to heat radiations. Smoke the surface of the bottle thoroughly in a candle flame, push the tube through a one-hole stopper, and support the bottle so the tube dips into colored water. If the bottle has just been smoked, it will still be warm. As it cools, the air inside will contract, drawing colored water part way up the tube. To cause the thermometer to register the effect of heat radiations, hold a lamp a foot or two from it. The water will drop quickly. Hold a book in front of the lamp, and the water will rise again.

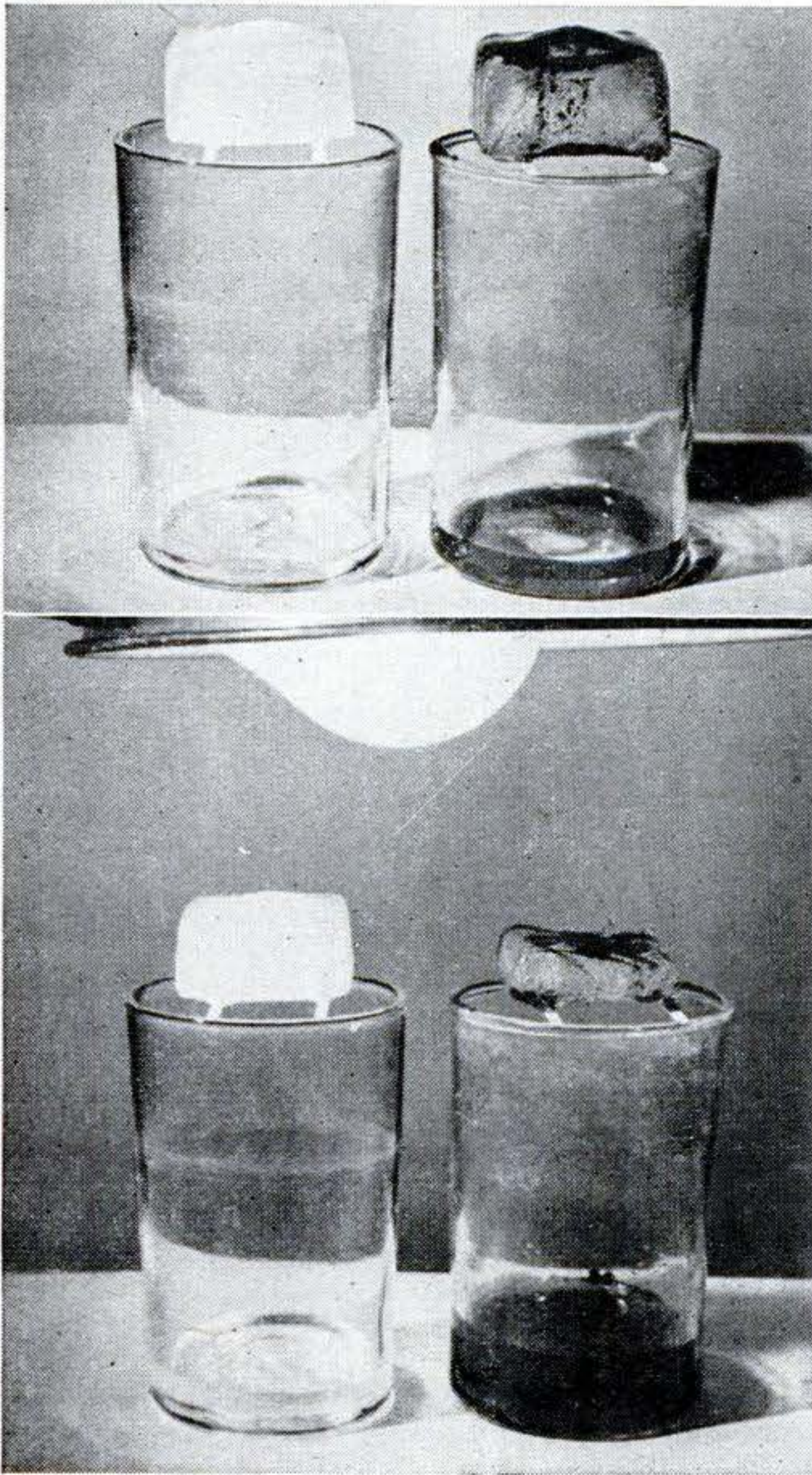
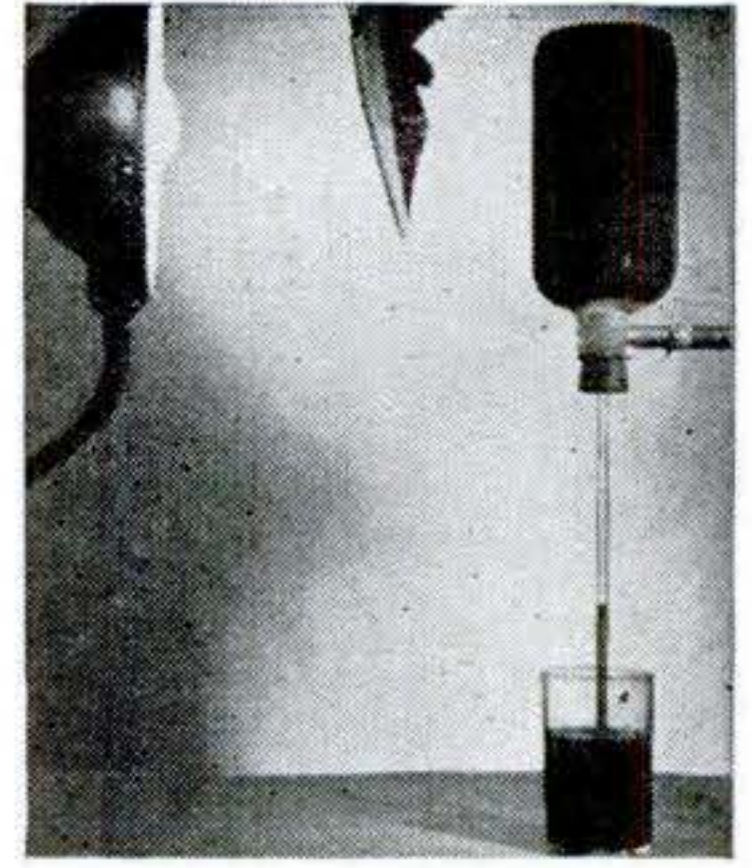

**Dirty Ice Melts Faster.** Because dark rough substances absorb radiant heat much faster than those that are light in color and smooth, dirty snow and ice melt rapidly when exposed to an electric light or to the sun's rays. This may be shown by supporting two ice cubes, one of them soot covered, on toothpicks over two tumblers. At ordinary room temperature, the melting will be about equal. But if an electric light is placed above the two, you soon will have the result seen in the bottom photo.

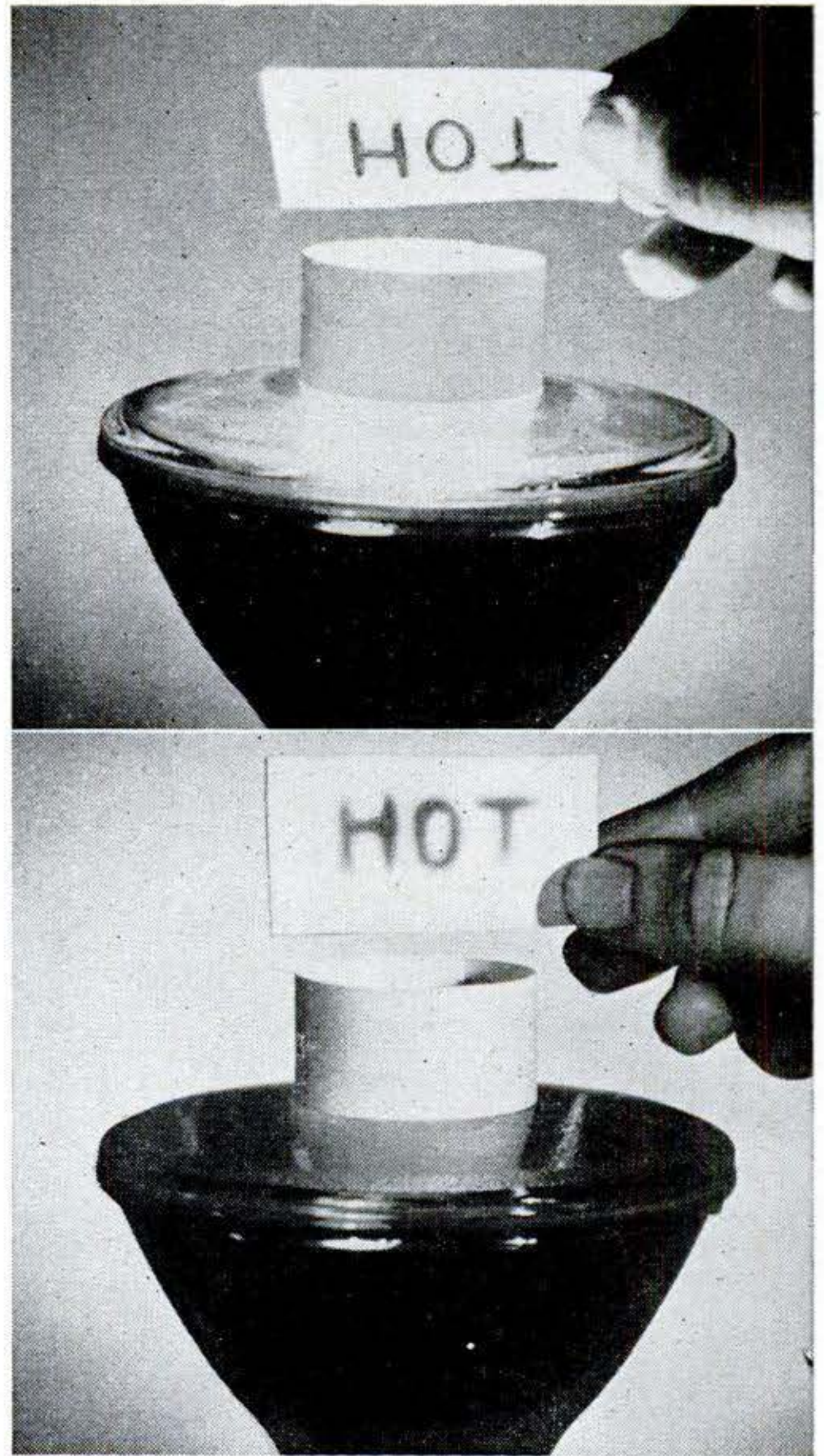

**Lettering Burns Through.** The difference in the rate of radiant-heat absorption between black and light objects can be shown by writing a word with India ink on a sheet of paper. (The stunt is more dramatic if you print each letter upside down, as at the top.) When the ink is dry, support the lettering face down on a reflector spot lamp. Within a few minutes, the lettering will come through on the other side, the paper having charred because of the great absorption of the black ink.

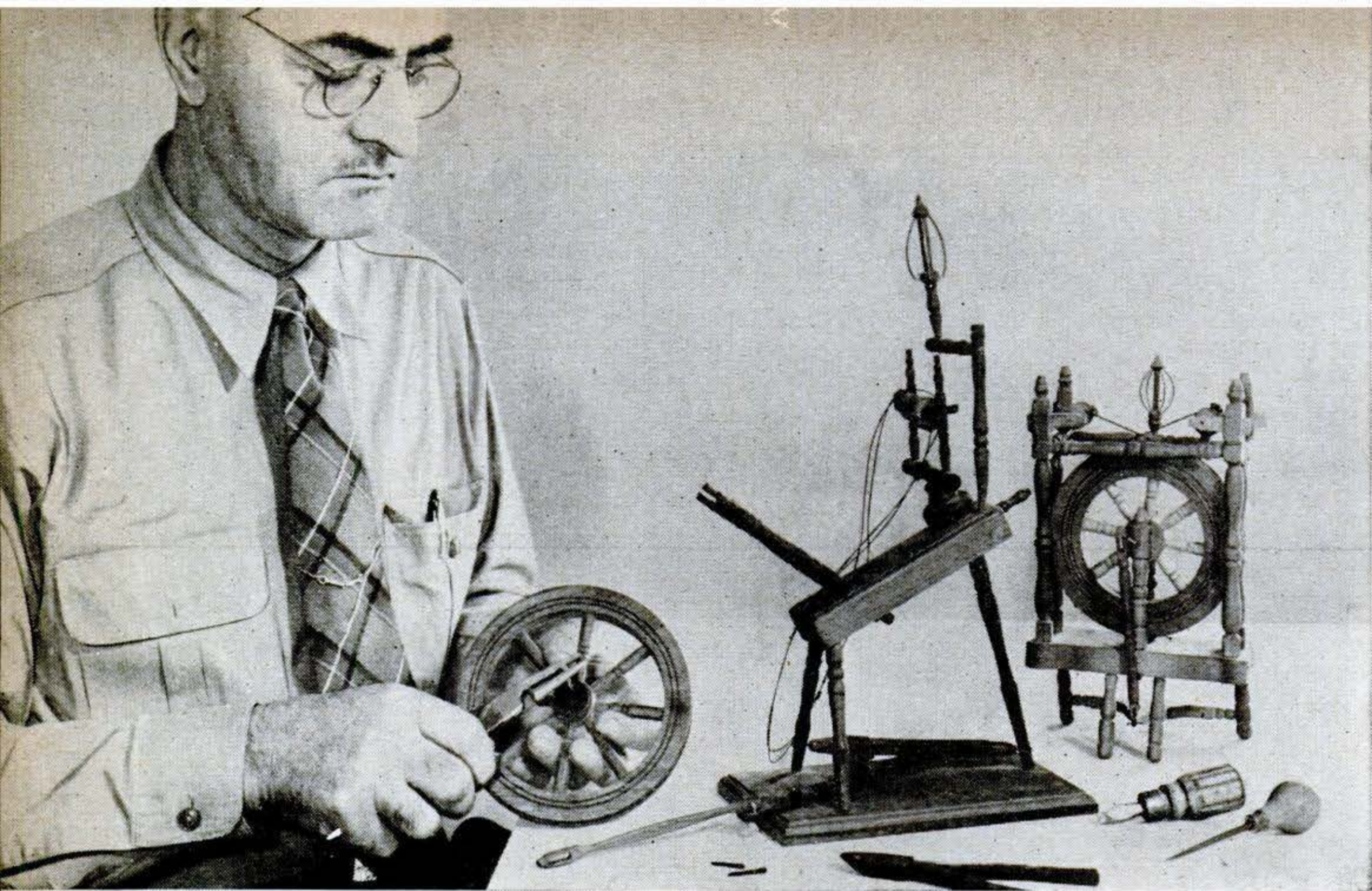

Treadle, pitman, and crank work just as in the full-size spinning wheels E. J. Waltner uses

as his prototypes. At right is a Dutch wheel, unusual for having twin fliers instead of one.

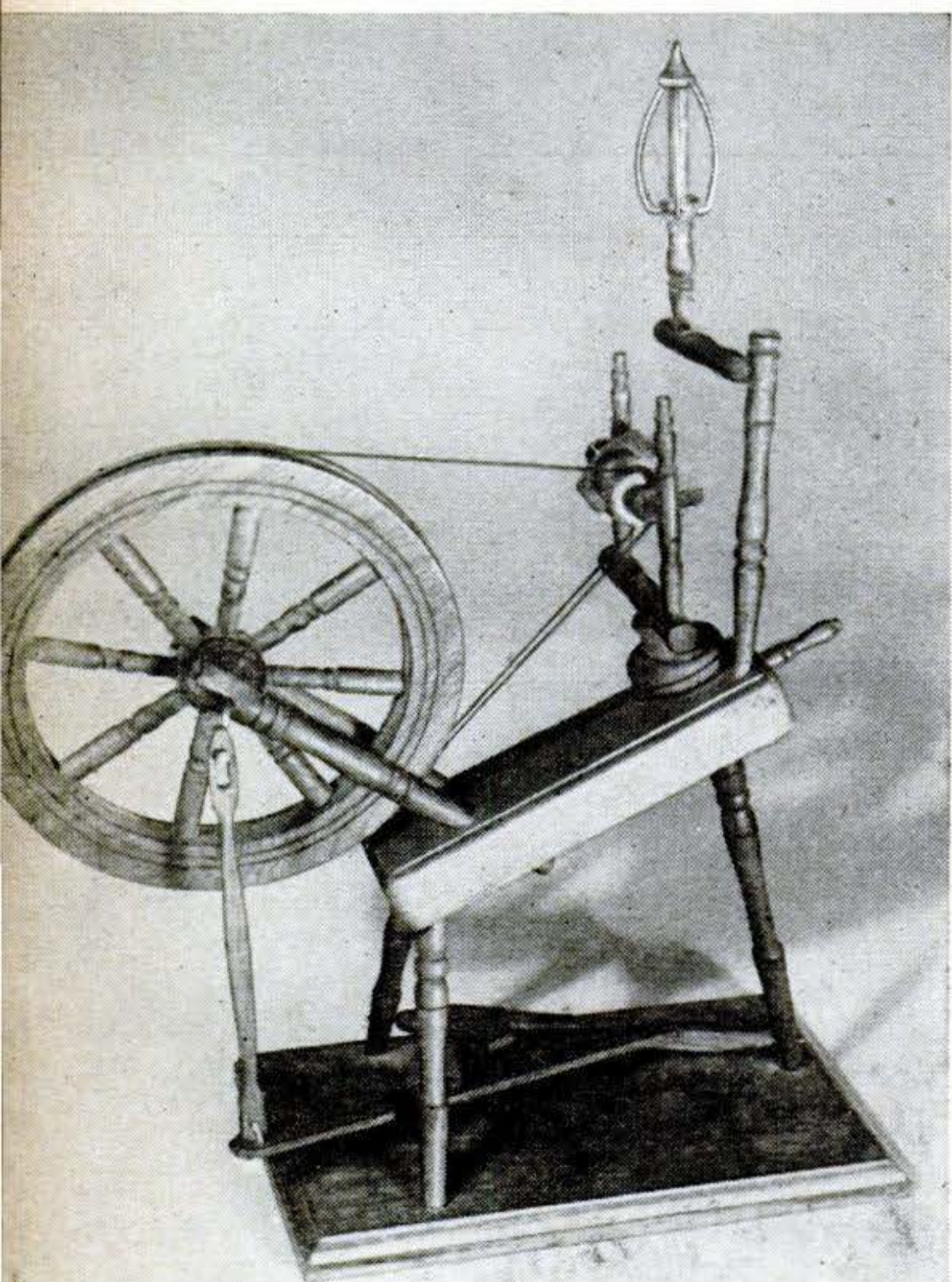

**Ready for a spin,** this model of a Russian flax wheel was scaled down from one discovered in a cobwebby attic. The original traveled to the prairies with immigrants who became pioneers.

## Model Wheels Spin Yarns of Pioneer Days

IF Tom Thumb had a wife, she could spin yarn for family clothes on these tiny spinning wheels, for they're realistic working models right down to the distaff. Making them is the hobby of E. J. Waltner, of Hurley, S. Dak. A descendant of the pioneers who settled the Dakota prairies, he first saw such a wheel at work under his grandmother's fingers. These photos show models of the old wheels he has found in museums, attics, and barns. Though all work on the same principle, their details are as different as their origins. The models are all built to scale, legs and wheel spokes being lathe-turned like those of their prototypes.

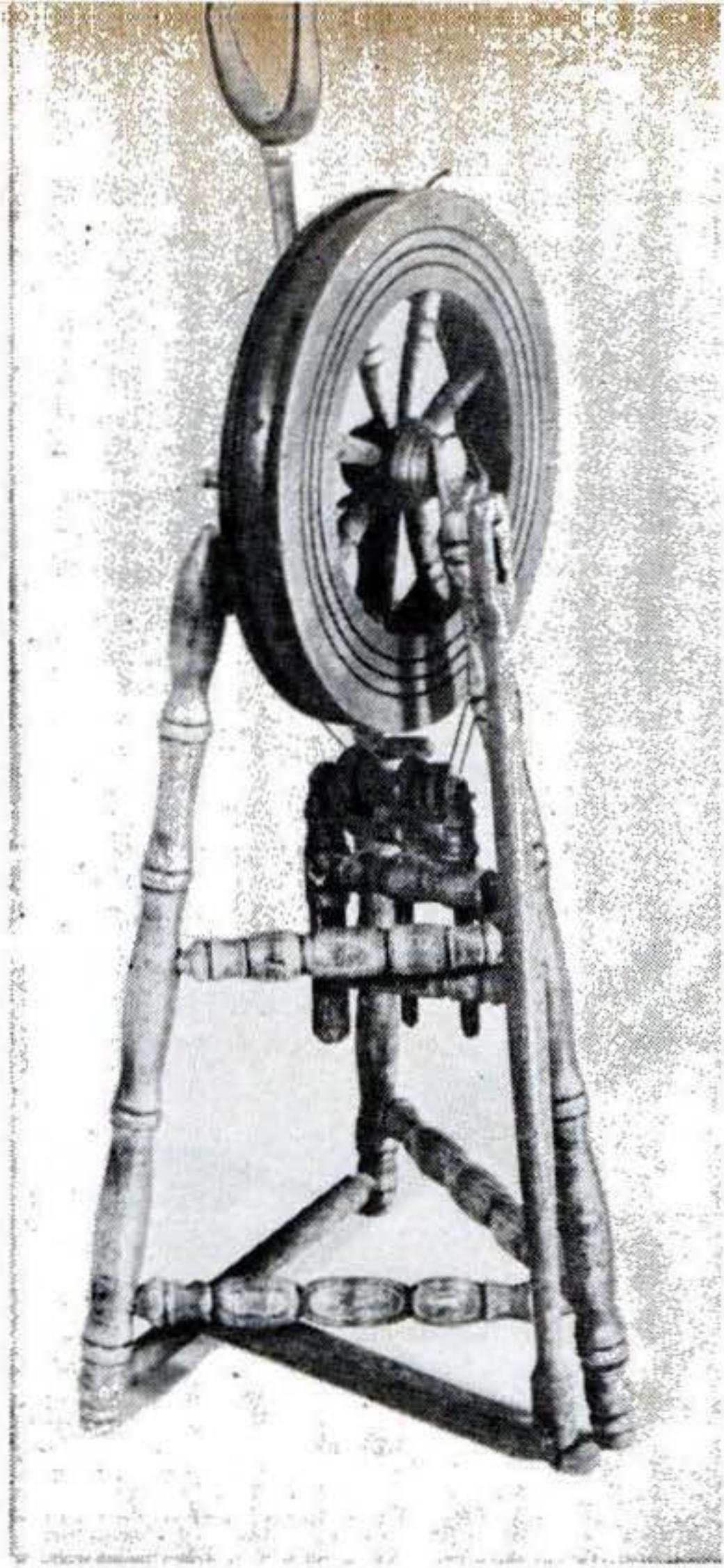

**Irish eyes** smiled over wheels of this kind. The flier, which twists the yarn, and the spool that reels it up are set below.

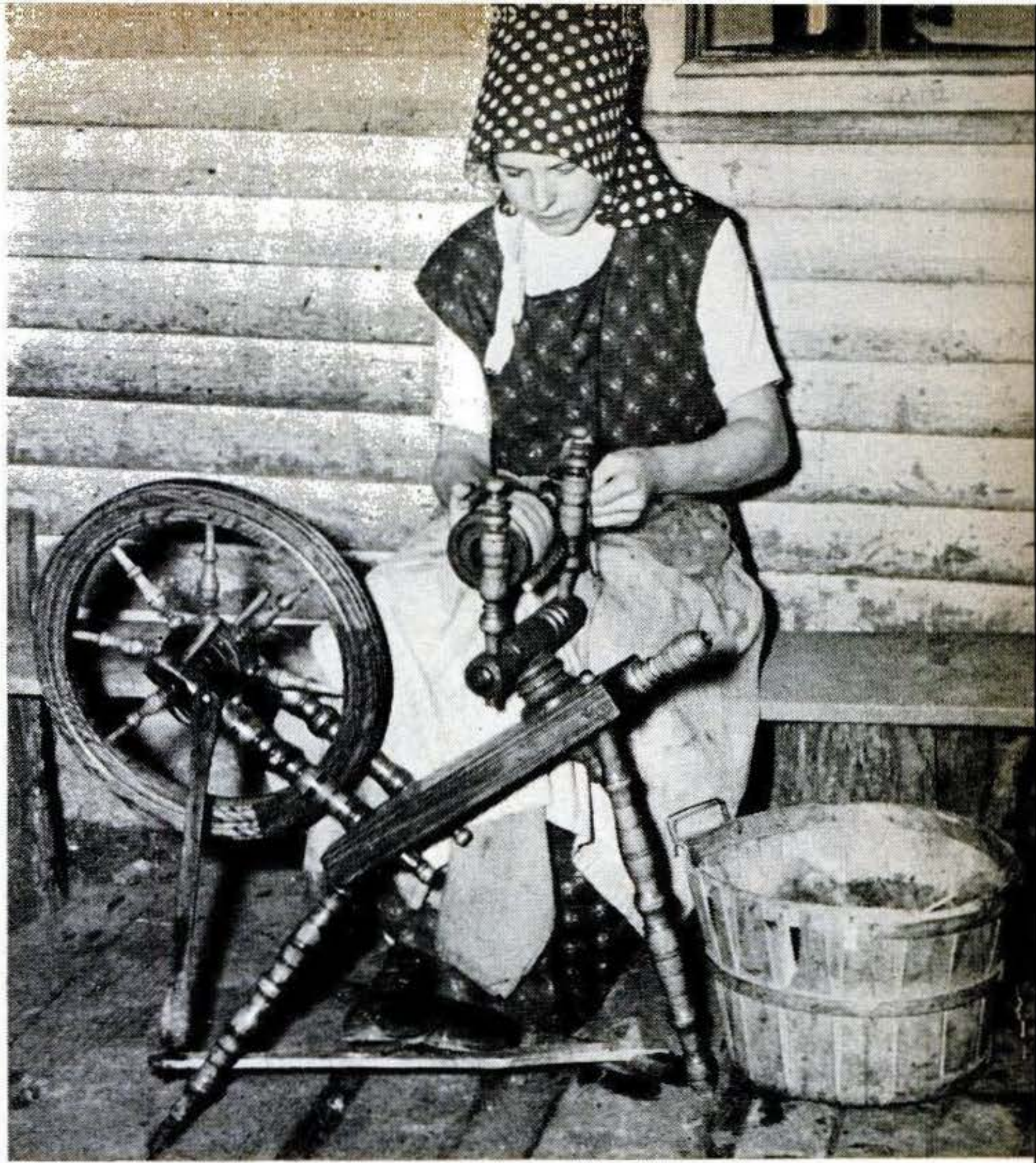

**And still they spin.** Even today, women of the Hutterian Brethren, a group who settled in South Dakota in 1874 to escape persecution abroad, make spinning wheels whir. Raw wool is spun, and the yarn washed until snow white.

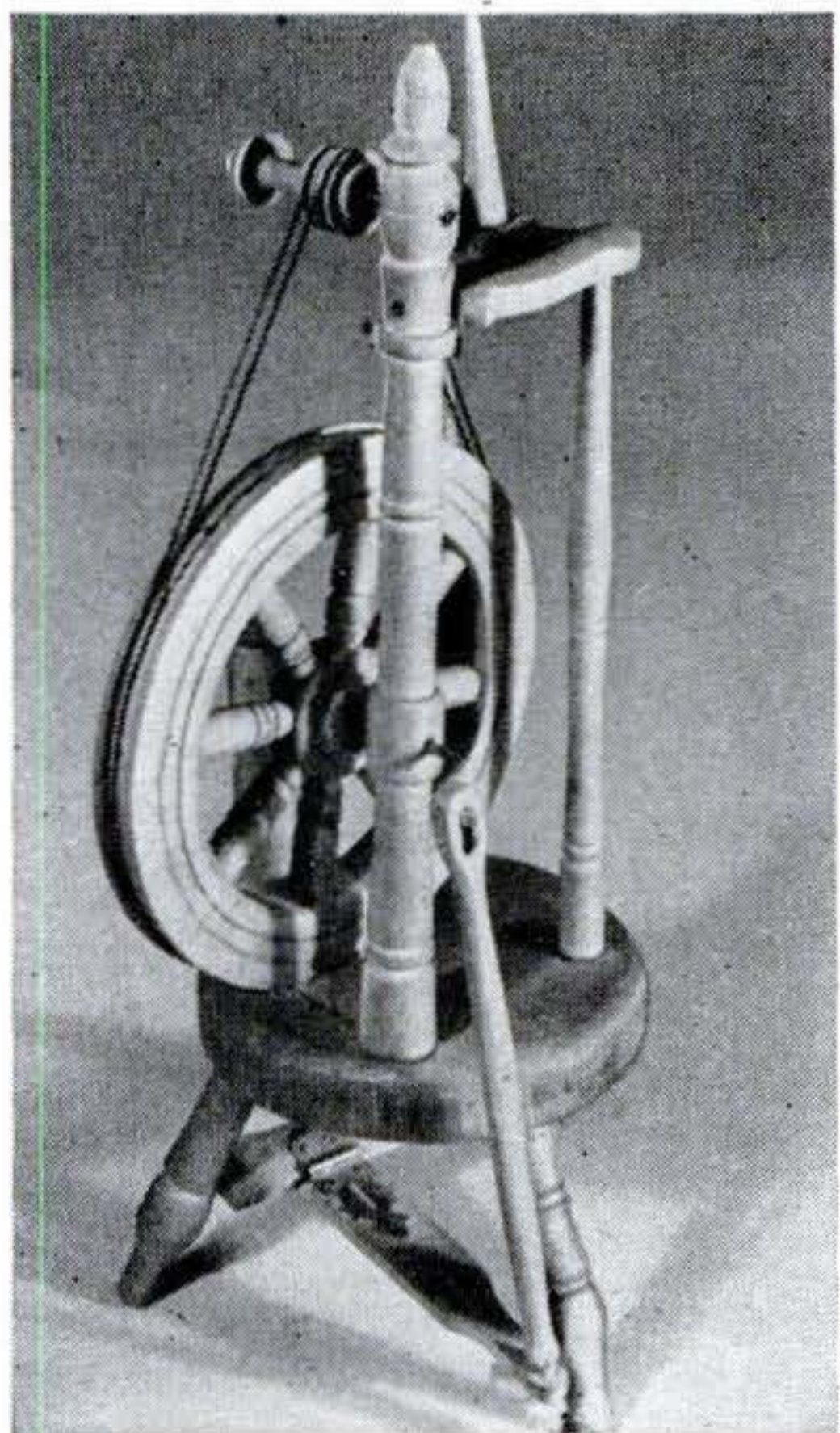

**The Czechoslovaks** had a word for it, but the wheel was much the same. The spool was set high. A simple wood spike held the wool.

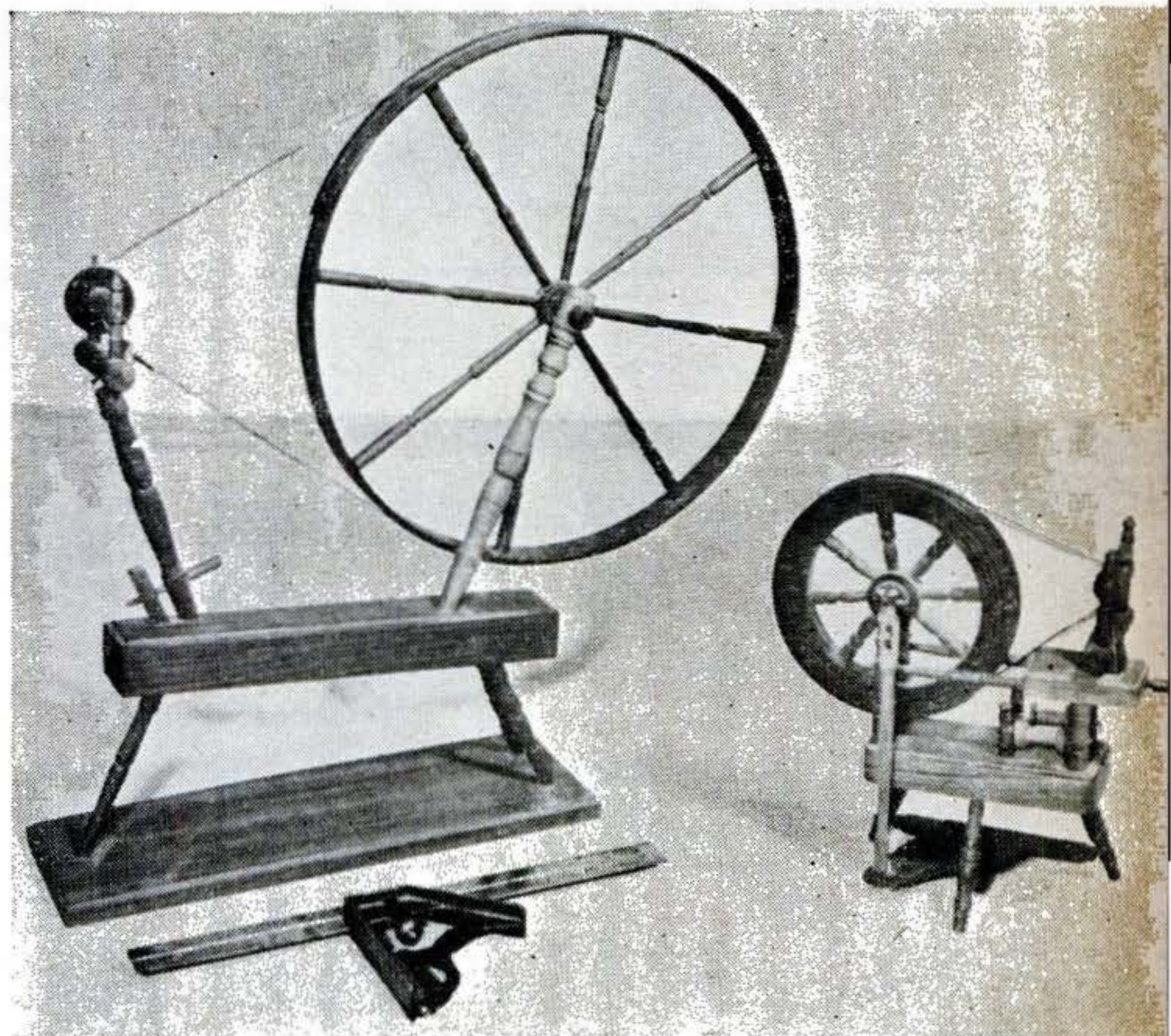

**Pilgrim fathers** let the ladies stand. Their wheel, the big one at left, had no treadle and was run by striking the spokes with a stick. The Swedish wheel at the right, modeled to the same scale, was run by a foot treadle.

# Use Those Extra Asbestos Shingles

Who ever heard of the shingling job that ended in a perfect tie between the number bought and the number needed? Whether you like it or not, part of that last bundle will be left over. But you certainly ought to like it, because left-over shingles—both asbestos and asphalt—have countless uses around the house. A few are illustrated here, and you will think of others. Both types are good for friction uses, but stick to asbestos for jobs that call for heat resistance.—*B. Halpern, Jackson Heights, N. Y.*

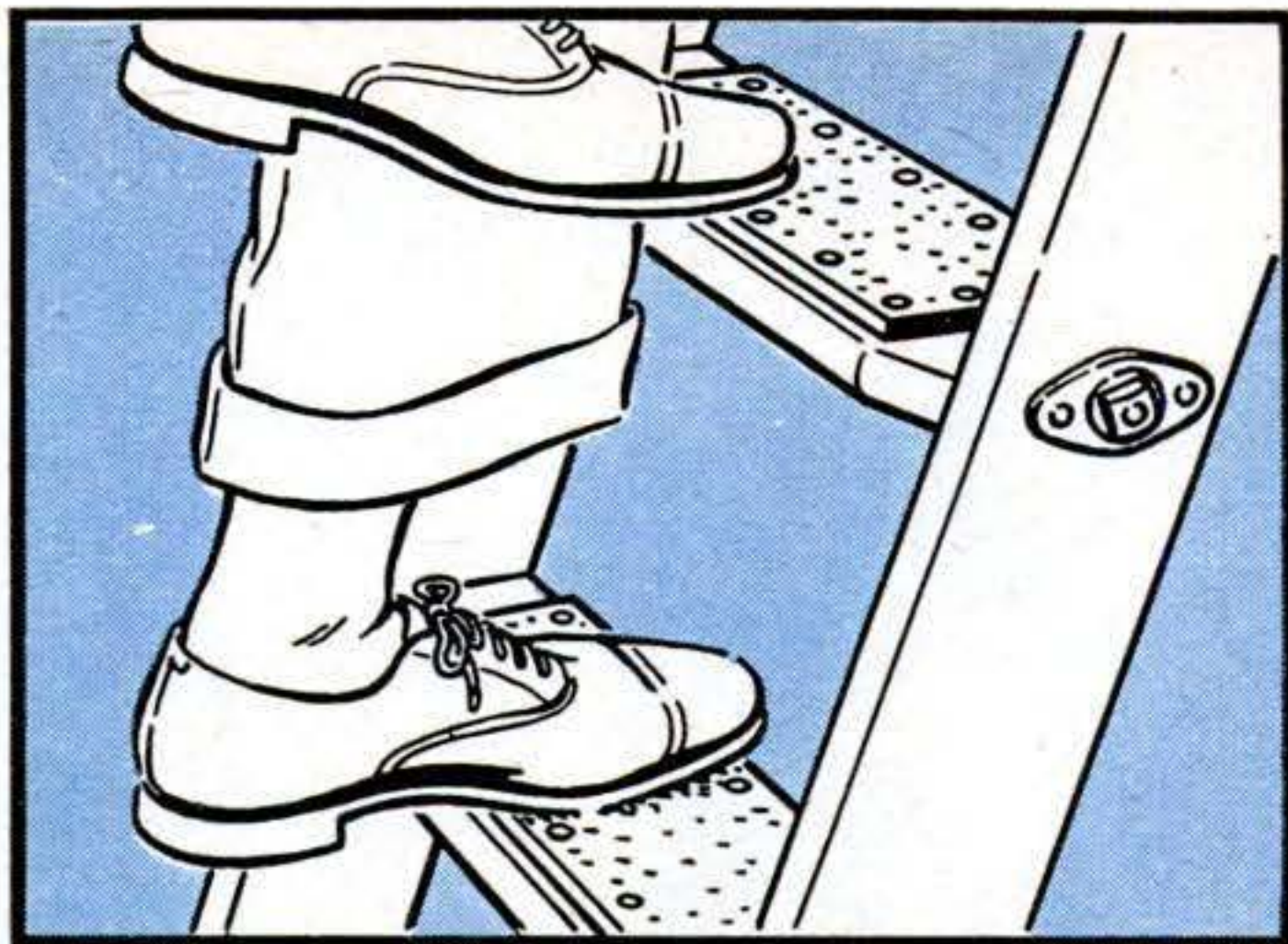

**Prevent slipping** by nailing strips to ladder rungs or to worn cellar steps. Lessen the danger of electric shock through a damp floor by laying a shingle platform near the fuse box.

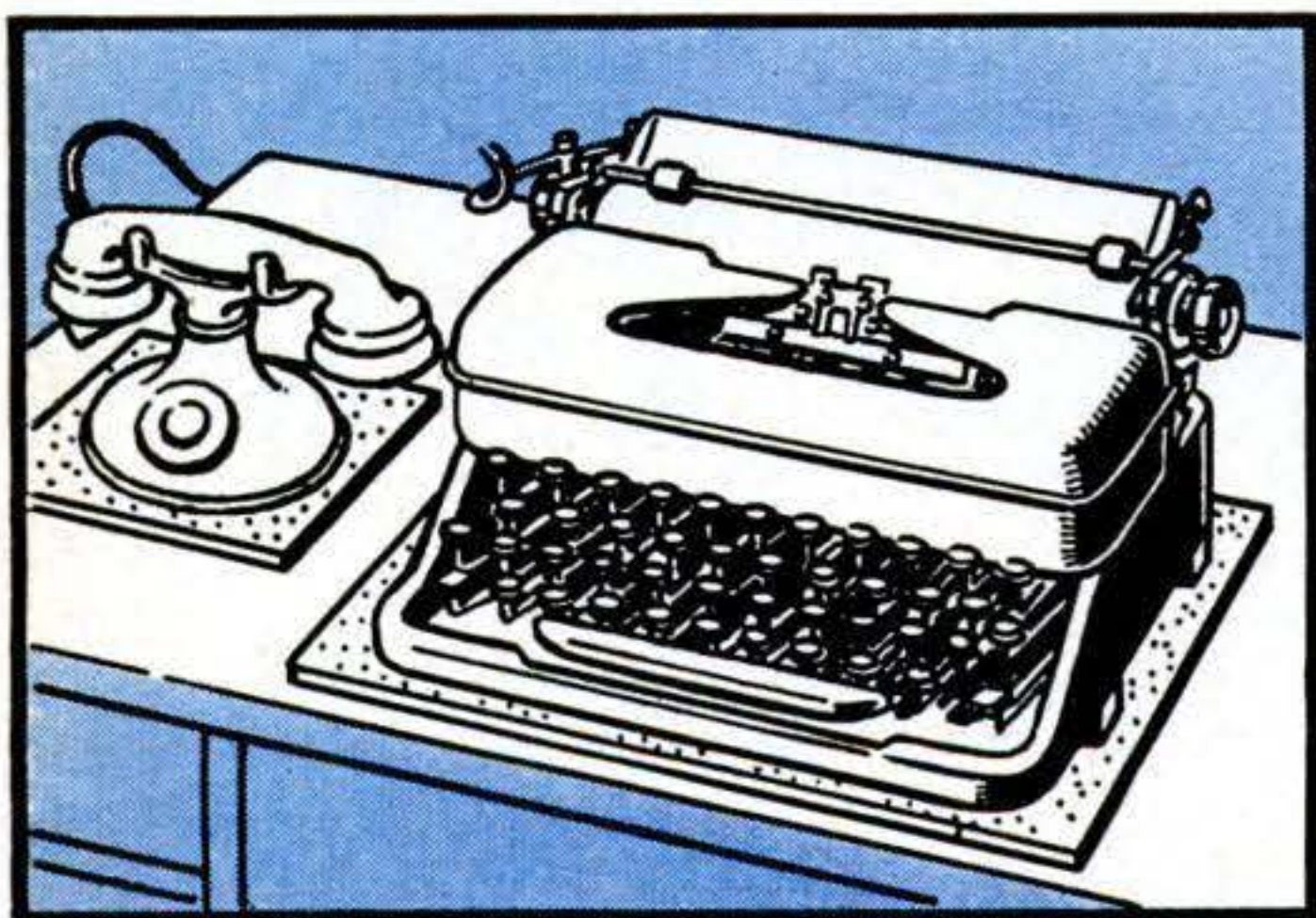

**Deaden the noise** and vibration of a typewriter and keep the machine from crawling by putting it on a shingle. Use another under the phone, especially a dial type, which tends to slip.

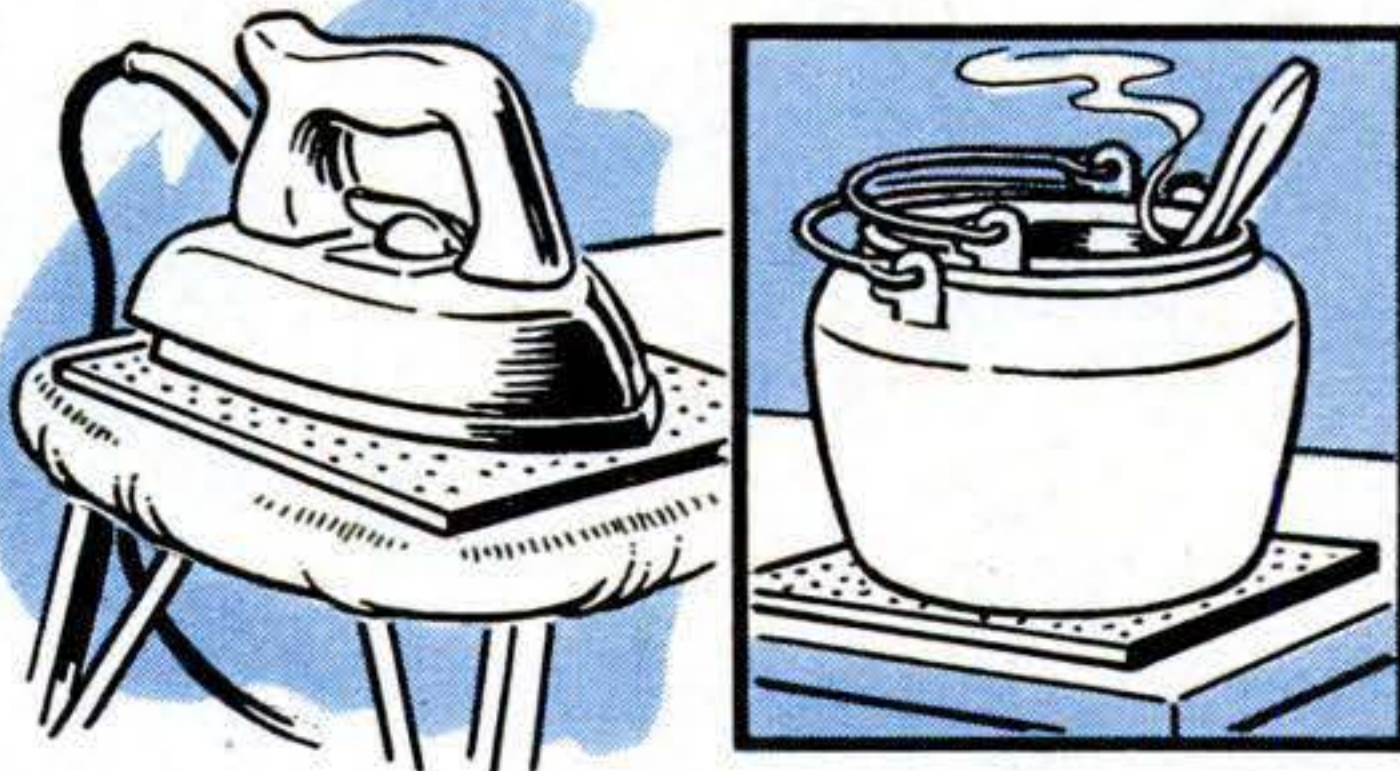

**Under an iron**, or as a hotplate for glue pots, asbestos shingles protect working surfaces.

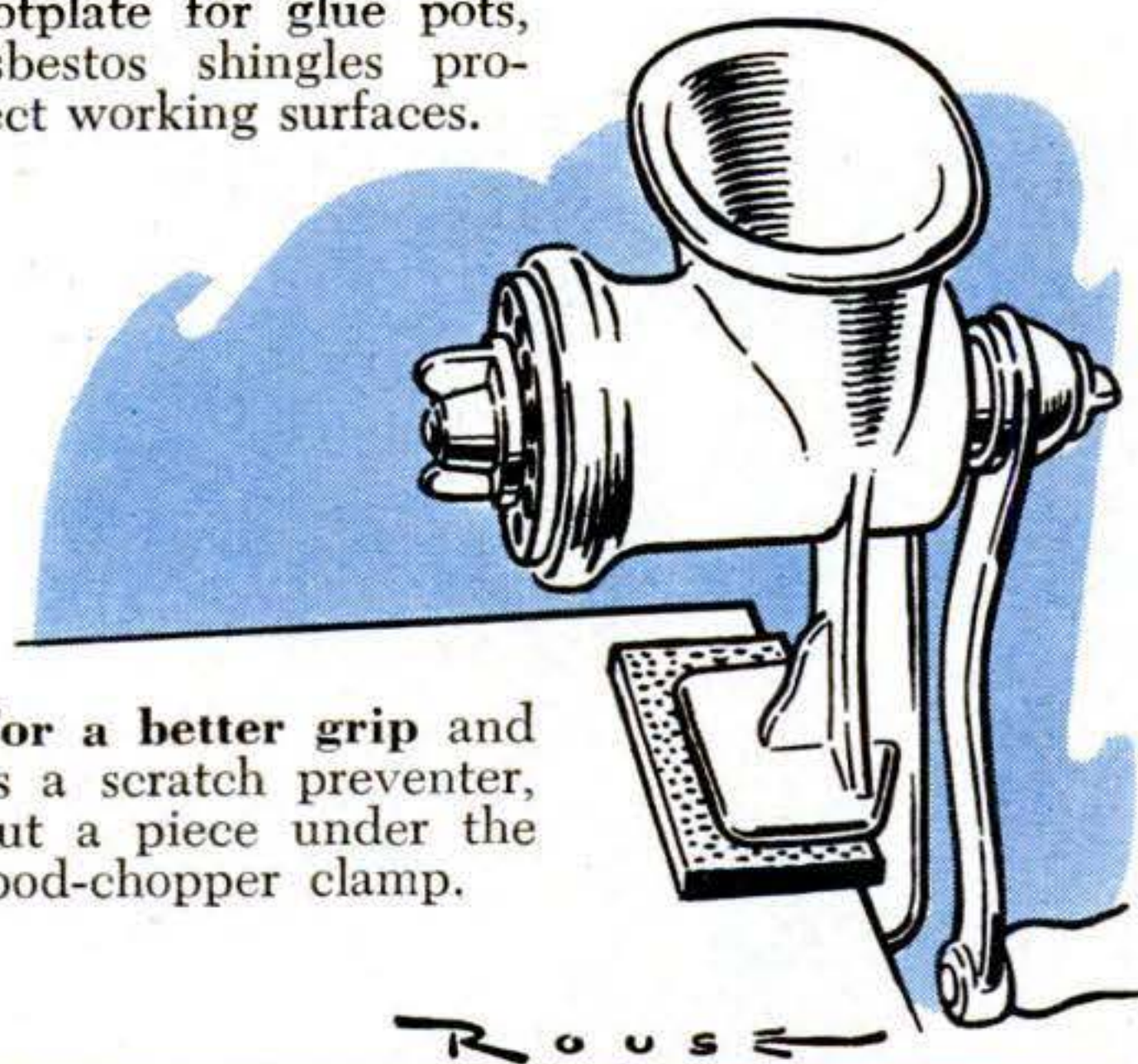

**For a better grip** and as a scratch preventer, put a piece under the food-chopper clamp.

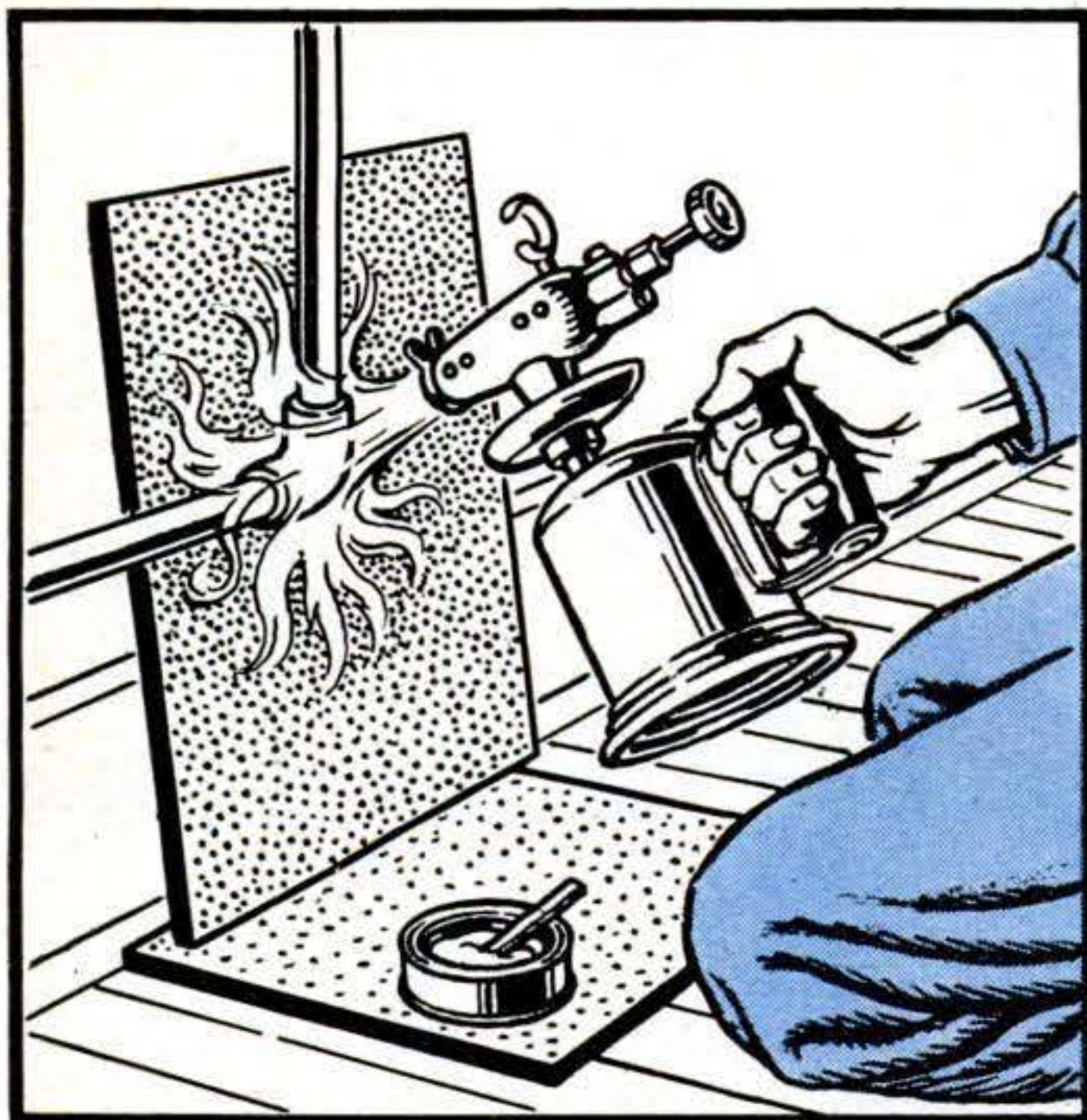

**Protect walls and floors** with asbestos sheets when soldering or using a torch on a pipe. If you use a torch to remove old paint, protect the surrounding wall area with the shingles.

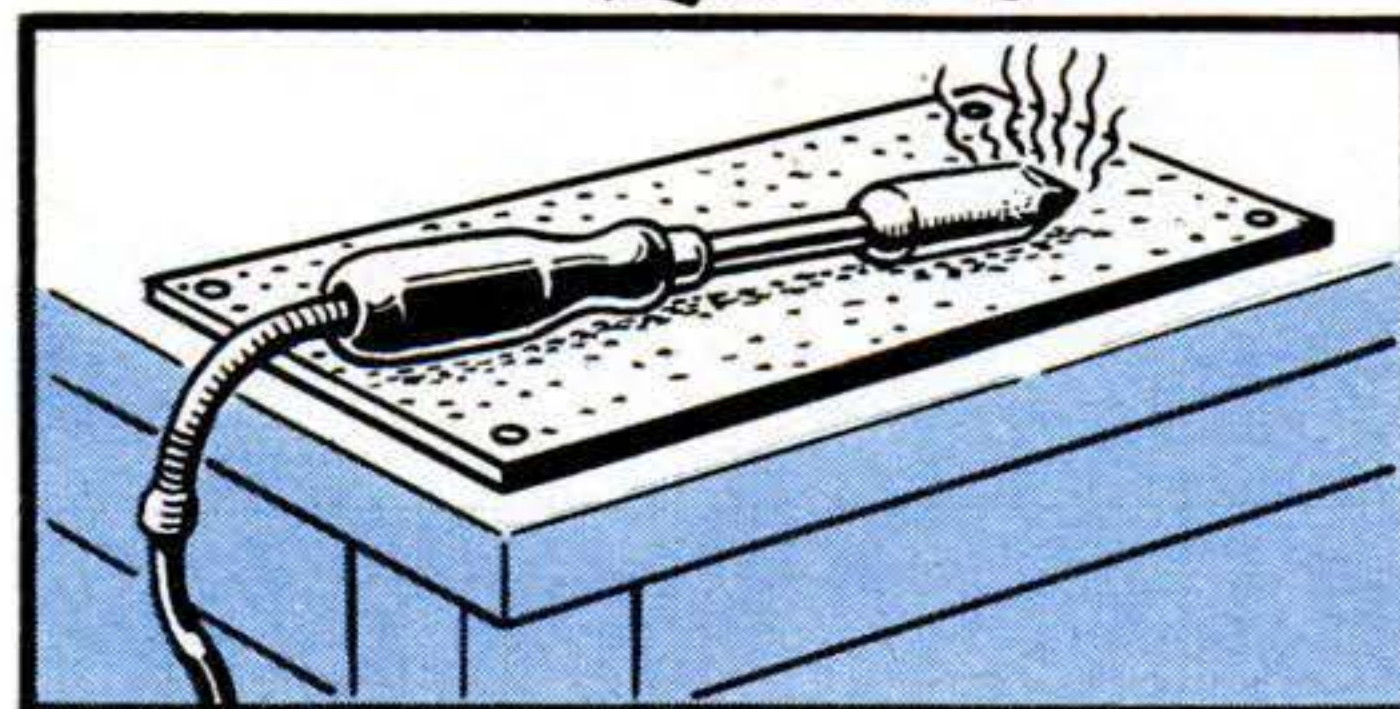

**Rest a hot soldering iron** on asbestos shingle and stop worrying about scorching the bench. You can even do your soldering right on the pad; it won't draw heat away from the work.



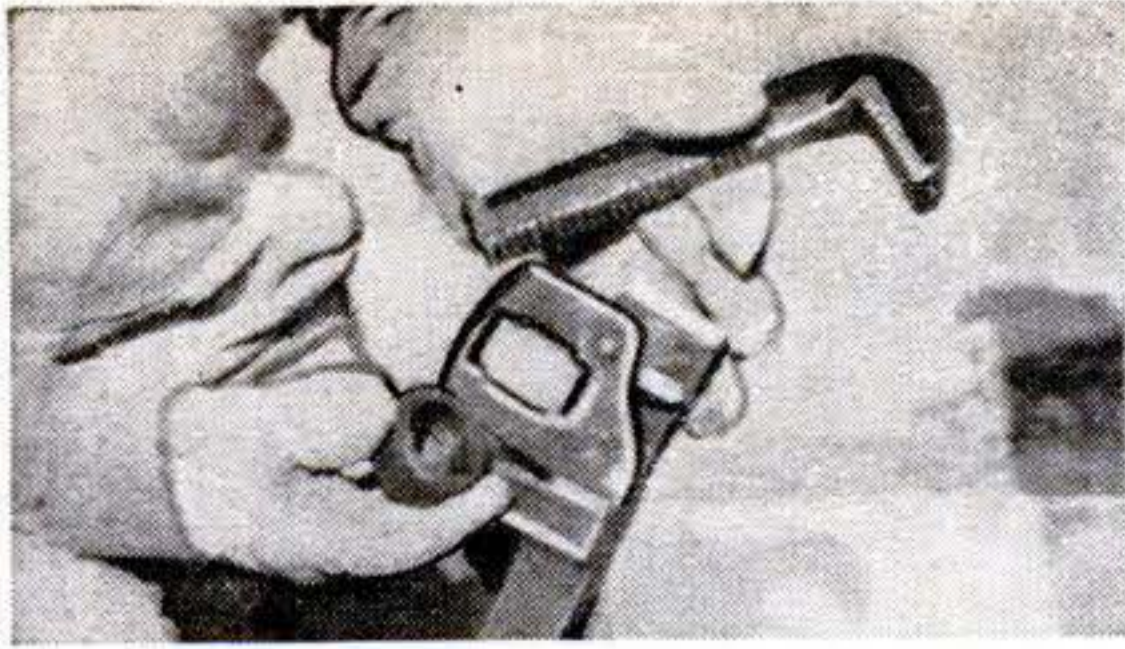

Remove the nut and jaw of a big pipe wrench to use it as a chain wrench.



Loop a sturdy chain around the pipe and fasten it as shown at the right.

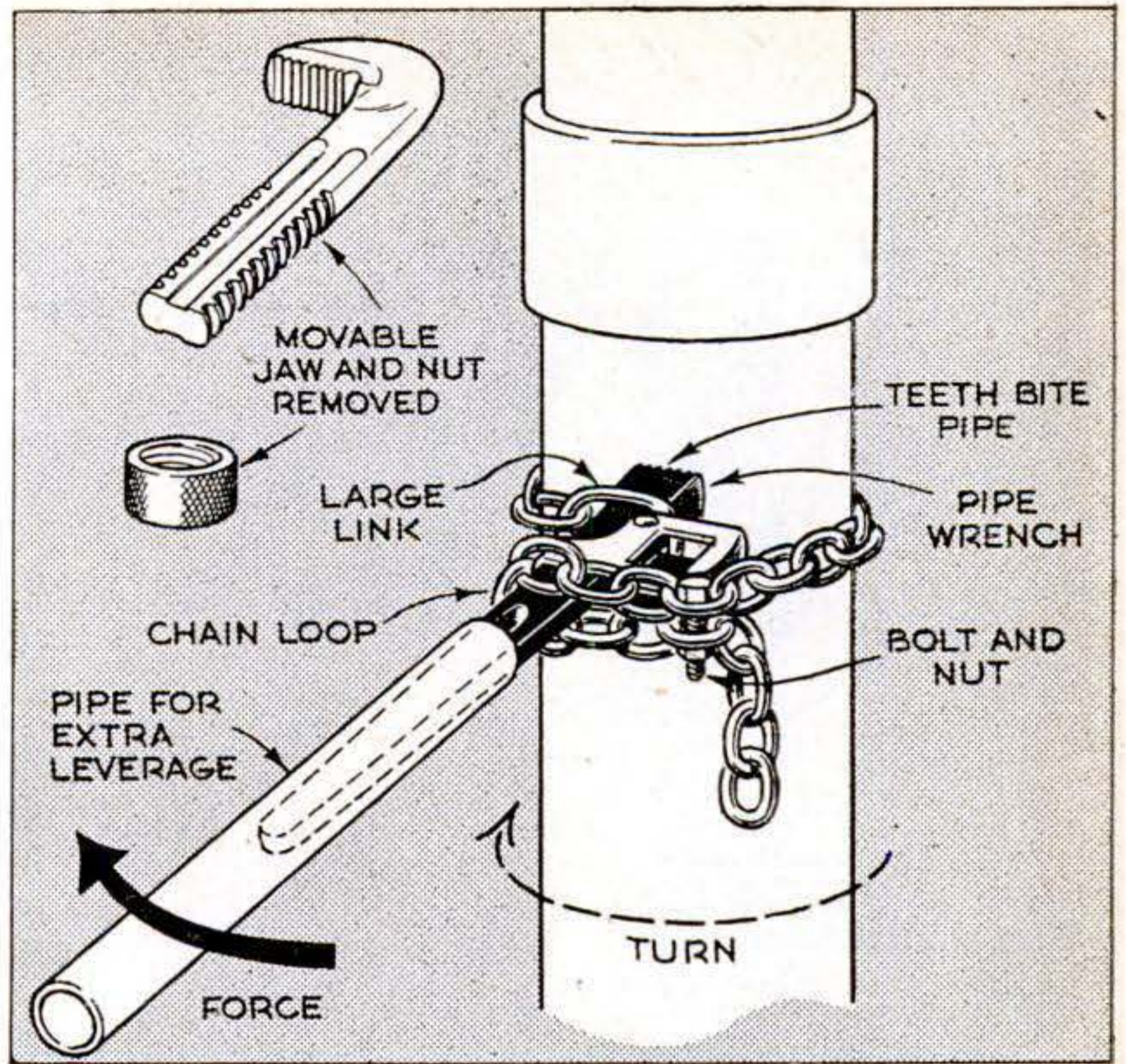

## Chain on Pipe Wrench Grips Large Diameters

WHEN you have to turn an out-size piece of pipe and have no wrench that will make it, use the largest one you can find and improvise the rest with a length of sturdy chain.

One end of the chain should have a link large enough to fit over the fixed jaw of the wrench. Take off the nut and movable jaw, and pass the chain around the pipe. The large end link is then hooked

onto the remaining jaw and the other end of the chain is looped and bolted around the wrench handle as shown in the drawing. If the chain is too loose, make it shorter by twisting.

Applying pressure on the wrench handle makes the jaw bite in and assures a firm grip even when the pipe turns. A small piece of pipe slipped over the handle will furnish extra leverage.—*Andrew Vena, Philadelphia.*

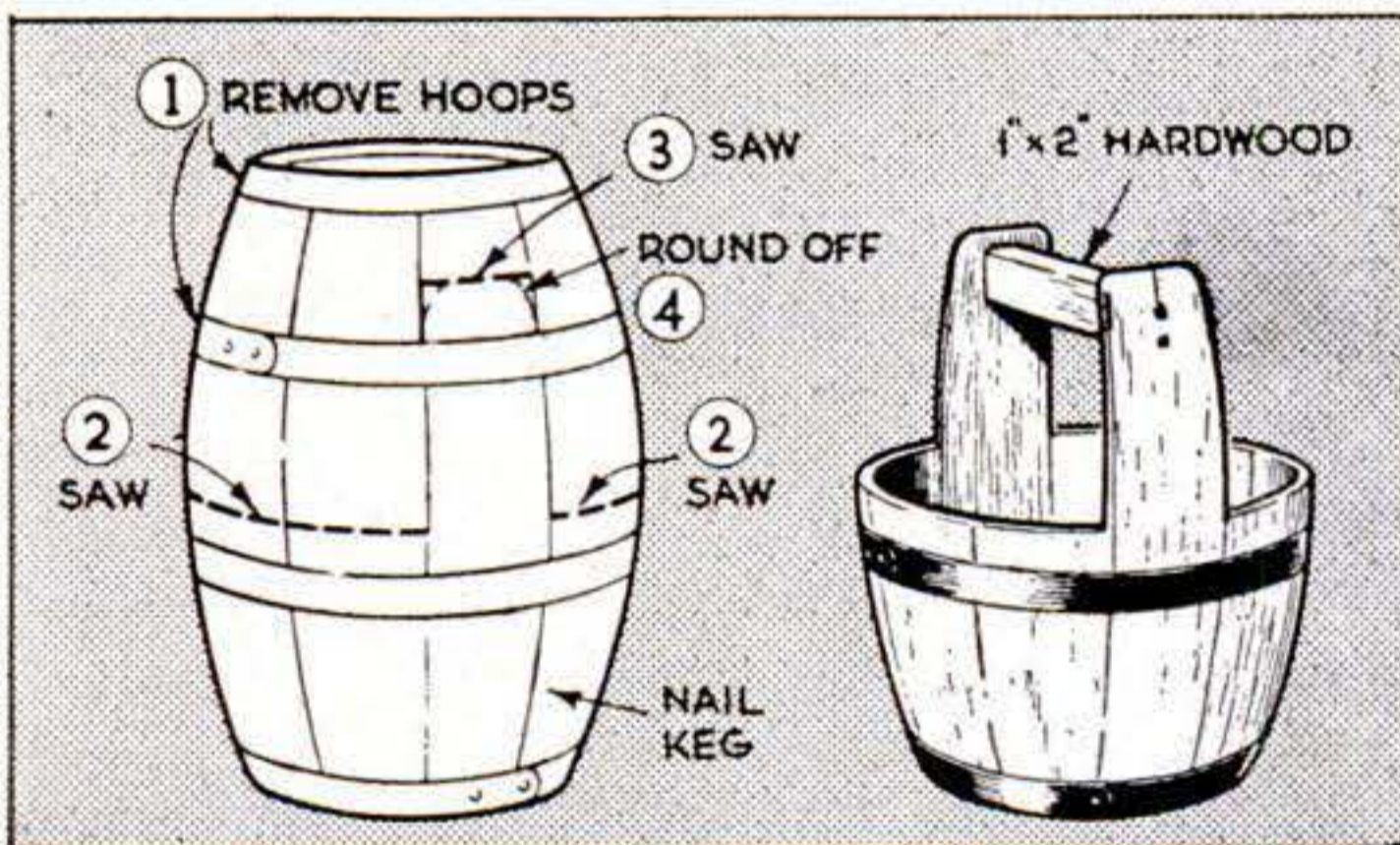

## Nail Keg Converted to Bucket

A HANDY bucket for a variety of uses can be made from an empty nail keg. Slip the two upper hoops off the keg and cut the staves as shown in the drawing. A dowel or a piece of 1" by 2" hardwood, fastened between the two tall staves, serves as a handle. Such a bucket is especially useful for carrying plumbers' fittings and tools. It's strong and makes less noise than a metal one.—*Arthur Trauffer, Council Bluffs, Ia.*

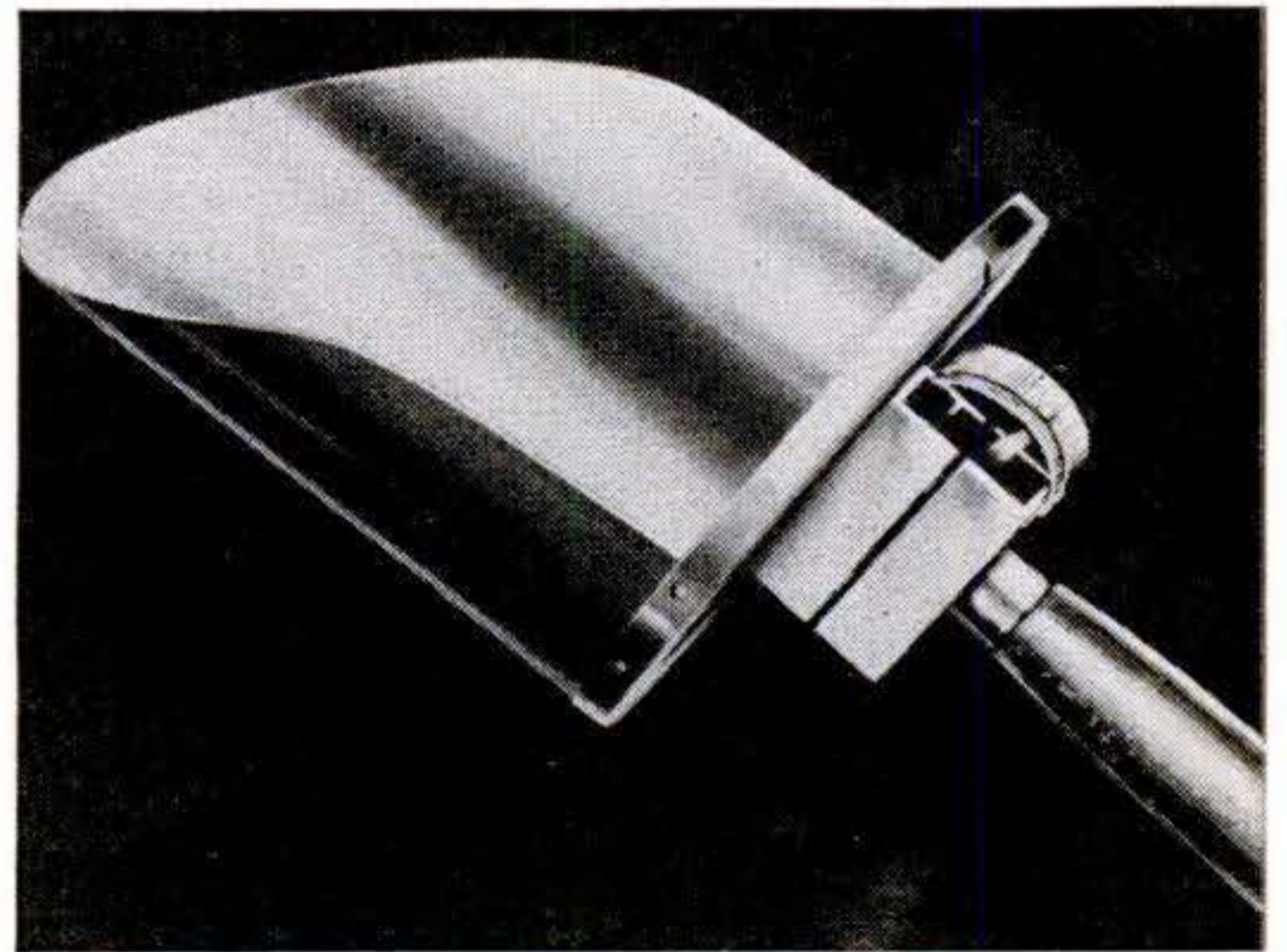

## New Scoop Has Built-In Scale

THIS new scoop weighs feed as it shovels it out and indicates poundage on a dial in front of the handle. Called the Dollydale Scoop-Scale, it will hold four pounds and is rust and corrosion resistant. It is made by the Robson Corp., New York, and costs about \$7.50.

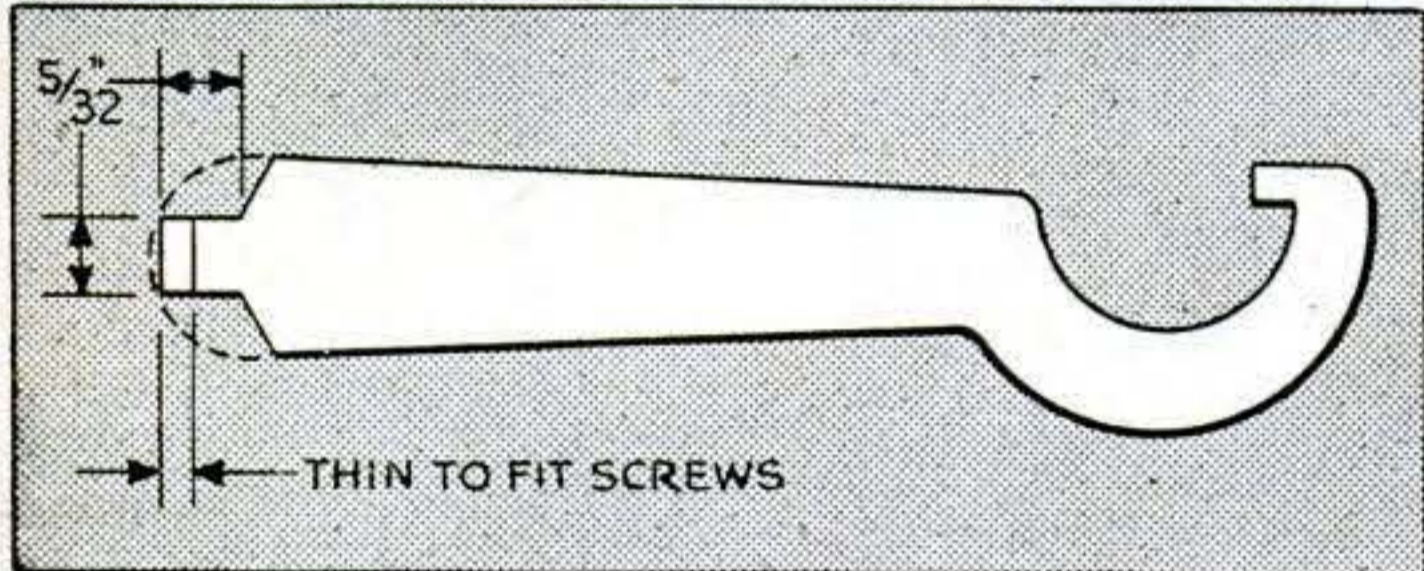
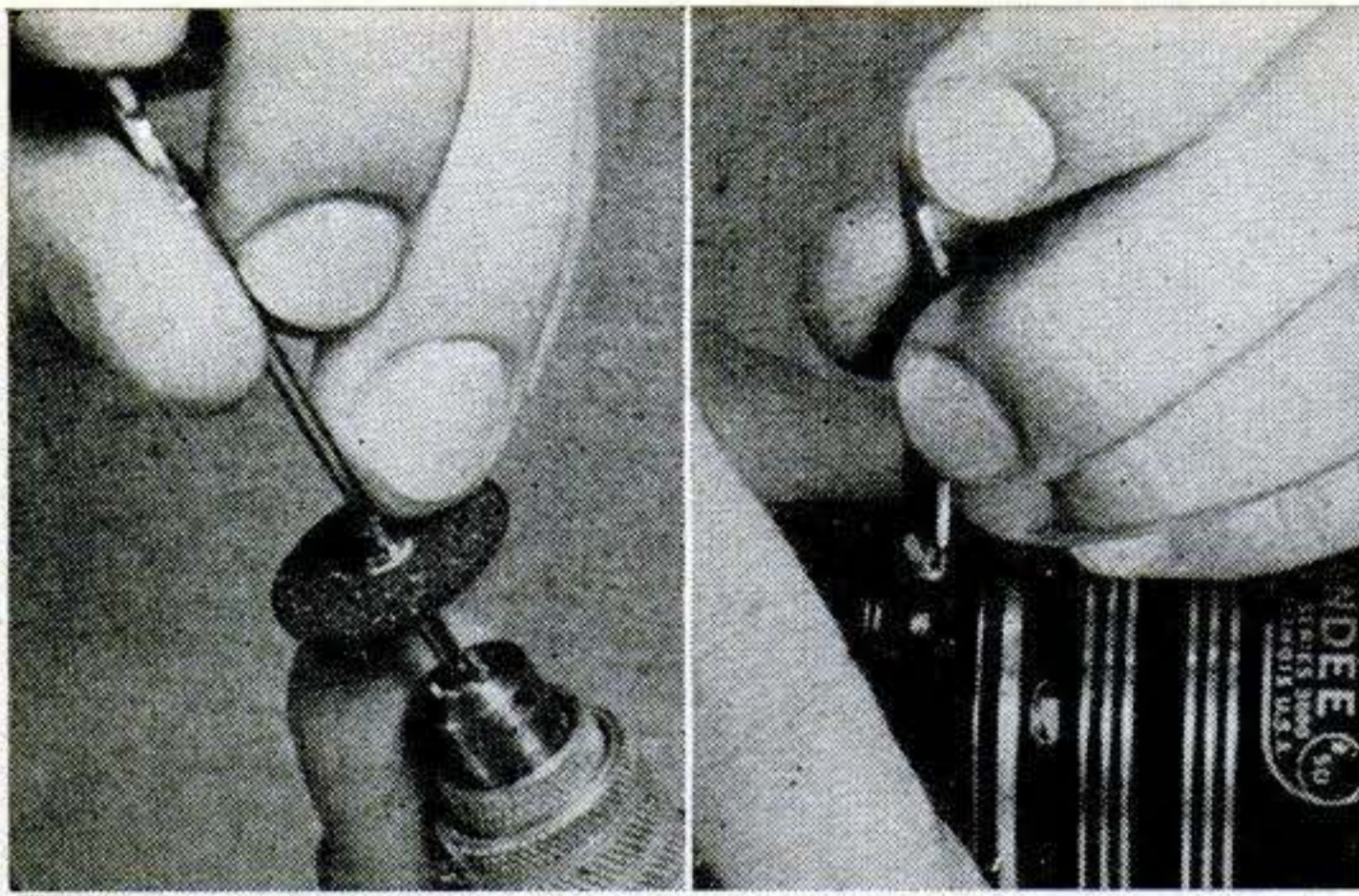

### Wrench Ground as Screwdriver

Two extra uses can be built into the chuck wrench or spanner that's usually provided with a hand grinder or motor tool. By grinding the end of the wrench down to the dimensions shown, it will serve both as a fine screwdriver for the frequently removed screw at the end of a mandrel, and as a huskier screwdriver for the slotted oiling plug on the grinder body. The wrench is not needed for its original purpose while the mandrel screw is tightened or loosened, since the position of the protective sleeve locks the chuck. Don't thin the small blade more than necessary or it may bend in use.—*Jack Wilson, San Pedro, Calif.*

### Hooked Steel Rod Serves as Handy Bucking Bar

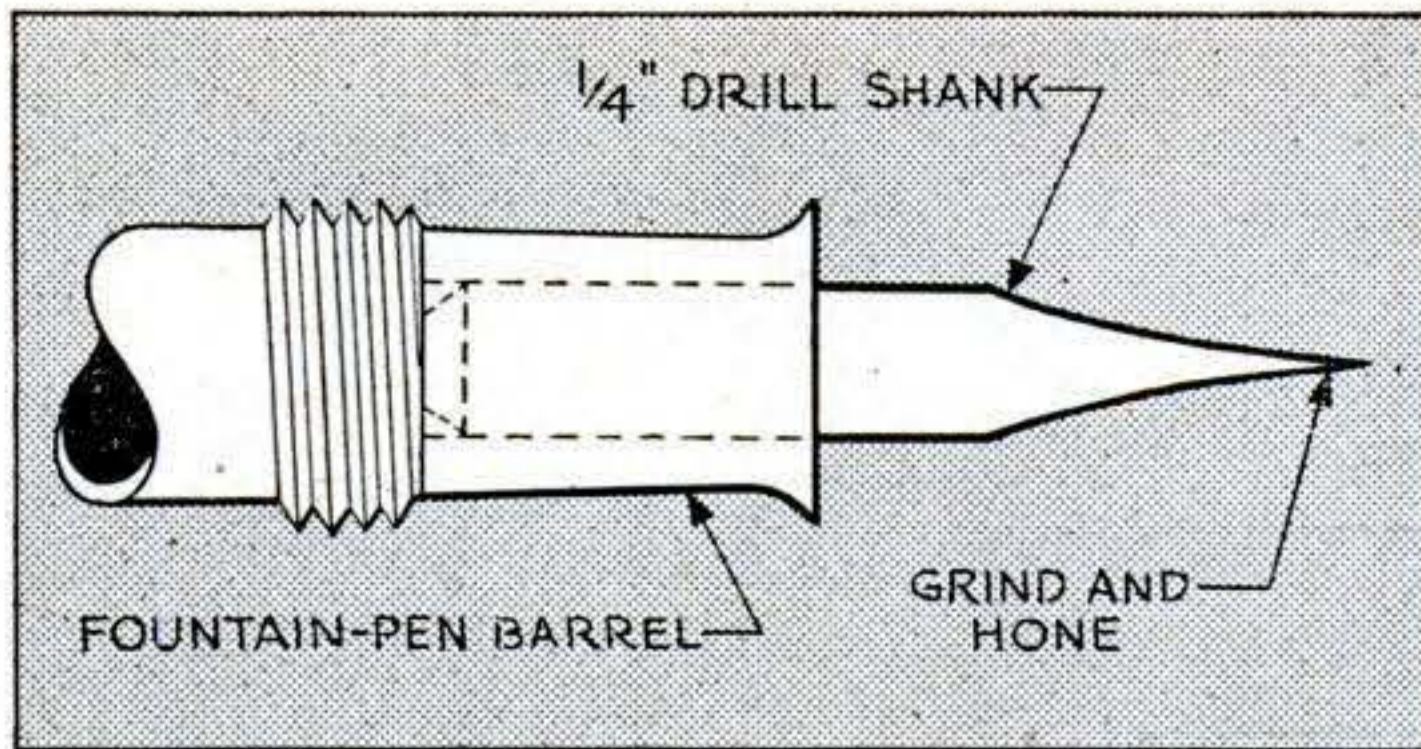
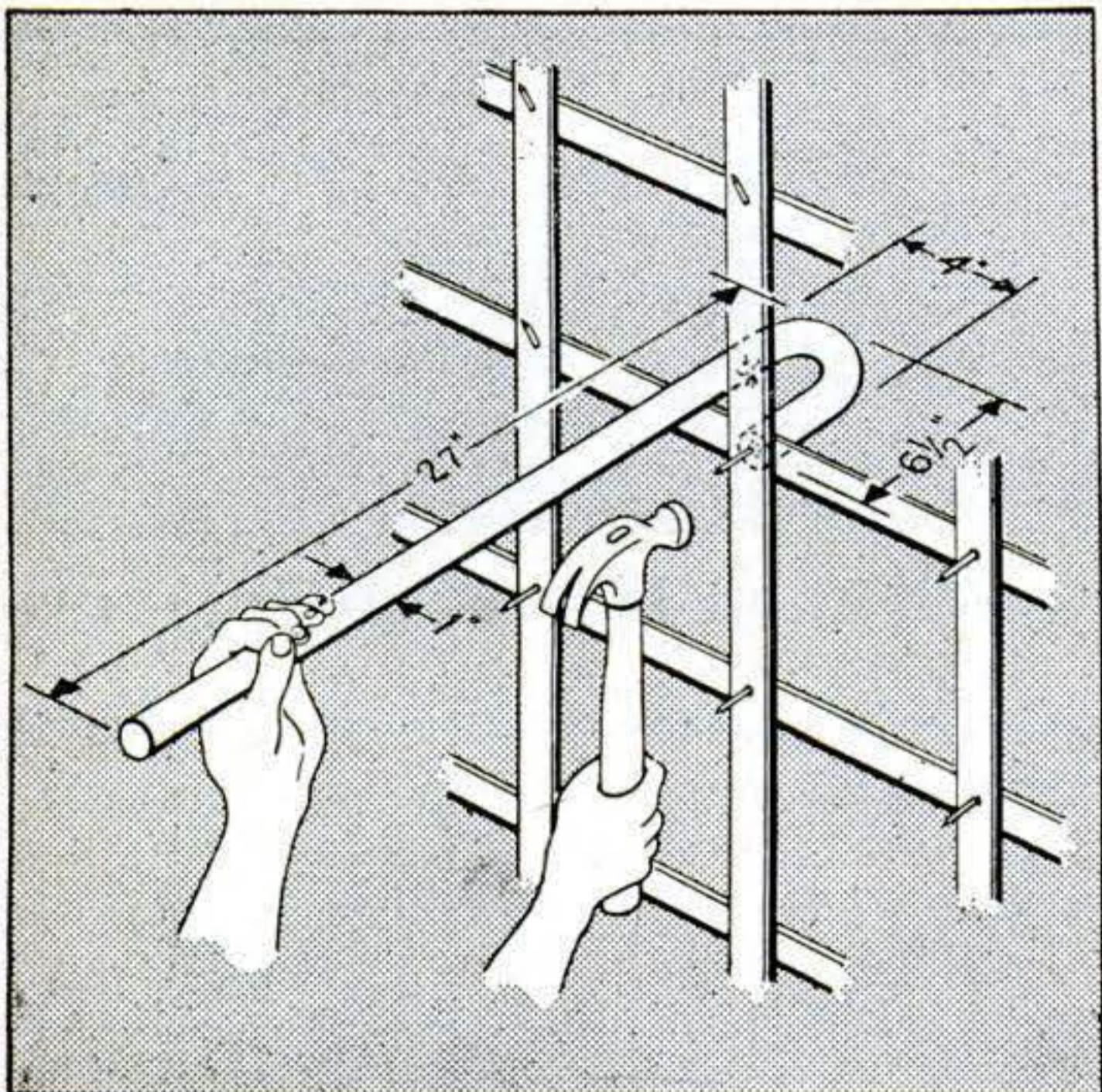

### Old Pen Converted to Scriber

WORKING in an aircraft plant calls for plenty of layout scribing, but I find most scribes too thin to permit constant handling without tiring the fingers. I removed the point from an old fountain pen, and pressed in the pointed shank of a broken high-speed-steel drill. An easy way to develop the point is to chuck the shank in an electric drill and hold it against an emery wheel, after which it is polished with emery cloth and honed with a fine India stone. The fountain-pen cap protects the point and makes it safer if you carry it around in your pocket.—*J. G. Martin, Milford, Conn.*

### Buffing Sharpens Small Tools

CARVING chisels and gouges, especially small ones, can be made extremely sharp if you first work them on a fine stone and then buff on a cloth wheel charged with tripoli or rouge. Stop when a little "feather" forms on the cutting edge; it will disappear the moment you start to carve.—*Herbert R. Pfister, Bronx, N. Y.*

FACED with the job of building a 100' lattice fence 6 1/2" high, I was puzzled as to how I could nail and clinch the 2,500-odd unsupported junction points without a helper to buck from the other side. The bent steel rod pictured at the left proved to be the answer. Using the hook extended through the lattice to brace it, I drove the nails in from one side, first making sure they'd clear the rod. Then I moved to the other side and used it as illustrated to clinch them.

Although 3' of 1" steel rod may seem a bit too heavy at first, I find it desirable because 1" face area is large enough to prevent marring of the wood, and because the weight is sufficient to prevent rebound.—*John F. Ewing, Hollywood, Calif.*



## ... and Oil Pumping is the First Symptom

It's possible to ignore oil pumping for a while, and to continue buying and wasting oil. But this kind of neglect is bound to cost *real* money later because oil pumping and engine wear go hand in hand.

Destructive engine wear is not far off when oil pumping starts.

By installing Hastings Steel-Vent Piston Rings promptly you can *check* this engine wear, *stop* oil pumping and *restore* performance. It's the best money you can spend on your car. Hastings Manufacturing Co., Hastings, Michigan. Hastings Ltd., Toronto.

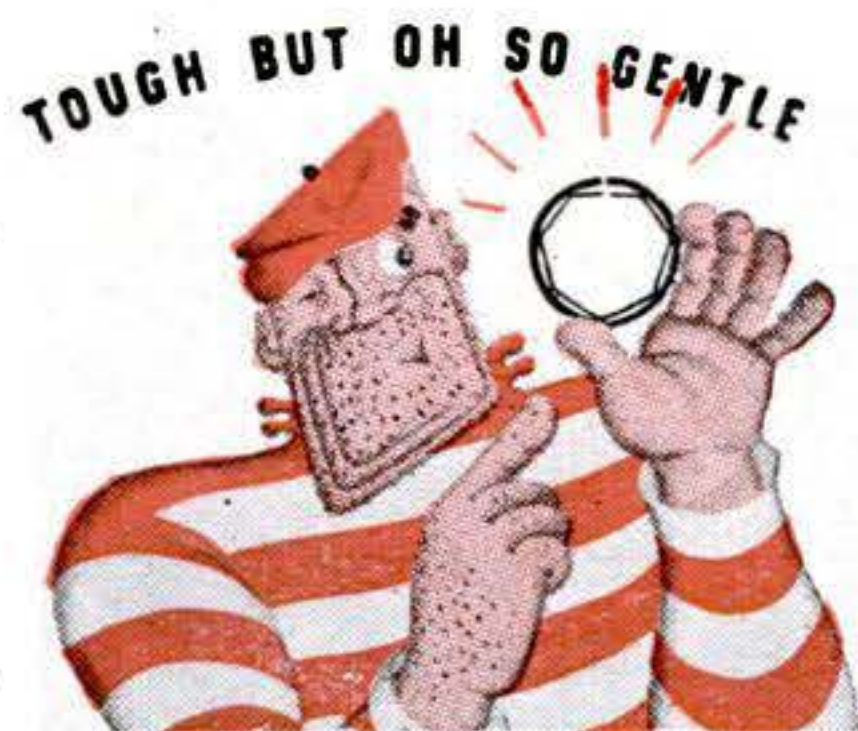

# HASTINGS

**STEEL-VENT PISTON RINGS**

**TOUGH** on Oil Pumping  
**GENTLE** on Cylinder Walls



# GET BEHIND A STEVENS . . .

. . . For small game hunting, pest riddance, plinking or informal target shooting — for *more* all around sport and greater values — get behind a rifle or shotgun built by Savage Arms Corporation. Write for new free catalog. Savage Arms Corporation, Firearms Division, Chicopee Falls, Mass.



**Stevens Model 87\***— .22 Long Rifle cal. Auto-loading Rifle. 15 shots as fast as you can pull the trigger. Also, instantly adjustable as bolt action repeater or single shot rifle; shooting .22 long rifle, .22 long and .22 short cartridges.



**Stevens Model 84\***— .22 cal. Bolt Action Repeating Rifle. 5 shot clip magazine. Full pistol grip. Stock designed for steady holding. Shoots .22 long rifle, .22 long and .22 short cartridges.



**Stevens Model 15** — .22 cal. Single Shot Bolt Action Rifle — barrel bored and rifled with the same precision which characterizes all Stevens-Savage rifle barrels. Shoots .22 long rifle, .22 long and .22 short cartridges, hi-speed or regular.

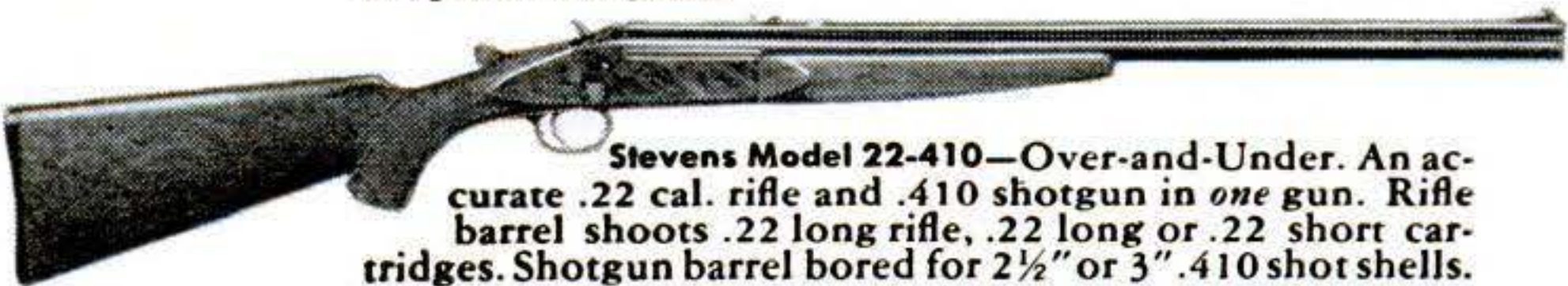

**Stevens Model 22-410**—Over-and-Under. An accurate .22 cal. rifle and .410 shotgun in *one* gun. Rifle barrel shoots .22 long rifle, .22 long or .22 short cartridges. Shotgun barrel bored for 2½" or 3" .410 shot shells.



**Stevens Model 59** — Tubular Magazine Bolt Action, .410 Gauge Repeating Shotgun. 5 shot (3" shells), four in magazine, one in chamber. 6 shot (2½" shells), five in magazine, one in chamber.



**\*New Peep Sight**— Now these Stevens .22 caliber rifles are available, at slight extra cost, with a new, specially designed peep sight with elevation and graduated click windage adjustment.

## HELP! —

### For The New Shooter

The safe and accurate handling of firearms is an American tradition. It's worth perpetuating and you can help by starting the young or new shooter off right. For advice and special literature on setting up a program, write: Sporting Arms and Ammunition Manufacturers' Institute, Dept. 4, New York 16, N.Y.

**STEVENS**  
PIONEERING BETTER GUNS  
AND GREATER VALUES SINCE 1864

**SAVAGE**  
WORLD FAMOUS FOR DEPENDABILITY  
AND ACCURACY

IF YOUR HAM RIG ACTS  
LIKE THIS... IT'S TIME TO  
HUNT 'BUGS' AND...



IF YOUR CAR FEELS LIKE THIS...  
IT'S TIME FOR MARFAK  
CHASSIS LUBRICATION



THAT CUSHIONY FEELING LASTS LONGER WITH MARFAK!

When you get a lubrication job, get a *good* one. Ordinary grease peters out after a couple of hundred miles. But *Marfak* Chassis Lubrication lasts 1,000 miles and more. *Marfak* takes road shocks with ease, clings to wear points and bearings. And notice that long-lasting "cushiony" riding ease! That's *proof* that *Marfak* is on the job. Applied by chart, never by chance. Ask your Texaco Dealer, the best friend your car ever had, for *Marfak* Lubrication.



**THE TEXAS COMPANY**

**TEXACO DEALERS IN ALL 48 STATES**

Tune in: TEXACO STAR THEATER presents the TONY MARTIN show featuring ALAN YOUNG every Wednesday night. See newspaper for time and station.

APRIL 1948 243

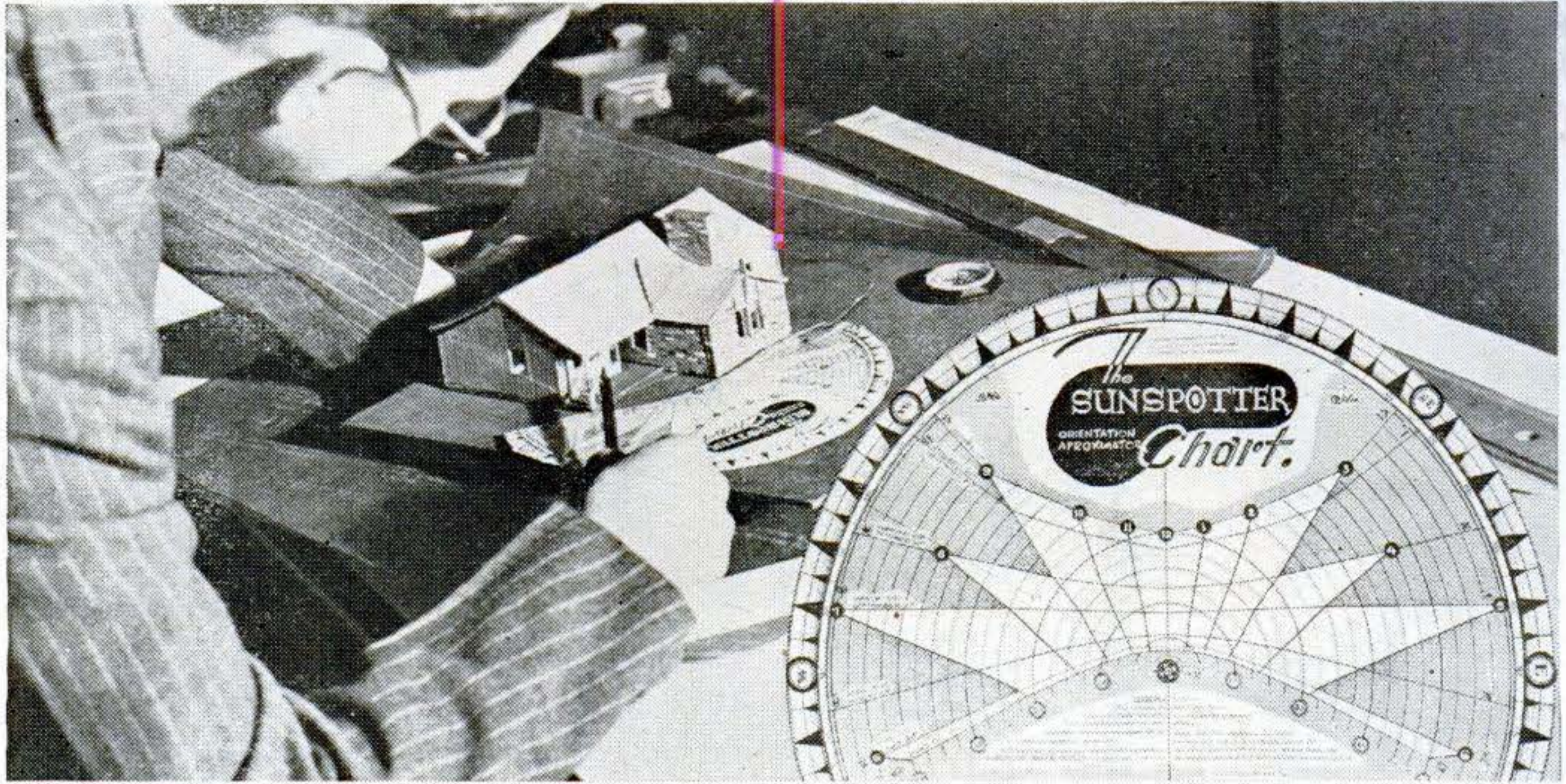

## Chart Plots Sunlight

ORIENTATION—planning the position of a building in terms of a desired relation with the sun—can be an architectural headache. To simplify the job, William Briggs, an industrial designer, developed a two-dimensional Sunspotter Chart that helps an architect determine—without time-consum-

ing observations—how much sunlight will enter a particular room during any hour of any day in the year. By interpreting solar angles and indicating the depth to which sunlight will penetrate an interior, the chart provides answers that, according to Briggs, would otherwise require as much as two whole days of complex plotting and figuring for even a six-room house.

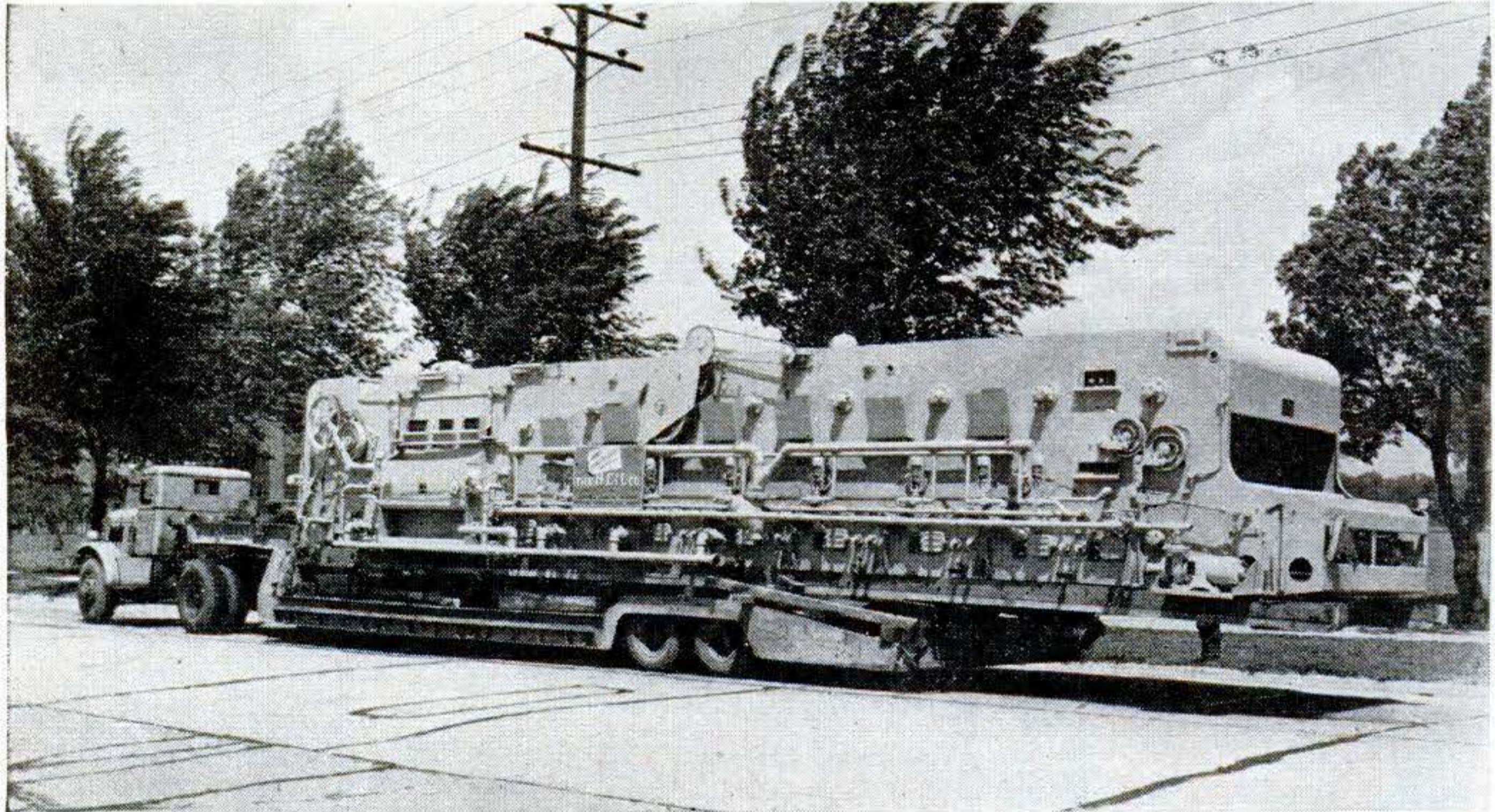

## Biggest Bottle-Washer

THIS 65-ton mass of machinery is probably the world's largest automatic bottle-washer. Built by the Heil Co., of Milwaukee, the \$35,000 unit can clean 280 bottles a minute, holding 12,768 at a time.

The bottles are sterilized by water jets and caustic solutions at temperatures up to 180° F. for 30 minutes. Shown above en route to the John Graf bottling company, whose building had to be reinforced to support it, the 48-foot-long, 11-foot-wide giant will weigh 100 tons when fully equipped.

# NOW... LIGHT WHEN YOU NEED IT!

Ray-O-Vac LEAK PROOF batteries  
stay fresh for years!

(because they're sealed in steel!)



©1948 BY RAY-O-VAC COMPANY, MADISON, WIS., RAY-O-VAC (LIMITED) CANADA, WINNIPEG, MAN.



Man! Oh, man! It sure is dandy  
Always having *fresh* spares handy!

Sealed in steel to keep their power,  
So you can use them any hour.



You can safely stock up stacks  
Of modern, *power-full* Ray-O-Vacs!

*Guarantee:* If your flashlight is damaged by corrosion, leakage, or swelling of this battery, send it to us with the batteries and we will give you FREE a new comparable flashlight with batteries.

Ask for Ray-O-Vac  
Leak Proofs

## Buy Spares... they stay fresh

Copyrighted material

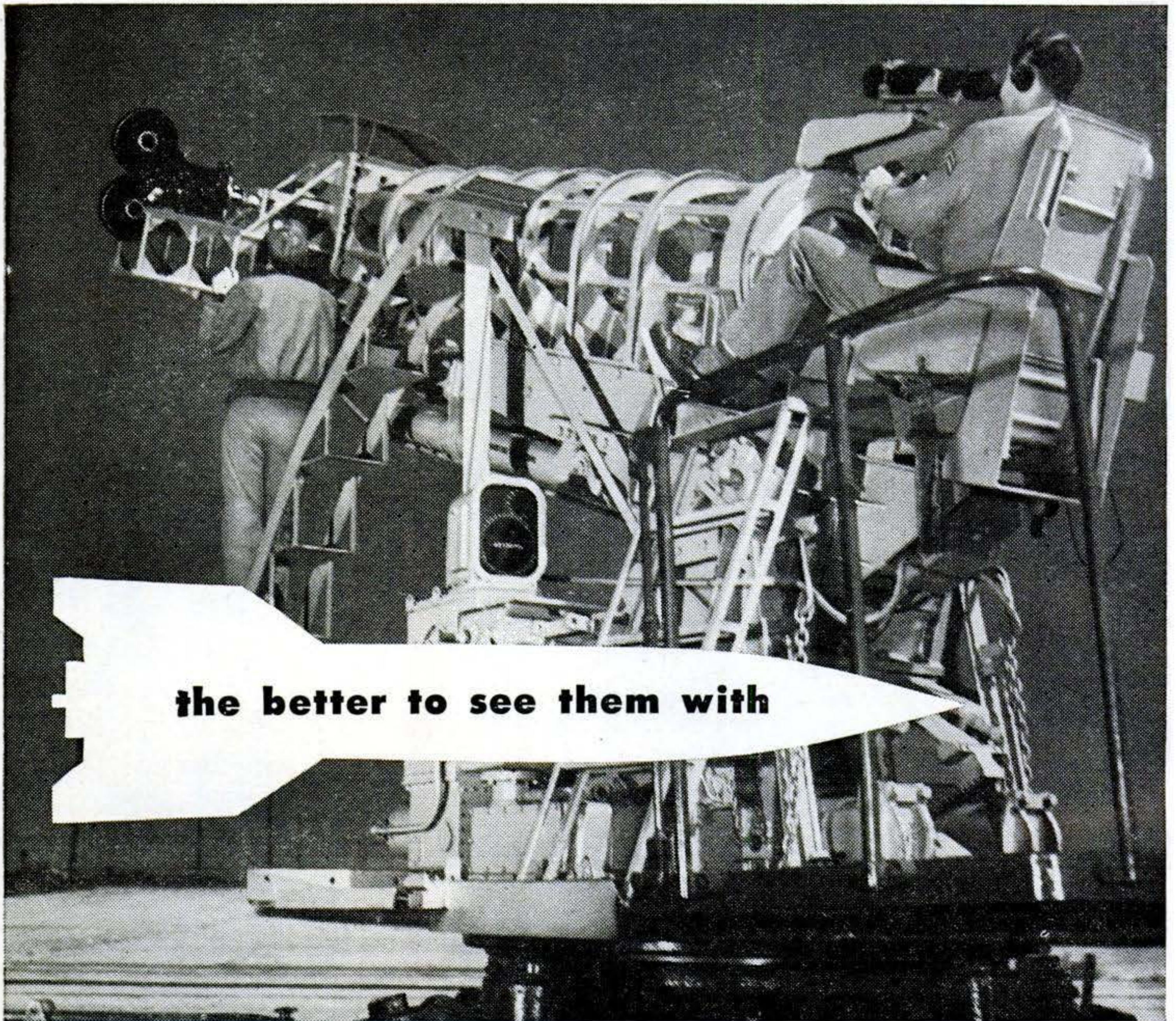

**the better to see them with**

This colossal 16-inch reflecting telescope was designed and built by the U. S. Army's Ordnance Department. Artillerymen and airmen will use it to study the flight of guided missiles whizzing along at 3000 miles an hour at altitudes of 100 miles or more.

The telescope, fixed to an antiaircraft gun mount, tracks three and four degrees per second in azimuth and elevation, respectively. A 35-mm. camera attachment records the image produced by the telescope, takes 15 exposures every second. Experts are thus able to check missile controls, collect aerodynamic information, and follow ejection of instruments attached to the missiles.

The reflecting telescope is another spectacular example of what the U. S.

Army is accomplishing in the fascinating realm of research and development. Thousands of projects, covering virtually every scientific field, are going forward daily at Army laboratories and proving grounds. If you want to be a member of an organization that is leading the way to great new things for the future, consider the U. S. Army. There are many new programs available specifically to young men interested in science. Your nearest U. S. Army and U. S. Air Force Recruiting Station will be glad to give you full details.

**U. S. Army and U. S. Air Force Recruiting Service**

**CAREERS WITH A FUTURE**

**U. S. Army and  
U. S. Air Force**

**APRIL 6  
IS ARMY DAY**

• Watch your local papers for announcement of nearby exhibits.



# *Any time is time for fun* with a **HARLEY-DAVIDSON**

You've got the "greenlight" to good times, when you own a Harley-Davidson. Fun is around every corner, happiness along every highway in the world's greatest sport — motorcycling! Alone or with gay companions, there's no end to enjoyment. Within easy reach whenever you want to go are gypsy tours, hillclimbs, race meets, sightseeing trips, exciting vacations, all beckoning to new pleasures and adventures. Owning a Harley-Davidson is easier than you think. See your dealer today.

## **HARLEY-DAVIDSON MOTORCYCLES**

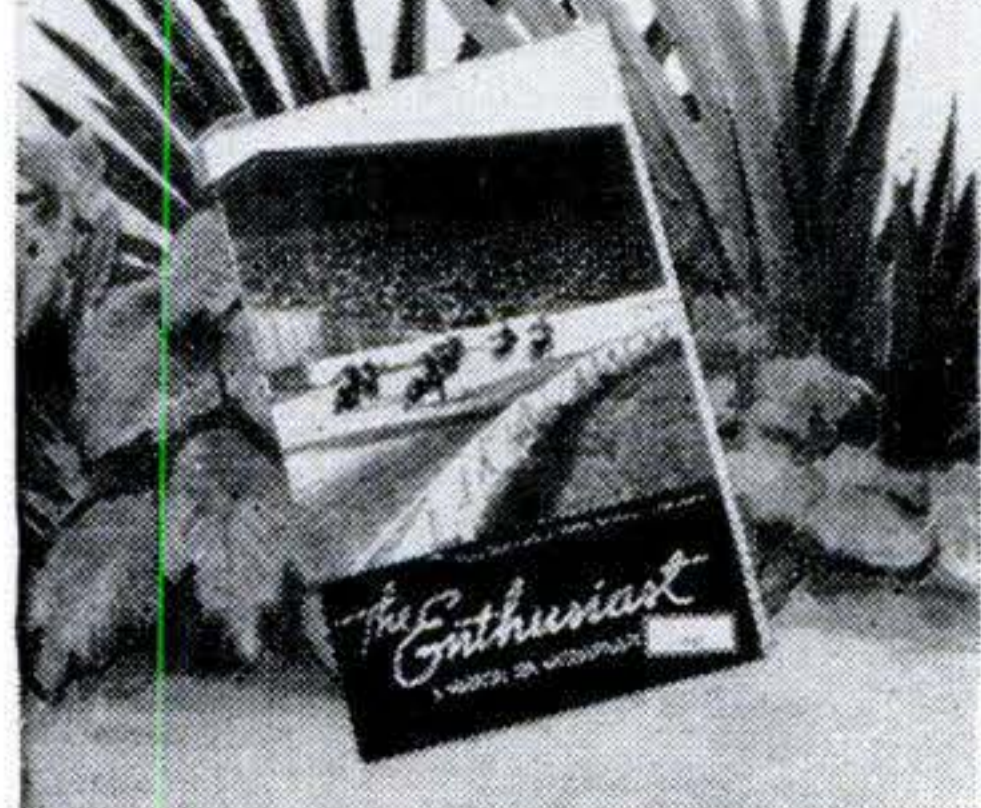
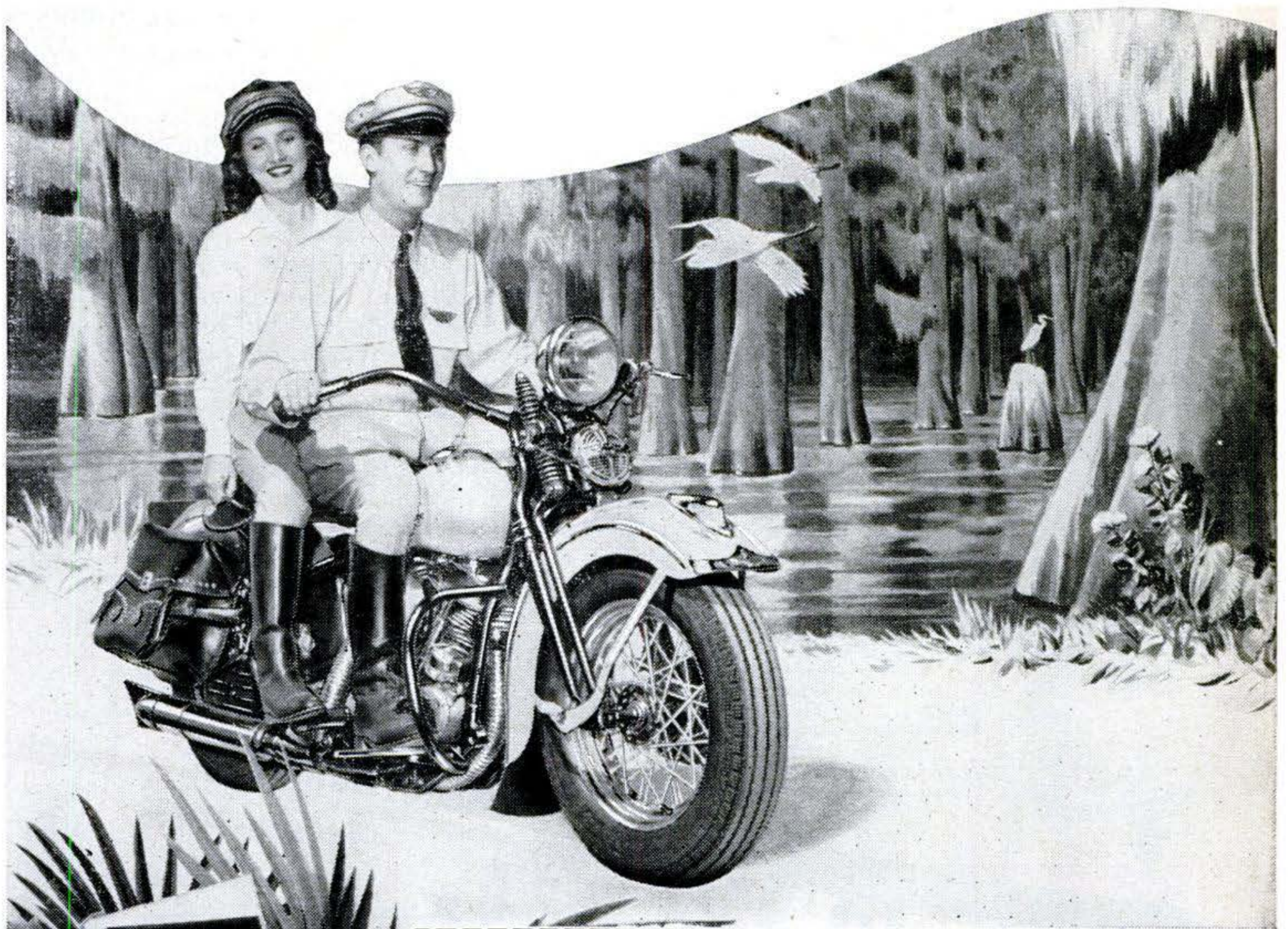

**HARLEY-DAVIDSON MOTOR CO., Dept. PS, Milwaukee 1, Wis.**

Send free copy of ENTHUSIAST magazine, filled with motorcycle action pictures and stories; also literature on 1948 models.

Name.....

Street or R.F.D.....

City..... Zone..... State.....

**ALL YOURS  
FOR YEARS  
in a Johnson**



Perfected Alternate Firing  
Dual Carburetion  
Reverse  
Ready-Pull Starter  
Positive Primer  
Synchro-Control  
Co-Pilot  
Salt Water Protective Treatment  
Rubber Rotor Pump

Weedless Propeller  
Stainless Steel Propeller Shaft  
Grease Seals  
Big Grease Capacity  
Big Gas Capacity  
Automatic Oiling  
Hardened Steel Gears  
Rubber Flow Shock Absorber



**Yours for YEARS  
OF SWEET  
PERFORMANCE**

**FREE HANDY CHART**

New! Illustrates and charts the 5 great Johnsons for '48. Sent free. Write! Look for the name of your Johnson dealer under "Outboard Motors" in your classified phone book. See him!

JOHNSON MOTORS  
500 Pershing Rd., Waukegan, Ill.  
Johnson Motors of Canada  
Peterboro, Canada

**JOHNSON  
SEA-HORSES  
for DEPENDability**



**Pulls Staples with Ease**

IT MAY look like a nail clipper, but it's actually a gadget that pulls out staples without tearing the paper or your fingernail. The tip is pushed under the staple and the top lever is pressed, pulling out the staple. When the handle is released, a spring snaps the staple out of the remover. It is made by Metal Products, Inc., of Los Angeles.

**How to Be Happy if Haptical**

IF YOU'RE a haptical person, your bent is for mechanical jobs that need the touch of your skillful fingers, advises Dr. V. Lowenfeld, art education professor at Penn State College. The word, invented by the Greeks, means "able to lay hold of" things. Opposite of the haptical people are the "visuals", who work chiefly with their eyes and get along best in such professions as surveying and architecture.

**Muscles Are the Sole Trouble**

IF YOU'RE footsore, you can blame any one of the 18 separate muscles, grouped in four muscle layers, found in the sole of your foot alone.

**Model Builders  
Attention!**

	V	V-2	V-3
Hex	1/2"	3/8"	5/16"
Thread	3/8"-24	1/4"-32	1/4"-32
Thread Length	7/32	7/32	5/32
Weight, Grams	8	3 1/2	2 1/2

Actual Size V-Plug

Champion Spark Plugs for model gas engines give the same dependable performance as regular Champions. Champion Ceramic insulation—Sillment sealed. Alloy needlepoint electrodes for easy starting. One piece construction.

**CHAMPION**

SPARK PLUG COMPANY • TOLEDO 1, OHIO

Dependable

# CHAMPION

America's Favorite Spark Plug

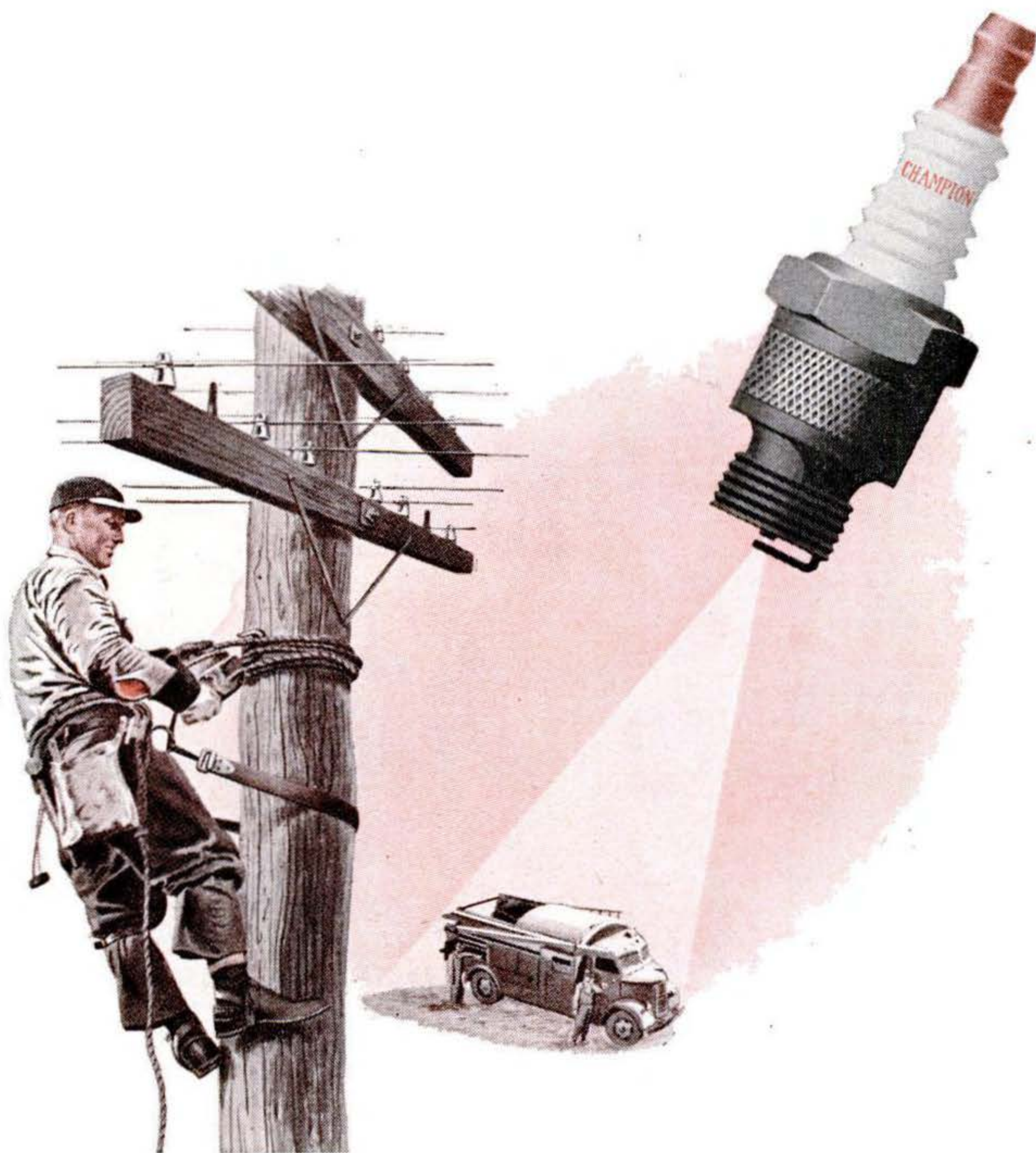

Utilities having a direct obligation to the public are exacting buyers of such vital equipment as spark plugs. Their fleets must have dependable ignition. Ex-

perts on spark plug performance and dependability, the majority specify dependable Champion Spark Plugs. Champion Spark Plug Company, Toledo 1, Ohio.

***FOLLOW THE EXPERTS—DEMAND NEW DEPENDABLE CHAMPIONS FOR YOUR CAR***

Listen to the CHAMPION ROLL CALL . . . Harry Wisner's fast sportscast every Friday night, over the ABC network

APRIL 1948 **249**



Wading a trout stream, or fly casting for bass or panfish — there's angling sport that's tops. You're sure of more exciting fun, greater thrills if your tackle is *right*. Outfit yourself with South Bend fly fishing tackle . . . and experience the difference that fine quality makes. Its sweet performance will make you want to keep fishing all day.

**No. 59 SPLIT BAMBOO FLY ROD**

Famous for action and quality. Patented "Comficient" grip. Lgth. 9'. Bass or steelhead action—\$16. Dry fly action models — \$16, \$22.50, \$25. Other bass or steelhead models — \$22.50 and \$25.

**OREN-O-MATIC REEL**

*The balanced reel.* Most popular automatic fly rod reel ever made. Free-stripping. Silent. Maroon finish. \$10 and \$10.50.



**EXCEL-ORENO LINE**

*Long wearing, easy casting nylon line.* Level sizes G to C, \$1.85 to \$2.80 a coil. Double tapers HEH, HDH, HCH, \$9. Silk slightly higher.



**No. 593 TRIX-ORENO**

*The marvel fly rod lure.* The "trickiest" lure ever designed—flutters like a bug. 65¢. Also, 2 bait casting models.



**FREE!** New '48 Book on Fishing "Fishing — What Tackle and When" shows South Bend and Oreno tackle. Color pictures of fishes. Fly and bait casting instructions. Every fisherman needs a copy. *Write for your copy today.* Sent FREE!

**SOUTH BEND BAIT COMPANY**  
892 HIGH ST., SOUTH BEND 23, INDIANA

BETTER FISHING INC.

**SOUTH BEND**  
*A Name Famous in Fishing*



**CALL TO ADVENTURE**

You're a wilderness ranger in your Old Town Canoe. Paddle to hidden pools and cast your line where the big ones rise. Trust to your Old Town Canoe to get you there — and back. Birchbark-light, yet wiry-strong. Perfectly balanced. Built to last.

**FREE CATALOG** shows all kinds of canoes for paddling, for sailing, for outboards. Also sailboats, outboard boats, dinghies, rowboats. Send for it today. Address Old Town Canoe Company, 444 Wood Street, Old Town, Maine.



**20 DIFFERENT BLADES**

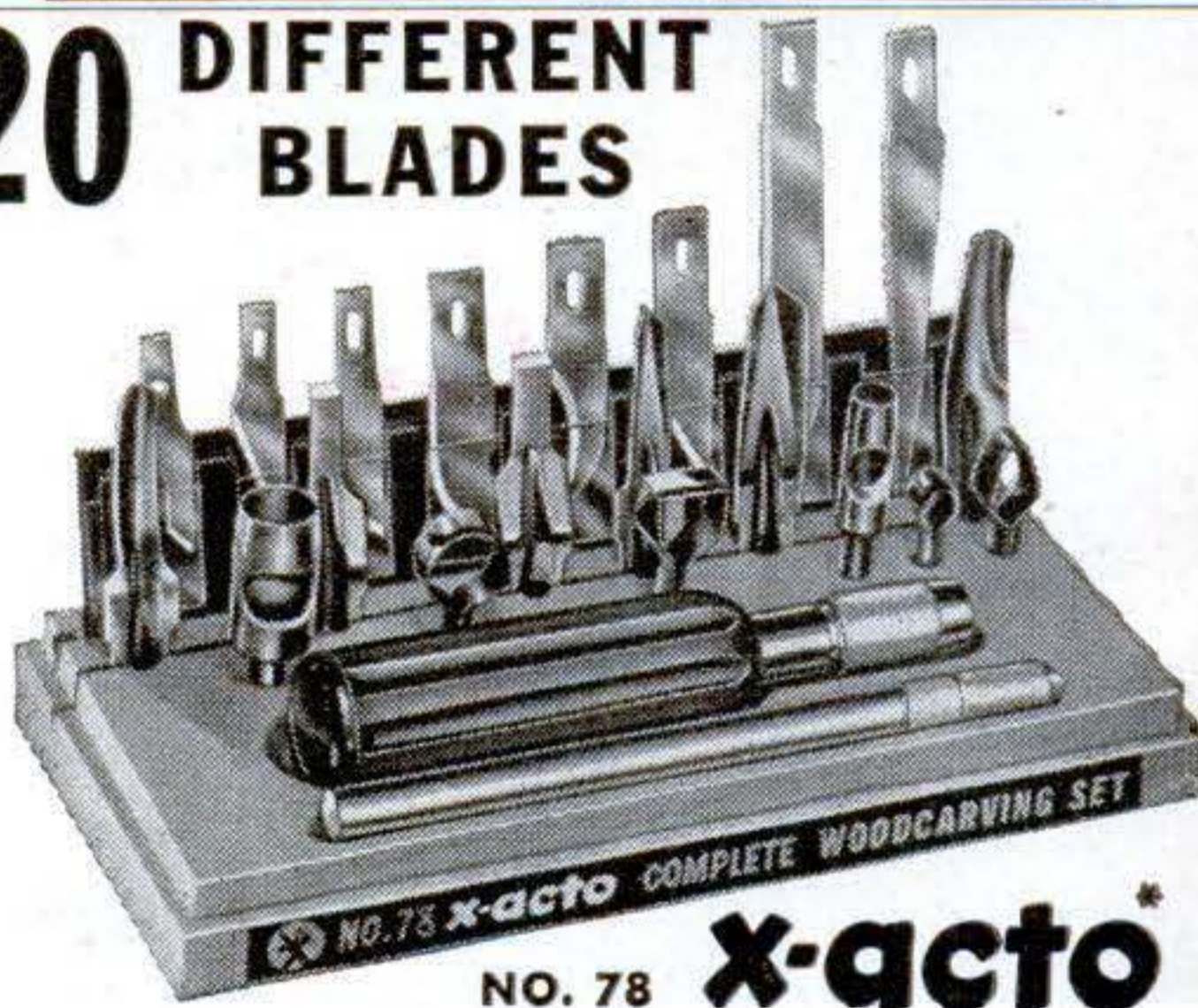

**NO. 78 X-acto COMPLETE CARVING SET**

Here's everything you need for a super-slick job, from toothpicks to totem poles. Super-sharp blades, firm-grip handles for light and heavy work. Ideal for wood, linoleum, plastics, etc. Contains: 6 different gouges, 4 routers, 2 punches, 6 regular blades, 2 three-inch blades, one No. 1 knife, one No. 5 knife. On wooden block, complete.....**Only \$5.00**

\*Reg. U. S. Pat. Off.

Other X-acto Knives, Blades, Tools and Sets, 50¢ to \$50  
*Prices slightly higher in Canada*

At hobby, gift, hardware and department stores

X-acto Crescent Prod. Co., Inc., 440—4th Ave., N. Y. 16  
In Canada: Handicraft Tools, Ltd., Hermant Bldg., Toronto

*No rust  
for the  
wary!*



*Clean rust out of your radiator with*

### **DU PONT Cooling System CLEANSER**

Drain out your anti-freeze, and clean out winter's accumulation of scum, scale, and rust. Neglect now may mean trouble and costly repairs later. Just pour a can of DU PONT COOLING SYSTEM CLEANSER into your radiator, run the engine 30 minutes or more, and drain. It dissolves rust—cleans thoroughly—improves engine performance. It's safe, sure, and easy to use.

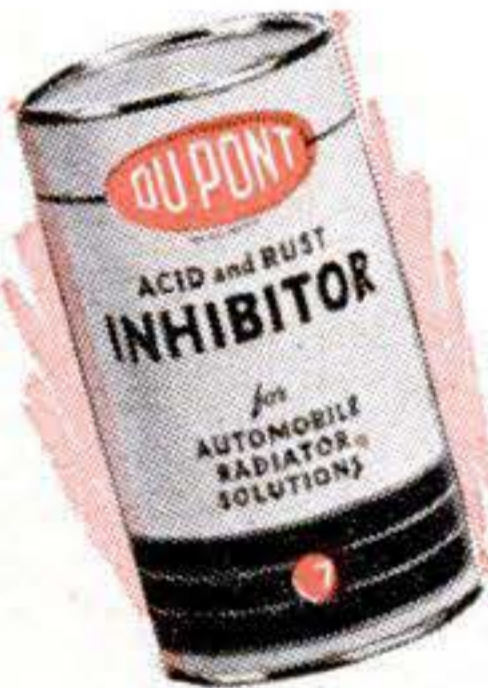

*Keep out rust with*

### **DU PONT Acid and Rust INHIBITOR**

After cleaning out the radiator, you can keep it free from rust all season by pouring in a can of DU PONT ACID AND RUST INHIBITOR. It prevents rust forming, and keeps out acid, too.



*Avoid radiator leaks with*

### **DU PONT Cooling System SEALER**

Stop leaks quickly and securely—and make the cooling system LEAKPROOF—by pouring in DU PONT COOLING SYSTEM SEALER. It will not clog the radiator.

**DU PONT**

REG. U.S. PAT. OFF.

BETTER THINGS FOR BETTER LIVING  
... THROUGH CHEMISTRY

"Thanks a Million,  
American..."

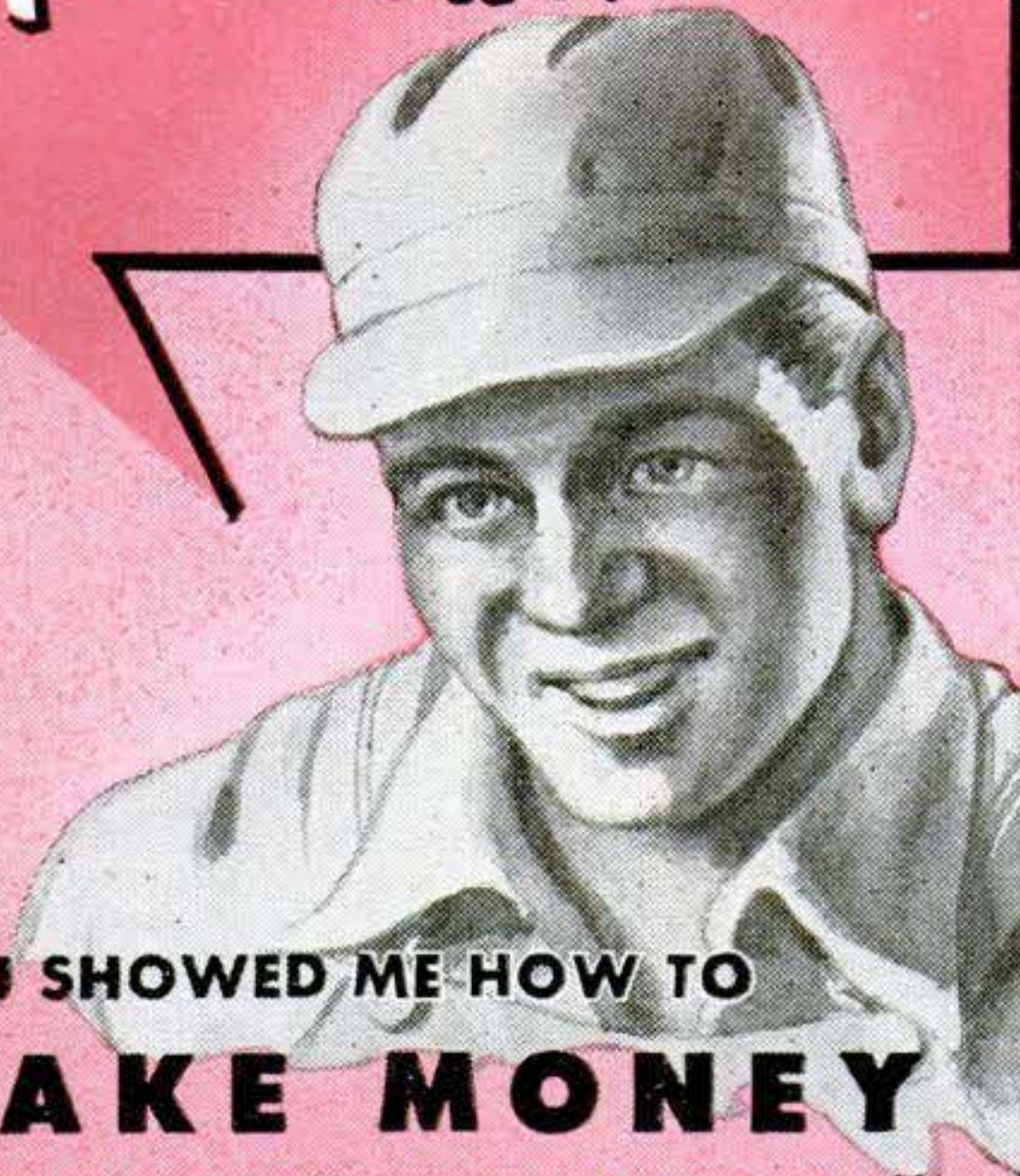

YOU SHOWED ME HOW TO  
**MAKE MONEY**  
IN A BUSINESS ALL MY OWN!"

Now—you, too, can be your own boss and step into *big profits* in the building industry as a floor surfacing contractor! Make \$35 to \$50 a day—that's what

hundreds of men everywhere are earning in floor surfacing work today with an American Floor Sander! Easy to operate—no big overhead—no large investment—no special schooling. Prospects everywhere—sand new and old floors. Start *now* and get ahead! Send coupon for money-making booklet.

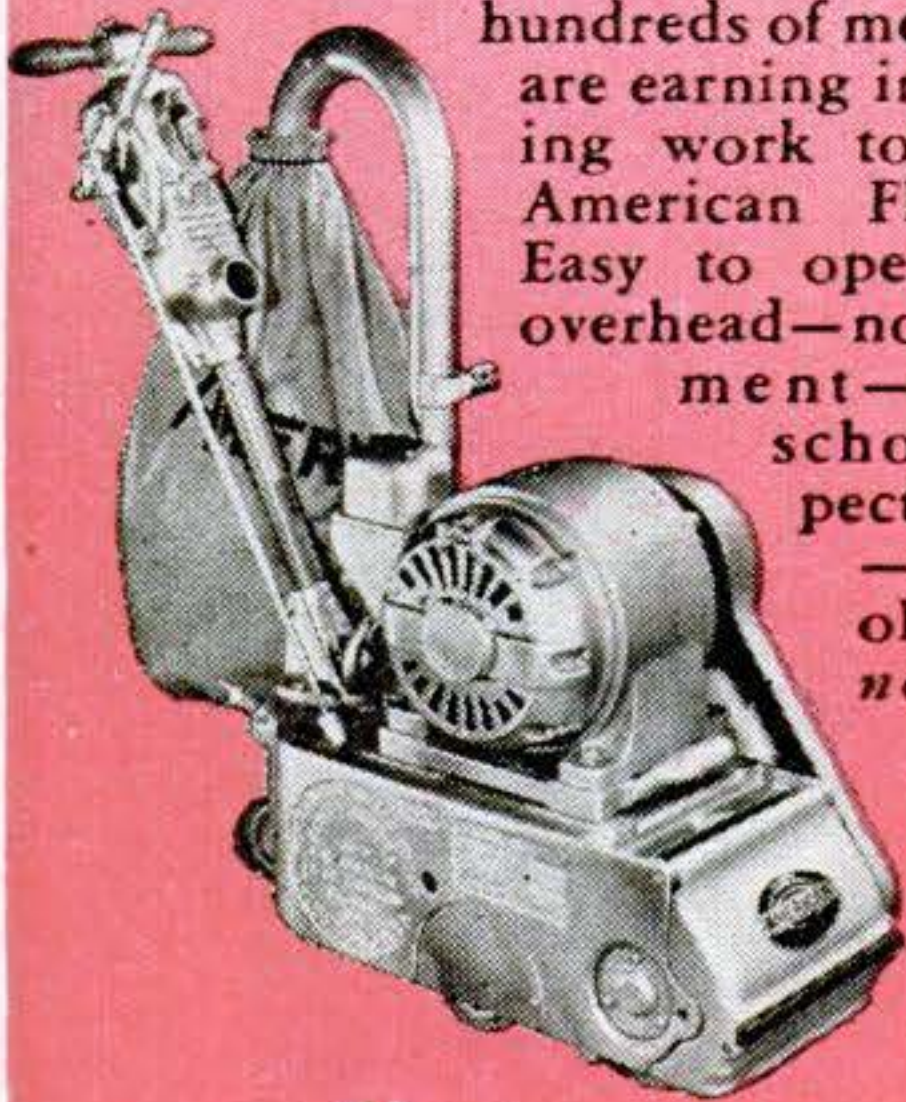

**A** **AMERICAN**  
FLOOR MACHINES

The American Floor Surfacing Machine Co.  
532 So. St. Clair St., Toledo 3, Ohio

Enclosed find 25c in stamps or coin for booklet "Opportunities in Floor Surfacing", telling me how I can start my own floor sanding business.

Name.....  
Street.....  
City..... State.....

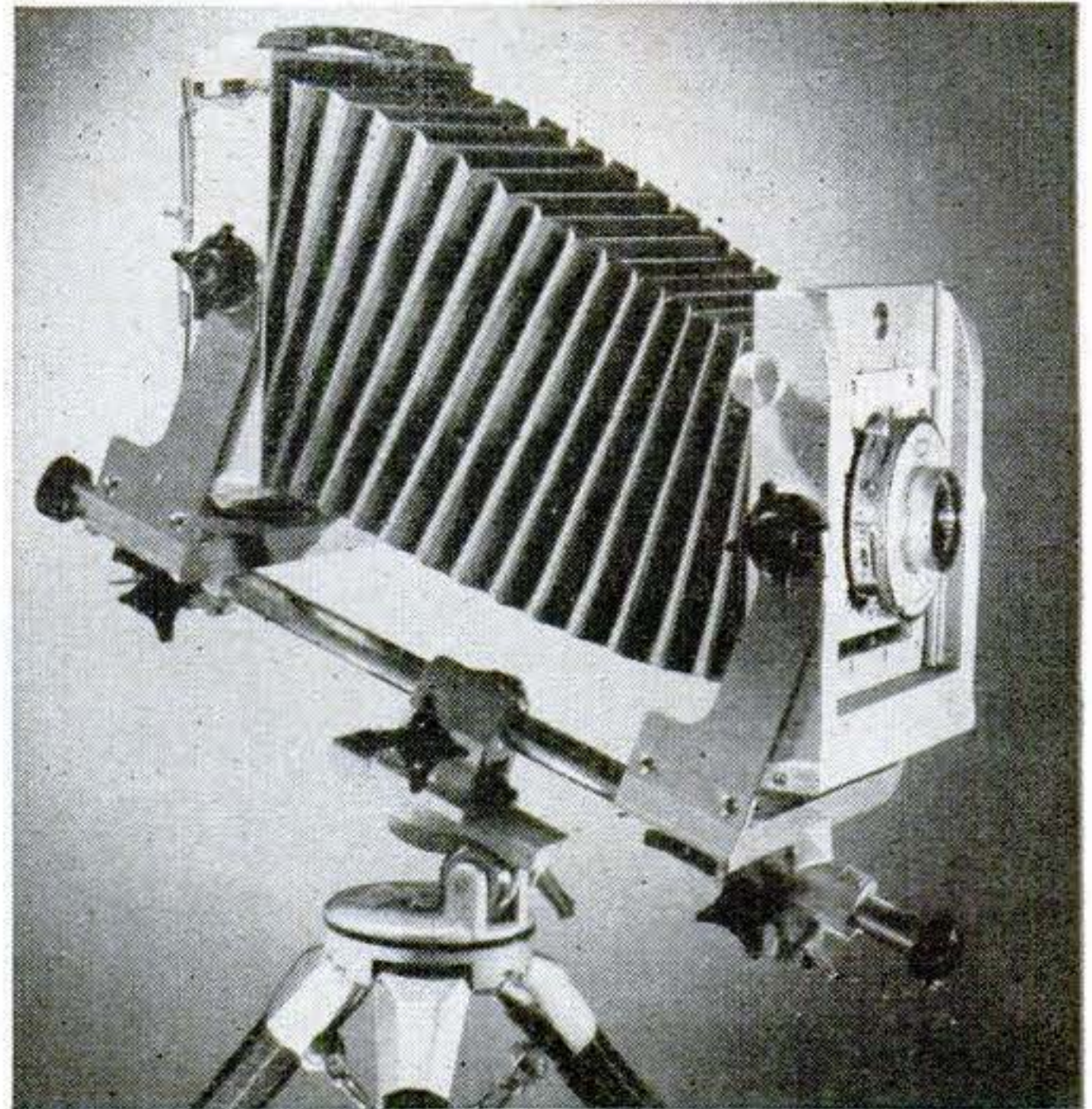

### Improved View Camera

A REVOLVING back that can be used for framing pictures at any point throughout a complete circle is featured in this new Kodak 4x5 Master View Camera. Both the back and front swing, and spirit levels on both top and side assure perfect camera alignment. The monorail track permits a 15-inch bellows extension, and a special ground-glass-release handle makes it possible to insert or remove film holders without jarring the camera. It uses film or plate holders as well as film-pack adapters.

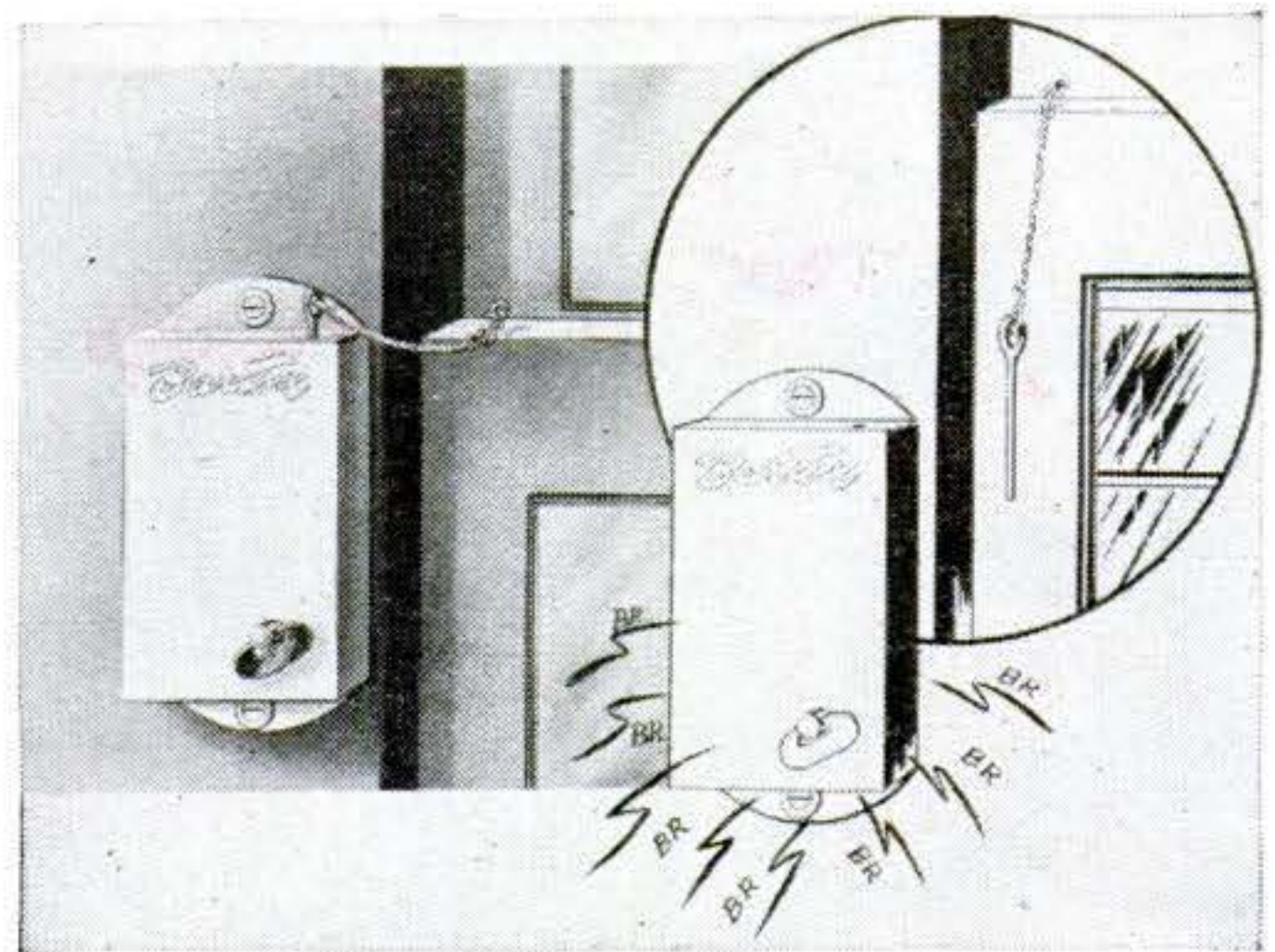

### Window Burglar Alarm

OPENING of a window sets off this new, simple burglar alarm. A pin inserted in top of the alarm box (above, left) is attached to the window. When the latter is raised the pin is pulled out (above, right), operating a loud alarm mechanism. The device, which requires no batteries, is made by the Barton Engineering Co., of Detroit.

# What's your choice of these

## *Marlin .22's?*

Marlin Model 39-A—25-shot Lever Action Repeating Rifle. \$50.45\*

Marlin Model 81-DL—25-shot Tubular Magazine Repeating Rifle. \$26.95\*

Marlin Model 80-DL—8-shot Clip Magazine Repeating Rifle. \$22.90\*

*\*Prices slightly higher west of the Rockies*

Be sure to see these three fine Marlin '48 models at your dealer's soon! Each is an outstanding rifle in its class.

● Here you have three great rifles for small game and all around sport. Marlin's 39-A is the only lever action .22 repeater made...a favorite in hunting circles the world over since 1892. As a practical weapon for vermin and small game, the 81-DL is a wise selection. It carries a full day's ammunition, and its light weight is a great asset in the field. The loaded clip of the 80-DL provides extra shots for fast-running game ...and allows use as a single loader for target work. All three are rugged, man-sized Marlins, famous for accuracy and dependability. All shoot .22 short, long and long rifle cartridges—regular or high speed—without adjustment. Whichever you choose, you'll buy years and years of trouble-free sport!

*American Black Walnut Stocks & Forends Standard on All Models*

## *Marlin .22 Rifles*

*Outstanding for accuracy, dependability, long life*



Often called the "world's best all around .22," Marlin's 39-A is a light rifle of remarkable accuracy and versatility. Only lever action .22 made. Extra fast for snap and exhibition shooting.



A full day's hunting is provided by the large 25-shot capacity of the Marlin 81-DL. Removable bolt assembly; Off and On safety...a fine "learning gun."



12 for 25¢ • Single or double edge

THE MARLIN FIREARMS CO., NEW HAVEN, CONN. • Fine Guns Since 1870

APRIL 1948 253

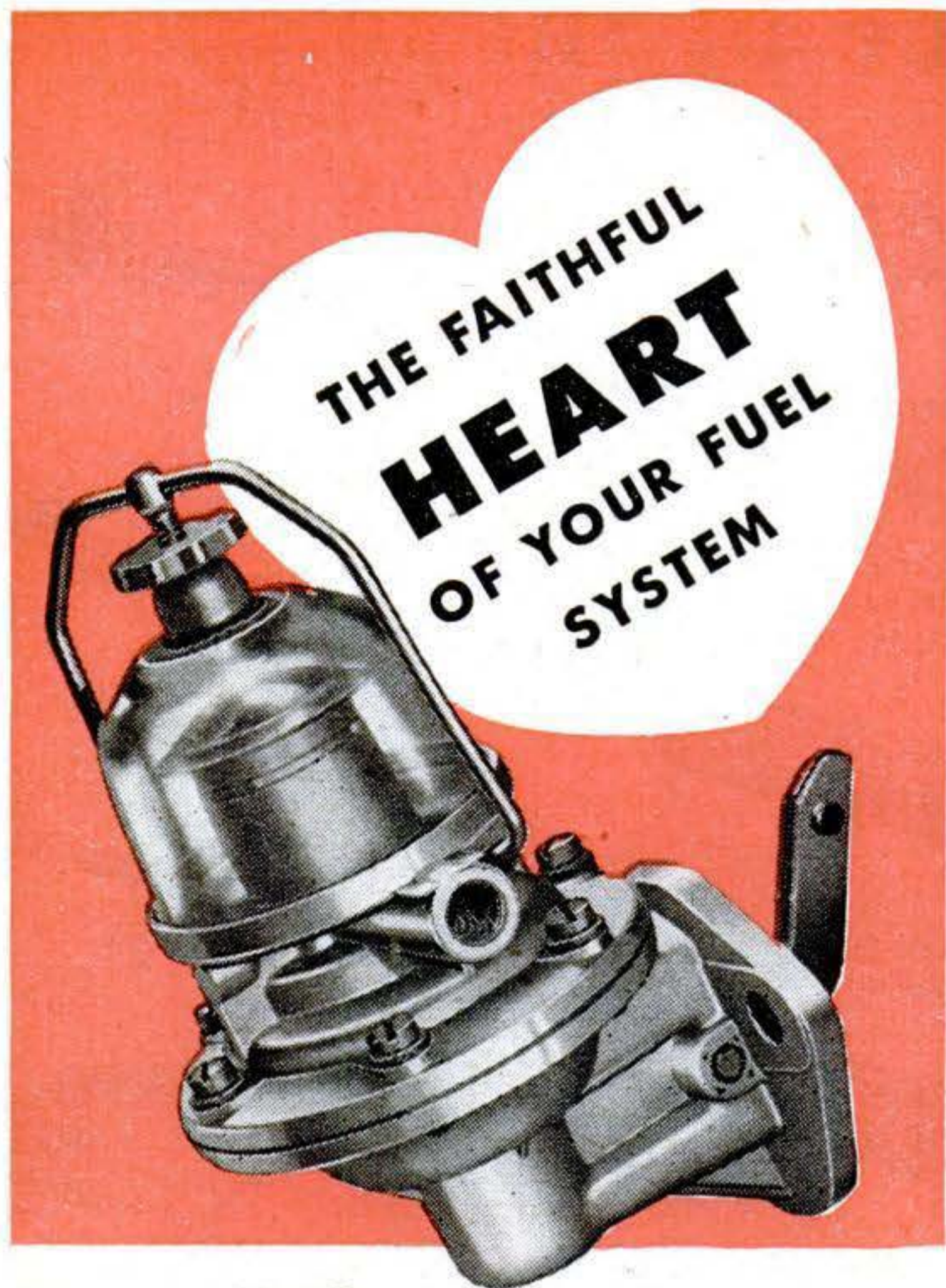

THE FAITHFUL  
**HEART**  
 OF YOUR FUEL  
 SYSTEM

**OVER  
 30,000,000 IN USE  
 TODAY**

Pulsing steadily, nearly 100,000 times an hour, your AC Fuel Pump is the strong, reliable heart of your fuel system. It has given you long, faithful service because of its inbuilt quality and scientific design.

You can prolong that faithful service indefinitely, if you insist upon a new AC when you replace your present pump.

There is no satisfactory substitute for quality.



AC SPARK PLUG DIVISION • GENERAL MOTORS CORPORATION

## Keep Brushes like New

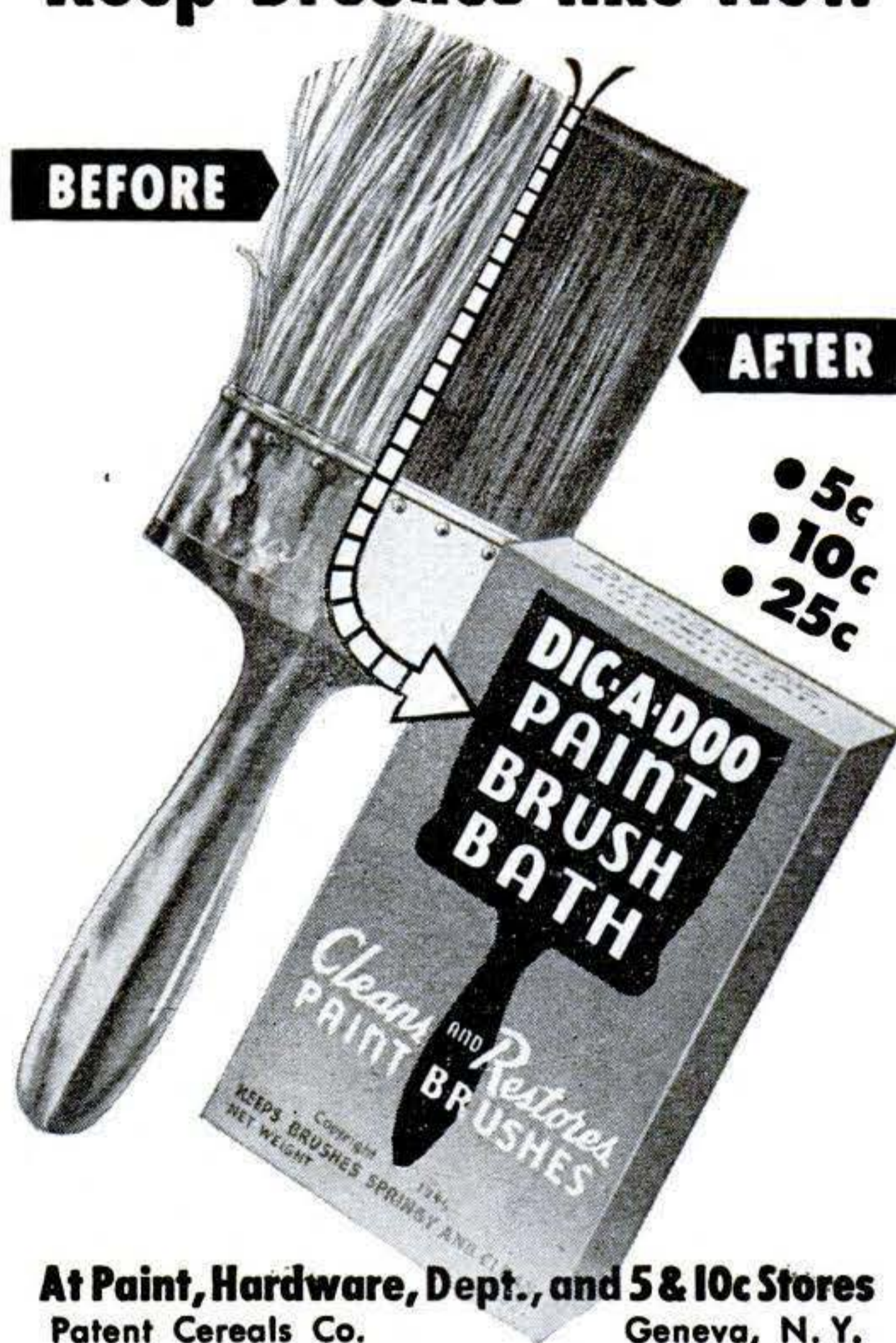

## PRESSURE QUEEN

FOUR CYLINDER  
 PORTABLE AIR COMPRESSOR  
 SPRAY PAINTING OUTFIT

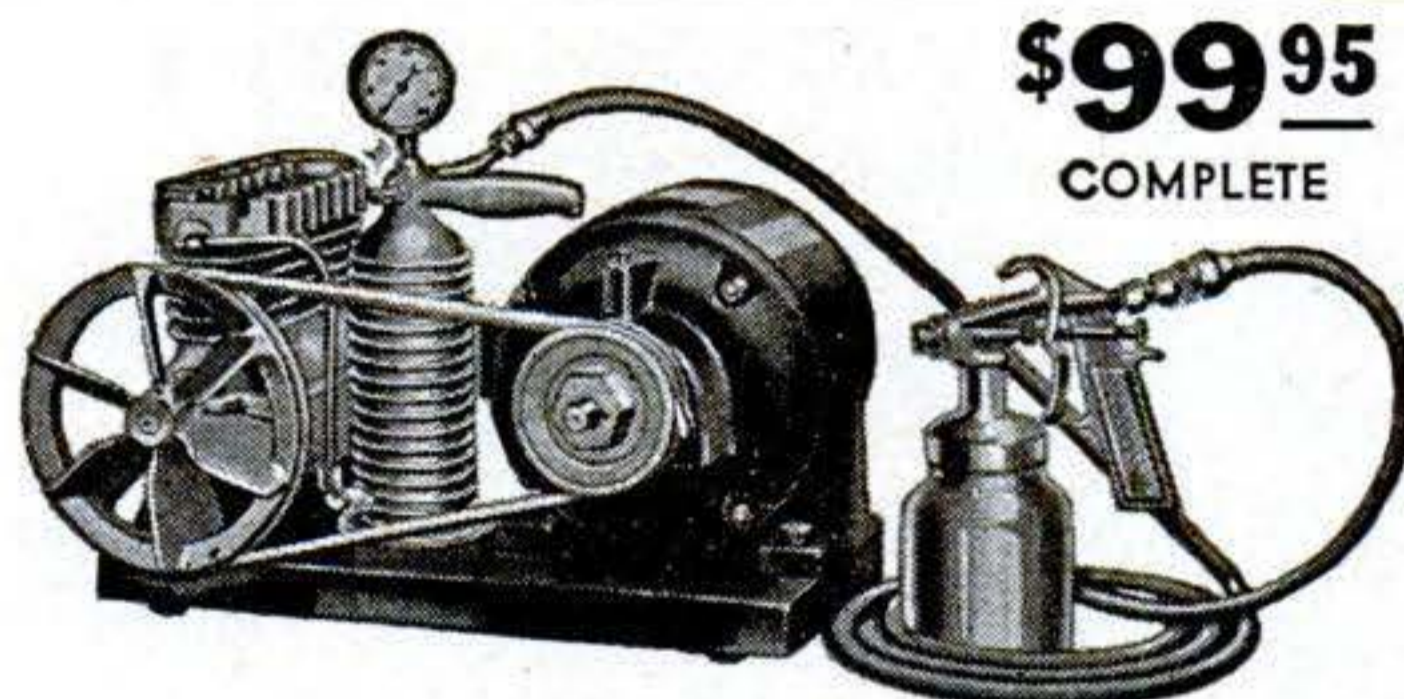

**\$99<sup>95</sup>**  
 COMPLETE

COMPACT • RUGGED • POWERFUL

The ideal air supply for home and farm workshop, machine shop, garage, service station and contracting painter. Inflates tires; refinishes automobiles, trucks, implements and furniture. Paints buildings better, faster and at lower cost than brush work. Compressor has 4 cylinders, drop forged crankshaft, heat treated valves and pistons, bronze bearings, forced feed lubrication. 50-60 lbs. pressure without pulsation. Price includes compressor as shown, with air gauge, 15 ft. hose, spray gun and 1/3 h.p. motor; fully guaranteed. With 1/2 h.p. motor—\$109.95.

IF YOUR DEALER DOES NOT SELL  
 PRESSURE QUEEN WRITE DIRECT.

**THE CAMPBELL-HAUSFELD CO.**

151 RAILROAD AVE.

HARRISON, OHIO





**8 QUALITY**

# TABLE MODEL TILT-ARBOR SAWS

OIL IMPREGNATED BRONZE BEARINGS OR DOUBLE SHIELDED BALL BEARINGS, BOTH WITH THE PATENTED BALL BEARING TRANS-AXIAL MOTOR DRIVE

**TABLE 18" x 16"**

**BRONZE BEARING**

**\$4495**

F.O.B.

ROYERSFORD, PA.

(Less Blade & Motor)

**IMMEDIATE  
DELIVERY**

Double  
Shielded  
Ball Bearings  
\$5 Extra

Aluminum Guard  
Easily Removed  
for Dadoing

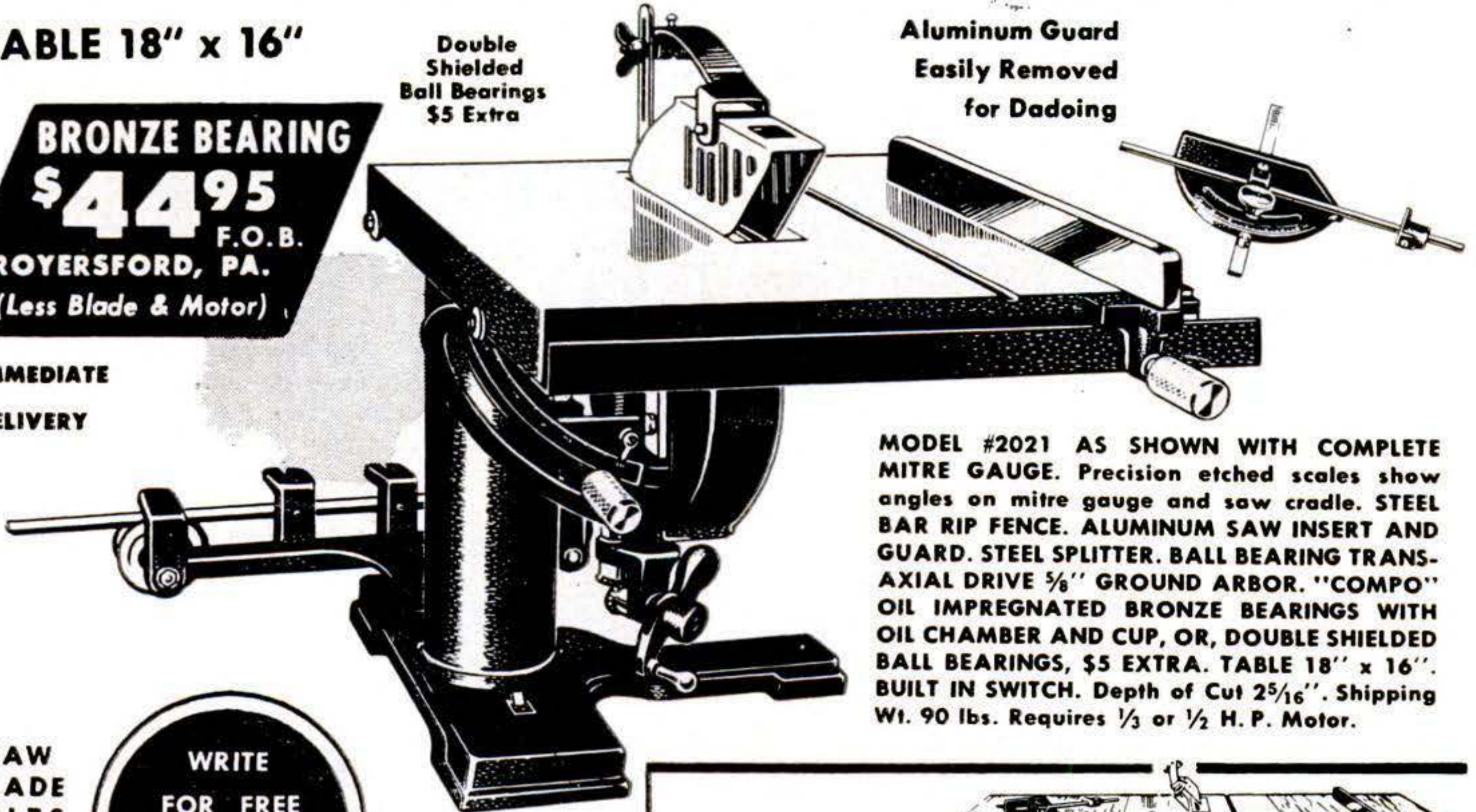

MODEL #201 AS SHOWN WITH COMPLETE MITRE GAUGE. Precision etched scales show angles on mitre gauge and saw cradle. STEEL BAR RIP FENCE. ALUMINUM SAW INSERT AND GUARD. STEEL SPLITTER. BALL BEARING TRANS-AXIAL DRIVE  $\frac{5}{8}$ " GROUND ARBOR. "COMPO" OIL IMPREGNATED BRONZE BEARINGS WITH OIL CHAMBER AND CUP, OR, DOUBLE SHIELDED BALL BEARINGS, \$5 EXTRA. TABLE 18" x 16". BUILT IN SWITCH. Depth of Cut  $2\frac{5}{16}$ ". Shipping Wt. 90 lbs. Requires  $\frac{1}{3}$  or  $\frac{1}{2}$  H. P. Motor.

SAW  
BLADE  
TILTS

WRITE  
FOR FREE  
ILLUSTRATED  
FOLDER

TABLE  
STAYS  
LEVEL

**FLOOR  
MODEL**

Model #201  
With 2 Extensions  
Makes Table 18" x 48"

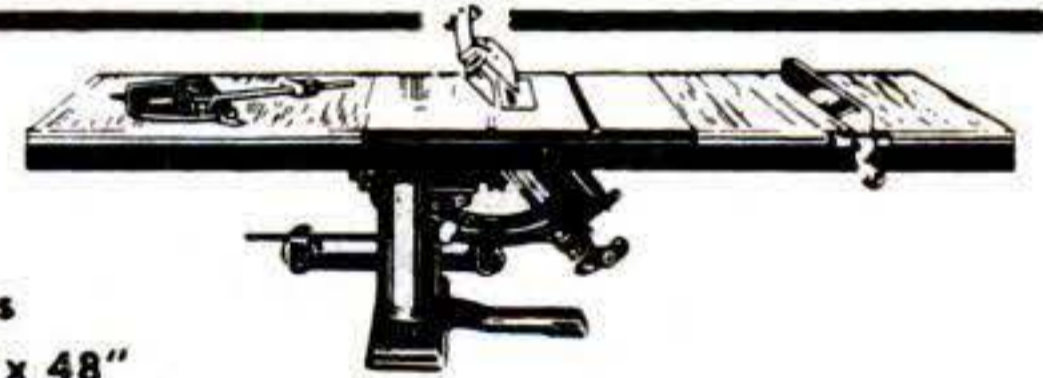

**TABLES PRE-DRILLED FOR EXTENSIONS**



1 EXTENSION  
MAKES TABLE  
18" x 32"

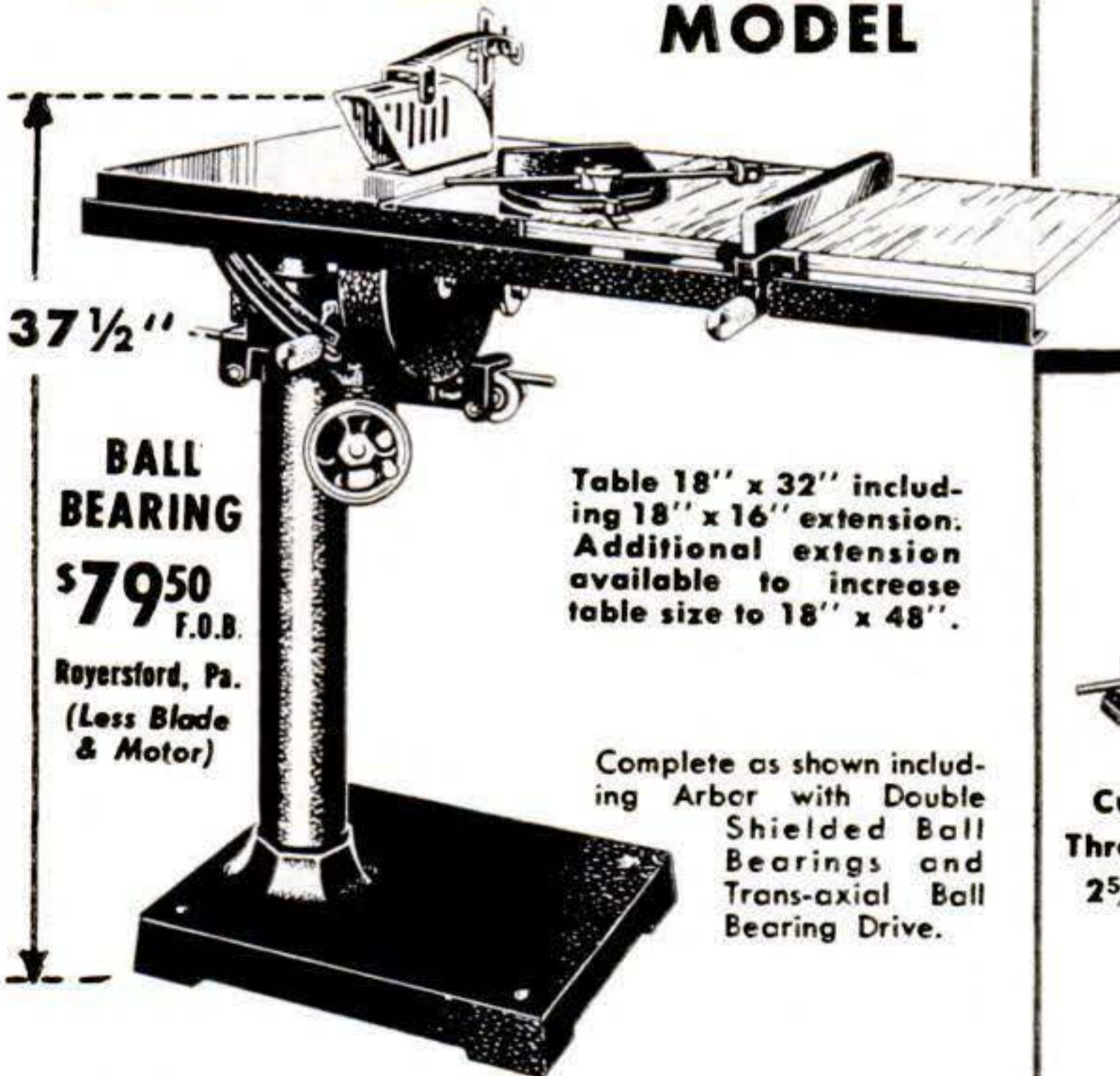

37 1/2"

**BALL  
BEARING**

**\$7950**

F.O.B.

Royersford, Pa.  
(Less Blade  
& Motor)

Table 18" x 32" including 18" x 16" extension. Additional extension available to increase table size to 18" x 48".

Complete as shown including Arbor with Double Shielded Ball Bearings and Trans-axial Ball Bearing Drive.

**8" TILT TABLE  
BENCH  
SAW**

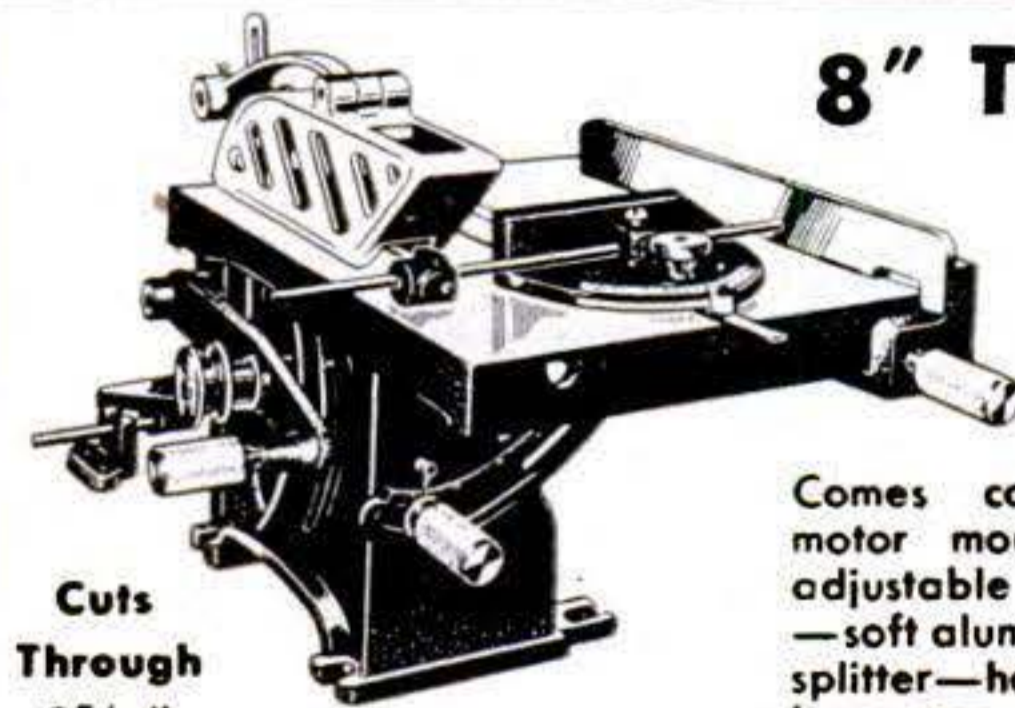

Cuts  
Through  
 $2\frac{5}{16}$ "

Comes complete with Floating motor mount—mitre gauge with adjustable stop—aluminum guard—soft aluminum insert—spring steel splitter—heavy gray iron fence—(no motor—no blade).

Table 12" x 14" Tilts to 45°—Oilite bearings. Shipping Wt. 50 lbs

**\$2495**  
F.O.B.  
ROYERSFORD, PA.

**COMPLETE AS SHOWN**

MARCUS • POLLAK

**AMERICAN MACHINE & TOOL CO. INC.**

—DEPT. 20—  
ROYERSFORD, PA.

MACHINE BUILDERS AND IRON FOUNDERS FOR OVER A QUARTER OF A CENTURY

TRY THIS AMAZING NEW  
**ANCO® CLEAR-FLEX**  
Trade Mark  
**WINDSHIELD WIPER BLADE**

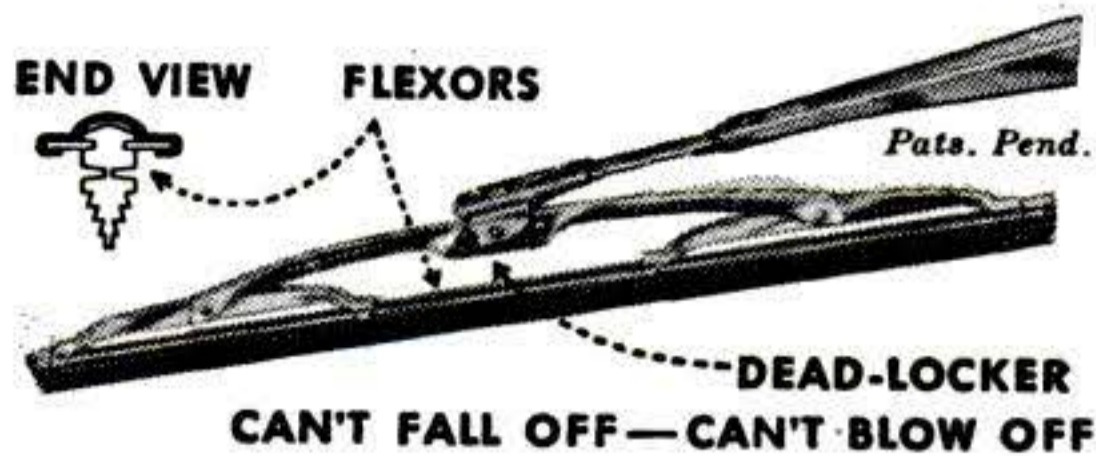

**FLEXES TO CLEAR THE LOW SPOTS**

Know CLEAR-FLEX . . . the first Wiper Blade to conform fully to all windshield surface irregularities. Even wipes uniformly all types of curved windshields. Keeps clear those annoying hard-to-reach low spots common to all FLAT windshield glass. Clears quickly blinding road muck . . . slapped against your windshield from sloppy pavements . . . by passing cars. CLEAR-FLEX already has engineering approval for original equipment on coming models of high-grade cars.

**THRILL WITH CLEAR-FLEX AS OUR "GUEST"**

Deposit with your dealer only the regular retail price. Use CLEAR-FLEX through the next storm. Then IF you are willing, dealer is authorized to remove CLEAR-FLEX and refund all your money.

**ANCO DEAD-LOCKER®**



**WIPER ARM**

ANCO Arm fits quickly any wiper shaft. Suits any good wiper motor. Holds Blade true . . . at correct pressure. If not now on your car, ask serviceman to install a PAIR quickly for you. More than 250,000 good gas stations and service stores sell ANCO BETTER Blades and Arms.

Made by the makers of long-famous ANCO RAIN-MASTER® Blades and Arms . . . original equipment for years on DeLuxe models of high-grade cars. Your dealer knows ANCO.

**Get yours next time you buy gas.  
 May save you a costly smashup.**

Quality Protected Under Fair Trade Laws  
 ANCO Patented Products—Patents Make Jobs

**THE ANDERSON COMPANY**  
 Established 1918  
 GARY, INDIANA

*No other tool like it!*

**BURGESS**  
**vibro-tool**  
Trade Mark Reg. U. S. Pat. Off.

Writes on . . .  
 Watches  
 Glassware  
 Tools  
 Leather  
 Plastics  
 Costume Jewelry  
 Pots and Pans  
 Sporting Equipment



**\$7.50**

Engrave your name . . . etch letters or designs . . . place permanent identification marks on anything with this unique hand tool. Carves wood and linoleum, cuts cardboard and balsa, tools leather. Just plug in on any 110 volt AC line. No home shop is complete without a Burgess Vibro-Tool. See your dealer or write for information.



**DELUXE KIT**

Vibro-Tool complete with 22 attachments in handsome, polished wood chest. . . . \$16.50

**BURGESS Vibro-Tool Division**

LAKE ZURICH, ILLINOIS

Get that NEW-CAR FEEL again!  
**SEALED POWER PISTON RINGS**  
*The only ring with the Full-Flow Spring!*  
 SEALED POWER CORP., DEPT. H2, MUSKEGON, MICH.

**U. S. NAVY 7x50**

**PRISM BINOCULARS**

with Coated Optics  
 Used but in  
 EXCELLENT CONDITION

**\$95**

Complete with leather carrying case and sling

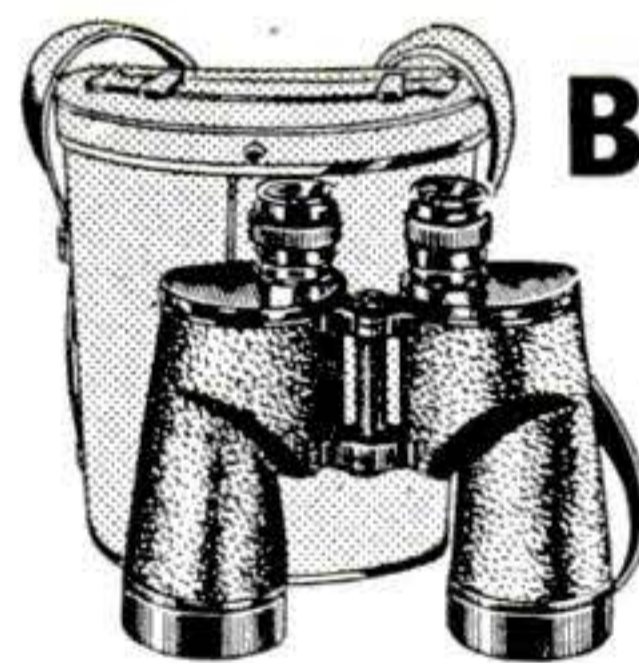

Universal, 6 x 30 Navy Prism Binoculars, used but in excellent condition, complete with leather case and sling straps. . . . \$42.50

With Coated Optics, \$10 Extra.

Field Glass, 4 x 40 Wollensak. Ideal for bird study. Brand New. . . . \$17.95

Engineers All Metal Army Type Hand-Sighting

**LEVELS**

**\$2.00** PRECISION QUALITY



Send \$1.50 for 3rd Edition of Gun Digest with our complete catalog of new and used guns, etc. Our separate catalog 25c.

**PUBLIC SPORT SHOPS**

11 S. 16th St., Phila. 2, Pa.

No COD's

★ **New Atlas  
8" and 10"  
TABLE SAWS**



★ **New Atlas  
24" JIG SAW**

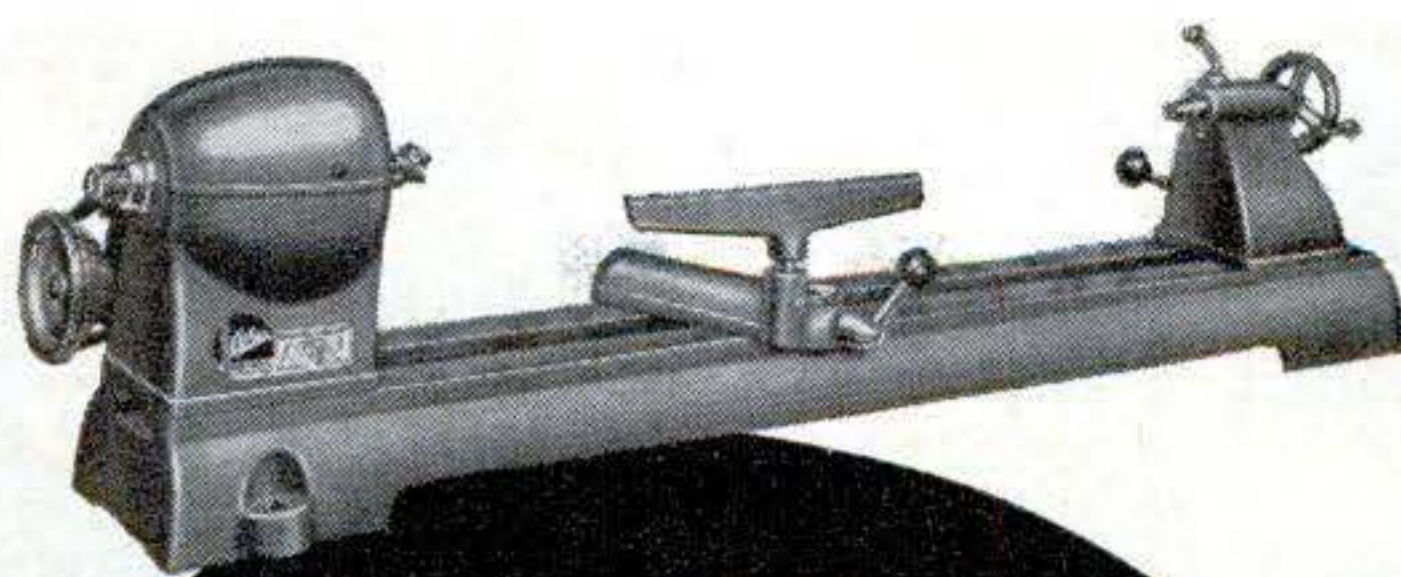

★ **New Atlas  
12" WOOD LATHE**

★ **New Atlas  
WOOD SHAPER**

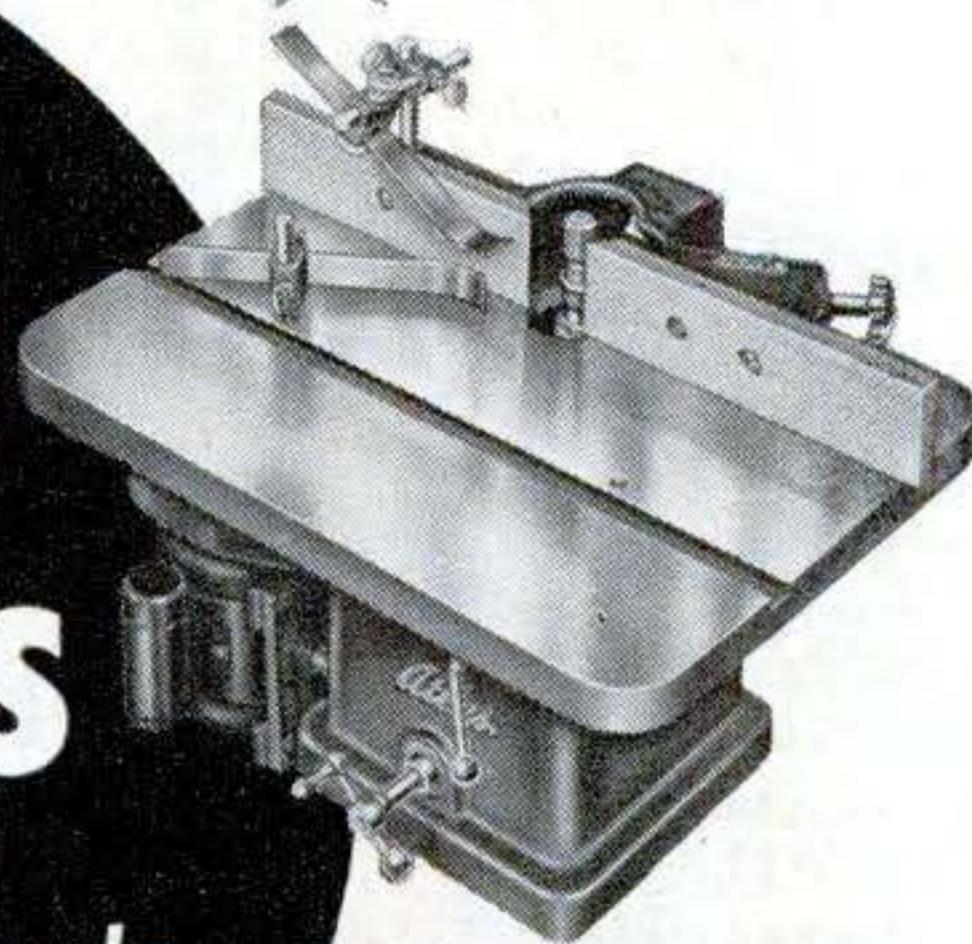

★ **New Atlas  
BELT and  
DISC SANDER**



**6 MORE  
New  
Atlas TOOLS**

**Built to Industrial Standards  
For New Perfection  
in Your Shop**

**AVAILABLE NOW!**



**New Atlas 10"  
Floor Saw.** Every  
feature you want  
for fine workman-  
ship. Heavy-duty.  
Extra-large table.  
Unique rip fence.  
Easy-operating  
controls.  
**PRICE \$179.50**



**New  
ATLAS 12<sup>3</sup>/<sub>4</sub>"  
BENCH DRILL, \$59.00  
ATLAS 15"  
BENCH DRILL, \$69.00  
ATLAS 15"  
FLOOR DRILL, \$79.00**

See them today at your  
Atlas dealers.

All prices, less motors, F.O.B.  
Kalamazoo, subject to change without notice.

★ **THEY'RE COMING YOUR WAY...**  
6 brand-new Atlas woodworking tools . . .  
precision-built throughout . . . for the finest  
work you've ever produced in your shop!  
These are the kind of tools the real craftsmen  
in America have long been waiting for . . .  
built to exacting industrial standards . . . with  
every latest feature for accuracy, easy opera-  
tion, and long service life. They'll make your  
shop the best-equipped, most practical in your  
neighborhood. Keep in touch with your Atlas  
distributor — he'll have them to  
show you soon!



**SEND FOR FREE CATALOG**

**ATLAS PRESS COMPANY**  
455 N. Pitcher St., Kalamazoo 13D, Mich.

Kindly send latest literature on Atlas woodworking  
tools to:

NAME \_\_\_\_\_

ADDRESS \_\_\_\_\_

CITY, STATE \_\_\_\_\_



# NOW—a New Kind of Screening

rustproof! stainproof! never needs painting! lasts a lifetime!



## Don't fuss with screens anymore! Replace old screens with Lumite!

Millions of homeowners have been amazed at this revolutionary plastic window screening. And no wonder it's sweeping the country! Just think of having screens that will *never* rust, *never* rot, *never* corrode. Imagine screens you never have to paint or scrub clean—that never stain the sills or sidewalls of your house. Yes, here's an amazing new kind of screening (woven of SARAN) that's been tested the world over—and proved virtually indestructible! If it's time to rescreen, don't wait, order LUMITE at your Hardware, Lumber, or Building Supply Dealer's today!

**For further information and free sample**  
write Dept. 33, Lumite Division

Chicopee Manufacturing Corporation, 47 Worth St., N. Y. 13, N. Y.



### STAINPROOF!

Guaranteed never to "bleed" or "run"—never to stain the sills and sidewalls of your house. LUMITE keeps its glistening fresh beauty always.



### RUSTPROOF!

Absolutely cannot rust or corrode in any climate. Completely unaffected by hot or cold weather, water, sun, smoke, acid fumes, or salt spray.



### NEVER NEEDS PAINTING!

Requires no protective coating. Any dust or dirt that collects on a LUMITE screen can be wiped off in seconds with a damp cloth.



### LASTS A LIFETIME!

LUMITE is unbelievably strong—has greater impact strength than any other type screening by actual test. Lasts as long as your house.

\* (R)

Screen once and for all with

# LUMITE\*



# A TOOLSHOP IN YOUR HAND!



- GRIND • DRILL • ROUT
- POLISH • ENGRAVE
- CUT • SAND • SAW • etc.

MAKE THINGS FROM WOOD  
PLASTICS—METALS—GLASS  
LINOLEUM—LEATHER  
ALLOYS—HORN—STONE  
BONE, etc.

**HANDEE** TOOL OF 1001 USES

**THE FIRST TOOL OF THIS KIND—TODAY'S FINEST!**  
Smooth, steady power at your fingertips! Perform precision operations not possible with any other portable tool! With a Handee you can turn out professional looking projects for pleasure or profit—ship, plane and train models, delicate, internally carved costume jewelry, wood carvings, puppets, initialed tumblers, etc. AC or DC. 25,000 r.p.m. Wt. 12 oz. Over 500 accessories made especially for the Handee!



**A GOOD START—THE HANDEE KIT**

HANDEE Tool and 40 most popular accessories packed in compact steel carrying case. You'll be amazed at what you can accomplish! At stores or postpaid **\$27.50**

Handee only, with 7 accessories, \$20.50

FOR YOURSELF OR A FRIEND...  
THE GIFT OF A LIFETIME!



**NEW PLASTIC-CRAFT KIT**

For internal carving. Contains special plastic cutters, buffers, sanding discs, buffing compounds, a liberal supply of clear plastic, dyes, cement and instructions. At stores or postpaid **\$6.95**

GET A HANDEE at stores everywhere. If they can't supply you we'll send it postpaid. Satisfaction guaranteed. Free 52-page Manual on request.

**CHICAGO WHEEL & MFG. CO.**  
1101 W. Monroe St. Dept. PO, Chicago 7, Ill.

Send  Handee Kit  Handee Tool  Plastic-Craft Kit  
 C.O.D.  Remittance enclosed  Send Manual

Name.....  
Address.....  
.....



Use it to save time and money when you cultivate, plow, disc, mow, harrow, or plow snow.

## PAGE

### the streamlined Garden Tractor

does your job quickly, easily, at low cost

This new Page, backed by 20 years' experience, gives you "big-tractor" features at low cost. *Headlight* and *equipment light* for night work. New quick-change hitch. Balanced for easy handling. Direct drive, worm-gear transmission, using cut gears and ball bearings. No cheap belts or chains. Gears and clutches in dust-free case. Adjustable wheels. Individual wheel clutches make turning easy. 1½, 2, 3, and 4 H.P. Prices are surprisingly low. Write for dealer's name and free catalog.

**Page Dairy and Farm Equipment**  
1916 S. 81st Street P-4 Milwaukee 14, Wisconsin



### DEEP TONE Dual Mufflers for Ford, Mercury

Scientifically designed straight-thru muffler reduces back pressure. Greater power, speed, and economy. NEW brilliant Deep Tone makes your car stand out. Heavy blowout-proof construction. Rugged steel tube throughout (No aluminum).

**Simplified Installation.** No cutting, no holes to drill. Rubber mounted clamps eliminate usual rattle. Complete with all necessary fittings, etc. Order direct and save. State year and model. Sent C.O.D. from Los Angeles. Price \$20.

"Deep Tone" single muffler for Chevrolet, Ford, Plymouth—\$4.86.  
All other makes—\$5.50. Chrome tail pipes, 2½" dia. \$1.75

**ADVANCE MUFFLER CO.**  
6800 S. Vermont, Dept. PS-48, Los Angeles 44, Calif.

## The SPEED SAW FILER

Saves You Time, Money

Now you can do expert saw filing at home. Lifetime tool makes precision filing easy for even the most inexperienced. Two simple adjustments make it fit any type hand saw. Keep your saws extra sharp and true-cutting with a Speed Saw Filer. Complete with file, ready to use. Money back guarantee. Cash with order, prepaid (C.O.D. postage extra.)

**THE SPEED CORP.**  
2025-B N.E. Sandy, Portland 12, Ore.

Now FILE YOUR OWN SAWS

ORDER NOW!

**\$295**



# New

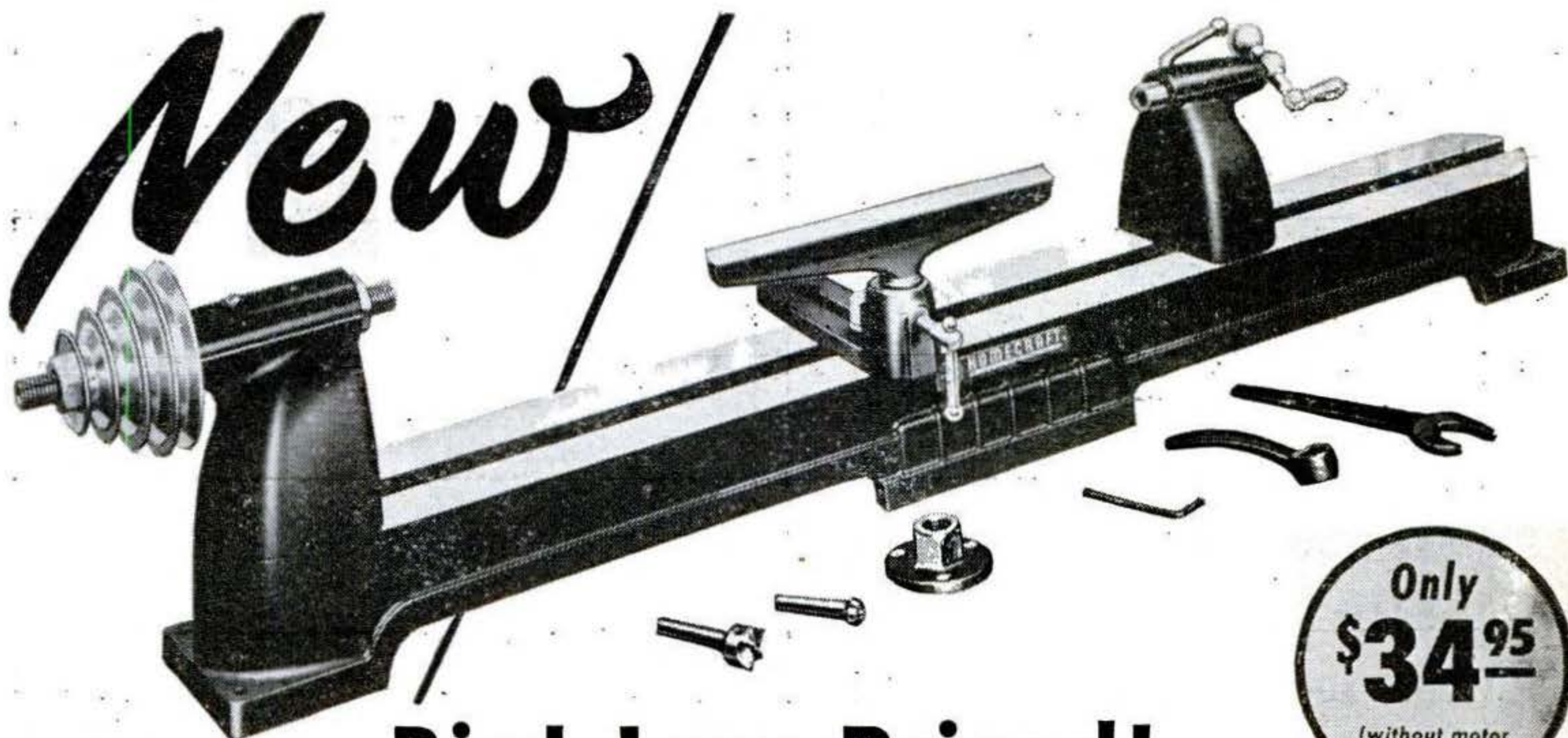

Only  
**\$34<sup>95</sup>**  
 (without motor  
 or pulley)

## Big! Low-Priced! HOMECRAFT® 10-inch Lathe

No. 46-110

Designed specifically to satisfy hobby-shop requirements, this lathe is a real value for the money!

You find many uses for this low-priced No. 46-110 *Homecraft* 10-inch Lathe — turning wood, light metals, and plastics. It handles 36 inches of stock between centers; swings 10 inches over the bed.

It is heavy, rigid, smooth-running. With this versatile tool, you get more pleasure in making furniture, lamps, toys, games, novelties, and other interesting objects.

### A Tool You're Proud to Own!

The *Homecraft* 10-inch Lathe is a really good, popular-priced tool that is exactly suited to your home woodworking needs.

It's as fine a lathe as can possibly be built for the money! Look at some of the features that are included:

- Built-in indexing mechanism in headstock has double row of holes — 8 holes and 60 holes — for maximum number of divisions. Index pin engages either row.
- Spindle is carried on oil-impregnated bronze bearings which provide long, trouble-free service and smooth operation.

- $\frac{3}{8}$ " hole in spindle permits repetition work and use of long-rod stock.
- All thrust is absorbed by a sealed-for-life ball bearing.
- Head and tailstock use No. 1 Morse taper accessories.
- Nose of spindle is right-hand threaded for chucks, face plates, etc. Outboard end is left-hand threaded for large turnings and face-plate work.
- Carefully-ground ways, front and back, provide sturdy base for locking headstock, tailstock, tool support base, and accessories.

### See It At Your Dealer!

Ask your *Homecraft* dealer to show you this new No. 46-110 lathe, and his complete display of *Homecraft* Power Tools that range in price from \$29.95 to \$41.95.

Visit your *Homecraft* dealer now!

**HOMECRAFT®**  
**POWER TOOLS**

General Sales Office • Chicago 2, Ill.

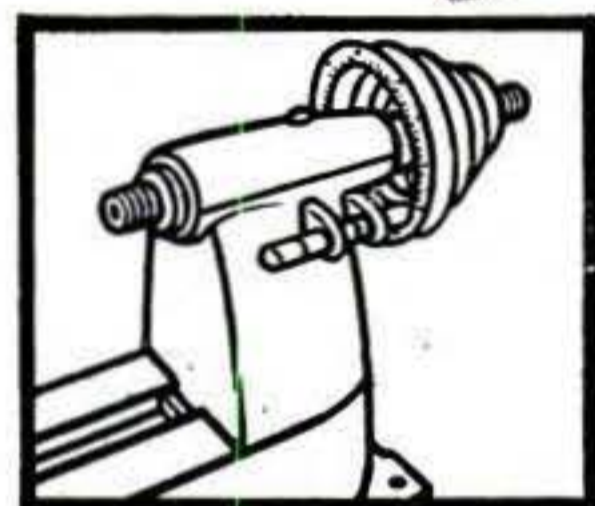

Husky headstock drives from either bottom or rear. Machined for No. 1 Morse taper. Indexing mechanism is built in.

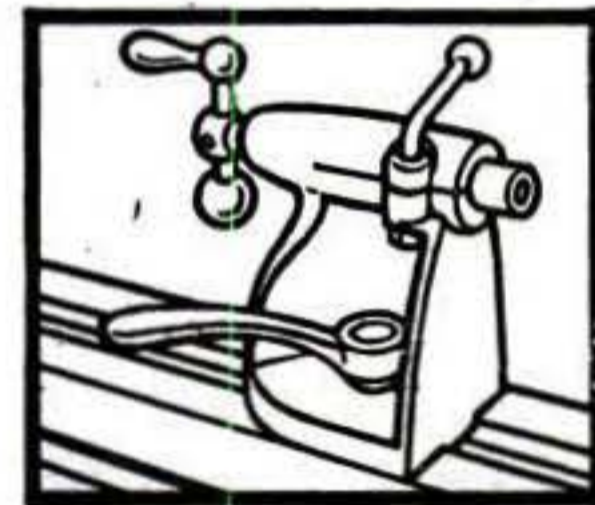

Substantial tailstock locks to bed with convenient hand lever. Centers are self-ejecting — machined for No. 1 Morse taper.

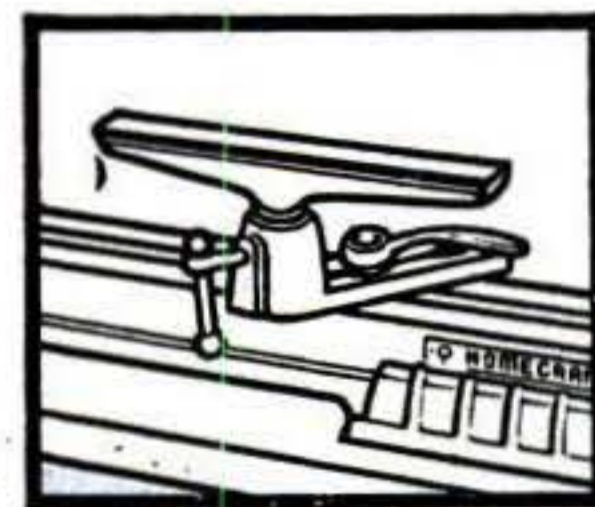

Above: Tool support locks quickly and firmly to groundways of lathe bed. Provides secure support for tool rest.

Below: Cast-iron bed is heavily ribbed, to prevent any warping or "give".

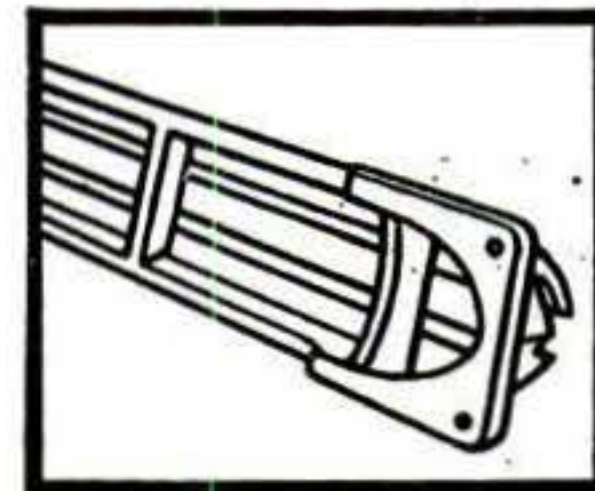

## HOMECRAFT POWER TOOLS

are built by the makers of Delta-Milwaukee\* Power and Machine Tools — the tools with a widespread reputation for safety, accuracy, and dependability, in factories and schools, as well as home shops.

If your goal is a shop equipped with power tools that embody the most advanced principles of engineering, design, and construction, then be sure to insist on reliable Delta-Milwaukee Power Tools.

Descriptive Literature! Shows all *Homecraft* Power Tools and accessories. Sent to you free. Use coupon, for your copy.



**Tear out coupon and mail today!**



DELTA MANUFACTURING DIVISION  
 Rockwell Manufacturing Company  
 683D E. Vienna Ave., Milwaukee 1, Wis.

Please send descriptive literature on *Homecraft* Power Tools.

Name.....

Address.....

City..... (.....) State.....

HM-57

\*Trade Mark Reg. U. S. Pat. Off.

APRIL 1948 261

# Speed Sweep

THE BRUSH WITH  
THE STEEL BACK



*Sweeps  
cleaner, faster—  
Out lasts ordinary  
brushes 3 to 1!*

Mail Coupon Today

Milwaukee Dustless Brush Co.  
530 N. 22nd St., Milwaukee 3, Wis.

Please send me complete information about  
Speed Sweep brushes.

Name \_\_\_\_\_

Street Address \_\_\_\_\_

City, State \_\_\_\_\_



## MENDS

DISHES, TOYS, ETC.

It's clear, water-  
proof, flexible,  
durable.



### DUCO CEMENT

REG. U. S. PAT. OFF.

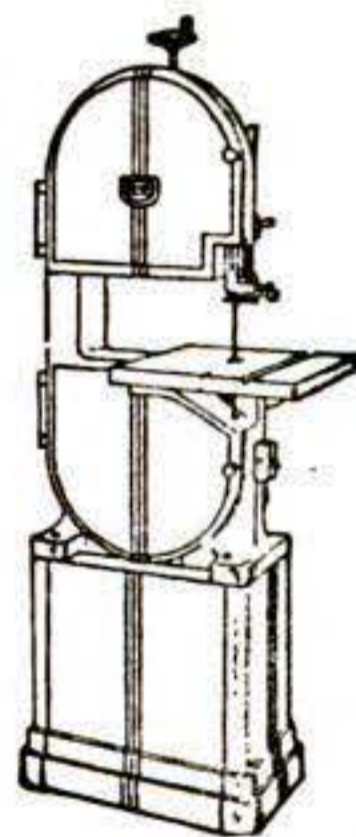

## COMPLETE LINE WALKER-TURNER

IMMEDIATE DELIVERY!

Drill Presses, Saw Tables,  
Lathes, Band Saws, Jointers, Ra-  
dial Saws, Sanders, and many  
other Machines—large and small.  
We invite your inquiries.

Send for FREE Catalog "B"

**CARPENTERS MACHY. CO.**

213 N. 11th St., Philadelphia 7, Pa.

## UTICA TOOLS

FOR MORE TOOL MILEAGE

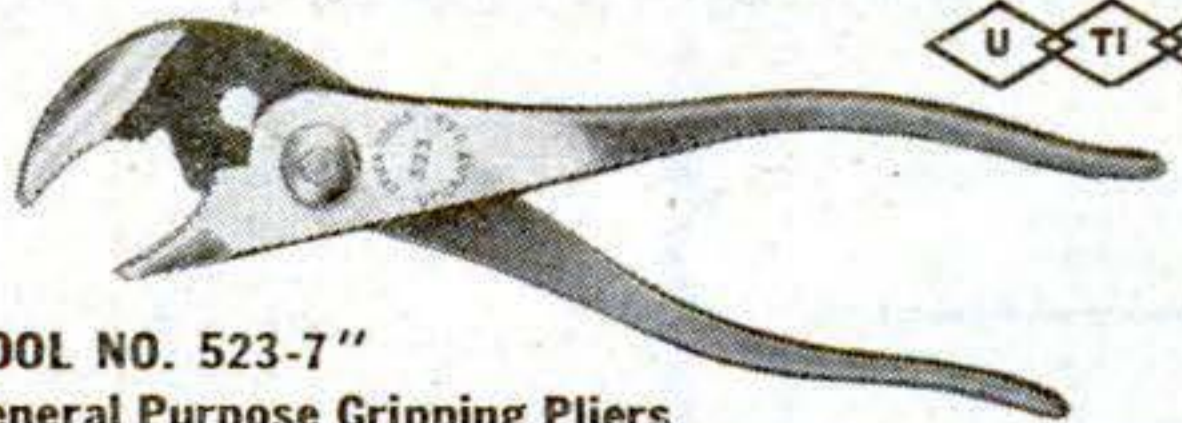

TOOL NO. 523-7"

General Purpose Gripping Pliers

**UTICA DROP FORGE & TOOL  
CORPORATION**  
UTICA 4, NEW YORK



**HERE'S VALUE!**  
**Sturdy Cast Iron Construction**  
**TOMLEE BAND SAW**



AVAILABLE  
 NOW!

Rip Fence \$4.95  
 Mitre Gauge \$4.95

PRICE  
**\$59.50**  
 F. O. B.  
 Minneapolis

**FEATURES**

- ★ With Mitre Gauge and Rip Fence Slot
- ★ Chrysler Oilite Bearings
- ★ Table Tilts 45°
- ★ Large, Easy-to-Read Dials
- ★ Will Cut 6-Inch Lumber
- ★ Full 12-in. Capacity
- ★ Uses 78-Inch Blade up to 3/4 Inches Wide
- ★ Fully Enclosed with One-Piece Cover
- ★ Handwheel Adjustment for Alignment

Available at Hardware Stores

**TOMLEE TOOLS**

SANDERS... BENCH SAWS... JIG SAWS... BAND SAWS... LATHES... JOINTERS... DRILL PRESSES

Tomlee Tool & Eng. Co., 740 No. Washington Ave., Minneapolis 1, Minn.

**WOODWORKERS... Get this**  
**CONSTANTINE MASTER MANUAL**

**Get the Most Fun From Your Hobby**  
 Indispensable to woodworkers. Newest, biggest edition, more pages, more color, helpful how-to-do-it articles, pre-war and new items, more bargains. Send 25c today and we will include **FREE! FULL YRS. SUBSCRIPTION** to Chips and Chats, published bi-monthly. Keeps you up-to-date on everything in woodworking, offers big money-saving bargains. Send now.

ALBERT CONSTANTINE & SON, Inc.  
 793-S 135th Street, New York 54, N. Y.



**Every MILE Saves You MONEY!**

"PAY AS YOU RIDE"



Cushman Solo Model



Enjoy America's new ride. The Cushman Motor Scooter travels 300 miles on a dollar's worth of gas. Operates for less than 1c per mile. Will carry 2 passengers. Has rugged 4 H.P. Cushman "Husky" engine, two-speed transmission, automatic clutch, balloon tires and knee-action springing for added comfort. Park anywhere. Gives you a "second car" at low cost.

5 Models. Finest selection. Cushman offers SOLO, SIDE-KAR, PACKAGE-KAR, STAKE-KAR, SPORT models.

**FREE** Write for Free Folders, name of your nearest dealer and details of the new, liberal Cushman TIME PAYMENT PLAN.

**Cushman Engines**  
 For 47 years Cushman has produced high quality small air-cooled and water-cooled engines. These engines are available to original equipment manufacturers and other users. Write for details.

CUSHMAN MOTOR WORKS, INC., Dept. S-400, Lincoln, Nebr.

**DON'T YOU BELIEVE IT!**  
**... THAT PISTON RINGS ARE ALL ALIKE**

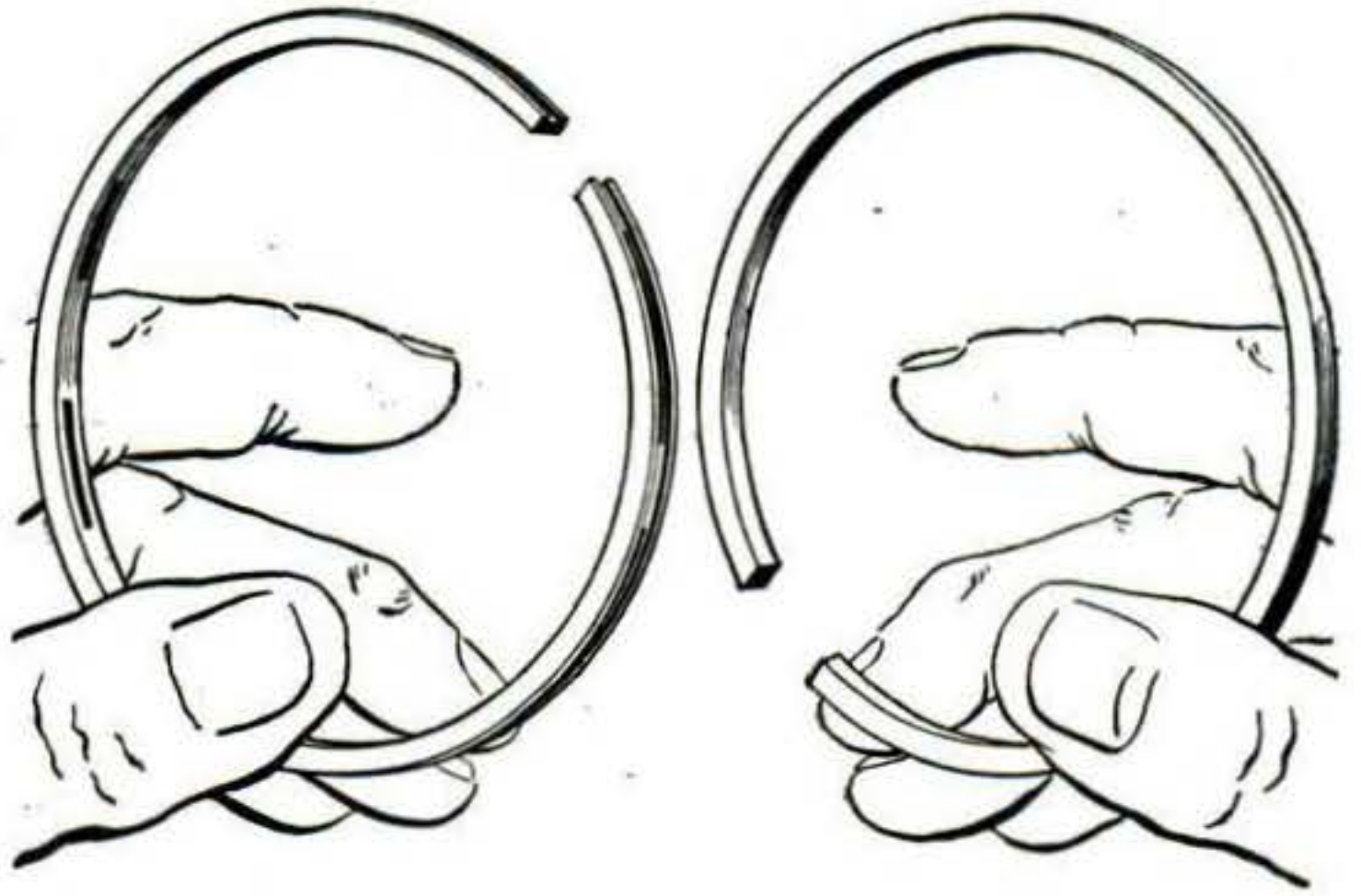

● Some people think one make of piston ring is as good as another. But don't be fooled just because piston rings all seem to look alike. Burd "Graf-Flox" Piston Rings, made of electric furnace iron, are unrivaled in meeting the demands of increasingly high speeds and high compression in modern engines... even excessively worn cylinders can't stop their efficiency. With flexibility to follow worn cylinder walls faster, Burd "Graf-Flox" treated Piston Rings help correct piston slap... restore lost power... stop fuel and oil waste... bring quiet, smooth, new-car performance to your automobile. The coupon will bring you more information in two FREE booklets.



**BURD**  
 AUTOMOTIVE PRODUCTS



*Engineered for results*

**MAIL THIS COUPON FOR THESE FREE BOOKLETS**  
 BURD PISTON RING CO., DEPT. 128-D  
 Rockford, Illinois

I'd like copies of your "Servicemen's Handy Handbook" which tells how to keep my car in good working order, and the booklet "No Job For a Dub."

Name.....  
 Address.....  
 City..... State.....



# STOP LEAKS

In Concrete, Brick or Stone  
**WALLS and FLOORS**



Apply Smooth-On No. 7 Iron Cement to cracks, holes, seams and porous spots, using a trowel or stiff brush. The surface to which you apply it may be either wet or dry.

Smooth-On will set hard, sealing the leaks. It will stay in place, because it expands slightly as it sets.

Use Smooth-On No. 7 also to line cisterns, swimming pools, troughs, fountains, septic tanks, etc. Use it to seal openings where piping passes through walls.

Buy Smooth-On No. 7 in 1-, 5-, 25-lb. or larger size at your hardware store; if they haven't it, write us.

## FREE REPAIR HANDBOOK

40 pages. 170 illustrations. Clear, simple directions for stopping leaks, sealing cracks, tightening loose parts in household equipment and autos. Every home needs this useful repair guide. Just mail the coupon for YOUR free copy.



-----Sign and Send NOW-----

**SMOOTH-ON MFG. CO., Dept. 58D,**  
570 Communipaw Ave., Jersey City 4, N. J.

Please send me a Smooth-On Handbook and Folder on #7.

Name.....

Address.....

4-48.....

Do it with **SMOOTH-ON**  
NO. 7 IRON CEMENT

## FOREDOM FLEXIBLE SHAFT MACHINE

only  
**\$19.95**

with **PENCIL SIZE HANDPIECE**  
for Finger-Tip Control

Works effortlessly and with marvelous ease. Tens of thousands of users attest to its infinite superiority over other small grinders. Affords you vastly more satisfaction and fun.

### 5 REASONS WHY FOREDOMS ARE TOPS IN THE FIELD:

1. Extra power and longer motor life because motor not dwarfed to fit hand. 2. Correct handpiece size for deft, sensitive, finger-tip control. 3. No obstructed view of your work. 4. Freedom from gyroscopic action—hence better work. 5. Small handpiece size lets you get into hard-to-reach places.

### HUNDREDS OF USES

Foredoms handle hundreds of tasks. Use them for pleasure or profit, for tinkering or expert craftsmanship. Their versatility is unlimited. Use them to grind, polish, mill, engrave, sharpen, slot, rout, saw, carve, clean, sand, etch, cut, etc. Ideal for internal carving of plastics, the astounding new craft. You can work on wood, glass, plastics and all metals with a Foredom.

### OVER 60,000 FOREDOMS NOW IN USE

The power grinder you'll eventually buy if you want true operating ease and results which genuinely satisfy. Foredom's quarter century experience in building fine tools for home and industry is your assurance of superior performance.



Order your Foredom today, direct on 10-day trial. Send check or M.O. for \$19.95 (price not increased since OPA) and we send postpaid in U. S. or send \$2.00 and you pay postman balance plus postage. 50-piece accessory set \$1.50 extra. Catalog on request.

**FOREDOM ELECTRIC COMPANY, Dept., F-105**

27 Park Place

New York 7, N. Y.

## TOYS COMPLETE PLANS FOR JUST 10¢

**STANLEY**

PLAN SET No. 16

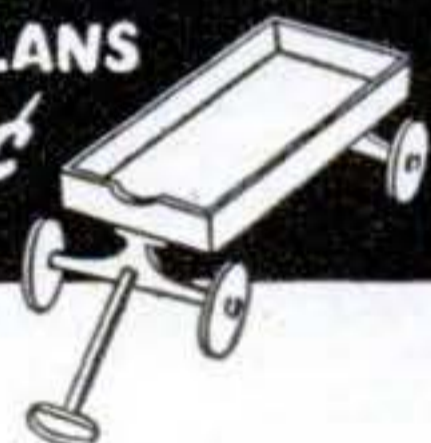

Happy evenings for you . . . joyous days for your children . . . holiday gifts for all. Detailed plans for easy to make, hard to buy toys . . . wheelbarrow, rocking horse,

kiddie push car, scooter and toy wagon. Send just 10¢ and ask for free list of all the Stanley Plan Sets. **STANLEY TOOLS, 248 Elm St., New Britain, Conn.**



IF you stop, look and listen, we can show you how to build a business of your own NOW with Tradio, the radio functionally-designed for coin operation in hotels, tourist camps, restaurants, taverns, etc., in your community. Hundreds of men and women are entering this new depression-proof business daily. It's a natural for big earnings and a steady income. Tradio has pioneered in this flourishing postwar industry. Only a small investment is needed to get in on the ground floor.

WRITE Dept. G-4 for complete information and free illustrated brochure.

**TRADIO, Inc.** ASBURY PARK  
NEW JERSEY



# MOTO-TOOL

## THE "POCKET-SIZE" MACHINE SHOP



### A SHOP-TESTED TOOL

Moto-Tool is backed by over 10 years of industrial use . . . packs extra years of pleasure . . . yet, due to increased production, pre-war prices still prevail!

About 27,000 R.P.M.  
Cuts Cleaner . . .  
Saves Cutters



### LOOK FOR THESE MOTO-TOOL FEATURES

Approximately 27,000 R.P.M. plus dynamically balanced armature provides vibrationless finger-tip control. Moto-Tool has oil-less, sealed bearings • Patented automatic chuck lock pin • Over-size armature shaft, hardened, ground, polished • 110 Volt, AC-DC motor • Sliding snap-type switch • Cord protector • Shock-proof bakelite housing • Dust-filtered air-cooling system • Weighs only 13 oz.

### New DREMEL DRILL PRESS Only \$9.95

(Less Moto-Tool)

Here's a light, portable precision drill press at an amazingly low price. Just the thing for creating costume jewelry, model making, wood carving, routing, etc. Utilizes Model No. 2 Moto-Tool, which can be raised or lowered, swung in any direction or quickly removed in a few seconds for off-hand use. Drill Press stands 12" high. Base is 6 3/4" x 4". Weighs approximately 3 1/2 pounds.



**HERE'S BIG VALUE**  
**Model No. 1**  
**Moto-Tool Kit**  
Only \$17.50  
This popular Kit contains the smaller, lighter (Model 1) Moto-Tool and 34 accessories in attractive, lacquer-finish wood box. It's the biggest bargain in the field.

**MOTO-TOOL KIT NO. 2**  
With 23 Accessories  
(High speed steel Cutters, Grinding Wheels, Polishing Accessories)  
Only \$23.50

**MONEY-BACK GUARANTEE:** Buy Dremel Moto-Tools from your dealer. If he cannot supply you, order direct from factory on 10 day trial, money-back guarantee. Shipped postpaid for payment in full (send check or money order); or send only \$2.00, we will ship C.O.D. You pay postman balance plus postage.

**DREMEL MANUFACTURING COMPANY**

Dept. 128-D

Racine, Wis.

# Now for EVERY WORK SHOP! NEW Invention Electroplates by BRUSH



## Easy to Plate CHROMIUM GOLD, SILVER, NICKEL, COPPER . . . For Pleasure and Profit!

If you have a workshop—at home or in business—you need this new Warner Electroplater. At the stroke of an electrified brush, you can electroplate models and projects—you can replate worn articles, faucets, tools, fixtures, silverware, etc. with a durable, sparkling coat of metal . . . Gold, Silver, Chromium, Nickel, Copper or Cadmium. Method is easy, simple, quick. Everything furnished—equipment complete, ready for use. *By doing a bit of work for others, your machine can pay for itself within a week.* So make your shop complete, by getting a Warner Electroplater right away. Send today for FREE SAMPLE and illustrated literature. **ACT AT ONCE! Mail Coupon.**  
**WARNER ELECTRIC CO., DEPT. S-15**  
1512 Jarvis Avenue, Chicago 26, Ill.

## FREE Details & Sample!

WARNER ELECTRIC CO., 1512 Jarvis Avenue, Chicago 26, Dept. S-15

Gentlemen: Send Free Sample and Details to:

Name \_\_\_\_\_  
Address \_\_\_\_\_  
City \_\_\_\_\_ State \_\_\_\_\_

## You Can't Catch Fish Untangling BIRDS' NESTS



## EVERY CAST BACKLASH-FREE with Shakespeare's WONDEREEL

**CASTING SKILL'S BUILT IN** Shakespeare's amazing WONDEREEL. No backlashes to spoil your fishing fun. No untangling birds' nests. Only Wondereel gives you this great fishing advantage. The reason is an exclusive, light-weight spool and patented, spin-controlling bearings. After 5 minutes practice, even beginners get long, accurate casts. Get Wondereel at any sports store.

**FREE TACKLE BOOK** and pocket fishing calendar. Reels, Rods, Lines, Accessories, Fishing Tips. Mail coupon.



**Shakespeare Company**  
Dept. 94, Kalamazoo 2, Michigan  
Send me your Free Tackle Book and Pocket Fishing Calendar.

Name \_\_\_\_\_  
(Please write address and zone no. below)





*New*  
**POWER KING**  
8" TILT/ARBOR  
SAW

**SPEEDS YOUR  
WORK ON:**

*Furniture, Cabinets, Cupboards,  
Shelves, Toys, Equipment, Etc.*

Watch how much faster you do finer work with a new Power King saw as your "helper"! Gives you 10 times the speed of tedious hand sawing. Cuts *accurately every time.*

The new Power King 8" saw has a 18" x 20" precision-ground table — with 10 5/8" ahead of blade for wide boards. Cuts 2 5/8" deep. Blade tilts — table stays flat — for safe angle sawing. Precision ball bearings. Unique table-length rip fence locks at both ends.

Get into real "production" on things for your home this Spring with this fast, accurate, ruggedly built saw. Send for free literature and name of nearest dealer.

**POWER KING  
TOOL CORP.**

435 Cleveland St., Warsaw, Ind.  
Division of Atlas Press Co.

EASI-BILD PATTERNS are sold by Power King dealers. Send for pictures of scores of practical projects.



**OTHER POWER KING SAWS**



12"  
BAND SAW



18"  
JIG SAW

for **Homecraft Use!**



Use Kester Cored solders for hobby-craft work as well as home repairs and be sure of the finest solder bonds. Acid-Core solder for general work; rosin-core solder for all electrical work.

**KESTER  
SOLDER COMPANY**

4254 Wrightwood Ave., Chicago 39, Illinois

Eastern Plant: Newark, N. J. Canadian Plant: Brantford, Can.

Sand Casting—Forging—Heat Treating—Case Hardening  
**BRONZE FOUNDRY**



In your own workshop allows you to design and build your own GASOLINE ENGINES, STEAM ENGINES, STATUARY, ART OBJECTS, SPECIAL TOOLS, NEW INVENTIONS, ETC. You can also make forgings and case harden steel. Your shop is not complete without a FOUNDRYETTE. Three sizes are available capable of making bronze castings of 1 1/2, 3 and 6 pounds weight. aluminum, copper, brass, etc., \$22.50, \$29.50, \$42.00 f.o.b. Kansas City. Domestic gas supply

and 110 volt AC or DC energy required for operation. Write for circular.

**KANSAS CITY SPECIALTIES CO.**  
Box 6022, Dept. S-3 Kansas City, Mo.

**HOLD-E-ZEE**  
*Automatic Grip*

**SCREWDRIVERS**

... not only tools of finest quality, with chrome-vanadium blades, hand-ground bits, insulating, unbreakable handles ... but possessing the exclusive Gripper which holds, starts, and sets up screws in unhandy places. At leading dealers everywhere. Upson Bros., Inc., 86 Exchange St., Rochester, N.Y.

QUALITY UNSURPASSED • CONVENIENCE UNEQUALLED

**YOUR CIRCLE SAW BLADE  
CAN CUT GROOVES LIKE THIS**  
Easily — Quickly — Accurately



YES—THIS NEW INVENTION WILL FIT THE ARBOR OF ANY WOOD POWER CIRCLE SAW—AND WILL SAW ANY DESIRED GROOVE CLEANER, EASIER AND FASTER THAN ANY DADO HEAD ON THE MARKET TODAY... GRADUATED IN 32nds AND NUMBERED TO CUT ANY WIDTH GROOVE WITH YOUR SAW BLADE... MICRO-MATIC ADJUSTMENT MAKES POSSIBLE A CHANGE IN CUTTING ANGLE IN 15 SECONDS... **WARREN DADO SAWING WASHERS** CAN BE LEFT ON THE ARBOR OR QUICKLY REMOVED FOR CUT OFF SAWING.

ORDER YOUR SET OF FOUR WASHERS TODAY, TRY THEM FOR TEN DAYS. IF NOT SATISFIED, YOUR MONEY WILL BE REFUNDED.

Arbor  1/2  3/4  
 Sizes  5/8  
 Check  
 Money Order  
 Free Booklet

Gentlemen:— Please send \_\_\_\_\_ sets of sawing washers:  
 Name \_\_\_\_\_  
 Address \_\_\_\_\_  
 City \_\_\_\_\_ State \_\_\_\_\_

ALL SETS SHIPPED POSTPAID

**WARREN DADO SAWING WASHERS CO.**  
 P. O. BOX 98 NORTH END STATION  
 DETROIT, MICHIGAN

## Print Your Own

Cards, stationery, circulars, tags, labels, photo and movie titles, advertising, etc. Save money. **Print for Others, Good Profit;** easy rules sent. Raised Printing like Engraving, too. Send dime for press samples, supply book, all details and advice on your needs. No obligation. **KELSEY INC., B-33, Meriden, Conn.**

## AIR CORPS Type P23 Headphones

**AT A FRACTION OF ORIGINAL COST**  
 8000 ohm impedance, bipolar magnets. Extremely comfortable sponge rubber cushions, stainless steel leather covered headbands, concealed terminals. 6 ft. cord with PL55 plug. **BRAND NEW. \$15.00 Value.**  
 No. 5A134 Plus 25c each for Postage.  
**Spec. Per Pair..... \$2.95**

FREE Catalog on Everything in Radio and Electronics.  
 Burstein-Applebee Co. 1012 McGee, Kansas City 6, Mo.

## New MILLING ATTACHMENT

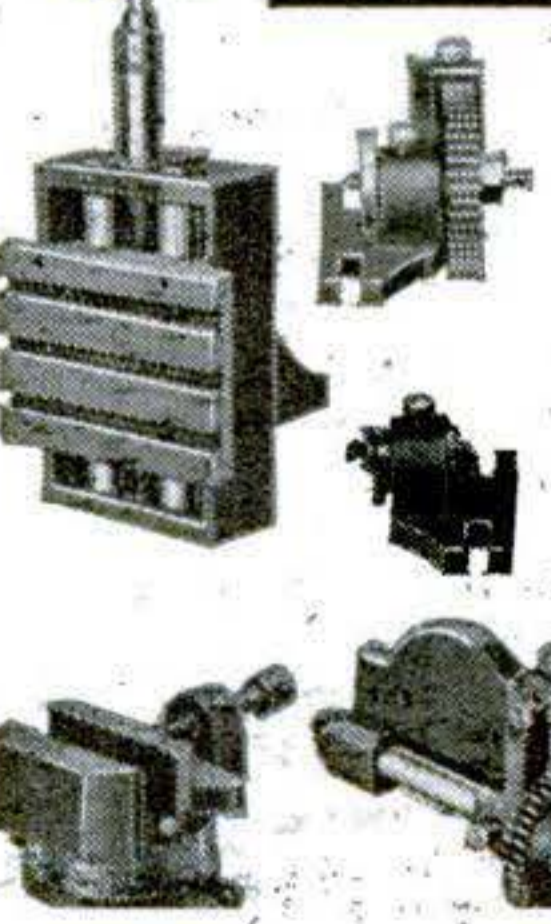

Sizes for 8" to 16" metal lathes  
**BUILD IT YOURSELF** from our sets of semi-machined castings and save \$\$\$. Can be finished on your lathe alone. Complete working drawings and step-by-step instructions furnished.  
 Mill keyways, slots, splines, dove-tails; flutes in reamers, taps, hobs, and special cutters; produce spur, bevel, mitre and worm gears, ratchets and racks; mill flat surfaces, square shafts, mill hexes, spot face, drill spaced holes, bore, etc. on your lathe with this precision attachment. It has a T-slotted table, a vise which swivels for angular milling, a gear cutting fixture and dividing centers.  
**FREE!** Illustrated folder and price list. Includes milling cutters, keyway cutters, drill rod, slitting saws and many hard to get shop items. Mention your lathe. Write today.  
**HURON MACHINE AND TOOL CO.**  
 YALE 2, MICHIGAN

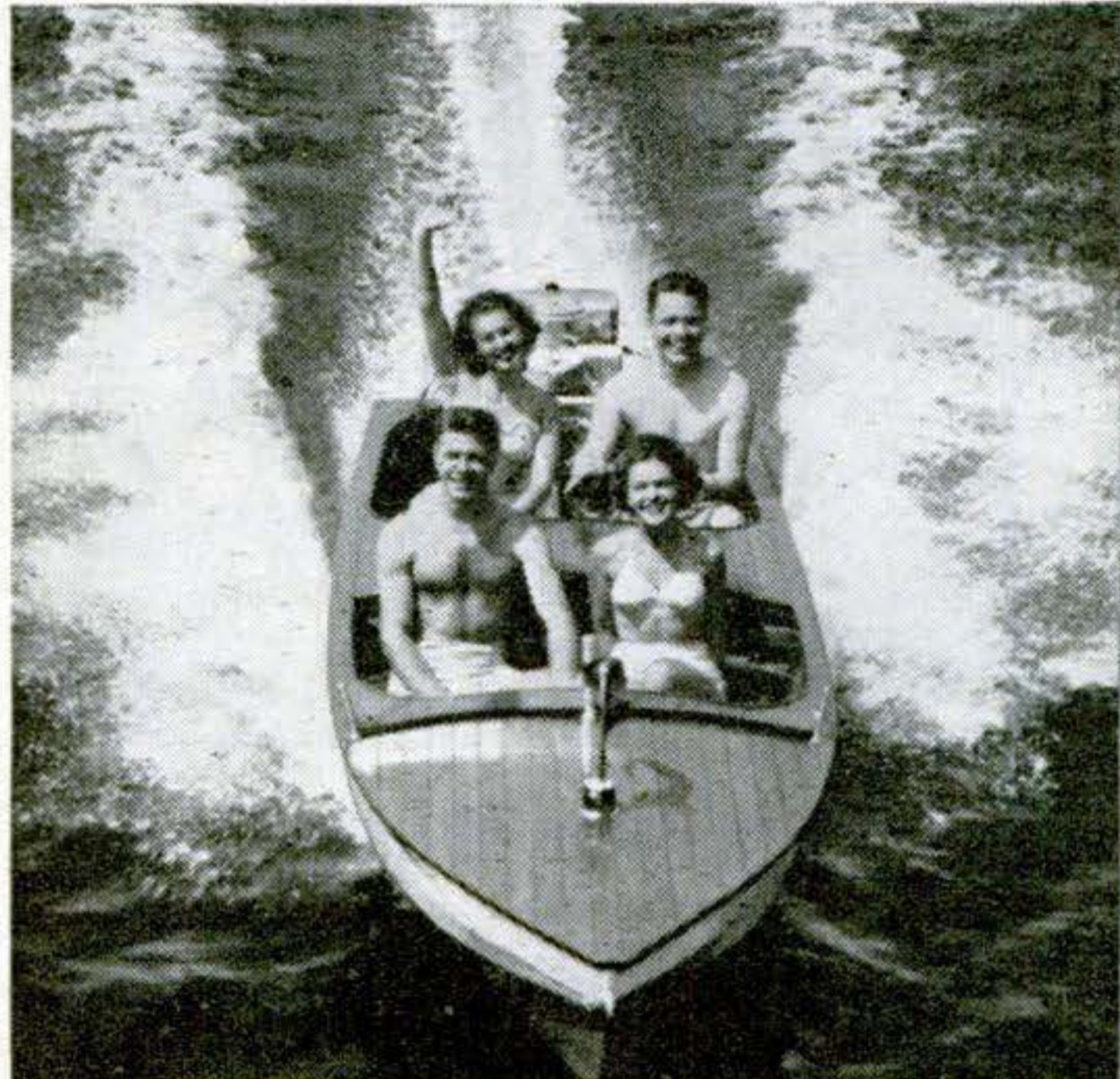

every mile's **More Fun**

with an  
**Evinrude "4"**

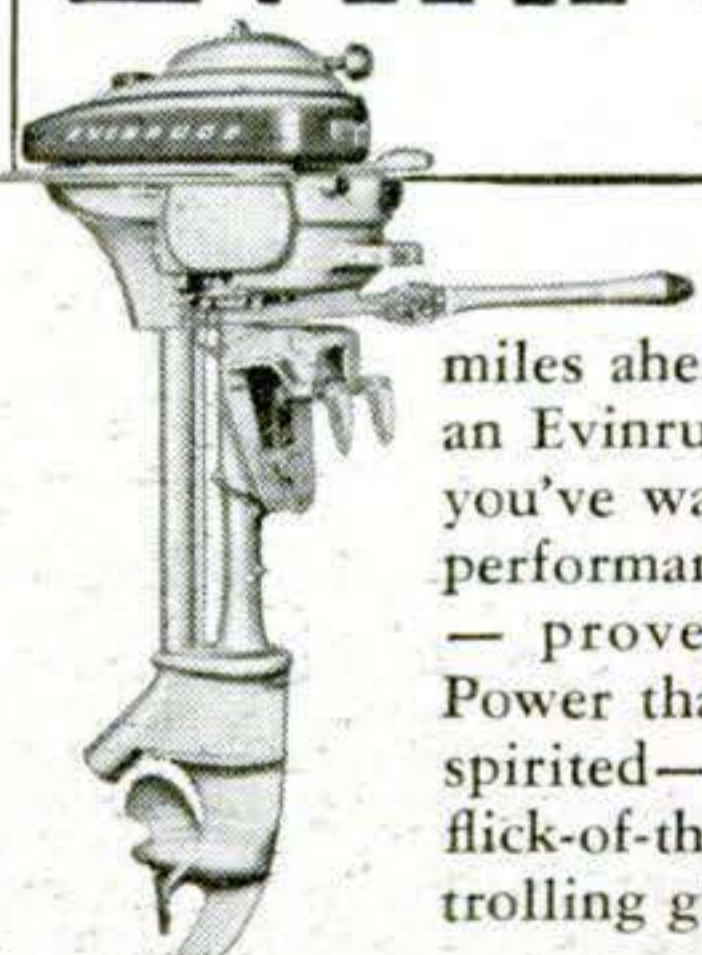

New thrills for all the miles ahead — they're yours with an Evinrude "Four". Everything you've wanted in deluxe outboard performance is here — perfected — proved — and eager to go! Power that's superbly smooth and spirited—famed starting ease—and flick-of-the-throttle flexibility from trolling glide to surging top speed!

There are three great "Fours" to choose from in Evinrude's complete line of 6 models. See your Evinrude Dealer — look for his name in the yellow pages of your phone book.

### Send For FREE Catalog

Write today for full-color catalog of the complete Evinrude line. Address, **EVINRUDE MOTORS, 5741 N. 27th St., Milwaukee 9, Wisconsin.**



In Canada: Evinrude Motors, Peterboro, Ontario.

**EVINRUDE**  
 FIRST IN OUTBOARDS • 39th YEAR

**FREE!**

SEND FOR  
**ALLIED'S  
NEW RADIO  
CATALOG**  
172 PAGES OF  
BIG VALUES!



**Everything in Radio at Lowest Prices**

Get ALLIED'S new Catalog—biggest and most complete in Radio! Tremendous values in new Television receivers, home radios, latest Amateur receivers and station equipment, new builders' Kits, Sound Systems. Thousands of parts, tubes, test instruments, tools, books and diagrams—the world's largest stocks—all at money-saving low prices! Send for your FREE ALLIED Catalog today.

**HERE'S A TYPICAL ALLIED VALUE!**



**A Quality Electric Drill Kit at a Big Savings**

A wonderfully handy tool for light-duty, intermittent service in every shop. This sturdy 1/4" drill comes complete with 14 popular size drills for wood, plastics, iron and steel. Dependable AC-DC motor operates efficiently at 1100 rpm. Has

self-lubricating oilite bearings; heavy chuck; built-in on-off switch and 7 foot cord and plug. Entire unit is balanced for easy, non-tiring work even in close quarters. For 115 volts AC-DC. An outstanding value, 46-027 (FOB Chicago) **ONLY \$15.95**

**GET THESE VALUABLE ALLIED RADIO BOOKS!**



- Radio Formulas & Data No. 37-752.....10c
- Dictionary of Radio Terms No. 37-751...15c
- Radio Circuit Handbook No. 37-753.....25c
- Radio Builders' Handbook No. 37-750...15c
- Simplified Radio Servicing No. 37-755...10c
- Radio Data Handbook No. 37-754.....25c
- ALL 6 BOOKS above No. 37-799.....\$1.00
- Parallel Resistance and Series Capacitance Calculator. No. 37-960....25c
- R-F Resonance and Coil Winding Calculator. No. 37-955.....25c

**ALLIED RADIO**

**ALLIED RADIO CORP.**  
833 W. Jackson Blvd., Dept. 7-DD-8  
Chicago 7, Illinois

**FREE Catalog**

Send FREE New ALLIED Catalog  
 Send Drill Kit No. 46-027  
 Send 6 Books No. 37-799  
 Send Calculator No. .... } \$.....enclosed

Name.....  
 Address.....  
 City.....Zone....State.....

**IT'S NEW!**  
**Crosman "Bullseye"**  
**TARGET PISTOL**



Here's new fun for shooters! For the new Crosman "Bullseye" offers adjustable "power without powder" for accuracy with safety indoors and out! No noise, no recoil, no odor, no cleaning! Perfect balance! Rifled barrel! Fine gunsmithing! Low cost! THAT'S what you get in this new .177 cal. single-shot pistol of regulation target type and weight. Shoots Crosman Super-Pells at 1/4 cent per shot. No wonder they say no other pistol provides so much fun at such small cost. At your sporting goods or hardware dealer's... or write direct.

**Crosman Silent RIFLE**



... most amazing gun ever invented for target shooting indoors or out and for small game! Adjustable "power without powder" ... no noise, recoil, odor or cleaning. Rifled barrel. Shoots low-cost Super-Pells. .177 or .22 cal. single-shot or magazine models. At your dealer's... or write direct.

**CROSMAN ARMS CO., INC.**  
9 HENRIETTA ST. • ROCHESTER 7, N. Y.

**USE YOUR BENCH SAW**  
FOR JOINTING & CUTTING MOULDINGS

With our six inch tool steel cutters make mouldings, casings, drop-leaf tables, grooves beading and jointing. Moulding cutters, A 1 in. wide \$1.50, 1 1/2 in. \$2.00, Jointing cutters, B 1 in. \$1.50, 1 1/2 in. \$2.00, E 1 in. for drop-leaf tables, \$1.50, E 1 1/2 in. Makes 3/4 in. cove & Quarter. \$2.00. Postpaid. Guaranteed. State size hole. List & Folder free.  
**JOHN A. SANDSTROM**  
Rt. 1-P, Clearwater, Fla.

**LAW** STUDY AT HOME for PERSONAL SUCCESS and LARGER EARNINGS. 39 years expert instruction—over 108,000 students enrolled. LL.B. Degree awarded. All texts furnished. Easy payments. Send for FREE BOOK.

**AMERICAN EXTENSION SCHOOL OF LAW**  
Dept. 88-S, 646 N. Michigan Ave., Chicago, Ill.

**ELECTRICITY Anywhere**

for HOMES, FARMS, SHOPS, BOATS, RADIO USE

Onan gasoline-engine-driven Electric Plants supply reliable, economical electric service for any use. Portable, stationary or stand-by models. Water or air-cooled, compact and rugged.

A C : 350 to 35,000 watts in all standard voltages and frequencies. D C : 600 to 10,000 watts, 115 and 230 volts. BATTERY CHARGERS: 500 to 3,500 watts, 6, 12, 24, 32 volts.

Write for folder  
**D. W. ONAN & SONS INC.**  
2782 Royalston Ave., Minneapolis 5, Minn.



# EASIER TO OPERATE

## Smith-Corona

### PORTABLE TYPEWRITER



Has regulation keyboard same as on big office machines

Check these points!

**FLOATING SHIFT**, famous exclusive feature that makes typing easier, faster.  
**TOUCH SELECTOR**, gives you 7 positive adjustments from *light* to *heavy*!  
**ALL AROUND FRAME**, surrounds and protects mechanism. Smith-Coronas last longer.

AT YOUR DEALERS TODAY

## Smith-Corona

### PORTABLE TYPEWRITER

**LAWN ORNAMENT-NOVELTY PATTERNS**  
 28 Lawn Ornament Patterns, 25c, Other patterns: 15-20" high; Dutch Girl, Dutch Boy, Pirate, Bull Terrier, Mexican Girl, Mexican Boy, Dwarf, Penguin, Flower Girl, 10c each. 25 Novelty Patterns, 30c. All 62 Full Size Patterns, \$1.00 Postpaid. Strother Pattern Service, Dept. 7-AD, Box 383, Belington, W. Va.

## ATTENTION FARMERS!

Now is the Time to Get a SEAMAN ROTARY TILLER for Your Spring Work

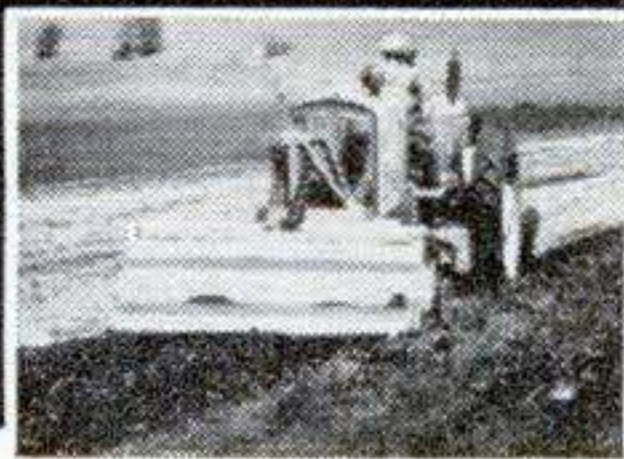

Speeds up tillage; makes better seedbed; use for finishing seedbed prepared with conventional equipment or for complete seedbed preparation with this ONE machine. Provides ideal tillage control — fine pulverization, coarse, or medium to suit soil and crop conditions. Promotes higher yields . . . holds more moisture, longer; mixes fertilizer and green manure into GROWING AREA of seedbed; hastens germination; aerates seedbed; helps control weeds, grubs and many other crop pests; reduces wind and water erosion; makes plants more drought-resistant. Available in complete range of sizes from 3 ft. to 7 ft. tillage widths, power take-off and motorized (gas or diesel) models. See Your Seaman Tiller dealer and write for complete descriptive literature.

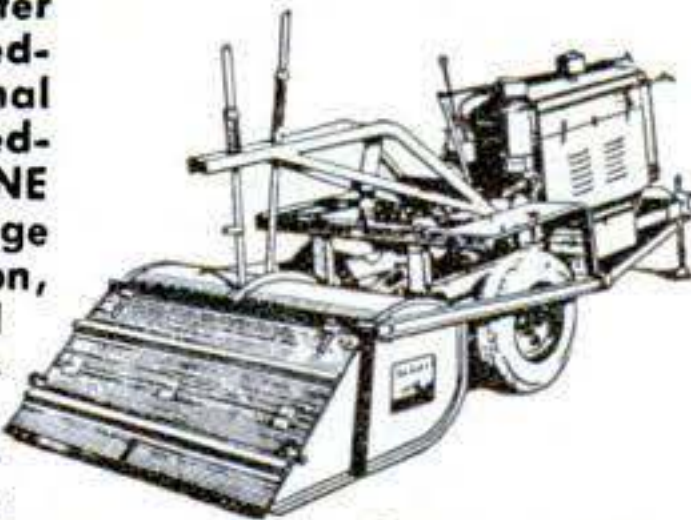

**SEAMAN MOTORS, Inc.** 365 N. 25th Street Milwaukee 3, Wis.

# CASH

## FOR YOUR SPARE TIME

### MACHINE SAW FILING PAYS UP TO \$2 or \$3 an Hour



Start AT HOME in Basement or Garage

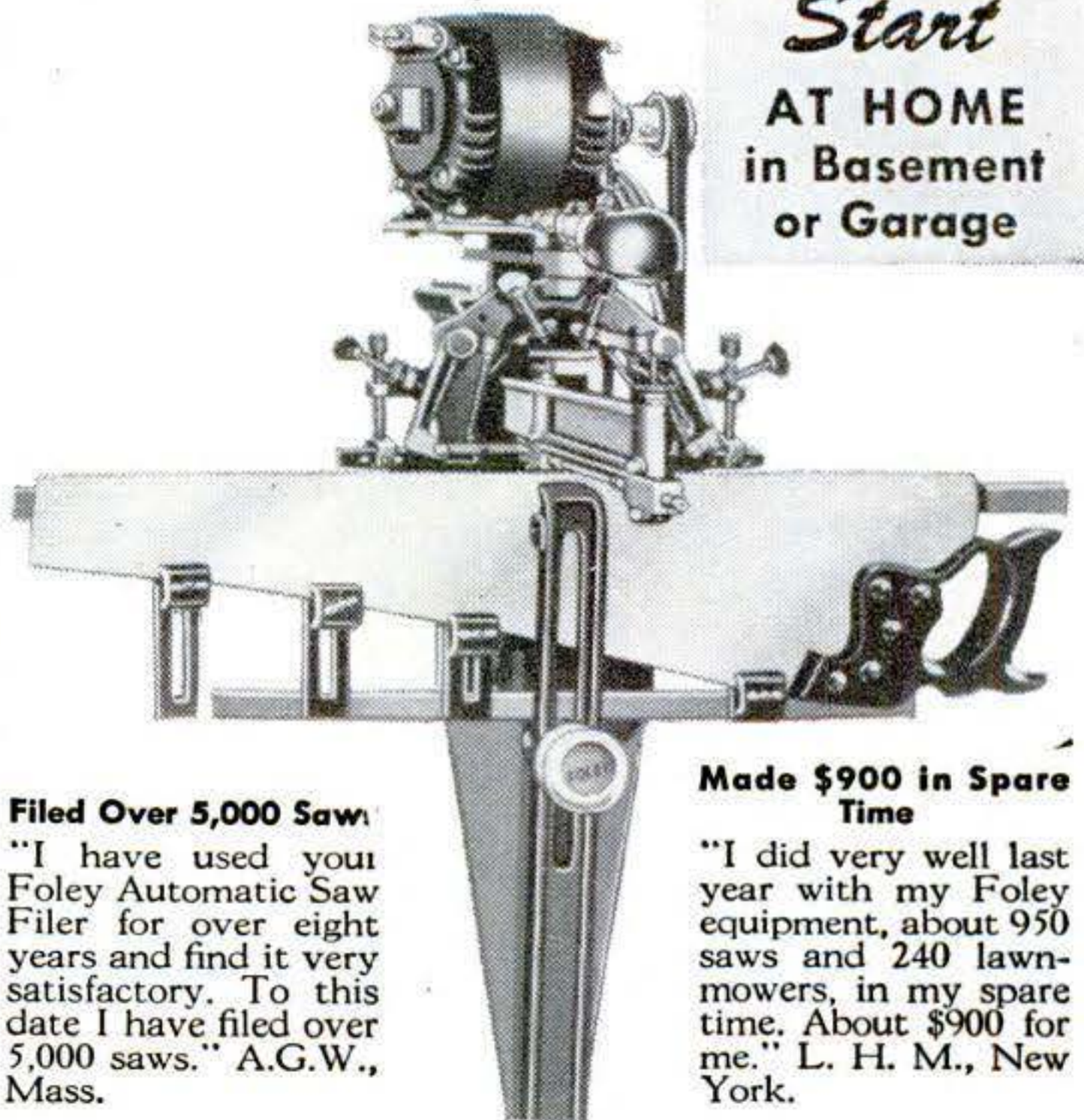

**Filed Over 5,000 Saws:**  
 "I have used your Foley Automatic Saw Filer for over eight years and find it very satisfactory. To this date I have filed over 5,000 saws." A.G.W., Mass.

**Made \$900 in Spare Time**  
 "I did very well last year with my Foley equipment, about 950 saws and 240 lawnmowers, in my spare time. About \$900 for me." L. H. M., New York.

### MAKE OLD SAWS CUT LIKE NEW

"The first saw I sharpened came out 100%. I have been filing saws for 15 years by hand, and my Foley Filer showed me that I didn't know a thing about filing saws"—writes C.E.P., Penn. H.S.W., Iowa says—"Didn't think there were so many saws in my whole territory. I am working all day and late at night trying to keep ahead of the rush."

With a Foley Saw Filer you can file all hand saws, also band and cross-cut circular saws. It is easy to operate—simple adjustments—no eyestrain. Patented jointing principle evens up all irregular teeth and makes an old saw cut just like new.

### FREE PLAN SHOWS HOW TO START

No canvassing necessary—"I advertised in our local paper and got in 93 saws—I only work spare time at present" says M.L.T., Ohio. You can get IMMEDIATE DELIVERY on a Foley Saw Filer. Send coupon today—no obligation.

FOR A STEADY REPEAT CASH BUSINESS GET A



## FOLEY Automatic SAW FILER

FOLEY MFG. CO., 419-8, Foley Bldg., Minneapolis 18, Minn.  
 Send Free Plan on Saw Filing business, no obligation.

Name.....  
 Address.....

# For smoother shaves and more of 'em

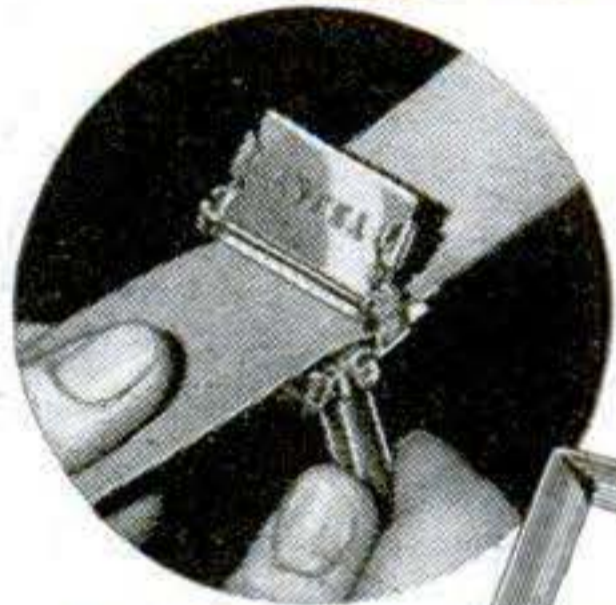

**use**

RAZOR, STROP AND 5 VALET BLADES

**\$1.25**



**STROPS—CLEANS WITHOUT REMOVING BLADE**

SELF-SHARPENING . . . ONE PIECE



## LATHE CENTERS and DRILL PADS



Description	No. 2 Taper	No. 3 Taper
L—SCREW CENTER . . . . .	\$3.00	\$3.25
G—DRILL PAD . . . . .	2.50	2.75
H—CROTCH CENTER . . . . .	2.50	3.25
J—HOLLOW CENTER, 60° . . . . .	2.00	2.75
I—60° CENTER . . . . .	2.25	3.00
P—CARBIDE TIPPED CENTER . . . . .	4.50	8.00
Q—HALF CENTER . . . . .	2.25	3.00
N—CUP CENTER . . . . .	2.00	2.75
M—SPUR CENTER . . . . .	3.00	3.25

**SOUTH BEND LATHE WORKS** 456A E. Madison St. South Bend 22, Ind.

## NEW 1948 Plastics Supplies Catalog

Just off press. Full details on Plexiglas, Lucite, rods, sheets, tubes. Acetates, cements, dyes, buffs, molding sets, tools, carving kits, accessories. Everything in plastics. Gives prices, sizes, colors, etc. Price 10c, stamps or coin, with ad for catalog.

PLASTICS MFG. & SUPPLY CORP. Dept. S-4, 4707 Euclid Ave., Cleveland 3, Ohio



## HANDYMAN'S Steel-Cutting SHEAR

Cuts flat steel up to 1/8" thick, with ease. Can be mounted in vise or bolted to bench. Built for hard use by maker of famous "Hand-nib" Machine Shop tools. EXTRA: Has built-in die for cutting rods up to 5/16". Shipped express prepaid for cash with order. **ONLY \$27.50**

National Machine Tool Co., Dept. 228-D, Racine, Wis.

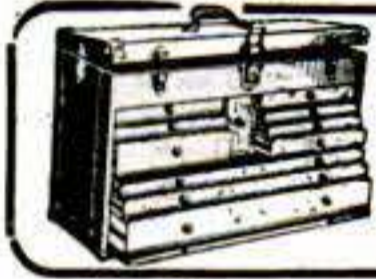

## GERSTNER Tool Chests

Always popular with good Machinists and Tool-makers because of durable construction. Free catalog. **GERSTNER TOOL CHESTS** 548 Columbia St. Dayton 7, Ohio



Beaconlite illuminated, \$5.95; Streamline, \$3.95. At your dealer's. Write for illustrated literature.

HULL MFG. CO., P.O. Box 246-E4, Warren, Ohio



**"I'LL TAKE THE WHITE ONE EVERY TIME!"**



**WYTEFACE**  
TRADE MARK  
**STEEL MEASURING TAPES**

**K=Σ**  
**KEUFFEL & ESSER CO.**





SANDING FURNITURE

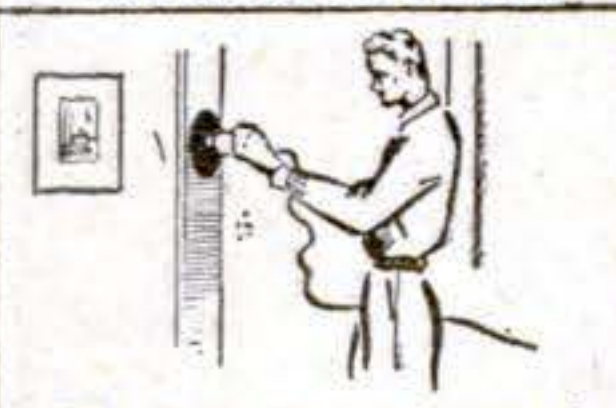



SANDING WOODWORK

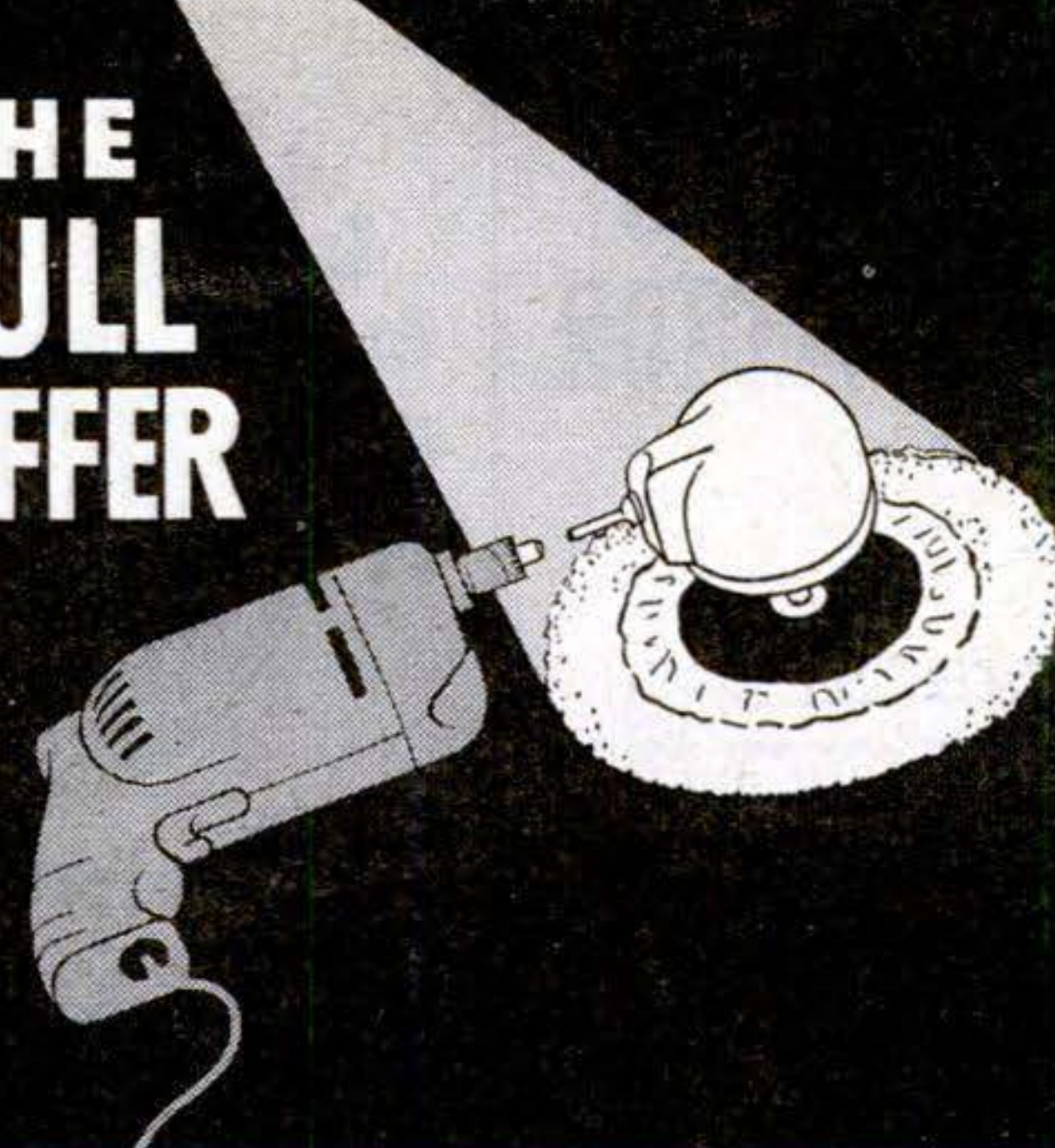

REFINISHING CARS

# THE BULL BUFFER





POLISHING CARS



POLISHING FLOORS



POLISHING FURNITURE

PAT. PEND.

For the  
HOME  
FARM  
FACTORY  
GARAGE  
OFFICE BLDG.  
STORE  
SHOP  
SERVICE  
STATION  
CABINET SHOP  
METAL SHOP  
UPHOLSTERING  
SHOP

The very first time you polish your car, sand your own floors, refinish furniture, this tool has more than paid for itself. And what a kick you'll get out of doing all the polishing and sanding jobs that used to cost lots of money! With the Bull Buffer, you can do beautiful, professional work—make your car, furniture, floors, woodwork gleam like new. You'll find no limit to the ways Bull Buffer will save time and money in your home and business. **THE BULL BUFFER FITS ANY CHUCK ON AN ELECTRIC DRILL (OR FLEXIBLE SHAFT).** Attach it quickly . . . polish and sand . . . then disconnect it and use your drill for any other purpose.

**HIGHLY MANEUVERABLE, EASY TO OPERATE.** Holding drill stationary, buffer can be turned in a complete circle. It's **RUGGED—POWERFUL—BUILT TO LAST A LIFETIME.** Sturdy aluminum casting houses self-lubricated bearings and steel gears that operate in a bath of oil. All materials and workmanship are **guaranteed.**

The sooner you order, the sooner you'll have this handy new tool in your hands. It's a real bargain—only \$9.95, complete with five-inch rubber disc, sheepskin bonnet, and 2 sanding discs. If your dealer doesn't stock, send cash, check or money order for \$9.95, postage prepaid. C.O.D. plus postage. **\$9.95**

## BERTRUM ENGINEERING COMPANY

3034 MAIN ST.

KANSAS CITY, MO.

DEALERS WRITE FOR INFORMATION

### NU-WAY LAWN MOWER

Write for  
FREE Circular

Price **\$12.50**  
Why Pay More

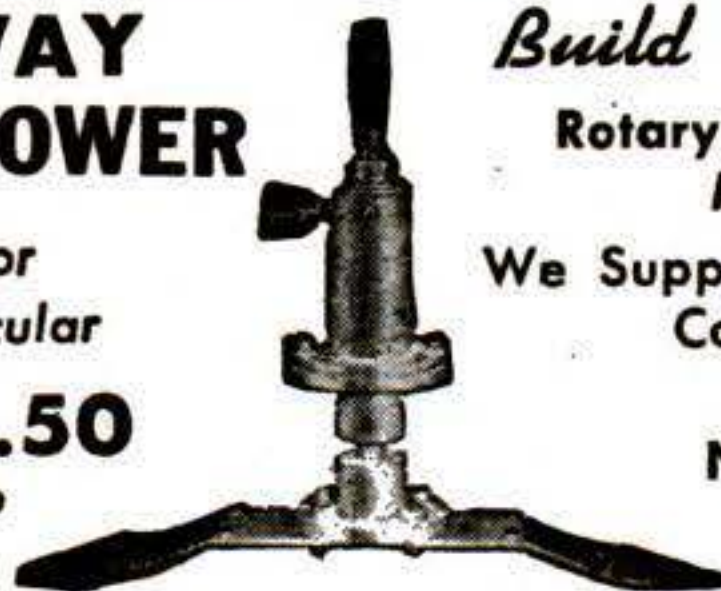

*Build Your Own*  
Rotary Type Lawn  
Mower  
We Supply Cutting Unit  
Complete.

**NO INCREASE  
IN PRICE**

**TRACTOR-LITE MFG. CO., SPIRIT LAKE, IOWA**

Say You Saw  
It In Popular Science

## MAKE THESE LEATHER *and* LEATHERETTE ITEMS LIKE NEW

With New Plastic **LEATHER-NEW**

Covers leather, leatherette and cloth and gives new finish and color—wears like leatherette. Easily applied with brush—quickly renews with liquid artificial leather. Write for FREE sample. **AVAILABLE IN ALL COLORS**

**Own Your Own LEATHER-NEW Contracting Business — Big Profits**

Renew equipment for Bars, Restaurants, Hotels, etc. Profits possible up to \$125.00 on a single job . . . write for details.

**FREE** Sample of coated material—Write for it—No Obligation  
**LEATHER-NEW 4723B Troost, Kansas City, Mo.**

- Leather Covered Furniture
- Grill & Cafe Equipment
- Any Leather or Leatherette Item

## Live in a House?

This light, strong, easily handled device—weight-tested to 500 pounds—will let you *Wash—Paint—Putty Your Windows—Hang Screens and Awnings—Service Combination Storm Windows without a Ladder!* Protective steel railing—wide substantial floor—rubber house protectors. Model H adjustable to all household wall thicknesses—9" to 17". \$10.50 postpaid. \$9.85 C.O.D. plus fee. Money back guarantee. Patents pending. A Morsafe\* Product. Agents—Dealers—Territories Open. \*Trademark



## THEN YOU NEED A WindoStep\*

FOR ALL OUTSIDE WINDOW WORK  
...UPSTAIRS OR DOWN

An Ideal Gift

**MORRISON CRAFTERS**  
703 Miami Street, Toledo 5, Ohio

NAME .....

ADDRESS .....

CITY ..... STATE .....

C.O.D.  PREPAID

PS-4 SEND CIRCULAR

**NOW!  
MULTIPLE  
SPEEDS FOR ALL  
POWER TOOLS!**

with  
**MCKELVEY'S  
RPM SELECTOR**

(all patents applied  
for or pending)



RPM Selector on drill  
press, drilling 1 3/8"  
hole in cast iron  
counter balance

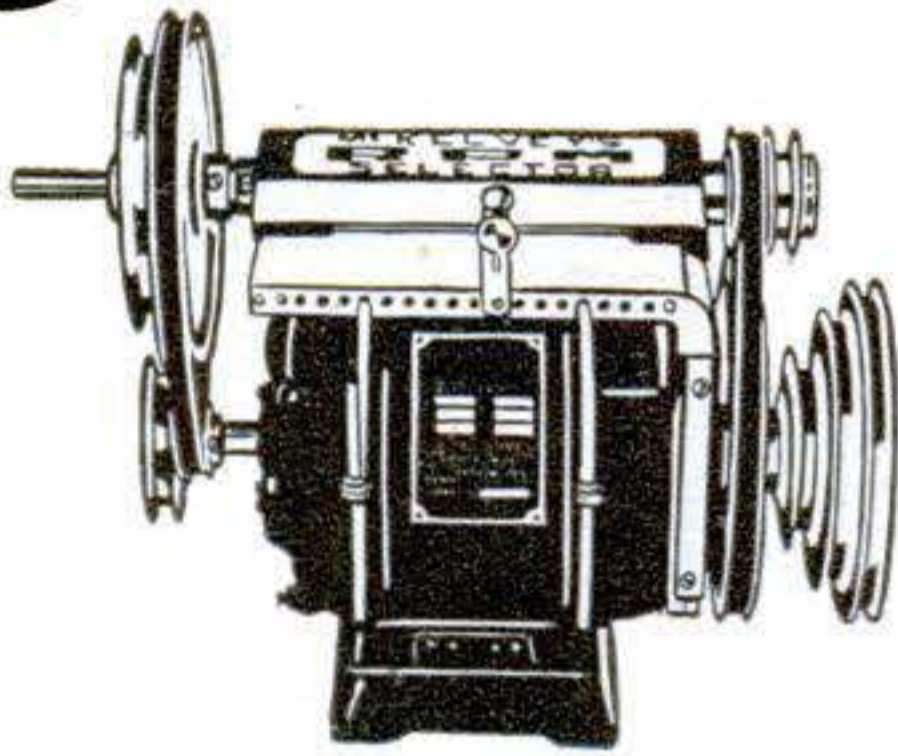

66 to 10,000 RPMS from average  
motor (up to 1 h.p.) On the average  
drill press or lathe with standard  
accessories and belts of the selector,  
120 different speeds may be ob-  
tained—"spindle speeds" ranging  
from 25 r.p.m. and lower to a high  
of 3 times the leaving-the-motor  
speeds — *almost unlimited opera-  
tions from one power tool without  
changing the position of the motor!*

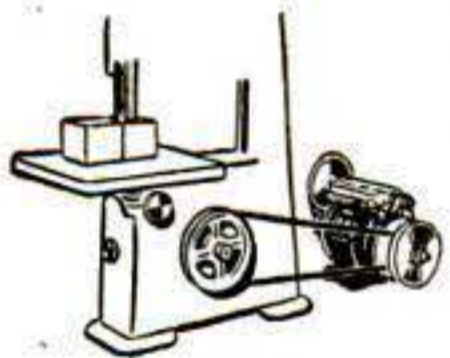

Band saw with RPM  
Selector easily saws  
through 6' x 6' 24 ST  
Dural.

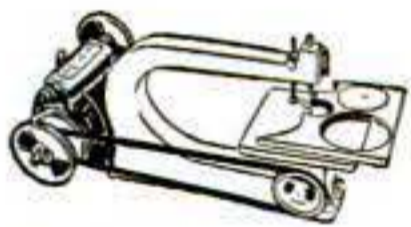

Cutting 1" boiler  
plate is no problem  
on this RPM-  
equipped jig saw.

**MONEY BACK GUARANTEE**

At your dealer or order direct. Sent  
prepaid on receipt of check or  
money order for \$34.95. **NO  
C.O.D.'S, PLEASE!**

Dealer and distributor  
inquiries invited.

**SUNSET EQUIPMENT CO.**

1813 W. 11th St. • Los Angeles, Calif.

**SAFETY & ECONOMY**

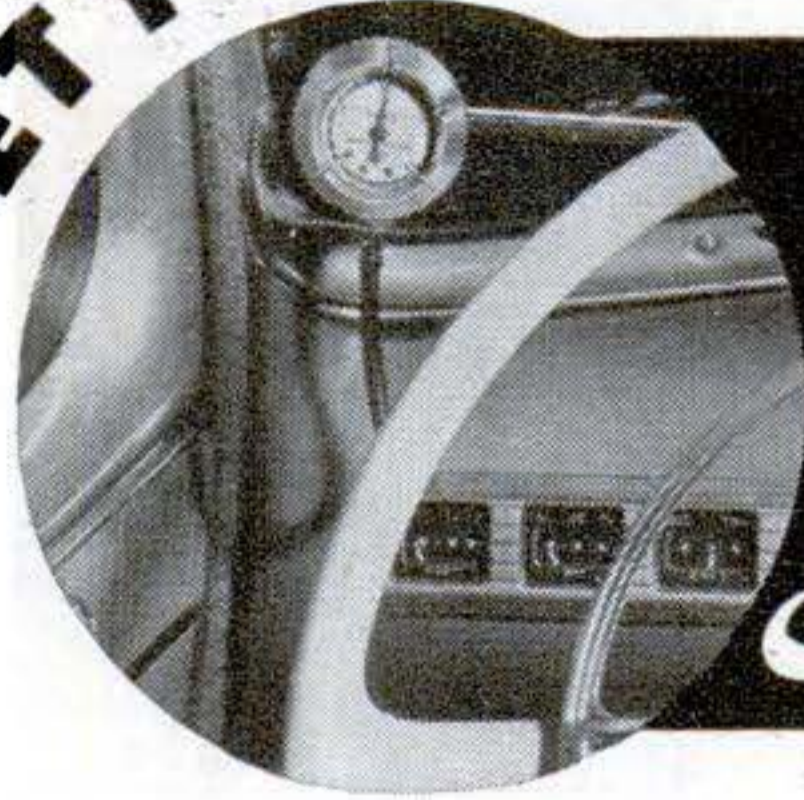

go hand  
in hand  
when  
you use

*Snow*

**GASOLINE MILEAGE GAUGE**

You know your exact gas mileage at any speed, under any driving conditions, right while you're driving when you use a Snow Gasoline Mileage Gauge! It's easy to cut gas consumption at least 10 % and drive more safely too, because the Snow Gauge shows up fuel waste in careless acceleration, high speed driving and other bad driving habits—thus economy becomes a constant safety reminder!

**cut repair bills, too!**

Fouled spark plugs, faulty valves and other engine troubles show up on the Snow Gauge in lower gas mileage—you catch these troubles in time and save costly repair bills — thanks to your Snow Gasoline Mileage Gauge!

Your dealer will install your Snow Gasoline Mileage Gauge quickly — no special tools or drilling necessary. Made for Ford 85 and 100; Mercury; Chevrolet; and Plymouth only. If your dealer can't supply, send \$6.00 to Snow Plastics Corporation, 221 E. 26th St., Chicago 16, Illinois. Specify make of car!

**BUILD YOUR POWER TOOLS**

WITH OUR GUARANTEED INDUSTRIAL

10,000 rpm

**POLY BALL ARBORS**

(No extra charge for  
left hand threads) **ORDER NOW!**



C4-1/2x12 1/2 spindle, housing 2x8 \$7.95 pp.

C5-5/8x12 1/2 spindle, housing 2x8 \$8.25 pp.

C6-3/4x12 1/2 spindle, housing 2 1/4x8 \$9.25 pp.

D8-1x17 1/2 spindle, housing 2 5/8x11 \$17.00 pp.

C5-5/8  
Pictured

New Departure Self  
Lubricating Bearings

Complete Line of Shaper Arbors Also Available.

**POLY PRODUCTS, 2032-B E. Walnut, Pasadena 8, Calif.**

**NEW! TRUE TEMPER "SPEED SHAD"**

5/8 oz.



6 best finishes

**\$1.25**

**AT YOUR  
DEALER'S**

**CAN YOU TOP THIS?**

"Congratulations on a wonderful bait—the Speed Shad. I caught my limit on it the last 6 times out. Only fished 2 hours at a time." Ray Huff, Reynolds Landing, Cheboygan, Michigan. If you have a better story, we'll print it. The American Fork and Hoe Company, Cleveland, Ohio. Write: Sporting Goods Division, Box 4-D, Geneva, Ohio.

- ★ A deep swimmer
- ★ Live minnow action
- ★ Patented Stump guard
- ★ Each, factory tested to insure perfect action

Produced and recommended by the Makers of True Temper, Rod of Champions.

*Used on  
more new cars  
-sold by more  
dealers!*



replace with a  
**DELCO**  
BATTERY

**DELCO-REMY WHEREVER WHEELS TURN OR PROPELLERS SPIN**

**EASIER SANDING  
10 Times Faster!**



**HOME  
Craftsmen!**

Why wear your skin down to the bone with hand-sanding drudgery? This sturdy, light Belt Sander turns out smooth, expert sanding in minutes—instead of hours.

On wood, metal, stone or plastics . . . on flat, straight or curved surfaces, this time-tested Porter-Cable Sander gives you a beautiful, professional finish. Does refinishing, clean-up work. Smooths glued joints. Hollows out. Removes paint and varnish. Gives final finish.

Powerful motor speeds 2" x 21" abrasive belt at 600 surface feet per minute. Overall size 4" x 12" x 6". Weighs only 12 lbs. Operates in any position.

Model A-3 — 3/4 hp — \$99.50

Model A-2  
**\$57.00**

**For Heavier Sanding in Less Time**

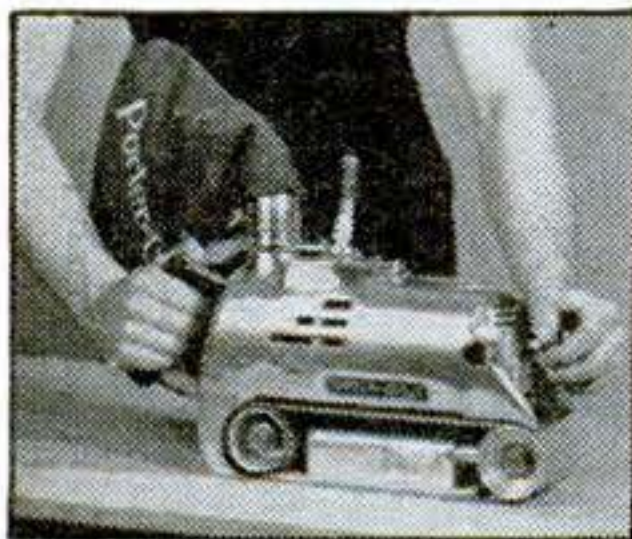

**BB-10 Sander**

Size and speed suits it to production sanding and planing. Easy to handle in continuous work. Perfect balance . . . Instant belt change . . . Dust-free operation. Excellent for wood shop, maintenance jobs, and many industrial uses. Extra powerful 1

HP motor. Abrasive belt is 3" x 27". Speed: 1475 s.f.p.m. Overall size 5" x 18" x 9 1/4" . . . Weighs only 36 lbs.

**COSTS ONLY \$148.00**

Pays for itself in a few weeks.

**New Abrasive-Belt  
BENCH GRINDER**

Unit can be attached to bench motor. In any shop—on production lines—or in the home—this abrasive belt-type Handy Grinder increases production 200% over ordinary wheel grinder. Deburrs, chamfers, bevels, knocks off corners, etc. Eliminates wheel loading, wheel dressing, wheel digging. Grinds on contact wheel, formed contour wheel, platen or free belt. Easily adjusted to any position within 90° arc.

**COSTS ONLY \$39.50**

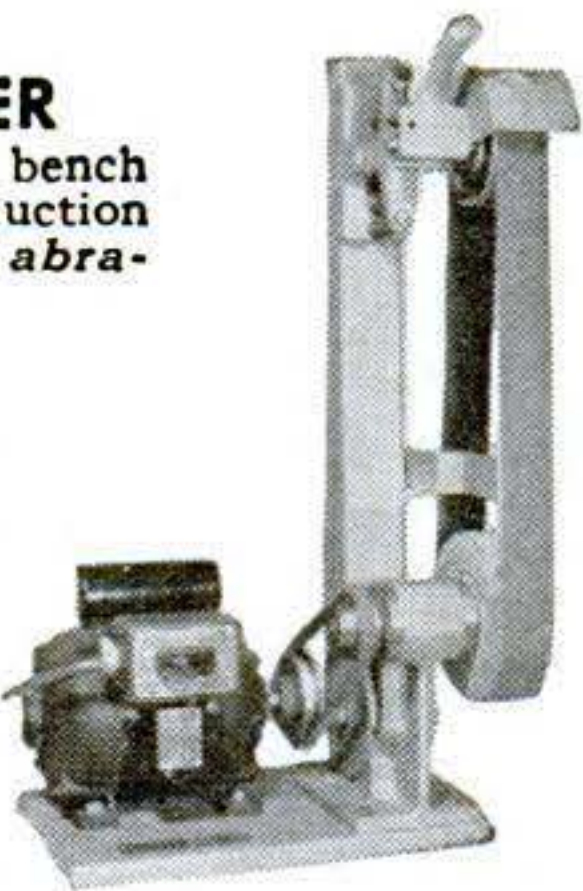

**See These Time-Saving Tools**

At leading hardware stores, mill and building supply houses. Meanwhile, write us for further information on the many uses of these tools, carrying lifetime guarantee. We'll also send you the name of your nearest dealer.

**PORTER-CABLE Machine Co.**  
1902-4 N. Salina St. Syracuse 8, N. Y.

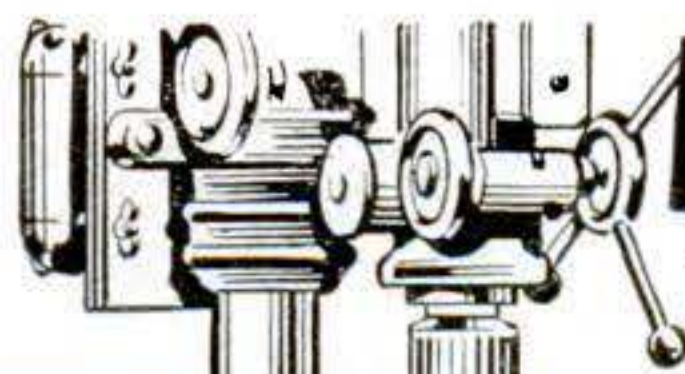

**NEW!**

**HANDY  
FLEXIBLE SHAFT**

**ONLY  
\$2.95**

● Converts Any Motor, Drill Press, Electric Drill, Electric Fan Into A Handy Rotary Tool.

● Attach ROTA-SHAFT in a Jiffy. Can Be Used for Grinding, Polishing, Sharpening, Cleaning, Engraving, Marking Tools, Carving, On Metal, Plastic, Wood, Glass.

**YES!** Only \$2.95 and ROTA-SHAFT turns your old motor, drill press, electric drill or electric fan (10 inch or larger) with blades removed, into an efficient, versatile Flexible Shaft Tool for doing hundreds of grinding, polishing, sharpening jobs, especially in hard-to-get-at places. Attaches to motor shaft or in chuck. Convenient handpiece for ease of handling. Generous 40-inch overall length. Comes complete with buff and sanding disc ready to use in a drill press chuck. Order today.

**OLD FAN MOTOR**



**YOUR ELECTRIC MOTOR**



**VACUUM CLEANER MOTOR**



**SEND NO MONEY!** Just mail order. Pay postman only \$2.95 plus postage on delivery, or send \$2.95 and we pay postage. Try 10 Days—if not delighted return for money-back.

If you order Rota-Shaft for use on motor add 35c for Special Coupling and State Shaft Diameter. **MAIL ORDER NOW!**

**STRADER PRODUCTS CO.** Dept. B-102  
259 Strader Ave. Cincinnati 26, Ohio

**Profit with LARSON Leathercraft**

Make as gifts—or to sell—practical leather items. Complete stock of leathers, tools and accessories. No experience necessary. Instructions with materials. Send ten cents for new catalog of 101 money-making ideas.

**J. C. LARSON COMPANY**  
826 S. Tripp Ave. Chicago 24, Illinois

**\$10-\$25 DAILY FOR LIVE SALESMEN**

**CASH COMMISSION ADVANCED**  
DEALER SALESMEN—Earn \$10 to \$25 daily. Easy \$1 deal all merchants need and want, you keep the dollar, and big repeat commissions. Free actual samples and kit offer. Write Quick!

**FAST DOLLAR DEAL  
YOU KEEP THE \$**

**STATES TRADING CO.**, 330 So. Wells St., Dept. 13, Chicago 6, Ill.

**Save Fingers  
with  
Steel-Grip Finger Guards**



Hundreds of factories are saving time and protecting workers with Steel-Grip Finger Guards. Used for handling rough, sharp articles, buffing, grinding, sanding, polishing, punch press work, many other jobs. Wear on fingers or thumb, front or back. Durable leather, elastic web back for snug, cool, comfortable fit. Easy on and off. One size fits all, men or women. Send 10c each for samples or trial order box of 50 at \$4.25 less 10%.

Catalog of Steel-Grip Safety Apparel free on request.

**INDUSTRIAL GLOVES COMPANY**  
1420 Garfield Blvd., Danville, Ill.  
(In Canada: Safety Supply Co., Toronto)

**OLD HICKORY  
STEEL GRIP**  
Famous Industrial Safeguards Since 1910

# SpeedWay



## No. 117 PORTABLE BENCH *Electric* GRINDER \$1495

Light weight, complete with built-in 1/15 H.P. motor, one "fine" and one "coarse" grinding wheels (4 1/2" x 3/8" x 3/8") 6 ft. rubber cord and even rubber feet, the capable little grinder goes anywhere, plugs into any 110-115 V. AC outlet and will do a hundred grinding, sharpening and touch up jobs easily and quickly. Quality built-completely housed in cast aluminum that has formed in wheel guards and tool rests. Specially wound, powerful long life air cooled motor. Oil impregnated bronze bearings. Built in switch.

*Available now. Your local SpeedWay dealer has this attractive light duty grinder in stock. Ask for a demonstration.*

### No. 129 GRINDER \$825



### No. 69 1/4" DRILL \$1180



### No. 229 DRILL STAND (Less Drill) \$525



### No. 209 Drill Stand (Less Drill) \$1295



### No. 89 1/2" ELECTRIC DRILL \$2995



### GA KIT \$1395



## "Blue Line" Tools

SpeedWay Blue Line Tools are especially designed and priced for the home workshop, the farm, garage and repair man, for every job where a handy light weight, "light duty" tool is called for.

Each is a quality tool correct in speed with its specially wound high torque SpeedWay tool motor. Each will do its work well and give long satisfactory service for it embodies an excellence developed thru SpeedWay's 35 years of leadership in the design and manufacture of portable electric tools and motors . . . each is fully guaranteed for 1 year.

Blue Line tools are sold in most leading hardware, mill supply and tool stores, automotive and appliance outlets.

*Write for Circulars, or ask your local dealer.*

**SPEEDWAY MANUFACTURING CO!**  
1864 S. 52nd AVENUE • CICERO, ILL.

# Greenlee 22

## SOLID-CENTER AUGER BITS

### FOR FAST, ACCURATE WORKMANSHIP

GREENLEE 22 is a name it will pay you well to remember whenever you buy Auger Bits. For it assures you sharp cutting edges, accurate sizing, bright, high finish, and that smooth, easy action so necessary in fine craftsmanship. You can be certain, too, that every GREENLEE 22 Solid-Center Auger Bit is "factory sharp" when it reaches you. For each is "Plastic-Sealed" with a special protective coating to keep it in perfect condition for you. To buy top quality, buy GREENLEE.

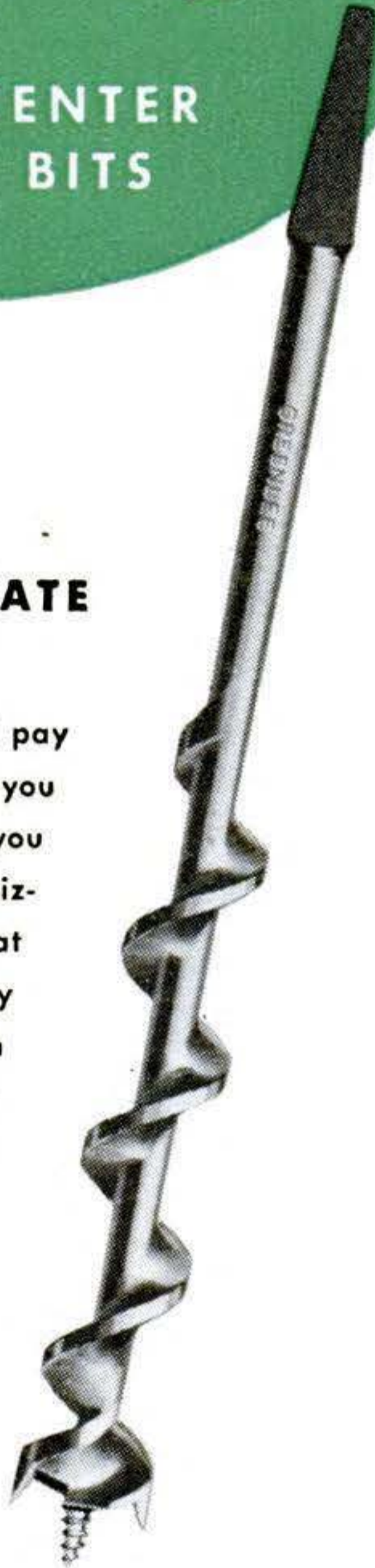

TOOLS FOR CRAFTSMEN

# GREENLEE



### SPECIAL OFFER... ONLY 10¢ FOR HANDY WOODWORKING CALCULATOR

Quick solutions to countless woodworking problems. Just set dial: convert linear feet to board feet; compare characteristics and workability of various woods. Also shows bit



sizes; nail specifications; tool sharpening hints; etc. Heavily varnished cardboard, 6" diameter. Send 10c to Greenlee Tool Co., 2124 Columbia Avenue, Rockford, Illinois, U. S. A.

## ASSEMBLE

# King Midget



45 MILES AN HOUR

90 MILES A GALLON

Practical, safe, low cost Highway Runabout, with all the snap and looks of the finest midget track racers. Home assembly keeps cost low. Just bolt together from our factory built parts. Immediate delivery. Send 25c for complete circular with large picture, 4-view drawings, price of all parts. Or send \$1. (refunded first order) for this plus 24-page assembly book with 42 photographs and drawings, blueprints, etc.

**MIDGET MOTORS MFG. CO.** Athens, Ohio

### Everything in Radio!

Make Radolek your buying headquarters for Radio-Electronic repair and replacement needs. Large stocks assure finest, most complete selections of all available items at lowest prices. Your orders receive special attention for fastest delivery. Send today for FREE Radolek Buying Guide.

RADOLEK CO., Dept. A-048, 601 W. Randolph St., Chicago 6, Ill.

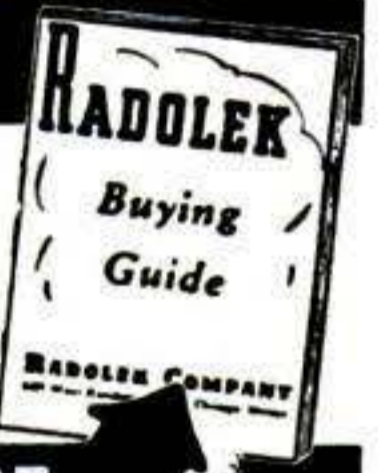

**FREE RADIO BUYING GUIDE**

## Genuine Snap-on Tools

Available Only Through Snap-on's  
Direct-To-User Tool Service

WRITE FOR INFORMATION

**SNAP-ON TOOLS CORP.** • Kenosha, Wisconsin

LOOK!

**\$1.50**

**FINDER SAX-SLING**

NEVER SLIP OR KINK  
HIGH SPEED ADJUSTING  
BALLBEARING

AT ALL GOOD DEALERS

Mfg. by FINDER, San Diego, Calif.

**NEW!**

## BUILD YOUR OWN TRAILER

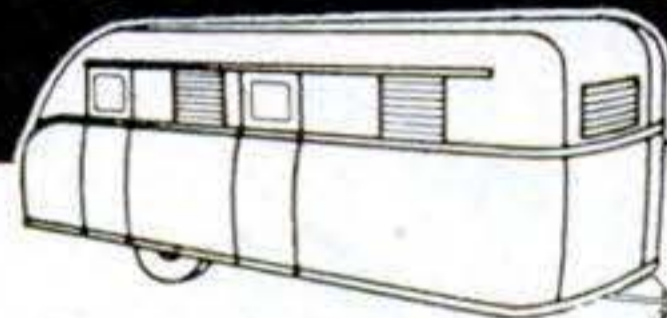

Get these Modern  
Complete Plans

Select just the model you want—for hunting—travel—camping—or as a home. Each plan is complete with simple, step-by-step instructions and a bill of materials. Easy to follow. Three models!

STOCK No. H27 NATIONAL MODEL 27. A sleek 27-foot trailer with 3 rooms, lavatory, etc. Sleeps six. complete plan \$1.00

STOCK No. H20 NATIONAL MODEL 20. A good-looking, easily-built 20-ft. trailer. 3 rooms, sleeps four. complete plan \$1.00

STOCK No. H10 NATIONAL CAMPER. A compact unit for traveling, camping, hunting, fishing. Sleeps two. Complete plan .50

Special—Order all 3 of above plans.....\$2.00

**FREE!** Big parts catalog with any order

**NATIONAL TRAILER STORES**

Dept. 9 Box 2353 Terminal Annex — Los Angeles 34, Calif.

# Now Available...

## Amazing New P&H AC Arc Welder with Dial-lectric Control

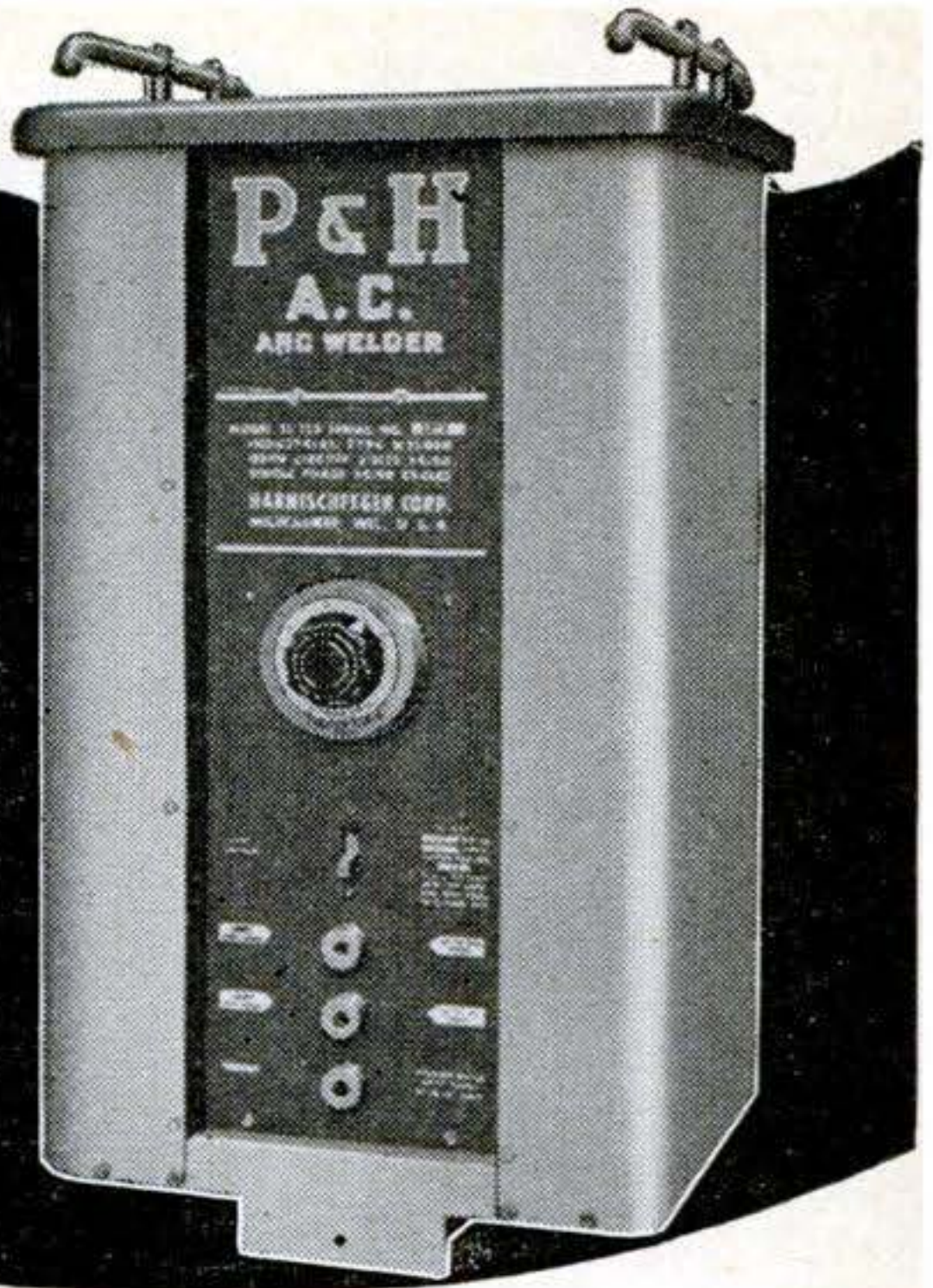

### Makes sound welds easier, faster, and at lower cost

These industrial and commercial arc-welding jobs are easier to do and cost less when you use a P&H Dial-lectric AC Arc Welder:

- All types of industrial welding
- Sub-contracting work for large manufacturers
- Air conditioning
- Home heating
- Truck body building
- Trailer building
- Automotive repairs { blocks fenders frames
- Fuel-oil tanks
- Contractors' welding
- Bridge work
- Construction equipment repairs { excavators tractors graders ditchers, etc.
- Kitchen equipment
- Cabinet work
- Fabricated housing
- Fabricated garages
- Cast iron repairs for foundries
- Maintenance work for industrial plants
- Ventilating systems
- Bicycle repairs
- Stainless steel bar equipment
- Ornamental iron work
- Fabricating equipment of your own design

Built for heavy industrial use, with welding service range from 20-275 amps. Also ideal for automotive, general repair, job welding, and machine shops; foundries; schools; etc.

#### The only welder with easy-to-use Dial-lectric Control

Anyone can quickly learn to use the new P&H Dial-lectric welder. There is only one control — the dial is clearly marked and a ¼ turn of the radio-like knob covers the entire welding range. There are no plug-ins to make, no wheels or levers to crank or adjust — welding is just plain easy with a P&H Dial-lectric machine. A clearly illustrated, easily understood welding manual is supplied with each machine so that beginners can learn to weld in an extremely short time. Old hands may pick up some new tricks, too.

#### No maintenance is needed

Dial-lectric control eliminates all moving parts. That is why P&H AC Welders require no attention or maintenance — why operating costs are lower — why so many industrial users are switching to this new welder. Also, NEMA rating assures you of long life and dependable operation.

#### You produce sounder, better-looking welds in a shorter time

The P&H remote control feature permits proper heat selection at the job. You waste no time or energy walking back and forth to the machine to make adjustments. There is no temptation to skimp — remote control lets you use the right heat. Welds are sound and better looking. Work is done faster. Additional features that make for better, faster welding are: Easy quick-start arc. High-low welding range. Elimination of arc blow.

#### Requires only 2¼ feet of floor space

You can put a Dial-lectric welder most any place — it is connectible for 220 or 440 volts. Despite its weight of 307 lbs., it is remarkably compact. The Dial-lectric is easy to move around, too — it's mounted on wheels, you handle it just like a hand truck.

#### A complete electrode service is provided by convenient P&H Shop Packs

P&H Shop Packs contain eight different packages of electrodes. Detailed instructions are printed on each individual package so that you can use the right electrode for every

job. Guesswork is eliminated. Welds are stronger, better-looking. You can weld anything made of steel, alloy or stainless steel, sheet metal, cast iron. You can put hard, protective, long-life coatings on new parts, or build up worn parts better than new. The cost of all 8 types, individually packaged and labeled for your convenience, is only \$11.75.

It pays to use P&H electrodes. No matter what make of welder you have, order a P&H shop pack today from your nearby P&H distributor.

#### Reduce welding costs in your plant or business

If you are connected with, or are interested in welding, use your influence to bring in a P&H Dial-lectric AC Welder. A comparison of its performance with that of other units quickly shows that a Dial-lectric improves the quality of the welds, speeds the work, and reduces costs.

A P&H Dial-lectric AC arc welder can be purchased for as little as \$209.75. Also get P&H Shop Pack electrodes (\$11.75). You will want to standardize on these weld rods after you have checked their speed, quality, easy manipulation, and great variety of uses. Contact your nearby P&H distributor, or send in coupon below, clipped to your business letterhead.

**P&H ARC WELDERS**  
 4674 W. National Ave.  
 Milwaukee 14, Wisconsin

**HARNISCHFEGER CORPORATION**

Manufacturers of  
 America's Most Complete Welding Service

**TEAR OUT COUPON, ATTACH TO YOUR BUSINESS LETTERHEAD, AND MAIL TODAY**

HARNISCHFEGER CORPORATION  
 4674 W. National Avenue, Milwaukee 14, Wisconsin

Yes, I'm interested in the new P&H AC Arc Welder with revolutionary Dial-lectric control, and money-saving P&H electrodes. I would like information on the items that I have checked below.

- P&H AC Welders       Send address of distributor  
 P&H "Shop Pack" Electrodes       Send representative  
 Send Free Book, "Simplified Welding"

Name.....  
 Position..... Company.....  
 Address.....  Home  Business  
 City..... State.....

**Hobart**  
helps you  
**SUCCEED**

**in ARC WELDING**



The HOBART "Build Your Own" (Generator Only)

**A Big Pay Business**—and it's all yours! It's so easy to start your own job welding shop and reap the big dividends that Hobart Arc Welders bring you. There's plenty of arc welding repair and construction work everywhere, customers even bring it to you.

**Hobarts Weld Better**—that's because of exclusive operation features that save you time and money. The exact welding heat is easy to get, for Hobart lets you select from 1000 volt-amp combinations. Hobart's Remote Control saves valuable time by allowing you to adjust welding heat at the work. Hobarts last longer because they're built better!

**"Build Your Own"**—and save hundreds of dollars! Make your own gas drive portable arc welder using the Hobart "Build Your Own," a reconditioned motor and chassis. Free booklet gives complete instructions.

**Send the Coupon**—for complete details on the Hobart Arc Welder you desire—there's no obligation.

**HOBART BROTHERS COMPANY**

BOX P-48, TROY, OHIO. "One of the World's Largest Builders of Arc Welders"

**HOBART Jr. Electric 150 Ampere Welder**



The HOBART A. C. Welder for single phase lines

**The HOBART SCHOOL of ARC WELDING**

It's a modern trade school in which students learn by doing. Expert instructors give individual attention. Each student has own welding booth and welder. Fully accredited under G. I. Bill of Rights. Send coupon.

**HOBART**

HOBART BROS. CO., BOX P-48, Troy, Ohio

Send me the Free Book, and also information on items I've checked below:

- Electric Drive     A. C. Welder  
 "Build Your Own"     Welding School

NAME \_\_\_\_\_

ADDRESS \_\_\_\_\_

**Free!**

Arc Welder's Vest Pocket Guide contains tables, equations, charts, etc.



**SMALL EFFICIENT SPEED REDUCER**

Just the thing for the Home Work Shop, Hobby Shop, Bench Work, Animated Displays, Light Production work. Used daily in thousands of homes and shops. Sturdy, compact, (see dimensions). Case of aluminum. Gears, SAE 65 (British) Gear Bronze. Worm of case hardened steel. Timken Bearings throughout. Torque capacity 100 inch pounds Available in 4 different assemblies (shown below) and in these standard ratios:



**\$18.56**

NET — POSTPAID

4-1	25-1	64-1	200-1
8-1	30-1	75-1	200-1
10-1	40-1	80-1	400-1
16-1	50-1	100-1	600-1
20-1	60-1	150-1	800-1

When ordering be sure to specify assembly and ratio required. Shipping weight in carton, 8 lbs. Full money back guarantee. Prompt deliveries.

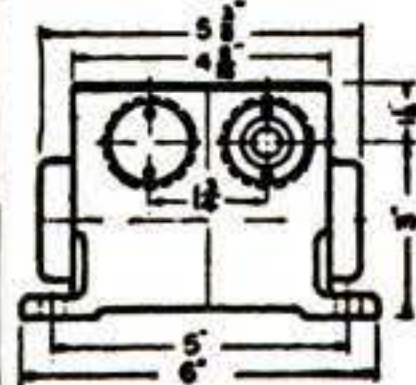
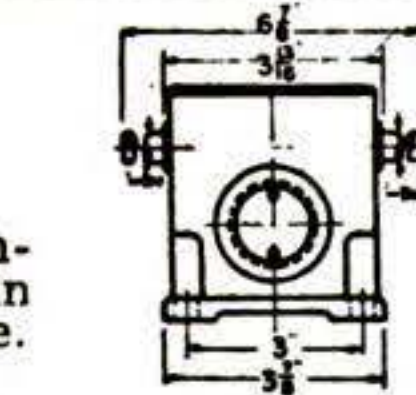
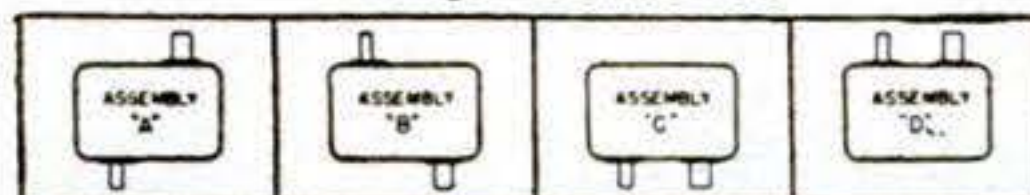

**THE OHIO GEAR CO.**

1424 EAST 179th ST. • CLEVELAND 10, OHIO

**NONE BETTER!**

**SUPER DRILL GRINDER**



Sharpens round shank drills from 3/32" to 1 1/16" in diameter, up to 11" long. Grinds old drills like new in 4 different point angles, using hand or power grinding wheels. Money-back guarantee.

Price only **\$2.95**

At Dealers or Postpaid

Crandall Mfg. Co. 1512 W. Slauson, Dept. FB-28 Los Angeles 44, Calif.

**V-8 DUALS & SINGLES**



DEALERS WANTED

**MUFFLERS**

**STEELS and ALUMINUMS with a motorboat tone**

SINGLES, Chev., V-8, Plymouth, Steels \$5.50, Aluminum \$7.00. Chry., Olds., Buicks, etc., Steels \$7.50, Aluminum \$9.00. V-8 and MERCURY DUALS, Steel \$17.50, Aluminum \$21.00. Split Manifold Sets, Steels \$35.00, Aluminum \$45.00. Aluminums are guaranteed for life of your car.

**SANDEE MUFFLER CO.**

BOX 296 LA TIJ., LOS ANGELES 43, CALIF  
2624 W. SLAUSON AVE., LOS ANGELES, CALIF.

**\$2.95**

**TORNADO GAS TORCH**

*The Modern Way of Soldering*

Ideal for hard and soft soldering. Will heat quickly; solder will flow freely and smoothly. No compressed air required. Self-adjusting. Safe. Economical. Can be used for annealing small parts and bending metal parts. Generates a heat of 1700° F. Simply connect to any illuminating gas jet with a rubber hose and operate. Tornado Torch No. 119 comes with three tips, (1/8", 1/4", 3/8" blast).

Tornado Gas Torch No. 119—Complete with 2 tips, for Natural Gas or Bottled Gas; with 3 tips for Manufactured Gas. \$2.95 per set. See your dealer or order direct. Send check or money order—post paid.

Robco Corporation, 204 E. 44th Street, New York 17, N. Y.



# QUICK PROFITS!

**\$84.00**

A WEEK FROM  
2 SALES A DAY

## SELL RANDOLPH Fire Extinguishers



NEW...  
MODERN...  
APPROVED...



Every building holds a prospect. Homes, Boats, Cars, Garages, Gas Stations, Shops, Laundries, Farms, Hotels, Stores, Factories.

THEY WANT A RANDOLPH with its panic-proof trigger action that smothers the fire instantly in a snowy blanket of carbon dioxide. No mess, no water, no damage, even to food. It evaporates without a trace.

YOU CAN QUALIFY for exclusive territory to sell the famous, nationally advertised Randolph used by leading industrial concerns everywhere. Approved by Underwriters' Laboratories.

Quick profits await those who act at once. Four sales a day net \$168.00 a week. Write today for full or part-time plan, territories, demonstration kit, etc. Don't delay.

### Randolph Laboratories, Inc.

4 EAST KINZIE ST. CHICAGO 11, ILLINOIS, U. S. A.

### 250 PIECE MASTER ARBOR SET

catalog value \$28.00

for only

**\$6.95**

Post Paid



The very finest tools for your handy drill bench or anything with a chuck, 1/8" and 3/32" shafts.

Set contains the following mounted items: 15 burs, 8 stone grinders, 1 large stone point, 5 large carbon stones, 2 saws, 1 large buff, 3 ass't brushes, 1 rubber wheel polisher, 6 ass't stones, 5 cut-off wheels, jewelers polish, 2 rubber polishers, 100 ass't sanding discs, 100 black discs.

GENERAL AIRE CO. Dept. A  
447 W. Norris St., Philadelphia 22, Pa.

### Do You Ride a Bike? Here's the Real

## SHOCKMASTER

for all Bicycles

- LEVELS ROUGH ROADS
- PREVENTS BROKEN SPOKES, WHEELS, FORKS
- MAKES RIDING SMOOTHER, SAFER
- EASY TO INSTALL



A Shockmaster and front wheel shock absorber ruggedly constructed of nickel plated steel and engineered for years of real service. It'll pay for itself in added pleasure, saves tires and eliminates many costly repair bills. 20,000 satisfied users. Order yours today. Only \$3.69 postpaid. No C.O.D.'s. Complete satisfaction or money back. Dealers Wanted.

H. M. GIBB and COMPANY  
1304 PENOBSCOT BLDG. DEPT. B DETROIT 26, MICH.

# You've never used a finer tool than this new drill

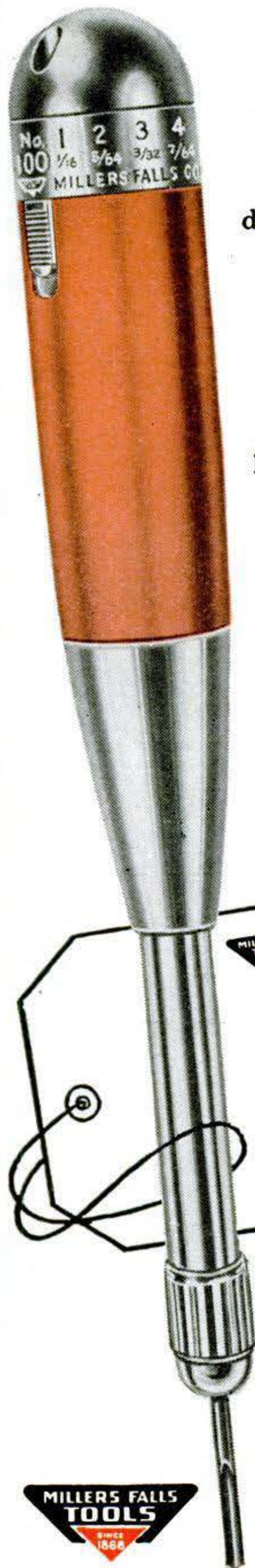

Hop right down to your favorite hardware store and take a good look at this brand new automatic drill . . . (it'll be prominently displayed). See if your fingers don't itch to hold it . . . heft it . . . put it to work. Note that *man-size* handle . . . feel how snugly it fits your grip. Sense that *balance*. See how easily and rapidly this drill works . . . how smoothly it's controlled. Clean lines, slick design, bright nickel-plated shaft — a honey of a drill no craftsman can resist. MILLERS FALLS CO. Greenfield, Mass.

### DIAL THE DRILL POINT YOU WANT

. . . and out of a hole in the handle drops any one of 8 points, 1/16" to 1 1/64"



# Millers Falls Tools



Celebrating 80 Years of Toolmaking



## A SCHULT IS "TOPS" IN VALUE!

● Your modest investment buys *more* in a Schult . . . dozens of *plus-values* that cost you nothing but ADD to comfort, privacy, livability and convenience. A Schult is a dependable, *quality* product, backed by more than a decade of experience and research. Let your Schult dealer show you the new 1948 models. Or write SCHULT CORPORATION, Dept. 3104, Elkhart, Indiana. *In Canada:* John Inglis Co., Ltd., Toronto.



★ ★  
You'll have to spend some time in a SCHULT to appreciate the living comfort it offers.

**Free** Write today for book on trailer coach living showing latest, comfortable 1948 Schult models.



# SCHULT Trailer Coaches



## LATHE COLLETS

Precision Steel and Brass Collets for use in any make of lathe or other machine that they will fit.

### SPECIFICATIONS



Collet No.	Thread Dia. In.	Thread Length In.	Th'ds Per In.	Body Dia. In.	Collet Length In.	Head Dia. In.	Head Taper Deg.
3	.650	3/4	26	.6495	2-11/16	.852	12
2	.855	13/16	20	.8595	3-5/16	1.095	15
5	1.250	3/4	20	1.2495	3-9/32	1.452	10
4	.950	13/16	20	.9495	3	1.150	10

	No. 3	No. 2	No. 5	No. 4
STEEL COLLET	\$3.75	\$4.00	\$4.75	\$4.25
BRASS COLLET	2.00	2.25	2.50	2.35

**SOUTH BEND LATHE WORKS** 456A E. Madison St. South Bend 22, Ind.



## NEW 30" SHEET METAL BRAKE

Forms angles, channels, vees, flanges, locks, zees, boxes. Handles 26 gage sheet steel, heavier gages of aluminum, copper, plastic, etc. Portable. Can be held in a bench vise, or bolted down. All steel construction. Wt. 40 lbs. Shipped exp. collect. **ONLY \$24.50**

**12" BRAKE.** Cast iron and steel construction. Price \$14.50 PP.  
**18" CURVE FORMER.** Forms cylinders, round corners and cones in sheet metal and strap iron. Price, \$10.00 PP.  
**VISE IRON BENDER.** Forms rings, hooks, eyelets, etc. in 1/2" round or square; 1/4" up to 2" wide in bar iron. All steel construction. 8 parts. Price \$10.00 PP. For bending 3/4" pipe, \$2.00 extra.



**SHEET METAL PLIERS, 2 1/2".** Forms angles and channels. \$2.00. Sheet Metal and Wire Forming booklet, 50c.

WISE BRAKE MFG. CO., Dept. 54, 1318 So. 30th Ave., Omaha 5, Nebr.



## BUILD YOUR OWN ENLARGER

Enjoy Photography's most fascinating hobby at a fraction of usual cost. With simple step-by-step instructions and diagrams plus a screwdriver and pliers you assemble your own Enlarger and Save! Get all features of more expensive Enlargers: precision machined aluminum alloy castings, 90° tilt for wall projection of prints, spherical aluminum lamphouse, helical rack and pinion focusing with extra large knobs, unconditional guarantee.

Write Today for Free Illustrated Folder  
**CALIFORNIA TECHNICAL PRODUCTS CO.**  
8510 Warner Drive, Dept. K-4, Culver City, Calif.

## MORE POWER FROM YOUR ENGINE WITH PERFECT TIMING



Keep the timing of your car, motorcycle, outboard or boat engine, tractor or any gasoline engine "right on the nose", with this amazing new **TIMERLIGHT**. Easy to use. Attach one clip to engine block, the other to spark plug wire. Flash shows timing. A must for motorists, boat owners, farmers, mechanics. Nothing else like it. Send for yours NOW. Money back guarantee. **DEALERS: Good territory open. Write for details.** **CONNIE BERT CO.,** 8115 Clinton Road, Cleveland 9, Ohio



Say You Saw It In Popular Science

THE ONLY SAW BLADE THAT CUTS IN ALL DIRECTIONS WITHOUT TURNING WORK OR SAW

## TYLER Spiral SAW BLADES

Saws in any Direction for Most Intricate, Difficult Patterns.... Oil-tempered spring steel wire blade...outlasts other type blades

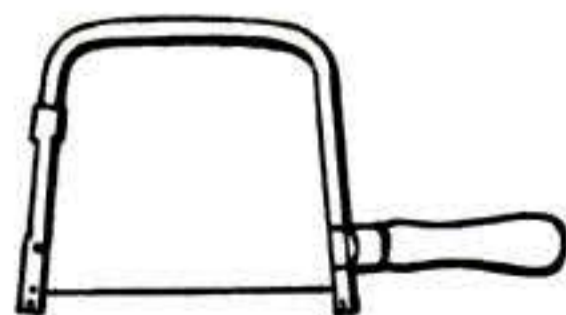
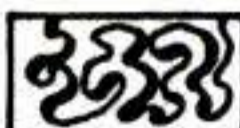

**COPING SAW..** Entirely new, better way of sawing . . . Only coping saw blade that cuts plastics . . . wood . . . metal . . . with absolutely clean, even edges. Won't tear. Now . . . anything you can draw . . . you can saw 360° cutting blade 1 coping saw frame 5 spiral blades, complete . . . only \$1.00

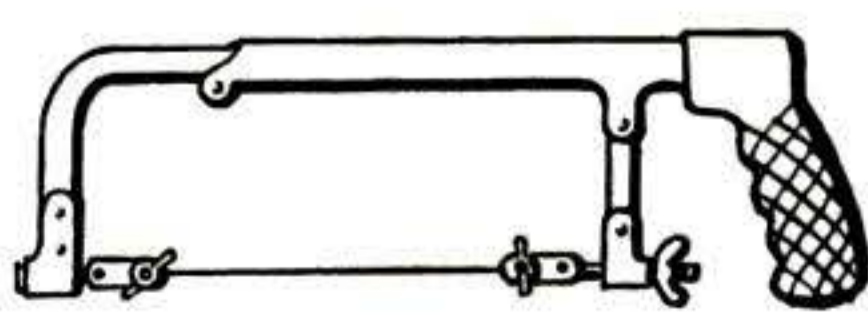

**REVOLUTIONARY SPIRAL HACKSAW BLADE..** Cuts iron, steel, bronze, brass, aluminum, plastics . . . any direction. Only blade that cuts tubing without tearing or grabbing. For intricate internal work . . . before impossible. Fits any standard frame. Merely slip adapters over pins. Length 10". 2 blades and pair of adapters. . . a real buy. . . only 39¢



At Your NEAREST HARDWARE STORE Or order direct today . . . Prompt shipment Your money back if not delighted.

YOUR BLADES ARE THE ANSWER TO MY CUTTING PROBLEMS..SEND AT ONCE..SAWING IS BELIEVING

**TYLER MFG. CO. — 938 Pico Blvd., Santa Monica, California, Dept. S-4**  
Please Rush  Send 1 coping saw frame  Send 2 hacksaw blades and 5 blades (enclosed \$1.00) pair adapters (enclosed 39¢)  
 Send BOTH — 1 coping saw frame 5 blades plus 2 hacksaw blades and pair adapters complete (enclosed \$1.39)

NAME \_\_\_\_\_  
ADDRESS \_\_\_\_\_  
CITY \_\_\_\_\_ STATE \_\_\_\_\_

**TYLER MANUFACTURING CO.** 938 PICO BOULEVARD SANTA MONICA, CALIF

**STRIPE  
WITH  
PAINT  
EASY  
AS  
USING  
A  
PENCIL**

## PAINERS' STRIPING TOOL

NOW you can do your own expert striping on furniture, bikes, model planes, bulletins, autos, toys, signs, linoleum, wall board . . . make plain walls look like tile! It's easy to paint straight, curved, circular, even parallel lines with any color. Handiest paint tool in your workshop! Type "M" Master Painters' Striping Tool complete with tip for 1/16" stripe, \$1.00. Extra tips 1/64", 1/32", 3/64", 1/16", 5/64", 3/32", 1/8"—75c each. Tool with complete set of 7 tips \$5.00. (C.O.D. orders 25c extra.) WENDELL MFG. CO., 4234—A Lincoln Ave., Chicago 18, Ill.

**A TOOL...  
NOT A BRUSH**

**\$1.00  
POST  
PAID**

Dealers  
Write  
Today!

## FLASH THAT VOLTAGE

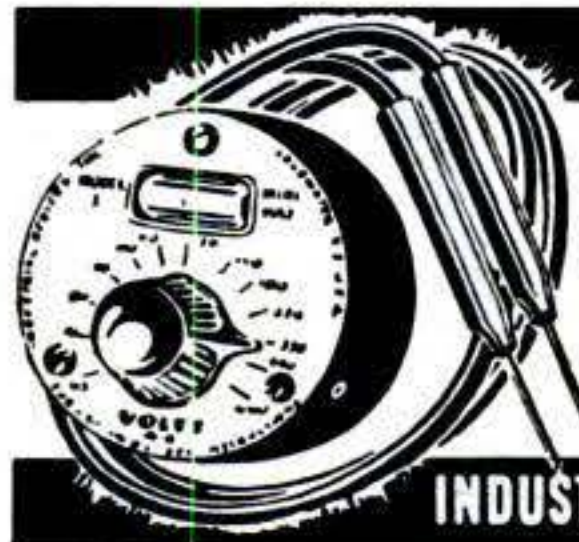

Turn that knob. Extinguish the neon glow. Instantly read voltage right off dial. MINI-VOLT measures 65 to 660 v. AC. Also DC. Tells whether AC or DC. Virtually burnout-proof. Guaranteed for 10,000 hours' operation. Bakelite case. 12" flexible test leads and test prods. A "must" in electrical and radio work. Only \$2.50 postpaid!

INDUSTRIAL DEVICES, INC., EDGEWATER 2, N. J.

## WHEELS AT BARGAIN PRICES

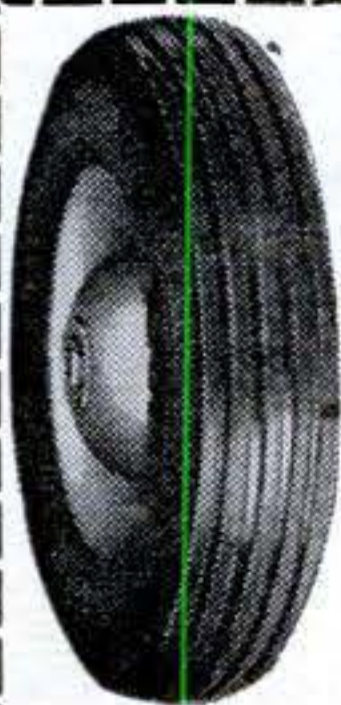

- ...4" wheel & tire, 5/16" sleeve bearing & hub cap .....\$0.45 ea.
- ...5" wheel 5/8" solid tire 5/16" shaft hole.... 0.65 ea.
- ...6" wheel 5/8" solid tire 5/16" shaft hole.... 0.75 ea.
- ...7" wheel 3/4" solid tire 3/8" shaft hole.... 0.85 ea.
- ...8" wheel 1" solid tire 1/2" sleeve bearing.. 1.25 ea.
- ...8 x 2" wheel, semi-pneumatic tire  
7/16" ball bearing..... 2.50 ea.
- ...10 x 1.75 wheel semi-pneumatic tire  
7/16" ball bearing..... 3.25 ea.
- ...12 x 1.75 wheel semi-pneumatic tire  
7/16" ball bearing..... 3.50 ea.
- ...10 x 2.50 wheel semi-pneumatic  
1/2" ball bearing.....4.50 ea.
- ...6 x 2" wheel 5/8" ball bearing, solid tires.. 3.95 ea.

**BUILD YOUR OWN Wagons, Scooters, Soap Box Racers, Welding Carts, Baby Pens, etc.**  
To order above wheels write number wheels wanted in space provided, tear out and mail this ad with check or money order and your name and address. If other sizes are wanted write for FREE LIST. TRULSON MFG. CO., 811 E. 31 St., Dept. M114, Kansas City, Mo.

## Nimrod PIPELITER



**\$3.50  
AT YOUR  
DEALER**

- WINDPROOF
- LIGHTWEIGHT
- LARGE FLAME

*Unconditionally Guaranteed*

*May is National Nu-Enamel Month*

# Paint Your Automobile

Paint Your  
Entire Car With  
**NU-ENAMEL**

**\$3.45**

For Only

Paint All  
Your Fenders **\$1.95**  
For Only



ONE COAT COVERS  
**NU-ENAMEL**

TRADE MARK REG. U. S. PAT. OFFICE  
**NO BRUSH MARKS**

Ask Your NU-ENAMEL Dealer  
For This Instruction Folder

Contains the step-by-  
step story of how you  
can Paint-It-Yourself  
with Nu-Enamel and  
get a professional  
looking job.



*"Paint-it-Yourself"*

**It's EASY! It's FUN!**

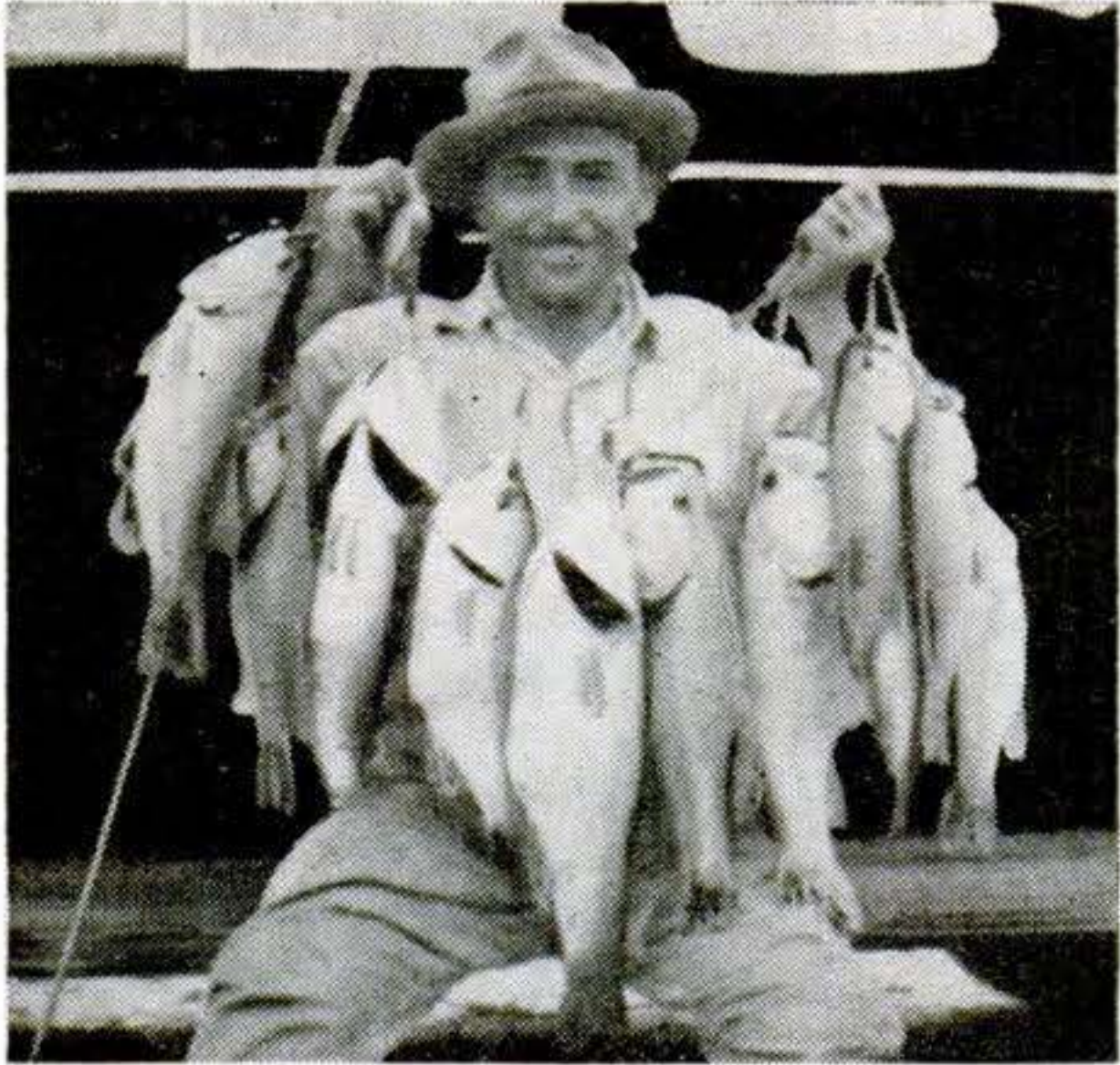

## "JITTERBUG— the greatest bass getter"

"Fred Arbogast Co.: I can't resist showing these bass I caught on your Frog Jitterbug. It took just two hours. In the string are one 6-pounder and two 5-pounders. Smallest was 3½ pounds. Later I caught 29 large-mouth bass in two weeks' time—all on the same Jitterbug. They weighed 84¾ lbs. Jitterbug is the greatest bass getter on the market—a bait I shall never be without."  
—John D. Sullivan, Tow, Texas.



Frog Jitterbug \$1.21 ea.

Choice of 6 colors. At your dealers.  
Write for Interesting, Free Catalog.

**FRED ARBOGAST & CO., INC.**

1724 North St., Akron 3, Ohio

## HARGRAVE CHISELS & PUNCHES

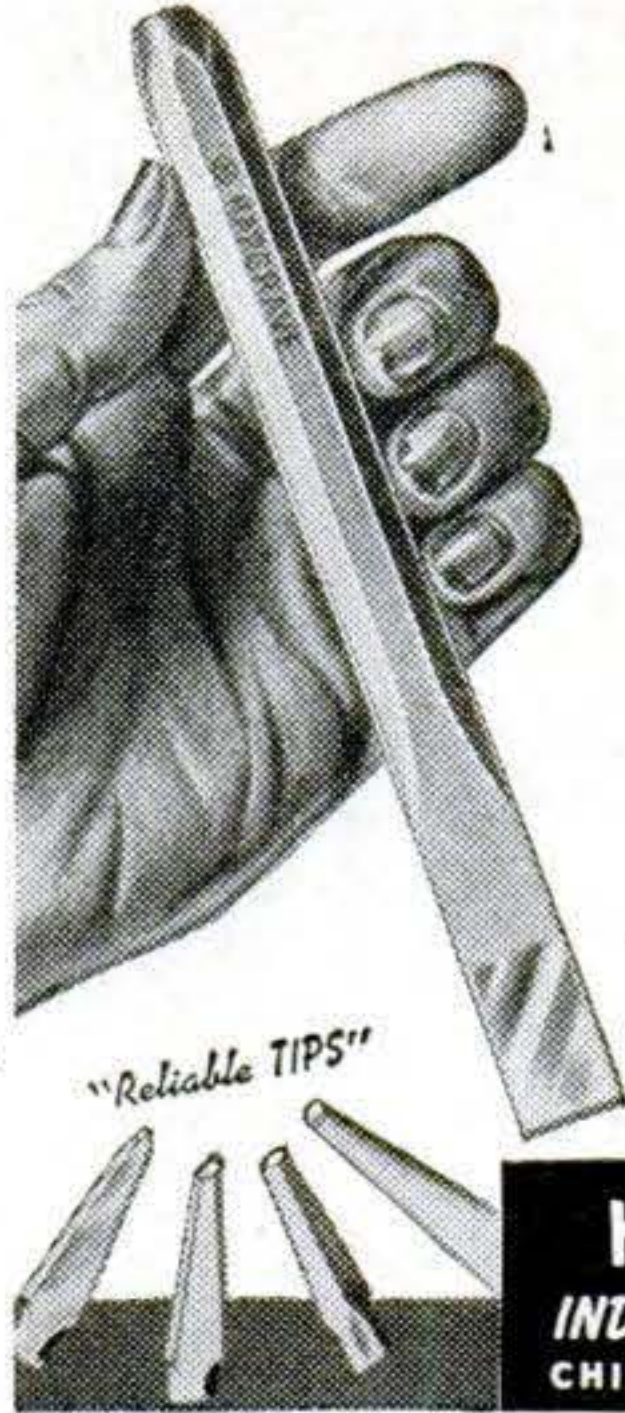

Individually Tested. Use the same chisels and punches in your workshop as the leading manufacturers do in their plants. Hargrave Chisels and Punches give your work that professional touch. Fourteen different types in almost 80 sizes.

WRITE FOR CATALOG.

At Hardware and Mill Supply Dealers Everywhere.

**THE CINCINNATI TOOL CO.**  
1955 Waverly Ave.  
Cincinnati 12, Ohio

**HARGRAVE**  
INDIVIDUALLY TESTED  
CHISELS AND PUNCHES

## RE-STRING RACKETS AT HOME

● EARN MONEY ●  
WITH THE WONDER VISE



FREE  
Write for  
our 1948 Catalog  
and Instruction Sheet.

It's pleasant, profitable work. No experience or skill required. Easy to learn. Full line of guaranteed Stringing Tools, Frames, Gut and Silk Strings. Every item high quality.

**W. A. BICKEL & CO.**

803 South Boulevard, Dept. A-51 Oak Park, Ill.

## MAKE YOUR OWN DISC SANDER

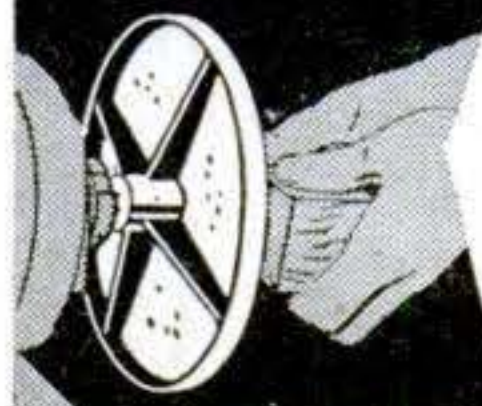

Mount this 8" cast aluminum sanding disc on any ½", 5/8" or ¾" spindle. Sturdy ribbed design. Order direct—\$2.00 postpaid. Threaded bore 25¢ extra. Abrasive paper discs, 8"—1 doz. asst. grits \$1.25.

1754 Clinton Street  
**EMRICK INC. KALAMAZOO, MICH.**

WRITE FOR FREE TOOL LIST.

# LAW

STUDY AT HOME for PERSONAL SUCCESS and LARGER EARNINGS. 39 years expert instruction—over 108,000 students enrolled. LL.B. Degree awarded. All texts furnished. Easy payments. Send for FREE BOOK.

AMERICAN EXTENSION SCHOOL OF LAW  
Dept. 88-S, 646 N. Michigan Ave., Chicago, Ill.

## WRITE FOR YOUR FREE COPY OF THE NEW KRW HYDRAULIC PRESS BOOK

Describes all manner of Production and Shop Work on KRW Hydraulic and Bench Type Arbor Presses. 32 pages illustrating the new KRW Hand-operated, Electric-operated and Air-operated Hydraulic Presses.

Write for your copy today.

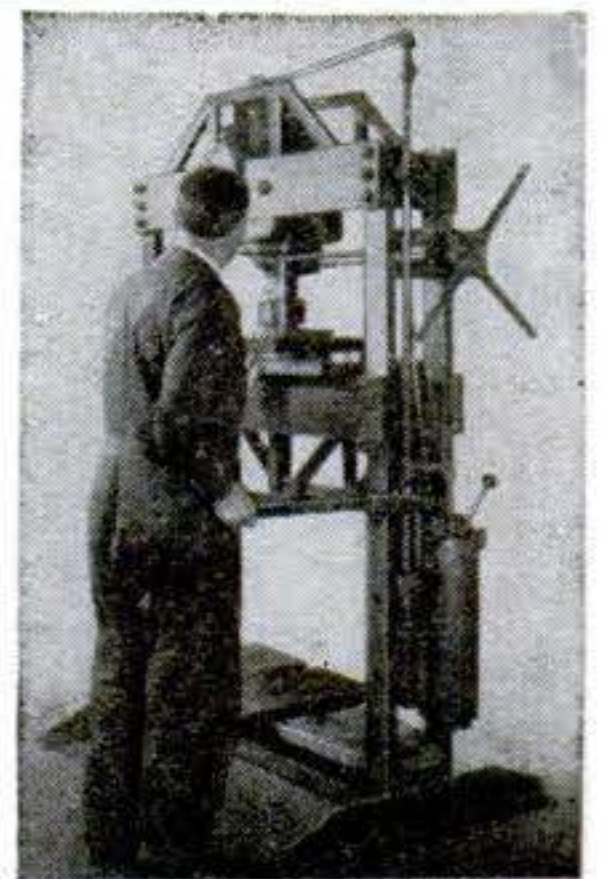

**K. R. WILSON, DEPT. 54, 215 MAIN ST., BUFFALO 3, N. Y.**

**LOOKIT! HARD-TO-GET ITEMS -- AT EASY-TO-PAY PRICES!**  
**SUPER SAVINGS! WAR AND OTHER TYPES OF SURPLUS!**

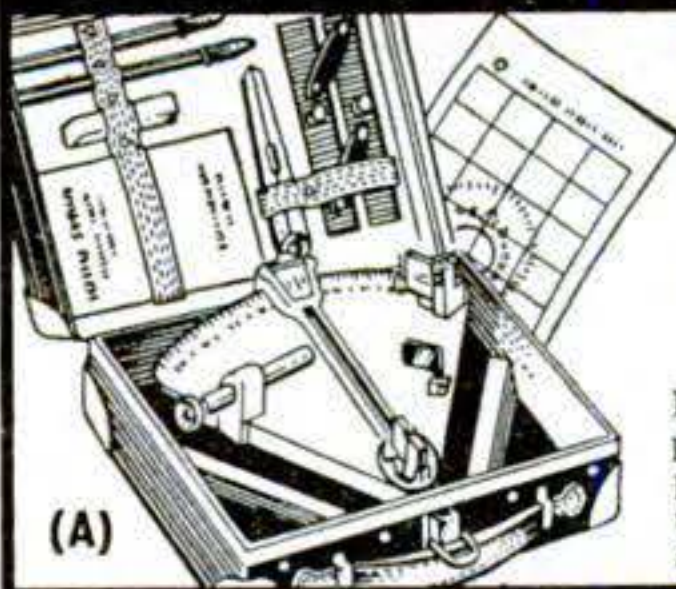

**(A) U.S. Maritime LIFEBOAT SEXTANT \$14.95**  
 Plastic sextant, caliper, parallel triangulator, plotting charts, instructions, pencils, eraser—all in sturdy fibre case!



**(B) Guaranteed 15-JEWEL WATCHES \$15** Fed. tax included  
 Luminous dial. Waterproof. Stainless steel case. Sweep second hand. Swiss movement. Choice of black, white, pink dial. Steel stretch band included.

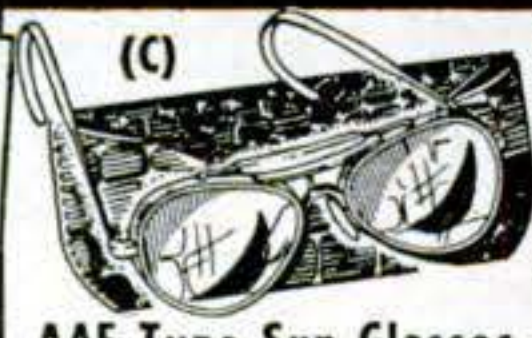

**(C) AAF Type Sun Glasses \$2.50**  
 Scientifically ground & polished. True green. Plastic nose piece, sweat bar. Case included.



**AEROSOL BOMBS (D) \$1.00**  
 Sprays 1000 cu. ft. in 4 seconds. Non-inflammable; non-toxic. Full 16 oz.  
**(E) Army #3 SASH TOOL BRUSH \$0.50**  
 Painter's pal! 10 inches long. Selected pure bristles. Polished wood handle.



**(G) NAVY GOB HATS 2 for \$1.00**  
 Swell for school and camp! Choice of gray or white heavy drill. Small, medium, large.

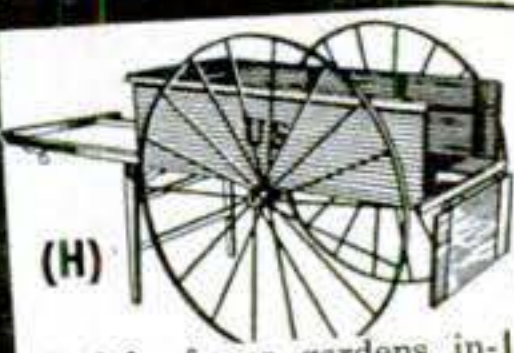

**(H) ARMY CARTS 19.95**  
 Ideal for farms, gardens, industrial use. Steel reinforced. Back drops for unloading. Legs fold flat under handles. Comes knocked down—assembles easily!  
 Length 91 in. Wheel diameter 48 in. Wgt. 225 lbs. F.O.B. Williamsport, Pa.

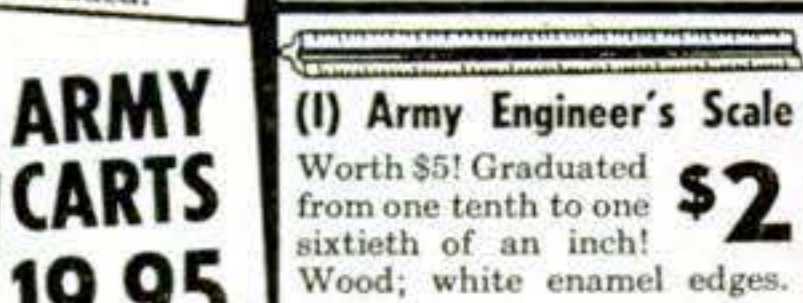

**(I) Army Engineer's Scale \$2**  
 Worth \$5! Graduated from one tenth to one sixtieth of an inch! Wood; white enamel edges.



**(K) Adjustable ELECTRIC LAMP \$2.00**  
 For drafting, work bench, home study. Heavy metal tubing. 4-way swivel. 44-in. reach. Heavy-duty clamp. 10 ft. of heavy cord.

**STAR SURPLUS SPECIALS FOR CAMPERS!**

**(L) Army Watch Compass \$1**  
 Highly polished brass snap-open case. Radium-painted needle for night use!

**(M) OFFICER'S CANVAS BEDROLL & RECON. ALL-WOOL ARMY BLANKET... BOTH FOR \$7.50**  
 Bought separately, \$4 each

**(N) NEW NAVY MESS TRAYS...\$1**

**(O) USED NAVY MESS TRAYS...50c**  
 Stainless steel; 6 compartments

**(P) ARMY PUP TENTS \$3.95**  
 Comes in 2 halves. Poles included! Plenty of room for 2 campers! Buy two, put 'em together, and sleep 4! As good as new!

**(Q) NAVY 7-INCH HUNTING KNIFE \$1**  
 For hunters, fishermen! Worth \$6! Tempered steel; gunmetal finish. Leather sheath free!

**SLEEPING BAGS — \$15**  
 Army officer's type! Kapok-filled. New OD poplin. 6 1/2 ft. long. 106-in. zipper.

**ORDER DIRECT FROM THIS AD!**

Send check or money order. No C.O.D. orders. Orders must total \$1 or more. For orders outside U.S. and possessions, add 25% for special packaging. Order items by key letter. Specify size and color where necessary.

On items B,C,E,G,I,J,L,Q, add 10c postage east of Mississippi River, 20c west of Miss. On items D,F,N,O,R, add 20c east; 40c west. On items A,K,M,P, add 50c east; \$1 west.

**BALTIMORE LUMBER Company**  
 War Surplus Division Dept. S  
 418 N. HOWARD ST., BALTIMORE 1, MD.

**C-THRU-MIRRORS**  
 See thru one side. Mirror on other side. Leisurely watch others at close range who imagine themselves unseen. Loads of fun. Lasts a lifetime. 3"x4" or 2"x6" sizes only. \$2.95 postpaid. No C.O.D. One day shipment. **Bruce Enterprises, Dept. GB, North Hollywood, Calif.**

**WHAT'S THE GREATEST CANDID FOR COLOR?**  
 See Universal Camera Corporation's advertisement in Popular Science for May.

**Hagerty Sea Shell\***

**\$35**

**Assemble your own boat ... Save up to \$100.**

**Rugged for hunting and fishing**

**Easy to handle, light to carry**

**Takes an outboard up to 2 H.P.**

The Sea Shell is an inexpensive, all-purpose man-sized boat for salt water or fresh. Ideal for fishermen, duck hunters, yachtsmen and youngsters. It's easy to assemble, with precision-cut wood and waterproof plywood parts. Everything is furnished—all you need is a few hand tools, a little leisure time, and a pot of paint. Fun to build and fun to use—you can row it, tow it or use it with an outboard. Sailing kit extra. Ample freeboard makes the Sea Shell sturdy and safe. Fully guaranteed. Send for free illustrated booklet.

\* Reg. U.S. Pat. Off.

Length 8' Depth 16"  
 Beam 4' Wght. 65 lbs.

● If not available at your dealer's, order direct. Dealers—write for attractive franchise information

**Hagerty, 4 Border St., Cohasset, Mass.**

Send me free booklet on Sea Shell kit.

Send Sea Shell freight collect. Enclosing check or M. O. for \$35.

Name \_\_\_\_\_

Street \_\_\_\_\_

City \_\_\_\_\_ State \_\_\_\_\_

The meter with a MEMORY

THE NEW

**G-E**

**Exposure Meter**

**Type PR-1**

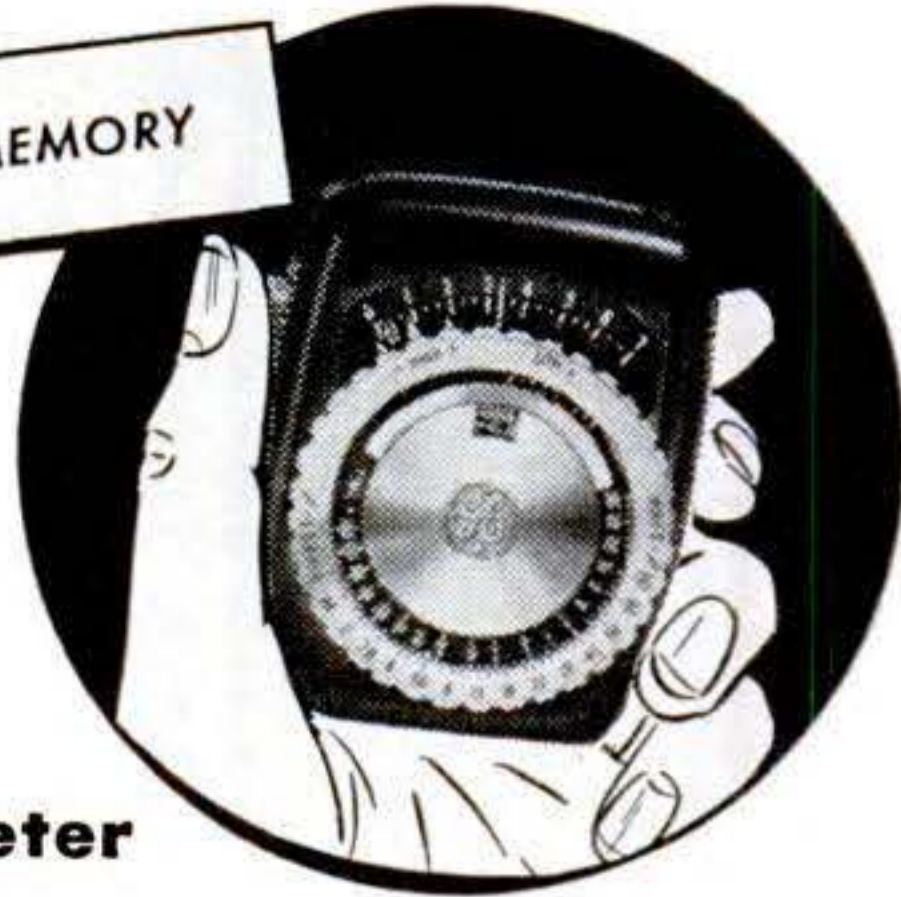

Only G-E gives you  
all these advantages . . .

- Easy to use—gives correct camera settings in 5 seconds for better movies, stills, color
- Extra help for tricky scenes
- Precision built
- Automatic shift for bright light or dim
- Sturdy, lightweight, vest-pocket size
- At photo dealers everywhere. General Electric Company, Schenectady 5, N. Y. **\$32.50\***

ALSO famous Type DW-58 meter . . .  
a big value at **\$19.95\***

\*In states where Fair Trade Contracts are in effect; includes Federal Tax.



**GENERAL ELECTRIC**

**BUILD YOUR OWN TILTING TABLE SAW!**



with  
**GIL-BILT**  
PLANS—PARTS  
PRECISION ARBOR

- 21 x 27 in. table tilts full 45 degrees; 13 in. capacity in front of blade.
- 8 in. blade mounted to cut from 0 to full 2 1/2 inches.
- Self-aligning and calibrated rip fence and miter gauge.
- No machining, no welding, no blueprint reading.
- Sturdy wood, steel, and aluminum construction. Built easily with common hand tools.

**GIL-BILT Step-by-Step Plans**—Simplified perspective drawings, full size patterns; illustrated with 15 actual photographs. Postpaid anywhere in the world. **\$1.00**

**GIL-BILT 5/8 in. Arbor**—Machined spindle, two precision ground lubricated for life ball bearings, assembled ready to run in one piece cast aluminum housing. **\$6.95**

**GIL-BILT Special Metal Parts Kit**—Includes Step-by-Step Plans, 5/8 in. ball bearing arbor, aluminum channel and bar, cast aluminum handwheels, steel hinges, V-pulley and all other metal parts (less blade). **\$14.95**

Same Kit with high quality 8 in. combination blade. **\$18.95**

(Prices include postage up to 600 miles)

**GILLIOM POWER TOOLS** P.O. Box 1-C, Lambert Field, St. Louis 21, Missouri

**LUCAS MILHAUPT CARBIDE SCRIBER**  
NON-MAGNETIC

Tungsten Carbide — carefully ground on diamond laps, brazed into stainless steel 6" handle for marking steel and other metals — for etching, marking, cutting glass. In plastic case with pocket clip.



**\$2.00**

PRICE POST PAID

**PRICK PUNCH**

Tungsten carbide tip, silver brazed into 3 1/2" heat treated steel body.



**\$1.50**

Price Post Paid

**LUCAS-MILHAUPT ENGINEERING CO.**

5051 SOUTH LAKE DRIVE • CUDAHY, WISCONSIN

Say You Saw  
It In Popular Science

**COMPLETE TRAILER**

Chassis-Axle  
2 Wheel Assembly  
ONLY **\$52.50**

Shipped KD.,  
F.O.B. Yonkers  
or send \$10 &  
bal. C.O.D.

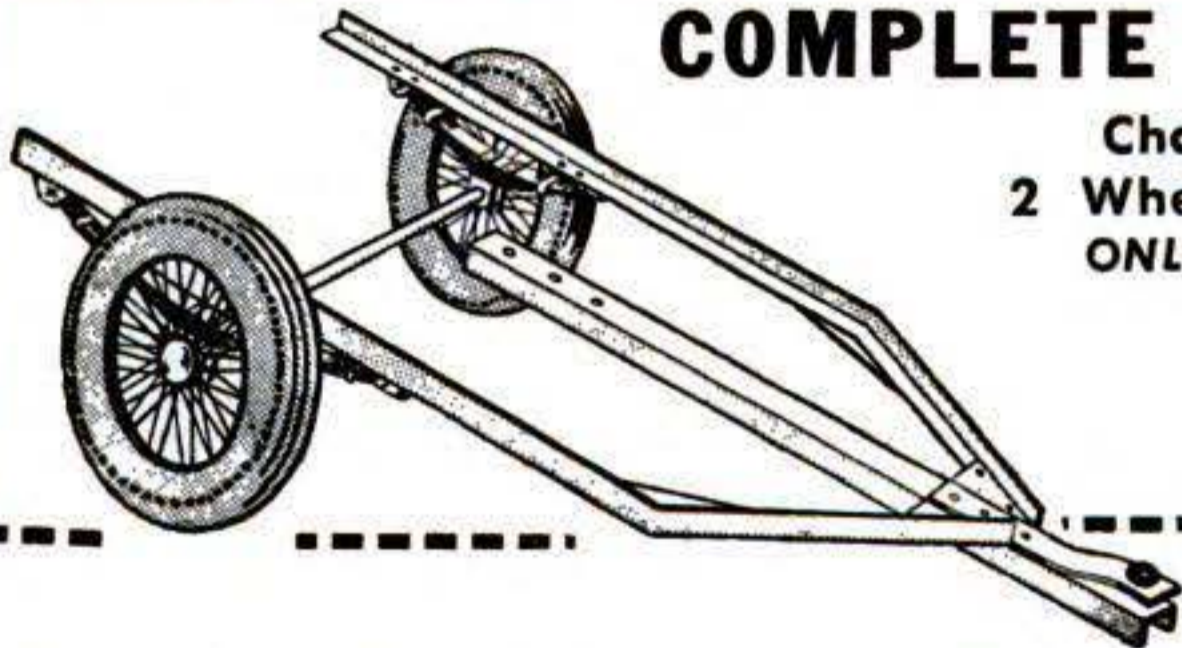

Never before offered at this low price. Tested to carry 1000 lbs.—built to take hardest usage . . . **COMPARE!**—in construction—utility—value! You'll agree there's nothing like it.

**YOU GET:** Complete draw bar assembly, chassis of steel angle, 2 automobile type springs; 2 wheels with Timken roller bearings take standard 4.75 x 19 tires, 2 hub caps and grease rings . . . 91" Overall, 57" Tread. Less Tires, Tubes.

**BEST BENCH VALUE ON MARKET.**

Solid, tough wood construction—**ALL STEEL LEGS.** Very large drawer, tool rack, shelf, 34 1/2" high, 59" x 23". **COMPLETE WITH ALL HARDWARE.** Shipped KD with easy instructions. **ONLY \$15.35 F.O.B., Yonkers.**

Send Check, Money Order on all Items. **SATISFACTION GUARANTEED.**

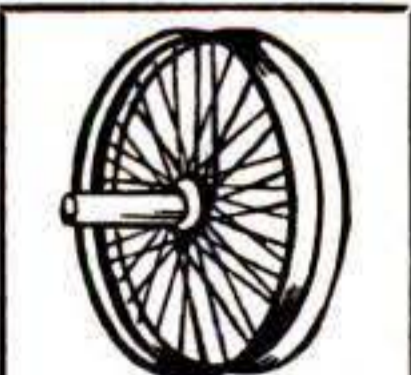

Complete wheel, hub assembly & bearings \$9.00 ea.

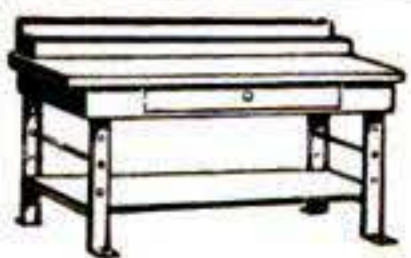

**HEAVY CAST ALUMINUM BLOWER**  
Now Only \$10.00

**SINGLE EXHAUST BLOWER** DELIVERS 100 CU. FT. AIR PER MINUTE. Ready to install yourself with any household tools. It's built for that. Housing is solid cast aluminum to last indefinitely. 110 V., 50-60 cycles. Cont. duty motor.

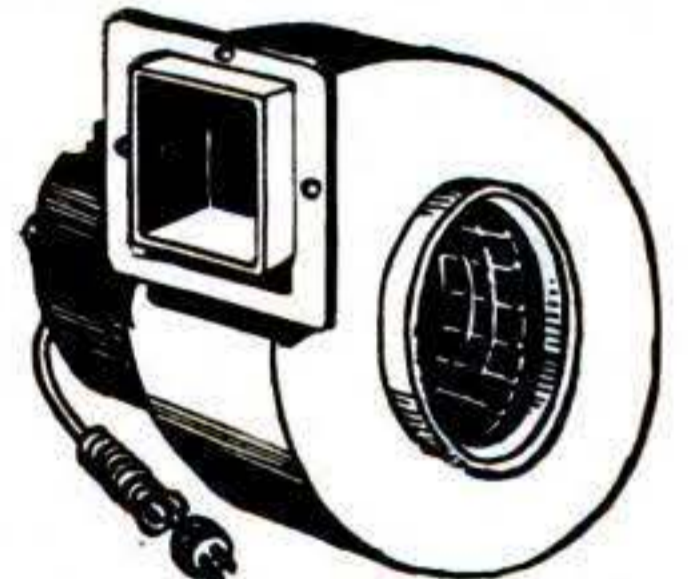

**DOUBLE EXHAUST BLOWER**

Same wonderful construction, performance, easy installation as the Single. Adaptable for any Blower need. **ONLY \$15.85.**

On Blowers, west of Mississippi, add \$1 for mailing, handling.

**MIKE**

Designed especially for speech . . . amateurs, P.A., recording . . . High impedance, output 54.2 db below 1v per bar. All chromium plated; rubber covered, shielded cable, 8' cord. Remove from base for hand use, 5 day, money back guarantee! Ship. wt. 2 lbs. Lists for \$10.75. Cost to You \$4.95.



**Universal Column Jack**

with the overlapping pin that reinforces the telescopic joint . . . Raises, levels, supports sagging floors.

- 3'8" to 5'7" **\$6.95**
- 5'7" to 8'4" **\$7.95**
- 18" to 37" **\$4.95**



**UNIVERSAL YONKERS CORP. (S-4) 137 Alexander St., Yonkers 2, N. Y.**

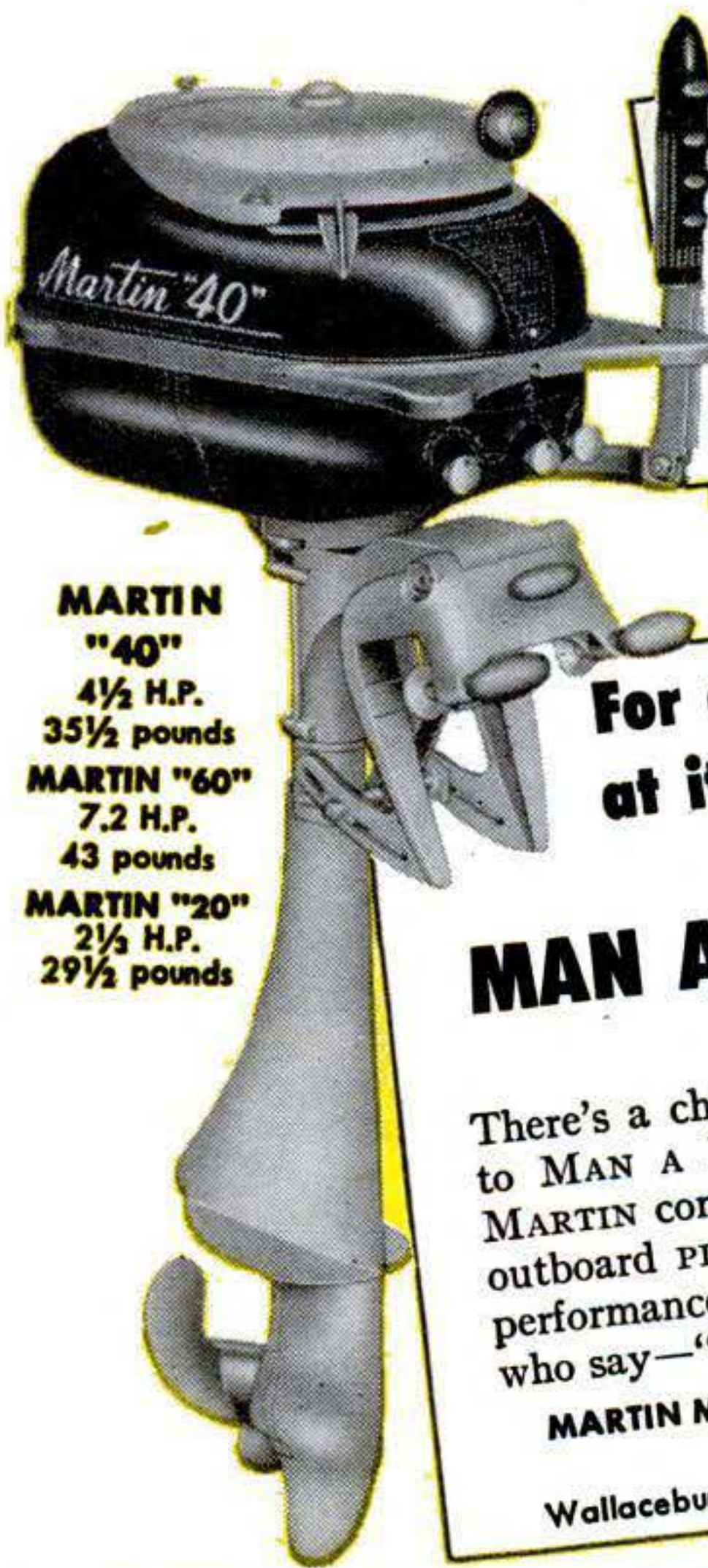

**MARTIN**  
**"40"**  
 4½ H.P.  
 35½ pounds  
**MARTIN "60"**  
 7.2 H.P.  
 43 pounds  
**MARTIN "20"**  
 2½ H.P.  
 29½ pounds

**MAN A MARTIN** for thrilling top speed performance. MARTIN's exclusive patented, mechanically-controlled poppet valves set a new standard of performance in outboard motors.

**MAN A MARTIN** for smooth, unbelievably slow trolling speeds. MARTIN's sputter-free operation at slow speeds adds to fishing pleasure.

**MAN A MARTIN** for more family pleasure on the water. MARTIN has the features for all around easy handling by any member of the family.

For outboard motoring  
 at its best . . .

**MAN A Martin**

There's a choice of three great outboard motors, when you decide to MAN A MARTIN, and enjoy outboard motoring at its best. A MARTIN combines all the finest features you would expect in a great outboard PLUS exclusive features which have enabled it to set new performance records. Take a tip from America's keenest sportsmen, who say—"for tops in outboarding . . . Man a Martin!"

**MARTIN MOTORS, Eau Claire, Wis.,** Division National Pressure Cooker Company  
 Canadian Sales by: **MARTIN MOTORS,**  
 Wallaceburg, Ontario, Division National Pressure Cooker Company (Canada) Ltd.

The NEW Standard of Performance!

Say You Saw  
 It In Popular Science

**AUTOMATIC  
 RETOOTHER**

Cuts new saw teeth in 50 seconds—any size 4 to 16 points. Old teeth fall off as chips. Easy to operate. A perfect job.

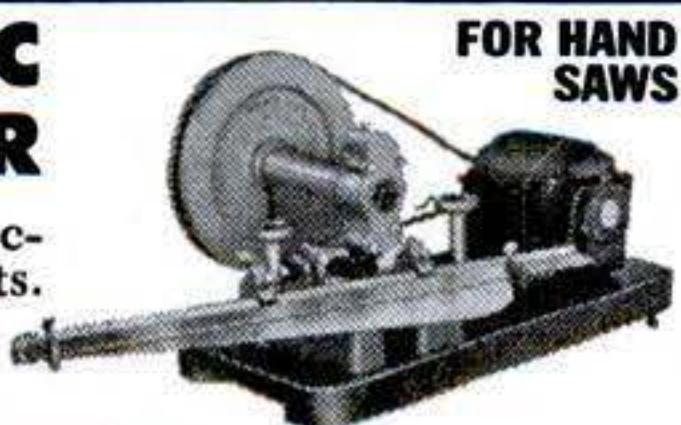

FOR HAND  
 SAWS

Write today for details on

**GREATER PROFITS FOR SAW SHOPS**

**BURR MFG. CO.**

8943-Q Venice Blvd.  
 Los Angeles 34, Calif.

**CONVERT HAND MOWERS  
 TO POWER MOWERS**

Takes less than 3 hours

The Handy-Dandy Lawn Mower Kit fits any hand mower from the 16 to the 20 inch size. Complete with all necessary parts. Kits can be purchased separately or complete with power units.

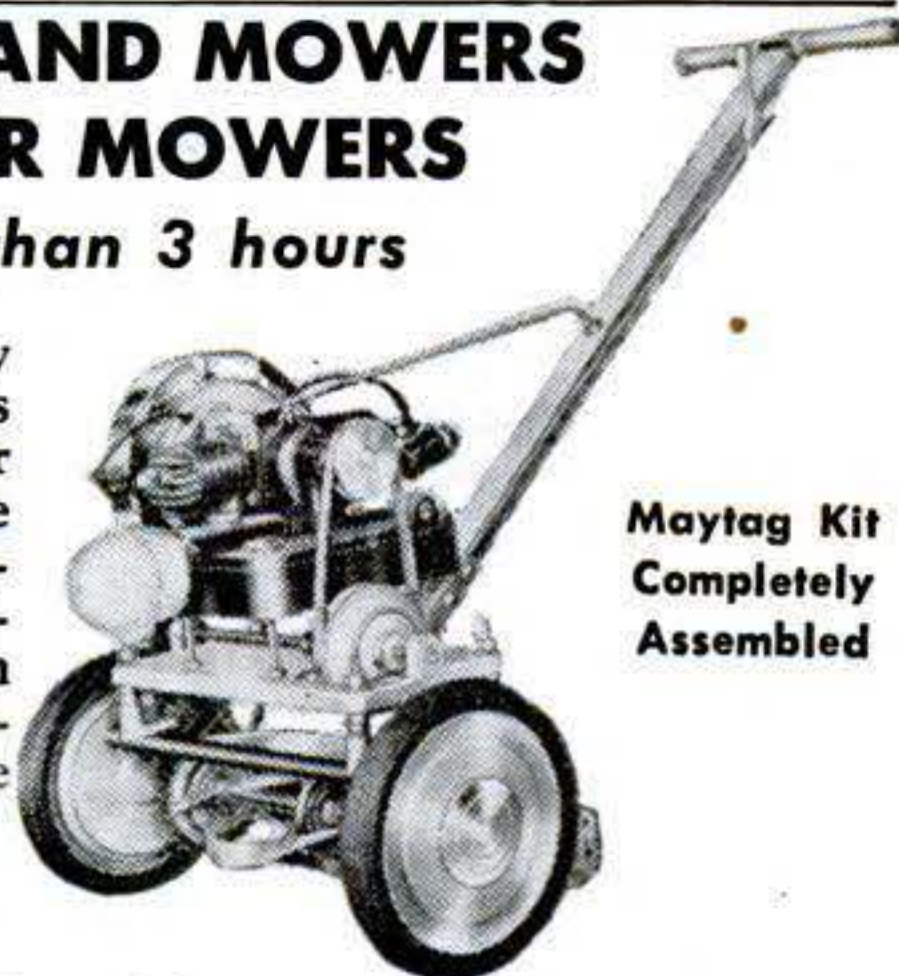

Maytag Kit  
 Completely  
 Assembled

DEALERS WANTED

**LE CLAIRE MFG. CO.**

**LE CLAIRE, IOWA**

Mfg. of Handy-Dandy Aluminum Clothes Pole

**SUPER-MITE PACKS POWER!**

**NEW 1948 MODEL! IMPROVED CIRCUIT!**

• • SUPER-MITE FEATURES • •

- WORLD'S MOST POWERFUL MINIATURE RADIO
- USES WAR-BORN MINIATURE ELECTRON TUBES
- COVERS BROADCAST BAND
- 2,000 MILE RANGE
- MIDGET VARIABLE CONDENSER TUNING
- MIDGET VOLUME CONTROL
- CLEAR AS A BELL TONE
- POWERED BY NEW MIDGET BATTERIES
- PICTURE DIAGRAM FOR RADIO BEGINNERS
- EASILY WIRED BY ANYONE
- NO EXPERIENCE NEEDED



**\$4.99**

New Super-Mite 1948 Model is really a honey! Super-Mite is not a toy or gadget but is a very practical Miniature Radio! Super-Mite was designed for the Radio Minded both young and old and especially for those who delight in an Ultra Tiny Radio. Perfect for classes in Radio Science. . . . Perfect for the Radio Beginner who desires something better than weak crystal and poorly designed, complicated, One and two tube sets usually offered. Super-Mite for 1948 with new greatly improved circuit includes a brilliant red crackle finish chassis, silver and black dial, streamlined bakelite control knobs, amphenol sockets, midget variable condenser, midget volume control, midget condensers and resistors, polystyrene coil, and all parts precision finished. Complete Set (less tubes) Only \$4.99 postpaid. Midget electron tubes 95c ea. Sent C.O.D. for \$1.00 deposit.

**ELECTRONIC RESEARCH (Dept. P-S1) 1216 Park Row Bldg. New York City 7**

**4016 MILES  
for \$35.81**



Smart! Practical. Seats 4—or hauls a ¼ ton load. Costs \$600 to \$700 less than any other station wagon—operates for about half as much. Here's the experience of one Crosley Car owner:

Vinal H. Lobley, Stillwater Ave., Bangor, Me., has driven his Crosley 4016 miles, averaging 33 miles per gallon. Spent only \$35.81.



← **SEDAN:** Seats 4 plus ample luggage space.

**PICKUP:** Cuts → service, delivery costs.

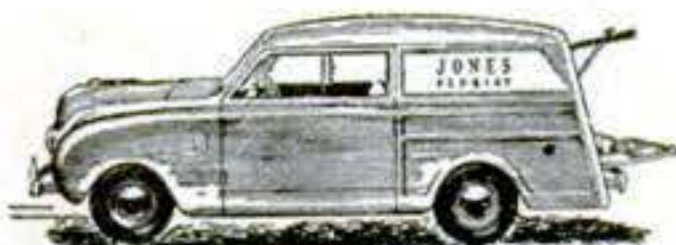

← **PANEL DELIVERY:** Full ¼-ton capacity.

Revolutionary 4-cylinder engine

**CROSLEY**

*a FINE car*

For beautiful full-color catalog, write: Crosley Motors, Inc., 2532-JL Spring Grove Ave., Cincinnati 14, Ohio

**KAYAKS**  
**AQUA V-18**  
*Easy to Build*

**OUTBOARDS  
ROWBOATS**

**V-23 CRUISER**  
Length 23 Ft.  
Beam 7 Ft., 10 In.  
Draft 14½ In.  
Sleeps Two. Open or With Cabin.

**BOATS for  
Home Assembly**

KAYAKS, ROWBOATS, DINGHIES,  
INBOARDS, OUTBOARDS, RUNABOUTS  
Cut-To-Fit for Quick Assembly.  
Everything Complete plus Illustrated  
Instructions. No Experience  
Necessary. Simple as A. B. C.

**25¢ COIN  
FOR ALL  
THREE**

SEND 25¢ POSTAGE (COIN) TODAY  
FOR 3 MONEY SAVING ILLUS. CATALOGS  
Showing all '48 Models (marine  
plywood) & construction details.

**AQUAMOBILE V-18**  
Designed for Auto  
Engines. Open or with  
cab. Length 18 ft.  
Fast VEE Bottom Hull.

Established 1928—Mfgr's U-MAK-IT-KITS  
**KAYAK BOAT CO.** 703R-WHITTIER ST.  
NEW YORK 59, N. Y.

# NOW you can PREVENT RUST and SCALE from forming in your AUTO RADIATOR



**KEEP WATER CRYSTAL CLEAR.** Installed in radiator hose, Butler De-Scaler's Galvanic Cell Action prevents RUST and SCALE throughout the entire cooling system. Causes the removal of OLD RUST AND SCALE.

PROTECT your new car's cooling system from the start . . . end radiator rust-ups in your old car. Butler De-Scaler has been used with great success industrially for over ten years . . . proven in thousands of truck and bus fleets. Now available for car owners. Unconditionally guaranteed . . . for one year . . . will not interfere with Anti-freeze or stop leak. Easily installed . . . available at service stations, garages, and car dealers everywhere. If no dealer near you, write BUTLER ENGINEERING CO., 2624 Rousseau St., New Orleans 11, Louisiana.

**New Fair Trade List Price \$2.95**

Butler De-Scalers are also available for use in boilers, home hot water systems, Diesels, etc.



## BUTLER De-scaler



### ASSEMBLE THIS BEAUTIFUL COLONIAL POST LAMP

• These new kits bring the popular colonial lamp within reach of all craftsmen. Complete instructions furnished, all parts correctly sized and formed. 16" high, 10" square, 3" post diam. These rugged lamps make ideal gifts.

**Kit No. 1.** You solder frame. \$7.95 each  
**Kit No. 2.** Frame ready-welded, you complete job with screwdriver. . . \$9.95 each  
**Complete Lamp** as shown, finished in dull black, ready to install, less bulb. . . \$14.95  
We pay postage, money-back guarantee. Send check or money order, or ask for free literature.

LORENZEN INDUSTRIES, Dept. PS-4, Niles, Mich.

### Now! A fine air pistol at a low price SPORTSMAN JR. complete with ammunition

Including 2 extra barrels, plus

- Lead Pellets
- BB Shot
- Steel Darts
- Corks

**\$5 set**

Gun alone \$3.50  
**AMMUNITION**

- Lead pellets 500 for \$1.25
- BB shot—lb. (1500) \$1
- BB shot tube, 25c
- BB shot pkg. 10c
- Steel darts doz. 60c



Beautifully engineered air pistol, amazingly accurate, unconditionally guaranteed. Compares with far costlier models. Rush in your order!

**J. J. ANTHONY**

WE PAY POSTAGE

1517 W. NORTH AVE.

MILWAUKEE 5, WIS.



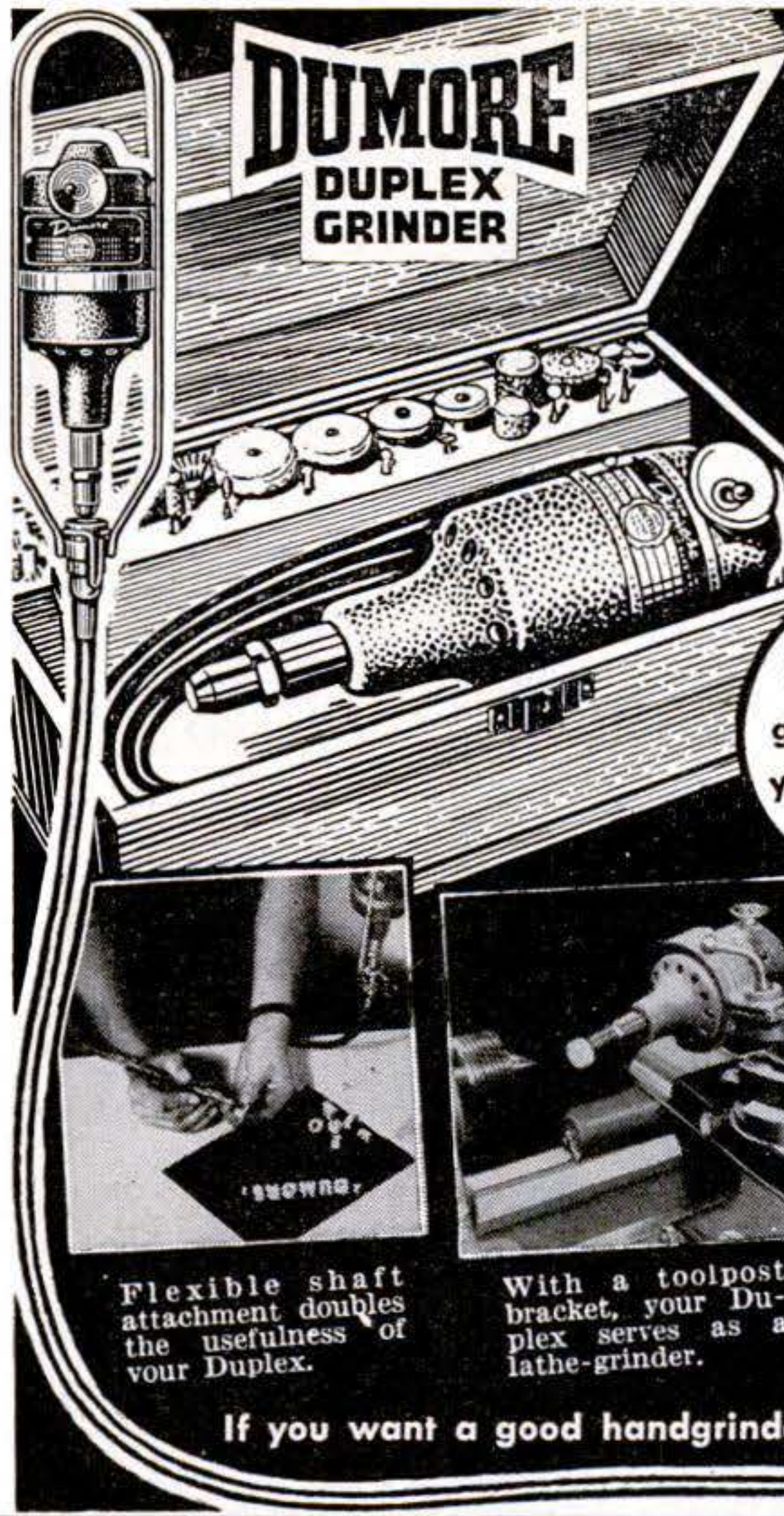

**DUMORE  
DUPLIX  
GRINDER**

# More Power, More Capacity, and More Versatility - than any other handgrinder!

**Makes your work easier, faster, twice the fun!**

Here's the handgrinder you've always wanted for your workshop — the tool that gives you more of everything you want, than any other handgrinder. Its full 1/14 HP motor has the extra power for "heavy" jobs. Its extra-capacity chuck takes all 3 tool sizes—1/4", 1/8", 3/32". With a simple, easy-to-use attachment, your Duplex becomes a flexible-shaft tool. Other attachments convert it in-

stantly for bench or lathe work.

Think what you can do with the extra power, capacity, and versatility of the Dumore Duplex! Work in wood, metal, and plastics is faster, easier — and twice the fun!

The powerful Duplex is the perfect gift for any hobby-minded man or boy. See it in your local hardware store today — or send in the coupon below!

Satisfaction guaranteed or your money back in 10 days!



Flexible shaft attachment doubles the usefulness of your Duplex.

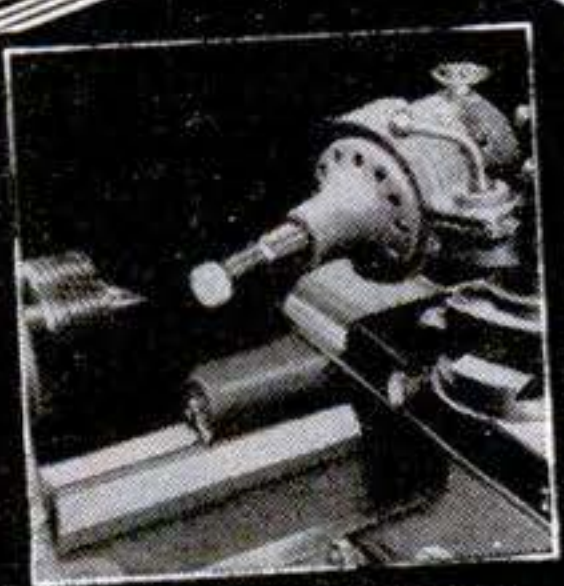

With a toolpost bracket, your Duplex serves as a lathe-grinder.



Bench stand converts your Duplex into a third tool.

**If you want a good handgrinder — buy a Dumore!**

**Tear out this coupon and mail today!**

- The Dumore Company, Dept. D-52, Racine, Wis.
- Please send complete information on Duplex Grinder.
  - Send me DeLuxe Duplex Kit (27 accessories as illustrated); \$27.50 enclosed.
  - Send me Standard Duplex Kit (9 accessories); \$19.75 enclosed. Shipping charges C.O.D. Attachments are extra.

Name \_\_\_\_\_  
Address \_\_\_\_\_  
City \_\_\_\_\_ (\_\_\_\_) State \_\_\_\_\_

H-6B

## LOWEST PRICE IN HISTORY! Sensationally New WELDRITE Electric Welding-Cutting Torch

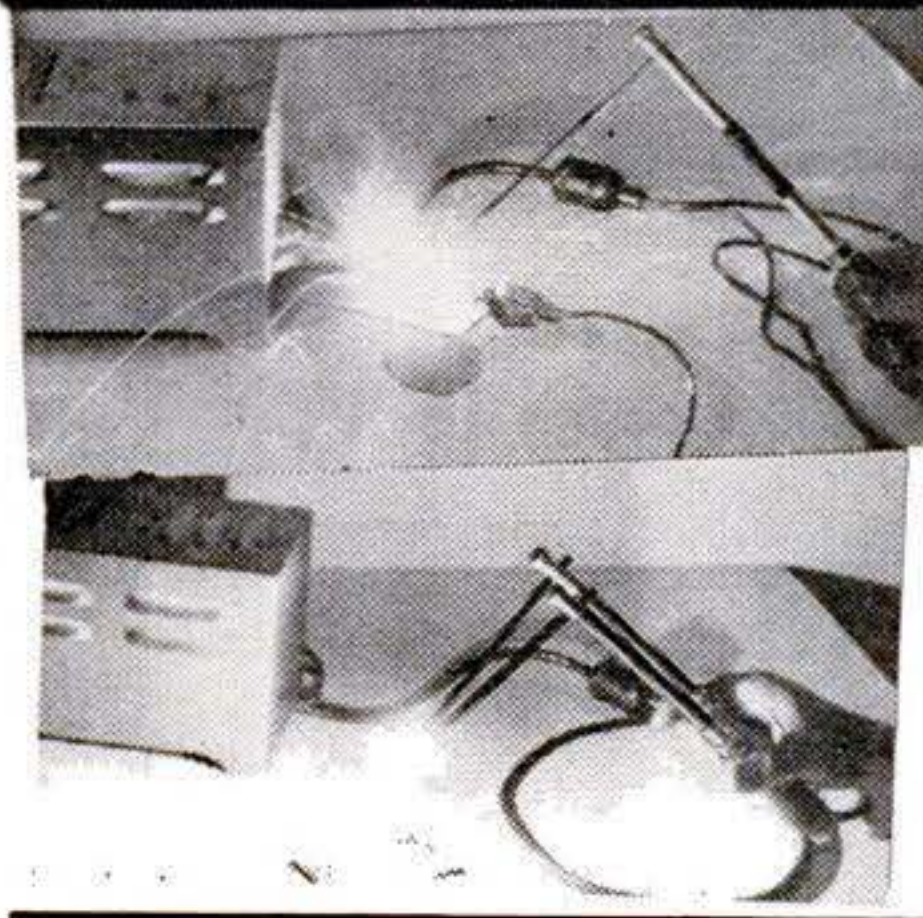

Plugs into any convenient AC-DC Socket  
**WELDS - BRAZES - CUTS - MELTS - SOLDERS - HEAT TREATS**

The WELDRITE Torch—tested and proven by countless commercial and amateur users, is now offered direct to you at the amazingly low price of only \$12.00. No Gas—No Gauges—No Spark Lighter needed. Always ready for immediate use—Just plug WELDRITE into any 110 AC or DC outlet. Uses standard welding and brazing materials available at all welding supply stores. WELDRITE furnished complete with Converter Unit, Single Holder with attached Alligator clip, for Welding metal up to 3/16" thickness, using up to 3/32" rod, and Double Holder with Carbon-Tipped Dual Copper Electrodes for Cutting, Brazing, Heat Treating,

Soldering, etc. Supply of welding materials included free.

Ideal for home workshop. Invaluable for body and fender shops, garages, repair and machine shops, manufacturers, etc.

SEND NO MONEY. Order your WELDRITE Electric Welding-Cutting Torch today. Pay postman \$12 plus postage charges (wt. 4 lbs.) or send \$12 and we pay postage. Either way, if not satisfied, return WELDRITE in 5 days, and money will be refunded. California orders please add sales tax.

**CALIFORNIA TECHNICAL PRODUCTS COMPANY**  
8510 Warner Drive • Culver City, California • Dept. B-4

**NOW ONLY  
\$12  
FULLY GUARANTEED**



Pat. Applied for  
**Rotary Garden Tillers and Tractor Power Take-Off Units**



**FIRST CHOICE BECAUSE IT'S  
GUARANTEED  
to Increase Crop Yield  
22% to 51%**

**ROTARY TILLERS**

REBUILDS SOIL — NATURE'S WAY  
Milwaukee Equipment Mfg. Co., So. Milwaukee, Wis., U. S. A.

## M-E Rotary Tiller Does All This with LESS Work!

Prepares perfect seed bed... increases mineral and moisture content... rebuilds soil Nature's way. M-E makes work easier... does it better... than any other equipment you can buy. Write today!

Milwaukee Equipment Mfg. Co.  
Dept. PS-4, So. Milwaukee, Wis.  
Please send illustrated folder.

Name \_\_\_\_\_  
Address \_\_\_\_\_

Replace Your Old-Fashioned Wooden Cellar Doors  
Once For All Time With NEW PERMANENT

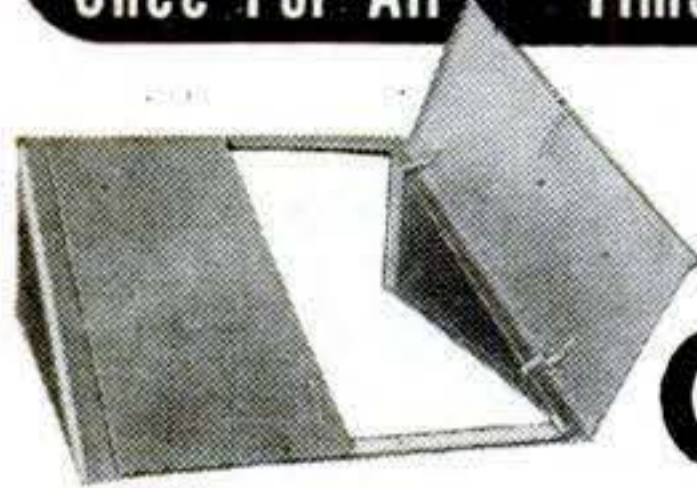

## ALL METAL BILCO CELLADOORS

DO IT YOURSELF, EASILY, INEXPENSIVELY, IN JUST A FEW HOURS

End once and for all the nuisance of shabby, rotted, leaky, old-fashioned wooden cellar doors that so often need repairs or replacement. Install a neat, attractive Bilco CELLADOOR—a complete basement door unit in your choice of permanent copper-steel or aluminum—for a lifetime of trouble-free service. It will never need replacement.

Weatherproof, leakproof, slamproof, rotproof, verminproof and burglar-proof, Bilco CELLADOORS give you a safe, convenient way to get more out of and into your basement.

Installation is a cinch for any home handyman. Bilco CELLADOORS are shipped knocked down in five easily assembled parts. All necessary bolts and instructions are contained in the package. If your favorite building supply dealer can't supply you, order direct. Send for our FREE dimension sheet to decide the size you need. The cost is usually less than for temporary wooden doors. If your basement lacks an outside entrance, you can easily make one. Ask about Bilco Cellastair units.

FREE! Send for our booklet "How To Make The Most Of Your Cellar." It's crammed with suggestions to make your basement more useful . . . for storage, for a hobby shop, a rumpus room, projects that are fun to do.

DEALERS: A FEW VALUABLE TERRITORIES AVAILABLE



**THE BILCO COMPANY**  
175 Hallett Avenue, New Haven, Conn.

Without obligation on my part, please send me your dimension sheet which shows how to measure for and order a CELLADOOR, and also send me your helpful booklet on making the most of my cellar.

NAME \_\_\_\_\_  
STREET \_\_\_\_\_  
CITY \_\_\_\_\_ STATE \_\_\_\_\_

## Your Drill Press will DO MORE with a GADREN SHAPER, PLANER, JOINER WOODWORKING ATTACHMENT

with BALL-BEARING Table!



Fits standard Drill Press. No chatter! Quick change-over! 4-in. Joiner or Planer cut; Shaper Cutter for all types joints, trims, moldings. Aluminum Table with Guides and Hold-downs. Does the work of machines costing 5 times its price of. . . . . **\$29<sup>95</sup>**

**FREE!** Illustrated, descriptive booklet shows what it will do. SEND COUPON TODAY!

GADREN MACHINE CO., PS/4/48  
OAKLYN, N. J.

Send booklet, without obligation, to

Name.....

Address.....

## Now a "10-FOOTER" with Standard Size Blade

*in a  
Standard Size  
Case*

A TOP QUALITY, inside-measuring rule with sturdy etched steel blade and standard size case with triple-chrome plated finish. Also made in 6 and 8 ft. lengths and metric measures.



**Carlson & Sullivan, Inc.**  
MONROVIA, CALIF.

SOLD BY LEADING HARDWARE STORES

**CARLSON STEEL TAPE RULES**

## REYNOLDS CIRCULAR SAW GRINDER



SAWS  
5"-30"

FOR JOINTING  
GUMMING • SHARPENING  
ALL TYPES OF CIRCULAR SAWS  
WRITE FOR CIRCULAR

**REYNOLDS MACHINERY CO.**  
303 EDDY ST., PROVIDENCE 3, R. I.

## BUILD YOUR OWN MACHINE TOOLS! Blueprints \$1.00 - Catalog FREE

Make your own Milling Machines, Shapers, Drill Presses, 8" Circular Saws, 6" Jointers and similar tools with Lewis ready-to-machine castings. Save up to 80% of finished machine cost. \$1.00 brings complete blueprint specifications for above 6 tools. Catalog describing Lewis line sent free with blueprint order.

**LEWIS MACHINE TOOL CO.**

P. O. Box 7446, Sta. L, Dept. S, Los Angeles 23, Calif.

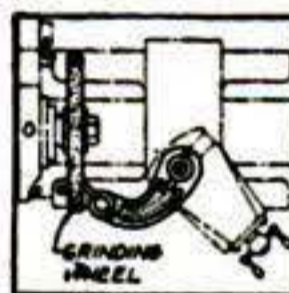

## GRIND TOOL BITS ON YOUR LATHE

A simple, versatile, fast-adjustable holder for every home workshop. Makes precision tool bit grinding possible, increases capacity of your lathe, permits you to do things heretofore thought too large for present set up. Facilitates edge turning and grooving. At your dealer or order direct. Introductory price \$2.65 postpaid.

**HURON FACTORY SERVICE CO.**  
505 Lafayette Bldg., Detroit 26, Mich.



## "PLASTICS"

Work in a fascinating and profitable hobby. Just out—our latest fabricating manual. Tells you how to work with Plastics. Our new Catalog provides all needed materials: Plexiglas—Lucite—Tenite—Catalin—Acetate—all in sheets, rods, and tubes. Complete line of cements, dyes, accessories and supplies. Send 20c today for Fabricating Manual & Catalog. We apply this amount on initial order.

**HOUSE OF PLASTICS**

8648 Linwood Avenue, C.M.O. Dept., Detroit 6, Michigan



**NOW!**  
**BUILD 15 RADIOS** \$14<sup>75</sup>  
COMPLETE KIT ONLY...

**Absolutely no Knowledge  
of Radio Necessary**

**You Need NO Additional Parts**

**THE PROGRESSIVE RADIO KIT is THE ONLY COMPLETE KIT.** Contains everything you need. Instruction Book, Metal Chassis, Tubes, Condensers, Resistors and all Radio parts.

The 36-Page Book written by Expert Radio Instructors teaches you to build radios in a Professional Manner. You start with a 1-tube receiver. Before you are done with this kit, you will have built 11 Receivers, 1 Public Address System and 3 Transmitters.

**SPECIAL FREE OFFER!**

Electrical and Radio Tester sent absolutely FREE with each Progressive Radio Kit. PLUS FREE membership in Progressive Radio Club. Entitles you to free expert advice and consultation service with licensed radio technicians.

Write for further information, or ORDER your KIT NOW! ONLY **\$14.75**

**BUILD A 5 TUBE AMPLIFIER—only \$9.75**

Ideal for phonograph, FM tuner or microphone. Has 5 tubes including rectifier. Kit is complete with tubes, chassis, volume control, tone control, radio parts, hook-up wire, solder and instructions. We can provide a 4-inch PM speaker with mounted output transformer to fit on chassis, priced at \$1.95. Or use this kit with your own speaker. It has 5 watts output, more than enough to drive a 12-inch speaker.

Postage prepaid with check or money order.  
(Postage not prepaid with C.O.D. orders)

**PROGRESSIVE ELECTRONICS CO., Dept. 95**  
497 Union Avenue Brooklyn 11, N. Y.

**Get genuine full-color**

**KODACHROME PRINTS**

and look for the name stamped on the back

Order through your Kodak dealer

**EASTMAN KODAK CO., Rochester 4, N. Y.**

**Build AIR-CONDITIONING UNIT**  
FOR YOUR HOME

We show you how. It's easy to build and a pleasure to use. An individual unit that fits your window and really cools the room. Up to 18° cooler than outside. Sleepless nights banish with a cool bedroom. Real Air-Conditioning, not just a fan. Different sizes to fit any room. No expert knowledge needed. Mail \$1 now for complete simplified **PLANS** and valuable Catalog.



**LEJAY MANUFACTURING COMPANY**  
523 LeJay Building, Minneapolis 8, Minn.

**PLANS COMPLETE**



**IT'S EASY TO  
"Trim-it-Yourself"**  
with  
**CHROMTRIM**  
METAL MOULDINGS

The perfected metal trim for wall or floor linoleum and building materials. 6' lengths, 8 shapes, easy to cut and apply.

Send 10c for "Trim Ideas" 16 page booklet. Over 30 projects and remodelling suggestions on where and how to use CHROMTRIM. Hints on lino-laying.

**REMODEL  
KITCHEN  
BATH • ATTIC**



**MAKE METAL  
PROJECTS  
with  
CHROMTRIM**

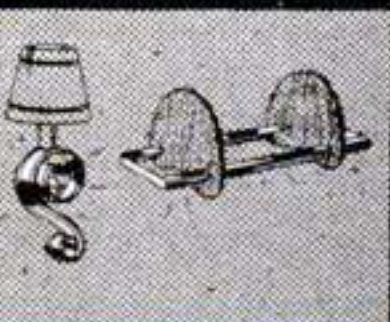

R. D. Werner Co., 291 Fifth Ave., N.Y. 16  
Enclosed is 10c for CHROMTRIM "Trim Ideas" booklet P

Name \_\_\_\_\_  
Address \_\_\_\_\_  
City \_\_\_\_\_ Zone \_\_\_\_\_ State \_\_\_\_\_

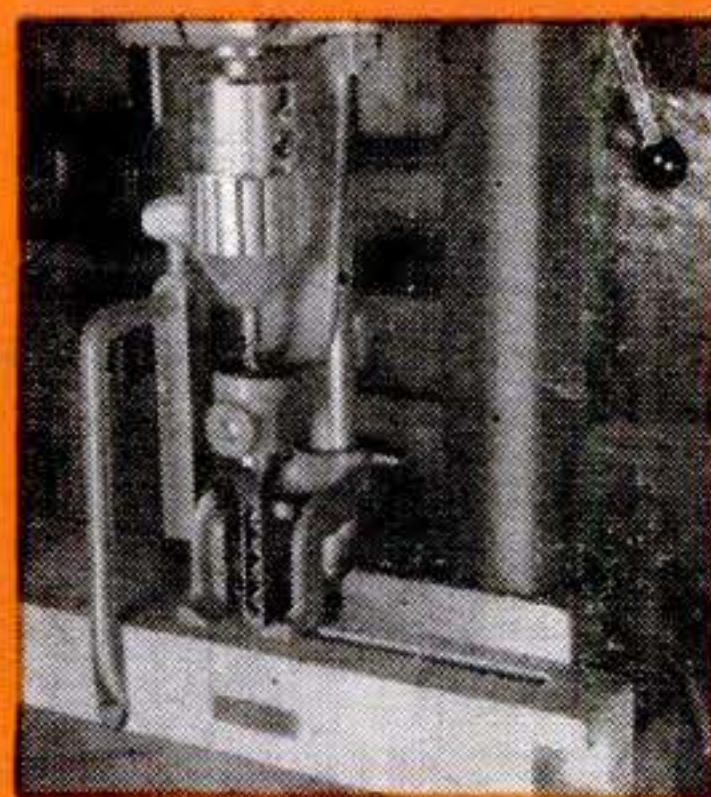

**TEACH YOUR  
DRILL PRESS  
THIS TRICK**

Mortising on the drill press... results in fast accurate work with a skilled "custom" look about it. It's easy when you have a hollow chisel and mortising attachment, held true and tight with a JACOBS HEX-KEY CHUCK.

Your drill press can do many extra jobs when you outfit it with a tight-gripping JACOBS CHUCK. Mortising on the drill press is just one example of how your home workshop equipment multiplies in value when you enlist the aid of JACOBS CHUCKS.

Get greater gripping power... Better accuracy... Longer life with Jacobs' New Rubber-Flex Collet Chucks — Designed particularly for home workshop use.

Exclusive, bonded rubber-and-steel construction... no loose jaws... no springs... not harmed by oils or coolants. Real precision chucks at popular prices. SEE THEM AT YOUR LOCAL HARDWARE DEALER'S.

**IF IT'S A JACOBS... IT HOLDS**



**HEX-KEY CHUCK**... fits 1/2" or 3/8" drill press spindles—motor shafts—jack shafts. With Morse taper arbor, fits lathe headstock, tailstock. 4 models, capacities to 1/2"



**HAND-TITE CHUCK**... fits all hand tools and power tools with threaded spindles... used on polishing heads, bench grinders, flexible shafts, etc. 3 sizes... capacities to 1/2". Models to fit 3/8-24, 1/2-20 and 1/2-24 threaded spindles.

ONLY

**Jacobs Chucks**

Have The Rubber-Flex Collet  
Its Parallel Bite Holds True And Tight



**The JACOBS MANUFACTURING COMPANY**  
200 Jacobs Road, Hartford 2, Conn.

Please send me your new illustrated folder on the Jacobs Rubber-Flex Hex-Key and Hand-Tite Chucks.

NAME.....

STREET.....

CITY.....ZONE....STATE.....

MAKE YOUR RADIO A  
**WIRE RECORDER  
COMBINATION**

WITH A  
**WEBSTER-CHICAGO  
WIRE RECORDER**

*Foundation Unit*

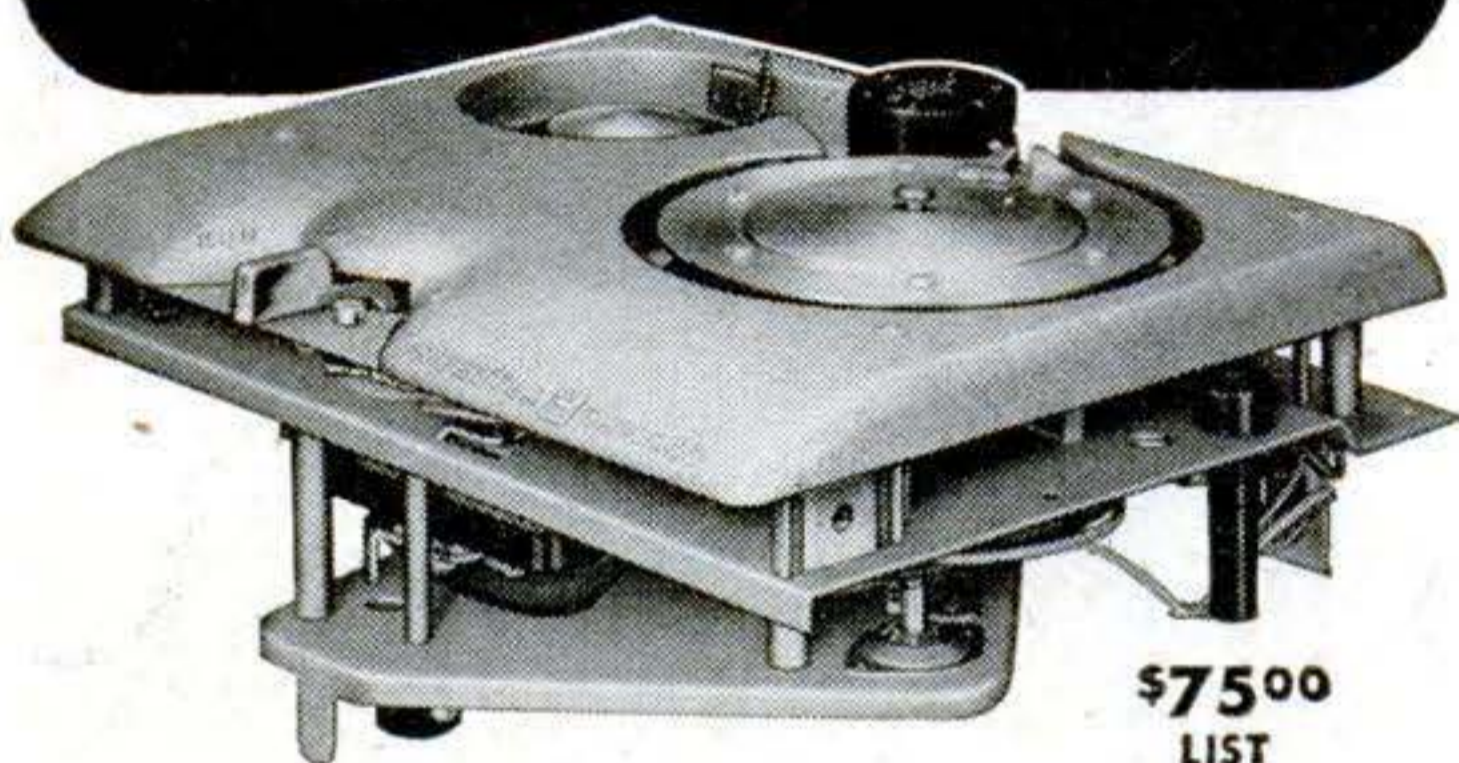

**\$75.00**  
LIST

Designed for Amateurs, Experimenters, Professionals, complete with new improved Webster-Chicago circuit for easy connection to existing amplifier circuits. Supplied with oscillator coil, 15-minute spool of recording wire and construction manual. Hook it up yourself to record radio programs... short-wave broadcasts... messages... speed checks. Records and plays back up to a full hour. Small, compact size: 10½ x 8¾ x 5½ inches. Net weight 10 lbs.

SEE YOUR HAM SUPPLY HOUSE  
OR RADIO PARTS DEALER



Recording Wire—  
15 min. \$2.00  
½ hr. \$3.00  
1 hr. \$5.00



Sensitive Crystal  
Hand Microphone,  
8-ft. Cord \$14.00

BY THE MAKERS OF  
**WEBSTER-CHICAGO**  
Nylon Needles & Record Changers



**WEBSTER-CHICAGO**

5610 BLOOMINGDALE • CHICAGO, ILLINOIS

290 POPULAR SCIENCE

**SOUTH  
BEND**

**NEW SURFACE PLATE,  
V-BLOCKS, ANGLE PLATE**

**SURFACE PLATE** for checking, laying out, etc. Precision ground to .001". 12" x 17" x 3", top 3/4" thick. \$37.50

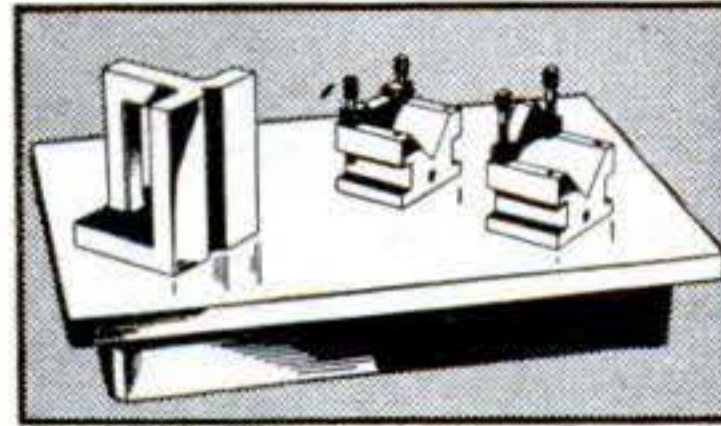

**V-BLOCKS** for holding cylindrical parts. Precision ground. 1-15/16" x 2-15/16" x 2-1/4". Cap. 1/4" to 2". Per matched pair.. \$32.00

**ANGLE PLATE.** Precision ground. 3-1/4" x 3-1/4" x 4-1/4" \$20.00

**SOUTH BEND LATHE WORKS** 456A E. Madison St. South Bend 22, Ind.

**MAN-SIZED**

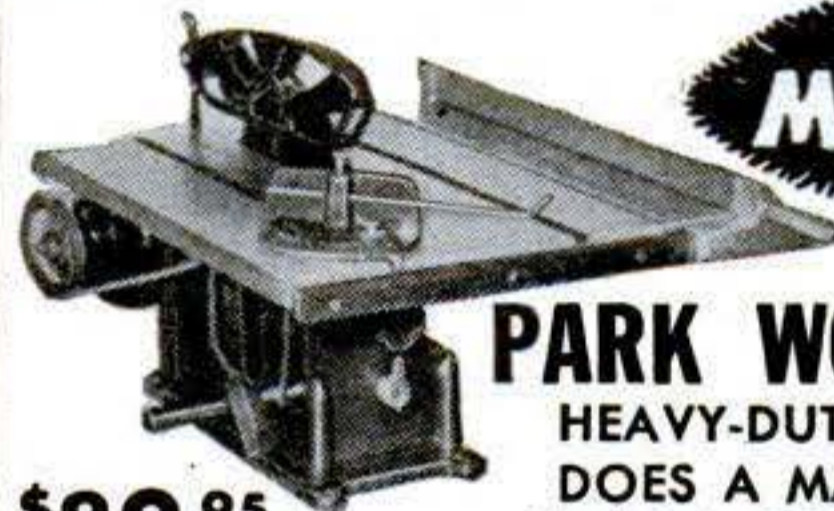

**PARK WOOD-WORKER**

HEAVY-DUTY MACHINE THAT  
DOES A MAN-SIZED JOB . . .

**4 MACHINES IN 1**

**\$89.95**

Limited Offer

- SAW
- SHAPER
- MULTI-SANDER
- JOINTER

Carpenters! Hobbyists! Save time and money with Park Wood-Worker, a precision-built machine constructed to professional specifications. Four individual machines in one that bring down costs 50%. Park Wood-Worker has been specially designed for maximum strength and lasting efficiency. . . 10" saw cuts 3½ x 3½'s—table-top size 15" x 21". All parts fit easily and quickly. Get the facts—write for free, illustrated folder now!

**PARK AVENUE TOOL MFG. CO.**

1938 Park Avenue

New York 35, N. Y.

**ONE-MAN SAWMILL LESS THAN**

Easy To Turn Trees Into Money

**\$200.00**

Makes Lumber ties, shingles, crates, lath, studding.



**BELSAW MODELS**

in 10 to 24 foot sawing lengths. MECHANICAL FEED, accurate set works and positive dogs. Use tractor or old auto engine for low cost power. Thousands used for commercial sawing. Pays for itself quickly. Send post card today for FREE booklet, "How To Make Lumber" and Catalog of Woodworking Equipment.

**BELSAW MACHINERY COMPANY**

2846-N Field Bldg., 315 Westport Rd., Kansas City 2, Mo.

**WATCH FORD IN '48**

**\$19.95**



**PORTABLE PHONOGRAPH**

3 Tube Amplifier, Volume and Tone Controls, 5" Alnico P.M. Speaker, light weight crystal pickup, heavy duty motor, A.C. operation only. Handsome luggage type carrying case.

Kit form \$17.50 Completely assembled \$19.50

Table Model Phonograph—same as above, but with Walnut finish cabinet.

Kit form \$16.50 Completely assembled \$18.50

Record Player—attach to any radio—\$9.95

**PHONO AMPLIFIER KITS**

3 Tube Phono Amplifier, Tone and Volume Controls Kit form \$2.35. Wired and Tested \$2.85.

3 Tubes for above 125k7, 50L6, 35Z5 . . . . . \$1.75

5" Alnico Permanent Magnetic Speaker and Transformer . . . . \$1.95

Astatic or Shure Crystal Pickup \$1.95

Self Starting Phono Motor . . . \$3.25

V.M. Automatic Record Changer \$16.95

Write for Free Catalog. 25% deposit on C.O.D. orders. Order From This Advertisement.

**RAYTONE ELECTRONIC CO.**



All prices F.O.B., N.Y.  
255 Frankfort St.  
New York 7, New York

# Foredom PRESTO-FLEX

← YOUR MOTOR

**NOW! For Only \$5<sup>95</sup> You can have an Amazing New FLEXIBLE SHAFT TOOL**

with PENCIL-SIZE HANDPIECE  
**Grinds, Polishes, Sharpens, Cleans, Mills, Carves Engraves, Etches on Metal, Wood, Glass and Plastic**  
 Now you can turn your old motor, drill press, or electric drill into a Flexible Shaft Tool. Amazing new Presto-flex, latest addition to the Foredom flexible shaft-family. Simply attach to your electric drill, drill press or motor. Presto—a flexible shaft machine! Off again in a jiffy! Pencil size handpiece gives you finger-tip control. Gets into tight places you can't reach with any other tool. Handy 35" overall length. And—only \$5.95 complete! Order NOW.

**—SEND NO MONEY—**  
 Just send your name and address. We will rush your Presto-flex COD. Pay postman \$5.95 plus postage or send \$5.95 now and WE pay postage. Money back if not delighted! If you order Presto-flex for use on motor, specify motor shaft diameter and add 50c for motor coupling. (Available for 1/4", 5/16", 3/8" and 1/2" shafts.) 50 piece accessory set available \$1.50 extra. Order TODAY from

**FOREDOM ELECTRIC CO., Dept. 105  
 27 PARK PLACE NEW YORK 7, N. Y.**

## NEW! ROTARY SANDER

FOR DRILL PRESS OR ELECTRIC DRILL  
 No Gluing—No Special Discs

Uses 3" square of any paper. Change in one minute without messy gluing. 3/8" shank for drill press. 1/4" shank for electric drill. Specify size. Write for literature on other time-saving tools.



**\$3.95**

**MASTERCRAFT 60 SOUTH ST.  
 BOSTON, MASS.**

# MAKE \$ MORE MONEY

Applying or Selling

## CORKSTONE

A General Purpose Magnesium Oxychloride Flooring

THE MODERN PLASTIC FLOORING

**EASY TO APPLY**  
 Here's your opportunity to get into business for yourself applying or selling Corkstone, the economical, top-grade plastic flooring. Plenty of profit. Act without delay!



**Dealers & Agents Wanted**  
 WRITE FOR DETAILS

**LASTING PRODUCTS COMPANY**  
 200 Block S. Franklinton Rd., Baltimore 23, Md.



Made to FIT YOUR GRIP

FOR FASTER MORE ACCURATE BLOWS!

The handle on every PLUMB Hammer is made from sturdy, seasoned Hickory. It's shaped for comfort grip and tested for strength. The black, one-piece head is double tempered from special-analysis steel. It's securely anchored to the handle by a patented screw-wedge. You can count on a Plumb to give you speed, power and precision in every blow. Yes, Plumb is a lifetime tool, built for permanence. Fayette R. Plumb, Inc., Philadelphia 37, Pa.

**Quality Comes FIRST  
 PLUMB  
 is FIRST in Quality**

The red handle with the black head —exclusively Plumb.

# PLUMB

HAMMERS • HATCHETS • AXES • FILES

APRIL 1948 291

1947 National League Batting Champion  
 ←  
 1947 American League Batting Champion  
 →

Harry Walker Ted Williams

THE  
*Signatures*  
 OF THE  
 CHAMPIONS

ARE FOUND ONLY ON  
 THE BAT OF THE  
*Champions*

The 1948 edition of H & B's Famous Slugger Year Book is ready now. Get your copy from your Louisville Slugger dealer or send 5c direct to us (stamps or coin) to cover mailing. Address Dept. Z-34, Hillerich & Bradsby, Inc., Louisville 2, Ky.

1948 Famous Slugger Year Book

LOUISVILLE SLUGGER  
 HILLERICH & BRADSBY CO.  
 LOUISVILLE, KY.

**LOUISVILLE SLUGGER BATS**

**CURIOUS?**

ABOUT A  
**SHIP-IN-A-BOTTLE**  
 HERE IS THE SECRET  
 PLUS all of the material for only 75c postpaid, less bottle.—For other unusual and beautiful projects send 10c for the new, fully illustrated catalog.

**75c**  
 Postpaid in U.S.A.

*Braun-Craft* 1232 ETOWAH, DEPT. PS4  
 ROYAL OAK, MICHIGAN

*Wagemaker*  
 GRAND RAPIDS, MICH.  
**WOLVERINE BOATS**

**FOR MORE FUN—FOR BETTER BOATING**

Thousands and thousands of boating friends who own a Wagemaker built "Wolverine" know what real boating pleasure is like. You, too, will enjoy one of our 60 models. Outboards in De Luxe and Super De Luxe Molded Plywoods, the last word in super construction and design. Round Bottom Strip Boats, Canvas Car Tops, and many others. This year make it a "Wolverine". Free literature on request.

**WAGEMAKER COMPANY**  
 DEPT. 26 GRAND RAPIDS, MICHIGAN

**WOOD WORKERS**

**Lumber—Plywood Available**  
 Harold Hunt wants to send you big new No. 15-A Catalog. Over 148 pages of wood-working ideas. 12 pages of rare woods in colors. UNEQUALED BARGAINS in imported and American woods, supplies, hard-to-find hardware. Send only 15c to cover postage and handling.  
**CRAFTSMAN WOOD SERVICE CO.**  
 2729 S. Mary St., Dept. B-92 Chicago 8, Ill.

only **15¢**

**STRONGHOLD** **SKRU-KITS**

**20 Assortments—49c Each**

Machine Screws, Wood Screws, Nuts, Washers, Cotter Pins, etc. Each assortment features one type fastener in wide variety of sizes and styles . . . Every fastener for your work. For workshops, garages, repair shops, hobbyists, mechanics. Stock up with several assortments at your favorite hardware counter. Look for **STRONGHOLD!**

Stronghold Screw Products Inc., 235A W. Hubbard St., Chicago 10, Ill.

You, too, will say . . .

**NEW "HANDIEST"**  
*thing I've ever used!*

**LEVERLOK**  
**VICE-CLAMP**

FOR EVERY CRAFT IN HOME or INDUSTRY

**TOGGLE PRINCIPLE**  
 ALL-STEEL STURDY  
 NICKEL-PLATED 12" LONG  
 RED ENAMELED STANDARDS

STANDS ON ITS OWN FEET in ANY position . . . ANYWHERE . . . attached or unattached. Adjustable from "touch-to-ton" of DIRECT holding power. No twisting tendency like ordinary screw-type vise. Own a LEVERLOK and KNOW all its advantages for YOUR particular needs. With every order, leaflet TELLS how LEVERLOK converts to clamp with jaw-openings up to 68". Ideal, useful GIFT. Get a LEVERLOK NOW. Satisfaction Guaranteed. \$7.30 postpaid. Check or M. O. Your LEVERLOK sent to you on same day we receive order.  
**C. G. SCHULZE CO., Inc. - Dept. L, 1859 HILLHURST - LOS ANGELES 27, CALIF.**



*RCA scientists—pioneers in radio-electronics—apply the “radio tube” to communications, science, industry, entertainment, and transportation.*

## ***This “magic lamp” makes Aladdin’s look lazy***

You will remember the fabulous lamp—and how it served its master, Aladdin. Serving you, today, is a real “magic lamp” . . . the electron tube.

You are familiar with these tubes in your radio, Victrola radio-phonograph or television set . . . but that is only a small part of the work they do. Using radio tubes, RCA Laboratories have helped to develop many new and useful servants for man.

A partial list includes: all-electronic television, FM radio, portable radios, the electron microscope, radio-heat, radar, Shoran, Teleran, and countless special “tools” for science, communications and commerce.

The electron microscope magnifies bacteria more than 100,000 diameters to help fight disease, radar sees through fog and darkness, all-electronic television shows events taking place at a distance, radio-heat “glues” wood or plastics, Shoran locates points on the earth’s surface with unbe-

lievable accuracy, Teleran adds to the safety of air travel.

Advances in radio-electronics are a major objective at RCA Laboratories. Fully developed, they are part of the instruments bearing the name RCA, or RCA Victor.

When in Radio City, New York, be sure to see the radio, television and electronic wonders at RCA Exhibition Hall, 36 West 49th Street. Free admission. Radio Corporation of America, RCA Building, Radio City, N. Y. 20.



**RADIO CORPORATION of AMERICA**

# 7x50 BINOCULARS



WITH COATED  
OPTICS

**\$58**

Weight 36 oz.  
Height 7 in.

ALSO AVAILABLE  
with uncoated optics..... **\$48**

These magnificent 7x50 prism binoculars have the brilliant luminosity, precise clarity, and wide, undistorted field of view obtainable only with a large glass having hard coated lenses and prisms. Because 7x50 glasses give the highest performance obtainable they are now the official choice of the Army, Navy and Marine Corps. Why be satisfied with a smaller glass when you can now have a brand new coated 7x50 at 1/3 of the usual price. Lifetime construction. Lightweight aluminum body. Ultra-precise optics that prompt users to remark, "The finest glass I have ever looked through." Sold with a guarantee of complete satisfaction or money refunded. Fine carrying case and straps included. Price, only \$58 plus 20% Federal tax. We pay the shipping cost. Immediate delivery. Supply limited so don't delay.

## BROWNSCOPE CO.

Dept. 4P, 24 West 45th St., New York 19, N. Y.

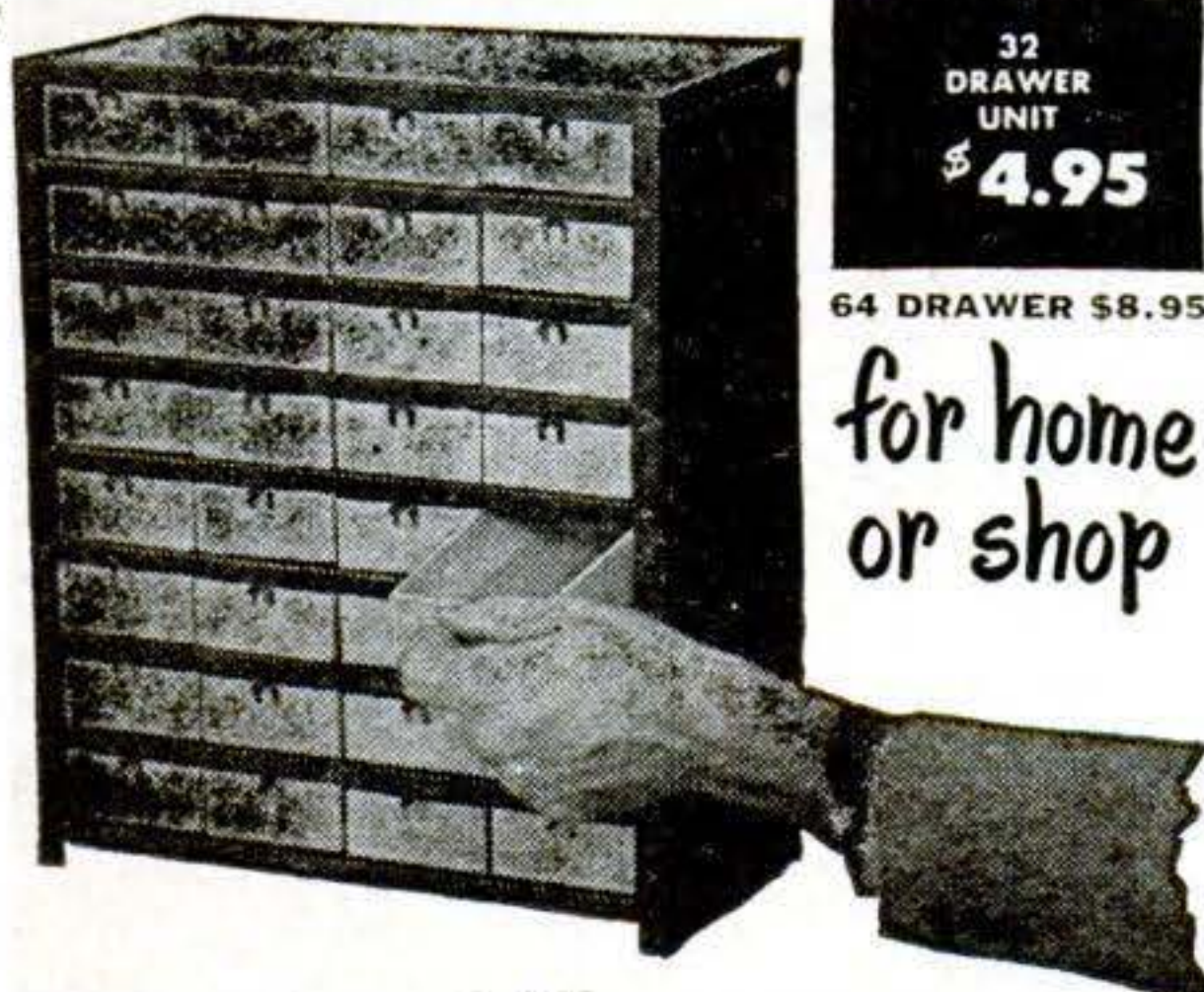

32  
DRAWER  
UNIT  
**\$4.95**

64 DRAWER \$8.95

for home  
or shop

## THE JIFFY all metal CABINET

With Laminated Fibre Board Drawers

THE HANDY WAY TO KEEP SMALL PARTS, WASHERS,  
NAILS, SCREWS, NUTS, BOLTS AT HAND

### DRAWER SIZE

1 1/4" Deep  
3" Wide  
6" Long

### CABINET SIZE

32 Drawer Unit

6" Deep  
12 3/4" Wide  
15 1/4" High  
Shipping Weight  
approx. 9 lbs.

64 Drawer Unit

6" Deep  
25 1/2" Wide  
15 1/4" High  
Shipping Weight  
approx. 18 lbs.

For small items, the low-cost Jiffy Cabinet, 32 or 64 drawer units that put office, shop, work bench, household and hobbyist needs at your fingertips. Metal flange drawer guides. Spot welded all metal cabinet with sturdy laminated drawers insures long time-saving service. Why fumble? With the Jiffy you know where it is. 32 drawer unit—\$4.95; 64 drawer unit—\$8.95. Send check or money order—No C.O.D.'s please. Ohio orders please add 3% Sales Tax. Shipping charges Parcel Post Collect.

## KAYTEE PRODUCTS

Dept. S • Box 588 • Canton, Ohio

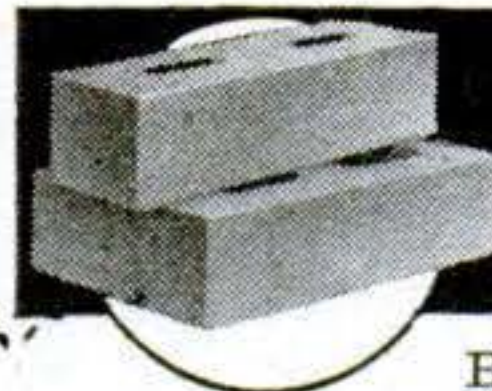

## More Local Manufacturers are Needed-NOW

Brikrete is sweeping the country. More local plants are badly needed. Several hundred territories are being opened up for local Brikrete manufacture by men of vision and aggressiveness. Brikrete ties in with today's huge building program. Makes possible better construction at lower cost. Truly better than brick; actually cheaper than lumber. Combines strength, safety, insulation value, colorful beauty.



## World's Most Modern Masonry

Brikrete is made in locally owned plants, using local materials and local labor. That's why high quality and low price still permit a 100% to 150% mark-up. We supply complete equipment; easy terms if required. Generous cooperation. Exclusive manufacturing privileges in protected territory. Write or wire for information.

BRIKRETE ASSOCIATES, INC.  
4675 S. Division, Grand Rapids, Mich.

## BRIKRETE

## TRAILER BUILDERS!

BUILD or BUY... SPECIFY

• Torq-Less Axles • Bull Dog Hitches and  
Parking Jacks, Safety-Engineered by  
HAMMER BLOW TOOL COMPANY  
D-23 Wausau, Wisconsin

Send for FREE Catalog

## BUILD YOUR OWN FAST FREEZER

PLANS  
\$1

It's easy to build this household appliance with LeJay Plans. Made from new or used parts. Save up to 75%. No expert knowledge needed. Plans show 5 sizes and are easy to follow. All details clearly explained. Enjoy making one of these freezers. Mail \$1 for set of plans and catalog. LEJAY MFG. CO., 423 LeJay Bldg., Minneapolis 8, Minnesota



5 sizes  
8 to 40 cu. ft.

## AIR COMPRESSOR AT A BARGAIN

Piston type, size 2 x 1 3/4, head in valves, bronze bearings, splash lubrication, "V" Belt drive, Intake muffler and cleaner. Capacity 2.8 c.f.m. at 100 lbs. continuous pressure or 150 lbs. Intermittent, with 1/2 HP motor. Can be used with 1/4 HP or 1/3 HP at lower speed. Weight 14 lbs. Operating instructions furnished.

Immediate delivery. **\$17.95**  
Price only

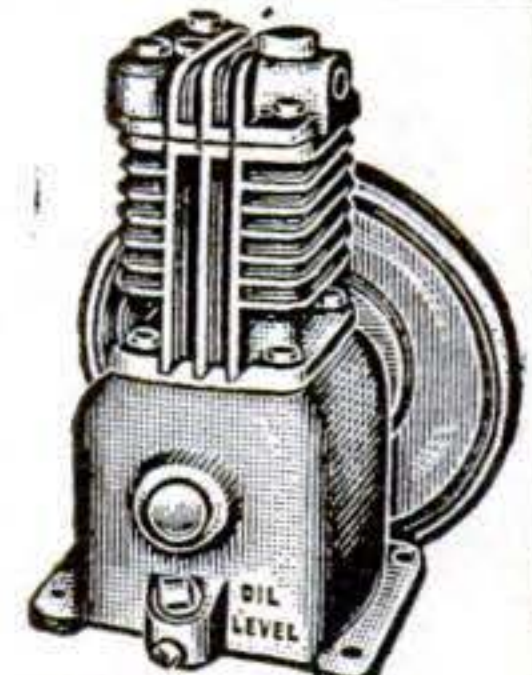

## AUTOMATIC PRESSURE SWITCH WITH UNLOADER



125 to 150 lb.  
Pressure.  
Use with 1/4 to 5  
HP Unit.

Only **\$8.95**

1/4" air check valve... \$2.50  
1/2" air check valve... 4.25  
2 1/2" air gauge, 160 lb. 1.75  
1/4" safety valve,  
125 lb. .... 1.50

Prices are F.O.B. Chicago. Immediate delivery. **SOLD ON MONEY BACK GUARANTEE.** Send check or money order today.

DEALERS - WRITE...  
**C & M EQUIPMENT COMPANY**



1/4"  
REDUCING  
VALVE &  
GAUGE

**\$5.75**

Oil resistant, pressure 0-to-200 lb. Reduced pressure 0-to-75 lb.; 3 outlets 1/4". Wt. 2 lbs.  
1831 S. State St.,  
Dept. D-4, Chicago 16, Ill.



NONE BETTER AT ANY PRICE!

PAINT YOUR CAR WITH

# KAR-WIPE

NEW AUTO ENAMEL SENSATION

GUARANTEED

WIPE IT ON!

NO SPRAYING!

NO BRUSHING!

2 FULL YEARS \$1.95

No Lap Marks

No Masking

No Streaks



YOU CAN DO A FACTORY-LIKE JOB

One Quart Covers Average Car With Two Gleaming Coats. A Glowing Professional Finish!

Not a streaky wax or polish. KAR-WIPE is the new miracle high lustre auto enamel that is so easy to use. Anyone can do a professional looking job quickly.

KAR-WIPE CO. Dept. S-4 828 S. 18th St., St. Louis, Mo.

Almost anyone can get high-gloss job that looks like a Professional finish. KAR-WIPE does the trick!

Easy to apply! No brush! No masking! Simply WIPE IT ON with the applicator that we give you FREE. Get a factory-like finish that's GUA-

RANTEED against chipping, cracking, peeling, fading when simple directions are followed. Dries dust free quickly. In newest colors.

SEND NO MONEY! Order one or more quarts today. Just mail postcard Pay postman plus C.O.D. upon delivery. Send remittance, save postage.

SEND NO MONEY! ORDER Kar-Wipe TODAY! In Black, Grey, Firey Red, Brewster Green, Washington Blue, Maroon ... \$1.95 per qt.

## Build YOUR OWN BOAT



Complete parts cut to exact size—ready to assemble. Marine waterproof plywood, hardwood frame; rustproof oarlocks. Ideal for car top carry. Also models with laminated airplane spruce frames; mahogany decked outboard motor, high speed runabouts. Build now for personal use or sale at attractive profit. Exclusive franchise to local builders. Send 10 cents (one dime) for illustrated literature today.

\$39.50 and up

OZARKA

704 Washington Ave.

WOODSTOCK, ILL.

## How to Make Liquid Marble

### And BIG PROFITS In Your Own Business

Amazing Liquid Synthetic Marble can be made at home without machinery. Needs no heat or pressure. Can be poured into molds for casting expensive novelties. Liquid Synthetic Marble can be made in any color. It is even more beautiful than genuine marble because of its highly glazed finish. Costs far less. FLEXIBLE MOLDS: Make your own Flexible Molds. Cast novelties, statuary, desk sets, book-ends, etc. out of Liquid Marble, plaster and many other molding compositions. A large sized mold costs but a few cents. Hundreds of casts can be taken from a single mold. UNLIMITED MARKET: You will find steady year-round demand in your own community. No selling problem. We supply names of buyers for your finished products. Let BING PRODUCTS show you how to start with a small investment and build a permanent, independent, profitable business! Write now for FREE CATALOG!

BING PRODUCTS: Dept. B-30 88 BROAD STREET BOSTON 10, MASS.

# HERE'S THE NEW SAFER JIGSAW

for

# YOU!



World's Safest Saw

Complete with Cord 3 Blades

No Motor Needed . . . Just Plug In! Portable! Safe! Cuts Clean, Smooth . . . Needs No Sanding.

Join the thousands of satisfied Syncro Jig Saw owners getting real pleasure, profit and relaxation using this amazing wonder tool! Think of the fun you can have making wall lamps, magazine racks, picture frames, games, many other articles for profit and pleasure. Easy to use! Just plug into any 50 or 60 cycle AC 110-130 volt outlet. Portable. Use anywhere...kitchen, basement, garage, attic. Ideal for apartments! Syncro's self-contained power unit needs no oiling—clean! Leaves no grease stains on table tops—no sawdust cloud. Its the perfect, safer educational tool for adults and younger children! Teach Junior to make fancy cut-outs, model planes, bookends, toys. Girls will love to make plastic monogram pins, jewelry, model furniture for doll houses. This amazing Syncro jig saw cuts wood, leather, plastic, 1/16" brass, aluminum, zinc, other thin metals, all with the same blade. It will follow the most intricate design, on that fancy what-not or cabinet you want to make, with perfect accuracy and ease. Syncro's safety stroke feature makes it the world's safest saw! Designed especially for you and your family. Low price. Mail coupon below for complete information without obligation.

WHY SYNCRO IS THE SAFEST

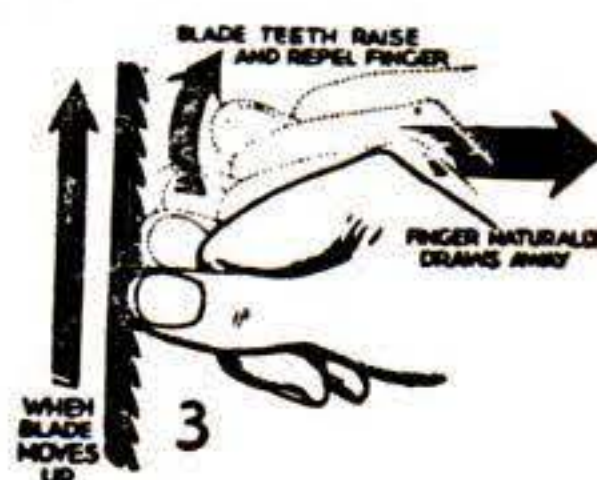
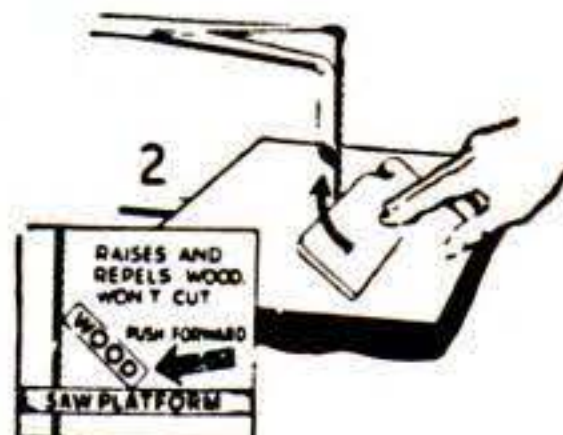

Write for FREE CIRCULAR And Details of our 10 DAY TRIAL

Mail coupon now for FREE circular containing complete Syncro information and details on our liberal money back 10 DAY TRIAL OFFER. Paste coupon on penny post-card or mail in envelope today!

Dealers Write!

FREE INFORMATION COUPON!

SYNCRO SAW CORPORATION, Dept. B-48 Rochester, Michigan (Export Address: 120 Wall St., N. Y. City)

Gentlemen: Rush me, without obligation, free, complete details of Syncro Saw, your 10 Day Trial Offer, amazing low saw price.

NAME.....

St. & No.....

CITY.....ZONE NO.....STATE.....



**ONLY \$5.85**  
(With 3 Saw Blades)  
Postpaid



## MOTO-SAW

THE AMAZING ELECTRIC SCROLL SAW

Boys from 8 to 80 (and girls, too) have fun with a Moto-Saw . . . it works more like magic than any tool you ever saw! It takes no effort to run, no perceptible pressure to feed. Runs 7,200 strokes a minute . . . easily cuts intricate scroll designs in medium hard wood up to 3/4" thick. Blade holder faces blade 4 ways . . . permits you to saw sideways as well as forward and backward. No limit to length of stock it will cut . . . saws to center of 19" widths. **Moto-Saw is as safe as a hand saw . . . has only two moving parts . . . never needs oiling.** Uses 110-120 V. 50 or 60 cycle A.C. (only). Thousands of satisfied users.

**MONEY-BACK GUARANTEE:** If your dealer does not yet have Moto-Saw, send only \$5.85 . . . we'll pay postage. Or send \$1, and pay postman balance plus postage. Money back if not delighted after 5 days' trial.

**DREMEL MFG. CO., DEPT. S128-D, RACINE, WIS.**

## DEAFNESS EXPLAINED

IN NEW FREE BOOKLET

New, authoritative booklet, fully illustrated, can help you solve your hearing problems. Learn more about hearing loss—its causes—its correction.

**Western Electric Dept. 380-PS-4**  
195 Broadway, New York 7, N. Y.

Send free copy of "Modern Science and Your Hearing." Include illustrated booklet on two new all-in-one Western Electric Hearing Aids.

Name \_\_\_\_\_

Address \_\_\_\_\_

City \_\_\_\_\_ Zone \_\_\_\_\_ State \_\_\_\_\_

Distributed in Canada through Northern Electric Co., Ltd.

**Easy and Cheap to Operate**

**SAVE TIME, WORK, MONEY!**

# SHAW "DU-ALL"

and "PEPPY PAL" TRACTORS

**PLOW**

These rugged walking or riding tractors ideal for farm, truck garden, orchard, poultry farm. They operate on a few cents an hour. A child can handle them.

**CULTIVATE**

**DO DOZENS OF JOBS**  
The Shaw Du-All or Peppy-Pal does many jobs quickly and easily. Plows, cultivates, harrows, disks, bulldozes, sprays, hauls, grinds, and saws wood.

**MOW**

**BUILT FOR RUGGED WORK**  
Sturdy, extra-strength construction means low upkeep, long life. Full year's guarantee.

**RIDE**

**LOW FACTORY PRICES**  
Buy direct or through your dealer! Almost anyone who owns a garden can afford a Shaw Du-All or Peppy Pal. Mass production holds prices down—quality up.

**RIDING TRACTORS**  
4 models, from 5 to 12 1/2 H. P., 58 in. wheel-base, 36 in. wide, 24 in. plant clearance. Hand or electric starter. Improved steering device, brakes enclosed in differential housing shaft. Heavier frame and bearings. Standard hitch for trailers and wagons. Plow, harrow, cultivator, cutter bar, snow plow, bulldozer available.

**FREE:** Illustrated folders giving complete details and price lists—write today!

5704 Front St., Galesburg, Kan.  
668 PS North 4th St., Columbus, O.

**SHAW MFG. CO.**

## PLYWOOD BOAT KITS

**\$49.00**  
(Including Freight)



This **READY-CUT 12** ft. fishing boat can be assembled in 8 hrs. without forms or special tools. Kits are complete including all hardware, paint, and etc. Send for free folder.

**TAFT MARINE WOODCRAFT**  
Dept. K 636 39th Ave. N.E. Minneapolis 18, Minn.

# STOP CHANGING MOTOR OIL!

End this needless waste and expense forever with

## RECLAIMO

Today's Most Advanced Oil RE-REFINING Filter

Continuously cleans and **RE-REFINES** motor oil as you drive (by utilizing motor heat)—keeps oil in high grade lubricating quality at all times—reduces motor wear to a minimum! Proves conclusively that "Oil Does Not Wear Out Mechanically" as stated by U. S. Bureau of Standards, (Bulletin 86).

**"RECLAIMO"**

- REMOVES SOLIDS (by filtration)
- REMOVES WATER (by distillation)
- PREVENTS Excess Fuel Dilution
- PREVENTS Acid and Sludge Formation

**MAINTAINS Stable Viscosity** **ELIMINATES All Oil Changes**

**CAR • TRUCK • TRACTOR OWNERS!**

You'll want to know more about Reclaimo's Oil, Motor and Money-Saving Features. **FREE 40-PAGE BOOK "OIL FACTS"** gives you the complete "Reclaimo" story plus details about our **New 90-Day No Risk-No Cost TRIAL OFFER!** WRITE for YOUR COPY TODAY!

**RECLAIMO MFG. CO.**

5083 ELSTON AVE., Dept. 74, CHICAGO 30, ILL.

**NEW ADDED FEATURE!**  
Gas - Moisture Vapor Injector  
Increases Mileage with Smoother Performance

**Sensational  
MANI-DAPTOR** →

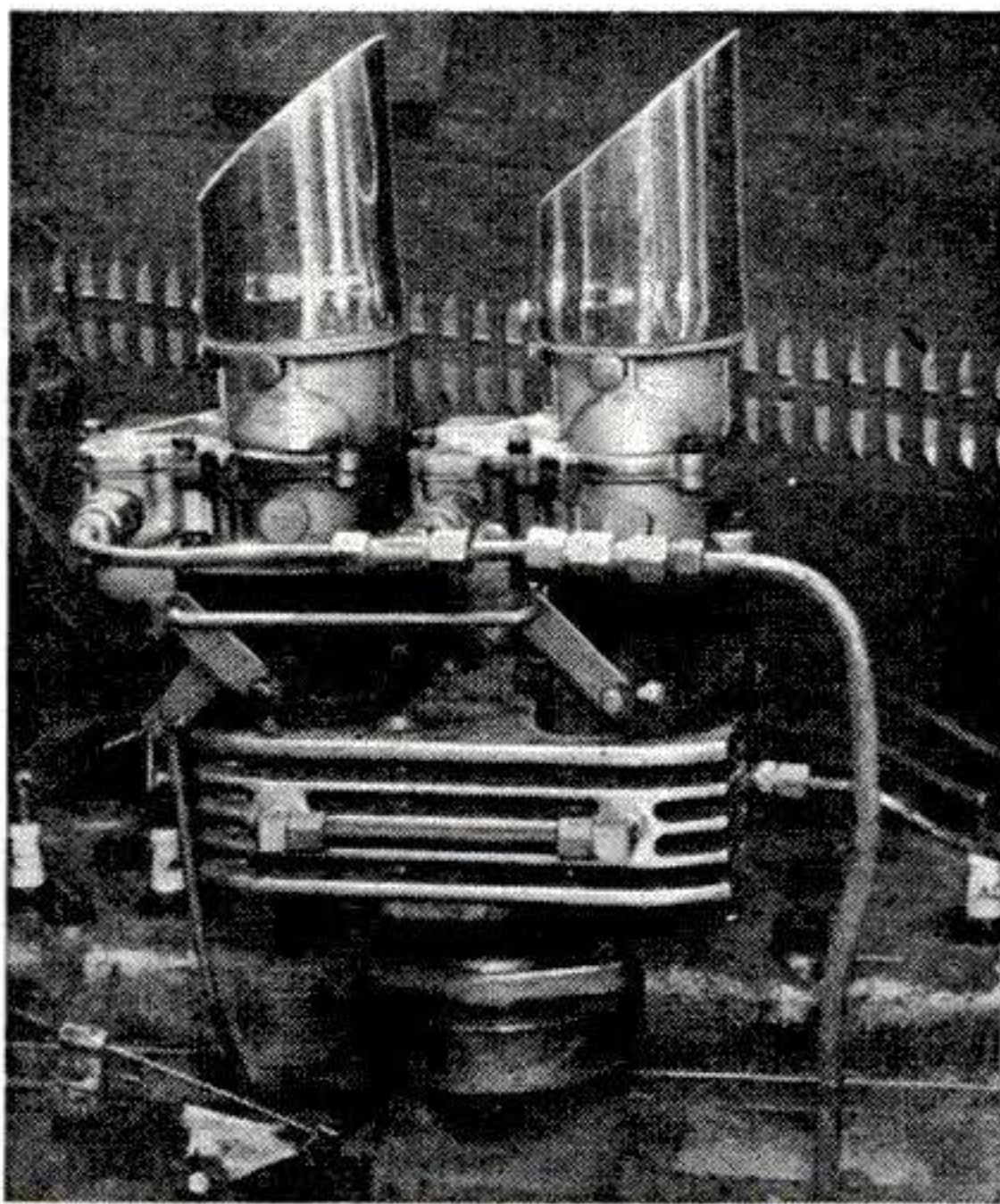

# TWIN CARBURETION UNIT

Available for installation on any car with down-draft manifold.

● **POWER**      ● **SPEED**      ● **ECONOMY**

The Mani-Daptor steps up your motor's efficiency by approximately 20%—it puts to work horsepower that has been lying idle. The firing order is at no time affected by fade-outs and yet you save on gas! More high gear driving, more pick-up and quicker, more economical driving is attained with the Mani-Daptor.

**POWER & SPEED.** A 33 Ford V-8 (stock) was clocked at a top speed of 72 mph. With a Mani-Daptor installed it was clocked at 96 mph. There is a marked increase in power and speed in every car or truck equipped with the sensational, new Mani-Daptor.

**ECONOMY.** One Chevrolet owner reports a mileage increase from 16 to 23 miles per gallon. Top speed increased 20 mph. Due to increased performance with the Mani-Daptor, engine repairs and upkeep were cut to a minimum.

DEALER OR DISTRIBUTOR INFORMATION ON REQUEST

**NOW AVAILABLE!** Mani-Daptors for immediate installation, complete with linkage and easy-to-follow instructions.

8 cylinder cars **\$26.50** Chrome Stacks  
POSTPAID \$1.25 ea.  
6 cylinder cars **\$32.00** Finned Stacks  
POSTPAID \$2.00 ea.  
Velocity Stacks and Carburetors extra

**LES B. BACKUS**  
10617 Prairie Avenue  
Inglewood, California

**ORDER NOW**

Orchard 7-8545

Please rush a Mani-Daptor unit for a.....  
make model cylinders

Deposit..... Prepaid..... COD.....

Name.....

Address.....

City..... Zone..... State.....

SEND INFORMATION ON HIGH SPEED EQUIPMENT

**FREE Photo Catalog**  
Fresh off the press— from America's photographic department store! Cameras, Projectors, Film, Darkroom needs, etc. . . . thousands of photo buys.  
**128 PAGE BARGAIN BULLETIN**  
**FOTOSHOP** Dept. 23E 18 EAST 42nd ST. N.Y.

## **PALMGREN** Rotary, Indexing, Milling TABLE

**DUAL CROSS FEED and ROTARY FEED No. 83**

Has 8" table, 360° movement and 4" cross feed travel. Adjusting wheels and dials graduated in degrees and thousands. Slotted for bolting to table. No. 83 Priced \$49.50. No. 82 without rotary feed \$39.75.

Write for Circular No. 10

**CHICAGO TOOL and ENGINEERING CO.**  
8396 South Chicago Ave., Chicago 17, Ill.



## HOW TO GET THE MOST OUT OF YOUR HOME WORKSHOP

Here's how to **DOUBLE** the use and enjoyment you get from your Home Workshop! In this brand-new book, experts reveal know-how knacks of woodworking craftsmanship that will enable you to build furniture, make money-saving home repairs and improvements, enjoy scores of *additional* workshop hobbies! Covers use of all hand tools and jigsaw, lathe, drill press, circular saw, jointer, sander, bandsaw, carving motor, grinder, planer, shaper, etc. 690 illustrations! Order this big, handsome workbench manual now! Pay postman only \$1.98 plus postage when book arrives. (Or, if you want Special DeLuxe edition, Buckram bound, stamped in brilliant aluminum foil, pay \$2.73.) Use it *a whole week*. Then, if not fully convinced it can **DOUBLE** the value of your Home Workshop to you, you may return it for refund of every penny! Send in the Order Form now!

### MAIL FREE-TRIAL COUPON NOW!

**Popular Science Publishing Co., Dept. 48**  
353 Fourth Avenue, New York 10, N. Y.

Send me **How to Get the Most Out of Your Home Workshop**. I will pay postman price checked plus few cents postage when book arrives. If not 100% satisfied, I may return book within 7 days for full refund.

- DeLuxe Edition**, Buckram bound, stamped in aluminum, **\$2.73**
- Regular Edition**, cloth bound, **\$1.98**

Name.....

Address.....

City..... Zone..... State.....

Check here if you send remittance now, and we will pay postage. Same return and refund privilege.

**RUGGED? YOU BET!**

**BELL** WATER-SHOCK RESISTANT

Handsomely styled, precision tested, built to take hard usage, ready to go places.

No. PI 220—**ALL-STAINLESS STEEL CASE**, 17 jewels, anti-magnetic, radium dial and hands, unbreakable crystal, sweep second hand. (Price includes Fed. Tax **\$29.95** and Postage).....



**NOW AT NEW LOW PRICES**

Order Direct from **BELL**. Mail check, money order or pay C.O.D. Write for **FREE Booklet "PI"**

**BELL WATCH COMPANY, INC.**

9 Rockefeller Plaza, Suite 909, New York 20, N.Y.

# Announcing SHAPER and MOLDING Cutters

## FOR ALL MAKES OF DRILL PRESSES!



**NO SET SCREWS TO LOOSEN!**  
**BLADES AUTOMATICALLY ADJUSTED. CANNOT SLIP OR FLY OUT!**



### OTHER EXCLUSIVE FEATURES

Blades instantly replaceable—automatically drop into position—cannot loosen or fly out . . . quickly rehoned or reground. Variety of blade shapes for varied contours. Balanced, concentric, built for lifetime use. One locking nut only. Fits tapered, threaded, or 1/2" I.D. spindles. Specify type and size spindle.

**\$9.00**

Complete as illustrated with 3 sets of blades. Full Money-Back Guarantee



**\$7.95**

**ALL-METAL SHAPER FENCE**  
 For use with shaper and molding cutters, planers and drum sanders. Fits all drill presses and shapers. Complete—with tempered hold down springs. Fully rust proofed. A real buy.



**2 1/2" DRUM SANDER**  
**\$3.95**  
 with 5 Sleeves



**ROTARY WOOD PLANER**  
 Most sensational, versatile drill press tool ever built. Planes, trues-up, tenons, panels, rabbets, grooves, beads, bevels, etc. An all purpose, lifetime tool. Complete.

**\$7.50**



**4" ROTARY SANDER**  
 Sands wood and plastic surfaces to agate smoothness. Available for hand drills, flexible shafts and drill presses. Two size arbors 1/4" or 1/2". Complete with 20 discs. **\$5.95**

**FULL 10 DAY MONEY-BACK GUARANTEE**

**FREE Workshop Catalog**

**BARRON TOOL COMPANY, INC.,**  
 270 Architects Bldg.: Detroit 1, Mich.



**BARRON PRECISION WORK SHOP TOOLS**

# WORLD'S LOWEST PRICED ADDING MACHINE

**VEST POCKET SIZE IDEAL FOR BUSINESS OR PERSONAL USE**

**FREE TRIAL ONLY \$2.95**  
**TOTAL COST SEND NO MONEY**

**FREE!!**  
 Each Baby Calculator in Beautiful, rich-looking Leatherette case—at no extra cost.



Fits vest pocket or purse. Guaranteed accurate. Operated as easily, and as reliable, as machines costing many times as much. Not a toy. Precision made, very durable—guaranteed for life against defects in construction. You positively can't buy a calculator of equal quality for as little money. **ACCEPTED AS THE FINEST LOW PRICED CALCULATOR FOR OVER 35 YEARS!** Operates with a flick of your finger. Adds, subtracts, multiplies, divides—counts up to one billion. Pays for itself over and over in mistakes avoided, and time saved. **MAKES IDEAL GIFT.**

Sold on a positive money back guarantee. Send only \$2.95, Calculator sent postpaid, or send name and address and pay postman \$2.95 plus postage. **MONEY BACK IN 10 DAYS IF NOT DELIGHTED!** (If outside U. S., send \$3.50.) **AGENTS WANTED.**

**CALCULATOR MACHINE CO., (Mfrs.)**

Dept. 499, P. O. Box 248, Glenview, Illinois

## FLOYD CLYMER'S unbiased book

### "INDEPENDENT TEST REPORT ON KAISER-FRAZER CARS"



Read what 3000 owners now think of their K-F cars. Expert, part-by-part analysis. 100 photos. Tells all. 3000-mile test run, Pike's Peak closed car record, gas mileage. Thousands are buying. Order now. \$1.50 postpaid. \$2.50 deluxe ed. Cash, money-order, or specify C. O. D. Money-back guarantee. Clymer, Publisher, Dept. PS-4 2125 W. Pico, Los Angeles 6, Calif.

## IT TAKES 30 MINUTES TO MAKE YOUR OWN WORK BENCHES

### BENCH LEGS

Arc welded rigid assembly steel bench legs providing support for storage platforms, wood tables and steel benches. 28" deep, 31 1/4" high, 2 1/2"x14 gauge steel channel.

Each leg will safely hold 5000 lbs. 2 legs make a 6-ft. Bench

**WHOLESALE HARDWARE CO.**

761 Tenth Ave., New York 19

Tel. CO. 5-1816



Includes all Bolts for Table Tops

# Now a DYNAMIC Industrial Transformer Type Super Charged WELDER

## FOR AUTO, HOME APPLIANCE AND FARM REPAIRS

DESIGNED TO DO HIGH GRADE WELDING *inexpensively*—Maintenance Men, Farmers, Mechanics, Machine Shops, Foundries, Auto, General Repair and Job Welding Shops, all using the DYNAMIC find it so indispensable and useful that they can't afford to be without it. **EASY-TO-OPERATE.** If inexperienced you can easily learn to do a variety of high grade welding jobs by following the practical, *simplified Welding and Operating instructions furnished.* Once you see the DYNAMIC in operation you won't want to be without it. Its simplicity will amaze you. In a year the DYNAMIC only costs you about 7c a day. Comes complete ready to operate with helmet, rods, cable, holder, operating and welding instructions, etc.

## Saves You Valuable Time and Money!

This portable, industrial transformer type *Dynamic Welder* easily carried right to the job can be operated from any convenient properly wired 110 Volt 60 Cycle Line. **WORKS on IRON, STEEL, BRASS, BRONZE and Other Metals.** Has 8 metallic and carbon arc heat stages. Does work you would think only possible with a larger more expensive machine . . . Can also be supplied for 220 VOLT 60 CYCLE operation and other voltages and cycles at slight additional cost.

**DYNAMIC WELDER CO., 15 East 23rd Street, AF, CHICAGO 16, ILL.**

FOR ONLY

**\$2850**  
 COMPLETE

## DO YOUR OWN WELDING

Just a few repair jobs will pay for this machine. A practical and profitable machine tool for any workshop. Make money doing repair work for others.

Write for Particulars Get Details on our 10 day Trial Offer Member Chicago Association of Commerce.



# BETTER JOBS BETTER PAY IN RADIO

EVERYTHING IN  
RADIO  
AND ELECTRONICS  
in **ONE** book!  
Over 1000 pages

All the expert knowledge  
at your fingertips . . .  
quick to find . . . easy  
to read in the

## RADIO DATA BOOK

This new radio bible will be your lifelong tool. You will use it every day for every operation in radio and electronics. The **RADIO DATA BOOK** provides complete information on any radio subject . . . in clear-cut, easy-to-understand, completely illustrated style. It is a complete course in radio for the beginner . . . it is packed with money-making knowledge—for the professional . . . and it is a complete reference for the master. Advance sale, only 10,000 available—to make sure you get your copy of the **RADIO DATA BOOK** send in your order now!

Handsomely bound in red and gold—12 complete books in one, only \$5.00—less than 42c per book! **SATISFACTION GUARANTEED—OR YOUR MONEY BACK.**

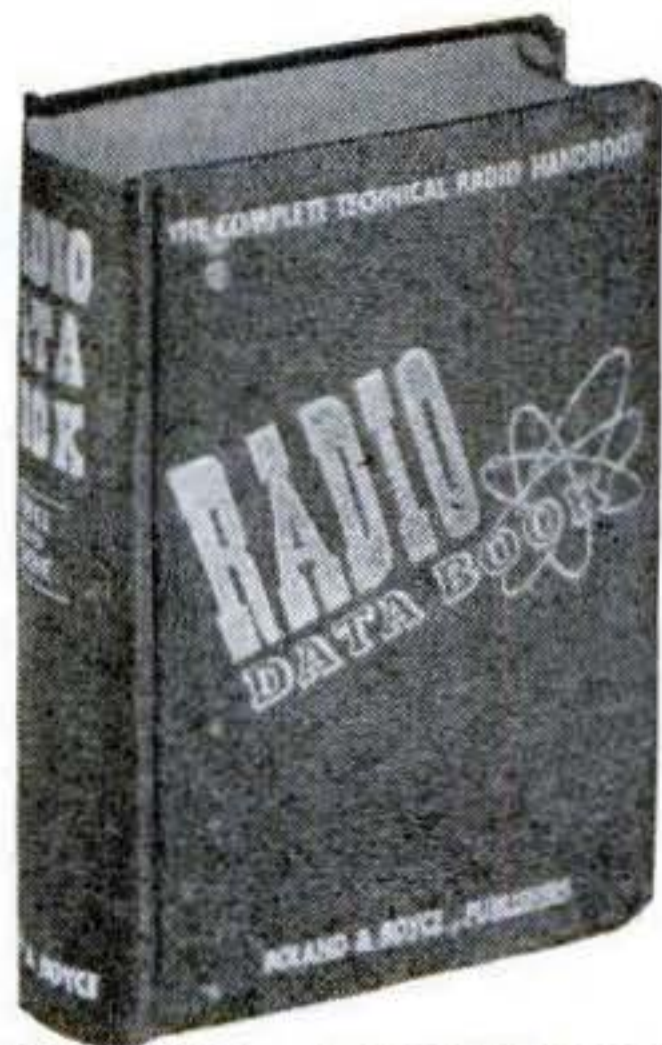

12 Sections . . . Over 1000 pages  
Completely illustrated.

- Section 1. The 150 Basic Circuits in Radio.
- Section 2. Complete Test Equipment data.
- Section 3. Testing, Measuring and Alignment.
- Section 4. All About Antennas.
- Section 5. Sound Systems.
- Section 6. Recording.
- Section 7. Complete Tube Manual.
- Section 8. Charts, Graphs and Curves.
- Section 9. Codes, Symbols and Standards.
- Section 10. 50 Tested Circuits designed for optimum performance.
- Section 11. Dictionary of Radio and Electronic Terms.
- Section 12. Radio Book Bibliography.

**BOLAND & BOYCE, INC., PUBLISHERS** PS-2  
460 Bloomfield Ave., Montclair, N. J.  
Send me the RADIO DATA BOOK. Enclosed is \$5.00.

NAME.....  
ADDRESS.....  
CITY.....ZONE.....  
STATE.....

**BOLAND & BOYCE INC., PUBLISHERS**

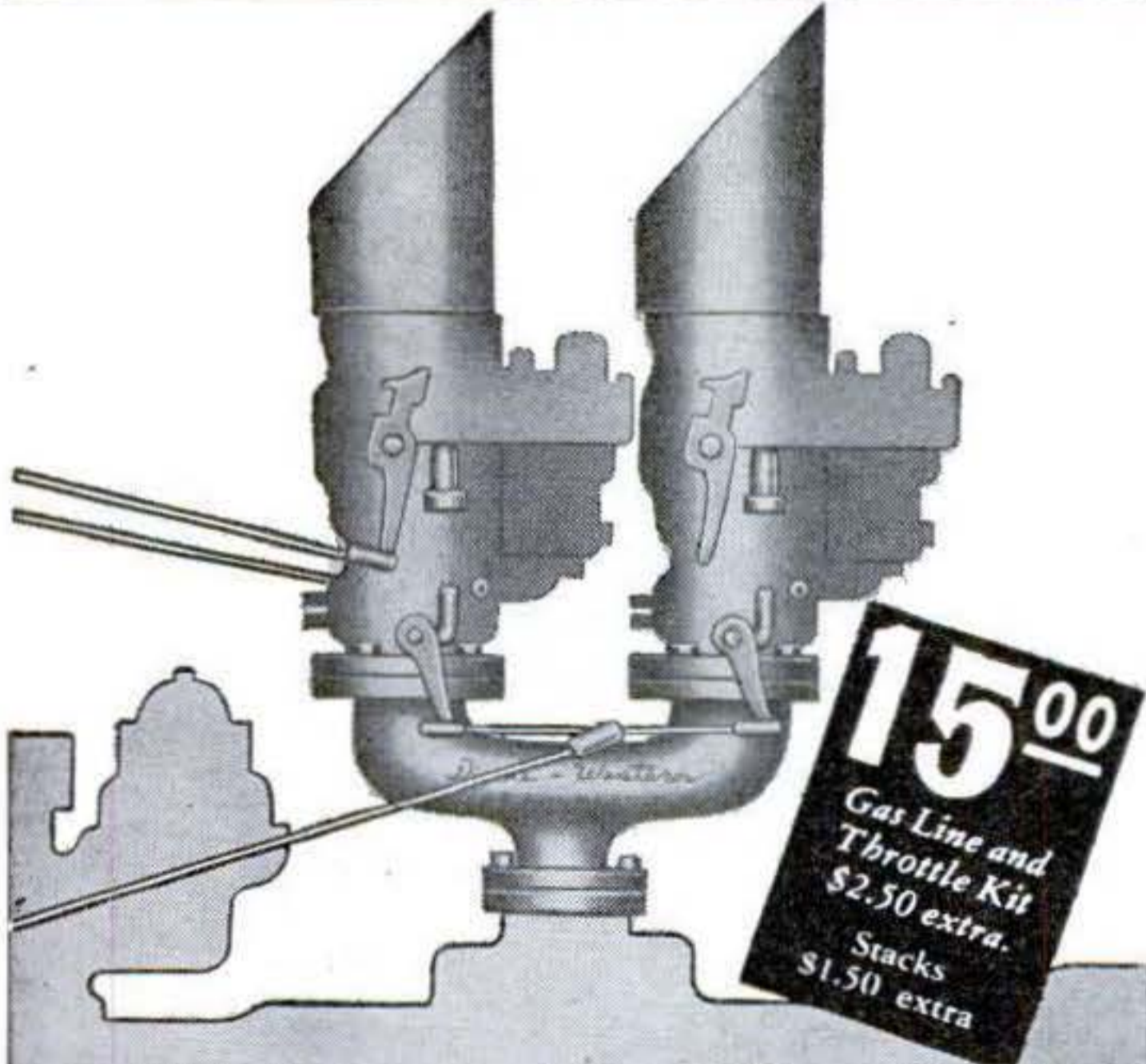

for **AMAZING Acceleration**

GET THIS  
**DIXIE WESTERN  
Polished Aluminum  
DUAL INTAKE  
MANIFOLD**

For Fords and Mercurys  
increases mileage  
speed and performance

DIXIE WESTERN MANIFOLD CO.  
Dept. S, Box 364, Los Angeles 43, Calif.  
Gentlemen Please send me:

- Dual Manifold Set
- Gas Line and Throttle Kit
- Chrome Plated Velocity Stack

to fit my \_\_\_\_\_

(year and make of car)  
 Check enclosed  Ship C.O.D.

Name \_\_\_\_\_

Address \_\_\_\_\_

City \_\_\_\_\_ Zone \_\_\_\_\_ State \_\_\_\_\_

**DIXIE WESTERN MANIFOLD CO.**  
Box 364 Los Angeles 43, California

# Free



*Concord*  
**RADIO  
CATALOG**

23 pgs. Radio & Television  
Sets • 62 pgs. Radio Parts  
18 pgs. Sound Amplifiers &  
Accessories • 23 pgs. Ham Gear  
9 pgs. Electronic Test Equipment

**160 VALUE-PACKED PAGES**

Thousands of items for every Radio need. Buy with confidence—over a quarter century of reliability. Satisfaction guaranteed or your money refunded.

## SPECIAL! Photoflash Condenser



Small lightweight unit for use with battery or 110 volt power supplies. Peak volts 2500, energy storage 21.9 watt seconds, capacity 7 mfd. Professional results can be obtained by the use of 3 or 4 condensers in parallel. Size 2 3/8" dia. x 6". Shipping weight 5 lbs.

**5B3240CD** ..... \$3.95

## Air-Core Condenser Tuned IF Transformers

Double tuned with compression mica trimmers adjusted from top of aluminum shield can. RMA color coded leads. Tuned to 456 KC. Size 1 3/8" x 1 3/8" x 3".

**X185CD—Input** ..... 29c  
**X186CD—Output** ..... 29c



## Model Maker's Heavy Duty 1 1/2" Vise

Ideal for radio servicemen, amateurs and experimenters when working on small parts. Twin guide rods, precision cut worm (not rolled) and finely machined jaws insure firm grip of work without marring. Easily mounted on or attached to any work bench. Jaws can be extended 2 1/4". Size closed 4 1/4 x 1 3/4 x 6". Shpg. wt. 5 lbs.

**C15735CD** ..... \$1.51

# CONCORD RADIO CORP.

**CHICAGO 7**      **ATLANTA 3**  
901 W. Jackson Blvd.      265 Peachtree Street  
Downtown Chicago Branch: 229 W. Madison  
**LAFAYETTE RADIO CORPORATION**

MAIL THIS COUPON NOW!

Concord Radio Corporation, Dept. 114  
901 W. Jackson Blvd., Chicago 7, Ill.  
Yes, rush FREE COPY of the comprehensive new  
Concord Radio Catalog.  
Name.....  
Address.....  
City.....State.....

**BRAND NEW**



## HYDRAULICS

Use hydraulics on arbor presses, hydraulic presses, hay lifts, manure loaders, lift trucks—push or pull, tilt or turn, press or squeeze, open or close, lift or lower—and other hydraulic and industrial applications. Use with

either air or oil . . . of finest precision workmanship.  
 1. Double action, 3" bore, 12" stroke, all steel hydraulic cylinder, will lift up to 12,000 lbs. (7,000 lbs. in 3 seconds with Vickers Pump.) . . . \$78.00 value . . . **\$19.50** postpaid. Weight 12 lbs.  
 2. Double action, 1½" bore, 27" stroke. (Will lift 1760 lbs. in 2 seconds with Vickers Pump.) A \$55 hydraulic cylinder value for only **\$12.95** postpaid. Wt. 8 lbs.  
 3. Double action, 2¾" bore, 8" stroke. (will lift 4400 lbs. in 1 second with Vickers Pump.) A \$50 value, available now at **\$14.50** postpaid.

### VICKERS MODEL MF6 HYDRAULIC PUMP

Compact, powerful, rated 1,000 P.S.I., .507 cu. in. per revolution, 8 gal. per min. at 3750 r.p.m. Brand new, wt. 4½ lbs. \$60 value for **\$14.95** postpaid.

U. S. SURPLUS BARGAIN

## Polaroid Goggle Kit



Brand New! In original packing. Each with four interchangeable lenses.

Shock Proof Frame Shatterproof Lenses

Use them for all outdoor sports, beach, motoring, boating—anything. Heavy windproof sponge rubber ventilated frame with snap button lens retainers! Adj. elastic head band. Clear, red, green, amber, flexible, shatterproof lenses, all instantly interchangeable, with carrying case. They won't last long at this price—it's smart to buy an extra.

**\$1.00** Prepaid in U.S.A.



## CLUTCH WITH UNIVERSAL JOINT

Brand new. Formerly used on Amphibious Jeeps. Has shaft 3 feet long and 5 inch pulley . . . with ball bearings in pulley can be used for power take-off with winch and hoist. Only . . . **\$4.95**

WORTH A LOT MORE!

## VACUUM-AIR HYDRAULIC GENERAL PURPOSE PUMP

Original Cost  
**\$45.00**  
 Now Only  
**\$9.95**  
 Prepaid in  
 U. S. A.

**BRAND NEW!**

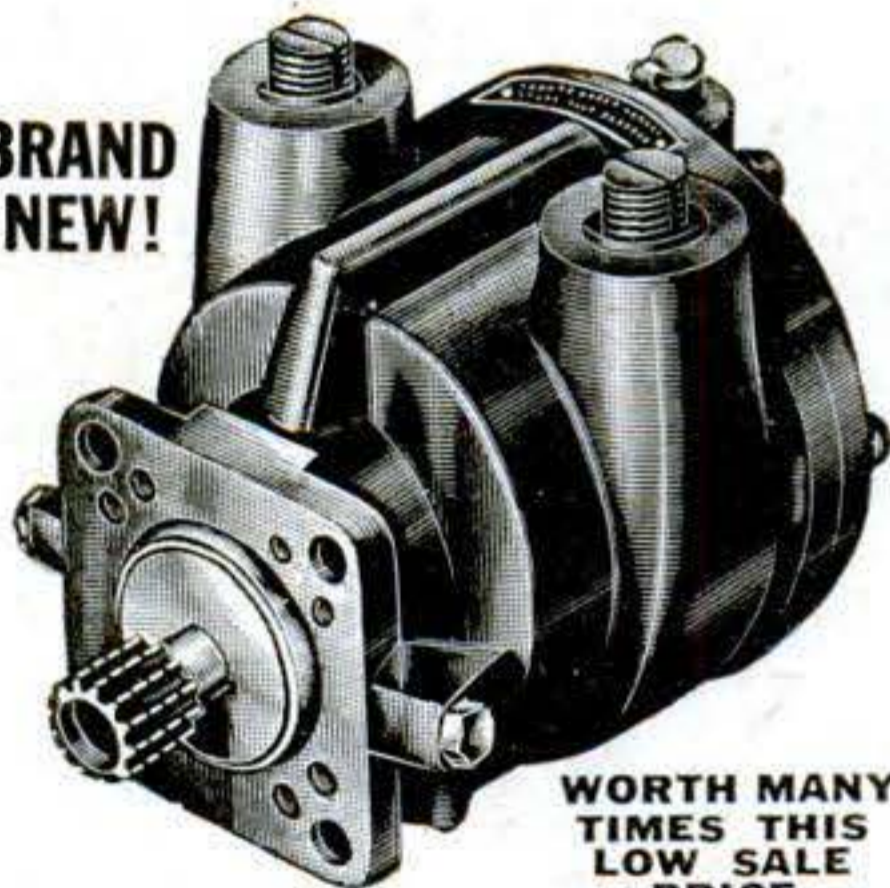

WORTH MANY TIMES THIS LOW SALE PRICE

• Originally cost \$45.00. May be used as air or fluid pump—for pressure or vacuum. Standard ¾ inch pipe thread with interchangeable ports. Will pump 7½ gal. SAE 30 oil per minute at 300 RPM. Builds air pressure of 30 lbs. per sq. in. at 1000 RPM. Vacuum will draw 26 inches of mercury at 1750 RPM. Develops up to 120 lbs. per sq. inch of hydraulic pressure, which in conjunction with a 3 inch hydraulic cylinder will lift 840 lbs. minimum. Runs forward or reverse. Self aligning shaft. Die cast aluminum housing 6x4x4 inches. Has stainless alloy steel vanes and impeller. Made by Bendix Avia. Corp. Spline terminal for direct drive—readily replaced with a pulley. Recommend a ¼ H.P. or stronger electric motor. Rated capacity 1500 RPM with high overload factor. Special price for quantity users. Complete illustrated engineering report and instruction booklet FREE with every pump. Send check or money order today! Postpaid in U.S.A. . . . **\$9.95**

Use them for  
**OIL BURNERS**  
 —  
**SPRAYING MACHINES**  
 —  
**MILKING MACHINES**  
 —  
**COMPRESSORS**  
 —  
**VACUUM PUMPS**  
 —  
**HYDRAULIC SYSTEMS**  
 —  
**MANURE LOADERS**  
 —  
**PRESSES, etc.**

# CENTRIFUGAL PUMP

BELT DRIVEN

Ready for use on any Liquid Pumping Need

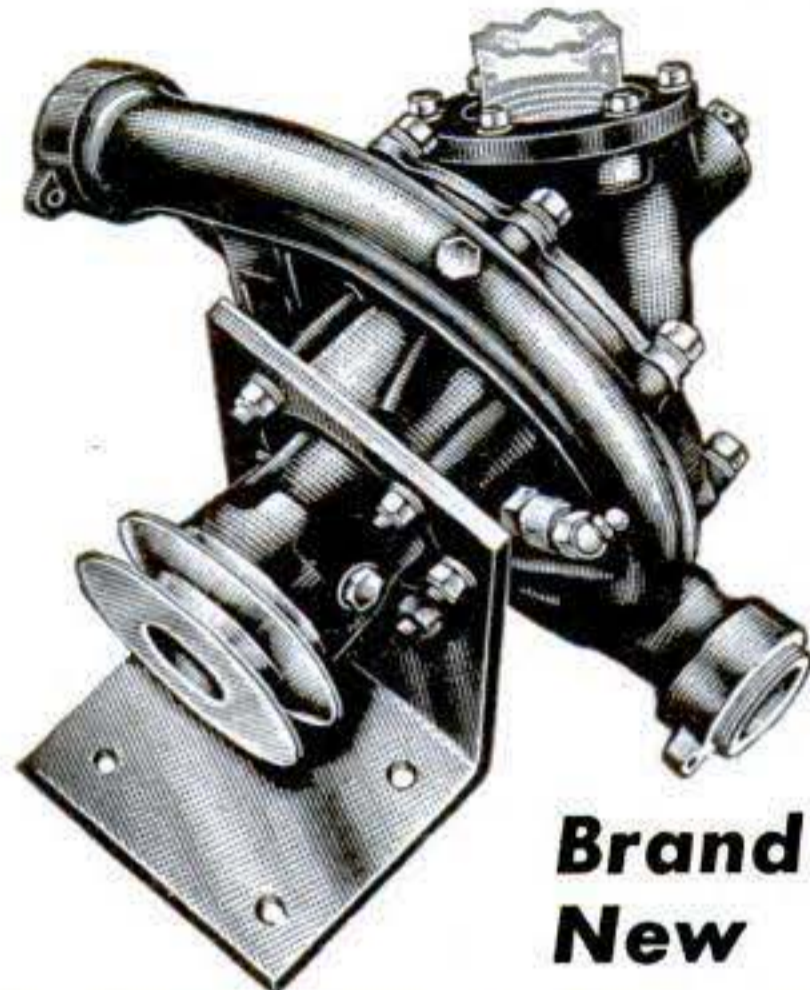

Brand New

Use it for DRAINING BASEMENTS

• HOME WATER SYSTEMS

• IRRIGATION

• STOCK WATERING

• FIRE PROTECTION

• DRAINING PONDS, TANKS, etc.

• INDUSTRIAL PUMPING

A super value for all types of intermittent service in pumping large volumes of liquid in home, farm and industrial service. Ideal for home water systems, draining basements, fire protection, etc. On the farm for watering stock, draining ponds, sprinkling, etc. In shops and factories for all types of pumping service.

### MOVE LARGE VOLUME QUICKLY

When operated at 1750 RPM, will pump 42 gallons per minute on a 23 foot head; at 3600 RPM on 52 foot head will pump 88 gallons per minute. May be run with electric motor, gas engine or power take-off on tractor.

### COMPLETE ENGINEERING REPORTS AND OPERATING INSTRUCTIONS FREE WITH PUMP

Pump has cast aluminum housing—accurately machined bronze impeller vanes. Complete with mounting bracket and 3½" V belt pulley. Shaft rotates on sealed ball bearings with grease gun fitting. Has 1½" threaded intake flange, two 1 inch outlets. Use one or both, as necessary. Made for Packard Motor Car Co. for use in Rolls-Royce Merlin Aircraft engines.

### GREATEST PUMP VALUE IN YEARS

Original cost approx. \$147.00. Sold F.O.B. Chicago. Shipping weight 23 lbs. You can't beat this value at anywhere near this price. Satisfaction guaranteed. Original Cost Approx. **\$147.00.**

Complete with Pulley and Mounting Bracket—Ready for Use . . . **\$29.75** F.O.B. CHICAGO

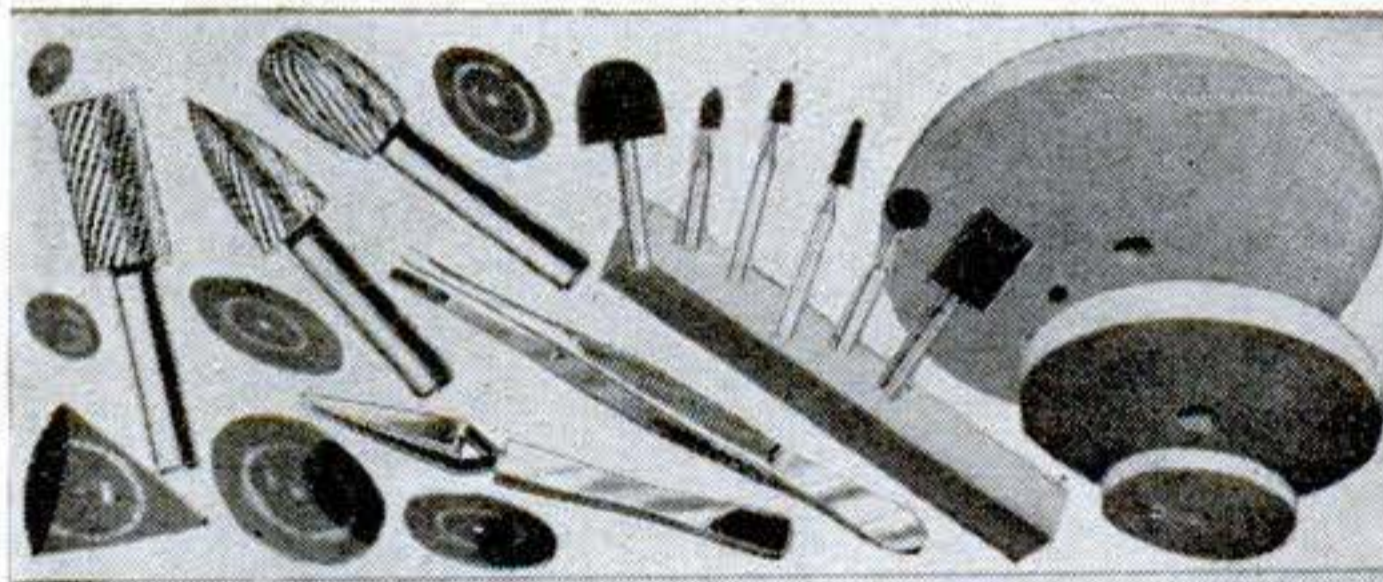

## GRINDING WHEELS

Actually Worth \$50.00

A wonderful buy! 350 pieces incl. 35 ass't. Grinding and Cut-off wheels up to 10 inches diameter, 1/16 to 1¼" face, 1/8 to 3 in. holes. Ass't. grits—all brand new—Made by Norton, Carborundum, Macklin, Bay State, etc. Also included are 100 slotted disc cloths; 100 paper discs; 10 pencil rolls; 20 abrasive strips; 2 felt bobs; 2 felt wheels; 1 4" rag buff; 3 honing stones; 10 abrasive sleeves; 10 mounted stones, 1/8 and 1/4" shank; 2 mandrels; 2 rotary files, 1/4" shank; 50 abrasive discs; 2 72" abrasive belts; 5 9x11 abrasive sheets. Satisfaction Guaranteed. **350 Pieces—Ass't. sizes FOB Chicago—All for \$6.95 Only** . . . . .

SURPLUS SPECIAL

## HI-PRESSURE TANK



NEW, 11¼"x2". 1CC3A 1800-P.S.I. Can be filled with CO2 and used as tire inflater or fire extinguisher. Also as pulsating tanks, storage tanks. Wheel control brass valve. COST THE **\$1.95** GOVERNMENT \$9.80 . . . Now Only . . . . .

**GROBAN SUPPLY CO. DEPT. P 5-4, 1507 S. MICHIGAN AVE., CHICAGO 5, ILL.**

# Paint Your Own Car in One Hour with the NEW AUTO ENAMEL

## YOU WIPE ON Like Magic POWDER PUFF

With only a

# 2 YEAR Guarantee LUSTR-WIPE

TRADE MARK

Dries in about one hour to smooth, mirror-like professional finish.

**GUARANTEED FOR 2 YEARS** not to crack, chip, peel or fade, if simple directions are followed. Lustr-Wipe is NOT a wax or a polish but a marvelous new Auto Enamel.



**NO Brushing  
NO Spraying  
NO Masking  
NO Streaks**

Follow the simple instructions and LUSTR-WIPE will give your car that new FACTORY-LOOK. Dries dust-free in about an hour. Goes over any color, enamel or lacquer.

### ONE QUART PAINTS YOUR ENTIRE CAR ANYONE CAN DO A BEAUTIFUL JOB

LUSTR-WIPE is the easy, speedy, economical, yet most successful way you've ever seen to PAINT YOUR OWN CAR. It's different-works almost like magic! All you need is ONE QUART of LUSTR-WIPE, the Miracle Auto Enamel, and the powder puff we send you AT NO EXTRA COST. Almost ANYONE, can do a magnificent job in about ONE SHORT HOUR. It seems unbelievable but true. JUST WIPE IT ON. No brush needed. No spray required. No masking of any kind. LUSTR-WIPE dries dust-free in about an hour. You'll be amazed—thrilled beyond words with the results! Your friends will think you spent \$75 to \$125 for a professional paint job. YOUR CAR WILL LOOK "LIKE NEW". Rush your order for a quart of LUSTR-WIPE TODAY.

This Price for Immediate Delivery

**SAVE by  
Ordering  
NOW!**

**\$3.95**  
PER  
QUART

ORDER ONE OR MORE  
QUARTS TODAY

Applicator  
Furnished

#### SEND NO MONEY! ORDER LUSTR-WIPE TODAY!

BLACK	.....	\$3.95 per Qt.
GREY (Gunmetal-Dark or Air Wing-Light)	.....	3.95 per Qt.
GREEN (Brewster-Dark or Jewel-Light)	.....	3.95 per Qt.
BLUE (Washington-Dark or Monticello-Light)	.....	3.95 per Qt.
RED or MAROON	.....	3.95 per Qt.

Order one quart or more today! SEND NO MONEY! Mail penny postcard. Then pay postman for LUSTR-WIPE plus postal charges. Or, if you send money with order, WE pay postage. See your dealer or order direct.

Send for free details of powerful money-making plan. Why wait? The weather is ideal for painting cars. **START NOW BY ORDERING ONE OR MORE QUARTS OF LUSTR-WIPE TODAY!**

#### MAIL COUPON TODAY! SEND NO MONEY!

**AGENTS WANTED FOR NEW MONEY-MAKING BUSINESS!** CAN MAKE GROSS PROFITS UP TO \$275.00 IN ONE WEEK.

Go into business for yourself selling LUSTR-WIPE in cans, or painting cars yourself or having others to do the work. Owners of old cars everywhere (who can't get new cars) are easy prospects. Send now for our MONEY-MAKING PLAN.

**DISTRIBUTORS WANTED:** A few wonderful territories now available. Write at once for our SPECIAL OFFER.

LUSTR-WIPE CORP. 166 W. Washington St. Dept. D, Chicago 2, Ill.

LUSTR-WIPE CORP. 166 W. Washington, Dept. D, Chicago 2, Ill.

Please send me \_\_\_\_\_ quarts of LUSTR-WIPE AUTO ENAMEL at the special price of \$3.95 per quart.

COLOR \_\_\_\_\_

Send Postpaid. Full Payment \$\_\_\_\_\_ enclosed.  
 Send C.O.D. plus Postal charges.

NAME \_\_\_\_\_

ADDRESS \_\_\_\_\_

CITY \_\_\_\_\_ ZONE \_\_\_\_\_ STATE \_\_\_\_\_

Send information regarding AGENT PLAN.  
 Send information regarding DISTRIBUTORSHIP.

TO: Reader  
FROM: Editor

# Autos to Atoms

LAST month's issue was hardly cool before a couple of significant reactions came into the office.

Buick, not unnaturally, liked the article on its new Dynaflo transmission that offers literally limitless gear ratios in driving speeds. Buick was finding out that the development of the device was almost simple compared to the job of explaining how it worked.

We could well understand what they meant. One time or another most of the PS Editorial Staff had been doodling diagrams and cutting out paper dolls in attempts to explain the obvious but mysterious principles of the super-gadget. We even hauled out the office electric fans to test our theories. Such are the difficulties of picturing three-dimensional hydraulics.

The Dynaflo humbled the writer, the editors, and the whole art department into accepting the eventual explanation with the assurance that if *we* could understand it, anyone could get it.

Perhaps it was this unusual humility that convinced the Buick people that our explanation was just what they needed. Anyway, the Buick magazine is reprinting the POPULAR SCIENCE article on the Dynaflo. Glad to

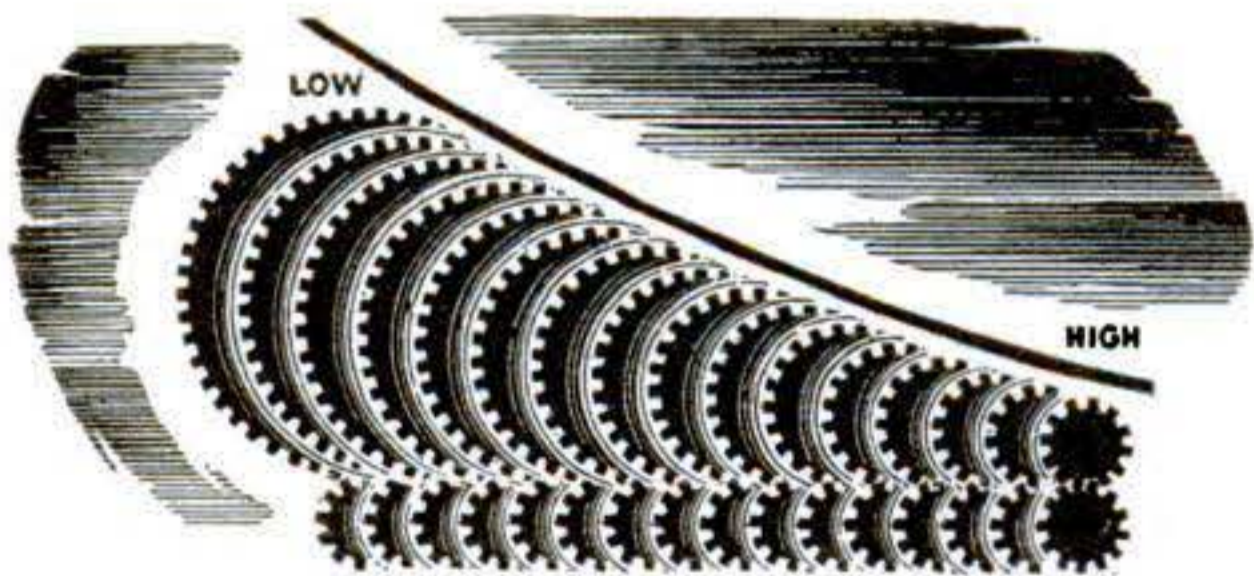

get rid of it, gentlemen. Some of our people are still cutting circles in the air with their forefingers. Frankly, we'd rather drive than describe one.

Incidentally, the Dynaflo story wasn't born at Buick. It began with a Washington rumor that the torque converter used on tanks was being fiddled up for passenger

cars. Detroit detective work by Devon Francis led to Buick as the first to get a truly automatic drive on the road.

The other big boot we got out of the February POPULAR SCIENCE was the atomic energy business.

It began as a Chicago local story. We assigned Martin Mann to get on out there on the chance he might see a power pile in actual operation. We told him to look for the practical details that would let him write



an article honestly entitled, "How To Run An Atomic Power Plant."

"Be sure," we said as we bade the Mann good-bye, "you keep your pores open for how a going atom plant sounds and smells."

On his safe, unatomized, return we pounded him with the questions that were answered by the article. It looked, he reported, like a concrete garage inside a warehouse. The only sound was a faint hum—caused by the fans in the ventilation systems. It smelled, he said, "like a physics lab—kind of a vague machinery smell."

Since he had been shown nothing off the record, Mann sat down with artist Ray Pioch and talked out a drawing of a practical atomic power plant.

It must have been a pretty good drawing and article. Anyway, the Atomic Energy Commission thought so. The atom people called up for a couple of thousand reprints. They want to send them to—that's right!—the guys who work in the atom business.

This kind of thing makes us pretty cocky here at POPULAR SCIENCE. If it's good enough for the guys at Buick and the Atomic Energy Commission who really know these things, it ought to be good enough for the whole million of the rest of you readers.

But I guess I'd better pipe down. Too many experts in the audience, and we live on the end of too long a limb. Some knitting-machine expert is going to count the needles in the picture and tag us out!\*



\*It has happened here: See PS, March '47, p 286.



# SHORT, SHORT LESSON IN FM AND TELEVISION



Here's *why*  
**WARD Magic Wand<sup>\*</sup> Aerials**  
*make all receivers work better*

Attach a Magic Wand aerial to your FM or television receiver, and the effect is almost magical. Fuzzy television pictures become sharp, clear, easy to see. FM tones ring out rich, full-throated, completely free of static and distortion. You get more stations, and you get them at their best.

Your FM or television receiver needs a Magic Wand outdoor aerial because it receives waves which are *very* short. Unlike the long waves of standard radio (AM) broadcast, which penetrate like sound; these short FM and television waves travel line-of-sight. They reflect off solid surfaces like light waves. Another difference: the longer, more powerful AM waves are reflected downward from the ionosphere (layers of ionized air which begin about thirty miles above the earth), thus they carry over the curvature of the earth for longer distances. FM waves are not so reflected, they carry out into space after they pass the horizon.

Tested and perfected in the famous Ward experimental laboratory, Magic Wand aerials are available in several types to fit varying conditions. They are quickly installed outdoors, at any roof or wall angle, where they pass maximum signal strength down to your receiver.

See your radio dealer, or serviceman, today. Have him help you choose the Magic Wand aerial best suited to your needs. They're priced from \$9.00 to \$18.00, and are complete with instructions and accessories. Get yours installed immediately, and start to enjoy the kind of performance you paid for.

**THE WARD PRODUCTS CORPORATION**  
Dept. P, 1523 East 45th Street, Cleveland 3, Ohio  
DIVISION OF THE GABRIEL COMPANY



Like Sound

AM . . . PENETRATING WAVES

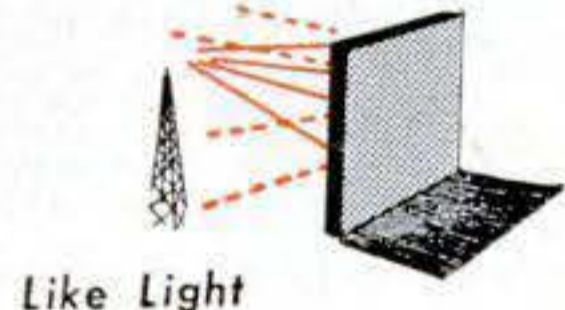

Like Light

FM . . . NON-PENETRATING WAVES



STANDARD AM WAVES



TELEVISION AND FM WAVES

*\*Trade Mark Registered*

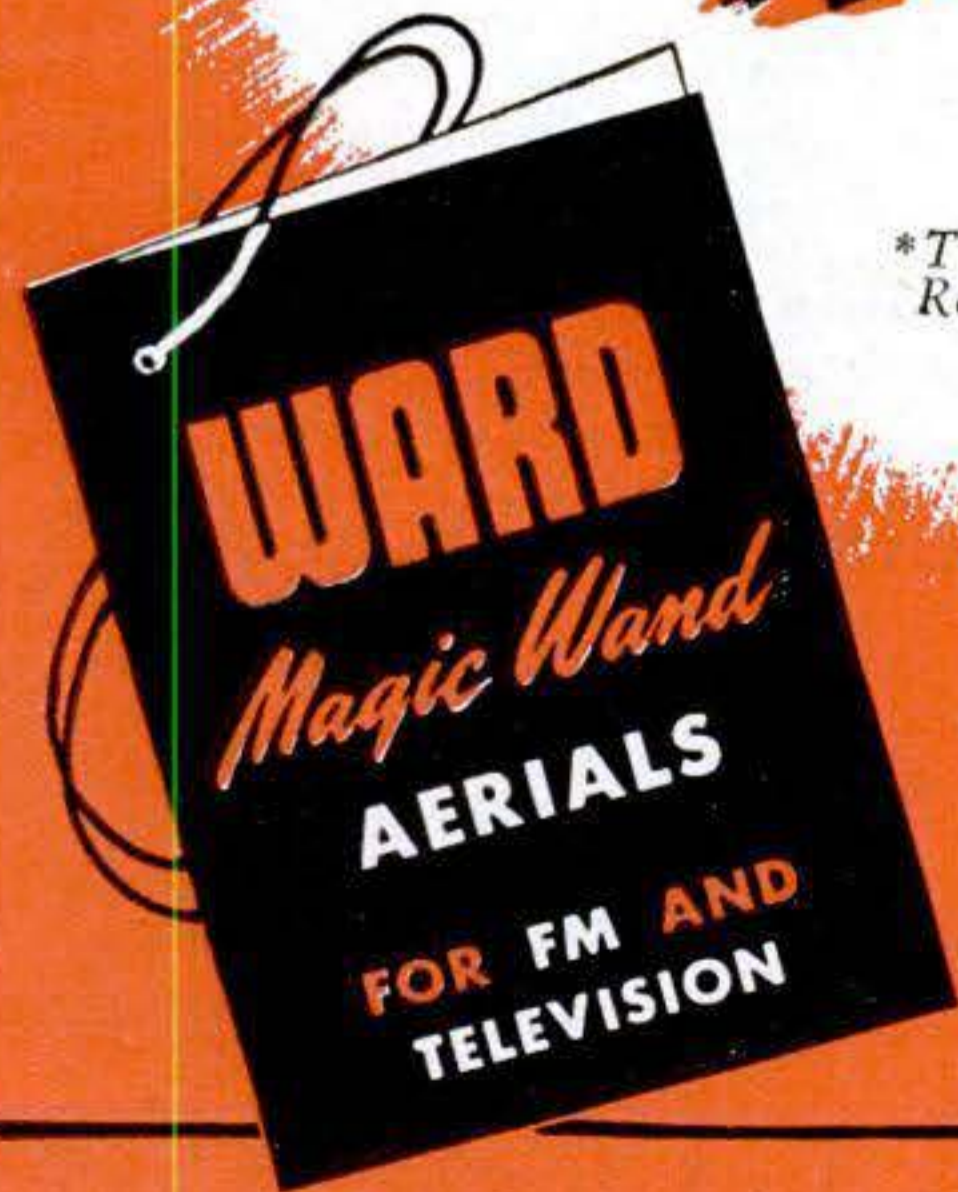

WORLD'S LARGEST PRODUCER  
OF AERIALS FOR CAR AND HOME

**THE WARD PRODUCTS CORP.**  
Dept. P, 1523 East 45th Street, Cleveland 3, Ohio  
Please send me your new free booklet about Magic Wand Aerials. Also send me the name of my dealer.

Name \_\_\_\_\_

Address \_\_\_\_\_

City and State \_\_\_\_\_

(DEALER INQUIRIES ALSO INVITED)

# SOUTH BEND 9" PRECISION LATHES

## \$14500 AND UP

f. o. b. factory, less electrical equipment and bench.

*You can buy a South Bend 9" Lathe on time payments.*

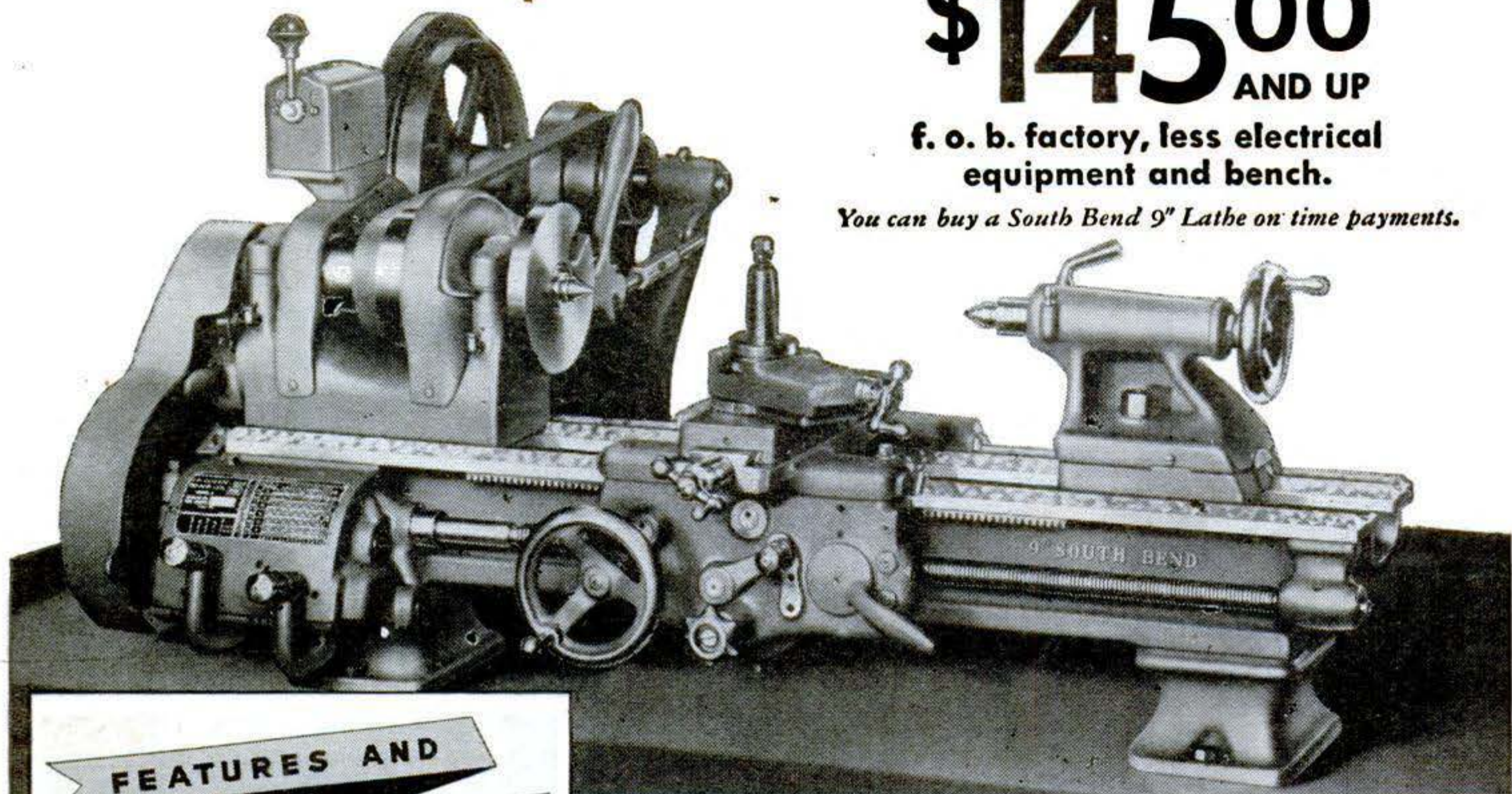

9" x 3' South Bend Model A Bench Lathe — \$270.00

### FEATURES AND SPECIFICATIONS

**SWINGS**—9¼" over bed and saddle wings  
5½" over saddle cross slide

**BED LENGTHS**—3, 3½, 4 and 4½ feet

**DISTANCE BETWEEN CENTERS**—16 to 34 inches

**SPINDLE SPEEDS**—  
*depending on type of drive equipment*

Six—41 to 658 r. p. m.  
Twelve—41 to 1270 r. p. m.  
Sixteen—46 to 1176 r. p. m.

**POWER LONGITUDINAL FEEDS**—  
Model A Lathes—48, .0015" to .0853"  
Model B Lathes—26, .0021" to .0155"  
Model C Lathes—14, .0021" to .0156"

**POWER CROSS FEEDS**—  
Model A Lathes—48, .0004" to .0252"  
Model B Lathes—23, .001" to .0046"  
Model C Lathes—manual operation

**THREAD CUTTING RANGE**—  
Model A Lathe—48 pitches,  
4 to 224 per inch  
Models B and C Lathes—45 pitches,  
4 to 160 per inch

**MAXIMUM COLLET CAPACITY**—½ inch

**QUICK CHANGE GEAR BOX**—Model A Lathes

**PLAIN CHANGE GEARS**—Models B and C Lathes

The quality that is built into South Bend 9-inch Precision Lathes enables them to produce quality work with efficiency under all conditions. Regardless of the type of machining—between-centers, collet, fixture, or chucking—close tolerances can be maintained and a maximum volume of fine work produced with a minimum of effort. Write for Catalog 9-J which fully describes and illustrates all South Bend 9" Precision Lathes and attachments. Larger sizes with 10", 13", 14½", and 16" swings are also shown.

**PROMPT DELIVERY**—See your South Bend Lathe distributor today—immediate delivery from his stock or early delivery from factory.

**PRICES**—Starting at \$145.00, f. o. b. factory, South Bend Lathes now represent a greater value per dollar of cost than ever before. Average price increase over prewar level less than 15 per cent.

**TIME PAYMENT**—South Bend Precision Lathes, tools, and attachments are available on Factory Time Payment terms. 25% down payment, twelve months to pay balance. Moderate finance charges.

#### SPEED PRODUCTION WITH THESE ATTACHMENTS

TAPER ATTACHMENT  
MILLING ATTACHMENT  
COLLET ATTACHMENTS  
HANDLEVER BED TURRET  
DOUBLE TOOL CROSS SLIDE

CENTER REST  
SQUARE TURRET  
CARRIAGE STOPS  
FOLLOWER REST  
ELECTRIC GRINDER

BUILDING BETTER LATHES SINCE 1906

## SOUTH BEND LATHE WORKS



456 EAST MADISON STREET  
SOUTH BEND 22, INDIANA

# VETERANS

You can get this training in your own home under G. I. Bill. Mail coupon for full details.

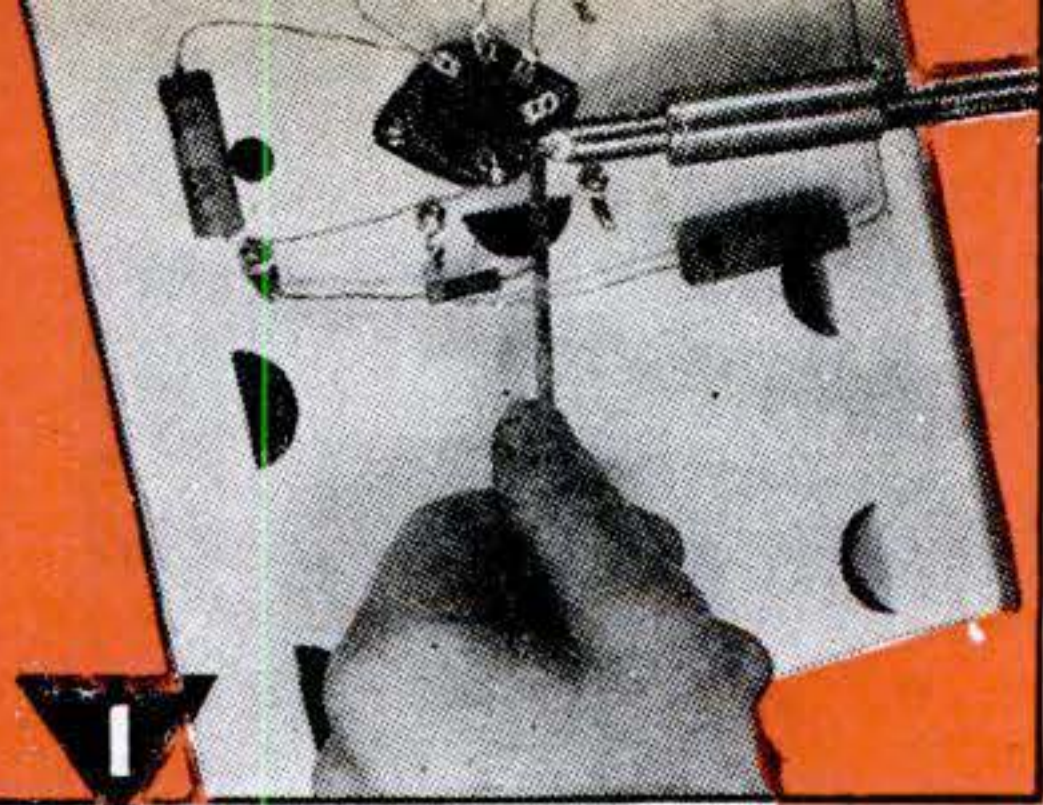

I send you Soldering Equipment and Radio Parts; show you how to do Radio Soldering, how to mount and connect Radio parts; give you practical experience.



Early in my course I show you how to build this N. R. I. Tester with parts I send. It soon helps you fix neighborhood Radios and earn EXTRA money in spare time.



# Learn Radio by PRACTICING it

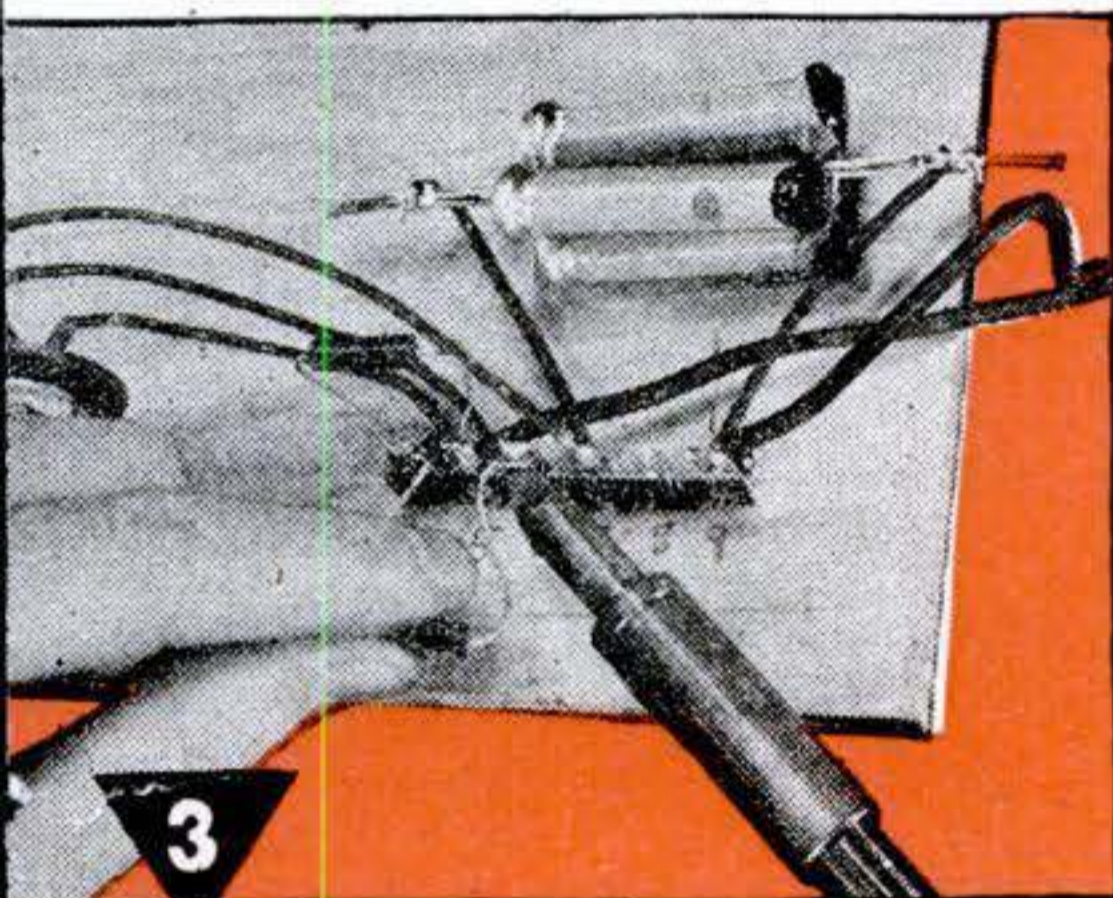

You get parts to build Radio Circuits; then test them; see how they work; learn how to design special circuits, how to locate and repair circuit defects.

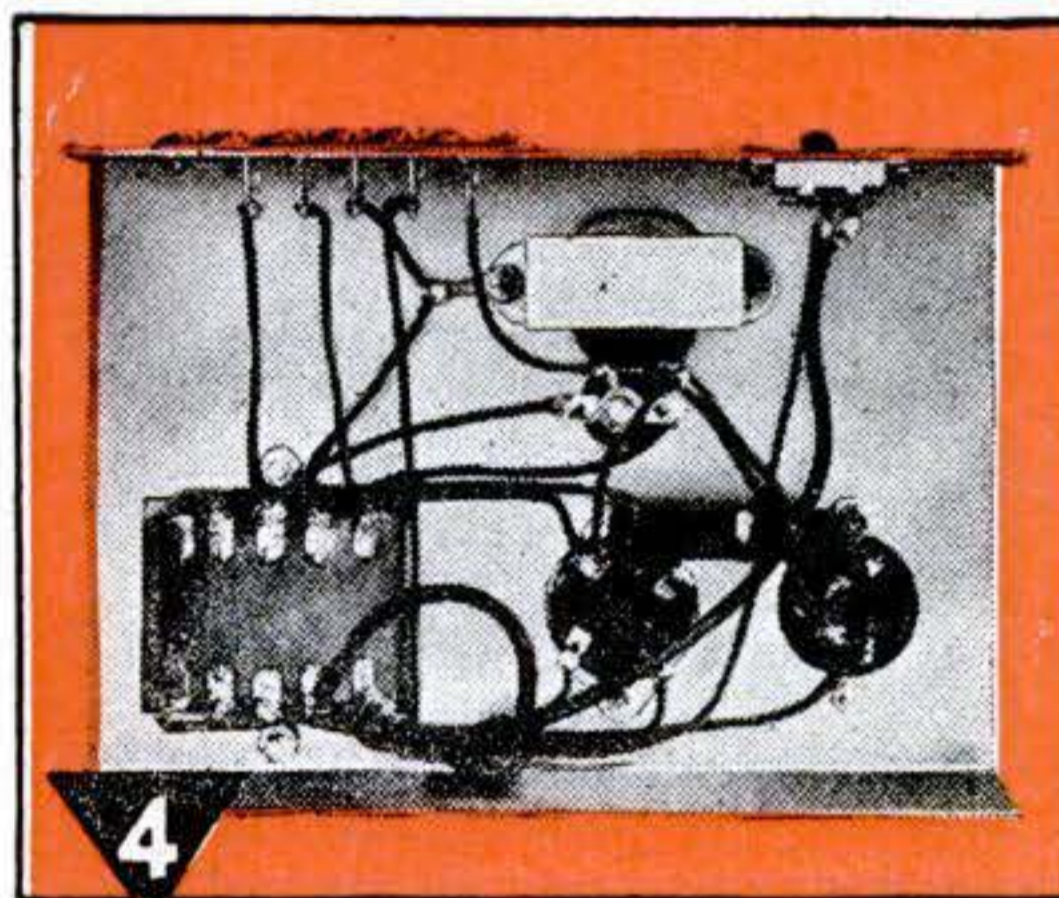

You get parts to build this Vacuum Tube Power Pack, make changes which give you experience with packs of many kinds; learn to correct power pack troubles.

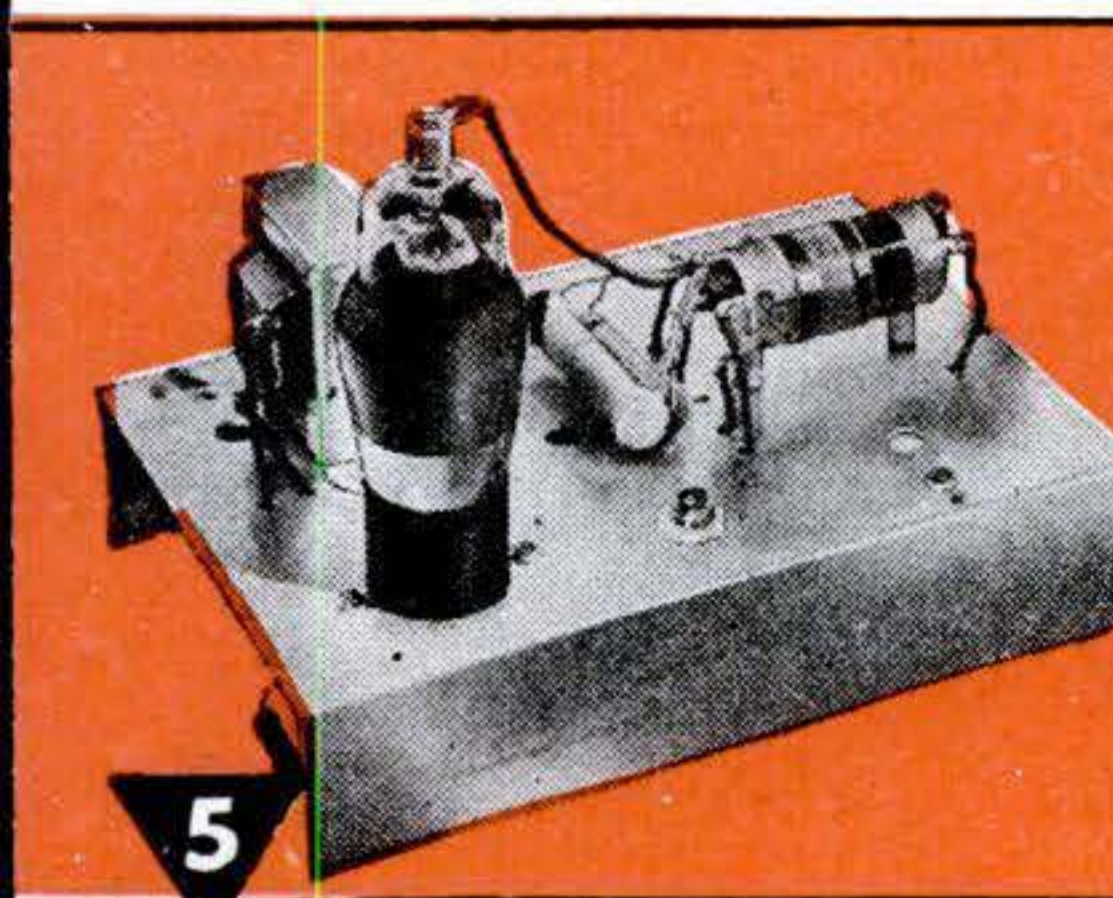

Building this A. M. Signal Generator gives you more valuable experience. It provides amplitude-modulated signals for many tests and experiments.

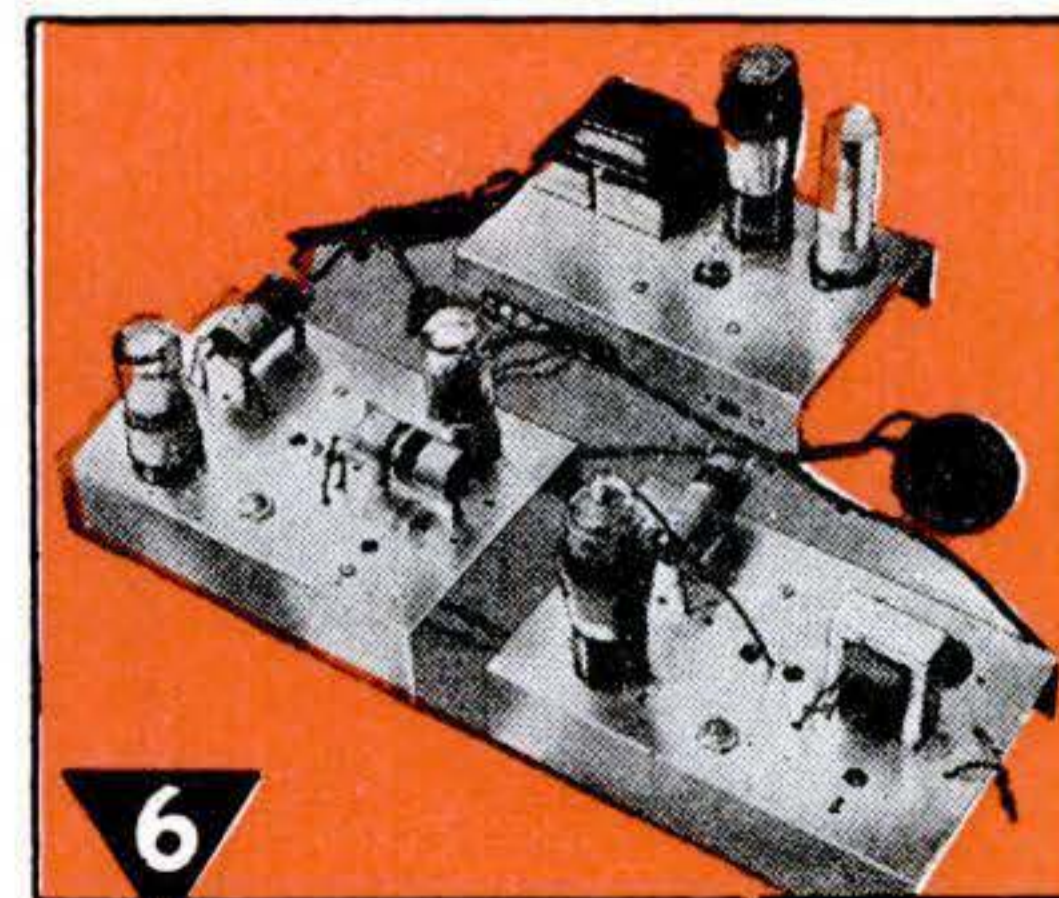

You build this Superheterodyne Receiver which brings in local and distant stations—and gives you more experience to help you win success in Radio.

with **BIG KITS**  
of **RADIO PARTS**  
I send you

Do you want a good-pay job in the fast-growing Radio Industry—or your own Radio Shop? Mail post card at right for a Sample Lesson and my 64-page book, "How to Be a Success in RADIO," both FREE. See how I will train you at home—how you get practical Radio experience building, testing Radio circuits with **BIG KITS OF PARTS** I send.

**Many Beginners Soon Make Extra Money in Spare Time While Learning**

The day you enroll I start sending **EXTRA MONEY** manuals that show you how to make **EXTRA** money fixing neighbors' Radios in spare time while still learning! It's probably easier to get started in Radio now than ever before, because the Radio Repair Business is booming. Think of even **GREATER** opportunities as public demand for Television, FM and Electronic devices continues to grow. Cut out and mail post card for **FREE** books now!

Mail post card for **Sample Lesson** and **FREE** 64-page book. Read details about my Course, letters from men I trained; see how quickly, easily you can get started. No obligation! Just **MAIL POST CARD NOW!** **J. E. SMITH, President, Dept. 8DP3, National Radio Institute, Pioneer Home Study Radio School, Washington 9, D. C.**

**FIND OUT ABOUT THIS TESTED WAY TO GOOD PAY**

IT TAKES EXPERIENCE TO SKIM THE SURF AT

*40 miles an hour on one foot!*

...and Champion  
**NANCE STILLEY**  
agrees that  
in water skiing—and  
in cigarettes too...

**"EXPERIENCE  
IS THE BEST  
TEACHER!"**



In twisting slaloms  
... in tricky jumps  
... this petite young  
Cypress Gardens  
aquamaid is in a  
class by herself.



You watch her and  
you *know* Nance  
Stilley has plenty  
of experience. Her  
cigarette? That's a  
"choice of *experi-  
ence*" too... Camel!



I NOTICE MORE  
AND MORE PEOPLE  
SMOKING CAMELS.  
THEY'RE GREAT!

I LEARNED  
BY EXPERIENCE...  
BY COMPARING...  
THAT CAMELS SUIT  
MY 'T-ZONE'  
BEST!



**THE "T-ZONE"**  
T for Taste...  
T for Throat...  
your final  
proving ground  
for any  
cigarette

R. J. Reynolds Tobacco Co., Winston-Salem, N. C.

Let your  -Zone tell you why

**More people are smoking  
Camels than ever before!**

● Now that people can get all the cigarettes they want... any brand... more people are smoking Camels than ever before.

Why? The answer is in your "T-Zone" (T for Taste and T for Throat). Let your taste... your throat... tell you why, with smokers who have tried and compared, Camels are the "choice of experience"!

**CHOICE OF EXPERIENCE!**



According to a  
Nationwide survey:

**MORE DOCTORS  
SMOKE CAMELS  
THAN ANY OTHER  
CIGARETTE**

When 113,597 doctors were asked by three independent research organizations to name the cigarette they smoked, more doctors named Camel than any other brand!