

Nov. 1949

25¢

POPULAR SCIENCE

Monthly

30 Pages of
Gifts To Make
for Christmas

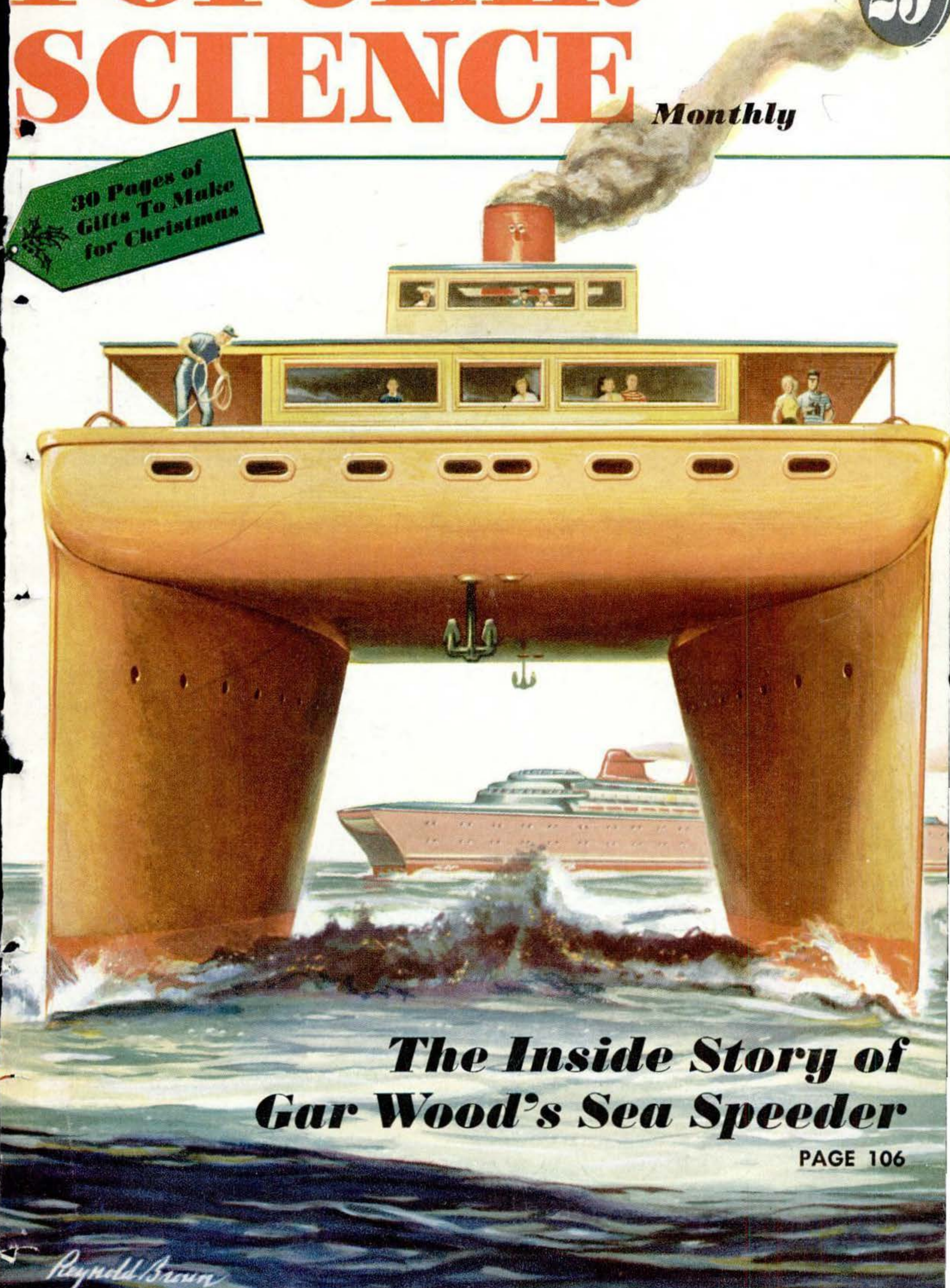

The Inside Story of Gar Wood's Sea Speeder

PAGE 106

Reynold Brown

IT'S FUN TO BE YOUR

and enjoy the home of your dreams!

Actual Size
8 1/2 x 5 1/2 in.

The COMPLETE HOME HANDYMAN'S GUIDE

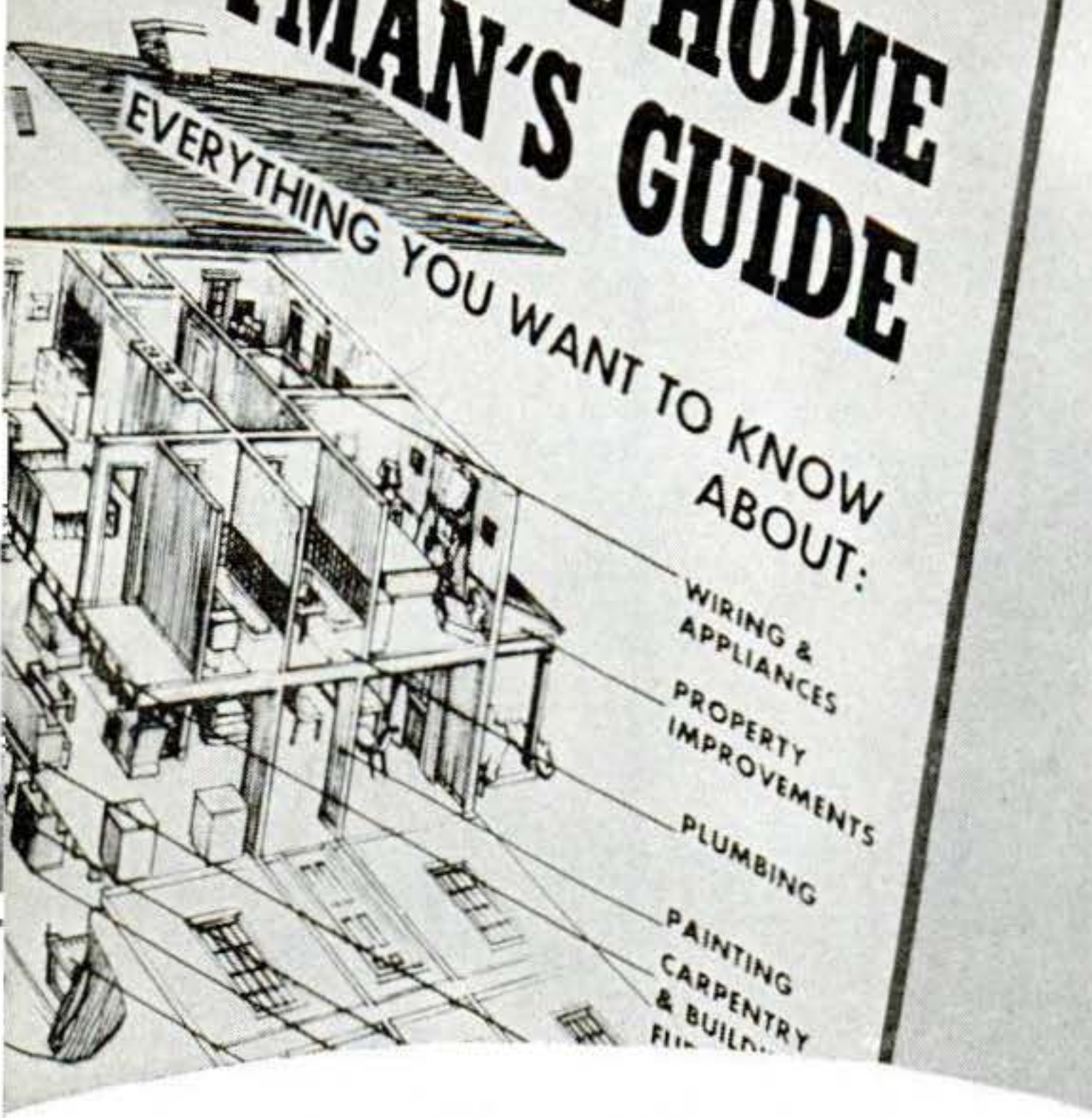

EVERYTHING YOU WANT TO KNOW ABOUT:

- WIRING & APPLIANCES
- PROPERTY IMPROVEMENTS
- PLUMBING
- PAINTING
- CARPENTRY & BUILDING

with the aid of the

COMPLETE HOME

Here's How This Book Will Save You Hundreds of Dollars

THIS amazingly comprehensive volume shows you how to do yourself all of the jobs around the house that have long needed doing—and a lot more you've *wished* could be done. In 8-Books-Bound-as-One, pictures and words show you how to make your own repairs on your Plumbing, Wiring, Carpentry, Electrical Appliances, Masonry, Plaster, Heating System, Furniture, etc., also how to *make valuable improvements* in your home, from a new closet to a whole new roof—from a new floor to a whole new modern kitchen.

No longer need today's high labor costs keep you from having the kind of home you'll be proud of—attractive, smooth-running, free from hazards, and equipped with every comfort! This COMPLETE GUIDE makes even the most unfamiliar job easy to do—and *fun* to do! You not only save time and money, you also enjoy the thrill of watching your home acquire new luxury, comfort and value.

8 BOOKS ALL IN ONE

AT THE BARGAIN PRICE OF ONLY ONE!

MORE THAN 1000 "HOW-TO-DO-IT" PICTURES
300,000 WORDS! 512 PAGES!

Here is Just a Partial List of the Hundreds of "How-To-Do-It" Articles in this One Book:

HOUSE CONSTRUCTION AND MATERIALS

How to Build a Foundation
Types of Girders and Sills
Beams and Floor Joists
Building Materials
Types of Lumber
Roofing Materials—
Asphalt, Asbestos,
Aluminum, Wood
Shingles
Concrete forms, mixing
How to Make All Types
of Tinsmith Repairs

INTERIOR REPAIRS

Repairing Creaky Floors
Repairing and Storing
Screens
Repairing Windows—sash
cord, windowpanes;
loosening stuck
windows
Linoleum-laying, patching
Fixing Loose Tiles
Mending China,
Metal Utensils
Repairing Door Locks,
Hinges
Fire Fighting Equipment
Basement into Game Room
Building Partitions
Laying Hardwood
Flooring, etc.

DECORATING

Wallpapering
Cleaning Wallpaper
Cleaning Painted Walls
Repairing Plaster

Scraping Floors
Refinishing Floors
Care of Carpets
and Draperies

PAINTS AND PAINTING

Types of Paint Brushes
Types of Paint
Varnishes, Enamels
Lacquers, Shellac
Calcimine
Paint Thinners
Mixing Paints
Surface Preparation
Removing Paint
Painting a New Surface
Porch Floors and Steps
Painting Metal
Preparing Plaster
Fillers, Staining, etc.

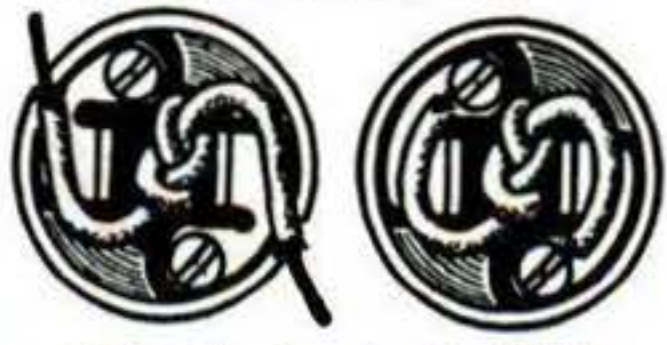

(Above) A simple little trick like knotting the wire inside extension plugs can save you severe burns, blown-out fuses, and fire hazards. Protect your home and family with the advice in this book!

ELECTRICITY IN THE HOME

Approved Electrical Equipment
Home Generators
Fuse Boxes and Fuses
Appliance and Extension Cords
Replacing Fixture Sockets
Electric Motors
Home Signalling Systems
Burglar Alarms, etc.

HEATING THE HOUSE

Chimneys
Coal Furnaces, Oil Burners
Automatic Draft Regulators
Thermostats
Fuel Economy
Warm Air Heating Systems
Steam Heating Systems
Cleaning, Adjusting Radiators
Noise in Steam System

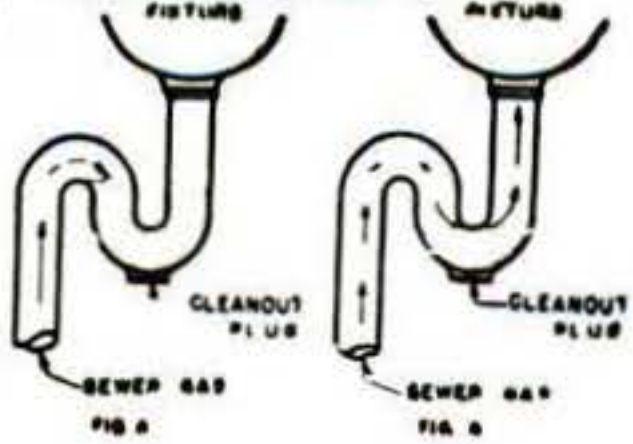

Hot Water Heating System
Repacking Leaky Valves
Cleaning Boilers
Cleaning the Furnace
How to Insulate Your House
How to Build and Install Storm Windows
Efficient Weather Stripping, etc.

PLUMBING

Water Supply
Cause of Dirty Water
Repairing Sewage System
Cesspools, Septic Tanks
Stopped Up Sewer Pipes
Stopped Up Drains
Chemical Drain Cleaners
Plumbing Traps
Noisy Plumbing
Repairing Hot Water Tanks
Thawing Frozen Pipes
Water Softening Equipment
Repairing Faucets, Flush Tanks, Leaky Pipes, etc.

EXTERIOR REPAIRS

Waterproofing Damp Basements
Waterproofing Masonry Walls
Repairing Cracks in Foundation, Stucco Walls

(Left) You SEE diagram that help you locate and, with little effort, fix plumbing noises, leaks, and drain stoppages.

Repairing Brick Walls
Repairing Leaky Roofs
Caulking Seams
Gutters and Downspouts
Ridding the House of Termites, etc.

YOUR GARDEN

Building Garden Paths
Building Garden Pool
Care and Use of Garden Tools
Cold Frames
Rustic Screens and Arches
Building an Outdoor Fireplace
Erecting Garage, Summer Guest House or Play House in Garden, etc.

Learn the correct way to care for brushes, tools, etc., to make them work better and last longer. This information in the book saves you money.



OWN HANDYMAN!

Here's Everything You Need to Know to Do Your Own Repairing, Beautifying, Modernizing, Converting! The A to Z of CARPENTRY, PLUMBING, PAINTING, DECORATING, WIRING AND APPLIANCES, MASONRY, FURNITURE REPAIR, HEATING SYSTEMS—all in one book!



HANDYMAN'S GUIDE

Make a New Kitchen, Game Room or Bathroom! Build an Extra Apartment and Live Rent-Free!

Here's 1,001 methods to help make your house more liveable—and add hundreds, even thousands of dollars to its value. Need new closet space? Want to eliminate that dangerous draft in the baby's room? Redecorate sister's room? Build a garden walk? Lay a new linoleum floor? Get better winter heat for less money?

Want to convert your basement or attic into an extra apartment and give yourself a rent income that may well offset a good part or all of your taxes, mortgage payments and other expenses?

You can make these improvements yourself, at surprisingly little cost, with the help of *The Complete Home Handyman's Guide*.

Easy Step-by-Step Instructions in Clear Pictures and Simple Text!

This book assumes no mechanical knowledge or skill on your part. It starts from the very beginning, explaining how to select and use tools and materials. It gives you detailed information every step of the way, from repairing a lamp or iron to installing a complete wiring system; from repairing chair-leg to rebuilding your upholstery; from using a paintbrush to repainting the house inside and out. More than 1,000 ILLUSTRATIONS, accurately and explicitly drawn, make the complete instructions easy to follow. This 8 Books-in-One is the *number one* book for your home. It will repay its astonishingly small cost many times over.

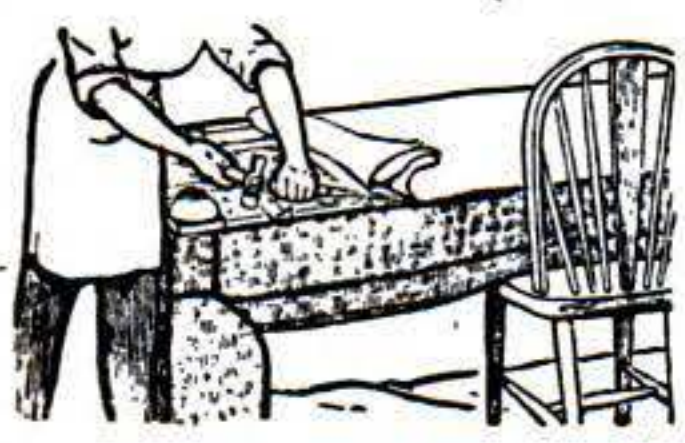

(Left) Furniture upholstery and repair is a fascinating and money-saving hobby when you follow the easy step-by-step instructions in this book.

FURNITURE CARE AND REPAIR

- Upholstery of Chairs, Sofas, etc.
- Replacing Worn Springs
- Strengthening Frame
- Furniture Upkeep, Cleaning, Removing Water Stains, Marks, Scratches, etc.
- Loose Joints
- Broken Chairs
- Polishes and Polishing
- Staining, etc.

YOUR TOOL KIT

- Equipping Your Workshop
- Selecting the Right Tools
- Correct Use of Tools
- Care of Tools
- How to Sharpen Tools
- Sandpapers, Glues, etc.
- Soldering Equipment and Technique

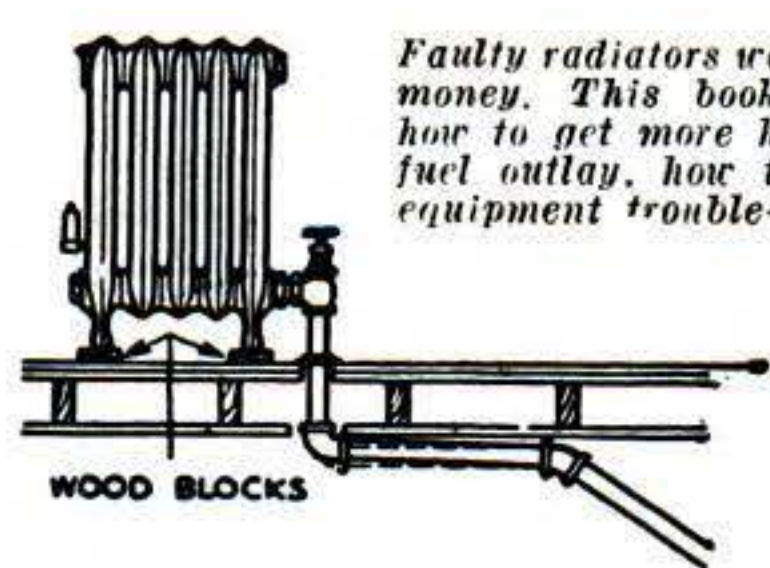

Faulty radiators waste heat and money. This book shows you how to get more heat for your fuel outlay, how to keep your equipment trouble-free.

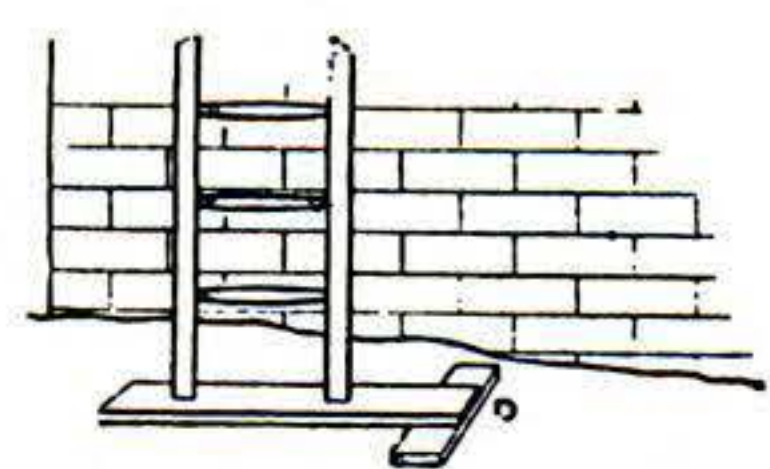
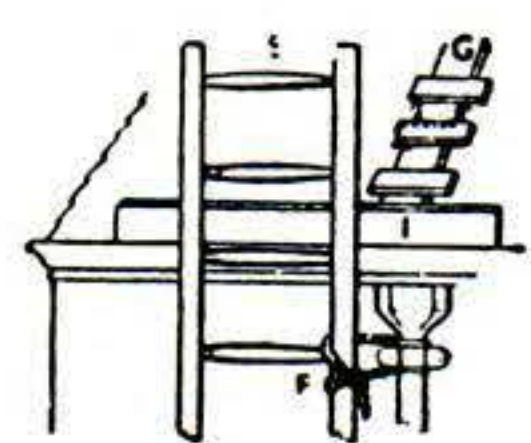

Avoid hazards. This illustration shows how to secure a ladder when you make roof repairs. Complete instructions for repairing walls, foundations, gutters, shingles, etc.

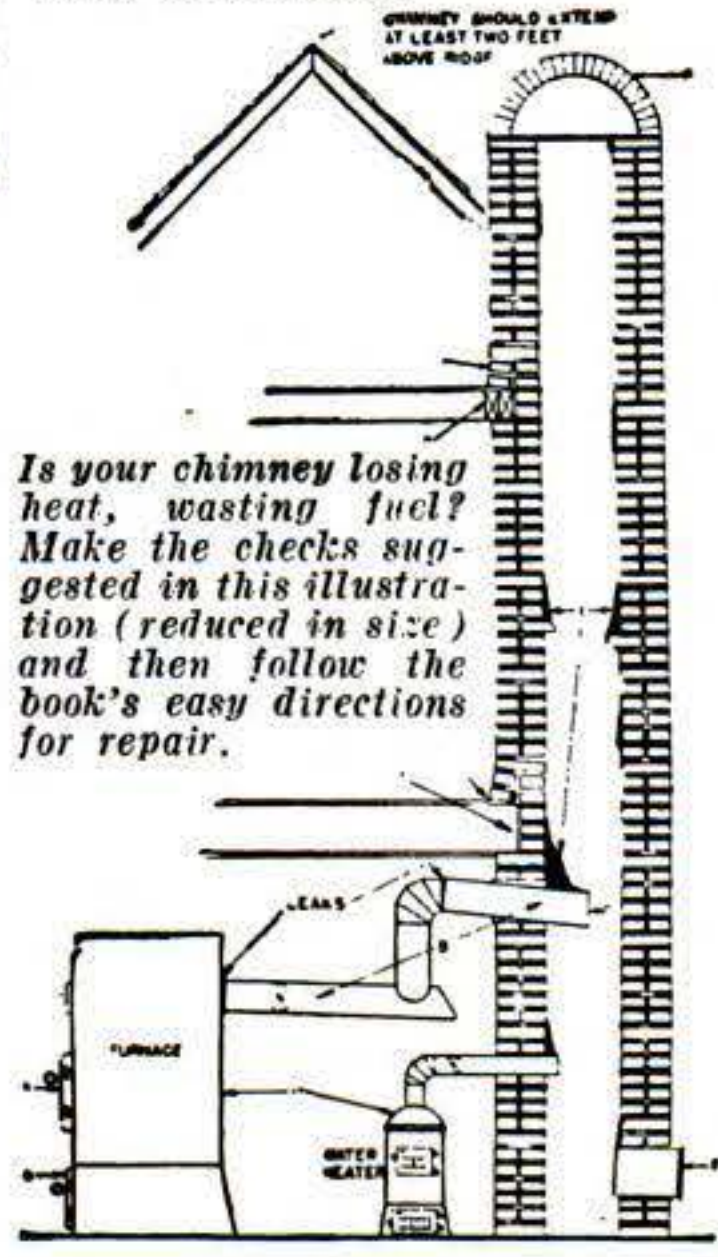

Is your chimney losing heat, wasting fuel? Make the checks suggested in this illustration (reduced in size) and then follow the book's easy directions for repair.

How to equip a workshop, how to use all types of tools, how to use sandpaper and glues—all are fully covered in this "show-me-how" volume.

Yours for a Week's Free Trial!

Think of getting in this one big 512-page volume all the practical information you need to do a good professional-looking job of repairing or improving any part of your home—from cellar to chimney-top! Think of getting all this—not for the \$24.00 you would expect to pay for 8 books covering all these fields—but for the miracle price of \$3.95! But don't take our word for this big value. Examine FREE, at our risk and expense, a copy of the *Complete Home Handyman's Guide*. Just mail the coupon below. When the book arrives, test it a full week FREE! If you don't agree it's the best money-saving buy ever, return it without further obligation. If you keep it, pay the small price in small monthly installments. Edition after edition has been sold out, so act at once to be sure of getting your copy promptly. Our limited printing is inadequate to meet the demand. Mail FREE-Trial coupon today.
© 1949 Wm. H. Wise & Co., Inc.
50 W. 47th St., New York 19, N. Y.

MAIL THIS FREE-TRIAL COUPON!

Wm. H. Wise & Co., Inc., 50 West 47th Street, New York 19, N. Y. Without obligation to me, rush me immediately, for Free Examination, a copy of the big new 512-page "COMPLETE HOME HANDYMAN'S GUIDE", bound in sturdy rich Novelex and profusely illustrated with more than 1,000 "How-to-do-it" pictures. After a full week's free trial, I will either return the book promptly and owe you nothing, or I will keep it and remit only \$1 monthly until the amazingly low price of only \$3.95 plus a few cents postage, is paid.

Check here for De Luxe Edition at only \$1 extra.
SAVE CHARGES on 3 LB. SHIPMENT. Send only \$3.95 with this coupon and we will stand all shipping charges. Same return & refund privilege. (\$4.95 for De Luxe.)

MR. }
MRS. }
MISS } (Print Plainly in Block Letters)

ADDRESS.....

CITY & ZONE NO..... STATE.....

COMPANION VOLUME. Initial here to reserve "PRACTICAL AND TECHNICAL ENCYCLOPEDIA"—to be shipped to you for FREE trial, 640 pages, over 1,000 pictures, thousands of subjects. Covers Autos, Mechanical, Electrical, and Aeronautical Engineering, Building, Plumbing, Metallurgy, Chemistry, Printing, Sheet Metal and Foundry Work, Radio, and Television, etc. Only \$4.95 plus postage. Same easy terms.

153

8011

POPULAR SCIENCE

MECHANICS AND HANDICRAFT *Monthly*

America's Most Widely Read Science Magazine

Perry Githens, EDITOR

Fred O. Newman, Volta Torrey
MANAGING EDITORS

Howard C. Jensen, ART EDITOR

Harry Walton, MECHANICS & HANDICRAFT EDITOR

Hartley E. Howe, Frank Rowsome, Jr.
ASSISTANT MANAGING EDITORS

ASSOCIATE EDITORS: Howard Allaway, Alden P. Armagnac, Devon Francis, Richard Giovine, Robert Gorman, Sheldon Gallager, Herbert Johansen, Martin Mann, Denis Sneigr, Robert P. Stevenson.

ART DIRECTOR: Harry Samuels. ART ASSOCIATES: Herbert Anthony, Eric Karminski, Jr., Richard Meyer, Edward Hallstrom, Frances Cooper (Production).

EDITORIAL ASSISTANTS: Julia Charnif, Carol Ennis, Georgette Sparks, Harriet Trowbridge, Ruth Westphal.

STAFF PHOTOGRAPHERS: W. W. Morris (Chief), Hubert Lockett, Orlando Guerra (Darkroom).

WESTERN EDITOR: Andrew R. Boone (Los Angeles).

WASHINGTON CORRESPONDENT: John F. Loosbrock.

EDITORIAL OFFICES: 353 Fourth Avenue, New York 10, N. Y. Manuscripts and illustrations submitted at regular rates should be so marked, addressed to "The Editors" and accompanied by stamped, self-addressed envelope. Popular Science Monthly exercises all possible care but assumes no responsibility for unsolicited material.

TRADE NAMES by which products or materials are commonly known are indicated by the symbol ©. These names may or may not be Registered Trademarks (see PS, Mar. '49, p. 294). This symbol is used only as a service to readers and Popular Science Monthly assumes no responsibility by use or omission.

Godfrey Hammond, PUBLISHER

Stephen P. Glennon, ADVERTISING DIRECTOR

Edward Roeder, Jr., ADVERTISING MANAGER

ADVERTISING OFFICES: NEW YORK—353 Fourth Avenue; CHICAGO—360 North Michigan Avenue; DETROIT—820 Book Building; SAN FRANCISCO—1003 TWA Building; PORTLAND (ORE.)—907 Terminal Sales Building; CLEVELAND—328 Citizens Building; LOS ANGELES—Granada Building.

Popular Science Monthly is published monthly at 353 Fourth Avenue, New York 10, N. Y., by Popular Science Publishing Co., Inc., Godfrey Hammond, President and Treasurer; R. C. Wilson, Raymond J. Brown, Stephen P. Glennon, Vice-Presidents; F. W. Briggs, Secretary. Entered as second-class matter Dec. 28, 1918, re-entered as second-class matter July 26, 1948, at the Post Office in New York, N. Y., under the act of March 3, 1879; additional entry as second-class matter at Dayton, Ohio. Entered as second-class matter at the Post Office Department, Canada. Printed in U.S.A. Copyright, 1949, by Popular Science Publishing Co., Inc. All rights reserved in the United States, Great Britain, and in all countries participating in the International Copyright Convention and Pan-American Copyright Convention. Yearly subscriptions to United States, its possessions and Canada, \$3.00 (2 years, \$5.50; 3 years, \$7.50); foreign countries \$1 per year extra. Subscribers must notify us of change of address four weeks before next publication date. Be sure to give both old and new addresses, including zone numbers. Vol. 155: No. 5.

Highlights

PS Features

Inside Story of Gar Wood Ship....106

Read how this speed king's strange craft may lead to seasick-free, ultrafast ocean liners.

Army Breeds New Workhorses...121

GI truck drivers won't have to wrestle the new prime movers—they're easier to drive than a jeep.

Shooting a 5-Ton Skyrocket.....129

Getting a rocket ready to soar into upper space takes more hours than the flight takes seconds.

I Fly the World's Fastest Bomber..139

Test pilot Jim Fraser tells you how it feels to ride 60 tons of bomber at near-sonic speeds.

Santa Makes Toys the Easy Way..145

Here's how it's done in Santa's Workshop at the North Pole (shh. . . it's really upstate New York).

How Knives and Forks Are Made..171

Old-time craftsmanship plus modern techniques make table silver everyone can afford.

Gus Wins a Bet.....178

Even a sure-thing gambler doesn't stand a chance against Gus's knowledge of engine trouble.

Good Cars Never Die.....182

This mechanic's mechanic rebuilds old Cord cars—and the world has beaten a path to his garage.

How an Expert Builds a Boiler...212

Here's a fast-steaming water-tube boiler that will put real muscle in a model steam engine.

Things to Make for Christmas

Want to Run a Bulldozer?.....186

Stroller Carries Her Doll.....191

It's Easy to Use Our Mixer Now.....192

Two Marble Games to Play Indoors.....196

Stove Cooks with Infrared Rays.....197

Every Child Needs a Desk.....199

Keg Toys Are a Barrel of Fun.....200

Glove Turns Watch into Clock.....204

Ducks to Shoot on a Table Top.....207

Cards Your Friends Will Save.....225

Monorail Streamliner.....230

Handy Shelves Fit Odd Corners.....234

Dragon Candlesticks.....234

Hide a Radio in a Skillet.....242

Science & Industry

Magnetism Poses for Photo.....117

Chrysler Adopts New Disk Brake.....128

Enlarger Diffuses Light.....135



You've got to compete with trained men!

The untrained man stands a slim chance today. Right now there are 14 million more highly skilled, experienced workers in the country than before the war.

Jam-packed schools and colleges are turning out record classes two and three times a year. The armed services continue to return thousands of technical experts to civilian life every month.

That's why it is so important that you get all the training you can—now, before "the squeeze" begins. Continue your formal

education if you can. If not, investigate the opportunities offered by I. C. S.

For more than 58 years, I. C. S. has been training those determined to make good regardless of the odds. Leaders in nearly every field of business and industry are counted among the men and women who have taken I. C. S. courses. Their records of success prove the worth of sound, practical I. C. S. training. Don't gamble with your future. It may be later than you think. Mark and mail the coupon today!

INTERNATIONAL CORRESPONDENCE SCHOOLS

APPROVED
under the
G.I. BILL

BOX 7641-M, SCRANTON 9, PENNA.

Without cost or obligation, please send me full particulars about the course BEFORE which I have marked X:

- | | | | |
|--|--|--|--|
| <p>Air Conditioning and Plumbing Courses</p> <p><input type="checkbox"/> Air Conditioning <input type="checkbox"/> Plumbing</p> <p><input type="checkbox"/> Heating <input type="checkbox"/> Steam Fitting</p> <p><input type="checkbox"/> Refrigeration <input type="checkbox"/> Steam Fitting</p> <p>Chemical Courses</p> <p><input type="checkbox"/> Chemical Engineering</p> <p><input type="checkbox"/> Chemistry, Analytical</p> <p><input type="checkbox"/> Chemistry, Industrial</p> <p><input type="checkbox"/> Chemistry, Mfg. Iron & Steel</p> <p><input type="checkbox"/> Petroleum Refining <input type="checkbox"/> Plastics</p> <p><input type="checkbox"/> Pulp and Paper Making</p> <p>Civil Engineering, Architectural and Mining Courses</p> <p><input type="checkbox"/> Architecture</p> <p><input type="checkbox"/> Architectural Drafting</p> <p><input type="checkbox"/> Bridge and Building Foreman</p> <p><input type="checkbox"/> Building Estimating</p> <p><input type="checkbox"/> Civil Engineering</p> <p><input type="checkbox"/> Coal Mining</p> <p><input type="checkbox"/> Contracting and Building</p> <p><input type="checkbox"/> Highway Engineering</p> <p><input type="checkbox"/> Lumber Dealer</p> <p><input type="checkbox"/> Reading Structural Blueprints</p> <p><input type="checkbox"/> Sanitary Engineering</p> <p><input type="checkbox"/> Structural Drafting</p> | <p><input type="checkbox"/> Structural Engineering</p> <p><input type="checkbox"/> Surveying and Mapping</p> <p>Communications Courses</p> <p><input type="checkbox"/> Electronics</p> <p><input type="checkbox"/> Practical Telephony</p> <p><input type="checkbox"/> Radio, General <input type="checkbox"/> Radio Operating</p> <p><input type="checkbox"/> Radio Servicing <input type="checkbox"/> Television</p> <p><input type="checkbox"/> Telegraph Engineering</p> <p>Electrical Courses</p> <p><input type="checkbox"/> Electrical Drafting</p> <p><input type="checkbox"/> Electrical Engineering</p> <p><input type="checkbox"/> Electric Light and Power</p> <p><input type="checkbox"/> Lighting Technician</p> <p><input type="checkbox"/> Practical Electrician</p> <p>Internal Combustion Engines Courses</p> <p><input type="checkbox"/> Auto Technician <input type="checkbox"/> Aviation</p> <p><input type="checkbox"/> Diesel-Electric</p> <p><input type="checkbox"/> Diesel Engines <input type="checkbox"/> Gas Engines</p> <p>Mechanical Courses</p> <p><input type="checkbox"/> Aeronautical Engineer's, Jr.</p> <p><input type="checkbox"/> Aircraft Drafting <input type="checkbox"/> Flight Engineer</p> <p><input type="checkbox"/> Forging <input type="checkbox"/> Foundry Work</p> <p><input type="checkbox"/> Heat Treatment of Metals</p> <p><input type="checkbox"/> Industrial Engineering</p> <p><input type="checkbox"/> Industrial Instrumentation</p> | <p><input type="checkbox"/> Industrial Metallurgy</p> <p><input type="checkbox"/> Machine Shop <input type="checkbox"/> Mech. Drafting</p> <p><input type="checkbox"/> Mechanical Engineering</p> <p><input type="checkbox"/> Mold-Loft Work</p> <p><input type="checkbox"/> Patternmaking—Wood, Metal</p> <p><input type="checkbox"/> Reading Shop Blueprints</p> <p><input type="checkbox"/> Sheet-Metal Drafting</p> <p><input type="checkbox"/> Sheet-Metal Worker</p> <p><input type="checkbox"/> Ship Drafting <input type="checkbox"/> Ship Fitting</p> <p><input type="checkbox"/> Tool Designing <input type="checkbox"/> Toolmaking</p> <p><input type="checkbox"/> Welding Engineering</p> <p><input type="checkbox"/> Welding—Gas and Electric</p> <p>Railroad Courses</p> <p><input type="checkbox"/> Air Brake <input type="checkbox"/> Car Inspector</p> <p><input type="checkbox"/> Diesel Locomotive</p> <p><input type="checkbox"/> Locomotive Engineer</p> <p><input type="checkbox"/> Locomotive Fireman</p> <p><input type="checkbox"/> Locomotive Machinist</p> <p><input type="checkbox"/> Railroad Section Foreman</p> <p><input type="checkbox"/> Steam-Diesel Loco. Eng.</p> <p>Stationary Eng'r's Courses</p> <p><input type="checkbox"/> Boilermaking</p> <p><input type="checkbox"/> Combustion Engineering</p> <p><input type="checkbox"/> Engine Running</p> <p><input type="checkbox"/> Marine Engineering</p> <p><input type="checkbox"/> Power Plant Eng'r's <input type="checkbox"/> Steam Engr.</p> | <p>Textile Courses</p> <p><input type="checkbox"/> Cotton Manufacturing</p> <p><input type="checkbox"/> Loom Fixing <input type="checkbox"/> Rayon Weaving</p> <p><input type="checkbox"/> Textile Designing</p> <p><input type="checkbox"/> Woolen Manufacturing</p> <p>Business and Academic Courses</p> <p><input type="checkbox"/> Accounting <input type="checkbox"/> Advertising</p> <p><input type="checkbox"/> App. Psychology <input type="checkbox"/> Bookkeeping</p> <p><input type="checkbox"/> Business Administration</p> <p><input type="checkbox"/> Bus. Correspondence <input type="checkbox"/> Bus. Law</p> <p><input type="checkbox"/> Certified Public Accounting</p> <p><input type="checkbox"/> Commercial <input type="checkbox"/> Commercial Art</p> <p><input type="checkbox"/> Cost Accounting</p> <p><input type="checkbox"/> Federal Tax <input type="checkbox"/> First Year College</p> <p><input type="checkbox"/> Foremanship <input type="checkbox"/> French</p> <p><input type="checkbox"/> Good English <input type="checkbox"/> High School</p> <p><input type="checkbox"/> Higher Mathematics <input type="checkbox"/> Illustration</p> <p><input type="checkbox"/> Industrial Supervision</p> <p><input type="checkbox"/> Motor Traffic <input type="checkbox"/> Postal Civil Service</p> <p><input type="checkbox"/> Retailing <input type="checkbox"/> Retail Bus. Management</p> <p><input type="checkbox"/> Salesmanship <input type="checkbox"/> Secretarial</p> <p><input type="checkbox"/> Sign Lettering</p> <p><input type="checkbox"/> Spanish <input type="checkbox"/> Stenography</p> <p><input type="checkbox"/> Traffic Management</p> |
|--|--|--|--|

Name _____ Age _____ Home Address _____

City _____ State _____ Working Hours _____ A.M. to _____ P.M.

Present Position _____ Employed by _____

Length of Service in World War II _____ Enrollment under G.I. Bill approved for World War II Veterans. Special tuition rates to members of the Armed Forces.

Canadian residents send coupon to International Correspondence Schools Canadian, Ltd., Montreal, Canada.

Build A FIREPLACE Yourself



around this scientifically designed steel form which also provides circulating heat that assures perfect fireplace operation.

free folder tells how

TELLS HOW TO BUILD YOUR FIREPLACE—Step by Step

- Foundation
- Steel heat-circulating form
- Cold and warm air ducts
- Chimney and flue construction
- Mantel or decorative front



Foundation

ASK FOR BOOK
"100 FIREPLACE IDEAS"

Beautiful fireplace designs modern and conventional—shows artistic use of available material.

Enjoy circulating heat and the radiance of an open fire in your Home, Playroom, Cottage or Camp.

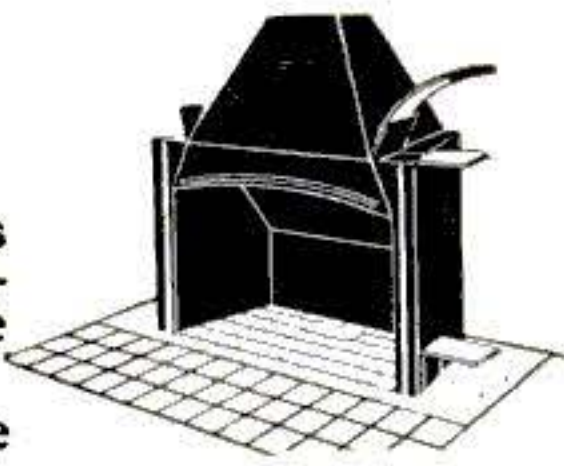

Fireplace form including firebox, damper, down draft shelf and smoke dome.

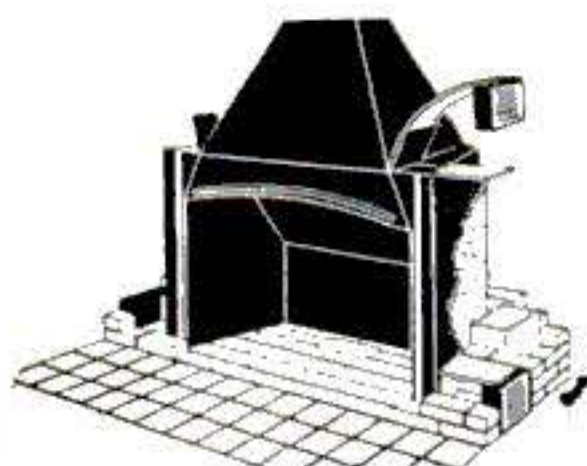

Brick, stone or cement block can be used around the form.

- Send free directions for building heat-circulating fireplace.
- Send Book "100 Fireplace Ideas." Pocket size, book, sent free.
- Send larger book, 8½ x 11, beautifully illustrated, 25c.
- Send outdoor fireplace folder with 10 beautiful designs Free.

Name

Street

City

Sold Through Leading Building Materials Dealers

PRICE FIREPLACE HEATER & TANK CORP.
137 W. Austin Street, Buffalo 7, New York

Refinery Treks Across Subarctic.....	136
New Glass Sharpens TV Pictures.....	138
Far North Cabins Are Now Prefabs.....	151
Christmas "Snow" Made of Plastic.....	153
Plush Job for the Bush.....	154
'Copter Top Tilts to Cure Shakes.....	158
Riders Walk Mechanical Animals.....	161
Machine Finds Facts for You.....	162
"Seater Meter" Samples Shapes.....	166
The Case of the Missing Sardines.....	168
Negative Spring Does New Tricks.....	170
Backstage in a TV Tube.....	209
How Air Force Snaps Night Photos.....	228

Mechanics & Handicraft

Tobacco Box Holds Pipes.....	195
Repair Your Rowboat Now.....	218
Even a Doghouse Can Be Warm.....	222
Tracking Down the Fuel You Waste.....	235
News in Home Heating.....	238
Amuse Kids with a Tin Can and Fan.....	240
Ice Aids Pile Driving.....	246

Departments

Letters	8
I'd Like to See Them Make.....	98
Voice of Science.....	103
New Ideas from the Inventors.....	115
Keeping the Home Shipshape.....	118
New Tools.....	152
Hints from the Model Garage.....	205
Photo Ideas and Equipment.....	208
New Shop Ideas.....	216
Aids to Modern Living.....	300
P. S.—Last-Minute News and Notes.....	304

Furniture an Amateur Can Build

The high cost of furniture need not keep you from being comfortable.

A double-length feature in Popular Science next month will show you a whole roomful of furniture that anyone can build. And without a shopful of expensive tools. The low cost will surprise you.

FREE
7-DAY TRIAL

JUST MAIL COUPON
Pay Nothing to
Postman

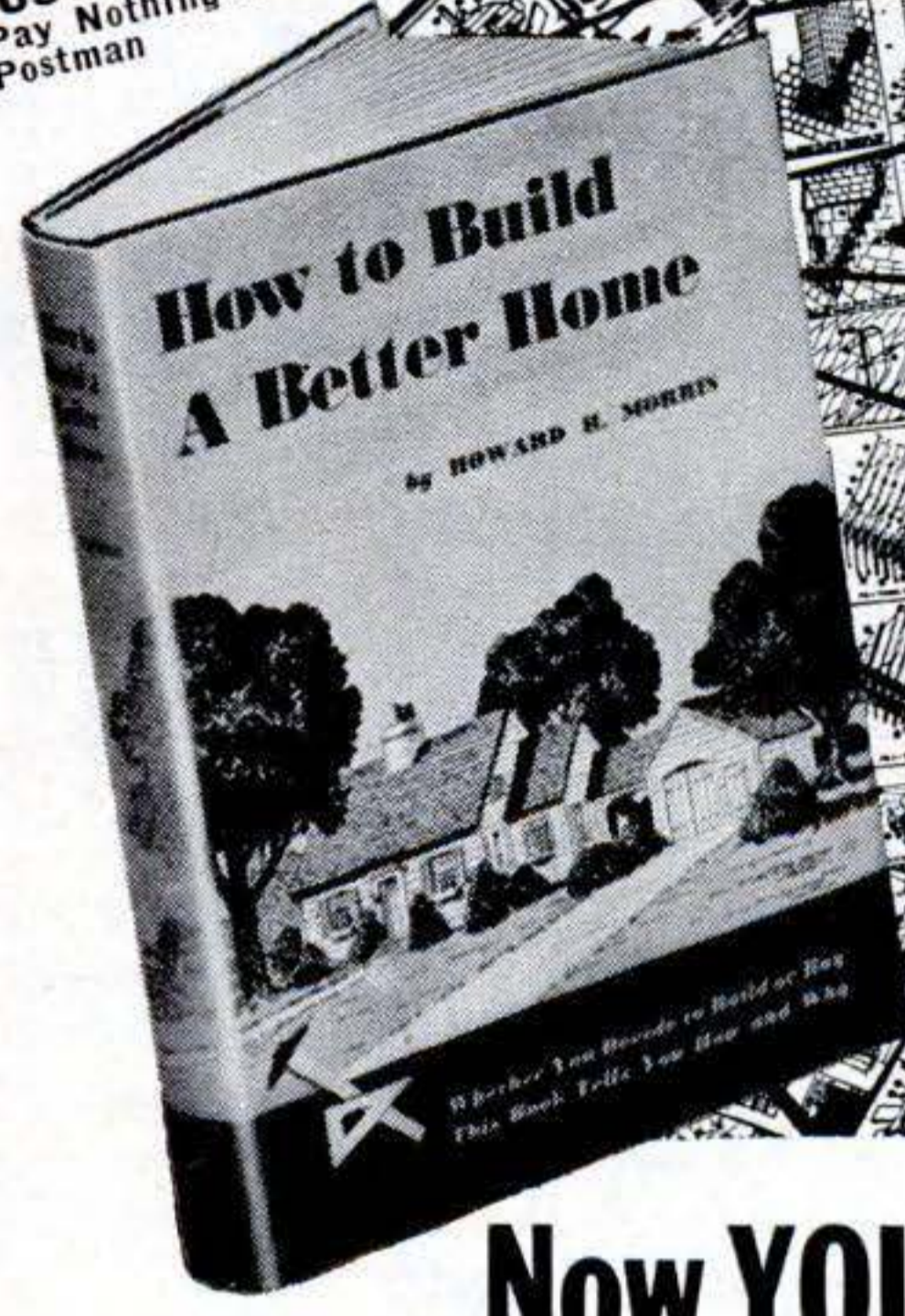

See the
Numbers

Just
Follow the
Numbers and
YOUR HOME
is Built!

30 Easy Steps!

Now YOU-TOO Can Lick

ANY Home Building Job!

Secrets That Produce Fine Homes—Completely Revealed in This Great Easy-Reference Book!

How to Start • Deciding Upon Ownership
• How to Select Service • How to Finance
• Building Lot • How to Plan • Fill Out Documents • Obtain Good Construction
• How to Prevent Termites • Decay • Corrosion • How to Lay Out Building, Excavate, Grade • Monolithic Concrete Construction • Masonry • Footings • How to Build Piers, Foundation Walls • Basement
• How to Waterproof • Build Chimneys, Fireplaces • How to Select Woods • House Framing Methods, Details • Finish Carpentry, Millwork • How to Insulate • Sheet-Metal Work, Roofing, Stucco, Lath, Plaster
• How to Paint, Finish • Tile Work, Electrical Work, Plumbing, Heating • List of Publications for Home Builder (Most are free or cost few cents) • Stock Plans • Taxes, Insurance, Interest, Maintenance, Assessments • How to Choose Bank, Real Estate Dealer, Contractor • Locating House on Lot, Tax Searches, Comparative Costs, Design • Prefabricated Houses? Bungalows, List of Usual Mistakes • Architectural Don'ts! 300 additional paragraphs important information.

QUICK REFERENCE INDEX TO SPECIAL PAGE SIZE PLATES (HUNDREDS OF ILLUSTRATIONS)

Footings—foundation walls—basements • Garage floor, footings, etc.—septic tank—grease trap—basement window • Concrete porches, steps, automobile runways, driveways, walks • Brick steps, terraces • Brick, tile, stone wall details—flagstone, stepping stone walks • Masonry dwellings—brick veneer walls • Chimney, fireplace details • Balloon framing details (minimum-shrinkage type), (box sill type) • Roof framing details • Basement columns, girders—framing openings—bridging • Miscellaneous details • Watertables—exterior sidewalls, siding, shingles—cornices—porch columns • Double-hung wood window details • Door frame details—points for millwork—stock doors, windows—sash details • Paneling—stairwork—baseboard details • Termite shields • Flashing details • Gutters, leaders (downspouts) • Roofing details. One Simple Fact May Repay HUNDRED Times Small Cost. A Book You Will Refer to for Years!

HUNDREDS OF LETTERS ARE POURING IN!
"Book arrived in time to save me a serious error in regard to my lot." "I just caught the basement floor in time." "Best ever written on the subject of houses." "This is my third copy. Every time I show it to one of my friends he talks me out of my copy." "We are making many changes in our plans because of articles we have read in the book." "I do not feel that I could proceed without a copy of this book." "Wish to thank you." "Finest of its kind I have seen."

"How to Build a Better Home" Is Showing Tens of Thousands How to Handle Any Construction Job—Faster, Easier! Now Let It Build Your House for YOU!

HERE'S how to "knock over" every construction job—including "tough-nuts". Thousands are letting "How to Build a Better Home" tackle toughest building, remodeling, alteration problems—in LESS TIME, with less work, more fun than ever!

Everything You Need to Know

All diagrams—only book of its kind—8 years in making! Worth \$50! Answer to prayers! The WORKS—how to plan, construct, supervise—simply, clearly explained. Jam-packed with everything you need. Your insurance against warped floors, smoking chimneys, sagging insulation, decay. Now let these hundreds architect's diagrams, instructions, facts go to work for YOU! Tackle anything—footings, roof, small bungalow, two-family house, light frame construction, solid brick—quickly, easily, right! Just look up job in index; then let diagrams show you number by number, step by step, how to put homes together!

WHY PAY RENT?

If you are leery of 'cheap' building, shoddy work, poor design—if fed-up dreaming, get started! Prove it yourself, free. Why pay landlord? Get more, better rooms, for less than rent! Why wait, hope, never know? Get started now. Be ready for "rainy days". Remember, how you swore you would own your own home. With this book you can. Your security! Rent to others, add another floor, apartment, get extra income to pay off taxes, interest, mortgage!

SAVE THOUSANDS OF DOLLARS

Whether you spend \$2,000 or \$20,000—use architect or stock plans—in Maine, Calif., or Florida—let this book help you. Get "in the know," talk building language. Be respected, admired, proud. Here is happiness, a place of your own! The way to lick housing shortage. Employ uneducated labor—show them how—save THOUSANDS. Try it YOURSELF FREE. How can you lose? Start small, build UP. Get home, free and clear. Pay loan back in small sums like rent, yet get twice as much room! Aluminum windows, radiant heating, air conditioning, garbage disposals. Build part now, rest later, pay as you go!

How To Build—from Plans to Paint

See for yourself. One page can be worth fortune. We have files and files of letters to prove. You can do own plans in evenings. WHERE TO BEGIN? Just a quick glance at contents will show you. Those who bought write they have never seen such a book for any price, anywhere!

HUNDREDS Construction Details

Every type home discussed in FULL. Read what fraction of enthusiastic purchasers have to say. See how they bless day they sent coupon for free examination. See how they came back with orders for friends, relatives—business associates. Read, study, every word in this "ad"—FOR WE TELL YOU THE TRUTH, and we back up these little printed words with this no-risk offer:

SEND NO MONEY Examine it—7 Days FREE!

Don't spend cent. Just mail coupon. See hundreds of step-by-step diagrams, large 8 1/2" x 11" size. See how to supervise or build YOURSELF—even if you know nothing NOW! Then, if you are THRILLED, send only \$2.98 (plus shipping charges). If not thrilled, return book, and pay nothing! This is your chance. Awake! Mail FREE EXAMINATION COUPON NOW, to the Westport Publishing Company, Dept. PS11, Westport, Conn.

FREE Examination Coupon—Mail Now

The Westport Publishing Company
"Books of Merit", Dept. PS11, Westport, Conn.
Send "How to Build a Better Home." After 7 days I either return and owe nothing, or keep it and send \$2.98 (plus shipping charges). (Or will split it into two payments, the second payment to come a month later.)

Name.....Age...
(please print)

Address.....

City & Zone.....State.....

Save shipping charges. Enclose \$2.98 (check or money order) WITH coupon. WE then pay shipping. If not thrilled, return and we refund \$2.98 by AIR MAIL! Foreign Orders \$3.50 Cash with order.
 DeLuxe Library binding \$4.98.

In your Mind's Eye

The Secret of MENTAL CREATING

IF you just like to dream, read no further. There comes a time when your fancies *must be* brought into light—and stand the test of every-day, hard realities. Are you one of the thousands—perhaps millions—whose thoughts never get beyond the stage of *wistful wishing*? Do you often come to from a daydream with the sigh, "If only I could bring it about—*make it real*?"

All things begin with thought—it is what follows that may take your life out of the class of those who hope and dream. Thought energy, like anything else, can be dissipated—or it can be made to produce actual effects. *If you know how to place your thoughts* you can stimulate the creative processes within your mind—through them you can assemble things and conditions of your world into a happy life of accomplishment. *Mental creating* does not depend upon a magical process. It consists of *knowing how* to marshal your thoughts into a power that draws, compels and organizes your experiences into a worth-while design of living.

ACCEPT THIS *Free* BOOK

Let the Rosicrucians tell you how you may accomplish these things. The Rosicrucians (not a religious organization), a world-wide philosophical fraternity, have preserved for centuries the ancients' masterful knowledge of the functioning of the inner mind of man. They have taught men and women how to use this knowledge to *recreate their lives*. They offer you a free copy of the fascinating book, "The Mastery of Life." It tells how you may receive this information for study and use. Use coupon opposite.

The ROSICRUCIANS
(AMORC)

SAN JOSE

CALIFORNIA

SCRIBE: M.C.K.
The Rosicrucians (AMORC),
San Jose, California.

Please send free copy of "The Mastery of Life,"
and I shall read it as directed.

Name.....

Address.....

City.....

How to Become Well-Known

Exposes the Tricks of Publicity

YOU have a **RIGHT** to progress, to secure a better position, to make more money, to develop talents, skills, abilities that will make you more valuable. It is up to **YOU** to make yourself well known to others as an individual of above-average ability. In this amazing book you will discover that people with **LESS** ability than you are making **MORE** money—*simply because they are more well-known!*

Here, for the first time, the secrets and techniques used to make persons well known are revealed. "*How to Become Well Known*" talks facts. It is the result of years of study, observation, and practical work.

Shows you how to become well known locally, regionally, nationally, how to achieve fame in business or profession, avocation or hobby, in industry or in organizations, in clubs or social groups, in villages and big cities. Here are case histories of success which explain how the many goals of man's activities can be reached through achievements, speeches, publicity, determined campaigning, and careful work. The author, a prominent New York publicity and public-relations counsel, has devoted twenty successful years to the job of making persons, firms, organizations and causes well known. Henry F. Woods, Jr., has written this readable, helpful, inspiring book with a knowledge gained from vast experience in this field.

How to Get Ahead in Life, Gain Reputation, Fame, Wealth

How far do you think Lincoln, Franklin, Carnegie and Henry Kaiser would have gotten without the successful publicity methods? Read their life stories for **PROOF** that most of their fame was due to a skillful knowledge of how to make themselves well known. You will find yourself acquiring new poise, confidence, courage. You will lose fears or inhibitions which you may now have. Great rewards lie ahead for you if you are willing to follow the easy path in "*How to Become Well Known*"!

How to Reach America's Millions Without Paying For It!

Newspapers, magazines, radio stations are **HUNGRY** for news about you—what you do, who you are, where and at what you work. There are **THOUSANDS** of ways to get free publicity. "*How to Become Well Known*" tells you how to take advantage of these wonderful opportunities. How to get people to talk about you. To spread your name far and wide. To build you into the kind of person you want and *ought* to be!

How to Write and Get Free Publicity For Yourself!

Mr. Woods shows you all the "ropes". How to write a news release, how to make a speech, how to address a meeting, how to be chairman of a committee. How to make friends of editors, reporters, radio announcers, columnists, your public. He cites hundreds of actual experiences in this fascinating, profitable occupation—the one means by which it is almost impossible *not* to succeed. *No stone is left unturned!*

Everything You Need to Know, Step-by-Step

No big words, no fancy phrases—the **TRUTH**, simply, clearly explained. How to direct your thinking, actions, behaviour, attitude to the sole purpose of becoming well-known. Moreover, the publishers are so sure it can help you, too, to succeed that they are making you this amazing offer!

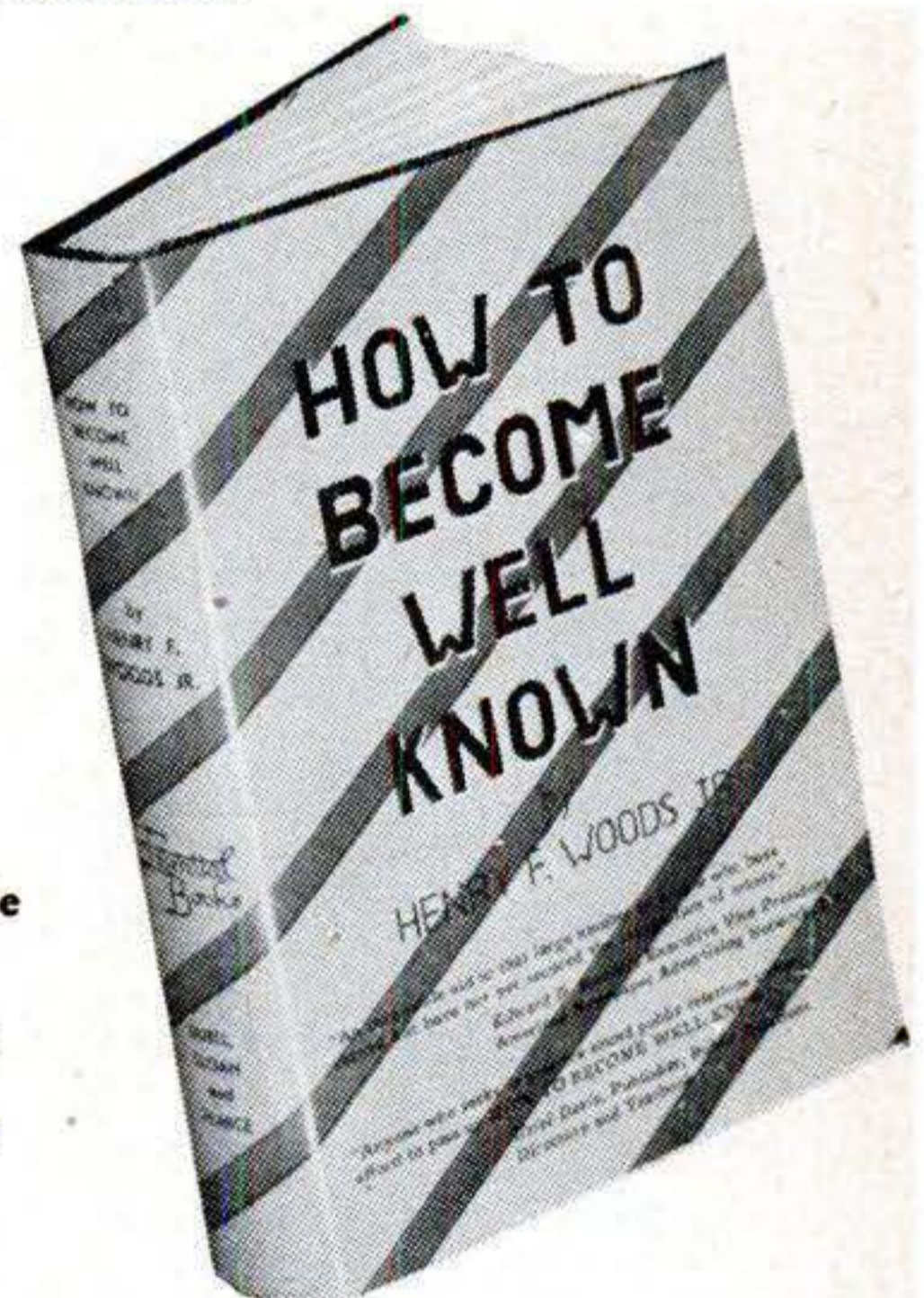

SEND NO MONEY!

Pay **NOTHING** to **POSTMAN**
Read, Study it **FREE** in Your
Own Home, for a Full Week!

Unless you are **absolutely** sure that it is exactly what you want and need, return it at our expense and owe nothing; or keep it by sending in only the low price of \$2.50. Take advantage of this opportunity to become well-known, to gain the things you want, to achieve success. Mail coupon NOW to

Duell, Sloan & Pearce, Publishers,
Dept. PS11
270 Madison Ave. New York 16, N. Y.

CUT OUT, MAIL COUPON NOW For FREE EXAMINATION

Duell, Sloan & Pearce, Publishers, Dept. PS-11,
270 Madison Ave. New York 16, N. Y.
Send me your 244 page publicity encyclopedia "*How to Become Well Known*," in beautiful buckram binding. In 7 days I will either return at your expense or send you the low price of \$2.50 (plus a few cents shipping charge).

Name..... Age.....
(please print)

Address.....

City..... Zone... State.....

Save shipping charges. Enclose \$2.50 NOW and WE pay postage. If not *delighted*, your money back by AIR MAIL.

Here is a Sample of the Contents

IT PAYS TO BECOME WELL KNOWN

You Know These Well-Known Persons
How Many of Today's Average Americans Will Become Well Known?
Why Becoming Well Known Is a Requisite to Success
Is the Desire To Become Well Known Laudable?
Why Being Well Known Brings Many Rewards
How To Profit by Experience of Others

WHAT IS MEANT BY "WELL KNOWN"?

How To Be Well Known in Business
What Is Back of the Desire To Become Well Known?
How Grover Whalen Became Well Known
How To Weigh Your Own Abilities
Self-Analysis Check List

THE MANY ROADS TO FAME

How Accomplishments Bring Fame
How To Widen Your Acquaintanceship
How To Become Interested in Others
How To Study Modern Advertisements
Why Leaders Act in the Interest of Others
How To Organize Groups or Associations
Why the Well-Known Were Once Obscure

THE STARTING POINT TO FAME

How To Work on a Committee
Why Fame Doesn't Come Overnight
How To Be Original in Reports
The Opportunities To Serve
The Value of "Big Name" Associates
Are There Many Fields Open?
What One Woman Accomplished

USING THE UNUSUAL TO BECOME WELL KNOWN

You Can Do the Unusual
How To Stand Out from the Crowd
How To Get Clues to the Unusual
How To Lift Things Out of the Routine
Why There Is Little Interest in the Ordinary
How Many Ways To Do the Unusual?

BECOMING AN EXPERT TO BECOME WELL KNOWN

You Can Be an Expert
Choosing a Special Field
Why Experts Are Made—Not Born
Why the Expert Is Practical
How Experts Function in All Lines
How To Become an Expert
How Experts Started from Scratch
Why Most Well-Known Persons Are Experts

GETTING YOURSELF OVER TO MASSES OF PEOPLE

Communicating Information to Millions
Why the System Is Open to All
How To Meet the Medium's Standards
How To Learn Through Studying Newspapers
How To Tie in with News of the Day
Why Study of Newspapers Has Many Advantages
Does Radio Offer a New Field?
Why Magazines Are High on the List
Keeping Abreast of Periodical Literature
Making Use of Public Libraries

BECOMING WELL KNOWN THROUGH CONFLICT

How Conflict Helped Roosevelt
Why Everyone Admires a Fighter
Why Conflict Is Interesting
How to Get in the Fight
How to Avoid Oblivion
Why Labor Leaders Are Well Known
Fighting in Your Own Business
What Are You Opposed To?
How to Get Into a Controversy
How Many Started the Climb

WHAT YOU SAY CAN MAKE YOU WELL KNOWN

What Do You Say?
How Sayings Bring Fame
How to Study What Others Have Said
How to Learn to Use Words
The Use of Humorous Sayings
How to Steer Clear of Cliches
Where to Say It
What's Needed to Speak Out?
Test Yourself on Words
Define Your Words

USING THE WRITTEN WORD TO BECOME WELL KNOWN

The Value of the Written Word
Using Letters to Become Well Known
How to Look for Letter-Writing Opportunities
How to Learn to Write
How to Use the Letter to the Editor
Why Editors Seek Letters from Readers
Use of Pamphlets
Using Lists of Names

USING THE SPOKEN WORD TO BECOME WELL KNOWN

Why the Spoken Word Is Powerful
Becoming Prominent by Speaking
You Can Learn to Be a Speaker
How to Prepare Remarks in Advance
How Research Aids the Speaker
Using Reprints of Speeches

BECOMING WELL KNOWN THROUGH STUNTS

What the Stunt Should Be
How to Conceive a Stunt
The Stunt and Showmanship
The Leap from Showmanship to Stunts
Why Simplicity Is Valuable
How to Learn Value of Emotional Appeal
The Use of Tie-ups
Other Tie-up Opportunities

USING PUBLICITY TO BECOME WELL KNOWN

What is Publicity?
How Publicity Has Come Into Its Own
Why Editors Rely on Publicity Material Today
Why Publicity Is an Aid to Becoming Well Known
A Definition of "News"
How to Learn to Judge News Values
Studying Daily Papers for Tips
Learning What Interests Others
The Value of Talking to Others

HOW TO WRITE AND DISTRIBUTE PUBLICITY

Writing the News Release
Writing a Story Lead
The Details of the Story
Physical Preparation of a Release
The Various Editors on a Newspaper
Should Publicity be Localized?
The Press Associations
Using Columnists and Syndicates
Use of Pictorial Publicity
Use of Mats in Publicity
How to Check on Publicity
How to Contact Editors

and thousands of other facts to help make you well known!

What Enthusiastic Readers Say:

"Becoming well known today calls for a certain skill which any person can develop if he learns the techniques set down in this unusual, interesting and informative book."
Earl Ferris, President
National Association of Public Relations Counsel.

"Here's a book that is both interesting and educational. The author has laid down a program which can be followed by those thousands who seek to become better known, and he has made it both easy and interesting to follow."
John A. Clements, Public Relations Director
Hearst Magazines.

"An invaluable aid to that large number of people who have earned but have not yet secured the recognition of others."
Edward D. Madden, Executive Vice President
American Newspaper Advertising Network, Inc.

"I want you to know that before using this book I had no idea of the importance, use, or magnitude of scope of this work. Since using it, I have been able to secure pages of publicity for myself and for others."
John B. Oakey, Bridgeport, Conn., Factory Newspaper Columnist

GIVE IT GOOD LOOKS



Whole Room

with handsome **WESTERN PINES***



Single Piece

It's bound to be beautiful—if you work with wood that's tasteful and rich. And the Western Pines yield just the quality and tone you'll admire when you remodel—paneled walls, built-in cabinets and bookcases, bunk bedrooms, rumpus rooms and dens. And there's many an hour of workshop pleasure ahead, making furniture with these luxurious woods.

They are clean to work with—straight-grained, soft-textured, versatile. They grip paint, take stain or wax or look luxurious left natural. For suggestions on what to remodel or make, send coupon for our Idea Packet No. 216-L, showing many pictures and design details. Yes, it's free.

These are the Western Pines

- ★ IDAHO WHITE PINE
- ★ PONDEROSA PINE
- ★ SUGAR PINE

BRINGS FREE IDEA PACKET

WESTERN PINE ASSOCIATION, Dept. 216-L
Yeon Bldg., Portland 4, Oregon

Please send me your free IDEA PACKET No. 216-L containing illustrated booklets, folders and how-to-do-it instructions—"Enchanting Homes of Western Pines"—"Bunk Bedroom Details"—"How to Treat Knotty Pine Paneled Walls"—etc.

Name _____

Street _____

City _____ State _____

Letters



Gus Cuts a Garage Bill

Sir:

Just a few lines to tell you how PS arrived in time to save me close to \$90. Last week my old Chrysler developed a fast oil consumption—30 miles to a quart—clouds of smoke from the exhaust. An estimate for new rings, etc., was \$90, and the job was going to take several days.

As I had planned a lengthy trip, I was stopped until I read the "Gus" story [Sept., p. 170]. Tried his trick—and the smoke stopped! Now, for about \$8, I can get the booster pump repaired when I get back.

H. C. WARNER

New York, N. Y.

PS Behind the Curtain

Sir:

Here in Hungary we have a popular scientific magazine called "Life and Science." I was surprised to find in it an article about atomic energy illustrated with the same pictures you used with Volta Torrey's article, "U. S. to Breed Own Atoms," in the June issue [p. 124] of POPULAR SCIENCE. As one of your regular subscribers, I was angry only because there was no mention of where the pictures came from.

L. ZELENKA, M. D.

Szeged, Hungary

Apparently PS not only gets through the Iron Curtain, but gets read—and copied.

Can This Be Progress?

Sir:

Sing alas and alack for the Great American Automobile! Your September cover depicting the 1950 Studebaker is more than the conscience can bear. This perversion of automotive "engineering" has reached its nadir. The postwar greenhouses, bathtubs, and cracker boxes were shameful indeed, but this new airplanelike monstrosity indicates shockingly the depravity and poverty of imagination in the automotive industry today.

Is it unheard of that an automobile should resemble an automobile? Where is the beauty and distinctiveness of the auto of, say, 15

THESE MEN ARE GETTING PRACTICAL TRAINING IN **ELECTRICITY**



On Real:

**A.C. and D.C. MOTORS
GENERATORS
SWITCHBOARDS
CONTROLLERS
WIRING JOBS
APPLIANCES
ELECTRONIC UNITS**

(Shown at left—Instructor demonstrating latest type of Test Unit for checking the efficiency of a Motor.)

AND **RADIO-TELEVISION**

On Real:

**TELEVISION SETS
RADIO RECEIVERS
F.M. (Frequency Modulation)
RECORD CHANGERS
AUTO RADIOS
AIRPLANE RADIOS
PUBLIC ADDRESS Systems**

(Right—Instructor explaining operation of 20-inch Cathode Ray tube used in Dumont Television Set.)

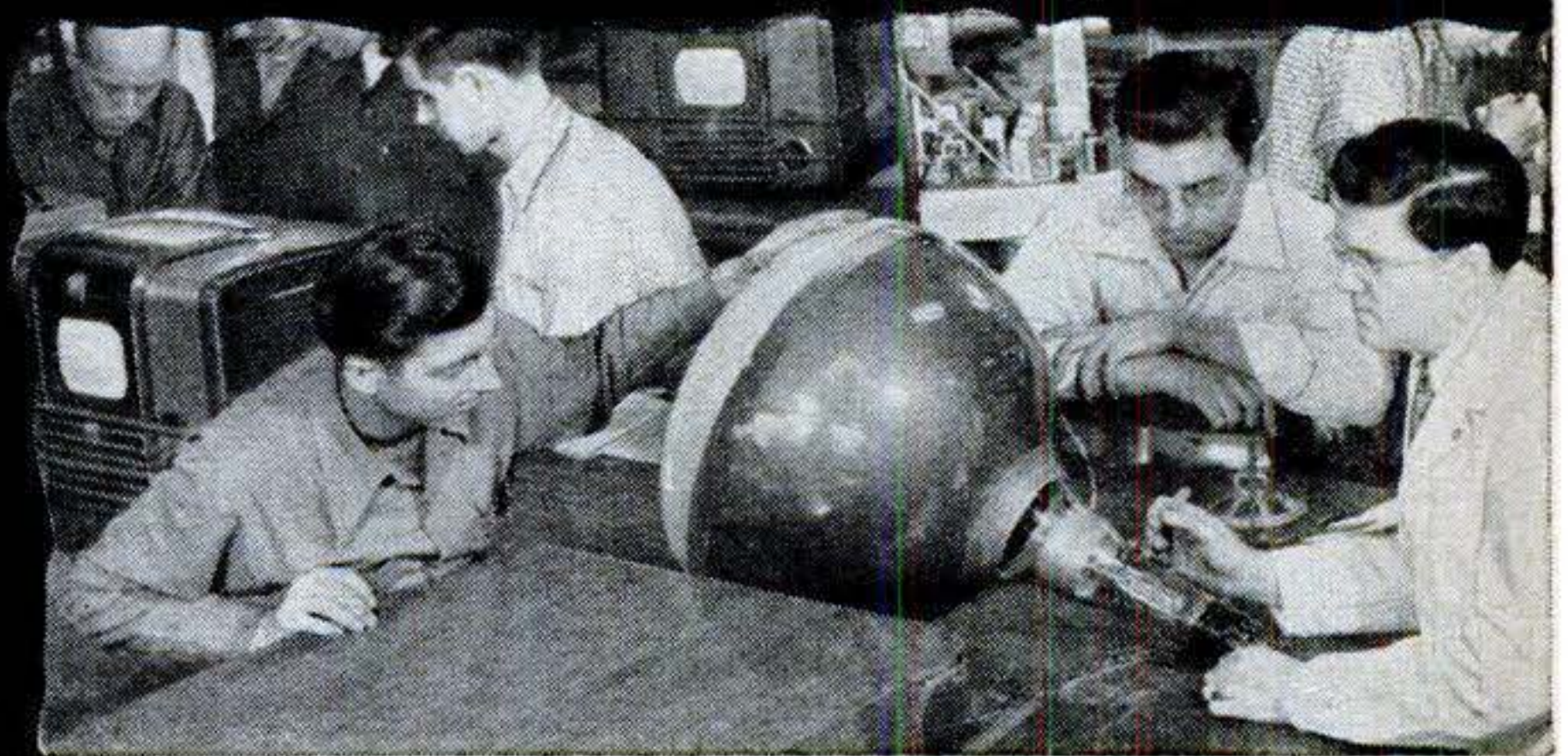

Just Like YOU Can Get in the Great SHOPS of COYNE

Prepare NOW for a real future the quick, practical way. Come to the Great Shops of COYNE in Chicago. Largest and best equipped school of its kind—now celebrating our 50th Anniversary. GI approved. Finance plan for non-veterans. **Mail coupon.**

NOT "HOME-STUDY" COURSES! At Coyne you learn on real, full-size equipment. Trained instructors show you how, then you do typical jobs yourself. We don't teach by mail.

CLIP COUPON NOW for big new illustrated Coyne book on either **ELECTRICITY** or **RADIO-TELEVISION** or both. No obligation; no salesman will call. Get the facts now!

COYNE

**B. W. COOKE, Pres.
ELECTRICAL &
RADIO SCHOOL
500 S. Paulina St., Dept. 89-73H
Chicago 12, Ill.**



**Mail Coupon for
FREE BOOK!**



**B. W. COOKE, President
COYNE ELECTRICAL &
RADIO SCHOOL, Dept. 89-73H
500 S. Paulina St., Chicago 12, Ill.**

Send **FREE**, the book checked below, and details of your training offer. This does not obligate me and no salesman will call.

ELECTRICITY **RADIO-TELEVISION**

NAME

ADDRESS.....

CITY.....STATE.....

Lots of DIESEL



IN THE
PACIFIC NORTHWEST

Yes, DIESEL is BIG business in Oregon, Washington, and adjoining states where industries and populations are growing so incredibly fast.

DIESEL IS THE KING OF POWER . . . on our railroads, highways, waterways and in our industries.



L. L. ADCOX,
President

MEN WHO ARE equipped with the thorough training they get at the **ADCOX SCHOOL**, are prepared for a splendid future in the great Northwest. A fine place to live and enjoy life.

**I PRODUCE
DIESEL MEN
IN 3
SHORT MONTHS**

NEWEST FACILITIES AND EQUIPMENT, Advanced Instruction Methods by highly paid, Expert Instructors, combined with my 40 YEARS of trade school experience, enable me to turn out **REAL DIESEL ENGINE TROUBLE SHOOTERS**. When you receive your Adcox Diploma you are ready to begin your career in Diesel.

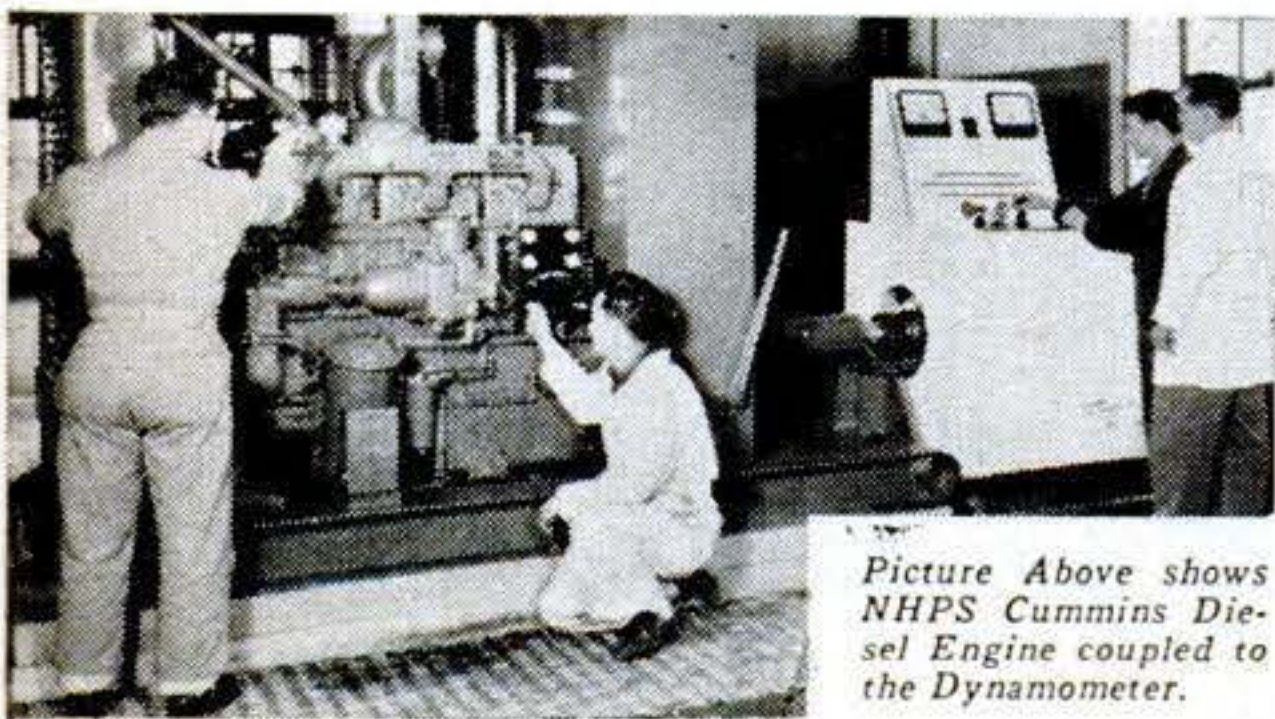

Picture Above shows NHPS Cummins Diesel Engine coupled to the Dynamometer.

YOU LEARN ENGINE CONSTRUCTION FROM THE GROUND UP. Special laboratory for Injection, Fuel Pumps, Nozzles and Governors. Trouble Shooting under full Dynamometer Load (as shown in picture).

This kind of training puts ADCOX out in front!

CLASSES LIMITED — Latest type equipment (no obsolete engines). Skilled Instructors — combine to insure best possible training. You learn Diesel **RIGHT**, and you learn it **FAST** . . . in this Nationally Famous School!

DIESEL SCHOOL CATALOG FREE

APPROVED FOR
VETERANS

L. L. ADCOX, President
ADCOX SCHOOL
237 N. E. Broadway, Portland 12, Oregon
Without obligation, please send me your
FREE Catalog No. PS.

Name

Address

Town.....State.....



Studebaker Champion, 1950

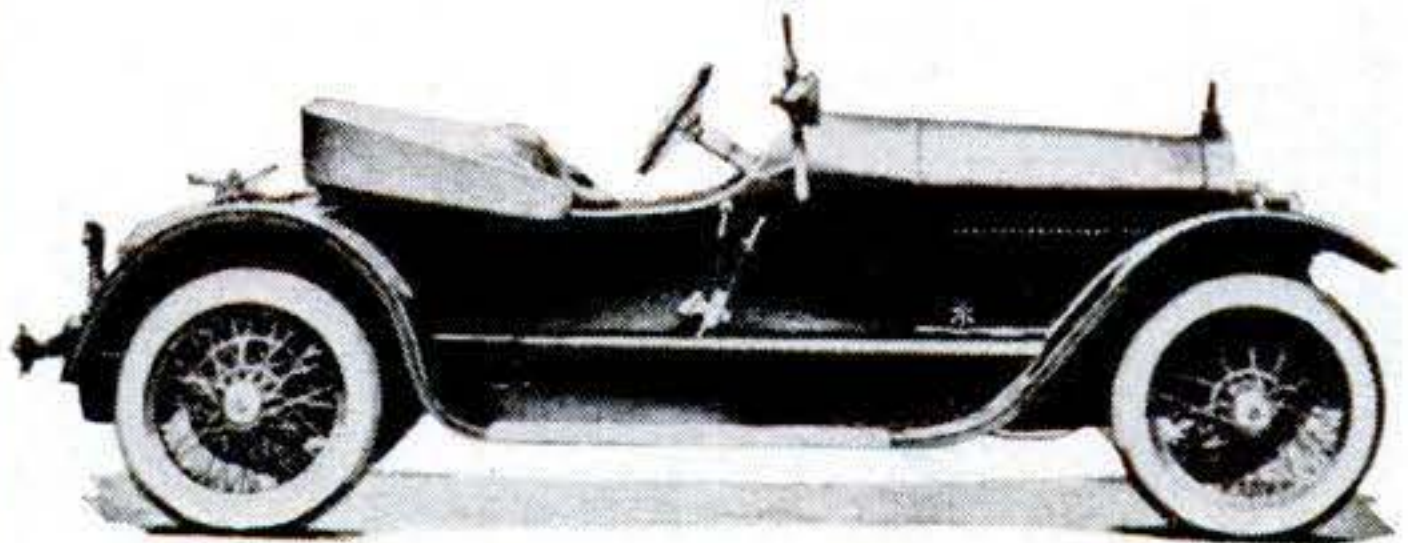

Stutz Bearcat, 1921

years ago? What has happened to the fine styling found in the Cord, Duesenberg, and, more recently, the Lincoln Continental? Go back even a third of a century to the noble lines of the Mercer Raceabout and the Stutz Bearcat. Can this 1950 rocket-to-the-moon be called progress?

Mr. Raymond Loewy and his cohorts, "industrial designers," have, for the sake of novelty and cheap sensationalism, taken the individuality and integrity out of a great American institution.

A plague on them.

O. LEE GORDON

Jacksonville, Fla.

Home-Safety Tip

Sir:

No matter how much you caution youngsters, they will get themselves into predicaments. As a step toward home safety, it is a good idea to remove the door catch from any old refrigerator or cabinet with tight-fitting doors that you are storing unused in your basement, attic, or garage. That will keep children from getting themselves locked in.

D. B. JOHN

Chicago, Ill.

Old Idea from an Inventor

Sir:

Among the "New Ideas from the Inventors" in your September issue [p. 106] is one that it's hard for me to believe is original. This is the one about a watering bowl for livestock that refills itself when a cow, pok-

MORE MONEY \$\$\$ a BETTER JOB



YOU'RE in the biggest competition — yes, the biggest battle in the world — that of making a living. You have to work for a living—so does everyone else. Competition for

promotion is keen—people all around you are looking for more money—a better job—and so are you.

You can get a head start. Other men have—and in a short time you should be able to out-distance those who have no progress plan, make more money—have a better job—a more certain future.

Few people prepare themselves for that promotion—that better job and more money. Not many are making any special effort to learn outside of the time they put in each day on their work. They're taking the long, hard road to success. *How about you?* Are you, too, taking that same old, winding road—with its many disappointments and heartbreaks?

Here at LaSalle we have been training ambitious men and women for success for more than 40 years—enrolled hundreds of thousands of students—and our files overflow with grateful letters from students who have attained success and earnings far beyond their fondest dreams.

Perhaps we can help you—at any rate it will be well worth a three cent stamp to mail the coupon below. **DO IT NOW!** Just check the field of your choice and we'll send you full information on that field without obligation—plus "Ten Years' Promotion in One"—a book which has helped many men. It may be the turning point in your life to a successful career, and more money.

Your Competition is Keen

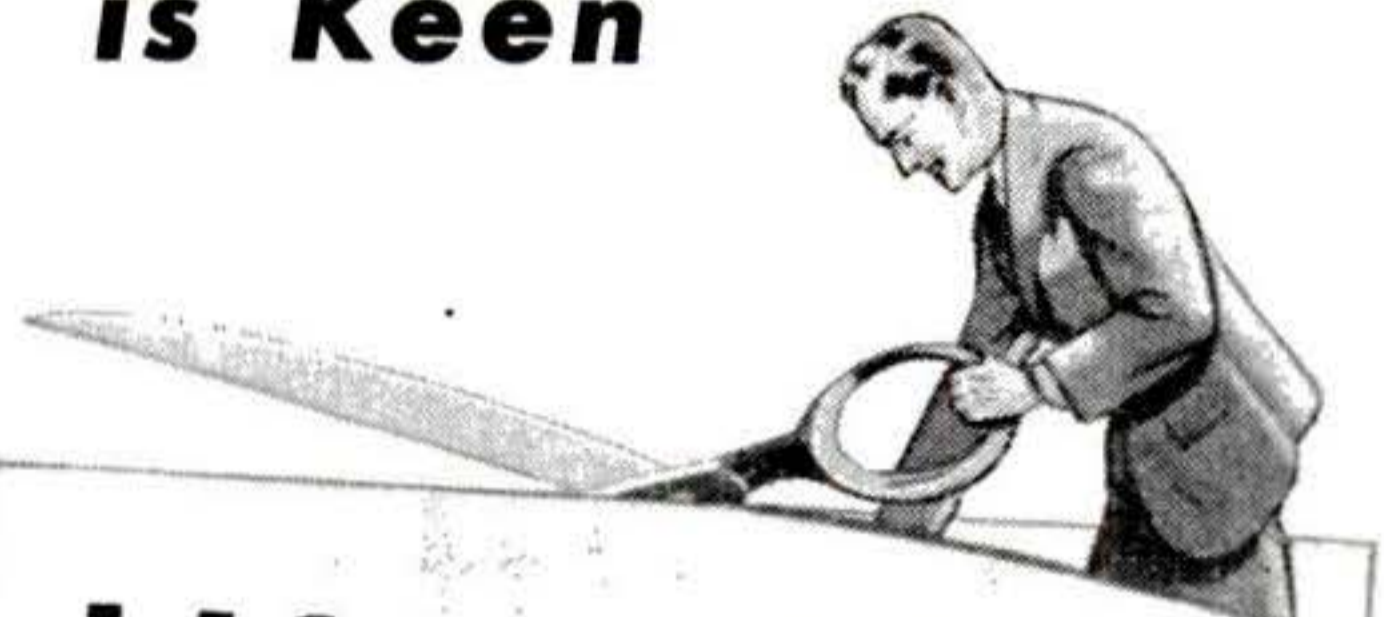

LASALLE EXTENSION UNIVERSITY

A Correspondence Institution
417 So. Dearborn St.

DEPT. 1183-R

CHICAGO 5, ILL.

I am interested in preparing myself for a better job and more money. Please send me your free 48-page booklet on the training course I have checked below—plus "Ten Years' Promotion in One."



- Higher Accountancy
- C.P.A. Coaching
- Bookkeeping
- Law: LL.B. Degree
- Business Management
- Salesmanship
- Traffic Management
- Foremanship
- Industrial Mgt.
- Stenotypy (Machine Shorthand)

Name _____ Age _____

Street Address _____

City, Zone and State _____

LASALLE EXTENSION UNIVERSITY
A Correspondence Institution
Dept. 1183-R Chicago 5, Ill:

CLIP AND MAIL THIS COUPON TODAY!

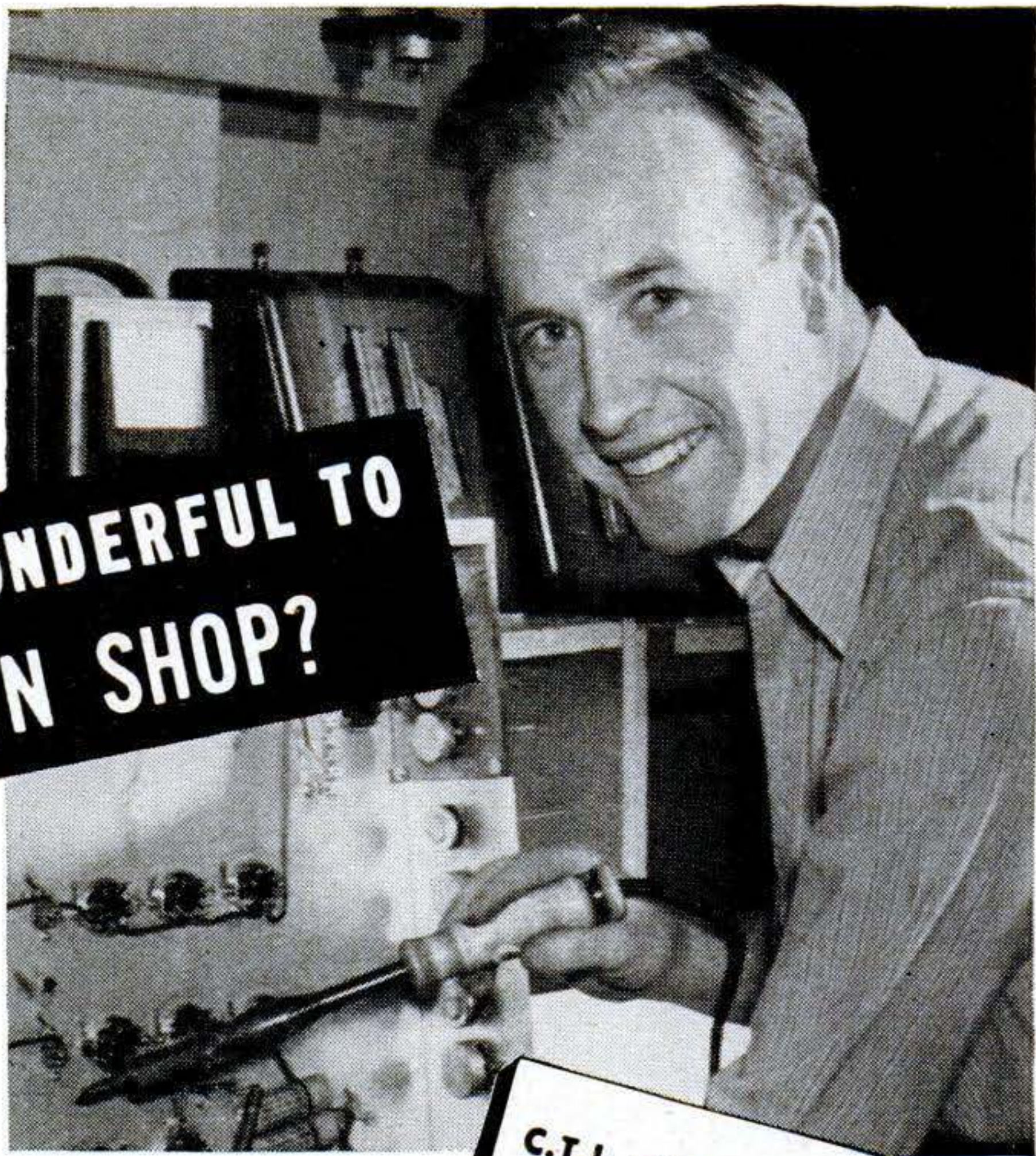

WOULDN'T IT BE WONDERFUL TO OWN YOUR OWN SHOP?

**Prepare for Independence—
Learn a Good Trade!**

How would you like to own your own business—be your own boss—enjoy greater income and security? This goal is not beyond your reach—if you take the time to learn a good trade!

Again and again, C.T.I. graduates prove that independence can be gained by the man who is determined to train himself. Judge for yourself—read these comments culled from letters in our files. "Since I graduated, I have built a garage, bought the most important equipment, and have a waiting list of customers." . . . "I have a shop on the north side and have four men working for me." . . . "As a result of my training at C.T.I., I am now in full charge of the shop where I am employed. I expect to own my own shop shortly." . . . "Since I finished my home training thru C.T.I., I've made enough money to buy tools, and now have a small business started." . . . "I am in partnership with a fellow student from good old C.T.I. Business is very good. Our schooling at C.T.I. has been of great value to us."

If you aren't happy with your present job—if it pays poorly or offers no real future—learn a trade in one of America's great industries. Train thru C.T.I.—either at home in spare time, or in our great Chicago shops. *Get the facts now! Mail coupon today! Act!*

- C.T.I. OFFERS PRACTICAL TRAINING IN**
- AUTOMOTIVE MECHANICS
 - BODY & FENDER REBUILDING
 - DIESEL MECHANICS
 - REFRIGERATION & AIR CONDITIONING
 - ELECTRICITY & ELECTRONICS
 - RADIO & TELEVISION
 - BUILDING CONSTRUCTION
 - MECHANICAL DRAFTING

C. T. I. TRAINING IS G. I. APPROVED

All C.T.I. courses, both residential and home study, are fully approved by the Veterans' Administration—which means that eligible veterans will have their tuition paid by the government. Remember, there's a time limit on when training must begin, so act now!

NON-VETERANS—We'd like to tell you about our Easy-Payment Finance Plan and Pay-After-Graduation Plan. Write for information.



R. C. Anderson
President

**COMMERCIAL TRADES
INSTITUTE, Dept. E1-11
1400 Greenleaf, Chicago 26**



FILL OUT - CUT OUT - MAIL TODAY

**Mr. R. C. Anderson, President
COMMERCIAL TRADES INSTITUTE, Dept. E1-11
1400 W. Greenleaf, Chicago 26, Ill.**

Send free illustrated Brochures and other information about the field I have checked below:

Veteran Non-Veteran

<input type="checkbox"/> Automotive Mechanics	<input type="checkbox"/> Electricity & Electronics
<input type="checkbox"/> Body & Fender Rebuilding	<input type="checkbox"/> Radio & Television
<input type="checkbox"/> Diesel Mechanics	<input type="checkbox"/> Building Construction
<input type="checkbox"/> Refrigeration & Air Conditioning	<input type="checkbox"/> Mechanical Drafting

Name _____ Age _____

Address _____

City _____ State _____

BUILDERS

TRADE GUIDES

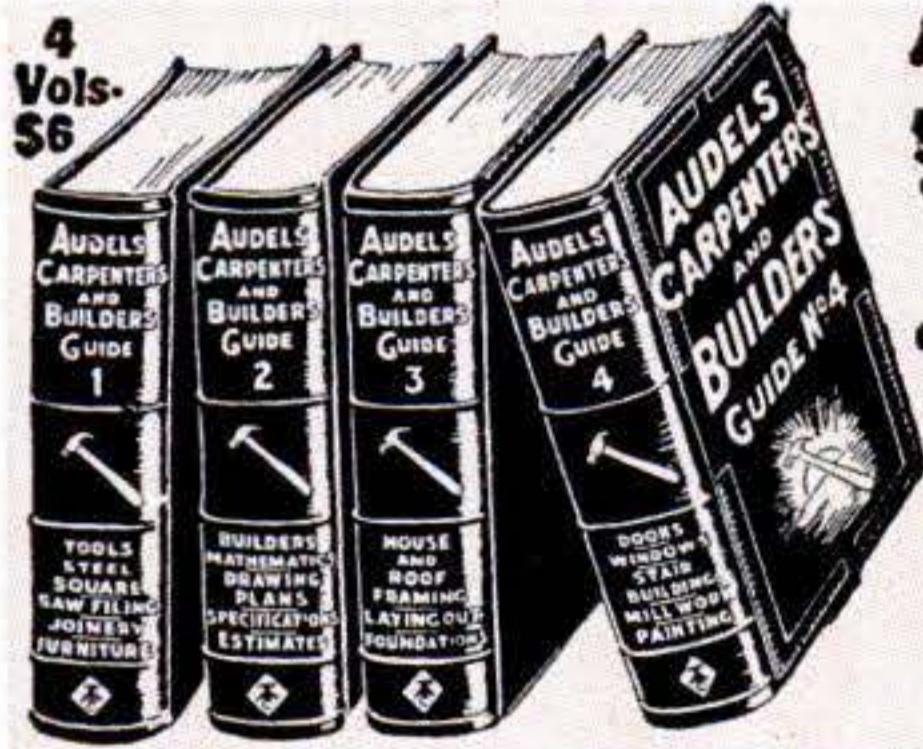

AUDELS CARPENTERS AND BUILDERS GUIDES—4 VOLS. \$6

Inside Information for Carpenters, Builders, Joiners, Building Mechanics—all Woodworkers. 1600 pages; 3700 diagrams; flexible; pocket size. Short-cut instructions, new methods, ideas, solutions, plans, systems—money saving suggestions. An easy progressive course for the apprentice. A practical daily helper and Quick Reference for the master worker. A Helping Hand to Easier and Better Work and Better Pay. To get this aid for yourself, simply fill in and mail the FREE COUPON below.

INSIDE TRADE INFORMATION ON:

How to use steel square; How to file and set saws; How to build furniture; How to use mitre box; How to use chalk line; How to use rules; How to make joints; Carpenters' arithmetic; Mensuration problems; Estimating strength of timbers; How to set girders and sills; How to frame houses and roofs; How to estimate costs; How to build houses, barns, garages, bungalows, etc.; How to read and draw plans; Drawing up specifications; How to excavate; How to use settings 12, 13 and 17 on the steel square; How to build hoists and scaffolds—skylights; How to build stairs; How to put on interior trim; How to hang doors; How to lath—lay floors; How to paint.

"Audels Guides worth four times their price—handy too as I carry them in pocket for reference." **W. J. Bates, Knoxville, Pa.**

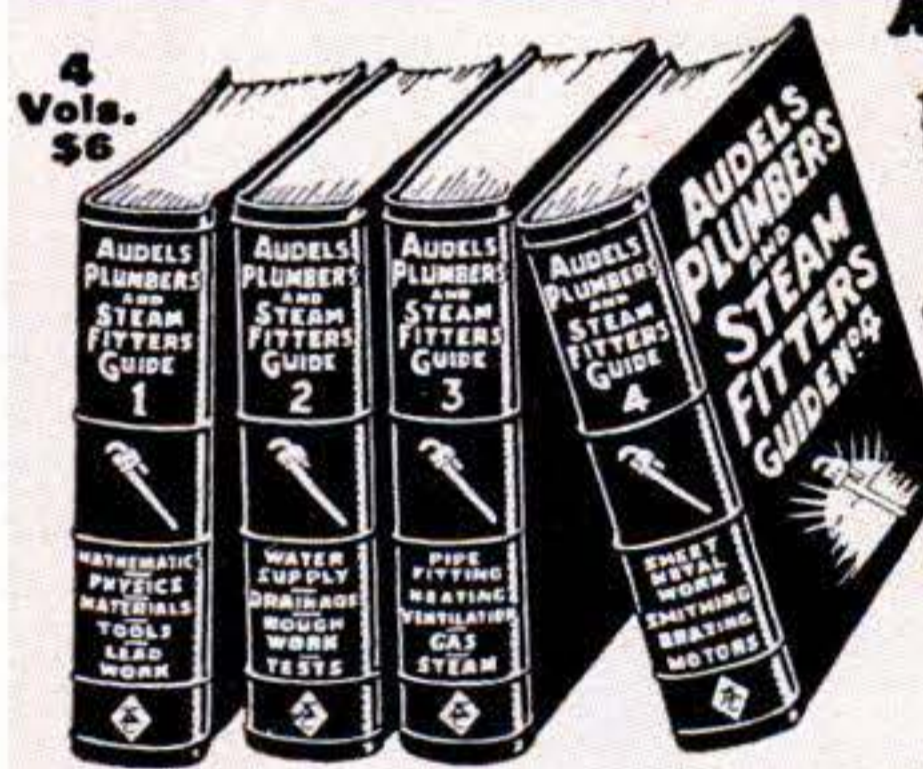

AUDELS PLUMBERS AND STEAMFITTERS GUIDES—4 VOLS. \$6

A new edition—just out! A practical, illustrated, Reference Library and Study-Course for Master Plumbers, Journeymen and Apprentice Steamfitters, Gas Fitters and Helpers, Sheet Metal Workers, Draughtsmen, Master Builders, Engineers and all Building Trade Students. 1670 pages; 3642 diagrams; flexible; pocket size. Guides explain all the principles, advances and short cuts of the Plumbing and Heating trade. Contains instructions on how to figure and estimate jobs. Use FREE COUPON below to examine, without obligation, this valuable work.

INSIDE TRADE INFORMATION ON:

Air Conditioning. Soldering, tinning. Joint wiping, bending, beating. Pipe—iron—steel, threading. Mathematics, tables, physics. Materials—iron, steel, copper, brass, lead, tin, antimony. Sheet metal—galvanized—plate. Sanitation, syphonage, tanks. Drainage, sewage, purification. Fixtures—bath—kitchen. Pipe fittings, soil pipe, tools. Laying out work. Roughing. Screwed fittings, flanges, joints. Pipe bending, examples. Elbows. Heating, ventilation, refrigeration. Water supply, mains, wells, tanks. Gas-fittings. Underwriters. Sheet metal work, problems, methods, Brazing, heating, lead burning. Welding, various welds, methods. Blacksmithing, forges, tools.

"Audels Guides are practical, easy to understand, reliable. Cover the field in plain language." **W. F. Arminger, Annapolis, Md.**



AUDELS MASONS AND BUILDERS GUIDES—4 VOLS. \$6

A complete, illustrated trade reference library, for Bricklayers, Cement Workers, Plasterers, Tile Setters and Stone Masons, including a practical outline of Steel Construction. 1100 pages; 2067 diagrams; flexible; pocket size. A practical Trade Assistant explaining modern methods of masonry construction. Easy to understand and apply. A reliable and authentic reference work and study-course for Master Journeyman and Young Mechanic. Use FREE COUPON below and find out for yourself, without obligation, whether this set will benefit you.

INSIDE TRADE INFORMATION ON:

Bricklaying, tools, materials; Brick designs, patterns, bonds; Setting frames and foundations; Mortars, scaffolds, estimating; Mortars and mortar mixing; Tile setting, mosaic, hollow tile; Straight edge test, troweling; How to figure brick work; Safe loads, piers, chimneys; Boiler settings, anchors, fire stops; Labor tables; Concrete, forms; How to figure concrete work; Stucco—on old and new buildings; Plastering—wood lath—metal; Plasterers agreement; Plastering on various surfaces; Stone masonry; Cutting, finishing, estimating stone; Derricks, rigging; Steel construction; Fire proof; How to read blue prints.

"Audels Masons Guides are the best books on the subject. Have laid brick 12 years and am able to judge." **H. A. Sonnett, Corliss, Pa.**

PRACTICAL ELECTRICITY—1 VOL. \$4

Audels Handy Book of Practical Electricity is a simplified Ready Reference and Study Course in one pocket size volume—for Engineers, Professional Electricians and Students. 1040 pages; 2600 diagrams; flexible bound. A reliable authority and handy helper for every electrical worker. Contains important and valuable wiring diagrams, calculations, machine sketches, helps on maintenance and repair. Use this FREE COUPON today and find out, without obligation, how this handy book will help you in your daily work.



INSIDE TRADE INFORMATION ON: Electro-Therapeutics, X-Rays, Shocks, Welding, Brazing, Radio Hook-ups, Motion Pictures, Telephone, Telegraph, Cranes, Bells, Elevators, Pumps, Tools, Ship Drive, Railways, Vehicles, Automobile Electric Systems, Ignition, Generation, Lighting, Plant Management, Power Plans, Armature Winding, Repairing, A. C. Motors and Apparatus, D. C. Motors and Apparatus, Alternator Construction, Dynamos, Wiring, Diagrams, Sign Flashers, Cable Splicing, Power Wiring, Outside Wiring, Switches, Lighting, Rectifiers, Converters, Transformers, Fuses, Circuit Breakers, Rheostats, Electro Plating, Electrolysis, Storage Batteries, Magnetism, Electrical Energy, Conductors, Insulators, Static, Dynamic, Radio Electricity, Applications, Ready Reference and Index Covering the entire field of Modern Electricity.

Learn More and You Will Earn More!

Know your job and you'll never be without one. The skilled man is always in demand. Knowledge is power. Learn your trade thoroughly by easy reading. This coupon is your opportunity for advancement and better pay. You risk nothing in sending for Audels Guides for free examination. Send it NOW!

FREE EXAMINATION COUPON

THEO. AUDEL & CO.
49 W. 23 ST., NEW YORK CITY

Please mail me for free examination the books marked (x) below. If I find them satisfactory, I agree to mail \$1 in 7 days, on each set ordered, and to further mail \$1 monthly on each set until I have paid the purchase price.

4 CARPENTERS GUIDES \$6 | 4 PLUMBERS GUIDES \$6

4 MASONS GUIDES \$6 | 1 ELECTRICIANS HANDY BOOK \$4

NAME.....

ADDRESS.....

OCCUPATION.....

EMPLOYED BY..... PSM

ing its nose into the bowl, pushes down an arm to open a valve. The inventor, H. E. Bremer, of Milwaukee, is several years too late. If they have none of these in Milwaukee, it is about time.

JACK MATHEWS

Shreve, Ohio

... To my knowledge, this type of cup has been in use for several years.

BYRON COOPER

Nehalem, Ore.

... My father has had such bowls in the stables since before the war.

FRANCIS R. BARLETT

North Hollywood, Calif.

... at least 10 years. ...

JAMES TRUSDLE

Clyde, Ohio

... 10 to 12 years.

ROLAND B. SICKLER

Clarks Summit, Pa.

... 15 years ago. ...

K. O. NELSON

Pinto, Md.

... since 1932.

JOHN W. FISHER

Vergennes, Vt.

... two decades ago.

NOBLE E. PEELER

St. Paul, Minn.

... even 50 years ago. ...

ROGER SESSLER

Jamaica, N. Y.

We surrender—but not unconditionally. The bowl PS pictured was patented May 10, 1949. The inventor claims its valve is an improvement over those of somewhat similar bowls on which seven U. S. and two British patents were issued from 1890 to 1930. He says it provides a smooth flow of water that doesn't startle the animals.

Buick's Right-Handed Dog

Sir:

In your picture of the heating ducts in the new Buick Special [Sept., p. 164] it appears that the driver's controls are on the right side. Was this particular car built for use in



HOLIDAY
every day!

Enjoy that real Holiday feeling every day with HOLIDAY—the aromatic High Grade pipe mixture —at a popular price. Only 15 cents!

Also in vacuum pounds
TO MAKE NEW FRIENDS—FOR HOLIDAY
Here's a Sensational PIPE OFFER!

Cool-smoking aluminum pipe with genuine imported briar bowl!

Only **50¢ plus** inside paper wrapper from 12 tins of Holiday Pipe Tobacco.

Offer limited to U. S. A.
Expires January 31, 1950
Send to Holiday, Dept. PS-2, Richmond, Virginia

AROMATIC IN THE PACK
AROMATIC IN THE PIPE

AN ADVENTURE IN GOOD SMOKING

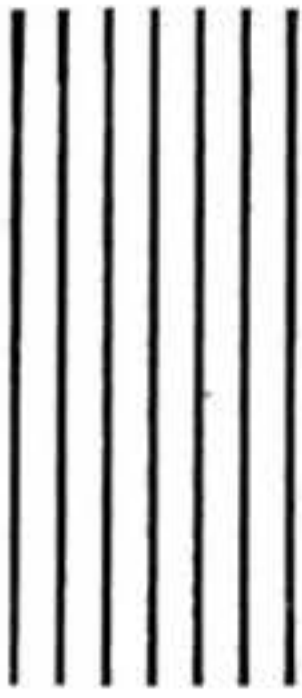

INVENTORS

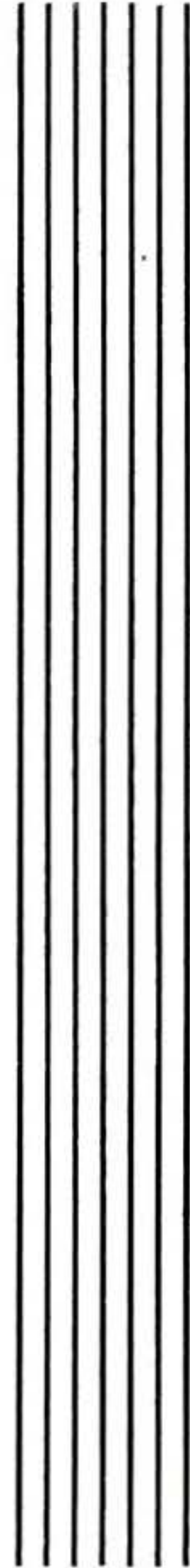

Learn how to protect your invention. The U. S. Patent Laws provide that any new and useful art, machine, article of manufacture, or composition of matter, or any new and useful improvement thereof, may be patented if the act of invention is involved. Therefore, every inventor with a valuable invention should take advantage of the Patent Laws and proceed for patent protection in order to safeguard his rights.

A patent gives the inventor the exclusive right to prevent others from making, using, or selling the invention claimed in the patent for a period of seventeen years.

The Patent Laws were enacted for the benefit of the inventor to give him protection for the features of his invention which are patentable. These features must be properly and concisely set forth and claimed in a formal application for patent, in order to comply with the requirements of the Patent Laws. For that reason, unless the inventor is familiar with patent matters, he should engage a competent registered patent attorney or agent to represent him. We are registered to practice before the U. S. Patent Office and are prepared to serve you in the handling of your patent matters.

A specially prepared booklet entitled "Patent Guide for the Inventor", containing detailed information with respect to patent protection and procedure, together with a "Record of Invention" form will be promptly forwarded to you without obligation upon request.

CLARENCE A. O'BRIEN & HARVEY JACOBSON

Registered Patent Attorneys

92-L DISTRICT NATIONAL BUILDING • WASHINGTON 5, D. C.

Patents

Trademarks

Copyrights

CLARENCE A. O'BRIEN & HARVEY JACOBSON
Registered Patent Attorneys

92-L District National Bldg., Washington 5, D. C.

Please send me copy of "Patent Guide for the Inventor" and also "Record of Invention" form. This request does not obligate me.

Name _____

Address _____

City _____ State _____

(Please write or print plainly.)

YOU Need My PRACTICAL Training to Make Money in

TELEVISION- RADIO and ELECTRONICS!



I'll Send You
8 BIG KITS of
Radio Parts and Equipment

Learn at
HOME
IN YOUR
SPARE TIME

Now is the Time to Get Into This Fast
Growing Industry—Prepare for a Fine
Paying Job or Your Own Business!

I have trained hundreds of men to become technicians—and I'm ready to do the same for you. Whether your goal is a fine paying job in one of Radio's many branches—or a successful Radio and Television business of your own—you need the kind of training I offer! My training is practical and down to earth. YOU NEED NO PREVIOUS EXPERIENCE. I start you with basic fundamentals and give you plenty of practical shop-bench training with many kits of parts I send you. This is the training that sticks with you and makes money for you on the job!

GET PAID FOR SPARE TIME WHILE LEARNING

Soon after you start training I send you my famous BUSINESS BUILDERS that show you how to make money in spare time doing interesting Radio jobs. I send you 8 big kits of Radio parts and equipment and help you build step-by-step a powerful 6-tube superhet radio, a 16-range test meter, plus other mighty useful equipment for Radio and Television servicing. You will perform over 175 fascinating experiments while training. You will learn about Television—so that you will be qualified to step into this fast growing, profitable field. I also send you many valuable service manuals, diagrams, and my book telling exactly how to set up your own Television and Radio shop. Clip and mail the coupon below for my two big FREE Radio books. I employ no salesmen—and nobody will call on you.



HAVE A BUSINESS OF YOUR OWN

A profitable Radio and Television Service Shop may be started with little capital. I will show you how to get started. At left is pictured one of my graduates, Mr. Merrit C. Sperry, Fairmont, Minn. in his own shop.

Radio and Television Industry Booming

You couldn't pick a better time to get into Radio-Television and Electronics. New Television stations are going on the air to serve every major city—hundreds of new AM and FM Radio broadcasting stations are also on the air. All this creates new and bigger opportunities for the trained man who knows Radio-Television and Electronics.

VETERANS

THIS
TRAINING
AVAILABLE TO
YOU UNDER
THE G.I. BILL



All Kits Are YOURS TO KEEP

Each of the hundreds of Radio parts and other items I send my students is theirs "for keeps." You may use this equipment in your Radio and Television service work and save many dollars by not having to buy expensive "ready-made" test equipment.



CALVIN SKINNER of New Orleans, La. tells us he makes \$5 to \$10 in spare time repairing radios. He is now also working with a Television set.



LOREN D. SAUCIER of Coloma, Mich. reports that my training has made it possible for him to repair large numbers of Radio and Television sets.

RUSH COUPON Today!

SPRAYBERRY ACADEMY of RADIO, Dept. 55-C
111 North Canal Street,
Chicago 6, Illinois

Please rush my FREE copies of "How To Make Money In Radio-Television and Electronics" and "How To Read Radio Diagrams and Symbols."

Name.....Age.....

Address.....

City.....State.....

() Check here if you are a Veteran

My Training
Includes...
**Television,
FM (Frequency
Modulation),
Public
Address
and High
Frequency
Applications**

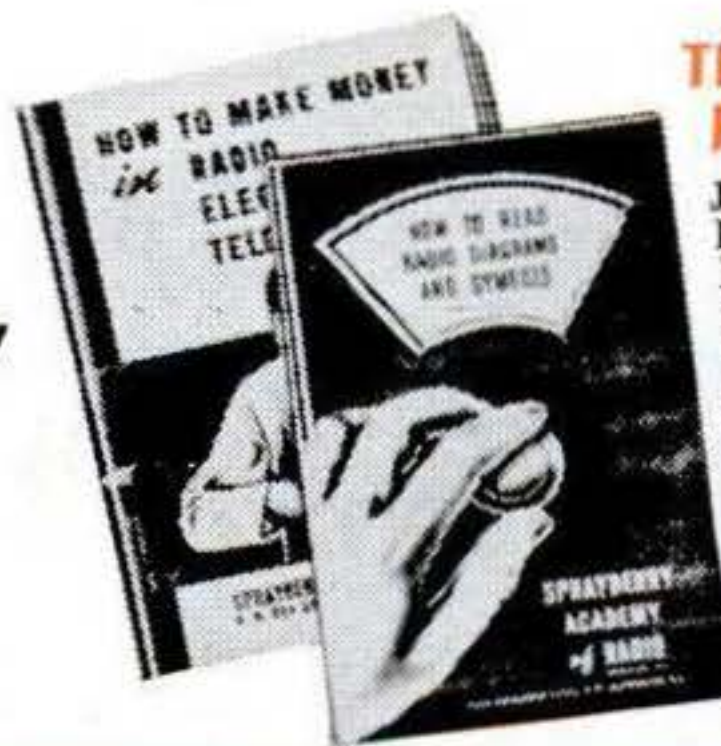

These Two Big FREE! Radio Books

Just mail coupon for a FREE sample Sprayberry Lesson and my big FREE book, "How To Make Money In Radio-Television and Electronics." Learn why my really practical training is best of all for you. Discover what's ahead for you in Radio-Television and Electronics. No obligation. Don't delay! Mail the coupon now—and count on me for fast action.

SPRAYBERRY ACADEMY OF RADIO
111 N. CANAL, DEPT. 55-C, CHICAGO 6, ILL.

INVENTORS

Patent laws encourage the development of inventions.

We recommend that an inventor employ a registered Patent Attorney or agent, if the inventor is not familiar with patent matters. This is because the value of a patent depends largely upon the skillful preparation of the specification and claims in the patent application.

The firm of McMorrow, Berman and Davidson is registered to practice before the United States Patent Office. Additionally it engages patent attorneys able to readily understand inventors' disclosures, to advise concerning patentability, and to prepare appropriate specifications and claims.

If an inventor believes he has an invention, a search of the most pertinent prior U. S. patents should be made and a report obtained relative to its patentability. Where such report indicates that the invention appears patentable, in order to secure protection, diligence should be exercised in making application for a patent.

Send for a copy of Patent Booklet entitled "How To Protect Your Invention." This booklet contains information on patent protection and procedure. You will also receive an "Invention Record" blank. This will be promptly forwarded to you upon request—no obligation.

McMORROW, BERMAN & DAVIDSON

Registered Patent Attorneys

PATENTS • TRADE MARKS • COPYRIGHTS

1425 VICTOR BUILDING, WASHINGTON 1, D. C.

McMORROW, BERMAN & DAVIDSON

Registered Patent Attorneys

1425 Victor Building, Washington 1, D. C.

Send me your Patent Booklet, "How To Protect Your Invention", and also "Invention Record" form at once. I understand this request does not obligate me.

Name.....

Address.....

City.....

(WRITE OR PRINT NAME CLEARLY)

FREE! MY PLAN FOR YOUR SUCCESS

Learn
ELECTRICAL
APPLIANCE
REPAIR
and
SERVICING



OPEN YOUR OWN SHOP

PTS training is more than a home study course in electric appliance repair and service. It gives you the know-how on the operation of your shop from a business standpoint—what to charge — how to get customers. Everything possible is done to assist you to start on the road to your success.

EARN WHILE YOU LEARN

You can actually start earning before your course is finished. I send you your first lesson showing you easy jobs that can be done in your SPARE TIME AT HOME. Remember, one good repair job will pay for the cost of your course. NO BIG OVERHEAD needed. Start in your garage, basement, attic or spare room. When you are ready to expand. I will give you the benefit of my advice and experience.

Yours! AT NO EXTRA COST

Big kit of tools and ELECTRICAL APPLIANCE TESTER

Free!

Big book containing all of the details of my plan for your success.

WRITE NOW!

USE THIS COUPON

PACIFIC TRAINING SCHOOL — Dept. 5 911
7217 So. Broadway, Los Angeles 3, Calif.

Please send me your FREE BOOK.

NAME _____ AGE _____

ADDRESS _____ ZONE _____

CITY _____ STATE _____

SPARE OR FULL TIME

Want a good-paying business — a job in a fast-growing industry? Learn electrical appliance repair and service. I will teach you this interesting, good-paying business. The EASY step-by-step home study method, taught by PTS, prepares you NOW to reap lush profits to be made in this unlimited field. Have YOUR OWN BUSINESS — spare or full time — prepare for one of the many openings for trained men.

ACT NOW

Millions of new appliances in homes — millions of new homes being wired for electricity assures hundreds of customers in nearly every neighborhood.

EASY TO LEARN!

Men of all ages, yes, even the man of 60 can get into this ever expanding field—a business well suited to men who like to use their hands—a REAL OPPORTUNITY for the practical man who is not happy in his present job. Get started NOW—send for FREE BOOK giving all details.

YOU LEARN TO REPAIR

Vacuum cleaners,
Washing machines,
Lamps, Motors, Irons,
Ranges (gas and electric),
Auto electricity, Garbage disposal units, Fluorescent lights, Electric shavers, Refrigeration, House Wiring.

Europe, or did someone in the darkroom put the photo negative in the printing frame upside down?

NORMAN THRASHER

Sharpsville, Ind.

The controls are on the right, all right; and the photo is not reversed. It happens to show—as PS probably should have noted—the driver's compartment of what Detroit calls a "dog" car: an experimental model.

Objection Denied

Sir:

On page 150 of your June issue is shown a radarlike device for the blind. It seems to me that its use would be rather limited, since the reflecting surface must be at just the right angle with the emitted light ray for the reflected beam to be directed exactly into the photoelectric cell.

SIGFRIDO LICHTENTHAL

Buenos Aires, Argentina

The Army Signal Corps, which developed the blind-man's eye, points out that reflected light is not bounced back in a straight line but scatters—something like what happens when a fire hose is turned on a brick wall. Hence the photo cell need not be at a 90-degree angle from the reflecting object. Besides, in actual use the device is moved back and forth in a scanning motion.

Merry-Go-Round or Carrousel?

Sir:

Instead of giving away a free subscription to artist Pioch for repairing your merry-go-round [PS, Sept., p. 10], you would do better to hire an answer man.

As I was taught, a merry-go-round goes clockwise and a carousal goes counterclockwise.

ERIC R. PLANITZER

Brooklyn, N. Y.

Coney Island's Steeplechase Park insists that its ride—which goes clockwise—is a carrousel (Webster's preferred spelling), and that any self-respecting merry-go-round goes counterclockwise. But Coney's American Museum of Public Recreation holds that either one can go either way without violating custom or offending precinct cops. Webster won't take sides, either—it uses the two names synonymously.

WHICH OF THESE *Opportunities* INTERESTS *You* MOST?

Accounting
Air Conditioning
Architecture & Building
Automotive Engineering
Aviation—Practical
Aviation Drafting & Design
Better Foremanship
Bookkeeping
Business Management

Contracting
Diesel Engineering
Drafting & Design
Electrical Engineering
Electricity—Practical
Electronics, Industrial
High School Courses
Machine Shop Operations
Mechanical Engineering

Plastics Engineering
Plumbing—Practical
Private Secretary
Radio Operating & Servicing
Railway Training
Refrigeration
Sheet Metal Pattern Drafting
Shop Management
Tool Making

THINK! LOOK FORWARD!

Business is making big, new plans

Men and Women are preparing for the future

WHAT ARE YOU DOING ABOUT YOUR TOMORROWS?

● *Today*, choose the job you want—and prepare for it. Or if you are already engaged in the work you like best, start training *now* for quicker promotion. Acquire the knowledge that will help you to get ahead faster, make more money and have greater security.

Invest part of your spare time in more rapid progress. Start training now, in spare time in your own home. Be ready to grasp your opportunity and step out ahead of those who lack the ability you have attained.

American School, founded in 1897 as an educational institution *not for profit*, can help you to reach your goal just as it has helped others during the past fifty-two years. Give serious thought to the list above. Pick one or more subjects that interest you. Then check the coupon at right, add your name and address and mail it at once. The school will send you details on its training plan and outline of study prepared by specialists. There is no charge, no obligation, so send the coupon immediately.

PRACTICAL, EFFECTIVE HOME

— STUDY TRAINING SINCE 1897

Take This First Easy Step

CHECK, CLIP AND MAIL COUPON NOW

AMERICAN SCHOOL, Dept. G-846, Drexel at 58th, Chicago 37, Ill.
Without obligation, Please send FREE and postpaid, bulletin and details of the Subject checked.

- | | | |
|--|--|--|
| <input type="checkbox"/> PLASTICS ENG'R | <input type="checkbox"/> Accounting | <input type="checkbox"/> Drafting and Design for Men and Women |
| <input type="checkbox"/> Refrigeration | <input type="checkbox"/> Electrical Engr. | <input type="checkbox"/> Radio |
| <input type="checkbox"/> Architecture and Building | <input type="checkbox"/> Electricity-Pract. | <input type="checkbox"/> High School |
| <input type="checkbox"/> Contracting | <input type="checkbox"/> Electronics, Industr. | <input type="checkbox"/> Air Conditioning |
| <input type="checkbox"/> Practical Plumbing | <input type="checkbox"/> Bookkeeping | <input type="checkbox"/> Mechanical Eng. |
| <input type="checkbox"/> Automotive Engineering | <input type="checkbox"/> Private Secretary | <input type="checkbox"/> Shop Management |
| <input type="checkbox"/> Aviation Drafting | <input type="checkbox"/> Diesel Engineering | <input type="checkbox"/> Tool Making |
| <input type="checkbox"/> Aviation | <input type="checkbox"/> Sheet Metal | <input type="checkbox"/> Better Foremanship |
| <input type="checkbox"/> Business Mgmt | <input type="checkbox"/> Pattern Drafting | <input type="checkbox"/> Machine Shop Operations |
| <input type="checkbox"/> Railway Training | | |

Name..... Occupation.....
Address..... Age.....
City..... State.....

AMERICAN SCHOOL

Dept. G-846 Drexel at 58th Street, Chicago 37

NOVEMBER 1949 19



**Start As High
As \$3,351.00 a Year**

**Get Ready Now for Coming
Examinations In Your Section**

Veterans Get Preference

Railway Postal Clerks

Railway Postal Clerks get \$2,750 the first year regular, being paid on the first and fifteenth of each month. (\$114.60 each pay day.) Their pay is automatically increased yearly to \$3,850. Advance may be had to Chief Clerk at \$5,850 a year. (\$243.75 each pay day.)

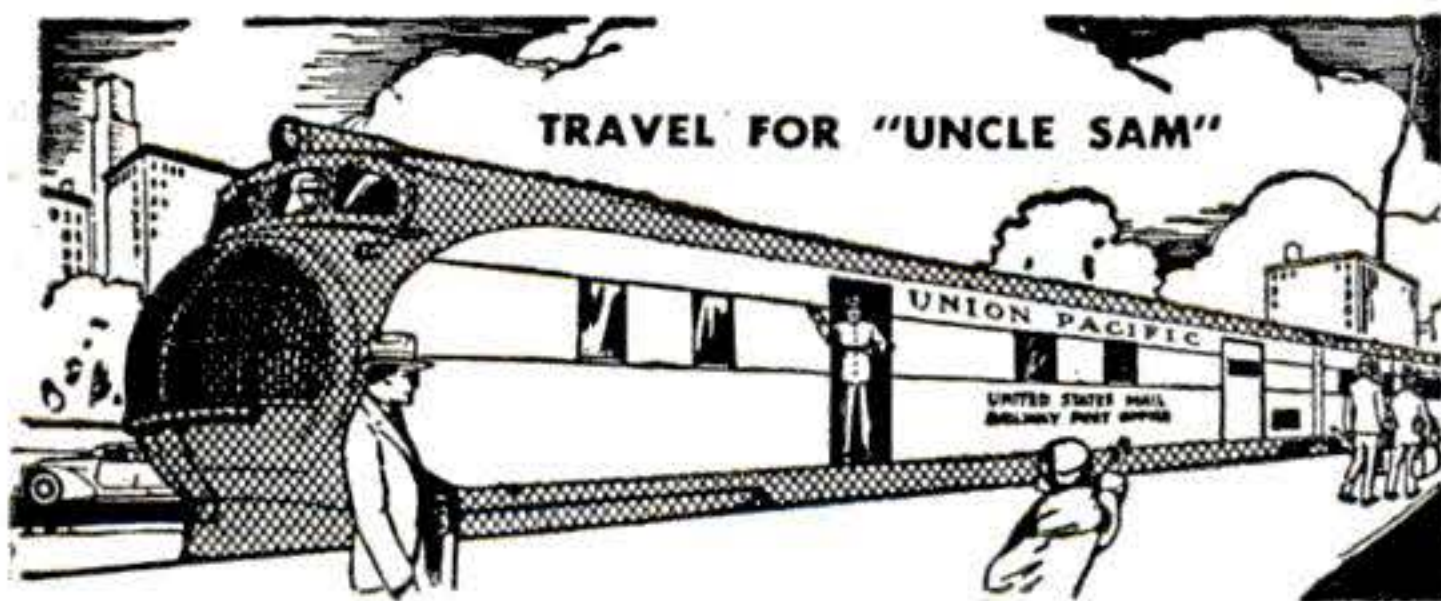

3 Days On—3 Days Off—Full Pay

Railway Postal Clerks on long runs usually work 3 days and have 3 days off duty or in the same proportion. During this off duty their pay continues just as though they were working. They travel on a pass when on business. When they grow old, they are retired with a pension.

City Mail Carriers, Post Office Clerks

Clerks and Carriers now get \$2,500 the first year on regular and automatically increase \$100 a year to \$3,550. Open to men-women 18 to 50.



Many Other Positions

Many other positions are obtainable. Rural Carriers—Stenographers—Typists—Assistant Statistical Clerks—Customs Inspectors—Office Machine Operators—etc. Those wishing these positions should qualify at once.

Get Free List of Positions

Fill out the following coupon. Tear it off and mail it today—NOW, at once.

This investment can help you to get a big-paid government job.

FRANKLIN INSTITUTE, Dept. X-80, Rochester 4, N. Y.

(Not Government Controlled)

Rush to me, entirely free of charge (1) a full description of U. S. Government Jobs; (2) Free copy of illustrated 40-page book, "How To Get A U. S. Government Job"; (3) List of U. S. Government Jobs; (4) Tell me what to do to qualify for one of these jobs.

Name.....

Address..... Vet?

Use This Coupon Before You Mislaid It. Write or Print Plainly.

STUDY AT HOME

With An Educational Institution

Men with specialized training win higher positions, insure larger earnings, and are bigger successes in business and public life. Opportunities NOW greater than ever before. Send for our Catalog.

ARTS and SCIENCES

Courses in Philosophy; Education; Letters; Public Health; Medical Jurisprudence; Psychology; Sociology; Physics; Chemistry; Geology; Political Science; Theology; Business and Commerce; Accounting; Mathematics; Statistics; Agriculture.

ENGINEERING

Courses in Electrical, Civil, Mechanical, Drafting, Architectural, Steam, Aeronautical, Radio, Structural, Mining, Industrial, Petroleum, Marine, Chemical, Diesel, Automobile, Refrigeration, and Air Conditioning Engineering.

LAW

Complete Professional Law Course includes 18 Hornbrook Series college grade textbooks. Courses also in Commercial Law, Patent Law and Medical Jurisprudence.

McKinley-Roosevelt Incorporated, 4610-AB, Sheridan Rd., Chicago 40, Ill.

FREE BARGAIN CATALOG of BOOKS

1,000 books of all publishers listed in our 32-page Bargain Catalog of Gift Books. Old-time favorites—latest "best sellers." Reference, Fiction, Juvenile, History, Scientific, etc. Send postcard today for our new 1950 32-page catalog.

THE BOOK SUPPLY COMPANY, DEPT. 220
564-566 West Monroe St. Chicago 6, Ill.

WATCH REPAIRING

be a master watchmaker!

- Graduates earn big money—many in business for themselves. The famous Sweazey System of Instruction teaches you quickly and easily. Our 42nd year. Write today for free book about watchmaking, gem setting and engraving.

CHICAGO SCHOOL OF WATCHMAKING
Dept. 4119, 1608 Milwaukee Avenue, Chicago 47, Illinois

MAKE MONEY IN LANDSCAPING

Thorough training by Internationally known Landscape Architect to start your own business, improve your home or advance in this well paid field. Many Opportunities. Approved for Veterans. Send for FREE BOOK.



NATIONAL LANDSCAPE INSTITUTE
310 So. Robertson Dept. PS-11 Los Angeles 36, Calif.

NO WIRES! TALK! SING! GAGS!

MICRO-VOX Home BROADCAST Station

Amazing! Portable! Complete miniature broadcast outfit. Same principle as big stations. Any radio within 50 feet receives clear, life-like voice or music. No wire connections to radio. Easy to operate. Self-contained. Watch-like precision. **Hundreds of Uses.**—Sing, Play, Sound Effects, Shows, Records, Inter-Com, Public Address System, Baby Listener, etc. **SEND NO MONEY!** \$6.95 C.O.D. plus postage, or remit \$7 and we pay postage. **Money-Back Guarantee** . . . 24 hour trial.



- Studio Quality Mike
- 45 V. "B" Battery
- 1 1/2 V. "A" Battery
- TUNER • SWITCH
- TUBE Write:

\$6.95
Ready to Use

ALL THE FAMILY LISTENS ON YOUR RADIO



NATIONAL ELECTRONICS
DEPT. 58 622 KINZIE, CHICAGO

UP TO 50 FT.! CLEAR! LIFE-LIKE!

Get
Into

RADIO, TELEVISION and ELECTRONICS Master ALL Phases

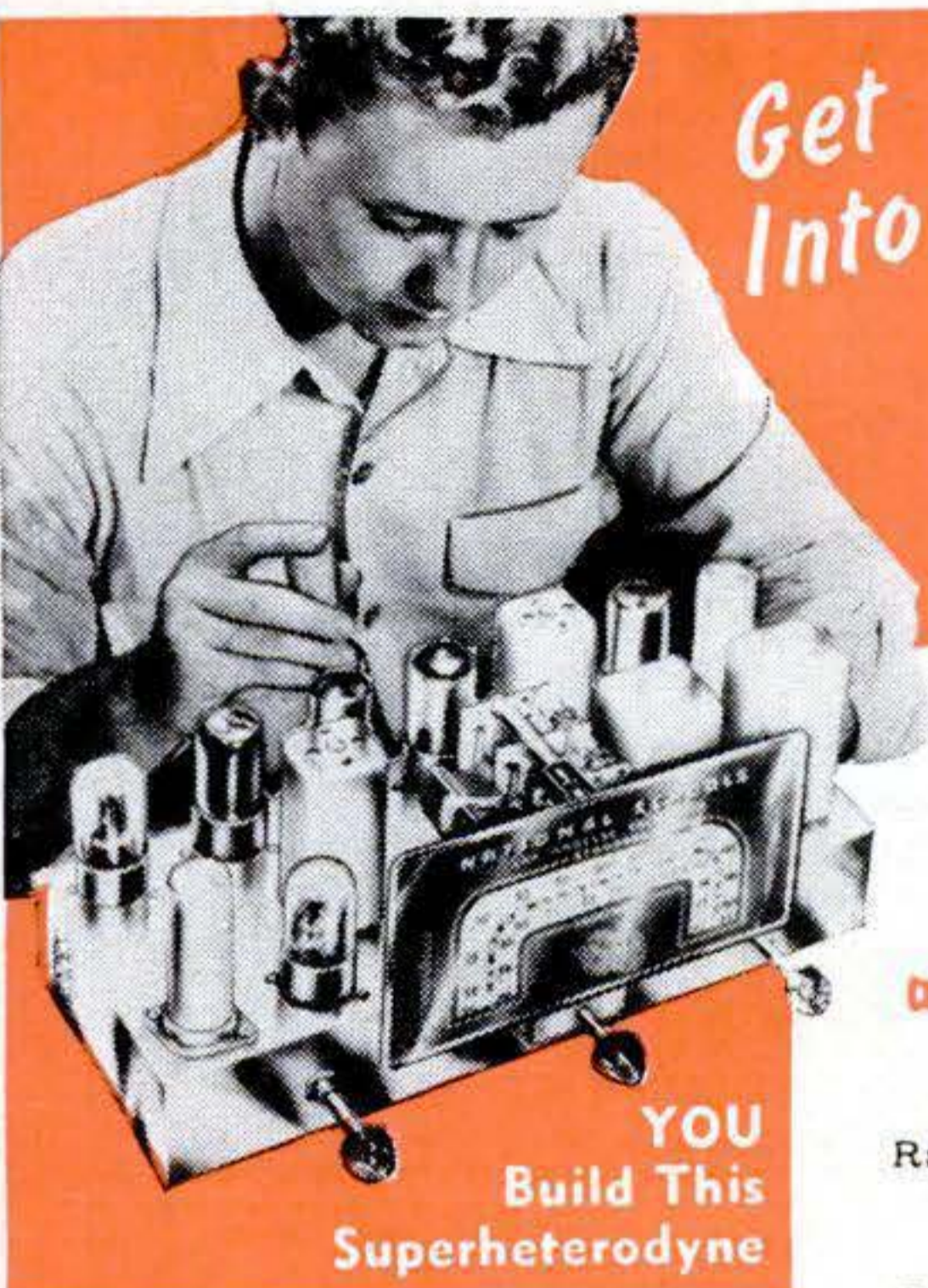

**YOU
Build This
Superheterodyne**

**Get Complete Training. You Receive and Keep All
Equipment, Parts and Lessons. No Extra Charges.**

**GOOD PAY
and Unlimited Opportunities
in JOBS LIKE THESE:**

Business of Your Own
Radio Manufacturing, Sales, Service
Broadcasting Telecasting
Television Manufacturing,
Sales, Service
Laboratories: Installation, Maintenance of Electronic Equipment, Electrolysis, Call Systems
Garages: Auto Radio Sales, Service
Sound Systems and Telephone Companies; Oil Well and Drilling Companies; Engineering Firms
Theatre Sound Systems Police Radio
**And scores of other good jobs
in many related fields**

**YOU CONDUCT MANY
EXPERIMENTS LIKE THESE!**

Checking action of condensers
Experiments with AF and RF Amplifiers
Experiments with resonance
Producing beat frequencies
Calibrating oscillators
Experiments with diode, grid-bias, grid-leak and infinite impedance detectors
Practical experience in receiver trouble shooting
Application of visual tester in checking parts and circuits
Experiments with audio oscillators
Advanced trouble-shooting
... and many, many others

You will find all lessons easy to understand because they are illustrated throughout with clear diagrams and step-by-step examples that you work out yourself. Every piece of the equipment and complete lesson material we send you is yours to keep and enjoy, including the multitester, experimental equipment, all parts of the Superheterodyne, tube manual, radio dictionary, and complete, modern Television texts. All parts are standard equipment.

**Shop Method Home Training . . .
Earn While You Learn**

With our practical resident Shop Method Home Training, you study in your spare time. You receive Spare Time Work Lessons, which show you how to earn while you learn. Service neighbors' radios and TV receivers, appliances, etc., for extra money and experience. Many National students pay all or part of their training with spare time earnings!

**DON'T DELAY! The Radio-Television
Industry needs trained men NOW!**

**APPROVED
FOR
VETERANS!
Check coupon below!**

For quick action,
mail coupon
today and we'll
rush you full information.

Free!

**NEW, ILLUSTRATED
OPPORTUNITY
BOOK AND SAMPLE
LESSON SHOW YOU
HOW WE TRAIN
YOU . . . SEND FOR
THEM TODAY! NO
COST. NO
OBLIGATION.**



You receive complete standard equipment, including latest type High-Mu Tubes, for building various experimental and test units. You progress step by step until you build a complete Superheterodyne Receiver. It is yours to use and keep.

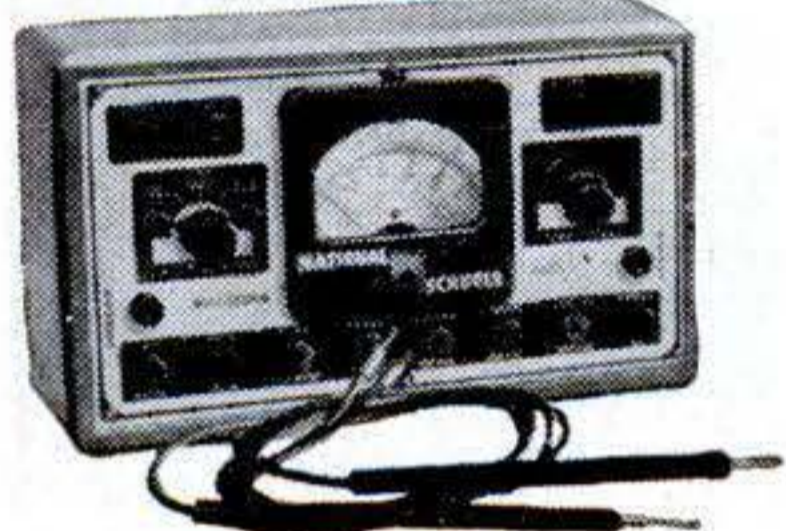

**YOU RECEIVE THIS
PROFESSIONAL MULTITESTER!**

You will use this professional instrument to locate trouble or make delicate adjustments—at home—on service calls. You will be proud to own this valuable equipment. Complete with test leads.

SIGNAL GENERATOR

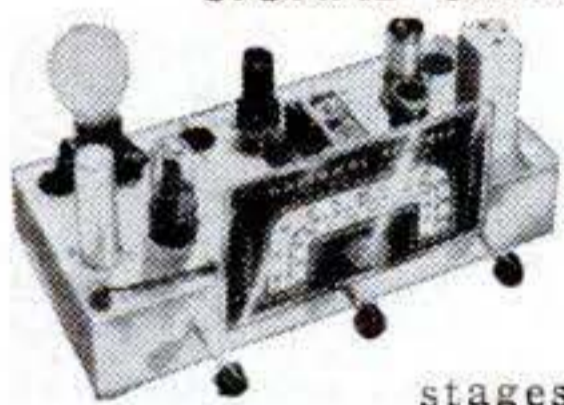

You construct the Transatron Signal Generator shown here, demonstrating Transatron principles in both R.F. and A.F. stages. You study negative type oscillators at firsthand.

AUDIO OSCILLATOR:

An electronic device, which produces audio-frequency signals for modulating R.F. (radio frequency) carrier waves, testing A.F. (audio frequency) amplifiers, speakers, etc.



**T.R.F.
RECEIVER**

You build several T.R.F. Receivers, one of which, a 4-tube set, is shown here. You learn construction, alignment, make receiver tests, and do trouble shooting.

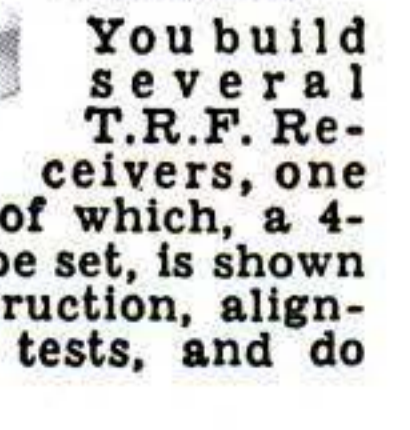

**Complete Training by Practical
Resident Trade School, Est. 1905**

The same highly trained faculty, instruction materials and methods used here in our large, modern resident school, are adapted to your training in your own home. Shop Method Home Training has been proved by hundreds of successful graduates.

**Both Resident and Home Study
Courses Offered**

**YOU
LEARN BY
DOING**

You receive special laboratory experiment lessons to show you how to build with your own hands various experimental units such as those shown at left, and how to conduct many tests.

NATIONAL SCHOOLS
LOS ANGELES 37, CALIF. • EST. 1905

FIND OUT NOW . . . MAIL COUPON TODAY

National Schools, Dept. 11-PS
4000 South Figueroa Street
Los Angeles 37, California
Send me your FREE book "Your Future in Radio" and the sample lesson of your course. I understand no salesman will call on me.
NAME.....AGE.....
ADDRESS.....
CITY.....ZONE.....STATE.....
 Check here if Veteran of World War II



Mail in envelope
or paste on
penny postal.

The 97 Pound Weakling

who became "The World's Most Perfectly Developed Man"

"I'll Prove that YOU, too, can be a NEW MAN!"

Charles Atlas

I KNOW, myself, what it means to have the kind of body that people pity! Of course, you wouldn't know it to look at me now, but I was once a skinny weakling who weighed only 97 lbs.! I was ashamed to strip for sports or undress for a swim. I was such a poor specimen of physical development that I was constantly self-conscious and embarrassed. And I felt only HALF-ALIVE.

Then I discovered "Dynamic Tension." It gave me a body that won for me the title "World's Most Perfectly Developed Man."

When I say I can make you over into a man of giant power and energy, I know what I'm talking about. I've seen my new system, "Dynamic Tension," transform hundreds of weak, puny men into Atlas Champions.

Only 15 Minutes a Day

Do you want big, broad shoulders—a fine, powerful chest—biceps like steel—arms and legs rippling with muscular strength—a stomach ridged with bands of sinewy muscle—and a build you can be proud of? Then just give me the opportunity to prove that "Dynamic Tension" is what you need.

No "ifs," "ands," or "maybes." Just tell me where you want handsome, powerful muscles. Are you fat and flabby? Or skinny and gawky? Are you short-winded, pepless? Do you hold back and let others walk off with the prettiest girls, best jobs, etc? Then write for details about "Dynamic Tension" and learn how I can make you a healthy, confident, powerful HE-MAN.

"Dynamic Tension" is an entirely NATURAL method. Only 15 minutes of your spare time daily is enough to show amazing results—and it's actually fun! "Dynamic Tension" does the work.



Send for FREE BOOK

Mail the coupon right now for full details and I'll send you my illustrated book, "Everlasting Health and Strength." Tells all about my "Dynamic Tension" method. Shows actual photos of men I've made into Atlas Champions. It's a valuable book! And it's FREE. Send for your copy today. Mail the coupon to me personally. CHARLES ATLAS, Dept. 1Z, 115 East 23rd Street, New York 10, N.Y.

**CHARLES ATLAS, Dept. 1Z,
115 East 23rd St., New York 10, N. Y.**

I want the proof that your system of "Dynamic Tension" will help make a New Man of me—give me a healthy, husky body and big muscular development. Send me your free book, "Everlasting Health and Strength."

Name _____ Age _____
(Please print or write plainly)
Address _____
City _____ State _____

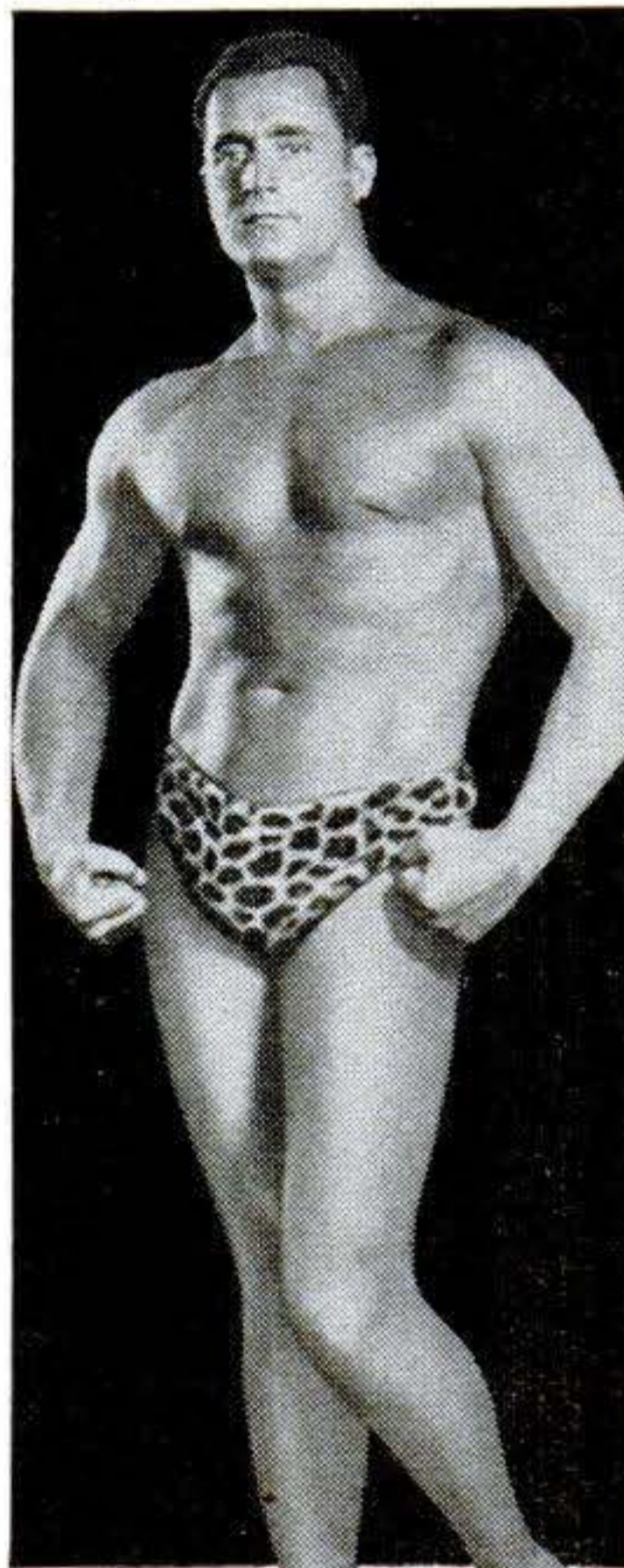

CHARLES ATLAS
Holder of title "The World's Most Perfectly Developed Man."

CAUGHT BY THEIR FINGER PRINTS



YOU

Can Train for
CRIMINAL INVESTIGATION
and **IDENTIFICATION**
WORK AT HOME!

During the past 30 years the I. A. S. has trained hundreds of men at home to fill positions of responsibility and steady pay as finger print experts. This fascinating, profitable profession can be learned at home during spare time. More than 800 American Identification Bureaus employ I. A. S. graduates or students. Write today for complete list of these Bureaus.

Send Now for "BLUE BOOK of CRIME"

Thrilling, inspiring, helpful. Be sure to state your age when sending for book. **FREE!**

INSTITUTE OF APPLIED SCIENCE

Dept. 1368, 1920 Sunnyside Ave., Chicago 40, Ill.

LEARN IN SPARE TIME— by Easy PICTURE CARTOONING CHART METHOD!

Same Simplified Method that has helped train creators of "Steve Canyon," "Winnie Winkle," "Out Our Way," "Secret Agent X-9," "The Neighbors," "Reg'lar Fellers," "Strange As it Seems," and many others. Send 10c for Picture Chart (to test your ability), and full details. (State age.)

LONDON SCHOOL OF CARTOONING
4931 Cleve. Transit Bldg., Cleveland 14, Ohio



LEARN TO WRITE a Good Hand!

FOR BUSINESS AND SOCIAL SUCCESS!

Improve your handwriting at home quickly with my new instruction books just off the press. Master all the secrets of better penmanship. Simple and easy, fully illustrated, highly endorsed. Begin today. Write for: New Free Book, "How to Become a Good Penman", or check books wanted. \$1.00 each. Business Writing Artistic Writing Card Writing Engrossing Alphabets Bird and Design Flourishing Complete Set \$4.50 Enclose 10c for your name beautifully written and shading penpoint.

S. A. Ziller, President, **TAMBLYN SCHOOL OF PENMANSHIP**
439 Ridge Bldg. In Business Over 52 Years Kansas City, Mo., U.S.A.

WELDING SHOP TRAINING



G.I. APPROVED—GAS AND ARC

Classes start on Monday each week. Payment Plan for Non-Vets. Welders needed in practically every industry—train for a field where you have greater assurance of Steady Work, Good Pay. Write for Free Information.

A & S VOCATIONAL WELDING SCHOOL
1212 E. 63rd Street, Dpt. PS-11, Chicago, Illinois

Learn How to HYPNOTIZE!



Develop your personal POWER! NOW...revealed for you...are the secrets of practical hypnotism...that strange, compelling force by which an expert operator can bring others under his power. He can sway people at will—issue commands and be obeyed—virtually cast a spell over his subjects. This sensational knowledge may make you a more dominant, masterful personality.

Illustrated SELF-INSTRUCTION COURSE in Useful Hypnotism

Amazing lessons in simple, easy-to-understand language. How to select a subject—how to hypnotize by telephone—how to make money from hypnotism—mental telepathy—stage hypnotism—self-hypnosis—how to use

COMPLETE modern hypnotism to conquer inferiority complex, timidity, etc. Clear helpful pictures show operating positions, movements. Startling low price. Satisfaction guaranteed or money back.

ONLY \$1.95

SEND NO MONEY! Simply pay postman \$1.95 plus C. O. D. postage—or send \$1.95 and we pay postage; same money-back guarantee. Order "Hypnotism Course" today!

Nelson-Hall Co., 1139 S. Wabash Avenue, Dept. 2L-1, Chicago 5, Illinois

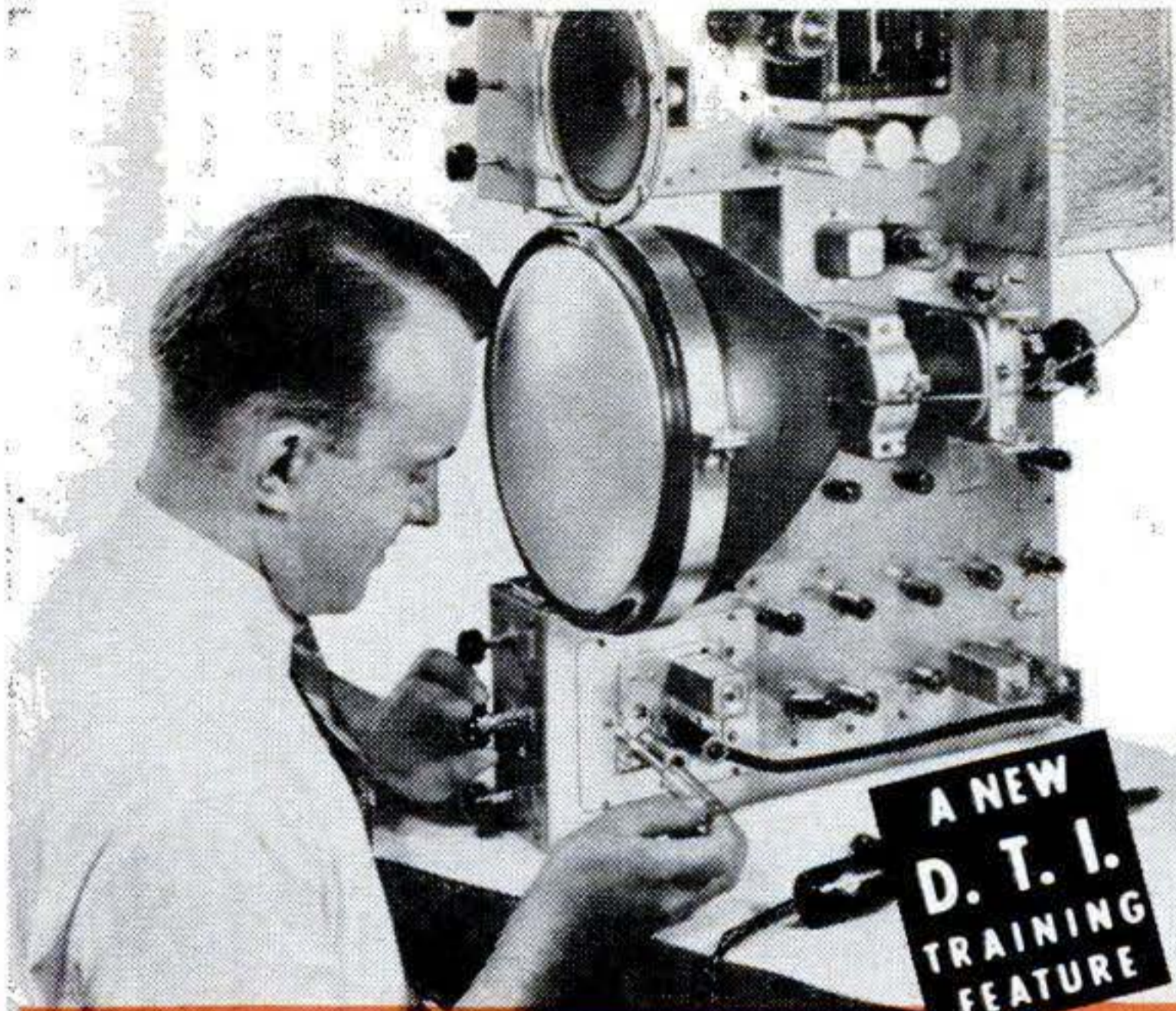

NOW! Build and Keep
Big Screen Top Quality
Television Receiver at Home
as You Prepare for a
Profitable job in
**TELEVISION
RADIO-ELECTRONICS**

Choice of 10, 12½ or 16 inch picture tube

Now you can get this amazingly practical aid for learning Television at home, to help you get started toward **FASCINATING WORK . . . GOOD MONEY . . . a THRILLING FUTURE**—in a real job, or your own sales and service business. * When you complete our regular home training—described below—you can build and keep a top quality commercial-type Television Re-

ceiver. Standardized chassis is adaptable for a 10, 12½ or 16 inch direct view tube that gives big, bright, sharp, steady pictures. This is an optional training advantage—designed to provide the utmost in practical “learn-by-doing” home training in Television. Mail coupon for complete details. See why you owe it to your “Television Future” to enroll for DeForest’s Training, Inc.

Mail Coupon NOW for FREE Information!

See how D. T. I.’s amazingly effective methods help start you toward a **GOOD JOB** or your **OWN BUSINESS** in one of America’s most promising fields—including Television, F.M. Radio, Aviation, Train, and Taxi Radio, Broadcast Radio, Industrial Electronics. Get modern lessons . . . plus 16 shipments of Radio-Electronic parts. Work over 300 experiments and projects—including building of (1) commercial-type **OSCILLOSCOPE** for practical

T-V circuit training, (2) double-range R-F **SIGNAL GENERATOR**, (3) jewel-bearing **MULTIMETER**, (4) quality 6-tube **SUPERHET RADIO**. Then build and keep that big new Television Receiver. Here’s **EVERYTHING YOU NEED** for real laboratory type training . . . **AT HOME!**

You also build and keep this Professional Type Equipment

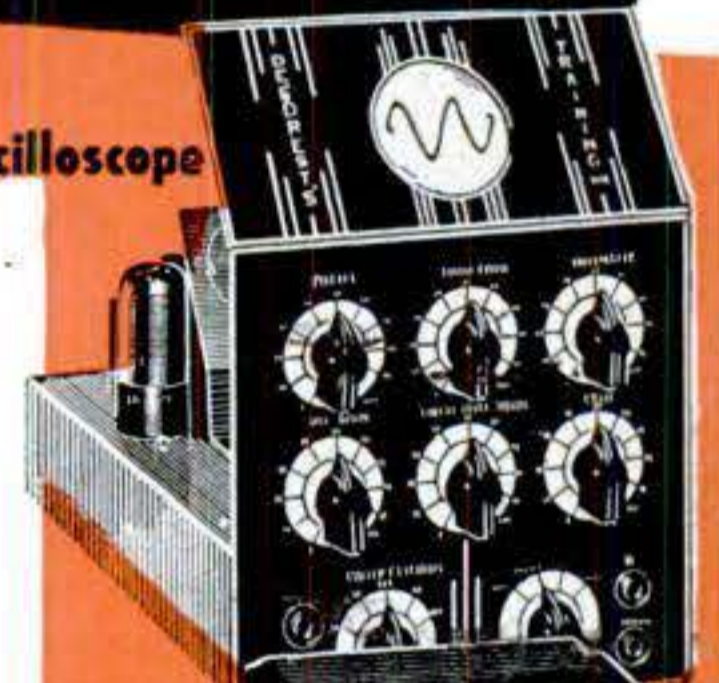

Oscilloscope



Multimeter



R-F Signal Generator

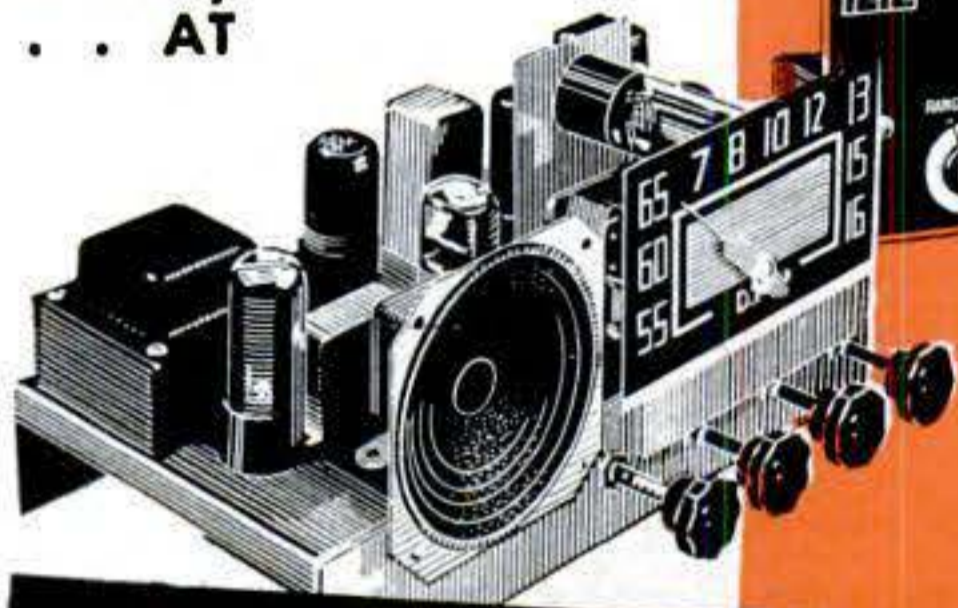

6-Tube Receiver

Modern Chicago Laboratories

* If you prefer, you can get ALL your preparation in our new, Chicago training laboratories . . . one of the finest of its kind. Ample instructors . . . modern equipment. Write for details!

Employment Service

* When you complete your training, our effective Employment Service helps you get started toward a real future in Television—Radio—Electronics.

You also use HOME MOVIES! a D. T. I. Exclusive!



D. T. I. alone includes the modern, visual training aid . . . **MOVIES** . . . to help you learn faster, easier at home. See electrons on the march and other fascinating “hidden action”—a remarkable home training advantage that speeds your progress.

De FOREST’S TRAINING, INC.
CHICAGO 14, ILLINOIS
A DE VRY Institution

MAIL THIS COUPON NOW!

DeFOREST’S TRAINING, INC.
2533 North Ashland Avenue, Dept. PS-F11
Chicago 14, Illinois

Without obligation, give me complete facts showing how I may make my start in Television-Radio-Electronics.

Name..... Age.....
Street..... Apt.....
City..... Zone..... State.....



\$250,000

FOR THIS!

2100 Other Inventions Badly Needed— Big Cash Waiting for Your Little Ideas

IT'S OFTEN the *simplest* ideas that make the *most* money! The Kiddie Kar brought its inventor a cool MILLION dollars. A 70-year-old grandmother made \$350,000 on an improved overall buckle. The paper clip, the hair-pin, the rubber pencil tip all made fortunes for the people who "dreamed" them up.

You can cash in, too—if you concentrate on the inventions that are really needed!

The EASY Way to Get Started

Don't waste time and brain-work on something nobody wants! Find out WHAT to invent. A valuable book by Raymond F. Yates, noted science editor and inventor, lists and describes over 2100 PRACTICAL, money-making ideas that are crying aloud to be invented!

These 2100 ideas are the things *most needed* and *surest to make money*. They are listed under 34 different headings for quick reference: Electrical, Radio, Automotive, Agricultural, Building, Household, Clothing, Toys, Timesavers, etc.

This book ALSO tells how to think inventively; how to PROTECT your ideas; how to develop an invention STEP-BY-STEP, etc.

FREE EXAMINATION OFFER SEND NO MONEY

Wouldn't you like a slice of the \$280,000,000 that American inventors get each year in royalties? Get started now! You don't risk a penny. Simply mail coupon below WITHOUT MONEY—and get "2100 Needed Inventions," by Raymond F. Yates, for 5 days FREE TRIAL. If, even in that short time, you are not convinced that this book can help you make money—just return it and owe nothing. Otherwise, send only \$2.50 plus few cents postage, as payment in full.

Any one of the 2100 ideas in this book can bring somebody a fortune. Maybe it can be YOU! Mail coupon at once! Wilfred Funk, Inc., Dept. T5911, 227 East 44th Street, New York 17, N. Y.



FREE 5-DAY EXAMINATION

WILFRED FUNK, Inc.
Publishers, Dept. T5911,
227 East 44 Street, New York 17, N. Y.

Please send me 2100 NEEDED INVENTIONS, for FREE EXAMINATION. If I keep the book I will send you \$2.50 plus few cents postage. Otherwise I will return it within 5 days, without further obligation.

Name.....

Address.....

City..... Zone No. (if any)..... State.....

Check here if enclosing \$2.50 WITH this coupon, and we will pay all postage charges. Same 5-day return privilege, for full refund, applies. *Canadian Orders*—25c extra for carrying charges. (Only U.S. funds accepted.)

REMEMBER THIS You can't buy a \$20 goldpiece for \$10. So it's dangerous to pay less—if you want safe, balanced, matched tires. We repeat—consider your family's safety—not just price! You see our adv. every month. Buy now & take 10%. Positively not recaps. Buy 1 or 100. We serve ambulances, fire trucks, school-busses & pass. cars.

GOODYEAR Goodrich, Firestone, U. S. & others. Original high tread, slightly worn. 26 months Golden Rule guarantee bond—Genuine factory adjusted "All-purpose" "AAA" tires. Read that top line again! You'll save more than \$.

600-16	\$5.50	650-16	\$5.50	700-15	\$5.45
600-16 (6)	6.50	650-16 (6)	6.50	650-15	5.25
700-16	6.50	750-16	7.77	550-17	7.00
710-15	5.95	475-19	6.00	525-18	6.65

America's Great Lo-Price Value. 15 Month Guarantee
600-16 \$3.50 | 650-16 \$3.50 | 700-16 \$4.95
650-15 3.50 | 700-15 3.75 | 750-16 6.75

Lo-Price Truck Tires. 15 Month Guarantee
600-20 \$7.20 | 750-20 (10) \$9.35 | 1100-20 \$13.75
650-20 7.60 | 825-20 11.35 | 1100-22 16.85
700-20 8.65 | 900-20 11.75 | 32x6 (8) 8.75
750-15 \$11.50 | 750-20 8.20 | 1000-20 12.75 | 32x6 (10) 9.50

WE ARE TRUCK-TIRE EXPERTS
Matched Tires. Truck-owners the world over, depend on us to keep their trucks rolling "ON TIME" at lowest cost.

FACTORY ADJUSTED "ALL-PURPOSE" "AAA" GRADE GOLDEN RULE 26 MONTHS REPLACEMENT GUARANTEE BOND

600-20	\$9.20	32x6 (8)	\$11.75	900-20	\$15.95	34x7	\$13.95
650-20	9.20	32x6 (10)	12.95	1000-20	16.95	1000-22	18.50
700-20	10.52	825-20	15.95	1100-20	17.50	1100-22	18.95

600-16 Military Guar. 15 Mos. \$5.55
Deluxe Snow-Tread \$7.50 Guar. 30 Mos.
Militarys. Top Grade Guar. 30 Months—(Supers 14 Months)
750-16 Super \$ 9.75 | 900-16 Super \$ 8.60 | 750-20 Super \$ 8.95
Top Grade 12.75 | Top Grade 10.90 | Top Grade 13.00

BLATT GIRARD & LANCASTER AVE., DEPT. PS
BLATT BUILDING PHILADELPHIA 31, PA.
Send ck. or money order and this ad for rush shipment. We won't ship a tire we wouldn't use ourselves. Instant shipment down South, Far West and the world over. The name to trust in rubber.

ANALYZE Handwriting

Try it FREE, use it—to understand yourself and others in business and social life—more clearly than you ever thought possible. Many use their knowledge of handwriting to make more money full or part time. Simply send your name today for FREE ILLUSTRATED lesson. No obligation. Must be over 21.

INTERNATIONAL GRAPHO ANALYSIS SOCIETY, INC.
204 Wilhoit Building Springfield 4, Mo.

TRI-STATE COLLEGE

B. S. DEGREE IN 27 MONTHS
66th Year. Students from all over the world.

ENGINEERING—Courses in Civil, Elec., Mech., Chem., Aeronautical and Radio. Television. Also Bus. Admin., Acc't. and Sec. Science. Visitors welcome. See beautiful campus, well equipped laboratories. Graduates successful. Enter Jan., March, June, Sept. Write for Catalog.
5119 College Avenue, Angola, Indiana

SEND FOR THIS FREE!

Make money. Know how to break and train horses. Write today for this book FREE, together with special offer of a course in Animal Breeding. If you are interested in Gaiting and Riding the saddle horse, check here () Do it today—now.

BEERY SCHOOL OF HORSEMANSHIP
Dept. 5811 Pleasant Hill, Ohio

FREE HOBBY BOOK

For MEN and BOYS TELLS HOW TO LEARN TO MOUNT BIRDS and animals, fish, pets, and all game. Learn to TAN SKINS with wonderful Krome-Tan. Simple as ABC. Many earn big PROFITS in spare time mounting for others. Great FUN. Wild game not needed. Over 500,000 students since 1903. RUSH postal TODAY for STRANGE BOOK, over 100 game pictures. FREE. No obligation. State AGEI N. W. School of Taxidermy, 2611 Elwood Bldg., Omaha 2, Neb.

**YOU BUILD THIS
23-TUBE
TELEVISION
RECEIVER**

NOW!

FOR THE FIRST TIME YOU CAN GET
Real Practical HOME TRAINING In

TELEVISION

RADIO AND ELECTRONICS

RTS LEADS THE WAY

WE GIVE YOU

**11 BIG
TELEVISION
AND RADIO KITS
AT NO EXTRA COST**

**YOU BUILD THIS
6-TUBE STANDARD
SUPER HETERODYNE
RADIO SET with
SHORT WAVE
CONVERTER**

**YOU
KEEP ALL
EQUIPMENT
-it's Yours!**

**★
SEND
FOR THIS
30-PAGE
FREE
BOOK!
★**



to earn WELCOME EXTRA CASH, even BEFORE FINISHING YOUR TRAINING! In fact, when friends and neighbors know you are studying Radio-Television you may—like many RTS students—actually get MORE REPAIR WORK THAN YOU CAN HANDLE.

**27 YEAR
SUCCESS RECORD**

Backed by over a quarter-century of experience in home training, RTS (formerly Radio Training Association of America) offers practical "Learn-by-doing" methods, assuring you quick step-by-step progress. Begin preparing for your future in Radio-Television now while the time is ripe. If you are at all mechanically inclined—and have a grammar school education, RTS can teach you how to MAKE GOOD in Radio-Television.

GET THE FACTS

Send for FREE BOOK which tells you all about the RTS "time-tested" home-training plan, developed by technicians in the heart of the Radio-Television field. Fill out the coupon now—TODAY! and your FREE BOOK entitled "How To Make Good in Radio-Television" will go out to you AT ONCE. No Obligation. No salesman will call. ACT NOW!

**YOU WORK AND LEARN
WITH REAL TELEVISION
AND RADIO EQUIPMENT**

RADIO-TELEVISION TRAINING SCHOOL'S master Technicians guide you. Located in the very heart of America's Television, Broadcasting, Radio and Sound Industries, RTS is right "on-the-spot" where new technical improvements are first introduced; is in the best possible position to bring students ACTUAL METHODS and practices developed by the RADIO-TELEVISION industry, leading to real money making opportunities. The 11 BIG KITS RTS GIVES YOU enable you to do many practical jobs, build the equipment illustrated; perform more than 100 other fascinating, valuable experiments. These jobs you do give you ACTUAL SHOP experience so vitally necessary to your future success. Thus RTS methods assure you BALANCED TRAINING—Theory PLUS Real Experience.

**OPPORTUNITIES NOW
WIDE OPEN FOR
Properly Trained Men**

Latest reports estimate 400 MILLION new television and radio sets will be built in the next 10 years . . . more than 72 million dollars is being spent RIGHT NOW just for radio repairs ALONE! When you are thoroughly trained by RTS Experts—who have their fingers on the pulse of the Radio-Television industry—a field of unlimited opportunities will open up for you in Your Own Radio-Television Sales & Service Business, F.M., Equipment Manufacturing, Communications and allied fields.

**EARN EXTRA MONEY
while learning at HOME**

Under the RTS amazingly easy, practical home-training plan there is no need for you to quit your present job. You study in SPARE TIME ONLY! RTS Experts show you how

RADIO-TELEVISION TRAINING SCHOOL
5100 SO. VERMONT AVE., LOS ANGELES 37, CALIF., U.S.A.
ESTABLISHED 1922 — 27 YEARS AGO
formerly RADIO TRAINING ASSOCIATION of AMERICA

**RADIO-TELEVISION TRAINING SCHOOL, DEPT. 11-PS
5100 South Vermont Avenue, Los Angeles 37, Calif., U.S.A.**

Send FREE Illustrated Book showing how I can make good in TELEVISION and Radio through training under the guidance of expert RTS Technicians. No obligation. (No Salesman will call).

NAME _____ AGE _____
St. & No. _____
CITY _____ ZONE _____
STATE _____

INVENTORS

A patent is a valuable right. On the basis of a provision in the Constitution of the United States, Congress has established a system under which inventors may secure the exclusive right to prevent the unauthorized use, manufacture and sale of their inventions for periods of seventeen years. The inventor secures this protection for his invention by obtaining a patent.

This firm is registered to practice before the U. S. Patent Office and is available to assist inventors in the preparation and prosecution of their cases. Detailed information and the steps to take to obtain patent protection will be furnished upon request.

Form below for mailing convenience

VICTOR J. EVANS & Co. *Merlin M. Evans*
REGISTERED PATENT ATTORNEY

440-M MERLIN BUILDING, WASHINGTON 6, D. C.

• • • • •

• VICTOR J. EVANS & CO. •
• 440-M Merlin Building, Washington 6, D. C. •

• Please send me without obligation a copy of your •
• booklet "Patent Protection For Inventors" together •
• with your convenient "Evidence of Invention" form. •

• Name..... •

• Address..... •

• City and State..... •

• • • • •

PATENTS TRADEMARKS COPYRIGHTS

Career Training in a Minimum of Time RADIO—ELECTRONICS TELEVISION ENGINEERING

GRADUATES of CREI residence school are preferred by industry because of their *training and ability*. CREI prepares the young man for a good job in industry in a minimum of time. 22 years practical experience. CREI offers an outstanding faculty, modern laboratories, shops and equipment. New students accepted twice monthly and each may advance as rapidly as he is capable. Basic course with one specialized course requires an average of 20 months to complete.

Approved for Veteran's Training.

• Write for Details and Free Catalog



**CAPITOL RADIO
ENGINEERING INSTITUTE**
Dept. 1811A, 16th & Park Rd. N.W.
Washington 10, D. C.

TRAIN

Your VOICE!

RESULTS GUARANTEED
STRENGTHEN your voice this tested, scientific way. Yes—you may now be able to develop the POWER of your speaking and singing voice in the privacy of your own room. Self-training lessons, mostly silent; no music required. Write TODAY for Eugene Feuchtinger's great booklet "How to Strengthen Your Voice." It's absolutely FREE! You must state your age. Booklet mailed in plain wrapper. No salesman will call. Send your name and age RIGHT NOW!
Perfect Voice Institute, 1141 S. Wabash Ave., Studio L-1, Chicago 5, Ill.

HOW TO CUT RAFTERS

New vest pocket book gives lengths, side cuts, plumb cuts, deductions, for all rafters any building from one inch to forty feet wide. Gives numbers to cut on square. All standard pitches from 11½" to 12 up to 17½ and 12 rise. Any one can frame a roof with this great book. Just open book to your pitch page and there in plain print is your lengths cuts and deductions for any pitched roof. Also gives how to figure elevations. How to figure lumber. How to lay out window and door openings. Written by Harry (Dad) Bleam and it's a dandy. Price only \$2.00 each.
BUILDERS' TOPICS, LOCK BOX 828, SEATTLE, WASH.

NEW! ADVERTISING MACHINE

PRINTS & ILLUSTRATES **FREE**
PENNY POST CARDS
An Illustrated Book of New Plans, Business Getting Ideas for your own business. Get it.
Easy to boost sales with Cardmaster. Thousands are doing it. Not a toy but a sturdy Advertising Machine Guaranteed 5 years. Get money-making facts today. Act now!
CARDMASTER, 1920 Sunnyside, Dept. 1611, Chicago 40

FURNITURE MAKING and CABINET WORK

By B. W. PELTON

Complete Step-by-step Directions for making Every Type of Furniture—
Including Built-in Conveniences and Home-remodeling Jobs

Here, in a great new handbook is everything you want to know about furniture making: cabinet work, repair jobs, and remodeling projects. Accurate drawings and practical instructions show you all the tricks of the trade and the real professional methods of repairing, refinishing and reupholstering worn or broken pieces. And there are complete directions for every type of home-remodeling project. Every job is explained in careful detail by a master craftsman who gives you authentic instructions on exactly how to carry out each step in the work—from obtaining the materials to the final finishing operations: staining, varnishing, waxing, etc.

MAIL THIS COUPON

D. VAN NOSTRAND COMPANY, INC. Examine This **FREE!**
250 Fourth Avenue, New York 3, N. Y. Great New Book
Please send me a copy of "Furniture Making and Cabinet Work". Within 10 days I will either return the book, or send you \$2.95, plus postage, as a down payment, and \$2.00 a month for two months until the total price of \$6.95, plus postage, is paid. (If you send entire amount of \$6.95 with this coupon, we will pay postage. Same return privilege and refund guarantee if not completely satisfied.)

SEND NO MONEY NAME.....
ADDRESS.....
CITY.....ZONE...STATE.....
Pop Sci-11-49

there's a TIME LIMIT on veteran training



Training under the G.I. Bill is a *limited offer*. You must enroll within four years after your discharge or before July 25, 1951 — whichever is later. Plan to take full advantage of the benefits to which you are entitled under the law. **START NOW.**

YOU MAY CHOOSE I. C. S. TRAINING

More veterans study with International Correspondence Schools than with any other school. Send *today* for full information on practical, authoritative I. C. S. training!

INTERNATIONAL CORRESPONDENCE SCHOOLS

APPROVED
under the
G.I. BILL

BOX 7642-M, SCRANTON 9, PENNA.

Without cost or obligation, please send me full particulars about the course BEFORE which I have marked X:

- | | | | |
|--|--|---|---|
| <p>Business and Academic Courses</p> <ul style="list-style-type: none"> <input type="checkbox"/> Accounting <input type="checkbox"/> App. Psychology <input type="checkbox"/> Business Administration <input type="checkbox"/> Bus. Correspondence <input type="checkbox"/> Certified Public Accounting <input type="checkbox"/> Commercial <input type="checkbox"/> Commercial Art <input type="checkbox"/> Cost Accounting <input type="checkbox"/> Federal Tax <input type="checkbox"/> First Year College <input type="checkbox"/> Foremanship <input type="checkbox"/> Good English <input type="checkbox"/> Higher Mathematics <input type="checkbox"/> Industrial Supervision <input type="checkbox"/> Motor Traffic <input type="checkbox"/> Retailing <input type="checkbox"/> Salesmanship <input type="checkbox"/> Sign Lettering <input type="checkbox"/> Spanish <input type="checkbox"/> Advertising <input type="checkbox"/> Bookkeeping <input type="checkbox"/> Bus. Law <input type="checkbox"/> Bus. Management <input type="checkbox"/> Secretarial <input type="checkbox"/> Stenography <input type="checkbox"/> Traffic Management <p>Air Conditioning and Plumbing Courses</p> <ul style="list-style-type: none"> <input type="checkbox"/> Air Conditioning <input type="checkbox"/> Heating <input type="checkbox"/> Refrigeration <input type="checkbox"/> Plumbing <input type="checkbox"/> Steam Fitting | <p>Chemical Courses</p> <ul style="list-style-type: none"> <input type="checkbox"/> Chemical Engineering <input type="checkbox"/> Chemistry, Analytical <input type="checkbox"/> Chemistry, Industrial <input type="checkbox"/> Chemistry, Mig. Iron & Steel <input type="checkbox"/> Petroleum Refining <input type="checkbox"/> Pulp and Paper Making <p>Civil Engineering, Architectural and Mining Courses</p> <ul style="list-style-type: none"> <input type="checkbox"/> Architecture <input type="checkbox"/> Building Estimating <input type="checkbox"/> Civil Engineering <input type="checkbox"/> Contracting and Building <input type="checkbox"/> Highway Engineering <input type="checkbox"/> Lumber Dealer <input type="checkbox"/> Reading Structural Blueprints <input type="checkbox"/> Sanitary Engineering <input type="checkbox"/> Structural Drafting <input type="checkbox"/> Structural Engineering <input type="checkbox"/> Surveying and Mapping <p>Communications Courses</p> <ul style="list-style-type: none"> <input type="checkbox"/> Electronics <input type="checkbox"/> Prac. FM and Television <input type="checkbox"/> Prac. Telephony <input type="checkbox"/> Radio, General <input type="checkbox"/> Telegraph Engineering <input type="checkbox"/> Radio Operating <input type="checkbox"/> Radio Servicing | <p>Electrical Courses</p> <ul style="list-style-type: none"> <input type="checkbox"/> Electrical Drafting <input type="checkbox"/> Electrical Engineering <input type="checkbox"/> Electric Light and Power <input type="checkbox"/> Lighting Technician <input type="checkbox"/> Practical Electrician <input type="checkbox"/> Power House Electric <input type="checkbox"/> Ship Electrician <p>Internal Combustion Engines Courses</p> <ul style="list-style-type: none"> <input type="checkbox"/> Auto Technician <input type="checkbox"/> Diesel-Electric <input type="checkbox"/> Diesel Engines <input type="checkbox"/> Aviation <input type="checkbox"/> Gas Engines <p>Mechanical Courses</p> <ul style="list-style-type: none"> <input type="checkbox"/> Aeronautical Engineer's, Jr. <input type="checkbox"/> Aircraft Drafting <input type="checkbox"/> Forging <input type="checkbox"/> Heat Treatment of Metals <input type="checkbox"/> Industrial Engineering <input type="checkbox"/> Industrial Instrumentation <input type="checkbox"/> Industrial Metallurgy <input type="checkbox"/> Machine Shop <input type="checkbox"/> Machine Shop Inspection <input type="checkbox"/> Mechanical Drafting <input type="checkbox"/> Mechanical Engineering <input type="checkbox"/> Foundry Work | <ul style="list-style-type: none"> <input type="checkbox"/> Mold-Loft Work <input type="checkbox"/> Patternmaking—Wood, Metal <input type="checkbox"/> Reading Shop Blueprints <input type="checkbox"/> Sheet-Metal Drafting <input type="checkbox"/> Sheet-Metal Worker <input type="checkbox"/> Ship Drafting <input type="checkbox"/> Ship Fitting <input type="checkbox"/> Tool Designing <input type="checkbox"/> Toolmaking <input type="checkbox"/> Welding Engineering <input type="checkbox"/> Welding—Gas and Electric <p>Railroad Courses</p> <ul style="list-style-type: none"> <input type="checkbox"/> Air Brake <input type="checkbox"/> Diesel Locomotive <input type="checkbox"/> Locomotive Engineer <input type="checkbox"/> Locomotive Fireman <input type="checkbox"/> Locomotive Machinist <input type="checkbox"/> Railroad Section Foreman <input type="checkbox"/> Steam and Diesel Loco. Eng. <p>Stationary Engineering Courses</p> <ul style="list-style-type: none"> <input type="checkbox"/> Boilermaking <input type="checkbox"/> Combust. Engrg. <input type="checkbox"/> Marine Engineering <input type="checkbox"/> Power Plant Engr. <p>Textile Courses</p> <ul style="list-style-type: none"> <input type="checkbox"/> Cotton Manufacturing <input type="checkbox"/> Rayon Weaving <input type="checkbox"/> Woolen Manufacturing <input type="checkbox"/> Engine Running <input type="checkbox"/> Steam Engineer <input type="checkbox"/> Loom Fixing <input type="checkbox"/> Textile Designing <input type="checkbox"/> Car Inspector |
|--|--|---|---|

Name _____ Age _____ Home Address _____

City _____ State _____ Working Hours _____ A.M. to _____ P.M.

Present Position _____ Employed by _____

Length of Service in World War II _____

Enrollment under G.I. Bill approved for World War II Veterans. Special tuition rates to members of the Armed Forces. Canadian residents send coupon to International Correspondence Schools Canadian, Ltd., Montreal, Canada.

Get...
**YOURS
FREE!**
BOOKLET



**OF COMPLETE
COAST INDUSTRIES
PROFIT PLAN**



NELS IRWIN
Will help you start your
own successful business
— at home, spare time
or full time



BIG PROFITS

Rich profits are waiting to be tapped in this new field. New **MIRACLE** finish gives a velvety, luxurious surface to radios, lamps, toys, signs, store displays, figurines, auto dashboards, and hundreds of other items. Make old objects beautiful and salable—make new things worth much more with this soft, rich covering that can be applied to any surface, even if old and worn.

START RIGHT AWAY

Yes, you can learn in a few days to start **MAKING MONEY!** Everything you need is furnished, including fully detailed, illustrated instructions that are complete and easy to understand. Every point is explained, to show you how to start on the road to big money, full or spare time, right in your own home.

EVERYTHING COMPLETE

In addition to full instructions you get a complete set of materials that enables you to start at once. A few cents worth of materials can mean many dollars in return to you—you can earn up to \$5 per hour and more spare or full time. Add to your income from your present job or start a profitable business of your own. Our Business is Booming. Help us fill **HUGE DEMAND.**

ACT NOW

Grasp this opportunity **TODAY!**—Start your own business. It's too good to miss! **SEND NO MONEY!**—fill out the coupon and stick it on a post card or in an envelope and mail today for full details. **FREE** samples of **FLOK-KRAFT** covered material, and hundreds of useful and profitable **IDEAS** Do it **NOW!**—be first!

**COVERS WOOD, FABRIC, METAL,
GLASS, PLASTER, PLASTIC OR
ANY SURFACE**



USE COUPON FOR FREE SAMPLE

COAST INDUSTRIES Dept. 1-B
1004 S. Los Angeles St., Los Angeles 15, Calif.

Gentlemen: Please rush me all the details.

NAME _____

STREET _____

CITY _____

STATE _____

BE AN AUTO MACHINIST



Draw Top Pay • No Job Worries

Earn more money in auto mechanics—Specialize! New **FREE** booklet tells how to prepare for good jobs with high pay and job security. Our modern equipment and practical instructions make it easy to learn—get experience in:

**ENGINE REBUILDING or
GENERAL AUTO MECHANICS**

**Job
Placement
Service
FREE**

VETERANS
American is a
G.I. approved
school.

**PLANNING
YOUR FUTURE IN
AUTO MECHANICS**

Practical Shop Training
Learn to operate the very latest shop machinery. Friendly instructors take a real interest in preparing you for a good job.

**WRITE TODAY FOR
FREE BOOKLET**

AMERICAN TRADE SCHOOL
2407 McGee Kansas City, Mo.

**WALKIE
TALKIES**

**A COMPLETE 2-WAY ELECTRONIC
COMMUNICATION SYSTEM**

Don't let the unbelievable low price fool you! A genuine two way system operating on a new Electro-sonic principle developed for the U. S. Armed forces. Amazing clarity and high volume make it effective for all types of operation.

(2 complete units included)
Nothing to build—Nothing to buy—Guaranteed to work indoors—outdoors—anywhere.

C.O.D.'s, send \$1.00 deposit, pay **\$2.95** post
postman balance plus postage. **\$2.95** paid
NORTH EAST SALES CO.
314 MARKET ST. Dept. PS 4, NEWARK, N. J.



**We'll Pay You
\$1000.**

for 3 gallons of
"worn out" motor oil
from your own auto,
truck or tractor en-
gine. Details, page 30
in our **FREE BOOK**
"Oil Facts."

RECLAIMO MFG. CO., 5083 Elston Ave., Dept. 17, Chicago, 30, Ill.

WALTHAM

U. S. ARMY WALTHAM

Air Force Type A-11

The wrist watch that timed Army Air Corps Pilots

- 15 Jewel
- Rust Proof
- Sweep Second Hand
- Chrome Case
- Precision Movements
- Unbreakable Crystal
- Non-Magnetic Hair Spring
- Stainless Steel Back



\$19.95

NOW at about 1/3 regular price. **SEND NO MONEY.** Pay postman on delivery \$19.95 plus 10% excise tax and C.O.D. fees. Free Catalog

SHACKELFORD'S, Dept. 217, 332 E. 31st St., Kansas City 8, Missouri

**ELECTRIC PHONOGRAPH
MOTOR**

*For hobbyists, Schools,
Mechanics, Tinkers!*

Single speed, 60-cycle single phase AC, fan cooled. Complete with leads and mounting bracket. New, guaranteed well known make. Use it for phonographs, displays, erector sets . . . and many other ways.



**\$2.00 EACH
Delivered**

10" Webster standard turntable, felt covered. Bronze sleeve and 75c gear

ABE COOPER — SYRACUSE, INC.

Lodie and W. Hiawatha Blvd.

Syracuse 8, N. Y.

Want to be in **BUSINESS** for **YOURSELF**

or Get a Good Pay Job?

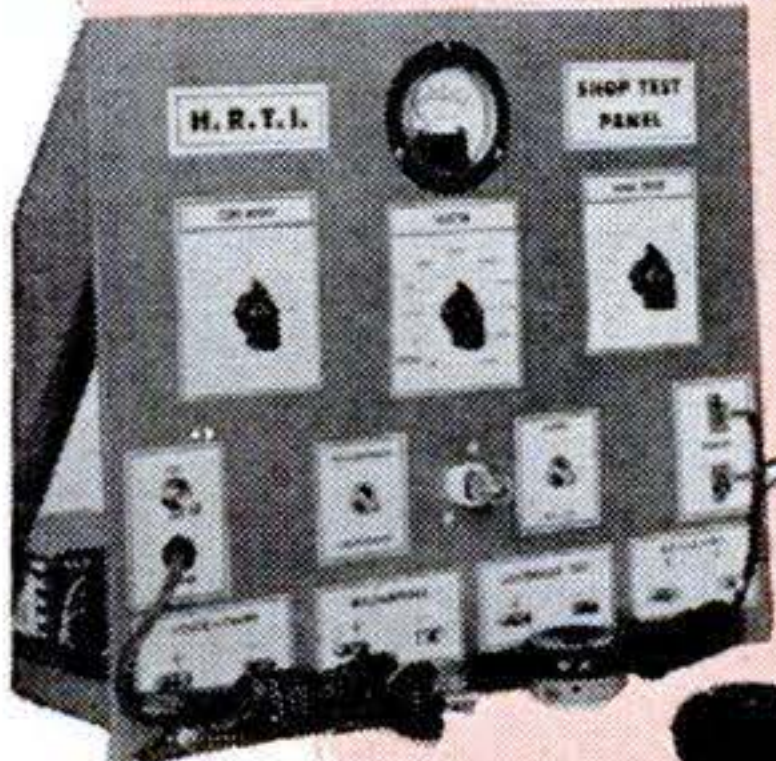

You Construct the Multi-purpose Shop Test Panel Shown at Left and Build SCORES of Radio Circuits Like Those Shown Below With the Parts I Send You.



Since 1929 I have been training men ALL OVER THE WORLD for success in radio. Find out how easy it is to learn right in your home through my two-way method - lessons plus actual practice. Send for big FREE book, TODAY.

H.R.T.I. Trained Men Win in Big Contest

FIRST, SECOND and FOURTH prizes in open contest for best Radio Technicians in Cuba WERE WON BY HRTI students and graduates! In fact, SEVEN of the first ten prizes were won by HRTI trained men! Over 250, graduates from many schools, as well as professional radio technicians, competed! Convincing proof of the quality of HRTI training. Get the facts about this amazing contest in my big FREE book.

APPROVED FOR VETERANS
CHECK COUPON

BIG BOOK FREE

Sending for this book has marked the turning point in the lives of many men. You owe it to your future to find out about H.R.T.I. Training. Mail the coupon TODAY.



LEARN **Radio and Television**

Make Money in Spare Time While Learning at Home

Want to make more money? Want to be your own boss - have your own money-making business - with your future assured? Then learn Radio & Television with my proven 2-Way Method that can help you get into this great and growing business QUICKER.

Many of my students make money, some even start their own business in spare time - while learning.

Take the first step toward a successful career - NOW - send for my big 56-page illustrated book that tells how my home training can help prepare you to cash in on Radio and Television's opportunities. It's free, but it may mean your future success!

You Learn by Doing!

YOU GET 10 KITS OF RADIO PARTS!

YOU DO OVER 300 FASCINATING TESTS



You Build This 3 Tube Experimental Receiver (above) and This A-C Power Supply (right)

During your training you get 10 big kits of radio parts with which you perform hundreds of tests and experiments, build scores of circuits and testers, to help you learn faster, more thoroughly.

You learn first hand, by doing.

You Also Construct This Powerful, Four-Band, Six-Tube, A-C or D-C Superheterodyne Receiver



MAIL COUPON NOW

C. H. MANSFIELD, Pres., Dept. D-23
Hollywood Radio and Television Institute, Established 1929
810 West Sixth St., Los Angeles 14, California, U.S.A.

Send me your FREE book, "Your Opportunities in Radio, Television and Electronics," which explains your 2-way home study training method.
No salesman will call.

NAME _____

ADDRESS _____

CITY _____ STATE _____

If a veteran of World War II, check here

HOLLYWOOD RADIO & TELEVISION INSTITUTE
810 West 6th St., Los Angeles 14, California, U.S.A.

EARN MORE IN DRAFTING



**STEADY
EMPLOYMENT**
●
**MORE OPPORTUNITIES
FOR PROMOTION**

"Here I am at work making good money as a draftsman. I'm glad I sent the coupon to Chicago Tech for that Free Trial Lesson and found out how easy it is to learn Drafting in spare time at home. Today I feel secure in my job because the draftsman's work comes first on any new project. And, in addition, draftsmen can't be replaced with machines. What's more, I feel I'm slated for promotion and more pay, because I see so many draftsmen advancing to high-pay jobs."

LEARN IN SPARE TIME—AT HOME!

(or at the College in Chicago)

A few hours of pleasant home study every week—that's all. No interference with your present job. All the tools you need; drawing outfit included. With Chicago Tech's help, you train yourself step by step. This tested method—developed over 45 years of C.T.C. progress—prepares men quickly for good positions in industry.



FREE INFORMATION—SEND COUPON

To prove to you how easy it is to learn Drafting at home by the Chicago Tech method, we will send you this FREE TRIAL LESSON. No charge for this lesson, now or later. Fill out and mail coupon, or send post card today.

CHICAGO TECHNICAL COLLEGE

P-226 Tech Bldg., 2000 So. Michigan Ave.,
Chicago 16, Illinois

Mail me FREE Lesson with information about big opportunities in DRAFTING.

Name.....Age.....

Address.....

City.....Zone.....State.....

SANDEE

Mufflers—All Ford, Chev., Ply.....\$4.45
All Buick, Pont., Olds., Chrys.,
Dodge, Hudson, K.F., Pack., etc.....\$5.45
V-8 and Merc. Duals
(32-49 incl.)
\$15.95

● TONE

DEALERS
WANTED

**SPORTONE
MUFFLERS**
(Pats. Pend.)

DURABILITY

Beautiful
SANDEE
Fender Skirts
\$16.95

A SANDEE Sportone will outlast two ordinary mufflers and give More Power! More Speed! More Mileage!—plus a tone quality unsurpassed.

Please ship (item):.....Price.....

Car and Year.....Name.....

Address.....

SANDEE MUFFLER CO. 5643 Corryne Pl. Culver City, Calif.

30 POPULAR SCIENCE

Is Your Job DEPRESSION PROOF?

Can you lose employment because of depression, business failure or old age? Learn watchmaking, the mechanical profession called "depression-proof for trained men" by impartial national authorities. Old age brings increased respect rather than insecurity. Study veteran training approved courses in watch and clock repair, jewelry engraving, chronograph repair at the world's largest, best-equipped watchmaking school.

SEND FOR FREE 116-PAGE INFORMATION PACKET

WESTERN PENNSYLVANIA HOROLOGICAL INSTITUTE

WORLD'S LARGEST WATCHMAKING SCHOOL



DESK 39, 808 RIDGE AVE., PITTSBURGH 12, PA.

SPEED & POWER HANDBOOK



**BUILD FAST STOCK CARS!
COVERS FORDS to CADILLACS**

Build California Roadsters! Hollywood Sport Cars! 150 MPH Rods! Breathtaking methods—Authentic—Direct from California!

SAVE MANY DOLLARS! Build your own Dual Manifolds! Superchargers! Hot Cams! Water Injectors! Hi-Compression Heads! Mileage Devices! Get up to 10 extra miles per gallon! Get racing speed, lightning acceleration, dynamic power increases from any make passenger automobile! Get construction drawings! Tuning techniques! Speed tricks! Economy secrets! Ingenious formulas! Including "Racing Frames"—"Reciprocating Masses"—"Jet Engines"—"Braking Characteristics"—"Dynamometers"—Dual Pipes, Gears, Fuels, Manifolds, Porting, Relieving, Lowering! Balancing. Also, complete Racing Equipment Catalogues!

Includes "CALIFORNIA AUTOMOBILE CUSTOMIZING"—Glossy photographs! Diagrams! Newest Ideas! Conversions! Re-Styling all makes! Streamlining! Chopping! Channeling! Customizing!

50 CHAPTER LIBRARY EDITION—complete—\$1.98 Postpaid.

NEWHOUSE AUTOMOTIVE INDUSTRIES
5805-A4 EAST BEVERLY BLVD. LOS ANGELES 22, CALIF.

make your own Gems 29.50 F.O.B.

All necessary lapidary equipment is furnished, including a super-charged diamond blade for sawing, and all wheels for grinding, shaping and polishing; also complete instructions. The complete equipment as shown, less motor and belt, for only \$29.50, f.o.b., Burlington, Wisconsin. Write today for information and literature.

B&I MANUFACTURING CO.
Dept. M Burlington, Wis.



Bar Bells

Buy Direct From Factory

\$8.95
up

Write for free booklet
and price list

INDEPENDENT IRON WORKS
2416 East 23rd Street, Dept. C
Los Angeles 11, Calif.



SURPLUS BARGAINS



LINEMAN'S TOOL & SAFETY BELT

Brand new web type belts in the original package. Only..... **\$3.95**

POLE AND TREE CLIMBERS

Without straps. Used, good. **\$1.50**
Per Pair, only.....

Send 10c for our jam-packed Catalog!

Enclose full amount with order. All Equipment F.O.B.

C & H SALES COMPANY

2176 S-11 E. COLORADO ST. ● PASADENA 8, CALIF.

IMAGINE THEIR JOY

WHEN THEY FOUND THEY COULD PLAY

This easy as A.B.C. way!



LEARNED QUICKLY AT HOME

"I didn't dream I could actually learn to play without a teacher. You can imagine my surprise when after 3 or 4 weeks I found I could play real tunes. Now, when I play for people they hardly believe that I learned to play so well in so short a time."
*H. C. S., Calif.

INVESTMENT PAID BACK A THOUSAND FOLD

"Anyone with musical ability should make good with your course. My little investment paid back a thousand fold. I have been playing for 4 years now. Today I play in one of our top bands."
*J. M., San Juan, P. R.



PLAYS AT DANCES

"I have completed your course and your lessons have been most satisfactory. I can play all of the popular songs. I have also earned money playing at dances."
*E. N. J., New York.

FUN TO LEARN

"Your lessons are everything you said they would be. Never before have I seen such an easy way to learn music. It's easy, encouraging and fun. I thank you with all my heart for introducing me to your wonderful course."
*G. M., Berlin, N. H.



AFTER 10 MONTHS PLAY IN BAND

"I had no idea I would accomplish so much musically. After only 10 months I was playing in bands. I now am employed in a music store as an instructor. This I owe to your marvelously simple lessons."
*R. C., Patterson, New Jersey.

Thousands Have Learned to Play Quickly, Easily At Home

WHAT instrument would you like to play? We'll show you how you can learn to play it—quickly, easily, in spare time at home for only a FEW CENTS A DAY! Never mind if you don't know one note of music from another—don't worry about "special talent."

The truth of the matter is that thousands now play who never thought they could! Yes, men and women everywhere are enjoying the thrilling satisfaction of playing the piano, violin, guitar, saxophone or other favorite instrument. Some of them are playing in orchestras and over the radio; others are teaching music, making money in spare or full

time. And thousands are playing for their own enjoyment and the entertainment of their friends.

It all came about when they wrote to the U. S. School of Music for the Free Booklet that shows you how EASY it is to learn music at home this modern way. No tedious scales, no tiresome exercises. You learn to play by playing—start right in almost at once with the melody of a simple tune! It takes only a few minutes a day and the cost is trifling; you save the expense of a private teacher. Mail coupon and get FREE PROOF! (Instruments supplied when needed, cash or credit.) U. S. School of Music, 811 Brunswick Bldg., New York 10, N. Y. (Est. 1898—51st year)

NOTICE

Please don't confuse our method with any systems claiming to teach "without music" or "by ear." We teach you easily and quickly to play real music, any music, by standard notes . . . not by any trick or number system.

SEND TODAY → FOR COMPLETE DETAILS

• You'll open your eyes when you find how quickly and easily you can learn to play your favorite instrument. Don't doubt; don't hesitate. Send for the fascinating illustrated booklet that answers all your questions; let the free Print and Picture Sample show you how this method actually works. If interested, mail the coupon NOW.

*Actual pupils' names on request. Pictures by professional models.

FREE PRINT AND PICTURE SAMPLE

U. S. SCHOOL OF MUSIC

811 Brunswick Bldg., New York 10, N. Y.

I am interested in music study, particularly in the instrument checked below. Please send me your free illustrated booklet, "How to Learn Music at Home."

Piano	Saxophone	Modern Elementary
Guitar	Trumpet, Cornet	Harmony
Hawaiian Guitar	Reed Organ	Clarinet
Violin	Tenor Banjo	Practical Finger
Piano Accordion	Mandolin	Control
		Other Instrument

Have you Instrument? _____

Mr. _____
Miss _____
Mrs. _____

(Please Print)

Address _____

City _____ State _____

NOTE: If you are under 16 years parent must sign coupon.

Save 2c—Stick coupon on penny postcard.

Lafayette

RADIO ELECTRO NEWS

★ 29th YEAR SERVING AND SAVING YOU MONEY

NEW YORK: 100 Sixth Avenue and 542 E. Fordham Road
 CHICAGO: 901 W. Jackson Blvd. BOSTON: 110 Federal St.
 NEWARK: 24 Central Avenue ATLANTA: 265 Peachtree St.

SIZZLING VALUES from New Lafayette Catalog

(return Coupon for yours NOW)

FAMOUS-MAKE ELECTRIC HAND DRILL

Save \$3 on this well-known electric hand drill. Ideal "general purpose" tool for home and shop use. Takes bits up to 1/4". Self-tightening chuck. Precision 1400 rpm motor. On-off toggle switch. Pistol-grip handle. Strong die-cast zinc housing with aluminum finish. 110 volts, 60 cycles, A. C.



List Price: \$11.95
 LAFAYETTE'S PRICE: \$8.95

No. 17N15796P (weight: 4 lbs.)

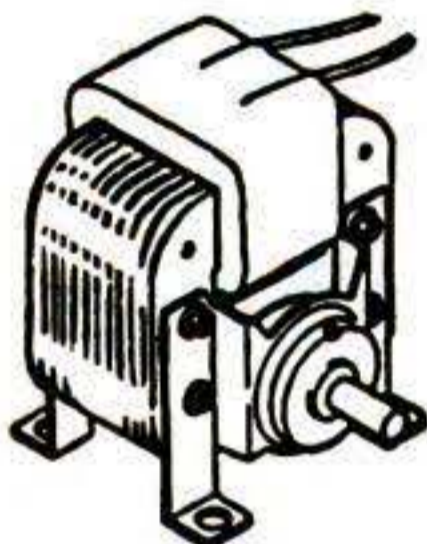

1/20 HP MOTOR "BUY"

LAFAYETTE'S PRICE: Only \$3.89
 You'll find many uses for this little giant 1/20 hp motor. 2900 rpm. 110 volts, AC, 50 or 60 cycles, 3 1/2 x 2 3/4 x 3 1/2 high. Shaft is 1/4 dia., 3/4 long.

No. 99N7079P (wgt.: 5 lbs.) \$3.89

FREE

GET THIS BIG
 NEW 1950 EDITION

• Bumper Crop of Values in Lafayette's BARGAIN CATALOG Of Everything New in Radio-Electronics!

Save up to 40% on everything you buy from this new 1950 Lafayette Radio Catalog, hot off press! Special Bargain Section included in 164 pages sizzling with newest famous-make electronic equipment! TV sets, chassis, viewing tubes, antennas, high fidelity, equipment, ham gear, 3-speed record changers, tools, parts, appliances, etc. For FREE bargain-hunter's handbook, mail coupon now!



JUST OUT

LAFAYETTE RADIO, Dept. KK-9
 901 W. Jackson Blvd., Chicago 7
 100 Sixth Avenue, New York 13

MAIL COUPON NOW

- Check here for FREE Catalog. (Please don't check if you have already gotten yours.)
 Please fill my order for items checked above for which I enclose \$..... in postal note, money order or check. I'm including shipping charges based on weight and zone.

NAME.....

ADDRESS.....

CITY.....ZONE.....STATE.....

BE A SUPERVISOR



Franklin Technical Institute
 Helps Young People Get Ahead

• Specialized technical training opens wide the door to well-paid supervisory jobs in industry. 50,000 young men and women have graduated from this Boston school and found good jobs in engineering and technical fields. Practical two-year day courses in industrial electricity and electronics, industrial chemistry, mechanical and machine design, structural design and architectural drafting, automotive service and management, electric wiring and maintenance. One-year course in professional photography. Also preparatory and evening classes. Approved for veterans. 41st year. Write for catalog.

FRANKLIN TECHNICAL INSTITUTE
 39 Berkeley Street Boston 16, Mass.



New Automotive Discovery—replaces present idle adjustment screws in carburetor OVER A MILLION NOW IN USE.

Famous GANE "Air-flow" NEEDLE

Users report up to 25% MORE MILEAGE, EASIER WINTER STARTING, FASTER PICK-UP, PERFECT IDLING. Fits all cars—install in 5 minutes. \$1.50 each (8 cyl. cars take 2) SEND NO MONEY, just mail card with name, address, make of car and carburetor. Needles sent postpaid with illustrated data for FREE TRIAL IN YOUR CAR. MAIL CARD NOW!

NATIONAL AUTOMOTIVE RESEARCH CO.
 BOX 3097-HK, LOS ANGELES 54, CALIFORNIA

SAVE GAS!
 FREE TRIAL
 IN YOUR CAR!

Protect Your O-V-E-R-D-R-I-V-E!! Save Money



FITS ALL CARS FROM '46 THRU '50*

"SIG-NA-LITE" flashes green light the instant car is ready for Overdrive! No guessing or forgetting! Permits effortless "CLUTCHLESS SHIFTING" in conventional gear! Saves gas! Reduces wear! Beautifies dash! Install in 5 min. Only \$2.95 complete, postpaid, including "Overdrive Hints" folder. (COD's small fee). *Also includes—DeSoto, Chrysler and '49 Dodge "Gyro-Matic."

C. D. HILL PRODUCTS 5227 Parker Ave., Dept. PS-11, Chicago 39, Ill.

AMAZING NEW WOOD-TURNING TOOLS

SHARPEN ONCE IN 12-YEARS! (UNDER NORMAL USE)

These remarkable tools tipped with TUNGSTEN CARBIDE will astound you with their performance. They work FREE HAND equally well in wood, plastic or soft metals—and at the same time hold their razor-like edge almost indefinitely. Tests show that they will turn wood or plastic for days and days CONTINUOUSLY without showing any signs of dulling. They are the finest tools available at any price. Beautifully finished 5" blade—flush ground, polished tip—finest brass tube ferrule—9" hardwood handle—over all length 14"—10 tools to choose from: round and square nose from 1/8" to 1/2";—1/8" cut off; and 1/2"x30° skew. Amazingly Low Prices! Write at once for free literature. JOHNS MFG. CO., DUNELLEN 5, N. J.

ENORMOUS PROFITS CASTING AT HOME

Write today for NEW FREE CATALOG

Learn to cast thousands of perfect figurines, plaques, book ends, ash trays, etc. Start NOW—NO EXPERIENCE, LITTLE CAPITAL needed. Earn GREAT PROFITS with X.L. RUBBER MOLDS. X.L. Rubber. Pts. \$2.00; Qts. \$3.50; Gallons \$8.95; Models and enough rubber for 3 molds . . . \$1.30 postpaid.

PLASTIC ARTS STUDIO 303 S. Madison St. MUNCIE, IND.



FREE FACTS SENT



DEEP TONE MUFFLERS

Duals • Singles

Advance Mufflers scientifically designed. Reduce back pressure. Greater power, speed, economy. NEW brilliant ultra DEEP TONE makes your car stand out. Heavy, rugged steel (no aluminum). Easy to install. No cutting, welding, holes to drill.

Rubber mounted clamps (no rattle) and all necessary fittings with duals. Order direct. State make, year, and model. Sent C.O.D. Deep Tone duals \$19.95 (Fords and Mercury only). Singles for Chev., Ford, Plymouth—\$4.86. Other cars \$5.50. Chrome tail pipes 2 1/2" dia. \$1.75. Write for Free Catalog. Money back if not satisfied after 5 day trial.

ADVANCE MUFFLER CO. of Los Angeles
 1458 E. Compton Blvd., Dept. PS 11-9, Compton 3, Calif.

AUDELS CARPENTERS & BUILDERS GUIDES—(4 Book Set).....\$6

A practical illustrated trade assistant on modern construction for carpenters, joiners, builders, mechanics and all woodworkers. 4 vols., 1600 pages, 3700 illustrations. Fully indexed, flexible covers. Each volume sold separately \$1.50 a vol.

AUDELS PLUMBERS & STEAMFITTERS GUIDES—(4 Book Set).....\$6

A Practical Trade Assistant & Ready Reference. Explains in plain language & by clear illustrations, diagrams, charts, graphs, pictures principles of modern plumbing practice including Marine Pipe Fitting and Air Conditioning. 4 Vols.—1670 Pages—3642 Diagrams & Illustrations. Each Vol. Sold Separately \$1.50 a Vol.

AUDELS OIL BURNER GUIDE.....\$1

384 Pages Covering Installation, Servicing & Repairs All Types Domestic & Industrial Burners. Illustrated. Highly Endorsed.

AUDELS HOUSE HEATING GUIDE..\$4

1000 Pages Covering Working Principles, Installation, Service of All Modern House Heating, Ventilating & Air Conditioning Systems. Explains New Radiant Heating. Fully Illustrated & Indexed.

AUDELS REFRIGERATION & AIR CONDITIONING GUIDE.....\$4

New from Cover to Cover—1280 Pages, Fully Illus. Covering basic principles, servicing, operation & repair of household, commercial & industrial refrigeration & air conditioning. A gold mine of essential important facts for engineers, servicemen, users.

AUDELS SHEETMETAL WORKERS HANDY BOOK.....\$1

Practical inside information. Fundamentals of Sheet Metal Work. 388 pages. Illustrated. 11 sections. Clearly written. Essential & important facts, figures, pointers in everyday language. Ref. Index.

AUDELS SHEETMETAL PATTERN LAYOUTS\$4

Developed by Experts for Sheet Metal Workers, Layout Men & Mechanics. A Practical Encyclopedia in 10 Sections, size 7 x 10 x 2—1125 Pages—350 Layouts—1600 Illustrations. 1001 Key Facts. Fully indexed for ready reference in answering your layout problems. Covers all phases of sheet metal work including Pattern Cutting, Pattern Development & Shop Procedure.

AUDELS BLUE PRINT READING.....\$2

For Mechanics & Builders. Covers all types of blue print reading including ship & airplane. 416 pages, fully illustrated.

AUDELS MATHEMATICS & CALCULATIONS FOR MECHANICS \$2

Mathematics for home study or reference. 700 pages, 550 illus. Practical mathematics from beginning. How to figure correctly. Easy, correct methods covering complete review. Illus. & Indexed.

AUDELS AUTOMOBILE GUIDE.....\$4

A practical quick ready reference book for auto mechanics, service men, operators & owners. Explains theory, construction & servicing of modern motor cars, trucks, buses & auto type Diesel engines. 1700 pages, fully illustrated. 55 chapters. Indexed. A standard book for mechanics. New Hydraulic drive covered.

AUDELS DIESEL ENGINE MANUAL...\$2

A practical, concise treatise with questions and answers on the theory, operation and maintenance of modern diesel engines. Over 400 pages, fully illus. All details plainly brought out, this book is of extreme value to engineers, operators & students.

AUDELS WELDERS GUIDE.....\$1

A concise, practical text on operation & maintenance of all welding machines for all mechanics. Over 400 pages, illustrated. Covers all methods of electric and acetylene welding including airplane work.

AUDELS MACHINIST & TOOLMAKERS HANDY BOOK\$4

Covers modern machine shop practice in all its branches. Tells how to set up & operate lathes, screw and milling machines, shapers, drill presses & all other machine & hand tools. 1600 pages, fully illustrated. Indexed. 5 sections. 1—Modern Machine Shop Practice. 2—Blue Print Reading & How to Draw. 3—Calculations & Mathematics for Machinists. 4—Shop Physics. 5—How to Use the Slide Rule. 60 chapters. Easy to read and understand. A shop companion that answers your questions.

AUDELS ELECTRIC MOTOR GUIDE \$4

Practical Information Covering Construction, Control, Maintenance & Wiring Hookups of All Types Electric Motors also Armature Winding. 1000 Pages Fully Illustrated & Indexed.

AUDELS ELEC. WIRING DIAGRAMS \$1

210 Pages. Illustrated. Gives practical facts on wiring of electrical apparatus. It shows clearly how to wire apparatus for practically all fields of electricity. Each diagram is complete & self-explanatory. Highly Endorsed Pocket Companion.

AUDELS PRACTICAL ELECTRICITY \$4

A key to a practical understanding of Electricity. For maintenance engineers, electricians & all electrical workers. 1440 Pages, 2600 Illus. Covers important electrical information in handy form—including wiring for Light & Power. Indexed.

AUDELS RADIOMANS GUIDE\$4

A key to the practical understanding of radio including Frequency Modulation, Television, etc., Aircraft & Marine Radio. For radio engineers, servicemen, amateurs, 914 Pages, 633 Illustrations & Diagrams. Photos. Review Questions & Answers, Reference Index.

AUDEL, Publishers, 49 W. 23 St., N.Y. 10

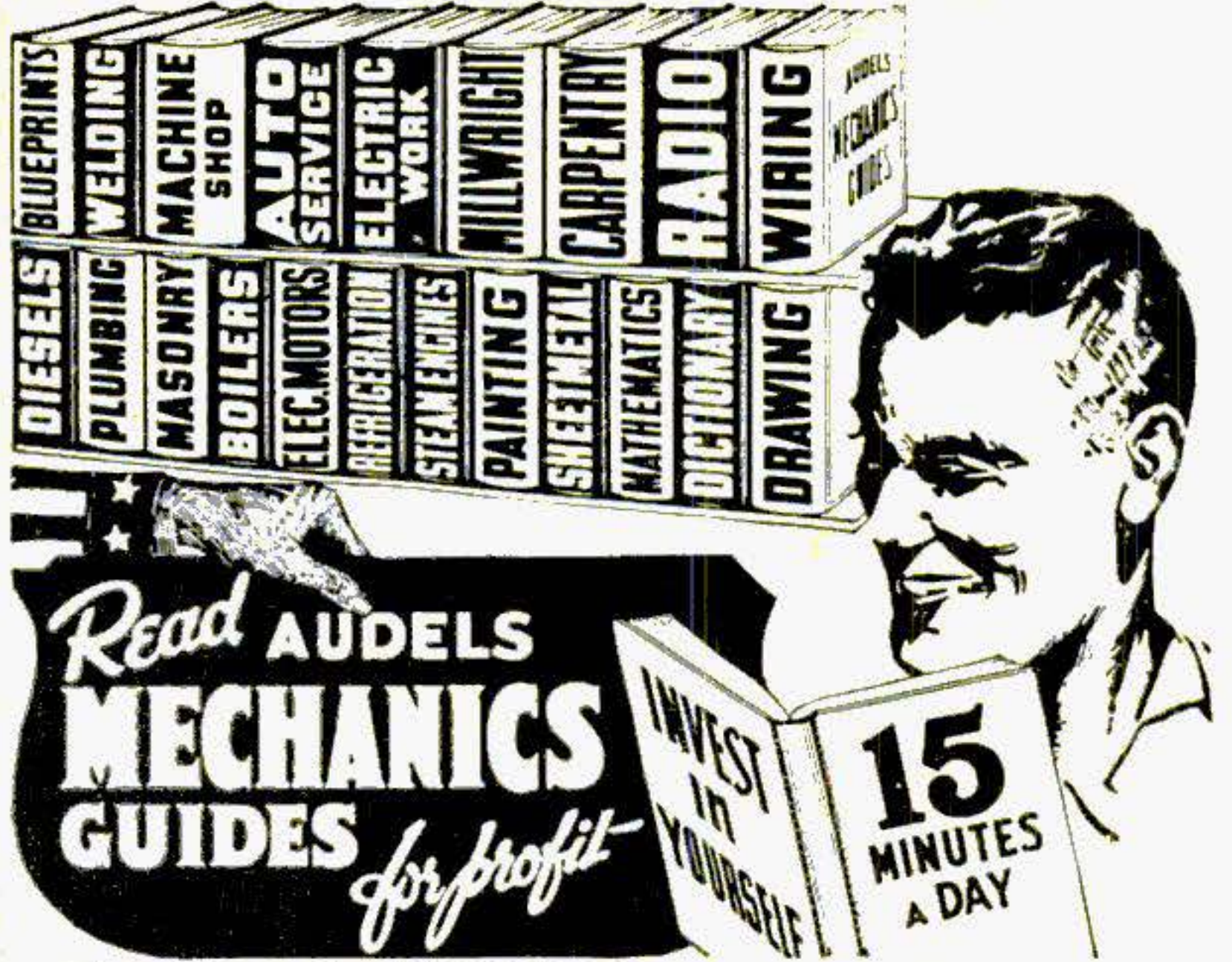

AN AUDEL GUIDE IS A GOOD FRIEND!
Step Up Your Own Skill with the Practical Facts and Figures of Your Trade. Save time and money with right methods, short cuts, labor saving ideas. CHECK NOW! You can look over any Audel Guide in your home. Start the Easy Payments if satisfied.

— — — CUT HERE — — —
MAIL ORDER

AUDEL, Publishers, 49 W. 23 St., New York 10, N. Y.

Please mail me for 7 days' free examination the books marked (X) below. I agree to mail \$1 in 7 days on each book or set ordered, and to further mail \$1 a month on each book or set ordered until I have paid the purchase price. If I am not satisfied with Guides I will return them.

- AUTOMOBILE GUIDE, 1700 Pages** \$ 4
 - DIESEL ENGINE MANUAL, 400 Pages** 2
 - WELDERS GUIDE, 400 Pages** 1
 - CARPENTERS & Builders Guides (4 Book Set)** 6
 - PLUMBERS & Steamfitters Guides (4 Book Set)** 6
 - MASONS and Builders Guides (4 Book Set)** 6
 - BLUE PRINT READING, 416 Pages** 2
 - MASTER PAINTER & Decorator, 320 Pages** 2
 - GARDENERS & GROWERS GUIDES (4 Book Set)** 6
 - OIL BURNER GUIDE, 384 Pages** 1
 - HOUSE HEATING GUIDE, 1000 Pages** 4
 - REFRIGERATION & Air Conditioning Guide, 1280 Pages** 4
 - SHEET METAL WORKERS Handy Book, 388 Pages** 1
 - SHEET METAL PATTERN LAYOUTS, 1100 Pages** 4
 - AIRCRAFT WORKER, 240 Pages** 1
 - MECHANICAL DRAWING GUIDE, 160 Pages** 1
 - MECHANICAL DRAWING & DESIGN, 480 Pages** 2
 - MATHEMATICS and CALCULATIONS, 700 Pages** 2
 - MECHANICAL DICTIONARY, 968 Pages** 4
 - MACHINISTS & Toolmakers Handy Book, 1600 Pages** 4
 - MILLWRIGHTS & Mechanics Guide, 1200 Pages** 4
 - POWER PLANT ENGINEERS GUIDE, 1500 Pages** 4
 - ENGINEERS & FIREMANS EXAMINATIONS, 528 Pages** 1
 - PUMPS, HYDRAULICS & Air Compressors, 1658 Pages** 4
 - MARINE ENGINEERS Handy Book, 1280 Pages** 4
 - ENGINEERS and Mechanics Guides (8 Book Set)** 12
 - Answers on Practical ENGINEERING, 254 Pages** 1
 - ELECTRIC WIRING DIAGRAMS, 210 Pages** 1
 - ELECTRICIANS EXAMINATIONS, 250 Pages** 1
 - ELECTRIC DICTIONARY, 9000 Terms** 2
 - ELECTRIC MOTOR GUIDE, 1000 Pages** 4
 - PRACTICAL ELECTRICITY Handy Book, 1440 Pages** 4
 - ELECTRICAL POWER CALCULATIONS, 425 Pages** 2
 - RADIOMANS GUIDE, 914 Pages** 4
 - ELECTRONIC DEVICES, 216 Pages** 2
 - NEW ELECTRIC LIBRARY, 7000 Pages (12 Book Set)** 18
- Vols. I, II, III, IV, V, VI, VII, VIII, IX, X, XI, XII—\$1.50 Each

Name _____
Address _____
Occupation _____
Employed by _____

PSM

I need 500 Men to wear SAMPLE SUITS



Pay No Money— Send No Money

My values in made-to-measure suits are so sensational, thousands of men order when they see the actual garments. I make it easy for you to get your own suit to wear and show—**MAKE MONEY IN FULL OR SPARE TIME THIS EASY WAY!**

My Plan is AMAZING!

Just take a few orders at my low money-saving prices—that's all! Get your own personal suit to wear and show—make money fast taking orders. No experience needed. Spare time pays big. You pay no money, now or any time.

MAIL COUPON!

Rush this coupon today for full facts and **BIG SAMPLE KIT** containing more than 100 fine woollens in all popular weights and shades. Be one of the 500 top-notchers I need to wear, show, and take orders for my suits. Act now!

JOHN GRANT, Stone-Field Corp.
532 S. Throop St., Chicago 7, Ill.

FREE
Costly Sample
Kit containing
over 100 actual
fabric samples.

JOHN GRANT, Stone-Field Corp.
532 S. Throop St., Dept. Y-820, Chicago 7, Ill.

Dear Sir: I WANT A SAMPLE SUIT TO WEAR AND SHOW, without paying 1c for it. Rush Valuable Suit Coupon and Sample Kit of actual fabrics, **ABSOLUTELY FREE.**

Name.....

Address.....

City..... State.....

War Surplus — DYNAMOTORS

D-2 Converts to 110 V AC in ten minutes, diagram included, contains integral gear box having four 1/4" drive shafts turning simultaneously at the following speeds:
4000 RPM—Grinders, buffers, flexible shaft tools, etc. **150 RPM**—Wrapping fishing rods, slow speed tools.
25 RPM—Dev. tray rocker for photo darkroom.
5 RPM—Turning barbecue spits.

Adv. Disp. Beams. A Thousand Other Uses Around the Work Shop. **ONLY \$5.95**
Converted to 110 volts AC. **\$7.95**

D-1 Converts to 110 V AC in ten minutes, diagram included, has shaft with squirrel cage blower, also gear reducer with 2 shafts and pulleys at the other end. **1001 uses. New. \$4.95**

6 V MOTOR A real beauty, removed from aircraft. Type used for auto fan. Many uses. Ea. **\$1.50**

RM-29 PORTABLE FIELD TELEPHONE

An ideal portable field telephone. Complete in a rugged steel case for years of wear. Ringer circuit and TS-13 handset. 5"x6"x9". Simple two wire operation. 15 miles distance and upwards. Can be used for television installation. Intercom system. construction companies outside and inside work, etc. **13 lbs. As good as new, each. \$9.95 2 for \$18.95**
HEADSETS HS-23 and 33. Used. **.98c**
HS-30 NEW. **\$1.59**



All prices F.O.B. Chicago. 20% deposit required on all C.O.D. Orders. Write for free catalog.
NESCORP ELECTRONICS Dept. PS-11, 2635 W. Grand Ave. Chicago 12, Ill.

AMAZING PROFITS

From Your Workshop!



New, improved Home Craftsman Magazine brings you simple, step-by-step methods used by thousands of successful craftsmen who make their home workshop **pay BIG PROFITS**—At your fingertips, tested, proved methods, for making a "killing" even in tough times. Tells how to pick projects that sell fastest; how and where to sell. Shows how to actually have fun, yet earn money in spare time.

For the next two years we want to send you Home Craftsman Magazine to show you the hundreds of amazing plans and ideas. Best of all you take it on **FREE TRIAL**. Also Big Free book "How To Make Money With Your Workshop" yours to keep **absolutely Free** even if you decide not to continue taking each issue of the magazine—So what have you to lose—a 3c stamp? Hurry—Send \$3.00 (check or M.O.) as payment in full. If not truly delighted, return magazine and your money will be refunded in full.

The Home Craftsman Magazine, Dep't. S-12
115 Worth St. New York 13, N. Y.



You can be an "ALL-AROUND HE-MAN"

By **GEORGE F. JOWETT, World's Greatest Body Builder**

Now all 5 Famous Jowett Courses in 1 complete muscle building volume (valued at \$5 each) now only 10c as a friend-winning offer! Packed with How-to-Do-it pictures giving you Jowett's secrets on: 1. How to Mold a Mighty Arm—2. How to Mold a Mighty Chest—3. How to Mold a Mighty Back—4. How to Mold a Mighty Grip—5. How to Mold Mighty Legs. This "Progressive Power Method" must make you a Husky He-Man quickly, simply in 10 minutes a day at home—or your money back guaranteed. Send only 10c with name, address and age today!

Jowett Institute, Dept. PS-911, 230-5th Ave., NYC

ONLY 10c
and photo book of strong men
FREE!

Give him a
"Bulls-Eye"



Noiseless • Harmless • Accurate INDOOR TARGET PISTOL

A perfect gift for fun and serious target practice. America's favorite for 25 years. Harmless, extremely accurate. Brilliant nicked steel, automatic size, repeater action, target sights. Complete target set included for home entertainment and serious target practice. Send check or money order. Postpaid. **\$5**

BULLS-EYE MFG. CORP., Fay Ave., La Jolla, Calif.

SECRETS OF MENTAL POWER CAN BE YOURS

You have heard of the power of the mystics of the East—you wonder HOW? WHY? "WHAT have they got that I haven't got?" That power is **KNOWLEDGE**. The knowledge and assurance that the human mind is all powerful. You have the same power, it *needs only training*.

YOU have the ability to realize your every good desire. You have the power to command respect—you only need be shown how. Why let others get the good jobs, the big commisions, while you stand aside? The power to succeed is yours. Learn how to use it. Write now for **FREE** personality chart and full details of our plan for your success.

SELF-HELP FOUNDATION, Desk 111, 746 S. Lake St., Los Angeles 5, California



LEARN MOVIE PROJECTION THEATRE MANAGEMENT

The Motion Picture Theatre Business offers big opportunities for trained men. Get into a fascinating field with a promising future. Train at home in spare time. Free Catalog. Established 22 years.

THEATRE INSTITUTE, 385 Washington St., Elmira, New York

CARPENTERS SAVE MONEY HOBBYISTS SAVE MONEY ON REPAIRS & MAINTENANCE OF SAWS AND LEVELS

Stop damaging your saws and levels. Keep them at your fingertips by using a Caldwell **AUTOMATIC Tool Hanger**. Permits you to hang your tools on any porous surface, anywhere. Works on roofs, vertical surfaces, etc. No more dulled or bent saws, broken levels, when this amazing unit is installed in handles.

Precision constructed of machined finest aluminum. Complete with simple illustrated instruction for quick installation. Easily pays for itself. Patented. Every hobbyist needs one. Carpenters, cabinet makers can use several. Sent postpaid, anywhere for \$1.00. Adaptable to many tools, uses. Get yours today. Ideal gift. Simply send \$1 to

BRUCE ENTERPRISES, Dept. H, P. O. Box 235, North Hollywood, Cal.

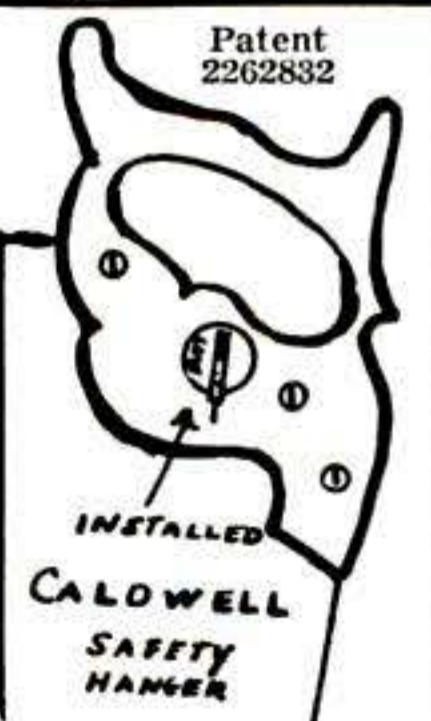

Patent
2262832

INSTALLED
CALDWELL
SAFETY
HANGER

This mammoth bridge is made entirely of Erector girders. So strong it can support 200-lb. man.



Made of **STEEL** to Build like **REAL**

World's greatest construction toy
Developed at the Gilbert
Hall of Science

ERECTOR®

"Real engineering" nuts and bolts lock Erector parts firmly together.

Other Erector features—curved, straight and giant structural girders. Base plates in 7 sizes and shapes. Electro-magnet. Wheels, radiator, axles and other automotive parts. Total of over 135 different parts.

Dazzling Merry-Go-Round. Whirls round and round. Horses go up and down. Built with No. 10½ Erector and up.

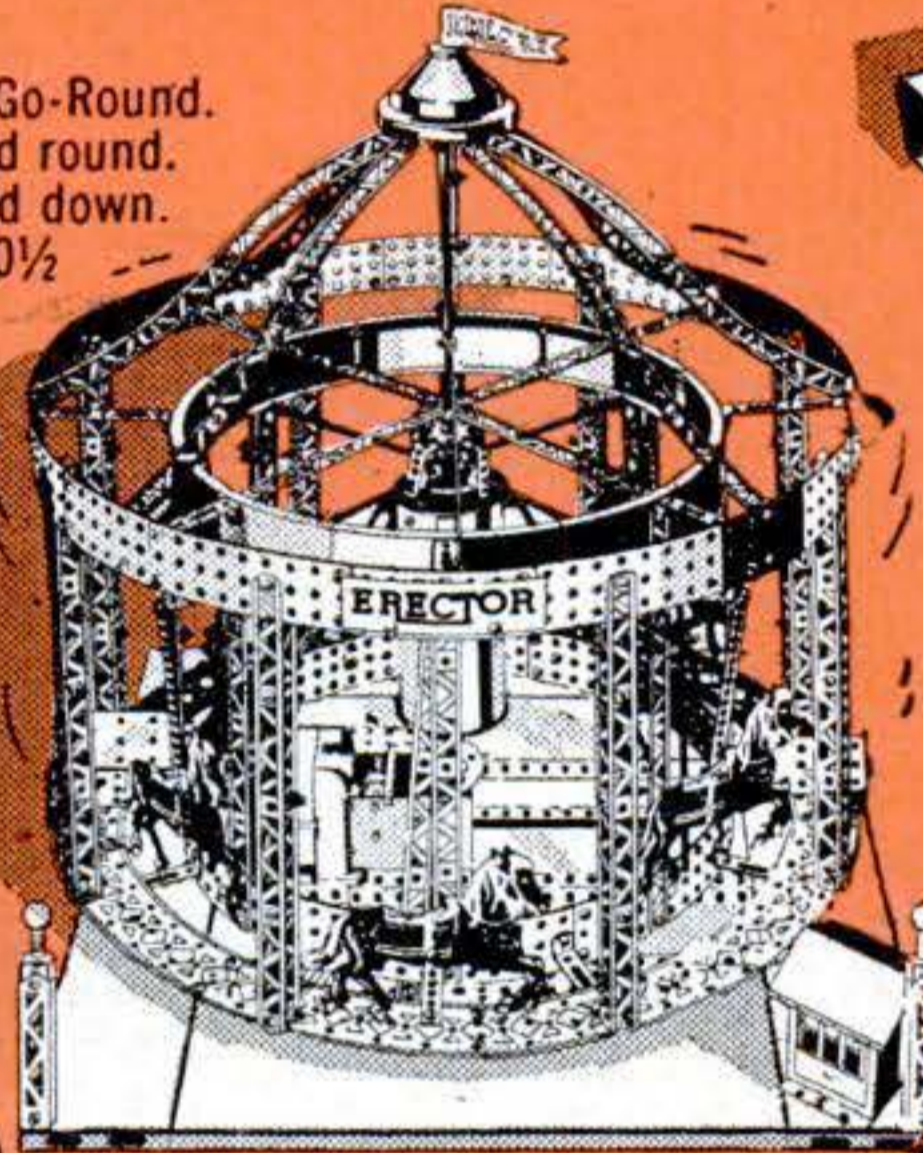

Famous square girder with interlocking edges—built only with Erector.

Powered by famous Gilbert Electric Motor.

Exciting airplane ride. Revolves at dizzy speed. Built with No. 6½ Erector and up.

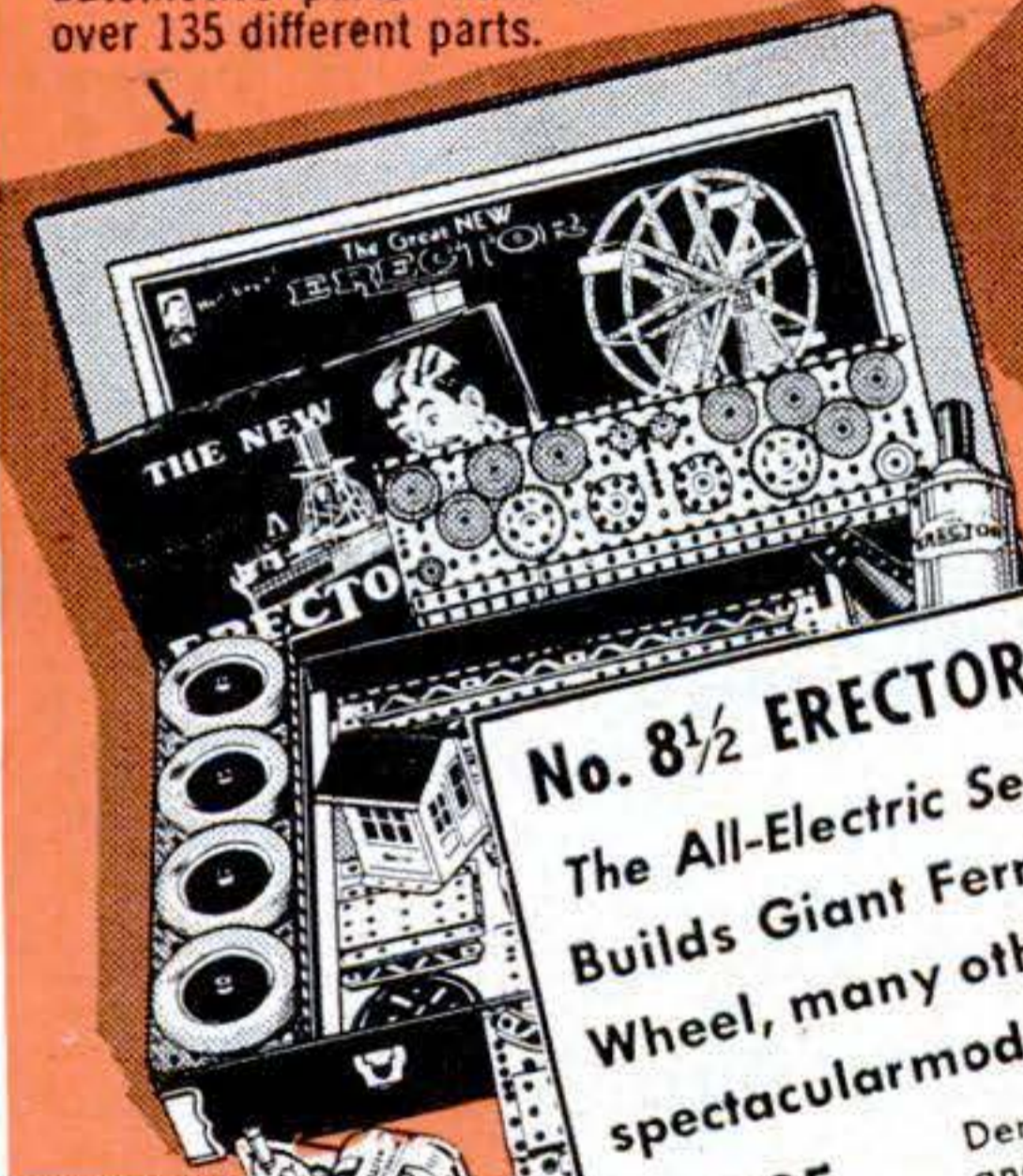
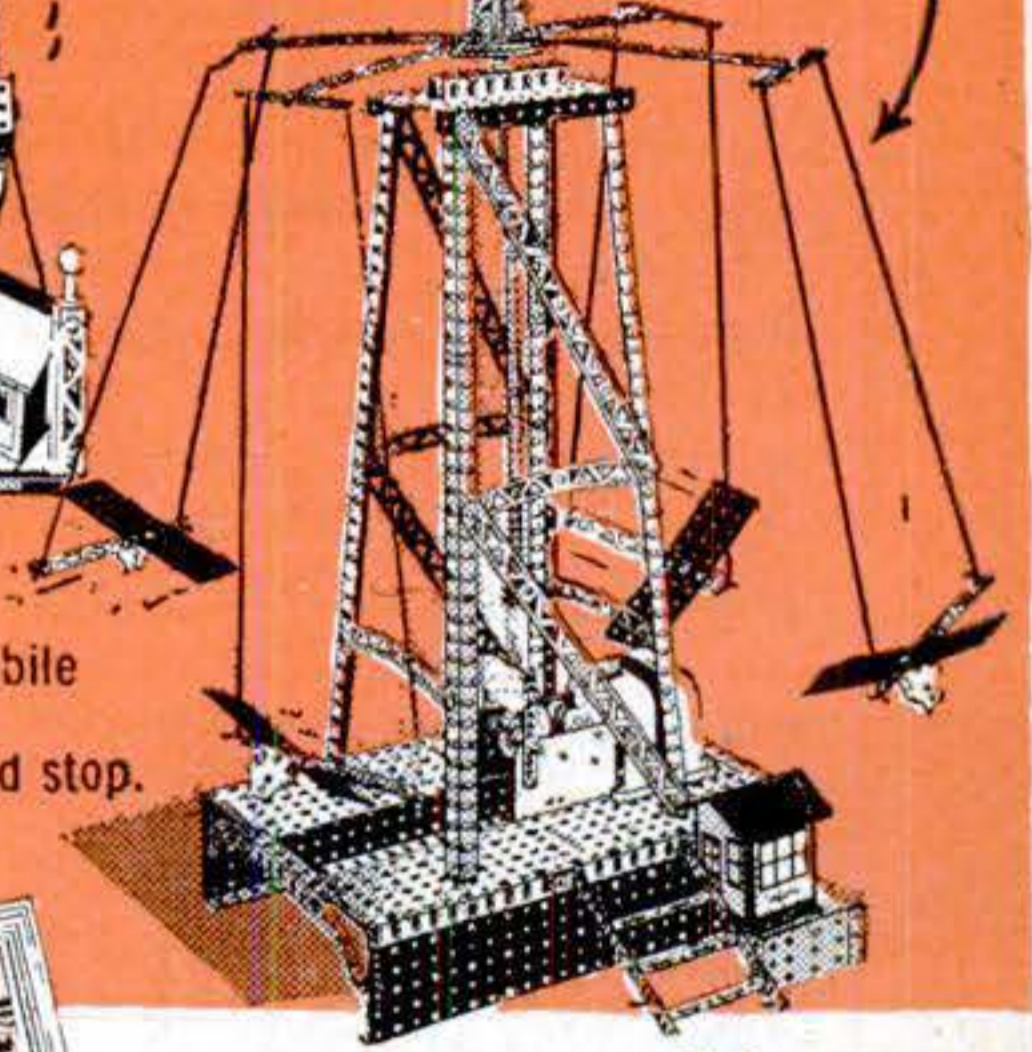

No. 8½ ERECTOR
The All-Electric Set Builds Giant Ferris Wheel, many other spectacular models.
\$19.95 Denver and west \$20.95

Electric lights. Can be installed to blink or revolve.

Gilbert Electric engine with automobile type gear shift for forward, reverse and stop.



HELLO BOYS! ERECTOR GIVES YOU MOST OF EVERYTHING!



FREE — Big
"Fun and Thrills" book combined with giant American Flyer Train Book.
40 large pages.
Over 100 color pictures.

**Most fun—most different parts—
most action—most realistic models**

Look at these spectacular Erector models. You build them yourself. Piece by piece—with your own hands—you fit gleaming girders, gears and other exciting parts together—see them grow into gigantic engineering marvels. Then hook up the powerful Erector electric engine—with amazing new Flex-O-Matic Drive—and make your models buzz with action. You can build hundreds of realistic models with one Erector set. Tell Dad you want a genuine Erector. Prices start at \$1.75. Denver and west, \$1.85.

125 Erector Awards worth over \$2,000.00. Win an R.C.A. Television Set, movie camera outfit or other big awards for building original Erector models. Mail coupon for details.

Shows all Erectors and tells how to win Television Set or other thrilling Erector Awards. Also contains pictures and descriptions of all American Flyer trains and equipment. Mail coupon today.

Gilbert Hall of Science
118 Erector Square, New Haven, Conn.
RUSH "FUN AND THRILLS" BOOK—FREE

.....
NAME
.....
STREET
.....
CITY STATE

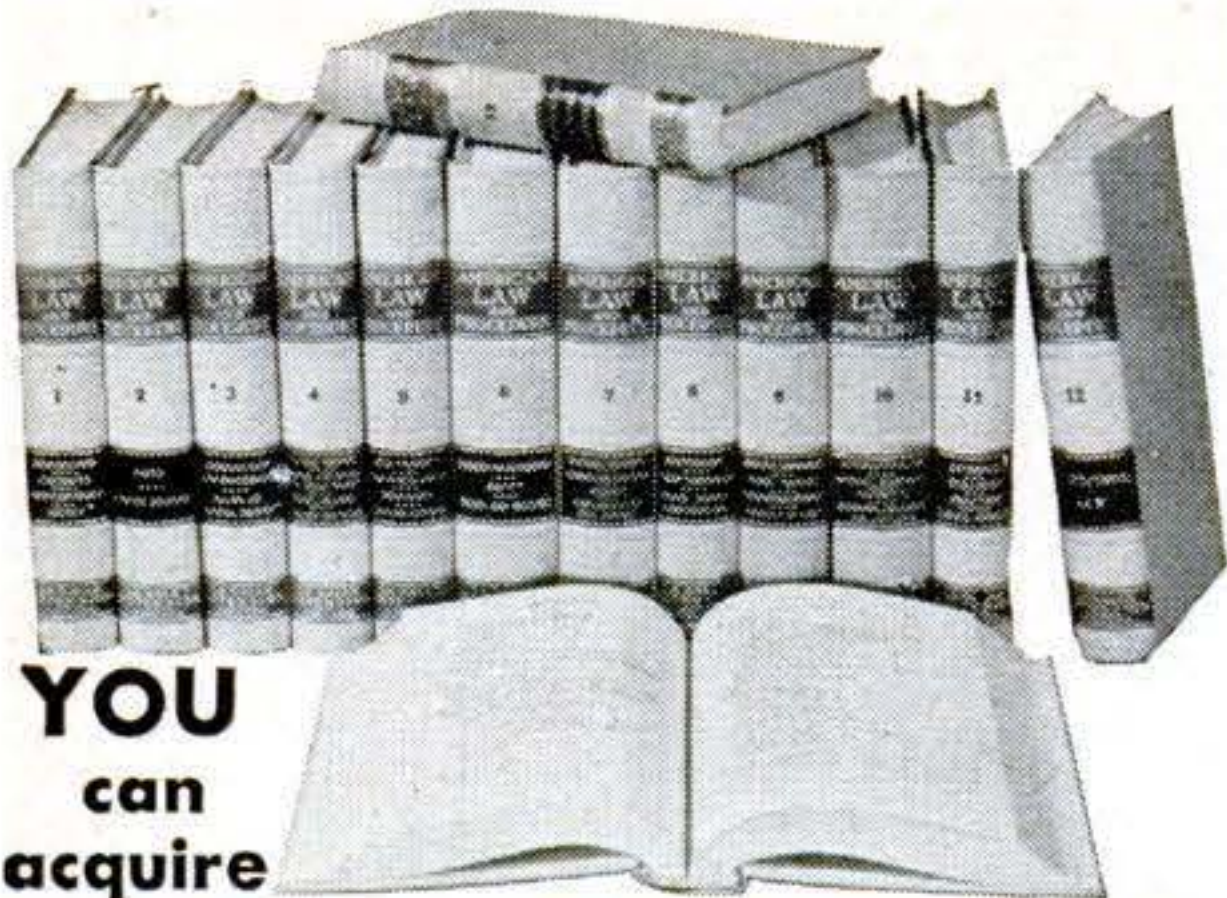

**YOU
can
acquire**

LAW NIGHTS AT HOME! L L.B. DEGREE

LaSalle's famous Law Library—used as reference in many Law libraries and Law offices—has enabled thousands to master Law surprisingly fast, in spare hours at home, for business and professional advancement.

These 14 remarkable volumes, compiled by leading professors and lawyers, cover the whole basic field of Law in condensed, orderly, simplified manner.

You advance rapidly with this great library, plus special lectures furnished. We guide you step-by-step with personalized Problem Method of instruction . . . you *learn by doing*—handling legal problems—not by memorizing rules.

Send for two FREE 48-page booklets, "Law Training for Leadership," and "Evidence," answering questions about Law and its value to you, and telling how LaSalle Law graduates are winning rapid advancement in business and public life. Mail coupon below. No obligation.

LA SALLE EXTENSION UNIVERSITY

A Correspondence Institution

417 S. Dearborn St. Dept. 1183-L Chicago 5, ILL.

Send me your two FREE booklets described above, without obligation.

Name.....Age.....

Street.....

City, Zone & State.....

**FULLY
GUARANTEED
TIRES COST LESS!**



Nationally famous FIRE-STONE, GOODRICH, U.S. ROYAL, GOODYEAR, and other makes. Trucking Fleets, Busses, Hospitals and Schools buy from PYRAMID with confidence. Every tire selected and inspected for your safety.

NEW TREAD SNOW TIRES

Designed for winter service in snow or mud. NO CHAINS NECESSARY.

600x16	8.95	670x15	9.95
650x16	9.95	710x15	10.45
650x15	9.95	760x15	10.95
700x15	10.95	820x15	11.95

Reg. Treads—Tube Given FREE with Every Tire—10% Disc. to Vets

550x16	3.48	700x15	3.69	700x20	8.98	34x7(10)	9.48
600x16	3.48	700x16	4.98	32x6(8)	8.98	825x20	11.45
650x16	3.59	750x16	6.48	32x6(10)	10.89	900x20	11.60
650x15	3.59	600x20	7.68	750x20(8)	8.09	1000x20	12.59

Reg. Treads—AAA Premium Grade—Guaranteed to Give Longer Service							
600x16	5.19	700x16	6.19	700x20	10.89	34x7(10)	12.98
650x16	5.19	750x16	7.59	32x6(8)	10.69	825x20	14.68
650x15	5.09	600x16(6)	6.45	32x6(10)	12.48	900x20	14.98
700x15	5.29	650x16(6)	6.95	750x20(8)	10.68	1000x20	15.98
820x15	6.98	900x16	8.89	1100x20	13.98	1000x22	17.59



MILITARY "ALL-PURPOSE" TREADS
 900x16 8.65 | 750x20 8.95 | 1100x20 16.95
 900x20 13.95 | 1000x20 14.95 | 1400x20 22.95
 600x16 MILITARY "NEW TREAD" TIRES 7.95
 750x20 MILITARY "NEW TREAD" TIRES 19.45

Largest stock of used tires in the East. Thousands of satisfied customers. Tires shipped to all parts of the world. Mail orders given personal attention.
SEND MONEY ORDER OR CHECK WITH ORDER.

PYRAMID TIRE CO.
 1333-35 North 5th St.
 Dept. S, Phila. 22, Pa.

NEW! BIG FIELD FOR PROFIT AND PLEASURE COPPER TOOLING & ETCHING



No Experience Needed

DO IT AT HOME

At last a way to get in on the **Big Money** made every day in Copper Art. You make plaques—Bowls—Trays—Gifts—Souvenirs of all kinds. Art talent not necessary. Our New Method makes it easy to learn. **Big Markets waiting.** Anyone can learn quickly—you start **making money** right from the start. Don't miss this opportunity to cash in at once on this big-paying easy to operate business. Be your own boss. **SEND NO MONEY—Act Now** to get all the free details—just send your name on a penny postcard today—**Do it Now!** Write Today—Money-Back Guarantee.

**HOLLYWOOD COPPER ART STUDIOS, Dept. PS-11
 4257 BEVERLY BLVD., LOS ANGELES 4, CALIF.**

Locksmithing & Keymaking

PRACTICAL HOME TRAINING OUTFIT INCLUDES EVERYTHING NECESSARY TO GET STARTED IN YOUR OWN BUSINESS

Excellent full or part time earning opportunities. Professional outfit includes supplies, tools, key cutting machine. Get practical training from Master Locksmiths on house locks, auto locks, padlocks, etc. Learn to cut keys by code, master locks, change combinations, quickly identify key blanks, many profitable "tricks of the trade." Booklet of Information FREE. Write today.

**UNITED SUPPLY & SERVICE
 3327 Madison St., Dept. PS-11 Chicago, Illinois**

Print Your Own

Cards, stationery, circulars, tags, labels, photo and movie titles, advertising, etc. Save money. **Print for Others, Good Profit!** easy rules sent. Raised Printing like Engraving, too. Send dime for press samples, supply book, all details and advice on your needs. No obligation. **KELSEY INC., B-33, Meriden, Conn.**

HEY GUYS - LOOK!

**THE FINEST SLING-SHOT MADE!
 STURDY—POWERFUL—ACCURATE**

Here it is—the sling-shot with the punch and killing power of a .22 cal. rifle. Heavy aluminum yoke. Slings are tough, powerful, red-tempered rubber. Chrome cured leather thongs. 6 extra slings, 2 extra thongs included. When ordering ask for details special offer.

only 49¢ postpaid

Sling-Shot Co., Box 1029-PS, Pittsburg, Calif.

BUILD YOUR OWN ENLARGER

Enjoy Photography's most fascinating hobby at a fraction of usual cost. With simple step-by-step instructions and diagrams plus a screwdriver and pliers you assemble your own Enlarger and Save! Get all features of more expensive Enlargers: precision machined aluminum alloy castings, 90° tilt for wall projection of prints, spherical aluminum lamp-house, helical rack and pinion focusing with extra large knobs, unconditional guarantee. For 35mm to 2 1/4 x 3 1/4 negatives. Time payment plan.

Write Today for Free Illustrated Folder

CALIFORNIA TECHNICAL PRODUCTS CO.
 448 S. Hill, Dept. K-11, Los Angeles 13, Calif.

THE New VISE-GRIP WRENCH

Does jobs no other tool can do. Double-lever action **LOCKS** jaws with tremendous grip—quickly adjusts to non-locking action. New Involute Jaw Curve holds all shapes—nuts, rounds, irregular shapes, with unbelievable ease. Has Knurled Jaw Tips, Thin Nose and Super Wire Cutter. With cutter—No. 7W, 7-in., \$2.25; No. 10W, 10-in., \$2.50. Without cutter—No. 7C, 7-in., \$1.85; No. 10C, 10-in., \$2.25. If not at your dealers, order direct.

PETERSEN MFG. CO. Dept. E-11 DeWitt, Nebr.

Worth Big Money To: Mechanics, Handymen, Garagemen, Farmers, Repair Men, Service Station Operators, Taxi Owners.

NOW ANY Auto Repair Job IS A "Cinch" for YOU!



"MoToR's Manual paid for itself on the first 2 jobs and saved me valuable time eliminating guesswork."—W. SCHROP, Ohio

MoToR's BRAND-NEW 1949 Edition AUTO REPAIR MANUAL is Showing Thousands of Men How to Handle ANY Job on ANY Car—Faster and Easier! Now Let It Go to Work For You!

WITH MoToR's amazing brand-new AUTO REPAIR MANUAL you can whiz through ANY job—in LESS time, and with LESS work! Just look up make, model, and job—and go to it! With this easy-to-follow book, any job—from radiator to rear end—becomes a pushover for you!

"EVERYTHING You Need to Know about EVERY Make and Model Car Since 1935!"

MoToR's Manual brings you the complete "dope" from over 150 Official Factory Shop Manuals, boiled down in simple easy-to-read and understand words and 2100 big clear pictures. Over 200,000 service, repair, tune-up facts on all standard makes and models built from 1935 thru 1949! 35,000 essential dimensions and specifications. 795 big 8½ x 11-inch pages. Used by the U. S. Army and Navy technical schools! No wonder thousands of auto repairmen call it their auto "Bible"!

Win Prestige! Earn More Money!

MoToR's Manual makes every operation so easy that you'll find yourself tackling jobs you wouldn't think of doing before. And you'll win added prestige and more money in the bargain.

Beginners will find usable, helpful guidance on every kind of repair and service job imaginable. Experts will be amazed by time and labor-saving short cuts they'll discover.

Used by U. S. Army and Navy

COVERS ANY CAR BUILT SINCE 1935!

- | | |
|------------|---------|
| Auburn | Cord |
| Austin | Crosley |
| Buick | De Soto |
| Cadillac | Dodge |
| Chevrolet | Ford |
| Chrysler | Frazer |
| Graham | |
| Hudson | |
| Hupmobile | |
| Kaiser | |
| Lafayette | |
| La Salle | |
| Lincoln | |
| Mercury | |
| Nash | |
| Oldsmobile | |
| Packard | |
| Pierce | |
| Arrow | |
| Plymouth | |
| Pontiac | |
| Reo | |
| Studebaker | |
| Terraplane | |
| Willys | |

ABOVE: Showing operation of Buick Dyna-Flow — and BELOW: How to adjust Ford Clutch. Every moving part is covered in simple words and BIG, CLEAR Pictures.

Same FREE Offer on MoToR's TRUCK MANUAL

Covers EVERY job on EVERY truck made from 1936 thru 1946! 1400 pictures, 952 pages, 300,000 facts. All types Gasoline Engines, Truck Diesels, Hesselmanns, Fuel Systems, Governors, Lubrication, Ignition, Starters, Clutches, Axles, Brakes, etc., etc.

ALSO covers many buses, tractors, contractor and road building equipment, stationary power machinery. Check box in coupon.



FREE TRIAL

SEND NO MONEY

Find out for yourself—without risking a cent—how this book pays for itself the first few times you use it. Mail the coupon without money. Try it out—FREE—for 7 days. Then if not convinced it's the greatest time-saver and work-saver you ever saw, return the book and pay nothing. MoToR Book Dept., Desk 211, 250 W. 55 Street, New York 19, N. Y.

Published by MoToR. The Leading Automotive Business Magazine



MAIL COUPON NOW FOR 7-DAY FREE TRIAL

MoToR BOOK DEPT.
Desk 211, 250 W. 55th St., New York 19, N. Y.

Rush to me at once (check box opposite book you want):
 MoToR's New AUTO REPAIR MANUAL. If O.K., I will remit \$1 in 7 days (plus 35c delivery charges), \$2 monthly for 2 months and a final payment of 95c one month after that. Otherwise I will return the book postpaid in 7 days. (Foreign price, remit \$8 cash with order.)
 MoToR's TRUCK REPAIR MANUAL. (Described at left.) If O.K., I will remit \$2 in 7 days, and \$2 monthly for 3 months, plus 35c delivery charges with final payment. Otherwise I will return book postpaid in 7 days. (Foreign price, remit \$10 cash with order.)

Print Name Age.....

Print Address

City..... State.....

Check box and save 35c delivery charge by enclosing WITH coupon entire payment of \$5.95 for Auto Repair Manual (or \$8 for Truck Repair Manual). Same 7-day return-refund privilege applies.

IT'S FUN TO LEARN A LANGUAGE By LINGUAPHONE



You learn through natural everyday conversation . . . with effortless ease and real pleasure. First you LISTEN and in an amazingly short time you SPEAK, with correct accent and the right swing.

In your own home you can study alone in privacy or have wife and children or friends join you in a delightful pastime that is an asset in a career, business, profession and for cultural enjoyment.

It will take you only 30 minutes a day to master any of 29 important languages the Linguaphone Way.

SPANISH **FRENCH**
PORTUGUESE **GERMAN**
ITALIAN **RUSSIAN**

or 23 other languages

Linguaphone courses were made astonishingly simple, easy and practical by more than 150 expert linguists of international fame. Endorsed by educators, used by colleges, schools and the choice of more than one million home-study students.

-----SEND FOR FREE BOOK-----
LINGUAPHONE INSTITUTE,
95 RCA Bldg., New York 20, N. Y.

Send me the FREE Linguaphone Book.
I want to learn.....language.
Name.....
Address.....City.....

FAST PUSH-BUTTON POWER CAR!
ALL ELECTRIC **REMOTE CONTROL**
1951 AUTO SENSATION!

- Driven By Powerful Remote Control
- Powered with Electric Mini-Motor
- Latest All Electric Marvel
- Balloon-type Rubber Tires

Push the Button!
IT STARTS! REVERSES! STOPS! STEERS!

Imagine only **\$3.49** COMPLETE!

The greatest new electrical toy since the electric trains. REMOTE CAR is a thrillingly realistic scale model, made of colorful shining plastic. It runs and steers by remote control—no wind-up or friction motor, but an ALL-ELECTRIC PRECISION-MADE MOTOR, powered by 2 long lasting flashlight batteries. Push the magic rheostat button, and you really make things happen. Here's real action to fascinate every child, and daddy too. RUSH YOUR ORDER TODAY! SEND NO MONEY! Remit with order and we pay postage, or C.O.D. plus postage.

NOVELTY MART • 59 East 8th Street, Dept. 417, New York 3, N. Y.

FREE!! HOW TO MAKE BIG MONEY

METALIZING BABY SHOES AND OTHER PRECIOUS KEEPSAKES AT HOME

FREE FACTS SHOW HOW TO MAKE \$5 PER HOUR, UP TO \$25—\$50 PER DAY. START EARNING AT ONCE. YOUR OWN BIG PAY BUSINESS STARTED AT HOME ON A SHOESTRING. DON'T PASS THIS UP. WRITE FOR FREE DETAILS TODAY!

KIKTAVI CO.

2111 W. MANCHESTER, LOS ANGELES 47, DEPT. PS-11



CORRESPONDENCE COURSES IN RADIO and ELECTRICAL ENGINEERING

Tuition \$25

ELECTRICAL ENGINEERING. Get good grasp of wide electrical field. Modern. Very understandable. Theory made easy. **RADIO ENGINEERING.** Extra fine course in radio, public address, photo-electric work. Trains you to be super-service man, real vacuum tube technician. Tuition ONLY \$25, either course. Deferred payment plan. Servicemen needed badly.

FREE Write for free copies of school catalogs, student magazines, etc.
LINCOLN ENGINEERING SCHOOL, Box 931-S-11, Lincoln, Nebr.

it's fun to earn RAISING HAMSTERS

Cash in on the growing demand for SYRIAN GOLDEN HAMSTERS recently introduced into the U. S. Ideal pets . . . big laboratory demand. Hardy, clean, odorless. Easily and profitably raised anywhere.



AKOPIAN HAMSTERY
the largest in the West write for FREE il-
7358-BC Varna • Van Nuys, Calif. illustrated booklet

Write your name

IN BEAUTIFUL GOLDEN RAYS LETTERS THAT LOOK AND FEEL LIKE EXPENSIVE ENGRAVING

Write your name in Gold, Silver, Copper on Christmas Cards, Christmas Gifts, Stationery, Books, etc. Secret Golden Ray Process. Amazing—looks like most expensive engraving. Simple to do. Make spare Xmas money engraving for friends. Complete kit sent post-paid. Only \$1. Satisfaction guaranteed. Order today. Excellent gift.
WEST COAST TRADING CO., 1204 Russ Bldg., San Francisco 4, Calif.

WATCHMAKING

Be a Watchmaker—Be Independent

Get practical training at the only school in Chicago, accredited by the Horological Institute of America and U.H.A.A. Day and Evening Classes—Approved for Veterans

Write today for free information

CHICAGO INSTITUTE OF WATCHMAKING

6 East Lake Street Dept. PS-11 Chicago, Illinois

FOAM RUBBER

For Experimenters, Home Craftsmen, Hobbyists

16 x 16 x 1 1/2".....ea.	\$1.25	AUTO SEAT TOPPER PADS
16 x 22 x 1 1/2".....ea.	1.55	Place on seat cushion and cover with your seat cover.
18 x 24 x 2".....ea.	2.00	24" x 60" x 1 1/2".....ea.
24 x 24 x 2".....ea.	2.75	24" x 60" x 2 1/4".....ea.

Use for furniture cushion fillers, mattresses, Mattress pads, cushions. Foam Rubber is available in any size or thickness. Send For Free Price List. Immediate delivery. No C.O.D.'s.

RIOR RUBBER COMPANY, Dept. S-2
50 East 22nd St. Chicago 16, Ill.

GET INTO

DIESEL-AUTO

MECHANICS *Master All Phases*

JOBS LIKE THESE ARE AVAILABLE TO TRAINED MECHANICS. CHOOSE THE FIELD YOU LIKE BEST

Get Complete Training

Diesel Fuel Injection
 Automotive Motor Tune-up
 Diesel Engine Rebuilding
 General Garage Mechanic
 Agricultural Implements
 Auto Engine Rebuilding
 Auto Elec. Service
 Public Utilities
 Parts Dealers
 Bus & Truck Lines
 Industrial Maintenance
 Contracting & Excavating
 Business of Your Own
 AND MANY other similar openings.

As a National Schools graduate, you are trained for ALL opportunities in the Diesel & Auto Industries.

EARN WHILE YOU LEARN

With our practical Master Shop-Method Home Training, you study at home in your spare time. You receive Spare Time Work Lessons, which show you how to earn while you Learn... for extra money and experience. You Learn by DOING.

TOOLS AND EQUIPMENT

To make your training complete, we give you selected mechanic's tools and equipment, illustrated below, including all-metal tool-box — as a regular part of your instruction.



Shop-Method Home Training by an Established Resident School Prepares you for Many Good Jobs

Opportunity is everywhere for the trained Diesel - Auto Mechanic. Highways throng with cars, busses, trucks tractors. Garages and Service Stations are kept busy. Factories, ships, farms, railroads, general industry, are dependent upon engine power. Here's a dynamic, fast - growing field that needs trained men who know ALL phases: installation, operation, maintenance and repair. Now—National Schools offers you a practical, all-embracing Diesel-Auto Mechanic's Course, including all of these advantages:

Complete training, covering—Diesels, High Speed and Heavy Duty; Semi-Diesels, Gasoline and Special Fuel Engines AND Allied Mechanics.

- Basic Lesson Texts
- Diesel Installation
- Operation—Maintenance
- Diesel Chart Manual
- Spare Time Lessons
- Engine Service Manuals
- Engine Repair
- Drive Systems
- Diesel Electric Power
- Thermodynamics

TOOLS AND EQUIPMENT INVESTIGATE

Secure Full Information

NEW, ILLUSTRATED BOOK & SAMPLE LESSON SHOW HOW WE TRAIN YOU... SEND FOR THEM TODAY!

NO COST NO OBLIGATION

APPROVED FOR VETERANS

Check coupon below

WE GIVE YOU TOOLS OF YOUR TRADE

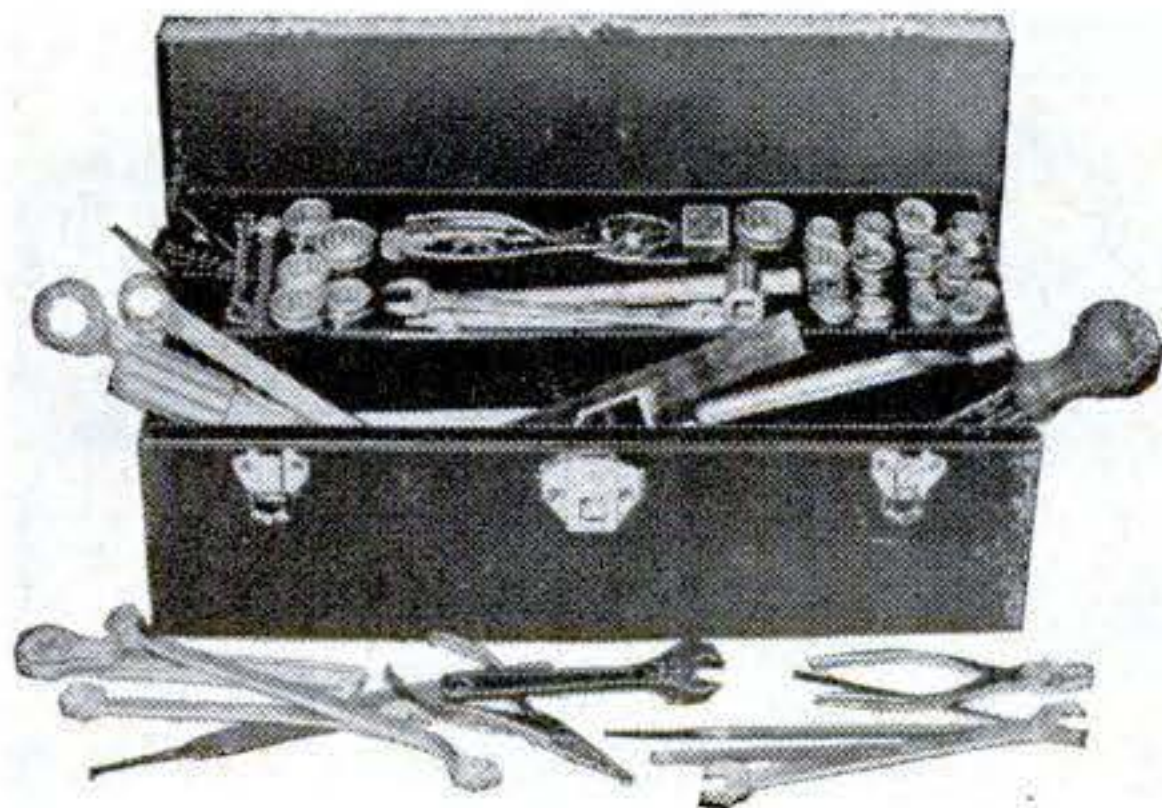

NATIONAL SCHOOLS

LOS ANGELES 37, CALIF. • EST. 1905



FIND OUT NOW... MAIL COUPON TODAY

NATIONAL SCHOOLS, Dept. 11—PSD
 4000 South Figueroa Street
 Los Angeles 37, California

(Mail in envelope or paste on penny postcard)

Mail me FREE the book, YOUR FUTURE IN DIESEL-AUTO MECHANICS, together with the Sample Lesson. I understand I may keep and use the information with no obligation.

Name..... Age.....

Address.....

City..... Zone..... State.....

Check here if Veteran of World War II

MEN! WOMEN!

There's a Well Paying Job Awaiting You in Aviation

Assure your future with a well paying job. Prepare yourself for a well paying career in the rapidly expanding Aviation Industry through training at Brayton—specialists in co-educational aviation training. The aviation industry recognizes the superiority of Brayton graduates. The demand for trained men and women exceeds the supply.

FOUR COURSES AT BRAYTON TO FIT YOUR NEEDS

Airplane & Engine Mechanics Course . . . 54-week course. Prepares you for your A & E certificate and qualifies you as a mechanic in the constantly expanding field of Aviation.

Base Operators & Maintenance Course . . . Prepares you for a career as a flying mechanic—trouble shooter—a flying salesman for a manufacturer of parts—or to operate a base. Flight training begins immediately.

Aeronautical Engineering . . . Upon successful completion of this course, you will be fully prepared to begin a promising and eventful career in Aeronautical Engineering. Flight training begins immediately.

Comprehensive Flight Courses . . . Practically any type of flight training is available—Private Pilot; Commercial Pilot; Instrument Flight; Multi-Engine; Flight Instructor; Airline Transport Pilot.

Aeronautical Training Division . . . Co-Educational

BRAYTON FLYING SERVICE, Inc.

11P Lambert-St. Louis Airport, St. Louis 21, Missouri

START NOW! The Aviation Industry Needs You
Send for **FREE** Catalog

AERONAUTICAL TRAINING DIVISION

Brayton Flying Service, Inc., Dept. 11P
Lambert-St. Louis Airport, St. Louis 21, Missouri

Yes, I am interested in Aviation as a career. Send me your illustrated catalog of available courses. I am particularly interested in:

- A & E Mechanics Course Aeronautical Engineering
 Base Operators & Maintenance Course Flight Training

Name.....

Address.....

City.....Zone.....State.....

My Age.....Male....Female....I am....am not.....a veteran.

YOU ARE IN DEMAND IF YOU CAN DRAW!

Make Money WITH YOUR
BRUSH and PEN

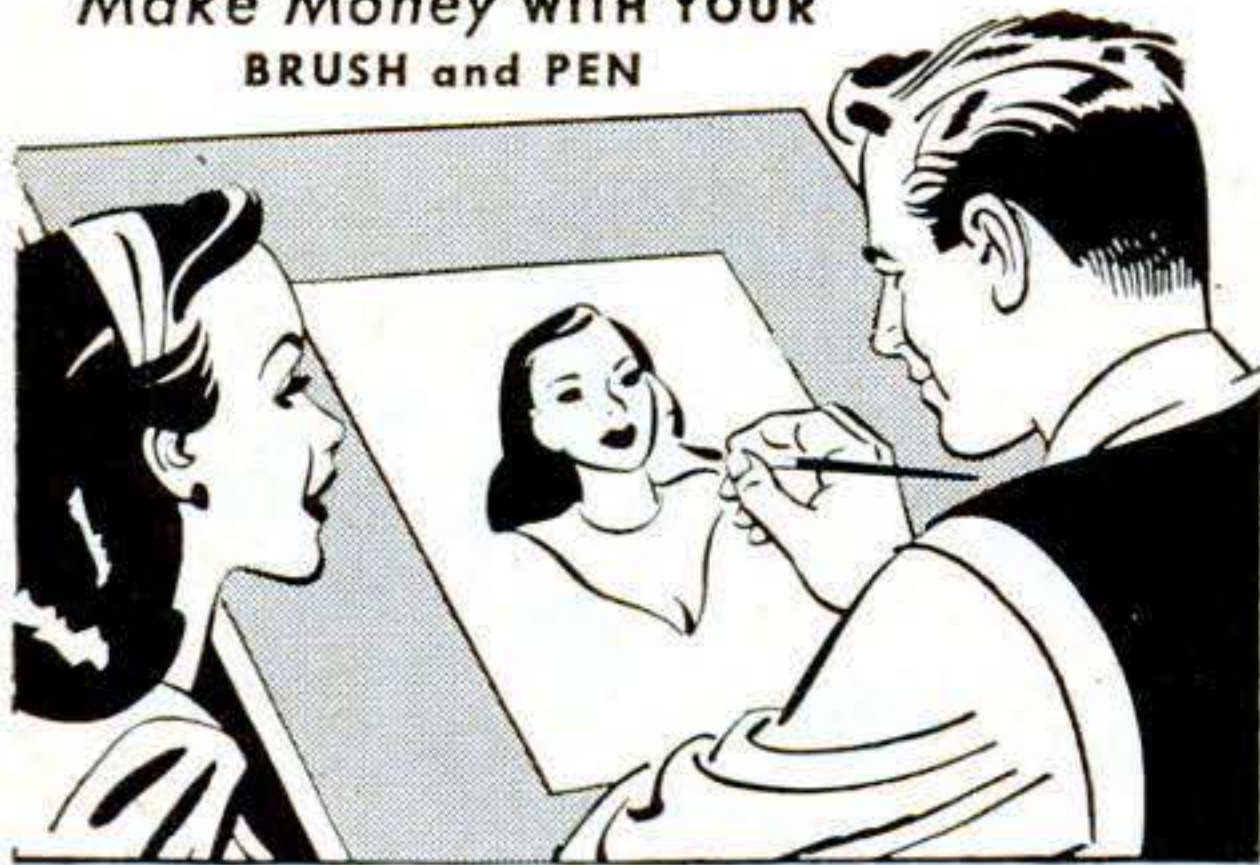

If you like to DRAW, SKETCH or PAINT,
write for TALENT TEST. No Fee!

ART INSTRUCTION, INC.

11149-C MINNEAPOLIS 15, MINNESOTA

Please send me your **FREE** Talent Test:

NAME _____ AGE _____

OCCUPATION _____ PHONE _____

ADDRESS _____ CITY _____

ZONE _____ COUNTY _____ STATE _____

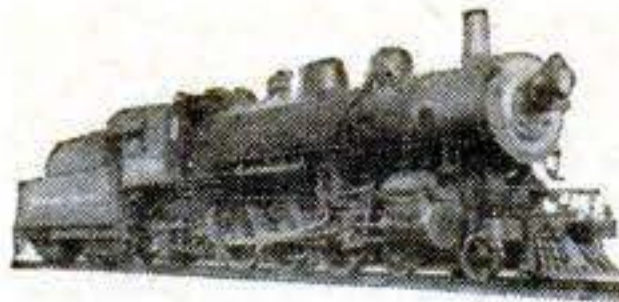

Is this real or a model?

Get the answer in this picture-packed book on Model Railroading only 10c

● Learn about the greatest of all hobbies. Model railroading is the hobby that fascinates hundreds of thousands of men all over the world.

This exciting book tells you that model railroading is simple, is inexpensive, and is constructive. Fully illustrated. Send 10c today for your copy of "Model Railroading for You," written by a well-known authority. The MODEL RAILROADER, DEPT. 1635, Milwaukee 3, Wis.



ENGINEERING BUILDING, DRAFTING, ETC.

Degree in 27 mos. Approved for G.I. Training. Prepare in Chicago, the Industrial Hub. Earn part living expenses. 45th year. Other shorter courses in Air Conditioning, Refrigeration, Radio, Electricity. Enter Jan., March, July, Sept.

Write for catalog

P-88 TECH BLDG., 2000 SO. MICHIGAN AVE., CHICAGO 16

"PLASTICS"

FABRICATING MANUAL AND CATALOGUE

Work in a fascinating and profitable hobby. Just out—our latest fabricating manual. Tells you how to work with Plastics. Our new Catalogue provides all needed materials: Plexiglas—Lucite—Tenite—Catalin—Acetate—all in sheets, rods, and tubes. Complete line of cements, dyes, accessories and supplies. Send 20c today for 1949 Catalogue and Handbook.

HOUSE OF PLASTICS

8648 Linwood Avenue Dept. MO 11 Detroit 6, Michigan

BE A NOTARY PUBLIC

Get paid for life for signing your name. Old legal-supply house, 22 cities, helps you get your appointment by governor if you qualify. No training needed, no course to study. As a public notary your signature is important; you certify legal papers by signing, get paid. Money intake grows as you become known. Like compound interest. Income steady for life. We equip you completely. Pay us after you are appointed—2 payments \$12.50 each. That's all. Details free.

STATIONERS EXCHANGE

Boerne 31, Texas

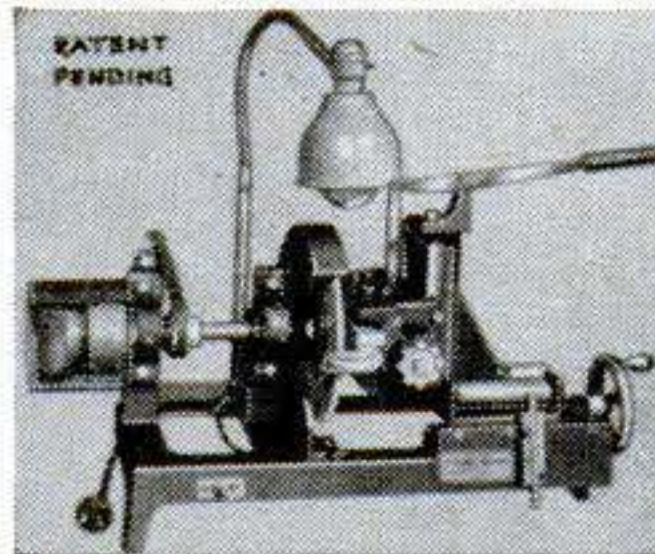

Start a NEW BUSINESS!

or Add to your present
Repair Business

SHARPEN DULL PIPE WRENCHES

PIPE TAPS & DIES
"GUM" CIRCULAR SAWS

Write for Information

J. C. MOORE INDUSTRIES

BOX S 276, Fredonia, Pa.



BUILD A MODEL OCEAN LINER THAT ACTUALLY RUNS

"24" QUEEN ELIZABETH"

Complete Kit with electric motor, propeller, universal, shafting, plans and instructions. Easy to build, fun to operate. **\$4.95**

Buy at your dealer or order direct.

SCIENTIFIC MODEL AIRPLANE CO.
216 Market St. Newark 2, N. J.

Let me send you this amazing- ELECTRONIC KIT!

OWN THIS ELECTRONIC KIT

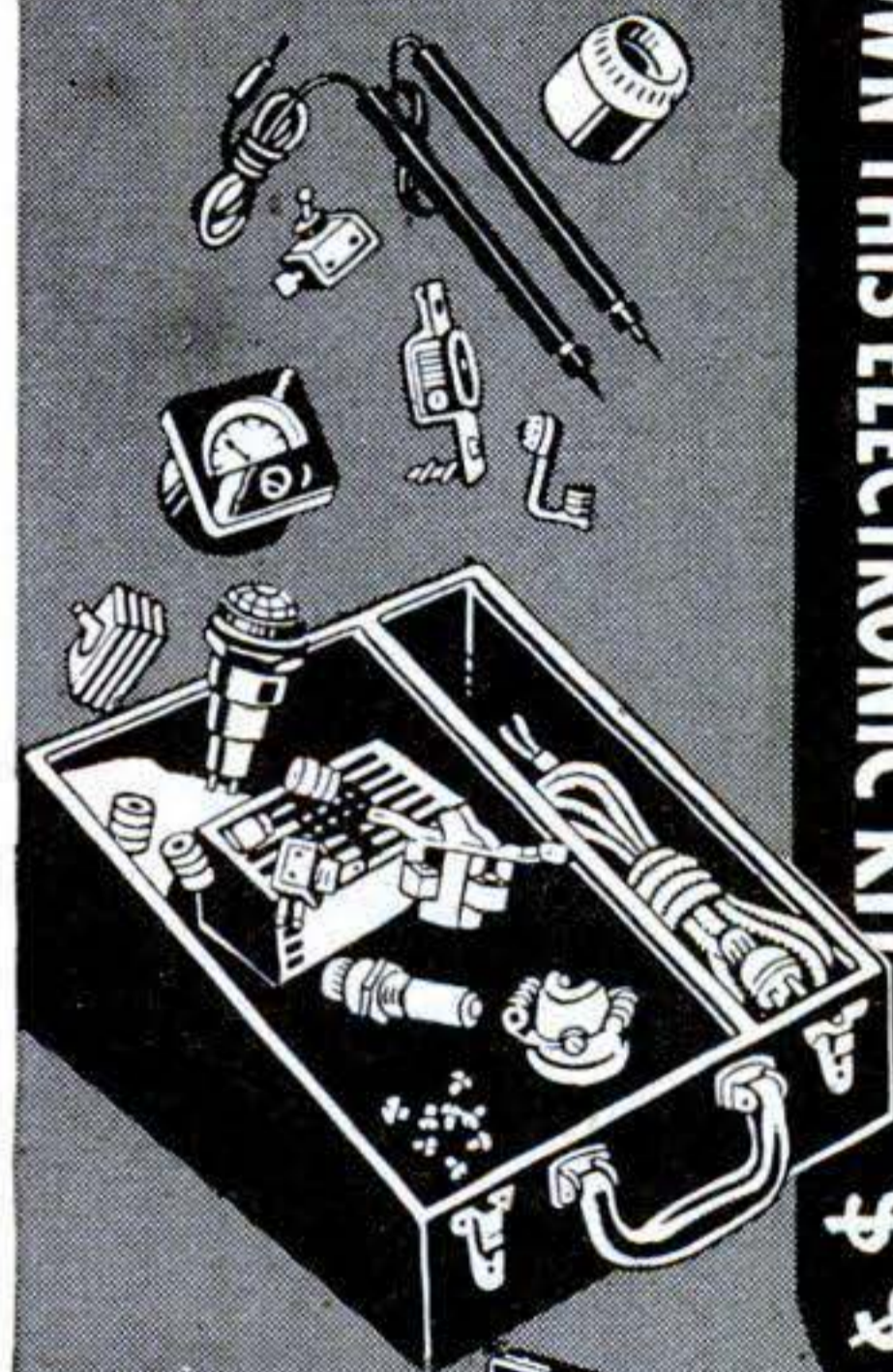

\$\$\$



GET IN ON THE BIG MONEY NOW! Assure Financial Security—Independence

Our Christy Electronic Kit checks and tests electrical equipment, current consumption, heat controls, shorts, motor winding, etc., and reveals where repairs are needed! Electrical appliance repairing is a fascinating, big money-making business. Millions of appliances now in daily use will eventually require repair. Thousands of new appliances sold daily in all parts of the country! These unlimited prospects mean you always will have places to do profitable jobs. If you are mechanically inclined (can hold and use tools), you can qualify for this big steady-paying field. It is not unusual for appliance repairmen to charge on the basis of \$5.00 to \$6.00 an hour! Whether you want a lifetime business of your own or a better job testing factory equipment or household appliances, you will want our Christy Electronic Kit.



S. T. Christensen

REPAIR ELECTRICAL EQUIPMENT!

ILLUSTRATED COURSE SHOWS EVERYTHING

Our Christy Electrical Appliance Repair Course is written in simple, easy-to-understand language. It is profusely illustrated with photographs and drawings. It shows you each and every step! What trouble to look for and then how to quickly fix it. In addition, our thorough course shows you how to build at low cost any power tools you may need! Should intricate technical problems arise or the need for a special repair part, simply call on us, for we offer YOU our FREE Advisory Service for LIFE! We teach you how to solicit business and how to keep business coming to you! Not a theory course, but a practical, honest-to-goodness course written by and used by repairmen all over the country. The combination of our Electronic Kit will go a long way toward ASSURING YOUR SUCCESS.

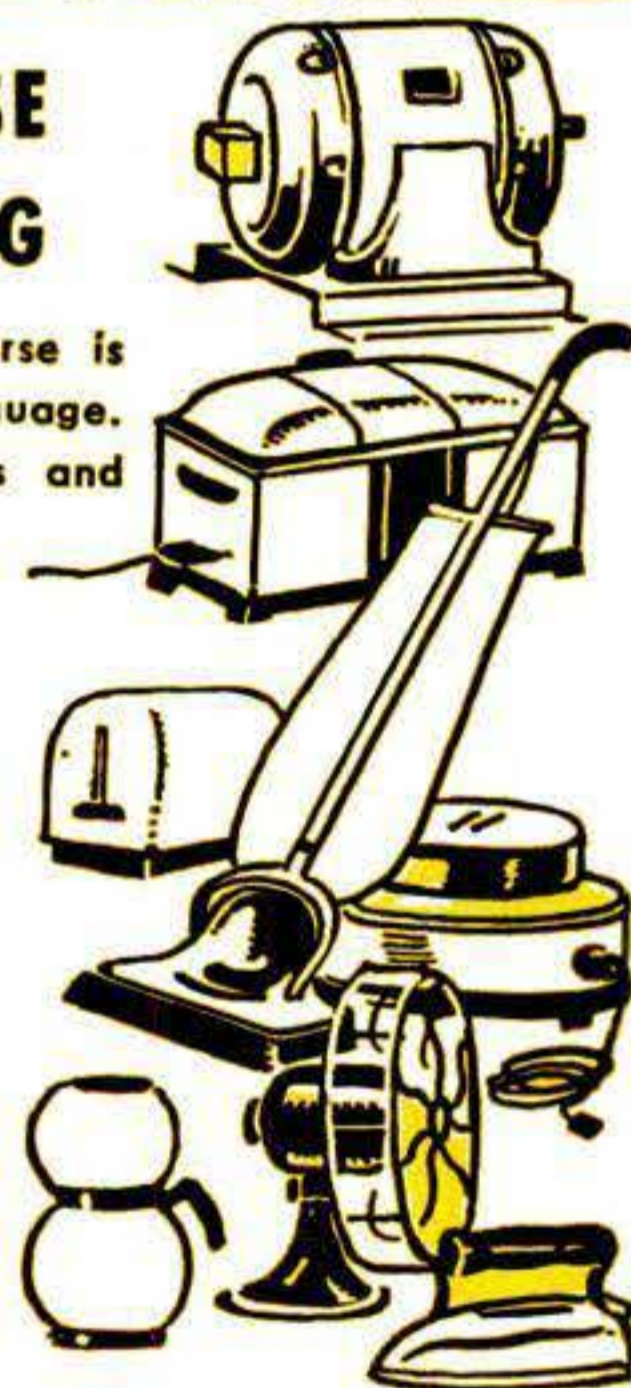

3 EASY STEPS TO SUCCESS

- 1 WE SEND YOU AN ELECTRIC KIT
- 2 WE TEACH YOU ELECTRICAL APPLIANCE REPAIRING
- 3 WE GIVE YOU LIFE-TIME ADVISORY SERVICE

RUSH THIS COUPON TODAY!

Christy Trade School, Dept. D-8301
4432 N. Kedzie Ave., Chicago 25, Ill.

Mail me FREE without obligation complete illustrated information on how to get the Christy Electronic Kit and Christy Appliance Course, and how I can pay for them with "Earnings Made While Learning" order blank.

Name.....Age.....

Address.....

City.....Zone.....State.....

INVENTORS

When you are satisfied that you have invented a matter of value—write me, without obligation, for full information as to what steps you should take to secure a Patent. The usual first step is to have a search of the prior U.S. Patents conducted, so that I can report to you on the question of Patentability.

PATRICK D. BEAVERS
(Formerly RANDOLPH & BEAVERS)
Registered Patent Attorney

937 Columbian Building, Washington 1, D. C.

PATRICK D. BEAVERS, Registered Patent Atty.
937 Columbian Bldg., Washington 1, D. C.

Please send me full information on how to secure Patents & Trademark Registration.

Name.....

Street.....

City.....State.....

SALESMEN!

10-Second
Demonstration
Nets You
\$9.95



Yes—Storekeepers now "Write with Light"—wipe off and write new sign—all in 10 seconds. Fastest seller in years. 10-second demonstration pays you \$9.95 cash in advance. Orders pour in HAND-OVER-FIST. Get started in your territory while "LITEWRITER" is brand new and hot as a pistol.

Litewriter "MAGIC CRAYON"
MAKES SIGNS THAT
GLOW LIKE BRILLIANT NEON!

Merchants everywhere—in small town and big city—all stare with amazement at this newest of all Fluorescent Sensations! They write on glass with "MAGIC CRAYON"—and Presto!—before their very eyes—there's a 5-color Advertising Message that glows like a brilliant Neon Sign!

FREE! Complete Sales Kit. Send name on penny postcard NOW for Big FREE Sales Kit and Free offer of Sample Demonstrator. No cost now or ever. Rush postcard now.

MAXILUME CO., 125 W. Hubbard St.
DEPT. L-911 CHICAGO 10, ILLINOIS

THE TONE YOU LOVE TO HEAR

REG. U.S. PAT. OFF.

HOLLYWOOD MUFFLER

GREATER SPEED, POWER, MILEAGE are yours with a Wilkinson Hollywood Muffler . . . plus a tone you'll love to hear. Improved design, precision made, electrically welded . . . outlasts ordinary mufflers 3 to 1. Low priced. Manufacturer's central location saves you freight.

DEALERS
WRITE

All Ford, Chevrolet, Plymouth \$5.00

All other cars \$6.00

(FOB Fort Wayne)

Order direct, or thru your dealer. Also Fender Skirts, \$10.95; Chrome Air Horns, Low as \$49.00; 3" Barker Tips, \$3.25.

TOM WILKINSON MUFFLER CO. 811 Wilt St.
Ft. Wayne, Ind.

INVENTORS

Whether an invention is patentable can be substantially determined by a search of the U. S. Patent records. Without obligation, write for information explaining the steps you should take to secure a patent.

JOHN N. RANDOLPH

Registered Patent Attorney

205 Columbian Building Washington 1, D. C.

PATENTS PATENT LAWYER

TRADE MARKS

GUSTAVE MILLER

119 PS WARNER BLDG.
WASHINGTON 4, D. C.

ASSOCIATE EXAMINER
U. S. PATENT OFFICE 1922-1929
PATENT ATTORNEY AND ADVISOR
U. S. NAVY DEPT. 1930-1947
REGISTERED PATENT ATTORNEY

Send for Form
"INVENTOR'S RECORD"

PATENTS

AND TRADE MARKS

C. A. SNOW & CO.

REGISTERED PATENT ATTORNEYS

WRITE FOR INFORMATION TO

246 SNOW BUILDING, WASHINGTON 1, D. C.

HELP FOR INVENTORS

Hundreds of manufacturers have requested our assistance in locating marketable new products.

Complete information, free.

INSTITUTE of AMERICAN INVENTORS
Dept. 3, 1926 Eye St. N.W., Washington 6, D. C.

INVENTORS

IF YOU WISH TO PROTECT YOUR INVENTION, You should take steps to protect it by a U. S. Patent. Write me for "Record of Invention" form.

CARL MILLER
REGISTERED PATENT ATTORNEY

Woolworth Bldg., 35th Floor, Dept. 110-C, New York City
Please send me "Record of Invention" form.

NAME.....

ADDRESS.....

Specialize in fields of opportunity

EVERY course of study at this school is geared to an expanding industry. Here the young man can secure practical, specialized training in various technical fields, plus a solid educational background in the basic sciences. The curricula keeps pace with technological developments and the demands of industry.

BUILD YOUR CAREER IN 6 TO 36 MONTHS . . .

Because of continuous year-round study, a B.S. Degree may be earned in 36 months. The unique concentric curriculum permits the student to pass step-by-step through a 6-month

service course and on to technician and professional levels. Each course is complete in itself and serves as a prerequisite for higher level study in the school.

To Help Plan Your Future . . . You are Invited to Request This Free 48-Page Pictorial Bulletin

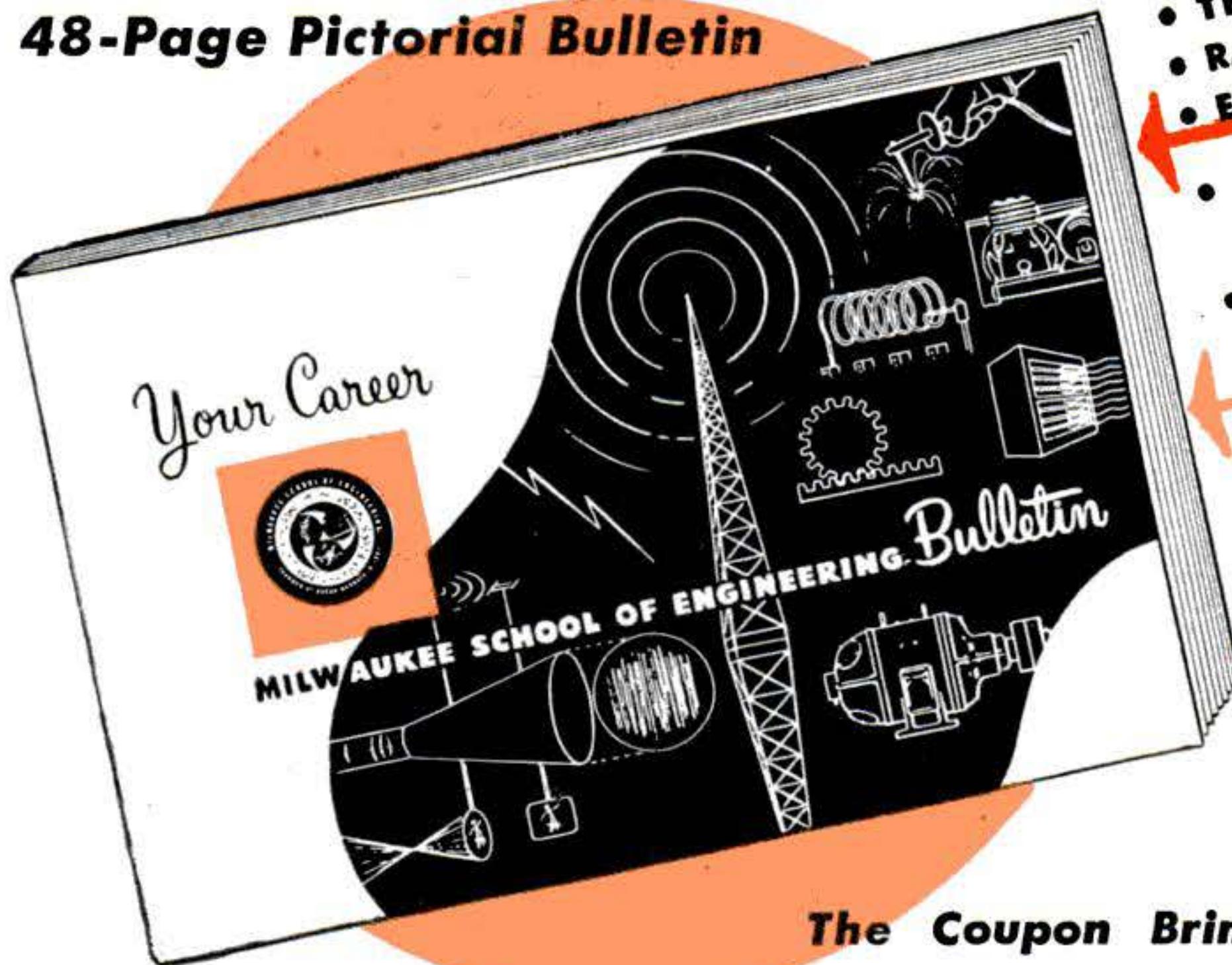

- TELEVISION
- RADIO
- ELECTRONICS
- ELECTRICAL POWER
- ELECTRICAL ENGINEERING
- AIR CONDITIONING
- REFRIGERATION
- HEATING
- WELDING
- METAL FABRICATION

The Coupon Brings You This . . .

The above new pictorial bulletin features 103 action photos of student life, fascinating experiments and well-equipped laboratories. Helpful data is featured on career opportunities in the above mentioned fields.



OVER 1500 STUDENTS are currently enrolled in this non-profit institution. Faculty of 85 specialists. Experts chosen from private business serve on advisory committees. The Board of Regents comprises leaders from commerce and industry. Over 35,000 former students.

ACCREDITATION: The National Council of Technical Schools approves the technician's curricula. Technician courses in the Institute of Electrotechnics are accredited by E.C.P.D. Certificates and degrees conferred by authority of the State of Wisconsin Charter.

MILWAUKEE SCHOOL OF ENGINEERING
 Founded 1903 by Oscar Werwath

Terms start
 January, April,
 July, September

MILWAUKEE SCHOOL OF ENGINEERING
 Dept. PS-1149, N. Broadway & E. State,
 Milwaukee, Wis.

Without obligation send me free bulletin "Your Career" and more details on course in

.....
 Send 110-Page Catalog
 NAME.....AGE.....
 ADDRESS.....
 CITY.....ZONE...STATE.....
 Check here if World War II Veteran

Surplus Bargains

ANTENNA REEL



\$3.30

Postpaid

New Electric Antenna Reel (RL-42) operates on 24 volts DC (will also operate slightly slower on 12 volts DC). Complete with one bobbin for winding wire, rope, etc. Price Now Only \$3.30 each Postpaid in continental U.S.A.

LIVE RUBBER SHOCK CORD

5/8" Diam. This cord contains approximately 500 strands of live rubber. May be used for boat snubbers, gymnastics, etc. Price only 5c per foot postpaid, minimum order \$1.

New Willard 2 Volt Battery Only \$1.25



Brand new, compact, spillproof built-in hydrometer, group several together to get higher voltages. Fully guaranteed. Shipped dry, add 35c to cover postage and handling.

No C.O.D.'s—Michigan Add 3%

N. SILVERSTINE CO.

6532 EAST McNICHOLS ROAD DETROIT 12, MICHIGAN

Seven Acres of Surplus

★ GLOWS in the DARK ★ ★ LUCKY SKULL RING ★ ★ AMAZING ★



BY DAY an impressive, handsome, mystic skull with flashing ruby-red eyes—massive design—a heavy-duty ring for he-men.

BY NIGHT—glows with mysterious blue fire—a haunting novelty that will make you the envy of your friends.

DAY OR NIGHT—packs a wallop—a knockout for luck and protection.

MADE OF GENUINE ETERNIUM

Eternium, "THE ETERNAL METAL," that is actually harder than steel. Brilliant as silver, luxurious as platinum, never becomes dull, can't tarnish, can't wear away. SOLID Eternium, not plated. It looks expensive!

SEND NO MONEY. Mail name and address with ring size (small, med., large or ex. large). Pay postman \$2.98 plus tax and a few cents postage. 10-day money-back GUARANTEE.

THE MONTROSE CO., Dept. SR-40, 114 E. 32nd St., N. Y. 16, N. Y.

NOTE: Send \$3.58 (including tax) and we pay postage. Same refund guarantee.



Precision-Built Chronometer WRIST WATCH 14K Gold Plate

Try to beat this bargain ANYWHERE in America! Imported Stop Swiss CHRONOMETER and Wrist Watch combined!

11—WONDER FEATURES—11

It's a tachometer, telemeter, DOUBLE Push Button STOP Watch, measures SPEED as well as DISTANCES of horses and auto races, sports, airplanes, boats, moving objects. Has SPLIT-SECOND calibration, unbreakable crystal, sweep-second hand, LUMINOUS numerals and hands, sturdy SHOCK-RESIST case in 14 Karat Gold plate. Everyone wants one. Race Fans, Doctors, Aviators, Photographers, Sportsmen, Engineers, Soldiers, Sailors, Students.

5-YEAR SERVICE GUARANTEE

Full instructions and gift case with each watch. SEND NO MONEY. Pay postman 7.98 plus tax and postage or send only 8.78 and SAVE postage. Try 10 days free. Money back if not thrilled.

Thoresen Direct Sales, Dept. 211 PS-11
131 W. 33rd St., New York 1, N. Y., Phone LA 4-8799 or visit Room 707

BABY SHOE METALLIZING BUSINESS

Profitable - Simple - Pleasant

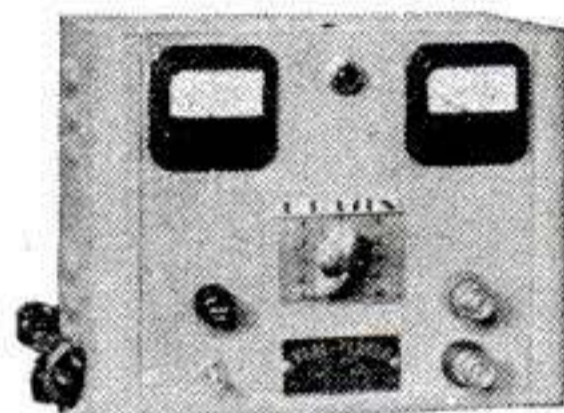

The Vari-Plater technique for metallizing baby shoes. Complete FREE Course. 116 illustrated pages and text with each plating set-up order. Write today for free details and descriptive literature.

LEWIS ELECTRICAL MFG. CO.
1943 Walton Ave., N. Y. 53, N. Y.

END GENERATOR REGULATOR BATTERY TROUBLE!!

With the greatest advancement in auto-ignition since the self-starter

THE AMAZING NEW WATTAGE REGULATOR

Drive with or without your battery
100,000 Mile Money-Back Guarantee

State make and model of car.
Write for free catalog today.

SCIENTIFIC ELECTRIC CO.

P. O. Box 2162PZ, Sta. H, Cleveland 8, Ohio

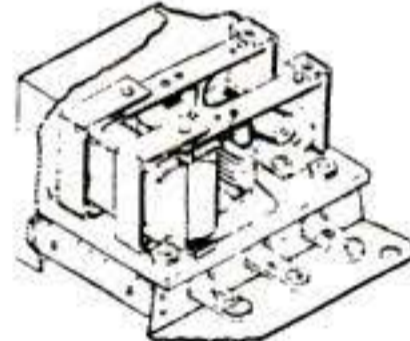

ACCORDION MART

Offers Outstanding Bargains

Buy outright or on rental plan. New and used accordions at lowest prices. Full credit for every dollar you pay when you want to turn in used accordion purchased from us for new one. Instruction course included at no extra cost. Complete, guaranteed repair service. Write today for FREE catalog.

ACCORDION MART, IMPORTERS
1736 W. 18th Street, Dept. PS-11, Chicago, Ill.



Free Book

RAISE HAMSTERS



The new wonder animals from Syria. Often called Toy Bears. Delightful pets. Everyone wants them. Laboratories need thousands. Clean, odorless. Raise anywhere. A profitable and interesting hobby or business. We furnish breeders and instructions. Write today for free book.

GULF HAMSTERY, 1540 BASIL ST., MOBILE, ALA.

WHAM-O SPORTSMAN

\$1.00 postpaid

HITS LIKE A .22 RIFLE —
KILLS RABBITS, SQUIRRELS.
For Hunting, Target,
Routing Pests.



HUNTING SLINGSHOT

Powerful, silent, accurate.
Complete with 40 pellets and extra rubber straps. Send \$1.00 today to—

Wham-O Mfg. Co., Box 13-N, South Pasadena, Calif.
PROFESSIONAL MODEL OF THE NAT'L SLINGSHOT ASSN.

Dealers Write

HEAVY DUTY STOCK

Ready Now!



The New

LIONEL CATALOG

40 FULL PAGES IN COLOR WITH NEW 1949 SURPRISES

Get your Lionel catalog early. The supply is hardly enough to go around, even though we print over one million. It tells all about the new Lionel trains for 1949 — the new Diesel Switcher, and the Big Twin-Diesels. And it shows

some of the most realistic and exciting accessories. Big *Special Offer* will bring you the catalog and all the items listed below. Remember Lionel Train sets are priced as low as \$15.95. Mail coupon and 25¢ now.



Special offer consists of:

- 1) 40-page Full-color catalog
- 2) "Whistles & Bells" Sound Effects Record
- 3) R.R. Planning Book for "Pop"
- 4) 8 Miniature Billboards, featuring Ford, Heinz, Kellogg's, Baby Ruth, Wrigleys, Kleenex, and Nash Cars, etc. Realistic outdoor boards for your model railroad.

Send 25¢ for special Catalog offer!

MAIL COUPON FOR 1949 COLOR CATALOG

LIONEL TRAINS, P. O. BOX 242
 Madison Square Station, New York 10, New York
 I enclose 25c for "Special Offer"—including 40-page full-color Lionel Train Catalog, Sound Effects Record, 8 Miniature Billboards, and Railroad Planning Book for "POP"

Name _____

Address _____

City _____ Zone _____ State _____

THIS IS YOUR SEASON — CASH IN ON IT!

Any man with a tool can do wonders for his pocketbook before Christmas with . . .

PLASTIC CRAFT

This book gives you hundreds of dollars worth of ideas, designs, and complete, illustrated directions for making readily saleable Christmas gifts.



With the tools you have and inexpensive materials you will get beautiful results.

Get a copy of this book today and see how easily you can make all kinds of gifts for all ages and tastes — useful, beautiful, colorful. When most people are spending money, you can be making it—and contribute to your own Christmas as well.

SEE IT ON APPROVAL

The Macmillan Co., 60 Fifth Ave., New York 11

Please send me a copy of PLASTIC CRAFT. I will either remit the price—\$5 or return the book within 10 days.

Signed.....

Address.....

S

HOW I STEPPED into a Big Pay HOTEL JOB!

Nelson Davis, Newspaper Route Man, Now Assistant Manager, Knew Nothing About Hotel Work.

"I had nothing to look forward to but monotonous work and poor pay. Then I answered a Lewis advertisement and shortly afterwards, enrolled. Soon after graduation, the Lewis School placed me in a fine Pennsylvania hotel. Now Assistant Manager. Lewis Training did it all."



HOTELS NEED TRAINED MEN AND WOMEN

Thousands of Lewis-trained men and women winning success and a sound, substantial future in the colorful hotel, club and institutional field. They are making good as Managers, Assistant Managers, Stewards, Hostesses, Executive Housekeepers and in 55 other types of well-paid positions. Not only has this fascinating business been breaking records, but authorities agree the greatest travel boom in history is now under way. The demand for trained men and women, therefore, is greater than ever.

Previous experience proved unnecessary in this business where you are not dropped because you are over 40. Good grade school education, plus Lewis Training qualifies you at home, in spare time. Write your name and address in the margin and mail this ad TODAY for Free Book which tells how you are registered free of extra cost in Lewis National Placement Service.

Course approved for Veterans' Training,
() Check here if eligible.

Lewis Hotel Training School
Room PS-2785 Washington 7, D. C. **34th SUCCESSFUL YEAR**

Save UP TO 25% ON QUALITY BALL-BEARING WHEELS



Bilt-Rite wheels roll smoothly and easily, are semi-pneumatic, ball-bearing, painted red; guaranteed top quality—and you save up to 25%! Compare Bilt-Rite's quality and price; then get your order in today! Dealer inquiries invited.

Ball-Bearing Wheels at Bargain Prices			
(For 1/2" axles)			
6 x 1.00	\$1.30	10 x 1.25	\$1.95
8 x 1.25	1.65	10 x 1.75	2.15
8 x 1.75	1.80	10 x 2.00	2.45
(For 3/8" axles)			
6 x 2.00	\$3.95	8 x 2.50	\$4.45
10 x 2.75 Only \$4.65!			

If size you need isn't listed, write for Folio A. Order Today—Send cash, check, or M. O.—Pay postage on arrival.

BILT-RITE WHEEL COMPANY
520 East Missouri Ave. Dept. 66 Kansas City 6, Missouri

EYE-GLASSES BY MAIL
16 Days Trial

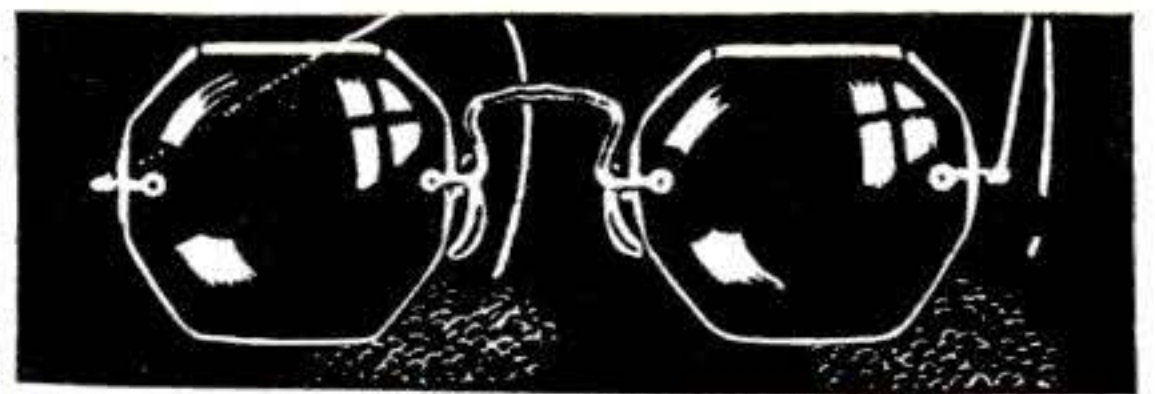

Write Today for Free Catalog. Send no Money
ADVANCE SPECTACLE COMPANY
537 South Dearborn Street, Dept. SP-11, Chicago, Illinois

MECHANICAL DENTISTRY

Learn

A profession offering unlimited opportunities. Most modern and complete course embracing every branch from Plate to Porcelain Work, which prepares you to work for Dentists or start your own business. Individual instruction—practical training in day or night school. No books—no classes. Catalog upon request.

McCARRIE SCHOOL of Mechanical Dentistry
207 N. Broad St. Dept. 1190 Philadelphia, Pa.



AMAZING NEW MAGIC CATALOG

350 pages of mystifying, easy-to-do tricks and illusions. 600 illustrations. Send \$1.00 now for catalog, credited on your first \$5.00 purchase.

NATIONAL MAGIC CO.
119 S. State St. Dept. S-11 Chicago 3, Ill.

Secrets of fast calculation revealed in
"HOW TO USE THE CHINESE ABACUS"

By W. D. Loy

with more than 60 illustrations \$1.00 per copy

1949 model Loy's Abacus, all purpose rapid calculator. Does the work of adding machine and slide rule. With above instructions, \$6.50 postpaid.

Money back guarantee. FREE details.

LOY'S CHINESE CALCULATOR, Dept. 965
1317 R. I. Ave., N.E. Washington 18, D. C.

WAR SURPLUS BARGAIN

HEATERS

Only \$5.00

Originally designed by U. S. Army as Water Heater for use in Alaska. Ideal for heating water in cottages, hunting lodges, etc. Instruction sheet included showing all phases of operation and easy removal of coil for use as SPACE HEATER. Operates on any liquid fuel. No C.O.D.'s. Shipping Weight 32 lbs.



Includes 6-quart fuel supply tank and telescopic flue.

MICHLIN SURPLUS 4360 Larkins Ave., Detroit 26, Mich.



Aeronautical Engineering offers a wide choice of interesting duties. Here two engineers install a guided missile model in the Northrop Aircraft, Inc. wind tunnel.



Wing-top classroom—an example of how engineering instruction at Northrop comes vividly to life in the midst of this famous aircraft research and production center.

There's a BIG Future for YOU in AERONAUTICAL ENGINEERING —with NORTHROP Training

You can ride to success on wings of the great Air Age. Aviation is progressing at "super-sonic" speed. Things to come defy your imagination. Stretching ahead of you can be a lifetime career of fascinating work and rich rewards—in Aeronautical Engineering. Many types of creative duties call for men with *imagination* and *originality*. Many *practical* kinds of work call for men who like *action* and the *use of skill*.

Northrop training in Aeronautical Engineering has won choice jobs for graduates. Many of even the more recent Northrop graduates are in such important work as design, research, testing, stress analysis, aerodynamics and power plant engineering. They have drawn top pay brackets for starting jobs...have moved up fast to even better jobs.

Learn all about your big opportunities in Aviation. Get full details on Northrop's 2-year Aeronautical Engineering Course. You can begin your training soon—classes start every 8 weeks.

SEND COUPON FOR CATALOG NOW

NORTHROP AERONAUTICAL INSTITUTE
1525 East Broadway, Hawthorne, Los Angeles County, Calif.
Please send information on opportunities in Aeronautical Engineering, your catalog, and starting dates of classes. I am interested in:

Aeronautical Engineering Aircraft & Engine Mechanics

Name _____ Age _____

Address _____

City _____ Zone _____ State _____

Check one: Veteran Non-Veteran



APPROVED FOR VETERANS



Division of Northrop Aircraft, Inc. ★ James L. McKinley, Managing Director

1525 EAST BROADWAY, HAWTHORNE, LOS ANGELES COUNTY, CALIF.

GADGETEERS!!

JOIN THE

FASTEST GROWING CLUB in the WORLD

NEW • DIFFERENT • EXCITING

Gadget-of-the-Month Club, Inc.

TRIAL MEMBERSHIP

YOU'VE read about it in the newspapers and magazines—heard it on the radio, seen it on television! Here's your last chance to join the greatest club in the world!

Created especially for you "gadget lovers," the Gadget-of-the-Month Club sends you new patented practical gadgets before they are marketed anywhere! Members get an exclusive preview of tomorrow's gadgets before the general public.

Hundreds of thousands of gadget-minded men and women are already enjoying this exclusive privilege. One dollar and this coupon brings you a trial membership: six gadgets in six months! Get in on the fun NOW. Preview new gadgets before public sale. Send your dollar in today for six-months membership in the most exciting club in America—The Gadget-of-the-Month Club! (This offer is for a limited time only and may be revoked without notice.)

GUARANTEE

The total retail price of the six gadgets you will receive must be far greater than the cost of your membership or your money will be cheerfully refunded.

G.M.C. Memberships make Ideal Christmas Gifts
Send in your Christmas Gift List at once!

GADGET-OF-THE-MONTH CLUB, INC.
P. O. Box 2000, Los Angeles 54, California
(Memberships outside U.S.A. \$1.50 each)

Name _____
Street _____
City _____
Occupation _____ Age _____

STERLING AREA: Send memberships to Gadget of the Month Club, Ltd., 131 Queen St., Melbourne, Australia.

6 NEW GADGETS FOR \$1.00

MEMBERS SAY:
"Received my first gadget today and would like to order five more for gifts... P.K.M."
"Was thrilled today when I found the postman had delivered my first gadget. My wife insists that I order a membership for her dad, and one dollar is enclosed... R.B.H."
"My secretary has swiped the gadget you sent me yesterday to start my membership. Please enroll her so I can enjoy them myself... P.O.W."

BE A LEADER IN INDUSTRY

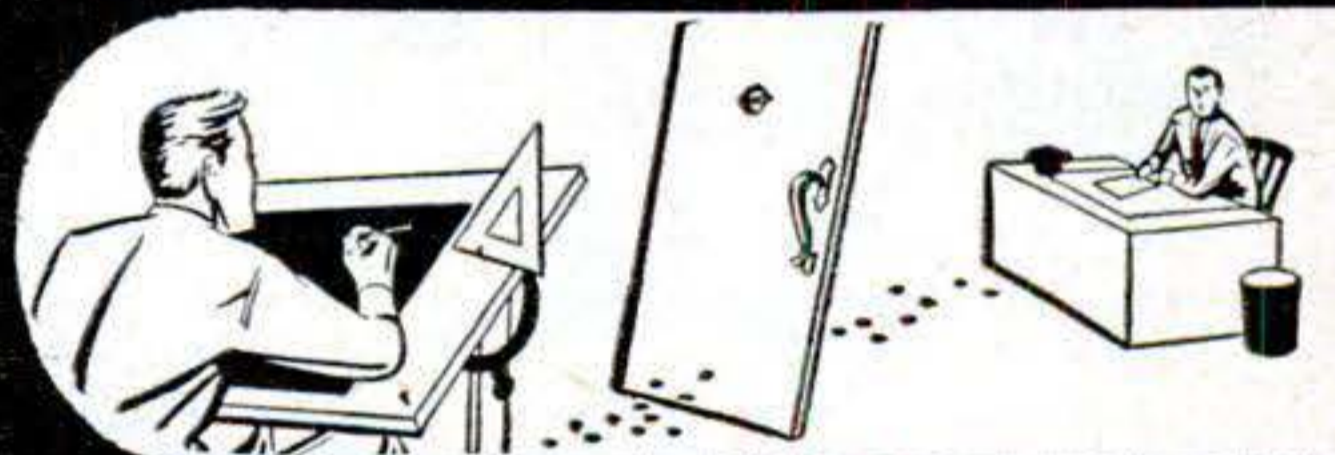

USE DRAFTING AS YOUR DOORWAY TO SUCCESS

It's EASY if you use CEI Simplified Training & Coaching

You can have security, a car, a home and a big pay job. Be like industry's leaders and use drafting as your springboard to success. Get in on the big money industry is offering for draftsmen. CEI will teach you Drafting easily and quickly in your spare time at home and help you get a job. Mail coupon now!

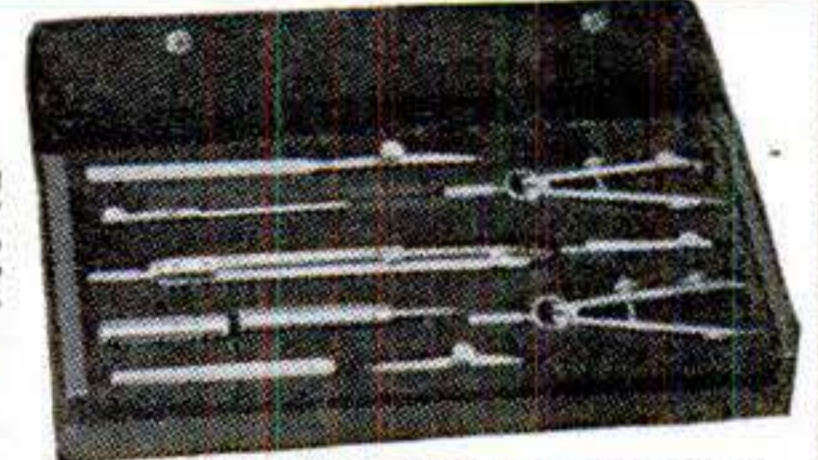

You Get This Professional Set of Instruments at no Extra Cost



GET FREE SUCCESS BOOK

Cleveland Engineering Institute
Extension Div. PS-11A
2325 Chester Ave., Cleveland 14, Ohio
Rush your FREE Success Book showing how Drafting is the Doorway to Success.
 Veterans Check Here

NAME _____
ADDRESS _____
CITY _____ STATE _____
No Obligation—No Salesmen

APPROVED FOR VETERAN TRAINING UNDER THE "G. I. BILL OF RIGHTS"

IT'S THANKSGIVING SALE MONTH AT C-H WA

A TERRIFIC BUY! GAS ENGINES

Briggs & Stratton NEW in original cartons

Model	HP	Shaft	List	Your price
AP	1 1/2 to 2 1/2	Tapered	\$102	\$49.00
AP	1 3/4-2 1/2	3/4"	\$102	\$49.00
BP	2 1/2 to 3 1/2	1"	\$115	\$66.00
ZZP	5 to 7	1"	\$141	\$69.50

But TODAY these BARGAINS just can't last.



AC ARMY GENERATORS

300 WATT, 12 volt DC, 2000 RPM. Heavy duty with current cut out relay. High and low switch. 30 amp. meter. Can be bought less shaft and base to be used directly mounted to a Briggs & Stratton 1 HP engine. Tapered shaft engine required. Stock #323. NEW only.....\$7.00 Complete with shaft, base and bearing. Stock #324.....\$15.95

300 WATT, 110-220 volt AC, generator. Mfg. by Electric Specialties Co. Weighs 20 lbs. Stock #416. NEW only.....\$29.50

750 WATT, 110 volt, 60 cycle, Elcor, ball bearing, with volt meter & rheostat, radio filter, self excitor. Generator fastens for direct drive to model AP & BP Briggs & Stratton tapered shaft. Price \$69.50. With AP engine assemble yourself, add.....\$56.00

1500 WATT, 110-220 volt, 60 cycle, 1800 RPM, Master ball bearing to fasten on ZZP Briggs & Stratton engine, direct drive.....\$109.50

2500 to 3000 WATT, Leland generator 110 volt, 60 cycle. Self excitor, radio filter, junction box for plug in. Stock #525. New.....\$145.00

3000 WATT, Delco, 110 volt DC. Plug in, ball bearing 2800 RPM. List price \$343.00. Used but like new. Stock #321.....\$99.50

50 KW or 62 1/4 KVD Cummins diesel generator. 240 volt, 3 phase, 60 cycle, AC. 1200 RPM. 150 amps. Rating 50% continuous excitor; 110 volts Cummins diesel engine, water cooled exhaust, complete with operating panel starting. All automatic controls plus 3 point suspension. Rubber mount. Full set of diesel major operating parts. Was used as stand-by, 200 appx. running hrs. Appx. 6400 lbs. GUARANTEED. Like new. Price \$7400.00. Save \$3000.00. Stock #575. Your price.....\$4400.00

C & H ELECTRIC CO.

Payswell SPRAY-PAK



Complete spray kit. Gun has built in compressor & motor weighs less than 5 lbs. Use with any sprayable liquid. Kit includes 29 items plus carrying case and instruction manual. Farmers spray animals, auto repairmen spray autos, use for stenciling, etc. Develops 50 lbs. pressure, 2.2 cu. ft. of air per min. disp. Self lubricated bearings. GUARANTEED. Complete kit. \$49.00 Stock #569. Only.....\$49.00

PLASTIC TUBING

Good for water, oil, air, electrical installations & radio work. Available in 100 ft. lengths. Min. order 50 ft.

1/8", 3/16", 1/4" (your choice) per ft..2c	1" 3 ft. lengths only. Per ft.6c
5/16", 3/8" per ft. 3c	1 3/8" per ft.....8c
7/16" per ft.....4c	

STAINLESS STEEL FLAT TOPS

Stainless steel one side, 1/2" veneer center, overall 3/4" thick. Ideal for shelves, back bar work board, work table, etc. Stock #411.

22 x 19 1/2.....\$1.95	22 x 21 1/2.....\$1.95
22 x 34.....\$3.45	22 x 37.....\$3.95

CLUTCH



For motor-scooters, motorbikes, lawn mowers, etc. Mercury centrifugal clutch for use with any small gas engine. "A" belt pulley, 5/8" & 3/4" bore. Stock #9.95 #400. Brand new only.....\$9.95 In lots of 12. Each.....\$8.00 Add 25c postage for handling.

HEAVY DUTY FARM WAGON



5 to 7 ton capc.

Heavy duty wheel 5-7 ton trailer, 27" high, rack size is adjustable 12 to 20 ft. Built of heavy 6" I beam channel iron and a 3" dia. seamless tube. Double bronze king pins, heavy duty hitch, double high speed Timken bearings. Width of track is 6'. This trailer will not whip & has been tested at speeds up to 50 MPH. Use it for chopper wagon, boat trailer, machine mover, logging, construction work. Trailer comes with 4 wheels and spare tire. All tires are airplane type and are GUARANTEED. Value is appx. \$500. Stock #558. Your price is \$149.50 only.....\$149.50

WESTINGHOUSE

3 phase motors. All models 1/2HP to 1 1/2HP. 22 volts. Motors totally enclosed, ball bearing. Stock #541. 40% off list prices.

ALL BRONZE GEAR PUMP



All bronze corrosion resistant gear pump. Lift water 25'. Delivers 102 gal. per hr. at 120 RPM. Develops 110 lbs. pressure or 250' head. Self locking packing nuts, drain cock, reversible head. Will pump brine, salt water, oil, vinegar, gasoline, etc. Dimensions: 10" L x 7" H x 5 1/2" W. Base holes 1 3/4" x 3". Shaft 1 1/8" x 1" inlet & outlet. Wt. 24 lbs. Mfg. by Sherwood Brass Works. All pumps belt driven. All bronze gear pump with 8" V pulley. PUMP \$24.00 ONLY. Stock #314. \$80 value.....\$24.00 Same pump as above with motors, (electric). Stock #549.

1/2 HP \$67.00; 1 HP \$81.00; 3/4 HP \$74.00
Same pump with Briggs & Stratton gas engine. Stock #550.
2 1/2 HP.....\$83.00 3 1/2 HP.....\$103.00
6 HP.....\$123.00

The MORE HP the more PRESSURE CENTRIFUGAL PUMP

with 2" intake 1 1/2" discharge with 6" variable speed pulley. Stock #557.....\$35.00

CENTRIFUGAL ALL BRONZE

Mfg. by Grey Marine. Width 5" adjustable. pulley for A., B., or C. belt. 6000 gal. per hr. 2" intake, 1 1/2" discharge. Stock #581.....\$40.00 Your price.....\$40.00

Same pump with Briggs & Stratton gas engine. Belt drive. Less than price of engine.

HP	Model	GPH	List	Your price
2 1/2	AP	5000	\$182	\$98
3 1/2	BP	7000	\$195	\$114
5 1/2	ZZP	9000	\$222	\$137

HEAVY ELECTRIC CABLE

DUTY

3 wire #10 super cable. Stock #351. 65' with lugs. Value \$26.00. \$13.00

3 wire #10 government submarine type. Us underground, underwater, overhead. Cost U.S. 90c ft. Stock #542.

YOUR PRICE

100 ft.....\$24.00	500 ft.....\$100.00
250 ft.....\$55.00	2900 ft. reel \$530.00

2 conductor rubber cable # 4 stranded—75 ft length with connectors. Stock #543. \$80.00 List price \$177.00. Your price.....\$80.00

4 wire #6 stranded heavy duty. List price \$2.36 per ft. Stock #547.

YOUR PRICE

50 ft.....\$30.00	250 ft.....\$125.00
100 ft.....\$55.00	500 ft.....\$225.00
1000 ft.....\$400.00	

225 ft. lengths 3 wire # 10 rubber cable, twin male connectors. Value \$109.50. Stock #554. Your price.....\$35.00

Underground parkway cable. 2 wire #6. Rec 1500'-30c per ft. 500'-35c per ft. 250'-37 1/2c per ft. Stock #582. Small lots 40c per ft.

EARN MORE MONEY!

Personal Attendance Courses

Be your own boss! Earn more money! Learn photography quickly through our unique LEARN-BY-DOING methods taught by famous photo "aces" at our Resident School. Resident Training is available with subsistence under the G. I. Bill to serious workers.

Home Study Course

You can train yourself for an action-packed, thrilling, profitable career in photography! N. Y. I.'s INDIVIDUALIZED Home Study Course is a spare time short cut to success. Invest your time in your future—don't waste it!

— Don't delay! Write today for FREE literature —

New York Institute of Photography
Dept. "5", 10 West 33 Street
New York 1, New York

Please send me complete information regarding
 Resident Training Home Study Course

Name.....
(Please Print)

Address.....

City.....Zone.....State.....

NEW YORK INSTITUTE OF PHOTOGRAPHY

10 West 33 Street, New York 1

40th
YEAR



LIGHTWEIGHT Now Only \$346.30

9.5 hp. 4-cycle. 3-speed. Foot-shift. Over 70 miles per gal. Over 60 m.p.h. Write for free circular.

MUSTANG, Dept. GP21
635 W. Colorado, Glendale 4, Calif.



Imported Swiss Stop **CHRONOGRAPH** with 2 push buttons

WRIST WATCH \$6.90
Plus 69c Fed. Tax

1 Year Written Guarantee and Instructions

GIVEN STAINLESS STEEL EXPANSION BAND

"Wonder" Watch. Used to time autos, airplanes, horse races, athletic events.

Tachometer • Telemeter • Hands & Nos. Glow in Dark • Unbreakable Crystal • Large Red Sweep Hand • Tells Time • Measures Speed & Distance • Stop Watch • Precision Made.

SENT ON APPROVAL. Deposit \$6.90 plus tax and postage with postman or send money order, save postage. (Same money back privilege.)

THE JEWELBOX, Dept. GE, 1674 Broadway, N. Y. 19, N. Y.



7-Day Money Back Guarantee

BOMB HOIST WINCH

\$15.95

2500 LB. CAPACITY

PERFECT for garage, trucks, shops, boats, farms, etc. BRONZE worm gear with 24-1 controlled ratio. 19' of 1/4" steel cable with hook. DUAL

SPEED handle for greater leverage. A WAR SURPLUS VALUE. F.O.B. Los Angeles. 20% with C.O.D.'s. MONEY BACK GUARANTEE. Shipping weight 18 lbs.



Semlers' ASSOCIATED SURPLUS CO.

5720 WILSHIRE BOULEVARD, DEPT. PS-119, LOS ANGELES 36, CALIF.

SURPLUS AND OTHER ITEMS & ALL ARE BARGAINS

WOOD BUTCHERS & HOBBYISTS

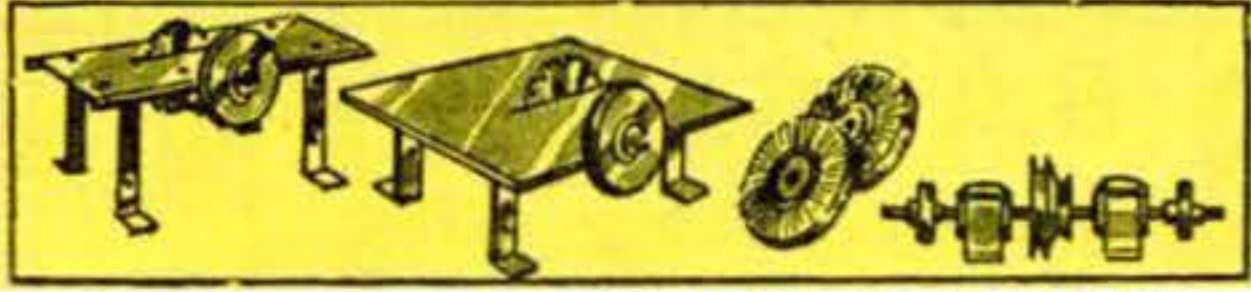

Steel table saws, 10" high. 1/8" thick table 131/2" x 27". With 7" combination blade, 6" grinding wheel, double end ball bearing arbor 1/2" shaft & steady rest for grinding. Makes 2 1/2" cut. Will take a 10" blade. All holes drilled, saw is ready to assemble. **Stock #556.** Your price\$9.95

Table saw. Steel table top 3/4" thick with solid hardwood veneer center, 19 1/2" x 22" x 10" high. 7" comb. blade, 6" grinding wheel, double end ball bearing 1/2" shaft arbor & steady rest for grinding are included. All holes drilled, ready to assemble. Will take 10" blade. **Stock #555.** Priced for the buyer at.....\$11.95

Build your own saw. Saw table top only with legs, hardware, grooved for 10" blade. 22" x 35" size. Your price\$6.95

Double end ball bearing arbor 1/2" shaft 11 1/2" long. Bearings alone worth \$10.00. **Stock #305. ONLY \$4.95**

TILT TOP BENCH SAW with 7" blade. 18" x 13" table. 2 1/8" cut ball bearing. Wt. 48 lbs. **Stock #574.** Your price\$31.95

DRILL PRESS 1/2" chuck, ball bearing. Drills to a 12" circle. 4 step pulley. Wt. 50 lbs. **Stock #575.** Your price\$31.95

JOINTER PLANER 4" ball bearing 3/8" deep cut x 4" wide. Wt. 45 lbs. **Stock #576.** Your price.....\$31.95

BELT SANDER 4". 11" table, 4" x 34" belt, oilite bearings. Wt. 22 lbs. **Stock #577.** Your price.....\$14.95

JIG SAW, cuts 2", 15" deep throat. 9" x 9" tilting table. Wt. 46 lbs. **Stock #578.** Your price.....\$31.95

WOOD LATHE, 12" x 31", ball bearing, head stock spindle, removable standards, steady rest, 4 step pulley. Wt. 40 lbs. **Stock #579.** Your price.....\$31.95

BAND SAW, 12" circular table 45 degree tilt. 3 1/2" cut. 52 1/2" length blade. Overall 15 1/2" x 22". Wt. 52 lbs. **Stock #568.** Your price \$21.95

DRILL PRESS VISE, opens to 7 1/4". 4 1/8" wide x 2 1/2" deep. 7" handle, 5/8" sq. thread. Wt. 8 lbs. **Stock #570.** Your price\$6.95

ANVIL BENCH VISE, 3 1/2" jaw. 4 1/2" opening, 1" thread. 1/2" bar. Semi steel, semi swivel. Wt. 15 lbs. **Stock #580.** Your price\$5.95



price



1/2" ELECTRIC DRILL, Mfg. & advertised at much higher cost by nationally known concern, it's the buy of the year and includes all the features you look for. Has motor power, Jacobs 33B geared chuck, key gears, and all features of drills priced as high as \$58. SEPCS Universal motor AC-DC, 115 V. HD switch. Ball, roller, oilite bearings. Helical cut gears. Aluminum alloy frame. **Stock #565.** Your price \$29.95.

Same as above with drill press stand. **Stock #566.** Your price.....\$41.95
 Drill press stand only. **Stock #567.** Your price\$14.00

Special! HEAT BOOSTER

Fits any 8", 9", or 10" furnace pipe. 1500 RPM motor with 6' cord, mounting frame, 7" blade. Motor can be oiled from outside. Easy to install. Silent operation. Warm those rooms with long runs. **Stock #583.** Regular \$9.95. Your price....\$4.95



4 WHEEL ARMY BOMB TRAILER

Costs less than price of tires. Can be used for compressors, const. work, light plants, foundries, machinery, etc. Wt. 375. Goodrich & Firestone 6 x 9 tires, 21" high. Trailer is 6' 5" long, axle size 1 3/4". Cone ball bearing race. 3" center channel 36" wide. Pay load 1 ton, will take 2 ton. 36" tongue. Zerk fittings. Tires list at \$28.00 each. **Stock #559.** Our price for complete trailer is \$90.00

NEW ELECTRIC MOTORS

Less Than 1/2 Price
 Single phase, heavy duty capacitor type, 60 cycle, Standard Nema frame, slashproof. All NEW in original cartons. ALL GUARANTEED.

HP	MAKE	LIST PRICE	YOUR PRICE
1/3	Jack & Heintz	\$29.50	\$17.50
1/2	Eicor	\$45.50	\$23.50
3/4	Eicor	\$57.65	\$28.00
1	Eicor	\$81.00	\$36.00

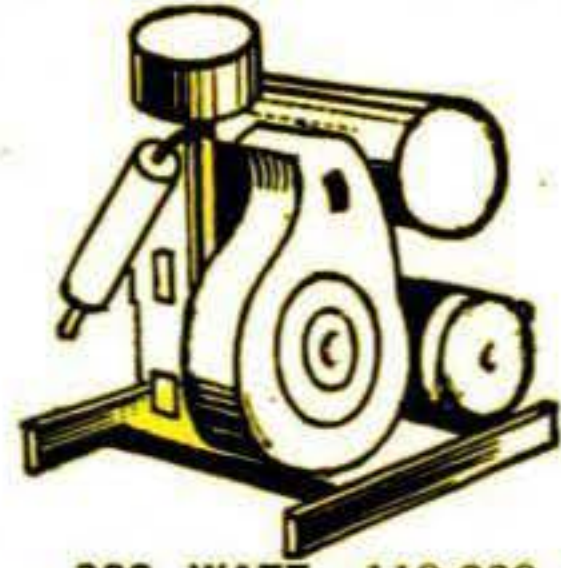

AC ARMY LIGHT PLANTS

300 WATT, 110-220 volt AC, 60 cycle light plant powered by 1 HP gas engine direct drive. Mounted base weight 40 lb. **Stock #409**.....\$89.50

500 WATT, 110 volt AC, 60 cycle. One direct connected. **Stock #414.** New \$139.50

750 WATT, AC 110 volt, 60 cycle, direct drive, air-cooled, Briggs & Stratton mod. AP, Eicor generator, radio filter, self excito volt meter & regulator, rope start, 110 lbs. 20" long, 17" wide, 16 1/2" deep. **Stock #573.** Your price.....\$149.50

New 1000 WATT, 110 volt, 60 cycle A plant with Briggs & Stratton directly couple to a Leland generator. **Stock #351.** \$189.50

New 1500 WATT, 110 & 220 volt, 60 cycle, AC plant with Briggs & Stratton direct coupled to a Master generator. **Stock #352.** \$209.50.

2500 WATT, 110 volt AC, 60 cycle w/ Briggs & Stratton Model Z and Leland generator. **Stock #317.** Used but like new \$265.00
 New \$295.00. Add \$10.00 for tools and spare parts.

5000 WATT, 110 volt AC, 60 cycle w/ automatic remote control. Powered by 4 cy Jeep gas engine. Used but like new. **Stock #318**.....\$545.00

7500 WATT, 110 volt AC, 60 cycle powered by a VE 4 Waukesha 4 cyl. gas engine Continental or Hollinsworth generator. Remote control starting. Complete with switch board. Used but like new. **Stock #347**.....\$625.00

Add \$65.00 for transformer to make the plant 3 phase 220 volt.

10,000 WATT, 110-220 volt AC, 60 cycle Remote control. Powered by a Jeep 4 cy gas engine. Used but like new. **Stock #319**.....\$800.00

New job original crate only.....\$1100.00

25,000 WATT, 220 volt AC, 3 phase Spare parts. New packed for export. **Stock #415**.....\$2150.00

4000 ITEMS IN STOCK

ALL ITEMS GUARANTEED C & H ELECTRIC Co.

438 W. JUNEAU AVE.
 MILWAUKEE 3, WISCONSIN

All prices F.O.B. Milwaukee. 25% deposit required on all C.O.D. orders. No C.O.D.'s under \$10.00. Use stock number when ordering. Many other bargain items not listed—write for our free circulars.

Learn this Profitable Profession



IN 90 DAYS AT HOME

Money-Making Career Open to Men and Women, 18 to 50

Hundreds of men and women between 18 and 50 make \$10 to \$20 in a single day giving scientific Swedish Massage and Hydro-Therapy treatments. There is big demand from doctors, hospitals, sanatoriums and clubs. Graduates earn large full time incomes from these or in private practice in their own offices. Others make good money from home treatments given in spare time. Learn this interesting, money-making profession in your own home, through our home study course. Same instructors as in our nationally known resident school. You can win independence and prepare for future security by qualifying for your Diploma. Course can be completed in 3 to 4 months. Many earn while they learn. Begin your training at once.



Anatomy Charts & Booklet FREE

Enroll now and we will include, at no extra cost, many needed supplies. Fit yourself to help meet growing demand for Scientific Swedish Massage. Send the coupon at once for complete details, Anatomy Charts and 32-Page Illustrated Booklet, FREE, postpaid.

THE COLLEGE OF SWEDISH MASSAGE
 Dept. 970-P, 41 E. Pearson, Chicago 11

Please send me FREE and postpaid, Anatomy Charts, 32-page Booklet and complete details on Home Training.

Name.....Age.....

Address.....

City.....State.....

YOUR FUTURE 3 TRADES in 1 Career



WATCHMAKING



JEWELRY—
 STONE SETTING



ENGRAVING

Each Trade can be a full-time job; together they assure numerous high paying opportunities, or a business of your own. Profit by the **Nationally Recognized Training Methods** of the **Kansas City School of Watchmaking.** Enrollments now available.

CLIP AND MAIL THIS COUPON TODAY

KANSAS CITY SCHOOL OF WATCHMAKING

Admiral & Tracy, Kansas City 6, Missouri

Please send me, without obligation, complete information on training in the above courses.

Name.....

Street.....

City.....State.....

Check if Veteran.

G.I. Approved

WAR SURPLUS AND OTHER BARGAINS



PNEUMATIC RIVETER & CHIPPING HAMMER

Mfd by Ingersoll-Rand. Chicago Pneumatic and Thor. Pistol grip. Ideal for fender, brake lining, concrete breaking work. Like new. Six rivet sets and bucking bar included, making a complete combination. Weight 9 lbs. Each **\$6.95**



HAND MITRE "It pays its way IT'S SENSATIONAL! in just one day!"

New HAND MITRE saves the carpenter - picture framer - cabinet maker and craftsman hundreds of hours . . . a "flick" of the hand and a few seconds for a precision mitre every time. The HAND MITRE will cut any desired angle. Its rugged construction will handle hard and soft wood mouldings, plastic trim, base shoe, dowels, laminated materials, rubber extrusions, leather, linoleums and asphalt tile. Made of heavy gauge stainless steel, electro polish finish. Will endure years of hard usage. Eliminate bulky mitring equipment - save valuable hours and labor. **\$3.95** postpaid.

TRANSFORMERS

Stalle Engineering Co. Transformer Primary Input, 115 Volts, 60 Cycles. Flexible color-coated leads. Output, 6-12-24 Volts. Will work aircraft gadgets, heater relays, signal systems, radio test filaments, home chimes, etc., off house current. A good item for the home gadgeteer. Weight 7 lbs. New. Each **\$7.95**



Stalle Engineering Co. Transformer Output 12-24-32 V Otherwise same as above. Weight 15 pounds. **\$14.95**

FANCY BRIAR PIPES

We have been awarded 100,000 fancy briar pipes by Quartermaster Corps. Assorted shapes and sizes. All popular makes. Buy now for Christmas Gifts. Set of 7. **\$3.50**



MICROMETERS



Chrome plated, precision engineered and carefully tooled to give long life. All new. 0-1" capacity . . . each **\$2.25**
1-2" capacity . . . each **3.50**
2-3" capacity . . . each **5.50**
3-4" capacity . . . each **6.50**

EXPANSION REAMERS



Spiral Flute. Mfd. by Alvord Polk Tool Co. All New, original pack. 1/4"-3/8"-7/16" Recommended expansion limit, .006" Original value \$12 Set of 3. **\$4.95**

MICROSWITCH



Type Z - 2"x1"x 1/2". Used open or closed. For automatic contacting-light, sound, model train systems, chimes, etc. New . . . 5 for **\$2.** Aluminum Spring Actuator to fit above Microswitch . . . 5 for **\$2.**

HIGH SPEED DRILL BITS



ALL NEW! Fractional and numbered. Original value \$15. 30 assorted sizes and lengths. **\$3.50**

Send check, money order or cash. 25% Deposit required on C. O. D. orders. All prices F. O. B. Culver City, Calif.

SEND 25c FOR ILLUSTRATED CATALOG

AIRBORNE SALES CO., INC. DEPT. PSM 11-9 CULVER CITY, CALIF.

NOW...



BIGGER PREFAB BOAT VALUES

Build a better boat than you can buy for the money! Complete parts, expertly cut to size, ready for quick, easy assembly by following simple blueprints. Many models to choose from—\$39.50 to \$199.50. Colorful 1950 catalog 10c. OZARKA, 7119 Borden St., Woodstock, Ill.



← **EXCLUSIVE** laminated rib construction

Only Ozarka gives you laminated oak ribs, preformed and mortised, in all models of 12 ft. or more. No shrink! No warp! No weakness! No extra cost! Investigate the Ozarka plan before you buy!



BE STRONG USE BARBELLS



95 POUND SET
Only **\$10.80**
Extra Plates 10c. pound

Send for our **FREE** Barbell Catalog.

We have been selling the finest barbell equipment since 1928. We operate our own foundry and sell direct to you at a very low profit. No other company can match our low prices.

BUR BARBELL CO.
LYNDHURST 11,
NEW JERSEY

ARTISTS MAKE MONEY

DO YOU LIKE TO DRAW?

Send name, address, age and occupation for **FREE ART TEST**, to find out your ability.

ART INSTRUCTION, INC.

11149 Art Instruction Bldg., Minneapolis 15, Minn.

COMMERCIAL TRADES' GRADUATES GET THE BETTER JOBS because they are PROPERLY TRAINED!

Practical Shop Training In
Air Conditioning—Refrigeration
and/or

Electricity Major Appliances
Service, Maintenance & Installation

Write for Catalog PS4

COMMERCIAL TRADES INSTITUTE

200 South 20th St. Birmingham, Ala.
Member: Southern Association of Private Trade Schools
An approved school to TRAIN Veterans & Non-Veterans

EXPORT PAYS BIG

World Trade firm offers men and women plan for big pay positions or unlimited-profit businesses of their own in Export-Import. Mail order World-wide without capital, from home, or travel abroad. Write today for Free Book. State if veteran. Airmail reaches us over night. The Mellinger Co., 1422-JZ Westwood, Los Angeles 24, Calif.



DRAFTSMEN!

AND TEMPLETMAKERS

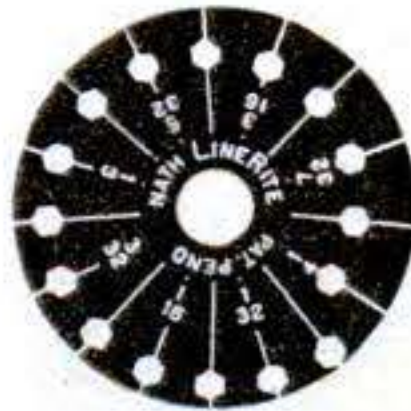

The "Linerite" saves time and insures accuracy in drawing curved or straight PARALLEL LINES, spaced any 1/64 dimension to 1/4. Quick, accurate, easy to use. Simply insert pencil or scribe in any of the specially designed holes and slide against curve or straight edge.

Celluloid (specify white or transparent) . . . **\$1.00**
Steel, for metal layout work. **1.50**

Postpaid in U.S.A. Satisfaction Guaranteed.

M. NATH, 4831 Woodhall Ave., Detroit 24, Mich.

TRAIN TO BE A TOP-NOTCH



DENTAL TECHNICIAN

Day & Evening Courses

FOR A BRIGHTER FUTURE

Study at a modern, well-equipped school under skilled, professional teachers. Approved for Veterans.

KERPEL SCHOOL OF DENTAL TECHNOLOGY
820 Seventh St. N. W., Washington 1, D. C.

Famous BAILEY TECHNICAL SCHOOLS

OFFER THE FOLLOWING COURSES:

**COMMERCIAL ELECTRICITY
PRACTICAL DIESEL ENGINEERING**

Your future success depends largely on the reputation of the school you attend. Don't take chances! Train at America's foremost school of mechanical specialization. Bailey is recognized and approved by industry. Bailey graduates get the top pay jobs! Send for FREE Catalog.

Check course in which you are most interested:
 Diesel Electricity

BAILEY TECHNICAL SCHOOLS

1655 So. Grand Blvd., St. Louis 4, Mo.

LOCKSMITHING & Key Making

PRACTICAL UP-TO-DATE COURSE



Easy-to-learn modern information for self-instruction. How to work on locks, pick locks, de-code, make master-keys, repair, install, service, etc. For every handyman, home owner, carpenter, mechanic, service station operator, fix-it shop, hardware dealer, gunsmith. 53 plain illustrated lessons. Full price only \$3.95. SEND NO MONEY. Just pay postman plus C.O.D. postage. Or send \$3.95 with order, we'll ship postpaid. Satisfaction guaranteed or refund. Address below.



WATCH & CLOCK REPAIRING

Learn at Home in Your Spare Time! . . . Prepare for a happy future, with security—and qualify for a good job NOW. A fascinating and thorough self-instruction training in American and Swiss watches and clocks. Special section on alarm clock repairs. Fast-growing field. Satisfaction is guaranteed. Full price only \$4.95, postpaid—or COD plus postage.

Nelson-Hall Co., 1139 S. Wabash Ave., Dept. L-1, Chicago 5, Ill.

Look —a 10½x4. 6-ply Tire. Tube. Machined Wheel and Bearing at a "give away" price. Supplied in two types:—

1. With Highspeed TIMKEN BEARING (with Grease Retainer) \$8.95
2. With Slowspeed NEEDLE BEARING (with Grease Retainer) \$5.95

Freight Collect (8½ lb.)

Ideal for Handcarts, Bogies, Trailers, Soap-box Racers, etc. A bargain from the world's largest stock of all types of Airplane Tires. Send your check or money order to:

Airplane Tire Co., 99 Hiway, Tulare S., California

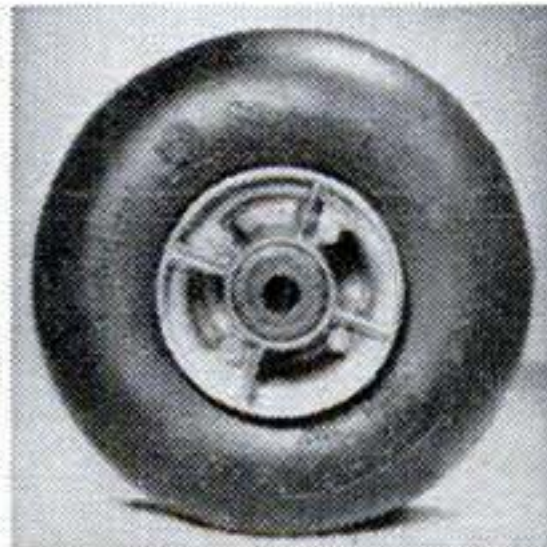

Build your own JET ENGINE!

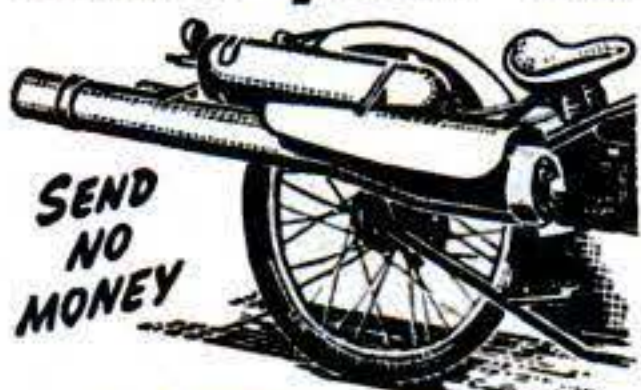

SEND NO MONEY

Order these plans today

1. JET PROPELLED BICYCLE. Assemble your own. Photo and instructions \$1.00.
2. HOW TO MAKE EXPERIMENTAL JET ENGINES. Seven sheets drawings with information and instructions \$2.95.
3. BOTH OF ABOVE in one order \$3.75. SEND NO MONEY. Order both at once \$3.75 C.O.D. in USA plus c.o.d. postage. Send check or Money Order and we pay postage. Get other information too. Rush Order.

J. HOUSTON MAUPIN, Dept. 66, Tipp City, Ohio

TRAVEL - for 'UNCLE SAM'

**ARE YOU JOB-SATISFIED?
GET A U. S. GOVERNMENT JOB
Many Positions to Be Filled**

Railway Mail Clerks—Postoffice Clerks—Mail Carriers—Stenographers—Typists, Statistical Clerks—Liquor Inspector, etc. 40 page Civil Service Book—FREE.

MEN — WOMEN

Veterans Get Preference

Mail Coupon immediately—today sure.

Although not government controlled this can be your first step toward a secure Civil Service career.

As high as \$3,351.00
**FIRST
YEAR**



COUPON

FRANKLIN INST., Dept. X-81, Rochester 4, N. Y.

Gentlemen: Rush to me, without charge, 40 page book with list of U. S. Government big paid positions. Advise me also regarding salaries, hours, work, vacations, etc. Tell me how to qualify for a position.

Name

Address..... Vet?.....

Put your future
in your own hands

BE AN ARTIST

Here's the Amazing
Way We Teach You
Step-by-Step to Draw
At Home in Spare Time

Draw for money. Prepare yourself now for a fascinating, pleasant and profitable Art career. COMMERCIAL ART, DESIGNING, CARTOONING—all in one complete home study course. No previous art experience necessary. We teach you step-by-step and prepare you for good art jobs in advertising, television, newspaper and magazine publishing, department stores, printers, engravers, or in art studios, etc. You can become your own boss. For 35 years our graduates have been "making good"—WHY NOT YOU?



Trained Artists Are Capable of Earning
\$65 - \$80 and MORE a WEEK

Write for FREE BOOK, "Art for Pleasure & Profit"—tells about our course, instruction service, material furnished, what our graduates say, and commercial opportunities for you. TWO ART OUTFITS and other features included with training. Low cost—only \$5 monthly.

VETERANS! Course G.I. Approved

FREE BOOK gives details!

WASHINGTON SCHOOL OF ART, STUDIO 1311R

1115—15th St., N.W., Washington 5, D. C.

Please send me full information and your Free Book, "Art for Pleasure and Profit." (Please print name, etc.)

Name.....AGE.....

Street.....

City.....Zone.....State.....

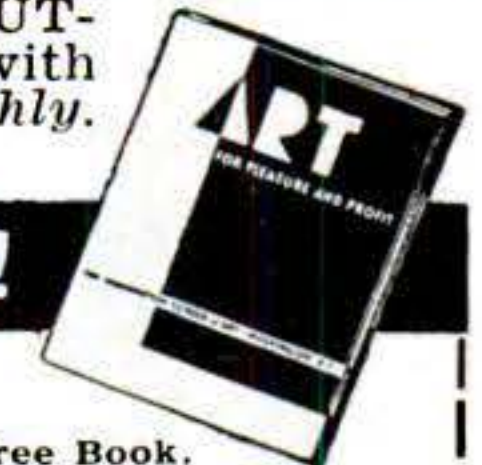

WAR SURPLUS

BIGGEST BARGAINS IN YEARS

ELECTRIC MOTOR. 1/2 H.P. 27V D.C. R.P.M. 4000, No. 750 for intermittent or continuous duty 5/8" shaft. VARIABLE SPEED MOTOR. Can be adapted to 110 Volt A.C. or R.E.A. line by re-arranging armature brush leads. UNUSED. Instructions incl. **\$5.50**

HAND HYDRAULIC PUMP BRAND NEW. Use it for hydraulic jacks, presses, hoists, etc. For operating hydraulic cylinders, to pump oil or hydraulic fluid under pressure. Ruggedly constructed, built by WEAVER. The handle is telescoping, length variable from 12" to 20". Has built in check valve and is capable of delivering 1000 lbs. of pressure. Dimensions, 8" long x 6" high x 4" wide. Wt. 10 1/2 lbs. A \$50 value, directions incl. Now... **\$8.50**

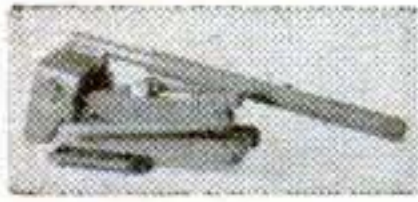

VICKERS CONSTANT DISPLACEMENT HIGH PRESSURE PUMP. Use it for any type liquid pumping job. 375 gal. per hr. at 3750 R.P.M. 1000 pounds pressure per sq. in. Can be used as hydraulic motor. O. Acq. cost \$100 Brand New. Wt. 7 lbs. Directions incl. **\$8.95 post paid**

HYDRAULIC CHECK & RELIEF VALVE, adjustable for any pressure. **\$2.50 post paid**

VICKERS UNLOADING VALVE. Brand New—By passes full amount output of the pump while the cylinder is not in operation. Takes starting load off of electric motor driving the pump. Price **\$4.95 post paid**



BRAND NEW HYDRAULIC CONTROL VALVE. This is a TWO CYLINDER DOUBLE ACTION VALVE with unique arrangement allowing the operator to raise both cylinders simultaneously, to lower them simultaneously, or to raise one and lower the other at any predetermined rate and speed. BRAND NEW. A \$75.00 value. **\$9.95 post paid**



SPEED REDUCERS. G.E. 10 to 1 ratio, or 5 to 1. Shaft Driven 1/2" spline Shaft. 3 mounting holes 5/16". Unused Ea. **\$3.50**

LUBE PUMP. Brand new precision Gear Impeller pump. Pumps liquid up to 3 G.P.M. Pressure up to 200 lbs. per sq. in. For high vacuum, air pressure, operating Hydraulic units, etc. For St'd. 1/2" threaded and keyed. Shaft Instructions incl. **\$4.50 post paid**

Sensational Fascinating Mysterious **SELSYN.** Two or more connected together can be adapted for 110V. A.C. For weather vanes, rotating directional antennae or controlling distance operations. With diagram and instructions. (wt. 3 1/2 lbs.) **\$3.50 Plus Postage PER PAIR.**

BRAND NEW WONDERFUL ROTATOR MOTOR For rotating Ham FM Antennas, Turntables, Telescopes, etc. Operates directly on 110 V. A.C. 60 cycles (requires only 12 MFD condenser) 3/4 R.P.M. For operating Ventilating Louvers such as used with Attic Fans. Furnace Dampers or check drafts. Instructions incl. Ea. **\$3.95**



NEW PUROLATOR GASOLINE FILTER. Aircraft type for all cars, trucks, tractors and motorboats. Re-refines and cleans gasoline as you drive. Install at home in a few minutes. STOP GASOLINE WASTE & EXPENSE. Permanent. Needs no replacements. Instructions incl. Ea. **\$4.95**



NEW CUNO OIL FILTER aircraft type. Filters oil without cartridge replacements. For Autos, Trucks, etc. Install at home in a few minutes. STOP CHANGING MOTOR OIL. Instructions incl. **\$4.95 Ea.**

Send check or money order. No c.o.d's. Prices f.o.b. K.C.

GENERAL SALVAGE COMPANY

Dept. 27, 2922 E. 27th St. Kansas City, Mo.

Get Facts About Fistula — FREE

NEW BOOK—Explains Causes and Latest Treatment

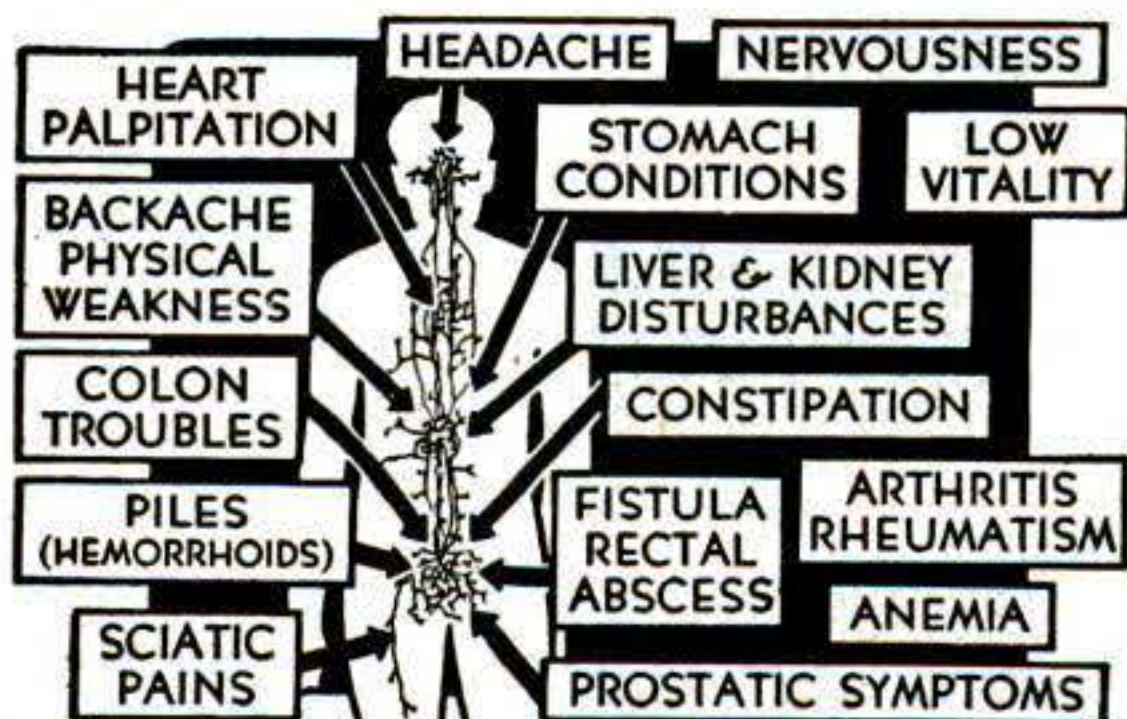

Illustrated, authentic 40-page book on Fistula, Piles (Hemorrhoids), related ailments as shown in diagram and colon disorders is yours FREE. Send postcard to Thornton & Minor Clinic, Suite 1149, 911 E. Linwood, Kansas City 3, Missouri.

Chronograph Wrist Watch

LOWEST MARKET PRICE \$6.75



Sweep Second Hand: Precision Workmanship; Rugged Shock-resistant case; Radium hands and numerals; Leather strap. It measures distance, speed of cars, planes, horses and other moving objects. It's a time keeper, stop watch, telemeter, tachometer. ONE YEAR WRITTEN GUARANTEE. Full operating instructions enclosed. SEND NO MONEY. Mail your order today. Pay postman \$6.75 plus 10% Federal tax. Total \$7.43 plus postage. Or send cash (money order or check) with your order and save postage charge.

Gold Case Model—\$8.50 including tax.

MARDO SALES CO., Dept. 1804

480 Lexington Ave., Rm. 1115 N. Y.: 17, N. Y.

Trained Men Get the Better Jobs PRACTICAL SHOP TRAINING in AUTOMOTIVE MECHANICS BODY and FENDER REBUILDING

If interested write or wire

ATLANTA MOTIVE TRADES INSTITUTE

Dept. C 254 IVY St., N.E. Atlanta, Georgia

Member of the Southern Association of Private Trade Schools

Veterans ask about G I Training

Learn ACCOUNTING BOOKKEEPING

This nationally renowned school has demand for graduates in good salary positions thru Nationwide recognition and placement service. Write Department PSG today for Big 32 page Success Book to be sent to you **FREE**



Hills BUSINESS UNIVERSITY AND EXTENSION SCHOOL

619 W. MAIN ST. OKLAHOMA CITY 2, OKLAHOMA

AMAZINGLY LIFELIKE TROPHIES IN MINIATURE

Amazingly lifelike heads in miniature on plaques 6" x 7". Real-looking Buffalo, Bear, Deer, Wildcat; flocked rayon "fur", flame-resistant; real glass eyes. Swell for den, boy's and rumpus room, club, workshop, livingroom. Ideal Christmas gift. \$2.50 ea. (2 for \$4.50) plus postage; or postpaid if check or m.o. with order.

MACEY ARTCRAFT CO., BOX 254, NEW BEDFORD, MASS.

Learn BAKING at home

Baking is one of America's high industries in wages. Not seasonable, but year 'round good field for trained and experienced men. Thorough basic spare time home study course lays solid foundation. If you have the aptitude for this type of work, send for FREE Booklet, "Opportunities in Commercial Baking."



NATIONAL BAKING SCHOOL
1315 S. Michigan Ave., Dept. 1368, Chicago 5, Ill.

DON'T DRIVE BLIND Be SAFE with PANA-VUE THE CURVED REAR VIEW MIRROR WITH MAXIMUM VISION

Eliminate blind spots—Pana-Vue lets you see out quarter panel as well as rear window. Letter A in drawing shows limited vision with old style mirror. Letter B shows increased scope with Pana-Vue. • Pana-Vue is made of non-distorting fire tempered glass mounted in protective rubber rimmed frame. • Easy to install—universal clamps fit over old mirror.

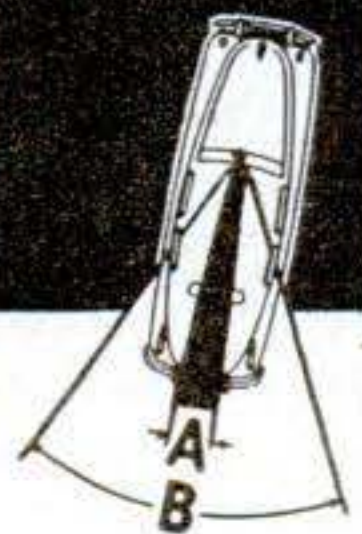

\$1.85 In Ohio add 6c sales tax

MONEY BACK GUARANTEE! Send check or M. O. plus 10c postage today!
Moto Products Sales Co. 5410 Stone Ave. Cleveland 2, Ohio

FOR YOUR CAR'S ENGINE

Scientific Lubrication begins here

THE MARVEL INVERSE OILER ASSURES LUBRICANT PROTECTION FOR EVERY ENGINE PART

The upper cylinder area of your car's engine is the hottest, most critical spot in the operating motor. Here, ordinary lubricants fold up, causing rapid wear of pistons and cylinder walls. You can keep wear down and performance up with the MARVEL INVERSE OILER! Shown above is the operating head (without dust cap) of this famous, low cost device that meters MARVEL MYSTERY OIL to the engine, precisely in accordance with the demands of the engine under load. When used with MARVEL MYSTERY OIL, it's guaranteed for TWO YEARS!

MARVEL MYSTERY OIL is not just an oil but the famous Additive that produces a slow idle, faster engine pick up, easier starting and an even, power pull. Thousands of economy-minded car owners have used it enthusiastically for years. Learn what MARVEL can do for you to make your car do more and last longer.

Easily Installed on All Engines

**EMEROL MANUFACTURING CO., INC.
242 W. 69th ST., NEW YORK 23, N. Y.**

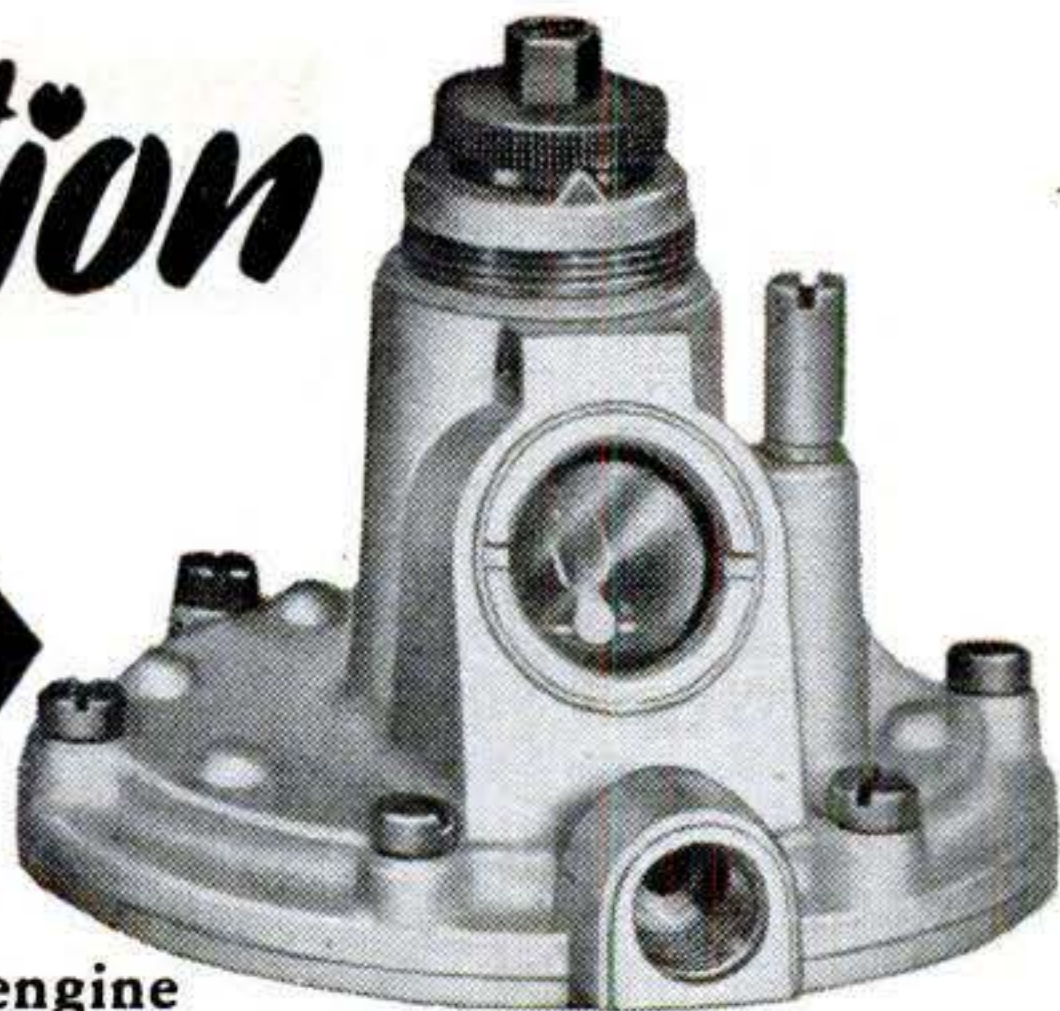

WRITE FOR THE FACTS—NOW!

4 SPEED MOTOR

The Xmas Gift with 1000 Uses!

The built in integral gear box has four 1/4" drive shafts turning simultaneously at the following speeds:
 4000 RPM for grinders, buffers, small drills, flex shaft tools, etc.
 150 RPM for wrapping fishing rods, driving pumps, slow speed tools, fans.
 25 RPM—rocker for photo developing tray, cabinet makers glue wheel, erector sets, film puller for 16 mm. developer, operating laboratory equipment, etc.
 5 RPM for turning barbecue spits, advertising displays and antennas.

A THOUSAND OTHER USES AROUND THE WORKSHOP

This 1/20th HP, 115 V., 50/60 cycle, AC motor is precision built throughout.

Fully guaranteed—Money refunded if not satisfied

Pulleys, belts, shaft couplings, Mandrels and other equipment at 15c to 60c. List sent with motors. SPECIAL—while they last.....

Californians please add 25c sales tax

- For amateur beam & television antenna
- Drives working models, toys and gadgets
- For action displays, miniature fountains
- For doctors, dentists, jewelers, technicians

TROUP ENGINEERING CO., Dept-111, 3201 E. Pacific Coast Hy., Long Beach, Calif.



\$9.95
SENT POSTPAID

Shoe Repairing Hat Cleaning & Blocking

Prepare quickly in one of the finest and best equipped schools. Practical shop work and shop management taught by experts. Widespread need for trained men in this good pay field. Get the facts. Write today.

Practical Shop Training

COMPLETE YOUR TRAINING IN ONLY 12 WEEKS in Hat Cleaning and Blocking. As a trained man you can start your own business with very little investment. Pay in this field is good, fine opportunities for steady jobs. "Learn-By-Doing."

Prepare for Good Job or Own Business in One of These Big Fields



Help in finding part time work while a student, employment service to graduates. No minimum educational requirements since these are practical courses. Training in large, modern brick building.

Largest and Best equipped School of its kind in U. S.

G.I APPROVED PAYMENT PLAN FOR NON-VETERANS

**CHICAGO SCHOOL OF SHOE REBUILDING
124 E. 26th St., Dept. PS-11, Chicago, Ill.**

Please send me information and free facts about the course I have checked.

() Shoe Repairing () Hat Cleaning & Blocking

Name

Address

City State

Mail Coupon Today for Free Information

CHICAGO SCHOOL OF SHOE REBUILDING, 124 E. 26th St., Dept. PS-11, Chicago, Ill.

PLASTICAST

THE GREATEST THING IN PLASTICS!



A NEW HOME INDUSTRY AND HOBBY!

We have combined two of our most popular Kits into one **GIANT COMBINATION PLASTICS OUTFIT** as described; **Makes a Treasured Christmas Present!** **PLASTICAST** . . . a transparent liquid plastic; can be poured into ANY kind of mold or container. Hardens in a few minutes into a beautiful transparent solid, clear-as-glass, tough-as-steel plastic! No tools, equipment or skill required. *Our casting plastics are as easy to use as pouring water out of a glass!* Ideal for imbedding pretty flowers, butterflies, photos, souvenirs, biological specimens, etc. Makes a **PERMANENT** and **ATTRACTIVE** display! Make beautiful jewelry, novelties, etc. Casts easily into any shape or form.

HERCULOX . . . liquid plastic, works same as above but hardens in 5 minutes into a very attractive white opaque solid. A general all-purpose plastic. Can easily be made to imitate Ivory, Onyx or Marble. May be dyed any color, cast into ANY shape, used for ANY purpose. Extremely hard and durable. Ideal for statuary, figurines, novelties, gadgets, models, tools . . . a million useful things! In addition, **COMBINATION OUTFIT** contains 3 attractive molds for making about \$100.00 worth of novelties, dye, pipette, hardeners, measure, imbedding material, jewelry accessories and instruction manual.

COMBINATION PLASTICS OUTFIT, Cat. No. 636, postpaid . . . \$4.95
PLASTICAST OUTFIT ONLY, complete with 3 molds . . . \$3.50
HERCULOX OUTFIT ONLY, complete with 3 molds . . . 3.50

FREE!

Let us show you how extremely easy it is to make beautiful and useful things out of **LIQUID PLASTICS, LIQUID MARBLE, LIQUID IVORY, LIQUID GLASS, CERAMICS, ETC.** . . . as easy as pouring water out of a glass! Make novelties, jewelry, gifts, artware, gadgets, toys, ceramics . . . a million useful things! We supply everything—**MATERIALS, INSTRUCTIONS AND BUYERS!** Send only 25c for 1. Big catalog of 300 casting materials, molds, and accessories, 2. A beautiful **CAMEO** free (to show you what you can do), and 3. Actual **INSTRUCTIONS** on how to cast and start in the **CASTING BUSINESS!** Send 25c today—this may be the lucky coin that will start the most fascinating and profitable phase of your life! (Catalog only—10c)

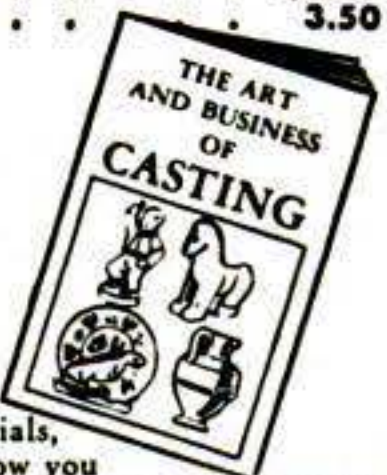

TERMS: We pay the postage (U.S.A. only) if full cash accompanies order. C.O.D. accepted (U.S.A. only) if \$1.00 deposit included for each item ordered.

DEALERS: WRITE FOR CATALOG, DISCOUNTS & PROMOTIONAL MATERIAL.
PLASTICAST COMPANY (DEPT. A)
 4637 N. Kedzie Ave. (Write to nearest address) P. O. Box 987
 Chicago 25, Ill. Palo Alto, Calif.
CANADIAN CUSTOMERS, please order directly from: CANADIAN INDUSTRIAL PLASTICS, LTD., 1056 1/2 Pender West, Vancouver, B. C.

BUILD YOUR POWER TOOLS

WITH OUR GUARANTEED INDUSTRIAL **POLY BALL BEARING ARBORS**



New Departure Self Lubricating Bearings

10,000 R.P.M.



C4-1/2" Pictured

B33—\$5.45 PP.
 3/8 x 4 1/2 Spindle
B15 Plain Spindle \$3.95 PP.

(No extra charge for left hand threads)
 C4—1/2x12 1/2 spindle, housing 2x8, \$7.95 PP.
 C5—5/8x12 1/2 spindle, housing 2x8, \$8.45 PP.
 C6—3/4x12 1/2 spindle, housing 2 1/4 x8, \$9.45 PP.
 D8—1x17 1/2 spindle, housing 2 5/8 x11 \$18.75 PP.
 1 INCH BETWEEN WASHER AND COLLAR
SHAPER ARBORS—Free literature on request.

POLY PRODUCTS, 2032-B E. Walnut, Pasadena 8, Calif.

SHARPEN SKATES!

NEW ICE SKATE GRINDER grinds all makes and types of ice skates!

Here's a speedy way to make extra money all winter! Sharpen ice skates of any type on the new Ideal Model 50 Bench Grinder, with skate grinder attachment. It's the finest—and **FASTEST**—method. Write **TODAY** for free folder with complete money-making facts!

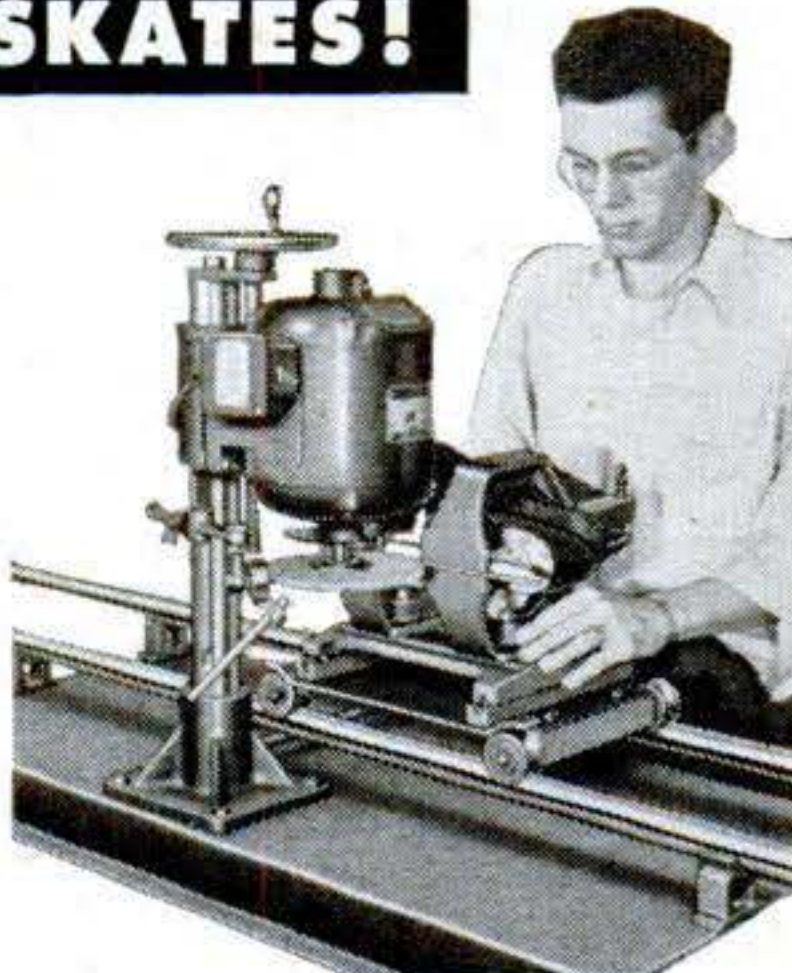

THE FATE-ROOT-HEATH CO., Dept. D-4, Plymouth, O.

MANUFACTURER'S

SURPLUS



PAY ONLY **4.95**

PERFECT XMAS GIFT FOR YOUNG AND OLD ALIKE. SELLS FOR \$15.00 AND MORE

This fine microscope is created by the world famous optical craftsman of Rochester, N. Y. Especially designed for use in labs & schools and for scientific study in the home. Precision built with special lense construction. Each microscope comes complete with slides.

SPECIFICATIONS

- Magnifications of 60, 90, 150
- All-metal body, 8 ins. high
- Adjustable tilt stand
- Automatic turret with lock
- Rack & gear adjustments
- Chrome & black crinkle finish

Money back guarantee

AVOID XMAS RUSH—ORDER NOW
 Send check or money order please.

NAT LEHRER Dept. PS, 73 Canal Street NEW YORK, NEW YORK

Learn Upholstering

A money-making business or fascinating hobby. Practical home training. You get materials to make and upholster a fine Ottoman with your first lesson. Professional upholsterer's tools available. Write today for free, illustrated booklet. State whether interested for career or hobby.

WEST COAST UNIVERSITY, Extension Dept. PS-119 1601 S. Western Ave. Los Angeles 6, Calif.

ORDER NOW—SAVE 20%

U-MAK-IT BOAT KITS EASY TO BUILD

- 5 ROWBOATS 8 TO 14 FT.**
- 6 OUTBOARDS 12 TO 16 FT.**
- 3 INBOARDS 16 TO 23 FT. & CABIN CRUISER**



SEND 25c (coin) ORDER YOUR CATALOGS TODAY
U-MAK-IT PRODUCTS 703R-WHITTIER ST. New York 59, N. Y.



LEARN

MEAT CUTTING

through actual practice. Profitable Meat Cutting and Self Service Meats taught easily, quickly. **LEARN BY DOING** at Toledo in just eight short weeks under actual market conditions. For beginners or men with experience. All subjects taught thoroughly and completely. Diploma. Job help. Get store of own. People must eat. School in operation over 25 years. Approved for GI training. Send today for **FREE** illustrated catalog. No obligation.
NATIONAL SCHOOL OF MEAT CUTTING, Dept. 51-O, Toledo 4, Ohio

SIMULATED DIAMOND RING \$5



14 Kt. R. G. P. or St. Silver wedding & engagement rings made as single ring. 1 kt. simulated diamond with 12 smaller stones. Guaranteed. Send no money. Pay postman. Fed. Tax incl. Send finger size or string.

HAYES RING COMPANY P. O. Box 7526 Balto. 7, Md.

Performance that excels • Stamina that endures

DOUGLASS Steel-Pack MUFFLERS



FOR ALL MAKES AND MODELS

Rugged construction. Steel tubing. Straight-thru-design. Solid tube with steel packing. "Throbbing Deep Tone." Complete for Easy Installation

32-40 FORD V-8	\$5.95	29-49 CHEVROLET	\$5.96
41-49 FORD V-8	6.85	31-41 PLYMOUTH	5.96
39-49 MERCURY	6.85	42-49 PLYMOUTH	6.85
35-48 FORD & MERCURY DUAL SETS			\$23.00
49 FORD & MERCURY DUAL SETS			25.00

Specify Year and model • Satisfaction Guaranteed
 Enclose Full Amount With Order All Equipment F.O.B.
1949 COMPLETE RACING EQUIPMENT CATALOG 25c

DOUGLASS MUFFLER MANUFACTURING COMPANY 1916 W. Valley Blvd. Alhambra, Calif.

\$350 IN A SINGLE WEEK **GROSS**



IN MY OWN BUSINESS

Some Make More, Some Less . . .
Start This Business for YOUR OWN

FREE BOOK! MAIL COUPON

VON SCHRADER MFG. CO.
42N Pl., Racine, Wisconsin

Send at once (no obligation) your FREE booklet containing information about your Electric Upholstery Cleaner and how I can own my own permanent, profitable business.

Name _____
 Address _____
 City _____ Zone _____ State _____

George Held earned \$350 in one week with

ELECTRIC UPHOLSTERY CLEANER

• Here's YOUR chance to start a money-making, year-'round business of your own and make the success you've dreamed about. R. O. Donnley took in \$40 in seven hours. O. W. Ware landed a \$750 hotel job and made a fine profit. J. S. Corbit grossed \$279.50 his first month. P. D. Ash cleaned 23 auto seats at \$5 each in one week. And so it goes. Homes, hotels, offices, clubs, all places where furniture is used, offer you big profit possibilities. Auto seats and interiors, also.

NO SHOP OR OFFICE NECESSARY

You clean furniture on customers' premises. No hauling costs. No high rents. Supplies are in-

expensive and you operate, at low cost, from your home. What you take in is mostly profit. Surely YOU will want to investigate an opportunity like that—right away. Own your own business. Be your own boss. If you are ambitious, honest and courteous, we will help you to start and succeed.

FULL INFORMATION FREE MAIL COUPON TODAY

Send the coupon or write for Furniture Cleaner Booklet. It tells all about this electric cleaner—how to start YOUR business—how to make a profitable success. Don't delay. It's your BIG opportunity.



MAIL COUPON TO

VON SCHRADER MFG. CO., 42 N PL., RACINE, WIS.



WAKE UP YOUR Scalp
 WITH THE NEW ELECTRIC-AUTOMATIC Vitabrush

BE FAIR TO YOUR HAIR Want better looking hair? Embarrassed by falling dandruff, itching scalp? Get the new VITABRUSH, the electric-automatic brush with built-in brush head motor. . . gives scalp and hair an invigorating "workout" in just 3 minutes. Cleans scalp, stimulates blood supply, distributes the natural oils. Fun to use—relaxing. Write for satisfaction-guaranteed offer—today. Hershey Mfg. Co., 3730 Field Bldg., Chicago 3.

LEFAX POCKET SIZE TECHNICAL DATA BOOKS \$1. EACH

Printed on loose leaf, six hole, 6 3/4" x 3 3/4" bond paper, each book contains about 140 pages of technical data, presenting condensed, accurate and essential data for the student, engineer, technical worker and business man.

- | | | |
|--------------------|------------------------------|---------------------|
| Architecture | Reinforced Concrete | Surveying |
| Home Heating | Building Constr. | Mechanical Drawing |
| Illumination | Radio | Machine Design |
| Electrician's Data | Television & FM | Machinists Data |
| Builder's Data | Electricity, AC | Piping Data |
| Lumber Data | Electricity, DC | Surveying Tables |
| Air Conditioning | AC Motors and Generators | Trig-Log Tables |
| General Math. | Transformers, Relays, Meters | Metallurgy |
| Math. Tables | Hydraulics | Analytic Chemistry |
| Physics | Automotive Engineering | Highway Engineering |
| Chemical Tables | | |
| Metals | | |
| General Chemistry | | |

Write for FREE catalogs (over 2000 listings). See for yourself how helpful LEFAX can be to you. Send \$1 for each book, (or \$5 for any six books listed above) to

LEFAX DEPT. PS-2 PHILADELPHIA 7, PA.

Train Now for Big Pay Open to Carpenters & Brick Layers



IN A FEW SHORT MONTHS IN MODERN WELL EQUIPPED Midwest Shops

Approved for Veterans. Non-veterans may pay tuition by the month. MAIL COUPON TODAY FOR FREE INFORMATION.

Get into the billion dollar building trades. Demand widespread, check your own neighborhood for shortages of carpenters and brick layers. Our graduates are actively employed in the Building Trades, stepping directly from school into jobs or business of their own in various parts of the country. Many of our students supplement their income with part time earnings while attending school. Pleasant inexpensive living quarters in beautiful, healthful surroundings. Enroll now. Limited classes. MSBT teaches building trades only. If you prefer, you can begin your training at home.

MIDWEST SCHOOL OF BUILDING TRADES
 411 N. Center St. Dept. PS-11 Bloomington, Ill.

MIDWEST SCHOOL OF BUILDING TRADES
 Dept. PS-11
 411 N. Center Street, Bloomington, Ill.

Please send me free information about training in the field I have checked:

Carpentry Brick Laying

Name

Address

City State

Are you a veteran? Yes No

Copyrighted material

FINANCING

PROFITS

POLICIES

TAXES

COSTS

AUDITS

BECOME AN EXPERT

ACCOUNTANT

Choice of Bookkeeping—Advanced Accounting or CPA Coaching—No experience necessary!

The demand for skilled accountants—*men who really know their business*—is increasing. National and State legislation is requiring of business much more in the way of Auditing, Cost Accounting, Business Law, Organization, Management, Finance. Men who prove their qualifications in this important field are promoted to responsible executive positions.

Free Book—"Accountancy, the Profession that Pays"

Knowledge of bookkeeping unnecessary. We train you from ground up, or according to your individual needs. Low cost; easy terms.

Send for *free* 48 page book describing the LaSalle accountancy training, and the opportunities in this highly profitable field.

LASALLE EXTENSION UNIVERSITY A CORRESPONDENCE INSTITUTION

417 South Dearborn Street
Dept. 1183-HR Chicago 5

Please send me information on the training checked below, also "Accountancy, the Profession that Pays"—all without obligation.

- Accounting
 CPA Coaching
 Expert Bookkeeping

FREE

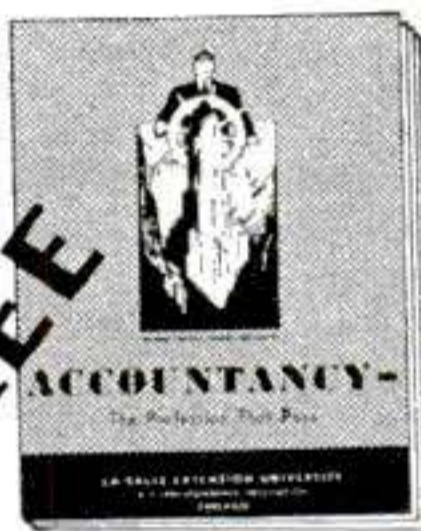

Name..... Age.....

Address.....

City..... Zone..... State.....

ENGINEERING DEGREE IN 27 MONTHS

Big Demand for Graduates

AERONAUTICAL, CHEMICAL, CIVIL, ELECTRICAL, MECHANICAL and RADIO ENGINEERING (including Television).

Hundreds of young men are earning engineering degrees in this recognized institution each year—continuous operation. New terms start quarterly. Many students earn a major part of their college expenses in this large industrial center.

Low tuition. Competent instruction. Thorough intense practical program. Modern laboratory facilities including new physics lab. and modernized wind tunnel. Individualized instruction emphasized.

Approved for Veterans. Engineering preparatory courses. Students from 48 states and 21 foreign countries. Enter December, March, June, September. Send coupon for free catalog and full information. Enroll now.

SEND COUPON TODAY

INDIANA TECHNICAL COLLEGE

6119 E. Washington Boulevard
Fort Wayne 2, Indiana

Please send me free information on B. S. Engineering. Degree in 27 months as checked.

- Aeronautical, Chemical, Civil,
 Electrical, Mechanical, Radio-Television.

Name.....

Address.....



The Ideal Xmas Gift for Automobile, Tractor, Trailer or Truck Driver

Pumps up tires, anywhere, anytime. The car engine does the work... unscrew a spark plug, replace it with the ENGINAIR, attach hose to tire, and, idle the engine till pressure gauge indicates proper inflation (2 to 5 minutes)... then stop engine and replace the spark plug. No waiting for service. No slow leak or soft spare worries. Over a million in use. Used by 6 armies. Develops up to 105 lb. pressure. Guaranteed for 2 years and to pump only pure air.



ENGINAIR SPARK PLUG TIRE PUMP \$5.00



with pressure gauge and 16 ft. air hose. If your dealer can't supply the up to 105 lb. capacity ENGINAIR, order direct. State make and model of your car.

G. H. MEISER & CO. (Est. 1906)
314 E. Marquette Road, Chicago 37



SUPERETTE DUAL VACUUM AUTO HORNS

ONLY
\$8.95
POSTPAID

Compares with
\$25 to \$100
Air Horns

The voice of authority and commanding warning for safer highway driving. One BLAST and those "Road Hogs" really move over. Installed under the hood or on the front fender. Beautiful lacquer finish. Operates from intake manifold. No tank needed. Only \$8.95 complete with cylinder head bracket, steering column lever, hose, fittings etc.—Send check or money order today. We pay postage. \$1.00 deposit required on all C.O.D. orders. THE PROTECTUROD CO., Dept. 400, 4033 Windsor Road, Youngstown 7, Ohio



GENUINE BRAND NEW GOV'T SURPLUS

Excellent for Ice Fishing, Outdoor Wear, Hunting and Sportswear

ORDER BY MAIL

- A-8 Down-filled Flight Pants, size 40. Fits 34 to 40 waist. \$8.95
A-11 Alpaca-lined Flight Pants, size 30-32 Fits 34 to 40 waist. 5.95
N-1 Blanket-lined Bib Pants. Small, medium or large size. 4.95

Shipped Postpaid Except C.O.D.

These items cost Gov. over twice these prices. BEN'S SURPLUS 138 Michigan St., Dept. A-2 Grand Rapids, Mich.

AMAZING NEW CHEMICAL MAKES

OLD BUMPERS LIKE NEW!

NOT A PAINT! NOT A POLISH! Looks like expensive chrome plating! Wonderful new chemical puts chrome-like finish on car bumpers, door handles, trim, etc. No electricity—no plating tanks—no acids needed. Just smooth it on and watch it gleam! Takes a brilliant polish JUST LIKE CHROME—so simple a child can do it. REFINISH BUMPER IN 10 MINUTES! WORKS LIKE MAGIC—finish lasts for years. Increases resale value of your car and adds NEW beauty to other chrome plated or metal items. TRY AT OUR RISK! SEND NO MONEY! Just send name and address. Pay postman amazing low price of \$1.00 plus few cents postage for each kit ordered, or send cash and we pay postage. Try kit 10 days. If not delighted return for instant refund! JACK B. ERMAN, Box 147, Hamtramck, Mich. \$100



LEATHER FLYING HELMET

NO HOOKS, TUBES, OR HOLES

Genuine NAVY aviators flying helmet. Cordovan brown leather. Warm—fleece lined. Brand new! Detachable chin strap. Perfect for cyclists, flyers, farmers, hunters, children and all-around outdoor wear. Best helmet service had. Govt. cost, \$10.00. Sizes 6 3/4 thru 7 5/8 (1 1/8 spread). Send check, cash, M.O. C.O.D.'s accepted. Money back guarantee. \$1.49 p.p.

GRAND-HAWTHORNE SURPLUS
1439 SE Grand, Dept. PS-119, Portland, Oregon

Send for this FREE BOOK on

RHEUMATISM

Arthritis • Neuritis • Sciatica

If you suffer the aches, pains and discomforts of these diseases, learn about a proven specialized system for treating them. Find out why drugs and medicines give only temporary relief and fail to remove the causes of the trouble. Fully explained in the Ball Clinic's **FREE BOOK. No Obligation. Write Today.** BALL CLINIC Dept. 36 Excelsior Springs, Mo.

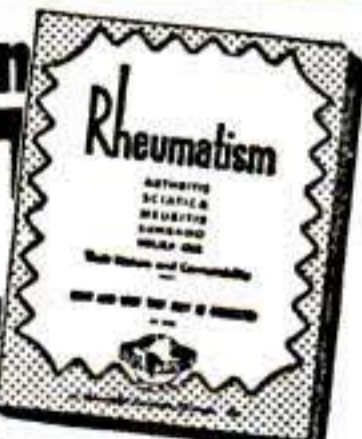

SELL AMAZING NEW STOCK SIGNS

BIG commissions on fast-selling revolutionary window signs.

Adheres magically to any glass or mirror. Handsome, economical, durable, washable. No tape, glue or suction required. Terrific seller. Every hotel, restaurant and store can use them. Territories open. Write for descriptive literature or send \$1 for complete sales kit and samples. State territory covered.

Dept. C, CLAYTER CORP.
509 Fifth Avenue, New York, N. Y.

For Hard-to-Heat Rooms



Only
\$8.95
each
Postpaid

INSTALL this 7" **NESTER** Booster Fan in a few minutes with cutting tool furnished by us at price below. Fan throws extra heat to cold room as desired. Furnished assembled to curved mounting brim 6" x 10" for simple fastening with 2 metal screws. Quiet motor is 110 V. 60 cycle, has 4 ft. cord & plug. Fan delivers 300 cu. ft. min. Complete instructions and cutting tool furnished. See your dealer or send check or money-order today \$8.95 ea. postpaid U.S.A. or COD plus charges.

Money-Back Guarantee.
NESTER METAL PDCTS., ALBION, MICH.

LOTS \$300 LOW TERMS

In California's loveliest Garden Spot, on scenic shores of beautiful Morro Bay. Enjoy future independence with excellent soil, soft water, wonderful fishing, hunting, boating, bathing, etc. Grow fruits, vegetables, poultry. Perfect temperate climate. Congenial community. Finest investment. Free literature.

RICHARD S. OTTO

Dept. PS San Luis Obispo, California

How to get BETTER FINISHES



Do Like Professionals. Use "TACK CLOTH" Before you PAINT or VARNISH

If you paint, varnish or lacquer woodwork, furniture, etc. at home, "TACK CLOTH" is the professional's secret of a slick, smooth, glistening finish every time. Used by all large industrial finishers. Just wipe over surface and remove every trace of lint, dust, sand, or dirt. No more specks, spots or rough places to mar your finishes. To introduce to Home Users, send only \$1 for 4 large 18" x 36" "TACK CLOTHS".
BAUGHN CHEMICAL PRODUCTS CO.
7025 N. Ravenswood, Dept. 311, Chicago 26, Ill.

ELECTRICAL TRAINING

Intensive 32 weeks residence course in fundamentals of industrial electrical engineering, including radio, electronics. Prepares for technician, engineering aides. Approved for veteran training. 57th year. Enter March 6. Write for catalog.

BLISS ELECTRICAL SCHOOL
7620 Takoma Ave., Wash. 12, D.C.

AIR TANK and ACCESSORIES

Air receiver, stainless steel, 12 1/2" x 24". 400 lb. test. Ideal for carrying on trucks, autos and wherever compressed air is needed. Equipped with 500 lb. air gauge, tire chuck, 3 ft. highest air hose, air inflation valve with core for retaining pressure in tank, and fittings.

Complete outfit **\$6.95**
Shipping wt. 20 lbs.
Tank only . . . **\$4.95**

Prices F.O.B. Chicago. Sold on money back guarantee. Send check or money order today. CATALOG FREE.

WELLWORTH TRADING CO.
1831 S. STATE STREET, DEPT. B-11 CHICAGO 16, ILL.

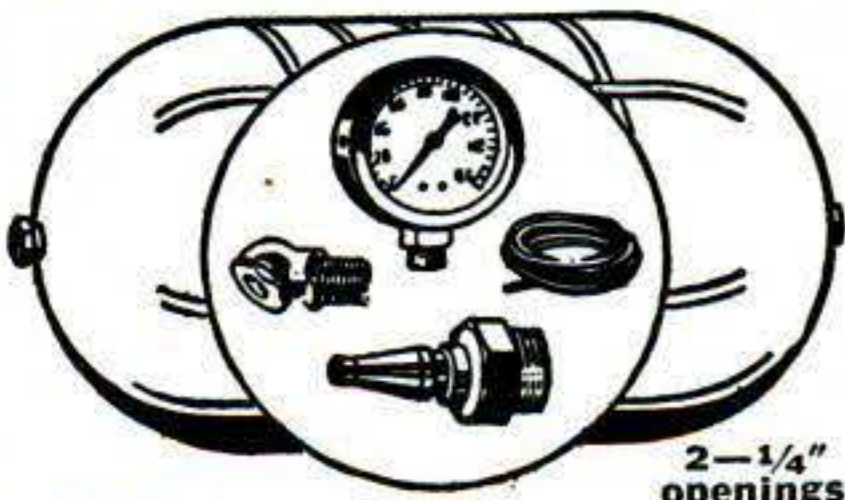

2-1/4" openings

NOW... 5 TIMES MORE USEFUL POWER FROM YOUR 1/4" ELECTRIC DRILL

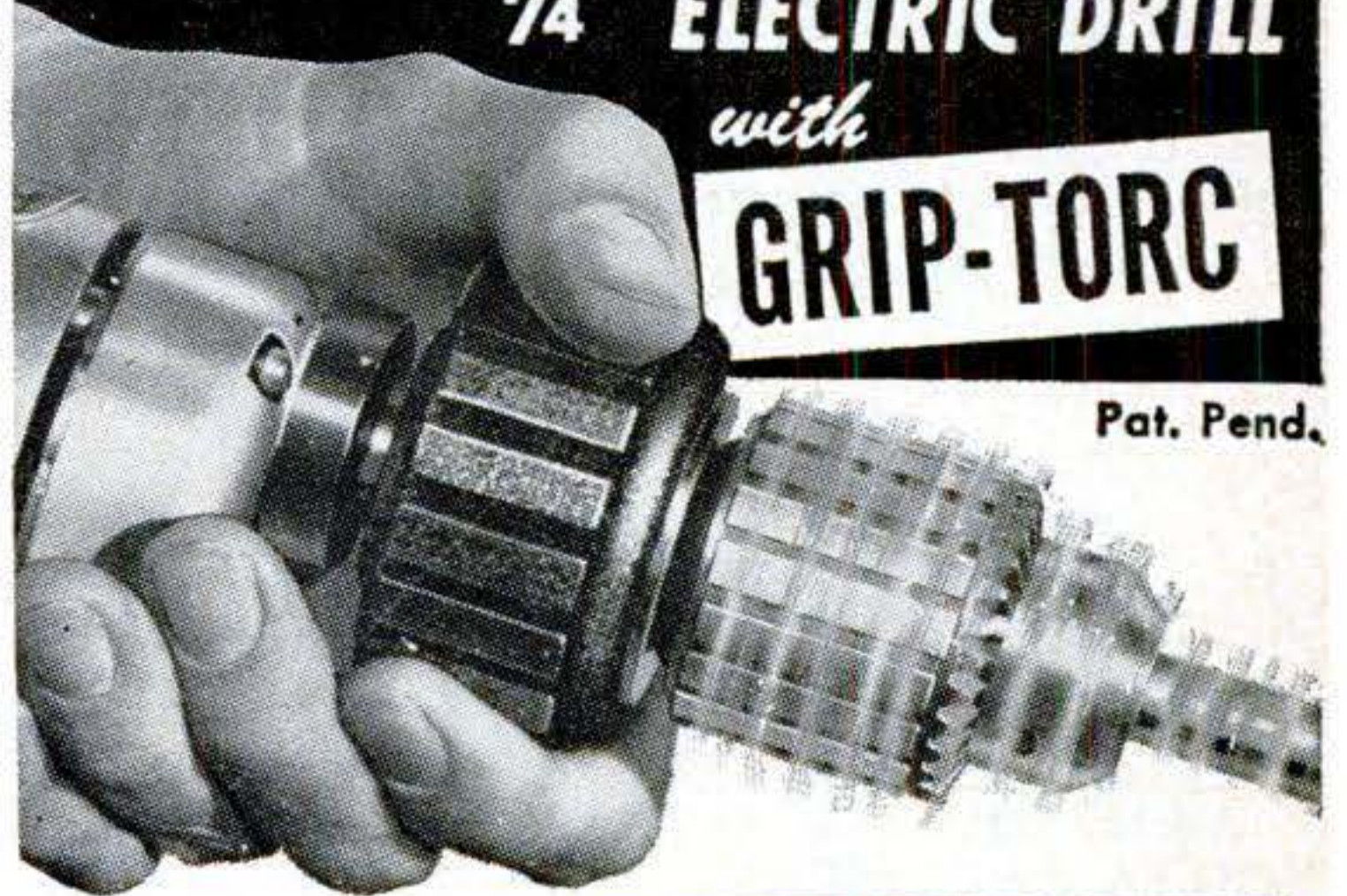

with
GRIP-TORC

Pat. Pend.

When you grip it the working tool **STARTS** . . . Release it . . . and the working tool **STOPS**. Gives you instant start-stop control with power unit operating.

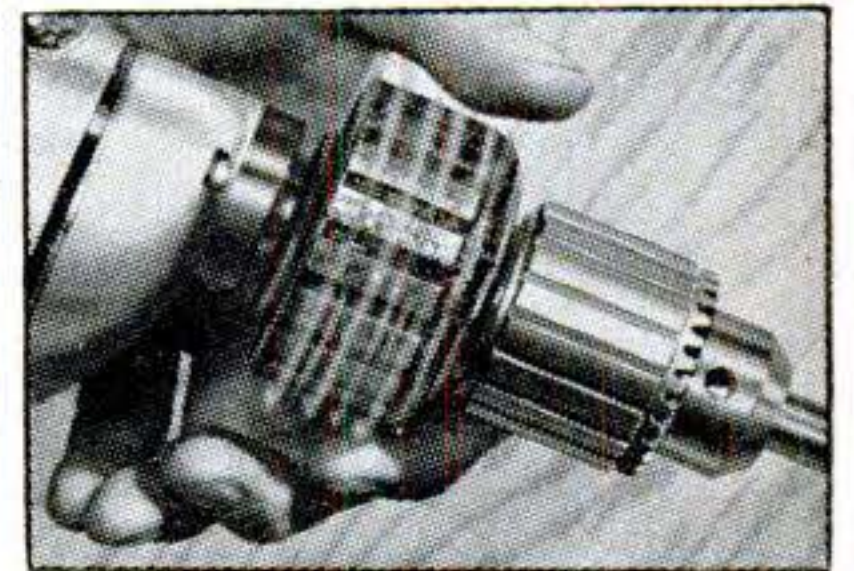

GRIP-TORC converts your 1/4" electric or air drill into a multi-purpose tool of super capacity. You can now drill, bore, ream, drive screws, run nuts, etc., which previously has required a combination of many expensive specialty tools. Note the partial list below of heavy duty jobs you can now do with your present power drill.

GRIP-TORC screws on the spindle or fits in the chuck of your 1/4" power drill or press. It is a geared mechanism, (not friction drive) which you control by the grip of your hand. **GRIP-TORC** is a precision quality tool built to aircraft standards.

GRIP-TORC makes greatly increased power available to you — gives you instant start-stop control — prevents overloading — minimizes tool damage — reduces accidents, no kick or twist from jamming.

GRIP-TORC AND YOUR 1/4" DRILL DOES ALL THESE JOBS AND MANY MORE!

Wood Boring up to 1 3/4" with expansion bit • Drilling Steel up to 1/2" • Power Screw Driving with instant start-stop control • Hole Sawing up to 3" in steel
Power Reaming with hand reaming control • Nut Running with positive control
Honing with accurate, perfect "feel" • Masonry Drilling drills smooth, clean holes...faster • Flexible Shaft increases capacity and versatility with all of above features.

Get a **GRIP-TORC** today for home workshop, for farm or industrial use. Fully guaranteed, ready to attach to your 1/4" power drill. At your dealers or mail coupon NOW.

ONLY \$14.95
prepaid

Distributors
Inquiries
Invited

MAIL COUPON TODAY

McLAUGHLIN & CO.

909 East 59th Street, Los Angeles 1, Calif.

Enclosed is money order or check for \$14.95 for which please send me one guaranteed **GRIP-TORC** prepaid.

Name _____

Address _____

City _____ Zone _____ State _____

(In California add sales tax)

UP TO 80% SAVINGS ON WAR SURPLUS

LT. WT. ALUMINUM PIANO HINGE
 Length 72 inches, thickness .040—width 1 1/4"—Operating radius 275 degrees. Made of aluminum alloy, sold in 6 feet lengths only—\$114 per length....

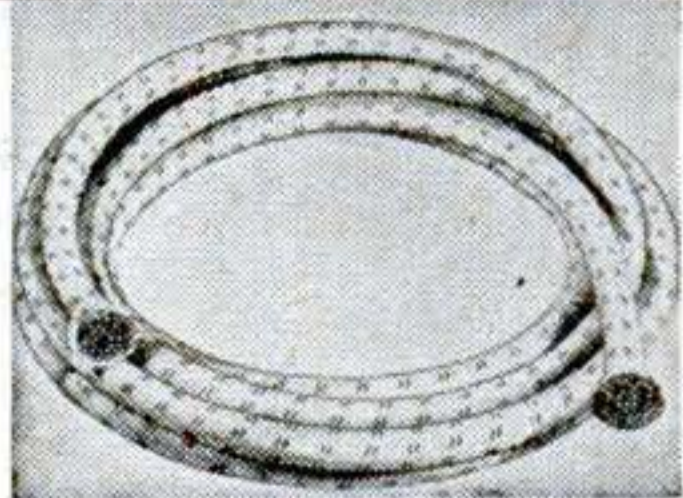

LIVE RUBBER SHUCK CORD
 Made in accordance with rigid army specification. Clean fresh stock. 5/8" contains approx. 500 strands of live rubber, 3/8" approx. 100 strands, 1/4" approx. 40 strands. Sold in 25 ft. lengths or more. At about 20% of original cost.
 DIA. PRICE (per 25') Ship. Wt.
 1/4" \$1.00 2 lbs.
 3/8" \$1.25 2 lbs.
 5/8" \$1.75 3 lbs.

HEAVY DUTY STEEL PIANO HINGE
 Length 56"—Thickness 3/32"—Width (open) 3-5/16"—Operating radius 330 degrees—Made of heavy duty steel—Drilled ready for use. Ideal for drop tables, heavy tool boxes, heavy doors, and many other uses where heavy hinges are required. Sold in 56" lengths only. Ship. Wt. 7 lbs. At a fraction of original cost. . . . \$145

HEATING ELEMENTS
 For home made photo print dryers, chicken brooders, etc. Wiring diagram for use on 110-volt; 50 watts each. Each element 14 1/2"x2 1/4"x3/16". Set of four. . . . 96c

NEW 10 1/2 x 4 WHEEL ASSEMBLY
 6 ply tire 10" high, 4" wide plus new tube plus 4" ball bearing wheel with grease fitting. Uses 5/8" axle. Ideal for midget soap-box racers, wheel-barrows, trailers, etc. Ship. wt. 8 1/2 lb. ONLY. . . . \$995

6 VOLT DOUBLE SHAFT MOTOR
 1/30 horse-power motor made by Delco. This is a 6 volt D.C. motor with two 1/4" shafts, used on Auto Heaters, Auto Fans, etc. Ideal for use in the shop, garage, and wherever 6 volt D.C. is available. RPM 3700. Ship. wt. 3 lbs. List price is \$4.20, our price is a real money saving buy. Our price, only \$295

OIL IMMERSION HEATER
 110 volts AC or DC. Three position. High Heat (1250 watts), Medium Heat (625 watts), Low Heat (312 watts). Make winter starting on your car, truck, tractor, or farm equipment, easy. Just plug in your 110V Immersion Heater, insert it into your oil tank through the oil filler hole, and have hot oil in a jiffy. At a fraction of original cost. Each. . . . \$7.95

Prices F.O.B. Chicago. Include approx. postage on orders paid for in advance. C.O.D. orders enclose 25%, balance sent C.O.D. WRITE FOR FREE ILLUSTRATED CIRCULAR.

U. A. S. Corp. Dept. PS-11 5637 W. 63rd Pl. Chicago, Illinois

TUBE GIVEN WITH EVERY TIRE

Why Pay More?

NEEDLESS TO PAY MORE — RISKY TO PAY LESS

VETS—GARAGES Service Stations
 Take 10% DISCOUNT ON 1 TO 100 TIRES

OUR GUARANTEE
 OUR TIRES must make good or WE WILL If You Want SAFE TIRES
 Be Wise—See Us Before You Buy
 Our Experience Insures Your Safety
 You get what we advertise

ORIGINAL TREAD—USED TIRES
 BUY IN CONFIDENCE safe dependable selected POPULAR BRANDS—Guaranteed to give A-1 SERVICE. These tires are absolutely NOT Re-caps or Re-molds.

REMEMBER: Tube SENT with EVERY tire regardless of QUALITY—PRICE or GRADE SELECTED for TOUGHEST JOBS Not just good . . . THE BEST. These are genuine Values! One Trial will CONVINCE YOU

TOPS IN VALUE—TOPS IN SAFETY	
6.00-16 . . . \$5.02	6.50-16 . . . \$4.72
6.50-15 . . . 4.72	7.00-16 . . . \$6.02
	7.50-16 . . . 7.62

WORLD'S BEST TRUCK TIRE VALUES, TOP SERVICE, MINIMUM PRICES

6.00-20(6) \$9.22	8.25-20(10) 15.52	11.00-20(12) \$16.42
6.50-20(6) 9.22	9.00-20(10) 15.52	11.00-22(12) 18.42
7.00-20(8) 10.52	32x6 (8) 10.02	
7.50-20(8) 10.52	10.00-20(12) 16.22	32x6 (10) 12.82
7.50-20 MILITARY 8 PLY REGULAR \$9.62	—SUPER \$12.92	
9.00-16 MILITARY 8 PLY REGULAR \$8.72	—SUPER \$10.92	

ONE QUALITY THE BEST AVAILABLE

HERE'S MAXIMUM QUALITY IN THESE O.K. SAFE TIRES

6.00-16 . . . \$3.42	6.50-16 . . . \$3.62	7.00-16 . . . \$4.42
6.50-15 . . . 3.62	7.00-15 . . . 3.72	7.50-16 . . . 5.62

Thousands of Tires Shipped to Satisfied Customers Throughout United States and Many Distant Points. Please Note: We've made Thousands of Friends by giving a Tube with Passenger and Truck Tires. MAIL ORDERS given Personal Attention—Send This Ad with Check or Money Order. Dep't. 5

STANDARD 834 N. Broad St., Phila. 30, Pa.

SPEED & MILEAGE MANUAL

140 ILLUSTRATIONS EASILY GET THRILLING ACCELERATION—AMAZING MILEAGE—RACING PERFORMANCE FROM ANY AUTOMOBILE!



Famous New Book shows simplified Soup-up Methods—Speed Tuning—Economy Secrets—“Customizing Plans”—Latest Track Proven Methods for all cars! Tells how to build your own SPEED EQUIPMENT! FAST SPORT CARS! “HOT RODS”! 155 MPH ROAD & TRACK CONVERSIONS! Complete instructions on building inexpensive Superchargers! Dual Manifolds! “Water Injectors”! Hi-Speed Heads! Twin Mufflers! Economizers! All about—Fast Engines, Gas Saving, Restyling, “Cam Secrets,” Multiple Carburetion, Fuels, Porting, Ratios, Frames, “Offys”! BRAND NEW METHODS. Plans, Formulas, “Racing Tricks”—“STOCK CAR SPEED SECRETS”! Also latest “HOLLYWOOD CUSTOM STYLING”! Streamlining! Sport Changes! Lowering! Speed Conversions! Including—California Roadster Plans! Racer Diagrams! Working Drawings! Performance Charts! Graphs! Beautiful Photographs! Etc.!

COMPLETE MANUAL (plus) “California HOT ROD Handbook” and Equipment Catalog— \$1.98 paid

ALMQUIST ENGINEERING, Milford 35, Pennsylvania

Earn High School Diploma at Home

Guided study permits you to complete High School education in shortest possible time. Modern methods make it interesting, easier. Prepare for better jobs, pre-professional, college entrance exams. Recognition for H.S. credits already earned. Books supplied. Low tuition, easy terms. Write for Free information.

HOME STUDY INSTITUTE
 209 Vine Avenue Dept. PS-11 Park Ridge, Ill.

EASY TO LEARN CODE

Learn or increase speed with an Instructograph—the Radio-Telegraph Code Teacher that takes the place of an operator-instructor and enables anyone to master code without further assistance. Available tapes from beginners alphabet to typical messages on all subjects. Speed range 5 to 40 WPM. Always ready—no QRM. Thousands have “acquired the code” with the Instructograph System. Write today for convenient rental and purchase plans.



INSTRUCTOGRAPH COMPANY
 4701-P Sheridan Road, Chicago 40, Illinois

LIMITED TIME OFFER!

3-DIMENSIONAL VIEWER FREE!

To introduce a new series of Hollywood Art Studies in full color, we offer you, free, a valuable three-dimensional Viewer with your first order for 2 Art Study Slides at 50c each. Send \$1 today to:

M. G. MALNICK 7402 Santa Monica Blvd. Dept. P. S. Hollywood 46, California

MASTER MIND!

Learn Short-Cut Mathematics
 Juggle figures, do baffling number tricks. Make people gasp at your marvelous lightning-quick mind. Multiply 4 figures by 4 figures without using old-fashioned multiplication! Big cloth-bound volume; fully illustrated course. Includes worked-out problems, answers, etc. Sensational bargain, only \$1.49, postpaid—or COD plus postage. Satisfaction guaranteed or refund. Order this amazing “Short-Cut Mathematics” today!

NELSON-HALL CO., 1139 S. Wabash Ave. Dept. 3L-1 Chicago 5, Ill. \$1.49 Complete

MEN: “KEEP TRIM—Wear the original Sportflex for Comfort and Support!”

Says Mr. A. P.—Before I started wearing my SPORTFLEX support I looked and felt like an old man. Today, with this wonderful figure aid, I look 10 years younger and feel like a million!



Sportflex Reg Appd

A wonderful way to control those bulges! SPORTFLEX simply e-a-s-e-s you into upright, perfect posture without any restraining stays to dig into soft flesh! Wide 2-way stretch band of quality lastex can't roll, bunch or bind. Soft, smooth detachable crotch gives sanitary super-support. A sturdy, resilient figure aid for porous non-chafe control; launders like magic! Please specify waist & height size. Send check or money order. C.O.D.'s accepted. Sizes over 48 made to order, \$5. Extra Crotch 75c. **\$3.00** Post Paid

SPORTEX FOUNDATIONS 14 W. 17 St. Dept. PS-11 NEW YORK 11, N. Y.

SURPLUS SALE 1000's OF REAL BARGAINS

PNEUMATIC TOOLS

AIR GRINDERS

- Aro, Model 22 L.G.S., 1/4" Collet, 17,000 RPM, ea.....\$11.45
- Thor, Bantam, 14,000 RPM, 1/4" Collet Chuck, ea..... 10.85
- Ingersoll Rand Multivane, Size 00, 1/4" Collet Chuck, ea..... 10.85
- 10 Mounted Stones, assorted, 1/4" Shank, for above, New..... 3.85
- 10 Rotary Files, 1/4" Shanks, Good Assortment of Shapes, Includes Files Listing from \$1.35 to \$4.50. Some new, all good, set..... 6.75

AIR SCREWDRIVERS

- Chicago Pneumatic Powervane, No. 301, non-reversible, ea.....\$13.75
- Thor, Size 218RY, Reversible, Pistol Grip, ea..... 28.50
- Phillips and Straight bits for above, ea..... .20

PNEUMATIC HAMMERS

- Cleveland, No. 16, Pistol Grip, ea.....\$ 6.45
- Cleveland, E2, Pistol Grip..... 6.75
- Chicago, 3X, Pistol Grip..... 6.95
- Thor, 3S, Pistol Grip..... 11.95
- Rivet set retaining springs, Used 60, New..... 75c

AIR DRILLS



- Chicago, Pistol Grip, 1/4" Jacobs Chuck.....\$16.50
- Chicago, Pistol Grip, 5/16 Jacobs Chuck..... 17.25
- Chicago, Pistol Grip, 3/8" Jacobs Chuck..... 19.25
- Thor, Straight Grip, 1/4" Jacobs Chuck..... 11.95
- Thor, 90 degree, Size 210S for threaded shank drills 18.75

All Pneumatic Tools Used But Tested and Guaranteed.

SOCKET SET

Truth, 1/2" drive 18 pc., large metal box, sliding tee, speeder, ratchet, two extensions, 13 twelve pt. sockets, 7/16 to 1 1/4 chrome plated.
(NEW)\$12.95

HAND VISE

1 1/2 Milled Steel jaws and handle. Sold by mail order houses at \$1.95.
Only 79c

FREE CATALOGUE—Write for It!

(Shipments Prepaid If Cash Accompanies Order, Otherwise C.O.D. Plus Postage, Minimum Order \$1.00)
MAIN SUPPLY STORE, Dept. A, 521 Main Street, Kansas City 6, Missouri

RIVET SETS



- (B) Flush Set, Face 1 1/4 Dia. Length 3" (Pictured) ea.65
- (C) Long Flush, Face 1 1/4, Length 6", ea..... .85
- (D) Swivel Flush, Face 1 1/4 Length 4", ea.....\$1.25
- MBH 3/32, 1/8, 5/32, 3/16, ea.35
- R.H. 5/32, 3/16, ea..... .40
- F.H. 1/8, 5/32, ea..... .40

Some New—All Good

TORQUE WRENCHES



- Kent Moore 3/8 drive, 25 pound, for Chevrolet Service Depts.....\$1.85
- Duro, 1/2" drive, 100 lbs. No. 8099 1/2. Shockproof Plastic Handle. In Green Enameled Case\$5.85
- Special Offer, One Duro and One Kent Moore, both for..... 6.95 (All Torque Wrenches New)

CHUCK KEYS, No's. 1 & 7, 30c, No's. 2 & 30, 35c, No. 3, 45c

STARRETT TOOL MAKERS DIVIDERS 3", \$1.00, 4", \$1.25, 6" \$1.50.
Starrett "Wiggler" No. 828.....85c
(All Above Items New)

SLOCUMB "MIKES"

Plain (Used but Good)
4 to 5", \$5.00, 12 to 13", \$9.50
13 to 14" \$10.00, 15 to 16", \$11.50.
16 to 17", \$12.00.

NOW YOU TOO CAN BUILD 15 RADIOS



Absolutely no Knowledge of Radio Necessary

You Need NO Additional Parts

The PROGRESSIVE RADIO KIT is THE ONLY COMPLETE KIT. Contains everything you need. Instruction Book, Metal Chassis, Tubes, Condensers, Resistors and all Radio parts.

The 36-Page Book written by Expert Radio Instructors teaches you to build radios in a Professional Manner. You start with a 1-tube receiver. Before you are done with this kit, you will have built 11 Receivers, 1 Public Address System and 3 Transmitters.

SPECIAL FREE OFFER!

Electrical and Radio Tester sent absolutely FREE with each Progressive Radio Kit, PLUS FREE membership in Progressive Radio Club. Entitles you to free expert advice and consultation service with licensed radio technicians.

Write for further information, or ORDER your KIT NOW! ONLY\$14.75

Postage prepaid with check or money order.
(Postage not prepaid with C.O.D. orders)

PROGRESSIVE ELECTRONICS CO., Dept. 114
497 Union Avenue Brooklyn 11, N. Y.

TRAIN NOW FOR AN

AVIATION CAREER

IN SUNNY SOUTHERN CALIFORNIA

MAXIMUM TRAINING IN MINIMUM TIME

Specializing in AERONAUTICAL ENGINEERING and MASTER AVIATION MECHANICS since 1929... America's Finest Aeronautical Institute... 7000 successful graduates... MAKE MORE MONEY... MAIL COUPON TODAY. APPROVED FOR VETERANS. Board and Room now available.

Without obligation, send free catalogue with full information.

NAME _____ AGE _____ PS-13
ADDRESS _____
CITY _____ ZONE _____ STATE _____

CAL-AERO TECHNICAL INSTITUTE
GRAND CENTRAL AIR TERMINAL • GLENDALE 1, CALIFORNIA

HIGHEST ROYALTIES and CASH

FOR YOUR INVENTIONS

Write for FREE booklet without obligation

UNIVERSAL MARKETING CO.

354 S. SPRING ST. (Suite C)

LOS ANGELES 13, CALIF.

ELECTRIFY your SEWING MACHINE



COMPLETE KIT ONLY
\$11.75
 1 YEAR GUARANTEE

Now make mother's or wife's sewing a pleasure. Easy to install. Fits all machines.

- Motor & Bracket
- AC-DC 60c. 115 v.
- Pulley & Belt
- 7 Speed Foot Control
- Cord Set
- Complete Instructions

10 DAY FREE TRIAL AT OUR RISK

SEND NO MONEY, pay postman plus C.O.D. or enclose money order and we will pay postage. MONEY BACK after ten days if not completely satisfied. Shipping Wt. 6 lbs. State whether wheel on your machine turns towards or away from you.



2-TONE LUGGAGE CARRYING CASE
 Specify base width, length and make of your machine. Wt. 11 lbs. **\$9.95**
 Kit complete with Sewlite (as illustrated) \$12.95

CONTINENTAL SALES CO.
 Dept. PS7, 83 Graham Ave., Brooklyn 6, N. Y.

Every Electric Drill A PORTABLE SAW

JUST TRY IT! YOU WON'T USE A HAND SAW ANYMORE. FITS ANY 1/4" ELECTRIC DRILL



"ARCO-SAW" is a rugged precision tool with right angle gear drive. (No clumsy direct drive with drill sideways.) Works like high priced Portable Saw. EXCLUSIVE SAFETY YOKE connects drill and saw, ABSOLUTELY SAFE TO USE. All Parts Guaranteed.

Cuts 1 1/8", 2 x 4 BY TURNING OVER

ARCO-SAW Patent Pending **\$9.95**

DEALERS: Write for name of nearest wholesaler.

5 DAY MONEY BACK GUARANTEE

ORDER YOURS TODAY at your Dealer or send M.O. or Check for \$9.95 (compl. with 4" "Hycarbon" Blade) Manufactured by—

ARROW METAL PRODUCTS CO.
 Dept. B, 140 West Broadway New York 13, N. Y.

FREE TO HOME PLANNERS



"Little Blue Booklet" of 29 popular plans sent FREE to acquaint you with our MONEY SAVING home planning service which includes 1200 Tested Designs; beautifully illustrated plan books; working drawings; material lists; specifications—all at LOW COST. Write today for FREE BLUE BOOKLET and complete information. America's pioneer residential plan service.

Small Homes Plan Book—68 beautiful designs. \$1.00
Budget Homes Plan Book—78 economy plans for 1 and 2 story homes. BOTH BOOKS FOR \$1.00

L. F. GARLINGHOUSE CO., Inc. Box PS-2, Topeka, Kans.

OPPORTUNITIES AHEAD



For Men Who are Trained in AUTO BODY & FENDER WORK

Men 18 to 60. Want a future with good pay, perhaps a business of your own later? If you are mechanically inclined, start now to learn to become an auto body mechanic and fender repair man. This fast growing field has great possibilities for trained men with experience. U. E. I. spare time, home-study training combined with actual shop practice gives you sound, basic knowledge of latest, best methods so you may get the experience which may bring you big pay. Capable instructors supervise your studies and actual practice. Course includes acetylene welding, spray painting, use of hand and power tools, etc.

THOROUGH, RELIABLE TRAINING

U. E. I. has trained men for new opportunity fields since 1927 and many students are now making good. Auto body and fender repairing is one of the best profit-makers in any garage or service station. Little capital required. . . . placement service, or we will show you how to start your own shop. Get the facts FREE, without obligation. Write today.

WRITE FOR FREE FACTS

STOPS FOGGY WINDSHIELDS NEW Chemical Mitt



Amazing Discovery! Autoists wild over new "NO-FOG" Windshield Cleaner. Simply glide over windshield chemically-treated Mitt—at once glass sparkles crystal clear. Blurry mist, frost, sleet, snow disappear like magic. Stops fogging. Sells like wild!

SAMPLES FOR AGENTS Sample offer sent immediately to all who send name at once. A penny postal will do. SEND NO MONEY—just your name.

KRISTEE CO., 731 Bar Street, AKRON, OHIO

Imported Simulated MEN'S DIAMOND



COPY OF \$500 ORIGINAL WEAR 10 DAYS AT OUR RISK \$265 PLUS TAX

SEND NO MONEY Pay postman \$2.65 plus 20% Tax and a few cents postage. Send string or paper for size.

Your Choice of Massive 14K or 12K Yellow Gold Finish Mounting Set with Fiery White Center & Ruby Red Sides, All White, Ruby Red Center & White Sides or Flashy solitaire with no side stones. 10 Day Money Back Guarantee.

GRAND JEWELRY CO., Dept. P, Des Moines 11, Iowa

UTILITIES ENGINEERING INSTITUTE

AUTO-CRAFTS DIVISION
 2523 Sheffield Ave., Dept. XM-4, Chicago 14, Ill.

Gentlemen:—YES! I want to get into profitable Auto Body and Fender Repair Work. Please send me FREE FACTS at once.

Name _____ Age _____
 Address _____
 City _____ Zone or County _____ State _____

Check here for Special Information if under 17.

AMAZING INVENTION SOLDER-MATIC AUTOMATIC SOLDERING IRON



AUTOMATICALLY FEEDS SOLDER TO THE TIP OF THE IRON
 • LEAVES ONE HAND FREE TO HOLD WORK
 • HOLDS OVER 6 FEET OF SOLDER 1/16" TO 3/16" DIA.

FEED ATTACHMENT REMOVABLE IN A MATTER OF SECONDS, FOR USE ON OTHER IRONS FROM 75 TO 250 WATT-SIZES. Slight pressure on trigger brings solder to the tip of the iron in the exact quantity needed. Speeds production in workshop or factory. Comes complete with instructions, Underwriter Approved 85 watt precision electric iron and six feet of solder. Fully guaranteed—money back in five days if not satisfied.

C. O. D. add postage—prepaid, we pay postage.

ACT TODAY THE STERN CORPORATION
 219 B2 Investment Bldg. Pittsburgh 22, Pa.

ONLY \$5.95 COMPLETE

DEALER INQUIRIES INVITED

WAR SURPLUS BARGAINS

WAR SURPLUS BARGAINS

\$500,000.00 INVENTORY for QUICK LIQUIDATION

Surplus items—hundreds of them for home, shop, factory, farm and outdoor use. New items, used items, reconditioned items—all at tremendous savings—all priced for quick sale.

PAGE AFTER PAGE OF VALUES
This big catalog shows page after page of amazing money saving values. Write for your copy today. Send 10c to cover postage, mailing, etc. Write today!

10c

SEND TODAY FOR YOUR COPY

STARK'S 509 So. State St.
Dept. PS-11
CHICAGO 5, ILL.

LAW FREE BOOK

THE LAW TRAINED MAN

Your **FREE** copy of "The Law-Trained Man" shows how to gain prestige and greater earnings through Blackstone home law study. All instruction material furnished including 18-volume Law Library written by 65 well-known law authorities. Lawyers, judges among our graduates. LL.B. degree. Low cost; easy terms. Write today.

BLACKSTONE COLLEGE OF LAW 225 N. Michigan Ave.
Dept. 128, Chicago 1, Ill.
A Correspondence Institution Founded in 1890

DEPENDABLE CRAFT SUPPLIES

WRITE FOR CATALOG

LEATHER CRAFT • PLASTICS • POTTERY CRAFT • BLOCK PRINTING • BELT CRAFT • TEXTILE COLORS • POWER TOOLS • WOOD BURNING • INSTRUCTION BOOKS • ETC.

DWINNELL CRAFT SHOP
Dept. PS 911—Wheeling, W. Va.

Train for BIGGER PAY in REFRIGERATION AIR CONDITIONING

GET FREE BOOK! Prepare yourself for a fine paying job. Trained men find opportunities installing and servicing Refrigeration and Air Conditioning. Get practical training in spare hours at home—plus four full weeks in the great ITI shops. Job Placement Help. **FREE BOOK.** Write Industrial Training Institute 2130 Lawrence Avenue Dept. C-2 Chicago 25, Ill.

TALK—SING—PLAY OVER YOUR RADIO

with the newest **Real Radio Mike!** Attaches in a jiffy—Full Instructions Given! Swell for "Parties"—"Cut In" on or "Kid" Regular Network Programs or put on Your Own Broadcasts! Amaze Your Friends—Real Fun. Beautiful Metallic Plastic 6" high.

12 RADIO BROADCASTING LESSONS GIVEN with each mike

SEND NO MONEY. Just pay postman \$2.99 C.O.D. plus postage or send \$2.99 and we pay postage! **Radio Mike** is available *Only* from us by mail—Guaranteed.

MIDWAY CO., MPS-11, KEARNEY, NEBR.

Wheels Wheels

Wheels Wheels

5" Disc Wheel	5/8" Tire	5/16" or 3/8" Sleeve	30c ea.
6" "	5/8" "	5/16" or 3/8" Sleeve	35c ea.
7" "	3/4" "	3/8" sleeve	45c ea.
8" "	1 1/8" "	1/2" sleeve	70c ea.
7" "	1" "	1/2" ball bearing	80c ea.
8" "	1 1/8" "	1/2" ball bearing	\$1.00 ea.
8" "	2" "	semi-pneum. T. 1/2" B.B.	\$1.35 ea.
10" "	1.75" "	" 1/2" B.B.	\$1.50 ea.

Above wheel prices includes hub cap.
10" Aluminum Wheel 2 3/4" semi-pneum. T. 1/2" B.B. \$4.50 ea.
Plus Postage, 20%. C.O.D.'s accepted.

UNITED WHEEL STAMPING CO.
2756 W. 115th STREET PS-11 CHICAGO 43, ILLINOIS

Time for a new tobacco pouch?



Rogers air-tite*

Enjoy a pouchful of fresh tobacco with a Rogers Air-tite tobacco pouch—with its patented[†] inner pouch of seamless rubber that "seals as it closes"... The largest selling tobacco pouch made. Exquisitely created in many styles and leathers.

Above: Combination Model pouch of Brazilian Peccary \$10 (Rogers Rarity Pipe \$5). Other models, \$1.50 to \$20.
At left: Daily Model holds one day's supply compactly. Beaver Calfskin, illustrated \$2.50. Other leathers, and other models for full pack of tobacco, \$1.50 to \$15.

Rogers imports, inc.
419 Fourth Avenue, New York 16, N. Y.
EXCLUSIVE U.S. DISTR., PETERSON'S PIPES, DUBLIN, LONDON
Rogers Air-Tite Pouches in Canada, G. T. Lanning Ltd., Toronto

*TRADE MARK REGISTERED †U.S. PAT. NO. 1,801,193. CAN. PAT. NO. 374,167

WE CAN TEACH YOU TO MOUNT BIRDS

GEE, BILL, THIS SQUIRREL ACTUALLY LOOKS ALIVE. ALL THE FELLOWS THINK YOUR DEN IS GREAT.

IT'S EASY, FRED, ONCE YOU GET THE HANG OF IT. I LEARNED BY MAIL IN MY SPARE TIME.

TAXIDERMISTRY IS THE GRANDEST HOBBY IN THE WORLD—AND PROFITABLE, TOO. IN FACT, THIS

OWL BOOK-END IS FOR A CUSTOMER. FRED, WHY DON'T YOU WRITE TO THE NORTHWESTERN SCHOOL FOR THEIR FREE BOOK?

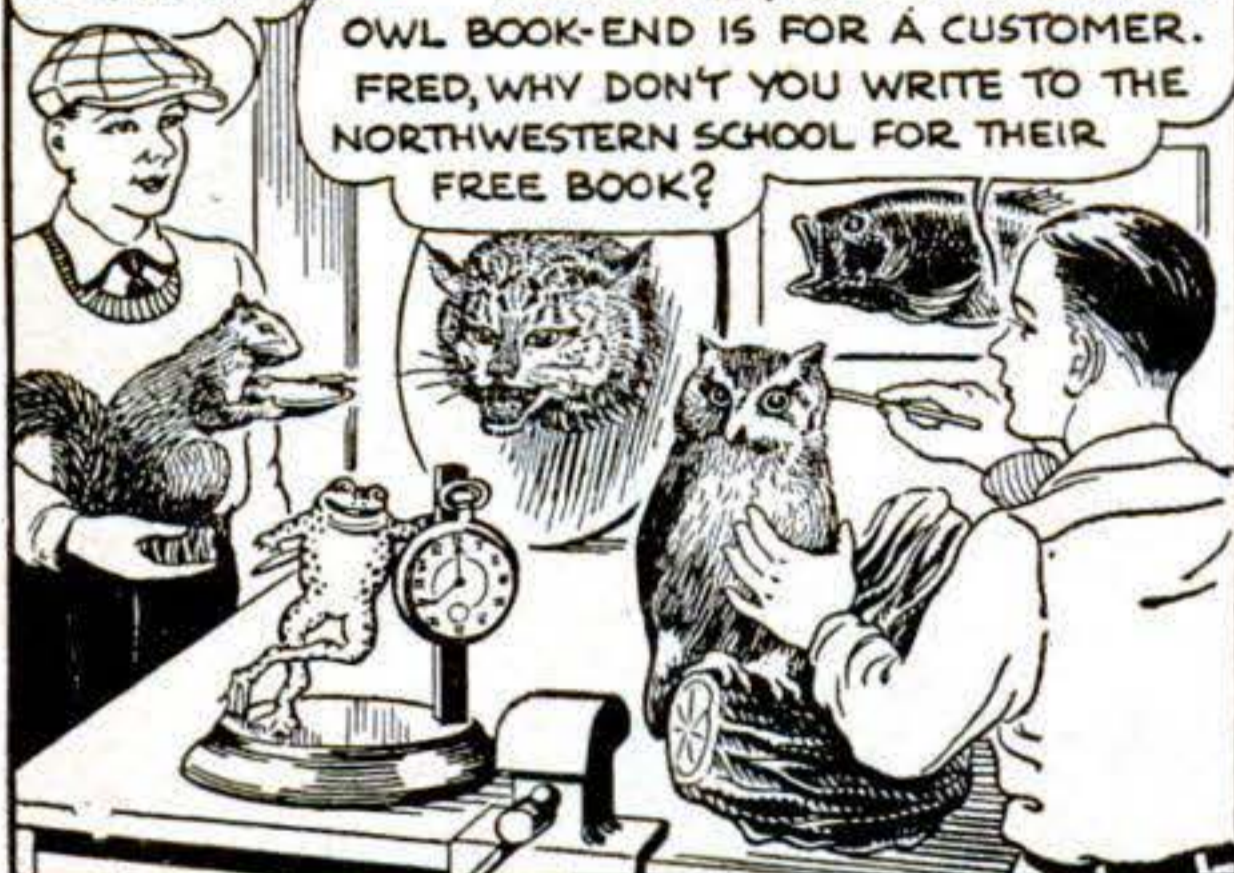

FUN - FASCINATION - PROFIT

Be a Taxidermist. New Profitable business. Learn quickly at home, to MOUNT life-like Birds, Animals, Game-Heads, Fish. Save your valuable trophies. Decorate your home and den. Learn genuine Chrome Tanning for harness and sole leather, buckskin and fine furs. Mount Common specimens, squirrels, rabbits, owls, even frogs, into marvelous craft-work groups, both useful and humorous, Wild-game not necessary. Send Today for Free Book!

BIG PROFITS Turn your spare time to cash. Have a side-line profitable business. Mount game trophies for sportsmen; sell your own mounts: save money and Make Money with expert tanning. Learn by mail from old reliable school, with 400,000 graduates. Investigate Today.

FREE BOOK 48 pages, very interesting. 100 beautiful GAME PICTURES. Tells how YOU can become a taxidermist. Absolutely FREE if you send at once. Write for YOUR copy TODAY—THIS MINUTE. State your AGE.

N. W. School of Taxidermy, 2611 Elwood Bldg., Omaha, Neb.

Send for Free Book Now!

Plastic Coasters and Tiles

EMBED REAL FLOWERS in NEW Magic PLASTIC

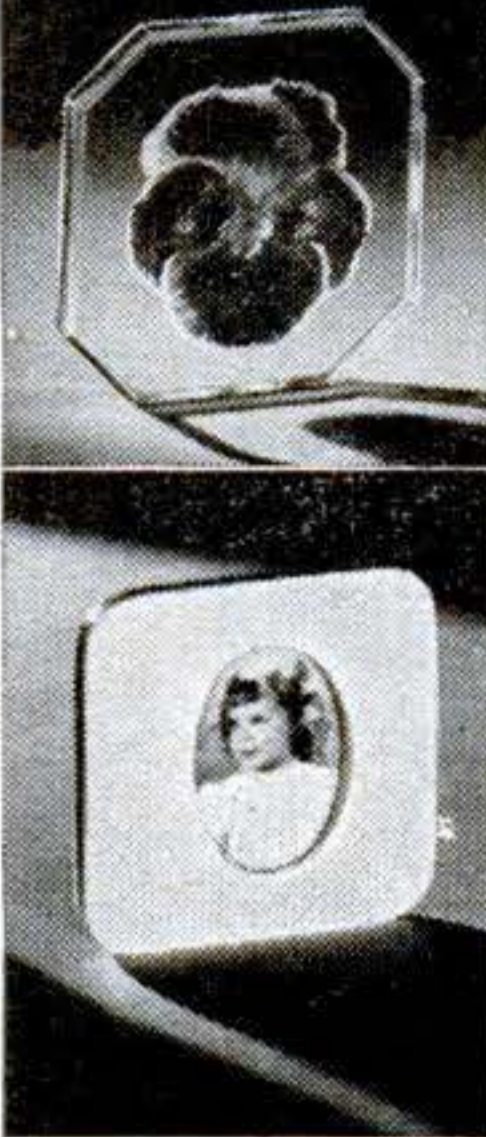

Now, create many unusual things like the distinctive pansy coaster shown—made by embedding real pansies in Castolite—the "magic" liquid plastic that "pours cold like honey" . . . sets at room temperature like glass. Comes crystal-clear or may be dyed for brilliant color effects. Embed other flowers, too, also coins, medals, stamps, butterflies. Cast gorgeous bookends, art objects, figurines for gifts or to sell. New pleasure, fine profits are possible. No special artistic ability required.

EMBED YOUR PHOTOS

Preserve your treasured photos in Castolite. Make beautiful medallions like the one shown, unusual photo-lampshades, lamp bases, distinctive paperweights with embedded photos. Sell your photos in unique plastic mounts. Use only home utensils. Follow simple step-by-step method. Send 25c today for exciting new Instruction Manual, packed with pictures showing how to get started. Write today!

The Castolite Co., Dept. M-4
Box 391, Woodstock, Ill.

MANUAL
25c

Binoculars for X'mas! Order Now. Quantity Discounts.

SAVE UP TO 50% BINOCULARS
DIRECT From IMPORTER

THE WORLD'S GREATEST VALUES

GERMAN ENGINEERED. BRAND NEW. DELUXE LEATHER CASE INCLUDED. Each instrument precision built to rigid military specifications. Buy direct at lowest unheard of prices! Free Catalog. Lifetime guarantee. Use at our risk and expense.

6 x 15	\$18.00	with Coated Optics	\$19.50
8 x 30	33.00	with Coated Optics	39.50
7 x 50	42.50	with Coated Optics	49.50
10 x 50	52.00	with Coated Optics	62.00

Many other models. Largest Stock in the West. ORDER TODAY! Send check or money order: \$2.00 Deposit on C.O.D.'s. **MONEY-BACK GUARANTEE!**

"HOW TO SELECT BINOCULARS" Add 20% Fed. Tax. Postage Included

BUSHNELL IMPORTERS Dept. P-11, 43 E. Green, Pasadena 1, Calif.

BRIMMS PLASTI-LINER

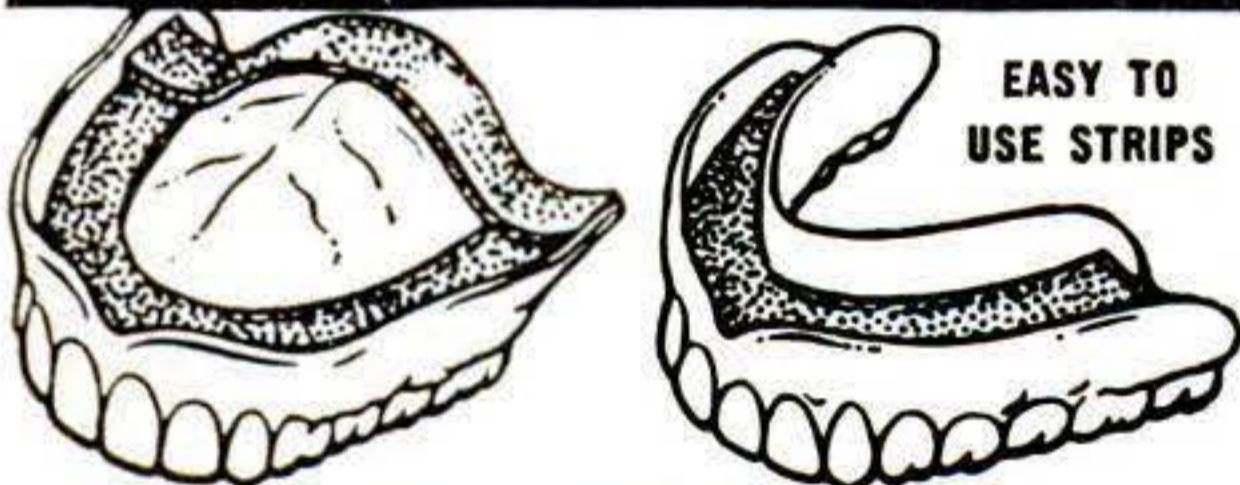

EASY TO USE STRIPS

One application
MAKES FALSE TEETH FIT
for the life of your plates

If your plates are loose and slip or hurt... if they rock and cause sore gums... you need *Brimms Plasti-Liner*. Brimms Plasti-Liner gives instant relief, perfect fit and lasting comfort. Lets you eat anything... talk freely without embarrassment. Ends forever the mess and bother of temporary "stickums" that last a few hours or days.

EASY TO USE... REFITS FALSE TEETH PERMANENTLY Lay soft Plasti-Liner strip on upper or lower plate. Bite and it molds perfectly. Tasteless, odorless, harmless to you and your plates. It hardens to your plate for lasting fit and comfort. Even on old rubber plates, Plasti-Liner gives good results six months to a year or longer. Removable as per directions. *Guaranteed satisfaction or your money back.*

SEND NO MONEY Order a \$2.25 package to reline both upper and lower plates. Or a \$1.25 package to reline one plate. Pay your postman when he delivers. Or send money now and save C. O. D. charges. Generous sample of special plate cleaner included free.

PLASTI-LINER COMPANY, 1740 Bailey Avenue
Buffalo 11, N. Y., Dept. 41-F



FOR MEN!

BOYS! Here's the real thing! Just what you're looking for. You'll have the time of your life! 10 small different booklets with chockfull funniest cartoons (and other THRILLING offers). You'll be missing plenty—if you don't buy'em NOW. Don't delay! Send a BUCK and we'll ship this fun-packed package prepaid. No C.O.D.

NUDKI, Dept. 245

Box 126-80., New York 1, N. Y.

NATION'S LARGEST EXCLUSIVE ELECTRICAL SCHOOL

"LEARN-BY-DOING"

ELECTRICITY

PRACTICAL TRAINING NOT "HOME STUDY"

G.I. APPROVED

Get actual experience in great shops of M.T.I. Learn all phases Practical Electricity; Housewiring, Motors, Const., Maintenance, etc. Living arrangements, Part-time jobs, etc.

A post card brings the story,
MICHIGAN TECHNICAL INSTITUTE, Dept. PS-11
2281 W. Fort St., Detroit 16, Michigan

STOP AUTO ACCIDENTS



with new **STOP LIGHT FLASHER!**

Makes Your Stop Light Flash 115 Times a Min.

FREE OFFER TO YOU! The "Stop-It" warns cars behind—makes your stop light flash on & off, on & off! Completely automatic, acts instantly when you step on foot brake . . . attaches in 5 minutes to any car or truck. Approved by safety engineers, used by Police & Fire depts. Non-rusting, dust, oil, vapor, waterproof. Write NOW for free introductory offer—no obligation. Get this amazing "Stop-It" for your car at no cost to you! Dealers, salesmen wanted.

MACCHI & CO., Dept. PB, 927 Larkin St., San Francisco 9, Calif.

O.D. WOOL SHIRTS
13 to 15
244

PANTS
28 to 32
266

Used, reg issue perfect condition 100% wool serge Cleaned & pressed by Q.M. Corp Add 12c ea. post

BRAND NEW KHAKI SHIRTS-PANTS
14 to 17 **25.9**
28 to 42 **33.3**

Genuine 8.2 chino khaki sultan material. Pants with cuffs. Add 11c post. per garment.

GEN. NYLON 50 FT PARACHUTE CORD
3/16" dia White or khaki 550 lb ten strength For clotheslines, venetian blind and drapery cords and other uses Add 4c post

50% WOOL HOSE
NEW Medium weight, rugged and warm Post 3c. **39¢**

CUSHION SOLES
NEW 63% wool, double sole These are known as the desert sov. Khaki and white Add 4c postage per pr **49¢**

WAR SURPLUS AND OTHER BARGAINS
ORDER FROM THIS AD PLEASE

MAIL ORDERS
Please send remittance with order. Include postage. Guaranteed satisfaction. You are privileged to return an unsatisfactory purchase for refund.

WATCH CAPS
77¢

NEW Navy watch caps Color, blue 100% pure wool knit Please add 5c postage each

all wool WRISTLETS
13¢ 8 PAIR \$1.00

NEW 100% O D wool knit Ideal for glove and mitt inserts. wristlet replacements etc Worth 75c per pair Add 3c postage per pair.

12.99

B-15 Style FLIGHT JACKET

NEW Renders greatest warmth per oz. of weight. Mountain cloth outside, pile lined body and sleeves. Genuine mouton collar. 4 pockets—2 outside 2 inside. Wool knit cuffs and waistband. Add 27c postage.

NAVY T-SHIRTS
WHITE **59¢**

NEW Combed yarn, full cut. Small, medium and large. 5c postage

SIZZLING SPECIALS

ARMY STYLE 688 COMBAT BOOTS

NEW For sportsmen and outdoor wear. 10" high. Reversed uppers, full oak leather sole, with composition outer sole Add 27c post

6 TO 12

DUST MASKS
33¢

New \$1.50 value Ideal for millers farmers paint and insecticide spraying Add 6c postage for each.

GREATEST WATCH VALUE IN U.S.A.

17 JEWEL Military Style WRIST WATCH

BRAND NEW GEN. INCABLOC WATERPROOF SHOCKPROOF

Non-magnetic, radium dial, sweep second hand. St steel case Complete with leather strap. Guaranteed Swiss 17-Jewel movement. A truly remarkable value. Add 15c post.

19.95 PLUS 10% FED. TAX

WAR SURPLUS CIRCULAR SEND FOR FREE

Over 200 War Surplus and other outstanding bargains

SIoux FALLS SURPLUS STORE
113 NO. PHILLIPS SIOUX FALLS, S. DAK.

NAVY SUN GLASSES 66¢

Navy issue Ground & polished lenses, plastic frame wire center. \$4.00 value Add 6c post

AVIATORS 24K GOLD PLATED RIMS 1.33

Large size 52mm lenses. Shuts out max violet & infra red ray. Pearl sweatband Comp with handsome case Add 7c post

OUR BETTER QUALITY ... 2.55

26" OPERATING SCALE MODEL SUBMARINE

Heavy duty spring motor drives twin propellers thru sealed gears, running in oil. Water ballast chamber with air valve control for diving or operating submerged.

CONSTRUCTION KITS AND ASSEMBLED MODELS
Price Range \$3.95 to \$16.50. Send 3c stamp for detail literature.

WESTLAKE MODEL CO. Dept. PS 119 ERIE, PA.

Pioneers Leaders

AIR RIFLES BENJAMIN AIR PISTOLS
WITH SAFETY LOCK

SEND FOR FREE FOLDER OF LATEST MODELS TODAY

If you want a REAL GUN for PRACTICAL USE inside or outdoors, get a SAFE—CLEAN—ECONOMICAL—BENJAMIN with Adjustable Power and Amazing Accuracy. Use BENJAMIN H-C PELLETS for BEST RESULTS in all rifled models. WRITE AT ONCE.

BENJAMIN AIR RIFLE CO., 811 MARION ST., ST. LOUIS 4, MO.

SET THE PACE WITH THE

Powell P-81!

- Cruises at 45 MPH—with faster pickup than car
- 39" high, 71" long overall, wt., 190 lbs.
- 8 HP motorcycle engine
- 50 miles to the gallon
- Automatic clutch
- Internal expanding brakes—handle-grip throttle controls

POWELL MANUFACTURING COMPANY
DEPT. PS-11 • COMPTON, CALIF.

ONLY \$247.34
AT COMPTON, CALIF. EXCISE TAX INC.

Write for FREE folder and name of nearest dealer

SHOE REPAIR OFFERS BIG INCOME • Learn in 12 Short Weeks!

Own your own shop. Earn big income. Get into business in this depression-proof work. Hard times only make shoe repairing thrive. 12 short weeks. Packed with practical training on actual shoes and professional machinery. No book studies. No educational or age requirements. Anyone can be a successful shoe repairman—from 18 to 80. Our fast "Learn By Doing Method" is easy, complete. Three modern schools, Chicago, Los Angeles, Oakland. 150 million customers for shoe repairs in U.S. alone. Get the facts on this big paying skilled trade today. Write for free booklet.

MODERN SHOE REBUILDING SCHOOL, Dept. PS-119
2937 Belmont Ave., Chicago; 361-12th St., Oakland, Calif.
Established 1927 806 So. Figueroa St., Los Angeles 14, Calif.

FREE! Big 20-page Illustrated Book tells how you can get into this big paying skilled trade Today! Complete details. No obligation. Fill in coupon Now!

Gentlemen: Please rush me the facts on how I can learn shoe repairing and get into my own business.

Non-vets check here.... Vets check here....

Name.....
Street.....
City.....State.....



AUTO BOOKS ON APPROVAL



SEND NO MONEY. Just mail the coupon for a complete set of 4 Big, Thick Auto Books. 20th Edition. Over 2700 Pages! Whether you are a mechanic or helper, expert or apprentice, auto owner or driver, take immediate advantage of this FREE EXAMINATION OFFER.

MAKE GOOD MONEY NOW HOLD A PERMANENT JOB

America wants its automobiles kept in good repair. Men with "know how" are in demand, at big pay. These books will help you get and hold an important job, or give you a chance to go into business for yourself now or later. Any man who half tries to improve himself can learn auto servicing and repairing by this quick reference method. Use the JIFFY INDEX to find easily understood answer to any auto problem. These wonder books prepared by eleven of America's great automobile engineers. Many hundreds of valuable illustrations. Send the coupon TODAY.

CAN YOU FIX IT?

These wonder books tell step by step HOW to make difficult repairs and adjustments, how to keep a car at maximum efficiency, including latest improvements in car design and operation. Engine troubles and how to correct them well covered.

4 BIG, THICK VOLUMES Over 2700 pages, 2000 illustrations, wiring diagrams, etc. Beautiful modernistic, washable cloth binding.

[A year's consulting privileges with our engineers now given with these books without extra charge.]

Publishers Since 1898-

AMERICAN TECHNICAL SOCIETY, Dept. A8-20

Drexel Ave. at 58th St., Chicago 37, Ill.

I would like to examine your 4 Volume Set of Auto Books. I will pay the delivery charges only, but if I choose I may return them express collect. If after 10 days' use I prefer to keep them, I will send you \$2 and pay the balance at the rate of only \$3 a month until \$24.80 has been paid. Include consulting service as offered above.

Name.....

Address.....

City..... State.....

Please attach letter stating age, occupation, employer's name and address, and name and address of at least one business man as reference. Men in service, also please give home address.



WHOLESALE USED TIRES DIRECT TO YOU with Lifetime Tire Guarantee

(10% discount on 2 or more tires if you send this ad with order)

TUBE DELIVERED WITH TIRE AT NO EXTRA COST For 15" or 16" Passenger Tires

Safe—Our tires used on school buses and ambulances

EXCEPTIONALLY GOOD TREAD—NO RECAPS

600-16...6 ply Military—Mud and Snow Tire...\$6.37	600-20 \$ 9.75
550-16 \$5.19	550-15 \$4.81
825-20 .. \$15.98	650-20 9.75
600-16 5.29	525-18 6.69
900-20 .. 15.98	700-20 10.98
650-16 5.29	550-17 7.99
1000-20 .. 16.89	32-6(8) 10.49
700-16 6.29	650-15 4.98
	700-15 .. 5.29
	32-6(10).. 13.75

ALL GOOD TIRES

550-16 \$3.54	600-20\$7.98	825-20\$11.19	1000-22\$17.70
600-16.... 3.59	30-5 7.98	900-20.... 11.89	1100-22.... 16.89
650-16.... 3.89	650-20..... 7.69	1000-20.... 12.89	900-24
700-16.... 4.59	700-20 (8).. 9.29	1100-20.... 13.89	(40-8).... 21.60
550-15.... 3.79	700-20	1200-20.... 18.78	900-16..... 8.98
650-15.... 3.89	(10)12.48	750-24	825-15
700-15.... 3.98	750-20 (8).. 8.19	(36-6).... 12.21	(14 ply) 14.10
550-17.... 5.69	750-20	38-7	750-15
750-16.... 8.40	(10) 9.19	(825-24).. 13.75	(12 ply) 11.30

GOLD BOND SPECIAL—750-20 MILITARY TIRES
Will fit 650 x 20 700 x 20 (8 & 10 ply) 34 x 7 (8 & 10 ply)
900 x 16 SPECIAL \$9.03 900 x 16 EXTRA \$11.19
Special.....\$10.49
Superior Quality.....\$12.98
Gold Bond Finest.....\$14.98

Send check or money order with this ad

GOLD BOND TIRE CO., Dept. PS 24
512 NORTH 1ST ST., RICHMOND, VA.

"A gold bond written guarantee with every tire"

PRECISION TAPPER

Bench-type, for sensitive precision small hole tapping. For tool and die, school and service shops, experimental depts., light production, model builders, etc. Increases tap life by guided accuracy. 4 collets supplied for #0 to 1/4" right or left hand taps. Distance from base to tap 6". Two clamps for holding work on slotted base. Rigidly built for long life. Weight 10 lbs.



\$1875 Postpaid U.S.A.

Money-Back Guarantee. No C.O.D.'s Please.

H. D. HERDER TOOL SPECIALTIES
2723 E. Michigan Kalamazoo, Michigan

A MAN'S BEST FRIEND IS HIS POCKET KNIFE

All CAMILLUS knives have hand honed blades. Many styles at your dealer's.



No. 72 "WOODWORKER" About \$2.25 3 3/8" closed

CAMILLUS CUTLERY COMPANY, N. Y. 17, N. Y.

A \$50 A DAY BUSINESS IN YOUR SPARE TIME



Take BELSAW Portable Sawmill right to the trees—turn out valuable lumber for local yards—do "custom sawing" for neighbors. BELSAW lasts a lifetime. No crew needed. Power with old auto engine or tractor. Beginners get excellent results. \$62.50 down Send postcard for FREE BOOK, "How To Make Lumber."
BELSAW MACHINERY CO
846A Field Bldg., 315 Westport Rd., Kansas City 2, Mo.

LIVE STEAMERS BUILD THEM AND RIDE THEM!

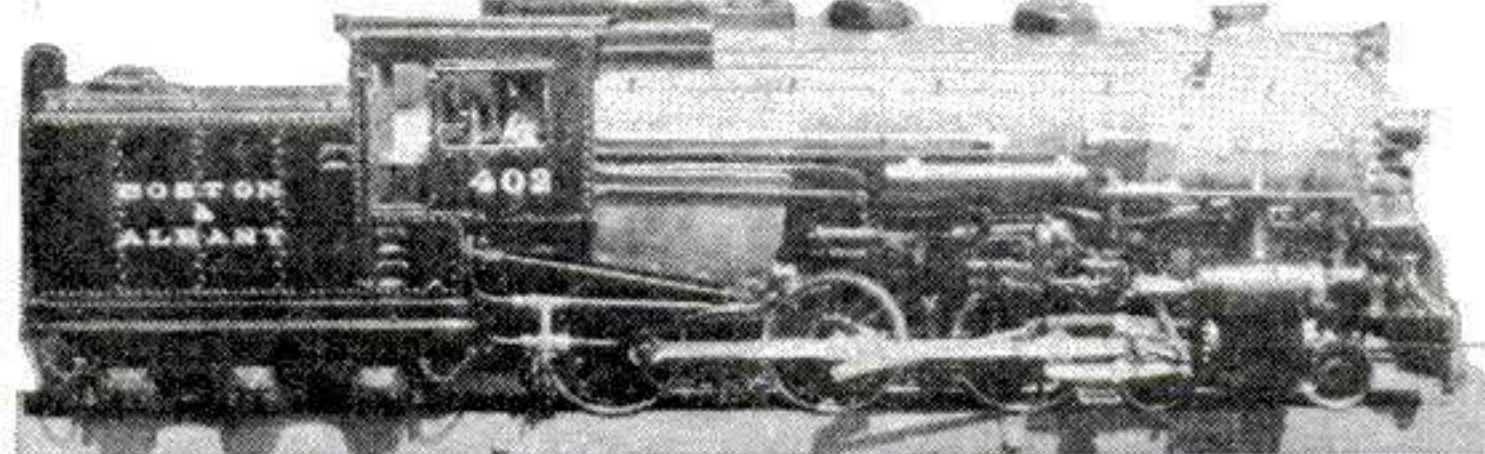

3/4" and 1" scale castings and parts to build eight different engines, all man hauling. 1 1/2" scale, 7 1/2" gauge—B. & A. Hudson. Send twenty cents (20c) for booklet.
YANKEE SHOP MACHINISTS 88A HIGH ST., DANVERS, MASS.



A REAL SURE-FIRE SELLER! THUGS AND THIEVES BEWARE!

Here is a tear gas pencil gun which discharges smothering clouds of tear gas to instantly stop, stun and incapacitate the most vicious man or beast. A safe and effective substitute for dangerous firearms. No permanent injury. Needed in Stores, Banks, Autos and Homes, everywhere to protect Life and Property. No skill required. Handle our tear gas as a side line and you'll soon give it full time. For a quick start send \$3.60 for complete demonstrator outfit consisting of an Automatic Pencil Gun with 10 demonstrators and 3 powerful Tear Gas cartridges fully guaranteed. Many thousands now in use. Order your outfit today. Not sold to minors.
Hagen Supply Corp. Dept. D-511 St. Paul 4, Minn.

COMPLETE LOCKSMITH SHOP only

ALL NEW MERCHANDISE! POPULAR STANDARD EQUIPMENT **\$99.00**

START YOUR SHOP **NOW!** At Home, Garage, Basement, or rent a small store, or add a key department to your present business.

- | | |
|---|---|
| 1 Precision key machine complete with three cutters | 3 Locksmith instruction books |
| 1 Heavy plywood key display board with 100 hooks | 1 Automotive lock manual |
| 1000 Popular key blanks and cut keys | 1 Assortment of pins and springs |
| | 1 Assortment of disc tumblers and springs |
| | 1 Misc. set of locksmith tools |

ALL FOR ONLY \$99.00 Easily Worth \$130.00

Slightly higher out of U.S.A. 25% deposit on C.O.D. orders. Start making money at once! Order your outfit today! Complete satisfaction guaranteed. Write for FREE Catalog today.

REPAIR SHOP SERVICE • Box 264 Y • SKOKIE, ILL.

CARBURETOR TOO RICH MAKES MOTORIST TOO POOR



Car owners who are wasting money and not getting proper gas mileage due to over-rich mixtures will be pleased to learn how to save gasoline by VACU-MATING over-rich mixtures. VACU-MATIC fits all cars, trucks and tractors. It is automatic and operates on the supercharge principle. Easily installed in a few minutes.

SALESMEN WANTED! Big Profits! Send name, address on penny postcard for free particulars and how to get yours for introducing.

VACU - MATIC CO., 7617 - 1543 W. State St., WAUWATOSA, WIS.



BIG MEN

Send For

FREE CATALOG showing smart

Clothing & Haberdashery in sizes 48 to 60. Low Prices.

BURNS MARTIN, 147 Summer, Dept. 33, Boston, Mass.

HYDROPONICS

24 Page FREE Illustrated Book



• Fascinating Hobby! • Profitable Business! You can grow vegetables, flowers or any plant WITHOUT SOIL every day of the year. Learn the easy, clean, pleasant way to grow any plant indoors or out. No experience needed. Realize BIG RETURNS from a limited space. Send postcard today for free illustrated book showing how others from every state are succeeding in this wide open field.

GILBERT & COMPANY, 840-A WEST IVY ST., SAN DIEGO 1, CALIF.

MACHINE SHOP EQUIPMENT



• The 1949 edition of the famous Center Tool Co. Catalog is now ready! Every workshop owner should have a copy. 240 pages full of illustrations, descriptions, and prices of the latest tools made by best known manufacturers in U.S. You pay the cost of printing—50c. We refund your 50c with your first order of \$10.00 or more. Prompt delivery on most tools. Send check or money order today!

CENTER TOOL CO.

153 Centre Street, Dept. D, New York 13

NEW WAR SURPLUS HOIST & WINCH

Originally made to be used on B-29s for lifting bombs. Mounted on welded steel base, can be attached to truck body or any solid base. Ideal for lifting or moving loads onto trailers, trucks or tractors or for machine shops, garages or warehouses. Capacity 2,000 lbs. Equipped with ratchet for holding load and 18 ft. 3/16" steel cable. Shipping weight 50 lbs. **\$29.95** FOB, Kansas City, Mo.

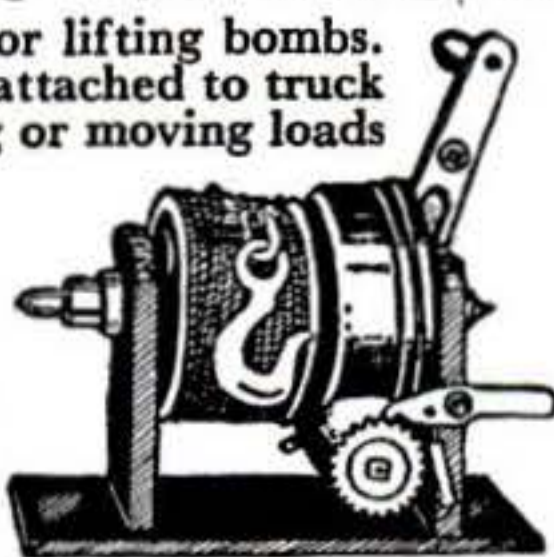

Send check or M.O. for immediate delivery. No COD's.

UNITED AUTO PARTS, INC.

1901 Troost

Dept. PS10

Kansas City, Mo.

SECURITY & SUCCESS

Insure your future! STUDY LAW at home

Want security and advancement—in good times or bad? Then study law at home—to become more valuable in any business! *Insure your future* by enrolling *now*—with America's oldest extension school, devoted exclusively to law. It's the school that has paved the way to success for more than 114,000 students in the past 40 years! LL.B. Degree awarded. Texts furnished. Easy payments. Send for FREE BOOK—"Law and Executive Guidance." Tells how law can be *your* stepping stone to security and success. Send for your copy, Today.

(G. I. APPROVED)

AMERICAN EXTENSION SCHOOL OF LAW

Dept. 20PS 646 N. Michigan Ave. Chicago 11, Ill.

★ WORLD'S FINEST MODEL AIRCRAFT CLEVELAND

"EXACTLY LIKE REAL THING" Great Show value. World famous since '19. Wide range free lance, commercial, military planes, old and new. 1/8" scale, 30" span and misc. sizes, 8" through 10 ft. giants. 35c to \$14.50. Balsa frames. All fly For rubber, CO2 or gas motors. Kits less liquids, flying props. Add 25c pack-post. Products 30 yrs. designing. Avoid copies! Get the real thing. Send for catalog, 2, 3c stamps or 5c.

A-LIGHTNING, 36" T-Kit, \$2. B-Ryan NAVION, 25 1/2" M-Kit, \$1.75. C-AERONCA, 17-Kit, \$1. D & E PANTHER & ERCOPE, also 30" each \$1.00

SEND FOR NEW CATALOG **5c**

CLEVELAND MODEL & SUPPLY CO.
4515L22 LORAIN AVE., CLEVELAND 2, OHIO

PEARL

FINISHING OFFERS YOU

BIG MONEY

RIGHT AT HOME

AMAZING NEW PEARL FINISH can be instantly applied to any article—leather—wood—plastic—glass—metal, etc.

BABY SHOES preserved for life in beautiful Baby Pink, Blue, and Ivory thrill mothers and bring immediate sales.

Nothing else like it! Costume jewelry, buttons, earrings, treasured mementos, etc., etc., take on new splendor and beauty at once.

TREMENDOUS DEMAND—Help us fill it—Fantastic profits await those who act NOW. Be First! Scoop the market. Never before has such an opportunity been offered. Never before such Big Profits made so quickly.

DON'T PASS THIS UP—It costs Absolutely Nothing to get the FREE FACTS that show you the EASY WAY to QUICK, BIG MONEY overnight. Mail Coupon TODAY!

PEARL-KOTE CO. Dept. 31
2111 W. Manchester Ave., Los Angeles 47, Calif.
Okay! RUSH me FREE FACTS at once.

Name

Address

City

Zone State

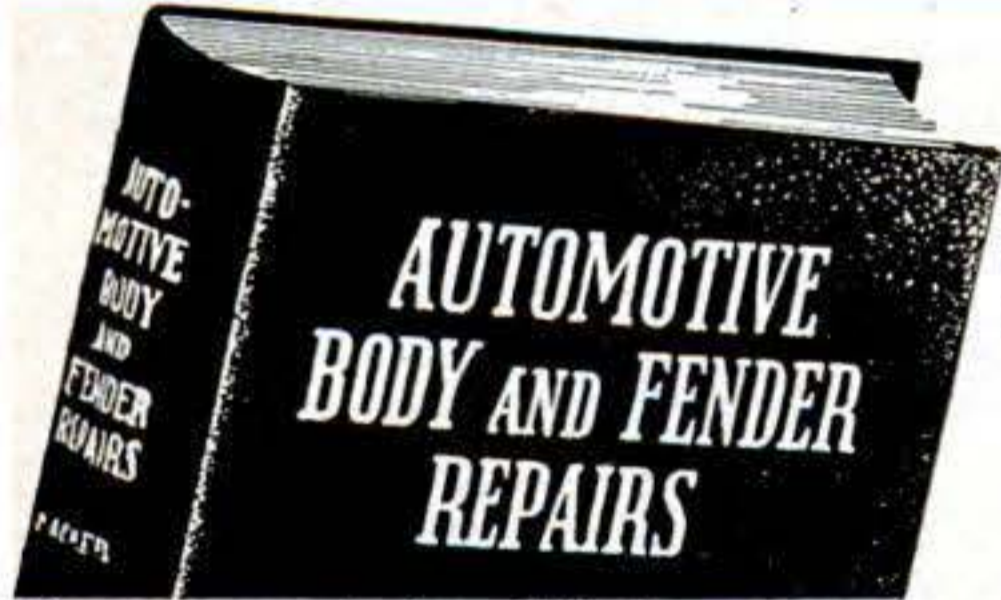

Famous PAY Raising AUTO BOOKS

These famous books will help you on every job—prepare you for a better job—bigger pay—a business of your own. Order today.

DYKE'S Auto Book

Leading auto book for 32 years. Now new 21st edition. 1483 pages. 4600 illustrations. Complete instruction in auto mechanics—trouble shooting, testing, adjusting, repairing. Combines practical instruction with basic principles. New edition includes passenger cars, 1948 buses, tractors, diesels, Buick Dynaflo and other new developments. (Book No. 1) \$7.50

Auto Service Managm't.

Every detail of profitable auto service station management drawn from hundreds of successful operators. Tells how to start—how to get capital—how to run a service shop or station and make money out of it. Can easily be worth hundreds of dollars to any man who is looking forward to a business of his own or a managerial position. 470 pages. 223 illustrations. (Book No. 3) \$5.00

Auto Body-Fender Repair

Completely covers this big, profitable field. Includes all approved methods, tools, equipment, materials, how to do a real professional job, operate a shop successfully. Ideal for mechanics who want to earn more. 325 pages. 232 pictures. (Book No. 2) \$3.50

Dyke's Carburetor Book

Specialize in engine tune-up with this book. Includes carburetion, compression, ignition, fuel pumps, valves, etc. The recognized authority on modern high compression engines. Gives you everything you need to know. 233 pages. 549 illustrations. (Book No. 4) \$3.50

MONEY BACK IF NOT SATISFIED. Draw circle around number wanted in coupon below and mail today.

Goodheart-Willcox Co., Dept. 103
1321 S. Michigan Avenue, Chicago 5

Send books circled below. () C.O.D., I will pay postman plus charges (C.O.D. in U.S. only) () Remittance enclosed. Send postpaid. If not O.K. I will return in 5 days and you will refund purchase price.

1 2 3 4

Name

Address

City State

READY CUT HOMES

Order Now

Homes \$1885.00 and up, freight paid. Orders filled in order received. Save up to \$1000 on modern production method homes. Much more compared with builders' prices. Anyone can assemble with simple plans furnished. Complete, including paint, hardware, roofing, glass, nails, etc. Send 25c in coin for full color catalogue showing 57 modern low-priced homes and floor plans. Low cost building plans complete ready for filing. Sold separately if desired. Dept. PS-119



NEW COLOR CATALOG FOR ONLY

25¢

INTERNATIONAL MILL & TIMBER CO.
Bay City, Mich.



FORMING WITHOUT DIES

with DI-ACRO BENDER

Many small parts can be rapidly formed without dies, to accuracy of .001" with DI-ACRO "Die-Less Duplicating" Machines, — Benders, Brakes, Shears, Rod Parters, Notchers, Punches. Save die expense and time delay. For experimental work, samples, models, etc., as well as regular production runs. Write for "Die-Less Duplicating" circular.



O'NEIL-IRWIN MFG. CO. 342 8th Ave., Lake City, Minn.

SAVE ANTI-FREEZE

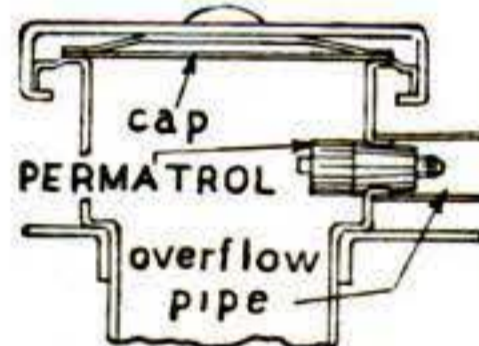

The new PERMATROL pressure valve traps all vital vapors in your car radiator. Simply slides into overflow pipe—thoroughly tested and set at safe pressure—will not rust—simple instructions furnished. Price \$1 each postpaid. Order now, no C.O.D.'s. Give make and year of car. Satisfaction guaranteed.

PERMATROL COMPANY

14375 Terry Ave. Detroit 27, Mich.

BOMB HOIST



Ideal for garages, truck loading, machine shops, home work shops, etc. Wt. 7 3/4 lbs. 1500 lb. capacity—30 to 1 ratio. Dimensions, 6 1/2 x 5 1/2 x 5. Pulley will hold 18 ft. 3/16" 7 x 19 cable or 16 ft. 1/4" cable. Rust-proof all bronze bevel cut gears. ONLY \$9.95! For \$2.50 extra we can furnish larger pulley that takes up to 35 ft. of 3/16" cable or 25 ft. of 1/4" cable. Also available, 3.16" 7 x 19 hi-carbon galv. air craft control cable—5c ft. Same in 1 1/4"—7 1/2 ft. Special! Hi Power 1/4" electric drill. Reg. \$18.95. Now, \$12.95. Both items postpaid. Money-back guarantee. C.O.D.'s with \$1.00 deposit.

B & M DISTRIBUTING CO., P. O. Box 1343, Dept. B-15, Tacoma, Wash.

For AUTO REPAIRS AT NITE

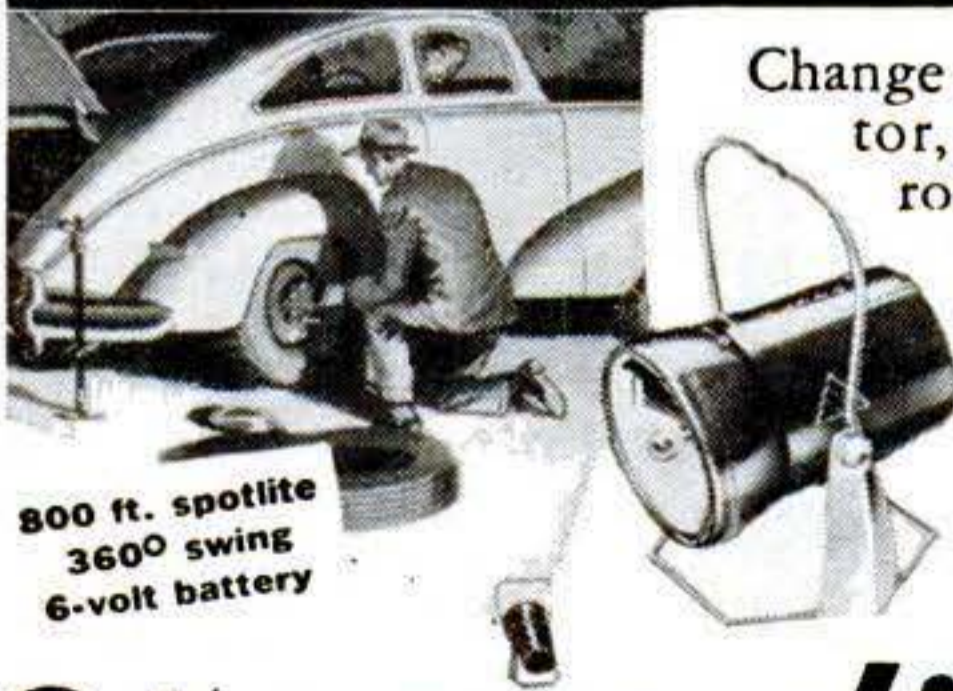

Change a flat, repair motor, warn traffic, spot road signs, etc.—with brilliant Reddylite beam. "Stays put" at any angle. Buy at hardware, sport or electric store.

Less 6-volt battery \$3.25

Delta REDDYLITE ELECTRIC LANTERN
DELTA ELECTRIC COMPANY, MARION, INDIANA

AT LAST!

**Real
AIR
HORNS**

—at a price
YOU can pay!

**BE A MAN OF DISTINCTION
IN YOUR NEIGHBORHOOD!**

Everything formerly found ONLY in more expensive models. Compact, easily installed under hood. A perfect gift. Spun brass bells, rich harmonized tone heard-for-miles. SELF-FILLING Air Tank, ELECTRIC CONTROL VALVE, Installation Kit. GROVER, for over 18 years the last word in air horns. Satisfaction guaranteed.

ORDER TODAY—Specify make, year and model of car
GROVER PRODUCTS CO. 1221 S. Hope St.
Los Angeles 15, Calif.



**GROVER
TRUMPETTE**

with self-filling air tank and kit for pleasure cars.

**ONLY
\$31.50**

**Complete
Plus 5% Fed. Tax**



**WASHES DISHES
IN JIFFY!**

BRAND NEW... Nothing else like it. Amazing "Sponge" Dish Cloth washes dishes lightning fast. Replaces messy dishrags. Suction action works like magic. Dishes gleam like a mirror. Truly a Godsend to busy housewives.

SAMPLES FOR AGENTS

Sample offer sent immediately to all who send name at once. A penny postal will do. **SEND NO MONEY—JUST YOUR NAME.**

Kristee Co., 732 Bar St., Akron, Ohio



**STAMP COLLECTORS
SENSATIONAL \$1.00 SALE!**

ROOSEVELT ISSUES of many Nations. 31 scarce Historic stamps. Net \$2.15! AXIS PUPPETS on stamps of Italy, Germany, Bohemia and scarce occupation issues of Ukraine & Ostland. Value \$2.98! MAMMOTH COLLECTION of many hundreds fine stamps. War issues. Airmails. Pictorials. African Colonies. Vatican City, etc.! Regular Value \$6.41! ALL THREE LOTS (Regular net Value \$11.54) only \$1 during

this SALE. Fine approvals included. **MONEY BACK GUARANTEE.**
NATIONAL STAMP SALES, Dept. 208
140 W. 44th NEW YORK 18, N. Y.

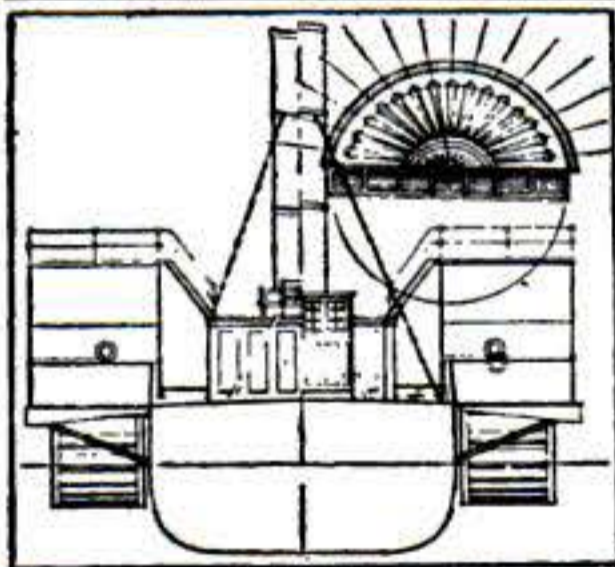

—READY!

OUR 1950 CATALOG. Two new kits—a paddle steamer and a modern diesel tug. New fittings too! **Send 25c for catalog**
MODEL SHIPWAYS, Folio 40
476 Main St., Fort Lee, N. J.

Order your NEW DEFLECTO

The only Deflector that Really Deflects
BEAUTIFY YOUR CAR. PROTECT ITS FINISH

The most beautiful chrome dome deflector ever produced. Actually deflects gases to roadbed away from car. Guaranteed free of back pressure. Brilliant polished chrome finish on 18 ga. steel. Send year and make of car with order. Price \$2.25 each. Postage Free on Prepaid Orders. 25% deposit on C.O.D.



ONLY \$2.25
SEND FOR
BIG FREE

AUTOMOTIVE MILLINERY OF HOLLYWOOD CATALOG
P.O. Box 2452 Terminal Annex Los Angeles 54, California

TINY RADIO—REALLY WORKS



FITS IN YOUR HAND!

Works on new "PERMA-CRYSTAL" so it NEVER NEEDS TROUBLESOME TUBES, BATTERIES OR ELECTRIC "PLUG-INS"! Easy to use—Plays for nothing—Should last for years.

GUARANTEED TO WORK

on local programs by following instructions. C.B. of Ala., says "Tiny Radio is just Wonderful!"

SEND ONLY \$1.00 (bill, ck, mo) and pay postman

\$2.99 C.O.D. plus postage or send \$3.99 for postpaid delivery. **READY TO PLAY** on simple attachment. Has personal phone. **WONDERFUL GIFTS FOR BOYS.** Low priced. Order **YOUR** Tiny Radio Now!

MIDWAY COMPANY DEPT. TPS-11 KEARNEY, NEBR.

Do you want

→ .. to go to College?

→ .. or to enter a Profession?

(Such as Accounting, Architecture, Nursing, Dentistry, Teaching, Social Work, Osteopathy, Beauty Culture, Optometry, Embalming, Chiropody, Law, Medicine, etc.)

→ .. or get an Office Position?

To get anywhere, you practically **MUST** finish High School **FIRST**. You can complete our simplified High School Course in **SPARE** time at home, as **FAST** as your time and abilities permit. Equivalent to resident school work—prepares you for college, pre-professional examinations, business, industry. Standard texts furnished. Diploma. Credit for H.S. subjects already completed. Single subjects if desired. Low tuition, easy terms. American School, Chicago, est. 1897—endorsed by educators. Finish your high school education **NOW**. Write **TODAY!**

**High School Course
at Home** Many Finish in 2 Years

American School, Dept. H-846, Drexel Ave. at 58th St., Chicago 37

Gentlemen: Send me **FREE** information covering special training in subjects checked below. No obligation on my part.

- | | |
|--|--|
| <input type="checkbox"/> High School Course | <input type="checkbox"/> Diesel Engineering |
| <input type="checkbox"/> Electronics, Industrial | <input type="checkbox"/> Drafting and Design for Men and Women |
| <input type="checkbox"/> Architecture and Building | <input type="checkbox"/> Plastics |
| <input type="checkbox"/> Automotive Engineering | <input type="checkbox"/> Private Secretary |
| <input type="checkbox"/> Business Management | <input type="checkbox"/> Mechanical Engineering |
| <input type="checkbox"/> Electrical Engineering | <input type="checkbox"/> Aviation |
| <input type="checkbox"/> Elec. and Gas Refrigeration | <input type="checkbox"/> Salesmanship |
| <input type="checkbox"/> Air Conditioning | <input type="checkbox"/> Radio |
| <input type="checkbox"/> Railway Training | |

Name.....

Address.....

**SURPLUS BARGAINS
ASSEMBLE YOUR OWN BINOCULARS!**

Complete Optics! Complete Metal Parts!

WE SUPPLY FULL INSTRUCTIONS

**GOVERNMENT'S 7x50
BINOCULARS**

Save More Than 1/2 Regular Cost

METAL PARTS—Set includes all Metal Parts—completely finished—for assembly of 7 X 50 Binoculars. No machining required. A sturdy Binocular Carrying Case is optional with each set of Metal Parts.

Stock #842-N \$39.40
Postpaid, plus \$4.80 for Case.
Total \$44.20



OPTICS—Set includes all Lenses and Prisms you need for assembling 7 X 50 Binoculars. These are in excellent condition—perfect or near-perfect—and have new low reflection coating.

Stock #5102-N \$25.00 Postpaid
(These are standard American-made parts . . . not Japanese, French or German.)

NOTICE! If you buy both Binocular Optics and Binocular Metal Parts, add 20% Federal Excise Tax to above prices.

ARMY'S 6x30 BINOCULARS—We have complete Optics and Metal Parts. Write for Catalog N.

SLIDE PROJECTOR SETS—Consist of all unmounted lenses you need to make the following size projectors:

Stock #4038-N—2 1/4" x 2 1/4" \$3.35 Postpaid
Stock #4039-N—2 1/2" x 3 1/2" \$3.35 Postpaid
Stock #4035-N—35 mm. \$4.85 Postpaid

SIMPLE LENS KITS!—THE LENS CRAFTERS DELIGHT! Fun for adults! Fun for children! Kits include plainly written, illustrated booklet showing how you can build lots of optical items. Use these lenses in photography for copying, **ULTRA CLOSE-UP SHOTS**, Microphotography, for "Dummy Camera", Kodachrome Viewer, Detachable Reflex View Finder for 35 mm. cameras, Stereoscopic Viewer, ground glass and enlarging focusing aids. And for dozens of other uses in experimental optics, building **TELESCOPES**, low power Microscopes, etc.

Stock #2-N—10 lenses \$1.00 Postpaid
Stock #5-N—45 lenses \$5.00 Postpaid
Stock #10-N—80 lenses \$10.00 Postpaid

Order by Stock No. Satisfaction Guaranteed

Edmund Salvage Company BARRINGTON, NEW JERSEY

WAR EQUIPMENT MAIL SALE!

We Pay All Freight and Mail Charges.

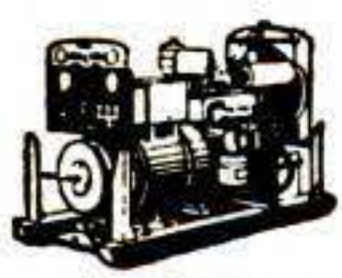

● **Power Plants.** 110-V. 60-C. 3,000-W. Remote switch electric self-starter. Easily made full automatic. Army's finest plants. Full instructions. Ideal for farmers, sportsmen, contractors. New condition. Fully guaranteed. **Cost Gov't. \$756** **Sale Price— \$345.00**



● **Industrial Engines.** New 1-cyl. Briggs 3.5 heavy duty, air cooled. Excellent for boats, garden tractors, weed sprayers, elevators, pumps, scooters, saws, etc. Complete instructions. **Cost Gov't. \$130.00** **Sale Price— \$75.50**



● Same engine with Utility Clutch **\$86.50**
 ● **Winch—3,000 Lb.** 12" x 14", 9" high. New finest steel and bronze gears 80-to-1 power ratio. Useful for farmers, truckers, merchants, factories, etc. Used by leading truck lines for loading. Excellent for any hoist boat docks, wagon unloaders, etc. Drive with old car 6-volt starting motor, power take-off, fan pulley, etc. Easily mounted on tractors, trucks, docks, jeeps, etc. Pays for itself. **Cost Gov't over \$75.** **Sale Price \$24.95**

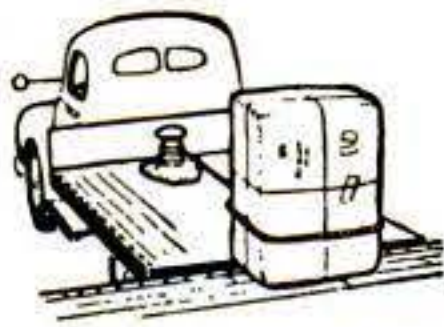

● **Welding Generators.** 275-400 Amp. Brand new. Genuine G. E. units. Ready to operate. Complete with pulley, heat control rheostat, etc. Build and repair your own machinery. Do professional work for pay. Drive with tractor, old auto engine, or electric motor. Hundreds uses. Complete with instructions on "How To Weld." **Cost Gov't over \$275.00.** **Sale Price \$89.90**



● Same unit with helmet, rods, holder, cables, etc. **\$104.50**
 ● **Pressure Air Unit and Sprayer.** Portable wheeled Briggs-N 1 1/2 h.p. engine driven unit. Bendix 2-cylinder compressor, gauge, regulator, valves, hose—complete. Excellent for painting, weed or insect spraying, tire pumping, cleaning and greasing equipment, etc. Hundreds uses—our most popular item. Guar. **Cost Gov't \$259.** **Sale Price \$99.50**

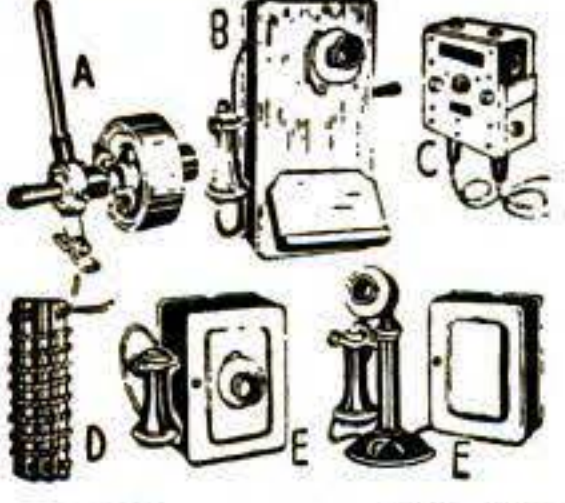

MANY OTHER BARGAINS SALE
 A. Utility Clutch, up to 6.5 h.p. **\$13.95**
 B. Magneto Rural Telephones **12.40**
 C. Burglar Alarm System **6.99**
 Fire Alarm System **9.90**
 D. 2000-watt 110-volt Elements **.99**
 E. City Wall or Desk Phones **4.99**
 ● Rotary Gear Pumps **3.95**
 ● Briggs 1.5 h.p. Engine **49.50**
 ● Multi-Speed 110-V. 60-C Motor **8.75**
 Also dozens electronic, hydraulic, mechanical bargains. Send Card for Free Catalog.

We Pay All Freight and Mail Charges

FREE CAT-ALOG

BURDEN SALES COMPANY
 821 "O" ST. LINCOLN, NEBR.

MONEY for MEN ALL DATA FREE

THE PLASTEX Industry needs manufacturers on small scale and for big production of Lamp and Clock Stands, Art Goods and Novelties in Plastex and Marble imitation. Experience unnecessary. 1/2c material makes regular 10c store sellers. Rubber moulds furnished for speed production. Small investment brings good returns. Big chain store orders now being placed. Ambitious men have chance for real prosperity. Our Free booklet will interest and benefit you.

PLASTEX INDUSTRIES, Dept. 2, 3400 Third Ave., New York 50, N. Y.

FISHERMAN and POULTRY SHEARS

PERFECT CHRISTMAS GIFT for
 ● FISHERMAN
 ● HUNTER OR
 ● HOUSEWIFE

AN INDISPENSABLE ITEM IN THE KITCHEN
 Perfect for Fishermen, Hunters and Housewives. Cleans, cuts fish and poultry in a few seconds. Many handy uses: screw cap opener, nut cracker, bottle opener, hammer, screw driver, pliers and hook extractor—all in one tool! It's a "gadget" that really works! Slightly over 9" in length. Made of first-quality hot drop-forged steel. Fully Guaranteed! Send cash, check, M.O. No C.O.D.'s please. Dealers: **\$3.95** postpaid
 Write for prices.
GABE MFG. CORP., 320 BROADWAY, DEPT. P, NEW YORK 7, N. Y.

Low Cost FOOT-SWITCH



FREES BOTH HANDS FOR JOB—THOUSANDS IN USE

Here at last is a compact, trouble-free, tested foot-switch—economically priced for every shop—that does the job of switches costing up to \$15.00! Famous California-built Smith-Switch comes complete with cord and plug, no soldering or wiring. Frees both hands for work, giving instant start and stop control of drill press, grinder, power saw, sander, darkroom equipment, etc., etc. Heavy-duty tungsten points, bronze spring, etc. Just Three Dollars postpaid, or send \$1 for C.O.D. plus fee. (Foreign \$4). Money-Back Guar. In Calif. include 2 1/2% Sales Tax



NATHAN R. SMITH MFG. CO.
 105 L Pasadena Ave., South Pasadena, Calif.

"WOVEN-Gards"

BETTER Hand Protection at Amazing Low Cost

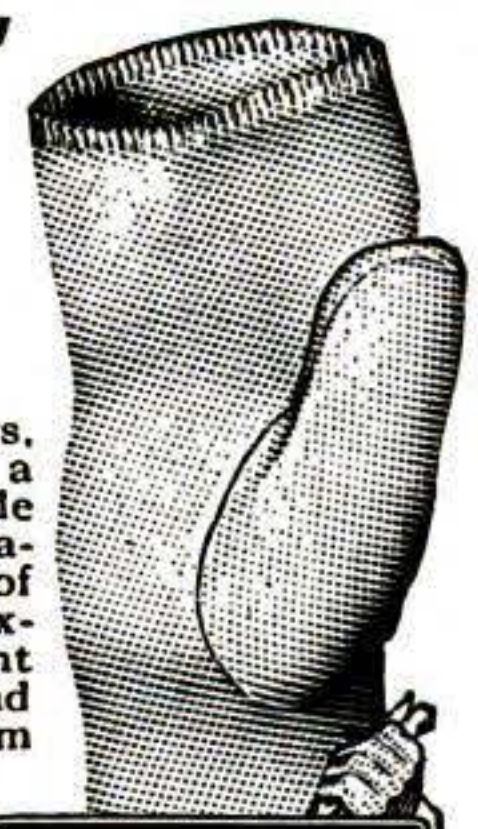

"Woven-Gards" are hand protectors, mitts, pads and sleeves made out of a wholly new safety material to provide flexibility, comfort, resistance to abrasion and cutting far beyond that of anything used before. They are extremely oil-absorbent for excellent handling of oily, slippery sheets and slabs. The porous weave makes them the best "hot" handlers ever offered. Thousands of enthusiastic users say they have never seen values like "Woven-Gards," best protection at lowest cost. Send now for descriptive folder and prices.

INDUSTRIAL Safety Apparel

INDUSTRIAL GLOVES CO.
 1428 Garfield St., Danville, Ill.
 (In Canada: Safety Supply Co., Toronto)

COMPOUND ANGLE VISE

for GRINDING MILLING DRILLING AT ALL ANGLES

Base 4" x 6"—Vise 1 1/2" x 2 1/4"—Vise Detachable
 Shipped postpaid cash with order or C.O.D. plus charges. WRITE FOR FREE CIRCULAR.
EN FAB, INC. 338 PARSONS ST., KALAMAZOO, MICH.

ELECTRIC SHEAR SHARPENER

Over 65,000 Sold—It Must Be Good!

Genuine Carborundum Motor driven wheel ideal for shop or home use. Send remittance with order and shipment will be made at once, prepaid to your door. complete with electrical goods catalogue.

\$9.75 complete with vise

WILLIAM MARVY COMPANY, Dept. 8
 479 St. Peter Street St. Paul 2, Minn.

"IDEAL" PRECISION RANGE FINDER

Get professional, sharp, clear pictures from your movie or still camera with the beautiful precision built "IDEAL Range-Finder." Easy to use—guarantees perfect focusing. Works the same as \$15.00 models. Highest quality optical system. Three year guarantee with each instrument. At your dealer or send \$3.00 (postpaid) to:

FEDERAL INSTRUMENT CORP.
 14-02 Broadway, Dept. 11, L.I.C. 6, N. Y.

Only **\$2.95** Incl. Tax

Piles May Lead to Associated Ailments

FREE BOOK Explains Causes, Effects and Treatment

If you have Piles, Fistula, rectal abscess, or any rectal or colon disorder—here is good news.

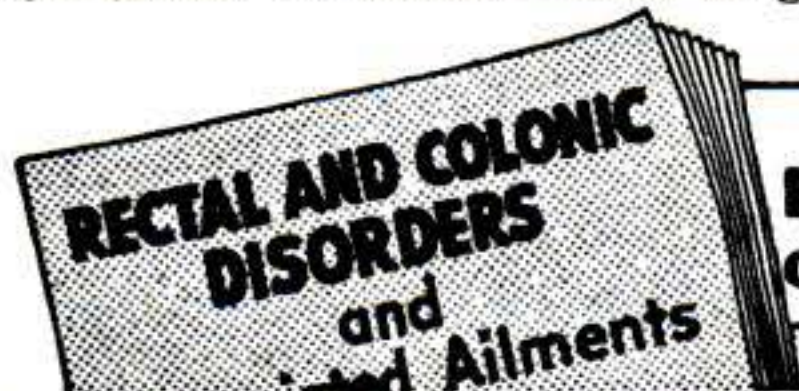

Avoid Dangers of Delay

Write today—McCleary Clinic and Hospital, 1171 Elms Blvd., Excelsior Springs, Mo.—for your FREE copy of their 160-page, illustrated book.

BE A LOCKSMITH

Learn Locksmithing and Keyfitting from experts in your spare time at home.

Uncrowded field! No layoffs, no slow seasons. AGE OR PHYSICAL HANDICAP is no disadvantage. Year round steady income in this permanent, respected career. Full or part time. Practical, easy lessons show how to make money even while learning! ALL MATERIALS AND SPECIAL TOOLS SUPPLIED.

write DEPT. PS1

Institute of Locksmithing

55 Park Ave. Rutherford, New Jersey



LEARN TO HYPNOTIZE



Yes, anyone. Modern speed hypnotism. Methods revealed. You are told exactly what to say & do. Many interesting experiments. Self-hypnosis fully explained. Personal instruction available.

Send for Hypnotism Revealed \$2
12" Hypnotism record inducing Group-Hypnotism & Self-Hypnosis \$5

MELVIN POWERS, Professional Hypnotist, 1324 Wilshire, Dept. 81, Hollywood 14, Calif.

MAKE EASY MONEY IN YOUR SPARE TIME

Popular Science Magazine has a limited number of openings for agents to sell subscriptions to this famous magazine—in all parts of the country. Our regular part-time agents make amazing commissions by representing the magazine that sells itself. If you too want to make easy spare-time money, just print your name and address on the back of a penny postcard and address to—Manager of Agents, Dept. 119, Popular Science Publishing Co., 353 Fourth Ave., New York 10, N. Y.

REAL ESTATE BE A BROKER

PAYS BIG! SEND FOR FREE, BIG, ILLUSTRATED CATALOG NOW! No obligation. Graduates report making substantial incomes. Start and run your own business quickly. Men, women of all ages, learn easily. Course covers Sales, Property Management, Appraising, Loans, Mortgages, and related subjects. **STUDY AT HOME** or in our classrooms in big cities. Diploma awarded. G.I. approved. Nationally known.

WEAVER SCHOOL OF REAL ESTATE (Est. 1936)
15 E. Pershing Road, Dept. PS, Kansas City, Mo.

FREE BOOK TELLS HOW

Play GUITAR in 10 DAYS

or Get Your Money Back!

Let Ed Sale teach you to play with his famous diagram-photo system. Book contains 53 photos, 43 diagrams showing exactly how to place your fingers. Gives you 110 popular songs, words and music—along with complete, easy to learn instructions. Imagine your joy when you find after only two weeks you are playing beautiful music! Amaze your friends! Be the life of the party! **SEND NO MONEY. Pay postman \$1.95 Plus Postage.** INSTRUMENTS SUPPLIED on cash or credit, ask for Price List and Credit Plan.

ED SALE DEPT. I POINT PLEASANT, N. J.

DELIVERED TO YOUR DOOR POSTAGE PREPAID!

MAIL ORDERS WE PAY POSTAGE ON ALL ARTICLES



ARMY SURPLUS \$8.95 VALUE!

BOOTS

IDEAL ALL WEATHER BOOT FOR WORK—SPORTS

LEATHER UPPERS—RUBBER BOTTOM
• Flexible double chrome, tanned, tough wearing leather uppers! • Leak-proof gusset tongue!
• Non-skid heavy duty rubber soles.

\$3.45 WE PAY POSTAGE

SIZES 6-7-8-9-10 11-12-13

Reconditioned and LOOK LIKE NEW!

NEW POLISHED STEEL ALL PURPOSE HOUSEHOLD MEAT CLEAVERS IDEAL KITCHEN SIZE

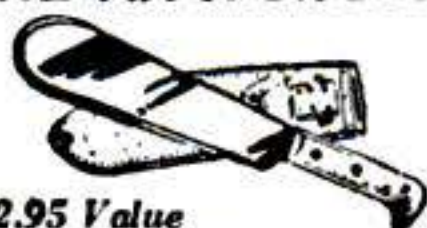

\$2.95 Value

Fine quality cutlery steel-riveted hardwood handle. Polished blade 11-inches long, 1/2-inch thick!—For meat, fish, fowl—every kitchen use.

COMPLETE WITH ALL LEATHER SAFETY SHEATH \$1.15

Delivered to You We Pay Postage

Genuine ACTIVATED CARBON KILLS ODORS!

In Refrigerators Ice Boxes Coolers, Freezers We Pay Postage

29¢ 97¢ VALUE



Absorbs unpleasant odors of fish, meat, onions, garlic, etc. Made to rigid U.S. specifications! Absolutely harmless. Just place it inside the refrigerator and it goes to work. **GUARANTEED ONE YEAR!**

NEW-100% WOOL BLANKETS



\$7.95 VALUE!

\$5.25 WE PAY POSTAGE

Soft, fleecy, warm. Closely woven nap, whipped ends. Ideal for every purpose.

Choice of GREY or KHAKI (30% Pure Wool—70% Pure Processed Wool)

SEND FOR FREE CATALOG—AMAZING VALUES!

UNIVERSAL ENTERPRISES

DEPT. 11 P.S., 946 S. MAIN ST. LOS ANGELES 15, CALIF. WE PAY POSTAGE, TAXES, INSURANCE ON ALL ARTICLES.

WOODWORKERS... Get this! CONSTANTINE MASTER MANUAL

Get the Most Fun From Your Hobby Indispensable to woodworkers. Newest, biggest edition, more pages, more color, helpful how-to-do-it articles, pre-war and new items, more bargains. Send 25c today and we will include **FREE! FULL YRS. SUBSCRIPTION** to Chips and Chats, published bi-monthly. Keeps you up-to-date on everything in woodworking, offers big money-saving bargains. Send now.



ALBERT CONSTANTINE & SON, Inc. 793-E East 135th Street, New York 54, N. Y.



SENSATIONAL CANDID CAMERA

at a new low price!

Makes brilliant black & white photos. 16 pictures for cost of 8. Double-element lens with view-finder at eye-level. Uses standard size film. Guaranteed for 1 year. Packed attractively.

Send \$3.00 Postpaid. No C.O.D.

MERRITT SALES CO., P.O. Box 334, Alameda, Calif.

WORLD'S LARGEST DENTAL PLATE MAKERS By Mail

FALSE TEETH

TRANSPARENT ROOF New FALSE PLATE Way NO IMPRESSION REQUIRED



We duplicate your OLD, LOOSE, DEAD-LOOKING plates in NEW BEAUTY-PINK PLASTIC with new SPARKLING, LIFE-LIKE TEETH. We do not use YOUR OLD WORN teeth. We also repair and replace missing teeth. If your plates are loose, we tell you how to make them feel tighter before duplicating them. We duplicate or repair or clean and polish your plates. FREE information. Write now.

UNITED STATES DENTAL CO., Dept. B-42
1555 MILWAUKEE AVENUE CHICAGO 22, ILLINOIS

NEW LOW PRICES

Don't Envy The PLUMBER-Be One

Make \$15 to \$50 a Day

Every skilled workman will tell you Plumbers have the best of it. WINTER and SUMMER the Plumber is busy at top wages. No skilled Plumber is ever out of a job. Compare his opportunities with any trade. To the man with know how, Plumbing means profit. Investigate Universal Plumbing School. Not a "war born School," but a plumbing school developed and operated by plumbers since 1923.



Own Your Own BUSINESS

Have your own business and big profits with little other than training and a kit of tools.

JOURNEYMAN Gets Good Salary

Master Plumbers own their own shop. A Journeyman works for a Master. With this training journeymen can depend on high wages.

G. I. Approved. Established 1923
UNIVERSAL PLUMBING SCHOOL
800 Holmes Kansas City, Mo.

BE A PLUMBER IN JUST 32 WEEKS

Learn With Tools—Not Books
No need ever serve an apprenticeship. Don't envy the plumbers big profits—enjoy them. Learn every trick of the trade—Leadwork—Blueprint for plan reading, etc. under Licensed Master Plumbers.

Over 7,000 Successful Plumbers Recommend This School

This system has made more than 7,000 plumbers. Investigate our past performance. If you like to work with tools this is your opportunity. Become a Plumber in America's largest and only school devoted exclusively to plumbing. Write today for FREE information.

Genuine HANDI-SCOPE



IDEAL FOR
Machinists
Hobbyists
Photographers
Engineers
Students
Naturalists

The Sensational All-Purpose Microscope With Sharp PUSH-BUTTON Focusing

Use the amazing HANDI-SCOPE in your work at home, office, shop or school. Easy push-button focusing gives fine-detail examination of screw threads, finishes, insects, plants, minerals, etc. Fits easily into pocket, requires no special illumination.

Not just a magnifying tube, but a real fine-focusing microscope with precision 20-power compound optical system. Price, postpaid—\$4.95, check or M.O. Money-back guarantee.

Desk C-117, 1009 Beech Ave., Pittsburgh 12, Pa.

BUHL OPTICAL COMPANY

MONEY BACK GUARANTEE

OFFICER'S TROUSERS

Pinks & Greens
Brand new. Fine quality officer's elastique trousers. Sizes 29 thru 42. Add 25c for mailing. **1.195**
• GABARDINE •
OFFICER'S SHIRTS
Brand new pinks and greens. Made of finest quality gabardine. Shoulder epaulets. Sizes 14 1/2 thru 17. Sleeve **695**
sizes 32 thru 34. Add 25c for mailing.

AIR CORPS TYPE

B-15 JACKET
Brand new. Extra warm and light-weight. Mouton fur collar. Zipper front. Knit wristlets and waist. Sizes 36 thru 46. **988**
Add 25c for mailing.
SEND FOR FREE CATALOG

NATIONAL JOBBING CO.

Box 1485 Dept. S-11 Omaha, Nebr.



2-Way Communication WITHOUT BATTERIES Up To 1 MILE!

AMAZINGLY LOW COST!

NOTHING ELSE LIKE IT!

2-way communications up to 1 mile with sound power. Set of two specially adapted headphone and microphone combinations, plus 25 ft. of wire. Simply add more wire for greater distance. All ready to use! **ONLY \$3.95**

WON'T WEAR OUT

Made to rigid Signal Corps standards. Self-powered; no batteries; no parts to wear out. Lasts a lifetime!



\$3.95 COMPLETE
SEND CHECK OR MONEY ORDER

Shipped postpaid anywhere in U. S.

A. BARON
168 Washington St., New York 6, N. Y.

IF C. O. D. PAY POSTMAN \$3.95 PLUS POSTAGE CHARGES.

GENUINE DIAMOND SCRIBER!
Writes on glass, metals, plastics. Hex. Aluminum 6". Money back guarantee. Agent inquiries invited.
\$2.00 Postpaid
CLIPPER DIAMOND TOOL CO., INC. 21-A W. 46 St., N.Y. 19

ENJOY MAKING YOUR OWN TOOLS
Machine your own lathe attachments from semi-finished castings of proven design. Faceplates, Carriage Stops, Boring Bar Holders, Tailstock Drill Pads, etc. All can be completed on your own lathe. Complete drawings and details. Save over 50%. Write for information. Give size, make and model of lathe.
THE VESTA ENGINEERING CO.
5226 N. Hollywood Ave., Milwaukee 11, Wis.

Sensational New Electric

① WELDER ② CUTTER!

FOR 110-115 AC or DC • WELD—BRAZE—CUT—SOLDER—HEAT TREAT
INSTRUCTIONS INCLUDED **WAS \$15---NOW ONLY \$12!!**

The **WELDRITE** Combination—tested and proved by countless commercial and amateur users, is now offered direct to you at the amazingly low price of only **\$12.00**. No Gas—No Gauges—No Spark Lighter needed. Always ready for immediate use—Just plug **WELDRITE** into 110-115 AC or DC outlet. Uses standard welding and brazing materials. **WELDRITE** furnished complete with Converter Unit, #1 Single Holder for welding metal to 3/16" thickness, using up to 3/32" rod, and #2 Double Holder with Copper Coated Carbon Electrodes for Brazing, Cutting, Heat Treating, etc. Starting welding

materials and instructions included.

Ideal for home workshop. Invaluable for garages, repair shops, farms, etc.

SEND NO MONEY! 10 DAY TRIAL. Order your **WELDRITE Electric WELDER-BRAZER-CUTTER C.O.D.** today. Pay postman **\$12** plus postage charges (wt. 4 lbs.) or send **\$12** and we pay postage. Either way, if not satisfied, return **WELDRITE** in 10 days for refund, less postage charges. **WELDER HOOD**—Approved Arc Welding lens—only **\$3.95**. Calif. orders add 2 1/2% tax.

BOTH only \$12

① WELDER

② BRAZER-CUTTER

CALIFORNIA TECHNICAL PRODUCTS CO.

Dept. B-11, 448 So. Hill St., Los Angeles 13, Calif.

ONE YEAR WRITTEN GUARANTEE!

ARMY AIR CORPS 16 JEWEL

ELGIN

\$19⁹⁵



Made for Pilots and Navigators of the U. S. Army Air Forces. They had to be good. Sturdy 16 Jewel Elgin men's wrist watches. Shock resistant. Sweep second hand. Luminous hands and dial. Stainless steel back. Unbreakable crystal. Water repellent. Made by ELGIN one of America's outstanding watch manufacturers. Fully reconditioned. One year written guarantee sent with each watch. Supply limited! **SEND NO MONEY.** Simply pay postman \$19.95 plus 10% tax and postage on delivery. Cash orders sent postpaid. United Products Co., 7941 S. Halsted, Dept. RES-1820, Chicago 20.

RUPTURE

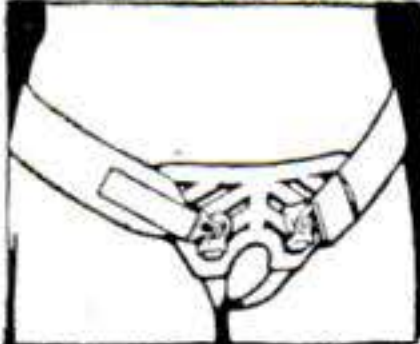

RELIEF...OR YOUR MONEY BACK

A simple... sturdy truss support built nature's way by old surgical appliance manufacturer. You risk nothing... relief or your money back. Send now for free booklet.

WEB TRUSS CO. Dept. S-94 Hagerstown, Md.

EARN \$5 an HOUR—ON THE SIDE
WHILE LEARNING WATCH & CLOCK REPAIRING AT HOME

WITH OUR NEW 15 ITEM SELF TRAINING KIT

Containing: AMERICAN JEWELLED WATCH MOVEMENT for practicing; PROFESSIONAL TOOLS: Loupe; 6 Watch Screw Drivers; Clock Screw Driver; Tweezers; Clock Tweezers; Material Tray; Case Opener & Knife; Movement Gauge; plus COMPLETE, easy to understand, ILLUSTRATED COURSE IN MODERN WATCH & CLOCK REPAIRING incl. use of tools and materials. (If C.O.D., plus charges!) **\$14.95** Post Paid
BACK GUARANTEE.....

MODERN TECHNICAL SUPPLY CO.

Dept. 11 MPS 55 W. 42nd St. New York 18, N. Y.
All inclusive instructive Tool Catalog with about 600 illustrations & descriptions FREE with KIT or send \$5.50 credited to 1st order.

Learn SALESMANSHIP

This nationally renowned school has demand for graduates in good salary positions thru Nationwide recognition and placement service. Write Department PSH today for Big 32 page Success Book to be sent to you **FREE**



Hills BUSINESS UNIVERSITY AND EXTENSION SCHOOL
619 W. MAIN ST. OKLAHOMA CITY 2, OKLAHOMA

Photography



for **PLEASURE or PROFIT**

Learn at home. Spare time. Practical basic training. Long-established school. Many have earned while learning. Send coupon below for free booklet, "Opportunities in Modern Photography" and full particulars.

AMERICAN SCHOOL OF PHOTOGRAPHY

1315 S. Michigan Avenue Dept. 1368 Chicago 5, Illinois
Send booklet, "Opportunities in Modern Photography," full particulars and requirements. No salesman will call.

Name.....Age.....
Address.....
City.....Zone.....State.....

Learn A Trade NOW! PRACTICAL SHOP TRAINING!

In Our Chicago Shops

- AUTO MECHANICS
- DIESEL MECHANICS
- REFRIGERATION
- BODY-FENDER
- WELDING—ARC and GAS
- MACHINIST
- PIANO TUNING

Above Approved For G. I.'s and Civilians
One of America's Leading Practical Schools
7 Floors of Fully Equipped Shops
Over 48,000 Successful Graduates
Expert Individual Instruction
Learn by Doing—Low Living Expense
Established 1902—Day and Evening Classes

Also the following Home Study Courses

- PLASTIC
- REFRIGERATION
- DIESEL

CALL IN PERSON OR MAIL THIS AD TO

GREER SHOP TRAINING

(Desk 12) 460 South State St., Chicago 5, Ill.

Please send without obligation free information regarding trade checked above. (Specify whether you are a Veteran or Civilian)

Name.....Age.....
Address.....
City.....State.....

PARTS FOR MILITARY TRUCKS

4 or 6 Wheel Drive at a SAVINGS
1/4 ton to 20 ton

Parts List Available on Most
Military Trucks and Jeep Models.



JEEP TOPS and CURTAINS

(Weatherizing Kit), complete top with back curtain and side curtains with zip-in-doors, 5 windows. Waterproof O.D. color, shipping weight 40 lbs. Wonderful value. **\$49.50**
F.O.B. K.C.....

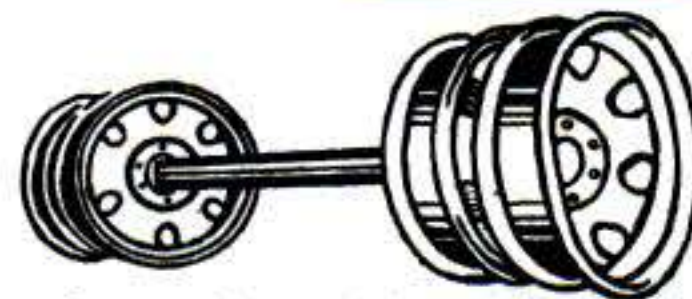

TRAILER AXLE

Heavy duty trailer axle suitable for many types of trailer construction. Also excellent for building of heavy farm trailers and wagons. It is a 12,000 lb. capacity square type straight trailer axle complete with Timken roller bearings, hubs, and 6 hole 7.50 x 20 Budd Wheels. Without brakes. Axle is 2 inches square and 69 inches between wheel mounting flanges. Std. width. AN EXCELLENT BUY.

With Single Wheels \$59.50 With Dual Wheels \$69.50

Save \$30.00 On JEEP Spare Parts KIT

Originally packed for Amphibious Jeeps. Also adaptable for all military and some civilian jeeps. Containing 29 major items. Offered at our low price of **\$8.95**

WINCH CABLE—1/2", 250 ft. \$30.00

Hundreds of Other Truck & Jeep Parts and Supplies
All prices quoted good 30 days FOB, Kansas City, 25% Deposit Required on All Orders.



UNITED AUTO PARTS CO. INC

1901 TROOST GR. 1800 KANSAS CITY, MO.

TODAY'S "GOLD MINE" A REAL BONANZA!

**SENSATIONAL INVENTION
Proved All-time Best Seller!**

Ends cleaning drudgery forever! This amazing Artmoore invention Fully Patented, scrubs, sweeps, mops, washes walls, waxes floors! No stooping or kneeling! Wrings automatically. Hands never touch water. Hundreds of thousands sold until war cut off materials. **NOW BACK AGAIN and Selling Faster Than Ever.** Former distributors ordering again in one, two and three gross lots. New dealers and distributors clamoring for rush orders. Hurry! GET THE FACTS ABOUT THE BIGGEST MONEY MAKER OF THE YEAR.



Exclusive Territory to Responsible Distributors and Crew Managers

Nothing so sensational in years! Guthmuller sold 21 in a single order. Boehme, took 20 orders from 17 customers. McIntyre cleared \$800 in one month. Many others producing top earnings of their lives. A chance for DISTRIBUTORS and CREW MEN to make similar sensational returns in EXCLUSIVE and PROTECTED territories. Mail coupon today!

**A. L. MOORE, Pres., ARTMOORE COMPANY
Dept. 511, 1319 N. 3rd St., Milwaukee 12, Wis.**

National Advertising supports you

- GOOD HOUSE-KEEPING
- BETTER HOMES & GARDENS
- FARM JOURNAL
- POPULAR MECHANICS

Mail this for **FREE** Information

Rush full particulars about the New Art Cleaner, and details of your exclusive territory Offer for Distributors and Crew Men. No cost or obligation in getting the facts. No franchise is sold.

**A. L. MOORE, Pres.
ARTMOORE CO., Dept. 511,
1319 N. 3rd St., Milwaukee 12, Wis.**

Name _____
Address _____
City _____ Zone _____ State _____

FROM HOLLYWOOD LIFE STUDIES

that help you learn to draw the human figure
GET THESE 3 BOOKS

\$2.50 POSTPAID
ONLY or \$1.00 each singly

24 ACTUAL PHOTOS of beautiful live Hollywood models in glamorous poses illustrate the volume "Life Drawing from Photographs."

CHARMING SKETCHES in the volume on "Figure Drawing" develop your knowledge of anatomy, with emphasis on the body in action.

"Your Career in Art" provides background material you won't want to miss.

SPECIAL OFFER
All three of these beautifully illustrated books only \$2.50 postpaid. Or, any one book for \$1.00. Supply is limited. Order today! Specify books wanted. Send cash, check, m.o., or order C.O.D. (Calif. residents add sales tax.)

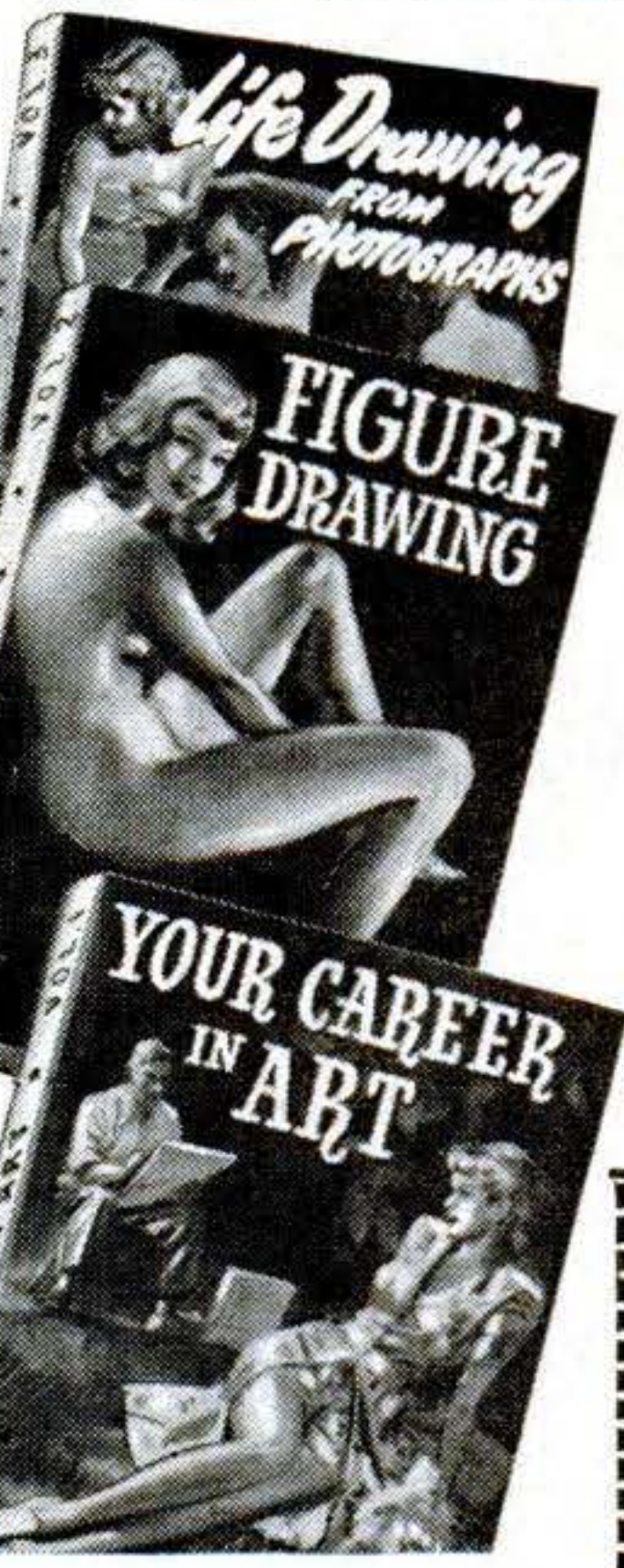

**HOLLYWOOD ART ASSOCIATES
ROOM 420, MARKHAM BLDG., HOLLYWOOD, CALIF.**

New FALSE PLATE

for OLD
IN 24 HOURS

Low As Only
\$18.50



Wonderful New Scientific Method Transforms OLD, LOOSE, Cracked or Chipped Plates into LUSTROUS BEAUTY-PINK DUPONT PLASTIC PLATES

NO IMPRESSION NEEDED

Why envy beautiful false teeth of others? We will transform your old, loose, cracked or chipped plate into a beautiful new, lightweight DuPont Beauty-Pink Plastic Plate, using your own teeth. All missing and broken teeth matched and replaced. Your cost amazingly low; actually save many dollars. No impression needed under our new scientific False Plate Method. 24-Hour Service. Perfect fit guaranteed.

SEND NO MONEY Enjoy life again, and save money on beautiful, new, natural-looking plastic plate. Rush name, address for full details sent FREE. If your plate is loose, we show you how to make it comfortable, tight-fitting before duplication.

West Dental Laboratory, 127 N. Dearborn St., Dept. L-34, Chicago 2, Ill.

Money Back Guar.



7x50 PRISM BINOCULARS

PRECISION OPTICS-BRAND NEW

\$36*

6x50 Achromatic Field Glasses

\$16*

*20% Federal Tax

Send for Free Catalog of Binoculars, Telescopes & Microscopes

BROWNSCOPE CO.
Dept. 11P, 24 W. 45th St.,
New York 19, N. Y.

ALNICO MAGNETS LIFT 125-lb.

AMAZING PERMANENT MAGNETS - WILL NOT WEAKEN! NON-ELECTRIC. Retrieve guns, tackle, tools and other steel items from lake, river, plating tanks, drains or other hard-to-reach spots. Recover drills, taps, etc. from floor sweepings. Clear alley of harmful tacks, nails. Many other uses listed. Pays for itself quickly. **GUARANTEED:** Try any magnet one week. Money refunded if you are not well-pleased. Cat. #P430 (Has a pull of 125 lbs. on a flat steel block) ... \$7.50 Cat. #P410 (40 lb. pull) \$2.50 Cat. #P528 (10 lb. pull) \$1.10 Cat. #P500 Hobbyists assortment of seven small magnets... \$1.10 **RONALD EYRICH, 2566 N. 49th St., MILWAUKEE 10, WIS.**

HEAVY CAST ALUMINUM BLOWER, NOW ONLY \$9.75

SINGLE EXHAUST BLOWER, DELIVERS APP. 100 CFM. For workshops, labs, kitchens, refrigeration, air conditioning. Ready to install yourself with any household tools. 110V AC 50-60 cycles cont. duty motor. **DOUBLE EXHAUST BLOWER**—with 2 housings on extended shaft motor. Now only \$15. Also **LARGE 275CFM BLOWERS. DUST-O-VAC**—Picks up & bags shavings and dust from all machines only \$19.95.

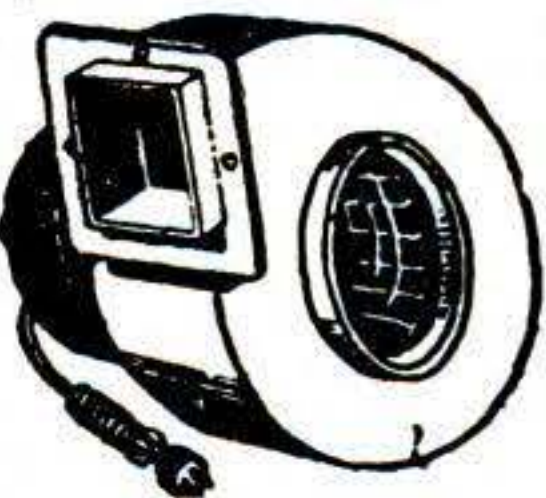

FREE Literature. Send check, M.O. All shipments F.O.B. Yonkers, N. Y. Pay postman delivery charges.

UNIVERSAL YONKERS CORP., (P11) 137 Alexander St., Yonkers 2, N. Y.

WONDERFUL GIFT!



GETS YOU THERE F-A-S-T!

Quick! Convenient! Handy for going to and from work... running errands... making deliveries... going to school, etc. Makes a wonderful Christmas gift! Safe! Dependable! Economical! Costs less than 1/4c per mile to operate, own, maintain. See your Cushman Dealer today or write us for facts.



CUSHMAN MOTORWORKS
Dept. PS-11 Lincoln, Nebr.

75 miles per gal.

Amazing FOUNTAIN PEN GUN

Shoots Tear Gas 15 Feet

Fits Pocket or Purse...
Guaranteed to stop man or beast

Complete Protection With Just a Flick of Your Finger

Here's quick, easy "finger-tip" protection. Shaped like a regular fountain pen, this pistol pen throws a powerful charge of tear gas 15 FEET! Cloud of gas spreads 4 to 6 feet. You can't miss. Just point pen like you point finger and release trigger. Ideal for home, office or car. May be clipped in pocket like pen. Loads like gun. Fires 38 Caliber S. & W. "Special" TEAR GAS cartridge. Will not kill. Renders mad dogs, robbers, etc., helpless. Can not harm user. Effective indoors or out. NOT SOLD TO MINORS or persons residing in state prohibiting sale of firearms. ONLY \$7.50. Cartridges 5 for \$2.50. Order TODAY!

SEND NO MONEY Just send name and address. Specify Pen, Cartridges or both. On arrival pay cost plus Express Shipping charges. Send cash with order, we pay express charges. Use 10 days. If not delighted return for money back. Order NOW!

DEFENDO PRODUCTS CO. Dept. 459, 3700 W. Roosevelt Road Chicago, Ill.

LEATHERCRAFT

COPPER TOOLING

TEXTILE PAINTING

Make your spare time PROFITABLE. Send today for FREE illustrated catalog showing everything you need.

KIT KRAFT, 7377 Melrose Ave., Dept. BD-11, Los Angeles 46, Calif.

Hobbyist Catalog

64 pages

WE PAY POSTAGE!
SHIP MODELS... TRAINS... PLANES
Cars... Art Supplies... Tools...
Project... Games.
U.S.A. and Canada Orders Only.

10¢ write **Braun-Crafts**
1232 ETOWAH, DEPT. PS-4A, ROYAL OAK, MICH.

NEW SHAPING MACHINE

Does work of metal and wood cut-off, planer, lathe, saw. Notching and grooving up to 30". Adjustable slide box with clamps, lever, or screw feed. Eight different set-ups. Also cuts tile, rock, brick. Does round turning in metal, or wood. Fast cut-off for pipe, rods. Steel welded construction. Ballbearing arbor. 15" x 38". No special skill needed. 1/2 HP motor not included. Shipping Wt. 50#. Price, \$36.50. Order direct, or send for circular.

HOME CRAFT INDUSTRIES
1116 So. 27 St. Omaha 5, Nebr.

100,000 WASHER REPAIR PARTS

Start Your Own Washing Machine Repair Business

RETAIL CUSTOMERS MAIL IN OLD PARTS OR MODEL NO. OR SERIAL NO.

Tremendous field, excellent profits! Get our large complete wholesale catalogue showing thousands of repair parts illustrations: wringer rolls, V-belts, motors, gears, etc. Price \$2.00 per copy postpaid in U.S. Send check or money order today—price of catalogue refunded on first \$20.00 order. Established 20 years

WESTERN APPLIANCE CO., Inc.
5650 GRAND RIVER AVE., DETROIT 8, MICH.

A Vital New Book for Radio Men!

TELEVISION Servicing

Get This Much Needed Book Now and Keep Up-to-Date • Helps You Earn More

Television Servicing by Manly is for the professional radio man. It starts where the radio man's knowledge and experience with AM sound receivers stops and provides simplified instruction, easy to follow, on all service operations. If you are in radio work get this timely book now. Protect your job and your future with TELEVISION SERVICING—the complete TV service manual. Covers alignment and other adjustments, replacements, test setups and connections, and trouble shooting with test patterns and oscilloscope traces. Includes instructions for using sweep and marker generators, oscilloscopes, and electronic voltmeters in such work. Over 400 pages, 302 illustrations. (Book No. 1) \$4.00.

Other Drake Books for Radio and TV Men

Cyclopedia of Radio and Electronics
A complete, easy to understand, reference-instruction book. Standard radio, high frequency and UHF, public address and sound, television, phototubes, industrial electronic tubes, and applications. 764 pages, 900 illustrations, tables and graphs, all especially prepared for this book. (Book No. 2) \$6.00.

Electrical and Radio Dictionary
More than 3800 definitions of the technical words and terms used in all branches of radio, including aviation, navigation and industrial control, photo-electricity, photocell applications, sound pictures, public address systems, television, telephotography, electricity and magnetism. 300 pages, 550 illustrations. (Book No. 3) \$3.00

MAIL COUPON NOW

Frederick J. Drake & Co., Dept. 58
117 Green Bay Road, Wilmette, Ill. (Circle numbers wanted)

Please send me the books checked below. If not satisfied I will return them in 3 days and money will be refunded.

Check or money order enclosed \$..... Send books postpaid.
 Send C.O.D. plus postage.

Name.....
Address.....
City..... State.....

Drake Books are Sold by Leading Booksellers

OVER 500 WAR SURPLUS BARGAINS!

WAR SURPLUS CATALOG

NEW! GOVT. SURPLUS CATALOG FREE!

HONEY OF THE TANK CORPS TANKER JACKET
Poplin outer shell. 100% wool OD lining, wool knit semi-turtle neck, wristlets and bottom. Zip front, slash pockets. \$888

36-46. **ORDER NOW!**

JACKET—SHEEPLINED TYPE AN-14
Genuine Air Force Issue! The Air Corp's finest jacket. Top grade leathers, trimmed at cuff and waist. Ex. lge. sheeplined collar. Adj. tabs at side, zip front. Reconditioned. \$42.50 value. Med. sizes only. \$19.50

Mail orders add 10% for packing and shipping. Send deposit or check with order. Every item guaranteed as advertised.

FAMOUS U. S. NAVY N-1 DECK JACKET
Alpaca pile lined. Poplin outer shell. Zip front, outside button fly, draw string bottom. 2 slash pockets. Knit wristlets in cuffs. Sizes 34-46. Brand New! \$14.88

B-2 FLYING CAP. Now, all leather cap, square visor, sheeplined, turn-up flaps. \$5.00 value. State size. \$2.50

- 12.50 PARATROOPER BOOTS, Double sole \$8.90
- 10.00 A-6 SHEEPLINED BOOTS, reconditioned. (new \$12.50) \$6.95
- 35.00 AAF PARKA COAT, quilt or alpaca lined! fur parka! \$24.44

• 17.50 NAVY PEA COATS, regulation type \$12.88

AIR FORCE FLYING TROUSERS LEATHER • SHEEP LINED! Brand New! The Navy's finest! Zippers entire length of pant. Suspenders included. All sizes. Government cost over \$20.00. State waist size and length. \$888

AAF ALPACA LINED PANTS ALPACA LINED THRU-OUT! Weatherproof poplin outer. Complete with pockets, zippers and suspenders. Warm, light weight. State waist size. \$688

FISLER SALES CO. 723 Walnut St. Kansas City 6, Mo.

NOW EASY TO START A Big Business ON A SMALL INVESTMENT



WARNER SUCCESS PLAN Gives exact instructions showing you

- How to start in spare time
- How to use home as headquarters
- How to bring in the business
- How to do real METALIZING in genuine GOLD, SILVER, or BRONZE, by the easy Warner Method
- How to start without risking your job
- How to pyramid your profits
- How to be sure of steady, big income.

Don't turn this page until you've given serious thought to your future. In the uncertain years ahead, the men who own their businesses are the ones who will be happiest. A small start now easily can lead you to complete independence, freedom from time clocks, freedom from fear of lay-offs, freedom from the limits of a pay check.

Now, while you can do it without risk—now is the time to investigate the exceptional opportunity offered you by the Warner Success Plan. Looking into the market, checking up on the possibilities for big sales and big profits will not cost you anything. Isn't this the time to lay the foundation for a future of complete independence—a life of happiness—a steady, dependable income?

METALIZING BABY SHOES AND OTHER KEEPSAKES

offers an exciting new opportunity to men or couples who want personal independence

If you'd like the feeling of being boss instead of being bossed—the Baby Shoe business is made to order for you. Just think of the appeal. A mother's love for her child—her desire to preserve forever the tiny shoes in which her baby took its first toddling steps. No wonder orders come easy and fast. No wonder profits are big. Then think of the Future. Fifteen Million babies in the last five years—three million last year—millions more next year. As long as babies are born, this business will prosper—in good times or bad. Think of the fun. Every job is different, interesting. And when you deliver a job and collect the money, you get a tremendous glow of satisfaction out of the mother's happy exclamations over your work. There's not another business I know of that offers you such big rewards in cash, in security, in a future, in independence that can be started on such a shoestring. You'll be glad you saw this ad—IF YOU SEND THE FREE COUPON.



READ THE ENTIRE PLAN 7 DAYS AT MY RISK

DON'T SEND A PENNY NOW — Just Send Your Name

This is one of the most fascinating businesses you can imagine. There are 15 MILLION pair of baby shoes waiting right now to be METALIZED. The opportunities are unlimited. The future is very big. And it's a business in which the whole family can have fun helping. A perfect business for man and wife to start—or for two partners. And I want you to read the whole Plan at my risk. Don't spend a cent unless you go ahead.

I want every serious minded man to let me show what I've done in our own shops here in Chicago—reveal the exact facts about the profits to be made and the way to make them. I don't want you to spend a cent for supplies until you've studied the facts, talked them over with the family and satisfied yourself that this is the ONE BIG OPPURTUNITY FOR YOU. That's why I allow you to read all trade secrets contained in the Warner Success Plan at My Risk. If you don't go ahead, you don't pay a cent.



You Have Nothing to Lose

ALL FACTS FREE! MAIL!

Raymond E. Brandell, Mgr., Warner Electric Co.,
1512 Jarvis Ave., Dept. 211, Chicago 26, Ill.

As long as it doesn't cost me a cent, I am willing to read the facts, investigate, then give you my decision. Send the facts by next mail. Everything you send now is FREE!

NAME _____

ADDRESS _____

CITY _____ Zone _____ STATE _____



\$5.00 AN HOUR

Yes, it's possible for one man to turn out enough work to make \$5.00 an hour for his time. Think of how that pyramids when a partner or the whole family works.

Old Established Firm Backs You Up

The Warner Electric Company just celebrated its 26th year of success. You get a *Real Start* when you "join up with Warner"—you get real *Guidance to Success*.

Warner Electric Co., Dept. 211,
1512 Jarvis Ave., CHICAGO 26, ILL.

WE SUPPLY EVERYTHING

You don't have to go "hunting" when Warner is behind you. We supply all materials, all mounts, chemicals, and metals. And you get the low prices made possible by our big quantity purchases and our own manufacture. You send for just what you need—and never have any big investment tied up in stock.



CLASSIFIED ADVERTISING DEPT.

Popular Science Monthly • 353 Fourth Avenue, New York 10, N. Y.

Classified Ads only 80c per word per insertion, payable in advance. Minimum ad 10 words. To be included in January issue, copy should be in our office by November 25th. January issue on sale January 1.

1 AUTOMOBILES

FORD Owners Handbook. Service information all 1932-1949 Models \$1.50—Model "A" Handbook \$1.00—Model "T" Handbook \$1.50—Motor's Automobile Repair Manual \$7.00—Motor's Flat Rate \$7.50—Chevrolet Car, Truck Book 1930-1940 \$3.50—Outboard Handbook \$3.50—all Postpaid. Clymer, Dept. 11B, 1268 S. Alvarado, Los Angeles 6, California.

RACING Car Equipment for all cars. Engines, Racing Heads, Manifolds, Carburetors, Mufflers, etc. Speed instructions and literature \$1.00—refunded first order. Lee Motorcraft Co., 1412-B Great Northern Bldg., Chicago 4, Ill.

FROM Speedway to Roadway! Track-proved Hi-speed Heads and Manifolds now available for your passenger car! No special tools needed! Increase horsepower 25%! Astounding getaway! Free illustrated catalog. Speedsport, 6215AB Diversey, Chicago 39.

BUICK Parts. Enjoy new-car pep and power in your old Buick. Same day service from World's largest stock of new (not rebuilt) Buick parts and engines. Ship anywhere. Write today. Robertson Buick Co., 1002 S. Wabash Ave., Chicago 5, Ill.

LIFE of Ted Horn, American Automobile Racing Champion \$2.00—Hot Rod Pictorial \$1.50—How To Build Racing Automobile \$2.00—Indianapolis Race History Book since 1909, 360 large pages, 1100 illustrations \$3.50—Power and Speed \$2.50—Postpaid. Clymer, Dept. 11B, 1268 S. Alvarado, Los Angeles 6, Calif.

"WATER Injection." Free descriptive illustrated information. Neher Industries, La Verne 6, Calif.

SEE our ad under motorscooters for Midget Car Bargains. Midget Motors Directory, Athens, Ohio.

"SPEED & Power" Handbook—50 chapter Library Edition! Breathtaking methods—Authentic—Direct from California! Covers Fords to Cadillacs—all makes! Build your own Dual Manifolds! Superchargers! Hot Cams! Water Injectors! Hi-Compression Heads! Mileage Devices! Save many dollars! Get up to ten extra miles per gallon! Get racing speed, lightning acceleration, dynamic power increases from any make automobile! Build fast Stock Cars! California Roadsters! 160 MPH Rods! Get construction drawings! Tuning Techniques! Speed Tricks! Economy secrets! Ingenious formulas! Including—"Racing Frames"—"Reciprocating Masses"—"Jet Engines"—"Braking Characteristics"—"Dynamometers." Also—Dual Pipes—Gears—Fuels—Porting—Relieving—Lowering—Balancing! Including complete Racing Equipment Catalogues! Also "California Automobile Customizing—Glossy photographs! Diagrams! Very newest ideas! Conversions! Re-styling all makes! Streamlining! Chopping! Channeling! Customizing!—Complete—\$1.98 postpaid. Newhouse Automotive Industries, 5805-A2 East Beverly, Los Angeles 22.

NEW Catalog '49-'50 British Cars. Complete specifications, address each manufacturer; comparison charts. Descriptions in English, French, German, Spanish. Beautiful photos all makes British cars including latest AC, Allard, Alvis, Armstrong-Siddeley, Aston-Martin, Hillman Minx, H.R.G., Humber, Invicta, Jaguar, Jensen, Jowett, Lanchester, Lagonda, Lea-Francis, Lloyd, M.G., Morgan, Morris, Riley, Rolls Royce, Rover, Singer, Standard, Sunbeam-Talbot, Triumph, Vauxhall and Wolseley. The finest book ever published on British cars! Postpaid \$2.00. Clymer, Dept. 11B, 1268 S. Alvarado, Los Angeles 6, Calif.

AUTOMOBILE Racing, Sixth Edition, 100 illustrations. Drawings, building instructions Ford-60 midget, California Roadster, Offenhauser racer, World's record 158.5 m.p.h. car, \$2.00 postpaid, \$2.40 C.O.D. Ray Kuns, Dept. 63, Cincinnati 27, Ohio.

CLYMER'S Steam Traction Engine & Threshing Machine Book \$2.50—No. 5 Scrapbook Antique Cars \$2.00—Steam Automobile Scrapbook \$2.00—Motor History of America Book \$3.00—Life of Henry Ford \$3.00—All Postpaid. Clymer, Dept. 11B, 1268 S. Alvarado, Los Angeles 6, California.

AUTOMOBILE Racing Book, fifth edition, well illustrated, Building bodies, frames, engines, Ford conversions, Plans, Roadsters, Indianapolis cars, \$1.00 postpaid. Ray Kuns, Dept. 47, Cincinnati 27, Ohio.

"VAPO-Steamatic" Water Injector. Easily built! Finest automatic "Moist-Humidity" system! Engineering triumph—Tremendously increases horsepower! Eliminates ping, carbon, overheating! Reduces wear—Lengthens engine life! Copyrighted "Water Injection Handbook"—with working drawings covering automobiles, motorcycles, airplanes, tractors! Includes Plans, Speed Equipment, Catalogues, Diagrams, Instructions—\$1.00 complete. Newhouse Automotive Industries, 5805-A1 East Beverly, Los Angeles 22.

NEW Catalog every American Car, 120 photographs, specifications. All G-M, Ford, Chrysler and independents including Del Mar, Playboy, Gregory, Tucker, Davis, Keller. Compare all cars in one book \$2.00 Postpaid. Clymer, Dept. 11B, 1268 S. Alvarado, Los Angeles 6, California.

CALIFORNIA Custom accessory headquarters. Buy direct from original designers and save. Solid hood sides, grille panels, lowering kits, fender skirts, dual pipes, chrome motor accessories, speed equipment, push button door conversions. Revised 1949 catalog, 32 illustrated pages, new low prices—25c. Eastern Auto Supply, 3319-D South Frand, Los Angeles, Calif.

NEW '49 Chevrolet Test Book Just Out \$1.50—New '49 Kaiser Vagabond Test Report. Information good and bad all K-F Cars. Travelogue Complete Mechanical Information, 300 Owners' letters, comments. Postpaid \$1.50. Clymer, Dept. 11B, 1268 S. Alvarado, Los Angeles 6, Calif.

DUALTONE'S New Muffler—the "California 99"—now ready in singles or duals. Superior in every way, yet no increase in price! Dealers inquiries invited. Catalogue 20c. Dualtone Mufflers, 2636B India Street, San Diego 1, California.

CUSTOM-Restyling, Super Handbook. Brand new! 200 graphic photographs, sketches, Medley cutaways. Thousands ideas. Guaranteed: Biggest, Best Buyable! \$2 pp, including catalog. Post Publications, Box 723-KC, Arcadia, California.

"SPEED and Mileage" Manual—140 Illustrations! (Guaranteed finest most authoritative book of its kind!) Easily obtain greater speed, mileage, acceleration—racing performance from any car!!! Shows how to build inexpensive "Speed Equipment"!—Beautiful Custom Cars!—California Hot Rods!—"155 m.p.h. Road, Track Conversions"!—Superchargers—Dual Manifolds—Heads—Twin Mufflers—"Water Injectors"—Economizers!—All about Fast Engines!—Speed Tuning! Restyling! "Customizing"! Gas Saving! "Racing Tricks"!—Cams! Fuels! Ratios! Frames! Offys!—Reveals "Stock Car Speed Secrets"!—California Speed Shop Methods!—"Custom Styling Information"! Streamlining! Sport Changes! Lowering! Working Diagrams! "Hollywood Roadster Plans"! Speed Conversions! Drawings! Charts! Photographs!—Covers All Cars!—"Complete Manual" (Plus) "Hot Rod Handbook" and Equipment Catalog—All three \$1.98. Almquist Engineering, Milford 34, Penn.

"HOLLYWOOD" Mufflers—Beautiful deeptone rumble! "Straight-thru" design increases efficiency, speed, acceleration, mileage! Singles, All cars \$4.85. Finest V-8 Duals \$15.90—(Satisfaction Guaranteed) Speed equipment catalog 25c. Almquist Engineering, Milford 5A, Pennsylvania.

"SPEED Equipment" Bargains—California Mufflers \$4.50, V-8 duals \$15.90. Chrome Carburetor Stacks 98c. Dual Manifolds \$9.95, Chrome Echo Cans \$1.65. Racing Camshafts \$29.95 Exchange, Hi-Compression Heads \$45.00.—All Popular Brands! Illustrated Catalog 25c. (Dealers Wanted). Almquist Automotive Engineering, Milford 34, Pennsylvania.

1949 Indianapolis Race Yearbook. Just Out. Complete information, articles, photographs. Postpaid \$1.50. Clymer, Dept. 11B, 1268 S. Alvarado, Los Angeles 6, Calif.

"200 Ways to Save Gas"—and increase efficiency, speed, power, life of your automobile! "Illustrated Manual" \$1.98. Almquist Engineering, Milford 5A, Pennsylvania.

CALIFORNIA Speed Equipment. Doll'em up chrome accessories, Hollywood mufflers, skirts, lowering kits. Illustrated Fall Catalog 25c. Von Esser's, 3307 W. Irving Park, Chicago 18, Ill.

2 AUTO SUPPLIES & EQUIPMENT

BE Independent! Fifty valuable formulas. Only \$1.25 complete. Young's Productions, Saint Heleus, Oregon.

INITIALS for your car. Send 50c for 6. Stilwell, Empress Bldg., Decatur, Ill.

POPULAR SCIENCE OPPORTUNITIES

BRUSH Plating Outfits connect to a battery. No tanks or shop required. Free particulars. Gunmetal Co., Avenue K, Decatur, Illinois.

AUTO parts. Buy direct. Get dealers' prices. Represent us in your territory. Write requirements. Specify car make. Mechanics Auto Parts, Factory Warehouse, 3807-PS N. Ashland, Chicago 13.

SAVE Gasoline! Quick Starting! "Air-flow Needles." \$1.50. Free Trial! Specify Car, Carburetor, Neher Industries, La Verne 6, California.

"**SMITHY** Mufflers" for all cars. Free list, Buck's Auto Parts, 1629T, Merced 6, California.

FUEL Oil conversions for gasoline motors. Free literature. Write Houston & Logan, 2112 Addison, Berkeley, California.

WELDING Pays good profits. Bodies, blocks, frames, fenders—easy with Hobart Welders. Low cost. Easy Terms. Free Catalog. Write Hobartweld, Box P-1192, Troy, Ohio.

CHEVROLET Parts. Scarce motor, body, sheet metal parts. Grossman Chevrolet, Minneapolis, Minnesota.

TILLOTSON carburetors, parts, manuals. Wholesale and retail. Free list. Agencies available. 600 LaPrairie, Ferndale 20, Mich.

CHRISTMAS present trouble? Auto bells, the newest warning device, \$8.95. Free details. Bermuda Auto Bells, D-53, 16 Concord St., West Hartford 7, Conn.

CONVERTIBLE Top Covers. Tailored. Snap-on. \$19.50. Vassar, Cleveland 5, Ohio.

SCREWDRIVERS. Save 20%. Plastic Handles. Complete sets \$3.40. All Orders C.O.D. T. W. Sales & Co., 1507—30th St., N.E., Canton, Ohio.

OVERDRIVE—"Sig-Na-Lite" for cars with Overdrive. Write for Free "Overdrive Hints." Sig-Na-Lite, 5227D Parker, Chicago, Ill.

VAPOR Injector gives super performance more power, smoother running and saves gas. Send car year and number of cylinders. \$9.75 postpaid. Money back guarantee if returned 30 days. Vapojet, 14424 Biona, Los Angeles 34.

CHEVROLET Parts. Any part for any year, any model Chevrolet. Don Allen, Buffalo, New York.

SAVE Gasoline. Sensational Gane Needles. Free Trial—see page 32.

"**LEKTRON**" atomic coil booster saves gas! Instant starting, smoother power. Easily installed. \$2.00. Money-back guarantee. Specify car. Electronic Industries, Cleveland 11, Ohio.

PISTONS American, Foreign and Racing Catalog. 10c. Merryman Co., Lawn-dale, Calif.

NEW Sensational Seat Covers. Mono. 6545 Santa Monica Blvd., Hollywood 38, Calif.

NEW Automatic Thief Chaser Burglar Alarm. A Life Guarantee electrical unit installed on any car or building. Once installed it works automatically. Only \$4.98. Novak Manufacturing Company, 1358 Chase, Gary 2, Indiana.

MOTORISTS save gasoline by Vacuumating overrich mixtures. Fits all cars. For Free particulars write Vacuumatic, Dept. 1544, Wauwatosa, Wis.

3 AUTO TRAILERS

TRAILER plans—house, utility, boat, etc. Axles, chassis, hitches, windows, etc. Catalog with booklet. "Trailer Hints." \$1.00. Catalog only. 50c. Marine Mart, Buffalo 7-A, N. Y.

BUILD Your own trailer! Save money! Have every feature you want! Plans for house, sport, camp and utility trailers. Catalog describing 9 models 10c. 15c in Canada and overseas. Jim Dandy, Box 125-B, Wausau, Wisconsin.

TRAILER Coaches. Save Money. Buying? Building? Sound engineering construction, chassis, bodies, furnishings. Travel, dwelling, trailer plans. \$1.50 postpaid. Ray Kuns, Cincinnati 27, Ohio.

4 MOTORCYCLES BICYCLES, SUPPLIES

MOTORSCOOTERS. New Design. 6 big features. Literature 10c. Rollaway Motors, Lancaster, N. H.

WHEELS! Build wagons, scooters, mowers, trailers, wheelbarrows, grocery carts, baby carts, play pens, baby carriages. 4" to 16". Free list. Trulsen Mfg. Co., 811 E. 31, Kansas City, Mo.

RECONDITIONED motorcycles and motors. Chromium accessories. Complete stock Indian parts. Expert rebuilding. Fast service. Indian Motorcycle Sales, Kansas City 1, Mo.

MIDGET car \$5, motorbike conversions \$5 brand new Regal motorscooters \$37.50 less motors. Indian motorcycle \$25, midget car \$20, Custer motorscooter \$25, all complete. Gasoline engines \$2 up. Super-cycles. Cushman's, Salsburys. Plenty new motorscooters, midget cars, homebuilders parts, automatic clutches, transmissions, engines, tires, etc. at factory prices. Special sale: Four balloon tires for \$3. Over 5500 tires in stock. Mailorder only. Send 25c for Big War-Bargain Catalogue just out listing these and hundreds of other bargains. (35c by First Class Mail.) Midget Motors Directory, Athens, Ohio.

MOTORCYCLE Journal—Worldwide Coverage. Illustrated. Year's Subscription \$1.00. Sample 15c. Motorcycle News, 5424-H Sawyer, Chicago 25.

KNEE ACTION motorbike \$15; Midget car (steel frame) \$25; Moto-Scoot \$15; Whizzer motorbike with all attachments \$25; Indian motorcycle \$30. Other motorscooters \$8 up, motors \$3 up. Send 25c for new catalog #943 listing many other sensational bargains in used motors, motorscooters, motorcycles, parts, etc. Associated, Box 1764-CS, Toledo, Ohio.

WHIZZER bike—motor \$25; Cushman motorscooter \$15; Midget Racer \$40; Shaw bicycle motor \$15; Harley-Davidson motorcycle \$15; Smith motor-wheel \$25; Good motorscooter (twist grip) \$22.50. Rush 25c for new catalog #15 listing many other amazing bargains in motorscooters, used motors, midget cars, parts, wheels, etc. Gail, 538 Erie, Toledo, Ohio.

CUSHMAN Scooter. Prompt shipment: parts for all models. Higgins Scooter Sales, Inc., Dept. PS-1, 414 So. 11th St., Lincoln, Nebraska.

5 AVIATION

JET Engine \$3.00; Plans \$1.00; Literature 10c; M.E.W., 387 University, St. Paul, Minn.

PROPELLERS—2-3 Blade, for sleds, air-drive boats. Catalog. Standard Aero Craft, Box 387, Ft. Worth, Texas.

6 AVIATION INSTRUCTION

PASS your C.A.A. examinations with a Ross guaranteed questionnaire. Free Folder. Ross Aero Publishers, Tulsa, Okla.

7 ELECTRICAL SUPPLIES & EQUIPMENT

ELECTRIC Pencil: Engraves all Metals \$1.25. Beyer Mfg., 10511-C Springfield, Chicago 43.

BUY Lamp Parts Wholesale. Parts you need for building, repairing, or assembling. Save money on large or small orders. New catalog for 10c. Gearon Company, Dept. 300-A11, 27 South Desplaines, Chicago, Illinois.

OIL Lamps—Electrify them in 1/2 minute. Catalog all lamp parts and instructions 10c. Gyro Lamps, 5402B Clark, Chicago 40.

BUILD your own electric motors from scrap automotive generators—complete illustrated instructions for all makes. Only \$1.00. Autopower, 918 Theresa, St. Louis 3, Mo.

LAMPS—Build own Originals. Parts Wholesale, any amounts. Catalogue 10c. Brown Lamp Co., No. 501 Wellston, St. Louis 12, Mo.

ELECTRICAL testing made easy. All purpose electric tester, 50c. Hahco, 1760 Hillview Rd., Cleveland, Ohio.

SELSYN motors, 115 volts, 60 cycles, 3 1/4" x 5 1/2", \$7.25 per pair. Weber Electric, 150 Maple, Hershey, Pa.

PERFECT for Electroplating, Model Trains, Battery Charging, etc. Factory Wired Fullwave Bridge Selenium Rectifier Pack. Just plug into 115V. A.C., output continuous 12 volts, 5 amperes \$10.25. Also 12 volts, 10 amperes \$15.25. Eton Electronics, 919 Dawson St., New York 59, N. Y.

8 WELDING, SOLDERING, PLATING

"**BANTAM-Champ**" Welder starts you in profitable welding business. Pay only \$16 monthly. Write for information on this new, low-cost 200 Amp. Welder and free "Guide to Better Welds." Hobartweld, Box P-1193, Troy, Ohio.

WELDERS for all requirements. Free catalog. Write Hobartweld, Box P-1194, Troy, Ohio.

WELDING—a profitable trade. Learn quickly at best equipped school in U. S. Low Cost. G.I. Approved. Free Catalog. Write Hobartweld, Box P-1195, Troy, Ohio.

RADIATOR Repairing, Cleaning, Recoring. How to equip small shop at low cost. Supply sources, trade secrets, instructions now only \$3.50. Postpaid. Radiator Service, McBain, Mich.

WELDERS 110V. Welds 1/2" steel, \$29.50. Morris Welding Service, 1850B State, Schenectady 4, New York.

ELECTROPLATING Units—Complete \$2.00 and up. Free Literature. Regency Sales, 5316 S. Justine, Chicago 9, Illinois.

LOWEST Prices on A.C. Welders. Save. Holgerson Co., Canton, Kans.

RADIATOR Repairing Books, Supplies, Equipment, Gasoline Torch. Write for circular. Curfman Mfg. Co., Marvville, Mo.

WELDERS! New Portable Champion Special Transformer Welder: 110/120 volts, AC 9 heat stages up to 75 amps; Welds, brazes, solders, cuts all metals. Easy to use. Simple instructions. Special Flame Weld Torch Free. Splendid for Shop, Farm, Home repairs. Saves hundreds of dollars yearly. Only \$27.50. Also heavier models. 10 Day Free Trial. Magic Welder Co., 239 PS Canal St., New York, N. Y.

10 MACHINERY, TOOLS, SUPPLIES

DRILL GRINDER for twist drills \$2.95. See ad on page 296.

"**BUILD-Ur-Own**" Welder—AC Power Combination. Portable—welding plus AC Power anywhere. Your engine plus Hobart Generator saves \$350. Free instruction book. Write Hobartweld, Box P-1196, Troy, Ohio.

WAR Surplus in small tools for machine shop. Send 15c for Bulletin. Travers Tool Co., Dept. S, 5 Court Square, Long Island City 1, New York.

POWER tools, equipment wholesale prices. Free Bulletin. Homecrafters Cooperative, Grand Rapids 6, Michigan.

BAND Saw for home workshop & Hobbyists. Special \$14.95—Factory to you—Circular Free. American Band Saw Co., 147 E. Lake St., Minneapolis, Minn.

13 BATTERIES, GENERATORS, ETC.

GENUINE Edison Batteries. Fifteen year life. Unconditionally guaranteed. Free literature. See-Jay Company, 3522 Webster Avenue, New York 66, New York.

EDISON Non-Acid lifetime storage batteries for home lighting, motors, industrial uses, radio, etc. Free interesting literature. Hawley Smith Co., Croton Falls 2, N. Y.

14 BOATS, OUTBOARD MOTORS, ETC.

STEERING Wheels, windshield brackets, from \$6.95. Modern fittings at lowest prices. Complete pre-cut plywood boats. Bargains galore. Folder 10c. Marine, Box 681, Mendota, Minnesota.

FULL size, cut to shape boat patterns, blueprints, 7 1/2-38 feet. Illustrated "Build a Boat" catalog, 25c (coin). "How to Build Boats" book, \$1.00. PolyWog Houseboat Plans \$10. Marine Catalog \$1.00. Cleveland Boat Blueprint Co., Dept. A-77, Cleveland 13, Ohio.

P38 Belly Tanks \$9.95. Steel, Unused. Ten foot. Free picture. Anzio Boat Company, 1627 "T," Merced, California.

POPULAR SCIENCE OPPORTUNITIES

PACKAGED Lumber—Marine plywood, seasoned oak and cedar, sized, selected. Send \$1.00 for booklet, "Plywood Boats," with quotation form and literature. Forms and literature, 25c. Marine Mart, Buffalo 7-A, N. Y.

NEW, used, rebuilt marine motors. Marine conversions, fittings. Free Catalog. Stokes Marine Supply, Dept. 23, Coldwater, Mich.

MARINE Specialties and motor conversions catalog. Sixty pages of struts, finishes, hardware, plexiglass windshield kits, electric tachometers, inboard and outboard air cooled motors, etc. Immediate delivery. Catalog with booklet, "Conversion Hints," \$1.00. Catalog only, 50c. Marine Mart, Buffalo 7-A, N. Y.

BOAT Builders' guide—250 pages—15,000 items pictured, priced, deliverable. Send \$1.00. Marine Mart, Buffalo 7-A, N. Y.

SHIP Modelers—are you looking for authentic, precision-made kits? Send 35c for richly illustrated catalog describing more than 30 models retailing from \$3.95—Clipper ships to modern cruisers—also decorative authentic Naval and Field Gun Kits from \$4. Address Marine Model Co., Dept. A, Halesite, Long Island, N. Y.

CONVERSION parts for all engines, marine manifolds, transmissions changed to high-speed reverse, propellers, shafts, couplings, etc. Money Back Guarantee. Conversion Parts Co., 277 Adams Street, Boston 22, Mass., U. S. A.

BOAT Plans: Over 300 designs Easy-To-Build Outboards, Sailboats, Runabouts, Cruisers, etc. Get Free Catalog now. MoToR Boating, 572B Madison Avenue, New York 22, N. Y.

MARINE conversions for Ford and Jeep engines. Catalog 10c. Lehman Manufacturing Company, Department A, Newark 2, New Jersey.

SAVE 2/3 cost. Assemble your own boat. Complete plans and boat parts machined ready for assembly. No experience necessary. Rowboats to cruisers. Illustrated catalog 25c. Midwest Boat Company, Menomonee Falls, Wisconsin.

IS your boat worth \$17.50? Complete new CO-2 Automatic Fire Extinguisher units, easily installed. Fit any boat. Full price \$17.50. Payment Please. Western Aircraft Service, Hawthorne, California.

15 ENGINES, MOTORS, ETC.

WINDING Data, listing 225 motors, single and three phase, \$1.00. Motor Data, Box 7631, Kansas City 3, Mo.

"Build-ur-Own" Welder, Hobart Generator plus auto engine saves \$350. Free instruction book. Write Hobartweld, Box P-1197, Troy, Ohio.

WELDING Generator 150 ampere \$47.50. Motors 1/2 horse \$15. 1 horse \$30. Water pumps \$12.50. Butler, 1885 Milwaukee, Chicago 47.

HOTTEST surplus list in the country. Electronics, Hydraulics, Aircraft, Gadgets. Dick Rose, Everett, Washington.

16 AMERICAN POLICE JIU JITSU

DEADLY Judo—Fiercest fighting technique, Trick knockouts. (Over 200 illustrated pictures.) Expert instructions—Three volumes Complete \$2.25. Variety House, Box 46-A, Wall Station, New York 5.

18 BODY-BUILDING COURSES

BARBELLS—finest quality \$8.98 up. Catalog Free. Lurie Barbell Co., 1729-S11 Rockaway Parkway, Brooklyn, New York.

6 BODYBUILDING Courses, four Barbell, two dumbbell, in 53-page muscle-building book with six illustrated Wall-charts, \$1. Paramount, 2418 E. 23rd, Los Angeles 11, California.

HANDBALANCING and Acrobatics easily learned. Write, Power, 923-A, W. Vine, Kalamazoo, Michigan.

BARBELLS, Dumbbells. Exercise equipment. Courses. Free booklet. Good Barbell Co., Reading, Penna.

HAIR, Eyesight, Facial, Teeth, Bone, Muscular, Organic, Height, etcetera. Rehabilitation! Lifemolder, 186 Rutledge, Brooklyn 11, N. Y.

19 SPORTING GOODS, GUNS, FISHING TACKLE, ARCHERY

"SHOTGUNS"—"Rifles"—"Handarms"—"Ammunition"—"Rods"—"Reels"—List 10c. PS-Rudolph's, Atchison, Kansas.

BOWS—Arrows—Quality Archery Equipment. Popular prices. Catalog 10c. Illustrated Archery Instruction Book 50c. Archery, 617-J So. State, Chicago 5.

190 PROFUSELY illustrated pages antique and modern pistol, sword, etc. values, 50c. Robert Abels, PS860 Lexington Ave., New York 21.

AMMUNITION Prices Slashed. American and Foreign Loads below retail. Dime for List. Central Sports, Delphos 11, Ohio.

CHECKERING Tools—Hand-filed Set of three—Checker, Border and Cleaner—also directions. Popular 16 line set \$2.75; 18 and 20 line—\$3.50 postpaid. Thousands satisfied; sold last 15 years. Free catalog. Warner Products, Baldwinsville 6, N. Y.

5,000 BARGAINS, firearms, binoculars, war relics, catalog 40c. Smith Museum, Rummeneide, N. J.

ANTIQUe and Modern Guns, Bargain List 10c. Rywell, Harriman, Tennessee.

SHOTGUNS, Rifles, Revolvers, Over 500 Modern, Obsolete. Also Cartridges. List .10 coin. Ed Howe, 26 Main Street, Coopers Mills, Maine.

SEND 10c for list 100 used guns. Frayseths, Willmar, Minn.

1950 CATALOG, Selling 400 Firearms, 20,000 Indian Relics, Coins, Gold Dollars, Flintlocks, Kentucky Rifles, Pistols, Cartridges, Swords, Percussion Caps, Bayonets, Bullet Molds, Powderhorns, Confederate Currency, Agates, Fossils, Ramrods, Steerhorns, Blunderbusses, Mounted Owls, Civil war Muskets, Arrowheads, Tomahawks, Birdpoints, Blo-horns, Bo-wood, 1950 illustrated catalog 25c. Heike, Wena 14, Illinois.

20 FIELD GLASSES, TELESCOPES, ETC.

TELESCOPES, Binoculars, Microscopes,—big bargain catalog free. Brownscope Company, 24 West 45th Street, New York.

WAR Surplus Bargains, Binoculars, Tele-scopes, Sextants, Millions of Lenses, Prisms, Reticles, Eyepieces, Objectives, etc. Request Free "Catalog CN". Send \$1.00 for Stock CN—10—Piece Lens Kit and Big Instruction Booklet. Edmund Salvage Co., Barrington, N. J.

REFLECTING Telescopes, completely assembled, 60X, \$25.00. Guaranteed Observatory clearness. Free information. Skyscope, 475 Fifth Avenue, New York 17.

"FREE" Catalogue! Thousand war surplus optical Bargains, Lenses, Prisms, Telescopes, Binoculars, etc. G. Jaegers, 93-08—95th Avenue, Ozone Park 16, N. Y.

POWERFUL astronomical telescope easily made. Perfect lenses and instructions; 100X \$3.00; 100X and 200X \$4.00; 100X, 200X and 400X \$6.00. Full power, clear vision guaranteed. Instructions alone 10c. Suffolk Science Service, Box 308, Manorville, N. Y.

SAVE 50% on New Binoculars—The Ideal Gift! Free Catalog and Booklet, "How to Select Binoculars." Write Today! Bushnell Importers, 43-P11 East Green, Pasadena 1, California.

ASTRONOMICAL telescopes, binoculars, microscopes; Bought, sold, repaired. Books. Lists 10c. Rasmussen-Reece, Amsterdam, New York.

22 BABY CHICKS

U. S. APPROVED—Certified chicks, Egg or meat strains. Year Around. Amstutz Hatcheries, Box 70, Orrville, Ohio.

24 DOGS, BIRDS, PETS, RABBITS

MAKE Money! Raise Chinchilla Rabbits. Experience unnecessary. Valuable Breeders. Extra profits from meat, furs, laboratories. Pleasant hobby. Write today! Rockhill Ranch, Sellersville 16, Pa.

SEE Gulf Hamstery ad page 44. Shows picture of Hamster.

\$400 MONTHLY Raising Angora Rabbits. No experience required. Details free. White's Rabbitry, Newark, Ohio.

RAISE Angora Rabbits, highly profitable! Terrific business! Write: Santiago Angora Rabbitry, 2024 West Eighth Street, Santa Ana, California.

RAISE Mink, Amazingly profitable. Free booklet gives inside "secrets." Molgard, Brigham City, Utah.

GOLDEN Hamsters—Novel Pets, \$5 brings breeding age pair including two metal cages, instructions. Hathaway Hamstery, 609 Deerfield, Silver Spring, Md.

\$50 WEEKLY Raising Angoras, Free Illustrated Booklet tells How. Wilson's, Stanton, Calif.

HAMSTERS \$2.75 pair, Mice \$3.50 dozen, Turtle 35c, Alligator \$2.50, Chameleon 35c, Mealworms 50c hundred. Hobby Catalog 10c. Reptile List 5c. Quivira Specialties, Topeka, Kansas.

RABBITS! For tasty Food and Profits. Write for information and Free Illustrated Booklet. Dr. Frank Baddour, Lebanon 8, Tenn.

"PLACING your Chips on Chinchillas" booklet concerning genuine South American Chinchillas, \$1.00. Sherwood, Ranch, Box 3612, Cleveland 19, Ohio.

25 FROG RAISING

"FROG Raising"!—New book tells how. Marlboro-B, Box 7002, New Orleans 19, La.

30 FARMS, OTHER REAL ESTATE

GOOD FARMS—Ranches, Washington, Minnesota, Montana, Idaho, Oregon, North Dakota. Dependable crops, favorable climate. Write for literature, lists describing typical farm opportunities. Specify which state. J. W. Haw, 120 Northern Pacific Ry., St. Paul 1, Minn.

OZARK Lands for All purposes. Actual river frontages, 5 acres \$90.00 and upwards. Free list and literature. Hubbard, 424-H, Minnesota Ave., Kansas City 4, Kans.

FARMS, Ranches, lodges, resorts, Big selection. Milwaukee Road territory. Washington, Idaho, Montana, Dakotas, Minnesota, Iowa, Missouri, Michigan, Wisconsin, Illinois, Indiana. Free colorful descriptive folders, price lists. L. H. Robbins, 738K Union Station, Chicago 6, Ill.

FARMS—Homes: 124-page catalog, 2790 Bargains, 35 States. Mailed Free. Strout Realty, 255-3B—4th Ave., New York 10, N. Y.

NEW Free Winter Catalog! Farm and country real estate bargains, good pictures, many states, easy terms, many equipped, crops included. For Special Service, state requirements, desired location. United Farm Agency, 428-PS BMA Bldg., Kansas City 8, Mo.

31 POULTRY AND SUPPLIES

RAISE Turkeys the new way. Write for free information explaining how to make up to \$3,000 in your own backyard. Address National Turkey Institute, Dept. 57, Columbus, Kansas.

32 PROFITABLE OCCUPATIONS

\$40.00 WEEKLY, Made growing mushrooms. Fresh, Dried, Dominion Patent 331.583, free spawn, North American, 169Y Yonge, Toronto, Canada.

NO selling, operate coin machines, amazing profits, details Free. Parkway Corporation, Dept. 12, 623 W. North Avenue, Baltimore 17, Maryland.

\$5000 FROM half acre growing Ginseng, crop bought, Particulars 10c. Associated Growers, 1169 Corydon, Winnipeg, Canada.

RAISE Ginseng; roots bring \$10.00 pound. Seeds for fall planting; circular free. Fezler Seed Company, Patchogue, N.Y.

BE Independent, Be Secure, have your own profitable business—earn \$10.00 and more a day making beautiful, fast-selling lamps at home. No equipment needed. Illustrated course teaches you quickly. Course, parts catalog, wholesale price list—only \$2.00. Gearon Company, Dept. 200-A11, 27 South Desplaines, Chicago 6, Ill.

FREE Book "How to Make Money with Home Workshop" describes amazing methods used by hundreds of successful craftsmen. Tells what to make, how to sell workshop output spare time. Write at once for details. Remember it's free! Craftsman, 115B Worth St., New York City.

POPULAR SCIENCE OPPORTUNITIES

DETECTIVES Earn Big Money. Excellent opportunity. Detective Particulars free. Write, Wagoner, P-125 West 86th, N. Y. 24.

MAKE Beautiful Holiday Flowers, Novelties. Wonderful home business pays excellent profits. Literature free. Velva Art-crafts, 324-X East 14, New York 3, N. Y.

\$400 MONTHLY Raising Angora Rabbits. No experience required. Details free. White's Rabbitry, Newark, Ohio.

LOCKSMITHING secrets! Key fitting, lock repairing, opening; prices, sources. Illustrated book \$1.00. Wexler, 7 West 36, New York City.

RAISE Fishworms. Easy, Profitable. Send 25c in coin for complete instructions. Huffman's Worm Ranch, Rives Junction, Michigan.

MAKE money with hamsters. New Tiny animal. Easily raised at home. Write for details. Hudson Hamstery, Newfoundland 2, N. J.

33 BOOKS, PERIODICALS, ETC.

MAGAZINES (back dated)—foreign, domestic, arts, books, booklets, subscriptions, pin-ups, etc. Catalog 10c. (refunded). Cicerone's, 863 First Ave., New York 17, New York.

USED Correspondence Courses and Books bought, sold, rented and exchanged. Catalog Free. Lee Mountain, Pisgah, Alabama.

ADULT Stories. 25c. Eight—\$1.00! Free catalogs! Hirsch, Spring Valley 3, N. Y.

HYPNOTISM. Mental phenomena students—adults only. Send 10c for unique Hypnotic Catalog. Power Publishers (Un-usual-Book Specialists), PS9, 790 Broad Street, Newark 2, N. J.

QUICK profits taking magazine subscriptions, handling greeting cards. Cas-sell Publishers Service, Westfield, N. J.

BOOKHUNTERS! All Subjects. Send Wants! Jaher Book Service, 620-K East 178 Street, New York 57.

SELF-Hypnosis, amazing new book! Free. Details, Psyche, 542-BE, 5th Ave., N. Y. 19.

NATIONAL Geographic Magazines 1888-1949, any issue. Periodical Service, Box 327-PS, Swarthmore, Pa.

ADULT Books—Unusual—Revealing—Il-lustrated. Five \$1.00. Catalogs 10c. Kogan, 1032-DP, Church Annex, New York 8.

BACK-date Magazines. Specific issues; years. Arkell's, Tarzana 2, Calif.

15c CARTOON magazine. Illustrated gags. Comic ideas. Hilarious belly laugh jokes. Witticisms. Wisecracks. Fun packed button busting humorous cartoons. Laughs on funny side of street. Sample copy 15c. K. Harris, Box 1567, Portland 7, Oregon.

ADULT Readers. Four—\$1.00! Free List. Mespa, Box 55, New York 19.

ADULTS—Intimate Books, Booklets. Particulars! Justco, 326 Park Row Building, New York 7.

ADULTS Only "Daring Books." Free lit-erature. Home Pix, 1674 Broadway, N. Y. 19.

NEW book. "How To Live Without Money." ends your money worries. How-ard, 1778-S Hamburg St., Schenectady 4, New York.

35 MAGIC TRICKS, PUZZLES, ETC.

MAGICIANS' Gamblers' secrets ex-posed. Cards. Dice. Punchboards. Slot Ma-chine. Catalog 10c. Book Co., Box 671, St. Louis 1, Mo.

FREE Dollar Magic Set with Profes-sional Catalog 25c! "Mysto," 4462-PS Germantown, Philadelphia.

ITCHING, Sneezing Powders. Eighteen Other Tricks and Joker's Catalog 25c. 2404N15, Philadelphia.

WE supply every noted magician. Large professional catalog 50c. Holden's, P220 West 42nd Street, New York.

500 TRICKS Catalog and book "84 Card Tricks". Both only 50c. Robbins Co., 152-P West 42nd St., New York.

MAGIC, novelties, money-makers. Cat-alog, 10c. Newton Company, Bonham, Texas.

500 TRICKS you can do! Send 25c for Douglas famous Catalog, best in magic at lowest prices. Unequaled service to magicians for 30 years. Douglas Magicland, Dept. 2, Dallas, Texas.

VENTRILOQUISM Taught. 3c stamp brings particulars. Smith, 801 Bigelow, Peoria 5, Ill.

200 ELECTRIC stunts. 110 volts, \$1.00. Cutting Sons, Los Altos 2, Calif.

400-PAGE Catalogue of 2000 Tricks, pocket, parlor, stage. World's Finest Magic. Send \$1.00 for Catalogue (refunded first \$5.00 order). Kanter's, S-1311 Wal-nut, Philadelphia 7.

12 LATEST Tricks, Puzzles, and Cata-logue 25c. Laramie Sales, 4800 So. Laramie Ave., Chicago, Ill.

LEARN magic. Ventriloquism, Mind-reading. Write for particulars. Quacken-buch, Big Flats, N. Y.

VANISHING Quarter trick and catalog 25c. Sterling Magic Co., Royal Oak, Mich.

VENTRILOQUIST Dummies. Catalogue 10c. Be a ventriloquist. Free Particulars. State age. Maher, Box 36-S119, Kensington Station, Detroit 24, Michigan.

BE a Magician. Large professional magic catalog of latest tricks, 35c. Ireland, F-109 North Dearborn, Chicago.

MYSTIFYING Three Shell Trick with Disappearing Pea. Easy Directions. Oad, 276 Carey Avenue, Wilkes-Barre, Pa.

101 MAGICAL stunts described. 25c postpaid, circular free. Vine, Hill & Co., Box 35P, Swanton, Ohio.

36 GAMES, ENTERTAINMENT

NEW Ball in Disc game. Thrilling, ex-citing. Send now for Christmas \$2.95. Luther Creasy, Catawissa, Pa.

37 COIN COLLECTING

FREE! Foreign coin, banknote and Coin Collectors' Illustrated Catalog to ap-proval service applicants. Send 3c postage. Tatham Coin Co., Springfield-D50, Mass.

GET profit and pleasure in collecting old coins. Send 10c for 56 page illustrated coin catalog. You'll be delighted with it. Send for it now. B. Max Mehl, 374 Mehl Bldg., Ft. Worth, Texas. Largest rare coin estab-lishment in U. S. Established 48 years.

OLD Money Wanted. Will pay Fifty Dol-lars for nickel of 1913 with Liberty Head (no Buffalo). We pay cash premiums for all rare coins. Send 4c for Large Coin Folder. May mean much profit to you. Numismatic Co., Dept. 30, Fort Worth, Texas.

OLD Uncirculated Dollars! \$3.00 each. 2 different \$5.00. Willard, 5719 Kenmore, Chicago 40.

BIG Coin Bargain List 20c. Charles Fos-ter, 851 Lake, Rushville, N. Y.

COINS Wanted: Itemized list 20c. Elsholz, Box 9014-S, Pittsburgh 24, Pennsylvania.

U.S. coins lowest prices. Send stamp for lists. Hutchinson, 3463 I Street, Philadel-phia 34, Penna.

COMMEMORATIVE \$½ — Columbus, Washington, Cleveland, Stone Mountain, \$1.50 ea. Illustrated Catalogue 25c. Norman Schultz, Salt Lake 9, Utah.

BARGAINS, All different—3 Large Cents \$1.00, 20 Indian Cents \$1.00, 4 Copper-Nickel Cents \$1.00, 4-2c Pieces \$1.00, 20 Foreign Coins \$1.00, 1932-D Quarter \$1.00, 1932-S Quarter \$1.00, Giant Guidebook \$1.50, Handbook 75c, 4 Albums \$1.00. Cata-logue 15c. Bebee Coin Company, 1180 East 63rd, Chicago 37, Illinois.

BARGAINS! 20 different dates Indian Cents and Complete Buying-Selling Cata-logue \$1.00. Catalogue Alone 25c. Colonial Coin Before 1790 \$1.00, Half Cent Before 1810 \$1.00, 1798 Cent \$1.00, \$100.00 Con-federate Bill \$1.00, Ancient Roman Coin Over 1500 years old \$1.00, Or Everything, \$5.00. Worthycoin Corporation, 294 Wash-ington (D-202), Boston, Mass.

GENUINE Roman coins 2000 years old. Large size \$1.00 or two small \$1.00. One hundred different foreign coins \$3.00—Chelsea 40, W. 18, N. Y. 11.

40 STAMP COLLECTING

ZOWIE-E-E! A Barrel of Fun for only a Dime! 500 United States Stamps—Abso-lutely unpicked and unsorted, just as re-ceived from church missions. Many varie-ties, including large commemoratives, air-mails, high denominations up to \$5.00! Stampdom's biggest package of fun, and you might find something really valuable!! Price only 10c to serious approval service applicants. Money back if not delighted. Illustrated bargain lists with each order. Mystic Stamp Co., Dept. 55, Camden, New York.

DEALER'S Wholesale Catalog. Postage 3c. Franksco, 5031 Queensbury, Baltimore, Maryland.

128-PAGE United States Catalog. 1,000 illustrations, 25c. Harris & Co., 204 Tran-sit Bldg., Boston.

200 DIFFERENT, including Roosevelt triangle, 5c to approval applicants. S. A-Valon Stamp Co., Springfield, Mass.

WOW! \$10.00 Worth of Fun 10c! What a treasure hunt! Big package 500 Foreign Stamps, including airmails, pictorials and others from the world over; stamps worth up to 25c each. This offer sent for 10c to Approval Applicants Only. Jamestown Stamp Co., Dept. 5, Jamestown, New York.

FREE! Illustrated United States Cata-log. Low Prices! Americo, Bristol, Conn.

UNITED STATES approvals complete coverage fine quality, attractive prices. Seminole Stamps, Box 1138-S, Coral Gables, Florida.

CASH For Your Duplicates. Particulars free. Goliath, Bethlehem 8, N. H.

FREE—Famous Americans Set, Flag Set, National Parks Set, and Presidential Set to \$5.00. A total of 90 Stamps Free to Customers for our unsurpassed U. S. and foreign selections. Send 3c for 15 of the above Stamps and full particulars. Tri-boro Stamp Co., 145 Nassau St., Dept. 211, N. Y.

POSITIVELY Greatest Free Offer! Lat-est Scott's International \$6.00 stamp al-bum—covering entire world, contains 36,000 illustrated descriptive spaces; Scott's 1950 Standard \$7.00 catalogues "Philately's Encyclopedia"—absolutely Free to appli-cants for foreign approvals becoming cus-tomers. Approval Service, P. O. Box 1700, San Francisco, California.

FREE! Powerful magnifying Glass—to approval applicants; also big bargain lists. Jamestown Stamp Co., Dept. 202, James-town, New York.

TOPS! Our book "How to Collect Stamps." Send for your free copy today! Littleton Stampco, Littleton 29, N. H.

YOU Need These! All six for 10c! To introduce our Exceptional Approval Ser-vice, we'll send you: 1. Pocket Stock Book. 2. Watermark Detector. 3. Stamp Tongs. 4. Perforation Gauge. 5. Book for Dupli-cates. 6. Package of Stamp Hinges. All only 10c to approval applicants! Free! Big list other bargains. Jamestown Stamp Co., Dept. D, Jamestown, New York.

UNITED States Commemorative Collec-tion. Thirty-seven different unused, Col-umbians to 1943 issues only. Price \$1. Re-quest approvals. "Stamps," Albany 5, New York.

WORTHWHILE New Zealand Semipost-als (1943 Princesses Triangulars) only 10c with approvals. George Richie, 840 Oak, Alameda, California.

FREE "Round the World" packet to ap-proval applicants. Lange, Box 21, Hub Station, New York 55.

543 BARGAIN Offers—Free!! Kenmore Stamps, Arlington 74-D4, Mass.

FREE—Illustrated Catalog! Kenmore Stamps, Arlington 74-C8, Mass.

200 BRITISH Empire Stamps! Norfolk, Tokelau Islands, Grahamsland, Pakistan, Nepal, big stamp of murdered Mahatma Gandhi; many others! Stamps cataloging up to 20c each! Only 10c!! Kenmore Stamps, Arlington 74-A9, Mass.

750 FRANCE and Colonies stamps 10c. Littleton Stamp Co., Littleton 26, New Hampshire.

AIRMAILS on approval. Excellent qual-ity. References required. Gerspacher, 159 Irving, Kenmore, New York.

POPULAR SCIENCE OPPORTUNITIES

UNITED States stamps nearly 100 years old. Roosevelt set, others, 40c value—only 5c to applicants United States approvals. Wakonda, 140F Nassau, New York 7.

\$1—\$2—\$5 UNITED States, commemoratives, airmail, high values in large collection United States stamps only 5c to applicants United States approvals. Metropolitan, 140A Nassau, New York 7.

300 DIFFERENT given free with approvals. Postage 3c. Windsor Stamps, 1435 E. 67th Place, Chicago 37.

MAGNIFIER. Big Stamp Magazine; First U.S. Commemorative; plus unused \$5000.00 Foreign Legion, diamond, Giant, and other worthwhile stamps. Everything free to approval buyers. Capital Stamp Company, Little Rock 10, Arkansas.

\$5.00 CATALOG Price For 10c. (1) Big collection 112 all different stamps from Africa, South America, South Sea Islands. (2) Four desirable unused U. S. cataloging 40c. (3) Fine packet 25 British Colonies—Burma, Solomon Islands, etc. (4) U. S. \$5.00 high value. Everything (all four items) only 10c with approvals. Crystal, Littleton 41, N. H.

FREE! 100 Worldwide different stamps to approval buyers. Big U.S. and illustrated bargain lists sent with approvals. Bookman, Maplewood 1, N. J.

FREE. Absolutely free. \$22.50 catalogue value in better grade stamps, including Airmails, Pictorials, Commemoratives. Also free. International albums and Scott catalogues. Free hinges. Free mystery sets to \$1.00 value. Free \$5.00 Presidential. All free to approval applicants buying under colossal Raymax plan. Raymax, 123-X William St., N. Y. C. 7.

FREE! Tiny Chinese "Midget" War set. Approvals. Seminole, Leeds 10, Ala.

FREE! Complete Balkan aviation set with approvals. Beaman, Leeds 10, Ala.

FREE! Porto Rico Airmail Triangle (World's Only American Colonial Triangle!) Cook Islands, Syria, Ivory Coast, Damascus, Elephant Land, Cambodia, Harem, Philippine "Slave," others. All Free for 3c postage. Approvals. Belmont Stampco, Washington 10, D. C.

UNUSED Commemorative Stamp Collection including airmails, pictorials, high values, sets. Only 3c. Approvals. Sunlite, Box 1259-S, Grand Central, New York 7.

FIFTY Different Countries Abyssinia-Zanzibar 3c to approval applicants. Mohawk, Box 141S, West Springfield, Mass.

GIANT United States Catalog! Complete! 128 pages, 1,000 pictures! Only 25c (deductible). Harrisco, 204 Transit Bldg., Boston 17, Mass.

100 DIFFERENT stamps free with approvals at 60% discount. Martinsen, Box 115C, Washington Bridge Station, New York City 33.

FREE United States Price List. Mark Hanna, 335 Fifth Avenue, Pittsburgh 22, Pa.

FINE Approvals. Fast, personal service. What countries do you prefer? I'll send their stamps. Milton Skinner, 438 Locust, Long Beach 12, Calif.

FREE U. S., Foreign, Illustrated Lists. Schneider, Box 555, Route 3, McHenry, Ill.

1875 WURTTEMBERG Set Free! Approvals. Colonial, Box 326B, Passaic, N. J.

MONACO Nudes Set—10c!! Approvals. Atlas, 3210 Republic, Racine, Wisconsin.

BARGAINS! 2,000 Foreign Stamps \$1.00, 5,000 \$2.00, 2,000 U. S., \$1.00, 5,000 \$2.00. Post-All, 930-F Street, Washington 100, D. C.

307 ALL Different Free. Commemoratives, Triangles, Bicolored Beauties, High Values, Strange Countries, New Varieties Galore. Free to Approval Buyers. Garcelon, Box 518, Calais, Maine.

FREE "Stamp Finder." Tells instantly country to which any stamp belongs. 36 pages profusely illustrated. Approvals. Garcelon, Calais 18, Maine.

50,000 STAMP Grabbags 25c each. Anderson, 630 Bingaman, Reading 2, Pa.

25 DIFFERENT stamps 10c. F. Tunis, Wakeman Ave., Newark 4, N. J.

FREE! Twelve different Luxembourg to approval applicants. Litten, 318A North Fifth Avenue, Maywood, Illinois.

STAMPS 100 Years old. Every collector should have at least a few stamps nearly 100 years old. Although hard to get, we offer a wonderful selection of ten old 19th century foreign stamps and also the blue re-issue of the 100 year old first U. S. stamp, the famous 5c Franklin. All for only 10c. Kindly state whether approvals shall consist of U. S. or foreign stamps or both. Globus Stamp Company, 268 Fourth Avenue, Dept. 222, New York 10, N. Y.

50 DIFFERENT, United States Block, Russia Airmails Packet, Package Hinges, 10c. Approvals, Greenwood, 263 Meridian, Miami Beach, Florida.

50 GREECE plus Albania error, 10c. Approvals, price lists, Chase, 1026 Walker Ave., Oakland 10, California.

ABSOLUTELY Free—Gilbert Ellice, Cook Islands, Tonga, Seychelles, Ascensions—free to approval applicants. Viking, 130-P Clinton St., Brooklyn, N. Y.

100 DIFFERENT foreign 10c. Approvals. Karr Ross, Dept. B, Box 3266, Washington, D. C.

TURKEY 15 different 5c with approvals. Parks, 97-08-125 Street, Richmond Hill, N. Y.

50 DIFFERENT U. S. 10c. No approvals. Price list free. Seidenberg, Cassopolis, Michigan.

U. S. 797 SPA Sheet only 5c to applicants for U. S. approvals. M. Haycock, 333-86th St., Brooklyn, N. Y.

PENNY Approvals by Country. M. H. Hoerning, 102 Farmington, Arkansas.

OLD, scarce U. S. seconds on approval. Slightly defective, bargain prices. Hearnfeld, Clintonhill Station, Newark 8, N. J.

U. S. PRICE List. Send Postage. State Stamp Studio, 1225 Park Building, Pittsburgh 22, Pa.

ALBUMS, new used, 25c up. Stamp bargains also; Lists free. Aletalo, Maynard, Massachusetts.

FIFTY Canadian and Newfoundland, 10c Approvals. Reade, 696 Gerrard, Toronto 8.

FREE Gift Packet. Also approvals. Richard Kitchen, North Lewisburg, Ohio.

POUND stamps containing thousands \$1.00. Grossman, 106 West 42, New York 18.

CANADA Peace set 10c with attractive approvals. Rheume, 8949 Routhier, Montreal, Canada.

EXOTIC Collection; Fezzan Ghadames, Togoland, Cameroons, Andorra, Reunion, Miquelon, Algeria, Somalis, Guadelope, Guiana, Natives, Maps, Ships, Idols, Snakes, Rhinoceros, others, 5c. Imperial Stampco, Tampa, Florida.

1c EACH and Less! Thousands of Bargains! Cole, 43-G Rinewalt, Buffalo 21, N. Y.

FLAG Stamp Free, if you request my U. S. approvals. E. Wenigman, 1933 Patterson, Chicago.

75 STAMPS from 75 countries 10c to approval applicants only. Bjorn Nielsen, Monmouth 1, Maine.

MORE than 2000 All different stamps from many countries, cataloguing over \$50.00, stamp hinges, tongs, and book entitled, "Essentials of Stamp Collecting"—all for only \$4.00. Russell, 224 West 17th St., New York City.

100 STAMPS, Album, Watermark Detector, Hinges, Gauge—25c. Box 6618, Northeast, Kansas City, Mo.

115 DIFFERENT Hitlers, Roosevelt, Liberia, Vatican, etc., 25c. Buckley PS-208, Ludlow Bldg., Dayton 2, Ohio.

U. S. Price catalogue free. S. Stone, 618 Washington, Dorchester 24, Mass.

SELECTED U. S. Mint Roosevelt and Flag sets. Both, Only \$1.00. Approvals. Equin, 570 Madison, Wisconsin.

AIRMAILS—worldwide variety. Bargain. With approvals 5c. Arthur Wirth, Norwichtown 2, Conn.

WORLDWIDE Stamps, All Different, 200—25c; 500—50c; 1000—\$1.25; 2000—\$3.00; 5000—\$15.00. Beacon Sales, Northboro 3, Mass.

FREE: China Navigation Issue with foreign approvals. Modern Stampco, Box 12A, Wakefield Station, New York.

10 U. S. Over 40 years Old 5c Approvals. Scott, Middle St., Lexington, Mass., 73.

HAVE Fun, add thousands of stamps to your collection at 1c each. Write for my Economy 1c Approvals. Joe Goldman, (PSM), Lynbrook, New York.

118 WORTHWHILE Stamps, including Chinese hunger stamps, strange countries, pictorials aplenty. Only 10c with surprise-packed approvals. Atlas Stamps, 4220 West 16th, Little Rock 16, Arkansas.

COSTA Rica, complete unused Diamond Airmail Set, 10c with approvals. Vargo Stamps, 6044 South Fairfield, Chicago 29, Ill.

1200 UNITED States Mixture (off-paper) —\$1. Runont, 108 S. Crawford, New Castle, Penna.

WHOLESALE Dealers list, 3c postage. Whitlows, 3535 Clarendon, Dallas, Texas.

25 DIFF. 19th Century given to approval applicants. Rossom, 218 West 59th St., Chicago 21, Ill.

STAMP Magazine! Copy free! "Stamp Post." South Catalina, Pasadena 1, Calif.

AMAZING "Queer Countries" Packet—Free with Approvals! Saxon, Walden, N. Y.

ALL-Aboard! The Philatelic Special, 12 Train Stamps and packet of 100 different stamps for 10c with approvals. Reich Stamp Co., 4647 Kenmore, Dept. S19, Chicago 40, Ill.

APPROVALS—Many 40% Catalog References Please. H. K. Bardsley, Roslyn, Pa.

FREE! 25 Different Stamps From 25 Different Countries. Approvals included. Ciula, P. O. Box 2511, Paterson, N. J.

U. S. \$5 Used Block of 4 only 15c. for U. S. Approval Applicants. D. Kelly, 333-86th St., Brooklyn 9, N. Y.

ROMANIA #558-567, B251, Big, beautiful, scarce, mint commemoratives. Just 25c with outstanding European approvals. GeeKay, 13E Overlea Avenue, Baltimore 6, Maryland.

42 HOBBIES, COLLECTIONS

INVENTING can be an interesting and profitable hobby. Write for complete particulars. Institute of American Inventors, Dept. 30-E, 2926-Eye St., N. W., Washington 6, D. C.

KITE Fans! Roll-O-Kite—Looks like giant spool—Spins as it flies—Sensational performance. 50c. Roll-O-Kite, 737 So. Westlake Ave., Los Angeles 5, Calif.

UNUSED matchbook covers—100 different \$1.00—Catalog 10c—Charles Edelman, 1311P East 84, Cleveland 3, Ohio.

UNPAINTED plaster ornaments, Loxite for moulds. Free literature. Midwest Novelty Manufacturers, Box 788-B, Anaconda, Montana.

44 ANTIQUES, RELICS, INDIAN GOODS

10 ANCIENT Indian Arrowheads \$1.00. Tomahawk \$1.00. List Free. Lear's, Kirby, Arkansas.

1950 CATALOG:—Selling 400 Antique Firearms, 20,000 Indian Relics, Coins, Gold Dollars, Kentucky Rifles, Flintlocks, Percussion caps, Tomahawks, Gempoints, Powderhorns, Steerhorns, Rifles, Pistols, Blunderbusses, Ammunition, Swords, 1950 illustrated catalog 25c. Heike, Wenona 31, Illinois.

SPECIAL:—8 Arrowheads, \$1.30—Civil War Musket \$12.50. Sword \$7.50. Bayonet \$1.58. Tomahawk \$3.88. Heike, Wenona 31, Ill.

46 MINERALS & PRECIOUS STONES

TURQUOISE, Beautiful massive specimens, \$1.00. D. Levy, 97 Burr Ave., Hempstead, New York.

GEMSTONES, Mineral specimens, Every variety, Lowest prices. Postcard brings free list. Plummer's, 2177D Bacon, San Diego 7, Calif.

GEMS, precious and semi-precious, all genuine from world wide sources. Deal direct, no overhead, save money. Catalog 10c. Hill Co., Route 7-K, Salem, Oregon.

MINERAL Identification Simplified—Valuable book identifies 2000 minerals. \$3.50. Wetzel Publishing, Los Angeles 13, D. Calif.

POPULAR SCIENCE OPPORTUNITIES

MINERAL Collectors. Attention! 2 garnet crystals 35c. Talc specimens 20c. Gsthite geode \$1.00. 75c. 50c. All three with medium gsthite geode \$1.00. Jensen, 422 West 115th. N. Y. C. (25).

AUSTRALIAN Opals. Gems from one dollar. Woodrow Oldfield, 22 Russell Street, Drummoyne, Sydney, Australia.

47 CAMERAS, PHOTO SUPPLIES

BASS Says: Bargaingram 257 ready and waiting for you. The book which tells all the finest in new and used camera equipment, a veritable encyclopedia. Write, phone or call the sign of the old "Horse Trader". 39th year of satisfaction or your money back dealing. Bass buys, sells and trades. Bass Camera Company, Dept. AG, 179 W. Madison St., Chicago 2.

KODACHROME 2x2 Slides—Join the West-View Color Slide Club and receive monthly approval selections. Club membership is Free. Write today for first approval slides. No obligation. West-View, Dept. K, 1518 Montana Ave., Santa Monica, Calif.

ENLARGERS, all sizes, lowest price. Booklet "B" Free. J. B. Photo, 41-09-19th Ave., L. I. City, New York.

FREE Catalog—Terrific surplus buys. Write today. Free-style Sales Co., 1431 N. Western Ave., Hollywood 27, Calif.

BUY photographic supplies wholesale. Free catalog. Expert camera repairing. Capitol Photo Supplies, 2428 Guadalupe, Austin, Texas.

KODACHROME Slides on approval. Grand Canyon, Glacier, Zion, Yellowstone, etc. Douglas Whiteside, Yosemite, California.

ENLARGING or Projecting F2/8 lens system, mounted, 2" F.L. Iris Diaphragm. Ready to use. Actual cost \$24.00. Closeout \$10.00. Optical Assembly Co., Celina, Ohio.

16X MAGNIFIER: Exceptional power, beautifully mounted. Factory closeout. \$1.00. Optical Assembly Co., Celina, Ohio.

NEW Photocraft Kit includes Camera, complete darkroom equipment; enlarger, easel, paper, chemicals, tank, trays, etc. only \$12.95. Write Tam Products S11, 3814 Wrightwood, Chicago 47.

GUARANTEED quality cloth cable releases 59c. Box 103, Malden, Mass.

48 PHOTO FINISHING

16 ENLARGED, Jumbo, oversize deckled prints from any 6-8-12-16-20 or 36 exposure roll film developed only 35c and this ad. Electronically exposed. Enlargement coupon free. Skrudland, 6444-W Diversey, Chicago.

ROLL developed and 8 prints 25c. Smart Photo, Winona, Minnesota.

18 CHRISTMAS Cards and envelopes \$1.00. 60-\$3.00. send negative. Your 8 exp. roll with 3 prints each good negative 45c. 2 each good negative 35c. One each good negative 25c. Reprints 3c. L. A. Eastman, Bode, Iowa.

FINEST quality double weight bromide enlargement. 5x7 20c; 8x10 25c; 11x14 50c. Satisfaction guaranteed. Minimum order \$1. Foto Portrait Co., 1172-S Ogden Avenue, New York City 52.

8 BEAUTIFUL Double Size pictures and roll developed 30c. 8 hour service. Free Mailers. Pacific Photo Service, Box 666, San Francisco, Calif.

UNBEATABLE for Quality and Price. You will be surprised and pleased with the beautiful results from our celebrated Jumbo Oversize finishing. New low prices, same as contact, 8-exp. roll superfine finish only 30c. 12-exp. 45c. 16-exp. 55c. 36-exp. \$1.25. Oversize reprints 4c each. Send us your order, you will be delighted. Free Mailers. Mailbag Film Service, Box 5440A, Chicago 8, Ill.

EIGHT Beautiful Super-Prints and roll developed—Premium Coupon. Enlargement Certificate. Portrait Photo from any negative—all for 40c. QuickPrint, Box 23, PS, Springfield, Mo.

2 BEAUTIFUL Hi-Gloss prints each good negative and enlarging coupon with each 6 or 8 exposure roll developed 28c. Owl-photo Co., Weatherford, Oklahoma.

SPECIAL—five 8x10 Enlargements, \$1.00—Photo Service, 233 S. Main Street, Columbiana, Ohio.

50 PHOTOPRINTS, PHOTOCOPIES

PHOTOCOPY anything yourself. Papers, books. No darkroom. 8 1/2 x 11" complete. \$6.95. Fotoflek, 4801 Yarmouth Place, Cincinnati 29, Ohio.

51 MOTION PICTURES, SOUND EQUIPMENT

GUARANTEED fresh anti-halo outdoor movie film! Weston 16! Daylight loading! Processing free! Three spools double 8mm. \$4.50! Six single 8mm for Univex. \$4.60! Postpaid! Catalog. Filmcraft, 47th Holly, Kansas City 2, Missouri.

BASS Says: 39 years of leadership guarantees satisfaction. Finest Cine equipment. 8mm., 16mm., and 35mm., silent and sound. Write the old "Horse Trader". Satisfaction or your money back always! Bass Camera Company, Dept. A., 179 W. Madison St., Chicago 2.

85 KODACHROME movies! War, Atom Bomb, Travel, Air, National Parks, Beautiful Models. Catalog, 4c stamps, 2 scene "Waikiki" sample, \$1.00. Specify 8mm. or 16mm. World In Color Productions, Elmira, N. Y.

BETTER 8mm and 16mm Movie Camera Film. Lower prices. Better Films, 742 New Lots, Brooklyn 7, N. Y.

8-16MM. Silent-sound films. Complete rental library. All latest subjects. Free catalogue. (sample film 10c). Garden Film, 317 West 50th, New York 19.

ORIGINAL Party Films and Records. Adult Entertainment. Details, interesting offers dime. Alberts, Dept. P, 6369 De Longpre Ave., Hollywood 28, Calif.

COLOR Film 50' 8MM \$3.95. F-a-s-t Panchromatic \$1.65. MK Photo, 451 Continental, Detroit 14, Mich.

BEAUTIFUL Artist Models in action movies. Sample reel, 50 Ft. 8mm, \$3; 100 Ft. 16mm, \$6. Color slides (2x2) sample 40c. Shipped Ppd. Send cash. M.O. Free Catalog. Joy Studios, Dept. S-20, Box #150 Main P. O., Jersey City 3, N. J.

UNUSUAL 8-16mm Film Subjects. Kodachrome projection length sample "Allure." \$1.00. "Strip Polka" 100-ft. 16mm sound, \$6.50. Art slides in color, sample 50c. 5 for \$2.00. Films exchanged. Bargains! Big catalog, 25c; refunded first order. National Film Supply, Broadway Sta. (E), Toledo 9, Ohio.

LEARN movie projection, management. Free Catalog. Theatre School, Elmira, N. Y.

RENT 16 mm, sound films 50c reel. Large selection; free catalog. U. C. Film Service, 128 Chestnut St., Roselle Park, N. J.

YOU develop it. Get a 33 ft. developing rack, safe light, all chemicals, trays and instructions for \$5.85. Fully guaranteed. Free circulars and film samples. Fromader Genera, Davenport 5, Iowa.

BARGAINS in 16mm sound films. Big new list out each month. Blackhawk Films, Davenport, Iowa.

RENT 16mm sound films. Complete programs features—shorts low as \$4.95. Write our nearest office for complete list. Dept. PSC, Eastin Pictures, Davenport, Iowa; Colorado Springs, Colo.; Chattanooga, Tennessee.

ONE cent home movie film sale. Send 10c for 1949 photographic catalogue. Sterling's, 679 Northampton, Easton, Pa.

FREE movies. Hundreds of subjects. Interesting. Entertaining. Fascinating. New directory—only 50c. International Cine Society, Dept. 102-D, 1300 Taylor, N.W., Washington 11, D.C.

RARE films. Medicals, Oldtimers, others. International, 2120 Strauss, Brooklyn, New York.

"LADY Eve" Glamour Movies. Equipment. Free catalog. Home Pix, 1674 Broadway, New York 19.

ART model films 16mm rentals exclusively. adults list. Enclose stamp. Revere Films, Box 1051, Detroit 31, Mich.

WE Buy, Sell, Rent, Exchange Home Movies. Details for dime. Midland, Box 429, Oak Park 3, Ill.

35 MM Bargains, silent—sound films, projectors. Edward Elwell, Brockport, N. Y.

WANT a real buy in 16mm Sound Films? Take advantage of the I.C.S. 1949 Clearance Sale of 16mm sound films—features, comedies, educational, cartoons, novelties, etc. Send for our giant list "A" today stating machine you own (make and model). Institutional Cinema Service, 1560-PS Broadway, New York 10, N. Y.

PARTY Films. Guaranteed fresh, guaranteed to please! 100 ft. 8mm \$5.50; 16mm \$6.00, available with sound. Complete listing on request. Helene Dist. Co., 182 Peace St., Providence, R. I.

SUPER-Special Hollywood Movies for the connoisseur of the unusual. "Fighting Females." "Bobby Soxer." "Office Girl." each 8mm—\$2.75. 16mm—\$6.00. Two-color brochure of unique 8-16mm silent-sound subjects, plus sample film strip, 10c. Camera Corner, 391 Bridge Street, Room 135, Brooklyn 1, New York.

52 MUSIC, MUSICAL INSTRUMENTS

HILLBILLY, Polka Records—Late, Old—29c. Catalog 3c. F-L Shop, Box 19-S, New York City 35, New York.

VOICE! "Effortless-Control!" 15 lessons \$10.00. Cor Studio, 14356 Jersey Ave., Norwalk, California.

SWISS Music Box Movements suitable for novelties. 400 Tune Selection, \$1.00 to \$3.50. Send for Catalog. Bell Music Box Company, Box 49, Planetarium Station, New York 24, New York.

MAKE \$300.00 "Strad" violin! Supplies. Fraser, 2025 Stark, Saginaw, Mich.

SWISS Music Movements. Finest Make. Assorted Tunes, \$1.90 Direct Imports. Helax Company, 233 West 72 Street, New York.

PHONOGRAPH Records 15c. Catalogue. Paramount, TF-313 East Market, Wilkes-Barre, Pa.

53 SONG WRITERS

POEMS Wanted to be set to music. Free examination. Send poems. McNeil, Master of Music, 510-PS, S. Alexandria, Los Angeles, California.

SONGWRITERS. Songs Published Monthly. Advance Royalty. Send your songs or poems today for our exciting offer. Hollywood Tunemiths, Dept. 10F-C, 1537 N. Vine, Hollywood 28, Calif.

POEMS Wanted For Musical Setting. Send poem for free examination. Five Star Music Masters, 646 Beacon Bldg., Boston, Mass.

POEMS considered for musical setting. Send poem for immediate examination and useful Rhyming Dictionary. Richard Brothers, 46 Woods Building, Chicago.

YOUR poems set to music, recorded. Free booklet, attractive offer. Write. Songland, 331 West 46th, New York.

SONGWRITERS—600 top recording artists who plug new songs—list 50c. "Songs," 931-C White Street, Dubuque, Iowa.

POEMS Wanted. Percentage basis collaboration. Terry Tune Master, 709 1/2 PS North Broadway, Oklahoma City 2.

POEMS Wanted. Splendid offer! Rush! Radio Composers, WPSJ, Clinton, N. C.

SONGWRITERS. Publication. Collaboration. Newart Music, GPO Box 1226, Syracuse, N. Y.

FREE Examination. Send Poems. New Rhyming Word List \$1.00. Broadway Song Service, Room 1208-S10, 1650 Broadway, New York City. Tel. Main 5 3553.

SONGWRITERS—600 Top song Publishers, publishing all types new songs—List 50c. "Songs" 931-B, White Street, Dubuque, Iowa.

54 RADIOS, SUPPLIES & EQUIPMENT

MAKE Simple, Tubeless, Batteryless, Distance-Getting Crystal Radios. Crystal and illustrated instructions 25c postpaid. Allen, 427-S, Clinton, Mo.

"HEADPHONES." 24 pages. Complete repair Handbook, including "Radiobuilder." Catalog—25c. Laboratories, 578-T, San Carlos, California.

POPULAR SCIENCE OPPORTUNITIES

FIX any radio. Amazing new instrument locates radio troubles double quick. Simple instructions show you how. Thousands now in use. Free—Write today for 28-page illustrated technical manual. "The Inside Story". Feiler Engineering Co., Dept. 11PS9, 945 George Street, Chicago, Ill.

FREE—Money Saving Bargain Catalogs in radio and television sets, record changers, tubes, parts, amplifiers, speakers, etc. Write today. Radionic Equip't Co., Dept. 1511, 170 Nassau St., New York 7, N. Y.

HEADPHONES. Guaranteed U. S. Signal Corps used headsets with adjustable leather headbands and Black Bakelite Earphones. Special now \$1.99. Allen Radio, Dept. HPS, Clinton, Missouri.

INFRA Red Snooperscope tube. Permits nighttime vision. Tube and complete instructions \$14.95. Very limited quantity. Precise, 942 Kings Highway, Brooklyn 23, New York.

X-TRA Long Distance Radio Crystals. Reception up to 100 miles guaranteed. With instructions, 25c. D-X 500, Box 201, Marshall, Mo.

55 TELEVISION

7 INCH TV Kit \$59.50. Write for Catalog. R & H Distributors, P. O. Box 51, Forest Park, Illinois.

56 BUSINESS OPPORTUNITIES

\$25 WEEKLY working two hours daily. No canvassing. No Manufacturing. Lycke, Box 2471, Cleveland 12, Ohio.

ENVELOPES addressed accurately, reasonably. Fast Service. We have capable addressers in your city. Glenway System, 5713-Z Euclid, Cleveland 3, Ohio.

137 PLANS to make money local, mail order. Particulars free. Elite Co., 220-A Grand St., N. Y.

GOOD Paying Business Silvering mirrors, plating autoparts, reflectors, bicycles, bathroom fixtures, etc., by late methods. No tanks or shop required, outfit furnished. Free Booklet. Gunmetal Co., Ave. E. Decatur, Illinois.

A FACTORY in your home garage! Mfg. and sales rights, mechanics' waterless hand cleaner, \$500-\$800 monthly. No special equipment necessary. Formula free. Western Aircraft Mfg., Dept. G, Los Angeles 6, Calif.

OPERATE profitable mail order business. Write Walter Service, 4159-B East 112th, Cleveland 5, Ohio.

MAKE money addressing envelopes. Our instructions reveal how. Glen Glenway, 5713 Euclid, Cleveland 3, Ohio.

VENDING machines earn big money! An investment as low as \$10.50 will start you in this fascinating, profitable business that can lead you to the road of success and independence. Routes can be established and operated in either full or spare time with no experience needed. Write for full details and our Free catalog illustrating our nut, candy, gum and stamp vendors; also pin ball machines, music boxes, etc. Write immediately to Parkway Machine Corporation, Dept. 9, 623 W. North Avenue, Baltimore 17, Maryland.

POPCORN Machines. Potato Chip outfits. Long Eakins Co., 4963 Hi St., Springfield, Ohio.

I MAKE big money in the mail-order business. You can do the same at home with copyrighted system. Write me, I'll tell you how. F. Little, RD # 1, Glenshaw, Pa.

START Mailorder Bookshop—Everything furnished, 25c brings booklet, samples, exciting ideas. General Publications, Ossining 1, New York.

CASH For your idea, 280 manufacturers need inventions, patented or unpatented. List free. Invention Bureau, 208-S Clinton, Oak Park, Illinois.

EARN \$50.00 or more weekly operating vending machine route in your spare time. As small an investment as \$13.95 will get you started. Details free. Danco Coin Machine Co., Dept. PS., 1302 E. Baltimore St., Baltimore 31, Md.

"SPECIALTY Manufacturing". Big money business. Start on small capital with dependable formulas. Send for Free interesting booklet. Howard Robinson, Ph. G., 1300-B South Ohio Street, Sedalia, Mo.

RECAST old batteries into new. Latest achievements. Battery Laboratories, Minneapolis.

UNPAINTED figurines—Wholesale—Retail. Illustrated list free! Oman, 642M Broadway, St. Paul 1, Minnesota.

MAKE money making new greaseless doughnuts at home on electric machine. Wholesale to grocers, drug stores, cafes, hamburger shops. Send for free recipes and plans. S. Ray Company, 3605 South 15 Ave., Minneapolis 7, Minnesota.

MAKE Money spare or full time, casting Metal Toys and Novelties. Big wholesale and chain store demand for cast Metal Autos, Soldiers, Ashtrays, Banks, etc. keeps manufacturers busy. Production moulds furnished for up to 100 and more castings per hour. No experience or special place necessary. "Cash-in" on holiday orders now being placed. Write for full information and illustrations of patterns needed. Mast Cast Products Co., Dept. E, 1696 Boston Road, New York 60, N. Y.

BIG money. Spare or full time in your home. No Selling! Spray New Miracle Finishes, Plush and Suede, on signs, radios, automobiles, figurines, lamps, toys, etc. Our business is booming. Help us fill huge demand. Cash in now on Big Christmas orders. New easy Flok-Kraft methods. Material costs few pennies. You get dollars. Free samples, complete powerful money making plan free. Write now! Coast, 1008 S. Los Angeles St., Los Angeles 15.

EARN Extra Cash Selling Personalized Stationery, Cards, Napkins, Particulars free. Stumpco, South Whitley 2, Indiana.

EXTRA Money—No selling—operate vendors. Amazing profits, details Free. Silver King, Suite 282, 622 Diversey, Chicago 14.

START mailorder business. Get details concerning beginners booklet guide. Wayne Burger, Baltic, Ohio.

USE Your Home as magazine subscription station. Represent all magazines. Liberal Commissions. Supplies furnished. Big Christmas Gift business now. Catalog, full details, free. McGregor Magazine Agency, Dept. 519B, Mount Morris, Ill.

WATCHES. Elgin, Waltham, other outstanding brands. Expertly reconditioned, priced low for quick, great profits! Send for Free catalog. Plymouth Jewelry, 163 Canal St., New York 13, N. Y.

DISTRIBUTE nationally advertised Sahara Waterless Hand Soap. Full or part time. Excellent profit. Steady Income. Sahara Waterless Soap Co., Grand Rapids, Michigan.

BRONZED Baby Shoe Mountings, Equipment and Supplies. We manufacture world's largest assortment of all metal mountings. Wholesale only. Ramyr Selenium Platers \$39.95. Gold and Silver Plating Assemblies low as \$97.50. Write for Free copy of Electroplating Instructions. Sales Division, Hollywood Bronze Supply, 1770 N. Vermont Ave., Hollywood 27, Calif.

EARN At home, casting novelties. Free course using latex molds. Major Chemical Co., 164 Portland St., Cambridge 39, Mass.

I'LL Put a "Shoe Store Business" in your Pocket! Nation's Leader trains you to make Big Money! Fit men, women. Free Sample Outfit—write today! Consolidated Shoe System, Dept. S-434, Chippewa Falls, Wisconsin.

FOR an extremely profitable lifetime business, operate a Collection Agency—Credit Bureau. Easily learned. Free Folder. Cole & Associates, Syracuse 2, N. Y.

CONVERT hand mowers to power mowers. Do it now, this winter. Sell the Handy-Dandy conversion kits. Easily installed on 16 to 20" mower. Use any small gasoline or electric motor. Quick delivery. Kits purchased with or without engines. Also new Garden Cultivator, Cultivates 3" deep. Attachments available—weed cutter, lawn mower, and snow plow. Retail \$124.50 with cultivator 1 H.P. engine. Snow plow only \$11.95. Discount to dealers. LeClaire Manufacturing Company, LeClaire, P.S. 11, LeClaire, Iowa.

MAIL Order Offers Increased Income, Independence. Unlimited Possibilities; free literature. Manhattan House, 126 Lexington, New York 16.

HOW To Set Up and Run a Mirror Shop! Resilver Mirrors. Make chipped glass nameplates. Electroplating Salts and Rectifiers. John Sprinkle, V 90, Marion, Indiana.

NATURAL molding latex. Extra thick. Free Sample. W. Wooley, 115-B Donald, Peoria, Illinois.

GLASY-Cast, The Liquid Plastic that works the quick and easy way. Cold-Set. 15 to 30 minutes for finished product. Free Samples and Instructions. Make embeddings, novelties, plastic frames, machine parts, etc. for real profits. Two lbs. for \$2.95. Elasto-Mold: Flexible production molds made in 20 minutes. Also finest quality Rubber Latex. Wholesale Prices. Plastic Service, 294 Washington Street, Dept. P-2, Boston 8, Mass.

MAKE Perfume—from Concentrates. Information Free—men-women write "Carey Laboratories." 1914 Chouteau PS St. Louis 3, Mo.

QUICK Money! "Repairing Car Batteries"! At home! Easy too! Batteryman, Grand Junction, Colorado.

READ: "Dental Mechanics as a Career." Gives full details. Send \$1.00. Equinox Press, S. Ardsley, N. Y.

TRADE Magazines—Current copies. Business, professions, agriculture, automotive, aviation, sports, hobbies—All fields. Price—list Free. Commercial Engraving Publishing Co., 34S North Ritter, Indianapolis 19, Indiana.

FREE Book "372 Unusual Worldwide Businesses." Successful! Australia, South America. Work home (U.S.A.)! "Different" plans. Get surprise! Publishers—7W, Carlsbad, California

AUTOMATIC saw setter used with Foley filer. Write to Stadick Manufacturing Co., New Ulm, Minn.

COLORGLAZED Concrete Pottery made without molds. Patented method. Cemetery products, novelties, tiles. Basement leak-sealing. Money-making projects. Booklet, details free. Men only. National Potteries, Grand Rapids, Minnesota.

LIQUID Rubber, make flexible molds. Free Sample. Chaney, 1130 E. 16th St., Jacksonville 6, Fla.

"EVERYBODY Likes Candy"—Learn to make professionally. (Our 39th year.) Ragsdale Candies, D7, East Orange, New Jersey.

"MAKE Perfume." Learn Profitable Mail order Business Free. "International." 6347 Parnell-PS-11, Chicago 21, Illinois.

EXPERIENCE Unnecessary. Earn \$300 month spare time sales and rental America's leading small tractor. Protected territory. Write Tiger Tractor, Fort Lee 2, N. J.

YOUR own profitable home business. Preserve live flowers to last forever. Spare or full time. New discovery—simple—fascinating. No experience necessary. Send \$2.00 for working equipment, instructions and valuable sales plans. Satisfaction guaranteed or money refunded. Hermansen, 210 Fifth Ave., Suite 1102, New York 10, N. Y.

"INDUSTRIAL Hand Cleaner." (Without Ammonia—Kerosene!) 400% Profit, manufacturing—distributing. Sample \$1. Refunded, first order. Information Free. "Rythmo-H-Ex." Kingsport, Tennessee.

AMAZING. Marble—glazed cement pottery. Hollywood style, without moulds. Benches, fountains, stucco-rock walls, garden ornaments; chemically colored. Dime brings sample, pictures. Hollywood Cementcraft, 8527-B Wonderland, Hollywood 46, Calif.

WOULD you pay 3¢—first \$350 made? Book "505 Odd, Successful Enterprises" free! Work home. Expect something odd! Pacific, Oceanside, Calif.

ELECTROPLATE on non-metals. Instructions \$1.00. Four ampere plater \$19.95. Eight ampere \$29.95. 30 ampere \$85.00. Kissel Electric Products, 431 Sherman, Gallion, Ohio.

TIN Cans. Turn them into cash. Nine methods. Instructions 50c. Charles, 12-FP, Norwood, Ohio

NEW Industrial Hand Cleaner. Free manufacturing-distributing plans. Unusual money-making proposition. "Acro-Sol-Ex." 623-D West 14th Ave., Denver 4, Colorado.

POPULAR SCIENCE OPPORTUNITIES

HOW and where to obtain Capital? Free details. Star Service. Wapakoneta, Ohio.

SAWDUST. Turn it into cash. Six methods. Instructions 25c. Charles. 12-FN. Norwood, Ohio.

MAKE Rich profits selling by mail—the "Natural" way. Hundreds successful! Interesting details free. Edward Lay. 3819 North Kenmore. Chicago 13.

HOSIERY. Sheets. Print Cloths. Etc! Wholesalers write for prices. Spartan Hosiery Company. Spartanburg. South Carolina.

MIX. Sell Chemicals Producing brilliantly colored wood fire flames. Unlimited winter sales. Sample 25 cents. Formula \$2.00. Booue Consultants. 1181 Wilshire. Court B. Cincinnati 30. Ohio.

"LIFETIME Repeat Orders!" Sell our Business Cards by Mail. \$5.85 "Starter" Plan. Lynn. 5710-A Bankfield. Culver City 1. California.

MAKE flexible molds! Cast plaques. novelties. bookends! Free sample! H. Tooker. Hamilton 7. Ohio.

LEARN Piano Tuning. repairing at home. Tremendous field! Piano parts. tools furnished. Established 1935. Empire School of Piano Tuning. 606-A East University Ave. Champaign. Illinois.

\$46 FROM Square Foot Plywood; Jigsaw necessary. Write: Woodart. Bridgewater. Massachusetts.

WHERE to buy 500,000 articles wholesale. Details free. Krueger. 3418B Wolcott. Chicago 13.

BABY Shoe Metalizing. Modern. Simplified. Practical system. Schoettle. Friendship 4. Ohio.

BIG Money—Spare or full time. Hand painting fabrics. ties. blouses. leathers. etc. is big business. New easy method. Help us fill demand. Free samples and complete plan. Hollywood Artlabs. 333-A E. 2nd. Los Angeles 12.

LIKE to Make \$20-\$40 Weekly at home? Proven mailorder Plan does it. Free Details. Perry Publications. 906-B North Wenatchee. Wenatchee. Washington.

MAKE Big Money in Home Mail Business! Few dollars starts you—interesting. profitable! Write: Smith. Box 2592-B. Hines. Illinois.

SELL Merchandise By Mail. Big Profit business! Everything furnished—orders filled for you! Easy. pleasant. Write: National. Box 88. Dorchester 22. Mass.

HAVE Home Mail Business Of Your Own—Run Ads. Mail Literature. Very profitable! Write: Ted Gordon. 711-L East 40th. Chicago 15.

MAILING postcards selling repeat merchandise is profitable. Everything supplied. Details free. Gordon Publishers. Box 23. Pawtucket. R. I.

TILE your own bathroom. kitchen. any room with colorful. guaranteed. amazing "Styron" Wall Tile. Save 30% at our prices. Save on labor costs. Simplified instructions. Free literature. U. S. Tile Co. 30-PS. West Washington. Chicago.

"QUICK Silverware. Gold. Jewelry. Metals. De-Tarnishing Atomic Plates." Dip. rinse. dry. 442% Profits. Manufacturers. 508-PS11B. New York St. Aurora. Illinois.

RUBBER! White liquid rubber! America's finest flexible molding rubber! New! Extra heavy viscosity! Quick drying! Ideal for home. classroom. or industry. Only \$7.95 per gallon. \$2.95 per quart. and \$1.00 per half-pint sample. Parcel post prepaid! Plastercraft Supply Co. 3051 St. Clair Ave. Cleveland 14. Ohio.

BIG Money Regraining-Refinishing Automobile Dashboards—Garnish Mouldings. Write Outman. 4323 So. 38th. St. Louis.

FIGURINES and all Supplies for Dresden painting. Gift ornaments. Unpainted. many to choose from. Start a profitable business—hobby. Send 25c for Catalog. Will refund on first order. Suiter Art Industries. 314 Westport. Kansas City. Mo.

FOR more business rent New York office under your name. Rates—individuals—\$12.00 yearly; firms—\$18.00 yearly. Established 1926. Co-operative Office Service. PS-126 Lexington Avenue. New York City 16.

PROSPER with Plating! Growing Field! Easily Learned! Send Post Card. New Particulars Free. Joseph Kushner. Electroplating Engineer. Stroudsburg 7S. Penna.

REAL money making opportunity making Interlocking Concrete building blocks. Rex Products Co. Dept. 21. Piqua. Ohio.

MAKE \$24.50 Using Formulas from "Schemer" Magazine. Box 775P. Alliance. Ohio. Year \$1.00. Three copies 25c.

"ELECTROPLATE" Baby Shoes! "We Furnish Everything." Foster. 1520 Ardmore. Chicago 26.

57 MONEY MAKING OPPORTUNITIES

NO selling. operate coin machines. amazing profits. details Free. Parkway Corporation. Dept. 18. 623 W. North Avenue. Baltimore 17. Maryland.

PROFIT with Larson Leathercraft. Belts. purses. 100 other ideas. Largest supply in U. S. Catalog 10c. Larson. Dept. C. 826 S. Tripp. Chicago 24.

LEARN Sewing Machine Repairing at home. Install our wholesale motor kits. Make \$125 to \$300 a week. Free particulars. Taylor Service Co. Hamilton PS. Ohio.

DETECTIVES Earn Big Money. Experience unnecessary. Particulars free. Wag-ner. P-125. West 86th. N. Y. N. Y.

MAKE Money At Home as renewal headquarters for all magazines. Big profit in Christmas gift sales. Liberal commissions. Supplies furnished. Catalog Free. Write McGregor Magazine Agency. Dept. 519C. Mount Morris. Illinois.

SCHOOL Seniors—Earn 40% commission selling classmates America's Most Beautiful Graduation Name Cards. Largest selection. Outsells all others. Free sample kit. Printcraft. Dept. M. 1425 E. Elm Street. Scranton 5. Pa.

"CAN You Wrap Packages?" Be popular during Christmas. Valuable throughout lifetime. Interesting gift. selling item. Copy. profitable offer. \$1.00. Holbrook Books. Box 1802. Milwaukee. Wisconsin.

WANT Notary Public appointment? Official in usually 10 days. Stationers Exchange. Boerne 50. Texas.

MAKE money at home. Sew garment bags. appliance covers. etc. from clear plastic. Patterns. instructions 20 items. \$1.00. 54" material 5 yards \$1.00. 100 yards \$17.00. Postpaid. Steidl. Inc. Box 1663. Fargo. N. D.

"GET dollars in your mail." Your orders filled free! Write—Siwaslian. 4317-B Gleane Street. Elmhurst. N. Y.

\$50 WEEKLY while learning Watch-Clock Repairing. See ad page 71.

MILLION Articles wholesale. "Supply Source Directory" 25c. Publisher's. Box 1302-AII. Detroit 31.

CASH in your spare time. Make Big Money sharpening circular saw blades with powered gummer. Free instructions. no experience necessary. Small investment. start with as little as \$13.50. Big demand—you earn immediately. Free catalog. Belsaw. 315-G Westport Road. Kansas City. Mo.

WOULD You pay 3%—first \$350 made? Book "505 Odd. Successful Enterprises" free. Expect something odd! Pacific. Oceanside. Calif.

15 MINUTES masters advertising and sign lettering. complete system; sign painters' secrets; cartooning book; all three. \$1; free circular. Abenterprizes. Box 875-A. Peoria. Illinois.

MAKE money at home in spare time. Raise Golden Hamsters. Small investment. Literature free. Golden Gate Hamstery. 631-G Richmond Street. El Cerrito. Calif.

WIN Contest Money. General Contest Bulletin gives hundreds of tips. Lists current contests and rules. Sample 25c. General Contests. 1609-A East 5th. Duluth. Minnesota.

ADDRESS. Mail circulars for advertisers. Full information and list of firms—25c. Write for other offers. Imperial. Dept. PS11. 902 South 9th. Wilmington. N. Car.

EARN Money Evenings. copying and duplicating comic cartoons for advertisers. Adservice. Argyle (2). Wisconsin.

MAKE Money! Apply photos on watch crystals. glasses. etc. Transparent. Complete directions. \$1.00. Alvin Coblentz. Uniontown. Ohio.

ELIMINATE Financial Worries with the biggest money making Opportunity you've ever seen. Write Ages. West Liberty. Iowa.

CASH for Simple Ideas. Household and Shop Hints. E. W. Moses. Jr. Blacksburg. Va.

58 FORMULAS, PLANS, ETC.

FORMULAS—All kinds. Latest products. Literature free. Kemico. Park Ridge 15. Illinois.

10,000 FORMULAS and trade secrets. Free Literature. Stillmans. 555 Kingston Ave. Brooklyn 3. N. Y.

SNOWBOUND? SnowCar detailed working drawings—Parts list—\$10.00. Callair. Afton. Wyoming.

FREE formula catalog. anything analyzed \$20.00. Western Chemical. Salem. Oregon.

LABORATORY tested formulas. Lists free. Pont. Box 635-PS. Terre Haute. Ind.

59 PLASTICS

PLASTIC supplies. materials. instructions for hobby or business. Send for free catalog. Tells about internal carving. Hays Plastics. 2333 Lincoln Avenue. Alameda. California.

LUCITE. Plexiglas. Any size sheets. masked. Square foot (12 x 12) cost. 1.16". 96c; 1/8" \$1.25; 3/16" \$1.52; 1/4" \$1.80. Colors add 10%. Include 10% postage. Almac Plastics. 230 Fifth Avenue. New York 1. N. Y.

NEW Liquid plastic. Clear. colors. Cast without heat. Embed flowers. insects. coins. Saw. drill. carve. Complete kit only \$3.95 postpaid. or send 25c for exciting new home project manual showing how to get started. Castolite. Dept. M-104. Woodstock. Illinois.

PLASTIC Hobbycraft: Material kit complete with instruction. project manual. \$5.95. catalog 10c. Plastics. Box 1415. Salt Lake City 11. Utah.

PLASTIC. Sheets. Rods. Tubes. etc. Free List. Plastic Supply Co. 2901 N. Grand Blvd. St. Louis 7. Mo.

INTERNAL carved roses. orchids. swans. goldfish. butterflies. etc. Jewelry and gifts. Crystal Floral Novelty Co. Bound Brook. New Jersey.

WHOLESALE Plastics supply catalog. 10c. Lucite. clear. colored. Metallic Acetate. Complete Castolite line. Phosphorescent. pearling pigments. dyes. Metal findings. Tools. Ideas—bargains galore. Fast delivery from stock. Gem-O'-Lite. Box 686-K11. North Hollywood. Calif.

PLEXIGLAS—Write for Free Price List. The Unique Glass Shop. 309 Cowardin Ave. Richmond. Virginia.

CARVING Special—Three color Dyes. one Drill.—\$1.95 Postpaid—Free Catalogue. Craft Plastics. Somerville. New Jersey.

60 CHEMICALS AND APPARATUS

NEW Idea Chemical and Apparatus Outfits for Home Experimenting. Photo-Scales. Microscopes. Chemicals. Biological and Laboratory Supplies in Small Quantities. Catalog 15c. Established 1931. John H. Winn. 124-B West 23rd Street. New York. N. Y.

LUMINOUS Paints will glow in dark. Six colors. Fairmount Chemical Co. 136 Liberty St. New York City 6.

NEW Laboratory supply catalog of Chemicals and Apparatus. Contains many thousands of items with illustrations. Send 25c. Standard Science Supply Company. 1232 N. Paulina St. Chicago 22.

NEW catalog: Chemistry. mineralogy. biology. physics 10c. Tracey Laboratories. Evanston. Ill.

CHEMICALS and apparatus for industrial. analytical. and private laboratories. Catalog 15c. Dept. M-26. Biological Supply Co. 1176 Mt. Hope Ave. Rochester 7. N. Y.

NEW. used. Catalog 10c. Atlantic Laboratory Supply. 21 Wenham. Boston. Mass.

POPULAR SCIENCE OPPORTUNITIES

61

HELP WANTED

BOYS Wanted. Over \$2.00 hour! Sell name plates for front doors. Free Sample. Write Dept. 72, National Engravers, 214 Summer, Boston, Mass.

ALASKA. The Last Frontier offers unlimited opportunities. \$1 brings government map and Directory listing firms in Fishing, Construction, Mining, Aviation, Fish & Game rules, Homestead data, Alaska Opportunist, Box 883-S, Hollywood 28, Calif.

\$1,000.00 CONSTRUCTION Job Project Report. \$1.00 brings Monthly News Bulletin giving authentic projects starting "world wide." U.S.A., Alaska, Canada, Pacific, Arabia, Latin America, India, Mexico, Africa, Europe. Tells How-When-Where to apply. Global Reports, P. O. Box 883-PX, Hollywood 28, Calif.

INTERESTED In Latin American And Foreign Employment??? \$1.00 brings copyrighted "Foreign Service Directory" with complete listing of firms in Oil, Mining, Aviation, Construction, Steamship, Manufacturers, Importers and Exporters with Hot Tips for immediate application. Published since 1944. Global Reports, P. O. Box 883-S, Hollywood 28, Calif.

IMMEDIATE opening for reliable man with car to call on farmers. No experience necessary. \$15 to \$20 in a day. Permanent. McNess Company, Dept. 179, Freeport, Ill.

MEN-Women mail circulars spare time at home. Good pay. Mail 25c for samples. Instructions, P.S.-2441 N. Patton, Philadelphia 32, Pa.

FOREIGN Employment. Construction men, building trades mechanics, helpers, office men. Good workers needed for oil projects, mining, pipe lines, dams, power plants, roadways, shipping, etc. Transportation and quarters furnished; high wages. Listings of firms actively working and hiring on projects in South America, Arabia, Asia, Africa, Alaska, Central America, etc. Send \$1.00 for foreign construction compendium and application forms. Foreign Service Bureau, Dept. P.S. 11 (Employment), P. O. Box 295, Metuchen, New Jersey.

FOREIGN Employment?? List of Overseas projects with application form. \$1.00 Cash (C.O.D. \$1.32). Foreign Service Institute, Box 3980, Miami 24-A, Florida.

62 AGENTS WANTED

GOOD Paying Business Silvering mirrors, plating autoparts, reflectors, bicycles, bathroom fixtures, etc., by late method. No tanks or shop required, outfit furnished. Free Booklet, Gunmetal Co., Ave. G, Decatur, Illinois.

EXCELLENT Sideline for printing and advertising salesmen. Decalomania name plates in small quantities. Great demand. Also, make money with our line of Automobile Initials and Sign Letters. Free Samples, "Ralco", XL-Roxbury, Boston 19, Mass.

AGENTS—300% profit selling genuine gold window letters; stores and offices. Free samples. Metallic Letter Co., 437 N. Clark, Chicago.

FREE water and our concentrates make flavors, lotions, shampoos, 125 products. Labels, bottles supplied. Qualco, F-20030 Russell, Detroit.

PHOTO-Salesmen-Agents. Sell beautiful hand-colored plastic enlargements. Collect deposit, we deliver. Profitable sideline. Send card for free sample kit. Novel Portrait Co., 3343-A North Ave., Chicago, Ill.

SEWING Machine electrification kit. Nationally advertised. Has Good Housekeeping Guaranty Seal. Can be demonstrated and sold in 5 minutes. Make at least \$5 per sale. For complete details write today to Brownell Distributors, Inc., Dept. PS, 308 Canal St., New York 13, N. Y.

NEW Jobs open in selling! Send name, address for five free issues of Opportunity Magazine's money-making guide, listing hundreds of companies who'll pay you well, full or part-time. No experience needed. Opportunity, 28 E. Jackson, Dept. 18, Chicago 4, Ill.

GOLD lacquered Window Sign Letters. Large Sizes Penny Each. New Foils, Absolutely Beautiful. Free Samples, Atlas, 544 W. 79th, Chicago 20.

START Your Own Business On Credit. Always your own boss. 1554 Dealers, sold \$5,000 to \$26,500 in 1948; their average \$6,742. We supply stocks, equipment on credit. 200 home necessities. Sales experience not needed to start. Wonderful opportunity to own pleasant, profitable business backed by world-wide industry. Write Rawleigh Co., Dept. K-U-PSC, Freeport, Ill.

FREE Samples. Big profits showing amazing Glow-In-The-Dark specialties. House numbers, pictures, plastic novelties, religious and nursery objects, etc. Large manufacturer, Madison Plastics, 303 Fourth Ave., New York 10, N. Y.

1949 CHRISTMAS Card Catalog Now Ready! Earn more money! Be a wholesale Jobber! A large selection of Box Assortments, Imprint Lines, Religious, Personalized Cards and Christmas Novelties. Three sample boxes, retailing for \$2.60, only \$1.00 postpaid. Catalog Free! Elfko, 440 North Wells, Chicago 10.

STOP! Want to make money all year round selling a complete line. Wool and Cotton Embroidered Uniforms for summer and winter wear, shirts, caps, ties, badges, 2000 emblems, personal initialed buckles, belts, and hundreds of other easy-to-sell items. Sales Kit furnished. Please write today. Hook-Fast Company, Box 480 PS, Roanoke, Va.

BE Renewal Headquarters for all magazines. Big profit in Christmas gift sales now. No experience—No capital needed. Free Catalog tells how. Write: McGregor Magazine Agency, Dept. 519A, Mount Morris, Illinois.

FAST profits—No investment. Send for big, free catalog. Plastic aprons, tablecloths, etc. 150 sure-fire items. We guarantee sales. Write The Halliday Company, Dept. P-11, 347 Broadway, Passaic, N. J.

ADVERTISING book matches—Cash in on big demand—sell Union Label matches. Cuts for all businesses and political parties—Free powerhouse selling kit—low prices—protection guaranteed on repeat orders—Cash commissions. Superior Match Co., Dept. P-119, 7530 Greenwood, Chicago.

NYLON, Poplin, Rayon Uniforms, white and colors. Immediate Delivery, Immediate Profits. Sell to Doctors, Dentists, Nurses, Waitresses, Beauticians, Housewives. Free Sales Kit, Superior Fabrics, Dept. A11, 3936 Market St., Phila. 4, Pa.

SCHOOL Seniors!!! Your postal will bring our wonder, Kwick-Sell Cardalog of popular Graduation Name Cards. Biggest profits!!! Only firm giving free souvenir chest and Card Case. Don't miss out! Hurry that postal!!! Craftcards, Box 235 (M), Pittsburgh 30, Pennsylvania.

BIG Bargains for Big profits. Over 100 sensational values. Men's used suits \$2, pants 35c, topcoats \$1.25, overcoats \$2, shoes 20c. Experience unnecessary. Free wholesale catalog. Superior, 1250-B Jefferson, Chicago 7.

OWN Your Own Business. Sell Men's Neckwear full or spare-time. Low investment, big profits. Send \$1.00, receive two Sample ties plus free catalogue, color portfolio, selling plan, Radio City Neckwear, Dept. P.S. 4, 112 W. 50th, N. Y. C.

STRANGE "Dry" Window Cleaner. Sells like wild. Replaces messy rags, liquids. Simply glide over glass. Samples sent on trial, Kristee 137, Akron, Ohio.

NEW Bathroom Deodorizer. Hangs on wall. Banishes odors bathroom, kitchen. Lightning seller. Samples sent on trial, Kristee 138, Akron, Ohio.

\$5,000 between now and Xmas showing new smart Firestone Velon, "3 in 1" Shopping Bag. Women buy several. Commissions Advanced daily. Sample Furnished. Lenard, 179-R, Washington, Chicago.

CANVASSERS, Crew Managers! Bigger profits with our beautiful popular priced fast selling stainless table-ware. Guaranteed for a Lifetime! A terrific door opener. Write direct to manufacturer for details on how you can become a direct factory dealer in your area without any risks. John Hull Cutlery Corp., 1239 Broadway, NY 1, NY.

DRESSES 18c; Men's Overcoats \$1.00; Skirts 50c. Free Catalog. Crown, 164-PS Monroe St., New York 2.

FREE Nylons given if Kendex hosiery runs or snags. World's only women's hosiery sold with written guarantee amazing everybody. Mere words could not express unbelievable money making opportunity. Fantastic earnings become reality. Armstrong earned \$202 in 9 days. Watkins sent 92 orders in one day. Imagine replacing hosiery free regardless of cause—whether use or abuse! Truly sales dynamite for terrific profits. Even if you never sold before, three magic words: "Guaranteed Against Everything" will open doors for you—make women listen and pour money in your pocket. Nationally advertised in Life, Ladies Home Journal, Saturday Evening Post, McCall's and Woman's Home Companion. Awarded Seal of Approval by Good Housekeeping. 75 million readers will see Kendex advertising to help you make quick sales and big money. Complete line from sheerest 15 denier 51 gauge to heavy 70 denier service. Sizes 8½ to 11½; lengths 28 to 35 inches; latest fashion colors plus white; full fashioned seamed and seamless. No competition because Kendex nylons are not sold in stores. Also complete line men's hosiery actually guaranteed for one full year or replaced free. Nothing like this anywhere. Includes rayon, nylon, lisle, wool, cotton, mixtures, etc. All styles, patterns, colors, prices to please everybody. 200,000 pairs constantly in stock for fast delivery. Thousands shipped daily. Over 30 years in business. You need no money or experience. Nothing to pay now or later. Just show free outfits. Write orders. We deliver and collect. Big advance cash plus huge bonus. Earn money spare or full time—exclusively or as side line. No restrictions. Become manager—appoint others to sell for you—earn steady income on their sales. Man or woman, young or old, experienced or beginner, you can make money and friends writing orders. Everything you need is furnished free, including sales books in color, samples of hosiery materials etc. Simply write your name and address on postcard and make money next week with money-making outfits sent free and prepaid. No obligation. Kendex Company, Babylon 24, New York.

SELL ultra-blue stock signs to stores, 1000 slogans, comedy, general, religious, "7x11" cost 6c—Sells 35c—Make money. 15 samples Ultra-blue signs "7x11"—\$1.00 postpaid. L. Lowy, 8 West Broadway, Dept. 505, New York City.

SELL Big Money-Maker to men and Women. Easy handwork makes fast-selling useful articles. Sample free. Sunmade Company, Brockton 64, Mass.

\$100 WEEKLY—Complete, modern Plastic line. Tablecloths, etc.—25 items. Every home prospect. 100% profit. Ideal for Demonstrators. Carwell, 6828-BB, South Chicago Avenue, Chicago.

NEW Items! Fast Seller! Big Profit! Large selection including billfolds, musical instrument novelties, household utensils. Perfect gift items for men, women, children. Write for Free Illustrated catalog. Ermo, Dept. S, 507 5th Ave., N. Y. 17, N. Y.

SELL Slot Machines, Games, Home Bars. Send for wholesale deal. Webb Distributing Co., 4966 West Chicago Ave., Chicago 51, Ill.

AGENTS! 100 Brand New Products. Confidential Bulletin Monthly. Publishers, Gardenville 4, N. Y.

BUY thousands of nationally advertised products direct from manufacturers and distributors. Write for "Buy Direct and Save". Service Publishing, 218-B Investment Bldg., Pittsburgh 22, Pa.

SELL Lamps for Big Profits . . . Fast selling quality table, boudoir, electric hurricane lamps, etc. Every home a prospect. Commission in Advance. High Profits on every sale. Write today for Free Selling Kit. Paramount Products, Dept. P-1, 1205 Sherwin Avenue, Chicago 26, Illinois.

LOOK! Make money all year round selling personal initialed individualized belts, buckles, cap badges, tie holders, complete line Police and Firemen's Badges, 2000 emblems to choose. Big profits, whole or part time. Please write today special outfit offer. Hook-Fast Specialties, Box 1425, Dept. 7, Providence, R. I. Established 1926.

FREE Folio, Wholesale Supply Sources. Business deals, Plans, Ideas, Formulas. Kolamite Co., Box 572 C, Dayton, Ohio.

POPULAR SCIENCE OPPORTUNITIES

SELL \$2 Fire Extinguishers. Locally mailorder. Lorrac Products, Albany 1, N. Y.

WOULD you pay 3%—first \$350? Book "505 Odd, Successful Enterprises" free! Work Home. Expect something odd! Pacific, Oceanside, Calif.

BIG Profits start your own business at home stamping key protectors, social security plates. Tools and stock \$17.50 complete. Sample name and address 25c catalog free. General Products, 11 No. Pearl (PS), Albany 7, N. Y.

WIN Suits and Earn Money! Both easy with amazing plan. Show finest made-to-measure tailoring to friends, neighbors. No experience or investment. Free outfit. Write Stonefield Corp., 1300 W. Harrison, Dept. Y-821, Chicago 7, Ill.

UP to \$50.00 in a week and tailored suit for yourself without paying one cent. Write for plan. Progress Tailoring Co., Dept. Y-221, Congress & Throop, Chicago 7, Ill.

MAKE Big Money! Selling our fine line of cosmetics the year around. Write: Sedoni Laboratories, 428-S, New York Bldg., St. Paul 1, Minn.

SELL!! Balloons, Combs, Specialty Merchandise. Carleton House Distributors, Texas City, Texas.

NEWEST money-making sensation, miniature authentic replicas, police and firemen's badges, also pocket pieces, key chains. Write for descriptive folder. Hook-Fast Specialties, Dept. 23, Box 1425, Providence, R. I.

WHERE To Buy 800,000 Articles Wholesale! Details Free. Schibani, Box 1576-S, Birmingham 1, Ala.

LOCAL Franchise. Power Mower—\$49.50. Delivered. Act Quick! Modern Products-4, North Kansas City, Mo.

SPECIAL pleasant work at home. Earn in your kitchen. Good earnings. Send no money. Styleco, Dept. 63, Cincinnati 2, Ohio.

SELL "NuSilver Plating Liquid", Cloth applied. Renews silverware like new. Silverplates brass, copper. NuSilver, 508-PS11A New York St., Aurora, Illinois.

PAINTS—Enamels, Roofing 65c gallon up. Your name on label. Certified Products, 812 F 38th, Louisville, Ky.

CHRISTMAS and Everyday Greeting Card Bargains. 4154-B Fifth Street, Philadelphia 40.

DOUBLE your Income Selling Colorful Sportswear. Shirts, Jackets, Nitewear, Nylons, Dresses. Free outfit. Jarod Manufacturing—Rockville Centre 12, New York.

AGENTS. Sell finest Food Products direct to homes. Successfully sold for 25 years. Big profits. Powerful combination sale plans make sales easy. Permanent repeat business. Samples furnished. Live territories open to Distributors. Mother Hubbard Products Co., 4139 Grand, Dept. PS, Chicago.

63 HIGHGRADE SALESMEN

BIG Money Taking Orders: Shirts, Ties, Sox, Pants, Jackets, Sweaters, Shoes, Uniforms, etc. Sales equipment free. Experience unnecessary. Nimrod, 4922-AV Lincoln, Chicago.

LOOK Here! Wanted—Men and women to start in business on credit. Sell some 200 farm-home Products. Thousands our Dealers now make quick sales, big profits. For particulars write Rawleigh's, Dept. K-192-PSC, Freeport, Ill.

SALESMEN—Put yourself in line for big money, real future. Keep stores supplied with 5c-10c to \$1 counter goods. Nationally advertised. Top profits for you and merchants. Liberal deals boost sales. Side-line or full time. World's Products, Dept. 83-A, Spencer, Ind.

SALESMEN: Take orders for Laminite Signs. No electricity yet glow like neon. Creating sensation: Big advance comm. No investment. Laminite, 1544 Cortland, Chicago 22.

67 EDUCATIONAL AND INSTRUCTION

MATHEMATICS. Individualized instruction. NCS, Box 27, St. Johns Station, Brooklyn 13, New York.

84 POPULAR SCIENCE

BOOKKEEPERS! Increase your earnings! Operate your own simplified "Dollar-A-Week" Bookkeeping and Tax Service. Full or Spare time. Details Free. No obligation. Ellis, Box 203, Cedar Grove, North Carolina.

EXPORT! Learn at home from established World Trader. Big paying positions. Your own profitable world-wide business by mail order without capital; or travel abroad. Experience unnecessary. Free booklet. Mellinger, 211 W. Los Angeles 24, California.

BE A real estate broker through home study or classroom instruction. Write for free book. Approved for veterans. Weaver School of Real Estate, 15 E. Pershing Rd., Box PC-11, Kansas City 8, Mo.

PIANO Tuning Pays. Learn this profitable profession at home. Our Tonometer and mechanical aids make learning easy. No knowledge music necessary. Diploma granted. Largest and oldest school—51st year. G. I. Approved. Write for booklet. Niles Bryant School, 77 Bryant Bldg., Washington 16, D. C.

MAKE Up To \$35-\$45 Week as a Trained Practical Nurse! Learn quickly at home. Booklet free. Chicago School of Nursing, Dept. M-11, Chicago.

BECOME a Doctor of Psychology or Metaphysics. Teach secret of contentment, happiness. Win degree of PsD. or MsD. Solve mental worries. Free book. College of Universal Truth, 5153-K N. Clark, Chicago.

STUTTERING or Stammering Corrected at Home. Amazingly successful method. Send for free literature showing how you, too, may overcome stuttering at home. The Athenium, P-211, 1714 Chestnut, St. Louis 3, Mo.

U. S. GOV'T Jobs! Start high as \$3,351.00 year. Men-women. Qualify now for secure positions. Free 40-page book, sample tests. Write: Franklin Institute, Dept. Y-22, Rochester, N. Y.

SHORTHAND in One Week! Easy long-hand system \$1.50. Zinman 215A, West 91, N. Y. C.

GRADUATE Degrees, psychology, divinity, others. Directed home study. Free bulletin. Central Ecumenical College, Inc., Dept. SP, 14 N. East Street, Indianapolis, Indiana.

WANT a steady Big Pay Job in Diesel? Our approved, easy-to-understand Diesel Training Course qualifies you. Placement advisory service Free. Learn as you earn. Write for free 24 page book today! Interstate Training Service, Dept. 2M, Portland 13, Oregon.

INEXPENSIVE Manual teaches air conditioning. Write Don Nelson, Warner Robins 3, Georgia.

HYPNOTISM. Complete course. 20 illustrated lessons \$1.00, moneyback guarantee. Baltimore School of Hypnotism, Dept. 23-A, 4214 Belmar Ave., Baltimore 6, Md.

LEARN Gunsmithing. Details and copy "Guns and Gunsmithing," 25c. Gunsmith's, Palatine, Illinois.

MEDICAL Laboratory Technicians in great demand. We train you in your own home. Catalogue free. Imperial Technical Institute, Box 973-B, Austin, Texas.

RAILROAD Telegraphy quickly learned by mail. Starting pay approximately \$265.00 monthly for 5 day week. Paid vacations. Free travel passes. Telegraphers needed Now. American School Railroad Telegraphy, 102 Phipps Bldg., Wenatchee, Wash.

DENTAL Technicians Kit. Artificial teeth, plastic, etc. Technicians' manual. Grant Laboratory, 219 W. 7th, Los Angeles 14, Cal.

USED Correspondence courses bought, sold, rented. Literature free. Baker, 5509-A Winthrop, Chicago 40.

SCIENCE of memory simplified. Free booklet. "Memory Development". Memorology Club, 2016 E. Sunnyside Ave., Chicago 25, Ill.

STUDY less! Learn more! Earn more! Recall facts, figures, names, faces with Better Memory. Harrison Books, 726 North Fifteenth, Waco, Texas.

PHOTOGRAPHIC mind with Super-memory, write Thor Books, S-11, Box 1210, Chicago.

HOME Study Courses. Chiro-Deo-Therapy, Drugless Healing Certificates, Diplomas, Degrees. Western University, 911-13 West University Ave., San Diego 3, Calif.

69 CONTESTS

WIN Cash, Cars In Prize Contests! Write for copy filled with current contests, winning hints and tips. Send only 25c. Wright Contest Digest, Dept. 20-M, P. O. Box 2266, St. Louis 9, Missouri.

HITCH Your Wagon to a ConteStar! Send 3c stamp. National Contest Bulletin, Box 2685-C, Miami 31, Fla.

70 LANGUAGE OUTFITS

LINGUAPHONE Makes Languages Easy. At home learn to speak Spanish, Portuguese, Italian, French, German, Russian, by quick, easy Linguaphone conversational method. Save time, work, money. Linguaphone Institute, 54 RCA Bldg., New York 20, N. Y.

72 AUTHORS SERVICE

I WANT New Writers to cash checks of \$1 to \$100 offered daily. The easiest way to write for pay. No previous experience necessary. Free Details. Saunders M. Cummings, 468-15 Independence Bldg., Colorado Springs, Colo.

73 BUSINESS SERVICE

SUCCESSFUL letters developed which pull results. P.O. Box 1067, San Francisco.

SHOWCARDS—Your copy, 7x11 35c. Free sample. Quick mail service. Sign Service, 6349 No. Clark St., Chicago, Ill.

74 CARTOONING, SIGN PAINTING, DRAWING AIDS

"HOW to make money with simple cartoons". A book everyone who likes to draw should have. It is free; no obligation. Simply address Cartoonists' Exchange, Dept. 1911-C, Pleasant Hill, Ohio.

CARTOON Your Way To Success! Internationally known instructor, Raye Burns, will personally teach you to create salable, original cartoons at home. Course of 26 lessons only \$2.85. Send remittance with order or write for Free Details and addresses of successful students. Raye Burns School, Box 3583-S, Cleveland 18, Ohio.

SIGN painting taught at home. Test lesson free. Ben Kerns, Box 812-PS, Greenville, S. C.

INTERESTED In Cartooning? Write Cartoons D3, Box 3291 San Francisco 19, Calif.

RAISED Wood letters for signs. Send 10c for catalog. Sign Letter Distributors, 273 Starke Ave., East Meadow, New York.

75 CHALK TALK-STUNTS

CHALK Talks, Laugh Producing Program, \$1.00. Illustrated Catalog 10c. Cartoonist Balda, Oshkosh, Wisconsin.

76 TYPEWRITERS AND OFFICE MACHINES

ADVERTISE. Increase business. "Printomatic" selffeeding "Mimeograph" Post Card Duplicator prints, reproduces, thousands anything typewritten, handwritten, \$13.50. Literature. Pittsburgh Typewriter Company, 336-2 Fourth Avenue, Pittsburgh 22, Pennsylvania.

77 OFFICE SUPPLIES & EQUIPMENT

TYPEWRITERS \$17.50. Adders \$12.50. Duplicators \$9.75. Burglar alarms \$2.95; Typewriters, 118 Spruce, Wichita, Kansas.

79 PRINTING OUTFITS, SUPPLIES

PRINTING Presses, type, supplies. Send stamp for details or dime for complete illustrated printer's supply book and samples. Kelsey Corp., J-8, Meriden, Conn.

PRINTING Presses, Type Supplies. Lists 3c. Turnbaugh Service, Loysville, Penna.

1000 ENVELOPES Printed. Five lines. 6 3/4 size, white wove, \$5.00 prepaid. Hatch Press, Meriden 2, Connecticut.

MAKE Your Own rubber printing cuts. Self-molding process. Plexirubber, Argyle 2, Wisconsin.

POPULAR SCIENCE OPPORTUNITIES

80

PRINTING, MULTIGRAPHING, ETC.

BUSINESS, Personal Stationery. State Requirements. Samples. Prices Free. How Printing Company, 717-23 Eunice, Webster Groves 19. Missouri.

SAVE Money On Printing—Stationery. Checks. Cards. Samples. Prices Free. Stumpprint. South Whitley 2. Indiana.

2000 **BUSINESS** Cards \$3.75 Postpaid. Colors—White. Buff. Blue. Samples Free. George Mather, 606 Milford Mill Rd., Pikesville 8. Md.

1000 **BUSINESS** Cards \$2.50 Prepaid. Samples free. Reliable Print Shop, 905 East Jefferson. Louisville 6. Ky.

250 **QUALITY** 8¹/₂x11 letterheads and 6³/₄ envelopes \$3.50 Postpaid. Advance. Starke. Florida.

500 3/4 x 2 1/4 **PRINTED** stickers 50c. General printing. Willis Myers Company. Owosso. Michigan.

1000 **BUSINESS** Cards—Raised Printing—\$3.75 Prepaid. Gardner Press. Costa Mesa. Calif.

NEW office Supply and Printing catalog. 10c. refunded first order. Eddy Co., Southington 16. Conn.

BUSINESS. Personal stationery. State requirements. Samples. Mero Products, 99 Morrison. Punxsutawney. Pa.

1000 **BUSINESS** Cards \$1.85. Prepaid. CPR. 914 E. 217 Street. Bronx 67. N. Y.

LETTERHEADS. drawings. photographs. printed matter. reproduced without cuts. Folder free. Pengad Offset Printing. Bayonne 5. New Jersey.

MIMEOGRAPHING. 8¹/₂x11. Quality Work less than 1c a copy. Photo Offset. Multigraphing. Send 10c (refundable) for Price List. Mimic Reproductions. 383P N. Corona. Valley Stream 11. New York.

MIMEOGRAPHING. Vari-typing. Cards. letters. bulletins. Free price list. Loyal Brush. 3303 Paseo. Kansas City 3. Mo.

500 Name Address Stickers 50c. Scholler. 530 Dunloe. Pittsburgh 12. Pa.

82 PATENT ATTORNEYS

INVENTORS: Write for free brochure "Evidence of Invention." Labiner. World Building. New York 7.

INVENTORS. For "Record of Invention" form. contact Carl Miller. Registered Patent Attorney. Woolworth Building. New York.

PATENT practice before U. S. Patent Office. Validity and infringement investigations and opinions. Booklet and form "Evidence of Conception" forwarded upon request. Lancaster. Allwine & Rommel. Registered Patent Attorneys. Suite 413. 815—15th St. N.W.. Washington 5. D. C.

INVENTORS: Without obligation. write for information explaining the steps you should take to secure a Patent. John N. Randolph. Registered Patent Attorney. 207 Columbian Bldg.. Washington 1. D. C.

INVENTORS: When you are satisfied that you have invented something of value write me. without obligation. for information as to what steps you should take to secure a Patent. Write Patrick D. Beavers (Formerly Randolph & Beavers) Registered Patent Atty.. 938 Columbian Bldg.. Washington 1. D. C.

INVENTOR'S Guide free on request. Frank Ledermann. Registered Patent Attorney. 154 Nassau St.. New York 7.

PATENTS—Trade Marks. Patent Lawyer. Gustave Miller. 119-B Warner Building. Washington 4. D. C.

INVENTORS—Patent Laws encourage the development of inventions. The Rules of Practice of the U. S. Patent Office advises—unless an inventor is familiar with such matters—that he employ a competent registered attorney or registered agent. as the value of patents depends largely upon the skilful preparation of the specifications and claims. Write for further particulars as to patent protection and procedure and "Invention Record" form at once. No obligation. McMorrow; Berman & Davidson. Registered Patent Attorneys. 143-F Victor Bldg.. Washington 1. D. C.

C. A. Snow & Co.—S-427. Snow Building. Washington 1. D. C. Registered Patent Attorneys. Write for information.

PATENTS. "Proof of Invention" folder mailed without obligation. E. E. Vrooman. Registered Patent Attorney. 512 McKim Bldg.. Washington 5. D. C.

INVENTORS: Learn how to protect your invention. "Patent Guide" containing detailed information concerning patent protection and procedure together with "Record of Invention" form will be forwarded upon request—without obligation. We are registered to practice before the U. S. Patent Office and prepared to serve you in handling your patent matters. Clarence A. O'Brien & Harvey Jacobson. Registered Patent Attorneys. 92B-K District National Building. Washington. D. C.

INVENTORS—If you have a valuable invention. the usual procedure is to authorize a preliminary search through appropriate classes of U. S. patents. This firm is registered to practice before the Patent Office.—is available to make such a search and report to you concerning the probable patentability of your invention. Booklet and convenient "Evidence of Invention" form sent upon request. Victor J. Evans & Co.. 441-M Merlin Bldg.. Washington 6. D. C.

PATENTS—Trade marks. Irving L. McCathran. 316 McLachlen Bldg.. Washington 1. D. C. Registered Patent Attorney.

83 FOR INVENTORS

INVENTORS: Without obligation. write for information explaining the steps you should take to secure a Patent on your invention. John N. Randolph. Registered Patent Attorney. 206 Columbian Bldg.. Washington 1. D. C.

INVENTORS: If you have an invention for sale. patented or unpatented. write Institute of American Inventors. Dept. 30A. 1926 Eye St. N.W.. Washington 6. D. C.

INVENTORS. For "Record of Invention" form. contact Carl Miller. Registered Patent Attorney. Woolworth Building. New York.

INVENTORS: Learn how to protect your invention. "Patent Guide" containing detailed information concerning patent protection and procedure together with "Record of Invention" form will be forwarded upon request—without obligation. We are registered to practice before the U. S. Patent Office and prepared to serve you in handling your patent matters. Clarence A. O'Brien & Harvey Jacobson. Registered Patent Attorneys. 92A-K. District National Building. Washington. D. C.

INVENTORS—Patent Laws encourage the development of inventions. The Rules of Practice of the U. S. Patent Office advises—unless an inventor is familiar with such matters—that he employ a competent registered attorney or registered agent. as the value of patents depends largely upon the skilful preparation of the specifications and claims. Write for further particulars as to patent protection and procedure and "Invention Record" form at once. No obligation. McMorrow; Berman & Davidson. Registered Patent Attorneys. 143-E Victor Bldg.. Washington 1. D. C.

INVENTORS—If you have a valuable invention. the usual procedure is to authorize a preliminary search through appropriate classes of U. S. patents. This firm is registered to practice before the Patent Office.—is available to make such a search and report to you concerning the probable patentability of your invention. Booklet and convenient "Evidence of Invention" form sent upon request. Victor J. Evans & Co.. 442-K Merlin Building. Washington 6. D. C.

CASH for your ideas. inventions. patents. A complete marketing and sales service with manufacturers and distributors covering entire country. Free List. Marketing Bureau 228. North LaSalle. Chicago.

PATENT Searches \$5.00. Includes nearest patent copies. 48 hour service. Free protection forms. Patent Research Engineering. 318 Evans Building. Washington 5. D. C.

PATENT Searches \$6.00. Includes patent copies. 48 hour service. Free protection forms. Patent Service Institute. 945-B Pennsylvania Ave.. Washington 4. D. C.

INVENTORS: Obtain patents without assistance. Details free. International Patent Library. 1420 New York Avenue. Washington 5. D. C.

INVENTORS: The usual First Step is to have a search of the U.S. Patents conducted. so I can report on Patentability. Write. without obligation. Patrick D. Beavers (Formerly Randolph & Beavers) Registered Patent Atty.. 939 Columbian Bldg.. Washington (1). D. C.

CASH For your idea. 280 manufacturers need inventions. patented or unpatented. List free. Invention Bureau. 208-S Clinton. Oak Park. Illinois.

"**INVENTOR'S** Guide" free on request. Frank Ledermann. Registered Patent Attorney. 154 Nassau St.. New York 7.

INVENTIONS Wanted. Prominent manufacturers and national distributors look to us for new products. You can also benefit by having us assist you with your invention from the idea stage through to the developed product. fully protected. Ask for Booklet "P". Elo Development Co.. Chatham Phenix Bldg.. L.I. City 1. New York.

COMPLETE services for inventors. Patent searches including analysis. patent copies. Patent applications prepared. Inventions marketed. Protection forms free. Industrial Patent Reports. Box 1081. Massachusetts Avenue and North Capitol. Washington 13. D. C.

84 INVENTIONS WANTED

INVENTORS: Hundreds of manufacturers have requested our assistance in locating marketable new products. Complete information. free. Institute of American Inventors. Dept. 30C. 1926 Eye St.. N.W.. Washington 6. D. C.

INVENTIONS Promoted. Patented or Unpatented. Write Adam Fisher Company. 183-A Enright. St. Louis. Mo.

CASH For your idea. 280 manufacturers need inventions. patented or unpatented. List free. Invention Bureau. 208-S Clinton. Oak Park. Illinois.

HIGHEST Royalties—Cash. Request free Booklet "C." Universal Marketing Co.. 354 South Spring St.. Los Angeles 13. Calif.

INVENTIONS Wanted. Patented or Pending only. Inventors Exchange-D. Hartford 1. Conn.

ATTENTION Photographic Inventors—Engineers. We can help you design. develop. and market your invention. Our experience assures you maximum return. All correspondence in strictest confidence. Photo Research Corp.. 127-129 West Alameda Ave.. Burbank California.

SMALL inventions wanted for manufacture and sales on royalty. Geo. Glenard Company. Dept. 10. Minneapolis 5. Minn.

EARN up to \$2,000 year. inventing simple gadgets. Special cash markets. Hendrickson. Argyle 2. Wisconsin.

85 PATENTS

INVENTORS: Test the commercial value of your patented or unpatented inventions. quickly and inexpensively. Write for free information. Institute of American Inventors. Dept. 30-B. 1926 Eye St.. N. W.. Washington 6. D. C.

NOVEL toy submarine. propelled by water turbine. fires torpedo. submerges to bottom. resurfaces. one moving part. 2405715-2452495 other patents pending. F. Sabini. Salem. N. J.

89 MODELS, MODEL SUPPLIES

SHIP and Yacht model fittings; blueprints. Send 25c for illustrated catalog No. 24—Listing hundreds of items. A. J. Fisher. 1002-2 Etowah Ave.. Royal Oak. Mich.

SHIP Models—most complete line in New England. Kits. parts. plans. books. Steam and electric power plants. Illustrated catalog 25c. James Bliss & Co.. Inc.. 220 State St.. Boston. Mass.

POWER Models. Unusual Steam. Gasoline and Traction Engines. Metals. Tools. Accessories. New Catalog 35c. Charles Cole. Ventura. Calif.

EVERYTHING for Miniature Steam Locomotives. 1/4". 1/2". 3/4". 1 1/2" scales. 64 page catalog 35c. Little Engines. Lomita. California.

SHIP Model and yacht supplies. complete large 64 page catalogue. 30c. Wm. Wild. 510 E. 11th St.. New York City.

BUILD Historic Ship Models. complete kits 39c to \$9.00. Catalog 10c. Ideal Models. 21 West 18th. New York 11. N. Y.

STEAM Marine Engines. Boilers. Casting Kits. Box 326. Evanston. Illinois.

HO RAILROAD. Airplanes. Boats. Cars. Craft Supplies. List 5c. Pete's Hobby Shop. 5743 1/2 Prospect. Kansas City 4. Mo.

STEAM engines. boilers. castings. Catalog 25c. Anton Bohaboy. 2297 Price. Rahway. New Jersey.

91 HOME CRAFTSMEN

PROFIT with Larson Leathercraft. Belts, purses, 100 other ideas. Largest supply in U. S. Catalog 10c. Larson, Dept. C. 826 S. Tripp. Chicago 24.

JUST Off The Press—8-page folder illustrated 6 beautiful, popular lamps you can make—for yourself, for Xmas gifts, or to sell others. It's fun, highly profitable—as hobby, or part or full time basis. 8-page folder, 32-page parts catalog, wholesale price list only 25c—refundable first order. Gearon Company, Dept. 400-A11, 27 South Desplaines. Chicago 6. Ill.

LEATHERCRAFT Supplies. Leathers and Tools. Low prices. Send 10c for Catalogue. Jonas Handicraft, 32-A Frankfort St., New York 7.

KLONDIKE Jewelry findings—bracelets, pins, earrings, chains, rings, stones, clips and other jewelry parts. Easy to assemble. Sample pound \$2.00, five pounds \$7.50. Imported Cut Stones, for rings, jewelry, novelties, etc. All shapes, colors, sizes. Sample 100 stones assorted \$1.50 lot. Thousand lots, \$5.00. Imported beads, all colors, sizes, sample pound \$1.00. Five-pound lots, \$4.00. Prepaid only. Merchandise Distributing, Dept. 1PS, 19 E. 16th Street, New York 3.

HOME Craft Booklets. 30 easy instruction books, many illustrations, \$1.00 each. Keyser, Plymouth Meeting, Pa.

VERY Large Size Leather Scraps, suitable for hobbyists, 5 pounds \$3.00. Sheepskin with 3/8" wool one skin \$5.00. Enterprise, Sheboygan, Wisconsin.

BANDSAW, Jigsaw owners, let your machine bring extra profits, fun. Free details. Nu-Art, Dept. C, Box 2235, Boston, Mass.

DARRA-JAMES Power Tools pay off! Save money—have fun in your own home workshop. Free illustrated Folder: Dept. P. Tool-Kraft Corp., Waterbury, Conn.

SPECIAL Offer: 80 Full Size Toy, Novelty, and lawn ornament patterns only \$1.00 Postpaid. Lynds, Box 193E, Medway, Mass.

8 BEAUTIFUL Full Size Whatnot patterns only 25c. Joanness, P. O. Box 141-S, Omaha 7, Nebraska.

JIGSAWED Money-maker! Sells itself, Plan 25c. Box 56, Braintree 84, Mass.

LEATHERCRAFTERS: Complete supplies and leather. Free Catalog. Arts Leather, 411 Joseph Ave., Rochester 5, New York.

LEATHERCRAFT. Copper tooling, textile painting, Materials, tools, supplies. Free illustrated catalog. Kit Kraft, Dept. BC11, 7377 Melrose, Los Angeles 46, Calif.

RUBBER Assortment—Over 50 quality new parts; hand, workshop and home. White Toilet Seat Set, bumpers, plumbing parts, tips, caps, washers, grommets, \$1.00 Postpaid. No C.O.D. please. Bond Rubber, 415 Brainard, Detroit 1, Michigan.

90 ALL new, full size lawn ornament and novelty patterns, up to 20" high. Only \$1.00. Mastercraft 11S2, 7041 Olcott, Chicago 31, Illinois.

16 NEW lawn chairs, 22 tables, benches, trellises, etc. All 38 plans, with full size patterns, \$1.00. Mastercraft 11S3, 7041 Olcott, Chicago 31, Illinois.

80 FULL sized patterns, toys, novelties, lawn ornaments, \$1.00. Modern Woodcraft, Saginaw, Mich.

KNOCKDOWN Cedar Chest, Lumber and Veneers, Free Price List, Giles Co., Brownsboro, Alabama.

ALUMINUM—Rounds, Shapes, Sheets, etc., Plywood, Bulletin Free, Kale Crafts, 2250 Milwaukee, Chicago 47.

TURN your workshop into cash. Send dime for new catalog describing hundreds of modern, saleable projects. Craftplans, 1321B South Michigan, Chicago 5.

HARDENED Alloy Steel Center =2—Fit South Bend—Atlas—others—\$1.00 postpaid—otherwise add COD. Service Grinding Company—Berea, Ohio.

93 BUILD IT YOURSELF

BUILD Your Own "Tractor". Plans, walking, riding. Send postcard. Free information. Ellsworth Tractor Co., D-5, Camptonville, California.

BUILD streamlined plywood kitchen cabinets; Plans 50c. Playnecabinets, 4617 Johnson Avenue, Western Springs, Ill.

BUILD block, brick, tile machine. Sell 15 items. Good profit. Build low cost home. Two blocks per minute—simple, inexpensive. Write U-Build-it, P.O. Box 7026, Tampa 3, Fla.

"CONCRETE Block Homes." 32 page booklet on how to build, \$1.00. Other Home Building booklets, \$1.00. H. C. Lightfoot, Civil Engineer, Richboro, Penna.

INEXPENSIVE Electrolytic Rectifier AC to DC. Electroplate at home. Charge Batteries. Directions \$1.00. Boone Consultants, 1181 Wilshire Court B, Cincinnati 30, Ohio.

GRANDFATHER clock building made E-Z. Shop tested money saving plans. Dollar, Kuempel Clox, Minneapolis 16.

ASSEMBLE ceramic figurine lamps, all parts furnished, circular 10c. Lamp 1933-S Rosemead, Calif.

94 WATCH REPAIRING

WATCHMAKERS Tools, Supplies. Sold—Bought, Catalogue! Bengale Company, Culver City, Calif.

WATCHMAKERS' Journal contains instructive articles for watchmakers. Send 20c for new copy. Dean Co., 116-B Nassau St., New York 7, N. Y.

95 OLD GOLD, WATCHES, ETC.

HIGHEST Cash for Old, Broken Jewelry, Gold Teeth, Watches, Silverware, Diamonds, Spectacles, Free Information. Satisfaction Guaranteed. Government Licensed, Rose Smelting Company, 29-Y East Madison, Chicago.

HIGHEST Prices Paid for Old Gold, Silver, Platinum, Diamonds, Watches, Gold Teeth, Spectacles. Cash immediately. Goods returned if offer unsatisfactory. Government Licensed, United Smelting Works, (The Old Reliable), 39-A South State, Chicago 3.

EXTRA Money for Christmas, mail your old gold, platinum, rings, teeth, watches, diamonds. Prompt payment insured. Mail to Watson, Dept. G, 7952 N.E. 2nd Ave., Miami 38, Fla.

96 JEWELRY

JEWELRY Making. Illustrated catalog 20c. George Sassen, 35 Maiden Lane, N. Y. C. 7.

STUN Your Friends with genuine sparkling, Brilliant-White Zircons. Cut, polished, mounted just like diamonds. Amazing diamond-like appearance. Top-quality. Hard for even experts to tell the difference. Beautiful settings 14K gold. Over 100 gorgeous latest-style rings to choose from. Attractive low prices. Send for Big Free Catalog. U. S. Zircon Syndicate, 139 N. Clark, Dept. 35, Chicago 2.

MAKE Your Own Jewelry! All types of findings, plastic and metal; cameos, beads, shellkits, illustr. catalog, 20c. Hobby Art, Dept. 6, POB 276, New York 18, N. Y.

MANUFACTURE costume jewelry. Literature 10c. Herber, 1360-S Hicks, New York 67.

97 TOBACCO & PIPES

CIGARETTES—Popular brands \$1.51 per carton postpaid. West of Mississippi add 7c per carton. Min. order 3 cartons. Send check or money order. King Co., Elkton 4, Maryland.

MAKE smoking pipes, briar pipe blocks and stems. Send for circular. Michelson & Sternberg, 23 West 47 Street, New York 19, N. Y.

FREE literature. Finest imported briar pipes (unfinished) \$1.00 postpaid. Carvape, 2829F Dixie, Hamilton, Ohio.

CIGARETTES—Popular brands, \$1.51 postpaid within 600 miles, \$1.53 beyond 600 miles. Min. order 5 cartons. All fresh stock. Same day service. Send check or Money Order to: National Tobacco Co., Inc., Dept. FOA, Elkton, Maryland.

100 MISCELLANEOUS

MEN! Large size shoes, large size socks! We specialize in large sizes 10 to 16, widths AAA-EEE. Dress, sport, work shoes. Guaranteed. Write for Free catalog. King-Size, Inc., 198, Brockton, Mass.

BOOKFINDERS! (Scarce, out-of-print, unusual books) Quickly supplied. Send wants. Clifton, Box 1377-PSM, Beverly Hills, Calif.

YOUR Leather Jacket renovated by our craftsmen expertly, reasonably. Request Free descriptive circular No. 7; Berlew Mfg. Co., Freeport, N. Y.

DRESSES 18c; Men's Overcoats \$1.00; Skirts 50c. Free Catalog. Crown, 164-PS, Monroe St., New York 2.

PILES? Worrynot. Free tip from an old relieved. Write: PS, 1409 Orange, Berwick, Pa.

MAIL Six Neckties and \$1.00. Receive six beautifully reconditioned different neckties. Tie Exchange, 161/S North Wabash, Chicago 1, Illinois.

AMAZING: New Car cigarette Lighter and Holder. Hands you lighted ready to smoke cigarette while you drive. Dependable and safe. Holds 23. Low price of \$6.95. Dealers wanted. Wooten Company, Box 228, Lumber City, Ga.

"INTERESTING Mails"—25c will keep your mail box full three months. Bentz, Jr., Desk A-38, Chatawa, Mississippi.

BIG Mails Three Months, Name Listed Directory 25c. Harvey Teeple, Decatur, Indiana.

PANNING Gold—Beginners Booklet, 36 pages, also catalogue supplies 25c. Old Prospector, B310, Dutch Flats, Cal.

GEIGER Counters \$48.50 and \$70.00. Complete. Prepaid. Guaranteed. Uranium Spintheriscopes (Scintilliscopes) with Samples \$6.00. Western Radiation Laboratory, 1107 West 24th St., Los Angeles 7, Calif.

URANIUM Prospector's Handbook \$1. Free Tips. Craft Publications, 601C S. Vermont, Los Angeles 5, California.

UNSURPASSED Glamorous Models. Three 5x7 glossies \$1. H. Greer, 117-S E. 60 St., New York 22, N. Y.

UNUSUALLY realistic 10" statuette of yourself or loved ones. Inexpensive, desirable lifetime keepsake. Write Ameri-Tech Industries, 1239 West 9th St., Cleveland 13, Ohio.

TREASURE Locators, Mineral Detectors, Geiger Counters for Uranium ores. Free literature. Fisher Research Laboratory, Inc., Palo Alto, California.

WEBSTER Chicago wire recorder, like new \$85.00. Box 103, Malden, Mass.

DAVID Wigransky, District of Columbia, desires buying old comic books and original comic art work.

101 FOR SALE—MISCELLANEOUS

WAR Surplus, Aircraft items, Shop Equipment, Machinery and a million other items. Send 10c for 64 page Catalog. Atlas Equipment, 229 Southwest Blvd., Kansas City 8, Mo.

FREE Catalog! War surplus clothing, Men's, women's. Amazing bargains. N. Y. Clothing Co., N. Y. 29.

TOY Pistols and Holsters. Wholesale & Retail. C. C. Groff, 116 Broad St., Lancaster, Pa.

RECEIVE Beautiful Box Christmas Cards. Send \$1.00. Justian's Service, 133 Dewey Ave., Syracuse, New York.

USED Vending Machines. Largest selection. Satisfaction guaranteed. Vassar, Cleveland 5, Ohio.

102 WANTED MISCELLANEOUS

SWAP—Buy-Sell anything. Free lists. Swappers' Guide, Box 415, Evansville, Indiana.

103 FOR THE HOME

NEW Invention—A-Just-O Paint-Can Handle. Fits quarts, pints, 1/2 pints, 1/4 pints. Prevents accidents. Every home needs one. 25c postpaid. Doty, Box 448, Port Richmond, S.I. 2, N. Y.

INEXPENSIVE home Turkish bath, lightweight, collapsible. Information free. Gordon Brothers, 658 Grand Street, Brooklyn 11, New York.

BEWARE! Diabetes Comes Stealthily. Test your urine for Sugar. Ten months test \$2.00. Peerless Specialties, Phoenixville, Pennsylvania.

104 PERSONAL

CORNS and Callouses positively removed permanently. Proven method. Complete kit and instructions \$1.00 postpaid. Cornaway, 137 Schuyler Avenue, Newark 8, N. J.

BORROW by mail. Loans \$50.00 to \$300.00 to employed men and women. Easy, quick. Completely private, confidential. No endorsers. Repay in convenient monthly payments. Details free in plain envelope. Write State Finance Co., 210 State Finance Bldg., Dept. B-14K, Des Moines 9, Iowa.

MEDICAL Prescriptions filled at guaranteed lowest cost. Ask for prices on all your drug, hormone, and vitamin requirements. Ace Mail Order Co., E. East Orange, N. J.

"**HOW Can I Find Out?**" You Can! Information discreetly developed. Any matter, person, problem, anywhere. Worldwide. Officially licensed, bonded service. Established 1922. Reasonable. Confidential. William Herman, 170 Broadway, New York.

DETECTIVE'S Opportunities. Particulars free. Write. Wagoner, P-125 West 86th. New York 24.

RUPTURED? Positive comfort, no understraps, no steel, no elastic. Write Smith Manufacturing Co., Preston, Ontario.

PSORIASIS Sufferers: Has everything failed to bring even temporary relief from scales, lesions, and itching? Then write today for Free important information. You needn't invest one cent! Pixacol Company, Box 3583-S, Cleveland, Ohio.

If you are nervous, write The Herbmater, Forestville 8, Va.

INFORMATION for single people by Human Relations Consultant, Dr. B. Long, Box 375, Los Angeles 53, Calif.

HAIR Falling? Dandruff? Write Elson, 139 Lewis, Phillipsburg, N. J.

ASTROLOGY Reading, Dime and Birthdate. Astrol Enterprises, Dept. E-29, Box 231, Kenilworth, Ill.

SEND It From Topeka! Letters Re-mailed, 25c each, R. Crum, 1116 N. Jackson St., Topeka, Kansas.

MEXICAN Law, General Practice Attorney, 1203 Arizona Street, El Paso, Texas.

ROUND-SHOULDERED? Straighten up. No braces, \$1.00. Martin Blank, 3120 Brighton 5th, Brooklyn 24, N. Y.

COMPLETE Letter Writing Service. Detailed Information 25c. Brown, Seaview, Swansea, Mass.

HAIR falling, dandruff, itching, stopped unless caused by physical ailment. Enjoy healthier, stronger hair. Guaranteed. Michael's, 3027-K Atlantic Ave., Atlantic City, N. J.

GALL Bladder sufferers write for free literature. Barlet Co., 6432-A Cass, Detroit 2, Mich.

LETTERS remailed from Paris (France). \$1.00, Airmail \$2.00. Box 4066, San Francisco 1.

STOP suffering Hay Fever discomfort, blinding Headaches, Sinus pains. Enjoy blessed relief almost instantly. Write today for Amazing 7 Day Trial Offer. Pinolator, Inc., Dept. 99, Minneapolis 4, Minn.

106 ADVERTISING

ADVERTISE: 24 words, 40 Newspapers, \$3.50. Lists free. Advertising Bureau, 10511-P Springfield, Chicago 43.

AVOID costly advertising mistakes. Get enlightening Ad-Guide and Ratebook leading newspapers, magazines, mailing lists. 10c Chicago Advertising Agency (Established 1900), Chicago 4.

24 WORDS in 50 Weeklies, \$4.96. J. Darnell, 730 Hays, Jackson, Tennessee.

ADVERTISE in 40 weeklies, \$3.50 (24 words). M. Pennebaker, San Marcos, Tex.

EVERYTHING you need in Advertising Sales Aids for the Bronzed Baby Shoe Business. Write for Free booklet "3 Ways to Successful Selling." National Ad-Aid Service, 4646 Melbourne Avenue, Los Angeles 27.

114 DRAFTING INSTRUMENTS

BEAM Compass, Adjustable, Diameters to 32 inches. Steel Beam, Brass Posts, Nickel plated, \$4.20 Postpaid. Grew Products, 664 East 126 Street, Cleveland, Ohio.

115 DRAWING & ART SUPPLIES

DRAFTING and artists' materials catalog—thousands of items—25c (deductible first \$2 order). Gordon's, 187 Madison, Chicago.

117 TATTOOING SUPPLIES

TATTOOING Outfits, Supplies, Illustrated List Free. Zeiss, 728 Lesley, Rockford, Illinois.

120 CANDY MAKING

MEN—Women—"Everybody Likes Candy." Learn to make professionally at home. (Our 39th year.) Ragsdale Candies, East Orange, New Jersey.

125 WOODS

WOOD cards, Business, Christmas, Announcement. Cards of Wood, Manlius 2, N. Y.

126 CAMPING

SURPLUS, tents, tarpaulins, outdoor clothing, camping, paints; free catalogue. Morsan, 10-19D 50th Ave., L. I. C. 1, N. Y.

131 TREASURE FINDERS

METAL Detectors. The very latest circuit. Send 25c for literature. Hedden Metal Detectors, 3329 Liberty Ave., Pittsburgh 1, Pa.

GEIGER Counters for locating Uranium; Metal Detectors for Gold, Silver and minerals. Lightweight, low cost, ultra-sensitive. None finer at any price. Free information. Detlectron Co., 5637 Cahuenga Avenue, North Hollywood, Calif.

SEEK Uranium, valuable minerals, buried treasure with latest scientific detectors. Free literature describing low cost, super-sensitive equipment. Glen Scientific, Box 151-D, Glen Ellyn, Ill.

TREASURE—Mineral Locators, M-Scope. Low Priced, lightweight, unsurpassed in efficiency. Revolutionizes locating of minerals and precious metals. Geiger Counters for Uranium ores. Time payment plan. Factory guaranteed. Free 16-page booklet upon request. Fisher Research Laboratory, Inc., Palo Alto, California.

137 DETECTIVES

DETECTIVES—Work home—Travel, Experience unnecessary. Write Wagoner P-125 West 86th, N. Y., N. Y.

DETECTIVE Training, Phillips Secret Service System, 1917C North Kenneth, Chicago 39, Illinois.

143 NAME LISTS

FRESH New Mothers' Addresses—Mrs. Peter Ball, 30 City View Avenue, West Springfield, Mass.

145 SOUVENIRS

THREE Military Emblems and price list 10c. Hobbyguild, 57X Sumner Ave., Brooklyn, N. Y.

Be a DETECTIVE

LEARN AT HOME IN SPARE TIME

Earn good money in respected profession. A School with modern ideas. Hundreds profited by our Easy to Learn methods. Course by former U. S. Govt. Agent. Expose of criminal methods. Basic training in detection; prevention methods. **FREE BOOK** describing training and opportunities.



INTERNATIONAL DETECTIVE TRAINING SCHOOL
1701 Monroe St. N. E. Dept. 2111 Washington, D. C.

NEW! MINIATURE DUST MASK

Wear when sanding, grinding, paint spraying, sweeping, dusting, furnace cleaning, etc. Handy as a pair of glasses. Just keep mouth closed and breathe through nose is all you do to operate. Protects against dusts, lint, coal, cement, grain dust. Has 9 sq. in. filter. Order today.



JERRY BRYANT, Dept. PS, 919 N. Michigan Ave., Chicago 11, Ill.

BARGAIN!

HIGH SPEED ROTARY FILES

- Set of 5 Assorted \$ 2.00
- " " 10 " 3.75
- " " 20 " 7.25
- " " 30 " 10.00

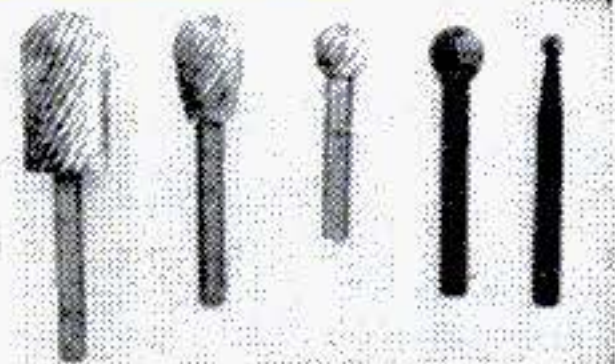

WE BUY SURPLUS TOOLS

SID TOOL CO., 183 Grand St., N. Y., N. Y.

SAVE ON ANY JEEP PART YOU NEED

Canvas Tops, used, A3216 GPW115-2700 \$12.50

Dual Vacuum Windshield Wiper Kits with 2 motors and attachments. Trico-SP-2467.....\$5.45

The King of Jeeps

BERG TRUCK & PARTS CO., INC.
1607 So. Wabash Ave. Chicago 16, Ill.

FREE JEEP PARTS CATALOG
1000's of Parts Listed. Wholesale prices. Write for your Copy Today!

FLASH Your Turns

THE SIMPLEX DIRECTIONAL SWITCH

Kits furnished with all necessary material for a perfect installation. No outside mounting of any kind. We make use of your present parking and tail lights.

SHIPMENTS ARE MADE FROM STOCK
Eliminate hand signaling. A safe and comfortable way of signaling your intention of making a right or left turn. Flashes from 60-80 times per minute. Either of our two models will fit most cars from 1942 to 1949.

\$8.95 Send check or money order. Postage extra on C.O.D.'s in U.S.

Specify year and make of car. Money back guarantee. Tested and Approved to meet SAE requirements.

DEALERS INQUIRIES INVITED

SIMPLEX SALES COMPANY 1303 W. JACKSON BLVD., Dept. B, CHICAGO 7, ILLINOIS

ONLY \$9.75 Post Paid

JET PERFORMANCE FOR YOUR CAR WITH VAPOJET

This aircraft developed water-oil vapor injector is designed to give faster pick-up, smoother running power, and tends to eliminate carbon, vapor lock and overheating. Users of the new Vapojet report up to 25% more mileage per gallon of regular gas. Complete, easily installed kit fits all car, tractor, boat or stationary engines. Agents Wanted.

MONEY BACK SATISFACTION GUARANTEE
(If returned within 30 days)
Order today. Only \$9.75 ppd. Send check or money order & save postage. \$1 deposit on C.O.D.

VAPOJET MFG. CO., 11424 Biona Dr., Dept. PS-10, Los Angeles 34, Calif.

MAIL COUPON TODAY

Rush me.....Vapo-Jet Kits including carburetor adaptor, copper tubing, fittings, etc. and illustrated instructions. Enclosed is my check or money order for \$.....

Car.....No. of cyl.....Year.....

Name.....

Street.....

City.....State.....

**BOYS! Have fun
with CHEMCRAFT!**



FREE-

This exciting new book



Send today for new, FREE Chemcraft Chemistry book—"The Wonders of Chemistry". Shows how to amaze friends and family with chemical magic. Describes many fascinating home experiments like making perfume, windshield cleaner, soap, etc. Loads of fun, thrills, excitement and adventure await boys who start now to obtain knowledge of Chemistry. Act now! Send for FREE Chemcraft Chemistry book—TODAY!

CHEMCRAFT
Now--with safe Atomic Energy

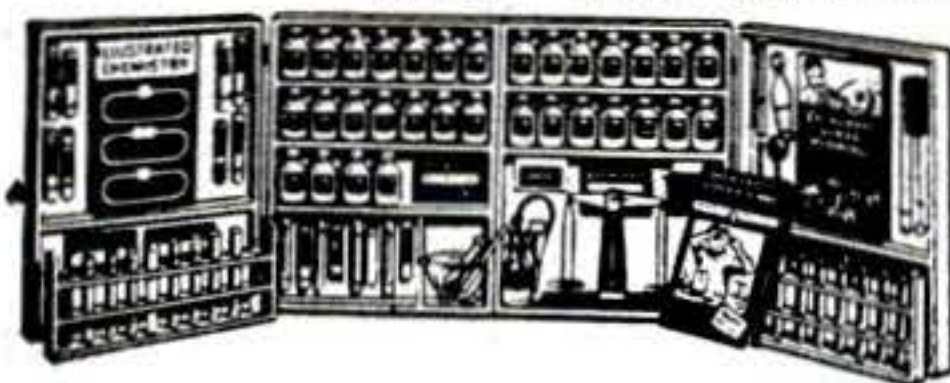

Sold in the best stores all over the country. Address below for your FREE copy of "THE WONDERS OF CHEMISTRY."

THE PORTER CHEMICAL COMPANY
60 Prospect Avenue • Hagerstown, Md.

**OWN
Your Own
Business**



PATENTED
PORTABLE
EQUIPMENT

Lifetime Income

Clean and Mothproof rugs and upholstery "in the home" or public buildings. Start full or part time. Gross profits up to \$15 and \$20 a day on EACH service man. Easy to learn . . . quickly established.

DURACLEAN cleans by absorption! No scrubbing, soaking or shrinkage. Dirt and grease vanish . . . matted pile rises . . . colors revive. Furnishings used again same day.

DURAPROOF resists moths and carpet beetles. Your service backed by a National Money Back 4 Year Warranty.

We furnish enough material to return your total investment. EASY TERMS. Send for FREE booklet . . . full details. No obligation.

Duraclean Co. 9-18N Duraclean Bldg.
Deerfield, Illinois

**Beautify
YOUR HOME
COLORFULLY
STAINED
WINDOW PANES**

Anyone Can Install Them

Your choice of hand made, beautifully-colored leaded glass window panes in 5 different Old English designs: **\$3⁸⁵ EACH**

- Lighthouse (Ill.)
- Windmill
- Flower
- Coat-of-Arms
- Sailboat

Handsome ornaments for steel casement windows, front door, small stair landing, etc. \$3.95 each, \$7.70 pair, postpaid (up to size 12" x 18"). Include choice of design, height and width of window with order. Sorry, no C.O.D.'s. Please remit with order.

ART GLASS CO., 3 Lester Court, Brooklyn 29, N. Y.

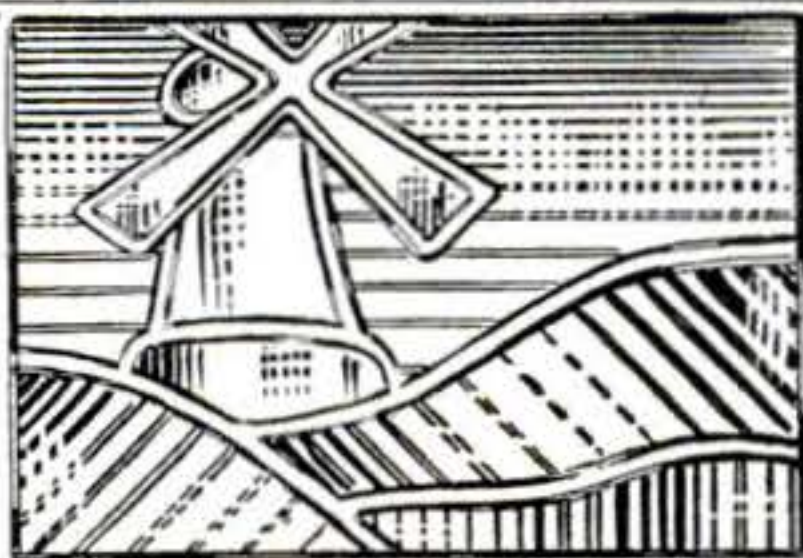

ALL METAL PARTS BINS

STACK 'EM

Each bin
20" x 6"
overall

2 1/2" high

24 and 19
Gauge Steel

LAST A
LIFETIME



#9—\$2.00
#5—\$1.75 from factory

For home work shop, garages or any shop where small parts are used. Why waste your time hunting through boxes, cans, drawers, etc. A swell present for that boy or Father. add to them as needed. Something he can use every day. Thousands in use. Green enamel finish. Send check or money order. Postage paid. Add 3% tax in Ohio.
H.C.R. Metal Fab. Co., 7000 W. 3rd St., Dayton 9, Ohio

**MAKE BIG PROFITS!
OPERATE YOUR OWN SAW-FILING SHOP**

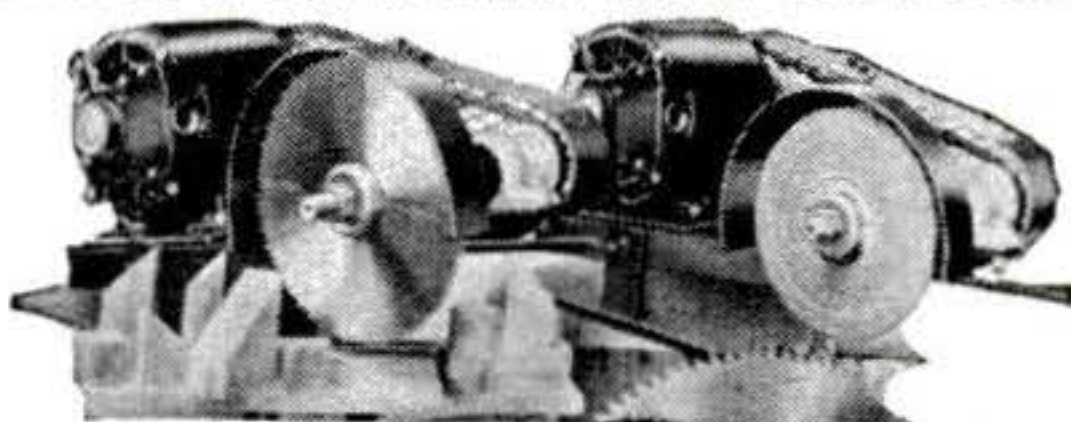

● Big earnings are yours with a saw-filing business. Prospects everywhere. Small investment starts you at once! Illus. shows how one Hand Gummer can be adapted to a saw sharpener and/or a cut-off saw. Machine will grind and gum out Rip & Cut-Off saws at any degree, bevel or hook. Also, rounds saws up. Easily adapted to grind skill saws. Up to 20" capacity. \$64 each. F.O.B., Portland. Act now!
WRITE FOR FREE LITERATURE - DEALER INQUIRIES INVITED
P. T. HOBBS MACHINERY 8375 N. Interstate, Dept. PS-119
Portland 17, Oregon

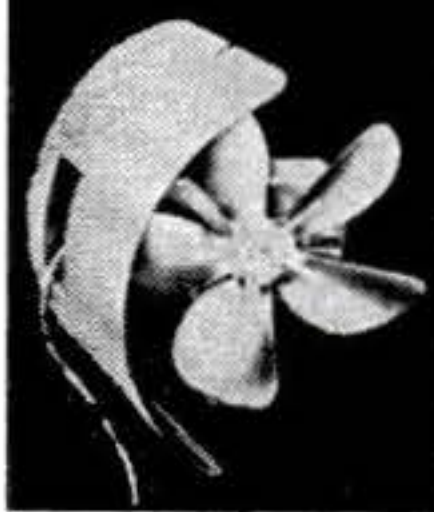

**HEAT THAT COLD ROOM
McLARTY VENTILATED BOOSTER FAN**

Don't shiver in a cold room. You can install this booster fan in warm air furnace pipe yourself, and get forced circulation. Patented cooling feature prevents motor failure common to unventilated fans. Fits pipe sizes from 8" to 12", runs on house current. If your furnace dealer cannot supply you, write for free circular or send check to

**\$10⁹⁵ Delivered
U.S.A.**

McLARTY SYSTEMS
Dickman Road Battle Creek, Mich.

**WILL YOU
WEAR this SUIT
Without Paying 1¢-**



**BE MY LOCAL AGENT
UP TO \$12⁰⁰ A DAY!**

How would you like to wear a fine made-to-measure suit without paying one cent? You can get it by taking a few orders from friends. Do this—get your bonus suit—and also earn up to \$12 in a day without house-to-house canvassing! Represent my big, old established company. I need ambitious men in every town, and this is your chance. **Experience Not Necessary**

SAMPLES FREE. I send you absolutely free gorgeous, valuable big, demonstration equipment containing actual samples of fabrics. Demonstrate these samples for me and take orders. Show great tailoring values. Save money for friends. Make money for yourself. **Write! SEND NO MONEY!** For quick action, tell us about yourself—age, etc. Get demonstration equipment FREE and opportunity to get your own made-to-measure suit WITHOUT one penny cost. **N. J. COLLIN, PROGRESS TAILORING COMPANY, Dept. Y220, 500 SOUTH THROOP STREET, CHICAGO 7, ILLINOIS**

MONEY BACK
if not delighted
IN 10 DAYS

AMERICA'S BEST WATCH VALUES
WHOLESALE PRICES • DIRECT TO USER

ORDER WITH CONFIDENCE
1 YEAR WRITTEN
GUARANTEE

men's fully guaranteed
15 JEWEL WRIST WATCH
ORIGINALLY \$30 to \$55

Luminous dial
... sweep
second hand.
water repellent
... shock pro-
tected
anti-magnetic.
Imported Swiss
precision move-
ment and case. Worth
triple this low price
Only \$12.95 plus \$1.30 tax
Don't delay. Order now

OUR PRICE
Now only
\$12.95



14-KT. LADIES
FILLED
YELLOW
17 JEWEL GOLD WATCH
ORIGINALLY \$39.75

A thrilling
precision watch
with beautiful
cord band.
Built for life-
time service.
Shock protected
construction.
Lowest price
ever. Only \$13.95 plus
\$1.40 tax. Don't delay
Order now.

OUR PRICE
Now Only
\$13.95



2 Push
BUTTON
17 JEWEL CHRONOGRAPH
ORIGINALLY \$71.50

Thousands
sold at \$71.50
2-push button
combination
wrist watch.
stopwatch,
telemeter,
tachometer.
Incablock shock resistant
feature. Sweep second
hand. Anti-magnetic.
Radium dial. Stainless
steel back. Unbreakable
crystal. Only \$21.95 plus
\$2.20 tax. Order now.

OUR PRICE
Now Only
\$21.95



Sturdy WRIST WATCH

- Sweep Second Hand
- LUMINOUS DIALS
- WATER-PROOF PLASTIC BAND

Sturdy guaran-
teed men's
watch. Built to
keep accurate
time. Many
formerly sold
at double this price and
more. Yours now at
only \$4.95 plus 50c tax
Order now for self and
gifts.

OUR
PRICE
Now
Only
\$4.95



17 JEWEL SELF WINDING
ORIGINALLY \$71.95

OUR PRICE NOW ONLY

One of World's
finest. Needs
no winding.
Winds self as
you move.
Water and shock
resistant. Anti-
magnetic. Ace
value at former \$71.50
price. Now only
\$24.95, plus \$2.50
tax. Order now.

\$24.95



17 JEWEL SHOCK PROOF
WATERPROOF

INCABLOCK—Shock Protected
ORIGINALLY \$59.00
OUR PRICE NOW ONLY

Handsome
accurate.
Has sweep
second hand.
Non-magnetic.
Kept accurate
time after 72-hour
test under water.
Amazing value at
\$16.95 plus \$1.70
tax. Order now.

\$16.95



FREE!

Handsome expansion band in-
cluded free if you send full
payment plus tax with your
order

ORDER DIRECT FROM THIS AD, FOR SELF AND FOR
THRILLING GIFTS. Lowest prices ever, for these guaranteed
watches! Order now on famous 1-year written guarantee. Send
only \$1 down payment with order. Pay balance to postman on
arrival plus postage. Or we pay postage if you enclose full pay-
ment plus tax with your order.

MARYLAND DISTRIBUTORS, Dept. 86 501 E. Baltimore St., Baltimore 2, Md.

BE A PHOTO-ENGRAVER

We furnish complete equipment and sup-
plies. Learn at home or in our modern, friendly
APPROVED school in MISSOURI. Get into this
big demand, high profit, high wage field. You
can start your own profitable, full time or part
time PHOTO-ENGRAVING business right in
your own home.

THE AURORA SCHOOL OF PHOTO-ENGRAVING, DEPT. PS-11, TASOPE BLDG., AURORA, MO.

Be independent, be your own boss or pave
the way to a high pay job with experience
gained in your own shop.

TASOPE TRAINING and TASOPE EQUIP-
MENT has enjoyed world wide recognition
since 1931. Write for descriptive literature
today. No obligation.

LEARN MEAT CUTTING EASILY - QUICKLY
At Home-In Spare Time



The steady, dependable trade of Meat Cutting taught easily,
quickly by improved HOME METHOD. National School,
established over 25 years, has organized its famous "Learn
By Doing" Classroom, Cutting room and Retail Market
training system into sound, practical HOME STUDY form.

Now, by the miracle of this EXTENSION TRAINING
you can prepare in Your Spare Time At Home, for a better
job, bigger responsibilities or success and security in a store
of your own. Remember, PEOPLE MUST EAT!

Buying, cutting, percentage, pricing, advertising, selling—
a complete meat education. For beginner or men with ex-

perience. Thousands of successful graduates. Send coupon
for FREE Bulletin NOW!

MAIL THIS COUPON TODAY FOR FREE BULLETIN

National School of Meat Cutting Div. 0-84, Toledo 4, Ohio

Send me your FREE Bulletin on Meat Cutting and Meat Mer-
chandising. No obligation. No Salesman will call.

Name

Street

City State

TERRIFIC CROSLEY ENDURANCE TEST!



Here's proof of the amazing ruggedness of the new Crosley car! The Crosley Station Wagon (shown above during refreshment "refueling") completed on July 7, 1949, a continuous run of 50,025 miles—a distance of twice around the world—in 105 days and nights, averaging 45 miles per gallon of gasoline!

"This car was powered by the same Crosley CIBA (cast-iron block) engine which is now standard in all Crosley models," says H. A. McClellan, Crosley dealer, Jacksonville, Fla., who sponsored the test.

CROSLEY OWNERS—The history-making CIBA (cast-iron block) is now available for 1946 and later models. Exchange your old engine for a factory-rebuilt engine with new cast iron block, and new engine guarantee—only \$89 (including Federal Tax), freight paid both ways! (Cost of removal and installation, about 5 hours labor time, extra.)

Order from your Crosley dealer today. For free literature on Crosley Cars and this offer, write Crosley Motors, Inc. 2530-JL Spring Grove Ave., Cincinnati 14, Ohio.

For a new thrill in motoring, drive the new Crosley Hotshot. See your dealer today for a free drive-it-yourself demonstration. The famous 2-passenger Hotshot is America's own sports car.

CROSLEY



a *FINE* car

"You see them everywhere."

The Original
KAY-DEE KAYAK
Knock Down

SHIPPED COMPLETE **\$39.95**
READY TO ASSEMBLE

F.O.B. Sarasota, Fla.

Kit includes all materials needed to assemble this famous lightweight all-purpose craft ready for launching. Pre-cut and fitted wood parts are Florida cypress. Ready fit waterproof canvas cover already sewn. Only tools needed are screwdriver, wrench and tack hammer. Length, 12 feet; beam, 29 inches; completed weight, 30 pounds; Capacity, two adults. **ORDER TODAY**—Dept. 111.

DEALERS WANTED



KAY-DEE Mfg. Co., Sarasota, Florida

Mortite

KEEPS THE COLD OUT

SAVES FUEL AND MONEY

Cordlike and pliable, Mortite is the perfect weatherstripping. Goes on in a jiffy without tools or tacks. Keeps out wind, dust dirt. Anyone can press it around windows, doors, transoms, baseboards. Weatherstrip a whole window for 29c—costs even less if you use the larger package. Get Mortite at stores or write for circular. J. W. Mortell Co., 534 Burch St., Kankakee, Ill.



**BURIED TREASURE. MINERALS
AMAZING NEW GOLDAK LOCATORS**

SENSATIONAL NEW MODEL!
ONLY 11 pounds weight! One hand operation! Money-Back Guarantee of Superiority. Write for full details.

THE GOLDAK CO.
1544 WEST GLENOAKS BLVD.
GLENDALE 1, CALIFORNIA

World's largest maker of fine locators.



Save 50%

Learn how to benefit from Estate Liquidations and Loan Foreclosures. Values from \$25.00 to \$25,000.00. Est. for over 35 years.

WRITE For **FREE VALUABLE CATALOG**

CITIZENS Diamond Brokers • Dept. F
195 MITCHELL ST. • ATLANTA, GA.



Free Sample!

Big profits showing amazing **GLOW-IN-THE-DARK SPECIALTIES**. House numbers, pictures, plastic novelties, religious and nursery objects, etc. Large manufacturer. Enormous demand. Sell on sight. Write at once for **FREE SAMPLES**. **MADISON MILLS, Dept. C-5** 303 Fourth Ave. NEW YORK 10, N. Y.

Want to Write

Short Stories, Mysteries, Articles?

Free Book Tells How You Learn at Home

The demand for writers is creating great new opportunities for people with an urge to write. It's not as hard to succeed as you may imagine. Most famous authors come from ordinary walks of life. At home, you too may learn fiction writing, the best basis for all fields—short stories, features, articles, technical, mechanical and business items. Palmer Institute's Home Study Training (Established 1917) is endorsed by Rupert Hughes, Gertrude Atherton, Keith Monroe, and other famous authors and by scores of successful graduates. Complete instruction material and professional coaching to develop your own style. **FREE** book tells how you may enjoy an ideal part time or full time career. Write today (no salesman will call). Veterans: advise us if you are eligible for G.I. Training.

APPROVED FOR VETERANS

PALMER INSTITUTE OF AUTHORSHIP • Desk U-119
1680 N. Sycamore • Hollywood 28, Calif.

REAL RELIEF
from Foot Fatigue!

REGAL'S
CUSHION-TRED
Shoe



ONLY
\$8.80

Now you can walk on a million air bubbles! Sponge rubber cushioned innersole protects your feet from jars and jolts. A handsome Regal Dress Shoe acclaimed by many as "the Most Comfortable Shoe in America". Wonderful for men who are on their feet all day. Complete range of styles—all at Regal's new reduced low price of \$8.80. Send for FREE CATALOG today!

REGAL SHOE CO. Dept. 232, Whitman, Mass.

WRITE FOR CATALOG

GIANT ASTRONOMICAL TELESCOPE



Ready for use. 6 ft. tripod. 100 diameters magnification. (10,000 area magnification). Extra eyepiece especially suited to observing Milky Way, Nebulae, Comets, Double Stars and Star Clusters. Sun projector lens for watching sun spots. Full power and clear vision guaranteed. \$15.00. 25% deposit on C.O.D. orders.

Shipped via Express F.O.B. Manorville

SUFFOLK SCIENCE SERVICE
DEPT. CT. MANORVILLE, N. Y.

"How to Make Money with Simple Cartoons"



A book everyone who likes to draw should have. It is free; no obligation. Simply address

FREE BOOK

CARTOONISTS' EXCHANGE

Dept. 1911-F Pleasant Hill, Ohio



Make your snapshots
EXACT-SHOTS
with a *Cadet*

**WESTON'S SIMPLIFIED,
BUDGET PRICED EXPOSURE METER**

The new CADET turns snapshotting into *precise picture* taking. Just take a quick reading . . . get a *perfectly exposed picture every time*. It's a space saver too . . . fits pocket or purse. Changes instantly to read reflected or incident light. See the Cadet at leading photo dealers everywhere. Priced at only \$21.50.

WESTON
Exposure Meters

WITH MOLLY YOU CAN FASTEN ANYTHING
and do it quickly, neatly and safely, MOLLY will hold fixtures securely to floors, ceilings or any hollow wall construction . . . Simple to install, all you need is a screw driver. Sold by leading hardware and lumber dealers everywhere.

MOLLY
SCREW ANCHORS

NO SPECIAL TOOLS NEEDED!

WHERE SCREWS WON'T HOLD... USE MOLLY'S

Write for Free Descriptive Folder

FIRST... DRILL HOLE SAME SIZE AS THE MOLLY... THEN INSERT MOLLY

USE A SCREW DRIVER TO TURN SCREW

NOW MOLLY IS FULLY INSTALLED

NEXT... REMOVE THE SCREW

NOW... PLACE FIXTURE IN POSITION. RETURN SCREW AND TIGHTEN.

MOLLY CORPORATION 522 COURT ST. READING, PA.

BUDGET-SAVING HAIR CLIPPER



THE VERSATILE

Cadet®

ELECTRIC HAIR CLIPPER

Put the practical "Cadet" Electric Hair Clipper to work . . . saves time and money for the whole family! You'll find this strong, yet inexpensive electric hair clipper mighty handy for removing superfluous hair, too. Has special design blade for clean, close cutting. Operates on 110 V., 60 cycle A.C. Fully approved by Underwriters' Laboratories. Only \$9.95 at barber and beauty shops, and drug, department, hardware and electric appliance stores. If your dealer cannot supply you, order direct from factory. Send check or money order. Money back if not delighted after 5-day trial.

ELECTRO TOOL CORPORATION

DEPT. 539-L • RACINE, WISCONSIN



The Original
POCKET HEATERETTE
KEEPS HANDS WARM
NEW, IMPROVED ELEMENT
lights quicker, extra heat

For hunting, skiing or attending football games. Pocket Heaterette keeps hands and body warm in coldest weather. Fits glove or pocket—stays 125 degrees warm for 24 hours on one filling of ordinary lighter fluid—no flame—safe even for children. See your sporting goods dealer or mail coupon with check or money order. Made in U.S.A. Nickle-plated brass in flannel bag—\$3.50 postpaid. New, improved Element to fit old or as extra for new Heaterette 75c.



DAVID T. ABERCROMBIE CO. (Est. 1892)
Dept. PS-11, 97 Chambers St., New York 7, N. Y.
Please send Pocket Heaterettes postpaid.
\$ enclosed. Money refunded if not satisfied.

Name

Address

PRINT YOUR OWN POST CARDS

COMPLETE
OUTFIT
only
\$7.50

Amazing results in sales, inquiries and contacts . . . saves time and money . . . very easy to use GEM STENCIL DUPLICATOR is ideal for Advertising, Announcements, Notices, Labels, Forms, Price Lists—hundreds of uses for every type of business and organization. Comes complete with all supplies, instructions and 60-page Book of Ideas.

FREE TRIAL OFFER: Try it before you buy it! Write and a GEM OUTFIT will be sent you postpaid After 10 days, send only \$7.50 or return the GEM, no questions asked. The GEM must sell itself; you be the judge.

BOND EQUIPMENT CO. • Dept. 151
6633 Enright • St. Louis 5, Mo.

SEND NO MONEY • FREE TRIAL OFFER

MEN'S WRIST WATCH

Ideal Xmas Gift

ONLY
\$5.95

. . . with gleaming, stainless steel Expansion Band. Amazing Value —1 year guarantee. Jeweled, smart chrome case, radium dial-hands; sweep second hand; shock-resistant. Wear with pride or give as a gift. Send \$5.95, plus 10% Federal Tax, postpaid. Or order C.O.D. plus postage. Satisfaction guaranteed.

Leather or stainless steel expansion free of extra cost



FREE Extra BAND

MUDIAL WATCH HOUSE 330 South Wells Street
Dept. BB, Chicago 6, Ill.

35 in. long—The JIM DANDY looks like the real thing! Weighs 14 ounces.
THE THRILL OF FIRING A REAL GUN without the DANGERS of SHOT or SHELLS

Shoots 6-inch rubber bands up to 50 feet! Real trigger action! 3 bands included; make more from inner tubes. Cash orders prepaid; C.O.D.'s plus postage. Order now!

ONLY
\$2

J-D MFG. Co. Dept. S9, 1408 W. 9th St., Kansas City 7, Mo.

LAWN ORNAMENT-NOVELTY PATTERNS

28 Lawn Ornament Patterns, 25c. Other patterns: 15-20" high; Dutch Girl, Dutch Boy, Pirate, Bull Terrier, Mexican Girl, Mexican Boy, Dwarf, Penguin, Flower Girl, 10c each. 25 Novelty Patterns, 30c. All 62 Full Size Patterns, \$1.00 Postpaid.

FLYING DUCK

Wind revolves wings. Realistic appearance. Pattern, Instructions and wing Pinion Kit; brass bearing, steel shaft, wing lugs, bolts, nuts and washers. 50c. Pattern and Instructions without kit. 25c. Postpaid.



Dept. 7-BC Box 128 Belington, W. Va.

MODERN LAWN MOWER SHARPENER

FOR LAWN MOWER SHOPS
FIX-IT SHOPS
GOLF COURSES • PARKS
101 OTHER JOBS

Sharpens All Reel Type Mowers • Hand, Power or Gang • 10 to 20 Minutes • No Dismantling • No Extra Attachments Needed.

All reel type mowers, from 5-inch edgers to 36-inch power mowers, are quickly sharpened to extreme ends of both left and right twist blades.

Handle, wheels, roller and motor remain in place when sharpening is in process. Bed knife is sharpened in same brackets. Grinding head rides on five ball bearing races. Easy to operate. Also sharpens chisels, joiner knives, planer blades. Big profit maker. Own your own business. Send Today for **FREE Illustrated Bulletin No. 11-C1**

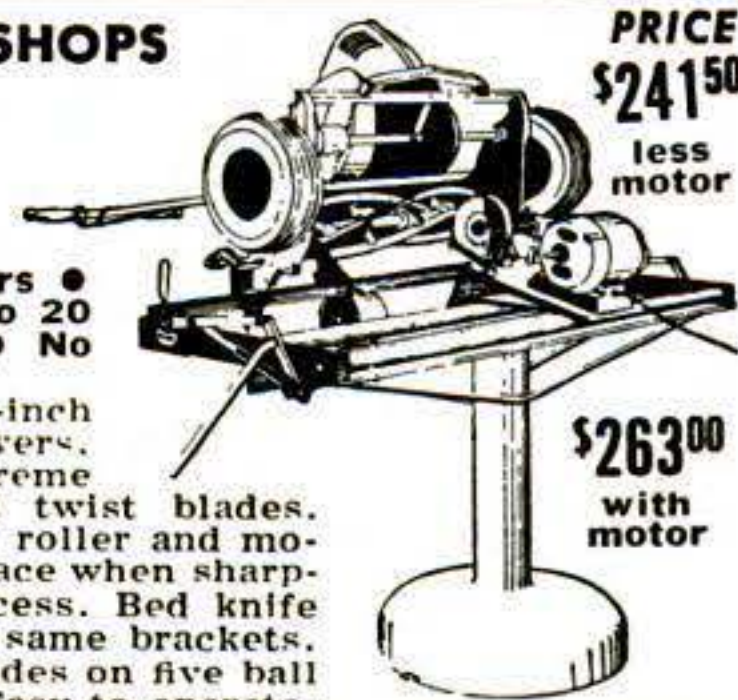

PRICE
\$241⁵⁰
less motor

\$263⁰⁰
with motor

ORDER NOW

Immediate Delivery

MODERN MFG. CO. 160 N. FAIR OAKS AVE
PASADENA 1, CALIFORNIA

BRIKCRETE



**Local Manufacturing
of this Modern Masonry
Has High Earning Power**

Several hundred territories are being opened up for local Brikcrete manufacture by men of vision and aggressiveness. Brikcrete ties in with today's huge building program. Makes possible better construction at lower cost. Truly better than brick; actually cheaper than lumber. Combines strength, safety, insulation value, colorful beauty that fits today's styling.

Brikcrete is made in locally owned plants, using local materials and local labor. That's why high quality and low price still permit a 100% to 150% mark-up. We supply complete equipment; easy terms if required. Generous cooperation. Exclusive manufacturing privileges in protected territory. Write for information.
Brikcrete Associates, Inc.
4675 Division Avenue South
Grand Rapids 8, Mich.



MAKE BIG MONEY!

Be a floor surfacing contractor and sand both new and old floors. Sanders are easy to operate and better still, you're your own boss. Write for latest "tell-all" booklet entitled "Opportunities In Floor Surfacing" enclosing 25 cents in coin or stamps to cover handling.



AMERICAN

FLOOR SURFACING MACHINE CO.
532 So. St. Clair Street • Toledo 3, Ohio



BARBELLS

Finest Quality \$8.98 up
FREE CATALOG

Send today for big new 4 color fully illustrated free catalog of BARBELLS, Dumbbells and Health equipment. Free—world famous \$15.00 Dan Lurie Barbell and Dumbbell training courses with every purchase.

DAN LURIE BARBELL CO.

Dept. 170-L, 1729-S11 Rockaway Parkway, Brooklyn 12, N.Y.



**Bargain BRAND NEW
7 POWER PRISM
BINOCULARS**

An unbeatable value in 7 x 50 precision made glasses. Field of view 375 yards at 1,000 yards. Made in occupied Japan. Complete with plush lined leather case. Reg. value \$100.00.

- Special \$41.80*
- 8 x 40 Binoculars, reg. \$90.00, Special \$44.50*
- 8 x 26 Binoculars—Excellent for yachting, sports, etc. With leather case and strap. Easily worth \$75.00. A sensational value at \$27.50*

*Plus 20% Fed. Tax

Satisfaction Guaranteed or Your Money Back. Write For Free Bargain Booklet



**50th
YEAR
1899-1949**

CENTRAL CAMERA CO.

230 S. Wabash Ave., Dept 48, Chicago, Ill.

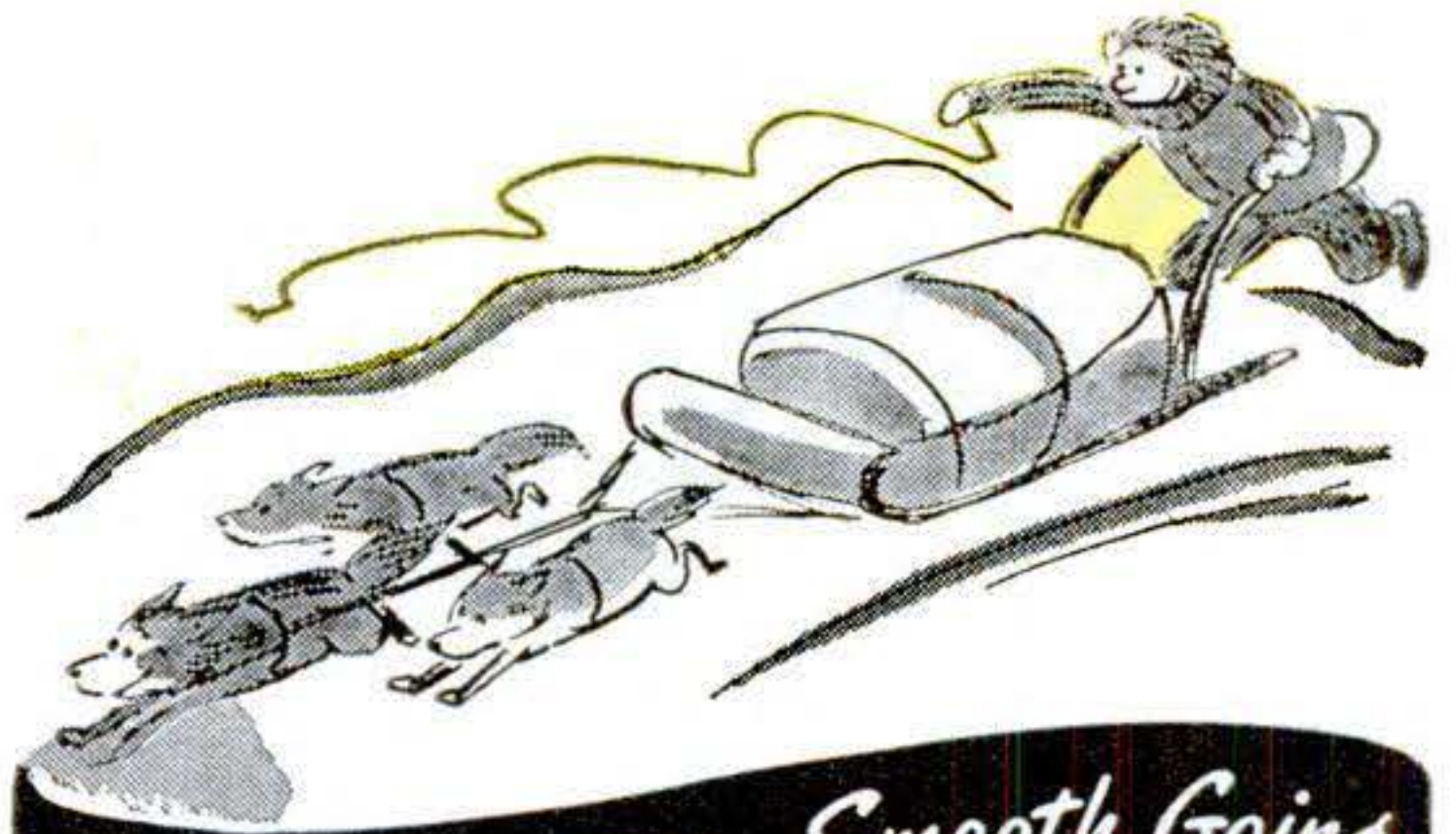

Quick Starting.. Smooth Going



With a CASITE Winter TREATMENT

A PINT IN THE CRANKCASE

**A PINT THROUGH
THE AIR INTAKE**



Quick starts everytime, smooth going all the time—that's what you get with a CASITE TREATMENT.

Casite in the crankcase retards congealing of oil . . . lets your motor spin over and go . . . no matter how cold the weather. It cuts dangerous start-up wear, cuts repair bills, too.

Casite through the air intake conditions your car for winter . . . frees sticky valves and rings . . . keeps the engine clean and free-running.

Get a CASITE TREATMENT today—from any garage, service station or car dealer.

THE CASITE CORPORATION • HASTINGS, MICH.
Casite Division, Hastings Ltd., Toronto

**QUICK STARTING—SMOOTH GOING
or Double-Your-Money-Back**

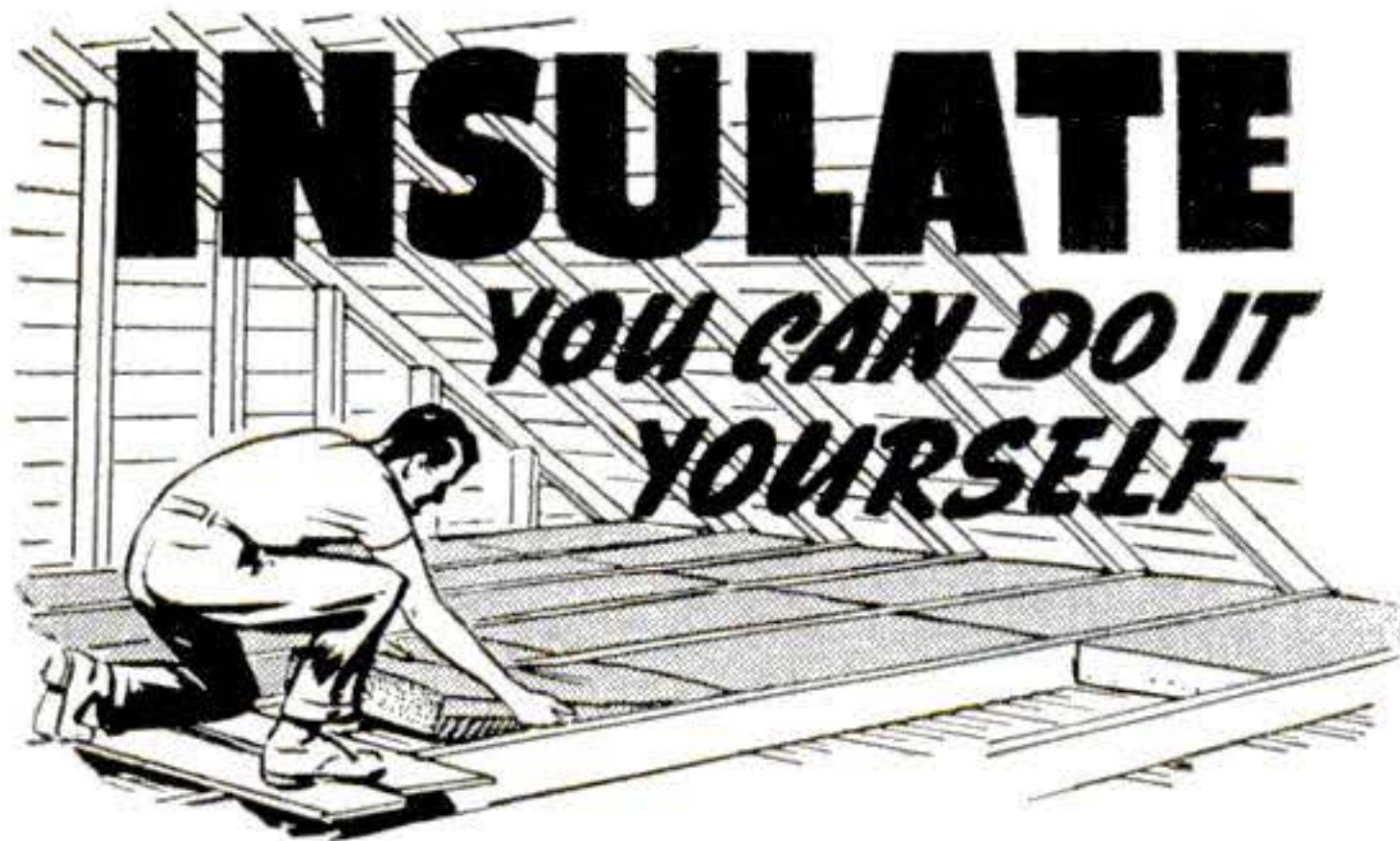

YES, you can insulate your home easily, quickly, and at low cost with Gold Bond Rock Wool Insulation. Light, easy-to-handle batts slide right in between attic floor joists or between rafters. Fireproof! Keeps homes warmer in winter, cooler in summer; pays for itself in fuel savings. For full benefits order "full-thick" Gold Bond Rock Wool Batts from your local Gold Bond Lumber and Building Supply Dealer today!

FREE BOOK OF SUGGESTIONS



NATIONAL GYPSUM COMPANY,
Dept. J -7, Buffalo 2, New York

Gentlemen: Send free copy of new Book-let, "Live Better for less!" showing full details on the benefits of insulation.

Name

Street

City State

(Please print name and address)

9 BIG BUILDING BOOKS

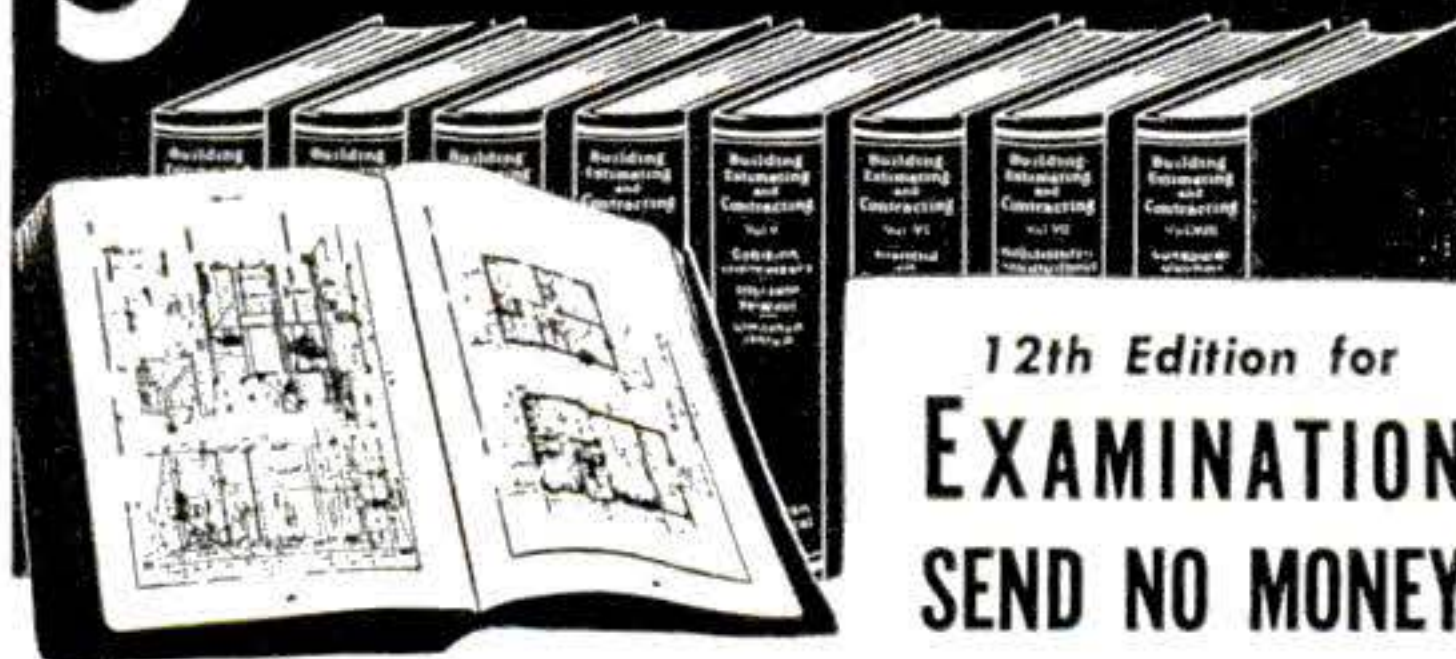

12th Edition for
EXAMINATION
SEND NO MONEY

Learn to draw plans, estimate, be a live-wire builder, do remodeling, contracting. These 9 practical, profusely illustrated books cover subjects that will help you to get more work and make more money. Masonry, concrete forms, carpentry, steel square, roof framing, construction, plumbing, heating, painting, decorating and many other subjects. More than 4000 pages—2750 illustrations.

BETTER JOBS—BETTER PAY UP-TO-DATE EDITION

A nationwide building boom is in full swing and trained men are needed. Big opportunities are always open for MEN WHO KNOW HOW. These books supply quick, easily understood training and handy, permanent reference information that helps solve building problems.

These books are the most up-to-date and complete we have ever published on these many subjects.

Coupon Brings Nine Big Books For Examination

AMERICAN TECHNICAL SOCIETY — Publishers since 1898
Dept. G8-20 Drexel at 58th Street Chicago 37, Ill.

You may ship me the Up-to-Date edition of your nine big books, "Building, Estimating and Contracting," without any obligation to buy. I will pay the delivery charges only, and if fully satisfied in ten days, I will send you \$2.00, and after that only \$3.00 a month, until the total price of only \$34.80 is paid. I am not obligated in any way unless I keep the books.

Name

Address

City State

Please attach a letter stating your age, occupation, employer's name and address, and name and address of at least one business man as a reference. Men in service, also please give home address.

FINE TOOLS NEED FINE OIL!



• Lubricates

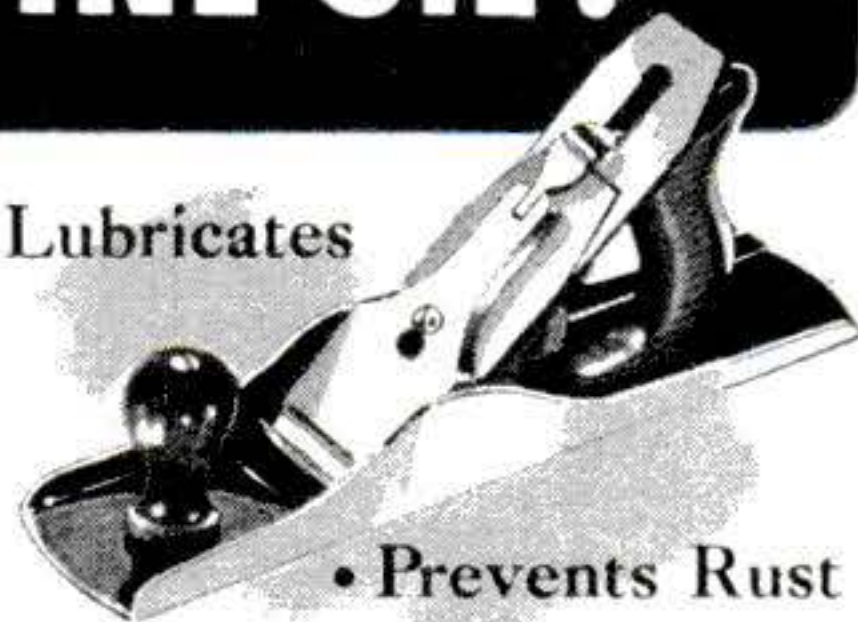

• Prevents Rust

• Cleans • Polishes

SOLD EVERYWHERE

3-IN-ONE Oil

KIDNEYS MUST REMOVE EXCESS ACIDS

Help 15 Miles of Kidney Tubes
Flush Out Poisonous Waste

When disorder of kidney function permits poisonous matter to remain in your blood, it may cause nagging backache, rheumatic pains, leg pains, loss of pep and energy, getting up nights, swelling, puffiness under the eyes, headaches and dizziness. Frequent or scanty passages with smarting and burning sometimes shows there is something wrong with your kidneys or bladder.

Don't wait! Ask your druggist for Doan's Pills, a stimulant diuretic, used successfully by millions for over 50 years. Doan's give happy relief and will help the 15 miles of kidney tubes flush out poisonous waste from your blood. Get Doan's Pills.



GEIGER COUNTERS TREASURE DETECTORS

Sensational new low cost detectors. Light weight, portable, highly sensitive. Low operating cost. None finer REGARDLESS OF COST.

Write TODAY for FREE literature.

The DETECTRON Company
5637 Cahuenga Drive, North Hollywood, Calif.

Learn SCIENTIFIC CRIMINOLOGY

Become a finger print expert, detective or investigator (civil or criminal). Luke S. May internationally famous criminologist, known as the "American Sherlock Holmes" will train you at home in spare time for a well paid position as a Scientific Criminologist. For complete information FREE write today to:

INSTITUTE OF SCIENTIFIC CRIMINOLOGY

521 N. La Cienega

Los Angeles 36, Calif.

WALL MODEL



TELEPHONES

We can meet any inter-communication telephone requirement.

Telephone set, 2 \$1795

of either model

Complete with batteries,

wire, etc. Telephone

supplies and parts of

every description. 25% deposit with order.

balance C.O.D., F.O.B. Brooklyn.

INQUIRIES WELCOMED

DESK MODEL



EASTERN TELEPHONE CO. Dept. PS-8 320 18th St. Brooklyn, 15, N. Y. South 8-6161



BRONZED
Baby Shoe
MOUNTINGS

NEW!

ORIGINAL DESIGNS to boost your baby shoe business. Completely new presentation of beautifully styled, superbly finished and heavily weighted bases.

BOOKENDS • ASHTRAYS • PHOTOFRAMES
"THEY SELL ON SIGHT"

These are just what you need to enhance the beauty of the shoes you bronze and to build your volume.

WRITE TODAY FOR
ILLUSTRATIONS AND PRICE LIST

Dorothy Lane, Inc.
VALLEY STREAM, N. Y.

SHORTHAND in
6 Weeks at Home

Famous Speedwriting system. No signs; no symbols; no machines; uses ABC's. Easy to learn; easy to write and transcribe. Low cost. 100,000 taught by mail. For business and Civil Service. Also typing. 26th year. Write for free booklet to:

Speedwriting
Dept. 2611-9, 55 W. 42 St., New York 18 (R)

Giffy **ELECTRIC HEATER** 

HOT WATER IN FIVE MINUTES

For baby's bath, your washing, shaving and many other uses in the home, camping, business or on the farm.

One Year Guarantee
See your local Dealer or order direct . . .

AMBORY CORPORATION
Dept. VE-5 Hazel Park, Michigan

ONLY \$6.50

MAKE YOUR OWN!
WITH

Griffin READYCUT LEATHER PROJECTS

Over 100 KITS in every kind of Tooling and Carving Leather, accurately cut, all parts included. Only Top Grade Leathers used. You do the choosing. You do the tooling, carving, stamping, the punching and assembling.

SEND FOR COMPLETE CATALOG
Please send 10c to cover mailing.

EVERYTHING FOR THE LEATHER WORKER
Largest, most complete stock of Leathercraft Tools and Accessories in U. S. A.

HIDES AND SKINS of Craft Leathers of every kind if you prefer to cut your own.

Griffin Craft Supplies
SINCE 1924
OUT OF THE WEST, THE HOME OF LEATHER CARVING
5626-B GROVE STREET
OAKLAND 9, CALIFORNIA

FREE

get it now—

ALLIED'S NEW 1950 RADIO CATALOG!

196 PAGES OF BIG VALUES

EVERYTHING IN RADIO AT LOWEST PRICES



TELEVISION AND HOME RADIOS



SERVICE SUPPLIES BUILDERS' SUPPLIES



AMATEUR GEAR



AMPLIFIERS, P.A. SYSTEMS, RECORDERS

Send for
Radio's Leading Buying Guide

Save money on every radio need! Get the new 196-page 1950 ALLIED Catalog, preferred and used by everyone in radio. See the world's largest stocks of top-quality equipment, all at low, money-saving prices! Latest TV releases, home radios and radio-phonos, Amateur equipment, PA systems and High-Fidelity Sound, recorders, test instruments, builders' kits—plus thousands of parts, tubes, tools, books and diagrams. Have all the advantages of quick delivery, complete selections, big savings and expert personal help from the World's Largest Radio Supply House. Send today for your FREE copy of the 1950 ALLIED Radio Buying Guide!

ALLIED RADIO

ALLIED RADIO CORP.
833 W. Jackson Blvd., Dept. 7-L-9
Chicago 7, Illinois



Rush FREE 1950 ALLIED Catalog

Name

Address

City.....Zone.....State

Make 100% to 150% Profit!

MANUFACTURE BUILDING BLOCKS

In Your Own Back Yard

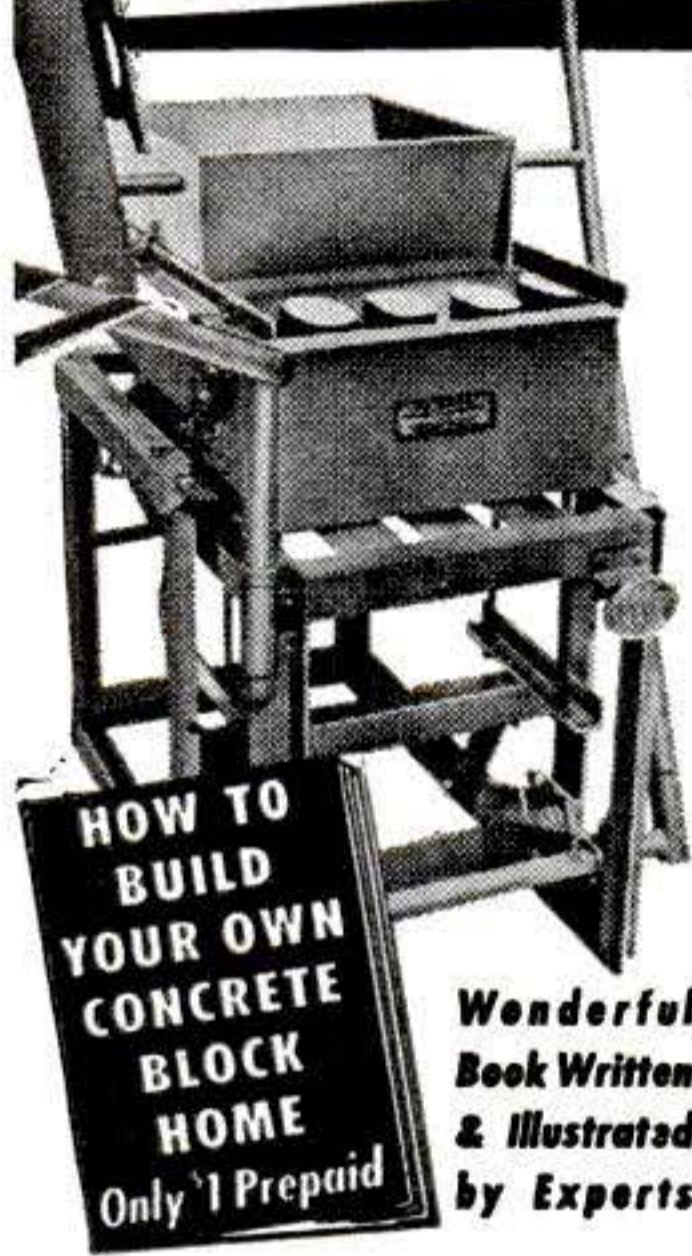

AMAZING GENERAL BLOCK MACHINE
CAPACITY 1000 BLOCKS PER DAY
Only \$199 LESS MOTOR F.O.B. PLANT
SHIPPING WEIGHT 400 lbs.

Here is an outstanding opportunity for men of vision and small capital. Cinder and concrete blocks are in great demand. Millions used for homes, factories, public buildings. Sell all you produce at 100% to 150% mark-up.

PEAK BUILDING DEMAND!

The General Block Machine is amazingly practical, foolproof. Simple to operate indoors or outdoors. Rugged all steel construction. Vibrator mounted in sealed ball bearings. Produces up to 1,000 blocks per day. Superior 3 Core Type that meets all building code requirements. Can produce 4 x 8 x 16, 8 x 8 x 16, 12 x 8 x 16 blocks. All materials obtainable anywhere. All operating instructions and mixing formulas supplied. Full details FREE without obligation.

Wonderful Book Written & Illustrated by Experts

HOW TO BUILD YOUR OWN CONCRETE BLOCK HOME Only 1 Prepaid

GENERAL ENGINES CO.

DEPT. S-2 • DREXEL BLDG. • PHILADELPHIA 6, PA.

Includes floor plans for 6 beautiful, easy to build concrete block bungalows. Shows ways to save money. How to lay blocks, lay out building lines, mix concrete, build steps, porches and concrete floors. Mail coupon at once with \$1.

Name.....
Address.....
City.....Zone...State.....



DO EVERY JOB
better-faster-cheaper-
WITH
COMPRESSED AIR

Paint Buildings, boats, tractors, trucks; refinish furniture and fenders; inflate tires; grease and lubricate motors, engines, implements. Destroy weeds. Rid livestock, poultry and pens of pests with portable air power.

Free Literature explains relative advantages of 4-cylinder **PRESSURE QUEEN** and single-cylinder **PRESSURE PRINCESS** spray painting outfits. Tells how to save material, time and money by using the proper outfit at the right price.

It Is Yours For The Asking
Write Today

THE CAMPBELL-HAUSFELD CO.
151 RAILROAD AVE. HARRISON, O.

ELECTRIFY YOUR OLD TREADLE SEWING MACHINE

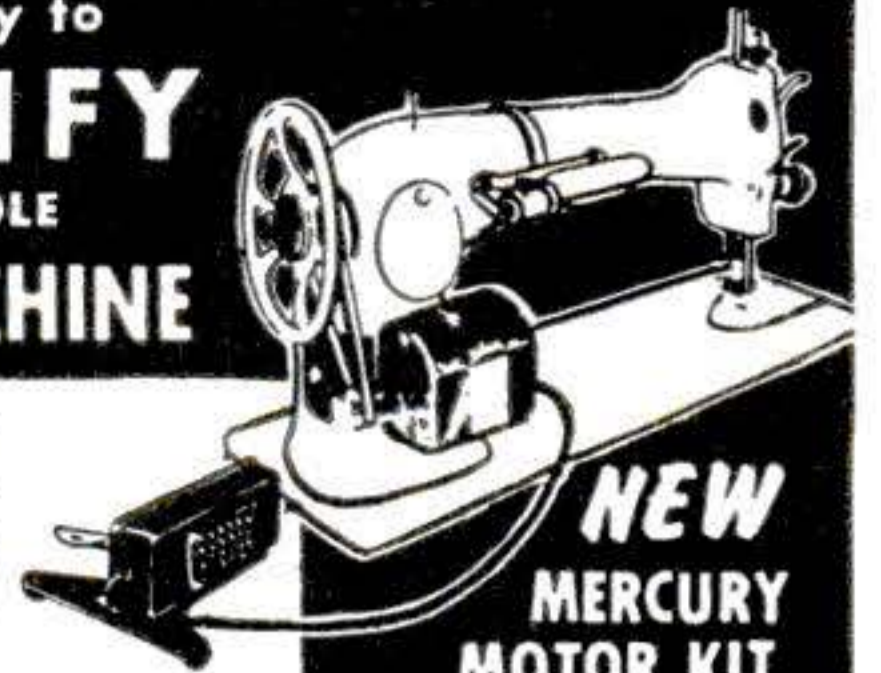

CONVERTS ANY MACHINE, no matter how old. Makes it a modern electric sew machine.

READY TO ATTACH. Even a child can do it! All parts wired and connected! Anyone can attach it in a few minutes!

GUARANTEED FOR 1 YEAR! KIT INCLUDES: AC-DC Mercury Motor, Speed Control Rheostat, Non-glare deluxe sew light, 3 rubber belts, steel pulley, two mounting brackets, cord set with plug and socket, instruction sheet.

FREE TRIAL OFFER - If not satisfied, return kit in 10 days for full refund.

Order by mail. Postpaid except on C.O.D.'s
MORSE SEWING MACHINE & SUPPLY CORP.
Dept. L 40 W. 27th St., New York, N. Y.

NEW MERCURY MOTOR KIT
\$14⁹⁵

Complete with Lamp. Saves you cost of new machine!



Treasure and Mineral LOCATORS GEIGER-COUNTERS

FOR URANIUM-ORES
CREDIT PLAN—FREE LITERATURE
FISHER RESEARCH LABORATORY Inc.,
Palo Alto, Calif.



SHIP MODEL MAKING

New book shows how to make any model. Shows the short cuts, kinks, time-saving methods of experts. Complete plans for gorgeous galleon, clipper ship, etc. Almost 100 illustrations. Full cloth bound \$2.00. Popular Science Monthly, Dept. 119, 353 Fourth Ave., New York 10, N. Y.

RUPTURE!

An amazing Air-Cushion Invention allows body freedom at work or play. Light, neat, cool, sanitary. Durable, cheap. Day and night protection helps Nature support weakened muscles gently but surely. No risk. **Sent on Trial!** Write NOW for free Booklet and Proof of Results. All correspondence confidential.
Brooks Company, 163-G State St., Marshall, Mich.



AMAZING CALENDAR WATCH

Tells minute, hour & day of month

Most intelligent watch we ever saw; a triumph of Swiss craftsmanship. Gives exact minute and hour; then tells you what day of the month it is. So good, that a printed 1-year guarantee is included. Glow-at-night dial; timed and tested movement; leather strap. In presentation box. **Send no money—10 day trial** Pay postman \$9.95, plus tax and C.O.D. postage (or send check for \$10.94 and we pay postage). Wear 10 days; return if not delighted.

SWISS WATCH DISTRIBUTORS
Dept. S-11, Sandy Springs, Georgia

ONLY \$9⁹⁵ plus 99c tax



CUTS YOUR BLADE COST 75%

Make every shave a new blade shave... easier... more comfortable.

Get an **INGERSOLL STROPPER**. It hones and strops each blade to a barber's edge. Better shaves at 75% less.



Easy to use. Full instructions come with each Stropper. For any type of blade.

\$1.25 Postpaid

If your dealer can't supply you, order direct—give make of your blade. No C.O.D.'s

INGERSOLL STROPPER

DURHAM ENDERS RAZOR CORP.
MYSTIC, CONN.

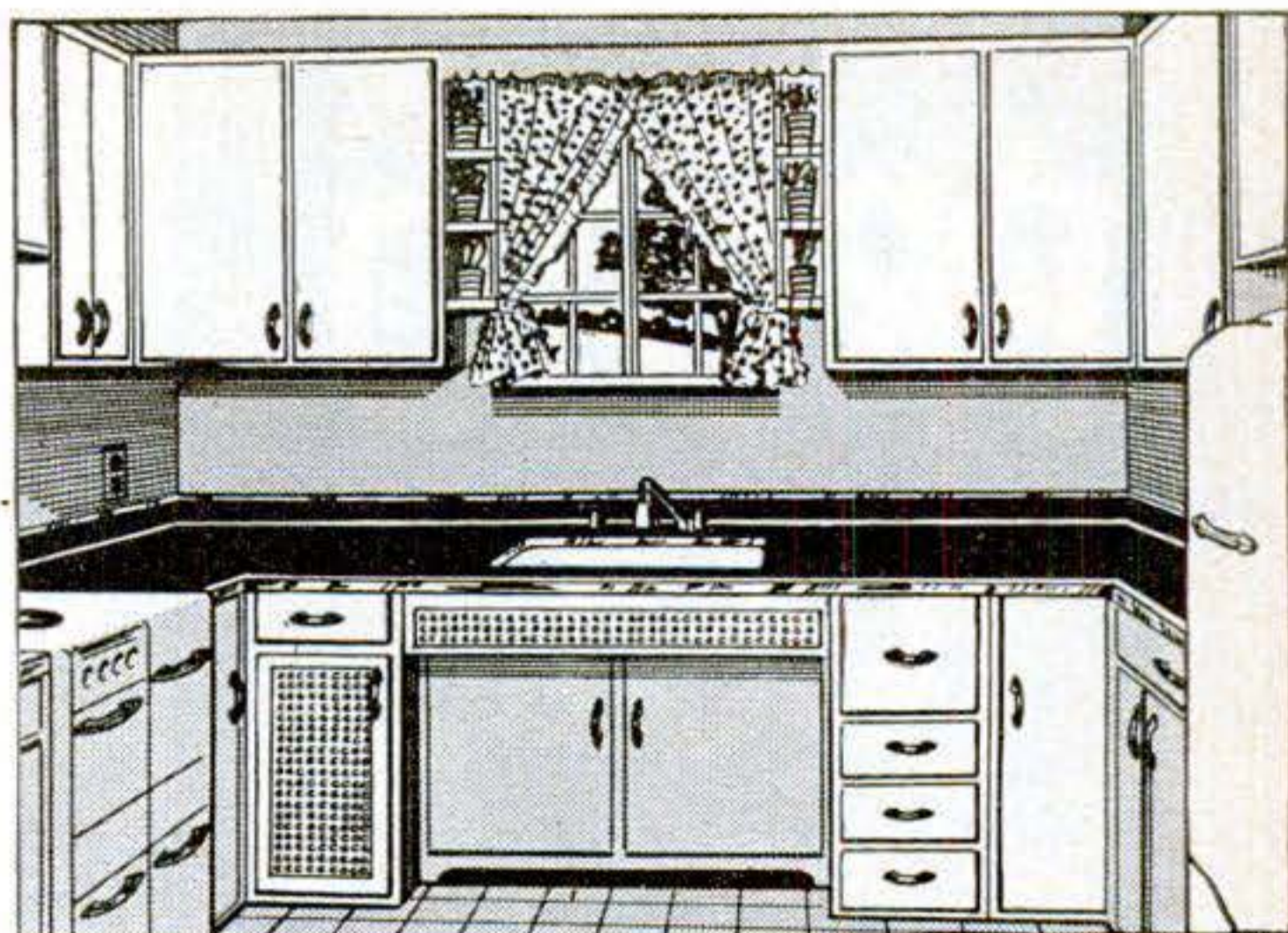

MAKE YOUR KITCHEN MODERN

... this low-cost easy way
... including today's new counter top

To help you modernize your kitchen the easiest possible way—and save up to 75%—we offer the famous Easi-Bild Build It Yourself* patterns for base and wall cabinets.

By this method, we help you discover the miracle counter top: Micarta . . . the plastic surface so smooth, so tough and lustrous, it resists any scratching, denting, or chipping—can't be stained or discolored by boiling fats, alcohol, fruit juices, greases or oil—so beautiful and colorful it's the choice of today's leading architects.

You can buy Micarta at your local lumber yard, already mounted on $\frac{3}{4}$ " waterproof Weldwood plywood. Ask for Micarta panels. They can be sawed, trimmed, planed and drilled by ordinary hand tools.

DO IT YOURSELF... SAVE BIG MONEY

And, to take all the mystery out of building Base and Wall Cabinets for your kitchen, child's room, playroom or bedroom, send for the patterns below. With them you buy only the materials the patterns clearly specify—at your local lumber dealer. You cut each piece exactly as the easy-to-follow, step by step directions indicate, then fasten into the positions shown by the "easy-as-pie" assembly illustrations. No special tools or skill are required.

Over a million Easi-Bild Patterns have been sold because they make your project easy, inexpensive and professionally perfect. Buy them at your lumber or hardware dealer or order them in the coupon below.

*TRADE MARK, Easi-Bild Pattern Company



MICARTA is manufactured by WESTINGHOUSE and sold for decorative purposes only, by UNITED STATES PLYWOOD CORP.



UNITED STATES PLYWOOD CORPORATION
PATTERN DEPT. P.O. Box 215, Pleasantville, N. Y.

Enclosed is \$..... for items checked below.

- Send FREE sample of Micarta
- Kitchen Base and Wall Cabinet Patterns No. 201 at \$1.00
- Service Counter Pattern No. 80 at 60c
- Easi-Bild Pattern Catalogue illustrating over 100 other "Build It Yourself" projects at 20c

Name.....

Address.....

City..... State.....

P.S.M. 11-49

Earn \$280 to \$340 a Month

3,000 R. R. Station Agents Needed Now

Be a R.R. station agent in 4 to 6 months. Important, responsible work—that's why the salary is high, \$280 to \$340 per month or more. Ask your local R.R. agent about this opportunity. Our placement record of qualified men is nearly 100%. We've placed hundreds; railroads want our trainees. A dependable school since 1897; located downtown. Start any Monday. Part-time work available. Get the facts free—write today. BOYLES COLLEGE—Dept. III—18th at Harney—Omaha, Nebr.

APPROVED
FOR
VETERANS



\$\$ EXTRA PROFITS! \$\$ Flocks & Sandblasts

Dual Purpose Spray Gun! Uses only 25 lbs. Air Pressure!

Thousands of uses in Home, Shop, Industry; Makes Auto Interiors Clean & New, Lines drawers, Marproofs lamp bases, Refinishes any object. All in colorful Flock. Etch & Frost windows, glassware, etc. Removes Paint & Rust from Autos, Tools. Guaranteed! Send \$19.75 or write for free information. Flocking supplies.

BLASTO SPRAY GUN MFG.

Dept. S-11, 7007 Haas Ave., Los Angeles 47, Calif.

Only \$19.75 complete

One Swipe of NEW PLASTIC Makes these LEATHER and LEATHERETTE Items LIKE NEW

Get Into A Money Making Business

Make like new, worn, scuffed or faded leather and artificial leather equipment. Either your own to renew, recolor and beautify, or cafe, restaurant and hotel equipment as a business. Single stroke with a brush renews. Does not crack, peel or scuff. Resists acid, alcohol, caustics and weather. All colors. Mail coupon for free sample.

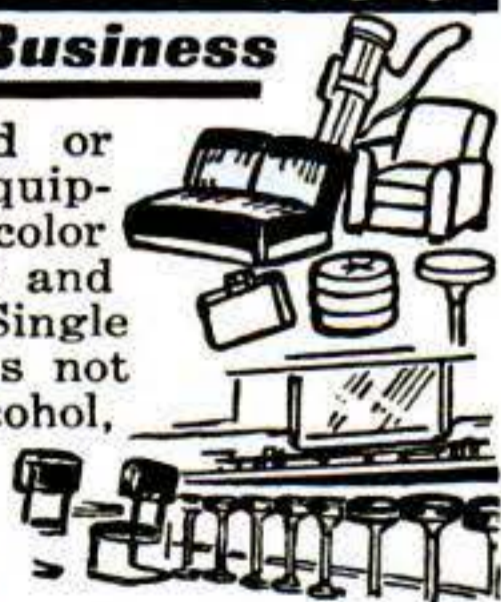

FREE Sample SHOWS EFFECT

\$50 to \$500 Profit On One Job Possible

Let me show you how, as I have shown others. Get your own exclusive territory while available. Mail coupon today, I'll do the rest. — Jack Edwards, Sales Mgr.

LEATHER-NEW PRODUCTS,
6082 Suney Slope, Kansas City, Mo.
Send me without obligation a sample of Leather-New coated material so I can inspect it.

Name.....

Address.....

City..... State.....

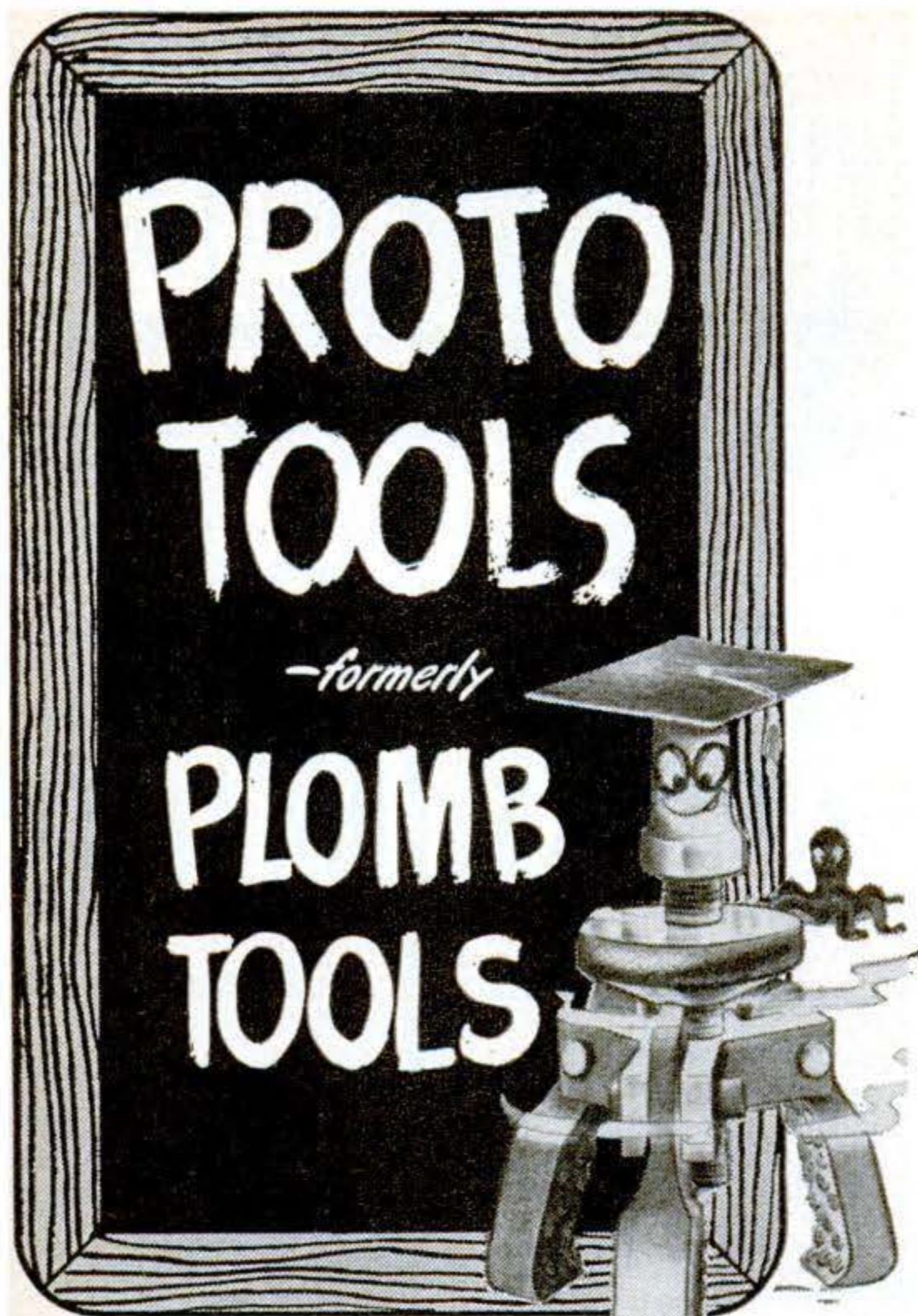

NOW!

**a different name for
your old friends!**

In PROTO tools—formerly Plomb tools—you get just what the name means, PROfessional TOols. They have the designs, special steels, scientific heat treating and over-all quality that have made them professionals' favorites for 42 years. Buy the best! Buy PROTO from your dealer now.

Write for catalog to

PLOMB TOOL COMPANY

2257-P Santa Fe Ave., Los Angeles 54, Calif.

4987



***I'd like
to see them
make...***

Everybody has his own pet idea of some gadget he would like to see in general use. What is YOURS? Popular Science will pay \$5.00 for each one published. Use government postcards only. Contributions cannot be acknowledged or returned.

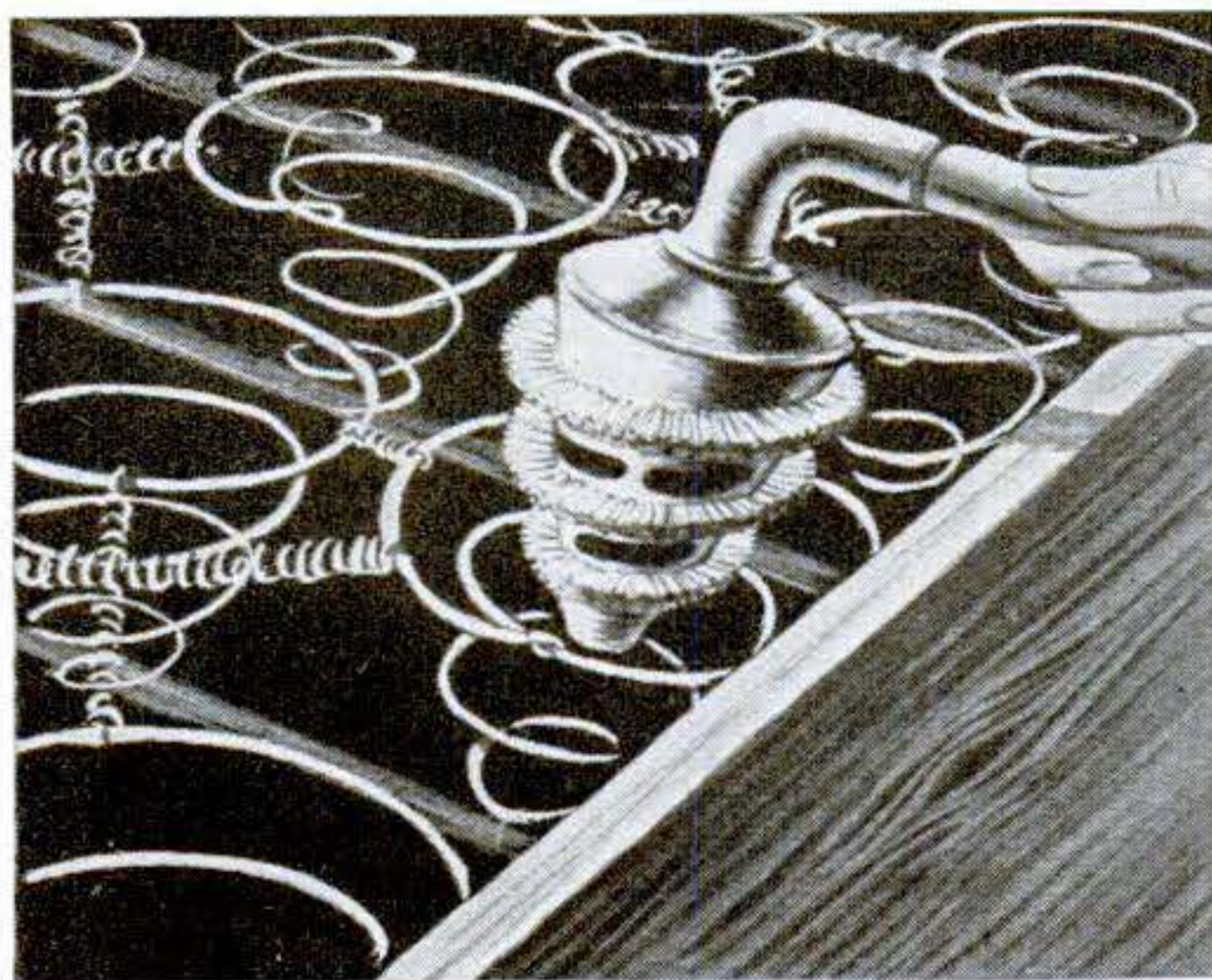

Vacuum brushes for bedsprings. A vacuum-cleaner attachment similar to a dusting brush, but cone shaped, would fit down into coil springs to suck the dust and lint out.—Mrs. Fred Heinrich, Rush City, Minn.



Guards on ice picks. These could be metal or plastic. Then when I'm chipping ice and the pick slips, I wouldn't scuff my knuckles on the ice.—Mrs. J. M. Huffman, Phoenix, Ariz.

Can you answer these 6 questions about the 3 leading low-priced cars?



..Which car has the highest compression ratio for greater engine performance and economy?



..Which car has the famous Air Pillow Ride for your greater comfort?



..Which car has Safety-Rim Wheels for your added protection in the event of a tire blowout?



..Which car has Automatic Ignition-Key Starting for your greater convenience?



..Which car has Floating Power for smoother engine performance and longer car life?



..Which car has Automatic Electric Choke for quicker warm-up, more economical use of gas?

You said it!

THE ANSWERS ARE ALL THE SAME —

PLYMOUTH

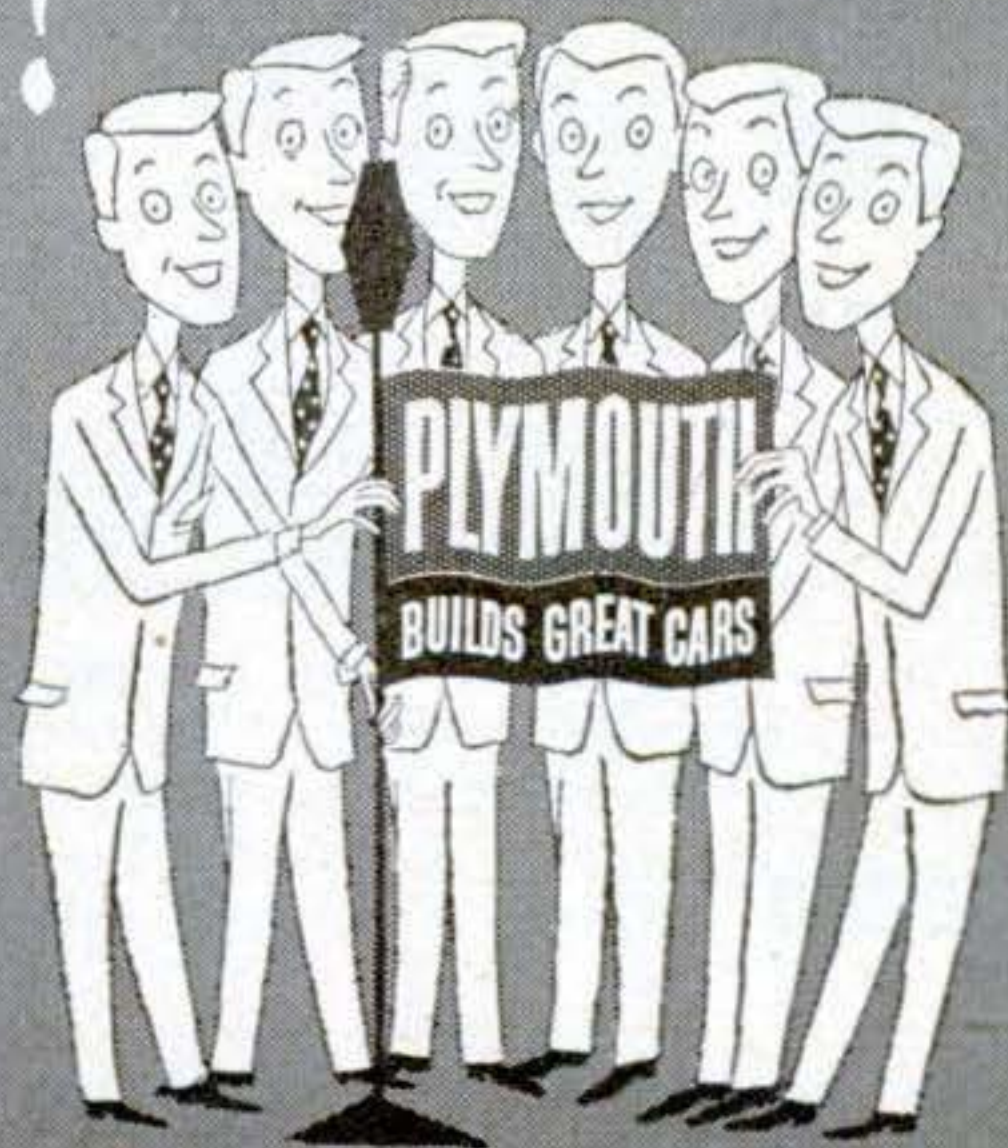

the car that likes to be compared

4 Keys to SUCCESS IN AVIATION

Through **Embry Riddle** Training

1 AIRCRAFT & ENGINE MECHANICS

1



We have hundreds of urgent requests for A. & E. Mechanics -- key men in Aviation -- from airlines, oil companies, fixed base operators, etc., both U. S. and Overseas. Training in a C. A. A. approved school is the quickest way to get ahead. Embry-Riddle students learn fast with modern equipment . . . working on live aircraft in airline-size hangars.

2 ENGINEERING

2



Embry-Riddle's Design Engineering and Maintenance course offers you eligibility for A. & E. certification plus necessary basic engineering knowledge required to fill positions such as Maintenance Foreman or Field Service, Project or Sales Engineer. If your aim is high, take this course.

A.&E. COMBINED WITH COMMERCIAL

3

Pilot Mechanics who can test fly the ships they repair . . . executive pilots able to service their own aircraft -- airmen with dual ability are needed by aviation companies and operators. Embry-Riddle combination training offers you the most in your aviation career.



COMMERCIAL PILOTS

4

Flying holds a real future for Embry-Riddle trained pilots. A quarter-century of experience with 30,000 students . . . the best instructors, up-to-date aircraft, superb year-'round flying weather . . . qualifications unexcelled anywhere. Instrument and instructor's ratings are also available.



Aviation needs you now! Never has there been such opportunity for you in Aviation. Start your career now at Embry-Riddle -- living facilities directly on the Airport. Write today for full information and proof of job opportunities.

LIMITED NUMBER OF VETERANS ACCEPTED

Dean of Enrollments - Dept. 91
Embry-Riddle School of Aviation
Miami 30, Florida

Please Print

NAME _____

ADDRESS _____

City _____

State _____ Age _____

I am interested in . . .

- A.&E. Mechanic
- Commercial Pilot
- Engineering
- A.&E. Combined with Commercial Pilot
- Flying Mechanic
- Drafting & Design

Check One Veteran Non-Veteran

TRAIN IN MIAMI -- AIR CAPITAL OF THE WORLD

I'd like to see them make . . .

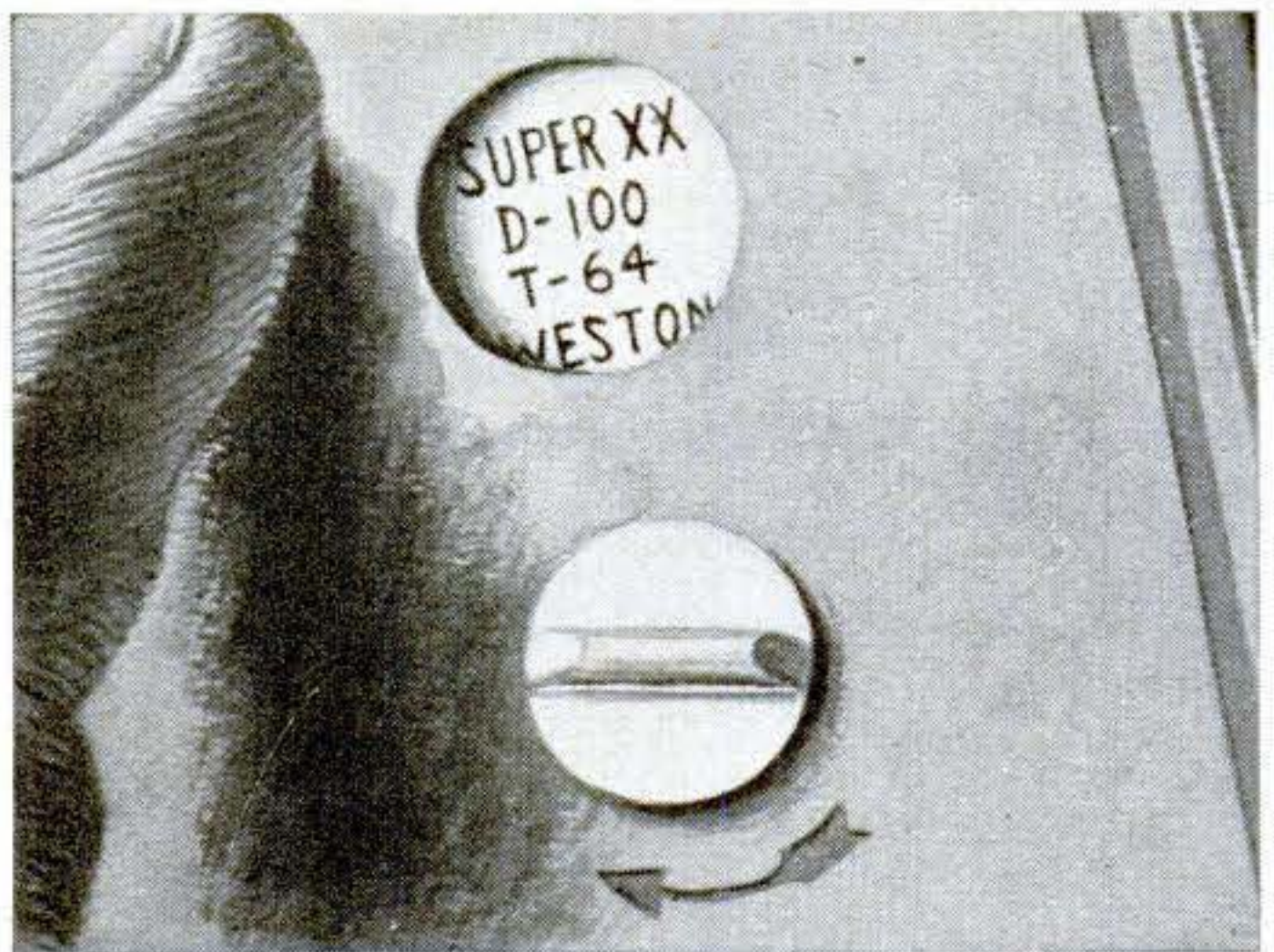

Identification marks on roll film. You'd always have pertinent information at your finger tips if the film type and speeds were printed on the paper leader between the frame numbers. —Roger M. Johnston, Glendale, Calif.

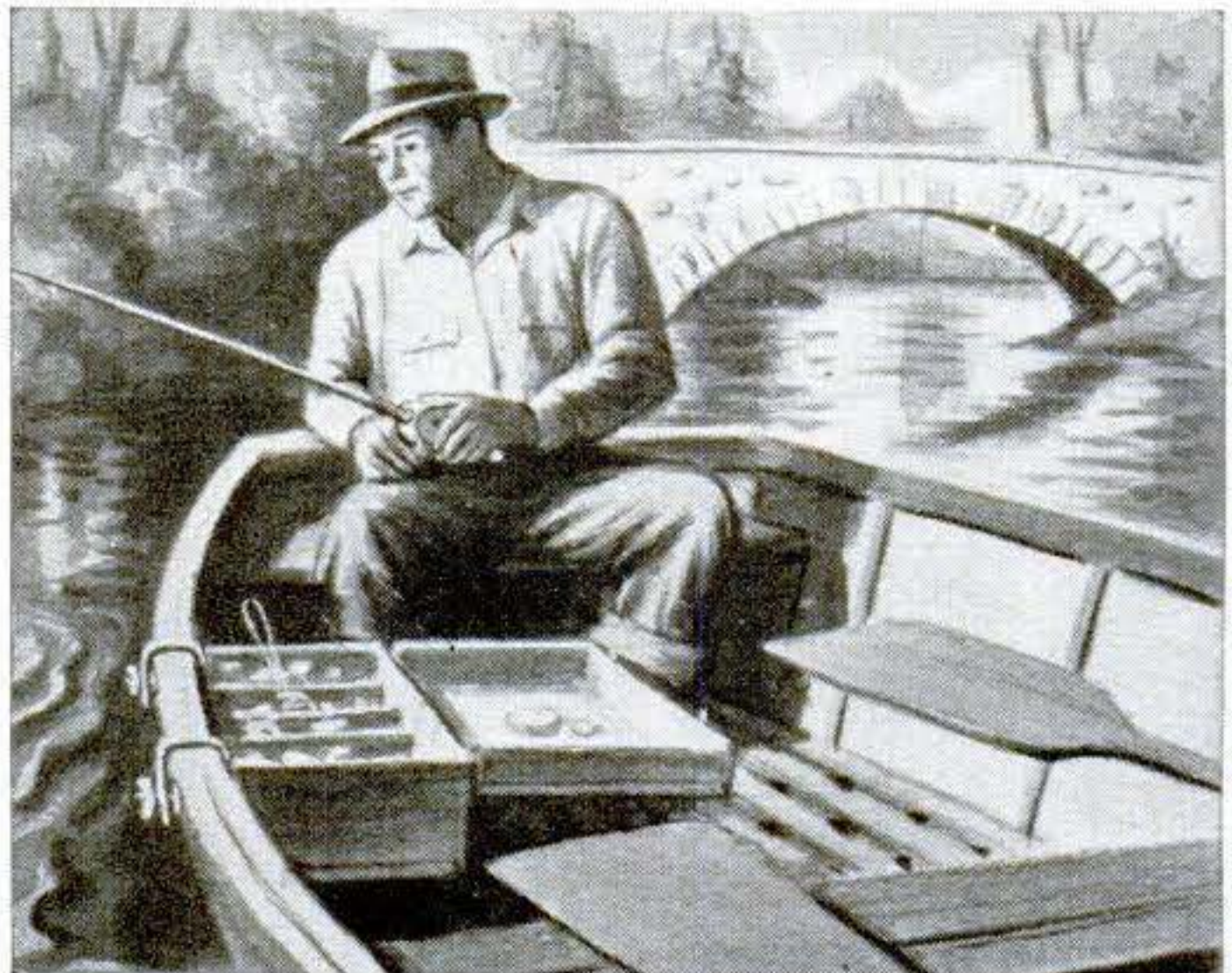

Tackle boxes with screw clamps. Then the box could be clamped to the gunwale. It would be easier to reach and there would be little chance it would be accidentally upset. —Charles Woods, Cambridge, Iowa.

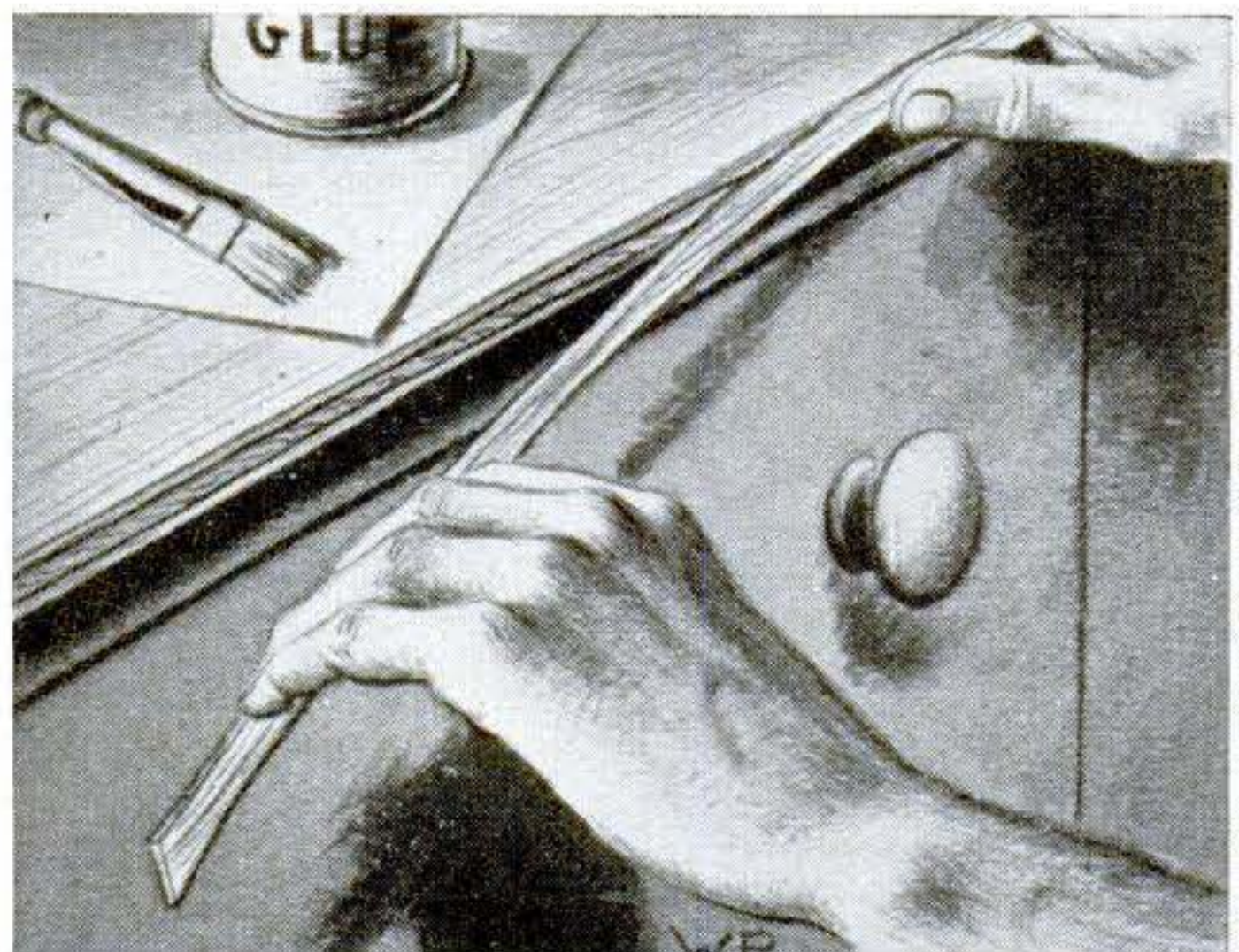

Wood edging for plywood. Finishing plywood edges would be a cinch if you could buy flexible wooden strips. Widths could be the same as plywood thicknesses. The strips would be glued in place. —Mrs. L. A. Boyer, Bremerton, Wash.

AMAZING NEW LOW-PRICED ELECTRIC SPRAYER

makes painting **EASY!**

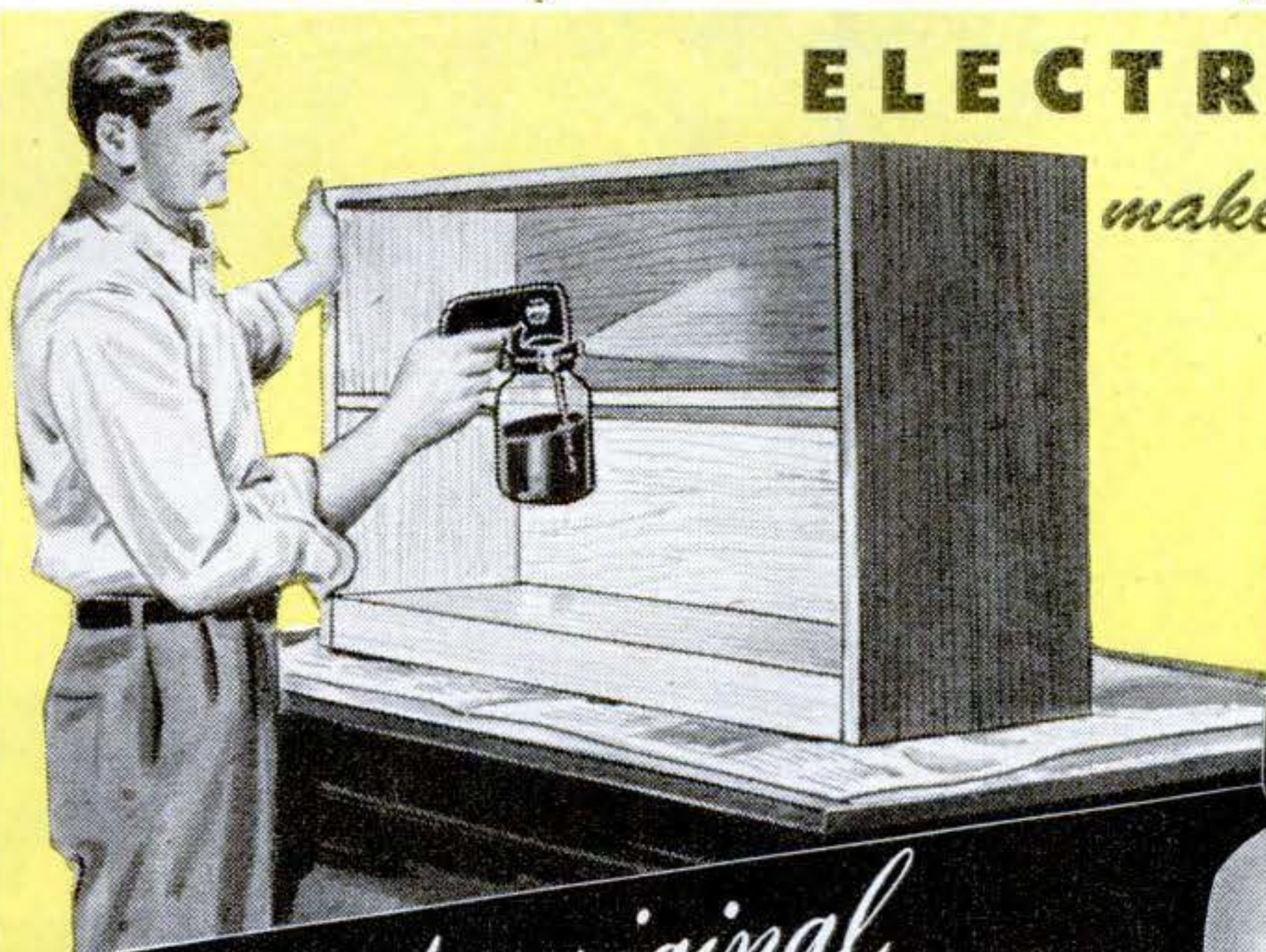

the original
BURGESS
vibro-sprayer

NO MOTOR... NO COMPRESSOR...
NO "EXTRAS" TO BUY

Unique **BURGESS**
vibro-tool
adds **POWER**
to hand skills!



This revolutionary marking tool delivers 7200 vertical strokes per minute to write like a pencil on hardest steel, mark tools, decorate glass, engrave plastics, tool leather, chisel wood or linoleum blocks, emboss metal foil, cut balsa wood, cork and cardboard. Specially designed kits for general use, leather tooling, and simple marking and engraving. All-purpose Master Craft Kit with 9 attachments shown, only... **\$9.95**
Leather Craft Kit plus 9 attachments... **\$9.95**
Marking Kit including Vibro-Tool and hard tantalum carbide point... **\$7.50**
3 different kits... each packed in sturdy, attractive storage case

Just Plug In and Spray!

Easy, economical paint spraying is now as convenient as your nearest electrical outlet. Just plug the sensational Burgess Vibro-Sprayer into any 110 volt A.C. socket, press the trigger and spray. You get a beautiful, smooth finish on tables, chairs, bookcases, toys, fences, screens, floors...almost anything around the home or shop... in minutes instead of hours. Refinishes car bodies and fenders, too. And Vibro-Sprayer handles enamel, lacquer, varnish, shellac...plus light oils, insecticides.) Weighs only 2½ lbs. Comes complete with 25 oz. Mason-type jar and 8 ft. cord. Fully guaranteed.

Write for **FREE Literature**



BURGESS BATTERY COMPANY, Handicraft Division
166 RAND ROAD, LAKE ZURICH, ILLINOIS

Please send me full information on: Vibro-Sprayer,
 Master Craft Kit, Leather Craft Kit, Vibro-Tool and Point.

My Name _____

Street Address _____

City _____

Zone _____

State _____

BURGESS BATTERY COMPANY HANDICRAFT DIVISION
LAKE ZURICH, ILLINOIS

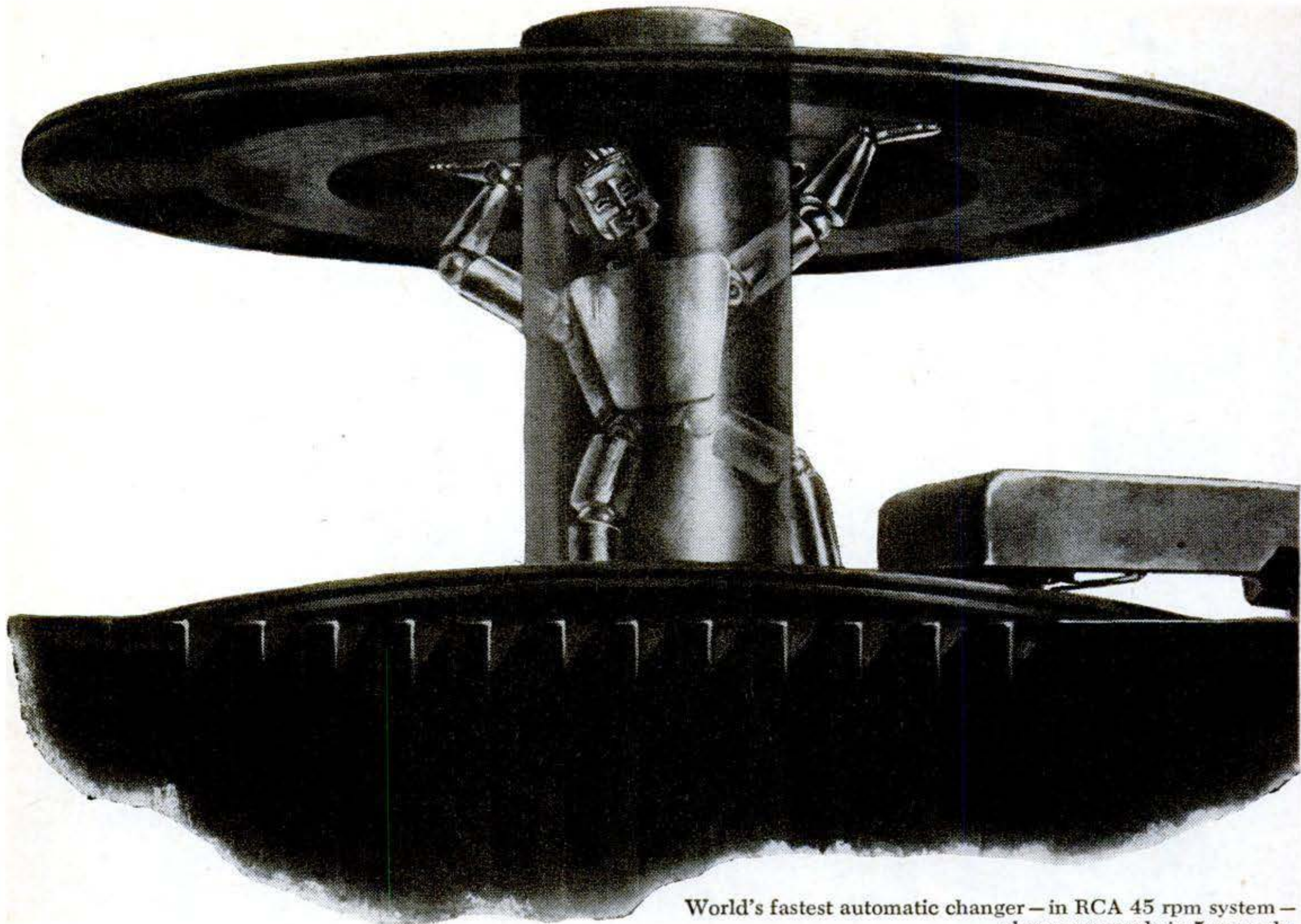

World's fastest automatic changer — in RCA 45 rpm system — changes records in 5 seconds.

Quick change artist

Hundreds of thousands are now enjoying RCA's thrilling new way of playing records . . . they marvel at its wonderful tone, its compactness . . . and the speed with which it changes records.

Prolonged research is behind this achievement, research which sought — for the first time in 70 years of phonograph history — a record and automatic player designed for each other.

Revolutionary is its record-changing principle, with mechanism *inside* the central spindle post

on which records are so easily stacked. Result: a *simplified* machine, that changes records in 5 seconds.

Remarkable, too, are the new records — only 6 $\frac{7}{8}$ inches in diameter — yet giving as much playing time as conventional 12-inch records. Unbreakable, these compact vinyl plastic discs use only the distortion-free "quality zone" . . . for unbelievable beauty of tone.

Value of the *research* behind RCA's 45 rpm system — which was started eleven years ago at

RCA Laboratories — is seen in the instant acceptance, by the public, of this better way of playing records. Music lovers may now have *both* the 45 rpm system, and the conventional "78."

* * *

Development of an entirely new record-playing principle is just one of hundreds of ways in which RCA research works for you. This continued leadership in science and engineering adds value beyond price to any product of RCA, or RCA Victor.



RADIO CORPORATION of AMERICA

World Leader in Radio — First in Television

Where Do Ideas Come From?

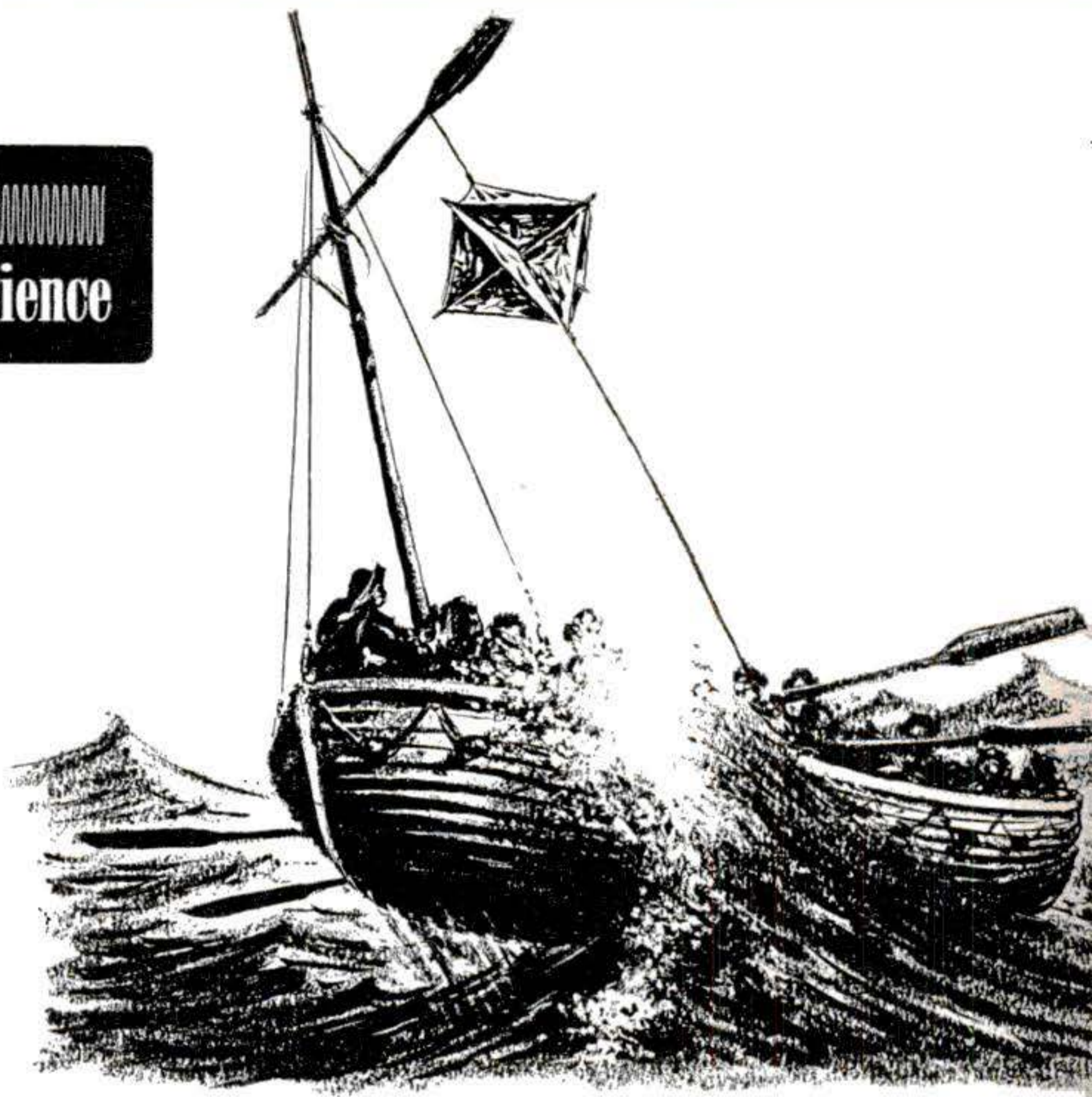

The man in the sport shirt was one of several who came forward for a private word after I had finished the talk before the local Air Force Reserve.

He said, as many do, "I've got an idea. . ."

People have some reason to be wary of other people's ideas. Too many ideas are too old, or involve too much trouble or money—yours, of course. So the natural rejoinder, sometimes unspoken, is "so what?"

But an editor must stoop for the smallest coins of thought. So I said politely, "Good! Just write it down and send it in." Editors also know that writing it down is the best test of thinking it out.

"Nuts," said the man in the sport shirt. "I don't want to write it down, or make anything out of it. I just want to see it happen."

"I'm a radarman, see? I was watching those blips on the scope one day, and I had an idea, see?"

"I said to myself, every big ship carries radar nowadays, but suppose something happens. Suppose you got people in lifeboats, in all that water.

"So you got radar, but a lifeboat's low in the water. Hard to see day or night. Hard to see on radar, too. Birds on seaweed can make as big a blip on the scope.

"My idea is why don't they put in every lifeboat these tinfoil targets they got. They got to carry water and biscuits and a lot of other stuff by law.

"So why don't they make a law that every

lifeboat should carry one of these tinfoil targets? They fold up small; but when you open them up and hoist them up on a mast or something, they sure make a nice big blip on the radar!"

I had not been talking about radar or sea disasters. But the man in the sport shirt saw a chance to put his idea into action by getting it into print. There was no question of profit, or even recognition. So many people were talking at once I didn't even get his name. But I know his real name.

I hope he sees this, because I think he has a wonderful idea. I'm going to make sure the Coast Guard sees it, too. That package of aluminum foil and struts, technically known as a Tetrahedron Reflector, can be radarseen many times visual distance. It might save more lives than some of the other gear now prescribed for lifeboats.

The interesting thing is that this idea sprang whole from a human mind scanning the possibilities, as a radar antenna squirts its searching waves, seeking a reflection of the projected thought.

Where do ideas come from? An idea is the Genie of the lamp of thought. Produced by the friction of the mind rubbing around a problem, or a necessity, or a hope.

The real name of the man in the sport shirt, as you have guessed, is Aladdin.

Perry Githeas

Anyone can tell he has P.A.*



P.A.* means *Pipe Appeal*
and *Prince Albert*

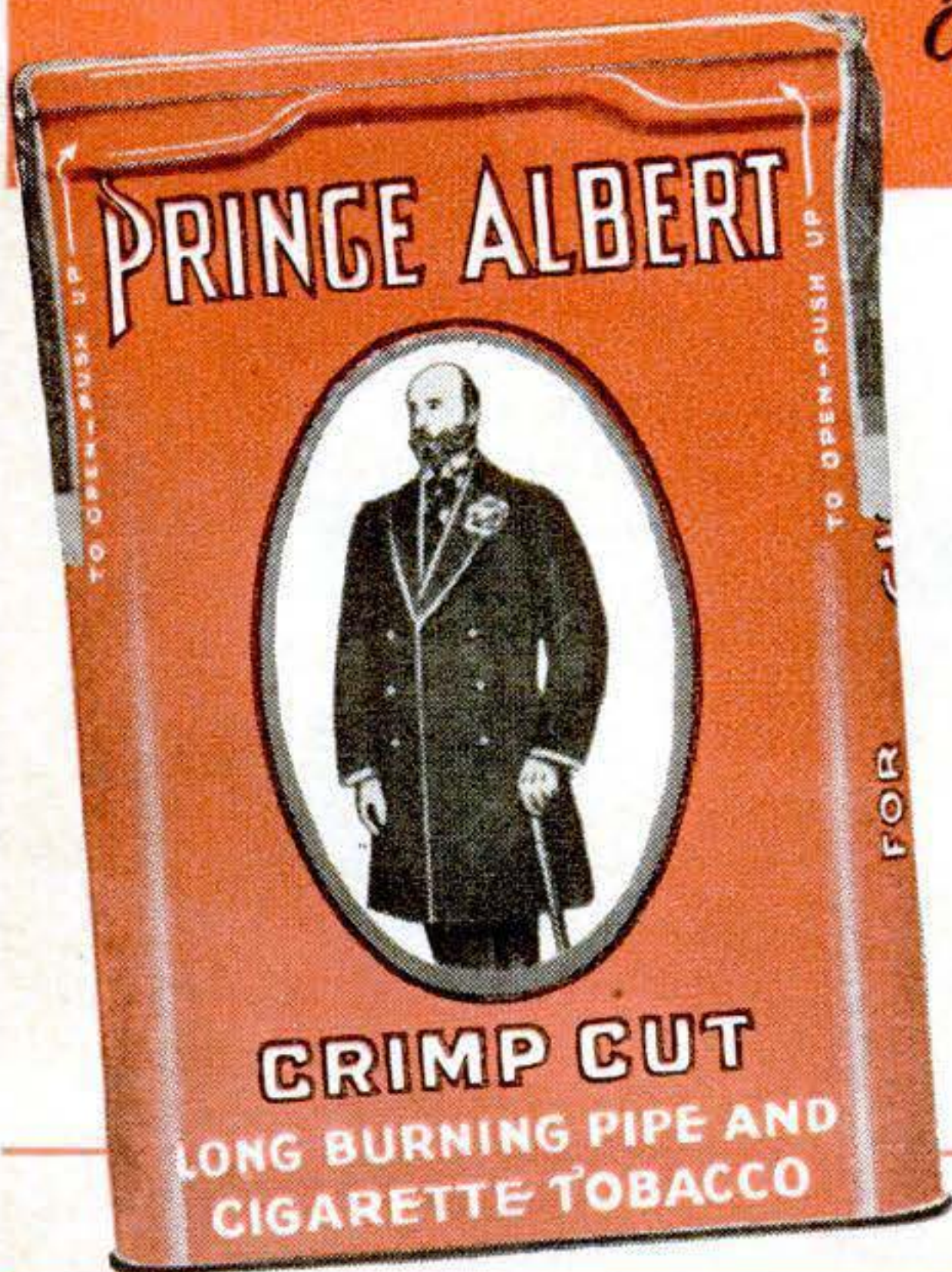

YOU CAN tell by the ladies' admiring glances when a man has Pipe Appeal. And you can tell by his contentment that he has that pipe packed with mild, rich-tasting Prince Albert! That choice, crimp cut tobacco is specially treated to insure against tongue bite. Get P.A.— and see why it's America's largest-selling smoking tobacco!

*P.A.'s GRAND
FOR ROLLING CIGARETTES,
TOO!*

R. J. Reynolds Tob. Co., Winston-Salem, N. C.



THE NATIONAL JOY SMOKE

POPULAR SCIENCE

REG. U.S. PAT. OFF. *Monthly*



Tail End of a Boom... Here you're looking down toward the rear end of one of two tapering throats that form the twin tail booms of a huge Fairchild C-119 Flying Boxcar transport plane. This unusual view, taken just before the boom was lowered into place for assembly, shows a worker putting the finishing touches on a heating duct that supplies the tail surfaces with hot air for de-icing. A successor to the original C-82 Packet, the C-119 has more power, longer range, and can carry a greater load for the armed forces.



Cover drawing by Reynold Brown

A racing champion designs a tunnel-shaped

By Alden P. Armagnac

PS photos by W. W. Morris

BECAUSE an inquisitive experimenter sawed a boat in two, tomorrow's ocean voyagers may enjoy unprecedented speed and comfort aboard liners of new design.

The man with the saw was Gar Wood, silver-haired king of American motorboat racing. He sliced a conventional boat hull

down the middle, transposed the two halves, and joined them with a superstructure. And he found he had a better boat.

Now the 68-year-old inventor envisions a superliner applying this design—a giant floating tunnel 900 feet long. Twin hulls would be bridged by decks with accommodations for at least 4,000 passengers. Four steam turbines, totaling some 120,000 hp., would propel the bizarre ship at 35 to 36 knots, a

Interior features of Gar Wood's seagoing twin-hulled yacht *Venturi* are seen in cutaway sections of PS air photo below.

How ship is run is shown, in inset on opposite page, by artist's drawing of controls in wheelhouse, with Wood at helm.

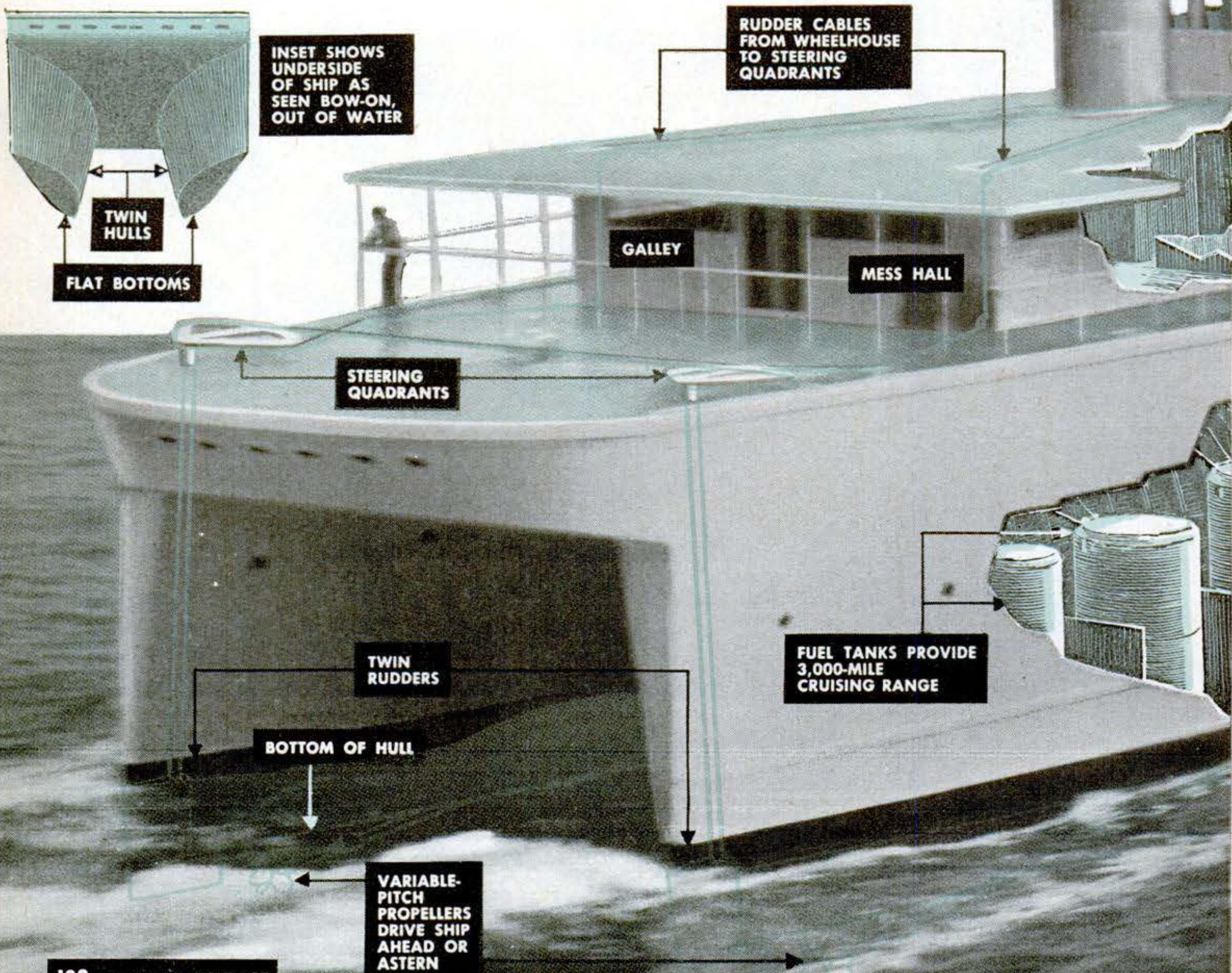

Gar Wood's Sea Speeder

boat that looks like an inventor's pipe dream—but works.

phenomenal pace for commercial vessels. (The 80,000-ton *Queen Mary* uses 200,000 hp. to carry about 2,000 passengers at a top speed of 32 knots.)

Free from rolling, pitching, and yawing, the "tunnel boat" would provide new comfort for its passengers. Since these motions slow an ordinary ship, their absence would contribute to the new liner's top speed and to economy of power and fuel.

A king-size working model, Gar Wood's \$600,000 dream boat *Venturi*, demonstrates the principles of his new design. First publicly exhibited last August in trial runs off Miami Beach, Fla., this radical craft currently serves as a floating laboratory to test and perfect its builder's plans.

Pictures don't prepare you for the impressive size of the big, white, brown-roofed, silver-funneled ship. The *Venturi* 

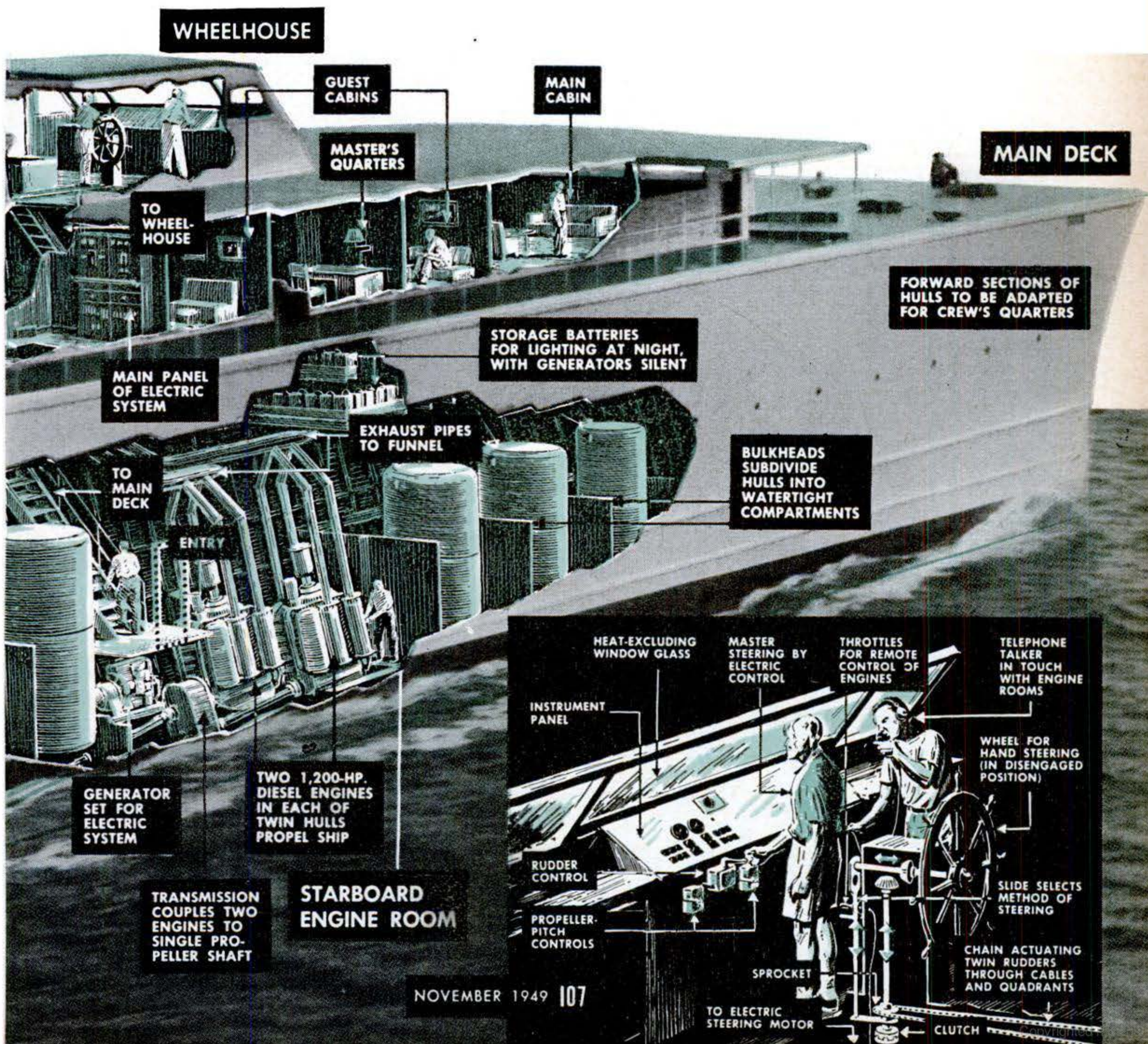



Using small wooden models, Gar Wood compares stability of conventional hull designs and his own in swimming pool on his Miami Beach estate. Although PT boat at left is one of most

stable of standard types, model lists to about twice the angle of twin-hulled model after same number of weights representing unbalancing force has been placed along the side of each.

is a seaworthy, ocean-going yacht, 188 feet long with a 40-foot beam. Cabins occupy the center of a nearly oblong main deck resembling an aircraft carrier's. Connecting the two hulls 22 feet above the water, the superstructure forms the roof of a floating tunnel, as wide as the ship at the bow.

Shoehorned into the narrow hulls, four

Diesel engines totaling 1,200 hp. turn two 4½-foot variable-pitch propellers. Top speed remains to be learned when the new engines are broken in and can be opened up. At less than full power, the *Venturi* has reached 26 knots in sea trials.

Weighing only 128 tons, the *Venturi* draws less than nine feet of water over-all,

Head-on photo of 20-knot turn shows *Venturi* squarely upright in apparent defiance of centri-

fugal force, with the complete absence of heeling over that characterizes this novel design.

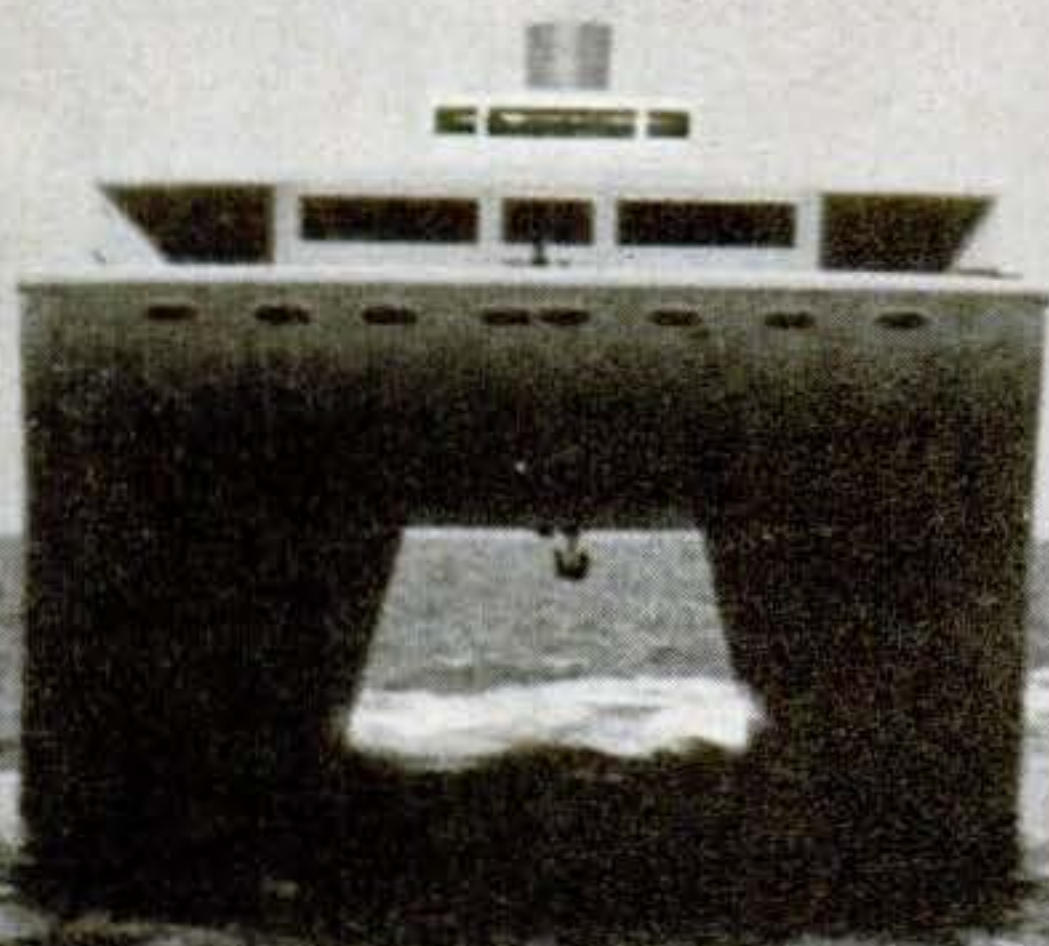

1 CONVENTIONAL HULL SAWED DOWN MIDDLE

2 POSITIONS OF TWO HALVES EXCHANGED

3 STERN CUT AWAY TO INCURVING LINES TO MAKE BOAT STEERABLE



Evolution of Wood's design is seen above. He cut an ordinary hull in two, then transposed the halves as shown. Incurving stern (dotted lines) solved problem of making boat steerable.

including propellers that project six feet below the hull. Hulls of mahogany plywood, thin but strong, contribute to its light weight and shallow draft.

What distinguishes the *Venturi* from all other catamarans or twin-hulled craft is the shape of its hulls. Outboard sides are ruler-straight except for an inward curve near the stern. Bowed-in tunnel sides give the hulls their maximum width, eight feet at the waterline and 12½ feet at the superstructure, two-thirds of the way aft.

These streamlined hulls part the water with hardly more than a ripple—in striking contrast to the big bow and stern waves set up by most fast vessels. And scientific tests show that a conventional ship, at high speed, wastes most of its power in uselessly creating waves. Picturesque as it may be, a ship with a “bone in its teeth” is no marine designer's ideal!

The flat bottoms of the hulls slope gently downward from bow to stern, drawing 2½ feet of water forward and three feet aft when at rest. As the big ship gains speed, their planing action lifts it bodily, until they draw only six inches of water forward and

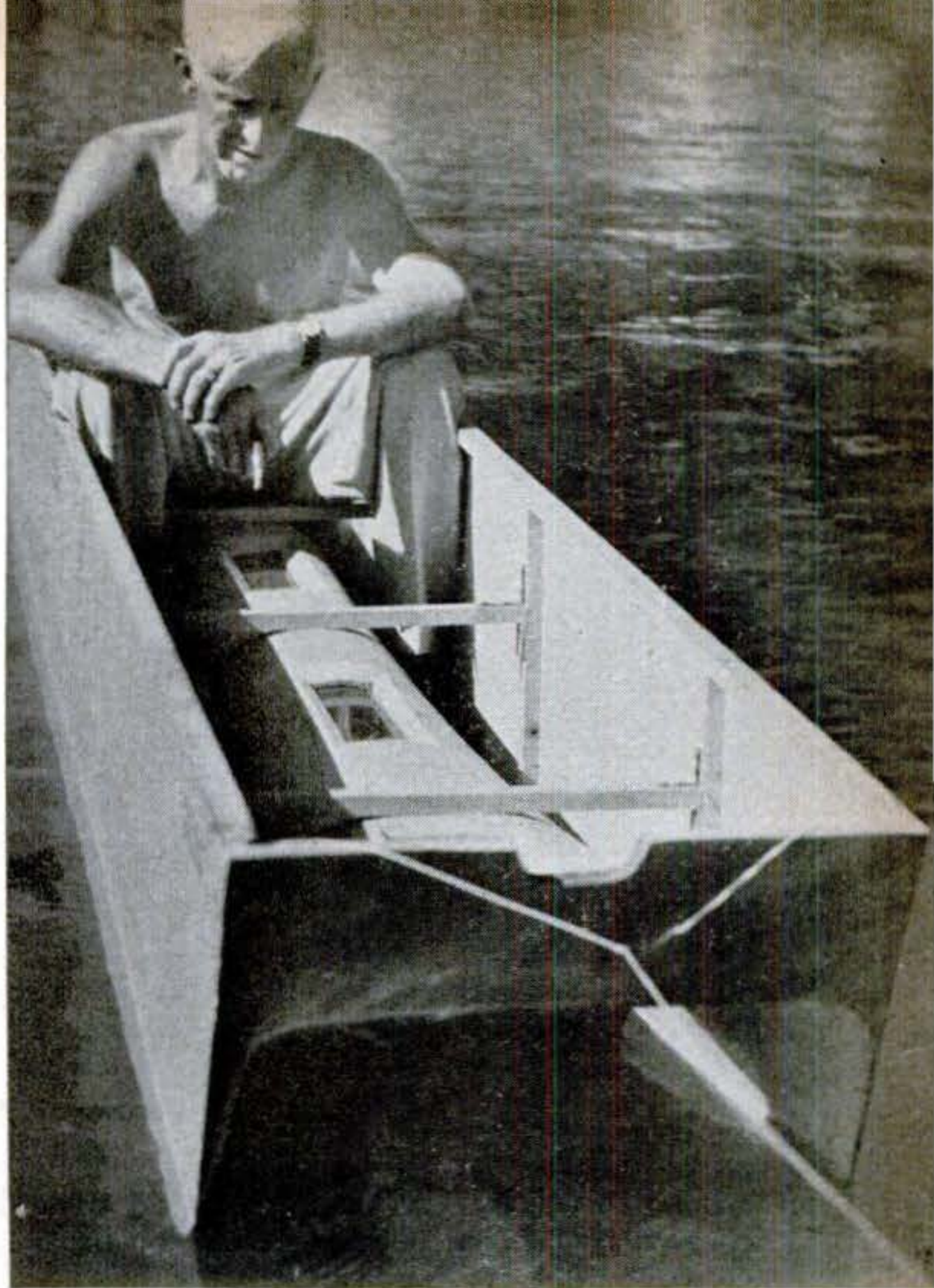

Glass windows, set along top of tunnel between hulls, enable Gar Wood to study wave patterns set up by 10-foot model of his “tunnel boat” as it is towed through water at various speeds.

Port engine room shows two of *Venturi's* four 1,200-hp. Diesels. The craft's propulsion machinery is fitted in two narrow hulls, which reach maximum waterline width of eight feet.

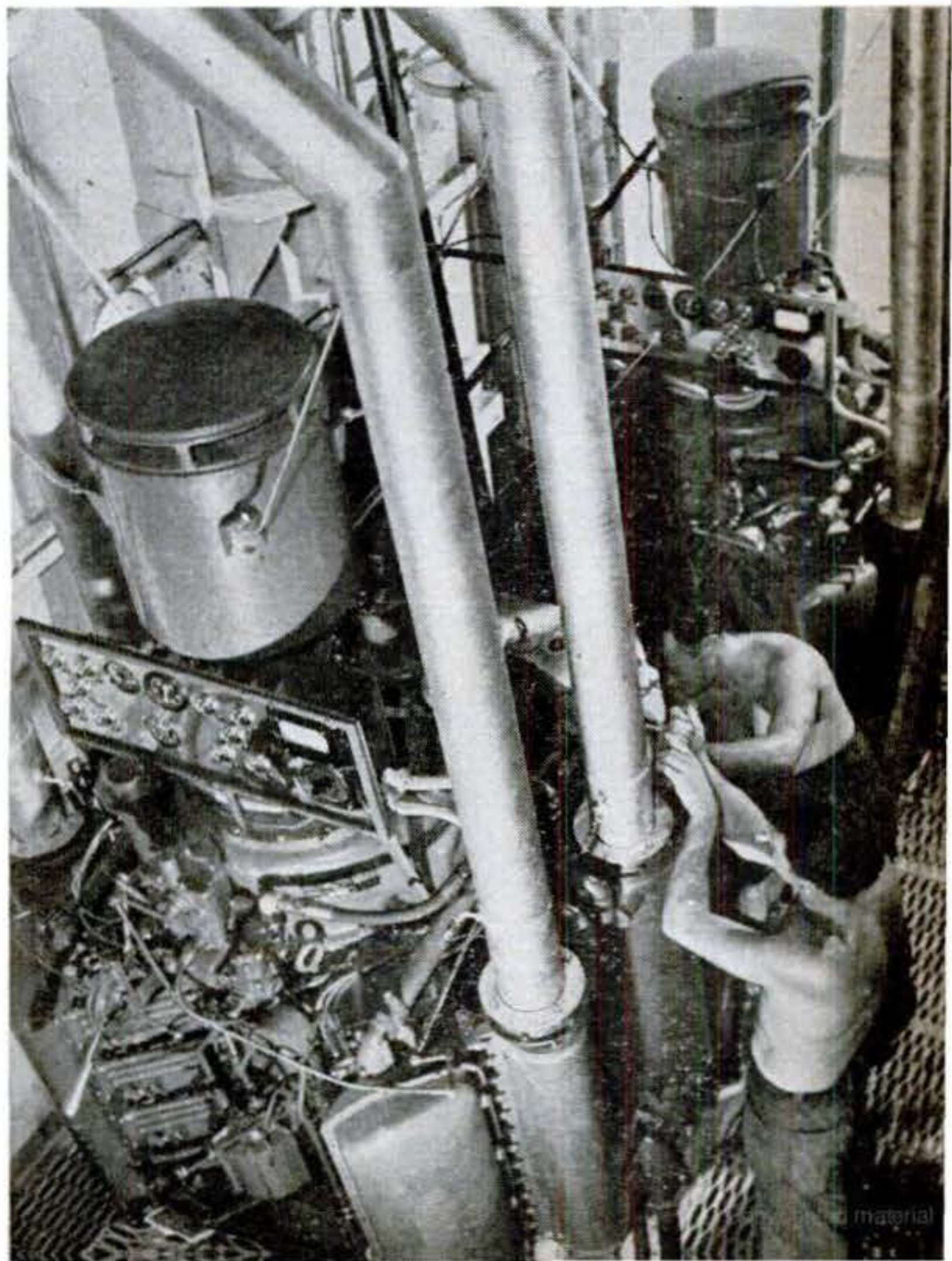

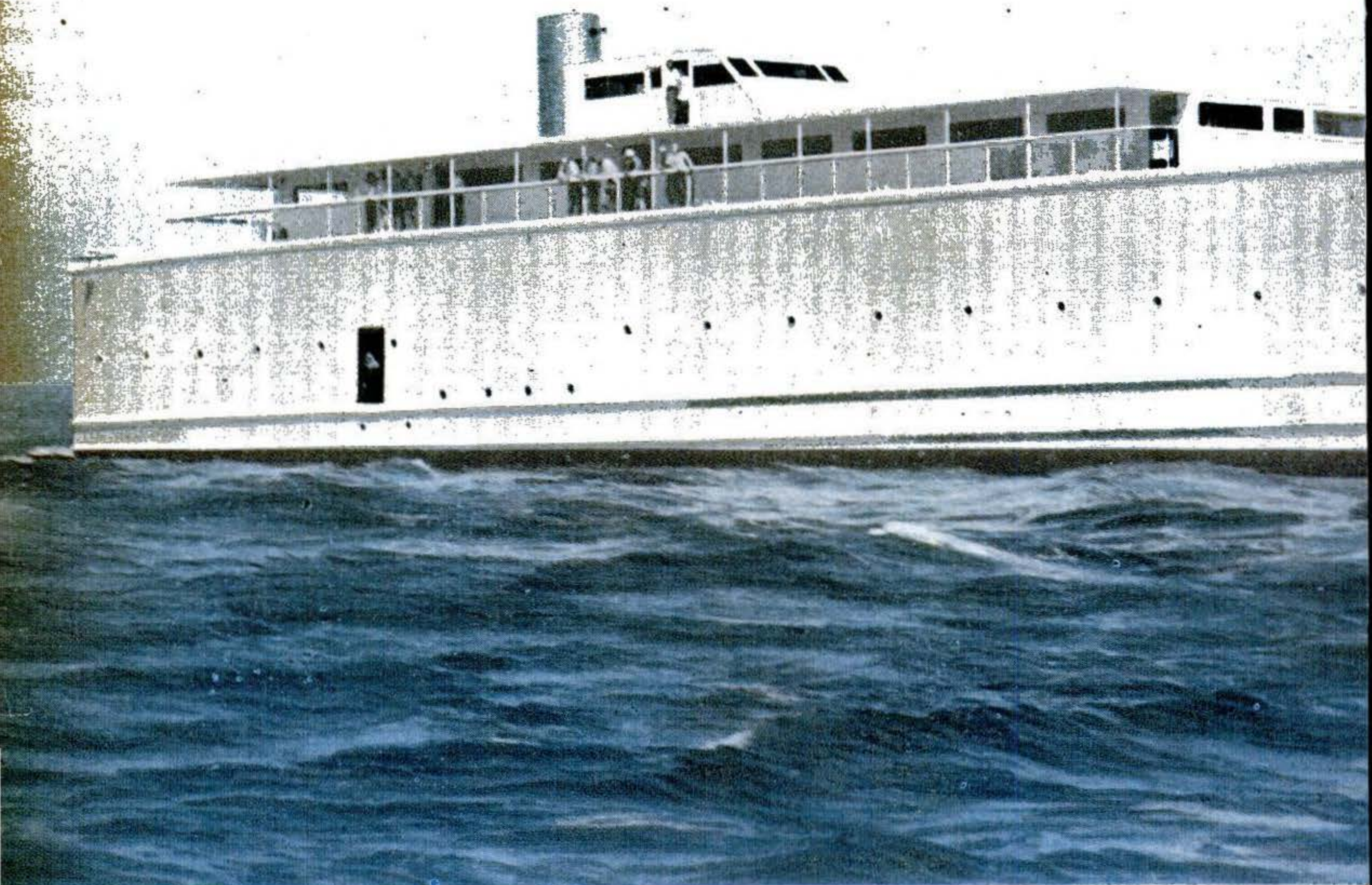

Is Gar Wood's 188-foot *Venturi*, above, the prototype of tomorrow's superliners? Some of

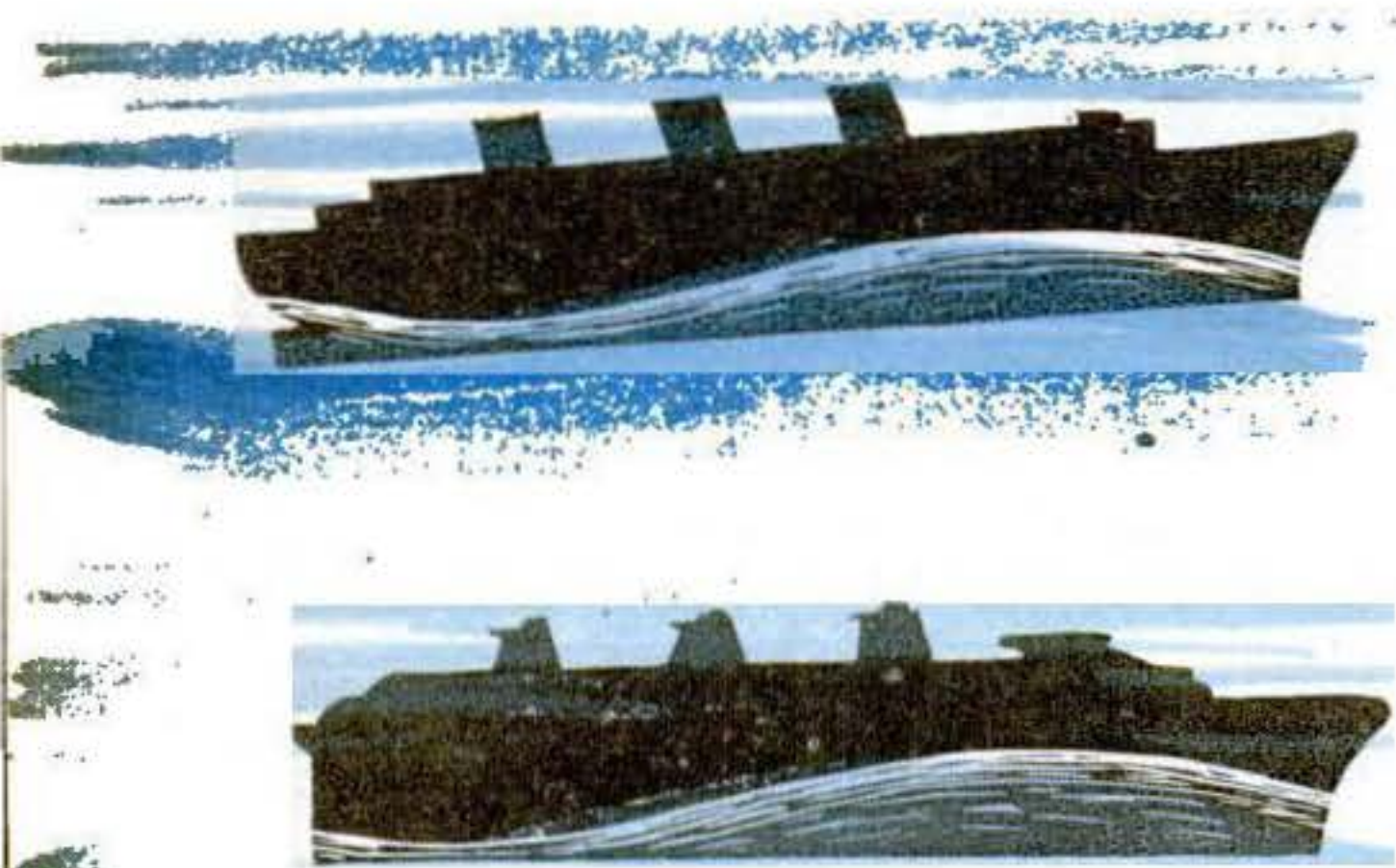

Instead of climbing *over* waves like standard hull, above, *Venturi*-type vessel below slices *through* them. This minimizes pitching, with its attendant discomfort and loss of speed.

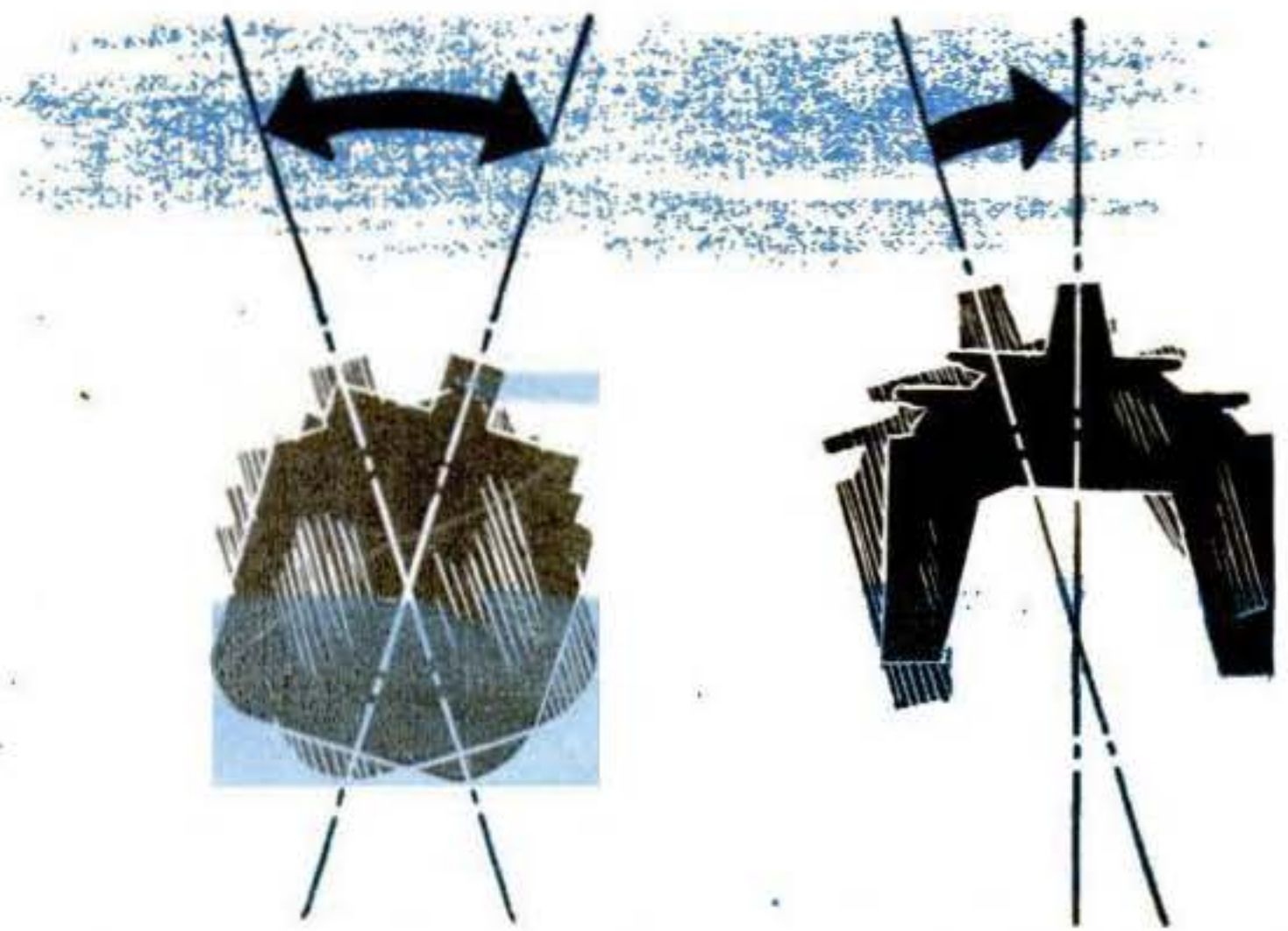

Standard hull, a pushover to start rolling, then continues swaying like inverted pendulum. *Venturi*-type hull strongly resists rolling and, if forcibly tilted, promptly rights itself.

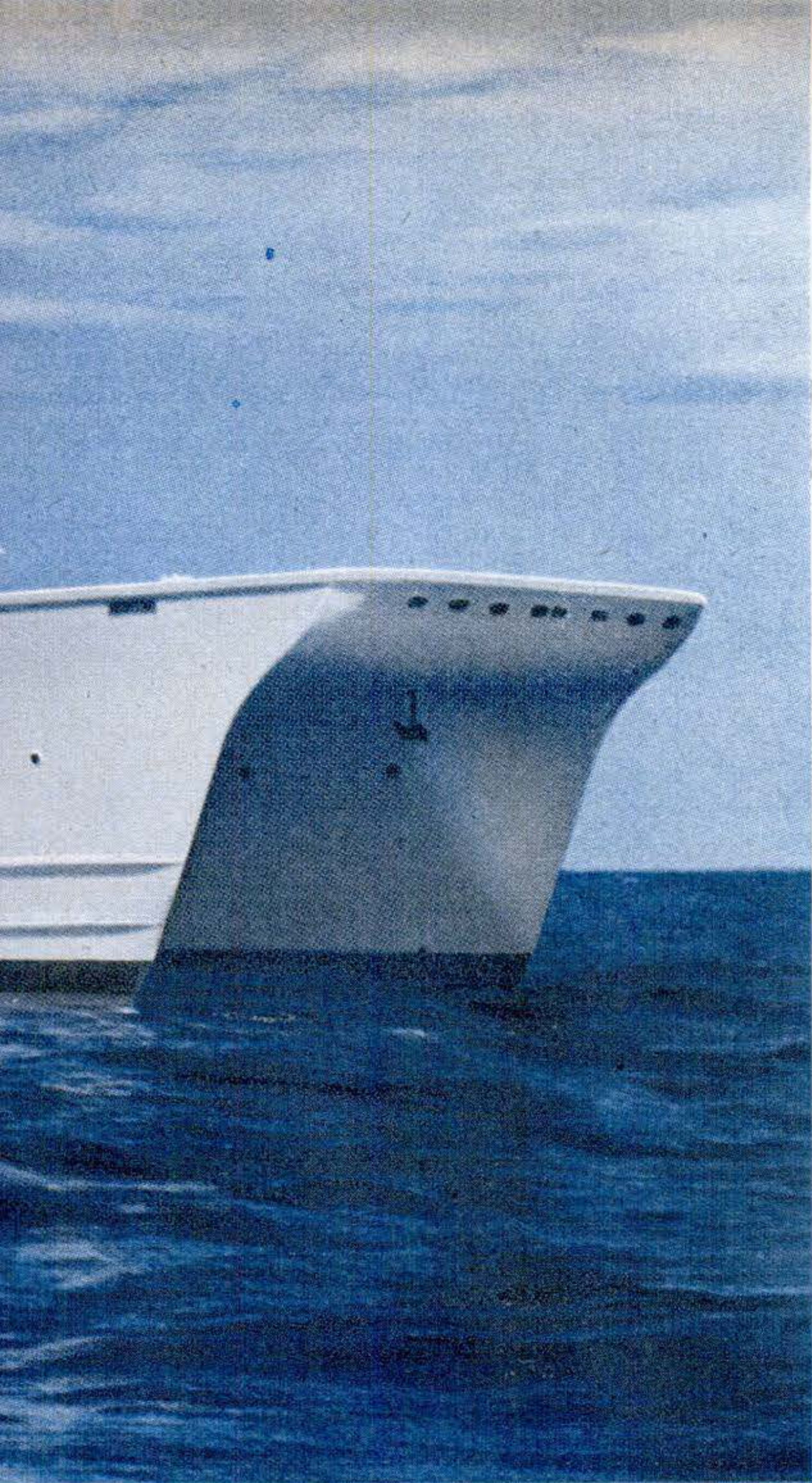

his reasons for thinking so are pictured below.

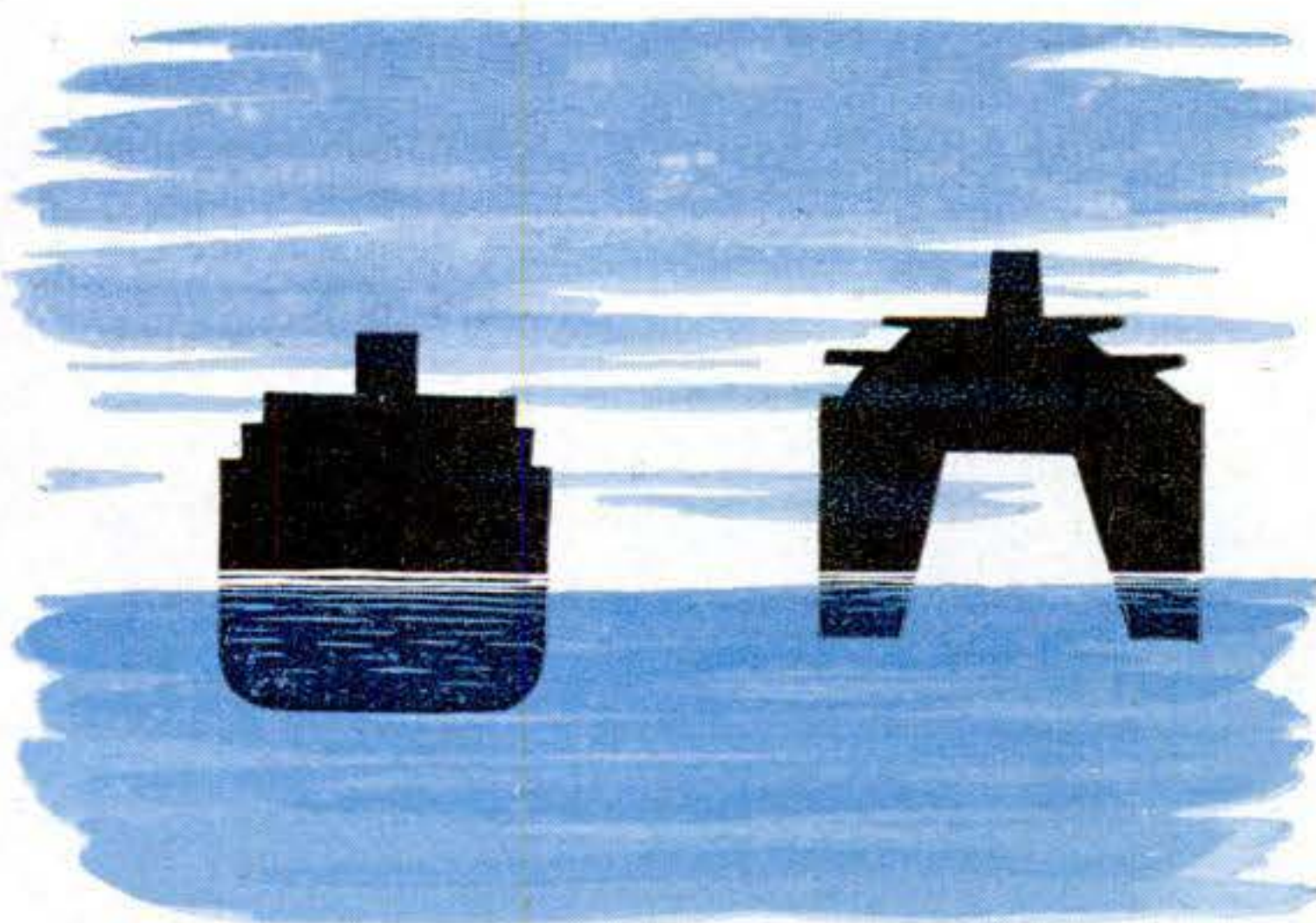

Shallow draft of lightweight Venturi-type ship, one reason for high speed, contrasts with submerged bulk of standard ships using huge power to push hole in water, pull in hole after them.

two to 2½ feet aft. By reducing submerged surface area, this cuts the “skin resistance”—frictional drag of water on the hull—that eats up power.

Pitching is eliminated because the narrow hulls slice *through* waves, instead of climbing over them. Wave crests roll along the sheer sides while the boat speeds ahead, undisturbed, on an even keel.

Instead of heeling over like an ordinary craft, the *Venturi* remains squarely upright, in full-rudder turns at high speed.

You need be no naval architect, versed in things like center of buoyancy and meta-centric height, to see why it doesn't roll. Viewed end-on, the broad water-straddling footing of the *Venturi* reminds you of a man standing with legs widespread and braced, instead of balancing on one leg. Pacific islanders long ago proved the soundness of the principle with their seagoing outrigger canoes.

Under way, the *Venturi* becomes a mobile wind tunnel, whose squeezed-in sides resemble a Venturi tube and give the ship its name. At high speed, Wood foresees that the wind stream in the tunnel will act as a shock absorber, cushioning up-and-down motion of the boat and improving its steadiness. Systematic measurements to be made of air pressure and velocity in the tunnel will check its aerodynamic effects.

From Dump Trucks to Tunnel Ships

Though best known as a racing champion, Gar Wood has long been an inventor, and a highly successful one. He made his fortune, years ago, with his invention of the hydraulic lift for dump trucks.

Since he retired undefeated from motorboat racing in 1933, he's been working on his tunnel-boat idea. It began with his curiosity about what makes a boat yaw, or veer from side to side.

Wood thought the bow was responsible. Others differed. So he built a motorboat that was practically nothing but bow, with a slender tail and rudder, shaped like a shoe tree. Veering crazily in try-outs, it dumped overboard all who tried to ride it. When the curved bow tipped even slightly, it acted as a rudder and yanked itself sideways, just as he'd surmised.

Could that same force be made to work the *opposite* way and hold a boat to its course? As Wood pondered how, it occurred to him to exchange the left- and right-hand sides of a boat. The result

Proposed high-speed, 900-foot superliner with Venturi-type hull is visualized by PS artist.

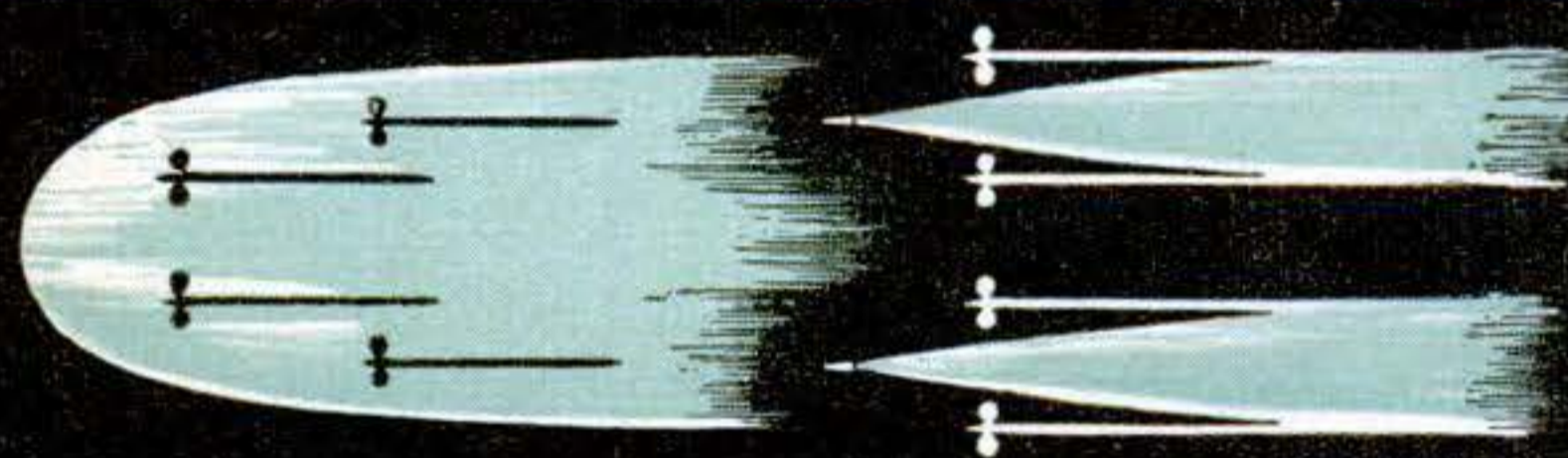
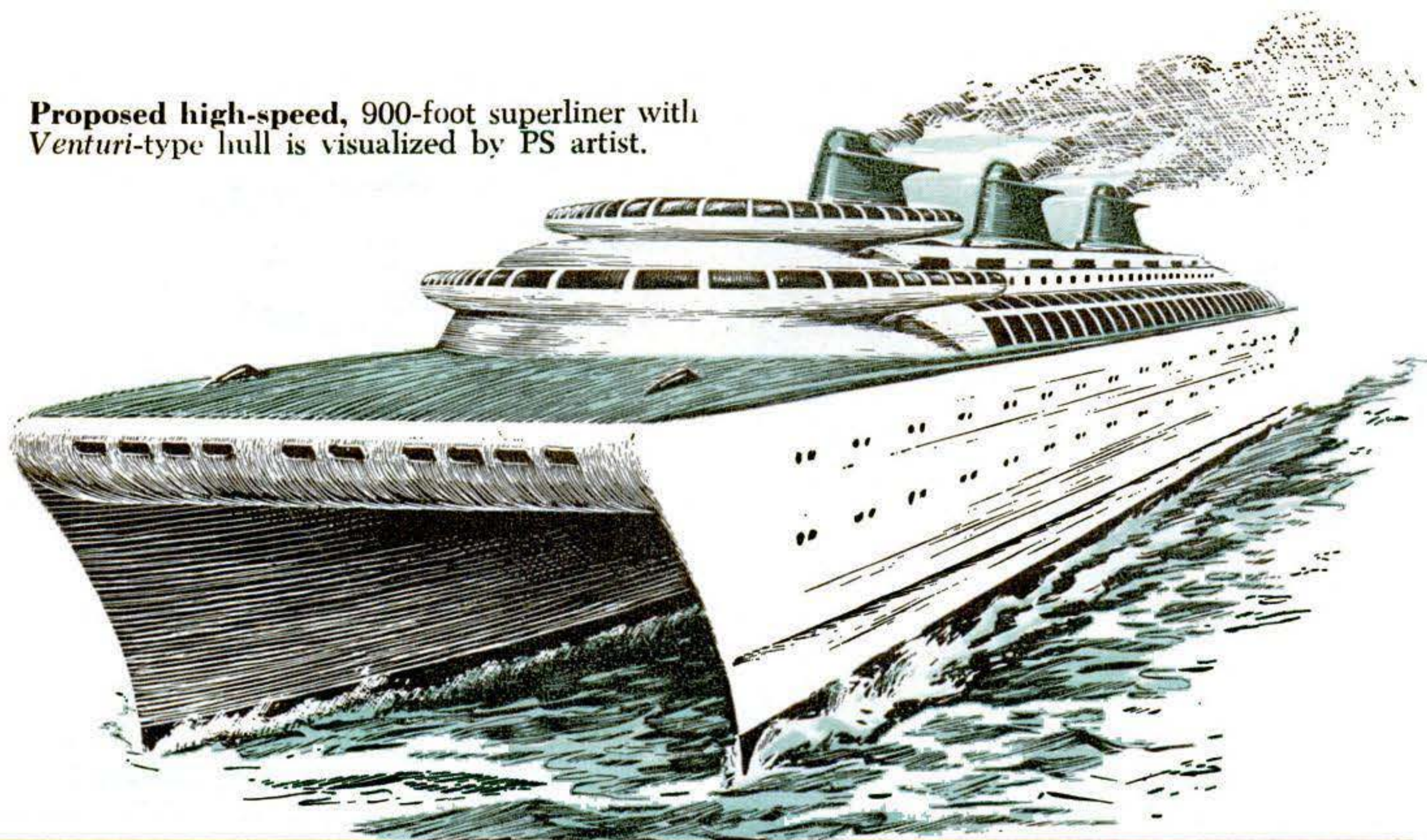

Twin-hull superliner design permits novel departure from conventional four-screw propeller arrangement shown at left above. Its steam turbines would drive four screws mounted abreast as at right.

If 160-foot beam is too wide for existing slips, superliner might be docked straddling special pier, using gangplanks on interior sides.

would be a twin-hulled craft. A sawed-in-two hull yielded a model so promising that larger ones followed.

At first, in fact, Wood was *too* successful. His straight-sided models held their course so firmly that they couldn't even be steered until he altered the outboard edge near the stern to an incurving shape that forms a basic part of his invention. With this incurve, the *Venturi* can turn in a radius of four times its length.

In 1944 the Army Air Forces commissioned Wood to build a full-sized tunnel boat to serve as a radio-controlled mobile target simulating an aircraft carrier. Called the *TA-1*, it was completed the same year, but Army plans had changed and it was never bombed. After the war the puzzled U.S. Maritime Commission sold it back to Wood as a "shelter for small boats." Wood removed protective armor, replaced gasoline engines with Diesels, and added cabins to convert it to a yacht. Relunched last February at Miami Beach, the *TA-1* became the *Venturi*.

Is this experimental vessel the prototype

of a practical liner? All its advantages, Wood maintains, will be retained when its dimensions are multiplied four times—length, a little more. He sees "tunnel ships" competing with ocean airlines, moving great numbers of passengers swiftly and economically.

Comparisons with existing ships must be made with reserve, for Gar Wood's is unique. No cargo carrier, it shares some of the problems of aviation design and economics. Strong but lightweight plastic replaces steel in construction to pare weight.

Problems remain to be solved—not the least of them, where to dock a liner of 160-foot beam, too wide for existing slips. Wood suggests a new transatlantic terminus at Montauk, on the seaward tip of Long Island—perhaps not too remote by land, considering time consumed in approaching and leaving New York by water. A more novel solution might be for the ship to straddle a pier of special design, and let down gangplanks from its interior! Whatever criticisms others may have of Gar Wood's ideas, no one can ever accuse him of being inhibited by precedent.

END

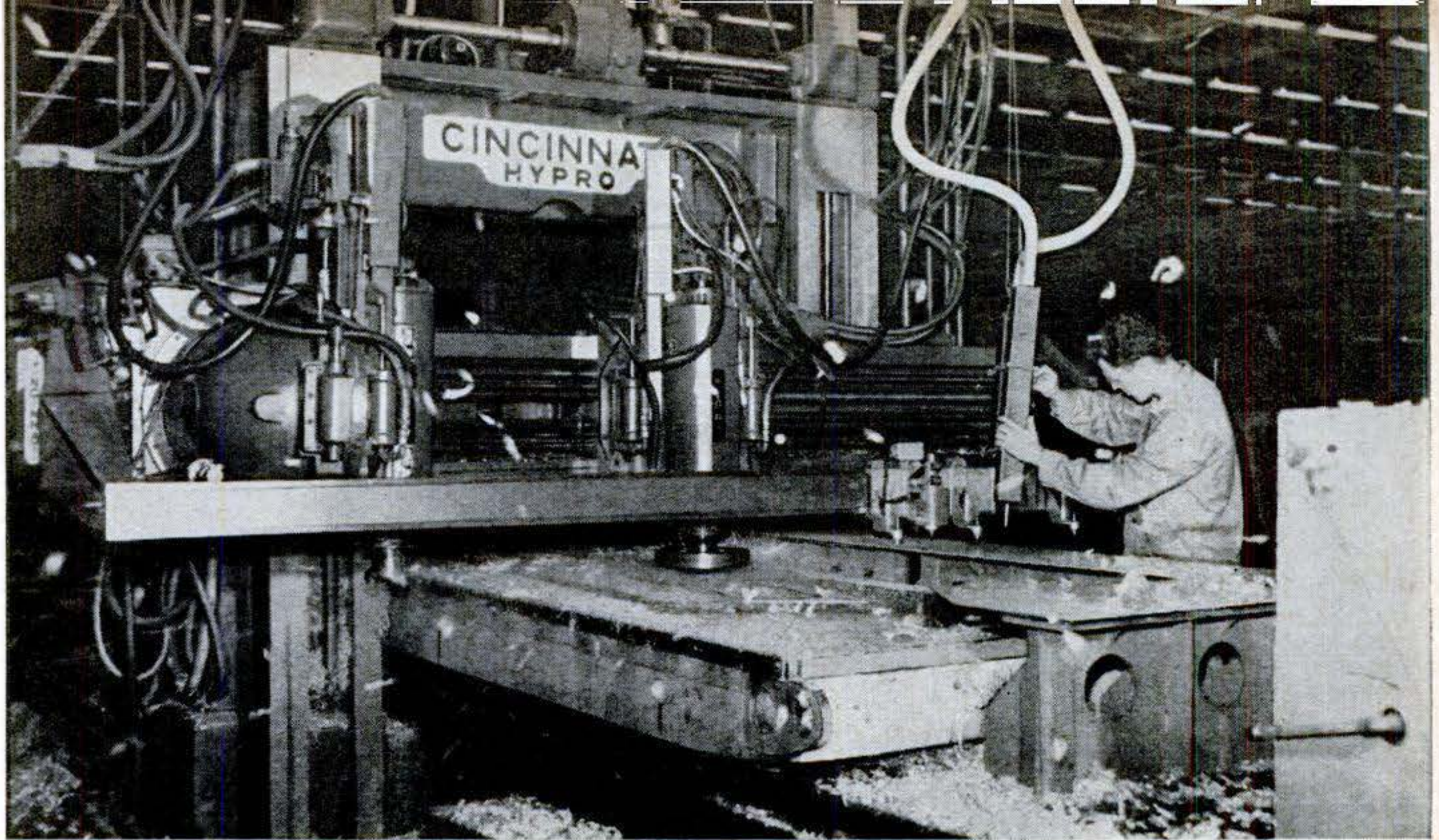

Wing Trimmer Pares Pounds

THIS huge machine "sculpts" aircraft wings with the accuracy of a jeweler's lathe. Its job is to whittle off weight where the load in flight will be lowest. As much as 16 lb. are saved on each wing skin of an F-86

jet fighter. Operator at right manipulates an electronic switch panel and guides a pointer at his left along a pattern. This controls the "knife" in center that does the cutting. The Hypro[®] planer was developed by the Cincinnati Milling Machine Co., and North American Aviation.

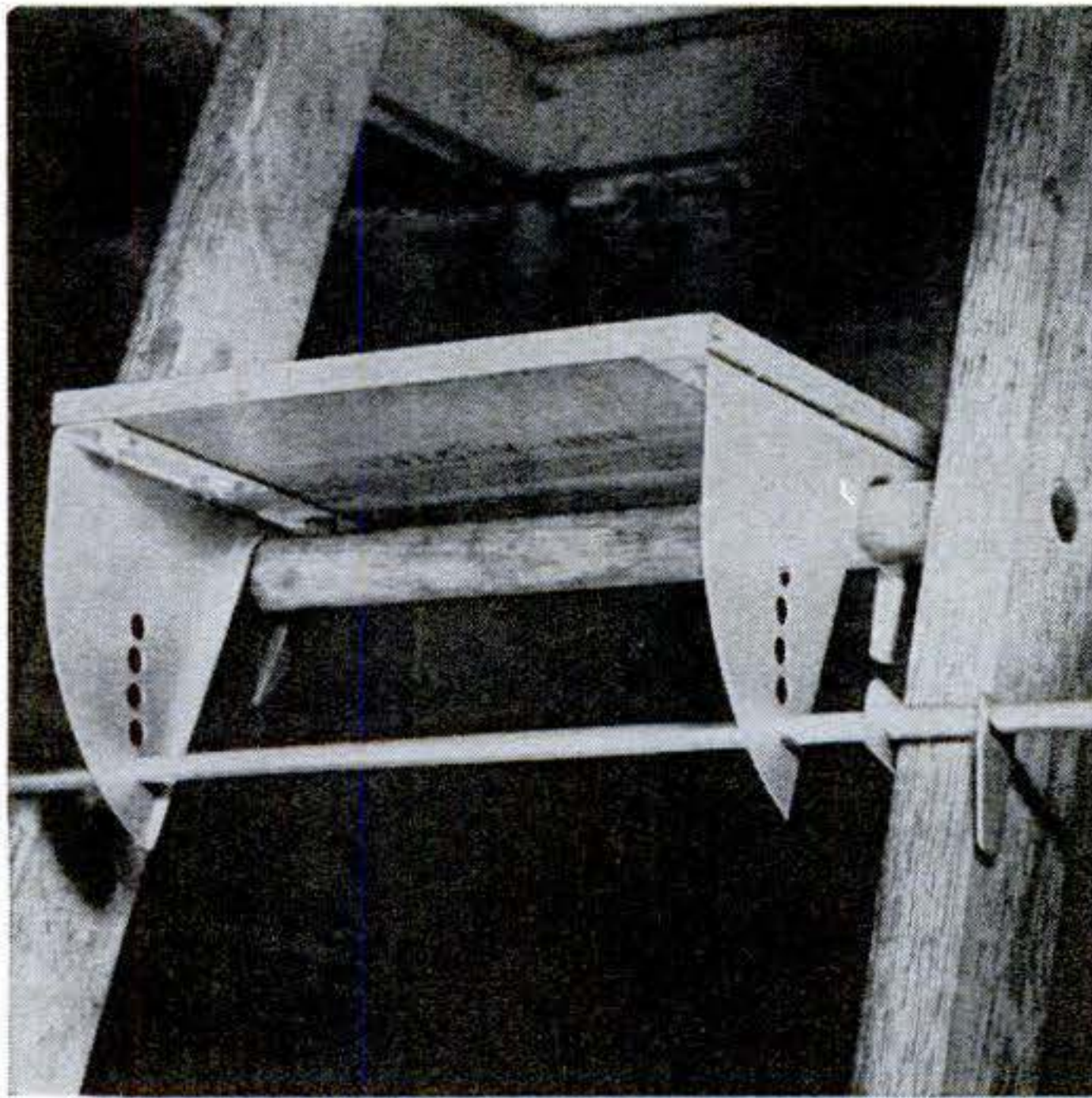

Ladder Step Is Platform

DOING an overhead painting or repair job need no longer be a balancing act. The platform step shown above is adjustable to fit any size ladder. Made of sturdy plywood, 7 by 11 inches, it is bolted to steel sides that slip over a ladder rung at any desired height and can be attached without the aid of tools. Called Add-A-Step[®], it is made by the Machinery Sales and Equipment Co., of Cincinnati, and sells for \$3.75.



Damp Basement Air Dried

CELLAR workshops or rumpus rooms can now be kept as dry as toast. The Frigidaire electric dehumidifier above protects lumber and equipment in a home wood-working shop. A fan draws the moist air over a series of cold coils, drying it by condensing the moisture into drops that drip into a drain. The device can be plugged into any outlet.

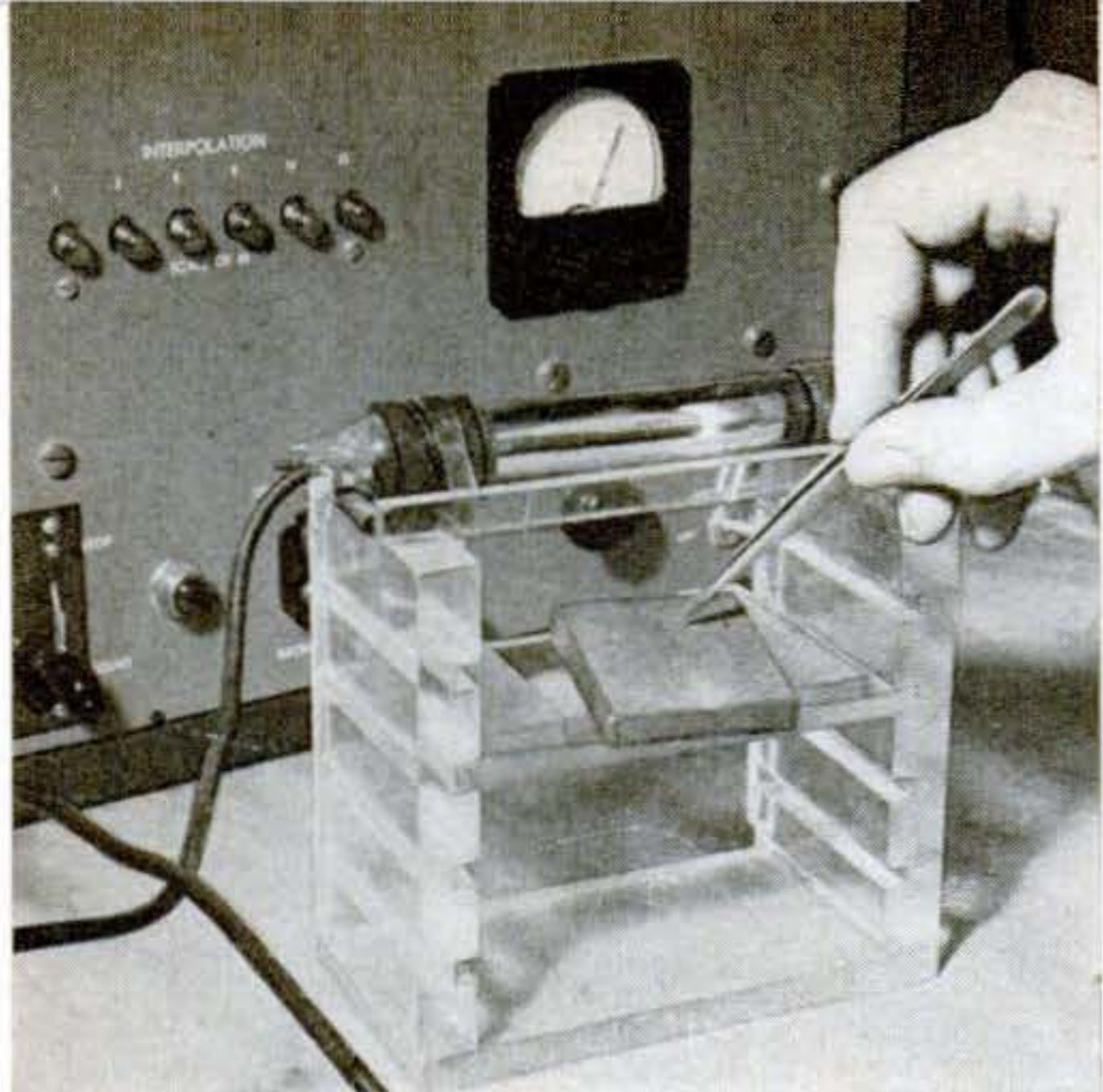

Isotope Spies on Rust

WITH the aid of an isotope—radioactive iron—GE scientists are now studying how and where rust starts and how deep it goes. Radioactive iron in a solution is electroplated onto another metal. Placed against a photographic plate, this coated surface makes an X-ray exposure. Where rust starts, the radiation decreases, leaving on the plate lighter areas that map the corrosion.

Above, the tweezers point to rust on metal under study. Just above it a Geiger counter checks the coating's radioactivity.



Prune Picker Lies Down on Job

IT HAS always been back-breaking work to pick prune plums from the ground—and that set Albert Aff, Redwood City, Calif., to thinking. Why not do it an easier way?

Here's what he came up with. The operator, lying face down on a cushioned bed, picks up the fruit, places it on a conveyer belt that empties into a bin on the machine. One foot rests against a pedal that swings his bed in a wide arc. A 1½-hp. gas engine propels the machine, swings the bed, and runs the belt at the will of the operator.

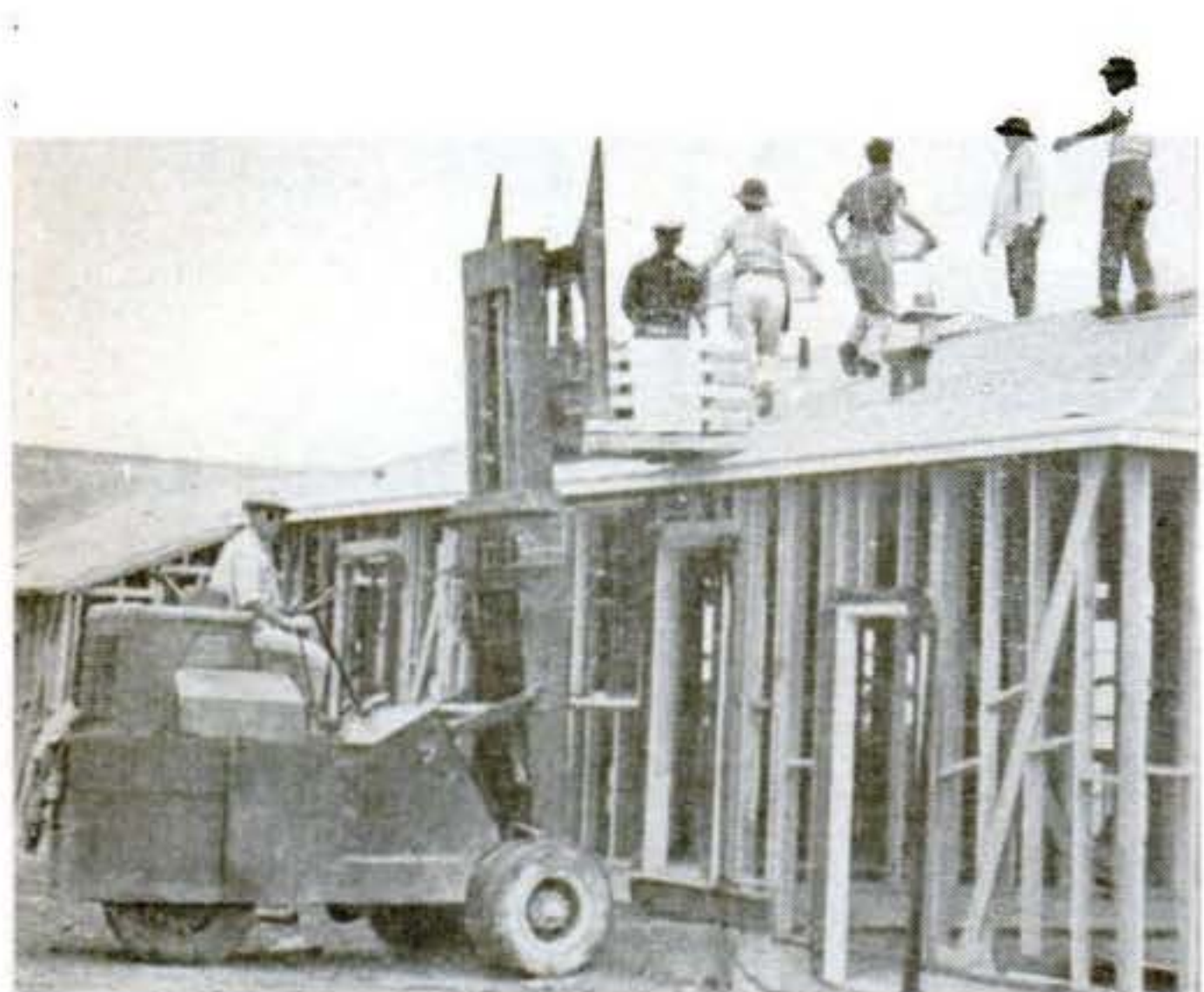

Roofs Cheaper by the Dozen

MASS production has finally hit house roofs. At a big housing development in California, a 90-man crew applies 25 roofs a day with a fork lift and pallet system.

Fork lifts remove pallet loads of asbestos roofing from trucks, carry them to each site, and hoist them to roof level—and a six-man crew rides right up to the rafters with them. The 10-ft. reach of the fork lifts limits the system to one-story homes. The 90-man crew is broken up into highly specialized teams.



Car Port Subs for Garage

IF YOUR new house lacks a garage, a car port like the above can help make up for it, especially if your winters are mild. Shown is an aluminum awning made by Kool-Vent Metal Awning Corp., Pittsburgh. It is finished with a high-gloss enamel in either stripes or solid colors.

If you plan to build a garage eventually, the awning will serve temporarily. Later, when you have the garage, it still will give a sheltered unloading area for rainy days.

New Ideas from the Inventors

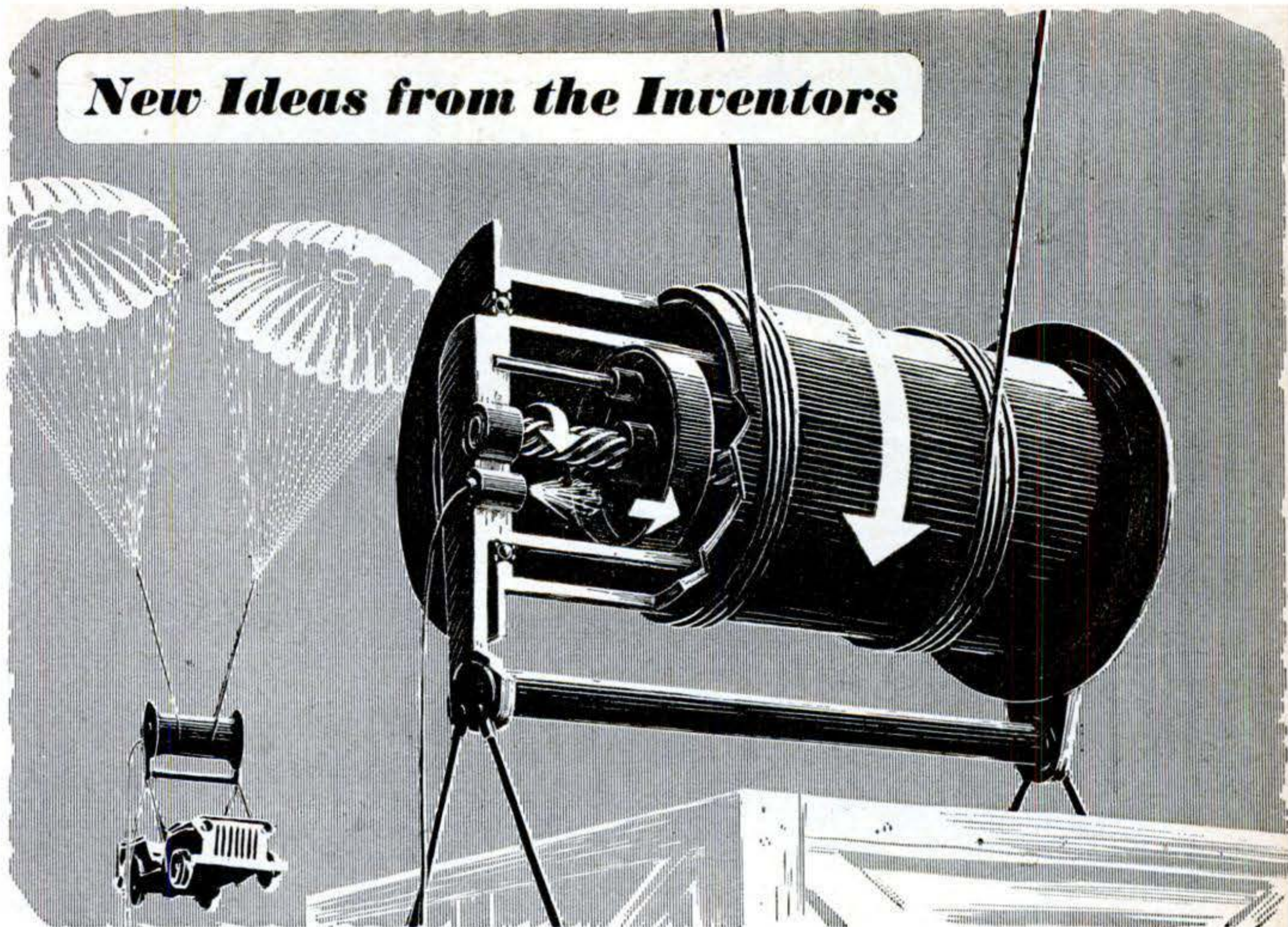

1 'Chute to Break Fall. When this parachute nears the ground, its cargo automatically winds itself up the ropes, slowing the fall and cushioning the landing. It is triggered by a weighted rope dangling

below the cargo. When this strikes the ground and goes slack, it releases compressed gas from a cartridge. The gas pushes a piston along a spiral shaft, turning it. The shaft in turn rotates the winding drum.



2 Tree Guide to Aid Trimming. Trimming small lawn trees would be simple with this guide. A fork on the lower arm slips around the trunk, which acts as a pivot, while the upright arm can be adjusted to the proper angle. Swinging the guide around the tree then shows just where and how much to snip for an even trim all around.

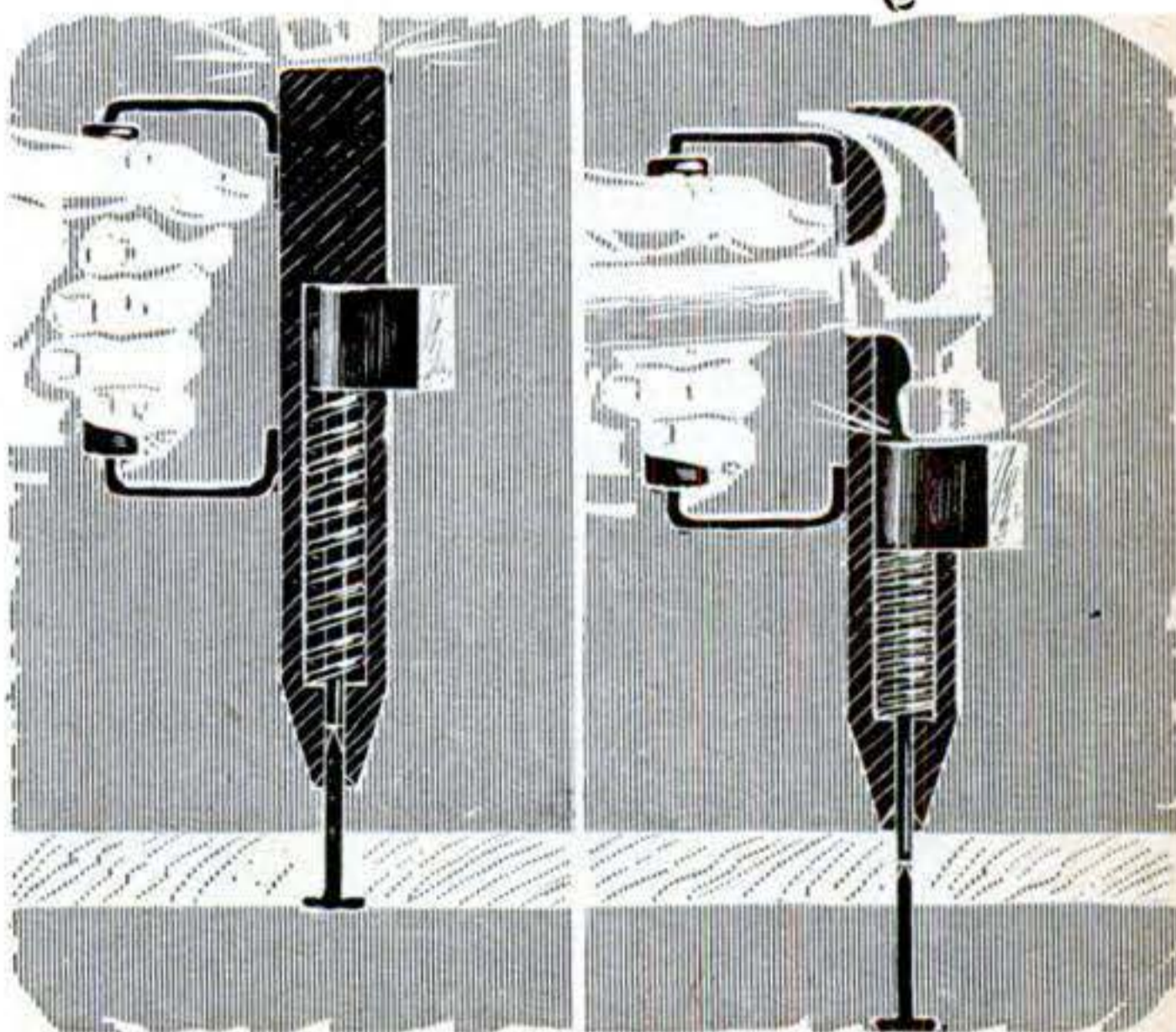

3 Tool to Remove Nails. You could take nails out of old lumber easily with this device. First slip it over the nail point and drive it down until it stops against the wood. Then hammer the arm at the side. This forces a rod inside the tool down against the nail point and through the hole until the nail is pushed out backward.

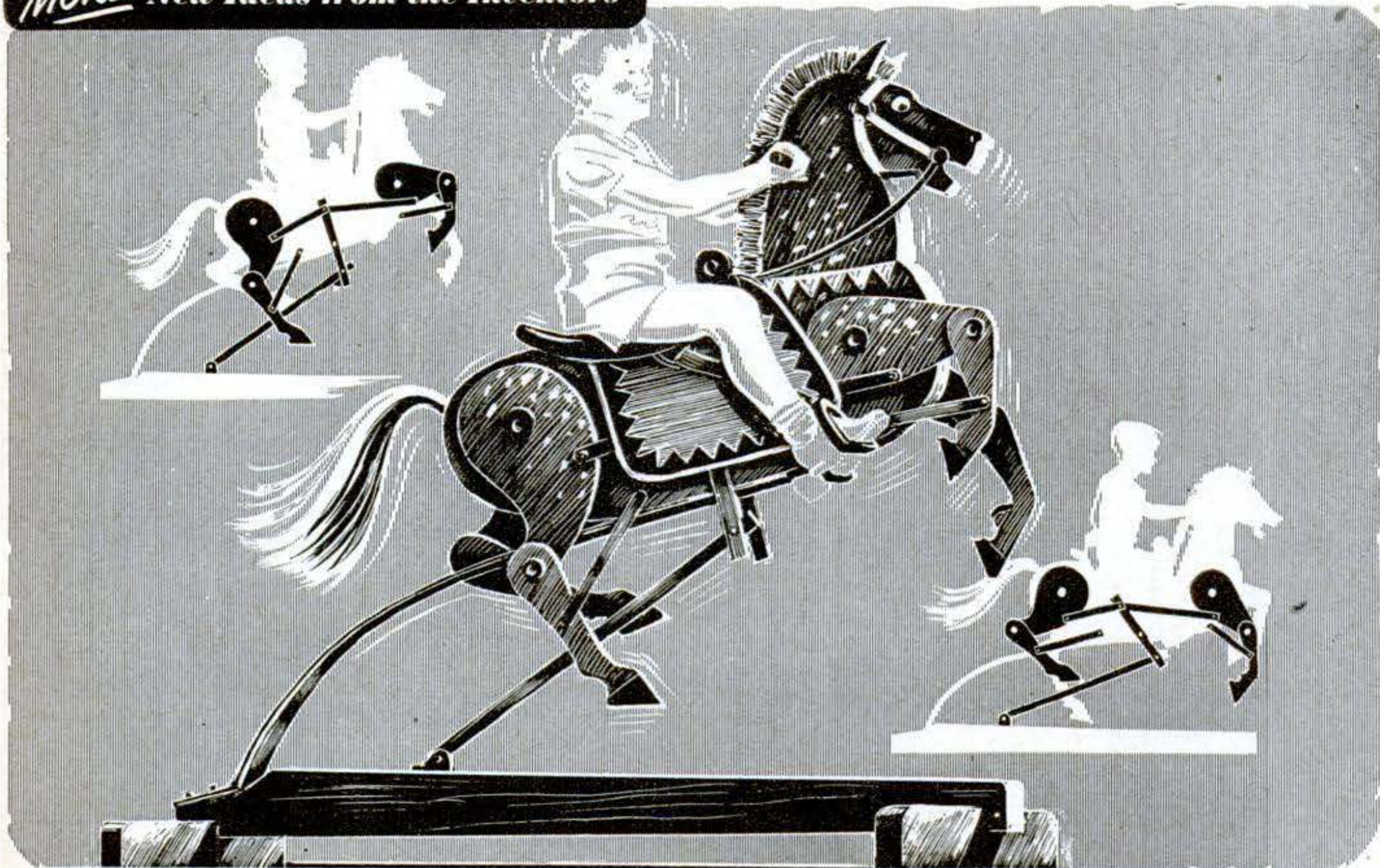

4 Hobbyhorse to Gallop. Playroom rough riders would get an added touch of realism from this hobbyhorse. It not only bounces but moves its legs like a real galloping horse. As it springs up and down,

a rod attached to the base moves rods pivoted at the sides under the saddle. These in turn move rods connected to the upper and lower parts of each leg so that the legs move back and forth in unison with each bounce.

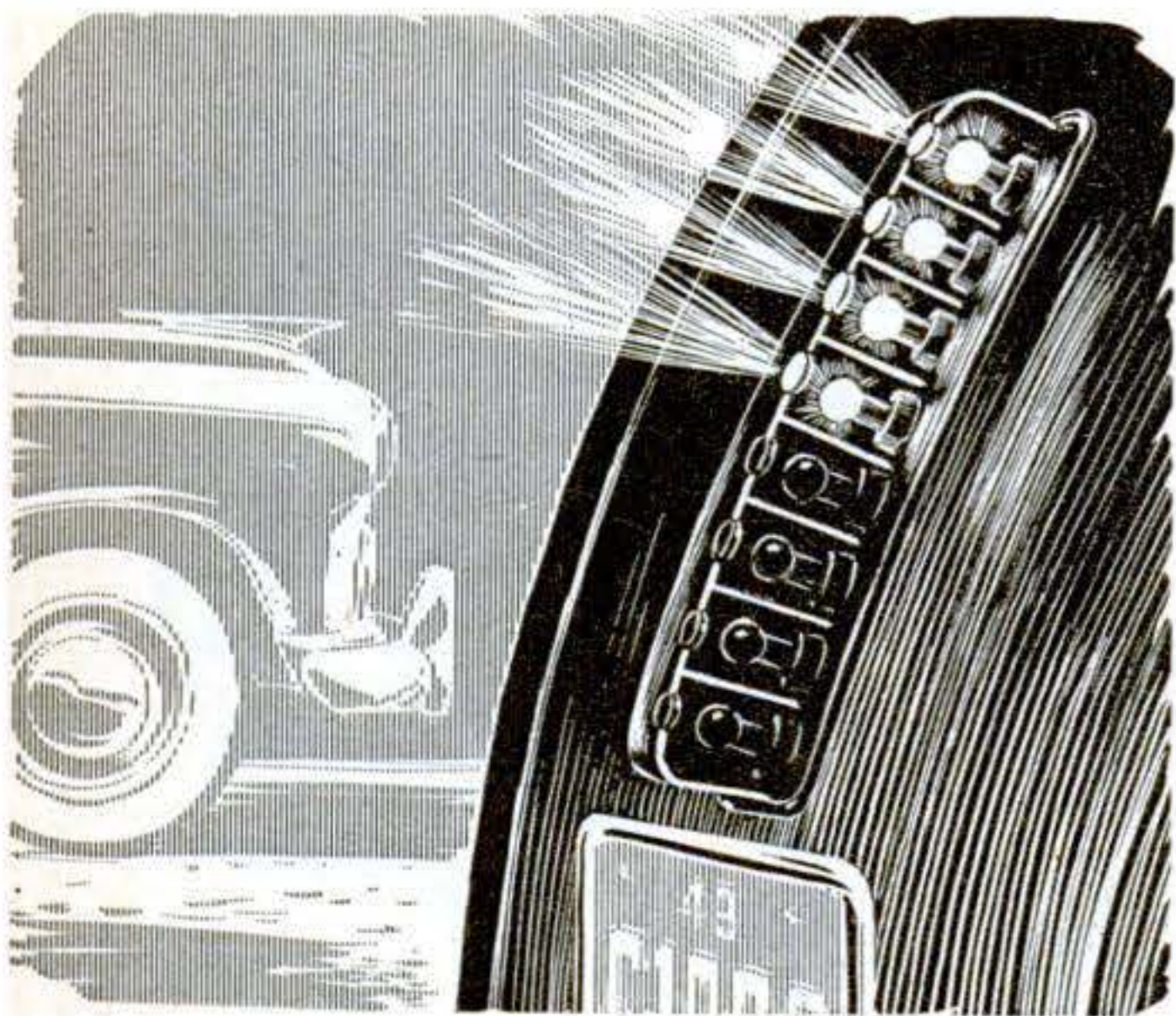

5 Lights to Show Car Speed. This row of tiny taillights would tell at a glance whether a car was speeding up or slowing down. Independent of the brake light, the lights are connected to the accelerator pedal. As the pedal is pushed down, they go on one after another to indicate speeding up; as it is released, they go off.

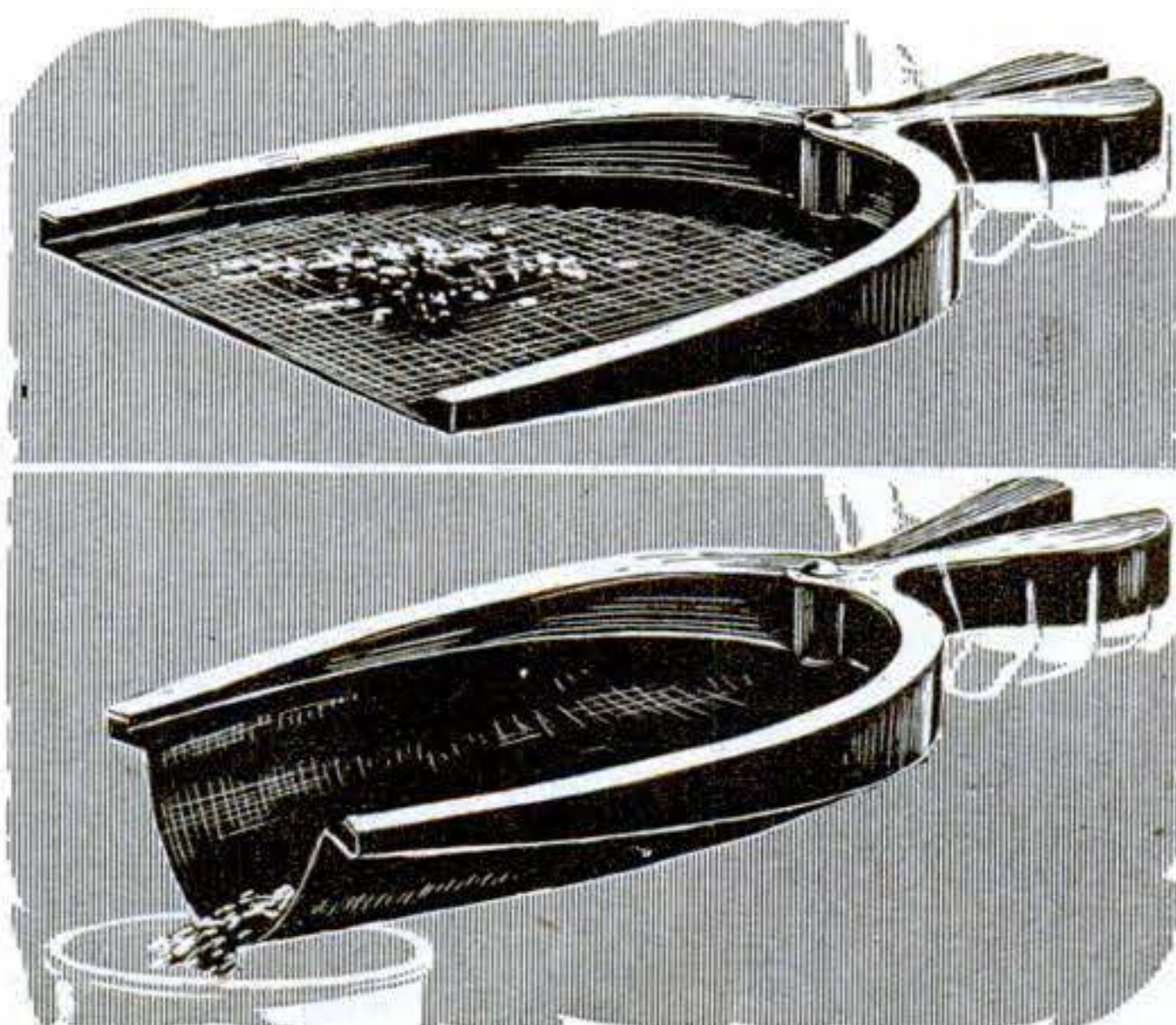

6 Dustpan to Fold Up. When you squeeze together the handle on this dustpan, its flexible bottom stretches taut for scooping up dirt. Then, for emptying, you simply spread apart the handle and the hinged side pieces swing inward, letting the bottom fold into a trough for easy funneling of the pan's contents into a narrow receptacle.

Patents on these inventions have been granted to: 1. P. F. Smith, Pacific Beach, Calif.; 2. A. I. Beets, Lansing, Mich.; 3. J. E. Brady, Dallas, Tex.; 4. W. P. Dwyer, Kansas City, Mo.; 5. M. L. Centrella, Philadelphia, Pa.; 6. P. W. Johnson, San Mateo, Calif.



Magnetic field around horseshoe magnet is traced in distorted shadow lines of fine screen photographed through electron microscope.

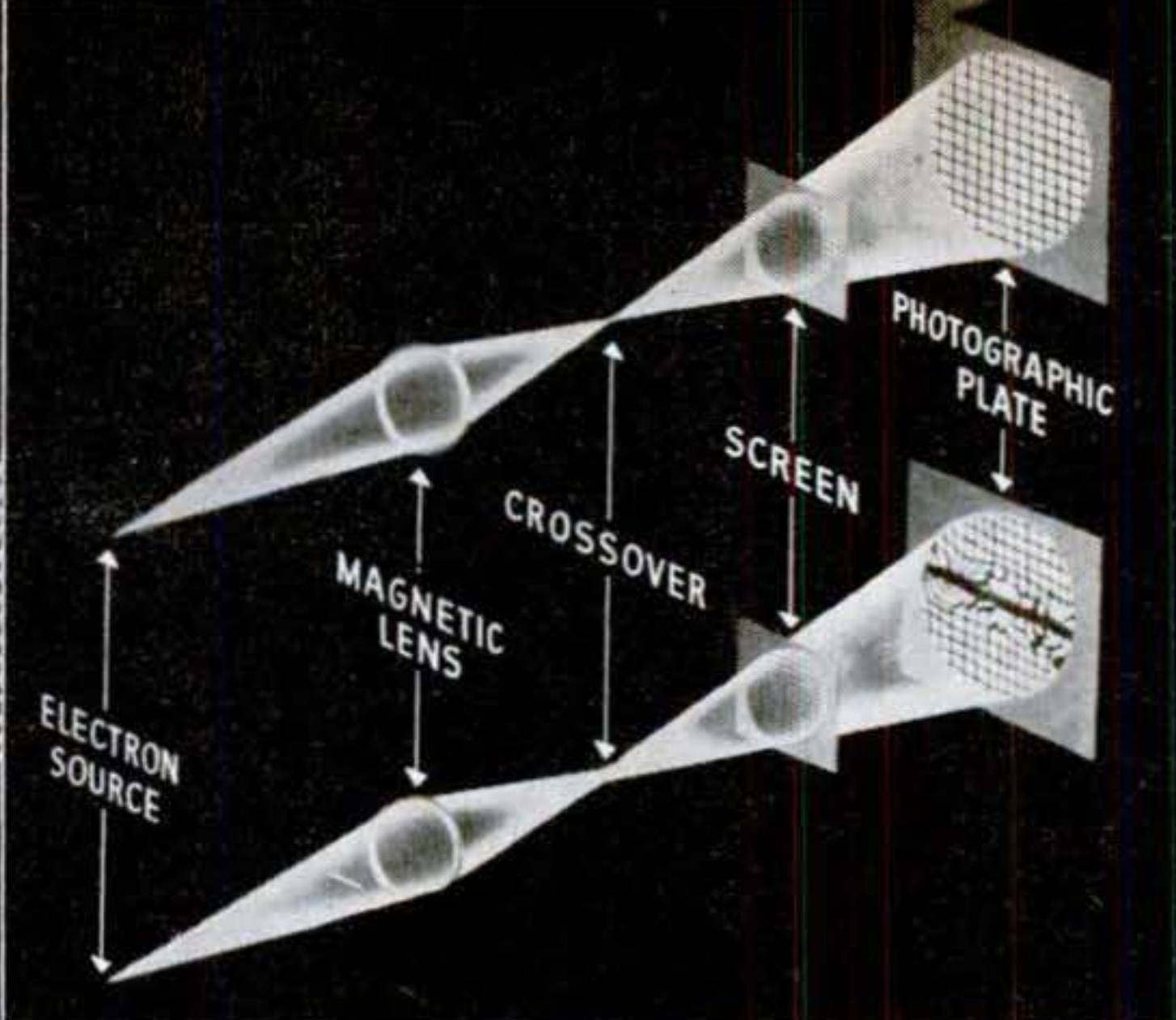

How it's done: Schematic drawings show how shadow of screen on film is distorted (lower sketch) by magnetic wire in electron beam.

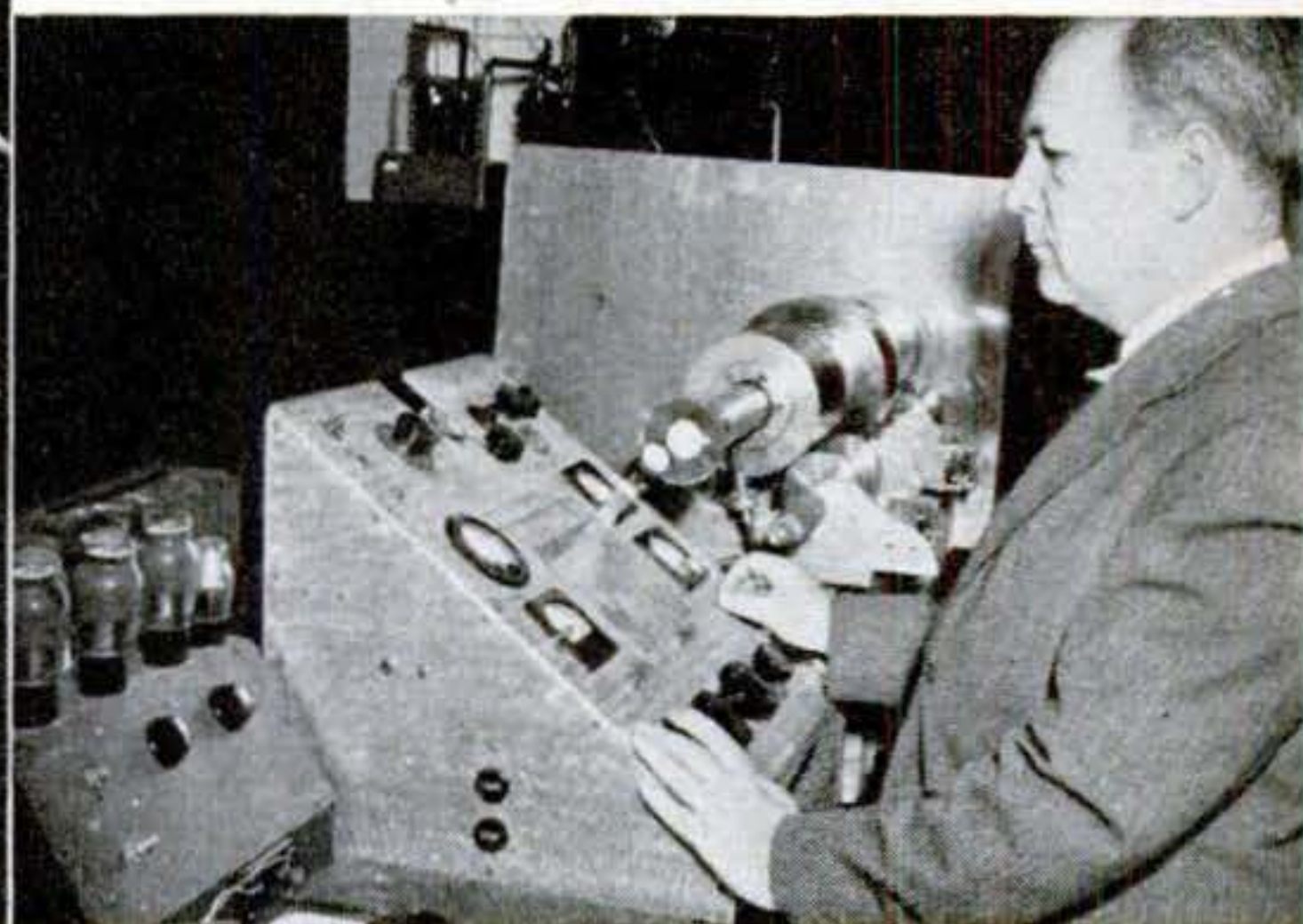

Horizontal electron microscope is used by Dr. L. L. Marton, of National Bureau of Standards, to form visual images of magnetic fields.

Magnetism Poses for Photo

THE National Bureau of Standards has a brand-new tool for measuring and mapping magnetic fields. From it may come better radio and television and new knowledge about what makes metals magnetic.

The tool is nothing but a shadow. This shadow is cast by a fine screen of non-magnetic wire on a photographic plate in an electron microscope. Instead of light rays, the electron microscope uses a beam of electrons and focuses them through doughnut-shaped magnets instead of optical lenses.

When you thrust an extra magnet into the beam, some of the electrons are deflected from their straight-line path. Result: distortion of the shadow of the wire screen. The effect is like looking at a stick thrust partly into water; the stick appears bent because some of the light rays from it are bent by the water.

Distortion of the image in the microscope is greatest where it is formed by those electrons that have been deflected farthest. Thus the bent crosshatching of the shadow forms a pattern that corresponds to the strength of the magnetic field under examination. Formulas have been worked out for calculating from this the absolute field strength of any magnetic material put under the microscope.

The Bureau of Standards' new method can be used, for example, to explore the magnetic fields of waveguides in ultra-high-frequency radio and television apparatus. These are traffic directors—the electronic plumbing that replaces wires, resistors, condensers, and inductors. Waveguide patterns become so complicated that there are no ways of calculating the energy distribution at critical points. Now it can be measured by electron shadowgraphs.

END

Keeping the Home Shipshape



Dress up flower arrangements in clear glass vases or bowls by adding a few drops of cake coloring to the water. Choose a shade that matches or contrasts with the flowers.

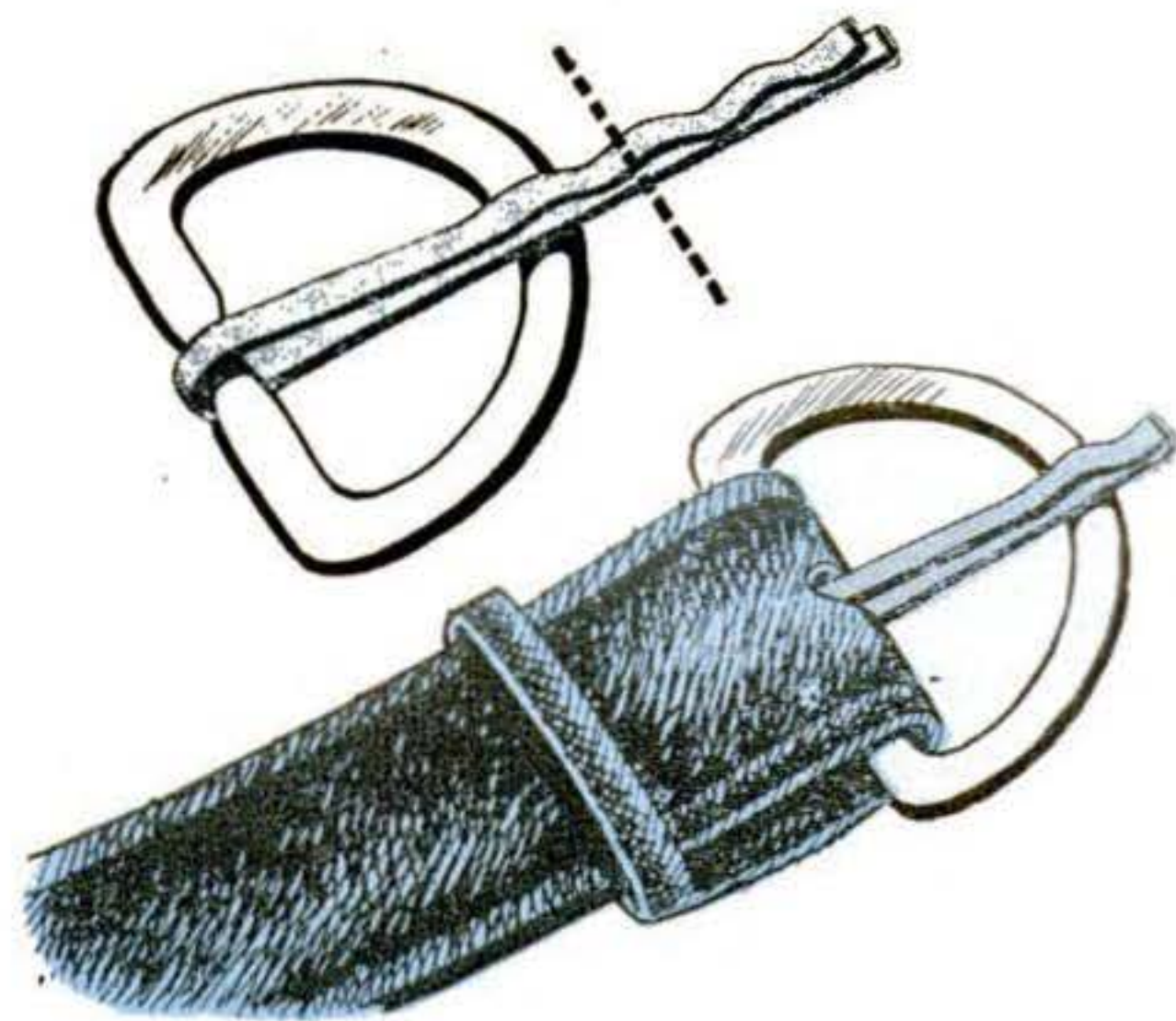

If you lose the tongue of a buckle, replace it temporarily with a bobby pin. Take off the buckle, fit the bobby pin to the crossbar, and cut it short. Then replace the buckle.



Small metal leveler arms, riveted to measuring spoons, let the cook quickly get a level measure. The arms swing out of the way along the handle when the spoons are being filled.

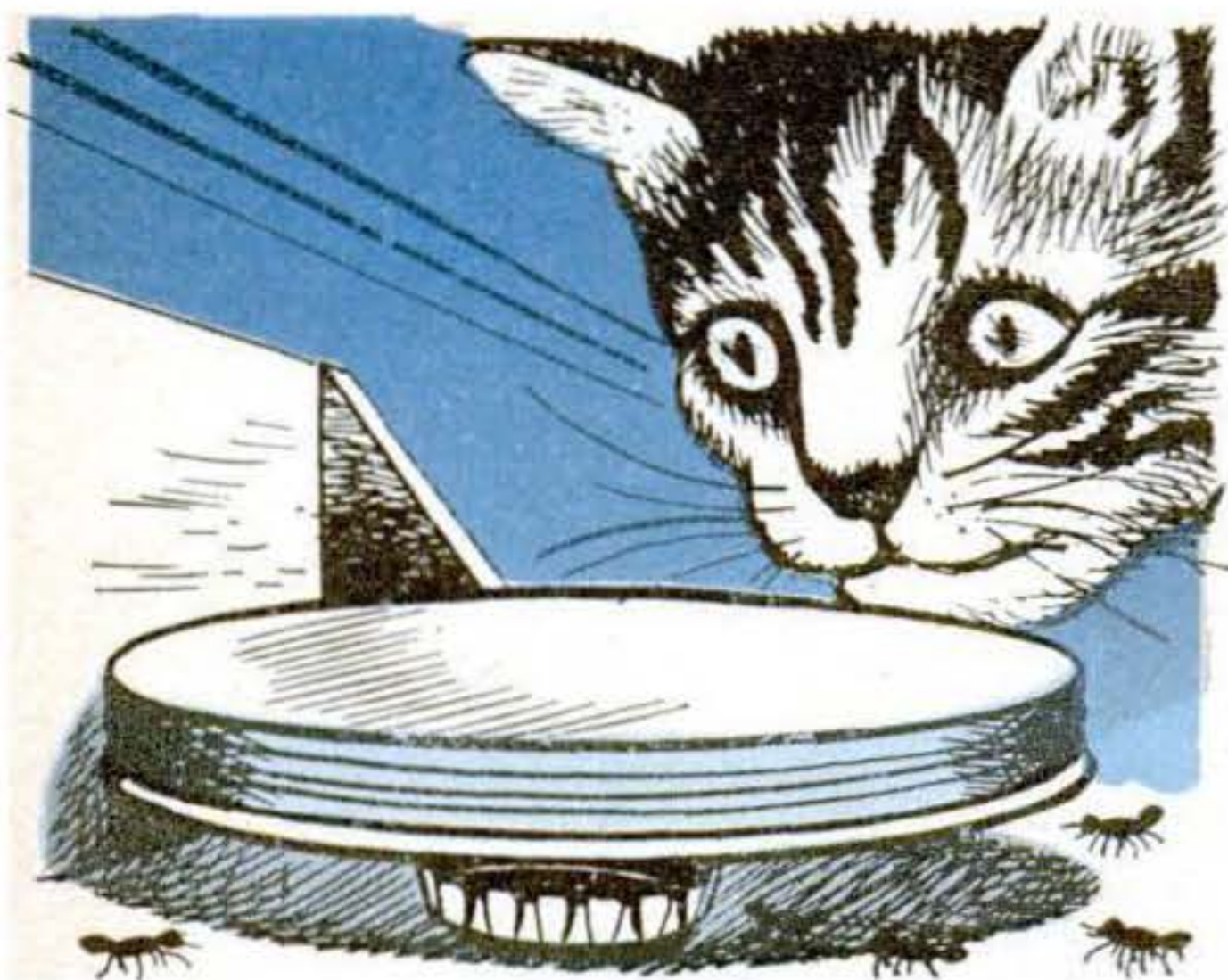

To keep ant poison from pets, put it in a bottle cap that's shielded by a jar top. Support the shield by nailing it to a vertical sidepiece, or to the baseboard.

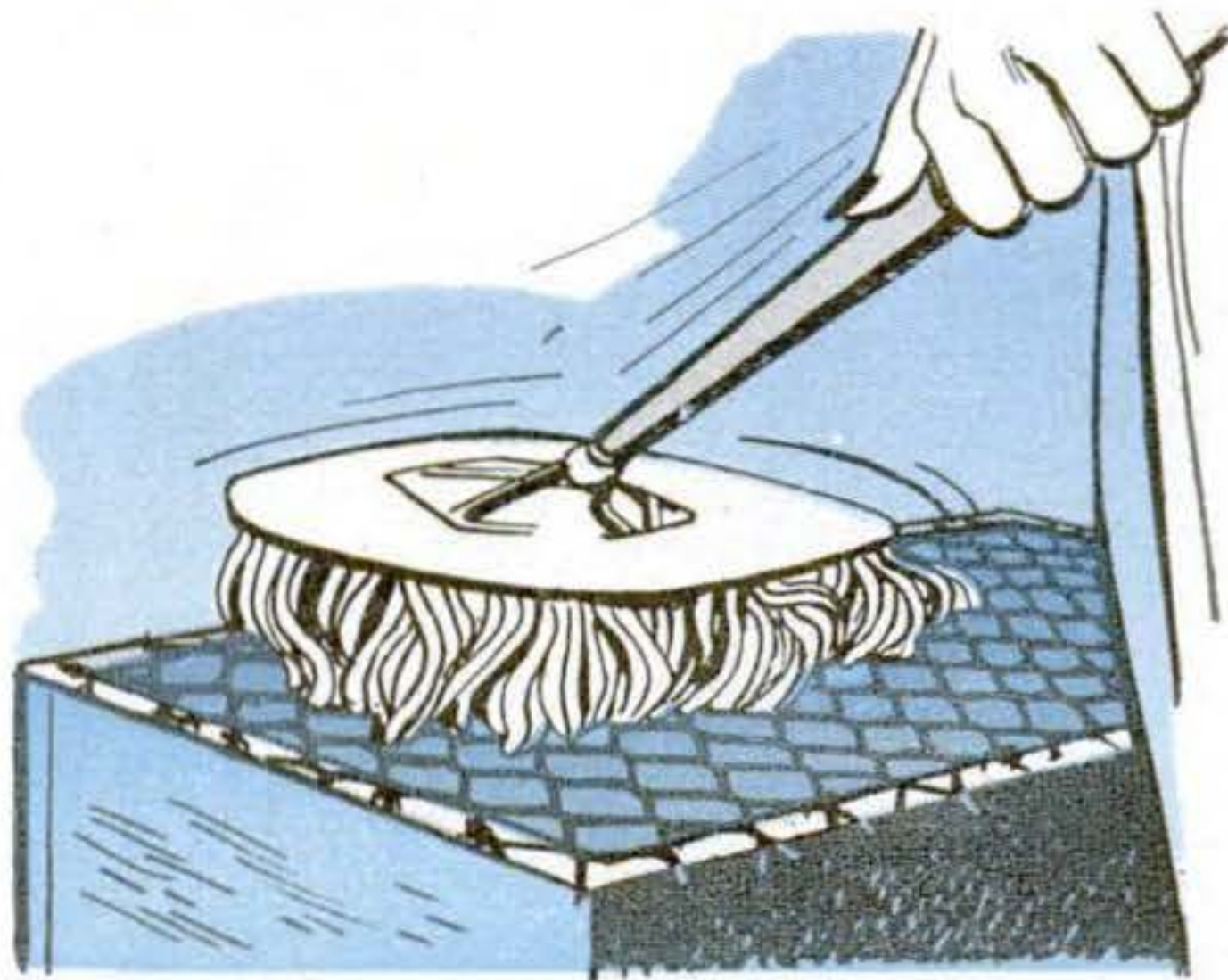

Chicken wire, stretched tightly across a box and stapled, makes a simple cleaner for dust mops. Rub and beat the mop on the wire. Dirt and lint will fall into the box.

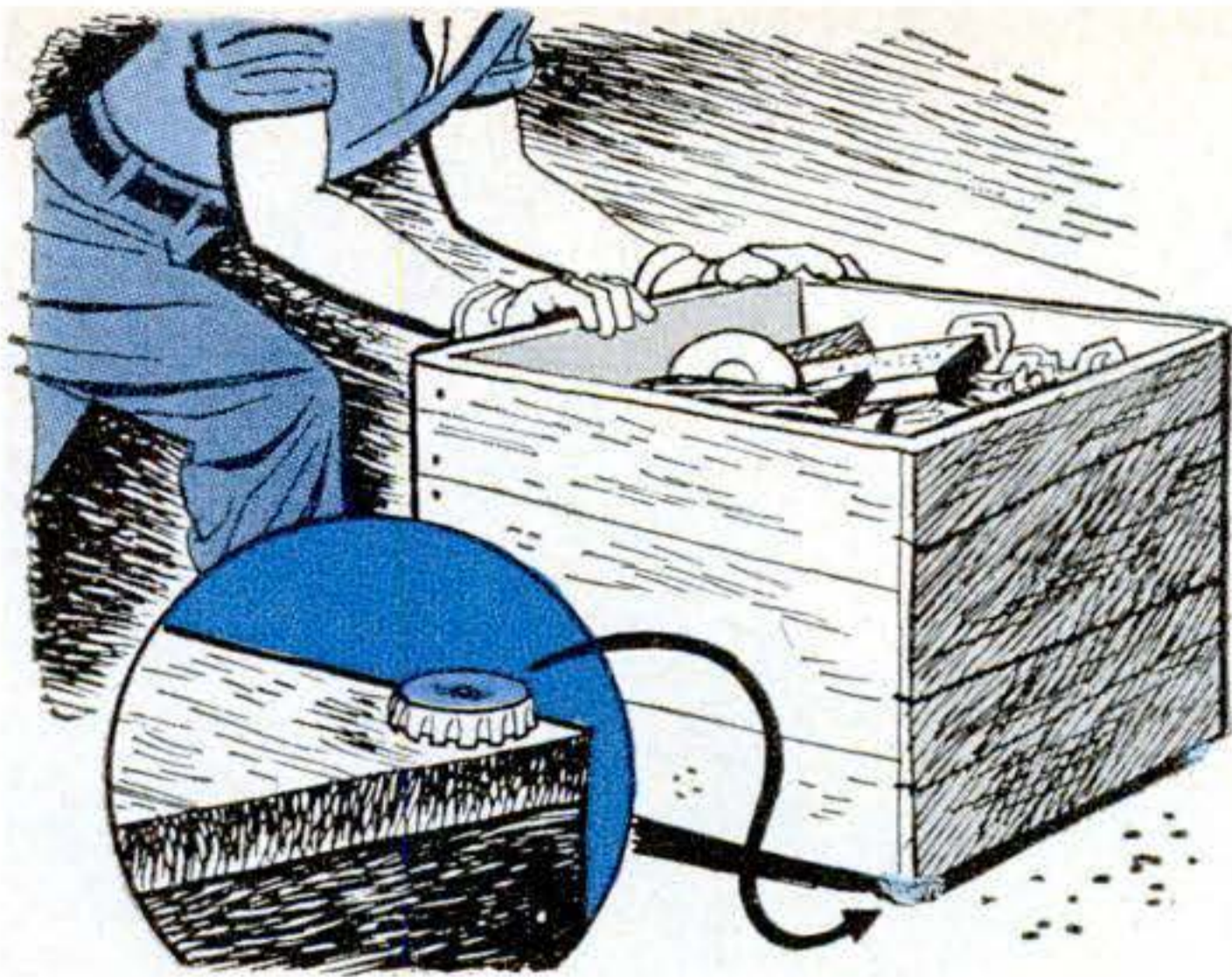

It's easier to slide heavy storage boxes if you tack four or more bottle caps to the base of the box. The caps raise the box and reduce friction between it and the floor.

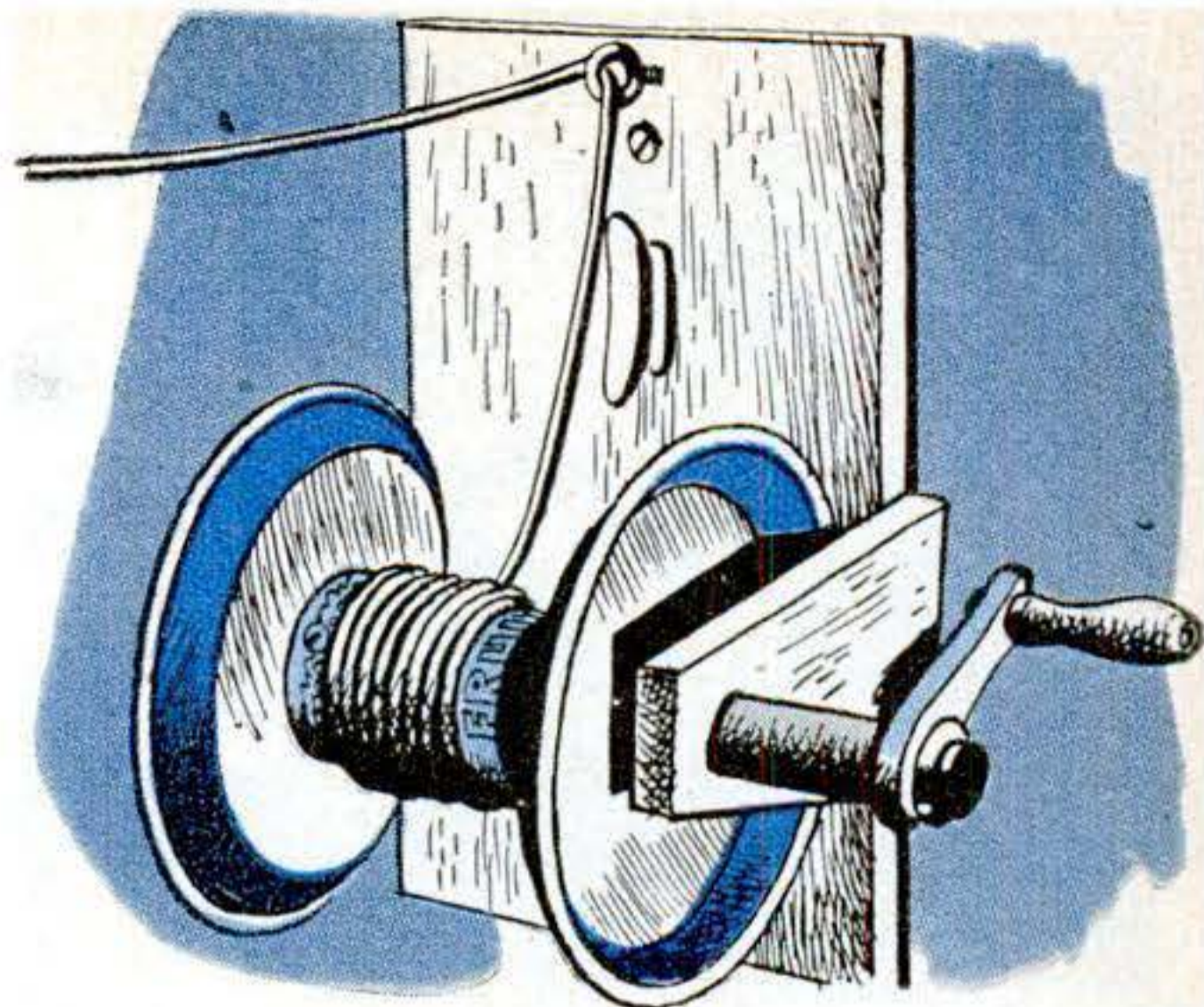

For a clothesline reel, solder pie tins to the ends of a tin can. Punch $\frac{1}{2}$ " holes in the center at both ends. Run a $\frac{1}{2}$ " dowel through and secure it with screws through the can.

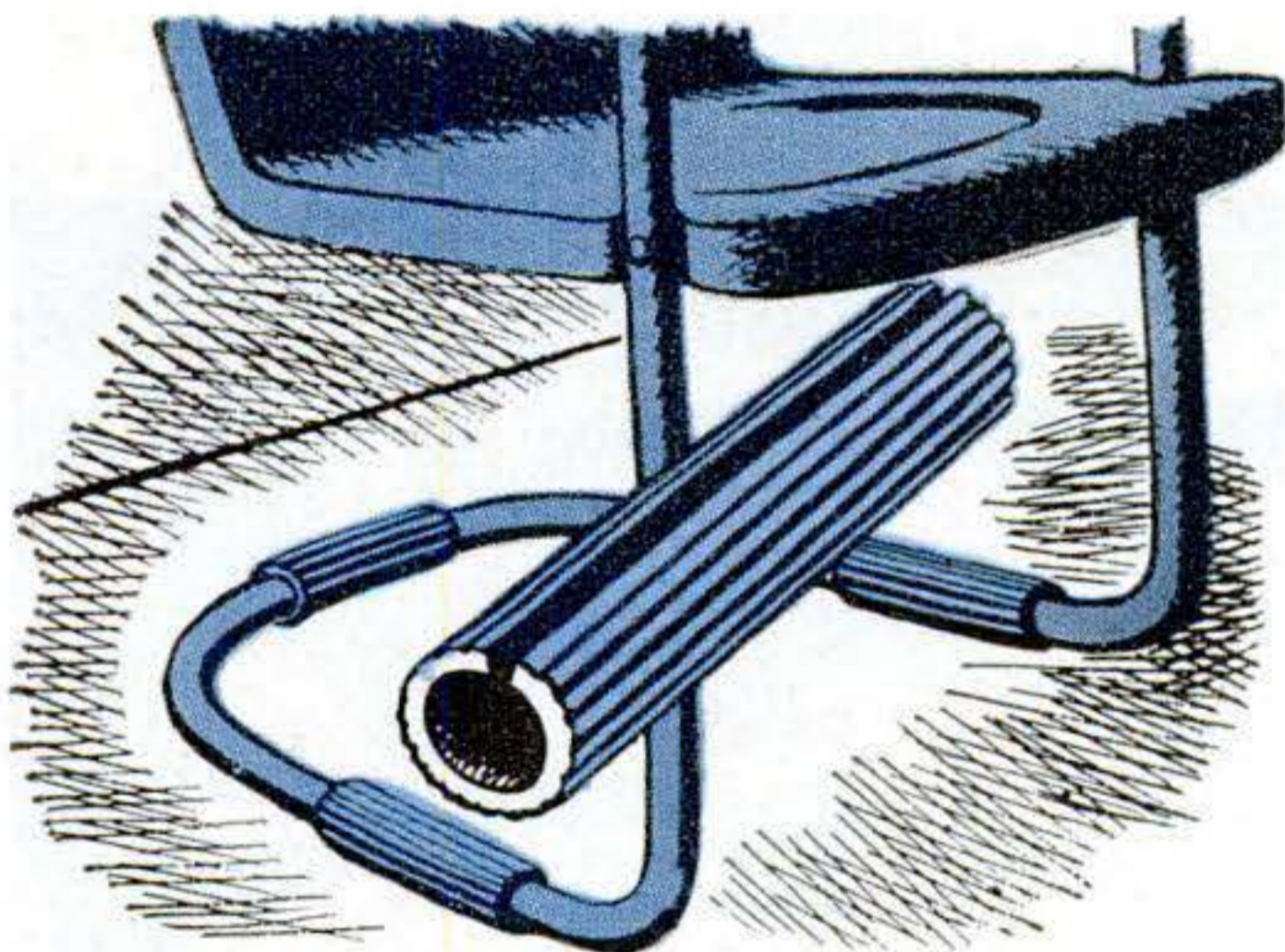

Rubber bumpers, cut from old garden hose, prevent tubular-metal chairs from marring floors. The elasticity of the slit hose will keep it in place, but it may be wrapped with tape.

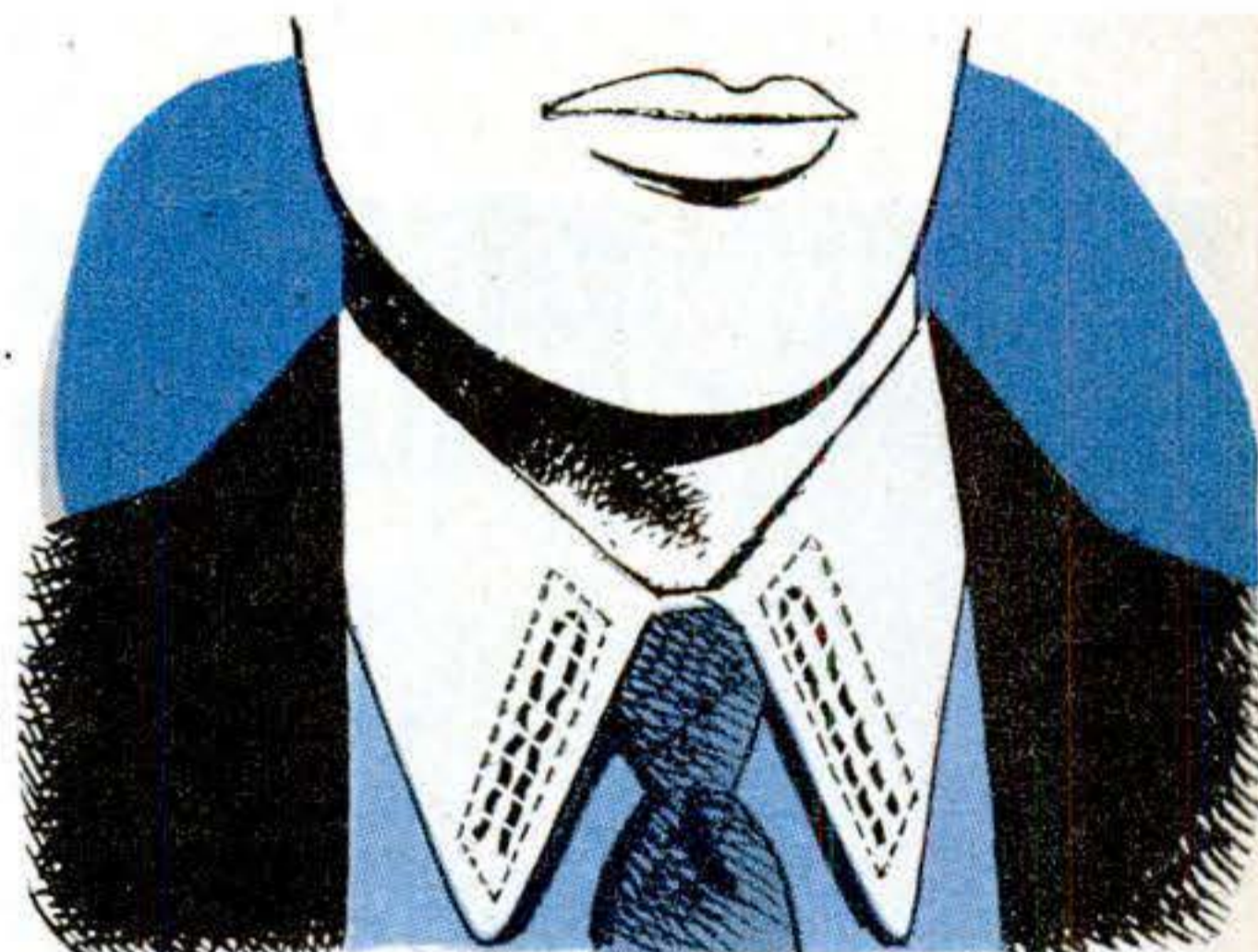

The tabs of unstarched collars can be kept neat and straight with hairpins and adhesive tape. Stick pins and tape to the underside. The stiffeners can be removed easily.

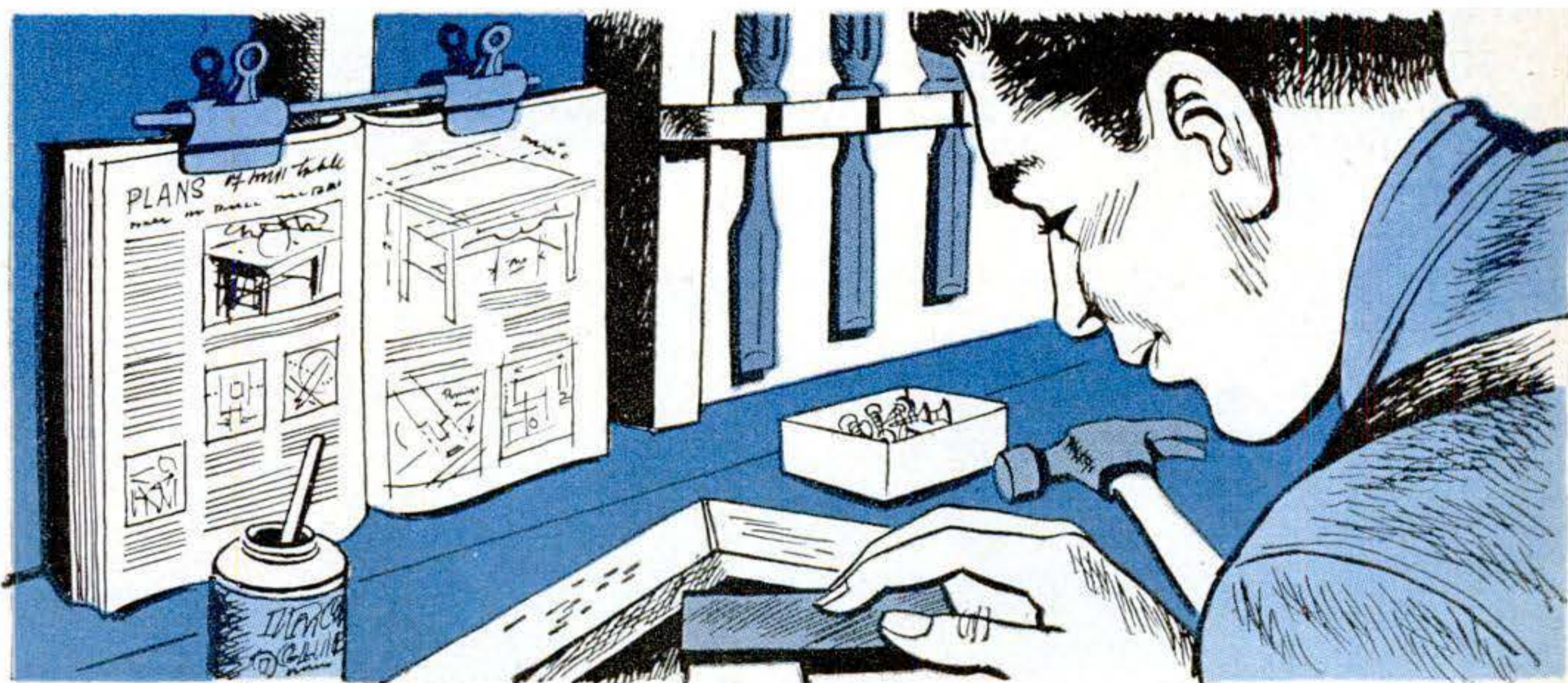

Notebooks or books of plans that you're working from will stay open at the right page if you'll

use a pair of spring clamps, as shown above, with a length of dowel inserted between them.



Tank Car Fuels Jet Bomber

A SINGLE fueling point under the fuselage of this North American four-jet B-45 feeds into all the plane's internal tanks. The result is that whereas it used to take four hours for

the Tornado to drink its fuel, the job now can be done in half an hour—and directly from a tank car at airfields. The system also will permit faster air-to-air refueling to extend the 800-mile tactical range of the Air Force's powerful jet bomber.

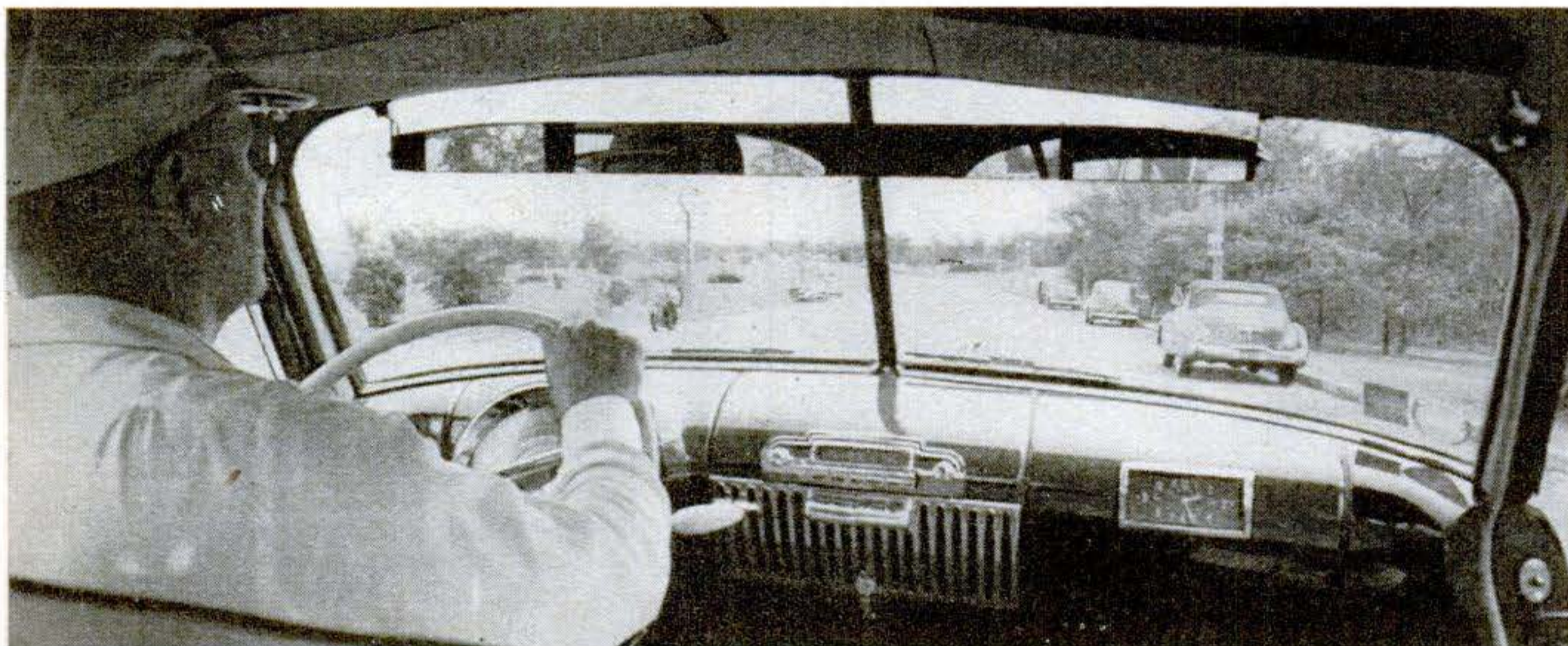

Rear Mirror Widens View

THE motorist above is getting a clear view of both sides of the road as well as directly behind. It's done with five 2- by 7-inch non-

glare mirrors fitted into a metal frame at various angles to cover a 160° arc. The Wyd-Vue®, seen in place across the top of the windshield, is made by the Am-Ben Corp., Chicago. It sells for \$7.50.

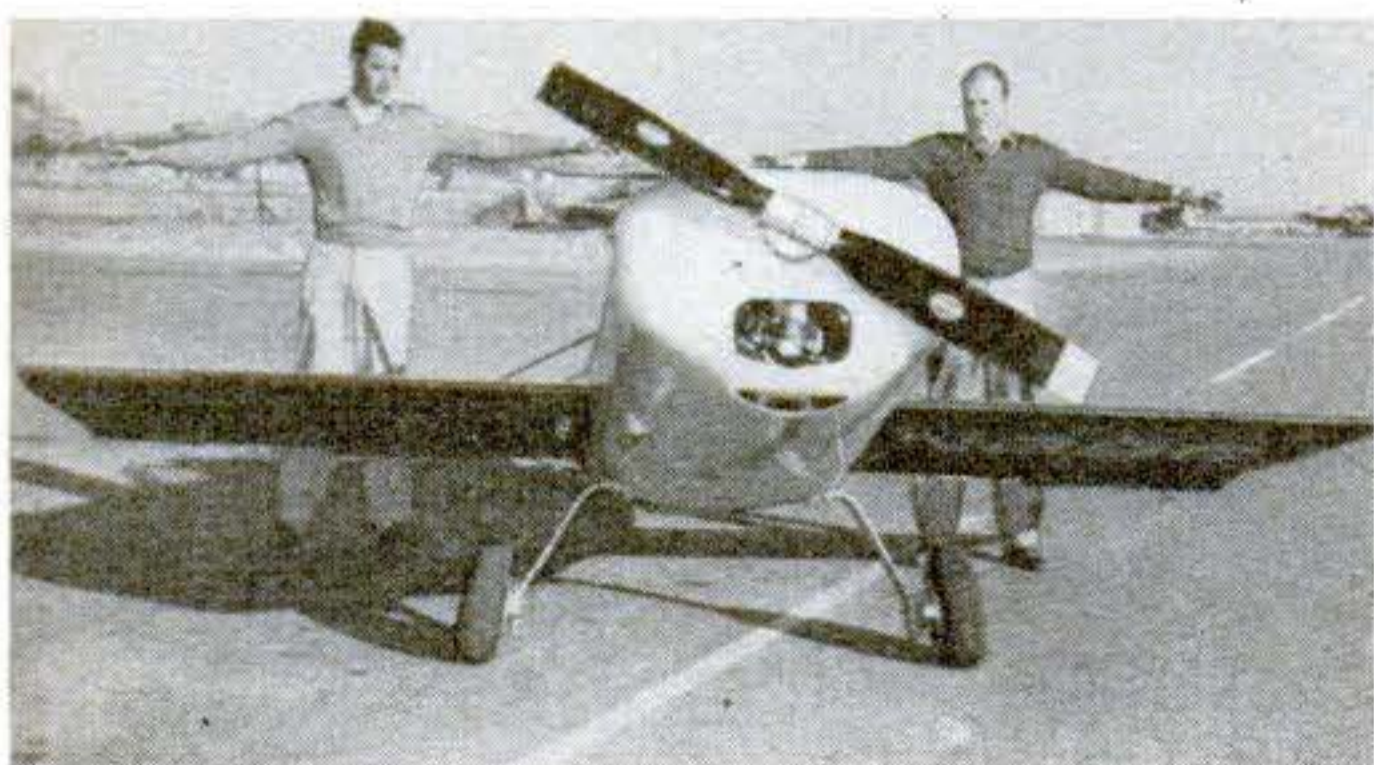

Midget Made at Home

WITH hands joined, Paul Holmes and Merle Larson, of California, show that they can almost reach across the 13 feet between wing tips of the tiny plane they designed and built without the assistance of aviation engineers. A few hours after it was assembled, Larson climbed into the cockpit for taxi tests. So well did it behave that he surprised his partner by taking off and putting the midget through its paces. An 85-hp. engine powers the miniature racing plane.



"Wrung out" on the frame twister, this 12-ton 8x8 shows the new look in Army trucks.

Army Breeds New Line of Combat Workhorses

To cut driver fatigue, new trucks are to have torque converters, huskier engines, and torsion-bar suspension.

By John F. Loosbrock

PS photos by W. W. Morris

CLIMB in, settle yourself behind the steering wheel. Flip the starter switch on the dashboard. Don't look for the choke—it's an automatic one, under the hood. Your left foot will fumble for the clutch pedal until you realize it isn't there. Just pull the control lever on the steering column down

into high, step on the gas, and you're off—it's that easy.

And while you're rolling along, reflect on this fact: you're driving not a luxurious new automobile, but a rugged 2½-ton Army truck, lineal descendant of the workhorse of World War II.

GI drivers who pounded down the Red Ball highways in France or over the coral roads on the Pacific islands wouldn't even recognize the new bloodlines that Army Ordnance vehicle experts are now breeding. I know I didn't when PS photographer Bill Morris and I visited Aberdeen Prov- ▶

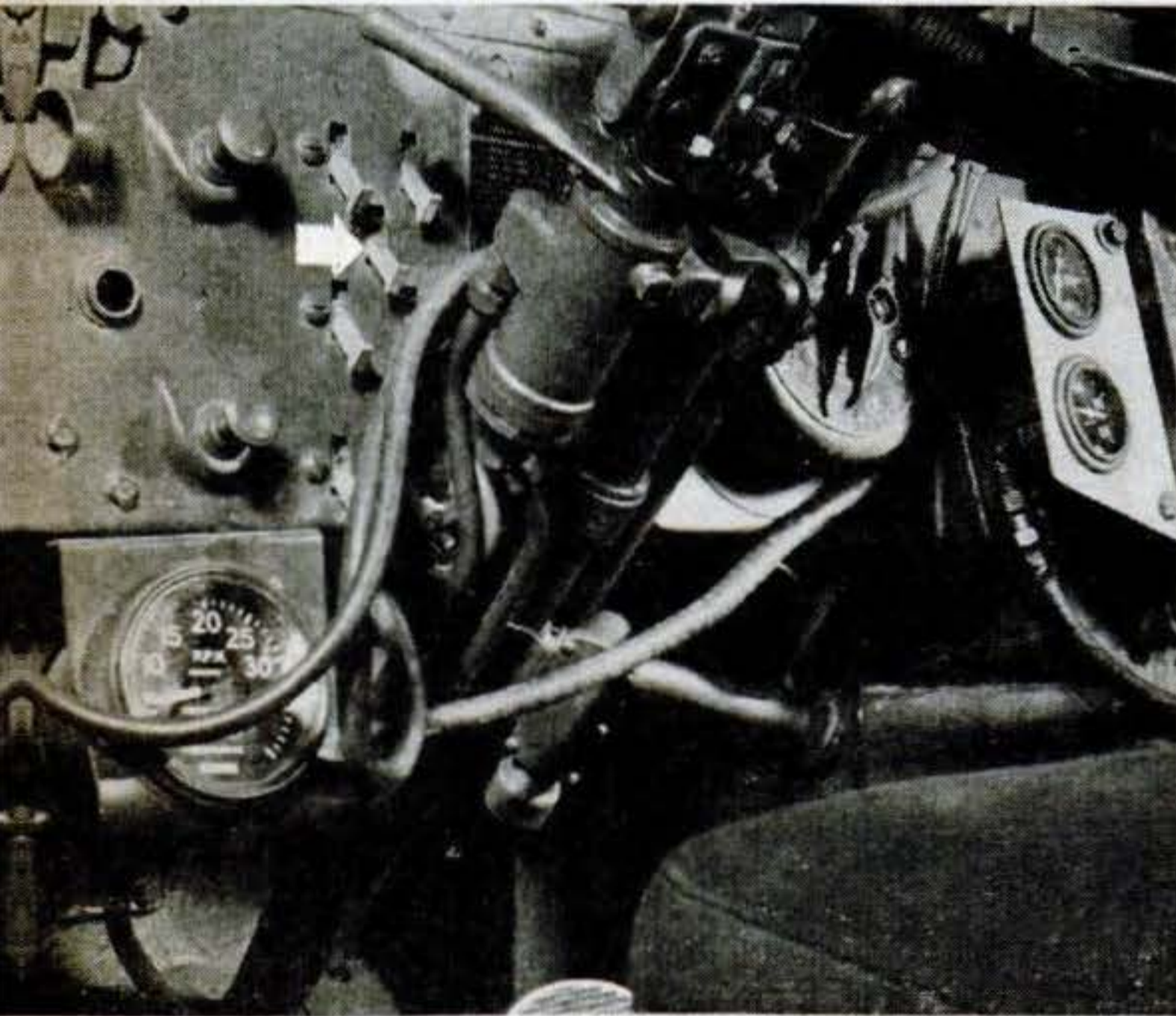
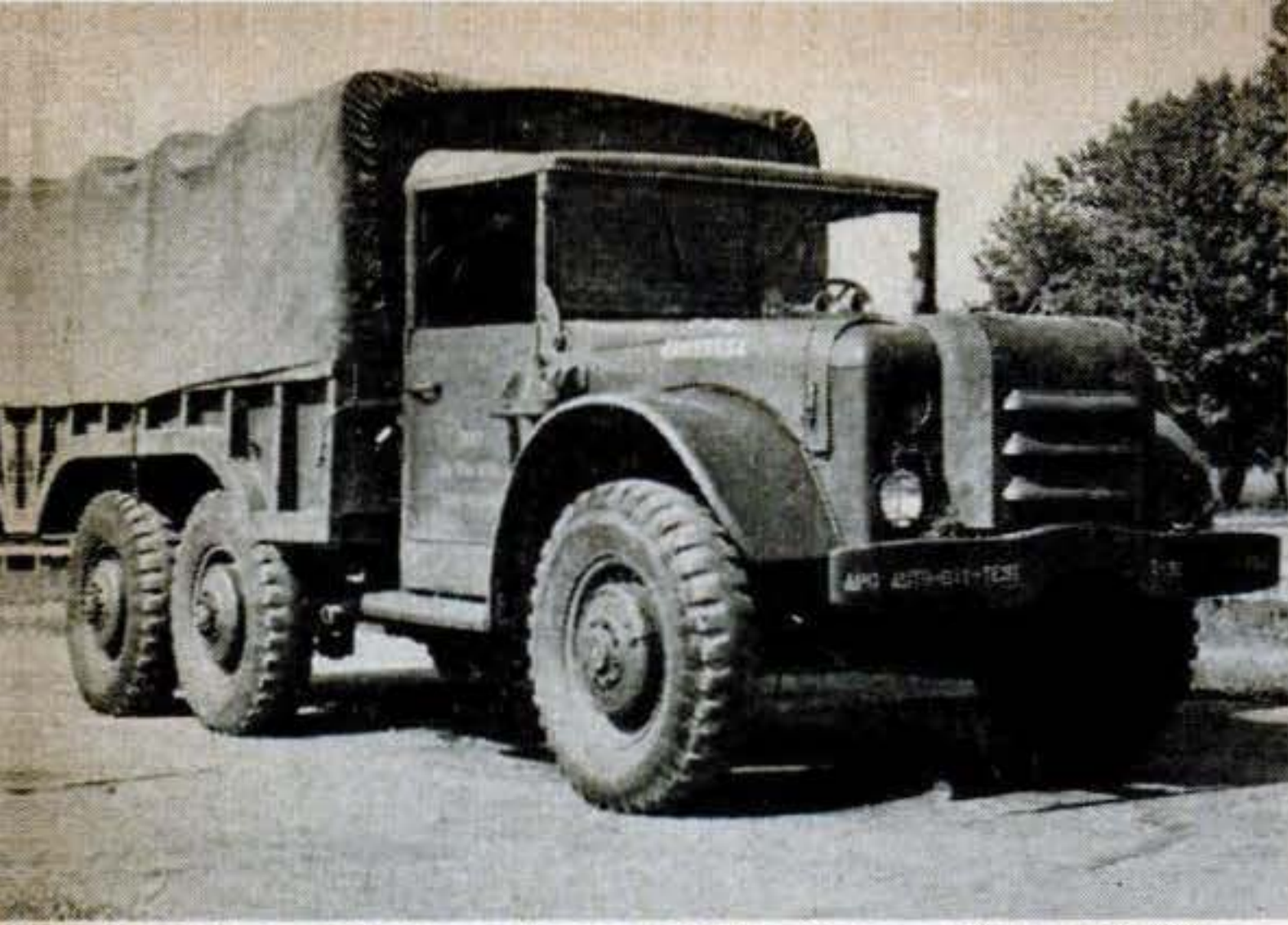

Test model 2½-ton, top, bears faint resemblance to its wartime brother. Close-up shows tire-pressure controls. Each tire has own control. Master knob (arrow) turns system on and off.



Wide doors and plenty of clearance under steering wheel make new trucks easy to get into. More important, as combat drivers will testify, they're easy to get out of in a hurry.

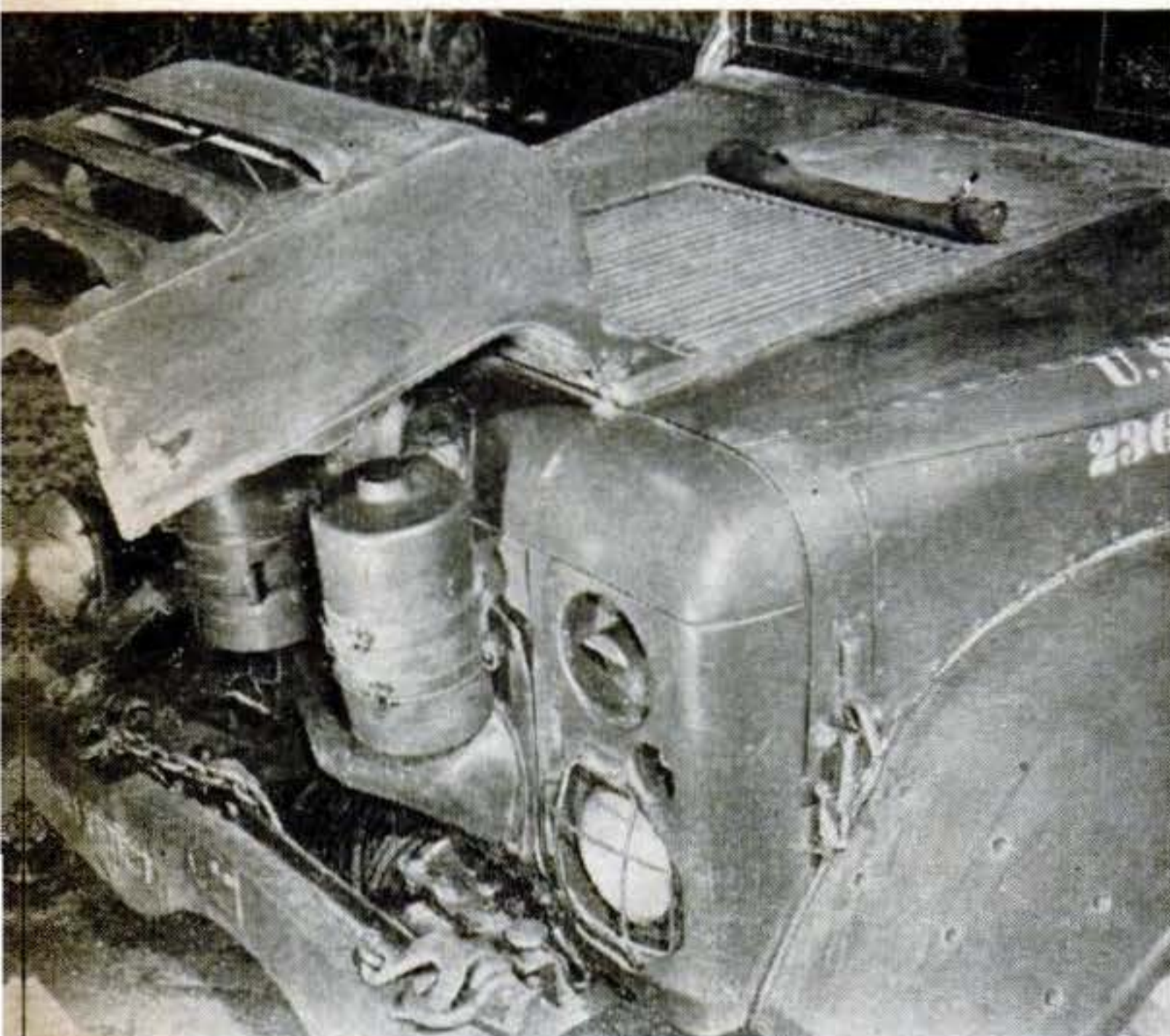

Raised cover on ¾-ton shows twin oil-bath air cleaners and power winch. Fan mounted on engine sucks in cooling air through grille atop hood. Lamp above headlight is for blackouts.

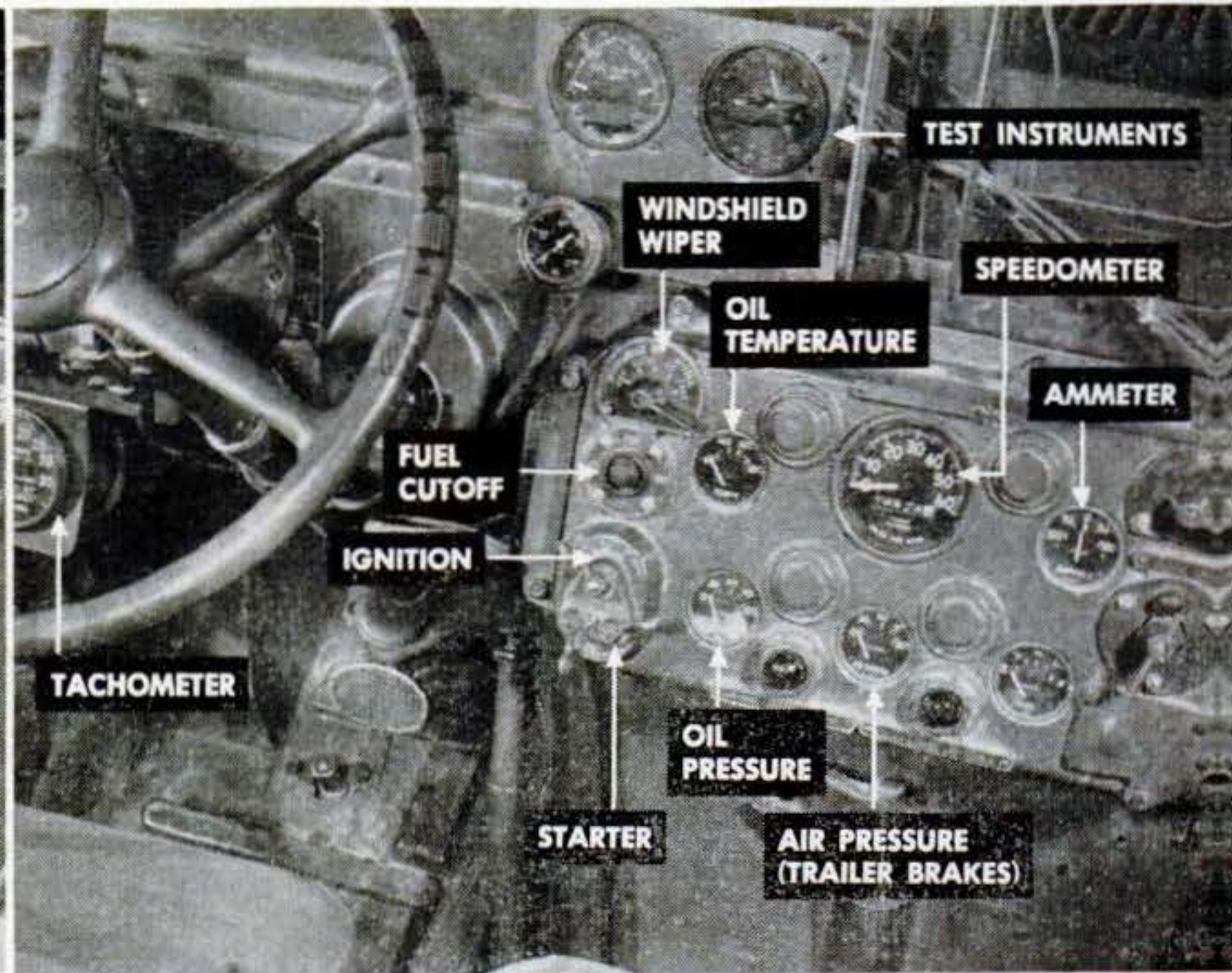

Dashboard of ¾-ton 6x6. Note the transmission-control lever on the steering column, new on military vehicles. Instruments mounted above and left of dash are for test purposes only.

ing Ground, in Maryland, to see the test models put over the jumps.

The new jobs still have steering wheels, but any resemblance to conventional wartime trucks stops about there. Transmissions are automatic, with torque converters and planetary gear systems. That makes them

easier to drive, with two sound military consequences: less driver fatigue when trucks are rolling day and night, and simplified driver training.

I hadn't driven a truck since I struggled with the intricacies of double clutching on a wartime 2½. Yet I climbed in one of the

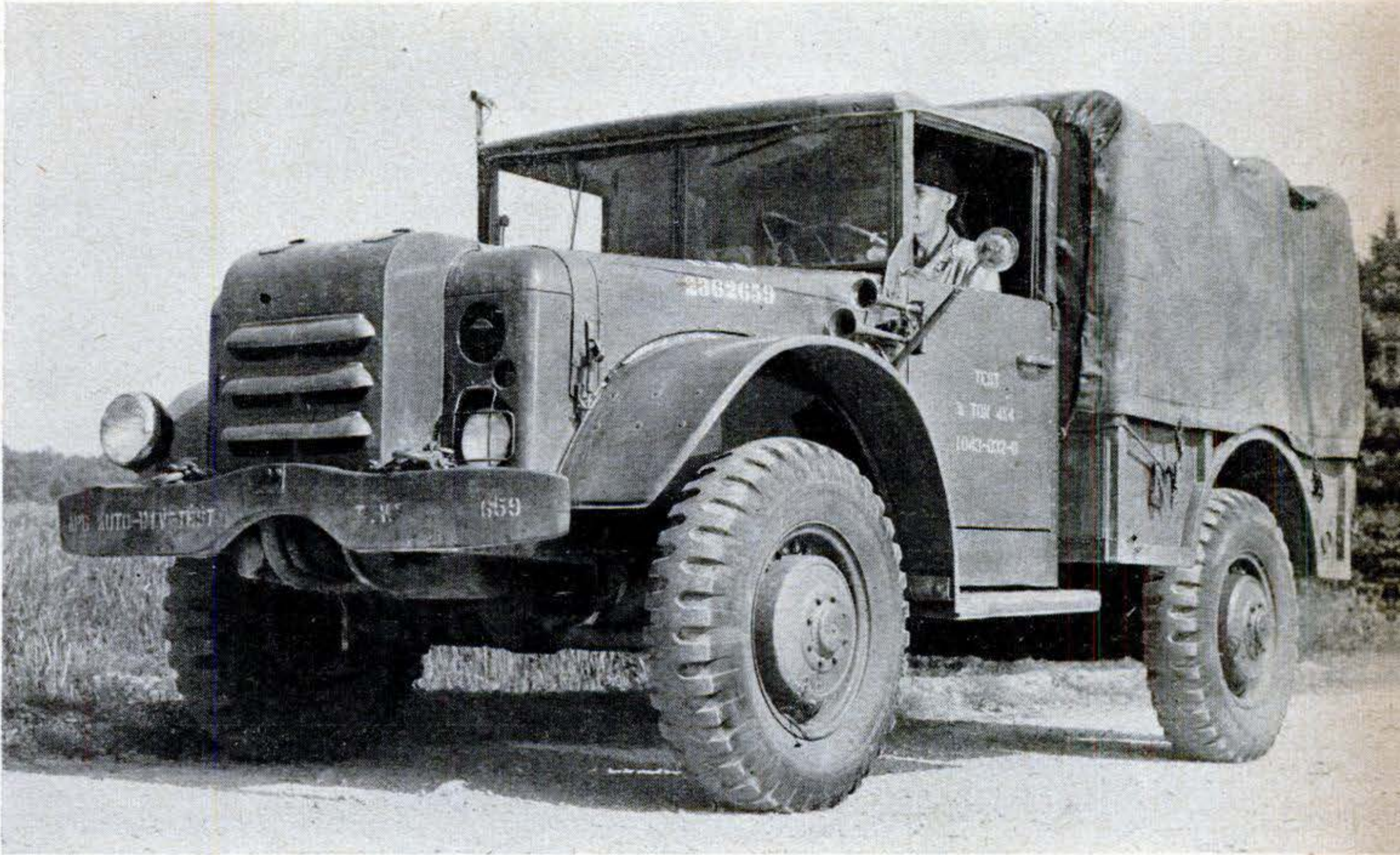

New ¾-ton cross-country truck has 187-hp. air-cooled engine, hits 60 m.p.h. on good road.

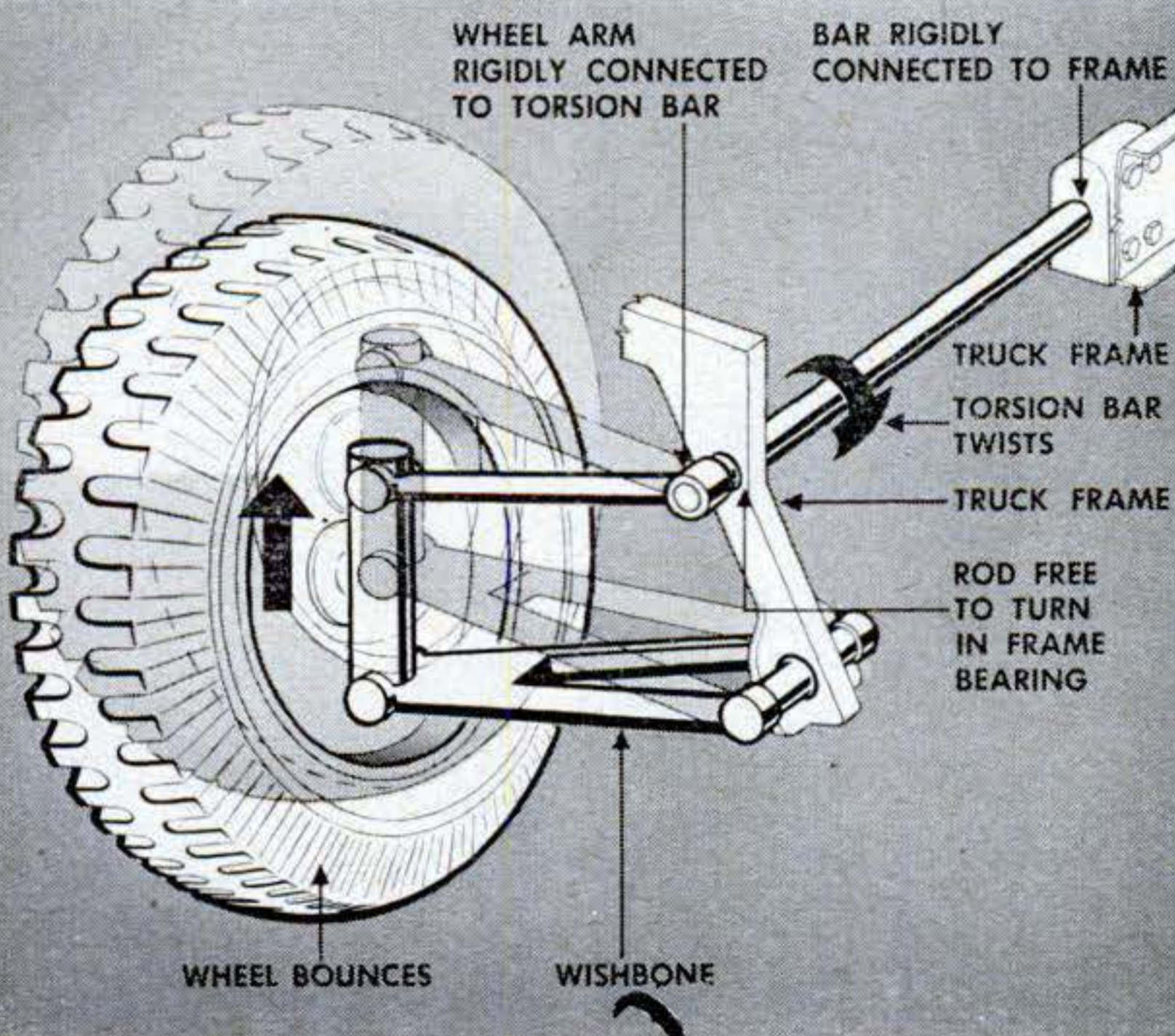

Here's how torsion-bar suspension works. When wheel passes over bump, linkage system twists bar, performing same function as conventional spring. Drawing is purely schematic.

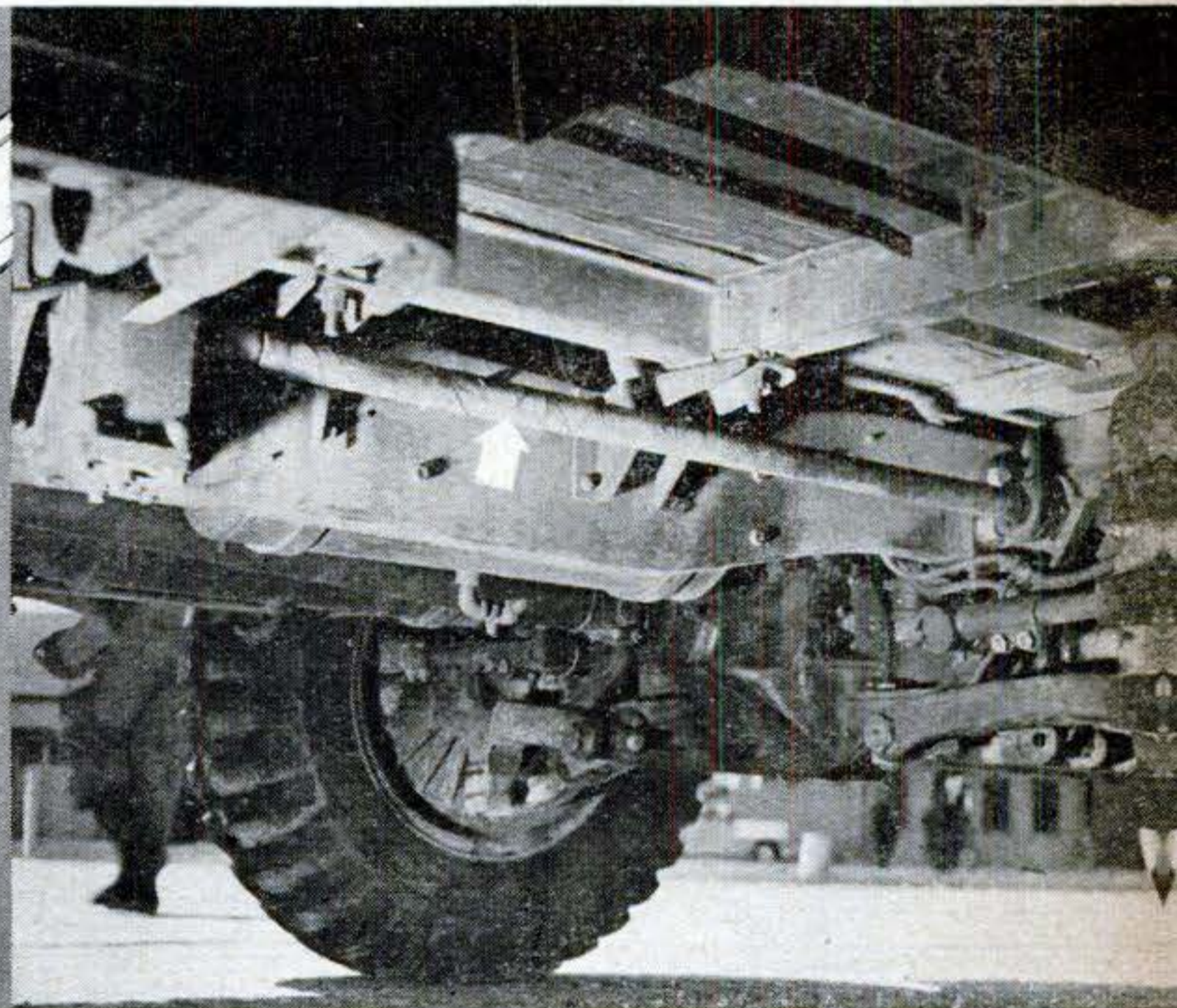

Close-up of torsion bar (arrow) on front of ¾-ton. Bars are high-quality steel, polished to mirror-like smoothness. Nicks or dents act as focus for strains, so bar has protective wrapping.



This 5-ton 6x6 has air-cooled engine, torque-converter transmission. Middle set of wheels

turns with front set, giving this 150-inch-wheel-base job a turning radius of only 35 feet.

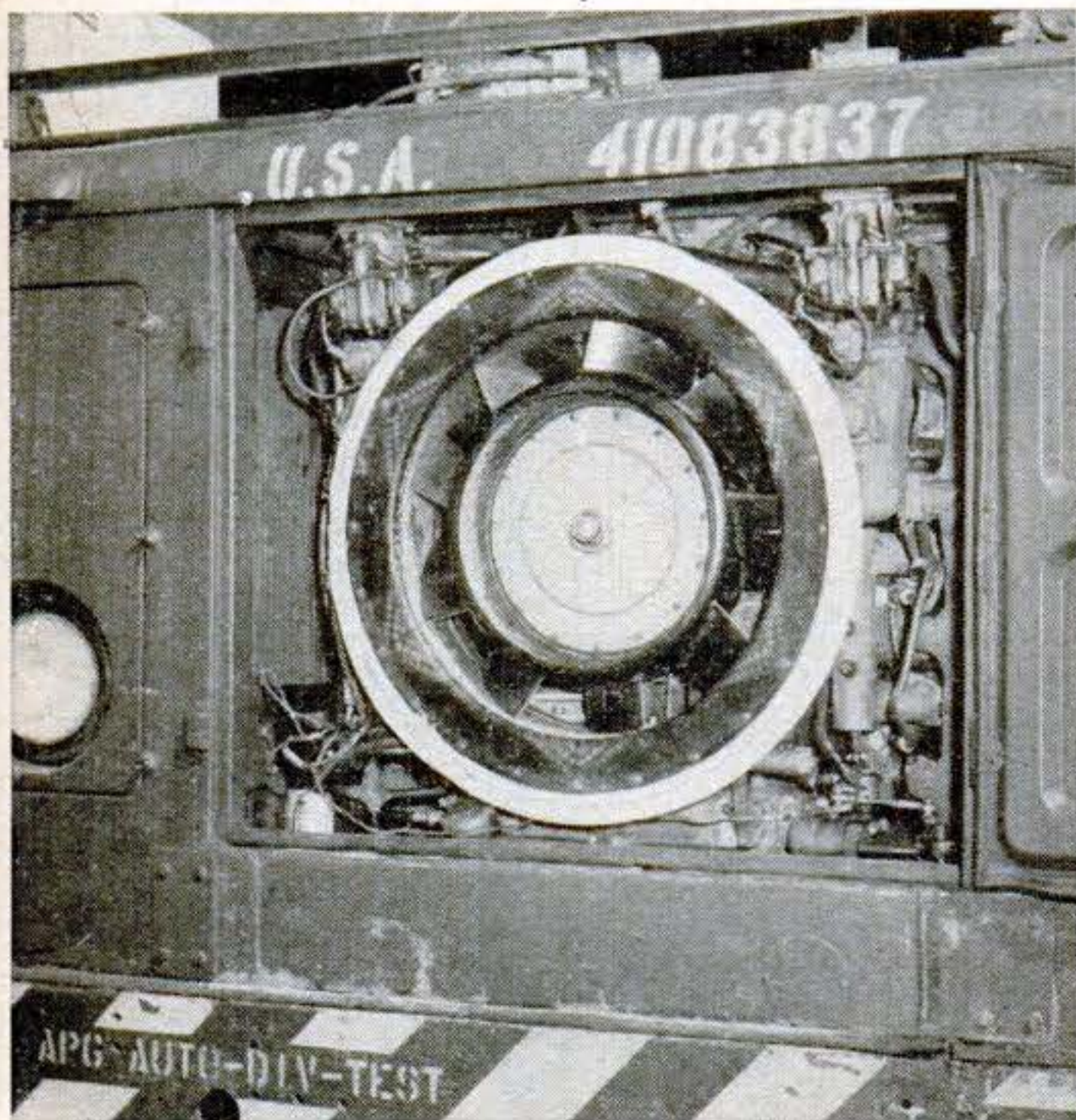

A huge cooling fan replaces the conventional radiator. The engine has eight opposed cylinders and is mounted on end with a vertical crankshaft. It develops 200 horsepower.

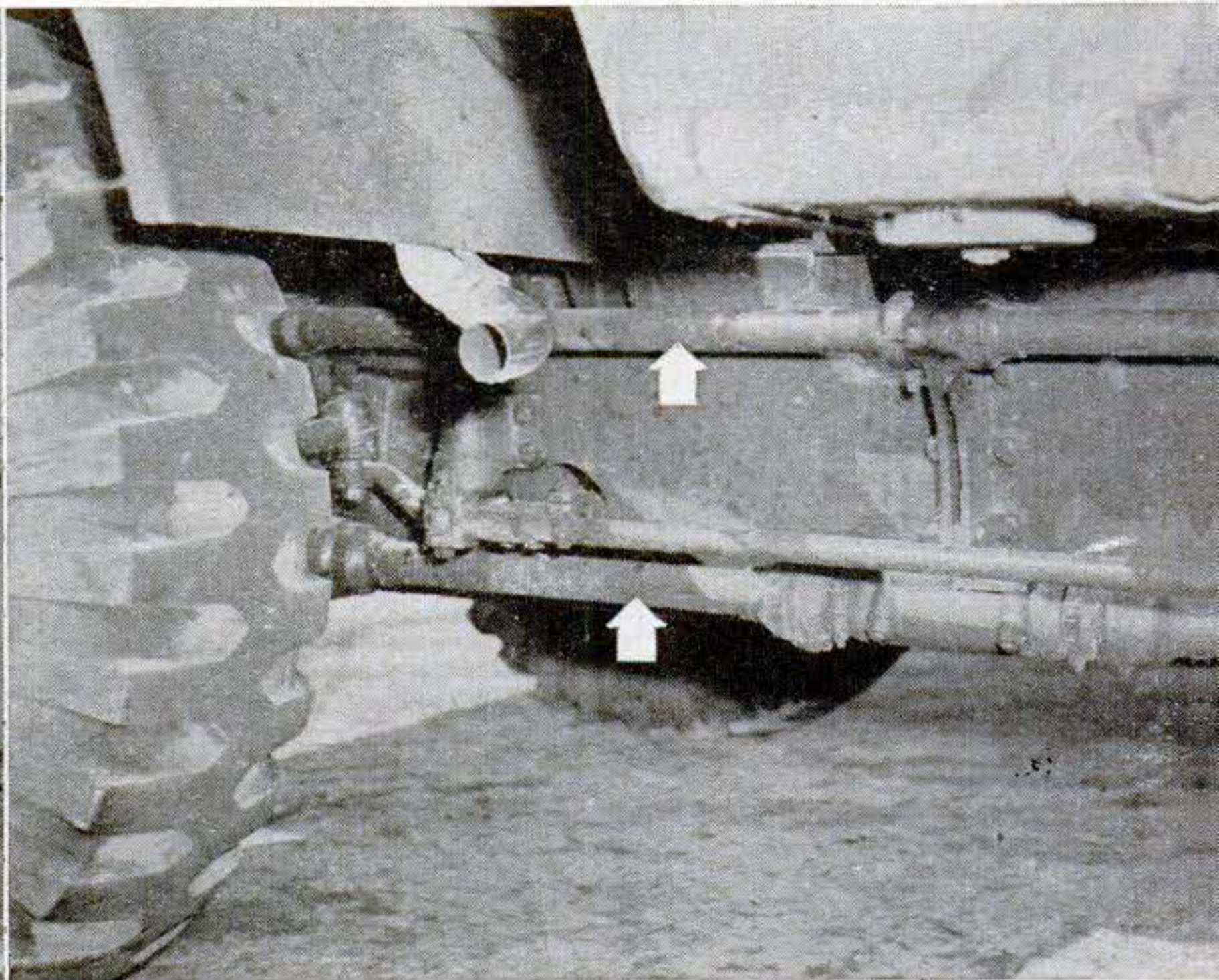

Close-up shows torsion-bar suspension (arrows) on the 5-ton truck. Twisting action of top bar takes care of ordinary road shocks. Bottom bar does same job as conventional overload springs.

latest GI jobs and wheeled it over Aberdeen's tough Munson test course without so much as a dry run. It was actually easier to drive than a jeep. This means that, in an emergency, every soldier is a potential driver.

Engines are the new air-cooled type, developed and built by Continental for Ordnance. No more radiators to be punctured by shrapnel, or to freeze in the Arctic and boil dry in the desert. Engines are more powerful, although the absence of radiators allows them to be crammed into smaller spaces. The test model of the $\frac{3}{4}$ -ton kicks out 187 hp. at 3,000 r.p.m., about double that of its wartime predecessor. The same engine powers the new 2½-ton, which differs from the $\frac{3}{4}$ only in a bigger cargo bed and an extra set of rear wheels.

Machines Cheaper Than Men

Torsion bars, like those on some of the new foreign cars, are replacing conventional spring suspension systems. They give a smoother ride with greater frame rigidity. Again, the idea is to lessen driver fatigue. Expensive as these new vehicles will be, our Army still holds to its theory that machines are easier to replace than men.

On some of the big jobs, more than one pair of wheels steer, either through a knuckle arrangement or by mounting them on a platform that turns. They have hydraulic-as-

sisted steering, so you can push a 25-ton tank retriever around a corner as easily as a jeep.

Tire pressures can be changed at will, merely by flipping a series of knobs on the dashboard. This will pay off primarily in amphibious operations. You can drive across a soft, sandy beach with tires at low pressures, and then pump them up when you hit firm ground—all without getting out of your cab.

Even the brakes are new, mounted outside instead of inside the wheel. To reline them, you just unscrew a few nuts and the drum slips off to expose the brake mechanism. Minor jobs, like bleeding a hydraulic line, can be done through a small inspection hatch, without pulling the drum. The arrangement is so simple and satisfactory that Ordnance experts shake their heads and wonder why someone didn't try it years ago.

These startling new trucks aren't in quantity production, as the Ordnance Department is the first to point out. They are strictly development models, for test purposes only. Various frame types are being experimented with. Some engines are mounted vertically, some horizontally.

But hang the various new features of these 1949 Model Ts (their official Army model number is preceded by T, for Test) on one truck and you'll get an idea of how the GI combat vehicle of the future will look. To me it looks good. END

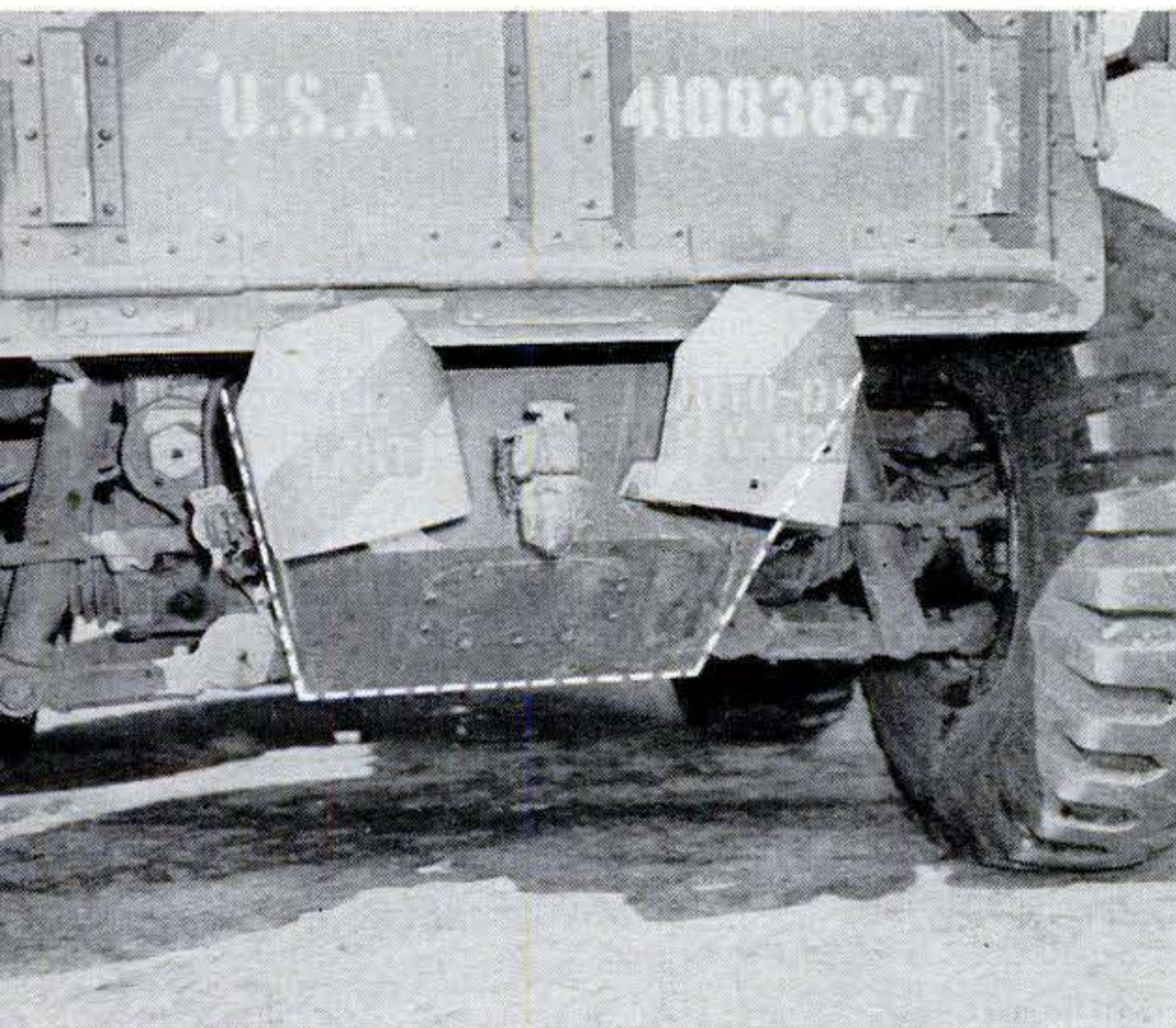

Rear view of 5-ton job shows new experimental frame resembling hull of a boat. Hull (outlined in white) gives great rigidity. Hanging wheels on hull eliminates rigid axle.



New sealed brakes are mounted in drum on outside of wheel for easy access. Brakes can be relined and adjusted without pulling wheel. Minor repairs can be made through opening.

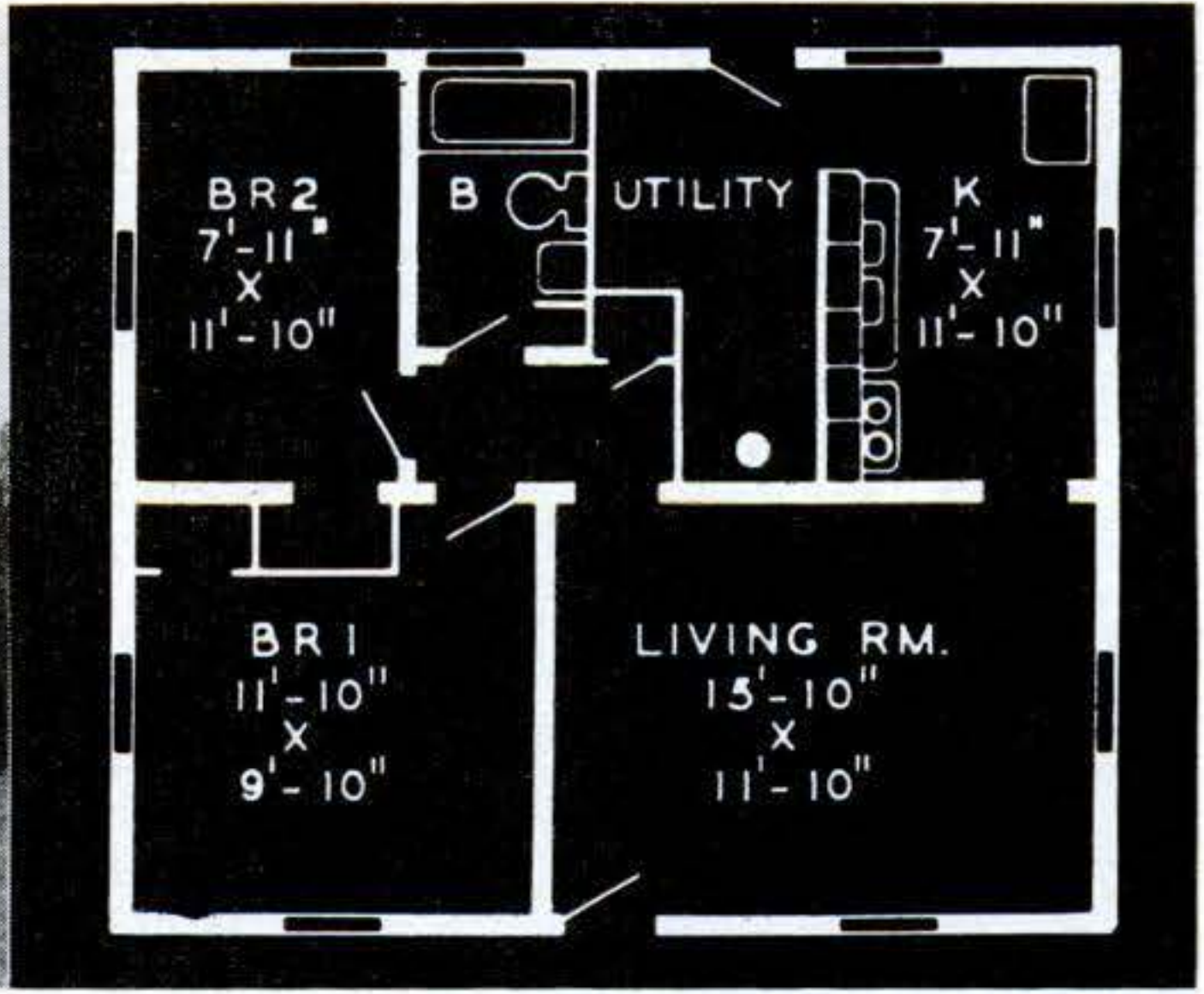
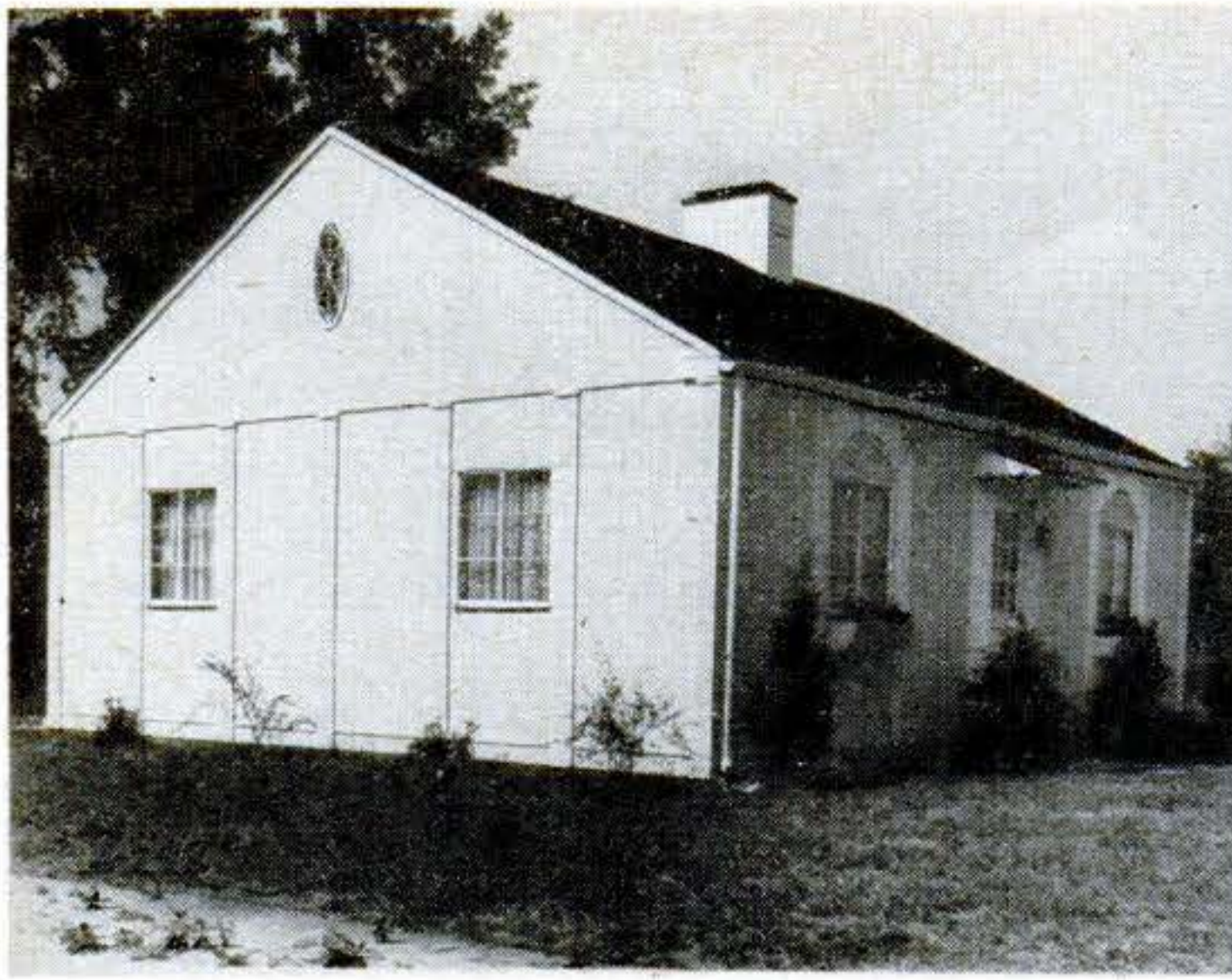

New Prefab Is Low in Cost

A NEW low-cost 4-room home on which the down payment is as low as \$350 and the monthly payments \$37 is being made by the U. S. Steel Corp. Total cost of the

house, including landscaped plot, is under \$6,300. It contains two bedrooms. This plywood-panel prefab is being turned out in New Albany, Ind., at a rate of one every 20 minutes. The company has made prefabs—called Gunnison Homes—for 15 years.

Trillionth of an Ounce Is a Lot

Even .000,000,000,000,03 ounce of radon gas is spotted by the measuring devices at right. They determine radon content—which tells how much radium is present, since radon is produced as radium decays—by measuring the radioactivity of samples in the metal cans. A fantastically small amount can be important to the Atomic Energy Commission's New Brunswick (N. J.) Laboratory, which tests materials for atomic work.

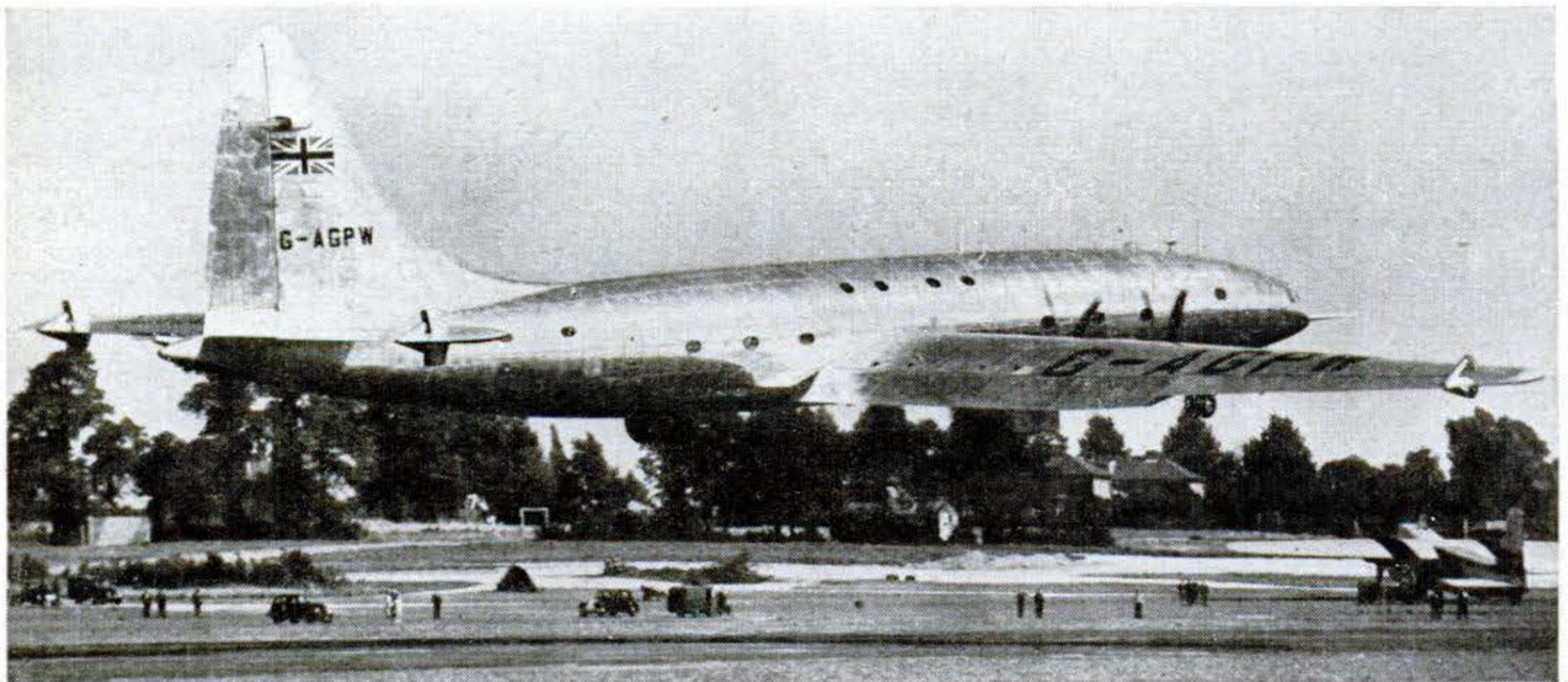

Biggest Landplane Flies

EIGHT-ENGINE Bristol Brabazon I, the largest landplane in the world, is shown above taking off on a test flight in England.

Her length of 177 feet compares with 110 feet for the Boeing Stratocruiser and 182½ for Air Force's 6-engine C-99 cargo plane. Brabazon's gross weight exceeds C-99's 132½ tons, however, by some 10 tons.

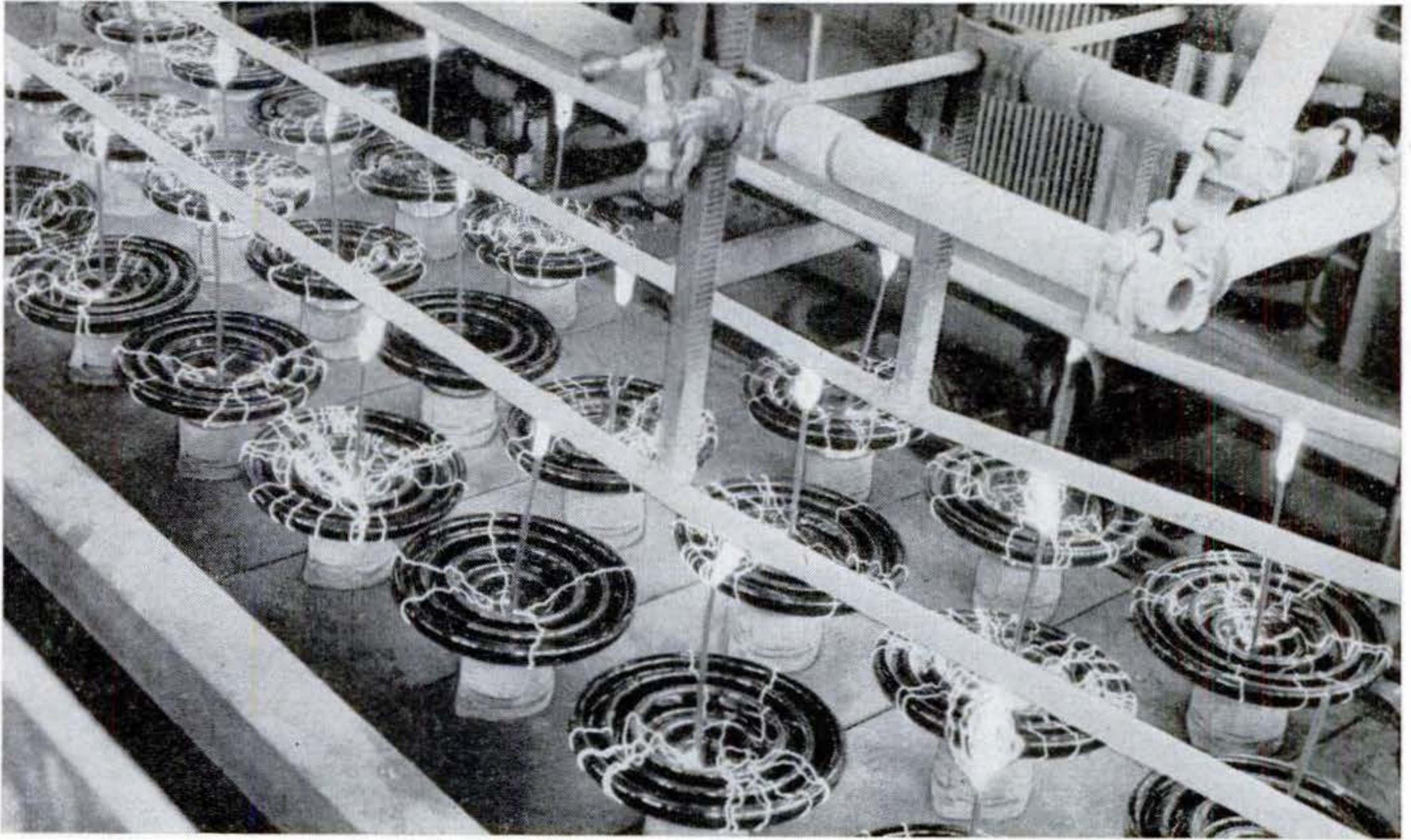

"Spaghetti" Tests Insulators

THE white threads crawling from these porcelain bowls are 90,000-volt arcs. The display is a Westinghouse test of power-line

insulators. They ride a conveyer under conductor rods from which electricity jumps to vertical electrodes, then flashes over the insulators themselves. The barrage reveals any flaws in the porcelain.

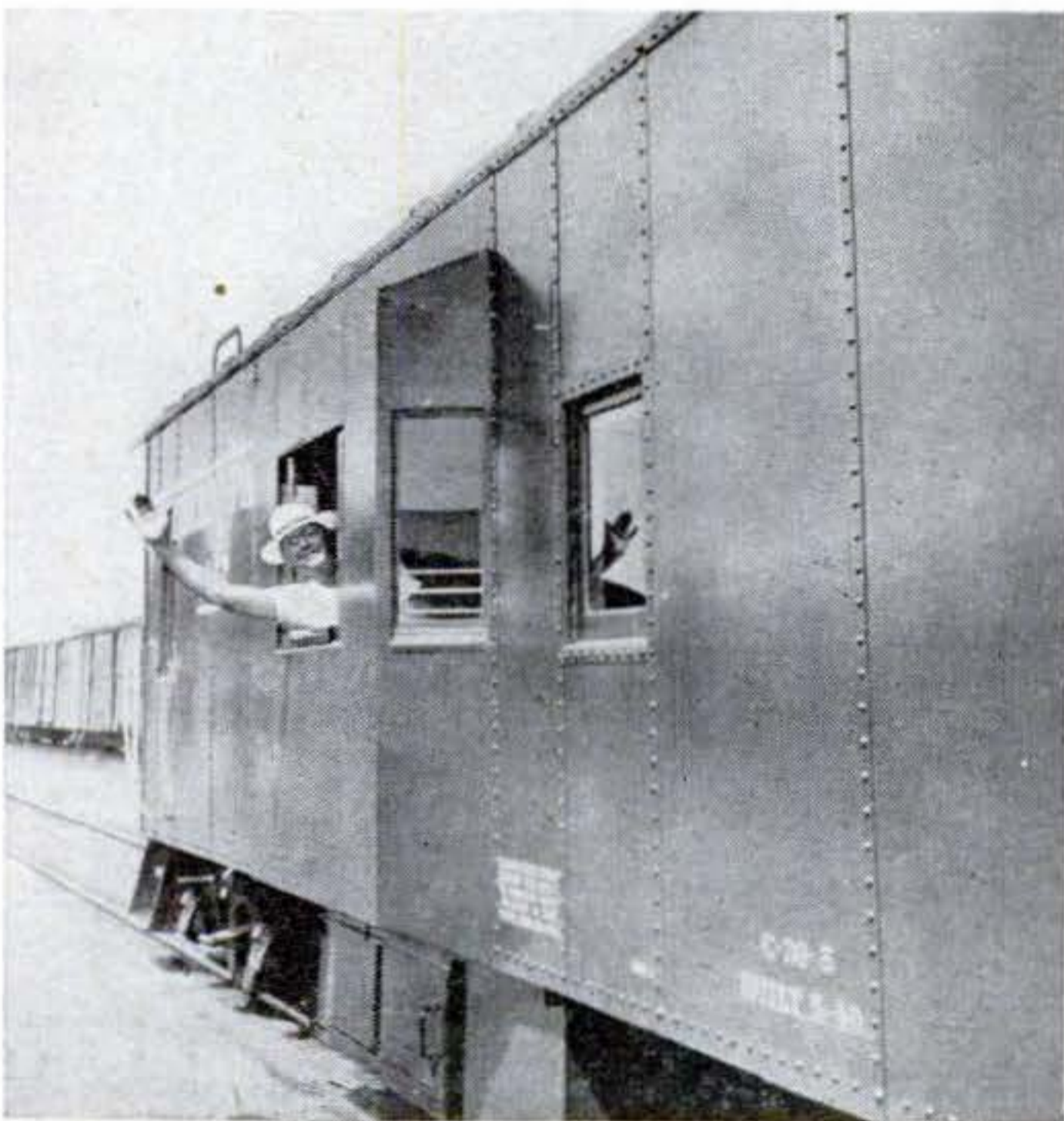

Caboose Gets Bay Windows

THE little red car on the end of every freight train is losing its familiar cupola. Instead, this new caboose has a bay window projecting from each side. Seated there, a trainman can see the doors of cars ahead, and the side windows slide open to let him signal the engineer. The Southern Pacific is building 80 of the new cars.

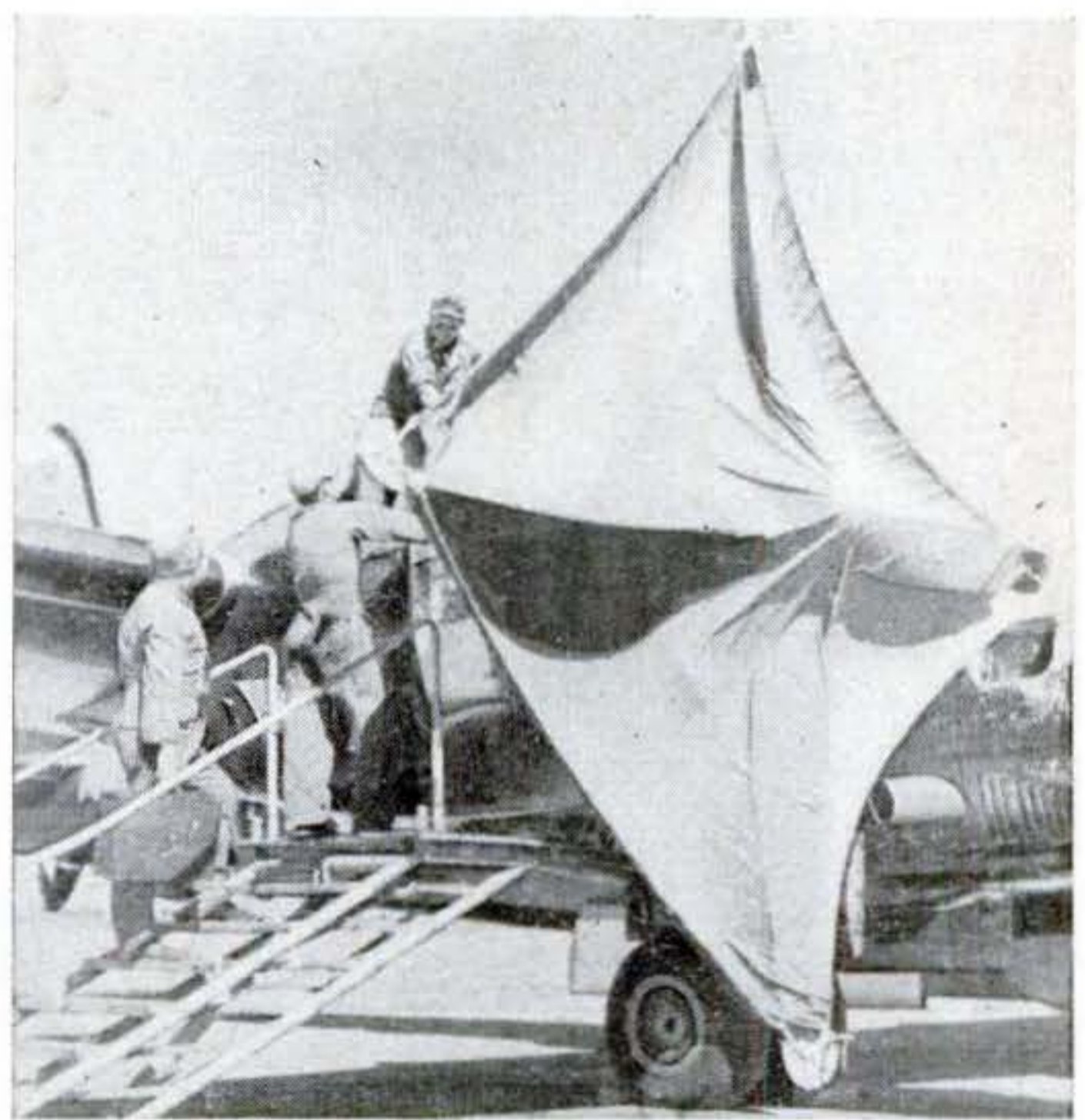

B-29 Windbreak Stops Dust

WIND-BLOWN dust can play hob with an airplane engine when it's stripped down for repairs. Mechanics at Fairfield-Suisun AF Base, Calif., solved the problem with this king-size windbreak. It is 12 ft. 8 in. square. A leather boot at each corner fits over a B-29 propeller tip. Mechanics can work behind it and forget about dust.

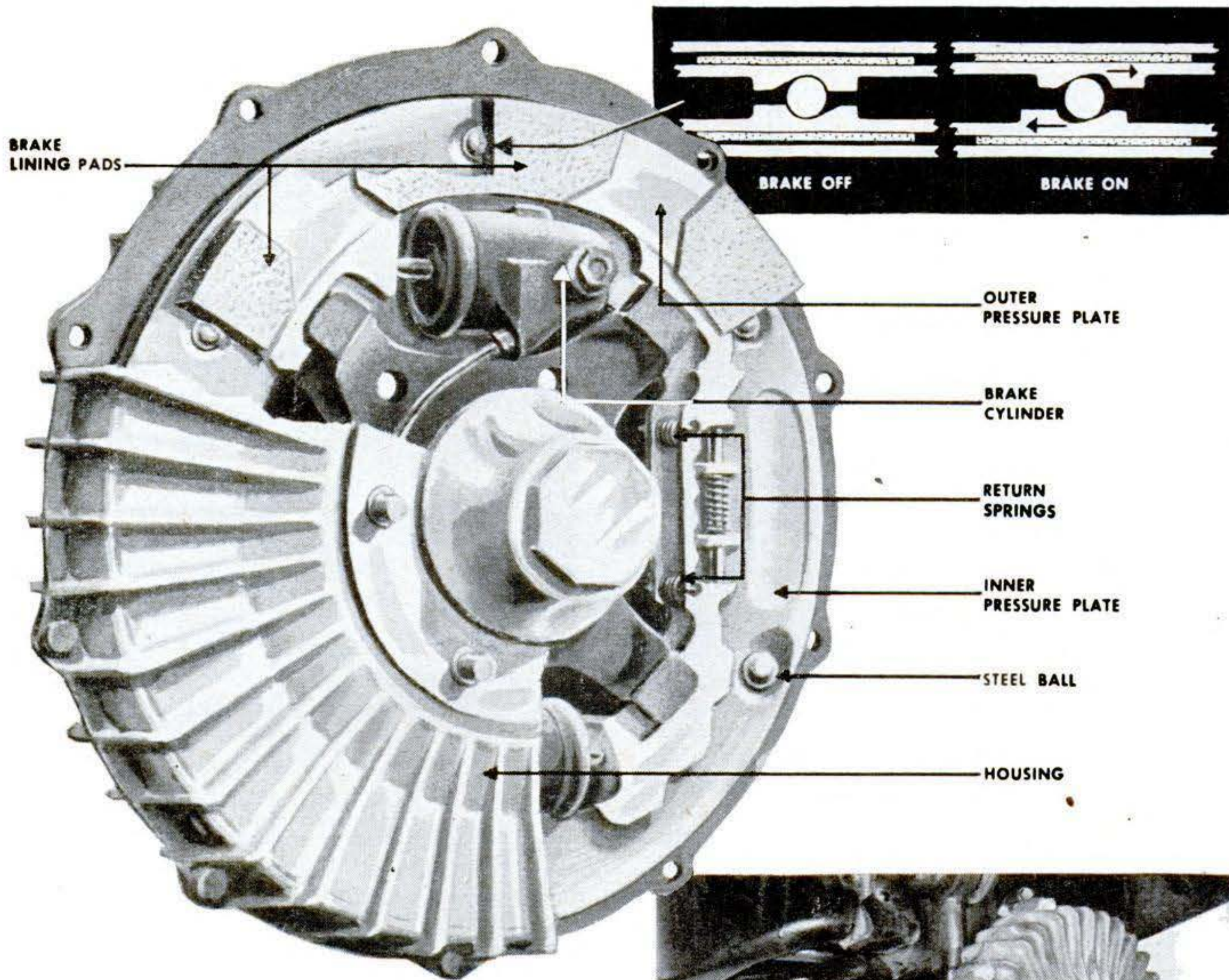

Chrysler Adopts New Disk Brake

ELIMINATION of those twin bogeymen of automobile braking—"fade" and loss of reserve—is claimed by the Chrysler Corp. for its new disk brake. Other advantages listed are less pedal pressure and automatic wear takeup.

"Fade" is what makes you have to press harder on the pedal when the linings get hot. Chrysler says its brakes won't fade because disk brakes lose heat faster, and because the lining area is greater.

Loss of reserve in conventional brakes can also come from heat—the drum expands away from the lining and the driver's foot has to travel farther. Chrysler says that any heat-caused expansion on its brake won't increase the lining-to-disk distance. No matter how much the disk expands radially, it won't get any farther from the lining.

Heart of the brake, adopted for Imperial models, is two 12-inch aluminum pressure plates with rings of lining bonded on them.

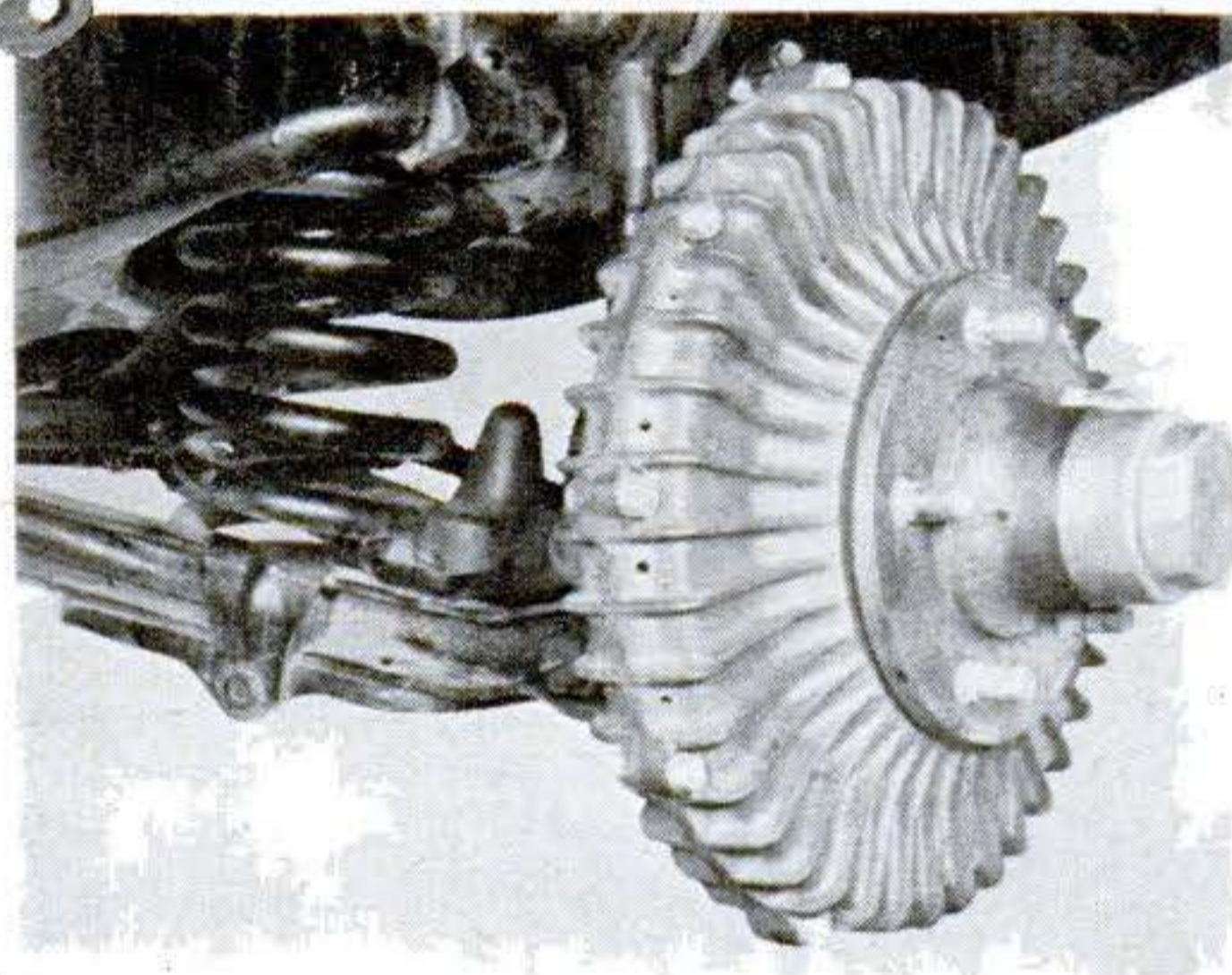

The finned outer housing of the new Chrysler disk brake gives rapid heat dissipation. Housing itself revolves with wheel. The company reports the design increases lining area 30 percent.

When you brake, these are forced outward against the inner walls of the housing, which turns with the wheel.

Six $\frac{7}{8}$ -in. steel balls, sandwiched in sockets between the plates, are what force them outward. When the brake pedal goes down, a hydraulic cylinder rotates these two plates slightly in relation to each other, rolling the balls out of their nests onto little ramps and spreading the plates apart. The brake is partially self-energizing, using some energy in the car's motion to reduce pedal pressure.

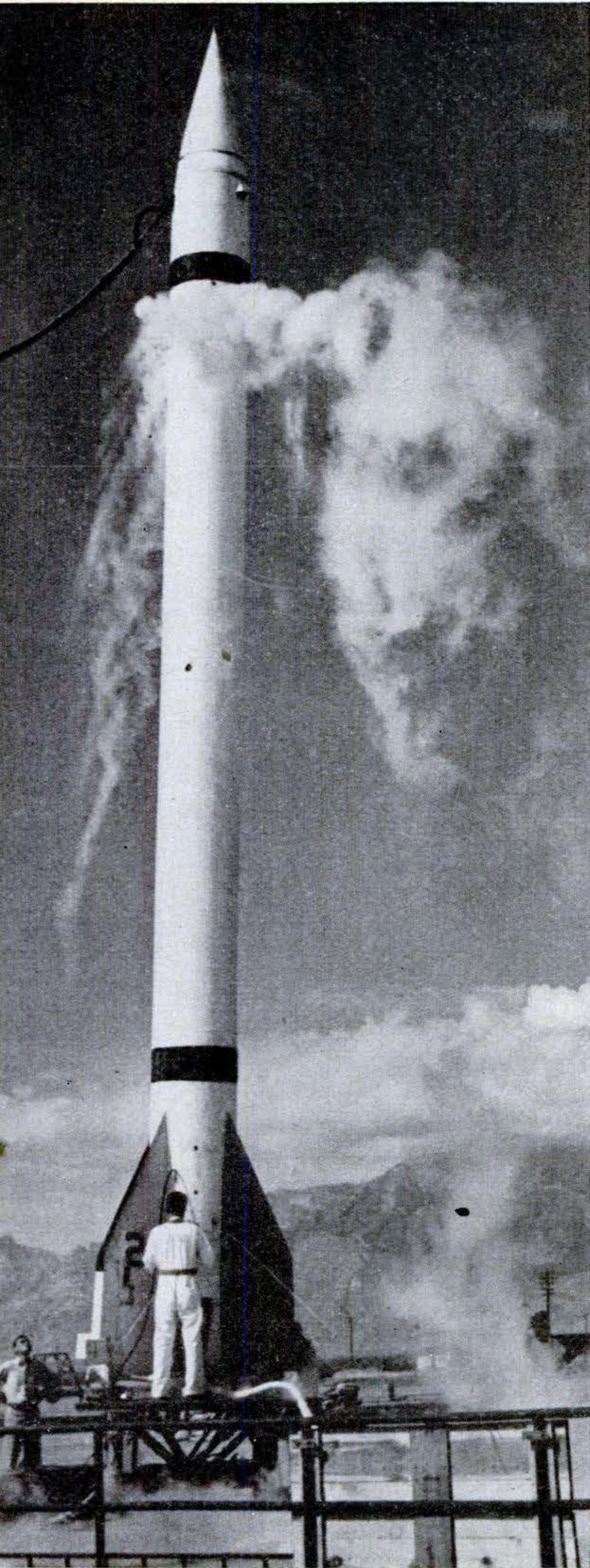

How to Shoot A 5-Ton Skyrocket

There's a lot of work for scientists on the ground before a supersonic research laboratory is zoomed skyward.

By Andrew R. Boone

TO STEAL secrets from space, the Navy's new Viking rockets hoist an automatic physics laboratory higher than any airplane has ever flown. A Viking makes only one flight and it's in the air only a few minutes. But since it must make a complete report of what it finds, those few minutes involve months of arduous preparation.

Radio does the reporting, as the Viking soars aloft at more than 1,700 m.p.h. A running case history on atmospheric pressure and temperature and data on solar and terrestrial radiations are sent over 30 channels. On the ground, 25 telescopes, cameras, "dopplers," and radars follow the missile to record its behavior and report its position.

For photographing cloud formations and the earth from high altitude, the Viking carries two movie cameras in its tail and two still cameras in the nose. The physical recovery of these cameras presents a problem. It has been figured out that if the rocket were to hurtle back in its original shape from a 100-mile height, it would hit the earth with an impact of thirty 80-ton 



A Viking rocket "blows off" liquid oxygen while being prepared for a sky flight. Its job is research. This is one of ten Vikings to be built for the Navy by Glenn L. Martin Co.

locomotives smashing into a wall at 60 miles an hour. One solution is to blow off the nose by a radio-triggered explosive charge as it descends. The unstreamlined parts then tumble end over end, landing slowly enough to permit instrument recovery.

Compared to the German V-2 rocket, the Viking is small and thin. The second missile of the type was 46½ feet long and 32 inches in diameter. It weighed 9,800 pounds and carried a 1,500-pound payload. Unlike the internally braced V-2, the Viking's strength is in its aluminum skin. The rocket rises slowly in the lower atmosphere, accelerating rapidly in the 60 seconds before the fuels burn out. Peak thrust is 23,000 pounds, about a third that of the V-2.

With new rocket motors, Navy scientists hope a future Viking will get up to 200 miles. To reach that altitude, it would have to hit a speed of 5,800 miles an hour. If it could keep going at that speed, it would reach the moon in 41½ hours. The first Viking launched reached 51½ miles, and a speed of 2,250 miles an hour. The second, shown in these pictures, turned downward at 33 miles.

Viking an Alcoholic

The Viking's fuel is primarily alcohol with oxygen added to allow combustion. The fuel is forced into a combustion chamber by two pumps operated by a steam turbine. The latter is turned by the decomposition of hydrogen peroxide into water, hydrogen, and oxygen. The rocket is stabilized in flight by a new gyro-controlled system in which pitch and yaw are corrected by swinging the entire motor. Exhaust steam valved through the fins corrects any roll, with an assist from small trim tabs. When the propellants and steam have been exhausted, the nitrogen that pressurized the propellants before the turbine and pumps took over stabilizes the missile.

Rockets have a way of getting out of bounds. One straying V-2 crashed in a Mexican graveyard, 40 miles away. If a Viking shows signs of wandering off the rocket reservation, a radio impulse can be sent out to cut the fuel and end the flight.

The first U. S. rocket built to explore the upper atmosphere, the Viking is essentially a mobile research tool. Two of the \$300,000 skyrockets have already been launched from the White Sands Proving Ground in New Mexico. How the experts fire them and keep them under close scrutiny is shown in the photographs on these pages. **END**

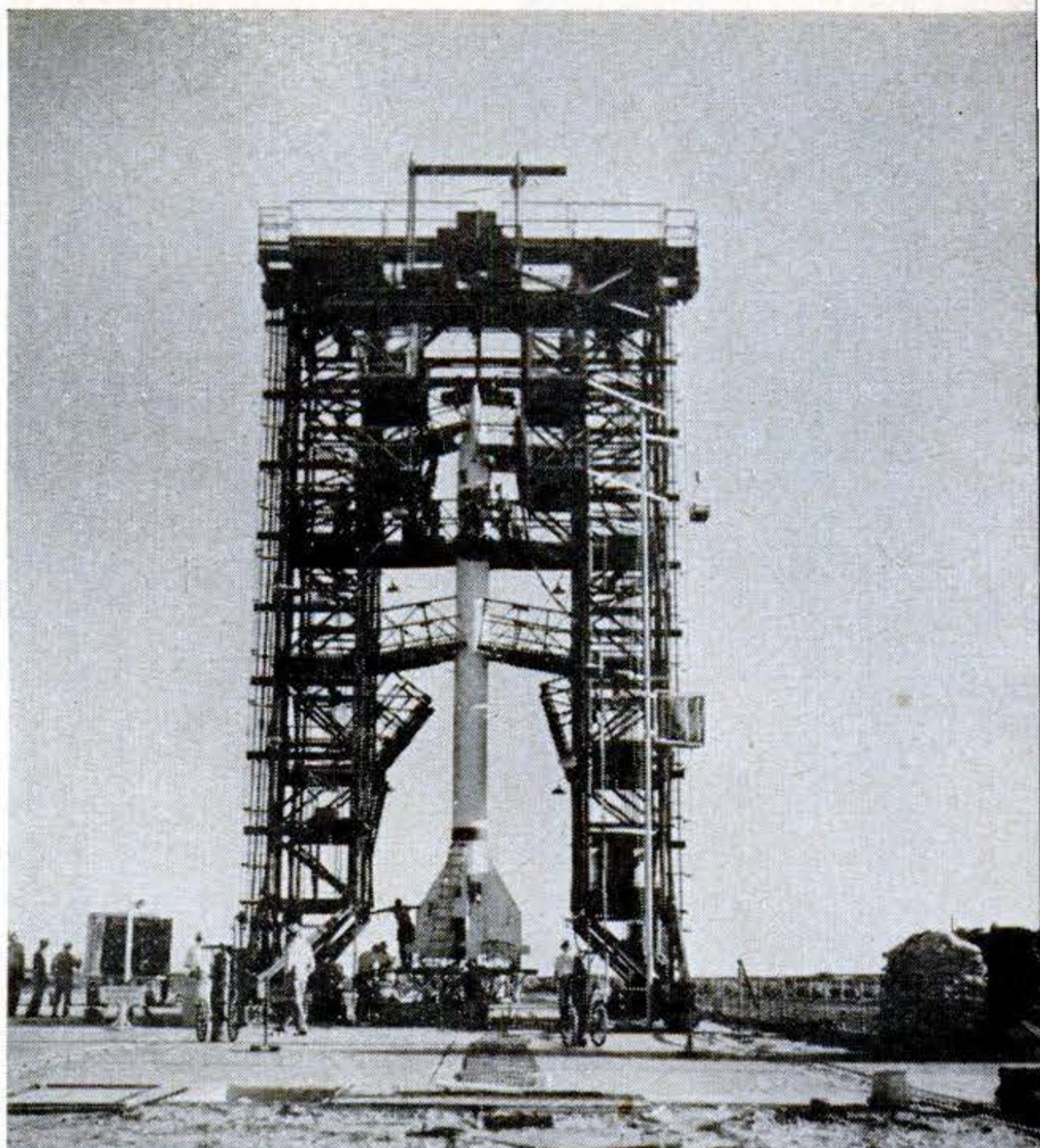

1 Huge steel gantry provides a working platform for Navy scientists as they adjust instruments and fuel the Viking. It is rolled away on rails before the big rocket is fired.



4 Delivering the 270-pound charge of 90-percent pure peroxide is a dangerous job. Workers transferring the drums to gantry crane wear protective suits and double rubber gloves.

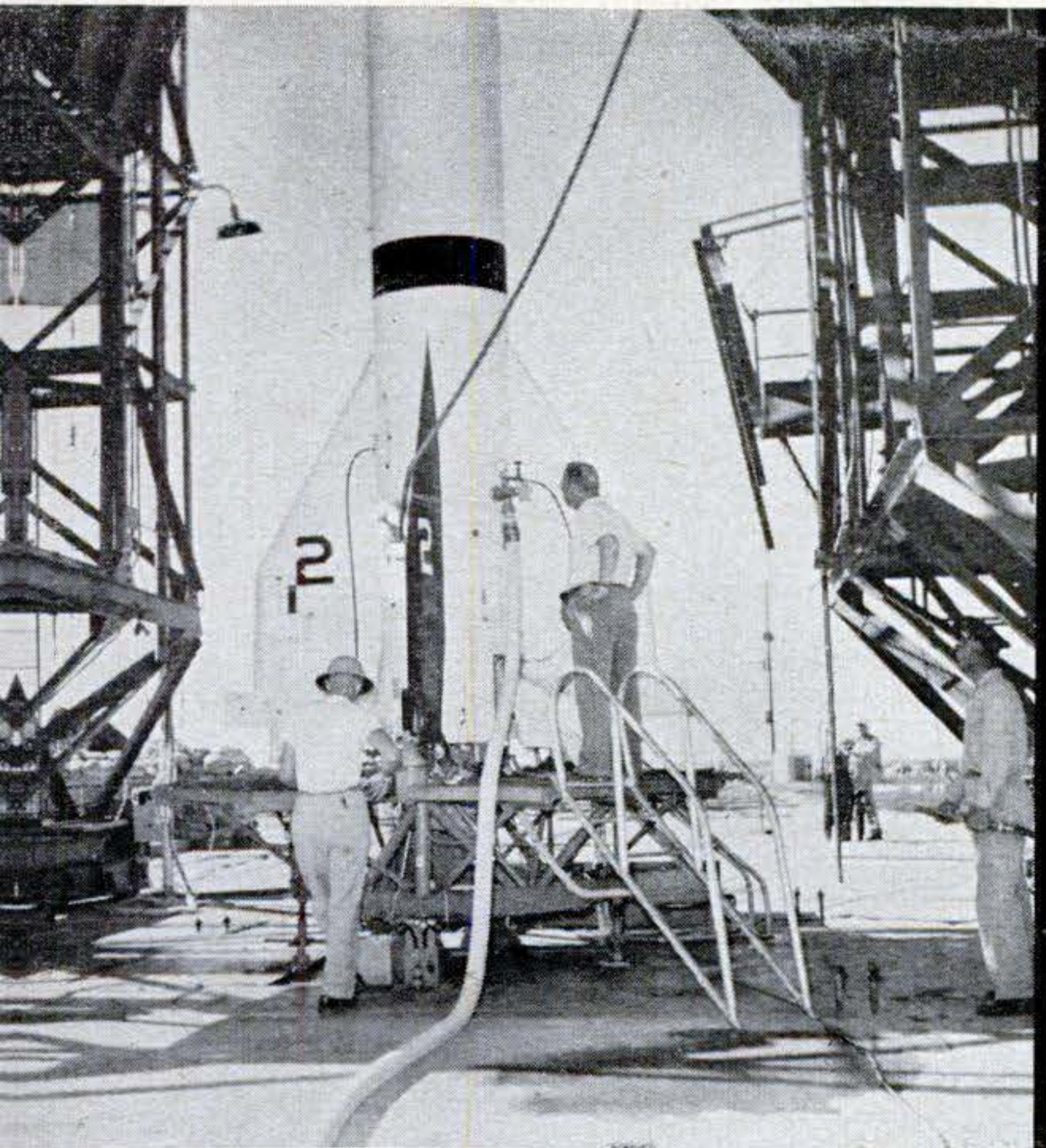

2 While others are busy aloft on the gantry, technicians check adjustments at the rocket's base. Man standing on platform is inspecting valves of the Viking's alcohol feed line.

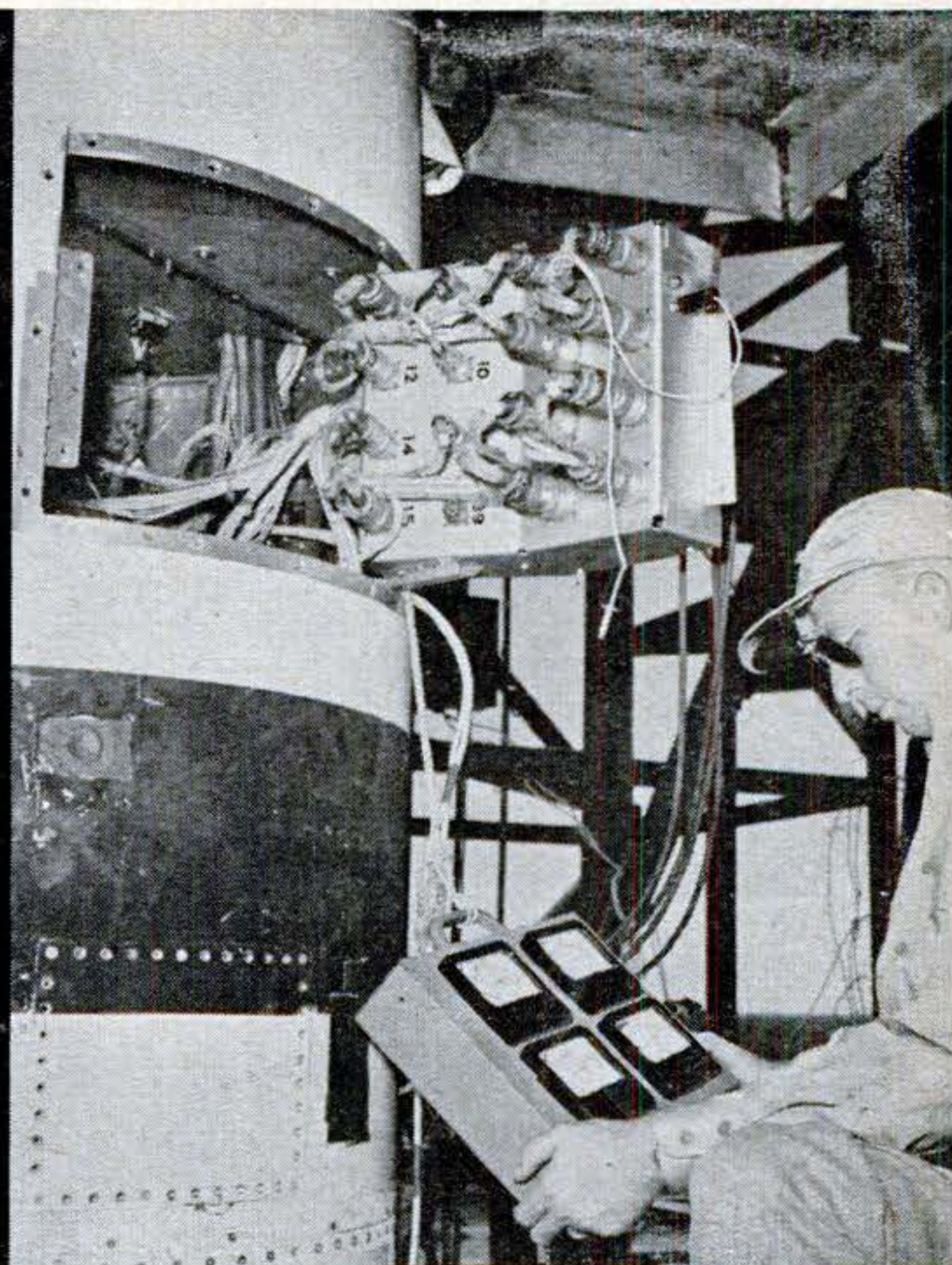

3 Meter readings are taken to test all electrical circuits. Mounted on a door that forms part of the missile's skin, this connection center is located near mid-point of the rocket.

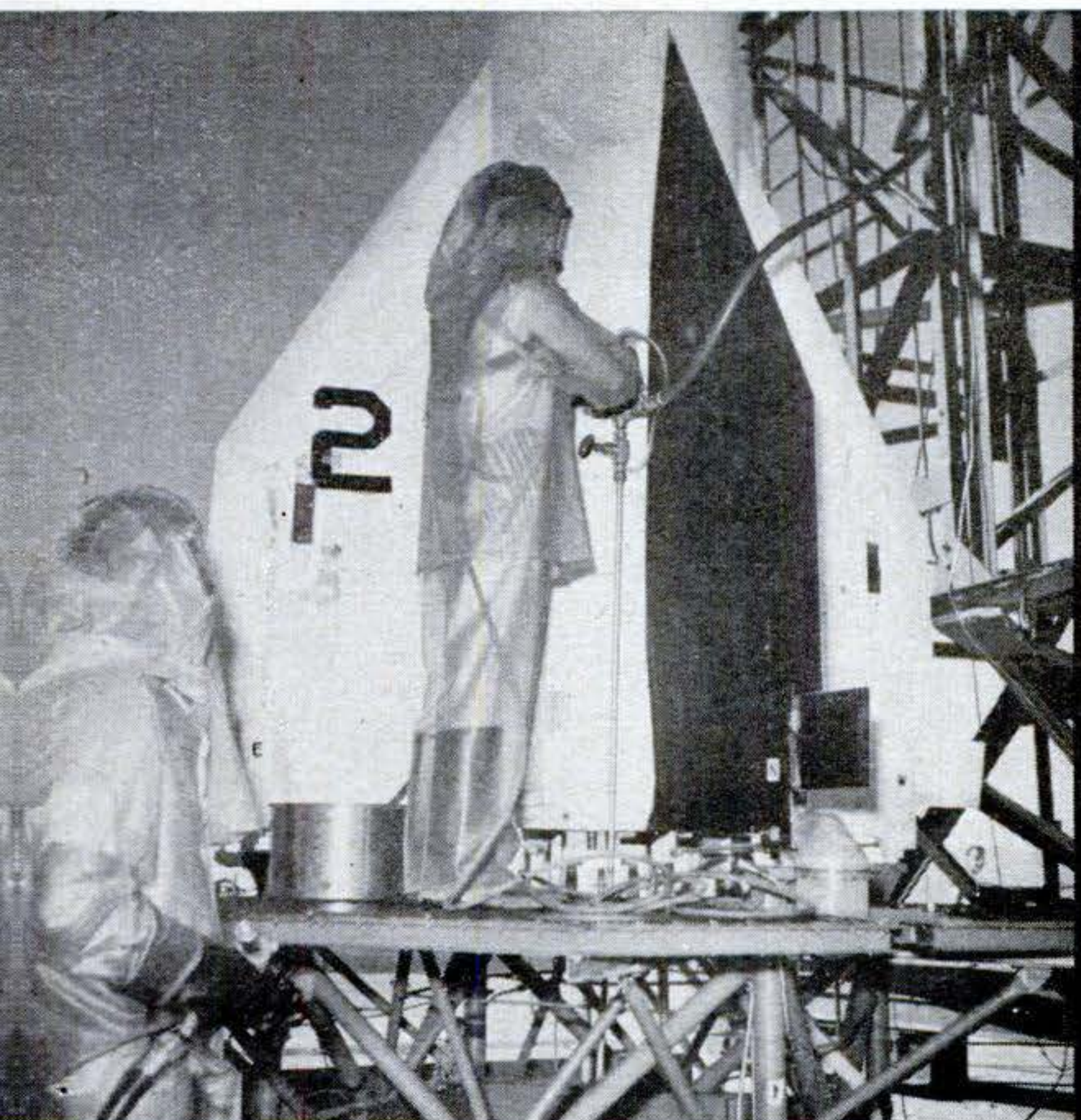

5 Also dressed in protective suit, technician charges the rocket with peroxide. Fireman at left is standing by, ready to douse him quickly in case some of the chemical should spill.



6 Gantry is rolled away as rocket is readied for firing. One of the last jobs is being done by the refrigerator truck at left, which is pumping in 3,700 pounds of liquid oxygen. ➤



7 Electrically operated "firecrackers" on a stick will ignite Viking's gas mixture. In less than a second rocket takes off. Cords lash assembly's plywood base to rocket understructure.

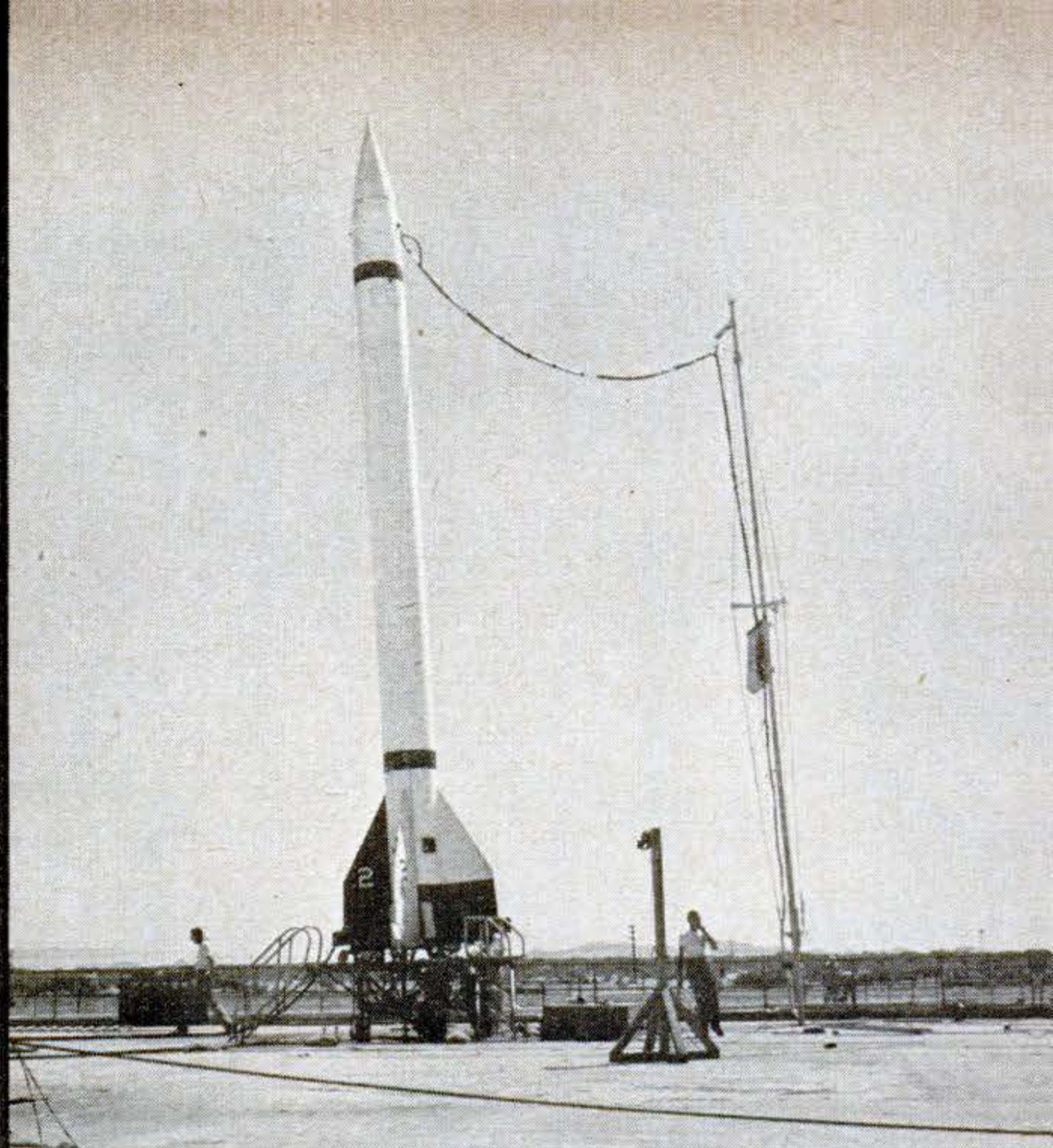

8 Ready for launching, the rocket is cocked 3° from vertical. The thin mast at right, carrying nitrogen and electrical circuits, drops away several seconds before rocket is fired.

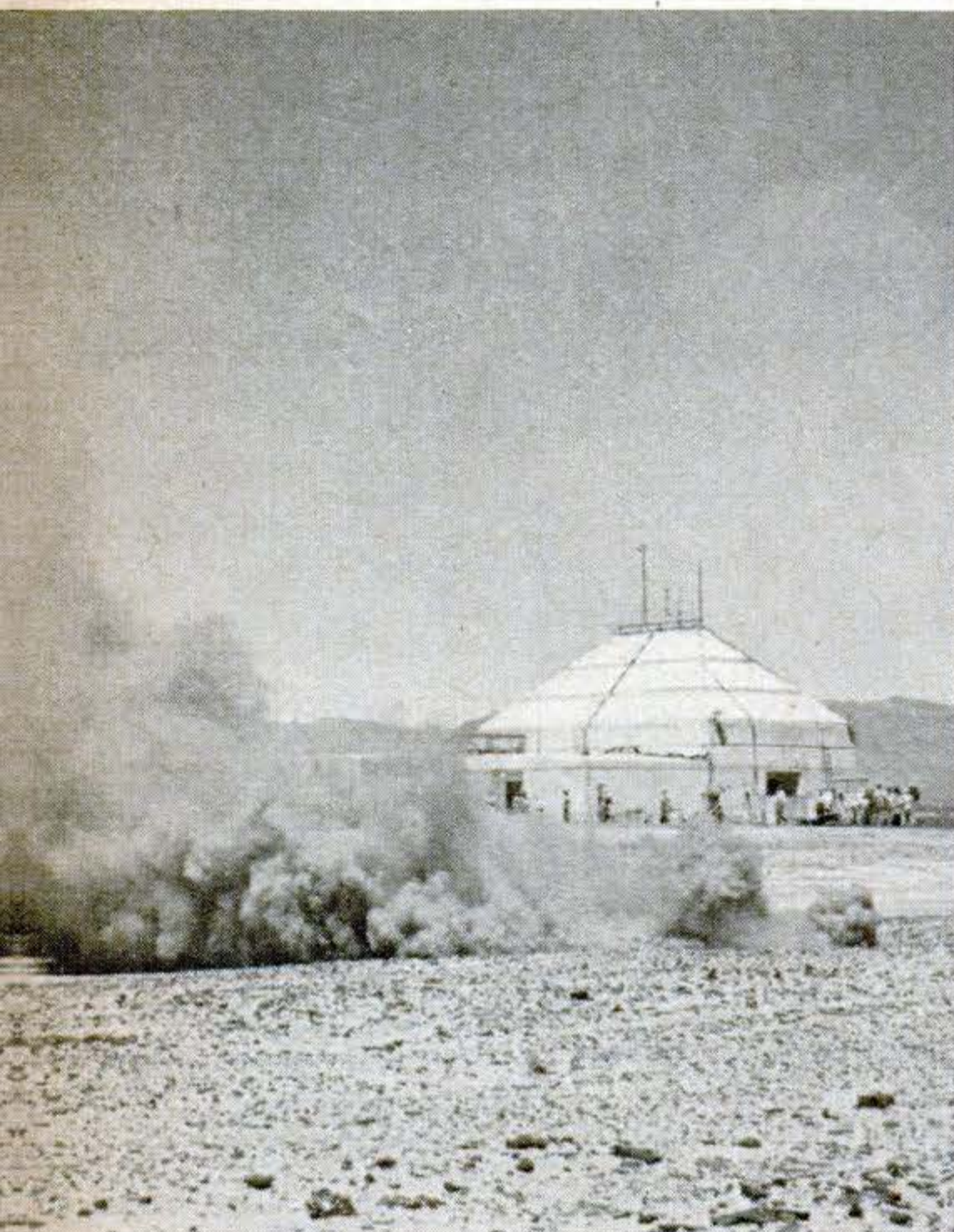

9 Fifteen minutes before launching, a red flare is shot off near the observation blockhouse, seen in the background, to alert trackers who do not have radio communication.



10 The man who shoots the big rocket is this Navy officer. Peering through a slot in blockhouse, he watches preparations, and, when all is ready, presses the firing button.

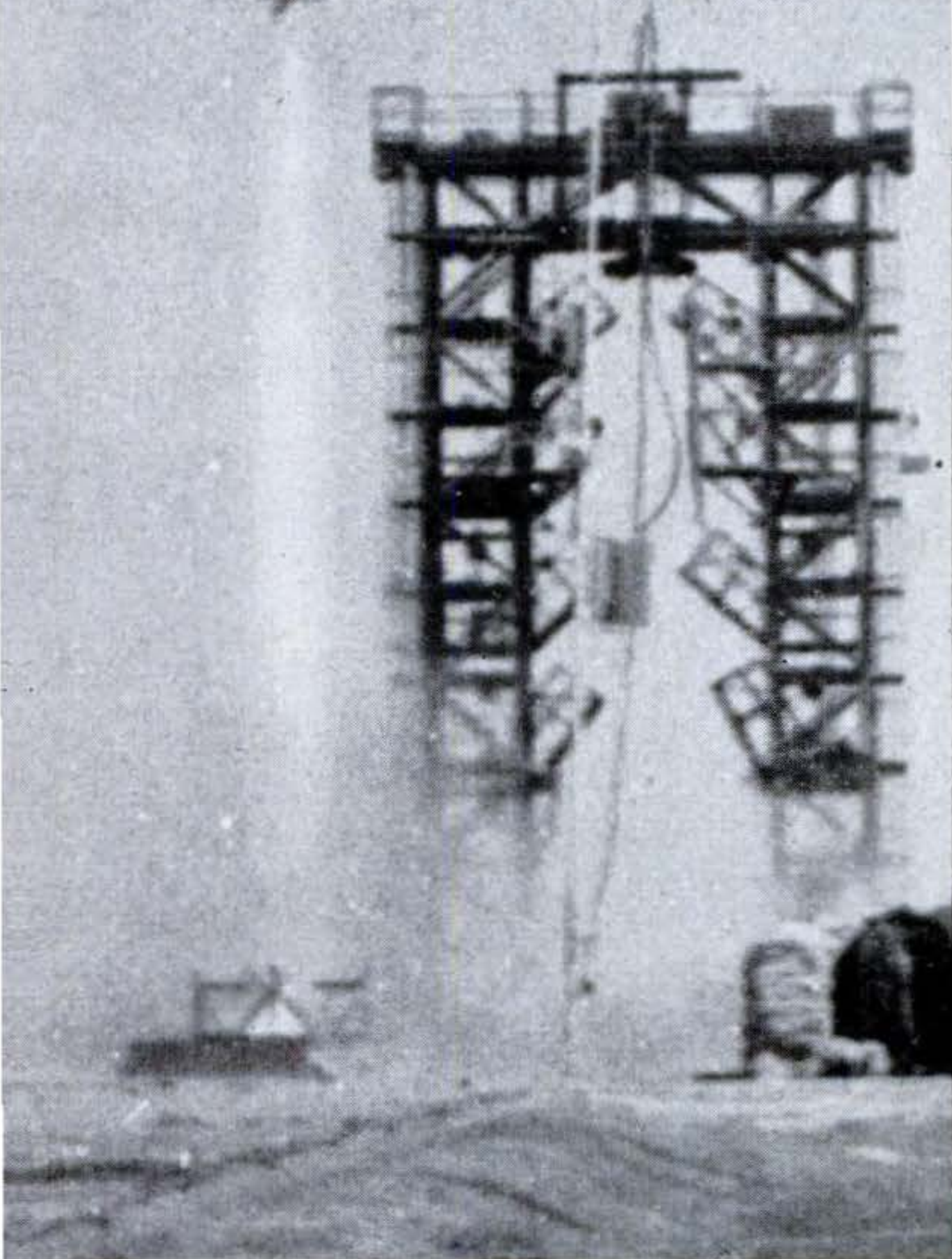
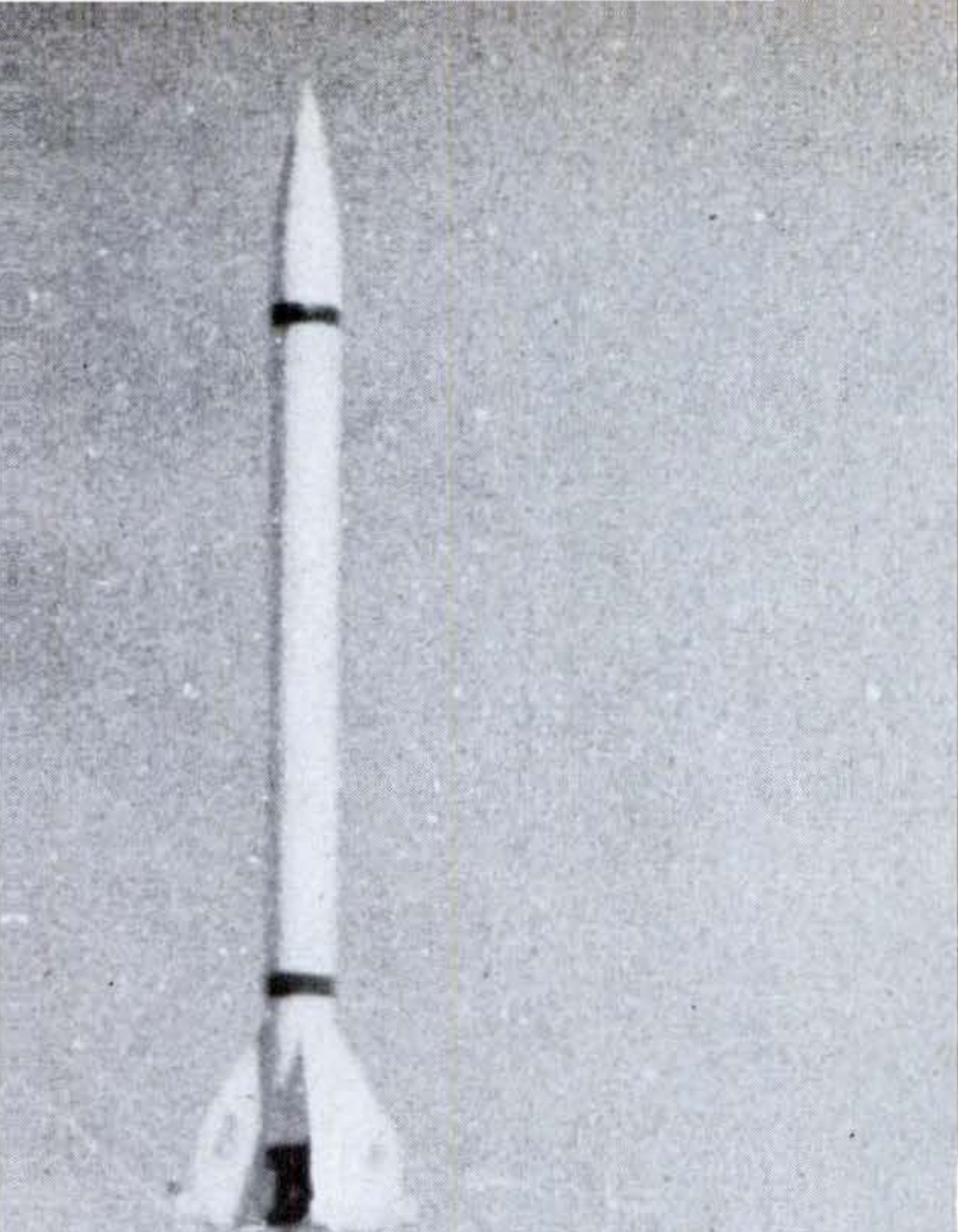

11 Up we go. The Viking soars aloft in deafening roar of exhaust gases. While this one went up only 33 miles in a recent launching, the Navy is aiming at a goal of 200 miles.



12 Keeping an eagle eye on the Viking in flight is the job of "Popeye" the telescope (PS, Jan. '48, p. 129), located 8,100 feet atop Mule Peak, 40 miles from the launching site.



13 Station Viking broadcasting. This telemetering antenna picks up the rocket's messages on conditions aloft, automatically sent out over 30 channels during flight.



Consistometer measures stickiness of creamed corn by showing how far a can of it spreads when dumped on plate ruled off in circles.



Stringiness gauge records how much pressure is needed to cut through a string bean. That helps to tell how long canner should cook it.

Precise Machines Test Canned Food for You

THESE pictures show three of the mechanical food testers developed at the University of Maryland. They are used in research to help farmers and canners in thirteen Eastern states improve their methods. Another, not shown, determines the ripeness of fruit by measuring its color photoelectrically. About the only quality the machines can't gauge is flavor. For that, the university still employs a panel of human tasters. Still, admits Dr. A. Kramer, director of the research project, "The people who buy the stuff are the ones who know best."

Trimotor Gets Glider's Job

THE new three-engine Northrop C-125 below—the Raider—will replace Air Force gliders for establishing "air heads" and for Arctic rescues. Full-span flaps and reversible props let it operate from unimproved fields. It can carry 32 soldiers and their gear.

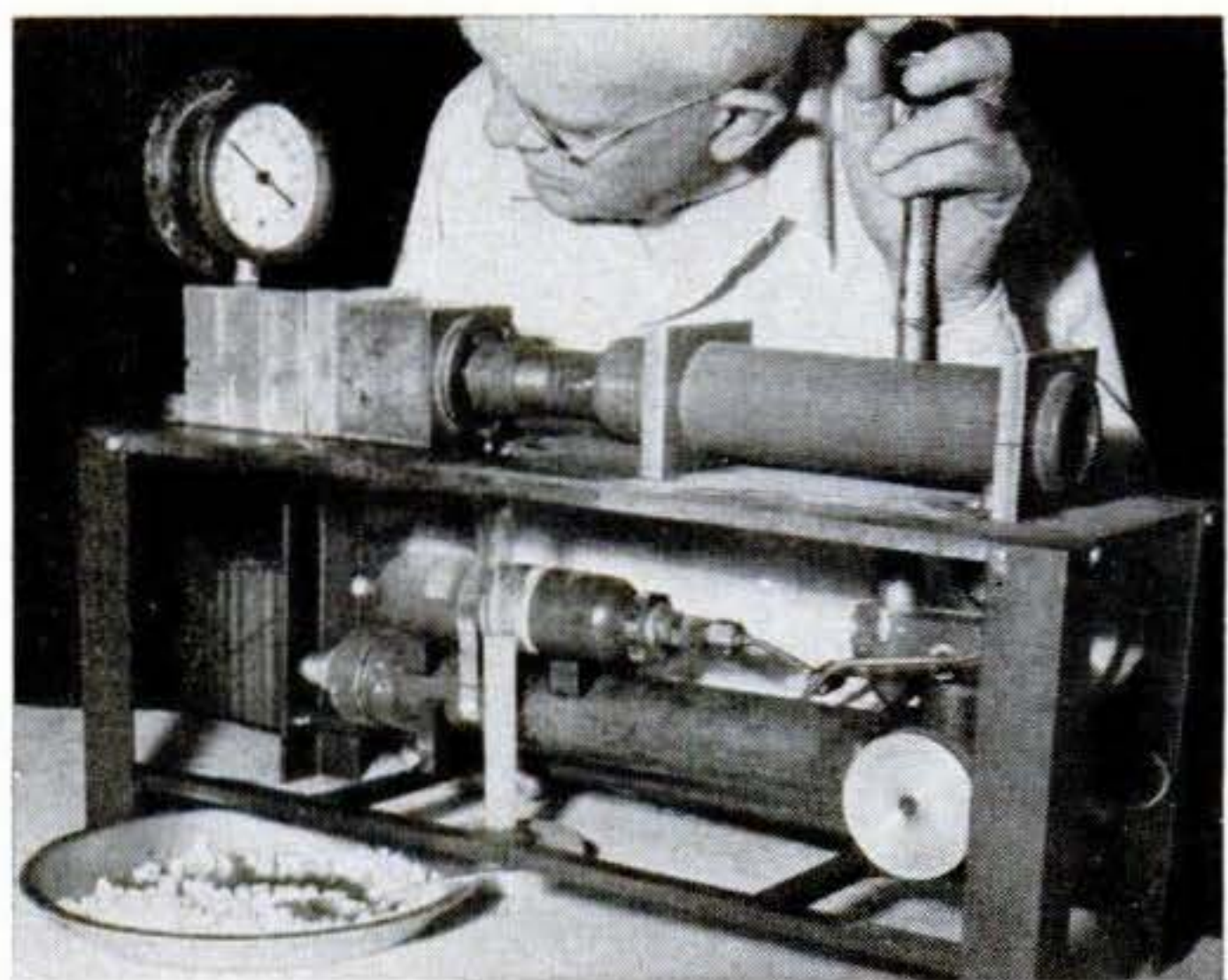
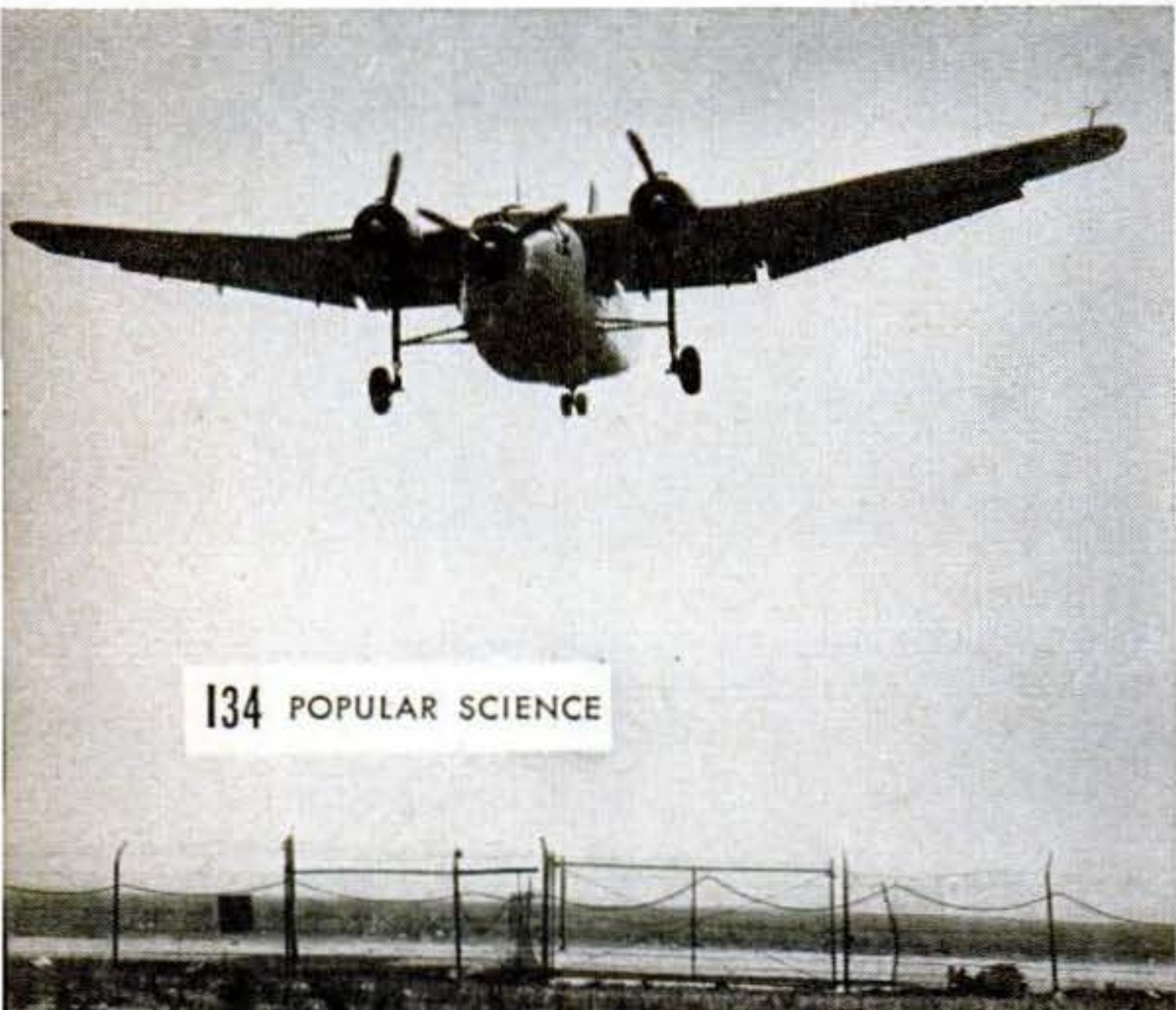

Succulometer measures how much juice is squeezed out of 100 grams of corn when hydraulic press subjects it to 500-lb. pressure.

Phones Use Prefab Exchange

To speed expansion of telephone service, Australians are building automatic exchanges on an assembly line and sending them out on trailers, as shown below, to rural towns. As lines are strung they need only to be plugged to the exchange.



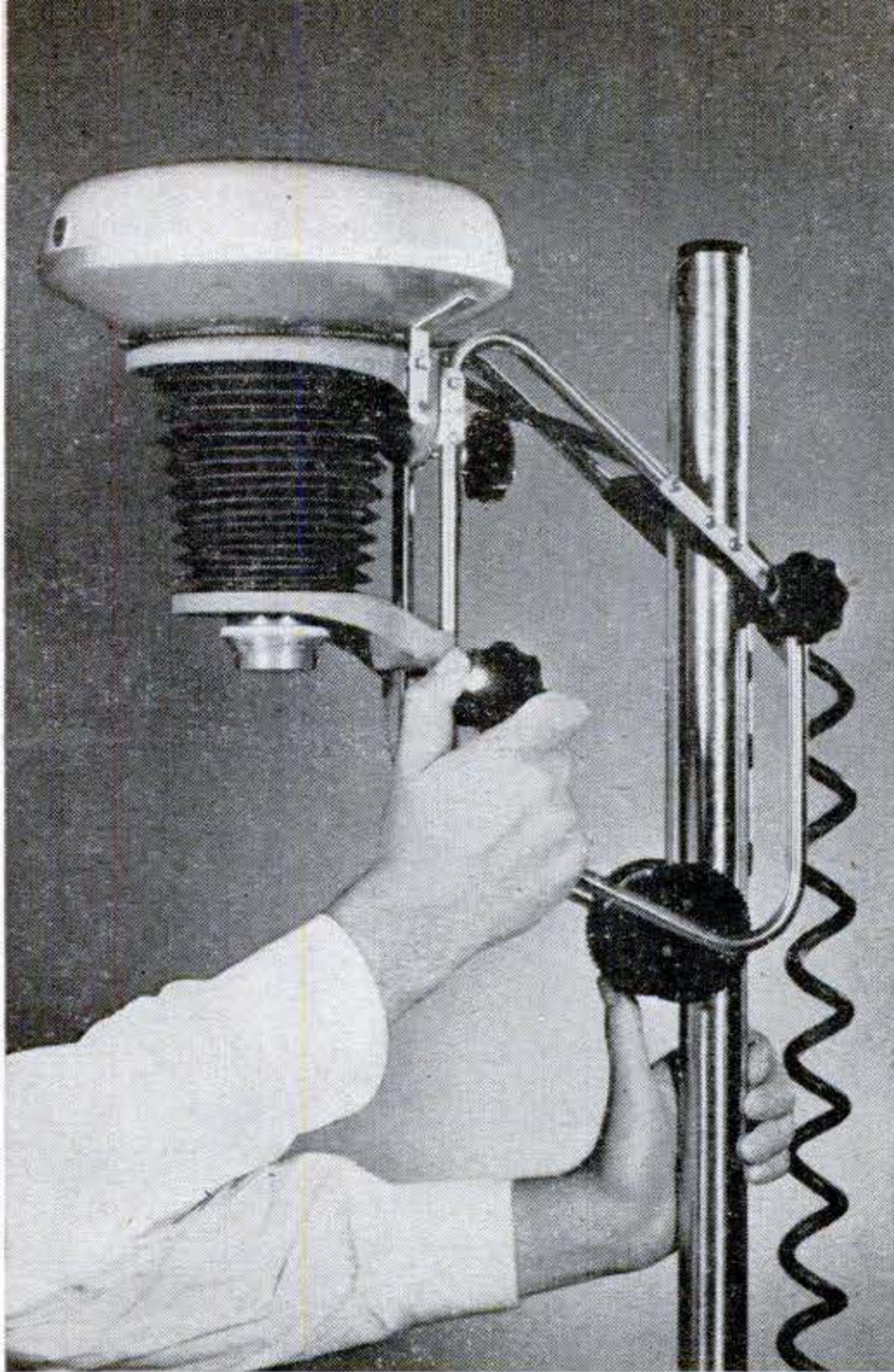

Enlarger Diffuses Light

THIS new type of photographic enlarger uses an "integrating sphere" as a light source. The sphere, coated with a special, highly reflective white paint, encloses a "cold light" bulb. The paint catches its rays and re-reflects them until the light is evenly distributed. Made by Eastman Kodak, the Hobbyist[®], is said to combine the good diffusion of enlargers employing diffusion glass, and the speed and contrast of condenser types.

Auto Fender Flips Up

WHEN a rear tire must be changed on this British car, you release a catch and the entire fender flips up out of the way. A counterweight holds it up until it's pushed down and locked. The convertible body that carries the trick fender was built by Hooper & Co. for use on a Daimler chassis. The release catch can be seen on the fender's side.

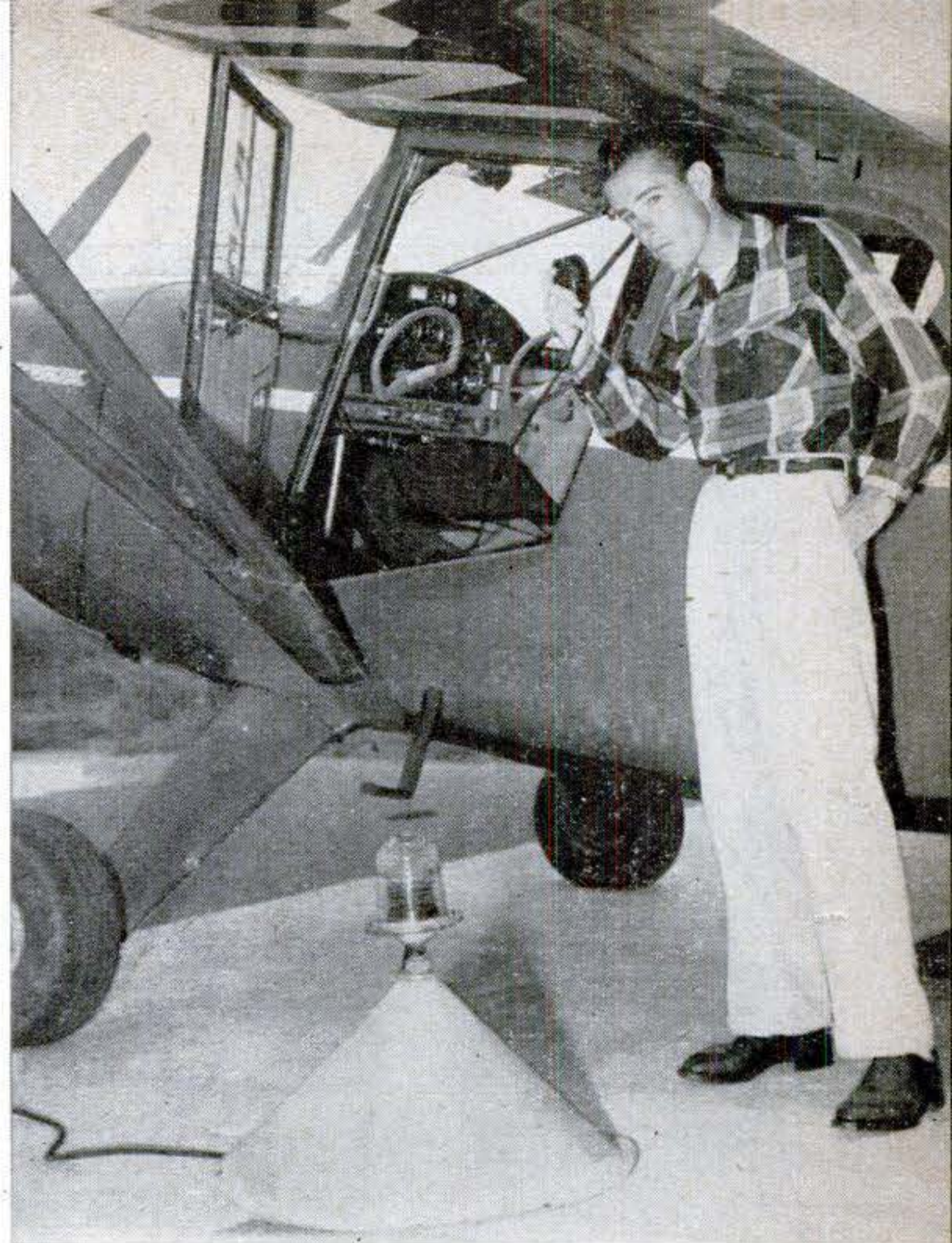
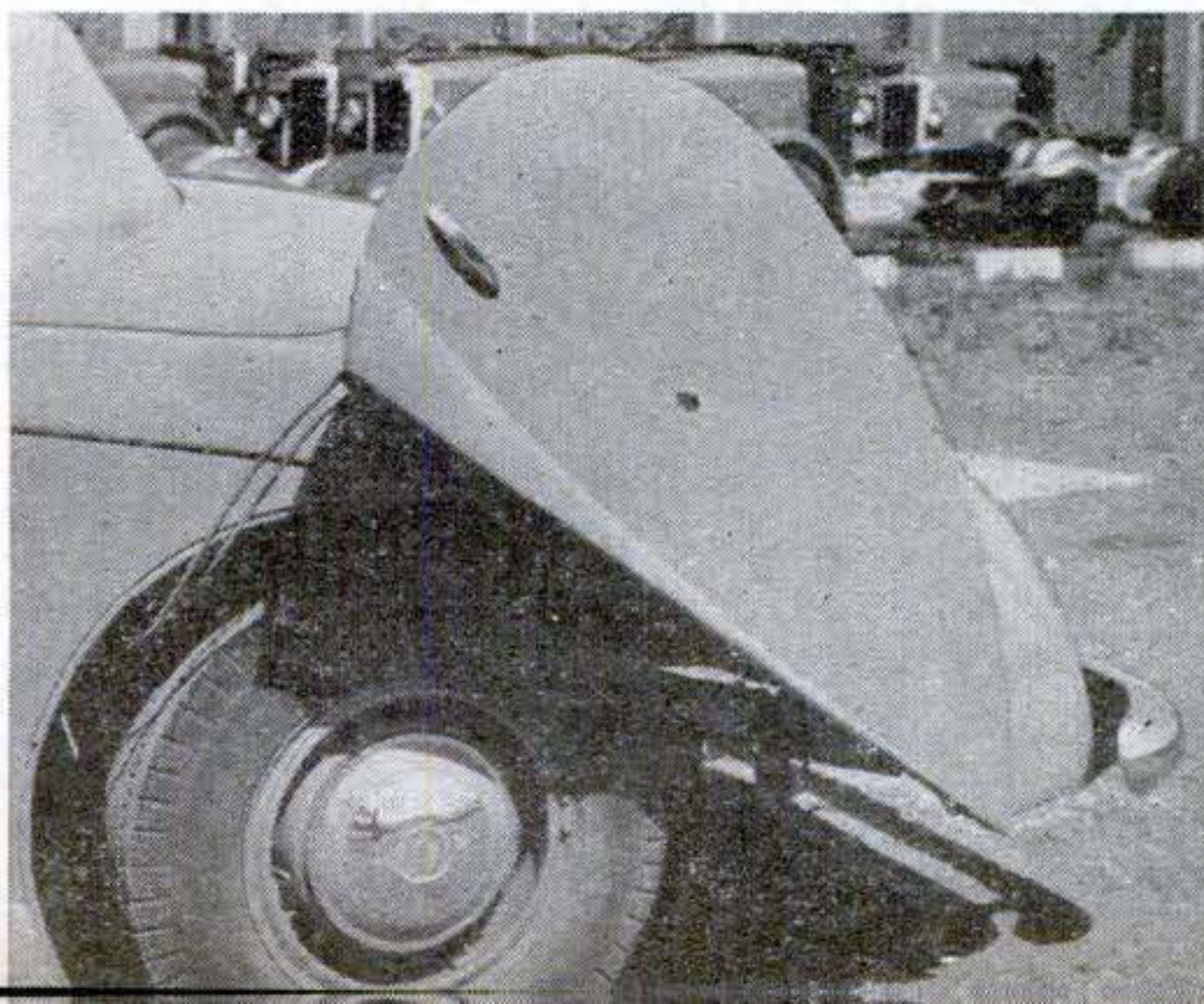

Pilot's Radio Lights Airport

THE pilot of an airplane who needs runway lights turned on for a landing at an untended airport can do it himself if the lighting system works like the one at the field in Bellflower, Calif. He needs only to press his regular communication microphone button seven times. On flash the lights. A radio receiver on the ground responds to the standard aircraft 3105-kc. frequency, switching on the lights for a preset interval.

Canada Builds Jet Air Liner

THIS Canadian-built Avro jet air liner is the British Commonwealth's second jet transport announced recently. The other is the de Havilland Comet (PS, Oct. '49, p. 152). The Avro is built to carry 36 to 40 passengers at 400 m.p.h. at a 30,000-ft. altitude on medium-range domestic routes. Cabin pressure simulates 4,000 ft.



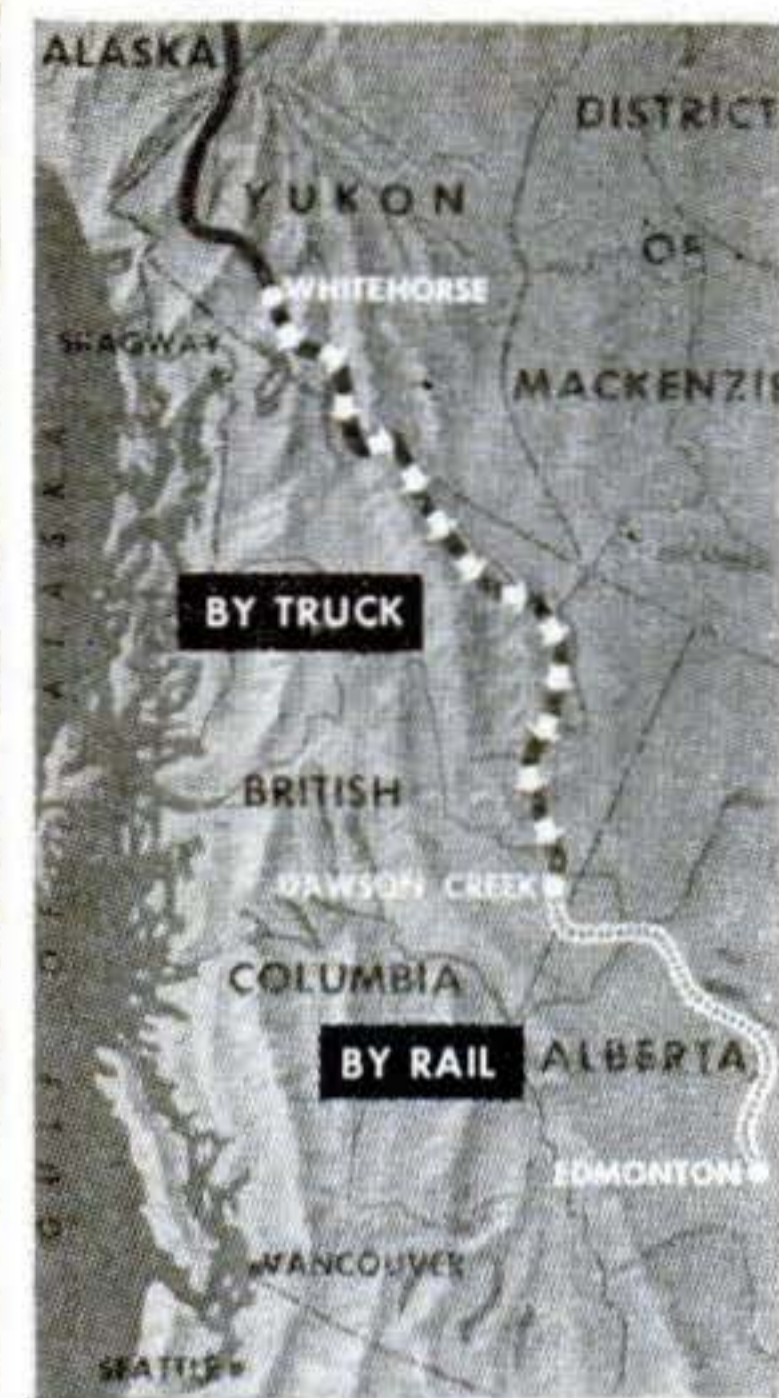

1 This war-surplus refinery at Whitehorse was uprooted and moved 1,414 miles by

truck and rail to Edmonton. Truck in the foreground is starting long haul. Map shows route.

Refinery Takes Truck Trek Across Subarctic

THESSE pictures show one of the biggest moving jobs in history. When oil was discovered in Edmonton, Canada, in 1947, a refinery was needed. It would have taken at least three years to build one. But at Whitehorse, nearly 1,500 miles to the north, stood an abandoned wartime refinery. Imperial Oil did some figuring and gambled

on the Arctic weather. In 18 months, 7,000 tons of tanks, towers, boilers, furnaces, and tubing were trucked 919 miles over the Alaska Highway to Dawson Creek, shipped by rail 495 miles more to Edmonton, and re-assembled. Cost: \$1,000,000 for the refinery, \$7,000,000 to move it—still cheap, say the oilmen, considering the time saved.

6 Along Alaska Highway, a 20-ton Diesel truck hauls refinery tower section on two trailers. Move took 200 truck trips, with loads

up to 40 tons, between Whitehorse and rail-head at Dawson Creek. Original schedule for 919 mi. was 50 hrs.; some loads took weeks.

136 POPULAR SCIENCE

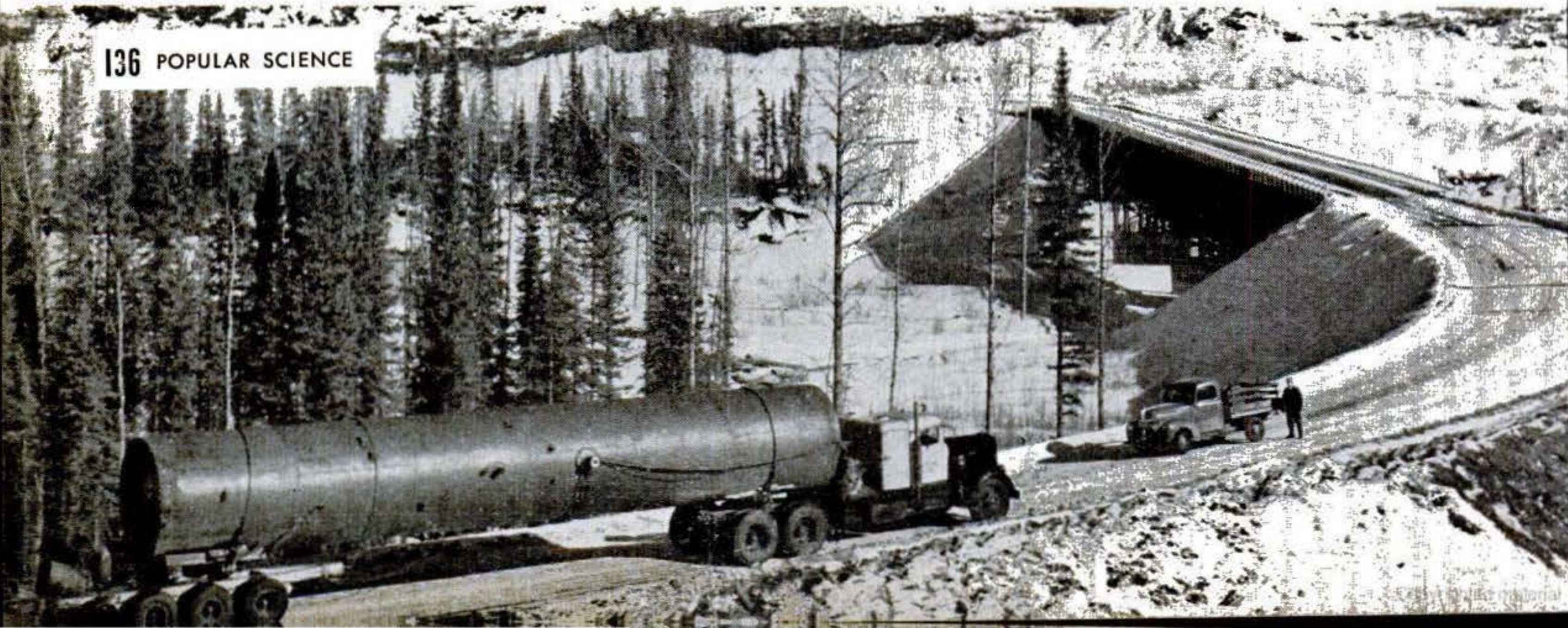



2 One of major dismantling jobs was lowering giant 146-foot refinery tower intact. Superstructure had been removed previously.



3 As the tower, held between steel rigging poles, nears the horizontal, workmen build up timber trestles to support "can" on ground.

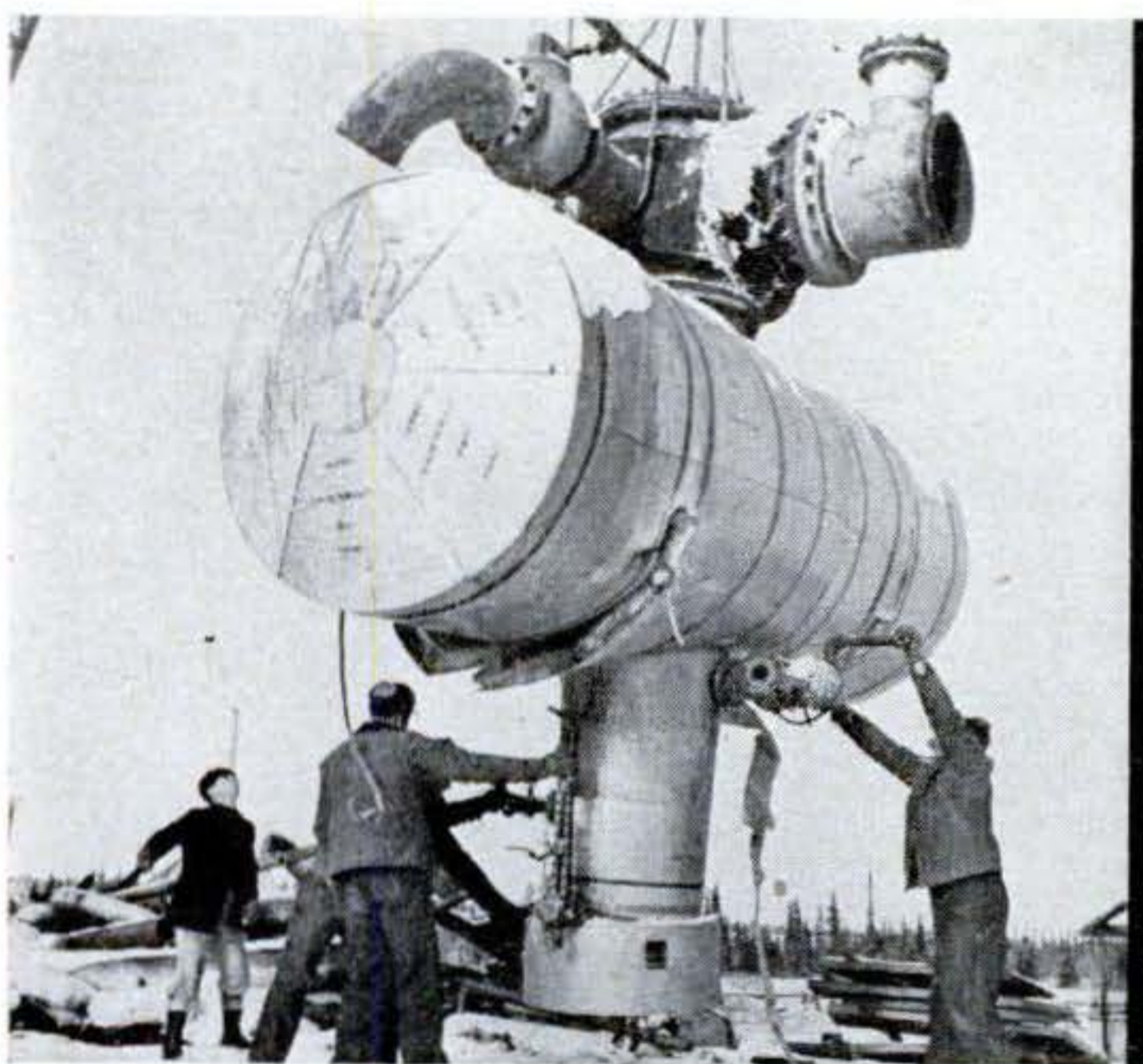

4 A huge condenser, being lowered by a crane, is maneuvered into a clearing where it was broken down for easier truck loading.



5 This log-cabin-like structure is a furnace being dismantled. Workman at top is one of many Yukon Indians engaged on the project.

7 Using steam, driver cleans frozen mud and ice from trailer. Rolling through two winters, the trucks covered 400,000 miles.

8 End of a journey. Towers that once were Whitehorse landmark today cast shadows over Imperial Oil's busy Edmonton refinery.

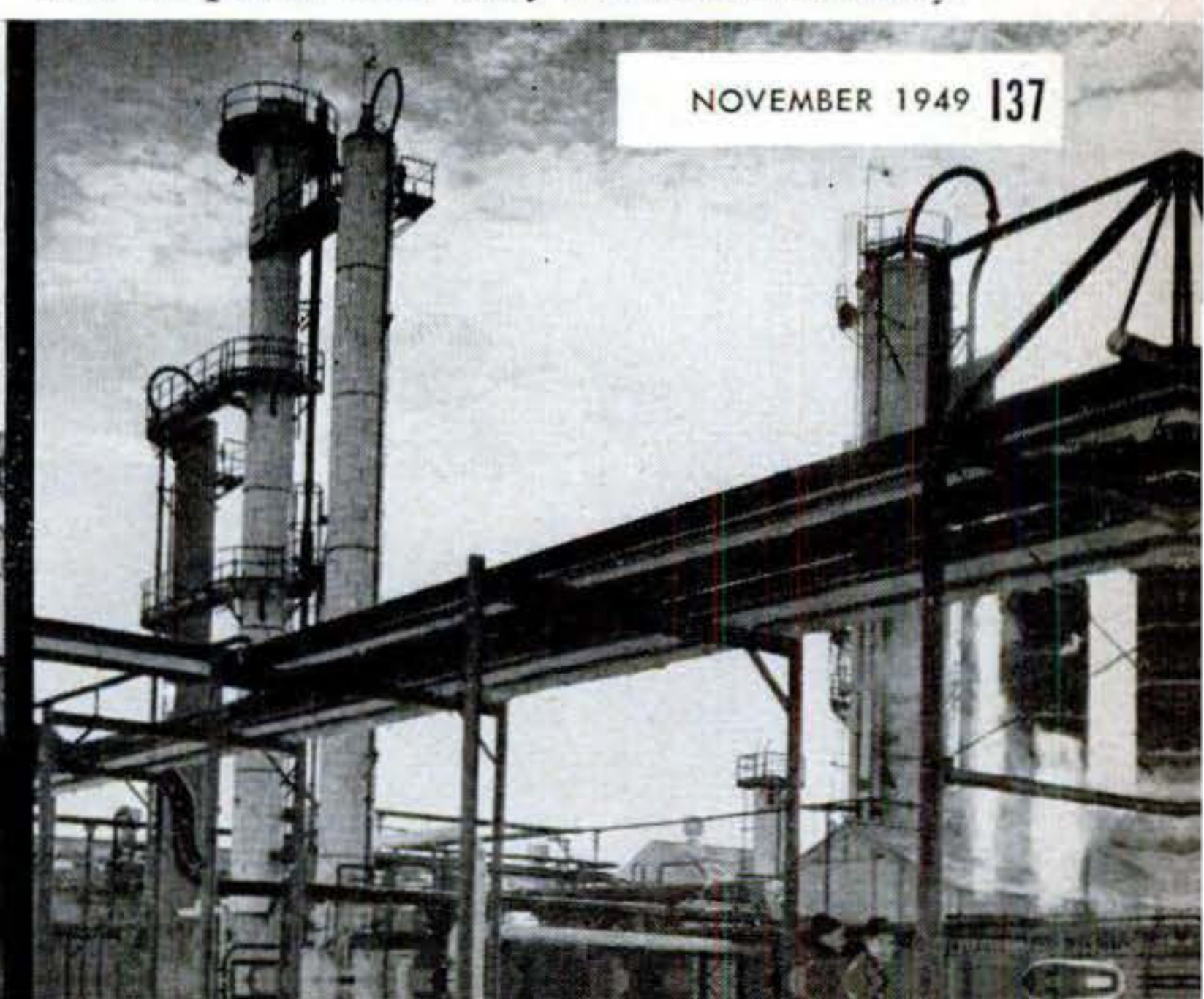

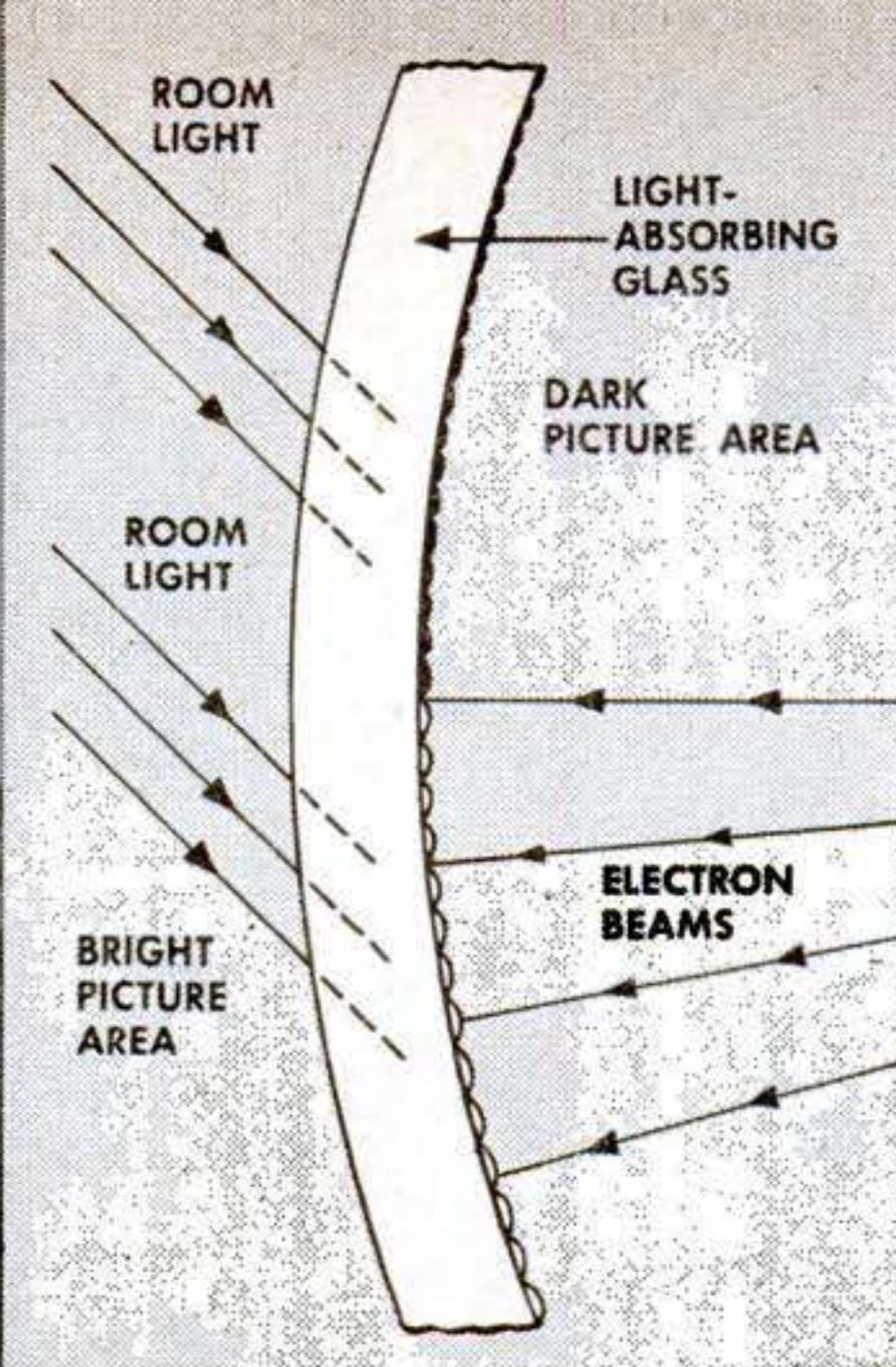
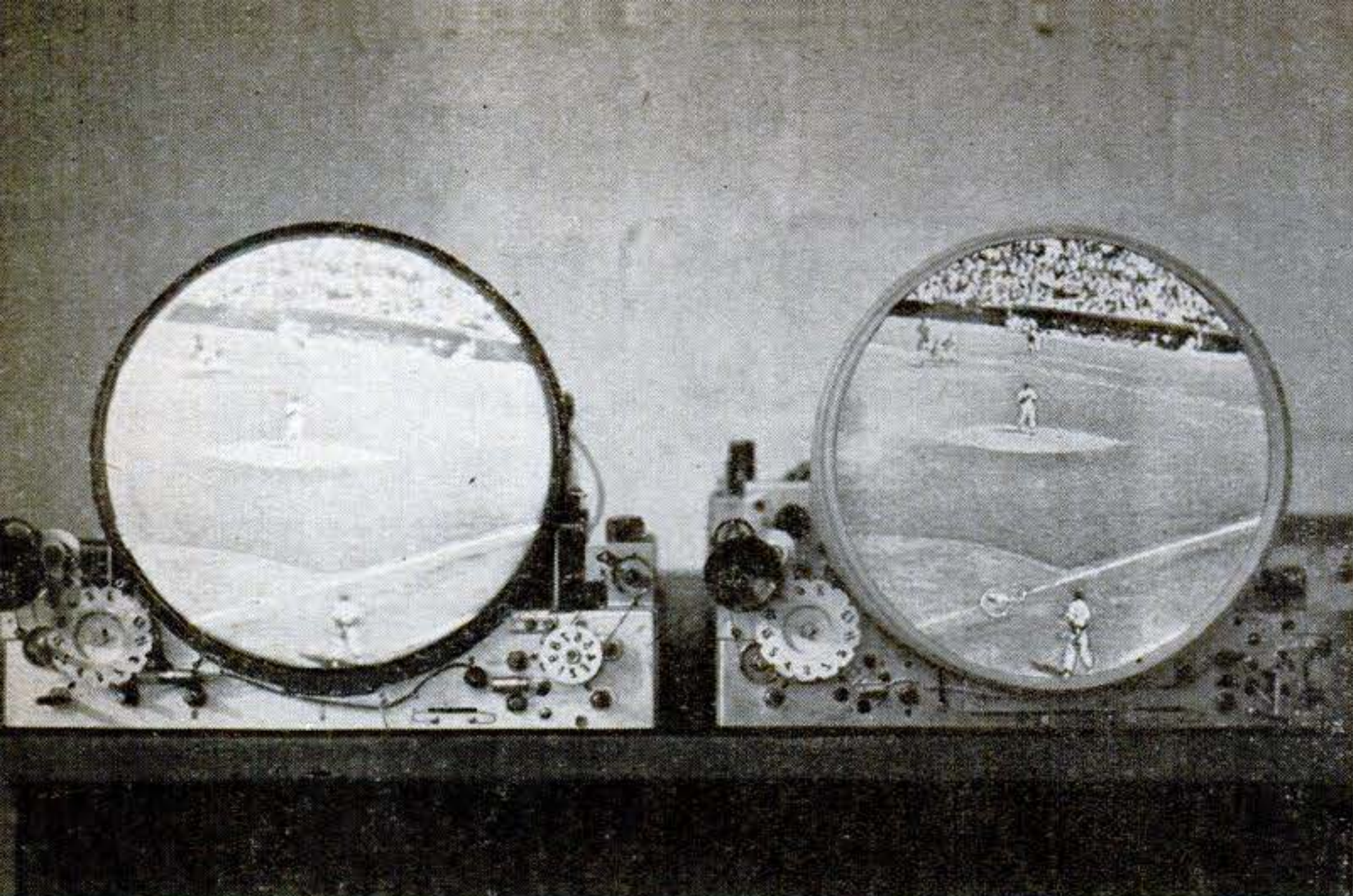

New Glass Sharpens TV Pictures, Cuts Glare

A NEW light-absorbing glass on the front of television tubes sharpens the pictures by soaking up room light instead of reflecting it from the viewing screen.

You can see the difference in the photo above. It shows the image on a tube surfaced with the new glass (right) alongside the image on a conventional tube receiving the same picture on the same type of set.

Darker than ordinary glass, the Teleglas® acts much the same as a dark filter. As shown in the sketch at right above, room light would have to pass through the filter

twice to be reflected from the tube. Light from the tube, forming the picture, is filtered only once—and so is comparatively much brighter. The filter also suppresses “halation” or light reflection from within the tube that decreases picture contrast.

The filter glass is made by Pittsburgh Plate Glass Co. and is used on metal-shell tubes in the new line of Zenith receivers. It is said to let you see comfortably under varying room illumination and to reduce eye strain by producing pictures of good contrast without excessive brightness and glare.

Light Lifeboat Carries 12 Men

THE Coast Guard has adopted a rubber abandon-ship boat that one husky man can toss overboard. It weighs 186 lb., with survival gear, and folds into the 4-foot package shown at right. Pulling a rip cord unzips the cover and triggers gas cartridges that inflate it in 30 seconds to 14 feet long and 6 feet wide. The craft, made by B. F. Goodrich Co., then seats 12 men and can support 13 more clinging to the side. Two of its four wooden paddles form a mast to support a nylon canopy.



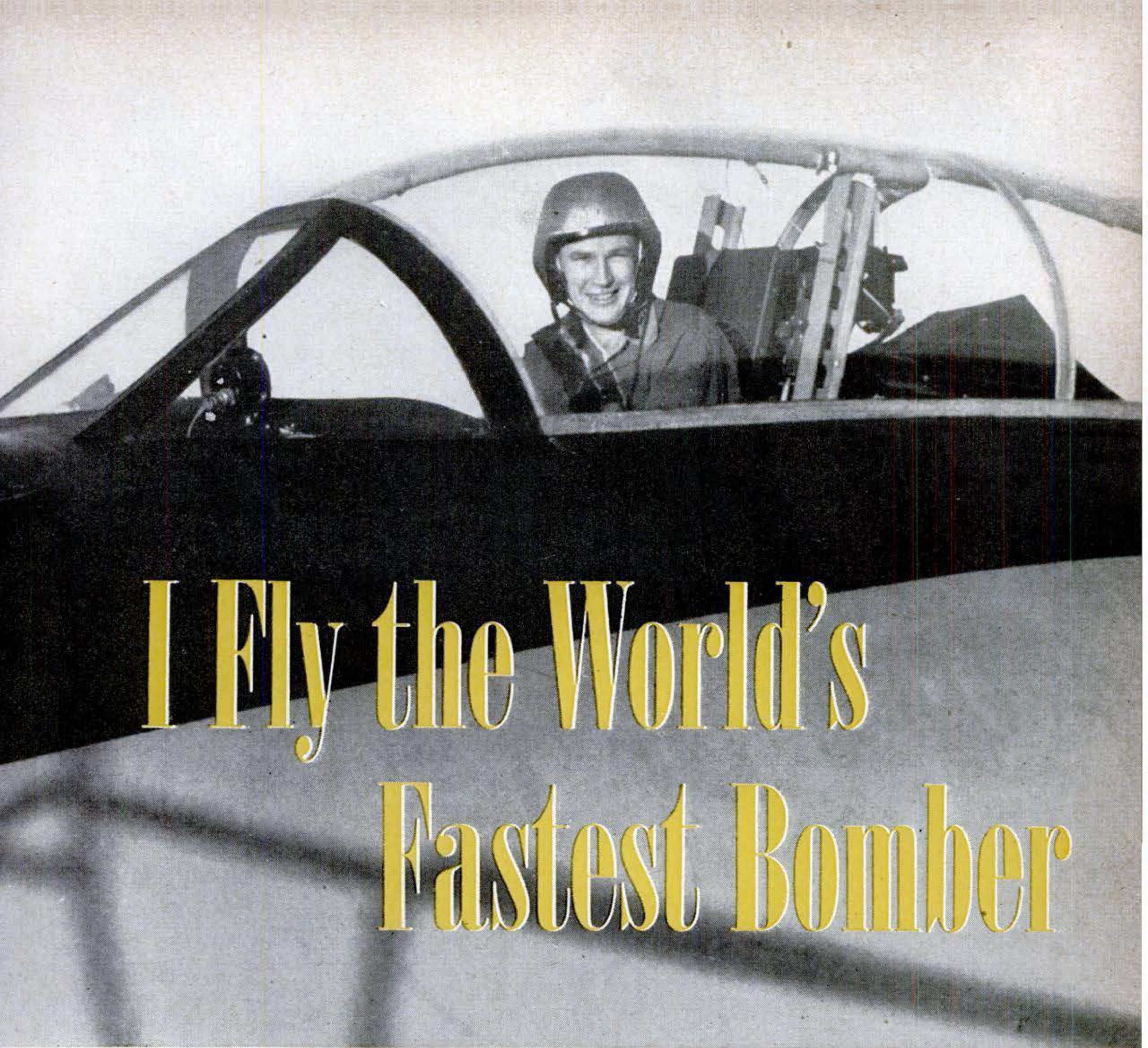

I Fly the World's Fastest Bomber

Test pilot Fraser sits in Stratojet's commodious front cockpit, ready for rocket-boost take-off.

By Jim Fraser, *test pilot*

YOU'VE heard tell that when a test pilot flies at better than 600 miles an hour a lot of unhappy things happen to him. His head feels as if it were splitting, his vision gets blurred, he gasps for breath, and the controls in his hands are as stiff as iron.

It would maintain the glamor of test flying in this age of jets if all this were true. But it isn't. It's pure hokum.

It's my job to fly the world's fastest bomber—the Boeing B-47 Stratojet. Fully loaded, it weighs more than 60 tons. Yet it handles like an airplane a fraction of its size, and the sensations of flying it are those of a passenger seated comfortably in any one of to-

day's fast air liners. The Stratojet pilot has no sense of extreme speed unless he flies near the ground or near another airplane—it's necessary to have a reference point to judge one's speed.

He feels, in fact, *fewer* sensations than an air-liner passenger. There is practically no vibration. That's due to the enormous reduction of moving parts, such as propellers, pistons, connecting rods, and associated mechanisms. A double wall, which contains the pressure cell and allows the pilot to be at the equivalent altitude of 8,000 feet while flying at 35,000, keeps a large amount of the sound out.

The control surfaces are powered to overcome the enormous air loads at high

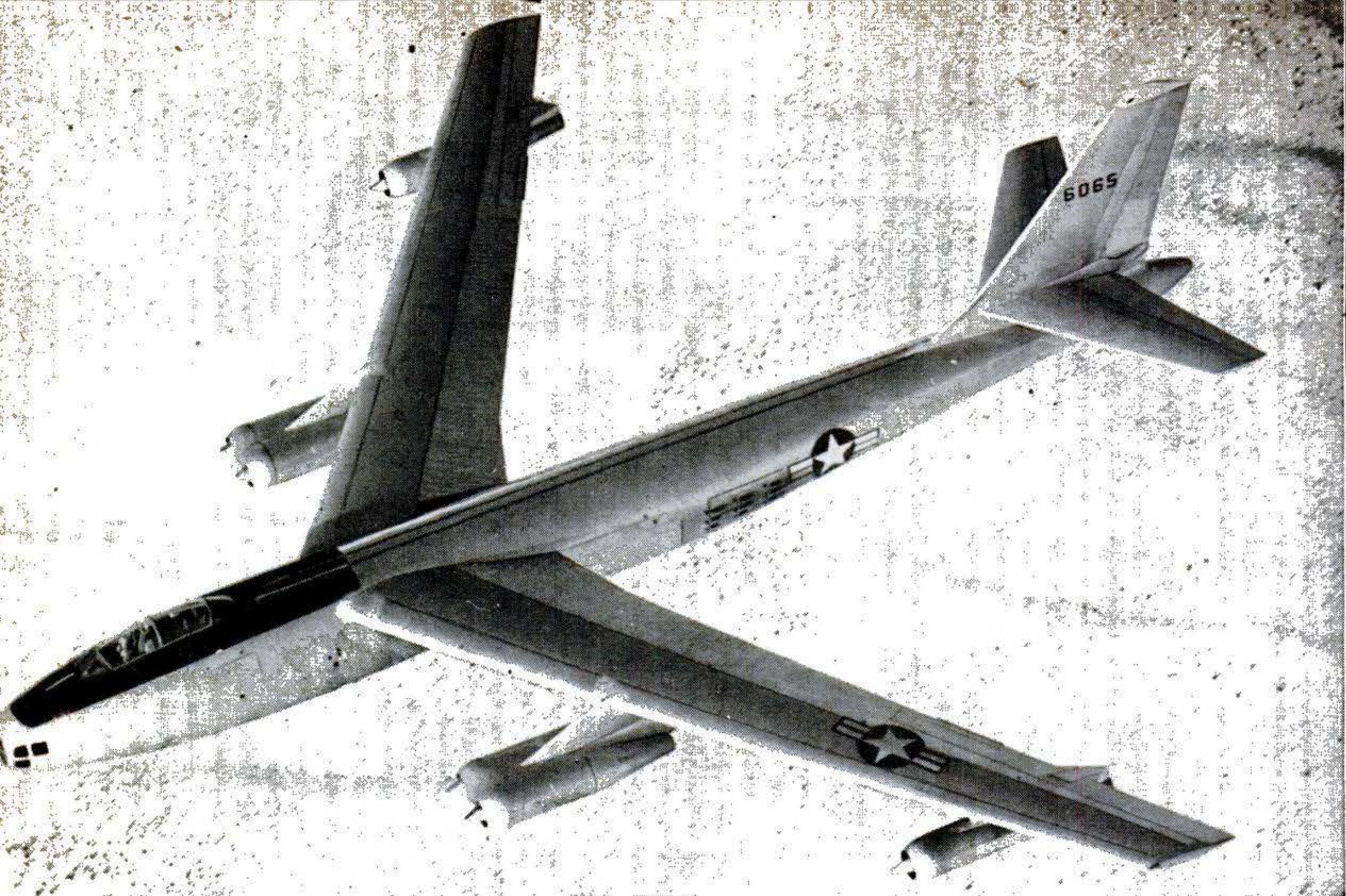

Sleekest of USAF's bigger planes, bomber is easily recognized by huge swept-back wing and pylon-supported engines. Angled wing, giving

effect of greater width, increases distance air must go to get over it, smoothing bumps and delaying compressibility at near-sonic speeds.

speeds. A pilot need exert only a small force to move them, the real work being done by boosters.

As for temperature, heaters keep you warm and refrigeration systems keep you cool. In short, you are comfortable, at ease, and less burdened with work than you would imagine. The main problem is navigation. Radio stations go by so fast that you are constantly tuning the radio compass to keep track of them.

The Stratojet, made for the U.S. Air Force by the Boeing Airplane Company, is

essentially a "pilot's airplane." In checking out Air Force pilots, some of them top brass with many thousands of hours in everything from Jennies to jets, we company pilots have met with an almost universal reaction: "It's a bomber all right, but it handles just like a fighter."

A look at this airplane will show why. It resembles an arrow. Sleek, tandem cockpit seating for two pilots cuts air drag to a minimum. Each pilot has nearly 360-degree visibility, the only limitation being the other fellow's head.

Photo of B-47 landing shows bicycle landing gear, wing droop (indicating its flexibility),



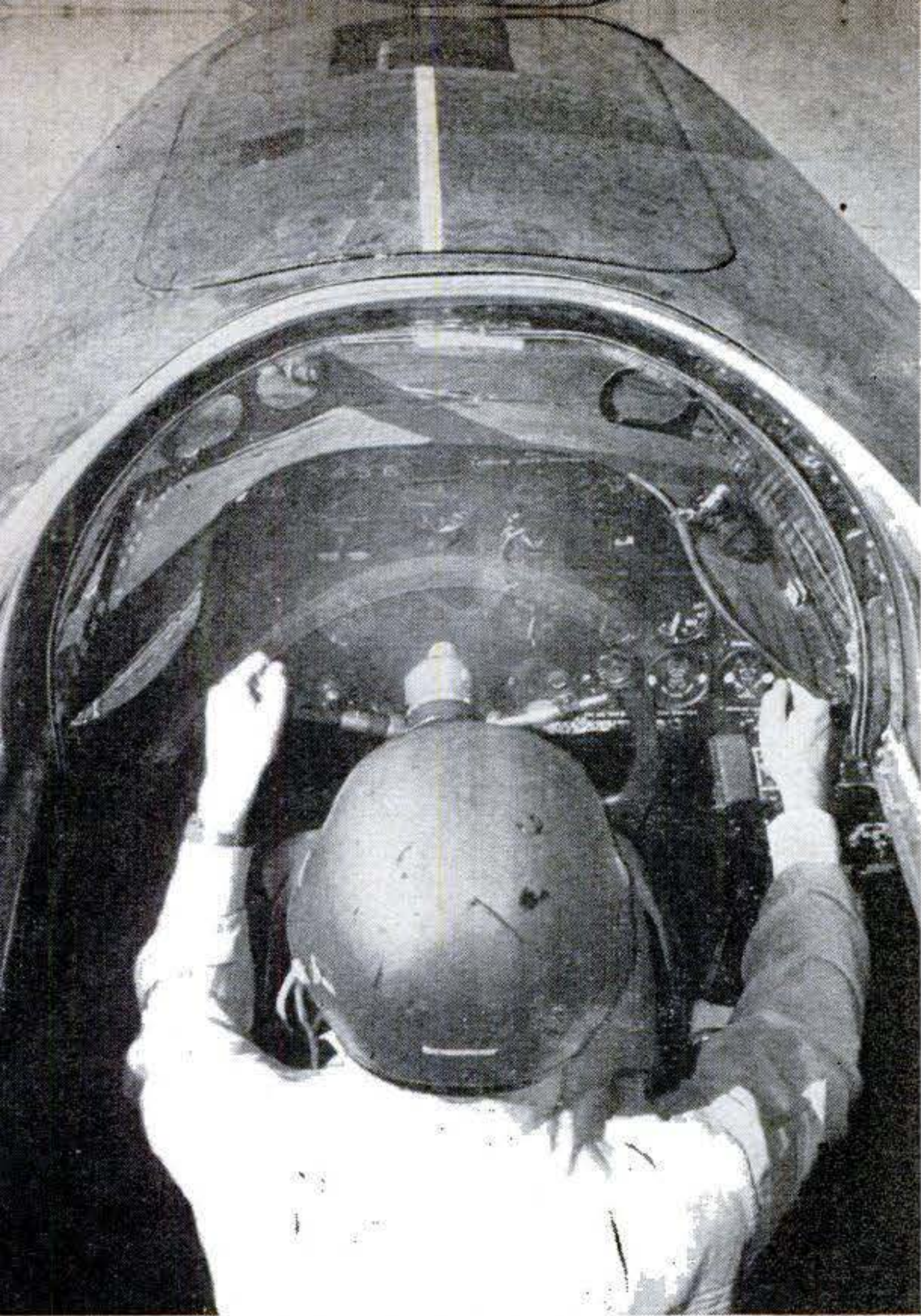

Cockpit view over pilot's helmet shows that jet bomber's controls are somewhat simpler than in piston-engine planes—but still complex.

The landing gear is novel. The two main sets of wheels are located one behind the other, bicycle fashion. This arrangement allows the bulky gear to be contained in the fuselage rather than having to enlarge the compact, twin-jet engine nacelle to accommodate it. Two small outrigger wheels keep the airplane upright when at rest.

As you approach the airplane, you will note that the engines are strung out along the wing—a pair midway out and one near each wing tip. This gives better distribution of weight along the wing. Imagine six

and drag 'chute to slow plane, shorten roll.

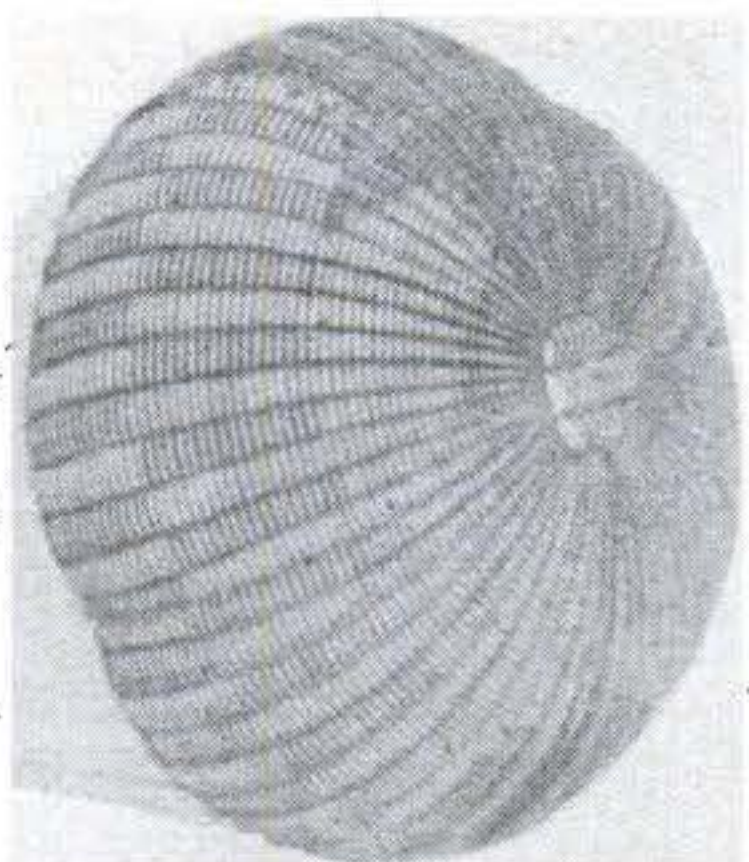

weights hanging on a long pole that is suspended at each end. If the weights were hung at the center, the pole would bend sharply. But if they were distributed along the pole, it would bend less or could be made thinner, the latter being just what the aeronautical engineer wants in order to knife his wing through the air. Distribution of engines along the wing also lessens their vulnerability to gunfire.

Still another benefit is a soft ride when the airplane encounters turbulence at high speeds. The wing, being thinner and therefore less rigid, does not convey the total shock to the airframe but absorbs it by deflection. This wing is designed to flex many feet, whereas comparable-sized aircraft may have a wing that flexes only a few inches. In other words, the wings bounce while the pilot stays still.

Sweep Back Gives More Speed on Less Power

There is a reason for those swept-back wings. When an air particle already moving near the speed of sound is diverted around the top and bottom of a wing, it must speed up even more. As it reaches the speed of sound, it begins to compress on the forward part of the wing rather than move around it. At this point the air takes on the characteristics of a solid. This creates what is known as a compressibility shock wave, which disturbs the flow on the wing and causes loss of lift and buffeting.

It has been known that this condition can be alleviated or postponed by decreasing the thickness of a wing in relation to its fore-and-aft width. Generally speaking, a wing one foot thick and six feet wide doesn't displace the air as violently as a wing one foot thick and five feet wide. If the same five-foot-wide wing is swept back 35 degrees, you will find that, in observing the path the air particle traces over the wing, the *effective width* of the wing has increased. This gives the air particle the break it needs, and an airplane so equipped can go faster under less power.

To get into the B-47, it's not necessary to scurry around for ground ladders. No gymnastics are required. You simply open the outer door and pull down an extensible ladder. As you climb aboard, it is easy to see that this cockpit layout was approved by a pilot before production. It is "right" and everyone who rides in the airplane is pleased with the arrangements.

Although the layman may not be fa- ➤

miliar with the hundreds of gadgets in the conventional airplane, he is nonetheless appreciative of the responsibility of keeping track of them and the value in decreasing the number. Because of reduced control for jet engines, this has been accomplished in the B-47, and the two pilots can handle everything without a flight engineer.

For example, the engine start is a simple operation. You just select the fuel tank to be used, turn on your ignition, press a momentary starter switch to turn the engine to the proper r.p.m., and open the throttle to meter in the fuel. When the tailpipe temperature indicator starts moving, you know you've started. Taxiing out is also simple, for you can use just one master handle to control all six throttles, differential throttling being unnecessary because of the excellent nosewheel steering device used for directional control.

Warm-up procedures are eliminated, and just ask any pilot what this means on a hot summer day.

When all engines are at 100 percent r.p.m., you release the brakes and you're away. Just as the airplane becomes "tender" on the runway, you hit the JATO switch, giving 18,000 additional pounds of thrust. With the 24,000 from the engines, you have a total of 42,000 pounds of thrust, which is roughly equivalent to 42,000 horsepower for the duration of the takeoff rockets.

Gentle Hand Gives Big Push

Things are very interesting at this point. A gentle but powerful hand grips the airplane and starts you up in a very steep climb, overcoming the hazards of a short runway and obstacles at the end that still plague many airports. Being abruptly free of the earth, you allow the airplane to accelerate to more than 300 m.p.h. *before you even start to climb.* What this airplane will do in terms of top speed is still being withheld by the military, but the Air Force says it's in the "600-m.p.h. class." You will recall that on February 8 the airplane flew from its test base at Moses Lake, near Seattle, Wash., to Washington, D. C., in 3 hours 46 minutes for a point-to-point average speed of 607.8 m.p.h. for the 2,289 miles, all at altitudes between 35,000 and 40,000 feet.

Once at his predetermined altitude, the test pilot's job is plain hard work, involving controlled flying and gathering data during dive tests and performance runs.

As you start down, the rate of descent hits

the peg at 10,000 feet per minute and you are soon on approach to the field. The gear comes down at 350 m.p.h. with a "chug"—the airplane feels that—and then the wing flaps come down for a slow landing. As you approach the runway you get ready to release the drag 'chute. This handy gimmick is a ribbon-type parachute attached to the airplane that enables the sleek, low-drag aircraft to stop on runways normally too short for it.

You taxi back with the drag 'chute riding off the ground. This is a valuable characteristic of the 'chute since it minimizes wear and allows the 'chute to be used repeatedly without repair.

Then you shut down and climb out.

You've just given a workout to a jet bomber that has many times outsped standard jet fighters—also in the 600-m.p.h. class—and at the same time is capable of carrying more than 20,000 pounds of bombs.

Racing the Clock

As a parting thought, you might recall the coast-to-coast flight of the Stratojet. If the airplane had flown from east to west, instead of from west to east, in 3 hours 46 minutes and you had been aboard and had changed your watch at each time line, you would have badly upset the standard airline schedule—breakfast in New York, dinner in Los Angeles.

You could have had breakfast in New York and 46 minutes later, according to your watch, had breakfast again—in Los Angeles. END

Shoptalk:

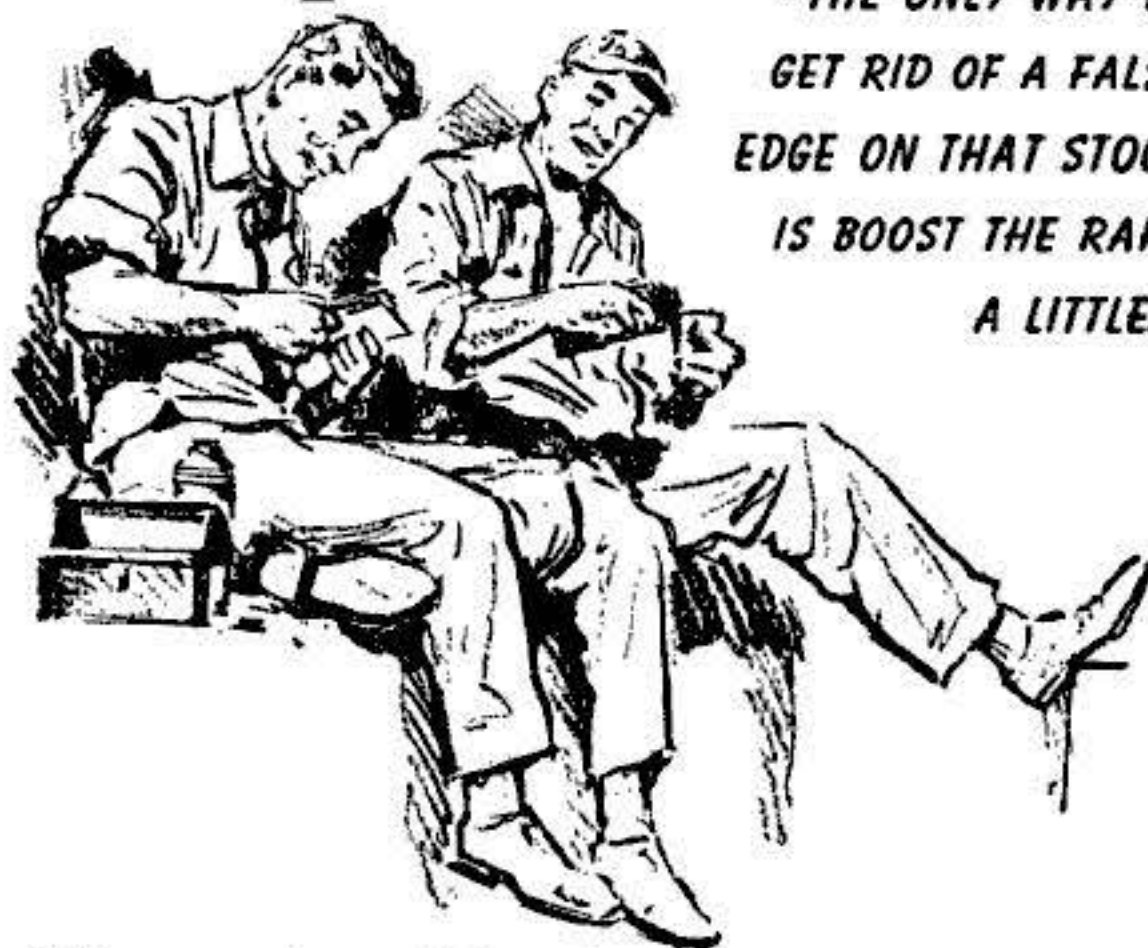

**"THE ONLY WAY TO
GET RID OF A FALSE
EDGE ON THAT STOCK
IS BOOST THE RAKE
A LITTLE."**

What are they talking about?

Where do they work? Answer below.

They're machinists. The alloy being machined builds up a false cutting edge on the top of the cutter bit, this can be prevented by grinding a somewhat greater angle at the upper surface of the cutter.

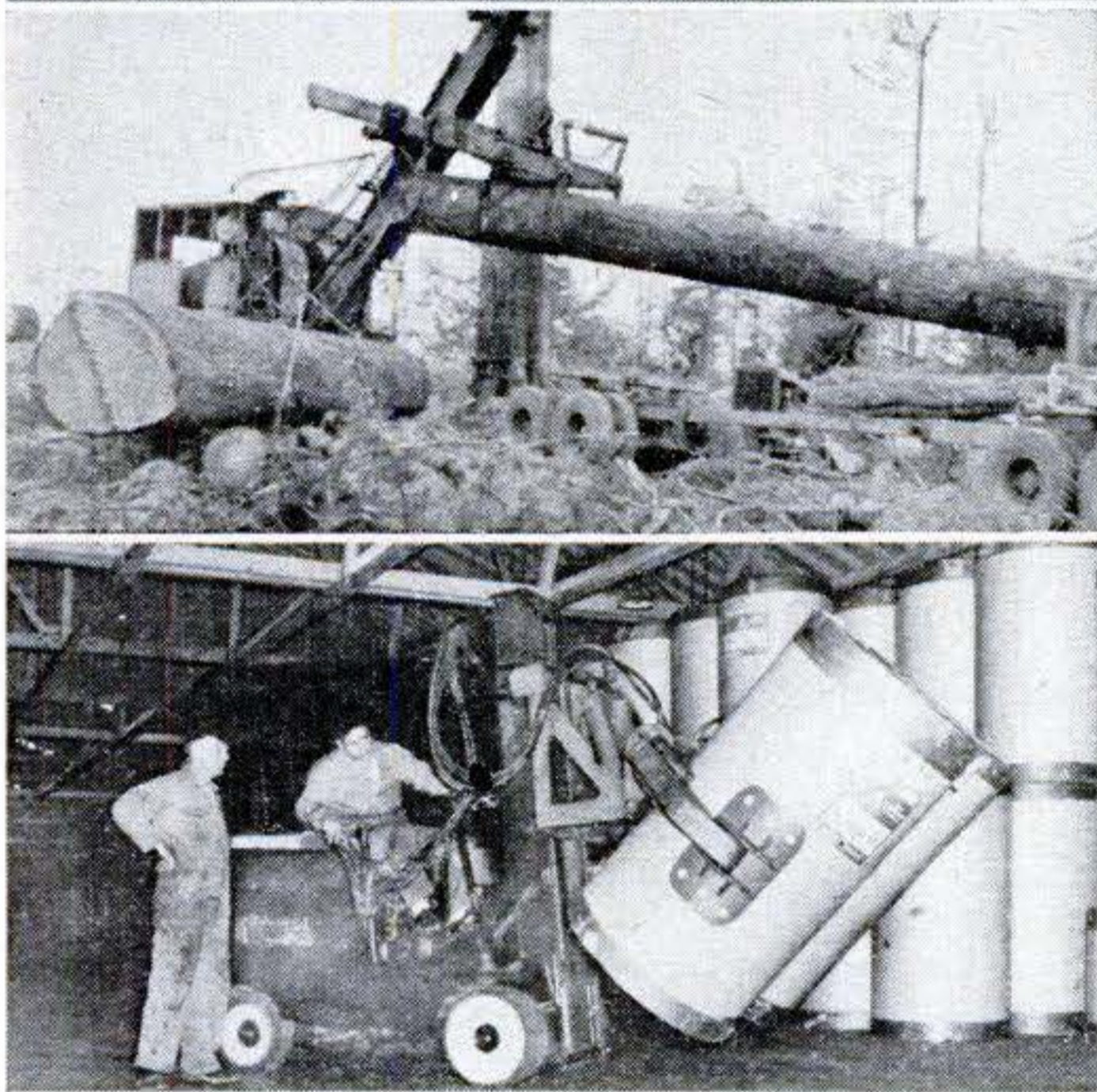
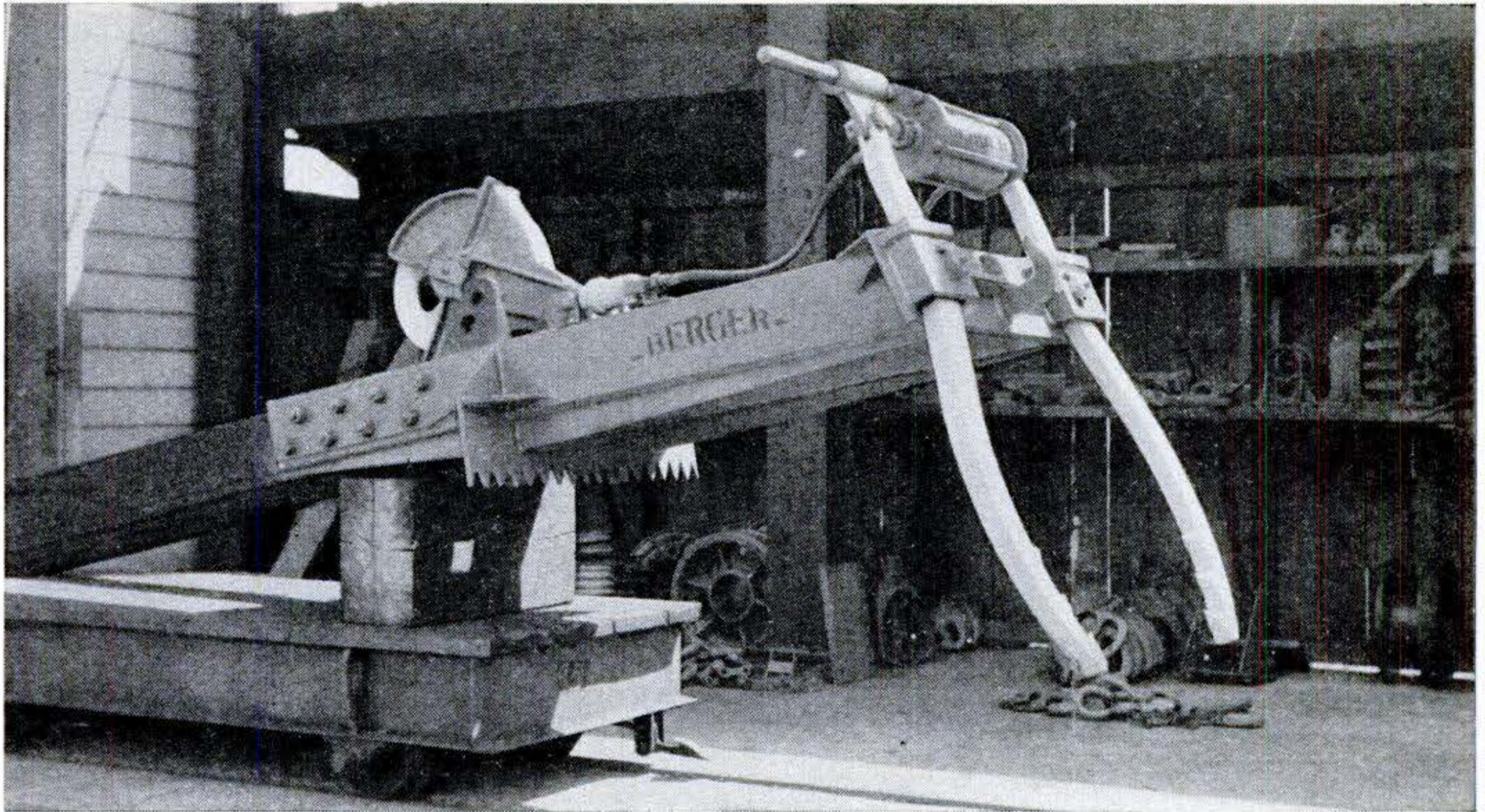

Paul Bunyan Gets Steel Fingers

HOISTING logs and heavy rolls of paper is easy for two new sets of steel fingers. In the forest (left), the toothed tongs above, controlled from the cab of a power shovel, lift logs with little damage to the bark. At the other end of the paper-making process (lower picture at left) curved fingers on the fork of a lift truck can hold two rolls of newsprint at a time. Hydraulic pressure provides the grabbing power in both sets of tongs. The log fingers are made by Berger Engineering Works, Seattle; the paper tongs by Marine Terminals Corp., San Francisco.



Water Tank Looks Like Golf Ball on a Tee

THE 50,000-gallon water tower at left gives a new look to the landscape near Houston, Texas. It's made of welded steel plates, cut and shaped so that the tank continues the outward sweep of the upper part of the supporting structure.

A ladder inside the tower, alongside the single filling and delivery pipe, goes on up through a vertical shaft within the spherical section. A trap door at the top of the ladder also gives access to the interior of the storage tank itself, and its rim provides an anchorage from which a bo'sun's chair can be hung when the structure needs painting or other attention on the outside.

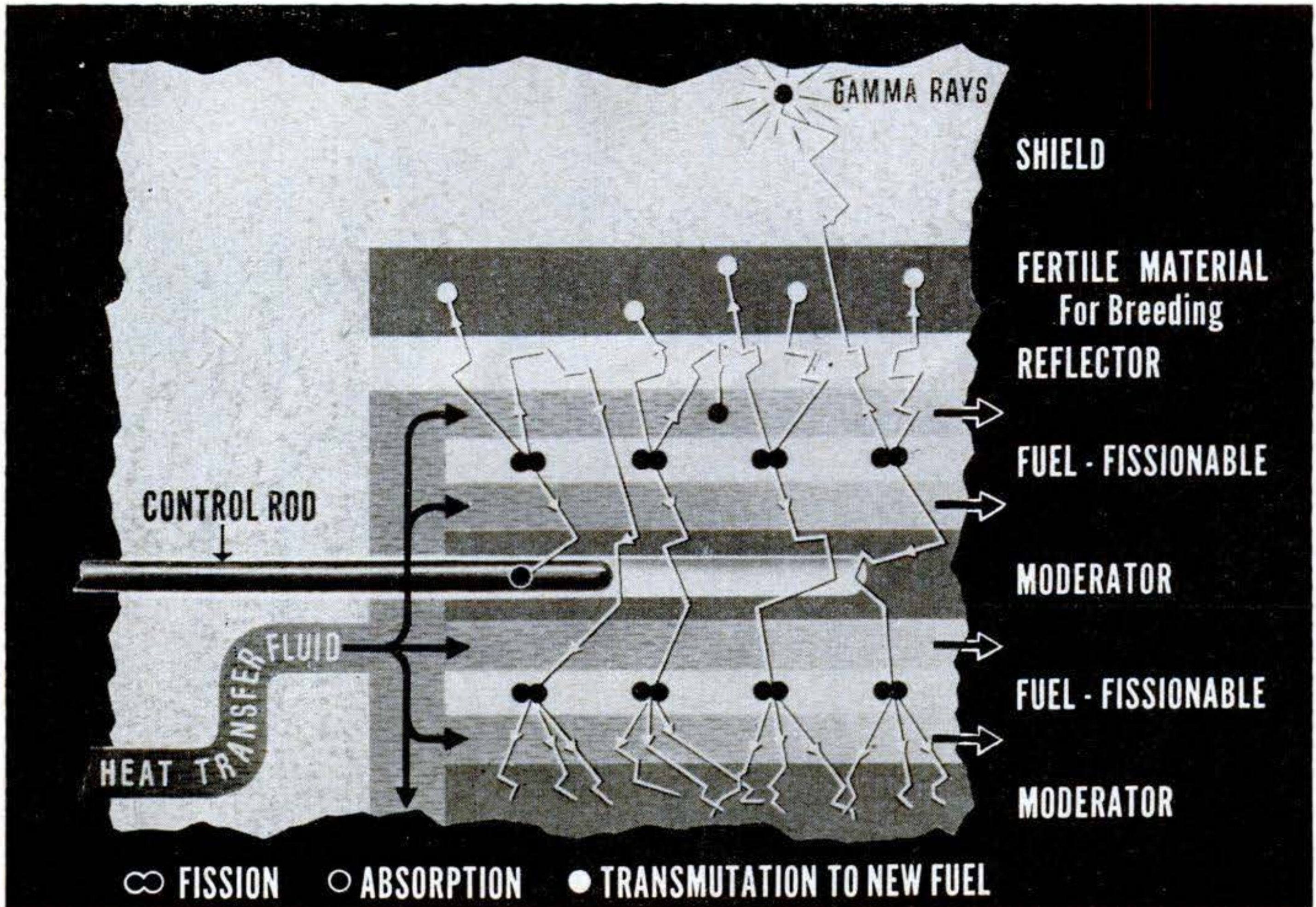

Boiler for an Atomic Engine

THIS schematic drawing shows what General Electric engineers expect to happen in their new nuclear reactor, planned both to produce power and breed more atomic fuel (PS, June '49, p. 124). Zigzag lines mark the paths of neutrons emitted when atoms of the fissionable material are split. The heat-

transfer fluid will be a liquid metal and will come out at a temperature of several hundred degrees. It will be used to drive electric generators. Meanwhile, other neutrons will be colliding with atoms of fertile material and converting them into fissionable atoms. Under construction near West Milton, N. Y., the new engine is called the KAPL (Knolls Atomic Power Laboratory) reactor.



X-4 Spears Sonic Speeds

BUILT to explore flight at high speeds, this swept-wing bullet is powered by two gas-turbine engines. The Northrop X-4 is to continue U. S. Air Force research pioneered by the Bell rocket-powered X-1, first to out-speed sound. The small, 7,000-lb. flying wing, measuring only 25 feet from wing tip to wing tip, has tricycle landing gear and an ejection seat for the pilot.

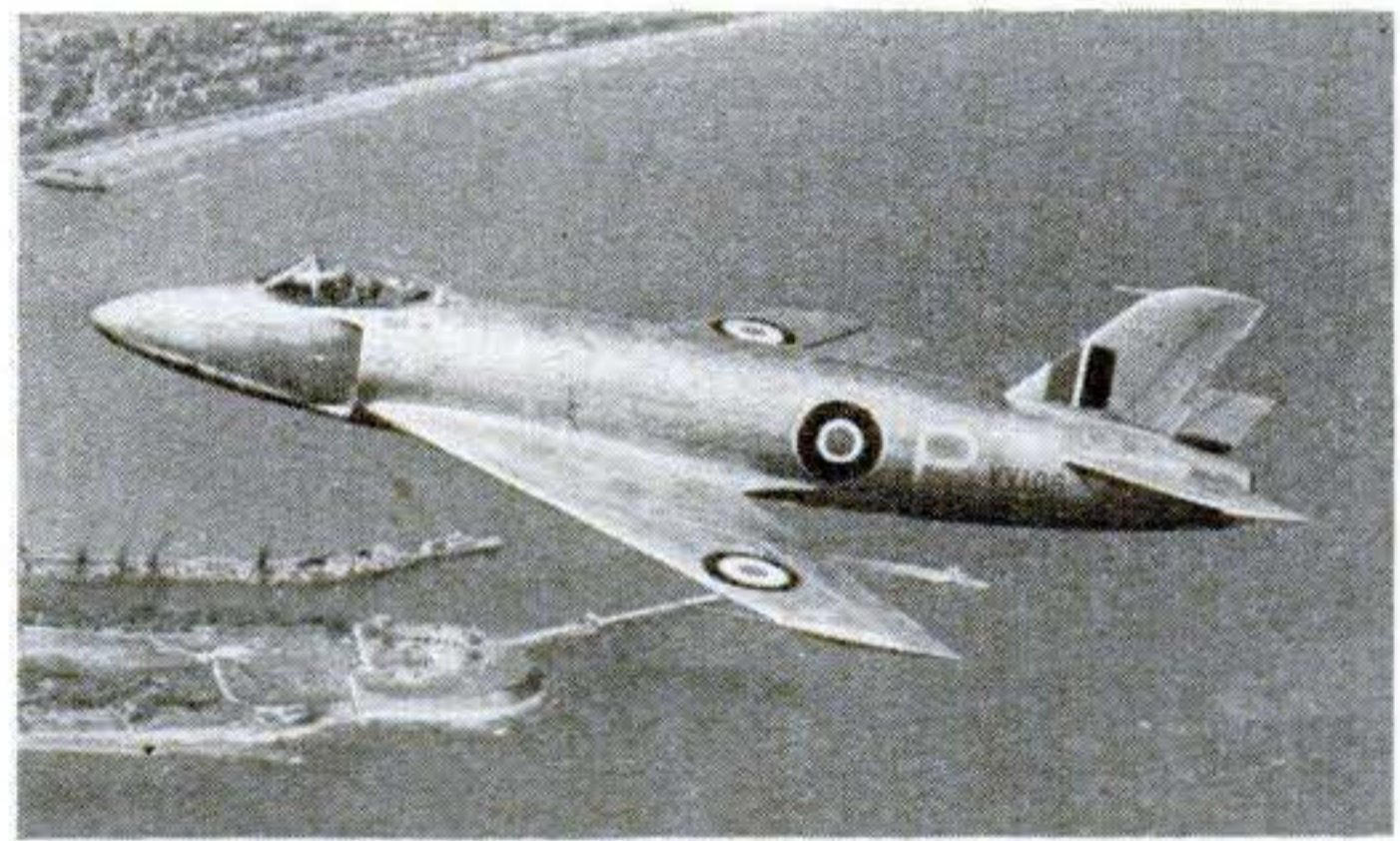

Flies Faster than Sound

BRITAIN is not saying much about the Vickers Supermarine 510, shown above, except that it's faster than sound. It is a research plane, powered by a Rolls-Royce Nene jet engine with a 5,500-lb. thrust. Unlike the X-4, at left, the Supermarine is designed for eventual service as a fast fighter. Britain has announced another supersonic plane, the Hawker P. 1052.

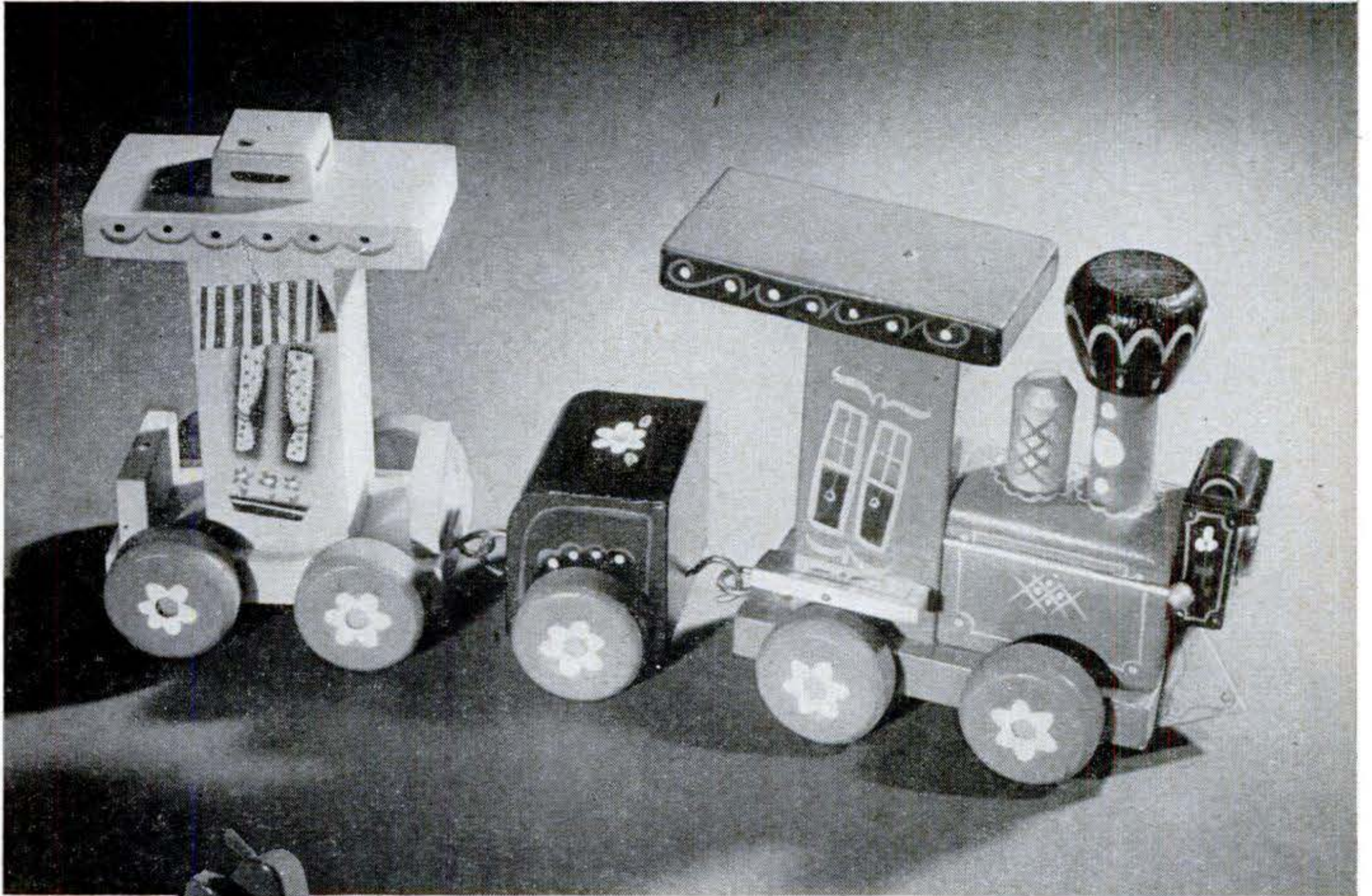

New kind of educational toy is being made of standard-sized wood stock in upstate New York valley. Caricatures, they are pegged together for juvenile disassembly. Couplings are hooks and eyes.



Santa's Factory Makes Toys the Easy Way

PS photos by W. W. Morris

IN UPPER New York State is a toy factory that would satisfy the most wistful dreams of childhood. Santa Claus lives just around the corner. Reindeer browse among white birch trees. A lollypop tree dispenses candy. There is a big iced white pole—the North Pole, of course.

This is the Children's Village, otherwise known as Santa's Workshop, North Pole, Whiteface Mountain, New York.

From the toy factory—the heart of the establishment, as it would have to be in any community at the North Pole—are coming thousands upon thousands of a new kind of toy. The toys are made of standard stocks of wood purchasable at any lumber yard. A man handy in a workshop could dup- ➤

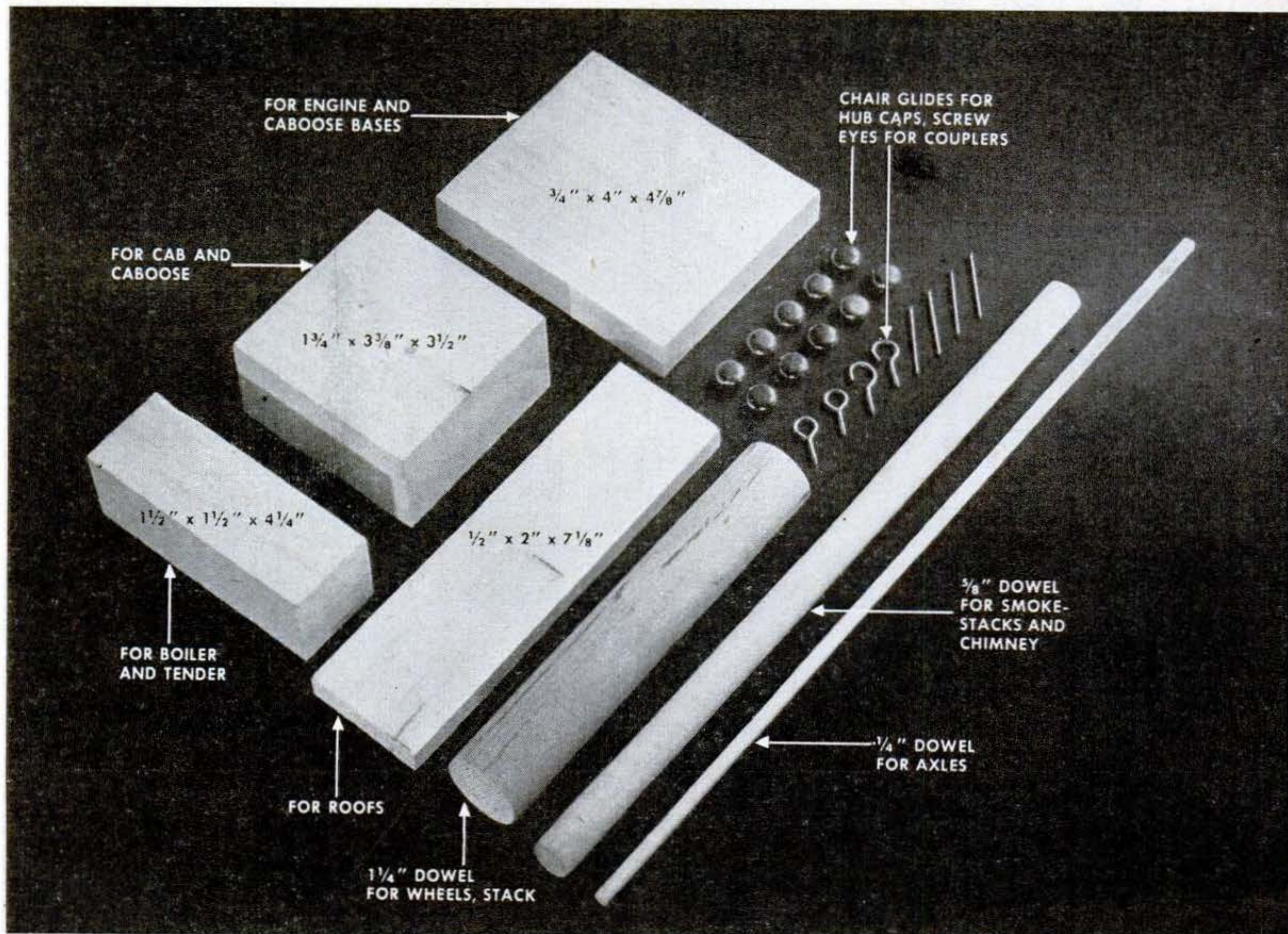

These are materials, mostly from lumber yard, that go into the train on the opposite page.

licate them in his own home with nothing more than a straight saw and a hand drill. These are the educational toys—all are done in caricature—that issue from the whirr of machinery at Santa's Workshop.

Another group of toys is comprised of circus animals, also made of wood, also caricatures. The camels, leopards, and clowns are a bit more complicated than the educational toys. Yet they are turned out with only hand saws, bits of felt, and paint.

Right now, the roof of Santa's Workshop is covered with snow, and everywhere you look there are alabaster mountain slopes, for this is in the heart of the Adirondacks. Almost a score of men and women are making toys under the direction of one of Santa's lieutenants. The lieutenant is a former Walt Disney artist who goes by the romantic name of Arto Monaco. For the record, he is an ex-GI. Also for the record he was down to his last buck when he began making toys.

Children's Village educational toys got that way because Monaco was looking for a

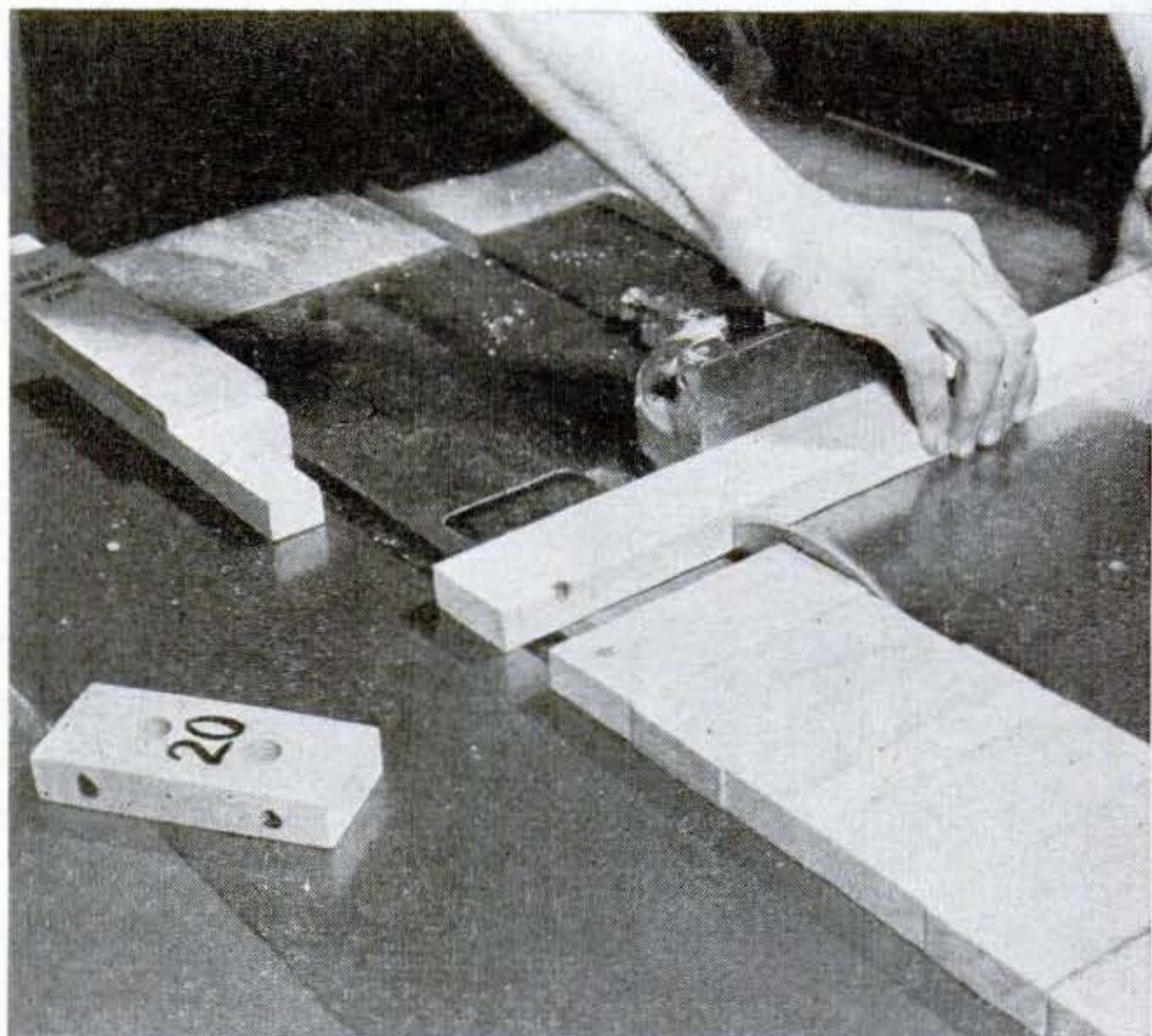

Cutting base for locomotive. It measures $4\frac{3}{4}$ by 2 by $\frac{3}{4}$ inches. Jig guides power table saw. Pre-Christmas work staff of Santa's Workshop is 18 men, women. Mailing address is Wilmington, N. Y.

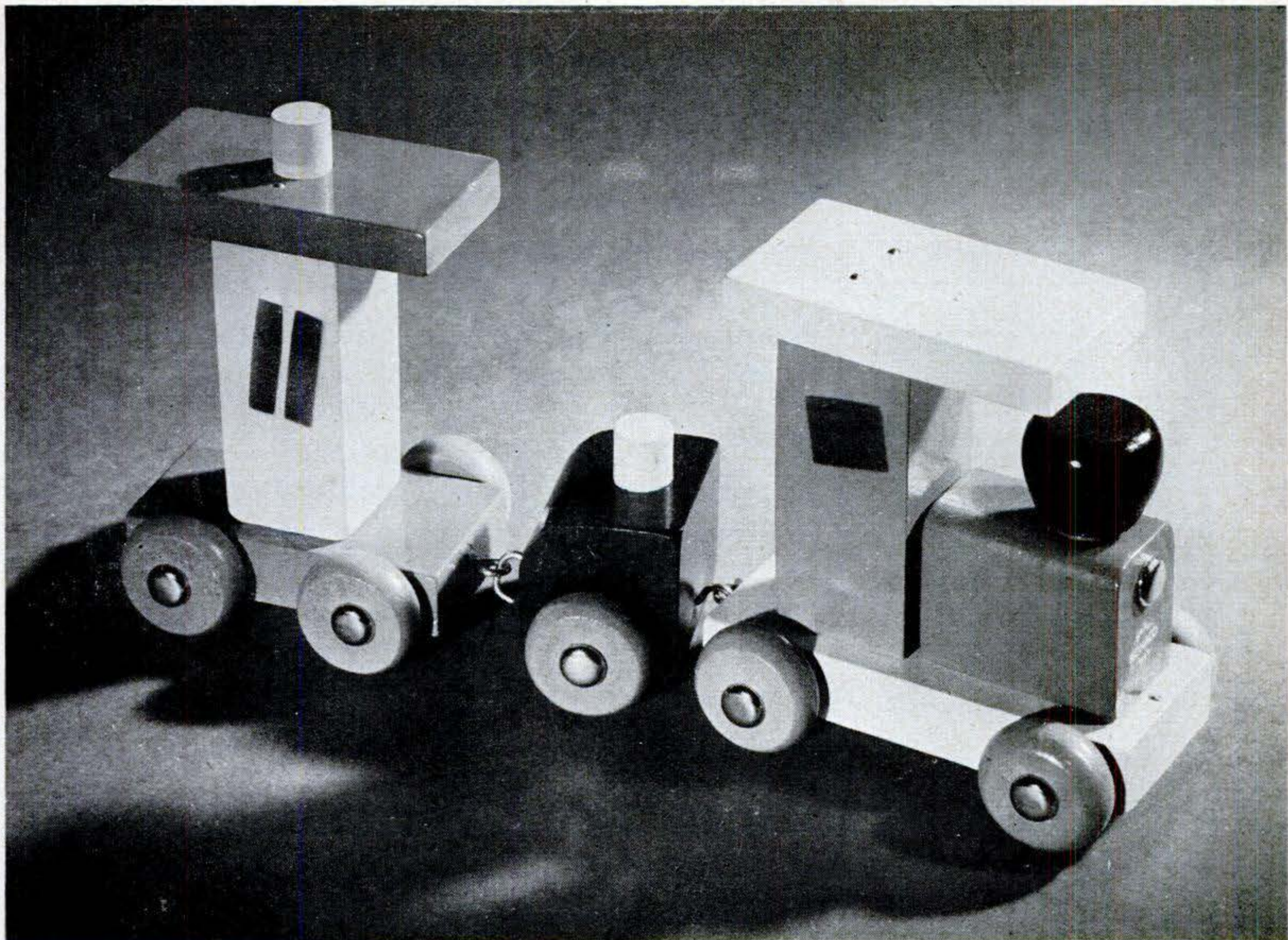

This is a simpler version of train shown on first page. Wood used is pine, soft maple, or gum.



Wheels can be cut from dowel on bandsaw, but factory can get them cheaper from toy factory specializing in wheels. They are 1½ in. in diameter. Rims are sanded to make "tires."



Holes for pegs are sunk with multiple drill. Depth, diameter are the same— $\frac{5}{8}$ in. Standard pegs are 1½ in. long; smokestack's, 2 in. Designer Monaco's father helped establish shop. ▶

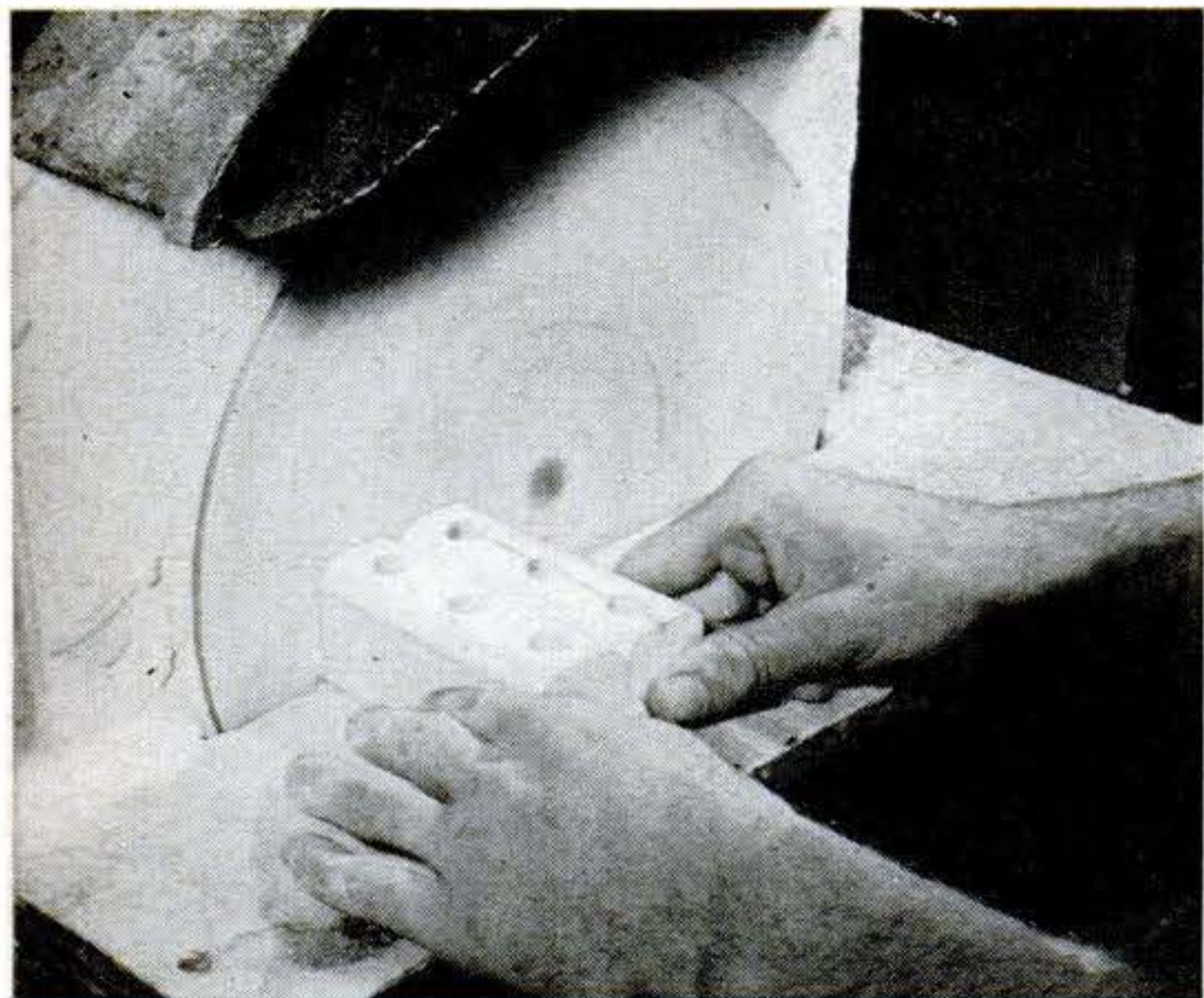

Locomotive boilers are smoothed down on disk sander. After this they are buffed to take off any sharp edges and then put under blower to remove wood dust from holes before painting.



In lacquering shop, boilers are put on screen rack and sprayed under 15-lb. pressure. Higher pressure would blow blocks off rack. Next step is stacking for a 6-hour drying period.



means of turning out toys with unskilled help. People up there in the mountains know a lot more about skiing and tobogganing—nearby Lake Placid is famous for its winter sports—than they do about making things in a factory. So Monaco reduced his caricatures to their barest essentials and planned his factory from scratch. Saws, hammers, drills, sanders, paint guns and paint brushes, and tumblers for sanding, painting, and waxing are his only tools.

The educational toys are pegged together with just enough play between peg and hole



Creator of new toys designs a donkey as an item for his circus line. Manufacturing materials will be 3-ply gumwood and felt. Typical other circus toys are the leopard, shown at the left above, and the camel at the right.

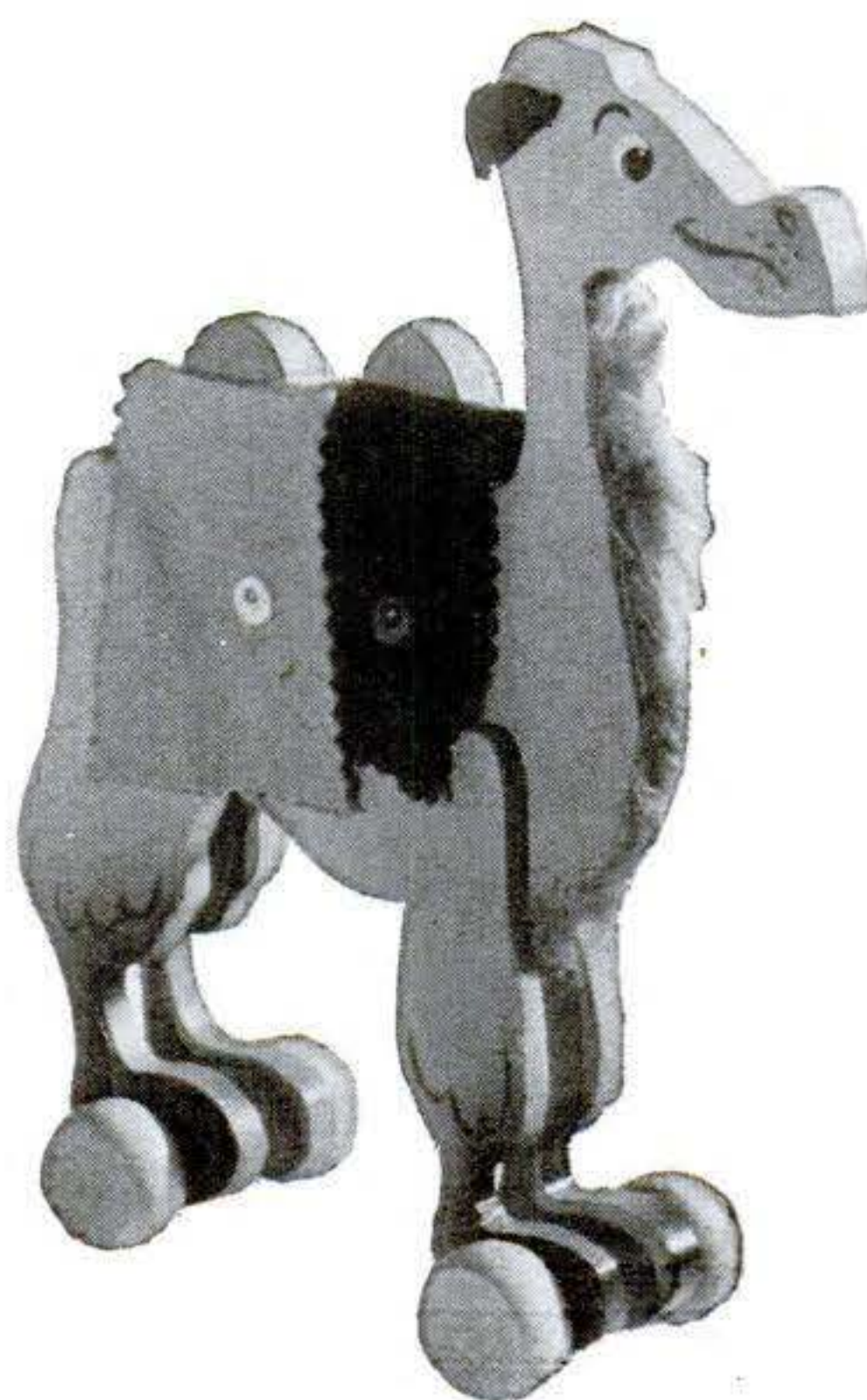

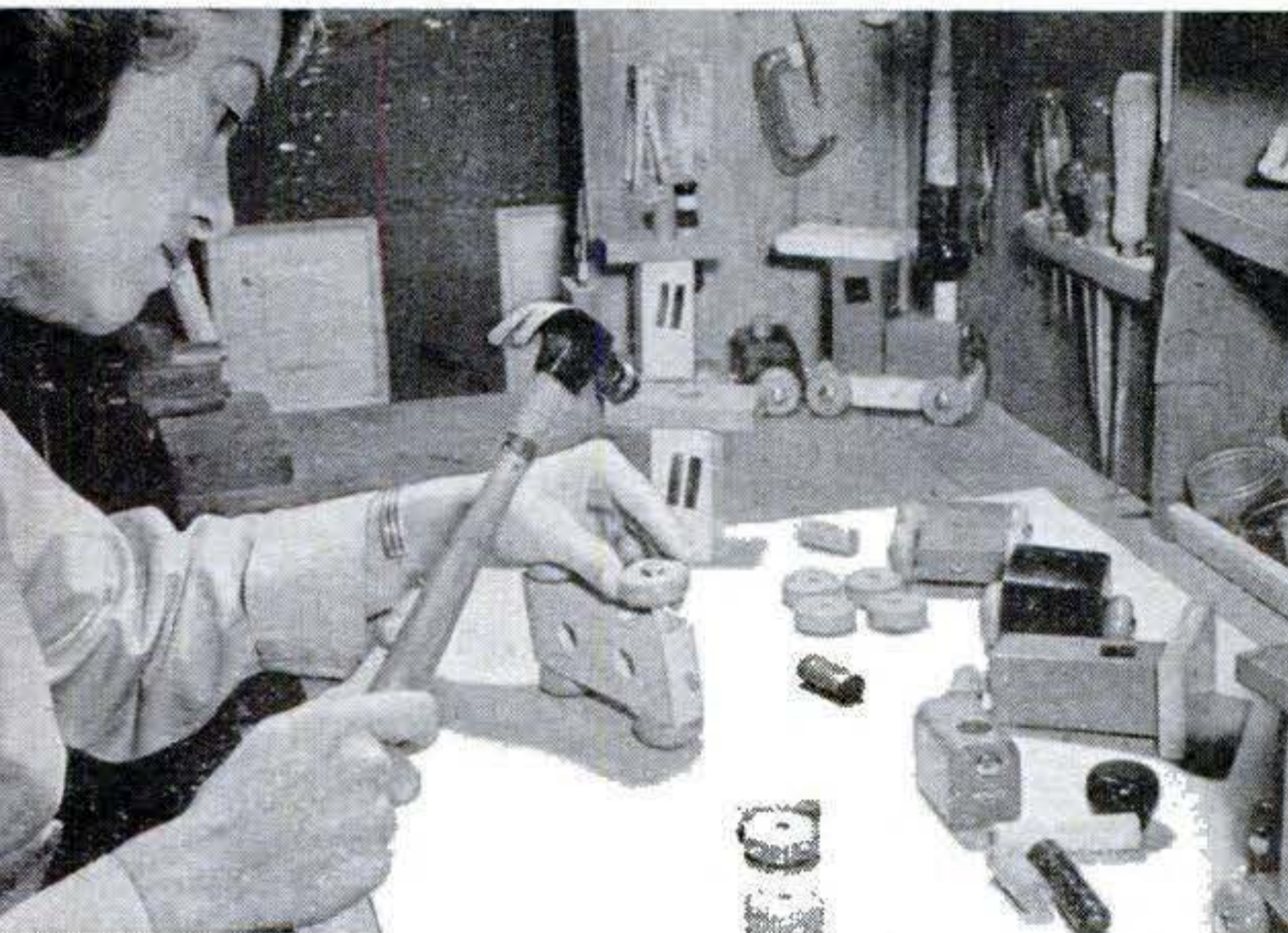

Wheels are attached by tapping $\frac{1}{4}$ -in. dowel into hole slightly smaller. Dowel, $2\frac{3}{4}$ in. long, runs through base of toy to form axle. It turns easily in a hole $\frac{3}{8}$ in. in diameter.



For fancier models, artist lacquers locomotive, paints in windows. Caboose gets wood awnings and painted polka-dot curtains and window box with flowers. Paints, lacquers are non-toxic.

to make them go together and come apart easily. Pegs are of a standard size so that if a preschool-age child whimsically wants to put a locomotive boiler on a caboose, that's his privilege. No nails are used.

At the start of his manufacturing, Monaco nailed his wheels onto the bases of his toys. The head of his sales department trotted down to New York City to sell some of the toys to one of the big department stores.

"Hmm," observed the matronly buyer for the store, yanking away at one of the wheels, "see!" It came off in her hand. "I won't buy anything," she stated almost accusingly, "that's not substantial."

The salesman reported to Monaco. "I'll fix her," said Monaco.

Imp-Proofing Ends Sales Resistance

Now his axles are dowels that run all the way through the base of the toys. They fit loosely, to turn. The wheels are hammered on to the ends of the dowel and fit too snugly to be pulled off by the most destructive imp in the neighborhood. (On the next trip, the department-store buyer bought.)

The toy factory and the children's village came about because a 6-year-old girl asked her father, one winter day, where Santa Claus lived. Her name was Patricia, and her father, Julian Reiss, New York and Lake Placid business man, got to mulling over the idea of establishing a home for Santa. The more he thought about it, the better he liked it.

He called in Harold Fortune, known for his original ideas in building showplaces,

and together they called on Monaco, who had settled in nearby Upper Jay, N. Y., to make toys. Monaco wasn't doing so well. Graduate of an art institute, he had worked in Hollywood and New York before being drafted into the Army in the spring of 1941.

While he was in service he was stationed for a time at Aberdeen Proving Ground, in Maryland, where he made models for the Ordnance Department. That's where the toy idea developed. He was bored stiff on week ends, and to while the time away he made wooden toys for a nephew and some of the youngster's playmates.

On the day that Reiss called on Monaco he hadn't said half a dozen words before the artist was planning the Children's Village. He designed the workshop, complete with nine pine log houses, all with colored roofs and crazy-tilt chimneys and enough of the gingerbread touch to draw 25,000 tourists a month.

There is a reindeer barn, Mother Hubbard's Cupboard, a post office where the small fry can write out their outrageous Christmas-toy demands, burros, sheep, goats, ponies, and such storybook characters as Little Bo Peep, Huckleberry Finn, and Peter Pan. There is an exhibition toy factory run by gnomes so Monaco can maintain his amateur standing. And there's Santa, of course, on duty twelve months a year.

There's a trout stream in the toy factory's back yard. It's real. One of Monaco's—pardon, Santa's—workmen pulled a 21-inch, $3\frac{3}{4}$ -pound trout out of it last summer during his lunch hour.

END

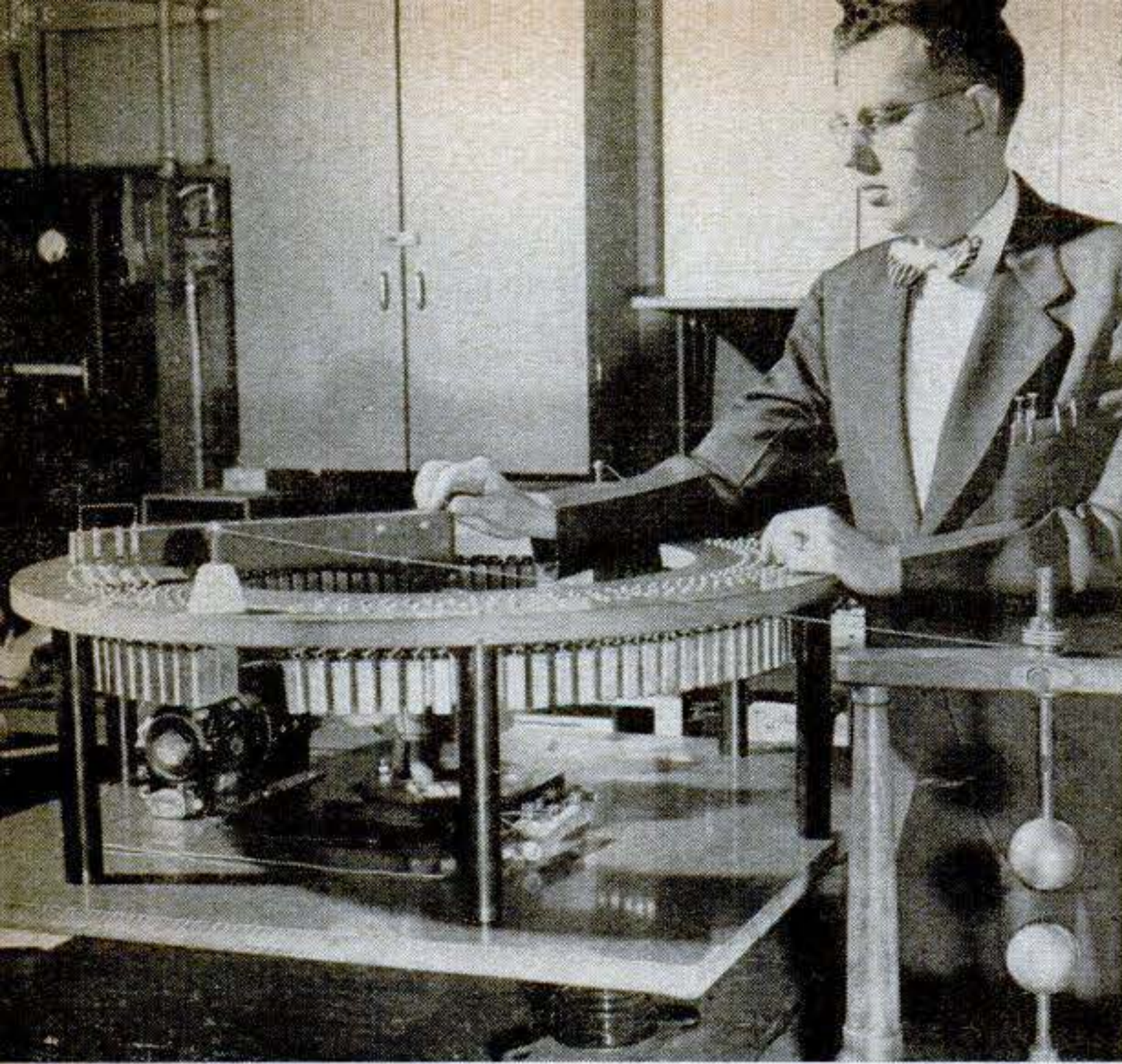

Wheel Multiplies Voltage

THE voltage of an ordinary generator, seen at lower left, is multiplied 100 times by this merry-go-round device developed for research by General Electric. It works somewhat like a water wheel that develops power as its buckets fill with water. A hundred capacitors accumulate energy by picking up charges through brushes on a sweeping arm. When the 1,000 volts of the generator have been raised to 100,000 volts, a tiny streak of "lightning" shoots between the two spheres at lower right.



How to Freeze in Comfort

THIS sailor, sitting in a tub of ice water, is trying out a new flying suit designed to protect pilots who may have to bail out into arctic waters. He is Navy Corpsman Melvin Maki, and the survival suit he's wearing is made of poplin and nylon. It weighs five pounds and is impregnated with a plastic that permits the passage of body perspiration. Maki claims that he was comfortable after a long ice-immersion at 34° F. In actual use the suit would ward off death from freezing for several hours.



Land Wheels for Sea Wings

FLOATPLANES are often built at landlocked factories. This presents a take-off problem in the delivery flight. De Havilland of Canada has found the solution in a wheeled cart on which the seaplane rides pickaback until it gains enough momentum to take off, as shown at lower left.

With the cart, the plane floats rest on two V-shaped troughs, designed for a snug fit and lined with sponge rubber to protect paint finish. These troughs ride on a pair of rubber-tired wheels. Behind the troughs is a wooden cross member that gives extra support to the float keels and is fitted with a swivel tailwheel. When the aircraft and its undercart reach a speed of about 60 m.p.h., the pilot takes off, and the dolly, weighted down by about 100 pounds of ballast, runs along the ground a few hundred yards.

Previously, the floats had to be removed after factory inspection, and replaced by a wheeled undercarriage. Then the craft was flown as a landplane to its delivery points, where a switch back to floats was made.





Rough outside, but modern inside, prefab log cabin is home of RCAF commander in Yukon.

Far North Cabins Are Now Prefabs

A COMBINATION of the old and the new is helping to solve the desperate housing shortage in the far North. From the outside, it looks like a traditional log cabin. Actually it is a completely prefabricated home, designed on a four-foot module. Manufactured in sections at Winnipeg, Man., they are shipped to places like Watson Lake, Aklavik, and Coppermine.

Inside, these homes are entirely modern, with up-to-date bathrooms, kitchens with work counters and cabinets, and forced hot-air heat. Except in the living room, all furniture—even the beds—is built in. Made by North American Buildings, Ltd., the houses sell for \$8,000 to \$10,000. **END**

Kitchen has up-to-date work counter and cabinets. Automatic clothes washer and drier, as well as built-in furniture, come in package.

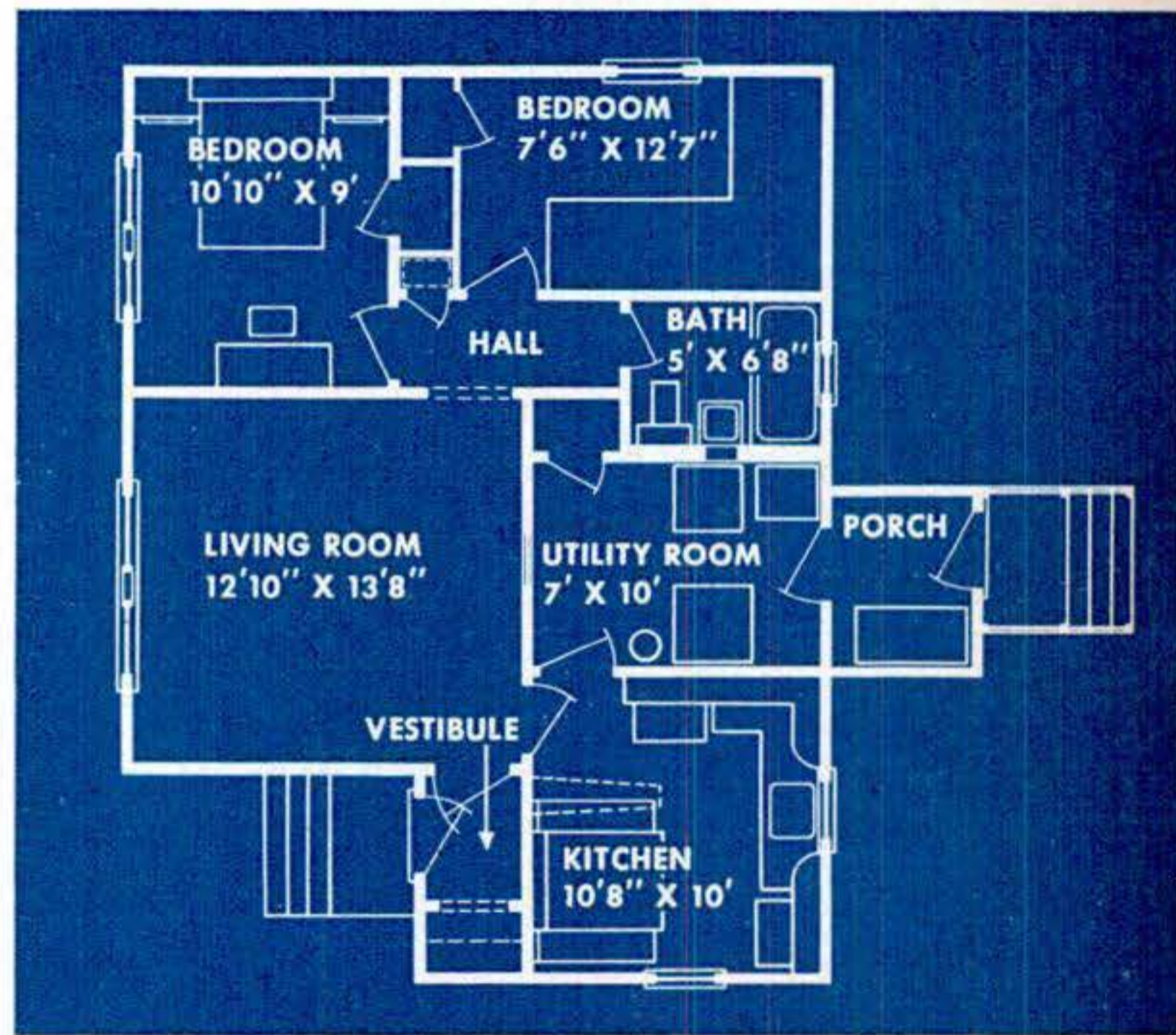

Floor plan above shows convenient layout of factory-built cabins. They are made in several sizes, with two to four bedrooms.

Workmen at home site need do little more than assemble the sections and add 1½-inch log siding, which also comes in panels.

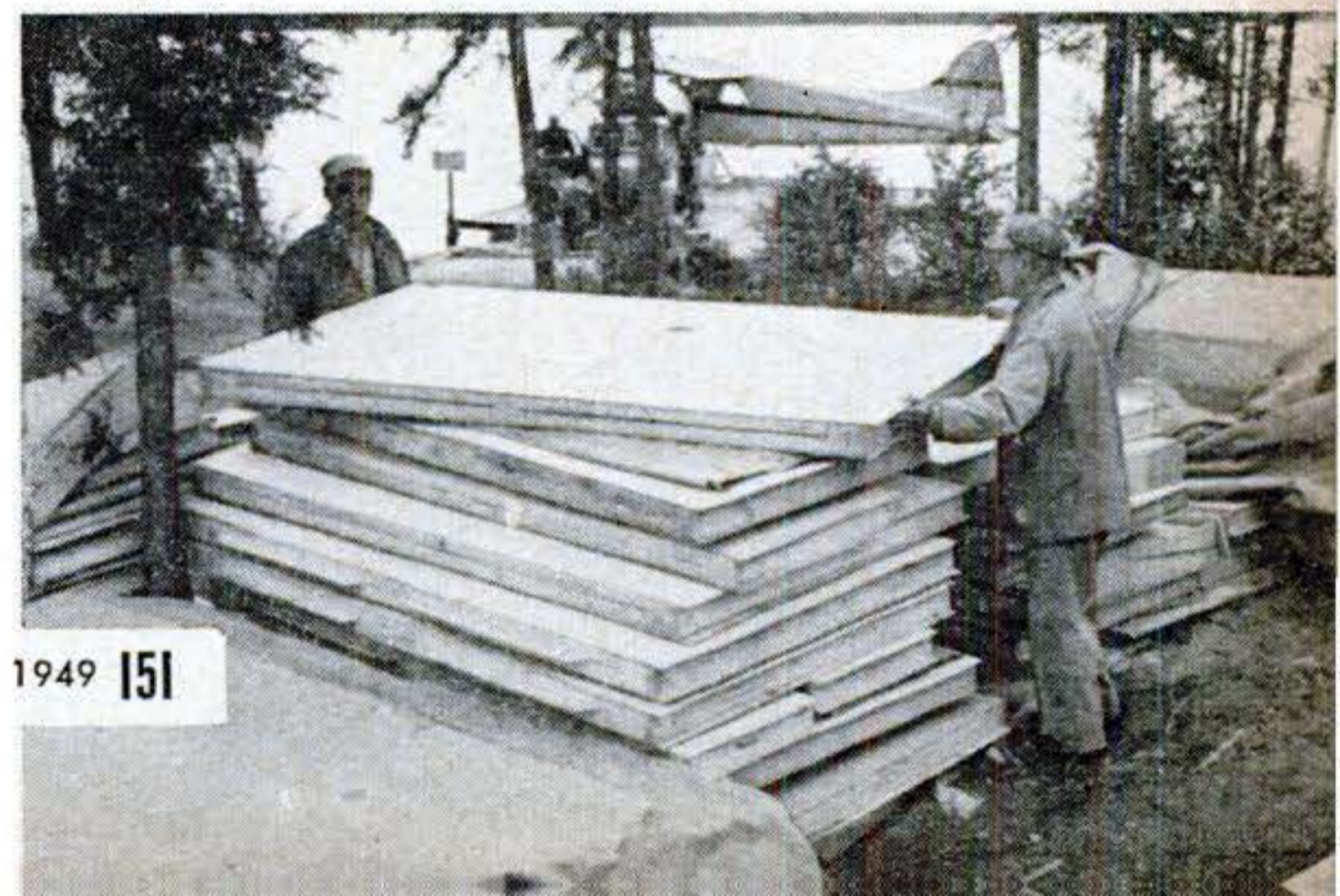



NEW TOOLS



Portable Bandsaw. Weighing only 30 lb., this combination bandsaw and shaper is a cinch to carry to the job. Double pulleys give blade speeds of 700 or 2,400 feet per minute. Unsnapping the two-part table top gives you access to the belt. The shaper at-



tachment, at the right-hand corner, uses rotary files to cut sharp contours. Guard, top, and case are heavy-gauge steel, welded and reinforced. A sheet-metal partition in the case keeps chips out of the motor. Maker is H. & S. Machine Co., Methuen, Mass.



Iron Holds Proper Heat. Big feature of this 6-oz., quick-heating soldering iron is that it can't overheat. When the fast-heating portion of the coil has brought the tip to the right temperature, a bucking coil cuts down the current and holds the heat at that point until the juice is cut off. Instant Tool Corp., Binghamton, N. Y., is the maker.

Vise Holds Small Parts. Made by Metal Items, Racine, Wis., the Mikro-Vise® consists of a vise and a fixture. The 1 1/8" wide jaws open to 1 1/4". Two Vs hold round stock, and insert pins are included to grip odd-shaped parts. The fixture can be set at various angles for milling, drilling, grinding, and shaping small parts.

Height Gauge.

Mikro Marker®, made by Metal Items, Racine, Wis., is a height gauge that reads like a micrometer. Readings run from zero to 1", graduated by thousandths. Priced at \$12, it's compact, easy to handle, and is convenient for working in restricted areas.



Circular Saw Has Tilt Arbor.

The ball-bearing arbor, not the table, of the Power King 3001® tilts to 45°. Adding two low-cost extensions enlarges the 12" by 16" table to 16" by 25 1/2", with 7 1/8" working space ahead of the blade. The price, \$39.50 less motor, includes blade, fence, miter gauge, guard, splitter, motor pulley, V belt, and motor rail. Atlas Press Co., Kalamazoo, Mich., makes the saw. Maximum depth of cut is 2 1/4". The fence has clamp locks at each end and can be quickly removed.

152 POPULAR SCIENCE

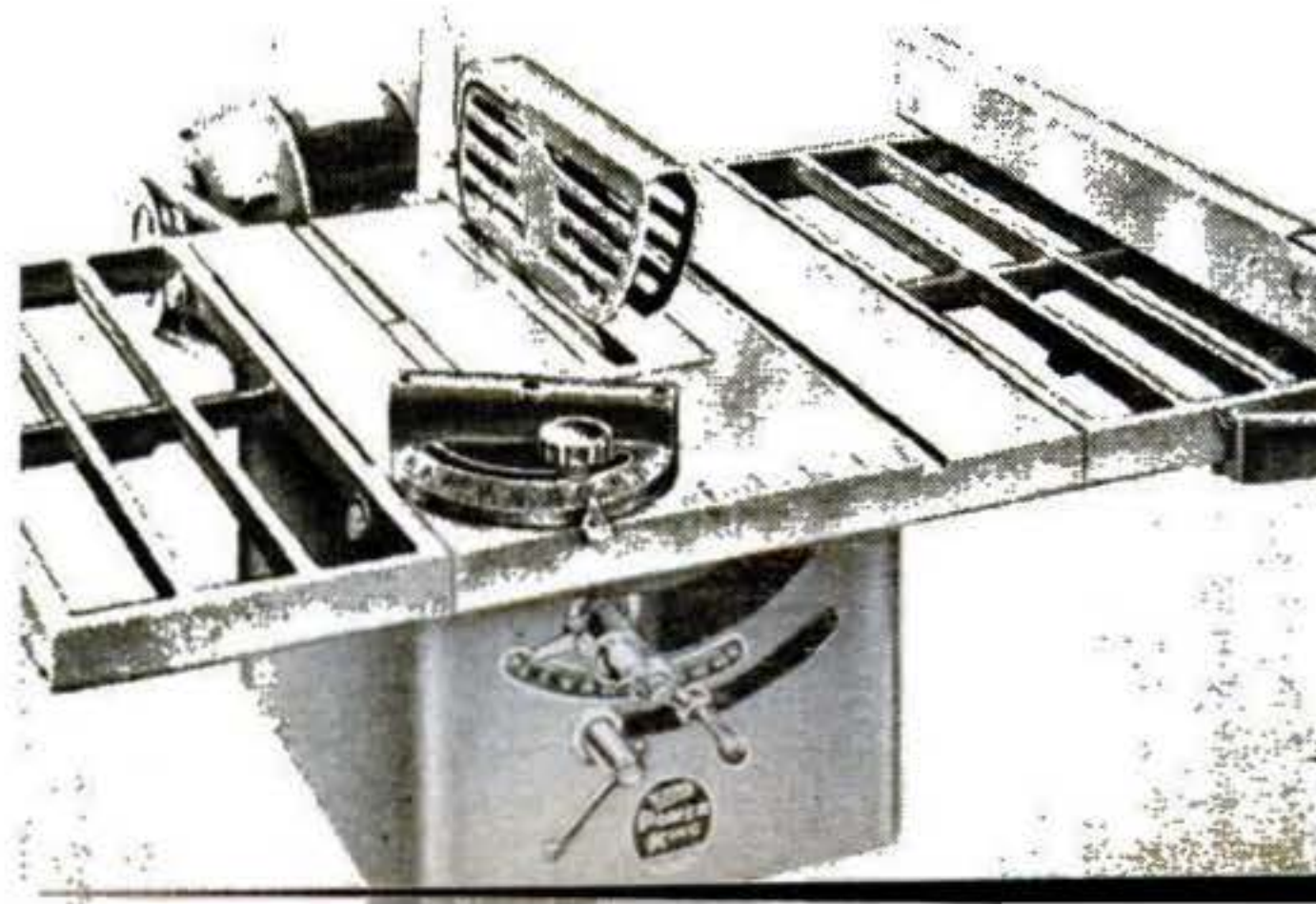
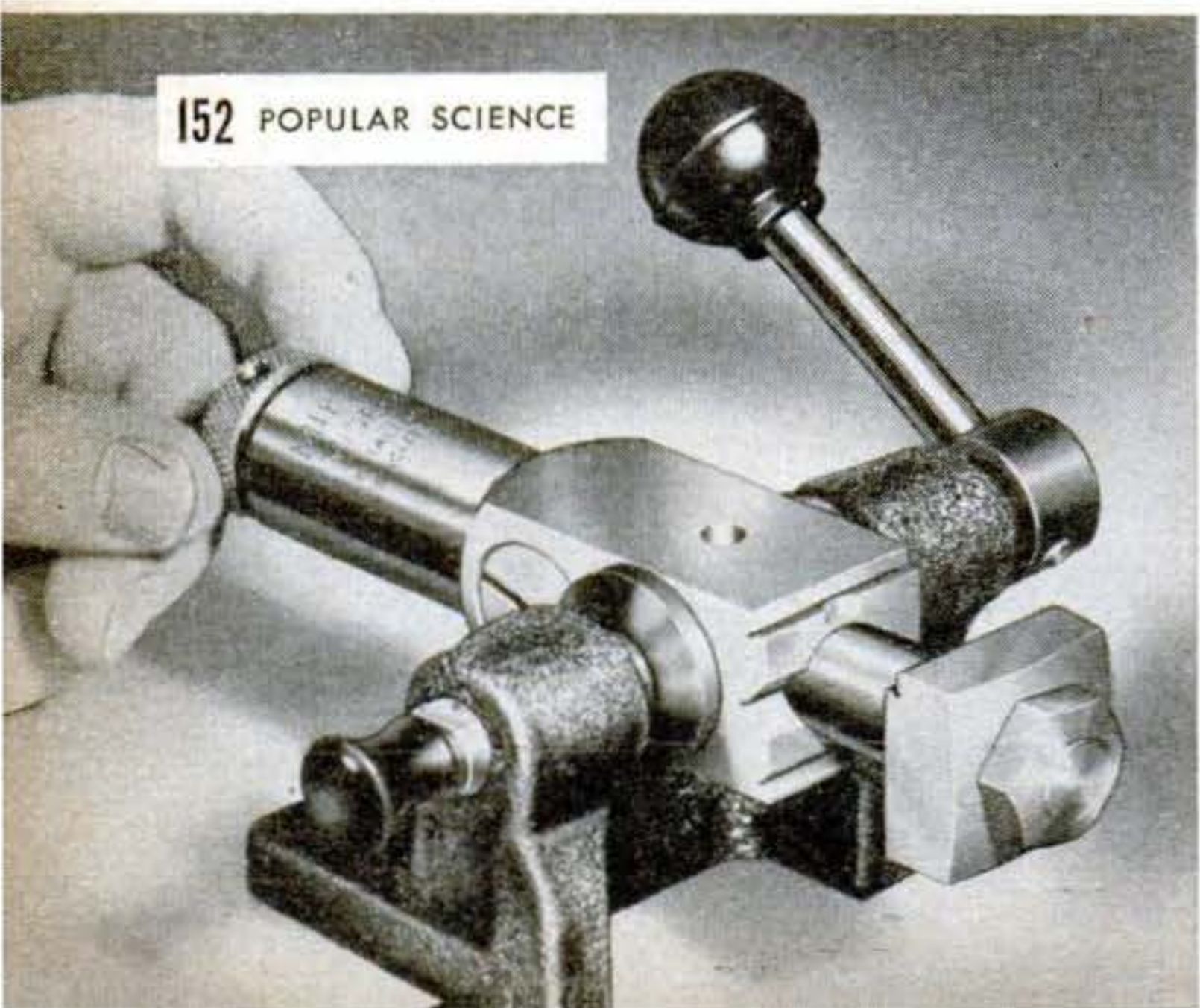



Polystyrene comes to manufacturing firm in big "logs" that have a rough, barklike exterior.

Christmas "Snow" Made of Plastic

YOU'LL be able to trim your Christmas tree this year with "snow" that looks and feels like the real thing and even goes it one better—it doesn't melt. Made of snow-white polystyrene plastic, it is about 97 percent air and actually has a texture like snow. A cubic foot of it weighs only two pounds. Buoyant, it was used during the war as a flotation material in life rafts. Schwab & Frank, Detroit, which developed special machines for forming the "snow," uses it to make snowballs, stars, bells, and other tree ornaments.



Shaping machine trims off rough surface and creates flat slabs from plastic sections. These are cut into smaller pieces with power saws. Ornaments are made with series of special tools.

Plastic is easy to carve. It is turned into shapes like snow man below. On a Christmas tree orna-

ments glisten like snow—but don't melt. Balls at right can't hurt if they hit you.

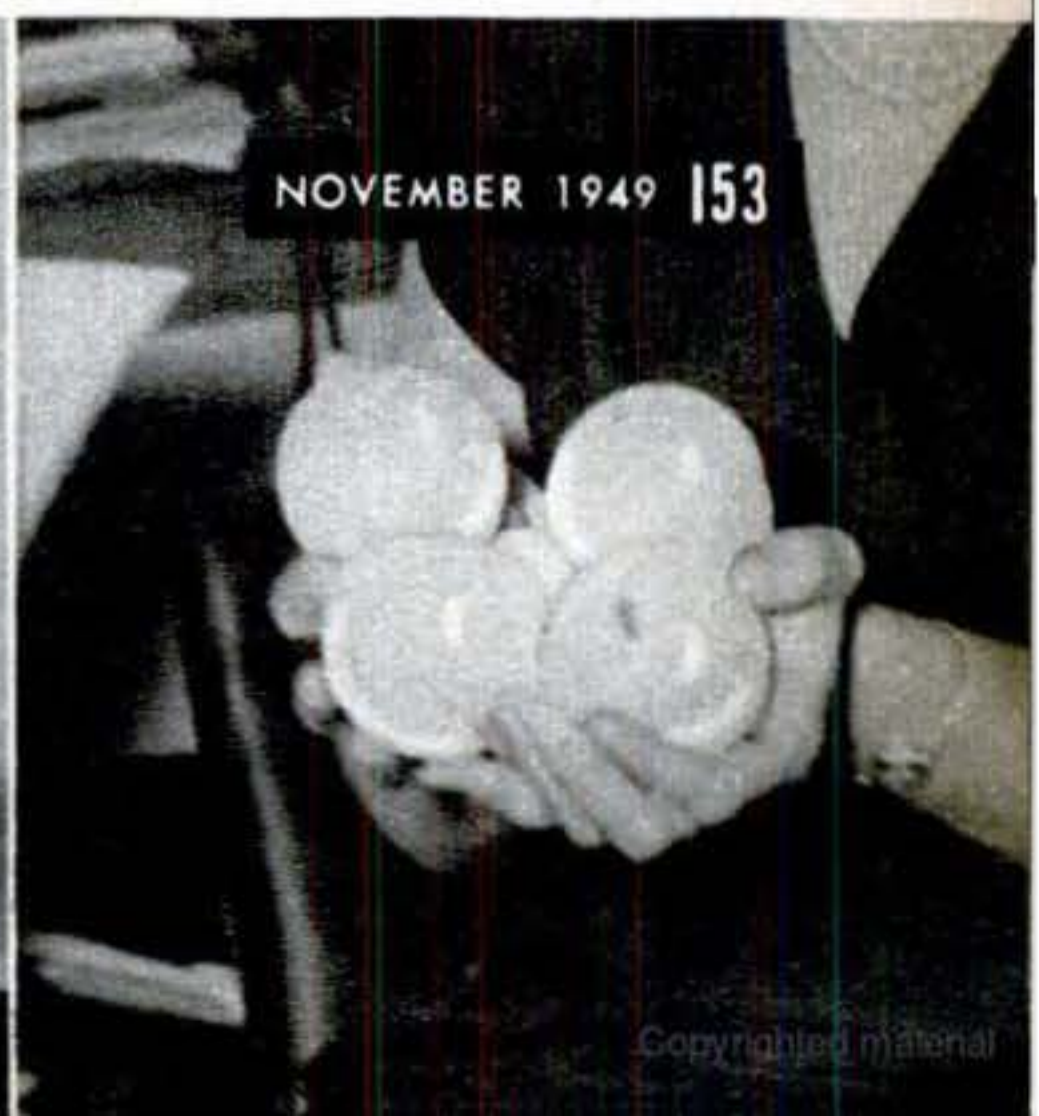



Plush Job for the Bush

Specially designed for rough-and-ready flying, the Beaver still gives a comfortable ride, reports PS Managing Editor Volta Torrey after his tour of the bush country in one of the new planes.

This is what the bush looks like. The innumerable small lakes and streams give you a landing spot wherever you want it—on water in summer,

ice in winter. One of the few good roads, the Alcan Highway, can be seen in the center of the picture above. Railroads are even scarcer.

The Beaver, new half-ton truck with wings, can land on or take off from anything bigger than a puddle.

PS PhotoStory by Volta Torrey

WHERE the dirt roads end and the rivers flow north, the bush flier must be cabbie, mailman, freighter, ambulance driver, and Santa Claus. His customers are trappers, prospectors, fishermen, traders, Indians, and Eskimos. He hauls everything, from oil drums to pregnant women. His everyday runs cover long distances over lonely, rugged terrain.

This frontier business was built up with all

kinds of planes, none specially designed for the job. But now de Havilland engineers have developed what amounts to a half-ton truck with wings. It is the Beaver, a high-wing, all-metal, seven-passenger plane with a Pratt & Whitney Wasp Junior engine.

The Beaver isn't pretty. But it can take off on floats within 795 feet in 15½ seconds—under the worst conditions. On wheels, a Beaver has left the ground in four times its own length. It can climb 1,290 feet per minute at sea level with wheels, and 1,200 with floats. It cruises at 110 m.p.h. or better.

Bush pilots appreciate other features, too, such as its widely spaced floats, and two doors on each side for easier loading.



To get at the batteries, you simply pull out a tray in the side of the plane. It can be reached from the shore or the float. Self-connecting contacts make it easy to service the batteries quickly—an important consideration to bush pilots, who must fly in very cold weather.

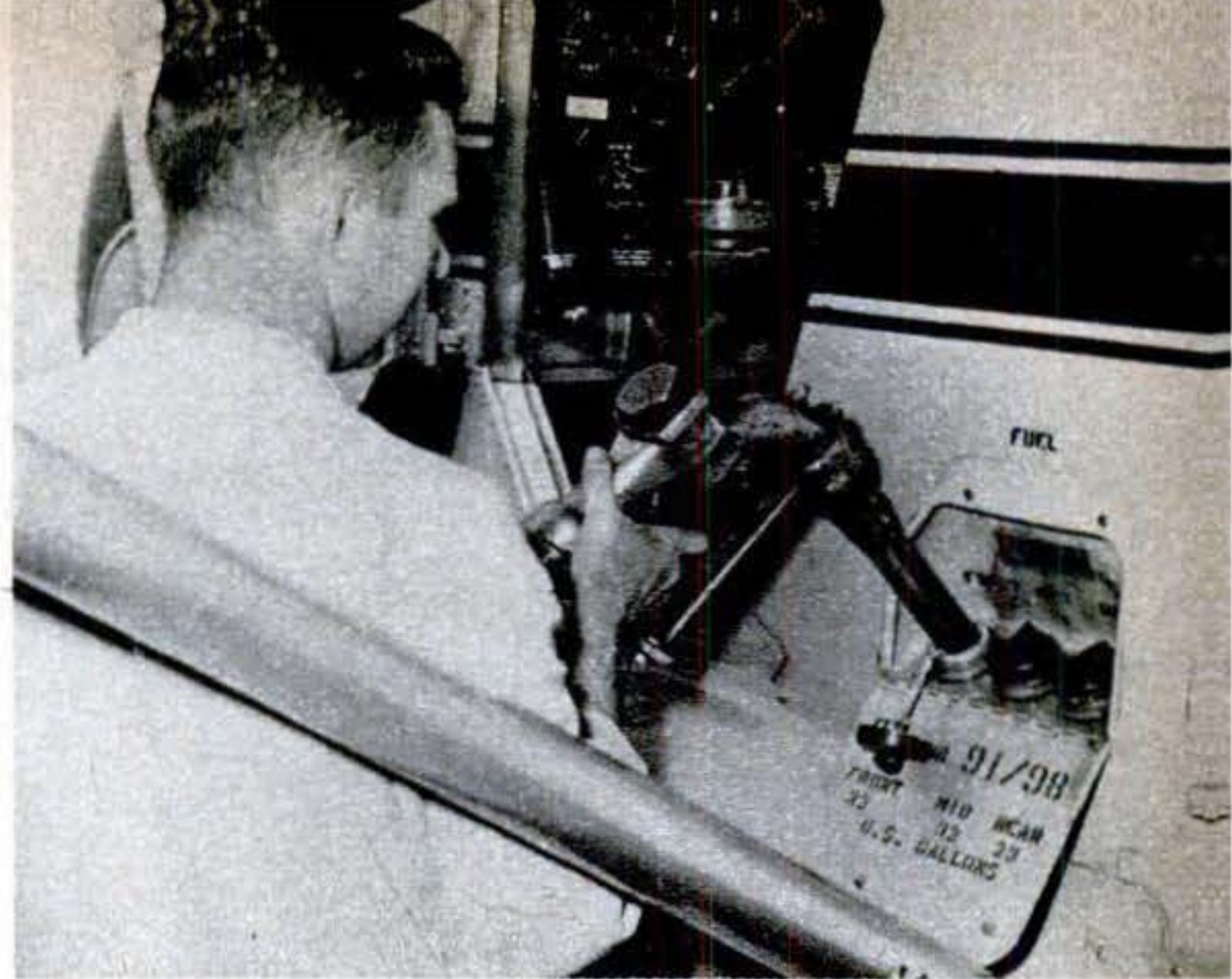

Fuel tanks, suspended from the floor in the fuselage belly, are filled from these ports on the side of the plane. This arrangement means you can gas up while standing on the float or shore, without climbing up on the wing. Capacity of all three tanks is 87 gallons.

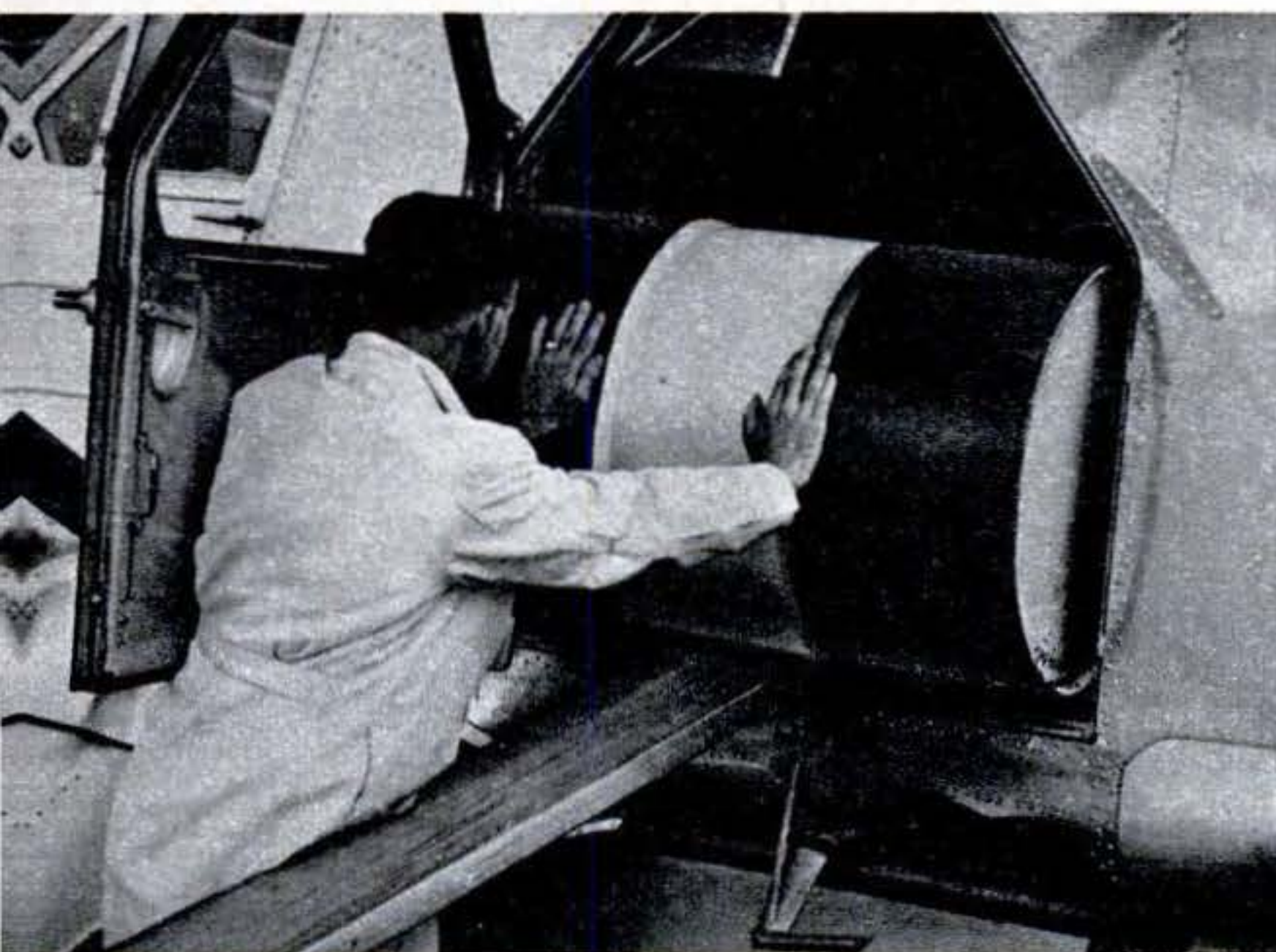

The rear door—there's one on each side—is 39 inches wide. Three 45-gallon gasoline drums, weighing 380 lb. each, can be carried easily.

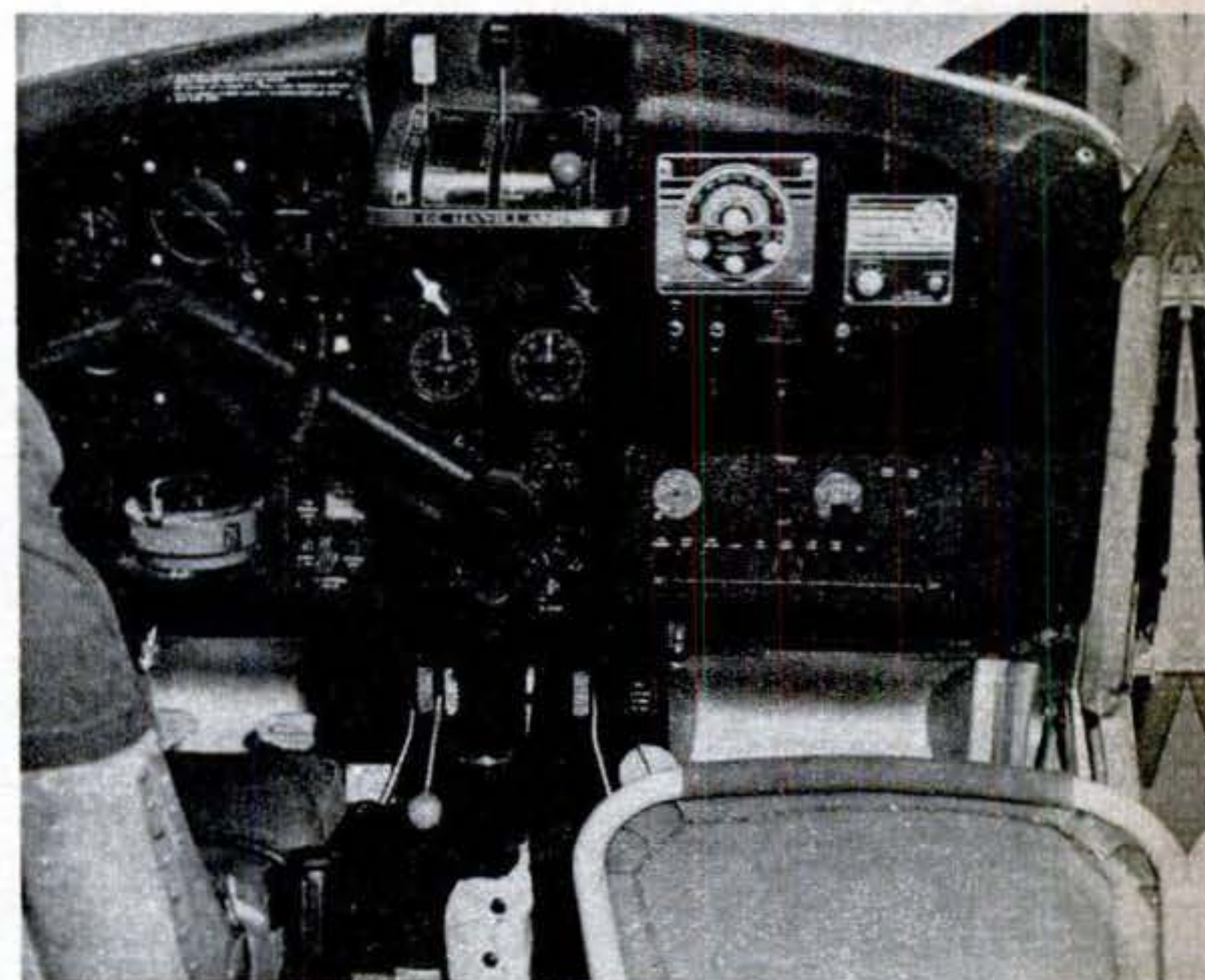

Flight-instrument panel is directly in front of pilot's seat (left), engine instruments are in center. The rear cabin seats six passengers.

As a seaplane, the Beaver rides up on the "step" (the notch in the bottom of its pair of floats) as soon as the throttle is wide open. It takes off

quickly, can clear a 50-ft. obstacle in 1,195 ft., under adverse conditions. Picture was made on typical Alaskan stream near Fairbanks.



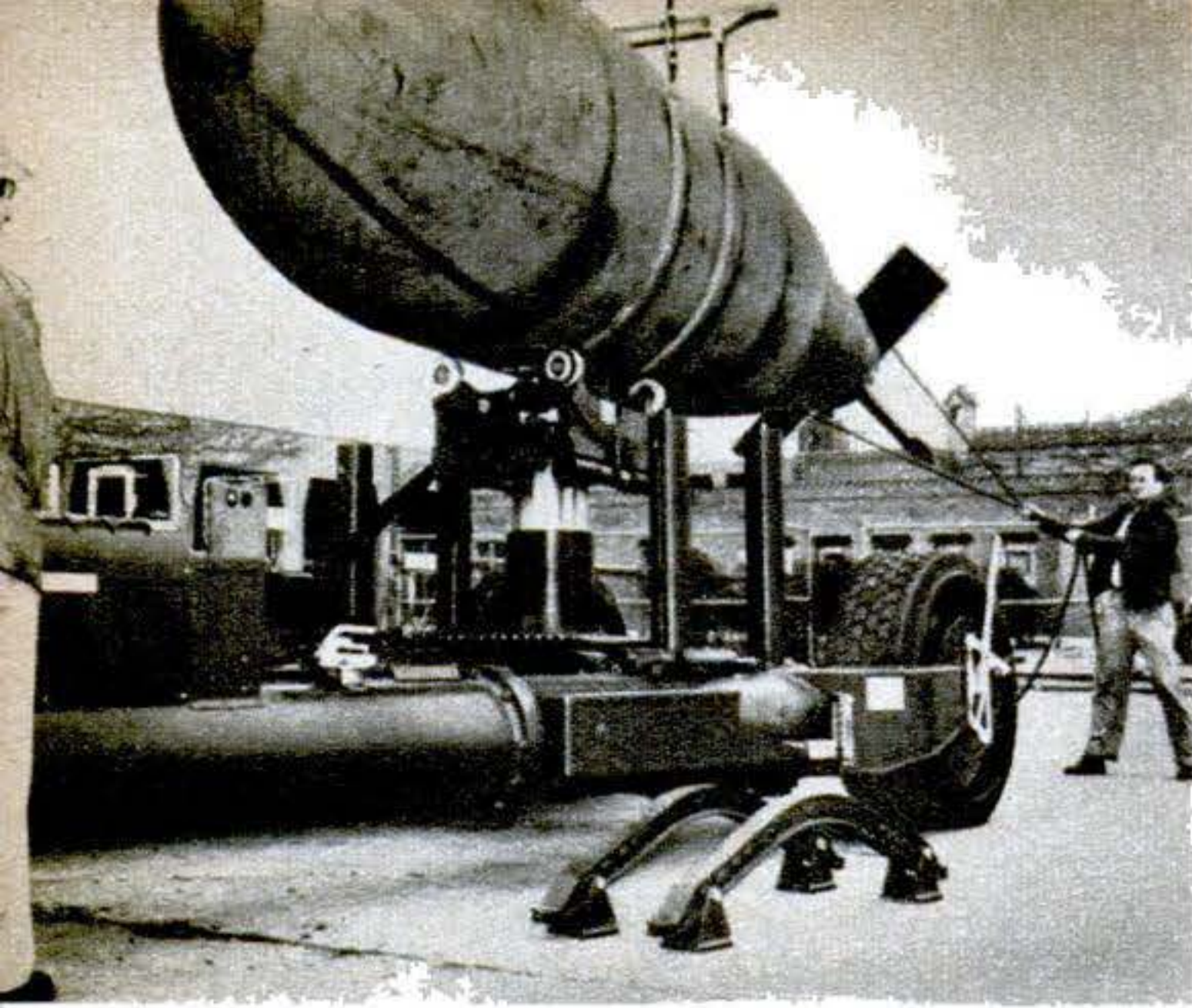

Bomb Lift Heaves Heavies

THIS new, mobile lift can push a 50,000-pound bomb around like a toy. Recently demonstrated at Wichita, Kans., it raised the giant bomb above 12½ feet from the ground into the bomb bay of an Air Force bomber. Hydraulically operated, it is mounted on a wheeled carriage so it can be used to haul bombs from storage to waiting planes. In addition to lifting the bomb, it can roll it around in a full circle, shift it eight inches sideways, move it 10 inches forward or backward, and tilt it six degrees up or down.



Mighty Midget Smashes Rock

A BIG hill in downtown Los Angeles and a concrete tunnel under it are being broken up and carted away without a single blast of dynamite. The secret of this quiet demolition job is shown above: a small, hand-operated hydraulic cylinder that pushes out a row of tiny pistons along one side. You put it in a hole, pump the handle a few times, and a pressure of 15,000 lbs. per sq. in. cracks off eight-ton chunks of rock or concrete in a single operation. Called the Duncan Roc-Jack®, it is only 24 inches long.

Tilting Easel Sports Light

THIS combination light and adjustable-tilt easel (right) is the latest thing for photographers, artists, stamp collectors, jewelers, and other persons who must do close work. The light can be rotated to any position to insure even lighting at any angle of the easel. Called the Easelite®, it can also be used as a sick-room or bedroom reading light and book support. Made by W. D. Rhodes & Co., of Chicago, it sells for \$5.95.

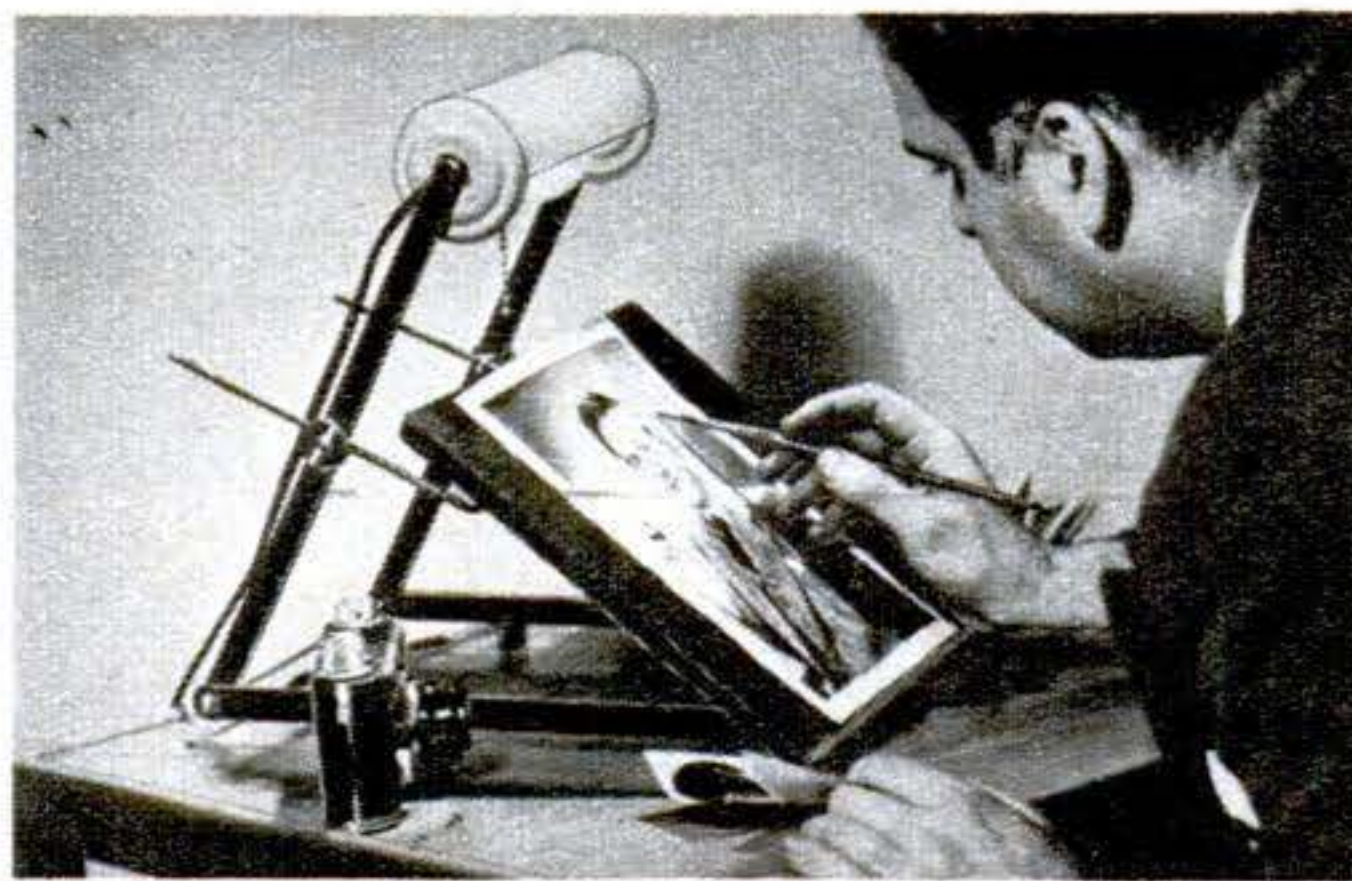

Ski Ladder Aids Ice Rescues

THIS new Ski-Ladder® lets rescuers reach ice-accident victims without falling in themselves. Consisting of a 22-foot fire ladder fastened to outsize skis, it permits rescuers to

straddle a hole in the ice and spreads their weight over a large area to prevent further breaking. A duck board provides a walkway. Invented by District Fire Chief Farquhar Langton, of Springfield, Mass., the device is made by A. G. Spalding & Bros.





Sound Waves Boil Water

A WAFER-THIN quartz crystal in the plastic case atop the cabinet above has been used by GE to cook eggs, shatter glass, mix paint, boil water, churn butter, and homogenize milk—all by setting up sound waves beyond the range of human hearing. Vibrated when an electric voltage is applied across it, the crystal generates frequencies up to 1,000,000 a second, used to study ultrasonic applications. Test objects are placed in a metal cylinder above the crystal. The tall glass tube catches spray of vibrated liquids.

“Brain” Has Elephant Memory

“EDSAC”—short for Electronic Delay Storage Automatic Calculator—is the name of Britain’s new automatic brain. It is the first of the giant mathematical machines (see PS, May ’49, p. 148) to “remember” by placing electric charges on a cathode-ray tube (center screen below). This system gives Edsac an unusually fast, high-capacity memory for holding numbers and instructions needed in solving complex problems.

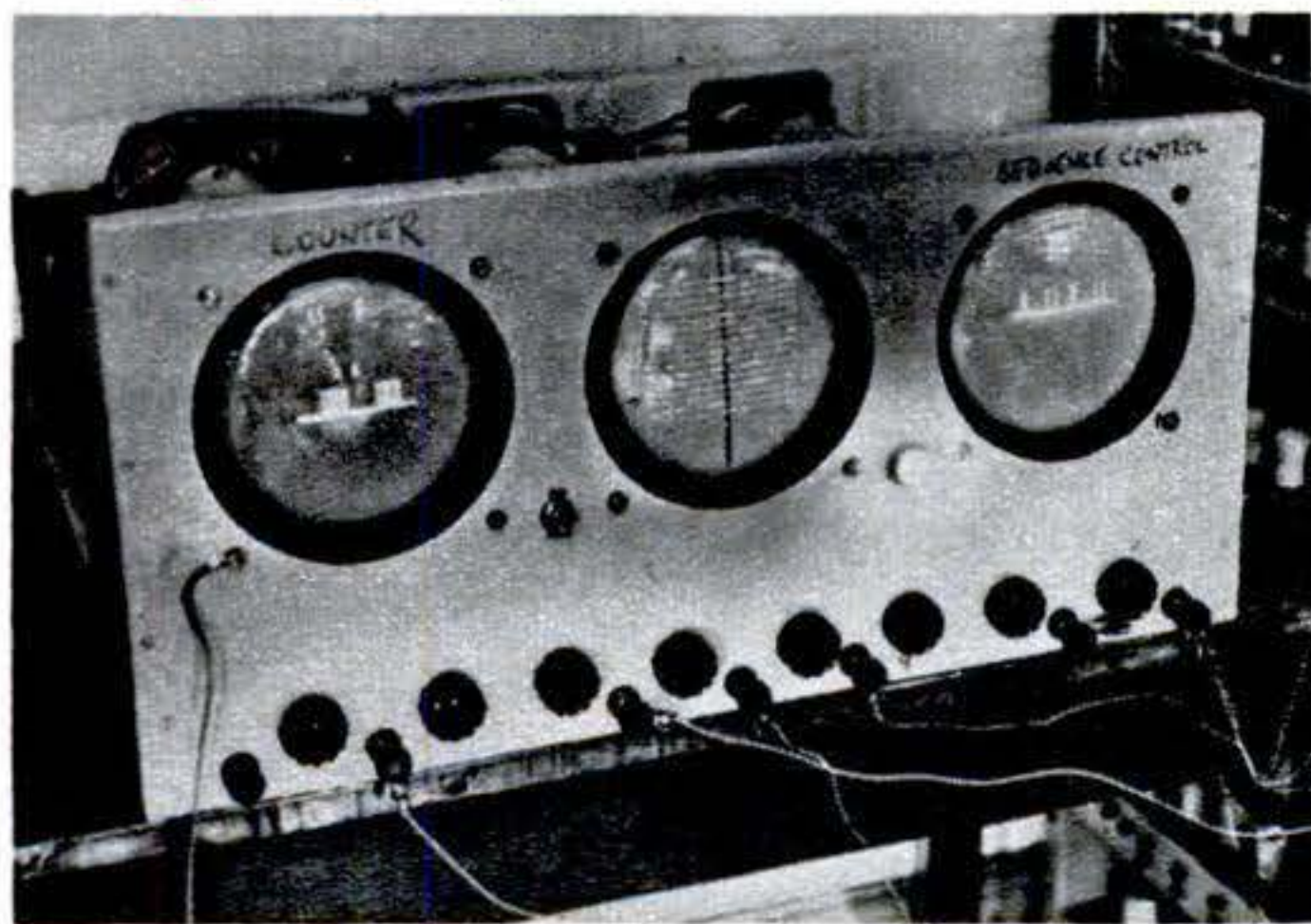

NOVEMBER 1949 157

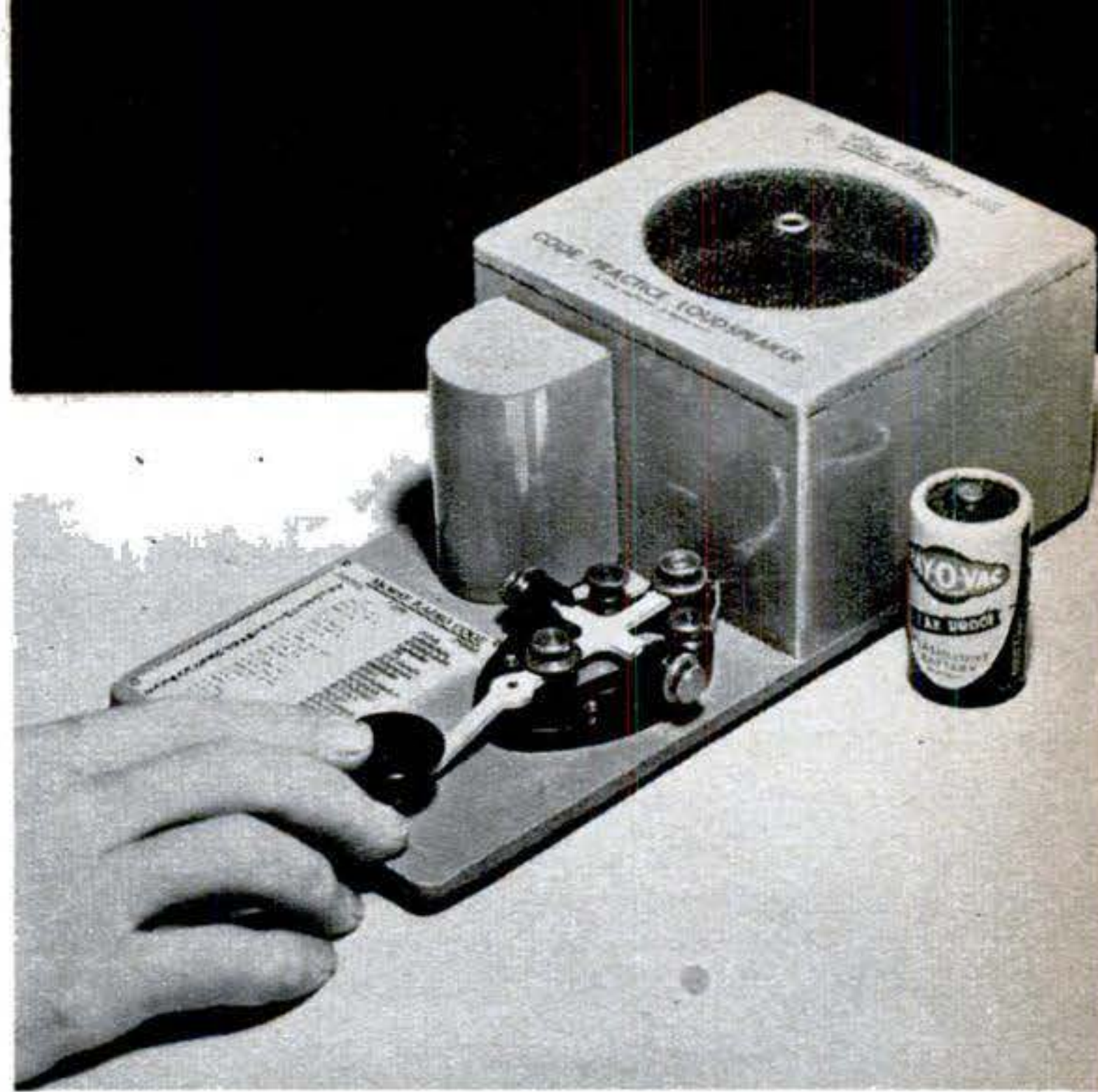

Code Trainer Uses Dry Cell

FOR radio hobbyists who want to learn dot-dash communication, a new type of practice set has been developed that uses no vacuum tubes. A single 1½-volt flashlight battery powers the set. Called the Duplex Practicode®, it has a 4-inch speaker, is non-radiating, and is completely portable. For long-distance duplex operation, external terminals are supplied. As many as six sets can be operated on one line. The set has a tone and volume comparable to those of professional sets. Martin Mfg. Co. makes it.

Pants Hanger Fits in Cuffs

A NEW kind of pants hanger that clamps from the inside out instead of from the outside in has been put on the market by a firm in Beverly Hills, Calif. Made of plated spring steel, it is known as the Hold-Tite Pants Hanger®. Instead of holding the garment by pressure and friction, the hanger is compressed to fit inside the cuffs. Released, the spring action holds the cuffs taut. The maker, Brubaker-Ungrin, also sells a skirt hanger.

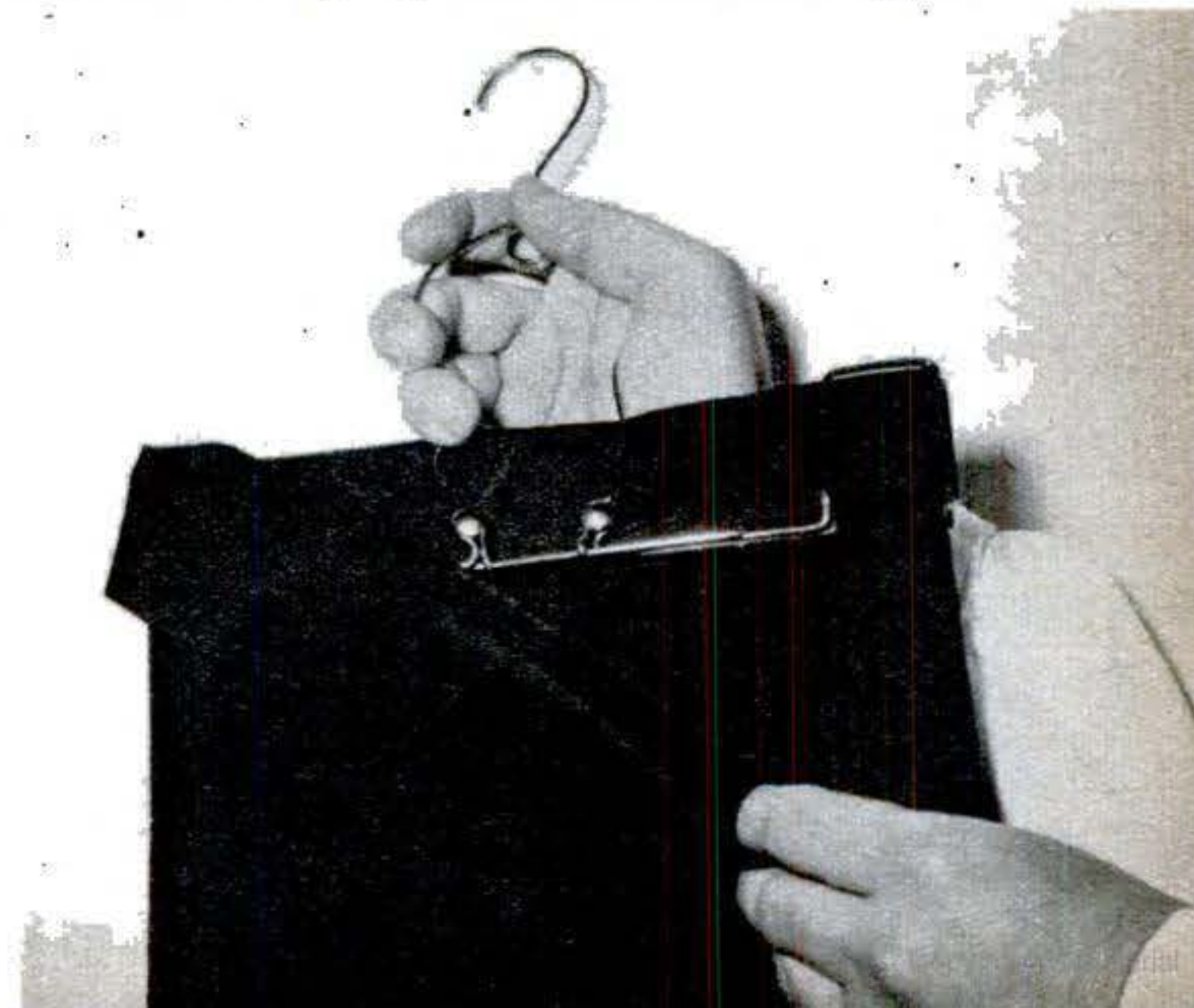



'Copter Top Tilts to Cure Shakes

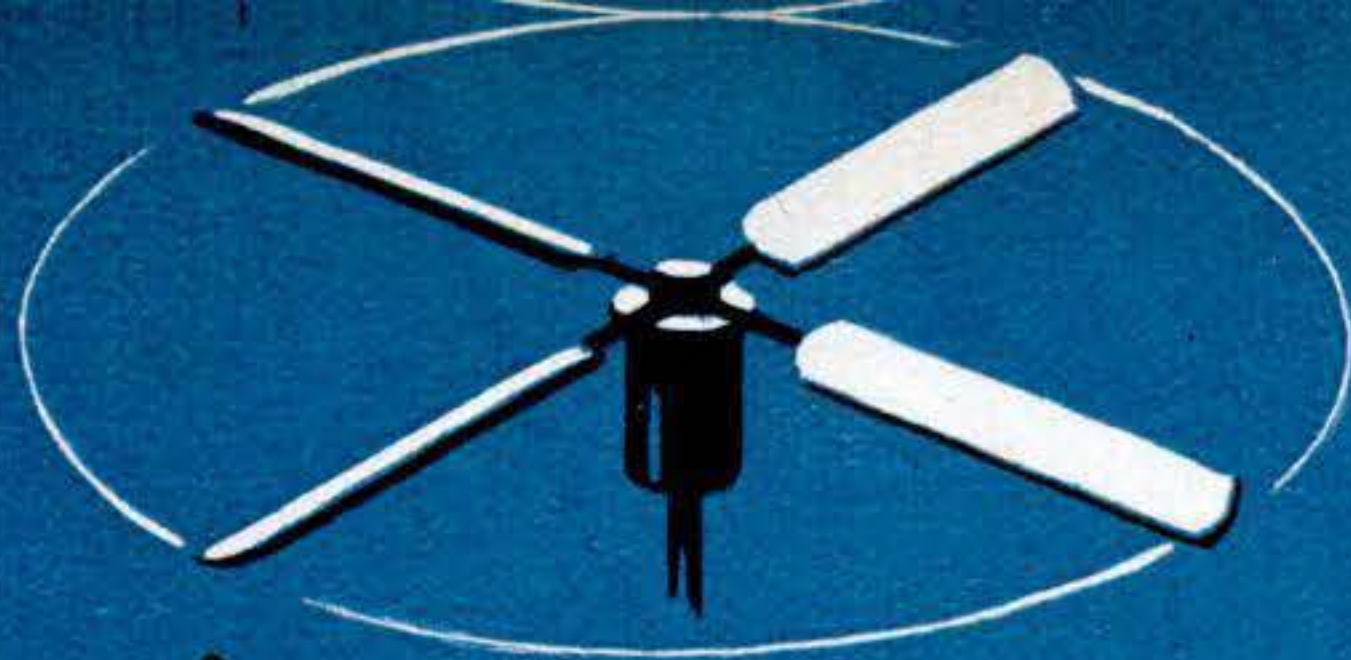

One of many helicopter problems arises from fact that rotor acts like gyroscope. Force at one point is felt 90° later due to precession phenomenon.

A 28-year-old engineer studying stresses comes up with a brand-new machine that's easier to handle, safer to fly.

By Devon Francis

PS photos by Hubert Lockett

AN ENGINEER with a king-size curiosity has taken a lot of the jitters out of a helicopter. His curiosity was about the almost incredible stresses developed by the flailing blades. It has led him to come up with a rotor head—the thing the blades attach to—that tilts freely to every point of the compass.

As a result, Glidden Doman's helicopter, now undergoing tests at Danbury, Conn., for a CAA Approved Type Certificate, is the first flying machine of its kind that doesn't have to be loaded as you would balance an apothecary's scale. Many helicopters have to tote lead weights around. These are shifted to keep the center of gravity directly under the center of the blade when cargo or passengers are taken on or discharged. Doman's doesn't.

Doman also claims that his ship can be put into violent maneuvers without danger, that it responds to control movements instantaneously, that it has what airmen call "inherent stability" in all attitudes. And the control stick doesn't vibrate. Both PS photographer Hubert Lockett and I flew in Doman's creation, and we can testify to that.

The tilting rotor head is a product of a number of cockeyed facts about helicopters. All helicopters have to be controlled by tilting the rotor *disk*. That's the pattern described by the blades as they whirl around. If the blades were attached rigidly to a fixed upright support, the sheer gyroscopic forces developed would throw the machine out of control. The rotor is a natural gyroscope. ▶

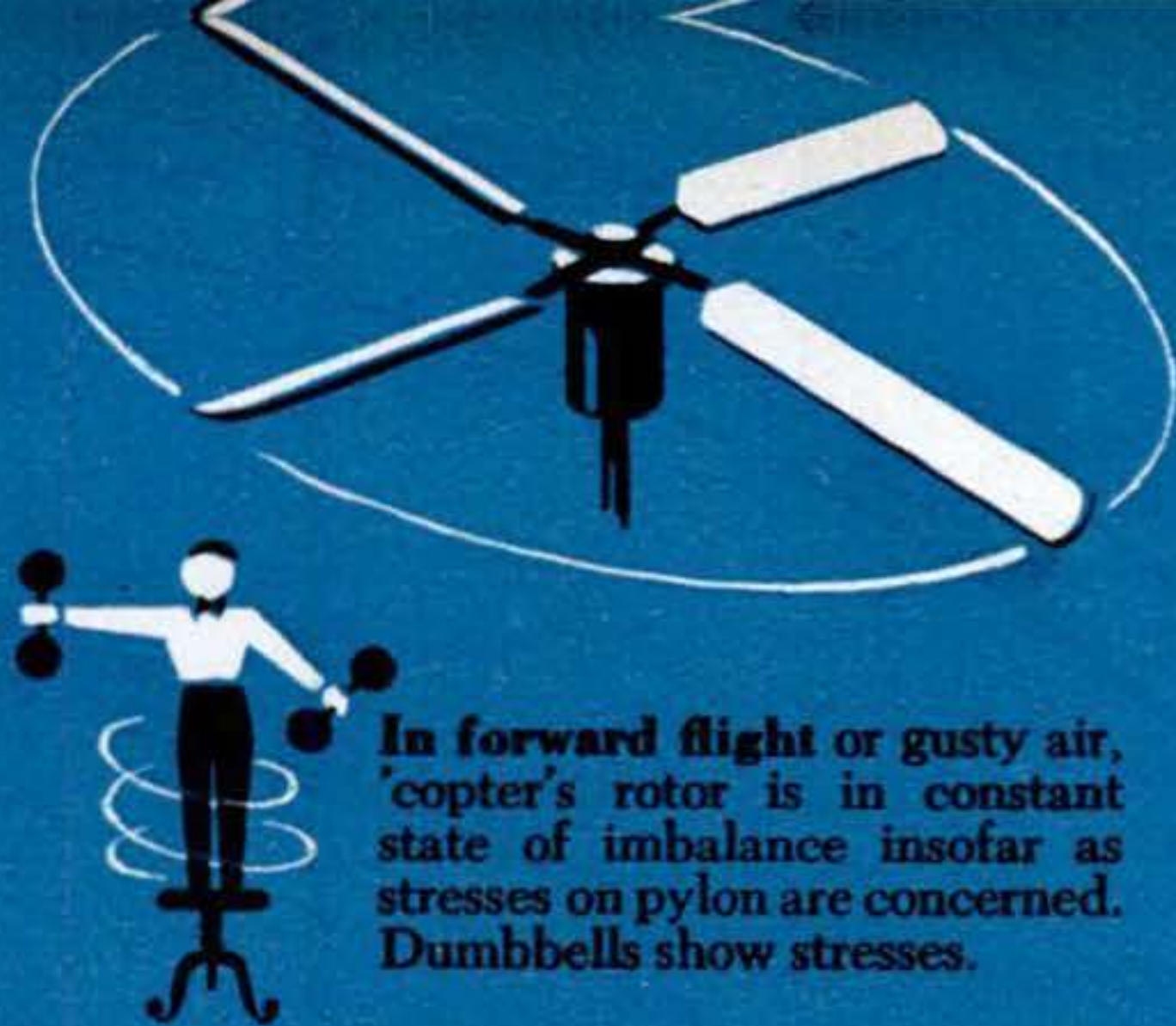

In forward flight or gusty air, 'copter's rotor is in constant state of imbalance insofar as stresses on pylon are concerned. Dumbbells show stresses.



Doman helicopter alleviates stresses by letting entire rotor head tilt. As dumbbell illustration shows, circles of same radius equalize opposing stresses.

Balanced Doman rotor (below) allows 3,200-lb. machine to tote unusual load of 1,400 lb.

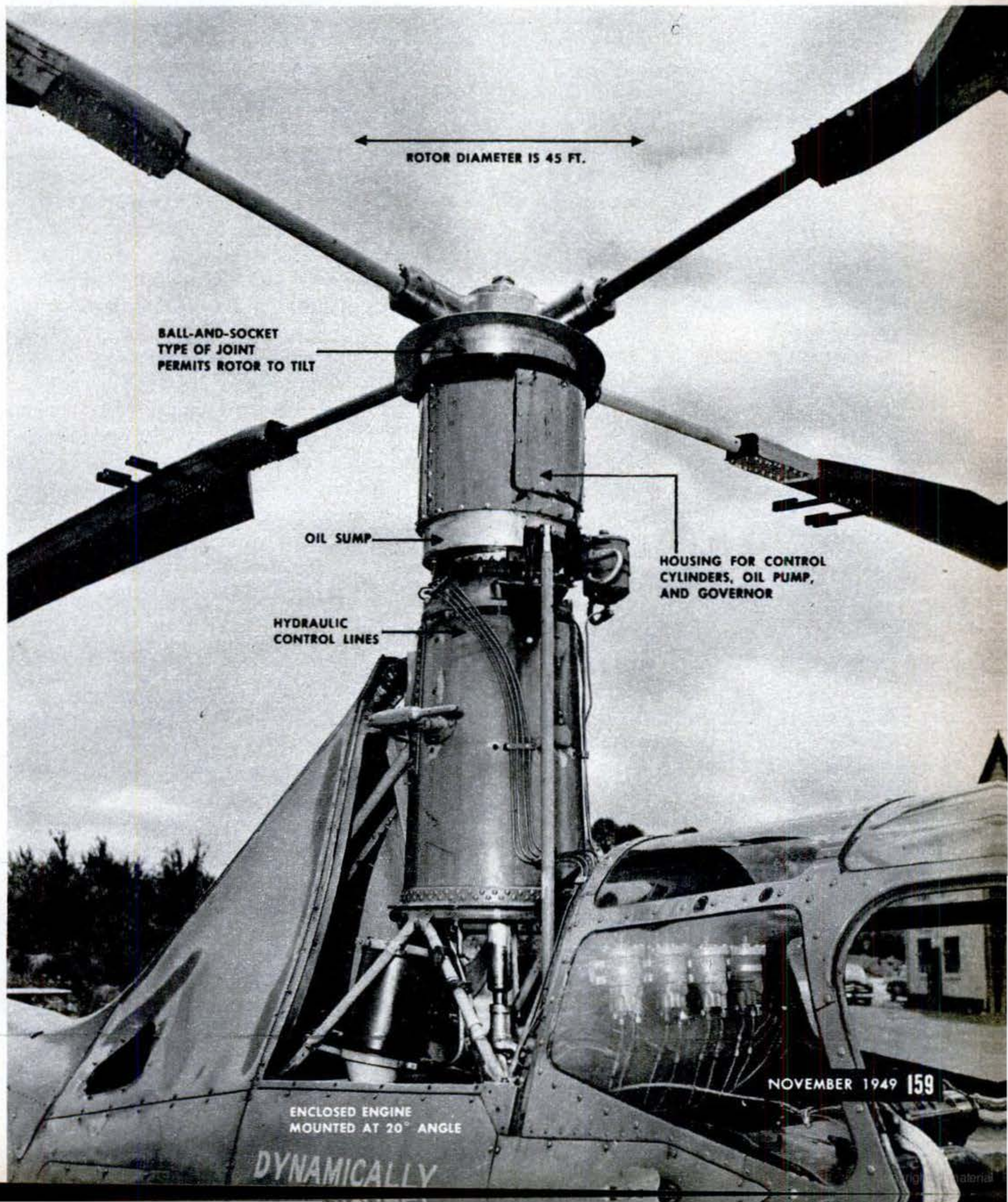

ROTOR DIAMETER IS 45 FT.

BALL-AND-SOCKET TYPE OF JOINT PERMITS ROTOR TO TILT

OIL SUMP

HYDRAULIC CONTROL LINES

HOUSING FOR CONTROL CYLINDERS, OIL PUMP, AND GOVERNOR

ENCLOSED ENGINE MOUNTED AT 20° ANGLE

DYNAMICALLY

A gyroscope wants to keep revolving in the same plane. To try to force control on such a gyroscope would invite fracturing the blades.

Up to the time of the Doman experiments, there were only two ways of attaching blades to the rotor head. If the rotor had more than two blades, they were hinged so that they could flap up and down. If it had only two blades, they were put on a teeter-totter, and the same flapping motion resulted.

That equalized the lift on both sides of the machine. As a blade swept into the wind stream in forward flight it flapped up to lose lift; as it retreated from the wind it flapped down to gain lift. In addition, it was necessary to provide cyclic pitch control (PS, Oct. '47, p. 148) so a pilot could maneuver.

That brought problems. A blade makes a complete flapping cycle for every rotation. And every time it flaps it yanks at the rotor head like a bulldog on a stick. That's because it describes a *smaller circle* when it's up and a *bigger circle* when it's down. You can demonstrate the stresses on the rotor head by holding a heavy dumbbell in each hand and whirling around on a piano stool. If you start with the dumbbells straight out from your body and then suddenly pull them in close, your speed will increase. That characteristic of helicopters makes a drag hinge necessary. This lets the blade move back and forth as well as up and down.

Taxiing Still Caused Trouble

Now everything should have been fixed. But it wasn't. Engineers discovered that when a helicopter is taxiing over rough ground the landing gear sets up vibrations that crawl up through the rotor head to those fore-aft blade hinges. The blades proceed to whip back and forth violently unless other corrective steps are taken.

So hydraulic dampers had to be introduced to limit their travel. They work, but they also re-introduce the stresses on the rotor head in flight. Rubber mountings to ease the shock of all these movements were also tried in place of drag hinges, but these upset the stable relationship of the engine, rotor head, and blades to the fuselage of the helicopter.

Doman decided to do away with the flapping movements of the blades on a horizontal hinge by attaching them solidly *and letting the whole rotor head tilt*. This automatically did away with the stresses imposed on the hub. It also did away with most of the vibration associated with helicopter flight because blade flapping is its main source.



Inventor shows additional control for balancing 'copter fore and aft. Lever works vestigial tail-plane. Behind right-hand stick is pitch-control lever and throttle. Craft's ceiling is 14,000 ft.

That wasn't all. Doman knew that if a blade hit a gust of wind, his tilting rotor head would put the machine in the scrap heap. That was because of the gyroscopic character of the rotor disk. If you lift one side of a gyroscope, it will respond when the point at which you apply the lift has revolved 90 degrees. Therefore, a blade struck by a gust as it came into the line of flight would have tilted up when the blade was in front of the machine. This automatically would have increased the angle-of-attack of the following blade, like an airplane wing in a climb. That would throw the machine out of control.

So he had to add one thing more—an automatic blade-feathering device inside the rotor head to keep the angle the blade makes with the air stream constant, regardless of the tilt of the disk.

The combination of the two developments lets Doman shift his load past the helicopter's center of gravity either way. Because vertical drag hinges aren't kicking the blades around, the control stick is smooth. The "feel" of his stick is the same as that in an airplane under varying conditions of gravity pull in maneuvers. That wasn't a principal object. It was just an extra dividend.

Doman is a stress-analysis expert. Before establishing his laboratory at Danbury, Conn., he spent two wartime years with an established helicopter company learning the established fundamentals. Now he has added some fundamentals of his own. END

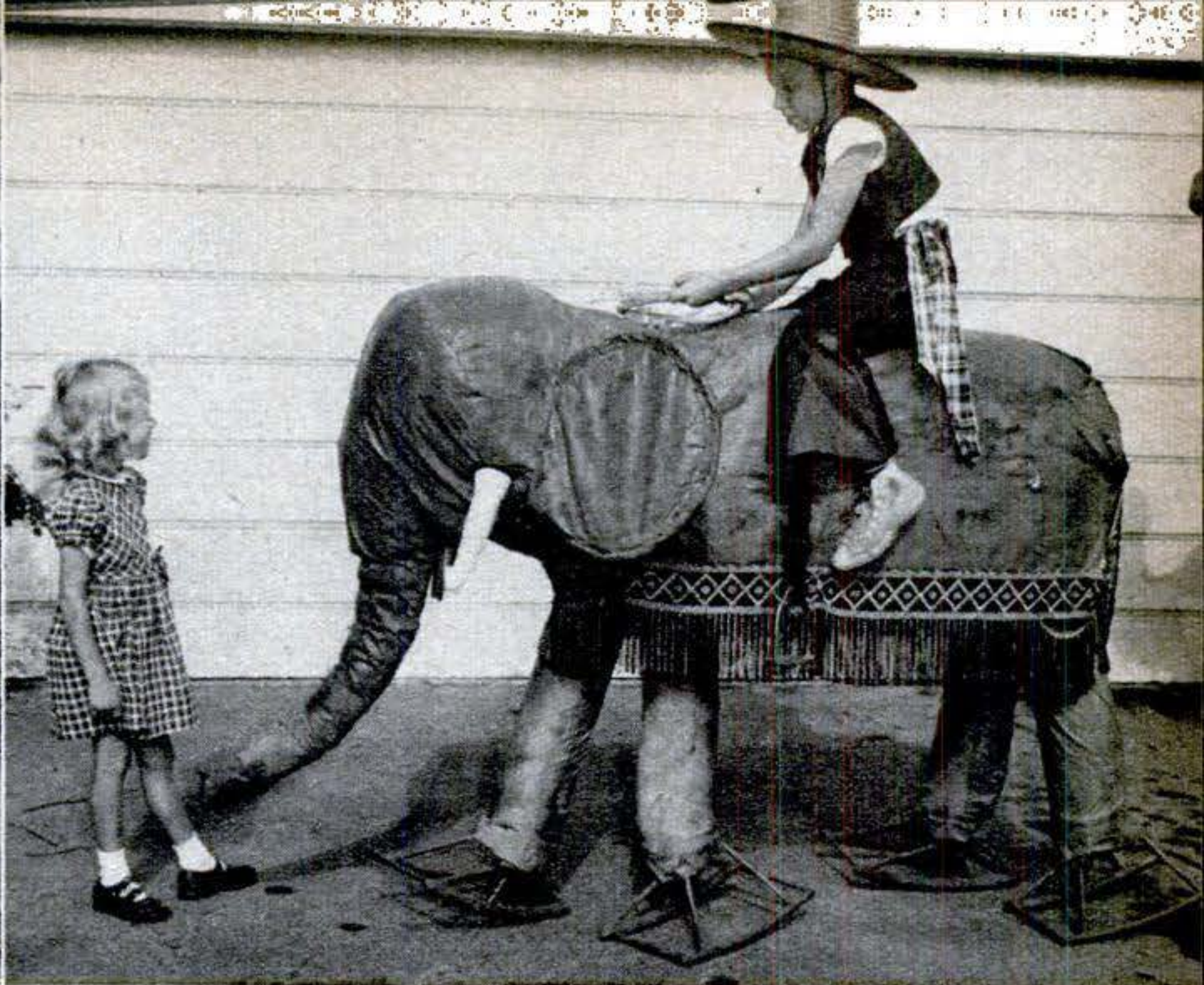

Riders Make Mechanical Animals Walk

IF YOU throw your weight around, you can make this toy elephant (above, right) walk. Each leg is connected to the body by an off-center pivot arrangement. When your weight is shifted from the legs on one side of the animal, the pivot swings them forward. Lean from side to side, and the elephant shuffles along.

Welded steel feet, curved like chair rockers

(above, left), slide easily over level ground. A lever that protrudes from the elephant's neck turns the front legs in the direction you want to go.

Inventor A. M. Bennett, of North Hollywood, Calif., says the gadget is more than a toy. Doctors think it may be used as a physiotherapeutic device for convalescents. Small models will retail for about \$35.

Hot Box Heats Lunch

TIRED of eating a cold meal every noon, Alva H. Privett, of Oakland, Calif., built a hot plate into his lunch box. A compartment in the bottom of the box contains a heating element that can be plugged into any 110-115-volt, AC or DC socket. Other compartments hold a vacuum bottle and sandwiches. Privett calls his lunch box the Thermette®. He hopes to market it for \$7.95.

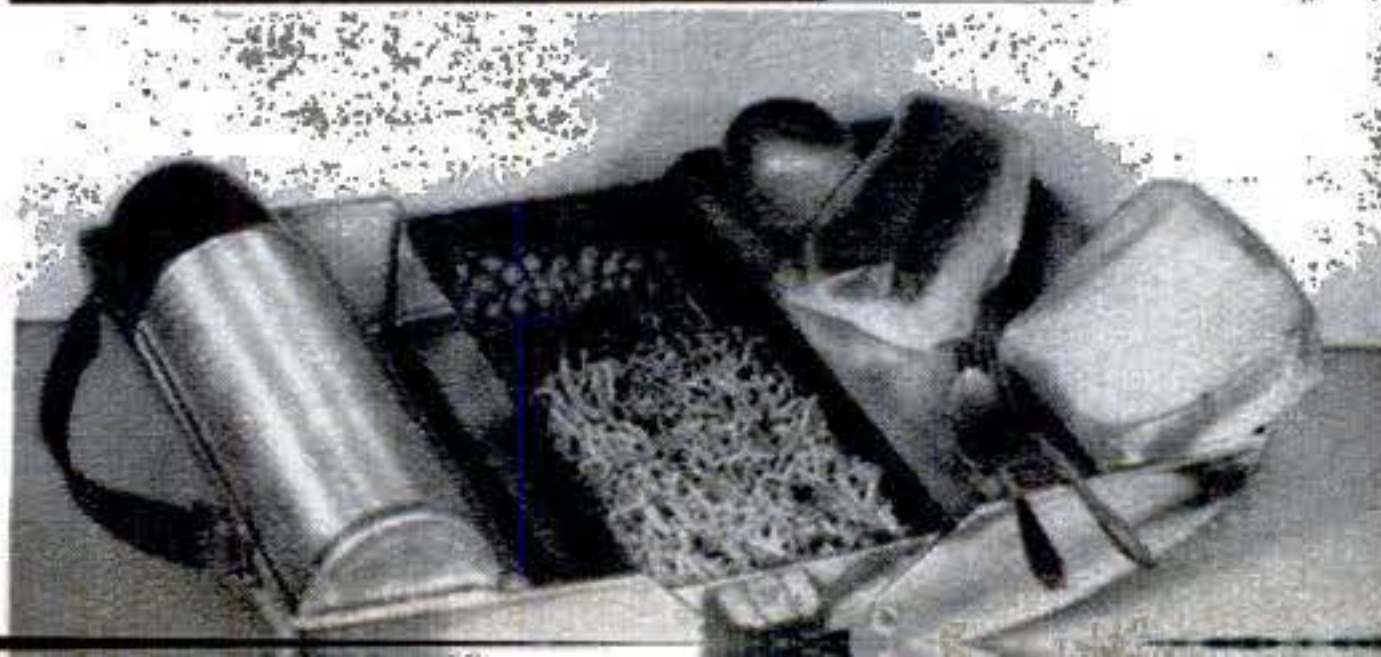
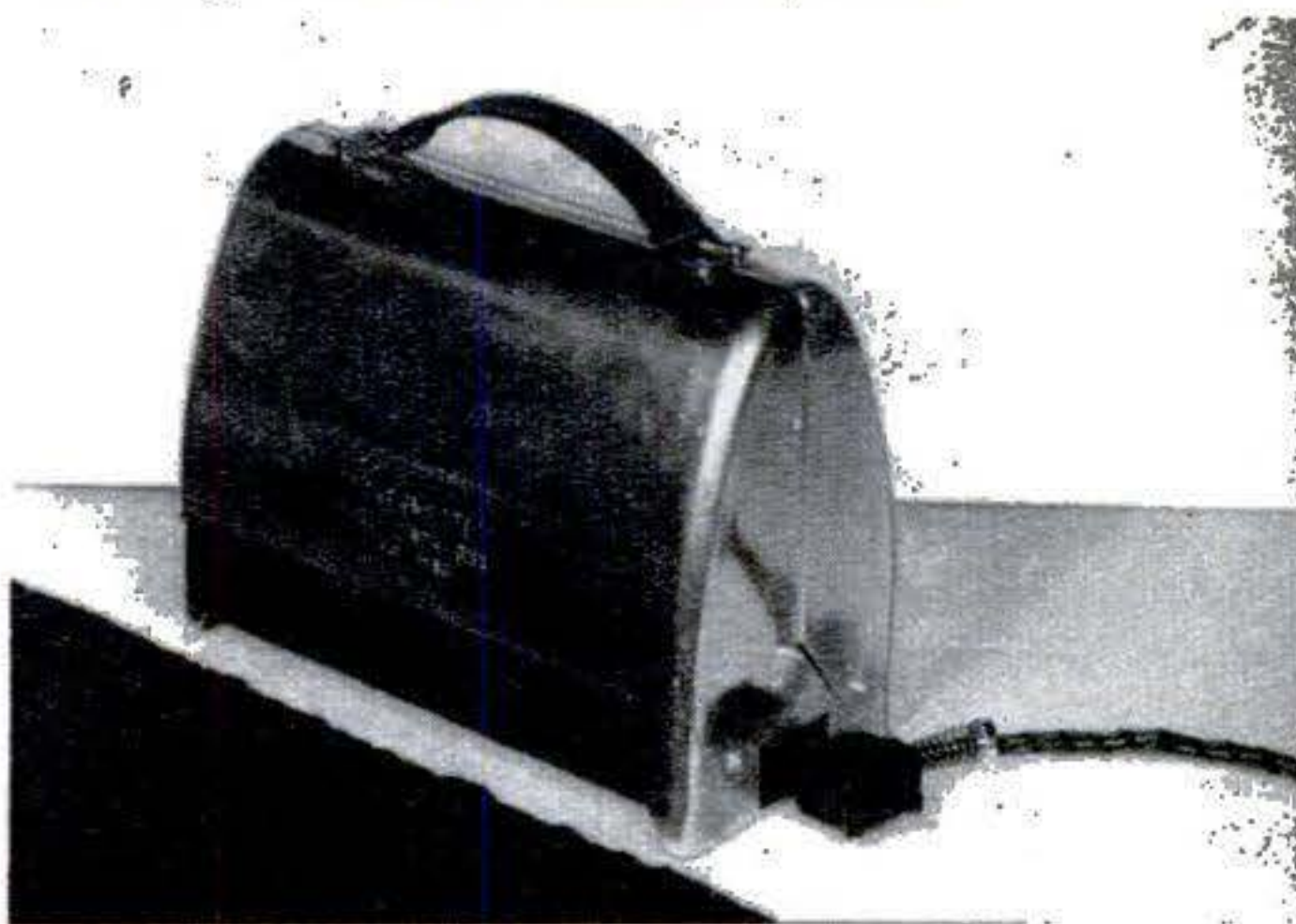

Hay Baler Air-Conditioned

IF YOU have to make hay while the hot sun shines, why not bale it in air-conditioned comfort? This setup, devised by Herbert Hahn, Jefferson City, Mo., lets you do just that. A V belt operating off the baler mechanism runs a blower that pipes fresh air into sacks fitting over the heads of the men who run the baler. Plastic windows in the sacks provide good visibility.

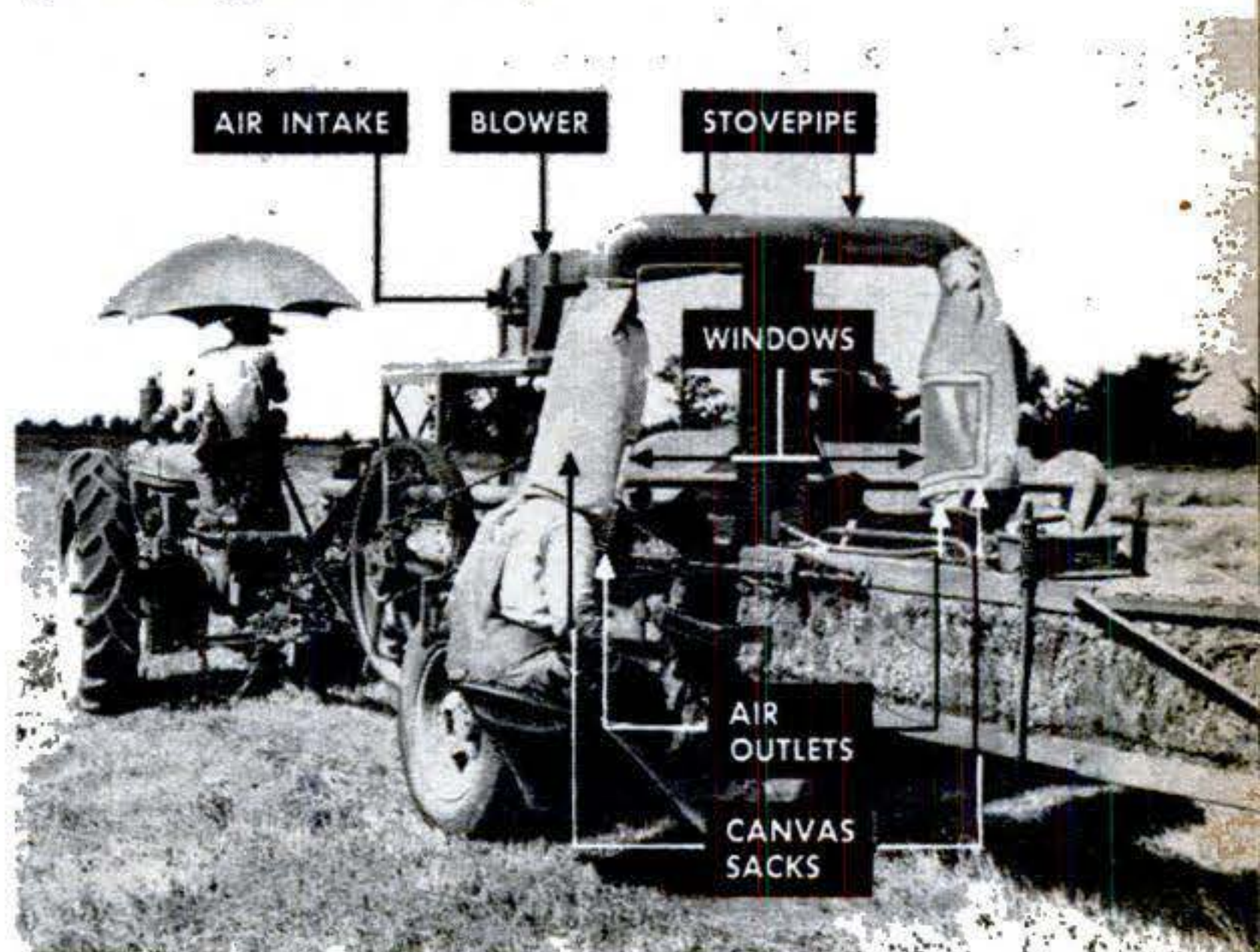

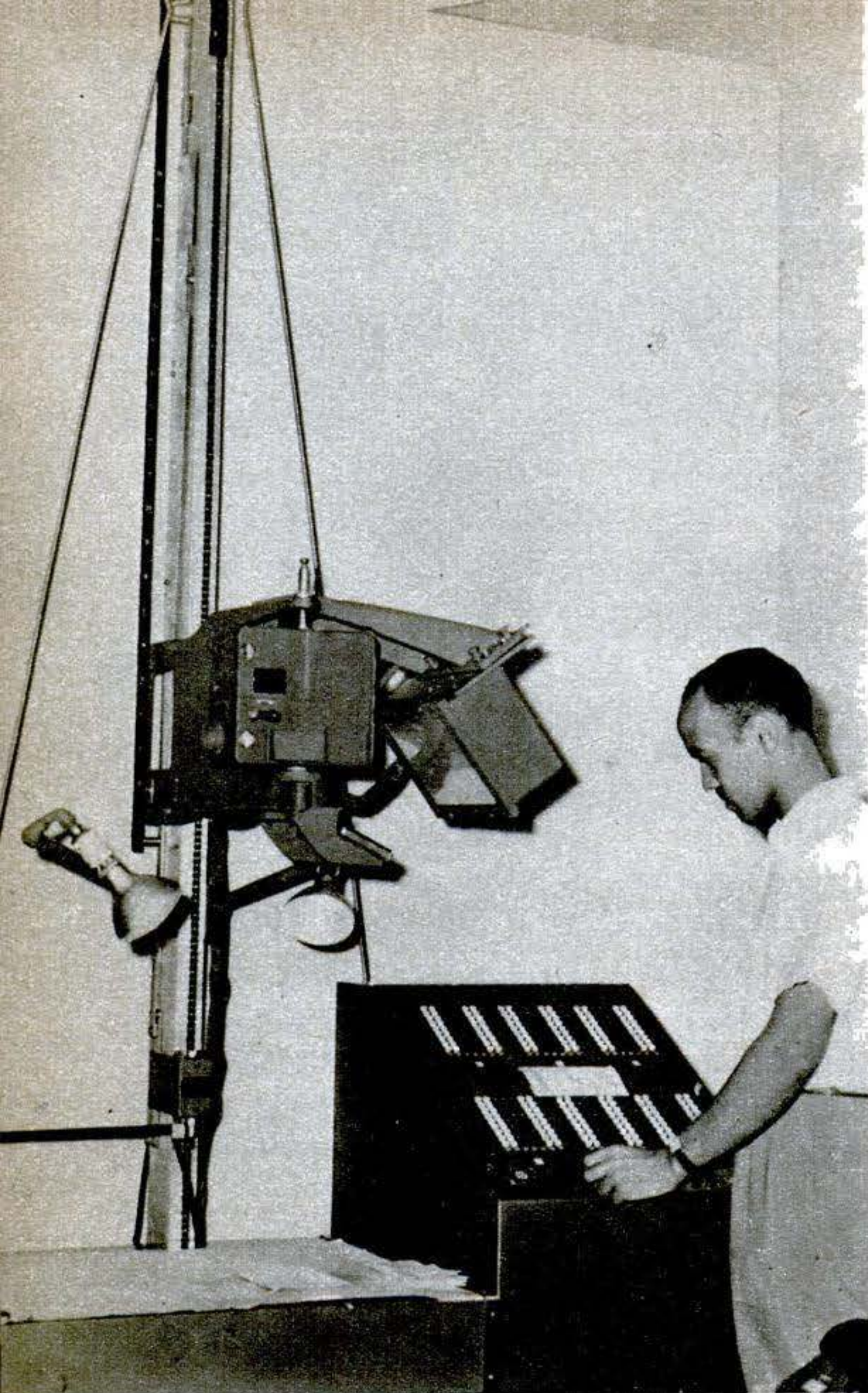

Modified Recordak® microfilm camera records data on movie film. Auxiliary lens and mirrors simultaneously project code pattern into camera from the panel of lights at the right.

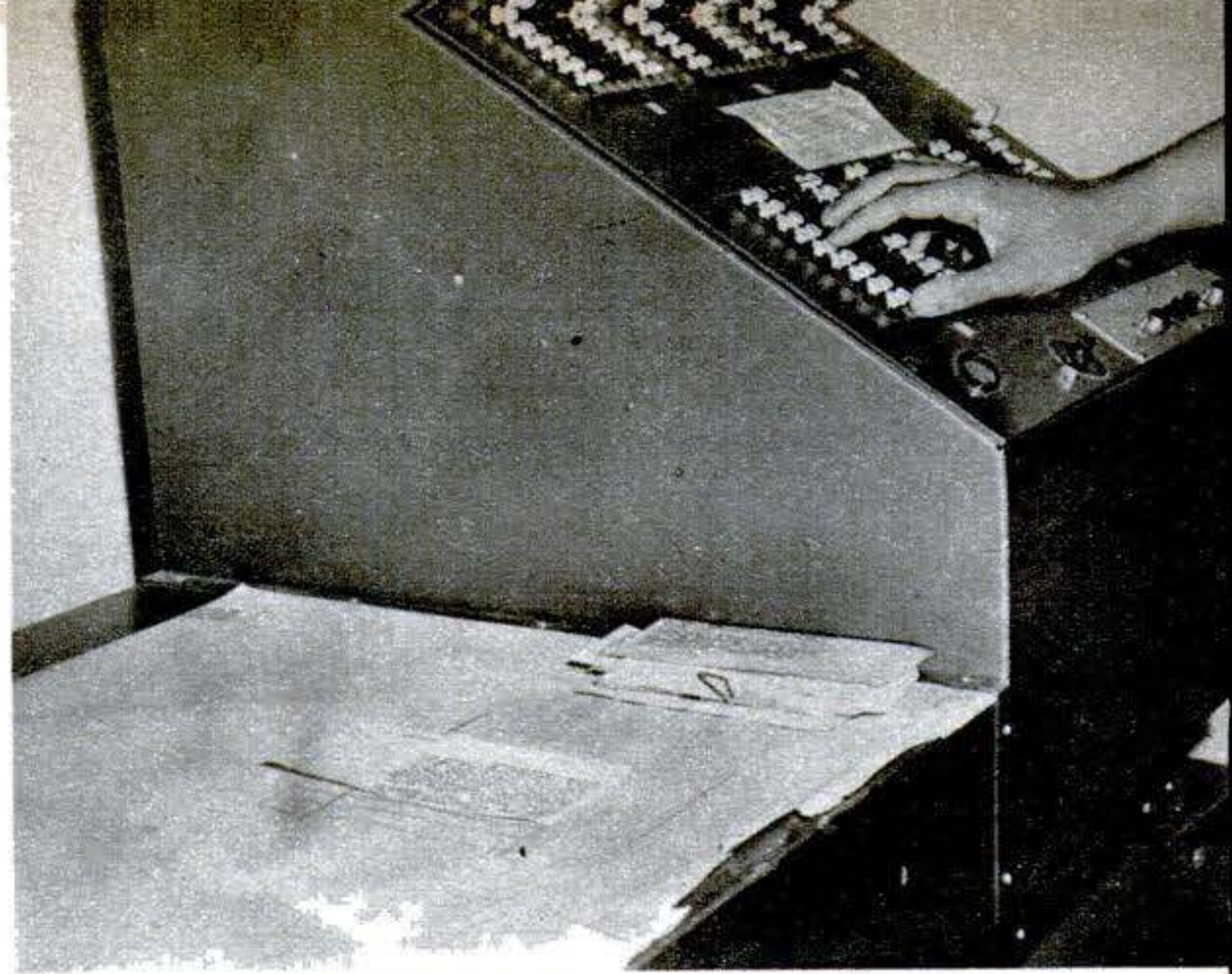

Operator punches out code pattern on this keyboard for data being photographed. Keys light up corresponding squares in bank of lights above as shown in the next picture, at right.

Machine Finds Facts for You

Electronic researcher scans 60,000 bits of information per minute and takes pictures of those that interest you.

By John F. Loosbrock

SUPPOSE you're a scientist beginning a research program on penicillin. You'd like to check everything written on the subject so you won't duplicate work that has been done. Just put a card with a lot of little holes in it into a machine, press a button, light your pipe, and relax. The machine will pore over 60,000 bits of information a minute, pick out what you're after, and make a picture of it that you can take back to your lab. You don't even have to take notes.

Pipe dream? Not any more. A device called the Rapid Selector, developed for the U. S. Department of Agriculture, makes child's play of the grim search through dozens of card files that is the researcher's nightmare. No more looking for a needle in a haystack. A camera, punch cards, reels of film, and a highly ingenious machine are taking the drudgery out of research.

To do this, the Selector uses photoelectric cells, like an electric-eye door. You know how your body breaks a beam of light and a relay opens the door. Now, imagine a door that's choosy. It opens only for a man who is five feet tall, weighs 187 pounds, speaks Spanish, lives in Hoboken, and is left-handed.

That's a rough idea of how the Selector works. It picks out the specific information you want from a mass of data photographed on 35-mm. movie film. Each 2,000-foot reel holds the equivalent of 500,000 3 x 5 cards. And beside *each frame* is photographed an identifying code of black and white squares.

To get your dope, you punch out in a black card a series of holes corresponding to the combination of squares that mean penicillin—or whatever your subject is—in code lan-

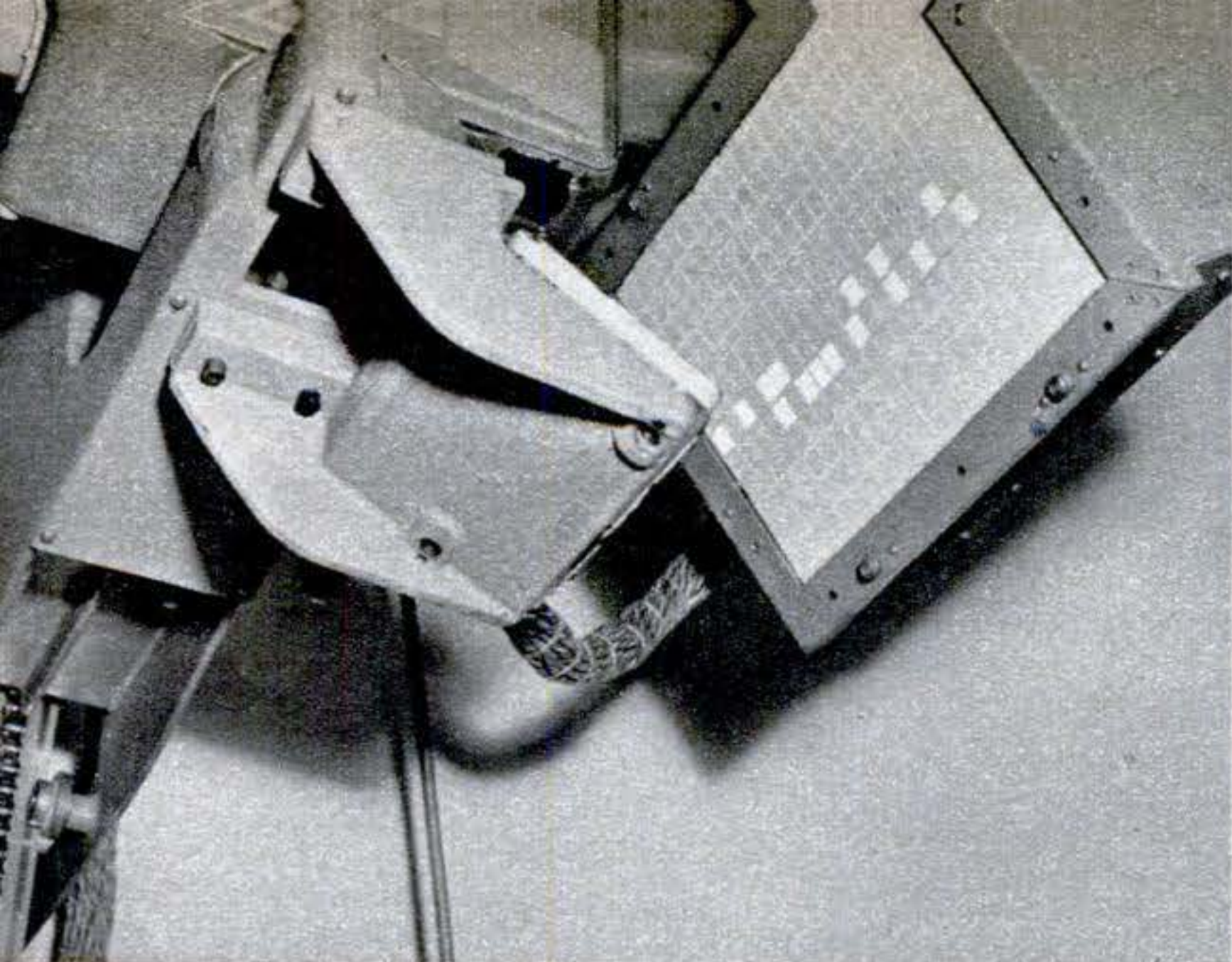

Each two rows of lights represents a different code that may be assigned to same piece of data. Mirror reflects light pattern into the camera alongside the image of the data card.

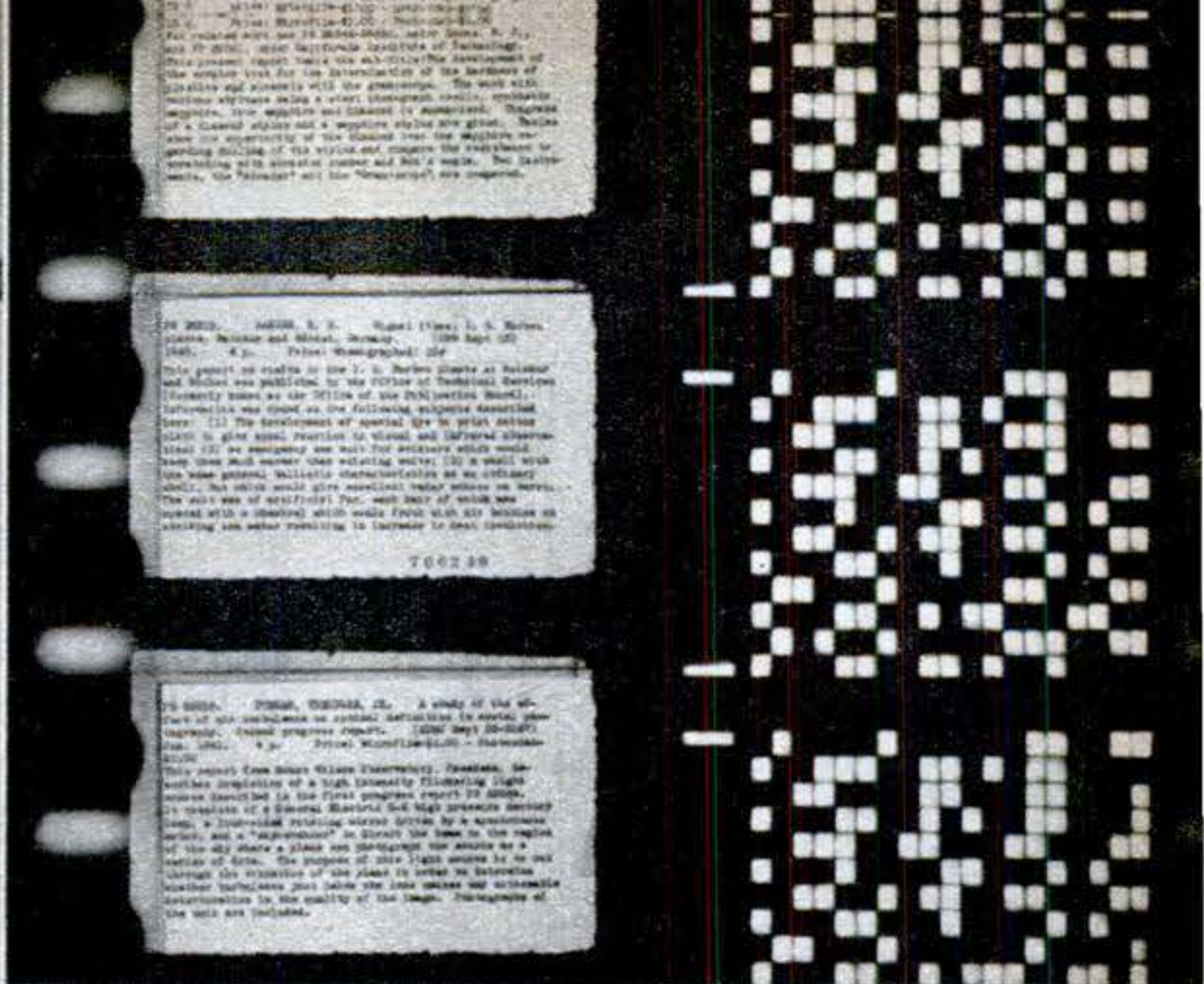

This sample piece of film shows how data are recorded and classified on microfilm. Patterns of white squares at the right of each image of typed card are codes to trigger copying camera.

guage. Slip that master card into a slot, press a button, and the machine takes over.

As the film unwinds, photoelectric eyes check 1,000 pictures a second. When the code pattern in a frame coincides with the master card, a very high-speed flash lamp activates a copying camera and makes a print of that frame. In a few minutes you have a picture of everything on that reel that pertains to penicillin.

The Selector breaks a tight research bottleneck. Man has been collecting information for thousands of years. With microfilm he can store vast amounts of it in a small space. The problem has been how to lay hands on the specific fact you want. Like rummaging through your attic for that old fishing hat, you know it's there. You just can't put your hand on it.

Elaborate cross-filing systems help. But reference cards take up storage space and winnowing through them also takes time.

In contrast, it takes the Rapid Selector only about 15 minutes to run through 30 years of *Chemical Abstracts*, a standard digest of articles on chemistry, when they have been microfilmed and coded. The Selector has a potential capacity of ten million different subjects. And it doesn't care in what order they are stored.

The machine at the Department of Agriculture in Washington is housed in a sleek gray cabinet about six feet high, eight feet long, and three feet deep. It looks like a de luxe air-conditioning unit. Yet it will store and classify material that, in its original form, would take 4,000 times the space occupied by the Selector and its file of film. ➡

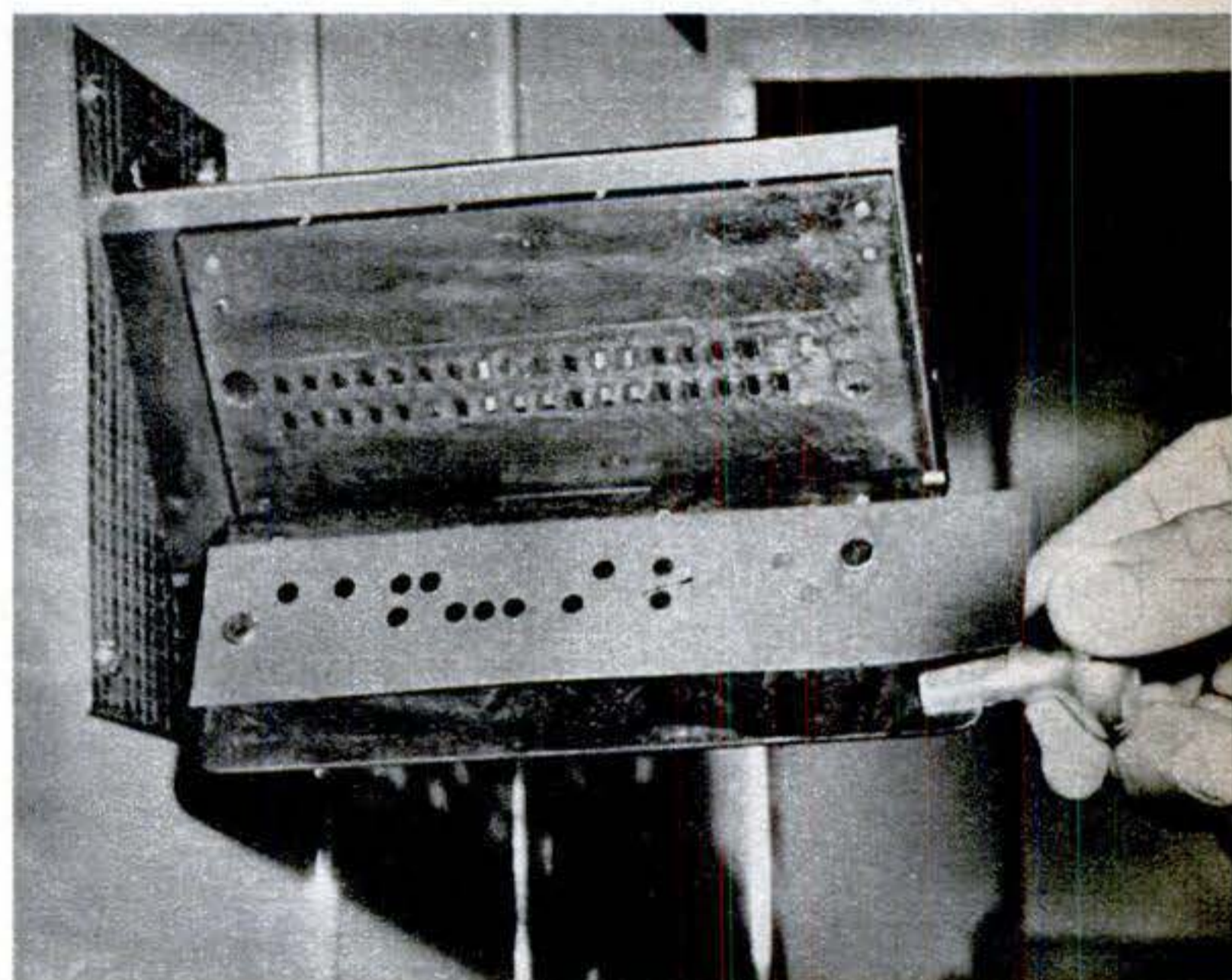

To extract particular information, its code pattern is punched out on this master card. When pattern on film corresponds to card, the machine knows it's time to take a picture.

The Rapid Selector is shown below with the doors of the working section open. The machine can operate with the film running in either direction. Film tension is kept at eight ounces.

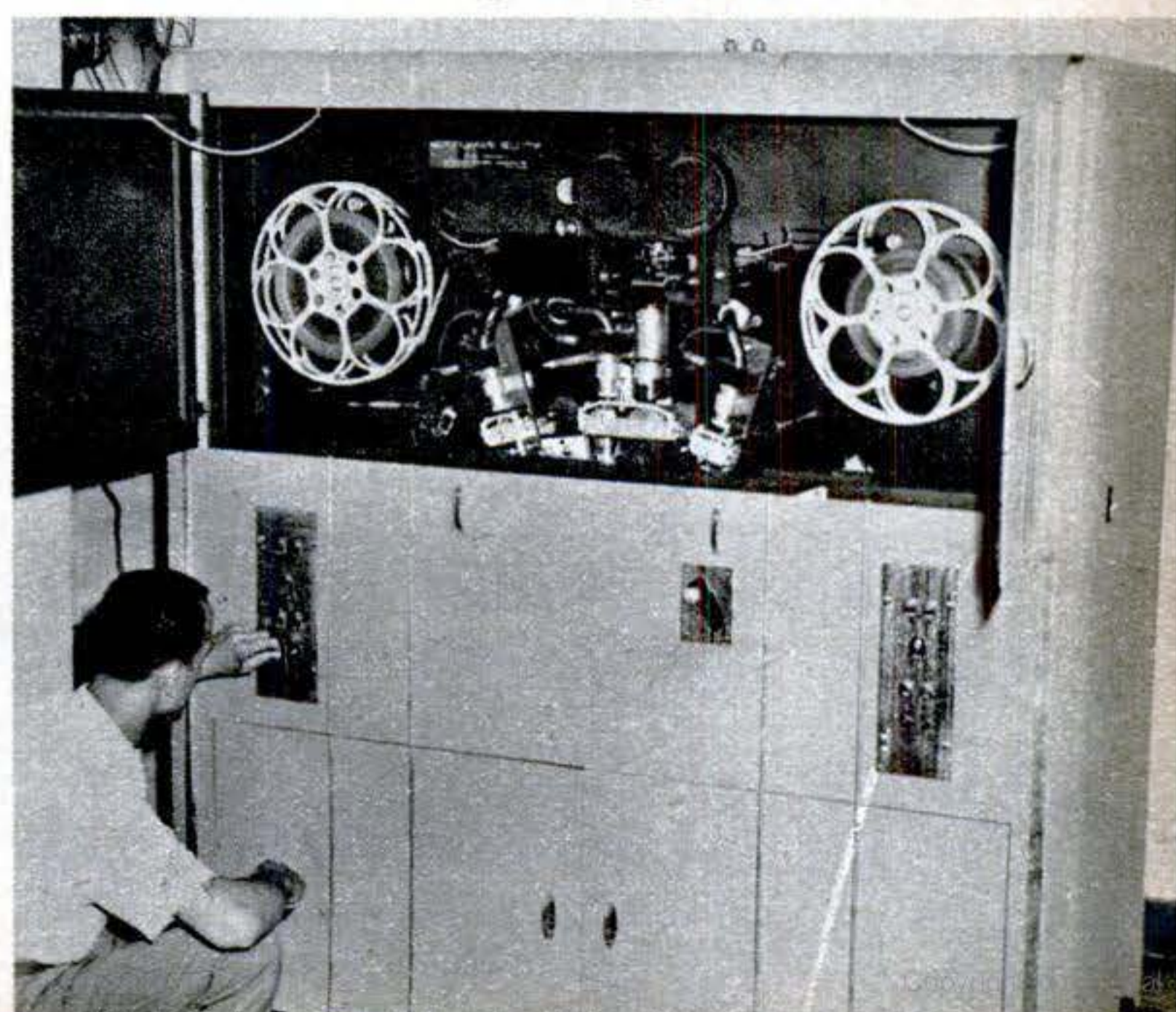

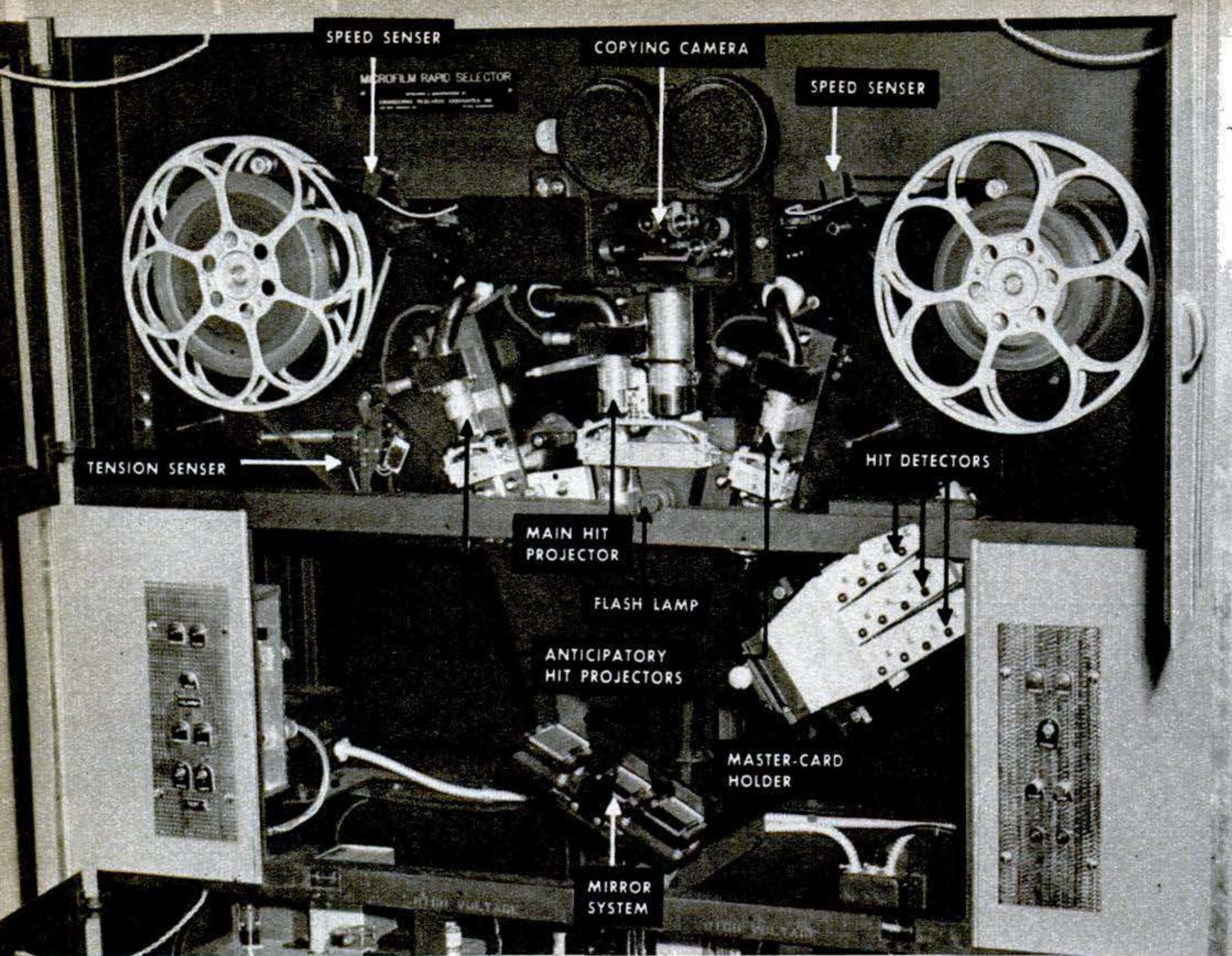

Close-up of working section. Light from "hit" projectors passes through coded area, is reflected

through mask onto detectors. When film pattern matches mask, flash bulb lights, taking picture.

There were plenty of bugs to lick during its development. For example, the flash lamp that snaps the selected pictures flashes for only two-millionths of a second. This effectively "stops" the film's action and eliminates the need for a shutter on the copying camera.

The system worked fine as long as the frames selected for copying were a few inches apart. But if they were too close together, the copying film couldn't move fast enough to

get its second frame in front of the camera in time. A second electric-eye scanner solved the problem. It senses when a double exposure is likely to occur and automatically slows down the film. After the second frame has been copied, the machine resumes its normal speed.

Literally, the Rapid Selector is a librarian's dream—the librarian being Ralph R. Shaw of the Department of Agriculture. Shaw supervised construction by Engineering Research Associates, of St. Paul, Minn. The Office of Technical Services, Department of Commerce, footed the \$75,000 bill.

The result is an approach toward realization of an idea advanced some years ago by Dr. Vannevar Bush, who was director of the wartime Office of Scientific Research and Development. Dr. Bush visualized a desklike device called the Memex. Press a button and the dope you want would be projected on a screen in front of you. It seemed a little far-fetched then, but now the Rapid Selector does almost that. And it's only a comparatively crude prototype. Its developers say improvements are already in the mill. **END**

The reel of film in the operator's hand contains the same amount of data as all seven of the card-file cabinets shown in photo below. The machine can scan a reel in less than seven minutes.



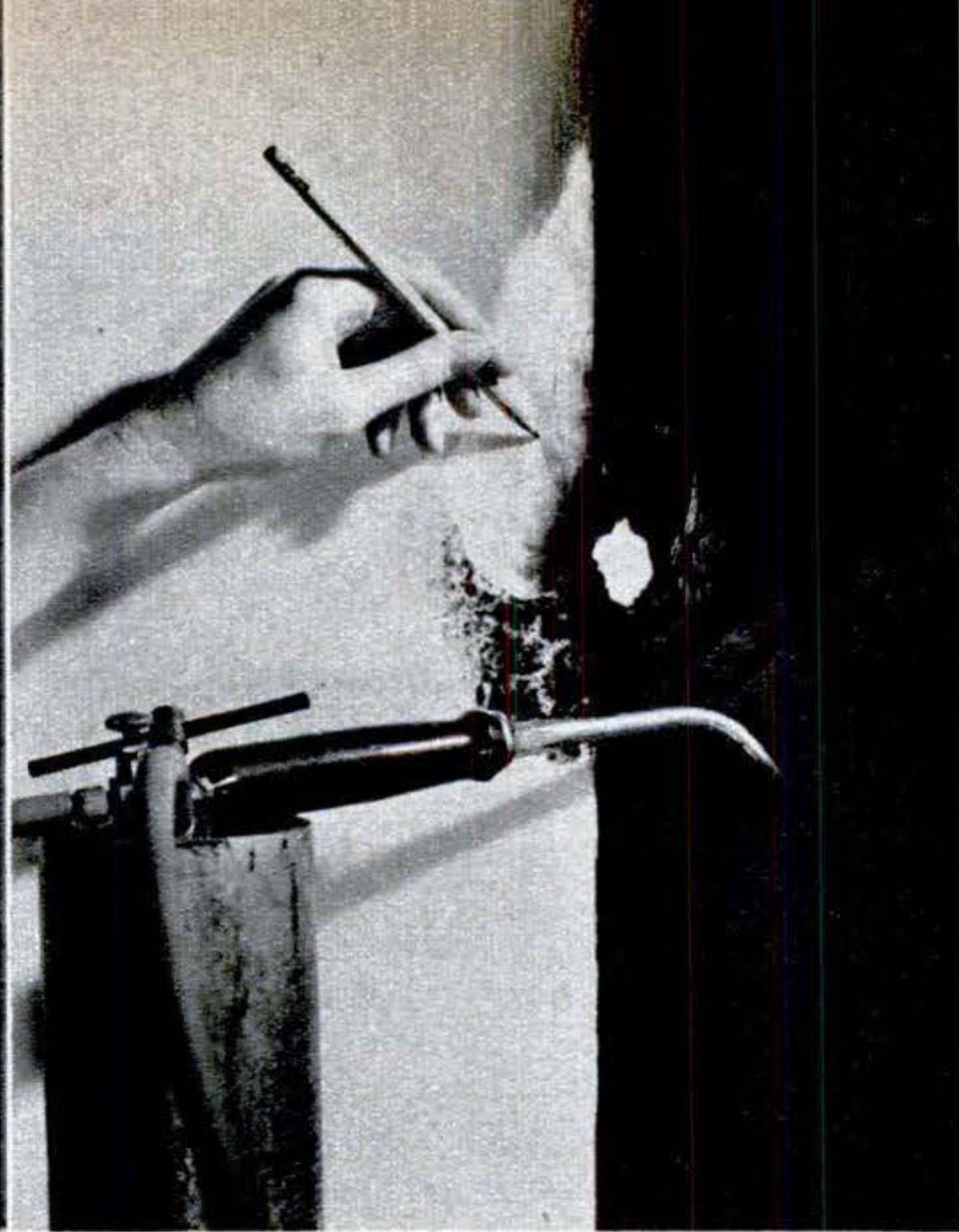

Paint Swells to Stop Fire

A NEW fire-retarding paint that looks like thin varnish may soon be available for such indoor jobs as protecting basement ceilings and airplane interiors. Under heat it fluffs up like a toasted marshmallow, forming a spongy insulating layer more than an inch thick. The

photos above show how Coating X[®] (white side) protects a wood panel from a torch flame for 20 minutes while the lead-painted black side is burned through. The new paint, a powder mixed with water, can be covered with ordinary paint. It is still experimental, reports Sherwin-Williams, which hopes to perfect it as an exterior undercoater.

Electronic Tester Culls Knobs

THIS electronic tester twists door knobs all day. If they do not slip on their shanks, they drop into the "accepted" box. If there is the slightest slippage, which would cause malfunctioning in use, an automatic gate flips the knob into the "reject" box. Photoelectric cells stop the device while the operator inserts a knob and start it again when he withdraws his hand. Yale & Towne makes it.

Tests Predict Tougher Shoes

SHOES that last 75 percent longer are predicted by tests of new impregnated sole leathers on the abrasion machine shown below. Researchers at the National Bureau of Standards found that leather impregnated with plastics or rubber showed much greater resistance to wear than untreated leathers. The improved leathers were tested by spinning them on the machine against an abrasive disk.

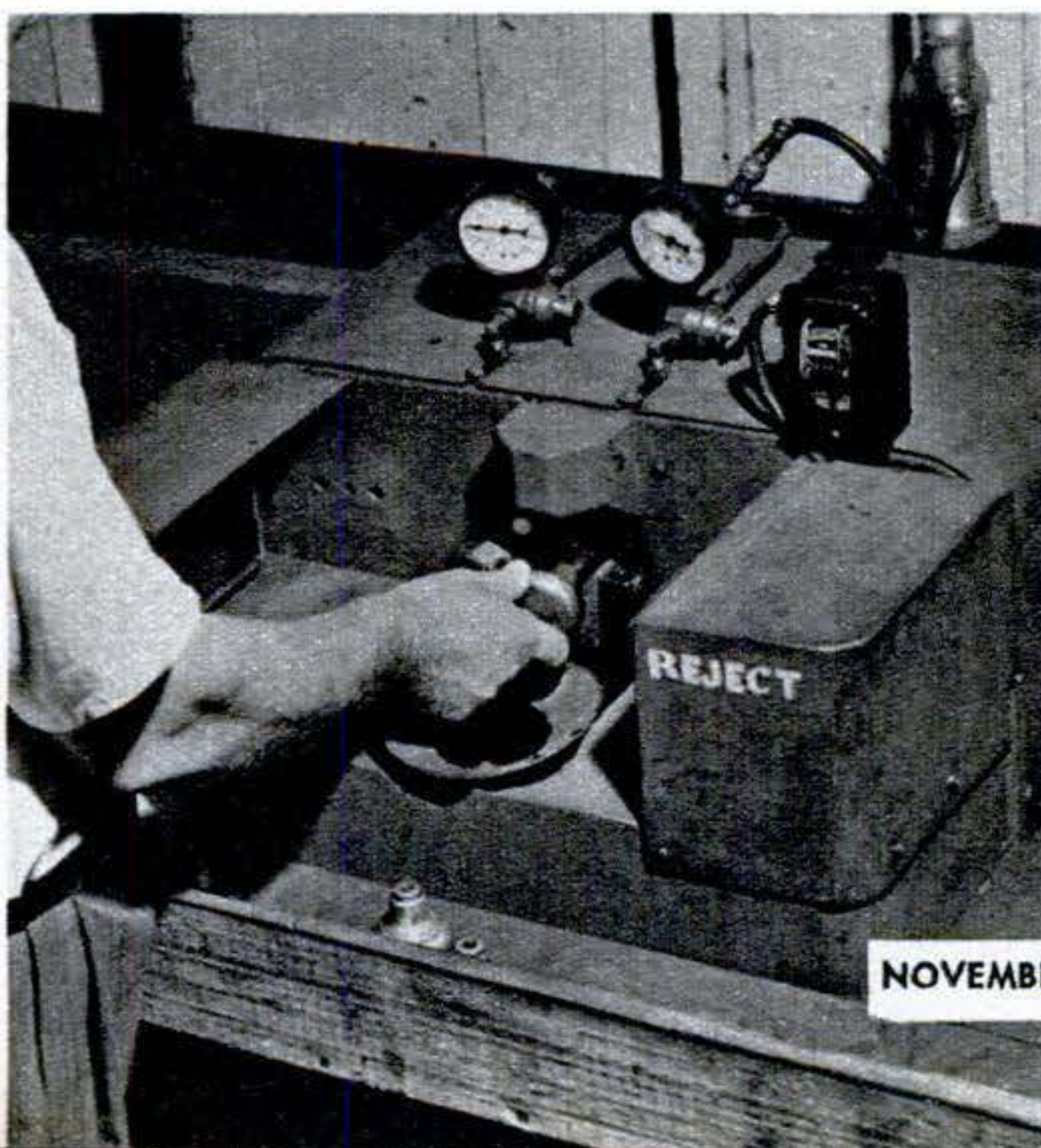

'Seater Meter' Samples Shapes and Tastes

EVERY day several University of Michigan students are taken for a ride. They don't go anywhere or do anything — just sit. But they're sitting in a fancy new device dubbed a "Seater Meter," and when a thousand or so have sat out their "rides," researchers hope to learn how automobiles can be better tailored to fit the collective anatomy of American motorists.

The Seater Meter is a dummy driving compartment that can be adjusted this way and that to accommodate the bodies and tastes of people of every size, shape, and personal prejudice. So far as is known, it represents the first scientific approach ever made to the problem of designing complete compartments for maximum convenience, comfort, and safety. Its objective is to arrive at basic dimensions, in terms of seats, floorboards, pedals, instrument panel and controls, and steering wheel, that will best fit the largest number of men and women motorists.

Officially known as the Universal Driver's Compartment, it is a project of the Marketing Research Department of the Ford Motor Co. It was designed by the automotive laboratory in the university's bureau of engineering research under authority of J. R. Davis, Ford's vice-president in charge of sales and advertising.

Collaborating in the research is Prof. Wal-

ter Lay who, as a member of the seating committee of the Society of Automotive Engineers, already has done much work on seating for automobile manufacturers. Findings bearing on safety may be made available to the entire industry for possible standardization in all makes of cars.

Professor Lay started out by collecting existing studies of the human frame. These included dimensions averaged out by the U. S. Air Force at Wright Field, Ohio, and by Dr. Ernest A. Hooton, Harvard anthropologist. Anthropologists and anatomists of the University of Michigan helped.

These studies resulted in a sort of baseline. They showed that something like 15 percent of all men are about 69 inches tall and that approximately 18 percent of all women are around 65 inches. These two percentages were the biggest single chunks in the study. They also appear to be about the over-all average.

Then the Seater Meter was built.

When a POPULAR SCIENCE reporter took the test, he discovered that he preferred a flatter trajectory for the clutch and brake pedals than is customary in today's cars, that he liked the steering wheel lower, and that instrument panels and windshields were too far away.

Already the meter has turned up some

Fender silhouettes of various cars can be fitted on "Seater Meter" to determine road visibility from driver's seat. For easy maintenance, one set of socket wrenches unbolts entire unit.

Sides come off, together with seven other basic parts, for shipment. Except for metal fittings, motors, cloth seat, and calibrated indexes, device is made of wood. It weighs 1,800 pounds.

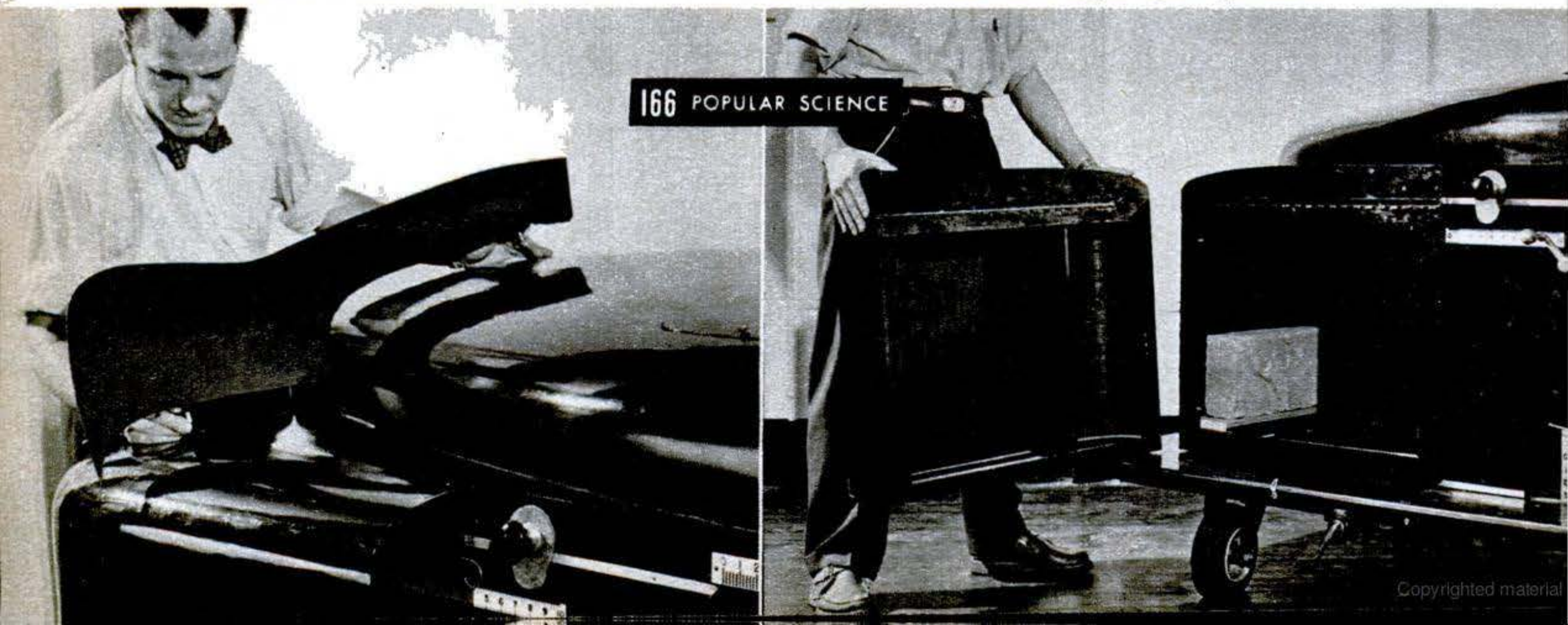

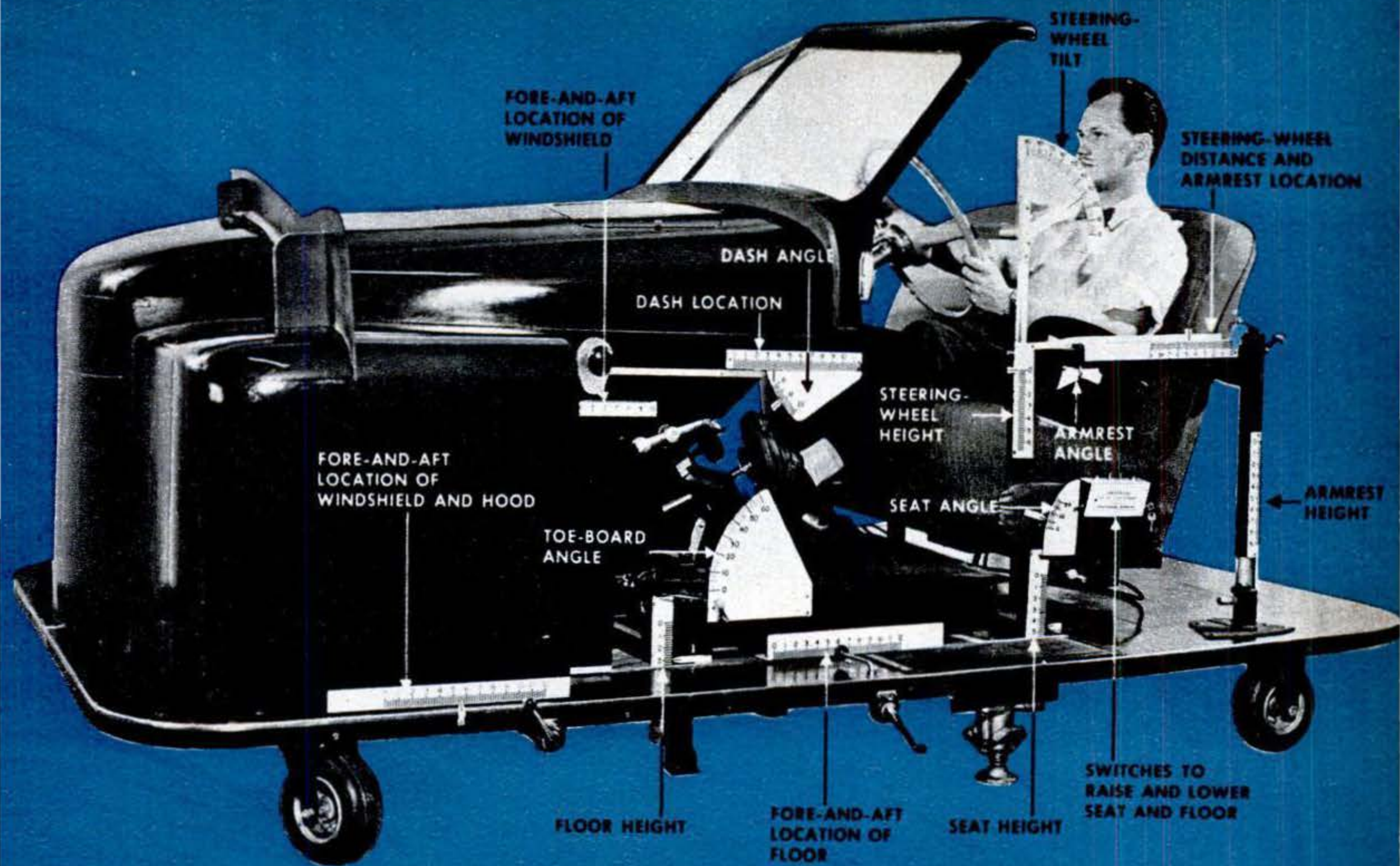

This experimental, adjustable driving compartment is expected to produce ideal auto front seat.

interesting information. Most subjects seem to like a tilted armrest—a flat armrest only rests the elbow. Many would like a stop on the right side of the accelerator pedal for a tired foot. They think the windshield should be closer to the driver and that footboards are too slanted for comfortable operation of the foot controls.

The meter shows that women are apparently able, through force of habit, to accommodate themselves to awkward driving

compartments better than men. Many of them look through the steering wheel instead of over it, and most want the seat moved forward. It's their only way of achieving reasonable comfort and visibility.

How can a single automobile be designed to accommodate such a wide variety of human tastes and torsos? The researchers aren't sure yet. But when a lot of people have finished sitting in the Seater Meter, they expect to have a pretty good idea. END

Four controls for altering slant of steering column and distance from driver are reached through hood opening. Device has 12 controls, 8 locks, some of which are spring-balanced

Four electrically operated columns, with solenoid limit switches, raise and lower seat and floor. Seat travels up and down 10 in.; floor, 8 in. Seat can be tilted up 20°; toeboard, 60°.

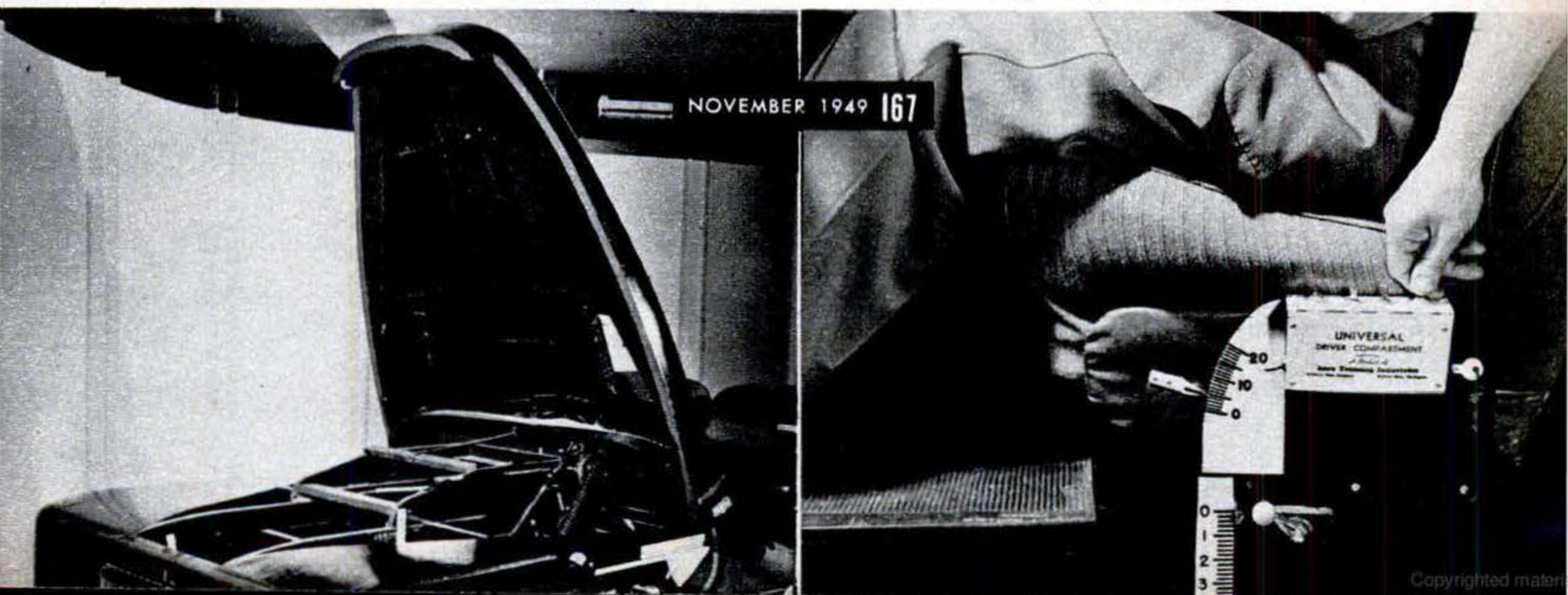

The Case of the Missing Sardines

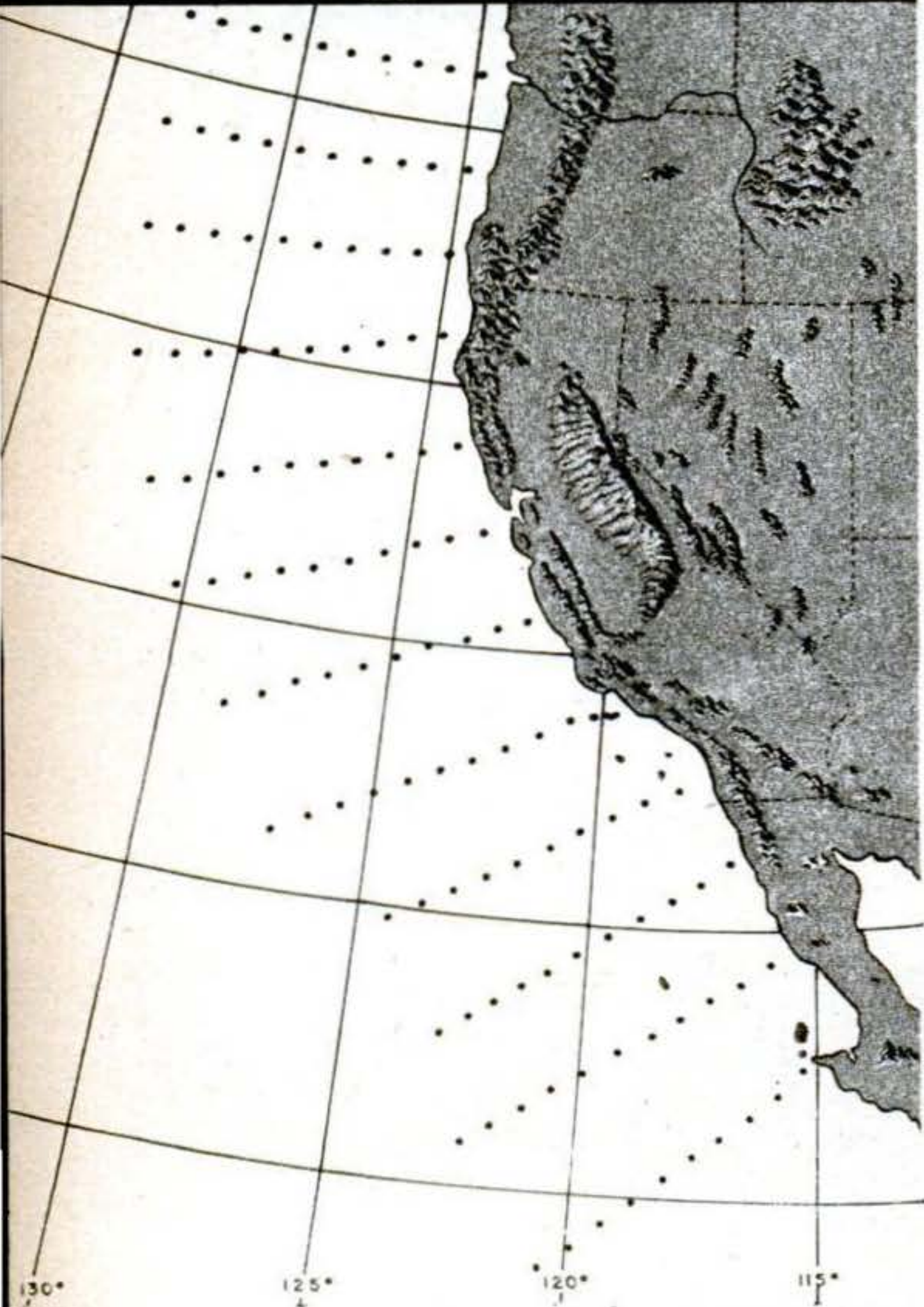

Former seagoing tug *Horizon*, at top, is one of six vessels that ply the Pacific in search of the missing sardines. Dots on map indicate points where observations are made every month.

CALIFORNIA has set seagoing detectives on the mystery of the vanishing sardines. The state's annual catch used to be 800,000 tons. In 1947-48, only 100,000 tons were taken. That means a loss of food and a loss of livelihood for a lot of fishermen and canners. So now several scientific and government agencies are co-operating in a giant fish hunt covering 670,000 square miles of the Pacific. By measuring water temperature and salinity at various depths, currents can be charted. Study of water samples reveals the distribution of sardine food. From these and other data the sea sleuths hope to discover where the sardines have gone.



This 85-pound concrete object is an undersea "kite." Attached to a cable, it carries scientific instruments down and holds them at desired depths while under tow at four or five knots.

To permit quick attachment of instruments, balls of low-melting indium alloy are formed over the cable. Molten metal is poured into the casting tool while it grips the cable as shown in

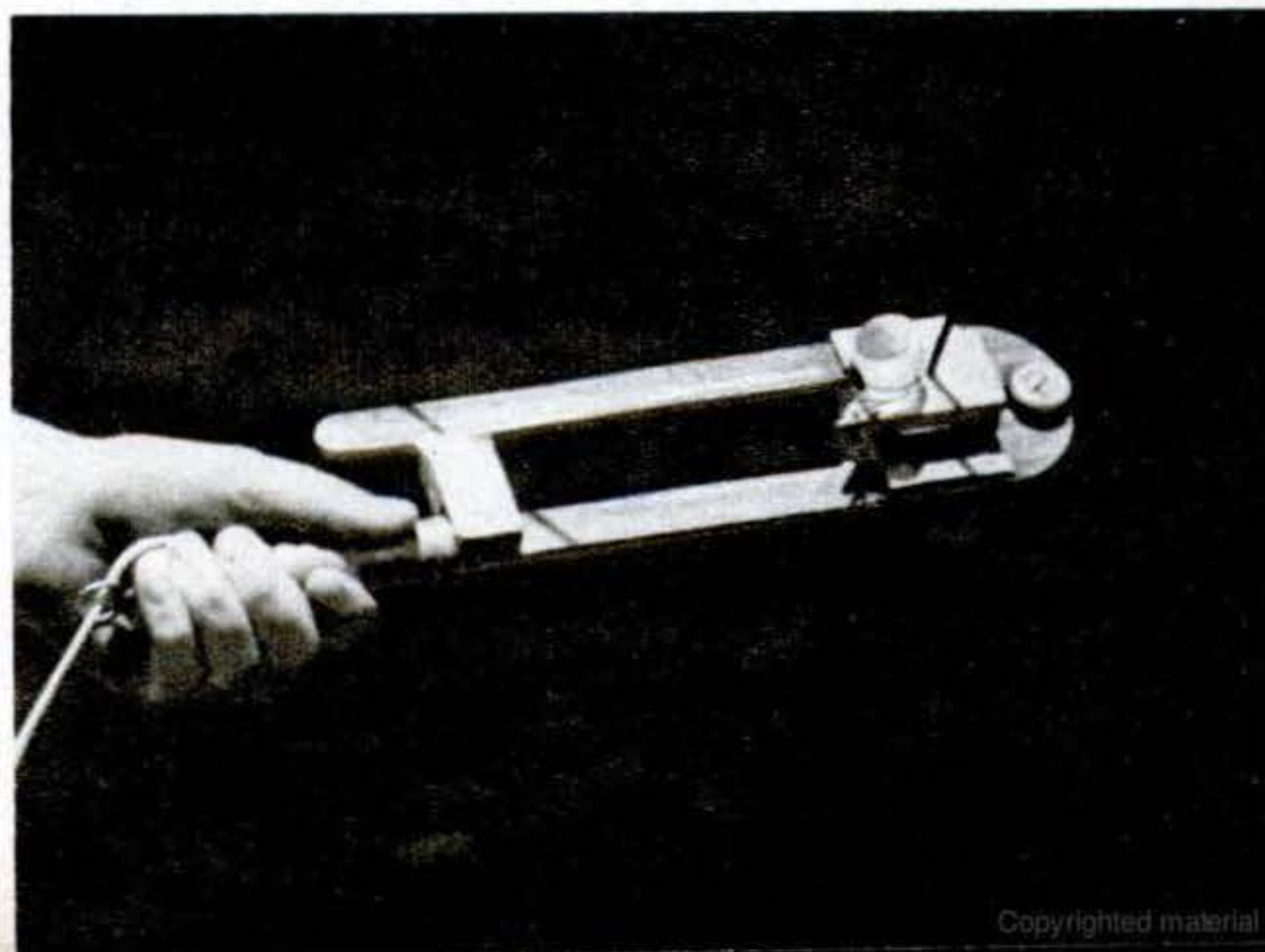



At the start of a run, scientists lower a dragnet that will gather samples of sardine eggs and other minute forms of sea plants and animal life. An instrument registers depth of catch.

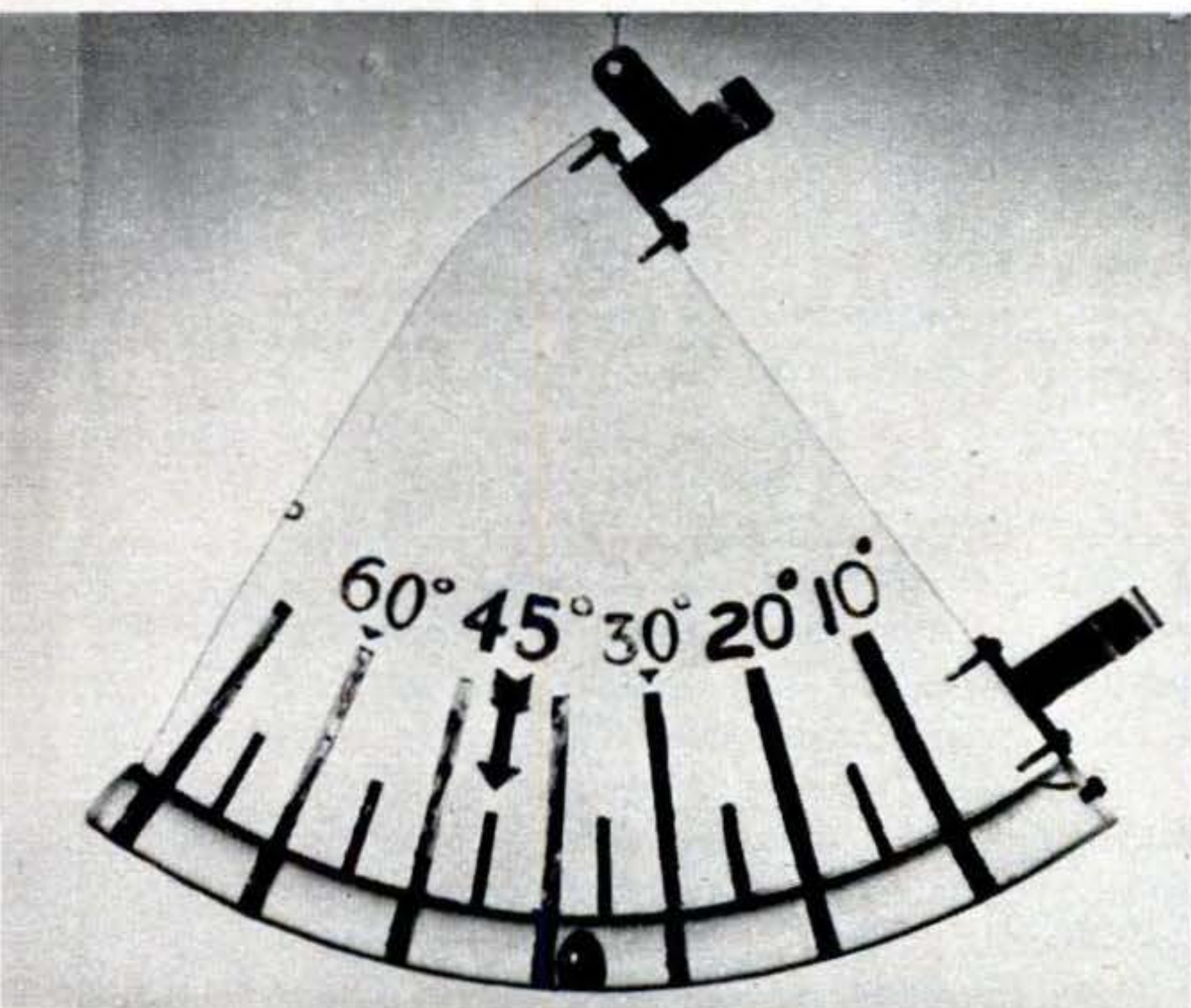

Angle of the tow cable is registered on this special inclinometer. The angle is read from position of the ball in the oil-filled, curved plastic tube seen at bottom of instrument.

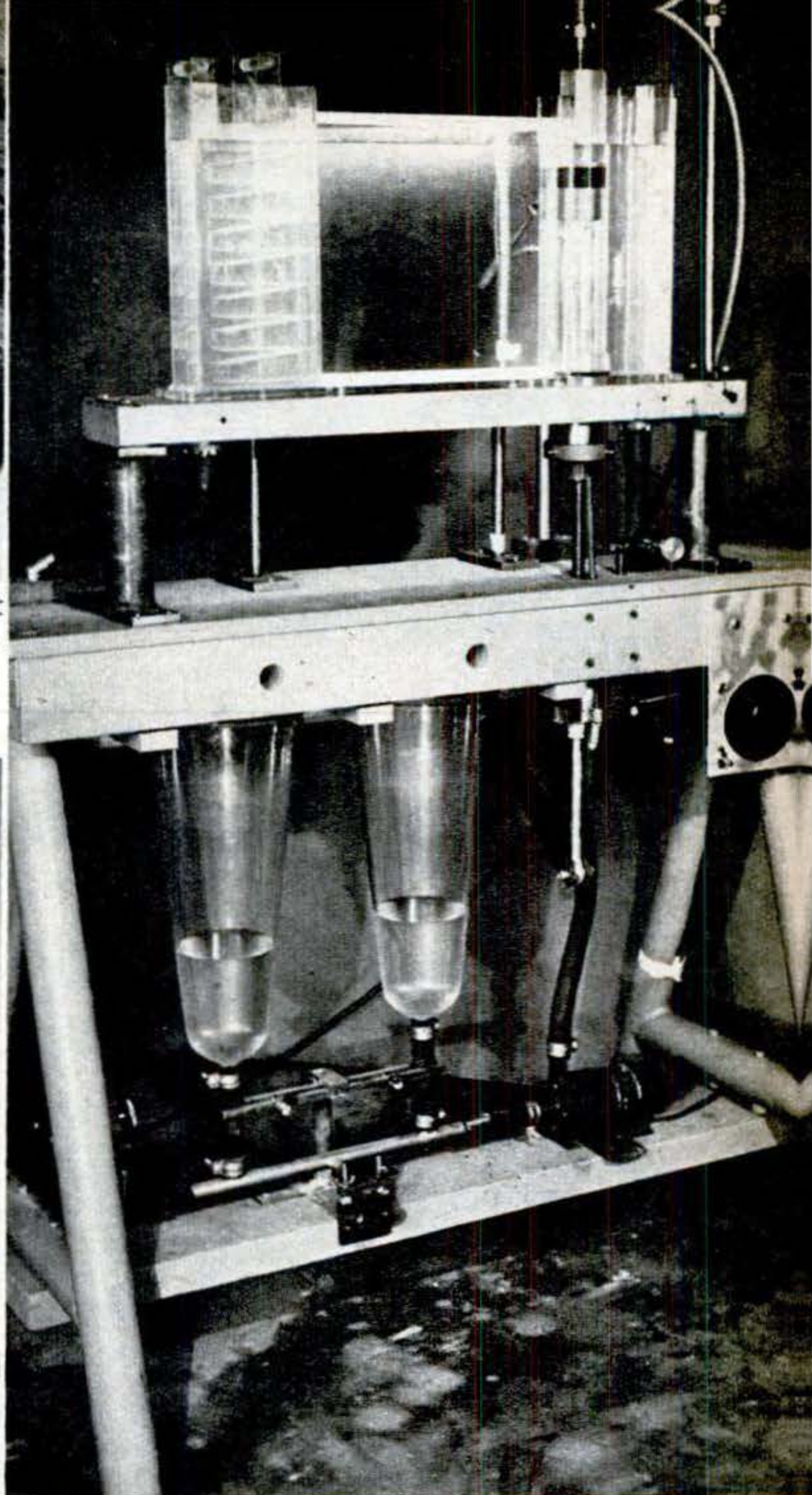

The contraption above is an Elutriator (meaning it purifies by flow). It separates tiny animals and plant life, taken in a sampling, according to how fast they sink through moving water.

photo at far left below. Next photo shows the ball, formed in 10 seconds, and solid enough to stand a pull of 400 pounds. In the third picture, a scientist is clamping a split section of a drag-

net's shaft over the ball. After a run, a chemically heated soldering iron, at far right, is fitted over the ball and melts it off in a few seconds, leaving the cable as clean as before.



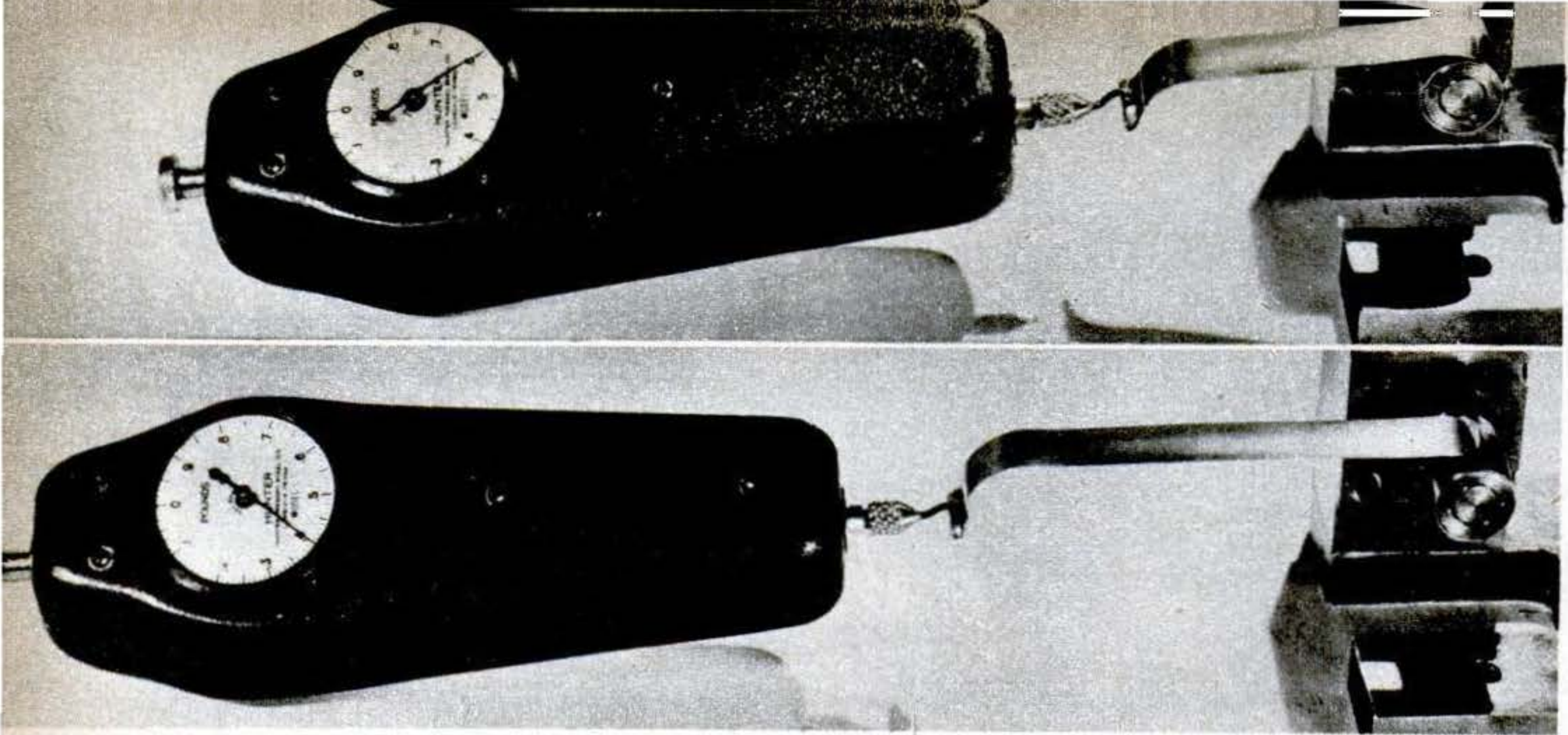

Meter at top shows .6 pounds pull, below only .4, although spring has unwound two inches.

Negative Spring Does New Tricks

THIS new spring breaks all the behavior rules.

The tighter you wind a clock spring, the harder the key turns. As you pull on a coil

spring, it takes more and more force to stretch the coils a given distance. But the Neg'ator® can be made to become weaker instead of stronger as its load increases. Or it can have either constant or increasing tension, depending on how it's made.

The Neg'ator begins as a flat strip of steel. Each successive section is prestressed a predetermined amount and the strip coils up like a steel tape. The force needed to unwind each section varies with the prestressing. Thus, if the free end is prestressed heavily and successive sections only lightly, the spring resists more at the beginning of the pull than at the end. Or if each section is prestressed the same, the pull will be even. Some uses are obvious. A conventional spring pulls a screen door hardest when it's open. But you want it to hold the door tightly shut. Using a Neg'ator, the pull can be greatest when it's shut, least when it's open. The new spring, made by Hunter Spring Co., can also be used to replace window sashweights; to make book-ends, self-winding tapes, vises, telescopic tubes; and to wrap insulated pipes.

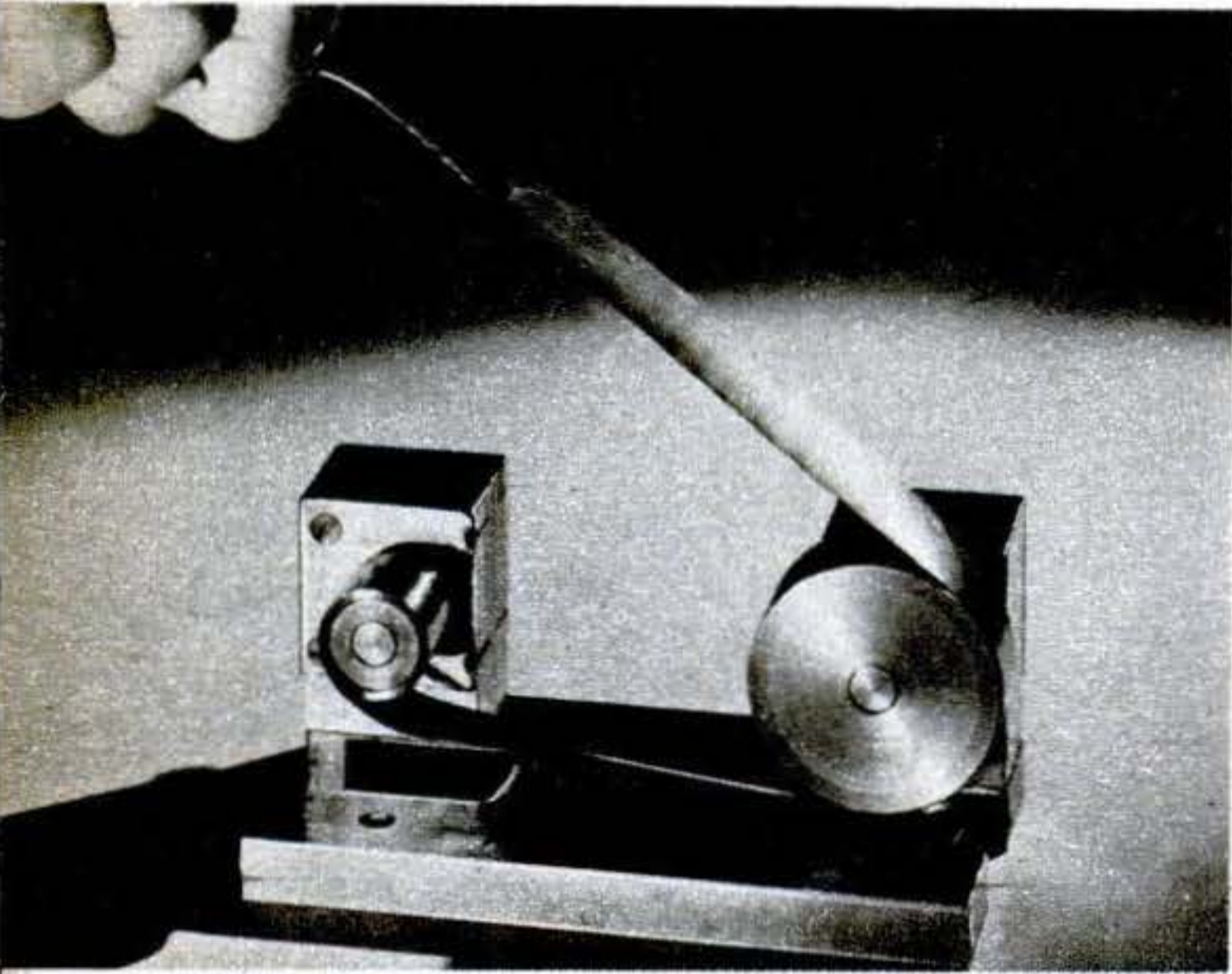

Unlike conventional springs, Neg'ator® can act around corners without loss or inaccuracy. Pull shown here, with spring around pulley wheel, is approximately 135° off normal line of action.

If wound on two spools of different sizes, the Neg'ator will run by itself from the larger to the smaller unless restrained. Picture below shows this action being resisted by a .78-pound pull.

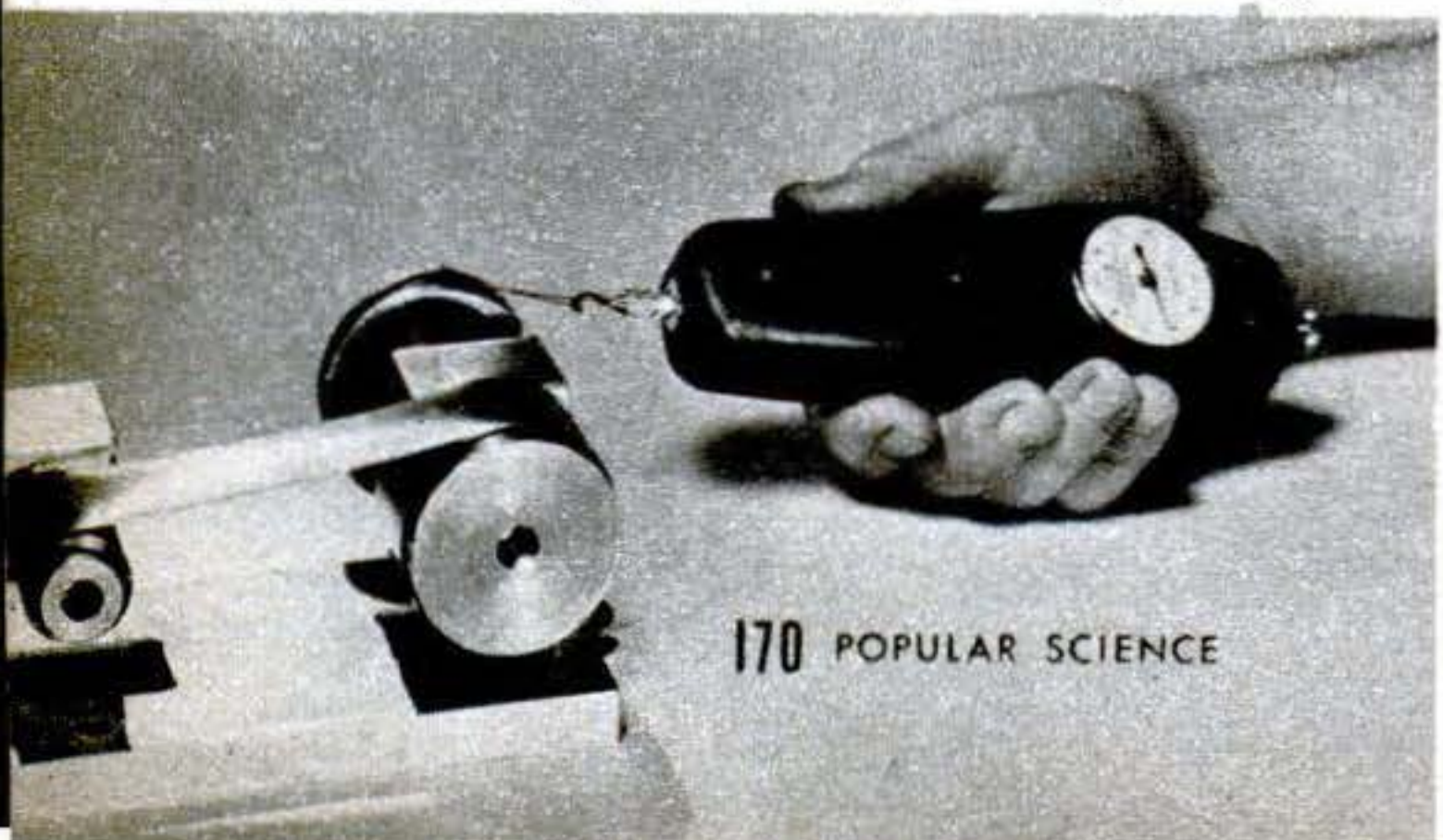
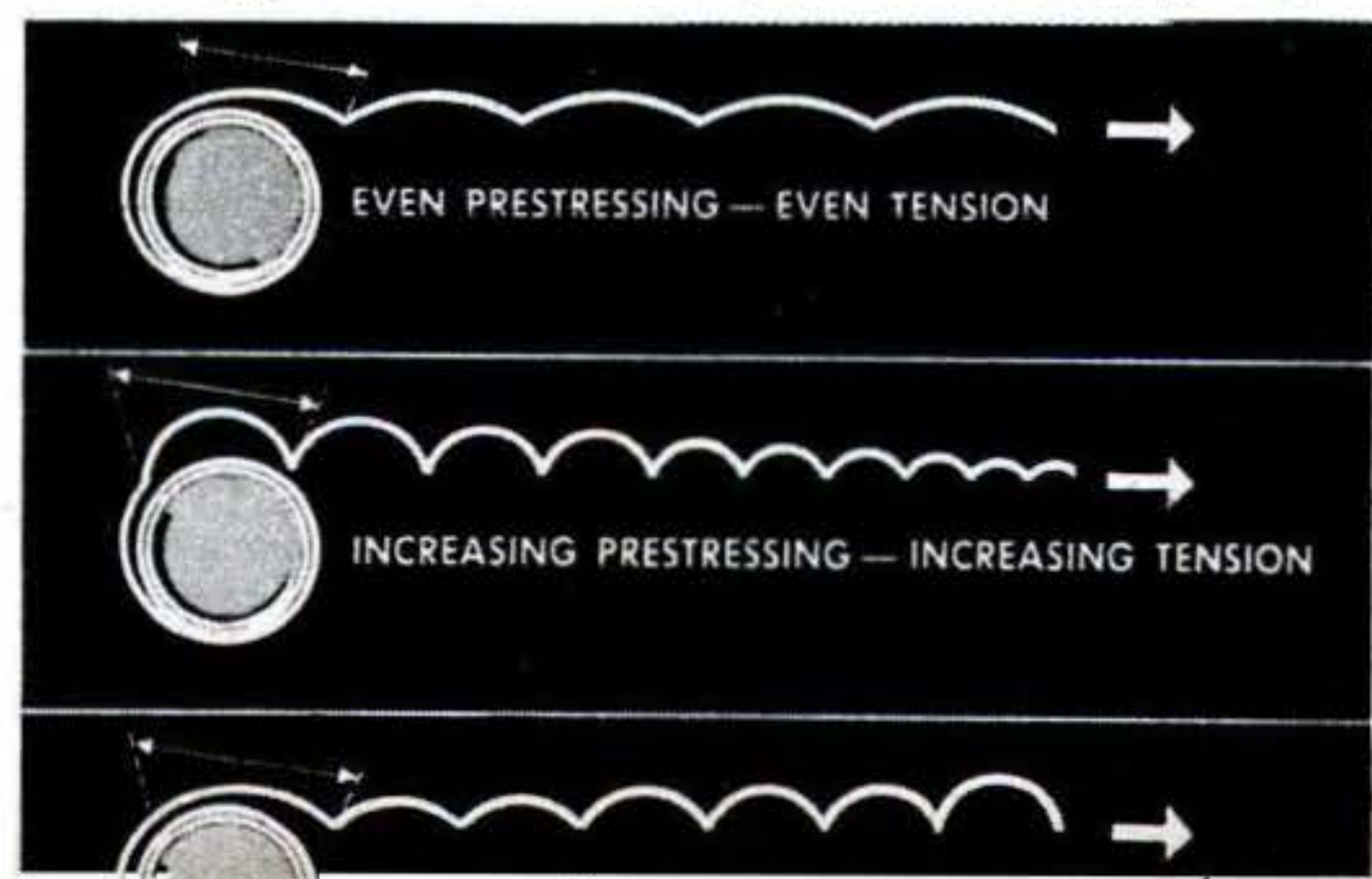

Diagram shows how new spring can be tailored by varying prestressing. Since spring's action takes place only at coil (arrows), prestressing at that point determines pull of entire spring.



Ancient craftsmanship teams up with modern mechanics in manufacture of plated silverware.

How Your Knives and Forks Are Made

By George H. Waltz, Jr.

PS photos by Hubert Luckett

THE next time you sit down to your dinner table, take a good look at the knife, fork, and spoon that bracket your plate. If they are silver-plated, you will be looking at the product of a unique blending of the deft handwork of master craftsmen and the mechanical magic of modern mass production.

The trick of electroplating tableware with silver was perfected more than a century ago in the Hartford, Conn., basement workshop of the three Rogers brothers, who have since been closely associated with silverplate. Little, however, has ever been told about modern production methods. Fearful that special

Working from artist's sketch, craftsman first makes hand-chased model of new design in metal. This must then get OK of production men, stylists, salesmen before going into production.



After model has been approved, a large-scale drawing of the design is made, usually about three times actual size. From this an enlarged model is hand-carved in wax as shown above.

Wax model serves as pattern for mold from which large bronze master die is cast. This die, at left, is cleaned up by hand and used, in duplicating machine, to make actual-size die. ▶



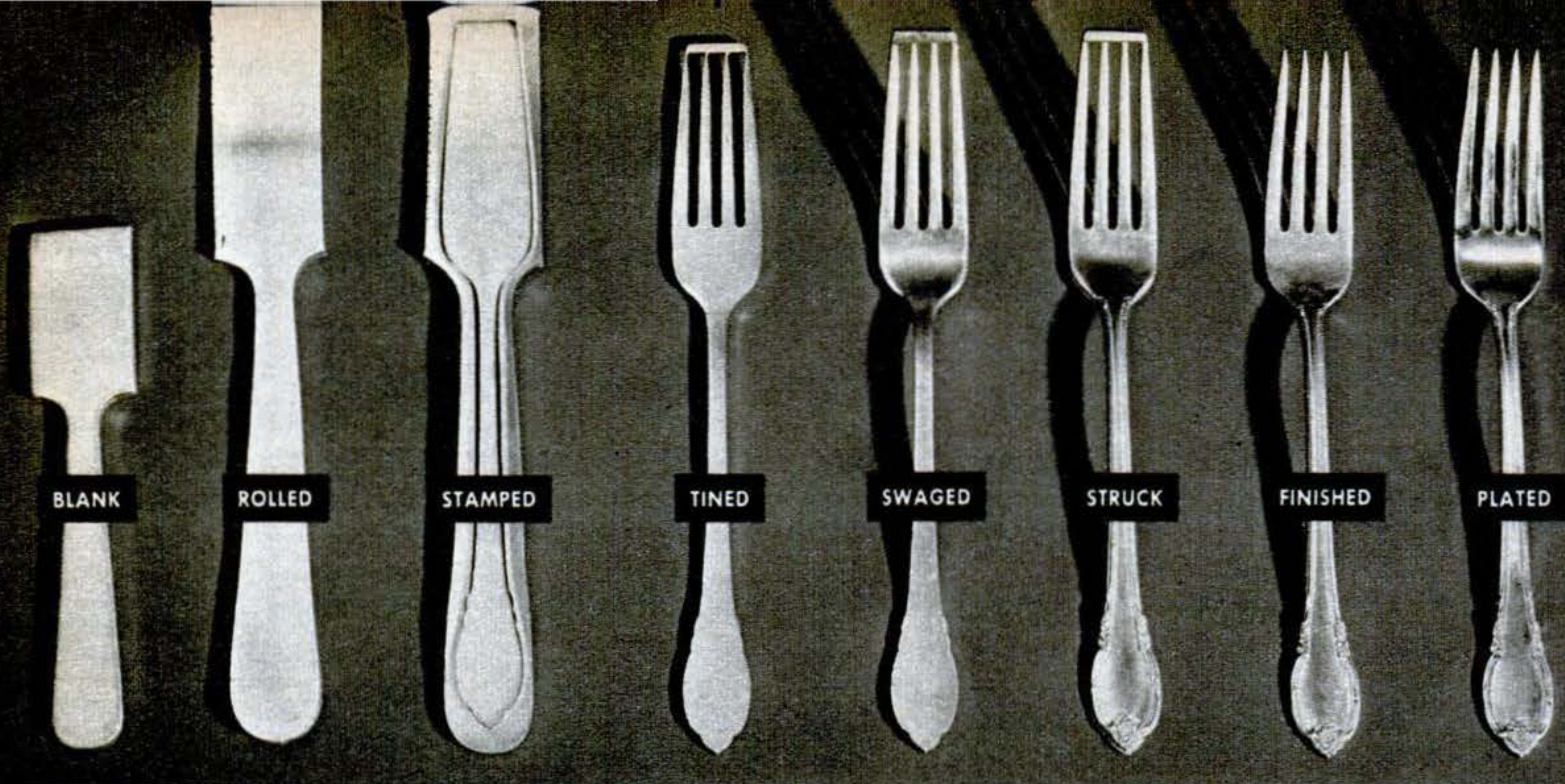

How a fork grows. Rough blank at extreme left is first grade-rolled to distribute metal so proper thicknesses are in proper places. Then form is stamped out, tines are punched in, curves of tines

are swaged in, design is struck, and fork is finally plated. Cross-piece at the top of the tines is left in place in order to provide strength until all the forming operations have been completed.

trade secrets might leak out, silverware manufacturers have kept the public in general, and writers and photographers in particular, a good distance away from their production lines.

brothers first succeeded in silverplating a metal cup, a new design for plated ware still starts out in the hands of master craftsmen. After an artist has put the original design down on paper, a skilled silversmith creates a full-size, hand-chased model. Then still another artisan literally sculptures a scaled-up model in wax to provide the pattern for a mold in which a large master die is cast in bronze.

Now, however, with the co-operation of the International Silver Company, which bought the Wm. Rogers Mfg. Co. 51 years ago, PS is able to take you behind the scenes at one of the largest manufacturers of plated ware and show you just how your plated knives, forks, and spoons got that way.

After more handwork to clean up the design, the enlarged bronze die is placed in a duplicating machine. Here a rotating burr or cutter, guided by the bumps and depressions on the bronze master, cuts the design in its

At the large, many-building ISC plant in Meriden, Conn., not more than 20 miles from the spot where the silversmithing Rogers

Striking the design. Double dies, one in a 900-lb. drop hammer and another, shown below, in the anvil of the press, imprint the design on both sides of the fork handle with one blow.

When all forming operations are completed, the reinforcing bar left on the tines is cut off. These cutting presses, like the swaging and striking presses, are hydraulically operated.

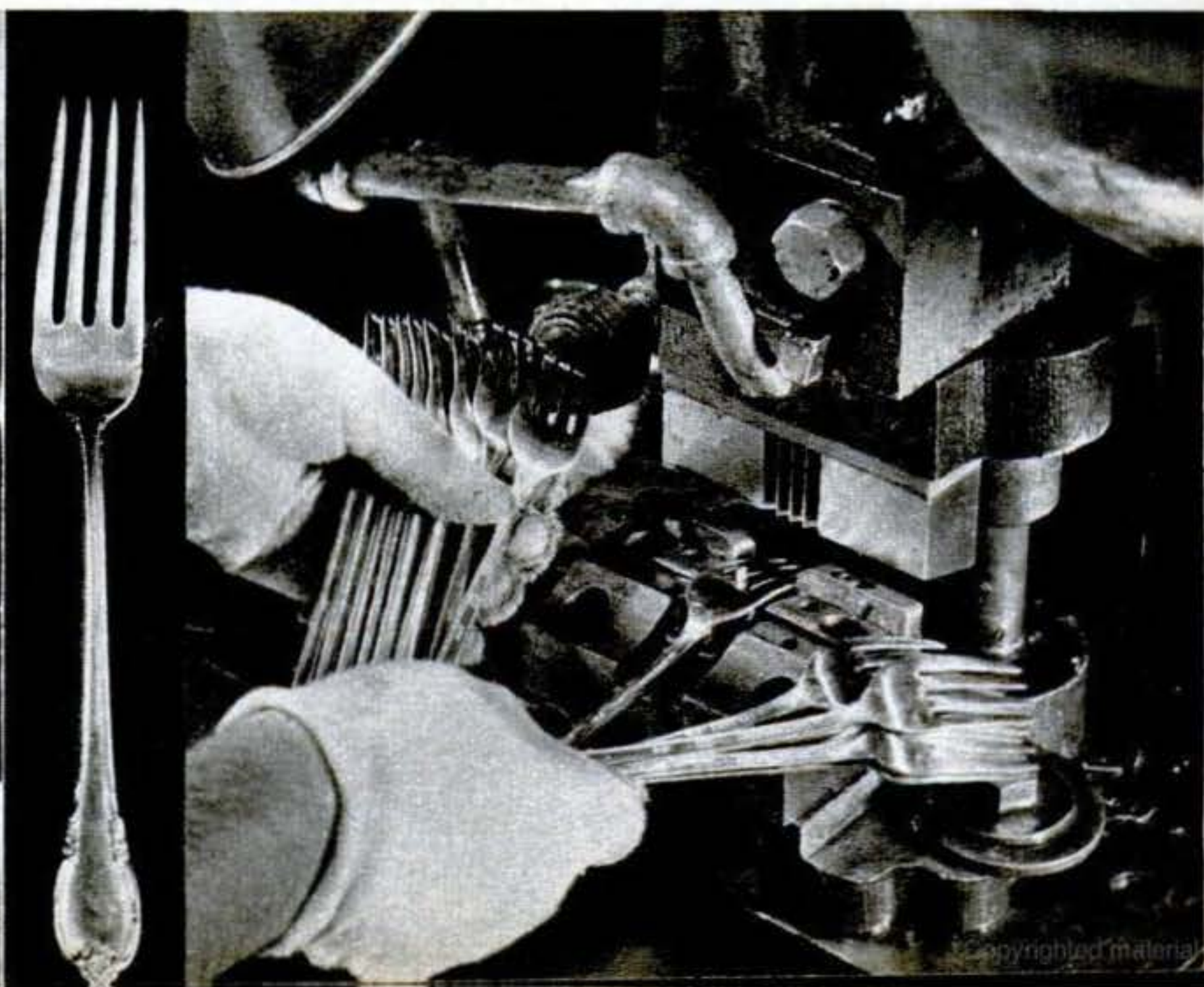
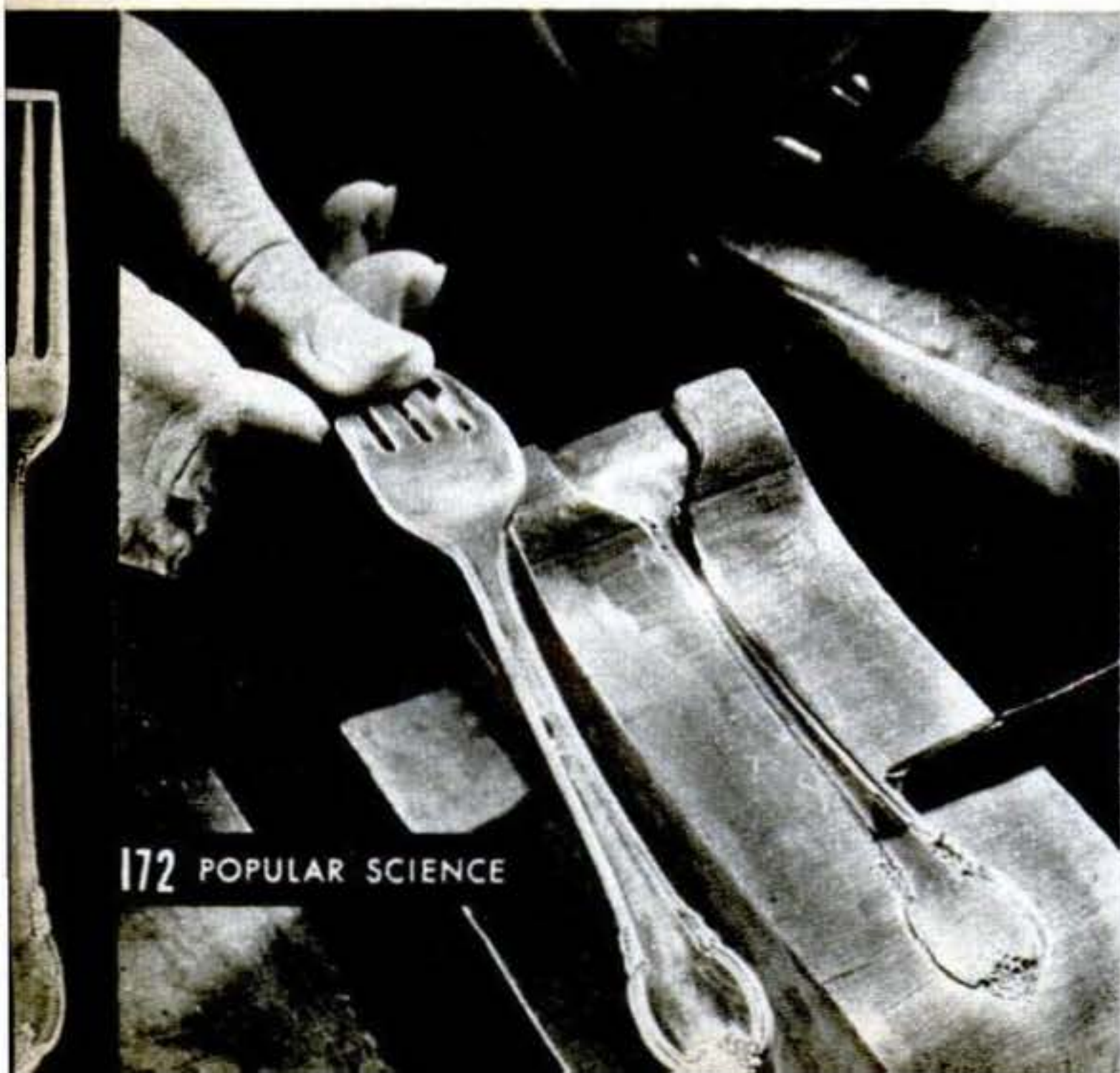



Forks and spoons start down production line in this blanking machine. By cutting two interlocking blanks with each stroke, machine keeps waste scrap to minimum. Metal is nickel silver.

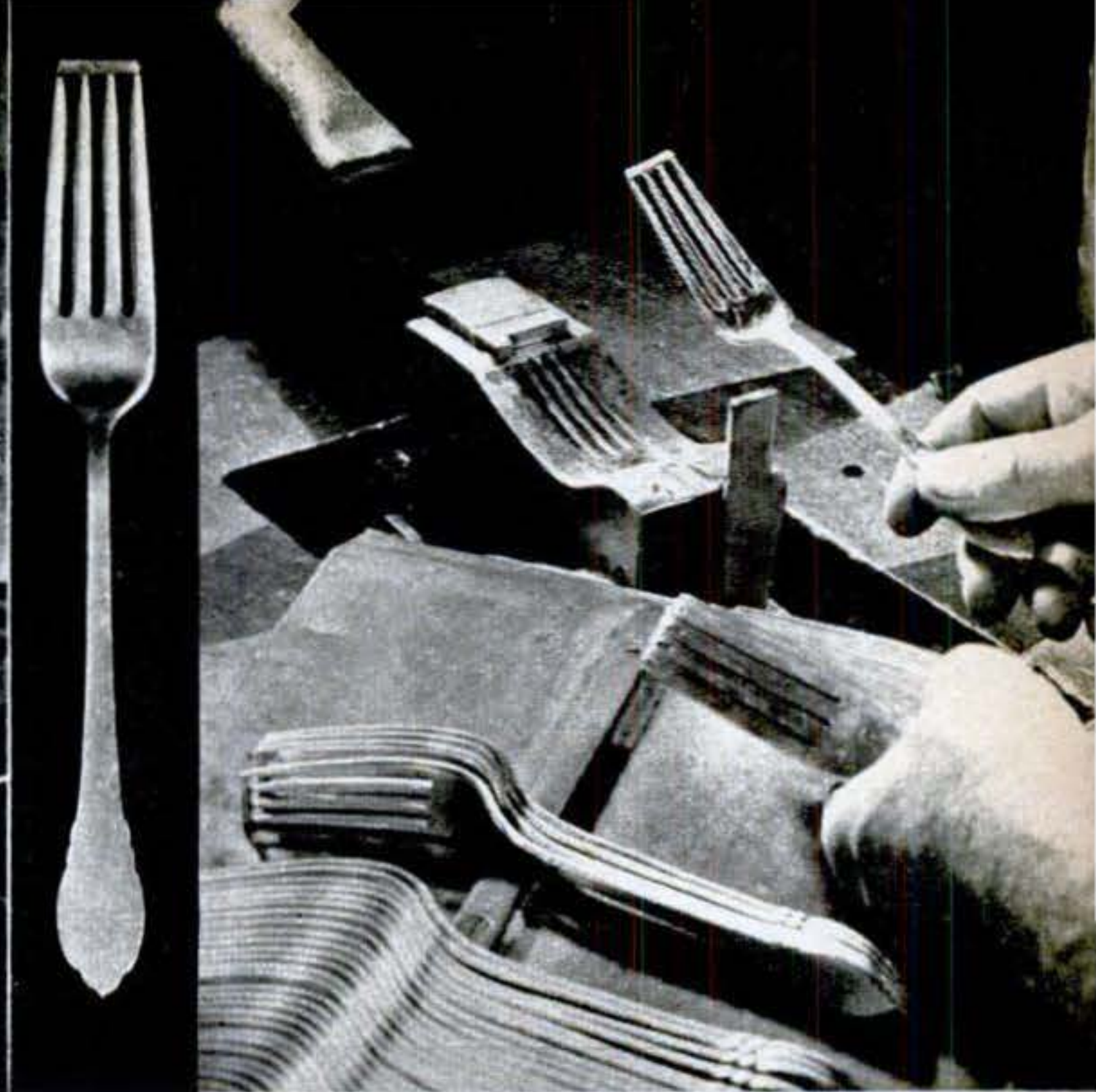

After blank has been rolled, stamped, and tined, swaging machine gives tines their graceful curves. A 600-lb. drop hammer containing male half of die forces the blank into lower, female die.

actual size into a block of steel. This first steel die, after still more handwork, becomes the master steel die. In preparing a new design for mass production, approximately 120 such original dies and special tools for stamping out the forms must be made.

Dies Do Job

The production of good-quality plated ware begins with the production of these dies. It is their job in "striking" the designs into the base metal to reproduce the delicate handwork of the master craftsman who created the original patterns. Their surfaces must be kept clean, sharp, and crisp.

Among many trimming, finishing, and polishing operations is hand trimming of tines on emery belt. Sixteen separate operations are necessary to give metal blanks proper finish for plating.

Under the continual hammering it receives from the blows of a drop-hammer press, the life of a die is relatively short. Under average conditions, it is good for about 80,000 impressions, which amounts to just a little more than approximately 22 hours of actual production use.

To cut a new steel die each time one wears out would be prohibitive in cost. Instead, replacement dies are made by forcing a hub or male die, made from the original steel die, into a block of die steel under the pressure of a giant hydraulic press. These rough, pressed dies are then worked over by hand by expert die makers, hardened, and cured

After plating (page 176), forks are given final polishing. Automatic machines like one below do most of work. Special chucks hold plated pieces against double, rotating buffing wheels.

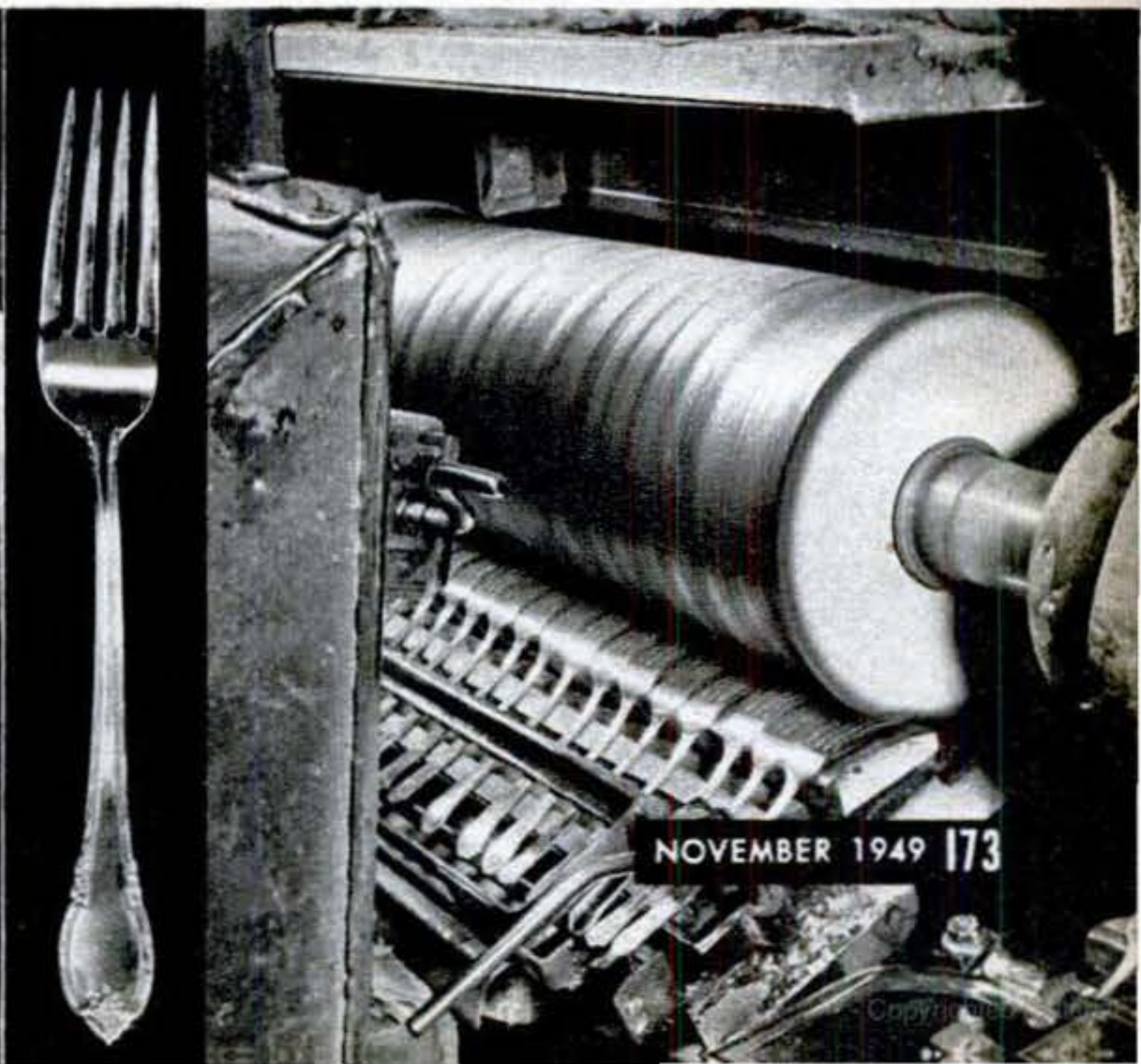
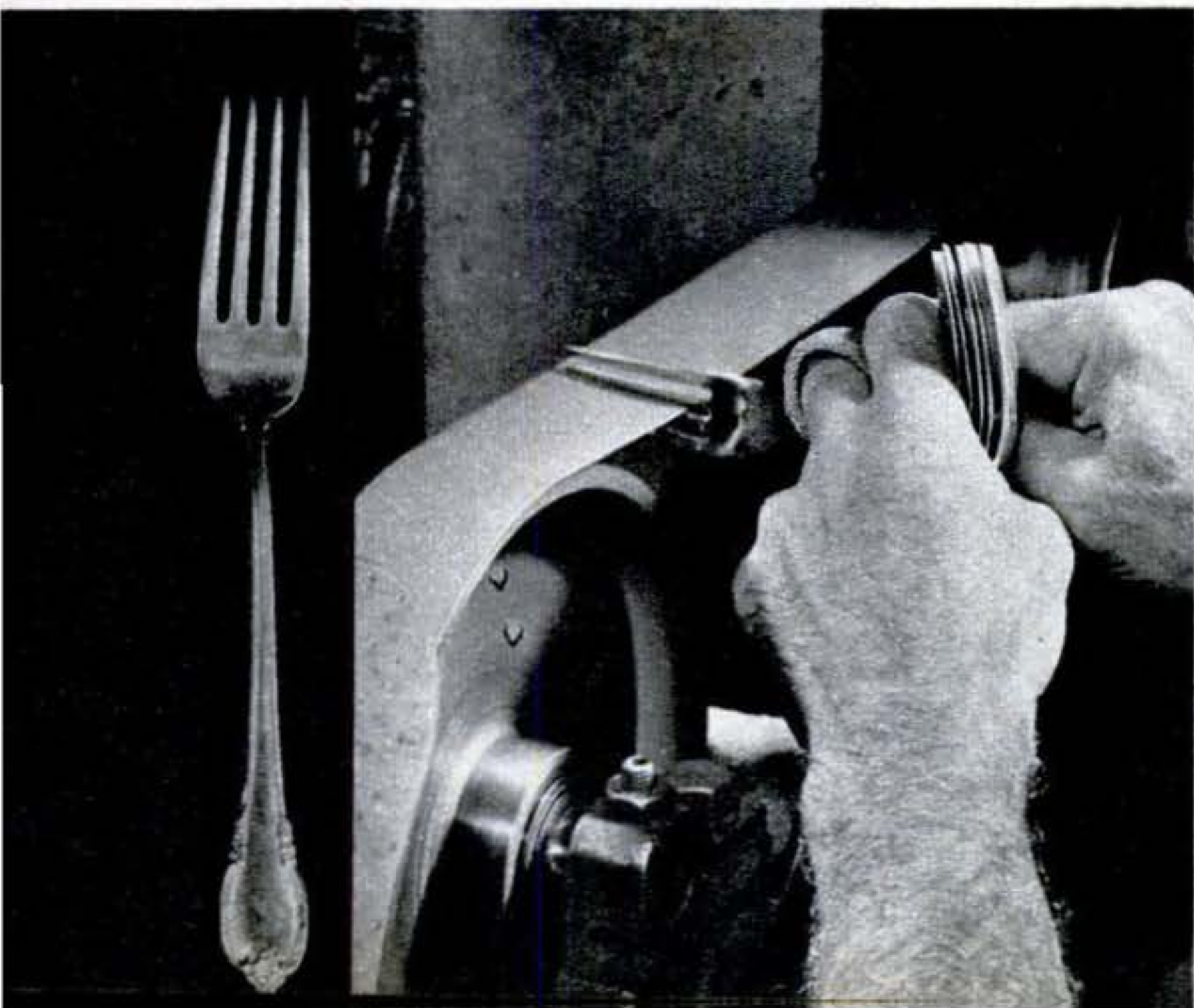

The eleven steps shown here transform a hollow metal cylinder into a knife handle.



How a knife grows. Rough cylinder for each knife handle is drawn in successive stages from hollow metal tube. After cylinder has been swaged

and stamped, design is imprinted in a drop-hammer press, the handle is trimmed and finished, the blade is attached, and the knife is plated.

before they are ready for use in the presses.

On the actual production line, knives, forks, and spoons start out in life as blanks of varying size, shape, and thickness that have been stamped out of flat sheets of nickel silver. This is an alloy containing 18-percent nickel, 18-percent zinc, and 64-percent copper. Once known as "German silver," nickel silver is the ideal base metal for plated ware. Because it is durable, easily worked, and resembles silver in color it is used almost throughout the silverplate industry.

Fifty operations after being blanked out, a short, squat, paddle-shaped blank has become a silver-plated spoon. A longer blank, after about 51 operations, has become a fork. And, after passing through some 111 operations, a round, disklike blank and some blade stock have become a hollow-handle, silver-plated knife!

\$30,000 Tanks

Before reaching the plating tanks, the blank, as it grows into a knife, fork, or spoon

In this swaging machine, cylindrical blank for handle gets first shaping. In next operation, it will be given handle shape in drop press. Note pail in foreground full of swaged handles.

Striking the design on the handle of a knife is done in a press similar to those used for fork and spoon handles. Double dies imprint design on both sides of knife handle simultaneously.

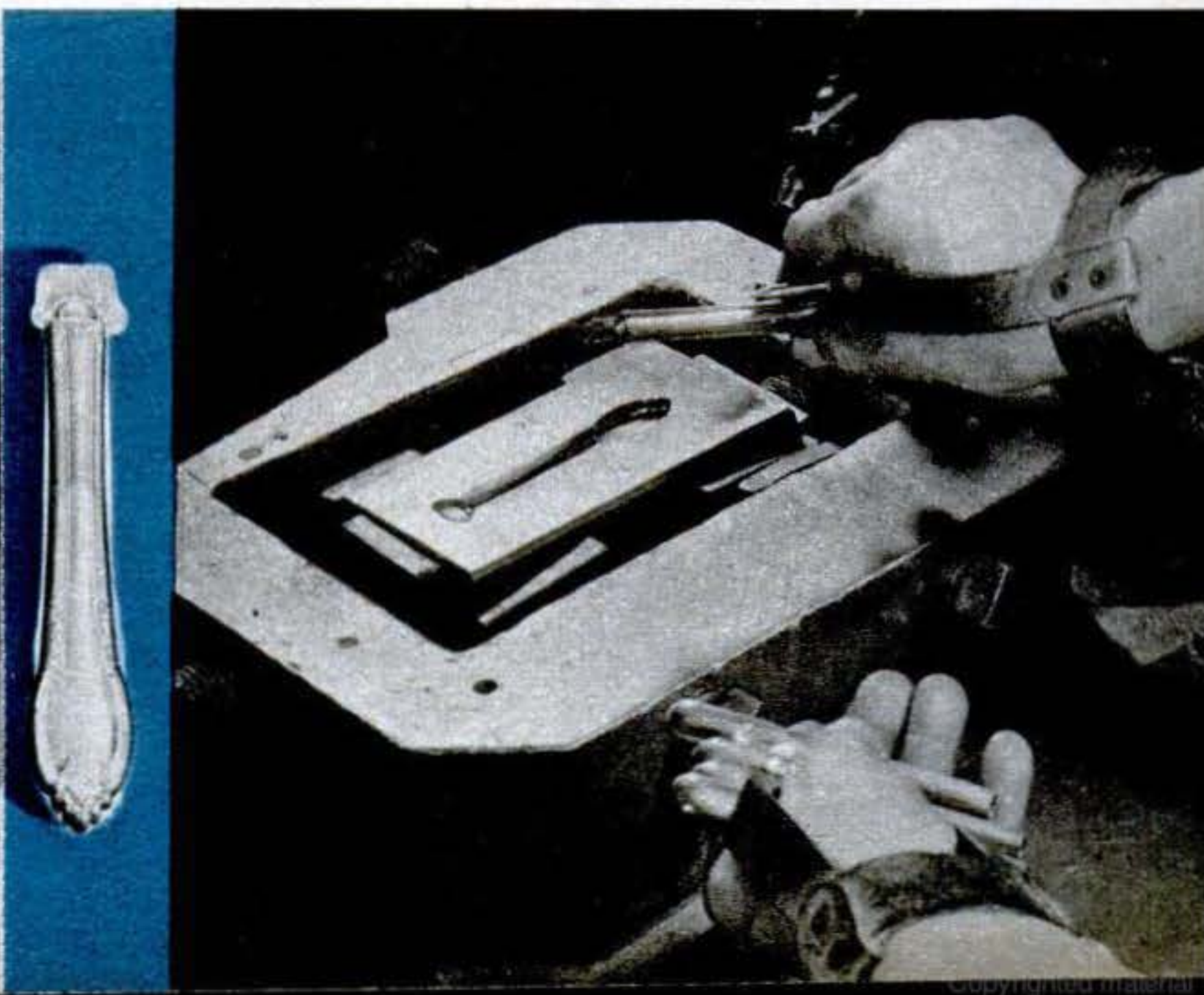
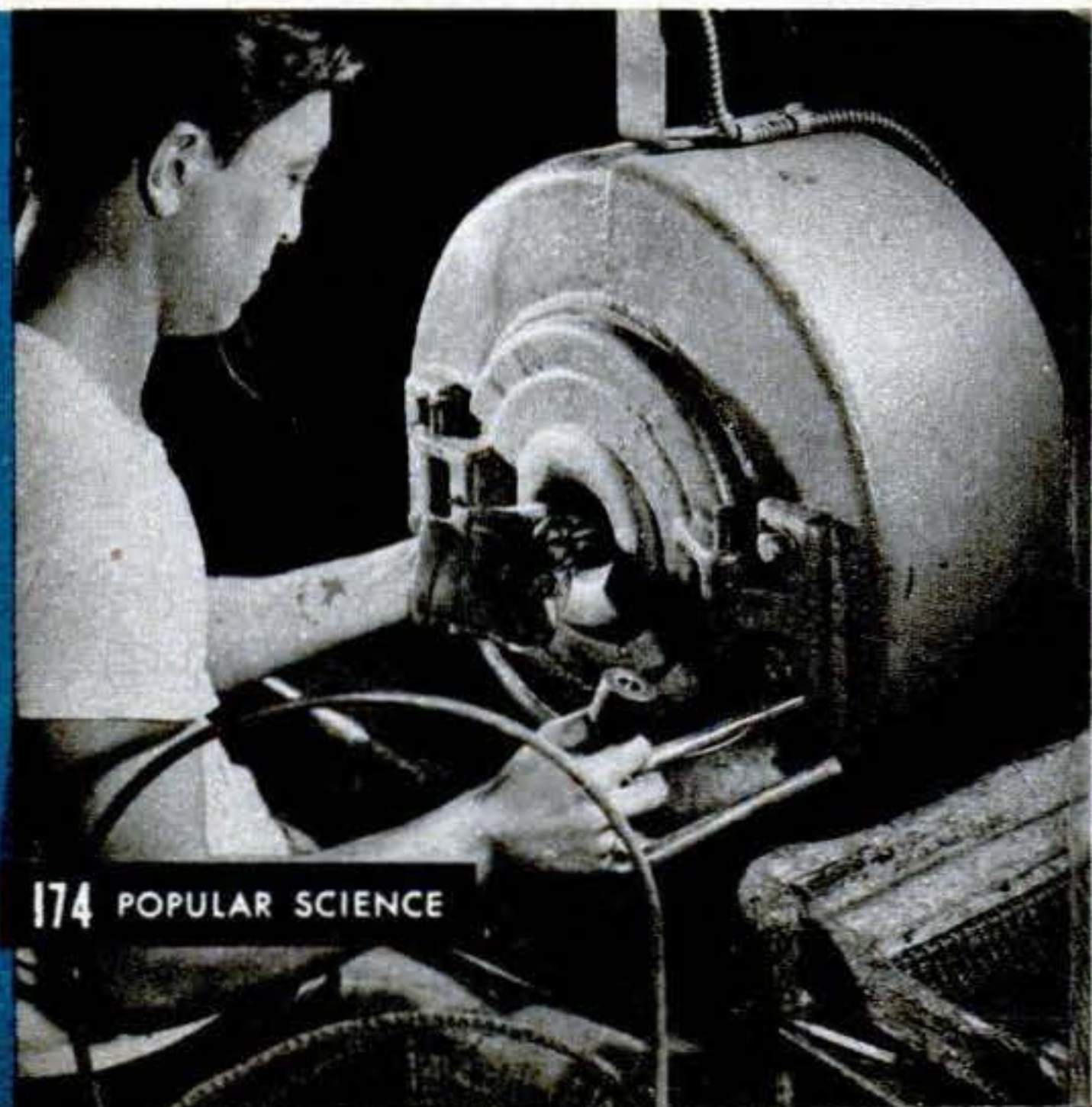

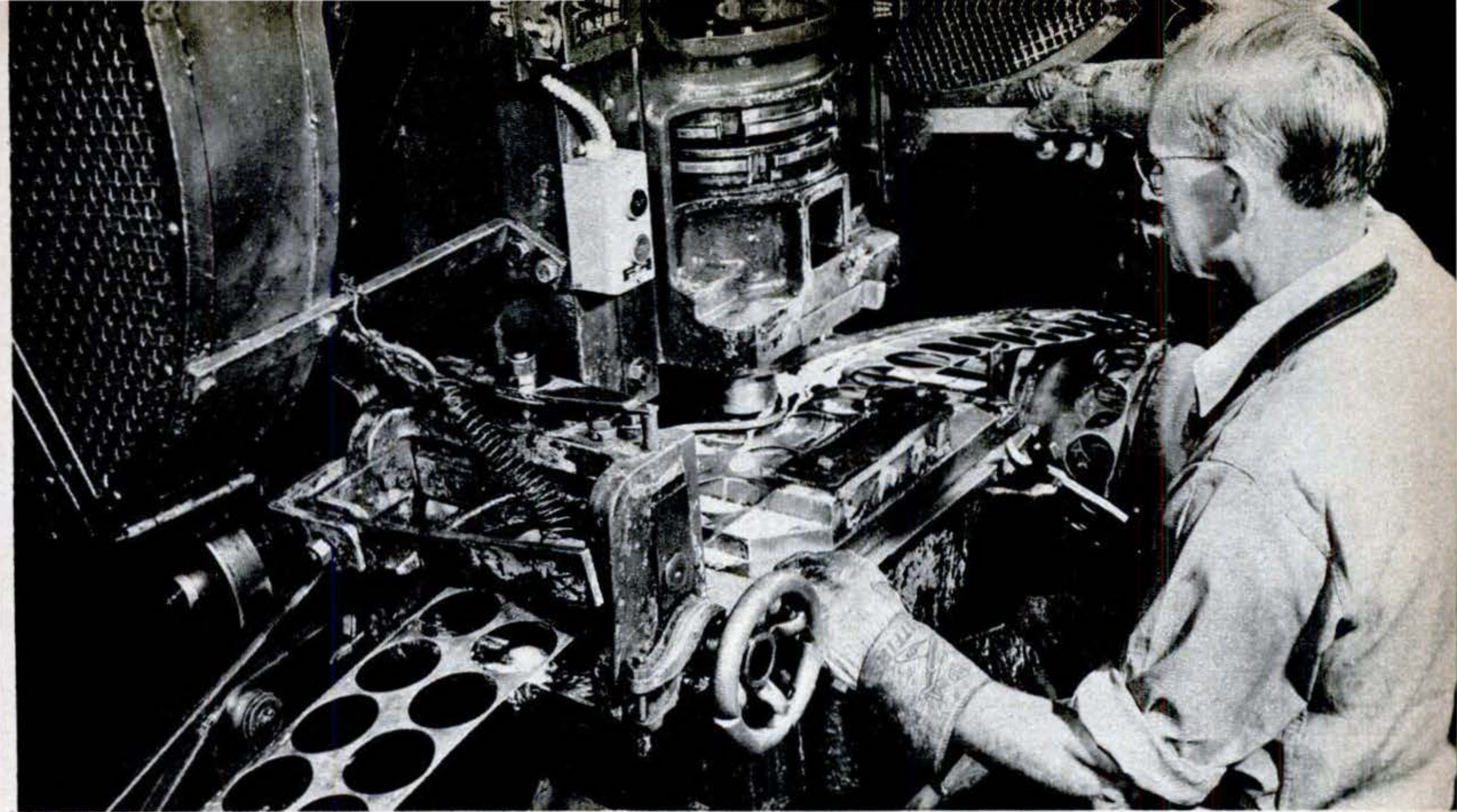

Drawing press cuts out disks from which hollow tubes for handle blanks are formed and makes first draw in one operation. Knife handles used

on most of Rogers 1847 patterns made by International Silver Co. are seamless as compared with two-piece construction normally used.

receives five general inspections plus one final inspection.

In the plating division, the blanks first are hung on racks and thoroughly cleaned in long automatic washers before they are immersed in the 35-foot-long plating tanks to receive their coating of silver. Freshly loaded with silver bars that serve as the anodes in the plating process, each of the three plating tanks contains approximately \$30,000 worth of the metal.

No precious silver is lost in the ISC plant.

Next step is assembly of knife handle and blade. Knife blade is soldered into handle in automatic machine that electronically times heat required. When solder has melted, knife (shown in jig at

When floors are washed, the wash water is collected, and the stray silver is reclaimed. When new floors are put in, the wood from the old floors is burned, and the silver is refined. Not long ago, enough silver was recovered from the wood in a floor that was being replaced to pay for the complete cost of the new flooring!

Once the plated ware has received its final luster finish by careful polishing, it never again is touched by a bare hand until it is used by the customer. All inspectors, wrap-

right) swings out and away from the heat of the flame. While solder is still soft, worker smooths joint with gloved finger the way a plumber hand-smooths a soldered pipe joint. ➡

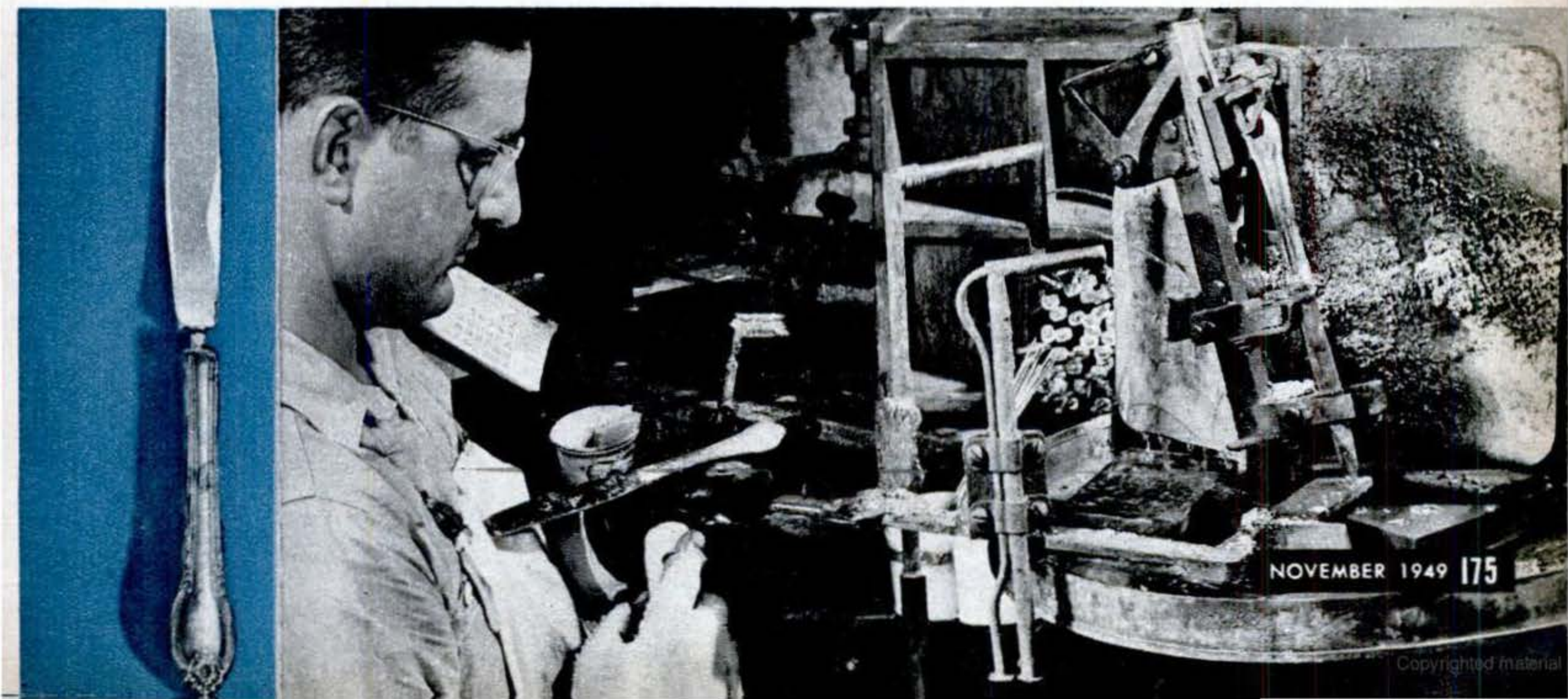

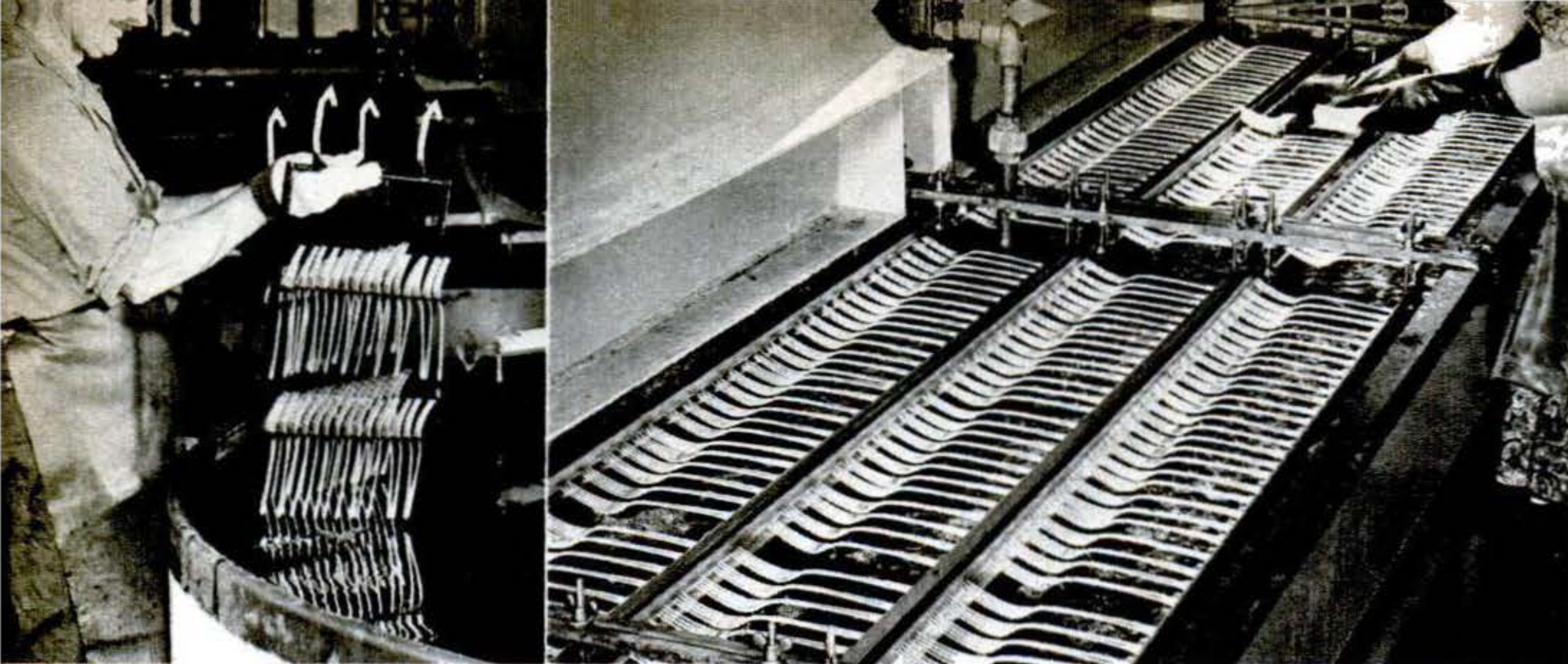

Plating operation is timed according to thickness of silverplate desired. Racks of silverware are hung on arms that carry them around 35-foot-long plating tanks (at left). For extra thickness at points of greatest wear, such as spots where utensils touch table, pieces are placed in spot-plating bath (right). Here only contact points touch plating solution.

pers, and packers wear cotton gloves to avoid the possibility of fingerprints that might damage the final finish.

Since sulfur is the arch enemy of any kind of silverware, whether plated or solid, all wrapping papers, cloths, and the materials used in manufacturing silver chests are carefully chosen for their sulfur-free qualities. By eliminating sulfur and any of its compounds, tarnish is kept at a minimum.

If you own silver-plated tableware, take care of it. If it is of good quality, it is the product of the careful handwork of skilled craftsmen. And it is coated with a silver finish that is designed to last a lifetime—and then some. **END**

Careful inspection is given finished silverware before final wrapping in sulfur-free tissue paper. Cloth is used to shield surfaces from light so that even smallest imperfections will show up. Most harmful silver-tarnishing agent is sulfur, found in coal fumes, gas, rubber, soot, and moisture from hands. Inspectors wear gloves.

How to Care for Your Silverware

THE best way to keep silver—either plated or solid—bright, is to use it. That means it is continually clean and free of tarnishing sulfur.

Don't use abrasive soaps.

Don't boil your plated or solid ware in a solution of a highly alkali soap in an aluminum pan to clean it. This amounts to a reverse plating process that will gradually remove silver along with the tarnish.

Wash frequently in hot water and ordinary soap suds and carefully rinse. Soap left on any silver surface tends to tarnish.

Wrap pieces used only occasionally in sulfur-free tissue and store them in a chest or drawer that is as nearly airtight as possible. This will keep sulfur-bearing fumes from the silver, and prevent unnecessary contacts with substances that might tarnish it.

Occasionally, silver and plated ware should be given a thorough cleaning with a good polish.

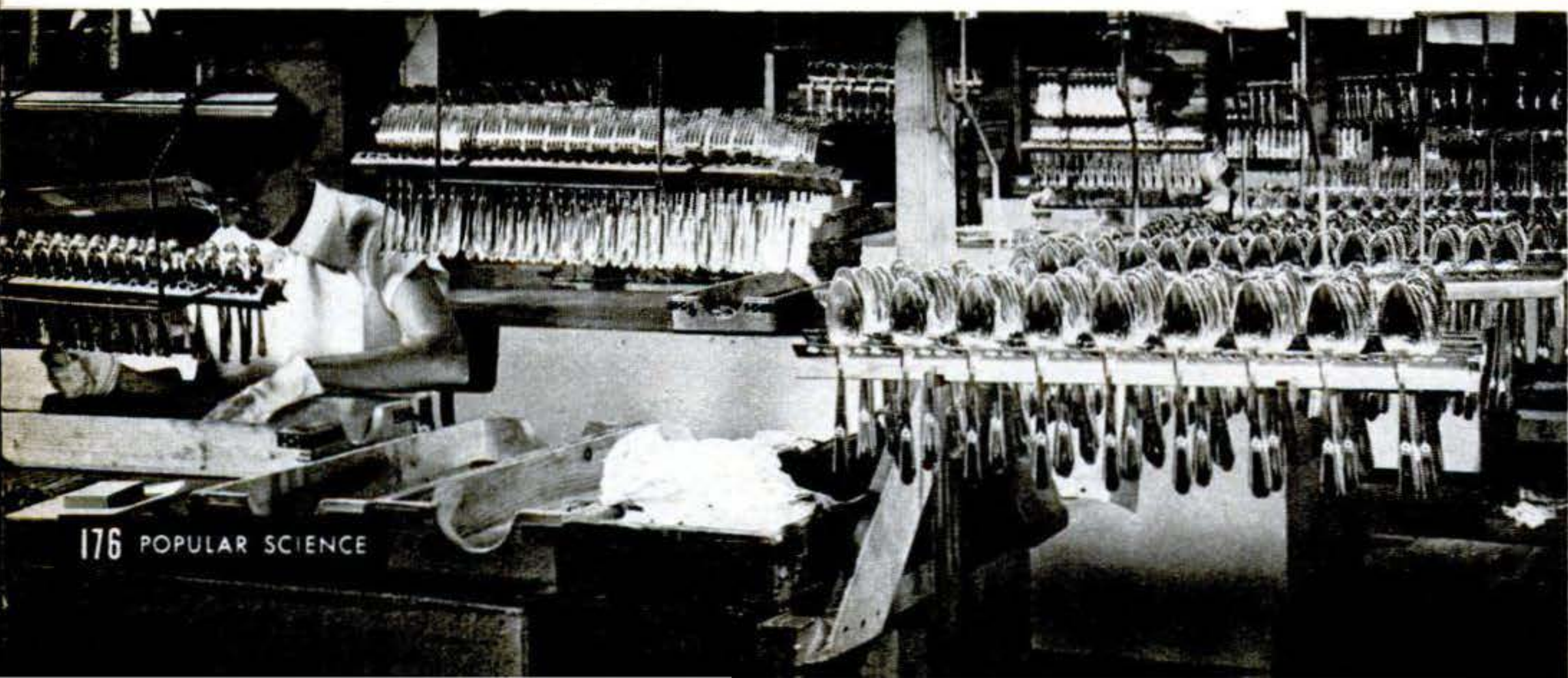

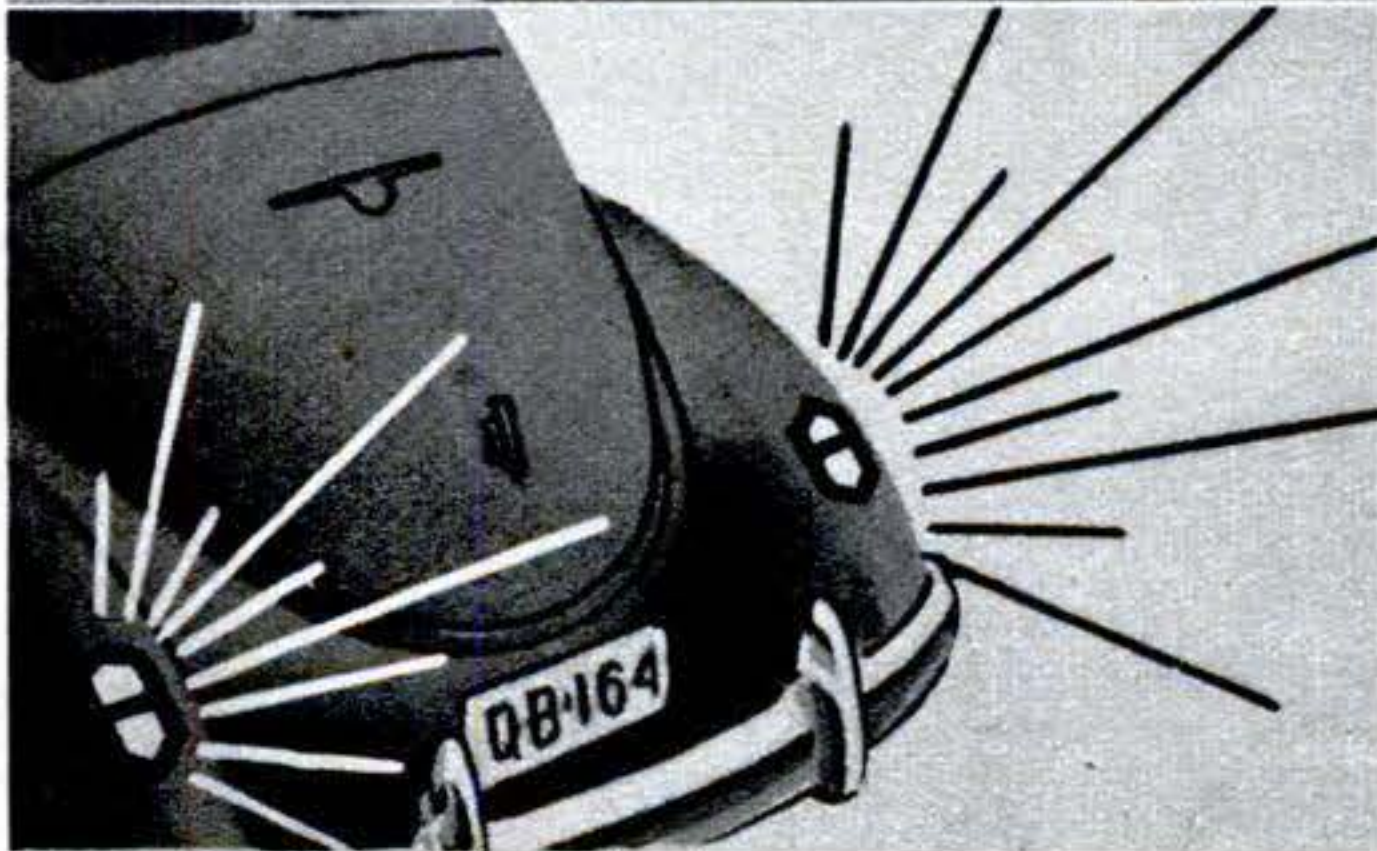
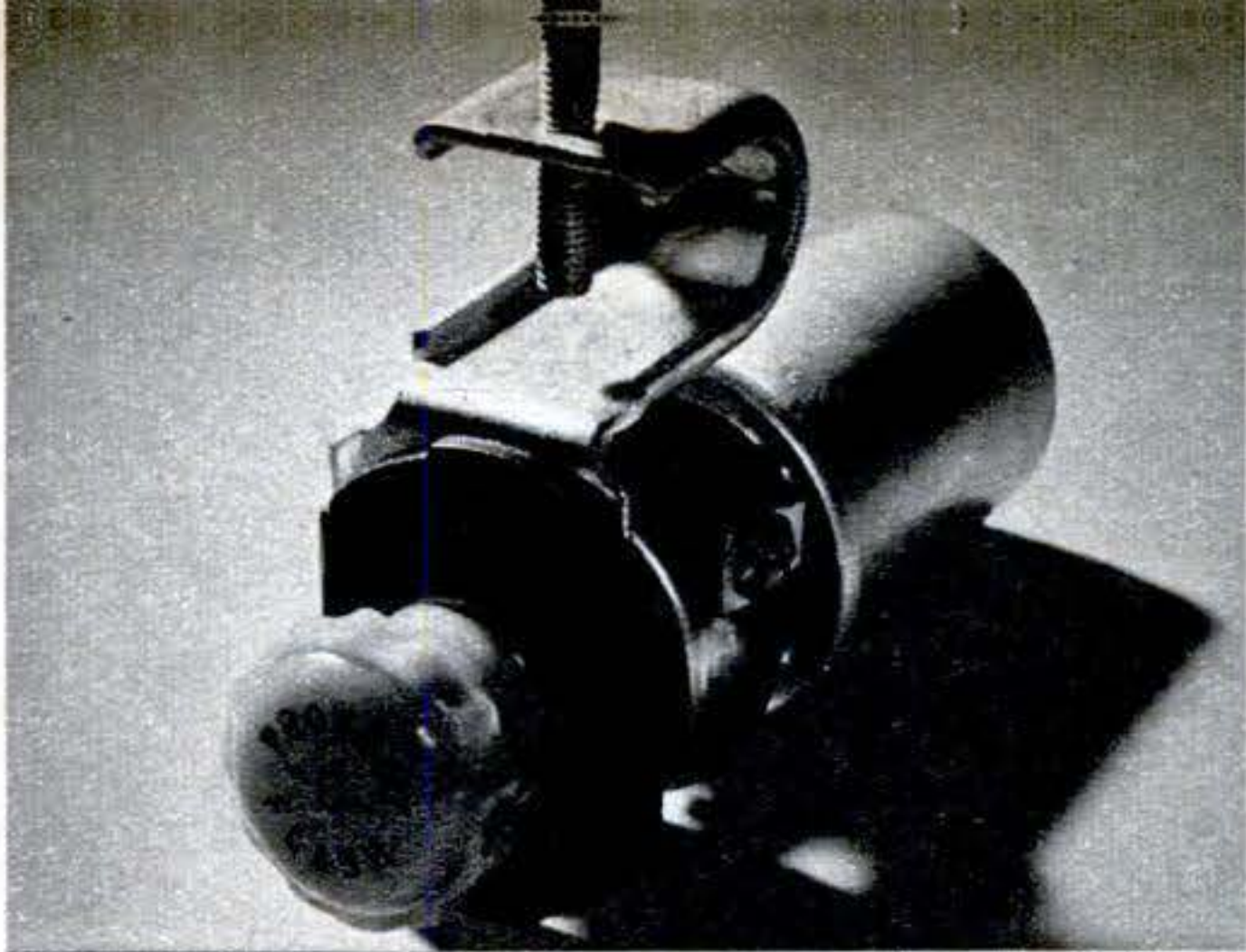

Stop Lights Flash Warning

A COMPACT unit clamped to the dashboard converts stop lights to flashing warning signals for use when you stop on a highway. Protect-O-Flash®, manufactured by United Accessories Corp., New York City, also may be connected to blink taillights or parking lamps. The dash unit includes a telltale to remind you it has been turned on.



Drains Oil in Two Minutes

OPERATING from a filling station's air line, the Jiffy Oil Drainer® empties a crankcase through an ejector tube inserted in the dipstick or oil-filler opening. Faster service and less congestion at the pits or lifts are said to result. The unit, distributed by Allen-Sims of Miami, is priced at about \$100. It weighs approximately 20 lb. and is 40" tall.



Switch Disconnects Battery

WHEN the Safety Master Switch® is pulled, the battery is disconnected from a car's electrical system—as if the battery were removed from the car. Fire and theft protection, and longer battery life, are advantages claimed. The switch, shown above, is mounted near the battery, preferably under the hood. A Bowden-wire control runs to it from the dash or from a hidden spot. It's made by R & C Mfg. of Penna., Inc., Ramey, Pa.

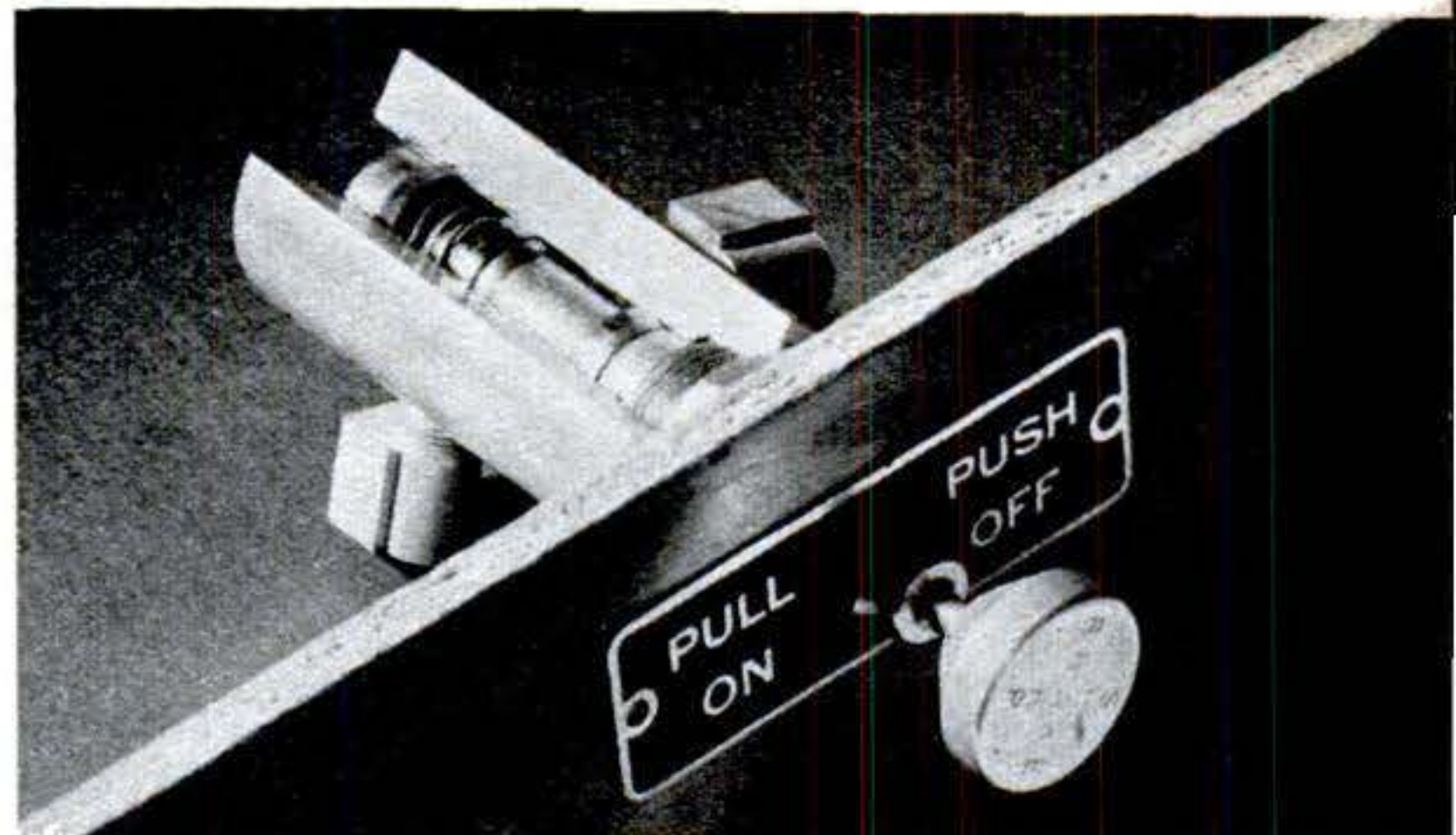

Valve Locks Brakes on Hill

INSTALLED between the master cylinder and the wheel cylinders, Sharp Brake® acts as an emergency and auxiliary parking brake. After brakes are applied, the dashboard button is pulled out. This holds fluid in the lines, locking the brakes. It holds the car for starts on hills and prevents creeping at traffic lights. Pushing the knob releases the brakes. The maker is the Sharp Manufacturing Co., of Nelsonville, Ohio.

Even a lawyer can be a wise guy when he wins too often. This case never went to trial, but Gus won a unanimous decision for Stan.



Gus Wins a Bet

By Martin Bunn

LEMUEL GASKINS, lawyer and solid citizen, stood in his garage and stared at the engine of his car.

"Hello," called a voice from the doorway. It was Bill Witte, Lem's neighbor.

"Come in," Lem answered.

"Just returning the soldering iron I borrowed," Bill said, stepping into the garage.

Gus led the way to the bench where he'd been working. One wire from a battery was bolted to the starter motor.



"Having a little trouble with the old bus?"

"Carburetor trouble. Engine coughs, spits, and misses when I accelerate."

"Could be the fuel pump," Bill suggested.

"No," Lem said with finality, "it's the carburetor."

"What makes you so sure it's the carburetor?"

"I know it is, that's all," Lem said flatly. "Want to bet?"

There's one in every town—a know-it-all guy who's always right, or at least thinks he's always right. That's the big difference between most of them and Lem. He's got the right answer 99 percent of the time.

"No," Bill replied, "I don't want to bet."

Lem's a notorious sure-thing bettor. Bill, as well as a lot of other people, knows it from experience. Lem likes to think of himself as well-informed. He uses that legal-eagle brain of his to dig up all facts on a particular subject and then he goes looking for a victim to bet with. The average guy, who picks up his misinformation from something he thinks he read or heard, doesn't stand a chance with Lem.

"I'm willing to bet anybody that it's the carburetor," Lem went on.

"Maybe so," Bill said. "As a matter of fact, I don't much care but I still think it could be the fuel pump."

"You want to bet on that?"

"No, no bets."

"I've already checked the pump. It works perfectly," Lem admitted. He picked up a screwdriver and began removing the plate over the float.

"Carburetors are pretty tricky things to take apart," Bill said. "I tried it once and wound up lugging the whole thing to the Model Garage."

"I know what I'm doing," Lem said.

"Well, good luck," Bill grinned. "I think you're going to need it. I got to go."

Lem was glad Bill left. It took him only a few minutes to discover that he didn't know what he was doing, and he didn't want anyone to find that out. He pictured himself walking over to Bill's house with a pan full

of carburetor parts and asking Bill to drive him to the Model Garage. He shuddered and put the thought out of his mind.

After he had replaced the cover plate, he tried the engine. It caught and idled smoothly but still spluttered and missed when he raced the engine. Probably something wrong with the high-speed jet, he thought. He decided he'd have to go to a repair shop after all.

By handling the accelerator very gently, he managed to make it to the Model Garage. On the way, though, he tried speeding up in hopes that the trouble would have cleared up. But each time he stepped on the gas the engine coughed and bucked.

It's the Carburetor, He Says

When he drove into the shop, Stan Hicks looked up and scowled.

"Clip anybody lately?" Stan asked. A couple of weeks before, Lem had stopped for gas and managed to maneuver Stan into a half-dollar bet that Stan lost.

"Never mind that," Lem grinned. "Something's wrong with my car. It runs all right at low speeds but when I speed up it sputters and misses. Some minor carburetor trouble. Dirt, probably. Check it but don't go trying to blow it up into a big job."

"Here's the boss," Stan said. "Tell him your troubles."

Lem repeated his story to Gus.

"Why do you think it's the carburetor?" Gus asked. "A fuel pump that wasn't working right could make an engine act like that."

Funny, Lem thought, how everyone wanted to blame the fuel pump. He was dead certain there was nothing wrong with the pump. He couldn't resist the opportunity to work up a small, sure-thing bet.

"Well," he told Gus hesitantly, "I guess you're right. It *could* be the fuel pump. But I still think it's the carburetor. What say we have a little fun out of this? I'll bet you two bucks it isn't the pump."

"Nothing doing," Gus grinned. "Knowing you, I'd say you just had the pump checked or else had a new one installed."

"No, I didn't," Lem protested. "That's the same old pump and I didn't have it checked." He realized he was skating pretty close to the line between a lie and the truth. But after all, he told himself, it wasn't a new pump and he hadn't had anyone check it. He'd just checked it himself.

"Take a seat in the office," Gus said. "Stan and I'll take the car out for a little run."

On the highway, the car ran smoothly

enough at low speeds, just as Lem had said. But when Gus accelerated, the engine began to miss. He pulled off on the shoulder and stopped. Gus raised the hood and took a screwdriver from his pocket. He held the screwdriver with the blade near one of the plug terminals. When he pulled the throttle linkage, the engine started to pick up, and then sputtered. Gus got back in the car.

"Find out what's wrong?" Stan asked.

"Not definitely," Gus admitted, "but I found out what isn't wrong. It's not the fuel pump and it's not the carburetor. The trouble is somewhere in the ignition. If you want to get your half dollar back from Lem..."

"I sure do," Stan said quickly, "and with something added, too."

Lem popped out of the office as soon as Gus drove the sedan into the shop.

"What's the matter with it?" the lawyer asked.

"I haven't checked thoroughly yet," Gus answered, "so I can't say exactly."

"It's the carburetor," Lem snapped. "I'll bet it is."

"Okay," Stan cut in, "I'll take that bet. I say it's not the carburetor. Five bucks."

Lem shot Stan a sharp glance, hesitated, and then agreed to the bet.

"It's a bet you're going to pay — for a change," Gus laughed.

"We'll see about that," Lem told him.

"There's nothing the matter with the carburetor," Gus said. "The trouble is somewhere in the ignition system."

"Says you," Lem scoffed. "Prove it."

What the Meter Shows

"That's just what I'm going to do right now. Get the low-reading voltmeter, Stan."

After switching on the ignition, Gus raised the hood and made sure the distributor points were closed. When Stan brought the voltmeter, Gus held one prod on the battery-cable terminal of the starter and the other one on the battery connection of the coil. The instrument registered a drop of only a tenth of a volt. A check of the distributor-ground connection showed the same slight drop.

"Primary circuit seems okay," Gus said.

Have you pulled off a smart one lately? We will pay for acceptable contributions showing ingenious solutions of problems in the home, shop, garage, or camp. It doesn't matter if it's wacky—if it works. Use government postcards only. Contributions cannot be acknowledged or returned.



"Why the heck don't you check the carburetor?" Lem yelled. "That's where the trouble is. You're just running up a big bill. Even when I win the bet, I'll still lose when I've paid you. I won't stand for it."

Gus grinned at Lem and went right on checking. He examined the terminals of the high-tension cable from the coil to the distributor, and then the spark-plug cables.

"Hey, boss," Stan whispered nervously, "don't forget I've got a bet on you."

"The money's as good as in your pocket," Gus answered in a low voice. "On the highway, I checked the spark with a screwdriver. When the engine is speeded up, the spark cuts out. That's what causes the missing."

"What are you two whispering about?" Lem demanded. He came around the car to where Gus and Stan stood. "Trying to cook up a deal so I'll lose that bet?"

Gus didn't answer. He just grinned and started going over the wiring again. After another minute or so, he laughed.

A Little Bare Spot

"Here it is. Take a look, Lem."

Gus bent up one of the primary wires running to the ignition coil and pointed to a tiny bare spot where the insulation had worn off. Lem looked.

"Sure," he conceded, "there's a little bare spot. But what of it? It's a quarter inch away from the engine block, so how could it cause a ground? Besides, the car runs fine at slow speeds. It's just when I accelerate that it acts up. If that bare spot caused a short, why wouldn't it do it at low speeds as well as at high speeds?"

Gus wrapped a few turns of tape around the worn spot.

"Satisfy yourself," he told Lem. "Drive up the highway. Then come back and I'll install a new wire."

The lawyer was gone almost 15 minutes.

"Well?" Gus asked him when he returned.

"No trouble," Lem admitted grumpily, "but you haven't proved anything yet and until you do, I'm not paying off."

"Leave the engine running," Gus said, "and take a look."

Lem hopped out of the car as Gus raised the hood and peeled the tape from the wire. He pushed the wire back to its original position. Then he took hold of the throttle linkage and abruptly opened her up. As the engine picked up speed, it shifted slightly on its rubber mounts and the engine block swung into contact with the wire. The engine instantly spluttered and coughed.

Payoff

"So what?" Lem demanded.

"The answer," Gus said, "is torque. That bare spot does no harm as long as the engine runs slowly. When the torque is increased by acceleration, it moves the engine on its mounts. The move is only a slight one, but it's enough to bring the block into contact with the bare spot. That causes a short. The short ends the torque. The engine shifts back. That ends the short and the engine picks up again. Watch this."

Gus led the way to the bench where he'd been working on a starter. One wire from a battery was hooked to the starter.

"Now," Gus said, "you'll see torque in action when I touch this other wire to the starter case. The force of the motor turning will roll the case in the opposite direction."

He touched the wire to the case. The motor whirred and the case twisted as it tried to roll across the bench top.

"Catch on?" Gus grinned.

"Oh, all right," Lem agreed. "You win." He was counting out five one-dollar bills into Stan's palm when a car drove into the shop. It was Bill Witte. "That makes five," Lem whispered, "and here's an extra one. In case he asks, I'd just as soon Bill thought I had carburetor trouble."

END



They look like junk, but in the hands of Leo Bertelsen these cars will get a new start in life.

Shown here are four Cords, a Duesenberg (at the left in back row), and an old Studebaker.

Good Cars Never Die

That's the working philosophy of Leo Bertelsen, former race mechanic who rebuilds many fine cars of the past.

Cords are the specialty of Bertelsen's repair shop. Although all of these cars are now at least a dozen years old, roadworthy examples still

By Murrelle Mahoney

SOME of the finest cars in the West are overhauled in an unpretentious one-man garage in San Francisco. The secret is the man who runs it, Leo Bertelsen. A mechanic's mechanic, he has an unusual knack for rebuilding high-performance autos.

Bertelsen's start in the footsteps of Gus Wilson was inauspicious. At the age of 12, he

command a stiff price. Here, Bertelsen checks over the V-8 engine of one job (left) and the front-drive transmission of another.

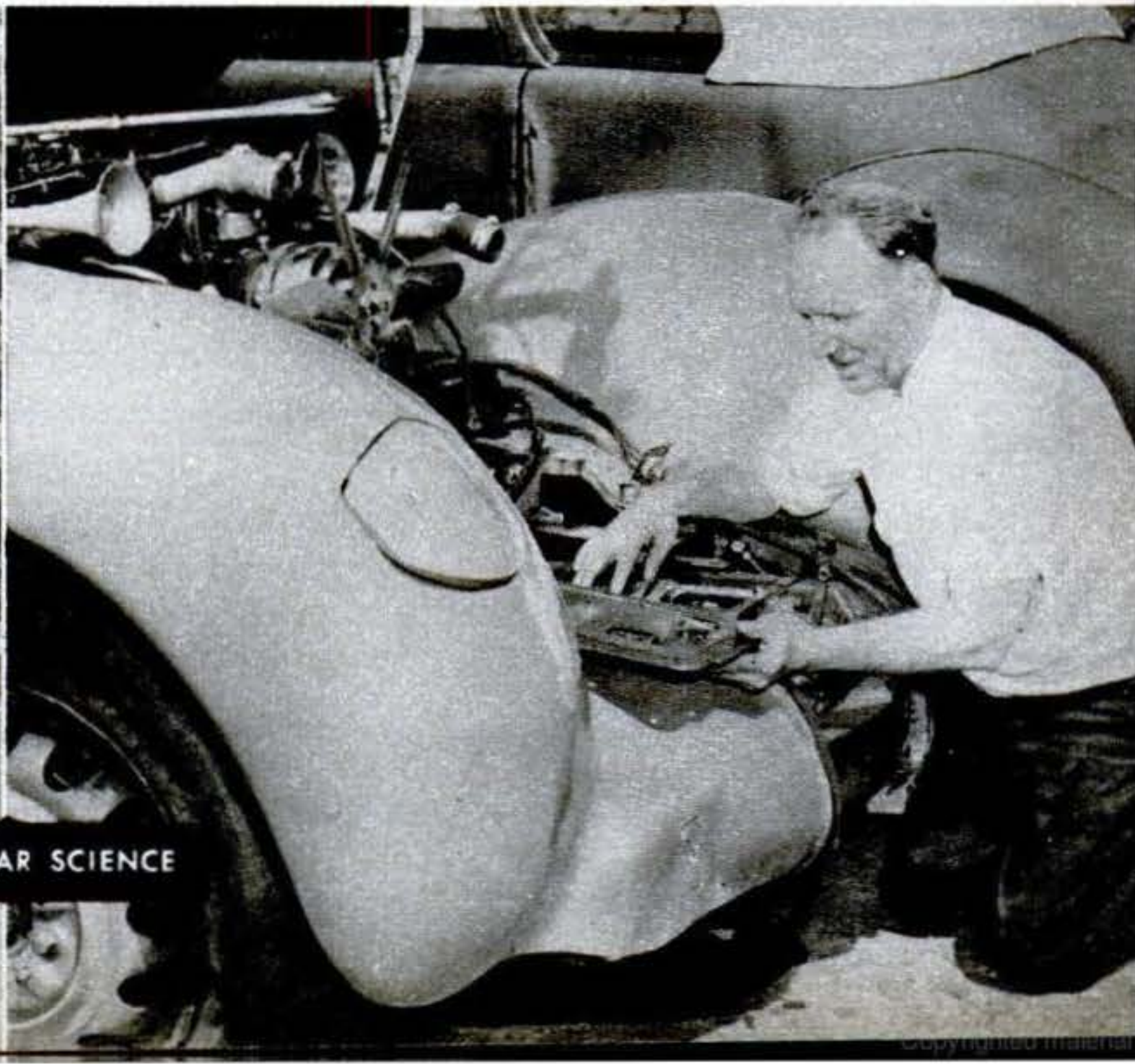
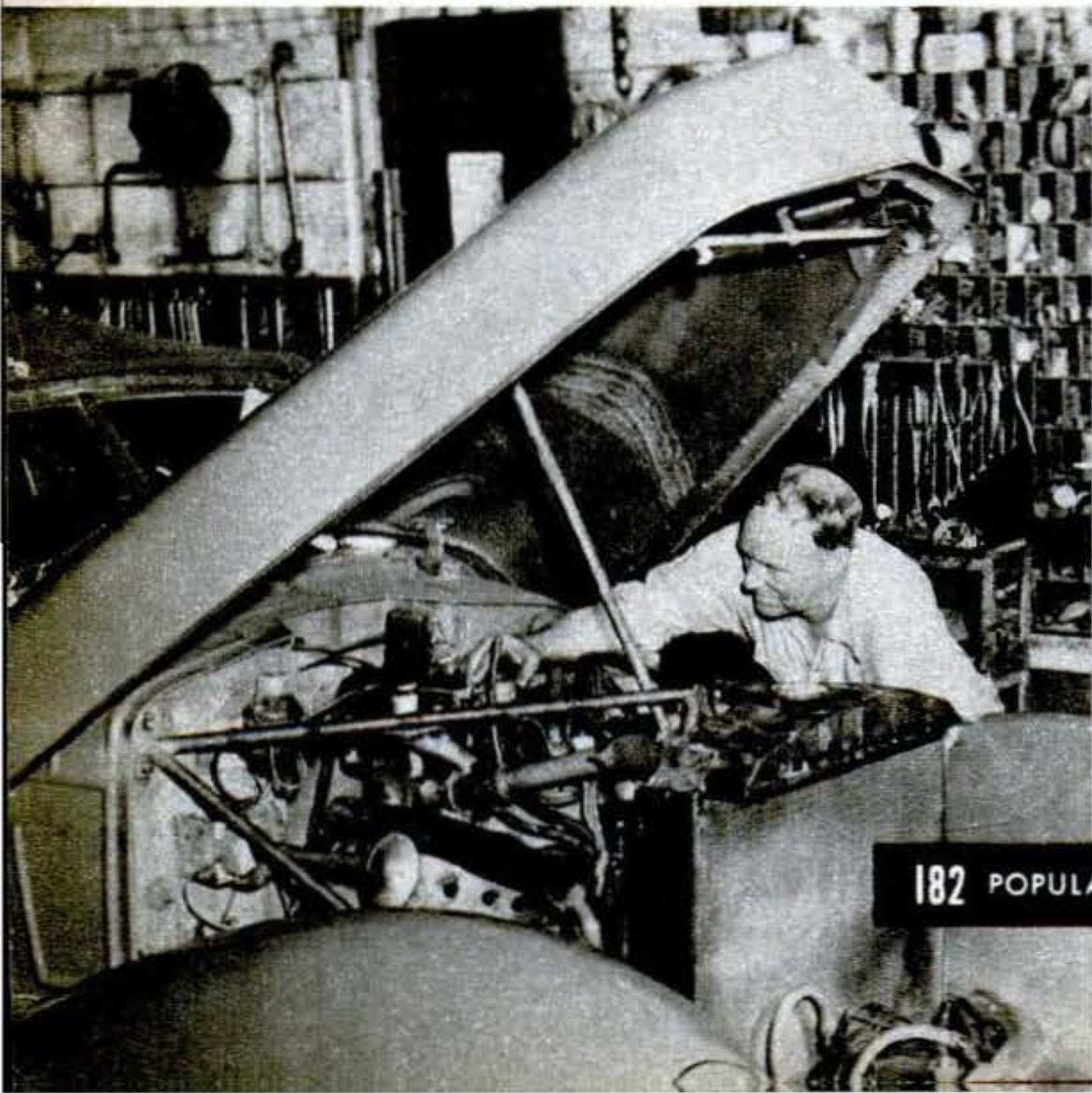

dragged a broken-down motorcycle into his living room and set out to make it run. He finally succeeded—and it promptly caught fire, burning up half the house.

This might have discouraged some youngsters, but it didn't stop Bertelsen. He has been repairing, rebuilding, and re-engineering gasoline engines ever since. In his shop you're apt to find a model of almost any high-quality car that's ever been made in America or Europe—Cord, Duesenberg, Alfa Romeo, Fiat, and Mercedes-Benz, to name just a few. Some look like junk. A few are museum pieces.

But whatever their condition on arrival, chances are they'll take the road again—or at least all except the few that Bertelsen must tear down to build up his stock of spare parts. But Bertelsen doesn't rely entirely on such spares. He resorts to a lot of improvising too.

Duesenberg Is His Pet Project

When a Duesenberg comes in, it's like old home week for Bertelsen. And for good reason. During the Twenties he worked as mechanic for a Duesenberg racing team that set a number of speed records.

After this experience, it's easy to understand that Bertelsen would choose a Duesy as his personal car. At present it's not on the road. It's still torn apart, as it has been for nearly two years. It's Bertelsen's pet project for spare time—and there isn't too much of that.

Bertelsen believes this car may do close to 200 m.p.h. when he gets it in running order. He has rebored the cylinders from 3 $\frac{3}{4}$ " to 3 $\frac{7}{8}$ ", chromed the cylinder walls, and plans to use

Mercedes-Benz stands ready for the road again after a Bertelsen repair job. Combining the names of two famous European manufacturers,



Foreign cars find a ready sale when Bertelsen reconditions them. The prewar B.M.W. above has a six-cylinder overhead valve engine.

high-domed pistons of special design. Sodium-cooled valves of the largest possible size are to be used and all ports have been highly polished and chromed. To reduce friction, the wrist pins and con rods run on roller bearings.

Because of the increase in horsepower, the Duesenberg transmission might not stand up. For this reason, Bertelsen will install a five-speed bus transmission.

All of this, however, is just play for Bertelsen. His major business is rebuilding Cords. He buys up practically all of these he can and reconditions them for resale. Orders far exceed the supply. At one time recently, he had orders for 12 convertibles. ▶

this supercharged car is said to do about 120 m.p.h. A pointed radiator shell has been a Mercedes styling characteristic since 1910.

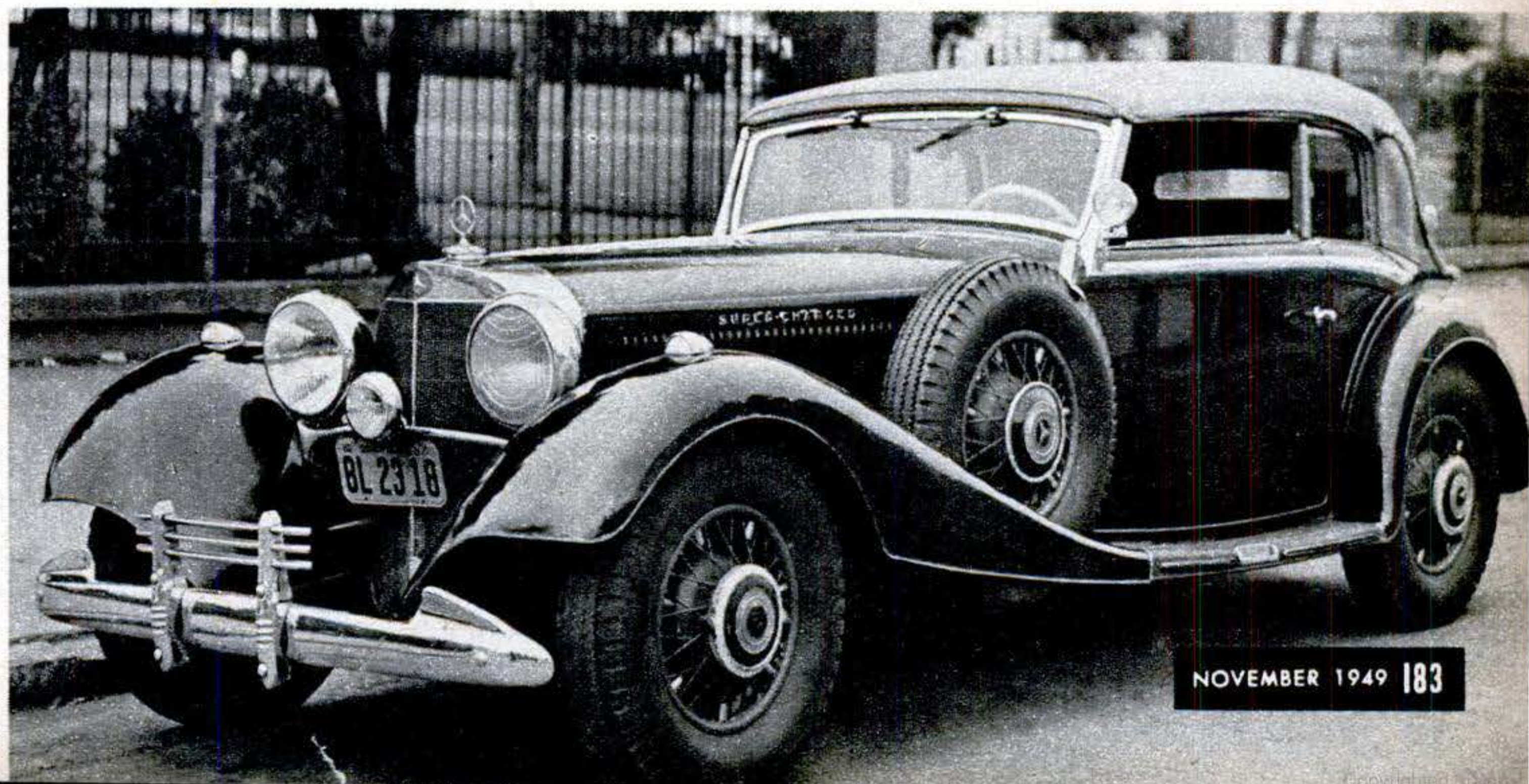

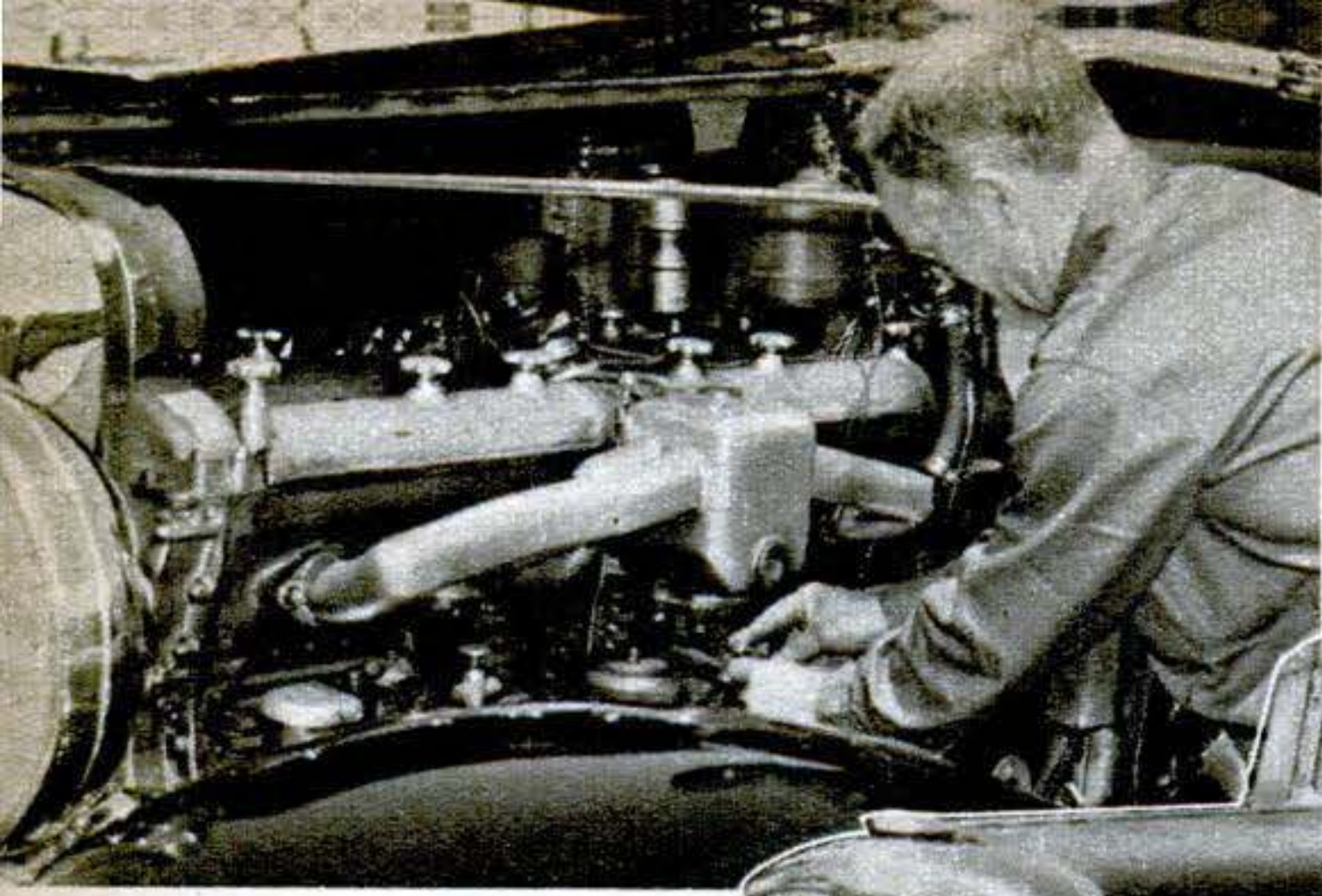

Duesenberg roadster below cost \$36,000 when built as a special job in 1937. At left, Bertelsen adjusts its carburetor after a recent overhaul. Just above his hands you can see the carburetor warmer, one of many unconventional features found in the Duesenberg Straight 8.

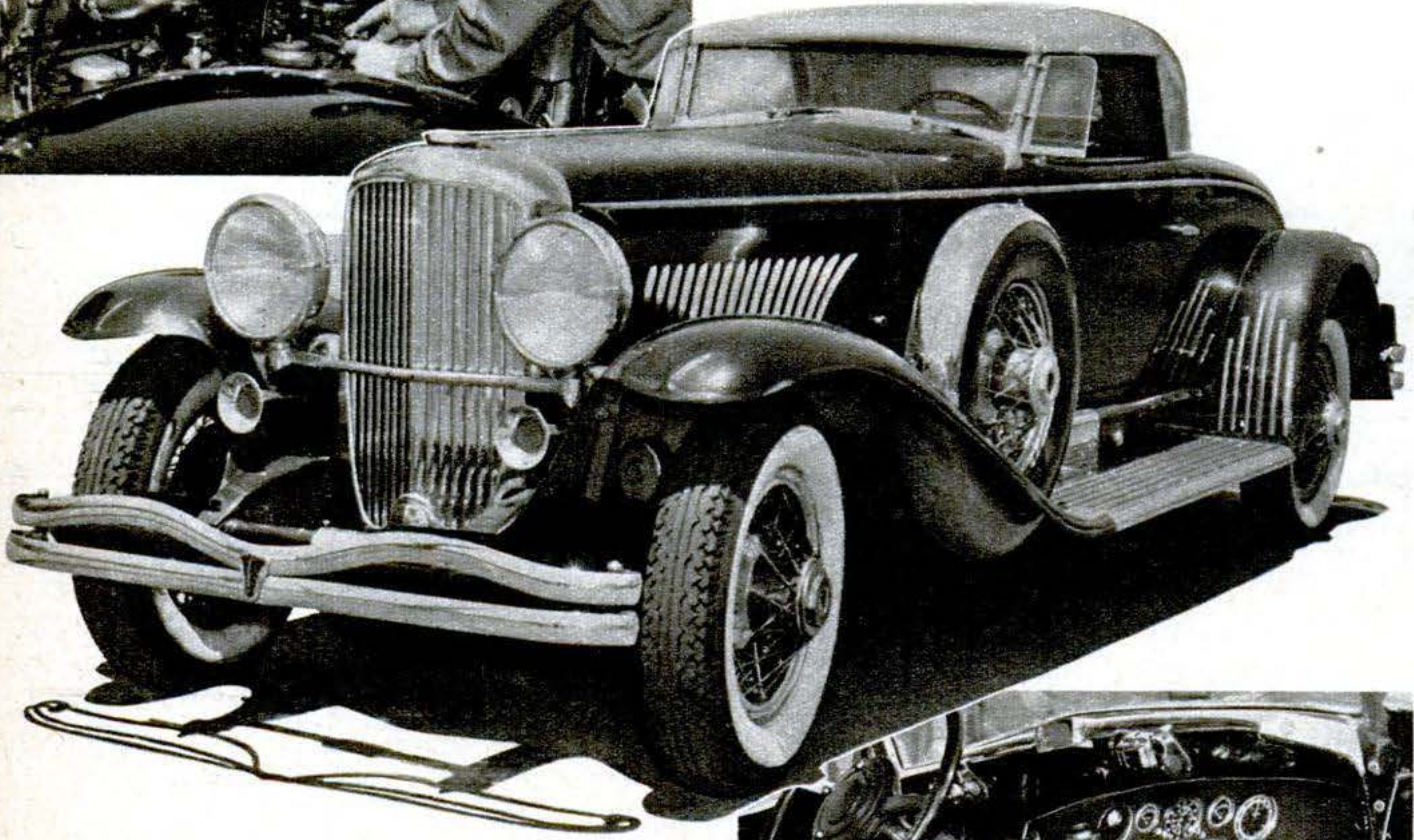

The Cord electric gear shift often gave trouble, but Bertelsen believes he has licked this. With the help of an electrician, he made a blueprint of the intricate wiring that controls the gears. After considerable study and trials, he succeeded in reducing the wiring by approximately half. His system now gives immediate and positive gear control when the driver operates the lever.

Other improvements include a redesigned universal joint and substitution of needle bearings for the bronze bushings on all the transmission gears.

END

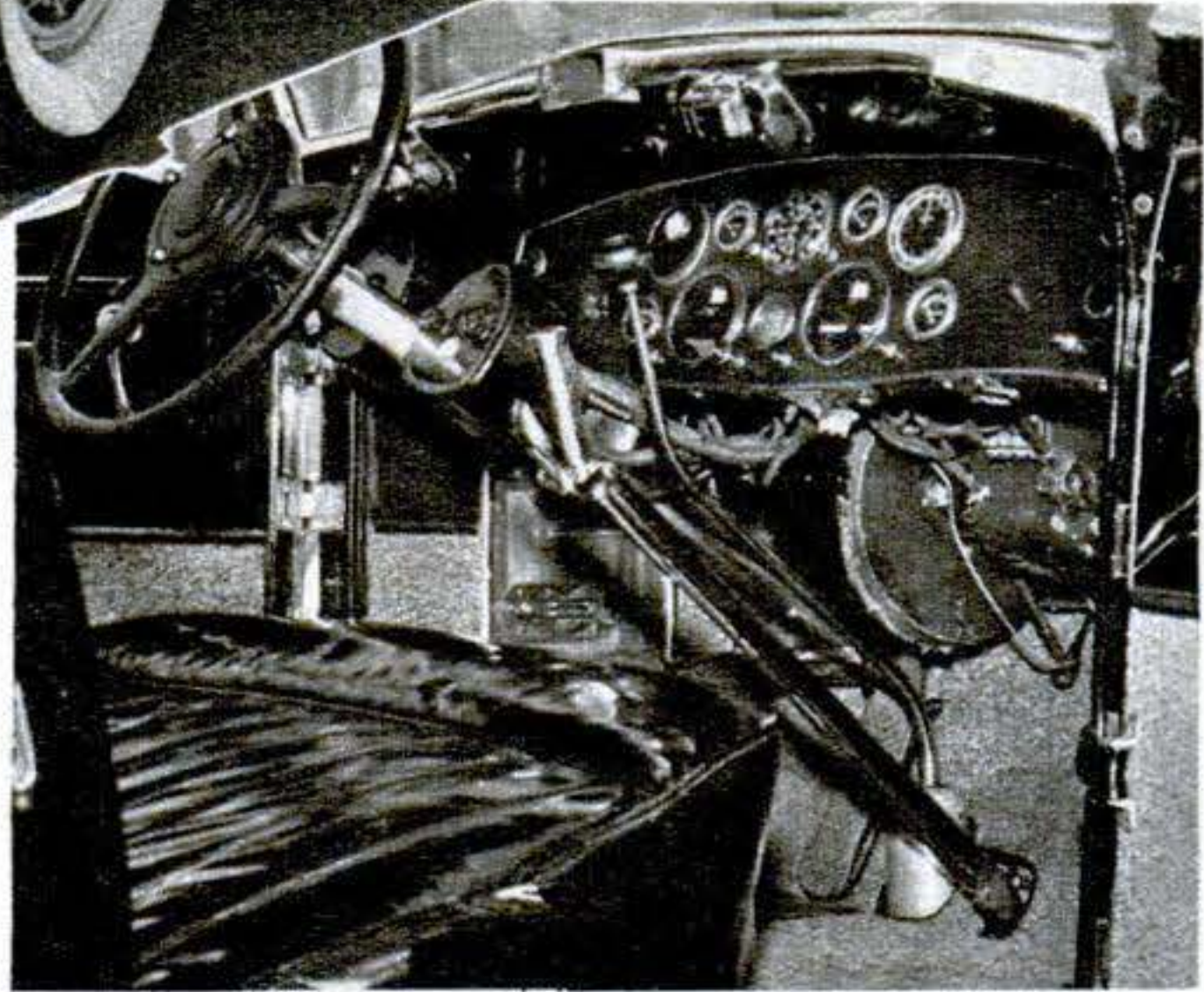

Dashboard indicators on a Duesenberg tell you just about everything, including the altitude. A light signals when you need crankcase oil.

A Mercer engine of unique design is owned by Bertelsen. It was manufactured in 1916 for racer Eddy Pullen.

Marmon V-16 engine undergoing overhaul is an example of huge power plants sometimes used in the old days. Note two carburetors and plated tubes for distributor wires.

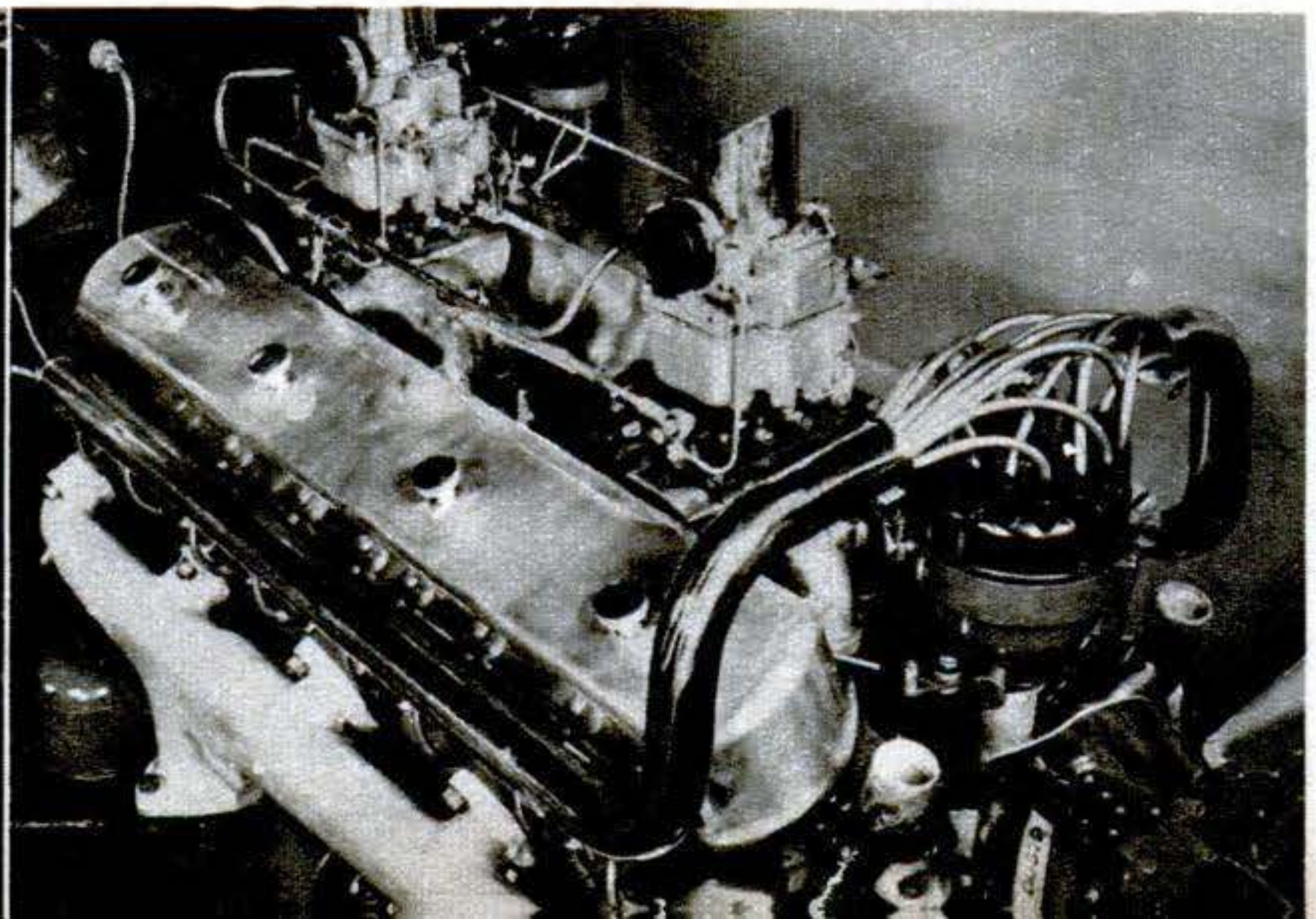
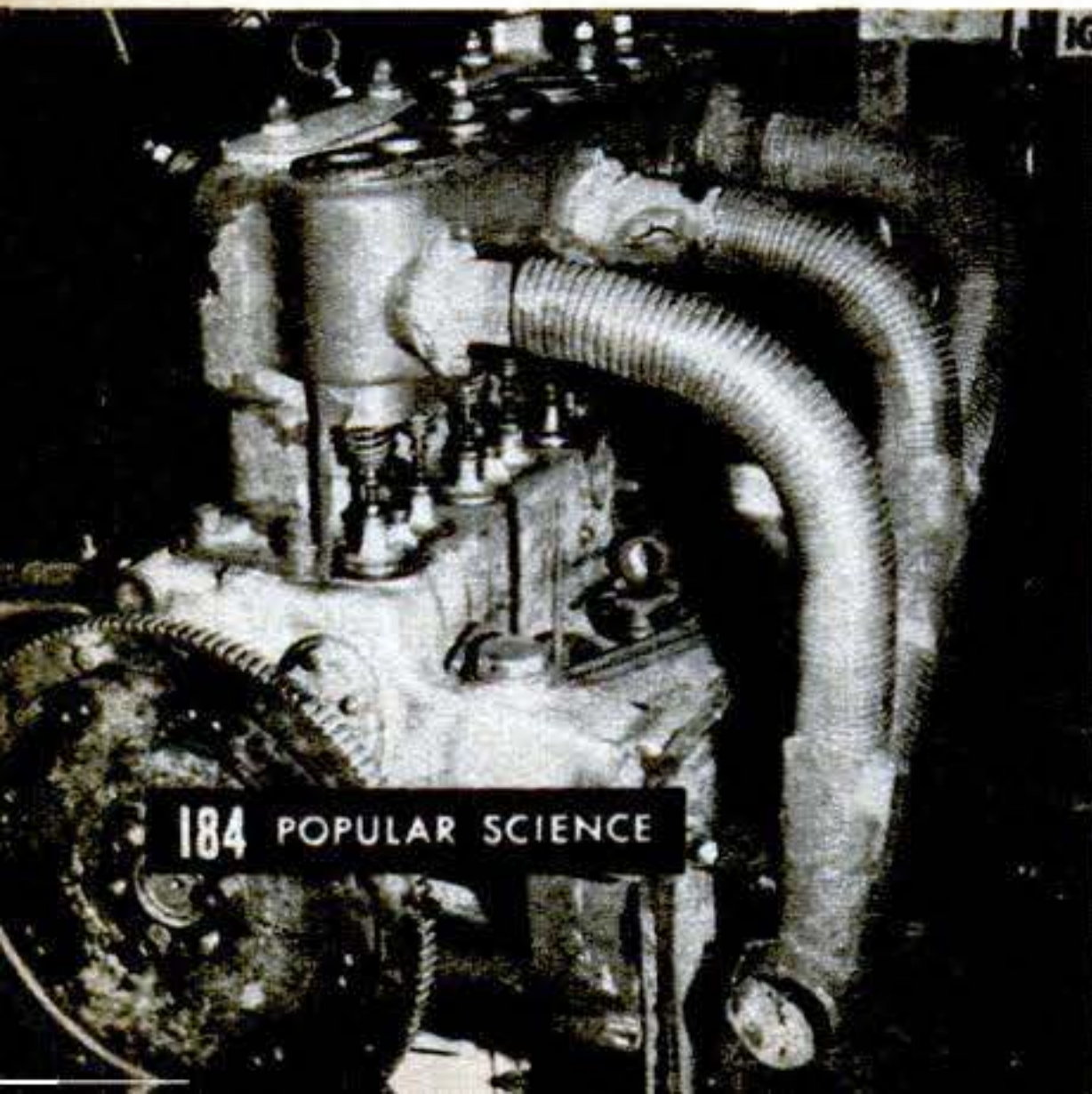

Mechanics and Handicraft

REG. U. S. PAT. OFF.

A Bulldozer for Christmas

PAGE 186

Making a Mixer Easy to Use

PAGE 192

Hints from the Model Garage

PAGE 205

Backstage in a TV Tube

PAGE 209

How to Stop Wasting Fuel

PAGE 235



When Anton Bohaboy
builds a model boiler, it steams.
Turn to page 212
for step-by-step photos.

Want to Run a Bulldozer?



Every sidewalk superintendent from 7 to 70 hankers to get his hands on this job. Here are full directions for making it.

*Make it Now
for Christmas*

By Andre C. Lampert

THAT baby bulldozer cavorting on the floor at the left performs all the maneuvers of the real thing. What's more, it does them the same way. By working controls that correspond to the standard ones on a regular bulldozer, you can make it climb hills, dodge obstacles, bulldoze small objects, haul a load, and start, stop, back up, or turn on a dime.

"More fun than an electric train," you and the kids will say. (When you give it to Junior, better get yourself an extra set of batteries so you won't run his down.)

Here's how to make it:

Drive. You need two identical worm-and-gear sets. As these will determine dimensions, you'd better get them and the motors first. The gears I used came from the oscillating mechanisms of two old electric fans. They have a 1 to 44 ratio (the worm makes 44 turns while the other gear makes one). Similar sets for model locomotives can be bought at hobby shops, but don't settle for a ratio lower than 1 to 40.

The motors are the permanent-magnet DC type in a plastic housing. They should

be identical to run at the same speed. Put them down close together and measure the center-to-center distance between their shafts. This will be the spacing of the worms in the drive frame, which is bent up from stiff copper or other sheet metal. The pattern given is only approximate; you'll have to space the holes to suit your gears. It pays to be finicky here, even if you have to throw away your first frame and make another; for unless the gears are well meshed, they'll be power thieves.

For the front-end bearings, solder short bits of brass tubing into the frame. Washers fore and aft help reduce friction.

Into the outer face of each gear, drill a hole $\frac{1}{4}$ " from center and solder in a short stub of $\frac{1}{8}$ " rod as a drive pin. Then solder the gears to separate short shafts. Slip them into bearing tubes in the frame and secure by a washer soldered to each shaft inside. Be sure they don't touch each other at any point; the two shafts must revolve independently. The gear sets should work equally freely. If they don't, a little judicious bending of the frame may help.

Chassis. Check the dimensions of your motors and drive frame before starting. Cut two sides to the outside lines in the

Motors are permanent-magnet type that require direct current. Four flashlight cells in box

provide juice. Two big doorbell dry cells will give same performance, and will last longer.

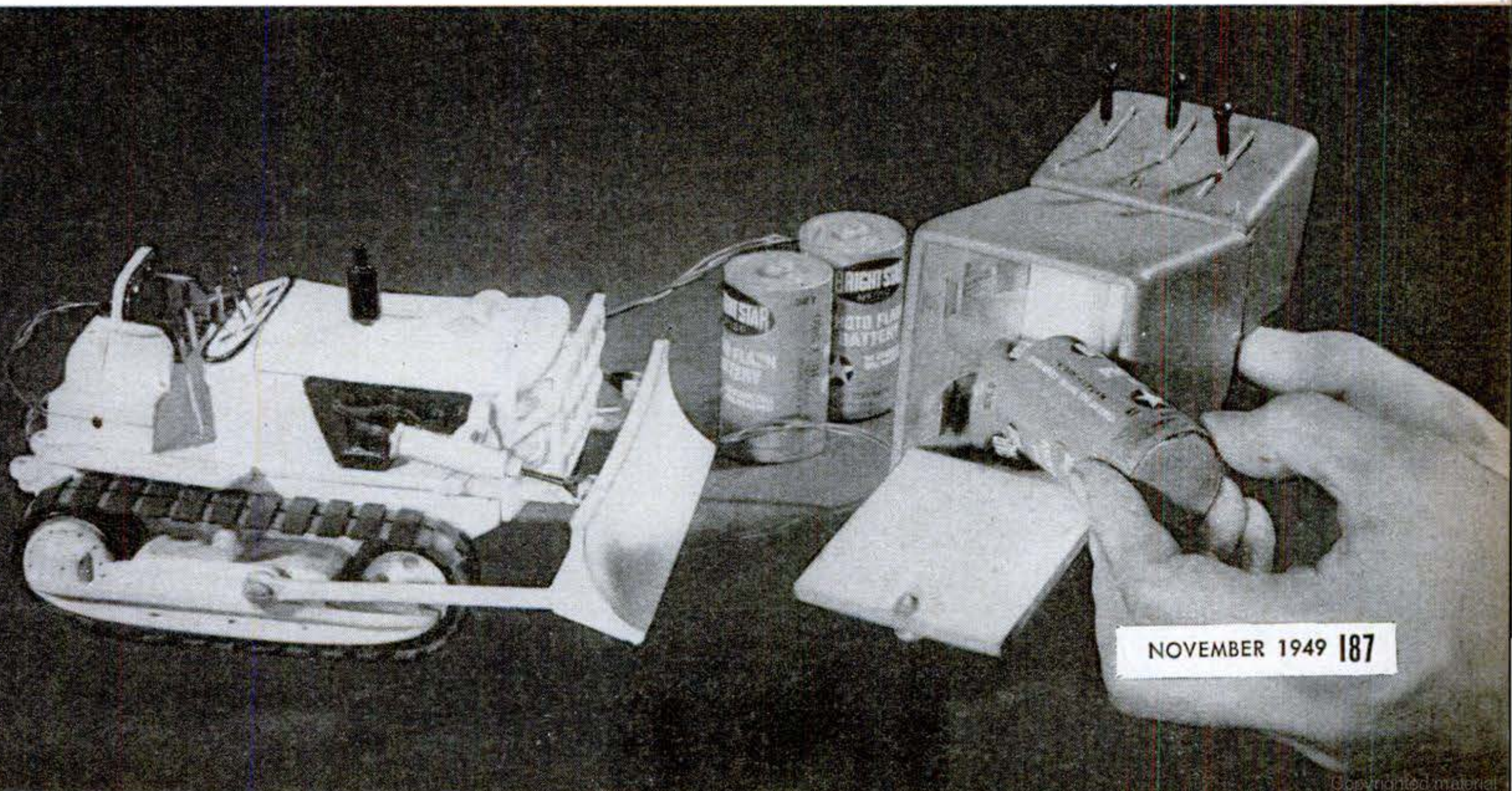

drawing. Between them cement the bottom, sloping front, and crosspieces at both ends. At the rear there's a centered block to which two rounded cheeks are glued. Cement $1/16''$ sheet from these to the chassis sides to form rounded ends.

Motors can rest flat on the bottom, their bases slipped under balsa pieces cemented to the sloping floor. Two machine screws through the bottom anchor them at the rear. The gear frame may have to be shimmed up with balsa to give the gears bottom clearance and to center them with the drive wheels. If worm and motor shafts don't line up, cement shims under one or both to raise or slant them into alignment.

If you haven't a lathe, you can whittle the drive wheels from pine, mount them on a bolt, and spin in a hand or electric drill to smooth them up with sandpaper. They'll work even if not 100-percent true. Notch the rear ones for better tread grip.

Where the rear axles go through the chassis sides, cement hardwood buttons inside and out and install short bits of tubing for bearings. Bend a $3/8''$ leg on a piece of $1/8''$ rod, solder on a small washer, and insert in the bearing from inside. Cement the drive wheel on the shaft and solder on an outer washer, also cemented.

The front tread wheels are bushed with bearings and should turn freely on an axle cemented to the body with hardwood spacers between. Three idler wheels on each side run on $1/16''$ wire axles pushed through the chassis just above the balsa bottom. The rims of these wheels come $1/8''$ below the others.

Treads. Cut two $1/4''$ by $12''$ strips of inner-tube patching rubber for each tread. Remove the cloth backing and lay them $1/8''$

Control box is detachable from battery case. Straps on latter touch spring contacts on open back of control unit. Don't put on the handles until top of case is in place.



HALF PATTERN OF DRIVE FRAME

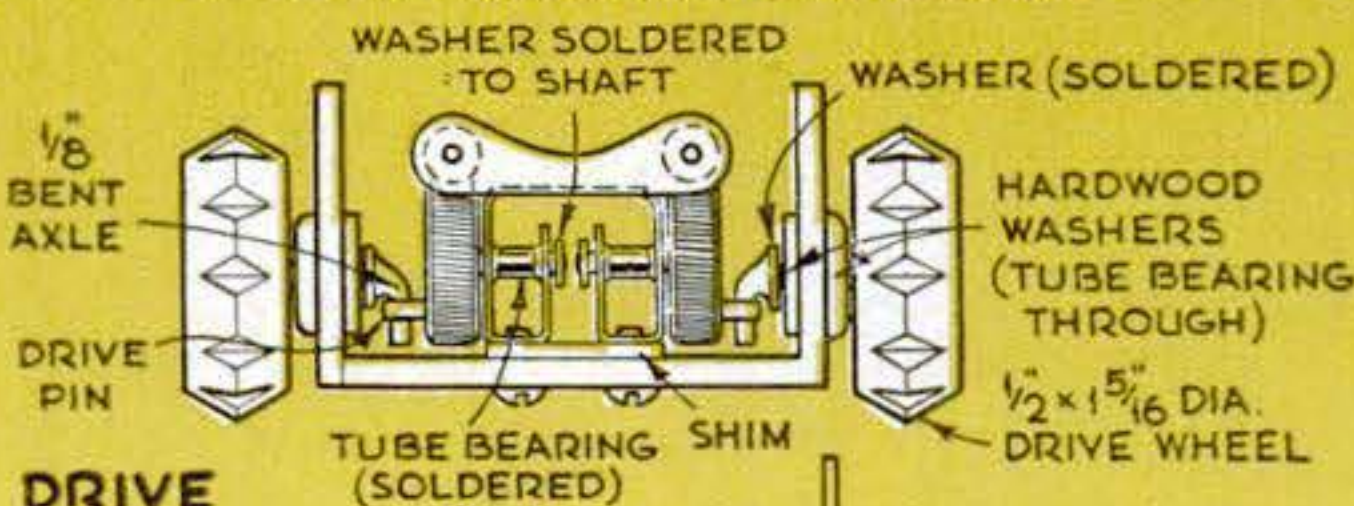
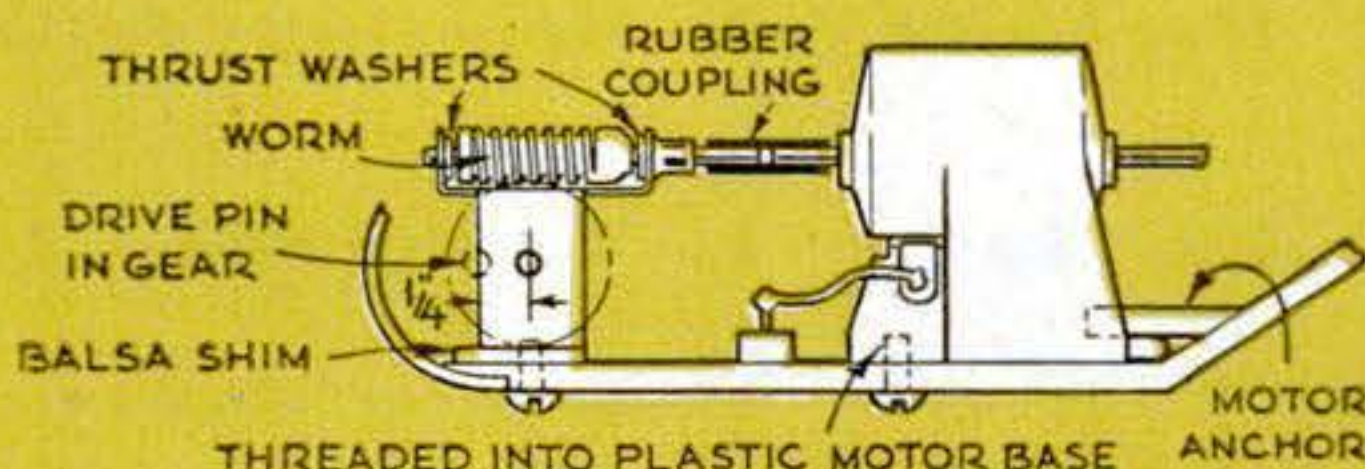

DRIVE

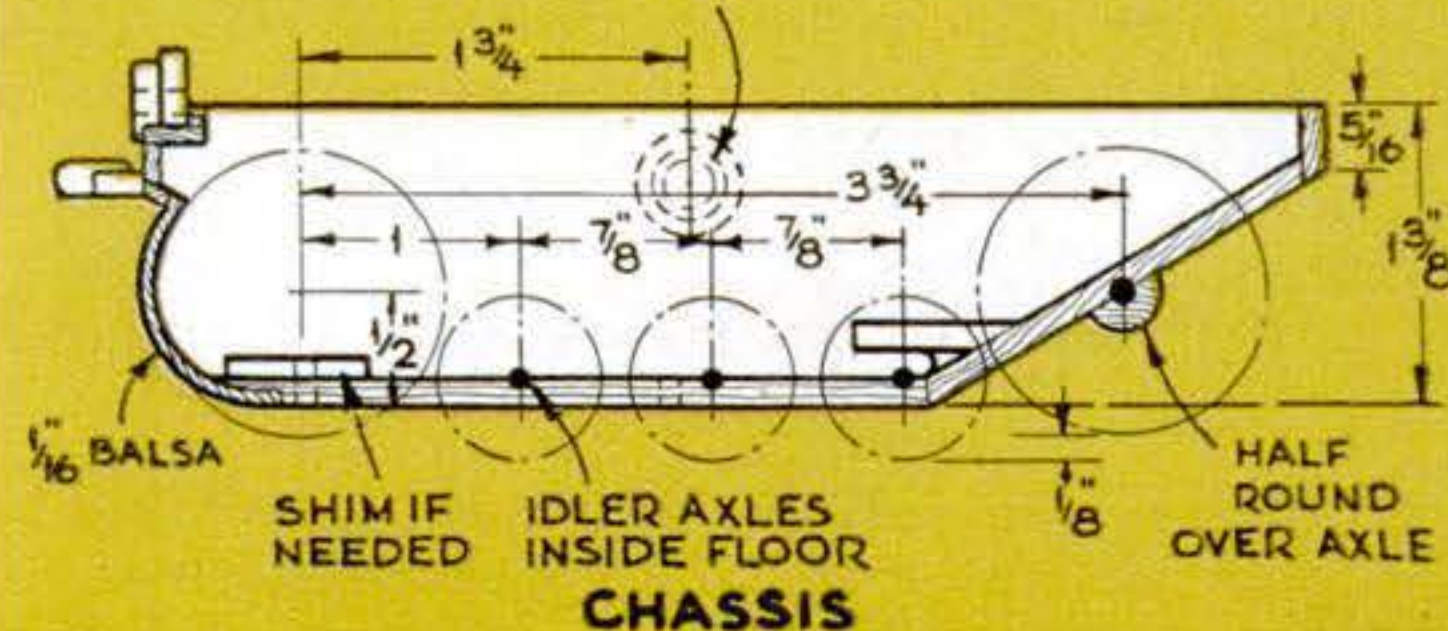
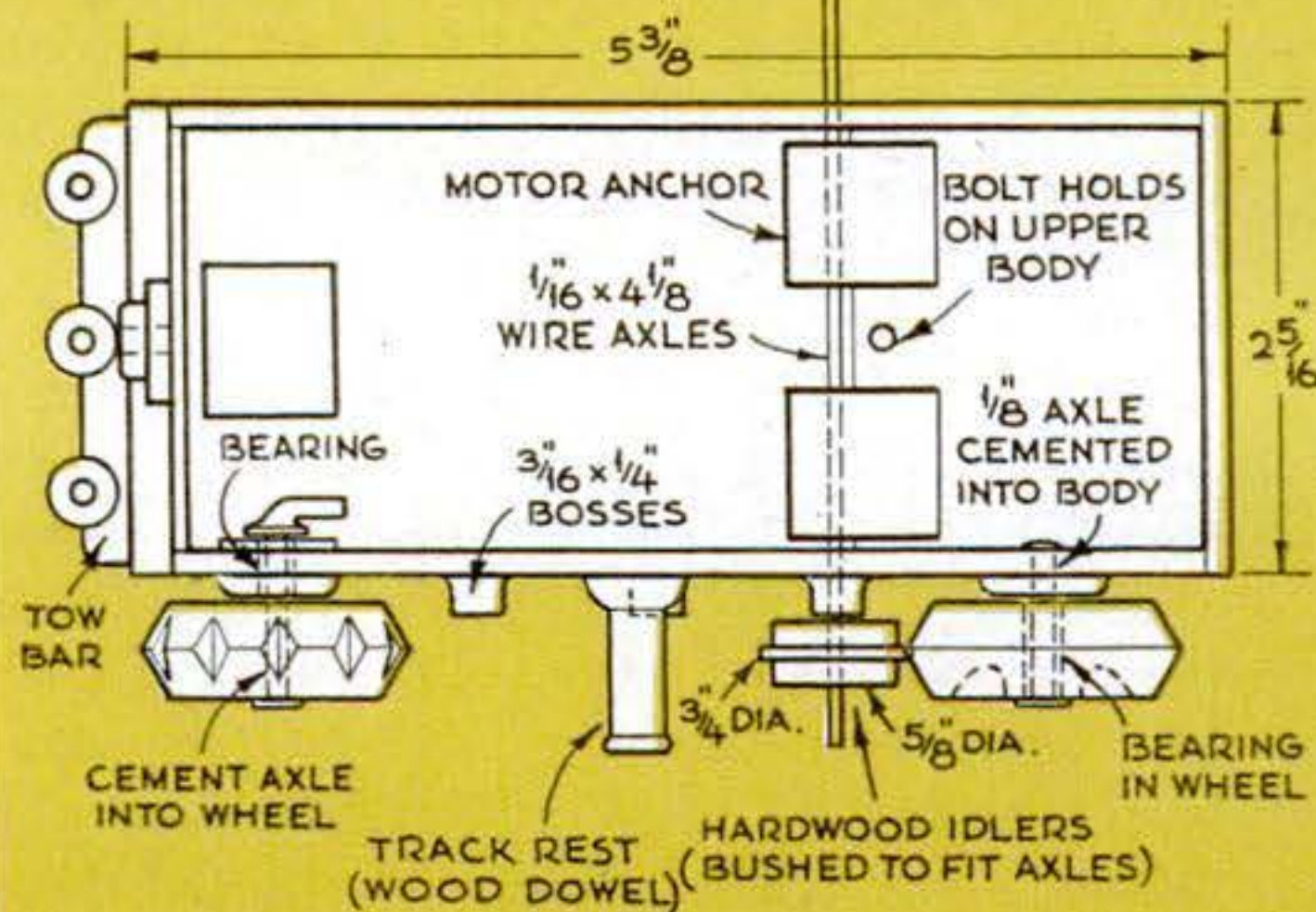

CHASSIS

Long bolt through chassis floor threads into balsa motor block to hold body. Bulldozer blade pivots on bolts in wheel covers. Balsa body is easy to make and stands up well.

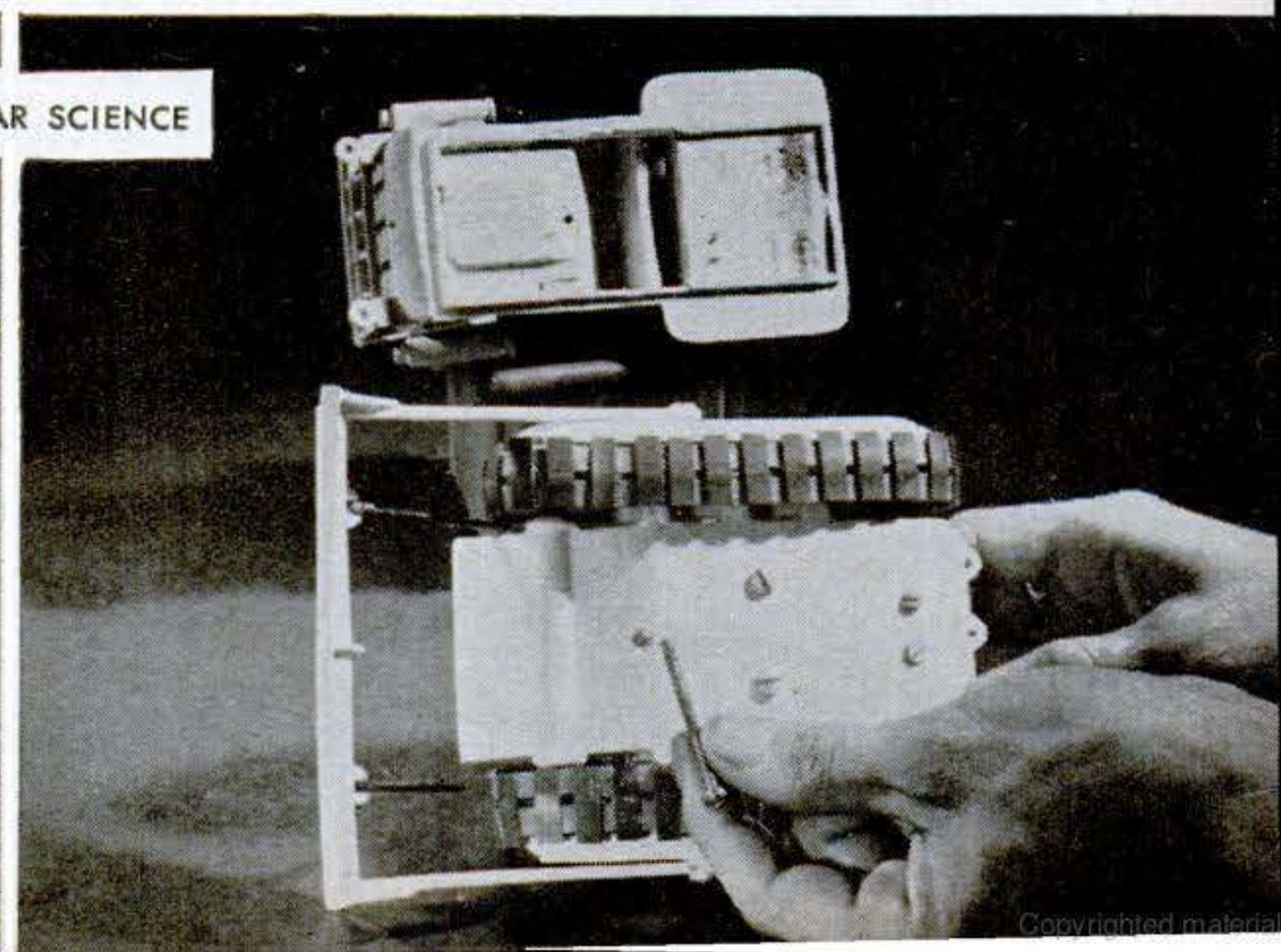
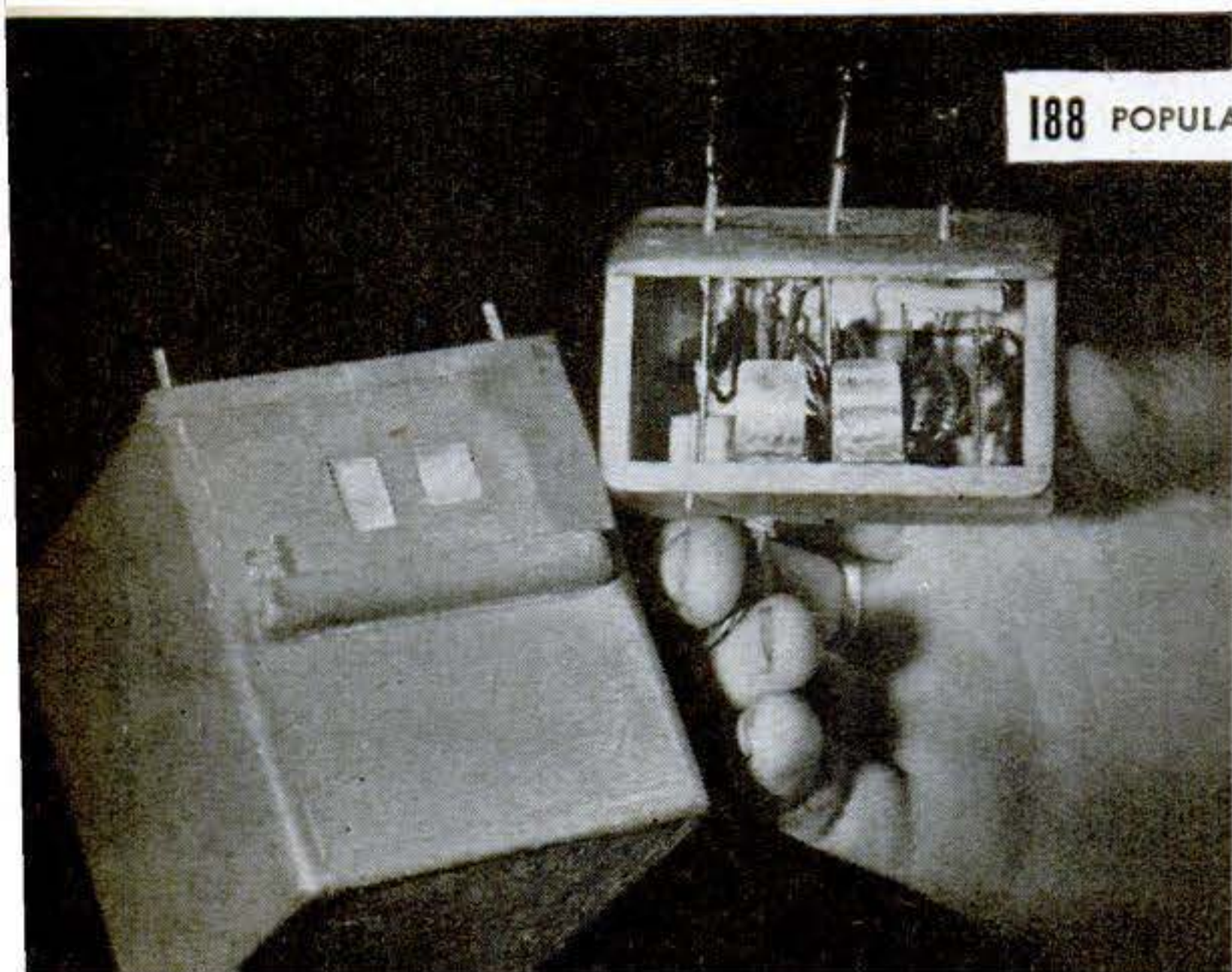

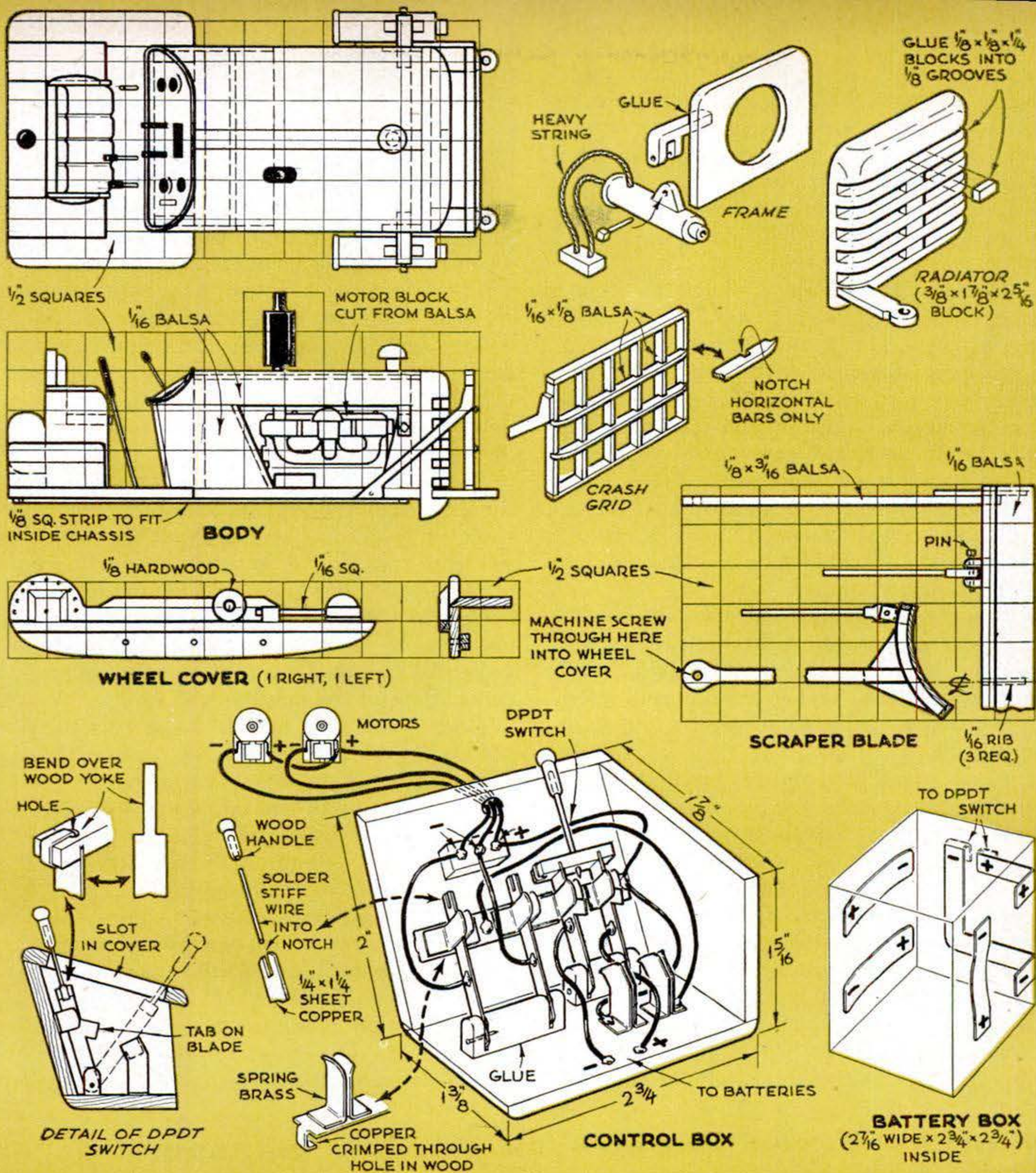

Twin motors are coupled to gear drive by rubber tubing. Clean shafts with solvent, apply cellulose cement, and slip tubing on. Upper tread rest is $\frac{1}{4}$ " dowel with disk cemented on.

Four bolts grip power unit. In reversing, gear makes almost a turn before track moves, adding difficulty—and fun. For quick reverse, put two pins in gear to straddle bent wheel axle.

NOVEMBER 1949 189

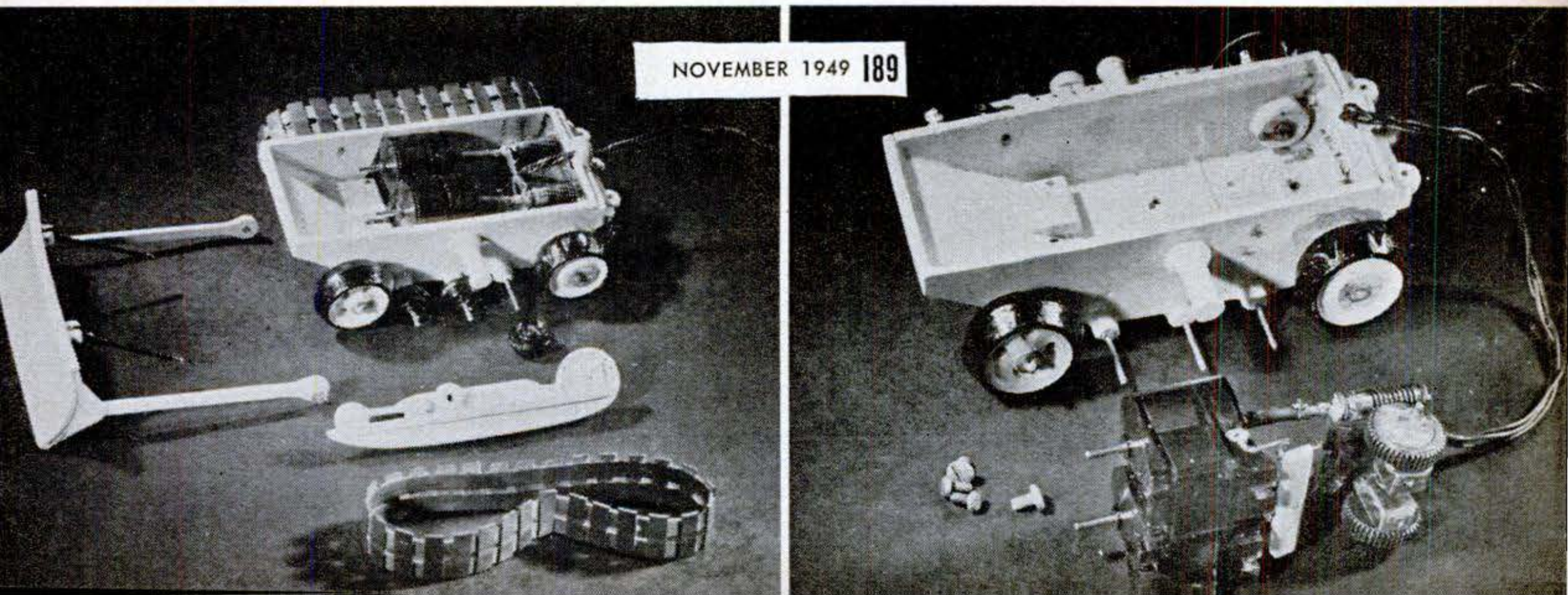

apart with the "live" surface up. Press on $\frac{1}{4}$ " by $\frac{3}{4}$ " strips of the same material crosswise $\frac{3}{8}$ " apart, flush at one edge. No cement is needed; the latex surfaces will stick at a touch if clean. To join the ends, use a slightly wider cross strip. Mount with flush edges inside. Treads should be barely snug, not tight.

Battery Box. Four flashlight cells in a case made of cigar-box wood are a handy power unit. The contacts inside are .010" shim brass, fastened with small escutcheon pins bent over outside. Cut slits in the case for the output straps to the control switch and bend the straps over outside. The internal contacts are arranged so the cells are wired in series. If you plan to label the directional control "Forward" and "Reverse," the cells should always be inserted so as to give the same polarity.

If you don't mind extra wires to the control box, you can omit the battery box and run the tractor nicely on two big (No. 6) dry cells, which having less internal resistance give about the same pep as four flashlight cells.

Controls. These also are built into a case of cigar-box wood. Glue the sides, front, and bottom together. Cut the switch blades from stiff copper, drilling the rounded end for a pivot pin that slips crosswise through a slot in a wooden block. Be sure the two pins don't touch inside. Slot the upper ends of the single-blade switches and solder in a stiff wire to mount a handle.

Three contacts, each consisting of two pieces of spring brass bent to an L shape and curved a bit at the top, are soldered to a

common copper strip. Three others are separately mounted. The blades of the double-pole switch have an angled tab and are narrowed down at the upper ends. The bar is a bit of hardwood around which the narrowed blade ends are bent. All switches should be a snug fit in the pivot slots so they won't drop of their own weight.

The control box shown has two spring contacts that meet the output straps on the battery box. Instead, you can solder short, flexible wires from the straps to the double-pole switch. All blade connections are soldered directly to the blades before the pivot blocks are glued in.

Wiring. Battery output leads go right to the two blades of the double-pole switch, which controls motor direction. The single switches control the treads separately for making turns. If when wired the motors run backward with the switch in forward position, reverse the battery leads to the double switch. If the motors run oppositely, reverse connections at the one that's at fault.

Body. This isn't scaled to any particular prototype. Make the body of balsa with a strip all around to make it fit properly on the chassis. The motor can be carved freehand. Drill out the hydraulic cylinders for the piston rods to slide in. Make the little forks on the ends of the rods from pine.

Wheel Covers. Although they look complicated, these become simple when built up of balsa parts. Drill them inside to slip over the idler axles, and cement on.

You'll find it takes some practice to put the little job through its paces. But play fair—let Junior have his turn too! END

Clothes Dryer Doubles as Washer Garage



INFRARED heating units, an ultraviolet germicidal lamp, and a blower simulate outdoor drying conditions in this unit, according to the maker, The Taylor Corp., Alliance, Ohio. Between washdays, the washing machine may be rolled into the cabinet for storage. Clothes being dried are hung on wire racks that slide out of the dryer for easy loading. Priced at about \$130, the dryer operates on 120-volt, 60-cycle current. It draws 1,280 watts per hour. A timer switch automatically shuts down the unit.



Stroller Carries Her Doll

LITTLE girls, like their mothers, can be pretty persistent when they want something. Judy, my seven-year-old daughter, wanted a baby walker for her dolls. And it had to be just like the ones she saw mothers wheeling along the sidewalks. She persisted, I gave in, and here's the doll walker—a Christmas toy that's a little different.

Patterns can be scaled off the squares at right. Part C is a brace that helps hold A and B together. Ordinary furniture casters serve as the front wheels. The rear wheels can be cut out on a bandsaw or jigsaw. Use $2\frac{1}{4}$ " roundheaded screws to fasten the rear wheels in place. I gave the walker a two-tone enamel finish, applying two coats to all parts.—*Ralph S. Wilkes, Keuka Park, N.Y.*

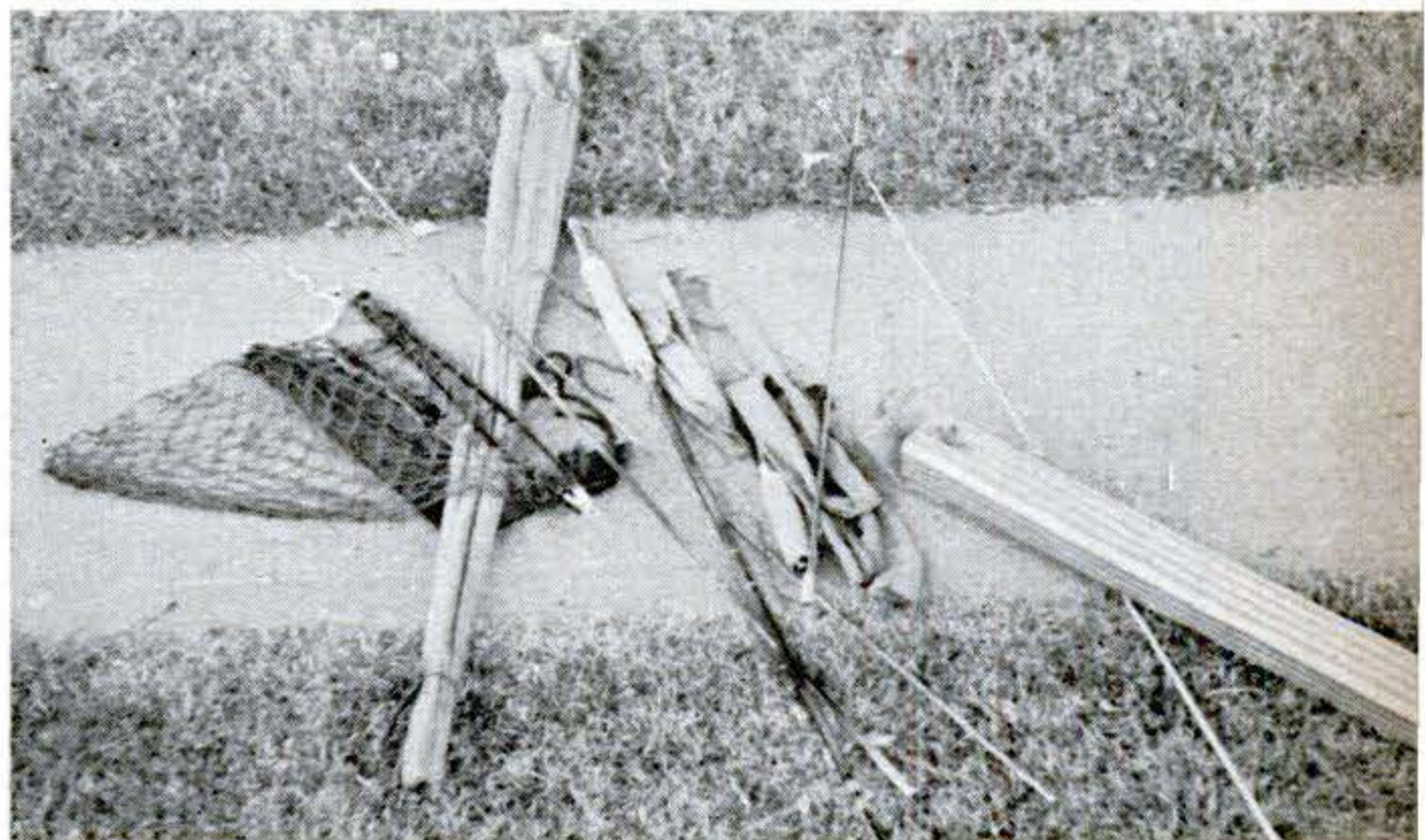
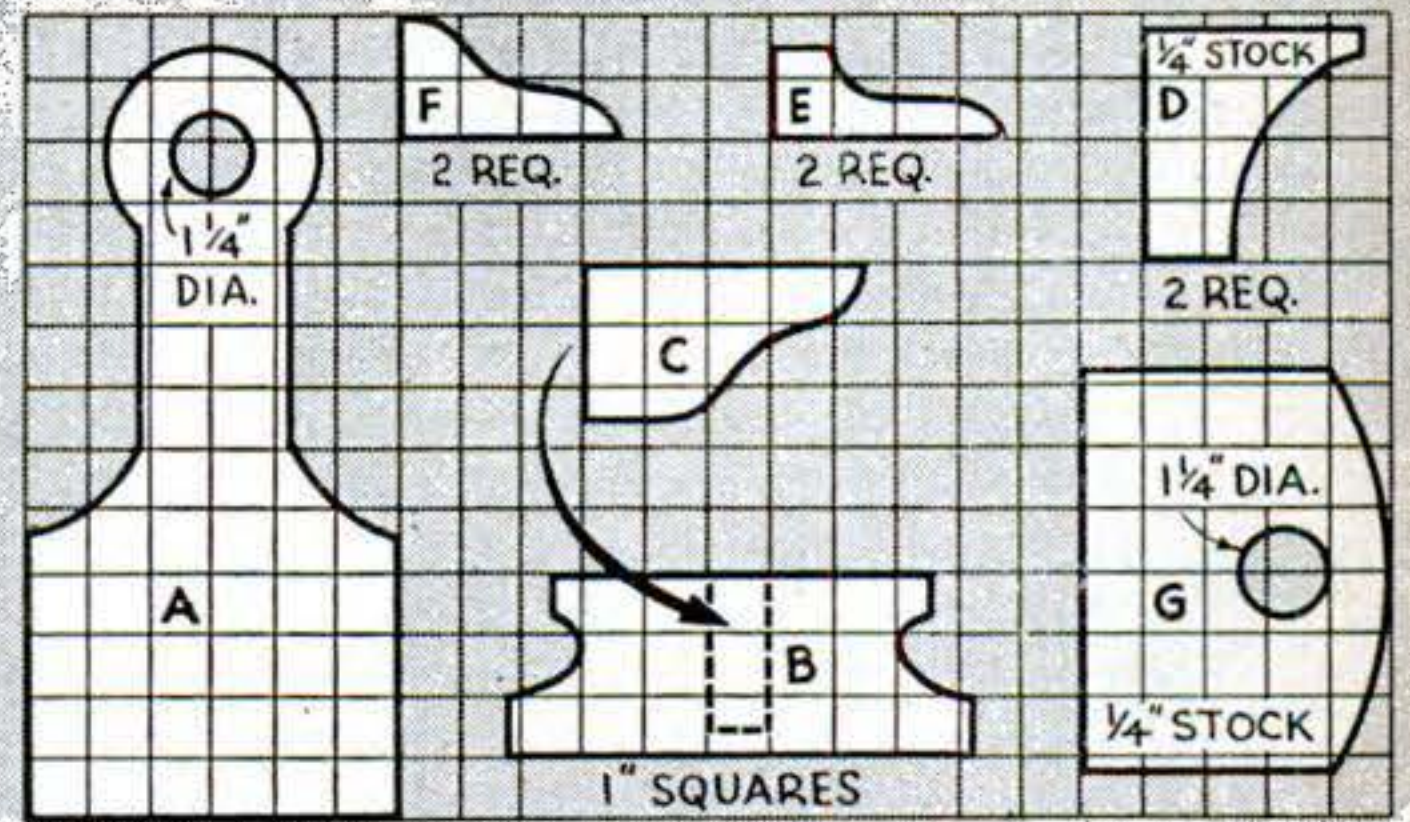
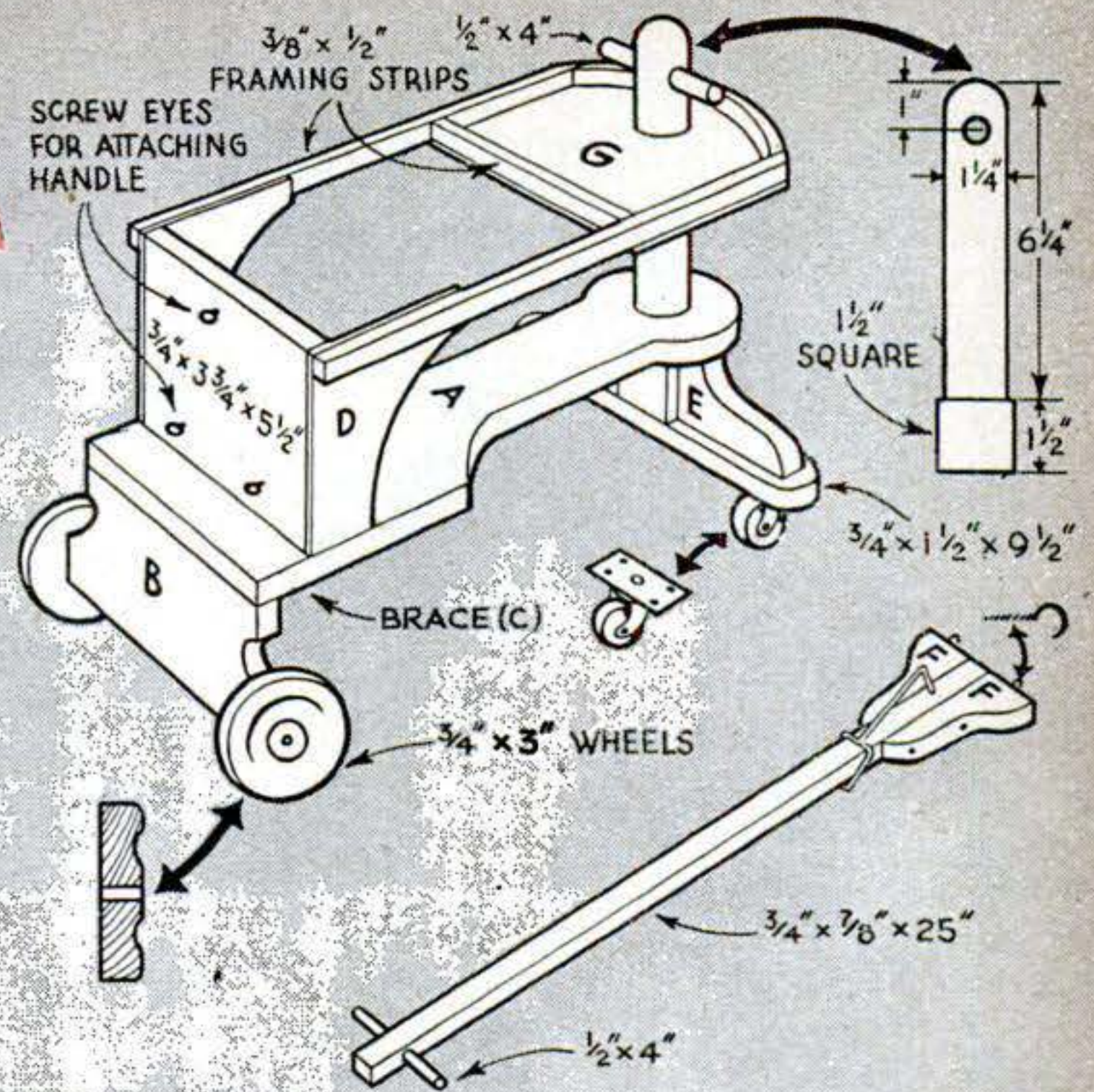

Rod Case Built of Downspout

A SECTION of aluminum downspout makes an attractive and serviceable carrying case for all the fishing equipment shown in the photo. Close one end of the spout with a hardwood plug. Drive roundheaded brads through the aluminum and into the wood. If you want a watertight closing, bind tape

around the end and finish with a couple of coats of waterproof varnish or shellac.

You can cap the other end with sheet metal, hinging it to the case. Or you can rivet a piece of scrap leather to the case as I did. As a final touch, you can add a regular luggage handle with two short straps. These may be shifted on the case for proper balance.—*Burnam Harmer, Seattle, Wash.*



Action station for better mixing, left, is all set up. Two large bins at bottom hold 50 lb. of sugar and flour. Photo above shows bins and spacious drawer.

Everything connected with the mixer, including all its accessories, is rounded up in one unit.

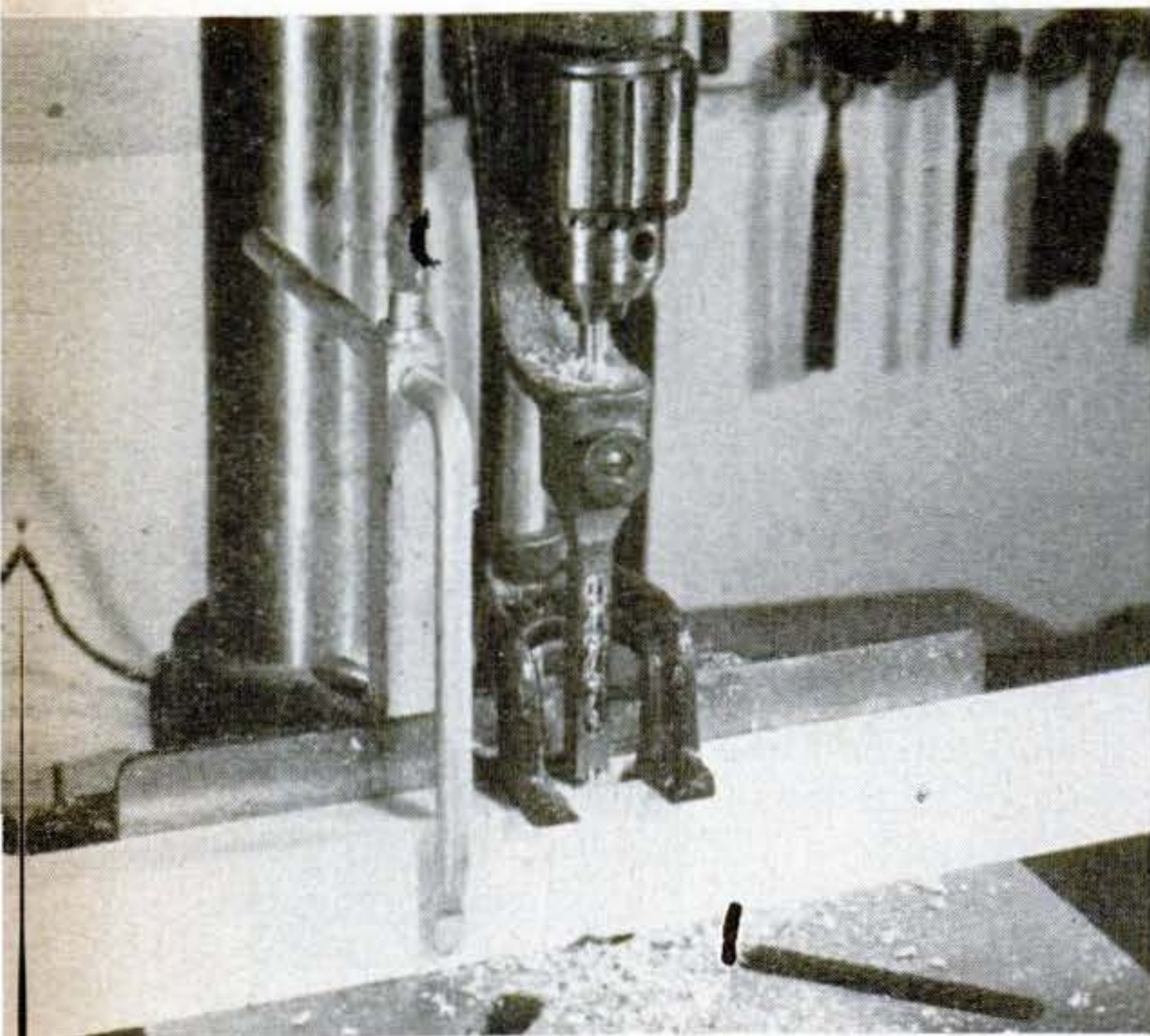

Front of frame is assembled with mortise-and-tenon joints. Shown above is the setup for cutting the frame mortises on the drill press.

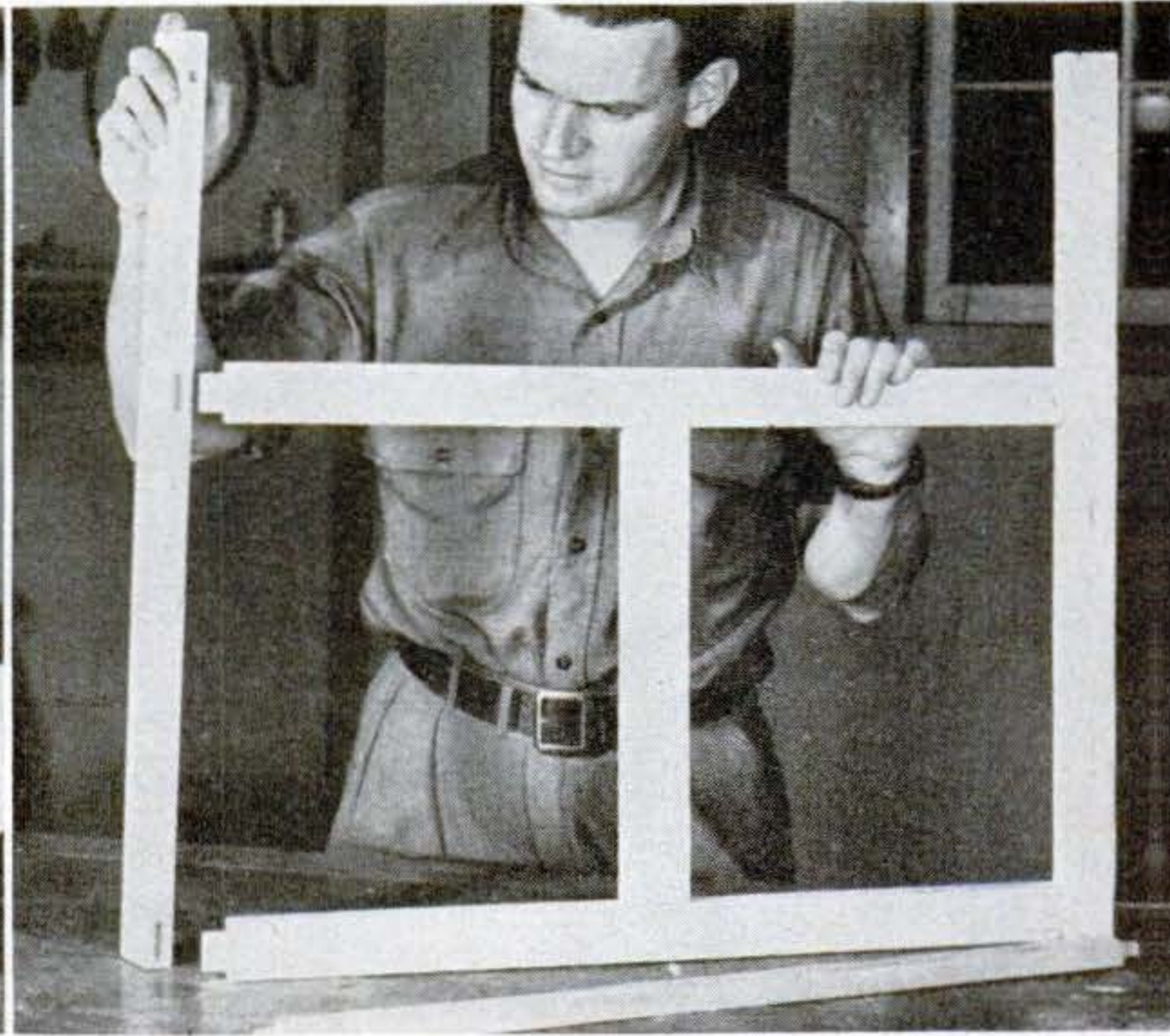

Before assembling, drill tiny hole through frame into each mortise to let air and excess glue escape when tenons are inserted.

It's Easy to Use Our Mixer Now

By Roland Cueva

JUST getting ready to use the electric mixer was a big production at our house.

The routine went like this: Clear space for it on kitchen table. Locate mixer and accessories, usually piece by piece in six different cupboards. Set up mixer. Then discover mixer cord won't reach outlet. Clear new space. Move everything again.

Building this cabinet put an end to that nonsense. Now the mixer and everything connected with it are compactly housed, ready for convenient use. Sitting in a recess on the top, the mixer is flanked by two drawers for small spice containers or recipes. Just beneath the top is a sliding board for rolling dough or for chopping foods. Next is a large compartmented drawer. This takes a rolling pin, mixing bowls, and other accessories. At the bottom are two tilt-out bins for sugar and flour.

First step is to cut out the $\frac{3}{4}$ " stock for



the sides and top. These are in two pieces, splined or doweled and glued. In making the frame, leave about a $\frac{3}{16}$ " shoulder around all tenons. Use glue in all joints. Construction details of the base are shown in the drawing. Fasten the backpiece in the notches with glue and screws. Round off all corners and edges.

Now assemble the sides—but not the top—to the frames. Sides are screwed first to the $\frac{3}{4}$ " framing pieces. Then the framing pieces are screwed to the front of the frame from the inside. After the plywood bottom is screwed in place, screw the cabinet to the base.

Cut out the $\frac{3}{4}$ " upper backboard and sidepieces with a bandsaw or jigsaw. Screws driven from under the top will fasten these parts. Assemble the small- 

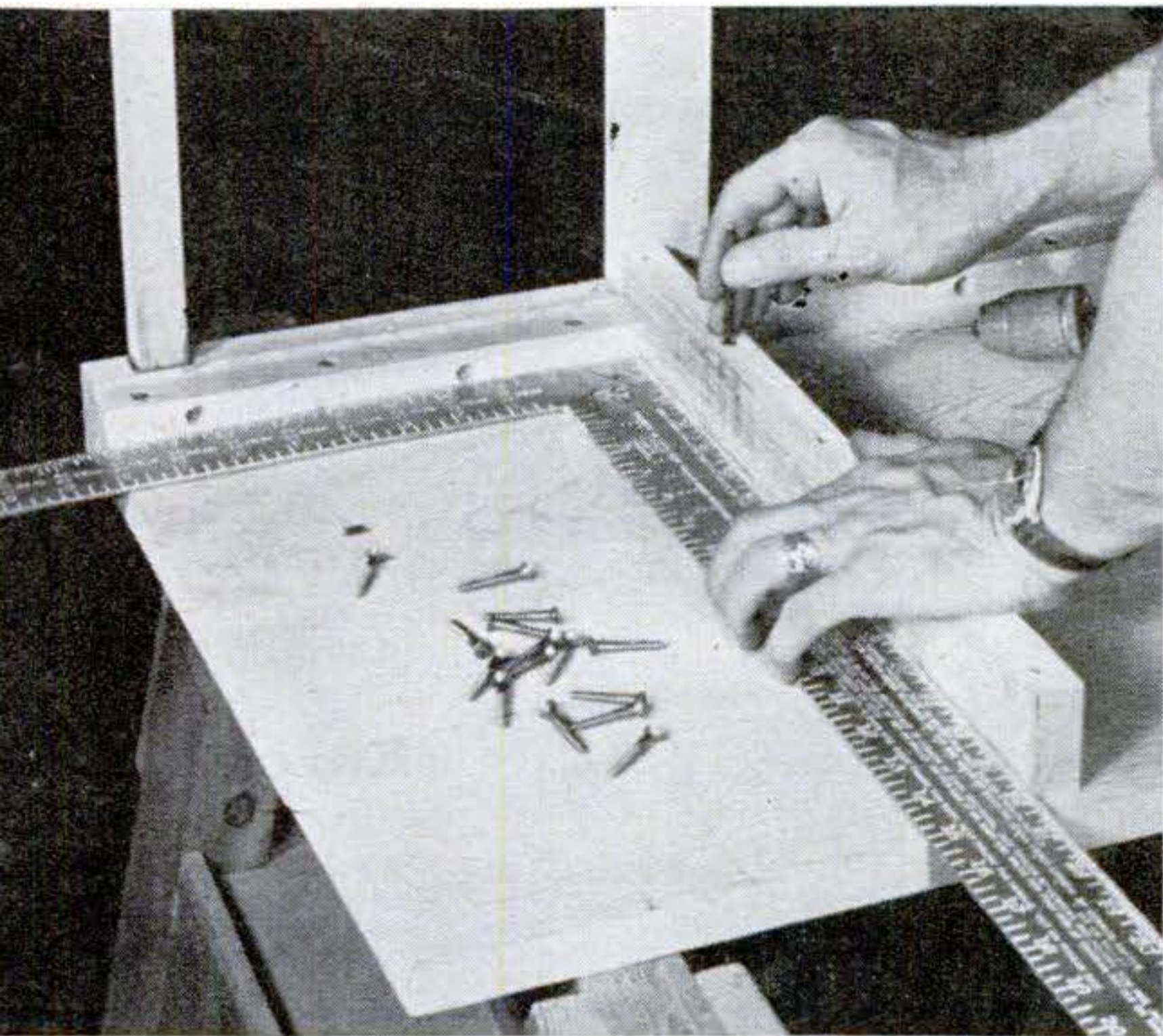

Drawer slides are screwed to sides of the cabinet. Here, a slide is squared up carefully before it is attached with countersunk screws.

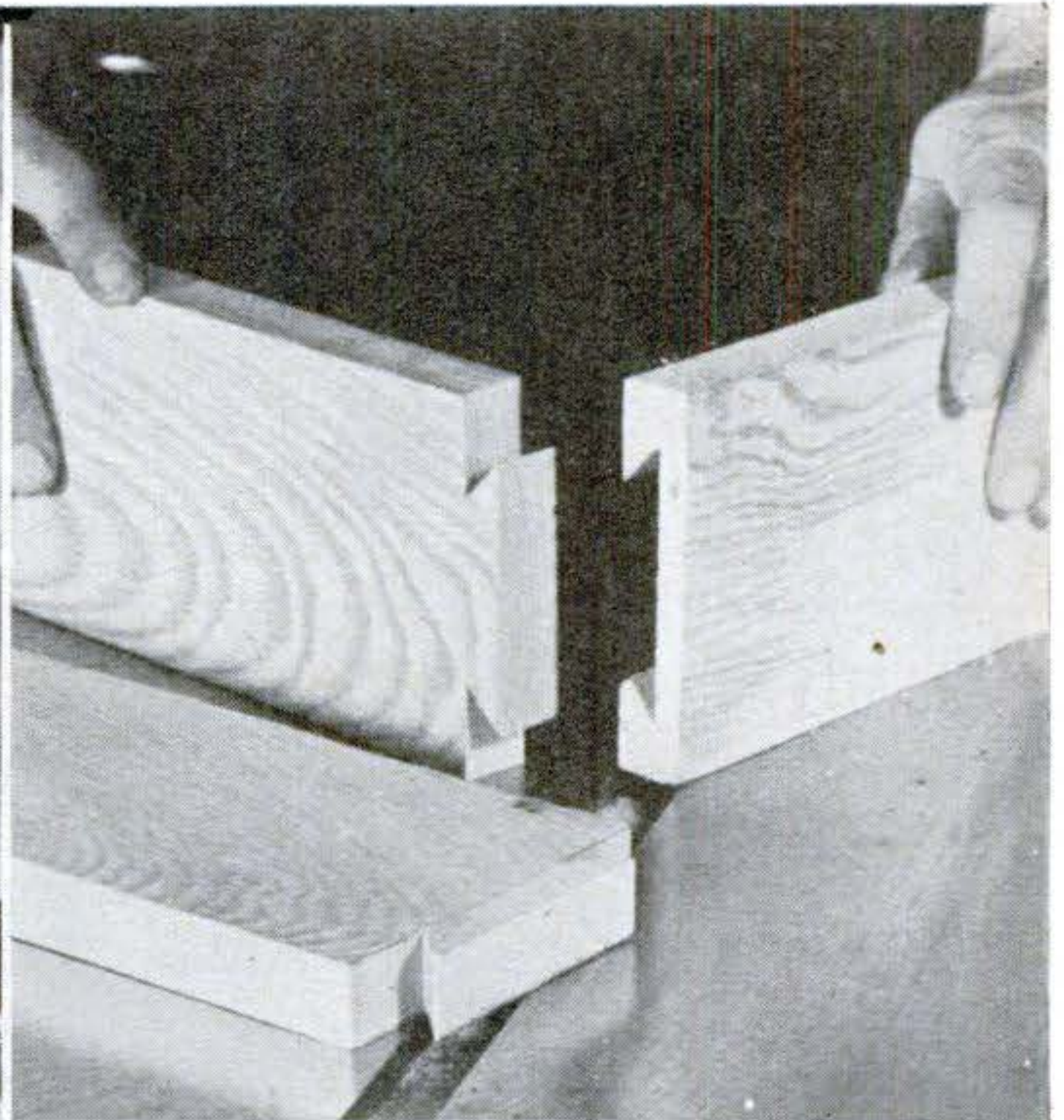

Front and sides of base are assembled with lap-dovetail joints. Rear of base is screwed into notches cut in the base sidepieces.

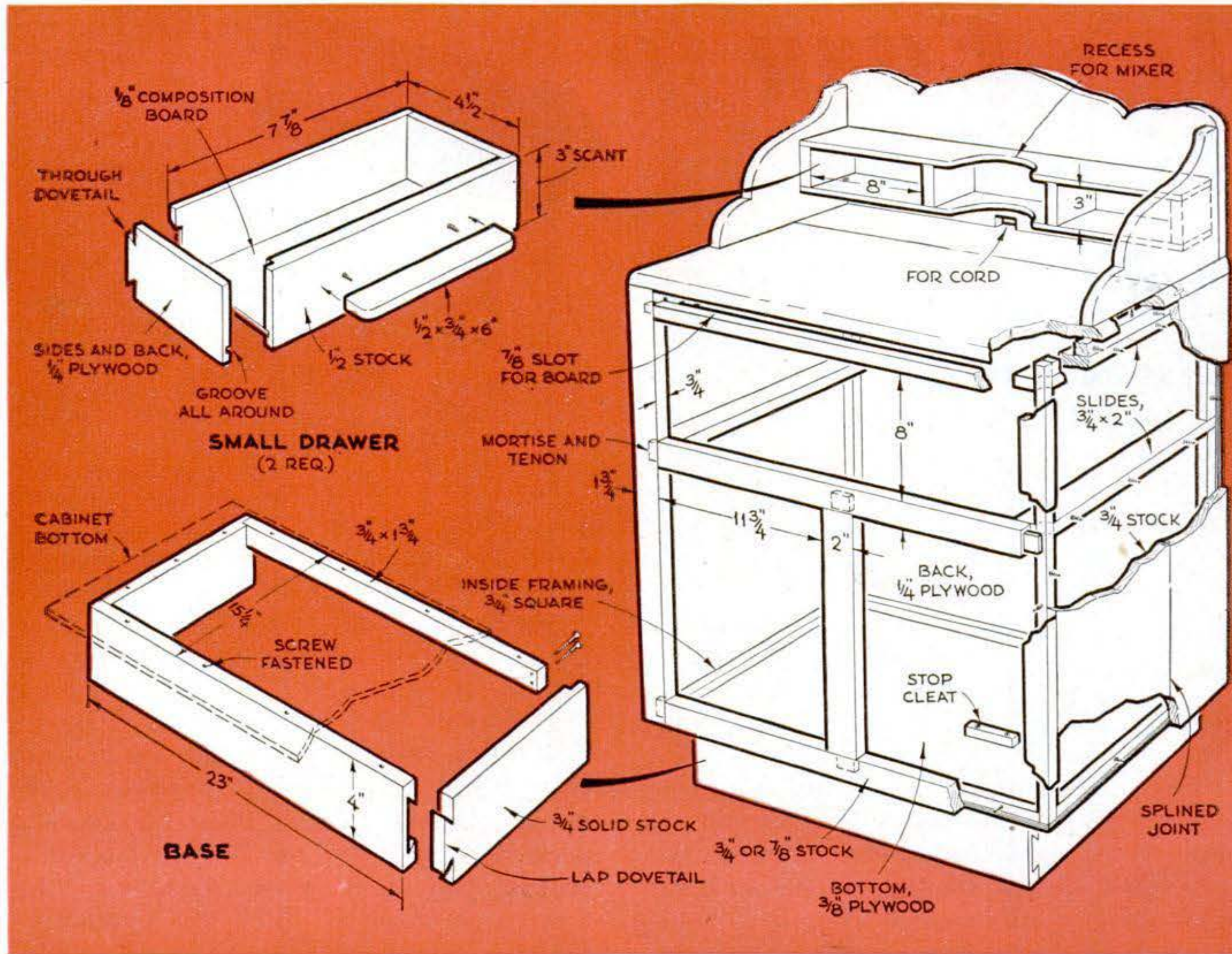

drawer tier and glue and brad it to the sides and back. Attach the top assembly to the cabinet with the cleats just above the work-board slides.

Drawers and bins are standard construc-

tion. The dovetail joints at the backs of the drawers need only glue. Handles can be cut as indicated on the squares, or you can buy wooden or metal ones. I finished the cabinet with enamel. **END**

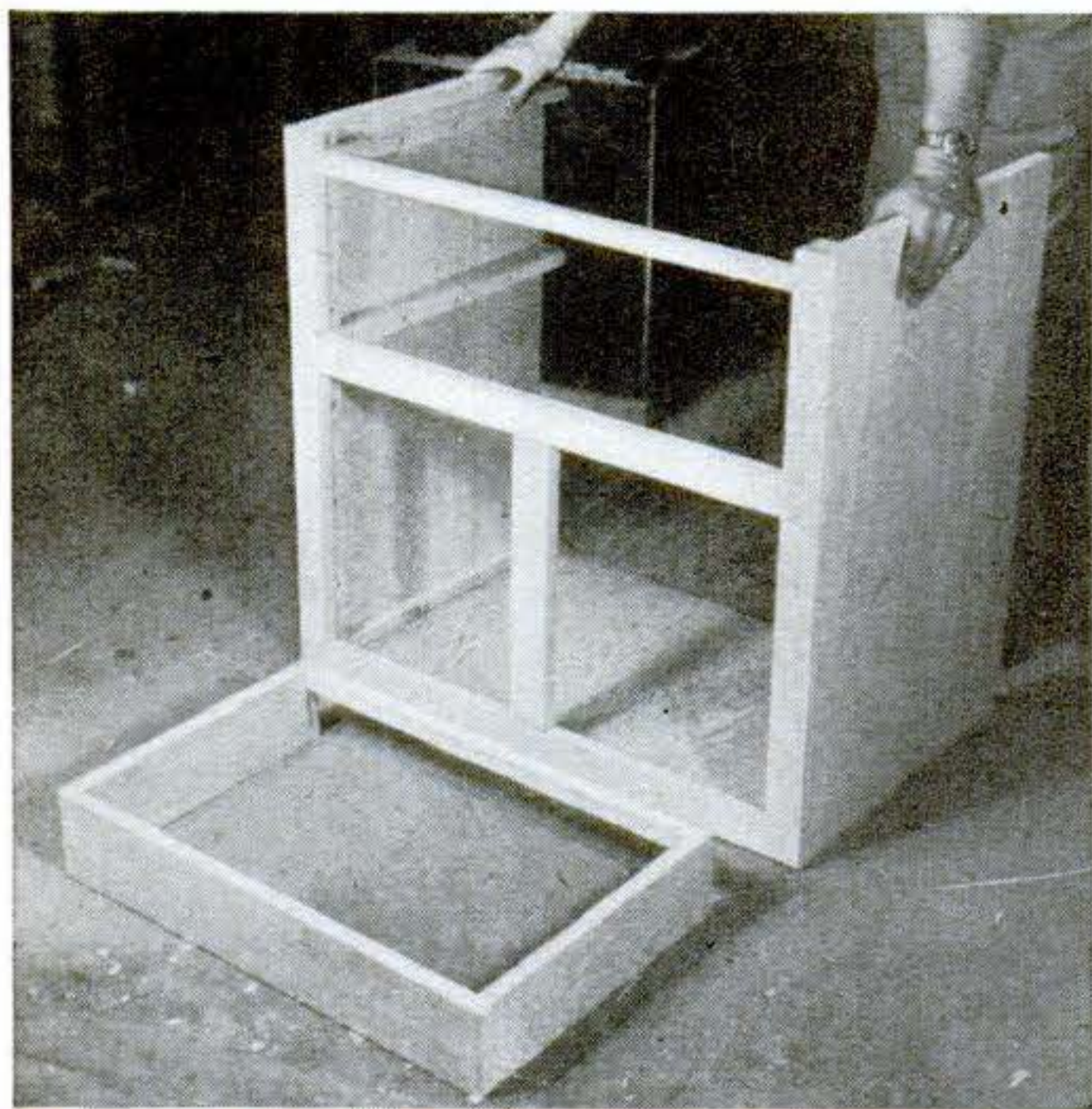

Plywood back has not yet been installed. Framework, with sides attached, is ready to be screwed down onto the base.

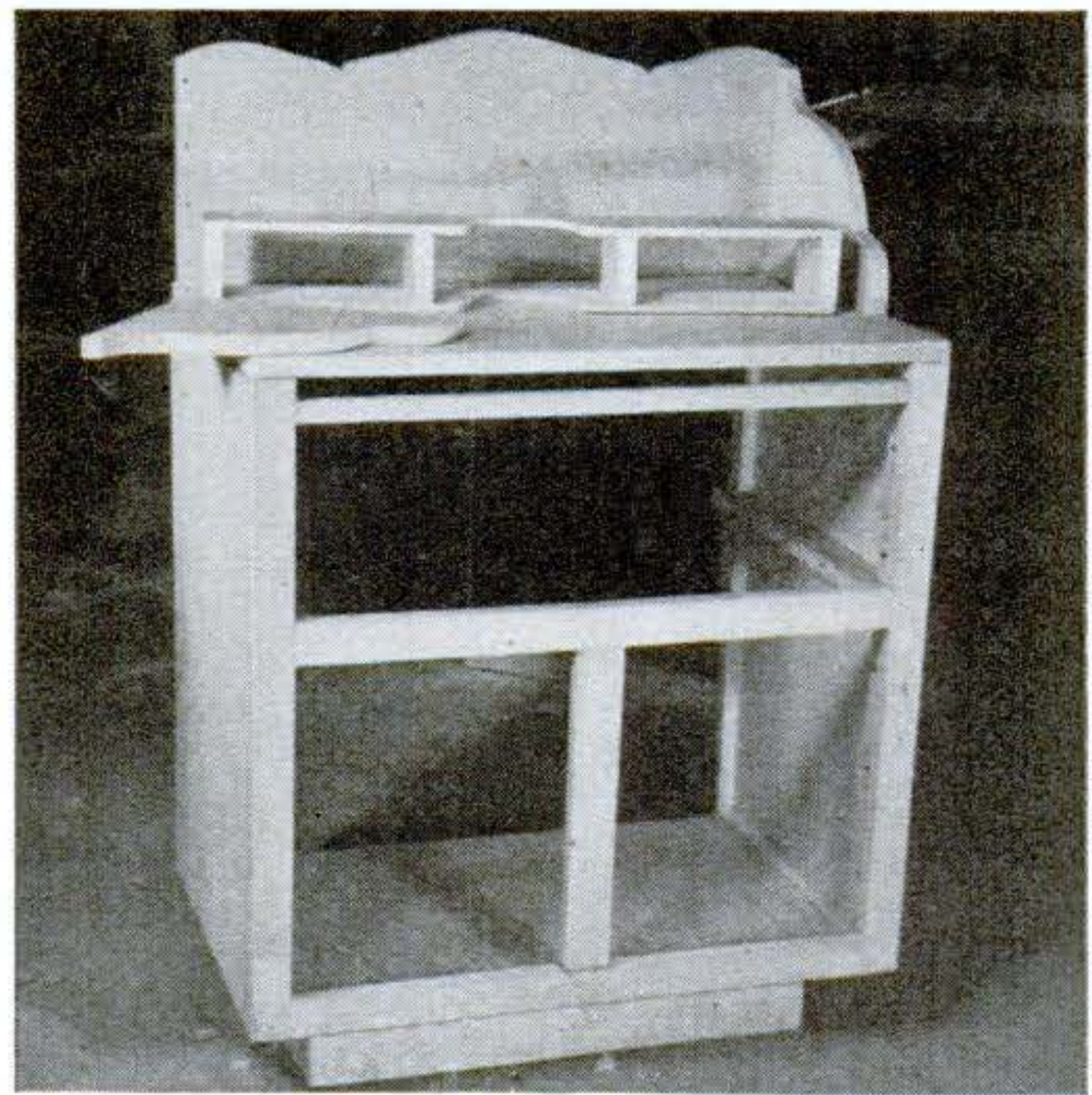

Top, including bandsawed backboard and sides, is attached by screws from underneath after small-drawer tier is screwed in place.

Two Marble Games To Play Indoors



$\frac{1}{2}'' \times \frac{3}{4}'' \times 8''$
WHEELS FROM DISCARDED TOY

START MARBLES IN CENTER GROOVE

$\frac{1}{2}'' \times \frac{3}{4}'' \times 4''$

LEVELING BLOCK

Make it Now for Christmas

Shallow dips, 4 in upper track and 6 in lower, catch marbles. Groove midway in each track holds marbles until start of game.

YOU can make either of these marble games in an evening—and they'll keep the kids out of mischief on stormy days. The photos above and below show you their dimensions, and here's how each is played:
Double-deck game (above) requires both

skill and speed. Start by placing four marbles in the top track and six in the bottom. Set a time limit to speed up the fun. Then remove the leveling block and try to roll as many marbles as you can into the shallow dips in the tracks by moving the handle up and down and back and forth. Each trapped marble scores the amount marked next to it. Work on the high-scoring top track first.

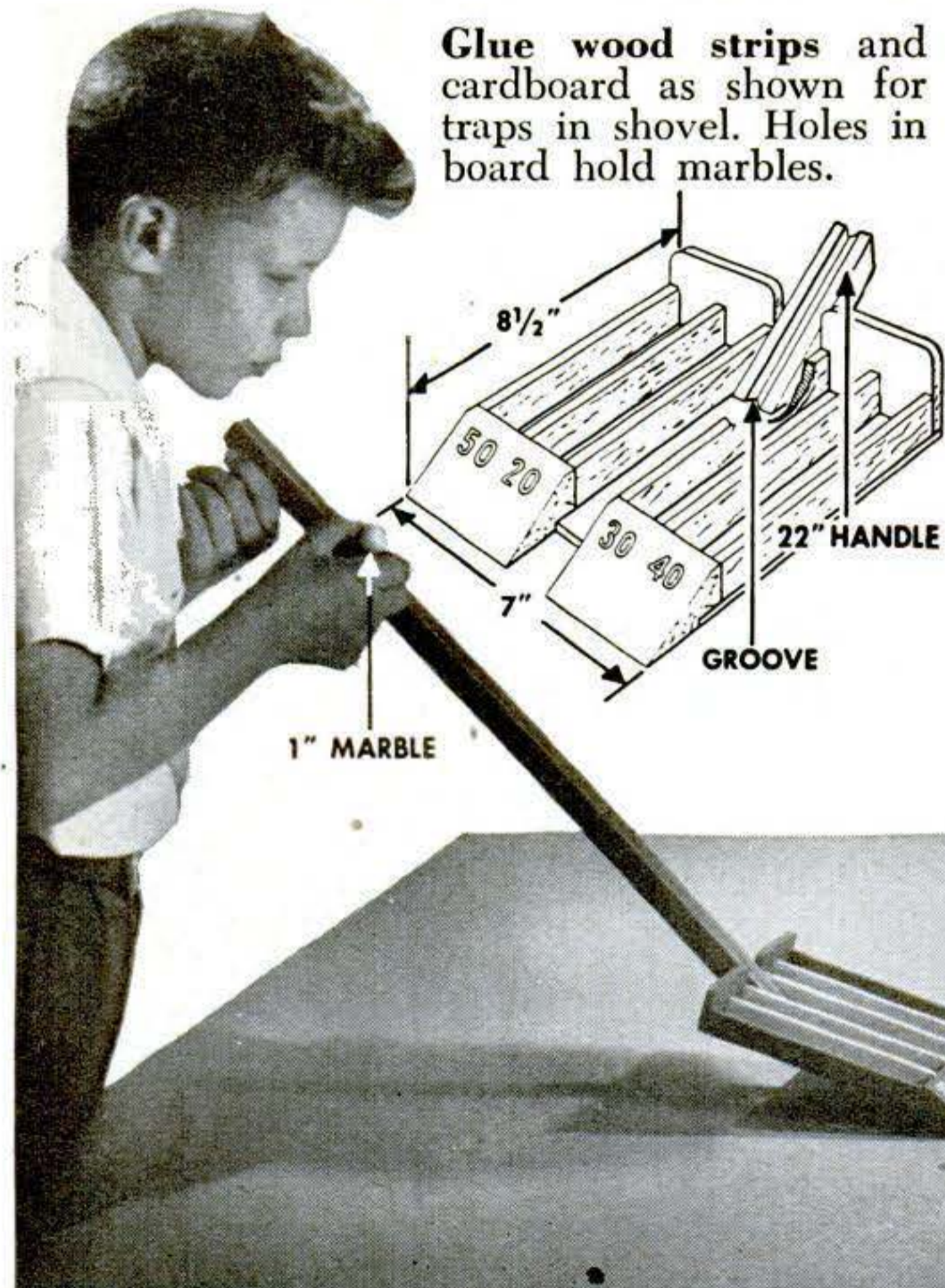

Glue wood strips and cardboard as shown for traps in shovel. Holes in board hold marbles.

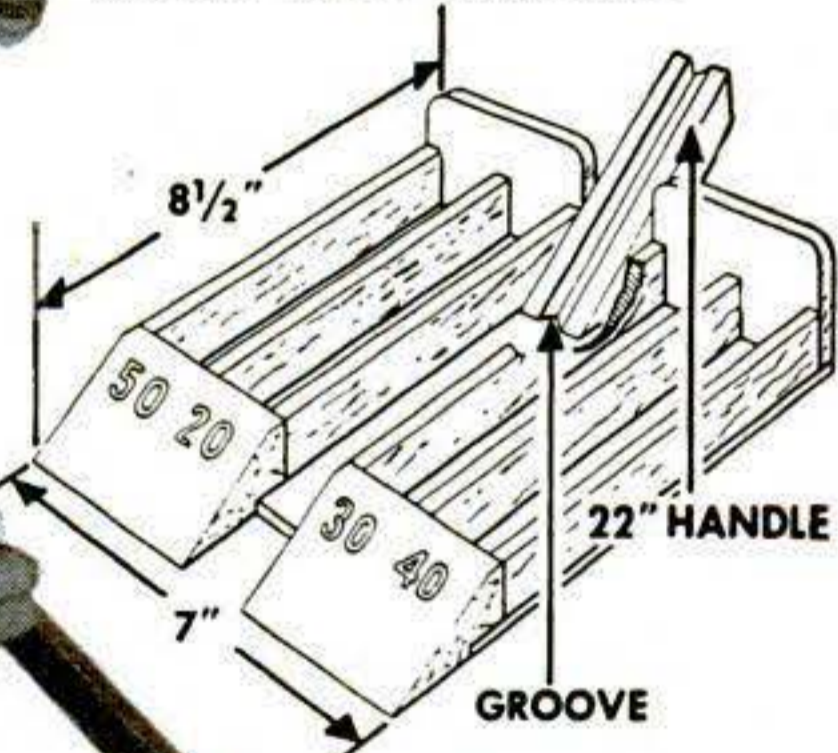

Shovel-up game (below) takes a good eye and a fast hand. Its object is to roll a large marble down the grooved handle of the "shovel" so it will run up the inclined board and bang into the triangle of smaller marbles, knocking loose as many as possible. As the dislodged marbles roll down the board, try to catch them in the high-scoring sections of the shovel. Marbles rolling to the sides of the board will be snagged in the low-scoring traps. Take three shots, then add up your score. High man wins.—Myron Fleishman, The Bronx, N. Y.

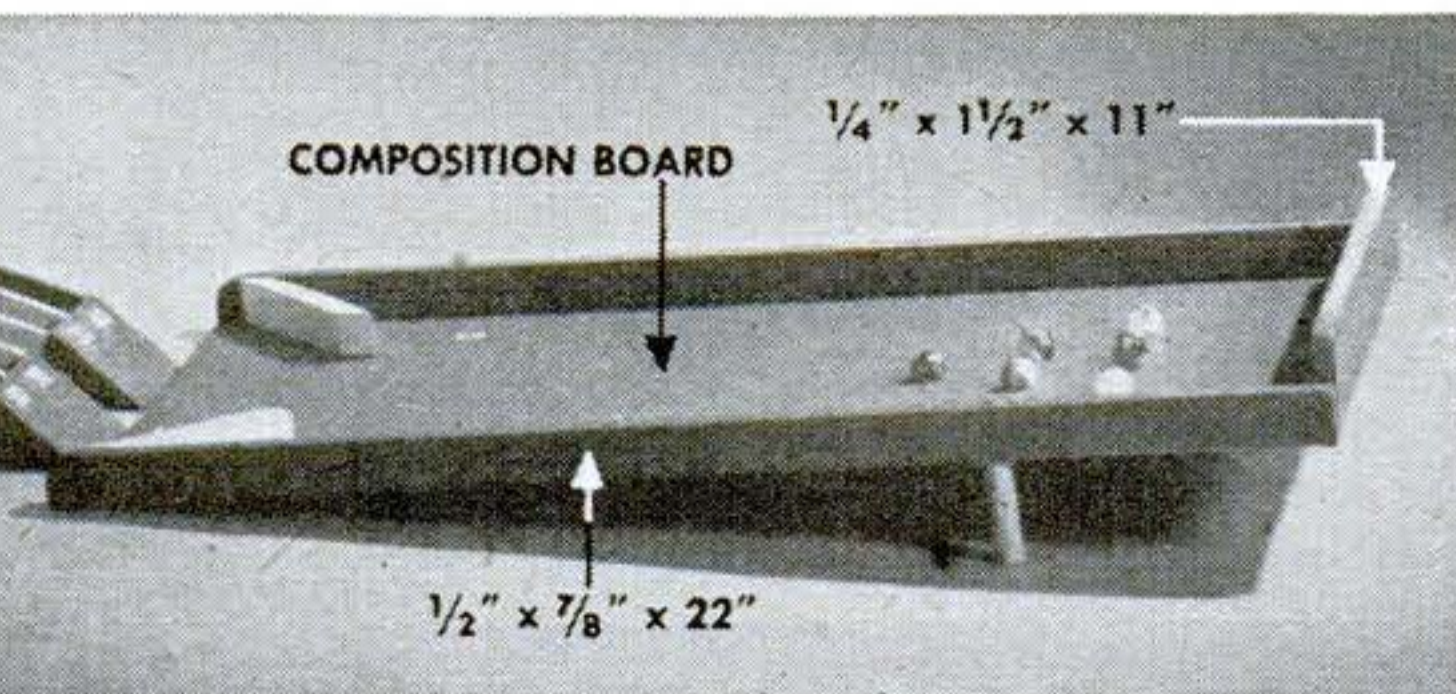



Cooking with both burners. Two portions of bacon fry to a crisp brown.

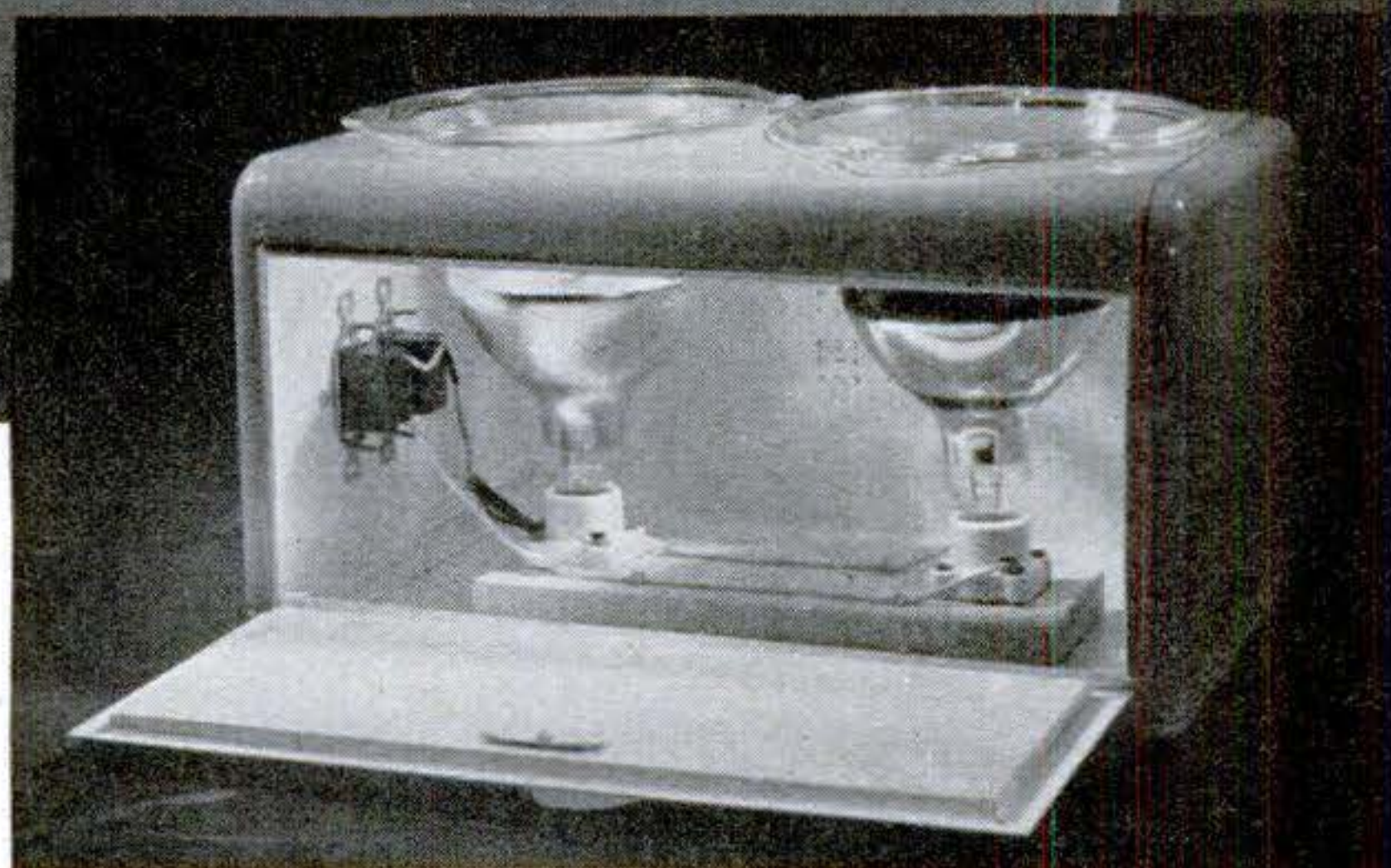

Breadbox Stove

Cooks with Infrared Rays

FOR a leisurely Sunday breakfast or a late snack, your wife can park this stove right on the dining table. It's easy to make—a splendid Christmas gift—and next summer, she'll appreciate the little stove's coolness. A regular stove puts out lots of wasted heat—heat that just warms the room. The infrared stove heats only what the rays are aimed at and

Cooking with heat rays is a little different. Here are a few tips.

EGGS	Can be fried or scrambled. When fried, whites are soft—similar to a poached egg. Use a little butter or shortening in the glass skillet.	CANNED FOODS	Are quickly heated. There's never any danger of the food boiling over. If it stays over the heat too long, it will only simmer.
FROZEN VEGETABLES	Should be thawed to reduce cooking time. Use minimum of water and stir frequently for better heat distribution and quicker cooking.	POTATOES	Can't be baked but can be creamed, fried, boiled, or scalloped. In boiling, rays heat potatoes, which heat water that holds right temperature.
SOUPS (Prepared)	Clear ones—like consomme—take longer to heat. Dark soups—pea or tomato—absorb heat rays faster and are ready to serve sooner.	MEATS	Can be fried. Thickness of meat determines cooking time. Bacon fries to rich, golden brown—never burns and doesn't splatter grease.

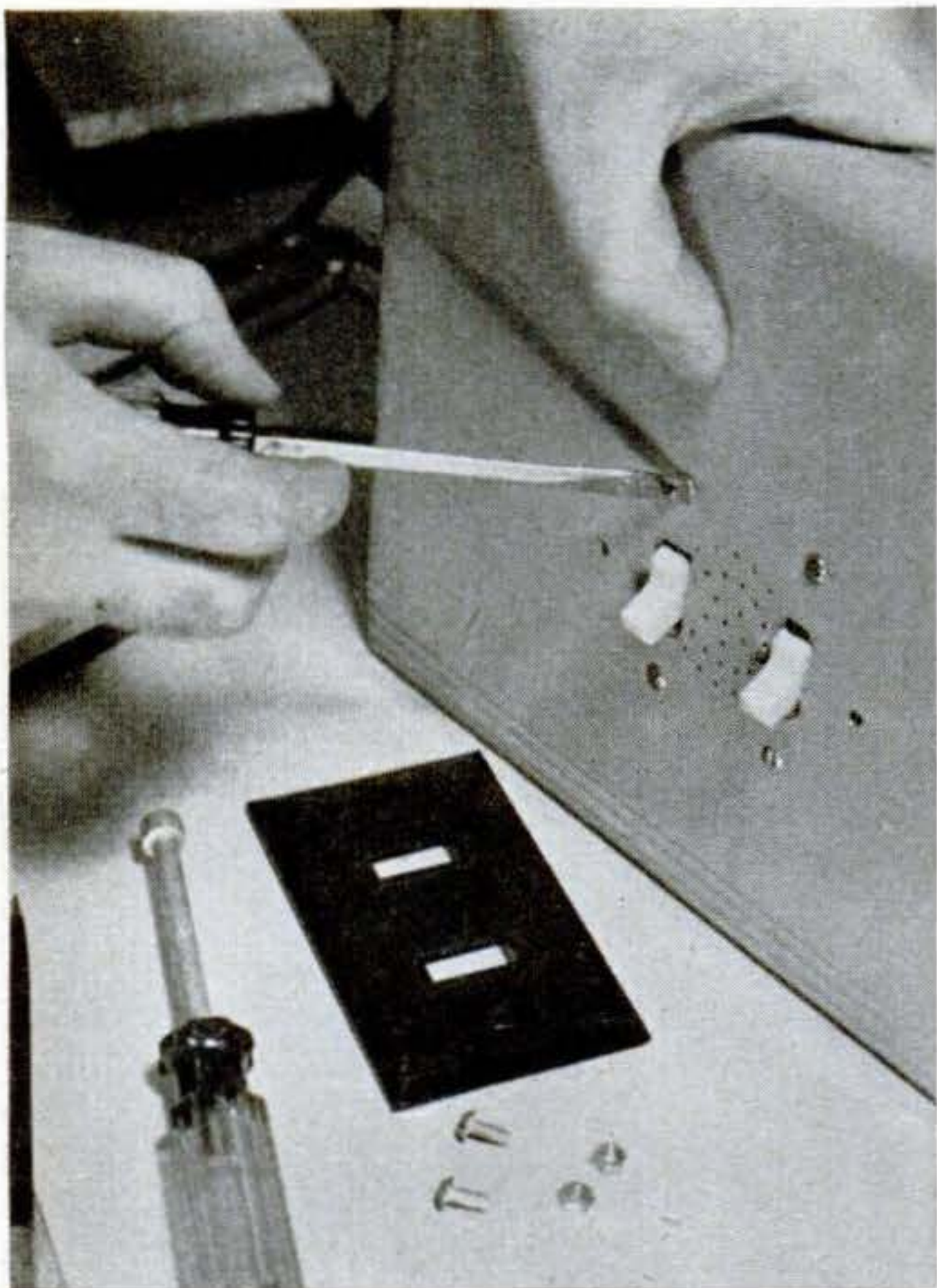

Two light switches, wired in parallel as shown below, control the infrared lamps individually.

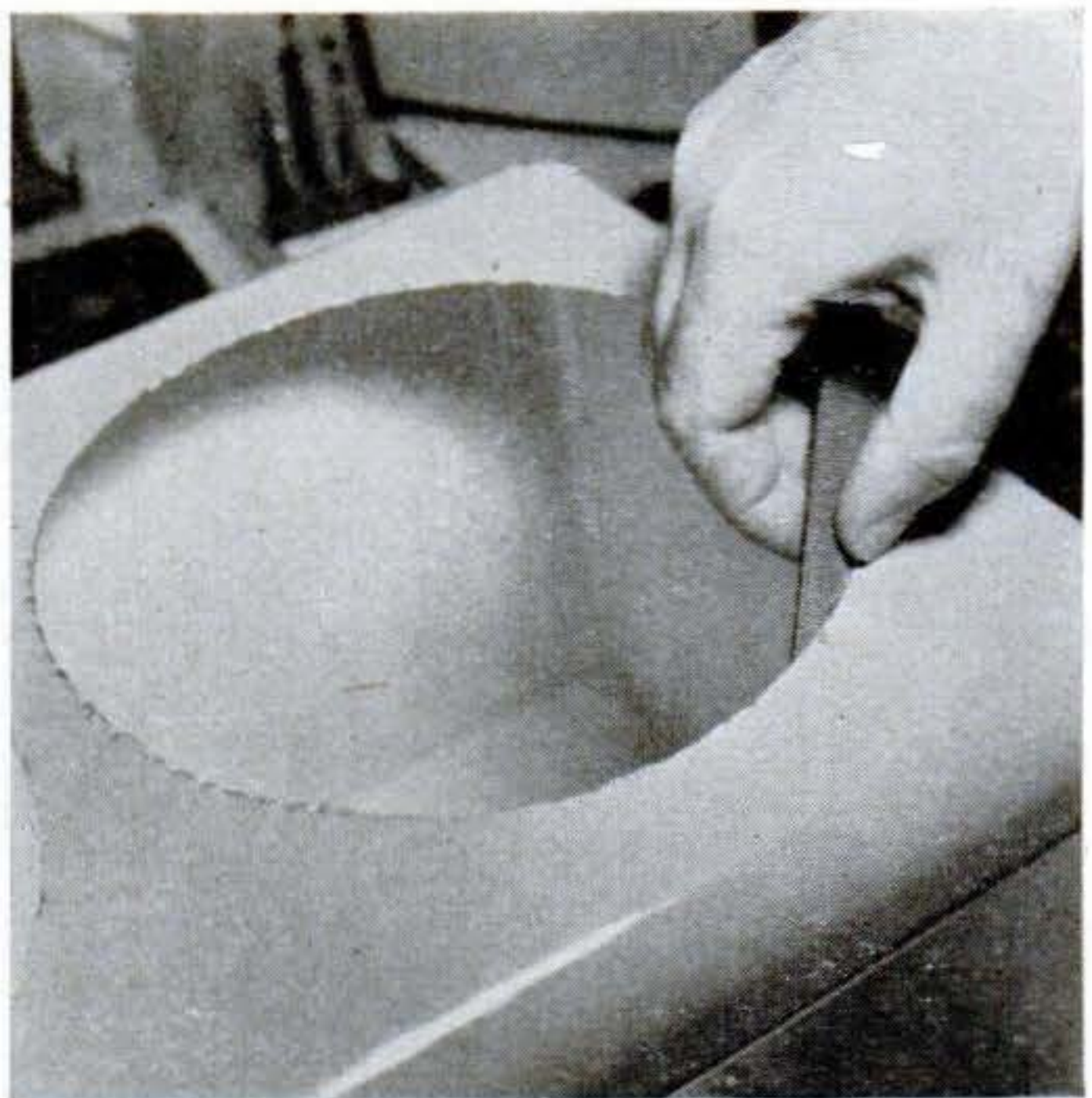

Hacksaw two circles in top of breadbox to fit Pyrex dishes. Use file to smooth metal edges.

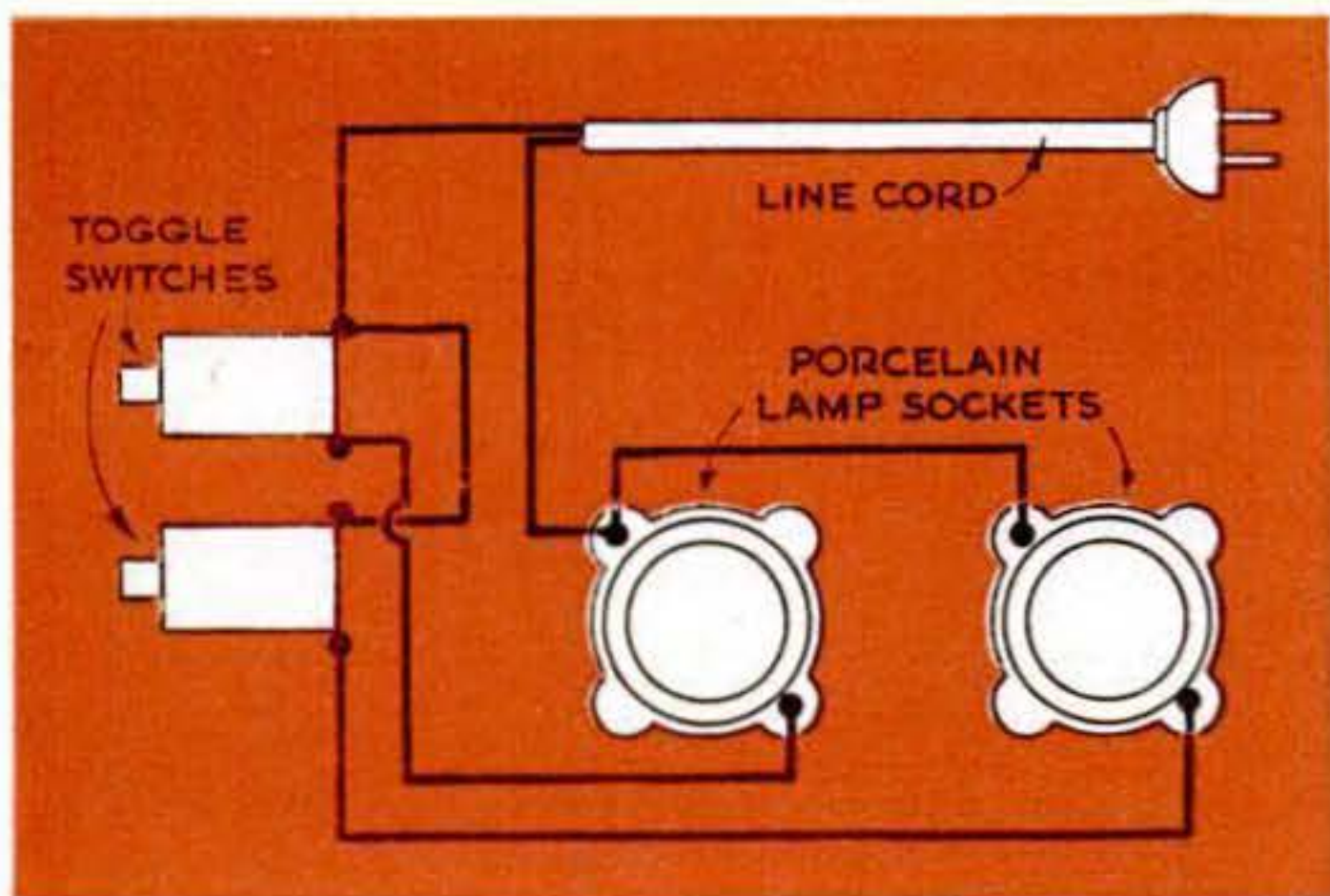

penetrate. The gentle cooking action of the rays doesn't splatter grease the way frying on a gas or electric stove does. And, with a power drain of only 500 watts for both bulbs, the cooker draws far less juice than a toaster, iron, or electric hot plate.

Use clear Pyrex® utensils. Aluminum, enamelware, or any other opaque pot will only block the rays and you won't do any cooking. You'll notice, too, that darker-colored foods cook faster than light ones. Dark colors absorb the heat rays better. I use two Pyrex dishes over each bulb. The bottom one stays permanently in place and the top one is used for cooking and serving.

The infrared bulbs with red filters cost more than the clear ones, but the filter cuts down the glare. That's the only difference. —Arthur Miller, Manhattan, N. Y.

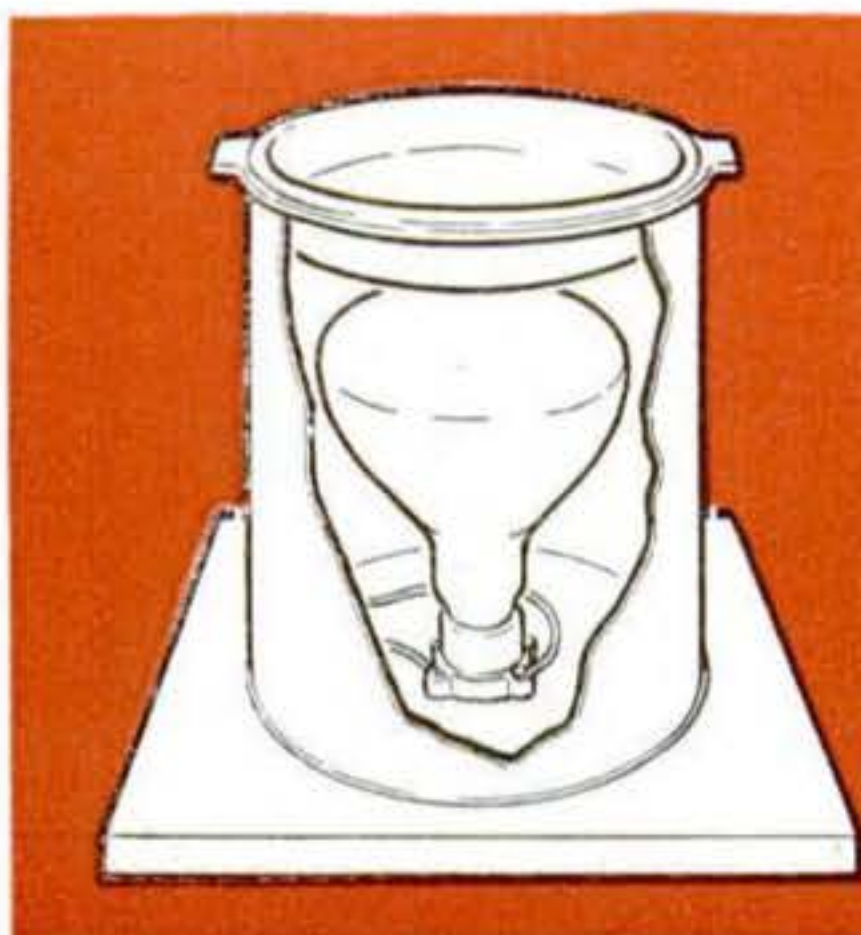

One-burner job can be quickly made with kitchen canister or a large tin can. Mount socket on square of wood.

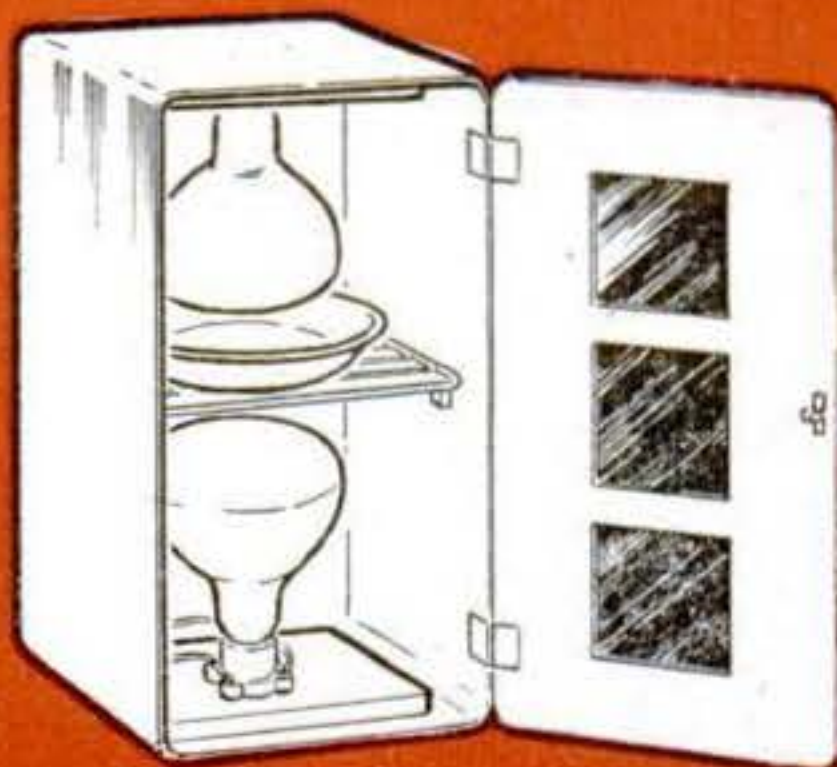

For faster cooking of meats, mount infrared lamps like this. Openings in breadbox door have red plastic windows.

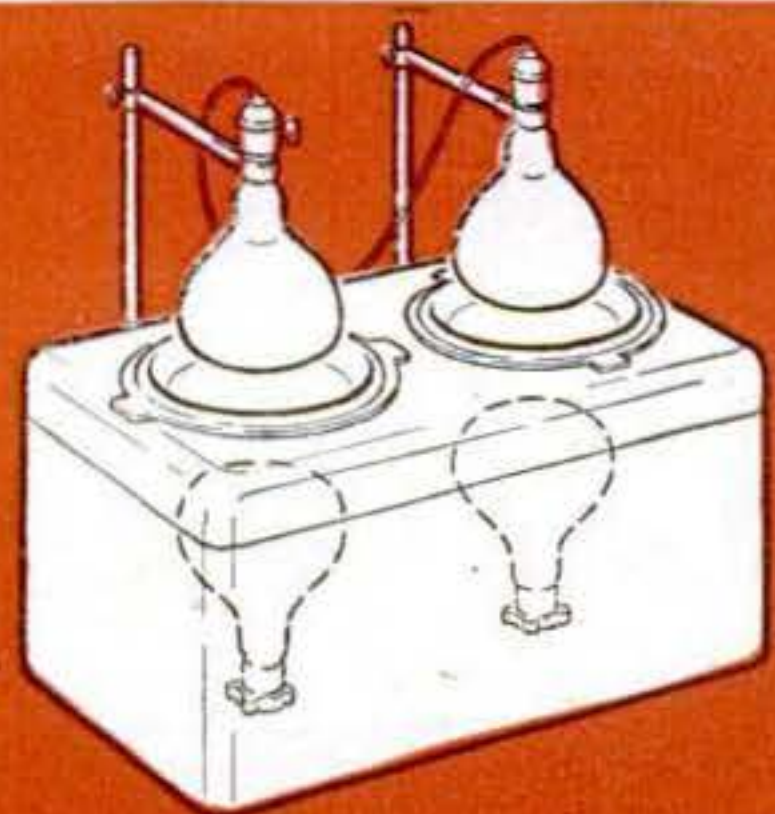

Here's a two-burner stove with four bulbs. This gets heat on two sides of food for faster cooking.

*Make it Now
for Christmas*

Every Child Needs a Desk



YOUR youngsters will get as much fun out of using this desk as you will making it.

I used doweled and edge-glued $\frac{3}{4}$ " pine, though you may prefer the greater simplicity of plywood. Use a bandsaw or jigsaw to cut out the two desk sides and a circular saw to cut the rectangular top. Add two cleats to the latter and one to each side, and bore and chisel out the square-ended slots for the footrest. Assemble the sides and top with glue and screws driven into the cleats. Close off the back of the drawer space with an apron 4" wide, cut to the same shape as the drawer front. The drawer itself is of conventional construction and has a bottom

of $\frac{1}{8}$ " hard composition board set in grooves in the drawer frame.

If you make the chair of edge-glued stock, be sure to lay it out so that the grain is roughly parallel to the legs and back. Before assembly, cut slots that are a snug fit for the $\frac{1}{2}$ " back slats. The two chair aprons are identical. Assemble with glue and screws, concealing conspicuously located screws with plugs if you plan to use a natural finish. Use a block plane to cut chamfers on all exposed edges, and sand thoroughly with medium and then fine paper. I finished my pieces with three coats of clear lacquer.—C. E. Sorenson, Burbank, Calif.

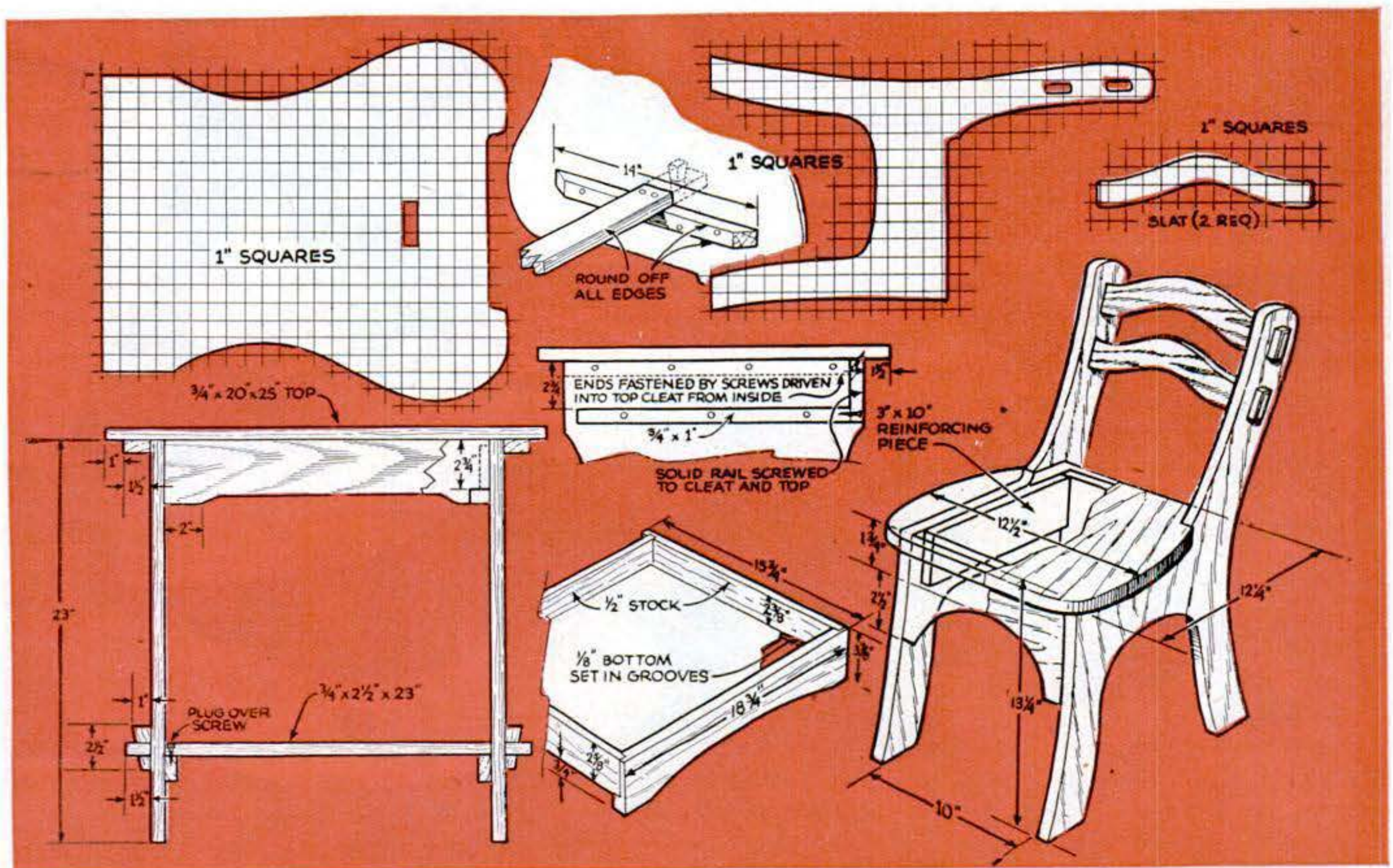

*Make it Now
for Christmas*

Keg Toys Are a Barrel of Fun



IF YOUR toy problems have you over a barrel, that barrel may be just what you need. This spirited pony, doll cradle, and toy bucket all started out as old nail kegs.

To make the rocking horse, cut the head, rockers, and spreaders from 1" lumber—"packing-case pine" will do—according to the patterns shown. Drill $\frac{1}{2}$ " holes in the rockers at the proper angle and assemble the unit by placing the spreaders at the ends of the keg and tightening 8" carriage bolts run through the rockers. Screw the keg onto the spreaders from the inside and run a bolt through the barrel and the back spreader. While the keg is still open, drill a hole through the back end for the rope tail, knotted and nailed from the inside to hold it in place. Also secure a chunk of 4" by 4" waste inside to balance the head.

Screw cleats to both sides of the neck and then screw through these to the half-circles fitted to the front of the keg. Slip the slot in the neck over the edge of the keg and nail the unit in place through the holes in the metal binding.

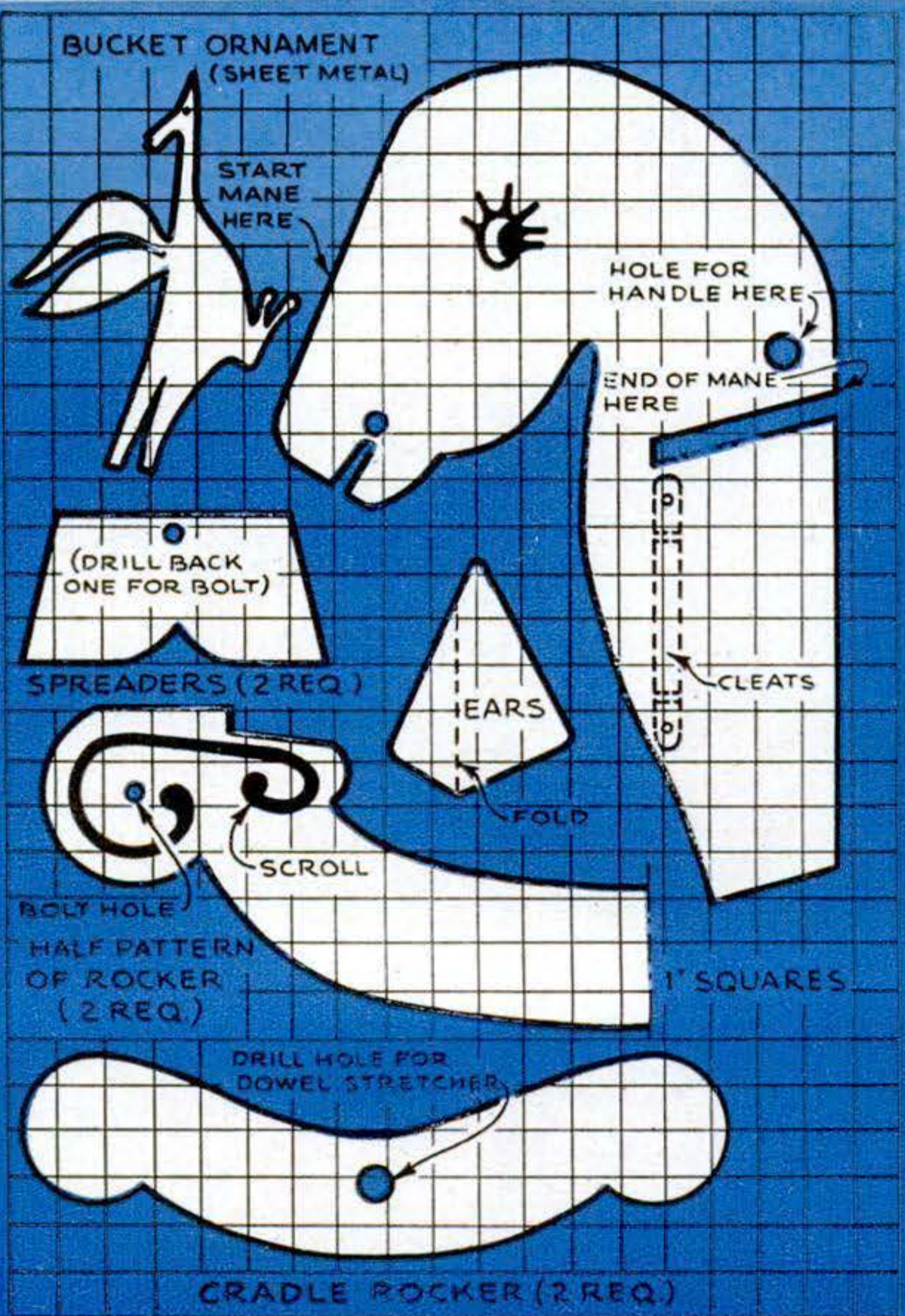

Make the mane by winding loops or knots of short, raveled strands of rope over heavy twine and stapling it along the profile of the head. Ears are cut from soft leather and tacked in place. Eyes, nostrils, and scrolls on the rockers are painted on. The gay saddle blanket is striped canvas tacked down with upholstery tacks.

The cradle is a simpler project. Cut away half of the staves a few inches from the bottom end. A half-circle must be cut to fill the open end of the keg, forming the cradle foot. Cut out the rockers and drill them for a $\frac{1}{2}$ " dowel to run lengthwise. Fasten on the cradle with screws from inside the keg. Pad the inside of the cradle with bright checked gingham or chintz. Bows of the same material cover the wire around the keg and the nails at the foot of the cradle.

Easiest of all is the toy bucket. Staves are cut away except for two, which are drilled near the top for the broomstick handle to fit across them. It may be painted or decorated with metal designs tacked on as shown.—*Doris Aller, San Francisco, Calif.*

Who Said a Dog's Life?

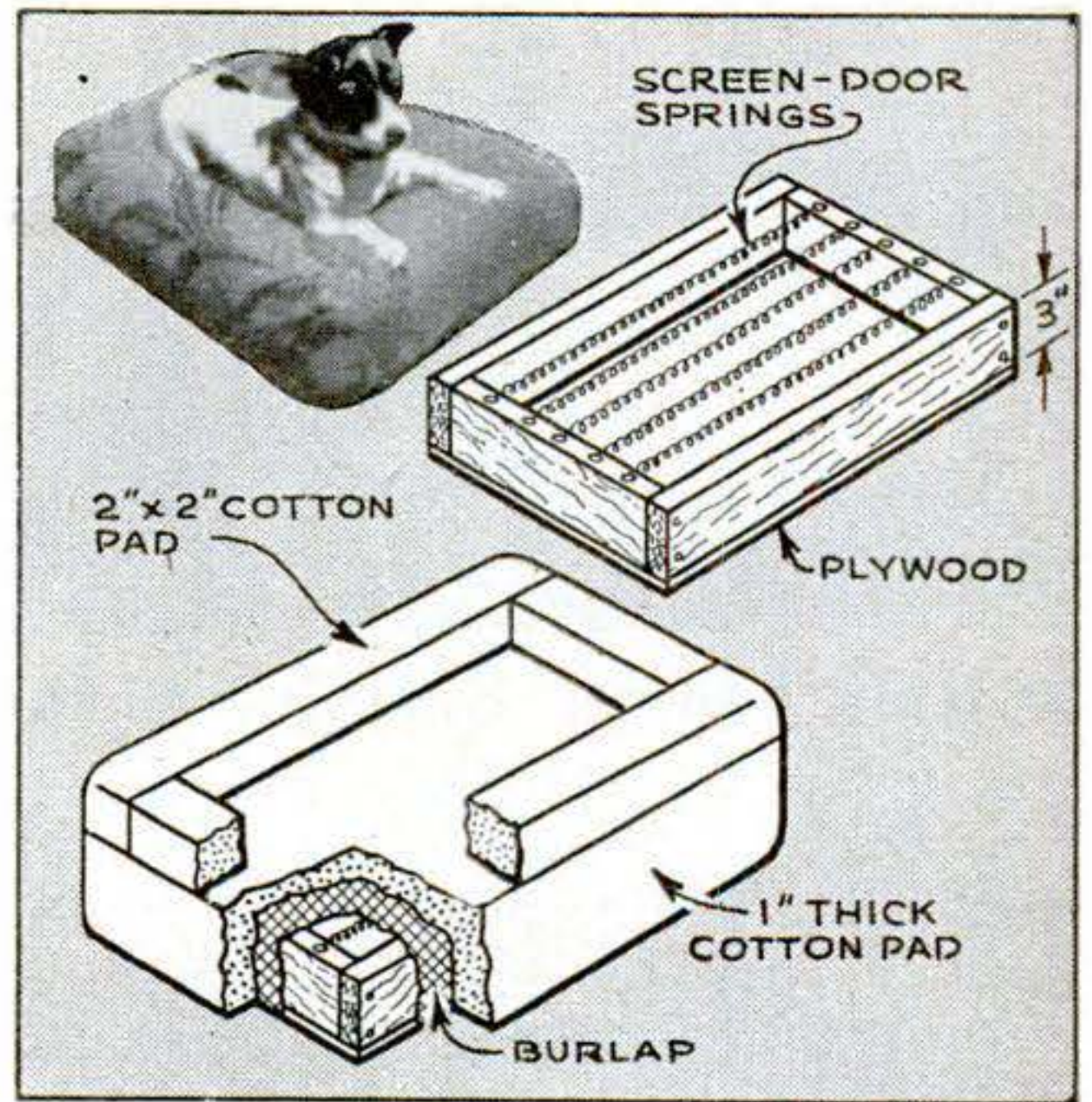

THE BEST way to keep your dog off the furniture is to give him a bed of his own. This one's de luxe—with springs and even the hollow a dog likes to make.

Stretch screen-door springs across a box frame, as shown above, and cover them with burlap and a cotton pad. Build up the sides with 2" by 2" strips of cotton padding. Then tack material over the top, leaving it a little slack so it will sink into the hollow when the dog lies down.

New Tool Is Jack-Of-All-Jobs



THIS new, all-purpose, portable electric tool gives you a choice of either rotary or reciprocating action at the touch of a control. Without attachments it can do such jobs as sawing, drilling, filing, honing, sanding, embossing, and burring. It can be used in a horizontal stand as a bench grinder or in a vertical stand as a drill press or jigsaw. It takes a $\frac{1}{4}$ " drill; a $\frac{3}{32}$ "-thick hacksaw blade. Weighing 6 lb. 8 oz., it is made by Sheldon Products, of Cleveland, to retail at \$79.50.

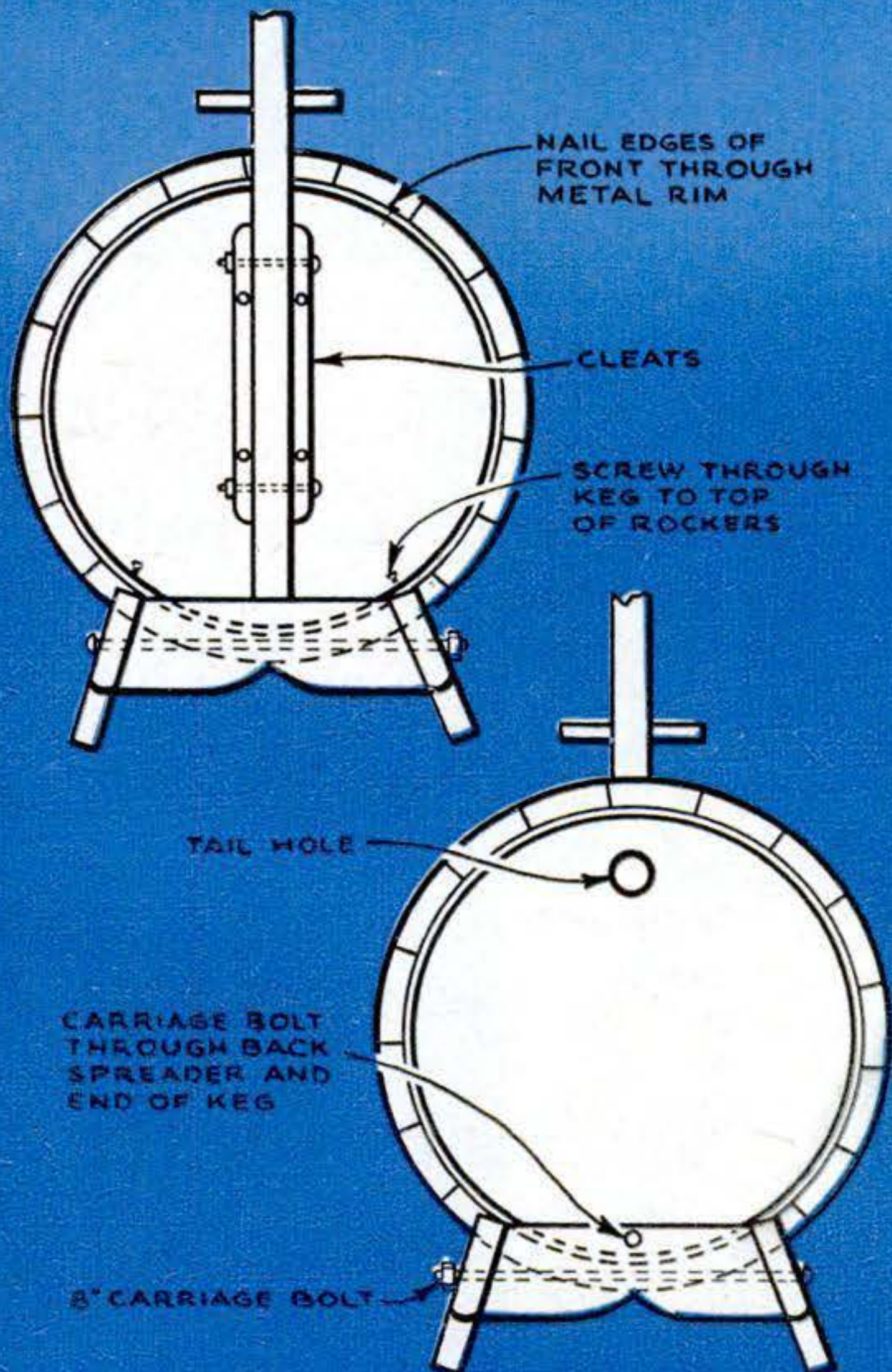



Match Flame Softens Solder

A NEW solder offered by the Proved Products Mfg. Co., San Fernando, Calif., has such a low melting point that you can do small jobs with a match flame. It's made in ribbon form $\frac{3}{8}$ " wide and contains flux. A 30" length costs 25 cents.

Beam Bender Ends TV Spot



THE bright white spot you see when you turn off your TV set may cause a burnt spot on the tube face. A new magnetic yoke made by Clarostat Mfg. Co., Dover, N. H., bends the fading beam to keep the bright spot out of the picture area.

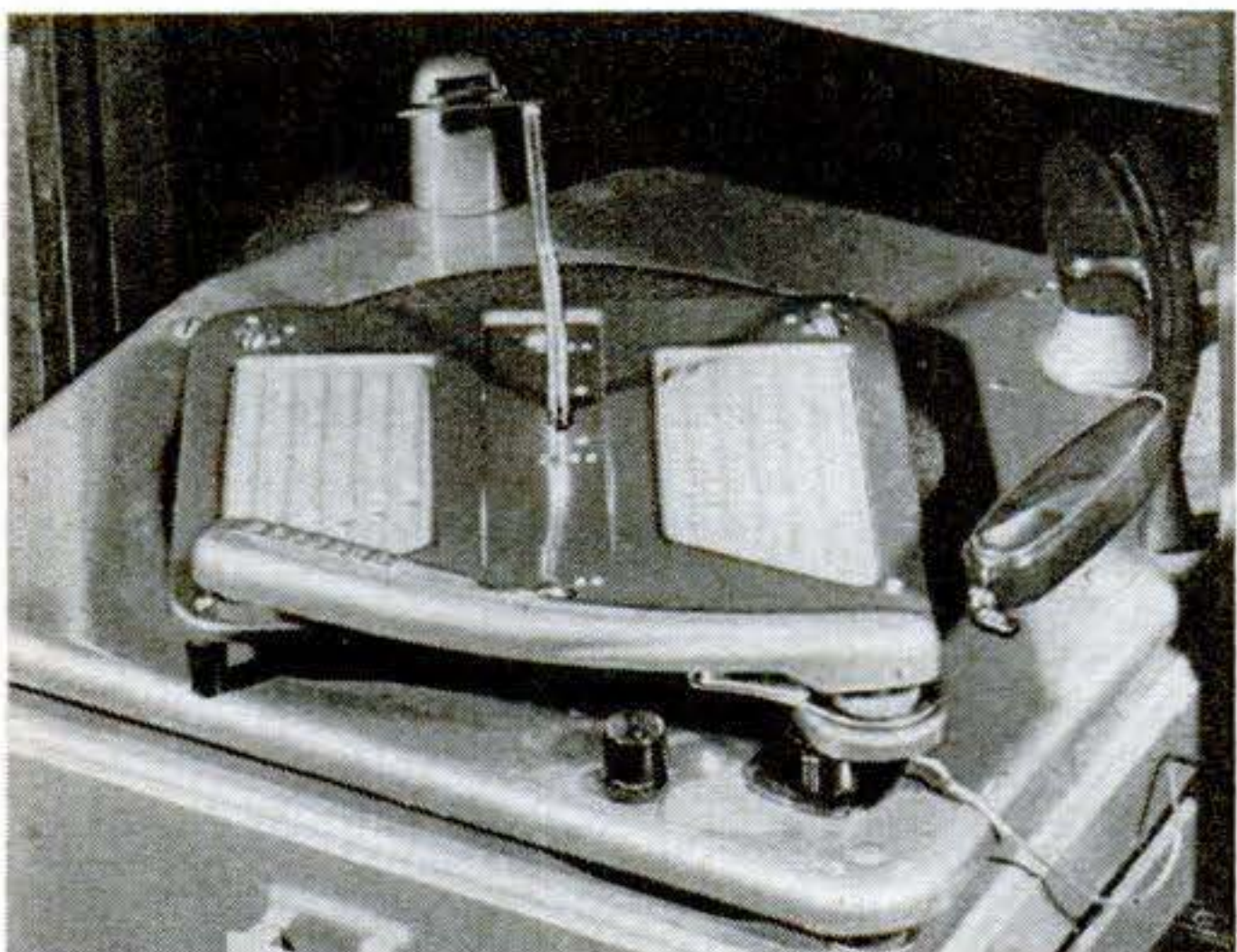

Adapter Plays All Records

THE adapter above will enable you to play records of all speeds—33 $\frac{1}{3}$, 45, and 78 r.p.m.—on your present phonograph. Made by Carbonneau Industries, Grand Rapids, Mich., it slips over the spindle. Small drive wheels vary the speed ratio.



Railroad Creeper Hauls Milk

TO MOVE milk cans from his barn to the pickup point at the highway, Paul Malyk, of Williamsfield, Ohio, adapted a railroad creeper to run on 1" pipe spiked to railroad ties. He feels the pipe track is better than regulation rails because the wheels easily cut off all snow and ice in winter.

Foot Scraper Has Hand Rail

ORDINARILY you must go into a stork act while using a foot scraper to clean mud or snow from your shoes. You stand first on one leg, then on the other, and there's always the chance of a fall.

The scraper shown gives you something to hang onto. This consists of a length of $\frac{1}{2}$ " pipe bent to a U shape and welded to the metal on either side of the scraper. Make the loop waist high so you can grasp it easily.—Elton Sterrett, Houston, Tex.





Sight Sees Big or Small

MAYBE this gun sight can't make a mouse look like a moose—but it comes close. A twirl of the knurled ring the hunter is fingering instantly changes magnification from $\frac{1}{2}X$ to $4\frac{1}{2}X$. The telescopic sight can be used with any number of rifles since it slips into a special mount made to fit most popular big game guns. Bausch & Lomb, the maker, claims that it is the first variable-power telescopic rifle sight made in this country.

Glue Spread by Old Squeegee

WHEN you're gluing up wood, especially large, flat pieces, a small window-cleaning squeegee provides an excellent means of spreading the glue in a thin, even coat over the wood.—Herbert R. Pfister, *The Bronx, N.Y.*

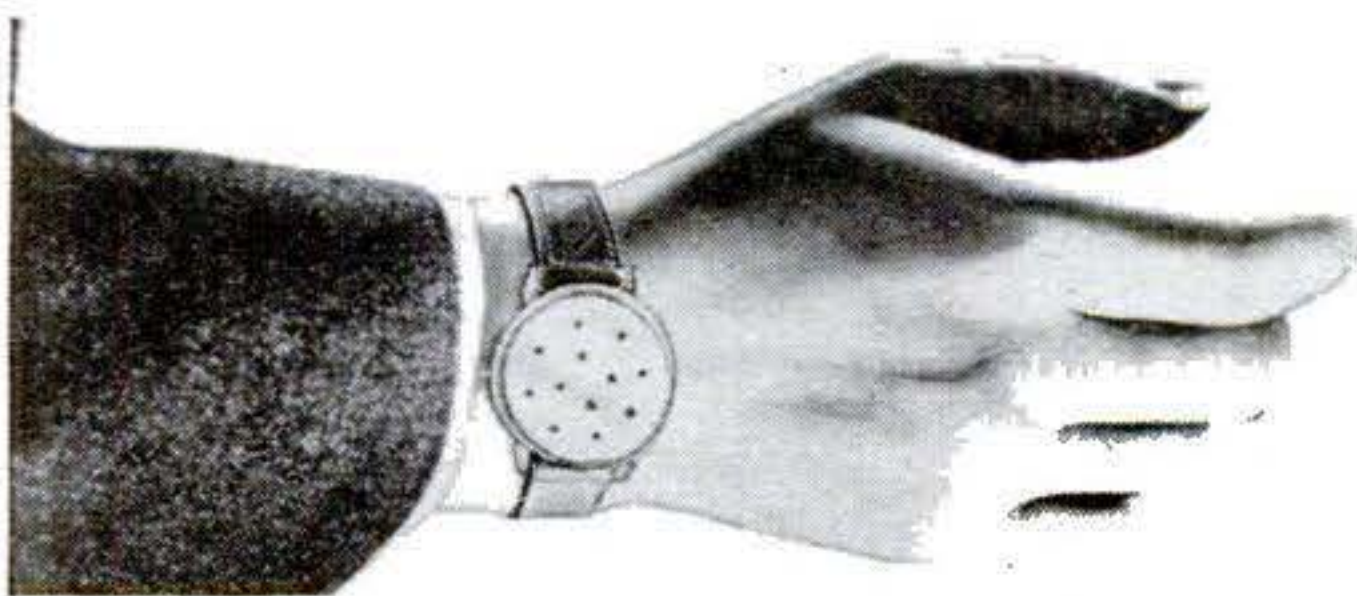

"Ears" to Wear on Wrist

A LONG way from the old-fashioned ear trumpet, this new hearing-aid microphone attracts no more attention than a wrist watch. And the Acousticon Wrist-Ear[®] is not only inconspicuous, but can pick up conversation behind the user. It is also convenient in making phone calls. Another microphone is disguised as a tieclasp. For women, there is a choice of attractive brooches. All the pick-up devices are used in conjunction with standard Acousticon hearing-aid amplifiers.

The Height of Ingenuity



We were stuck for water when workmen shut off the supply at the main. Instead of toting pails of water from a neighbor's house, I rigged up a system that put plenty of running water in our home. How?

I hooked one end of our garden hose to a faucet. Then I changed the connection on the other end of the hose so my neighbor's hose would fit it. When his hose was screwed to his faucet and the water turned on, the water flowed through the hoses and into the pipes in our house.—Leon L. Walters, Chicago.

New TV Tube Is 7" Shorter

BIG cathode-ray tubes for television receivers have always required deep cabinets to accommodate their length. A new 19" tube introduced by Du Mont Laboratories will fit into a much shallower cabinet. Only 21½" long, this tube is about 7" shorter than the old Du Mont tube of similar size.

Strap Stops Rattling Windows

THIN metal strapping of the type used on crates can be adapted to prevent house windows from rattling. Cut a straight strip about 18" long. Double over one end for 1½" and drill or punch this section for two small flathead screws. Bend the rest of the length in a slightly wavy form, making each bend about 3" from the other.

Make four of these for each window. Install one in the channel on either side of each sash. For the lower sash, fasten them as high as possible; for the upper, as low as possible.—John E. Baker, *Paterson, N.J.*

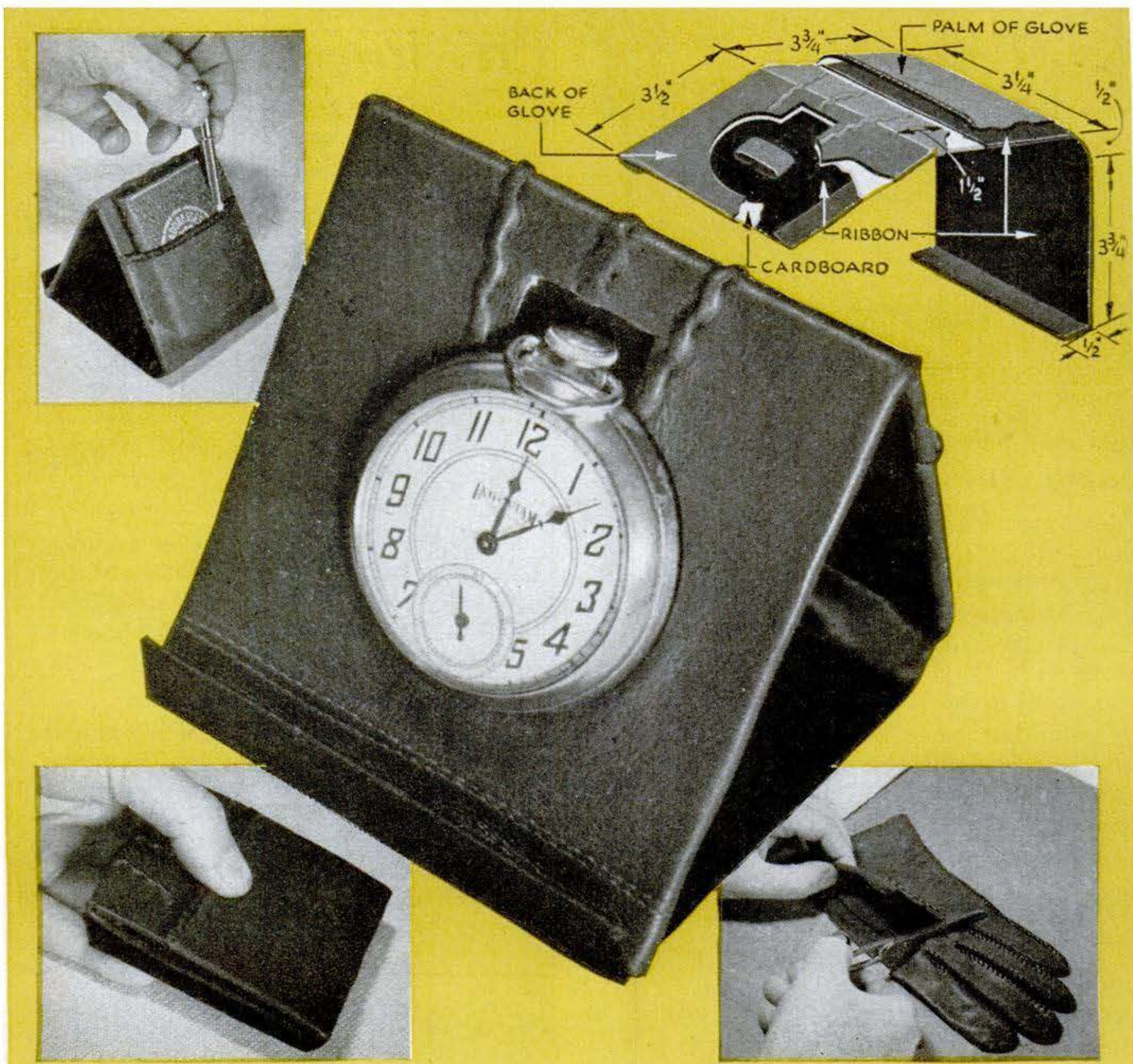

Glove Turns Watch Into Traveling Clock



YOU can turn a glove and an inexpensive pocket watch into a good-looking traveling clock. Folded in its leather case, it will pack safely into a briefcase or overnight bag, and even stay-at-homes will find it both handy and handsome on a night table or desk. A small pocket on the back holds pencil and notebook for phone numbers or midnight memoranda.

First step is to cut out a $3\frac{3}{4}$ " by 12" stiffener from a piece of stiff cardboard. Score fold lines and bend the card as shown. In the bottom section cut an opening the same size as the watch.

Now cut the glove. From the back snip

out a piece 4" by 5". Paste it to the cardboard with cellulose cement and cut an opening for the watch.

For back and lining, buy a yard of matching 4" ribbon. Fold under both edges to make it $3\frac{3}{4}$ " wide and cement it to the back of the cardboard around the end and up along the top side. The glove palm makes a pocket for an address book. Cut it $2\frac{1}{2}$ " by 4"; apply cement only to the bottom edge and the overlapping sides.

As a support for the watch, fold a strip of adhesive tape sticky side out, fasten it to the ribbon at the center of the cutout, and press the watch down over it.



Hints from the Model Garage

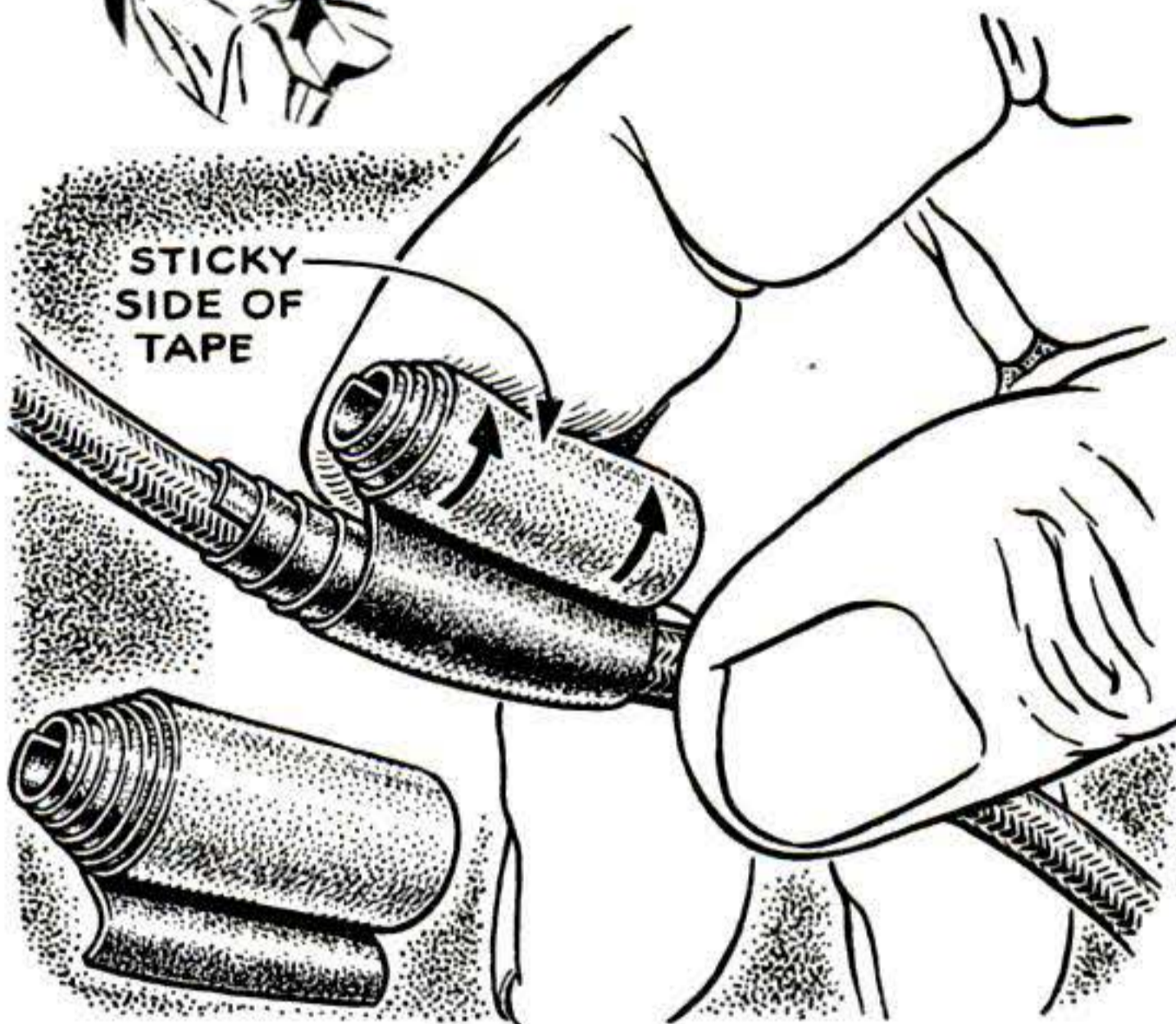

Look, One Hand! In a spot where there's barely space for one hand, how can you tape a wire? Simple enough, says Harry Morse, Oakland, Calif. Tear off a piece, re-roll with the sticky side out, and wind on with the fingers of one hand.

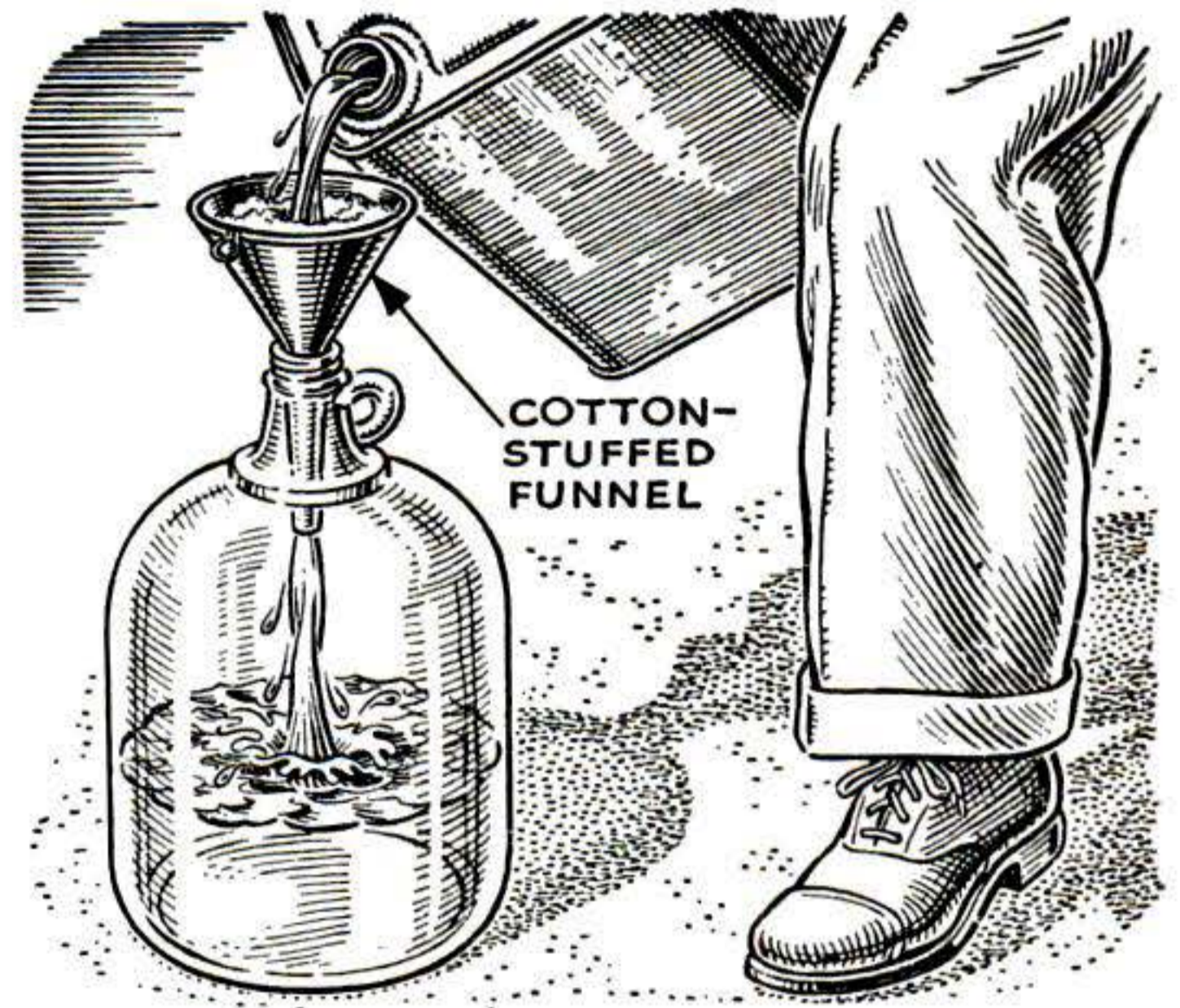

Filter Your Antifreeze. Before putting stored antifreeze back into your car, it's a good idea to filter it through a wad of absorbent cotton placed in a big funnel. You'll find a surprising amount of last year's dirt on the cotton.

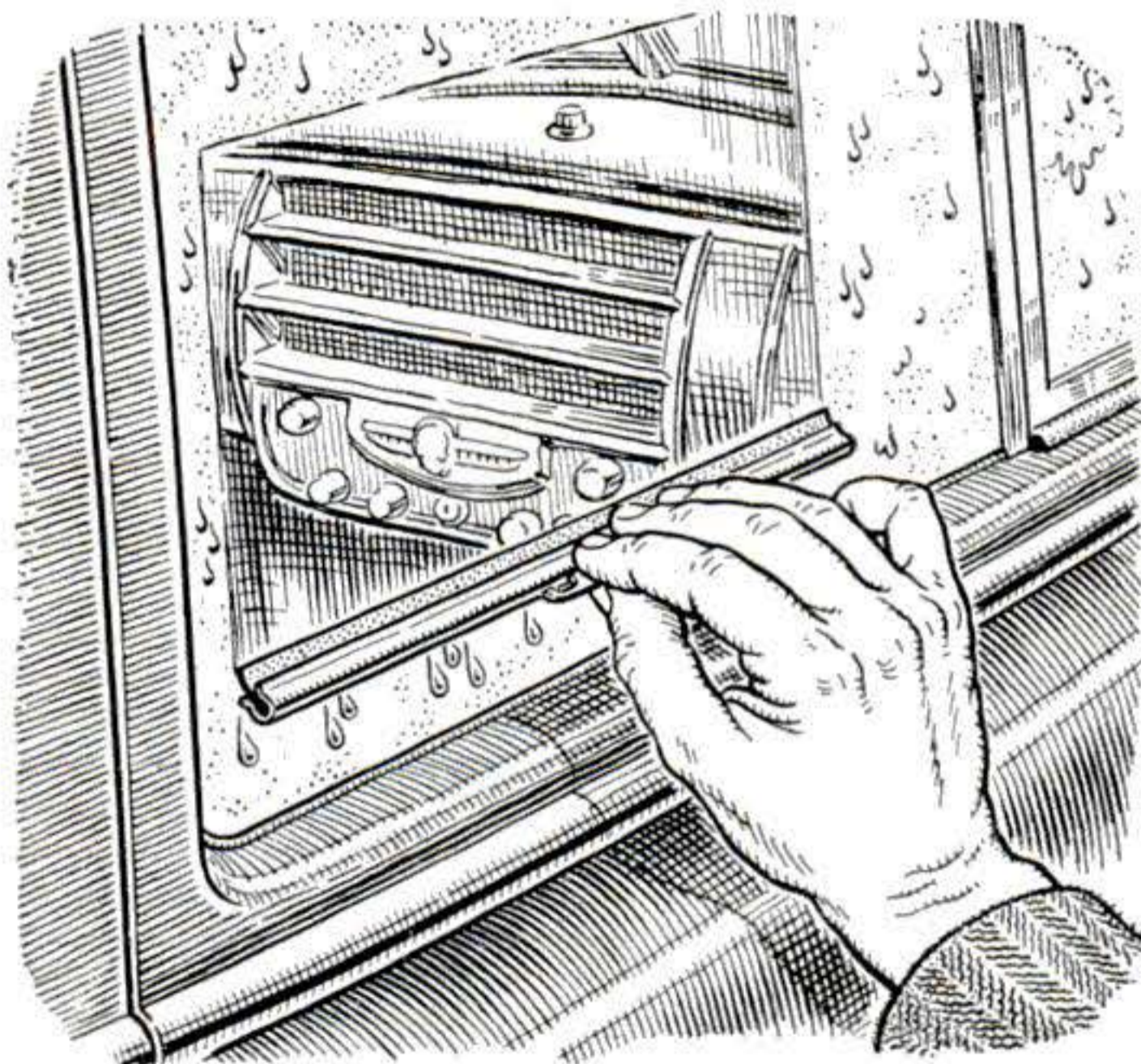

Clearing Fogged Windows. Richard H. Hanson, of Melrose, Mass., makes it a practice to carry an extra windshield-wiper blade. Besides serving as a spare in case of loss of one of the regular blades, it also comes in handy as a squeegee for clearing fogged windows. It's also useful for drying the windows after a car wash.

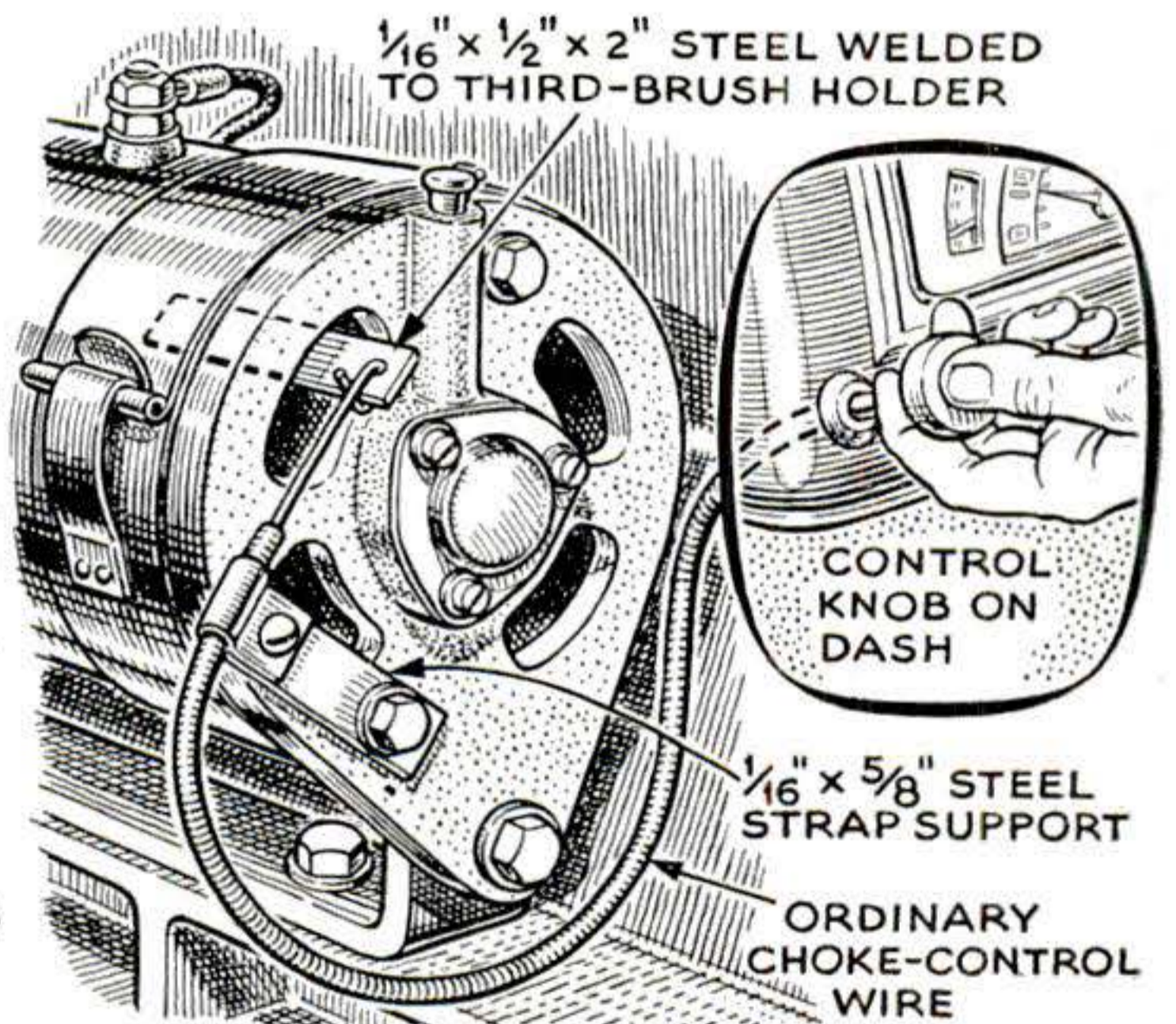

Varies Generator Output. This control enables Rowlin Howard, Rushville, Ind., to vary the generator output on his 1934 Chevrolet to suit conditions. On short hops and at night, he pulls the knob and gets readings of 15 or 20 amp. On a long trip he cuts output back to 4 or 5. This helps prevent battery overcharging. ➤

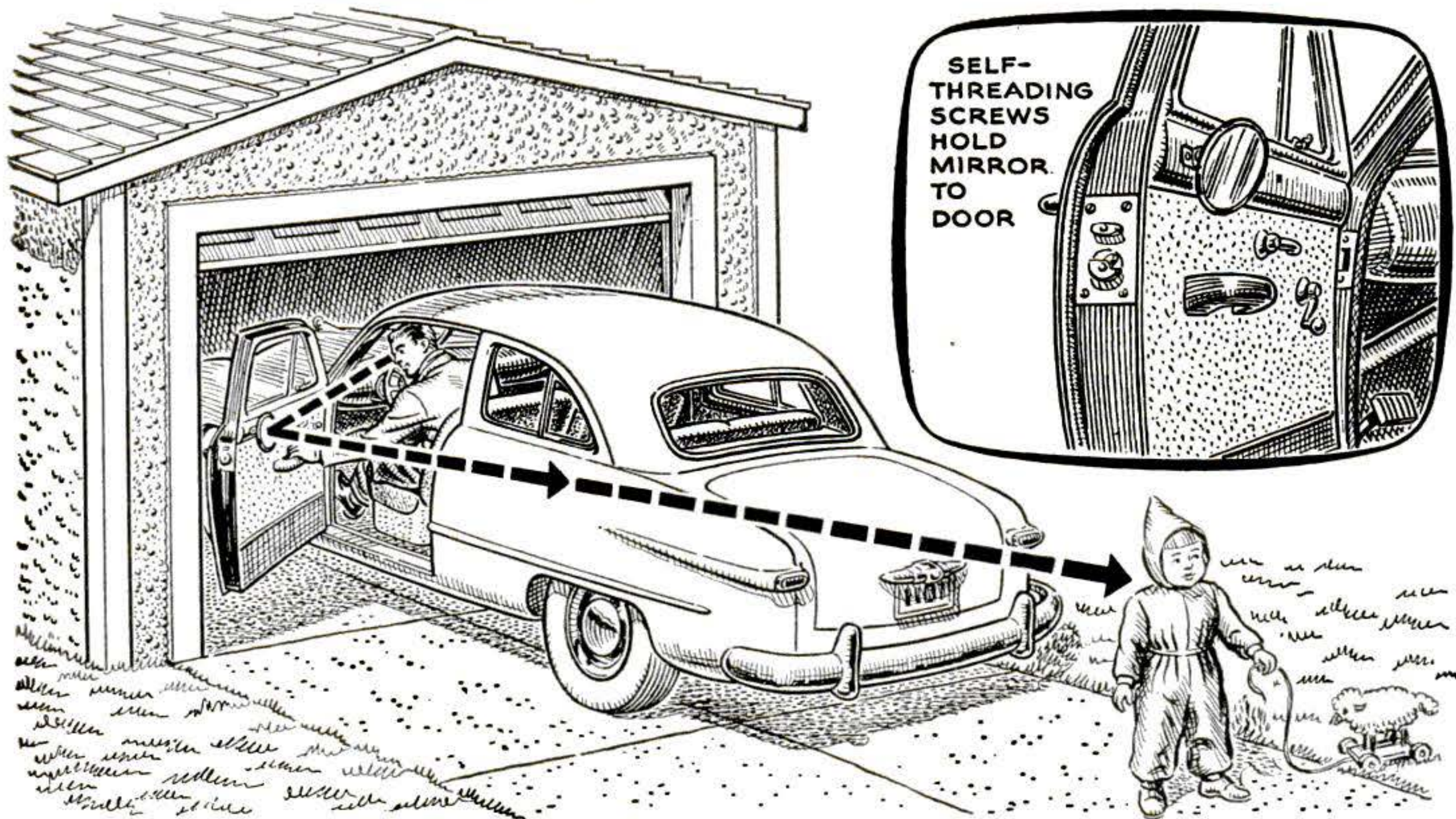

Door Mirror Widens View. If there are children in the neighborhood, backing out of a driveway is always a risky business. A mirror mounted on the driver's

door as above will help cut down any blind spot behind the car. Locate it as near as possible to the outer edge of the door to get a wide angle of vision.

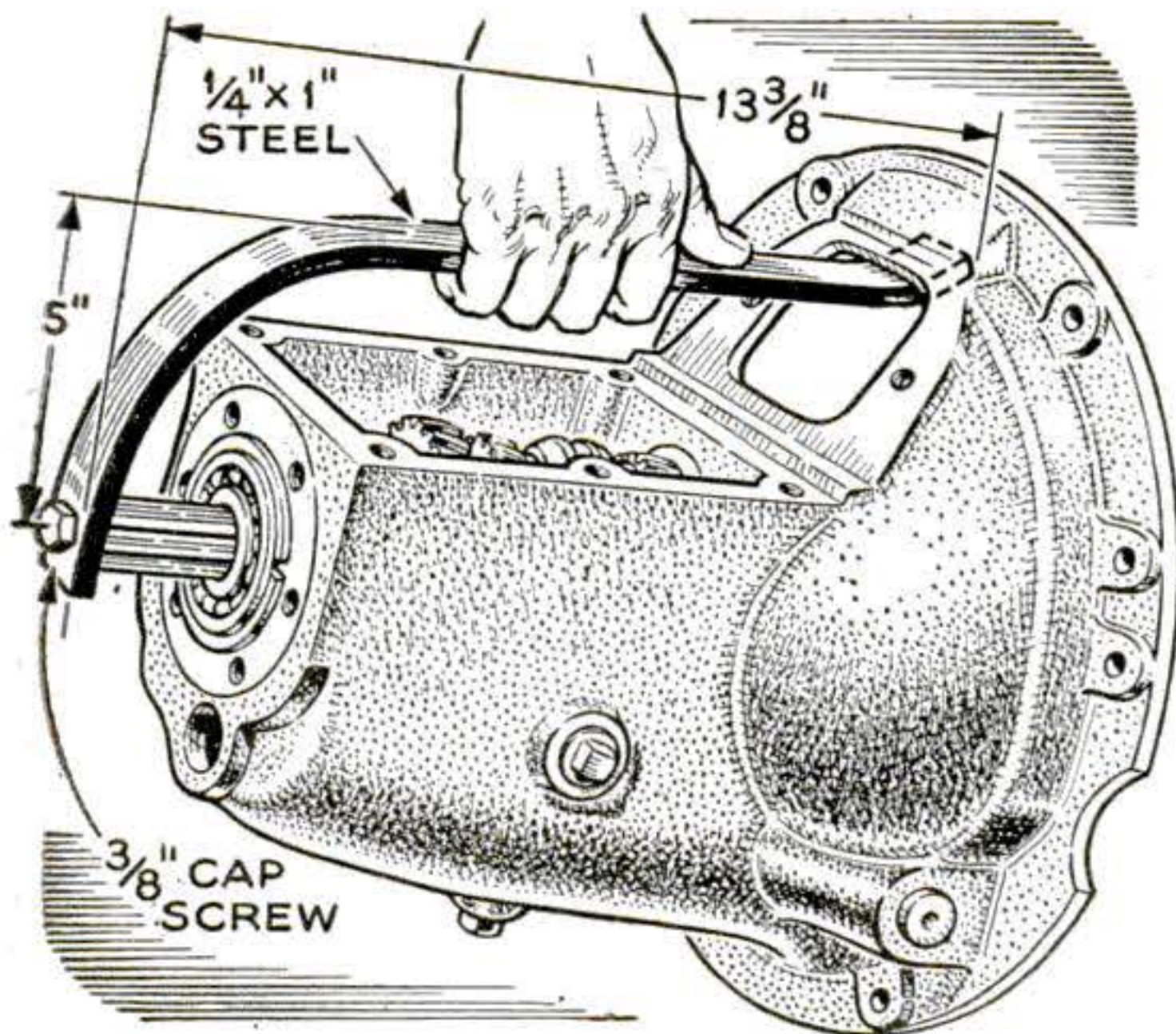

Transmission Lifter. Back in the days when Fords had the shift lever on the floor, the lever could be used to lift the transmission out of the car. But on later models there's practically nothing to which you can hold. To ease the job, mechanic William E. Ware, of Shirley, Ind., made the lifter shown here.

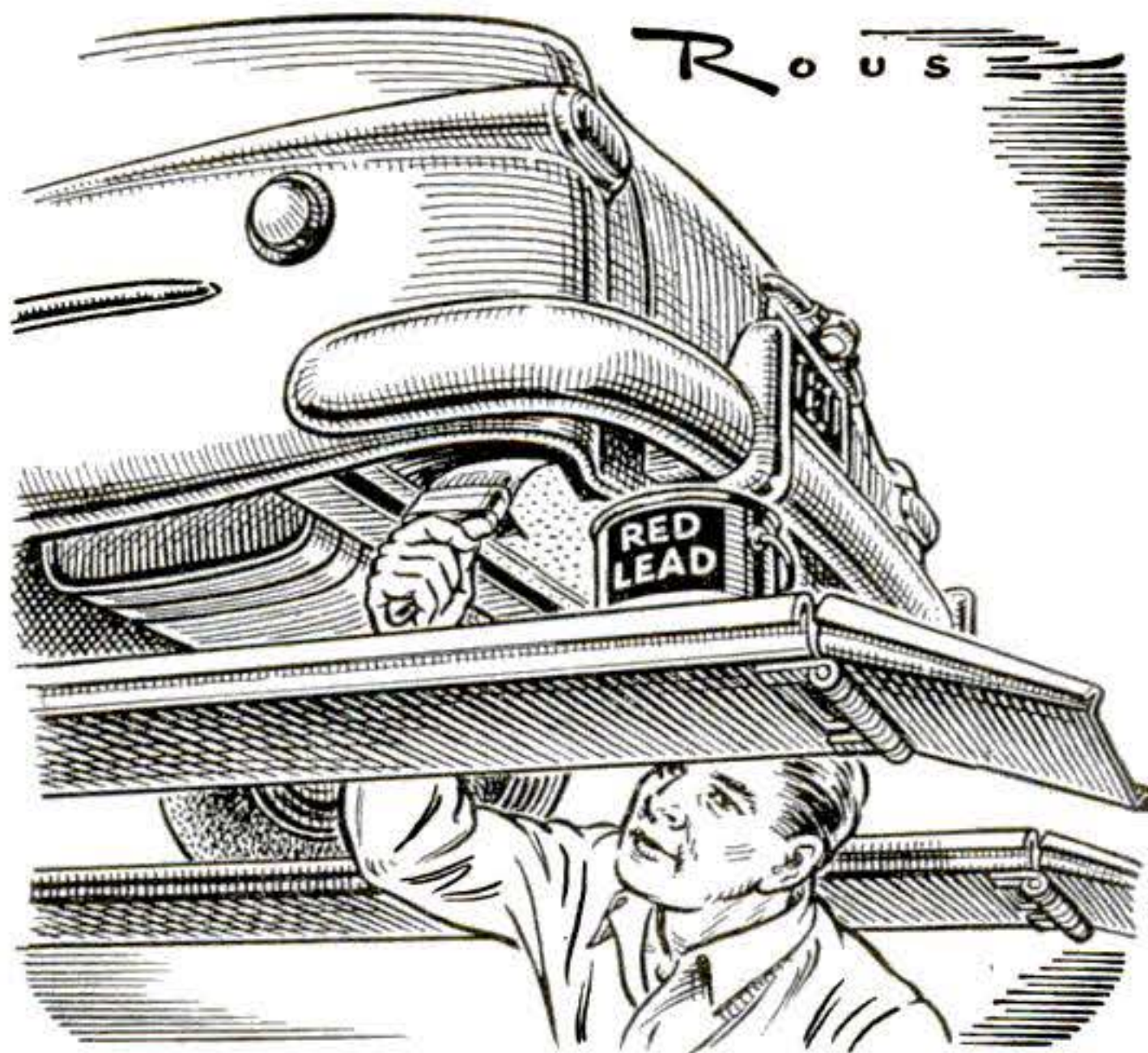

Red Lead Stops Rust. If you don't want to spend the money for a regular undercoating job, you may want to try red lead. You won't get any sound deadening, but at least you can protect the fenders and other metal from rust. A. Bogossian, Brooklyn, N. Y., reports he finds absolutely no rust two years after doing his car.

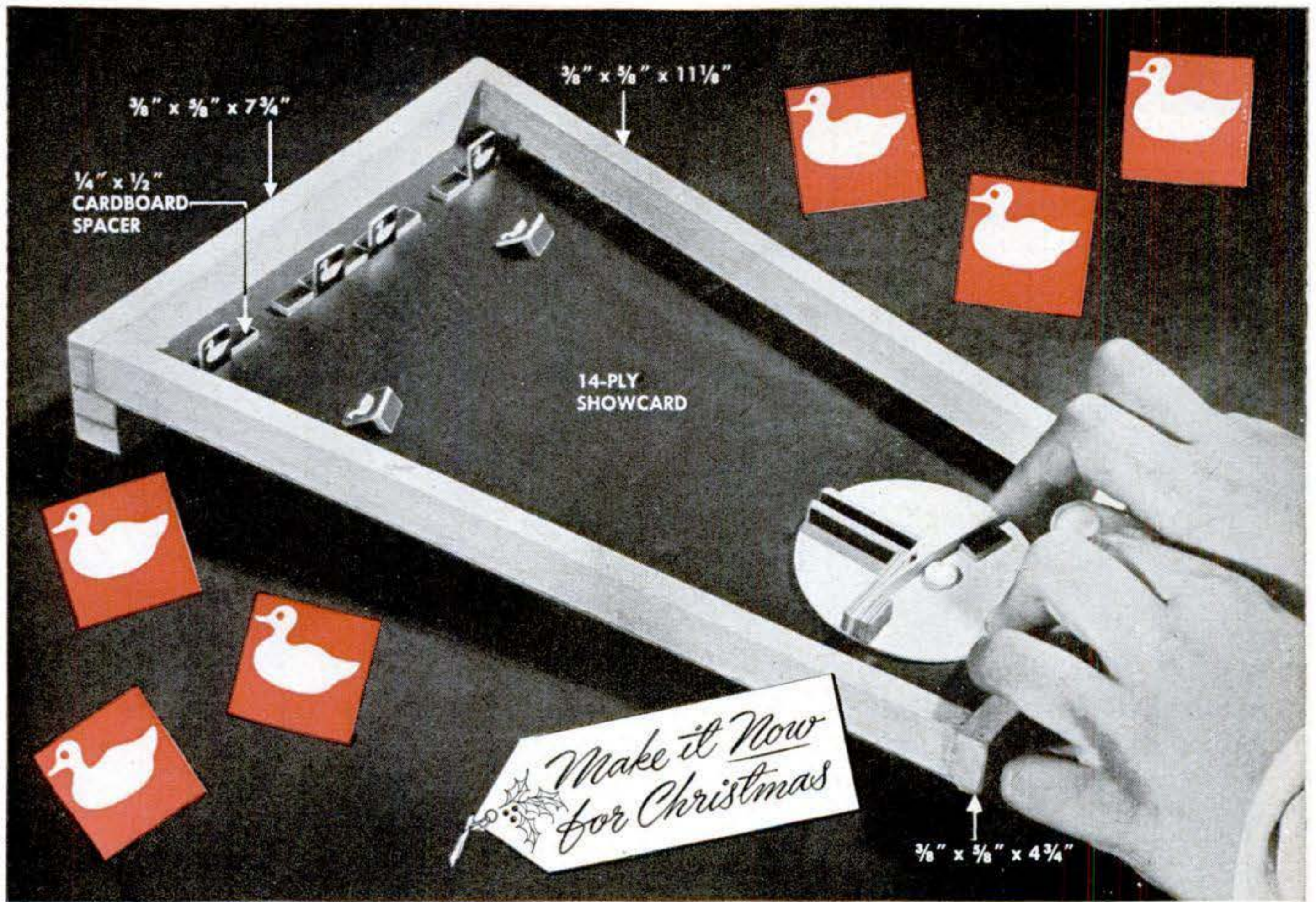

Ducks to Shoot On a Table Top

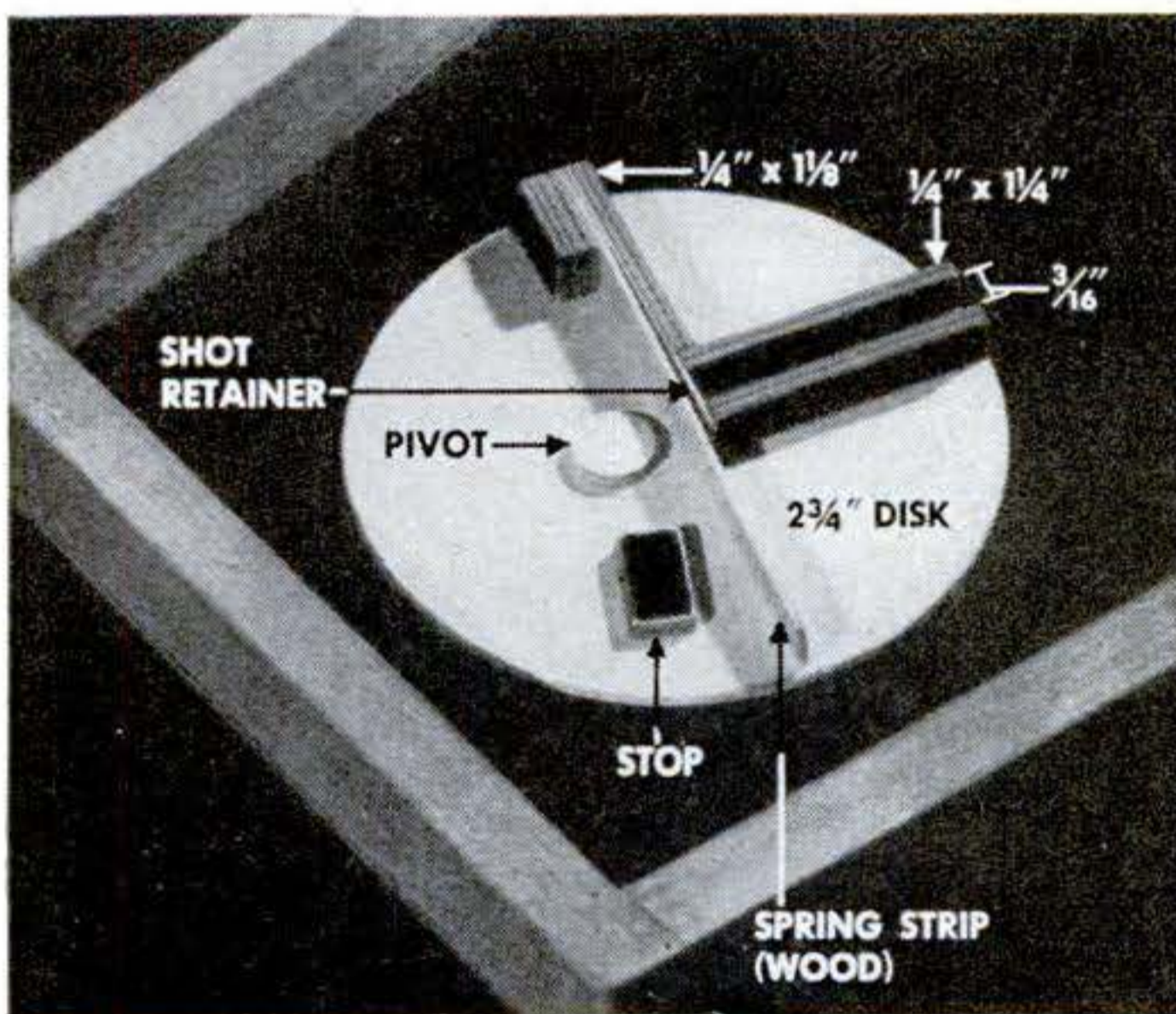

NO "MERE BAGATELLE," this is a real game of skill. You play by taking careful directional aim and then snapping a thin wood strip to hurl a lead shot at the ducks.

To make the board: Use heavy cardboard for the bottom, shaped as shown above. Wood strips frame the sides and raise the target end. Cut out six ducks on $\frac{1}{2}$ " x $\frac{1}{2}$ " cardboard squares and attach to $\frac{1}{2}$ " x $\frac{1}{4}$ " wood bases. Glue seven spacer strips to the board so targets fit loosely between them.

To make the shooter: A cardboard disk, pivoted on a thumb tack, forms the base, as at left. Two cardboard strips glued upright guide the shot. Across the rear end, a thin strip holds the shot, but a small hole lets it protrude enough so the wood snapper can get a good swat. The snapper's fixed end is mounted in cardboard, glued to the disk.—*Frank Shore, Manhattan, N. Y.*

A "Quickie" for the Baby

A CIGAR box and two wooden coat hangers are all you need to make a cradle for your daughter's doll. Simply remove the lid from the box and the wire hooks from the hangers. Then fasten the box onto the hangers with wire brads and glue, as shown at right. For a more solid job, you can mount the hangers flat against the sides of the box.

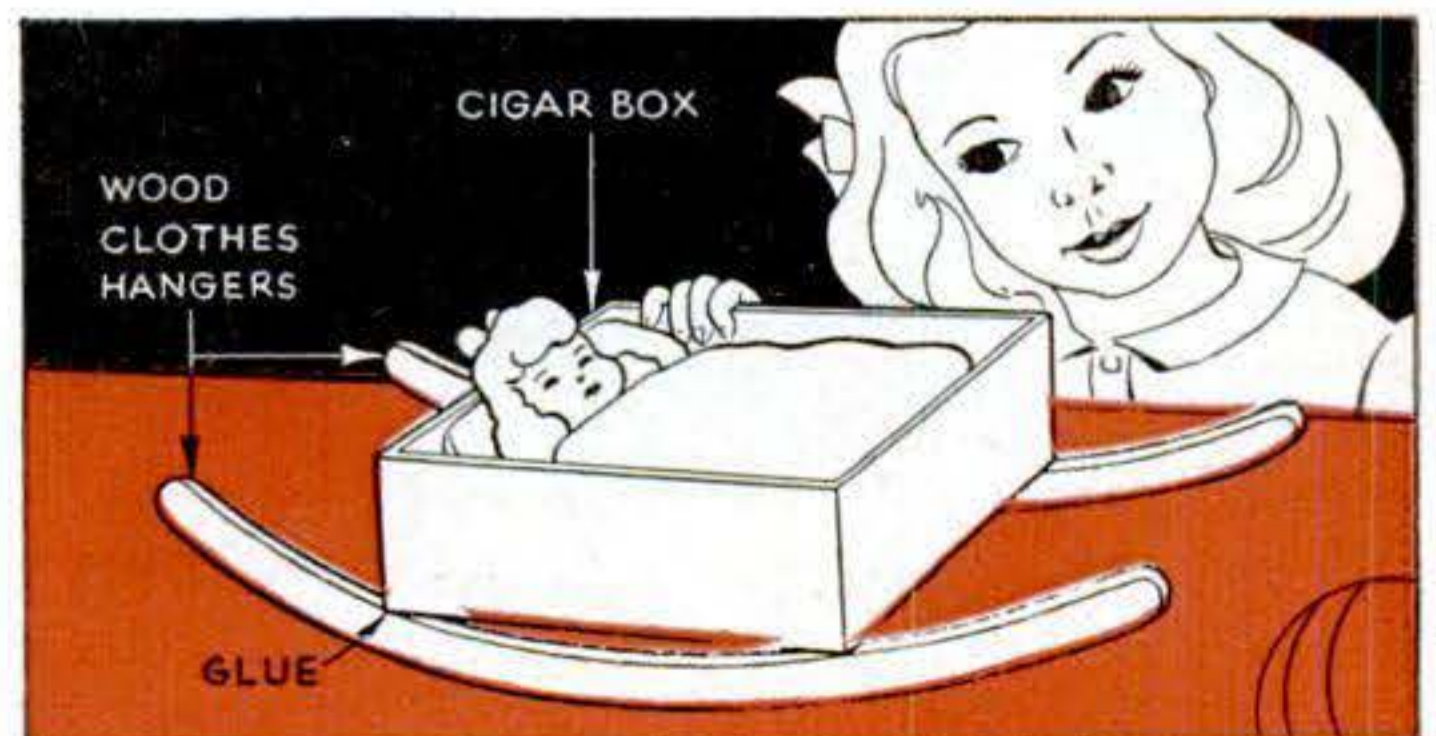



Tissue Diffuses Print. A piece of tissue paper, cut to fit on the top condenser of a condenser enlarger, will produce a soft print, more flattering to the subject in the case of portraits. Because the tissue holds back some of the light, it will be necessary to increase exposure time.—*Virginia Hanson, Santa Monica, Calif.*

Stills from Movies. This new Federal enlarging camera (below) lets you make stills from movies without cutting the film. Just pull it through a slot to the frame you want, then push a button to print it as a negative on 127 roll film. A magnifying viewer enlarges the movie film to aid selection. The exposure light is built in. Made in two models, for 8-mm. and 16-mm. film, the unit sells for about \$20.

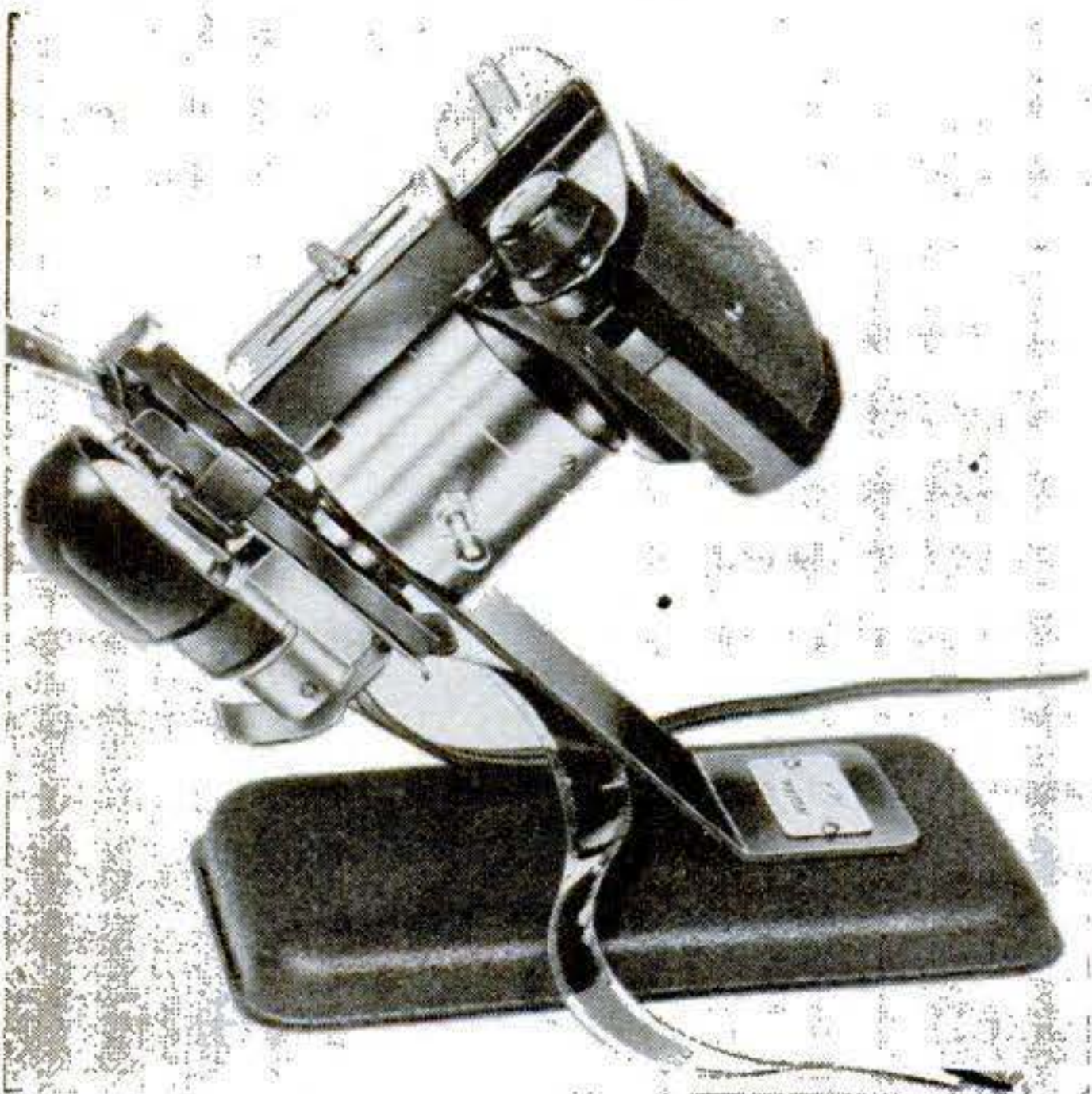

Meter for Land Camera. A matchbox-size exposure meter for use with the print-a-minute Polaroid Land Camera (PS, Feb. '49, p. 232) is being produced by General Electric. It is calibrated in numbers from 1 to 8 to correspond to the aperture settings on the camera. Film speeds are set by rotating the dial.

New Graphic Is Versatile. This new 2¼ by 3¼ Century Graphic, for around \$110, embodies many of the features of the more expensive Crown model. It's equipped with a Graflex Trioptar f/4.5 coated lens in a Century synchronized shutter with speeds from 1/10 to 1/200 sec. It will take cut film and film packs. A special holder, shown at left below, that adapts it for roll film is available for \$20 extra.

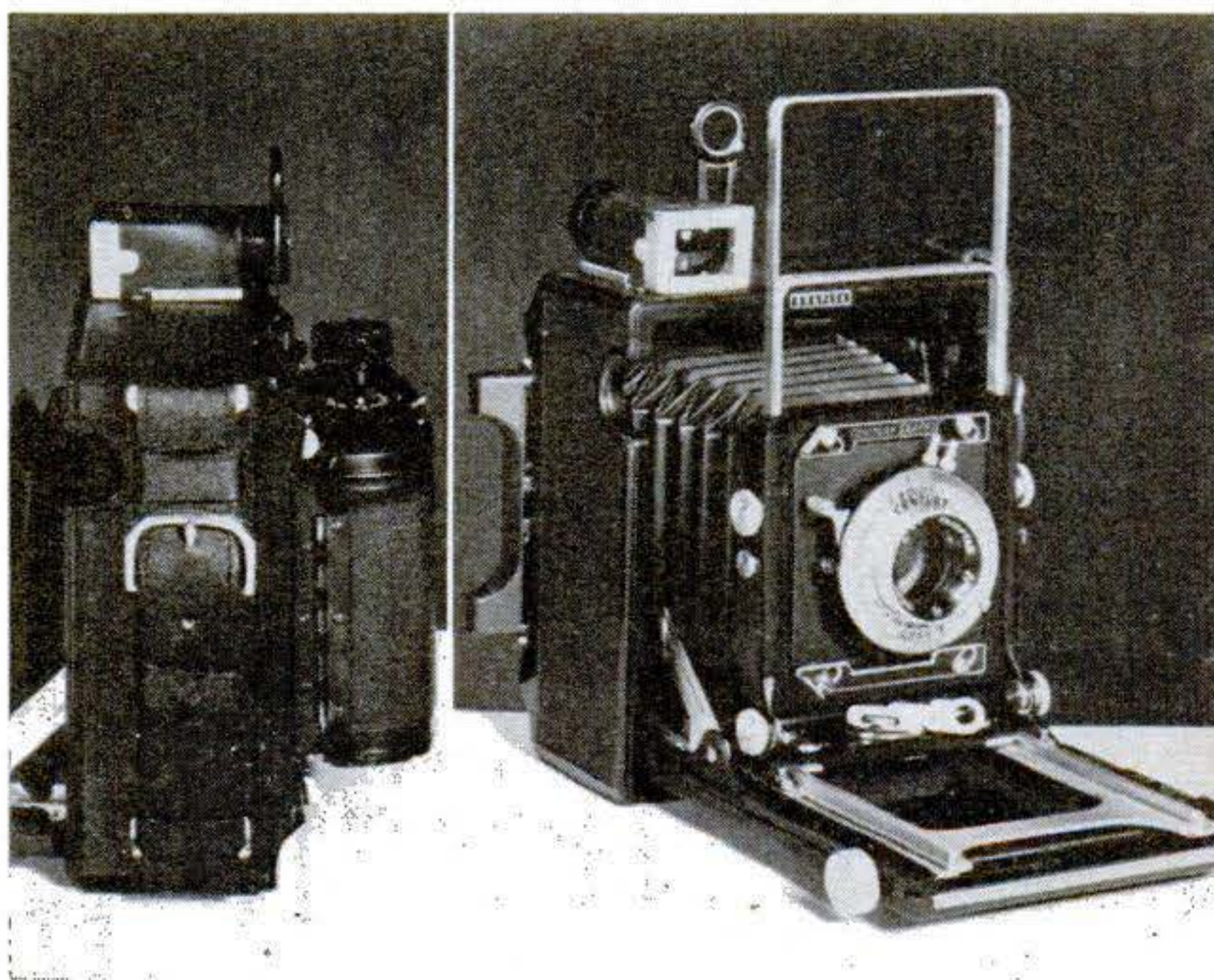



Liquid Mounts Photos. Most glues or cements are unsafe to use on photos because they may cause the print to discolor. A new solution made with Vinylite® resins by Photo Bond, Akron, Ohio, is said to overcome most of the problems usually encountered in cementing down prints in albums or on mounts. An 8-oz. bottle costs 65 cents.

Glass Makes Table Top. I have found that one of the best surfaces for photographic work is a sheet of tempered plate glass called Herculite®. Used as a table top, as below, it's easily cleaned and lets you see needed items in the drawer below it. In the ¼" thickness, it supports considerable weight and withstands heavy blows. It can be ordered with polished edges.—*John P. Arnold, Doylestown, Pa.*



Backstage in a TV Tube

OLD sailors who build ship models inside of bottles have nothing on electrons. These busy particles put on a whole picture show inside a sealed glass bulb. What happens and why are shown on the next two pages.

Most of the tubes and circuits in your TV receiver pipe "information" into the neck of the picture tube. This information arrives as many different kinds of voltages. Their job is constantly to alter a high-speed electron beam so that it paints a series of pictures on the phosphor-coated glass at the tube's end.

The electrons in the beam are pushed out from an oxide-tipped cathode by an electrically heated filament. However, a stream of ions is also pushed out. Both ions and electrons are negatively charged particles, but ions are about 2,000 times heavier. If they should hit the screen, they would chip the phosphor. To deflect the ions into a dead end, the tube we're studying uses a team of electrostatic and magnetic fields.

To make a bright picture, the electrons must move fast and hit the fluorescent screen hard. To pick up this speed, they are passed through successively higher voltage fields, getting a kick from each.

Magnetic coils focus the beam to pinpoint sharpness and bend it both up and down and from side to side. This is the vital step since the picture you see is put together in tiny pieces. Present standards call for 525 interlaced lines, each one changing 30 times a second. Actually there are fewer lines since time is lost when the beam jumps back from the end of one line to the beginning of the next.

For an inside view of a TV tube, turn the page. ➤

Accelerating anode increases velocity of modulated beam. First anode applies several hundred speed-up volts.

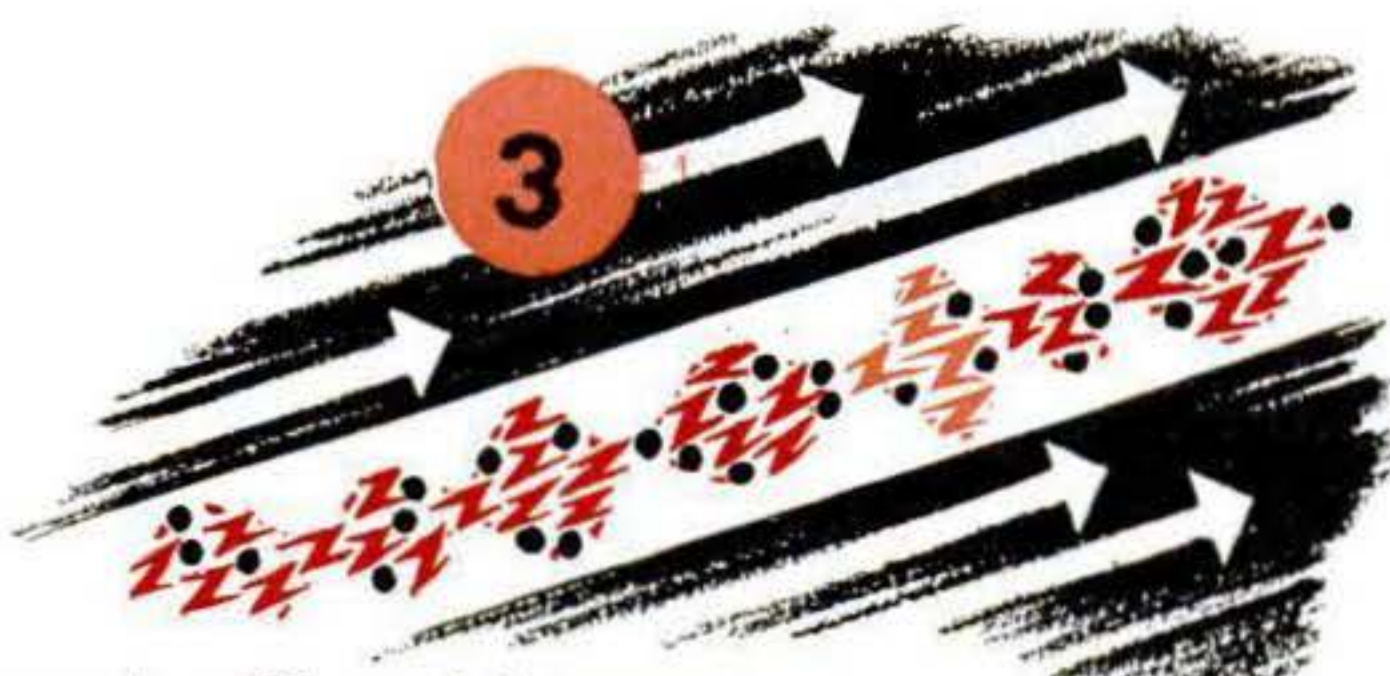

Control grid modulates—varies—the strength of ion-electron beam, matching it to the received signal.

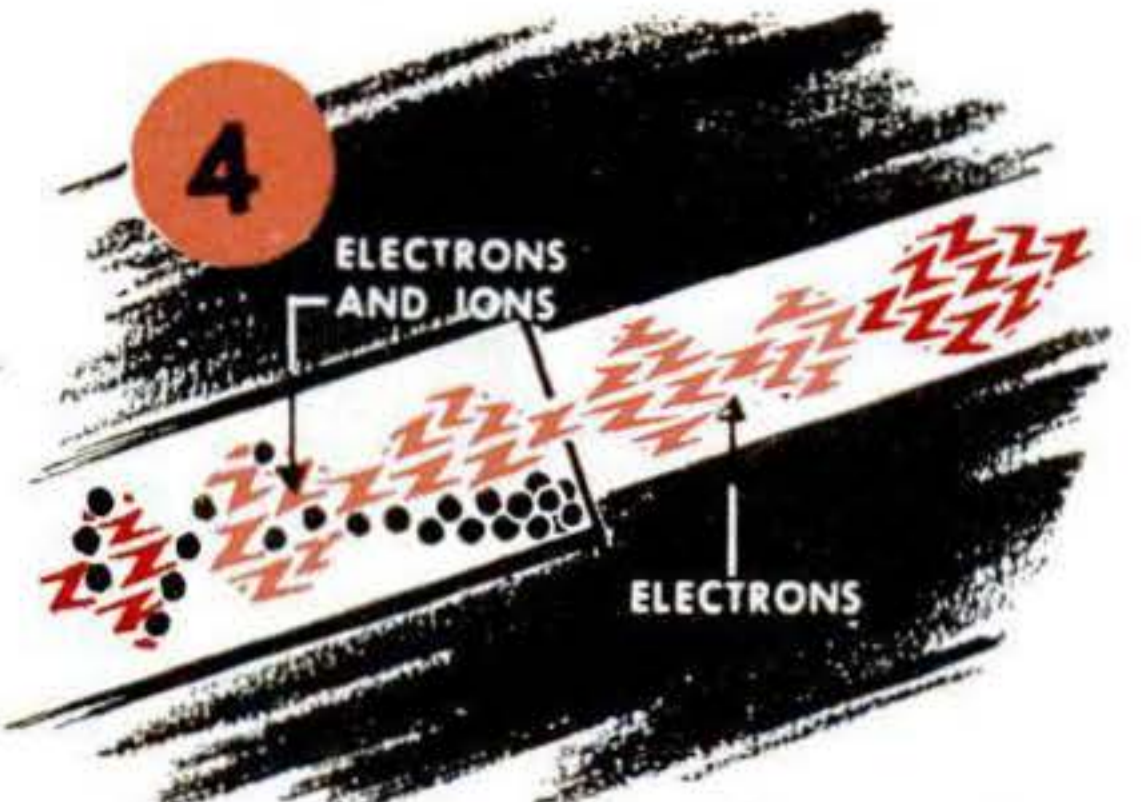

Ion trap takes ions out of the picture through a combination of electrostatic and magnetic fields.



Electron and ion particles are emitted from the cathode in a loose beam.

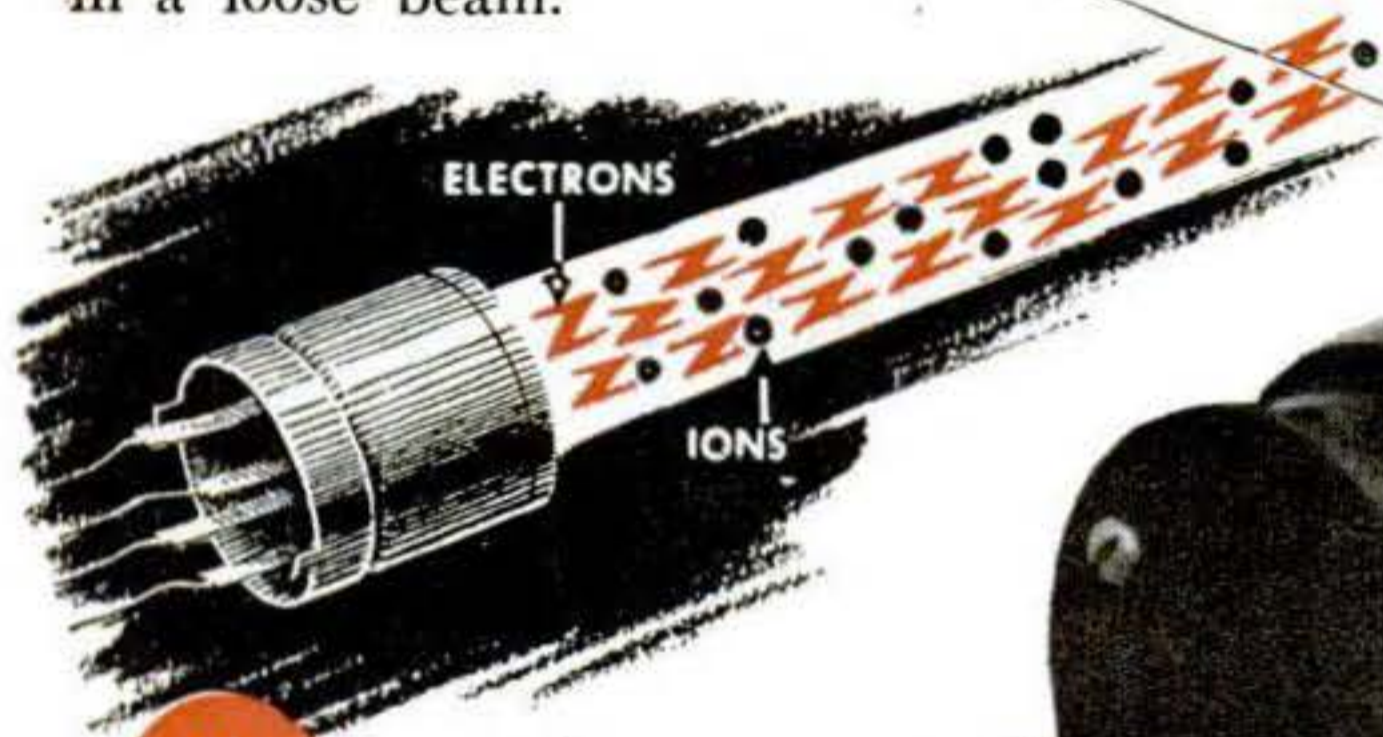

1

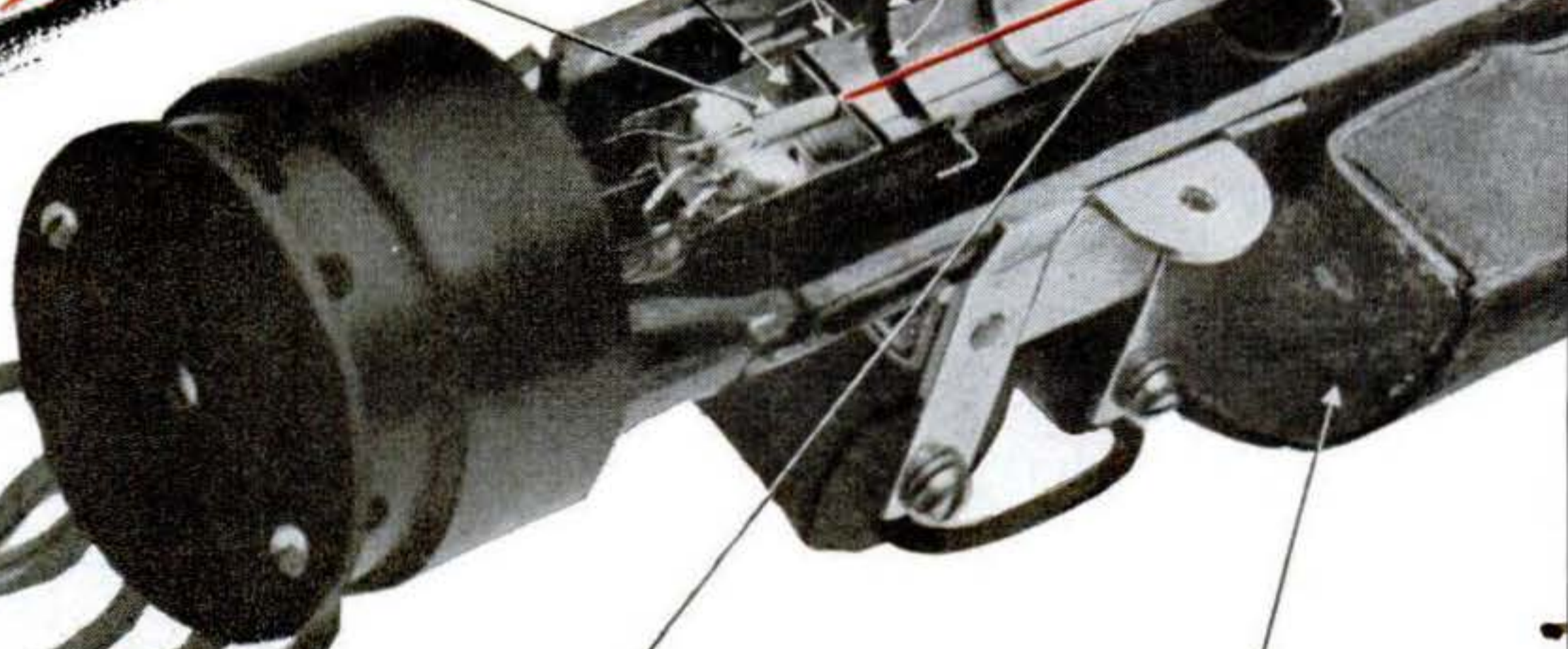

High voltage, applied through glass and conductive coating inside bulb, gives beam a final burst of speed.



6

Focus coil acts as a lens, but does it magnetically. It concentrates the spread-out beam to pin-point sharpness.

Tube cutaway by Sylvania Electric. Drawings by Ray Pioch

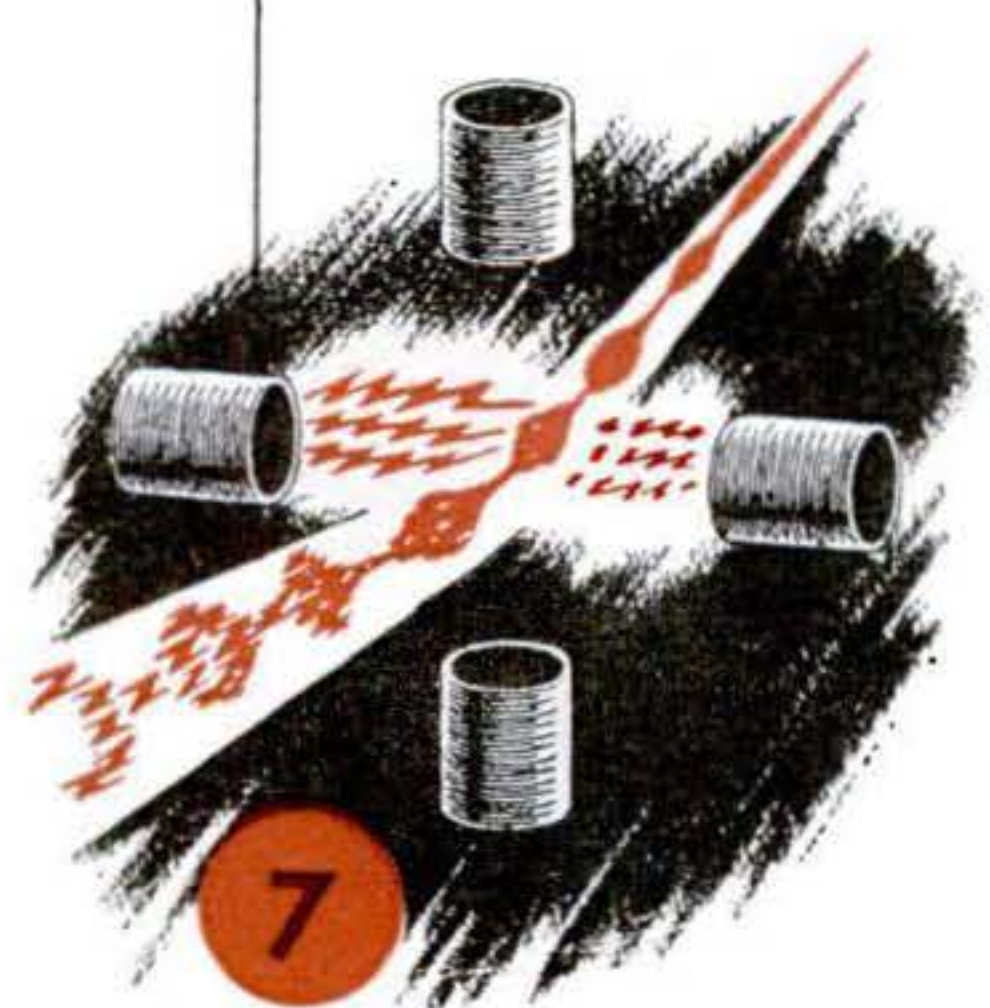
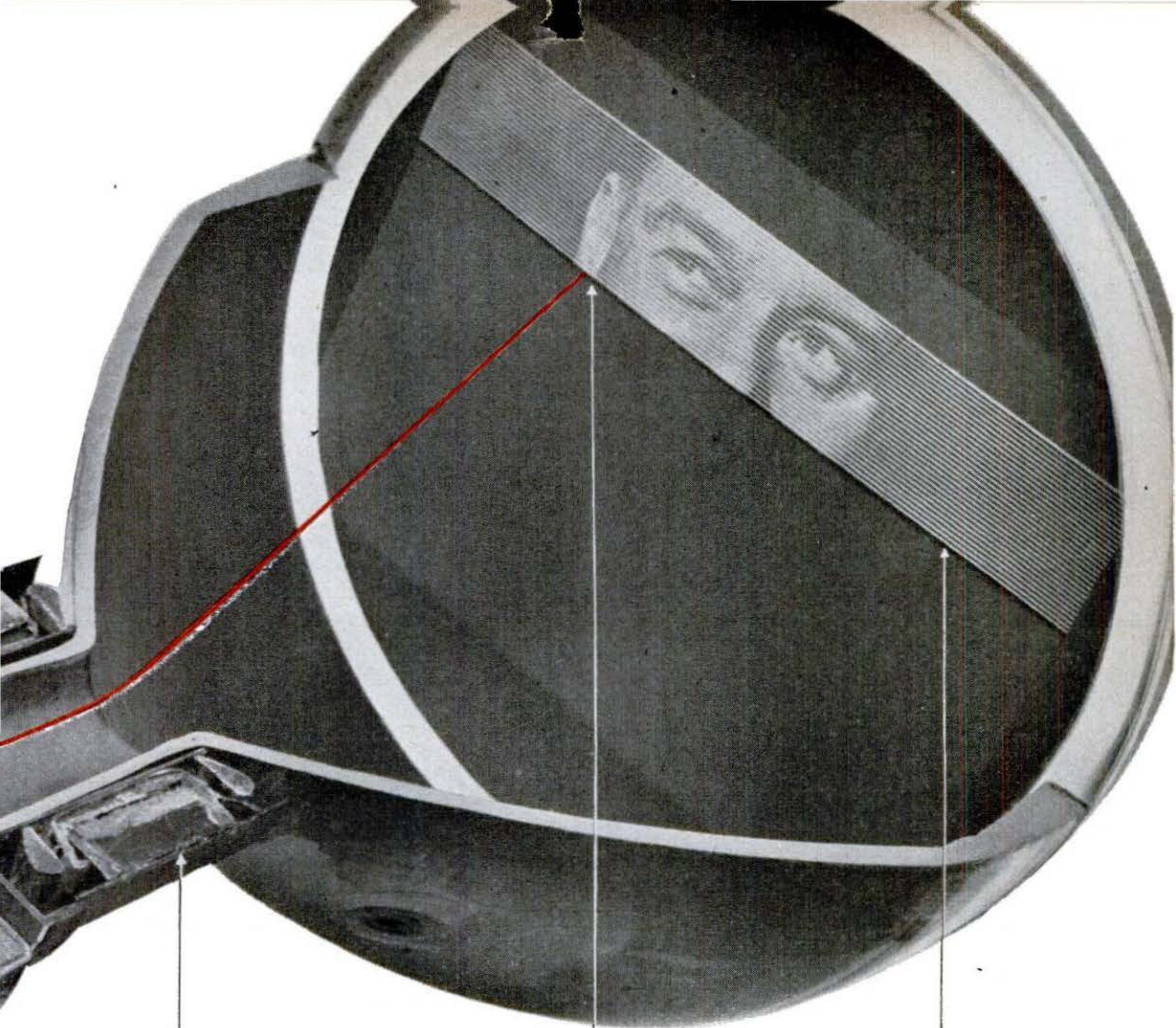

7
Deflection yoke around the neck of the tube bends the focused beam across the tube face and up and down.



8
Tube face is coated on inside with fluorescent phosphor. Phosphor lights up as electrons strike it. Amount of light is governed by the intensity of the beam.



9
Scanning action of deflection yoke moves beam across face in $1/15,750$ sec. Beam makes two interlaced half pictures. Trace 1 (white) draws $262\frac{1}{2}$ lines in $1/60$ sec. Trace 2 (red) then does the same in the spaces between trace 1. Resulting picture consists of 525 lines drawn and erased 30 times a second.



How an Expert Builds a Model Boiler

By Harry Walton

PS Photos by W. W. Morris

YOU can run a model steam engine on an air line, which is about as exciting as plugging in an electric motor. But when you use fire to boil water and let steam push the piston, you not only have a prime mover, but also a thrill that only the smell and spit of live steam can give. And cutting loose from the air hose gives you a nice portable power package for driving a model.

But even a small boiler, if badly made, can be dangerous. Water in a confined space stores heat as latent energy. Any sudden release of pressure, such as the rupture of a seam, lets it all flash into steam instantly, producing an explosion.

To find out how an expert builds *safe* model boilers, PS went to see Anton Bohaboy, of Rahway, N. J., who has been build-

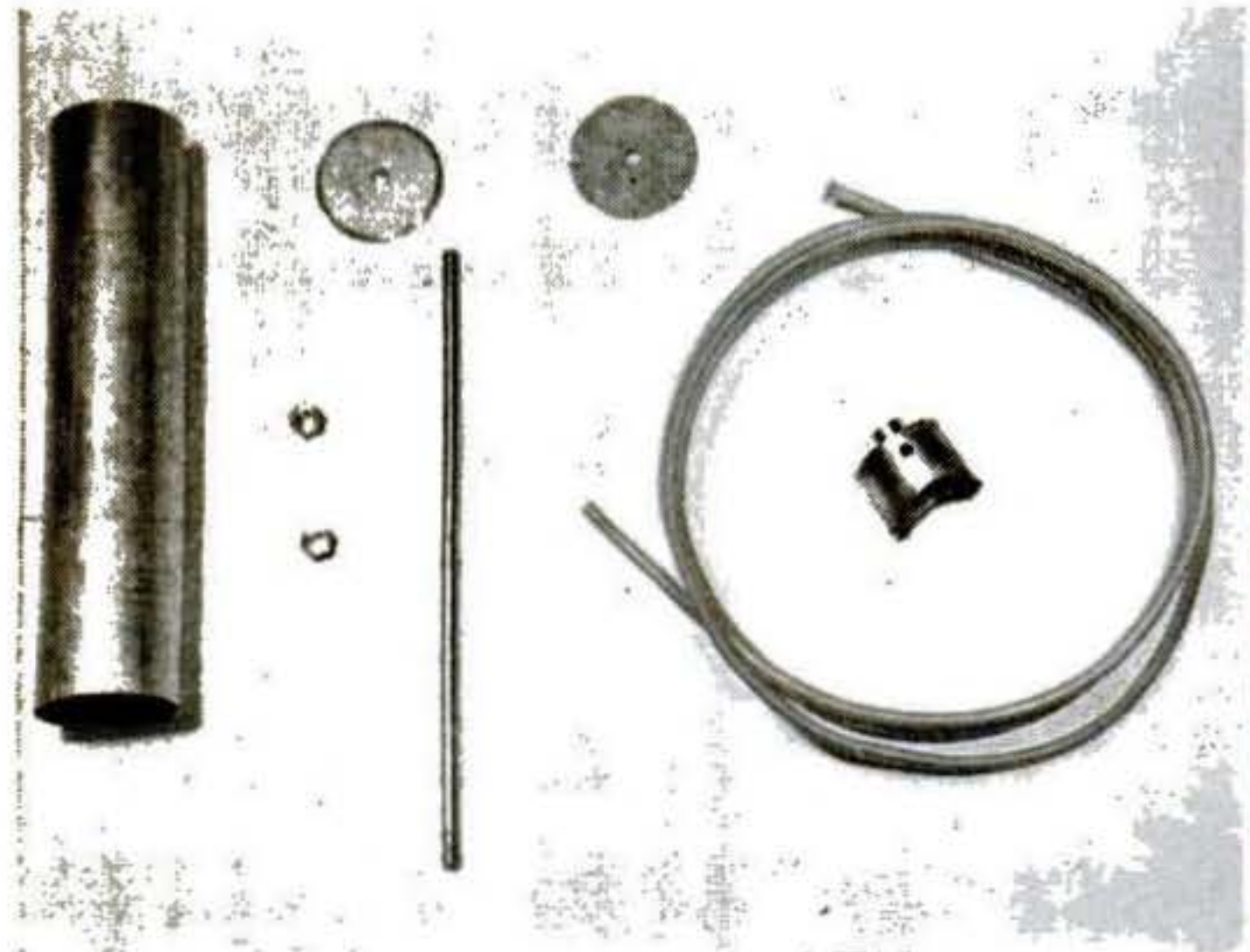

Here are parts for the boiler. A $\frac{1}{4}$ " stainless-steel stay is threaded $\frac{1}{4}$ "-20 at both ends. Water tubes are common copper tubing. Dome is built up of $\frac{1}{16}$ "-wall tubing and $\frac{5}{32}$ " disk.

The heat's on, applied with a small gas-oxygen torch that affords close control of the heating area. As the metal turns bright cherry red, silver solder in wire form is fed in.



To insure dry steam, dome goes over four holes drilled in boiler shell. Shell ends must be square and without burr so end disks will fit well. Holes for water tubes are staggered.

With all tubes in, the stay is threaded into one end disk and pushed through a plain hole in the other. Disks have outside chamfer for solder fillet and are push fit in shell.

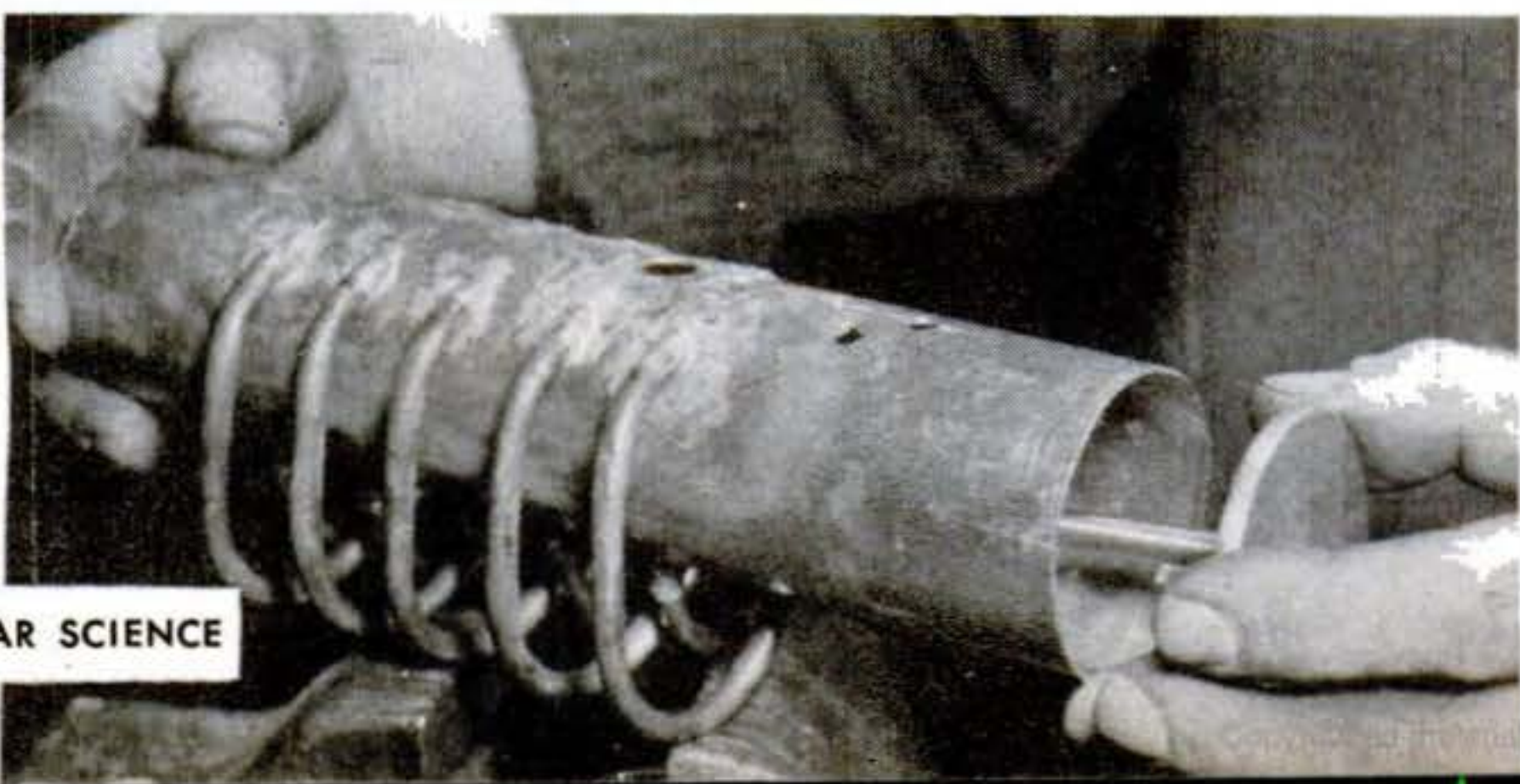
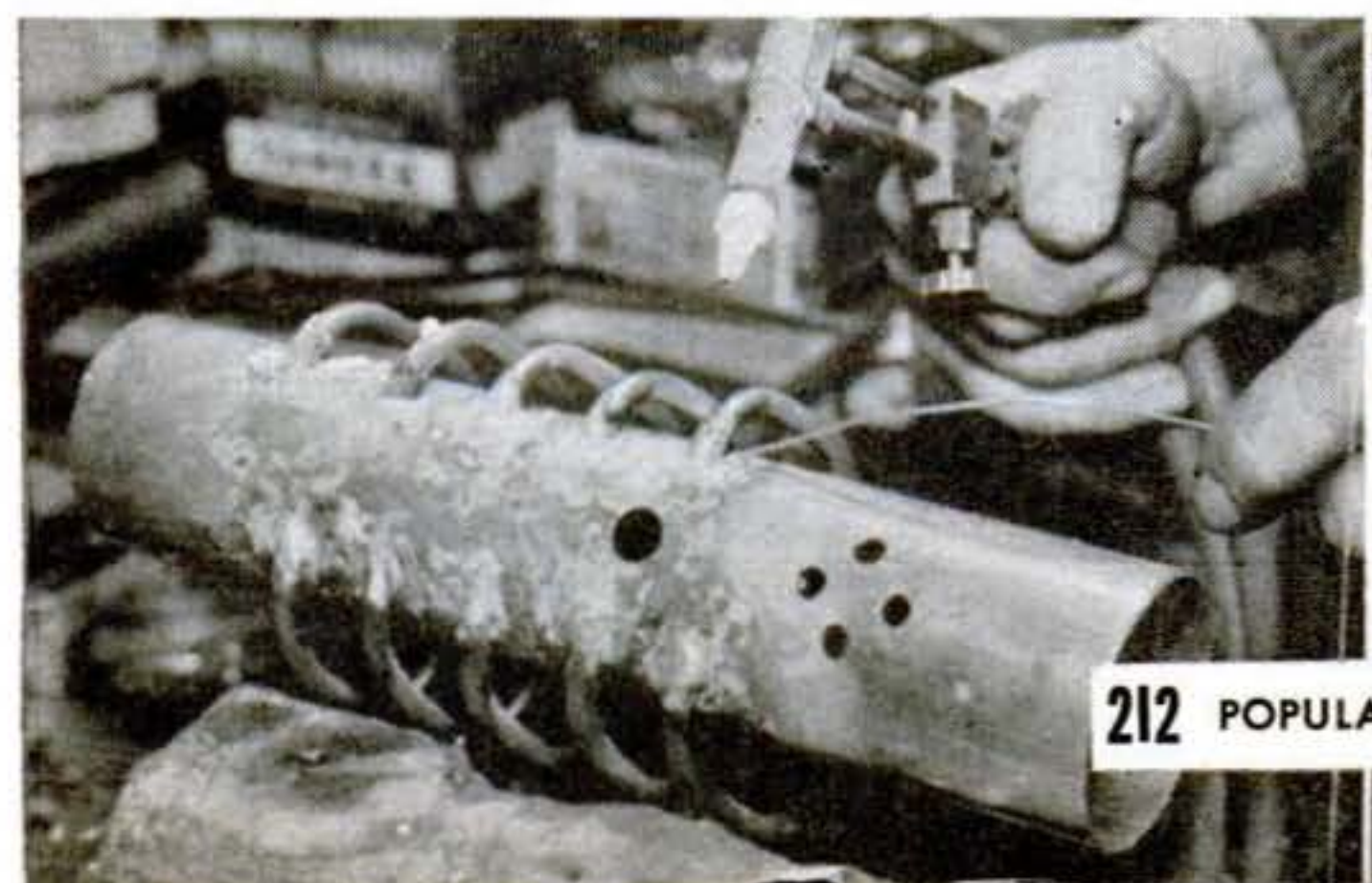

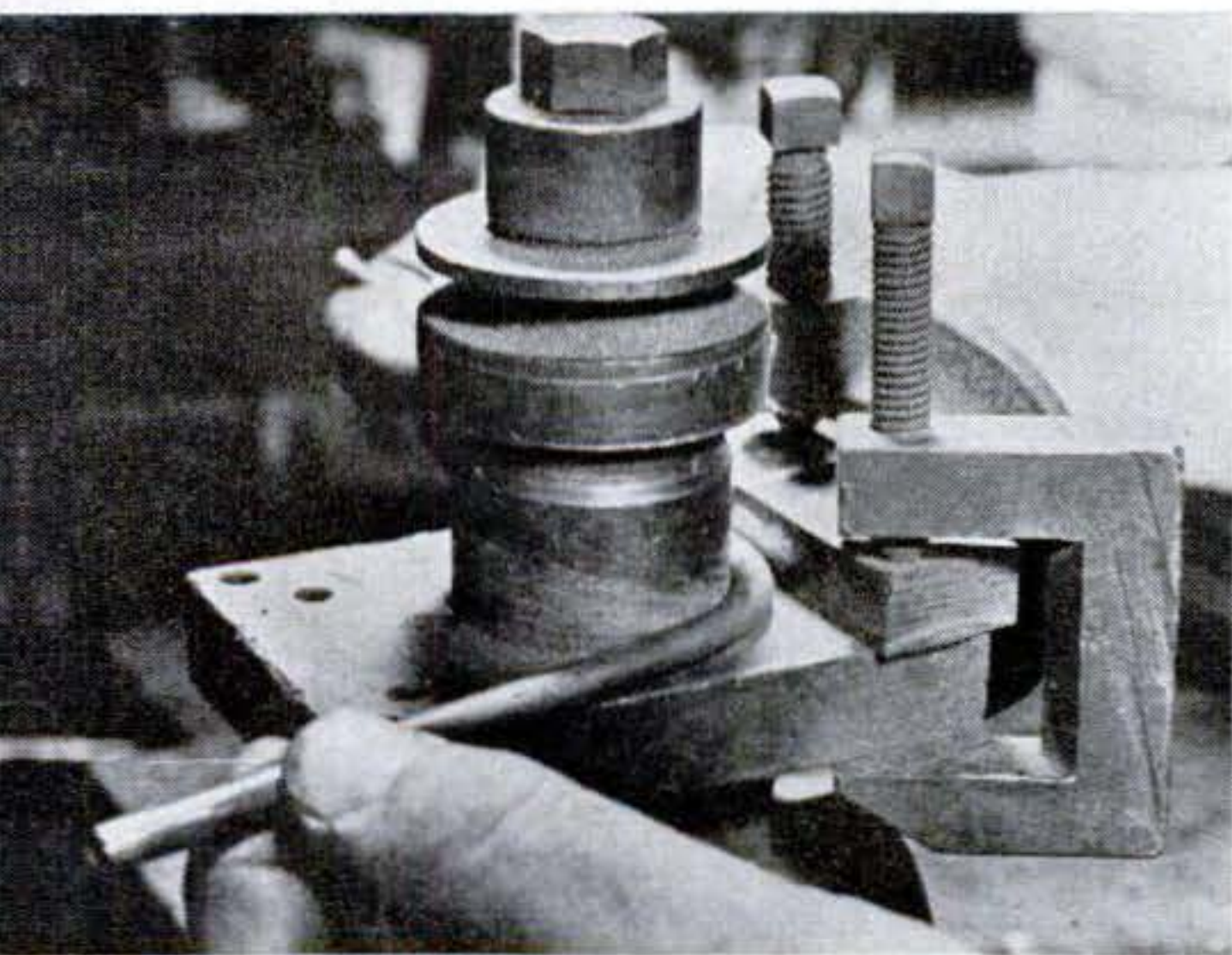
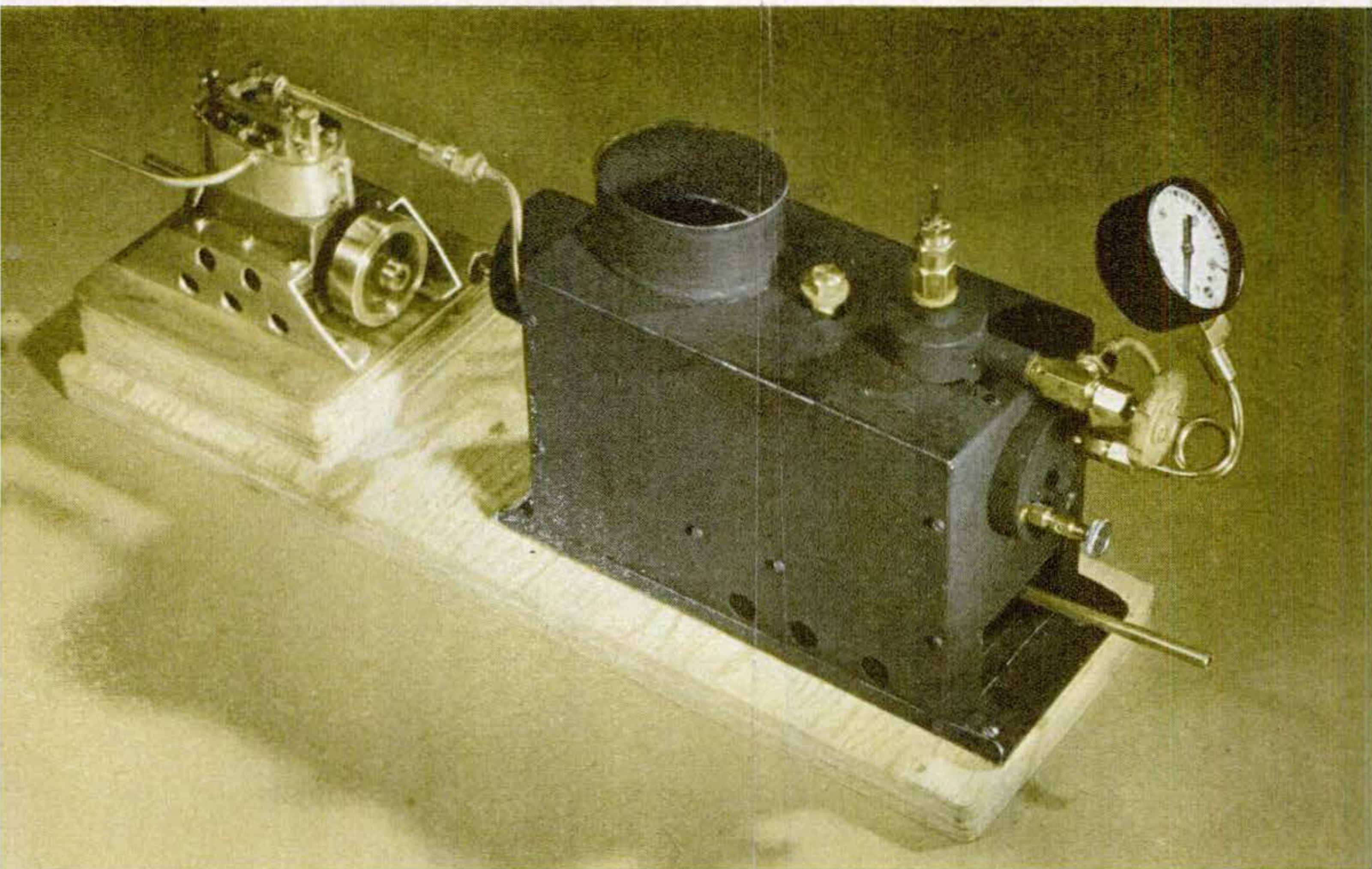

Pieces of copper tubing are bent to an open O shape on a jig. Correctly made, they have to be sprung into holes, which are cocked to suit by inserting rod, bending to position.

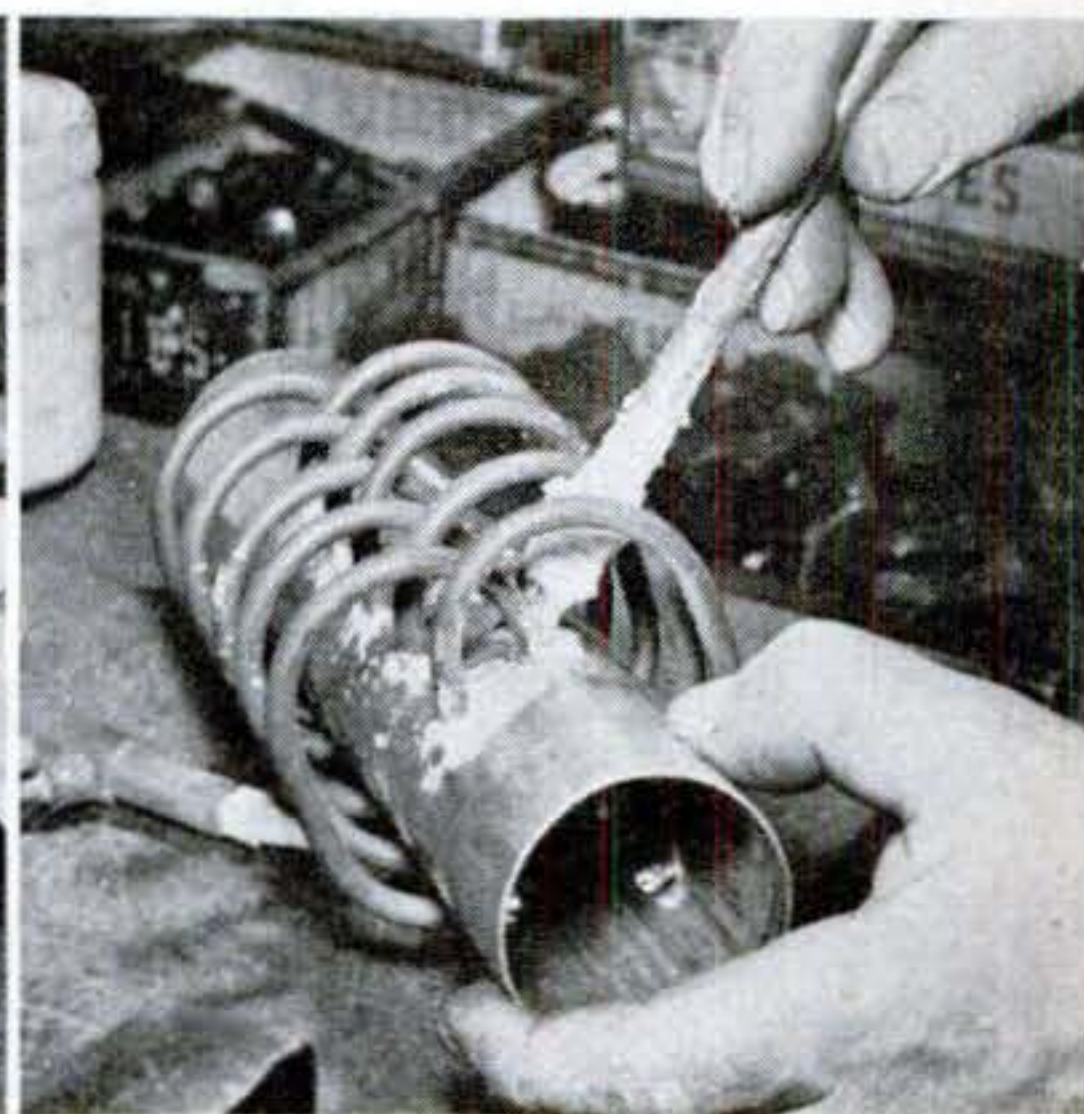
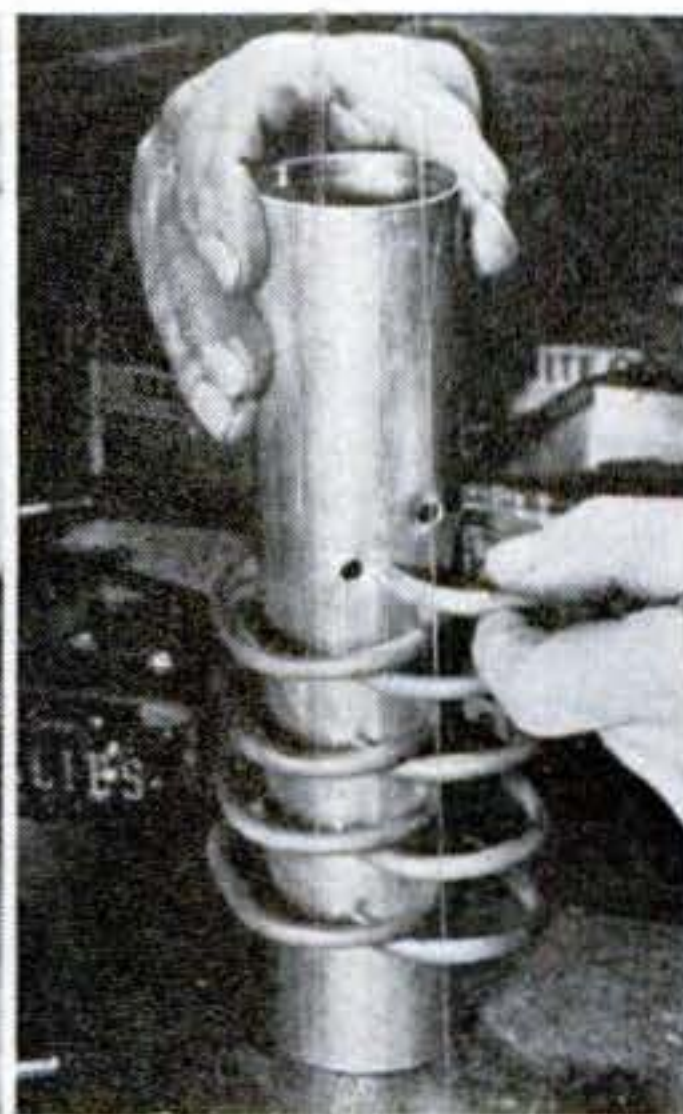

Silver-soldering flux is applied with brush. Anton Bohaboy uses commercial flux instead of borax. Note how upper ends of tubes protrude into shell. Lower ends are more nearly flush.

Nut is screwed on each end of stay. Then disk is silver-soldered to shell all around. Both nuts are sealed with silver solder all around and on top to prevent leakage.

Dome, shaped saddle fashion to fit shell, is brazed over four holes. Filler nipple goes over large hole nearby. Silver solder used flows at 1,200°, and has ample strength. ➡

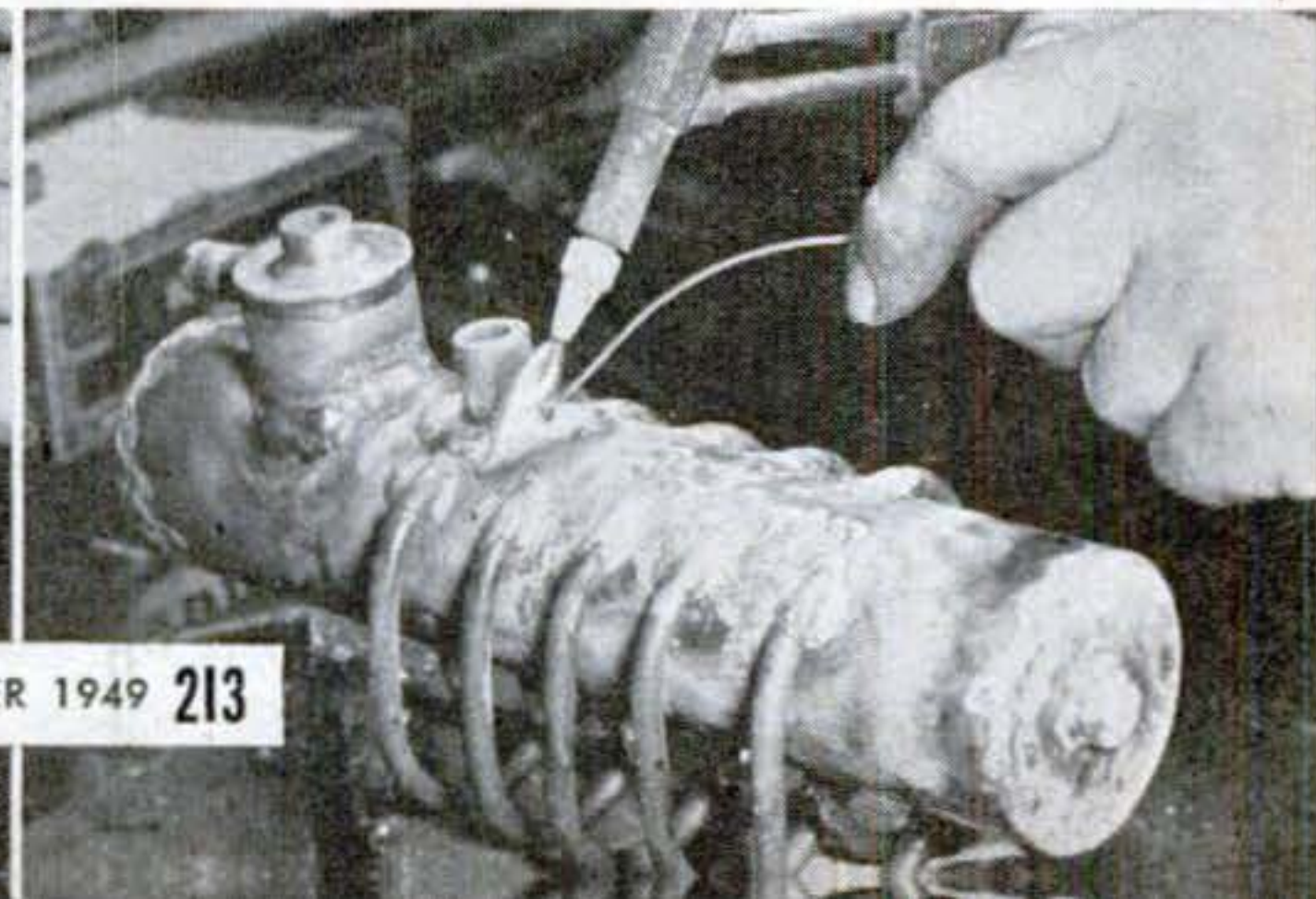
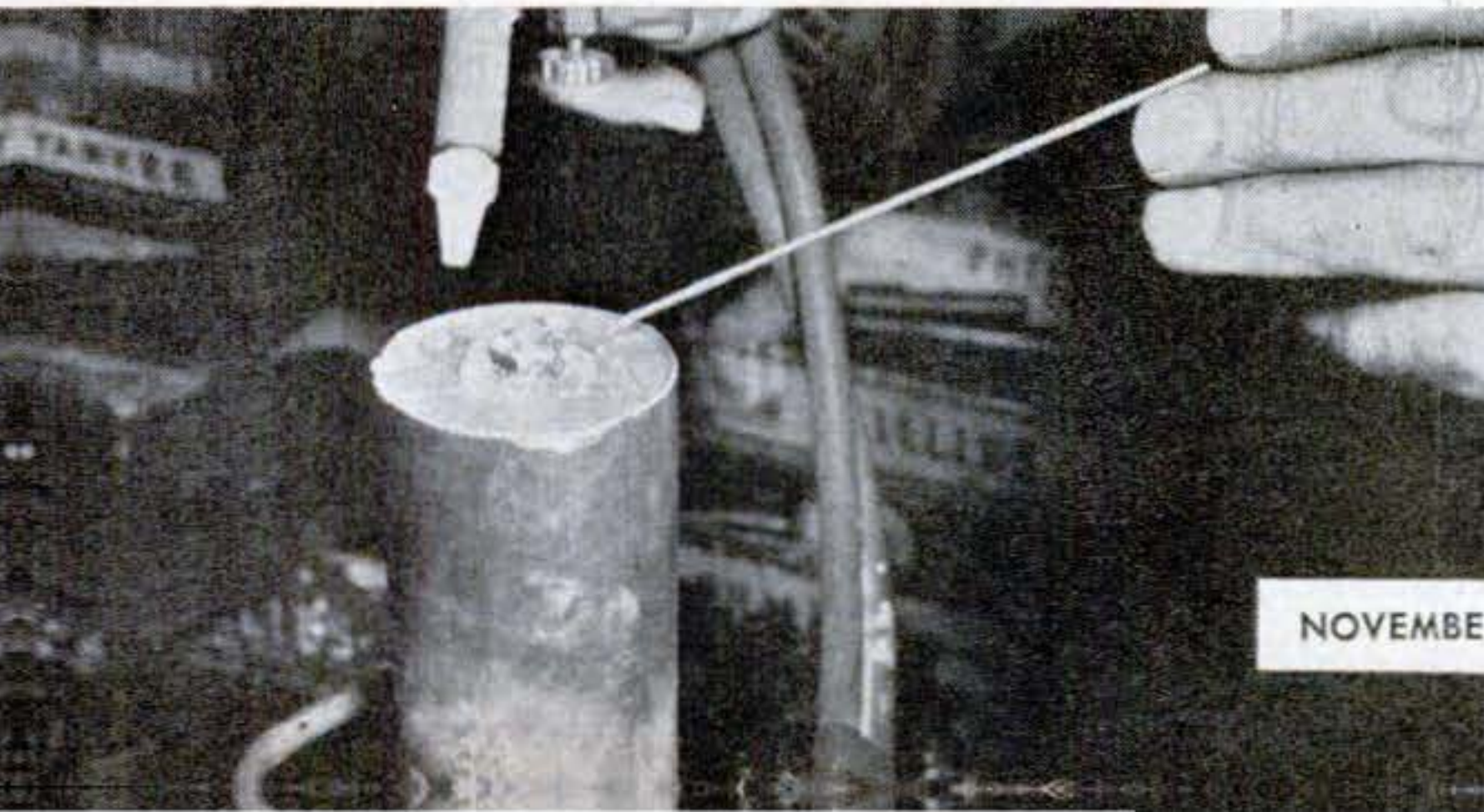

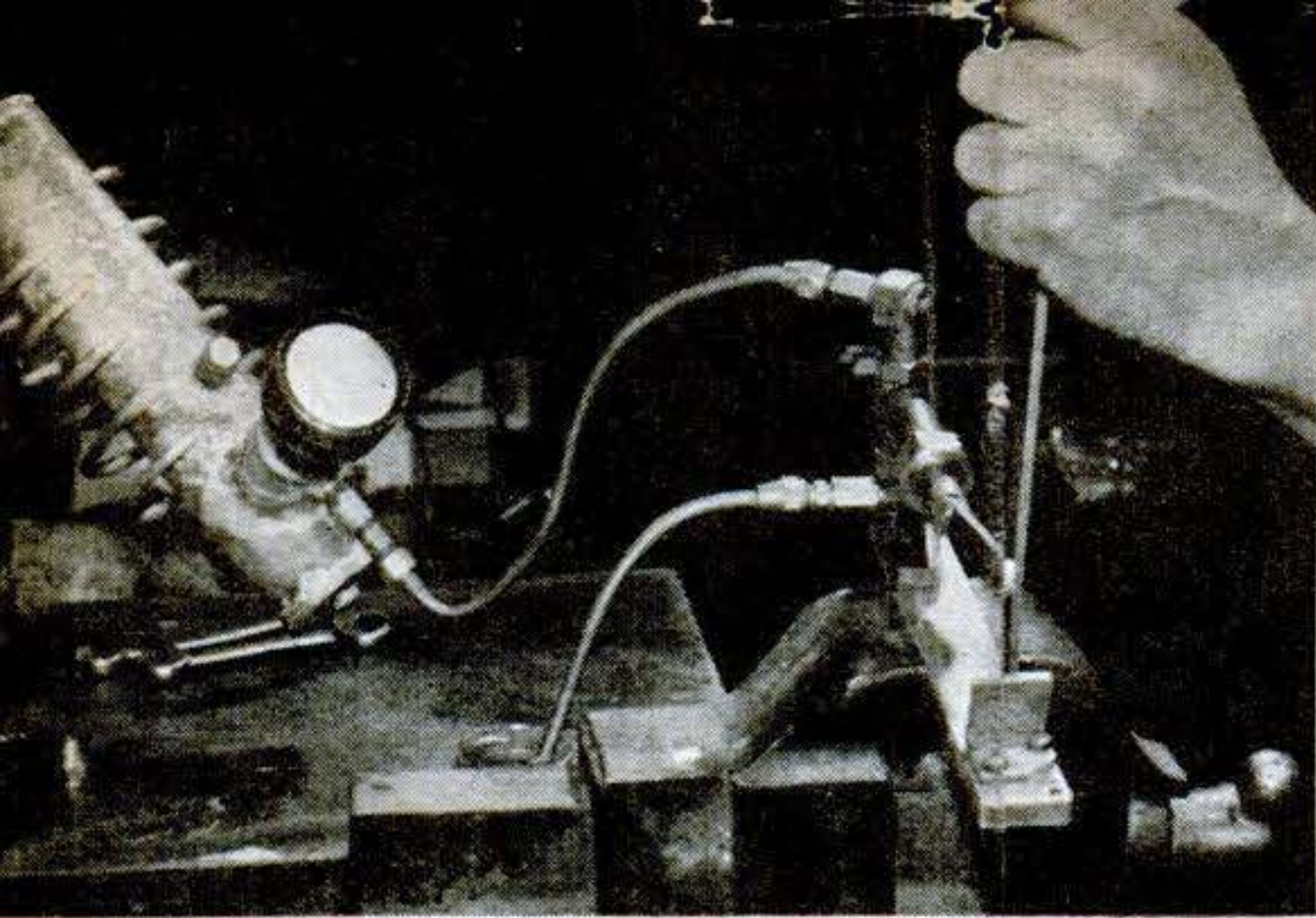

Boiler gets first test. Gauge is put on, shell filled completely with water, and small force pump connected. At 200 lb., pinhole leak was revealed. Quick work with torch sealed it.



After second test, in which boiler held 300 lb. pressure for an hour, fittings were taken off and holes drilled for steam gauge and try cocks. Next, washing in hot water removed flux.

Expert know-how enables Bohaboy to bend sheet-iron casing in a jiffy. Here he forms bottom on a homemade brake. Casing is asbestos-lined. Bead holds stack above top; tabs, below.

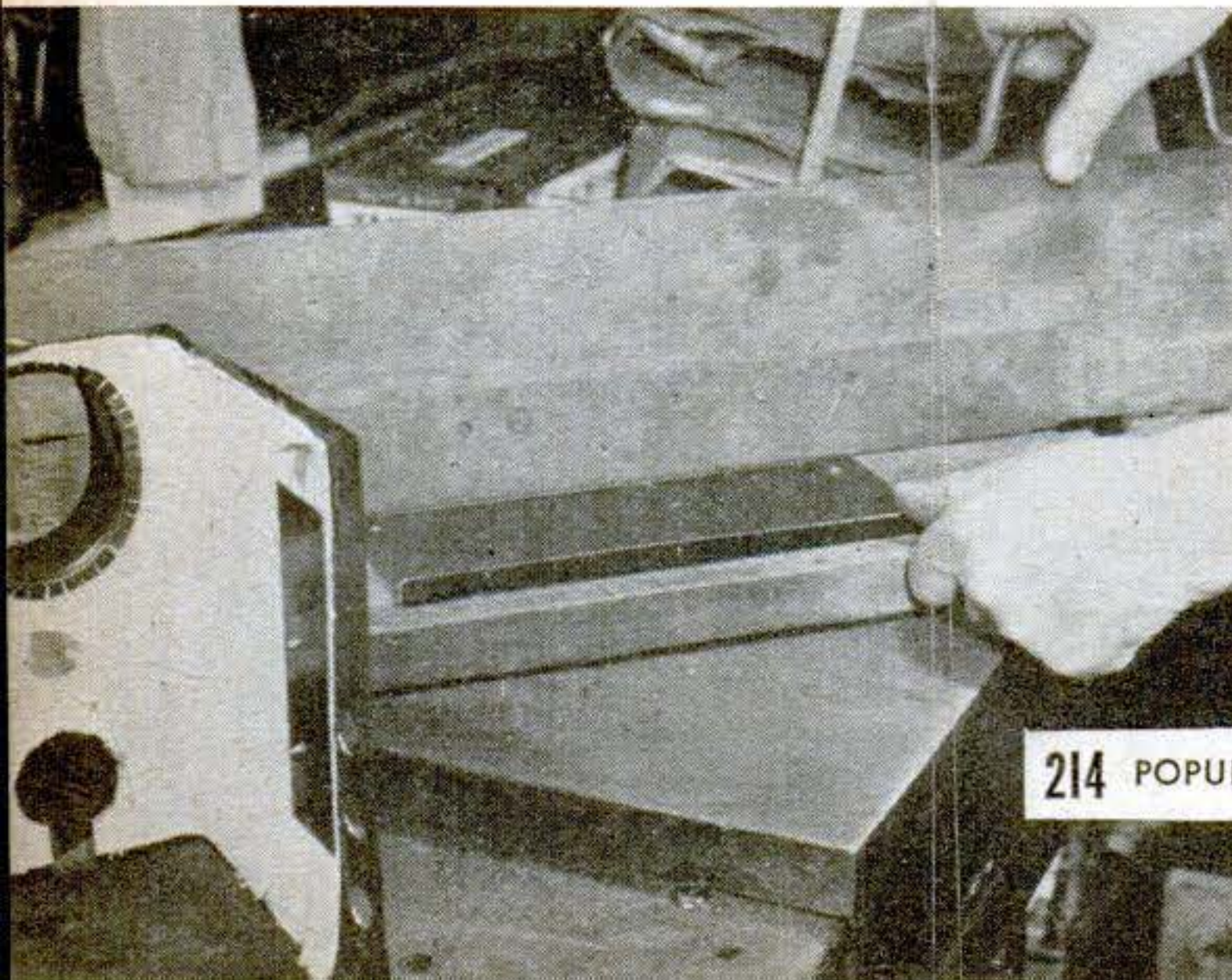

ing them for 28 years. A PS photographer and writer peered over his shoulder in his tool-crammed workshop as he built one. Starting with raw material cut to size, he wound up a few hours later with 75 lb. on the gauge and a twin-cylinder engine humming briskly alongside. The photos on these pages show how the job was done.

This boiler really steams. Showing pressure in about four minutes from a cold start, it'll run a $\frac{3}{8}$ "-bore, double-action engine about 25 minutes on less than a quart of water. Ten water tubes, a superheater coil, and an effective burner, all jacketed in an asbestos-lined case, turn the trick.

The joints are simple—they're butted and silver-soldered. But don't, Bohaboy warns, try to imitate this type of construction with soft solder. The boiler would be as dangerous as a live rattlesnake. Only low-pressure boilers can be built with soft solder, and then only if all parts are screwed or riveted for strength before any soldering is done. Silver solder, on the other hand, makes a joint almost as strong as the parts themselves. You need a gas torch for the work.

Safety valves, try cocks, and throttle are so cheap as to be scarcely worth making. Bohaboy prefers try cocks to a water gauge. Smaller steam gauges can be bought if one wants to stick close to scale size in details.

No boiler should be fired up until it has been given a hydrostatic test. One method is to fill it *completely* with water (plugging all openings) and with a gauge connected, lay it on a gas flame. Pressure will rise rapidly, but any rupture will harmlessly release the water. A better method is to attach a powerful water pump and build up pressure with this. Either way, no harm is done if the boiler can't "take it." Boilers are commonly tested to three times working pressure. **END**

Shell slips into casing ends, and body over all. Horizontal tube is part of superheater, a 3' loop of $\frac{3}{16}$ " copper tubing running from throttle and carrying steam through fire.

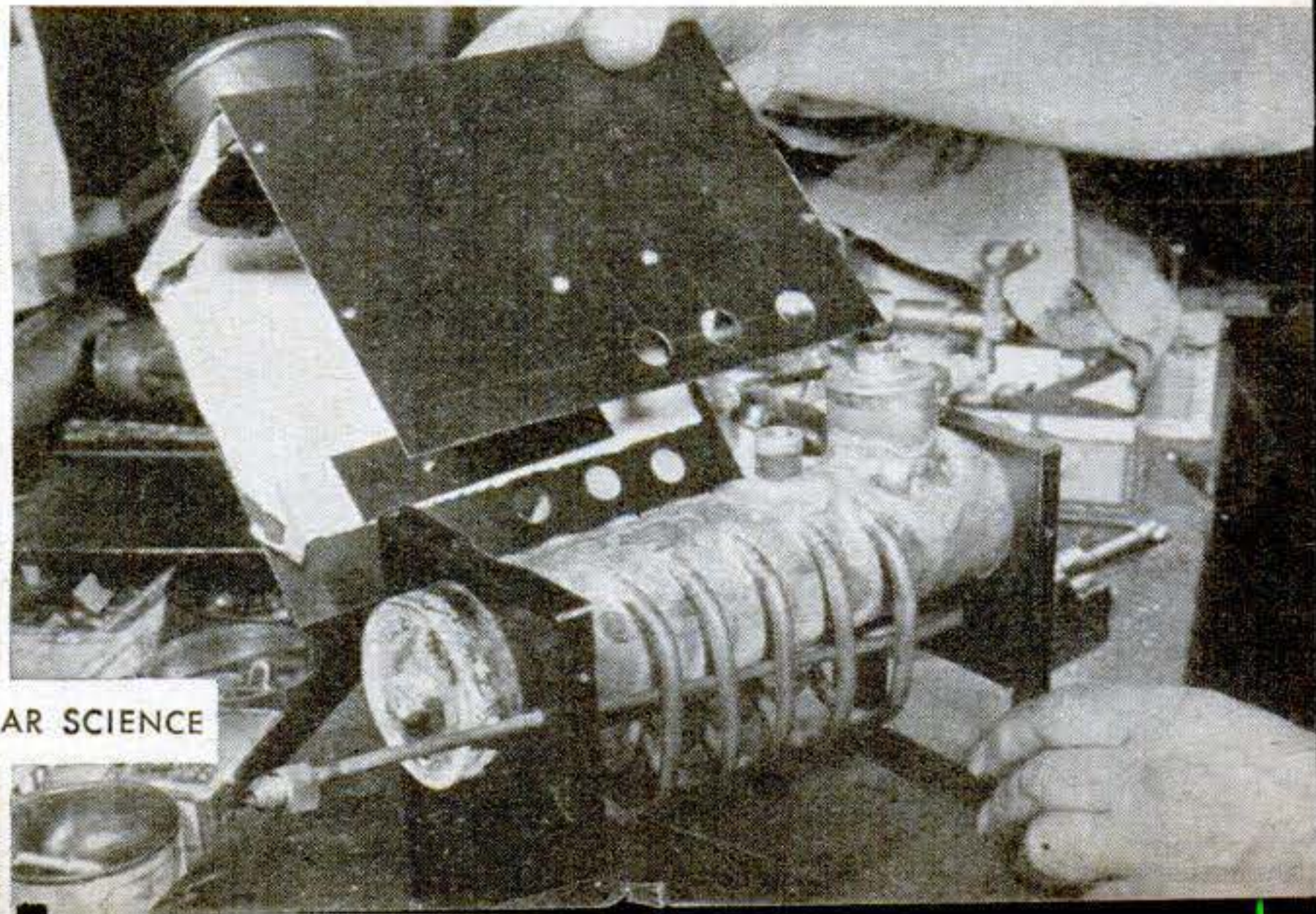

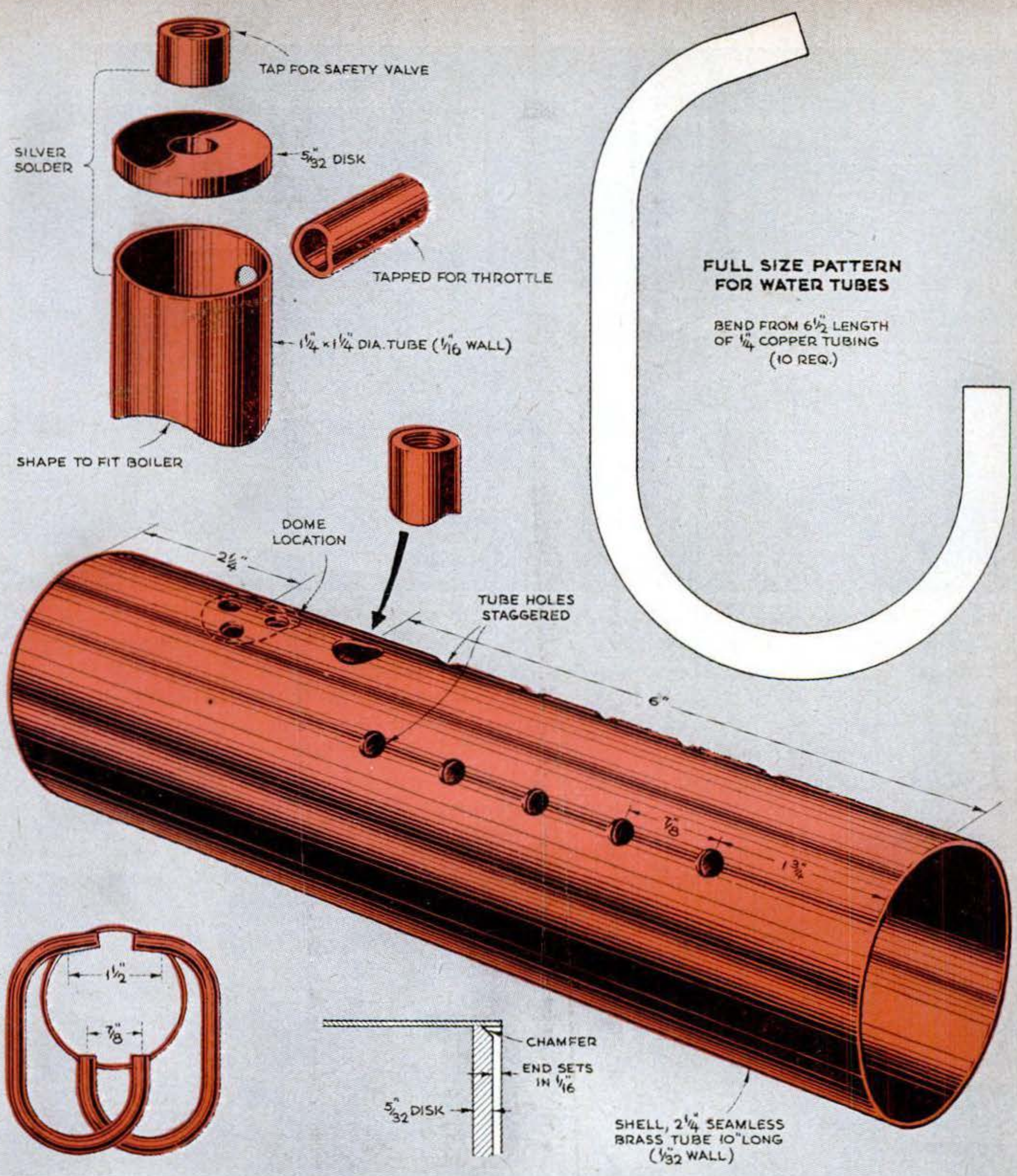

Safety valve is screwed into top of dome. The throttle has a big fiber wheel to protect fingers from heat. Gauge requires water loop shown to keep hot steam from internal parts.

Alcohol is poured on asbestos in brazed-up sheet-iron fire pan. With water above try cock, Bohaboy fires boiler. Safety valve pops at 70 lb., but boiler held steam safely at 100.

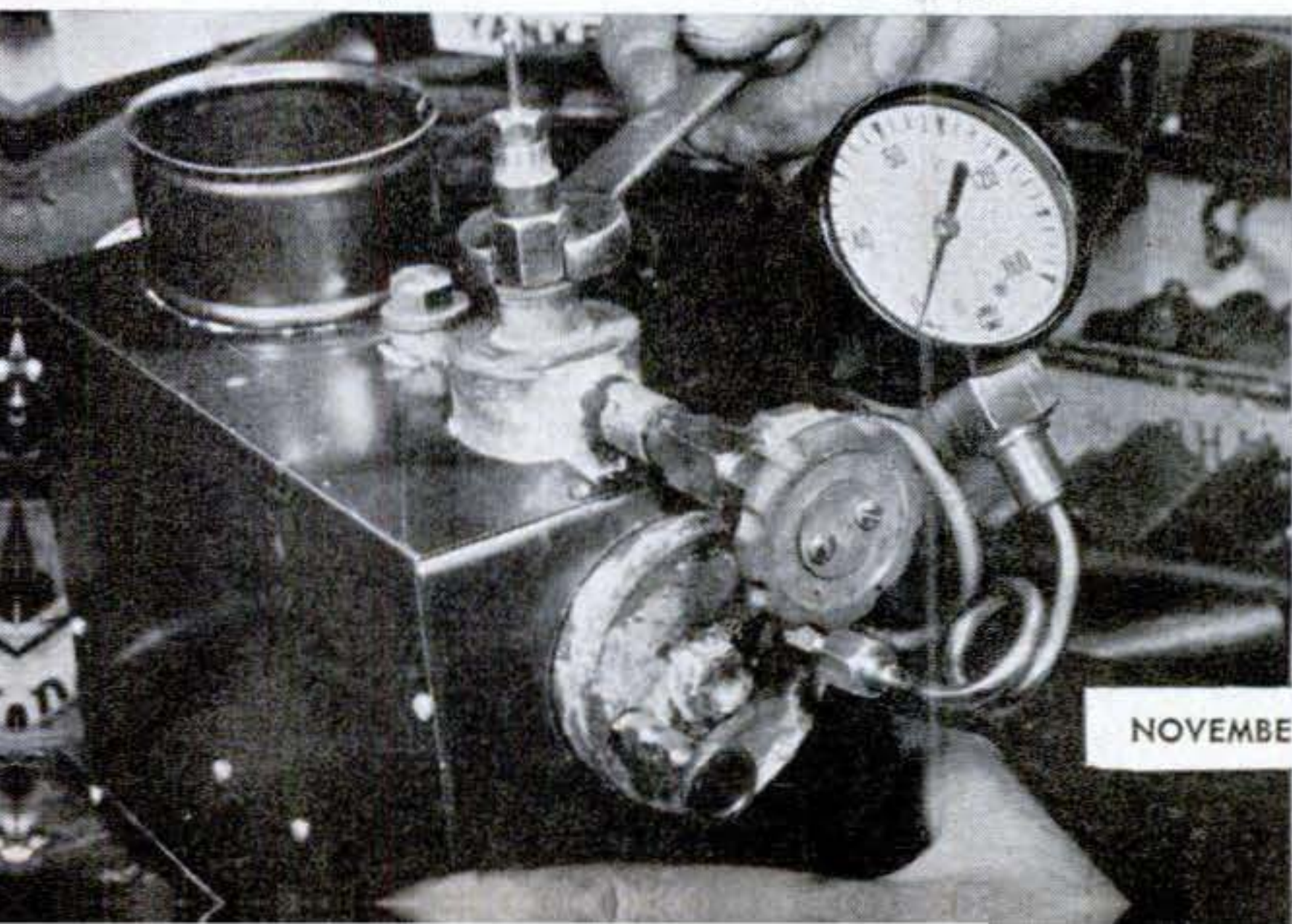



NEW SHOP IDEAS

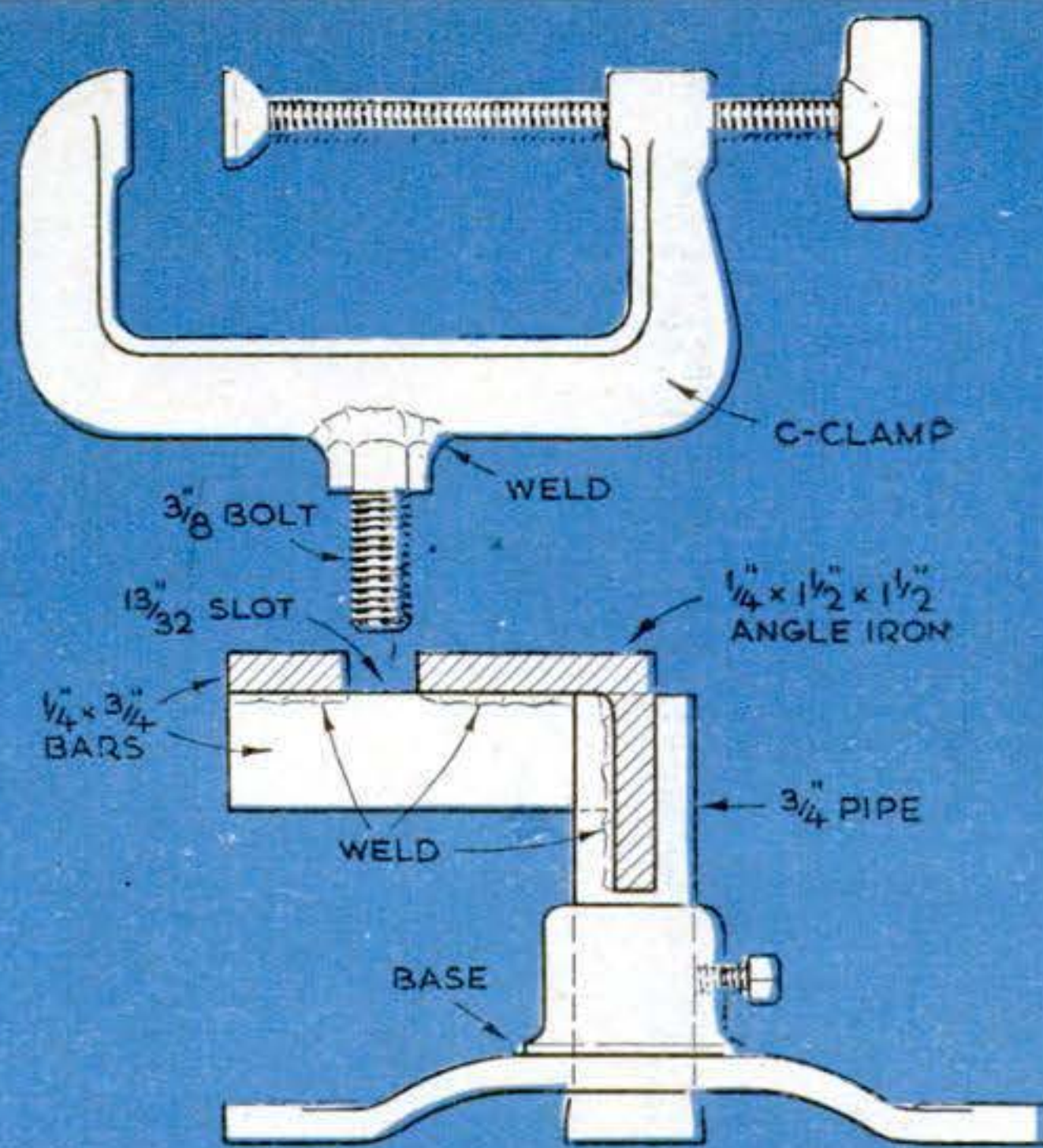

Twin Clamps Aid Welding. When you have a welding or brazing job, it's often difficult to keep the parts in position while you use the torch. But with this rig you can clamp the parts where you want them and have both hands free for your work.

The base was salvaged from an auto junk yard. You can use any similar piece that is

heavy enough to keep the device steady. The angle iron is fitted into a slot cut in the 3/4" pipe. It is then welded as shown. The slot between the front and back surfaces of the table provides lengthwise adjustment of the 3" C clamps. Since the clamps swivel, your work can be held together at any desired angle.—A. E. Kirk, Galveston, Tex.

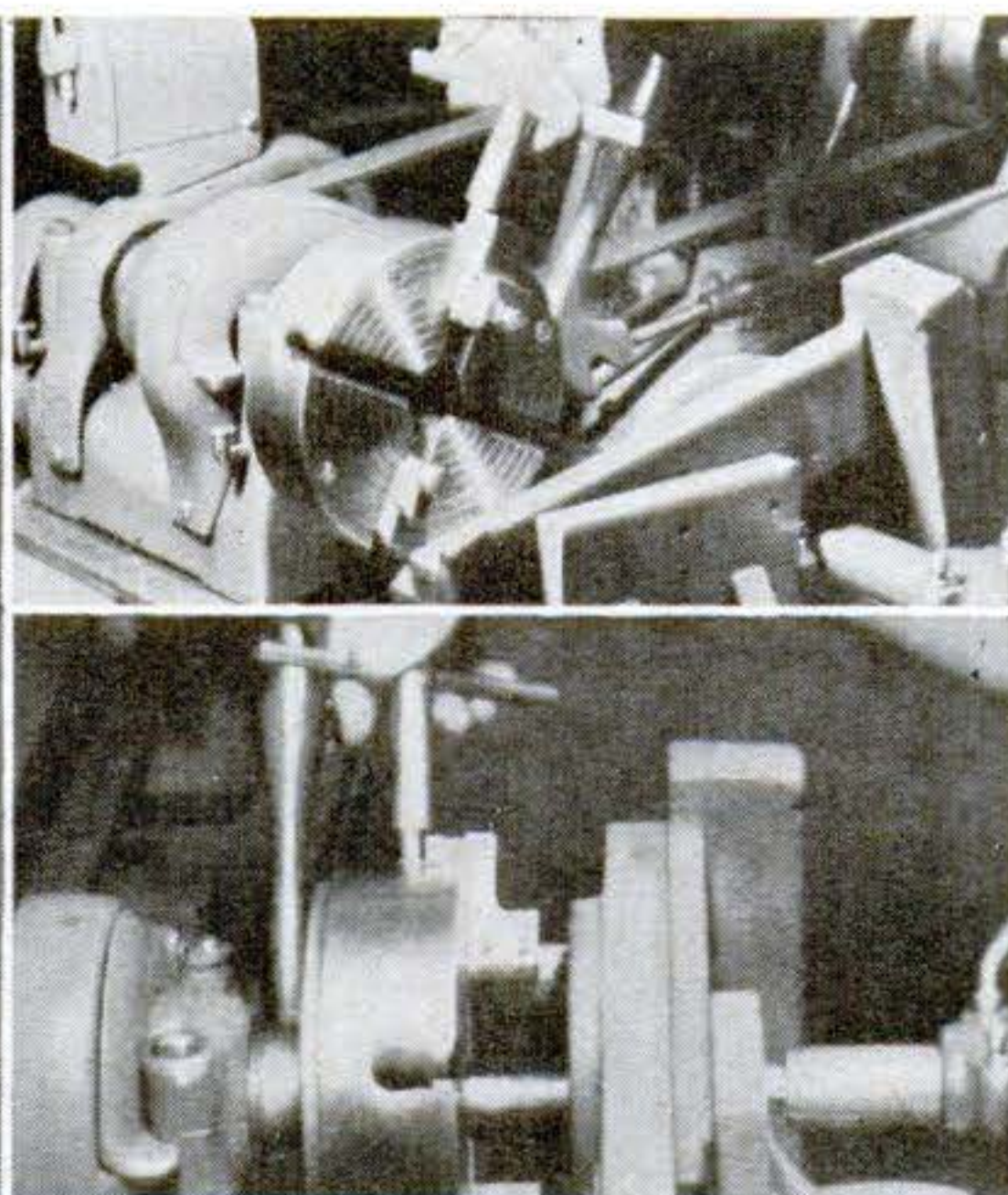
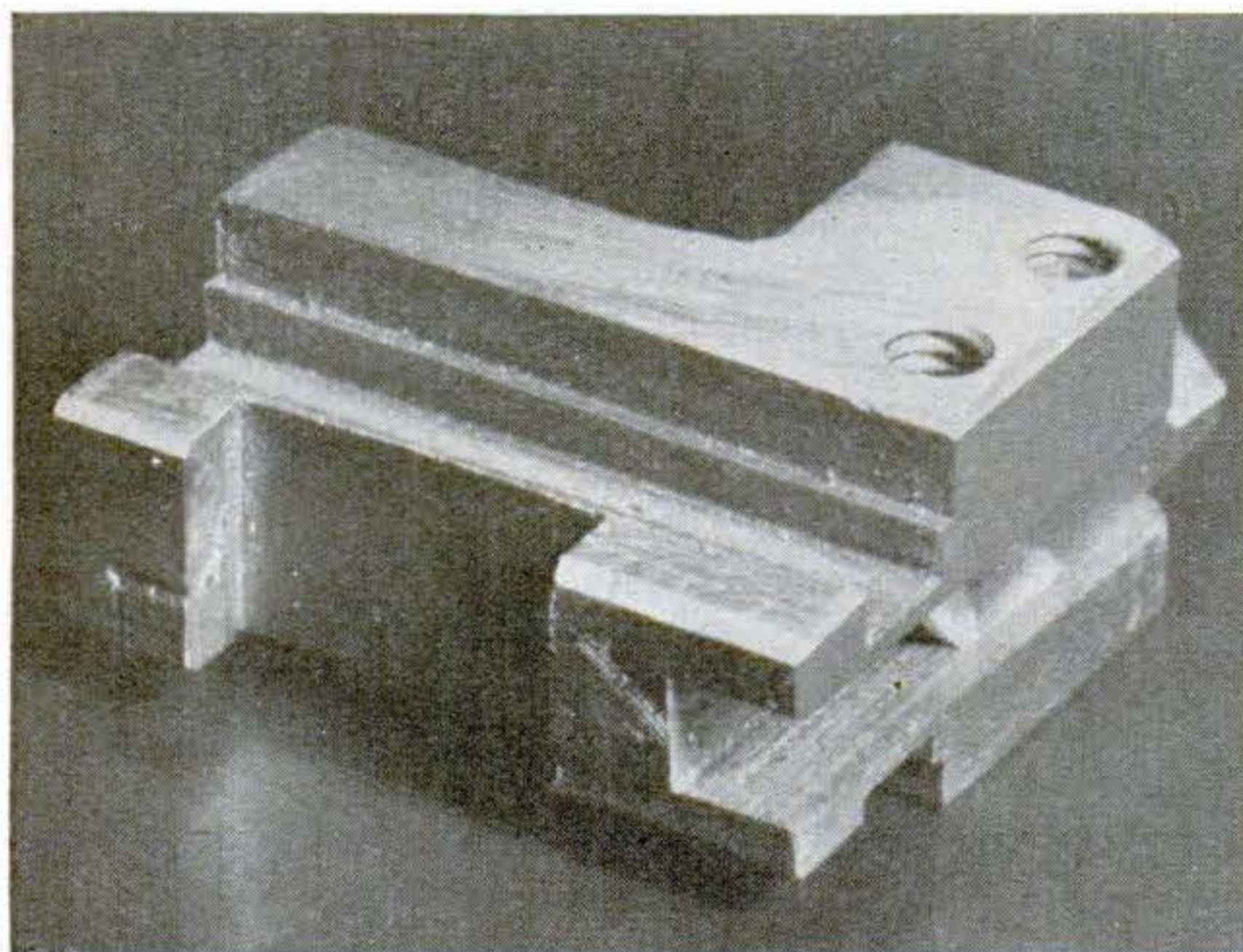

Expands Lathe Capacity. With this tool-bit holder you can face or bore any work that can be securely mounted and centered on the tool saddle. Just substitute it for one of the jaws of the four-jaw chuck.

For simple face milling, set the tool for a suitable diameter, revolve the chuck, and feed the work slowly across the lathe with the carriage locked securely on the bed. For boring and counter-boring, line up the work

and keep it on center. Depth of cut is controlled by screwing the tool along the slot after every pass. The work is fed against it by advancing the carriage.

Machine the holder to fit the chuck closely—looseness would permit the bit to dig in. Harden and temper it. Mild steel is not desirable because it would loosen in use. Dimension the holder like one of the chuck jaws.—A. W. Drieling, McKeesport, Pa.

Gear Puller. The simple tool shown pulling the stop assembly from a Selsyn® unit is mighty handy for removing gears, wheels, and other assemblies from shafts. It also doubles in a pinch as a light-duty arbor press. It can be scaled to provide the power and capacity you need.

A lack of hooks distinguishes the device from the usual gear puller.

Parallel rods passing beneath the gear or other part to be removed are used instead. These rods are held by two steel plates. Holes to receive the rods are drilled near the end of each plate. Toward the other end of each plate is a rectangular hole that receives the crossbar, through which a machine bolt passes. The notches in the crossbar can be made with a file, a saw, or by milling or

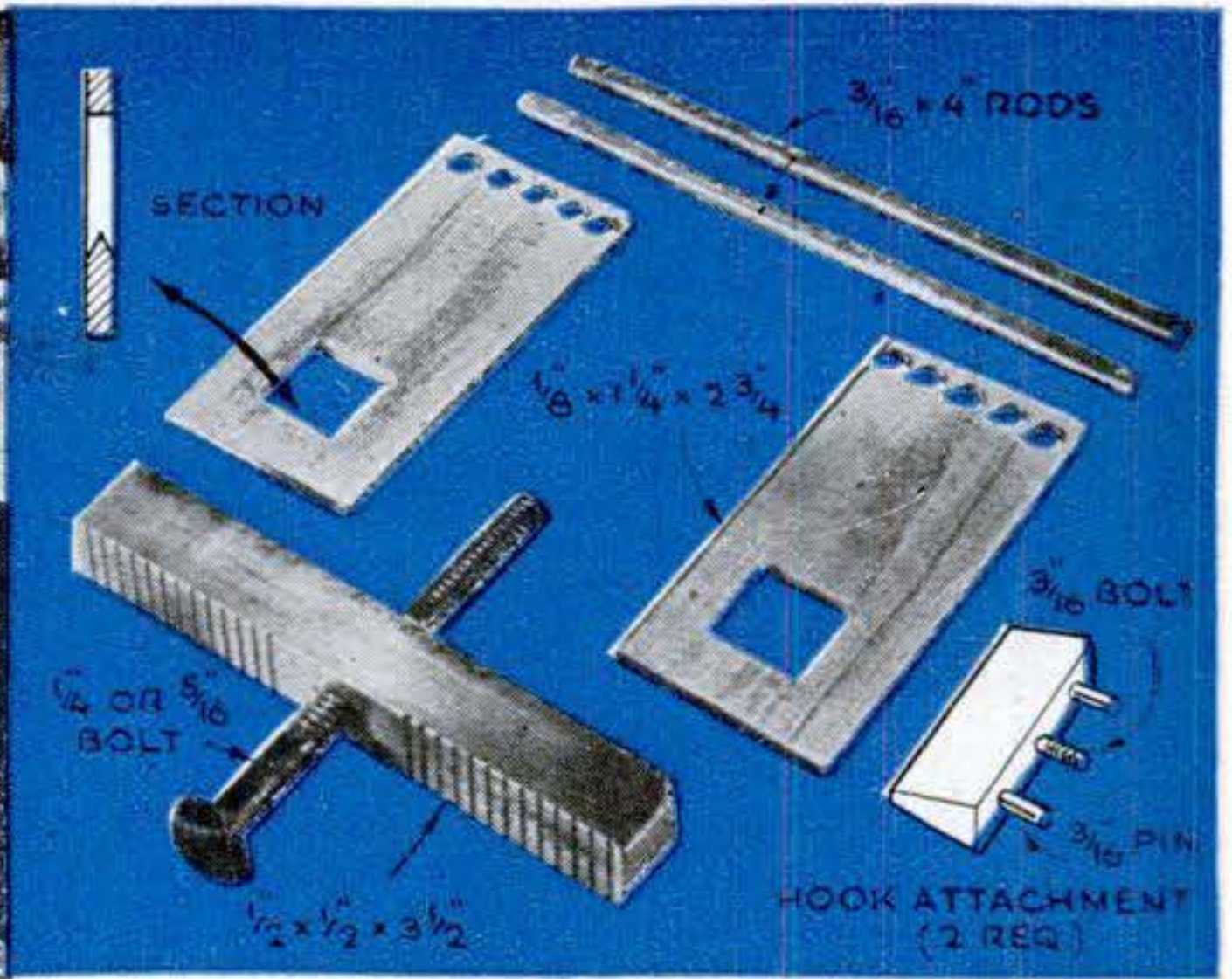
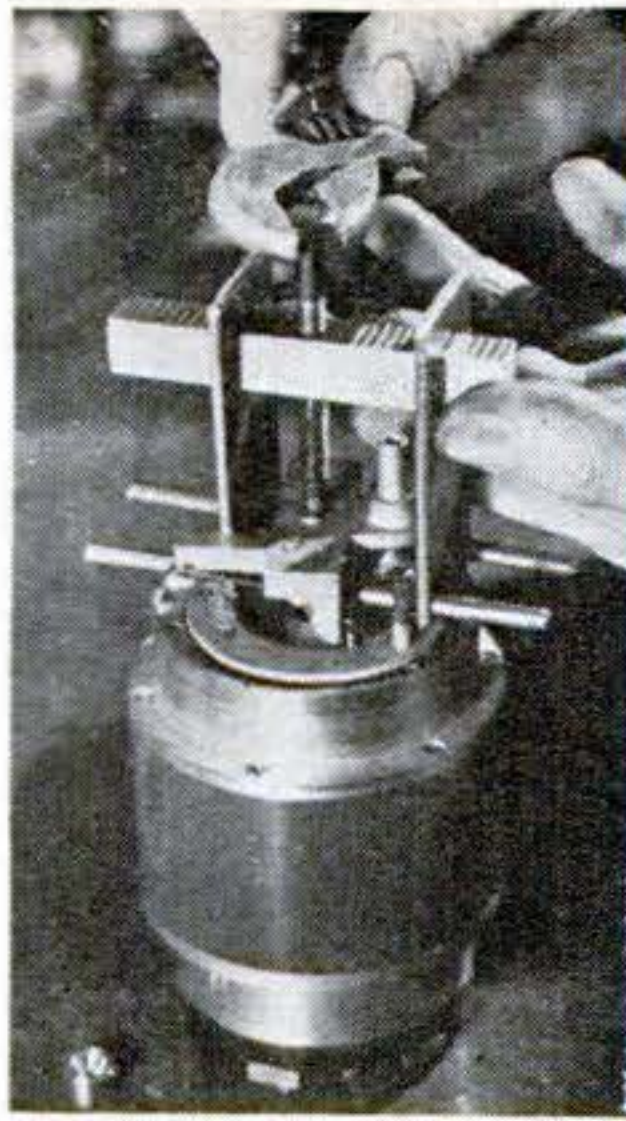

grinding. File the edges of the square openings to an angle, as in the section above, to engage the notches.

Jaws that convert the plates into hooks can be attached by means of bolts and pins passing through the rod holes. Cold-rolled steel is satisfactory for the rods, although hardened drill rod is stronger. Shape the jaws as above.—Walter E. Burton, Akron, Ohio.

Lapping Trues Chuck. To recondition an eccentric lathe chuck without an internal grinder, try this:

Catch a copper or steel bar in the lathe tailstock and coat with prepared abrasive or a mixture of 200 grit Carborundum® and oil. With the eccentric chuck on the spindle, tighten the jaws to exert pressure but still let the chuck rotate. Feed the abrasive rod in and out of the rotating chuck. Test progress with a dial indicator. Then clean off all abrasive.—L. W. Bonnell, San Diego, Calif.



Tool Pulls Oil Seal. Removing an oil seal often gives trouble. This tool does the job without removing the shaft. Turn down a piece of stock to about twice the diameter of the shaft. taper and thread one end,

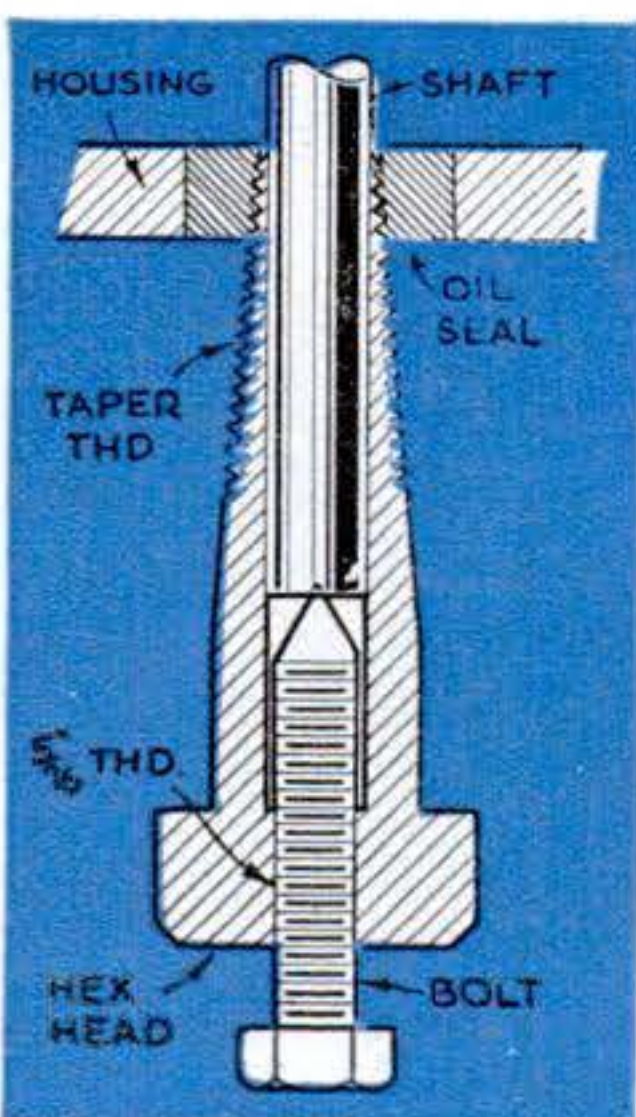

and form a hex head on the other. Bore it through for an easy fit on the shaft and tap the big end for a suitable bolt. To use, turn the taper thread into the seal. Then turn up the bolt. This will back out the seal.—G. Marasca, Brooklyn, N. Y.

Jar Preserves Instructions. An ordinary Mason jar placed near your bigger items of shop equipment—drill press, lathe, power saw, etc.—makes a handy and safe place to keep operating instructions and other data pertaining to the tool.

Small accessory fittings and special tools can also be kept in the jar. If several jars are placed in the same location, roll the instructions with the title page out for quick identification when needed. Keep the jar sealed.—Andrew Vena, Philadelphia.

Now's the Time To Repair Your Rowboat

By **Elon Jessup**



GOOD boats, like almost everything else these days, come high. A new plank here and there, plus a complete paint job, will put most old skiffs in first-class shape. Winter's a good time for such repairs, since small boats usually are stored during those

months. Put in a couple of hours of your spare time now and then, and by spring your boat will be ready for the early fishing. Use sound, seasoned lumber and copper or galvanized nails. And you'll find that it pays in the long run to buy a good marine paint.



Skiffs are easiest of boats to replank. Drill for nails to avoid splitting sides. If there are chines, drive nails into them.

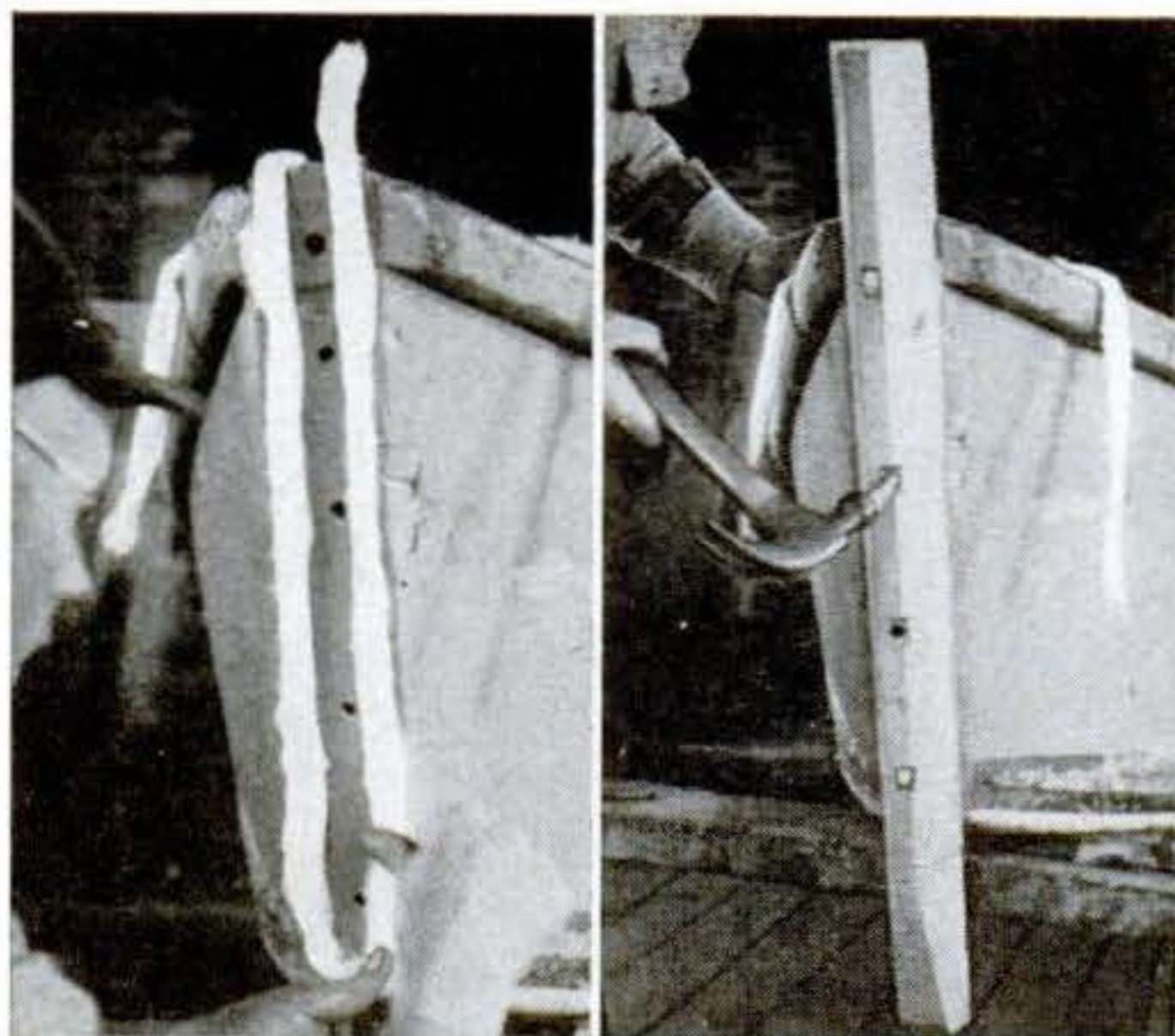

Use old outer stem as pattern for new one. Drill for bolt holes, calk, and put on new stem. If old bolts are badly rusted, hacksaw them.

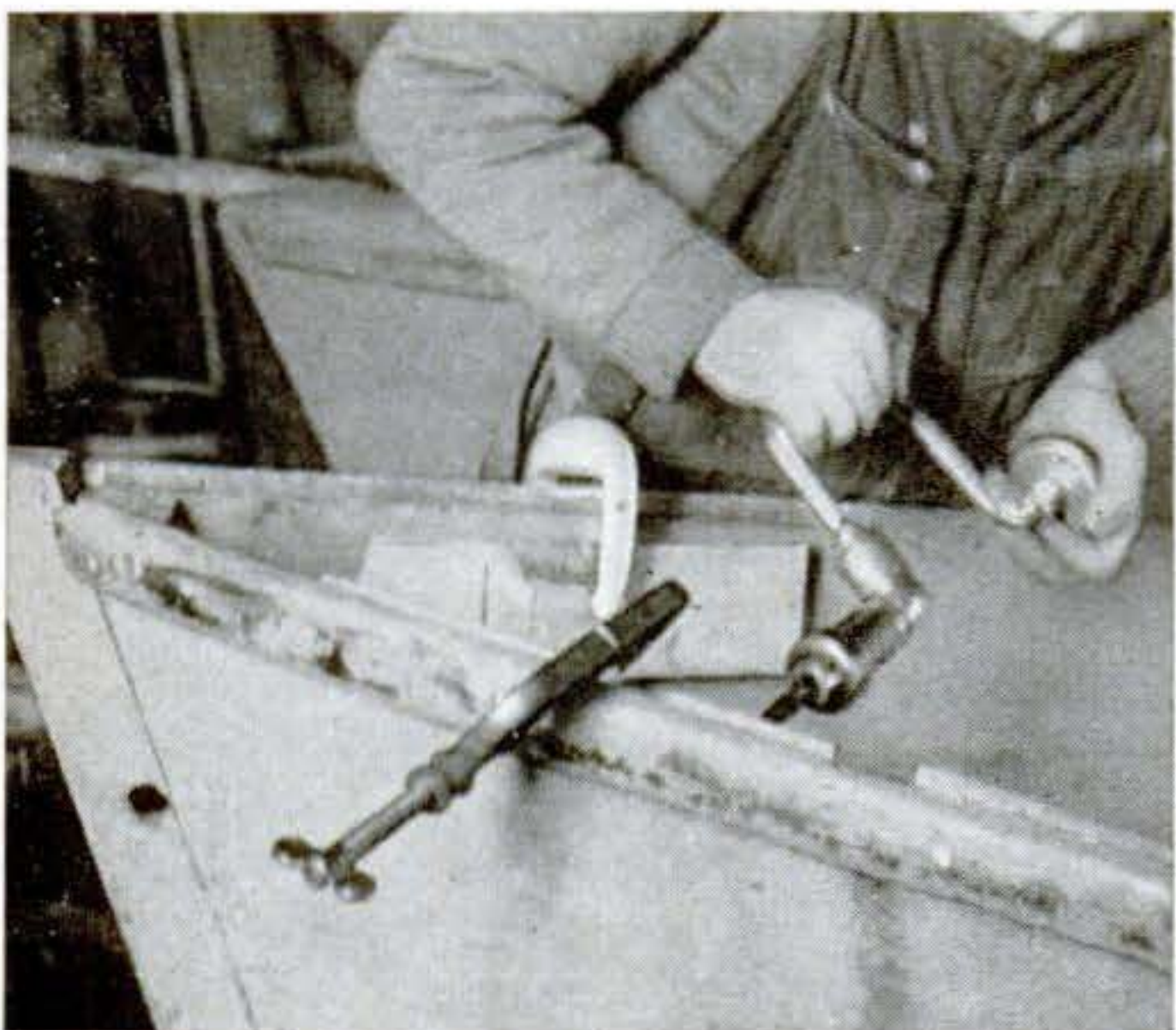

If skiff isn't decked, install one. It adds strength to hull and a dry spot for a lunch. Blocks for deck are being screwed to sides here.

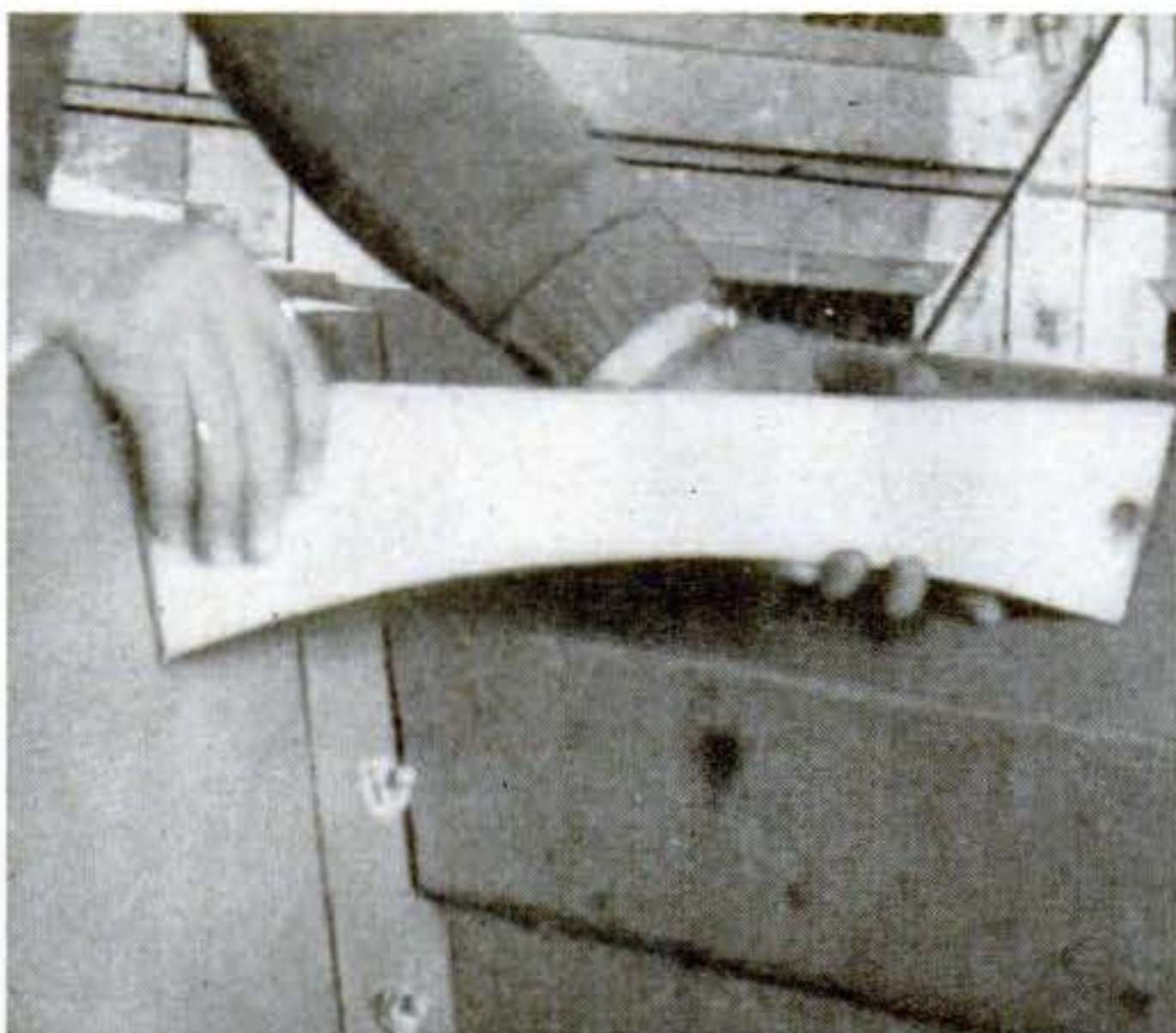

Sturdy crosspiece under rear of deck gives you a handhold when you're beaching boat. It keeps the strain off the deck planking.

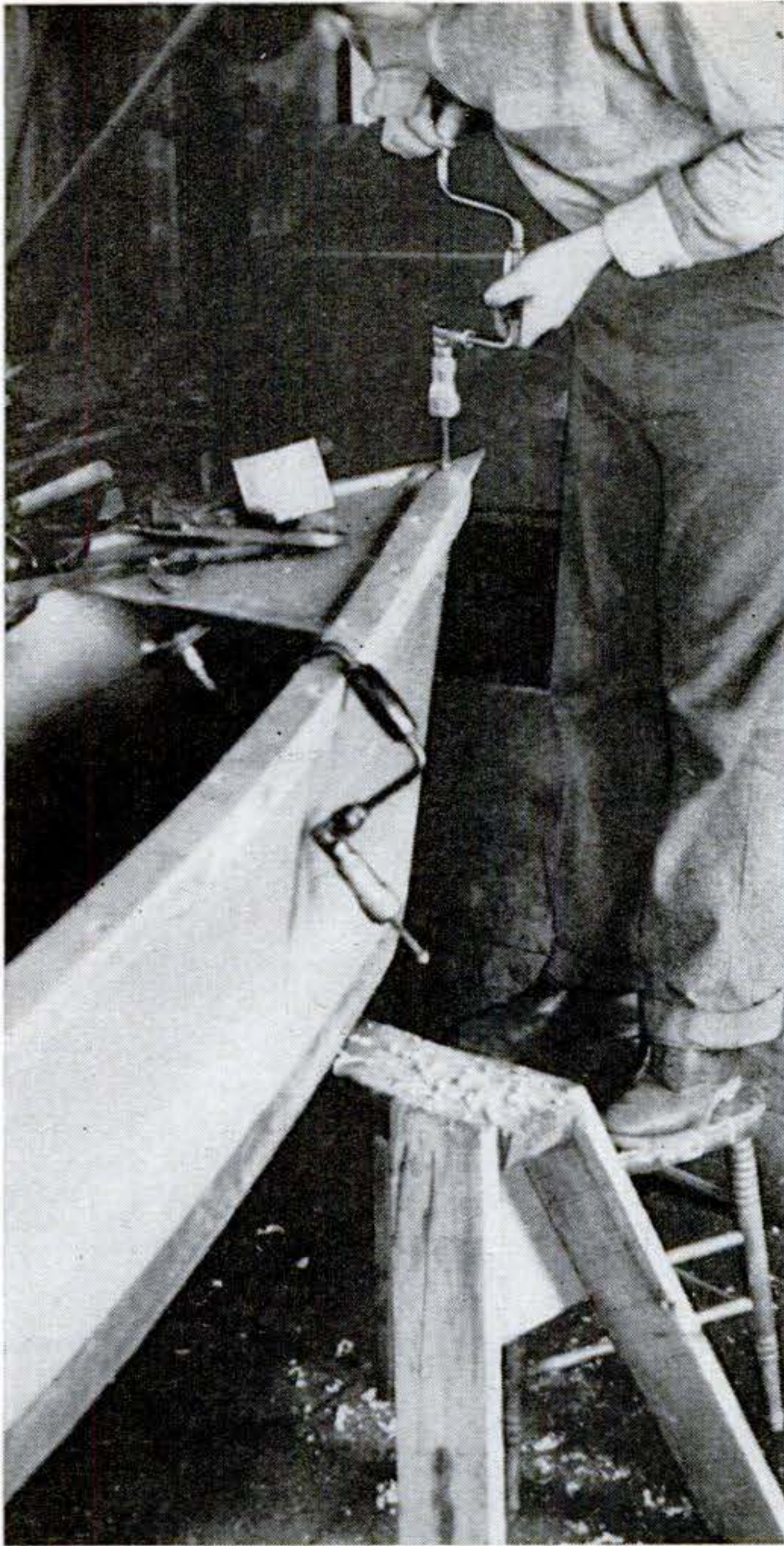

Battered top and guard rails are usually best replaced. Start at bow, bending and clamping hardwood strip in place as you drive screws.

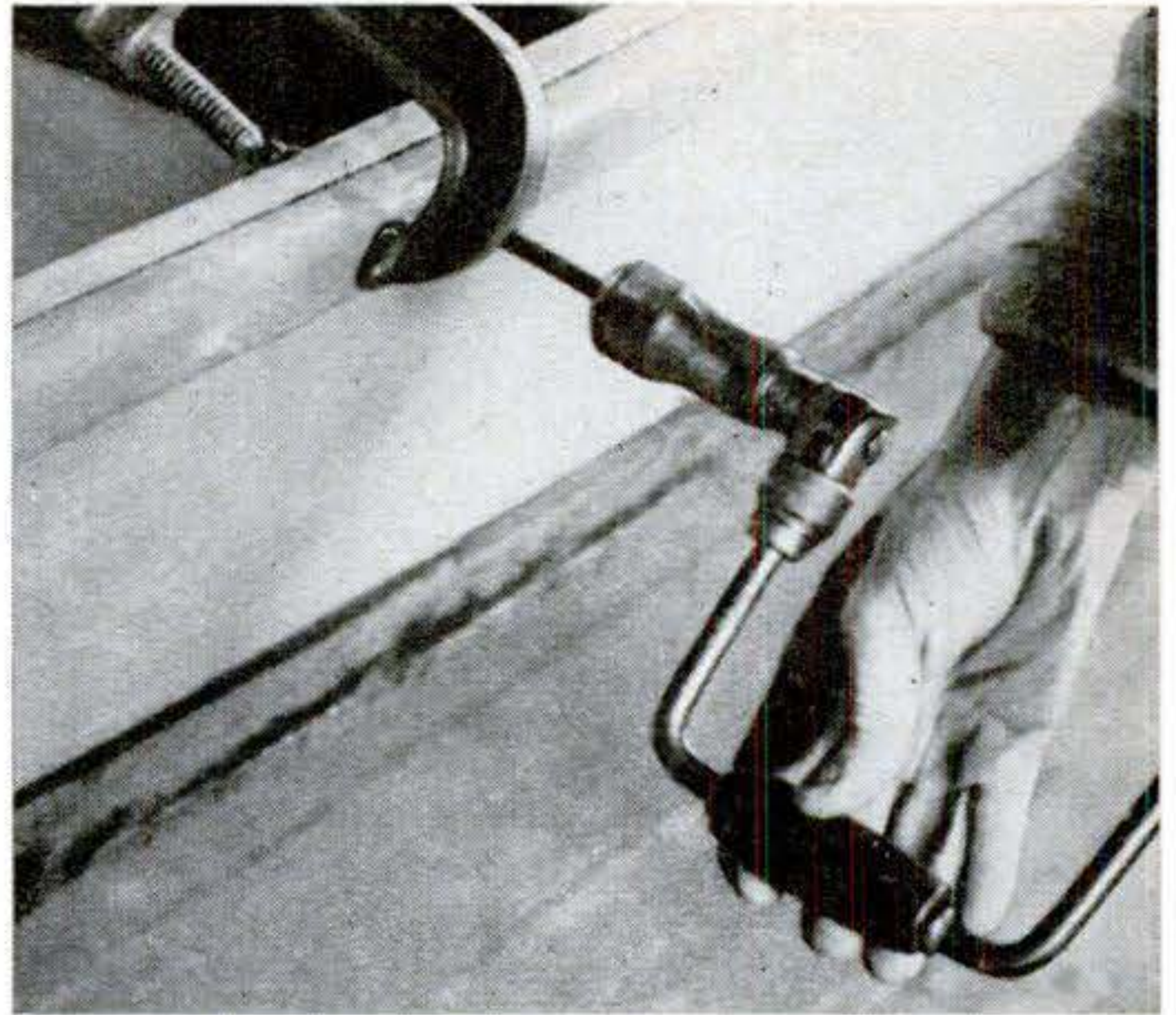

Watch for side planks that are pulling away from frames. Pull them up tightly with a C clamp and put in new screws wherever needed.

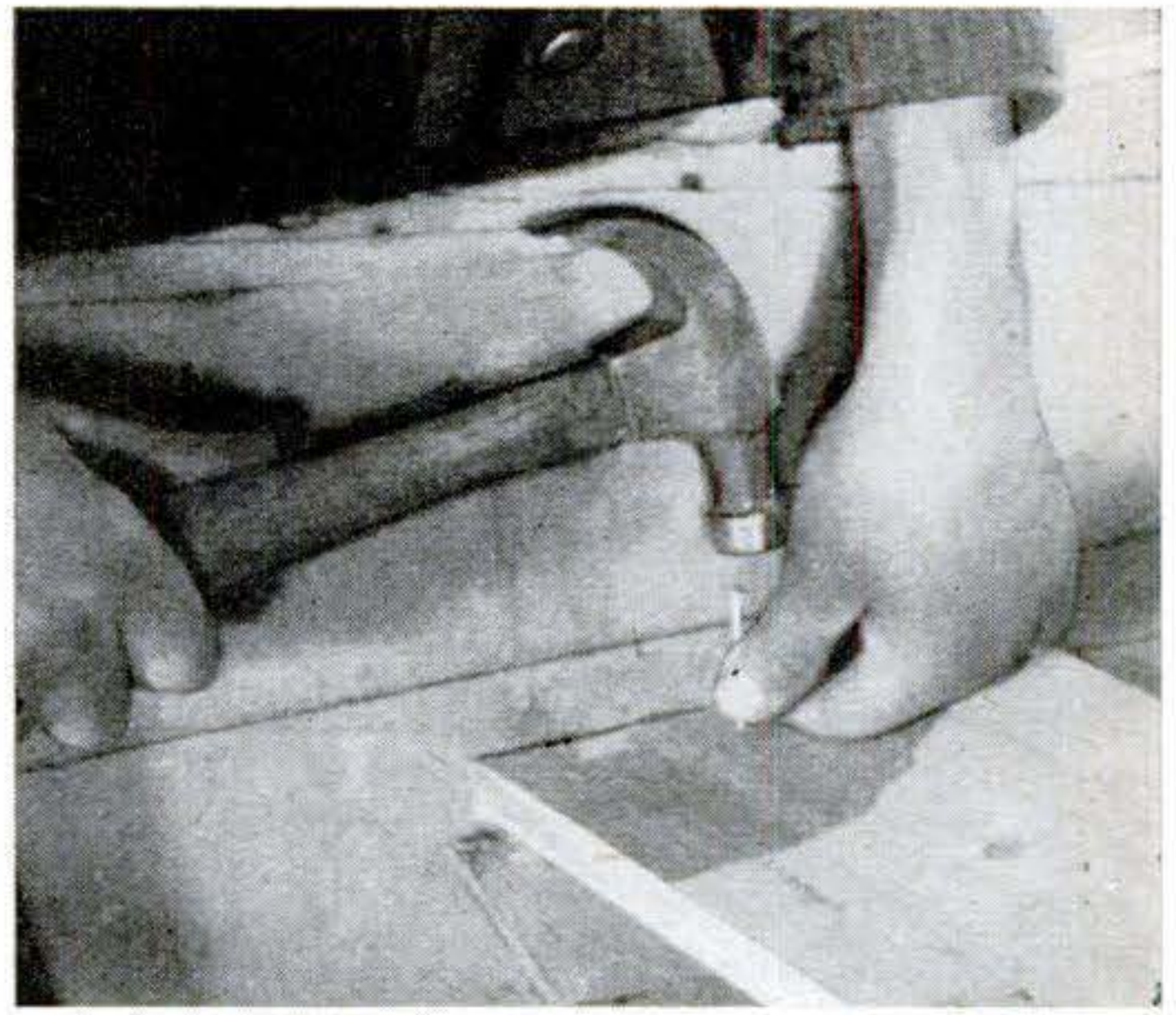

Seats help hold a skiff's sides together. Replace warped or rotted ones. Nails into the support will do for this part of the repair.

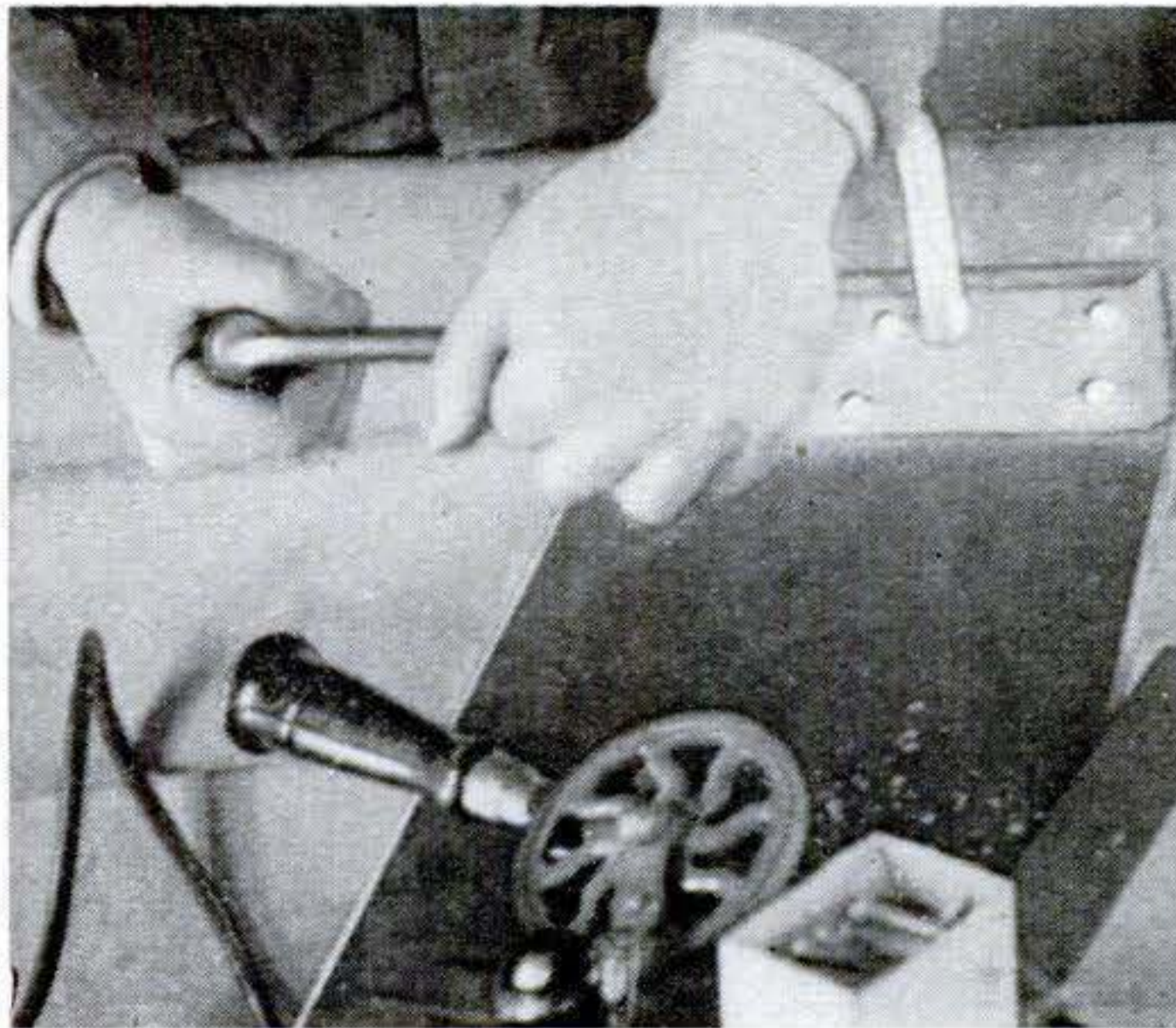

Seats won't buckle if you add extra cleats above. Cut pieces as long as the seat is wide. Clamp down on top of seat and screw to the side.

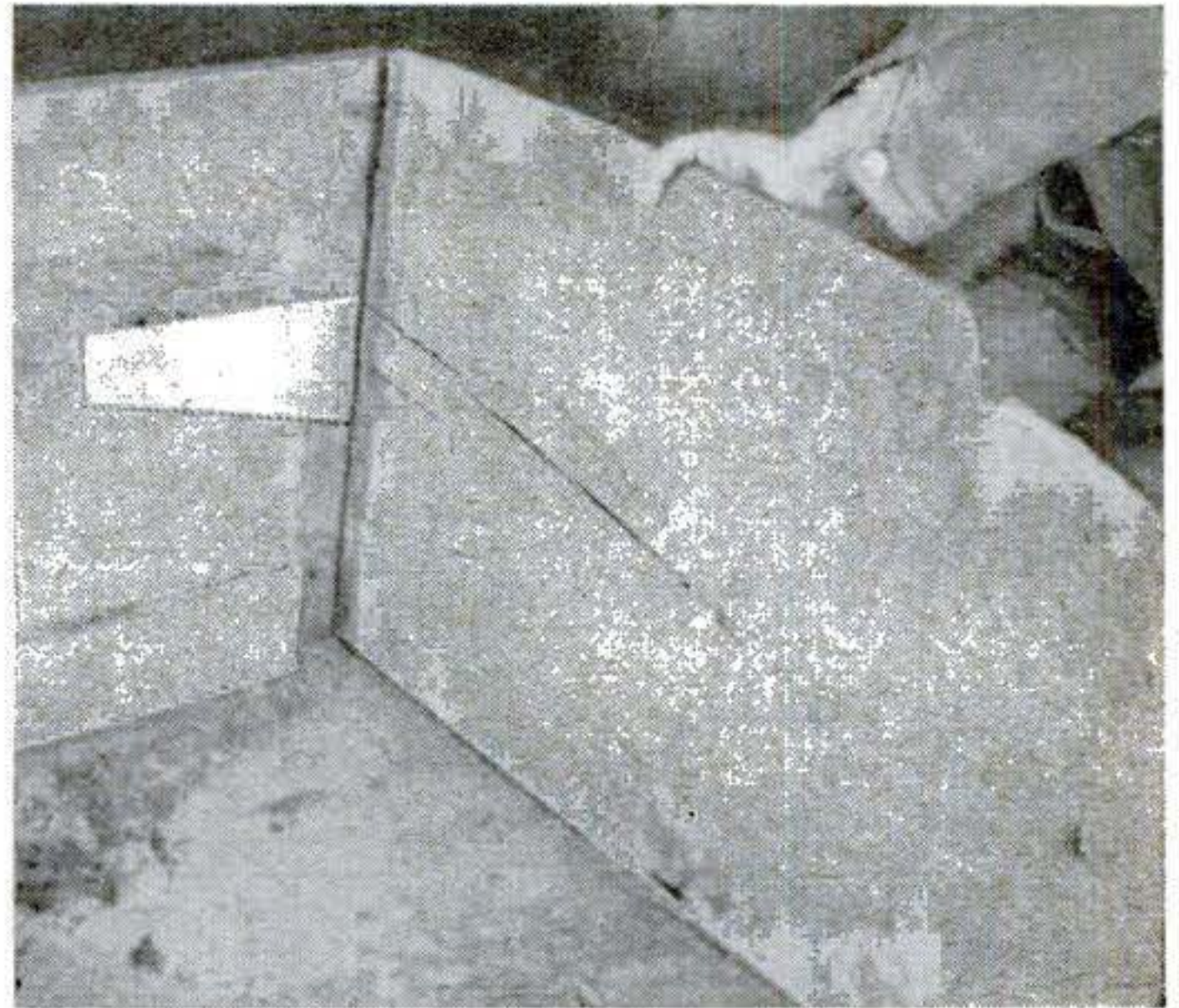

It's easy to take out an old transom without harming good sides and bottom. Use a metal-cutting saw to cut through nails. 

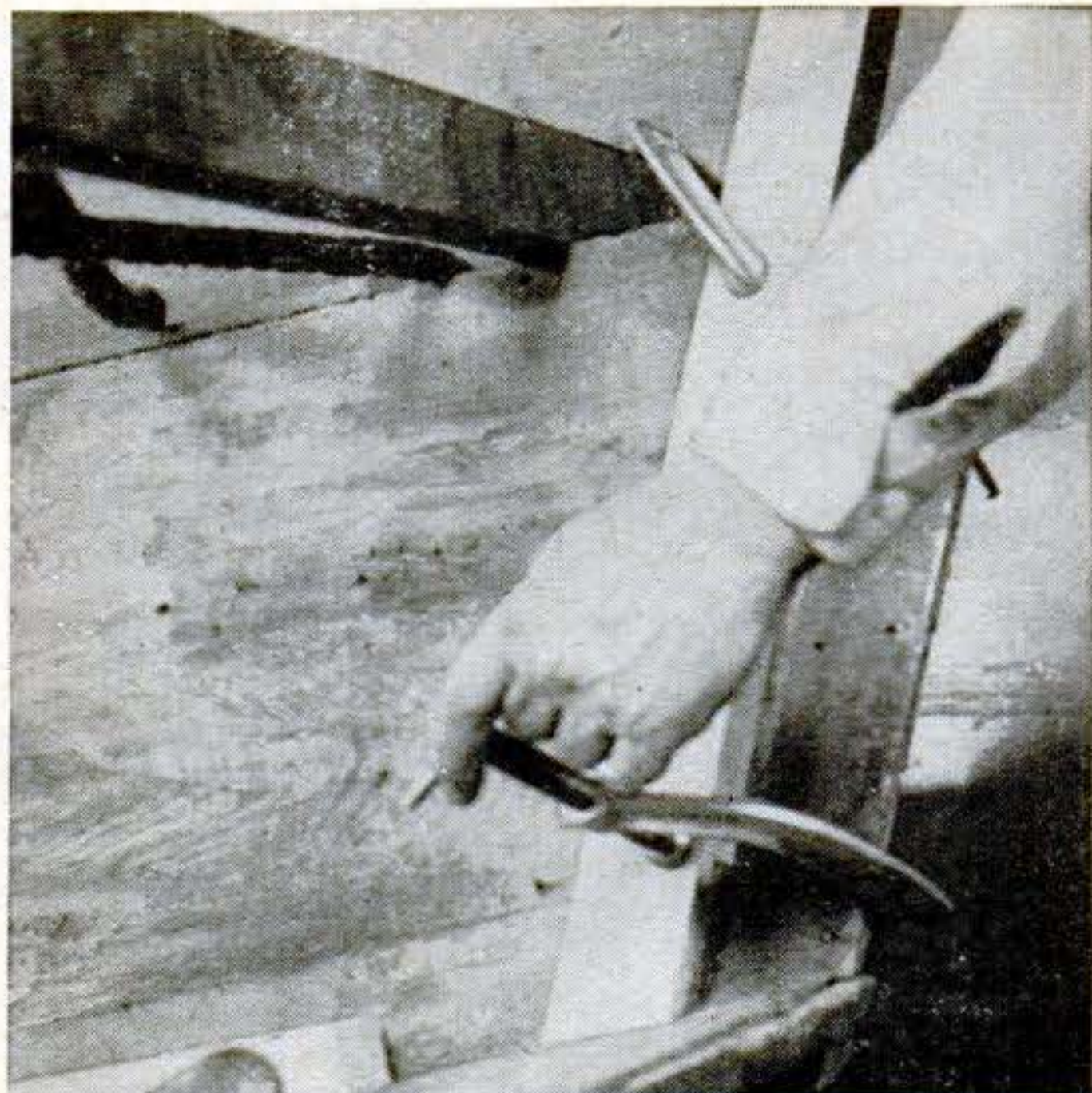

View of the stern after old transom has been removed. New supports are being fitted. Use boat clamp or rope to hold sides at proper angle.



Here the new transom has been cut and screwed in place. It's made up of two planks, calked at the joint. Seat support is being fitted.



New stern seat of two planks is being installed. Notch two corners of the aft plank to fit around the two supports at the stern.

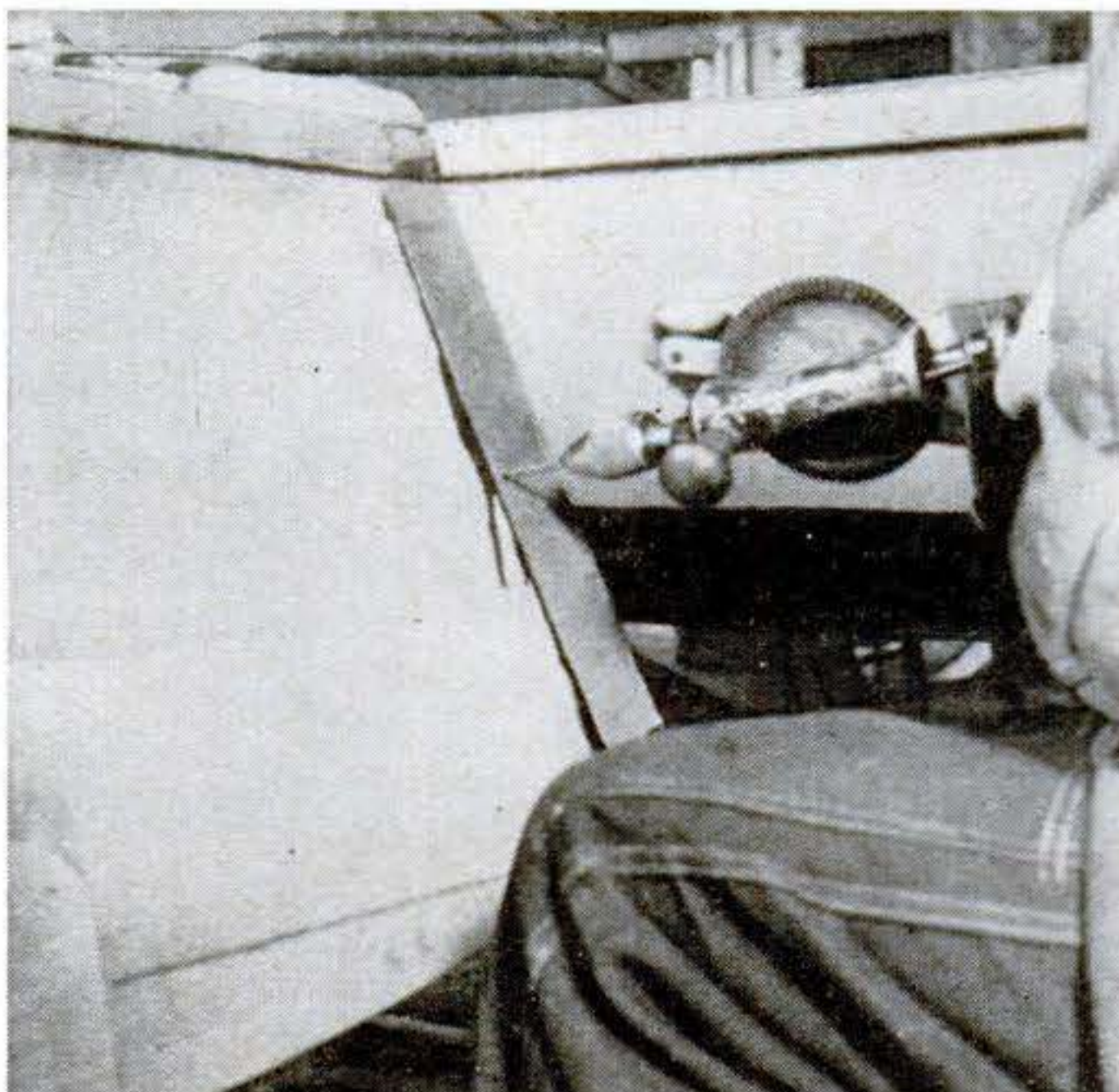

Final touch that's often overlooked is angled sheet copper on stern corners to protect them. Drill and fasten with copper nails.

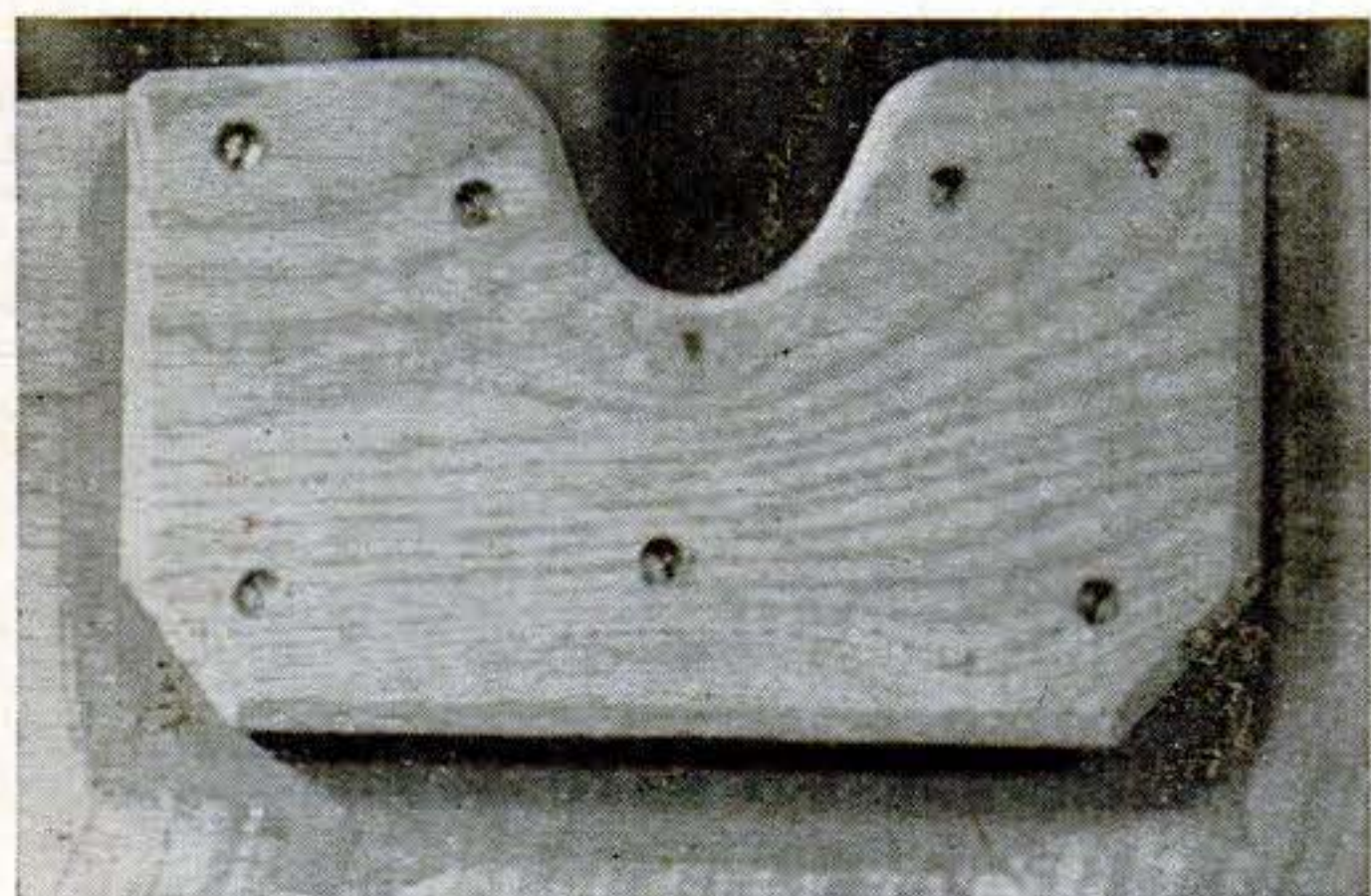

A reinforcement like this at the scull notch will save the transom from wear. Maintaining notch shape also makes sculling easier.

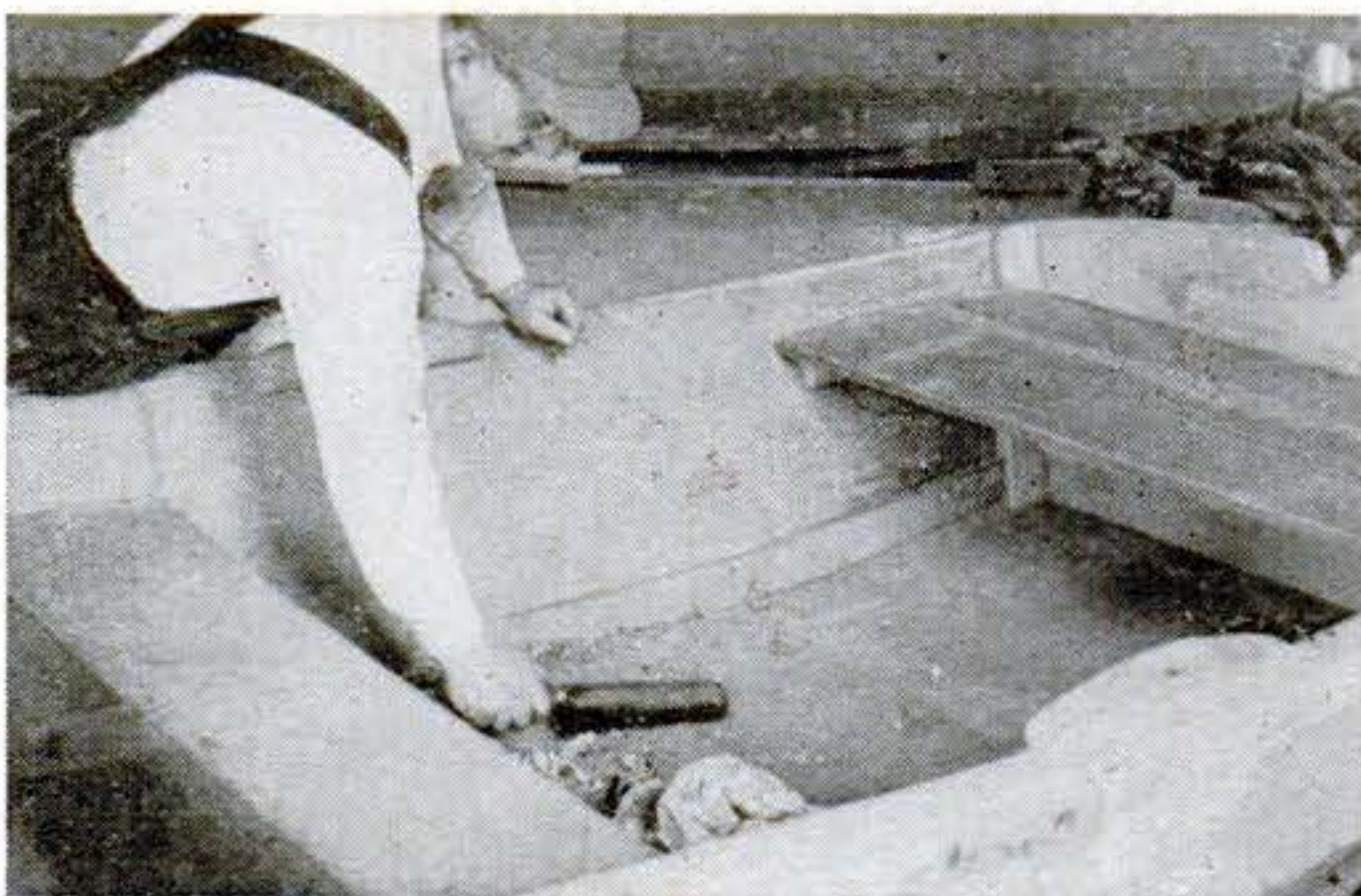

Now you're ready to sweep up all chips and sawdust. Paint the inside of the skiff first, turn it over, and paint the bottom and outside.

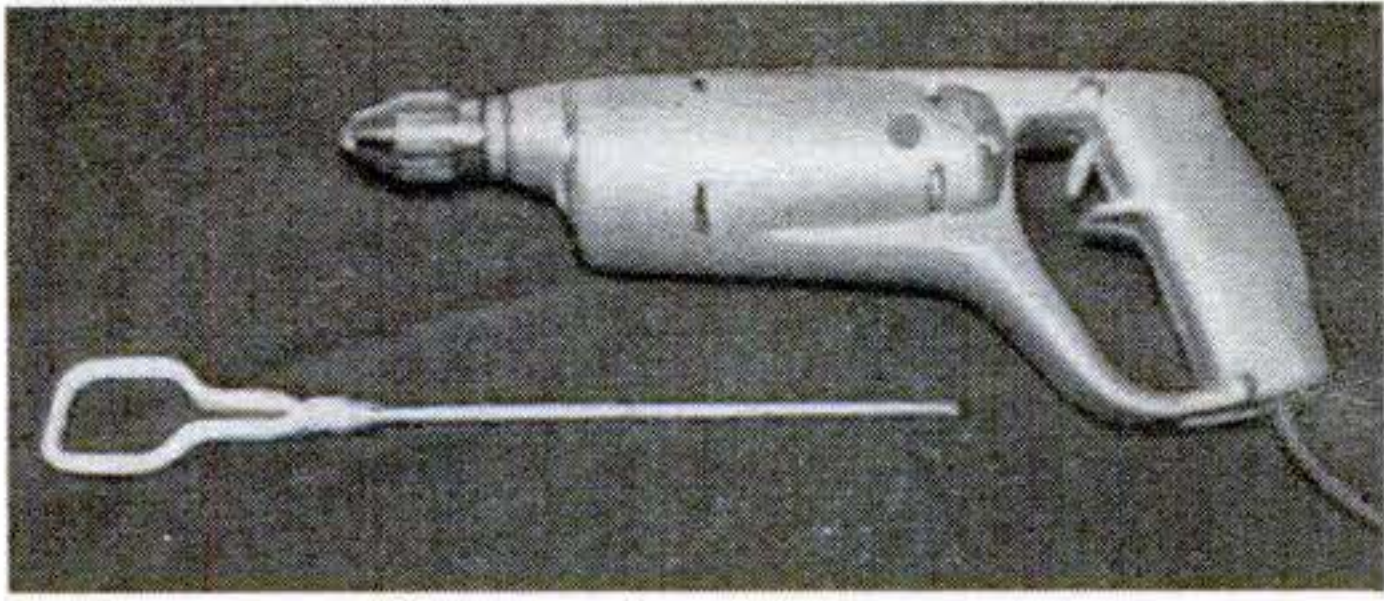

Let Your Drill Stir It

EVEN the messy job of stirring a gallon of paint becomes simple if you let your electric drill do the work. A paddle to fit the chuck can be made by adding a shaft to an impeller from an old kitchen mixer (top photo), or simply by twisting a loop in the end of a metal rod. The best way to handle the paint (inset) is by removing the lid of the can, drilling a hole in it, chucking the paddle through the hole, and replacing the lid. That way there's no splashing. —D. H. Ross, Ridgewood, N. J.



C Clamp Insures Smooth Siding

BOARDS for siding sometimes warp so that they won't fit snugly when you come to nail them on. To overcome this you need only a C clamp and a lever (any strong bar). Fasten the C clamp to the joist about level with the board top. Using the clamp as a fulcrum, force the board down with the lever until it fits smoothly against the one beneath. —Charles Hedges, Clearwater, Fla.

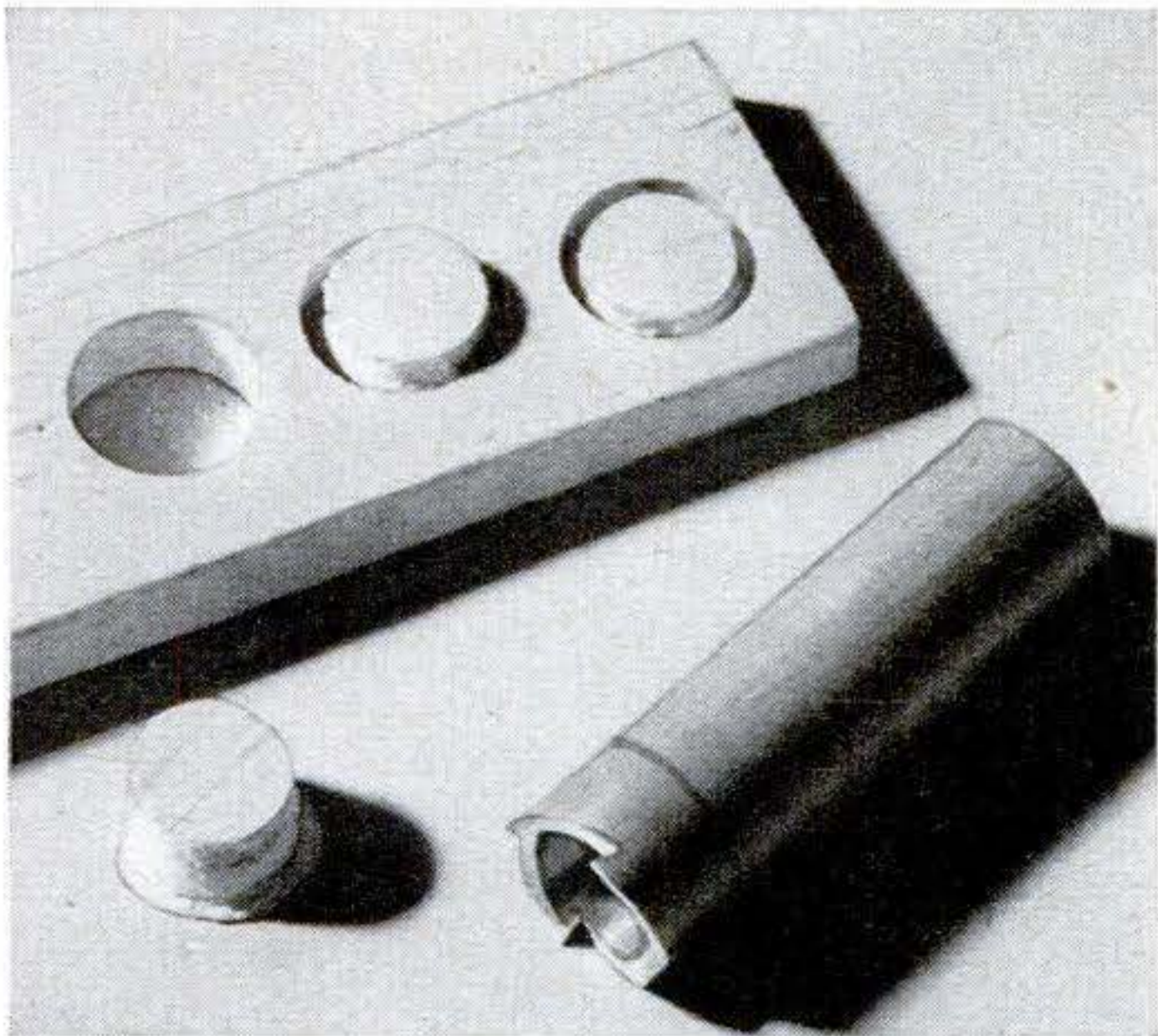

Scrap Tubes Make Plug Cutters

DON'T throw away scrap ends of brass tubing. A few minutes' free-hand filing converts them into excellent plug cutters. Choose tubes for their inside diameters—a $\frac{1}{2}$ " tube cuts a plug to fit a $\frac{1}{2}$ " hole.

Plugs $\frac{1}{2}$ " or bigger should be made in a lathe. Chuck the cutter, hold the wood against the tailstock pad, and feed into the cutter. Cut part way, then break the plugs out. —Herbert R. Pfister, The Bronx, N. Y.

Air Pressure Starts Pump

THE usual water float is missing from a new kind of sump pump. Instead it has a micro-switch operated by air pressure. Water rising in a tube compresses the air in the tube until it pushes in a flexible diaphragm that closes a switch to start the pump. The new pump, called the Smooth-Flo® by its makers, Tokheim Oil Tank and Pump Co., Fort Wayne, Ind., is intended for industrial, home, or farm use. Made of aluminum, it weighs only 30 lb., yet has a capacity of 3,600 gals. per hour.

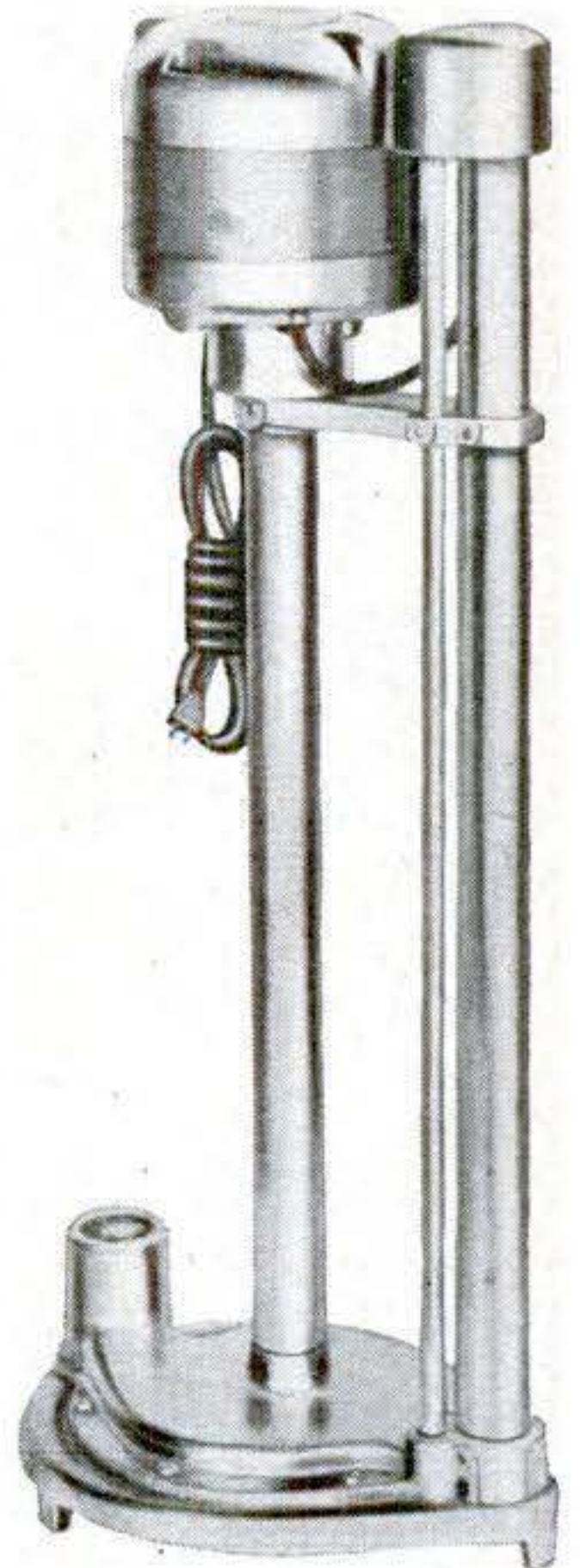

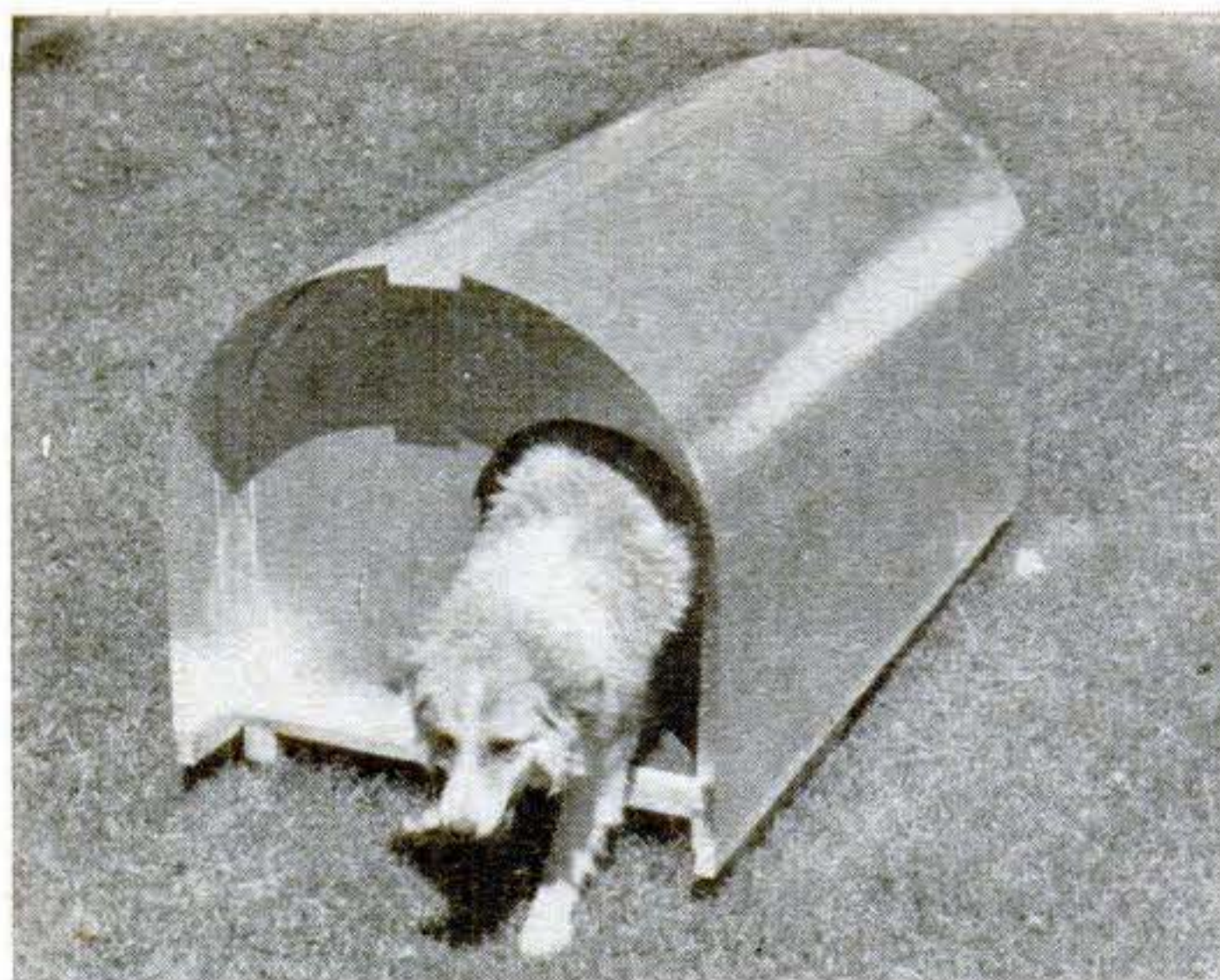

Sheet metal covers the hut. Here, the sheet was used on the ends as well as the top. Composition board or wood will serve for the ends, however, if it has been waterproofed.

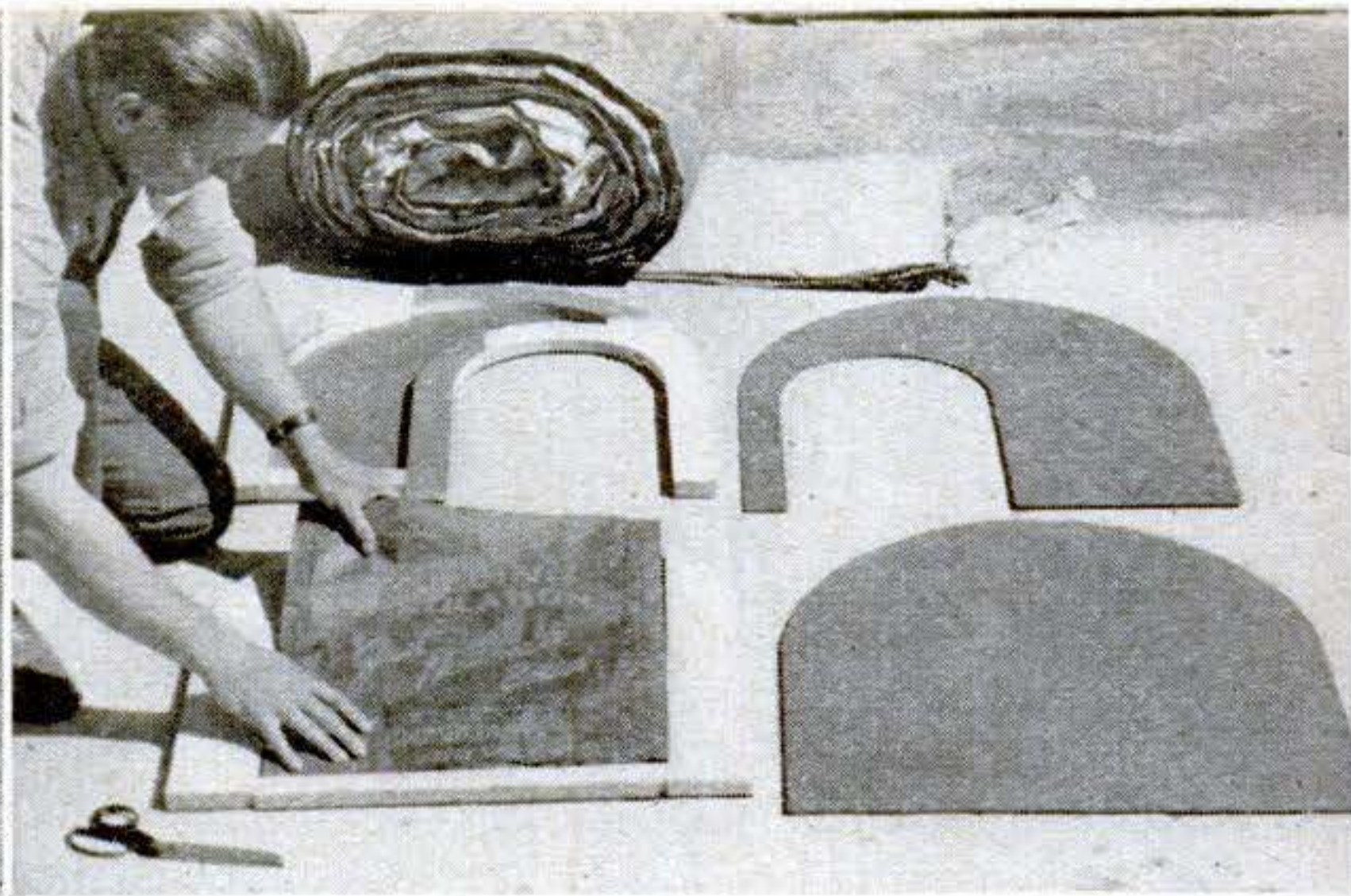

These are the parts. Insulation is here being fitted into the framework of the back end. In background, note how the framing members of the front were neatly bandsawed to shape.

Even a Doghouse Can Be Warm

Insulated, leakproof, and draftproof, this Quonset hut costs less than \$10—and your dog will love you for it.

By Roland Cuera

NO NEED to let your dog shiver out in the cold this winter when you can build him this insulated doghouse for under \$10. Warm and cozy, it can also be towed easily from one spot to another on its two-by-four skid runners.

WARNING: *This one's for a small or medium-sized dog. Change the dimensions for a big dog.*

The floor and ends: These are 1" sandwiches of $\frac{1}{8}$ " composition board with glass-wool batting in between for insulation. Cut two 24" by 36" pieces of composition board for the floor and two 24" by 24" pieces for the ends. Swing a 12"-radius curve to shape the top of the end pieces and cut on a bandsaw or jigsaw. Then cut the inside panel of each end 1" short so the outside will overlap the ends of the floor. Also saw the door opening in the front panels.

Cutting the framing: The frame for the floor consists of straight pieces of $\frac{3}{4}$ " stock.

Use a bandsaw to shape the end framework from stock of the same thickness. In the illustrations, the frame members are shown as pieces of regular width, but you don't have to be so finicky. The inner edges of the pieces need not be so nicely curved.

Assembling: Place the framing for each section on top of one panel. After cutting and fitting in the insulation, carefully clamp the second panel on top. Nail together, trim off any excess framing around the edges, and sand flush. Cut a ventilating hole in the back panel and frame a piece of screening over it. This hole can be covered on cold nights.

The ends can now be attached to the floor. Nail them from below and also through the overlapping parts of the outer panels. Set the assembly on the two-by-four runners and nail it onto these through the floor.

The inner shell: In this case, Tekwood® was used because it easily takes the bend across the top. But any composition sheet material that will take the curve can be substituted. You can determine the size of the sheet required by stretching a string around the curved panel and then measuring the string.

Attach this sheet by first tacking it to the edge of the floor on one side, and then bending it over the top to the other side, nailing it as you proceed. Use small wire nails with heads. Space them every two or three inches.

Now nail or screw the five longitudinal pieces in place. Then mark off and bandsaw curved members $\frac{3}{4}$ " wide to close in the end spaces between the longitudinals. Install insulation all around.

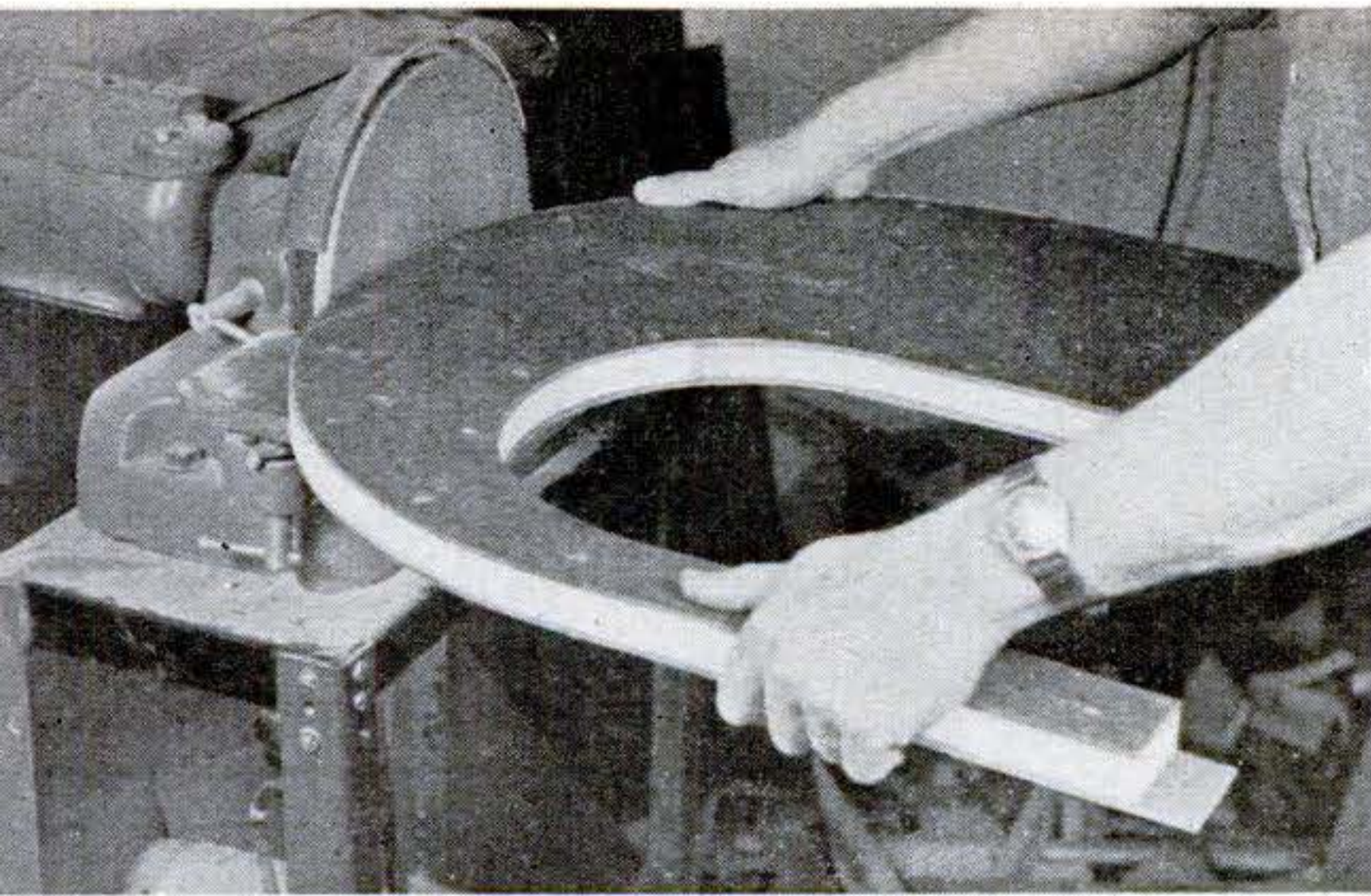

Front-end sandwich is sanded smooth after its assembly. Note that outside composition-board facing projects beyond the frame. When the hut is assembled, this overlaps end of floor.

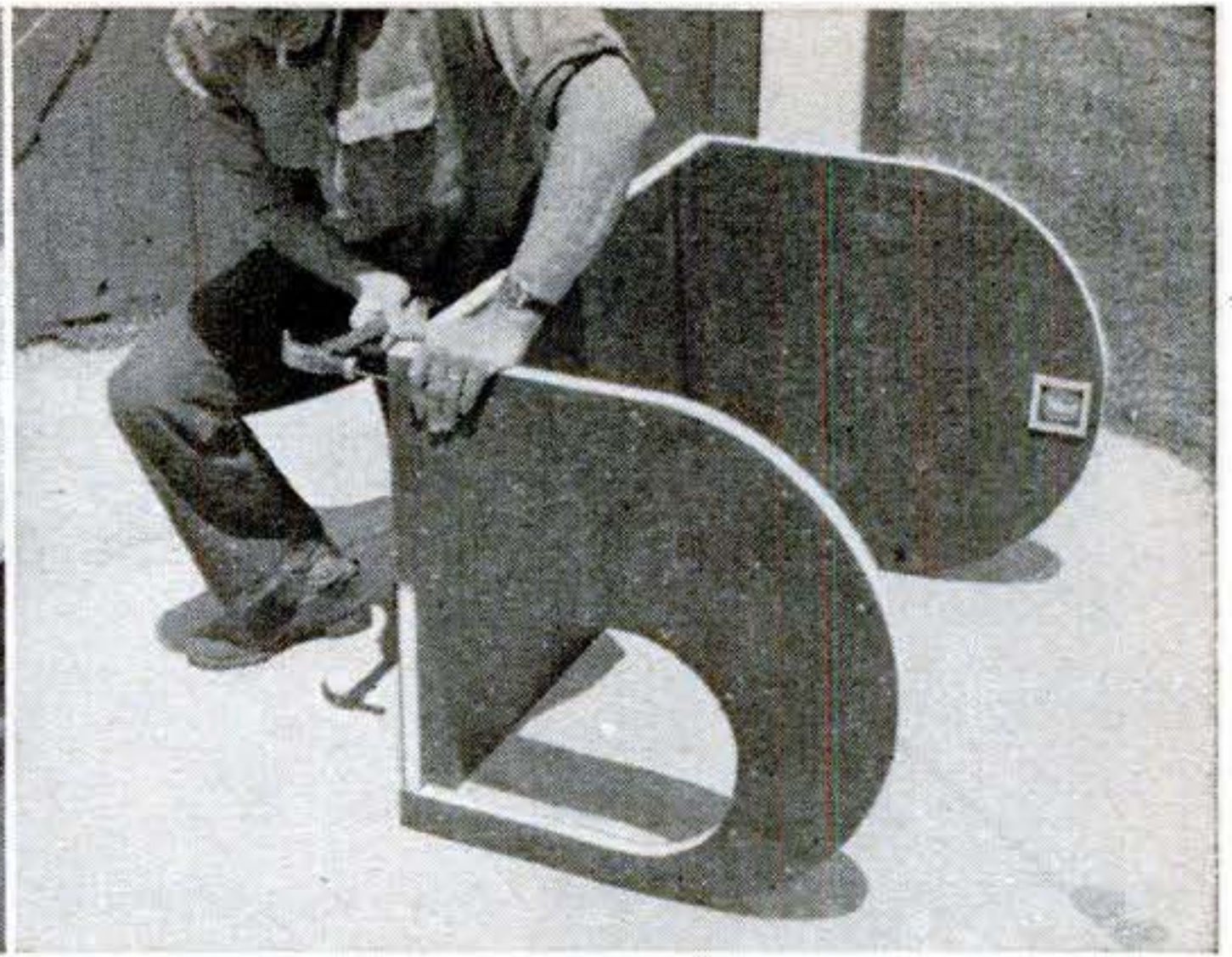

Ends and floor are assembled like this. Composition board was attached to frame with $1\frac{1}{4}$ " galvanized nails. Driven through, these were clinched inside the ends and under the floor.

The outer shell: One standard 30" by 96" galvanized roofing sheet is sufficient. Cut it in half to make two 30" by 48" sections. Nail the sheets to the top and bottom longitudinal pieces and the filler strips, first punching the metal for the nails. Let the sheets overlap the top longitudinal by $\frac{1}{2}$ " on each edge. A cover strip of composition board or sheet metal goes along this seam.

A full-width piece of sheet metal could be used, eliminating this top seam and cover strip. But it is more economical to employ

the standard roofing size—even if it's more work.

Finishing up: The final step is to fasten a slanted sill piece across the top of the runners under the door opening. Also drill a hole through the forward end of each runner. This will enable you to tie on a tow rope—or a long leash.

If the sharp ends of the sheet-metal roof bother you, slit sections of old garden hose lengthwise and slip them over the edges as a guard. END

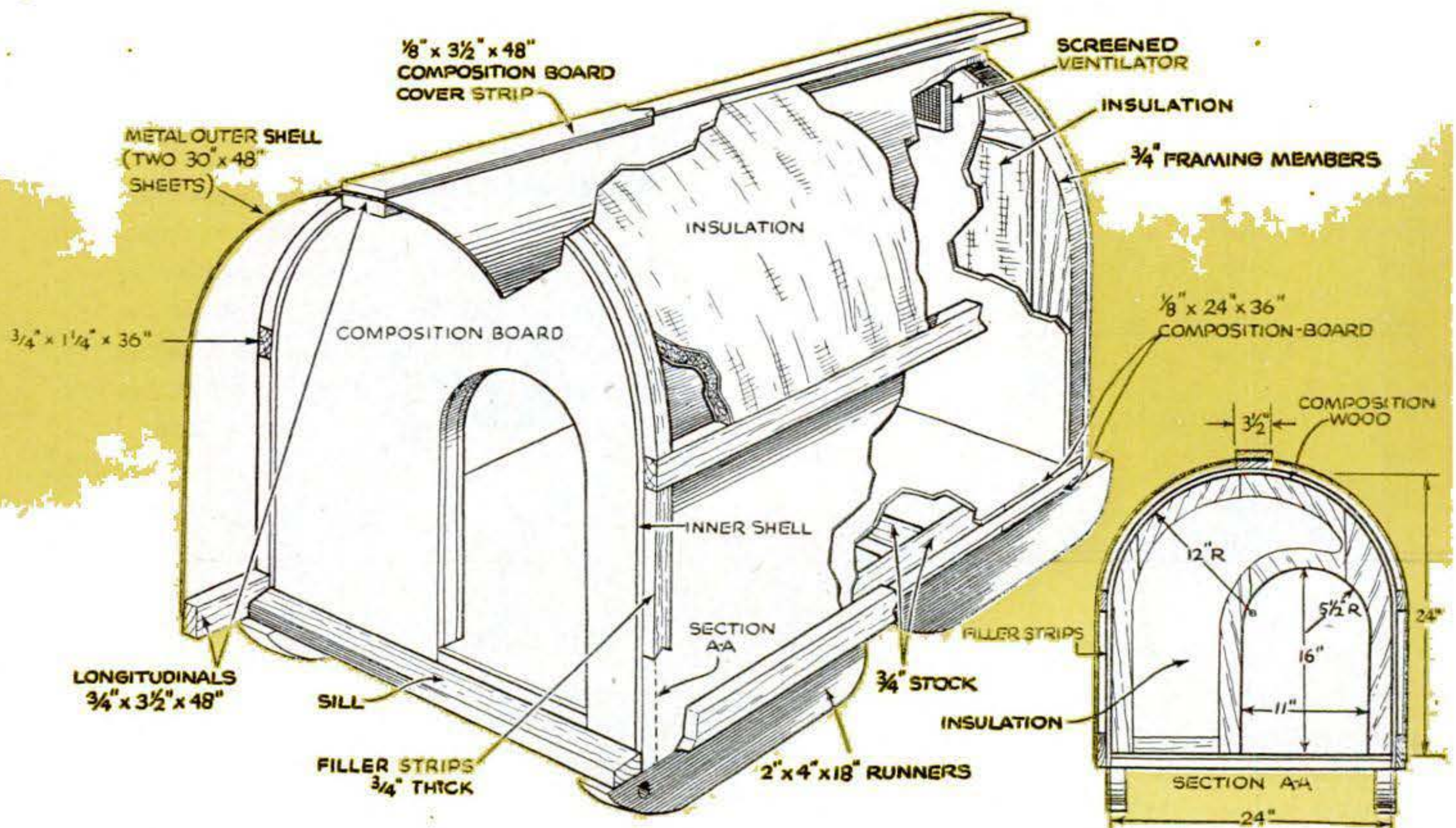

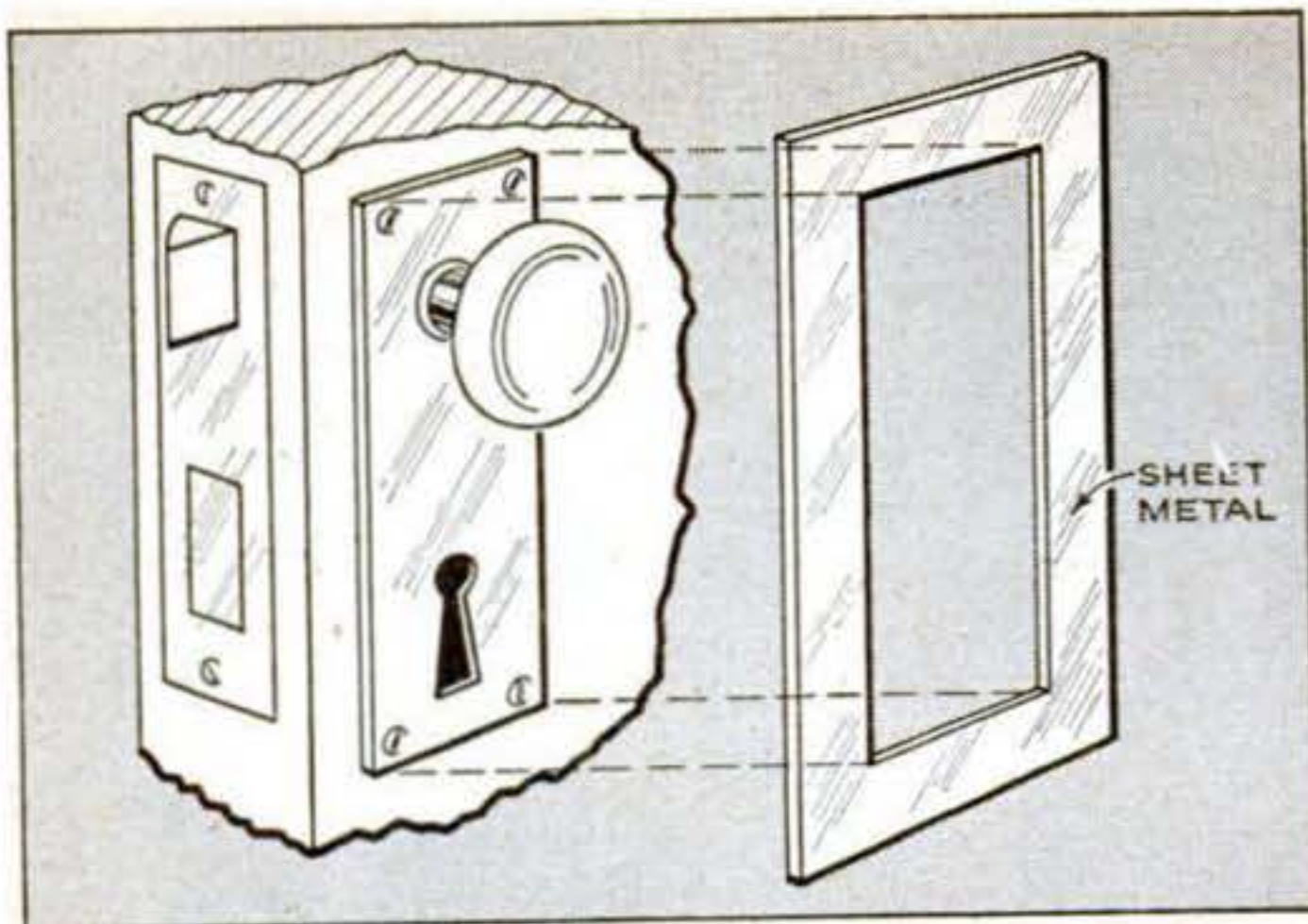

Polishing Shield Saves Paint

WHEN an abrasive polishing material is used to shine up a door plate, the surrounding paint is apt to get marred. To protect it, I cut out this metal shield. It fits snugly around the plate and can be held with one hand while you work with the other. The cleaning woman who uses it is very enthusiastic.—*J. A. Appelquest, Leonia, N. J.*

Stop Roof Leaks Caused by Ice

ICE forming along the lower edge of a low-pitched shingle roof sometimes causes water to leak into the house. As snow melts, the ice dams up the water, allowing it to seep under the shingles.

This trouble can be overcome by placing a strip of roll roofing along the edge. Pry the nails from the fifth course of shingles, slip the roll roofing under, and re-nail.—*D. W. Allis, Billerica, Mass.*

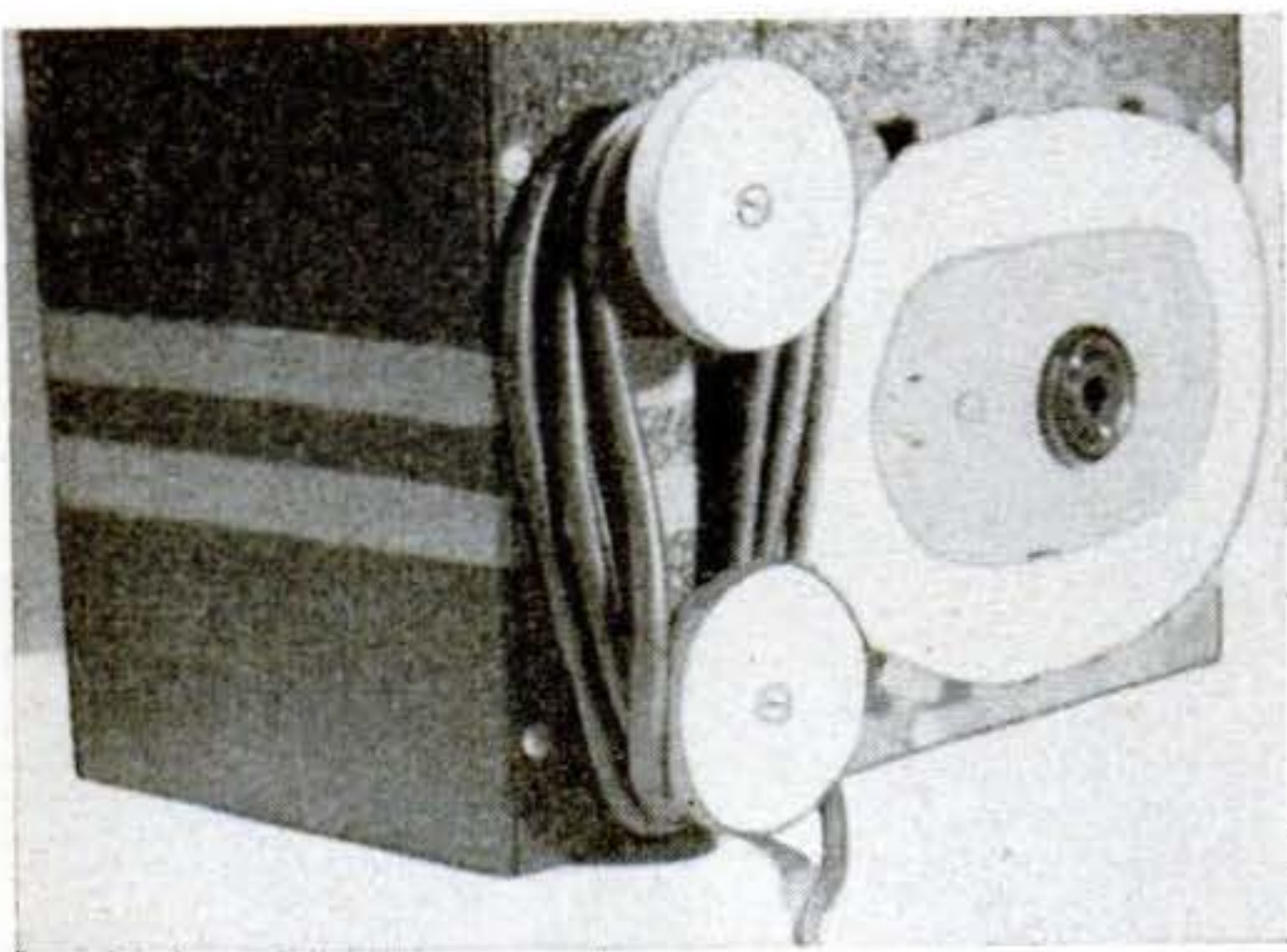

Spools Take Slack in Line Cord

SOMETIMES the line cord on a radio or appliance is so long that the slack clutters the floor. Take this up by winding it on the two halves of a spool attached to the back of the appliance, as above.

Tape Breaks if Cracks Widen

A LENGTH of cellulose tape stretched over settlement cracks in plastered walls will show whether the cracks are continuing to open. Since the tape is inelastic, the slightest opening of the crack will break it.—*R. Daily, Long Beach, Calif.*

Space Shelves to Fit the Cans

SHALLOW shelves in a closet or area next to the kitchen can give you a little extra room for storing canned goods. Since the rows are only one-can deep you'll always be able to spot what you want at a glance. To make full use of the wall, space the shelves just far enough apart to fit cans of the most commonly used sizes.



Chain Length Identifies Bulbs

WHEN bulbs of two wattages are used in a lamp to give dim or bright light, it's always annoying to turn on one when you want the other. But if the lamp is the type that has pull-chain switches, you can tell them apart by lengthening one chain.

Shoptalk:

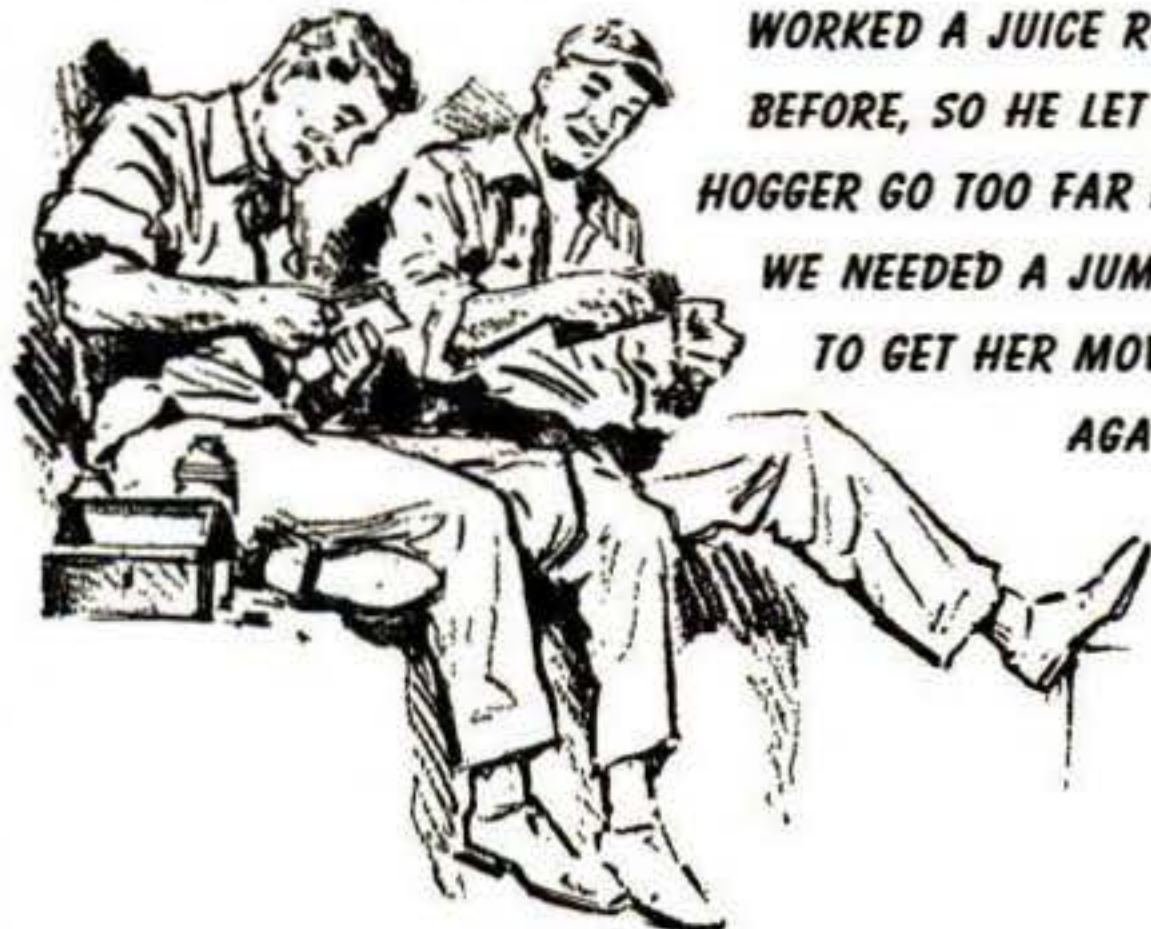

"THAT SHACK NEVER WORKED A JUICE ROAD BEFORE, SO HE LET THE HOGGER GO TOO FAR AND WE NEEDED A JUMPER TO GET HER MOVING AGAIN."

What are they talking about?

Where do they work? Answer below.

They're railroad men. The brakeman hadn't previously worked on an electrified division, and he permitted the engineer to overrun the end of the third rail, necessitating the use of a temporary cable connection to permit the locomotive to back up into contact with the third rail.

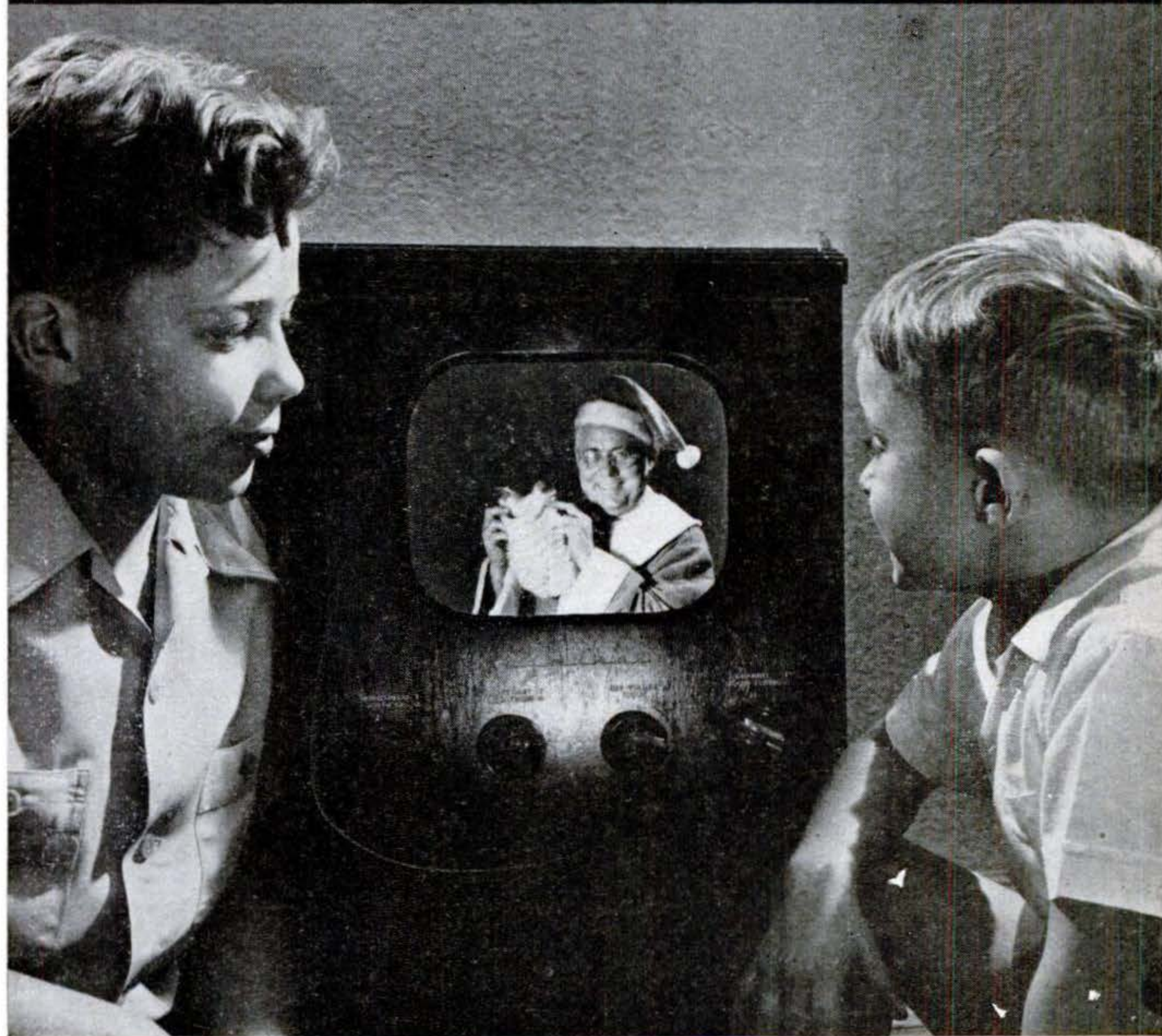

***Cards Your
Friends Will
Enjoy Saving***

By W. W. Morris

Chief, PS staff photographers

YOU'RE looking at one of my family's series of Christmas cards. Maybe you would like to start a similar series this year.

I began making photographic cards for my customers while managing a store. We made the cards from stock or master neg- ➤



Merry
Christmas
Happy
New Year
Larry
Bill
Peter

1939. Friends recognized my wife's handwriting and asked how we got it on the card. I copied her writing on 5" by 7" film and cut my own hole to fit the family picture.

atives, about 6" by 8", on which "Merry Christmas and Happy New Year" had been photographed. A space to fit either a 120 or 116 film had been cut in this. By simply inserting the customer's own negative of his child or home, the card was made as a contact print.

Later we cut an additional slot in the master negative to insert the sender's name. The names were set in type, hand proofs run off on glazed paper, and photographed on process film. This was developed in a special high-contrast developer and fitted to the slot in the master negative.

In 1939—I was then a proud father—we sent our first family card. It was amateurish, but the start of an interesting game. The next year we decided to make that year's card and all future ones to the standard size of 5" by 7". By 1945, making cards had become a habit. But getting a new idea and producing a better card were becoming more difficult.

Last year we wanted a television card and hit on the idea you saw on the preceding page. Centering the children's attention and backlighting them to make it look as if the light were coming from the set was the first step. No image showed on the television screen. So that part of the negative was carefully cut out. Then a friend shot me in a Santa suit and I made the negative to fit the hole in the larger one. The density of the two negatives had to be equal and the fitting done carefully. A third negative carrying the lettering was sandwiched with the other two between glass, and the cards made by enlarging the three negatives together.

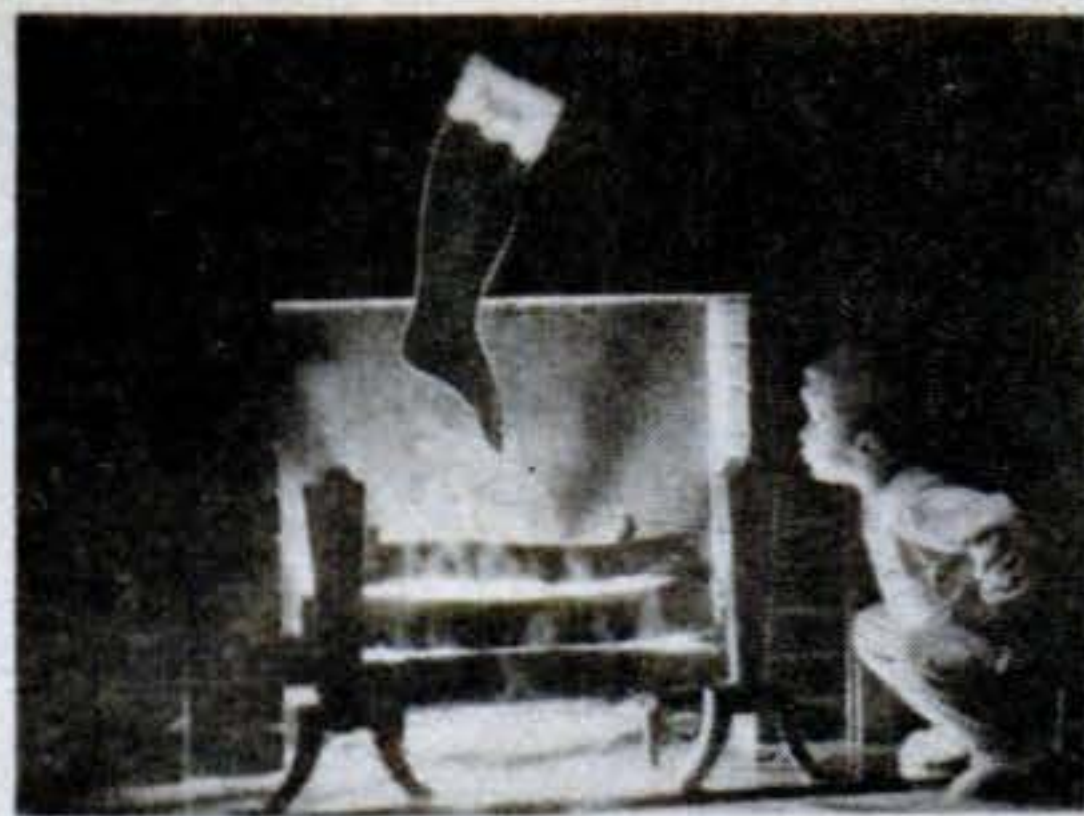

a merry merry Xmas
from
Daddy Mommie
and
me.
1940

1940. Flash bulb was placed behind logs and a weak front light used as fill-in. Some retouching was done on print and copy made.



1942. Message was printed in bold letters, copied, and print enlarged to fit blackboard. Photo was shot with backlight and fill-in.



Said Peter to Bill,
 "This Choo-Choo says 'Woo-Woo'"
 And from the Morrises
 this means
 Merry Christmas and A Happy New Year
 to You

1944. Something new has been added—a brother for Peter and job is twice as difficult. The trick here is to keep both kids looking interested. Flash shot at 1/100 sec., f/22. Verse set in type and copied.



1945. Circle mask was cut to fit original negative. Copy of art work was made to correct size and both negatives enlarged to 5" by 7". Photo was circled in red ink and stars colored in red by hand.

*"Happy Christmas to all,
 and to all a Good Night"*

The Morrises



FOR CHRISTMAS
 FOR NEW YEAR
 FOR ALWAYS

Best Wishes
 THE MORRISSES

1947. Last two lines of Clement Moore's poem suggested this card. Neg of white-on-black lettering was cut and butted against photo neg. Photo was posed. The children were not asleep.

1946. Santa made from paper. Getting proper backlight and fill-in while centering attention of kids was the difficult part of job. Shot at 1/100, f/22.



With the old wish
 that is ever new
 Merry Christmas
 and a
 Happy New Year too!
 The Morrises

How Air Force Snaps Night Photos



Lighting up New York's skyline as shown in the artist's sketch above, successive flashes were produced by 14-ounce, 50,000,000-candlepow-

er cartridges. Exploding behind plane, they created shadows, enabling interpreters to measure heights of buildings seen in the photo at right.

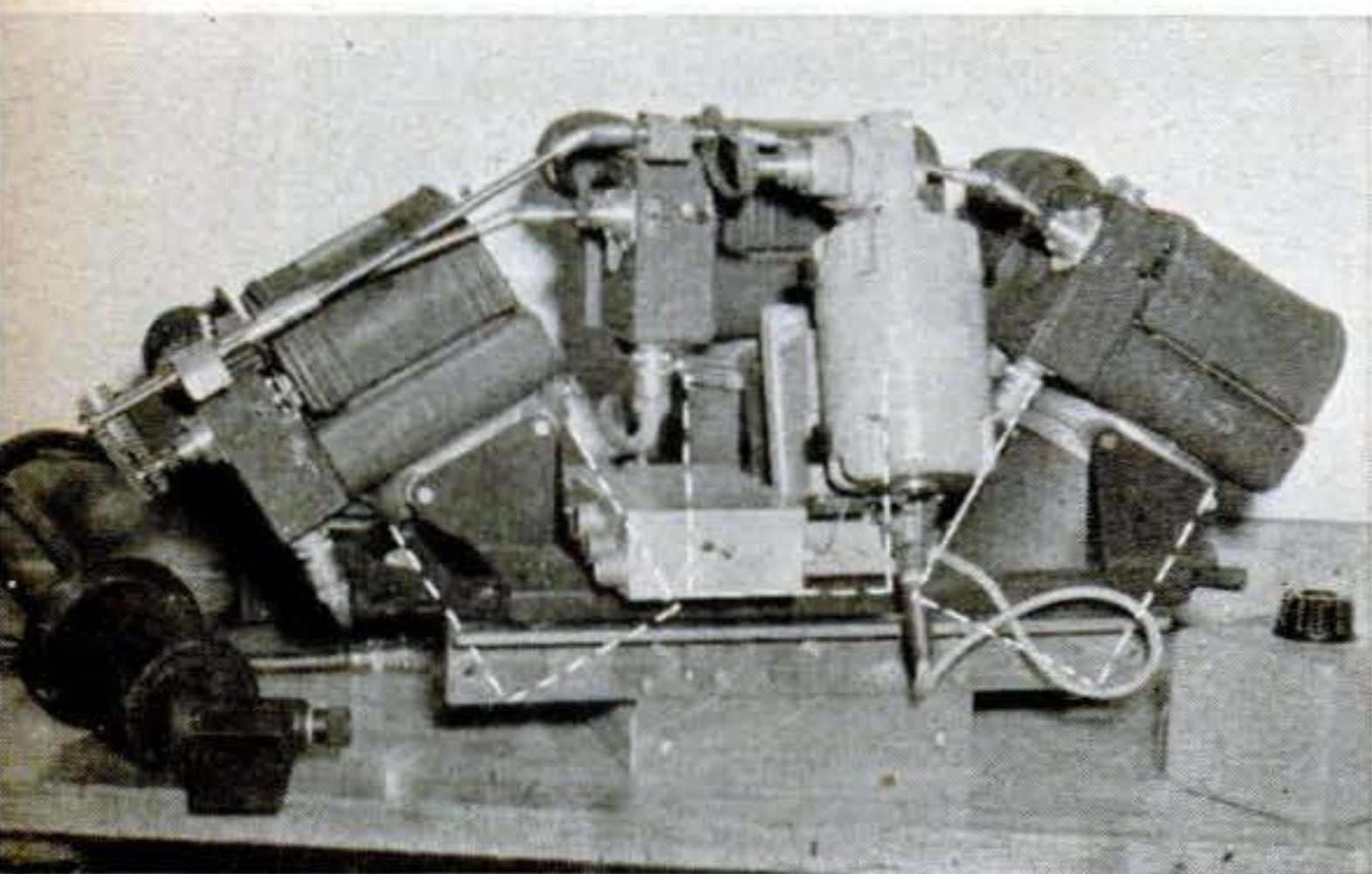

Photos were taken by three Air Force K-24 aerial cameras set in a trimetrogon mount as shown in photo above. Each camera has an f/2.5 lens with a focal length of 7½ inches.

LOWER Manhattan was recently the guinea pig for a new system of low-altitude aerial night photography. And although New Yorkers were disappointed in not getting the spectacular display of sky fireworks they had expected, Air Force technicians were highly pleased with the results.

Photographed from 2,500 feet by a B-17 Flying Fortress speeding at 175 m.p.h., Hudson River piers, ferry slips, buildings, and streets are clearly identifiable in the mosaic at the right. So sharp is the detail that an Air Materiel Command spokesman claims that sections of the mosaic can be blown up to identify makes of cars parked along the dock front.

Previous methods of night photography were unsatisfactory because a lack of shadows made it impossible to determine heights and vertical contours.

Secret of the new system is a 14-ounce, 50,000,000-candlepower photoflash cartridge that is ejected and timed so that it explodes from 500 to 1,000 feet behind the plane. This provides plenty of shadow detail by separating the light source and the view of the cameras, making possible night photography comparable to daytime photography.

During the photo run, the camera unit not only speeds along in the plane, but the film moves continuously through the camera. Between flash intervals, the film moves at a slow rate of travel, keyed to the ground speed of the airplane, thus preventing blur. Then the flash cartridge explodes, and the picture is taken. Immediately a photo cell picks up the light, throwing the film into high speed. This whips the exposed piece of film onto a take-up spool, placing a new section of film in place for exposure.

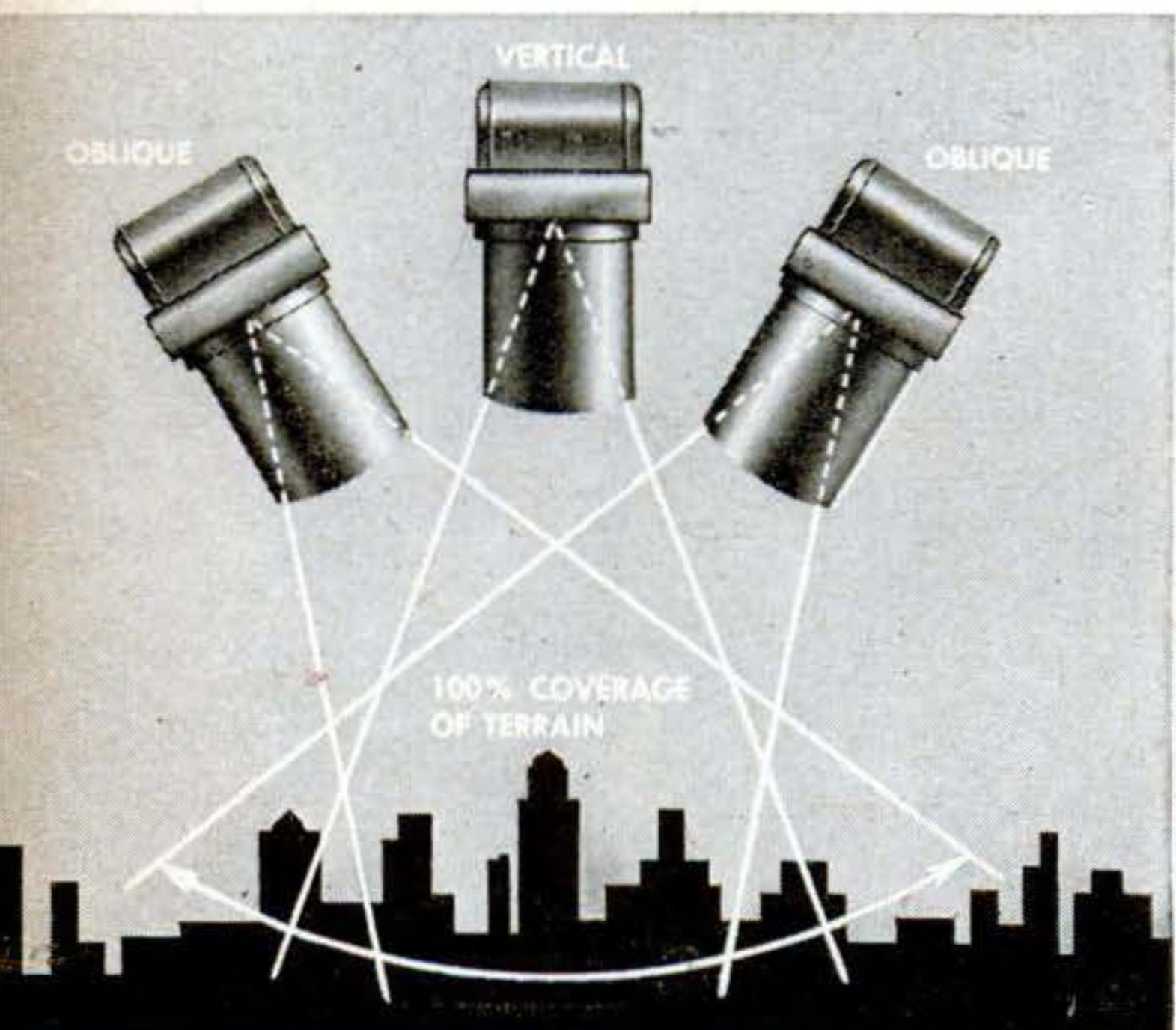

Trimetrogon arrangement of the cameras makes it possible to take one vertical and two oblique shots for every flash cartridge exploded. Each burst lasts 1/1,000 of a second.

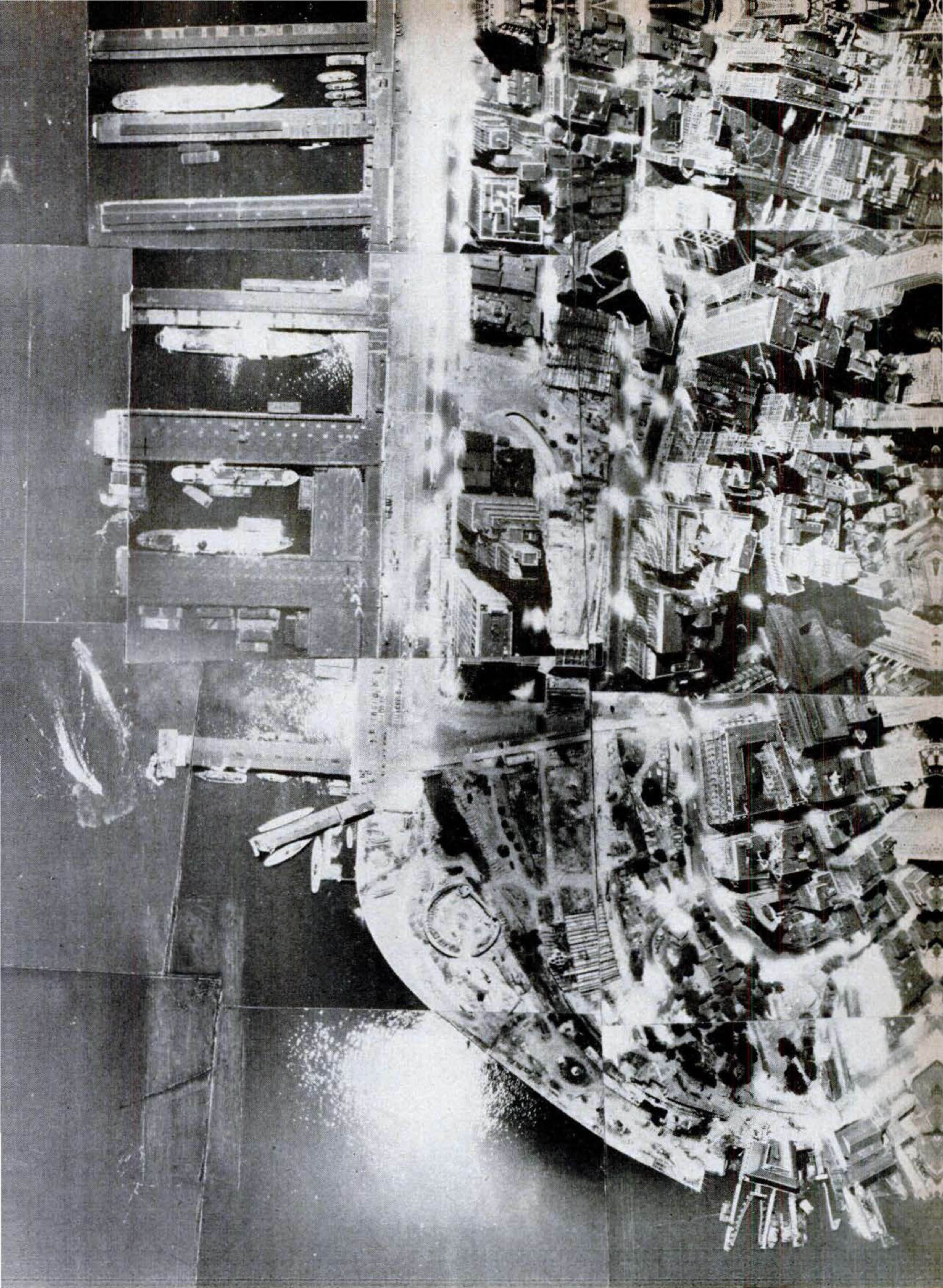

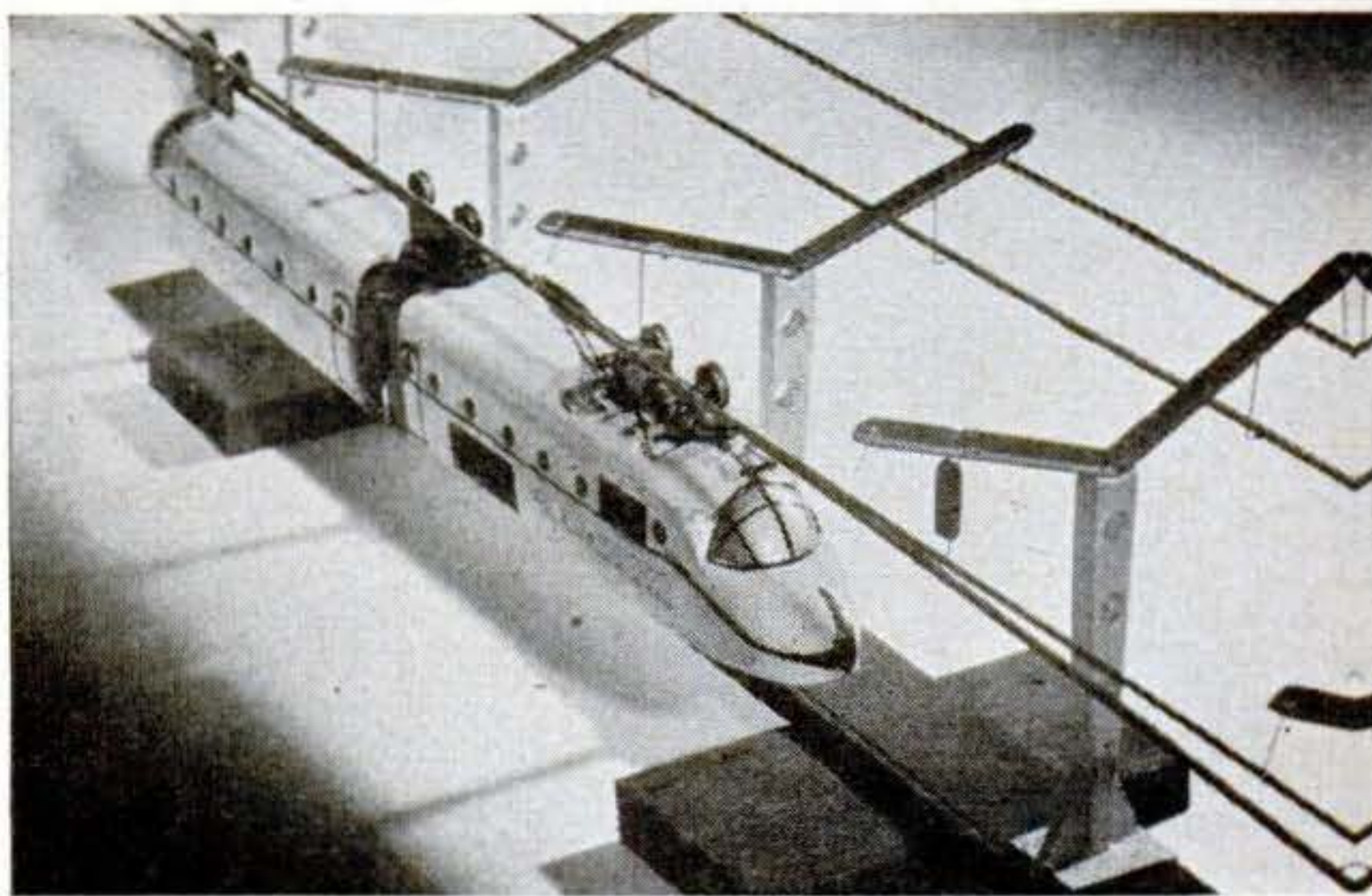
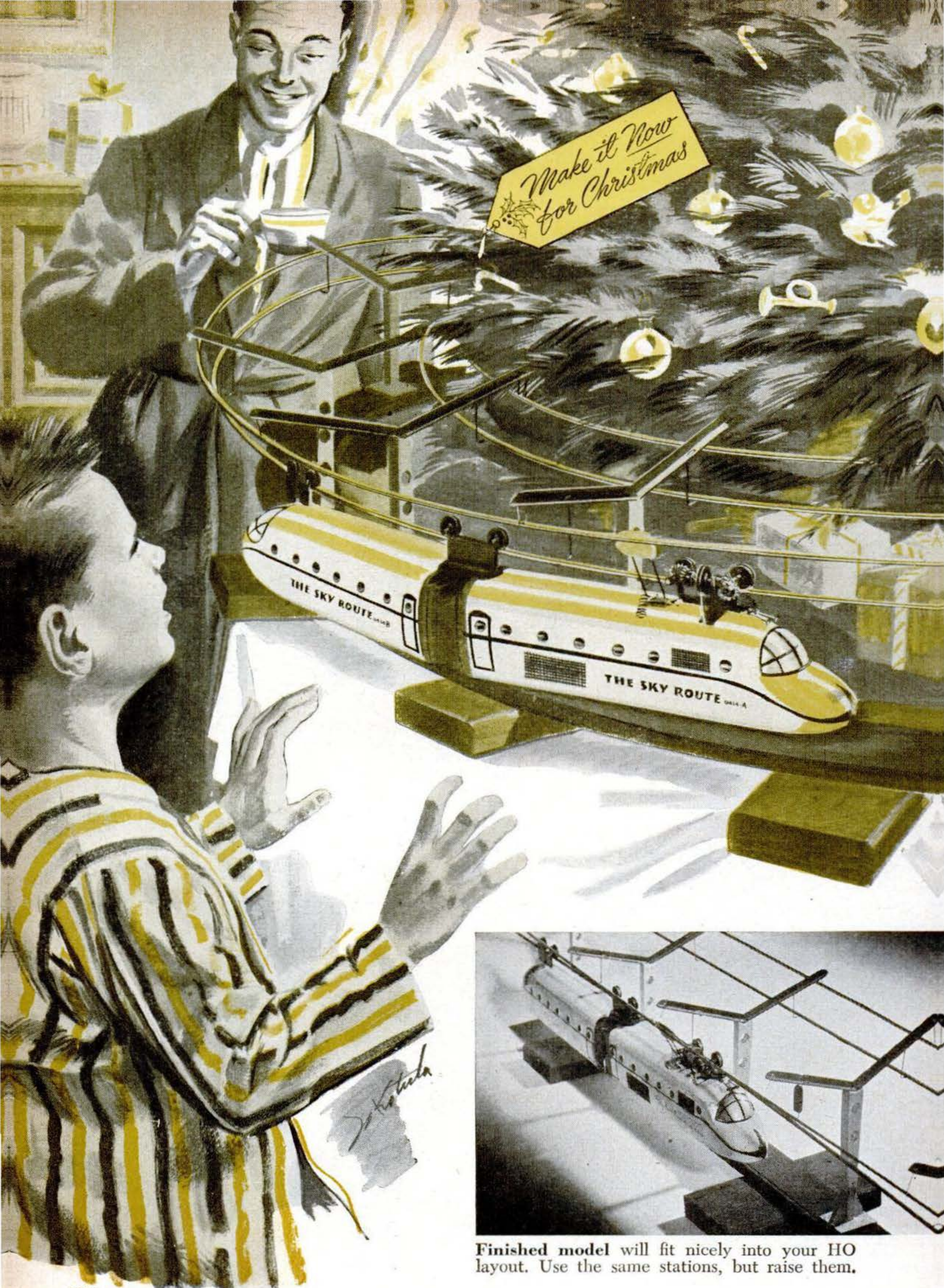

Finished model will fit nicely into your HO layout. Use the same stations, but raise them.

Here's a train that's different—and fun for a craftsman to build.

By Herbert Lozier

EVERY rail fan in your neighborhood—even the fellow who has every train, track, and switch that Lionel makes—will envy the boy who gets a sky train.

Monorails have been used in Europe for years, holding down some of the toughest jobs in railroading—mountain and river jumps where surface rails are impractical. A hanging train won't jump the track because its center of gravity is just about as low as it can get.

You can use standard HO rail and wheels to build this layout. The locomotive body should be large enough to house one of the common surplus 24-volt DC motors, which you can pick up for about \$3. They'll run well on a lower voltage, and can be reversed by switching polarity.

Installing the motor: Solder a $\frac{1}{2}$ " brass pulley on the drive shaft and center the motor on a $\frac{3}{16}$ " by $1\frac{1}{8}$ " by 6" wood floor so that the pulley is parallel with the front end

but 1" back. Fasten it with bolts if the motor is tapped for them, or bend a metal strap over the motor and screw the ends to the car floor.

When the motor is in place, butt the $\frac{1}{8}$ " by $1\frac{3}{8}$ " by $1\frac{1}{8}$ " wood back to the back end of the floor as shown on page 233, and secure it with glue and small brads. Install another upright $\frac{1}{8}$ " from the front edge. Since this is butted to the face of the floor, it has to be $\frac{3}{16}$ " shorter than the back.

The roof is glued and bradded across these uprights. Its outer edges are rounded as shown in the section view; the top is flat.

Sight a line from the motor pulley to the roof and drill and saw an opening that will clear the rubber-band drive belt. Before you're finished with the roof, you have to carve a recess for the center truck coupling. The streamlined nose of the car is shaped from a 1" by $1\frac{1}{2}$ " by $1\frac{3}{4}$ " pine block and the bottom is rabbeted to fit the overlapping front of the car.

If you'd like a headlight on your model, drill a $\frac{3}{16}$ " hole in the front to a depth of about $\frac{3}{8}$ ". Then drill a meeting hole from the back of the block. Make it large

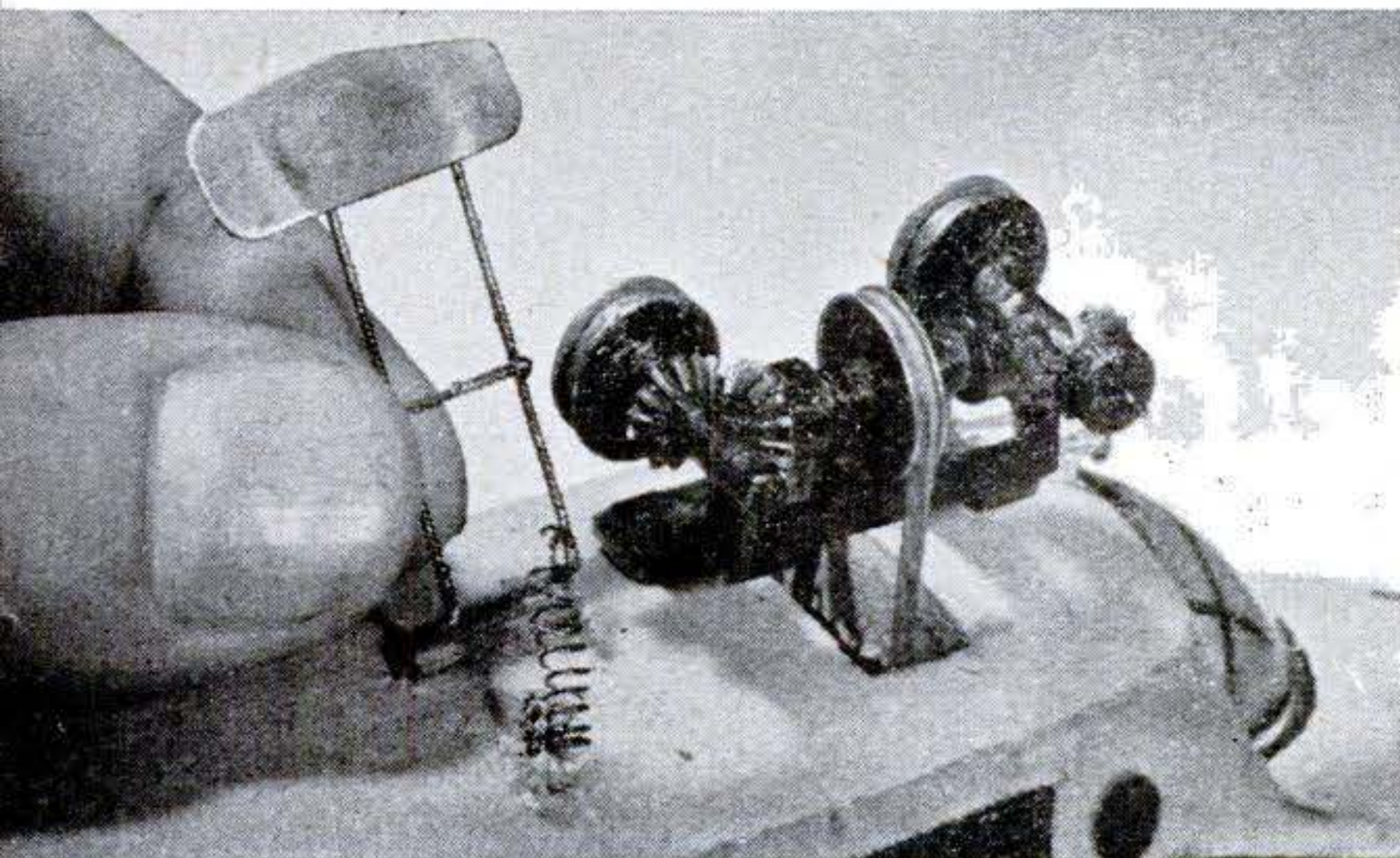

Contact shoe rides against the higher track. Other side of the circuit is through the driver.

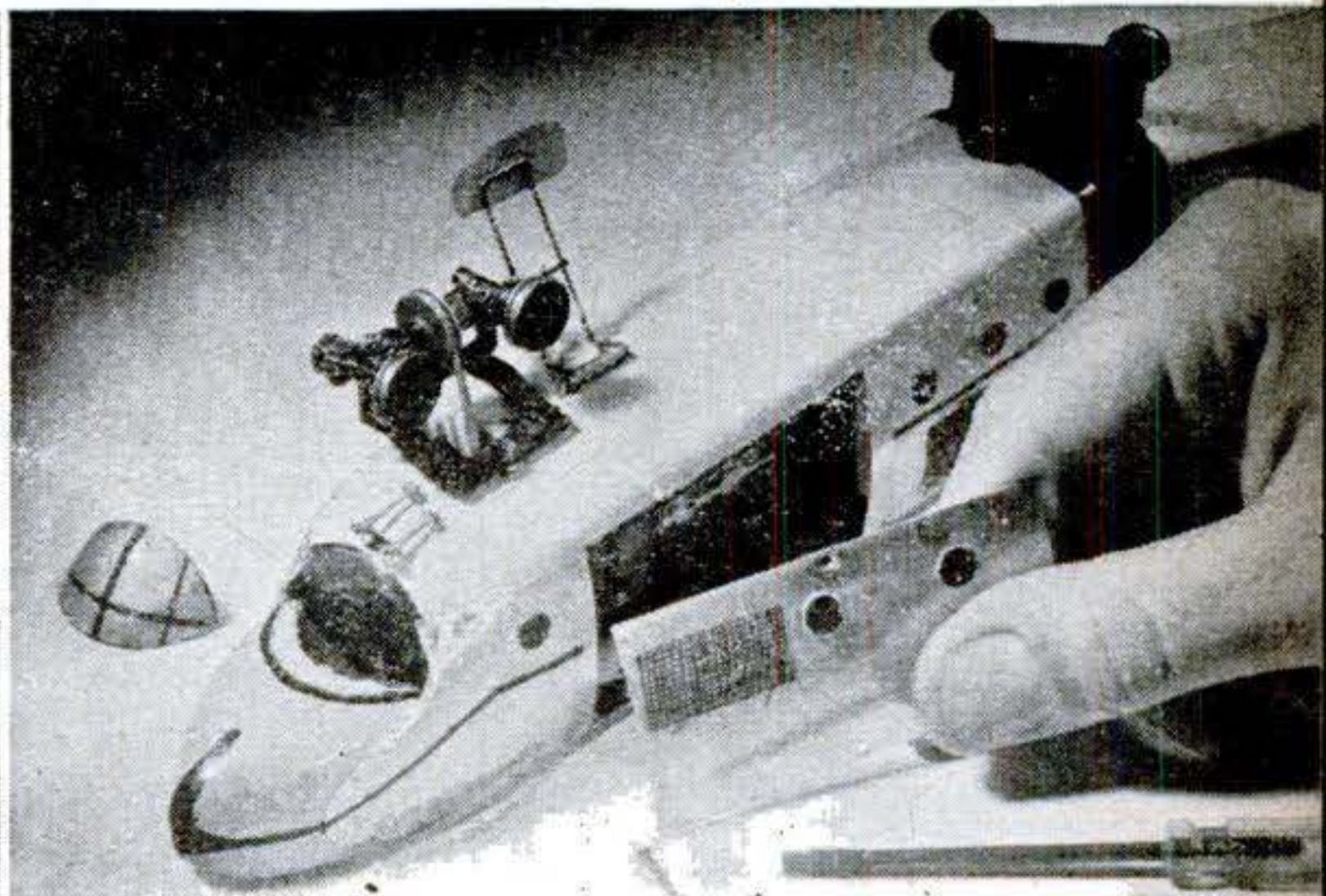

Inspection door allows access to motor on the side of the powered car that faces the pylon.

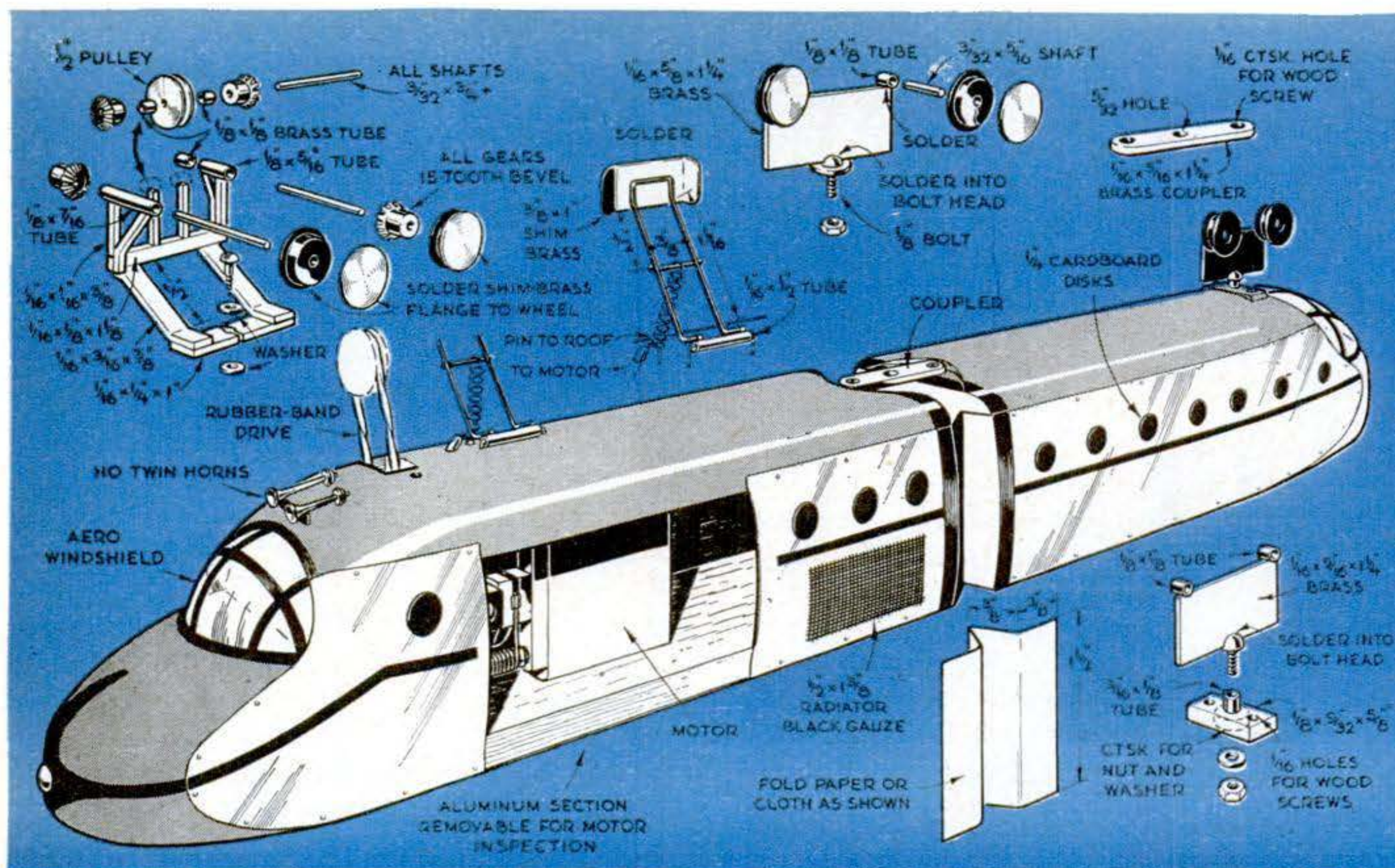

enough to take a 12- to 16-volt model-rail-road lamp. Solder two wires to this lamp and insert it in the larger hole. The wires are later connected in parallel with the motor leads. As an alternative, you can use a pea lamp with a suitable resistor in series with one of the leads.

Fitting the Sides: Aluminum Venetian-blind slats are good material for the car sides and bottom, for they're very slightly curved, have a smooth finish, and are easily cut. Fit them carefully, and tack on the bottom piece if you like, but leave the sides off for the moment. You'll find it simpler to install the drive truck and the wiring if the sides aren't in the way.

Before going on to the running gear, build the remaining car or cars. The trailer is made in the same way as the engine except for the shape and size of the nose block. If you want extra cars in between, make them with square ends. Use paper or cloth for the connecting diaphragms. Make them the height of the car sides, and fold them as shown. Extra diaphragms at top and bottom will give the couplings an authentic look.

Constructing the Driver Truck: The running qualities of your monorail will depend chiefly on the driver truck. It is more important that the pieces match each other than that they conform exactly to the specifications in the drawing. All stock for the frame is 1/16" brass. One leg of each fork is

not dimensioned, since it has to be fitted by trial so that the brass bearing tubes come out horizontal and parallel to the base of the frame. You may find it easiest to solder on these supports after the axles, gears, and wheels are in place.

Cut off a piece of 3/32" brass rod and solder a 15-tooth bevel gear—teeth facing out—at one end. Right behind the gear, slip on a length of 1/8" brass tube as a bearing.

Next add the pulley wheel, soldering it to the shaft. Follow this with another length of bearing and the second gear, also facing outward. Solder the bearing tubes to the two center members of the upright. Make sure the pulley wheel is exactly centered and free to turn without end play.

Driving wheels are ordinary HO ones with brass flanges soldered on. The front wheel is soldered to the axle, the bearing tube slipped on, and the gear added at the far end, teeth inside. Try out the fit till you have the right amount of play. Solder the bearing to the forked upright.

For the rear driving wheel reverse the assembly. Put the wheel on first and the gear right next to it. This time the teeth point away from the wheel. Add the bearing, and then solder a short piece of tubing to the end of the axle to hold the assembly together.

Drill a pivot hole through the center of the frame base. Saw an opening across this hole to let a rubber band slip over the drive

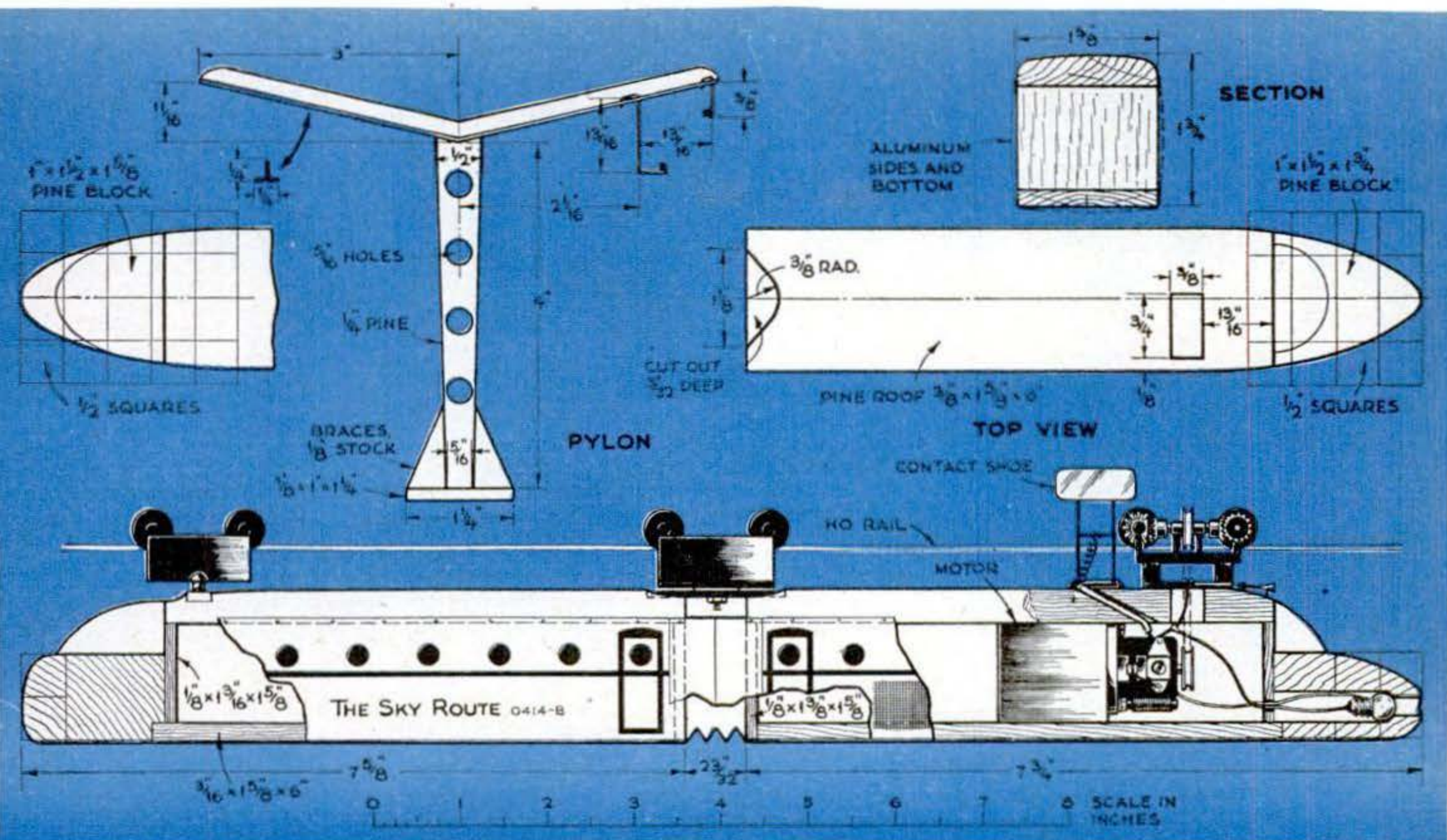

wheel. When in place the band must be just tight enough to prevent slipping under load. Bend the frame if necessary to bring the wheels over the center line of the car.

Solder a flexible wire to one motor contact, bring it up through the belt opening, and solder it to the driver frame.

The contact shoe is cut out of shim brass and soldered to a frame of fairly stiff wire. Connect it to the other motor terminal by soldering the wire to the brad that holds the tension spring to the roof.

Test the driver unit by connecting a battery across the frame and contact shoe. The wheels should run freely in both directions, depending on the polarity of the connections.

You're now ready to add the sides. Remember to leave an inspection door, held on by small screws, on one side. The windshield is made of model airplane windscreen material. It's painted on the inside—grey with black lines—trimmed to fit, and glued on.

Wheel bearings for the center truck are mounted on a flat brass plate. Solder a flanged wheel to the axle and slip the axle through the bearing. Peen the end just enough to keep it in, or solder on a retaining collar. A roundhead bolt with the slot filed $1/16$ " wide is soldered to the bottom of the brass plate.

The rear truck is made in much the same way although mounting methods and some of the dimensions differ slightly. Bear in

mind that the pivot screws must be set slightly to one side in order to bring the wheels over the center lines of the cars.

Check the height and alignment of the wheels. If necessary, shim up either or both of the followers, or cut the mounting recesses slightly deeper to lower them.

Finish and Trim: Windows are $1/4$ " black cardboard disks (a paper punch cuts them neatly). Striping is cellulose tape that is painted black and cut to width before being stuck on. The motor-compartment grilles are heavy gauze. Aluminum sides are sanded to a clean, bright finish. You can pick your own color for the wooden roof and nose; the model shown is done in bright yellow.

Pylons: Track-supporting pylons are carved from pine and mounted 6" apart on tieless rail bed. Cut a shallow V in the top of each upright so that the crossarms will rise as shown. The wood arms are glued in a T-shaped section; better build a jig for cutting them all to the same length and angle. Lengths of $3/32$ " wire are clinched and cemented to the outer tips of the arms, and the track is soldered to the wire.

This model will take an 18" HO curve with ease, so an oval track is your best bet for a long, smooth run. You can feed it from a battery or your regular model-train rectifier. Connect one wire to each rail, and just reverse the connections to make the train back up.

END

*Make it Now
for Christmas*

Handy Shelves Fit Odd Corners

ANY kitchen can use a few extra shelves—and they're the perfect answer for those odd-shaped, what-to-put-in-them problem spaces. The stand shown here fits neatly beside a refrigerator, but you can change the size and shape to fit your own needs.

Use white pine and cover the shelves with linoleum. Rabbet the back piece to support the shelf ends.

The base is made of two pieces as shown, nailed to the bottom shelf. The shelf-support posts can be 1 3/8" round or square stock.

Glue on linoleum with linoleum cement, edge shelves with metal molding, then apply white enamel.—*John N. Michel, Holbrook, N. Y.*

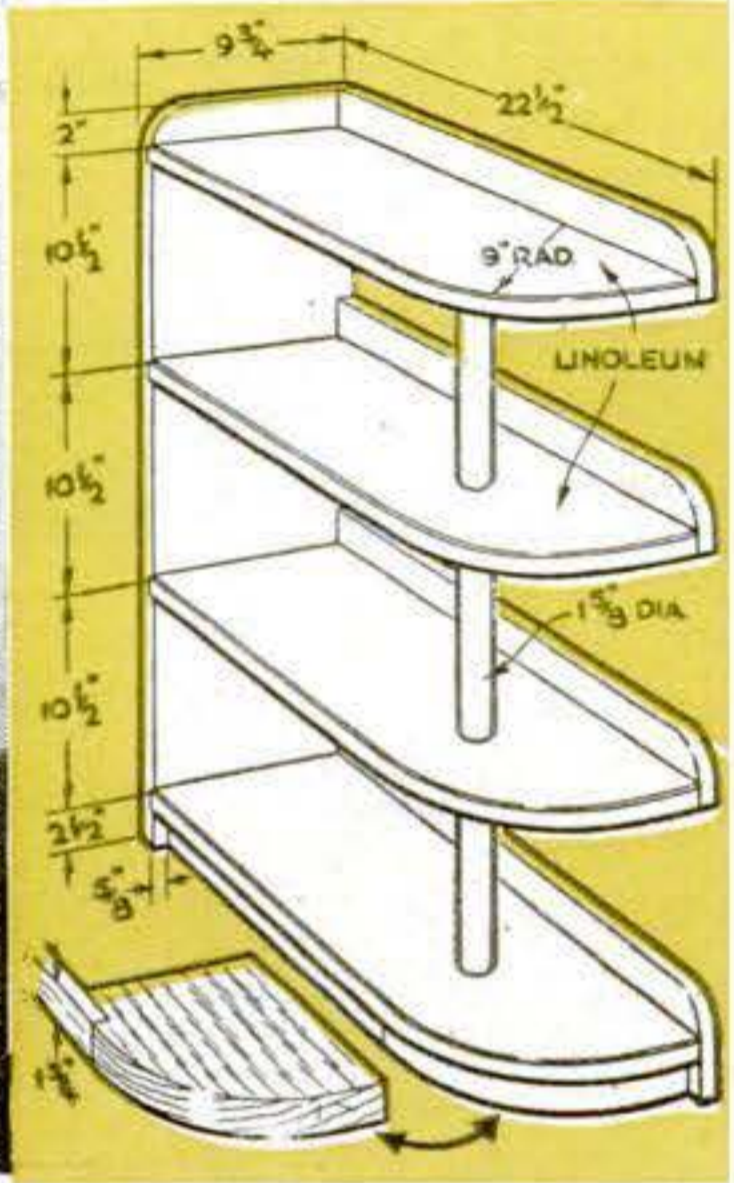

Guests Will Admire These Dragon Candlesticks

You can make these "fire-breathing" dragon candlesticks easily out of brass, copper, or aluminum sheet and 1/8" rod.

Form the legs and body from the rod, bent to shape as shown. File the tongue to a taper before coiling it and drill the rivet hole. File the tail. Solder the legs to the body.

Cut out the wings, head, and candle socket from the sheet stock. Hammer the ribs in the wings from the underside against a wood block. This will also cause the wings to curve so that little bending is necessary. Bend the wings and head over the frame and solder them on. Flare the long horns of the head slightly outward. Hammer the candle socket parts to shape, and rivet them on. Then polish and lacquer the candlesticks for a good finish.—*J. Brumfield, Philadelphia, Pa.*

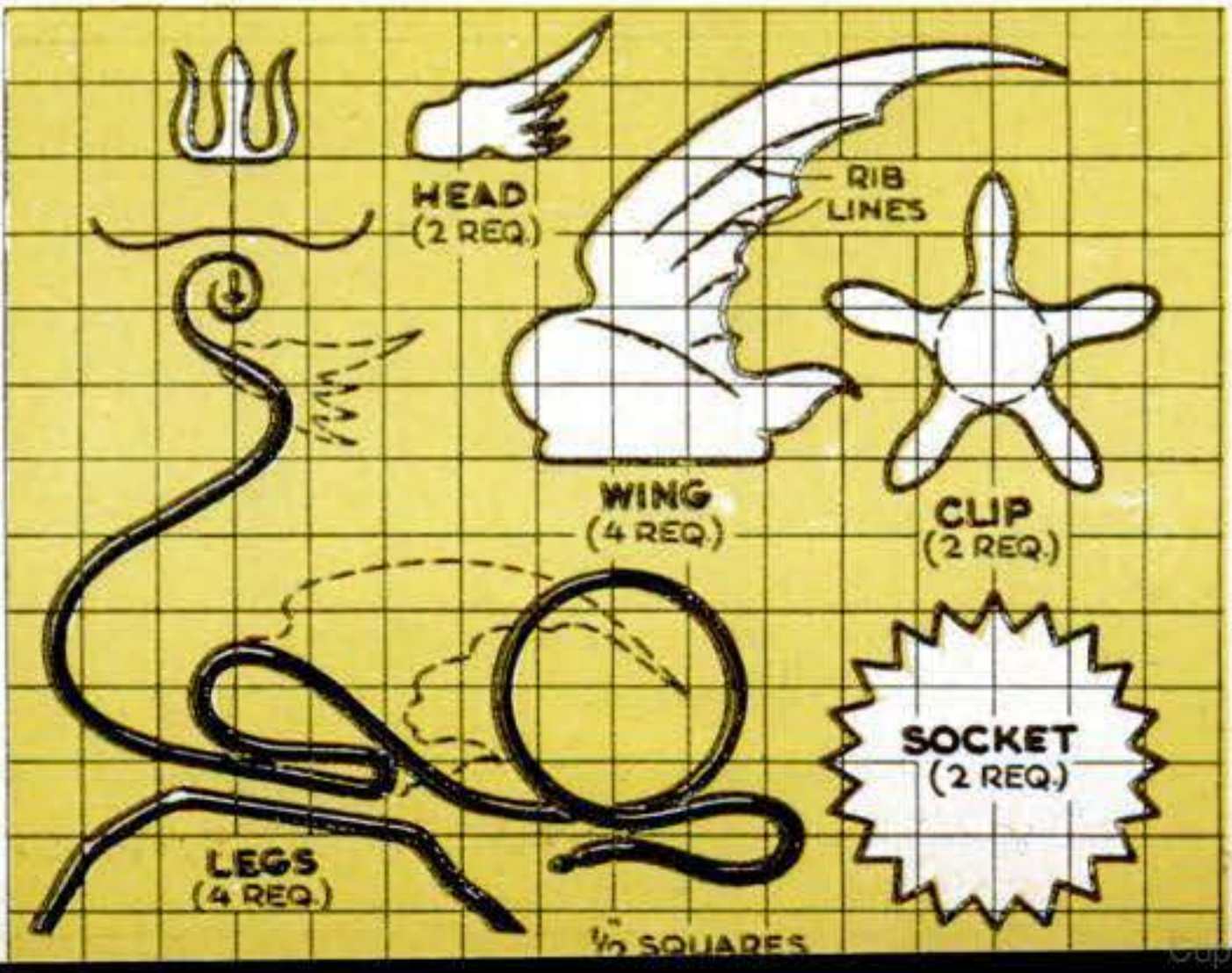
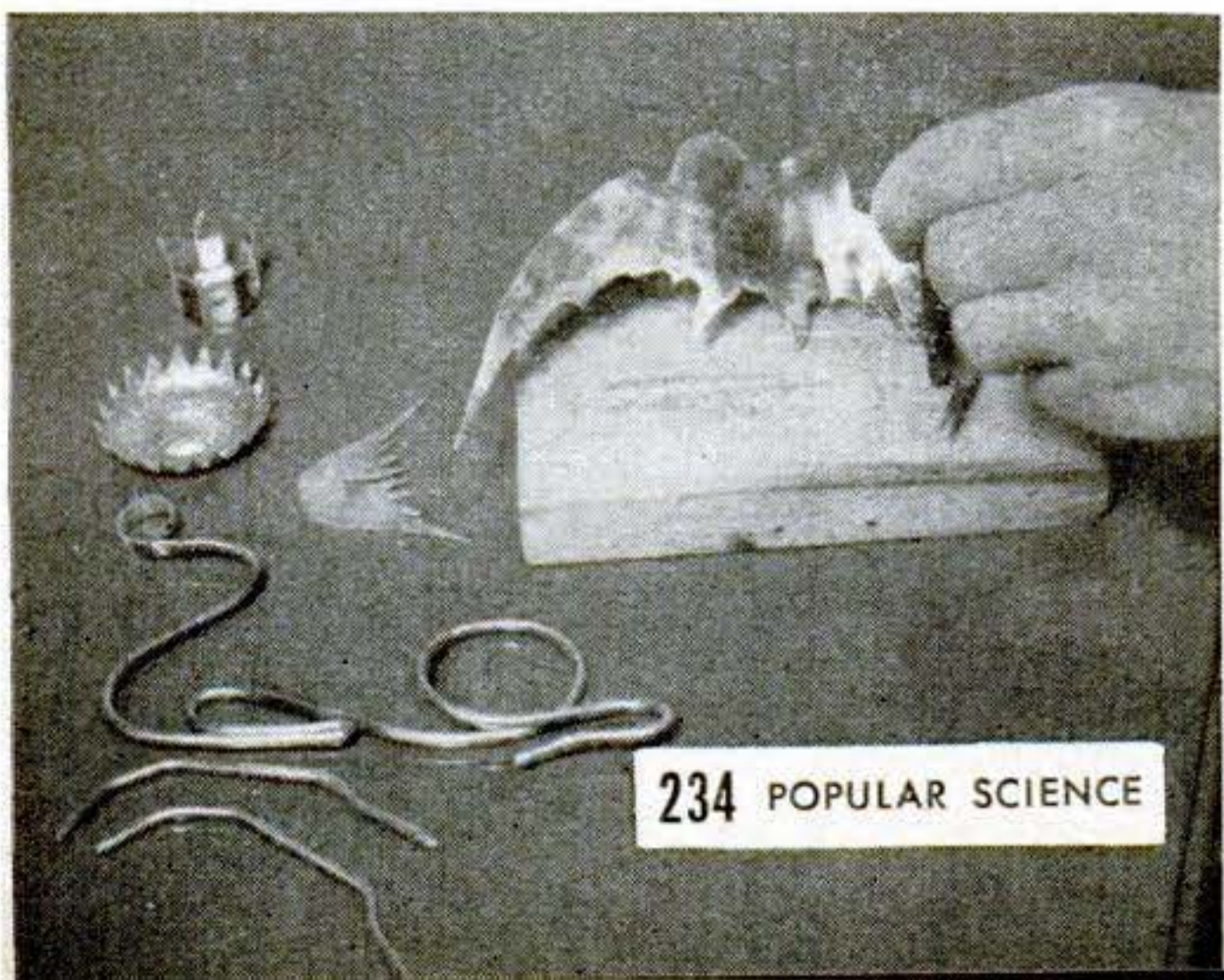

Tracking Down the Fuel You Waste



By **Walter E. Burton**

THE cold fact about home heating, the experts say, is that many people are paying for warmth they never feel. A lot of furnaces are operating far below their rated efficiency—either the fuel isn't being burned completely, or all the heat isn't being taken out of the gases before they escape up the flue. *As much as 70 percent of your fuel money may be going up in smoke!* Insulation, while reducing the total amount of heat required, won't improve furnace efficiency.

Until recently, there wasn't much you could do about it, except hire a combustion engineer to haul in his instruments, analyze your furnace's operation, and make necessary adjustments. Now, on several types of furnaces, you can do the job yourself. With a simple kit made by the Bacharach Industrial Instrument Co., Pittsburgh, Pa., you can tune up your furnace, just as you tune up your car, so that it gives the most heat for the least fuel. The kit, intended only for automatic furnaces, costs \$40, but there's no reason a group of householders can't split the cost and share the use of a single kit.

The kit has three easy-to-use tools:

- A gauge to determine the amount of draft;
- A thermometer for measuring flue-gas temperatures—obviously, you want the real heat in the firebox, not in the chimney;



You don't have to be a combustion engineer to tune up your heating plant for the winter. New kit makes job easy. Photo above shows measurement of draft in pipe to chimney.

- A device that analyzes the carbon dioxide (CO₂) in the flue gas. The carbon dioxide content should be as high as possible, for the carbon in the fuel that doesn't become carbon dioxide goes out in a form that could have burned.

The measurements these tools make are quickly converted into furnace efficiency with the kit's slide-rule calculator. A good oil burner should show close to 80-percent efficiency, but many run at efficiencies of 50 percent or even less. ➡



This is all you need. Instrument at left measures percentage of carbon dioxide in flue gas. Draft gauge is in center, thermometer at right. Calculator (rear) does the arithmetic for you.

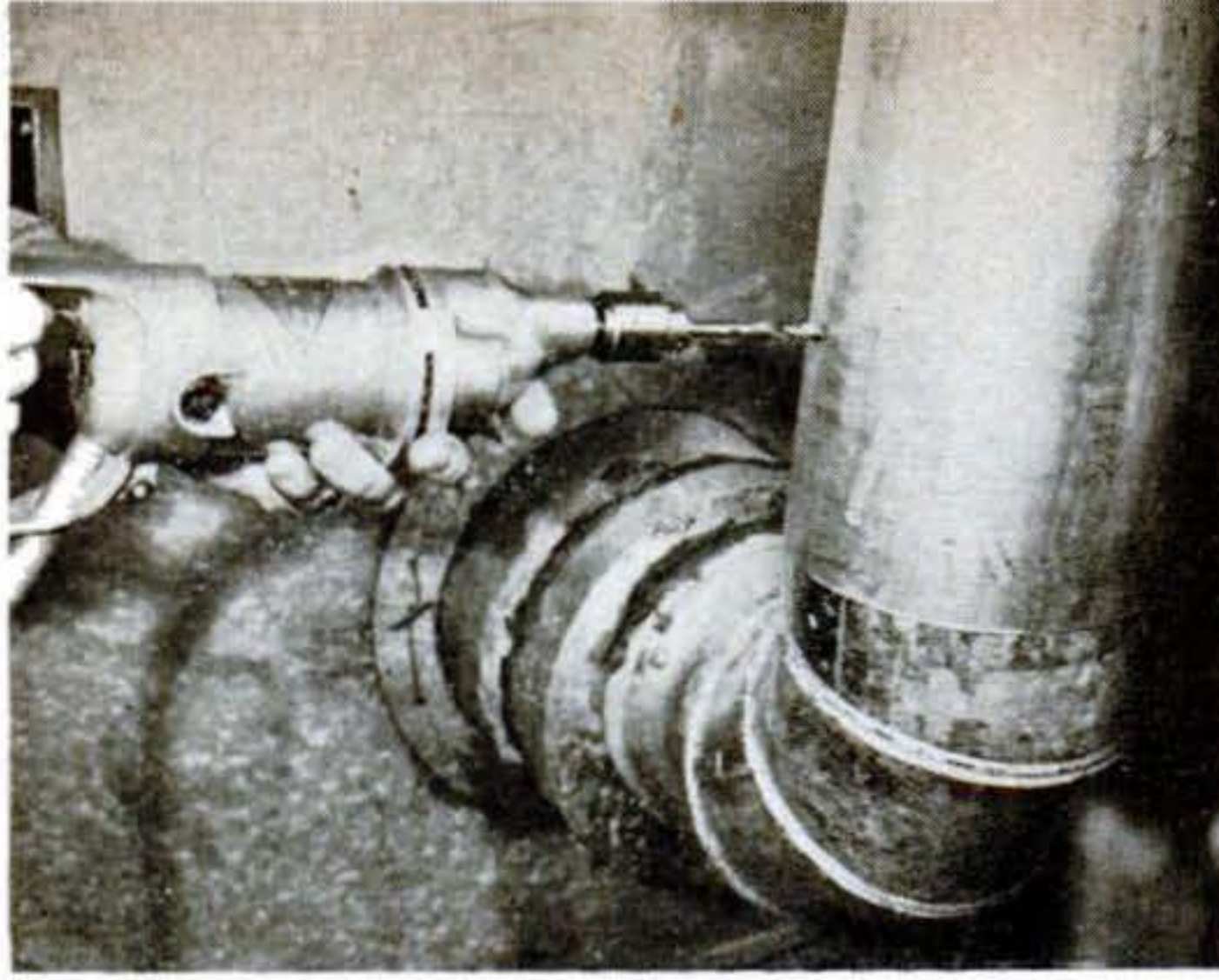

Small holes must be drilled or punched in smoke pipe and fire door to admit instruments. Holes do not affect furnace operation, but can be plugged up after tests with bolts or fire clay.



Most important draft measurement is taken by inserting gauge through hole in fire door. In some cases, it may also be desirable to measure draft in smoke pipe, below and above damper.

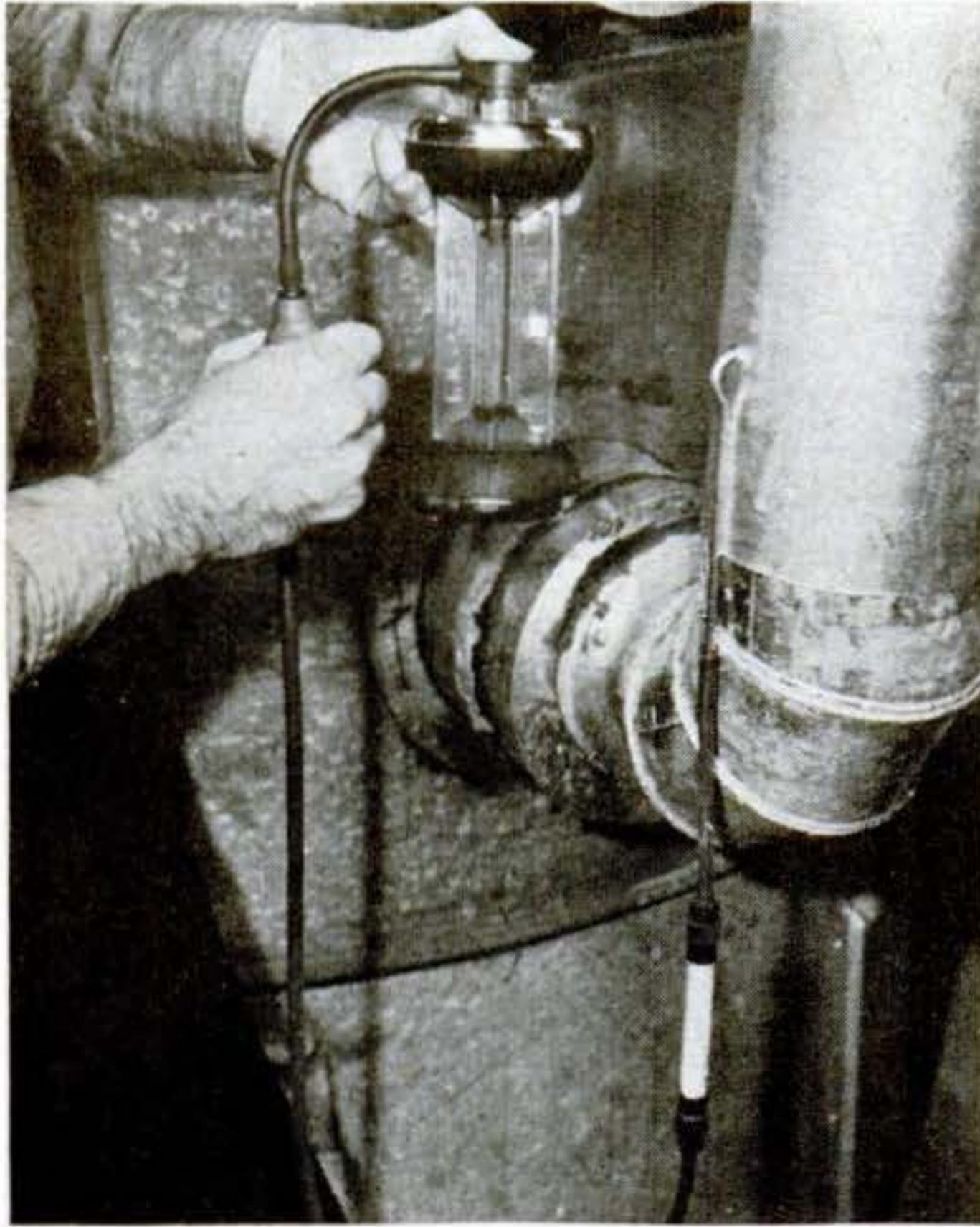

Rubber bulb sucks gases into glass container of liquid that absorbs carbon dioxide. Level of liquid after absorption shows carbon dioxide content. White tube removes moisture.



No pencil and paper are needed. Slide-rule calculator, called Fire Finder® by makers, Bacharach Industrial Instrument Co., gives efficiency directly from readings shown by instruments.

Let's suppose you want to analyze your oil furnace.

The first step is to drill or punch $\frac{1}{4}$ " holes for the instruments—one in the smoke pipe below the downdraft diverter or damper, the other in the fire door. The holes are too small to affect furnace operation, but they can be plugged later with bolts if you like.

The thermometer is slipped into the smoke-pipe hole, the end of its tube being kept in the center of the pipe for about two minutes. You subtract the room temperature from the dial reading to get the net stack temperature used to figure efficiency.

The draft gauge has a jointed tube sticking out of its back. You put this in the test hole, keeping the gauge vertical. Then hold your finger over a second hole in the back of the gauge and move the gauge until the pointer is at zero. Now remove your finger and read the draft as shown on the dial.

To determine carbon dioxide content, flue gases are drawn by a rubber bulb through a metal tube and drying filter into a liquid-filled container. It takes about 18 squeezes of the bulb to fill the test chamber, which is then sealed by releasing pressure on a spring-loaded stopper. The container is next turned upside down to mix the gas with the liquid. The liquid absorbs carbon dioxide, indicating how much was present by its level in the container.

Let's assume you've done this and find your worst suspicions true—your furnace isn't running as efficiently as it should. What do you do next?

In general, the draft should be strong enough for complete combustion, but not so strong that stack temperature is very high. Carbon dioxide content should be high. Compare the values you measure with those



Temperature of flue gases is measured by sticking thermometer tube in smoke pipe, holding it there for two minutes. The handle prevents burned fingers—gases are about 600°F.

recommended by the manufacturer of your heating plant. If the manufacturer's specifications aren't available, use the ones listed below, which apply to most common makes of oil burners.

Gun Type. The draft over the fire should be at least .02". If you measure draft below the damper, it should be .03" to .04"; above the damper, it should be .08" to .12". The carbon dioxide content of the flue gases should range between eight and 10 percent. Stack temperature should be 550° to 600°F.; but may be higher in a coal furnace converted to oil.

Vaporizing Pot Type. The draft over the fire should be .02" to .06". If you measure draft below the damper, it should be .04" at low fire, .05" at medium fire, and .08" at high fire. Draft measured above the damper should range between .08" and .12". Stack temperature should be 600° F. to 650°F., and the carbon dioxide content should be eight to 10 percent.

Dampers May Be at Fault

Damper settings and the fuel-to-air ratio of the burner are two of the first things to check. Other causes of low efficiency are shown in the chart at right.

While the Bacharach kit is simplest to use with oil burners, it can also check gas and coal-stoker furnaces. In these, however, a number of additional factors must be considered. The draft over a gas fire, for example, is too small to be detected with the gauge, but can be tested by observing the movement of a match or candle flame held near the furnace-door opening. Again, in analyzing coal-furnace operation the size and appearance of the coal bed must be taken into account.

END

CAUSES OF LOW CARBON DIOXIDE

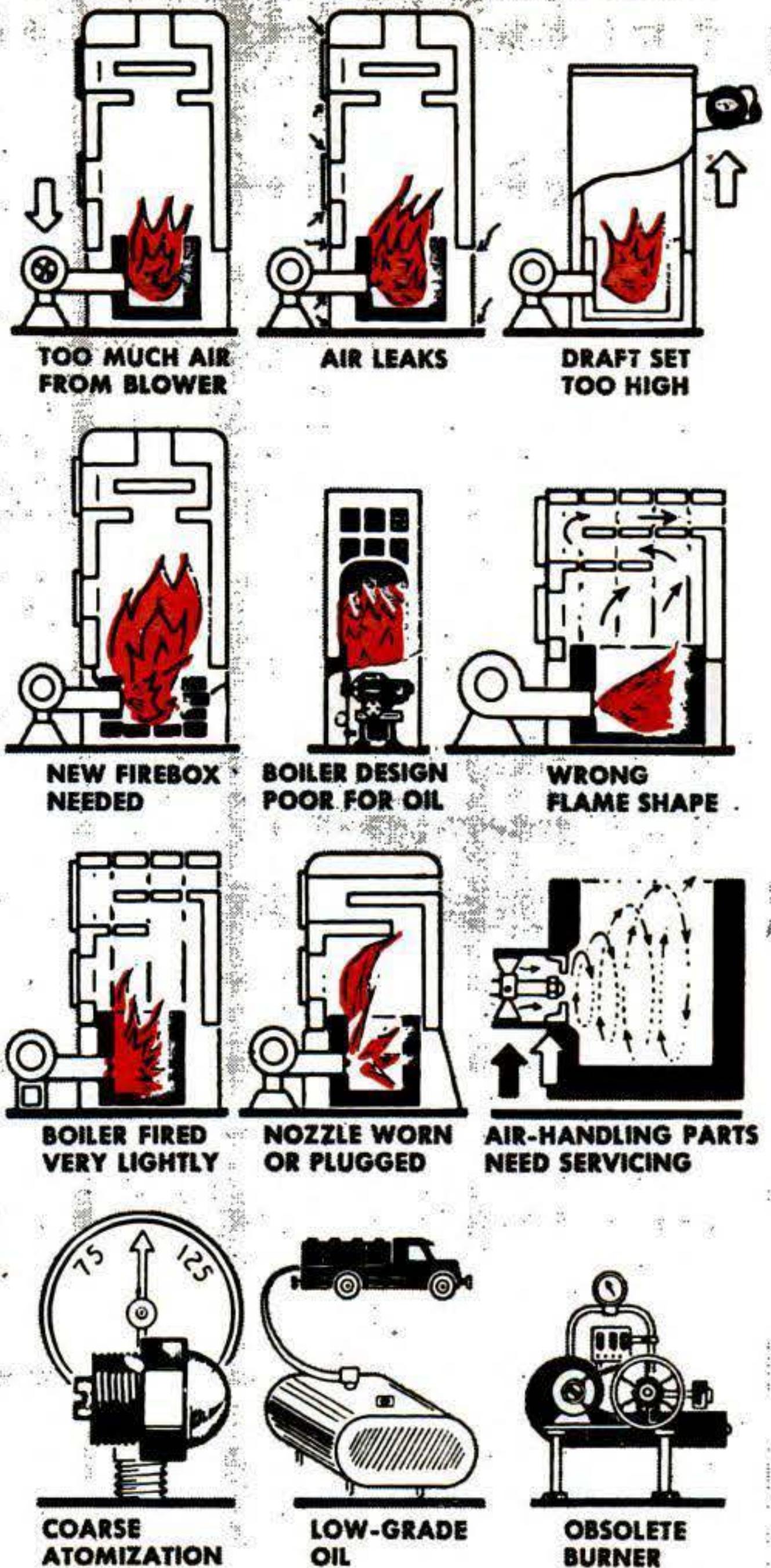

CAUSES OF HIGH STACK TEMPERATURE

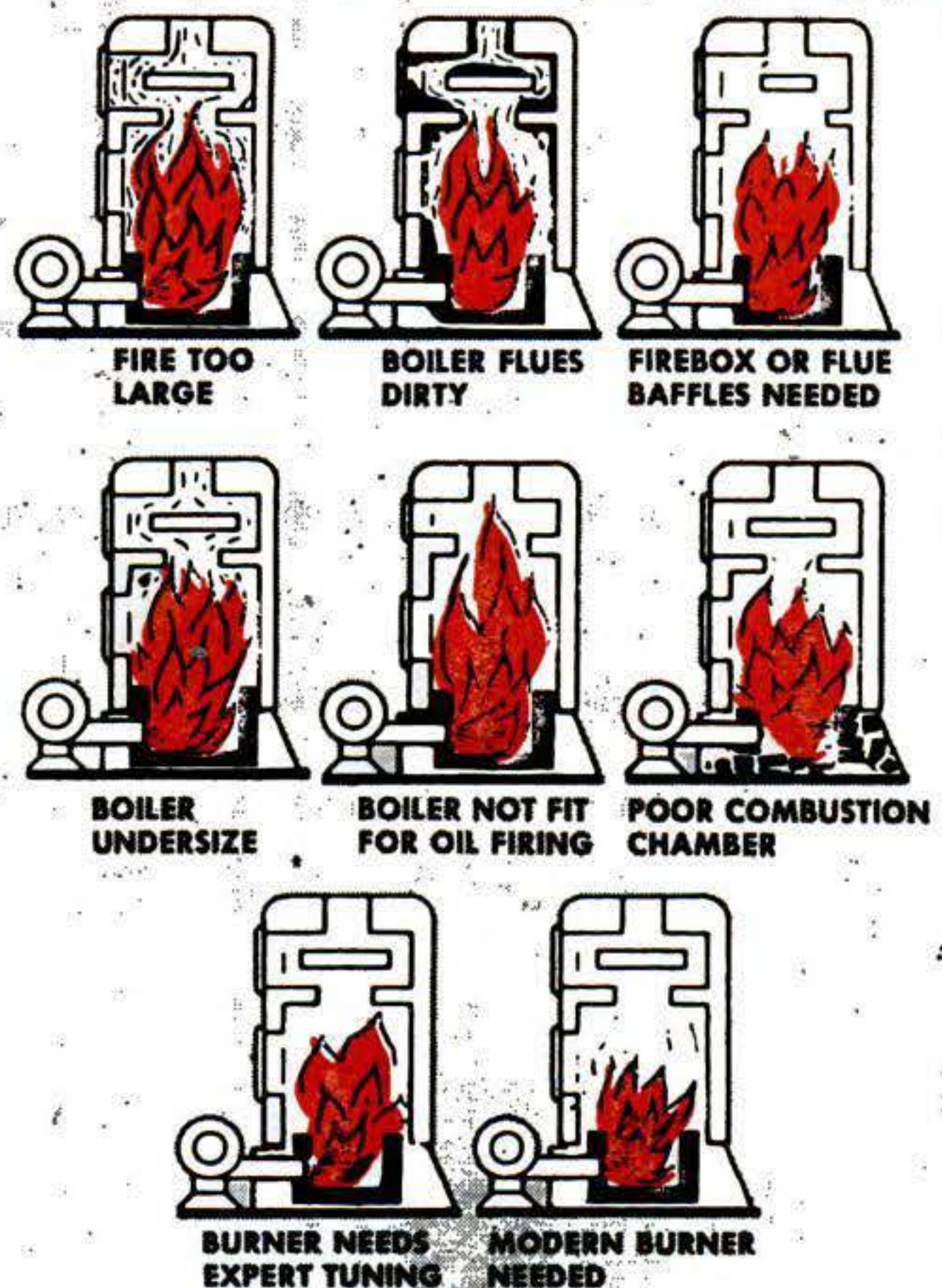

News in Home Heating

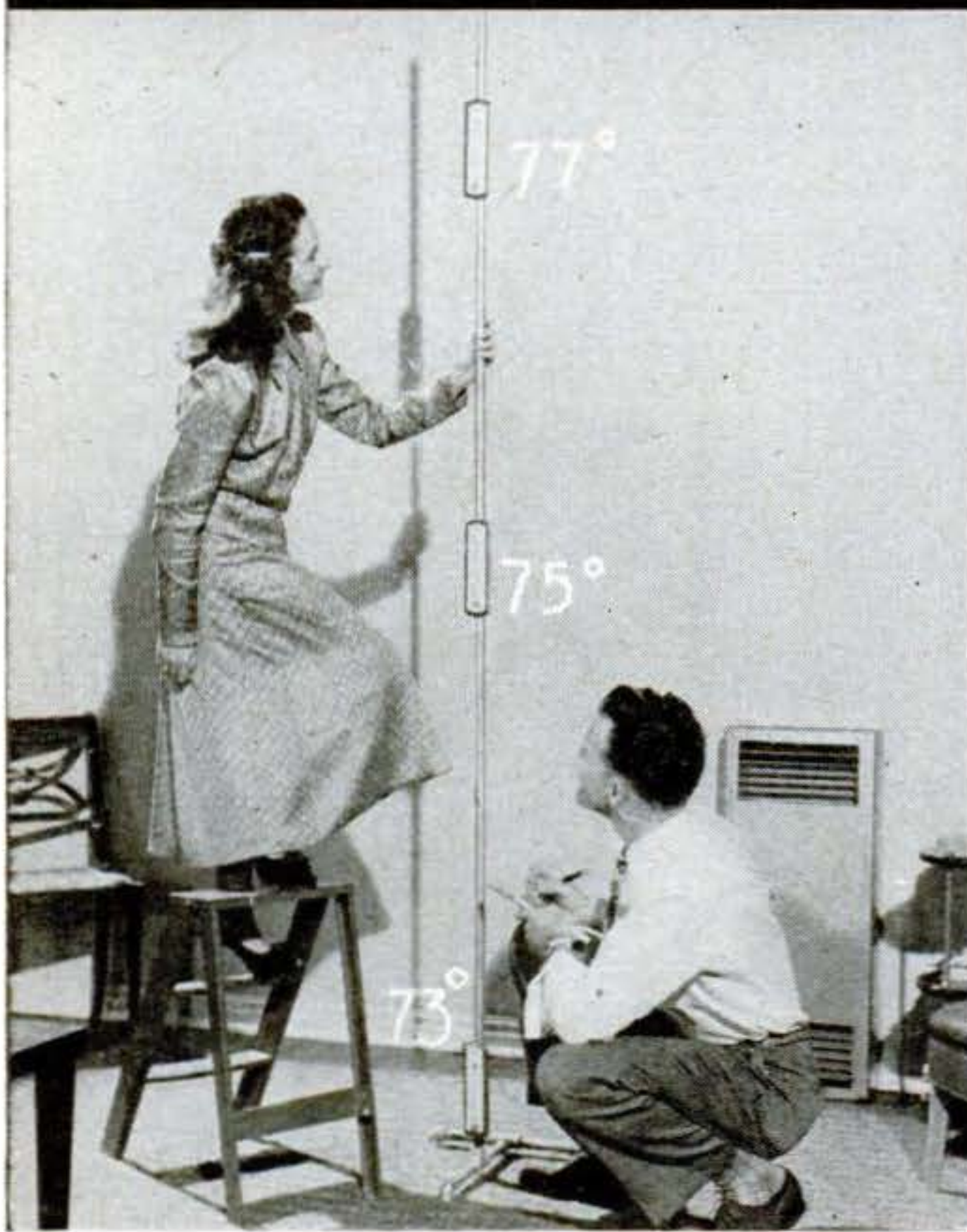

No Cold Feet. Even heating from floor to ceiling is the object of this Coleman warm-air recirculation system. Hot air from the furnace is forced through small ducts to blending units, installed in the walls or

Safe Space Heater. In areas where gasoline, cleaning fluid, or gas are in the air, the element of an electric heater could cause an explosion. In the space heater below the Electromode Corp., of Rochester, N. Y., eliminates this danger by sheathing the elements in a finned aluminum casting.

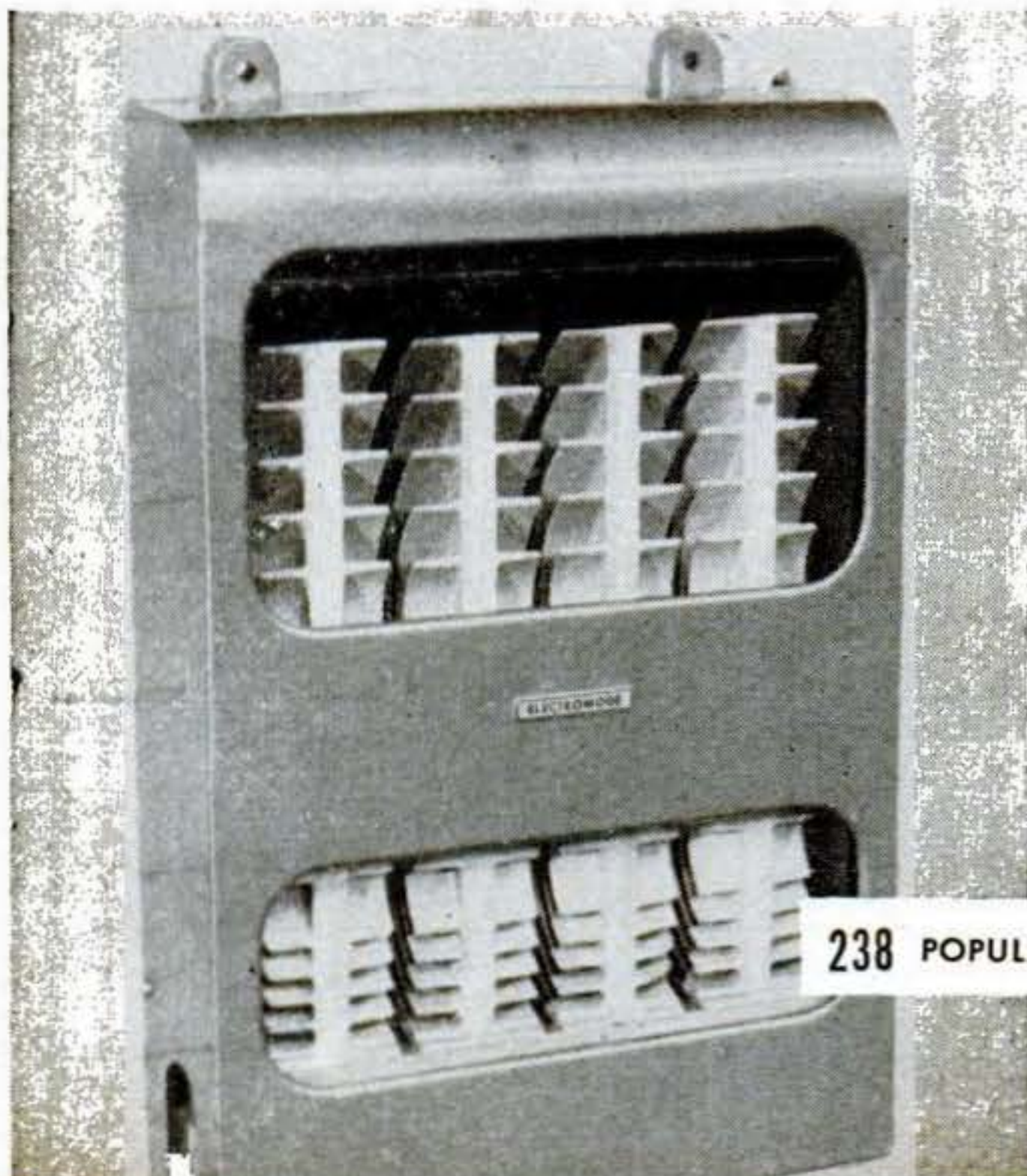

238 POPULAR SCIENCE

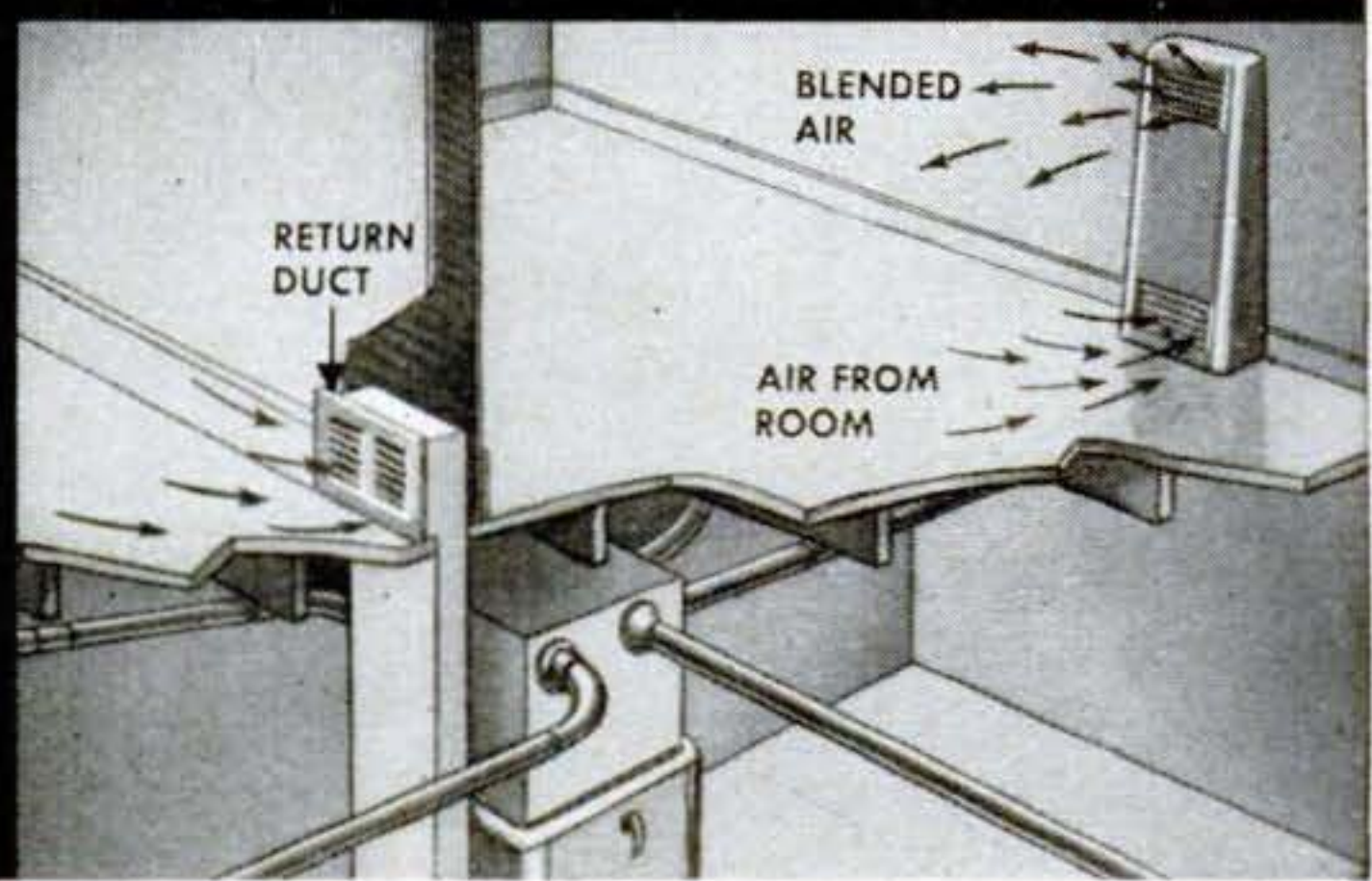
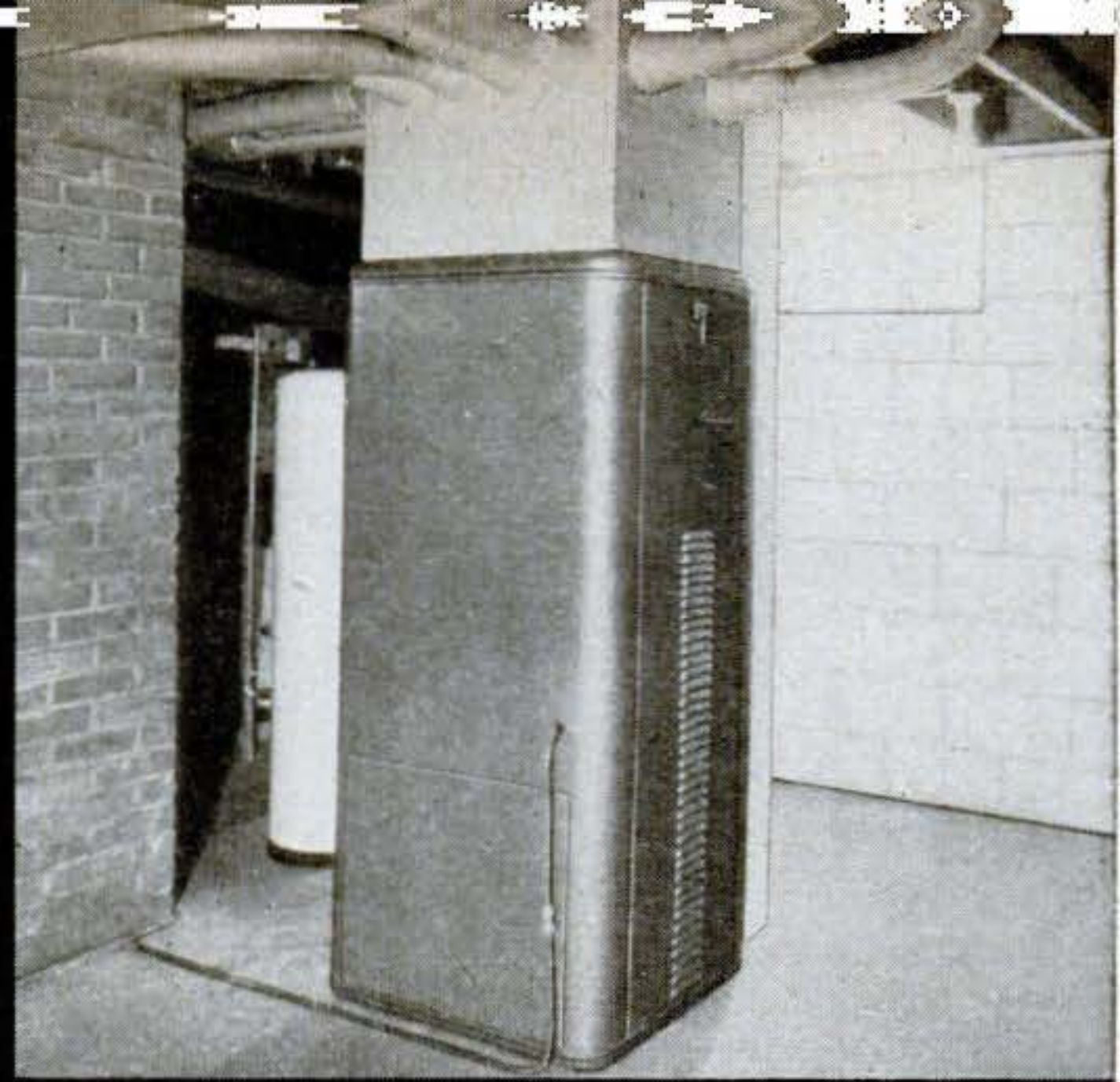

simply set in the rooms. Each blending unit sucks in air from the room through the bottom grille at floor level, mixes it with the hot air from the furnace, and discharges the heated mixture through the top grille.

Heaters Shrink. You still can't put a home-heating unit in your pocket—but they *are* getting smaller. The Aldrich Company, Wyoming, Ill., says its waist-high oil burner, below, has more than enough capacity for a four- or five-room house. It can be used for steam, hot-water, or radiant heat.

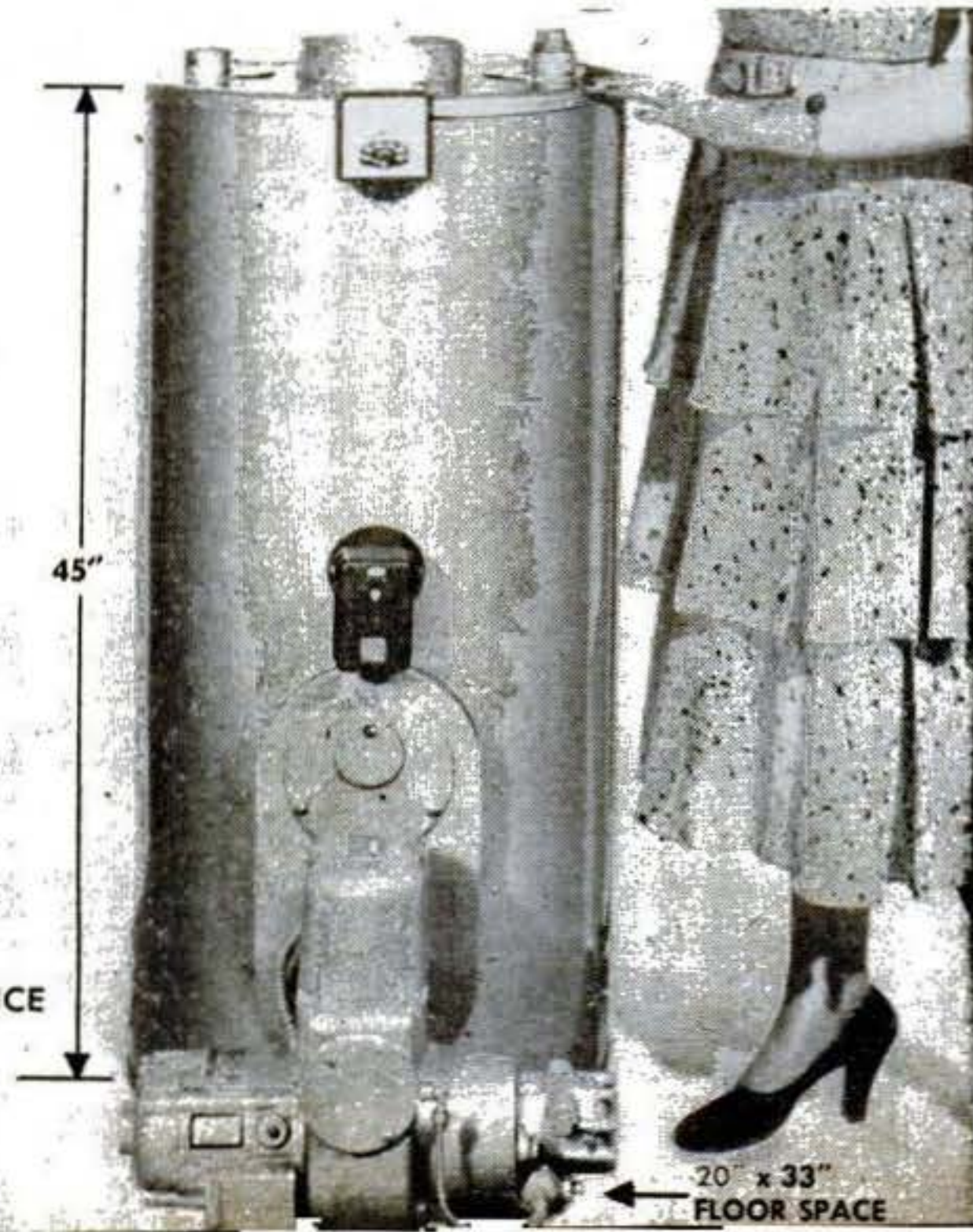

righted material

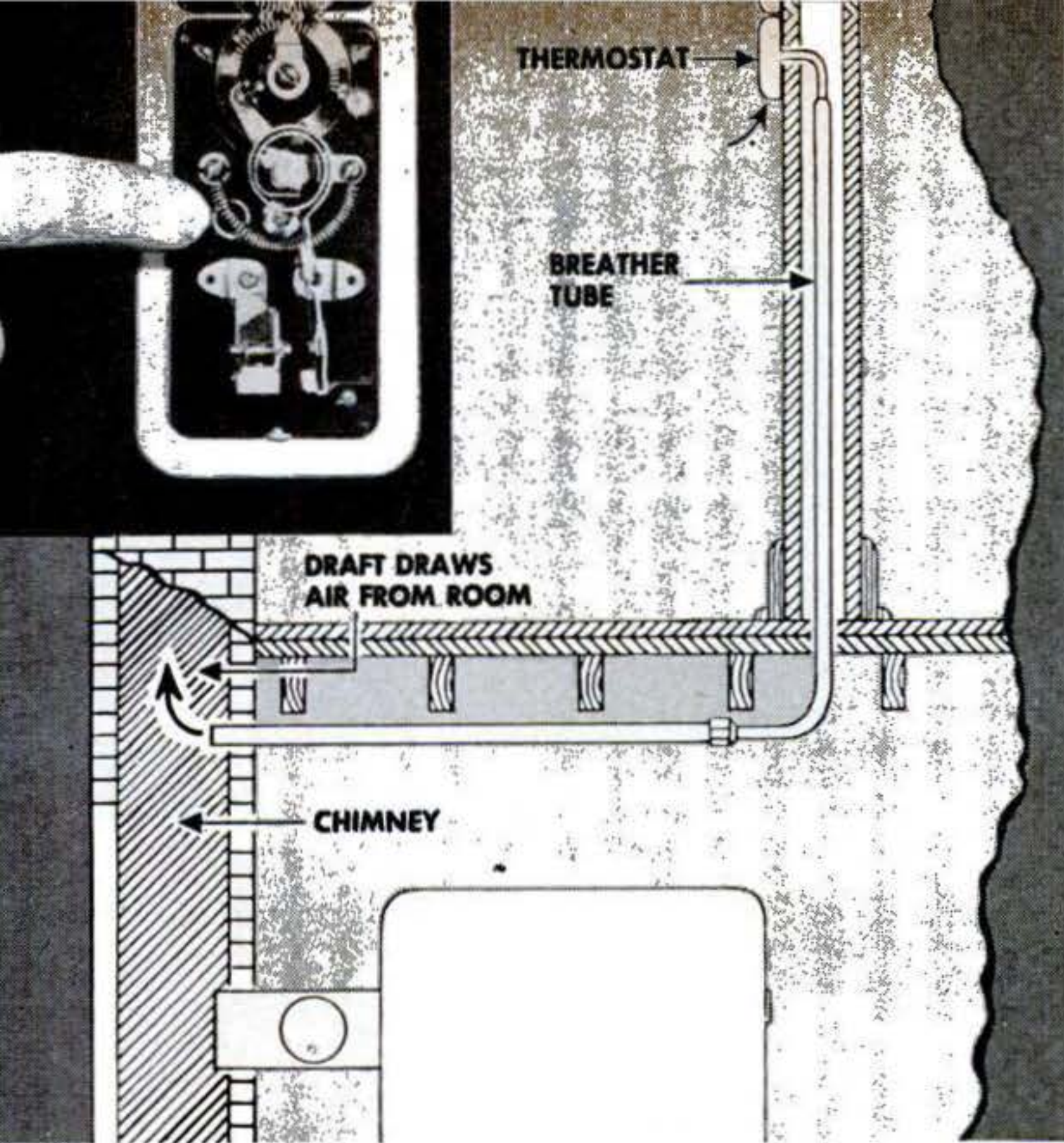

Draft Controls Heater. Breathe-O-Stat®, made by the McClarty Systems, Battle Creek, Mich., hitches operation of an automatic heating system directly to outdoor temperature changes. If wind rises or temperature drops, chimney draft increases, drawing more room air through the breather tube. This air cools the thermostatic control, which then allows the furnace to operate longer at a time, saving fuel. Finger (above) indicates the breather tube behind the control element of the thermostat.

Radiator Freed of Air. A hot-water radiator must be kept free of air. The valve below, made by Taco Heaters, of Providence, does this venting automatically. After the air escapes, water swells the fiber disks, sealing the valve. As more air gathers, it redries the disks and is released.

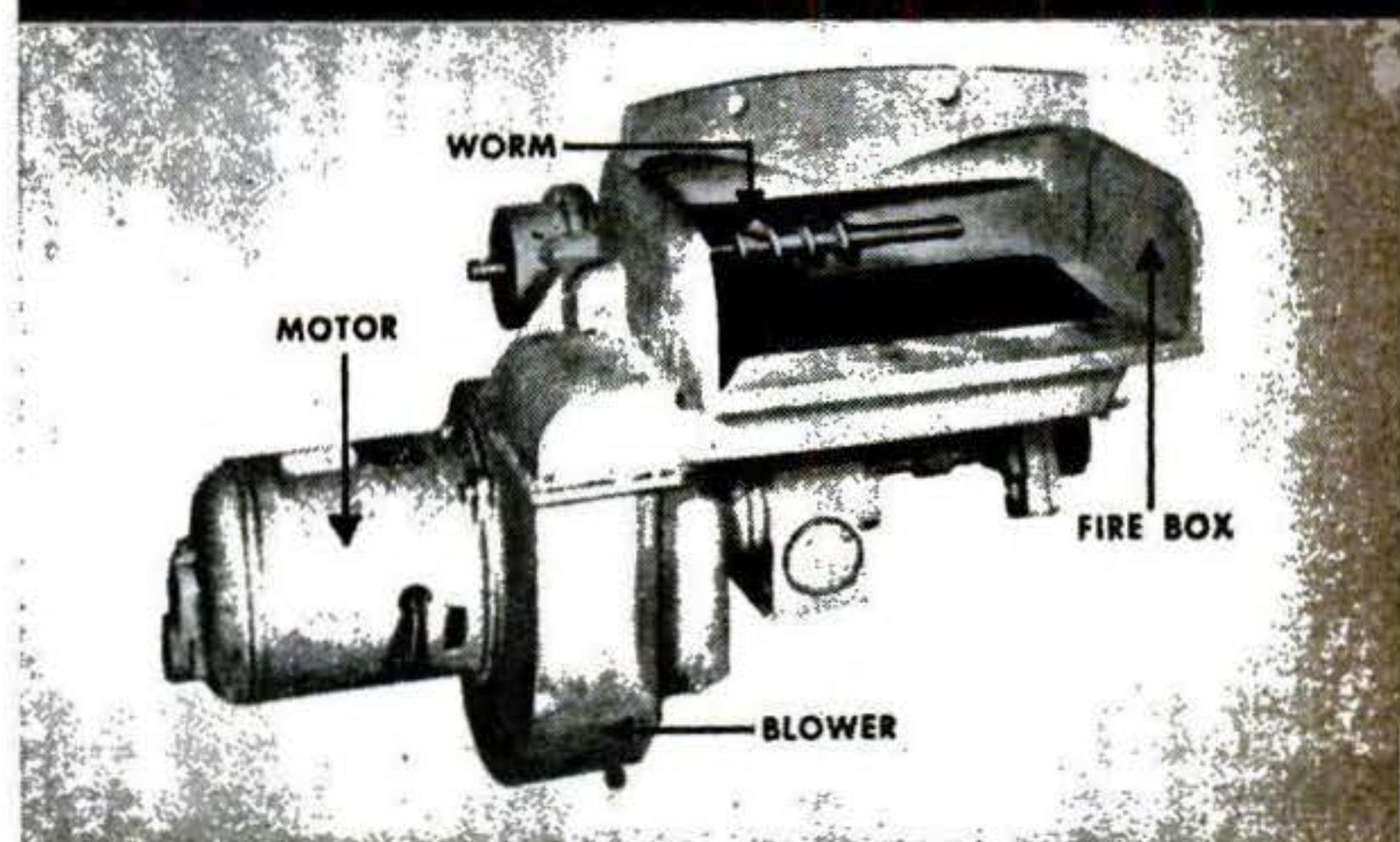
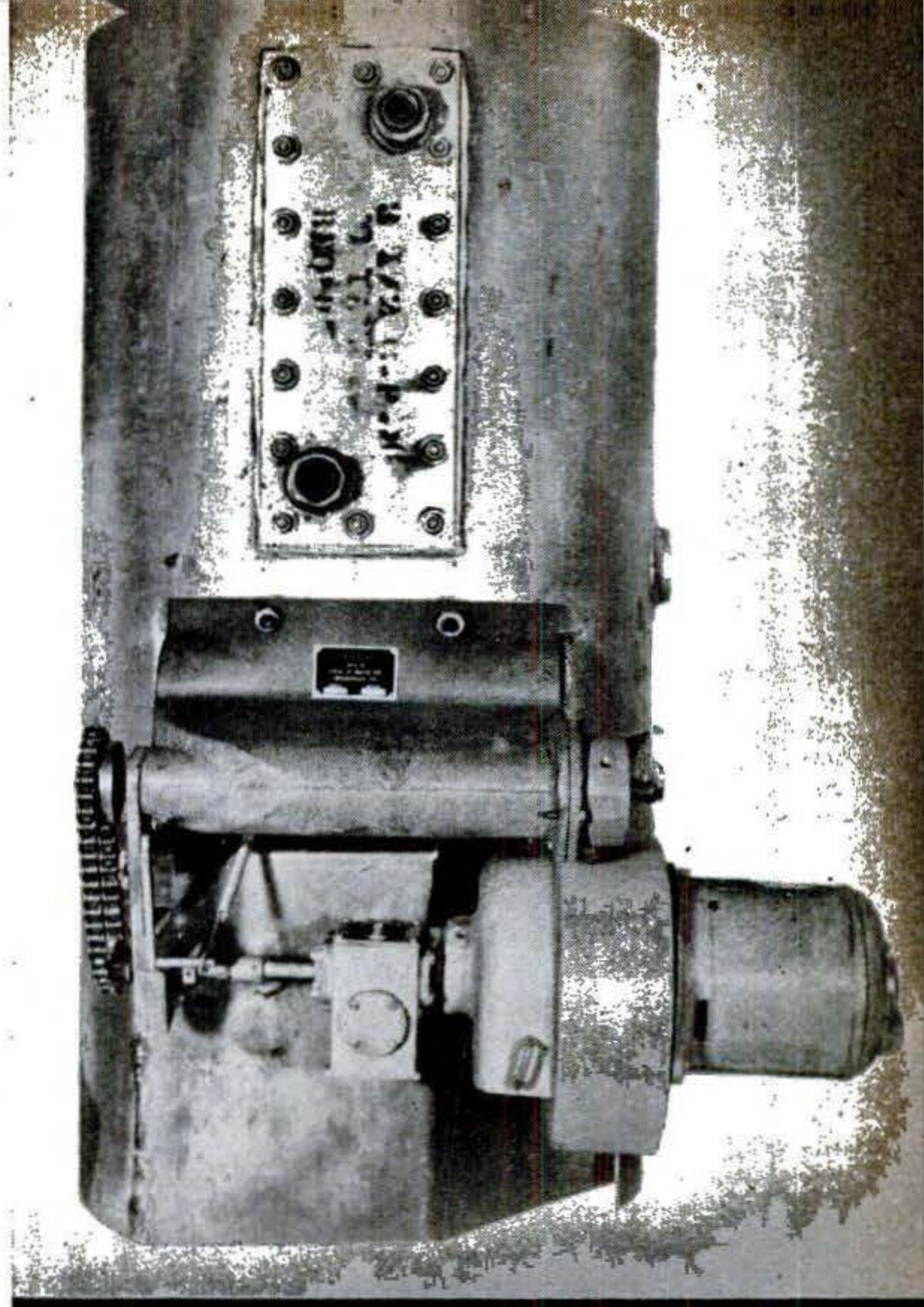
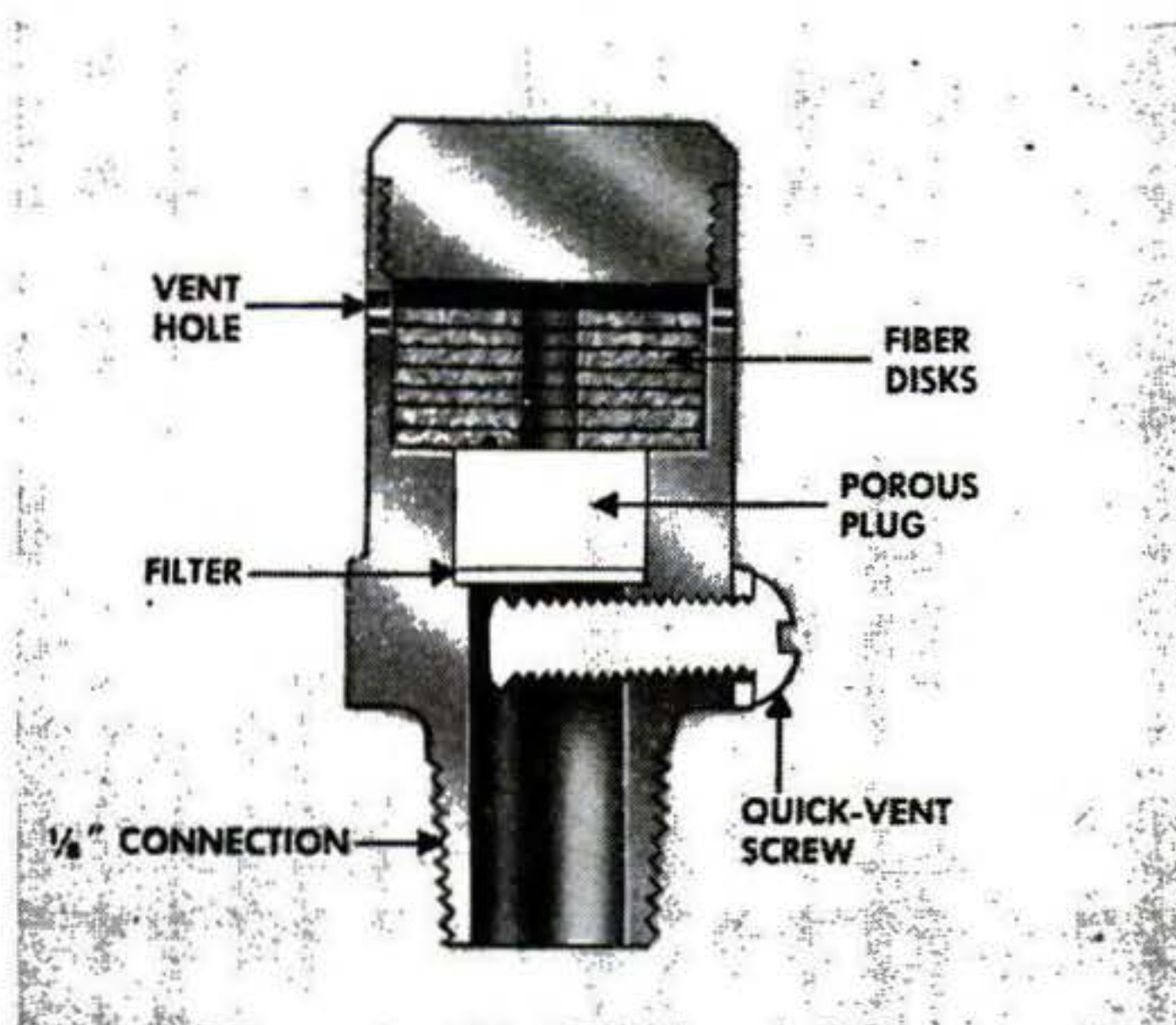

Air Speeds Coal Heat. In a blacksmith's forge, a blower forces air through the fire for quick heat. The heater above, designed to burn inexpensive buckwheat and rice anthracite, operates on a similar principle. A fan blows air up through the bed of coals. A worm feeds coal from the bin to the firebox. When the thermostat demands heat, an electric motor operates both the fan and worm, the fan directly and the worm through a reduction gear and sprockets and chain. Besides feeding the fuel, the worm helps shove ashes off the sloping grate into a receptacle below. The Coal-O-Matic Company, Trucksville, Pa., developed the burner. It sells for around \$400.

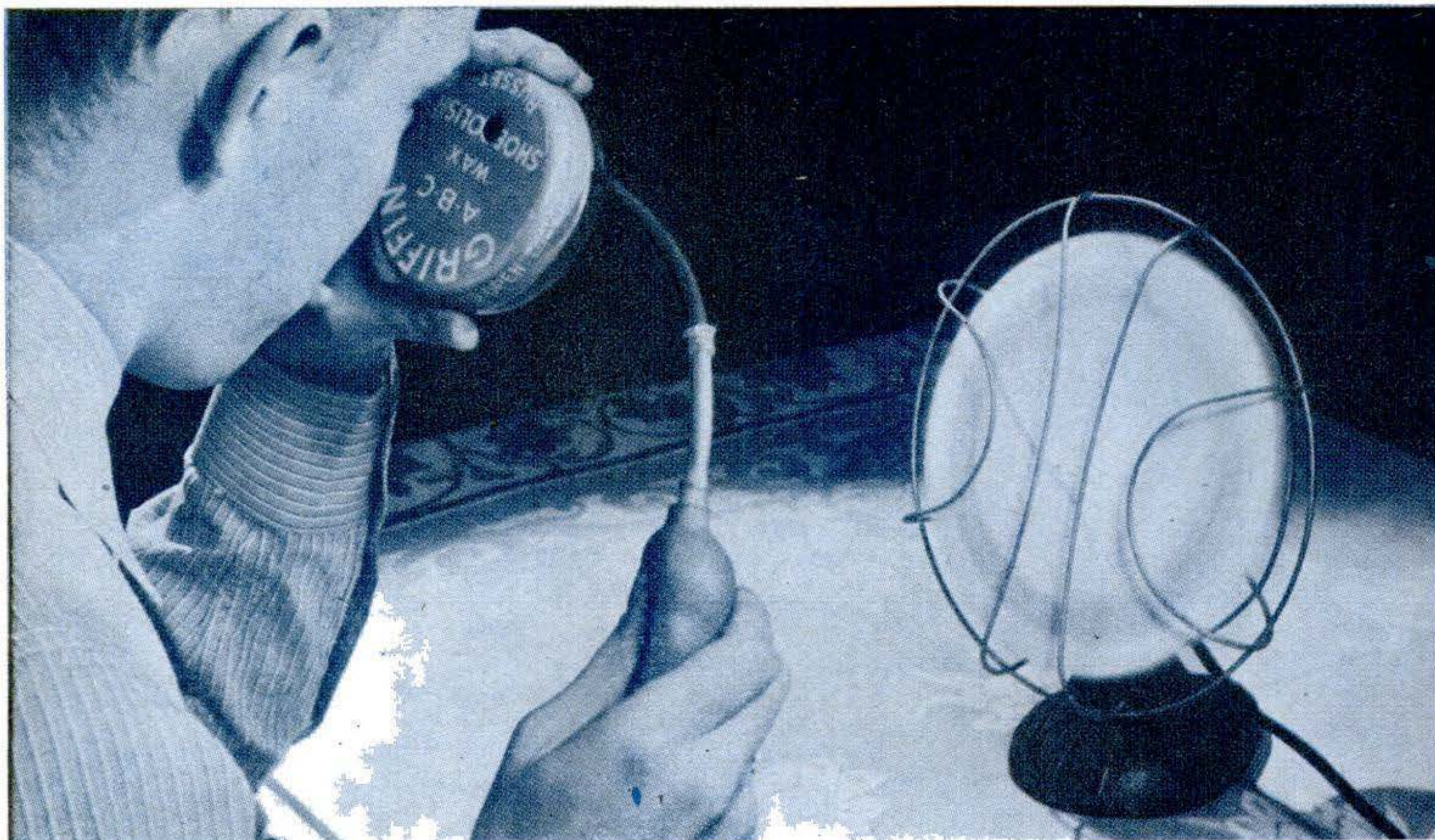

From where you sit, revolving disk on this fan looks blank. But look through stroboscope . . .

Amuse Your Kids with a Tin Can and a Fan

YOUR children will have fun, and learn a bit of science too, with this home-made, motion-freezing stroboscope.

With it, they'll be able to read words on a rapidly revolving disk. A fan will seem to stand still—or turn backwards. Half of a neon or argon bulb will glow brightly while the other half is dark. A clapper will ring a bell while apparently not moving. And many other things that are not tricks—but just science at play.

The basic stroboscope idea is very simple. All you need is a slit cut near the edge of a disk, a means of revolving the disk, and a housing that has a viewing hole in line with the circular path of the slit.

The surprising effects you get are produced by what technical people call persistence of vision. It works like this:

Suppose you look through a stroboscope at a revolving disk on which you have put some lettering. As the slit passes the eye-piece, you get a split-second view of the word. This image remains on your eye's retina for a fraction of a second. When

stroboscope and lettered disk are revolving at the same rate, you get a succession of glimpses of the word at exactly the same spot in its circular path.

Persistence of vision blends these repeated impressions into what appears to be one image. As a result, you can read the word. For the same reason, fan blades seem to stand still. If the stroboscope is revolving faster than the fan, the blades will seem to move backward. In the same way, a stroboscope will slow down or freeze any circular or vibratory motion occurring at regular intervals.

In the stroboscope shown, you revolve the disk by shooting a stream of air against the turbine blades. An atomizer bulb with a one-way valve is used for this. A shoe-polish can houses the disk.

Since air from a rubber bulb won't revolve the disk at a rate equal to a fan, it's necessary to have several slits in the disk. Four slits amount to the same thing as running a single-slit disk four times as fast. You get four times as many glimpses. **END**

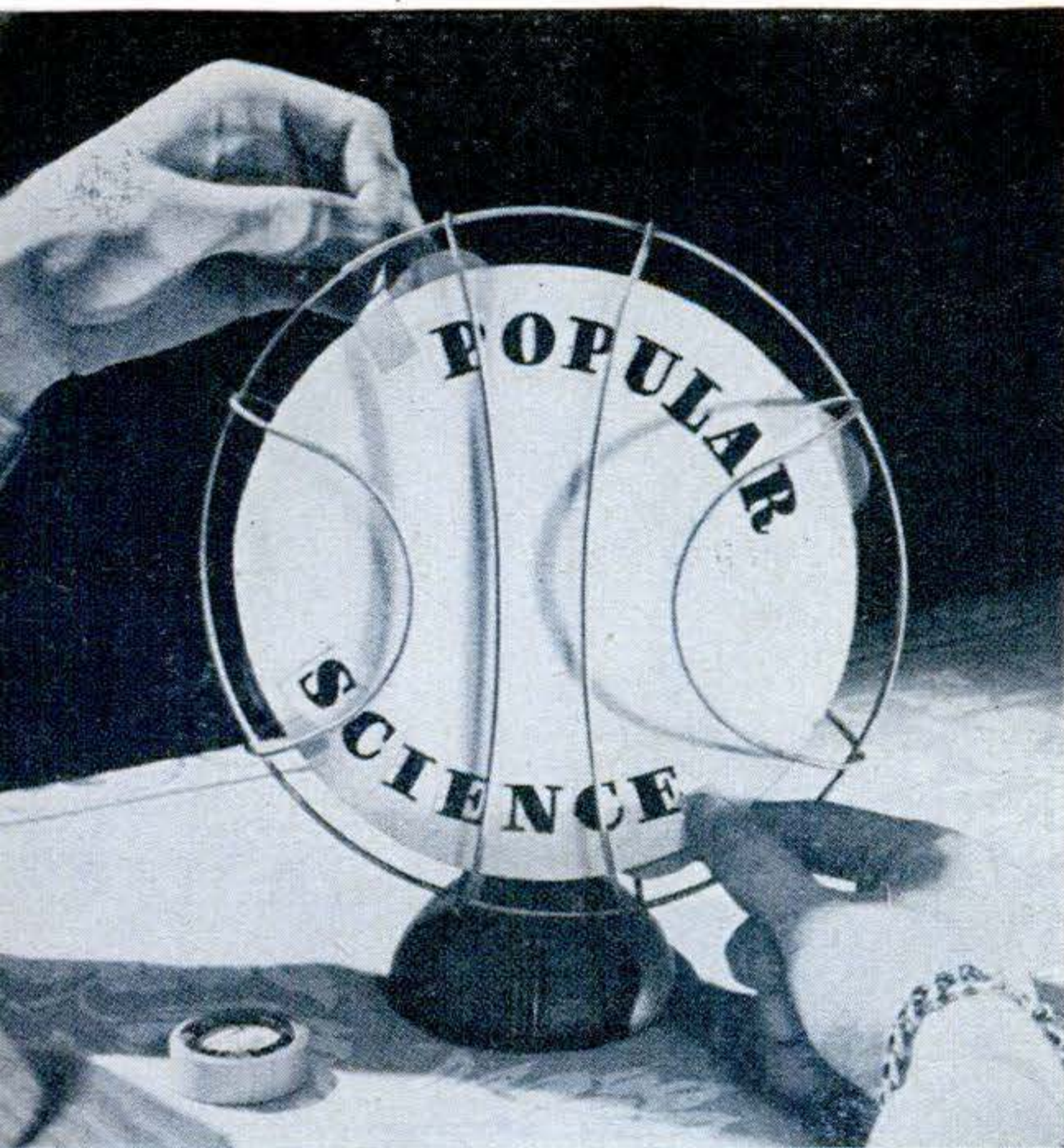

... and you can read the words quite clearly.

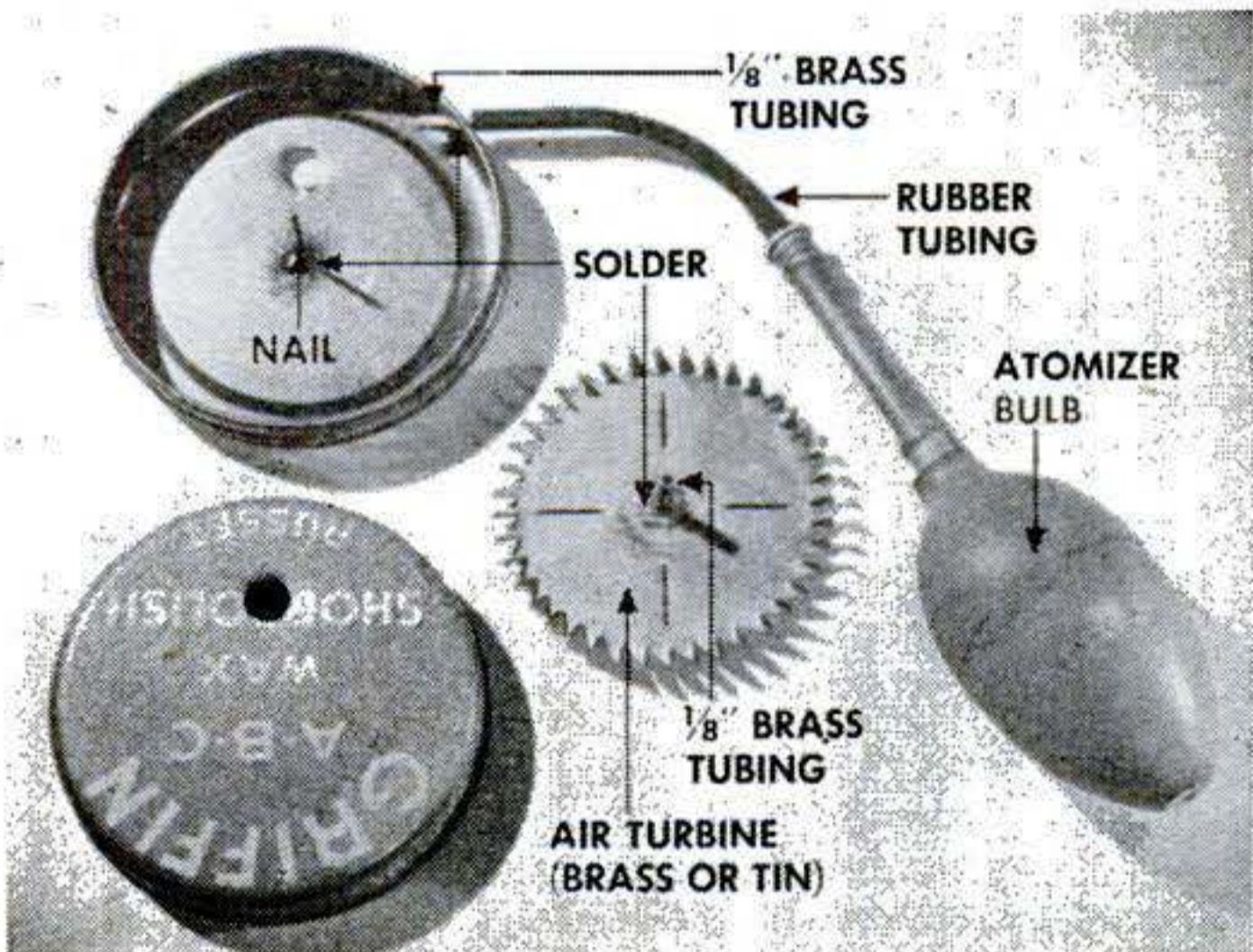
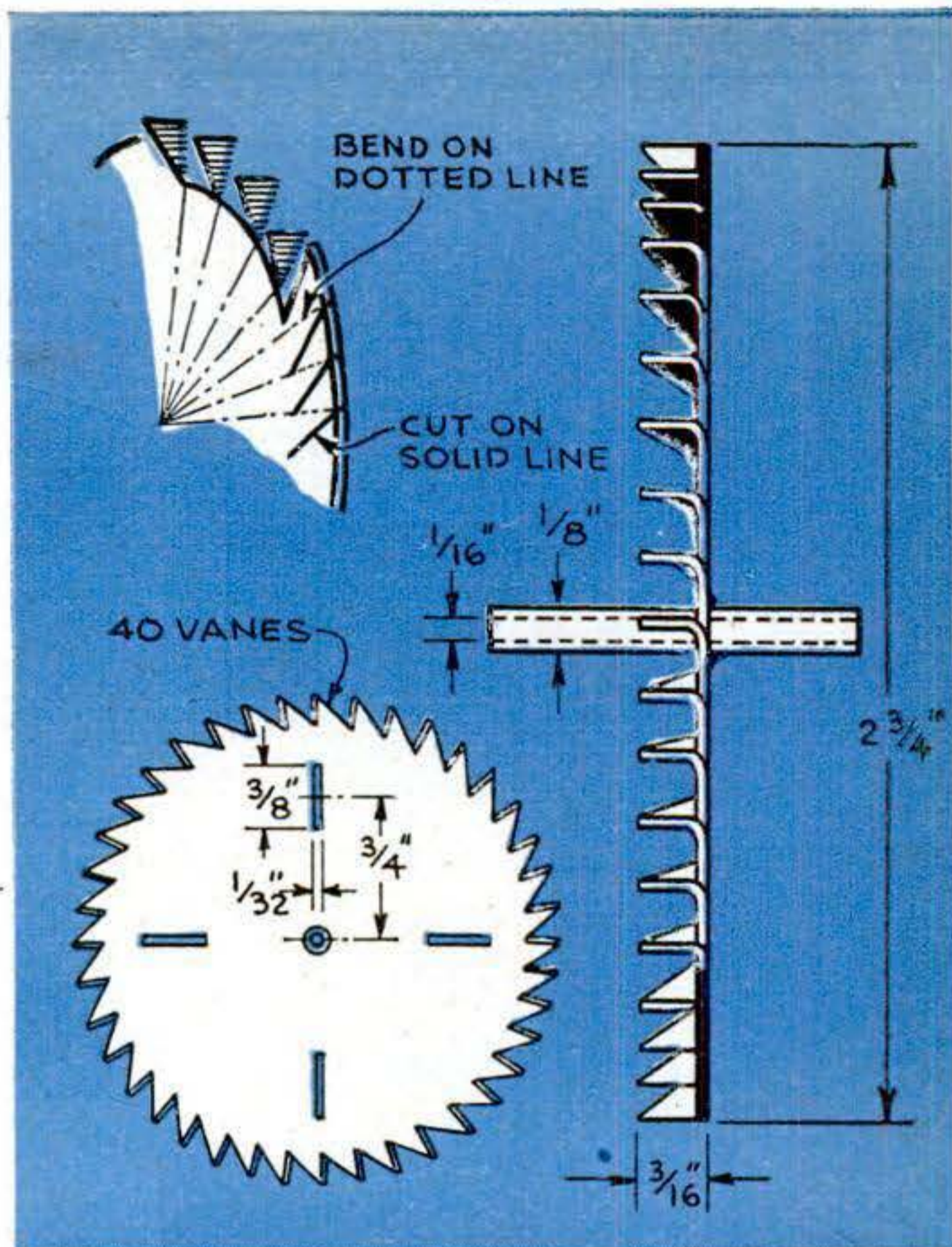

These are the parts. The air-turbine bearing slips over the nail shaft. In assembling, be sure to align peep holes. Note valve in bulb.

Clapper of bell or buzzer appears to slow down or stop when viewed through the stroboscope. Rotate the turbine disk quite slowly for this.

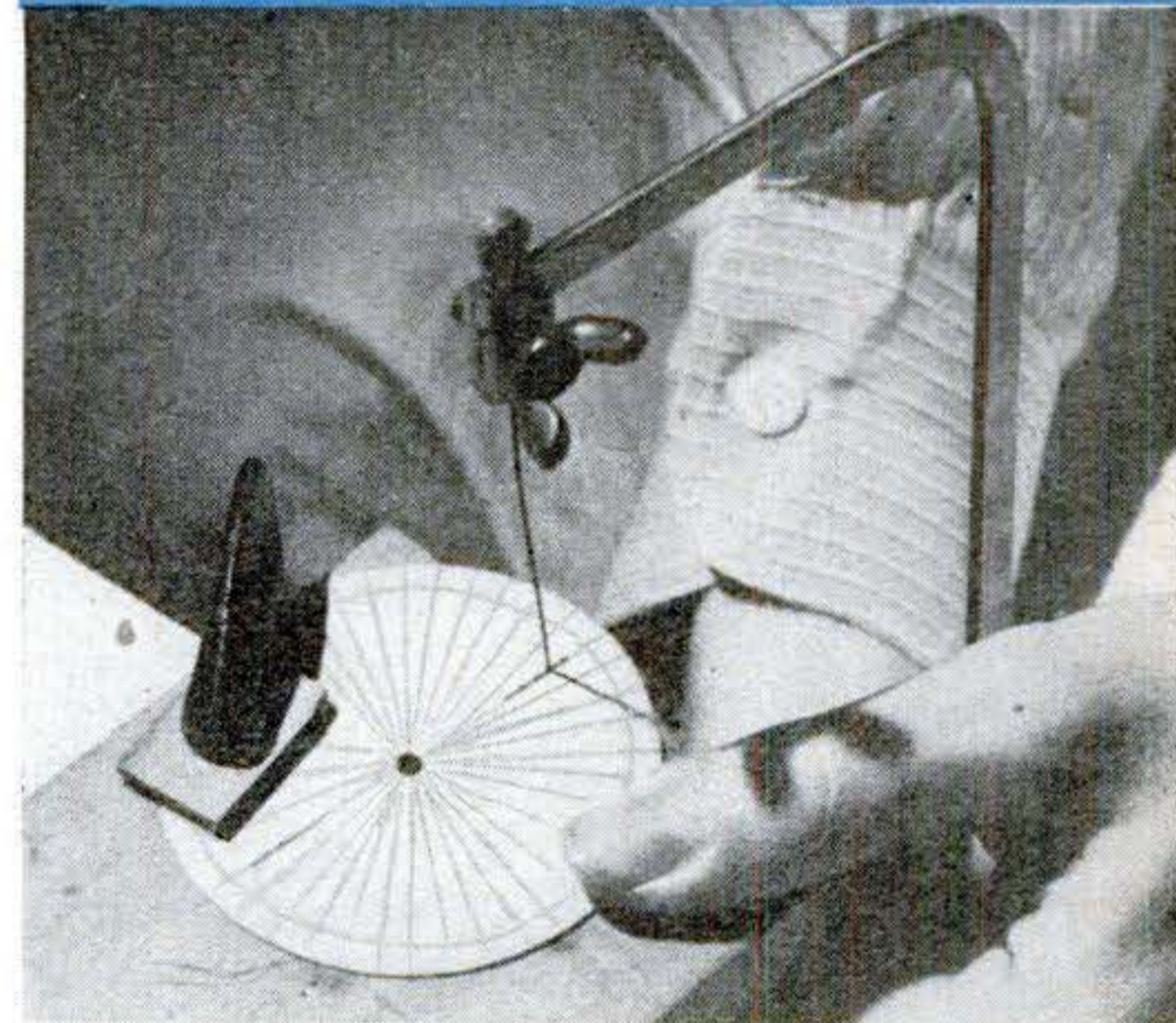

Slits can be cut with a jeweler's saw after you have made a hole with a small drill. A flat needle file will smooth the edges of slits.

Half a light. If you run stroboscope in step with each half-cycle of the current, one segment of a neon or argon lamp will black out.

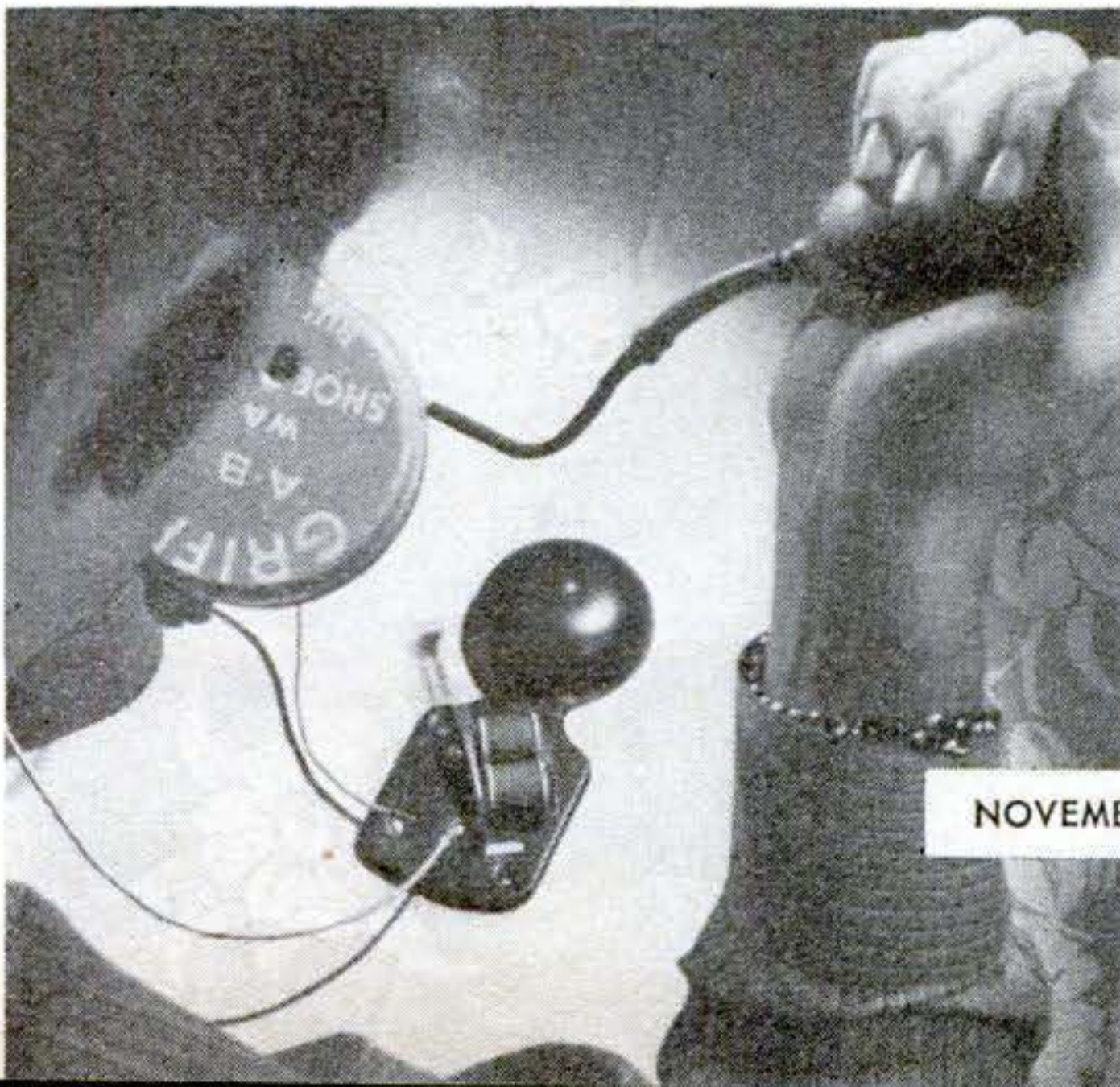

Hide a Radio in a Skillet

You can use miniature parts to produce this attractive 5-tube superhet job for kitchen entertainment.

By Edward Blanton

YOU can brighten up your wife's home workshop—the kitchen—with a little frying-pan art of your own. This radio in a skillet can be hung among other pots and pans as a decorative addition to her kitchen that will supply music, news, and soap operas—and sometimes remind her that it's later than she thinks.

Decide first, if possible, where the pan will be hung. If it goes against a metal cabinet, the loop antenna may not work well, but an antenna coil can be substituted for the loop as shown in the diagram on page 245. Should you hang the set on a plaster wall or the side of a wooden cabinet or spice shelf, the loop will give good service.

The circuit is a standard five-tube superhet design, which assures plenty of pickup and volume. The layout shown is for a 10" skillet; a smaller one may cause a little trouble. The pan can be old or new, aluminum, cast iron, or copper.

Making the Templates

After choosing your skillet, cut a cardboard template for the chassis. Determine its size by a cut-and-try process, but make one edge flat and the other semicircular. Bend a shelf for the tubes along the flat edge. The skillet shown is 2¼" deep, so the ledge was made 2" wide. On the semicircular edge, cut and bend two 1½" by 1¾" mounting brackets for the tuning condenser (C1) and volume control (R7). Place them so that the shafts will protrude slightly through clearance holes that are drilled for them along the lower side of the pan.

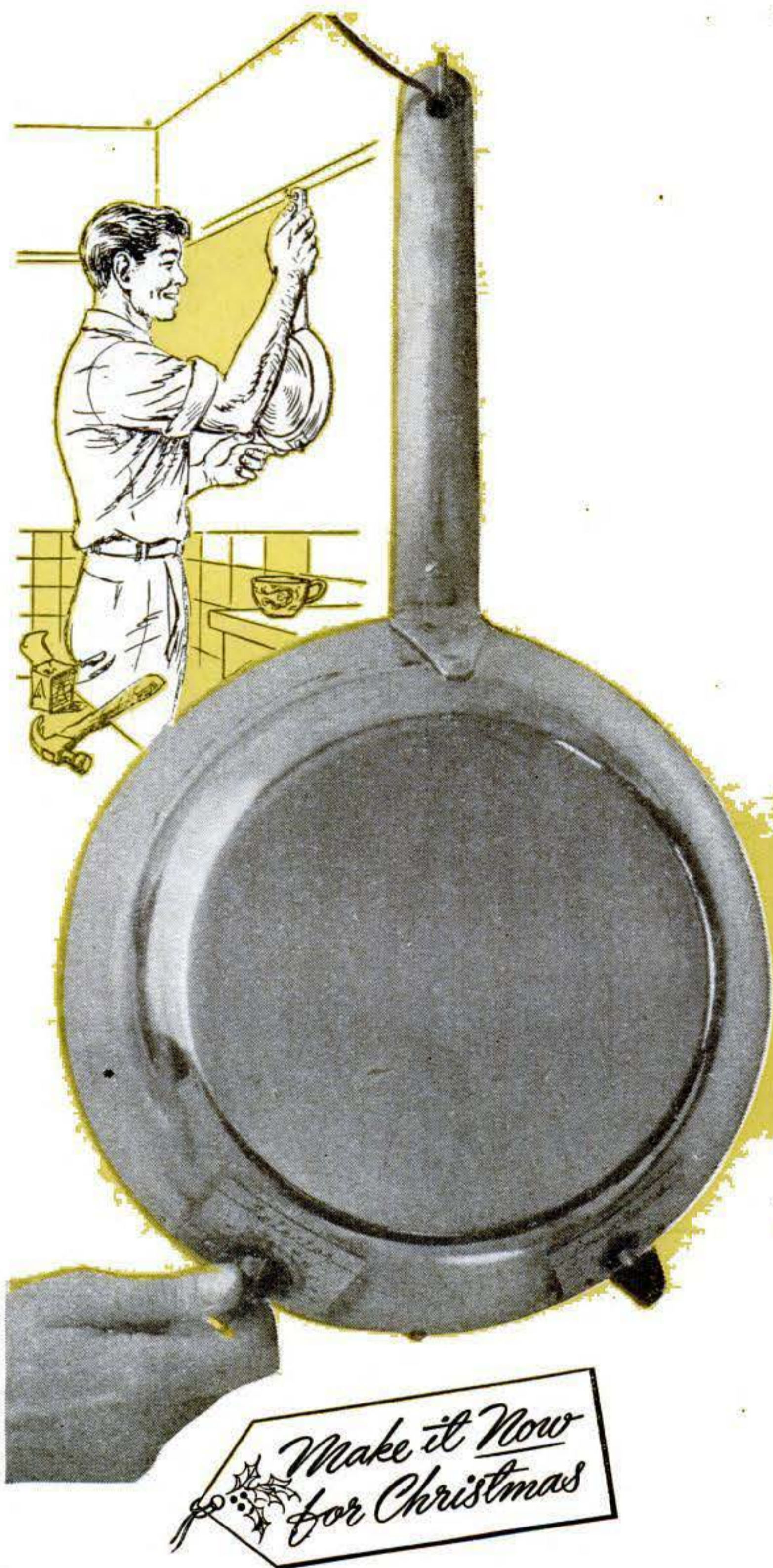

Snip out a second cardboard template for the speaker mounting board and clip it to the back of the chassis template. Spread your parts out on the cardboard then to make sure you have room for all of them (if you're not careful the speaker and the tubes may get in each other's way).

When you have the chassis and major parts arranged to fit, trace off the templates. The chassis can be cut from a 6" by 9" sheet of aluminum; the speaker board from a 6" by 10" piece of plywood, plastic, or composition board. Mounting holes are needed for the miniature tube sockets, IF transformers, tuning condenser, volume control, and other large parts.

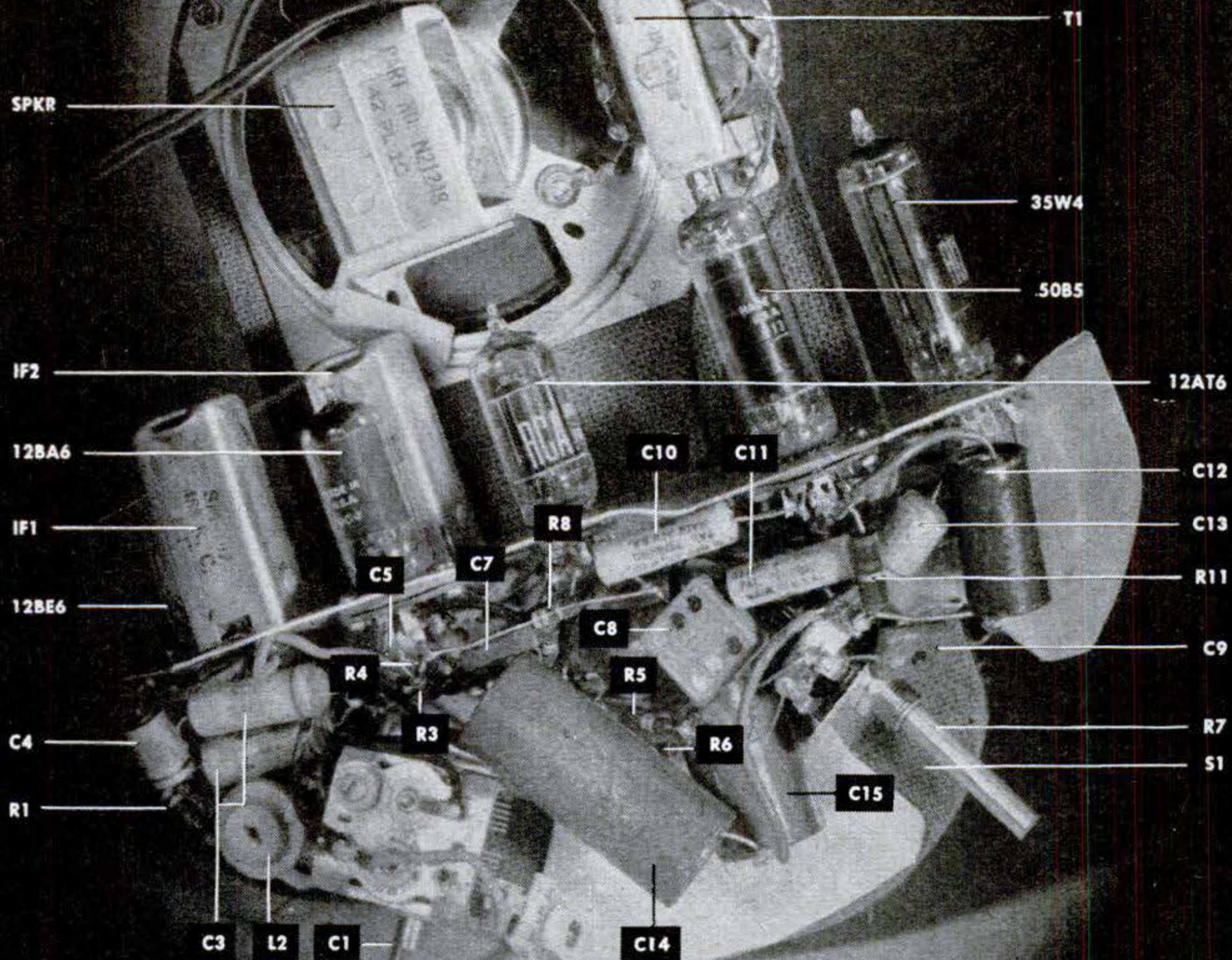

Parts layout must be planned before work begins if the set is to fit snugly in a skillet.

A common characteristic of AC-DC receivers is a "hot" chassis, since one side of the power line is connected directly to ground. When the wall plug is inserted one way, there is a potential of 115 volts between the chassis and an external ground such as a water faucet or pipe. This could be dangerous, so it's essential that you isolate the chassis from ground.

Note in the diagram that a common wire lead is used as a "floating" ground. This ground point is connected to the chassis at a few places through condensers and a resistor; it must never touch the chassis directly. Some additional circuit stability is obtained by connecting the ground and chassis to-

gether in this fashion, and the voltages that reach the chassis are too low to be dangerous.

For additional protection, line the skillet with tape at any place where the chassis may touch it directly. Make sure, also, that the control shafts don't rub against the edge of the pan.

Two Controls Do the Job

Only two controls are needed. The SPST power switch, S1, is mounted on the back of the volume control, R7. The other control belongs to the midget two-gang tuning condenser, C1. One section of this condenser tunes the antenna coil or loop, the other the oscillator. The oscillator section of the con-

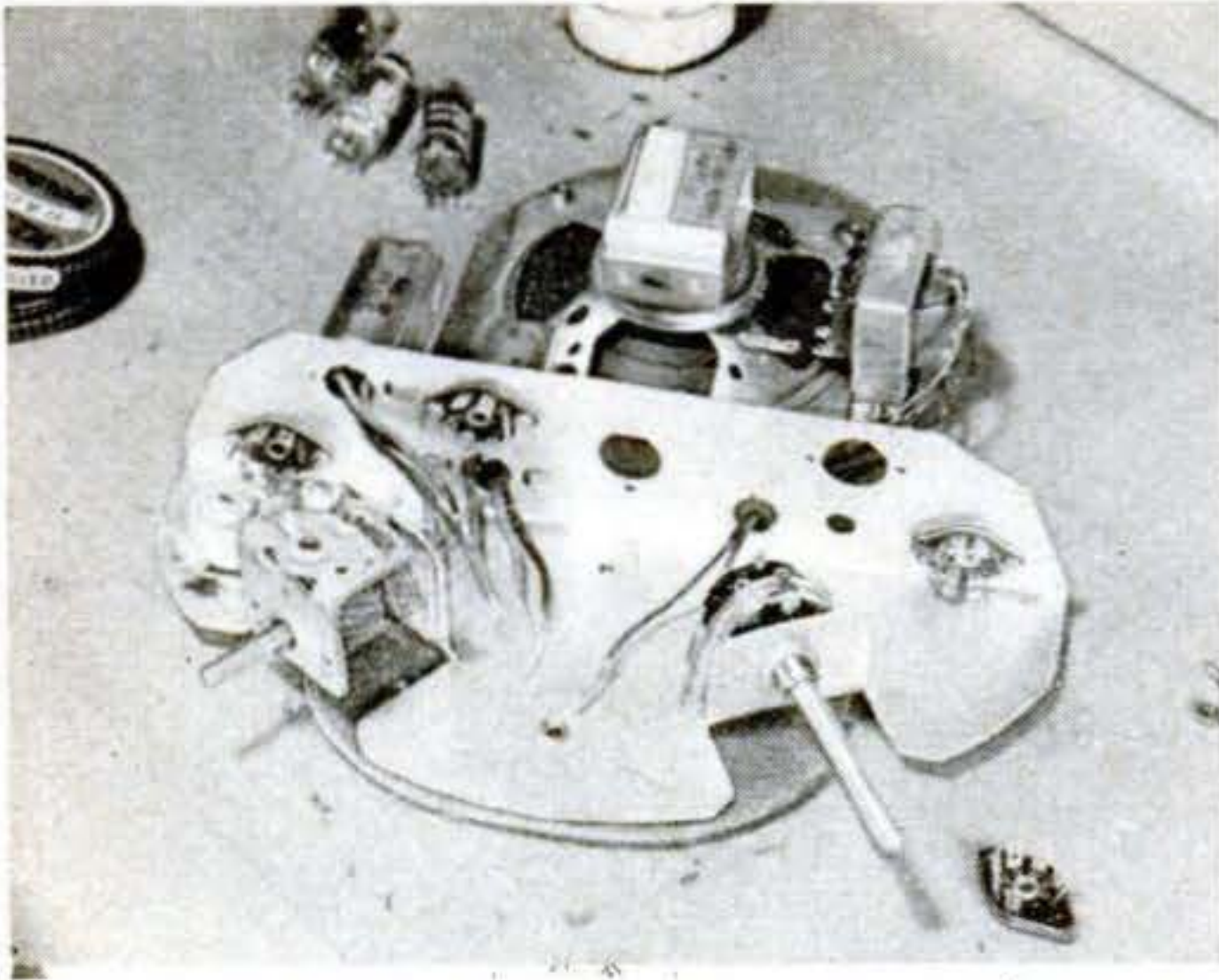

Cut and drill the chassis and assemble the major parts before wiring. Note flaps in the lower edge for volume and tuning controls.

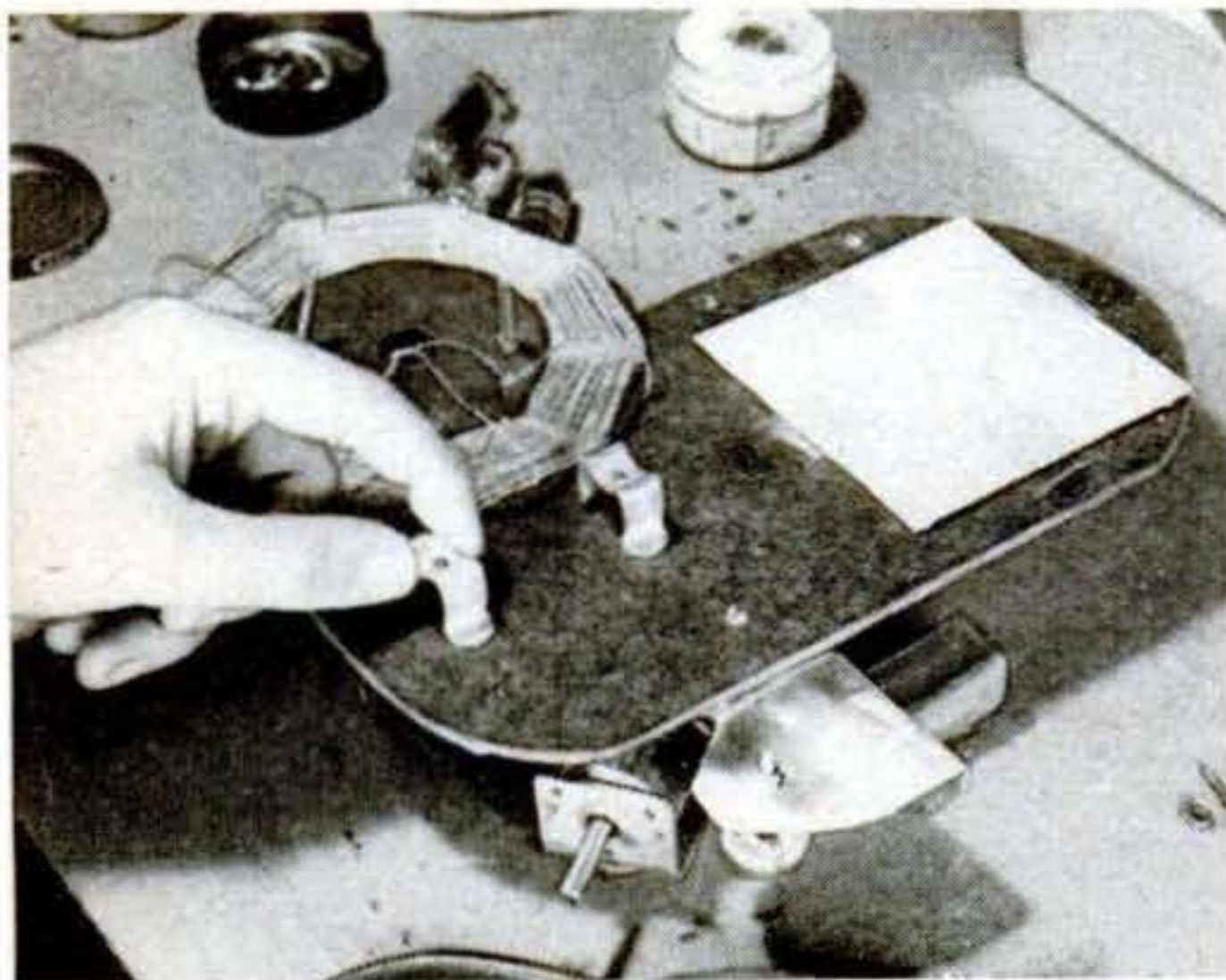

Set the loop antenna away from the back of speaker board to space the speaker off the wall and let the sound come out clearly.



To hold the set in the pan, use a flat bracket at top and a right-angle bracket at bottom. Chassis should not touch the pan.

denser has fewer and smaller plates than the antenna half. Try to buy a condenser with built-in trimmers for final adjustment.

The signal picked up by the antenna is tuned and amplified by the 12BE6 oscillator-mixer tube. The oscillator coil mounted next to the tuning condenser must be clear of the skillet when the set is assembled. When you buy the coil, be sure to specify the type with a single winding and center-tap. You don't want a coil that has two separate windings and four connections.

Choose Miniature Parts

Use miniature parts as much as possible. The paper condensers in this set are the new midget tubulars; resistors, too, are being made smaller than they used to be. Should you have trouble locating a .2-mfd., 400-volt condenser (C3), you can use two .1-mfd. capacitors in parallel. That was done in this set. Hence, the label C3 points to two units in the photo on page 243.

Any frequency that is tuned in is converted by the oscillator-mixer to a fixed frequency of 455 kc. This is amplified again by the 12BA6 IF amplifier and fed to the diode portion of the 12AT6 detector-first audio tube. There it is changed into an audio-frequency signal and amplified some more. It then goes to the 50B5 output tube where it is built up to loudspeaker volume.

A transformer in the plate circuit of the output tube matches the impedance of the tube (about 2,500 ohms) to the voice coil of the speaker (3 to 8 ohms, depending on the make). To be sure of getting a good match, you can use a universal output transformer that has several taps from which you can choose the best combination.

To cut out shrill tones, a by-pass condenser (C11) is wired between the plate and screen grid of the 50B5. If it makes the wiring easier you can connect this condenser from plate to ground instead.

Controls at an Angle

In the construction shown, the control shafts go outward at an angle. Hence, the holes in the skillet are oversize; they should be, anyhow, to prevent electrical contact between the shaft and the metal of the pan. The holes are covered on the outside by dial plates.

The speaker and output transformer are attached to the insulating panel that is bolted to the chassis. Use the back of the same panel for mounting the loop antenna. Space

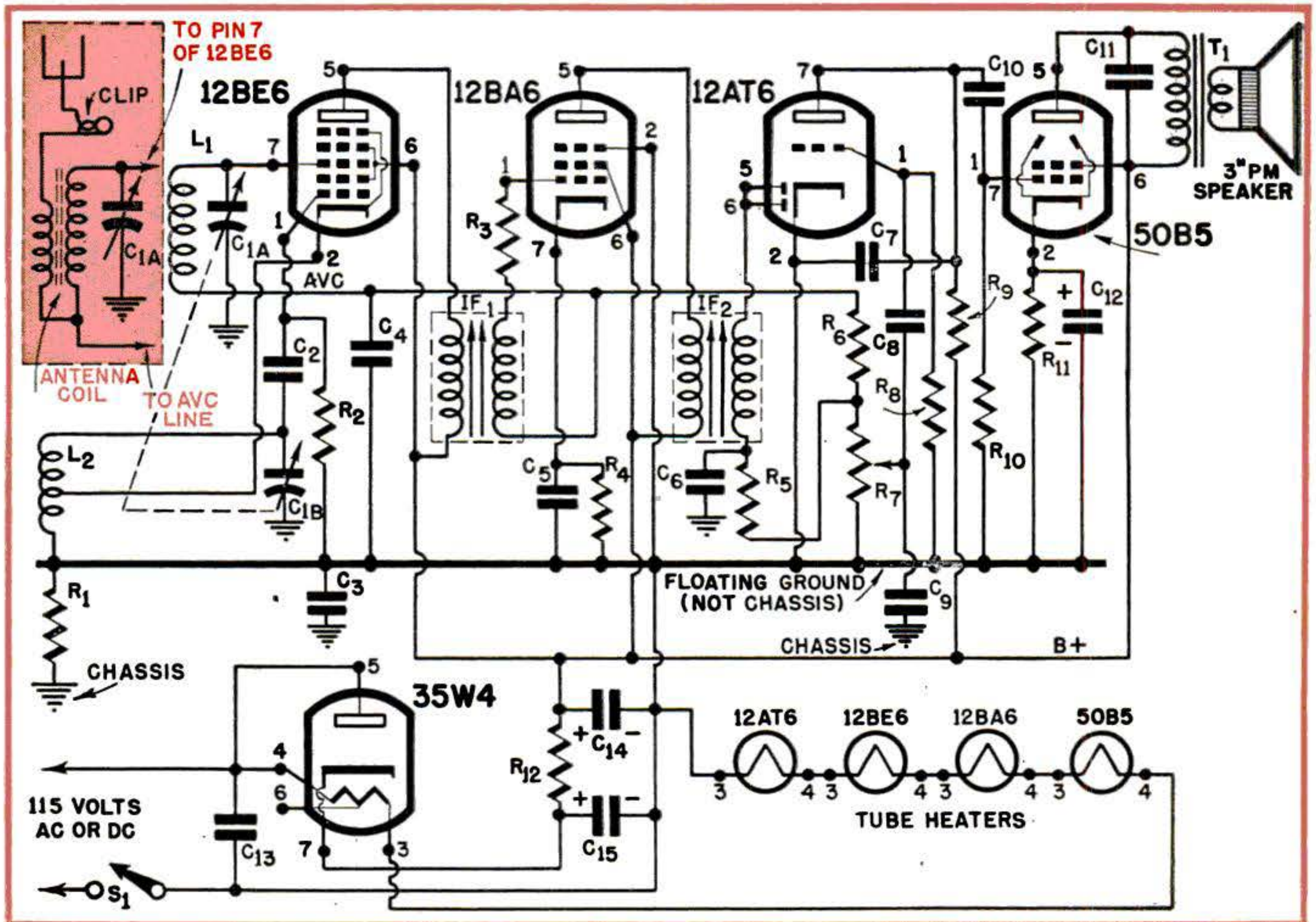

LIST OF PARTS

All resistors $\frac{1}{2}$ -watt carbon unless otherwise specified.

R1, R2, R5: 22,000 ohms.

R3: 1,800 ohms.

R4: 470 ohms.

R6: 2.2 meg.

R7: 500,000-ohm pot. with switch.

R8: 3.3 meg.

R9: 220,000 ohms.

R10: 470,000 ohms.

R11: 150-ohm, 1-watt carbon.

R12: 1,200-ohm, 2-watt carbon.

C1A, B: Two-gang midget tuning condenser with cut-plate oscillator

C2: 50-mmf. mica.

C3: .2-mfd., 400-volt paper (see text).

C4, C5, C13: .05-mfd., 400-volt paper.

C6, C9: 300-mmf. mica.

C7: 220-mmf. mica.

C8: .006-mfd. mica.

C10, C11: .01-mfd., 400-volt paper.

C12: 10-mfd., 25-volt electrolytic. C14, C15: 50-mfd., 150-volt electrolytic.

L1: Loop antenna or antenna coil for broadcast band (see text). L2: Center-tapped oscillator coil for 455 kc. IF.

IF1, IF2: Midget iron-core intermediate-frequency trans.

T1: Universal output transformer.

S1: SPST switch on R7. Tubes, miniature wafer sockets, 3" PM speaker, misc. hardware.

the loop off the panel with metal clips as shown in the photos.

Tube heaters are wired in series and are detailed separately in the lower right-hand part of the diagram. Since the rating of all tubes together is something over 121 volts, no dropping resistor is needed to operate them directly off the line. Wire them in the sequence shown.

Final Adjustments

When the wiring is complete, you may have to sharpen the alignment a trifle. Tune in a strong local station. Adjust the trimmers on the IF transformers to obtain the greatest volume possible. If the set gets too loud, turn down the volume control. Next, touch up the trimmer across the oscillator section of the tuning condenser. Tune in a station at the high end of the broadcast band

(with the plates out of the mesh) and adjust the oscillator trimmer until the station comes in at the correct dial setting. Finally, adjust the trimmer on the antenna section of C1 until stations are received at maximum signal strength.

P.S. How about giving your wife a new pan and using her old one for this project?

END

The Weight of Light

THE weight or mass of light has been shown by Dr. Einstein in his studies of other forms of energy. It is based on the fact that light coming from a distant star is pulled inward as it passes close to the sun. Calculations show that, during every second, the total mass of light and other radiation from the sun amounts to 4,620,000 tons. One percent of this amount will be used up in 150,000,000,000 years.

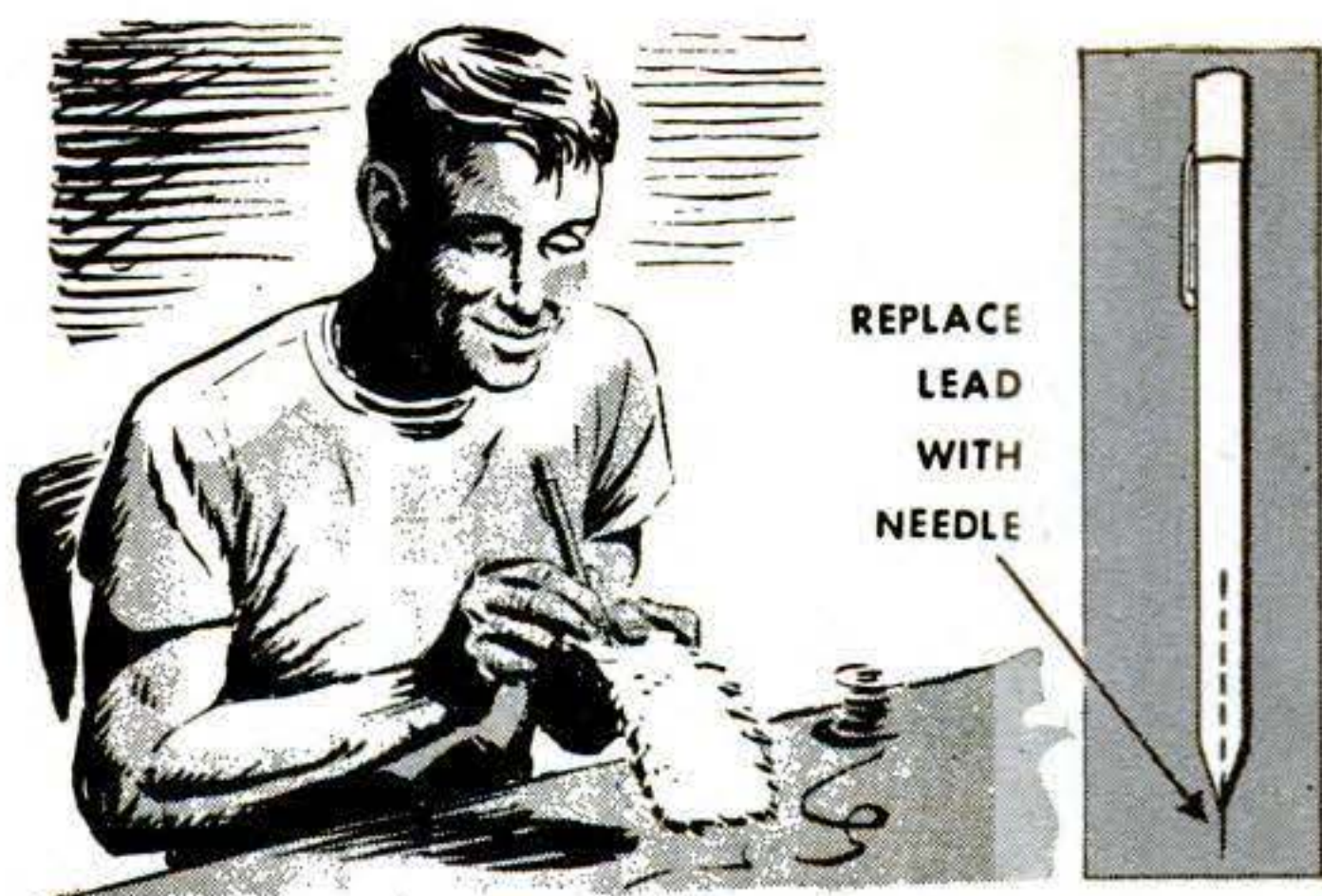

Pencil Adjusts Needle Point

TO PIERCE tiny holes to accurate depths in wood, leather, and similar materials, just replace the lead in an ordinary mechanical pencil with a sewing needle. Then you can easily adjust the length of the point.—*Henry S. Galus, New Bedford, Mass.*

Ice Aids Pile Driving

HERE'S a neat trick for driving piles for a boat house or dock—and you don't have to wait until spring to start work. When there's a good freeze on the lake, simply chop holes in the ice where you want the piles to go and drive them through to the bottom, as shown below. The ice will hold the piles a lot better than you can working from a boat. Comes the spring thaw, and there's your piling.—*Leonard O. Timm, Bennington, Neb.*

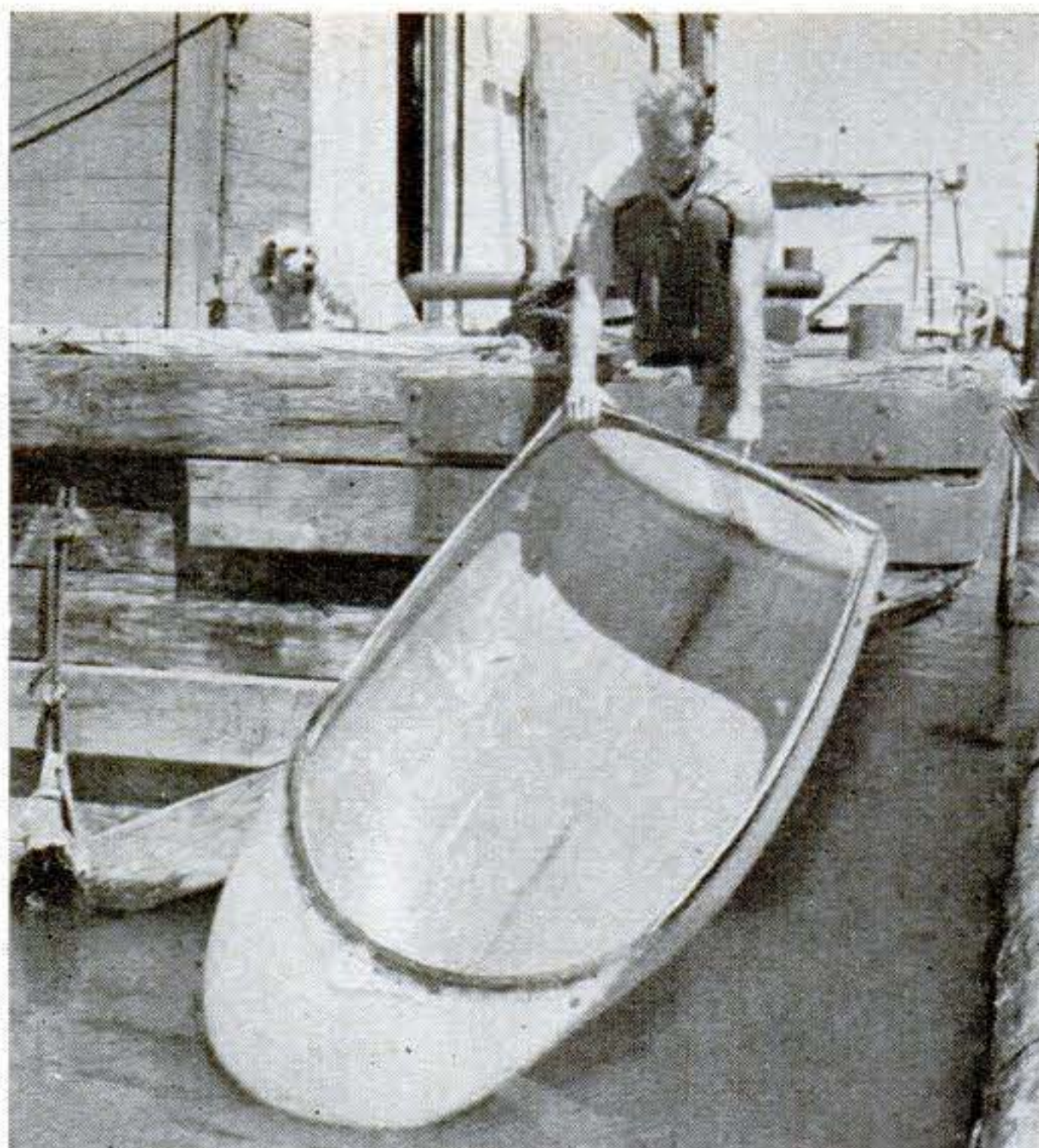

Glass Dinghy Rows or Sails

THIS new, all-glass dinghy may be an answer to the problem of making dinghies light and easy to handle yet strong and durable. Made of four plies of Fiberglas® impregnated with plastic, the six-foot-long, experimental craft was built by Sid Hall, California boat designer, aboard his small barge workshop at Sausalito. Molded in one piece, it is flexible yet tough and has no seams to dry out and open up. Its light weight—only 30 pounds—and covered foredeck allow it to be launched from considerable height without swamping (top photo). A long, shallow keel, rudder, and mast support permit a quick change for sailing.

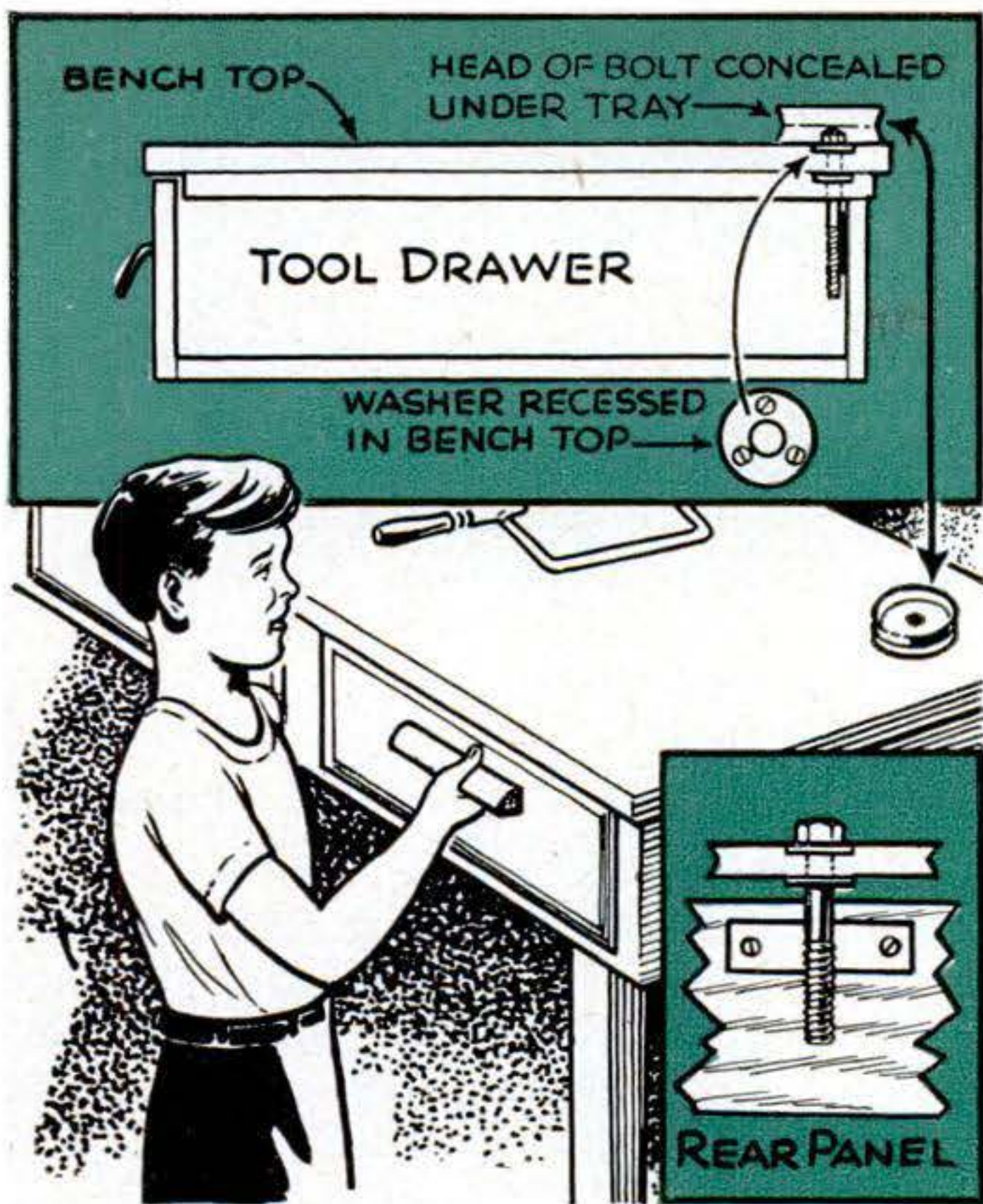

Secret Bolt Locks Up Tools

HERE'S a simple trick for keeping inquisitive youngsters out of your tool drawers. Drill a hole through the bench top so it lines up just inside the back of the drawer. Reinforce the hole with washers and the drawer back with a plate as shown. Then drop a $\frac{1}{2}$ " bolt down the hole and cover the head with an innocent-looking tray or jar cap.—*Charles H. Hardy, Los Angeles, Calif.*

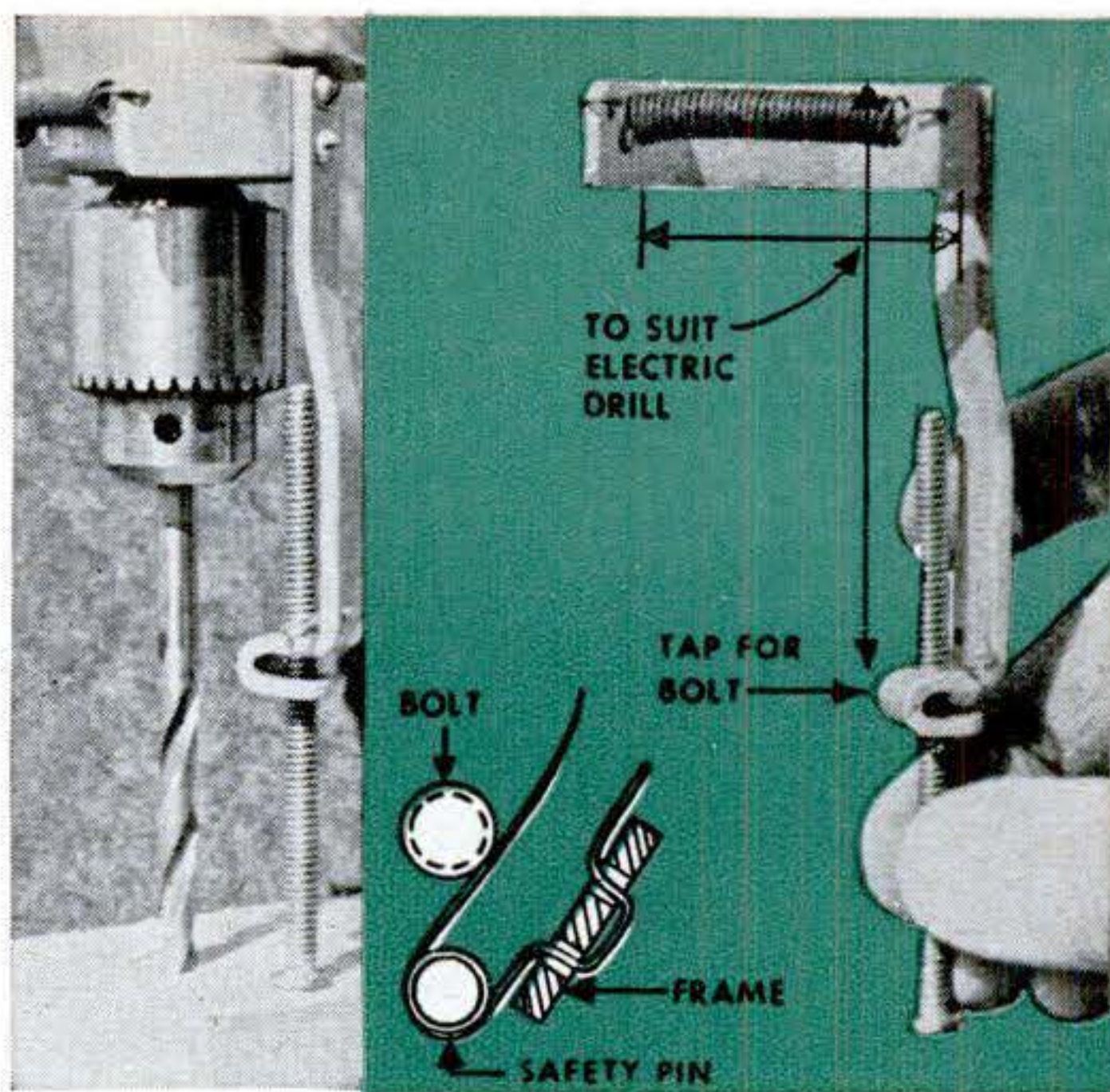

Gauge Sets Drill Depth

NO CHANCE of drilling too deep or too shallow if you make this simple depth gauge for your hand drill. All it consists of is a 3" bolt held in a frame alongside the drill. By adjusting the length of the bolt, you can easily set the depth of the drill cut. Bend the two frame parts out of strips of brass, aluminum, or steel, and screw or solder together. A spring across the top clips the frame to the drill. A safety pin wedged in between the bolt and the frame keeps vibration from moving the bolt once it's set.—*Robert Hoppough, Waukegan, Ill.*



Slag Stops Highway Skids

MADE by crushing slag to the size of fine gravel, this special grit is said to give better traction on snow or ice than sand or ashes. It does not absorb moisture and remains free-flowing at low temperatures. The J. P. Loomis Coal & Supply Co., Akron, O., puts it up in bags for use in mechanical sanders and in containers for carrying in car trunks.



Etching Done Without Acid

WITH this new kit, you can etch metal without using dangerous acid. It contains an etching agent so harmless that even children are said to be able to use it safely. You also get sample designs and a special knife for cutting your own designs in the tape that serves as a mask. Handmade by Hilary, New York, offers the kit for about \$5.

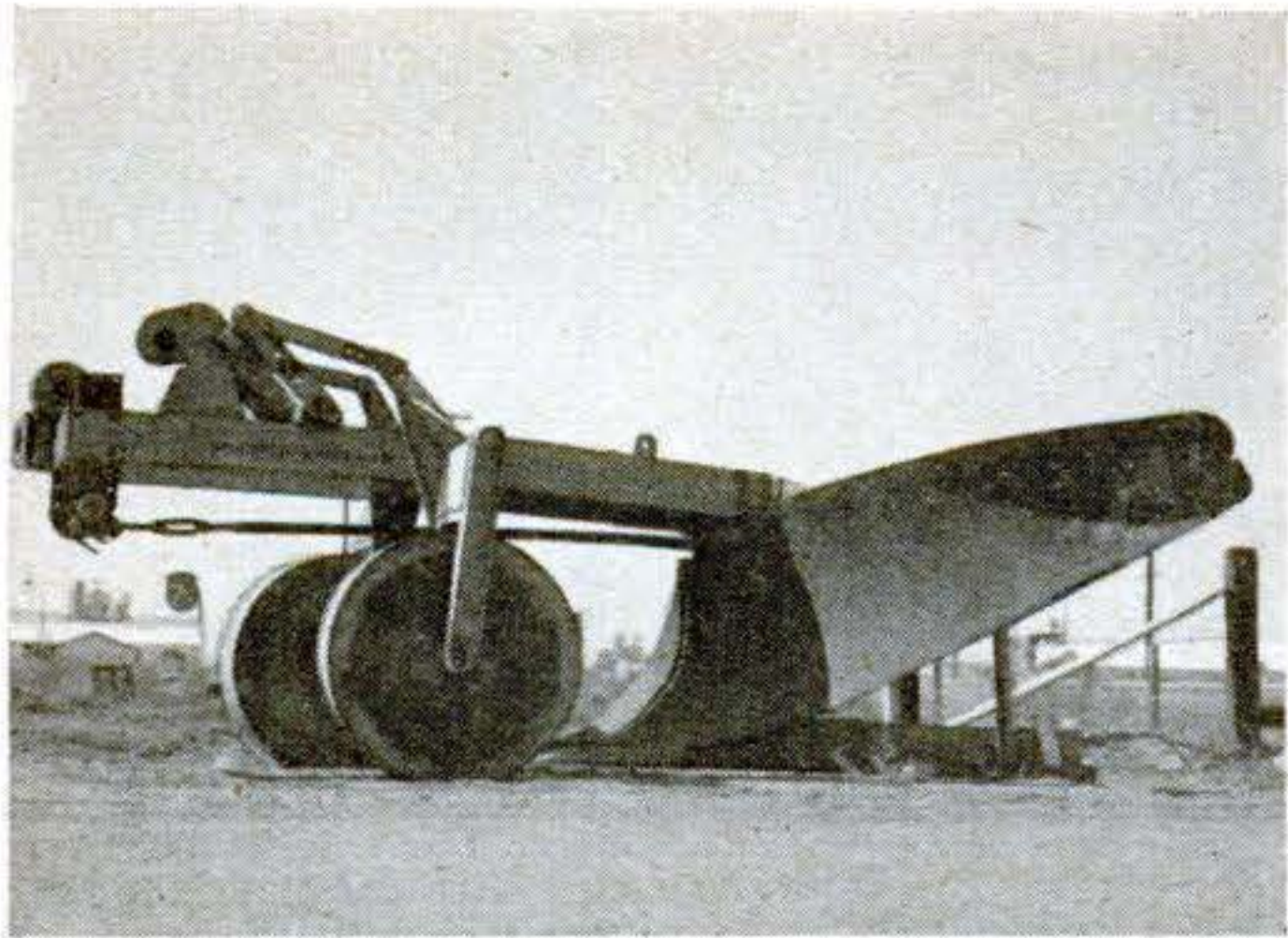

Paul Bunyan Could Use This

EVERY few years this massive earth ripper is used for deep plowing in California's Imperial Valley to maintain productivity of the topsoil. Constructed on a Paul Bunyan scale, the moldboard is 6' high and 9' long.—Robert Daily, Long Beach, Calif.

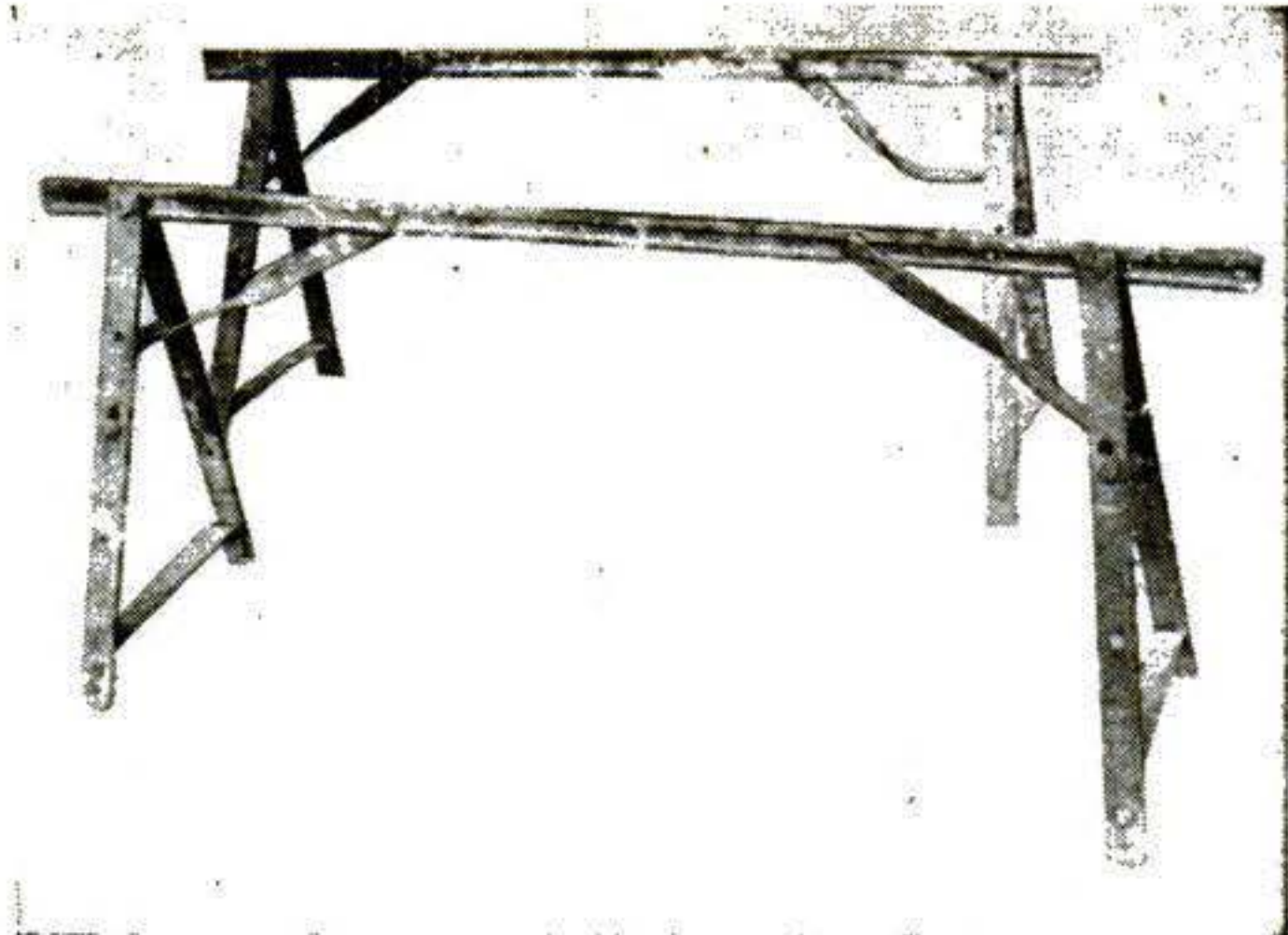

Scrap Used for Steel Horses

SHOVEL beams from an old corn cultivator form the main parts of these sturdy steel sawhorses that were welded up in the shop of the John J. Fitzpatrick farm near New London, Iowa. Other pieces from the scrap pile were used for the cross and angle braces.

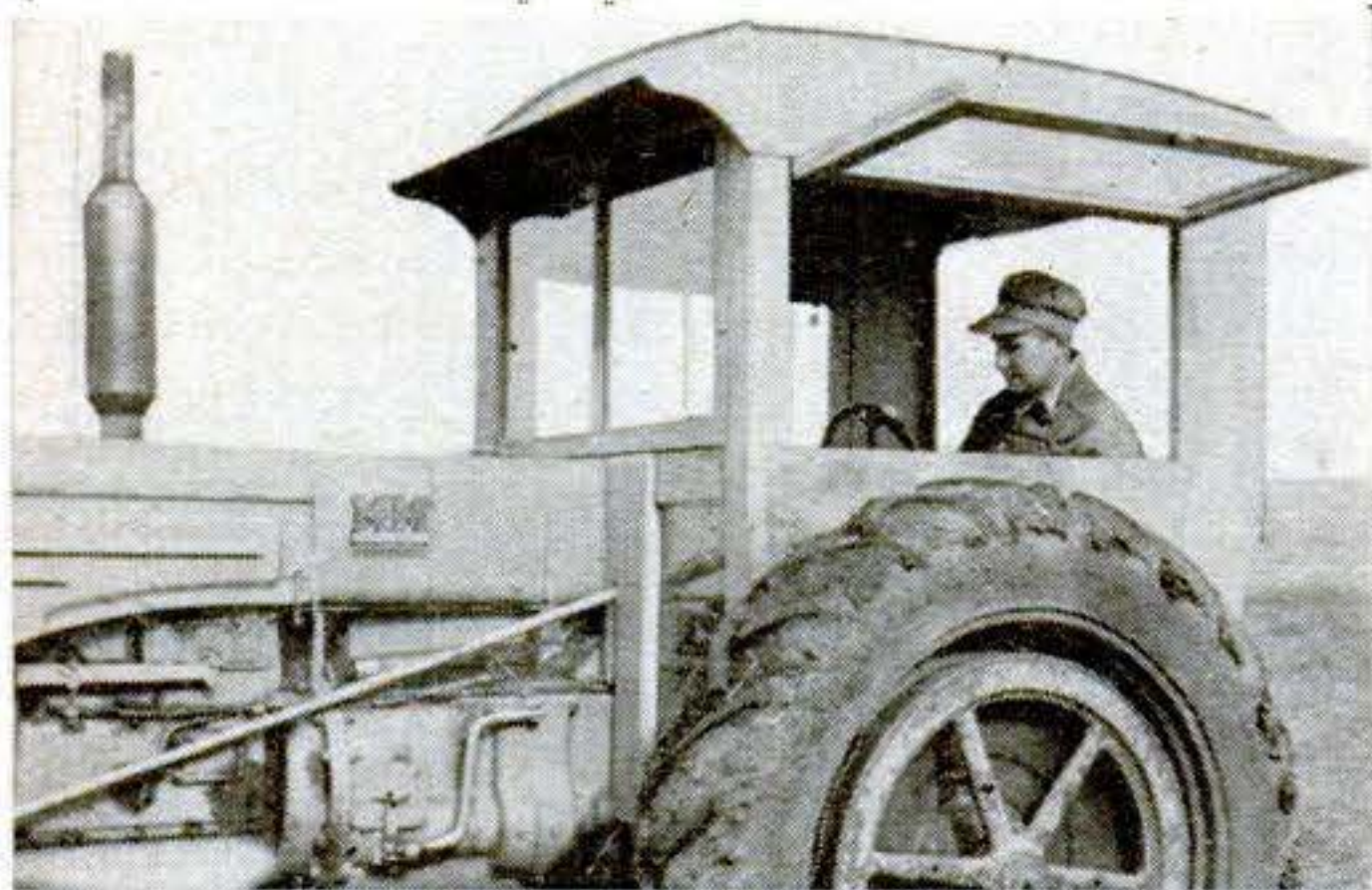

Wooden Cab Built on Tractor

YEAR-ROUND weather protection is afforded by this tractor cab built of plywood and 1" lumber. The hinged windows can be opened from inside the cab by draw cords. On rainy days, a canvas curtain closes the rear.—Willis Hinkson, Mt. Pleasant, Ia.



Steel Bar Makes Pipe Puller

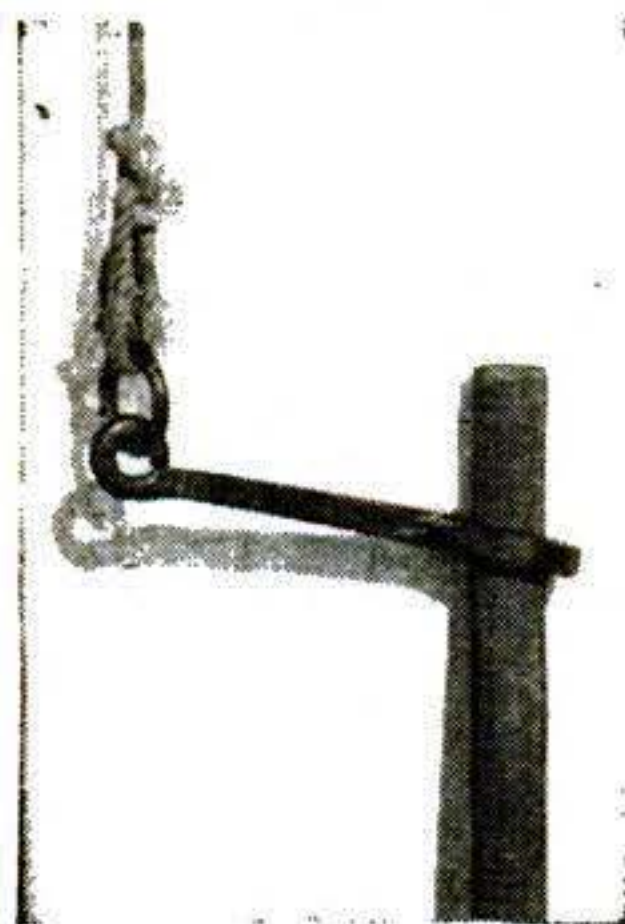

THIS steel-bar pipe puller has a ring slightly larger than the pipe to be drawn up. Made from square stock, the ring edge bites the pipe with its straight edges. When the rope is slacked, the tool takes a new hold.—A. M. Wettach, Mt. Pleasant, Ia.

Chews Leaves, Spits Dust

THIS attachment for the Mow-Master® rotary mower pulverizes leaves so finely that the particles scatter between the blades of grass like dust, leaving the lawn clean. This does away with the task of raking and burning leaves. The Propulsion Engine Corp., of Kansas City, the maker, claims that the attachment returns the mineral-rich contents of the leaves to the soil, providing plant food. The Mow-Master, powered by a 2-hp. engine, has both an automatic governor and a manual control.



**NOW... LIGHT
WHEN YOU NEED IT!**

**Ray-O-Vac LEAK PROOF batteries
stay fresh for years!
(because they're sealed in steel!)**

© 1949 BY RAY-O-VAC COMPANY, MADISON, WIS. RAY-O-VAC, CANADA LTD., WINNIPEG, MAN.

See how much more you get

in these truly modern batteries. Each Ray-O-Vac Leak Proof starts with a powerful, well made battery. Then . . .

1. Steel bottom is added.
2. And a steel top.
3. Next—Multi-ply insulation. Nine layers of protection against corrosion.
4. Last—a steel jacket. This completes an air-tight seal, to stop corrosion and keep the battery fresh and powerful. Only Ray-O-Vac builds batteries with all four of these safeguards.

GUARANTEE on every Ray-O-Vac Leak Proof: "If your flashlight is damaged by corrosion, leakage or swelling of this battery, send it to us with the batteries and we will give you FREE a new, comparable flashlight with batteries."

Ask for Ray-O-Vac Leak Proofs

Buy Spares . . . they stay fresh



Hangers Fold for Traveling

THESE folding hangers, molded of Monsanto's Lustron® plastic, will fit into your suitcase for traveling or may be stored out of the way if your closet gets too crowded. They are designed to fit both women's and men's clothing. Priced at \$1.00 for three, the folding hangers are sold by Kingly Plastic Products Corp., New York City.



Kitchen Fits 60-Inch Space

This GE kitchen squeezes stove, refrigerator, sink and storage cabinets into a unit 60 inches wide, 84 inches high, and 25 inches deep. The stove has three five-heat burners plus full-sized oven and broiler. The four-cu.-ft. refrigerator can freeze four pounds of ice cubes, has chiller tray for meat. The 39-in. sink has space for garbage disposer.



Spats Keep Off Spots

YOUR womenfolk won't have to worry about mud-spattered stockings if they wear these plastic spats that zip over their ankles in rainy weather. Glamour Spats® come in all colors, have a neat container that slips over the handle of an umbrella, and fit all types of shoes. Made by Wheaton Weather Wear, Detroit, they sell for about \$2.50.



Mat for Rubbers Saves Floors

THERE'LL be a welcome on the door mat the next rainy day if you use the new Rubber Roosts® to park your rubbers or boots. They are made of brown or green rubber with raised sides to protect the floor and deep corrugations to speed evaporation. Rubber Roost, St. Paul, Minn. makes them to sell for \$1.35.



Kodak Home Printer—One-piece top automatically works light. Accepts negatives up to 4 x 5½ inches. Strip-prints 35mm. and larger roll-film negatives. Price, \$12.50.

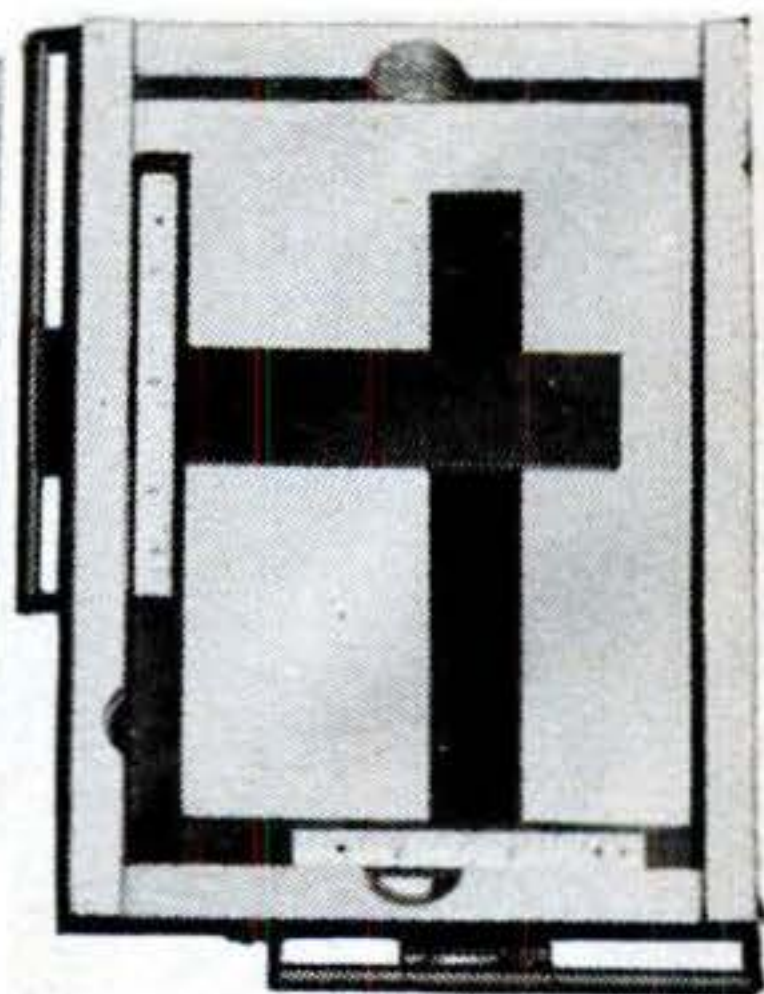
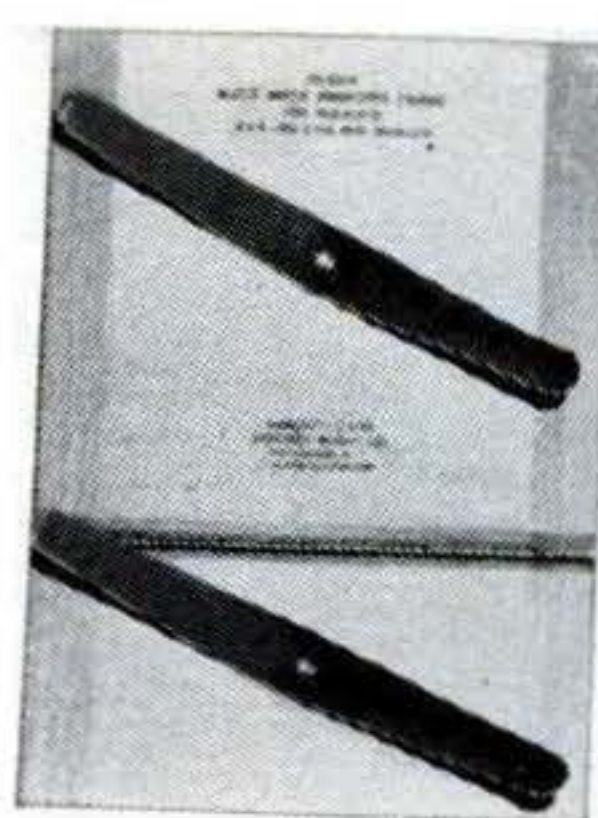

Kodak Auto-Mask Printing Frame—Clip holds negative firmly. Graduated scales on two sides also serve as paper guides. Price, \$3.25.

PRINTING AIDS

for your darkroom

Prints for your albums . . .
extra prints for your friends
. . . Kodak equipment makes
home printing easy. Inspect
these contact-printing aids
at your Kodak dealer's.

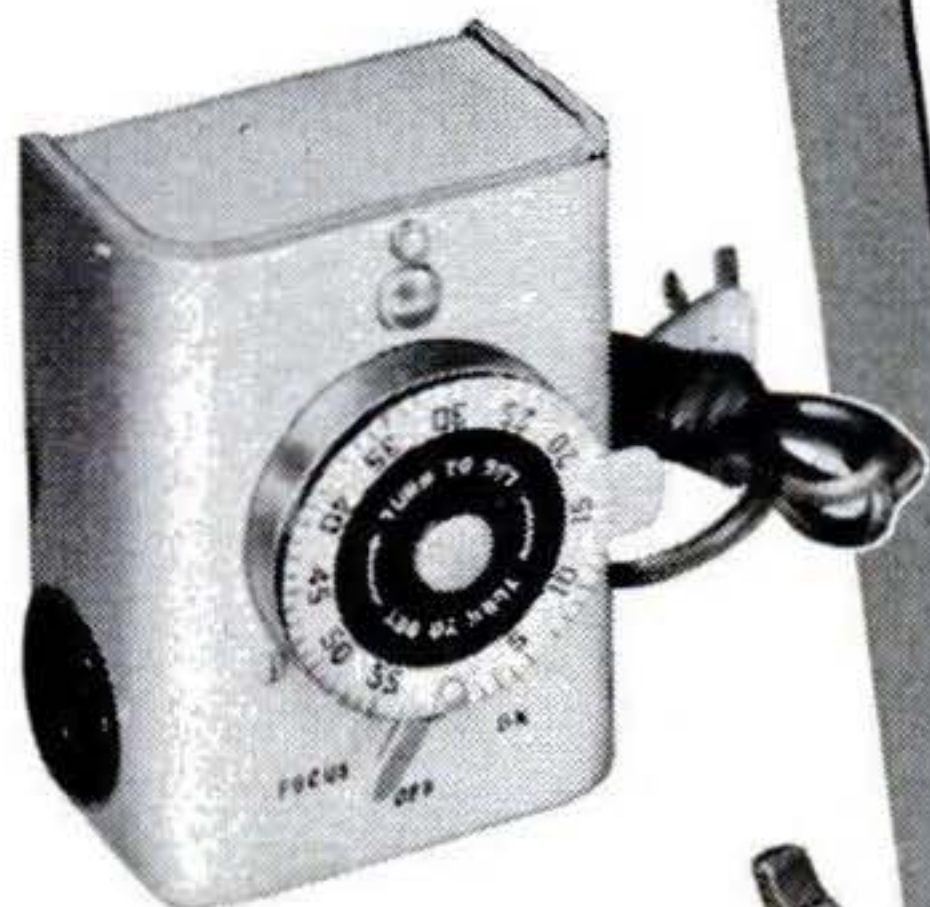

Kodak Electric Time Control—Plugs into printer or enlarger. 1 to 57 seconds. Repeat timing requires only original setting and turn of dial for each printing. Price, \$13.50.

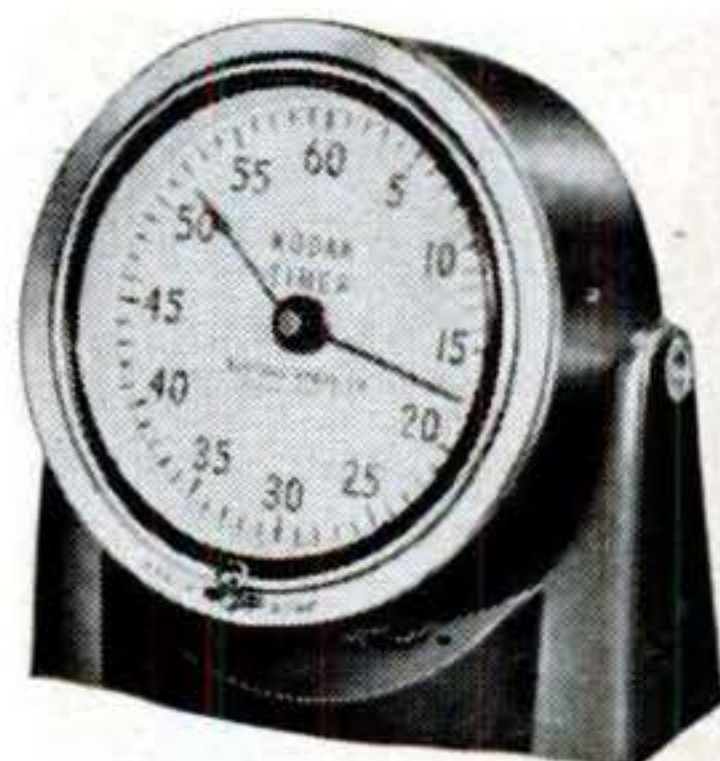

Kodak Timer with Tilting Base—Has both minute and split-second hands. Switch permits stopping timer and then restarting it without resetting hands. Easy reading in dim light. Price, \$7.50.

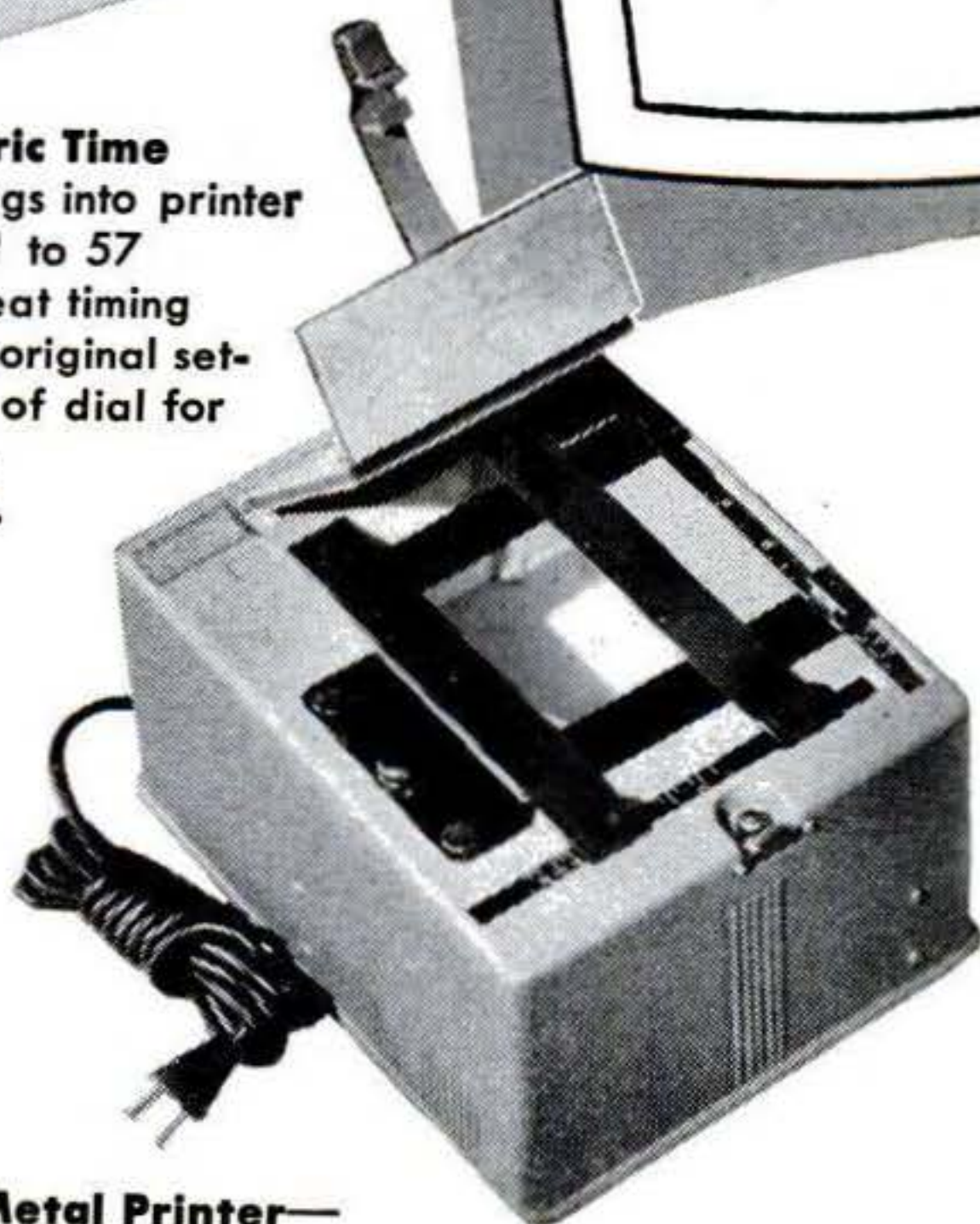

Kodak All-Metal Printer—For negatives up to 4 x 5 inches and paper through 5 x 7 inches. Illuminated masking scales; center masking; guide for lining up paper; 35mm. guides for strip-printing; negative-locking device. Price, \$22.50.

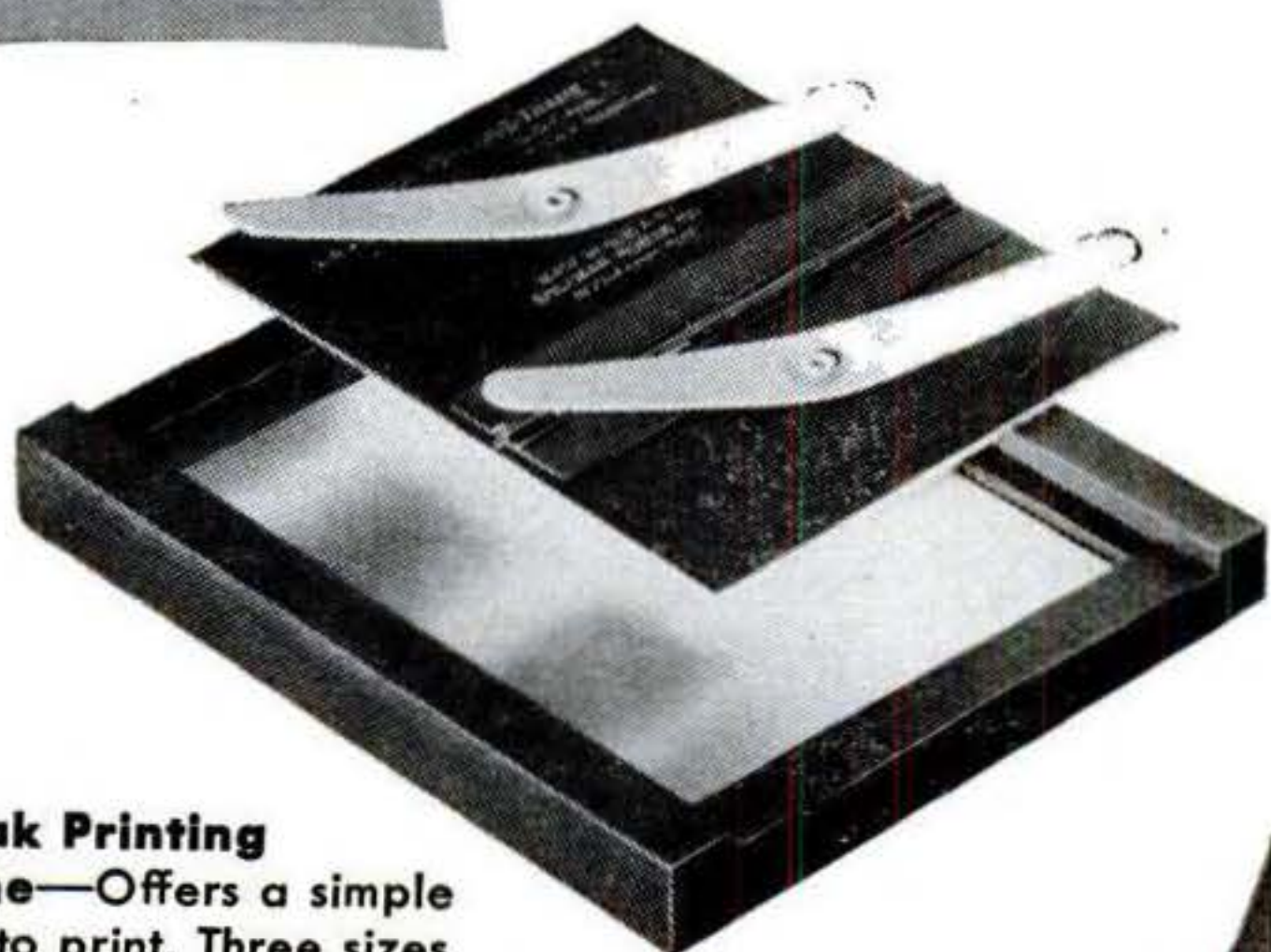

Kodak Printing Frame—Offers a simple way to print. Three sizes available: 3¼ x 5½, 4 x 5, 5 x 7 inches. Supplied with a glass front—you use ordinary house lamp for light source. Price, from \$1.25.

Prices include Federal Tax where applicable

Kodak
TRADE-MARK

EASTMAN KODAK COMPANY, ROCHESTER 4, N. Y.

**"NEW"
Better-Than-Ever**

**Atlas
DRILL
PRESSES**

**7 TOOLS IN!
For Your Shop**

★ **NEW**
4 Ball Bearing
Equipped Head

★ **NEW**
Direct Reading
Depth Stop

★ **NEW**
Extra Heavy
Construction

★ **NEW**
Operating
Smoothness



The finest low-priced drill press in America is ready for your inspection! Industrial, commercial, and home shop men have long known the many quality features of the Atlas drill press. Now come new improvements that make it better than ever.

Four ball bearings in the head give you a "floating drive" that is smoother and dependably accurate for years. The new depth stop is more convenient, and the heavier construction adds to smoothness and accuracy on heavy drilling in metal or high speed work on wood.

It's a perfect tool to add new work-range to your home shop. With low-

cost attachments it drills, taps, sands, carves, mortises, shapes... gives you clean, precision workmanship on metals, woods, and plastics... makes your workshop hours more productive than ever.

Three sizes are available. 12³/₄" bench model, and 15" in bench or floor models. Send the coupon today—see all of the exclusive and special features of the Atlas—before you select the drill for your shop this year.

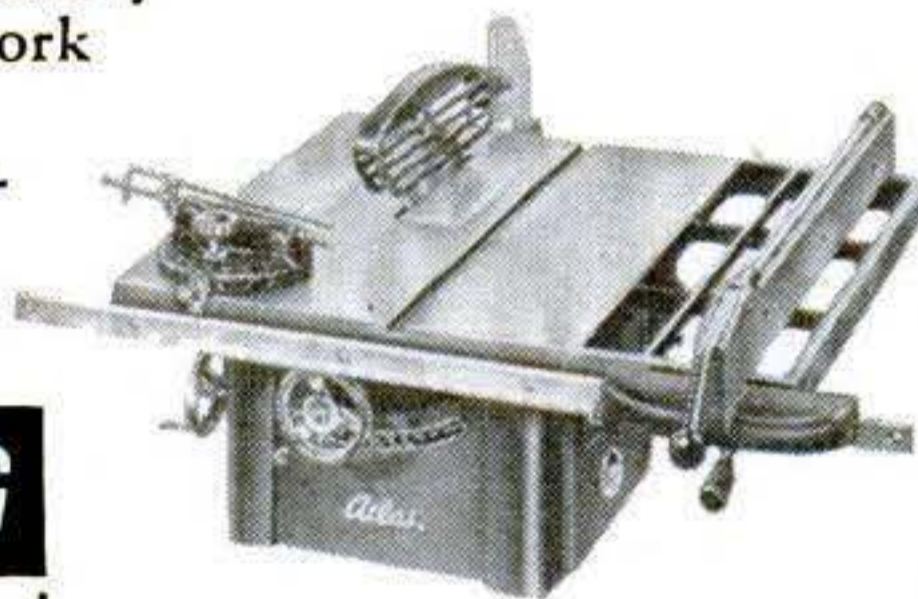

Atlas 8" TILT/ARBOR SAW

Draw an area 26³/₄" x 22" (table size of this saw, as shown) and you'll quickly see why it's the most popular low-cost circular saw on the market. Use the coupon for latest catalog with full details.

SEND FOR FREE CATALOG

ATLAS PRESS COMPANY

1155 N. Pitcher St., Kalamazoo, Mich.

Please send me latest literature on the new Drill Presses and on 8" and 10" saws

Name _____

Address _____

City, State _____

ATLAS PRESS COMPANY

1155 N. Pitcher St., Kalamazoo, Mich.



**MATCHED PRECISION TOOLS FOR
WOODWORKING AND METALWORKING**

Ready for **WINTER ?**



INSTALL NEW

CHAMPION

SPARK PLUGS

New Values **ZEPHYR MODELS** Portable Electric Tools

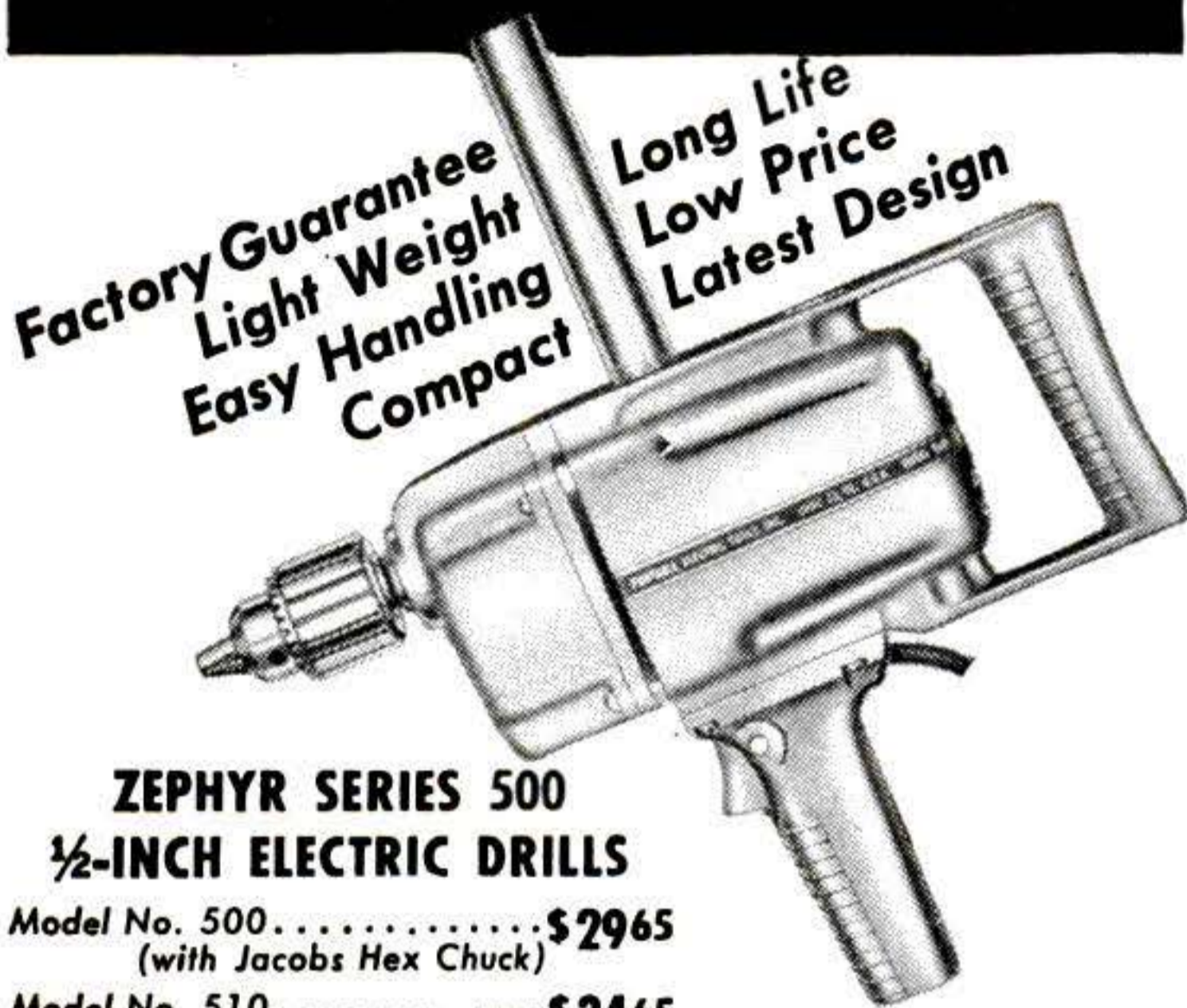

ZEPHYR SERIES 500
1/2-INCH ELECTRIC DRILLS
Model No. 500.....\$2965
(with Jacobs Hex Chuck)
Model No. 510.....\$3465
(with Jacobs Gear Chuck)

Full 1/2-inch drill capacity; removable side handle for close-quarter drilling; weight complete only 9 pounds. U. L. listed.

ZEPHYR SERIES 1950 1/4-INCH ELECTRIC DRILLS

Model No. 1950-H.....\$1795
(with Jacobs Hand-Tite Chuck)
Model No. 1950-G.....\$1995
(with Jacobs Gear Chuck)

Weight complete, only 3 pounds, 2 ounces. The speed, power, and small size make it the ideal power tool; handy to use as source of power for driving drill attachments for disc sanding and polishing, cleaning paint brushes, grinding and sharpening tools, buffing, removing rust and paint with wire wheel brushes, etc. A real money saver around the house, farm and home shop. U. L. listed.

SPRAYMASTER ZEPHYR MODEL SM-25 \$24.95

A complete electric sprayer unit with electric motor, two-cylinder air compressor, pressure equalizer storage tank, 25 to 30 pounds pressure. Sprays paint, enamel, lacquer, insecticides, and mothproofing solutions. Easy to use—no spraying experience necessary for fine job on furniture, cars, radiators, etc. Full instructions with every unit.

See these tools at your dealer, or write direct for full information. Dealer inquiries invited.

GET THIS FREE BOOKLET—16 pages of detail information on Portable's complete line of top-value electric tools, tool kits, and work-saving attachments.

PET PORTABLE ELECTRIC TOOLS, Inc.
326 W. 83rd St., Chicago 20, Ill.



Amazing INSTANT GLOSS

Cleans—Waxes with One Application

for Autos, Trucks, Buses, All Painted Surfaces, Windows, Mirrors, Venetian Blinds, Ranges

5-OZ. CAN

ONLY \$

Original all purpose dry cleaner. Just rub it on—let it dry—rub it off. Cleans and waxes—leaves a mirror-like gloss. Contains no grit or abrasive substance—will not harm the most delicate finish. Try it. You'll be amazed!

Enough to clean your car 6 times!

SAVE UP TO 70% on SOLDERING IRONS

Electric. Underwriters' Labs. Approved. Insulated cords and plugs.

	75 WATT, HOME	\$1.25
	100 WATT, HOME	1.50
	100 WATT, INDUSTRIAL	3.50
	150 WATT, INDUSTRIAL	4.50
	200 WATT, INDUSTRIAL	4.75

TRAILER HITCHES

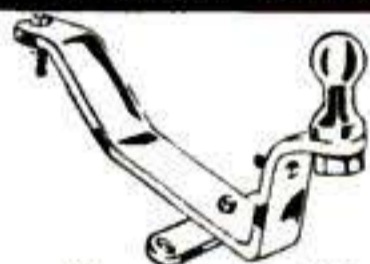

TOW-RITE \$995

Lincoln, Cadillac, Ford S W, Stude. Land Cruiser & Commander \$1245
Complete Tie-rod assembly \$450

Chrome plated steel. Attaches to car bumper & frame. No welding.

Adjustable POWER HITCH \$2375

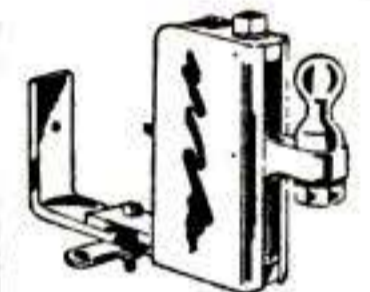

Tie Rod assembly \$450
Rides trailers level always. Ball elevates or lowers 7 full inches. Eliminates trailer pitching, joggling, sagging. Sparkling chrome finished steel. Use to haul all types of trailers.

ELECTRIC TIRE GROOVING IRON

with six No. 6 blades, only \$350

No. 6 passenger car tire blades 75c dozen

No. 9 truck tire blades \$1 dozen



SALESMEN-AGENTS

Huge profits, spectacular results proven on these items. Not a one time proposition—continual repeat business. Write for complete details today.

Prices F. O. B. Chicago. C. O. D. Orders enclose 25%—balance sent C. O. D.

POWER SALES CORP. Dept. 00, 514-30 S. Green St. Chicago 7, Illinois

Always Mention Popular Science when writing

AMERICA'S MOST-WANTED SMALL TRACTOR!

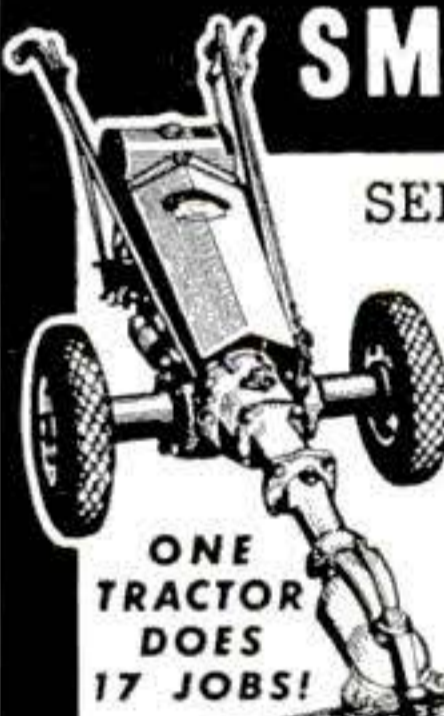

SEE THE POWERFUL 5-H. P. GRAVELY--

the world's finest, yet most moderately priced Garden Tractor. Complete line of exclusively designed power tools for every Garden, Lawn and Field job.

ONE TRACTOR DOES 17 JOBS!

GRAVELLY TRACTOR

FIELD-TESTED FOR 27 YEARS

MAIL NOW! FOR NEW FREE BOOKLET!

GRAVELLY MOTOR PLOW & CULTIVATOR CO. BOX 1184 DUNBAR, W. VA.

NAME _____

ADDRESS _____

TOWN _____ STATE _____

SOLVING YOUR LAWN & GARDEN PROBLEMS

Hailed as the Greatest of all time!

the NEW **1950**

HARLEY-DAVIDSON

HYDRA-GLIDE

YEARS AHEAD! More Power • Greater Acceleration • Road-hugging Stability • Feather Touch Steering • Positive Braking • Amazing Comfort.



Everywhere you go, experienced motorcyclists say this is the finest Harley-Davidson of them all! They acclaim its surging new power, its rocket-like acceleration, its easy steering, positive braking, ground-gripper stability and its amazing float-along comfort that lets you ride all day without tiring! You'll enjoy the outdoors as never before, as you take in thrilling race meets, hillclimbs, gypsy tours and sightseeing trips. And you'll agree, there's no sport like motorcycling, no fun like owning a Harley-Davidson! One ride will convince you. Small down payment and easy terms . . . and "you're in!" See your dealer without delay. Mail the coupon now.

HARLEY-DAVIDSON MOTOR CO., Dept. PS, Milwaukee 1, Wis.

Send free copy of ENTHUSIAST Magazine filled with motorcycle action pictures and stories; also literature on new 1950 models.

Name.....

Address.....

City..... State.....

DEALERS: Valuable franchises available for the full line of Big Twins and Lightweight. Write today!

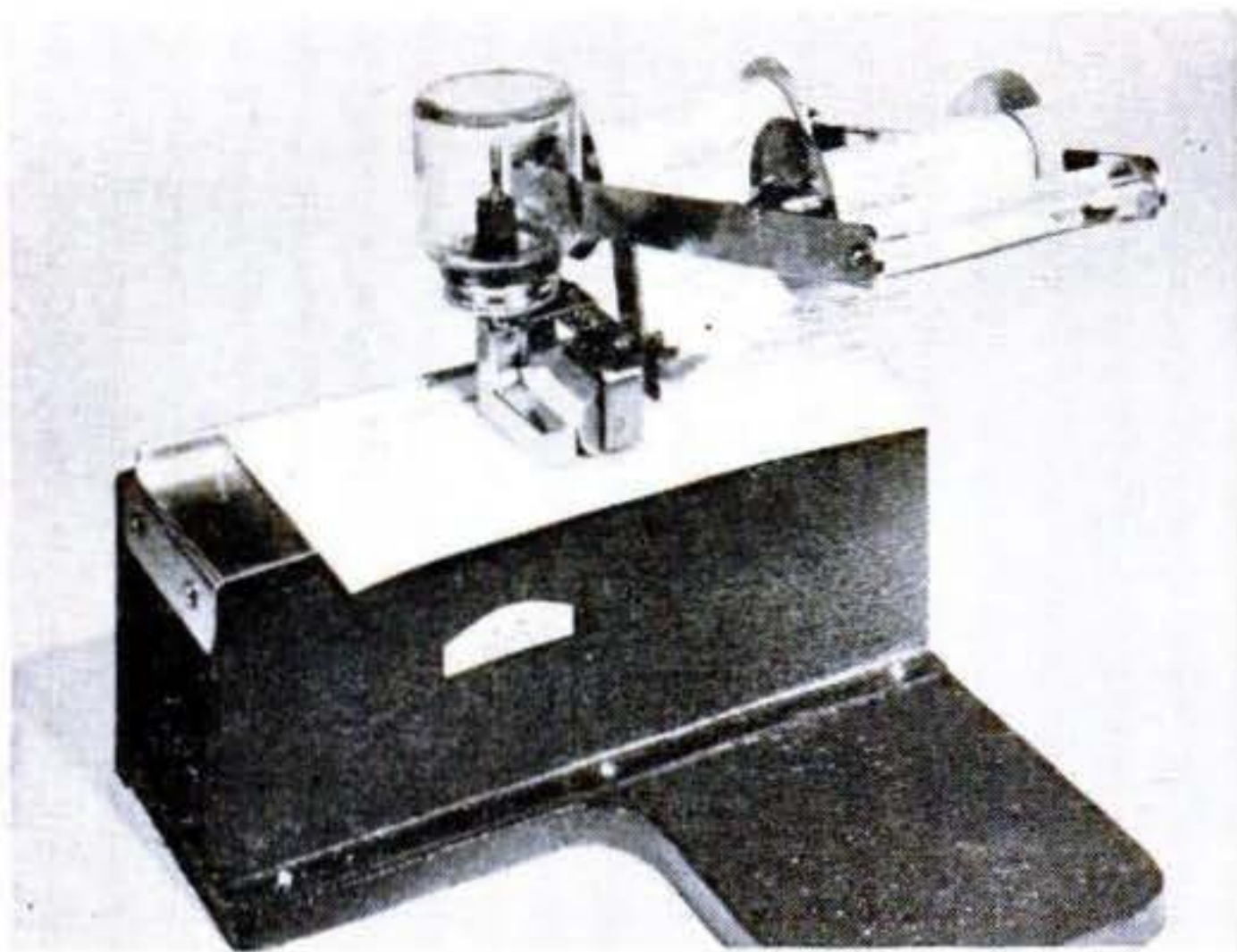

Paper Tape Stamps Addresses

THIS machine prints addresses on envelopes from a paper tape that can be used 100 times. The tape, backed by special carbon paper, is first typed, then mounted on the addresser, carbon side down. When an envelope is placed on the machine, a roller coats its face with invisible printing fluid. The tape is then pressed against the envelope, and its carbon impression imprints the address on the treated surface. The Weber Addressing Machine Co., of Mt. Prospect, Ill., makes the device.



Neon Sign Has Plug-In Letters

A STOREKEEPER can change an advertising message in a matter of seconds with this new display sign that has interchangeable neon letters. The letters in the sign plug like radio tubes into sockets, which are mounted on a double-tiered platform. Available in five colors, they consist of all the letters in the alphabet, numerals, dollar and cent signs, and punctuation marks. The display, which plugs into any 110-volt AC circuit, is made by the Neco Manufacturing Company, Inc., of Auburn, Ind.

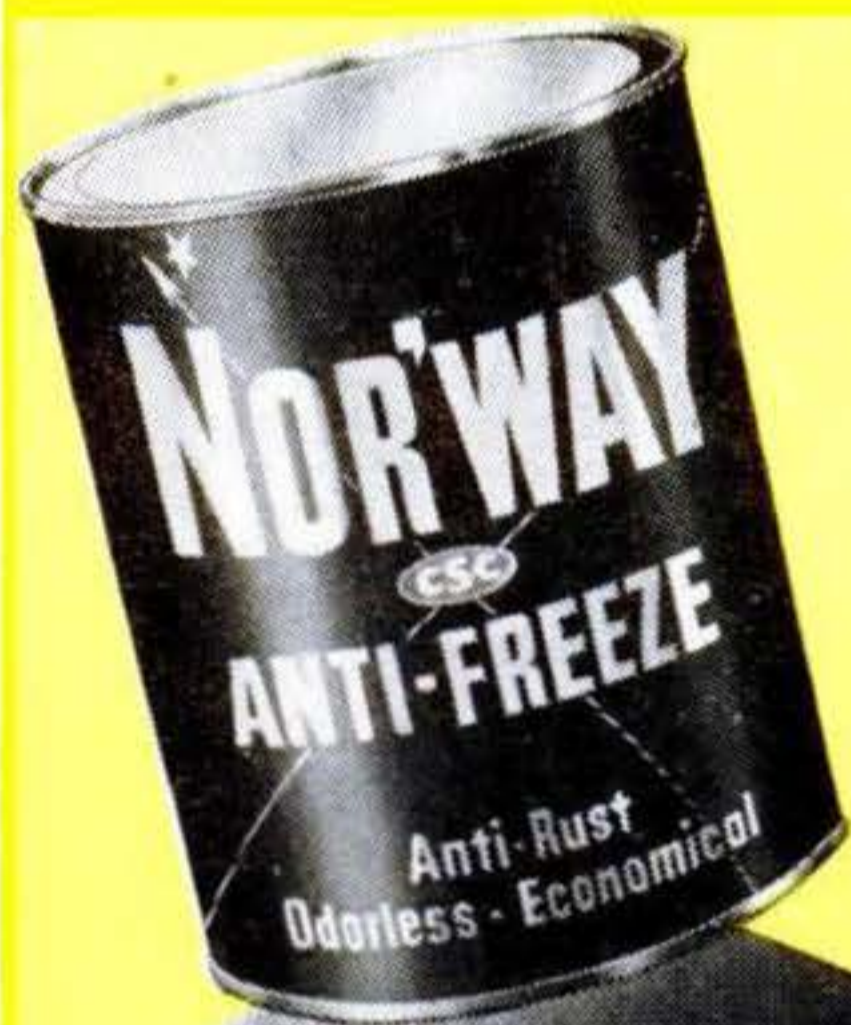

RADIATOR

NORWAY

2-WAY PROTECTION

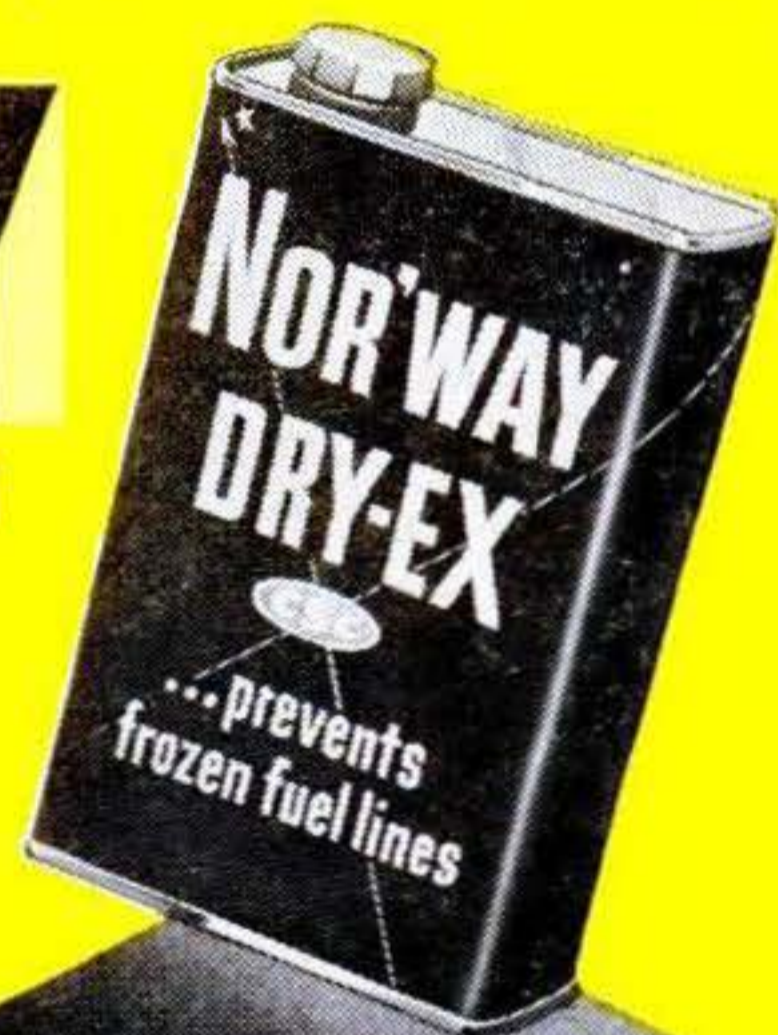

GAS TANK



Extra Strength gives the most protection at the lowest cost.

No disagreeable odors.

Long Lasting! Safe, sure protection with only an occasional check-up.

Prevents Corrosion of all cooling system metals!

Absorbs water in gasoline.

Prevents stalls from frozen fuel lines!

Stops motor spit and sputter.

Relieves hard starting due to moisture in fuel system.

NORWAY® DRY-EX®

PRODUCTS OF COMMERCIAL SOLVENTS CORPORATION

Model No. 37-510

\$89²⁰

As illustrated below, less motor and switch rod. About \$8.92 down!

Price subject to change without notice

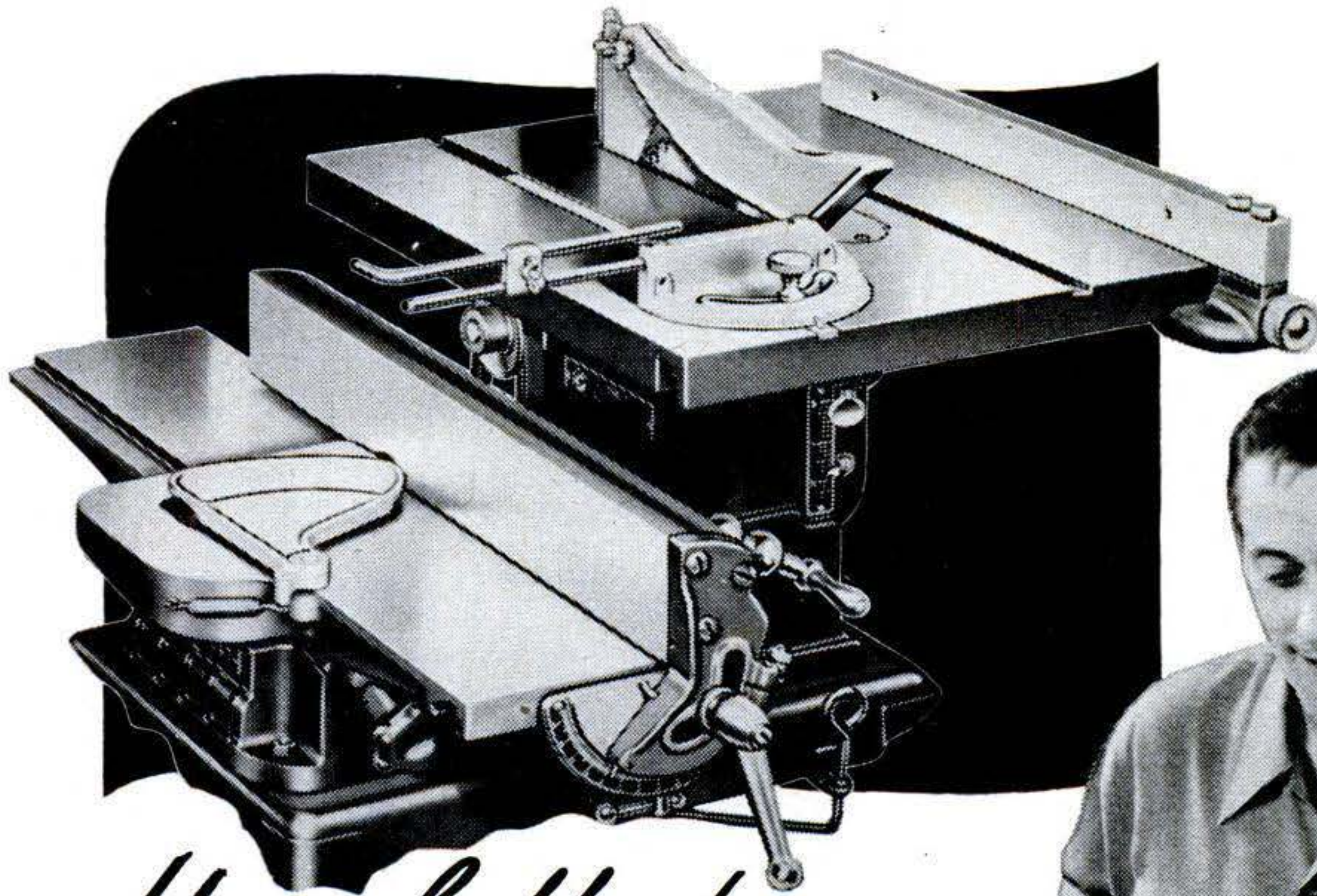

Have hobby fun...
cut cost of home repairs...with
New **Delta[®] Homecraft**
Saw-Jointer

Low-cost combination unit does most home-shop jobs

Two of the most versatile Delta Homecraft Power Tools, mounted on a single steel stand, driven by one motor — and offered at a money-saving price.

This new combination takes floor space of only 25 1/4" x 28 1/4". Husky 8" tilting-table circular saw cuts stock up to 2 1/4" thick on large 15" x 18" table. Jointer planes wood 4" wide and cuts rabbets 1/4" deep. Fence tilts 45° to right or left.

You can use this Delta Homecraft Saw-Jointer on many jobs around the house. Use it to make mouldings, picture frames, and railings. Fix broken drawers or make new ones, make those shelves you've wanted, make toys and gifts, and do countless other jobs.

See this new Delta Homecraft Saw-Jointer today at your nearest dealer. If you don't know who he is, send us coupon below for his name and address — and your free copy of shop-planning book.



DELTA MILWAUKEE HOMECRAFT[®]

FREE "How to Start Your Home Workshop"

BOOK Page after page of ideas, tips, and pictures to help you in planning and getting started. Send coupon at right for your copy.

TEAR OUT COUPON AND MAIL TODAY!

Power Tool Division
ROCKWELL MANUFACTURING COMPANY
682M E. Vienna Ave., Milwaukee 1, Wis.

Send me free book, "How to Start Your Home Workshop," and also list of Delta Homecraft dealers.

Name.....

Address.....

City..... (.....) State.....

HM-72

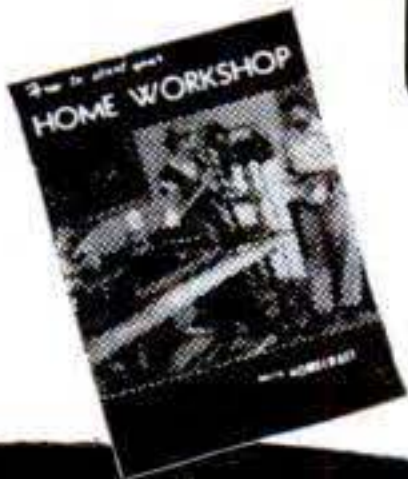

WHAT GOES ON INSIDE YOUR CAR?

Smooth, comfortable, carefree driving comes from "within". That's where Pyroil works for you. You can depend on Pyroil to clean your motor and keep it clean because it removes harmful carbon and sludge deposits. You can depend on Pyroil to maintain piston and cylinder surface lubrication, preventing dry friction wear and corrosion.

Next time you stop for gas or oil—add Pyroil—add more smooth miles to your car.

Pyroil for Aircraft Engines

Use Aircraft Pyroil B for lubricating oil, Aircraft Pyroil A for gasoline.

Ideal Christmas Gift

Surprise him with a practical gift that will be enjoyed for months—a twin quart Christmas wrapped package of Pyroil—one quart for the gasoline—one quart for the lubricating oil. Included in each package (without extra cost) are two useful auto accessories—a windshield scraper and a rubber key case—extra gifts he will appreciate.



**2 Extra Gifts
At No Extra Cost**

SPECIAL GET ACQUAINTED OFFER

This unusual gift—2 quarts of Pyroil and 2 extra gift items only \$3.25 postage prepaid anywhere in the U. S. You not only give a gift—but improved car motor performance that will thrill him. Mail your order today. It's a great way to remember all your friends who drive. Send remittance with order to save C.O.D. charges, we will have a local dealer fill your order or we will fill direct.

PYROIL COMPANY

442 Main Street La Crosse, Wisconsin

Transvener

HOME
APPLIED



Authentic

GRAIN TRANSFERS

Add the richness and beauty of Transvener's versatile finishes to your home furnishings. Do your own finishing and decorating, on new or old furniture, with these easily applied all-Lacquer reproductions of fine Wood Grains and Marbles.

Send 10c TODAY For

Descriptive Color Brochure showing Grain Transfer patterns and complete information on "Ready-to-use" Kits which contain all necessary materials to decorate over 15 Sq. Ft. of surface.

COMPLETE KIT (Postpaid in U.S.A.).....\$5.25

TRANSVENER PRODUCTS COMPANY

45R. East Main St. • Dept. G5 • Alliance, Ohio

DRAINS CELLARS, WASH TRAYS CIRCULATES OIL



Pumps 1800 GPH 300 gal. 30' high, uses 1/8 to 1/3 HP motor. Will not clog. **\$6.50**

Postpaid if cash with order.
(Add 50c for west of the Mississippi.)

Thousands in use since 1936

LABAWCO PUMPS, BELLE MEAD 3, N. J.

FILE SAWS FOR PROFIT!

NEW BeMaCo Rapid Saw Filer opens the door to extra income. Easy to operate. Fast, efficient power filer. Priced right! Does a beautiful job. Operator has complete control.

BeMaCo Rapid Saw Set—Finest Automatic Saw Set on the market. Manufactured exclusively by Beaver Mfg. Co. Sets 400 teeth a minute. No tooth breakage. For hand saws or band saws. Start earning now.

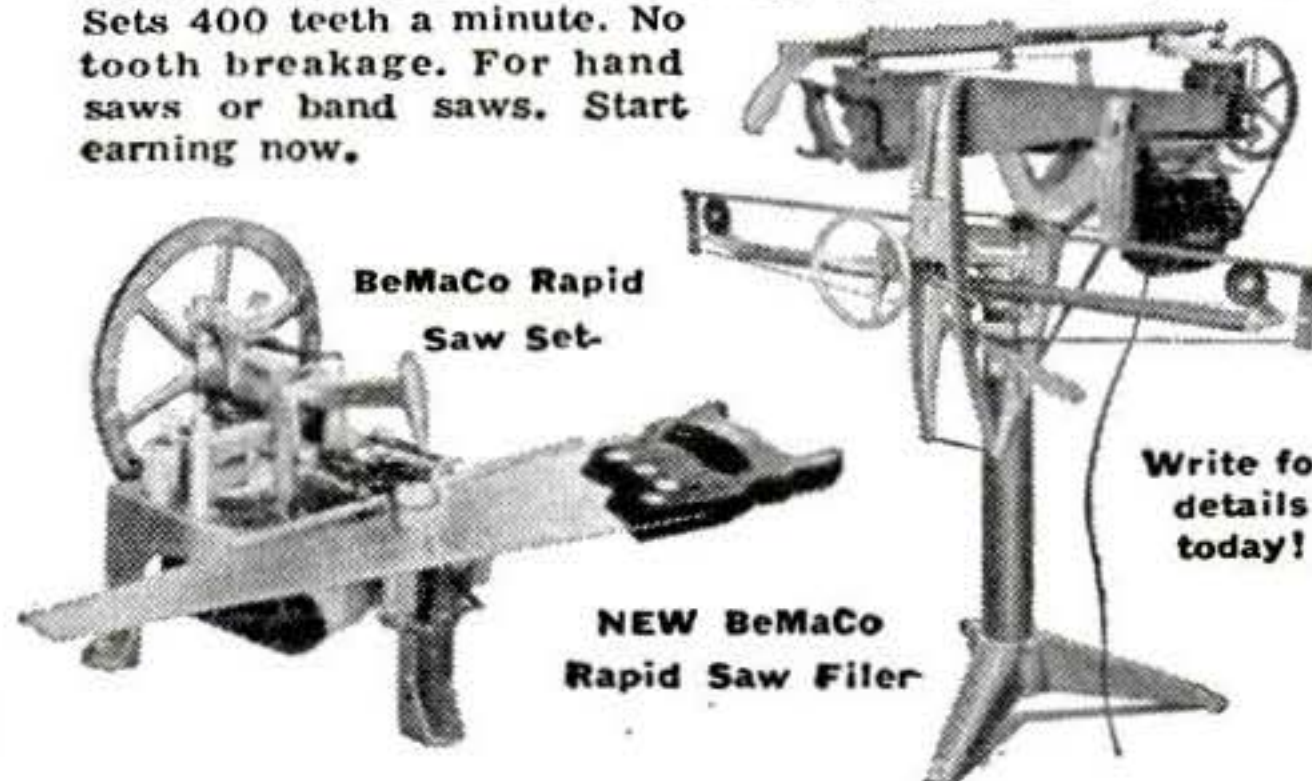

Write for
details
today!

BEAVER MFG. CO.

800-H South Isis Avenue • Inglewood, California

a practical gift for a merrier Christmas...

Home Craftsmen . . . Radio Men . . . Meter Men
 Carburetor Repair . . . Sewing Machine
 and Business Machine maintenance . . . and
 all home appliance repair men will find
 this set well suited for their work.

Snap-on's
MIDGET
TOOL SET
 Built for Professional Mechanics



X115-TMB
 Midget Sized
 Socket Set
 1/4" drive

HERE'S WHAT YOU GET:

- | | |
|---|-------------------------------|
| Midget Ratchet | Sliding Bar |
| 4" Extension Bar | Midget Gripping Plier |
| 6 Hex. Sockets,
3/16", 1/4", 5/16",
3/8", 7/16", 1/2" | Screw Driver |
| 3 Square Sockets
1/4", 5/16", 3/8" | Screw Starter |
| | Chrome-plated flock-lined box |

The man who gets this set of Midget Snap-on tools will say that they are the finest he ever owned for doing tiny, tricky jobs on small equipment. No more fumbling with oversized tools that can slip and break delicate parts.

Connecting drives, socket openings and ratchet parts are precision machined.

This smart set comes in a handsome chrome-plated metal box with beautiful red flock lining. All wrenches and sockets are chrome-plated.

\$14⁸⁵

Add local Sales Tax

Mail This Coupon Today!

SNAP-ON TOOLS CORP., 8060-K 28th Avenue, Kenosha, Wisconsin
 Please send me the Midget Tool Set in time for Christmas. I enclose Check, Money Order for \$14.85 plus local sales tax.

Name.....

Address.....

City..... State.....

GENUINE
Snap-on Tools

can be bought only from
 Snap-on branch sales
 offices and field represent-
 atives or Direct-by-Mail.



3 MACHINES IN 1!

MARVIN MACHINE TOOL ATTACHMENTS will multiply the value of your Bench Mill many times over. With **MARVIN** units you can do many more kinds of work at greater speed with finer accuracy and at lower cost. Let us prove it on your mill.

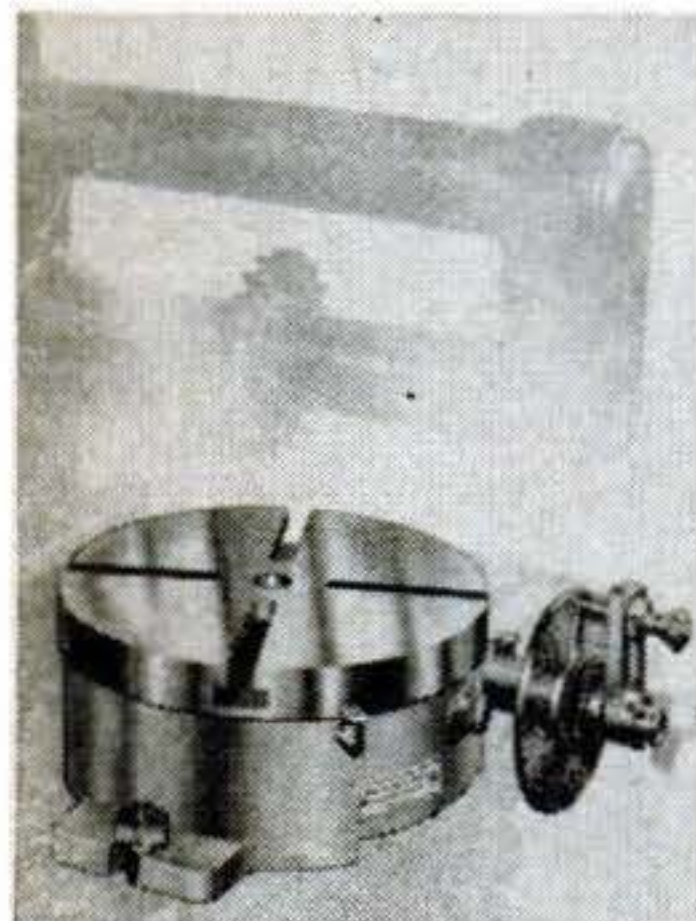

← **MARVIN ROTARY INDEX TABLE** takes guess work out of setting split graduations; it's indispensable to your milling machine, shaper, drill press and surface grinders. This table has a hardened and ground worm; 40:1 ratio, locks from the bottom, will not tilt. With three index plates, each having 6 sets of holes, indexing is simple, fast, accurate, positive. Nothing can beat a **MARVIN** Rotary Index Table. Price \$93.00 F.O.B. Factory.

→ With the **MARVIN VERTICAL MILL ATTACHMENT** you can do profile milling . . . produce cams and clutches . . . intricate molds and dies. It can be set at angles and pulled far beyond table travel for large overhanging work. Price \$65.00 F.O.B. Factory.

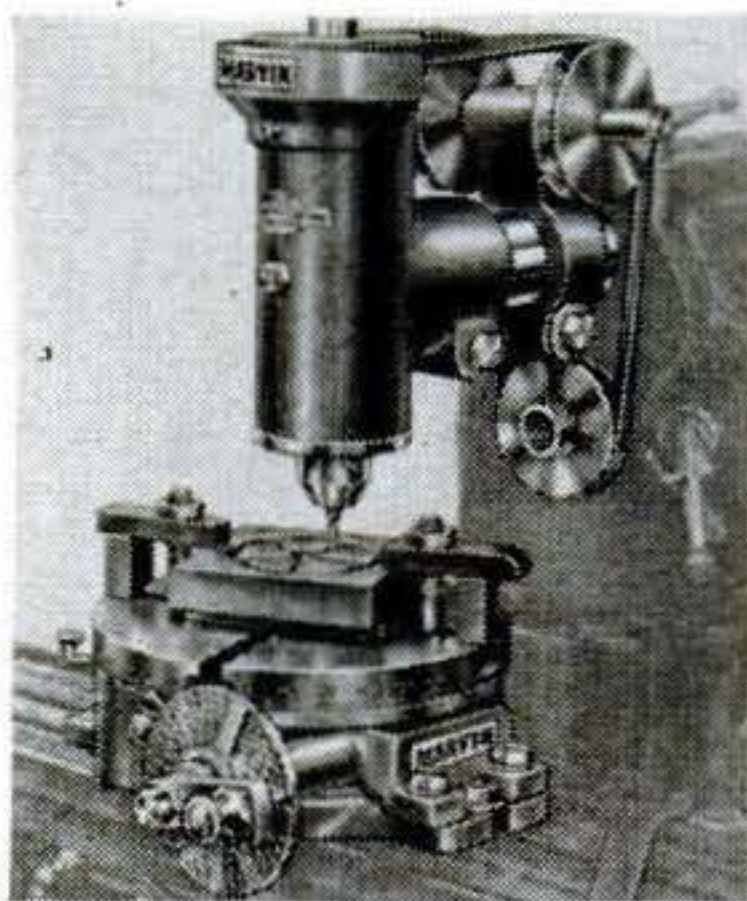

← **MARVIN SLOTTING ATTACHMENT** enables you to cut internal key sets, splines, gears, pulleys and sleeves; also internal gears. The **MARVIN** Slotter can be angled to provide proper draft for dies. Price \$82.00 F.O.B. Factory.

Write now for complete information.

Copyright 1949 by H. B. HAZERODT

MARVIN

MACHINE PRODUCTS, INC.

SALES OFFICE • 414 FORD BLDG.
DETROIT 26, MICHIGAN

Flex-O-Shaft

HANDLES LIKE
A PEN*

\$35⁰⁰



FLEX-O-SHAFT is an improved all-purpose machine for homes, schools, shops, or factories. The slender, light-weight aluminum hand piece is ideal for grinding, drilling, sawing, buffing, scoring, etching, polishing, and scores of other uses. There is no bulky, throbbing, pulling motor in your hand. The light-weight motor can hang on the wall, or can be set down on working table. Speed is controlled by foot-operated rheostat, leaving hands free. This precision ball-bearing tool is as easily guided as a pen, speeding up operation because of ease in handling. It is a wonderful, compact, power house for making all kinds of objects. This unit consisting of **FLEX-O-SHAFT** with 6-ft. cord, 1/16 H.P. Motor. Rheostat with cord and plug, all for \$35.00. Write today!

FLEX-O-SHAFT
and complete
Tool Kit with
66 accessories
ONLY

\$50⁰⁰

F. W. STEWART MFG. CORP.
Dept. D, 4311 Ravenswood Ave.
Chicago 13, Ill.

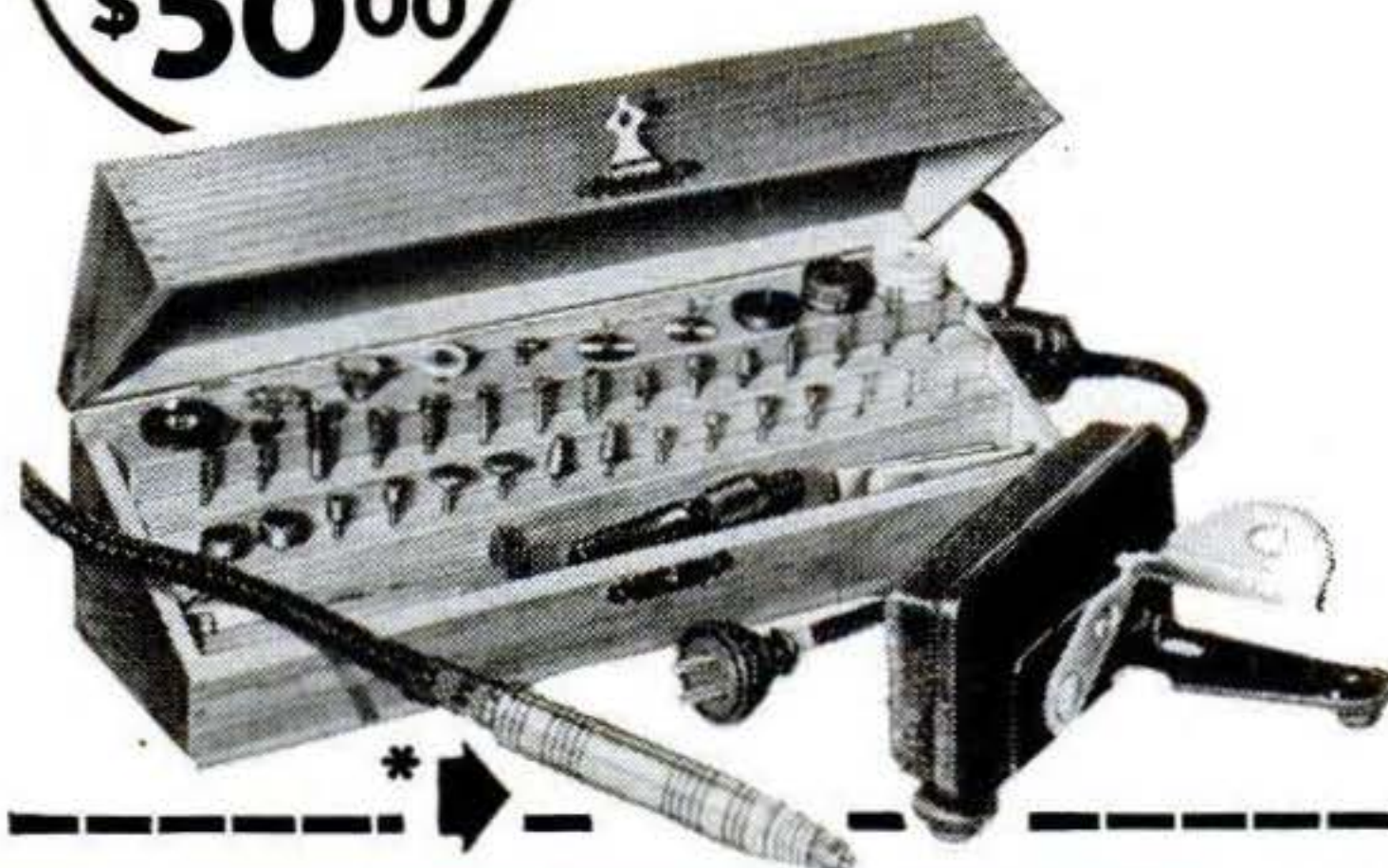

**Always Mention Popular Science
when writing**

**ALL NEW
FOR 1950**

- * PACKAGED BOAT KITS
- * MOLDED BOATS
- * PATTERNS • PLANS

PACKAGED BOATS — EASY TO BUILD

7 NEW TREDRONIC RACERS. 17 sensation-ally new models, skiffs, outboards, run-abouts, racing boats. 8' to 16', all new de-signs, increased performance, simplified as-sembly. World's best boat buy. Send 25c for 1950 literature. Literature & booklet "Ply-wood Boats" \$1.00.

INDUSTRIAL MOLDED HULLS

Made by Industrial Shipping Co., Ltd., Hal-ifax, Canada. Save time, save money, build your boat this sensation-ally new way from one piece, seamless hulls or complete kits (8-18 ft.). Send 25c for literature.

NEW PLANS & PATTERNS FOR 1950

Over 100 modern designs by famous naval archi-tects. Racing classes, cruisers, inboard, out-board, sail. 6 to 35 ft. Construction plans, full size patterns. Send 35c for catalog or \$1.00 for catalog and helpful booklet on Boat Building.

MARINE MART, 1700 NIAGARA ST., DEPT. 23, BUFFALO, N. Y.



When you use pliers . . .



you need CHANNELLOCK

Channellock's patented tongue and groove joint gives you these "plus" features: Greater Strength, Longer Wearing, Self-Cleaning, Closely-spaced Adjustments, Visible Adjustment, No Wear on Joint Bolt.



There are lots of "fussy fix-it" jobs around the house that Dad, Mom or the kids can easily do when Channellock pliers are handy. No matter what—electrical, automotive, plumbing, battery, or anything mechanical—you need Channellock pliers. Look for the Blue Channellock Display Board the next time you're shopping for tools. Step up and select the plier you need from the complete Channellock line. If you use pliers . . . you need Channellock.

CHAMPION DEARMENT TOOL CO.
MEADVILLE, PA.



Send for Catalog C-15 today.



Only CHAMPION DEARMENT MAKES . . .

CHAN NEL LOCK

TRADE MARK REG.

U. S. PATENT OFFICE

Famous CASCO ELECTR-O-TOOL



In New
PLASTIC CHEST
at Same
Low Price!

25-PIECES... Only **\$14⁹⁵**

Most terrific value ever! Electr-O-Tool now comes in a smart, jade-green plastic chest that lasts a lifetime! And at *no increase in price!* Full assortment of most popular accessories! Genuine Casco Power-Head that works wonders at vibrationless *super-speed*. Precision-built! Fractional HP, AC-DC motor. Pencil-grip. On-off switch. Unbreakable plastic Tenite case. Special safety-sleeve. Non-slip chuck. (Free 36-page Project Book with every Kit!)



**Drills! Carves!
Sands! Saws!
Sharpens!
Polishes!
Etches!
Grinds!
Buffs! Cuts!**
For Wood, Metal,
Plastics, Fibre,
Glass, Leather.

CASCO 40-pc. TOOL 'N' RAK Only **\$17.95**
40 pieces, and Power-Head in handy, solid hardwood wall rack.
CASCO 50-pc. ELECTROMATIC Only **\$19.95**
50 accessories, and Power-Head in serviceable, burgundy plastic chest.
Now at Dept., Hardware, Auto Supply, Appliance, Jewelry Stores.

CAR LIGHTER ON THE BLINK? REPLACE IT IN A WINK!

CASCO
"Pop-Out"
CIGARETTE LIGHTER UNIT

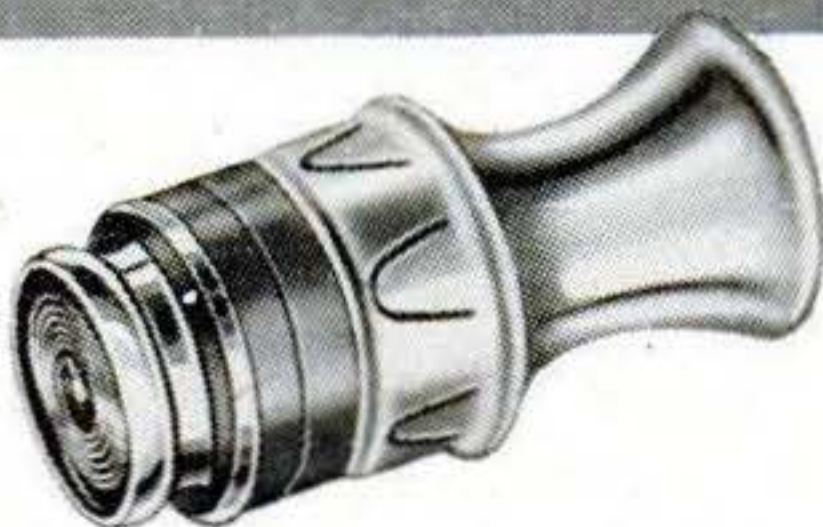

Why do without your lost or broken lighter? It's easy and inexpensive to replace it with a new, chrome-plated Casco "Pop-Out"... original equipment in 9 out of 10 cars. Pops out *automatically* in 10 seconds with a nice, even glow. Blends beautifully with any dashboard. Now at Car Dealers, Auto Supply Stores, Garages, Service Stations..... **\$1.50**

VIS-O-LITE... Amazing new car lighter with illuminated well for safer lighting-up at night..... **\$2.75**

CASCO

CASCO Products Corp.
Bridgeport 2, Conn.



HOW TO BUILD YOUR OWN LOG CABIN LODGE OR BUNGALOW!

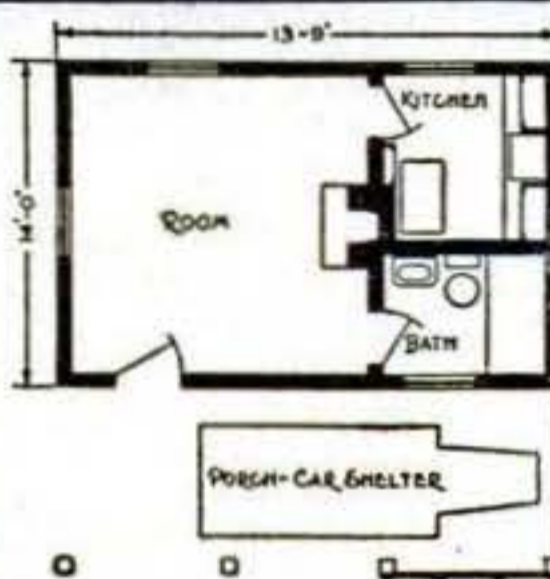

COMPLETE INSTRUCTIONS IN ONE GREAT BOOK!

Countless thousands say this great volume brings them *complete detailed plans* for building their own log cabins and bungalows!

180 PICTURES - 250 PAGES - ONLY \$1.98!

Just take your pick from the scores of cabins, lodges, tourist homes, wayside stands and bungalows jam-packed into this big book, "How to Build Cabins"! You'll learn how to lay a foundation... how to build walls... how to lay floor boards and roofs. Yes, you'll discover step-by-step details for building porches and garages... for cutting doors, windows, and attaching shutters... for building fireplaces and chimneys... and even for installing plumbing and lighting!

SAVES YOU HUNDREDS OF DOLLARS!

Now you can have a vacation spot of your own—a place where you won't be gouged by sky-high summer rentals—one that you can build yourself and *save hundreds of dollars* on the construction costs! And don't imagine that it's hard for you to build—for you'll find this great how-to-do-it book makes it as easy as pie—shows you every move!

SEND NO MONEY - 7-DAY FREE TRIAL!



Imagine! This big book with 180 pictures and 250 pages costs *only* \$1.98! So fill out the order form below right now! When book arrives pay postman only \$1.98 plus a few cents mailing charge as payment in full. If after 7 days' free trial you aren't delighted, return it for a full refund!

MAIL COUPON TODAY!

POPULAR SCIENCE Publishing Co., Dept. 119
353 Fourth Avenue, New York 10, N.Y.

Send me "How to Build Cabins" in edition checked below. I will pay postman price plus postage. If not delighted I may return it within 7 days for full refund.

- DeLuxe Edition in handsome Buckram binding, only \$2.48
- Regular cloth-bound Edition, only \$1.98

Name.....

Address.....

City..... Zone..... State.....

Check here if you send payment with order, and we will pay shipping costs. Same return privilege.

AT LAST! A REAL ONE-MAN POWER CHAIN SAW

HERE IT IS!

The McCulloch gaso-
line-powered portable
saw cuts like fury through
any kind of tree or timber—
and weighs less than 25 lbs. You
can take it anywhere without effort:
up hills, through brush, across wet or
snow-covered ground, or up in a tree. Wood-
cutting was once hard work; it's much
easier and far faster with a McCulloch.

**DOZENS
OF USES**

LAND CLEARING and LOGGING

McCullochs cut close to the ground—leave more wood in the log and less in the stump. They'll easily handle hard and soft timber up to 2 feet thick.

CORDWOOD and FIREWOOD

You can pile up cordwood fast with a McCulloch, for sale and for your own stove and fireplace. Cordwood has been getting more expensive each year.

TREE MAINTENANCE

The light-weight McCulloch is the ideal tool for all types of tree surgery and right-of-way operations. It has many uses in orchards, on estates, etc.

MAKING POSTS

It takes little time to earn back the total cost of a McCulloch and make a profit besides in cutting poles and lumber for fence posts.

CONSTRUCTION & MANY OTHER USES

Because the McCulloch will saw at any angle, crosscut or rip, in any kind of wood, it has literally dozens of uses, including making rough construction timber from logs, for buildings, bridges, docks, etc.

3 MODELS AVAILABLE

18-inch blade, \$295 • 24-inch blade, \$315 • 14-inch bow, \$325

All prices f. o. b. Los Angeles



GREATEST DEVELOPMENT IN POWER-SAW HISTORY

McCulloch Motors, who have manufactured thousands of chain saws for the logging industry, drew on their years of experience to design this truly outstanding power saw. Despite its light weight, the McCulloch Model 3-25 is a *production tool*, built for 8 hour a day sawing. Every feature for fast, convenient sawing is incorporated; automatic clutch, built-in chain oiler, anti-friction bearings throughout, *kick-proof* rewind starter, and special 3-horsepower 2-cycle McCulloch gasoline engine that operates at any angle or position at full power.

CASH IN ON TIMBER Whole new opportunities for saving money or for going into a profitable full or part time business are yours with the new McCulloch 3-25 chain saw. Be sure to send for complete information today.

FREE LITERATURE—SEND COUPON TODAY

McCULLOCH MOTORS Corporation, Dept. P1
6101 W. Century Blvd., Los Angeles 45, Calif.
Please rush complete information on the
new McCulloch Model 3-25 chain saw.
Send name of nearest dealer.

Name _____

Address _____

City _____ Zone _____ State _____

McCULLOCH MOTORS
CORPORATION
6101 W. Century Blvd., Dept. P1, Los Angeles 45, Calif.
NATIONWIDE SALES AND SERVICE
DEALERS Write for Information

THE BULL BUFFER

PAT. PEND.

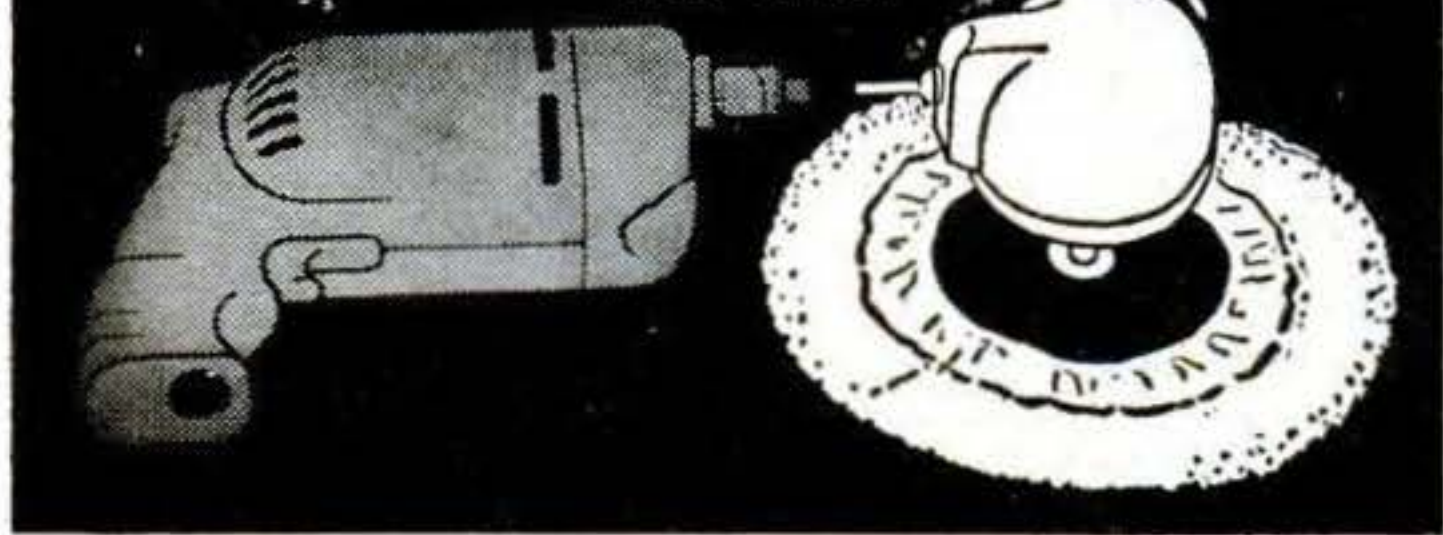

\$9.95 Famous angle-head polisher-sander complete with sheepskin bonnet and 2 sanding discs. Fits the chuck of any 1/4 inch electric drill. A heavy-duty, rugged tool you'll use to make your car, floors, woodwork, furniture gleam like new! It's America's First Choice—more than 100,000 in daily use. Order today!

ORDER THESE ACCESSORIES FOR YOUR BULL BUFFER

(For use with Bull Buffer only)

5 3/4" finest quality bark tan sheepskin bonnet, \$1.25. 5" aluminum oxide production sanding discs (0000-00-0-1-2 1/2-3), \$.10 each. #4 open grit, \$.15 each. 1/2" Jacobs Hex key chuck. When attached to the Bull Buffer, gives you angle-head drilling attachment. Increases 1/4" drill to 1/2" capacity, provides power for heavy drilling in wood or steel. \$5.00. 2 1/2" cup wire brush. Easily attached to Bull Buffer angle-head. Removes paint, rust, scale, etc. Right now! \$1.75.

NEW!

Just chuck it in your drill —and watch the chips fly!



Now you can mortise **on-the-job**, now you can rout **on-the-spot** with the new Bull Mortising Adapter! This amazing new adapter can be attached in either drill or drill press in a matter of seconds, and it gives you a powerful, portable tool that really makes the chips fly!

NOTE: Bull Mortising Adapter is designed specifically for use in any 1/4" electric drill or any drill press; it should not be used with 3/8" or 1/2" electric drills.

BULL MORTISING KIT

Includes Bull Mortising Adapter and 1/4", 3/8", and 1/2" chisels with corresponding bits. Complete, guaranteed, **\$23.90** only.....

MORTISING ADAPTER ONLY

Fits any 1/4" electric drill or drill press; also fits any standard mortising bit and chisel..... **\$6.95**



NEW AUTOMATIC SCREW DRIVER!

Now you can get to all those "tight places" and drive screws in seconds where it used to take minutes by hand! The new Bull Driver fits any electric drill, drill press or flexible shaft. **Automatically** centers on screw groove; **automatically** disengages when screw is firmly home in wood or metal. Three models—take your choice and order to-day! Any model.... **\$4.95**

When ordering, specify model in either standard or Phillips. **MODEL A**—Self-centering model for driving screws up to #14. **MODEL B**—Self-centering model for driving small machine screws. **MODEL C**—Without self-centering hood; long blade reaches those extra-deep counter-sunk jobs.



NEW PORTABLE DRUM SANDER

Uses Standard Sandpaper Sheets!

Now you can get to all those hard-to-reach places with the new Bull Drum Sander—a portable 2" drum sander that fits any electric drill (or drill press.) **MOST ECONOMIC!** drum sander on the market because you cut your own strips out of ordinary sandpaper sheets instead of buying costly sanding sleeves! No wedges or screws necessary; new patented feature lets you insert and remove sanding strips at the flick of a finger. Complete, with 6 sanding strips..... **\$4.95**

At All Leading Hardware and Department Stores or Order Direct For prepaid shipment, send cash, check or M.O. to

BERTRUM W. ENGINEERING COMPANY
3121 Main Street DEALERS WRITE TODAY Kansas City, Mo.



Be handier!
End hand work!

Get SKIL Home Shop Tools!

6" SKIL Home Shop Saw

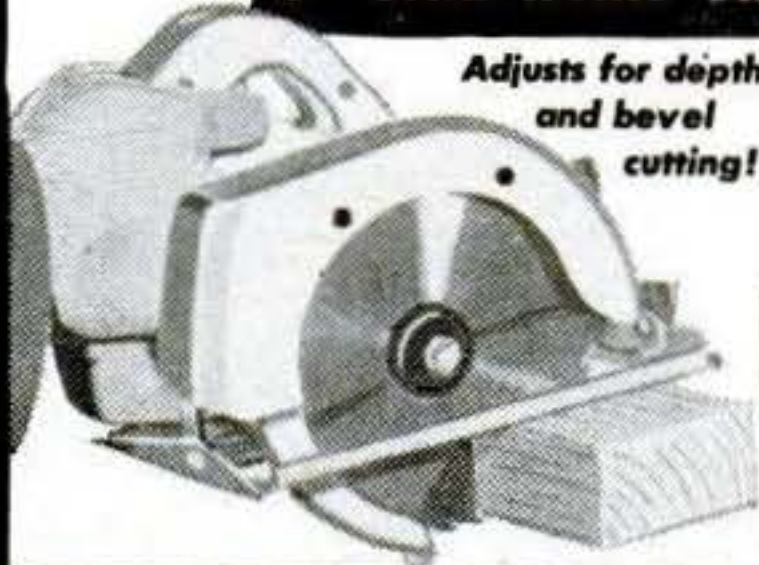

Adjusts for depth and bevel cutting!

Here's a low-priced saw with big-saw features. Fully adjustable for depth and bevel. Powerful, protected 6 in. blade zips through wood, metal, plastics. Easy to handle. Built to last.

1/4" SKIL Home Shop Drill



1/4" SKIL Home Shop Drill Kit

Steel case holds accessories for drilling, buffing, grinding, wire brushing. Includes horizontal drill stand, 13 drill bits, polishing compound, 3 in. grinding wheel, 3 in. buffing wheel, 4 in. wire brush and 1/4 in. SKIL Home Shop Drill.



A fist-full of drilling power! You'll speed countless jobs in home repairs, remodeling and hobby work with this streamlined, easy-handling, fast-working drill. Best quality chuck. Capacity up to 1/4 in. in steel, 1/2 in. in hard wood.



See them at your dealer's today

Made only by SKILSAW, INC., 5033 Elston Avenue, Chicago 30, Illinois

THAT ACCURATE TOUCH...



with the **FINEST IN STEEL TAPES**

It's easy to be right the first time — it's easy to get "that accurate touch" . . . if your measuring instrument is the Master Streamline. This fine tool simplifies and speeds measuring and cuts down time-wasting errors. Its outstanding features are Streamline's guarantee of better measuring . . . graduations on both sides of blade . . . new lever brake to hold reading . . . direct reading inside measure . . . extra long tip holds blade steady . . . and many others found only in the Master Streamline. See your local hardware dealer or use the coupon.

MASTER

REG. U.S. PAT. OFF.

WOOD AND STEEL TAPE RULES

Master Rule Mfg. Co., Inc. PS-11
201 Main Street, White Plains, N. Y.

I enclose \$2.25 for the 6 ft. Streamline
\$2.50 for the 8 ft. Streamline
Engrave my name (75c extra). Please print clearly.

NAME.....

ADDRESS.....

CITY..... STATE.....

· **How easy can night driving be?**
Get General Electric headlamps and see!

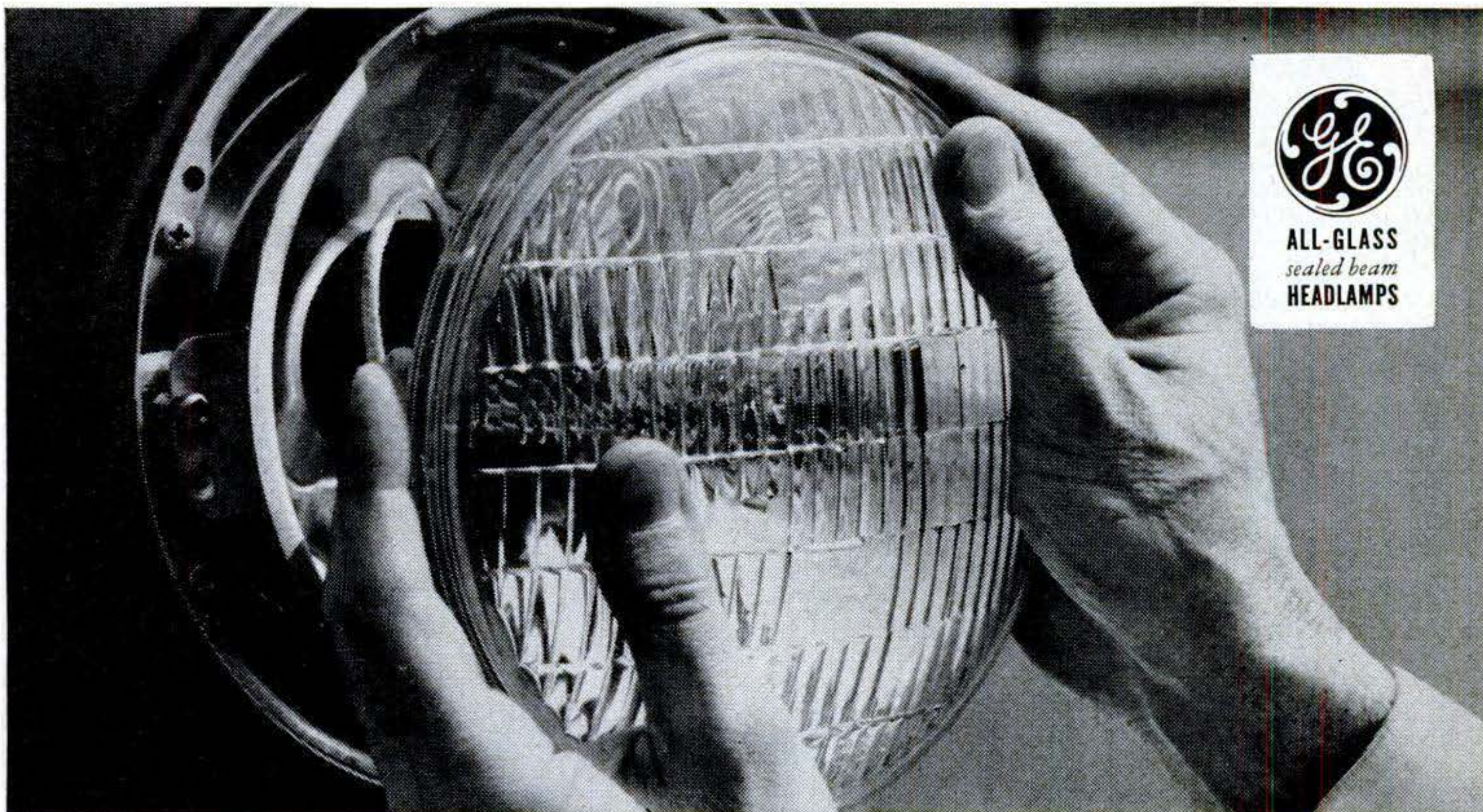

... they do not grow dim!

1. NIGHT DRIVING is easier with General Electric "all-glass" sealed beam headlamps because they average 99% of original light output at end of life. *They do not grow dim!*

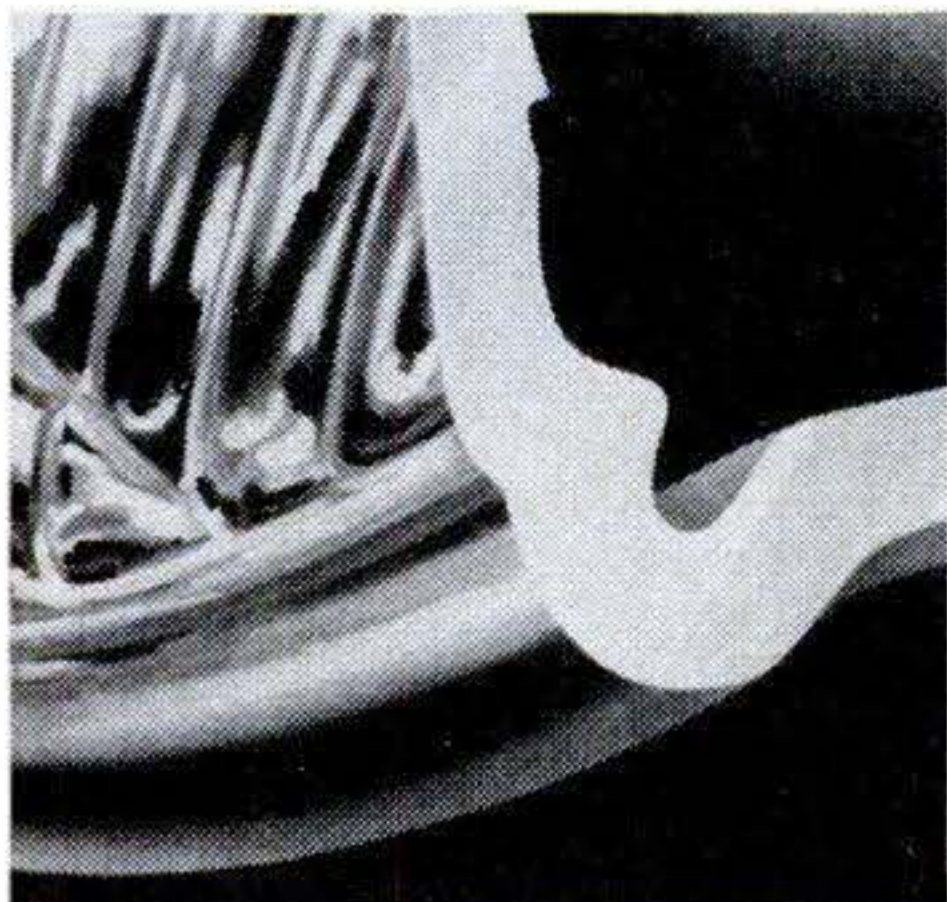

2. DIRT AND MOISTURE can't get in to steal the light—due to the rugged, "all-glass", one-piece construction of G-E sealed beam headlamps.

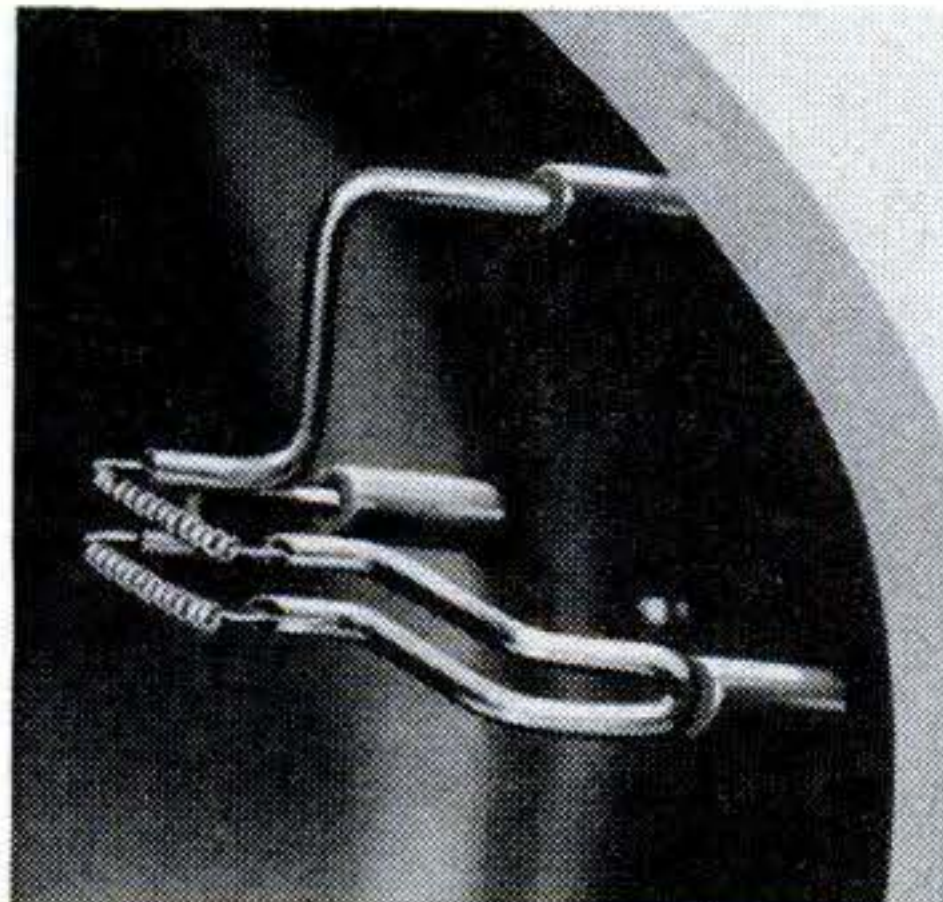

3. FILAMENTS are held in vise-like grip. Won't shake loose on bumpy roads. Give 12% more light on the road for driving, 16% more light for passing.

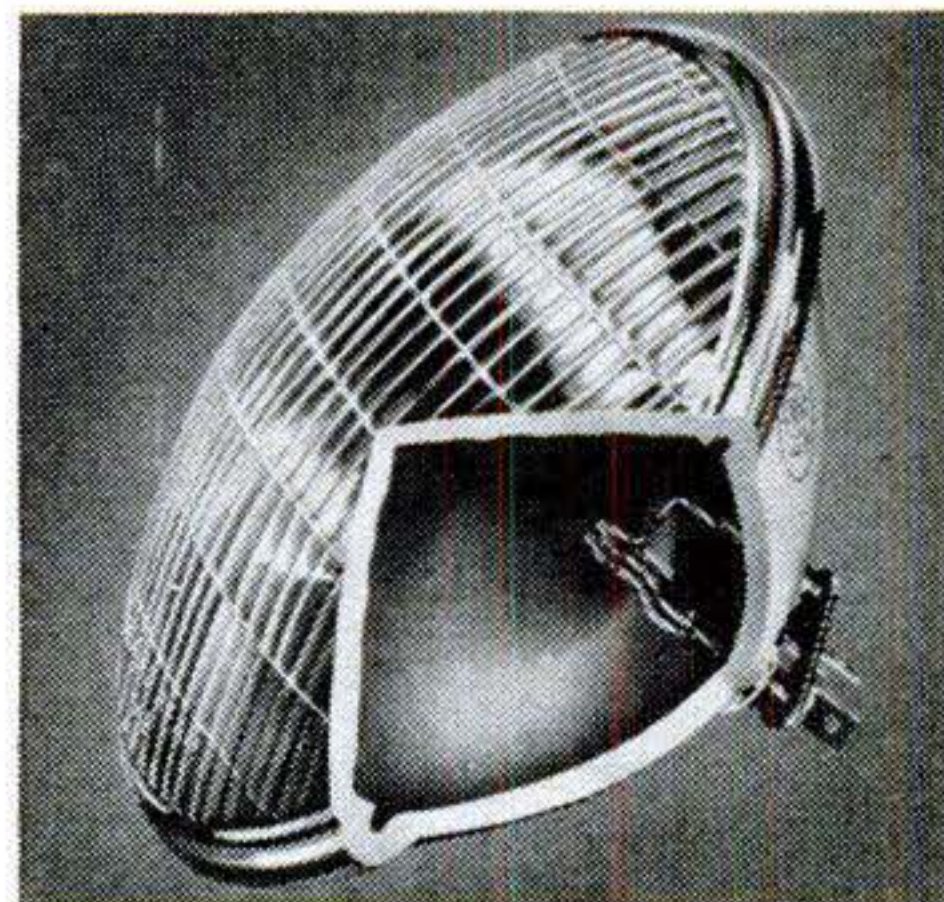

4. HARD-GLASS LENS is precision-made to throw maximum light on road. Have lights checked when car is serviced—and insist on G-E for replacement!

You can put your confidence in—

GENERAL  **ELECTRIC**

ONLY \$199.50 FOR A COMPLETE POWER WORKSHOP



Your complete power workshop in just 18" x 60" floor space. With 1/2-hp. ball-bearing motor illustrated, \$199.50.

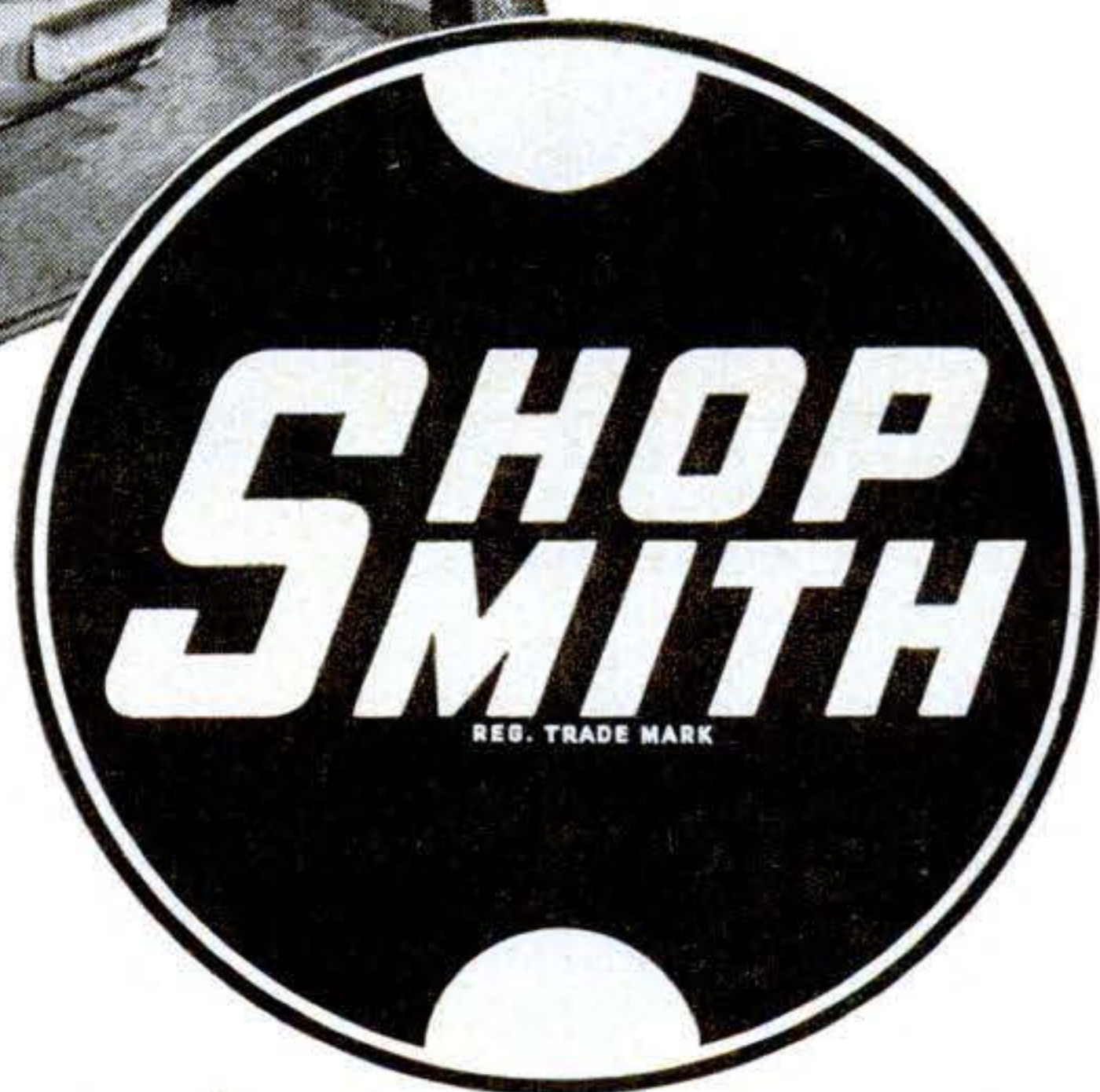

FOR less than \$200—and with eight square feet of floor space—you can have a power shop second to none in capacity, accuracy and flexibility. It's SHOPSMITH—five heavy-duty, extra-feature tools in one unit so beautifully engineered, so ingeniously designed that you can convert from tool to tool *in less than 60 seconds*.

NEVER BEFORE SUCH AMAZING CAPACITY

Imagine a circular saw that cuts to center of 8' plywood panels . . . a lathe that takes work up to 15 inches in diameter . . . a drill press that mortises doors and panels as easily as it drills miniature parts . . . a disc sander that squares, miters and

finishes with "try square" accuracy. You get these, and more, with SHOPSMITH.

OUTPERFORMS SINGLE-PURPOSE TOOLS

Compare SHOPSMITH with any combination of single tools at any price. Compare it for accuracy, capacity, all-round utility. You'll see why the thousands of men who own SHOPSMITH praise it so enthusiastically. On display at any Montgomery Ward store and at leading hardware or department stores. SHOPSMITH, complete with attachments, costs \$169.50. With heavy-duty 1/2-hp. ball-bearing motor, \$199.50.

5 RUGGED POWER TOOLS IN 1

1 EIGHT-INCH CIRCULAR SAW

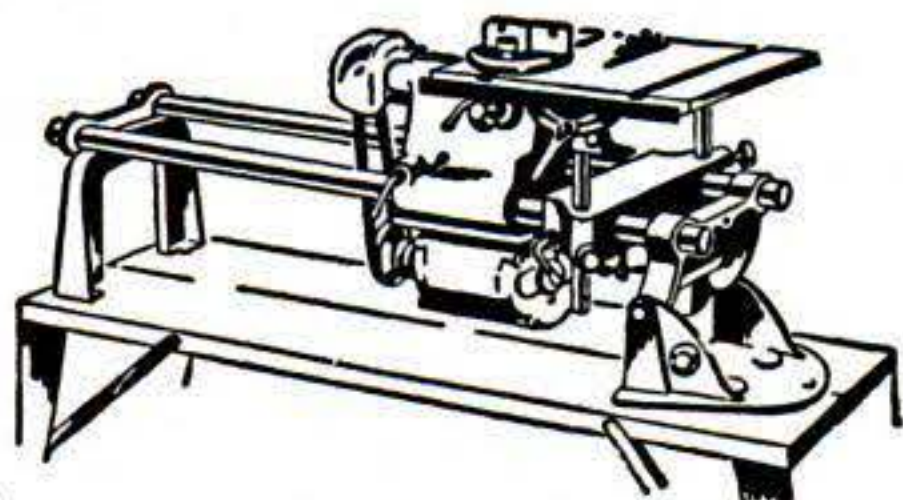

Effective table width up to 56". Maximum depth of cut, 2 1/4". Machined tilting table, ribbed for extra strength. Precision-tooled rip fence and miter gauge. Unique micro-adjustment permits extremely accurate ripping.

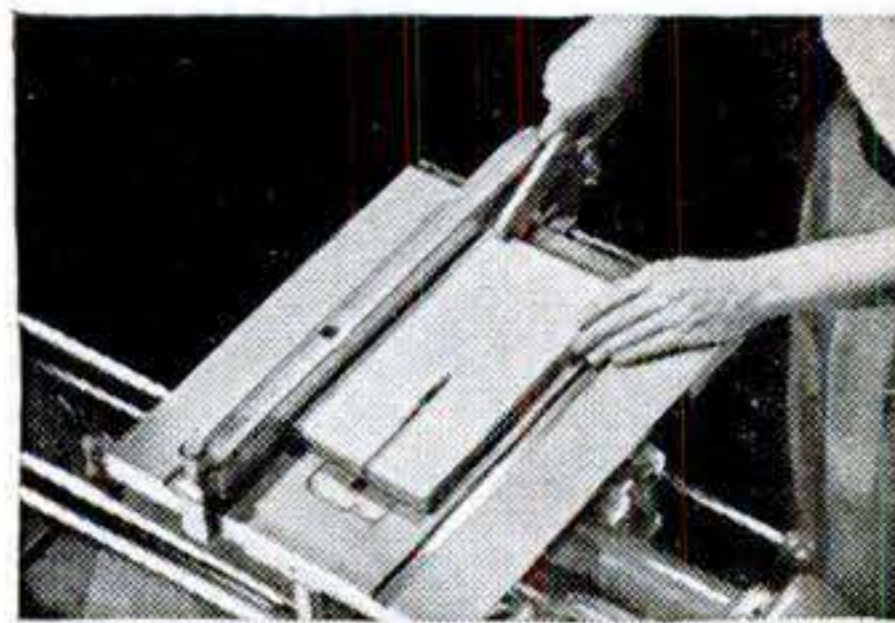

2 TWELVE-INCH DISC SANDER

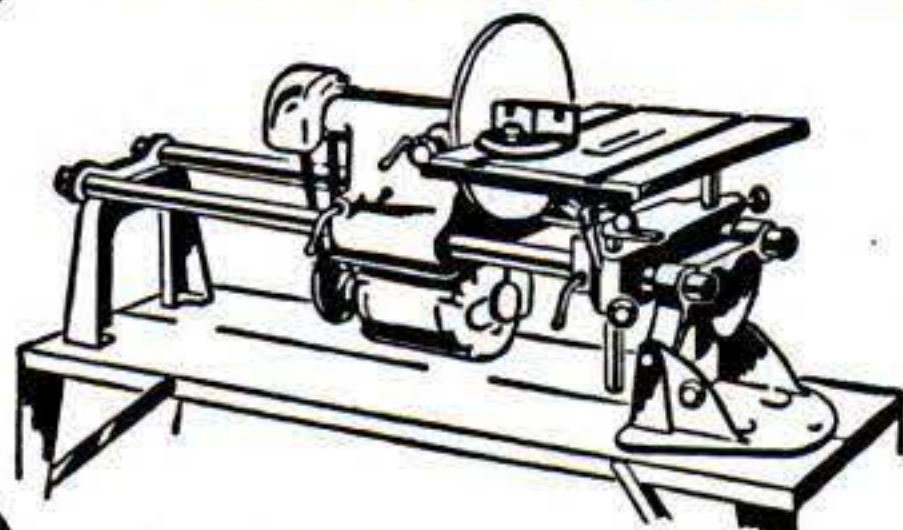

Cast-aluminum disc easy to attach and remove. Extra-large, adjustable table measures 14 1/2" x 17". Miter gauge and rip fence can be used for accurate squaring and jointing. Has features found in no other disc sander.

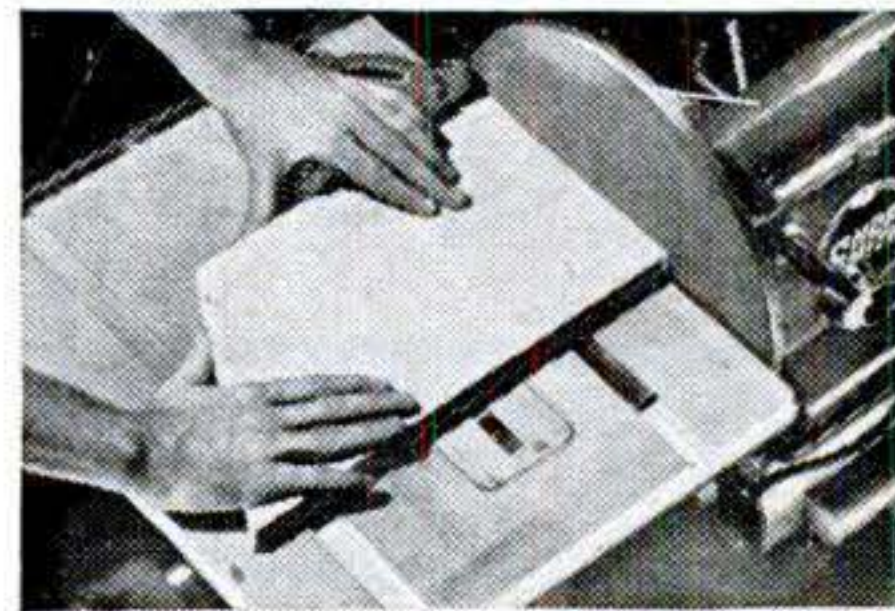

3 HORIZONTAL DRILL PRESS

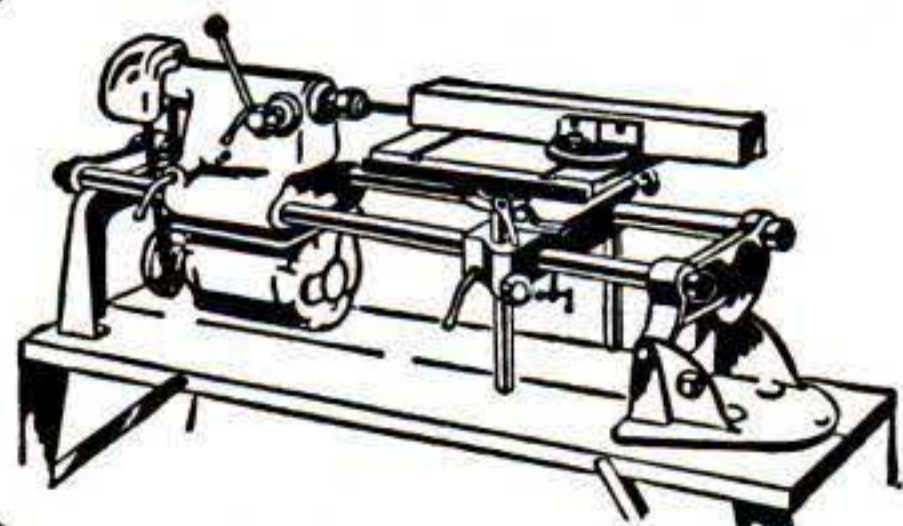

Extremely useful operation possible only with SHOPSMITH. 4" quill feed, automatic stops. Permits large, heavy pieces to be drilled or mortised quickly and accurately. Eliminates need for jigs. Length of work limited only by size of room.

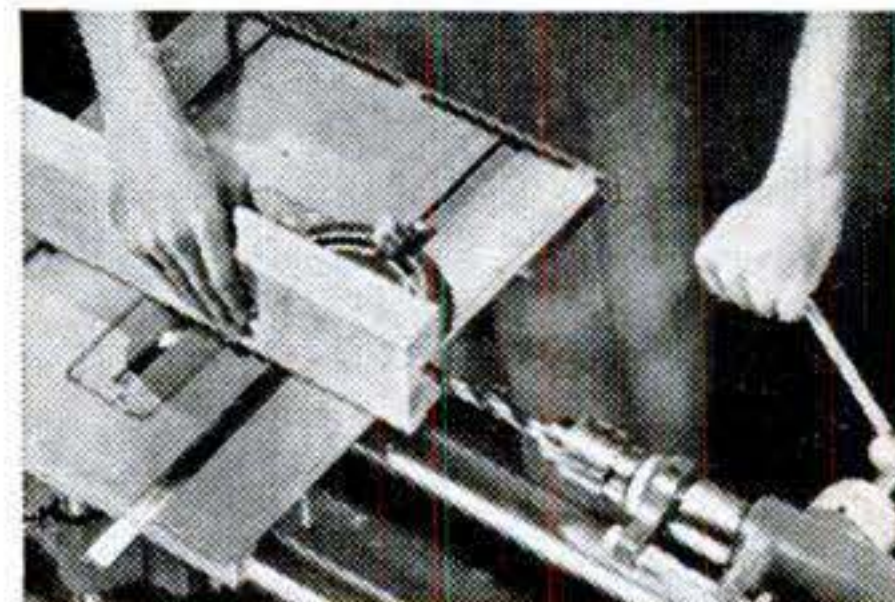

4 VERTICAL DRILL PRESS

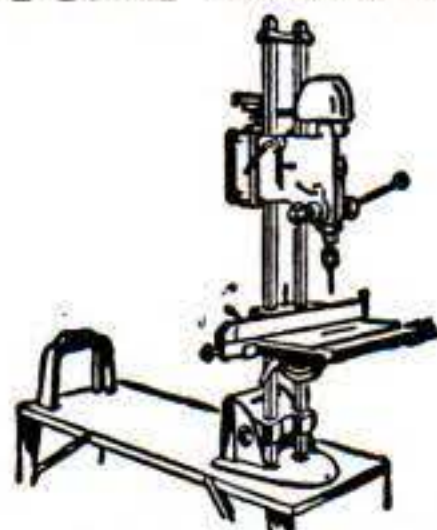

SHOPSMITH drills to the center of a 15" circle, has a maximum clearance table to chuck of 27". Jacobs key chuck takes drills from 5/64" to 1/2" diameter. Rugged, six-spline spindle with 4" feed. Variable speeds 875 to 3500 rpm.

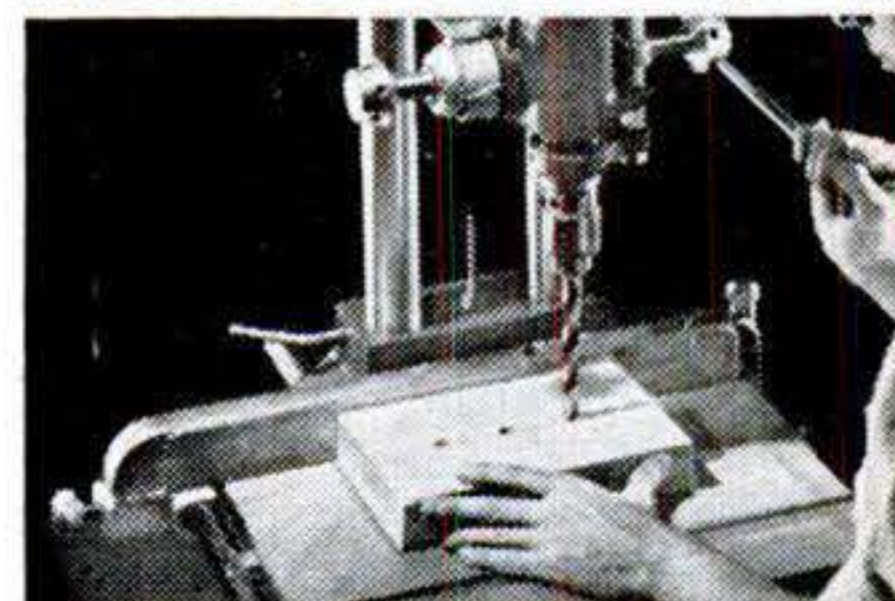

5 THIRTY-THREE-INCH WOOD LATHE

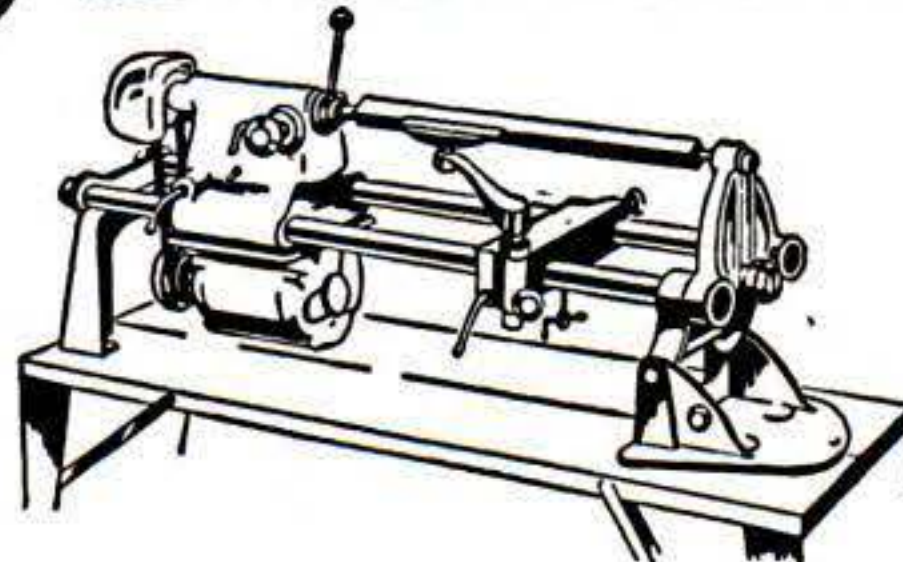

With a 15" swing, SHOPSMITH has greater capacity than most other heavy-duty lathes. Distance between centers, 33". Swivel-arm tool rest always slides parallel to ways—no need for constant adjusting. Has 4" quill feed. Quickly adaptable for oversized faceplate work.

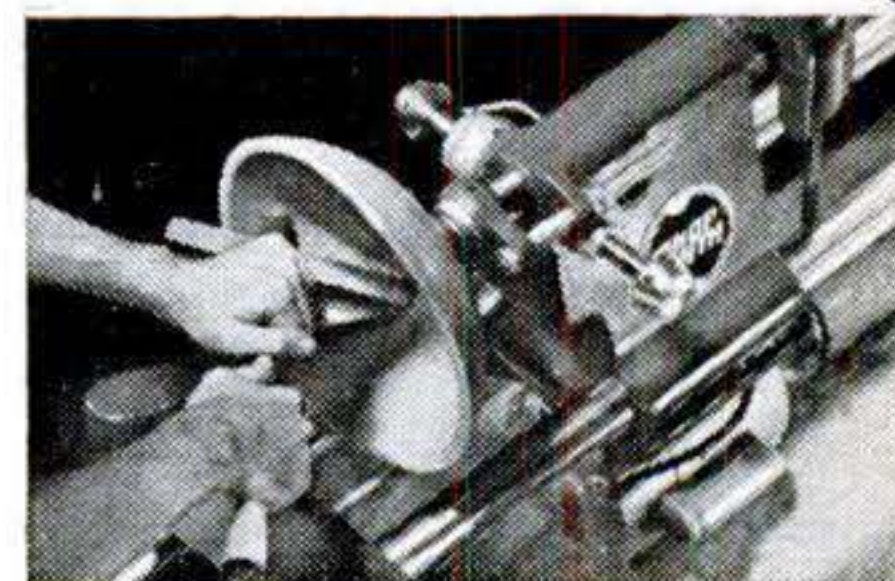

AND THAT'S NOT ALL! WE'VE MORE TO TELL YOU, BUT NO MORE SPACE TO TELL IT HERE. IT'S ALL COVERED IN AN ATTRACTIVE, ILLUSTRATED BOOKLET. WRITE FOR YOUR FREE COPY TODAY!

Address SHOPSMITH, Dept. 105-A,
at factory nearest you.
12819 Coit Rd., Cleveland 8, Ohio, OR
417 Montgomery St., San Francisco, Calif.

I'm interested in SHOPSMITH. Please send me a free copy of the descriptive booklet. And tell me where I can see SHOPSMITH demonstrated.

Name _____

Address _____

City _____ State _____

FREE ALLIED'S NEW 1950 RADIO CATALOG!



SEND FOR THIS
196-PAGE BOOK

Save on Everything in Radio



Get Radio's Leading Buying Guide!

Get everything you need from the world's largest radio supply house—and save money on every purchase! ALLIED's new 196-page 1950 Buying Guide offers widest selections of top quality equipment—ready for speedy, dependable shipment at lowest prices. Have the advantages of expert, friendly service, and guaranteed satisfaction on every purchase. To get more for your radio dollar, send today for your FREE 1950 ALLIED Catalog, the preferred Buying Guide to everything in radio and electronics.

**BUILDERS' KITS
TELEVISION SETS
HI-FIDELITY SOUND
AMATEUR GEAR
THOUSANDS OF PARTS
TUBES, TOOLS, TESTERS
BOOKS & DIAGRAMS**

Everything for
Servicemen, Engineers,
Experimenters, Builders,
Soundmen, Amateurs

ALLIED RADIO

ALLIED RADIO CORP.
833 W. Jackson Blvd., Dept. 7-LL-9
Chicago 7, Illinois

Rush FREE 196-Page Catalog

Name.....

Address.....

City.....Zone.....State.....

FREE
CATALOG

Keep Brushes like New

BEFORE

AFTER

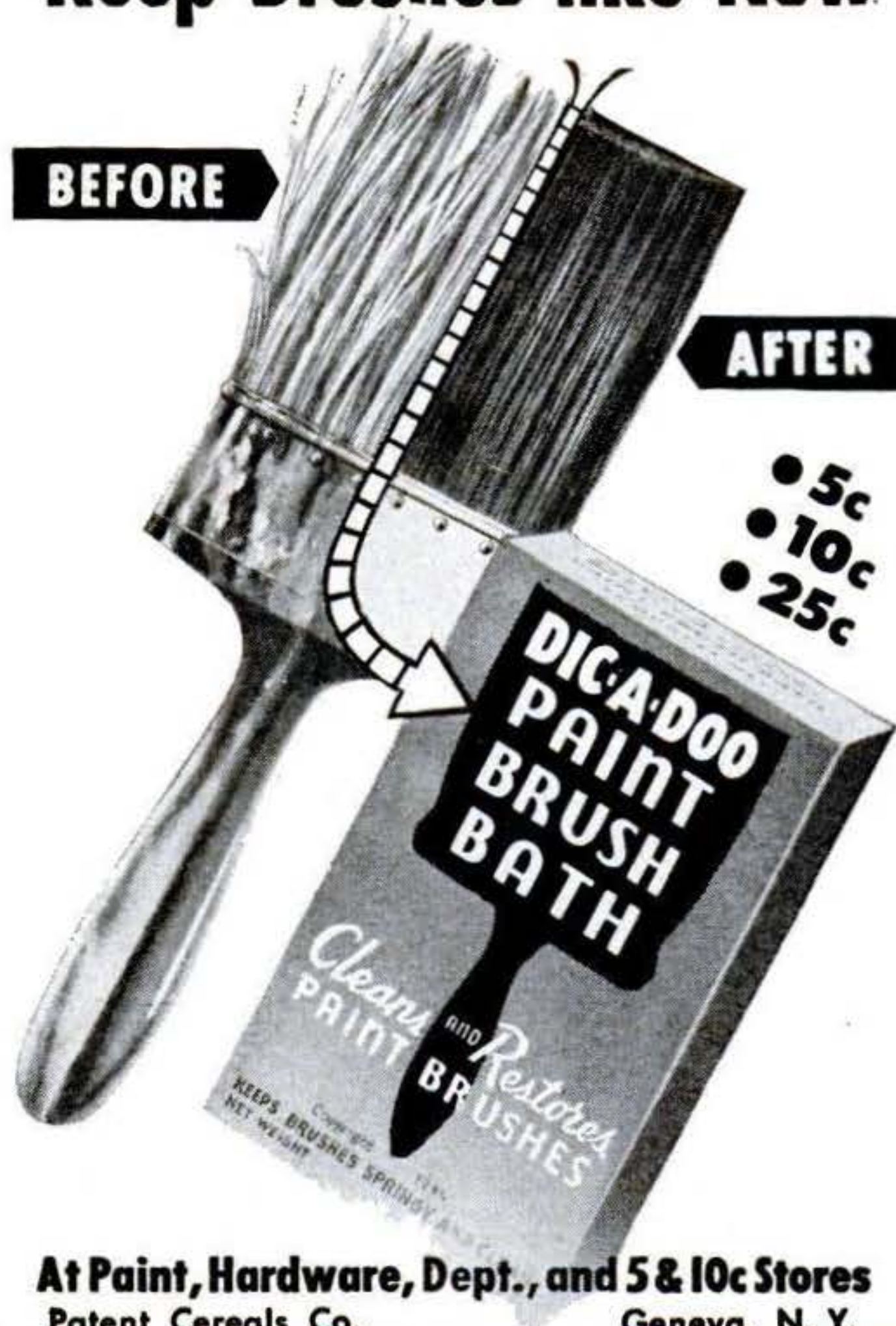

• 5c
• 10c
• 25c

At Paint, Hardware, Dept., and 5 & 10c Stores
Patent Cereals Co. Geneva, N. Y.

AMAZING RESULTS WITH THIS LOW PRICED, OILLESS

Paint
Sprayer



only
\$26.95

LESS MOTOR
\$29.65 WEST COAST

An Ideal
Xmas Gift

Get professional results, outside and inside, 3 to 10 times faster than brush method. New, full sized, streamlined Sprayit "Series 270" applies paint, varnish, enamel, lacquer, etc. Also pumps tires. Uses standard 1/4 H. P. motor. Delivers oil-free air in ample capacity from long-life diaphragm compressor.

Self-lubricating. No pistons or rings! No oil pumping! Easy to carry and use. Factory guaranteed. Complete with 15-foot hose, 1-quart container, internal mix spray gun with round, fan, and angle nozzles. A big value by the pioneers in portable paint spraying equipment. See Sprayit "Series 270" at paint, hardware or auto supply stores. *Accept no substitute!*

Write Dept. 1103 for FREE
Book on Spray Painting

ELSCO

SPRAYIT

ELECTRIC SPRAYIT CO.
SHEBOYGAN, WIS.

"Mr. Big"

of Hand Guns

the



.22 CALIBER, DOUBLE ACTION REVOLVER

Only \$24.75

BIG new features . . . BIG new performance!

NEW coil spring action. Gives match target trigger pull. Returns hammer to half cock automatically, preventing accidental discharge. *NEW* positive cylinder stop assures uninterrupted firing sequence. *NEW* cylinder release for easier, faster reloading. *NEW* front sight.

See . . . handle . . . sight the new improved "922" at your gun dealer's. It's a lot of revolver for little money.

FREE New catalog on all H & R sporting arms. Write for it.

SPECIFICATIONS

Solid frame; 9 shot; shoots long rifle, long, or short regular or high speed ammunition, both single and double action; 6", 4", or 2½" barrels; checkered Tenite stock.

MODEL 923

Same as model "922" except all metal parts are of chrome finish. \$26.78

HARRINGTON & RICHARDSON ARMS CO., 445 Park Ave., Worcester 2, Mass.

PAINTERS' STRIPING TOOL

A TOOL... NOT A BRUSH

NEW, IMPROVED

Modern—streamlined—fits the hand like a fountain pen! Easy to use as a pencil. Draws parallel lines—straight, curve, or circular. Does expert job on autos, furniture, toys, bikes, model planes, signs, bulletins, linoleum. (Makes wall board look like tile.) Every painter and craftsman needs one! Type "M" MASTER Painters' Striping Tool complete with tip for 1/16" stripe, \$1.00. Other tools complete with following tips: 1/64", 1/32", 3/64", 5/64", 3/32", 1/8", \$1.50 ea. Extra tips 75c ea. Entire kit with tool and 7 tips, \$5.00. (COD's postage collect) Paint dealers, write!

EASY AS USING A PENCIL!

\$1.00 POST PAID



WENDELL MFG. CO.
4234-A Lincoln Ave., Chicago 18, Illinois

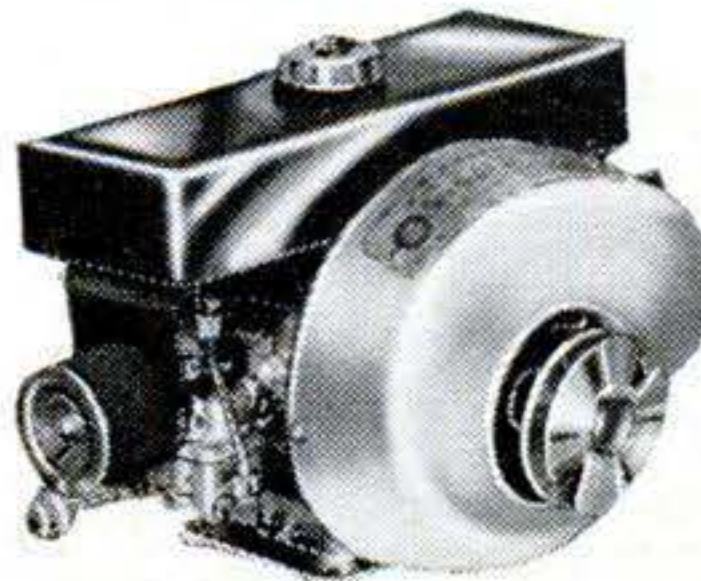

SAVE ABOUT 50%

Limited Supply of the Popular **POWER PRODUCTS** Lightweight, Air-cooled Engines, 1 h.p., 2 cycle

Brand new, complete with air filter, magneto, gas tank, Tillotson float feed carburetor, accurate speed governor. Pulley shaft 5/8" diameter. Speed range 2700 to 3800 R.P.M. Suitable for use on pumps, air compressors, power tools, portable generators, light scooters.

Net weight 18 lbs. Shipping weight 21 lbs.

\$47.50 value for \$24.95

Shipped transportation charges collect. Send postal or express money order with order.

OAKS MOTOR COMPANY

432 North Street

Ludlow, Mass.

GROBAN'S WAR SURPLUS SPECIALS!

Be Prepared with an Auxiliary AC LIGHT PLANT GENERATOR

Ideal For: • Home Lighting • Hunting Lodges • Stand-by electricity • Running all AC electrical appliances incl. fans, motors, electric razors, refrigerators, incubators, etc.

Protection for emergencies to operate oil burner, stoker, freezer, water pump and lights. These units built to exacting Signal Corps specifications are the answer to your lighting needs. Drive it with a 2½ H.P. gasoline engine at 1800 R.P.M.

• 800 watts • 0-150 voltmeter with regulator • 110 volts-60 cycle, AC. Ship. wt. 60 lbs.



AN OUT-
STANDING
VALUE
for

\$59.50

F.O.B. Chicago

(Item #67)

BRAND NEW HALE FIRE and IRRIGATION High Volume CENTRIFUGAL PUMP



For Fire Protection, Irrigation, De-Watering, Industrial Uses, Farm Uses, Etc.
Pumps Rated 500 Gallons Per Minute at 275 Ft. Head Pressure

Equipped with 1½" diameter straight splined shaft for direct coupling drive; 4½" threaded

suction intake; two—2½" threaded discharge outlets; Hale Pump Co. Model CF volute type; use any 4 or 6 cylinder gas engine or couple directly to front of truck or auto; or use 25 H.P. electric motor; dimensions 21" x 24" x 28". Complete with full accessory kit including suction and pressure gauges, priming equipment, and instruction book. Ship. wt. 415 lbs.

GOV'T ACQUISITION COST \$425.00 (ITEM #48) F.O.B. Chicago

NOW
\$149.50

WATEROUS PUMP (Item #71)

Rated 500 GPM at 120 P.S.I.

This high efficiency pump is designed for front end mounting on General Motors, Dodge and Ford trucks. Comes complete with gear box for speed step-up; easily mounted for drive from crank shaft. Net wt. 500 lbs. Ship. wt. 1200 lbs. A REAL BUY. . . .

\$149.50

F.O.B. Chicago

CENTRIFUGAL PUMP

BELT DRIVEN READY FOR USE ON ANY LIQUID PUMPING NEED

A super value for all types of intermittent service in pumping large volumes of liquid in home, farm and industrial service. Ideal for home water systems, draining basements, fire protection, etc. On the farm for watering stock, draining ponds, sprinkling, etc. In shops and factories for all types of pumping service.

Use it for
Draining
Basements

• Home Water
Systems

• Irrigation

• Stock
Watering

• Fire
Protection

• Draining
Ponds,
Tanks, etc.

• Industrial
Pumping



Brand
New

MOVE LARGE VOLUME QUICKLY. When operated at 1750 RPM, will pump 42 gallons per minute on a 23 foot head; at 3600 RPM on 52 foot head will pump 88 gallons per minute. May be run with electric motor, gas engine or power take-off on tractor.

COMPLETE ENGINEERING REPORTS AND OPERATING INSTRUCTIONS FREE WITH PUMP

Pump has cast aluminum housing—accurately machined bronze impeller vanes. Complete with mounting bracket and 3¼" V belt pulley. Shaft rotates on sealed ball bearings with grease gun fitting. Has 1½" threaded intake flange, two 1 inch outlets. Use one or both, as necessary. Made for Packard Motor Car Co. for use in Rolls-Royce Merlin Aircraft engines.

Greatest Pump Value In Years Complete with Pulley and Mounting Bracket—Ready for Use.

You can't beat this value at anywhere near this price. Satisfaction guaranteed. Shipping weight 23 lbs.

Original Cost Approx. \$147.00. **\$29.75**
(Item #64) F.O.B. Chicago

Self-Priming ELECTRIC PUMP

APPLICATIONS: oil burners, aquariums, fluid metering, fuel pump, tool post grinder, coolant pump, pressure lubricating pump, general industrial, etc.

MOTOR MFD. BY BLACK & DECKER; double ball bearing series wound, continuous duty, 1/30 H.P. electric motor, rated 12,000 R.P.M. Transformer included for use on 110 V AC current. Also applicable for 24-32 V DC.

PUMP MFD BY WELDON TOOL CO. with standard ¼" tubing ports; rated 2 G.P.H.; remove pump and use motor as high speed grinder.

OVERALL DIMENSIONS: 7¾" long x 3¼" wide x 3¼" high. Approx. wt. 5 lbs. \$51.00 value, **\$12.95**
(Item #1) postpaid



Compact—
Brand New

GROBAN SUPPLY CO.

DEPT. PS-II, 1507 S. MICHIGAN AVE., CHICAGO 5, ILLINOIS

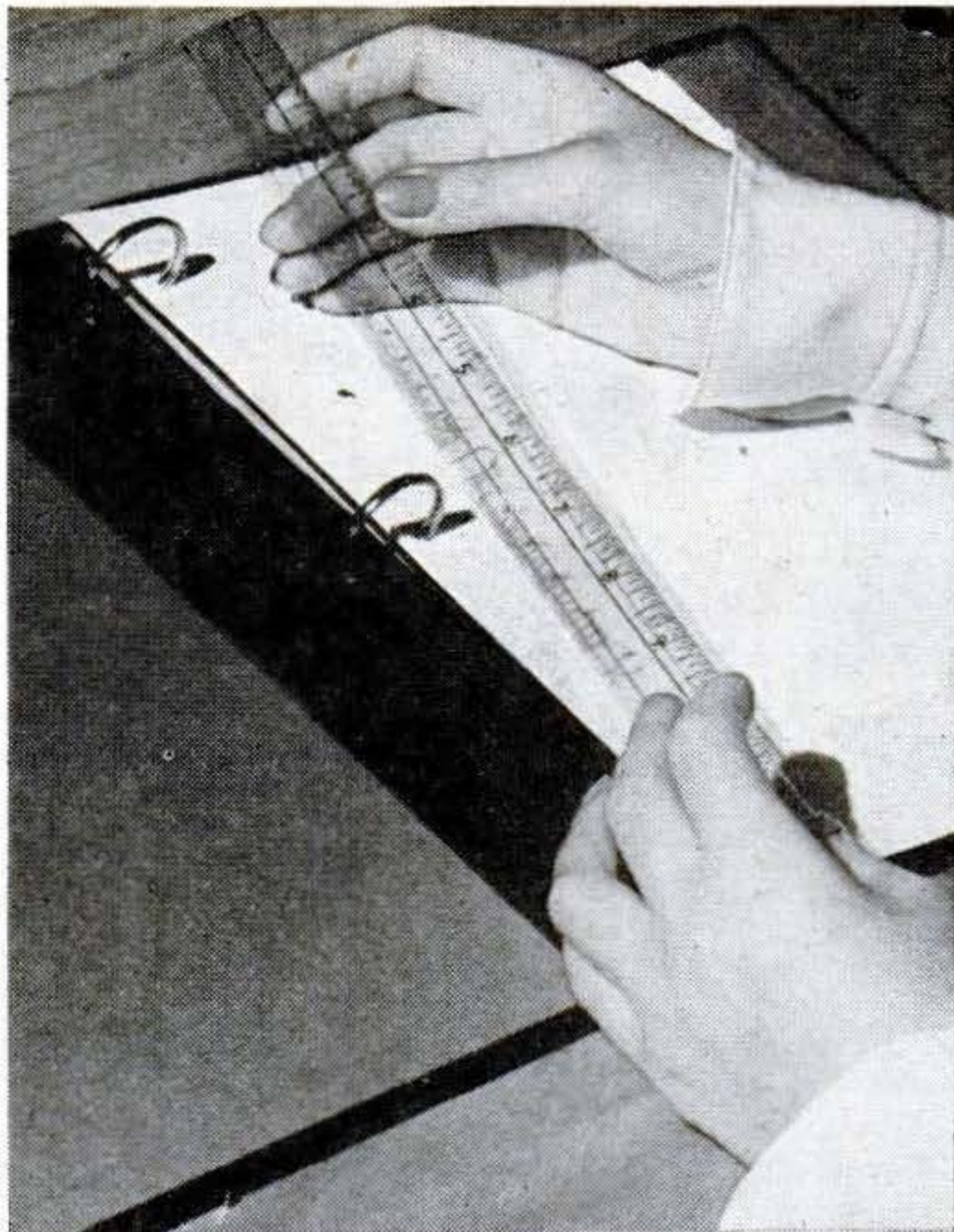

Ruler Hugs Notebook Rings

CUTOUTS that fit around the closed rings of a notebook keep this Vinylite® ruler from dropping out; yet it is easily inserted or removed. Made by Plastilite Products Co., of Pawtucket, R. I., it is suitable for both pencil and ink rulings on flat or curved surfaces.

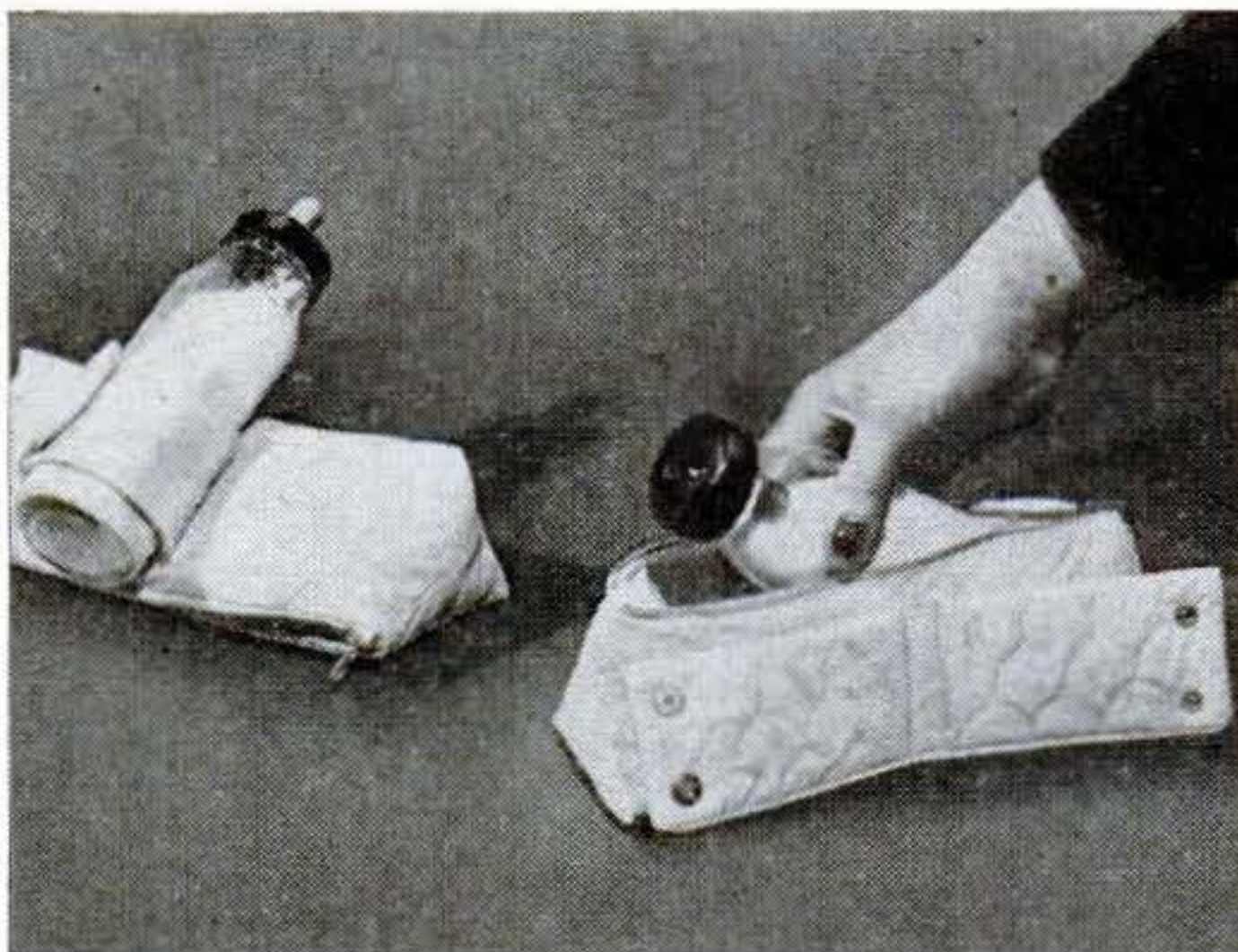

Case Holds Heat or Cold

SLIPPING Junior's bottle into this washable travel case will keep his refreshment either hot or cool several hours—thanks to the insulation with which it is padded. At feeding time the bottle can be propped up in the holder attached to the case. The Thermo-tainer® is made by Fashioncraft Cloth Products, Inc., of Brooklyn, N. Y.

All Merchandise Brand New-Order Today-Satisfaction Guaranteed!

HANNA AIR CYLINDER



Brand New

Used for heavy duty industrial applications on shop air lines or with low pressure systems. With 100 lbs. of air pressure, will deliver 1900 lbs. pressure at the ram shaft. All steel construction. Adjustable cushions at both ends of cylinder. Shaft dia. 1 1/2". Foot mounting with clevis on ram shaft. 26 1/2" double-acting stroke; 5" bore, 40 1/2" overall length closed. 7" overall width. 89 1/2 lbs. net wt. Gov't. acq. cost \$101.85.

(Item #61) **AN EXCELLENT VALUE for —**
F.O.B. Chicago

\$39.50

Hydraulic Cylinders-Air or Oil

Use hydraulics on arbor presses, hydraulic presses, hay lifts, manure loaders, lift trucks—push or pull, tilt or turn, press or squeeze, open or close, lift or lower—and other hydraulic and industrial applications. Use with either air or oil . . . of finest precision workmanship. **BRAND NEW.**

ITEM #4—Double action, 1" bore, 3" stroke, will lift 770 lbs. in 1/10 of a second using Logan Pump. All steel barrel. Ideal for controls, door openers, positioning. **postpaid \$4.95**

ITEM #32—Double action, 1 1/2" bore, 9" stroke, will lift 1760 lbs. in one second with Logan Pump. Wt. 4 lbs. A \$45.00 value. **postpaid \$10.95**

ITEM #16—Use these cylinders on farm trucks, bulldozers, hay lifts, manure loaders, etc. Double action, 1 1/2" bore, 27" stroke. (Will lift 1760 lbs. in 2 seconds with Logan Pump.) Wt. 8 lbs. A \$55.00 hydraulic cylinder value **postpaid \$12.95** for only . . . **postpaid \$14.50**

ITEM #17—Double action, 2 3/8" bore, 8" stroke. (Will lift 4100 lbs. in one second with Logan Pump.) Will withstand 1500 P.S.I. against wall. Wt. 7 lbs. A \$65.00 value. **postpaid \$16.50**

ITEM #20—Double action 2 3/8" bore, 4" stroke, two-way solid 5/8" alloy steel shaft (will lift 4400 lbs. in one second with Logan Pump). A \$73.00 value **postpaid \$19.50**

ITEM #15—Double action, 3" bore, 8 1/2" stroke. All steel hydraulic cylinder, will lift up to 12,000 lbs. (7000 lbs. in 3 seconds with Logan Pump.) Complete with fittings. Wt. 12 lbs. A \$78.00 value. **postpaid \$22.50**

ITEM #31—Double action, 3 1/2" bore, 11" stroke. (Will lift 9600 lbs. in 7 seconds using Logan Pump.) Complete with fittings. Wt. 15 lbs. A \$92.00 value. **postpaid \$27.50**

ITEM #6—Double action, 3" bore, 23" stroke, hydraulic cylinder will lift 7070 lbs. in 5 1/2 seconds using Logan Hydraulic Pump. Especially suited for farm and construction machinery. Clevis mounting for easy use. Wt. 22 lbs. A \$145.00 value. **F.O.B. Chicago \$32.50**

ITEM #42—Double action hydraulic cylinder. 4" bore, 18" stroke. Rated lift capacity with 1000 P.S.I. input is 12,560 lbs. using Logan Pump. Ship. wt. 30 lbs. **AN EXCELLENT VALUE for**
F.O.B. Chicago \$32.50

HI-PRESSURE FITTINGS for cylinders and valves available at 35c ea. for 3/8" pipe and 50c ea. for 1/2" pipe.



LOGAN 4-Way Foot Operated

AIR VALVE

Model 6520

BRAND NEW. For double-acting pneumatic devices. Fine for operating air vises, presses, air machinery of many types. Heavy cast construction. Threaded for

1/2" pipe. Dimensions of valve body: 8 1/2" L x 5 3/4" W x 7 1/2" H. Net Wt. 28 lbs. Gov't acquisition cost \$42.00. **AN OUTSTANDING BUY AT . . .**

(Item #59) **F.O.B. Chicago**

\$15.00

NOW . . . It's Easy to Weld with this handy ELECTRIC ARC WELDER

250 Amp.

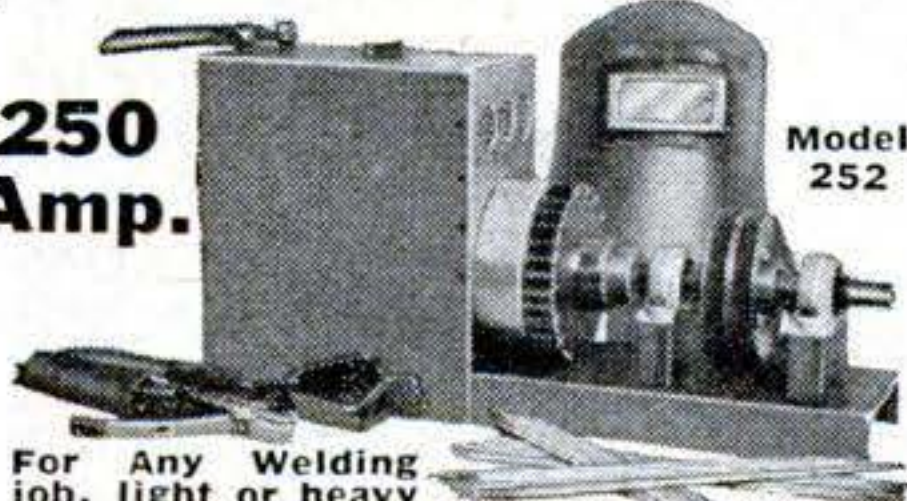

Model 252

For Any Welding job, light or heavy

Designed for many years of trouble-free service! Handles anything from light gauge sheet metal to 1/2" plate.

This precision-engineered direct current **ELECTRIC ARC WELDER** is offered at but a fraction of its original value. It can be mounted permanently or easily transported for portable use. Does the job instantly, where and when you need it.

The War Surplus generators for these Arc Welders were built by General Electric, Westinghouse, and Delco-Remy at a cost of over \$300.00. They are light in weight; have oversized lifetime grease-sealed ball bearings; air-cooled commutator; dial type rheostat for easy pinpoint control; high-low range switch; reactor coil for even arc; handles 1/16 to 3/16" rods. Run welder at 2500 R.P.M. from drive pulley or power take-off of tractor, a 7 1/2 H.P. electric motor or a 10 H.P. gas engine. Use one or two V-belts, or flat belts (on pulley). Continuous welding rating—200 amps.; intermittent rating—250 amps.; 0-40 volts. Now . . . **AT A FRACTION OF ITS VALUE.** Price includes double V or flat belt pulley and instruction book. Ship. wt. 95 lbs. Only one or two jobs will pay for entire welder. **\$99.50**

(Item #65) **F.O.B. Chicago**
ACCESSORY KIT including welding helmet, electrode holder, two 10 ft. cables with clamp, and 5 lbs. of assorted welding rods. **\$10.50**
(Item #66) **F.O.B. Chicago**
Remember, Satisfaction is Guaranteed

FREE CATALOG!

Write for free copy of our 40 page catalog including Hydraulic Manual featuring diagrams, photographs and instructions. Catalog lists excellent war surplus values: pumps, valves, hydraulics, lights, motors, etc.

G-1 Stainless Tank

Use these tanks on compressors, for tire inflators, pulsation chambers, floats, buoys, hydraulic reservoirs, fluid and milk containers, fuel containers, etc.



Tough, light, 450 lbs. P.S.I. Aviators Breathing Oxygen bottles, type G-1. 2100 cu. in. (approx. 9 gallons) int. vol. 24" x 12". 1/4" threaded openings at ea. end. Wt. 19 lbs. .051" thick. **\$4.95**
(Item #63) **F.O.B. Chicago**

Vickers MF9 Hydraulic PUMP or MOTOR

complete with mounting kit ready to install

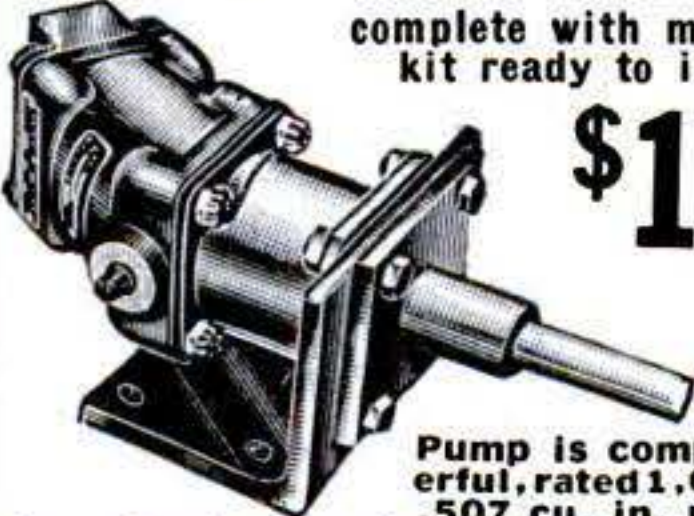

\$19.90 post-paid

\$75.00 value

Pump is compact, powerful, rated 1,000 P.S.I., .507 cu. in. per revolution. 8 gal. per min. at 3750 RPM. Change rotation by reversing flow. Delivers up to 6 H.P. Requires 1/3 to 6 H.P. to drive directly or by pulley. **BRAND NEW.**

Mounting kit has been especially designed to provide maximum utility and ease of mounting MF Series Vickers Pumps. Brackets are constructed of heavy steel plate; shaft is made of 1/2" steel with one end splined to fit pump; other end of shaft has machined flat for mounting a standard pulley with 1/2" hole. Shaft runs in oilite bronze bearings.

(Item #18) Pump only \$14.95 postpaid
(Item #38) Mounting kit only \$ 4.95 postpaid
(Item #39) Both as complete unit \$19.90 postpaid

VACUUM-AIR GENERAL PURPOSE PUMP

BRAND NEW

Use them for Oil Burners

Spraying Machines

Milking Machines

Compressors

Vacuum Pumps

Photographers

Vacuum Frames

etc.

Originally cost \$45.00. May be used as air or fluid pump—for pressure or vacuum. Standard 3/8" pipe thread with interchangeable ports. Will pump 7 1/2 gal. SAE 30 oil per minute at 300 RPM. Builds air pressure of 30 lbs. per sq. in. at 1000 RPM. Vacuum will draw 26 inches of mercury at 1750 RPM. Develops up to 120 lbs. per sq. in. of hydraulic pressure. Runs forward or reverse. 5 1/4" x 4 1/4" x 4". Has stainless alloy steel vanes and impeller. Flat shaft for direct or pulley drive. Recommend a 1/4 H.P. or stronger electric motor. Rated capacity 1500 RPM with high overload factor. Complete illustrated engineering report and instruction book **FREE** with each pump. Send check or money order today. **WORTH MANY TIMES THIS LOW SALES PRICE**
\$9.95
Ship. wt. 10 lbs.
(Item #9) **F.O.B. Chicago**

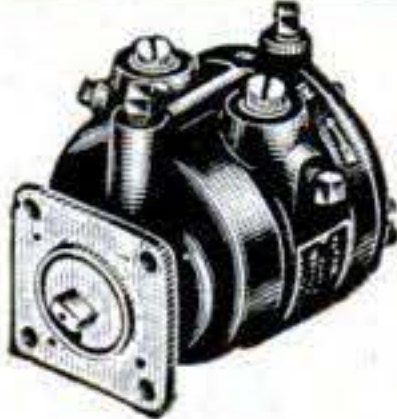

LOGAN HEAVY DUTY OIL Hydraulic Control Valve

BRAND NEW control valve with built-in adjustable relief valve, will operate one double-acting hydraulic cylinder or two cylinders as one or a reversible hydraulic motor. Valve handle latches in neutral position. Made of rugged cast aluminum alloy. Open center unloads the pump in neutral position. Throttling control allows operator to regulate the speed of movement of the hydraulic cylinder or motor. Has removable mounting brackets with 4 bolt holes, 3/8" pipe thread connections. Overall dimen.: 12 1/2" H x 8 1/2" D x 8" W. Ship. wt. 17 lbs. Govt. Acquisition Cost over \$100.00. An Excellent Buy. **F.O.B. Chicago**

LOGAN HEAVY DUTY OIL HYDRAULIC PUMP

BRAND NEW . . . for operating hydraulic cylinders and hydraulic motors on tractors, bulldozers, construction machinery, lift trucks, industrial applications, etc. Delivers 8 GPM at 1200 RPM at 1000 P.S.I. using 5 H.P. Has 1/2" pipe thread inlet, 3/8" pipe thread outlet. 3/4" shaft with flat and keyway for direct or pulley drive. Has flange with 4 bolt holes for convenient mounting. Ship. wt. 22 lbs. Overall dimen.: 7" L x 5 1/2" H x 5 1/2" W. A \$105.00 value. **FOR ONLY**

\$22.50

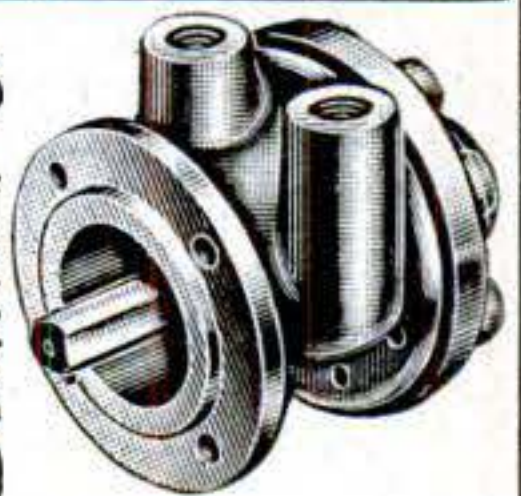

F.O.B. Chicago (Item #29)

GROBAN SUPPLY CO. 1507 SOUTH MICHIGAN AVE. Chicago 5, Ill.

Dept. PS-11

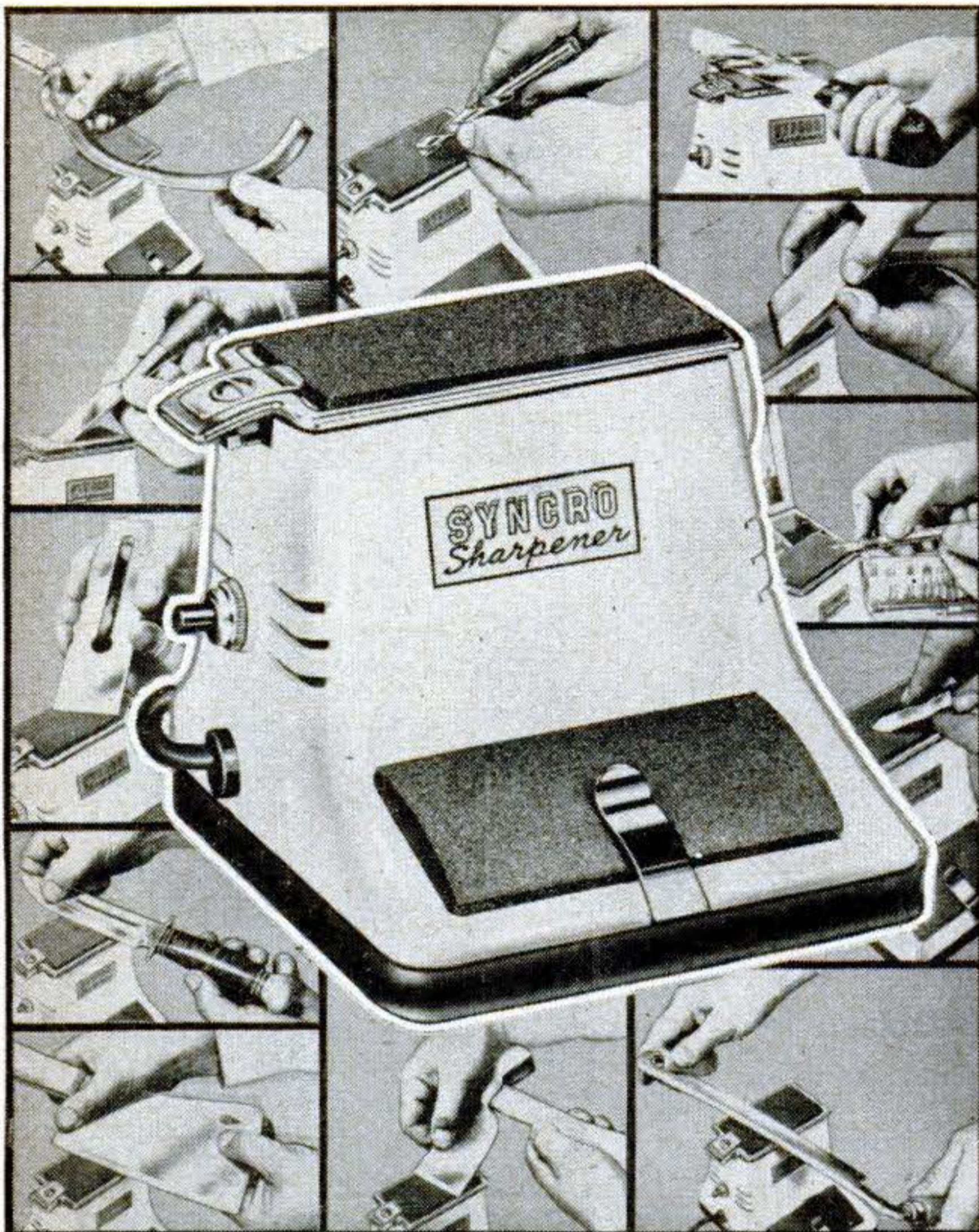

Hones all these sharp—hundreds more!

SAFE ELECTRIC JIG SAW

Here's a "Gift" tool that's safe for even small children yet powerful enough to be the most versatile tool in adult workshops! SYNCRO is the safe electric jig saw. Portable. No belts, gears or wheels. Operates on 60 cycle, 110-120 volt AC. Arm adjusts to permit cutting any length $\frac{1}{2}$ " wood, $\frac{1}{4}$ " plywood, thin metal and plastic. Not a "lumber cutter" but for delicate, fine craftsmanship. Perfect for family projects or making money. Made and GUARANTEED by the largest company of its kind. Built-in Motor. **\$17.50** Complete,

NEW SANDER—MASSAGER—POLISHER

You'll love this handy, beautiful, light-weight SYNCRO Electric SANDER-POLISHER! Also gives gentle body massage! 14,400 exclusive "Double Arc" strokes a minute makes sanding or polishing a pleasure instead of a chore! Just guide it. For light sanding, finishing, refinishing, redecorating. Perfect for polishing shoes, furniture, autos, etc. Give or get SYNCRO, 60 Cycle, 110-120 Volt AC. Comes with 9 sheets Aluminum Oxide sandpaper, felt and virgin lambswool pads, 8 ft. cord, plug, **\$14.50** only

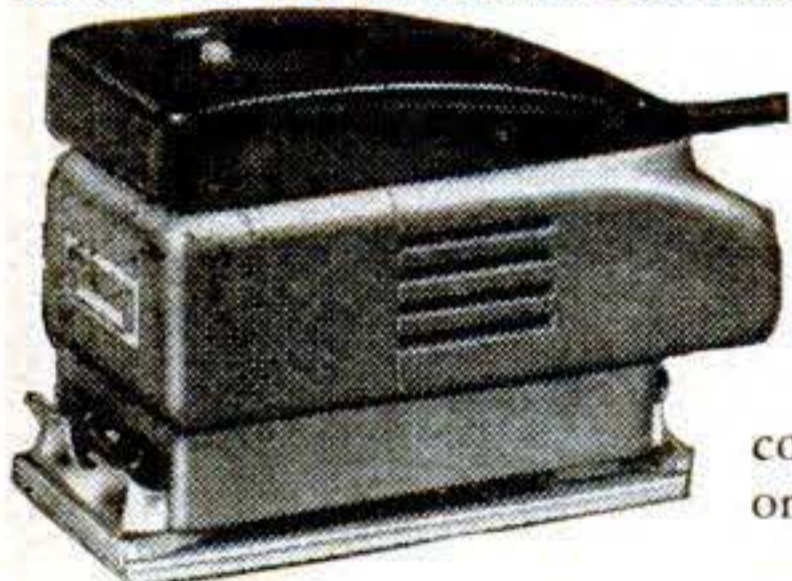

cord, plug, **\$14.50** only



NEW ELECTRICAL GIFT IDEAS

for

KITCHEN and WORKSHOP!

Presenting the

NEW and ONLY ALL-PURPOSE Electrical HONE SHARPENER

The Gift *any* woman or man will really appreciate! This beautiful new SYNCRO sharpens *not just knives* but hundreds of other articles safely, quickly—by HONING the edge. "Honing" helps preserve edges. 14,400 gentle, rapid HONING strokes a minute! NOTHING ELSE like SYNCRO! No belts, gears or wheels. 60 cycle, 110-120 Volt AC. Insist on genuine SYNCRO—the only electric ALL-PURPOSE HONE Sharpener! Comes with 3 Honing Stones, cord, plug, switch, only **\$10.50**



YOU CAN DO IT BETTER WITH

SYNCRO

QUALITY PRODUCTS

HOW TO GET YOUR SYNCRO:

Because SYNCRO HONE SHARPENERS and SANDER-POLISHERS are so new, dealers may not yet have them in stock. If dealer hasn't, order any SYNCRO product direct. Send full amount, we'll ship prepaid! Remember—don't be satisfied with anything but a genuine SYNCRO!

SYNCRO CORPORATION

DEPT. M-119, ROCHESTER, MICHIGAN, U.S.A.
World's Largest Makers of Safe Electric Jig Saws

Christmas

GIFT MART



M
E
R
R
Y

C
H
R
I
S
T
M
A
S



*Automotive
Products*

*Workshop
Tools*

*Sporting
Goods*

TAKE A TIP FROM ME!
CHECK THE GIFTS YOU LIKE
FROM THE FOLLOWING PAGES
AND SHOW YOUR WIFE, FRIENDS,
AND FAMILY
THAT'LL HELP THEM AND ME!
YOU CAN SAVE TIME BY
SHOPPING THIS WAY TOO!

*Gadgets,
Novelties*

*Photo
Equipment*

*Smoker's
Articles*

SAVE UP TO 85% IN WAR SURPLUS

Palley Clothing BARGAINS



B-15 Style BOMBER JACKET Sturdy, water repellent Mountain Cloth. Body & sleeves fully lined with 100% All Wool Pile. Mouton Fur Collar. Zipper Front & rib knit cuffs & bottom. Has two outside slash pockets. Sizes: 36 - 46 in O.D. Color only. \$10.95
 Sizes: 48, 50, 52. 12.45
 Boy's sizes: 6 - 18. 8.95



Motorcycle Jacket Like the best "custom made" jackets. Top grade Horsehide, zipper opening on sleeves & 3 pockets, 1 snap pocket. Snaps on collar & shoulder straps. Waist belt with large buckle. Body & sleeves fully lined with Rayon-tex. Flannel inner lining. Form fitting waist & action back.

Full length zipper closure. Rich Black. Sizes thru 46 . . . \$25.95



NAVY MELTON COSSACK STYLE JACKET

BRAND NEW!! ALL WOOL!! Extra warm & durable. Has 2 slash pockets. Full zipper front closing. Tailored to fit snug for added warmth. Ideal work jacket for farm, factory or outdoor wear. Sizes 40, 42, & 44. . . \$5.19



16 POCKET VEST

Sturdy, Yet Light Wt. Satin Lined with Tie Straps, 14 Outside Pockets, Plus Knife, gun, Tool, Leather Holder, 2 large 11" x 8" Pockets

Inside, Wonderful Hunting, Fishing, or Mechanic. A Steal at \$2.79



FLYING HELMET

Winter type with fleece or chamois lining. In good condition though used. Lots of good service left for \$1.95 pilots, cycle drivers, sportsmen, etc. .

NEW!! All leather, chamois lined with chin cup. For winter or summer. \$1.59



Marine PANTS

Made of 8.2 Twill. Ideal work pants for farm, factory, etc. Suntan color. Sizes: 26 - 38. Slightly used, but in good condition. Only \$1.99 PR

Specify Waist & Pant Length...

PALLEY SUPPLY CO

6321 SAN FERNANDO RD.

DEPT. P.S. 11 GLENDALE 1, CALIF

THE LARGEST FIRM OF ITS TYPE IN THE WORLD

HORSEHIDE Flight Jacket

Smart & stylish. Top grade Horsehide with furry Mouton collar. Has 3 roomy pockets & zipper slash pockets. Knitted wrist & waist band. Fully lined, body & sleeves, with blanket stitched Rayon-tex. Flannel inner lining. Full length zipper closure. Cordovan Brown. Sizes thru 46 \$23.65



MACKINAW

Here's a real outdoor, rough weather garment. Heavy Poplin cover - water repellent, wool blanket lined, thigh length. Sleeve flap adjustment. Full belt, 2 roomy pockets. Just right for the outdoor man, truck & tractor driver, hunter, farmer, etc.

Sizes 34 thru 38 . . \$7.95



FLYING SUIT or Blue Bunny SUIT

For hunting, winter sports, skiing or "bundling". As coveralls for cold outdoor, or farm work, 100% woven wool with extra flannel inner lining for double warmth & utility. Wiring so fine, flexible it does not interfere with movement. Can be used with or without heating or can be plugged into car, tractor, or truck battery. Sizes 36 thru 44. . . \$3.49

Wiring so fine, flexible it does not interfere with movement. Can be used with or without heating or can be plugged into car, tractor, or truck battery. Sizes 36 thru 44. . . \$3.49



AIR CORP CAP

All leather, sheepskin lined for cold weather. Turn down flap for ear protection. Leather bound long visor. Small, Med., & Large. . . \$2.98

MITTENS - Sheepskin lined, leather outer cover, For outdoor or winter work. Small, Medium, and Large. \$2.69 PR



Fleece Lined FLYING BOOT. Sizes: 7 - 12 ONLY \$11.95

Flying PANTS

Brown leather - Sheep lined pants. Front pockets. Zippers at side & fly. Ideal for Hunters & Outdoor Men. Sizes: 38, 40 & 42. Cost Gov't \$22.50. Used but Perfect. . . \$6.95



PROTECT YOUR EYES!!

Genuine ARMY AIR FORCES SUNGLASSES HERE'S THE REAL McCOY!



ARMY AIR FORCE 6 base. Precision Polished and Ground. Glare-Free lens with leather case that can be attached to belt. Gold plated adjustable frame. Pearlloid sweat bar and pads. A real Palley \$17.50 Value for Only \$3.95

ARMY AIR FORCE TYPE SUNGLASSES 4 base. polished and ground lens. 93% Ultra Violet Ray free, gold plated frame. pearlloid bar & pads. leatherette case. Our price \$2.39 ea.

SAVE A LIFE! IT MAY BE YOUR OWN!

KLEER-VUE NIGHT DRIVING GLASSES



With 57mm yellow amber, 6 base lenses. Optically Precision Ground and Polished! Your doctor will recommend these. Not a Cheap "Process" Lense. Reduces headlight glare & Sharpens 'object focus' during night driving.

In Men's size or Ladies Harlequin style. ND-1 \$16 VALUE \$5.89

SAME GLASSES but clip-ons. Fit-over style without temple bars \$4.59



Aviators (AN-6530) Windproof & Dustproof GENUINE GOGGLES

Sponge and leather protected frame with ground lens in clear, amber and green. Clear set in replaceable metal frame with hinged nose bar. Ideal for Motorcycling, etc. Go-65 \$1.69 ea.

CHRISTMAS WATCH BARGAINS

Chronograph WRIST WATCH



17 jewel - One of the finest made anywhere. Cased in Switzerland. Sweep sec. hand. stop & re-set buttons. Measures distance, airspeed, groundspeed, races. Ideal for the sportsman. Special CH-1 \$21.95

17 JEWEL - AUTOMATIC WINDING-SHOCK PROOF-WATERPROOF-SWISS WATCH.

Sweep sec. hand, stainless steel screw back, radium dial & hands. Body movements keep it properly wound. A PERFECT XMAS GIFT. AW-1 \$23.95



Nurses Watch

17 JEWEL - Stem wind & set. Incabloc (shock protective) movement. Sweep second hand, luminous dial. Waterproof, stainless steel case. 7 JEWEL NURSES WATCH - A dependable movement enclosed in sturdy case. Luminous dial with full sweep second hand. \$7.95

Hand COMPASSES

#151 - MARCHING - Lensite, with Luminous Dial . . \$1.59

#152 - MATCHBOX - both jewel & liquid floating dial 39c

#153 - NEW!!! JEWEL Watch Pocket Compass 1.59

#154 - WRIST STRAP Compass 69c



PLASTIC PARALLEL STRAIGHT EDGE

with knobs and rubber pads for non slippage on each section. A must for navigators, mechanics, draftsmen, and engineers . . . You've never seen 'em at 97c ea.



CLAMP-ON LAMP

WITH ADJUSTABLE BALL AND SOCKET SWIVEL HEAD, LONG RUBBER COVERED CORD AND WALL PLUG The All Purpose Lamp. Wonderful for indoor Photography, Floodlights, Baby Spot or Large Spot, Personal Bed Reading, Workbench, Garage, etc. Lamp Alone. 99c
Highly Polished 9" diameter Parabolic Reflector or 5" diameter Spot Reflector at ONLY 85c ea.

ORDER BY MAIL *from* GADGETEERS HEAVEN



No. 100 WINCH HOIST Thousands of Satisfied Users!! Capacity 2500 lbs. with 24 to 1 ratio. Controlled Bronze Worm Gear. Has 19 ft. of 1/4" alloy steel cable with hook and two-speed handle. Ideal for Boats, Factories, Shops, Garages, Tow Trucks, etc. A Real Holiday Special. **\$15.99**

PALLEY GIFT SPECIALS for the HOMECRAFTSMAN



19-PC. SOCKET SET

Sockets in sizes from 1/4" to 15/16". Handle fits all. With 2 wrenches, case and ratchet. ONLY. **279**

11 PC. SOCKET SET - Sizes 7/16" to 15/16". Fit-all handle & screw driver attachments. **\$2.19**

TWO HEAT SOLDERING IRON



Has Two Operating Heats!! Just push button & select 150 or 300 Watt Heat. Complete with tip & bench holder. For light or heavy work. Operates on 110 V. AC. JUST THE THING FOR HOME, SHOP OR INDUSTRY. **\$3.95**

Paint SPRAYER

SPRAYMASTER MOD. SM-25 Portable Spray Unit. Piston type compressor, built-in storage tank, 110 V-AC-DC motor & metal spray gun. Operates at 25-30 PSI. For furniture, auto or touch-up. Spray lacquer or paint. Weighs only 7 1/2 lbs. Complete with hose & all attmts. Unconditionally Guaranteed. **Only 24.95**



NAVIGATORS LAMP

A handy light for desk, work bench, chart table, engine room, etc. Can be used on 6-12-24-110 V by changing bulb. 3 ft. shaft has 4 joints to adjust position... ONLY. **\$2.95**

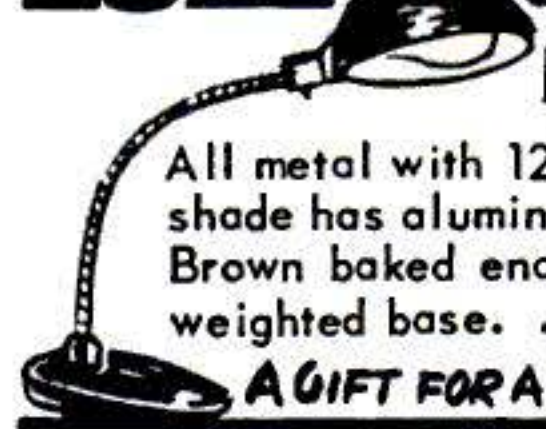

DESK LAMP

All metal with 12" flexible arm. 6 1/2" shade has aluminum painted reflector. Brown baked enamel finish - Sturdy weighted base. **\$2.59**

A GIFT FOR A STUDENT



HS 33 NEW LOW IMPEDENCE RADIO HEADSET

Latest & most improved style. Currently in use in aircraft. Packed in original boxes. Leather hd. band, sponge rubber ear pads. Includes Cord & Jack High-Low Impedence Adapter . . . 35¢ ea. **\$3.25**

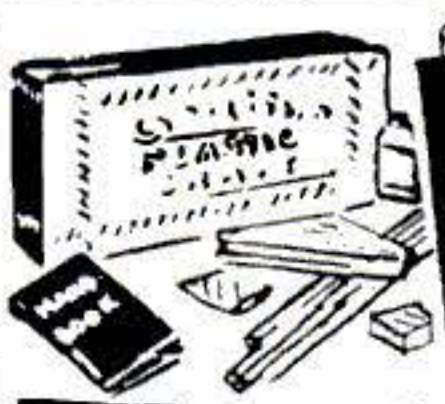

MAKE YOUR OWN XMAS GIFTS with these PLASTIC KITS

Kit #1 contains 2 lbs. plexiglass & Lucite sheet in various shapes, 1 oz. bottle of clearset cement, and 5 bottles of colors in Orchid, Red, Yellow, Peach, etc. Also a Plastic Handbook of uses & instructions. This set easily worth \$5.50. Our Price . . . **\$2.19**
Kit #2 contains 1 1/2 lbs. of plastic sheet, a 1 oz. bottle of clearset cement, and the Plastic Handbook. A \$2.50 Value for ONLY **99c**

Plexiglass & Nascolite clear plastic shts.

NASCOLITE - Full sheets app. 1/8" x 37 1/2" x 49 1/2", app. 10 1/2 lbs. each **\$12.50**
PLEXIGLASS - Full Sheet 5/16" x 36" x 24" . . . Per Sheet.. **\$13.00**
5/16" x 36" x 48" . . . Per Sheet.. **\$25.00**

MAKE YOUR OWN TELEVISION FILTER



Plastic CALABAR FILTER
Highly translucent Green Calabar Plastic: 3/16" thick in sheets 16" x 43" - Enough for 2 or 3 television filters (average size screen) Cuts down eye strain yet permits sharp, clear picture. **750**

PLASTIC POLISH

Made for Army to polish & brighten plastic surfaces. Can be applied by hand. Removes scratches, blemishes, etc. In 1/2 pt. cans **39¢**

Loose Leaf BINDER

3 metal post. Cylindrical locking heavy duty 3/16" fabricated hinged cover. End identification window Ideal for price books, salesmen catalogues, photo albums, students, publications, Reference books, etc. Will hold 500 sheets, 8" x 11". **59c ea.**

FOAM RUBBER

Molded & pre-shaped. Can be cut to fit your Chair seat, Boat, Auto, Truck or Trailer Seats. Ideal for all Sports Events.
25" x 62" x 1 1/2" **\$6.45**
25" x 65" x 2" **\$8.45**

FOAM RUBBER ADHESIVE - Specially prepared to cement all types of foam rubber. per qt. **\$1.55**

CHEMISTRY SET

Made for Chemical Warfare Division for testing water, etc. A handy addition to the chemistry lab. or an exciting experiment for the amateur. Set includes test tubes, complete instructions, 15 different items. Packed in attractive lucite box with cover & dividers. **\$1.39**

Black & Decker ELECT. DRILL KIT



Includes.
1/4" ELECTRIC DRILL with JACOBS. HEX KEY TYPE CHUCK & ACCESSORIES... Everything you need for drilling, grinding, cleaning, buffing & polishing is contained in this handy kit. A Real Asset To Home Workshop or Business. Drill has 110 V. AC-DC 'Universal' motor. Heavy duty cord. Weighs only 3 1/4 lbs. Complete Home Utility Set. **\$39.95**

DRILL ONLY - Including 1/4" JACOBS HEX-KEY type CHUCK **18.95**

METAL SNIPS

Hard steel blades. Comp'd action. Expansion spring. Lock device. Right & Left Hand. **\$2.59**

NEW CATALOG

10,000 Bargains in War Surplus. 92 Page, Illustrated with valuable information tables, charts & data. Send 25¢ to cover handling & postage.

Hand Mike Highly Sensitive with thumb control button on handle. Ideal for home recorders, public address systems, etc. Comp. with 2 ft. rub. cd. & phone plug. **\$1.19**

HUNTING KNIFE 6" chrome vanadium blade, handle, leather grip. In leather sheath. **\$5.98 Value \$1.89**

(Like Above) 5 in. polished blade **\$1.69**
With Parkerized black Finish **\$1.49**

BOLO KNIFE
10" x 2" Parkerized blade, 5" Grippled Handle. Weight 1 1/2 lbs. Ideal for Hunting Clearing Brush or Trails. With Case. **\$1.19 ea.**

ARMY Field Telephone #338

A private phone or intercom. system. Easy to operate. Reception up to 20 miles. Uses 2 standard flashlight batteries. Several phones can be used on same line. Set contains generator for ringing, leather carrying case & receiver. 1000s used daily in factories, farms, stores, mines, etc. A Real Palley Special. **795**

Order from this Ad. All sales final. All Prices F.O.B. Los Angeles. Pay by M.O. or Check. P.O.'s Acptd. from D & B firms. 1/2 deposit with C.O.D.'s.

**THIS XMAS GIVE
GENUINE DIAMONDS
AS GIFTS —**

SAVE ON DIAMONDS FROM ESTATES,
BANKS AND UNREDEEMED PLEDGES

SAVE UP
TO 50%
AND MORE

**OUT OF PAWN
GENUINE
DIAMONDS**

IN BRAND NEW 14 KT.
GOLD AND PLATINUM
MOUNTINGS

**MONEY-BACK
GUARANTEE**

Unmatched values in genuine blue white diamonds. Each diamond sold with a written iron-clad money back guarantee. All diamonds set in gorgeous new mountings. Send today for beautiful, illustrated catalog showing values from \$10.00 to \$10,000. Over 100,000 satisfied customers have bought Diamonds from Berman's. Our reference—your own bank or any mercantile agency.

BERMAN'S DIAMOND LOAN BANK
DEPT. PS — BERMAN BLDG. BALTO. 1, MD.

Send today for
Illustrated
FREE
Catalog
NO OBLIGATION



**BIG GAME FOR
FUN HUNTERS**

was \$15 NOW \$6.95

FAMOUS Johnson INDOOR TARGET GUN

Parties for adults or youngsters will never drag when you have this safe Johnson Target Gun! Nothing like it before—has amazing target rifle accuracy, even across a playroom, yet is safe enough to shoot in living room, and approved for use by children. Automatically feeds and shoots 65 re-usable pellets in rapid succession. Precision made with burnished steel barrel, adjustable sights, and strong propelling unit by makers of famous Johnson machine gun used by our soldiers, 28½" long, it has the heft and feel of a real gun; gives valuable training in marksmanship plus superb entertainment for family and friends. Comes complete with bull's-eyes, metal target gallery, paper targets, shot-saver backstop, pellets, and extra power unit. An extraordinary value—Ideal for Xmas-giving! Order No. F45

**ORDER BY MAIL
—POSTPAID**

526 BRECK BLDG.,
BOSTON 10, MASS.

Home and Garden Gifts
BRECK'S
RELIABLE SINCE 1818

**FACTORY-TO-YOU
FISHING RODS**

VALUES LIKE THIS \$15⁵⁰
Reg. \$26 4' Med. Action
7/8" Seat, 18" Butt
In Calif. add 3 per cent Tax

Nationally known Warren Beryllium Copper Rods — Fresh and Salt Water NOW AT NEW LOWER PRICES

- Attractive Carrying Case Included
- Written Guarantee
- 10 Day Free Inspection
- C.O.D. or 5% Discount With Cash.

BERYLLIUM (So. American "gem" metal) and fine copper used in WARREN RODS give farther, more accurate casting. Extra light, yet extra strong. You'll "feel" the difference. Endorsed and used by fishing experts.

Write today for FREE Catalog at New Lower Prices PLUS SPECIAL YEAR-END SALE PRICE LIST. Save Up To 45% on Xmas Gifts.

DEALERS: Write for Details.

WARREN PRODUCTS, INC. Dept. PS 11
110 E. 16th St. Costa Mesa, Calif.

CHRISTMAS SCOOP! MUSIC OF THE MOUNTAINS ON FAMOUS ACME RECORDS: . . . SANG AND PLAYED BY NATIVE MUSICIANS
Immediate Shipment To introduce Acme Records to thousands of music lovers who may not have an Acme distributor near them, we offer a Special Package of Our Greatest Hits at near Wholesale Price . . . 5 Great Records for only \$2.79! "Life's Railway To Heaven" (Harmonica Solo) backed by "Mother's Old Sun Bonnet" (vocal), by Curley Bradshaw, America's Harmonica King . . . "My Heart is Filled with Tears" backed by "Memories of Hawaii," by William Moore & His Country Cousins . . . "I'll Meet You in the Morning" and "We'll Soon Be Done with Troubles and Trials" by the Famous Erin Quartet . . . "Silver Bells" and "A Gay Ranchero" by the River Valley Ramblers, and "The Blood that Stained the Old Rugged Cross" and "A Saving Jesus", by the Tarheel Trio (from God's Bible School). Act Today! Clip this ad and mail with your name and address. You may remit with order or we will ship C.O.D. Complete catalog on request.
ACME RECORD & RADIO CORPORATION, Columbia, Kentucky

**NOW! Your garden hose
BLASTS DIRT**

with rich suds!
Your house, car, porch, basement, etc. come clean quickly and easily with new Suds-O-Matic nozzle gun. Blasts dirt with suds and rinses clean in one easy operation. Fits any standard garden hose. More than 25,000 in daily use! Send check or M.O. for your Suds-O-Matic nozzle today. Complete with large supply of detergent pellets, only \$4.95

Load Suds-O-Matic with our fertilizer pellets and spray on lawn or garden. Bottle of 75 pellets, \$1.00

TRU-VALU SALES CO.
818 Wyandotte Kansas City, Mo.

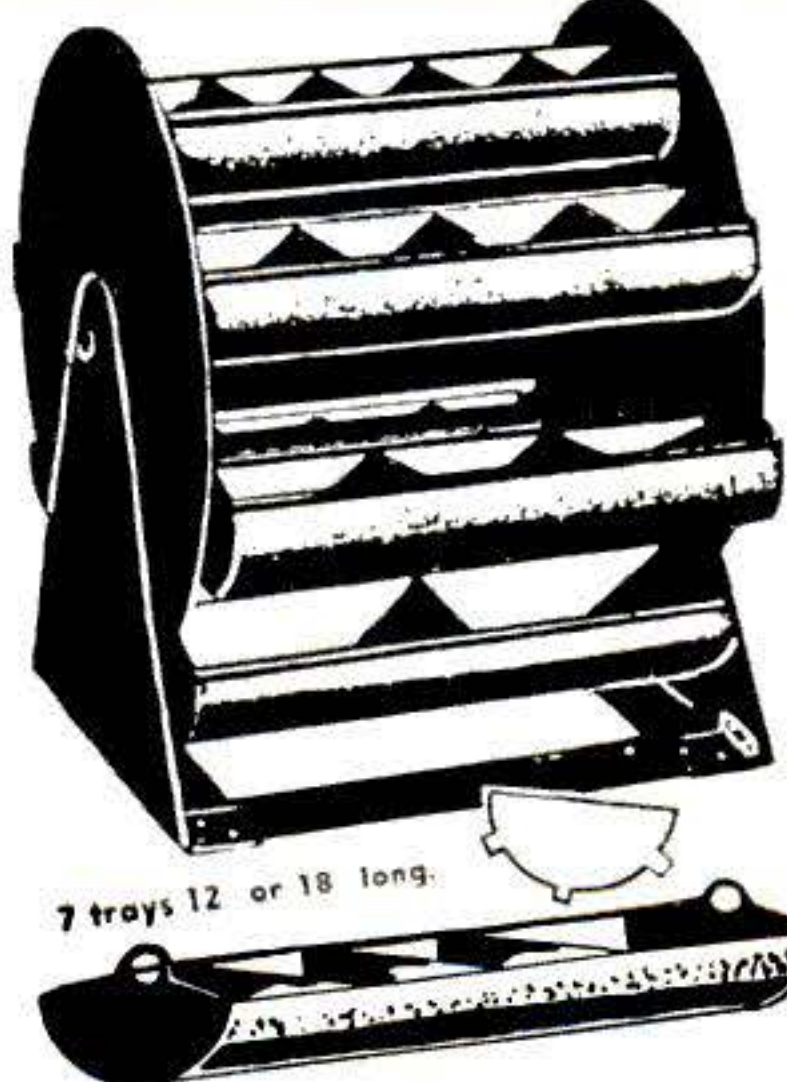

REVOLVING GADGET TRAY

For Carpenters, Machinists, Mechanics, Cobblers, and Hobbyists.

Keeps bolts, nuts, screws, nails and small parts at your finger tips for easy picking. Comes in two sizes, each having 7 trays 12 or 18 long. Built of durable lifetime steel with adjustable, removable tray separators. Can be set on workbench or hung from wall. Sold on money back guarantee.

12 SIZE 18 SIZE
\$3.88 \$5.88

HOMERY INDUSTRIES
P.O. BOX 981 WARREN, OHIO

**NEW for
1950**

MIDWEST

Celebrates its 30th YEAR of FACTORY-TO-YOU Selling with a Sensationally NEW 1950 LINE of

TELEVISION

CONSOLES and Complete CHASSIS

**New
GIANT 16" PICTURE**

Here is Television at its finest! . . . brought to you by Midwest, for 30 years a leader in the field of radio and electronics. Immense 151-square-inch screen on new 16" metal-glass tube . . . clear, steady, bright pictures . . . Synchronized sound and picture that a child can tune in perfectly . . . Highest quality FM sound . . . Big 12" Electro-Dynamic Panasonic Speaker. Available in beautiful Television-Radio-Phonograph Consoles, as illustrated, or in complete chassis (not a kit) ready for custom installation in your own cabinet. And you can buy Midwest Television at Low Factory Prices, with Low Down Payment and Long Easy Terms — and on 30 Days Trial! Send for Catalog TODAY!



LOW
FACTORY
TO-YOU PRICE

30 DAYS TRIAL

... also a Magnificent Line of NEW 1950
MIDWEST RADIOS
featuring the latest Improved FM Circuit
and the New 3-SPEED RECORD PLAYER



Powerful new 1950 Series 16 and Series 12 AM-FM Radio in complete chassis. Also beautiful new Console models including the magnificent Symphony Grand Radio-Phonograph with latest FM circuit and new 3-Speed Automatic Record Player.

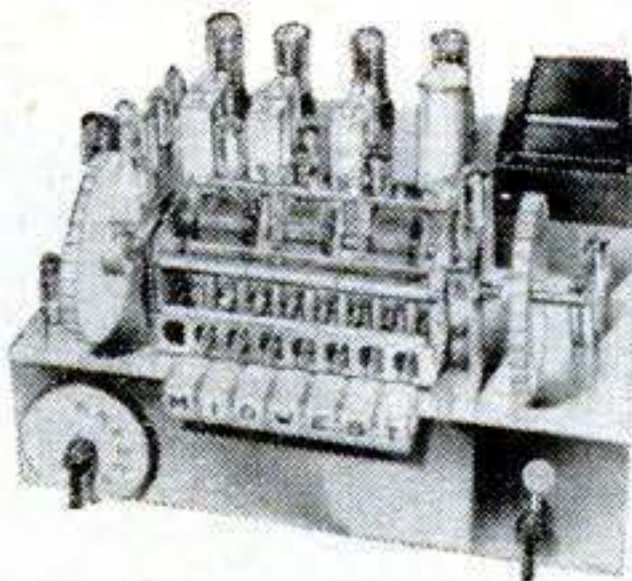

**BUY DIRECT FROM
THE MIDWEST FACTORY and SAVE!
MIDWEST RADIO & TELEVISION CORP.**

Dept. X244, 909 Broadway, Cincinnati 2, Ohio

SEND FOR
FREE
32-Page
Full Color
CATALOG



Write in Name and Address (Please Print) on Coupon or 1c Postcard.

MIDWEST RADIO & TELEVISION CORP.
Dept. X-244, 909 Broadway, Cincinnati 2, Ohio
Please send me your new FREE 1950 Catalog.

NAME _____

ADDRESS _____

CITY _____ ZONE _____ STATE _____

NOVEMBER 1949 277

The Chief

WORK BENCH

A CHRISTMAS PRESENT HE'D APPRECIATE

Built to Last a Lifetime!



With Bottom Shelf and 18" Sq. Drawer. 2"x6", Solid Plank, Grooved and Dovetailed Top and 1"x8" Back Rail, Shellacked to a Smooth, Satiny Finish.

MOHAWK LUMBER CO. Dept. 32
 14525 W. Chicago Blvd. Detroit 27, Mich.
 Enclosed Check Money Order for \$.....
 Ship..... CHIEF WORK BENCHES at
 Quantity.....
 \$16.95 each, F.O.B. Detroit, Mich.
 Send C.O.D., \$5 Deposit Enclosed.

NAME.....
 ADDRESS.....
 CITY..... STATE.....

• 6 Ft. Long • 34" High • 26" Deep. Shipped Knock-down, with Bolts, Nuts and Screws and ABC Chart for Quick, Simple Assembly.
Prompt Delivery
MOHAWK LUMBER CO.
 14525 W. Chicago Boulevard
 DETROIT 27, MICHIGAN

\$16.95
 F.O.B. DETROIT

Send Check or Money Order, or Will Ship C. O. D. (\$5 Deposit)

M
E
R
R
Y

C
H
R
I
S
T
M
A
S



Chronographs!
 MOST VERSATILE WATCH EVER MADE **\$5.95** P.P.
 Plus 10% Fed. Tax. Send \$6.55

- FULL YEAR GUARANTEE
- A STOP WATCH
- A TELEMETER
- A TACHOMETER
- A WRIST WATCH
- SWEEP 2nd. HAND
- LUMINOUS DIAL
- SHOCK RESISTANT
- UN-BREAKABLE CRYSTAL
- LOWEST PRICE IN U.S.A.

AS SHOWN
 P.P. with cash, check, M.O. COD's accepted
 1104 W. Burnside,
 Dept. PS-119, Portland 9, Ore.

DIX SURPLUS



ACTUALLY 11" LONG ABSOLUTELY HARMLESS

Here is the toy gun that all youngsters treasure... the ".45 Smoker". It looks exactly like a real .45 and automatically shoots a puff of smoke every time the trigger is pulled. No explosion... no loud noise... harmless!
 In stores everywhere or send check or money order to manufacturer.

Product Engineering Co.
 4707-a S. E. 17th Avenue, Portland 2, Oregon

ONLY \$1.95
 POST PAID

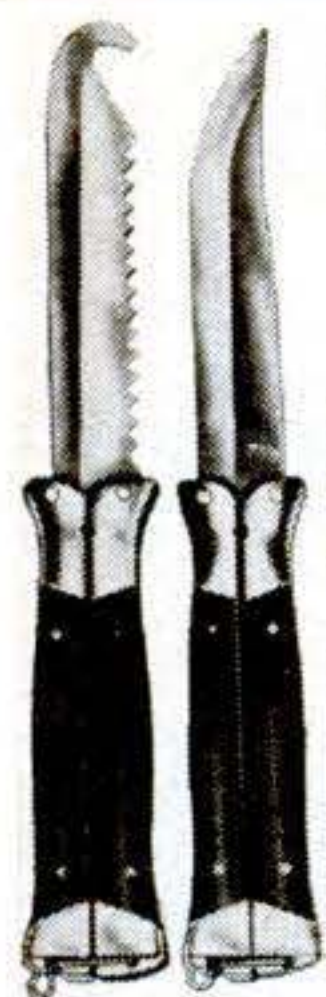

SAF-T-SHEATH FOLDING HANDLE

WOODSMAN *Knife*
 FISHERMAN

Handle folds around blade to form the sheath. Protects the blade, protects you. Keen, tool steel blade, 8 1/2" open, 4 3/4" closed, weighs 5 3/4 oz. No belt sheath necessary! Carry in pocket or tackle box.



\$2.95
 EITHER MODEL

If dealer can't supply, send check or money order
WALTCO PRODUCTS
 Dept. PS-911 2300 West 49th Street, Chicago 9, Ill.

THE XMAS GIFT FOR MEN!

• JIG & SABER SAW with TILTING TABLE •



Professional model, precision built. As Saber—upper arm removable, work not confined to throat depth. As Jig—cuts to center of 24" circle. Handles work up to 2" thick. Table tilts 45°. has graduated scale. Special Blade Chuck takes any blades up to 1/4" width (broken bandsaw blades, etc., can also be used). Smooth stroke, runs in oil. All metal—aluminum-alloy

main castings for strength & lightness. All working parts hardened for long life. Fully guaranteed. 4" pulley. Use with 1/4, 1/5 or 1/6 hp. motor..... **\$13.95** ea.

Send Check or M.O., we ship Prepaid; or send \$2.00, we ship Exp. Coll. (Jig-Lite extra, \$1.95. Motor not inc.) Ship. wt. 15 lbs. Add Postage outside continental U.S.

HOB-E-EZE TOOLS Box 396 Niles, Mich.

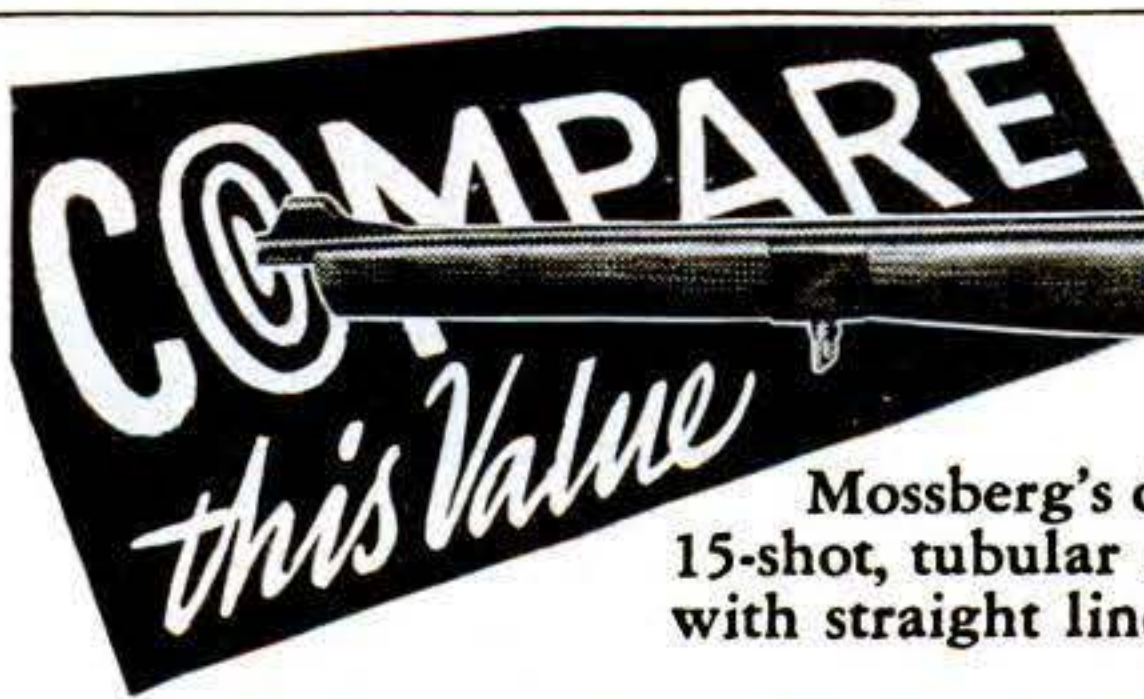

Mossberg's de luxe, .22 cal., 15-shot, tubular AUTOMATIC, with straight line feed..... **ONLY \$30.90**
 \$31.70 west of Rockies

SCOPE EXTRA \$9.35

And compare the quality, fine finish, precision workmanship, accuracy and faultless operation against any other automatic. Your dealer has it—or can get it for you. Ask and insist on Mossberg Model #151M.

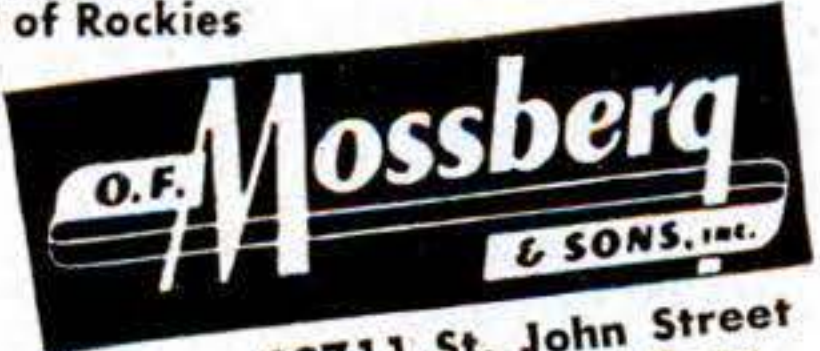

99711 St. John Street
 New Haven 5, Conn.

FREE ... Catalog of this and other Mossberg firearms.
 (No sales at factory)

STOP SANDING BY HAND!

use the new SAND-O-FLEX on curved and irregular surfaces

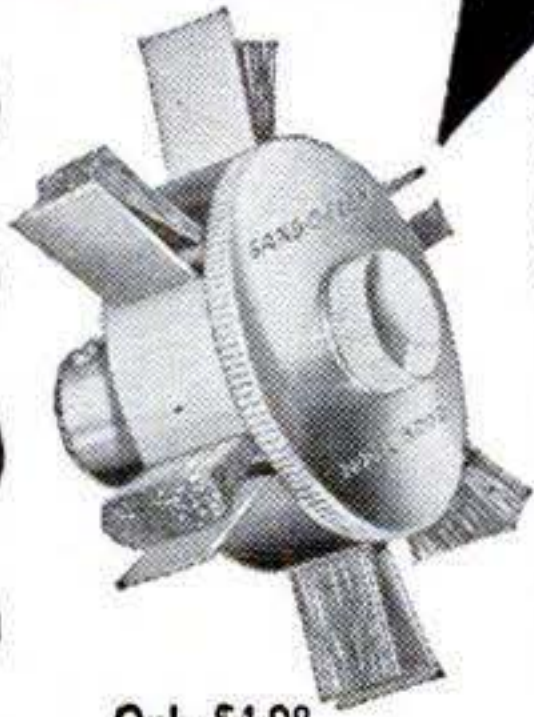

Use Sand-O-Flex on contoured and flat surfaces alike. This low-cost sander reaches into recesses, around intricate curves, and handles all those tedious finishing jobs that were formerly done only by hand. Fasten it to your motor shaft or any of your present stationary or portable power tools. The ideal sander for a hundred home uses. Finishes any material—woods, metals, compositions. Satin finishes stainless steel!

Sand-O-Flex consists of 6 abrasive strips backed by 6 separate brushes in a light-weight aluminum body. When rotated at usual motor speed the brushes "cushion" the abrasive cloth and mold it to the work shape. Abrasive unwinds as ends are worn. All parts are replaceable. Refill abrasive cartridges 3/4" wide, available in coarse, medium and fine for wood and metalworking. Fits 1/2" or 5/8" shafts. Adapters furnished on request.

Only \$4.98
The most versatile
sander ever made!

USE IT ON A



PORTABLE DRILL



FLEXIBLE SHAFT



DRILL PRESS



LATHE



MOTOR SHAFT

Sand-O-Flex contour sanders are attractively boxed, completely loaded with abrasive cartridge, ready for use. They make ideal gifts. Anyone can use them. Over a quarter million Sand-O-Flex sanders are in use today in home and industrial workshops. Larger models available for production jobs. Send for free catalog, prices and name of your nearest dealer.

Free
circular

MERIT PRODUCTS, INC.

4373 MELROSE AVENUE LOS ANGELES 27, CALIF.

NO EXTRAS TO BUY!

PROTECT YOUR TOOLS



Discourage "permanent" borrowers, thieves. Etch your name, initials on tools, instruments, with an ARKOGRAF Electric Etching Pen & Transformer Kit. Like using a pencil. Will write on any metal (incl. carbide tool bits) without changing point. Precision engineered. OK'd by Auto. Test Lab. of America. Ready to plug into 110 v. A-C outlet & use! Complete with instr'ns. Money-back guarantee. P.P. with cash, check, M.O. COD's accepted. Pen & Transformer (in metal box), \$9.95. Pen sold separately at \$3.95 (will operate from 6 v. battery). Write for free folder.

DEALER INQUIRIES INVITED.
GOURLEY MFG. CO., 7057 SE Powell, Dept. PS-119, Portland, Oregon

80 POWER MICROSCOPE TREMENDOUS VALUE!

All metal PRECISION instrument with 80X magnification. Fully ground and highly polished lenses. Special sensitive adjustment to insure clearest and finest enlargement details. Comes complete with viewing mirror, clamps and slide. Beautifully packaged in wooden chest. Not a toy. Will give comparable results to other microscopes selling for \$100.00. Worth many times our LOW LOW PRICE. Order from—

\$7.95

MARDO SALES CO.
480 Lexington Ave., Dept. MK-1, New York, N. Y.

MEN'S Cal-O-Date! CALENDAR WRIST WATCH

The Perfect Xmas Gift
Tells The Time!
Tells The Date!
Now... an amazing Cal-O-Date Watch for only \$14.95, Fed. Tax included—from 4 to 5 times less than generally priced—packed with these big value features: Guaranteed imported—Swiss movement—7 jewels—Sweep-second hand—24 hour military dial—Radium hands—Gold color numerals—Unbreakable crystal—Beautiful chrome case—genuine leather strap—Gift boxed.

Date Changes Daily In The Automatic Window!



Only \$14.95
Fed. Tax Incl.

ORDER NOW—supply limited—send \$14.95 for postpaid delivery or \$1.00 deposit, pay balance plus postage C.O.D. Money back on return within 5 days.

JEWEL BOX, 1810 W. 95th St., Chicago, Ill.

Pint Sized Power Miracle

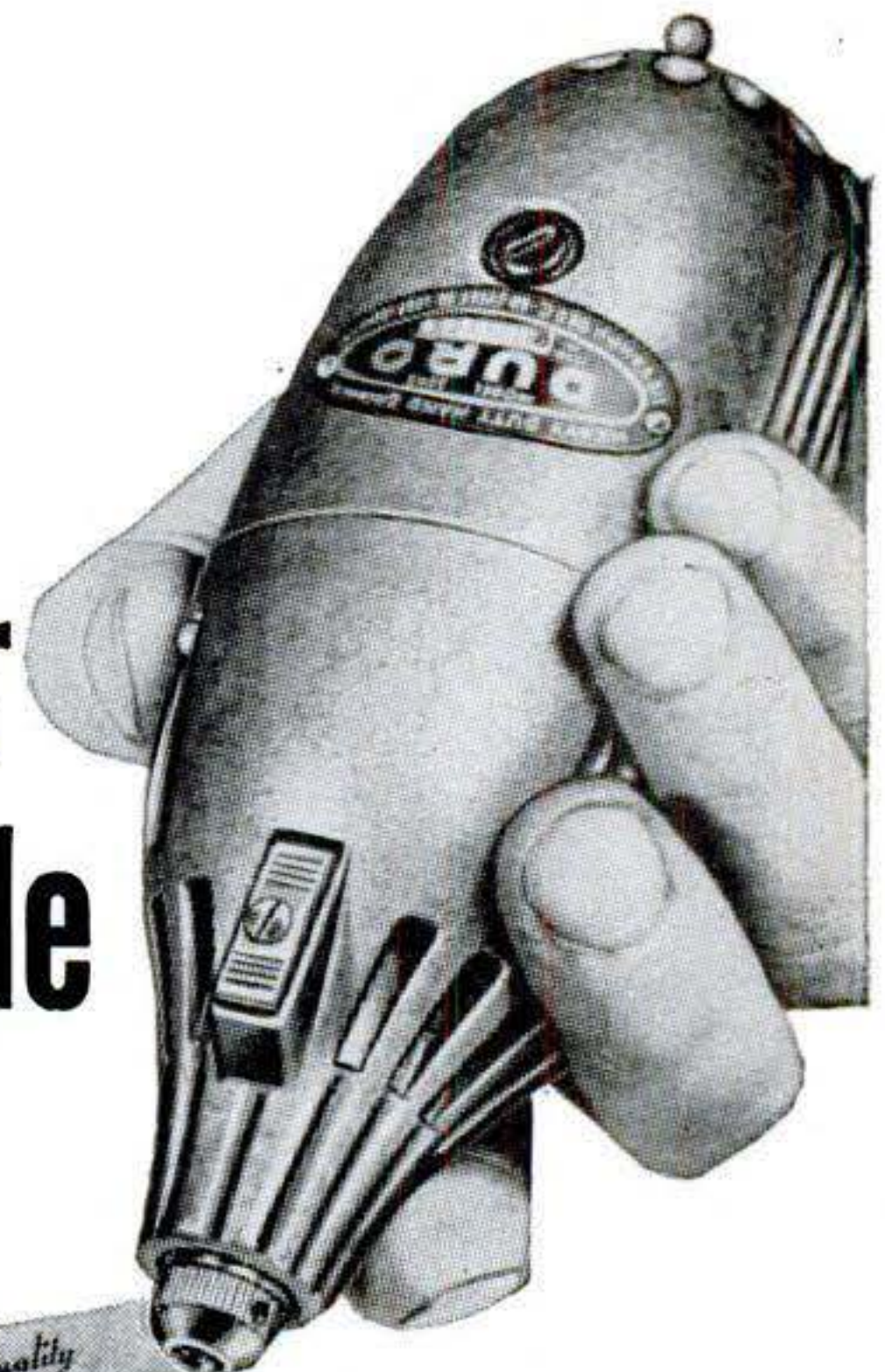

Complete Super Power
Tool Kit—Only

\$18.55

Contains power unit with cord, 5 abrasive points and cutting burrs, full operating instructions—all in one case.

New Duro Super Power Unit—the tool you'll use in a 1000 ways!

This is the kind of lightweight, perfectly balanced hand power tool that hobbyists and home craftsmen dream about! A compact fistful of super power, it runs cool and smooth at 20,000 RPM, develops 42 watts output. With it, you can do clean, professional-looking sanding, polishing, grinding, engraving, carving... and scores of other operations.

Start with this low cost tool kit and build a complete home workshop! One Duro Super Power Unit is used on all of these home workshop tools! You may buy them singly—or in a group.

- Grinder & Shaper Only \$8.80
- Drill Press Only \$11.95
- Router Only \$8.15
- Lathe—Only \$10.15

Ball Bearing Flexible Shaft Doubles the Fun
New Duro flexible shaft fits over nose-piece of power unit, makes free-hand carving, engraving lots more fun. Flexible shaft, complete with hanger, only \$15.55

Write for Free Illustrated Circular giving full details about the Duro Super-Power Unit and the low cost workshop units. Circular also shows almost a score of pictures and details about operations that you can do with these amazing power tools.

DURO METAL PRODUCTS CO.
2667 N. Kildare Ave., Chicago 39, Ill.
Gentlemen: Send me free circular giving full details on the Duro Super-Power Unit and the low cost workshop units.
Mail Orders Handled Promptly—Shipped Postpaid.

Name.....
Address.....



M
E
R
R
Y
C
H
R
I
S
T
M
A
S

ROYAL KNIBB WATCH BANDS



\$1.00
IN STAINLESS STEEL

\$1.50
IN GOLD PLATE ON STAINLESS STEEL

COOL—COMFORTABLE—FLEXIBLE

True basket weave design in flexible, gleaming stainless steel. Fits any wrist or watch. Will not discolor skin. Impossible for dust and perspiration to collect. Packaged in crystal clear display box, ideal for gift. Mail coupon. Sent prepaid within U.S.A. Money refunded if not satisfied within 3 days.

L. H. KNIBB CO., 122 S. Michigan Ave., Chicago 3, Illinois
Send postpaid the watch band checked below.

Stainless Steel @ \$1.00 Gold Plate @ \$1.50

Name _____

Address _____

Retailer and Wholesaler Inquires Invited

MIT-TEES



Miracle Plastic Golf Club Covers
Made of heavy blue Vinyl plastic over cotton twill. Attached with raw-hide cord. Yellow flannel numbers. Moisture-proof, scuff-proof—real protection for your woods. Each set boxed as gift. Set of 3—**\$2.70**; set of 4—**\$3.60**. Postpaid. No C.O.D.'s

WINTERSEAL CO.
3135 N. Cicero Ave., Chicago 41, Ill.

Table Top MODEL RAILROAD!



Have fun building and operating America's smallest railroad models. Accurately scaled 10 ft.—1 inch. Track (TT gauge) only 15/32" wide.

COMPLETE TRAIN SET KIT WITH ENGINE, 3 CARS, AND 10 1/2 FT. TRACK. \$29.95

Box car, Decals, Short Track, Catalog, postpaid . . . \$2.00
Literature \$.10

H. P. PRODUCTS CO., Hartford City, Indiana

DIRECTION SIGNAL



Flashes Your Turns Automatically

No more winter window cranking for arm signals. The new **SIGNALITE DIRECTION SIGNAL** fits any car. Flashes parking and tail lights 60-80 times a minute. No interference with regular lights, no extra lights to mount for most late cars. Works similar to factory-installed models. All parts furnished—install it yourself. **SPECIFY MAKE AND YEAR.** For cars earlier than 1942, write for price. **Money Back Guarantee.**

\$12.95 Postpaid in U. S. Send check or money order. Postage extra on C.O.D.'s.

The LESTER Company 1743 North Milwaukee Ave., Chicago 47, Ill.

DARK ROOM VENTILATORS

13 1/2"

D
I
A
M
E
T
E
R



4 1/2"

T
H
I
C
K
S
T
E
E
L

VENTILATE YOUR DARKROOM
\$25.00 Value—Price \$7.50 set or \$4.00 Each

New government surplus. Air flows through these steel louvers freely due to the arrangement of baffle plates. Light does not show through these ventilators. Hundreds of these vents have been installed in darkrooms. You will need two for your darkroom. Install one in or near the ceiling and one near the floor. \$7.50 for set of two, or \$4.00 each.



\$18.95
Postage Paid

1/4 INCH PORTABLE HOME-UTILITY
ELECTRIC DRILL

1/4" capacity in steel, drives wire brushes and many accessories. Fast Jacobs hex-key chuck. Instant release trigger switch. Strong, light die-cast aluminum housing fits hand. 3 wire cord for ground. Low price plus Black and Decker quality. Ideal as a gift.

SEND FOR OUR COMPLETE CATALOG ON POWER HAND TOOLS AND MANY SURPLUS BARGAINS.
Pay by Money Order or Check. 25% dep. on C.O.D.'s. Prices on ventilators are F.O.B. Fresno. Shipping weight 29 lbs. for set of two. **POSTAGE PAID ON ALL ELECTRIC HAND TOOLS.**

ARMY SURPLUS SALES
of FRESNO

Dept. 112 1820 Tulare Street Fresno, Calif.

AMAZING NEW FISH LURE!



The "Whammy" dives, darts, wiggles, spirals (up and down) shimmies. **GLOWS** under water! Tested & approved by thousands of fishermen. Tough, clear plastic with a brilliant luminous chemical sealed in. Won't wear or wash off. Money-back guarantee. Available for all size fish—ocean, stream or lake. Cash, check, M.O. C.O.D.'s accepted. Lake & stream lure—**\$1.20**. Ocean lure—**\$2.40**. State type of lure wanted. **DEALER INQUIRIES INVITED!**

GLO-RITE PRODUCTS, Dept. PS-119, 2928 SE Hawthorne Portland, Oregon

A Perfect Xmas Gift For Junior SUN-RAY ENLARGER



Takes From 35mm To 2 1/4 x 3 1/4 Negatives. Extra compact & Sturdy **\$10.95** Including Lens.

For the Junior Miss, we suggest Pixie Wrist Camera. **\$4.95**
Write For Free Bargain Book "P."

CONWAY CAMERA CO.
34 N. Clark St. Dept. PS Chicago 2, Ill.

AMAZING • NEW Swingster



CHILDREN 2 to 7 LOVE IT!

At last—a safe and sturdy self-propelling swing. It soars thru the air by simply pumping the handle. Keeps kiddies busy and happy—gives years of pleasure. Satin smooth hardwood, clear lacquered. Complete with all hdwe. and ropes. Ready to use in 10 minutes. Instructions furnished.

AN IDEAL GIFT

Complete satisfaction guaranteed or money refunded. Rush check or money order today.

SPECIAL \$7.95 POSTPAID CASH PRICE U.S.A.

Dealer Inquiries Invited!

PAULSON MACHINE WORKS
Dept. A, 1441 N.W. Quimby St. Portland 9, Ore.

SPECIAL XMAS OFFER

Now!
the beautiful
Yorkshire
WATCH



\$9.95

RHINESTONE DIAL . . . RAISED UNBREAK-
ABLE CRYSTAL . . . ONE YEAR GUARANTEE
. . . GOLD PLATED CASE . . . STAINLESS
STEEL BACK . . . GIFT BOX

MATCHING LINK BAND
Regular Price \$9.95. With every watch only
\$1.00 additional.

SEND NO MONEY! Order now. Pay
postman only \$9.95 plus 10% Federal Tax
and postage. If you are not delighted with
this fine watch, return within 10 days and
your money will be cheerfully refunded.

SPECIAL INTRODUCTORY OFFER FOR A LIMITED TIME ONLY

YORKSHIRE WATCH CO.
103 S. Wells St. Dept. 382
CHICAGO 6, ILL.

—IDEAL CHRISTMAS GIFT—
THEY'RE SUPER SCOPES!



36" 17 POWER

Extends to 36 inches. Precision and Polished Lenses. A Scientific Instrument. Ideal for Studying Stars, Plane Spotting, etc. Satisfaction Guaranteed or Money Refunded. Send Check or Money Order to **CRITERION CO., Dept. PS5**
438 Asylum St. Hartford 3, Conn.

\$2.95
Post Paid

JEWELER'S SCREW DRIVERS

8 Jeweler's Screw Drivers. A must for every hobbyist and model builder.



Ideal for precision work, camera and fine instrument repairs. In 8 sizes—from the smallest size 9 up to size 2. Finest tempered steel blades. Lowest price!
ONLY \$2.00
C.O.D. \$2 plus postage, or send \$2 and we pay postage.

THE IDEAL X-MAS GIFT!

PINE WATCH CO. 29 ELDRIDGE STREET Room 40 N. Y. 2, N. Y.

GOLFERS!

IDEAL CHRISTMAS GIFT!

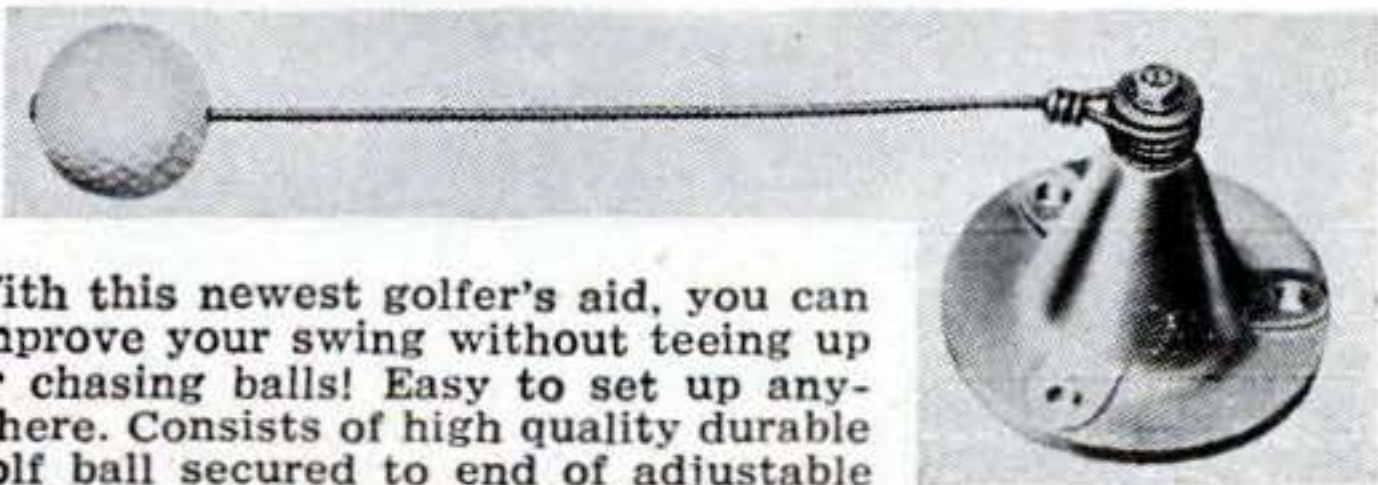

With this newest golfer's aid, you can improve your swing without teeing up or chasing balls! Easy to set up anywhere. Consists of high quality durable golf ball secured to end of adjustable steel arm—gives right feel when ball is hit properly, ball spinning smoothly on double ball bearing spindle. Begin this winter to develop the best golf habits. See your dealer or order direct \$4.85 each postpaid in U. S. cash or M.O. with order, or we will send C.O.D. plus charges. Satisfaction Guaranteed.

TAYLOR MADE PRODUCTS, 2242 LaBelle, Detroit 6, Mich.

SANTA SAYS:
"A WONDERFUL HOBBY WORKSHOP GIFT!"

Just dial ANY WIDTH CUT ON YOUR SAW

WITH
Warren
DADO SAWING WASHERS

Cut clean, accurate, parallel grooves—12 widths, any angle. No chatter, burning, chewing—or sanding! No more blade vibration—no screws to fuss with—just four balanced washers. Simply dial desired width with Micro-matic adjustment. Can be left on blade for straight cuts. Available in 5 sizes—1/2", 3/4", 5/8", 1", 1 1/8". A perfect gift for woodworkers. See your dealer or write—

\$4.95 SET

WARREN WASHERS CO.
Dept. 51 • 70 Medbury • Detroit 2, Mich.

NOVEMBER 1949 281

MERRY CHRISTMAS

MERRY CHRISTMAS



Take a Hot Tip
from
SANTA and—

For Pleasure and Profit — GIVE AN **EMRICK**

COMPLETE HOME WORKSHOP
HANDYMAN'S DREAM

5 POWER TOOLS

IN ONE MACHINE
only **\$39⁹⁵**



Make Money,
Save Money

SPECIAL SALE NOW ON

EMRICK 5-in-1 MACHINE — the gift he will really enjoy! Easy to learn 83 operations, working in wood, metals or plastics. Make furniture items of all kinds for yourself or for sale — turn out adorable presents — save many dollars annually doing home repairs. Fun for the entire family at only a few cents per hour.

An EMRICK includes big capacity, heavy-duty Lathe, Drill Press, Saw Arbor, Grinder, Sander — all in ONE power machine, using ONE motor. Only \$39.95 cash, or on Easy Payments. Christmas delivery assured. 10-Day Free Trial. MONEY-BACK GUARANTEE. Thousands of satisfied customers — our 51st year.

Write for FREE Catalog, describing Big Pre-Christmas Sale. EMRICK, INC., 1872 Clinton, Kalamazoo, Mich.



PERFECT XMAS GIFT

- Swiss precision movement **\$5.95** Plus 10% Fed. Tax
- Sweep second hand **WOMAN'S MODEL**
- Radium dial **\$6.95** Plus 10% Fed. Tax
- Gift box

Send only \$1.00 with order. Pay balance plus postage on arrival. We pay postage if you enclose payment in full with your order.

GUARANTEED JEWELRY CO.
1348-B Morrison Avenue, New York 59, N. Y.

IDEAL XMAS GIFT FOR COLLECTORS



E-Z-C STAMP VIEWER

Sensational gadget has exclusive features. 3 power magnification. Can be used either upright or tilted, insuring comfortable position for user. Fixed focus allows freedom for use of hands. Colored filters for studying watermarks and cancellations. Only \$1.00 cash or money order.

SEND \$1.00 TO CALGADCO, INC.

424 N. Edinburgh Ave., Dept. X Los Angeles 48, Calif.

DIVE for FUN and PROFIT

COMPLETE SHALLOW WATER DIVING KIT

Includes Miller Dunn hand pump good for 25' under water (Fig. 1), 3 foot hose for connecting pump to volume tank (2), Volume Tank complete with fittings (3), 50 feet of Air Hose (4), and new surplus Gas Mask (5) to be converted to an excellent shallow water diving mask. Belt for holding weights, "T" adapter and non-return valve furnished. Instructions for conversion, use of diving outfit and safety precautions are also included as part of the unit.

Form a diving club. Order your outfits direct from this ad Today. **Now \$49.50 F.O.B. Only** Wilmington

Complete stock of deep sea, shallow water and self-contained outfits also available.

DIVERS' SUPPLY
1136 Wilmington Blvd.
Dept. PS-119 Wilmington, Calif.



XMAS TOOL VALUES!



SET OF 3 OFFSET SCREWDRIVER SETS
SIMPLE—LIGHT—STRONG

Quickest, easiest way to start, tighten, or remove screws in close quarters. Adaptable to both finger and lever turning. Knurled head for finger turning to engage or remove free screws, hex-wrench handle engages bit in 6 positions for leverage in security setting or removing stubborn screws. Just what you need for those hard-to-get-at screws. Each set for those in handy holder package. Set of 3 **\$1.00** Post-paid

NEW U. S. NAVY PRECISION ENGINEERS GAGES

Specially designed for machinists and engineers who want a compact set of gages. Consists of taper gage with 3" rule on reverse side, wire gage with decimal equivalents on reverse side, 9 thickness gage leaves from .002 to 1/16". Overall length is only **\$2.00** Post-434". List price \$5.00.....**\$2.00** paid

Send check, money order or cash. No COD's. Satisfaction guaranteed.
HARDWARE SUPPLY CO. Dept. C
495 Atlantic Ave. Boston, Mass.

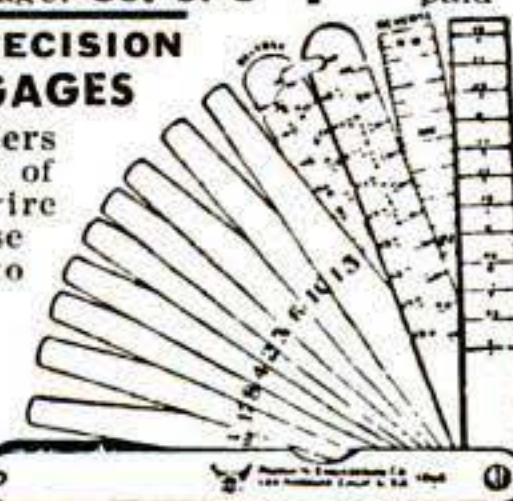

SWISS MUSIC MOVEMENTS



Make musical stuffed toys, cake plates, cigarette boxes, etc. for Xmas or for Xmas Gifts with our fine imported Music Movements. Single tune units — Mary Had a Little Lamb, Brahms Lullaby, Heigh Ho, Rockabye Baby, Ave Maria, Blue Danube, Anniversary Waltz. **\$2.25**. SPECIAL two tune units playing waltz and operatic selections for five minutes on one winding **\$3.50**. Dealers inquiries—Quantity Discounts.

MARITIME, 13 EAST 60th ST., NEW YORK 22, N. Y.

ITALIAN ACCORDIONS



All types, all models, Very best. Hand Made. Fully guaranteed. Buy direct from Factory representative at lowest wholesale prices, and Save Money. Also Button Accordions, Chromatic Accordions and Concertinas. Send name and Address for FREE catalog.

ITALIAN ACCORDION MFG. CO.

7600 Cottage Grove Ave., Dept. PS-11, Chicago 19, Ill.

MICRO-VOX . . . The Wireless "Mike"

Broadcasts Over Any Radio within 75 ft.

Here's a fascinating miniature transmitting system that will delight everyone! Practical jokes and dozens of other uses that will astonish one and all! Clear, Life-like tone. Easy to operate! Complete with tube, batteries, tuner and built-in high-fidelity microphone. SAVE MONEY! Send check or M.O. We Pay Postage. **\$6.95** C.O.D. Plus Postage.



TRUSOUND, Inc. (Dept. PS-11) 630 W. Randolph St. Chicago 6, Ill.

DEALERS WRITE

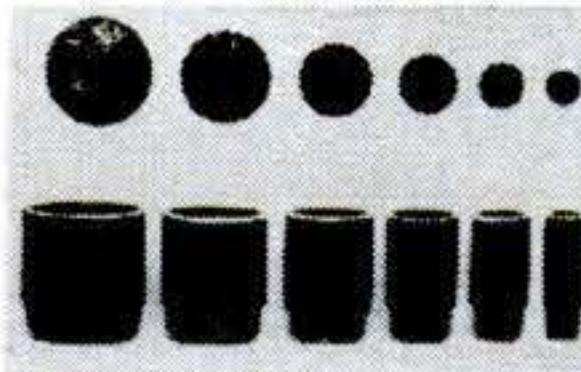

HAMMER PUNCHES

Indispensable to the hobbyist, home mechanic, or tinker. Makes neat round holes in graduated sizes from 3/4" to 1/4" through paper, leather, cardboard, cloth, linoleum, rubber, asbestos. Gives your gaskets or washers that professional look. A welcome addition to any tool kit. Set includes six, razor-sharp, seamless, hard steel dies, neatly packed.

\$1.95 cash, check, or postal note.

EASTLAND-SALESMAN, P.O. Box 211, Auburn, Mass.

AMAZING ELECTRIC MAGIC MOTOR

Drives toys from ordinary flashlight batteries. Have fun with this real, powerful electric motor. Easily assembled with your own hands, without tools, screws, bolts, nails or glue. Made of plastic and metal parts. Any child can build it. Drives most any free running toy. No transformer or house current needed. Complete with full instructions. **\$1.00** postpaid. Money Back Guarantee.

WILKIT TOY CORPORATION, Dept. S-11
20 N. Wacker Dr., Chicago 6, Ill.

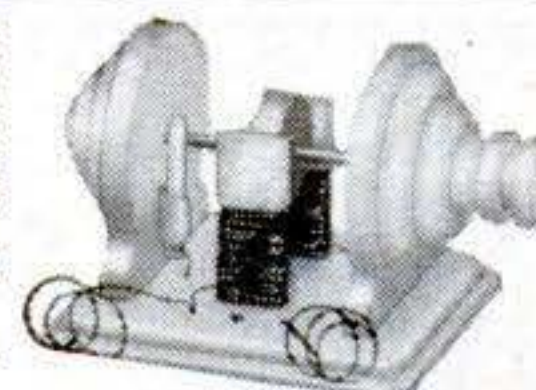

CHAIN LIGHTNING

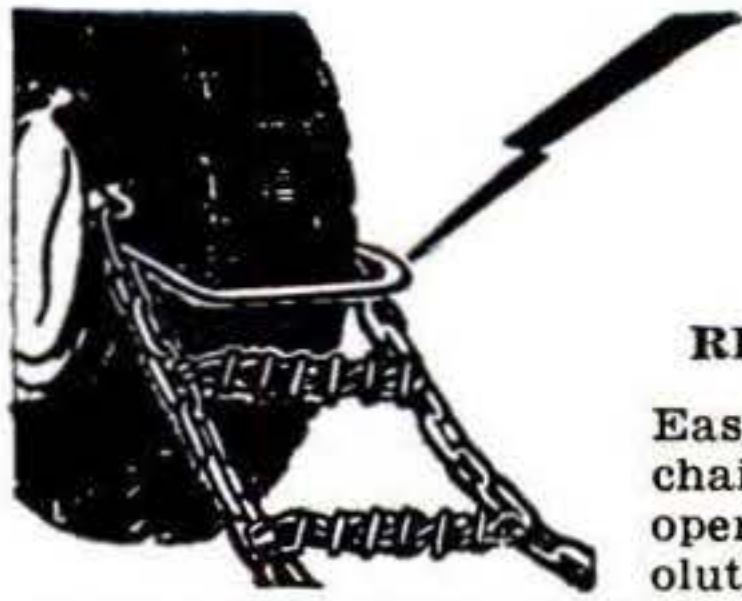

**New, Quick,
Clean, Safe Way
to put on Chains!**

**NO JACKING OR
REACHING UNDER FENDERS**

Easy-to-use spring steel clips fit chains to both tires in one simple operation. Drive forward one revolution and couple fastenings. No wasted time, soiled clothing, frozen hands. Packaged with one GLO-SLO Scotchlite Protective Reflector to guide traffic safely past. Complete instructions. Ideal Xmas gift. \$1.00 postpaid.

STODDARD PRODUCTS CO., INC.

P. O. Box 53042, Westville Sta., New Haven, Conn.

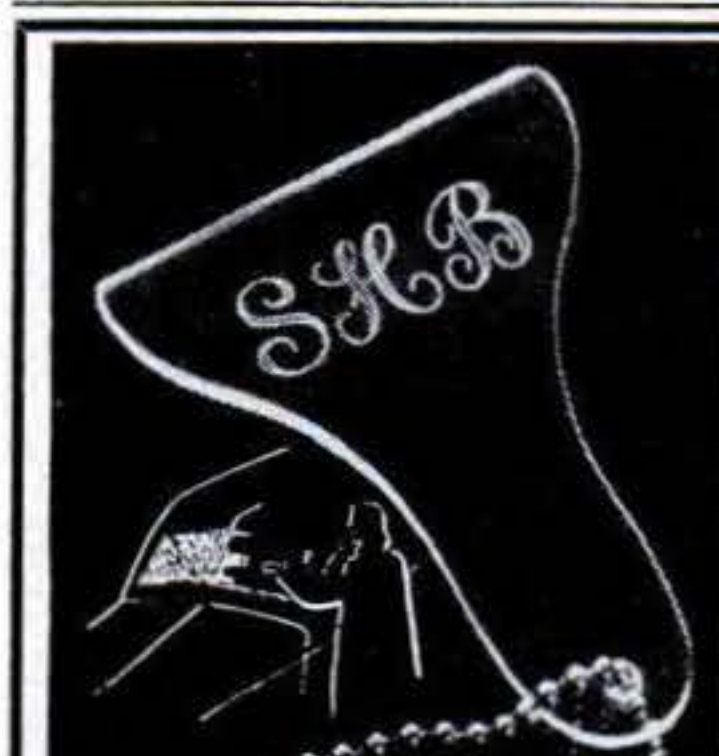

Windshield De-Icer

Flick ice and sleet off your windshield in a jiffy with this solid plexiglas scraper. Initials permanently engraved. 3" long with 2 1/4" blade. No. PE2235.

\$1.

postpaid



Write for Big Catalog... Free

Miles Kimball
KIMBALL BUILDING

44 BOND ST., OSHKOSH, WIS.

SAVE ON TRAIN ACCESSORIES

ILLUMINATED PASSENGER STATION—
Exceptional Value. All metal 7" x 14" x 5 5/8" hi. Realistically detailed with signs and poster. Finished in 5 colors. For "O" and "S" Gauge, \$3.95 p. p.

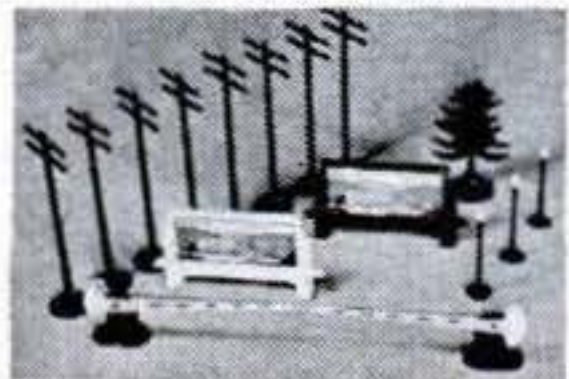

**32 PC.
ACCESSORY
OUTFIT
\$2.00**

Add detail to your R. R.—16 Tele. poles, 6 Lamps, 4 billboards, 4 crossing gates and 2 trees. "O" and "S" Gauge. Send stamped env. for Lionel circel. or HO TRIX Ready to Run train BROCHURE. Catalog of model books—plans 10c. 120 p. p. Ship models—fittings 35c. Everything for hobbyists. VISIT:—

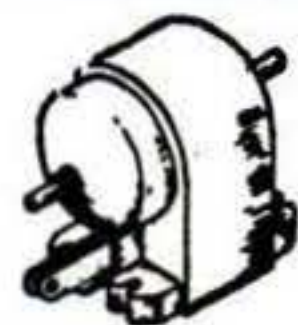

TINY ELEC. MOTOR \$1.50

Compact, powerful, reversible. Plastic housing. 1 1/2-4 1/2 V. Perm. Mag. 1" x 1 3/8" x 1 1/2" hi. 2 oz. Shaft 3/32 x 2".

MULTISPEED GEAR BOX \$2.—Plastic housing 1/2 oz. 4 diff. speeds & shafts. 1" wide. Set pulleys, etc. 25c.



**COLLECTORS' MINIATURES
"OLD-TIMERS"**
NEW! PRE-FAB KITS

Superbly decorative, exquisitely detailed 7 1/2". Also: Olds \$2; Stanley Steamer \$3.20, '09 Ford \$3.10, '10 T Ford \$2.75, '03 A Ford \$2.75, Rambler \$2.60, Reo \$2.75, Horseless Carriage \$1.75.

POLK'S HOBBIES, DEPT. P. S. 119—314 5th Ave., N. Y. C. 1

World's Most Startling Value!



**AUTOMATIC
DEVIL DOG**

MAKES THIEVES RUN

CAR WATCHMAN—BURGLAR ALARM

Sensational Xmas gift! Protects car, contents. Scares thieves away by intermittent horn blasts. Easily installed. 10-yr. factory guarantee!

2 for \$5

Or 2.95 Each

SEND NO MONEY!

Order C.O.D. plus postage. Include payment, we pay post. Money-back guarantee!

YOUNG DISTRIBUTING CO.

3325 Puritan Detroit 21, Mich.

FAMOUS MAKE

What a Watch! What a Buy!
17 JEWELS • 2 PUSH BUTTONS

CHRONOGRAPH

formerly up to \$71.50
• **WRITTEN GUARANTEE \$24.95** plus

A precision instrument. 10% Fed. tax
Wrist watch, stop watch, tachometer, telemeter all in one. Sweep-second hand, Radium dial, stainless steel back. Ideal for mechanics, sports, science, medicine, engineering. 10-day money-back guarantee of satisfaction.



FAMOUS MAKE

DURABLE, PRECISE, 17 JEWEL GUARANTEED SWISS WATCH

- Water-resistant
- Shock-resistant
- Radium Dial
- Anti-Magnetic
- Sweep-Second Hand

\$49.50 RETAIL VALUE . . . only

HANDSOME thin-model, expensive-looking, with matching expansion bracelet. Chromed top with stainless-steel back. Inca-bloc shock-feature found only in more expensive watches. 10-day money-back guarantee of satisfaction.

\$19.75 plus

**Smallest AUTOMATIC,
SELF-WINDING, WATER
RESISTANT Watch Obtainable**

\$62.50 RETAIL VALUE . . .

ONLY \$28.75 plus

10% Fed. tax
Famous make! Sweep-second hand! 17 Jewel! Radium dial! Leather strap! This smart-looking all stainless steel watch is equipped with a shock resistant "Inca-bloc" feature. NEW! REVOLUTIONARY! It winds itself with the motion of your wrist. Sent C.O.D. or pay in advance and we pay postage or try our . . .

LAYAWAY PLAN—Send a little each month till purchase price is accumulated. We reserve your watch for you. No extra charge.
SUPERIOR WATCH DISTRIBUTORS
580 FIFTH AVE., NEW YORK 19, N. Y.
Department PS. 1



ARMY FIELD

Telephones



**Compact . . Rugged . . Portable
Anyone can install and operate**

Just hook up terminals of two or more phones to any 2-conductor wire and you are ready to talk up to 17 miles! Powered by standard flashlight batteries. **HUNDREDS OF USES** for quick, dependable communication in **HOME, SHOP, FARM, INDUSTRY**. Complete with self-contained hand-operated ringer. **Checked for perfect operation and guaranteed.** USED, excellent condition. Each . . . \$9.95
Two for \$18.50

LIKE NEW, each phone undergoes thorough performance check in our reconditioning shop to assure peak operating efficiency. Best appearance of handsets and chassis units is restored **LIKE NEW**. . . . Each \$12.95, Two for \$24.50
6 phones on one line makes excellent intercom.

TELEPHONE WIRE



Weatherproof, durable, 2-conductor, twisted, communication wire, insulated, stranded 7X.013, reinforced with steel strands for extra tensile strength (3 copper & 4 steel).
W-110B. Unused, new, stored in open. Half-mile reels (2500 to 2750 feet). Wt. 85 lbs. Each . . . \$14.25
ONE-MILE REEL . . . \$27.50
500 ft. coil (14 lbs.) . . . \$3.95
1000 ft. coil (28 lbs.) . . . \$7.25
NEW W-130 Lightweight, Half-mile. (16 lbs.) . . . \$15.00

Telephone parts available. **WRITE for Free Folder**
All prices FOB Sacramento. No COD. California residents add 3% for sales tax. Small orders sent postage collect plus small handling charge.

SEND CHECK OR MONEY ORDER

LORIS SALES

P. O. Box 1896-A9-11

Sacramento, California

MERRY CHRISTMAS

How Many Leaves on a Tree?

ANY skeptics ambitious enough to count the leaves on a tree may test for themselves an expert's recent estimate. He says a sugar maple 50 feet high, with a trunk of 15-inch diameter, has 162,500 leaves. Their area available for photosynthesis totals 14,930 square feet.

Old Friend Gets New Name

THAT's not a tungsten filament in your incandescent lamp. The name is now *wolfram*, by which this element and metal has been generally known outside the U.S.A. The change,

to end confusion, was made by the International Union of Chemistry at a recent meeting in Amsterdam.

Knock, Knock—Who's There?

E. GEOFFREY MONTGOMERY, who lives near San Francisco, was puzzled when he discovered that his radio-operated garage door kept going up and down without command. Finally he tracked down the trouble: United Air Lines transports flying overhead used the same frequency as he did. When the airplane transmitters went into operation, so did the garage doors. Montgomery changed his frequency.

THE IDEAL CHRISTMAS GIFT

DREMEL *Electric* MOTO-TOOL

The "Pocket Size Machine Shop"

Grinds, Routs, Drills, Carves, Engraves, Cleans, Polishes, Finishes.

Approx. 27,000 R.P.M.

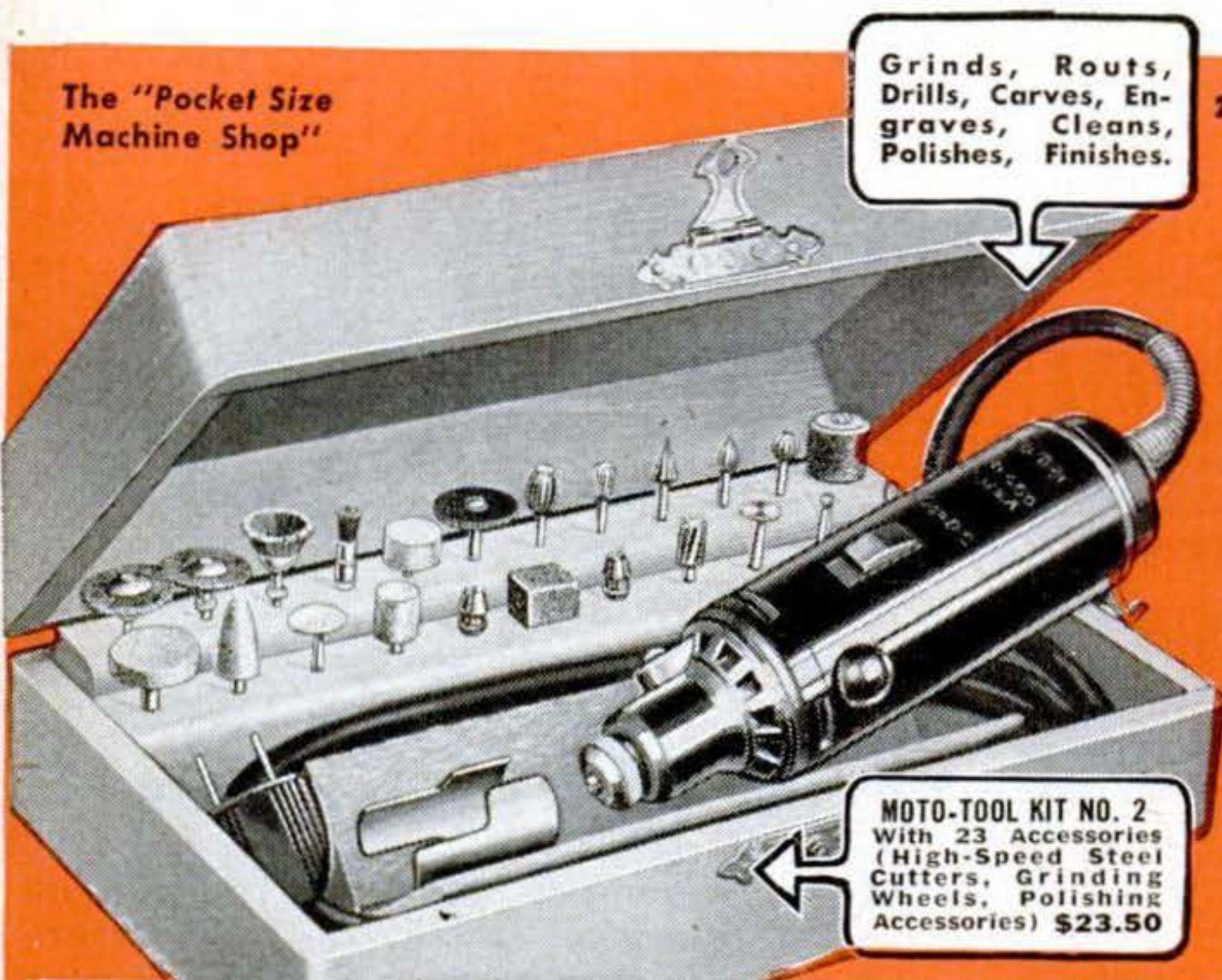

MOTO-TOOL KIT NO. 2 With 23 Accessories (High-Speed Steel Cutters, Grinding Wheels, Polishing Accessories) \$23.50



MOTO-TOOL NO. 2 with one emery wheel point \$16.50



Great for Hobbyists

Saves Time and Labor

10 Reasons Why Moto-Tool is a Better Buy

Here's what you get in a Dremel No. 2 Moto-Tool: Oil-less, sealed bearings • Patented automatic chuck lock pin • Oversize armature shaft, hardened, ground, polished • Shockproof, bakelite housing • Dust filtered air cooling system • Dynamically balanced armature (for vibrationless operation) • Exclusive hanger hook • Sturdy 110-120 Volt AC-DC motor • Weight only 13 oz. • Cutters in Kit No. 2 are made of high speed steel (not common high carbon steel) for longer life, faster cutting.

Moto-Tools, Kits and Accessories should not be confused with "bargain offers." We invite you to compare Dremel Products feature for feature with other similar equipment. If you are not fully convinced ours are far superior in quality, design and performance, we don't want you to buy.

WIDELY USED IN INDUSTRY—Moto-Tool is a precision-built electric tool, backed by over 13 years of industrial use in such plants as: GENERAL ELECTRIC • FORD • REMINGTON ARMS • NASH-KELVINATOR • WESTINGHOUSE • DOUGLAS AIRCRAFT, etc.

PRE-WAR PRICES STILL PREVAIL

MOTO-TOOL KIT NO. 2 with 23 accessories including high-speed steel cutters and Model 2 Moto-Tool in natural finish hardwood case \$23.50
MOTO-TOOL NO. 2 with one emery wheel point.....\$16.50

WHERE TO BUY—Buy Moto-Tool from your dealer. If he cannot supply you, send check or M.O. for items desired and we will ship postpaid. Or, send only \$2 now and pay postman balance plus postage on delivery. **MONEY-BACK** if not delighted after 5 days' trial. Catalog of Dremel Tools **FREE**.

Dremel Mfg. Co. • Dept. 129-L • Racine, Wis.

Portable DRILL PRESS

Add all-around versatility to your Moto-Tool with this 12" high drill press. Just the thing for creating costume jewelry, model making, carving, routing, drilling, etc. Utilizes No. 2 Moto-Tool, which can be raised, lowered or swung in any direction. Weighs 3½ lbs.

Only \$9.95

(Less Moto-Tool)



BIG VALUE!



MODEL NO. 1

MOTO-TOOL KIT Only \$17.50

Moto-Tool Kit No. 1 contains the lighter Model No. 1 Moto-Tool and 34 practical accessories (steel cutters, grinding wheels, etc.) in an attractive, lacquer-finish wood case. It's the biggest bargain in the field.....\$17.50
MOTO-TOOL NO. 1 with one emery wheel point.....\$9.85

A Gift the Whole Family Can Use

THREE TOOLS IN ONE

Only \$14.85

POSTPAID

Son, you'll have to wait to sand your boat until I polish some furniture.

A Dremel Sander sure takes the work out of sanding.



Patented



DREMEL Electric SANDER

Popular Labor Saver for the HOME and SHOP



Makes play of wax polishing



Soothes tired muscles by massage

The popular Dremel Electric Sander is more than a sander... it's also a polisher and massager. This miracle machine is so easy to handle, a child can use it. It delivers 14,400 strokes per minute. (1) As a sander, it gets into tight corners, takes the effort out of sanding walls, woodwork, furniture, workshop projects, etc. Its straightline (non-rotary) action will not burn or scratch surfaces. (2) As a polisher, it does a professional job on waxed surfaces of cars, furniture, refrigerator cabinets, etc. (3) As a massager, it's ideal for tired or sore muscles of the back, legs or arms. Users testify it is more effective than machines made expressly for this purpose.

LOOK AT THESE DREMEL FEATURES

Dremel Electric Sander does all the work... you merely guide it. It weighs only 2 1/2 lbs.; it's foolproof (has only two moving parts... never needs oiling). Quick-change clamps firmly hold abrasives and pads. Dremel Sander is sturdily built to give long, trouble-free service. Operates on 110-120 Volt, 60 Cycle, AC. Thousands and thousands of satisfied users prove its outstanding value.

WHERE TO BUY IT—Dremel Electric Sander comes complete with 6 sheets assorted grade Garnet Paper for sanding, plus felt pad and sheepskin for polishing. Buy it from your dealer. If he cannot supply you, use coupon below to order direct from factory. We ship postpaid if you send check or money order in full. Or, send \$2 now and pay postman balance plus postage, on delivery. Money back if not delighted after 5 days' trial.

If Your Dealer Cannot Supply You

USE THIS HANDY COUPON ORDER FORM

- DREMEL MFG. CO. • Dept. S129-L • Racine, Wisconsin**
- Enclosed find \$..... (Check or M. O.) in full payment for items checked below. Ship postpaid at once.
 - Enclosed find \$2.00 in part payment for items checked below. I agree to pay postman balance plus postage, on delivery.
 - Dremel Electric Sander.....\$14.85
 - Dremel Electric Coping Saw.....\$5.85
 - Free catalog of Dremel Electric Tools.

Name.....
Address.....
City.....Zone.....State.....

FUN FOR BOYS FROM 8 TO 80 DREMEL Electric COPING SAW

CUTS SCROLLS LIKE MAGIC—SANDS AS IT SAWS



BLADE FACES 4 WAYS

SAFE!
AS A HANDSAW

JUST GUIDE IT!

Only \$5.85
with 3 saw blades



For men who harbor a hobby or do their own repair work... for boys who like to make things... no other tool will give as much pleasure and satisfaction in the home or workshop for the small amount of money invested as a Dremel Electric Coping Saw. It works in any direction... delivers 7,200 strokes per minute... so easily, there is no effort... so smoothly, work needs no sanding. Makes child's play of tricky scroll designs... saws through 3/4" medium hard wood at a foot-a-minute speed. Touch-of-the-trigger, foolproof action. Saw has only two moving parts... never needs oiling. Operates on AC current. Thousands and thousands of satisfied users.

WHERE TO BUY IT—Buy Dremel Electric Coping Saw from your dealer. If he cannot supply you, use the coupon to order direct from factory. We ship postpaid if you send check or money order in full. Or, send \$2 now and pay postman balance plus postage, on delivery. Money back if not delighted after 5 days' trial.

Plans for making six useful, decorative projects packed with each Dremel Electric Coping Saw.

DREMEL MFG. CO. • Dept. S129-L • Racine, Wis.

1/4" POWERHOUSE ALL - PURPOSE ELECTRIC TOOL KIT

Give Yourself or Your Son This Wonderful Gift for Xmas!



COMPLETE
17.95
VALUE
23.95

UNDERWRITERS' APPROVED
FACTORY GUARANTEED

Powerhouse Drill Only **13.95**

POWERHOUSE outperforms most drills selling for \$20.00 and more! 17 to 1 steel gear ratio maintains power without danger of overloading. Contains EVERYTHING for home or workshop... 5" lamb's wool polishing bonnet; rubber back-up disc; 4 sheets sand paper; paint mixer; 3 HIGH SPEED twist drills, 1/16", 1/8", 1/4"; mandrel assembly; Powerhouse Drill. Packed in natural-grain wooden box. Perfect for mixing paint, for sanding, waxing, polishing furniture, woodwork and cars. Drills holes up to 1/4" in steel... 1/2" in wood.
DEALER INQUIRIES INVITED

SEND CHECK or MONEY ORDER. NO C.O.D.'S PLEASE
MONEY REFUNDED IF NOT SATISFIED IN 10 DAYS



110
120
VOLTS
A.C.
D.C.

G. E. BENNETT STORES
723 Granby St. (Dept. 5) Norfolk 10, Va.

WORLD'S LOWEST PRICED ADDING MACHINE

VEST POCKET SIZE

IDEAL XMAS GIFT!

FREE TRIAL
ONLY \$2.95
TOTAL COST
SEND NO MONEY

[FREE!!]
Each Baby Calculator in Beautiful, rich-looking Leatherette case—at no extra cost.



Fits vest pocket or purse. Guaranteed accurate. Operated as easily, and as reliable, as machines costing many times as much. Not a toy. Precision made, very durable—guaranteed for life against defects in construction. You positively can't buy a calculator of equal quality for as little money. **ACCEPTED AS THE FINEST LOW PRICED CALCULATOR FOR OVER 35 YEARS!** Operates with a flick of your finger. Adds, subtracts, multiplies, divides—counts up to one billion. Pays for itself over and over in mistakes avoided, and time saved.

MAKES IDEAL GIFT

Sold on a positive money back guarantee. Send only \$2.95. Calculator sent postpaid, or send name and address and pay postman \$2.95 plus postage. **MONEY BACK IN 10 DAYS IF NOT DELIGHTED!** (If outside U. S., send \$3.50.)
AGENTS WANTED

CALCULATOR MACHINE CO., (Mfrs.)
Dept. 518, P. O. Box 248, Glenview, Illinois

ARC WELDING FOR PROFIT OR PLEASURE

60 LBS. OF READY MADE PARTS

Only **\$24.95**

BUILD YOUR OWN HEAVY DUTY WELDER SAVE BUY ONLY NECESSARY PARTS

All parts Ready-Made and easy to assemble. You can do all around welding on steel, cast iron and other metals after only a few hours practice. Illustrated instruction manual included. Sold on 30 Day Money-Back Guarantee!

FREE: Write today for fully illustrated Pamphlet S-9.

Gives 100% penetration. Welds are stronger than original metal. Operates on 110 or 220 AC.

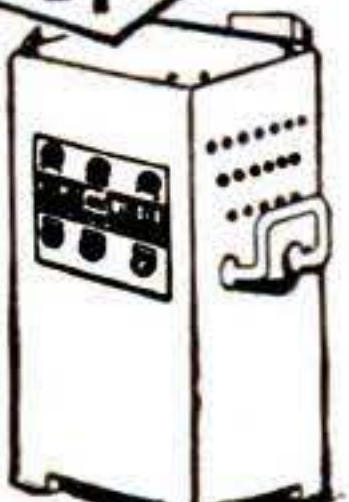

ATOMIC ARC WELDER CO.
1039 So. 39th St., OMAHA, NEBR.

MORE NEW CARS AND TRUCKS ARE EQUIPPED WITH

AC SPARK PLUGS

THAN WITH ANY OTHER MAKE

SHARPEN ALL TYPES OF CIRCULAR SAWS

ALSO MANY CARBIDE TIP TOOLS AND CUTTERS

This all-purpose sharpening fixture is the only one of its kind. Easiest, simplest, fastest sharpening method available and sharpens 95% of all saws used. Assures cleaner cuts. Save money and make money by sharpening tools, cutters and saws for yourself and others. Unlimited uses. Precision built at surprisingly low prices. Send check or money order... money-back guarantee... nothing to lose... shipped prepaid.

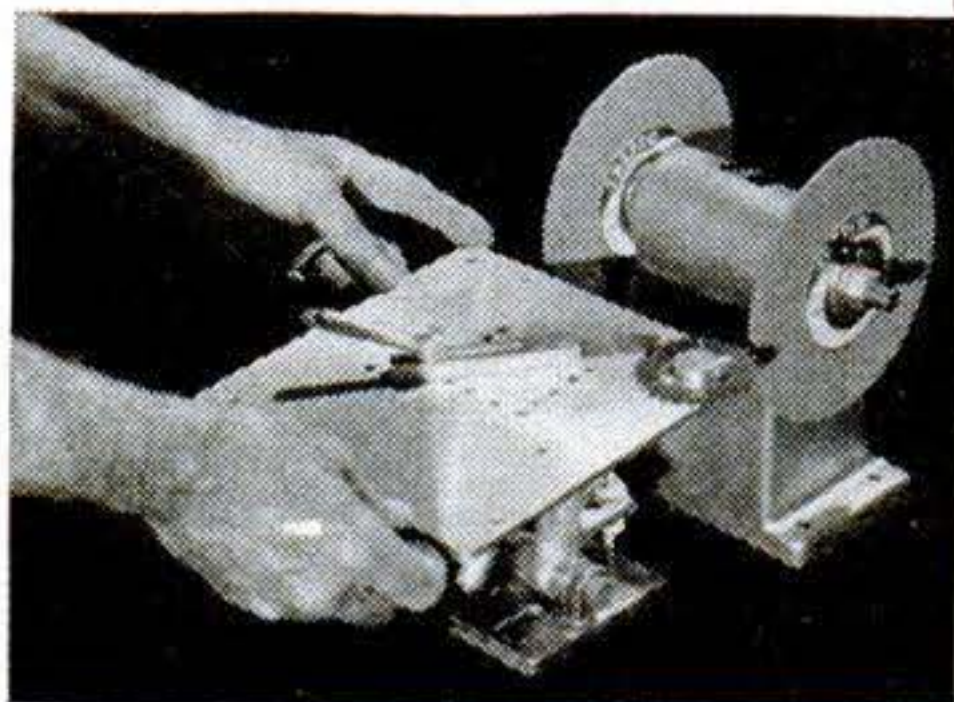

Model 135 (illustrated above) only \$29.95 for 11 1/2" to 12" diameter saws and cutters. Table tilts either side almost to 80°.
Model 160 only \$49.50 for 11 1/2" to 16" diameter saws and cutters. Table tilts either side over 30°.
Model 280 only \$11.95 for 7" to 8" diameter saws.
Model 100 only \$14.95 for 7" to 10" diameter saws.
Model 120 only \$16.95 for 7" to 12" diameter saws.
Model 130 only \$23.50 for 2" to 12" diameter saws.
Grinder stand and grinding wheels not included in price of fixture.
Dust Proof Ball Bearing Grinding Wheel Stand with 30" "V" Belt \$14.95. (Illustrated above).
2 grinding wheels \$5.00 extra.

TREYCO PRODUCTS

264 Hartford Avenue, Dept. PS-11, Buffalo 17, N. Y.

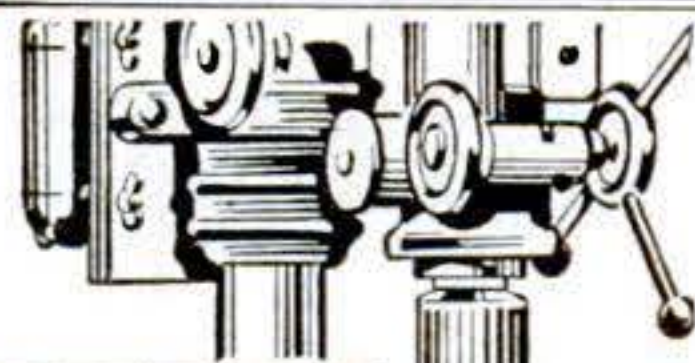

Handy Flexible SHAFT

Converts any motor, drill press, electric drill, electric fan (10 inch or larger) into a handy rotary tool

Attach ROTA-SHAFT in a jiffy. Use for grinding, polishing, sharpening, cleaning, engraving, making tools, carving on metal, plastic, wood, glass. Convenient handpiece for easy handling... with 1/8 inch Adjustable Chuck. 40-inch overall length. Complete with buff and sanding disc ready to use in a drill press chuck. Order today!

ONLY
\$2.95

OLD FAN MOTOR



VACUUM CLEANER MOTOR



SEND NO MONEY! Mail your order. Pay postman only \$2.95 plus postage on delivery. Try 10 days—if not delighted, return for money-back. For use on motor, add 35c for Special Coupling and state size of shaft diameter.

STRADER PRODUCTS CO.

DEPT. L-102
259 Strader Ave. Cincinnati 26, Ohio



GIGANTIC XMAS SAVINGS

New Precision Bilt MICROMETERS

Nationally known makes. Gives a lifetime of accurate service.

1" Central	\$3.50	5" Reed	\$7.25
1" Central, Tubular (also ideal for tubing)	\$3.75	6" Central	\$7.50
1" Slocumb	\$4.25	6" Slocumb	\$8.00
2" Central	\$4.95	7" Slocumb	\$9.00
5" Central	\$7.00	9" St. James	\$10.00
		11" St. James	\$11.00

NEW SURPLUS FIRE EXTINGUISHERS

1 gal. capacity fully charged, ready to use. Carbon-tetrachloride is non-conductor; stored pressure type shoots 40 foot stream; height 23", diameter 5". Ideal for home, garage, workshop, etc. Lists approx. \$65.00. Our price..... **\$14.95**

BARGAINS IN BENCH LEGS

Make your own workshop bench with steel bench legs. Heavy gauge, drilled for use. Used, good condition.

Heavy Duty:		Light Weight:	
Wide	High	Wide	High
28 1/2"	28"	28 1/2"	28 1/2"
28 1/2"	31 1/2"	34 1/2"	28 1/2"
34 1/2"	33 1/2"	28 1/2"	34"
Cross Brace: 5 ft.		8 ft.	10 ft.
	\$4.95	\$2.50	\$3.50
	\$5.50	\$3.50	\$4.50
	\$7.50	\$1.25	\$1.75
			\$2.00

Special Offer "Husky" 37 Piece SOCKET SET

New, 1/2" Drive, 14-Hex sockets 7/16"—1 1/8", 4 sq. sockets 1/2"—11/16", Sliding T ratchet, 15" Flex. hdl., 8" Crossbar, 11 piece Midge and Socket Set, Adapter, 2 extensions. Regular list, \$55.53. Our special price w/tool box..... **\$21.95**

Prices F.O.B., Kansas City, Mo. No C.O.D.'s.

Send 10c for New 64 page Jam-packed Catalog

ATLAS EQUIPMENT CO.

229 S.W. Blvd.

Kansas City, Mo.

OUR 209TH ADVERTISEMENT

REAL DIESEL ENGINE

\$2.95

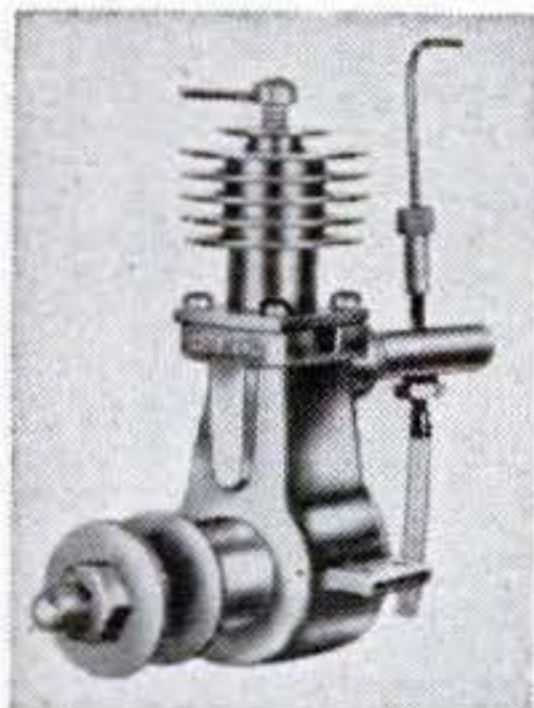

From Detroit, Mich., T.H.G. says—
"You would never believe that for the low price DEEZIL engine * * * you have such a smooth running engine. Starts so easily. No trouble at all. Thanks."

From East Chicago, Ind., R. J. B. says—
"Truly I am very well satisfied, and you can chalk me as one of your satisfied customers."

✓ Check These Superior Features

- ✓ DEEZIL is an ultra precision engine, as carefully machine-tooled as GIANT Army engines. Cylinder is honed to .0001 inch, and hand-fitted to its individual pistons.
- ✓ DEEZIL is compact, rugged, streamlined. Starts quickly. Easy to install. Will run for years without attention.
- ✓ DEEZIL is easy to assemble. No ignition headaches. Step-by-step instruction sheet included with kit.
- ✓ DEEZIL is perfect power plant for planes, boats, race cars, and experiments. Runs at 7500 R.P.M. Produces 1/7 HP. Weighs only 5 oz.

SEND \$2.95 plus 25c postage today

GOTHAM HOBBY CORP.

107 East 126th Street, New York 35, N. Y., Dept. "5"

MILLERS FALLS TOOLS

for a Merry Christmas



You'll surprise and delight any man or boy when you give him Millers Falls Tools — practical, handsome and appreciated gifts. Offered in Christmas boxes, they're all essential, dependable tools for shop or home. Best of all, their price is modest, their quality the very highest. See them in your hardware dealer's special Christmas display.

Millers Falls Co., Greenfield, Mass.

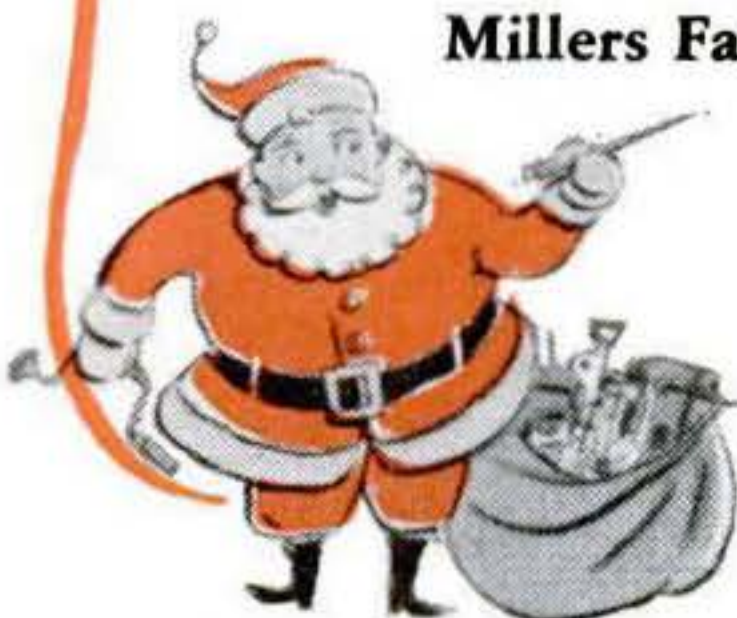

A lifetime gift for every man

Free...



NEW POWER TOOL AND WELDING EQUIPMENT BOOK

Beautiful rotogravure 52-page book contains hundreds of illustrations, descriptions and specifications of Wards well-known Powr-Kraft line of tools for wood and metal, and motors. Also shows the nationally-known Logan Metal Lathes, Mall Electric Saws, Burke Milling Machines, Burgess Hand Tool Kits, deluxe quality Beaver Power Tools, etc. Book features the popular Shopsmith, a complete 5-tool-in-1 workshop. All tools may be purchased on convenient monthly payments at Wards Mail Order Houses, Catalog Order Offices or Retail stores.

Every power tool beginner, advanced hobbyist and production shop should have a copy of this money-saving catalog. Use coupon for your free copy now!

Montgomery Ward

Chicago • Albany • Baltimore • Denver • Ft. Worth
 Kansas City • Oakland • Portland, Ore. • St. Paul
 Mail Coupon to Your Nearest Ward house—NOW.

MONTGOMERY WARD, Dept. 84PS-II
 Please send me free Power Tool and
 Welding Catalog.

Name _____
 (Print Plainly)
 Street Address, _____
 Route, Box _____
 Post Office _____ State _____
 Phone _____

The Ideal Gift for the Home Owner

NO COMPRESSOR
 HOSE • MOTOR
 WIRES • PUMP

BECKER Self-Contained SPRAY GUN

Take it Anywhere for

- Painting
- Varnishing
- Humidifying
- Insecticiding
- Rust-Proofing
- Starching
- Moth-Proofing
- Fire-Proofing



ONLY
\$18.50

Here is the first completely self-contained and fully portable spray gun . . . needs no wire or hose, no compressor or motor. Take the Becker gun anywhere to do dozens of spray jobs . . . in the house, workshop, garage or garden. Spraying pressure is provided by an inexpensive, easily replaced CO2 cartridge. One cartridge will spray up to 21 ounces of liquid (depending on viscosity). The Becker Spray Gun comes complete with 3 cartridges. Send only \$18.50 and we ship postpaid. Or, send only \$2 now and pay postman balance plus postage. MONEY BACK if not delighted after 5 days' trial. (Extra CO2 cartridges, 10 for \$1, postpaid).

SULLIVAN-BECKER CO. Dept. 129-L Kenosha, Wisconsin

SHARPEN CIRCULAR SAWS LIKE AN EXPERT



No experience needed. Two simple adjustments. Gets hollow-ground, cross-cut or combination saw blades true and sharp. Fits 6" to 12" blades with 1/2" to 13/16" centers. Includes file and complete instructions. \$6.95 postpaid. (Check or money order) C.O.D.s postage extra. Guaranteed—Money back if not satisfied after 10 day trial. A money maker for fix-it shops. Soon pays for itself. Order today. Free folder.

SURE SHARP MFG. CO., Dept. S-119
 P. O. Box 24 Santa Ana, Calif.

SNAPPY WRIST WATCH

Only \$4.98, not a penny more

You Too, will be proud to wear this classy new wrist watch imported from Switzerland. Made by precision artists that insure a perfect time-piece. Case is chromium plated with a stainless steel back that resists moisture and shocks. Big SWEEP SECOND HAND. LUMINOUS dial that can be seen in the dark. . . **\$4.98**
FREE: At no extra cost we will include a Brand New STAINLESS STEEL STRETCH WATCH BAND and a 1 year guarantee against mechanical defects. Send \$5.00. We Pay Postage.



MARDO SALES CO., 480 Lexington Ave., Dept. 1805-C, New York 17, N. Y.

SAVE ON TRAIN ACCESSORIES

Sensational Automatic GATE MAN rushes out a train approaches. Returns when it has passed. Push button control. 4 1/4 x 5 x 3 3/8" hi. Colorfully lithographed metal, with lock-on for 2 or 3 rail "O" or "S" gauge. Unconditionally guaranteed—forever! With 2 crossing gates and warning sign. **\$4.25** p.p. STREET LIGHT 75c. Brighten the Xmas scene or train layout. 6" hi. of beautiful green plastic—heat resisting globe. 14 V. bulb—long leads. FREE with each **\$2.95** gift package of 4 lamps, 4 lock-ons for 2 or 3 rail—8 screws to affix lamp to layout. For "O" and "S" trains.



FREE: send stamped envelope for TRIX "HO" Ready to Run train brochure.

POLK'S HOBBIES, DEPT. P.S. 119 — 314 5th Ave., N. Y. C. 1

\$4.95

REAL ENGINE VALUE



A miniature gas engine that really operates. Thousands of Buzz "B" gasoline engines have been sold at twice the price. Now is your chance to buy a real 1/6th H.P. gas engine for only \$4.95. Turns up over 8,000 rpm. For Boats, planes, midget cars, etc. Guaranteed and ready to run. Includes Champion spark plug and tank. Send only \$1.00, engine shipped collect for balance, same day. Write for free catalog or **SEND 10c FOR NEW MAMMOTH ILLUSTRATED CATALOG OF THOUSANDS OF HOBBY ITEMS.**

America's Hobby Center, Inc., Dept. S-119, 156 West 22 St., N.Y. 11

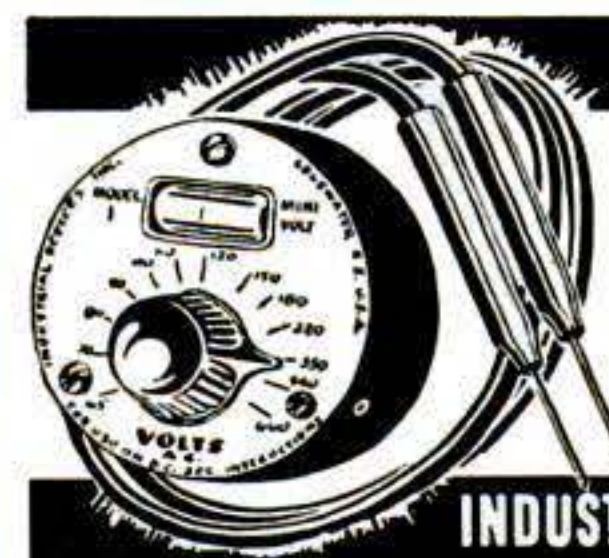

1,001 USES!

Turn the knob—read the voltage. Indicates whether AC or DC. On DC indicates polarity. Picks up 2 volt drop at 110 V. Measures from 65-660 V. Virtually burnout-proof. Guaranteed for 25,000 hours' use. Rugged! Throw it in with tools. 12" flexible test leads and prods. Not a gadget, but a proven tool. At your dealer's or postpaid. **\$2.75**

INDUSTRIAL DEVICES, INC., EDGEWATER 2, N. J.

MAKE MONEY at HOME

FULL or PART TIME

\$ Start your own business making beautiful, salable, wood or plastic carvings in your own home, full or part time. With the amazing new Carvit Duplicator it's easy and fun to be your own boss, or supplement your pay with easy, interesting work at home.

MAKE and SELL

Ash Trays	Ad Displays	Carved Pipes
Book Ends	Jewelry	Religious Articles
Plaques	Signs	Wooden Dishes

Sell homes, friends, gift stores, department stores, novelty shops, mail order, offices, etc. Big profits . . . steady repeat business!

20 MINUTES - YOU'RE an EXPERT

That's all it takes to be an expert on the Carvit. From one inexpensive, dime-store master model, you can create scores of beautiful carvings in rare woods, exotic plastics, each worth many times the cheap original. Don't miss this opportunity for fun and profits. Order today from your local hardware dealer or send coupon.

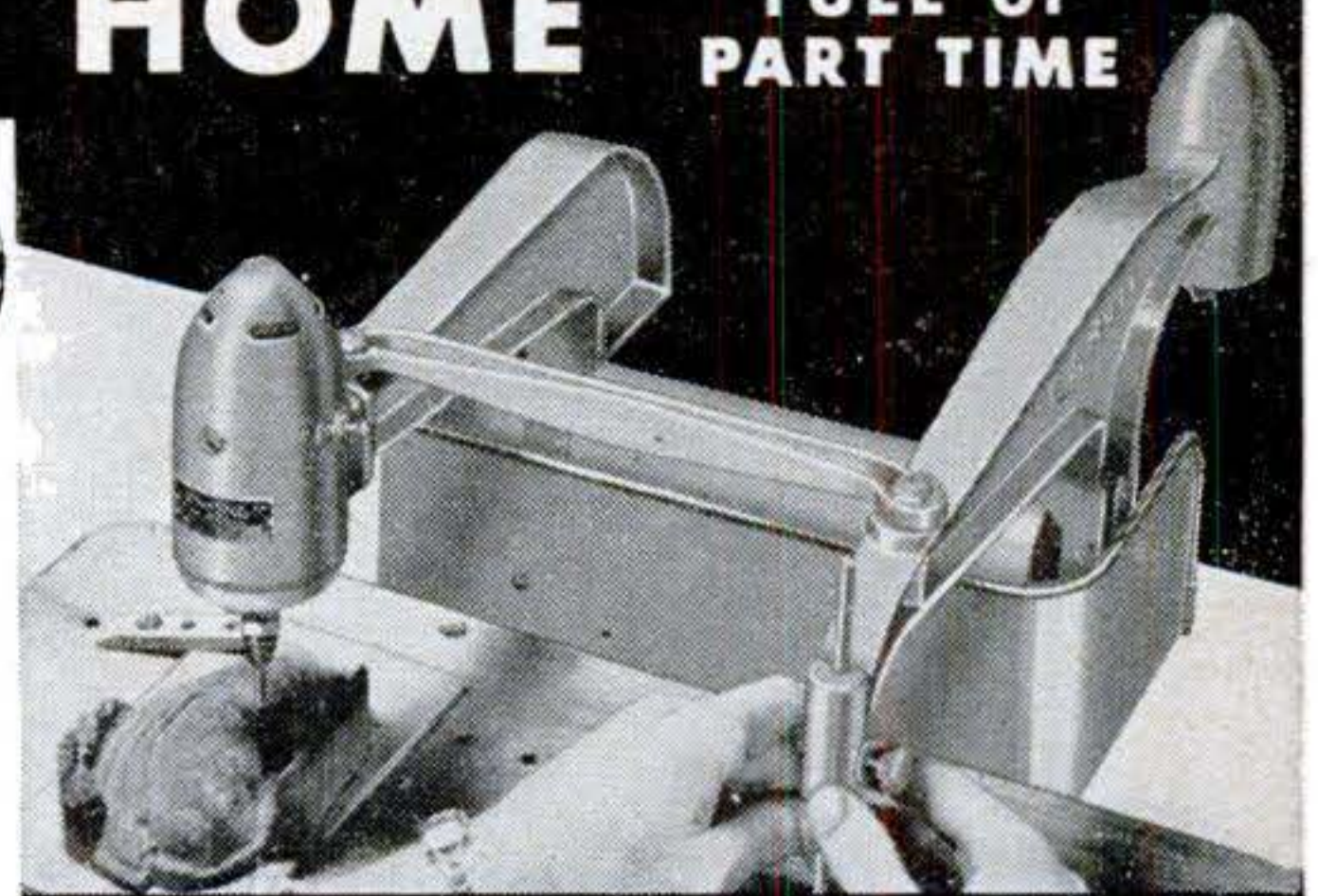

The DUMORE COMPANY

Dept. L-52 Racine, Wisconsin

- Please send complete information on the Carvit and indexing attachment for 3-dimensional carving.
 - Please send one Carvit. \$48.50 enclosed.
 - Please send one Carvit with index attachment for 3-dimensional carving. \$58.25 enclosed.
- Shipping charges C.O.D.

NAME.....
 ADDRESS.....
 CITY..... STATE.....

DC-1

CUT COUPON and MAIL TODAY

TURN YOUR SPARE TIME INTO CASH!

FREE ➔ 10 Official Ranger Rifle targets

FREE ➔ Descriptive Folder telling how you can become a sharp-shooting Ranger



You can win a Ranger Shooting Emblem with the 22 rifle you have now. No special equipment needed. Just put up the target on a safe backstop and start shooting. Send for 10 free official targets and free folder today.

HERE'S WHAT THE FOLDER TELLS:

How to be a RANGER—How to get the 3-inch orange, silver and black shooting emblem—How to "play safe" with a gun—How to get more free literature (tips on shooting, expert's advice)—How to start a RANGER Rifle Club.



SPORTSMEN'S SERVICE BUREAU, Dept. ROR-6
 343 Lexington Avenue, New York 16, N. Y.

Please mail to me *free and without obligation*: "How To Be An N. R. A. (National Rifle Association) RANGER," and 10 official RANGER targets.

Name _____
 Street _____ City _____
 Zone _____ State _____

This advertisement sponsored by **REMINGTON ARMS COMPANY, INC.**
 BRIDGEPORT 2, CONN.

Handy Power Drill Big Help in Homes!



Drills Metal,
Wood,
Plastics

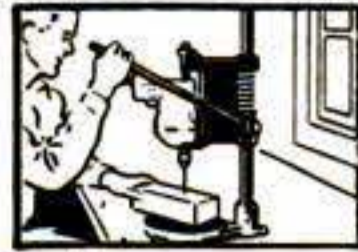

Fits in
Vertical
Stand



Drives
Sanding Discs

HOME-UTILITY
1/4" Electric
DRILL
\$18.95

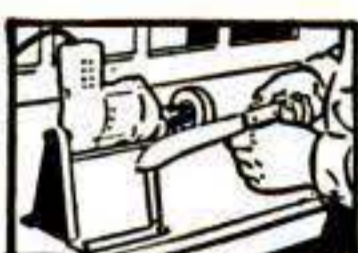

Drives 3"
Grinding Wheel

Saves Hours on Many Jobs!

This versatile Home-Utility 1/4" Drill gives you hundreds of ways to speed up building and repairing things around your house! You'll be amazed at its many uses—installing household hardware and fixtures; polishing silver ware; waxing furniture; sharpening cutlery; sanding down furniture; knocking off old paint and rust; and many other jobs!

Made by the world's biggest builder of portable electric tools, BLACK & DECKER! Its well-built universal motor operates on AC or DC, with a handy trigger switch. Compact, well-balanced, lightweight, shaped to fit the hand.

See it, try it, at your hardware, electrical or implement dealer. Write today for your free copy of our brand-new "How-To-Do-It" booklet. Gives many helpful hints on saving time and money in home-and-farm building and repair jobs! Write to: THE BLACK & DECKER MFG. CO., Dept. H11S, Towson 4, Md.

Products of The BLACK & DECKER Mfg., Co.

ELECTRIC HOME-UTILITY TOOLS



6" Saws



1/2" Drills



Sander-
Polishers



1/4"
Drill Kits

QUALITY DYNASAW*

Satisfaction
Guaranteed or Money Back

- Cuts curves like a band saw
- cuts metal like a hack saw
- cuts scrolls like a jig saw
- cuts straight or angular like a bench saw
- cuts to center of 48" circle
- cuts 1/4" steel—brass—aluminum
- 10" x 10" precision ground grey iron table tilts to 45°



Write for free catalogue on DYNASAW and other MP tools.

\$18.95
F. O. B.
ROYERSFORD, PA.

* MARCUS-POLLAK, DEPT. 2, ROYERSFORD, PA.



Easy and
Cheap to
Operate

SAVE TIME, WORK, MONEY!

SHAW 'DU-ALL'

and "PEPPY PAL" TRACTORS

PLOW

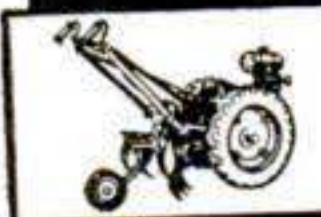

These rugged walking or riding tractors ideal for farm, truck garden, orchard, poultry farm. They operate on a few cents an hour. A child can handle them.

DO DOZENS OF JOBS

The Shaw Du-All or Peppy-Pal does many jobs quickly and easily. Plows, cultivates, harrows, disks, bulldozes, sprays, hauls, grinds, and saws wood.

BUILT FOR RUGGED WORK

Sturdy, extra-strength construction means low upkeep, long life. Full year's guarantee.

LOW FACTORY PRICES

Buy direct or through your dealer! Almost anyone who owns a garden can afford a Shaw Du-All or Peppy Pal. Mass production holds prices down—quality up.

MOW



RIDE



RIDING TRACTORS

4 models, from 5 to 12 1/2 H. P., 58 in. wheel-base, 36 in. wide, 24 in. plant clearance. Hand or electric starter. Improved steering device, brakes enclosed in differential housing. Heavier frame and bearings. Standard hitch for trailers and wagons. Plow, harrow, cultivator, cutter bar, snow plow, bulldozer available.

FREE: Illustrated folders giving complete details and price lists—write today!

5711 Front St., Galesburg, Kan.
668 PS North 4th St., Columbus, O.

MAKE THESE WOOD SHAPES

With Your Drill Press and This LOW COST TOOL

Your drill press and this tool does all types of wood shaping—Routing, Tongue and Groove, Fluting, Notching, Inlay and any type of joint. Make window stiles, cabinets, doors, grooved sash, etc.



Complete with fence and platform to run professional work without slipping. Write today for FREE facts about this unit, and special offer.



Complete
with 3 blades



T & H Mfg. Co., Inc., 811E31, Dept. SSA-11, Kansas City, Mo.



\$295
EACH

NOW! FILE YOUR OWN SAWS

Do expert saw filing at home. Precision filing easy without experience. Two simple adjustments. Keeps any hand saw extra sharp and true-cutting. Complete with file. Money back guarantee. Cash with order, prepaid. (COD postage extra.) Order today.

SPEEDCOR PRODUCTS, PS-11
512 N.E. 73 Portland 16, Oregon



For Loose Caster Guides

Remove the guide, fill the hole with a putty-like mixture of Smooth-On No. 1 Iron Cement and drive the guide back in. It will stay in place, because Smooth-On, in hardening, expands slightly and takes hold tight. Use Smooth-On for tightening other loose parts and also for stopping leaks in boilers, furnaces, piping, radiators, etc. Buy Smooth-On No. 1 in 1 3/4-oz., 7 oz., 1 lb. or larger sizes at your hardware store. If they haven't it, write us.

FREE Repair Handbook

Shows how to save time and money, making many household repairs. 40 pages. 170 pictures. Clear directions. Send today.

SO-313

SMOOTH-ON MFG. CO., Dept. 58
570 Communipaw Ave., Jersey City 4, N. J.

Do it with
SMOOTH-ON
THE IRON CEMENT OF 1000 USES



HUNDREDS OF ITEMS AND IDEAS FOR THE WOODWORKER

A board or carload—Top grade kiln dried Mahogany—Walnut—Wh. Hd. Maple—Cherry—Poplar—Aromatic Red Cedar—Red, White and English Brown Oak—Sapeli—Andiroba—Balsa wood.

HARD TO FIND LUMBER

BIG NEW NO. 16 CATALOG FOR WOODWORKERS.
144 PAGES
OF HARD-TO-FIND SUPPLY ITEMS.

The finest catalog we ever published. Full of unequalled bargains and useful information.

Greatest Selection of Fine Domestic and Imported Woods
Catalog shows in natural color 32 rare and fancy woods, 43 matched veneer designs, multi-colored bandings, inlays, overlays, 275 scroll patterns to choose from, labor-saving machinery and a section for beginner's instruction.

OVER 100 NEW ITEMS

My stocks are gigantic—bigger than ever before. Really FAST SERVICE on your orders. My new catalog includes a "gold mine" of hard-to-find hardware items. Whatever Wood Craftsmen need—I HAVE IT.

MAIL COUPON TODAY for GIANT NEW CATALOG #16

Only 15c Refunded on first order.

Harold F. Hunt, President
CRAFTSMAN WOOD SERVICE CO.
2729 S. Mary St., Dept. B-11, Chicago 8, Ill.

I enclose 15c, to be refunded on my first order. Please send me your big new Catalog No. 16.

NAME.....

ADDRESS.....

TOWN.....ZONE.....STATE.....

"Build Your Own"

remote control, trailer type
arc welder

Go to BIG PAY jobs like this man and thousands of others are doing.



SAVE \$150 to \$300 . . . or more!

It's easy with a good used auto engine, chassis and one of these new HOBART arc welding generators.

THOUSANDS HAVE DONE IT. There's nothing new or untried about this idea. It's sound and practical. Any man, with average mechanical ability, can do it easily in spare time.

HOBART HELPS YOU get started with ideas, suggestions, illustrations. You can build as simple or elaborate an outfit as you want.

FASTER WELDING EITHER A.C. OR D.C. Exclusive HOBART features make welding easy for the unexperienced and beginners. Easier to strike and hold arc. Liberally rated for overloads. Built for any shop or field need to help you handle more business.

HOBART WELDING SCHOOL gives you low cost training. Learn by doing in short time. Latest methods, newest equipment. Check coupon for details.

HOBART BROTHERS CO., Box P-119, Troy, Ohio

HOBART

"one of the worlds' largest builders of arc welders"



A.C.-A.C. Generator . . . welds, for lights, tools.



A.C. Transformer Welder speeds up shop work.

Free!
"Build Your Own" Booklet

HOBART BROTHERS CO., Box P-119, Troy, Ohio

Please send details on HOBART "Build-Your Own" Welders and other information checked:

- D.C. Generator to "Build-Your-Own"
 A.C. Gen., Welder to "Build-Your-Own"

- "Build-Your-Own" Booklet
 A.C. Transformer Type Shop Welder
 Hobart Welding Trade School

Name _____

Street _____

City _____

State _____

Now! FOREDOM offers 2 NEW ATTACHMENTS

You Get Unexcelled **UTILITY AND VERSATILITY ...**
AT SMALL COST!

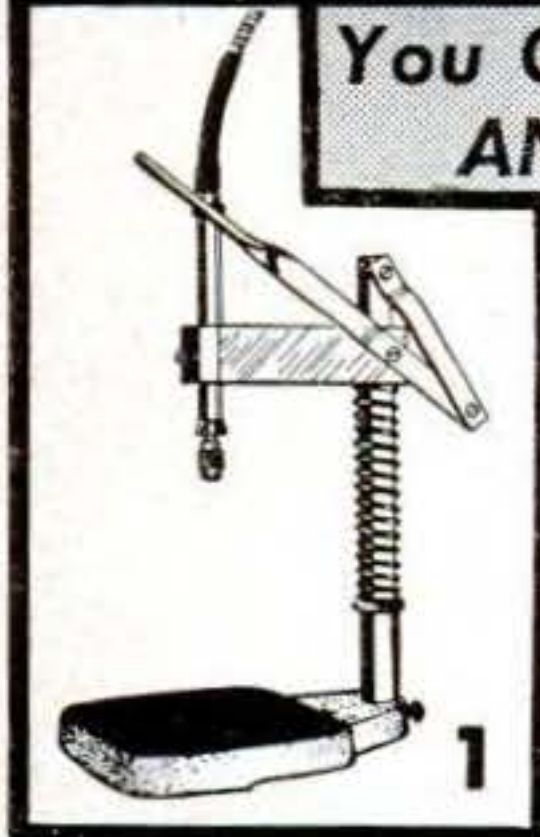

B-R-S ATTACHMENT

2. The new Foredom **B-R-S ATTACHMENT** (Bench Stand, Router, Shaper). Speedily clamp handpiece in place and magically you have one unit which serves as a bench grinder with angular adjustment, a router (complete with detachable guide for routing borders) and shaper. Can be used with Model 100 and thousands of Foredoms now in use, providing endless hours of fun and profit. **TRIPLE UTILITY FOR ONLY \$3.50.**

DRILL PRESS ATTACHMENT

1. Now Foredom offers you a **DRILL PRESS ATTACHMENT** for use with Model 100 (see below) and for the many thousands of Foredoms already in use. Handpiece quickly clamps in place and drill press is ready for use, ready to pay for itself over and over again! **PRICED AT A MERE \$4.95.**

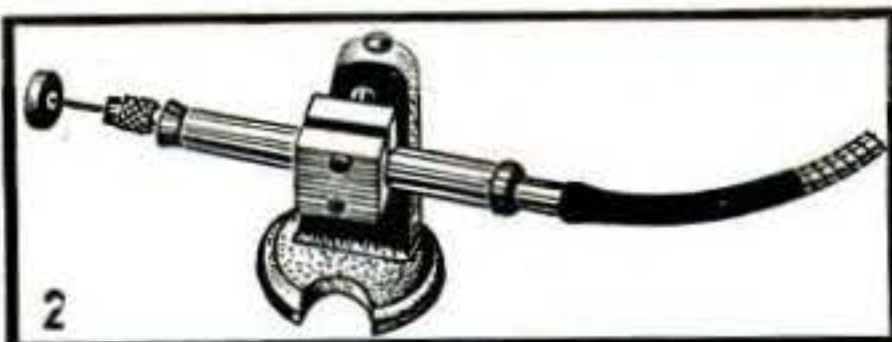

And there's still more— FOREDOM'S NEW MODEL 100 FLEXIBLE SHAFT MACHINE

3. Model 100 Flexible Shaft Machine with all-metal **PENCIL SIZE HANDPIECE** equipped with **CHUCK GUARD** to **PROTECT YOUR FINGERS** and provide **SENSITIVE, POSITIVE, FINGER-TIP CONTROL** for the most delicate tasks. Husky little high-speed universal motor. Foredom's quarter-century reputation for precision workmanship goes with each machine. Other heavier duty models at proportionately reasonable prices. No. 25 Accessory Set (a truly versatile assortment) \$5.50 extra. Also No. 1000 Kit, comprises No. 100 Machine illustrated and set of 12 accessories, all in wooden case for only \$21.50. 6-step Foot Rheostat \$4.85. **USE IT to GRIND, POLISH, DRILL, SAW, SAND, CARVE, MILL, CLEAN, ETCH, ENGRAVE, ETC.** on all metals, wood, plastics, glass, leather, linoleum, etc.

35" Flexible Shaft
\$16.95
COMPLETE WITH MOTOR



FOREDOM'S Multi-Purpose **THREESOME** comprising Model 100 Machine, Drill Press Attachment and B-R-S Attachment..... **\$24.95**

And here's another Amazing Foredom Product

FOREDOM PRESTO-FLEX with PENCIL-SIZE handpiece

Quickly Converts Motors or Drills into Flexible Shaft Tools **\$5.95**



Now turn your old motor, drill press or electric drill into a Flexible Shaft Tool. Simply attach it and presto—a flexible shaft machine! Off again in a jiffy! Pencil-Size handpiece gets into tight places. Handy 35" overall length. And—only \$5.95 complete! Precision made. Order NOW. If ordered for use on motor, specify motor shaft diameter and add 50c for coupling (Available for 1/4, 5/16, 3/8, and 1/2" shafts). No. 50 Accessory Set available \$1.50 extra. Order TODAY, at your dealer's or use coupon below.

SEND NO MONEY

FOREDOM ELECTRIC CO., Dept. 1023-E
27 Park Place, New York 7, N. Y. Mail Coupon Now!
Please send me FOREDOMS checked below on 10-day trial.
 Drill Press Attachment (\$4.95) No. 50 Accessory Set (\$1.50)
 Presto-Flex Tool (\$5.95) No. 25 Accessory Set (\$5.50)
 Motor Coupling (50c) No. 100 Machine (\$16.95) Foot Rheostat (\$4.85)
 Specify motor shaft dia. _____ No. 1000 Kit (\$21.50)
 B-R-S Attachment (\$3.50) Free Catalog
 Multi-Purpose Threesome (\$24.95)
 Send C.O.D. plus postage. I will pay postman.
 I enclose payment. Send postpaid.
(Money back either way if not delighted)

Name.....
Address.....
City & Zone..... State.....

AUTOMATIC COMPRESSOR UNIT

Best Buy of the Year!
A Practical Xmas Gift.

1/3 H.P. heavy duty capacitor motor. AC 110/220 volt, 60 cycle, 2 x 1 3/4 inch piston type compressor, splash feed lubrication, 12 x 24 inch tank, automatic pressure switch, CFM 2.8 at 100 lb. pressure, or 150 lbs. pressure for intermittent duty. Check valve, safety valve, air regulator with gauge and filter, 20 ft. air hose with air chuck for inflating tires. V. belt drive. Mounted on 2 wheels, ball bearing, with 2" x 10" pneumatic tires. Portable, with handle. Shipping wt. 90 lbs.



Sold only direct to user.

SPECIAL PRICE \$89.50

Prices F.O.B. Chicago. Sold on money back guarantee. Send check or money order today. CATALOG FREE.

WELLWORTH TRADING CO.
1831 S. STATE STREET, DEPT. B-11 CHICAGO 16, ILL.

18 ROTARY CUTTERS

Assorted sizes cutter on 1/8" or 3/32" shank. Will fit all hand grinders ideal for cutting wood, metal, or plastic. Brand new.

2 CIRCULAR SAWS

ON 2 MANDRELS—ALL AT ONE LOW PRICE
1" diameter saws on 1/8" Mandrels. For cutting wood, plastic, or soft metals. Order at once! Send Check or Money Order for this big bargain.

SCHUPACK SUPPLY CO., 7331 Cottage Grove, Dept. S7, Chicago 19, Ill.
ILLUSTRATED BARGAIN CATALOG FREE ON REQUEST

World Famed Skil Home Shop Sander

For carpenters, homeowners and cabinetmakers. Sands and polishes wood, metal, plastic, removes paint and varnish. A few minutes of practice makes you an expert. Equipped with resilient backed metal pad. 7 ft. rubber cord, connector, lubricant and one belt. Weight 9 1/2 Lbs. Size 3 3/4" x 12" x 7" high. Model #525—115 volt **\$64.50**

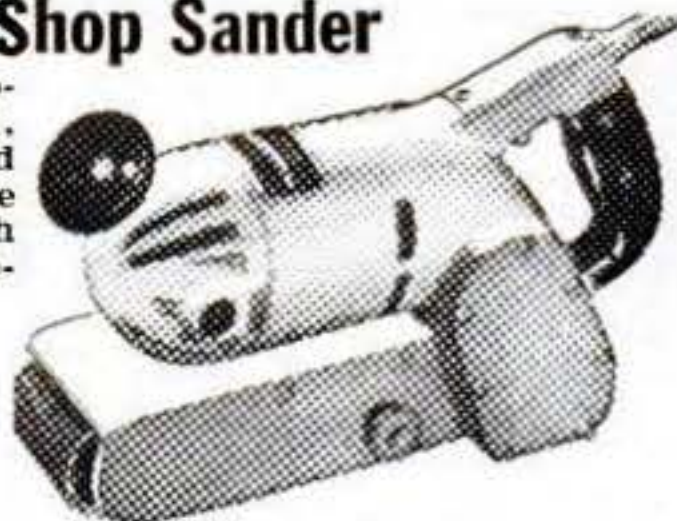

Send check or money order.
WOODWORKERS' TOOL WORKS
Jefferson & Quincy Sts., Chicago, Ill.

BURR HAND SAW FILER

Makes More PROFITS

Easy to Operate

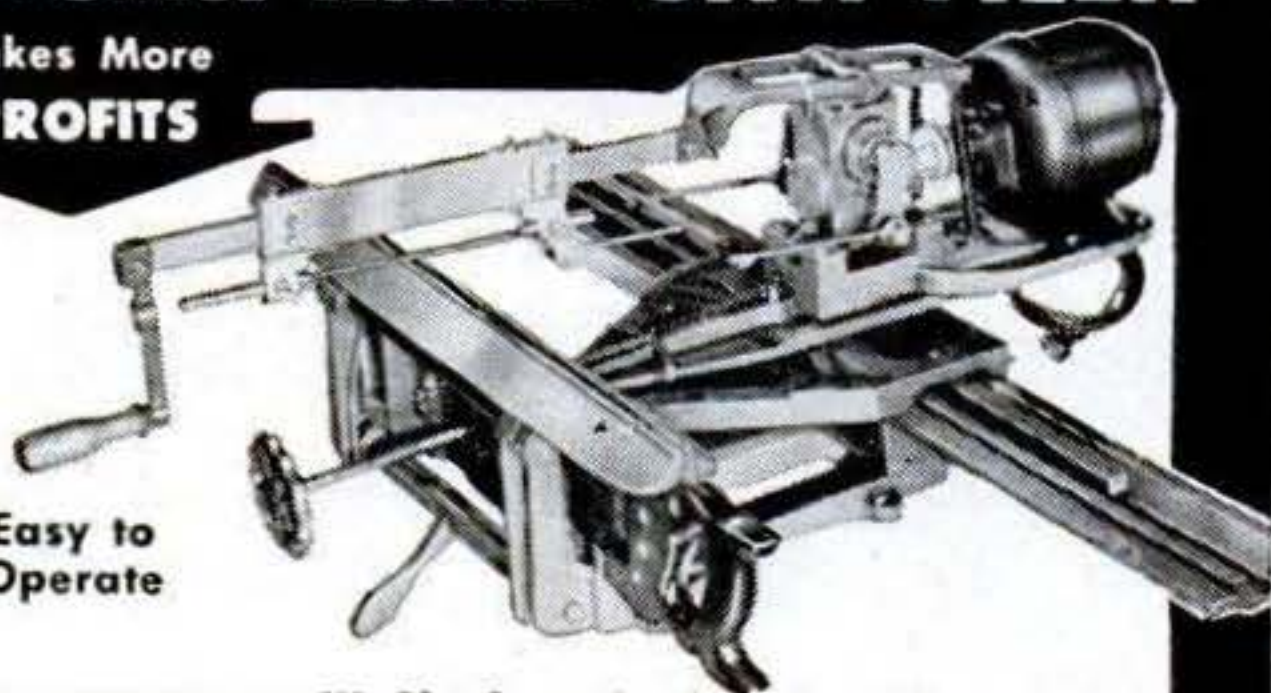

Fast, accurate, will file from both sides. Operator controls file arm. No saw carrier or adjusting screws to fuss with. A money-maker in any shop.

BURR MFG. CO.

8943 Venice Blvd.
Los Angeles 34, Calif.

WRITE TODAY!

IDEA FOR CHRISTMAS

Give A Super-Safe

SHERIDAN

The
"SILVER STREAK"

Only
\$19.95
RETAIL

The Only Pneumatic Rifle
With an Automatic Safety

Here's a quick - handling, easy - operating, trouble-free pneumatic rifle you'll be proud to own. "Silver Streak's" quality, accuracy, controlled power and shooting economy make it the best buy on the market. Ideal for target or small game shooting, it pays for itself in low-cost ammunition (\$2.15 per 500 rounds)!

See the "SILVER STREAK" at Your Dealer's!

Ask your dealer to show you this dependable addition to the famous Sheridan line. If he cannot supply you, mail check or money order direct. Money refunded if not satisfied upon inspection.

Dealers! Wholesalers! Write for our new discounts

SHERIDAN PRODUCTS INC.
Dept. 169-L • RACINE, WISCONSIN

SAVE **PIXIE** BIKE
MONEY Fits Any Standard Bicycle MOTOR

BOY'S
or
GIRL'S
Men's or Women's
INSTALL IT YOURSELF

Over 120 MPG ORDER DIRECT
Up to 30 MPH \$96.00 F.O.B.

-----MAIL TODAY-----

Endor Motors, Inc. U-1 PS
Simsbury, Conn.

Please send me C.O.D. one Pixie Bike Motor at \$96.00 plus freight charges from Simsbury
Rush me full details and illustrated Circular

Name.....

Address.....

.....State.....

(Please Print)

Add BAND SAWING To Your Shop's Capacity

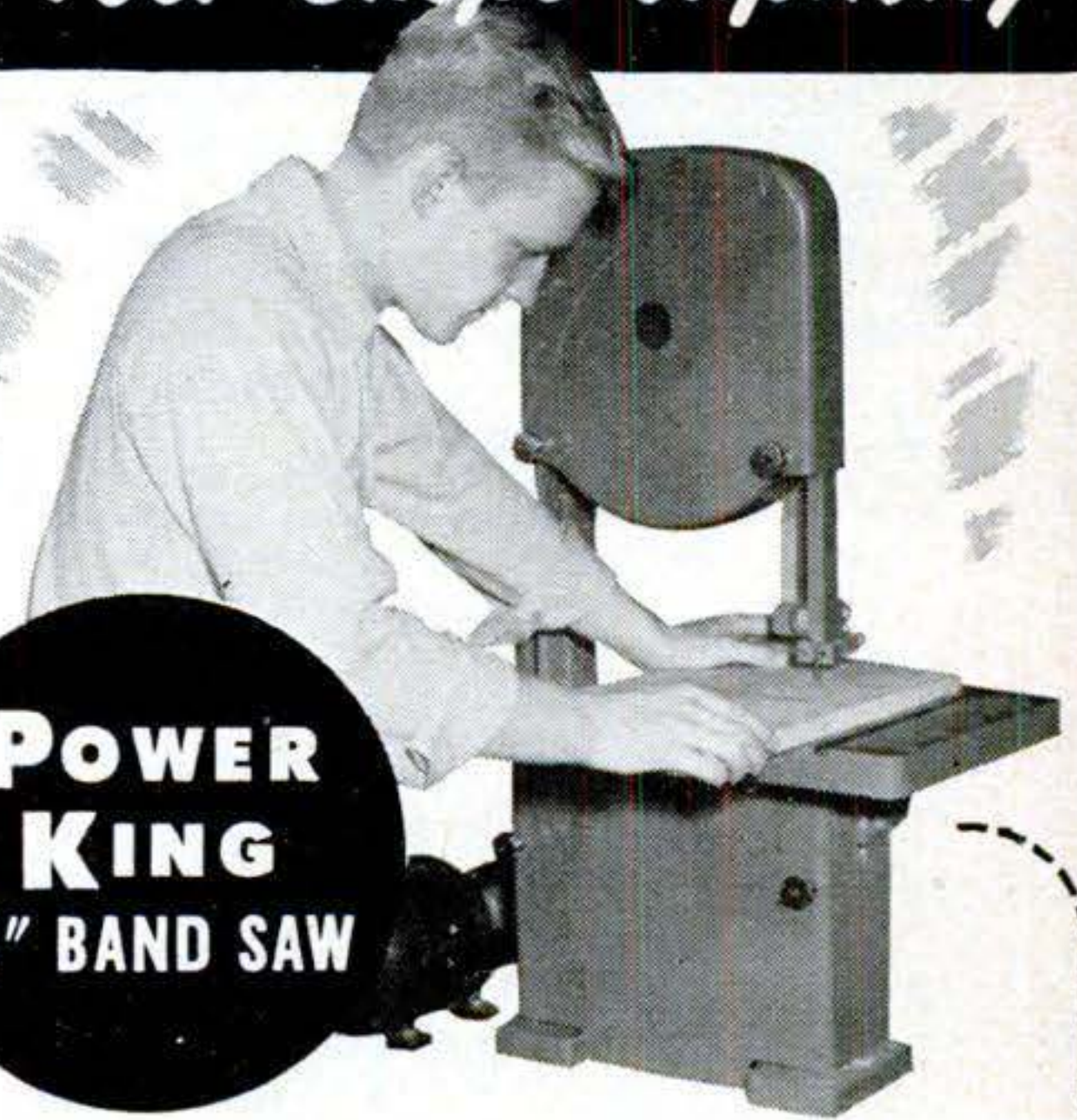

POWER KING
12" BAND SAW

Window valances, decorative shelf brackets, outdoor furniture, toys for the youngsters... all kinds of new projects come within your shop's work range with this Power King band saw. And it's really built for the work! Has big 14" x 14" precision-ground table... 12" capacity blade to frame... cuts up to 6 1/2" deep... table tilts 45°... 6 ball bearings, 4 Oilite blade guides... weighs 122 lbs. Built by Atlas

— and only \$7975*

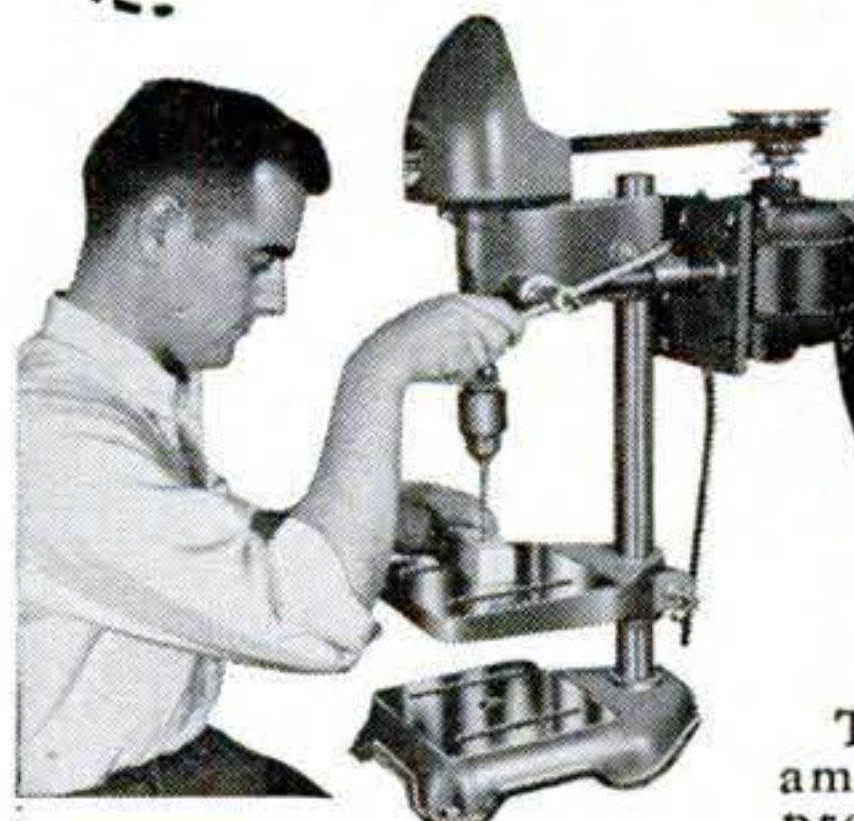

POWER KING
11 3/4" DRILL PRESS

The outstanding value among low cost drill presses today is this Power King No. 611. Jacobs chuck takes drills to 1/2". Makes fast, easy work of drilling metal, wood and plastics. And low cost accessories are available to help you get "professional" results on mortise and tenon joints, routing, shaping, sanding, carving, inlaying. With six-splined spindle, balanced pulleys, Oilite bronze bearings and ball bearing for end thrust, this PK 11 3/4" drill will give you good, long service. Built by Atlas

— and only \$4275*

There are 8 different tools in the Power King line, recognized in stores by their distinctive green color. Send postcard for complete FREE catalog.

ATLAS PRESS COMPANY
1142 N. Pitcher St., Kalamazoo, Mich.



**MATCHED PRECISION TOOLS FOR
WOODWORKING AND METALWORKING**

23 PIECE SOCKET SET

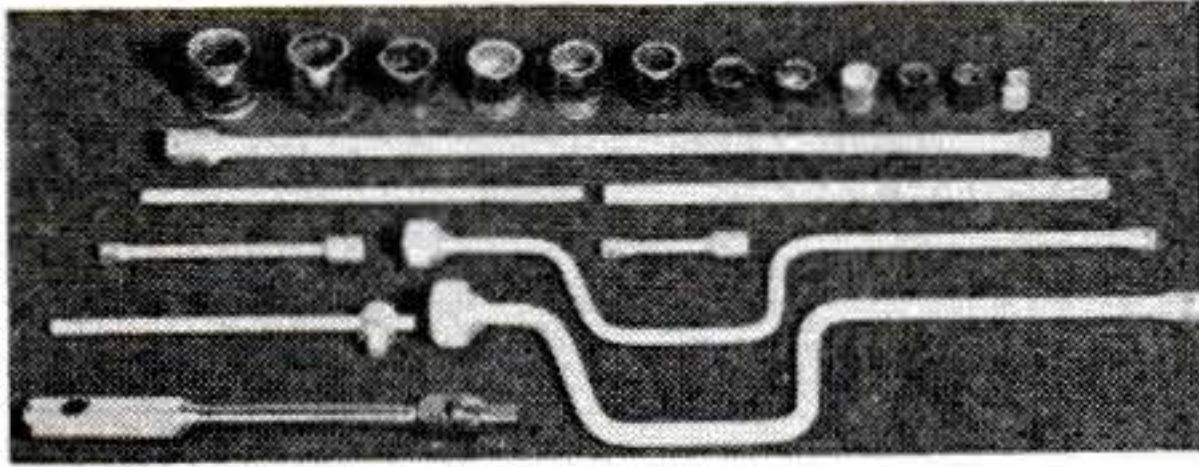

\$20 VALUE PRICE \$9.50

Our purchase of over 200,000 wrenches as unused U. S. Airforce surplus makes this low price possible. All tools are NEW, all sockets are plated. They are well-known popular standard makes such as Plomb, Snap-On, etc.

Set consists of 23 pieces. 1/2" and 3/8" drive. Shipping weight 10 pounds.

This is what you get.

1-1/4" Socket	1-3/4" Socket	2-Bar Handles
1-5/16" Socket	1-13/16" Socket	1-2" Extension
1-3/8" Socket	1-7/8" Socket	1-4" Extension
1-1/2" Socket	1-15/16" Socket	1-18" Extension
1-9/16" Socket	1-1" Socket	1-T-Handle
1-5/8" Socket	1-1-1/16" Socket	1-1/2" Flex Handle
1-11/16" Socket	1-1 1/8" Socket	1-3/8" Speed Handle
	1-1/2" Speed Handle	

ARMY SURPLUS SPECIALS

	Value	Our Price
Super 100 piece socket tool set	\$85.00	\$43.25
Sherrill Army Tank Compass	\$25.00	\$5.95 Post Pd.
New Rubber suits with boots & gloves	\$50.00	\$10.00 Post Pd.
Dark Room ventilators 4 1/2" thick, steel	\$25.00	Set of 2 \$7.50 Each—\$4.00
Twin beds—hardwood 2 beds, 2 springs, 2 new mattresses, 2 feather pillows	\$50.00	\$19.50
Mattresses, new 23 lb.—size 30" x 74"	\$9.50	\$5.25
Blankets, new, 64" x 84", grey or O.D.	\$7.50	\$3.95
Oxfords, black & brown, Military type	\$7.95	\$4.95
Jackets, all sizes, waterproof, sheep- skin lined, warm in coldest weather	\$29.00	\$17.50
8,000 candlepower, carbide flood lights	\$51.00	\$9.50
Rifle covers, waterproof, size 10" x 56"	\$2.00	4 for \$1.00
Hunting knife & sheath—chrome	\$4.50	\$1.95
5 gal. jeep gas can, with flexible spout	\$3.95	\$1.95
Rigid screw extractor set, No. 10 a mechanics friend.	\$12.00	\$5.95
1" drive, Snap-on, socket set with ratchet, 13 pieces, plated.	\$75.00	\$37.50
3/8" drive reversible ratchet—plated	\$3.50	\$1.95
1/2" drive reversible ratchet, Plomb—plated	\$6.50	\$2.95
Fraziers Solution—12 bottles	\$5.00	\$1.00



New aircraft emergency landing light—water activated—new complete with battery and 12 light bulbs—produces light equivalent to 12-4 cell flashlights—needed by motorists, truckers, campers, fishermen—excellent light for any emergency. Cost to govt. \$16.50 each, our price ONLY \$3.95 shipped postpaid.

2400 complete units available.

Send for catalog on home utility power hand tools, a product of Black and Decker electric drills, portable electric saws, etc. The best medium priced electric tools for less. We pay all postage on power hand tools.

All orders are filled the day they arrive. Pay by check or money order. 25% dep. on C.O.D.'s. Prices are F.O.B. Fresno, except for rubber suits, emergency lights and compasses on which we pay postage. All items listed are new, except for bunk beds and Jeep cans.

**ARMY SURPLUS SALES
OF FRESNO
1820 TULARE ST., FRESNO, CALIF.**

STOP CHANGING MOTOR OIL!



End this needless waste and expense forever with

RECLAIMO

Today's Most Advanced Oil RE-REFINING Filter
Continuously cleans and RE-REFINES motor oil as you drive (by utilizing motor heat)—keeps oil in high grade lubricating quality at all times! Proves conclusively that "Oil Does Not Wear Out Mechanically" as stated by U. S. Bureau of Standards. (Bulletin 86).

"RECLAIMO"

- REMOVES SOLIDS (by filtration)
- REMOVES WATER (by distillation)
- PREVENTS Excess Fuel Dilution
- PREVENTS Acid and Sludge Formation

MAINTAINS Stable Viscosity **ELIMINATES** All Oil Changes
CAR • TRUCK • TRACTOR OWNERS!

FREE 32-PAGE BOOK "OIL FACTS" (with bona-fide \$1000.00 offer on page 30), gives you the complete "Reclamo" story and details of our extraordinary 90-DAY NO-RISK TRIAL OFFER! Write for your copy TODAY!

RECLAIMO MFG. CO.

5083 ELSTON AVE., Dept. 15, CHICAGO 30, ILL.

NEW ADDED FEATURE!
Gas - Moisture Vapor Injector
Increases Mileage with Smoother Performance



ITS EASY — ITS FUN — ITS PROFITABLE!

MYSTERIOUS DEVICE WELDS BRAZES SOLDERS & CUTS

ANYONE CAN OPERATE



This newly invented FOUR-WAY PORTABLE ELECTRIC WELDER will do brazing, soldering, welding and cutting on brass, bronze, iron, steel, cast iron and other metals. It's easy to use. WORKS INSTANTLY off any properly wired 110 VOLT A.C. OR D.C. LINE. Does a thousand and one professional type repair jobs. SAVES TIME AND MONEY on auto, home appliance, farm and shop repairs. Ideal for maintenance men, farmers, repair shops, engineers, tin smiths, home and auto owners, bicycle and fix-it shops. **10 DAY TRIAL OFFER. COMES COMPLETE WITH ALL SUPPLIES READY TO OPERATE** including instructions. FULLY GUARANTEED. Order today for 10 DAY TRIAL or write for FREE particulars. **FOUR-WAY WELDER CO. Dept. PSF-119, 2326 S. Michigan Ave., Chicago 16, Ill.**

REAL ESTATE

BE A BROKER

PAYS BIG! SEND FOR FREE, BIG, ILLUSTRATED CATALOG NOW! No obligation. Graduates report making substantial incomes. Start and run your own business quickly. Men, women of all ages, learn easily. Course covers Sales, Property Management, Appraising, Loans, Mortgages, and related subjects. **STUDY AT HOME** or in our classrooms in big cities. Diploma awarded. G.I. approved. Nationally known.

WEAVER SCHOOL OF REAL ESTATE (Est. 1936)
15 E. Pershing Road Dept. PSB Kansas City, Mo.

FREE BOOK TELLS HOW

RETAIL PRICE \$125.00
FACTORY TO YOU! \$59.95
5 BIG POWER TOOLS in 1

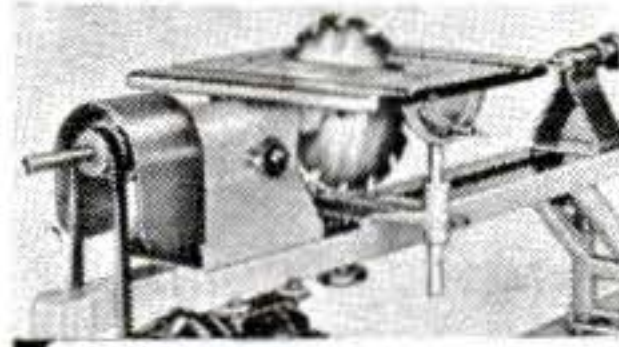

SUPERSHOP is the PRECISION-BUILT power tool WORKSHOP. Big

capacity tilting table saw, vertical and horizontal drill press, 30" lathe, sander, grinder. Lifetime-lubricated BALL BEARINGS. Running parts precision-ground. Bearing seats precision-bored. Compare with finest production tools. Buy direct from factory — save \$65.00. Write for FREE catalog, full details, trial plan.

THIS COUPON WILL BRING YOU FULL INFORMATION...FREE CATALOG, TRIAL PLAN

NAME _____

ADDRESS _____

CITY _____ STATE _____

SUPERSHOP POWER TOOLS INC.
205 YATES AVE., BELoit, WISC.

TAKE YOUR CHOICE OF THESE TWO GREAT RADIO BOOKS!

These two giant volumes are packed to the brim with everything you want to know about radio—how to build and repair all types of receivers, FM sets, portables, radio-phonographs, shortwave sets, wireless record players and recorders! If you ever want to "trouble-shoot" . . . make your own testing instruments . . . check circuits . . . or build magnificent sets . . . these are the books for you! Order today! SEND NO MONEY! Just deposit price of books with postman plus few cents mailing charge. If after 7 days' Free Trial you aren't thoroughly delighted return these books and your money will be refunded! SO SEND YOUR ORDER NOW WHILE THE SUPPLY LASTS!

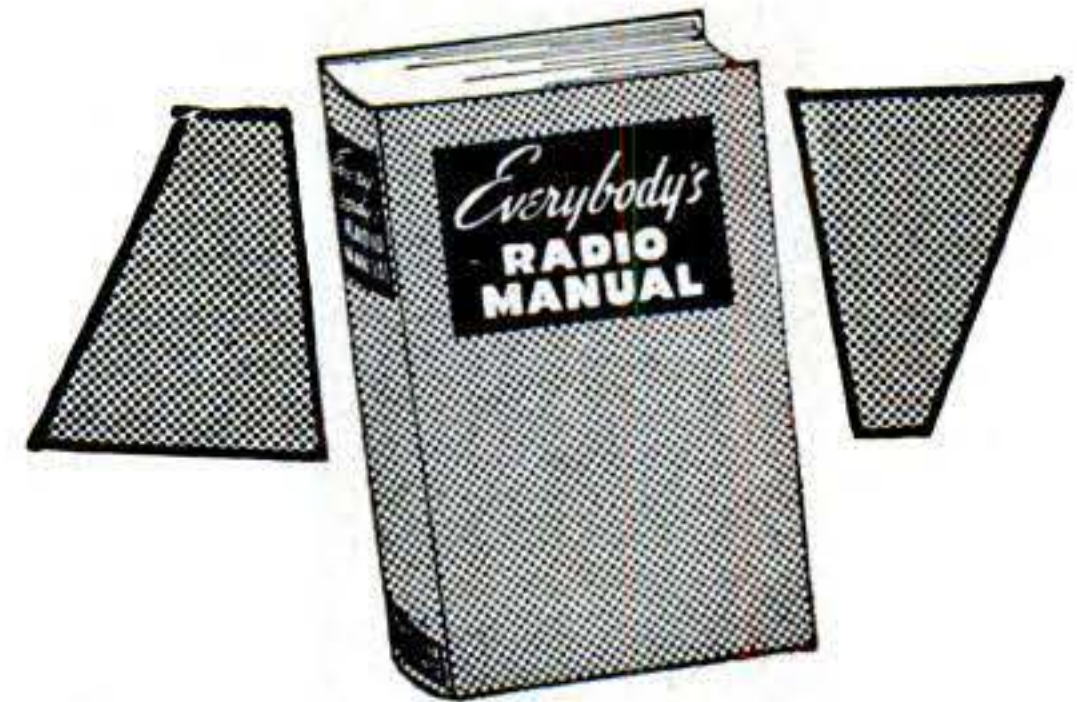

For the man who wants to build sets

RADIO FOR THE MILLIONS

648 Pictures!
192 Giant Pages
78 Complete Plans
ONLY \$1.98 DeLuxe Edition

SAVE MONEY!
And order both books together!
BOTH AT THE BARGAIN PRICE OF ONLY \$2.98!

OR SEPARATELY:
RADIO FOR THE MILLIONS \$1.98
EVERYBODY'S RADIO MANUAL \$1.49

For the man who wants to "trouble-shoot"

EVERYBODY'S RADIO MANUAL

256 Pages! 216 Pictures!
75 Wiring Diagrams
ONLY \$1.49 in DeLuxe Binding

Get your step-by-step instructions for radio repairing from this clear-cut, simply written manual! Here are hundreds of pictures and wiring diagrams to show you how to solder, cut and drill . . . how to read diagrams, check circuits, make testing instruments, measure capacities, identify high voltages, calculate resistances, and find open circuits.

How To Modernize Old Sets!

Read the big chapter on improving old radios, wiring battery sets for AC current, adding phonograph attachments, and adapting sets for short wave reception. You'll find complete plans for building 11 sets including an AC-DC short wave receiver, a 3-way portable, a home recorder, an FM receiver, and a high fidelity amplifier! It's just bursting with shortcuts, pictures, diagrams, conversion tables and codes! Be sure to order today!

How would you like to build your favorite type of radio? "Radio For The Millions" gives you simple clear-cut instructions and hundreds of detailed picture-diagrams for every type of radio you will want! It shows you exactly how to build no less than 78 radios, phonographs, and combinations. There's an 8-tube FM receiver, two-way radio station, bicycle radio, 2-tube set, floor lamp radio, tiny portable, midget AC-DC set, superhet, high fidelity amplifier, all-wave receiver, bed radio, and a vest-pocket receiver! You'll find scores of NEW IDEAS, too—and read how to build handsome new cabinets, a dual-turntable phonograph, a "B" supply for portables, a rectifier unit, a television antenna, a record player, a home recorder, and a light beam transmitter.

A SPECIAL BARGAIN PRICE!

Think of it! A giant book with 648 pictures, 192 pages, 78 complete plans for radios and phonographs—all for ONLY \$1.98 deluxe! Just one of the repair jobs described could save you several times small cost of the book.

MAIL COUPON TODAY!

POPULAR SCIENCE PUBLISHING CO.,
353 4th Ave., New York 10, N. Y., Dept. 119

Send me the following book(s) checked: } or \$2.98
 "Everybody's Radio Manual", \$1.49 } for both
 "Radio For The Millions", \$1.98

On delivery I will pay postman \$1.49 for *Everybody's Radio Manual* or \$1.98 for *Radio For The Millions*—or \$2.98 for BOTH (plus postage). If not delighted, I may return books within 7 days for full refund.

NAME.....

ADDRESS.....

CITY.....ZONE.....STATE.....

Check here if you send payment with order, and we will pay all shipping costs. Same return privilege.

BUILD YOUR OWN TILTING ARBOR SAW!

Exclusive GIL-BILT Build-It-Yourself Features

- No machining—build easily with hand tools only
- No blueprint reading—step-by-step pictorial plans, full scale patterns, actual photographs
- Sturdy wood, aluminum, and steel construction
- Capacity and performance of commercial saws selling for \$60 and up

SAVE \$50 OR MORE

GIL-BILT 10-INCH TILTING ARBOR SAW



- 27x28 in. table, 13 1/2 in. capacity in front of blade
- 10 in. blade cuts 3 1/4 in. deep, tilts full 45 degrees
- Floor model 34" high table always stays level

- New Departure ball bearing arbor, 3/4" precision shaft turned down for 5/8" bore blades, alum. housing, shipped ready to run
- Jackscrew and 4 1/2 in. dia. handwheel lowers and raises blade
- Cast aluminum miter gauge and self-aligning rip fence guide

GIL-BILT Metal Parts Kit includes Plans, ball bearing arbor, miter gauge and bar, rip fence guide, dado insert, lock knobs, jack screw mechanism and handwheel, and all other metal parts (less blade).....**\$20.95**
Same Kit with 10" Combination Blade.....**\$24.90**
Same Kit with 8" Combination Blade.....**\$23.90**

GIL-BILT 8-INCH TILTING TABLE SAW

- 21x27 in. table tilts full 45 degrees, 13 in. capacity in front of blade
- 8 in. blade cuts from 0 to 2 1/2 in.
- New Departure ball bearing arbor, 5/8" precision shaft turned down for 1 1/2" bore blades, alum. housing, ready to run
- Cast aluminum miter gauge and self-align, rip fence guide (same as above)



GIL-BILT Metal Parts Kit includes Plans, Ball Bearing Arbor, Miter Gauge and Bar, Rip Fence Guide, Machined Lock Knobs, Tilt Support Segments, and All Other Metal Parts (less blade).....**\$15.95**
Same Kit with 8" combination blade.....**\$18.90**

GIL-BILT 12-INCH BAND SAW

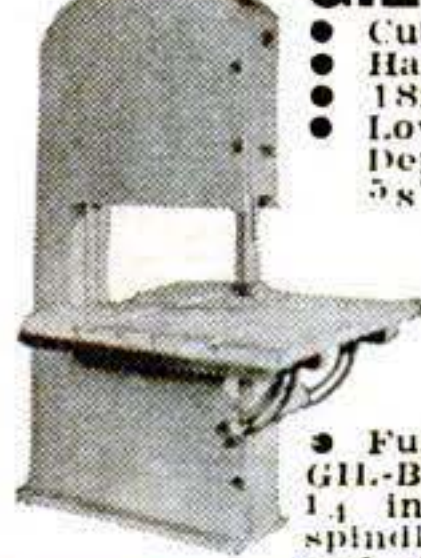

- Cuts to center of 24 inch circle
- Handles stock up to 6 inch thick
- 18x18 inch table tilts 45 degrees
- Lower wheel and drive pulley runs on sealed New Departure Ball Bearings; Upper wheel runs on two 5/8" bore Oilite Bronze bearings.

- Upper and lower blade guides. Each has ball thrust bearing, self-lub bronze jaws.
- Rubber tired wheels. Choice of cast aluminum or make-your-own wood wheels on metal hubs.
- Uses standard 78 inch blades up to 3 3/4 inch wide.

• Fully enclosed mechanism for utmost safety.
GIL-BILT Metal Parts Kit includes Plans, rubber tires, 1 1/4 inch blade, hubs for wood wheels, ball bearing spindle, tilt mechanism, guides, table tilt segments, and all other metal parts.....**\$16.95**

Same Kit with two machined ready-to-install 12" cast aluminum wheels.....**\$20.95**

NO DEALERS—One Low Factory Price! Return in 10 days for full refund if not satisfied. Prices include postage within 600 miles. Over 600 miles add 5%. Send cash, check, or money order for parts kit, or send \$1.00 for Step-by-Step Plans and order kit later less cost of Plans. Plans sent postpaid anywhere in the world.

GILLIOM POWER TOOLS
P.O. Box 1-VM, Lambert Field, St. Louis 21, Missouri

COMPLETE PLANS only \$1.00 EACH

Manufacturing Opportunities in Concrete Products Industry

The great building industry is your profitable market for masonry products. Low investment...high returns...wide-open opportunity to establish a lifetime business.

The biggest building years in the nation's history are just beginning. New construction, involving billions of dollars, means huge demands for block, drain tile, and other masonry products which YOU can manufacture locally, from local materials with local labor for local consumption. Remember, MASONRY products mesh with today's demands.

Use our modern machines and equipment to insure the finest quality products at pared-to-the-bone manufacturing costs. Sold direct. Backed by 40 years of manufacturing. Write for catalog. Gives prices and full information.

CONCRETE EQUIPMENT CO.
Ottawa Ave., Holland, Mich.



KING MIDGET HOME ASSEMBLED MIDGET AUTO



WORLD'S LOWEST PRICED AUTOMOBILE!

80-90 MI. PER GAL.—45-50 MI. PER HR.

Drive this car for as low as 50c per week. Precision built parts direct from factory with beautiful all steel body. Get all the facts on this amazing small auto—send 25c for detailed circular with large picture, 4 view drawings and price of all parts, or send \$1 (refunded first order) for this plus actual assembly book with 42 photos, drawings; blueprints of snow and ice conversions, etc.

MIDGET MOTORS MFG. CO., ATHENS, 2, OHIO

SEND FOR FULL INFORMATION TODAY!

King Midget is the ideal small car for errands, sports use, to and from work, short business or pleasure trips, delivery service or second-car utility for the whole family. Comfortable—room for husky six footer.

SCREWMIX—BEARINGS

Mixed screws & metal screws—30c Lb.	Bore	O.D.	Type	Price
Mixed wood screws—Mixed washers—Mixed cotter pins—30c Lb.	5/32"	5/8"	Ball	15c
Mixed nuts—Mixed aluminum rivets—50c Lb. Mixed steel rivets—20c Lb.	3/16"	1 1/2"	Needle	15c
BARGAIN OFFER (\$2.40 value) one lb. each of above 7 mixtures—\$1.95	1/4"	5/8"	Needle	15c
	5/16"	1 1/2"	Ball	22c
POSTAGE Screwy Mix, Add 5c per lb.	3/8"	7/8"	Ball	35c
POSTAGE Bearings, Add 10c per order, Minimum order \$1.00	5/8"	1 1/4"	Ball	30c
	5/8"	1 3/8"	Ball	40c
	3/4"	1 5/8"	Ball	60c
	1"	1 1/4"	Needle	28c

JAY-CEE SALES CO., 4554 Grand River Ave., Detroit 8, Michigan

IF YOU HAD A HULL AUTOMOBILE COMPASS WE WOULDN'T HAVE TO FLIP TO SEE WHO GETS OUT TO ASK DIRECTIONS

Streamline, \$3.95
AT YOUR DEALER'S.
Write for illustrated literature.
HULL MFG. CO., P. O. BOX 246-E11, Warren, Ohio

Beaconlite Illuminated \$5.95



NONE BETTER!

SUPER DRILL GRINDER

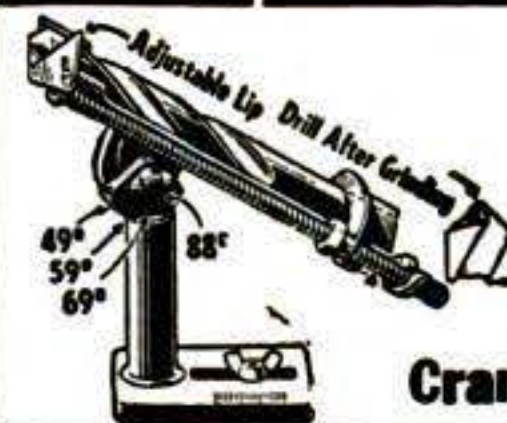

Sharpens round shank drills from 3/32" to 1/2" in diameter, up to 6" long. Grinds old drills like new in 4 different point grinding angles, using hand or power grinding wheels. Money-back guarantee.

Price only \$2.95

At Dealers or Postpaid

Crandall Mfg. Co. 1512 W. Slauson, Dept. FB-45, Los Angeles 44, Calif.

HYDRAULIC Power Transmission

WITH Infinitely VARIABLE SPEEDS, Clutch and INSTANT REVERSE OUTPUT TORQUE ADJUSTMENT UP TO 180 inch POUNDS

This positive displacement Hydraulic Torque Converter is the ideal fluid drive with thousands of uses. Output Speeds Infinite .0 to 550 R.P.M. in either direction. Change Speeds WHILE RUNNING. Control and Transmit your power this SMOOTH Oil-Way. Will handle 1/4 H.P. to 1 1/2 H.P. Motor. Industrial or Home & Farm Use. Cost Government \$300. High Quality Precision Workmanship. Buy this unit to get the most for your money. Case measures 7 1/2" long 7" high 6 1/2" wide. Input & Output Shafts 5/8" dia. Beautiful Red Crackle Finish Case.

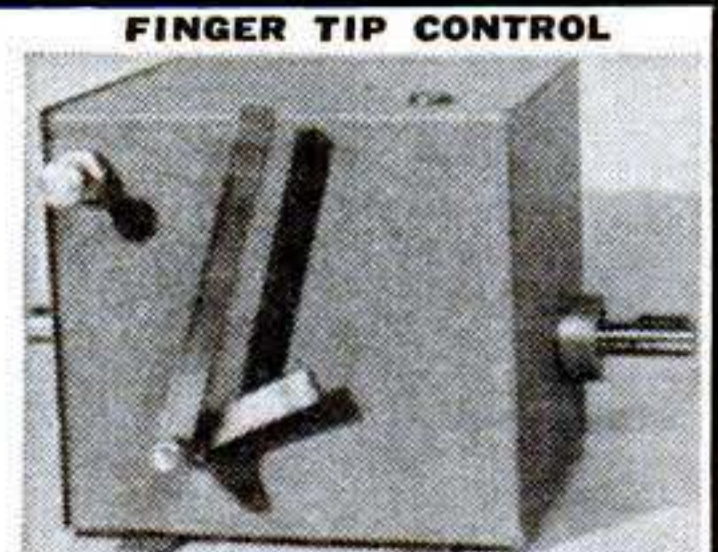

Shipping Wght. 25 pounds

Only \$54.50

PREPAID 2 quarts oil included FREE

If C.O.D. is requested a 10% Deposit must accompany order and we ship F.O.B. Chicago.

1 1/2"-8 thread Lathe Chuck Adapter, \$3 extra

DIRZIUS MACHINE SHOP "V" 1423-25 So. 52nd Ave., Cicero 50, Ill.

SAVE BIG MONEY ON HOME HAIRCUTS!



Guaranteed Home Methods of Haircutting with the Amazing Star Electric Hair Clipper!

This wonderful, new electric hair clipper *pays for itself in 10 haircuts!* Anyone can cut hair neatly with the Star Clipper. It does everything — cuts, trims, tapers. No shears needed. Easy to handle. Safe — shock and fool-proof. Works on either AC or DC. Cuts the family's hair quickly. Saves money and time. Thousands in actual use. Convince yourself — order one today! Guaranteed to satisfy — *or your money back!* Free instructions with each clipper. Furnished with special tapering comb. All for only \$9.98. If your local dealer cannot supply you, write direct to:

ALLOVER MFG. CO. • Dept. PS • RACINE, WISC.

BUILD ARC WELDER FROM OLD GENERATOR

WE SHOW YOU HOW
Light or Heavy Work

Produces 75-200 amperes. Takes no previous experience or hard work to make one of these welders. Complete plans 35c. Send for your **PLANS** today and we'll include **FREE** our Big **NEW** Catalog listing hundreds of electrical bargains.

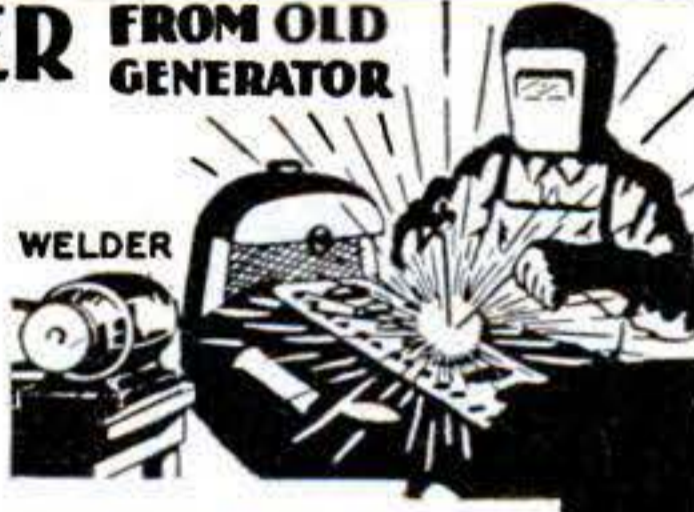

LEJAY MFG., 1323 LEJAY BLDG., MINNEAPOLIS, MINN.

Only \$498 OTTAWA Mule Team Tractor



Finest low-cost tractor. Costs too little to do without. Engines burn gasoline or kerosene. Starter and lights available. Other larger Models to choose from. Over 4,000 in world-wide use. Time-proved and tested. At low cost they easily mow, plow, disc, harrow, plant, cultivate, etc. Sold only direct to user. Write for **FREE** details.

OTTAWA MFG. CO., 2-901 Garden St., Ottawa, Kansas

EXPORT PAYS BIG

World Trade firm offers men and women plan for big pay positions or unlimited-profit businesses of their own in Export-Import Mail order World-wide without capital, from home; or travel abroad. Write today for Free Book. State if veteran. Airmail reaches us over night. The Mellinger Co., 1422-KA Westwood, Los Angeles 24, Calif.

New MILLING ATTACHMENT



Sizes for 8" to 16" metal lathes Build it yourself from our sets of semi-machined castings and save \$\$\$. Can be finished on your lathe alone. Complete drawings and instructions furnished with castings. Mill keyways, slots, splines, dovetails, flutes in reamers, special cutters. Produce gears, ratchets, racks; bore, face, etc., with this precision attachment.

FREE! Illustrated folder and price list of castings, milling cutters, etc. Write today. Mention your lathe.

HURON MACHINE AND TOOL CO. YALE 2, MICHIGAN

THE IDEAL XMAS GIFT

FOR THE RACING ENTHUSIAST
A NEW JET POWERED
AUTHENTIC
9 INCH MIDGET
RACER

Equipped with rubber tire metal wheels.

- All parts semi cut
- Easy to assemble
- 3 view detailed plans clearly illustrated



KIT
Only \$2.50
P.Pd.
C.O.D. you pay post

SPORT-O-SPEED, Dept. 3, 17 N. 5th St., Paterson 2, N. J.

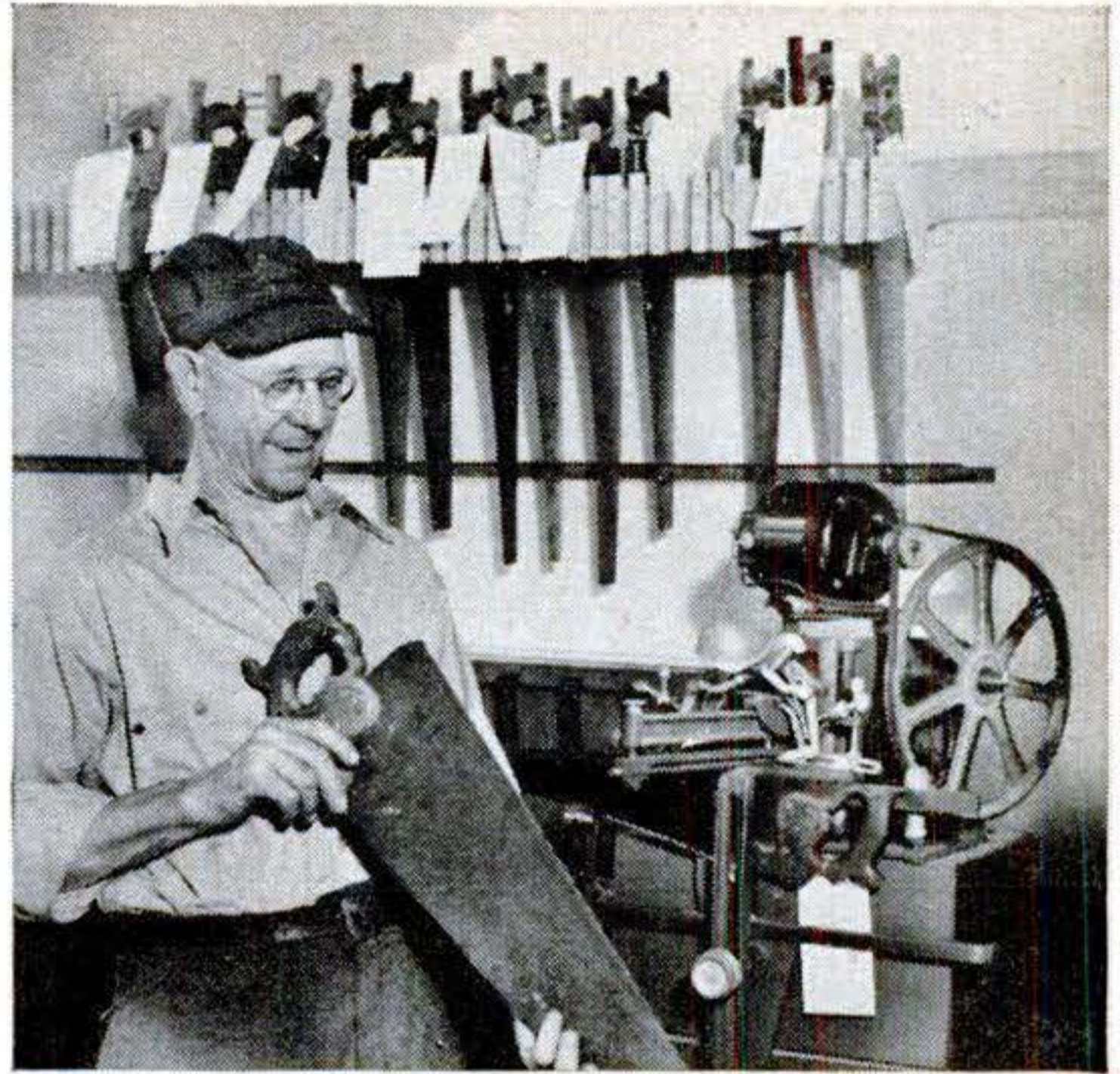

OWN YOUR BUSINESS

Start in Spare Time with a FOLEY SAW FILER

Here is a steady repeat CASH business you can start at home in your basement or garage, while you are working at your regular job. No experience is necessary to turn out perfect cutting saws — "the first saw I sharpened came out 100%." I think the Foley Saw Filer is a marvel of perfection," writes Clarence E. Parsons. Every saw you sharpen will bring you new customers. You will find you can make up to \$2 or \$3 an hour—\$20 to \$30 a week in your spare time as a starter.

With a Foley Saw Filer you can file all hand saws, also band and cross-cut circular saws. It is easy to operate—simple adjustments—no eyestrain. Patented jointing principle evens up all irregular teeth and makes an old saw cut just like new.

This Free Book Shows How to Start

"INDEPENDENCE AFTER 40!"

shows you how to get plenty of saws to file without canvassing, and how you can develop into a general repair shop that will be your own business. This is a helpful, practical book that tells just what to do—send for your free copy today.



Send For FREE BOOK

FOLEY MFG. CO., 1119-9 Foley Bldg., Minneapolis 18, Minn.

Send me free book "INDEPENDENCE AFTER 40!"

Name.....
Address.....

BARRON Drill Press TOOLS



ROTARY WOOD
PLANER \$7.50

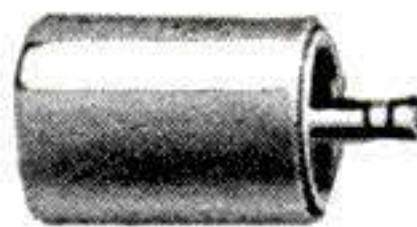

1" and 2 1/2" DRUM
SANDERS



ROTARY SURFACE
SANDER \$5.95



\$9.85
F.O.B. Detroit
ALL-METAL
DRILL PRESS TABLE

ALL-METAL
SHAPER FENCE
\$8.25
F.O.B. Detroit



ROUTER &
MORTISING
BITS
\$9.50
per set of six

SHAPER
CUTTERS
\$9.00
including
3 sets Blades



15 ESSENTIAL WORKSHOP OPERATIONS . . .

You can convert any standard make drill press into your most versatile, useful, low cost workshop tool. Barron Precision Tools now enable you to perform 15 indispensable shop operations—surface-plane woods and plastics—rabbet—tenon—panel—bead—groove—bevel—mortise—route—cut dovetail—sand surfaces and contours—shape—cut moldings—grind and buff. Over 200,000 Barron Tool users. Every tool sold on full 10 day money back guarantee.

See Your Dealer . . . Or Write Direct

BARRON TOOL COMPANY, INC.
570 Architects Bldg., Detroit 1, Mich.

FREE
Workshop
Guide &
Catalog

30 Early American Designs

New designs . . . Early American pieces adapted to modern living . . . in 2 series, A and B. Each packet contains 15 sheets, 8 1/2 x 11", with photos and working drawings. Easy to make practical gifts . . . cricket, napkin holder, candle stand, etc. Each packet 25c postpaid. Send for both packets, Stanley Tools, 249 Elm St., New Britain, Conn.

25c



STANLEY

Reg. U.S. Pat. Off.

THE TOOL BOX OF THE WORLD

Sand Casting—Forging—Heat Treating—Case Hardening BRONZE FOUNDRY

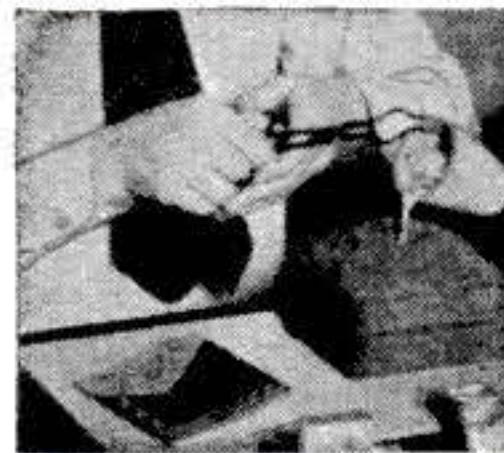

In your own workshop allows you to design and build your own GASOLINE ENGINES, STEAM ENGINES, STATUARY, ART OBJECTS, SPECIAL TOOLS, NEW INVENTIONS, ETC. You can also make forgings and case harden steel. Your shop is not complete without a FOUNDRY DRYETTE. Three sizes are available capable of making bronze castings of 1 1/2, 3 and 6 pounds weight, aluminum, copper, brass, etc., \$22.50, \$29.50, \$42.00 f.o.b. Kansas City. Domestic gas supply energy required for operation. Write for circular.

and 110 volt AC or DC
KANSAS CITY SPECIALTIES CO.
Box 6022, Dept. S-10 Kansas City, Mo.

DUAL CROSS and ROTARY FEED

PALMGREN ROTARY, INDEX, MILLING TABLE No. 83

Has 8" table, 360° movement and 4" cross feed travel. Adjusting wheels and dials graduated in degrees and thousands. Slotted for bolting to table. No. 83 Priced \$49.50. No. 82 without rotary feed \$39.75.



Write for Circular No. 10
CHICAGO TOOL and ENGINEERING CO.
8396 South Chicago Ave., Chicago 17, Ill.

"How to Make Money with Simple Cartoons"



A book everyone who likes to draw should have. It is free; no obligation. Simply address

FREE BOOK

CARTOONISTS' EXCHANGE
Dept. 1911D Pleasant Hill, Ohio



GEIGER COUNTERS for locating Valuable RADIOACTIVE MINERALS

There is a model to exactly fit YOUR requirements.....

Write today for details and prices

OMAHA SCIENTIFIC SUPPLY CO.
DEPT. 11, 3601 N 24th, OMAHA 10, NEBRASKA

HIGH POWER TELESCOPE

60 POWER-ALUMINUM TUBES-OPENS TO 33"

Variable Power Eyepiece Adjustable to 15X, 30X and 60X.

4.50

Leather Case Included

5 Sections. 4 Ground & Polished Lenses. Also used as 50X Microscope. Ready to use, only \$4.50 POSTPAID.

BROWNSCOPE CO. Dept. 11P, 24 W. 45th St., NEW YORK 19, N. Y.

Industrial Transformer Type

DYNAMIC Super Charged ARC WELDER

OVER 50,000 SATISFIED USERS!

IDEAL FOR AUTO HOME APPLIANCE AND FARM IMPLEMENT REPAIRS WORKS on IRON, STEEL and other metals. Does work you'd expect from a larger costlier machine. Portable, easily carried. OPERATES from any properly wired 110 Volt Line. Also available for 220 volt current at slight additional cost.

IT WELDS • BRAZES • SOLDERS • CUTS!

EASY TO OPERATE TRANSFORMER TYPE WELDER. If inexperienced you can learn to do professional work by following the SIMPLIFIED WELDING and OPERATING INSTRUCTIONS FURNISHED—comes complete ready to operate with helmet, rods, cable, instructions. SAVE TIME and MONEY—Do your own welding. Just a few repair jobs will pay for this machine. A practical and profitable machine tool for any workshop. Make money doing repair work for others. Write today for full particulars.

ONLY \$28.50 COMPLETE



DYNAMIC WELDER CO., Dept. ATD-119, 15 E. 23rd St., Chicago 16, Ill.

Mail Coupon for FREE FACTS

SPECIAL GIFT OFFER! ARC TORCH WORTH \$6.80 YOURS at NO EXTRA COST!

TWIN CARBON TORCH (illustrated) for use with DYNAMIC is unsurpassed for brazing, soldering, pre-heating and cutting iron, steel, brass, bronze and other metals. With it you greatly increase profitable uses of your welder. Does work of oxy-acetylene torch. Comes complete with instructions, carbons and cables. For LIMITED TIME ONLY we are giving a

Twin Carbon Electric Arc Torch worth \$6.80 with every DYNAMIC WELDER. Act now to get this valuable premium at the single low price of welder alone.



10-DAY TRIAL OFFER

DYNAMIC WELDER CO., Dept. ATD-119, 15 E. 23rd St., Chicago 16, Ill. Send me FREE details of your ELECTRIC Arc Torch Gift Offer and Dynamic Welder 10-Day TRIAL OFFER.

NAME.....
ADDRESS.....
CITY.....ZONE.....STATE.....

"Wellworth" Sensational Offer! Reg. \$60.50
WESTINGHOUSE AIR COMPRESSOR

**Model T-1
Brand
New**

2-CYLINDER PISTON TYPE

Operates with 1/2 H.P. Motor or equivalent gas engine.

Complete outfit consisting of compressor, pressure tank, air gauge, air chuck, 20-ft. hose, pop valve, copper tubing with 4 brass flared fittings for connecting compressor to tank, 4-way cross and 3 nipples. Complete outfit of 7 items. ONLY

\$29.95

SHIPPING
WT.
40 LBS.

COMPRESSOR
SEPARATELY

\$21.50

IDEAL for HOME • FARM • FACTORY

Wherever Compressed Air is Needed

For spraying paints, insecticides, etc.; inflating tires, operating air tools and many more uses. Automatic clutch makes it suitable for mounting and operating from trucks, tractors, etc. Instructions furnished. A fortunate purchase from the government enables us to offer you this amazing buy. All brand new equipment. Replacement parts available.

This low price is but a fraction of the price of manufacturer and of leading mail order houses.

Equipment less compressor **\$10.50**

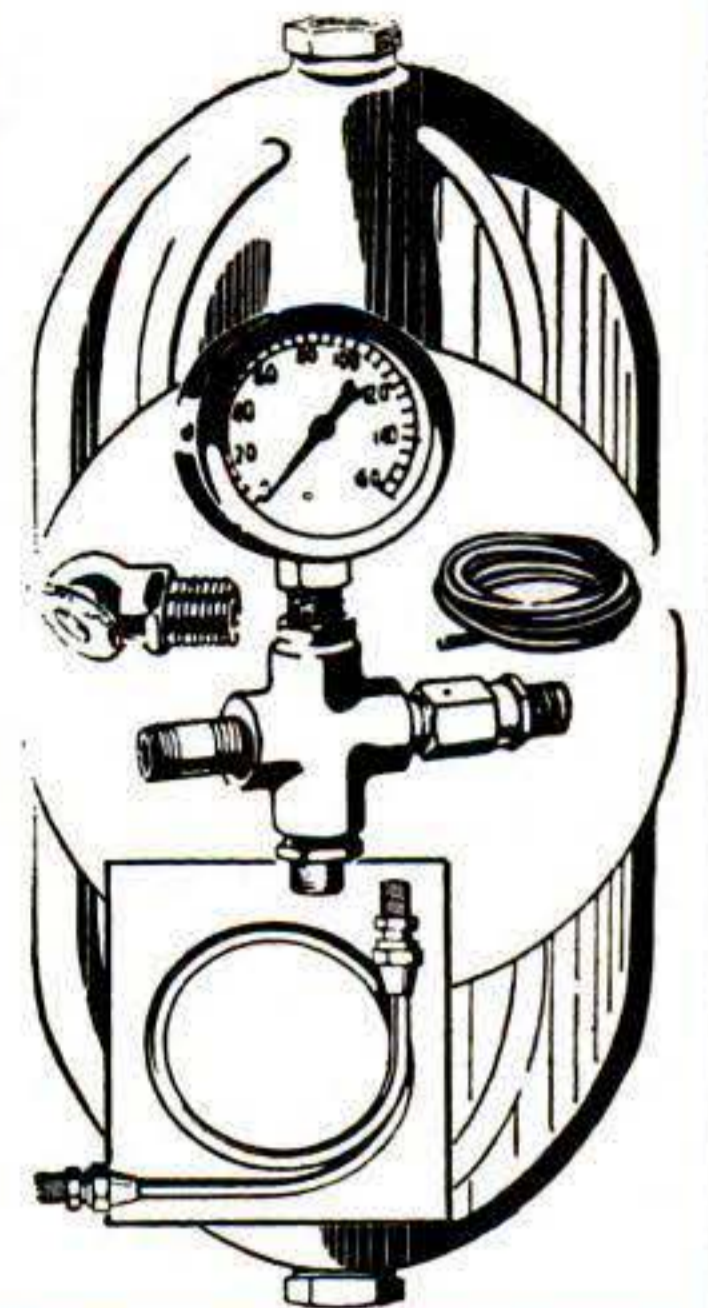
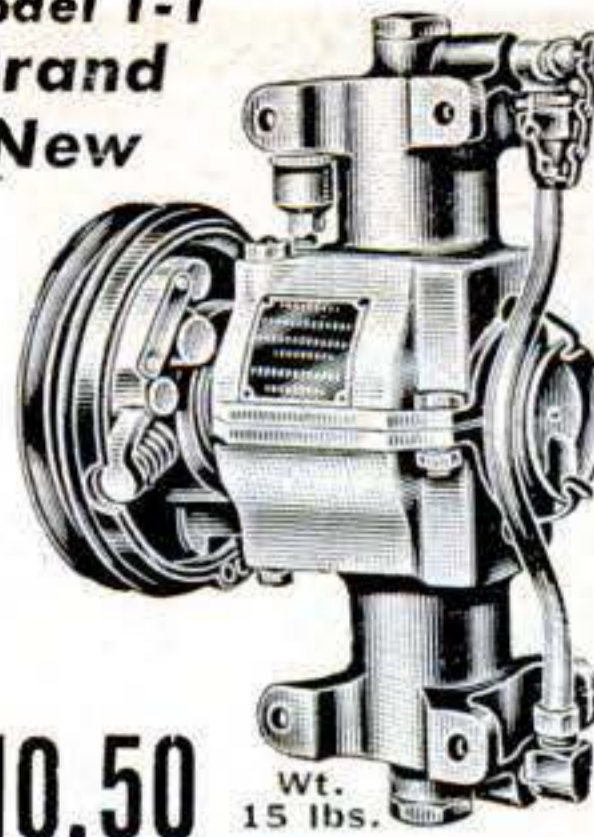

THE COMPRESSOR

Piston Type, 2-cylinder, 2 inch bore, 1 1/2" Stroke Ball Bearing, 3.27 C.F.M. at 600 R.P.M. Capacity up to 6.54 C.F.M. Suggested operating pressure 75 P.S.I. DIMENSIONS: 9" wide, 11 7/8" high, 6 5/8" deep. Wt. 26 lbs.

TANK and ACCESSORIES

6" x 24" stainless steel tank suitable for 150 lb. pressure. Two 1/4" openings. Air gauge, pop valve, air chuck, 20 ft. hose. Copper tubing and fittings as shown. Wt. 15 lbs.

WELLWORTH TRADING CO.

Dept. B-11 - 1831 S. STATE ST.
CHICAGO 16, ILL.

Prices f.o.b. Chicago. Immediate delivery. All items sold on money back guarantee. Send check or money order today. Catalog FREE.



**ONAN Portable
ELECTRIC PLANTS**

**FOR CABINS, TRAILERS,
CONTRACTORS, BOATS**

Light weight, compact, air-cooled engine-driven. Furnish regular city-type A.C. electricity for lights, appliances, radios, etc. Can be carried by hand. Fit trunk of car. Plug-in receptacles on plant. Larger models for farms, homes, businesses beyond highlines. Catalog shows over hundred models. 350 to 55,000 watts.

Gasoline or Diesel Powered

WRITE FOR CATALOG

D. W. ONAN & SONS INC.
2801 Royalston Ave., Minneapolis 5, Minn.



**AMES
UNIVERSAL DIAL
INDICATOR SETS**

New Surplus

Dial indicator-face-2 1/4" graduated in 1/1000ths. Dial reading-o-50-0; spindle travel-1/4"; can be used on stationary or revolving parts on lathes, milling machines, drill presses, etc. and for automotive work. Comes complete with dial gage, hole attachment, bar with upright, clamp sliding swivel, dial holding rod and 3 contact points—with case shown.

Reg. Sold
\$23.00
NOW
\$15.00

SID TOOL CO., 183 Grand St., New York, New York

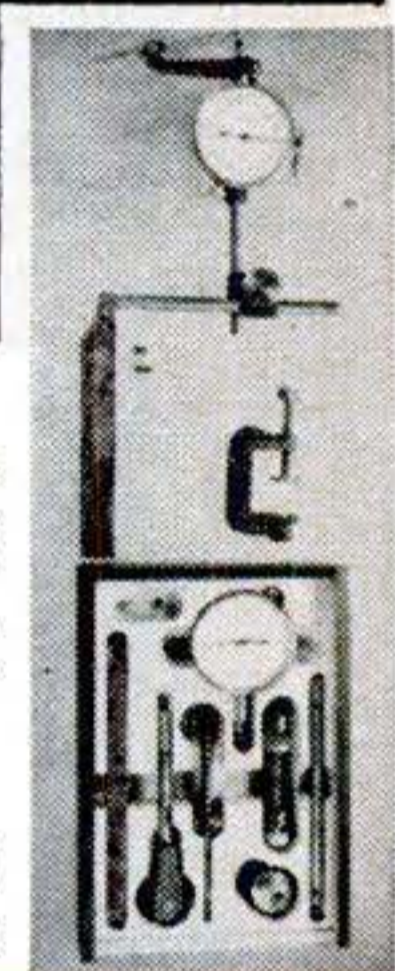

HERE IS EXTRA POWER

**Brand New Factory Guaranteed 3 H. P.
4 CYCLE GASOLINE ENGINE, PRECISION BALL
BEARING FOR BOTH THRUST & RADIAL LOAD**

**LESS THAN 1/2 PRICE
WHILE THEY LAST**

**REG. PRICE
\$84.50**

Now \$39.95

**While they last
F.O.B. Buffalo**

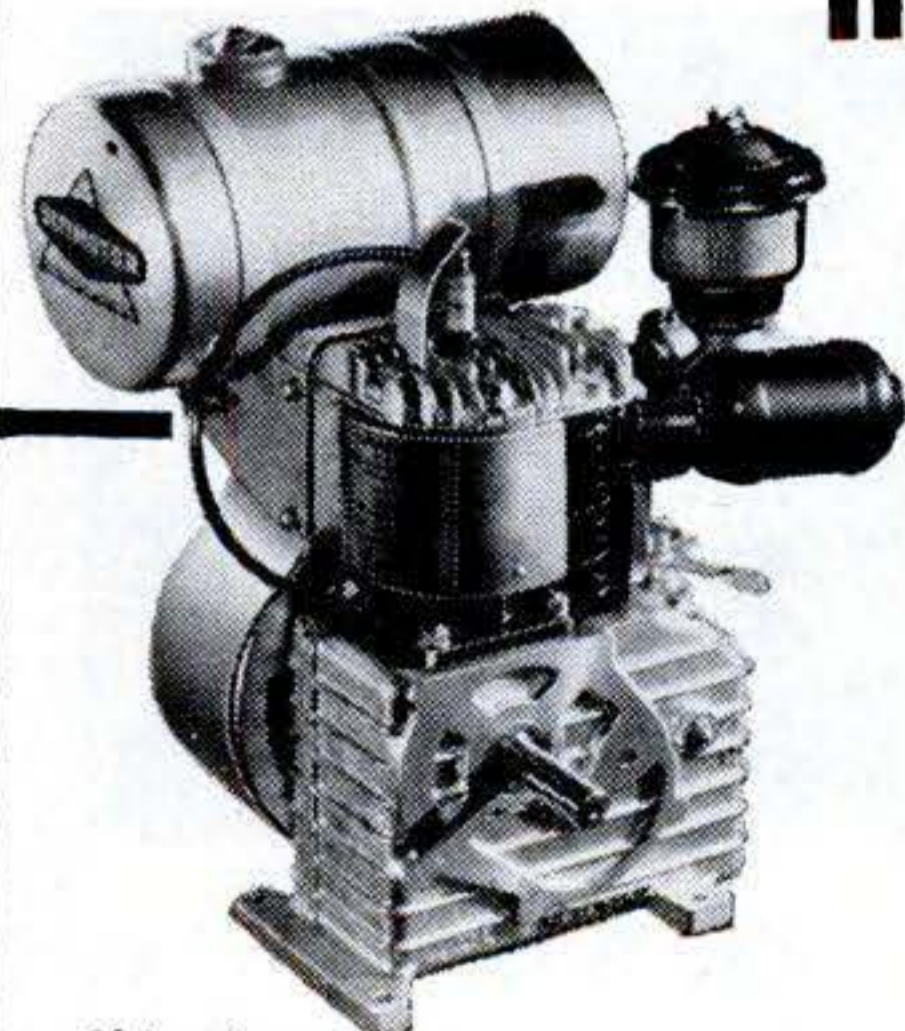

Shipping
Weight
48 lbs.

IN COMPARISON TESTS this engine is efficient, quiet, vibration free, economical to run, and has excellent torque.

**BEAUTIFULLY ENGINEERED
CAREFULLY INSPECTED**

DEALERS' Inquiries invited:— We took the Mfr's. entire model change close-out in order to offer this marvelous value. You know how fast this engine will be sold out at this price—so act at once.

**Some of the MANY USES
for this TERRIFIC ENGINE**

- | | |
|-------------|-----------|
| Saws | Mowers |
| Pumps | Garden |
| Sprayers | Tractors |
| Compressors | Hoists |
| Generators | Conveyors |
| Scooters | Boats |

If You Can Use Power, Don't Miss This Big Bargain Opportunity

You may enclose only \$10.00 with your order for each engine, balance C.O.D. We suggest you enclose full amount and save C.O.D. fee. Add postage to cover 48 lb. Parcel Post shipment.

DIRECT SYSTEM CORP.

63 GILL

BUFFALO 13, N. Y.

**Now!
A WATCH
THAT DEFIES
BREAKAGE**



**Only
\$7.95
plus tax**

**SHOCK RESISTING
(New Patented Unbreakable Balance Staff)
"CHAMPLAIN ROUGHNECK"**

• Drop It! • Shake It! • Jar It!

A handsome rugged stainless steel wrist watch that takes the roughest treatment and still keeps correct time. Ideal for active sportsmen. Luminous dial, genuine leather band. Written guarantee with each watch covers repairs for 1 year. Order today. Satisfaction guaranteed.



GIVEN WITH EVERY WATCH ORDERED

At no additional cost with every watch will be sent a handsome stainless steel expansion bracelet that regularly sells for over \$3.00.

CHAMPLAIN CO. 318 W. Schiller St. Chicago 10, Ill.

Rush... Champlain Shock Resisting Watches with Free Matching Expansion Bracelet. If I am not completely satisfied I will return within 5 days for a complete refund of purchase price.

Check Enclosed (\$7.95 plus 10% Tax—Total \$8.75). You pay postage.
 Send C.O.D. I will pay postage plus C.O.D. charges.

Name.....
Address.....
City..... State.....

A WELCOME GIFT



FROZEN ROOF DRAINS?

NO-FREEZE protects your home. It eliminates one of winter's most exasperating problems.

NO-FREEZE guards against the hazards of frozen drain pipes, bursting leaders and hanging icicles. Danger of damage to interior walls and ceilings from ice clogged drains is eliminated.

NO-FREEZE is a sturdy, easily installed brass container with chemicals which dissolve in freezing weather to melt ice and snow. Non-injurious to metals, woods, roofs, or shrubs. One filling normally lasts all winter.

\$7.00

Postpaid
Money Back
Guarantee

For **NO-FREEZE** Unit with container of chemicals. Refills for subsequent years 75c each—3 for \$2.00. West of Miss. add 25c postage for unit and 10c each refill. No C.O.D.'s please.

Write for details

CHESTERBROOKE CO.
ROCKAWAY 5, N. J.

**NEW! Trash Disposal Unit
Burns Refuse Safely**



• A new type outdoor dispose-all unit safely and quickly burns garbage and trash in any weather. All refuse, damp, green or dry is fully consumed. Scientific draft design completely eliminates fire hazard of flying ash, sparks, burning, blowing bits of paper. Intense combustion removes neighbor-annoying nuisance of flying scraps, smoke, smell.

Sturdily built to last for years. Nothing to get out of order. Needs no watching. Will not blow over. Will not destroy grass or shrubs. Ends refuse hauling and fire hazards to quickly pay for itself. Measures 23" square at base by 40" high. Weighs 19 lbs. Over 2 bu. capacity. Recommended by Bureaus of Fire Prevention. Full price \$9.95—nothing else to buy. Sent F.O.B. Cleveland. Money back guarantee. Send check, cash, or money order to:

ALSTO COMPANY, Engineers Bldg., Dept. PS-11, Cleveland, Ohio



Aids to



Plastic Drapes. Cleaning is no problem with these Vinylite® draperies. Dirt is removed by wiping them with a damp cloth. Vinylite, made by the Bakelite Corp., New York City, is processed into drapes of various designs by several different companies. Ready-to-hang drapes sell for about \$4. The plastic also is used as bedspreads.

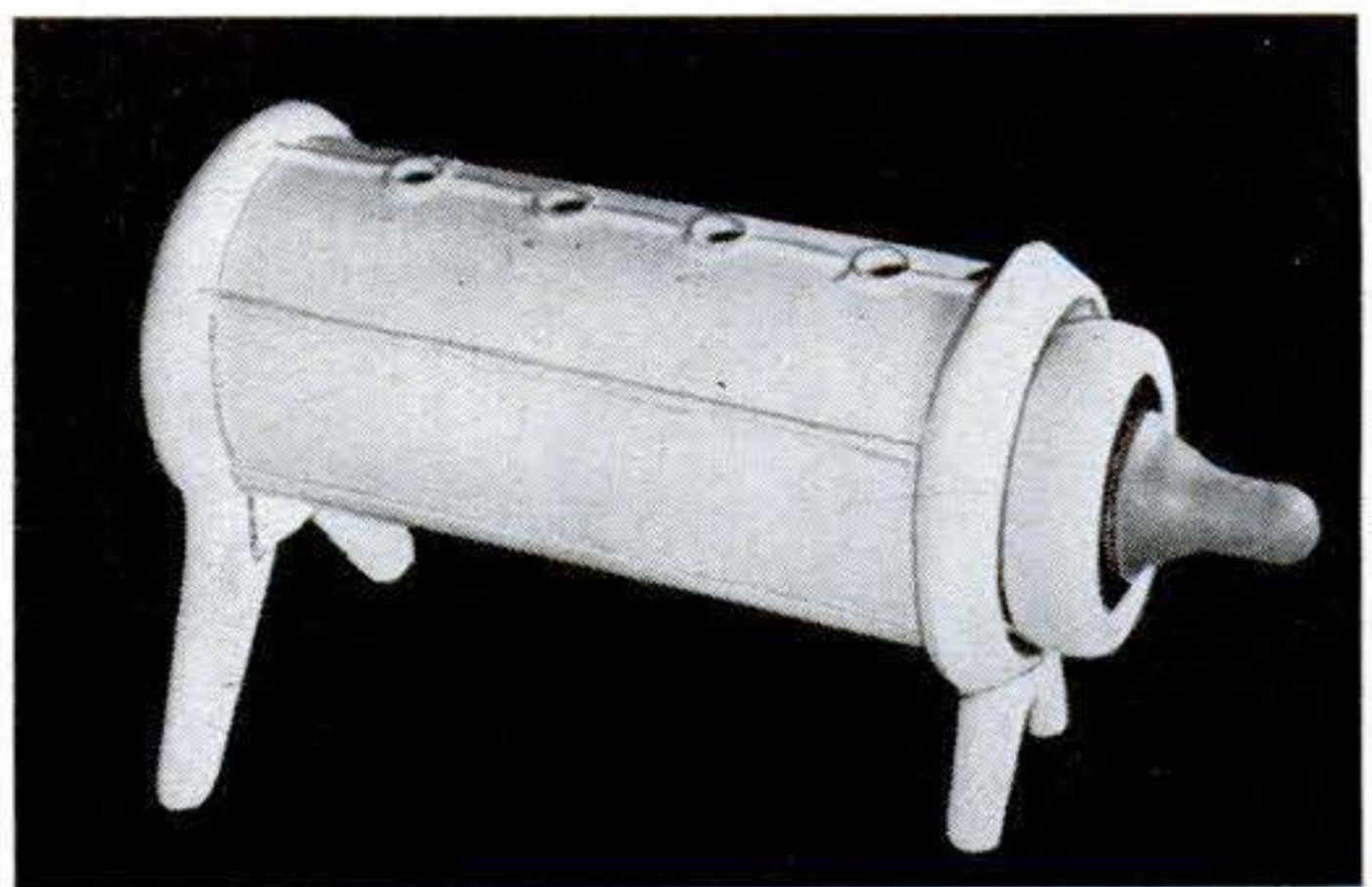

Protects Baby's Bottle. When baby gets the idea of throwing forward passes with his bottle, the Piggie Wiggle® protects it from breakage. It's made of non-toxic rubber and retails for about \$1.50 from Rock-A-Bye-Baby Creations, Los Angeles. A slight turn of the bottle locks it in the holder. Soap and water won't harm the rubber.

Modern Living

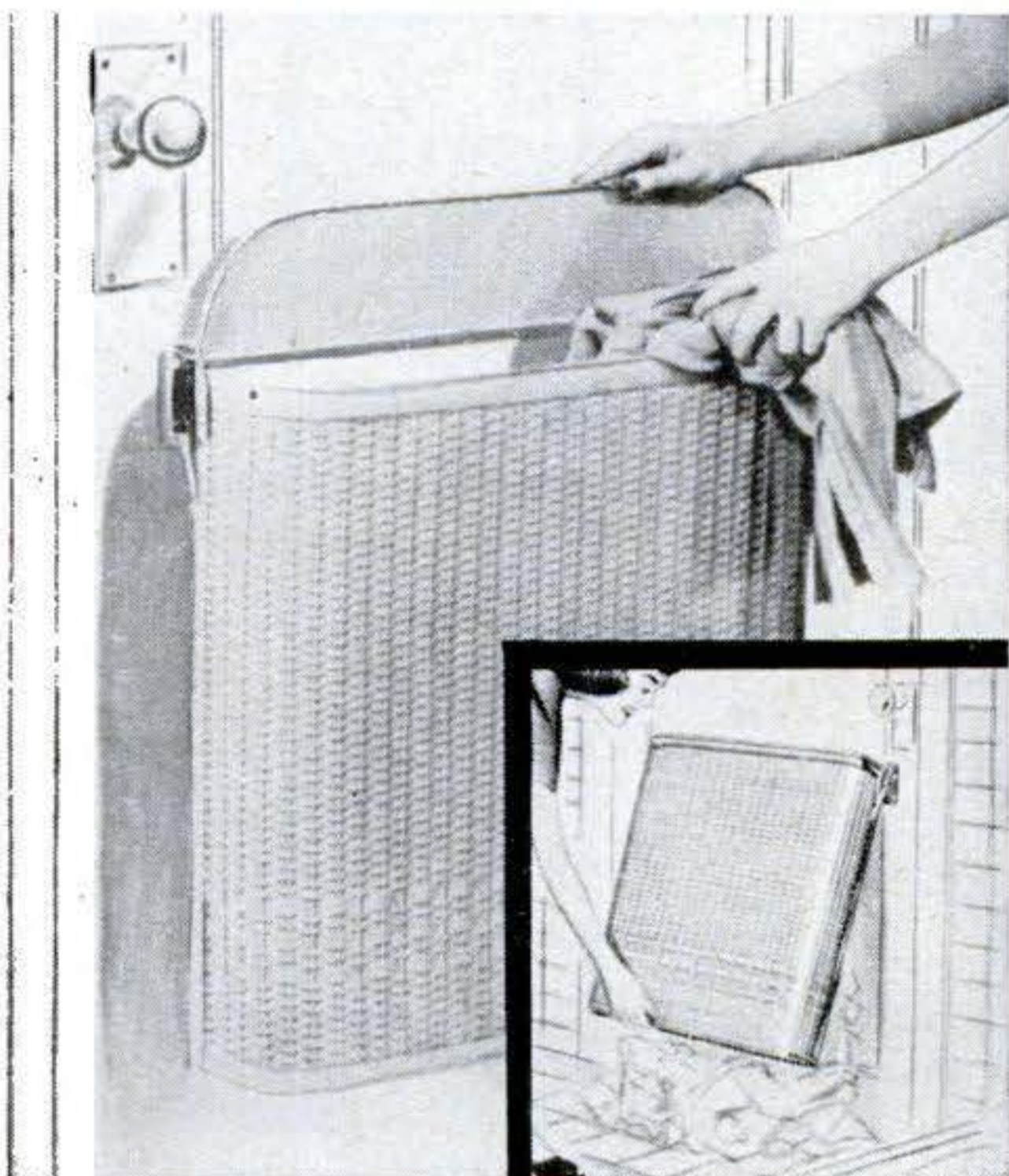

Self-Emptying Hamper. Laundry is easy to remove from this Dor-O-Matic® hamper. Pulling it out at the bottom dumps the soiled clothes. The hamper measures 5¼" by 21½" by 22½" high, comes in several colors, and is easily attached to a door or wall. The maker, Pearl-Wick Corp., of New York City, prices it at about \$4.



Fireplace Basket Tilts. The two halves of this grate hinge aside for easier removal of ashes. Manufactured by the Stainless Foundry and Engineering Co., Milwaukee, the Tilt-Away® comes in four widths to fit various fireplaces. Prices range from about \$10 to \$13. It's made of heat-resistant grey iron and is finished in black.

BUILD AN EXTRA ATTIC ROOM



IT'S easy to build an extra bedroom, workroom or playroom in your attic. You can do it quickly, at low cost with GOLD BOND Gypsum Wallboard. The handy panels are fireproof, moisture resistant, and easy to nail in place. Decorate with GOLD BOND Sunflex, the low-cost wall paint that dries in 1 hour. Get both at your local GOLD BOND Lumber and Building Material Dealer today.

SEND FOR FREE BOOKLET TODAY!

NATIONAL GYPSUM CO.
Dept. J-8, Buffalo 2, New York



Gentlemen: Send free copy of new Booklet, "Modernizing Magic" showing remodeling ideas and methods:

Name

Street

City State

(Please print name and address)

HANDY ELECTRIC HOME PAINT SPRAYER

NO BRUSH!
NO BACKACHE!



10 DAYS
FREE TRIAL

Weights
only 2½ lbs.

Why wear yourself out using old-fashioned brushes? VIBRA-SPRAYER quickly, evenly sprays glossy enamels, lacquers, insecticides satin-smooth. All-in-one instrument requires no compressor, motor or accessories. Piston activated, housed in sturdy plastic. Weighs only 2½ lbs., uses standard replaceable mason jar for paint container. Spray volume is adjustable, fingertip control. AC-110 volts.

FOR PAINTING, SPRAYING, DISINFECTING

Get professional results painting furniture, metal cans, partitions, concrete, brickwork, rough wood, boats, wagons, screens, cabinets, venetian blinds, metal equipment, etc.

Send NO MONEY — 10 Days' Trial

We guarantee that VIBRA-SPRAYER will supply paint smoothly, quickly, easily—or return it within 10 days for full purchase price refund. Only \$12.95 C.O.D. plus delivery, or send full payment now and we pay delivery. Order NOW from

FOSTER PRODUCTS, Inc., Dept. SG253
179 WOOSTER ST. NEW YORK 12, N. Y.

NOVEMBER 1949 301



"SAVE IT AND
FIX IT"

MENDS

DISHES, FURNITURE, LUGGAGE

It's transparent, water-proof, flexible and durable. Get a tube today.

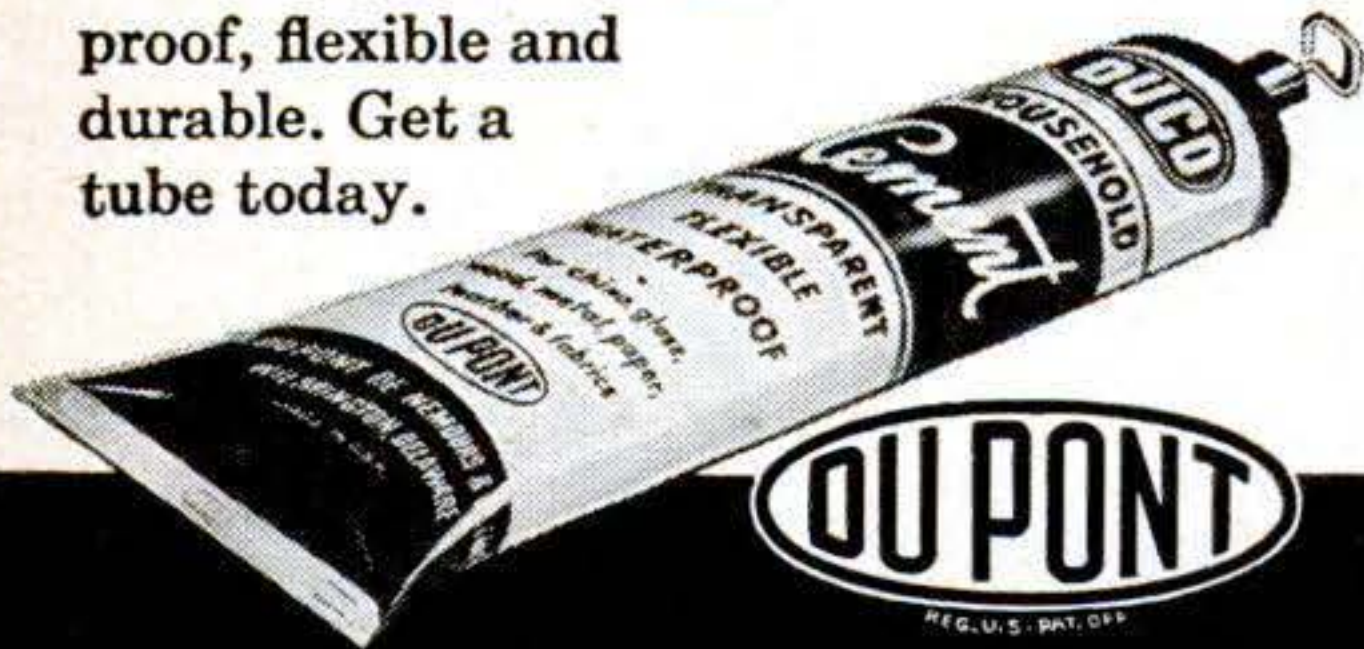

DUCO CEMENT

REG. U. S. PAT. OFF.

• VENETIAN BLIND KITS

- **Save as much as 50%**
- Assemble your own custom-made Venetian Blinds. Complete Kit takes only a few minutes . . . so simple anyone can assemble it.
- **NO "EXTRAS" TO BUY!** You get beautifully finished aluminum slats, all holes drilled, all hardware, screws, tapes and cord, headpiece, tilt, bottom rail, etc. You need only a hammer and screwdriver. Built for a lifetime of service!
- Available only by mail from the largest manufacturer of Venetian Blind Kits. Send for complete information today!

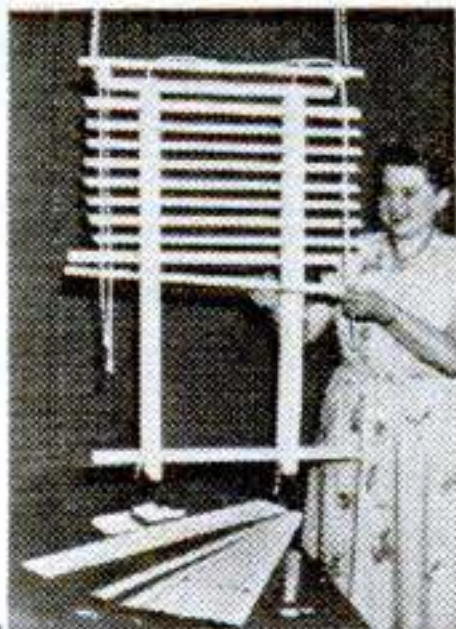

RUSH COUPON NOW!

Flexolite Manufacturing & Supply Co.
Dept. PS-11, 366 Wilson Avenue, Brooklyn 21, N. Y.
Please send complete information on Flexolite Venetian Blind Kits.

NAME.....
ADDRESS.....CITY.....STATE.....

Removing Paint is no problem now!

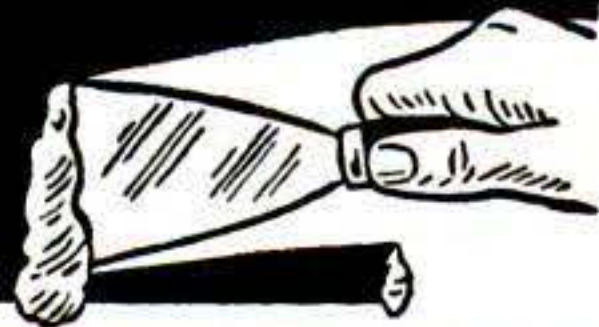

Yes, it's easy to remove any type of finish the professional WONDER-PASTE way. There's no arm-tiring work with a torch; no messy sanding needed afterward.

Simply apply WONDER-PASTE directly over the old finish with a paint brush . . . Allow time for complete penetration—then remove with a putty knife. The butter-soft sludge peels off easily, quickly, cleanly! Won't injure wood, metal, fabrics, or your hands.

At paint and hardware stores everywhere.

Write for Leaflet

WONDER-PASTE

Wilson-Imperial Company, 121 Chestnut Street, Newark 5, N. J.



Aids to Modern Living

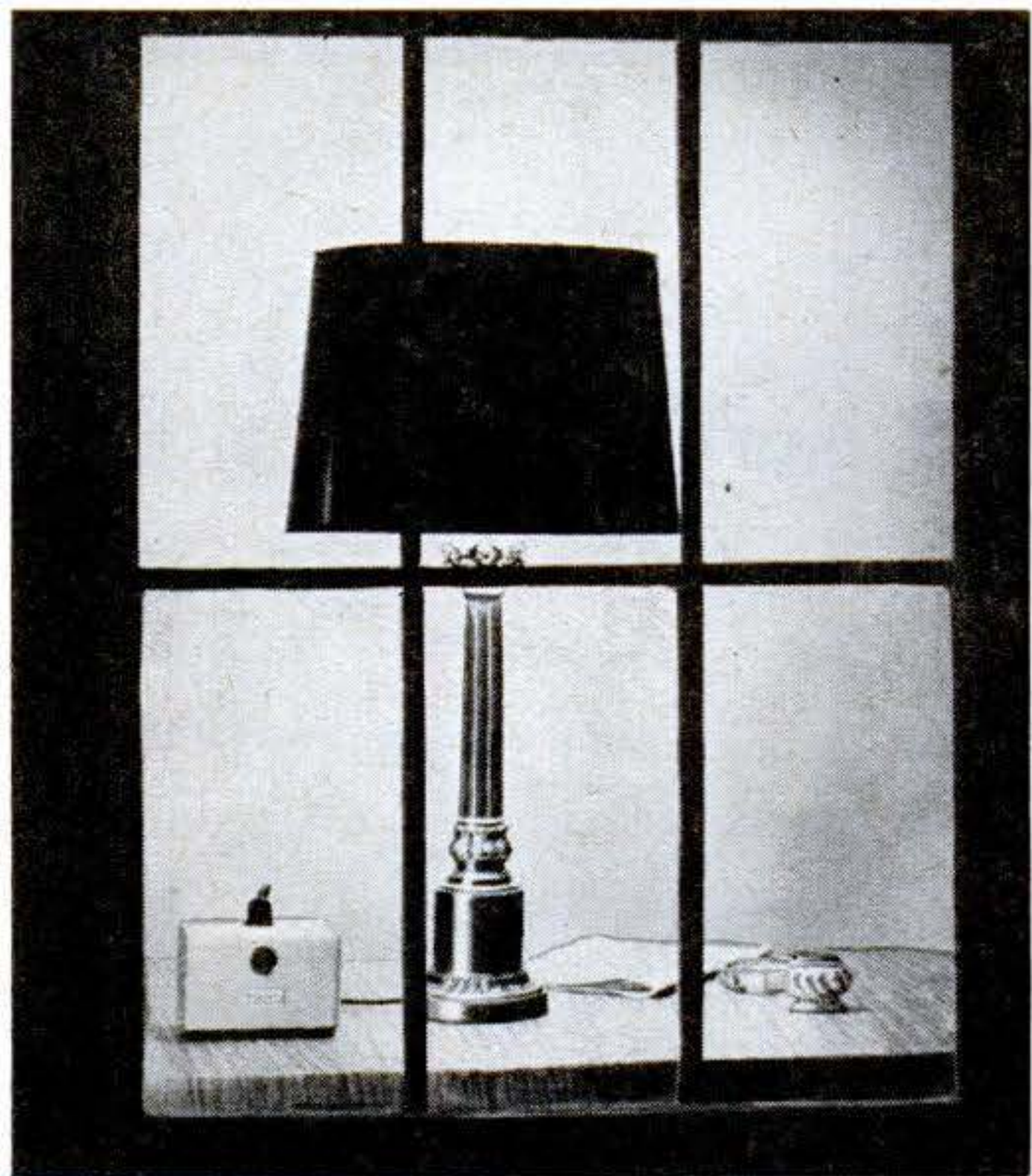

Automatic Lamp Control. The Light Watchman®—the little box at the left of the lamp—turns the light on at dusk and off at dawn. When daylight fades, a photo-electric cell in the box trips a relay, turning on the current. Encased in a steel housing, it measures 3½" by 4" by 5". The maker is Ripley Co., Inc., New York City.

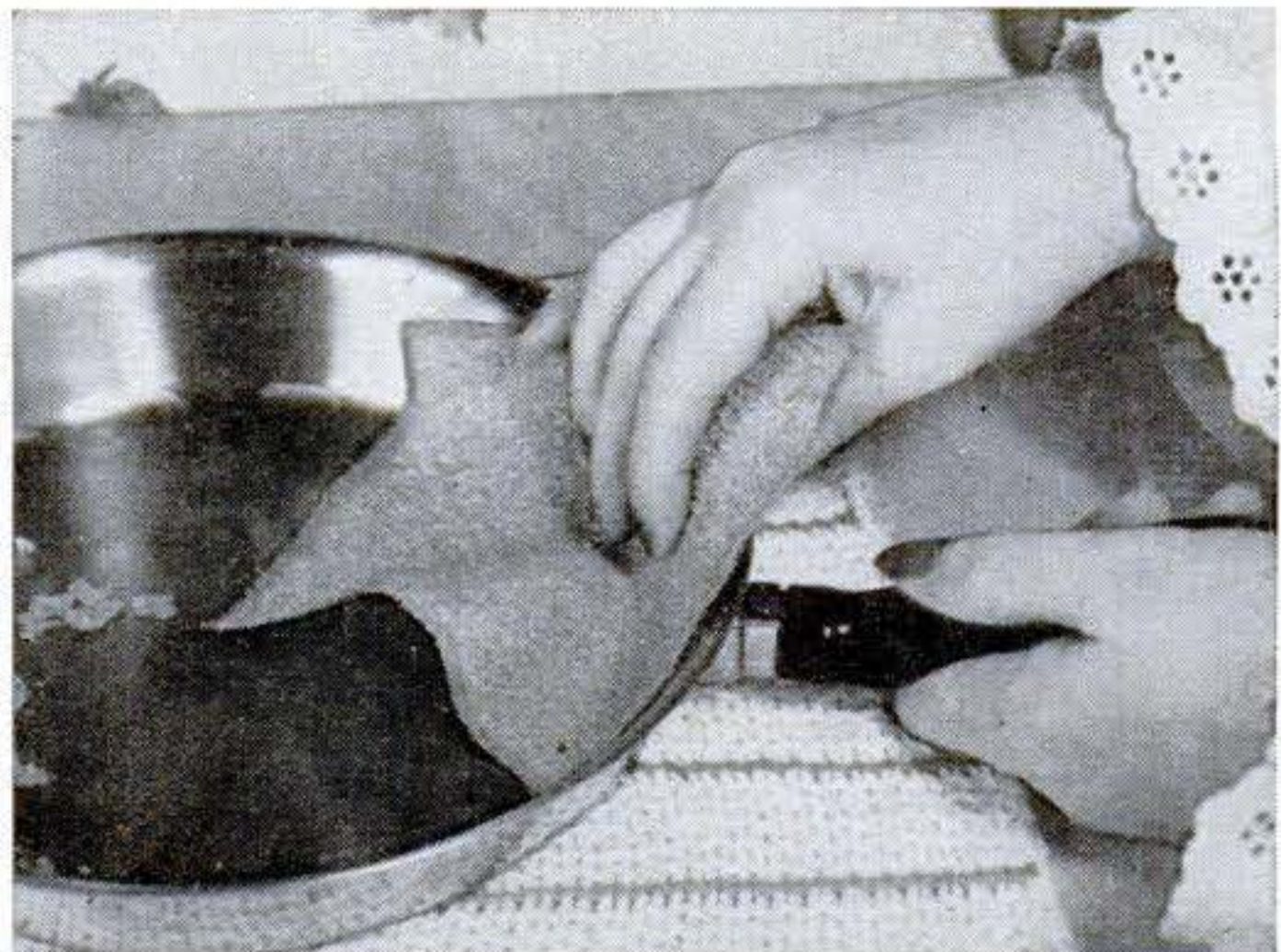

Cloth Coated with Abrasive. A fine, non-metallic abrasive powder on this dishcloth does the job of cleaning pots and pans. The adhesive used to hold the powder to the cloth is unaffected by soap, water, or grease. The cloth can be rinsed and used repeatedly. Metal Textile Corp., Orange, N. J., is the maker.

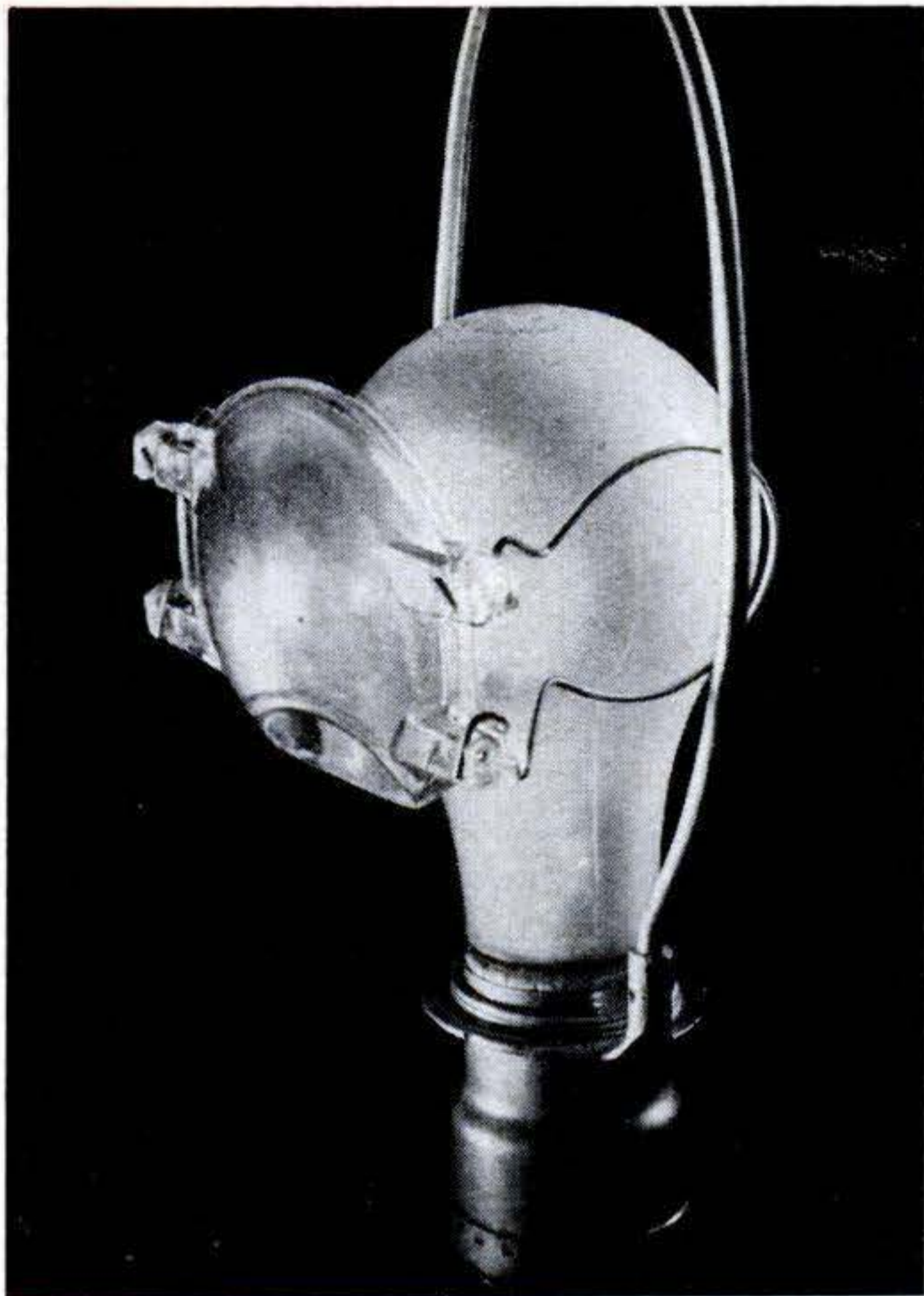

Clip-On Lens. The Lek-Tro-Lens® throws a large area of light about twice as bright as the illumination obtained from the bulb itself. It fits any bulb from 25 to 100 watts and may be positioned on the side or top of the bulb to throw extra light for close work. It's made by Fairbridge Co., Inc., of Bridgeport, Conn.

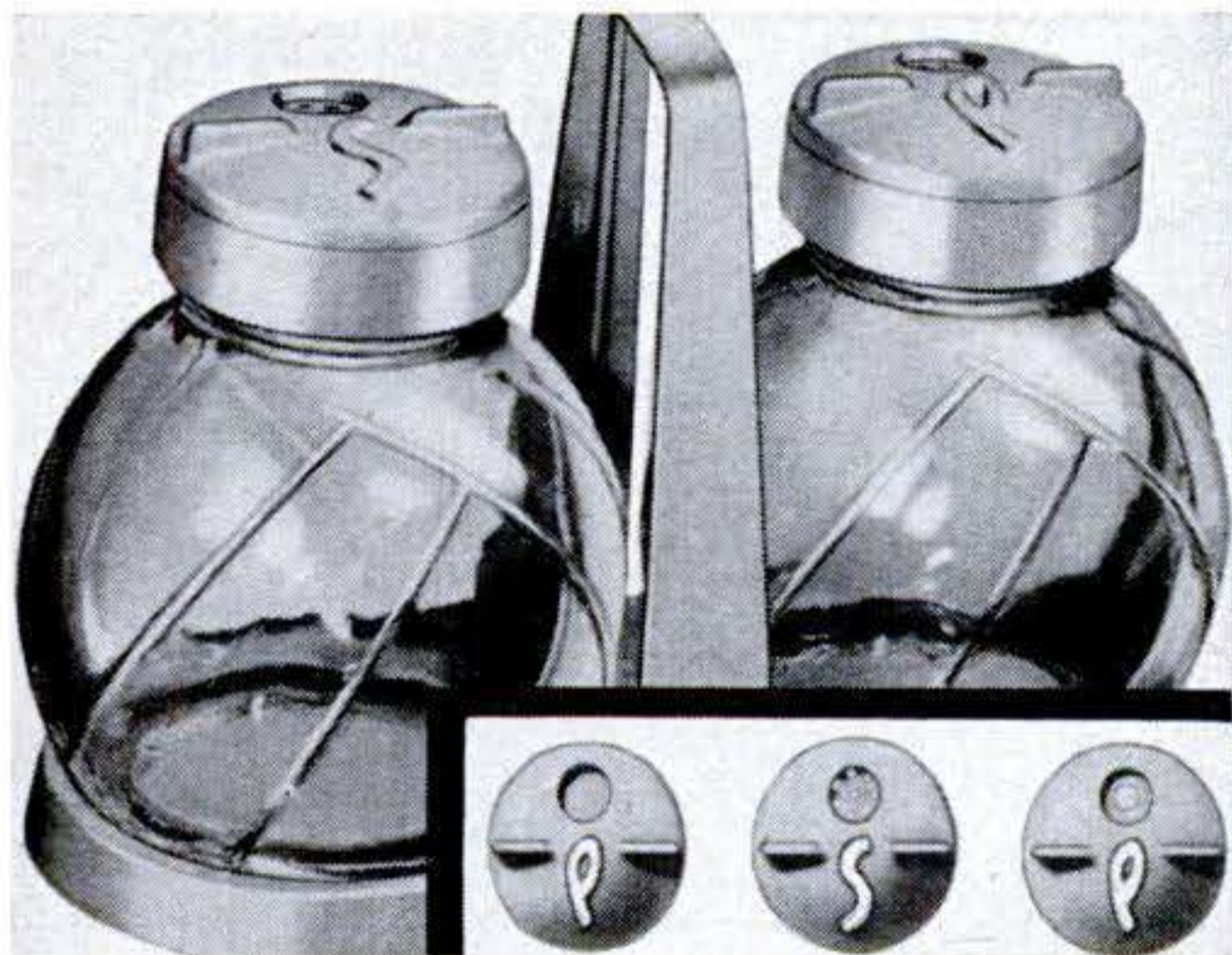

Tops Have Three Positions. The two-piece, pivoted caps of this kitchen salt-and-pepper set may be turned to free-stream quantity pouring, standard shaker action, or securely closed. Made by the Federal Tool Corporation, Chicago, the set includes a sturdy plastic tray for easy carrying. The retail price is about 50 cents.

The JIFFY metal CABINET

YOUR ANSWER TO SMALL ITEMS STORAGE at home, office, and shop (IDEAL GIFT, TOO)

So handy to keep nuts, bolts, screws, nails, parts, washers, stamps, hobbyists' needs, etc., at your fingertips.



THIS 32 DRAWER UNIT ONLY \$5.95 POSTPAID

Stop searching, get a 32 or 64 drawer Jiffy to keep those small items that usually get mislaid. Spot welded steel, gray enamel finish, metal drawer guides. Dividers included with aluminum drawers make possible three compartments per drawer. Looks good anywhere. Send check or money order, please—no C. O. D.'s. Prices below. Your money refunded if not satisfied. Dealers write for quantity discount.

SPECIFICATIONS	WITH ALUMINUM DRAWERS	WITH CARDBOARD DRAWERS
32 Drawer Unit 6" Deep 12 ³ / ₄ " Wide 15 ¹ / ₄ " High	Dividers and Index Cards Included	
64 Drawer Unit 6" Deep 25 ¹ / ₂ " Wide 15 ¹ / ₄ " High	One piece rustproof aluminum drawers for heavy service—good for work bench and industry use.	Suitable for most home uses. Heavy board kraft covered. Metal drawer pulls.
Drawer Size 1 ¹ / ₄ " Deep 2 ³ / ₄ " Wide 6" Long	32 drawer - \$8.95 64 drawer - \$15.95	32 drawer \$5.95 64 drawer \$9.95
	Ohio orders add 3% sales tax. Marproof Rubber Feet included with all cabinets POSTAGE PAID	POSTAGE PAID

KAYTEE PRODUCTS, Dept. S, Box 588, Canton, O.

for AUTOS...TRUCKS...TRACTORS



DON'T "CURSE" WINTER STARTING!
INSTALL A
SHUR-HETE No. 5 MOTOR WATER HEATER

Get easy starts and actually save money this winter. How? By installing a Shur-Hete No. 5—it will keep your engine warm all night long by heating the liquid in the water jacket. Operates on regular 110V, AC or DC electric current...consumes only 300 watts per hour.

Fits all straight engines with "freeze plugs" 1" to 2¹/₂" dia. (Except Ford 6, small Jeeps and V-type engines).

GUARANTEED only \$13.95
Shipped parcel post prepaid if remittance is enclosed; otherwise COD with postage added.

Save Time and Money with Shur-Hete No. 5

Eliminate run-down batteries... towing charges... needless engine wear... and wasted gas. Uses about 5 cents worth of electric power for overnight protection. Safe to use with any standard anti-freeze. Will not overheat engine or burn out.

Dealerships Open!

JOHANSON MOTOR HEATER CO. 821 W. Webster St. Chicago 14, Ill.

P.S.

Last minute news & notes...

WHAT GIVES? Supervisory employes at the East Pittsburgh plant of Westinghouse can get the latest dope by dialing a code number on any handy intra-plant phone. A tape recorder talks off the latest company news and policy.

TV HURT YOUR EYES? It may be a blessing in disguise, says the National Society for the Prevention of Blindness, by getting you to an eye doctor quicker. Difficulty in seeing at low TV levels may make you aware of sight problems sooner than normal conditions.

BOTTLE CAPS won't roll behind the refrigerator when lifted with a new magnetized opener called Magna-Katch. Made of high-carbon steel, it grabs the caps as they come off.

CLAY PIPE is getting its first improvement since man first fired clay thousands of years ago. A glass lining, developed by Texas Vitrified Pipe Co., is fused to the inside only, leaving the ends unglazed for a strong bond.

PENICILLIN cures a lot of things, but it won't keep you from catching cold, according to the results of a scientific test at Kaiser's West Coast plant. Some 3,000 people took part in the test;

half got penicillin pills, the other half harmless chalk pills. Nobody but the doctors knew which was which. Incidence of illness in the two groups was just about the same.

KITCHEN TELEVISION has arrived. An all-white job by Motorola to go on the shelf with the flour and sugar. Now Mom can mix a cake step by step with the pictures. But what happens while she is running the mixer and watching a soap opera?

WINNER of the original painting of the August PS cover, as promised in the Voice of Science of that issue, was Loy McGinnis, Friendswood, Texas. The editors assure all PS readers who contributed to the CARE book fund that their Bucks for Brain Food were most welcome.

YOU'LL LIVE LONGER than your father, barring A bombs and week-end motoring. Some 18 years longer than expectancy at the turn of the century; and about twice what the old-timers could hope for back when this nation was founded. That's the mathematical prophecy made in a new book by three statisticians of Metropolitan Life.

The Editors

YOU can find over 100 PRACTICAL USES and have LOTS OF FUN with

5 in 1 Miracle Projector

Electric Enlarger and Copy Maker

Magnify & Project

Stamps, coins, puzzles, clippings, maps, science specimens, plans, etc. Examine magnified details. Project on paper and sketch copies, large or small. Easier reading for weak eyes.

Magnifying Reader for Small Detail & Print



Amazingly Useful Invention

Home—Fun—Schools—Salesmen—Clubs—Artists—Teachers—Shops—Sign Makers—Doctors—Classroom—Scientists—Students—Money Maker—Photographers—Experimenters—Lab workers—Printers—Painters—Etc., etc., etc.

HIGH FIDELITY, TRUE VIEW, FULL COLOR

Learn to Draw & Sketch Signs, Cartoons, Pictures Easily

Posters, Lettering, Comics, Objects

Project sketches, pictures, objects, etc. on drawing paper. Sketch over with pen, pencil, colors, etc. Easy to make any kind of cartoons, drawings, signs, etc. either large or small. Make cartoons from pictures. Easy to do; no skill, no practise.



Large or Small

Copy Any Picture or Object

Project and focus it large or small. Make enlargements of plans or drawings. You'll be surprised how many practical and entertaining uses you can make. Advertising posters, cartoon sketches of friends, etc., etc., etc.

Natural Moving Pictures

Projecting Microscope Gives Live Show

Put ants, insects, flies & other bugs or animated objects under glass & let them walk around. See them in action greatly enlarged and magnified MOVING on screen. Amazing, real-life scientific motion pictures. Like having a projecting microscope.

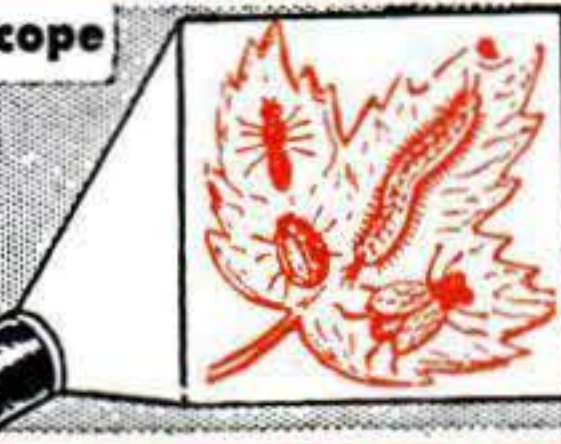

Make Photo Enlargements and Copies Without Negatives!

Use Any Photo or Picture

Direct positive photo enlargements and prints without negatives using Eastman direct positive paper. Use any black & white or color picture, colored transparency, etc. Easy to do; excellent results. No complicated dark room equipment. Makes correct copy (same as original), large or small. Also useful for making copies of important papers, stamps, sketches, maps, etc., etc. EASY, FUN, USEFUL, PROFITABLE.



Picture Enlarger and Projector

Project 3-Dimension Pictures



Put on your own show by projecting snapshots, pictures, post cards, photos, comics, clippings, etc. on wall or screen. Fine for school, clubs, talks, home shows, telling about your trip, salesmen, etc. Full color, correct projection, entirely readable & correct. Special device enables you to project real 3-dimension or stereoscopic pictures. Startling, life-like.

Make Money—Machine Pays for Itself

Many ways to make money. Make photo enlargements, photo copies, give shows, make sketches and drawings and advertising signs, etc. Easy to do—the machine does the work.

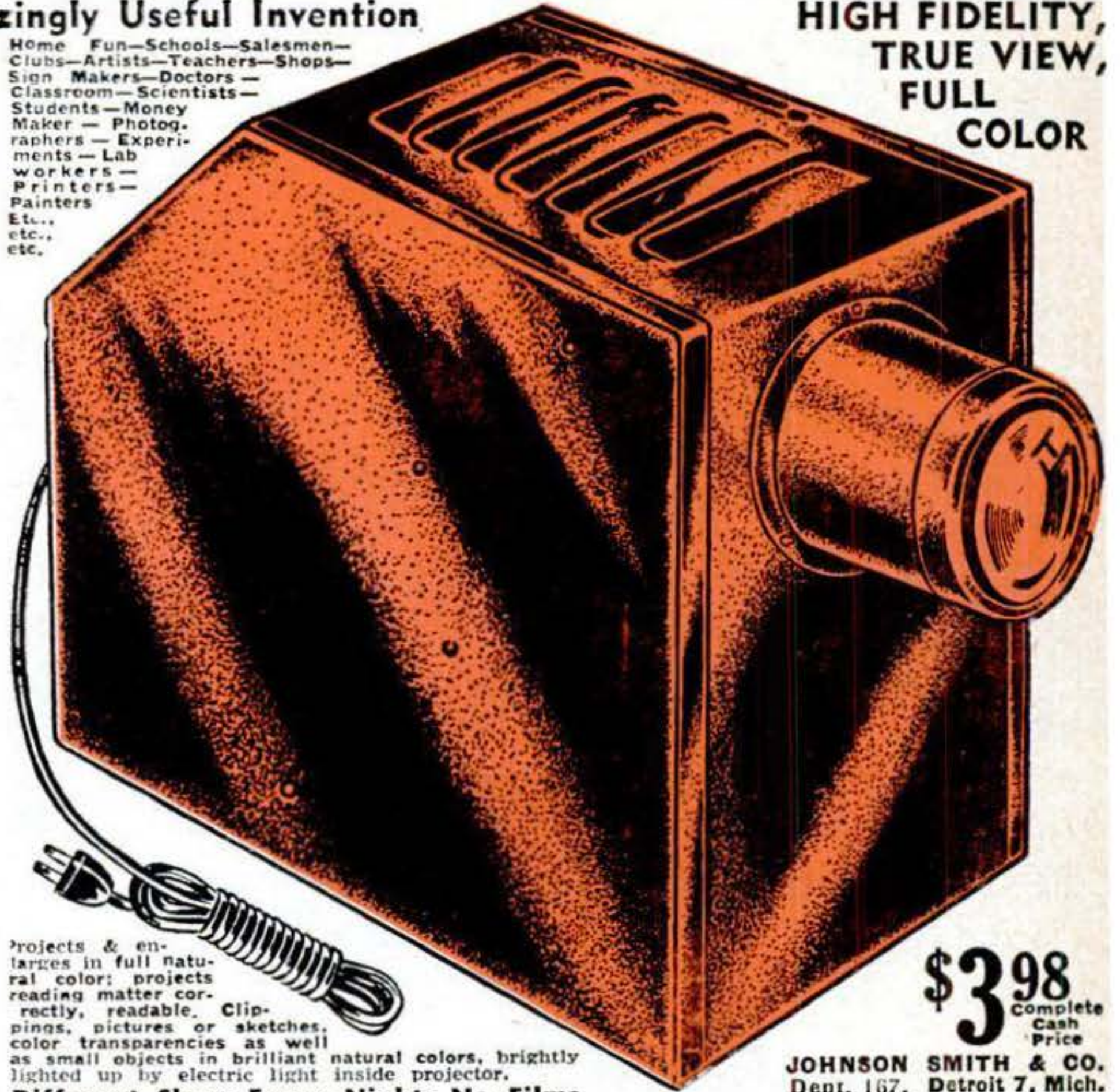

\$3.98 Complete Cash Price

JOHNSON SMITH & CO. Dept. 167, Detroit 7, Mich.

Projects & enlarges in full natural color; projects reading matter correctly, readable. Clippings, pictures or sketches, color transparencies as well as small objects in brilliant natural colors, brightly lighted up by electric light inside projector.

Different Show Every Night; No Films to Buy; No More Expense; Sports, Girl Beauties, Comics, Etc. Your favorite or COMIC PICTURES from papers & magazines. Enlarge action pictures. Project snapshots of your girl, family trip. Project and read comic strips to kids. Large pictures projected in full color!

Educational, Scientific; Real Life Action! Live ants, flies, bugs and small animals can be projected on screen; watch them in real life action, fighting, eating, playing. Great for amateur scientist experimenter and camera fan.

Make Signs, Sketches, Posters, Cartoons, Lettering, Etc. Quick! Easy! In Black & White or Full Color; From Clippings or Copy; Large or Small. Make sketch or cartoon of friends. Posters and signs for clubs, stores, dances. Easy to make, large or small. Project picture or rough sketch right on blank drawing paper. Using pen, pencil or colors, sketch OVER PROJECTED PICTURE. Project photos and make funny, life-like cartoons or sketches. Amazing & practical. Be a good artist, even though you never did it before! Lettering and signs easy to do.

Magnifies Stamps, Specimens, Objects for Close Examination; Reader for Weak Eyes. Collectors can enlarge objects. Examine in greatly magnified detail. **MAGNIFIES ABOUT 50 AREAS.** Make photo enlargements direct from objects! Enlarges small type, maps, etc., projecting it for easy reading.

Photo Enlarger; Makes Photo Prints, Photo Copies, Etc.—No Negatives. Uses Eastman direct positive paper. Correct true-image photos, large or small, from any photo; or even from color prints & color transparencies. Photo enlargements, copies, etc., done cheaply, quickly, easily. 3x10-in. enlargement costs 12c; sell up to \$1.00. **NO NEGATIVES.** Made by projecting picture on direct positive printing paper. Duplicate copies of blueprints, diagrams, papers; large or small.

3-Dimension Stereoscopic Pictures. By special process you can project 3-dimensional pictures and see in startling, life-like realism. So real you expect to reach out and touch them! Project beautiful girl pictures, travel scenes, etc.

No Skill—No Experience—Fun All Year Round. Low-priced instrument that quickly pays for itself. No experience and no skill to operate. Just plug into any 110-volt AC-DC standard home socket. Years of entertainment and practical uses for every member of the family. Lasts indefinitely; nothing to wear out, so only cost is low price of **MIRACLE PROJECTOR.** Schools, shops, offices, artists, etc., all find many uses for it.

Project on Table, Wall or Ceiling—No Screen Necessary. Project almost anywhere—even on table. No screen necessary—any blank wall or white paper will do. Wonderful for classroom, clubs and salesmen.

Electric, Optically Ground Double Lens, Enameled Steel Construction. Complete except for lamp bulb; use any household 60 to 100 watt lamp bulb. Steel construction, handsomely enameled in brilliant colors. Easy carrying; 7 1/4-in. high, 10-in long. Optically ground and polished lenses; slide focusing so you can PROJECT FROM VARIOUS DISTANCES to make picture large or small. Takes pictures up to 3 1/4 x 4-inches. With illustrated instruction booklet, views, price list for additional supplies, etc. (3 for \$10.50).

COMPLETE. POSTPAID. CASH PRICE ONLY. \$3.98

What Users Say: Artist & Signmaker: "Valuable aid; enables anyone to do all kinds of art work without training." Photographer: "Many uses; money maker and money saver." Teacher & Lecturer: "Makes talks ten times more interesting. Teaches faster, more fun." Collector: "Magnifies & illuminates specimens for easy study."

Rush This Coupon Today!

Johnson Smith Co., Dept. 167, Detroit 7, Mich.
(Since 1914 America's Leading Novelty House; Big 500 page Catalog of 7,000 Novelties 10c)

Rush... Projectors at \$3.98 each, postpaid; 3 for \$10.50.

Enclosed is \$.....

Name.....

Address.....

(Sorry, No C.O.D.'s at This Cash Price)



SOUTH BEND LATHE

The Basic Shop Tool

A FEW
OF THE MANY
OPERATIONS
YOU
CAN PERFORM

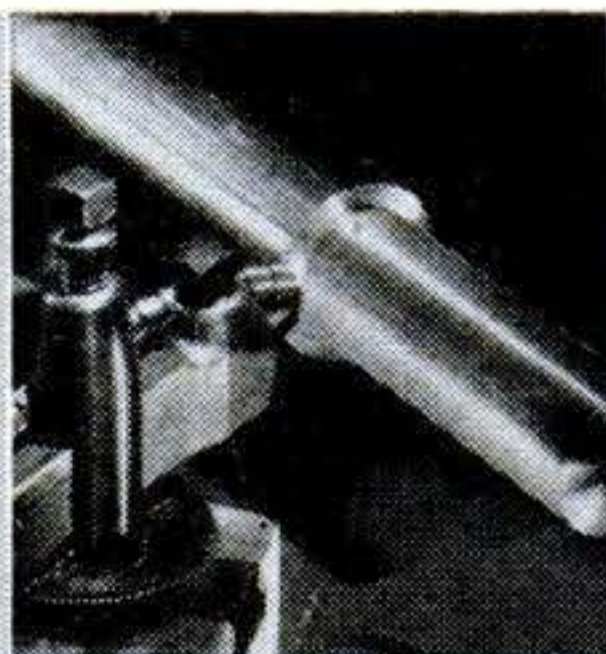

TURNING

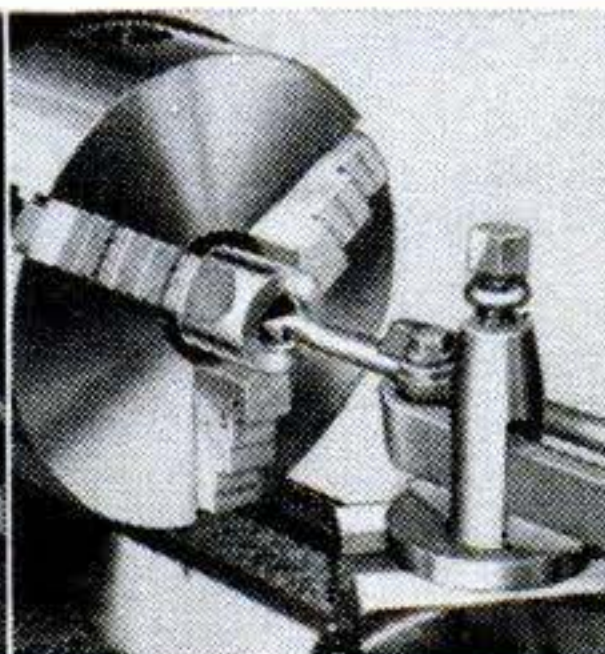

BORING

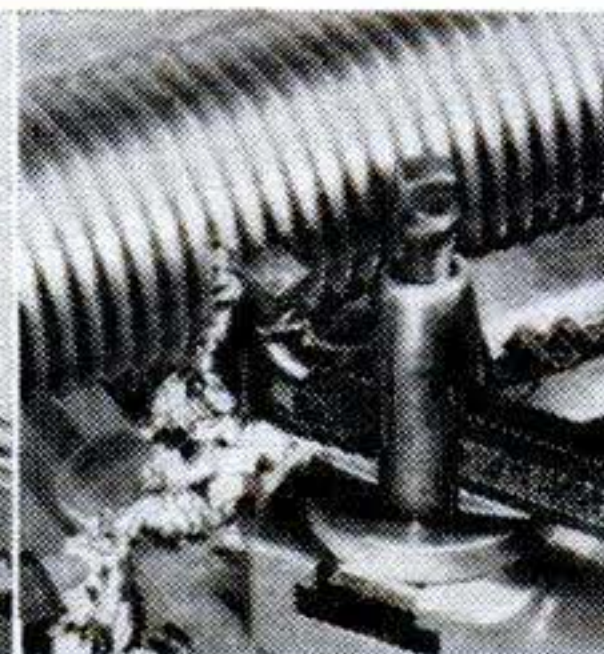

THREADING

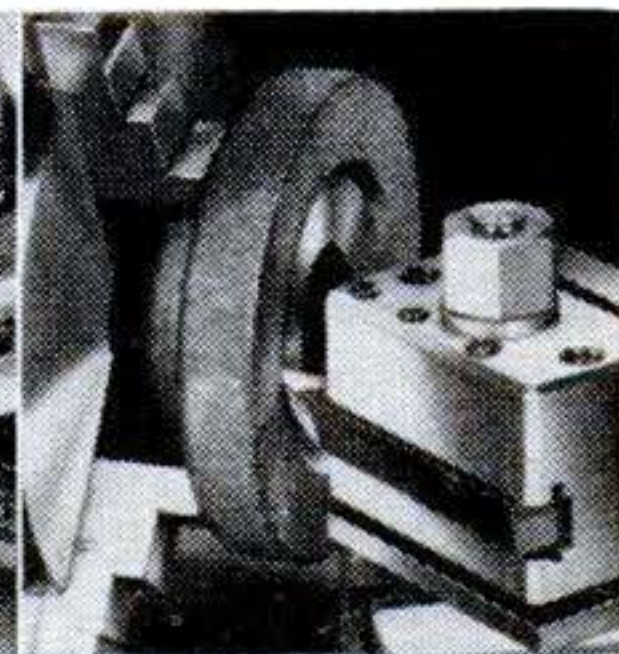

FACING



MILLING

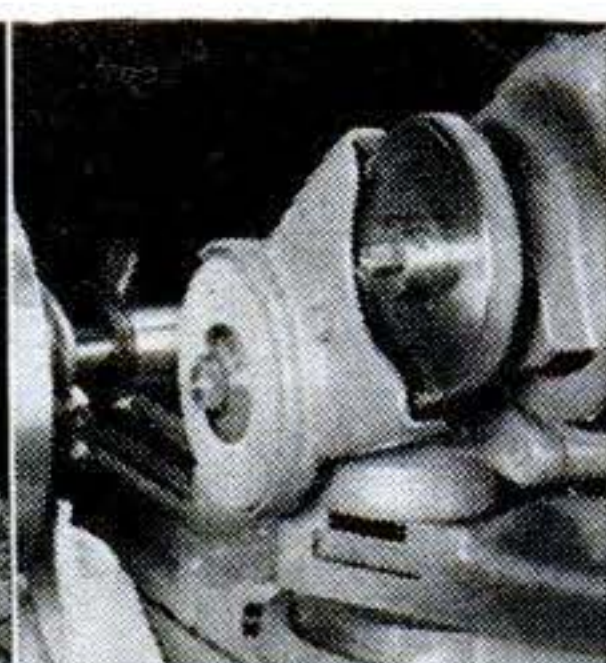

GRINDING

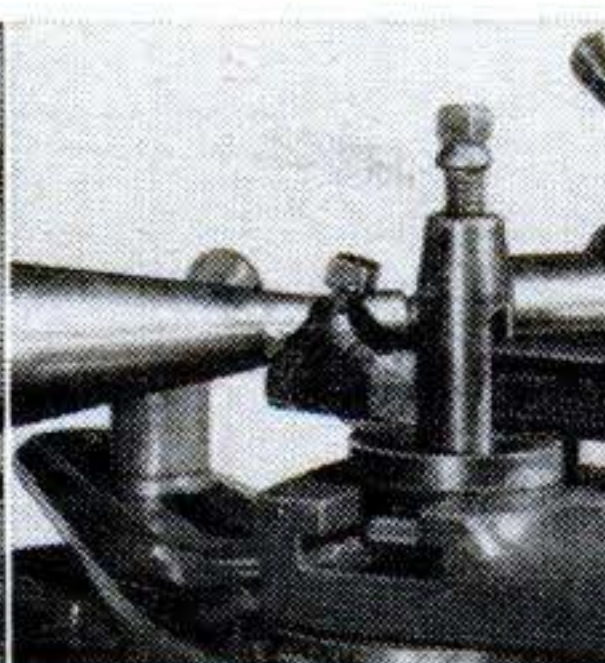

TAPER TURNING



PLASTICS WORK

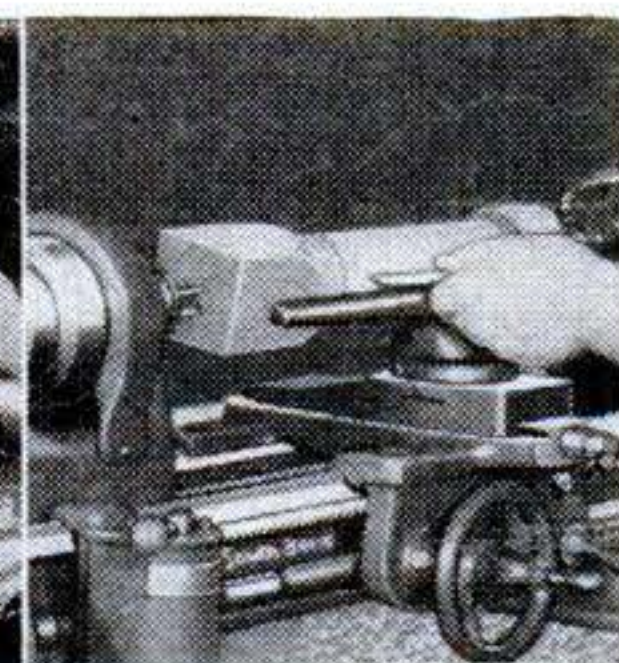

WOOD TURNING

A South Bend Lathe is the basic tool for your shop. It enables you to accurately perform the same full range of machining operations that are done on South Bend Lathes in the toolrooms and machine shops of industry.

With a South Bend Lathe as the basic tool in your shop, greater value for each dollar invested is assured. Write today for catalog

—please mention the size lathe you require; 9", 10", 13", 14½", 16" or 16/24" swing.

We also manufacture 14" Drill Presses, bench or floor models, and 7" Bench Shapers. Information on request.

Any South Bend Machine Tool can be purchased on time payments—25% down, 12 months to pay balance. Moderate finance charge.

BUILDING BETTER TOOLS
SINCE 1906



SOUTH BEND LATHE WORKS

456 EAST MADISON STREET • SOUTH BEND 22, INDIANA

LEARN RADIO-TELEVISION

I SEND YOU many Kits of Parts that "bring to life theory in my illustrated texts. As part of my Servicing Course you build a Radio, Set Tester, AM Signal Generator, etc. In my Communications Course, you assemble a low-power Broadcasting Transmitter, Wavemeter, Electronic Multitester, etc.

Keep all equipment you build (some from both courses shown below).

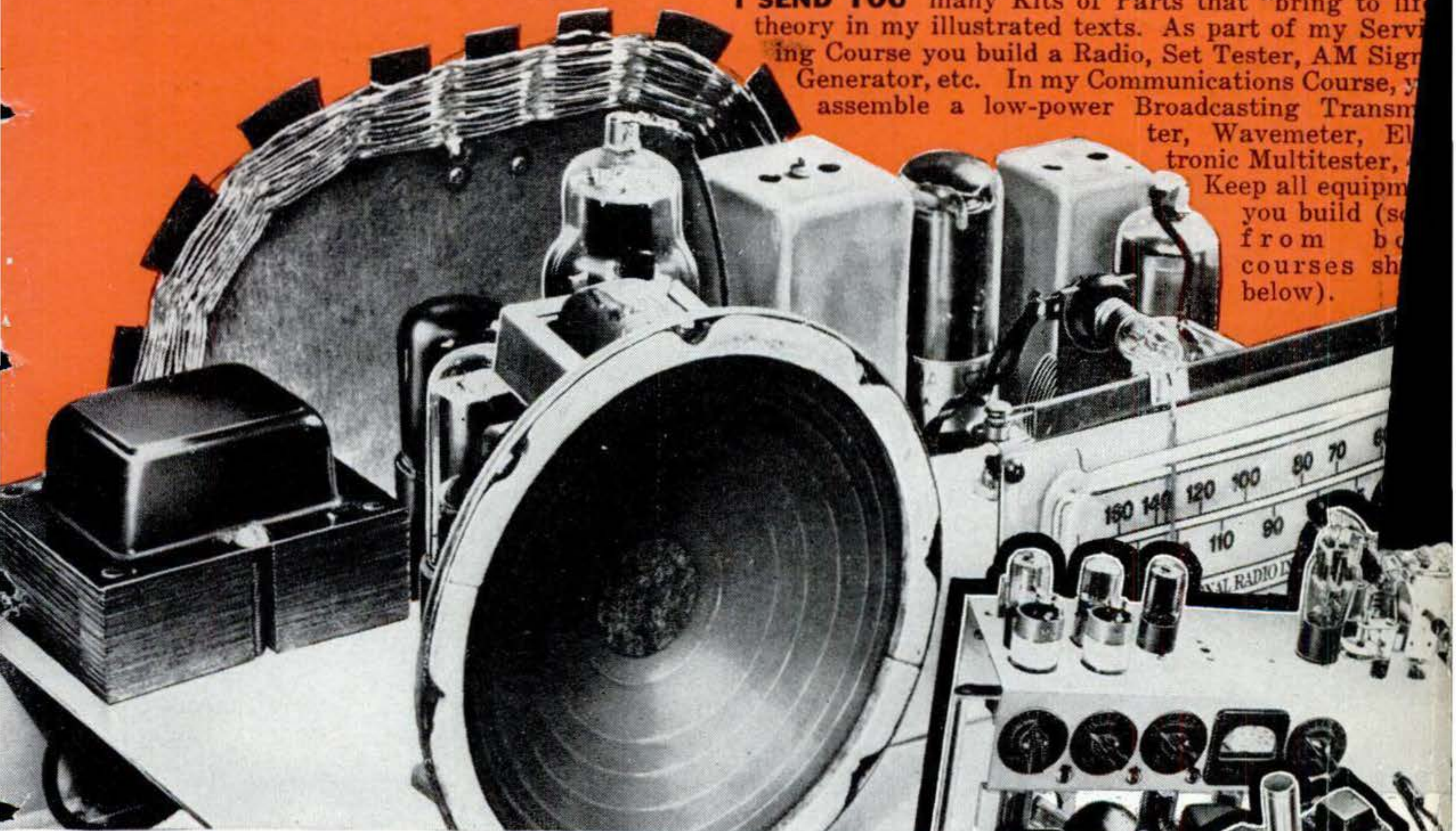

I TRAINED THESE MEN

"I am operating a Radio Sales and Service business. With Frequency Modulation and Television in the offing, we have a very profitable future."—Albert Patrick, Tampa, Florida.

"Am tied in with two Television outfits, and do warranty work for dealers. Fall back on N.R.I. text books often for helpful information."—Robert Dohmen, New Prague, Minnesota.

"Four years ago, I was a book-keeper with a hand-to-mouth salary. Now I am a Radio Engineer with key station of the ABC network."—Norman H. Ward, Ridgefield Park, New Jersey.

"Four months after enrolling for N.R.I. course, was able to service Radios . . . averaged from \$10 to \$15 a week fixing Radios in my spare time."—William Weyde, Brooklyn, New York.

"N.R.I. was my 'stepping stone' from a few hundred dollars to over \$4,000 a year as a Radio Engineer. Make extra money servicing Radios."—A. B. Michaels, Trenton, Georgia.

"For the past two years, I have been operating my own Servicing business. My net profit was \$6,850. N.R.I. training made it possible."—Philip G. Brogan, Louisville, Kentucky.

"I received my 2nd Class Radiotelegraph License and worked on ships. Now control operator, WEAN, and have 1st Class Telegraph License."—R. D. Arnold, Rumford, Rhode Island.

Get a Good Pay Job Have a Bright Future

Do you want a good pay job in the fast growing RADIO-TELEVISION Industry? Want your own money-making Radio-Television Shop? Here is your opportunity. I've trained hundreds of men to be successful Technicians, MEN WITH NO PREVIOUS EXPERIENCE. My tested and proved train-at-home method makes learning easy. You learn Radio-Television principles from my illustrated lessons. You get practical experience building, testing and experimenting with MANY KITS OF PARTS I send. All equipment yours to keep. The day you enroll, I start sending you SPECIAL BOOKLETS that show you how to make \$5, \$10 a week or more EXTRA MONEY fixing neighbors' Radios in spare time while learning. From here, it's a short step to your own shop or a good pay Radio-Television servicing job. Or be a licensed Radio-Television Operator or Technician.

TELEVISION OFFERS BRIGHT FUTURE

In 1945, there were 943 Radio Stations. Today, about 2700 are on the air! RESULT—THOUSANDS OF QUALIFIED MEN STEPPED INTO GOOD JOBS. Another example—only 19 Television stations were on the air in 1947. Today, more than fifty. Within a few months, 150, say the experts—and 1000 within three years. Then add developments in FM, Two Way Radio, Police, Marine, Aviation, Microwave Relay Radio. Think what this means! New jobs, more jobs for qualified men. The man who prepares NOW can reap rich rewards in this changing, developing, fast growing field!

Act Now! Cut out and mail post card to J. E. SMITH, President, Dept. 9MP3, National Radio Institute, Pioneer Home Study Radio School, Washington 9, D. C.



Make \$5, \$10, Weekly in Spare Time While Learning

Many of my students earn money fixing Radios in their Spare Time while learning, often average between \$5 and \$10 a week. I send you SPECIAL BOOKLETS that show how you can do this . . . and I send you parts to build SET TESTER that helps you do it.

VETERANS

GET THIS TRAINING WITHOUT COST

SEND NOW!

When safety's a must, it's "PRESTONE" ANTI-FREEZE

...al
ou
it-
ec-
etc.
ent
ome
th
own



**YOU'RE SAFE
IN EMERGENCIES**
You know your car won't freeze
up when you need it most!

**YOU'RE SAFE
FROM WORRY**
One shot lasts all winter; put 'Prestone'
anti-freeze in your car... and forget about it!



**YOU'RE SAFE
FROM BOIL AWAY**
You're safe no matter how warm
it gets between cold spells!

One shot lasts all winter!

Give your car the same, safe, all-winter protection that fire chiefs, ambulance drivers, police chiefs give theirs. Insist on "Prestone" anti-freeze.

There's nothing else like it!

"Prestone" anti-freeze, America's Number One Brand, is made to an exclusive formula. Year after year, more motorists depend on "Prestone" brand anti-freeze for safe, sure, all-winter protection.



**NO RUST • NO FOAM
NO FREEZE • NO FAILURE**

**\$3.50
PER GAL.**

GUARANTEED!
Ask your dealer to show you the guarantee. It's your assurance of all-winter safety.

The registered trade-marks "Prestone" and "Eveready" distinguish products of
NATIONAL CARBON COMPANY, INC.
20 East 42nd St., New York 17, N. Y.
Unit of Union Carbide **UCC** and Carbon Corporation