

POPULAR SCIENCE

Feb. 1950

25¢

Monthly



Sky Cow for Jets — page 114



**Big Mouth Eats
a Ton a Second**

PAGE 100

The Higher Education now yours at the Miracle Rate



IMAGINE! Eminent educators especially chosen from 47 great universities such as **Harvard, Pittsburgh, M.I.T., Oregon, Notre Dame, Princeton,** and dozens of others, bringing enjoyable instruction to you in your own home, for about 1 cent a lesson! Think what this means today—to have the advantages of a higher education when America is swinging into the greatest expansion of all time! Think how you can cash in—through a bigger job—bigger business—bigger earnings by entering this period with the equipment of a college-trained man! Now the N. E. A. brings you this training at a price that's truly a miracle!

To Help Millions Increase Their Earnings through Greater Knowledge, the Alliance now Offers its 57 Famous EASY-READING Courses at Amazingly LOW Cost!

HIGHER education and higher earnings go hand in hand! To aid men and women in developing all their possibilities for personal advancement the National Educational Alliance has now put all its famous 57 courses into book form—**THE POPULAR EDUCATOR LIBRARY.** These 57 Reading Courses—prepared by educators from such famed universities as **Yale, Stanford, Northwestern, Johns Hopkins, Cornell,** and many more—cover a great range of subjects. They provide a broad training that has lifted leaders in **EVERY** field to success.

An education of this scope would ordinarily cost you thousands of dollars and years devoted to school and college. Yet through **THE POPULAR EDUCATOR LIBRARY** you can educate yourself quickly in your spare time at home—at a cost of only a few cents per subject! Note that in each course the instructor-editor is an eminent educator carefully chosen for his specialty in one of America's great universities—every one an authority of the highest standing!

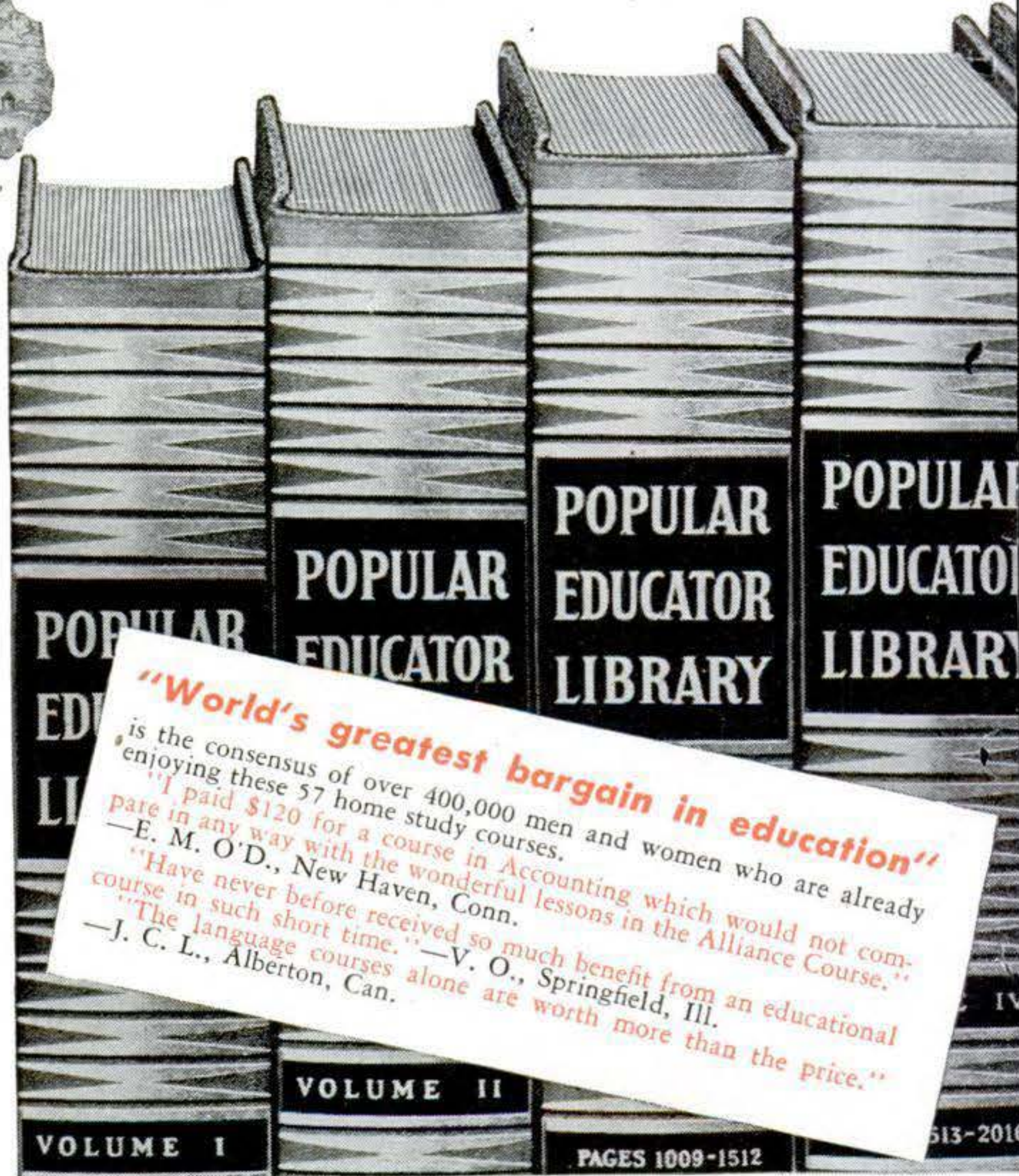

"World's greatest bargain in education"
 is the consensus of over 400,000 men and women who are already enjoying these 57 home study courses.
 "I paid \$120 for a course in Accounting which would not compare in any way with the wonderful lessons in the Alliance Course."
 —E. M. O'D., New Haven, Conn.
 "Have never before received so much benefit from an educational course in such short time."
 "The language courses alone are worth more than the price."
 —J. C. L., Alberton, Can.

Handsome, Life-Time Binding of Seal Grained Novelex Beautifully Embossed and Hand-Tooled in colors of Maroon and Gold.

Just as in College You Study Only the Courses You Want

Think of Studying Courses of Immediate Practical Value . . . **ACCOUNTANCY, PSYCHOLOGY, CHEMISTRY, MATHEMATICS, ENGLISH, etc., for only a few cents each!**

No longer need you believe the old saying that "there is no royal road to knowledge," for the **ALLIANCE** has surveyed and paved the path for you—and has made a higher education, **PRACTICAL KNOWLEDGE FOR ALL,** available at a cost that probably less than you now spend for our daily newspapers.
 Take, for example, a subject like **PSYCHOLOGY.** If you had to attend lectures on this subject in person at a college, it would cost you hundreds of dollars—and an elementary textbook would cost you one or four dollars. Yet the **NATIONAL EDUCATIONAL ALLIANCE** brings you a

complete and practical survey of this useful science in 38 individual lessons by an eminent educator especially selected from Northwestern University—**AT A TOTAL COST OF LESS THAN 35 CENTS!**

Learning Made as Enjoyable as Reading!
 These 57 Courses are as enjoyable as reading a popular picture magazine. They are so varied in appeal, so absorbing in interest that you will devour the lessons without realizing that you are "studying." Every Course is carefully graded and easy to follow. Every illustrated lesson is short enough to be absorbed in a few minutes. Your mind retains what you learn without effort—and opens to new horizons, new achievement, and greater earning possibilities than you have ever envisioned.

AVERAGE GRAMMAR SCHOOL GRADUATE EARNS
 \$64,000 UP TO AGE 60

AVERAGE COLLEGE GRADUATE EARNS
 \$194,000 UP TO AGE 60

Home-Study Yields \$10 An Hour!
 According to a famous survey, earnings of college graduates up to age of 60 averaged more than \$100,000 greater than the earnings of grammar school and high school graduates. Any person who absorbs the information in the N. E. A. Courses possesses a practical educational background comparable to that of the average university graduate.

ACT NOW—Bring this "University Education" to Your Home—Mail This

You Need for Success

of about 1¢ a Lesson!

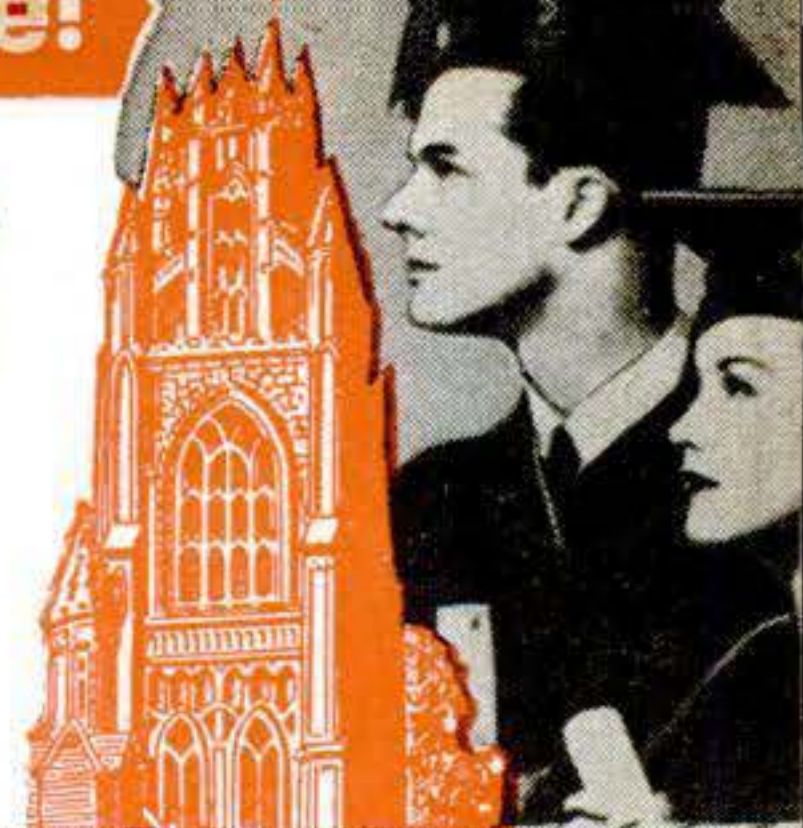

PREPARE NOW FOR YOUR FUTURE IN THE GREATEST EXPANSION IN HISTORY!

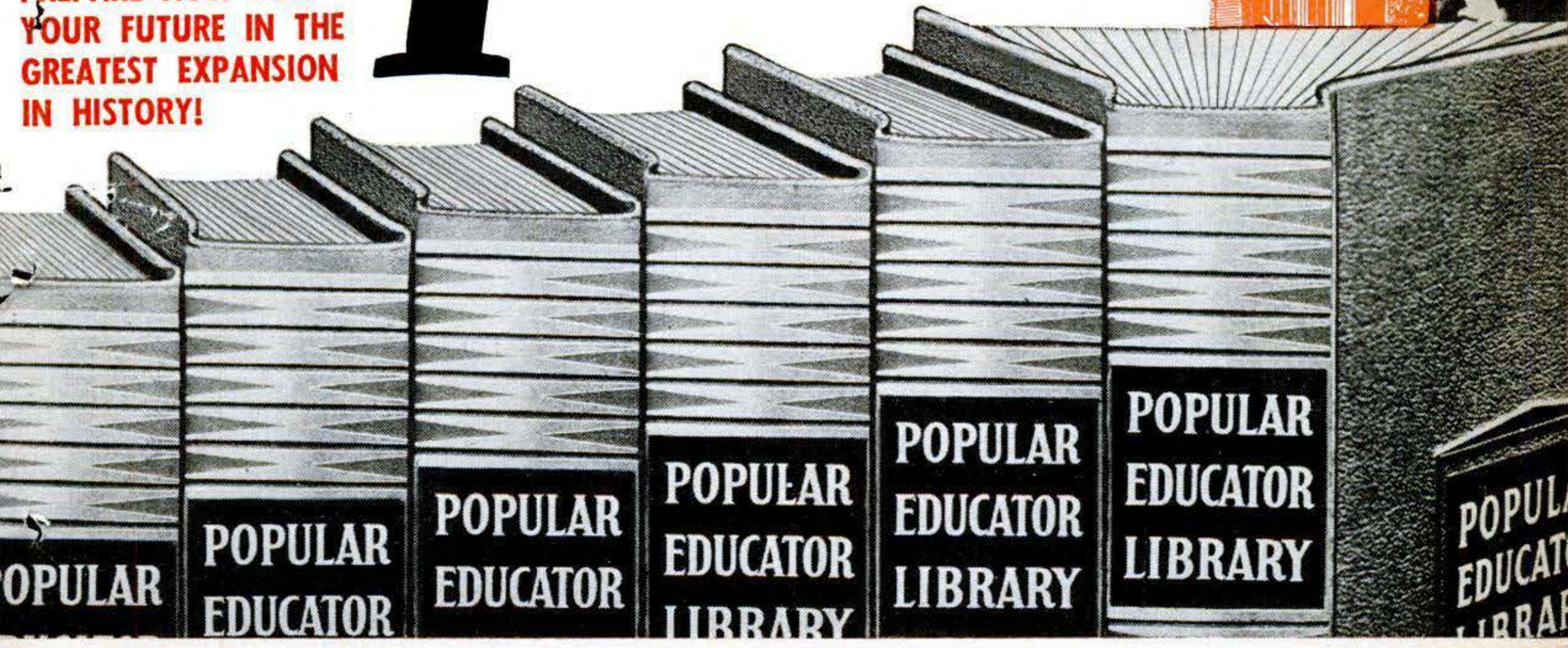

The Popular Educator Library—10 Magnificent Volumes

57 Complete Courses—1585 Illustrated Lessons!

Prepared by 61 Eminent Educators Selected From 47 Great Universities! 5120 Pages! 2437 Pictures!

- | | | | | |
|---|---|--|---|---|
| Accountancy. E. A. Saliers, B. S., M. A., Ph. D., Louisiana State Univ. | Chemistry. L. A. Goldblatt, Ph. D., University of Pittsburgh. | Geology. Terrence T. Quirke, M. Sc., Ph. D., F. A. A. A. S., Univ. of Illinois. | Philosophy. Harry A. Overstreet, A. B., B. Sc., City College of New York. | Spanish. Francis M. Kercheville, B. A., M. A., Ph. D., University of New Mexico. |
| Aeronautics. Theodor Von Karman, M. E., Ph. D.; Frank J. Malina, California Inst. Technology | Drawing and Design. Andrew McD. Vincent, University of Oregon. | History. Ancient, European and Modern. Walter Hyde, Univ. of Pennsylvania and Tibor Kerekes, Georgetown Univ. | Photography. S. G. B. Stubbs, General Editor, Waverly Technical Encyclopedias. | Also complete courses in American History, Anthropology, Archaeology, Bible History, Botany, Civics, Classical Literature, Drama, Economic Geography, English Language, English History, Eurythmics, Geography, German, Greek, Interior Decorating, Italian, Mnemonics, Money, Music, Penmanship, Philology, Phonetics, Physical Geography, Politics, Shorthand (Gregg & Pitman), Social History, Typewriting, Writing, Zoology. |
| Art and Architecture. Ernest Pickering, B. Sc., M. Arch., University of Cincinnati. | Economics. Frank T. Stockton, A. B., L. H. D., Ph. D., Univ. of Kansas. | Journalism. Grant M. Hyde, B. A., M. A., University of Wisconsin. | Physics. L. L. Hendren, M. A., Ph. D., University of Georgia. | |
| Astronomy. Clyde Fisher, Ph. D., L.L. D., Amer. Mus. of Nat. History. | Engineering. Fred Asa Barnes, C. E., M. C. E., F. A. A. A. S., Cornell University. | Latin. Roy J. Deferrari, A. B., M. A., Ph. D., Catholic University of America. | Physiology and Anatomy. Harold E. Himwich, B. S., M. D., Union University. | |
| Biology. John H. Gerould, Ph. D., Dartmouth College. | English Literature. Hoyt H. Hudson, Ph. D., Princeton Univ. | Law. E. Karl McGinnis, A. B., J. D., University of Texas. | Psychology. Adam R. Gilliland, B. O., B. A., Ph. D., Northwestern University. | |
| Business English. John Presley Fife, B. A., M. A., Stevens Inst. of Technology. | French. Earl F. Langwell, Ph. D., University of Notre Dame. | Mathematics. William Whitefield Elliott, A. B., Ph. D., Duke University. | Radio and Television. Richard D. Fay, A. B., S. B., Mass. Inst. of Technology. | |

Examine FREE All 57 Courses in this Great 10-Volume Library

Enjoy 5 days' FREE examination of these 57 courses, in 10 superb volumes, in your own home. If not delighted, return them and your examination will not have cost you one cent. But if you are convinced that these courses are indeed the world's greatest educational value—then keep the Library, and remit, in easy monthly installments, the incredibly low bargain price at the rate of about 1 cent a lesson! Only a limited number of sets available.

High paper cost makes reprint unlikely. Avoid disappointment. Mail Free-Trial Coupon NOW!

© NATIONAL EDUCATIONAL ALLIANCE, Inc.
37 West 47th Street, New York 19, New York

FREE-Trial Coupon! →

NATIONAL EDUCATIONAL ALLIANCE, Inc.
37 West 47th Street, New York 19, N. Y.

Please reserve for me, for free examination, a set of the 10-volume POPULAR EDUCATOR LIBRARY, bound in beautifully grained Novelex library cloth—57 courses of 1585 lectures, 5120 pages, 2437 pictures.

Notify me when the books are ready to ship and I will send only \$1.00 deposit. On receipt of it, ship me the books prepaid for 5 days' free reading. At the end of that time, I will either return the set and you will refund my \$1.00; or I will keep the set, count the \$1.00 deposit as first payment and send you only \$2.00 each month until the bargain price of only \$19.80, plus a few cents postage, has been paid.

SHIPPING WEIGHT 20 LBS.

If \$1.00 deposit accompanies this reservation, Library will be shipped postage free. Same return and refund privilege.

Name..... 87
Address..... 802
City..... Zone No..... State.....

Founded 1872. Vol. 156: No. 2

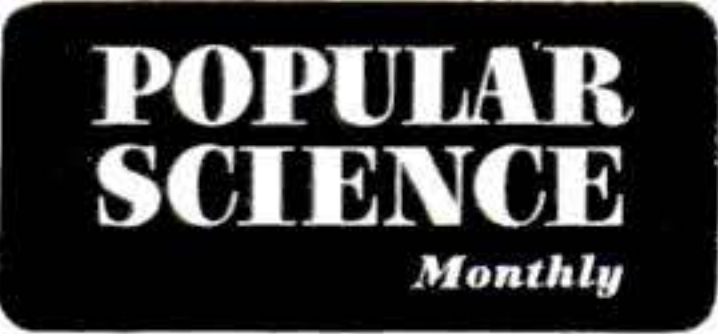

Mechanics and Handicraft

Perry Githens, EDITOR

Fred O. Newman, Volta Torrey, MANAGING EDITORS Howard C. Jensen, ART EDITOR

Harry Walton, MECHANICS & HANDICRAFT EDITOR

Hartley E. Howe, Frank Rowsome, Jr., ASSISTANT MANAGING EDITORS

ASSOCIATE EDITORS: Howard Allaway, Alden P. Armagnac, Devon Francis, Richard Giovine, Robert Gorman, Sheldon Gallagher, Herbert Johansen, Martin Mann, Denis Sneigr, Robert P. Stevenson.

EDITORIAL ASSISTANTS: Julia Charnif, Carol Ennis, Georgette Sparks, Harriet Trowbridge, Ruth Westphal.

STAFF PHOTOGRAPHERS: W. W. Morris (Chief), Hubert Luckett, Orlando Guerra (Darkroom).

ART DIRECTOR: Harry Samuels. ART ASSOCIATES: Herbert Anthony, Eric Karminski, Jr., Richard Meyer, Edward Hallstrom, Frances Cooper (Production).

WESTERN EDITOR: Andrew R. Boone (Los Angeles).

WASHINGTON CORRESPONDENT: John F. Loosbrock.

Highlights FOR FEBRUARY, 1950

Big Mouth Eats a Ton a Second...100

Meet machines that move mountains and see how they're helping man change the face of the earth.

Air Tankers Fuel Jets.....114

A speedy new system for refueling planes on the wing can vastly step up ranges and schedules.

One Hour: Coast to Coast.....126

A hard-headed research scientist shows how to design a rocket air liner that would hit 9,140 m.p.h.

Making a Lot Out of Nothing.....134

New uses for high vacuum have made empty space one of industry's most important raw materials.

New Atomic Charts.....143

Secrets of radioactive elements are revealed in four pages of PS charts you won't find in any textbook.

Gus and the Flying Keys.....178

The master mechanic convinces an irate customer that those gadgets on his new car aren't so crazy.

Homemade TV Booster.....187

An \$8 unit to amplify the signal from your antenna may give you grandstand reception in the bleachers.

Got Enough Hot Water?.....196

Here's the way to (1) measure how much you need and (2) figure what kind of system will fill the bill.

Mystery Engine Breathes Flame....206

Give yourself a capsule course in machining by building this. Then ask friends what makes it go.

Easy to Build.....217

Plans for five simple, attractive, inexpensive home accessories that you can build on your kitchen table.

Science & Industry

Army Improves Eskimo Boat.....108

Buick Boosts Power, Compression.....112

Jet Jockeys Get Ground Go-Around.....123

Water Jet Propels Boats.....128

Fliers Learn to Read Fast.....130

Digging Oil Out of the Wilderness.....132

Chevy Gets a Torque Converter.....141

Chrysler Lines Get Restyling.....153

Fire Chief Builds Fire Engine.....154

Raising Roof Builds Bins Fast.....156

Godfrey Hammond, PUBLISHER · Stephen P. Glennon, ADVERTISING DIRECTOR · Edward Roeder, Jr., ADVERTISING MGR.

EDITORIAL OFFICES: 353 Fourth Avenue, New York 10, N. Y. Manuscripts and illustrations submitted at regular rates should be so marked, addressed to "The Editors" and accompanied by stamped, self-addressed envelope. Popular Science Monthly exercises all possible care but assumes no responsibility for unsolicited material.

PS, Mar. '49, p. 294). This symbol is used only as a service to readers and Popular Science Monthly assumes no responsibility by use or omission.

TRADE NAMES by which products or materials are commonly known are indicated by the symbol ®. These names may or may not be Registered Trademarks (see

ADVERTISING OFFICES: NEW YORK — 353 Fourth Avenue; CHICAGO—360 North Michigan Avenue; DETROIT —820 Book Building; SAN FRANCISCO—1003 TWA Building; PORTLAND (ORE.)—907 Terminal Sales Building; CLEVELAND—328 Citizens Building; LOS ANGELES — Granada Building.

Popular Science Monthly is published monthly at 353 Fourth Avenue, New York 10, N. Y., by Popular Science Publishing Co., Inc., Godfrey Hammond, President and Treasurer; R. C. Wilson, Raymond J. Brown, Stephen P. Glennon, Vice-Presidents; F. W. Briggs, Secretary. Entered as second-class matter Dec. 28, 1918, re-entered as second-class matter July 26, 1948, at the Post Office in New York, N. Y., under the act of March 3, 1879; additional entry as second-class matter at Dayton, Ohio. Entered as second-class matter at the Post Office Department, Canada. Printed in U.S.A. Copyright, 1950, by Popular Science Publishing Co., Inc. All rights reserved in the United States, Great Britain, and in all countries participating in the International Copyright Convention and Pan-American Copyright Convention. Yearly subscriptions to United States, its possessions and Canada, \$3.00 (2 years, \$5.50; 3 years, \$7.50); foreign countries \$1 per year extra. Subscribers must notify us of change of address four weeks before next publication date. Be sure to give both old and new addresses, including zone numbers. Vol. 156, No. 2.

FILL THE GAPS IN YOUR TRAINING



No one goes into a job perfectly prepared. Sooner or later the "weak spots" are bound to show up. And when they do, the successful man is quick to recognize them, *quick to fill the gaps.* International Correspondence Schools can help you get whatever training *you* may need. You have some 400 famous, spare-time I.C.S. Courses to choose from. Or, if you wish, brief "refresher" courses, advanced lessons, or special instruction combining one or more specific business or technical subjects can be *tailored* to fit your needs. The coupon below brings full information without obligation. Mark and mail it today!

INTERNATIONAL CORRESPONDENCE SCHOOLS

APPROVED
under the
G.I. BILL

BOX 7648-M, SCRANTON 9, PENNA.

Without cost or obligation, please send me full particulars about the course BEFORE which I have marked X:

- | | | | |
|--|--|---|---|
| <p>Business and Academic Courses</p> <ul style="list-style-type: none"> <input type="checkbox"/> Accounting <input type="checkbox"/> App. Psychology <input type="checkbox"/> Business Administration <input type="checkbox"/> Bus. Correspondence <input type="checkbox"/> Certified Public Accounting <input type="checkbox"/> Commercial <input type="checkbox"/> Commercial Art <input type="checkbox"/> Cost Accounting <input type="checkbox"/> Federal Tax <input type="checkbox"/> First Year College <input type="checkbox"/> Foremanship <input type="checkbox"/> Good English <input type="checkbox"/> Higher Mathematics <input type="checkbox"/> Industrial Supervision <input type="checkbox"/> Motor Traffic <input type="checkbox"/> Retailing <input type="checkbox"/> Salesmanship <input type="checkbox"/> Sign Lettering <input type="checkbox"/> Spanish <input type="checkbox"/> Air Conditioning and Plumbing Courses <input type="checkbox"/> Air Conditioning <input type="checkbox"/> Heating <input type="checkbox"/> Refrigeration | <p>Chemical Courses</p> <ul style="list-style-type: none"> <input type="checkbox"/> Chemical Engineering <input type="checkbox"/> Chemistry, Analytical <input type="checkbox"/> Chemistry, Industrial <input type="checkbox"/> Chemistry, Mfg. Iron & Steel <input type="checkbox"/> Petroleum Refining <input type="checkbox"/> Pulp and Paper Making <input type="checkbox"/> Civil Engineering, Architectural and Mining Courses <input type="checkbox"/> Architecture <input type="checkbox"/> Building Estimating <input type="checkbox"/> Civil Engineering <input type="checkbox"/> Contracting and Building <input type="checkbox"/> Highway Engineering <input type="checkbox"/> Lumber Dealer <input type="checkbox"/> Reading Structural Blueprints <input type="checkbox"/> Sanitary Engineering <input type="checkbox"/> Structural Drafting <input type="checkbox"/> Structural Engineering <input type="checkbox"/> Surveying and Mapping <input type="checkbox"/> Communications Courses <input type="checkbox"/> Electronics <input type="checkbox"/> Prac. FM and Television <input type="checkbox"/> Prac. Telephony <input type="checkbox"/> Radio, General <input type="checkbox"/> Telegraph Engineering | <p>Electrical Courses</p> <ul style="list-style-type: none"> <input type="checkbox"/> Electrical Drafting <input type="checkbox"/> Electrical Engineering <input type="checkbox"/> Electric Light and Power <input type="checkbox"/> Lighting Technician <input type="checkbox"/> Practical Electrician <input type="checkbox"/> Power House Electric <input type="checkbox"/> Ship Electrician <input type="checkbox"/> Internal Combustion Engines Courses <input type="checkbox"/> Auto Technician <input type="checkbox"/> Diesel-Electric <input type="checkbox"/> Diesel Engines <input type="checkbox"/> Mechanical Courses <input type="checkbox"/> Aeronautical Engineer's, Jr. <input type="checkbox"/> Aircraft Drafting <input type="checkbox"/> Forging <input type="checkbox"/> Heat Treatment of Metals <input type="checkbox"/> Industrial Engineering <input type="checkbox"/> Industrial Instrumentation <input type="checkbox"/> Industrial Metallurgy <input type="checkbox"/> Machine Shop <input type="checkbox"/> Machine Shop Inspection <input type="checkbox"/> Mechanical Drafting <input type="checkbox"/> Mechanical Engineering | <ul style="list-style-type: none"> <input type="checkbox"/> Mold-Loft Work <input type="checkbox"/> Patternmaking—Wood, Metal <input type="checkbox"/> Reading Shop Blueprints <input type="checkbox"/> Sheet-Metal Drafting <input type="checkbox"/> Sheet-Metal Worker <input type="checkbox"/> Ship Fitting <input type="checkbox"/> Toolmaking <input type="checkbox"/> Welding—Gas and Electric <input type="checkbox"/> Railroad Courses <input type="checkbox"/> Air Brake <input type="checkbox"/> Diesel Locomotive <input type="checkbox"/> Locomotive Engineer <input type="checkbox"/> Locomotive Fireman <input type="checkbox"/> Locomotive Machinist <input type="checkbox"/> Railroad Section Foreman <input type="checkbox"/> Steam and Diesel Loco. Eng. <input type="checkbox"/> Stationary Engineering Courses <input type="checkbox"/> Boilermaking <input type="checkbox"/> Combust. Engrg. <input type="checkbox"/> Marine Engineering <input type="checkbox"/> Power Plant Engr. <input type="checkbox"/> Textile Courses <input type="checkbox"/> Cotton Manufacturing <input type="checkbox"/> Rayon Weaving <input type="checkbox"/> Woolen Manufacturing |
|--|--|---|---|

Name _____ Age _____ Home Address _____

City _____ State _____ Working Hours _____ A.M. to _____ P.M.

Present Position _____ Employed by _____

Length of Service _____
in World War II _____

Enrollment under G.I. Bill approved for World War II Veterans. Special tuition rates to members of the Armed Forces.
Canadian residents send coupon to International Correspondence Schools Canadian, Ltd., Montreal, Canada.

Build A FIREPLACE



around this scientifically designed steel form which also provides circulating heat that assures perfect fireplace operation.

free folder tells how

TELLS HOW TO BUILD YOUR FIREPLACE—Step by Step

- Foundation
- Steel heat-circulating form
- Cold and warm air ducts
- Chimney and flue construction
- Mantel or decorative front



Foundation

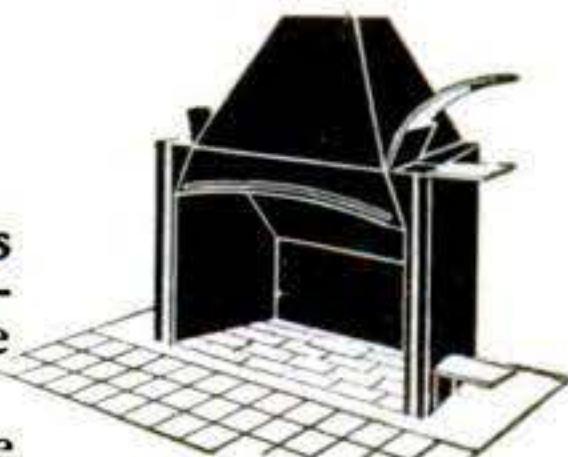

Fireplace form including firebox, damper, down draft shelf and smoke dome.

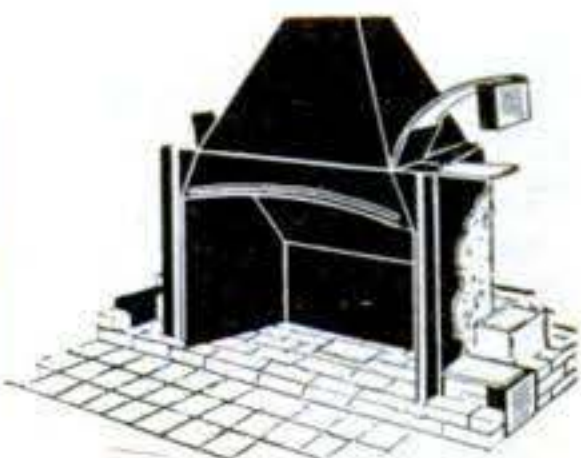

Brick, stone or cement block can be used around the form.

ASK FOR BOOK
"100 FIREPLACE IDEAS"

Beautiful fireplace designs—modern and conventional—shows artistic use of available material.

Enjoy circulating heat and the radiance of an open fire in your *Home, Playroom, Cottage or Camp.*



- Send free directions for building heat-circulating fireplace.
- Send Book "100 Fireplace Ideas." Pocket size book, sent free.
- Send larger book, 8½ x 11, beautifully illustrated, 25c.
- Send outdoor fireplace folder with 10 beautiful designs Free.

Name

Street

City

Sold Through Leading Building Materials Dealers

PRICE FIREPLACE HEATER & TANK CORP.
146 W. Austin Street, Buffalo 7, New York

New Truck Hitch Ends Jackknifing.....158
 How to Save Water.....159
 Electricity Aims Paint.....164
 Diamond Tools Sample Roads.....169
 Glider Seeks Birds' Secrets.....170
 Mobile Garage Mothers Sky Speedster....173
 Mystery Boat Runs by Wave Power.....224
 Splicer Simplifies Tape Editing.....226

Mechanics & Handicraft

How I Start My Car in the Morning.....183
 Foot Scrapers You Can Make.....191
 Wood-Turning Tricks.....192
 Inventor Tells How Tool Was Born.....200
 Deck Fittings for Model Ships.....202
 Hints for Users of Small Motors.....204
 Rig Picks Up Phone Conversation.....205
 Plastic Scraps Make Popcorn Scoops.....213
 How Your Car's Engine Is Cooled.....214
 Put Your Walls to Work.....227
 Spot-Welding on Your Drill Press.....230
 Model Plane Flies While You Sit.....233
 How to Finish Photos for 55 Cents.....234
 Negatives Go Down Drain.....237
 Motorized Bow Saw.....239
 Poultry Feeders You Can Build.....240

Departments

Letters 12
 Voice of Science..... 97
 New Ideas from the Inventors.....109
 Aids to Modern Living.....166
 Keeping the Home Shipshape.....175
 Hints from the Model Garage.....185
 I'd Like to See Them Make.....190
 New Shop Ideas.....228
 Photo Ideas and Equipment.....238
 Craftsmen at Work.....242
 New Tools.....284
 P. S. Last Minute News and Notes.....288

Learn Machine Work by Doing It

IF YOU have or hope to have a metal-turning lathe, the story on page 206 is for you. It shows, in pictures, a whole series of basic lathe operations and how to set them up—boring, facing, turning, drilling, and even simple milling. By following the procedures explained, you can teach yourself machining fundamentals in your home shop.

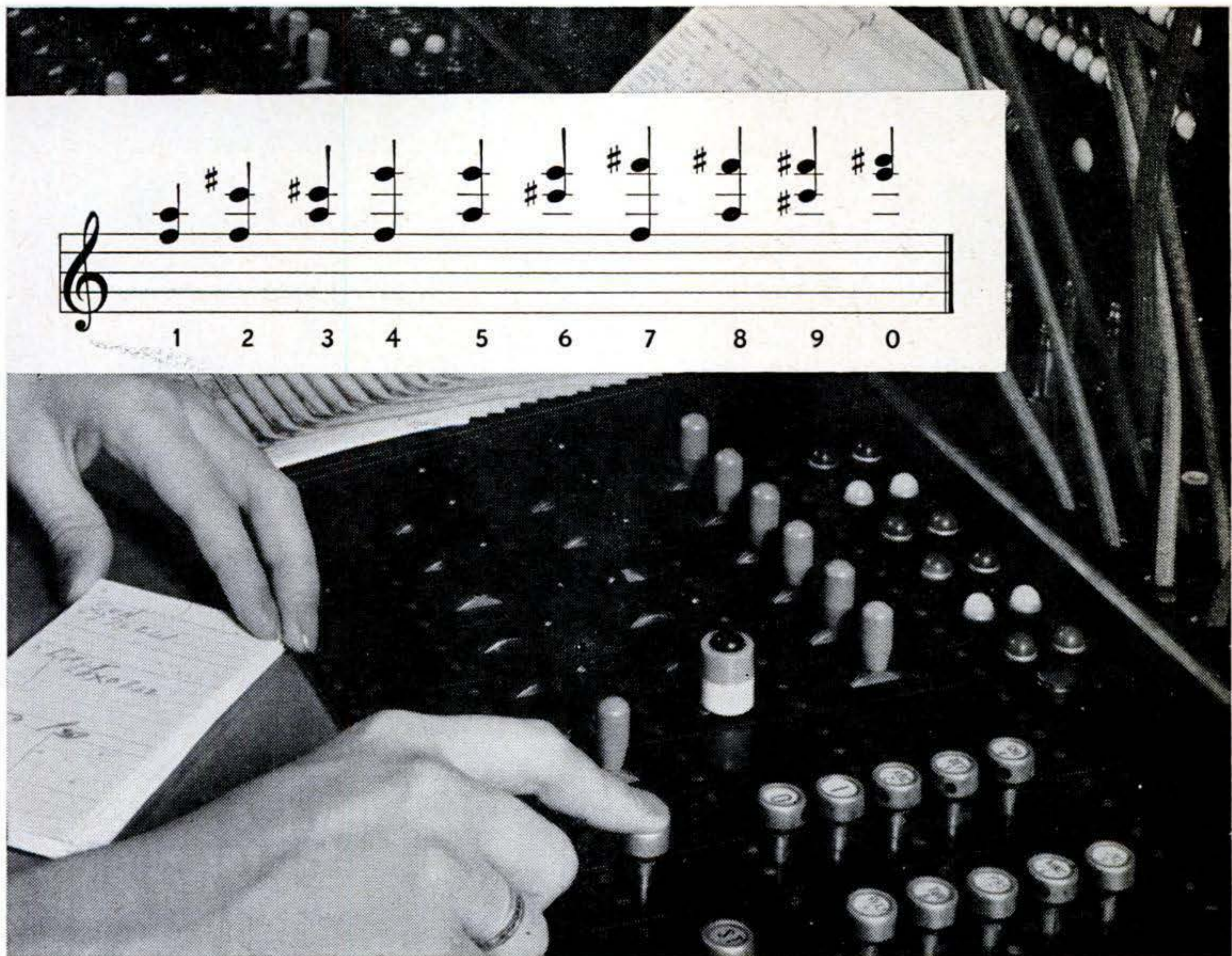

Above is the Bell System's new "musical keyboard." Insert shows the digits of telephone numbers in musical notation, just as they are sent across country.

Playing a tune for a telephone number

Before you talk over some of the new Bell System long distance circuits, your operator presses keys like those shown above, one for each digit in the number of the telephone you are calling. Each key sends out a pair of tones, literally setting the number to music.

In the community you are calling, these tones activate the dial telephone system, to give you the number you want. It is as if the operator reached across the country and dialed the number for you.

This system, one of the newest developments of Bell Telephone Laboratories, is already in use on hundreds of long distance lines radiating from Chicago, Cleveland, New York, Oakland and Philadelphia, and between a number of other communities.

It will be extended steadily in other parts of the country—a growing example of the way Bell Telephone Laboratories are ever finding new ways to give you better, faster telephone service.

BELL TELEPHONE LABORATORIES

Exploring and inventing, devising and perfecting, for continued improvements and economies in telephone service





The Magic of Mind

WERE the great personages of the past victims of a stupendous hoax? Could such eminent men of the ancient world as Socrates, Pericles and Alexander the Great have been deluded and cast under the spell of witchcraft—or did the oracles whom they consulted actually possess a mysterious faculty of foresight? That the human mind can truly exert an influence over things and conditions was not a credulous belief of the ancients, but a known and demonstrable fact to them. That there exists a wealth of infinite knowledge just beyond the border of our daily thoughts, which can be aroused and commanded at will, was not a fantasy of these sages of antiquity, but a dependable aid to which they turned in time of need.

It is time you realized that the rites, rituals and practices of the ancients were not superstitions, but super-fuges to conceal the marvelous workings of natural law from those who would have misused them. Telepathy, projection of thought, the materializing of ideas into helpful realities, are no longer thought by intelligent persons to be impossible practices, but instead, *demonstrable sciences*, by which a greater life of happiness may be had.

One of America's foremost psychologists and university instructors, says of his experiments with thought transference and the powers of mind—"The successes were much too numerous to be merely lucky hits and one can see no way for guessing to have accounted for the results." *Have you* that open-minded attitude of today which warrants a clear, positive revelation of the

facts of mind which intolerance and bigotry have suppressed for years? *Advance with the times*; learn the truth about your inherited powers.

Let this free book explain

The Rosicrucians (NOT a religious organization) have been leaders in introducing the ancient wisdom of mental phenomena. Established throughout the world for centuries, they have for ages expounded these truths to those thinking men and women who sought to make the utmost of their natural faculties. Use the coupon below—avail yourself of a pleasing book of interesting information which explains how you may acquire this most *unusual* and *helpful* knowledge.

The ROSICRUCIANS (AMORC)

USE THIS COUPON

Scribe: Q.C.H.
The Rosicrucians, AMORC
San Jose, California

I am sincerely interested in knowing more about this unseen, vital power which can be used in acquiring the fullness and happiness of life. Please send me, without cost, the book, "THE MASTERY OF LIFE," which tells me how to receive this information.

Name _____

Address _____

State _____

MORE MONEY \$\$\$ a BETTER JOB



YOU'RE in the biggest competition — yes, the biggest battle in the world — that of making a living. You have to work for a living—so does everyone else. Competition for

promotion is keen—people all around you are looking for more money—a better job—and so are you.

You can get a head start. Other men have—and in a short time you should be able to out-distance those who have no progress plan, make more money—have a better job—a more certain future.

Few people prepare themselves for that promotion—that better job and more money. Not many are making any special effort to learn outside of the time they put in each day on their work. They're taking the long, hard road to success. *How about you?* Are you, too, taking that same old, winding road—with its many disappointments and heartbreaks?

Here at LaSalle we have been training ambitious men and women for success for more than 40 years—enrolled hundreds of thousands of students—and our files overflow with grateful letters from students who have attained success and earnings far beyond their fondest dreams.

Perhaps we can help you—at any rate it will be well worth a three cent stamp to mail the coupon below. **DO IT NOW!** Just check the field of your choice and we'll send you full information on that field without obligation—plus "Ten Years' Promotion in One"—a book which has helped many men. It may be the turning point in your life to a successful career, and more money.

Your Competition is Keen



LASALLE EXTENSION UNIVERSITY

A Correspondence Institution
417 So. Dearborn St.

DEPT. 283-R

CHICAGO 5, ILL.

I am interested in preparing myself for a better job and more money. Please send me your free 48-page booklet on the training course I have checked below—plus "Ten Years' Promotion in One."



- Higher Accountancy
- C.P.A. Coaching
- Bookkeeping
- Law: LL.B. Degree
- Business Management
- Salesmanship
- Traffic Management
- Foremanship
- Industrial Mgt.
- Stenotypy
- (Machine Shorthand)

Name _____ Age _____

Street Address _____

City, Zone and State _____

LASALLE EXTENSION UNIVERSITY
A Correspondence Institution
Dept. 283-R Chicago 5, Ill.

CLIP AND MAIL THIS COUPON TODAY!

CHECK YOUR PET PEEVE:

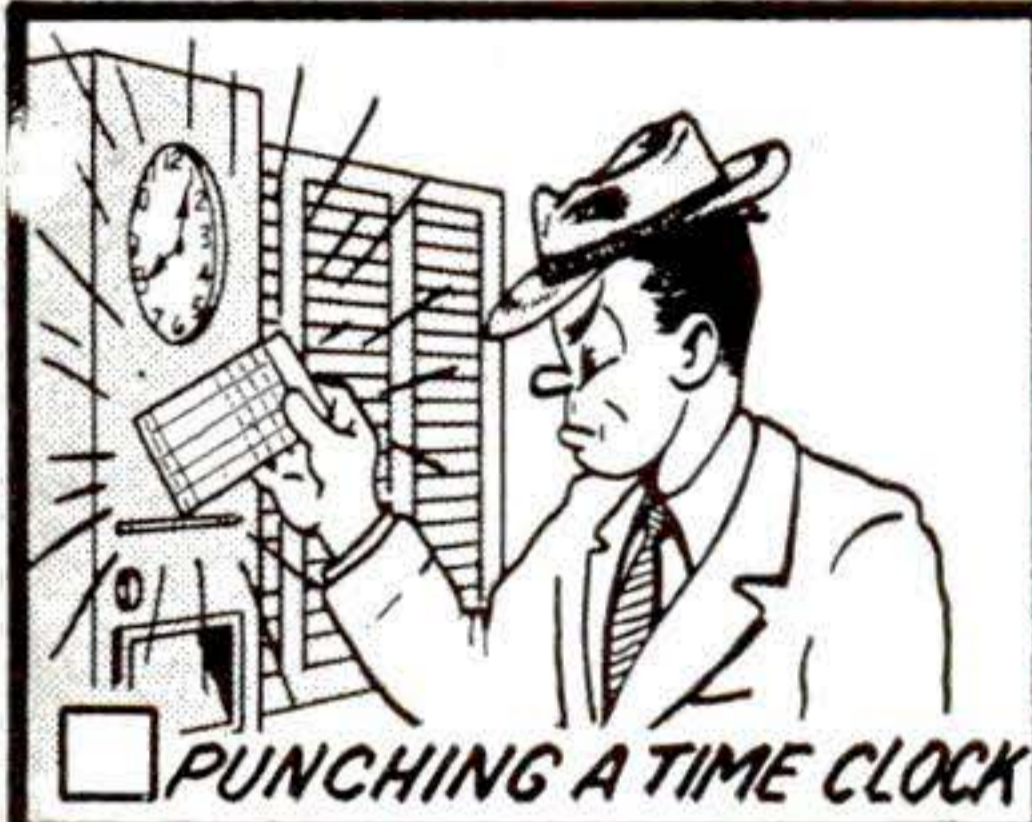

IF YOU CHECKED ONE OR MORE—YOU'D BETTER LEARN A TRADE!

Begin Your Training Now—with C.T.I.

A man who has a trade—a really trained man—puts up with none of the situations illustrated above. He commands the respect that usually accompanies a good job. He earns better money, has greater security, enjoys pleasant working conditions. Best of all, he can open a shop of his own—and thus gain independence!

These letters from C.T.I. students and graduates prove that training pays handsome rewards. If you are willing to apply yourself, you, too, can acquire training through C.T.I.—either at home in your spare time, or in our great shops in Chicago. Read what C.T.I. men write:

"I cannot thank you enough for the training I received. I have had three raises in pay within eight months." . . .

"I recently went into business for myself. I wish to thank you for C.T.I. training, for it has provided a great future for me." . . .

"I now operate a very successful business. Have a \$12,000 building and \$4,000 worth of stock and equipment." . . . "Since the news got around that I was a student with C.T.I., I have been offered three jobs paying over \$85.00 a week." . . . "When I was on my 34th

lesson, I quit my job and started a business of my own, and I'm doing fine."

Opportunities for success are great today—have never been better. Good jobs are waiting in leading industries for men who qualify. Better get the facts on your chances for success right now. Fill out and mail coupon today to C.T.I. Do not delay!

CHOOSE YOUR FUTURE NOW!

The list at right tells you what fields offer best chances for success. You can learn any of these great trades through C.T.I. Home Study or in our Chicago shops . . . in a matter of months. Investigate! Mail coupon!



G.I. APPROVED—All C.T.I. courses, both residential and home study, are fully approved by the Veterans Administration—which means that eligible veterans will have their tuition paid by the government. Remember, there's a time limit on when training must begin—so, act now!

COMMERCIAL TRADES INSTITUTE, Dept. E1-2

1400 Greenleaf - Chicago 26



FILL OUT - CUT OUT - MAIL TODAY

Mr. R. C. Anderson, President
COMMERCIAL TRADES INSTITUTE, Dept. E1-2
1400 Greenleaf Ave., Chicago 26

Veteran
 Non-Veteran

Send free illustrated Brochures and other information about the field I have checked below:

- | | |
|---|--|
| <input type="checkbox"/> Automotive Mechanics | <input type="checkbox"/> Electricity & Electronics |
| <input type="checkbox"/> Body & Fender Rebuilding | <input type="checkbox"/> Radio & Television |
| <input type="checkbox"/> Diesel Mechanics | <input type="checkbox"/> Building Construction |
| <input type="checkbox"/> Refrigeration & Air Conditioning | <input type="checkbox"/> Mechanical Drafting |

Name _____ Age _____

Address _____

City _____ State _____

WHAT Every AUTO MECHANIC Wants to Know

A motor vehicle is a machine of many parts, each part designed and constructed for its own special function. All good mechanics, like good doctors, should know the working theory and operation of each part and understand what causes trouble and how to remedy it.

LET AUDELS AUTO GUIDE SOLVE YOUR PROBLEMS

Every auto mechanic, helper, serviceman and operator can use a copy of AUDELS AUTOMOBILE GUIDE. The information it gives saves time, money and worry. Highly indorsed by all users. It presents the whole subject of auto mechanics from A to Z in plain language and simple terms. This Big Practical Book gives full information with working diagrams covering the principles, construction, ignition, service and repair of modern cars, trucks and buses.

A complete Guide of 1800 pages, with over 1500 illustrations showing inside views of the working parts, with instructions for service jobs. Diesel engines, Fluid and Hydra-matic drives fully explained.

IT PAYS TO KNOW HOW TO

How to fit pistons—How to locate engine knocks—How to fit connecting rod bearings—How to service main bearings—How to recondition valves—How to time valves—How to adjust fan belts—How to adjust carburetors & chokes—How to rebuild a clutch—How to service automatic transmissions—How to service brakes—How to adjust steering gear—How to cope with ignition troubles—How to service distributors—How to time ignition—How to "tune up" an engine.

INFORMATION IN A HANDY FORM

73 INTERESTING CHAPTERS—Read this partial list of subjects on which practical information is fully given for quick reference under the headings as shown below. Ready Reference Index.

All Parts of an Automobile—Automotive Physics—The Gas Engine—Gas Engine Principles—Multi-Cylinder Engines—Horse Power—Automobile Engines—Stationary Parts—Moving Parts—Pistons—Piston Rings—Connecting Rods—Crank Shafts—Valves—Valve Gear—Cams and Cam Action—Valve Timing—Cooling Systems—Fuel Feed Systems—Dual Fuel Feed—Mixture—Carburetors—Carburetor Service—Automatic Choke—Super-Chargers—Transmissions—Special Transmissions—Fluid and Hydra-matic Drives—Clutches—Universals and Propeller Shafts

A Ready Reference

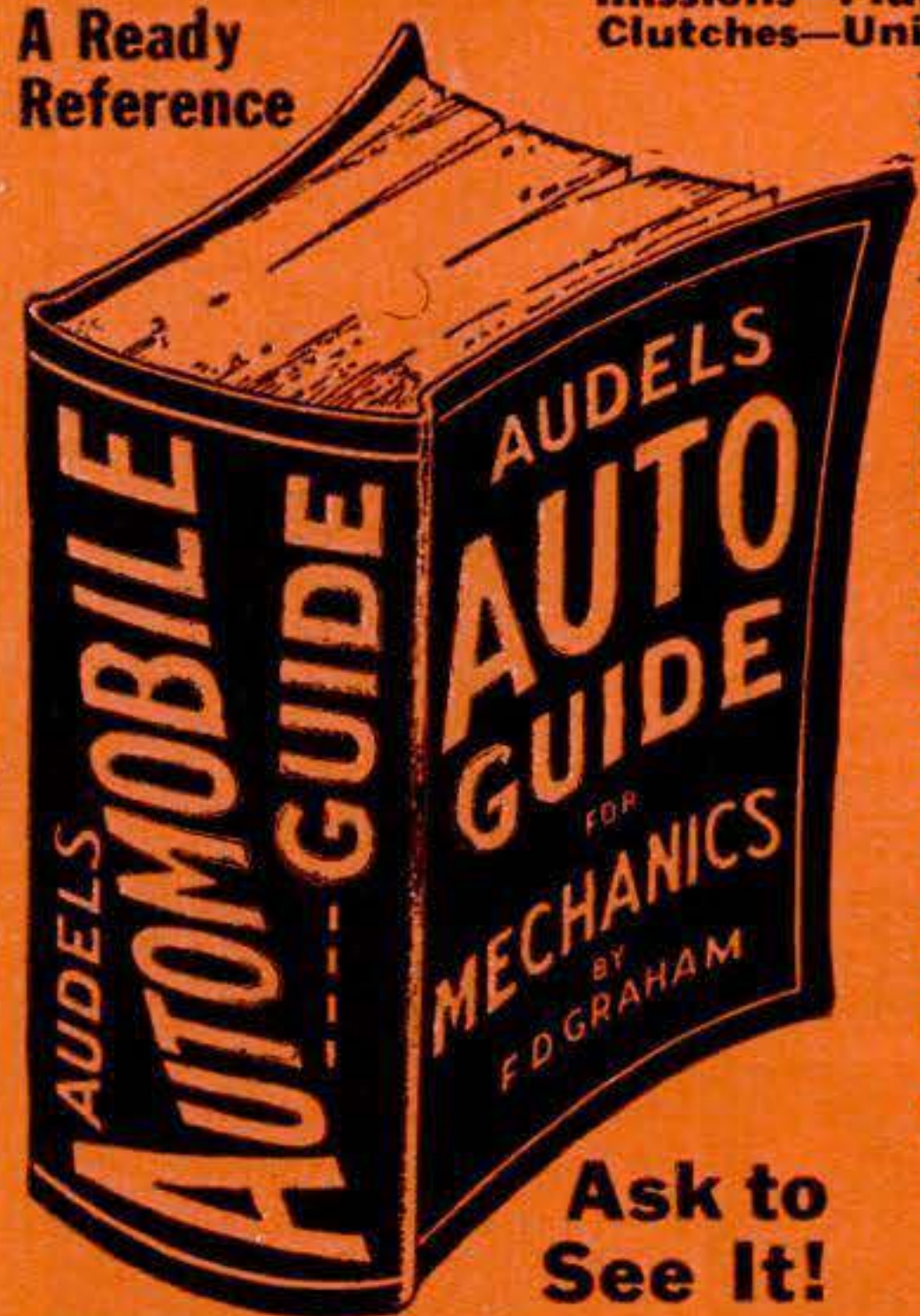

—The Differential—Rear Axles—Rear and Front Suspension—Running Gear—Brakes—Wheel Alignment—Knee Action—Steering Gear—Tires—Lubricants and Lubrication—Automotive Electricity—Ignition Systems—Magneto Ignition—Spark Plugs—Ignition Coils—Distributors—Automatic Spark Control—Ignition Timing—Generators—Starters—Generator and Starter Testing—Lighting Systems—Storage Batteries—Charging and Testing—Diesel Engines and Trouble Shooting.

7 DAYS' FREE TRIAL
TO GET THIS ASSISTANCE FOR YOURSELF SIMPLY FILL IN AND MAIL COUPON TODAY.

\$4 COMPLETE PAY \$1 A ONLY 1 MO.

Ask to See It!



Sent on 7 Days Approval

Step up your own skill with the facts and figures of your trade. Audels Mechanics Guides contain Practical Inside Trade Information in a handy form. Fully Illustrated and Easy to Understand. Highly Endorsed. Check the book you want for 7 DAYS FREE EXAMINATION. Send No Money. Nothing to pay postman.

CUT HERE MAIL ORDER

AUDEL, Publishers, 49 W. 23 St., NEW YORK 10, N. Y.

Please send me postpaid for FREE EXAMINATION books marked (x) below. If I decide to keep them I agree to mail \$1 in 7 Days on each book or set ordered and further mail \$1 monthly on each book or set until I have paid price, otherwise I will return them.

- AUTO GUIDE**, 1800 Pages **\$4**
- DIESEL ENGINE MANUAL, 400 Pages 2
- WELDERS GUIDE, 400 Pages 1
- MACHINISTS Handy Book, 1600 Pages 4
- POWER PLANT ENGINEERS Guide, 1500 Pages 4
- ENGINEERS & FIREMANS EXAMS, 528 Pages 1
- PUMPS, Hydraulics & Air Compressors, 1658 Pgs. 4
- MARINE ENGINEERS Handy Book, 1280 Pages 4
- ENGINEERS & Mechanics Guides (8 Book Set) 12
- Answers on Practical ENGINEERING, 254 Pages 1
- ELECTRIC WIRING DIAGRAMS, 210 Pages 1
- ELECTRICIANS EXAMINATIONS, 250 Pages 1
- ELECTRICAL DICTIONARY, 9000 Terms 2
- ELECTRIC MOTOR GUIDE, 1000 Pages 4
- HANDY BOOK OF ELECTRICITY, 1440 Pages 4
- ELECTRICAL POWER CALCULATIONS, 425 Pgs. 2
- RADIOMANS GUIDE, 914 Pages 4
- ELECTRONIC DEVICES, 216 Pages 2
- ELECTRIC LIBRARY, 7000 Pages (12 Book Set) 18
- Vols. I, II, III, IV, V, VI, VII, VIII, IX, X, XI, XII \$1.50 Ea.
- OIL BURNER GUIDE, 384 Pages 1
- HOUSE HEATING GUIDE, 1000 Pages 4
- CARPENTERS & Builders Guides (4 Book Set) 6
- PLUMBERS & Steamfitters Guides (4 Book Set) 6
- MASONS & Builders Guides (4 Book Set) 6
- BLUE PRINT READING, 416 Pages 2
- PAINTERS & DECORATORS MANUAL, 450 Pgs. 2
- GARDENERS & GROWERS Guides (4 Book Set) 6
- REFRIGERATION & Air Conditioning, 1280 Pgs. 4
- SHEET METAL WORKERS Handy Book, 388 Pgs. 1
- SHEET METAL PATTERN LAYOUTS, 1100 Pgs. 4
- AIRCRAFT WORKER, 240 Pages 1
- MECHANICAL DRAWING GUIDE, 160 Pages 1
- MECHANICAL DRAWING & DESIGN, 480 Pgs. 2
- MATHEMATICS & CALCULATIONS, 700 Pgs. 2
- MECHANICAL Dictionary, 968 Pages 4
- MILLWRIGHTS & Mechanics Guide, 1200 Pgs. 4

Name _____

Address _____

Occupation _____

Employed by _____ PSM

AUDEL, Publishers, 49 W. 23 St., New York 10, N.Y.

**I Will
Show You
How to**

Learn RADIO

You Build This Modern Superheterodyne Receiver

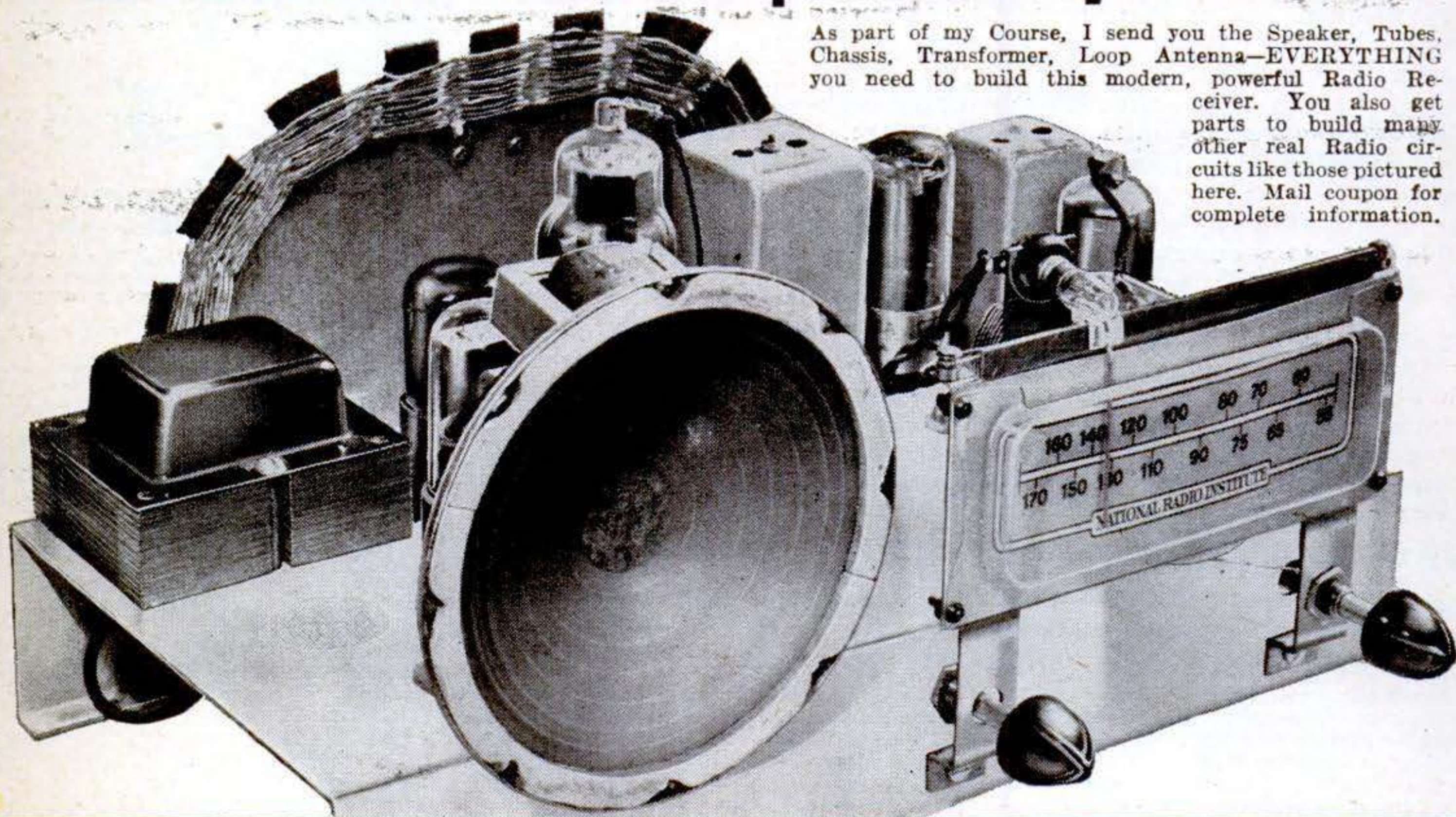

As part of my Course, I send you the Speaker, Tubes, Chassis, Transformer, Loop Antenna—EVERYTHING you need to build this modern, powerful Radio Receiver. You also get parts to build many other real Radio circuits like those pictured here. Mail coupon for complete information.

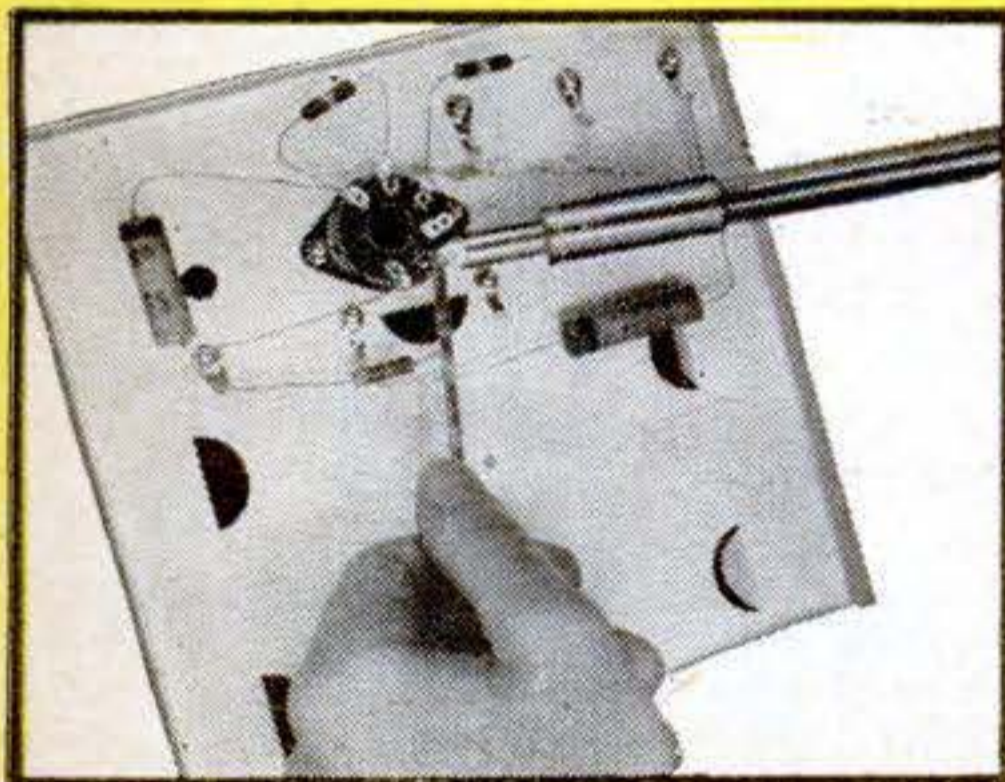

YOU PRACTICE Radio soldering with Soldering Equipment and Radio Parts I send you. Get practical experience mounting and connecting parts.



YOU BUILD this Tester with parts N. R. I. sends early in course. Soon helps you fix neighbors' Radios and **EARN EXTRA MONEY** in spare time.

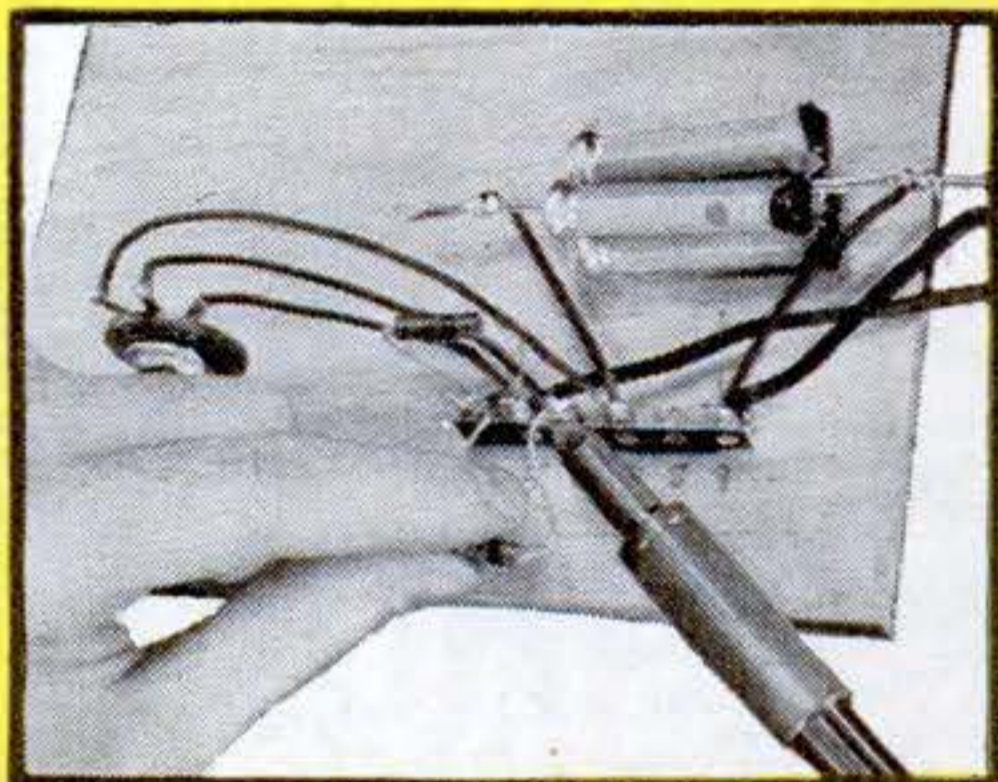

YOU TEST Radio Circuits like this built with parts I send. Build special circuits; learn how to locate and repair circuit defects.

MEN I TRAIN AT HOME GET GOOD JOBS LIKE THESE

MADE \$1500 WHILE LEARNING

"By the time I finished my NRI training I had made \$1500. When I started the Course I did not know a resistor from a condenser. I have bought my home. My income from Radio work, etc., is about \$3,000 a year." — **WILLIAM THOMAS**, Baldwyn, Mississippi.



ASSISTANT TO CHIEF ENGINEER AT STATION WHJB

"Have been employed for the past two years as assistant to the chief engineer at Radio Station WHJB. Knew nothing about Radio when I enrolled for the NRI Course." — **CECIL J. GIUNIPERO**, Greensburg, Pennsylvania.



KNEW NOTHING ABOUT RADIO

"I knew nothing about Radio when I enrolled. At present I am doing spare time work. I have more than paid for my Course and I have about \$200 worth of equipment which has paid for itself." — **RAYMOND HOLT-CAMP**, Vandalia, Illinois.



FULL-TIME JOB BEFORE FINISHING COURSE

"After completing about two-thirds of my Course I entered a Radio Repair shop. Later I branched out for myself and opened a shop in my own home. I am much pleased with the work I had during my first year of business." — **A. H. AYERS**, Washington 10, D. C.



by Practicing in Spare Time

I Send You
Big Kits
of Radio Parts

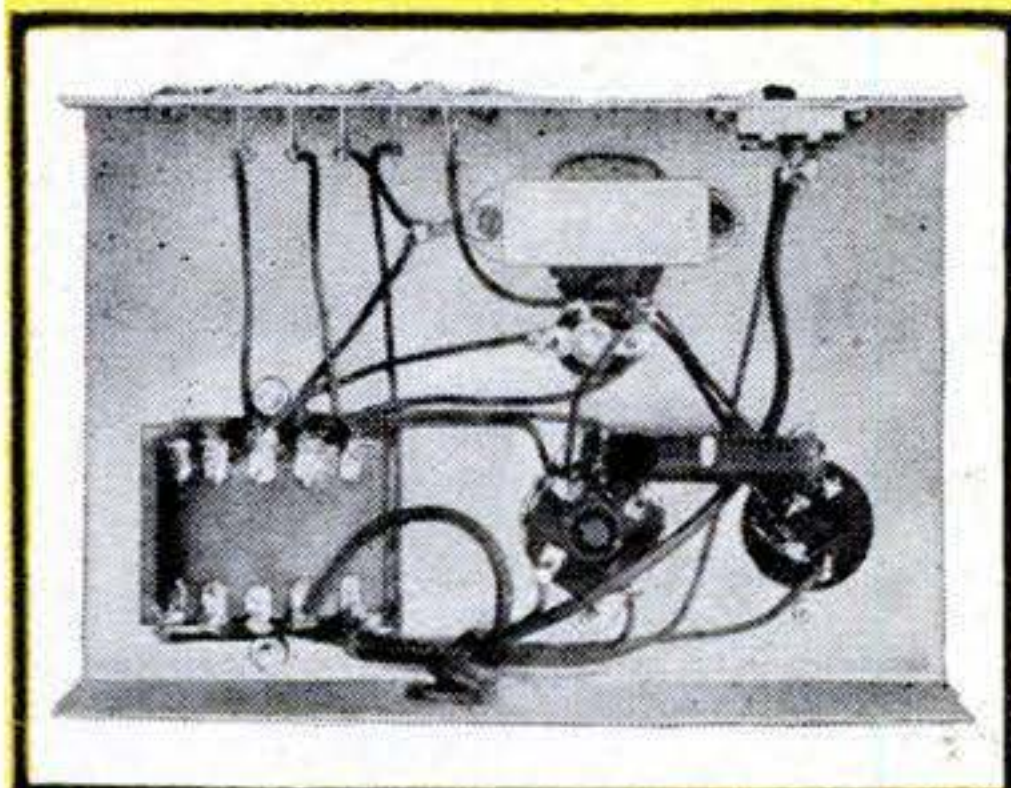

YOU BUILD Vacuum Tube Power Pack; make changes which give you experience with packs of many kinds. Learn how to correct Power Pack troubles.

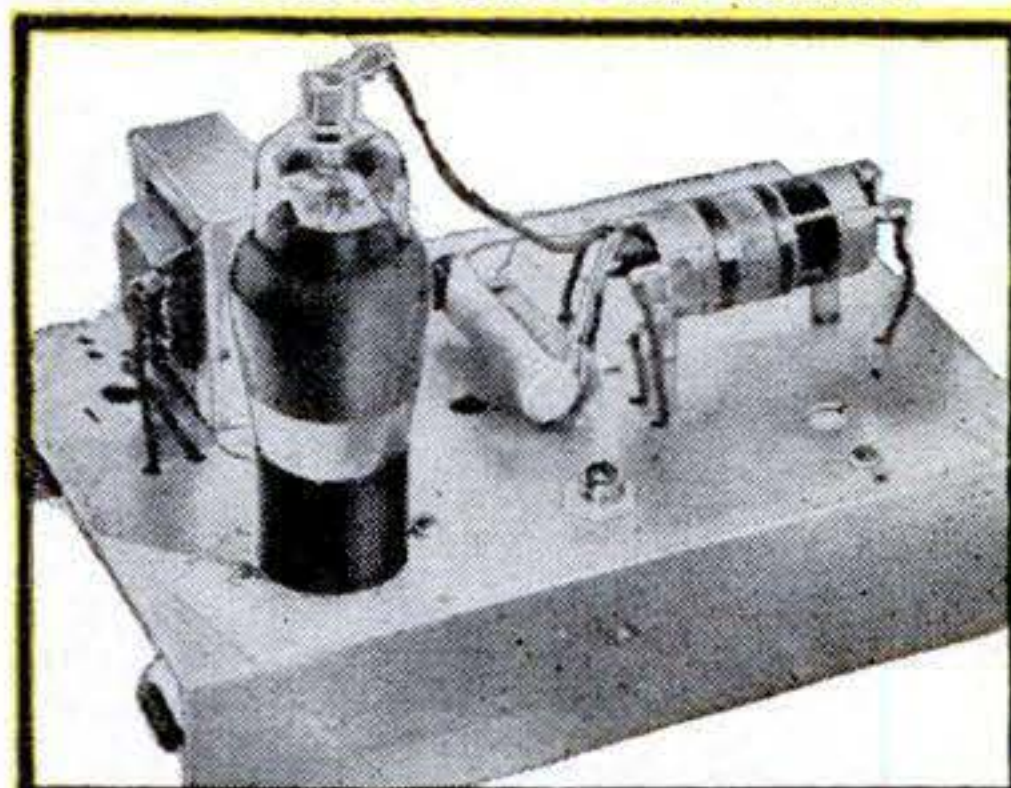

YOU BUILD this A. M. Signal Generator for more valuable experience. It provides amplitude-modulated signals for many tests and experiments.

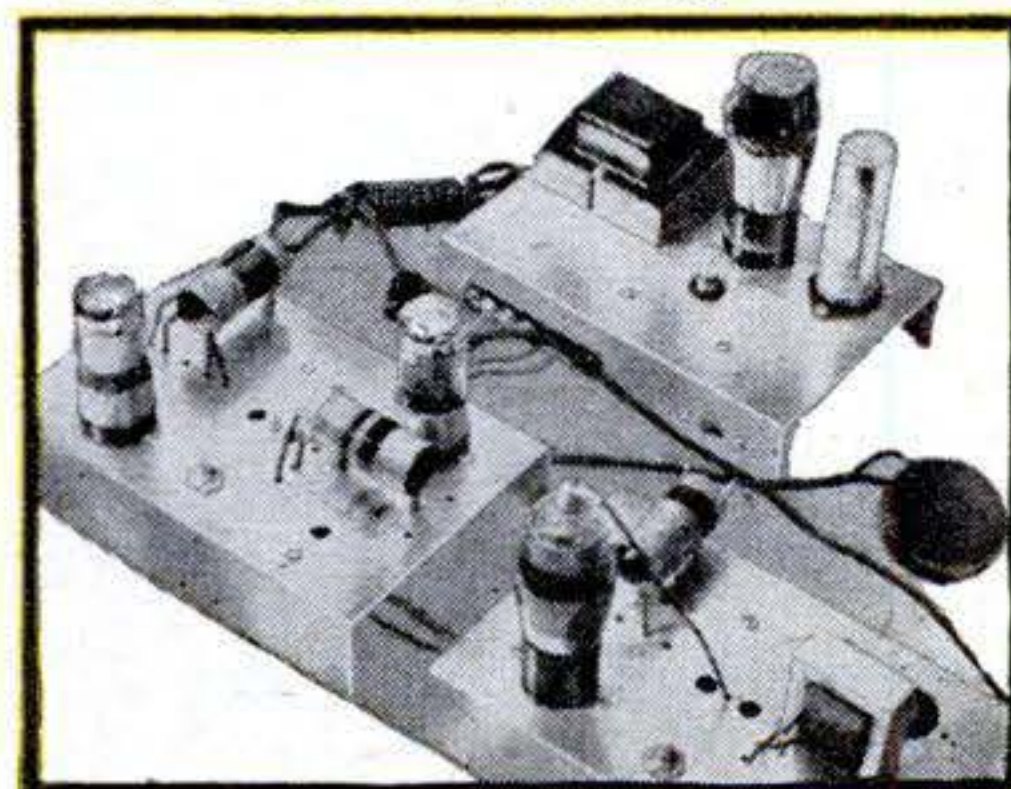

YOU PRACTICE FM (Frequency Modulation) experiments, get more experience with this Superheterodyne Receiver Circuit you build with parts I send.

KNOW RADIO & TELEVISION Train at Home-Win Success

Want a good-pay job in the fast-growing RADIO-TELEVISION Industry? Want a money-making Radio-Television shop of your own? I've trained hundreds of men to be Radio Technicians... **MEN WITH NO PREVIOUS EXPERIENCE.** My tested and proved train-at-home method makes learning easy. Learn Radio-Television principles from illustrated lessons. Get practical experience with **MANY KITS** of **PARTS** I send. All equipment yours to keep.

VETERANS

GET THIS
TRAINING
WITHOUT COST
UNDER G. I. BILL
MAIL COUPON

Make EXTRA MONEY in Spare Time

The day you enroll, I start sending **SPECIAL BOOKLETS** that show you how to make **EXTRA MONEY** fixing neighbors' Radios in spare time. From here it's a short step to your own shop, or a good-pay Radio-Television servicing job. Or get into Police, Aviation, Marine Radio, Broadcasting, Radio Manufacturing or Public Address work. And think of getting in on the ground floor of the booming Television Industry. Trained men are already in demand... new stations are going on the air, manufacturers are building over 100,000 sets a month, more and more homes are getting sets. The man who prepares now will reap rich rewards.

See What N. R. I. Can Do For You

Act now! Send for my **DOUBLE FREE OFFER.** Mail coupon for lesson and 64-page book, **"HOW TO BE A SUCCESS IN RADIO AND TELEVISION - ELECTRONICS."** Tells how quickly, easily you can get started. Send coupon in envelope or paste on penny postal. **J. E. SMITH, President, Dept. OBP3, National Radio Institute, Pioneer Home Study Radio School, Washington 9, D. C.**



Good for Both - FREE

MR. J. E. SMITH, Pres., Dept. OBP3
National Radio Institute, Washington 9, D. C.

Mail me **FREE**, your Sample Lesson and 64-page book. (No salesman will call. Please write plainly.)

Name..... Age.....

Address.....

City..... Zone..... State.....

Check If Veteran

Approved for Training under **GI Bill**

SAMPLE LESSON

FREE

Gives hints on Receiver servicing, locating defects, repair of Loudspeaker, I. F. Transformer, Gang Turner, Condenser, etc. Mail coupon.

**FIND OUT ABOUT THIS
TESTED WAY
TO BETTER PAY**

NEW!

a different name
for your old friends!

PROTO TOOLS

—formerly

PLOMB TOOLS

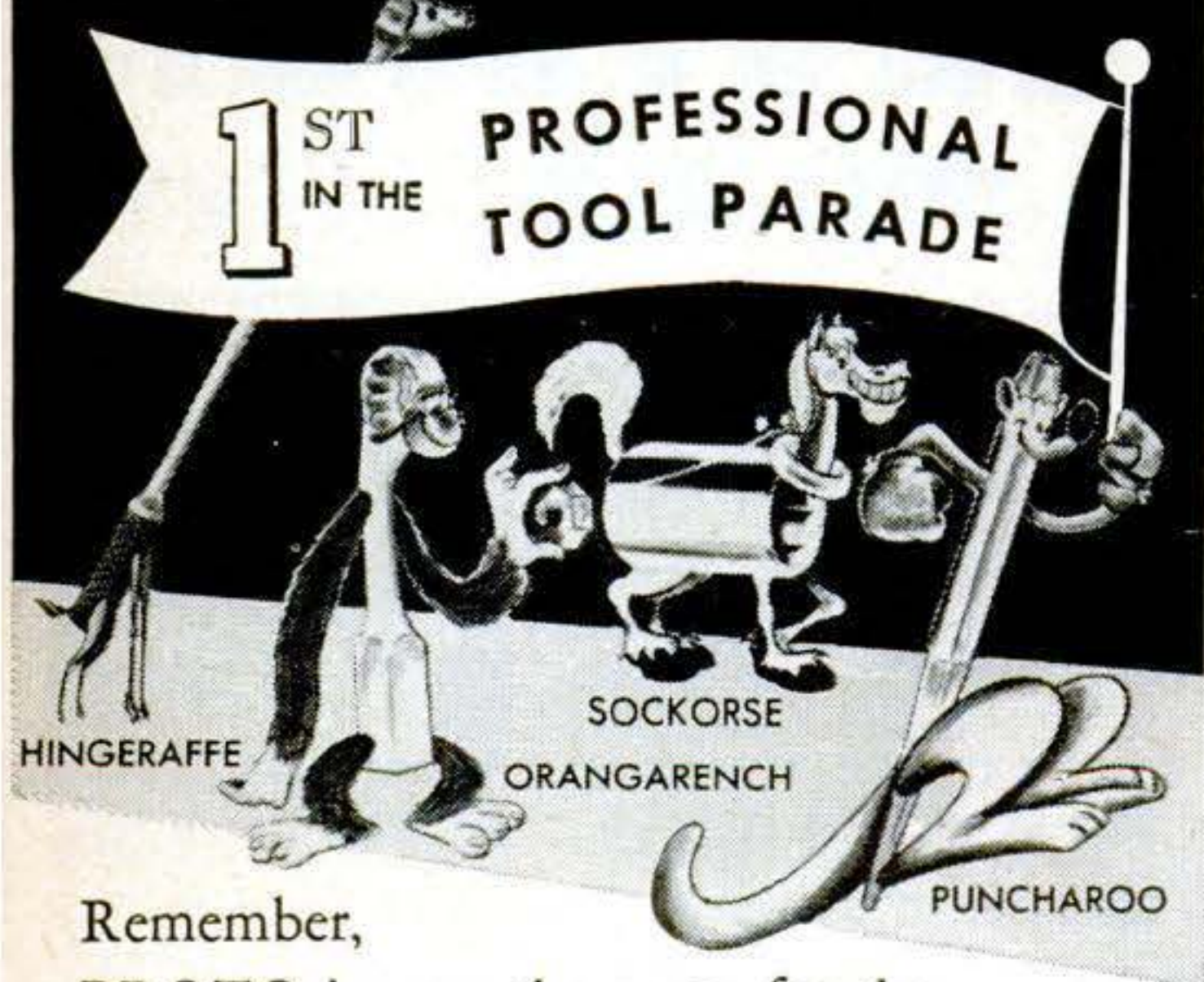

Remember,

PROTO is now the name for the leading brand of mechanics' hand tools. PROTO tools—formerly Plomb tools—are manufactured to the same high standards and are noted for superior design, special steels, scientific heat treating and long life. For the finest tools, buy the old-timers with the new name—PROTO tools.

Write for catalog to

PLOMB TOOL COMPANY

2257K Santa Fe Avenue, Los Angeles 54, Calif.



Letters



Too Good to Throw Away

Sir:

The unusual ideas printed in your book monthly have been beneficial to me in time and money. So, in return, I am sending you an idea that may help other readers:

Having quite a large number of copies on hand, I index articles for future reference by attaching a blank sheet of paper to the face of each copy by means of paper clips, glue, or adhesive tape and making notes of the title and page thereupon.

NASH R. PALMER

Chicago, Ill.

Sir:

When a guy has a lot of your magazines stacked flat and wants to locate a particular article, it is quite a job to find it. To make this easier, I paint a good-sized serial number across one end or side of each issue and then keep an index of interesting articles by book number and page.

A. C. BROCKWAY

Huntsville, Ala.

Carousal vs. Carrousel (cont.)

Sir:

I'd like to add my two-cents worth to the argument in your letters column (Nov., p. 18) about how to spell "carrousel" and whether it turns clockwise or backwards.

Perhaps reader Planitzer, with his preference for "carousal," is referring to what my dictionary defines as a "revelry or drinking bout accompanied by noisy jollity." Then he would be correct in assuming that it travels in a counterclockwise direction.

H. R. PARADISE

Seattle, Wash.

Car With a History

Sir:

I was particularly interested in the article "Good Cars Never Die," on p. 183 of your November issue, on account of the author, Murrelle Mahoney, being a Duesenberg expert.

It might interest him, and you, to know that I have the original "Mormon Meteor"

GET INTO

DIESEL-AUTO MECHANICS

Master All Phases

JOBS LIKE THESE ARE AVAILABLE TO TRAINED MECHANICS. CHOOSE THE FIELD YOU LIKE BEST

Get Complete Training

Diesel Fuel Injection
 Automotive Motor Tune-up
 Diesel Engine Rebuilding
 General Garage Mechanic
 Agricultural Implements
 Auto Engine Rebuilding
 Auto Elec. Service
 Public Utilities
 Parts Dealers
 Bus & Truck Lines
 Industrial Maintenance
 Contracting & Excavating
 Business of Your Own
 AND MANY other similar openings.

As a National Schools graduate, you are trained for ALL opportunities in the Diesel & Auto Industries.

EARN WHILE YOU LEARN

With our practical Master Shop-Method Home Training, you study at home in your spare time. You receive Spare Time Work Lessons, which show you how to earn while you Learn... for extra money and experience. You Learn by DOING.

TOOLS AND EQUIPMENT

To make your training complete, we give you selected mechanic's tools and equipment, illustrated below, including all-metal tool-box — as a regular part of your instruction.

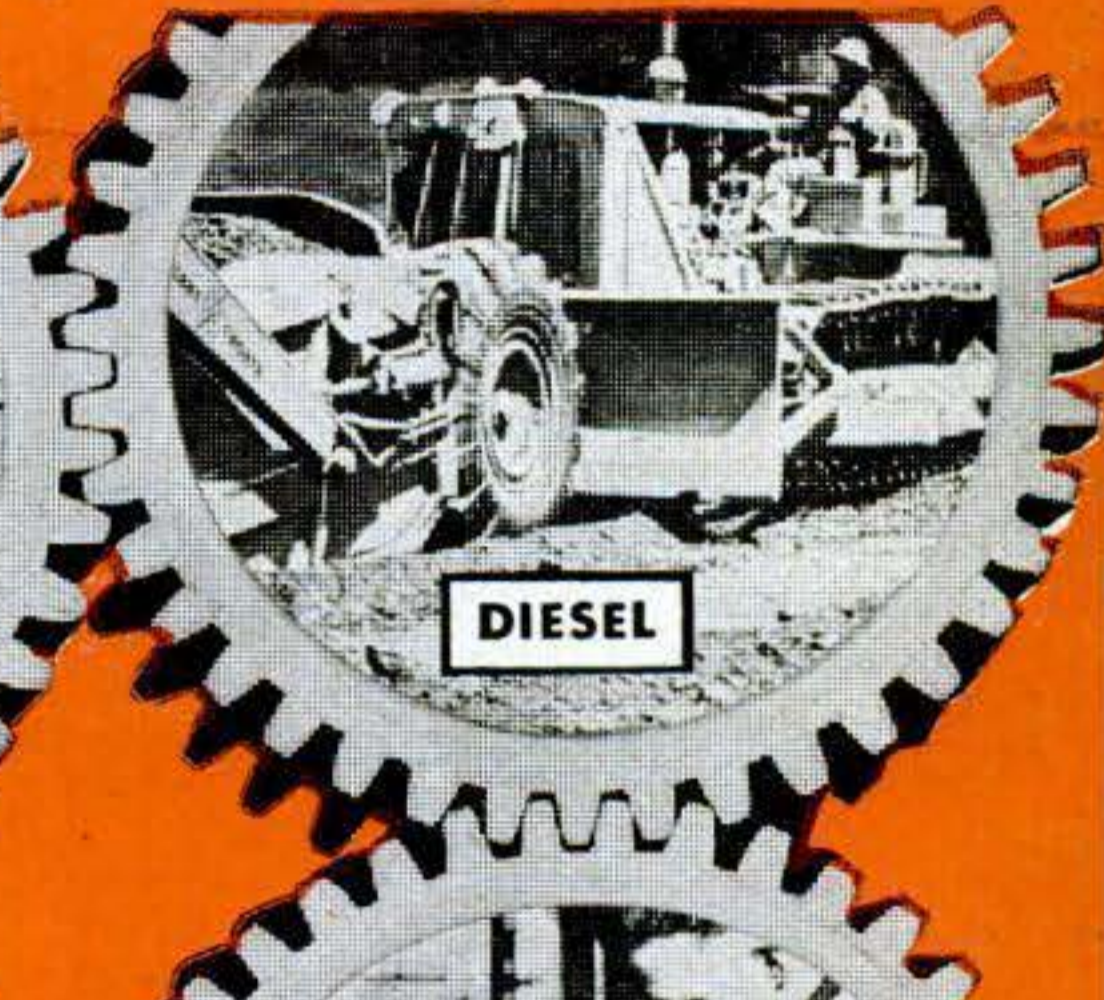
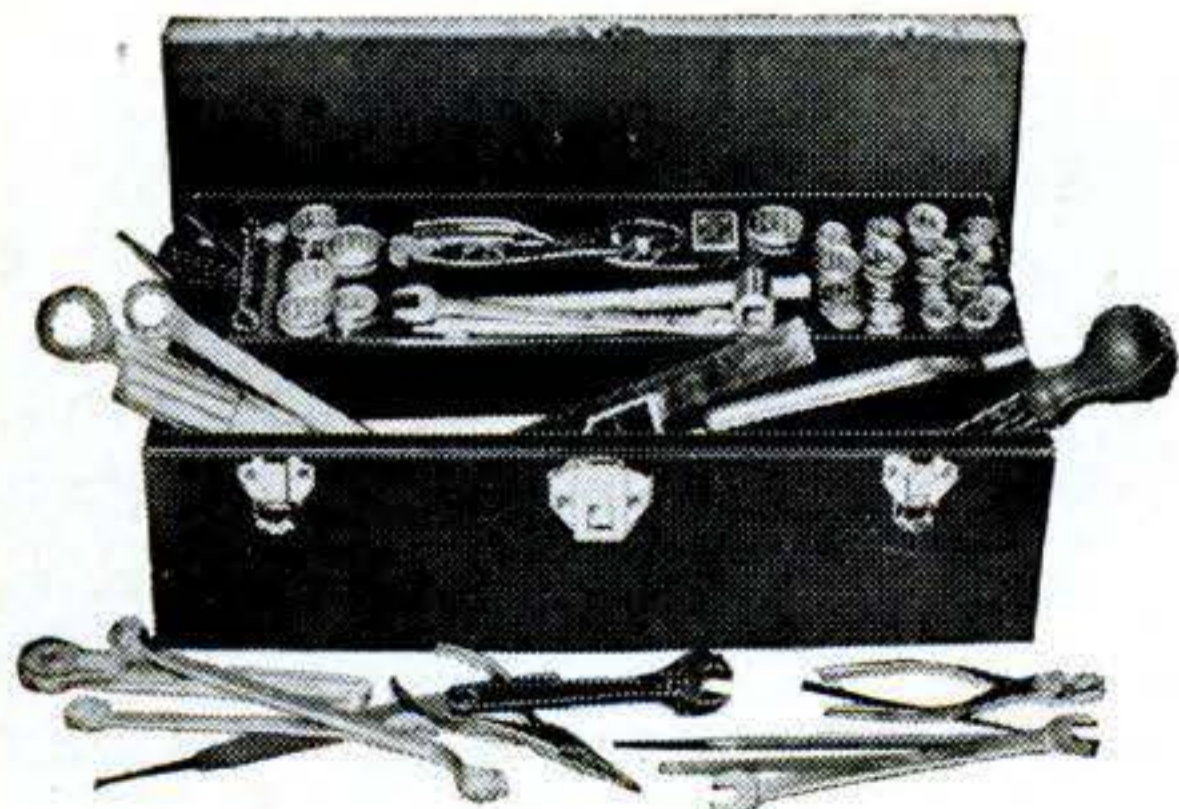

Shop-Method Home Training by an Established Resident School Prepares you for Many Good Jobs

Opportunity is everywhere for the trained Diesel - Auto Mechanic. Highways throng with cars, busses, trucks tractors. Garages and Service Stations are kept busy. Factories, ships, farms, railroads, general industry, are dependent upon engine power. Here's a dynamic, fast - growing field that needs trained men who know ALL phases: installation, operation, maintenance and repair. Now—National Schools offers you a practical, all-embracing Diesel-Auto Mechanic's Course, including all of these advantages:

Complete training, covering—Diesels, High Speed and Heavy Duty; Semi-Diesels, Gasoline and Special Fuel Engines AND Allied Mechanics.

Basic Lesson Texts
 Diesel Installation
 Operation—Maintenance
 Diesel Chart Manual
 Spare Time Lessons
 Engine Service Manuals
 Engine Repair
 Drive Systems
 Diesel Electric Power
 Thermodynamics

TOOLS AND EQUIPMENT INVESTIGATE

Secure Full Information

NEW, ILLUSTRATED BOOK & SAMPLE LESSON SHOW HOW WE TRAIN YOU...SEND FOR THEM TODAY!

NO COST NO OBLIGATION

APPROVED FOR VETERANS

Check coupon below

WE GIVE YOU TOOLS OF YOUR TRADE

NATIONAL SCHOOLS

LOS ANGELES 37, CALIF. • EST. 1905



FIND OUT NOW...MAIL COUPON TODAY

NATIONAL SCHOOLS, Dept. PSD-2
4000 South Figueroa Street
Los Angeles 37, California

(Mail in envelope or paste on penny postcard)

Mail me FREE the book, YOUR FUTURE IN DIESEL-AUTO MECHANICS, together with the Sample Lesson. I understand I may keep and use the information with no obligation.

Name.....Age.....

Address.....

City.....Zone...State.....

Check here if Veteran of World War II

YOU Need My PRACTICAL Training to Make Money in

TELEVISION- RADIO and ELECTRONICS!



I'll Send You
8 BIG KITS of
Radio Parts and Equipment

Learn at
HOME
IN YOUR
SPARE TIME

Now is the Time to Get Into This Fast
Growing Industry—Prepare for a Fine
Paying Job or Your Own Business!

I have trained hundreds of men to become technicians—and I'm ready to do the same for you. Whether your goal is a fine paying job in one of Radio's many branches—or a successful Radio and Television business of your own—you need the kind of training I offer! My training is practical and down to earth. YOU NEED NO PREVIOUS EXPERIENCE. I start you with basic fundamentals and give you plenty of practical shop-bench training with many kits of parts I send you. This is the training that sticks with you and makes money for you on the job!

GET PAID FOR SPARE TIME WHILE LEARNING

Soon after you start training I send you my famous BUSINESS BUILDERS that show you how to make money in spare time doing interesting Radio jobs. I send you 8 big kits of Radio parts and equipment and help you build step-by-step a powerful 6-tube superhet radio, a 16-range test meter, plus other mighty useful equipment for Radio and Television servicing. You will perform over 175 fascinating experiments while training. You will learn about Television—so that you will be qualified to step into this fast growing, profitable field. I also send you many valuable service manuals, diagrams, and my book telling exactly how to set up your own Television and Radio shop. Clip and mail the coupon below for my two big FREE Radio books. I employ no salesmen—and nobody will call on you.

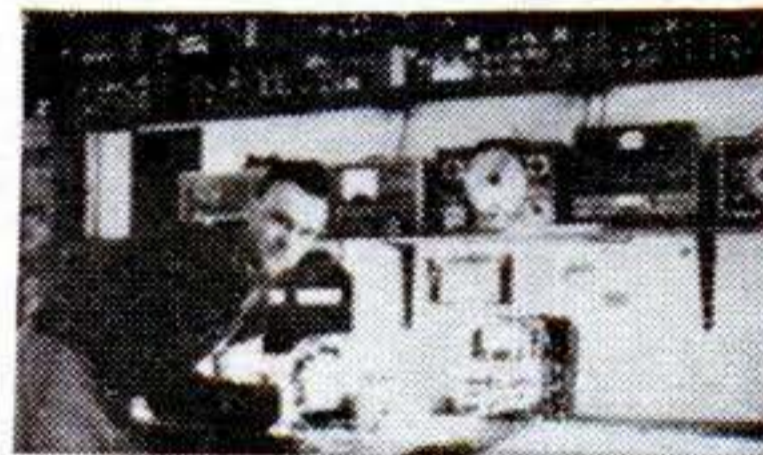

HAVE A BUSINESS OF YOUR OWN

A profitable Radio and Television Service Shop may be started with little capital. I will show you how to get started. At left is pictured one of my graduates, Mr. Merrit C. Sperry, Fairmont, Minn. in his own shop.

Radio and Television Industry Booming

You couldn't pick a better time to get into Radio-Television and Electronics. New Television stations are going on the air to serve every major city—hundreds of new AM and FM Radio broadcasting stations are also on the air. All this creates new and bigger opportunities for the trained man who knows Radio-Television and Electronics.

VETERANS

**THIS
TRAINING
AVAILABLE TO
YOU UNDER
THE G.I. BILL**

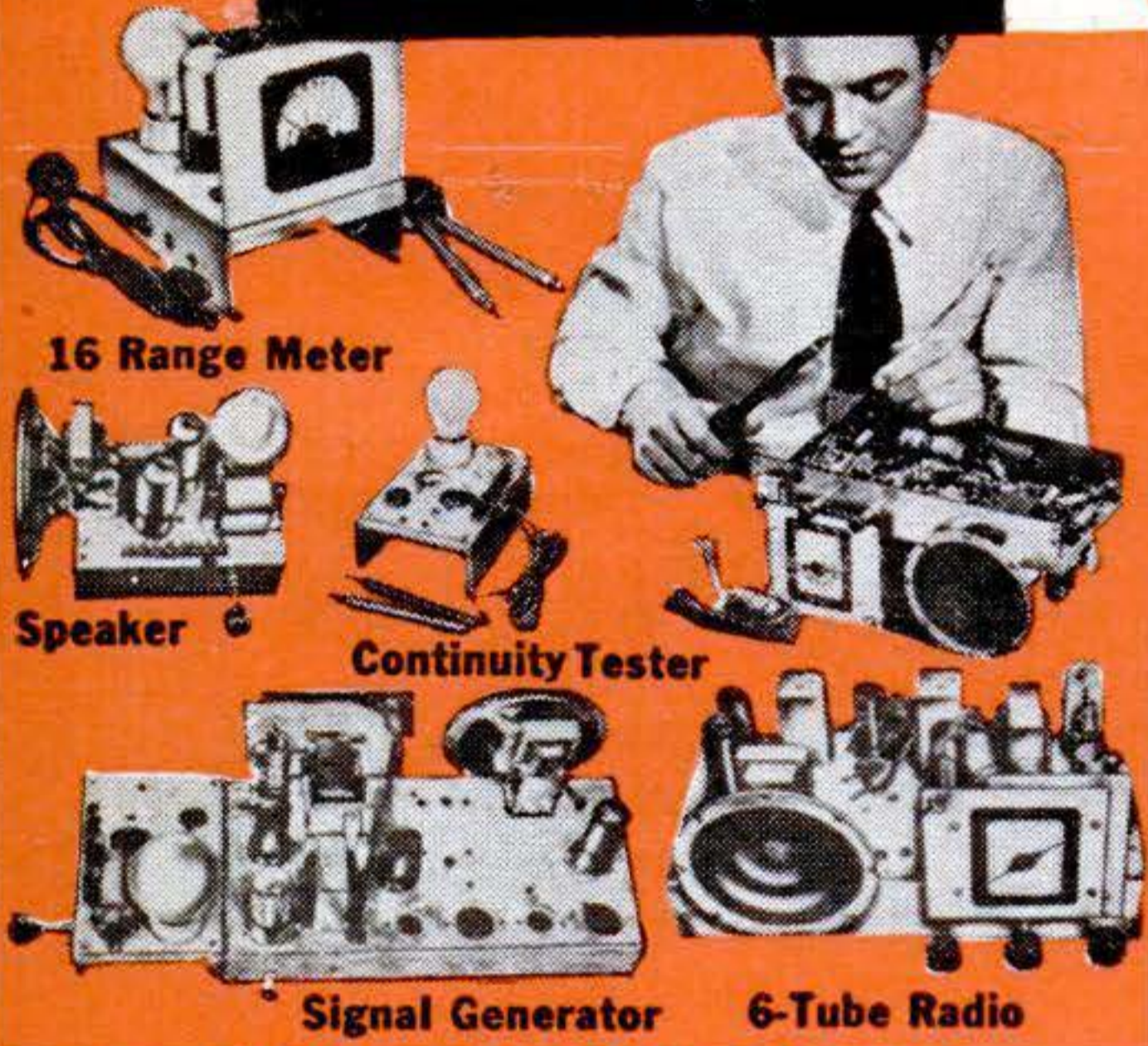

All Kits Are YOURS TO KEEP

Each of the hundreds of Radio parts and other items I send my students is theirs "for keeps." You may use this equipment in your Radio and Television service work and save many dollars by not having to buy expensive "ready-made" test equipment.



CALVIN SKINNER of New Orleans, La. tells us he makes \$5 to \$10 in spare time repairing radios. He is now also working with a Television set.



LOREN D. SAUCIER of Coloma, Mich. reports that my training has made it possible for him to repair large numbers of Radio and Television sets.

RUSH COUPON Today!

**SPRAYBERRY ACADEMY of RADIO, Dept. 55-F
111 North Canal Street,
Chicago 6, Illinois**

Please rush my FREE copies of "How To Make Money In Radio-Television and Electronics" and "How To Read Radio Diagrams and Symbols."

Name.....Age.....

Address.....

City.....State.....

() Check here if you are a Veteran

**My Training
Includes...
Television,
FM (Frequency
Modulation),
Public
Address
and High
Frequency
Applications**



These Two Big FREE! Radio Books

Just mail coupon for a FREE sample Sprayberry Lesson and my big FREE book, "How To Make Money In Radio-Television and Electronics." Learn why my really practical training is best of all for you. Discover what's ahead for you in Radio-Television and Electronics. No obligation. Don't delay! Mail the coupon now—and count on me for fast action.

**SPRAYBERRY ACADEMY OF RADIO
111 N. CANAL, DEPT. 55-F, CHICAGO 6, ILL.**

INVENTORS

Learn how to protect your invention. The U. S. Patent Laws provide that any new and useful art, machine, article of manufacture, or composition of matter, or any new and useful improvement thereof, may be patented if the act of invention is involved. Therefore, every inventor with a valuable invention should take advantage of the Patent Laws and proceed for patent protection in order to safeguard his rights.

A patent gives the inventor the exclusive right to prevent others from making, using, or selling the invention claimed in the patent for a period of seventeen years.

The Patent Laws were enacted for the benefit of the inventor to give him protection for the features of his invention which are patentable. These features must be properly and concisely set forth and claimed in a formal application for patent, in order to comply with the requirements of the Patent Laws. For that reason, unless the inventor is familiar with patent matters, he should engage a competent registered patent attorney or agent to represent him. We are registered to practice before the U. S. Patent Office and are prepared to serve you in the handling of your patent matters.

A specially prepared booklet entitled "Patent Guide for the Inventor", containing detailed information with respect to patent protection and procedure, together with a "Record of Invention" form will be promptly forwarded to you without obligation upon request.

CLARENCE A. O'BRIEN & HARVEY JACOBSON

Registered Patent Attorneys

02-B DISTRICT NATIONAL BUILDING • WASHINGTON 5, D. C.

Patents • • • Trademarks • • • Copyrights

FEBRUARY 1950 15

Choose Your Career! Become a RADIO - TELEVISION TECHNICIAN

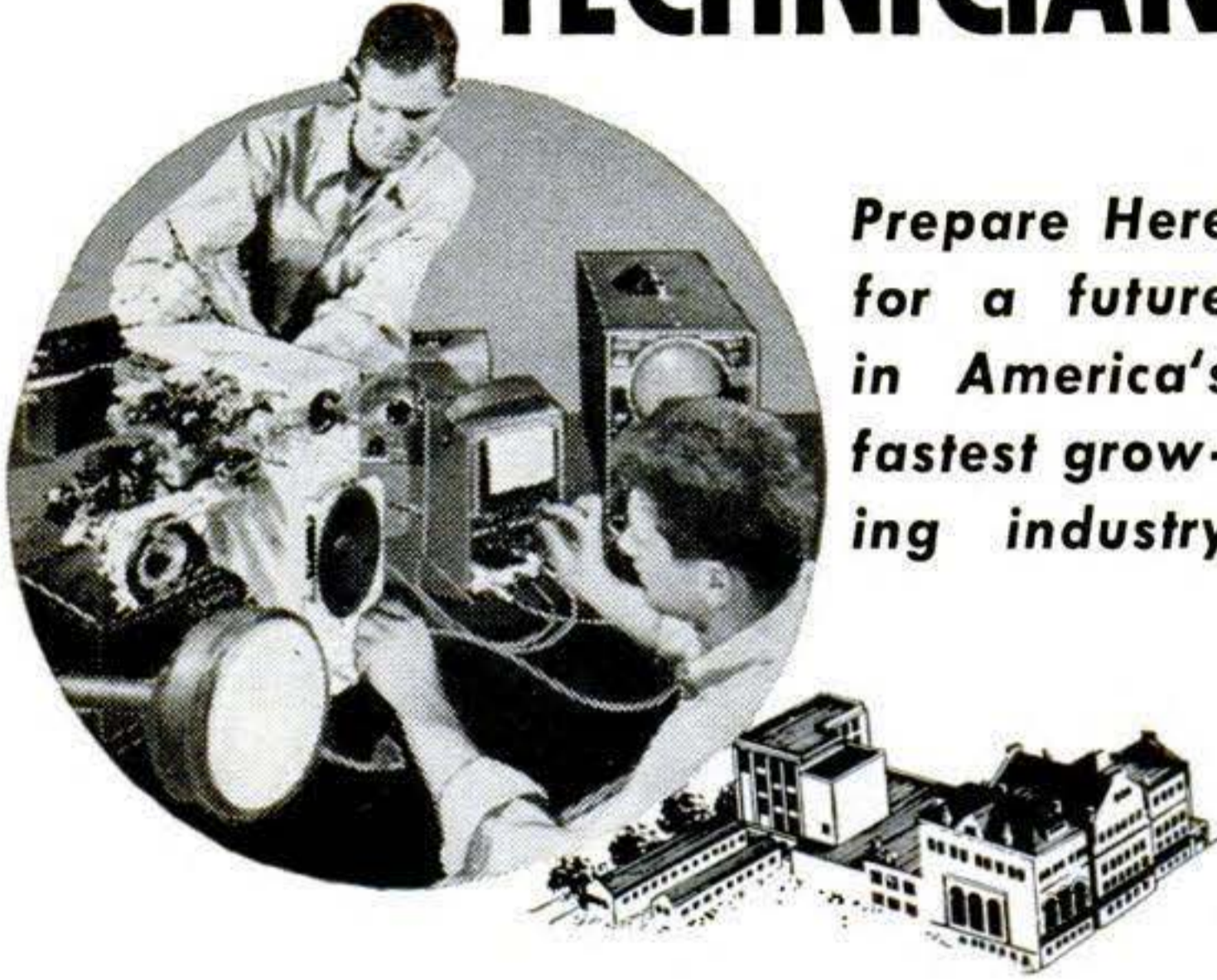

Prepare Here
for a future
in America's
fastest grow-
ing industry

TRAIN NOW for opportunities in television—the field which business leaders predict will be among the top ten industries by 1951. You can become a Radio-Television Technician in only 18 months of continuous study at this non-profit, well-equipped Technical Institute and College.

Choose the Course That Interests You Most

SERVICE

- 6 to 12 months
- Electricity
 - Welding
 - Refrigeration
 - Heating

TECHNICIAN

- 12 to 24 months
- Radio and Television
 - Electronics
 - Electrotechnics (Power)
 - Welding
 - Refrigeration, Heating, Air Conditioning

PROFESSIONAL

- 36 months
- Electrical Engineering —B.S. Degree. Major in Electronics or Power

EQUIP YOURSELF FOR SPECIFIC POSITIONS

in receiver and transmitter testing, servicing, sales, supervision, and production. Your technician's course will also be credited toward the B.S. degree in Electrical Engineering.

Practical, military or academic training will be evaluated for advanced credit. Preparation courses available.

Faculty of 85 specialists—over 1555 currently enrolled—35,000 former students.

Write for new 48-page
Pictorial Bulletin . . .
"Your Career"

Terms Begin April, July, Oct., Jan.



MILWAUKEE SCHOOL OF ENGINEERING
Dept. PS-250, N. Broadway & E. State, Milwaukee, Wis.
Without obligation send free bulletin "Your Career" and more details on course in.....

NAME.....AGE.....

ADDRESS.....

CITY.....ZONE.....STATE.....

Check if World War II Veteran

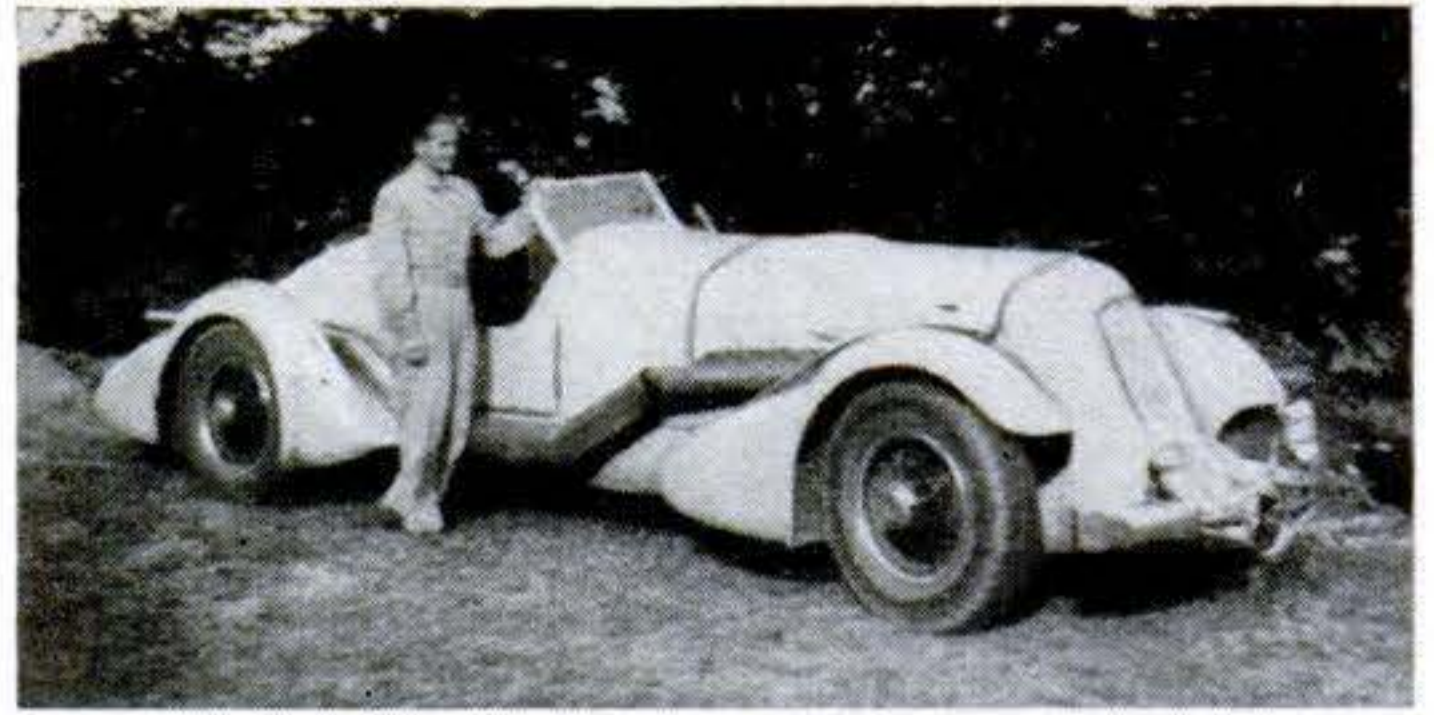

Reader Hudson and Mormon Meteor

that Ab Jenkins drove on the Bonneville Salt Flats to a world record of 135 m.p.h. for a 24-hour average on Aug. 31, 1935.

It's a Duesenberg SJ, a regular factory-produced model except for its special body. It was built at Indianapolis, and Augie Duesenberg personally was in charge of it during the endurance run.

This car was capable, at the time, of speeds over 170 m.p.h. on the straight-away. Jenkins's average over the first 300 miles was 152 m.p.h. His 24-hour record was later bettered by custom racing models but has never been approached for passenger cars.

I now drive the car every day, through traffic and on the highway. The original cost was \$30,000.

BEN H. HUDSON

Hapeville, Ga.

Bringing Up the Rear

Sir:

It seems to me that the Orientals, possibly the Japanese, were 'way ahead of us on the caboose with bay windows you reported in November, p. 127. I ran across this type of caboose some three years ago while serving in the occupation of Korea, formerly a protectorate of Japan. And from the looks of the ones I saw and rode in, they had been in existence a very long time before my arrival.

H. M. PROFFITT, JR.

Belleville, Ill.

Time Stands Still

Sir:

In his article "I Fly the World's Fastest Bomber," on p. 139 of your November issue, test pilot Jim Fraser says: "You could have had breakfast in New York and 46 minutes later, according to your watch, had breakfast again—in Los Angeles."

That statement seems to be based on the

INVENTORS

If you believe that you have an invention, you should find out how to protect it. The first step is to have a search made of the prior pertinent U. S. patents. If a report on this search indicates that the invention appears patentable you can apply for a patent, and the specifications and claims should be prepared.

The firm of McMorrow, Berman & Davidson, with offices in Washington, D. C., is qualified to take the necessary steps for you. We can make a preliminary search on your invention, advise you whether we think it can be patented, and prepare your application for patent.

Unless you are fully familiar with the U. S. Patent Laws, we recommend that you engage the services of a Registered Patent Attorney to protect your interests. The patent laws are *your* laws. A patent gives you the right to prevent others from making, using or selling the invention claimed in your patent for a period of 17 years.

Use these patent laws for your protection. Investigate whether your invention can be patented. If you have what you believe to be an invention, we suggest that you have this firm make a search for you.

Send for a copy of our Patent Booklet entitled "How To Protect Your Invention," containing information about patent protection and patent procedure. Along with this we will also send you an "Invention Record" form, for your use in writing down and sketching details of your invention. We will mail them promptly. No obligation. They are yours for the asking.

McMORROW, BERMAN & DAVIDSON

Registered Patent Attorneys

PATENTS • TRADE MARKS • COPYRIGHTS

1428 VICTOR BUILDING, WASHINGTON 1, D. C.

One Step AHEAD!



with
EMBRY-RIDDLE
Training

AIRCRAFT & ENGINE MECHANICS

An urgent need exists for properly trained A & E Mechanics throughout commercial aviation. Our C. A. A. approved school with a quarter-century of experience assures your quickest advancement. Embry-Riddle students learn fast with modern equipment...working on live aircraft in airline-size hangars.

ENGINEERING

Embry-Riddle's Design Engineering and Maintenance Course offers you A & E certification eligibility plus basic engineering knowledge necessary to fill such positions as Field Service, Project or Maintenance Engineer.

A & E COMBINED * WITH COMMERCIAL

Airmen with dual pilot-engineering ability are needed by aviation companies and operators. Embry-Riddle combination training offers you the most in your aviation career.

*Not available to veterans, but combined courses may be taken consecutively with proper justification.

COMMERCIAL PILOT

Embry-Riddle trained pilots benefit from our years of experience with 30,000 students...the best instructors, up-to-date aircraft, superb year-'round flying weather... qualifications unexcelled anywhere. Instrument and instructor's ratings also available.

Never has there been such opportunity for properly trained men in commercial aviation. Put yourself one step ahead of the crowd. Start your career now at Embry-Riddle -- dormitories directly on the airport. For full information fill in the coupon below and mail today!



Dean of Enrollments - Dept. 91
Embry-Riddle School of Aviation
Miami 30, Florida

Please Print

NAME _____

ADDRESS _____

City _____

State _____ Age _____

I am interested in...

- A.&E. Mechanic
- Commercial Pilot
- Engineering
- A.&E. Combined with Commercial Pilot *
- Flying Mechanic *
- Drafting & Design

Check One Veteran Non-Veteran

TRAIN IN MIAMI--AIR CAPITAL OF THE WORLD

Stratojet's record flight from Seattle to Washington, D. C., in 3 hours 46 minutes at an average speed of 607.8 m.p.h. for the 2,289 miles.

Even at that speed, the plane could not go much more than 460 miles in 46 minutes. Since it's much more than that from New York to Los Angeles, I don't see how he figures those two breakfasts so close together.

LAWRENCE JOHNSON

Walla Walla, Wash.

Author-pilot Fraser assumed that a traveler flying westward would set his watch back an hour three times on passing from one time zone into another. Thus he could eat breakfast at 6 a.m., New York time, and—3 hours 46 minutes later—eat again at 6:46, Los Angeles time.

How 'Chute Brake Works

Sir:

Your article on the B-47 (Nov., p. 139) leaves me with only one question: Just how is that parachute, used to slow the plane in landing, controlled so as not to touch the ground?

During the war I was a glider pilot, and I believe we were the first to use parachutes on the tail to slow landing speed. But we released the 'chute near the ground to prevent it from dragging and snaring. Thus the 'chute could be used over again.

In your picture of the B-47, I don't see how it is possible for that 'chute to be kept off the ground.

WAYNE CURTIS

Montrose, Colo.

Your gliders were powerless, producing no air blast to keep their 'chutes extended. The B-47, however, has six jets that blow quite a gale even when idling. This blast prevents the bomber's 'chute from touching the ground until the engines have been shut off. For similar use of a parachute as a landing brake on another jet bomber, see p. 111 in this issue.

Ham Ohmlet

Sir:

I have read PS almost constantly since 1929, but the most fascinating article I ever read in it was the one on p. 242 of your November issue, "Hide a Radio in a Skillet."

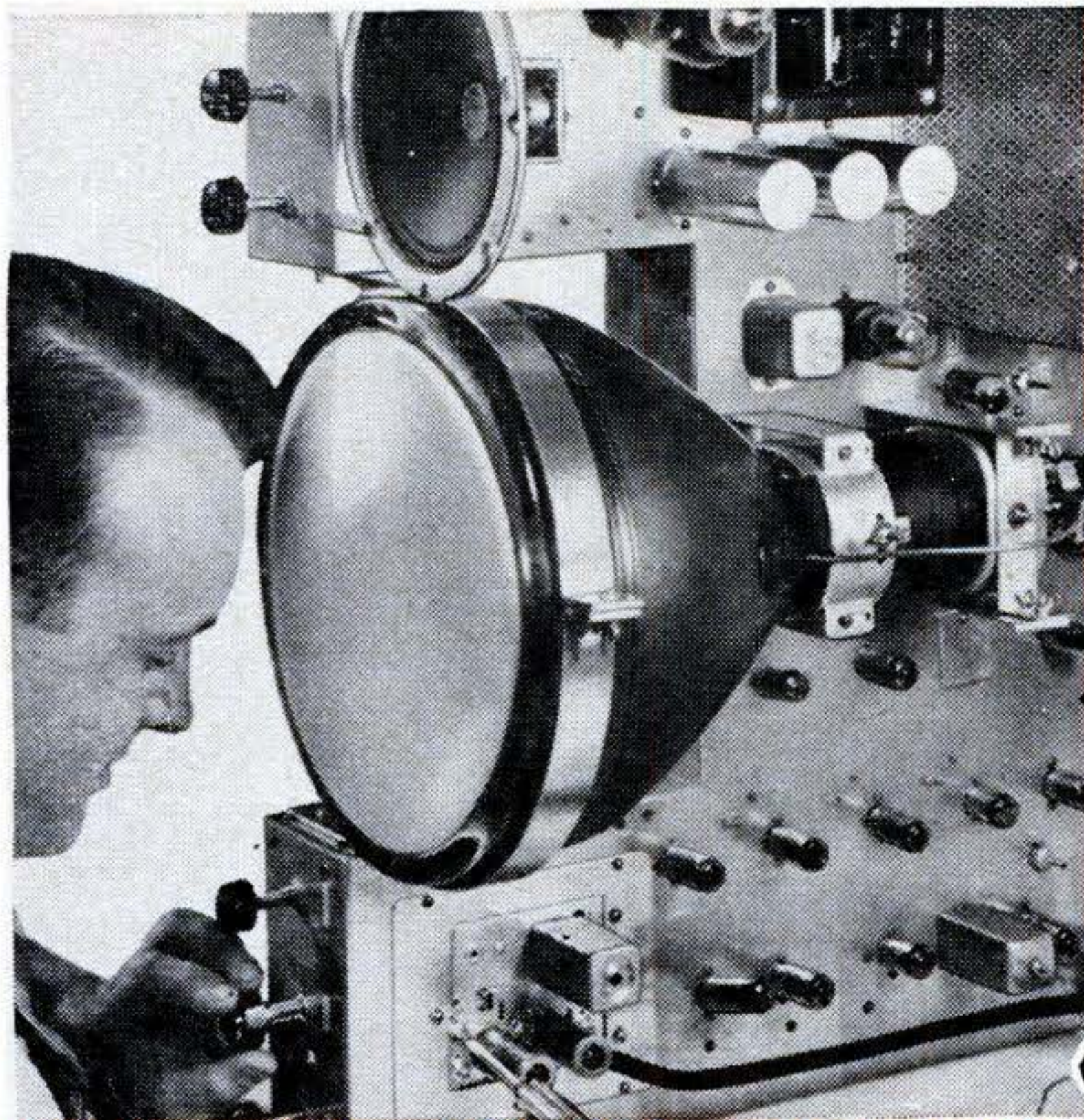

Only D.T.I.
offers you the
"BIG 5"
TELEVISION
RADIO-ELECTRONICS
Laboratory Type
HOME TRAINING

Build and Keep 10, 12½ or 16 inch Picture Tube Quality TELEVISION RECEIVER as you prepare for a Profitable Future



R-F Signal Generator

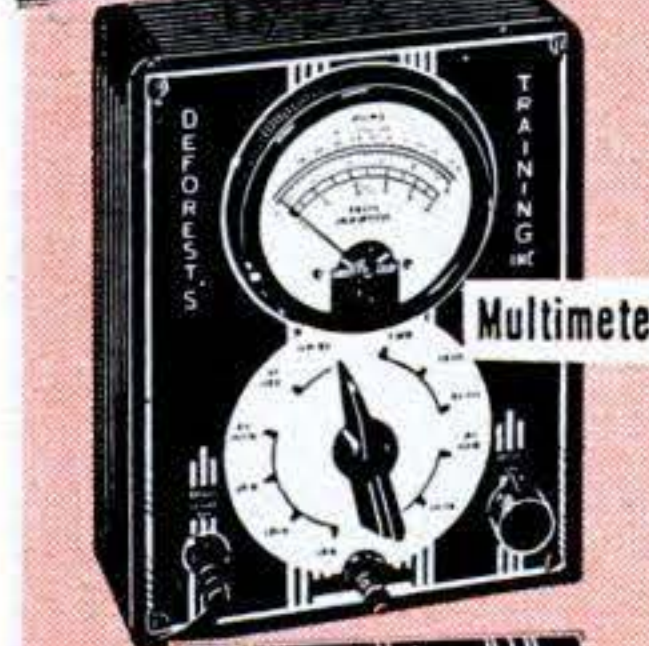

Multimeter



Oscilloscope



6 Tube Radio Receiver

Here is everything you need to prepare you at home for FASCINATING WORK, GOOD MONEY and a THRILLING FUTURE in one of America's most promising fields.

This includes the opportunity to build and keep the top quality Television Receiver shown above—with choice of a 10, 12½ or 16 inch picture tube that gives big, bright, sharp, steady pictures. This is an optional feature—available when you complete your training described below. Get the complete facts. See how D.T.I.'s wonderfully practical "BIG 5" method meets industry's needs. No previous experience needed. Mail coupon today!

16 Big Shipments of Parts — Plus Lessons

Work over 300 electronic experiments and projects from 16 big shipments of parts. This includes building and keeping all test equipment and radio set shown at left side of page. Modern easy-to-read lessons with handy fold-out diagrams simplifies your entire training.

You Also Use Home Movies

D.T.I., alone, includes the modern, visual training aid . . . MOVIES to help you learn faster, easier at home. See electrons on the march and other fascinating "hidden action"—a remarkable home training advantage that speeds your progress.

EMPLOYMENT SERVICE

When you complete your training, our effective Employment Service helps you get started toward a real future in Television-Radio-Electronics.

Modern Laboratories

If you prefer, you can get ALL your preparation in our new, Chicago training laboratories . . .

one of the finest of its kind. Ample instructors . . . modern equipment. Write for details!

DeFOREST'S TRAINING, INC.

Chicago 14, Illinois
A DeVry Institution

OPTIONAL FEATURE



You Learn-by-Reading from D.T.I.'s MODERN LESSONS



NEGATIVELY CHARGED ELECTRONS FLOW TO POSITIVE PLATE



MAIL THIS COUPON TODAY!

DeFOREST'S TRAINING, INC.
2533 North Ashland Avenue,
Chicago 14, Illinois.

Without obligation, give me complete facts showing how I may make my start in Television-Radio-Electronics.

Name _____ Age _____
Street _____ Apt. _____
City _____ Zone _____ State _____



Start As High As \$3,450 a Year Get Ready Now for 1950 Examinations In Your Locality

Veterans Get Preference

City Mail Carriers, Post Office Clerks

Clerks and Carriers now get \$2,870.00 the first year on regular and automatically increase \$100 a year to \$3,670.00. Open to men, women 18 to 50.

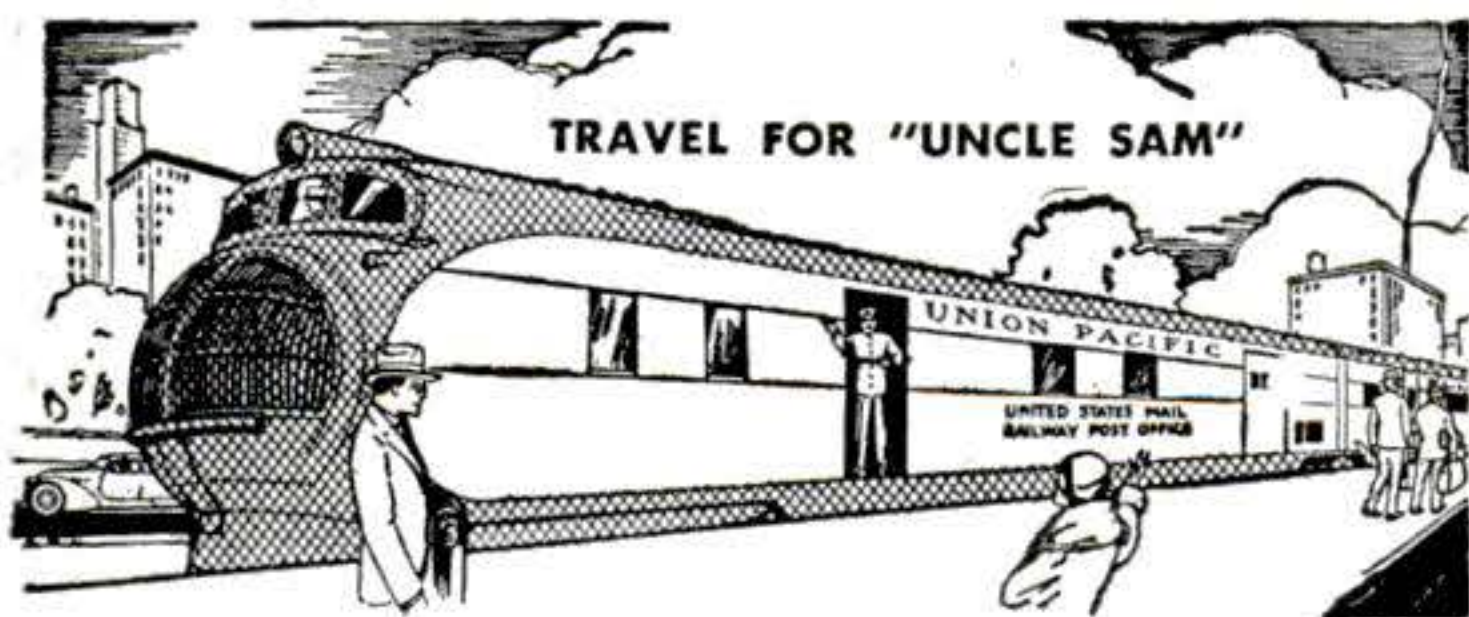

Railway Postal Clerks

Railway Postal Clerks get \$3,170.00 the first year regular, being paid on the first and fifteenth of each month. (\$132.08 each pay day.) Their pay is automatically increased yearly to \$3,970.00. Advance may be had to Chief Clerk at \$5,970.00 a year. (\$248.75 each pay day.) Male veterans only.

3 Days On—3 Days Off—Full Pay

Railway Postal Clerks on long runs usually work 3 days and have 3 days off duty or in the same proportion. During this off duty their pay continues just as though they were working. They travel on a pass when on business. When they grow old, they are retired with a pension.



Many Other Positions

Many other positions are obtainable. Rural Carriers—Stenographers—Typists—Assistant Statistical Clerks—Customs Inspectors—Liquor Inspectors—etc. Those wishing these positions should qualify at once.

Get Free List of Positions

Fill out the following coupon. Tear it off and mail it today—NOW, at once.

Although not government sponsored this investment can result in your getting a big paid government job.

FRANKLIN INSTITUTE, Dept. A-80, Rochester 4, N. Y.

Rush to me, entirely free of charge (1) a full description of U. S. Government Jobs; (2) Free copy of illustrated 40-page book, "How To Get A U. S. Government Job"; (3) List of U. S. Government Jobs; (4) Tell me what to do to qualify for one of these jobs.

Name.....

Address..... Vet?.....

Use This Coupon Before You Mislaid It. Write or Print Plainly.

I'm sure the designer thereof underestimated its capabilities or he would have patented it. It is bound to be a godsend to all who are hard pressed by the high cost of living.

Just think! All you have to do is build the set, tune in your favorite ham, wait till he cracks some yokes, and you have an ohmlet. Political speeches will supply bologna, applesauce, or even "pie in the sky."

CLYDE A. ARMS

Brooklyn, N. Y.

Smaller, Faster Workhorse

Sir:

The truck pictured in the upper left corner of p. 122 of your November issue, in the article "Army Breeds New Line of Combat Workhorses," looks more like the descendant of a GI 1½-ton truck than of a 2½-tonner. The 2½-ton truck, according to the way we saw them in France, had dual rear wheels and a rear compartment almost high enough to accommodate a man standing.

EUGENE H. MITCHELL

Dallas, Tex.

The fact that the new 2½-ton truck is smaller and faster than its wartime ancestor, yet carries the same load, points up the improvements resulting from the Army's "selective breeding." Physically, the new 2½-tonner does resemble the old 1½-ton truck. It also resembles the new 1½-ton model, except that it has a longer wheelbase and a longer bed.

Credit Where Due

Sir:

The Hypro® planer described on p. 113 of your November issue, in the short article titled "Wing Trimmer Pares Pounds," is manufactured by the Cincinnati Planer Co., a wholly owned subsidiary of the Giddings & Lewis Machine Tool Co.

S. L. LITTLE,

Giddings & Lewis Machine Tool Co.

Fond du Lac, Wis.

The information erroneously crediting development of this tool to another manufacturer of similar name was furnished to our Western Editor by North American Aviation, Inc., in whose plant our photo showed the planer being used.

How to Build—at a Price that will Make You **GASP!**

50,000 Now Letting This Book Build for Them—You, Too, Can Find Out **FREE** How to Plan, Buy, or Build! Get Top Quality—Save **HUNDREDS!**

Free 7 DAY TRIAL

Just Mail Coupon

When a Texas man who never built before, writes this "building instructor" helped him to "build his own . . ." when an experienced architect writes "the best book on building for the average man . . ." When hundreds of schools, colleges, universities rapidly replace old-time textbooks with this amazing volume. . . Then you, too, ought to have this book at your elbow! We have proof—a cabinet full of letters from people who are beating high costs, getting first class construction—their money's worth **NOW, today.** Let "How to

Build A Better Home" prove without risk, that it can tackle any building or remodeling job. Let it work with you on the job. Let it solve problems as they come up. Best of all, let it do all this, without risking a cent!

Some of the Things This Book Explains:

Here at Your Fingertips, the Secrets that Produce Fine Small Homes—Completely Revealed in this Great-Easy-Reference Book! How to Get Started; Deciding Upon Home Ownership; How to Select Professional Service; How to Finance Your Home; How to Select a Building Lot; How to Plan the Home; Where to Get Stock Plans; Taxes, Insurance, Interest, Maintenance, Assessments; How to Choose a Bank, Real Estate Dealer, Contractor; Locating House on Lot, Tax Searches, Comparative Costs, Designs; Prefabricated Houses; How to Fill Out Contract Documents; How to Obtain Good Construction; How to Prevent Termites; How to Prevent Decay; How to Prevent Corrosion; How to Lay Out Building, Excavate, Grade; Monolithic Concrete Construction; Masonry Construction; Footings for Foundation Walls, Chimneys, Piers; How to Build Piers, Foundation Walls; Basement Construction; How to Waterproof Basements and Foundation Walls; How to Build Chimneys and Fireplaces; How to Select the Proper Species and Grades of Wood; House Framing Methods and Details; Finish Carpentry and Millwork; How to Insulate; Sheet-Metal Work, Roofing, Stucco, Lath and Plaster; How to Paint and Finish; Tile Work, Electrical Work, Plumbing, Heating; **List of Over 100 Free Publications for the Home Builder;** Bungalows, List of Usual Mistakes; Architectural "Don'ts" and over 300 additional paragraphs of important information. **QUICK REFERENCE INDEX to SPECIAL PAGE-SIZE PLATES (HUNDREDS OF ILLUSTRATIONS)**

Footings—foundation walls—basements; Garage floor, footings, etc.—septic tank—grease trap—area for basement window; Concrete porches, steps, automobile runways and driveways and walks; Brick steps, walks and terraces; Brick, tile and stone wall details—flagstone and stepping stone walks; Masonry dwellings—brick veneer walls; Chimney and fireplace details; Balloon framing details (minimum-shrinkage type; Balloon framing details (box sill type); Roof framing details; Basement columns and girders—framing of openings—bridging; Miscellaneous framing details; Water-tables—exterior sidewalls of siding or shingles—cornices—porch columns; Double-hung wood window details; Door frame details—points for millwork—stock doors and windows—sash details; Paneling—stairwork—base-board details; Termite shields—miscellaneous flashings; Flashing details; Gutters and leaders (downspouts); Roofing details.

Nothing Like It Before! One Simple Fact May Repay you a HUNDRED Times its Small Cost. A Book You Will Refer to for Years to Come!

Read What Great Building Authorities Say About This Amazing Book (names on request)

Excerpts from typical letters of praise:
 ". . . the best book on the subject that has been published to date." . . . "was thrilled" . . . "valuable information for the new home-builder."
 ". . . an excellent piece of work" . . . "helped us decide our building plans" . . . "well worth price."
 ". . . very much impressed . . . an excellent reference book."
 ". . . the writing is clear and compact . . . complete and unbiased information."
 ". . . most interesting and complete." "You are to be congratulated. Contains more information than any volume seen . . . Everything you said."
 ". . . One of the best works of its kind I have ever seen. Send me 10 more for presents."
And from an amateur:
 "From this book, I did the plans myself! Had never done anything like it before . . . A neighboring architect said I was an up-and-coming designer and he found not one fault with my plans. . . The building is now finished and everyone says it's beautiful! . . . I saved \$1900!"

Honest-To-God Practical Guide Book

We will pay you **QUADRUPLE** if you can beat it. If Undecided Whether To Build or Buy—If Leery of 'Cheap' Building, Shoddy Work, Poor Design—If Fed-Up With DREAMING About Your New House and Want To Get Started—Then This Will Prove a **GOD-SEND** to YOU. Here is the answer to how to build. The **WORKS**—how to plan, construct, supervise—simply, clearly explained step-by-step. Jam-packed with everything you need to build your own, or have a contractor build it. Hundreds of clear-cut, **COMPLETE** diagrams. Amaze everyone! Read it **FREE AT OUR RISK!**

EVERYTHING YOU NEED to KNOW to GET STARTED

All the facts. Whether you spend \$2,000 or \$20,000—whether you employ an architect or use stock plans—or are going to buy instead of build, this book will help you. Before you build know the difference between good and bad. Now—save hundreds of dollars. Get a thrill out of being "in the know," "wise" to the game. Talk building language. Be respected, admired, get better workmanship, a feeling of pride as your friends admire the home being built.

Where to Begin

No matter what your problem, you will find the answer in this amazing volume. No truth is kept from you. You are told disadvantages as well as advantages. You are told of precautions to safeguard your investment, how to select a lending institution, lawyer, real estate dealer, architect, contractor. Discusses methods of buying fully. Glance at the partial table of contents on this page for some of thousands of **FACTS** on building which this volume contains. Those who have bought a copy write they have never seen so thorough a work on this subject for **ANY PRICE, ANYWHERE!**

Hundreds of Construction Details

Explains "mysteries" of permits, contracts, construction, how to build the right kind of home. Avoid cracker-box construction, get house suitably located, beautiful, priced right.

How To Build — from Plans To Paint Not one important step missing. See for yourself.

SEND NO MONEY Let It Build for You, Too, 7 Days FREE!

Don't risk a cent to examine "How to Build a Better Home." Just mail coupon. Study it for a week. **FREE!** See how easy it is to supervise or build, **YOURSELF**—even if you know **nothing** about construction **NOW!** Then, if **THRILLED**, send only \$3.98 (plus postage). If not thrilled, return book and pay nothing! This is your chance to build not just a house, but a **BETTER HOME!** Mail **FREE EXAMINATION COUPON** NOW to Westport Publishing Company, Dept. SP-2, Westport, Conn.

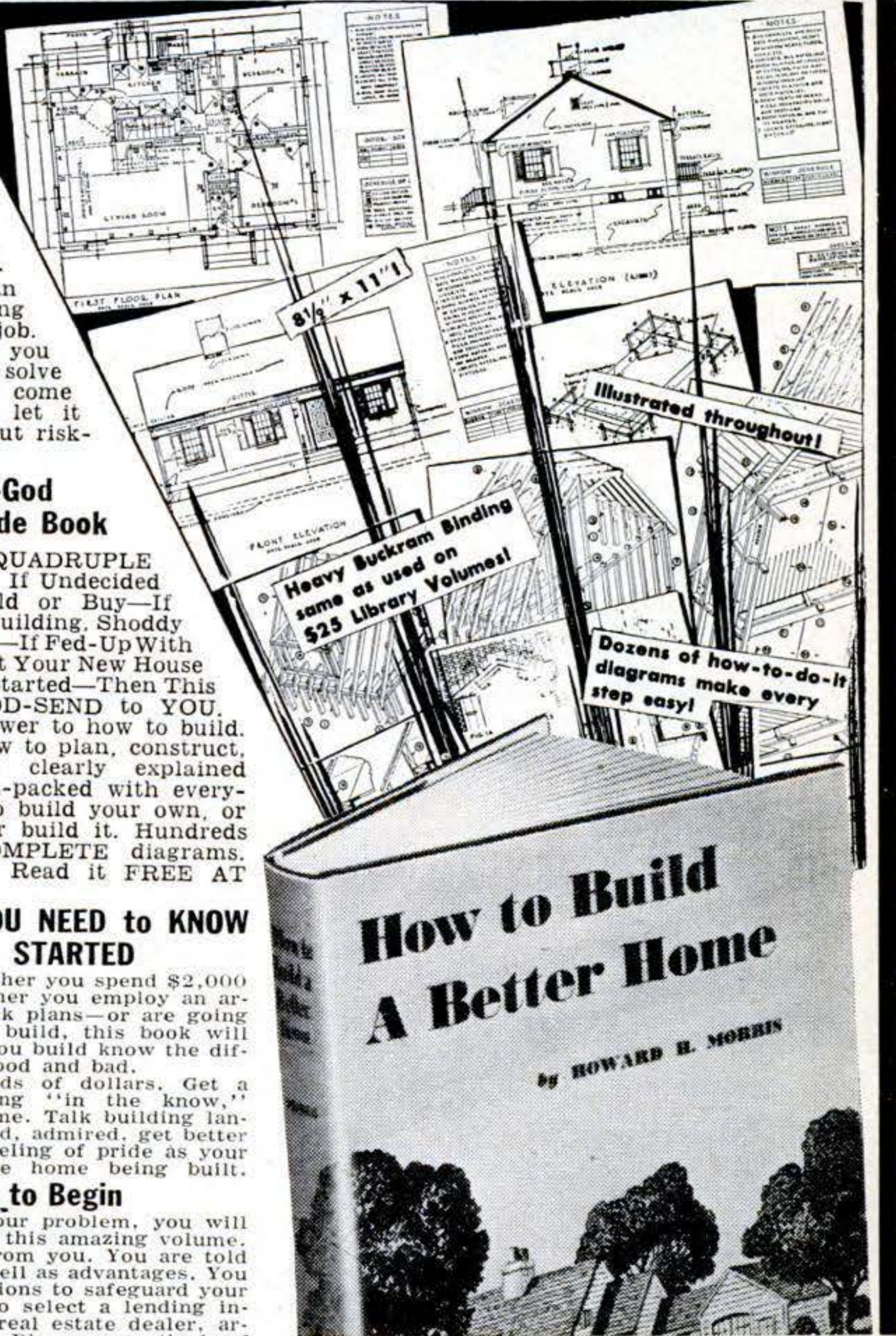

Heavy Buckram Binding same as used on \$25 Library Volumes!

Dozens of how-to-do-it diagrams make every step easy!

How to Build A Better Home
 by HOWARD H. MORRIS

FREE Examination Coupon—Mail Now

The Westport Publishing Company, "Books of Merit," Dept. SP-2, Westport, Conn. Please send me, for one week's **FREE EXAMINATION**, a new de-luxe edition copy of "How to Build a Better Home." After 7 days I will either return this book and owe nothing, or I will keep it and send you \$3.98 (plus shipping charges). (In two monthly payments, if I wish.)

Name Age
 (please print)

Address

City & Zone State

Save postage. Check here if you enclose full payment of \$3.98 (check or money order) WITH coupon. WE then pay shipping. If not thrilled return and we will refund your money by **AIR MAIL!** Foreign Orders \$4.50 Cash with order.

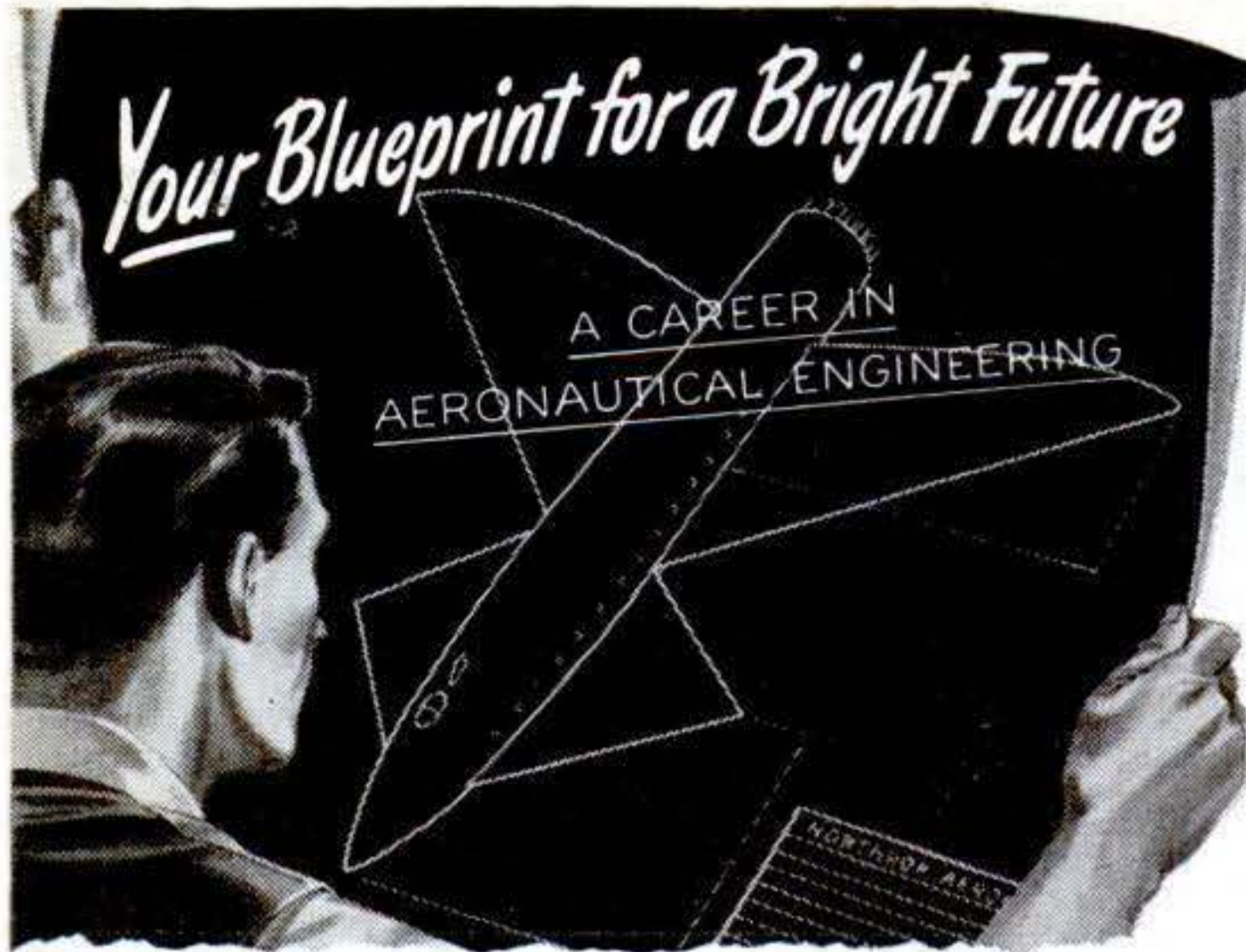

Blueprints guide the great aerial parade of spectacular new planes and aircraft power plants. Back of those blueprints is the *Aeronautical Engineer*. His original ideas, creative talents, technical knowledge, and professional skill produce the improved designs and new aircraft that give wings to the great *Air Age*. A career in the fascinating profession of *Aeronautical Engineering* can be *YOUR blueprint for a bright future*.

Lifelong Adventure — and Rich Rewards

Besides fascinating duties, you enjoy these practical rewards — good pay from the start . . . wide-open opportunity for quick advancement . . . the satisfaction of putting your own original ideas into action . . . the security of a field already huge, and still growing. *Northrop* graduates are enjoying these rich rewards, throughout *Aviation*. Hundreds hold good jobs with ALL leading aircraft manufacturers and airlines.

You are already IN *Aviation* when you train at *Northrop*. You enjoy many important practical advantages, such as illustrated by the training scenes at left and below . . . with many "live" aircraft giving *Northrop* students first-hand knowledge of aircraft construction and power-plant installation . . . and with actual aircraft



design projects providing advance experience in engineering duties. Get full details in the big, profusely illustrated Institute catalog. Classes start every 8 weeks—you can start *YOUR* training soon.

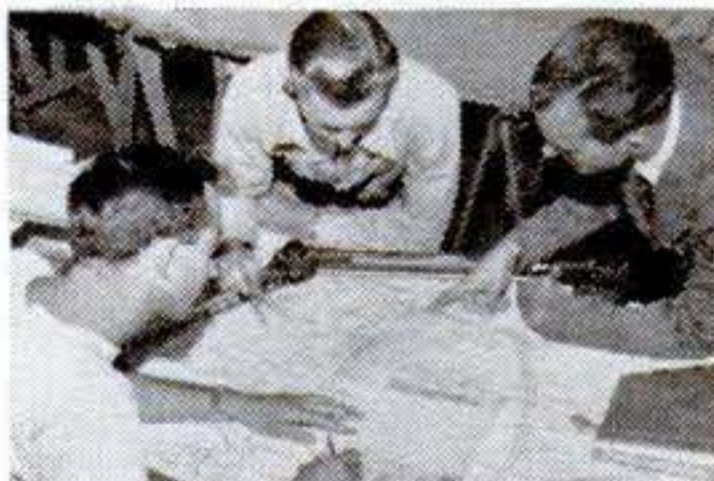

Send Coupon for this Catalog NOW
APPROVED FOR VETERANS

Northrop Aeronautical Institute
Division of Northrop Aircraft, Inc.
1525 EAST BROADWAY, HAWTHORNE, LOS ANGELES COUNTY, CALIFORNIA

NORTHROP AERONAUTICAL INSTITUTE
1525 East Broadway, Hawthorne, Los Angeles County, Calif.
Please send information on opportunities in Aeronautical Engineering, your catalog, and starting dates of classes. I am interested in:
 Aeronautical Engineering Aircraft & Engine Mechanics

Name _____ Age _____
Address _____
City _____ Zone _____ State _____
Check one, Veteran Non-Veteran

5 YEAR WRITTEN GUARANTEE
BULOVA 15 JEWEL

ONLY **\$14.95**
Plus \$1.50 Tax

ORIGINALLY SOLD AS HIGH AS **\$59.50**

Also Choice of
• BENRUS
• LONGINES
• WALTHAM
• or ELGIN
WATCHES

CHOICE **\$14.95**

Genuine Bulova, Benrus, Longines, Waltham, Elgin and other famous wrist watches in latest style Yellow Gold Cases. You get these unredeemed 5 year guaranteed lifetime quality famous make watches now at truly enormous savings because we bought out SURPLUS STOCKS of leading New York and Maryland Jewelers. Order now, while they last. State make preferred. Order men's or ladies.

15 or 17 JEWEL WRIST WATCH
Waterproof, Shockproof with Swiss Precision Movement. Originally \$30;
OUR PRICE NOW \$9.95 plus \$1 tax.

TRIAL OFFER! WEAR AT OUR RISK!
Money Back In 5 Days If Not Delighted!
SEND ONLY \$1 down payment with order. Pay balance to postman on arrival, plus postage. Or we pay postage if you enclose \$14.95, plus \$1.50 tax. Handsome Expansion Band included with prepaid orders. Order now.

MARYLAND DISTRIBUTORS, Dept. 24
501 E. Baltimore St., Baltimore 2, Md.

FREE FOLDER!
America's best Watch and Diamond Ring Values. Wholesale prices to user direct.

Learn ACCOUNTING BOOKKEEPING

This nationally renowned school has demand for graduates in good salary positions thru Nationwide recognition and placement service. Write Department PSM today for Big 32 page Success Book to be sent to you **FREE**

Hills BUSINESS UNIVERSITY AND EXTENSION SCHOOL
619 W. MAIN ST. OKLAHOMA CITY 2, OKLAHOMA

Hobbyist Catalog

64 pages

WE PAY POSTAGE!
SHIP MODELS . . . TRAINS . . . PLANES
Cars . . . Art Supplies . . . Tools . . .
Project . . . Games.
U.S.A. and Canada Orders Only.

10¢ write **Braun-Craft**
1232 ETOWAH, DEPT. PS-7A, ROYAL OAK, MICH.

Ball-Bearing SPEED WHEELS

Juvenile Wheels (No bearing, solid tires)
4"40c 6"65c
5"45c 8"75c
(Semi-pneumatic tire, ball bearing)
8 x 1.25.....1.85 10 x 1.25.....2.20
8 x 1.75.....1.95 10 x 1.75.....2.30
8 x 22.20 10 x 2.00.....2.65
12 x 1.75.....3.45

INDUSTRIAL WHEELS
Lug Base, Semi-Pneumatic tire
5 x 1.75.....3.65 10 x 2.00.....6.10
6 x 2 SW3.45 10 x 2.75.....5.15
6 x 2.00.....4.00 12 x 2.00.....6.90
8 x 2.00.....5.20 12 x 3.00.....9.20
8 x 2.50.....5.40 16 x 4.00.....15.15
Smooth Base, Pneumatic tire and tube
8 x 3.00.....11.00 12 x 4.00.....12.10
10 x 2.75.....6.80 4.00 x 8.....13.10
10 x 3.50.....10.55 14 x 4.50.....13.40

Dealers, Jobbers, and Manufacturers! Our new prices will interest you.

Available Now—CASTERS
Write for circulars on all wheels.
No c.o.d. orders. Prices F.O.B. our plant.

JIM BROWN TOY COMPANY
1093 Home Ave. Akron 10, Ohio

Let me send you this amazing- ELECTRONIC KIT!

OWN THIS ELECTRONIC KIT

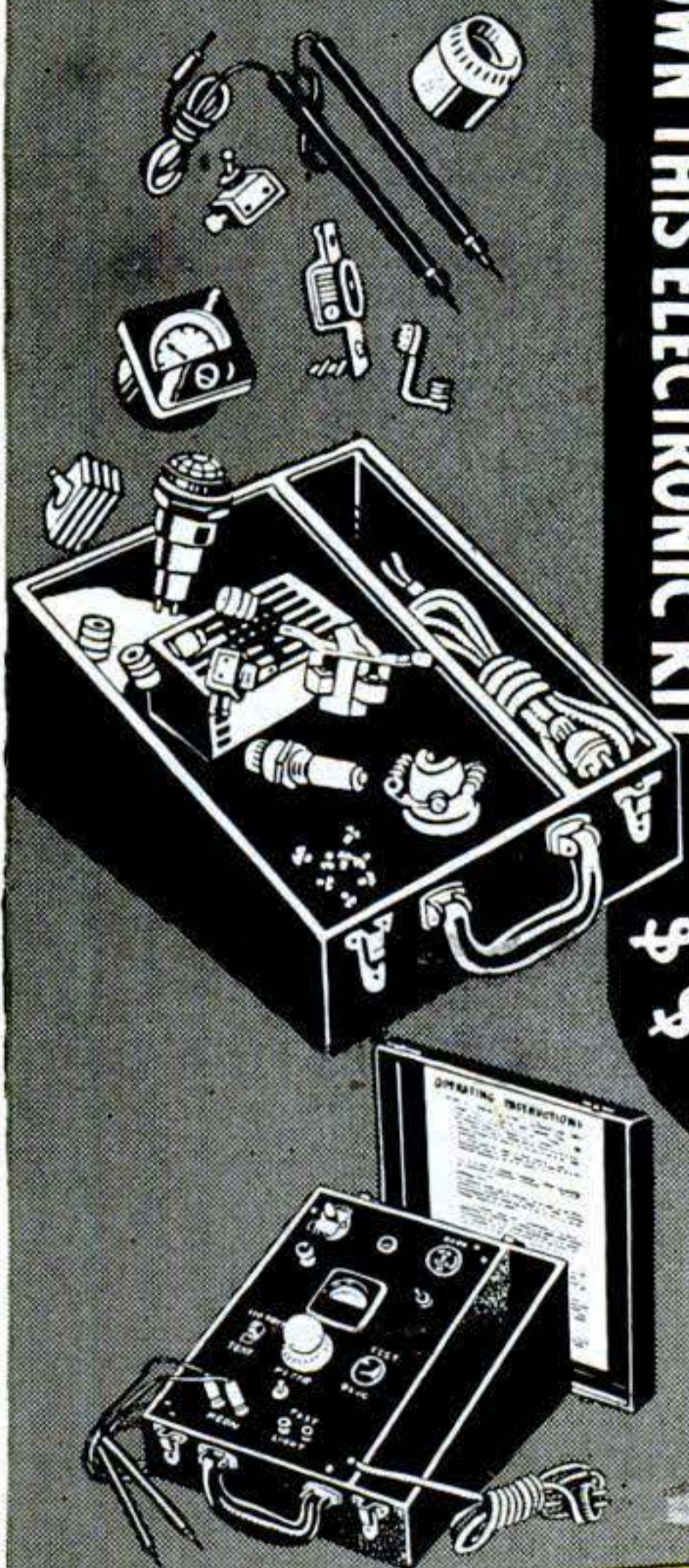

ESTABLISH YOUR OWN BUSINESS Assure Financial Security—Independence

The "CHRISTY" Electronic Kit checks and tests the current consumption, heat controls, shorts, motor winding, etc. of electrical equipment and reveals just where repairs are needed! Electrical Appliance Repairing and Equipment Servicing is a fascinating, big money-making business. There are millions of appliances in constant use. All will eventually need repairs. Thousands of new electrical appliances and equipment are sold daily. These unlimited prospects mean you will always have places to do profitable jobs. If you are mechanically inclined (can hold and use tools) you can qualify for this big, steady-paying field. It is not unusual for electrical repairmen to charge on the basis of \$5.00 to \$6.00 an hour! Whether you want a lifetime business of your own, a better factory electrical maintenance job or additional earnings for spare hours, you will want the Christy ELECTRONIC KIT.



S. T. Christensen

REPAIR ELECTRICAL EQUIPMENT!

NEW SHOP METHOD HOME TRAINING

You learn practical and advanced electricity, at home, in your spare time, building time saving testing kits. Gaining technical electrical knowledge by working with your hands! CTS gives you service manuals written in simple, easy-to-understand language, filled with hundreds of photographs and drawings. Shows where to look for trouble. How to quickly fix it. What to charge. How to get new and repeat business. Shows how to weld, nickel plate, etc. Gives complete "Fix-it-Shop" knowledge for making additional side line dollars.

PAY FOR TRAINING FROM EARNINGS

Make money right from the start! Many students report paying for entire course while still learning.

FREE BOOK SENT



3 EASY STEPS TO SUCCESS

- 1 WE SEND YOU AN ELECTRIC KIT
- 2 WE TEACH YOU ELECTRICAL APPLIANCE REPAIRING
- 3 WE GIVE YOU LIFE-TIME ADVISORY SERVICE

RUSH THIS COUPON TODAY!

CHRISTY TRADES SCHOOL, Dept. D-8701
4432 N. Kedzie Ave., Chicago 25, Ill.

Mail me FREE, without any obligation, illustrated book on Electrical Appliance Servicing. Also, how I can get the "CHRISTY" ELECTRONIC KIT and the CHRISTY REPAIR MANUALS. Include special form for "Paying for them From Earnings while Learning."

NAME..... Age.....

ADDRESS.....

CITY..... Zone..... State.....

INVENTORS

If you consider your invention to be something of importance—if you have invented any new and useful art, machine, manufacture or composition of matter or improvement thereof—you are advised to protect your invention by applying for a U. S. patent.

A patent is a valuable right. It grants you a monopoly—the right to exclude others from making, using or selling your invention as claimed for a term of seventeen years.

The specification and claims of a patent, particularly if the invention be at all complicated, constitute one of the most difficult legal instruments to draw with accuracy. Therefore, unless you are thoroughly familiar with such matters, you are advised to employ a competent registered patent attorney or agent.

This firm is registered to practice before the U. S. Patent Office and is available to assist in the preparation and prosecution of your patent application.

The "Evidence of Invention" form mentioned below is offered as a convenience to you in making your disclosure to us for search purposes.

You should date and sign your disclosure and have it witnessed by two or more persons who are capable of understanding your invention.

Your disclosure should be mailed to us together with a letter authorizing us to conduct a preliminary

search among previously granted U. S. patents for similar types of invention.

We then make this search and prepare a report of the probable patentability of your invention. If such report is favorable, we recommend the further course for you to take.

The "Evidence of Invention" form and booklet are suggested as conveniences to you and us in starting action on your invention.

VICTOR J. EVANS & Co. *Merlin M. Evans*
REGISTERED PATENT ATTORNEY
540-B MERLIN BUILDING, WASHINGTON 6, D. C.

We shall be glad to send you promptly and without obligation, an instructive booklet, "Patent Protection for Inventors", which was prepared to give inventors detailed information and steps to take toward patent protection—also our convenient "Evidence of Invention" form. Use address Victor J. Evans & Co., 540-B Merlin Building, Washington 6, D. C.

PATENTS COPYRIGHTS TRADEMARKS

WE CAN TEACH YOU TO MOUNT BIRDS

GEE, BILL, THIS SQUIRREL ACTUALLY LOOKS ALIVE. ALL THE FELLOWS THINK YOUR DEN IS GREAT.

IT'S EASY, FRED, ONCE YOU GET THE HANG OF IT. I LEARNED BY MAIL IN MY SPARE TIME. TAXIDERMISTRY IS THE GRANDEST HOBBY IN THE WORLD—AND PROFITABLE, TOO. IN FACT, THIS OWL BOOK-END IS FOR A CUSTOMER. FRED, WHY DON'T YOU WRITE TO THE NORTHWESTERN SCHOOL FOR THEIR FREE BOOK?

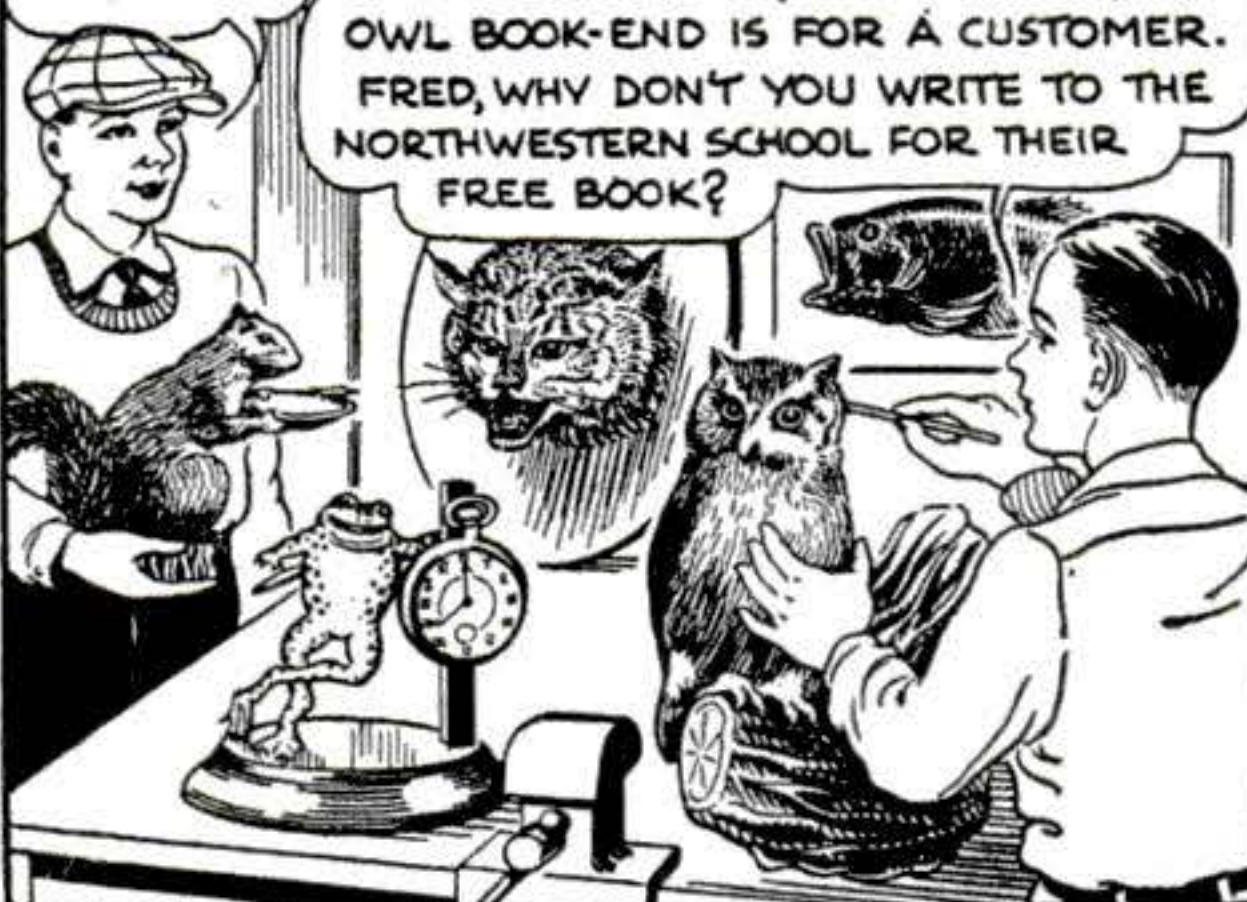

FUN - FASCINATION - PROFIT

Be a Taxidermist. New Profitable business. Learn quickly at home, to MOUNT life-like Birds, Animals, Game-Heads, Fish. Save your valuable trophies. Decorate your home and den. Learn genuine Chrome Tanning for harness and sole leather, buckskin and fine furs. Mount Common specimens, squirrels, rabbits, owls, even frogs, into marvelous craft-work groups, both useful and humorous. Wild-game not necessary. Send Today for Free Book!

BIG PROFITS Turn your spare time to cash. Have a side-line profitable business. Mount game trophies for sportsmen; sell your own mounts; save money and Make Money with expert tanning. Learn by mail from old reliable school, with 400,000 graduates. Investigate Today.

FREE BOOK 48 pages, very interesting, 100 beautiful GAME PICTURES. Tells how YOU can become a taxidermist. Absolutely FREE if you send at once. Write for YOUR copy TODAY—THIS MINUTE. State your AGE.

N. W. School of Taxidermy, 2602 Elwood Bldg., Omaha, Neb.

Send for Free Book Now!

HIGH SCHOOL

AT HOME—IN SHORTEST POSSIBLE TIME

Course prepares you for College entrance, professional schools, and personal advancement. Diploma awarded. Why be handicapped all your life when you can become a High School graduate with so little effort? Write for free prospectus. See what High School training did for so many of our graduates—what it can do for YOU. Residence course approved for veterans.

ACADEMY FOR ADULTS, Dept. 12
30 W. Washington, Chicago 2, Illinois

LEARN IN SPARE TIME— CARTOONING

by Easy PICTURE CHART METHOD!
Same Simplified Method that has helped train creators of "Steve Canyon," "Winnie Winkle," "Out Our Way," "Secret Agent X-9," "The Neighbors," "Reg'lar Fellers," "Strange As It Seems," and many others. Send 10c for Picture Chart (to test your ability), and full details. (State age.)
LANDON SCHOOL OF CARTOONING
5022 Cleve. Transit Bldg., Cleveland 14, Ohio



Command Bigger Money! STUDY LAW

STUDY AT HOME for BUSINESS SUCCESS and LARGER PERSONAL EARNINGS. 40 years expert instruction—over 114,000 students enrolled. LL.B Degree awarded. All text material furnished. Easy payment plan. Send now for FREE BOOK—"Law and Executive Guidance." It explains the course—how you may enroll and the many ways you may profit from Law Study. Write TODAY to:

AMERICAN EXTENSION SCHOOL OF LAW
Dept. 23-PS, 646 N. Michigan Ave., Chicago 11, Ill.



I MADE
\$14 PER DAY
While still learning!

T. E. H.—WEST VIRGINIA



I MADE
\$800 IN 3 MONTHS
While taking your course!

F. V.—NEW YORK

Get into the **ELECTRIC APPLIANCE
REPAIR & SERVICE BUSINESS**

SPARE OR FULL TIME. Want a good-paying business—a job in a fast-growing industry? Learn electrical appliance repair and service. I will teach you this interesting, good-paying business. The EASY step-by-step home study method, taught by PTS, prepares you NOW to reap lush profits to be made in this unlimited field. Have YOUR OWN BUSINESS—spare or full time—prepare for one of the many openings for trained men.

ACT NOW. Millions of new appliances in homes—millions of new homes being wired for electricity assures hundreds of customers in nearly every neighborhood.

EASY TO LEARN. Men of all ages, yes, even the man of 69 can get into this ever expanding field—a business well suited to men who like to use their hands—a REAL OPPORTUNITY for the practical man who is not happy in his present job. Get started NOW—send for FREE BOOK giving all details.

I SEND
YOU A
**BIG KIT
of TOOLS**
at No
Extra
Cost



H. T. ARMSTRONG

HERE'S MY
PLAN FOR
YOUR
SUCCESS

Big Book
Containing
All The
Details of My Plan
For Your Success.



SEND FOR
THIS
FREE BOOK

OPEN YOUR OWN SHOP

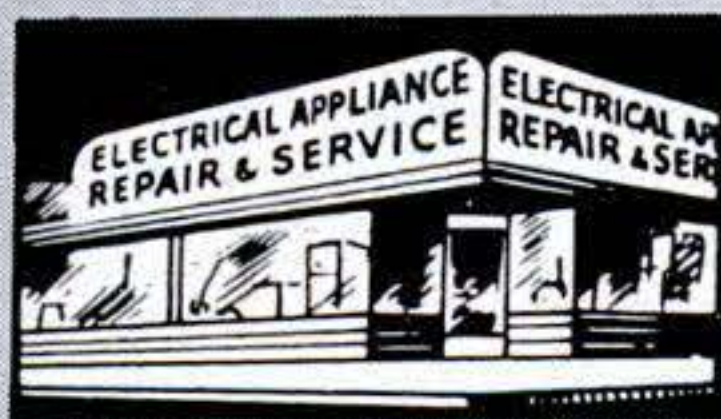

As soon as you enroll, I send you my New Book "How To Open Your Own Business" at no extra cost. PTS training is more than a home study course in electric appliance repair and service. It gives you the "know

how" on the operation of your shop from a business standpoint: What to charge, how to get customers. Everything possible is done to start you on the road to success.

EARN WHILE YOU LEARN. You can actually start earning before your course is finished. I send you your first lesson showing you easy jobs that can be done in your SPARE TIME AT HOME. Remember, one good repair job will pay for the cost of your course. NO BIG OVER-HEAD needed. Start in your garage, basement, attic or spare room. When you are ready to expand, I will give you the benefit of my advice and experience.

WE TEACH YOU:

How to repair:
Washing Machines, Vacuum
Cleaners, Ranges (gas and
electric), Auto electricity, Irons,
Motors, Garbage Disposal
Units, Fluorescent Lights, Elec-
tric Shavers, Refrigeration,
House Wiring.

**AT HOME IN YOUR
SPARE TIME OR FULL TIME**

MAIL THIS COUPON TODAY

**H. T. ARMSTRONG
PACIFIC TRAINING SCHOOLS**
7219 So. Broadway, Dept. S-502, Los Angeles 3, Calif.
Dear Sirs: Please send me, without obligation, your free
booklet and complete details.

Name _____

Address _____

City _____ Zone _____ State _____

Which of these 2 one WEAKLINGS PAID only a Few Cents to become an "All-Around" HE-MAN at Home?



Which One Paid Hundreds Of Dollars To Train At My Side? Rex Ferris, was a skinny weakling, paid a few cents to start building into a Champion All Around He Man! Larry Campbell paid me hundreds of dollars to train at my side years ago. Start to become an All-Around He Man at home with these same secrets for only a few cents—like Rex Ferris did!

Amazing get-acquainted offer—YOURS for only

10c

INSTEAD OF \$1 FOR ALL 5 COURSES Plus FREE Photo Book!

"The Jowett System is the greatest in the world!" says R. F. Kelly, Physical Director, Atlantic City

Be a Winner at Anything YOU Tackle with Progressive Power SPORTS! JOB! SCHOOL! FRIENDS!

Let's Go, Pal! I'll prove I can make YOU an

"ALL-AROUND" HE-MAN

FAST—OR NO COST! says George F. Jowett World's Greatest Body Builder

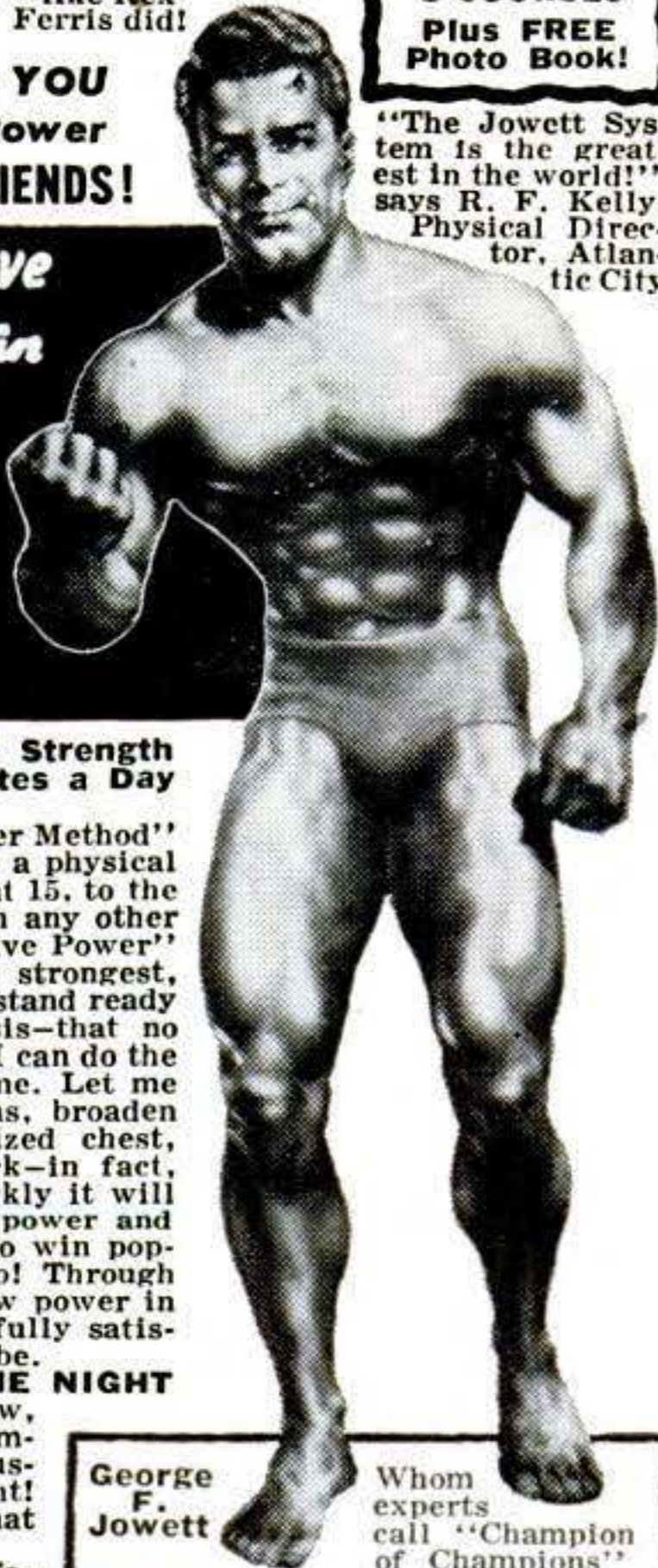

George F. Jowett

Whom experts call "Champion of Champions"

- World's wrestling and weight lifting champ at 17 and 19.
- World's Strongest Arms. • 4 times World's Perfect Body—plus other records.

Enjoy My "Progressive Power" Strength Secrets! Give Me 10 Easy Minutes a Day—Without Strain!

I'll teach you the "Progressive Power Method" through which I rebuilt myself from a physical wreck the doctors condemned to die at 15, to the holder of more strength records than any other living athlete or teacher! "Progressive Power" has proven its ability to build the strongest, handsomest men in the world. And I stand ready to show you on a money back basis—that no matter how flabby or puny you are, I can do the same for you right in your own home. Let me prove I can add inches to your arms, broaden your shoulders, give you a man-sized chest, powerful legs and a Rock-like back—in fact, power pack your whole body so quickly it will amaze you! Yes, I'll jam you with power and confidence to master any situation—to win popularity—and to get ahead on the job! Through my proven secrets I bring to life new power in you inside and out, until YOU are fully satisfied you are the man you want to be.

PROVE IT TO YOURSELF IN ONE NIGHT

Send only 10c for my 5 easy-to-follow, picture-packed courses now in 1 complete volume "How to Become a Muscular He-Man." Try it for one night! Experience the thrilling strength that surges through your muscles. 10 DAY TRIAL! Think of it—all 5 famous courses in one picture-packed muscle-building volume only 10c. You must actually FEEL results in ONE WEEK, or your money will be promptly refunded!

FREE!

Photo Book of Famous Strong Men!

HOW TO MOLD MIGHTY LEGS

HOW TO MOLD A MIGHTY BACK

HOW TO MOLD A MIGHTY ARM

HOW TO MOLD A MIGHTY CHEST

How to BECOME A MUSCULAR HE-MAN

with these 5 Complete Courses on Molding: 1. A Mighty Arm 2. A Mighty Grip 3. A Mighty Chest 4. A Mighty Back

FREE GIFT COUPON!

Jowett Institute of Physical Culture Dept. PS-02 230 Fifth Avenue, New York 1, N. Y.

Dear George:—Please send by return mail, prepaid, FREE Jowett's Photo Book of Strong Men, along with all 5 Muscle Building Courses. 1. Molding a Mighty Chest. 2. Molding a Mighty Arm. 3. Molding a Mighty Grip. 4. Molding a Mighty Back. 5. Molding Mighty Legs—Now all in One Volume "How to Become a Muscular He-Man." Enclosed find 10c for postage and handling. No C.O.D.'s.

George F. Jowett Champion of Champions

Name _____ Age _____

Address _____

LOWEST PRICE EVER

FOUR COLOR MECHANICAL PENCIL



ONLY **\$2.98**

THIS TYPE OF PENCIL USUALLY SELLS FOR

\$4.50- \$6.98

Never before at this low price—the repel-propel mechanical pencil that lets you write in red, blue, green or black! A flick of the thumb instantly changes the color of the lead. Light weight, beautiful chrome finish, fully adjustable—visible color indicator—non slip clip . . . special lead holder prevents lead breakage . . . comes with soft eraser and extra standard red, blue, black and green leads. Ideal for executives . . . engineers, architects, artists, draftsmen, editors, accountants, advertising people, students.

FULLY GUARANTEED . . . SATISFACTION OR YOUR MONEY BACK. SEND NO MONEY. PAY POSTMAN \$2.90 plus postage. If you send \$2.98 on our unconditional money back guarantee, we pay the postage.

STUDWELL PRODUCTS COMPANY, Dept. 200 70 East 45th St. New York 17, N. Y.

NEW! BIG FIELD FOR PROFIT AND PLEASURE COPPER TOOLING & ETCHING

EARN BIG MONEY—SPARE OR FULL TIME No Experience needed—start at once. BIG MONEY waiting in COPPER ART field. Plaques, Bowls, Trays, Gifts, Souvenirs of all kinds. Start on the road to success NOW! Here is an opportunity to get started in your own Big Paying Business—FREE DETAILS don't wait—WRITE NOW! **HOLLYWOOD COPPER ART STUDIOS** 4257 Beverly Blvd. Dept. PS-2 Los Angeles 4, Calif.



LEARN LANDSCAPING

Profitable career—absorbing hobby for men and women! Thorough home-study course in landscaping, garden design. 45 lessons beautifully printed and illustrated. Learn in spare time 8-12 months. Hundreds of successful graduates all over the world. 34th year. Write for Free Catalog.

AMERICAN LANDSCAPE SCHOOL 6568 Grand Ave. Des Moines 12, Ia.

LEARN TO HYPNOTIZE



Yes, anyone. Modern speed hypnotism. Methods revealed. You are told exactly what to say and do. Many interesting experiments. Self-hypnosis fully explained. Private & class instruction available.

Send for Hypnotism Revealed \$1

12" Hypnotism Record inducing Self-Hypnosis plus Individual & Group-Hypnotism . . . \$5

MELVIN POWERS, Professional Hypnotist, 1324 Wilshire, Dept. 64, Hollywood 14, Calif

BE AN AUTO MACHINIST



Draw Top Pay • No Job Worries

Earn more money in auto mechanics—Specialize! New FREE booklet tells how to prepare for good jobs with high pay and job security. Our modern equipment and practical instructions make it easy to learn—get experience in:

ENGINE REBUILDING or GENERAL AUTO MECHANICS

VETERANS American is a G.I. approved school.

Job Placement Service FREE

WRITE TODAY FOR **FREE BOOKLET**

AMERICAN TRADE SCHOOL 2407 McGee Kansas City, Mo.



YOU UNIVERSITY TRAINING

KEY TO SUCCESS IN BUSINESS AND INDUSTRY

Air Conditioning and Plumbing Courses

Air Conditioning
Heating Plumbing
Refrigeration
Steam Fitting

Chemical Courses

Chemical Engineering
Chemistry, Analytical
Chemistry, Industrial
Chemistry, Mfg. Iron
and Steel
Petroleum Refining
Plastics
Pulp and Paper Making

Civil Engineering, Architectural and Mining Courses

Architectural Drafting
Architecture
Building Estimating
Civil Engineering
Coal Mining
Contracting and Building
Highway Engineering
Lumber Dealer
Reading Structural
Blueprints
Sanitary Engineering
Structural Drafting
Structural Engineering
Surveying and Mapping

Communications Courses

Electronics Television
Practical Telephony
Radio, General
Radio Operating
Radio Servicing
Telegraph Engineering

Electrical Courses

Electrical Drafting
Electrical Engineering
Electric Light and Power
Lighting Technician
Power House Electric
Practical Electrician
Ship Electrician

Internal Combustion Engines Courses

Auto Technician
Aviation
Diesel-Electric
Diesel Engines
Gas Engines

Mechanical Courses

Aeronautical Eng'r's, Jr.
Aircraft Drafting
Flight Engineer
Forging Foundry Work
Heat Treatment of Metals
Industrial Engineering
Industrial
Instrumentation

Industrial Metallurgy

Machine Shop
Machine Shop Insp.
Mechanical Engineering
Mold-Loft Work
Patternmaking—
Wood, Metal
Reading Shop Blueprints
Sheet-Metal Drafting
Sheet-Metal Worker
Ship Drafting
Ship Fitting
Tool Designing
Toolmaking
Welding Engineering
Welding—Gas and Elec.

Railroad Courses

Air Brake
Car Inspector
Diesel Locomotive
Locomotive Engineer
Locomotive Fireman
Locomotive Machinist
Railroad Section Foreman
Steam-Diesel Loco. Eng.

Stationary Engineering Courses

Boilermaking
Combustion Engineering
Engine Running
Marine Engineering
Power Plant Engr.
Steam Engineering

Textile Courses

Cotton Manufacturing
Loom Fixing
Rayon Weaving
Textile Designing
Woolen Manufacturing

Business and Academic Courses

Accounting Advertis'g
App. Psychology
Bookkeeping
Business Administration
Business Correspondence
Business Law
Cert. Pub. Accounting
Commercial
Commercial Art
Cost Accounting
Federal Tax
First Year College
Foremanship French
Good English
High School
Higher Mathematics
Illustration
Industrial Supervision
Motor Traffic
Postal Civil Service
Retailing
Retail Bus. Mgmt.
Salesmanship
Secretarial
Sign Lettering
Spanish Stenography
Traffic Management

APPROVED UNDER THE G.I. BILL

IF YOU CAN READ AND WRITE
AND ARE WILLING TO STUDY
I. C. S. CAN TEACH YOU!

• Special service and attention are
always given to the student who may
need extra help in order to understand.

Coupon Brings Full Information

**The successful man DOES today what the failure
INTENDS to do tomorrow. Mail this coupon NOW!**

**INTERNATIONAL CORRESPONDENCE SCHOOLS
BOX 7647-M, SCRANTON 9, PENNA.**

Please send complete information on the following subject:

(Write above Technical, Business or Academic Subject in which you are interested.)

Name _____ Age _____

Address _____

City _____ State _____

Present Position _____ Working
Hours _____ A. M. _____ P. M.

Employed by _____

Length of Service in World War II _____

Enrollment under G.I. Bill approved for World War II Veterans.
Special tuition rates to members of the Armed Forces.

ARE YOU *NATURALLY* **INVENTIVE?**

**"Cash In" On Your Natural Talent
By Learning WHAT To Invent—**

2100 Inventions Needed Now!

TURN your talents into CASH! Invent the *simple* things that people need and want!

The Kiddie Kar brought its inventor a cool MILLION dollars. A 70-year-old grandmother made \$350,000 on an overall buckle. Others became independently wealthy by "dreaming up" the rubber pencil tip, the ordinary paper clip, the hair-pin, etc. YOU can cash in, too—if you concentrate your talent on the inventions that are really NEEDED!

The EASY Way to Get Started



\$250,000

\$135,000

Don't waste time and brain-work on something nobody wants! Find out **WHAT** to invent. A valuable book by Raymond F. Yates, noted science editor and inventor, lists and describes over 2100 PRACTICAL, money-making ideas that are crying aloud to be invented!

These 2100 ideas are the things *most needed and surest to make money*. They are listed under 34 different headings for quick reference: Electrical, Radio, Automotive, Agricultural, Building, Household, Clothing, Toys, Time-Savers, etc.

This book ALSO tells how to think inventively; how to PROTECT your ideas; how to develop an invention STEP-BY-STEP, etc.



\$100,000

\$1,000,000

SEND NO MONEY

FREE 5-DAY EXAMINATION

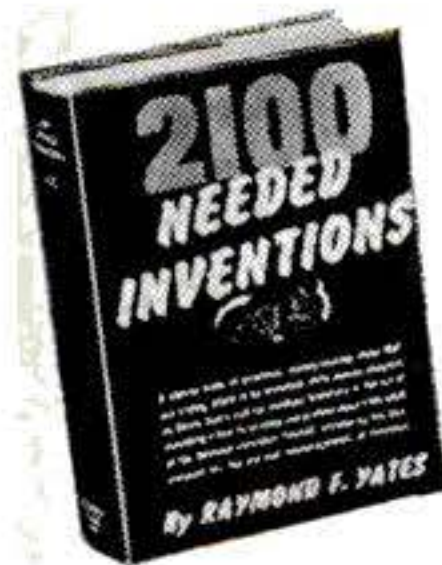

Would YOU like a slice of the \$280,000,000 that American inventors get *each year* in royalties? Get started *now!* Just mail the coupon and get "2100 Needed Inventions," by Raymond F. Yates, for 5 days' FREE trial. If, even in that short time, you are not convinced this book can help you make money—just return it and owe nothing. Otherwise, send only \$2.50, plus few cents postage, as payment in full.

Any one of the 2100 ideas in this book can bring *somebody* a fortune. Maybe it can be YOU! Mail the coupon and get

this book on FREE TRIAL *at once!* Wilfred Funk, Inc., Dept. T592, 227 East 44th Street, New York 17, N. Y.

**WILFRED FUNK, Inc., Publishers, Dept. T592,
227 East 44th Street, New York 17, N. Y.**

Please send me 2100 NEEDED INVENTIONS for FREE EXAMINATION. If I keep the book I will send you \$2.50 plus few cents actual postage. Otherwise I will return it within 5 days, without further obligation.

Name.....

Address.....

City..... Zone No. (if any)..... State.....

Check here if enclosing \$2.50 WITH this coupon, and we will pay all postage charges. Same 5-day return privilege, for full refund, applies. (Canadian Orders—25c extra for carrying charges. Only U. S. currency accepted.)

PRINT YOUR OWN POST CARDS

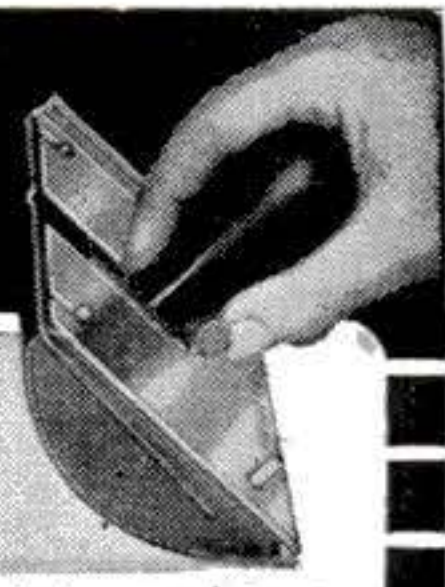

COMPLETE
OUTFIT
only
\$7.50

Amazing results in sales, inquiries and contacts... saves time and money... very easy to use GEM STENCIL DUPLICATOR is ideal for Advertising, Announcements, Notices, Labels, Forms, Price Lists—hundreds of uses for every type of business and organization. Comes complete with all supplies, instructions and 60-page Book of Ideas.

FREE TRIAL OFFER: Try it before you buy it! Write and a GEM OUTFIT will be sent you postpaid. After 10 days, send only \$7.50 or return the GEM, no questions asked. The GEM must sell itself; you be the judge.

**BOND EQUIPMENT CO. • Dept. 151
6633 Enright • St. Louis 5, Mo.**

SEND NO MONEY • FREE TRIAL OFFER

Freeland METAL BOATS

Rugged, low up-keep boats that feature electronic seam weld; spray rails; styro-foam safety floats; removable flooring.



Models from \$65.00.
Write Dept. 82
for folder, prices.

**GALVANIZES
STAINLESS
STEEL**

FREELAND SONS CO. Sturgis, Mich.

COMMERCIAL TRADES' GRADUATES GET THE BETTER JOBS because they are PROPERLY TRAINED!

Practical Shop Training In
Air Conditioning—Refrigeration
and/or

Electricity Major Appliances
Service, Maintenance & Installation

Write for Catalog PS4

COMMERCIAL TRADES INSTITUTE

200 South 20th St. Birmingham, Ala.

Member: Southern Association of Private Trade Schools
An approved school to TRAIN Veterans & Non-Veterans

MASTER SALESMANSHIP

IN 90 DAYS

UNLIMITED EARNINGS—NO UNEMPLOYMENT—NO AGE LIMIT
Simple—Complete—Home Study Course

N.M.S. DIPLOMA—AWARDED ON COMPLETION

Send for FREE OUTLINE of TRAINING PROGRAM

**NORTH
EASTERN MASTER SALESMANSHIP INST.**

210 FIFTH AVENUE, NEW YORK CITY 10

Save UP TO 25% ON QUALITY BALL-BEARING WHEELS

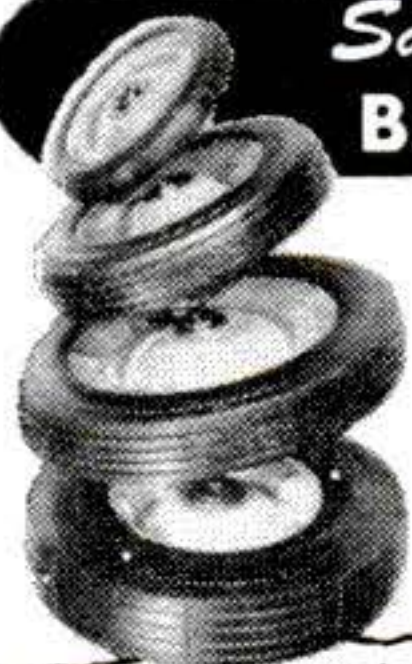

Bilt-Rite wheels roll smoothly and easily, are semi-pneumatic, ball-bearing, painted red; guaranteed top quality—and you save up to 25%! Compare Bilt-Rite's quality and price; then get your order in today! Dealer inquiries invited.

Ball-Bearing Wheels at Bargain Prices

(For 1/2" axles)	
6 x 1.00.....\$1.30	10 x 1.25.....\$1.95
8 x 1.25.....1.65	10 x 1.75.....2.15
8 x 1.75.....1.80	10 x 2.00.....2.45
8 x 1.50.....\$1.50	
(For 3/8" axles)	
6 x 2.00.....\$3.95	8 x 2.50.....\$4.15
10 x 2.75.....Only \$4.65!	

Bilt-Rite Guarantee
No better wheels are made regardless of price; 10 day return privilege.

If size you need isn't listed, write for Folio A. Order Today—Send cash, check, or M. O.—Pay postage on arrival.

BILT-RITE WHEEL COMPANY

520 East Missouri Ave. Dept. 72 Kansas City 6, Missouri

Plan Your Future in Fast Growing

**I Can Train You at Home
For a Fascinating Money
Making Career in RADIO
and TELEVISION**



C. H. Mansfield
President

Not in two decades has such an opportunity been available as is now presented to the ambitious, forward looking man to get into a giant new industry of the future, at the start of its growth.

Television, the hand-maiden of radio, has just started to grow. Now is the time to get the training that can equip you for a bright, successful career in this world's fastest growing industry. Such an opportunity may not come again in your life-time. My 2-way method of training, lesson instruction PLUS actual practice has been planned to train you **FASTER, MORE THOROUGHLY**, right in your home.

Thousands of new Television Receivers are being sold each day—more Television Stations are coming on the air each month. It is predicted that Radio-Television will be one of the world's top ten industries in the next 5 years.

MAKE YOUR MOVE NOW!

Now is the time to get the training that will help prepare you for success in Radio-Television. But be sure that you get the best training available, for your future success may well be measured by the quality of the training you get.

FREE!

Sample TV Lesson and 56-page Book which explains my 2-way method of training, actual practice PLUS lesson instruction.

Sending for this book has marked the turning point in the lives of many men. You owe it to yourself to find out about H.R.T.I. training. Mail below coupon TODAY!

My 2-way method gives you actual practice



You construct scores of circuits like those shown below



I SEND YOU 10 Big Kits
of parts with your training with which you make HUNDREDS of tests, build SCORES of circuits, to help you learn MORE THOROUGHLY, FASTER.

You Keep All Kits

After performing hundreds of tests and experiments, you then construct the 6-tube, 4-band super-heterodyne receiver, and Multi-purpose Shop Test Panel shown here, with the parts I send you. Thus, you have TWO valuable pieces of equipment.



APPROVED FOR VETERANS

Check Coupon

If a veteran of World War II

HOLLYWOOD RADIO & TELEVISION INSTITUTE
810 West 6th St., Los Angeles 14, California, U.S.A.

C. H. MANSFIELD, Pres., Dept. D-25 (Established 1929)
Hollywood Radio and Television Institute
810 West Sixth St., Los Angeles 14, California, U.S.A.

Send me your FREE book, "Your Opportunities in Radio, Television and Electronics," which explains your 2-way home study training method. Also the FREE Sample Television Lesson.
No Salesman Will Call

Name _____

Please print or write plainly your name and address

Address _____

City _____ Country _____

If a veteran of World War II, check here

EARN MORE IN DRAFTING



**STEADY
EMPLOYMENT**
●
**MORE OPPORTUNITIES
FOR PROMOTION**

"Here I am at work making good money as a draftsman. I'm glad I sent the coupon to Chicago Tech for that Free Trial Lesson and found out how easy it is to learn Drafting in spare time at home. Today I feel secure in my job because the draftsman's work comes first on any new project. And, in addition, draftsmen can't be replaced with machines. What's more, I feel I'm slated for promotion and more pay, because I see so many draftsmen advancing to high-pay jobs."

LEARN IN SPARE TIME—AT HOME!

(or at the College in Chicago)

A few hours of pleasant home study every week—that's all. No interference with your present job. All the tools you need; drawing outfit included. With Chicago Tech's help, you train yourself step by step. This tested method—developed over 45 years of C.T.C. progress—prepares men quickly for good positions in industry.



FREE INFORMATION—SEND COUPON

To prove to you how easy it is to learn Drafting at home by the Chicago Tech method, we will send you this FREE TRIAL LESSON. No charge for this lesson, now or later. Fill out and mail coupon, or send post card today.

CHICAGO TECHNICAL COLLEGE

B-227 Tech Bldg., 2000 So. Michigan Ave.,
Chicago 16, Illinois

Mail me FREE Lesson with information about big opportunities in DRAFTING.

Name..... Age.....

Address.....

City..... Zone... State.....



PATENTS

AND TRADE MARKS

C. A. SNOW & CO.

REGISTERED PATENT ATTORNEYS

WRITE FOR INFORMATION TO

246 SNOW BUILDING, WASHINGTON 1, D. C.

LAW

FREE BOOK



Write today for FREE book, "THE LAW-TRAINED MAN," which shows how to learn law for business and the bar easily in spare time at home through the famous Blackstone professional law course compiled by 60 expert law authorities including law college deans, professors, lawyers and Supreme Court judges. We furnish all necessary instruction material including big 18-volume Modern American Law library cited by the courts of last resort as "M.A.L." Many successful attorneys among our graduates. LL.B. degree conferred. Moderate tuition; low monthly terms. Money-back Agreement. Write today.

BLACKSTONE COLLEGE OF LAW
225 N. Michigan Ave., Dept. 122, Chicago 1, Ill.
A Correspondence Institution Founded in 1890

INVENTORS

Before you make any effort to market your invention, you should take the first steps toward proceeding for patent protection.

The usual first step is to have a search of the U. S. patent records conducted, so that I can report to you on the question of patentability.

I shall be pleased to furnish you with information relative to patent procedure and also on the matter of trademark registration, upon request from you, and this will be without any obligation on your part.

PATRICK D. BEAVERS

(Formerly RANDOLPH & BEAVERS)
Registered Patent Attorney

937 Columbian Building, Washington 1, D. C.

PATENTS PATENT LAWYER

TRADE MARKS

GUSTAVE MILLER

PS WARNER BLDG.
WASHINGTON 4, D. C.

ASSOCIATE EXAMINER
U. S. PATENT OFFICE 1922-1929
PATENT ATTORNEY AND ADVISOR
U. S. NAVY DEPT. 1930-1947
REGISTERED PATENT ATTORNEY

Send for PATENT INFORMATION
BOOK and "INVENTOR'S RECORD"
without obligation.

HELP FOR INVENTORS

Hundreds of manufacturers have requested our assistance in locating marketable new products.

Complete information, free.

INSTITUTE of AMERICAN INVENTORS

Dept. 3, 1926 Eye St. N.W., Washington 6, D. C.

INVENTORS

Whether an invention is patentable can be substantially determined by a search of the U. S. Patent records. Without obligation, write for information explaining the steps you should take to secure a patent.

JOHN N. RANDOLPH

Registered Patent Attorney

205 Columbian Building Washington 1, D. C.

INVENTORS

IF YOU WISH TO PROTECT YOUR INVENTION, You should take steps to protect it by a U. S. Patent. Write me for "Record of Invention" form.

CARL MILLER
REGISTERED PATENT ATTORNEY

WOOLWORTH BLDG., 35th FLOOR, 20C,
NEW YORK CITY

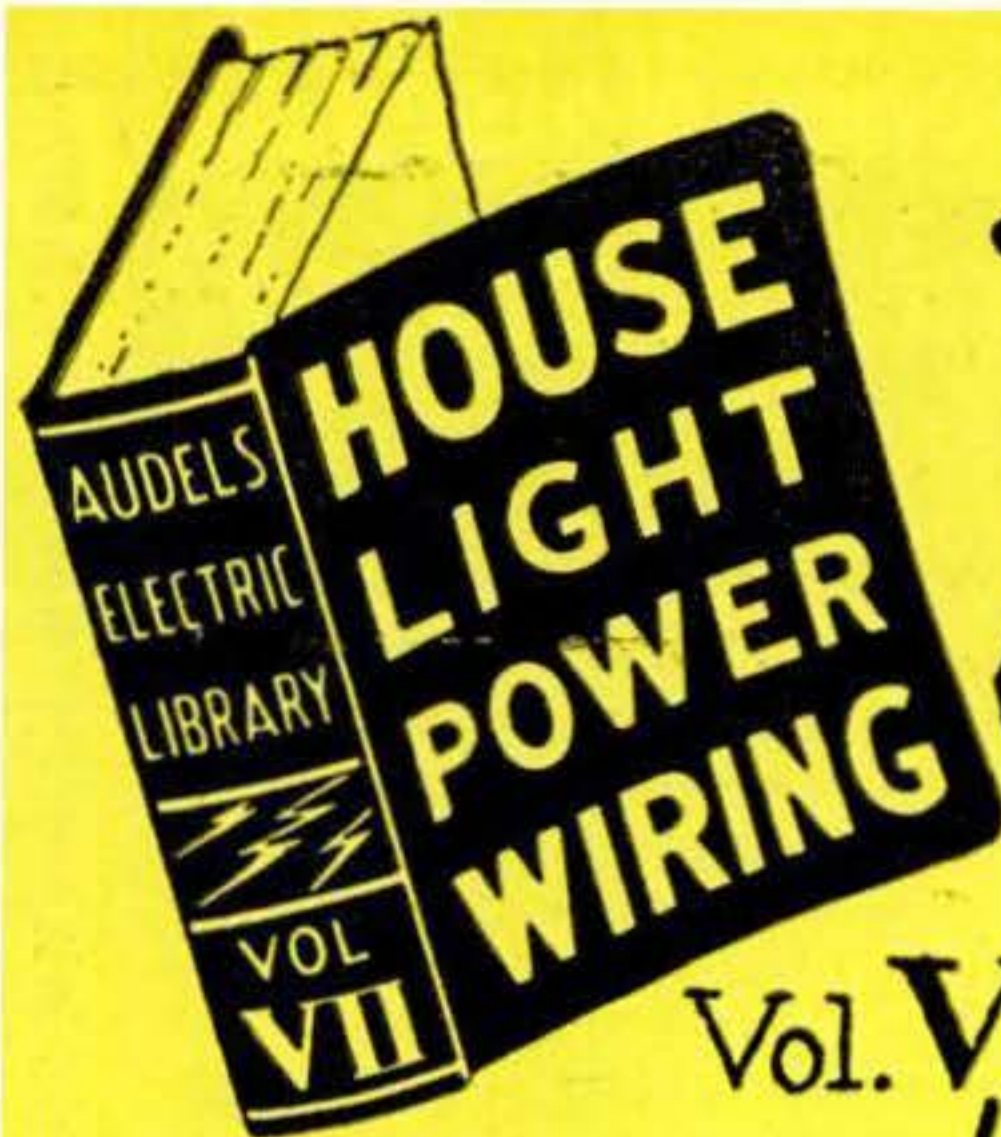

House Wiring

Vol. VII TELLS HOW!

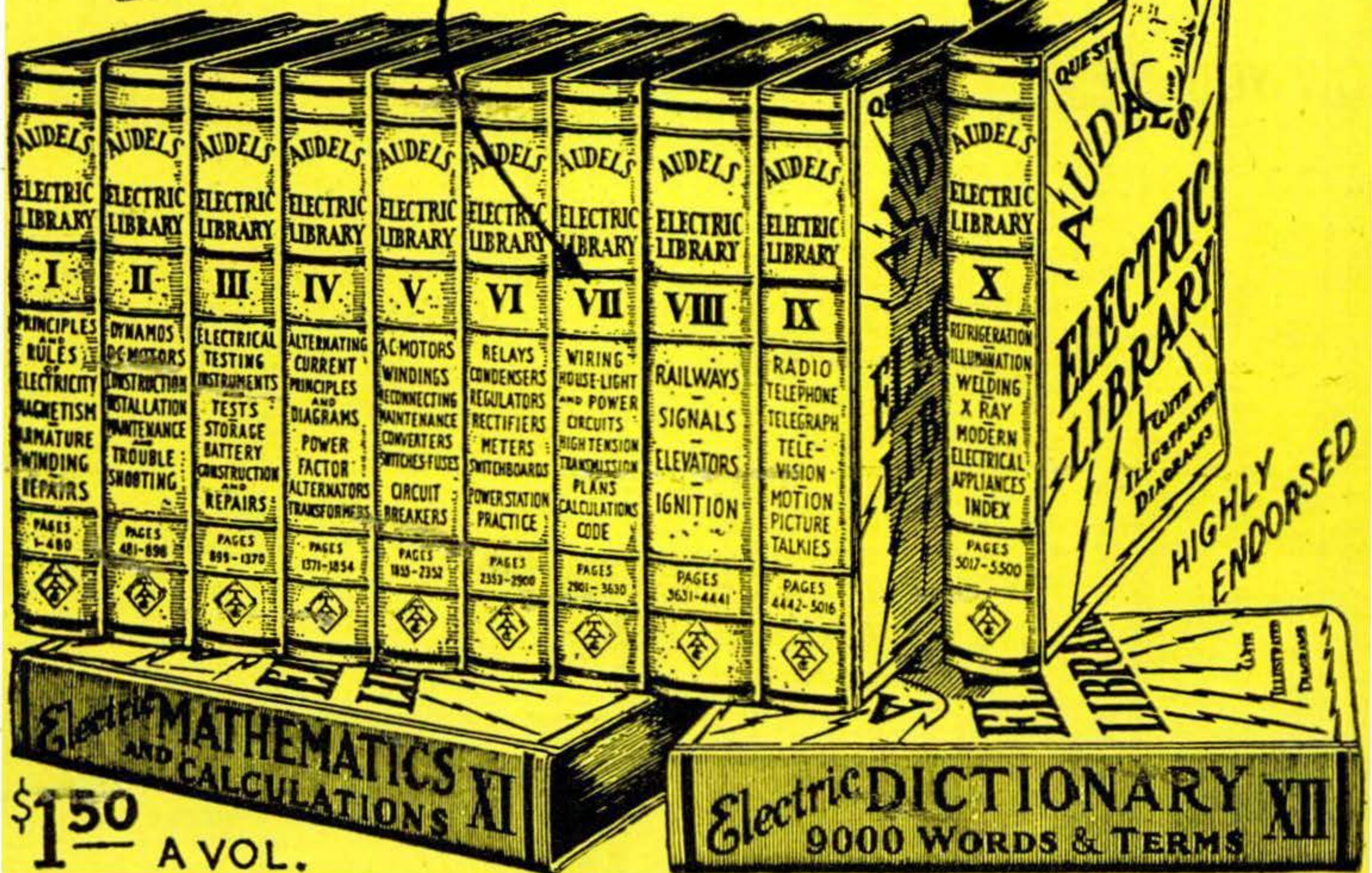

\$1.50 A VOL.

Electric DICTIONARY XII
9000 WORDS & TERMS

HERE ARE THE ANSWERS

Audels Electric Library gives thousands of answers to your electrical problems. Every Electrician, Engineer, Mechanic, Maintenance Man and Student should know about these very helpful books.

The 12 volumes contain 9500 clear, simplified illustrations of the Theories and Applications of Electricity, and 7200 interesting pages of Practical Trade Information relating to Construction, Operation and Maintenance. Valuable for Ready Reference or Home Study. Price only \$1.50 a volume, sold separately.

Audels Electric Library is truly a progressive home study course in Practical Electricity. Devote 15 to 30 minutes a day to its easy reading — acquire a practical working knowledge of Electricity in all its branches. Written in plain language.

AS A REFERENCE LIBRARY it is valuable. The Quick Finder Index helps you locate the desired information quickly. These books have helped thousands of men by giving them a broader knowledge of the whole field of Electricity. Take this opportunity to use our Book-A-Month Plan; mail the coupon today. No obligation unless satisfied.

AUDELS BOOK-A-MONTH PLAN
You will receive your first book for 7 days' Free Trial and Examination. If you are satisfied, send us only \$1.50. If not O.K., return the book to us and you owe us nothing. When we receive your payment for the first book, we send you the second book.

REMEMBER: You can Start Your Subscription with Any Number you choose or Stop at Any Time. Not a cent to pay until you get the books. No obligation to buy unless satisfied.

MAIL THIS COUPON TODAY

AUDELS, PUBLISHERS
49 West 23rd St., New York 10, N.Y.

Please enter my subscription for AUDELS ELECTRIC LIBRARY, price \$1.50 a volume. Mail one volume each month, for which I will remit \$1.50 promptly.

Start with Volume Number _____
Name _____

Address _____

Occupation _____

Employed by _____

PSM

AUDELS, PUBLISHERS, 49 WEST 23rd ST., NEW YORK 10, N. Y.

YOUR PROFIT \$28.50

on 3 Easy-to-Make Items

with **NEW LIQUID PLASTIC**



WE SHOW YOU **HOW**

YES, now it is possible to make the items shown, right at home, to sell at a profit of \$28.50. Such profit is possible because of high eye-appeal and low materials-cost. Think of making gorgeous, glamorous, IN-DEMAND articles at a profit of over 1000% above cost! That's possible with the new liquid Plastic known as Castolite. The articles shown are only a few of the many valuable things you can make with this material. Amateurs get professional results. We tell you how to make these things and many more besides.

BIG NEW BOOK Gets You Started

Send at once for this new book, combining a manual of step-by-step instructions with a modern, tested 6-Point Success Plan for having a Profitable plastics business of your own. Do like John Zack of Chatham, N. J., a former salesman, who writes: "I sold the things I made at a handsome profit. Therefore I have gone into manufacturing on my own." Or succeed like Gladys Smith of Steveston, B. C. She wrote: "I made buttons, brooches and wall plaques and took them to our leading department store. The manager was enthusiastic and asked me to make up more articles to sell to their trade. I never made anything to sell before in my life."

NEW SUCCESS PLAN

With the Castolite Success Plan you quickly learn how to make the things that sell fast; how to make your business self-advertising; how to get stores, novelty shops, even commercial photo studios to handle your line. All the methods and what-to-make-suggestions are explained in this big, interesting factual plastics book. Worlds of fun, big extra profits are within reach. To get off to a quick, sure start, get this new book at once. Send 35c today for your copy of "A Way to Success."

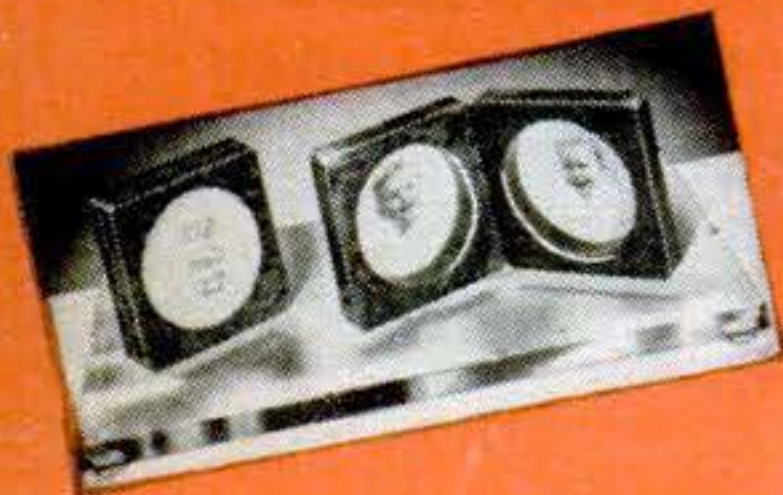
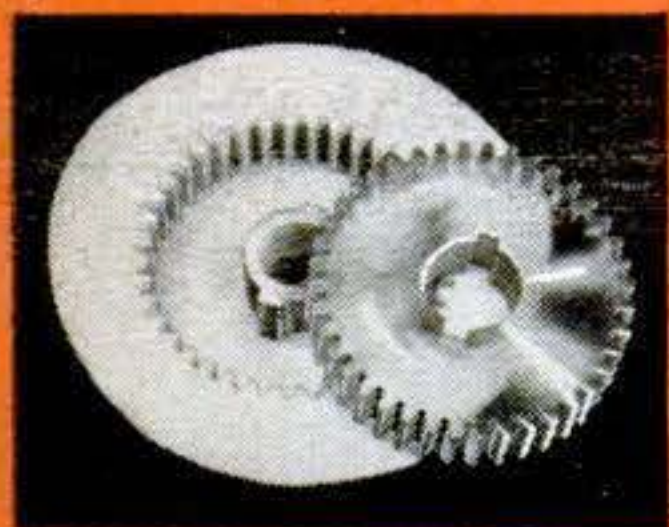
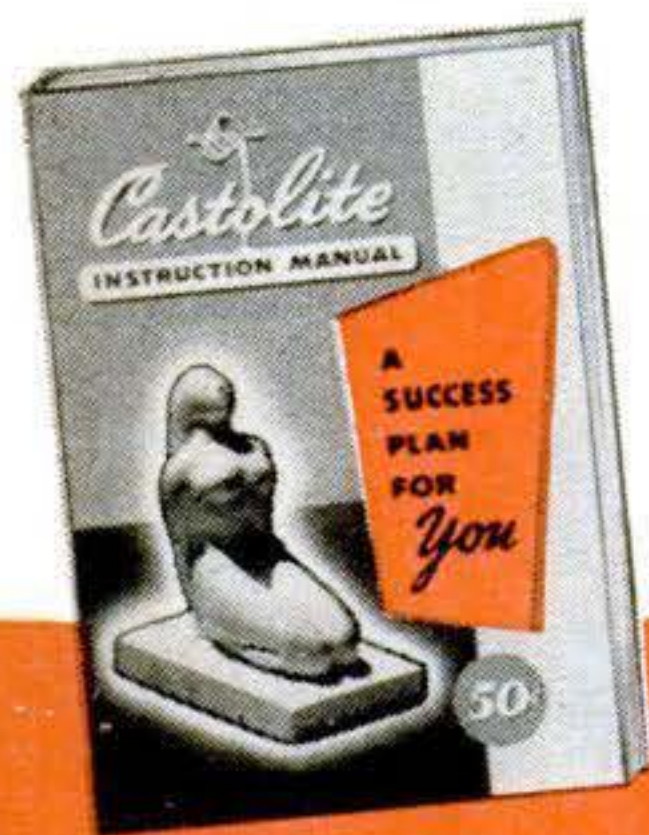

DEALERS

Many recognized Plastic Materials Dealers are now handling Castolite products. There may be an opportunity in your territory. Inquiries welcomed from financially responsible firms.

The CASTOLITE CO.
Dept. B-2, Woodstock, Ill.

Head Noises? Hard of Hearing? Try this simple Home Treatment

Many people have written us that our home treatment brought them blessed relief from the miseries of Hard of Hearing and Head Noises due to catarrh of the head. Many were past 70! For proof of these amazing results, write us today. **Nothing to wear.** Treatment used right in your own home — easy and simple.

THE ELMO CO.
Dept. 474
Davenport,
Iowa

SEND NOW FOR PROOF AND 30 DAY TRIAL OFFER

SPEED AND POWER Handbook

50 CHAPTER LIBRARY EDITION

Build Fast Stock Cars! California Roadsters! 160 MPH Rods! Covers Crosleys to Cadillacs—all makes. Breathtaking methods—Authentic—Direct from California! Save Many Dollars! Build your own Dual Manifolds! Superchargers! Hot Cams! Water Injectors! Hi-Compression Heads! Mileage Devices! Get up to 10 more miles per gallon! Get racing speed, lightning acceleration, dynamic power increases from any make passenger automobile! Get construction drawings! Tuning techniques! Speed tricks! Economy secrets! Ingenious formulas! Covers "Racing Frames"—"Reciprocating Masses"—"Jet Engines"—"Braking Characteristics"—"Dynamometers"—Dual Pipes, Gears, Fuels, Manifolds, Porting, Relieving, Lowering! Balancing! Including 1950 Racing Equipment Catalogues!



Photos Drawings



SPEED SHOP METHODS

Includes CALIFORNIA AUTOMOBILE CUSTOMIZING—Drawings, photographs! Diagrams! Newest Ideas! Conversions! Carson Tops! Re-Styling all makes! Streamlining! Chopping! Channeling!—complete—\$1.98 Postpaid.

NEWHOUSE AUTOMOTIVE INDUSTRIES
5805 East Beverly Blvd. Dept. A4
LOS ANGELES 22, CALIF.

Learn PHOTOGRAPHY at Home

Splendid Hobby or Vocation

Prepare in spare time. Practical basic training. Long-established school. Send for free booklet, "Opportunities in Modern Photography" and particulars. Sent postage prepaid. No obligation.

AMERICAN SCHOOL OF PHOTOGRAPHY
1315 S. Michigan Avenue, Dept. 1362 Chicago 5, Illinois

ROCKET PERFORMANCE FOR ANY CAR

The revolutionary new VAPOJET is designed on the war developed principle of WATER INJECTION. It offers an ideal, INEXPENSIVE way to gain superior performance from any car. For the owners of new cars with HIGH COMPRESSION engines, VAPOJET gives extra power with low octane gas. Thousands of VAPOJETS are now in use and users report better pick-up, smoother running power and BIG mileage increases on regular gas.

Complete, easily installed kit fits all cars, boats and stationary engines and is backed with a 30 day money back GUARANTEE.

U.S. Patent 2,188,175



VAPOJET MFG. CO.

11424 Biona Dr., Dept. PS-2 Los Angeles 34, California AGENTS WANTED

- Designed to give
- More Speed
- More Mileage
- More Power
- Eliminates Carbon & "Ping"
- Reduces Wear

Order Today only **\$9.75** Postpaid

Send check or money order and save postage. \$1 deposit on C.O.D. List car, year, and no. of cylinders.

**YOU BUILD THIS
23-TUBE
TELEVISION
RECEIVER**

NOW!

FOR THE FIRST TIME YOU CAN GET
Real Practical HOME TRAINING In

TELEVISION

RADIO AND ELECTRONICS

RTS LEADS THE WAY

WE GIVE YOU

**11 BIG
TELEVISION
AND RADIO KITS
AT NO EXTRA COST**

**YOU WORK AND LEARN
WITH REAL TELEVISION
AND RADIO EQUIPMENT**

RADIO-TELEVISION TRAINING SCHOOL'S master Technicians guide you. Located in the very heart of America's Television, Broadcasting, Radio and Sound Industries, RTS is right "on-the-spot" where new technical improvements are first introduced; is in the best possible position to bring students ACTUAL METHODS and practices developed by the RADIO-TELEVISION industry, leading to real money making opportunities. The 11 BIG KITS RTS GIVES YOU enable you to do many practical jobs, build the equipment illustrated; perform more than 100 other fascinating, valuable experiments. These jobs you do give you ACTUAL SHOP experience so vitally necessary to your future success. Thus RTS methods assure you BALANCED TRAINING—Theory PLUS Real Experience.

to earn WELCOME EXTRA CASH, even BEFORE FINISHING YOUR TRAINING! In fact, when friends and neighbors know you are studying Radio-Television you may—like many RTS students—actually get MORE REPAIR WORK THAN YOU CAN HANDLE.

**27 YEAR
SUCCESS RECORD**

Backed by over a quarter-century of experience in home training, RTS (formerly Radio Training Association of America) offers practical "Learn-by-doing" methods, assuring you quick step-by-step progress. Begin preparing for your future in Radio-Television now while the time is ripe. If you are at all mechanically inclined—and have a grammar school education, RTS can teach you how to MAKE GOOD in Radio-Television.

GET THE FACTS

Send for FREE BOOK which tells you all about the RTS "time-tested" home-training plan, developed by technicians in the heart of the Radio-Television field. Fill out the coupon now—TODAY! and your FREE BOOK entitled "How To Make Good in Radio-Television" will go out to you AT ONCE. No Obligation. No salesman will call. ACT NOW!

**YOU BUILD THIS
6-TUBE STANDARD
SUPER HETERODYNE
RADIO SET with
SHORT WAVE
CONVERTER**

**YOU
KEEP ALL
EQUIPMENT
—it's Yours!**

**OPPORTUNITIES NOW
WIDE OPEN FOR
Properly Trained Men**

Latest reports estimate 400 MILLION new television and radio sets will be built in the next 10 years . . . more than 72 million dollars is being spent RIGHT NOW just for radio repairs ALONE! When you are thoroughly trained by RTS Experts—who have their fingers on the pulse of the Radio-Television industry—a field of unlimited opportunities will open up for you in Your Own Radio-Television Sales & Service Business, F.M., Equipment Manufacturing, Communications and allied fields.

**EARN EXTRA MONEY
while learning at HOME**

Under the RTS amazingly easy, practical home-training plan there is no need for you to quit your present job. You study in SPARE TIME ONLY! RTS Experts show you how

★
**SEND
FOR THIS
30-PAGE
FREE
BOOK**
★

RADIO-TELEVISION TRAINING SCHOOL
5100 SO. VERMONT AVE., LOS ANGELES 37, CALIF., U.S.A.
ESTABLISHED 1922 — 27 YEARS AGO

**RADIO-TELEVISION TRAINING SCHOOL, DEPT. PS-2
5100 South Vermont Avenue, Los Angeles 37, Calif., U.S.A.**

Send FREE Illustrated Book showing how I can make good in TELEVISION and Radio through training under the guidance of expert RTS Technicians. No obligation. (No Salesman will call).

NAME _____ AGE _____
St. & No. _____
CITY _____ ZONE _____
STATE _____

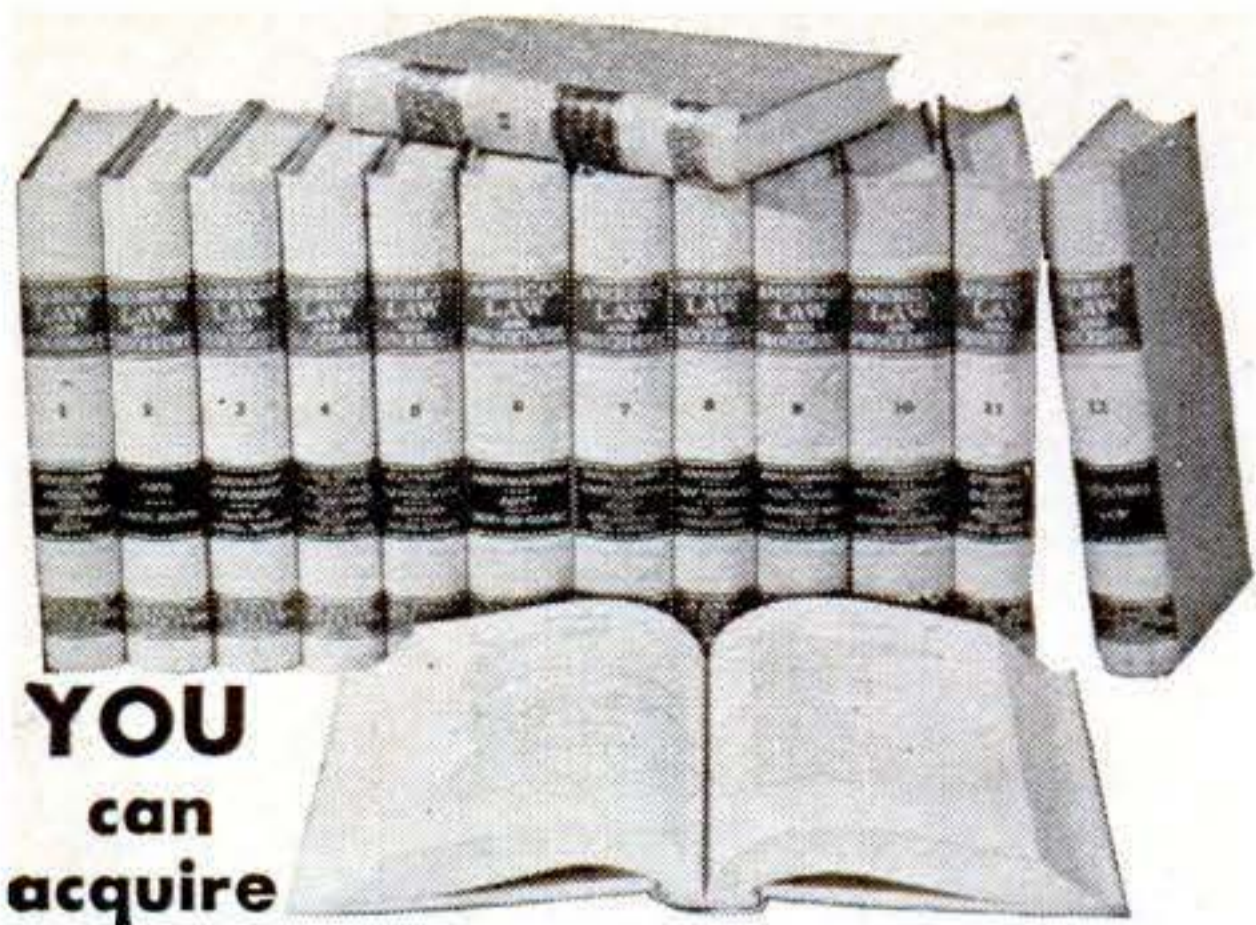

**YOU
can
acquire**

**LAW NIGHTS AT HOME!
L L.B. DEGREE**

LaSalle's famous Law Library—used as reference in many Law libraries and Law offices—has enabled thousands to master Law surprisingly fast, in spare hours at home, for business and professional advancement.

These 14 remarkable volumes, compiled by leading professors and lawyers, cover the whole basic field of Law in condensed, orderly, simplified manner.

You advance rapidly with this great library, plus special lectures furnished. We guide you step-by-step with personalized Problem Method of instruction . . . you learn by doing—handling legal problems—not by memorizing rules.

Send for two FREE 48-page booklets, "Law Training for Leadership," and "Evidence," answering questions about Law and its value to you, and telling how LaSalle Law graduates are winning rapid advancement in business and public life. Mail coupon below. No obligation.

**LA SALLE EXTENSION UNIVERSITY
A Correspondence Institution**

417 S. Dearborn St. Dept. 283-L Chicago 5, Ill.

Send me your two FREE booklets described above, without obligation.

Name.....Age.....
Street.....
City, Zone & State.....

Want a NEW Lease on Life?

GET IT NOW! Read Hal Falvey's book. Here's a formula to enrich daily living. Scientific, sound . . . immensely practical . . . teaches you quickly to reach new highs in personal power.

Hal Falvey writes well. He can. But between the lines is more. You feel his bubbling enthusiasm . . . the energy *anyone* has locked up, and can use . . . with the TEN SECOND formula! For a new grip to solve old problems get this book. 96 pgs, cloth bound.



SEND NO MONEY. Pay postman \$1 plus COD. Or remit: sent ppd. *Guaranteed* to help you NOW—today, tomorrow! Nothing like it. If 48 hours don't bring you greatly satisfying progress, send back. Full refund.

WILCOX AND FOLLETT, 1255 S. Wabash Ave., Dept. 26, Chicago

Send Hal Falvey's book. COD I enclose \$1, send ppd.

Name

Address

**ATOMIZED POWER
FOR YOUR CAR!**



Automatic GASOLINE INJECTOR

PATENT PENDING



\$9.95

More power, Greater acceleration, Top engine efficiency at all speeds. Stops Gas Waste—"cracks" fuel for fullest power! Dynamometer tests show up to 15% power increase resulting in decreased fuel consumption.

- MORE POWER
- QUICKER STARTING
- GREATER MILEAGE
- FASTER ACCELERATION
- LESS CARBON
- LONGER MOTOR LIFE

Quickly and Easily Installed

SOLD ON AN ABSOLUTE MONEY BACK GUARANTEE

Complete illustrated step-by-step instructions included

Send postal card for complete information. When ordering—state car make, year and model.

SEAPORT CORPORATION
1821 EGBERT • SAN FRANCISCO 24 CALIF.

**BOYS!
Make Your OWN RADIO!**
Learn Interesting Details



You may start a successful career in RADIO. Send 25c

Fun, interest and education in making your own simple, tubeless, batteryless crystal radio. Send 25c for a genuine Melomite crystal with complete illustrated instructions for making your own set. Compete with others for long distance reception. Crystal sent postpaid with instructions and our own publication "The Magic Crystal" which is full of news, diagrams, questions and answers of interest. Send 25c TODAY.

ALLEN RADIO, Dept. 132, Clinton, Mo.

LEARN MOVIE PROJECTION THEATRE MANAGEMENT

The Motion Picture Theatre Business offers big opportunities for trained men. Get into a fascinating field with a promising future. Train at home in spare time. Free Catalog. Established 22 years.

THEATRE INSTITUTE, 385 Washington St., Elmira, New York

**NEW! SENSATIONAL DEVICE
ENABLES ANYONE TO TEST
OWN EYES
RIGHT AT HOME**



SAVE up to \$15.00 On Glasses

Big News to the Millions of Spectacle Wearers and Prospects. Means Freedom from Outrageous Prices. Perfect Satisfaction Guaranteed! No Risk!

**MAKE BIG MONEY QUICK
FREE SAMPLE KIT!**

Send for Free Sample at once. Show it to friends and others. Let them use it Free and watch their amazement over this new system of Self Testing. Here is a great new opportunity in a tremendous new field of unlimited possibilities. Spare or full time. No experience or capital needed. Act quick!

Clark Optical Co., Dept. A-136, 1148 W. Chicago Ave., Chicago 22, Ill.



Will You Let Me PROVE I Can Make YOU a *New Man*?

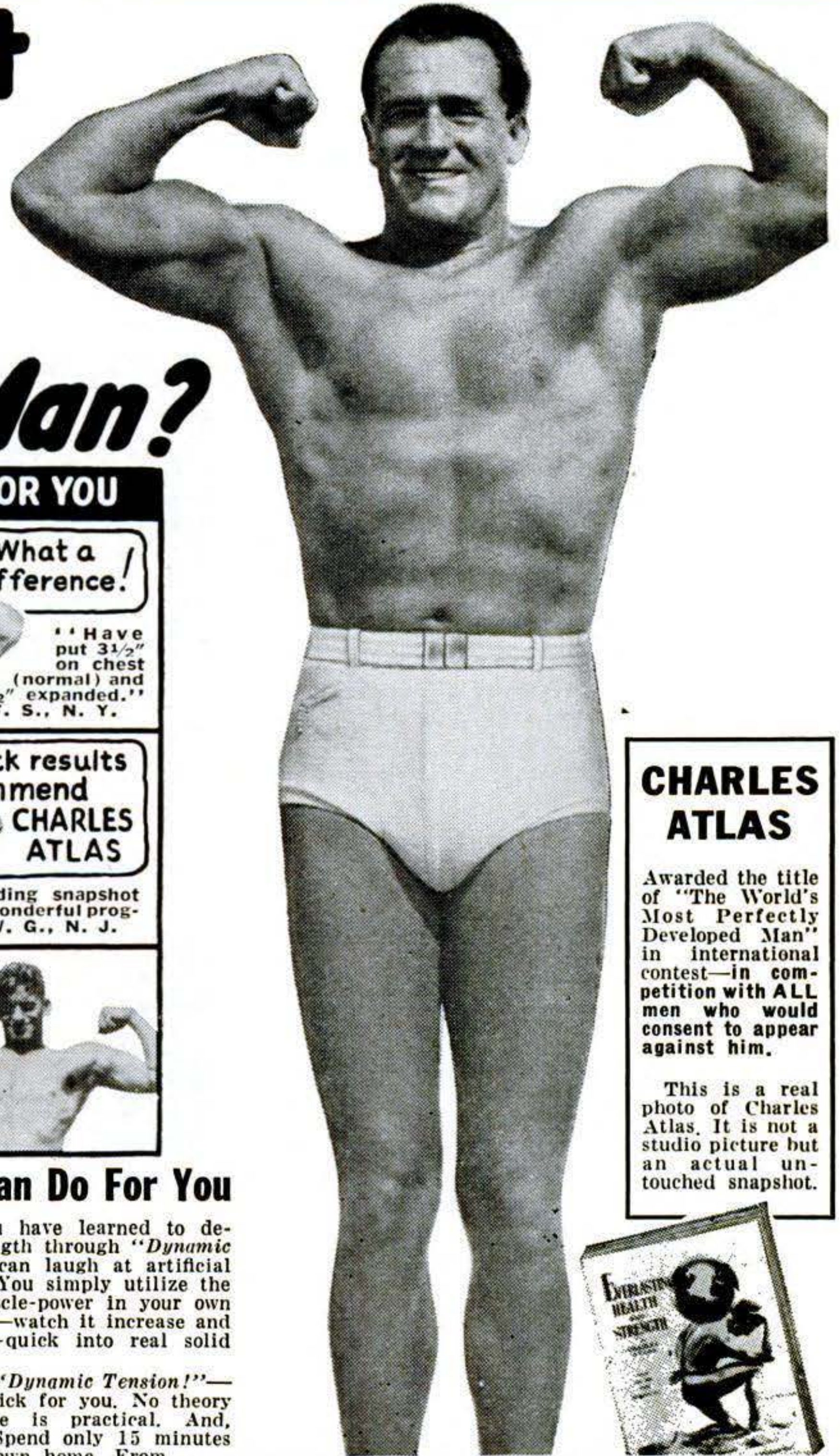

LET ME START SHOWING RESULTS FOR YOU

<p>5 inches of new Muscle</p> <p>"My arms increased 1 1/2", chest 2 1/2", forearm 7/8."—C. S., W. Va.</p>	<p>What a difference!</p> <p>"Have put 3 1/2" on chest (normal) and 2 1/2" expanded."—F. S., N. Y.</p>
<p>Here's what ATLAS did for ME!</p> <p>John Jacobs BEFORE John Jacobs AFTER</p>	<p>For quick results I recommend CHARLES ATLAS</p> <p>"Am sending snapshot showing wonderful progress."—W. G., N. J.</p> <p>GAINED 29 POUNDS</p> <p>"When I started, weighed only 141. Now 170."—T. K., N. Y.</p>

CHARLES ATLAS

Awarded the title of "The World's Most Perfectly Developed Man" in international contest—in competition with ALL men who would consent to appear against him.

This is a real photo of Charles Atlas. It is not a studio picture but an actual un-touched snapshot.



Here's What Only 15 Minutes a Day Can Do For You

I DON'T care how old or young you are, or how ashamed of your present physical condition you may be. If you can simply raise your arm and flex it I can add **SOLID MUSCLE** to your biceps—yes, on each arm—in double-quick time! Only 15 minutes a day—right in your own home—is all the time I ask of you! And there's no cost if I fail.

I can broaden your shoulders, strengthen your back, develop your whole muscular system **INSIDE** and **OUTSIDE**! I can add inches to your chest, give you a vise-like grip, make those legs of yours lithe and powerful. I can shoot new strength into your old backbone, exercise those inner organs, help you cram your body so full of pep, vigor and red-blooded vitality that you won't feel there's even "standing room" left for weakness and that lazy feeling! Before I get through with you I'll have your whole frame "measured" to a nice, new beautiful suit of muscle!

What's My Secret?

"*Dynamic Tension!*" That's the ticket! The identical natural method that I myself developed to change my body from the scrawny, skinny-chested weakling I was at 17 to my present super-man physique! Thousands of other fellows are becoming marvelous physical specimens—my way. I give you no gadgets or contraptions to fool

with. When you have learned to develop your Strength through "*Dynamic Tension!*" you can laugh at artificial muscle-makers. You simply utilize the **DORMANT** muscle-power in your own God-given body—watch it increase and multiply double-quick into real solid **MUSCLE**.

My method—"Dynamic Tension!"—will turn the trick for you. No theory—every exercise is practical. And, man, so easy! Spend only 15 minutes a day in your own home. From the very start you'll be using my method of "*Dynamic Tension!*" almost unconsciously every minute of the day—walking, bending over, etc.—to **BUILD MUSCLE** and **VITALITY**.

FREE BOOK "Everlasting Health and Strength"

In it I talk to you in straight-from-the-shoulder language. Packed with inspirational pictures of myself and pupils—fellows who became **NEW MEN** in strength, my way. Let me show you what I helped **THEM** do. See what I can do for **YOU**! For a real thrill, send for this book today. **AT ONCE. CHARLES ATLAS, Dept. 12, 115 East 23rd St., New York 10, N. Y.**

**CHARLES ATLAS, Dept. 12,
115 East 23rd St., New York 10, N. Y.**

I want the proof that your system of "*Dynamic Tension!*" will help make a New Man of me—give me a healthy, husky body and big muscular development. Send me your free book, "*Everlasting Health and Strength.*"

Name.....
(Please print or write plainly)

Address.....

City..... State.....

How to Write

Short Stories, Mysteries, Articles



Keith Monroe

**For Part-Time or Full-Time Income,
Learn at Home. Free Lesson Shows How**

HAVE you ever had an urge to write? Have you or friends had interesting experiences or ideas about people, places, hobbies, sports, business or social activities, that might make interesting stories or articles for general magazines, trade and technical journals, fraternal publications, etc.?

Editors agree: the demand for new writers is greater than ever, and you don't have to be a genius to make money. Many Palmer beginners earn while learning, receiving small but welcome checks for material that may be turned out quickly once you acquire the technique. And now it's easier to learn than you may imagine, through Palmer's unique method of training—for not just one field of writing, but for all: Fiction, Article, Radio. Endorsed by famous authors—including Rupert Hughes, Gertrude Atherton, Katharine Newlin Burt, A. E. Van Vogt, and by hundreds of successful graduates.

Now Sells to Big Magazines

"Since studying the Palmer course, I've been able to sell to *The Post, Life, American, Esquire, Reader's Digest*, and other top magazines. It's the finest course anywhere."—Keith Monroe, Santa Monica, Calif.

You get practical writing assignments to do at home, saving time, effort and money. Your work is individually handled by professional writers.

FREE sample lesson and free book, "The Art of Writing Salable Stories" show how you may earn extra income or make writing a full-time career. Be independent—work where, when, how you please. Send today! Palmer Institute of Authorship, Since 1917, Desk U-20, 1680 N. Sycamore, Hollywood 28, Calif.

**APPROVED
FOR
VETERANS**

FREE LESSON Palmer Institute of Authorship, Desk U-20
1680 N. Sycamore Hollywood 28, Calif.

Please send me free sample lesson and illustrated book explaining how your home-study training helps new writers get started. This is confidential. No salesman will call.

Mr. _____
Mrs. _____
Miss _____

Address _____

City _____ Zone _____ State _____

Please print clearly. Veterans: Check here

WAR SURPLUS - U.S. SIGNAL CORPS

Genuine EE 8 Portable Telephones
Telephone Wire - Equipment

Big Annual Money-Saving SALE

Amazingly simple to install your own private telephone system with portable telephones and wire. All you do is string wire, attach phones to each end and you are ready to ring and talk up to 17 miles! Add up to 6 phones on main line for dependable 2-way communication around Home, Farm, Shop, Construction Projects, Factories, etc. Powered by standard flashlight batteries. Phones checked for perfect operation. Fully guaranteed.

BRAND NEW EE8 Phones (Formerly \$21.50) NOW.....\$17.50 ea.
LIKE NEW. Each phone thoroughly reconditioned like new. Ea. phone \$12.95—SPECIAL: 2 for.....\$24.50
USED. Reconditioned. Excellent. Ea. \$9.95—SPECIAL: 2 for \$18.50
BRAND NEW EE99A TELEPHONE REPEATERS EA.....\$14.50

TELEPHONE WIRE. Prices slashed to near wholesale cost.
W110B Grade I unused, new, stored in open. Weatherproof, durable. 2-conductor, twisted telephone wire, insulated. Many extra uses for this handy item.
ONE MILE REELS, formerly \$27.50 mile.....SPECIAL \$21.00
1/2 MILE REELS, formerly \$14.25 ea.....SPECIAL \$11.00
500 FOOT COILS, formerly \$3.95.....SPECIAL \$ 3.00
1,000 FOOT COILS, formerly \$7.25.....SPECIAL \$ 5.75
W110B Grade II, unused, outer layer wire stained, weathered, but when removed inside layers perfect. Good for years of service.
ONE MILE REELS, formerly \$27.50 mile.....SPECIAL \$17.50
1/2 MILE REELS, formerly \$14.25 ea.....SPECIAL \$ 9.00
W130 Lightweight Assault wire, 2-conductor. TWO MILE REELS, unused, NEW. (10,500 ft. continuous) wt. only 85 lbs. A Real Special. Formerly \$57.50 reel.....SPECIAL \$37.50
BRAND NEW 1/2 MILE REELS. Wt. 16 lbs. Formerly \$15. SPECIAL \$12.95
1/4 MILE REELS slightly weathered, unused NEW.....\$ 4.95
Write for Free Folder. Sale on Field Telephone parts. Other specials! All prices F.O.B. Sacramento. No C.O.D. California residents add 3% for sales tax. Small orders send postage collect plus small handling charge.

SEND CHECK OR
MONEY ORDER

LORIS SALES

P. O. Box 1896-A-2

Sacramento, California

REMEMBER THIS You can't buy a \$20 goldpiece for \$10. So it's dangerous to pay less if you want safe, balanced matched tires. **WE REPEAT—Consider your family's safety, not just PRICE.** You see our adv. every month. Positively not re-caps. We serve ambulances, fire trucks, school buses, trucks and cars. "Out-of-town folks" buy now and take 10% discount.

GOOD YEAR Firestone
Goodrich U. S. ROYAL

& others. Original good tread. Slightly worn. Extra fine traction.

FREE Tube with each tire 26 MONTHS GOLDEN RULE GUARANTEE BOND
These are genuine "all purpose" "AAA" Tires. Read that top line again! You'll save MORE than \$.

600-16 \$5.55	650-16 \$5.85	700-16 \$5.85	475-19 \$5.85
600-16(6) 6.66	700-17 9.99	650-15 5.85	525-18 5.85
700-16 6.85	750-16 7.95	550-17 7.25	550-16 5.55

America's great Lo-Price Value. 15 Months Guar. Limited Supply

600-16 \$3.65	650-16 \$3.85	700-16 \$4.65	650-15 \$3.95
	700-15 3.95	750-16 5.95	550-17 5.55

Lo-Price Truck Tires. 15 Months guarantee

32x6 (8) \$8.88	750-20(10) \$8.88	1100-20 \$13.95	650-20 \$7.77
32x6 (10) 9.99	825-20 11.25	700-20 8.88	900-20 11.95
			1000-20 12.95

SUPERCUSHION TIRES (24 lb. air) to fit your present wheels

670-15 (600-15) \$6.25	760-15 (650-15) \$7.77	670-16 (600-16) \$6.66
710-15 (650-15) 6.85	820-15 (700-15) 7.77	760-16 (650-16) 7.77

WE ARE TRUCK-TIRE EXPERTS

Matched Tires. Truck-owners the world over, depend on us to keep their trucks rolling ON TIME at lowest cost.

6-8-10-12-14-16 PLY "ALL-PURPOSE" "AAA" GRADE GOLDEN RULE 26 MONTHS REPLACEMENT GUARANTEE BOND

600-20 \$ 9.20	32x6 (8) \$11.95	900-20 \$15.55	34x7 \$12.22
650-20 9.99	32x6 (10) 13.33	1000-20 16.65	1000-22 17.77
700-20 10.85	825-20 15.95	1100-20 17.77	1100-22 18.88

MILITARY "AAAA" guar. 30 mos. (Supers 14 mos.)

750-16 Super \$ 9.75	900-16 Super \$ 8.60	750-20 Super \$ 8.48
"AAAA" 12.22	"AAAA" 10.90	"AAAA" 13.00

Mud-Snow 2-1 Tred 600-16 \$7.77

BLATT GIRARD & LANCASTER AVES., DEPT. PS
BLATT BUILDING PHILADELPHIA 31, PA.
Send ck. or money order and this ad for rush shipment. We won't ship a tire we wouldn't use ourselves. Instant shipment down South. Far West and the world over. The name to trust in rubber.

WALKIE TALKIES \$2.99 SET OF 2

POCKET SIZE —ELECTRONIC VOICE POWERED

No tubes, batteries, adjustments, license or permit needed! Should last for years. Guaranteed to work anywhere up to 1/4 mile with extra wire. Clear tone. Swell for room to room—garage to house, etc! Your own private, talk-listen phone. Not war surplus. Brand new. Solid Aluminum Case. Guaranteed. Two absolutely complete units with wire—READY TO USE!

SEND \$1.00 deposit and pay postman \$1.99 plus postage charges or send \$3.25 for postpaid delivery. Ideal gifts for boys—girls. Order Now! Today!

THE MIDWAY COMPANY, Dept. WPS-2, KEARNEY, NEBRASKA

WASH YOUR CAR IN 10 MINUTES!

WITH FAST, EASY FOUNTAIN BRUSH. TURNS WORK INTO PLEASURE. WASHES AND RINSES IN ONE OPERATION, CARS, TRUCKS, WINDOWS PORCHES, BOATS, ETC.

NO COLD, WET HANDS!
Fits your garden hose. Genuine 5 1/2 Horse Hair Brush. Rubber covered 4 ft. tube handle. Will not mar your car. Cash, Check or Money Order. Postpaid. **\$6.95**
PAYS FOR ITSELF—SATISFACTION GUARANTEED

WINSLOW MFG. CO., Dept. P, 1428 Balfour, Detroit 30, Mich.

REAL ESTATE

BE A BROKER

PAYS BIG! SEND FOR FREE, BIG, ILLUSTRATED CATALOG NOW! No obligation. Graduates report making substantial incomes. Start and run your own business quickly. Men, women of all ages, learn easily. Course covers Sales, Property Management, Appraising, Loans, Mortgages, and related subjects. **STUDY AT HOME** or in our classrooms in big cities. Diploma awarded. G.I. approved. Nationally known.

WEAVER SCHOOL OF REAL ESTATE (Est. 1936)
15 E. Pershing Road, Dept. PS, Kansas City, Mo.

PRINT ANY PHOTO

on Paper, Cloth, Leather or Wood

SIMPLE, EASY TO USE

Magic liquid takes only 2 minutes to reproduce any snapshot you have onto stationery, handkerchiefs, ties, scarfs, etc. Use same picture over and over again if you wish. Won't wash off. Won't hurt negative or fabric it's used on. Personalize your belongings! An ideal gift. Complete outfit enough to transfer 100 photos—only \$1.95 post paid. Sent C.O.D. for \$2.23.

TIFFANY'S
2128 MONTROSE LA, CHICAGO 18, ILL.

Get
Into

RADIO, TELEVISION and ELECTRONICS Master ALL Phases

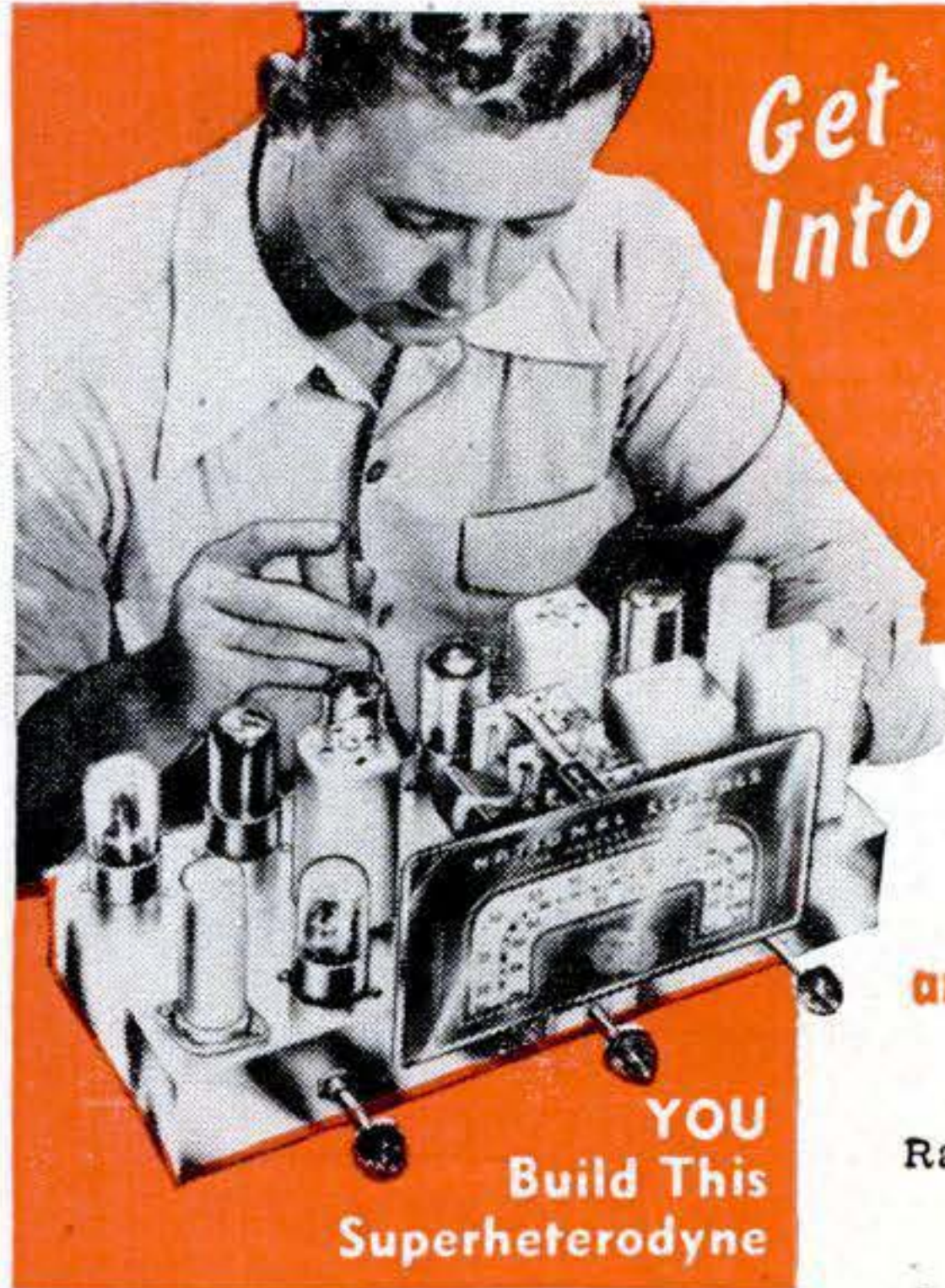

**YOU
Build This
Superheterodyne**

You receive complete standard equipment, including latest type High-Mu Tubes, for building various experimental and test units. You progress step by step until you build a complete Superheterodyne Receiver. It is yours to use and keep.



YOU RECEIVE THIS PROFESSIONAL MULTITESTER!

You will use this professional instrument to locate trouble or make delicate adjustments—at home—on service calls. You will be proud to own this valuable equipment. Complete with test leads.

SIGNAL GENERATOR

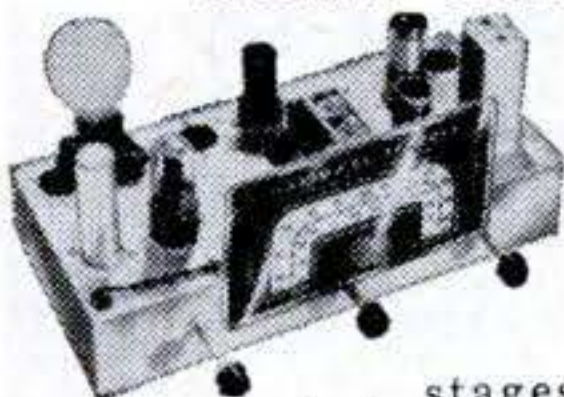

You construct the Transatron Signal Generator shown here, demonstrating Transatron principles in both R.F. and A.F.

stages. You study negative type oscillators at firsthand.

AUDIO OSCILLATOR:

An electronic device, which produces audio-frequency signals for modulating R.F. (radio frequency) carrier waves, testing A.F. (audio frequency) amplifiers, speakers, etc.



T.R.F. RECEIVER

You build several T.R.F. Receivers, one of which, a 4-tube set, is shown here. You learn construction, alignment, make receiver tests, and do trouble shooting.

GOOD PAY and Unlimited Opportunities in JOBS LIKE THESE:

Business of Your Own
Radio Manufacturing, Sales, Service
Broadcasting Telecasting
Television Manufacturing,
Sales, Service
Laboratories: Installation, Maintenance of Electronic Equipment, Electrolysis, Call Systems
Garages: Auto Radio Sales, Service Sound Systems and Telephone Companies; Oil Well and Drilling Companies; Engineering Firms
Theatre Sound Systems Police Radio
And scores of other good jobs
in many related fields

YOU CONDUCT MANY EXPERIMENTS LIKE THESE!

Checking action of condensers
Experiments with AF and RF Amplifiers
Experiments with resonance
Producing beat frequencies
Calibrating oscillators
Experiments with diode, grid-bias, grid-leak and infinite impedance detectors
Practical experience in receiver trouble shooting
Application of visual tester in checking parts and circuits
Experiments with audio oscillators
Advanced trouble-shooting
... and many, many others

Complete Training by Practical Resident Trade School, Est. 1905

The same highly trained faculty, instruction materials and methods used here in our large, modern resident school, are adapted to your training in your own home. Shop Method Home Training has been proved by hundreds of successful graduates.

**Both Resident and Home Study
Courses Offered**

YOU LEARN BY DOING

You receive special laboratory experiment lessons to show you how to build with your own hands various experimental units such as those shown at left, and how to conduct many tests.

Get Complete Training. You Receive and Keep All Tubes, Equipment, Parts and Lessons. No Extra Charges.

You will find all lessons easy to understand because they are illustrated throughout with clear diagrams and step-by-step examples that you work out yourself. Every piece of the equipment and complete lesson material we send you is yours to keep and enjoy, including the multitester, experimental equipment, all parts of the Superheterodyne, tube manual, radio dictionary, and complete, modern Television texts. All parts are standard equipment.

Shop Method Home Training . . . Earn While You Learn

With our practical resident Shop Method Home Training, you study in your spare time. You receive Spare Time Work Lessons, which show you how to earn while you learn. Service neighbors' radios and TV receivers, appliances, etc., for extra money and experience. Many National students pay all or part of their training with spare time earnings!

DON'T DELAY! The Radio-Television Industry needs trained men NOW!

**APPROVED
FOR
VETERANS!**
Check coupon below!

For quick action,
mail coupon
today and we'll
rush you full information.

Free!

NEW, ILLUSTRATED
OPPORTUNITY
BOOK AND SAMPLE
LESSON SHOW YOU
HOW WE TRAIN
YOU . . . SEND FOR
THEM TODAY! NO
COST. NO
OBLIGATION.



NATIONAL SCHOOLS

LOS ANGELES 37, CALIF. • EST. 1905

FIND OUT NOW . . . MAIL COUPON TODAY

National Schools, Dept. PS-2
4000 South Figueroa Street
Los Angeles 37, California

Send me your FREE book "Your Future in Radio" and the sample lesson of your course. I understand no salesman will call on me.

NAME.....AGE.....

ADDRESS.....

CITY.....ZONE.....STATE.....

Check here if Veteran of World War II

Mail in envelope
or paste on
penny postal.

New Advertising Machine

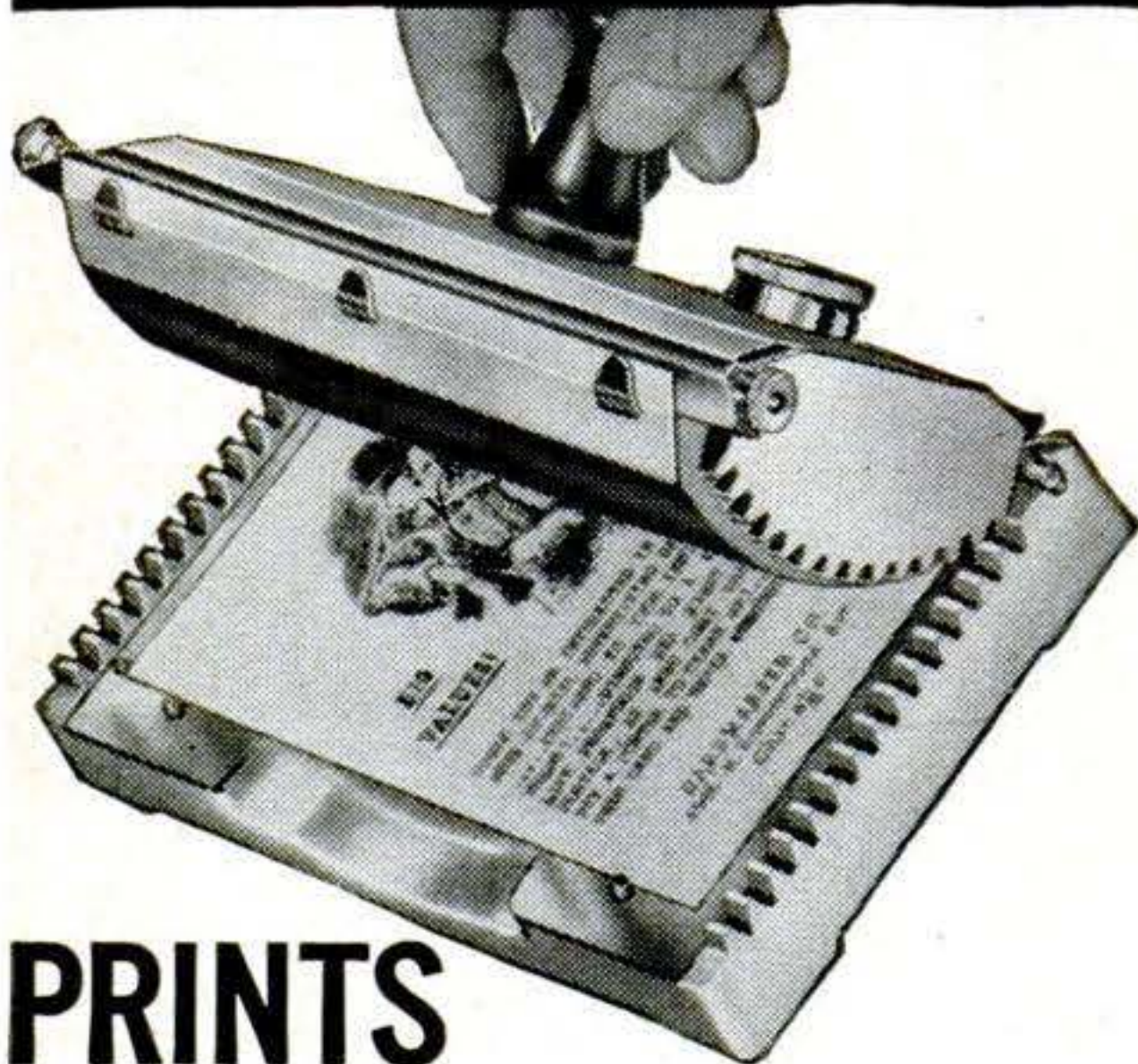

PRINTS and ILLUSTRATES

1¢ Post Cards

FREE Learn how thousands of business men, in every line, are boosting sales in spite of conditions—with 1¢ messages—printed and illustrated in a few minutes on gov't post cards—with amazing new patented **CARDMASTER**. Your "today's" ideas, read by your prospects next morning. Not a toy, but a sturdy advertising machine, built to last for years. Low price, sold direct. Guaranteed for five years. Send name today. **SEND NAME** We'll send **FREE** illustrated book of money-making **IDEAS** for your business and complete, unique advertising plans. **RUSH YOUR NAME TODAY.**

CARDMASTER COMPANY
1920 SUNNYSIDE, Dept. 162, CHICAGO 40, ILL.

ACCOUNTANT

BECOME AN EXPERT

Executive Accountants and C. P. A's earn \$3,000 to \$10,000 a year. Thousands of firms need them. We train you thoroughly at home in spare time for C. P. A's examinations or executive accounting positions. Previous experience unnecessary. Personal training under supervision of staff of C. P. A's. Placement counsel and help. Write for free book, "Accountancy, the Profession That Pays."

LASALLE Extension University, 417 So. Dearborn St.
A Correspondence Institution Dept. H-292, Chicago 5, Ill.



OUR GUARANTEE
OUR TIRES must make good or **WE WILL**
Tube Given With Each Tire
EVERYONE TAKE 10% DISCOUNT
ON ALL TIRES
Be Wise—Read this Before You Buy!
OUR EXPERIENCE ASSURES YOU
THE BEST BUY IN
GOOD USED TIRES
BUY IN CONFIDENCE
selected **POPULAR BRANDS**—
positively **NOT** Re-caps or Re-molds.

5.50-17	5.02	6.70-15	6.75	7.50-16	7.62
6.00-16	5.02	6.70-16	6.75	7.60-15	7.62
6.50-15	5.02	7.00-15	5.30	7.60-16	7.62
6.50-16	5.02	7.00-16	6.30	8.20-15	8.62

GOOD TREAD—NO RE-CAPS. THESE TIRES WILL CARRY YOU TWICE AS FAR!

6.50-20(6)	\$9.22	8.25-20(10)	15.52	11.00-20(12)	\$16.42
7.00-20(8)	10.52	9.00-20(10)	15.52	11.00-22(12)	18.42
7.50-20(8)	10.52	10.00-20(12)	16.22	32x6 (8)	10.02

750-20 MILITARY 8 PLY REGULAR \$9.62—SUPER \$12.92
900-16 MILITARY 8 PLY REGULAR \$8.72—SUPER \$10.92

Thousands of Tires Shipped to Satisfied Customers Throughout United States and Many Distant Points. Send This Ad with Check or Money Order. Dep't 5.

STANDARD 834 N. Broad St., Philadelphia 30, Pa.

New FALSE PLATE

for OLD
IN 24 HOURS

Low As Only
\$1850

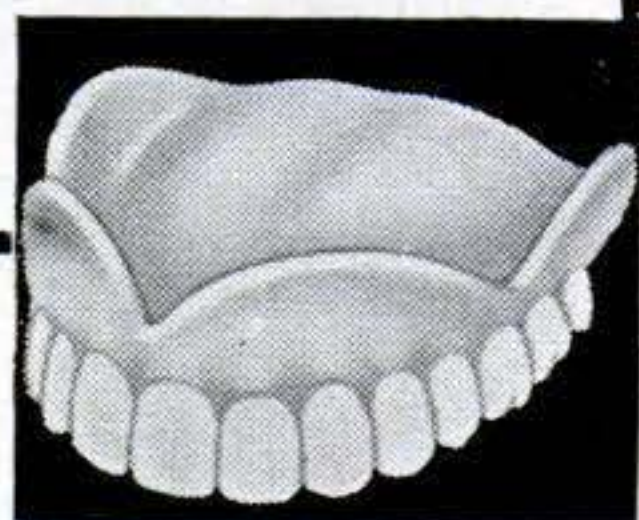

Wonderful New Scientific Method Transforms OLD, LOOSE, Cracked or Chipped Plates into LUSTROUS BEAUTY-PINK DUPONT PLASTIC PLATES

NO IMPRESSION NEEDED

Why envy beautiful false teeth of others? We will transform your old, loose, cracked or chipped plate into a beautiful new, lightweight DuPont Beauty-Pink Plastic Plate, using your own teeth. All missing and broken teeth matched and replaced. Your cost amazingly low; actually save many dollars. No impression needed under our new scientific False Plate Method. 24-Hour Service. Perfect fit guaranteed.

SEND NO MONEY Enjoy life again, and save money on beautiful, new, natural-looking plastic plate. Rush name, address for full details sent FREE. If your plate is loose, we show you how to make it comfortable, tight-fitting before duplication. West Dental Laboratory, 127 N. Dearborn St., Dept. P-34, Chicago 2, Ill.

How to Make Money with Simple Cartoons



A book everyone who likes to draw should have. It is free; no obligation. Simply address

FREE BOOK

CARTOONISTS' EXCHANGE

Dept. 192-D Pleasant Hill, Ohio

SANDEE CHROME SILENTIP

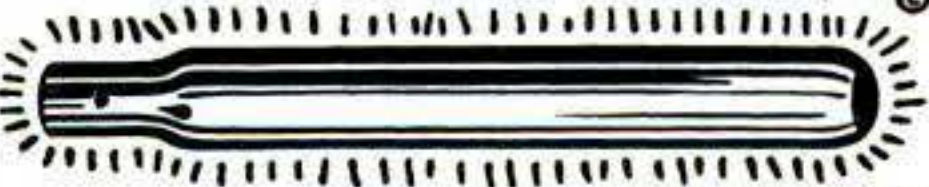

\$295
EACH

FOR QUIETER PERFORMANCE

An exhaust tailpipe extension that is actually a small muffler. Chrome plated. Will make a sport muffler or dual set quieter and still give straight thru performance.

SANDEE MUFFLER CO., 5643 Corryne Pl., Culver City, Calif.



FREE SAMPLES! GLOW IN THE DARK!

BIG PROFITS showing amazing Luminous Specialties—house numbers, pictures, plastic novelties, religious and nursery objects, ash trays, key-holders, etc. Large manufacturer. Enormous demand. Sell on sight. **WRITE AT ONCE** for **FREE** samples. **Madison Mills, 303 4th Ave., Dept. F-5, New York 10, N.Y.**

TRAIN NOW FOR AN

AVIATION CAREER

IN SUNNY SOUTHERN CALIFORNIA

MAXIMUM TRAINING IN MINIMUM TIME

Specializing in **AERONAUTICAL ENGINEERING** and **MASTER AVIATION MECHANICS** since 1929... America's Finest Aeronautical Institute... 7000 successful graduates... **MAKE MORE MONEY... MAIL COUPON TODAY. APPROVED FOR VETERANS.** Board and Room now available.

Without obligation, send free catalogue with full information.

NAME _____ AGE _____ PS-2

ADDRESS _____

CITY _____ ZONE _____ STATE _____

CAL-AERO TECHNICAL INSTITUTE
GRAND CENTRAL AIR TERMINAL • GLENDALE 1, CALIFORNIA



SALESMEN!

SALES GOING CRAZY!

Work hard for 7 months
...then LOAF the rest of the year!

AMAZING *Underground* SPRINKLER SYSTEM -

Retails for ONLY... **\$49⁵⁰**

...SWEEPING SALESMEN INTO THE BIGGEST MONEY
OF THEIR LIVES! "GOLD MINE" FOR DISTRIBUTORS!

Last year, EVERSPRAY created a nationwide sensation — poured spectacular profits into the laps of salesmen everywhere.

This year, the NEW, Improved EVERSPRAY is going to make last year's earnings look like small change! Because *this year*, we offer Salesmen TWO spectacular order getters until now unheard of in the history of Direct Selling.

1. A COMPLETE DEMONSTRATOR you carry right in your pocket.
2. An Everspray SYSTEM complete in every detail that you can

spread out on a prospect's lawn and have in full operation IN LESS THAN 10 MINUTES!

This year—right before a prospect's very eyes—you can show him exactly how his Everspray Underground Sprinkler System is going to work when it's installed in his lawn!

With *either one* of these two amazing demonstrations you clinch a sale 9 times out of 10. Every home owner who takes a speck of pride in his lawn will want to install an Everspray as quick as it can be delivered to his door!

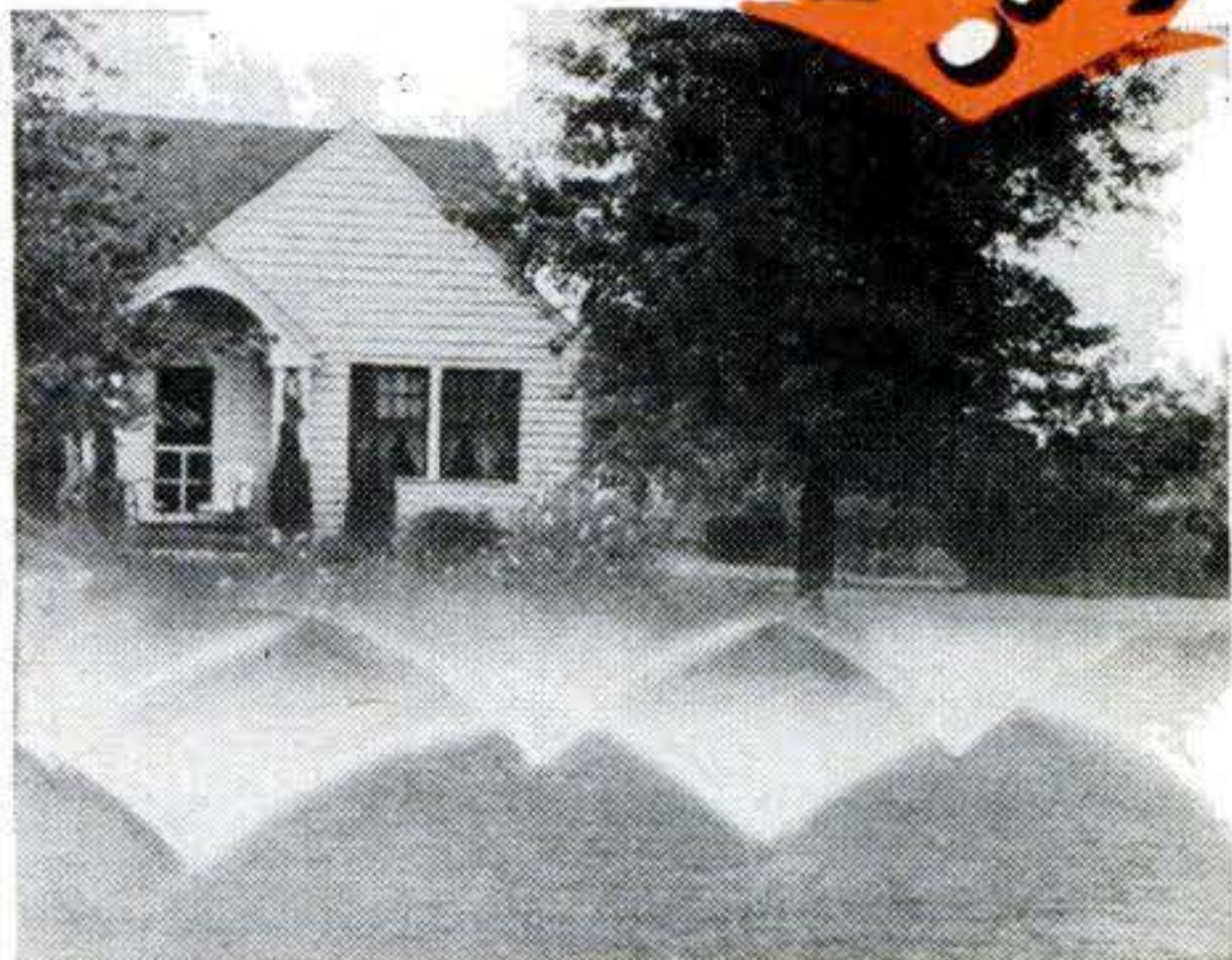

Everspray installed at North Acres Gardens, Anderson, Indiana

"People Tell Me I Have the Finest Lawn They've Seen in Years"

— writes Mrs. L. G. Johnson

"When my Everspray is in operation, people actually stop their cars to watch it and to admire the smooth, velvety green texture of my lawn. I never saw anything like Everspray in all my life."

And R. C. Freeman, Chicago, says: "It's amazing how EVERSPRAY keeps our lawn in tip-top condition all season long. Best of all, I don't have to waste hours of time sprinkling with a garden hose."

CUSTOMER INSTALLS IN FEW HOURS *without damage to lawn!*

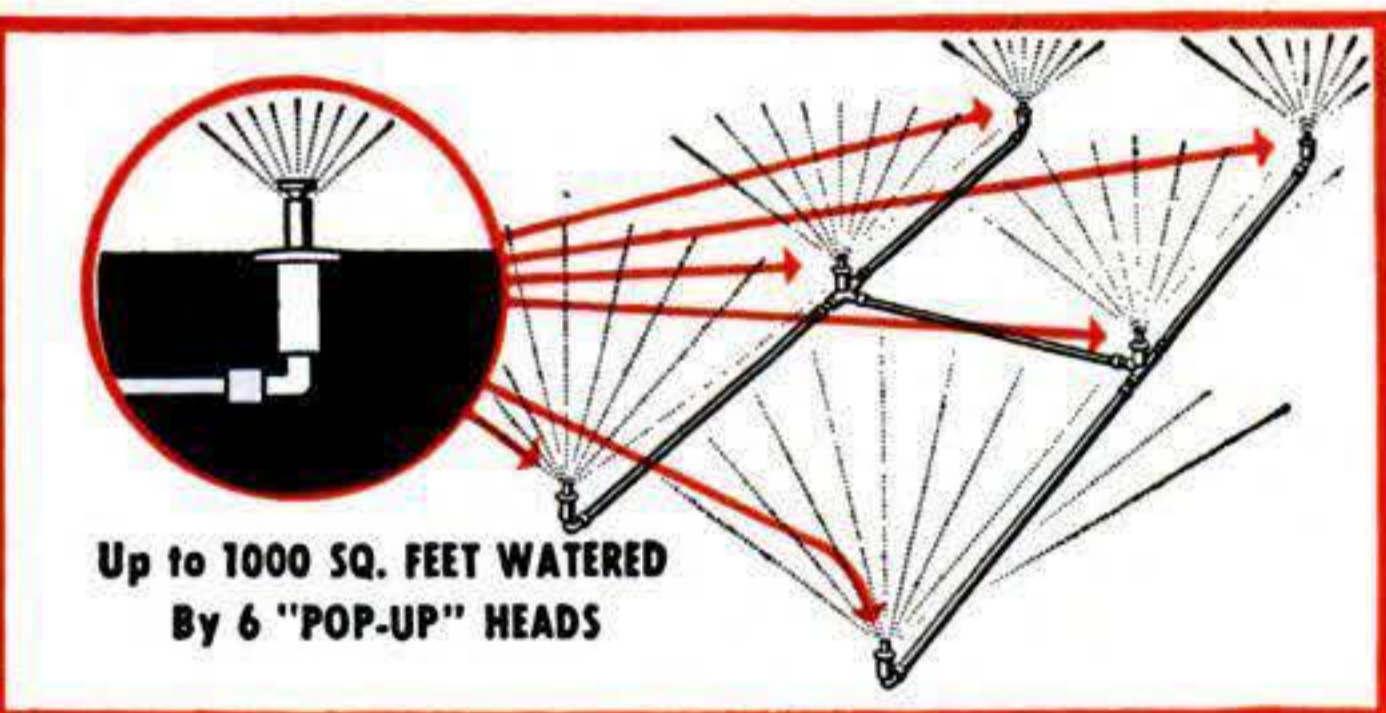

Now, for the first time in history, any home owner—anywhere—can get an Underground Sprinkler System at a price he can afford. Now his lawn can be sprinkled like a million-dollar estate. And look! Everspray is all solid brass and copper. Nothing to rust or wear out. No pipe fitting to do. No plumber's bills to pay. No repairs. No inspection. No maintenance. No freezing

because Everspray *drains itself*—automatically—every time it's shut off. No wonder home owners by the thousands are rushing to buy Everspray!

No wonder Ray J. Eckenrode says: "EVERSPRAY works like a charm. On the strength of this installation, a neighbor asked me to purchase the same layout for him."

DON'T CALL YOURSELF A SALESMAN IF YOU CAN'T MAKE

How to get an EVERSPRAY for your own use

If you want an Everspray for your own use, ask about Special User-Agent Plan that shows how you can get a complete system without a penny's cost to you. Ask for "Confidential User-Agent Plan" when you write or mail coupon.

\$60⁰⁰ A DAY!

In the NEW Improved EVERSPRAY you've got your hands on the biggest summer seller ever invented. When most lines are dead or dying, *Everspray is just coming to life!* Our sure-fire "Jack-Pot" Pyramid Sales Plan turns your *first* sale into TEN or more. Then EXTRA orders start pouring into your hands *automatically—without a bit of effort on your part!*

FREE! SEND NAME

This very minute, send your name on the coupon or penny postcard for beautiful Illustrated Folder that shows pictures of *actual Everspray* installations, Demonstrator Offer and Details of sure-fire "Jack-Pot" Pyramid Sales Plan. Everything is FREE. No charge now or ever. Time is precious. Send name today.

CARRY COMPLETE DEMONSTRATOR RIGHT IN YOUR POCKET!

You can't believe it until you see it. We show you how to use this amazing "POP-UP" Sprinkler Head to make a Demonstration, right before your prospect's very eyes! Special Demonstrator Offer sent FREE. Just mail postcard or handy coupon.



John Oakman, Sales Mgr.
EVERHOT PRODUCTS CO., (Everspray Division) Dept. 7-B
2001 Carroll Ave., Chicago 12, Ill.

Rush Illustrated Folder, Demonstrator Offer and details of your "Jack-Pot" Pyramid Sales Plan that offers me an opportunity to make \$59.40 a day on only 3 sales. Everything is FREE and costs nothing now or any other time.

Please send me "Confidential User-Agent Plan"

Name.....

Address.....

City..... Zone..... State.....

EVERHOT PRODUCTS CO.

(Everspray Division)

2001 Carroll Avenue, Dept. 7-B, Chicago 12, Illinois

Do you want

- .. to go to College?
- .. or to enter a Profession?
- .. or get an Office Position?

(Such as Accounting, Architecture, Nursing, Dentistry, Teaching, Social Work, Osteopathy, Beauty Culture, Optometry, Embalming, Chiropody, Law, Medicine, etc.)

To get anywhere, you practically **MUST** finish High School **FIRST**. You can complete our simplified High School Course in **SPARE** time at home, as **FAST** as your time and abilities permit. Equivalent to resident school work—prepares you for college, pre-professional examinations, business, industry. Standard texts furnished. Diploma. Credit for H.S. subjects already completed. Single subjects if desired. Low tuition, easy terms. American School, Chicago, est. 1897—endorsed by educators. Finish your high school education **NOW**. Write **TODAY!**

High School Course at Home

Many Finish in 2 Years

American School, Dept. H-246, Drexel Ave. at 58th St., Chicago 37

Gentlemen: Send me **FREE** information covering special training in subjects checked below. No obligation on my part.

- | | |
|--|--|
| <input type="checkbox"/> High School Course | <input type="checkbox"/> Diesel Engineering |
| <input type="checkbox"/> Electronics, Industrial | <input type="checkbox"/> Drafting and Design for Men and Women |
| <input type="checkbox"/> Architecture and Building | <input type="checkbox"/> Plastics |
| <input type="checkbox"/> Automotive Engineering | <input type="checkbox"/> Private Secretary |
| <input type="checkbox"/> Business Management | <input type="checkbox"/> Mechanical Engineering |
| <input type="checkbox"/> Electrical Engineering | <input type="checkbox"/> Aviation |
| <input type="checkbox"/> Elec. and Gas Refrigeration | <input type="checkbox"/> Salesmanship |
| <input type="checkbox"/> Air Conditioning | <input type="checkbox"/> Radio |
| <input type="checkbox"/> Railway Training | |

Name

Address

BUILD! DESIGN! CREATE!

With TECH

the New CREATIVE MODEL MAKER

An amazing **NEW** construction set of durable colorful plastic! Makes an immediate hit with the youngsters because it is so **simple and easy to assemble** without screws, bolts or nuts. A marvel for the model maker because parts are **precision engineered** to 1/1000 of an inch accuracy. Duplicates appearance and action of actual machines with fascinating realism. Gears, wheels, pulleys, girders, blocks, **LOOK and WORK** like real ones. Finished models may even be operated electrically. Erect engines, lathes, cranes, airplanes and 100 other designs that come with set or develop models of your own invention. Parts are big and strong, mar-proof, non-fading, brilliantly colored clear through. Don't wait! Get a **TECH Creative Model Maker**—now—and enjoy endless hours of instructive entertainment.

Regular price \$6.00

Special **NOW**

\$3.49

TECH, 6602 Lexington, Hollywood 38, Calif.

Gentlemen: Please rush me..... sets of TECH, the creative Model Maker, complete with **FREE** 48-page color illustrated model makers guide, for which I enclose.....

Name.....

Street.....

City..... State.....



New MODELS EASIER TO PLAY

Find out about these sensational new Conn Band Instruments. Many wonderful, exclusive features! Today, *more than ever*, Conns are the "Choice of the Artists." You'll advance faster and take more pride in a genuine Conn—made by the world's largest manufacturer. See your dealer or write us for free literature. Mention instrument. Conn Band Instrument Division, C. G. Conn Ltd., 232 Conn Building, Elkhart, Indiana.

Write FOR FREE FOLDER



MECHANICAL DENTISTRY

To make Crowns, Plates, Bridgework, etc., for Dentists. Easy practical way to learn mechanical dentistry at home in spare time. **FULL EQUIPMENT OF TOOLS AND MATERIALS INCLUDED WITH COURSE**. Low tuition. Easy terms. Write for **FREE BOOK** about this money making profession that is not affected by the machine age.

McCARRIE SCHOOL of Mechanical Dentistry
207 N. Broad St. Dept. 893 Philadelphia, Pa.

HOMESITES \$300 LOW TERMS

In California's loveliest Garden Spot, on scenic shores of beautiful Morro Bay. Enjoy future independence with excellent soil, soft water, wonderful fishing, hunting, boating, bathing, etc. Grow fruits, vegetables, poultry. Perfect temperate climate. Congenial community. Finest investment. Free literature.

RICHARD S. OTTO

Dept. PS San Luis Obispo, California

Rupture Troubles Ended

Advanced method has healed thousands. No leg straps, no elastic, no plasters. No pressure on hips or spine. Flexo-pad. Entirely different. Endorsed by doctors, mechanics, clerks. Very light. **INEXPENSIVE. GUARANTEED.** Write for information and trial.

SMITH MANUFACTURING COMPANY
EST'D 1893 Dept. PS, Preston, Ont. Can.

NEW AUTOMOTIVE DISCOVERY

FREE TRIAL

IN YOUR CAR!

REPLACES IDLE ADJUSTMENT SCREW IN YOUR CARBURETOR

HOLES FOR AIR FLOW

FITS ALL CARS

THE AMAZING NEW GANE "air-flow" NEEDLE

THE OBJECTIVE IS TO GIVE YOUR CAR

- ✓ MORE MILEAGE
- ✓ FASTER PICK-UP
- ✓ EASIER STARTING
- ✓ BETTER IDLING

Install it YOURSELF
in only 5 minutes

Up to 25% MORE MILEAGE, EASIER STARTING, FASTER PICK-UP, and SMOOTHER IDLING—many users report with this **SENSATIONAL NEW** automotive product. NOW, test them in your car AT OUR EXPENSE. Check mileage and engine performance. If satisfied (as 1/2 MILLION other users are) send \$1.50 per needle (8 cyl. cars take 2). If not entirely satisfied—just return them—**FAIR ENOUGH?** Send card TODAY—specify **MAKE** of car and carburetor. **SEND NO MONEY—TRY BEFORE YOU BUY—PAY POSTMAN NOTHING.**

Dept. H-2, Venice, Calif.

NATIONAL AUTOMOTIVE RESEARCH CO.

LEARN

ELECTRICITY

ON REAL EQUIPMENT

IN THE GREAT SHOPS OF **COYNE**



ALSO TRAINING IN **RADIO-TELEVISION**



NEW OPPORTUNITY FIELD

The fast-growing field of Television—the new development in the Radio field offers unlimited opportunities today. Coyne offers a separate course in **Radio-Television**, Installation, Testing, Trouble-Shooting and Service on Radio, F.M., and Television equipment. Get big free book today.

Get into the OPPORTUNITY FIELD OF ELECTRICITY

For many years Electricity has been a most vital factor in industry. This great field will continue to grow and become more important. Thousands of trained Electrical men will be needed. Why be satisfied with a "no future" job? Prepare for a good job with a real future in Electricity.

Coyne Trained Men in Good Jobs

Thousands of Coyne trained men in good jobs or in a business of their own in Electricity and Radio-Television, make real money while others putter along. Yes, you can get ready for Good Pay—a Big Future—by training at COYNE here in Chicago. Here you work on real equipment—do actual wiring and trouble-shooting—get the practical-technical training you need.

Not "Home-Study"

We do not teach by mail. All training is given in our Great Training Shops in Chicago, plus necessary theory. Expert instructors guide you. No advanced education or previous experience needed.

GI Approved — Finance Plan for Non-Vets

COYNE courses are approved under the G.I. Bill. Non-veterans may enroll now, pay most of tuition after graduation. If you need part-time work to help out with living expenses while at Coyne, we'll help you get it.

Mail Coupon for Big FREE BOOK

Whether you prefer Electricity, or Radio-Television, train on actual equipment, at Coyne. We have a big, fully illustrated book on each course, and we'll send you the one you want, or both, without obligation. Mail coupon—TODAY.

B. W. COOKE, President, COYNE ELECTRICAL & RADIO SCHOOL, 500 S. Paulina St., Chicago 12, Ill. Dept. 20-73H



B. W. COOKE, President COYNE ELECTRICAL & RADIO SCHOOL, Dept. 20-73H 500 S. Paulina St., Chicago 12

Send FREE, the book checked below, and details of your training offer. This does not obligate me and no salesman will call.

ELECTRICITY RADIO-TELEVISION

NAME.....

ADDRESS.....

CITY.....STATE.....



1 You are TOLD the how and why of each job.



2 You're shown how to do typical jobs by trained instructors.



3 You DO practical job YOURSELF on equipment.

BE A LEADER IN INDUSTRY

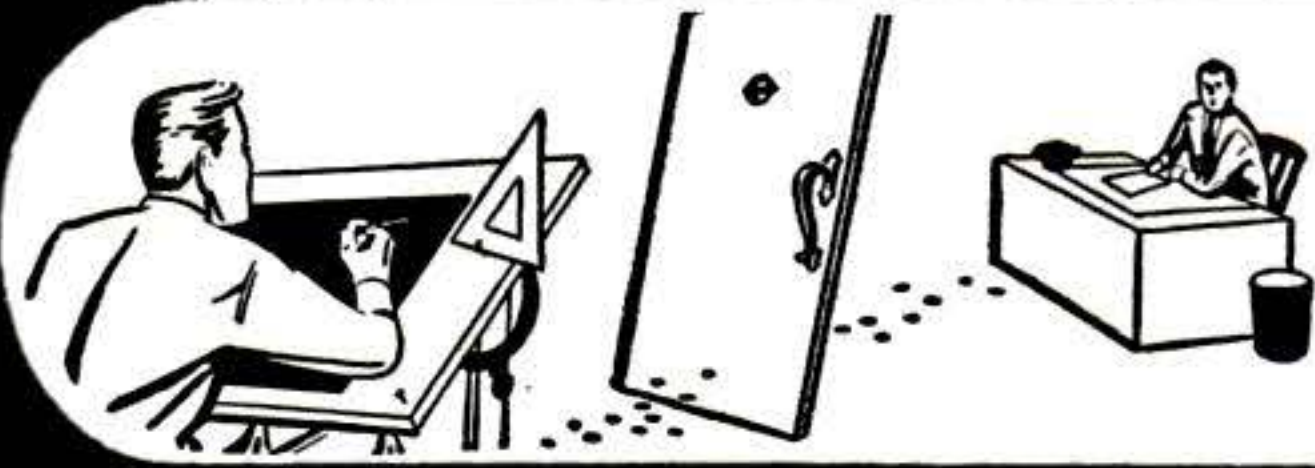

USE DRAFTING AS YOUR DOORWAY TO SUCCESS

It's EASY if you use CEI Simplified Training & Coaching

You can have security, a car, a home and a big pay job. Be like industry's leaders and use drafting as your springboard to success. Get in on the big money industry is offering for draftsmen. CEI will teach you Drafting easily and quickly in your spare time at home and help you get a job. Mail coupon now!

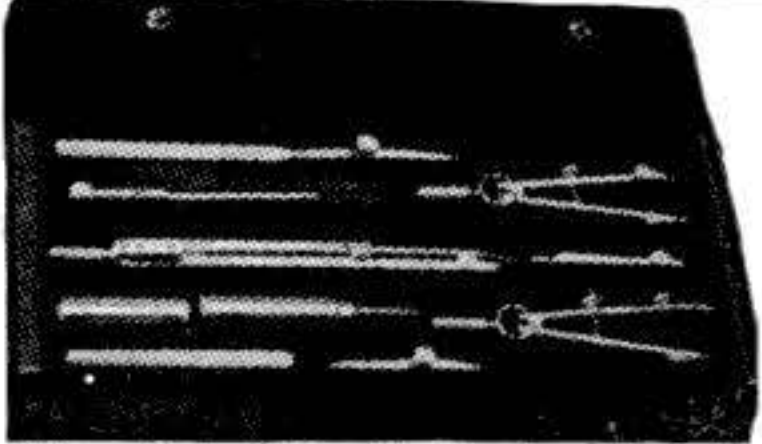

You Get This Professional Set of Instruments at no Extra Cost



GET FREE SUCCESS BOOK

Cleveland Engineering Institute
Extension Div. PS-2A
2325 Chester Ave., Cleveland 14, Ohio
Rush your FREE Success Book showing how Drafting is the Doorway to Success.
 Veterans Check Here

NAME.....
ADDRESS.....
CITY..... STATE.....
No Obligation—No Salesmen

APPROVED FOR TRAINING UNDER "G.I. BILL OF RIGHTS"

STUDY AT HOME

With An Educational Institution

Men with specialized training win higher positions, insure larger earnings, and are bigger successes in business and public life. Opportunities NOW greater than ever before. Send for our Catalog.

ARTS and SCIENCES

Courses in Philosophy; Education; Letters; Public Health; Medical Jurisprudence; Psychology; Sociology; Physics; Chemistry; Geology; Political Science; Theology; Business and Commerce; Accounting; Mathematics; Statistics; Agriculture.

ENGINEERING

Courses in Electrical, Civil, Mechanical, Drafting, Architectural, Steam, Aeronautical, Radio, Structural, Mining, Industrial, Petroleum, Marine, Chemical, Diesel, Automobile, Refrigeration, and Air Conditioning Engineering.

LAW

Complete Professional Law Course includes 18 Hornbrook Series college grade textbooks. Courses also in Commercial Law, Patent Law and Medical Jurisprudence.

McKinley-Roosevelt Incorporated, 4610-AB, Sheridan Rd., Chicago 40, Ill.

How to start SPARE TIME BUSINESSES

you can run at home for as little as \$4.45

Just published—and a copy is yours free of charge—the fascinating booklet that tells details of nine different businesses that can be run from the home—either in spare or full time—learn how to turn materials costing pennies into products selling for dollars. All the secrets of felt flocking, monogramming, plaster casting of objects of art, laminating in plastic, personalizing, wood carving, display advertising, drawings, electroplating, metalizing baby shoes and other keepsakes. All described with list of equipment needed at prices as low as \$4.45 for a complete outfit. Rush name for free book.
Warner Electric Co., 1512 Jarvis Ave., Dept. K-32, Chicago 26

NINE DIFFERENT BUSINESSES
Take your Pick. Just the business to suit your talents. ALL FREE. Just send name.



LEARN WATCHMAKING and REPAIRING

Have as your goal a STORE OF YOUR OWN

In California—intensive, practical training unsurpassed anywhere. Award of Graduation, West Coast University, School of Watchmaking. Accredited by United Horological Association of America. Approved for Veterans and Non-veterans. Part-time employment and housing assistance. Our catalog will interest you. Sent upon request. No obligation.

MAIL COUPON BELOW TODAY!

West Coast University, School of Watchmaking
5145 W. San Fernando Rd., Dept. PS 20
Los Angeles 26, California

Gentlemen: Please send me complete information about your training program.

NAME..... Age.....
STREET..... Zone.....
CITY..... State.....
Veteran..... Non-veteran.....

WOULD \$400 PER MONTH INTEREST YOU?



It is easily possible to earn \$400 to \$500 a month raising ANGORA RABBITS. No experience required. Wool brings \$9 lb. Plenty markets. WRITE TODAY for FREE INFORMATION, PRICES & WHERE to SELL.

WHITE'S RABBITRY
NEWARK 8, OHIO

LEARN MEAT CUTTING

through actual practice. Profitable Meat Cutting and Self Service Meats taught easily, quickly. LEARN BY DOING at Toledo in just eight short weeks under actual market conditions. For beginners or men with experience. All subjects taught thoroughly and completely. Diploma. Job help. Get store of own. People must eat. School in operation over 25 years. Approved for GI training. Send today for FREE illustrated catalog. No obligation. NATIONAL SCHOOL OF MEAT CUTTING, Dept. 51-B, Toledo 4, Ohio

MAIL THIS FREE TRIAL COUPON FURNITURE MAKING AND CABINET WORK

BY B. W. PELTON
Complete Step-by-Step Directions For Making Every Type of Furniture. Including Built-in Conveniences and Home-Remodeling Jobs.
D. Van Nostrand Company Examine This FREE!
250 Fourth Avenue, New York, N. Y. Great Book
Send me a copy of Furniture Making and Cabinet Work. Within 10 days I will either return the book or send you \$6.95 plus a few cents postage.

SEND NO MONEY Name.....
Address.....
City..... Zone..... State.....
Pop Sci-250

NOW! BRAND-NEW, UP-TO-THE-MINUTE Edition of Famous Manual
MAKES ANY AUTO REPAIR JOB

Your "Meat!"

ENLARGED!

95 MORE Pages!
 795 BIG Pages in All!
 More Chapters! More Facts!

REVISED!

418 NEW Pictures—
 2100 in All! 141 NEW
 Pictures on Hydramatic Drive!

NEW!

Now You Can Repair
 ALL 1949 MODELS—As Well
 As Any Car Built Since 1935!

TRY BOOK FOR A WHOLE WEEK—FREE
 Return and Pay Nothing if Not Satisfied!

HERE it is!—the brand-new, revised, enlarged edition of MoToR's Auto Repair Manual! Now you can "lick" any auto repair job on any car built since 1935—including all 1949 models! Just look up make, model, and job in quick index—and go to it.



ABOVE—Showing operation of Buick Dyna-Flow — and BELOW: How to Adjust Ford Clutch. Every moving part is covered in simple words and BIG, CLEAR Pictures.

EVERYTHING YOU NEED TO KNOW TO REPAIR ANY CAR!

795 BIG pages; 2100 "how-to-do-it" pictures; 200 "quick-check" specifications, charts, and tables; over 200,000 facts make every operation a "snap"! Beginners will find in this giant book the most helpful guidance on every kind of service and repair job imaginable. Experts will be amazed by the shortcuts they'll discover.

Win Prestige! Earn More Money!

Factory engineers from every auto plant in America worked out these time-saving procedures. Now you get all this wealth of "know-how" from over 150 Official Shop Manuals, "boiled down" into clear terms in one handy book! Now you can tackle jobs you wouldn't think of trying before. And you'll

win more prestige, more money!

Right at your fingertips you have every "How-to-do-it" fact you want. Over 35,000 essential dimensions on 697 car models! Whether you want to make a simple carburetor adjustment or completely rebuild a transmission, step-by-step instructions show exactly WHAT to do, HOW to do it. Used by U. S. Army, technical schools, thousands of auto service men.

Used by
 U. S. ARMY
 and NAVY

**COVERS ANY
 CAR BUILT
 SINCE 1935!**

- | | |
|--------------|---------|
| Auburn | Cord |
| Austin | Crosley |
| Buick | De Soto |
| Cadillac | Dodge |
| Chevrolet | Ford |
| Chrysler | Frazer |
| Graham | |
| Hudson | |
| Hupmobile | |
| Kaiser | |
| Lafayette | |
| La Salle | |
| Lincoln | |
| Mercury | |
| Nash | |
| Oldsmobile | |
| Packard | |
| Pierce Arrow | |
| Plymouth | |
| Pontiac | |
| Reo | |
| Studebaker | |
| Terraplane | |
| Willis | |

SEND NO MONEY

Send no money. Enjoy this brand-new book—at our risk—for a full week, FREE! Test it right in your own garage or shop. If book doesn't more than pay for itself in 7 days, simply return it and pay nothing. Mail coupon NOW to MoToR Book Dept., Desk 2C, 250 West 55th St., New York 19, N. Y.



Published by MoToR, The Leading Automotive Business Magazine

MAIL COUPON NOW FOR 7-DAY FREE TRIAL

MoToR BOOK DEPT.
 Desk 2C, 250 West 55th St., New York 19, N. Y.

Rush to me at once (check box opposite book you want):
 MoToR's AUTO REPAIR MANUAL. If O.K., I will remit \$1 in 7 days (plus 35c delivery charges), \$2 monthly for 2 months and a final payment of 95c one month after that. Otherwise I will return the book postpaid in 7 days. (Foreign price, remit \$8 cash with order.)
 MoToR's TRUCK REPAIR MANUAL. (Described at left.) If O.K., I will remit \$2 in 7 days, and \$2 monthly for 3 months, plus 35c delivery charges with final payment. Otherwise I will return book postpaid in 7 days. (Foreign price, remit \$10 cash with order.)

Print Name.....Age.....

Print Address.....

City..... State.....

Check box and save 35c delivery charge by enclosing WITH coupon entire payment of \$5.95 for Auto Repair Manual (or \$8 for Truck Repair Manual). Same 7-day return-refund privilege applies.

Same FREE Offer on

MoToR's TRUCK MANUAL



Covers EVERY job on EVERY truck made from 1936 thru 1946! 1400 pictures, 952 pages, 300,000 facts. All types Gasoline Engines, Truck Diesels, Hesselmanns, Fuel Systems, Governors, Lubrication, Ignition, Starters, Clutches, Axles, Brakes, etc., etc.

ALSO covers many buses, tractors, contractor and road building equipment, stationary power machinery. Check box in coupon.

Make 100% to 150% Profit!

MANUFACTURE BUILDING BLOCKS

In Your Own Back Yard

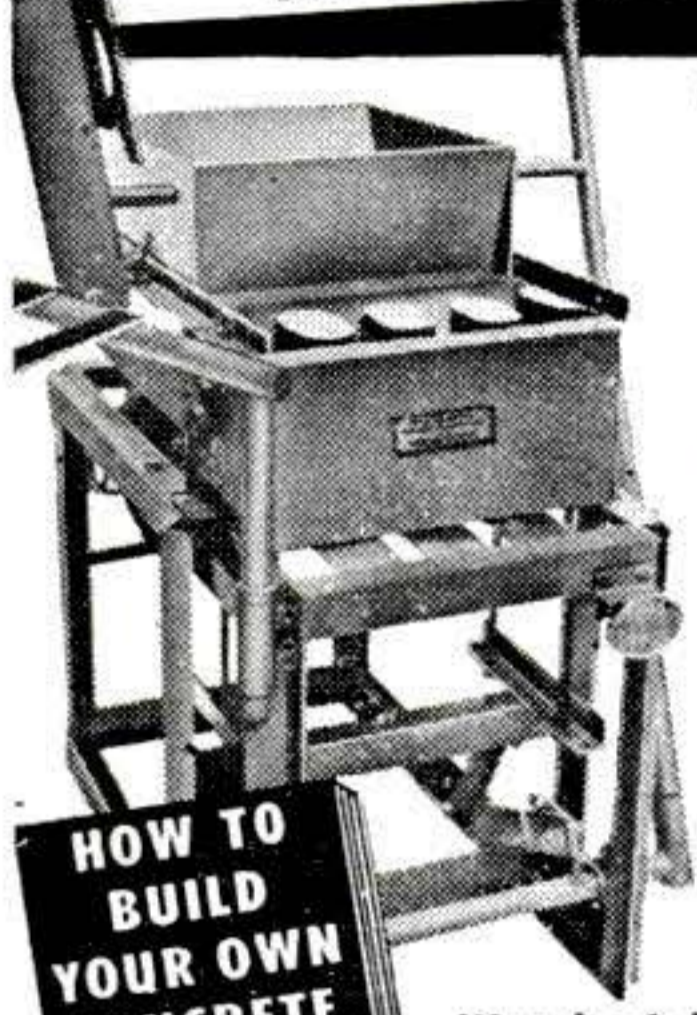

AMAZING GENERAL BLOCK MACHINE

CAPACITY 1000 BLOCKS PER DAY

Only \$199 LESS MOTOR

F.O.B. PLANT

SHIPPING WEIGHT 400 lbs.

Here is an outstanding opportunity for men of vision and small capital. Cinder and concrete blocks are in great demand. Millions used for homes, factories, public buildings. Sell all you produce at 100% to 150% mark-up.

PEAK BUILDING DEMAND!

The General Block Machine is amazingly practical, foolproof. Simple to operate indoors or outdoors. Rugged all steel construction. Vibrator mounted in sealed ball bearings. Produces up to 1,000 blocks per day. Superior 3 Core Type that meets all building code requirements. Can produce 4 x 8 x 16, 8 x 8 x 16, 12 x 8 x 16 blocks. All materials obtainable anywhere. All operating instructions and mixing formulas supplied. Full details FREE without obligation.

Wonderful Book Written & Illustrated by Experts

HOW TO BUILD YOUR OWN CONCRETE BLOCK HOME Only 1 Prepaid

GENERAL ENGINES CO.

DEPT. S5 • 307 HUNTER ST. • GLOUCESTER, N. J.

Includes floor plans for 6 beautiful, easy to build concrete block bungalows. Shows ways to save money. How to lay blocks, lay out building lines, mix concrete, build steps, porches and concrete floors. Mail coupon at once with \$1.

Name.....
Address.....
City...../Zone...State.....

9 BIG BUILDING BOOKS

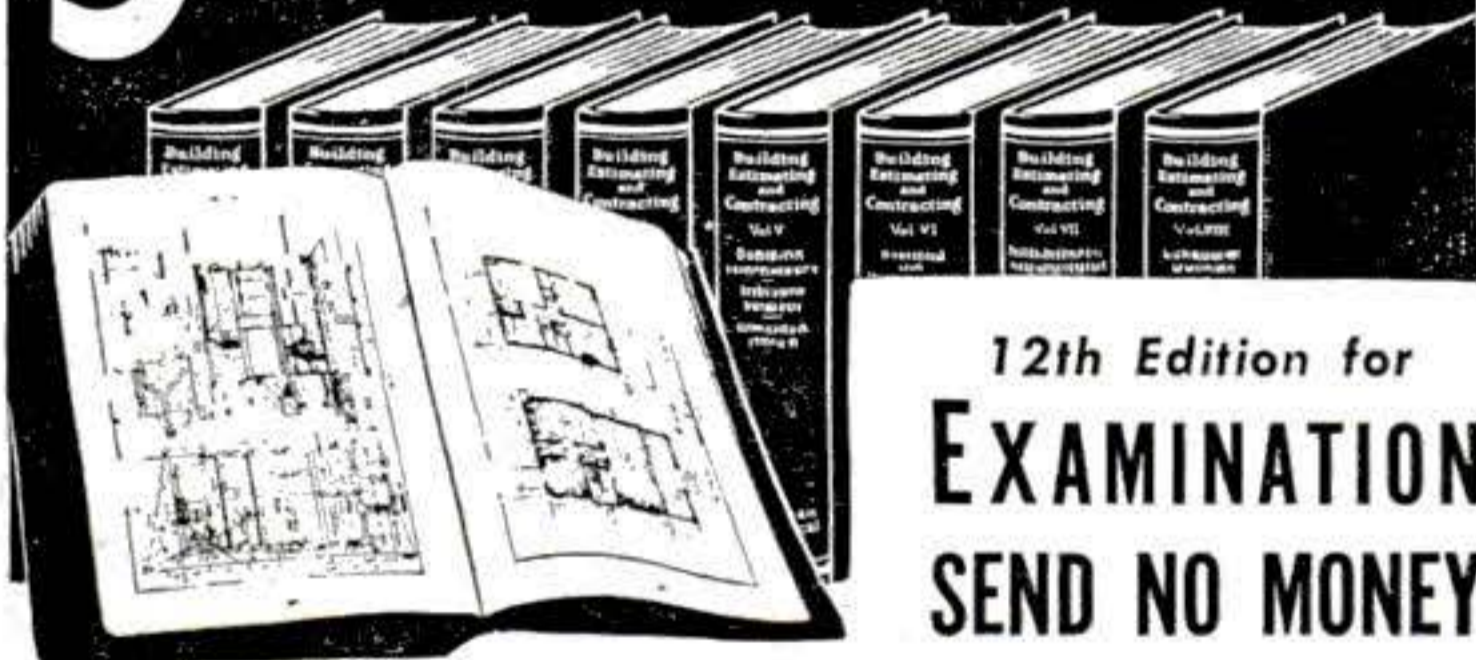

12th Edition for EXAMINATION SEND NO MONEY

Learn to draw plans, estimate, be a live-wire builder, do remodeling, contracting. These 9 practical, profusely illustrated books cover subjects that will help you to get more work and make more money. Masonry, concrete forms, carpentry, steel square, roof framing, construction, plumbing, heating, painting, decorating and many other subjects. More than 4000 pages—2750 illustrations.

BETTER JOBS—BETTER PAY UP-TO-DATE EDITION

A nationwide building boom is in full swing and trained men are needed. Big opportunities are always open for MEN WHO KNOW HOW. These books supply quick, easily understood training and handy, permanent reference information that helps solve building problems.

These books are the most up-to-date and complete we have ever published on these many subjects.

Coupon Brings Nine Big Books For Examination

AMERICAN TECHNICAL SOCIETY — Publishers since 1898
Dept. G220 Drexel at 58th Street Chicago 37, Ill.

You may ship me the Up-to-Date edition of your nine big books, "Building, Estimating and Contracting," without any obligation to buy. I will pay the delivery charges only, and if fully satisfied in ten days, I will send you \$2.00, and after that only \$3.00 a month, until the total price of only \$34.80 is paid. I am not obligated in any way unless I keep the books.

Name.....
Address.....
City.....State.....

Please attach a letter stating your age, occupation, employer's name and address, and name and address of at least one business man as a reference. Men in service, also please give home address.

Your Own Business IN TAILORING!



GET SAMPLE SUITS—NO MONEY NEEDED

Men! Here's an amazing business you can start in spare time *without investment*, taking orders for nationally-known big-value suits and overcoats at low prices. Everything you need supplied, *including opportunity to get sample suits to wear and show!* No experience needed. Age makes no difference.

Rush name and address today with letter about yourself. Get big, spectacular outfit containing more than 150 beautiful actual fabric samples, styles, etc. It's absolutely FREE! Act now!

PIONEER TAILORING CO., Dept. B-1120
Congress & Throop Sts., Chicago 7, Illinois

Utilities Engineering Institute

Founded 1927

Diesel • Auto Body & Fender REFRIGERATION • AIR CONDITIONING

Practical training in these big pay trades covers overhauling, troubleshooting, installation, maintenance techniques. Proved, easy-to-follow method prepares you at home in spare time, follows with actual shop practice. Also G. I. approved resident courses.

Full information **FREE!** Write today
2525 Sheffield Ave., Dept. M-2, Chicago 14, Ill.

HE-MAN MUSCLES YOURS 6 WKS. IN ONLY 6

OR YOUR MONEY BACK!

Proven body-building course given with Dan Lurie 50-lb. barbell. If not delighted with results after 6 weeks trial, return barbell for full \$8.95 refund. Order today.....

DAN LURIE BARBELL CO.
1729 S2 Rockaway P'kwy, B'klyn 12, N. Y.



TRI-STATE COLLEGE

B. S. DEGREE IN 27 MONTHS
Founded 1884
WORLD-WIDE ENROLLMENT

Civil, Elect., Mech., Chem., Aero, Radio and Telev. Engineering; Bus. Adm., Acct. Visit campus, see well equipped labs. Low cost. Prep. courses. Personalized instruction. Grads. successful. Enter March, June, Sept., Jan. Catalog. 520 College Ave., Angola, Ind.

Is Your Job

DEPRESSION PROOF?

Can you lose employment because of depression, business failure or old age? Learn watchmaking, the mechanical profession called "depression-proof for trained men" by impartial national authorities. Old age brings increased respect rather than insecurity. Study veteran training approved courses in watch and clock repair, jewelry engraving, chronograph repair at the world's largest, best-equipped watchmaking school. SEND FOR FREE 116-PAGE INFORMATION PACKET

WESTERN PENNSYLVANIA HOROLOGICAL INSTITUTE
WORLD'S LARGEST WATCHMAKING SCHOOL



Desk 39, Chamber of Commerce Bldg., Pittsburgh, Pa.

THOUSANDS NOW PLAY

who never thought they could!



After Ten Months Plays in Band

I had no idea I would accomplish so much musically. After only ten months I was playing in bands. I now am employed in a music store as an instructor. This I owe to your marvelously simple lessons.
*R. C., Paterson, New Jersey



Wouldn't Take \$1000 for Course

The lessons are so simple that anyone can understand them. I have learned to play by note in a little more than a month. I wouldn't take a thousand dollars for my course.
*S. E. A., Kansas City, Mo.



Shares Course With Sister

The teaching is so interesting and the pieces so beautiful I couldn't ask for anything better. I recommend your course highly. My sister shares it with me and feels the same way.
*D. E. G., Wausau, Wisc.



Lots of Fun

The progress I have made is thrilling. I'm on Lesson Seven and tossing off "Little Buttercup" like a maestro. The course is easy and what is most important—lots of fun.
*B. B., Jr., Hartford, Connecticut



Plays After 2 Months

I hesitated before sending for your course because of an earlier experience I had with a course by ear from another company. I am playing pieces now I never dreamed I would play after only two months.
*E. T., Prichard, Ala.

*Actual pupils' names on request. Pictures by professional models.

You, too, can play any instrument By this EASY A-B-C Method

YOU think it's difficult to learn music? That's what thousands of others have thought! Just like you, they long to play some instrument—the piano, violin, guitar, saxophone or other favorites. But they denied themselves the pleasure—because they thought it took months and years of tedious study to learn.

Learn in Spare Time at Home

And then they made an amazing discovery! They learned about a wonderful way to learn music at home—without a private teacher—without tedious study—and in a surprisingly short time. They wrote to the U. S. School of Music for the facts about this remarkable short-cut method. And the facts opened their eyes! They were amazed to find how easy it was to learn.

The result? Over 850,000 men and women have studied music at home this simple, A-B-C way. Now, all over the world, enthusiastic music-lovers are enjoying the thrilling satisfaction of creating their own music. They have found the key to good time, popularity and profit.

Costs Only Few Cents a Day

And that's what you can do, right now. Get the proof that you, too, can learn to play your favorite instrument—quickly, easily, in spare

time at home for only a few cents a day. Never mind if you have no musical knowledge, training or talent. Just read the fascinating booklet and Print and Picture sample that fully explain all about the famous U. S. School method. Instruments supplied when needed, cash or credit. If interested tear out the coupon now, before you turn the page. U. S. School of Music, 82 Brunswick Bldg., New York 10, N. Y. (52nd year)

FREE!

Print and Picture Sample



NOTICE

Prices of our courses have not gone up. Music lessons still cost only a few cents a day. Remember, we don't teach music "by ear" or by numbers. We teach you to play by standard notes.

**U. S. SCHOOL OF MUSIC,
82 Brunswick Bldg., New York 10, N. Y.**

I am interested in music study, particularly in the instrument checked below. Please send me your free illustrated booklet "How to Learn Music at Home," and your free Print and Picture Sample. (Instrument supplied when needed, cash or credit.)

Piano	Saxophone	Clarinet	Practical
Guitar	Trumpet, Cornet	Trombone	Finger
Hawaiian	Reed Organ	Flute	Control
Guitar	Tenor Banjo	Modern	Piccolo
Violin	Ukulele	Elementary	Mandolin
Piano Accordion		Harmony	

Mr. _____ Have you
Mrs. _____ Instrument? _____
Miss _____ (Please print)

Address _____

City _____ State _____

NOTE: If you are under 16 years of age, parent must sign coupon.

SAVE 2c—STICK COUPON ON PENNY POSTCARD

PEARL

FINISHING OFFERS YOU

BIG MONEY

RIGHT AT HOME

AMAZING NEW PEARL FINISH can be instantly applied to any article—leather—wood—plastic—glass—metal, etc.

BABY SHOES preserved for life in beautiful Baby Pink, Blue, and Ivory thrill mothers and bring immediate sales.

Nothing else like it! Costume jewelry, buttons, earrings, treasured mementos, etc., etc., take on new splendor and beauty at once.

TREMENDOUS DEMAND—Help us fill it—Fantastic profits await those who act NOW. Be First! Scoop the market. Never before has such an opportunity been offered. Never before such Big Profits made so quickly—**SPARE OR FULL TIME.**

NO INSTRUCTION COURSE TO BUY!

Complete Step-by-Step Instructions included at **NO EXTRA COST!** First time in History that such an offer has been made! Send **COUPON TODAY** for **FREE FACTS** on this **NEW BIG PROFIT BUSINESS.**

DON'T PASS THIS UP!—It costs Absolutely Nothing to get the **FREE FACTS** that show you the **EASY WAY** to **QUICK, BIG MONEY** overnight. Mail Coupon **TODAY!**

PEARL-KOTE CO. Dept. 34
2111 W. Manchester Ave., Los Angeles 47, Calif.
Okay! **RUSH** me **FREE FACTS** at once. I understand there is **NO INSTRUCTION COURSE TO BUY!**

Name _____
Address _____
City _____ Zone _____ State _____

SANDEE

Mufflers—All Ford, Chev., Ply.....\$4.45
All Buick, Pont., Olds., Chrys.,
Dodge, Hudson, K.F., Pack., etc.....\$5.45
V-8 and Merc. Duals
(32-49 incl.)
\$15.95



SPORTONE
MUFFLERS
(Pats. Pend.)

Beautiful
SANDEE
Fender Skirts
\$9.95

A SANDEE Sportone will outlast two ordinary mufflers and give More Power! More Speed! More Mileage!—plus a tone quality unsurpassed.

Please ship (item): _____ Price _____
Car and Year _____ Name _____
Address _____

SANDEE MUFFLER CO. 5643 Corryne Pl. Culver City, Calif.

Bay State PRE-BILT BOAT KITS

Half Put together at the factory

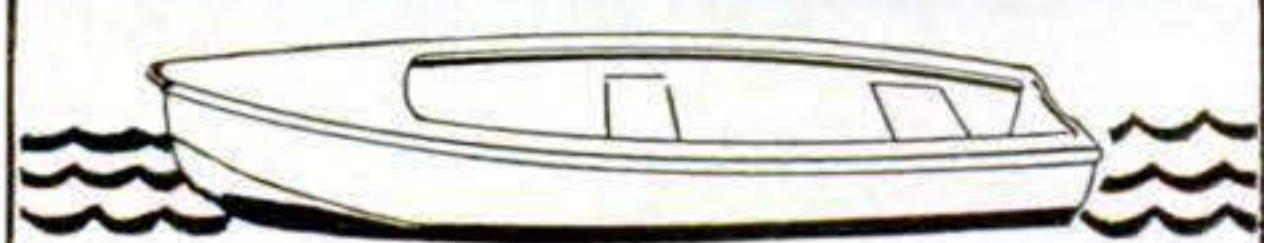

A Boat For Every Purpose

10' "Holiday"	\$ 59.50
12' "Deluxe Runabout" . . .	89.50
14' "Family Utility"	129.50
11' "Mercury V Class B Racer"	109.50

Easily completed! Just the thing to put your winter-nights to use and save real money.

Write for circular and name of your nearest dealer.

BAY STATE BOAT CO.
10 MAIN ST., CAMBRIDGE, MASS.

NATION'S
LARGEST
EXCLUSIVE
ELECTRICAL
SCHOOL

"LEARN-BY-DOING"

ELECTRICITY

PRACTICAL TRAINING
NOT "HOME STUDY"

G.I. APPROVED Get actual experience in great shops of M.T.I. Learn all phases Practical Electricity; Housewiring, Motors, Const., Maintenance, etc. Living arrangements, Part-time jobs, etc.

A post card brings the story,
MICHIGAN TECHNICAL INSTITUTE, Dept. PS-2
2281 W. Fort St., Detroit 16, Michigan

LEARN TO WRITE



FOR BUSINESS AND SOCIAL SUCCESS!

Improve your handwriting at home quickly with my new instruction books just off the press. Master all the secrets of better penmanship. Simple and easy, fully illustrated, highly endorsed. Begin today. Write for: New Free Book, "How to Become a Good Penman", or check books wanted. \$1.00 each. Business Writing Artistic Writing Card Writing Engrossing Alphabets Bird and Design Flourishing Complete Set \$4.50 Enclose 10c for your name beautifully written and shading penpoint. S. A. Ziller, President, **TAMBLYN SCHOOL OF PENMANSHIP** 439 Ridge Bldg. In Business Over 52 Years Kansas City, Mo., U.S.A.

WATCH REPAIRING

be a master watchmaker!

- Graduates earn big money—many in business for themselves. The famous Sweazey System of Instruction teaches you quickly and easily. Our 42nd year. Write today for free book about watchmaking, gem setting and engraving.

CHICAGO SCHOOL OF WATCHMAKING
Dept. 420, 1608 Milwaukee Avenue, Chicago 47, Illinois



Start Quickly BIG MONEY ROLLING WITH *LIFE CHARGE*



MAKE PLEASANT, DIGNIFIED CONTACTS The MIRACLE Chemical that helps Batteries stay AUTOMATICALLY charged. Adds Months of useful service. Eliminates freezing, overheating and cable corrosion. Revives old Batteries. Saves time and money for user. **EAGER BUYERS EVERYWHERE!** Fleet owners, garages, service stations and individuals all buy. **FOUR EASY SALES A DAY NETS YOU \$144.00 WEEKLY!** Advertising and Promotional Material free. Sold on satisfaction guaranteed or money back plan. Send \$1.00 for special sample offer enough for two batteries, or write for free details. **GET IN THE BIG MONEY FIELD! DO IT NOW. DON'T DELAY...WRITE TODAY!**

BATTERY CHARGE PRODUCTS COMPANY
728 W. Peachtree Street, Dept. A Atlanta, Georgia

WHICH OF THESE *Opportunities* INTERESTS *You* MOST?

Accounting
Air Conditioning
Architecture & Building
Automotive Engineering
Aviation—Practical
Aviation Drafting & Design
Better Foremanship
Bookkeeping
Business Management

Contracting
Diesel Engineering
Drafting & Design
Electrical Engineering
Electricity—Practical
Electronics, Industrial
High School Courses
Machine Shop Operations
Mechanical Engineering

Plastics Engineering
Plumbing—Practical
Private Secretary
Radio Operating & Servicing
Railway Training
Refrigeration
Sheet Metal Pattern Drafting
Shop Management
Tool Making

... In Job Competition
Where Do You Stand?

Specialized Training Will Help You to **GET AHEAD and STAY AHEAD!**

• Have you noticed that more and more the important, good-pay jobs are held by those who have had specialized training? Have you realized that Uncle Sam has turned out technically trained men by the thousands? Do you know that competition for jobs and promotions is strong now and will continue to grow stronger? Where do you stand now? *Where will you stand two, three, five years from now?* Can you keep up with job and promotion competition?

For more than 50 years we have trained men, in spare time at home, for better jobs ... higher pay ... brighter futures. We can do the same for you. Right now choose the job you want and prepare for it. Or if you are in work you like best, start training for quicker promotion. Then check that subject on coupon, add your name and address and mail it at once and we will send full details on our training plan.

PRACTICAL, EFFECTIVE HOME - STUDY TRAINING SINCE 1897

Take This First Easy Step

CHECK, CLIP AND MAIL COUPON NOW

AMERICAN SCHOOL, Dept. G-246, Drexel at 58th, Chicago 37, Ill.
Without obligation, Please send FREE and postpaid, bulletin and details of the Subject checked.

- | | | |
|--|--|--|
| <input type="checkbox"/> PLASTICS ENG'R | <input type="checkbox"/> Accounting | <input type="checkbox"/> Drafting and Design for Men and Women |
| <input type="checkbox"/> Refrigeration | <input type="checkbox"/> Electrical Engr. | <input type="checkbox"/> Radio |
| <input type="checkbox"/> Architecture and Building | <input type="checkbox"/> Electricity-Pract. | <input type="checkbox"/> High School |
| <input type="checkbox"/> Contracting | <input type="checkbox"/> Electronics, Industr. | <input type="checkbox"/> Air Conditioning |
| <input type="checkbox"/> Practical Plumbing | <input type="checkbox"/> Bookkeeping | <input type="checkbox"/> Mechanical Eng. |
| <input type="checkbox"/> Automotive Engineering | <input type="checkbox"/> Private Secretary | <input type="checkbox"/> Shop Management |
| <input type="checkbox"/> Aviation Drafting | <input type="checkbox"/> Diesel Engineering | <input type="checkbox"/> Tool Making |
| <input type="checkbox"/> Aviation | <input type="checkbox"/> Sheet Metal | <input type="checkbox"/> Better Foremanship |
| <input type="checkbox"/> Business Mgmt | <input type="checkbox"/> Pattern Drafting | <input type="checkbox"/> Machine Shop Operations |
| <input type="checkbox"/> Railway Training | | |

Name Occupation.....

Address Age.....

City.....State.....

AMERICAN SCHOOL

Dept. G-246, Drexel at 58th Street, Chicago 37

CUT-TO-FIT HOMES CUT BUILDING COSTS

ORDER NOW SAVE UP TO **1/3**

Build your own home and save the builders' profit—plus savings in lumber and labor with Sterling Ready-Cut-Homes. Anyone can assemble with simple, easy to follow plans furnished. Every house complete with all lumber, roofing, nails, glass, hardware, paint, doors and windows marked ready to erect. Freight paid. Complete building plans ready for filing at low cost. Sold separately if desired. Write today!

CHOICE OF 57 DESIGNS



PRICED FROM \$1885 UP

INTERNATIONAL MILL AND TIMBER CO.
DEPT. P.S.-250 BAY CITY, MICHIGAN

Send 25c for NEW COLOR CATALOG

Sensational New Electric

① WELDER ② CUTTER!

FOR 110-115 AC or DC • WELD—BRAZE—CUT—SOLDER—HEAT TREAT
INSTRUCTIONS INCLUDED

The **WELDRITE** Combination—tested and proved by countless commercial and amateur users, is now offered direct to you at the amazingly low price of only **\$12.00**. No Gas—No Gauges—No Spark Lighter needed. Always ready for immediate use—Just plug **WELDRITE** into 110-115 AC or DC outlet. Uses standard welding and brazing materials. **WELDRITE** furnished complete with Converter Unit, #1 Single Holder for welding metal to $\frac{3}{16}$ " thickness, using up to $\frac{3}{32}$ " rod, and #2 Double Holder with Copper Coated Carbon Electrodes for Brazing, Cutting, Heat Treating, etc. Starting welding

materials and instructions included. Ideal for home workshop. Invaluable for garages, repair shops, farms, etc. **SEND NO MONEY! 10 DAY TRIAL.** Order your **WELDRITE** Electric **WELDER-BRAZER-CUTTER** C.O.D. today. Pay postman \$12 plus postage charges (wt. 4 lbs.) or send \$12 and we pay postage. Either way, if not satisfied, return **WELDRITE** in 10 days for refund, less postage charges. **WELDER HOOD**—Approved Arc Welding lens—only **\$3.95**. Calif. orders add 2½% tax.

BOTH only \$12

① WELDER

② BRAZER-CUTTER

CALIFORNIA TECHNICAL PRODUCTS CO.

Dept. B-2, 448 So. Hill St., Los Angeles 13, Calif.

Thompson BEATS the World on BOATS



Better Built Lower Prices



Safe Boats With Full Length Spray Rails Keep passengers perfectly dry—even at high speeds. Catalog also shows two new models of "Take-Along" Boats. Two big factories—save you freight.

CATALOG FREE Write for your copy. State kind of boat in which you are interested.
THOMPSON BROS. BOAT MFG. CO. (151)
219 Ann St. (Write to either place)
PESHIGO, WIS. 119 Elm St. CORTLAND, N.Y.

Light Boat for Auto

Enjoy a hobby that's fun!

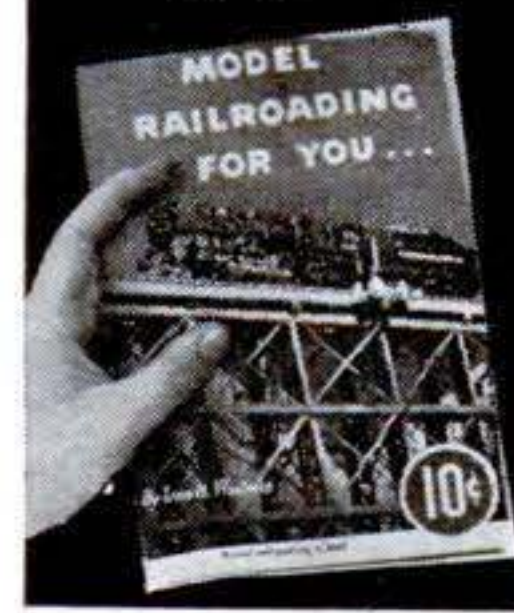

Get this picture-packed book on Model Railroad-ing now!

It's simple—this book will tell you how you can have your own railroad in your basement, attic, or even a corner. It's inexpensive—surprisingly little money is needed. It's constructive—hobbyists from 17 to 70 spend absorbing hours with the world's fastest-growing hobby. Fully illustrated—this book explains how you, too, can start. Send 10c today for your copy of "Model Railroad-ing for You," written by a well-known authority. **MODEL RAILROADER MAGAZINE, DEPT. 1638, Milwaukee 3, Wis.**

CHRONOGRAPHS



As Shown \$5.95 plus 10% fed. tax. Send \$6.55

- One Yr. Factory Guarantee
 - A Wrist Watch • A Tachometer
 - A Telemeter • A Stop Watch
 - Luminous Dial
 - Lowest Price in U.S.A.
- 17 jewel watch—same features with 5 separate min. & sec. hands. Only, \$24.50 plus 10% fed. tax.

SUBMARINE WATCH

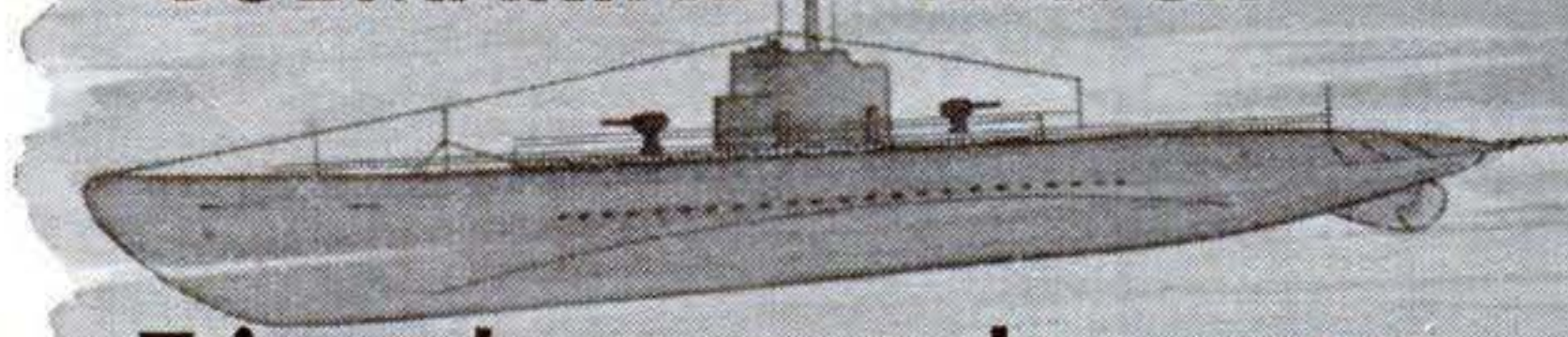

7 jewel - runs under water



As Shown \$9.95 plus 10% fed. tax. Send \$10.95

- Large Hand For Seconds • Water-Resistant Stainless Steel Case • 1 Yr. Factory Guarantee • Unbreakable Crystal
- Absolutely waterproof. Take a bath with it. Go swimming with it. You can't harm this fine watch. **Special!** 15 jewel watch with same features as above only, \$14.95 plus 10% fed. tax. Send \$16.45. 1 year factory guarantee on all watches. Send cash, check, M.O. or C.O.D.

LEONARD DIX CO., 1104 W. BURNSIDE, DEPT. PS-20, PORTLAND 9, OREGON



NOW! you can LEARN ELECTRIC MOTOR REPAIR

... A good-paying, modern profession



OPPORTUNITIES EVERYWHERE!

Don't drift into a rut! Don't train for something that everybody and his brother are studying! Consider the facts. . . . The average small home has at least 11 electric motors! Big homes have many more—in phonographs, recorders, oil burners, refrigerators, washers, fans, clocks, mixers, cleaners, air conditioners, etc., etc. Millions more in office, industrial, mining, and transit equipment. Be the well-paid expert who can keep them working!

FREE STUDY GUIDE

A unique Study Guide booklet of 500 practical motor study questions—priced and sold separately at 25c — is yours FREE with your request to examine ELECTRIC MOTOR REPAIR book. Makes learning easier—speeds up the work! See coupon.



... for only \$5

FOR THE COMPLETE TRAINING (while the present low-cost supply lasts)

Every day, more and more electric motors and motor control systems are being used BOTH in industry and in home appliances. The expert who can install, repair and keep them working properly is a valuable man in this Electrical Age. The pay is surprisingly good. The field is tremendous—and growing rapidly. Trained men find opportunities everywhere for full or part time work. ELECTRIC MOTOR REPAIR, the big 560-page training course book teaches you the work step by step—quickly and easily—at home in spare time. There is no other book like it. Ideal for beginners or for actual bench use in busy shops. Thousands of copies are already in use in leading vocational schools, shops, and, most important of all, home study.

SHOWS YOU HOW . . . Every Step of the Way!

Based on what you can learn quickly at home from ELECTRIC MOTOR REPAIR, you can train for prompt, profitable installation, servicing, repairing and complete rewinding of practically any motor in use today. You learn fast! You learn right! Every subject is clearly and simply explained by text AND ALSO by more than 900 clear-cut illustrations and diagrams. You not only read what to do—you actually SEE how it is done. Quick reference guides tell you how to handle specific jobs. When a certain motor comes in for repairs, just look it up. ELECTRIC MOTOR REPAIR tells you what to do—and exactly how to do it.

ELECTRIC MOTOR REPAIR is designed for use right at the service bench. Unique Duo-Spiral Binding divides the book into two sections so that both text and related diagrams can be viewed together. An instructor standing by your side could hardly do better! ELECTRIC MOTOR REPAIR covers the entire field—from alternating- and direct-current motors and generators, etc., to mechanical and electrical and electronic control systems. Right down the line, it explains every detail of trouble diagnosing, repair, rewinding and maintenance in a way you can easily understand.

PRACTICE FROM IT FOR 10 DAYS . . . At OUR Risk!

Send coupon today! Practice from ELECTRIC MOTOR REPAIR for 10 full days. See for yourself that really good home training doesn't need to cost you a lot of money. Then, if not more than satisfied, return book to us (you can keep the FREE Study Guide) and we will refund your \$5 promptly. What could be fairer than this?



LEARN FAST...No Lessons to Wait for!

If sold as a course and sent to you in lesson form, ELECTRIC MOTOR REPAIR would be a bargain at 10 times the price! You get it all at once. You learn rapidly. Here are just a few of the subjects covered:

- Split-Phase Motors
- Capacitor Motors
- Repulsion-type Motors
- Polyphase Motors
- Alternating-Current Motor Control
- Direct-Current Armature Winding
- Direct-Current Motors
- Direct-Current Motor Control
- Universal, Shaded-pole, and Fan Motors
- D-C Generators; Synchronous Motors and Generators
- Electronic Motor Control
- ... and essential motor data



10 DAY MONEY-BACK GUARANTEE

Dept. PS-20, MURRAY HILL BOOKS, Inc.
232 Madison Ave., New York 16, N. Y.

Send me a copy of ELECTRIC MOTOR REPAIR book for which I enclose \$5 (\$5.50 outside U.S.A.); or send C.O.D. for this amount plus postage. If this book is not what I want, I'll return it within 10 days and you guarantee to return my \$5. It is also understood that you will include a FREE copy of the electric motor STUDY GUIDE which is mine to keep, whether or not I decide to keep the ELECTRIC MOTOR REPAIR book.

Name.....
Address.....
City & Zone..... State.....

TRAIN FOR GOOD PAY IN A FIELD THAT ISN'T CROWDED!

Owners are making BIG MONEY



operating this FRANCHISED ROADSIDE STAND

One of the greatest opportunities in America! A business you can start with very little capital . . . and make thousands of dollars if you follow our *proved* methods of stand building and operating. A 28-page folder shows plans, testimonials from owners . . . gives hundreds of other essential facts. Send for your *free* copy!



RICHARDSON Corp.,
Dept. PS-2
Rochester 3, N. Y.
Please send me
FREE folder on the franchised
RICHARDSON refreshment stand.

Name _____
Address _____
Place _____

GO IN
BUSINESS
FOR
YOURSELF!
FREE
FOLDER
TELLS
HOW

Don't Envy The PLUMBER-Be One

Make \$15 to \$50 a Day

Every skilled workman will tell you Plumbers have the best of it. WINTER and SUMMER the Plumber is busy at top wages. No skilled Plumber is ever out of a job. Compare his opportunities with any trade. To the man with know how, Plumbing means profit. Investigate Universal Plumbing School. Not a "war born School," but a plumbing school developed and operated by plumbers since 1923.



Own Your Own BUSINESS

Have your own business and big profits with little other than training and a kit of tools.

JOURNEYMAN Gets Good Salary

Master Plumbers own their own shop. A Journeyman works for a Master. With this training journeymen can depend on high wages.

BE A PLUMBER IN JUST 32 WEEKS

Learn With Tools—Not Books
No need ever serve an apprenticeship. Don't envy the plumbers big profits—enjoy them. Learn every trick of the trade—Leadwork—Blueprint for plan reading, etc. under Licensed Master Plumbers.

**Over 7,000 Successful Plumbers
Recommend This School**

This system has made more than 7,000 plumbers. Investigate our past performance. If you like to work with tools this is your opportunity. Become a Plumber in America's largest and only school devoted exclusively to plumbing. Write today for FREE information.

G. I. Approved. Established 1923

UNIVERSAL PLUMBING SCHOOL

800 Holmes

Kansas City, Mo.

NEW GAS ENGINES

6.5 HP BRIGGS & STRATTON GAS ENGINES

Model ZZR-6. 4 cycle, single cylinder air cooled. Develops 6.5 HP at 533 RPM. Adjustable governor and built in 6 to 1 reduction gear. New in original crate. List price \$165.00

New Low Price **\$89.50**
F.O.B. Milwaukee

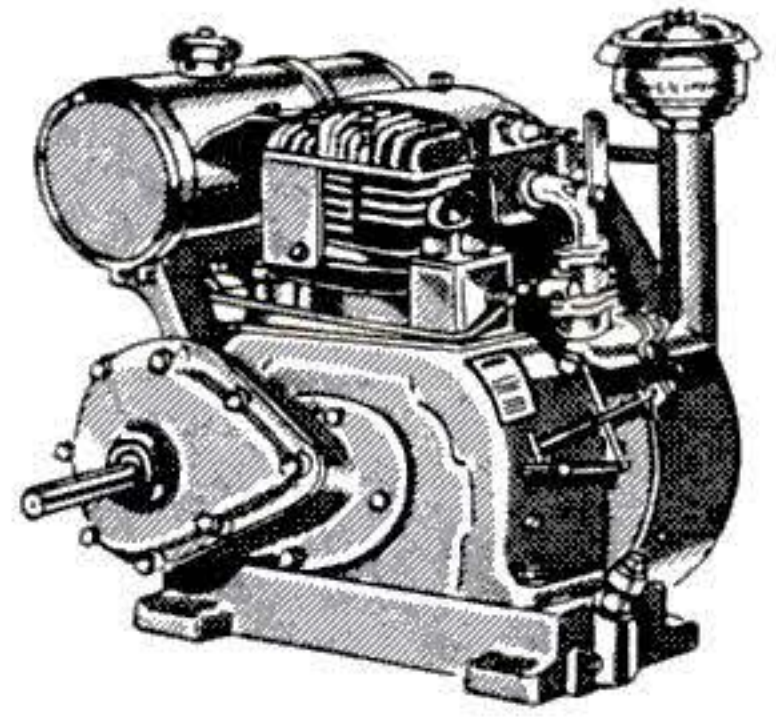

ORDER TODAY—LIMITED QUANTITY AVAILABLE
SEND MONEY ORDER OR CERTIFIED CHECK

J. J. TRUNDE

1937 N. Hubbard

Milwaukee 12, Wisconsin

FALSE TEETH KLUTCH holds them tighter

KLUTCH forms a comfort cushion; holds dental plates so much firmer and snuggler that one can eat and talk with greater comfort and security; in many cases almost as well as with natural teeth. Klutch lessens the constant fear of a dropping, rocking, chafing plate. 25c and 50c at druggists. . . . If your druggist hasn't it, don't waste money on substitutes, but send us 10c and we will mail you a generous trial box. © I. P. Inc.

KLUTCH CO., Box 5094-B, ELMIRA, N. Y.

MONEY for MEN ALL FREE

THE PLASTEX Industry needs manufacturers on small scale and for big production of Lamp and Clock Stands. Art Goods and Novelties in Plastex and Marble imitation. Experience unnecessary. 1/2c material makes regular 10c store sellers. Rubber moulds furnished for speed production. Small investment brings good returns. Big chain store orders now being placed. Ambitious men have chance for real prosperity. Our Free booklet will interest and benefit you.

PLASTEX INDUSTRIES, Dept. 2, 3400 Third Ave., New York 50, N. Y.

ACCOUNTANT BECOME AN EXPERT

Executive Accountants and C. P. A's earn \$3,000 to \$10,000 a year. Thousands of firms need them. We train you thoroly at home in spare time for C. P. A's examinations or executive accounting positions. Previous experience unnecessary. Personal training under supervision of staff of C. P. A's. Placement counsel and help. Write for free book, "Accountancy, the Profession That Pays."

LASALLE Extension University, 417 So. Dearborn St.
A Correspondence Institution Dept. H-293, Chicago 5, Ill.

**Always Mention Popular Science
when writing**

WATCH REPAIRING

Learn **Earn while AT HOME you Learn**

Learn this fascinating and profitable trade in your spare time at Home through our Correspondence Department. Each individual student receives individual attention! Post-Graduate course at resident school optional for correspondence students.

OUR MOTTO: Not how quickly, **OR** but how thoroughly we can train you.

AT OUR RESIDENT SCHOOL

APPROVED FOR G. I. TRAINING

Our school is set up on an individual basis where every student receives individual attention from our competent instructors in a home-like and cheerful atmosphere.

Write TODAY FOR FREE INFORMATION: 270-276 East Bldg., Grand Rapids 6, Michigan
Depts JOHN VAN PUFFELEN, Director
American Institute of Specialized Watch Repair

**\$200 GROSS IN MY
FIRST WEEK!**



**Some Make More, Some
Less . . . Start This Busi-
ness for YOUR OWN**

Would YOU like to own a permanent, year-round business in which it is possible to take in as much as \$200 gross the first week, as did L. A. Eagles? R. E. Traynor says, "I made \$62 gross in one day." R. R. Newlin reports, "I have averaged \$173 gross per week." Others report gross from \$100 per week to \$12,000 per year.

Surely YOU will want to investigate a golden opportunity like that. You need not have any special skill or experience, but if you are ambitious, honest and courteous, we will help you to start and succeed in YOUR OWN money-making business where net profits are high.

No Shop Necessary

Our Electric Rug Washer cleans rugs and carpets like new right on the customer's floor. This quick, thorough and highly efficient method removes dirt and grime, thus restoring the natural, fresh beauty of floor coverings. Anyone can run it. Rugs and carpets are not harmed.

There are hundreds of possible customers in YOUR vicinity. Most of them have several rugs needing regular cleaning. To get a quick start,

FREE BOOK! MAIL COUPON

VON SCHRADER MFG. CO.
211 PL, Racine, Wis.

Send at once (no obligation) your FREE booklet containing information about your Electric Rug Washer and how I can own my own permanent, profitable business.

Name _____

Address _____

City _____ (Zone) _____ State _____

shampoo a few rugs or carpets. These customers tell their friends and soon you should have an independent, prosperous business, and you should be able to keep it growing. Send the coupon RIGHT NOW for booklet that explains everything.

**Every Machine Guaranteed
and Easy to Own**

You take no risk. These wonderful, fully guaranteed machines have been used and endorsed by largest hotels, railroads—also used by U. S. Government. Many individuals have built up successful businesses that made big profits. Mail the coupon TODAY and we will send complete information, including how to start and succeed in YOUR business without a large investment. Don't delay your BIG opportunity. Send the coupon AT ONCE.



MAIL COUPON TO VON SCHRADER MFG. CO., 211 PL, RACINE, WIS.

BLISS Electrical Training

BLISS ELECTRICAL SCHOOL Intensive 32 weeks' residence course in fundamentals of industrial electrical engineering, including radio and electronics. Extensive laboratory, shop work, drafting. Prepares for electrical technician and engineering aides in communications, power, manufacturing, business machines, sales, service. G.I. approved. 57th year. Enter March 6, Sept. 5. Catalog. 7602 TAKOMA AVENUE, WASHINGTON 12, D. C.

LEARN MEAT CUTTING EASILY - QUICKLY At Home-In Spare Time



The steady, dependable trade of Meat Cutting taught easily, quickly by improved HOME METHOD. National School, established over 25 years, has organized its famous "Learn By Doing" Classroom, Cutting room and Retail Market training system into sound, practical HOME STUDY form. Now, by the miracle of this EXTENSION TRAINING you can prepare in Your Spare Time At Home, for a better job, bigger responsibilities or success and security in a store of your own. Remember, PEOPLE MUST EAT! Buying, cutting, percentage, pricing, advertising, selling—a complete meat education. For beginner or men with ex-

perience. Thousands of successful graduates. Send coupon for FREE Bulletin NOW!

MAIL THIS COUPON TODAY FOR FREE BULLETIN

National School of Meat Cutting Div. 0-87, Toledo 4, Ohio

Send me your FREE Bulletin on Meat Cutting and Meat Merchandising. No obligation. No Salesman will call.

Name

Street

City State

Copyrighted material

Learn A Trade NOW! PRACTICAL SHOP TRAINING!

In Our Chicago Shops

- | | |
|---|--|
| <input type="checkbox"/> AUTO MECHANICS | <input type="checkbox"/> WELDING—ARC and GAS |
| <input type="checkbox"/> DIESEL MECHANICS | <input type="checkbox"/> MACHINIST |
| <input type="checkbox"/> REFRIGERATION | <input type="checkbox"/> PIANO TUNING |
| <input type="checkbox"/> BODY-FENDER | |

Above Approved For G. I.'s and Civilians
One of America's Leading Practical Schools
7 Floors of Fully Equipped Shops
Over 48,000 Successful Graduates
Expert Individual Instruction
Learn by Doing—Low Living Expense
Established 1902—Day and Evening Classes

Also the following Home Study Courses

- | | | |
|----------------------------------|--|---------------------------------|
| <input type="checkbox"/> PLASTIC | <input type="checkbox"/> REFRIGERATION | <input type="checkbox"/> DIESEL |
|----------------------------------|--|---------------------------------|
- CALL IN PERSON OR MAIL THIS AD TO

GREER SHOP TRAINING

(Desk 12) 460 South State St., Chicago 5, Ill.

Please send without obligation free information regarding trade checked above. (Specify whether you are a Veteran or Civilian)

Name.....Age.....
Address.....
City.....State.....

EARN MORE MONEY!

Personal Attendance Courses

Be your own boss! Earn more money! Learn photography quickly through our unique LEARN-BY-DOING methods taught by famous photo "aces" at our Resident School. Resident Training is available with subsistence under the G. I. Bill to serious workers.

Home Study Course

You can train yourself for an action-packed, thrilling, profitable career in photography! N. Y. I.'s INDIVIDUALIZED Home Study Course is a spare time short cut to success. Invest your time in your future—don't waste it!

— Don't delay! Write today for FREE literature —

New York Institute of Photography
Dept. "5", 10 West 33 Street
New York 1, New York

Please send me complete information regarding
 Resident Training Home Study Course

Name.....
Address.....
City.....Zone.....State.....

40th
YEAR

NEW YORK INSTITUTE OF PHOTOGRAPHY

10 West 33 Street, New York 1

New ARMY MINE DETECTOR

An/PRS-1 is a portable device for detecting metallic and non metallic objects, Metals, Buried Cables and sewer Tile.

Our Special Price **\$26.40** with battery
\$17.50 without battery

By lengthening dipole rods operator will be able to increase the depth sensitivity. This unit comes complete with spare tubes, antenna dipole and reflector, and instructions manual, in wooden chest 9½" height x 28¼" length x 15½" depth. Weight in operation is only 22 lbs. LESS Batteries. Power supply: Three 45 volt and one 6 volt batteries. Uses standard batteries. Original COST \$364.00. Shipping weight appr. 80 lbs. F.O.B. New York. No C.O.D.'s. Send Order to:

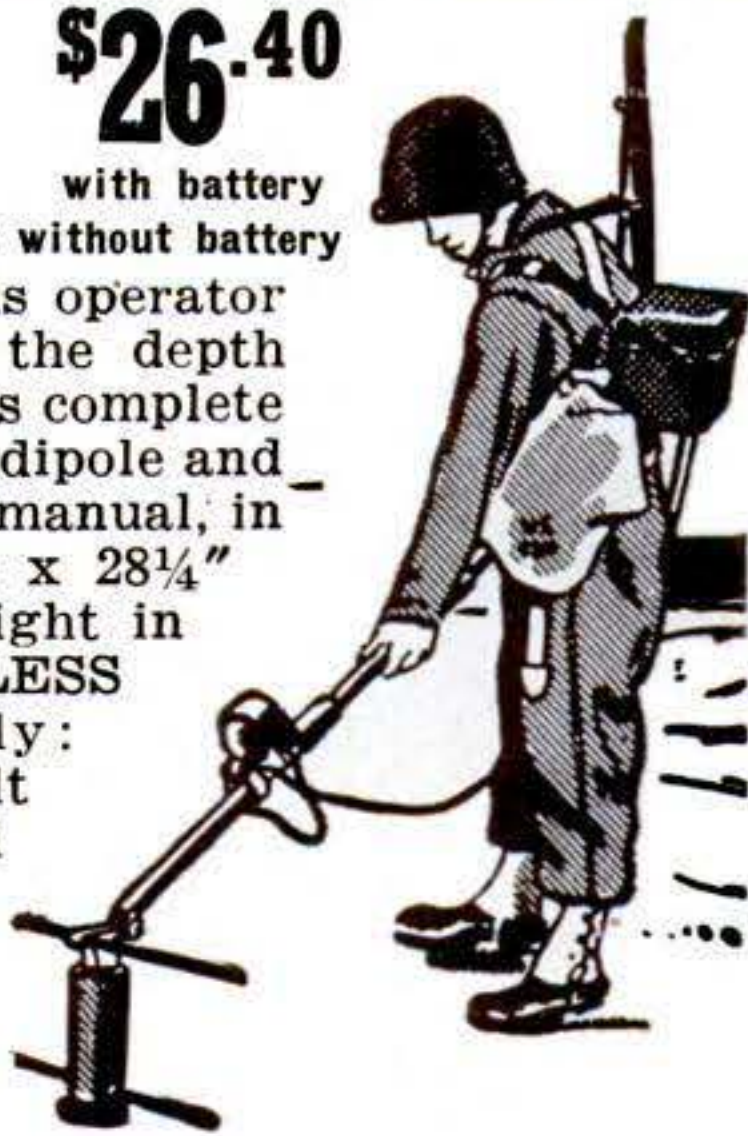

COLUMBO TRADING CO., INC.

304 CANAL ST. DEPT. P.S. NEW YORK 13, N. Y.

I'LL SEND YOU A FINE SUIT AND START YOU IN BUSINESS



Get your made-to-measure suit without cost taking orders from friends at direct-from-factory prices. Pocket big commission on all orders. Get splendid demonstration outfit and tested plans FREE. Work from home or office, full or spare time. Top men make up to \$12,000 in a year. Famous 37-year-old firm. Write

BUSINESS MANAGER

Dept. PS, Box 23, Cincinnati 6, Ohio

ARMY BUNK BEDS DOUBLE DECK

Used, but in excellent condition. They cost the government 4 times our price. Use as twin beds or double deckers. Built for and used by the Army. Sturdy hardwood frame. Green or brown finish. Steel springs. 30" wide—84" long. Complete with springs. BUY NOW. These bunk beds soon may not be available anywhere. New cotton Mattresses to fit Army bunk Beds, each Bunk Beds complete with two mattresses.....

FREE CATALOG

\$9.95 F.O.B.
\$7.95
\$25.85



SHACKELFORD'S, Dept. 70, 332 E. 31st St., Kansas City 8, Mo.

"PLASTICS"

FABRICATING MANUAL AND CATALOGUE

Work in a fascinating and profitable hobby. Just out—our latest fabricating manual. Tells you how to work with Plastics. Our new Catalogue provides all needed materials: Plexiglas—Lucite—Tenite—Catalin—Acetate—all in sheets, rods, and tubes. Complete line of cements, dyes, accessories and supplies. Send 20c today for 1949 Catalogue and Handbook.

HOUSE OF PLASTICS

8648 Linwood Avenue Dept. MO-2 Detroit 6, Michigan



Big money in spare time!
learn at home Tune pianos in 30 days

No musical knowledge needed. Piano tuners in great demand. Low cost training by experts. Revolutionary new phonograph records give true piano tones. We furnish professional tools (record player if needed), instruction manuals, including spinet tuning. Full training in piano repair—and how to line up work for BIG earnings. Send today for free literature.

CAPITOL CITY TUNING SCHOOL

Dept. 233, 129 E. Michigan Ave., Lansing 16, Michigan

New DIRECTION SIGNAL



Flashes front and rear lights

Durable, attractive brown or chromium case. Specify finish.

\$10.95 Postpaid in U.S. Send check or money order. Postage extra on C.O.D.'s.

The LESTER Company

Flashes Your Turns Electrically

No more winter window cranking for arm signals. The new AUTO-TURN DIRECTION SIGNAL fits any car, flashes parking and tail lights 60-80 times a minute. No interference with regular lights, no extra lights to mount for most late cars. Smoothly operating, featherlight control lever. Works similar to factory installed models. All parts furnished—install it yourself. SPECIFY MAKE AND YEAR. For cars earlier than 1942, write for price.

MONEY BACK GUARANTEE

Box S-2, 1743 North Milwaukee Ave. Chicago 47, Illinois

SEND FOR FREE PARTS CATALOGUE



BUILD YOUR OWN ELECTRIC MOWER AND SAVE \$\$\$\$

Electric mower reduces lawn care time by half. Cuts grass any height. Chops clippings into a fine mulch. No raking required. Build your own mower and save the difference. It's easy. Our FREE Parts Catalogue tells you how. Write today. No obligation.

MOWER PARTS COMPANY
Box PS 50 Ralston, Nebr.



BE A LOCKSMITH

Learn Locksmithing and Keymaking from Experts in Your Spare Time at Home!

Locksmiths in big demand! No layoffs, no slow seasons! Age or physical handicap no disadvantage. Year-round, steady income in this permanent, respected field. Full or part time. Practical, illustrated lessons show you how to make money even while learning! All materials and special tools supplied. Send for FREE BOOKLET.

INSTITUTE OF LOCKSMITHING, Dept. PS2,
55 Park Ave. Rutherford, N. J.

New Thrills for Model Railroaders!

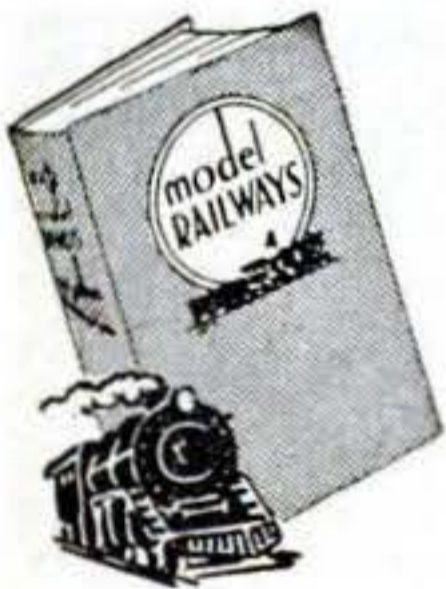

Hundreds of new ideas that will save you money and make model railroading more fun than ever! Shows how to lay your own track, how to make automatic signal systems, culverts, roundhouses, tunnels,

switches and other modern railroad equipment.

It's easy to follow the clear, simple instructions and diagrams in this new book. Shows how to make freight cars, baggage cars, pullmans and day coaches. In addition, there are complete instructions and blueprints for building a Pennsylvania R. R. type locomotive.

SEND NO MONEY

Just write for your copy of MODEL RAILWAYS today, and pay the postman only \$2.49 plus a few cents postage on delivery. If you prefer to remit now we pay postage. Money back if not satisfied. Address

POPULAR SCIENCE MONTHLY—Dept. 250
353 Fourth Avenue • New York 10, N. Y.

Invest in your future!



Be Your OWN BOSS In Building Field



NO SCHOOLING!



STEADY WORK!



BIG MONEY!

Stake your claim now to a money-making future—get started in a good, respectable, solid business of your own as a floor surfacing contractor!

This is not difficult—no schooling—no experience needed. Sanders are easy to operate—and you can start making money the first day your machines arrive! Earnings of \$25 and more a day are not uncommon! Hundreds of prospects everywhere in your community—new and old homes. Original investment small—no large overhead—you need no elaborate offices, workshop, storeroom or heavy trucking equipment. Many men operate from their own homes and use regular passenger car to transport equipment from job to job. Pleasant indoor work—steady year 'round—a real opportunity to MAKE MONEY and be your own boss! Send for "money-making" booklet entitled "Opportunities in Floor Surfacing"—use coupon and enclose 25c in coin or stamps to cover handling.



AMERICAN

FLOOR MACHINES PORTABLE TOOLS

SEND COUPON TODAY

The American Floor Surfacing Machine Co., 532 So. St. Clair St., Toledo, Ohio

Enclosed find 25c in stamps or coin for booklet "Opportunities in Floor Surfacing", telling me how I can start my own floor sanding business.

Name _____

Street _____

City _____ State _____



Become an
ACCOUNTANT-
Expert Bookkeeper—C. P. A.

The demand for skilled accountants—*men who really know their business*—is increasing. National and state legislation is requiring of business much more in the way of Auditing, Cost Accounting, Business Law, Organization, Management, Finance. Men who prove their qualifications in this important field are promoted to responsible executive positions.

Free Book—"Accountancy, the Profession that Pays"

Knowledge of bookkeeping unnecessary. We train you from ground up, or according to your individual needs. Low cost. easy terms.

Send name and address on the lines below for *free* 48-page book describing the LaSalle accountancy training and the opportunities in this highly profitable field.

LASALLE EXTENSION UNIVERSITY
A Correspondence Institution
417 S. Dearborn St., Dept. 283-H, Chicago 5, Ill.

Name.....
 Address.....
 City.....Zone.....State.....

Can a Man MY Age Become a
HOTEL EXECUTIVE

Even Though He Has No Previous Hotel Experience?

Would you like to step into a well-paid position as Hotel, Club, Restaurant or Inn Manager, Purchasing Agent, Social Director, or Assistant Manager? Would you like to look forward happily to the future? The success of Lewis graduates from 18 to 50 PROVES you can—though you have no experience in hotel work.



Harry E. Roorbach, Veteran,
Wins Success as Hotel Executive.

"While I was in the hospital awaiting discharge from the U.S. Navy, I enrolled for Lewis Training. Shortly after I had completed the course, the Lewis National Placement Service informed me of an opening near my home.
 "At present, I am Night Manager in the largest hotel in Rochester. I owe my success to the Lewis Course."

Step Into a Well-Paid Hotel Position
FREE Book Gives Fascinating Facts

Our FREE Book, "Your Big Opportunity," explains how you can qualify for a well-paid position at home, in leisure time; tells how you are registered FREE of extra cost in the Lewis National Placement Service. Most important, it shows how you can be a Lewis Certified Employee—certified to "make good" when placed in a position. Mail the coupon NOW!

Course Approved for Veterans' Training

.....
 • Lewis Hotel Training School
 • Room SB-2724, Washington 7, D. C. **34th SUCCESSFUL YEAR**
 • Send me the Free Book, "Your Big Opportunity," without obligation. I wish to know how to qualify for a well-paid position at home in my leisure time.
 • Name.....
 • Address.....
 • City.....Zone.....State.....
 • Check here if eligible under G.I. Bill of Rights.
 •.....

LEATHER FLYING HELMET

NO HOOKS, TUBES OR HOLES

Genuine NAVY aviators flying helmet. Cordovan brown leather. Warm-fleece lined. Brand new! Detachable chin strap. Perfect for cyclists, flyers, farmers, hunters, children and all-around outdoor wear. Best helmet service had. Govt. cost \$10.00. Sizes small, medium, large **\$1.49** pp



NAVY PHONES

VOICE POWERED—NO BATTERIES

Mfg. by RCA. Simple hook-up. Splice 2 wires & talk over 1 1/2 mile. Complete—no extras to buy. Each phone has headset, adjustable transmitter, chest plate, switch (on mike) PLUS 24' of rubber-covered cable. Navy cost \$99 pr. Brand new—never used. For home-owners, farmers, contractors, mines, mills, television set installators, etc. *Money-back guarantee on both items.* Send check, cash, M.O. C.O.D.'s **13.95** pp. for 2 complete sets pay postage.



GRAND-HAWTHORNE SURPLUS
 1439 SE Grand, Dept. PS20, Portland, Oregon

LAWN ORNAMENT-NOVELTY PATTERNS

28 Lawn Ornament Patterns, 25c. Other patterns: 15-20" high; Dutch Girl, Dutch Boy, Pirate, Bull Terrier, Mexican Girl, Mexican Boy, Dwarf, Penguin, Flower Girl, 10c each. 25 Novelty Patterns, 30c. All 62 Full Size Patterns, \$1.00 Postpaid.



FLYING DUCK

Wind revolves wings. Realistic appearance. Pattern, Instructions and wing Pinion Kit; brass bearing, steel shaft, wing lugs, bolts, nuts and washers. 50c. Pattern and Instructions without kit, 25c. Postpaid.



STROTHER PATTERN SERVICE
 Dept. 7-BF Box 128 Belington, W. Va.

JET AIRCRAFT SIMPLIFIED

JAN. 1950 EDITION
FIRST BOOK ON JETS

that is written in simple understandable language. U. S. Aircraft—and the various types of jet or rocket engines that power them—are described and illustrated. Beautiful photos and drawings aid in explaining basic principles and applications. Order C.O.D. or prepaid. We pay postage on prepaid orders. **Money Back Guarantee.**
\$3.75—Hardbound leatherlike cover.
\$2.75—Flexible cover.
 Write for free catalogue.



Aero Publishers, Inc., 2162-(PS) Sunset Blvd., Los Angeles 26, Calif.

Trained Men Get the Better Jobs

PRACTICAL SHOP TRAINING

in **AUTOMOTIVE MECHANICS**
BODY and FENDER REBUILDING

If interested write or wire

ATLANTA MOTIVE TRADES INSTITUTE

Dept. C 254 IVY St., N.E. Atlanta, Georgia
 Member of the Southern Association of Private Trade Schools
 Veterans ask about G I Training

RADIO ENGINEERING

Television, FM, Broadcasting,
 Servicing, Electronics, Aviation,
 Marine & Police Radio taught thoroughly. 72 weeks' Engineering course equivalent to 3 years' college radio work. Approved Veteran Training. Catalog upon request.

VALPARAISO TECHNICAL INSTITUTE

Dept. 503 Valparaiso, Ind.



TEAR GAS

100% PROTECTION

A REAL SURE-FIRE SELLER!

THUGS AND THIEVES BEWARE!

Here is a tear gas pencil gun which discharges smothering clouds of tear gas to instantly stop, stun and incapacitate the most vicious man or beast. A safe and effective substitute for dangerous firearms. No permanent injury. Needed in Stores, Banks, Autos and Homes, everywhere to protect Life and Property. No skill required. Handle our tear gas as a side line and you'll soon give it full time. For a quick start send \$3.60 for complete demonstrator outfit consisting of an Automatic Pencil Gun with 10 demonstrators and 3 powerful Tear Gas cartridges fully guaranteed. Many thousands now in use. Order your outfit today. Not sold to minors.

Hagen Supply Corp. Dept. D-502 St. Paul 4, Minn.



Put Your Future in Your Own Hands Be an **ARTIST**

HERE'S THE AMAZING WAY WE TEACH YOU STEP BY STEP TO DRAW AT HOME IN SPARE TIME

LEARN TO DRAW FOR MONEY

TWO BIG ART OUTFITS GIVEN

As soon as you enroll, we send you the first of the TWO complete Artists' Outfits. Later in the course you receive the second, advanced outfit . . . all at no extra cost.

Read What These Graduates Say:

FREE LANCE ARTIST—Gloria Bailey of Grants, New Mexico, sold around 150 paintings ranging from \$5 to \$50. (10/49)

STAFF ARTIST AND CARTOONIST—G. W. Thomas, Los Angeles newspaper artist says: "W.S.A. is Number One School in U.S.A." (1/48)



WRITE FOR FREE BOOK **ART**

for Pleasure & Profit

Tells about our method of instruction and commercial opportunities for you . . . also about W.S.A. students, what our graduates say, and shows reproductions of their artwork.

APPROVED FOR VETERANS EST. 1914

ENROLL NOW for a pleasant, profitable Art career. **COMMERCIAL ART, DESIGNING, CARTOONING**—all in one complete modern home study course. Good-paying art positions available for qualified artists. You can become your own boss. Many students earn extra money while learning by designing posters, signs, lettering, etc. W.S.A. is now in its 36th successful year of training ambitious men and women. No previous art experience necessary, our practical, easy method prepares you for professional art jobs in advertising, television, newspaper and magazine publishing, department stores, printing, engraving, etc. Get the facts now. **LOW cost—ONLY \$5 MONTHLY.**

FREE BOOK gives details!

WASHINGTON SCHOOL OF ART, STUDIO 132W
1115—15th St., N.W., Washington 5, D. C.
Please send me full information and your Free Book, "Art for Pleasure and Profit." (Please print).

Name.....Age.....

Street.....

City.....Zone.....State.....

I am entitled to training under the G.I. Bill.



WASHINGTON SCHOOL OF ART

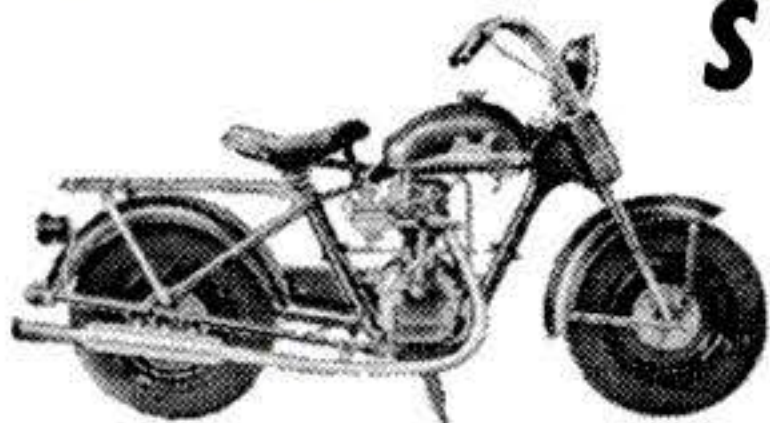

Dealer Inquiries Invited

SET THE PACE WITH THE

- Cruises at 45 MPH—with faster pickup than car
- 39" high, 71" long overall, wt., 190 lbs.
- 8 HP motorcycle engine
- 50 miles to the gallon
- Automatic clutch
- Internal expanding brakes — handle-grip throttle controls

POWELL MANUFACTURING COMPANY

DEPT. PS-250 • COMPTON, CALIF.

Powell

P-81!

ONLY \$247³⁴
AT COMPTON, CALIF.
EXCISE TAX INC.

Write for FREE folder and name of nearest dealer

BE A PHOTO-ENGRAVER

We furnish complete equipment and supplies. Learn at home or in our modern, friendly APPROVED school in MISSOURI. Get into this big demand, high profit, high wage field. You can start your own profitable, full time or part time PHOTO-ENGRAVING business right in your own home.

Be independent, be your own boss or pave the way to a high pay job with experience gained in your own shop.

TASOPÉ TRAINING and TASOPÉ EQUIPMENT has enjoyed world wide recognition since 1931. Write for descriptive literature today. No obligation.

THE AURORA SCHOOL OF PHOTO-ENGRAVING, DEPT. PS-2 TASOPÉ BLDG., AURORA, MO.

HIGHEST ROYALTIES and CASH

FOR YOUR INVENTIONS

Write for FREE booklet without obligation

UNIVERSAL MARKETING CO.

354 S. SPRING ST. (Suite C)

LOS ANGELES 13, CALIF.

TRAVEL *for* ★"UNCLE SAM"



**START
as high
as \$3,450 Year**

Prepare NOW For
1950 Examinations

15,000 appointments each month

**VETERANS GET
SPECIAL PREFERENCE**
Many examinations
expected soon
City Mail Carriers
City Postoffice Clerks
Stenographers-Typists
Messengers,
Liquor Inspectors—
and many others.
**40-Page Book
on Civil Service
FREE**

Mail
Coupon
today—
SURE
★

FRANKLIN INSTITUTE

(Not Government Controlled)

Dept. A-81
Rochester 4, N. Y.

Rush to me, entirely free of
charge, 40-page book with:
(1) A full description of U. S.
Government jobs; (2) A list of
U. S. Government jobs; (3) Tell
me how to qualify for a job.

Name.....

Address.....

.....Vet?.....

HIGH PAY • SECURITY When You LEARN A TRADE

Get ready for a well-paid, lifetime job
or a business of your own in one of
these FIVE ESSENTIAL TRADES. Complete
training under expert instructors with
practical experience prepares you to
step into a good paying job with a
future and security.

ELECTRICITY: Basic electricity, Residential
and Industrial Wiring and Appliance Repair

PLUMBING: Every phase — pipe cutting and
threading to complete installations, blue print
reading

AUTOMOTIVE & TRACTOR: Engine overhaul,
Transmissions, Carburetion Generator-Ignition
Systems, Tune Up

DRAFTING: College level training in general
Machine and Architectural Drafting.

SHOE REPAIRING: Complete practical training
includes reconditioning and rebuilding.

Approved For Veteran's Training

NATIONAL TRADE SCHOOL DEPT. C • 2610 Grand • Kansas City 8, Mo.

Without obligation to me please send full information
on the course checked.

.....Automotive and Tractor Technician Drafting
.....PlumbingElectricityShoe Répairing

Name.....Age.....

Address.....

City.....State.....

Veteran?.....

Fistula May Often Result From Piles

**FREE BOOK—Gives Facts On Associated
Ailments**

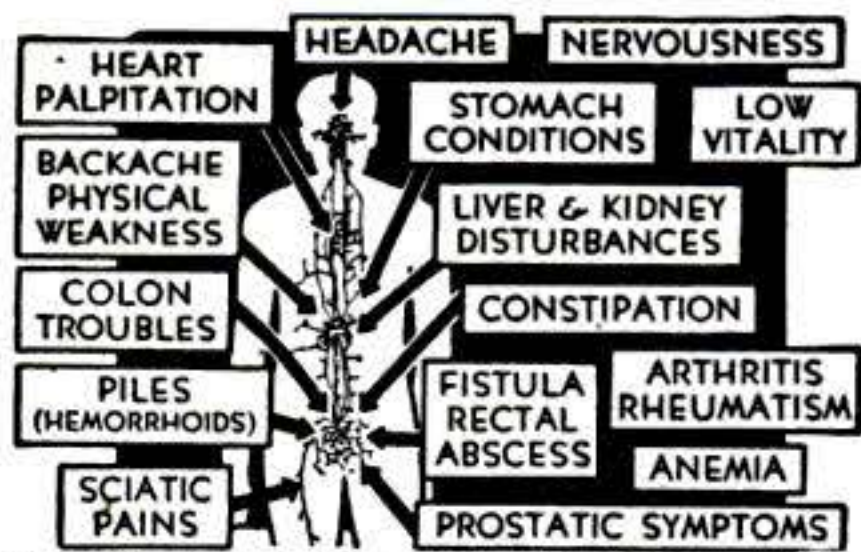

A new, illustrated 40-page book on Fistula, Rectal Abscess, Piles and other rectal and colon disorders is now FREE to all sufferers. Write today—a card will do. Thornton & Minor Clinic, Suite 249, 911 E. Linwood, Kansas City 3, Mo.

Learn CARPENTRY BRICK LAYING

Big money in the Building Trades. Learn now while opportunities are greatest. Train in our completely equipped shops under expert instructors, or by Home Study. Vets attending school entitled to G.I. Benefits. Write for FREE catalog.

MIDWEST SCHOOL OF BUILDING TRADES, Dept. PS-2
411 N. Center St. Bloomington, Ill.

MAKE MONEY IN LANDSCAPING

Thorough training by Internationally known
Landscape Architect to start your own
business, improve your home or advance in
this well paid field. Many Opportunities.
Approved for Veterans. Send for FREE
BOOK.



NATIONAL LANDSCAPE INSTITUTE
310 So. Robertson Dept. PS-2 Los Angeles 48, Calif.



SEND FOR THIS FREE!

Make money. Know how to break and
train horses. Write today for this book
FREE, together with special offer of
a course in Animal Breeding. If you
are interested in Gaiting and Riding the saddle
horse, check here () Do it today—now.

BEERY SCHOOL OF HORSEMANSHIP
Dept. 582 Pleasant Hill, Ohio



NO SWEAT

KEEPS BASEMENT PIPES DRY

Just wrap "NO SWEAT" insulation around
water pipes and seal with special Vapor Seal
Elastic Tape. Pipes will stay dry even in hot,
humid weather. Workshop and darkroom stay
dry. Tools won't rust. Easy to apply. No fuss.
No mess. No sticky tape. No tools required.
Neat, clean, attractive installation. Send \$1.00
for enough to protect 20 feet of 1/2" pipe. Full
instructions included. We mail postpaid.
MONEY BACK if you are not completely satisfied.

ASSOCIATED SPECIALTIES, 10660 Gratiot, Detroit 13, Mich.



Safeguard Your Health.. FLEX-a-FOAM Dust Masks

New Featherweight Flex-a-Foam Dust Mask
filters dusts and pollen as small as 1/25000
of an inch! Comfortable snug fit—unequaled
breathing freedom. Ideal for woodworking,
cleaning, furnace tending, etc. Attractive
design - easy to clean. With three extra wash-
able pure latex filters \$2.00 pp. - order now!

Order
now
\$2.00
Post
Paid

GOGGLE PARTS CO. — Dept. PS — Cleveland 13, Ohio

SHORTHAND IN 6 WEEKS

WRITE 120 WORDS PER MINUTE **AT HOME**

Age No Obstacle

Famous Speedwriting system. No signs; No symbols; No machines. Uses ABC's. Age is no obstacle. Fast preparation for a position and a sound, substantial future. Nationally used in leading offices and Civil Service; also by executives, writers, speakers, lawyers, scientists, students at college. Over 100,000 taught by mail. Complete typing course.

The very low cost will surprise you

27th YEAR

Write for Free Booklet to

Speedwriting
Dept. 2602-A, 55 West 42nd Street, N. Y. 18

LEARNS SPEEDWRITING IN FEW WEEKS OF STUDY!

"I enrolled for the Speedwriting Course and mastered it within a few weeks at less than an hour a day. Before enrolling I had spent considerable time trying to master a symbol system. Yet with Speedwriting I was writing shorthand at 100 words a minute only a few weeks after starting the course. Any person who knows the alphabet can master Speedwriting easily and effectively."
—Henry Stepp, Beauty, Kentucky.



CLEANS WINDOWS WITHOUT WATER

NEW CHEMICAL MITT

Sensational! DRY Window Cleaner! Uses no water, no messy liquids. Chemically Treated. Simply glide over windows; leaves glass sparkling clear. No heating water, no heavy buckets to carry. No rags, powders, sponges, chemicals. No mess or muss. No red chapped hands. Dust, dirt, grime, fog disappear like magic. Wonderful for auto windows, windshields!

SAMPLES FOR AGENTS Sample offer sent immediately to all who send name at once. A penny postal will do. **SEND NO MONEY—just your name.** KRISTEE CO., 714 Bar Street, AKRON, OHIO

EXPORT PAYS BIG

World Trade firm offers men and women plan for big pay positions or unlimited-profit businesses of their own in Export-Import. Mail order World-wide without capital, from home, or travel abroad. Write today for Free Book. State if veteran. Airmail reaches us over night. The Mellinger Co., 1418-AW Westwood, Los Angeles 24, Calif.

14K GOLD PLATED CHRONOGRAPH WRIST WATCH

LOWEST MARKET PRICE **\$7.25**



Sweep Second Hand; Precision Workmanship; Rugged Shock-resistant case; Radium hands and numerals; Leather strap. It measures distance, speed of cars, planes, horses and other moving objects. It's a time keeper, stop watch, telemeter, tachometer. ONE YEAR WRITTEN GUARANTEE and full operating instructions enclosed with each watch. SEND NO MONEY. Mail your order today. Pay postman \$7.25 plus 10% Federal tax. Total \$8.00 plus postage. Or send cash (money order or check) with your order and save postage charge. Chrome Case Model \$6.75 Plus Tax. Total \$7.43.

MARDO SALES CO., Dept. 1808
480 LEXINGTON AVE. NEW YORK 17, N. Y.



Blue Print for PROFIT

Here's Your Success Plan



a few cents worth of materials **BRINGS YOU DOLLARS!!**

Have Your Own Lasting, Successful Business—Be Your Own Boss—Help Fill Huge Demand ... No Experience Is Necessary

Rich profits are waiting to be tapped in this new field. New MIRACLE finish gives a velvety, luxurious surface to radios, lamps, toys, signs, store displays, figurines, auto dashboards, and hundreds of other items. Make old objects beautiful and saleable — make new things worth much more with this soft, rich covering that can be applied to any surface, even if old and worn.

START RIGHT AWAY

Yes, you can learn in a few days to start MAKING MONEY! Everything you need is furnished, including fully detailed, illustrated instructions that are complete and easy to understand. Every point is explained, to show you how to start on the road to big money, full or spare time, right in your own home.

EVERYTHING COMPLETE

In addition to full instructions, you get all materials that will enable you to start at once. A few cents worth of materials can mean many dollars in return. You can earn up to \$5.00 per hour and more spare or full time. Boost your present income or start your own profitable business. Our Business is Booming. Help us fill HUGE DEMAND.

ACT NOW

Grasp this opportunity TODAY — start your own business. It's too good to miss! SEND NO MONEY — fill out the coupon and stick it on a post card or in an envelope and mail today for full details, FREE sample of FLOK-KRAFT covered material, and hundreds of useful and profitable IDEAS. Do it NOW — be first!

SEND NO MONEY Covers Wood, Fabric, Metal, Glass, Plaster, Plastic or any Surface

FREE SAMPLE! MAIL COUPON NOW!

COAST INDUSTRIES Dept. 12

1004 So. Los Angeles St., Los Angeles 15, Calif. Please rush me all the details!

NAME.....
STREET.....
CITY.....STATE.....

It covers



TOYS old or new



LAMPS take on a new distinctive beauty



JEWELRY BOXES give perfect protection

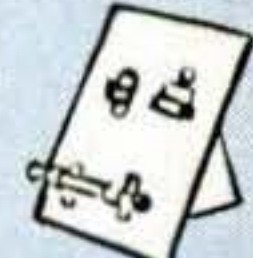

DISPLAY PIECES become unusually eye-appealing



CAR DASHBOARDS made soft as velvet



PLASTICS EVERYTHING YOU NEED UNDER ONE ROOF



CLARO-CAST A clear liquid casting plastic for imbedding insects, flowers, coins, etc. Tops for casting novelties.
Price—1 pt. \$1.95, 1 qt. \$3.75, 1 gal. \$16.00. Instruction book—\$.20.

METALLIC ACETATE Newest thing in plastics craft materials. Make costume jewelry, flowers, book covers, etc. Colors—Aquamarine, orchid, pink, copper, chartruese, black, purple, ice blue, gold, silver, red, blue, green, fuchsia, lime, iris, rose pink, white, multi-color. Sheets 10" x 25"—Price \$.85, 20" x 50"—Price \$3.00

CRYST-L-CRAZE Newest decorative coating. Easily applied by brush. Gives beautiful crystallized pattern—White or colors—to plastics, glass, copper and ceramics. Colors—Red, Blue, Green, Black, Violet, Orange, Yellow, Clear and Fluorescent Pink. Price—4 oz. \$.75, 1 pt. \$1.75, 1 qt. 3.10

FOR PLASTICS "KNOW-HOW" Latest book by Cherry. Recommended for all-round "how-to-do-it." Price—\$1.50

COMPLETE CATALOG—FREE! A catalog of plastics supplies for the hobbyist. Everything in plastics under one roof—at prices you can afford. GET YOURS NOW!



A catalog of plastics supplies for the hobbyist. Everything in plastics under one roof—at prices you can afford. GET YOURS NOW!

FRY PLASTICS CO. Dept. 12
7604 So. Vermont—Los Angeles 44, Calif.

DYE Deep, rich colors blend beautifully, dropper cap. Red, Old Rose, Fuchsia, Yellow, Green, Blue, Orchid, Black, Brown, Fluorescent Red.
Price—1 oz. \$.30
4 oz. \$1.00 1 pt. \$2.75

PRACTICE BLOCKS
Plexiglas and Lucite.
Special price—\$1.00
lb., 5 lb.—\$4.75, 10 lb.—\$9.00

DRILLS Special precision, machine made, tapered drills ground to perfect points, sharp cutting edges.
PRICE
Diameter Ea. Doz.
1/16" \$.95 \$10.45
3/32"95 10.45
1/8" 1.00 11.00

"INTERNAL CARVING IN PLASTICS" A COMPLETE course of instructions by an expert, H. A. Zoback. Price—Only \$1.50

PL-1 PLEXIGLAS-LUCITE CEMENT
Apply with brush, eye dropper or hypodermic needle. 30-second action. Permanent bond, no discoloration. Price—4 oz. \$.60, 1 pt. \$1.50

PLASTIC JEWEL BOX
Size 3 1/2" x 3 3/4" x 1 1/4". Modern style jewelry boxes add richness, charm to any merchandise. Price—Each \$1.15 Dozen \$1.50

TO ORDER—send check or money order. Add 15% of order to cover postage. (Any postage overpayment will be refunded).
Send 25% deposit with C.O.D. orders.

Yes, More Brilliant Than a Diamond!

No Other Gem Like It! Amazing New Discovery



Write today for the full story of the latest miracle of science, discovered in the laboratories of one of the world's largest corporations. The story of the Kenya Gem that so closely resembles a diamond that only an expert can tell the difference. They are more brilliant than the finest diamond of equal size, yet you can now own an unmounted Kenya Gem for only \$24 (1 carat) to \$96 (4 carats); also beautiful rings and earrings for as little as \$45. **Easy Payment Terms.** Kenya Gems are the marvelous discovery you read about in The Sat. Eve. Post, Jewelers' magazine and N. Y. Times, "the only thing on earth more brilliant than a diamond." Write today for **FREE** illustrated literature.

KENYA LABS, Dept. 302
18 W. Chelton Ave. Philadelphia 44, Pa.

SPECIAL OFFER!

LOCK-STITCH SEWING AWL \$1. Postpaid
Famous, patented lock-stitch sewing awl complete with needles, waxed thread and direction folder. Hundred uses—sewing, repairing leather goods, canvas, belting, harness, saddles, gun cases, awnings, golf bags. Extra needles and thread available. Satisfaction guaranteed or money back. Send currency, check or money order. Yates Mfg. Co., 611-K Main St., Lake Geneva, Wisconsin

Learn BAKING at home

Baking is one of America's high industries in wages. Not seasonal, but year 'round good field for trained and experienced men. Thorough basic spare time home study course lays solid foundation. If you have the aptitude for this type of work, send for **FREE** Booklet, "Opportunities in Commercial Baking."
NATIONAL BAKING SCHOOL
1315 S. Michigan Ave., Dept. 1362, Chicago 5, Ill.



JUST OUT! Get largest auto accessory and parts catalog in world. Over 15,000 items, including Hollywood accessories, hi-speed equipment, rebuilt engines; all parts and accessories for all cars, trucks. New, used, rebuilt! We have that hard to get part! Completely illustrated, jam-packed with bargains. Send 25c.

J. C. WHITNEY CO. 1917F Archer Ave. Chicago 16

Protect Your O-V-E-R-D-R-I-V-E!! Save Money

FITS ALL CARS FROM '46 THRU '50*
"SIG-NA-LITE" automatically flashes green light the instant car is ready for Overdrive! No guessing or forgetting! Permits effortless 'CLUTCHLESS SHIFTING' in conventional gear! Saves Gas! Reduces wear! Beautifies dash! Gleaming Chrome finish with Green Jewel! Install in five min. NOW \$2.95 complete, postpaid, including "Overdrive Hints". (COD's Accepted)*. Ford, Mercury, Lincoln '49-'50!
MARTINSON PRODUCTS, 3908 Berteau Ave., Dept. PS-2, Chicago 18, Ill.

CARBURETOR TOO RICH MAKES MOTORIST TOO POOR

Car owners who are wasting money and not getting proper gas mileage due to over-rich mixtures will be pleased to learn how to save gasoline by **VACU-MATING** over-rich mixtures. **VACU-MATIC** fits all cars, trucks and tractors. It is automatic and operates on the supercharge principle. Easily installed in a few minutes.
SALESMEN WANTED! Big Profits! Send name, address on penny postcard for free particulars and how to get yours for introducing.
VACU - MATIC CO., 7617 - 1562 W. State St., WAUWATOSA, WIS.

MASTER MIND!

Learn Short-Cut Mathematics
Juggle figures, do baffling number tricks. Make people gasp at your marvelous lightning-quick mind. Multiply 4 figures by 4 figures without using old-fashioned multiplication! Big cloth-bound volume; fully illustrated course. Includes worked-out problems, answers, etc. Sensational bargain, only \$1.49, postpaid—or COD plus postage. Satisfaction guaranteed or refund. Order this amazing "Short-Cut Mathematics" today!
NELSON-HALL CO., 1139 S. Wabash Ave. \$1.49
Dept. 3B-1 Chicago 5, Ill. Complete

MAKE YOUR OWN!

Griffin READCUT LEATHER PROJECTS

Over 100 KITS in every kind of Tooling and Carving Leather, accurately cut, all parts included. Only Top Grade Leathers used. You do the choosing. You do the tooling, carving, stamping, the punching and assembling.

SEND FOR COMPLETE CATALOG Please send 10c to cover mailing.
SINCE 1924
OUT OF THE WEST, THE HOME OF LEATHER CARVING
Griffin Craft Supplies
5626-B TELEGRAPH AVE. OAKLAND 9, CALIFORNIA

EVERYTHING FOR THE LEATHER WORKER
Largest, most complete stock of Leathercraft Tools and Accessories in U.S.A.
HIDES AND SKINS of Craft Leathers of every kind if you prefer to cut your own.

Colorful! Exciting! WILD WEST MINIATURES

Imported from England

EVERY red-blooded young American will want to start a collection of these perfectly designed little action figures that faithfully portray characters from America's adventuresome frontier days. 3/16" scale models, amazingly life-like. Painstakingly made of metal. Hand painted in true-to-life colors. Alive with action. All riders are demountable. Collecting these clever imports is fast becoming a great American hobby. Start now—with one figure or the entire series.

Order by mail! We pay postage!

- | | |
|----------------------------------|-------------------------------------|
| 1. Cowboy with lariat, 60c | 11. Cowboy lassoing wild horse, \$1 |
| 2. Indian with spear, 60c | 12. Mounted bandit, 60c |
| 3. Indian with bow, 60c | 13. Buffalo Bill, \$1 |
| 4. Cowboy surrenders, 60c | 14. Crawling Indian, 35c |
| 5. Standing Indian with bow, 35c | 15. Indian with tomahawk, 35c |
| 6. Cowboy roped to tree, 60c | 16. Wounded cowboy, 60c |
| 7. Mounted sheriff, 60c | 17. Cowboy firing, 60c |
| 8. Campfire scene, \$1 | 18. Indian attacking, 35c |
| 9. Cowboy scout, 60c | 19. Cowboy with pistol, 60c |
| 10. Indian with shield, 60c | 20. Cowboy pinioned, 60c |

10% discount on orders of \$10 or more

DEALER INQUIRIES INVITED

J. J. ANTHONY

Box 402, Milwaukee, Wisconsin

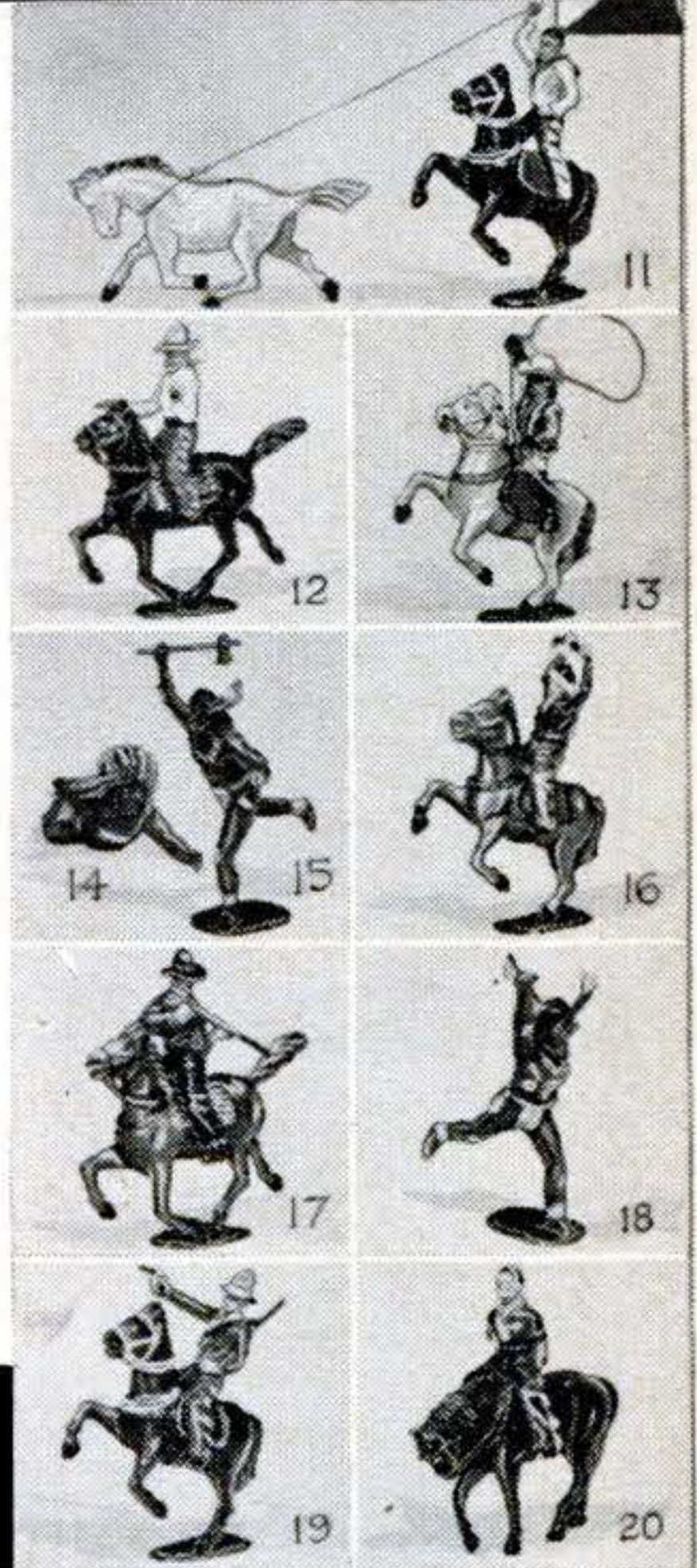
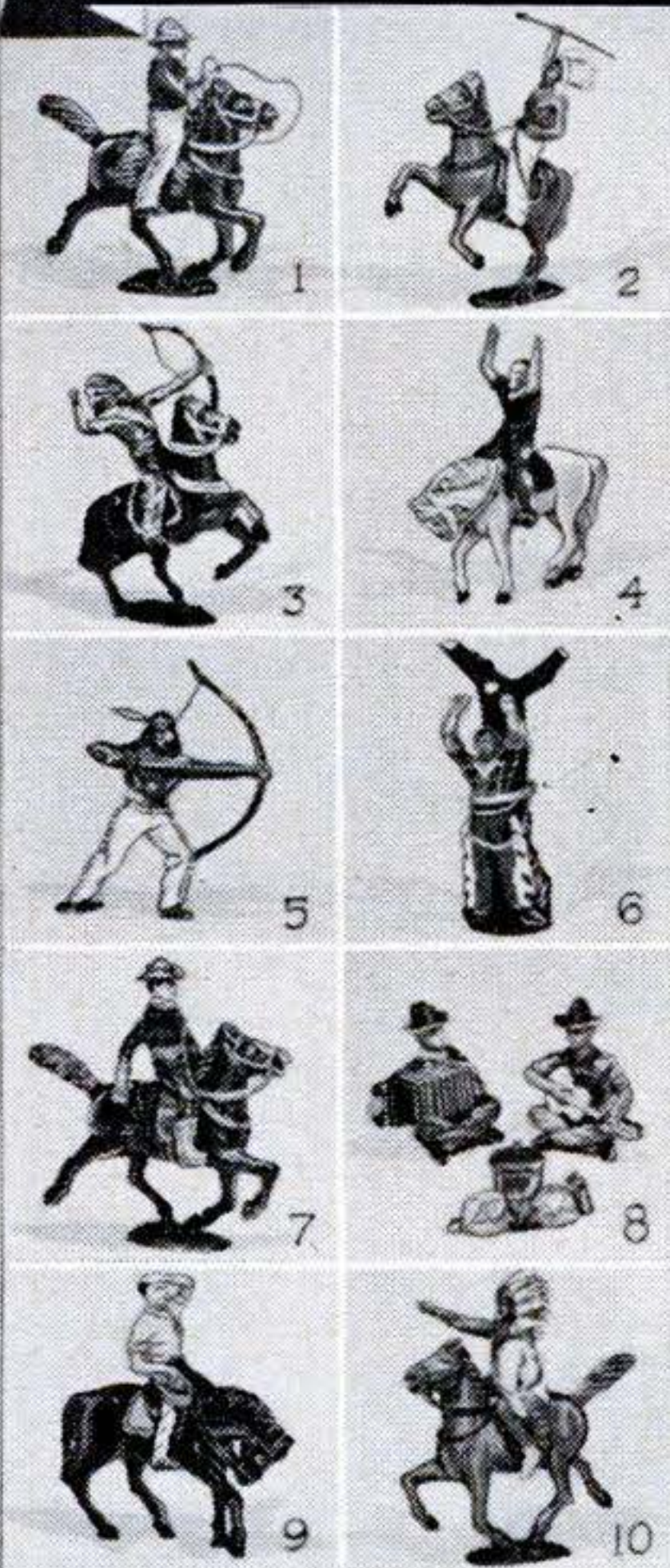

TODAY'S BIGGEST PREFAB BOAT BUY

Build a better boat than you can buy! Save up to 55%. See OZARKA'S new 1950 line of trim, top-quality 12- and 14-footers, with laminated rib construction, all oak frames and other exclusive features, for motors up to 25 H.P. Send 25c for complete Boat & Accessory Catalog of mahogany-decked runabouts, handy car-top models, to be refunded on first purchase. OZARKA, Inc., 720 Borden Lane, Woodstock, Illinois.

\$39.50 AND UP

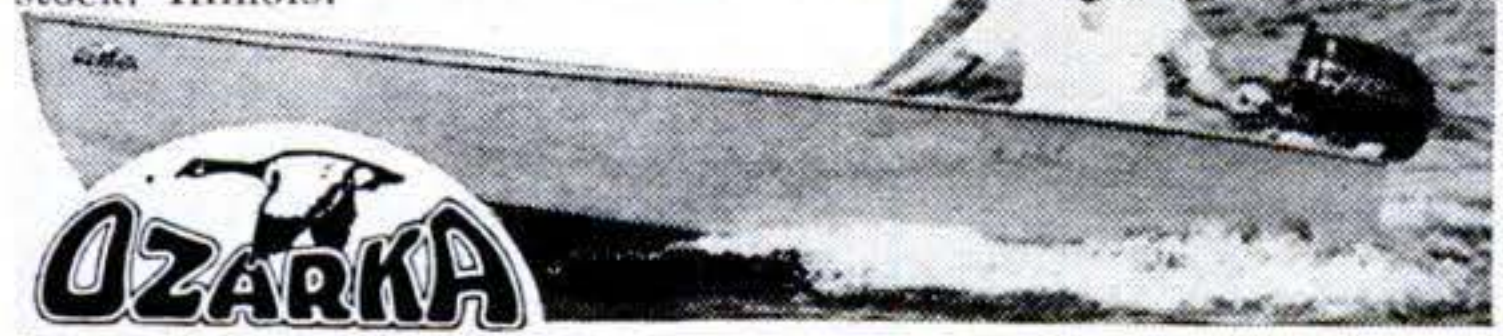

FREE TO HOME PLANNERS

"Little Red Booklet" of 29 popular plans sent FREE to acquaint you with our MONEY SAVING home planning service which includes 1200 Tested Designs; beautifully illustrated plan books; working drawings; material lists; specifications—all at LOW COST. Write today for FREE RED BOOKLET and complete information. America's pioneer residential plan service.

Small Homes Plan Book—68 beautiful designs. \$1.00
All American Homes—158 tested designs. All types. BOTH BOOKS FOR \$1.00

L. F. GARLINGHOUSE CO., INC., Box PS-5 TOPEKA, KANSAS

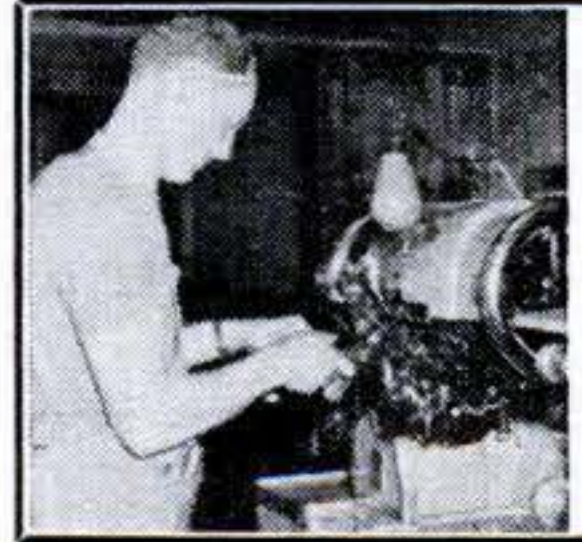

SHOE REPAIR OFFERS BIG INCOME · Learn in 12 Short Weeks!

Own your own shop. Earn big income. Get into business in this depression-proof work. Hard times only make shoe repairing thrive. 12 short weeks. Packed with practical training on actual shoes and professional machinery. No book studies. No educational or age requirements. Anyone can be a successful shoe repairman—from 18 to 80. Our fast "Learn By Doing Method" is easy, complete. Three modern schools. Chicago, Los Angeles, Oakland. 150 million customers for shoe repairs in U.S. alone. Get the facts on this big paying skilled trade today. Write for free booklet.

MODERN SHOE REBUILDING SCHOOL, Dept. PS-20
2937 Belmont Ave., Chicago; 361-12th St., Oakland, Calif.
Established 1927 806 So. Figueroa St., Los Angeles 14, Calif.

FREE! Big 20-page Illustrated Book tells how you can get into this big paying skilled trade Today! Complete details. No obligation. Fill in coupon Now!
Gentlemen: Please rush me the facts on how I can learn shoe repairing and get into my own business.
Non-vets check here.... Vets check here....
Name.....
Street.....
City.....State.....

New Easy Way TO MAKE

BIG MONEY!

AT HOME FULL OR SPARE TIME

Costs You Only 5¢ - You Get \$5.00

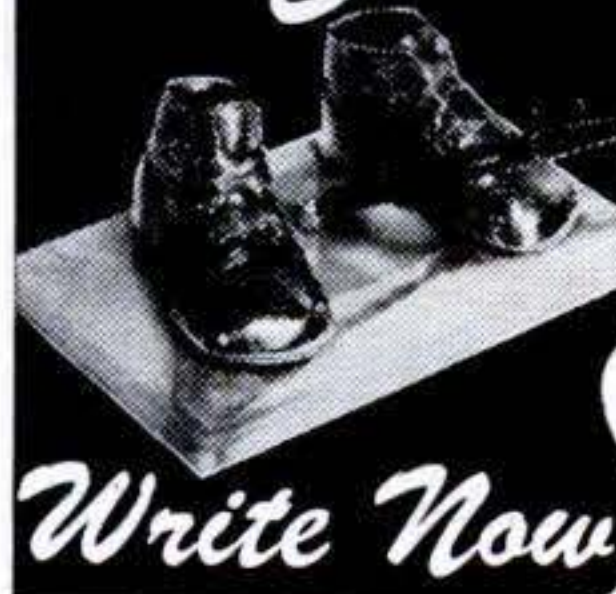

Now is the time to cash in on this big-paying easy-to-operate year 'round business, and you need no experience! Metallize Baby Shoes in real GOLD, SILVER, BRONZE, and PEARL. Everything furnished so YOU can start earning money in just one week—up to \$1,000 per month full time or \$50 to \$75 per week spare time—at \$5 per hour. They will last FOREVER, and there are 5 million eager customers every year, waiting to buy. DETAILS FREE—Send no money—a post card with your name will bring all the facts. Don't pass up this opportunity to start your own business on a shoestring—so ACT NOW. Write at once to

- Big Income
- Huge Demand
- Sales Plans
- Future Security
- Your Own Boss
- Money Back Guarantee
- Most Successful Name in Metallizing



FREE!

Course includes FREE — two actual metallized Baby Shoes guaranteed to be the most attractive on the market — or a pair of your own Baby Shoes metallized if you prefer

Write Now

KIKTAVI COMPANY, Dept. PS-2 2111 West Manchester, Los Angeles 44, California

DIESEL MECHANICS NEEDED BIG PAY . . . GOOD FUTURE



If you have no trade or profession that assures you steady employment and top pay through good times or bad, and regardless of whether you want to be a mechanic, technician, salesman, executive — or have your own profitable shop—you should investigate NOW this opportunity to enter world-famous Bailey Diesel Schools. Prepare yourself, this proven way, for an important place in the fast growing field of Diesel.

Why Gamble With Your Future!

Your future success depends largely on the reputation of the school you attend. Don't take chances! Train at Bailey's—America's foremost school of diesel training. Approved by Missouri State Board of Education. Approved, also, for G. I. Training. Full details FREE. Return coupon below NOW.

MAIL TODAY FOR FREE CATALOG

BAILEY DIESEL SCHOOLS
1655 So. Grand Blvd., St. Louis, Mo.
Please Send Me Your FREE Catalog.

Name

Address

Town State

Veteran Non-Veteran

Resident Training Home Study

CORTINAPHONE makes it FUN to Learn

French-Spanish GERMAN - ITALIAN

BIG OPPORTUNITIES and **JOB**s await Americans who can speak a foreign language. Millions being spent by gov't and industry in Europe, Latin America. Travel booming.



Only 15 Minutes a Day Listen to this Record!

Speak FRENCH, SPANISH, German or Italian like a native! CORTINAPHONE METHOD, famous for 67 years, teaches you—BY LISTENING to CORTINA RECORDINGS. Right in your own home, relaxed and at ease.

Sent on 5 Days Approval

THOUSANDS have learned a second language this quick, easy way for PLEASURE and BUSINESS! FREE 32-page book describes this famous method; tells how you can try it at home for 5 days. NO COST IF NOT DELIGHTED. Send for free book NOW!



Count Cortina

VETS! FRENCH OR SPANISH COURSE AVAILABLE UNDER G. I. BILL

CORTINA ACADEMY (Language Specialists for 68 Years)
Dept. 121, 105 W. 40th St., New York 18, N. Y.

Please send me—without obligation—your free book. I am interested in (check language interested in)

French Spanish German Italian

Name

Address

Check here if you are a VETERAN

ELECTRIFY your SEWING MACHINE

COMPLETE KIT ONLY \$11.75 1 YR. GUARANTEE

Kit comes fully wired . . . installed in a jiffy. Fits all machines! You get these all-new parts:

- Motor & Bracket
- AC-DC 115v 60c
- Pulley & Belt
- Multi-speed foot control
- Cord set & block
- Full instructions

KIT COMPLETE WITH CHROME PLATED SEWLIGHT (As illus.) Only \$12.95
10 DAY FREE TRIAL—ORDER NOW!

Send no money, pay COD or send money order and we'll pay postage. Please state whether wheel on your machine turns towards you or away from you. Shipping wt. 6 lbs.
Dealer Inquiries Invited

CONTINENTAL SALES CO.
83 GRAHAM AVENUE Dept. PS-8 BROOKLYN 6, N. Y.

WHAM-O SPORTSMAN

\$1.00 postpaid

HITS LIKE A .22 RIFLE — KILLS RABBITS, SQUIRRELS. For Hunting, Target, Routing Pests.

HUNTING SLINGSHOT
Powerful, silent, accurate. Complete with 40 pellets and extra rubber straps. Send \$1.00 today to—Wham-O Mfg. Co., Box 25 South Pasadena, Calif. PROFESSIONAL MODEL OF THE NAT'L SLINGSHOT ASSN.

HEAVY DUTY STOCK

AMAZING NEW MAGIC CATALOG

350 pages of mystifying, easy-to-do tricks and illusions. 600 illustrations. Send \$1.00 now for catalog, credited on your first \$5.00 purchase.

NATIONAL MAGIC CO.
119 S. State St. Dept. S-2 Chicago 3, Ill.

RAISE HAMSTERS

Free Book

The new wonder animals from Syria. Often called Toy Bears. Delightful pets. Everyone wants them. Laboratories need thousands. Clean, odorless. Raise anywhere. A profitable and interesting hobby or business. We furnish breeders and instructions. Write today for free book.

GULF HAMSTERY, 1540 BASIL ST., MOBILE, ALA.

JEWELER'S SCREW DRIVERS

8 Jeweler's Screw Drivers. A must for every hobbyist and model builder.

ONLY \$2.00

SET OF 8

Ideal for precision work, camera and fine instrument repairs. In 8 sizes—from the smallest size 9 up to size 2. Finest tempered steel blades. Lowest price!

MONEY BACK GUARANTEE IF NOT SATISFIED

C.O.D. \$2 plus postage, or send \$2 and we pay postage.

PINE WATCH CO. 29 ELDRIDGE STREET Room 40 N. Y. 2, N. Y.

Free for Asthma

If you suffer with attacks of Asthma and choke and gasp for breath, if restful sleep is difficult because of the struggle to breathe, don't fail to send at once to the Frontier Asthma Company for a FREE trial of the FRONTIER ASTHMA MEDICINE, a preparation for temporary symptomatic relief of paroxysms of Bronchial Asthma. No matter where you live or whether you have faith in any medicine under the sun, send today for this free trial. It will cost you nothing.

FRONTIER ASTHMA Co. 381-D FRONTIER BLDG. 462 NIAGARA ST. BUFFALO 1, N. Y.

ARTISTS NEEDED

IN ALL THESE FIELDS!

Advertising Agencies
Book Illustrating
Booklet Design
Calendar Illustration
Catalog Design
Direct Mail Design

Display Advertising
Employee Publications
Fashion Design
Fashion Illustration
Folder Design
Free Lance Art Work

Greeting Card Design
Hand Lettering
Magazine Illustrating
Moving Picture Art
Newspaper Cartooning
Package Design

Portrait Art
Poster Illustration
Retail Stores
Television Art
Textile Design
Wallpaper Design

DO YOU HAVE VALUABLE ART TALENT?

Now is the time to get started in money-making art jobs. Exciting work. Big future, in many fields.

If you like to draw or paint, find out **FREE** if you have money-making art talent. Take the famous free Art Talent Test, developed by one of the world's greatest art schools. It's an interesting test you take alone, at home. No fee. No obligation.

Find out if you have art talent by taking this easy test. You've nothing to lose—*everything to gain*. Tear out the coupon now. Mail it today.

.....

• **ART INSTRUCTION, INC., Dept. 2140**
 • 500 S. 4th St., Minneapolis 15, Minn.
 • Please send me your **FREE TALENT TEST**.

• Name _____ Age _____
 • Address _____ Phone _____
 • City _____ Zone _____ State _____
 • County _____ Occupation _____

Train for one of these Big Fields in the Largest & Best Equipped School of its Kind

HAT CLEANING AND BLOCKING

Learn by doing in modern training shops under experts. Fine opportunities for good jobs or your own successful business. Have the advantage of going to a big, well established school. **COMPLETE HAT CLEANING AND BLOCKING TRAINING IN ONLY 12 WEEKS.**

G. I. APPROVED

CHICAGO SCHOOL OF SHOE REBUILDING
124 E. 26th Street Dpt. PS-2 Chicago 16, Illinois

Shoe Repairing

Look to the future with confidence. Get into these great fields which are among mankind's oldest and most essential. Trained men needed in practically every locality the year around. No previous experience or advanced education necessary.

Write for Free Booklet Today

Tells How You Can Learn to

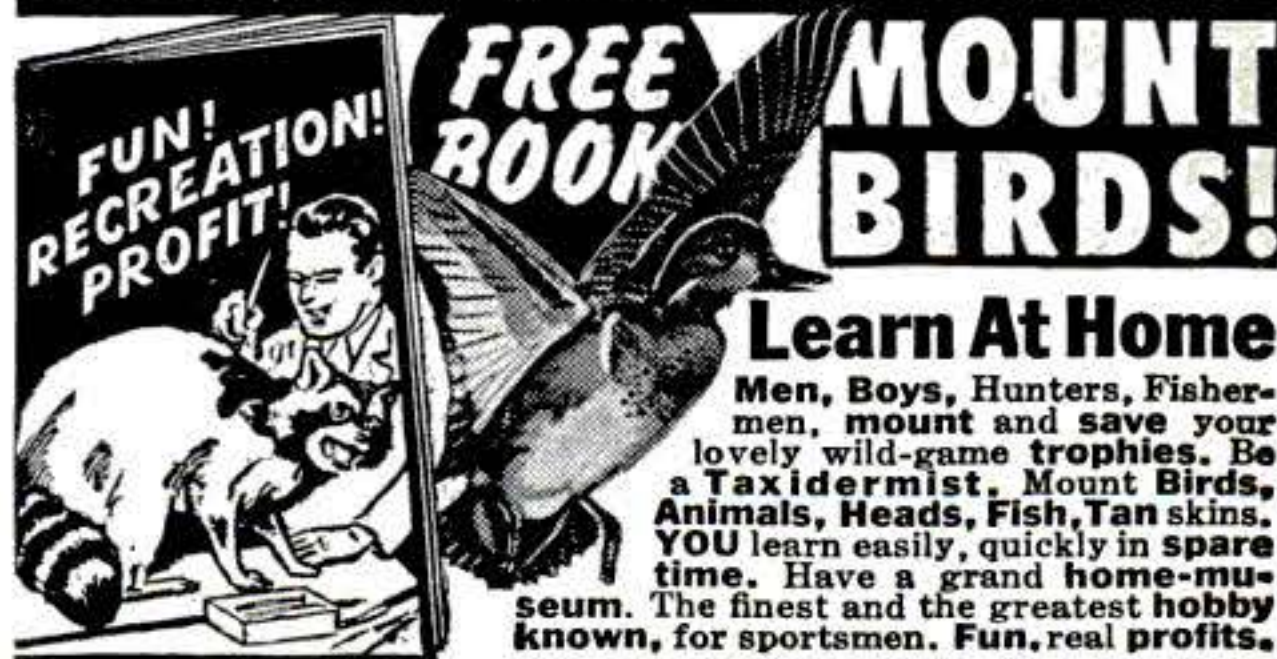

Learn At Home

Men, Boys, Hunters, Fishermen, mount and save your lovely wild-game trophies. Be a Taxidermist. Mount Birds, Animals, Heads, Fish, Tan skins. YOU learn easily, quickly in spare time. Have a grand home-museum. The finest and the greatest hobby known, for sportsmen. Fun, real profits.

FREE BOOK

Yes. **FREE**. Beautiful strange, valuable **Book**, telling all about Taxidermy. Contains over 100 beautiful game-pictures. And it's yours **FREE**, if you rush your request. You can mount all kinds of wild-game, and common specimens too. We can positively **TEACH YOU**. So **GRASP** this opportunity. **RUSH** letter or postal for this amazing **FREE BOOK**. Don't delay. State your **AGE**. **N. W. SCHOOL OF TAXIDERMISTRY, 2662 Elwood Bldg., Omaha 2, Neb.**

Cars and Trucks **START INSTANTLY**

WITH A
Stewart-Warner *Electric* Fuel Pump



Save Your Battery with instant starts—*every time!* Stewart-Warner's *Electric* Fuel Pump fits any car or truck. Feeds a steady, even flow of fuel into your engine as soon as you switch on the ignition. Thousands now in use!

Easy to Install. Complete fittings supplied. Do it yourself or see your local Carburetor Shop or Service Garage.

FREE—Illustrated Booklet on request
Stewart-Warner Corp., Dept. K20
1840 Diversey Pkwy., Chicago 14, Ill.
Please send **FREE** Illustrated Booklet on the dependable new Stewart-Warner *Electric* Fuel Pumps.

Name _____
 Address _____
 City _____ Zone _____ State _____
 For Cars For Trucks

The New MOTOR TUNE-UP MANUAL

Gives you *ALL* the information you need in order to understand **THOROUGHLY** the modern automobile engine and how to keep it in top running order.



ALL principles as well as detailed practical instruction

Explains all electrical and engine principles; the function of **EVERY** part in batteries, ignition system, distributor, spark plugs, fuel and accelerator pumps, carburetor, choke system, valves, power jet, bearings, manifold, cooling system, starter motor, generator, voltage regulator, etc. Shows step by step how to test each part, make sure meter readings are accurate, locate all types of trouble, make all adjustments. Full information on fuels included.

ONLY \$5.50

Handy lists of trouble symptoms and all possible causes.

Complete summaries of each step in all tune-up jobs.

190 diag., il.

SEE IT ON APPROVAL

The Macmillan Co., 60 Fifth Ave., New York 11

Please send me Motor Tune-Up Manual on approval. I will either remit \$5.50 or return the book in 10 days.

Signed.....

Address.....

Learn this Profitable Profession



IN 90 DAYS
AT HOME

Money-Making Career Open to Men and Women, 18 to 50

Hundreds of men and women between 18 and 50 make \$10 to \$20 in a single day giving scientific Swedish Massage and Hydro-Therapy treatments. There is big demand from doctors, hospitals, sanatoriums and clubs. Graduates earn large full time incomes from these or in private practice in their own offices. Others make good money from home treatments given in spare time. Learn this interesting, money-making profession in your own home, through our home study course. Same instructors as in our nationally known resident school. You can win independence and prepare for future security by qualifying for your Diploma. Course can be completed in 3 to 4 months. Many earn while they learn. Begin your training at once.

Anatomy Charts & Booklet FREE

Enroll now and we will include, at no extra cost, many needed supplies. Fit yourself to help meet growing demand for Scientific Swedish Massage. Send the coupon at once for complete details, Anatomy Charts and 32-Page Illustrated Booklet, FREE, postpaid.



THE COLLEGE OF SWEDISH MASSAGE
Dept. 070B, 41 E. Pearson, Chicago 11

Please send me FREE and postpaid, Anatomy Charts, 32-page Booklet and complete details on Home Training.

Name..... Age.....

Address.....

City..... State.....

CONSTIPATION

Is Too Often Serious

FREE BOOK—Explains Relation to Rectal-Colon Troubles

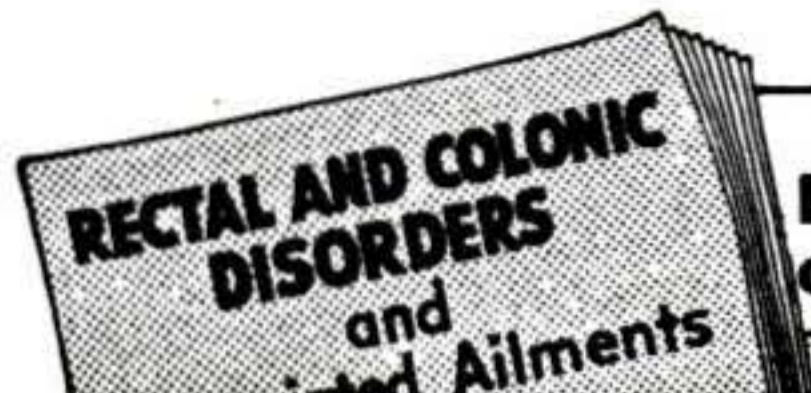

Avoid Dangers of Delay

Colitis, rectal troubles and constipation are often associated together. Write today—a postcard will do—for a FREE copy of an up-to-the-minute 160-page illustrated book on these and associated ailments. McCleary Clinic and Hospital, 271 Elms Blvd., Excelsior Springs, Mo.

ENORMOUS PROFITS CASTING AT HOME

Write today for NEW FREE CATALOG

Learn to cast thousands of perfect figurines, plaques, book ends, ash trays, etc. Start NOW—NO EXPERIENCE, LITTLE CAPITAL needed. Earn GREAT PROFITS with X.L. RUBBER MOLDS. X.L. Rubber, Pts. \$2.00; Qts. \$3.50; Gallons \$8.95; Models and enough rubber for 3 molds . . . \$1.30 postpaid.

3403 S. Madison
St. Dept. 3
MUNCIE, IND.

PLASTIC ARTS STUDIO



"OUT OF PAWN" WATCHES

\$14.95

ORIGINALLY PRICED UP TO \$95.00

Only because these are unredeemed men's watches "out of pawn" can we sell so cheap. All fully guaranteed. 15 & 17 jewels. Famous makes such as Bulova, Gruen, Elgin, Waltham, etc. Excellent condition. Written guarantee. Yellow gold filled cases. Beautiful leather straps. Choice of square, round, oblong, styles. An amazing bargain at \$14.95, plus \$1.50 Fed. Tax. Send only \$1. down payment. Pay bal. to postman, plus postage. Save on gifts! State style preference.

plus Fed. Tax



Free folder on Watches Diamonds Wedding Sets

PACIFIC LOAN CO., Dept. PS-129, 552 S. Main St., Los Angeles 13, Calif.

HOLLYWOOD MUFFLER

THE TONE YOU LOVE TO HEAR



All Ford, Chevrolet, Plymouth . . . \$6.00

All other cars . . . \$8.00

DEALERS WRITE

Duals, Ford & Merc. \$24.50. Send check or M.O. We pay postage.

TOM WILKINSON MUFFLER CO. 811 WILT STREET FT. WAYNE, IND.

ACCORDION MART

Offers Outstanding Bargains



Buy outright or on rental plan. New and used accordions at lowest prices. Full credit for every dollar you pay when you want to turn in used accordion purchased from us for new one. Instruction course included at no extra cost. Complete, guaranteed repair service. Write today for FREE catalog.

ACCORDION MART, IMPORTERS
1736 W. 18th Street, Dept. PS-2, Chicago, Ill.

Make Personalized HOUSE, LAWN MARKERS For Fun Or Profit



17 new silhouette cutouts (3 shown plus 14 other novel designs) complete alphabet and numbers. Ready to trace onto wood. Sawing is easy. Marker with name or address is distinctive personalized

gift or addition to your own home. Make markers for fun and to sell. Set of 17 full-size, ready-to-use patterns, alphabet numbers, only \$1.00, postpaid. Money Back Guarantee.

Clip This Ad and Mail With Dollar Bill or Check TODAY CRAFTPLANS Dept. S-157, Chicago 5, Ill. 1321 S. Michigan Ave.

HERE IT IS -

the all-new IDEAL LAWNMOWER SHARPENER



Model 300

—the result of 48 years experience—Catalog free!

A complete lawnmower shop in one machine Here it is, after four years of research and development, the **completely new Ideal Lawnmower**

Sharpener. Designed and built to sharpen post-war and pre-war hand and power lawnmowers with precision and speed, the **New Ideal Sharpener** includes a tapered-cup grinding wheel for sharpening bed knives and a "lapping-in" reconditioner as standard equipment. *Power mowers need not be dis-assembled*, engines and handles remain in place during sharpening. Chain hoists or ropes are not needed to support heavy mowers, the **Ideal** supports the entire weight of the mower within its rugged cast-iron frame. The **Ideal Sharpener** is a complete lawnmower shop all in one machine. Send for the **Ideal Catalog** describing the new Model 300 **Ideal Lawnmower Sharpener** and the other machines we manufacture for the lawnmower serviceman.

THE FATE-ROOT-HEATH CO.

DEPT. F-4

PLYMOUTH, OHIO

THE NEW WAY TO

ELECTRIFY TREADLE SEWING MACHINES

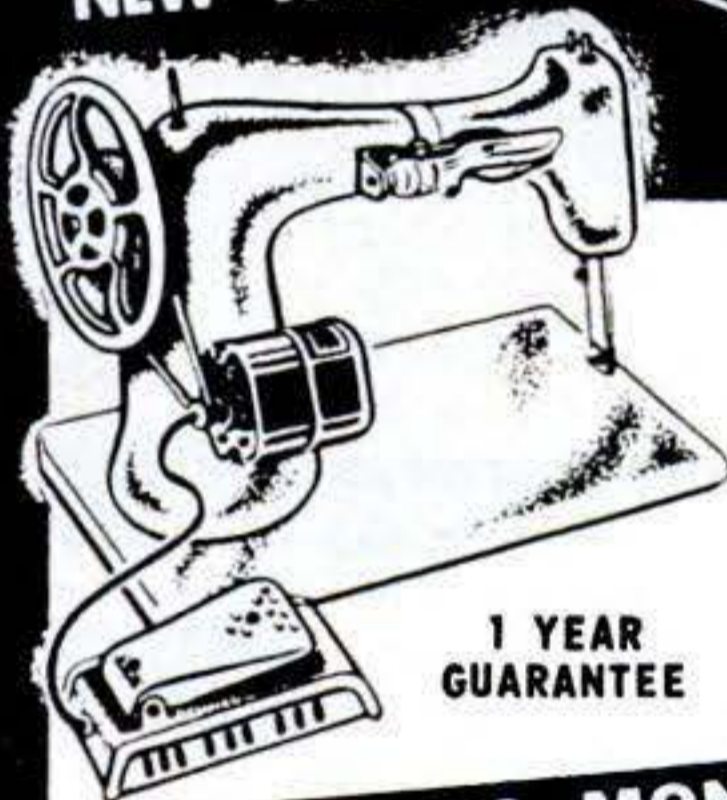

1 YEAR GUARANTEE

Terrific! Amazing! Changes any treadle sewing machine, regardless of age, into a modern electric! A child can do it in 5 minutes! Kit comes complete with Universal motor, foot control, belt, pulley, brackets. Completely wired — just clamp on and plug it in!

FREE!
\$2.95 Sewlight with each Kit.

MAKE BIG MONEY!

Start now! Make \$5.20 on every kit you sell. Millions of women who can't afford new electric machines are waiting for it! Easy to sell over 10 per day! And Brant's back you with a complete line,

from needles to new machines — for BIG profits without any investment! Sell from our catalog and collect commissions in advance! Send for your kit and free literature, today!

RETAILS FOR \$16.95
YOU PAY
\$11.75

BRANT SEWING MACHINE CO.

Department AW-1, Cincinnati 10, Ohio

- Rush motor kit C.O.D. I'll pay \$11.75 plus postage.
 I enclose \$11.75 — Ship postpaid.
 I want to be an agent! Send complete sales plan.

My machine is a.....

Hand wheel turns toward me. away from me.

Name.....

Address.....

City..... Zone..... State.....

Announcing the NEW MYERS

FOR SHALLOW AND DEEP WELLS

"HN" series Ejecto water system



Sets new standards for pump engineering

Every mechanically minded man will appreciate the advanced engineering of the new Myers "HN" Series Ejecto Water System. You can study its many innovations in a free booklet now available—see for yourself why this latest Myers quality-built system sets new standards for pump performance. Mail coupon today for detailed literature on all Myers Ejecto and Reciprocating Types.



FREE BOOK

THE F. E. MYERS & BRO. CO.
Dept. R-81, Ashland, Ohio
Send free water system booklet:

Name.....

Town.....

County..... State.....

Here's How CREI Prepares You for a Professional Career with Industry-Recognized Training in a Minimum of Time

TELEVISION RADIO - ELECTRONICS ENGINEERING

Graduates of CREI residence school are preferred by industry because of their *training and ability*. This recognition is the reason that CREI men quickly find good jobs. With 23 years of practical teaching experience in these highly technical fields, CREI offers an outstanding faculty, modern and complete laboratories, shops and equipment. New students are accepted twice monthly and each may advance as rapidly as he is capable. The basic course with one specialized course requires an average of 20 months to complete. CREI is recognized as one of the country's leading technical institutes. Its work is of college level. It prepares the young man for a good job in industry in a minimum of time.

G. I. Approved



CAPITOL RADIO ENGINEERING INSTITUTE

An Accredited Technical Institute Founded in 1927

Mail coupon for Free Catalog

Capitol Radio Engineering Institute, Dept. 182B
16th & Park Road, N.W., Washington 10, D. C.

Please send me your residence school catalog and complete details.
(If interested in Home Study check below)

Name.....

Age..... If in school, what term?

Street.....

City..... Zone..... State.....

I am entitled to training under G.I. Bill

Send information on Home Study Courses

Install a MILES PER GALLON & MOTOR TUNE-UP-GAUGE

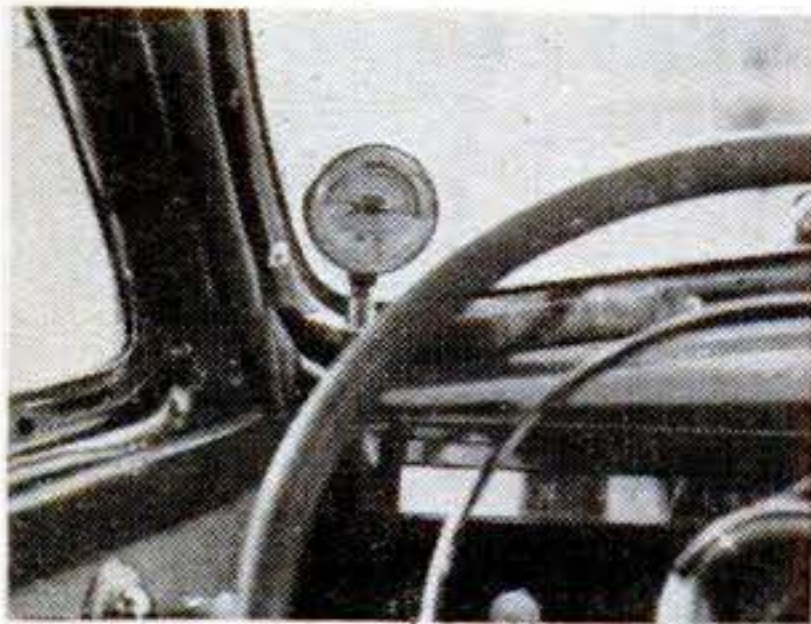

in 1 minute

- ★ NEW
- ★ ACCURATE
- ★ GUARANTEED

Fits all cars—permanent. Checks spark plugs—checks carburetor and 31 other motor adjustments. Registers miles per gallon at every speed.

Simple to read—Dial in 4 colors. No holes to drill—anyone can install in 1 minute.

Complete instructions furnished.



MONEY BACK GUARANTEE
2 3/4" in diameter.

SEND FOR YOURS TODAY—
Distributors' inquiries invited.

ONLY \$7.50 P.P.D.

GALE HALL ENGINEERING, INC.

Boston—18—Mass.

WORLD'S LARGEST MFR. OF AUTO GAUGES

SPEED & MILEAGE MANUAL

140 Illustrations



Easily Get Super Speed, Acceleration, Mileage—Top Racing Performance From Any Automobile!

Famous New Book shows simplified Soup-up Methods—Speed Tuning—Economy Secrets—Customizing Plans—Latest Track Proven Methods for all cars! Tells how to build your own SPEED

EQUIPMENT! FAST SPORT CARS! "CALIFORNIA HOT RODS"! 200 H.P. ROAD & TRACK CONVERSIONS! Complete Instructions on building inexpensive Superchargers! Dual Manifolds! "Water Injectors"! High Compression Heads! Twin Mufflers! Economizers! All about—Fast Engines, Gas Saving, Restyling, "Cam Secrets," Multiple Carburetion, Fuels, Porting, Ratios, Frames, "Offys"! BRAND NEW METHODS, Plans, Formulas, "Racing Tricks"—"STOCK CAR SPEED SECRETS"! Reveals 100 ways to save gas! Shows latest "HOLLYWOOD CUSTOM STYLING"! Streamlining! Sport Changes! Lowering! Speed Conversions! Including—California Roadster Plans! Racer Diagrams! Working Drawings! Performance Charts! Graphs! Beautiful Photographs! Etc.!

Large manual (plus) "California Equipment Catalog" and Racing Handbook. **ALL THREE \$1.98** Post paid

ALMQUIST AUTOMOTIVE ENGINEERING, Milford 75, Pa.

Be a DETECTIVE

A CHALLENGE FROM WASHINGTON, D. C.! Help Stop Crime! Train at home. Earn big money. Amazing training course from the NATION'S CAPITOL (center of law enforcement) by former U. S. GOVT. AGENT and NAVAL INTELLIGENCE Officer exposes actual methods used by Criminals. Write for FREE BOOK. State age.



INTERNATIONAL DETECTIVE TRAINING SCHOOL
1701 Monroe St., N.E. Dept. 212 Washington 18, D. C.

FREE—Amazing Book on RHEUMATISM, ARTHRITIS

If you suffer the aches, pains and discomforts of Rheumatism, as manifested in ARTHRITIS, NEURITIS, SCIATICA or LUMBAGO, send today for the FREE Book. It reveals important facts about why drugs and medicine give only temporary relief without removing causes. Explains fully a proven, specialized system of treatment that may save you years of distress. No obligation. Write for this FREE Book today!

BALL CLINIC, Dept. 36, Excelsior Springs, Mo.

FREE Bargain Book

Packed with hundreds of sensational bargains—new and used—in still and movie photo equipment and accessories. Write for your free copy today to

Central Camera Co.
Dept. 10-B, 230S. Wabash, Chicago 4, Ill

Photographic Headquarters Since 1899

100 ALL STAR MODEL POSES Only \$1

GORGEOUS PROFESSIONAL MODELS IN 100 POSES ON 16MM FILM Superb camera studies of 100 thrilling beauties in glamorous poses. Ideal for discriminating sculptors, artists, art students, photography students. Add 10c for postage. Order Now!

Full Life Size Projector. Up to 4' x 6'. \$10 Value. Now \$4.95, postpaid.

Magnifying viewer for perfect detail..\$1

BENEFIT CORP., Dept. A-22
3807 Benefit Street Baltimore 24, Md.

PLYWOOD BOAT KITS

\$67.50
(Freight Included)

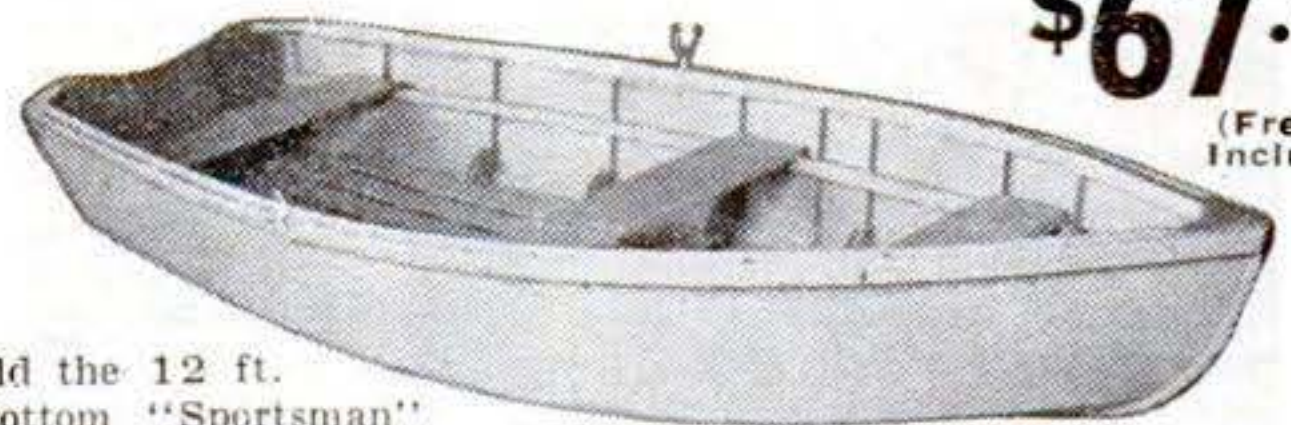

Build the 12 ft. V-Bottom "Sportsman" as shown. Ready-cut kits include all hardware, paint, etc. Send for free folder on all models as low as \$29.95, freight included.

TAFT MARINE WOODCRAFT
Dept. "R," 636 39th Ave. N.E. Minneapolis 21, Minn.

FASCINATING ART HOBBY Offers you a New Way to turn YOUR SPARE TIME INTO MONEY



YOU CAN MAKE THESE AND HUNDREDS OF OTHER BEAUTIFUL ART OBJECTS... WITHOUT PREVIOUS EXPERIENCE OR ARTISTIC TRAINING

Simple Process enables you to MAKE YOUR OWN MOLDS from any Statue, Plaque, Figure or other Object of Art... then Make Hundreds of Faithful Reproductions

This amazing process is your **FIRST STEP** to a new and fascinating hobby—it opens the door to a field that's rich in profits. You master the secrets of a method that allows you to reproduce practically **any object of art** that will beautify your home and make wonderful **GIFTS** for friends. **And**, these reproductions can be sold in quantity to gift shops, variety stores, gift departments and drug stores. The profits you make are **big**. For just a few cents' worth of material can bring **MANY DOLLARS** in return.

Think of being able to start this fascinating, money-making hobby for only **\$4.45**. One payment pays for **everything**—the Big, Plastic bound, **FULLY ILLUSTRATED** Instruction Book, the Special Molding Compound and a beautiful Metal Statuette to serve as your first model. With these materials you make **YOUR OWN** molds and turn out countless reproductions, using common plaster-of-paris, available anywhere for just a few cents a pound. Finish your castings in colorful paints, watercolors, felt flocking, or give them a gleaming coat of genuine metal by Electroplating. Every step—from the making of your molds to the final finishing is thoroughly covered in your **big BOOK OF INSTRUCTIONS**.



MAKE CASTINGS like these

Shown above is an example of the type of work you will be doing in just a short time. Only 84c worth of material was required to produce **ALL** these figures. Properly finished by you, they can sell retail for as much as \$2.00 or \$3.00 each!

MONEY BACK IF NOT DELIGHTED

For the **COMPLETE** Outfit that will get you started immediately, send only **\$4.45** or mark the coupon at right, and we'll ship C. O. D. You pay the postman when he delivers. **AND**—after reading the Instruction Book from cover to cover—if you don't say that this is the most interesting hobby work you've ever seen, return the entire outfit and we'll refund your \$4.45 by the next mail. So don't put off another minute... get started Now!

WARNER ELECTRIC CO., Dept. PC-52
1512 JARVIS AVE., CHICAGO 26, ILLINOIS

Send me the complete outfit so that I may get started immediately. I understand that if I am not completely satisfied after reading the **BOOK** I may return the **ENTIRE OUTFIT** and you will refund my \$4.45 by the next mail.

- I am enclosing remittance in full (\$4.45). Plus 25c postage.
- I am enclosing \$1.00. Ship C. O. D. for balance.
- I am enclosing \$1.00 for the Instruction Book **ONLY**.

I understand that if I am not completely satisfied after reading it I may return it and you will refund my \$1.00.

NAME

ADDRESS

CITY ZONE STATE

WARNER ELECTRIC CO. 1512 JARVIS AVENUE, Dept. PC-52, Chicago 26, Ill.

WORK SHIRTS

Embroidered
NAME FREE

69c

YOUR NAME



With Each Order Over \$1.00 **3 for 1.79**

AMAZING VALUES!

SAVE money! These are surplus stock from a big supply firm. Sturdy, serviceable work shirts, though used, have been washed, sterilized and reconditioned. Every shirt of long-wearing wash materials. Blue or tan. Strongly sewn; reinforced stitching at points of strain. Money back guarantee!

WORK PANTS TO MATCH.....99c

Blue or Tan. Send waist measure and leg length.

SHIRT & PANTS TOGETHER.....\$1.49

Blue or Tan. Send shirt neck size, waist and leg length.

COVERALLS Blue or tan. \$1.49

Send chest measurement.

Send No Money!

Give name, address, city or town, size and color choice, (also state 2nd color choice). Pay postman, plus postage. Or send cash and we ship prepaid. Keep 10 days. If not satisfied, return for refund!

Mail Your Order Today!

YOUNG DISTRIBUTING CO.

Dept. W 2605 Elmhurst Detroit 4, Mich.

LEARN NEON TUBE BENDING AND NEON SIGN FABRICATION



TRAIN FOR THE TOP JOBS IN A GROWING INDUSTRY!

Properly trained men go to the top in America's fast-growing neon sign and fluorescent lighting industries. Here is a field in which earnings of \$2.00 to \$3.00 per hour are commonplace among *competent* workmen.

Put yourself in line for these top-paying jobs by training at the one school that *prepares* you for them. Thorough, *practical* training at G.I.T.I. is conducted by an outstanding staff of instructors with modern professional equipment. To date, *not one G.I.T.I. graduate has failed to qualify for or hold a high paying job.*

Write today for complete information about our non-technical courses, approved for *all* G.I. training and excellent for many physically handicapped men. State whether veteran or non-veteran information is desired. *No correspondence courses are offered.*

GENERAL INDUSTRIAL TRAINING INSTITUTE

DESK S-101

STEUBENVILLE, OHIO

FEBRUARY 1950 65

THOUSANDS BUILD AT 1/2 THE PRICE



20 MODELS U-MAK-IT BOAT KITS

EASY TO BUILD

ROWBOATS

8 TO 14 FT.

Special Models For Fishermen



PRAMS

OUTBOARDS

Fast Round or V Bottoms
12 TO 16 FT. Newest Assembly Methods

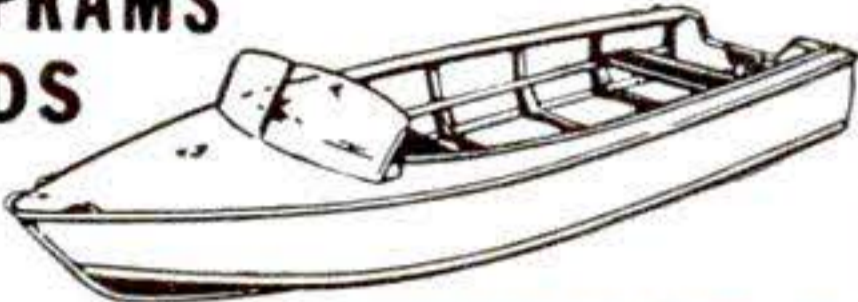

INBOARDS & CABIN CRUISERS

For Fishing, Racing or Cruising 16 TO 23 FT.

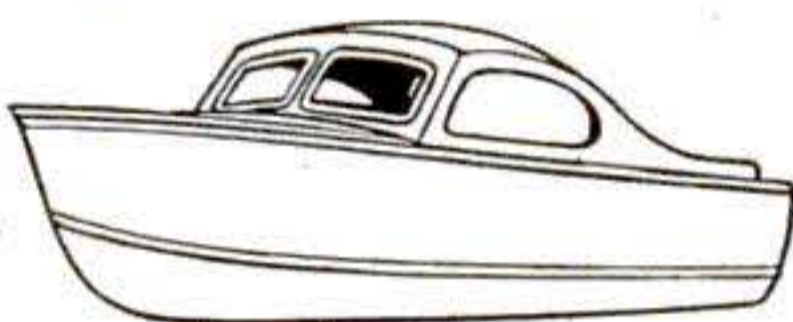

SEND 25c (coin)
ORDER YOUR
CATALOG TODAY

U-MAK-IT PRODUCTS 703R-WHITTIER ST.
New York 59, N. Y.

5 YEAR WRITTEN GUARANTEE 17 JEWEL CHRONOGRAPH 2 PUSH BUTTON

ORIGINALLY \$71.50

- POST-WAR SURPLUS
- WRISTWATCH
- STOPWATCH
- TELEMETER
- TACHOMETER

Our Price
Now Only

\$21.95
Plus \$2.20
Tax



Precision 4-in-1 Timepiece. Incabloc shock resistant feature. Sweep Second hand. Anti-magnetic. Radium Dial. Stainless steel back. Perfect for physicians, scientists, technicians, engineers, aviators, photographers, broadcasters, navigators, sportsmen, servicemen, etc. Thousands sold at \$71.50. Order now while they last at this record breaking low price.

5 YEAR WRITTEN GUARANTEE \$16.95 17-JEWEL WRIST WATCH

ORIGINAL PRICE \$59
INCABLOC SHOCK PROTECTED
WATER REPELLENT

Sacrificed Because They're POST-War Surplus. Luminous dial . . . Sweep second hand . . . Super Accurate . . . Imported Swiss precision movement and case. You get these Men's New 5 Year Guaranteed Watches now for a small fraction of the original price. Don't delay! Order now . . . while they last.

TRIAL OFFER! Wear at our risk! Money back in 5 days if not delighted. SEND ONLY \$1 down payment with order. Pay balance to postman on arrival plus postage. Or we pay postage if you include full payment plus tax with your order.

FREE! Handsome Expansion Band Included. ORDER NOW!

MARYLAND DISTRIBUTORS, DEPT. 17
501 East Baltimore St. Baltimore 2, Md.



AMAZING PROFITS

From Your Workshop!



New, improved Home Craftsman Magazine brings you simple, step-by-step methods used by thousands of successful craftsmen who make their home workshop pay **BIG PROFITS**—At your fingertips, tested, proved methods, for making a "killing" even in tough times. Tells how to pick projects that sell fastest; how and where to sell. Shows how to actually have fun, yet earn money in spare time.

For the next two years we want to send you Home Craftsman Magazine to show you the hundreds of amazing plans and ideas. Best of all you take it on **FREE TRIAL**. Also Big Free book "How To Make Money With Your Workshop" yours to keep absolutely Free even if you decide not to continue taking each issue of the magazine—So what have you to lose—a 3c stamp? Hurry—Send \$3.00 (check or M.O.) as payment in full. If not truly delighted, return magazine and your money will be refunded in full.

The Home Craftsman Magazine, Dep't. S-2
115 Worth St. New York 13, N. Y.



MASTER COURSE IN

HYPNOTISM

SECRETS REVEALED! Actual methods, techniques of master hypnotists . . . how to hypnotize suitable subjects at a glance—a command—by phone! How to control subjects after they awaken—help break tobacco, other habits. Self-hypnosis. Group hypnosis. Entertain with amazing hypnotic stunts for fun or profit. Get this easy-to-understand, how-to-do-it course now! Money-back guarantee. Fully photo-illustrated . . . \$2 (complete). EXTRA! Unique "ALARM-CLOCK MIND" instruction folio and catalog of unusual Power Books included. Order "Hypnotism Course" today!

POWER PUBLISHERS, Dept. M5, 790 Broad St., Newark, N. J.



MAKE and REPAIR YOUR OWN BAND SAW BLADES with the ERWOOD Electro Band Saw Brazer

No more slowdowns . . . it takes less than TWO MINUTES to repair a blade with the Erwood Brazer. Save money too . . . do inside contour sawing easier and faster. And make your own band saws from coil stock. 110 or 220 volt.

The ERWOOD Company
215 Woodstock, Crystal Lake, Illinois



GROW YOUR OWN...

vegetables, flowers, house plants by hydroponics (without soil). It's easy to get big returns in a small space, indoors or outdoors. A clean pleasant way to grow any plant for fun or profit. Send for FREE 24 page booklet.

GILBERT & COMPANY

840 West Ivy, San Diego, California

NERVOUS STOMACH

ALLIMIN relieves distressing symptoms of "nervous stomach"—belching, bloating and colic due to gas in stomach and intestines. ALLIMIN has been clinically tested by doctors and found highly effective. ALLIMIN is the world's largest selling garlic tablet. At all drugstores.

ALLIMIN Garlic Tablets

NEW WAR SURPLUS

HOIST & WINCH

Originally made to be used on B-29s for lifting bombs. Mounted on welded steel base, can be attached to truck body or any solid base. Ideal for lifting or moving loads onto trailers, trucks or tractors or for machine shops, garages or warehouses. Capacity 2,000 lbs. Equipped with ratchet for holding load and 18 ft. 3/16" steel cable. Shipping wgt. 50 lbs., FOB, K. C., Mo. Quantity discounts 6 or more.

\$29.95

Send check or M.O. for immediate delivery. No COD's.

UNITED AUTO PARTS, INC.

1901 Troost

Dept. PS10

Kansas City, Mo.

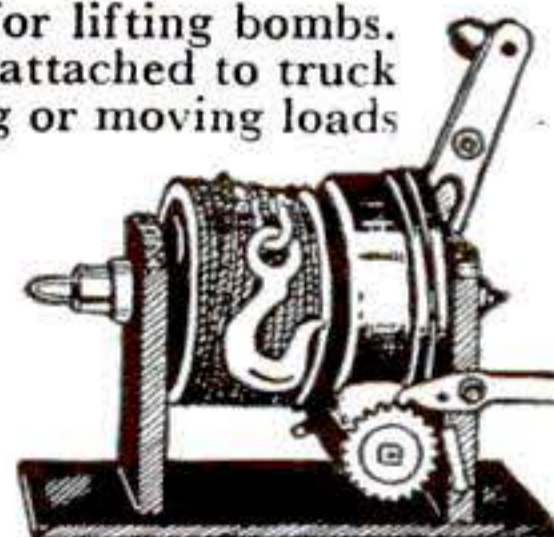

A FASCINATING... MONEY-MAKING art career can be yours

America's 12 Most Famous Artists Show You How!



Norman Rockwell
Al Parker
Jon Whitcomb
Ben Stahl
Stevan Dohanos
Robert Fawcett
Peter Helck
Austin Briggs
Harold von Schmidt
John Atherton
Fred Ludekens
Albert Dorne

If you like to draw—then act now to meet the coast-to-coast demand for artists. Famous artists show you their studio methods and short cuts to prepare you to be an illustrator, advertising and fashion artist. Learn quickly, at home in your spare time. Take the first step now—write today for big illustrated brochure about your art career. It's free!

FAMOUS ARTISTS COURSE

Institute of Commercial Art, Inc.

Dept. B-11, Westport, Conn.

FREE Please send book about Famous Artists Course.

Name _____ Age _____

Street _____

City, Zone, State _____

Phone No. _____

TAKE 3-DIMENSIONAL PICTURES WITH YOUR OWN 35MM CAMERA
NEW REDUCED PRICE (Outfit No. 101, was \$22.50)
STEREO-TACH \$17.70 Plus \$2.09 Fed. Tax
and 3-D Slide Viewer complete. Make marvelous stereo color slides. Get Stereo-Tach from your dealer or direct. Money back guarantee. Dept. 20.
ADVERTISING DISPLAYS, INC. Covington, Ky.

New BELT SANDER ONLY \$10.95
MODEL 324 **Stationary and Portable**
Ideal all-purpose sander for home or shop! Stop-Fence Unit adjusts to 4 positions — tilts to 45°. Sturdy aluminum construction. May be powered by electric motor, drill, lathe, etc.
Send for free circular NOW!
JOHNSON Mfg. Co., Dept. 2B, Lincoln Park 7, R. I.

Ugly BLACKHEADS OUT IN SECONDS

Keep your complexion free of Blackheads this new way — look attractive instantly!

Try VACUTEX Blackhead-Remover
The amazingly effective Vacutex extracts Blackheads automatically — WITHOUT squeezing the skin or injuring tissues. Easy to use with three fingers. It reaches Blackheads anywhere. Try it 10 days and if not delighted, return VACUTEX and your money will be refunded.

\$1.00

AT YOUR DEALER OR USE COUPON

10 DAY TRIAL COUPON
BALLCO PRODUCTS CO., Dept. A-1102
19 West 44th St., New York 18, N. Y.
 Enclosed find \$1. Send postpaid.
 Send C.O.D. I will pay postman \$1 plus postage; \$1 refund if not delighted.
SORRY. NO C. O. D.'s OUTSIDE U. S. A.

MEN WANTED as Local Manufacturers of New Masonry Wall Unit

CAVITEX is today's masonry — colorful, streamlined, scientific. Yet with price appeal to override competition. Size and proportion in direct line with modern architectural trends. Dimensions strictly according to modular standards. All the strength, safety and endurance of masonry at its peak point.

Outstanding Opportunities For Men of Vision — Cavitex can be made locally — of local materials, with local labor. Freight and distribution costs are saved. That's why Cavitex can be sold so low, yet still allow 100-150% mark-up on basic costs. Plants are compact, self-contained, require no skilled labor. We supply complete equipment — cash or time. Hundreds of territories open. Tie in with Cavitex and ride the tide of biggest building cycle in history. Write for full information at once.

W. E. DUNN MFG. CO.
410 W. 24th ST. HOLLAND, MICH.



AUTO BOOKS ON APPROVAL



SEND NO MONEY. Just mail the coupon for a complete set of 4 Big, Thick Auto Books. 20th Edition. Over 2700 Pages! Whether you are a mechanic or helper, expert or apprentice, auto owner or driver, take immediate advantage of this FREE EXAMINATION OFFER.

MAKE GOOD MONEY NOW HOLD A PERMANENT JOB

America wants its automobiles kept in good repair. Men with "know how" are in demand, at big pay. These books will help you get and hold an important job, or give you a chance to go into business for yourself now or later. Any man who half tries to improve himself can learn auto servicing and repairing by this quick reference method. Use the JIFFY INDEX to find easily understood answer to any auto problem. These wonder books prepared by eleven of America's great automobile engineers. Many hundreds of valuable illustrations. Send the coupon TODAY.

[A year's consulting privileges with our engineers now given with these books without extra charge.]

Publishers Since 1898

CAN YOU FIX IT?

These wonder books tell step by step HOW to make difficult repairs and adjustments, how to keep a car at maximum efficiency, including latest improvements in car design and operation. Engine troubles and how to correct them well covered.

4 BIG, THICK VOLUMES Over 2700 pages, 2000 illustrations, wiring diagrams, etc. Beautiful modernistic, washable cloth binding.

AMERICAN TECHNICAL SOCIETY, Dept. A-220
Drexel Ave. at 58th St., Chicago 37, Ill.

I would like to examine your 4 Volume Set of Auto Books. I will pay the delivery charges only, but if I choose I may return them express collect. If after 10 days' use I prefer to keep them, I will send you \$2 and pay the balance at the rate of only \$3 a month until \$24.80 has been paid. Include consulting service as offered above.

Name.....
Address.....
City..... State.....
Please attach letter stating age, occupation, employer's name and address, and name and address of at least one business man as reference. Men in service, also please give home address.

Tru Speed BOAT SPEEDOMETER



Accurate and practical, at a price you can afford. Polished aluminum case is 5 3/4" wide x 5 3/16" high. Requires only 1/2" hole through dash. Easy-to-read dial is full 3" diameter. Simply installed. Two models: 1 to 35 m.p.h.—\$10.95 and 10 to 50 m.p.h.—\$12.95 postpaid in U.S.A., complete with all connections. A guaranteed instrument. See your dealer or write direct.

MUSKEGON OUTBOARD SPECIALTIES CO., Box 426, Muskegon, Mich.

Train for BIGGER PAY in REFRIGERATION AIR CONDITIONING

GET FREE BOOK!

Prepare yourself for a fine paying job. Trained men find opportunities installing and servicing Refrigeration and Air Conditioning. Get practical training in spare hours at home—plus four full weeks in the great ITI shops. Job Placement Help. FREE BOOK. Write Industrial Training Institute, 2130 Lawrence Avenue, Dept. F-2, Chicago 25, Ill.

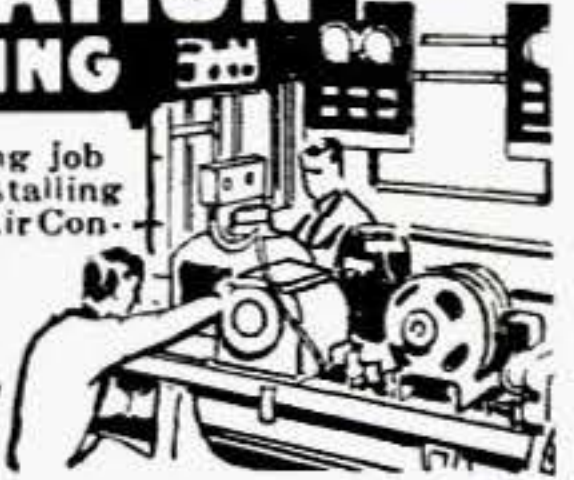

Now CHEAP OIL BURNER FOR HEATING AND COOKING STOVES • FURNACES

HEAT YOUR HOME, COOK YOUR MEALS WITH CHEAP FURNACE OIL

NO MORE SHOVELING COAL OR ASHES. Sensational Fuelizer Starter Vaporizing System turns Cheap No. 1 Furnace Oil, also Range, Heater, Tractor Distillate, Kerosene and like oils into oil heat—one of the quickest, hottest fires known. **LIFETIME GUARANTEE. \$1.00 Bonus Offer for Testing.** We will let you try it in your own stove or furnace for one month. Get yours for introducing. Big profits QUICK. Be first. Send in your name today for details and cash in on the tremendous demand for this Amazing Invention.

NORTHWEST MFG. CO. 731-B Mitchell, S. Dak.



PROFITABLE HOBBIES



Let us show you how extremely easy it is to make beautiful and useful things out of LIQUID PLASTICS, LIQUID MARBLE, LIQUID IVORY, LIQUID GLASS, CERAMICS, ETC. . . . as easy as pouring water out of a glass! Make novelties, jewelry, gifts, artware, toys, tools, dies, gadgets, ceramics . . . a million useful things! We supply everything—**MATERIALS, INSTRUCTIONS and BUYERS!** Send only 25c for 1. Big catalog of 300 casting materials, molds and accessories, 2. A beautiful **CAMEO** free (to show you what you can do), and 3. Actual **INSTRUCTIONS** on how to cast and start in the **CASTING BUSINESS!** Send 25c today—this may be the lucky coin that will start the most fascinating and profitable phase of your life! (Catalog only—10c).

PLASTICAST COMPANY (DEPT. A)
4637 N. Kedzie Ave. (Write to nearest address)
Chicago 25, Ill. P. O. Box 987 Palo Alto, Calif.
CANADIAN CUSTOMERS, please order directly from: CANADIAN INDUSTRIAL PLASTICS, LTD., 1056 1/2 Pender West, Vancouver, B. C.

Play GUITAR in 10 DAYS

OR GET YOUR MONEY BACK! Let Ed Sale, top radio guitarist, teach you to play with his famous diagram-photo system. Book contains 53 photos, 43 diagrams showing exactly how to place your fingers. Gives you 110 popular songs, words and music—along with complete, easy to learn instructions. Imagine your joy when you find after only two weeks you are playing beautiful music! **\$1.95** Amaze your friends! Be the life of the party! Pay Postman \$1.95 plus C.O.D., or save C.O.D. Send \$1.95 now! ED SALE, Dept. 1C Point Pleasant, New Jersey

LOCATE URANIUM



Model TX-9 Geiger Counter costs only \$79. Locates uranium, thorium and all radioactive ores. Other models to fit your particular need. Write Dept. P2.

OMAHA SCIENTIFIC SUPPLY CO. 3601 N. 24 OMAHA 10, NEBR.

BARBELLS



Save Money—Buy the finest barbell equipment direct from our foundry—No other company can match our low price or value! Send to-day for our FREE Barbell Catalog

BUR BARBELL CO.
Lyndhurst 2, New Jersey

make your own Gems 29.50 F.O.B.

All necessary lapidary equipment is furnished, including a super-charged diamond blade for sawing, and all wheels for grinding, shaping and polishing; also complete instructions. The complete equipment as shown, less motor and belt, for only \$29.50, f.o.b., Burlington, Wisconsin. Write today for information and literature.

B&I MANUFACTURING CO.
Dept. M Burlington, Wis.

POWER MOWERS & KITS FREE PLANS

LOW FACTORY PRICES DIRECT TO YOU on America's finest Lawn Mowers and Easy-To-Assemble Kits and Parts. TRIANGLE Mowers are quality-built and powered high for easy cutting and long wear.

SAVE MONEY 3 WAYS

1. Buy complete assembled mowers in 3 or 4 wheel models. 18" and 20" sizes.
2. You assemble complete mower from our precision built Kits and Parts.
3. Build your own from our FREE PLANS using Triangle Kits, Parts, Engines, Wheels, Etc.

WRITE TODAY for full facts, Free Plans, Parts List, and LOW Factory Prices.

TRIANGLE MFG. CO.
Dept. S-A, Box 185 Fort Scott, Kansas



Wholesale Exceptionally Good Used Tires Direct To You

with **Lifetime Tire Guarantee**

(10% discount on 2 or more tires if you send this ad with order)

TUBE DELIVERED WITH TIRE AT NO EXTRA COST
For 15" or 16" Passenger Tires

Safe—Our tires used on school buses and ambulances
EXCEPTIONALLY GOOD TREAD—NO RECAPS

600-16—6 ply Military—Mud and Snow Tires \$6.37	750-20(10) \$15.98
600-16\$5.49	700-16 ..\$6.79
600-16 (6 ply) 6.49	525-18 \$ 6.69
650-16 5.49	825-20 16.98
700-15 .. 5.79	600-20 9.89
650-20 9.98	900-20 17.79
550-17 .. 7.79	1000-20 18.29
750-16 12.50	

ALL GOOD TIRES

600-16 ...\$3.59	550-17 ...\$5.69	700-20(8) \$ 9.29	825-15(14) \$14.98
650-16 3.89	750-16 8.40	700-20(10) 12.48	825-20 11.19
650-15 3.89	600-20 7.98	750-20(8) 11.79	900-20 11.89
700-15 3.98	650-20 7.99	750-15(10) 11.97	1000-20 .. 12.89

GOLD BOND SPECIAL—750-20 MILITARY TIRES
Will fit 650 x 20 700 x 20 (8 & 10 ply) 34 x 7 (8 & 10 ply)
Special.....\$10.49
Superior Quality.....\$12.98
Gold Bond Finest.....\$14.98
900 x 16 SPECIAL \$9.03 900 x 16 EXTRA \$11.19

Send check or money order with this ad

GOLD BOND TIRE CO., Dept. PS 24
512 NORTH 1ST ST., RICHMOND, VA.
"A gold bond written guarantee with every tire"

WATCHMAKING

Be a Watchmaker—Be Independent

Get practical training at the only school in Chicago, accredited by the Horological Institute of America and U.H.A.A.
Day and Evening Classes—Approved for Veterans

Write today for free information

CHICAGO INSTITUTE OF WATCHMAKING
6 East Lake Street Dept. PS-2 Chicago, Illinois

Build your own JET ENGINE!

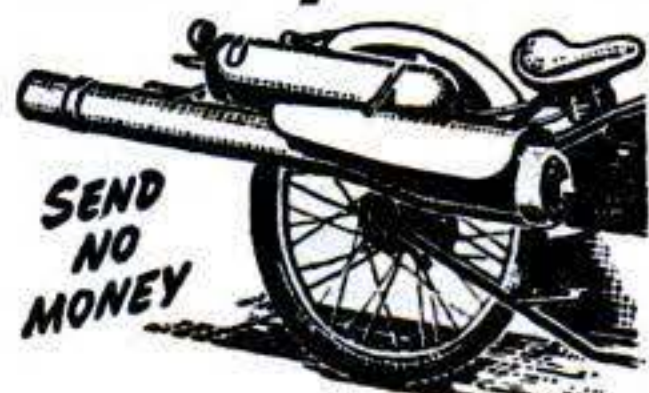

Order these plans today

1. JET PROPELLED BICYCLE. Assemble your own. Photo and instructions \$1.00.
 2. HOW TO MAKE EXPERIMENTAL JET ENGINES. Seven sheets drawings with information and instructions \$2.95.
 3. BOTH OF ABOVE in one order \$3.75.
- SEND NO MONEY. Order both at once \$3.75 C.O.D. in USA plus c.o.d. postage. Send check or Money Order and we pay postage. Get other information too. Rush Order.

J. HOUSTON MAUPIN, Dept. 66, Tipp City, Ohio

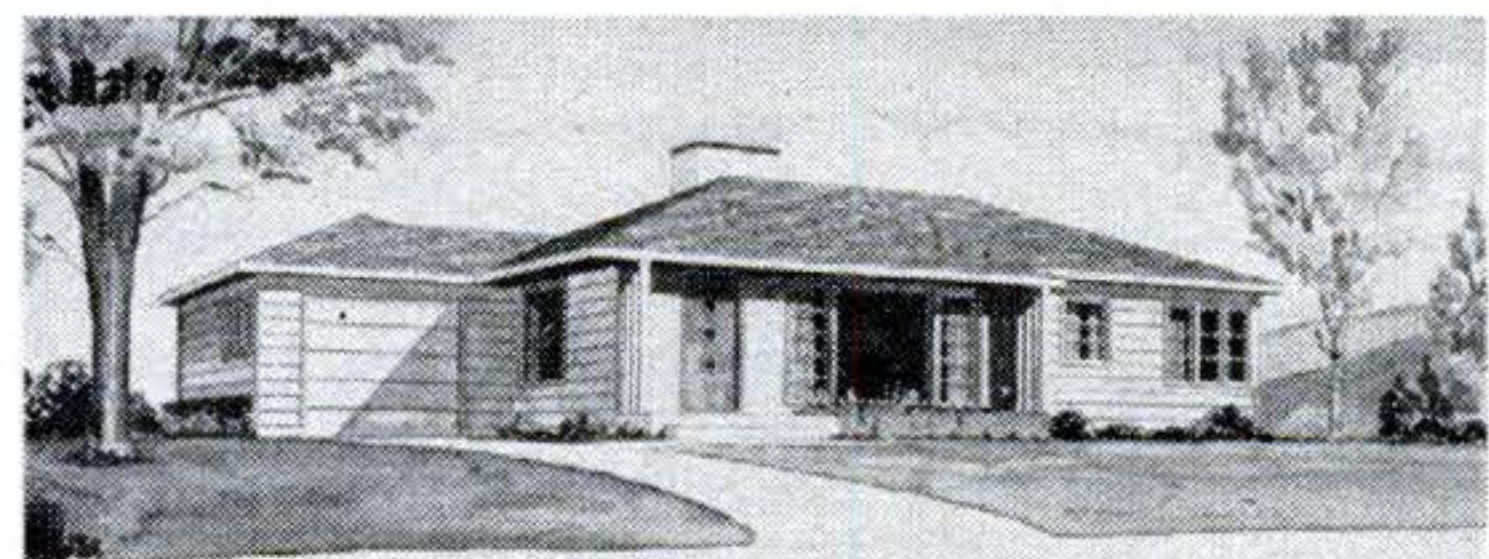

SEND FOR NEW HOME PLAN BOOKS
Concrete Block Homes \$1, Wood Frame \$1

Two brand new editions, one of frame homes, one of concrete block homes. Both chock-full of the latest plans for modern living, including starter and garage homes, small homes, three bedroom homes, western ranch homes, modern designs, Cape Cods. Best of all you can order complete blue prints and specifications at low additional cost for any plan in either book. Order frame book \$1 or block book \$1 or both \$2. No C.O.D.

HOME BUILDING PLAN SERVICE
2454-P N. E. SANDY PORTLAND 12, OREGON

FREE

get it now—

ALLIED'S 1950 TV & RADIO CATALOG!

196 PAGES OF BIG VALUES

EVERYTHING IN RADIO AT LOWEST PRICES



Send for **Radio's Leading Buying Guide**

Save money on every radio need! Get the new 196-page 1950 ALLIED Catalog, preferred and used by everyone in radio. See the world's largest stocks of top-quality equipment, all at low, money-saving prices! Latest TV releases, home radios and radio-phonos, Amateur equipment, PA systems and High-Fidelity Sound, recorders, test instruments, builders' kits—plus thousands of parts, tubes, tools, books and diagrams. Have all the advantages of quick delivery, complete selections, big savings and expert personal help from the World's Largest Radio Supply House. Send today for your FREE copy of the 1950 ALLIED Radio Buying Guide!



TELEVISION AND HOME RADIOS



SERVICE SUPPLIES BUILDERS' SUPPLIES



AMATEUR GEAR



AMPLIFIERS, P.A. SYSTEMS, RECORDERS

ALLIED RADIO

ALLIED RADIO CORP.
833 W. Jackson Blvd., Dept. 7-B-0
Chicago 7, Illinois



Rush FREE 1950 ALLIED Catalog

Name

Address

City.....Zone.....State

PAY RAISING

Get the specialized help you need to qualify for top pay on present job, a better job, or business of your own—from these practical books:

- AUTOMOTIVE SERVICE MANAGEMENT**
This new book shows you exactly how to start and run an auto service business profitably. Tells what to do, when; how to make money as shop owner or manager. 470 pages, 223 illus. \$5.00
- MODERN ELECTRIC & GAS REFRIGERATION**
Covers repairs, adjustments, overhauling of every type of domestic, commercial and industrial equipment. Non-technical. 928 pages, 408 pictures, 17 working diagrams in colors. \$5.00
- DYKE'S AUTO ENCYCLOPEDIA** (World's greatest auto book)
Complete course in auto mechanics, with special emphasis on trouble shooting, testing, adjusting and repairing. New 21st ed., 1483 pages, 4600 illus. \$7.50
- DYKE'S SELF-STARTER**
Provides complete self-instruction course for Dyke's Auto Encyclopedia. \$1.00
- AUTO BODY & FENDER REPAIRS**
Shows you how to get good job or start business of your own. Gives approved methods for doing professional jobs. 325 pages, 232 pictures. \$3.50
- HOUSE WIRING**
New 6th ed. — a working manual for student and electrician alike. Covers every phase of house wiring. 350 pages, 600 illus. \$3.00
- AIR CONDITIONING**
Makes you familiar with dif-

BOOKS

- ferent types of equipment. Tells how to figure requirements, make installations, etc. \$4.00
- A. C. POWER WIRING**
466 pages, 600 illustrations. \$4.00
- D. C. POWER WIRING**
497 pages, 533 illustrations. \$4.00
- DYKE'S CARBURETOR BOOK**
Testing, adjusting, diagnosing troubles, repairing \$3.50
- MODERN WELDING PRACTICE**
Information on every known welding procedure. \$4.00
- PLUMBING & PIPE-FITTING**
Be the one who lays out jobs for others. \$2.50
- BAILEY'S HANDBOOK**
Operating, maintaining steam plants. \$2.00
- VOCATIONAL MATHEMATICS** (Shop Arithmetic)
Learn mathematics without drudgery. \$1.25
- VOCATIONAL MATHEMATICS** (Geometry, Algebra, Trigonometry) \$1.50
- MECHANICAL DRAWING**
Effective way to learn fundamentals. \$1.50
- SHEET METAL DIE DESIGN**
\$2.25
- ELECTRICAL TROUBLE SHOOTING ON THE MOTOR CAR** \$5.00
- DIESEL HANDBOOK** \$5.00
- ELECTRONIC TELEVISION** \$2.50
- AIRPLANE DRAWING** (Design & Construction) \$1.50
- AIRCRAFT FLIGHT INSTRUCTOR** \$2.50
- AIRCRAFT SHEET METAL WORKERS' MANUAL** \$2.50

Check the books you want, clip this ad and mail with check, money order, or U.S. currency, carefully wrapped. Money Back if not satisfied.

GOODHEART-WILLCOX CO.

Dept. 112 1321 S. Michigan Ave. Chicago 5, Ill.

WHY DON'T YOU WRITE?

Writing short stories, articles on business, travel, shop crafts, sports, local and club activities, etc., will enable you to earn extra money. In your own home, on your own time, the New York Copy Desk Method teaches you how to write the way newspaper men learn—by writing. Our unique "Writing Aptitude Test" tells whether you possess the fundamental qualities essential to successful writing. You'll enjoy this test. Write for it, without cost or obligation.

Veterans: This course approved for Veterans' Training.

NEWSPAPER INSTITUTE OF AMERICA

SUITE 5720-B, ONE PARK AVENUE, NEW YORK 16, N. Y.

ENGINEERING DEGREE IN 27 MONTHS

Big Demand for Graduates

AERONAUTICAL, CHEMICAL, CIVIL, ELECTRICAL, MECHANICAL and RADIO ENGINEERING (including Television).

Hundreds of young men are earning engineering degrees in this recognized institution each year—continuous operation. New terms start quarterly. Many students earn a major part of their college expenses in this large industrial center.

Low tuition. Competent instruction. Thorough intense practical program. Modern laboratory facilities including new physics lab. and modernized wind tunnel. Individualized instruction emphasized.

Approved for Veterans. Engineering preparatory courses. Students from 48 states and 21 foreign countries. Enter March, June, September, December. Send coupon for free catalog and full information. Enroll now.

SEND COUPON TODAY.

INDIANA TECHNICAL COLLEGE

620 E. Washington Boulevard
Fort Wayne 2, Indiana

Please send me free information on B. S. Engineering. Degree in 27 months as checked.

- Aeronautical, Chemical, Civil,
- Electrical, Mechanical, Radio-Television.

Name.....

Address.....

NEW PACKAGED BOATS 1950 KITS

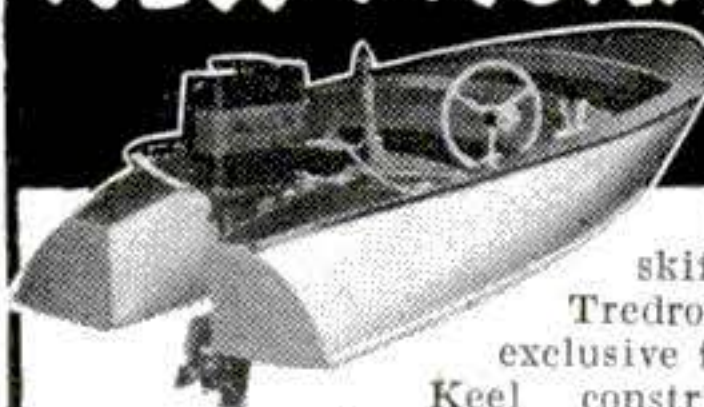

17 New models. Improved design, skiffs, outboards, inboards, sail boats. Tredronic racers, cruisers. 8 to 16 ft., exclusive features. Preassembled frames, Tri-Keel construction, Tredronic bottom, full length spray rails, widest beam, simplified construction, easy to build. World's best boat buy! Send 25¢ for new 1950 literature, or send \$1.00 for literature, plus booklet "Plywood Boats."

BOAT PATTERNS-BLUE PRINTS

1950 Catalog—over 100 modern designs by famous naval architects. Racing classes, cruisers, inboard, outboard, sail. 6 to 35 ft. Plywood—Steel—Plank. Construction plans, full-size patterns. Send 35¢ for catalog or \$1.00 for catalog and helpful booklet on "Boat Building."

MARINE MART-DEPT. 23-BUFFALO 7, N. Y.

PAY NO MONEY for this New SUIT!



YOU CAN GET this fine, tailored-to-measure suit as a bonus without paying one penny cash, by taking a few orders from friends. My plan also helps you make up to \$12.00 in a day without experience or house-to-house canvassing. Big opportunity—full or spare time. FREE! — Send for Samples and "Sure-Fire" money-making plans. For quick action write fully giving age, etc. Send no money. H. J. Collins, PROGRESS TAILORING CO., 5005 Throop St., Dept. B-220, Chicago 7, Ill.



Authenticast

SHIP KITS cost from \$6 to \$12.95

EVERY "AUTHENTICAST" KIT A COMPLETE BUY

They include all parts, file, brush, paint, steel wool, duccon cement, detailed plans, complete instructions... EVERY KIT READY-TO-BUILD. SEE YOUR DEALER OR WRITE DIRECT

Send for the new "AUTHENTICAST" catalog now only 25¢

COMET METAL PROD. CO., INC. Richmond Hill 18, N. Y.



Find HIDDEN TREASURES

GEIGER COUNTERS for uranium ore detection. TREASURE DETECTORS for Gold, Silver, other metals and minerals. Light weight, highly sensitive. None finer at ANY PRICE.

Detectron Co. Dept. 2-A
5637 Cahenga, No. Hollywood, Calif.



Bar Bells

Buy Direct From Factory \$8.95 up

Write for free booklet and price list

INDEPENDENT IRON WORKS
2416 East 23rd Street, Dept. C
Los Angeles 11, Calif.

FOAM RUBBER

For Experimenters, Home Craftsmen, Hobbyists

Lowest Prices—SAVE 50 %	AUTO SEAT TOPPER PADS
16 x 16 x 1 1/2".....ea. \$1.25	Place on seat cushion and cover with your seat cover.
16 x 22 x 1 1/2".....ea. 1.55	24" x 60" x 1 1/2".....ea. \$5.00
18 x 24 x 2".....ea. 2.00	24" x 60" x 2 1/4".....ea. 7.50
24 x 24 x 2".....ea. 2.75	

Use for furniture cushion fillers, mattresses, Mattress pads, cushions. Foam Rubber is available in any size or thickness. Send For Free Price List. Immediate delivery. No C.O.D.'s.

RIOR RUBBER COMPANY, Dept. S-3
50 East 22nd St. Chicago 16, Ill.



HERE'S EVERYTHING YOU NEED TO LEARN THE MATCHLESS ART OF LEATHER CARVING — AT HOME

Now carve your own beautiful bags, bill-folds, belts, moccasins, key cases—anything from leather—at one-tenth the cost. We supply everything: patterns, tools, leathers, fittings, instruction books for craftsmen. Turn hobby into a business. Send \$1 for big set patterns, or

Send Only 25c for New Catalog #103

BURTONS LTD. 1755 1/2 GLENDALE BLVD. LOS ANGELES 26, CALIF., DEPT. H-2

500 Pages, 7000 Novelties

Send 10c for mammoth, amazing catalog of 7000 novelties. 1-inch thick, roto picture section, 6-color cover. Carnival, circus, world's fair & science exhibit rolled into one! Includes live animals & pets, scientific supplies, hobbies, funmakers, planes & boats, looms, magic tricks, joke articles, unusual seeds, gadget timesavers, cameras, optical goods, projectors, movies, lucky jewelry, religious novelties, telegraph sets, disguises, musical instruments, stamps, coins, puzzles, fortune tellers, radios, experimental sets, auto & bike accessories, Western wear, telescopes, magnifiers, compasses, banks, smokers' gadgets, artists' supplies, printing sets, engines, motors, shockers, knives, billfolds, fireworks, guns, rifles, sports, money makers, swimming helps, 1000 fascinating books, games, locks, live chameleons, rings, exercisers, curious plants, etc., etc. (DeLuxe Hard Bound Library Edition 25c Postpaid.) Regular paper covered edition 10c. (Stamps accepted.) Sent Air Mail, \$1.00. **JOHNSON SMITH & COMPANY, Dept. 220, DETROIT 7, MICHIGAN**

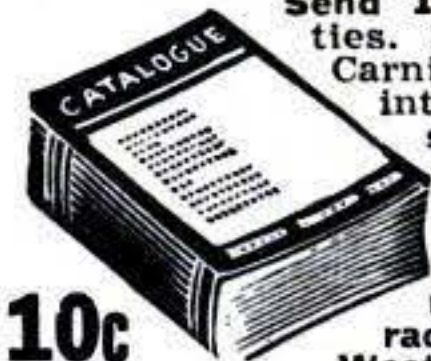

10c

ACCOUNTANT
BECOME AN EXPERT

Executive Accountants and C. P. A's earn \$3,000 to \$10,000 a year. Thousands of firms need them. We train you thoroly at home in spare time for C. P. A's examinations or executive accounting positions. Previous experience unnecessary. Personal training under supervision of staff of C. P. A's. Placement counsel and help. Write for free book, "Accountancy, the Profession That Pays."

LASALLE Extension University, 417 So. Dearborn St. A Correspondence Institution Dept. H-291, Chicago 5, Ill.

EASY TO LEARN CODE

Learn or increase speed with an Instructograph—the Radio-Telegraph Code Teacher that takes the place of an operator-instructor and enables anyone to master code without further assistance. Available tapes from beginners alphabet to typical messages on all subjects. Speed range 5 to 40 WPM. Always ready—no QRM. Thousands have "acquired the code" with the Instructograph System. Write today for convenient rental and purchase plans.

INSTRUCTOGRAPH COMPANY
4701-P Sheridan Road, Chicago 40, Illinois



Tired Kidneys Often Bring Sleepless Nights

When disorder of kidney function permits poisonous matter to remain in your blood, it may cause nagging backache, rheumatic pains, leg pains, loss of pep and energy, getting up nights, swelling, puffiness under the eyes, headaches and dizziness. Frequent or scanty passages with smarting and burning sometimes shows there is something wrong with your kidneys or bladder.

Don't wait! Ask your druggist for Doan's Pills, a stimulant diuretic, used successfully by millions for over 50 years. Doan's give happy relief and will help the 15 miles of kidney tubes flush out poisonous waste from your blood. Get Doan's Pills.

FREE
10-DAY TRIAL

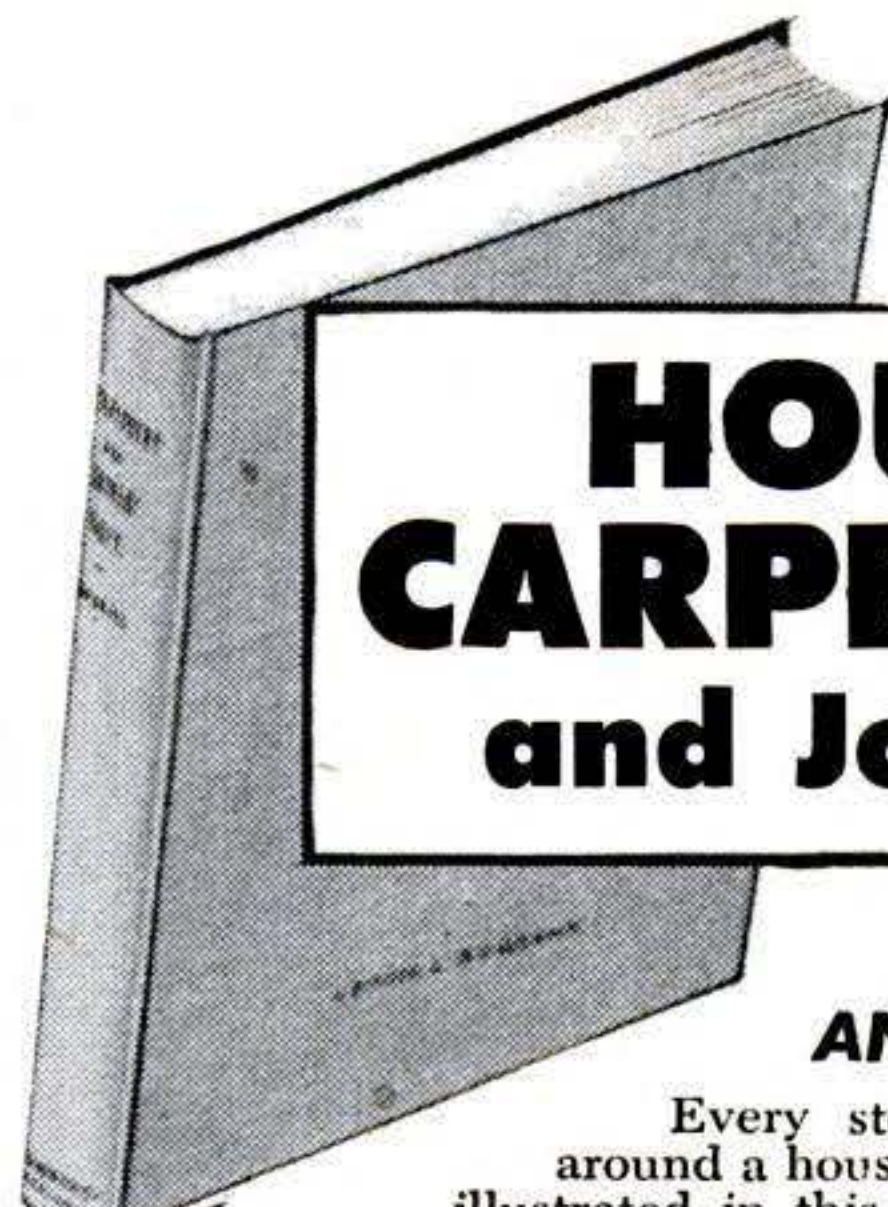

HOUSE CARPENTRY and Joinery

DO IT YOURSELF AND SAVE MONEY!

Every step of carpentry in and around a house is clearly explained and illustrated in this big, useful book. Shows you how to build forms for foundations, footings, walls, steps, walks—How to build sills, girder supporting posts and girders—How to figure loads for house framing—How to lay out, cut and erect floor joists—How to lay flooring—How to frame outside and inside walls, allowing for openings—How to check the plumb of studs—How to brace and sheathe up outside walls—How to erect ceiling joists—How to frame around a chimney and stair well—How to lay out rafters for a gable roof, dormer roof, porch roof—How to sheathe gable ends and rafters—How to build cornices—How to lay shingles—How to build porches and bays—How to apply siding—How to frame up inside walls—How to construct stairs—How to place trim around windows and doors—How to fit and hang sash—How to hang doors—How to make closets, shelving and built-in equipment—How to lay finished wood flooring, linoleum flooring—How to hang a set of garage doors—How to insulate.

OVER 600 ILLUSTRATIONS SHOW YOU JUST WHAT TO DO AND HOW TO DO IT

If you have a hammer, saw and plane, just follow the step-by-step directions and do any house carpentry job from foundation forms to interior trim. Here, in one remarkable volume, is the practical know-how that saves you time and money on house carpentry jobs of every description.

"I built my entire 5-room house myself with no other instruction except your book."—James Sidwell, Twin Falls, Idaho.

USE IT FOR TEN DAYS FREE

Don't send us a penny. Just mail coupon and get "HOUSE CARPENTRY" for 10 days FREE trial. If not delighted, send book back to us and owe nothing. If you keep it, entire cost is only \$3.98, plus few cents postage. Mail coupon below for your free-trial copy.

Send No MONEY

MAIL THIS COUPON

Simmons-Boardman Publishing Corp. Pop Sci—250
30 Church Street, New York 7, N. Y.

Send me for 10 DAYS' FREE TRIAL, "House Carpentry and Joinery." I will either return it in 10 days and owe nothing, or send only \$3.98 (plus shipping charges) in full payment.

Name

Address

City State

SAVE! Send \$3.98 with this coupon and we pay postage. Same return and refund privilege.

OVERSTOCK SALE

Chronograph Wrist Watch \$6.75 plus tax



(DeLuxe Model—Formerly \$9.95)
Sweep Second Hand; Precision Workmanship; Rugged Shock-resistant case; Radium hands and numerals; Leather strap. It measures distance, speed of cars, planes, horses and other moving objects. It's a time keeper, stop watch, telemeter, tachometer. ONE YEAR WRITTEN GUARANTEE and full operating instructions enclosed with each watch. SEND NO MONEY. Mail your order today. Pay postman \$6.75 plus 10% Federal tax. Total \$7.43 plus postage. Or send cash (money order or check) with your order and save postage charge.

CHARM SALES CO., Dept. 1809
125 East 46 St. New York 17, N. Y.

PRICES SMASHED!

SAVE 46% TO 71%

Water & Shock Resist

Wet it! Bang it! Drop it! Special gasket protection against water, dust, grime. Ruby jewels for main bearings. Stainless steel screw back. Sweep-second hand. Luminous. Unbreakable Kleervue Crystal. Thin! Handsome! Formerly \$24.50. Now 9.95, plus 1.00 tax, total: 10.95.



9.95

THORESEN WATCHES GUARANTEED 3 YEARS!

THORESEN'S Chronograph



17 JEWELS

PRECISION SWISS
3 SYNCHRO DIALS

beats, etc. Different—it remembers! Precise! A sleek, handsome watch. Directions given. Was \$75.00. Now direct-to-consumers for 22.95, plus 10% tax, total: 25.25.

The Chronograph that Remembers!

THORESEN'S genuine chronograph is a near-miracle of accuracy. Trim, highly functional, the pride and joy of every hobbyist, mechanic, scientist, physician, sportsman, student, aviator.

Over 20 Super-Quality Features

3 multi-function dials, automatically coupled, 30 min. register. Synchronized for hrs., min., sec., & 1/5th seconds. Anti-magnetic. Luminous. All steel back case, sturdy, yet THIN! Back to zero feature. Built-in Tachometer & Telemeter measure Speed & Distance airplanes, autos, boats, lightning, typing, pulse

MONEY BACK IN 10 DAYS IF NOT PLEASED!

AUTOMATIC! 24.95

It winds itself!

The carefree watch! It's AUTOMATIC—it winds itself as you wear it—then forget it! No danger of overwinding. SHOCK and WATER resistant. Patented Incabloc. Anti-magnetic. Sweep second, luminous dial. One of the smallest, thinnest made. Extremely accurate and impressively handsome. Save \$46.55 buying the THORESEN DIRECT WAY. Terrific value at \$24.95, plus 10% tax. Total \$27.45. 3 year guarantee.



SHOP—COMPARE—APPRAISE



Imitation diamonds! Terrific value! Heavy gold color mounting. Impressive! Wins admiration. Lasting satisfaction guaranteed. Price complete (no extras)—1.98

Distinctive! Extra heavy simulation of a Solid Gold 5 diamond ring. Well made. Rich \$500 appearance. Money back guarantee. Complete price (no extras)—2.98

Extra special! Genuine 14 K Rolled Gold Plate. Your own initial in raised gold effect, flanked by 2 pseudo zircons of sparkling brilliance. Complete, only—2.97

Men's Famous Brand RHINESTONE WATCH

Accurate, handsome, sturdy! Ruby and Diamond color rhinestones around dial. Genuine Swiss movement. Looks like \$200.00 watch. Fully guaranteed. Never a penny for repairs during 3 years. Formerly \$14.95. Now 7.99, plus 80c federal tax, total: 8.79



7.99

STURDY TARA



1/2 off our former price! Unbreakable crystal, luminous numerals, stainless steel band. Good, dependable, imported Swiss movement. Good time-keeper and only 4.94, plus 49c tax.

4.94

SEND NO MONEY

10 DAY FREE TRIAL

Pay price plus postage on delivery, or send check or money order and SAVE postage. Try, compare, appraise! Money back in 10 days if not pleased. 3 YEAR GUARANTEE—never a penny for repairs, parts or postage. Rush orders NOW!

THORESEN DIRECT SALES

131 West 33rd St., Dept. 7B-200, New York 1, N. Y.

72 POPULAR SCIENCE



MOTOR TUNE-UP GAUGE

new—Simple to Use

Aluminum case cast bronze movement—Guaranteed. Checks entire motor—Plugs, Points, Rings—Valves—Muffler—Fuel Pump—Carburetor, etc.

Dial in 4 colors—Instruct. chart included—4" —\$8.50; 8" —\$18.75; 12" —\$27.50 Postpaid. Works on vacuum. Attach to windshield wiper. Over 1,000,000 in use. Tune your own motor.

GALE HALL ENGINEERING
BOSTON 18, MASS.

WORLD'S LARGEST MFR. OF AUTO GAUGES

Your Search for Peace of Mind and Soul



When you learn to awaken the dormant Powers of your Soul... a more abundant LIFE awaits you. You will be deeply interested in the new Booklet "This Way to Life". It is yours, free! Send Name and Address on a postal.

Address **WAY TO LIFE, INC.**
3227b INDIANA AVE., ST. LOUIS 18, MO.



S-W Pal Radio

Shortwave beginners kit for 19 meter broadcast and 20 meter amateur bands with world-wide coverage. Terrific power from short antenna. Make 8 simple connections from picture plan and kit works. GUARANTEE you can make operate or return with \$1.25 for factory wiring. S-W Pal less phones and batteries \$2.98 postpaid. Send only \$1.00, balance C.O.D. plus fee.

Lee Electronics Laboratory, Dept. A-1
17 E. 48th St., New York 17, New York

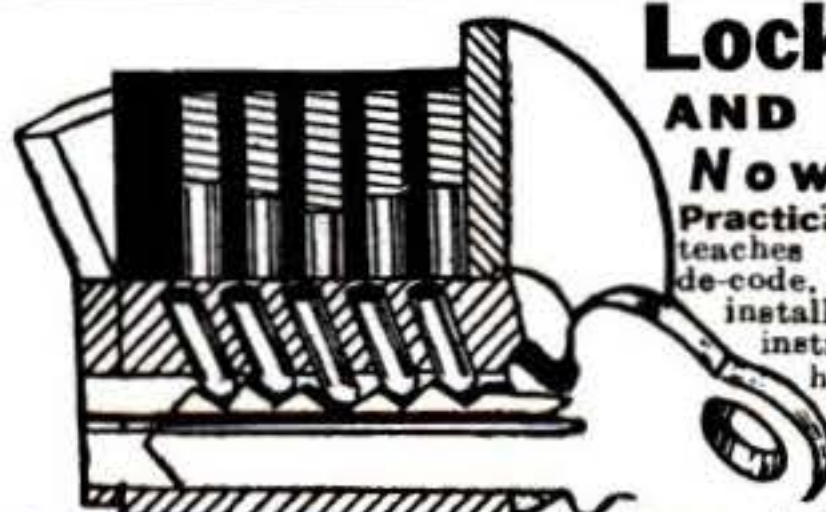

Locksmithing AND KEY MAKING Now Made Easy!

Practical up-to-date course teaches you how to pick locks, de-code, make master keys, repair, install, service, etc. New self-instruction lessons for every handyman, homeowner, carpenter, mechanic, service station operator, fix-it shop, hardware dealer, gunsmith. 53 easy

Complete course \$3.95, now only \$3.95, postpaid; or C.O.D. plus postage. Satisfaction or refund guaranteed. Nelson-Hall Co., 1139 S. Wabash Ave., Dept. B-1, Chicago 5, Ill.

GENUINE DIAMOND SCRIBER!

\$2.00 Postpaid

Writes on glass, metals, plastics. Hex. Aluminum 6". Money back guarantee. Agent inquiries invited.

CLIPPER DIAMOND TOOL CO., INC. 21-A W. 46 St., N.Y. 19

BURIED TREASURE, MINERALS AMAZING NEW GOLDAK LOCATORS

SENSATIONAL NEW MODEL! ONLY 11 pounds weight! One hand operation! Money-Back Guarantee of Superiority. Write for full details.

THE GOLDAK CO. 1544 WEST GLENOAKS BLVD. GLENDALE 1, CALIFORNIA

World's largest maker of fine locators.



DEPENDABLE CRAFT SUPPLIES

LEATHER CRAFT • PLASTICS • POTTERY CRAFT • BLOCK PRINTING • BELT CRAFT • TEXTILE COLORS • POWER TOOLS • WOOD BURNING • INSTRUCTION BOOKS • ETC.

DWINNELL CRAFT SHOP Dept. PS 502—Wheeling, W. Va.

WRITE FOR CATALOG SINCE 1928



We'll establish you in Your Own Business and help finance you!

Ever said to yourself, "I don't like the idea of working for others. Someday I'd like to have my own business, and be my own boss." . . . Here, then, is an opportunity made-to-order for you. We are NOW enlarging this **20 YEAR OLD**, Nationwide chain of individually-owned *Certified Service* businesses. If you are dependable, honest and willing to work, we invite you to mail coupon below for details on how to become financially independent in a profitable, life-

time *business of your own*. We will establish you in your own business and arrange finance terms to help get you started. You use the proven successful methods of long established **DURACLEAN** Dealers. Here is truly a sound, steady, life-time business. Dealerships grow from **REPEAT** and **VOLUNTARY** orders. Your gross profits (above materials and labor) are up to \$20 for a day's service on **EACH** of your service men. **It's easy to learn . . . quickly established.**



20 Years
of
**PROVEN
SUCCESS**

You Become an Expert in cleaning and protecting Rugs and Upholstery!

DURACLEAN cleans by *absorption*. An aerated foam, created by the patented electric Foamovator, restores the natural lubrication of wool and other animal fibers in rugs and upholstery. Dirt, grease and many unsightly spots vanish as if by magic. Fabrics and floor coverings are cleaned with a *new consideration for their life and beauty*. Cleaning is done *right in the home!* Fabrics dry in just a few hours. No inconvenience for customers. Rug pile again stands erect and even. Furnishings are left clean, fresh and enlivened.

DURAPROOF is another year 'round service rendered right in the home, office or institution—*without removing furnishings*. It protects carpets, upholstery, furs, clothing, piano felts and auto interiors against damage by moths, carpet beetles or mildew. The U. S. Government says, "**Moths are present in practically every household...No section of the country seems free from such infestations.**" **DURAPROOF** not only kills moths and carpet beetles . . . it makes materials non-eatable to both. To our knowledge, **DURAPROOF** is the only mothproof service backed by a National **MONEY BACK, 4 YEAR WARRANTY.**



Fabrics *last longer* because this modern, safe cleaning process avoids the use of strong soaps and harmful solvents that so often damage dyes or fabrics. . . . No machine scrubbing! This eliminates unnecessary wear on pile and the breaking of fibers. Choose your own territory anywhere in United States or Canada.

Easy To Learn • No Overhead Expense

Start Full or Part Time

No experience necessary! Some dealers establish shops or an office . . . others operate from their own homes. At the start you may want to render service yourself. Service may be rendered in homes, offices, hotels, theaters or institutions. Auto dealers buy your **DURACLEAN** Service to revive upholstery in used cars. Foamovator converts to easy carrying case. Almost every building in your territory houses a potential customer needing one or both services.

Repeat and Voluntary Orders

Demonstrations win new customers. Men with **DURACLEAN** Dealerships find **REPEAT** and **VOLUNTARY** orders become a major source of income. Customers are not merely satisfied—many are enthused with results and tell their friends and neighbors. Furniture and department stores and interior decorators turn over rug and upholstery cleaning and mothproofing to **DURACLEAN** Dealers. We show you **21 ways** to get *new* customers.

Two-Way Profit

You enjoy big profits on both materials and labor—after paying service men and salesmen. These are year 'round services for which there is always a constant need. You have National prestige and the cooperation of a National **20 YEAR OLD** organization interested in your services. The rapidly growing need for *Certified Service* makes **TODAY** the ideal time to become the owner of a **DURACLEAN** *Certified Service* business.

Dealer Comments:

R. Kimbrough: "Finished First White House of Confederacy and am to **DURACLEAN** Governor's Mansion."
E. C. Bristol: "Duraclean produced amazing results."
Milton Lassanske: "To date, most of my business comes from recommendations . . . My original investment was returned in about two months."
E. Schalchlin: "Have on hand 5 orders totaling over \$500.00 . . . obtained from recommendations of customers."

EASY TERMS!

A moderate payment establishes your own business. Easy terms permit you to pay balance from your sales. We furnish electric machines, folders, store-cards, introduction slips, sales portfolio, demonstrators and enough material to return your **TOTAL** investment. You can have your business operating in a very few days. Mail coupon today! No obligation.

Copyright 1948 by

Duraclean Co. O-182 Duraclean Bldg. Deerfield, Ill.

FREE Booklet

Our first letter and 16 page illustrated booklet will explain everything—the two modern, urgently needed services, waiting market, how business grows, your large profit, easy terms and **PROTECTED** territory.

Send Coupon TODAY!

"OWN a Business" Coupon

Duraclean Co.

Division of **HOME SERVICE CO.**
O-182, Duraclean Bldg., Deerfield, Illinois

With no obligation to me, send booklet and letter giving full details. Tell me how I may **OWN** a growing business of my own built upon satisfied customers.

Name _____ Age _____

Address _____

City _____ State _____

NOW EASY TO START A Big Business ON A SMALL INVESTMENT



WARNER SUCCESS PLAN Gives exact instructions showing you

- How to start in spare time
- How to use home as headquarters
- How to bring in the business
- How to do real METALIZING in genuine GOLD, SILVER, or BRONZE, by the easy Warner Method
- How to start without risking your job
- How to pyramid your profits
- How to be sure of steady, big income.

Don't turn this page until you've given serious thought to your future. In the uncertain years ahead, the men who own their businesses are the ones who will be happiest. A small start now easily can lead you to complete independence, freedom from time clocks, freedom from fear of lay-offs, freedom from the limits of a pay check.

Now, while you can do it without risk—now is the time to investigate the exceptional opportunity offered you by the Warner Success Plan. Looking into the market, checking up on the possibilities for big sales and big profits will not cost you anything. Isn't this the time to lay the foundation for a future of complete independence—a life of happiness—a steady, dependable income?

METALIZING BABY SHOES AND OTHER KEEPSAKES

offers an exciting new opportunity to men or couples who want personal independence

If you'd like the feeling of being boss instead of being bossed—the Baby Shoe business is made to order for you. Just think of the appeal. A mother's love for her child—her desire to preserve forever the tiny shoes in which her baby took its first toddling steps. No wonder orders come easy and fast. No wonder profits are big. Then think of the Future. Fifteen Million babies in the last five years—three million last year—millions more next year. As long as babies are born, this business will prosper—in good times or bad. Think of the fun. Every job is different, interesting. And when you deliver a job and collect the money, you get a tremendous glow of satisfaction out of the mother's happy exclamations over your work. There's not another business I know of that offers you such big rewards in cash, in security, in a future, in independence that can be started on such a shoestring. You'll be glad you saw this ad—IF YOU SEND THE FREE COUPON.



READ THE ENTIRE PLAN

7 DAYS AT MY RISK

DON'T SEND A PENNY NOW — Just Send Your Name

This is one of the most fascinating businesses you can imagine. There are 15 MILLION pair of baby shoes waiting right now to be METALIZED. The opportunities are unlimited. The future is very big. And it's a business in which the whole family can have fun helping. A perfect business for man and wife to start—or for two partners. And I want you to read the whole Plan at my risk. Don't spend a cent unless you go ahead.

I want every serious minded man to let me show what I've done in our own shops here in Chicago—reveal the exact facts about the profits to be made and the way to make them. I don't want you to spend a cent for supplies until you've studied the facts, talked them over with the family and satisfied yourself that this is the ONE BIG OPPURTUNITY FOR YOU. That's why I allow you to read all trade secrets contained in the Warner Success Plan at My Risk. If you don't go ahead, you don't pay a cent.



You Have Nothing to Lose

ALL FACTS FREE! MAIL!

Raymond E. Brandell, Mgr., Warner Electric Co.,
1512 Jarvis Ave., Dept. 22, Chicago 26, Ill.

As long as it doesn't cost me a cent, I am willing to read the facts, investigate, then give you my decision. Send the facts by next mail. Everything you send now is FREE!

NAME _____

ADDRESS _____

CITY _____ Zone _____ STATE _____



\$5.00 AN HOUR

Yes, it's possible for one man to turn out enough work to make \$5.00 an hour for his time. Think of how that pyramids when a partner or the whole family works.

Old Established Firm Backs You Up

The Warner Electric Company just celebrated its 26th year of success. You get a Real Start when you "join up with Warner"—you get real Guidance to Success.

Warner Electric Co., Dept. 22,
1512 Jarvis Ave., CHICAGO 26, ILL.

WE SUPPLY EVERYTHING

You don't have to go "hunting" when Warner is behind you. We supply all materials, all mounts, chemicals, and metals. And you get the low prices made possible by our big quantity purchases and our own manufacture. You send for just what you need—and never have any big investment tied up in stock.

Classified Ads only 80c per word per insertion, payable in advance. Minimum ad 10 words. To be included in April issue, copy should be in our office by February 22nd. April issue on sale April 1st.

CLASSIFIED OPPORTUNITIES

POPULAR SCIENCE MONTHLY-351 FOURTH AVE.-NEW YORK CITY 10

1 AUTOMOBILES

BUICK Parts. Enjoy new-car pep and power in your old Buick. Same day service from World's largest stock of new (not rebuilt) Buick parts and engines. Ship anywhere. Write today. Robertson Buick Co., 1002 S. Wabash Ave., Chicago 5, Ill.

SEE our ad under motorscooters for Midget Car Bargains. Midget Motors Directory, Athens, Ohio.

CUSTOM-Restyling. Super Handbook. Brand new! 200 graphic photographs, sketches, Medley cutaways. Thousands ideas. Guaranteed: Biggest, Best Buyable! \$2 pp. including catalog. Post Publications, Box 723-KC, Arcadia, California.

SAVE Gasoline! Sensational Gane needles. Free Trial. See Page 00.

DIRECT From California—The very latest in speed equipment for all makes of passenger automobiles! All of the nation's leading racing accessory manufacturers represented in one catalogue! See and compare brands, specifications, costs! We ship all over the world—Wholesale—Retail. Illustrated Catalogues—Speed, Power, Mileage Information—50c complete. Newhouse Automotive Industries, 5805-A7 East Beverly, Los Angeles 22.

"SPEED & Power" Handbook—50 chapter Library Edition! Photographs! Breathtaking methods—Authentic—Direct from California. Covers Crosleys to Cadillacs—all makes! Build your own Dual Manifolds, Superchargers, Hot Cams, Water Injectors, Hi-Compression Heads, Mileage Devices. Save many dollars! Get racing speed, lightning acceleration, dynamic power increases from any make passenger automobile! Build fast Stock Cars. California Roadsters, 160 M.P.H. Rods! Get construction drawings! Tuning Techniques! Speed Tricks! Economy secrets! Ingenious formulas! Covers "Racing Frames"—"Reciprocating Masses"—"Jet Engines"—"Braking Characteristics"—"Dynamometers". Also—Dual Pipes—Gears—Fuels—Porting—Relieving—Lowering—Balancing! Includes 1950 Speed Equipment Catalogues! Also "California Automobile Customizing"—Photographs, Diagrams. Newest ideas! Conversions. Carson Tops. Re-styling all makes. Streamlining. Chopping. Channeling. Complete—\$1.98 postpaid. Newhouse Automotive Industries, 5805-A 2 East Beverly, Los Angeles 22.

"NEW Catalog"—Over 400 Racing, Hot Rod, Speed Equipment, Custom items! Pictures! Speed Data! "Customizing Tips!" Bargains Galore!—Big Catalog 25c. Almqvist Engineering & Mfg., Milford 74, Pa.

"HOLLYWOOD" Depton Mufflers—"Straight-thru" design increases efficiency, speed, acceleration, mileage!—Singles, All cars \$4.85—Finest V-8 duals \$15.90. Satisfaction guaranteed. Speed equipment catalog 25c. Almqvist Engineering, Milford 74, Pennsylvania.

"SPEED Equipment" bargains—California mufflers \$4.50. V-8 Duals \$15.90. Chrome carburetor stacks 98c. Dual manifolds \$9.95. Chrome echo cams \$1.65. Racing camshafts \$29.95 exchange. Hi-compression heads \$19.75. All popular brands—Big illustrated catalog 25c (Dealers wanted) Almqvist Engineering & Mfg., Milford 64, Pennsylvania.

BOOKS on Hot-Rods, Stock Cars, Customizing, Engines, Race Car Building. Descriptive Illustrated Literature Including Catalog Listing 1500 Race Drivers, Cars. 25c. Frank Smith, 17 Watson St., Paterson, New Jersey.

ANSEN'S New Catalog! Only 25c—Complete History Hot Rod & Midget Racing. Speed Tuning Hints, Engine Specifications, Catalog of Speed, Power, Doll-Up Accessories. Latest parts, prices, pictures, information. It's Looseleaf. We'll send new sheets with latest dope to keep it up to date. Ansen Automotive Engineering, 3801-PS W. Jefferson Blvd., Los Angeles 16, California.

S-P-E-E-D & Mileage Manual—"New edition!" 140 Illustrations, Drawings, Charts, Photographs! "Guaranteed finest, most Authoritative book"! Easy, inexpensive ways to build Speed Equipment—California Hot Rods—Beautiful Custom Cars—200 h.p. Road, Track Conversions—Superchargers—Dual Manifolds—Racing Heads—Twin Mufflers—Water Injectors—Economizers! "Get super speed, mileage, acceleration—top racing performance from any car!" Complete instructions with working diagrams on Fast Engines, Speed Tuning, Restyling, "Customizing", Gas Saving, "Racing Tricks", Cams, Fuels, Balancing, Porting, Ratios, Frames, "Of-fys!"—"Learn 100 ways to save gas!" Reveals "Stock Car Speed Secrets"! California Speed Shop Methods! "Custom Styling Information"! Streamlining Lowering! Sport Changes! "Hollywood Roadster Plans"! Speed Conversions! (Covers All Cars)—"Large Manual" plus Equipment Catalog plus "Racing Handbook"—All three only \$1.98. Almqvist Engineering, Milford 74, Pennsylvania.

"If You Want To Go Let Us Know" Complete Line of Sport's Car, Stock Car, Road Car Equipment. Illustrated Catalog 15c. Dealer's Wanted. Hi-Speed Power Equipment, 228-20 Merrick Road, Laurelton L. I., N. Y. La-5-9535.

CALIFORNIA Custom accessory head-quarters. Buy direct from original designers and save. Solid hood sides, grille panels, lowering kits, fender skirts, dual pipes, chrome motor accessories, speed equipment, push button door conversions. Revised catalog, 34 illustrated pages, new low prices—25c. Eastern Auto Supply, 3319-D South Grand, Los Angeles 7, Calif.

RACING Books. Grand Prix Story 50c. Book of Race Cars \$1.00. Road and Track Magazine \$3.50 per year. Many others. list 10c. Enthusiasts Publications, Box 409-E, North Hollywood, California.

FREE Trial . . . On Ford "Speed and Power" manual! We will send you on approval this 128 page manual with cutaway construction drawings, photos, understandable technical data. Learn how to install a V-8 motor in a Model "A" chassis and install hydraulic brakes on any Ford. How to rework V-8, Mercury, Ford 6, Zephyr and Model "A" engines for terrific speed. If you don't agree this is the finest hot rod manual you've ever seen—just send it back within 15 days. If satisfied, send \$2.00 to California Bill, Box PSX, Eagle Rock, Los Angeles 41.

NEW Chevrolet Speed Manual! 90 pages of accurate information on how to increase speed and acceleration of any 1937 thru 1949 Chevrolet. How to install late engines in pre-1937 chassis. Full data on cams, high compression, multiple carburetion, supercharging, ignition, etc. Guaranteed the finest manual of its type! Proves that your Chevrolet can have Superior power and speed. Sent postpaid only \$2.00. California Bill, Box PS2, Eagle Rock, Los Angeles 41.

AMAZING! New! Ornamental! Jet Aerial Booster with Colored Streamers. Improves Auto Radio Reception, Increases Range of Car Aerial, Easily Attached To Car Aerial, Money Back Guarantee! Only \$1.50 Postpaid. Seymour's Auto Specialties, Box #23, Fresh Meadows, L. I.

WATER Injection. Also—Speed—Power—Economy—Methods! Free descriptive, illustrated, information. Neher Industries, La Verne 6, California.

2 AUTO SUPPLIES & EQUIPMENT

FOREIGN Car Parts. Tremendous stock. Inquiries invited. Foreign-Domestic Motors, N.E. 1 Ave., Cor 17 Street, Miami, Florida.

SAVE Gasoline. Sensational Gane Needles. Free Trial—see page 44.

MOTORISTS save gasoline by Vacuuming overrich mixtures. Fits all cars. For Free particulars write Vacuumatic, Dept. 1563, Wauwatosa, Wis.

AUTO parts. Buy direct. Get dealers' prices. Represent us in your territory. Write requirements. Specify car make. Mechanics Auto Parts, Factory Warehouse, 3807-PS N. Ashland, Chicago 13.

BRUSH Plating Outfits connect to a battery. No tanks or shop required. Free particulars. Gunmetal Co., Avenue K, Decatur, Illinois.

JUST Out! Get largest auto accessory and parts catalog in world. Over 15,000 items, including Hollywood accessories, hi-speed equipment, rebuilt engines; all parts and accessories for all cars, trucks, New, used, rebuilt! We have that hard to get part! Completely illustrated, jam-packed with bargains. Send 25c. J. C. Whitney Co., 1919-1 Archer Ave., Chicago 16, Illinois.

CHEVROLET Parts. Scarce motor, body, sheet metal parts. Grossman Chevrolet, Minneapolis, Minnesota.

"AIRFLOW Needles." Save gasoline! Free trial! If Satisfactory, \$1.50. Specify Car, Carburetor. Neher Industries, La Verne 6, California.

AUTO Thief Alarms! Protects your car. Prevents theft! Low cost. Particulars free. Write! Grand, 2506P—52nd, Kenosha, Wis.

ARC Welding frames, bodies, fenders. Pays with Hobart Welders. Easy terms. Catalog free. Box P-202, Troy, Ohio.

AUTOWELD training pays. G. I. Approved School. Free Catalog. Hobart Welding School, Box P-203, Troy, Ohio.

DOUBLESEAL stops drafts under overhead doors. Edwards Industries, Dept. 302, 4268 Shenandoah Ave., St. Louis 10, Mo.

USE Toilet paper for Oil Filter Cartridges. See ad on Page 270.

3 AUTO TRAILERS

BUILD Your own trailer! Save money! Have every feature you want! Plans for house, sport, camp and utility trailers. Catalog describing 9 models 10c. 15c in Canada and overseas. Jim Dandy, Box 125-B, Wausau, Wisconsin.

4 MOTORCYCLES BICYCLES, SUPPLIES

KNEE ACTION motorbike \$15; Midget car (steel frame) \$25; Moto-Scout \$15; Whizzer motorbike will all attachments \$25; Indian motorcycle \$30. Other motorscooters \$8 up, motors \$3 up. Send 25c for new catalog #944 listing many other sensational bargains in used motors, motorscooters, motorcycles, parts, etc. Associated, Box 1764-CS, Toledo, Ohio.

WHIZZER bike-motor \$25; Cushman motorscooter \$15; Midget Racer \$40; Shaw bicycle motor \$15; Harley-Davidson motorcycle \$15; Smith motor-Wheel \$25; Good motorscooter (twist grip) \$22.50; Rush 25c for new catalog #15 listing many other amazing bargains in motorscooters, used motors, midget cars, parts, wheels, etc. Gail, 538 Erie, Toledo, Ohio.

SALISBURY motorscooter \$25. shop built motorscooter \$15. Midget racer less motor and wheels \$10; Whizzer motorbike complete \$35; Indian motorcycle \$25; Bantam panel truck \$40; Briggs Stratton engine \$3.50. Plenty new motorscooters, midget cars, homebuilders parts, plans, automatic clutches, transmissions, engines, tires, etc., at factory prices. Special sale, four balloon tires for \$3. Over 5000 tires in stock. Mail order only. Send 25c for Big New War-Bargain catalogue Number Thirty-Three just out, listing these and hundreds of other bargains. (35c by First Class Mail). Midget Motors Directory, Athens, Ohio.

SUPPLIES for Older Harleys Complete. One Stop Sales Service, 813 Ohio, Wichita Falls, Texas.

MOTORCYCLE Journal—Worldwide Coverage. Illustrated. Year's Subscription \$1.00. Sample 15c. Motorcycle News, 5424-H Sawyer, Chicago 25.

POPULAR SCIENCE OPPORTUNITIES

5 AVIATION

JET Engine \$3.00; Plans \$1.00; Literature 10c; M.E.W., 387 University, St. Paul, Minn.

PROPELLERS-2-3 Blade, for sleds air-drive boats. Catalog, Standard Aero Craft, Box 387, Ft. Worth, Texas.

GENERATORS, Aircraft P-1 200 amps, 28V, good to make welders, etc. Good used condition, \$15.00 cash, FOB, Aero Parts Supply, 8102 Lockheed, Houston, Texas.

6 AVIATION INSTRUCTION

PASS your C.A.A. examinations with a Ross guaranteed questionnaire, Free Folder, Ross Aero Publishers, Tulsa, Okla.

7 ELECTRICAL SUPPLIES & EQUIPMENT

BUY Lamp Parts Wholesale, Parts you need for building, repairing, or assembling. Save money on large or small orders. New catalog for 10c, Gearon Company, Dept. 300-A2, 27 South Desplaines, Chicago, Illinois.

LAMPS—How to build lamps from vases, pitchers, etc. Chart for top and bottom lighting, alternately or together. How to wire oil lamps, all in 56 page illustrated catalog of all lamps parts, 25c. Gyro Lampos, 5416-N Clark, Chicago 40.

ELECTRIC Pencil: Engraves all Metals \$1.25, Beyer Mfg., 10511-C Springfield, Chicago 43, Illinois.

ELECTRIC Motors, Free Bargain list, Plenge 9, Stuyvesant Oval, New York 9, N. Y.

ELECTRIC Pencil: Engraves all metals, \$1.00 postpaid, Guaranteed, Reiss, 3017-M Ocean Parkway, Brooklyn 24, N. Y.

FREE Catalog—Motors, Generators, Welders from aircraft generators, Water Softeners, many other electrical bargains, LeJay Company, Minneapolis, Minnesota.

WATTHOUR Meters, Reconditioned, guaranteed, Ideal for cabins, shops, \$2.95, T. Price, 310-14th, Raymond, Wash.

8 WELDING, SOLDERING, PLATING

WELDERS! New Portable Champion Special Transformer Welder: 110/120 volts, AC 9 heat stages up to 75 amps.; welds, brazes, solders, cuts all metals, Easy to use, Simple instructions, Special Flame Weld Torch Free, Splendid for Shop, Farm, Home repairs, Eaves Hundreds of dollars yearly, Only \$27.50, Also heavier models 10 day Free Trial, Magic Welder Co., 239 PS, Canal Street, New York, N. Y.

RADIATOR Repairing Books, Supplies, Equipment, Gasoline Torch, Write for circular, Curfman Mfg. Co., Marvville, Mo.

110 V. PORTABLE Transformer Welders, \$29.50, Morris, 1850B State, Schenectady 4, N. Y.

BIG profits in welding business with a Hobart "Build-Your-Own" Portable, Catalog Free, Hobart Brothers Company, Box P-204, Troy, Ohio.

9 AIR CONDITIONING & HEATING

BLOWERS all sizes steel or rustproof aluminum blades, ball bearing \$47.50 up, Reynolds Mfg. Co., Grand Rapids 3, Mich.

10 MACHINERY, TOOLS, SUPPLIES

SURPLUS—electric drills 1/4" \$16.95; 1/2" \$29.95 (Jacobs geared chucks), 6" electric portable handsaws with case \$56.00, Send check or M. O. Money back guarantee, Send 10c for illustrated folder, Byron Tool Company, 1609 Unionport Road, New York 60, New York.

SALE Surplus Lauson gas engines 1 1/2 h.p. air cooled guaranteed running order, Converts to lawn mowers, scooters, bicycles, pumping water on farms and ranches, pumping bilge water, Including Carburetor & Tank reg. \$104.50 while they last \$33.00, Ennis Supply Co., 334 First St., No. Minneapolis 1, Minn.

LAWN Mower Repairmen, Free price list Blades, Rollers, Supplies, Vernon Goeller, Mountain Lakes 1, New Jersey.

POWER tools, equipment wholesale prices, Free Bulletin, Homecrafters Cooperative, Grand Rapids 6, Michigan.

13 BATTERIES, GENERATORS, ETC.

EDISON Nickel Batteries, 37 to 600 ampere, Also Kits with Edison Plates; make your own, Interesting literature, Hawley Smith Co., Croton Falls 2, N. Y.

14 BOATS, OUTBOARD MOTORS, ETC.

STEERING Wheels, windshield brackets, from \$6.95, Modern fittings at lowest prices, Complete pre-cut plywood boats, Bargains galore, Folder 10c, Marine, Box 681, Mendota, Minnesota.

NEW, used, rebuilt marine motors, Marine conversions, fittings, Free Catalog, Stokes Marine Supply, Dept. 23, Coldwater, Mich.

MARINE conversions for Ford and Jeep engines, Catalog 10c, Lehman Manufacturing Company, Department A, Newark 2, New Jersey.

SAVE 2/3 cost, Assemble your own boat, Complete plans and boat parts machined ready for assembly, No experience necessary, Rowboats to cruisers, Illustrated catalog 25c, Midwest Boat Company, Menomonee Falls, Wisconsin.

FREE! World's most complete catalog listing, Boat kits, plans, patterns, marine engines, conversions, boat building lumber, plywood, marine hardware, Trailer parts, Marine Mart, Buffalo 7A, New York.

SHIP Modelers—are you looking for authentic, precision-made kits? Send 35c for richly illustrated catalog describing more than 30 models retailing from \$3.95—Clipper ships to modern cruisers—also decorative authentic Naval and Field Gun Kits from \$4, Address Marine Model Co., Dept. A, Halesite, Long Island, N. Y.

YOUR own machine shop will enable you to make your own parts, repairs, etc. and your neighbors will pay you \$3.00 to \$4.00 an hour to do their work, 6 ft. engine lathe \$150; South Bend 16" x 8' \$310; Brainard, Garvin Milling machines \$240—have one at \$180; 21" Sibley drill press \$110; Putnam 24" shaper \$290; motors, tools, vises, General Elec. 300 Amp. arc welder \$145.00, Money back guarantee, Conversion Parts Co., 277 Adams St., Boston 22, Mass., U.S.A.

"SWEETEST boat afloat" say owners of outboards built from Dillabaugh boat kits, Write for details, Dillabaugh Company, Portland 11, Oregon.

15 ENGINES, MOTORS, ETC.

WINDING Data Single Phase Fractional Horsepower, Send Printed Full Name Plate, Reading Number of Slots in Stator & Rotor 50c Coin, Nemco, 32 Water Street, Newburgh, New York.

WELDING Generator 150 ampere \$47.50, Motors 1/2 horse \$15, 1 horse \$30, Water pumps \$12.50, Butler, 1885 Milwaukee, Chicago 47.

HOTTEST surplus list in the country, Electronics, Hydraulics, Aircraft, Gadgets, Dick Rose, Everett, Washington.

MOTOR Winders, send for testing and winding bulletins, Motor Industries, Quincy, Illinois.

MOTORS—Fans—Parts, Free bargain list, McLean Engineering, Nassau St., Princeton, N. J.

BARGAINS, Welders, Alternating or Direct Current, Gas or Electric Drive, Portable or Stationary, Advise us your needs, William Harrison Company, Box P-205, Troy, Ohio.

16 AMERICAN POLICE JIU JITSU

DEADLY Judo—Fiercest fighting technique, Trick knockouts, (Over 200 illustrated pictures.) Expert instructions—Three volumes Complete \$2.25, Variety House, Box 46-A, Wall Station, New York 5.

18 BODY-BUILDING COURSES

BARBELLS—finest quality \$7.98 up, Catalog Free, Lurie Barbell Co., 1729-S2 Rockaway Parkway, Brooklyn, New York.

BARBELLS, Build Muscular Bodies, Illustrated Catalogue, Jackson Barbells, Springfield 7, New Jersey.

BARBELLS, Dumbbells, Exercise equipment, Courses, Free booklet, Good Barbell Co., Reading, Penna.

19 SPORTING GOODS, GUNS, FISHING TACKLE, ARCHERY

190 PROFUSELY illustrated pages antique and modern pistol, sword, etc. values, 50c, Robert Abels, PS860 Lexington Ave., New York 21.

5,000 BARGAINS, firearms, binoculars, war relics, catalog 40c, Smith Museum, Runnemede, N. J.

SEND 10c for list 100 used guns, Frayseths, Willmar, Minn.

SPORTING Goods at Great Savings, Buy Direct, Exclusive Distributor Berlee Line used by champs, Free catalogue, Friart Inc., 140-T Liberty St., N. Y. 6.

CROW Shooting: Now, you Too, Can Knock off Crows by the dozen—Preserve games, grain! Amazing new book "Crow Shooting" shows how to recognize roosts, decoys, build blinds, employ cover, shoot crows, Real exciting fun, thrills, Send No Money, Sent C.O.D. for \$2.50 plus postage (money back guarantee), A. S. Barnes, Dept. PS3, 101 5th Ave., N. Y. C. 3.

SHOTGUNS, Rifles, Revolvers, Over 500 Modern, Obsolete, Also Cartridges, List .10 coin, Ed Howe, 26 Main Street, Coopers Mills, Maine.

25 INDIANHEADS, \$1.98—Tomahawk \$3.45—Violin Wood \$6.75—Bayonet \$1.98—Sword \$7.60—8 arrowheads \$1.44—New Powderhorn \$6.50, Blunderbuss \$68.00, Heike, Wenona 41, Illinois.

FLY Tying—For winter pastime tie flies for pleasure and profit, Excellent materials available, also trout, bass, bug kits complete in every detail, Send 25c (refunded with first order) for catalogue, The Wapsi Company, D7, Independence, Iowa.

20 FIELD GLASSES, TELESCOPES, ETC.

BINOCULARS—Guaranteed repairs Free estimates, Dealers invited, Tele-Optics, 5514 Lawrence, Chicago 30, Illinois.

TELESCOPES, Binoculars, Microscopes—big bargain catalog free, Brownscope Company, 24 West 45th Street, New York.

WAR Surplus Bargains, Binoculars, Telescopes, Sextants, Millions of Lenses, Prisms, Reticles, Eyepieces, Objectives, etc. Request Free "Catalog CN," Send \$1.00 for Stock CN—10-piece Lens Kit and Big Instruction Booklet, Edmund Salvage Co., Barrington, N. J.

REFLECTING Telescopes, completely assembled, 60X, \$25.00, Guaranteed Observatory clearness, Free information, Skyscope, 475 Fifth Avenue, New York 17.

TELESCOPIC discoveries, "Mars," "Saturn," Free illustrated circular, Donald Cyr, 1412 Palm Terrace, Pasadena 6, Calif.

GIANT, 100 power astronomical telescope with 6 ft. tripod (10,000 area magnification) Clear Vision, full power guaranteed, \$15.00 F. O. B. factory, Suffolk Science Service, Dept. TC, Riverhead, N. Y.

POWERFUL astronomical telescopes easily made, Perfect lenses and instructions; 100x \$3.00; 100x and 200x \$4.00; 100x, 200x and 400x \$6.00, Full power, clear vision guaranteed, Instructions alone 10c, Suffolk Science Service, Riverhead, N. Y.

SAVE 50% On New Binoculars! Free Catalog, Free Book, "How to Select Binoculars," Write Today! Bushnell Importers, 13-P2, East Green, Pasadena 1, Calif.

22 BABY CHICKS

BABY Chicks, Champion Mated, 52 varieties, 7 Grosses, licensed inspected, bloodtested, Rush postal, large colored book Free, low prices, Berry's Farm, Route 11, Clarinda, Iowa.

24 DOGS, BIRDS, PETS, RABBITS

MAKE Money! Raise Chinchilla Rabbits, Experience unnecessary, Valuable Breeders, Extra profits from meat, furs, laboratories, Pleasant hobby, Write today! Rockhill Ranch, Sellersville 16, Pa.

\$50 WEEKLY Raising Angoras, Free Illustrated Booklet tells How, Wilson's, Stanton 18, Calif.

POPULAR SCIENCE OPPORTUNITIES

RAISE Mink. Amazingly profitable. Free booklet gives inside "secrets." Molgard, Brigham City, Utah.

SALE—Pack outstanding Kentucky foxhounds \$30.00 to \$50.00 each. Harvey Satterfield, Princeton, Ky.

\$400 MONTHLY Raising Angora Rabbits. No experience required. Details free. White's Rabbitry, Newark, Ohio.

RAISE Guinea Pigs. Make extra money. Booklet free. Taylor, Box 426B, Hapeville, Ga.

GOLDEN Hamsters—Novel Pets. \$5 brings breeding age pair including two metal cages, instructions. Hathaway Hamstery, 609 Deerfield, Silver Spring, Md.

HOBBY catalog 10c. Reptile List 5c. Hamsters \$2.75 pair. Chameleon 35c. Turtle 35c. Quivira Specialties, Topeka, Kans.

RABBITS: New Zealand. Ringland Rabbitry, 1726-30th, Des Moines 2, Iowa.

HAMSTERS:—The best stock money can buy. \$2.50 Pair, \$3.75 Trio. Free Literature. Valley Hamstery, 734 North Milam, San Benito, Texas.

GRINSTEAD'S famous angoras! Giant chinchillas. World's most profitable rabbits. Finest pedigree, heavy-producing prize-winners. Literature free. Grinstead's, Edwardsville, Ill.

25 FROG RAISING

"RAISE FROGS!" New book tells how! Illustrated Literature Free. Marlboro-B, Box 7002, New Orleans 19, Louisiana.

30 FARMS, OTHER REAL ESTATE

FARMS. Ranches, lodges, resorts. Big selection. Milwaukee Road territory. Washington, Idaho, Montana, Dakotas, Minnesota, Iowa, Missouri, Michigan, Wisconsin, Illinois, Indiana. Free colorful descriptive folders, price lists. L. H. Robbins, 738K Union Station, Chicago 6, Ill.

STROUT'S Golden Anniversary Farm Catalog Over 2800 outstanding Bargains! Coast-to-Coast; 32 states. Mailed Free! Strout Realty, 255-ZB-4th Ave., New York 10, N. Y.

OZARK Lands for All purposes. Actual river frontages. 5 acres \$90.00 and upwards. Free list and literature. Hubbard, 424-H, Minnesota Ave., Kansas City 4, Kans.

FLORIDA Campsites—\$95.00 at \$5.00 monthly buys nice, high dry lot in Lake County (world's best bass fishing. Wonderful hunting) near Ocala National Forest, St. Johns River, beautiful lakes, pavement. Safe from Bombs. Folder Free. Winfred Vernor, DeLand, Florida.

GOOD Farms—Ranches. Washington, Minnesota, Montana, Idaho, Oregon, North Dakota. Dependable crops, favorable climate. Write for literature. Lists describing typical farm opportunities. Specify which state. J. W. Haw, 120 Northern Pacific Ry., St. Paul 1, Minn.

NEW Free Spring Catalog! Farm and country real estate bargains, good pictures, many states, easy terms, many equipped, crops included. For Special Service, state requirements, desired location. United Farm Agency, 428-PS BMA Bldg., Kansas City 8, Mo.

31 POULTRY AND SUPPLIES

RAISE Turkeys the new way. Write for free information explaining how to make up to \$3,000 in your own backyard. Address National Turkey Institute, Dept. 57, Columbus, Kansas.

32 PROFITABLE OCCUPATIONS

\$40.00 WEEKLY. Made growing mushrooms. Fresh. Dried. Dominion Patent 331.583. free spawn. North American, 169Y Yonge, Toronto, Canada.

BE Independent. Be Secure. have your own profitable business—earn \$10.00 and more a day making beautiful, fast-selling lamps at home. No equipment needed. Illustrated course teaches you quickly. Course, parts catalog, wholesale price list—only \$2.00. Gearon Company, Dept. 200-A2, 27 South Desplaines, Chicago 6, Ill.

LEARN Professional candy making. Profitable Home Occupation. Details 10c. Pate, Kissimmee 2, Florida.

\$5000 FROM half acre growing Ginseng, crop bought. Particulars 10c. Associated Growers, 1169 Corydon, Winnipeg, Canada.

\$400 MONTHLY Raising Angora Rabbits. No experience required. Details free. White's Rabbitry, Newark, Ohio.

HAVE Fun! Make Money! "Working with Leather"—64-page booklet tells how. Send 25c for copy. Free catalog and valuable information included. Wilder-Craft, 1038 Crosby, Chicago 10.

LEARN Watch—Clock Repairing at home, our easy way! Free information. Modern Technical Supply, 55-PS West 42nd Street, New York 18.

PLATING, technicians make money! Easily learned. Free details. Joseph Kushner, Electroplating Engineer, Stroudsburg 16S, Penna.

RAISE Fishworms. Easy. Profitable. Send 25c in coin for complete instructions. Huffman's Worm Ranch, Rives Junction, Michigan.

LOCKSMITHING secrets! Key fitting. Lock repairing, opening; prices. Sources. Illustrated book \$1.00. Wexler, 7 West 36 St., New York City.

33 BOOKS, PERIODICALS, ETC.

USED Correspondence Courses and Books bought, sold, rented and exchanged. Catalog Free. Lee Mountain, Pisgah, Ala.

BOOKHUNTERS! All Subjects. Send Wants! Jaher Book Service, 620-K East 178 Street, New York 57.

SELF-Hypnosis: A Guide To Its Wonders. Amazing new book—guaranteed! \$2.00. Psyche, 542-BW 5th Ave., N. Y. 19.

QUICK profits taking magazine subscriptions, handling greeting cards. Cassell Publishers Service, Westfield, N. J.

ADULT Books—Unusual—Revealing—illustrated. Five \$1.00. Catalogs 10c. Kogan, 1032-DP, Church Annex, New York 8.

NATIONAL Geographic Magazines 1888-1949, any issue. Periodical Service, Box 327-PS, Swarthmore, Pa.

CARTOON Booklet. Large pocket size! 15c. Harris, Box 550, Palm Springs, Calif.

MODEL Tells All. Rackets, Traps, Foul Play of Photographers, Agents. \$1.00—Hold-It, 41 W. 52nd St., N. Y. C.

ADULTS—Intimate Books, Booklets. Bookalogues 10c. Justco, 1216 Parl Row Building, New York 7.

BACK-date Magazines. Specific issues; years. Arkell's, Tarzana 2, Calif.

ADULT Readers—Five. \$1.00! Catalogue 3c. Mesa, Box 55-A, New York 19.

35 MAGIC TRICKS, PUZZLES, ETC.

200 ELECTRIC stunts, 110 volts, \$1.00. Cutting Sons, Los Altos 2, Calif.

500 TRICKS Catalog and Book "84 Card Tricks," both only 50c. Robbins Co., 131-P West 42nd St., New York.

500 TRICKS you can do! Send 25c for Douglas famous Catalog, best in magic at lowest prices. Unequaled service to magicians for 30 years. Douglas Magicland, Dept. 2, Dallas, Texas.

VENTRILOQUISM Taught. 3c stamp brings particulars. Smith, 801 Bigelow, Peoria 5, Ill.

LEARN Magic. Ventriloquism, Mind-reading. Write for particulars. Quackenbush, Big Flats, N. Y.

BE a Magician. Large professional magic catalog of latest tricks, 35c. Ireland, F-109 North Dearborn, Chicago.

VANISHING Quarter trick and catalog 25c. Sterling Magic Co., Royal Oak, Mich.

LATEST And Best Tricks Described in our New Large Catalog. Send 25c to Jeffries Magic Company, 17 North Hudson Street, Oklahoma City, Okla.

400-PAGE Catalogue of 2000 Tricks, pocket, parlor, stage. World's Finest Magic. Send \$1.00 for Catalogue (refunded first \$5.00 order). Kanter's, S-1311 Walnut, Philadelphia 7.

VENTRILOQUIST Dummies, Catalogue 10c. Be a ventriloquist. Free Particulars. State age. Maher, Box 36-S25, Kensington Station, Detroit 24, Michigan.

WE supply every noted magician. Large professional catalog 50c. Holden's, P220 West 42nd Street, New York.

37 COIN COLLECTING

FREE! Foreign coin, banknote and Coin Collectors' Illustrated Catalog to approval service applicants. Send 3c postage. Tatham Coin Co., Springfield-D50, Mass.

GET Profit and Pleasure in collecting old coins. Send 10c for 56-page illustrated coin catalog. You'll be delighted with it. Send for it now. B. Max Mehl, 374 Mehl Building, Fort Worth, Texas. Largest rare coin establishment in U. S. Established 50 years.

\$1,116.66 face value, Jap-U.S. invasion money, \$2. Approvals. Tatham Coin Company, Springfield 50, Mass.

OLD Money Wanted. Do you know that Coin Collectors pay up to \$100.00 for certain U. S. Cents and high premiums for all rare coins? We buy all kinds. Send 4c for Large Coin Folder. May mean much profit to you. Numismatic Co., Dept. 30, Fort Worth, Texas.

U.S. coins lowest prices. Send stamp for lists. Hutchinson, 3463 I Street, Philadelphia 34, Penna.

\$10.00 EACH for certain Lincoln pennies, Indianheads \$50.00. Send dime for catalogue listing prices paid. Lincoln Coin Company, Elkhart 4, Indiana.

COMMEMORATIVE \$1/2 — Columbus, Washington, Cleveland, Stone Mountain, \$1.50 ea. Illustrated Catalogue 25c. Norman Schultz, Salt Lake 9, Utah.

40 STAMP COLLECTING

200 DIFFERENT, including Roosevelt triangle, 5c to approval applicants. S. Avalon Stamp Co., Springfield, Mass.

WOW! \$10.00 Worth Of Fun 10c! What a treasure hunt! Big package 500 Foreign Stamps, including airmails, pictorials and others from the world over; stamps worth up to 25c each. This offer sent for 10c to Approval Applicants Only. Jamestown Stamp Co., Dept. 5, Jamestown, New York.

POSITIVELY Greatest Free Offer! Latest Scott's International \$6.00 stamp album—covering entire world, contains 36,000 illustrated descriptive spaces; Scott's 1950 Standard \$7.00 catalogues "Philately's Encyclopedia"—absolutely Free to applicants for foreign approvals becoming customers. Approval Service, P. O. Box 1700, San Francisco, California.

FREE! Powerful magnifying Glass—to approval applicants; also big bargain lists. Jamestown Stamp Co., Dept. 202, Jamestown, New York.

FREE—Illustrated Catalog! Kenmore Stamps, Arlington 74-C8, Mass.

FREE! 100 Worldwide different stamps to approval buyers. Big U.S. and illustrated bargain lists sent with approvals. Bookman, Maplewood 1, N.J.

FIFTY Different Countries Abyssinia-Zanzibar 3c to approval applicants. Mohawk, Box 141S, West Springfield, Mass.

UNITED STATES approvals complete coverage fine quality, attractive prices. Seminole Stamps, Box 1138-S, Coral Gables, Florida.

UNIVERSAL Mixture \$1.00 Per 1000. C. W. Ritchie, Watertown, S. Dak.

UNITED States stamps nearly 100 years old. Roosevelt set, others, 40c value—only 6c to applicants United States approvals. Wakonda, 140F Nassau, New York 7.

WORLD'S Largest Stamp (7 1/2 x 14 inches). A real curiosity! Retail for 50c, only 3c to approval applicants. Tatham Stamp Co., Springfield 50, Mass.

FREE. Scott's International Album, valuable colorful collection, hinges, other big premiums. Full particulars with approvals. Raymax, 123-X William St., N. Y. C. 7.

FREE Catalog! Illustrated. Forty pages. United States, Foreign, Albums, Supplies. "How to Collect," etc. Harrisco, 204 Transit Bldg., Boston 17, Mass.

\$1—\$2—\$5 UNITED States, commemoratives, airmail, high values in large collection United States stamps only 5c to applicants United States approvals. Metropolitan, 140A Nassau, New York 7.

POPULAR SCIENCE OPPORTUNITIES

FREE—Famous Americans Set, Flag Set, National Parks Set, and Presidential Set to \$5.00. A total of 90 Stamps Free to Customers for our unsurpassed U. S. and foreign selections. Send 3c for 15 of the above Stamps and full particulars. Triboro Stamp Co., 145 Nassau St., Dept. 202, N. Y.

300 DIFFERENT given free with approvals. Postage 3c. Windsor Stamps, 1435 E. 67th Place, Chicago 37.

25 U. S. Commemoratives—All Different from 1893 Columbian to present day issues. This U. S. commemorative collection only 5c to approval applicants. S. L. Engel & Co., 38 Park Row, New York 7, N. Y.

FREE! Liberia Triangle Airmail Set, Package Hinges, approvals, Greenwood, 441 Washington, Miami Beach, Fla.

EXCHANGE! Send 25 U. S. Commemorative duplicates. Receive 200 different world. Sundman, Littleton 2, N. H.

FREE \$25.00 Outfit Latest Large Scott album, valuable collection of 1050 all different beautiful stamps, airmails, triangles, diamonds, high values, etc. Plus watermark detector, tongs, "Stamp Finder" Magnifying glass, perforation gauge, hinges—actual value over \$25.00—but all absolutely free when you become a customer. Write for our foreign stamps on approval now. Americas' Stamp Service, Riverside, California.

UNITED States Commemorative Collection 37 different unused Columbians to 1943 issues only. Price \$1. Request approvals. "Stamps" 987, Albany, N. Y.

FREE! Negro Triangle: Turks Islands, Dakar, Guinea, Palestine, "Fairy Tale" Pirate Chart, Ship, Sea Lion, Snake Stamps; French, British Portuguese Colonies, etc. Free for 3c postage. Approvals, Potomac Stampco, Washington 15, D. C.

FINE Approvals. Fast, personal service. What countries do you prefer? I'll send their stamps. Milton Skinner, 438 Locust, Long Beach 12, Calif.

TASMANIA! included! Stamps from forty countries 10c. No approvals. Elzea, Bowling Green, Ohio.

200 **WORLDWIDE** Mixed 10c. 500—20c. 1000—35c. 3000—\$1.00. Arthur Sibley, Mendon, Mass.

TRIANGLE—Diamond Packet! Free! Approvals, Colonial, Box 326 B, Passaic, N. J.

FREE United States Price List. Mark Hanna, 335 Fifth Avenue, Pittsburgh 22, Pa.

50 **DIFFERENT U. S.** 10c. No approvals. Price list free. Seidenberg, Cassopolis, Mich.

OLD, scarce U. S. seconds on approval. Slightly defective, bargain prices. Hearnfeld, Clintonhill Station, Newark 8, N. J.

EXOTIC Collection; Fezzan Ghadames, Togoland, Camerouns, Andorra, Reunion, Miquelon, Algeria, Somalis, Guadelope, Guiana, Natives, Maps, Ships, Idols, Snakes, Rhinoceros, others, 5c. Imperial Stampco, Tampa, Florida.

U. S. Park Set Complete fine 25c with approvals. L. W. Hudson, Box 229, Whittier, Calif.

"ROOSEVELT with six fingers: Unique Stamp free to approval applicants. Apex Stamps, Box 2188, Miami 13, Florida."

FLAG Stamp Free, if you request my U. S. approvals. E. Wenigman, 1933 Patterson, Chicago.

25 **DIFFERENT stamps** 10c. F. Tunis, Wakeman Ave., Newark 4, N. J.

RARE Bargain—Six Mint German Sets—50c Value—Only 10c to Approval Applicants. Stamp Mart, 1412 Great Northern Bldg., Chicago 4.

POSITIVELY Free! Scott's Latest \$6.00 International Stamp Album or 1950 Catalogue to approval customers. Claire's, 7402 Bayparkway, Brooklyn 2, New York.

SAN Marino Collection Free—25 different. Old and New Issues, Airmails, Commemoratives, High Values—absolutely free with approvals. Viking, 130-PP Clinton St., Brooklyn, N. Y.

1000 **World Wide** 67c; Pacific, P. O. Box 5704, Los Angeles, Cal.

STAMP Magazine! Copy free! "Stamp Post." South Catalina, Pasadena 1, Calif.

1c **EACH and Less!** Thousands of Bargains! Cole, 43-G Rinewalt, Buffalo 21, N. Y.

WORLDWIDE Stamps. All Different. 200-25c; 500-50c; 1000-\$1.00; 2000-\$2.75; 5000-\$13.50. Beacon Sales, Northboro 3, Mass.

SCARCE Bahawalpur Jubilee Set free to approval buyers. Plymouth F3, Bell, Calif.

FREE! Ten different Newfoundland to approval applicants, Litten, 318A North Fifth Avenue, Maywood, Illinois.

BAHAWALAPUR. Oriental Scenes In Gorgeous Bi-colors. Complete Set Free. Garcelon, Calais 112, Maine.

FREE "Stamp Finder." Tells Instantly country to which any Stamp Belongs. 36 pages profusely illustrated. Garcelon, Calais 18, Maine.

307 **ALL Different Free.** Commemoratives, Triangles, Bicolored Beauties, High Values, Strange Countries, Free to Approval Buyers. Garcelon, Box 518, Calais, Maine.

"HOW To Recognize Rare Stamps"—Free Book, Illustrated! Kenmore, Arlington 74-H9, Mass.

200 **BRITISH Empire Stamps** plus valuable publications Only 3c. Kenmore Stamps, Arlington 74-B 18, Mass.

FREE Stamps. U. S. Foreign lists. Schneider, Box 555, Route 3, McHenry, Ill.

FREE Stamps, Approvals. Ren Stamp Company, 11407 Kinsman, Cleveland 4, Ohio.

110 **DIFFERENT Hitlers.** Roosevelt, Liberia, Vatican, Etc. 10c. Buckley, PS-208 Ludlow Bldg., Dayton 2, Ohio.

ATOMIC Bomb Airmail! Is only one in this collection of 100 all different Airmails—Pictorials—War Issues—Etc. from War-Torn China! Only 10c to Approval applicants! Star Stamps, Jamestown, N. Y.

HAVE Fun, build your stamp collection inexpensively. Write for Economy 1c Approvals. Joe Goldman, (PSM) Lynbrook, N. Y.

FREE! Big Packet! With Catalog! Stampart, Box 2071, Hartford 1, Conn.

GENUINE "Goya Nude" set (Catalogs 55c) 15c. Approvals, Royal Stamp Company, Tamaqua 2, Penna.

U. S. 797 SPA Sheet only 5c to applicants for U. S. approvals. M. Haycock, 333-86th St., Brooklyn 9, N. Y.

DJIBOUTI Steam Locomotive. Chinese Hunger Stamps, Angola, Seychelles, 100 fascinating others, 10c. Approvals, Atlas Stamps, 4220 West 16th, Little Rock, Ark.

51 **DIFFERENT Greece and Albania** 10c. Jumbo approvals, Chase, 1026 Walker Ave., Oakland 10, Calif.

ALBUM, 100 Stamps, Premiums—20c. Box 6618, Northeast, Kansas City, Mo.

U. S. \$5 Used Block of 4 only 15c. for U. S. Approval Applicants, D. Kelly, 333-86th St., Brooklyn 9, N. Y.

500 **Mixed Stamps and Surprise Packet** for 10c. with approvals. Fahsing, Dept. PS, Topanga, California.

PAYING High Prices for Approvals? If your collection numbers under 15,000 try our 1c and 2c approvals! In books of 1,000 different. Lots to choose from at lowest prices. Also special offer to customers. Clark, Box 544-U, Muskegon, Michigan.

25 **DIFF. 19th Century** given to approval applicants. Rossom, 218 West 59th St., Chicago 21, Ill.

SOUTHERN Rhodesia "Falls" set, 5c. approvals. Howard Laquerre, Camden 3, New York.

VATICAN City—50 Diff., \$1.00; 100 diff., \$3.75—Free price list. Russell, 224 West 17th Street, New York City.

BOY Scout sets complete. 1937 Netherlands, 10c with approvals, Vargo Stamps, 6044 South Fairfield, Chicago 29, Illinois.

FREE Gigantic, Beautiful, Mint U. S. George Rogers Clark commemorative stamp to approval applicants, Mohawk, Box 524, Albany, N. Y.

ILLUSTRATED U. S. Catalogue Free. S. Stone, Box 52, Dorchester 24, Mass.

BIG Bargain Stock! General Approvals, Peterson, Box 31, St. Paul 2, Minn.

POUND stamps containing thousands \$1.00. Longacre Shop, 100c West 42nd, New York City 18.

BARGAINS! 2,000 Foreign stamps \$1.00, 5,000 \$2.00, 2,000 US \$1.00, 5,000 \$2.00. Postall Sales Company, Washington 13, D. C.

42 HOBBIES, COLLECTIONS

50 **DIFFERENT army embroidered patches** \$1. Other bargains, Insignia Mart, 703B Broadway, New York 3, New York.

NEED help in your hobby? Trade ideas with fellow hobbyists. Big mailing list, \$1.00. State your hobby. Hobby Clearinghouse, P. O. Box 541, Indianapolis, Ind.

BATHING Beauties. 10 different glossy snapshots \$1.00. Frederick Forman, 868 Lorimer, Brooklyn 22, N. Y.

WANT to Buy—Curios, Relics, Guns, old Dolls, precious Stones, Minerals, Hobby Collections. Cooper, 106 A Court St., Brooklyn 2, N. Y.

WANTED Old cigarette cards, Write Charles Bray, East Bangor, Penn.

SNOOPERSCOPE Tube Permits night-time vision. Tube and complete instructions \$14.95. Infrared filters 15c. Voltmeter, Oscillator Kit Special \$2.95. Precise, 942 Kings Highway, Brooklyn 23, New York.

LEATHER Craft—Quality leather, lacing, tools and accessories at bargain prices. Free catalog. Frisco Krafts, Dept. B, Box 3016 Rincon Annex, San Francisco 5, Calif.

FUN and Adventure in Natural Science! Start off soundly with specimens, collections, equipment, and "know-how" from a famous museum supply firm. Send 35c for Student Catalog No. 498: Department P-1, Ward's Natural Science Establishment, Rochester 9, N. Y.

UNUSED matchbook covers—100 different \$1.00—Catalog 10c—Charles Edelman, 1311P East 84, Cleveland 3, Ohio.

UNPAINTED plaster ornaments, Loxite for moulds. Free literature. Midwest Novelty, Box 788-B, Anaconda, Montana.

CASH paid for almost anything! Big Guide 25c postpaid. Toole, Box 415, Evansville, Indiana.

44 ANTIQUES, RELICS, INDIAN GOODS

SELLING 400 Historical Firearms. 20,000 Indian Relics, Coins, Swords, Confederate Money, Gold Dollars, Holsters, Collectors Cartridges, Kentucky Rifles, Civilwar Muskets, Bayonets, Powder Flask, Ramrods, Stagecoach Carabines, Pistols, Rifles, Percussion Caps, Steerhorns, Powderhorns, Bo-Wood, Blo-Horns, Bulletmolds, Arrowheads, Gempoints, Tomahawks, Spearheads, Bannerstones, Blunderbusses, Agates, Minerals, Fossils—Mounted Pheasants—Owls, Catalog with photographs 35c. Heike, Wenona 41, Illinois.

46 MINERALS & PRECIOUS STONES

AUSTRALIAN Opals world's best multi-colored gems 8x10mm \$1.00, 12x16mm \$3.00, 14x24mm \$10.00. Woodrow Oldfield, 11 Cherry Road, Balwyn, Victoria, Aus.

GEMS, precious and semi-precious, all genuine from world wide sources. Deal direct, no overhead, save money. Catalog 10c. Hill Co., Route 7-K, Salem, Oregon.

GEMSTONES, Mineral specimens, Every variety. Lowest prices. Postcard brings free booklet. Plummer's, 2183D Bacon, San Diego 7, Calif.

SPECIMENS, Collections, supplies and equipment from a famous museum-supply firm to start you off soundly. Send 25c for Geology Catalog No. 499: Department P-1, Ward's Natural Science Establishment, Rochester 9, N. Y.

47 CAMERAS, PHOTO SUPPLIES

BASS Says: Bargaingram 257 ready and waiting for you. The book which tells all the finest in new and used camera equipment, a veritable encyclopedia. Write, phone or call the sign of the old "Horse Trader". 39th year of satisfaction or your money back dealing. Bass buys, sells and trades. Bass Camera Company, Dept. AG, 179 W. Madison St., Chicago 2.

POPULAR SCIENCE OPPORTUNITIES

ENLARGERS, all sizes, lowest prices. Booklet "B" Free. J. B. Photo, 41-09 19th Ave., L. I. City, N. Y.

FREE Photographic Bargain Book packed with hundreds of sensational values in still and movie cameras, lenses and latest accessories. Super savings for you in new and used equipment. Liberal trade-in allowances, too, on your equipment. Write now for your free copy to Central Camera Company, Dept. 11B, 230 S. Wabash Ave., Chicago 4 (Photographic Headquarters Since 1899).

FREE Catalog—Terrific surplus buys. Write today. Free-style Sales Co., 1431 N. Western Ave., Hollywood 27, Calif.

MAKE money. Magic photos. For information, write. Novelart, Laurens, S. C.

BUY photographic supplies wholesale. Free catalog. Expert camera repairing. Capitol Photo Supplies, 2428 Guadalupe, Austin, Texas.

KODACHROME Slides On Approval. Death Valley, Yellowstone, Glacier, Grand Canyon, Etc. Douglas Whiteside, Yosemite, Calif.

48 PHOTO FINISHING

OIL coloring photographs can be a fascinating hobby or profitable sideline for those with artistic talent. Learn at home. Easy simplified method. Send for free booklet. National Photo Coloring School, 1315 Michigan, Dept. 1722, Chicago 5, Ill.

YOUR 8 exp. roll with 3 prints each good negative 45c. 2 each good negative 35c. One each good negative 25c. Reprints 3c. A few cents postage appreciated. L. A. Eastman, Bode, Iowa.

GET acquainted—Roll Developed 16 contact prints 10c. Photo Service, Des Plaines 1, Illinois.

GET Acquainted—Roll Developed 8 enlarged Deckled prints in Album 10c. Photo Service, Des Plaines 2, Illinois.

2 BEAUTIFUL Hi-Gloss prints each good negative and enlarging coupon with each 6 or 8 exposure roll developed 28c. Owl-photo Co., Weatherford, Oklahoma.

8 BEAUTIFUL Double Size pictures and roll developed 30c. 8 hour service. Free Malters. Pacific Photo Service, Box 666, San Francisco, Calif.

GET Dye-Transfer Color Prints made in Hollywood. Send film, (any size, any make) to: Atkinson Laboratory, 7273 Santa Monica Blvd., Dept. PS-1, Hollywood 46, Calif.

50 PHOTOPRINTS, PHOTOCOPIES

PHOTOCOPY anything yourself. Papers, books. No darkroom. 8 1/2 x 11" complete. \$6.95. Fotoflek, 4801 Yarmouth Place, Cincinnati 29, Ohio.

51 MOTION PICTURES, SOUND EQUIPMENT

BASS Says: 39 years of leadership guarantees satisfaction. Finest Cine equipment. 8mm., 16mm., and 35mm., silent and sound. Write the old "Horse Trader". Satisfaction or your money back always! Bass Camera Company, Dept. A., 179 W. Madison St., Chicago 2.

ORIGINAL Party Films and Records. Adult Entertainment. Details, interesting offers dime. Alberts, Dept. P, 6369 De Longpre Ave., Hollywood 28, Calif.

EXCITING, novelty action films. "Merry Mary." "Miss Deb." "Baby Doll." "Blonde On the Water." "Cooling Off." "Frisolous Females." 8mm 50 ft. \$3. 16mm 100 ft. \$6. Free catalog on request. Also full color "model" slides (2 x 2), sample 40c. Free Viewer with order of 15 slides for only \$5. Shipped prepaid, send cash, money order. Joy Studios, Dept. S12, Box 150, Main P. O. Jersey City 3, N. J.

MOVIES—Black and White, Color, Sound or Silent; \$1.00 up. Large selection includes famous Disney Cartoons. Write laboratory for Free catalog. (State 8mm, 16mm or Sound). Hollywood Films, 6060-L Sunset Boulevard, Hollywood 28, California.

8-16MM. Silent-sound films. Complete rental library. All latest subjects. Free catalogue. (sample film 10c). Garden Film, 317 West 50th, New York 19.

RARE films. Medicals, Oldtimers, others. International, 2120 Strauss, Brooklyn, N. Y.

SOUND-Silent Film Duplicating Machines \$68.50 Up. MK Photo, 451 Continental, Detroit 14, Michigan.

SPECIAL movies for your private showings. 100 ft. 8mm \$5.50; 16mm \$6.00, sound available. Free list. Tasco Supply Co., P. O. Box 6, North Station, Providence, Rhode Island.

PARTY Films! 100 ft. 8mm \$5.50; 16mm \$6.00, sound available. Free list. Helene Dist. Co., 182 Peace St., Providence, R. I.

SUNSHINE and health Films available in 8mm and 16mm. Tel-A-Film Co., 935 Cincinnati St., Dayton, Ohio.

BETTER 8mm and 16mm Movie Camera Film. Free Equipment Catalog. Better Films, 742 New Lots, Brooklyn 7, N. Y.

RENT 16 mm, sound films 50c reel. Large selection; free catalog. U. C. Film Service, 128 Chestnut St., Roselle Park, N. J.

LEARN movie projection management. Free Catalog. Theatre School, Elmira, N. Y.

BIGGEST 16mm, sound film bargain! Twelve good used 100' "Soundies" musicals, \$9.95 plus postage. Hundreds of titles available at \$1.49 each. Write for our big list. Blackhawk Films, Davenport, Iowa.

HOME movies for your holiday parties entertain your friends 8mm \$2.50 16mm silent \$6.00 SOF \$7.50 all new subjects free list. Comet Productions, 11651 Riverside Dr., North Hollywood, Calif., Dept. B.

GUARANTEED fresh anti-halo outdoor movie film! Weston 16! Daylight loading! Processing free! Three spools double 8mm. \$4.50! Six single 8mm for Univex. \$4.60! Postpaid! Catalog. Filmcraft, 47th Holly, Kansas City 2, Missouri.

MOVIES for your gay gatherings. 8mm-16mm, color, black and white. Send self addressed stamped envelope. Cornell Enterprises, 7070B Hollywood Blvd., Hollywood 28, California.

SUPER Special Hollywood Glamour Movies for the connoisseur of the unusual. "Happy New Year", "Snow Girl", "Fighting Females", each 8mm \$2.75, 16mm \$6.00. Two-color brochure of unique 8-16mm silent-sound subjects, plus sample film strip, 10c. Film strip viewer, \$1.00. Camera Corner, 391 Bridge Street, Room 126, Brooklyn 1, N. Y. (Tel. Main 5-3553).

MAKE color stereo (3-dimensional) slides with your own 35mm camera and Stereo-Tach. Now only \$19.79 complete with viewer, tax included. Was \$24.59. Ask your dealer or write for illustrated literature. Dept. 71, Advertising Displays, Inc., Covington, Ky., U. S. A.

WILD Game Films, 8mm, 16mm. Natural color, black-white. Taken in natural habitat by famed Eberhart organization. Send for free list. Wild Life Films, Dept. 2-PS, 6063 Sunset Blvd., Hollywood, Calif.

ADULT entertainment, new. (Catalogue E). Trophy, #27 Valley Village Station, North Hollywood, California.

52 MUSIC, MUSICAL INSTRUMENTS

HILLIBILLY, Polka, Popular Records—12c up. Guaranteed. Collectors. Catalog 3c. F-L, Box 19-S, N. Y. 35, N. Y.

1950 Accordions—Wholesale—Free catalog—American Accordion Center 5329—Belmont, Chicago.

VOICE! Priceless! Secrets! Information Studio, 14356R Jersey Avenue, Norwalk, California.

53 SONG WRITERS

POEMS Wanted. Splendid offer! Rush! Radio Composers, WPSJ, Clinton, N. C.

SONG-Poems set to music. Send your poem for our proposition and useful Rhyming Dictionary. Richard Brothers, 46 Woods Building, Chicago.

INFORMATION How to get a song published with list of 60 leading music publishers \$1.00. John Dayfotis, 1658 Broadway, New York 19, N. Y.

POEMS Wanted For Musical Setting. Send poem for free examination. Five Star Music Masters, 646 Beacon Bldg., Boston, Mass.

54 RADIOS, SUPPLIES & EQUIPMENT

X-TRA Long Distance Radio Crystals. Reception of hundreds of miles. Guaranteed. Complete with instructions, 25c. D-X500, Box 201, Marshall, Mo.

ALL Steel TV Towers. Built to climb. \$8.50 per 10' section. Write The Youngstown Steel Towers, 1316A Wilson Ave., Youngstown, Ohio.

FIX any radio. Amazing new instrument locates radio troubles double quick. Simple instructions show you how. Thousands now in use. Free—Write today for 32-page illustrated technical manual. "The Inside Story". Feiler Engineering Co., Dept. 2PS5, 1601 S. Federal St., Chicago 16, Ill.

MAKE Simple, Tubeless, Batteryless, Distance-Getting Crystal Radios. Crystal and illustrated instructions 25c postpaid. Allen, 427-s, Clinton, Mo.

55 TELEVISION

SPECIAL offer—\$1.00 set of television schematics—only 50c. Melpro Company, P. O. Box 40, Brooklyn 20, N. Y.

56 BUSINESS OPPORTUNITIES

CASH For your idea. 280 manufacturers need inventions, patented or unpatented. List free. Invention Bureau, 208-S Clinton, Oak Park, Illinois.

EARN \$50.00 or more weekly operating vending machine route in your spare time. As small an investment as \$13.95 will get you started. Details free. Danco Coin Machine Co., Dept. PS., 1302 E. Baltimore St., Baltimore 31, Md.

RECAST old batteries into new. Latest achievements. Battery Laboratories, Minneapolis.

START Mailorder Bookshop—Everything furnished. 25c brings booklet, samples, exciting ideas. General Publications, Ossining 1, New York.

PEARL Finishing—New, Amazing—Huge Profits. Start Making Big Money first day. Free Facts show easy way to \$25 to \$50 per day at home. Absolutely no experience. Be first—scoop, the market. Write Pearl-Kote, Dept. S, 2111 W. Manchester, Los Angeles 47, Calif.

MOLDING Rubber for Hobbyists, Industry, Classroom Projects! Flexible Molds easily made from the best Quick-Drying White Liquid Rubber! (Gallon—\$7.95; Quart—\$2.95; Sample Half-Pint \$1.00) Prepaid Parcel Post! Plastercraft Supply Co., 3051 St. Clair Ave., Cleveland 14, Ohio.

"How to start a successful mail order Business." The guide to sound, profitable mail merchandising. 25c. Manhattan House, 126-R Lexington, New York 16.

MAKE Money spare or full time, casting Metal Toys and Novelties. Big Wholesale and chain store demand for cast Metal Autos, Soldiers, Ashtrays, Bands, etc. Keeps manufacturers busy. Production moulds furnished for up to 100 and more casting per hour. No experience or special place necessary. Write for full information and illustrations of patterns needed. Metal Cast Products Co., Dept. E, 1696 Boston Road, New York 60, N. Y.

GOOD Paying Business Silvering mirrors, plating autoparts, reflectors, bicycles, bathroom fixtures, etc., by late methods. No tanks or shop required, outfit furnished. Free Booklet. Gunmetal Co., Ave. E, Decatur, Illinois.

EXTRA Money—No selling—operate vendors. Amazing profits, details Free. Silver King, Suite 282, 622 Diversey, Chicago 14.

OPERATE profitable mail order business. Write Walter Service, 4159-B East 112th, Cleveland 5, Ohio.

A FACTORY in your home garage! Mfg. and sales rights, mechanics' waterless hand cleaner, \$500-\$800 monthly. No special equipment necessary. Formula free. Western Aircraft Mfg., Dept. G, Los Angeles 6, Calif.

I MAKE big money in the mail-order business. You can do the same at home with copyrighted system. Write me. I'll tell you how. F. Little, RD # 1, Glenshaw, Pa.

POPULAR SCIENCE OPPORTUNITIES

MAKE money addressing envelopes. Our instructions reveal how. Glen Glenway, 5713 Euclid, Cleveland 3, Ohio.

ENVELOPES addressed accurately, reasonably. Fast Service. We have capable addressers in your city. Glenway System, 5713-Z Euclid, Cleveland 3, Ohio.

EARN Money At Home With Your Typewriter! Spare time! Details free. Edwards, Publisher, 3915-PS, 12th, Des Moines 13, Iowa.

LEATHER Carving. Fascinating, highly-paid art; age-old secrets now taught by first time in home study course. For hobby, profession or profitable business, write; Baird School of Leather Carving, Box 1367-F, Manitou Springs, Colo.

BIG money. Spare or full time in your home. No Selling! Spray New Miracle Finishes, Plush and Suede, on signs, radios, automobiles, figurines, lamps, toys, etc. Our business is booming. Help us fill huge demand. Cash in now on Big Christmas orders. New easy Flok-Kraff methods. Material costs few pennies. You get dollars. Free samples, complete powerful money making plan free. Write now! Coast, 1008 S. Los Angeles St., Los Angeles 15.

POPCORN Equipment. Potato Chip Outfits. Long Eakins Company, 5063 High, Springfield 99, Ohio.

\$25 WEEKLY working two hours daily. No canvassing. No Manufacturing. Lycke, Box 2471-B, Cleveland 12, Ohio.

EXPERIENCE Unnecessary. Earn \$300 month spare time sales and rental America's leading small tractor. Protected territory. Write Tiger Tractor, Fort Lee 2, N. J.

TRADE Magazines help you get ahead. Latest copies. More than 1100 covering every trade, business or interest available through our easy-to-get-acquainted service. Full particulars and price-list free. Commercial Engraving Publishing Co., 34S North Ritter, Indianapolis 19, Indiana.

HOW To Set Up and Run a Mirror Shop! Resilver Mirrors. Make chipped glass nameplates. Electroplating Salts and Rectifiers. John Sprinkle, V 90, Marion, Indiana.

MANUFACTURE Camera at home. Experience unnecessary. Taylor, 4015 Oketo, Chicago 34.

COLORGLAZED Concrete Pottery made without molds. Patented method. Cemetery products, novelties, tiles. Basement leak-sealing. Money-making projects. Booklet, details free. Men only. National Potteries, Grand Rapids, Mich.

EARN at home, casting novelties. Free course using latex molds. Major Chemical Co., 164 Portland St., Cambridge 39, Mass.

BIG Money—Spare or full time. Hand painting fabrics, ties, blouses, leathers, is big business. New, easy method. Free samples and complete plan. Hollywood Artlabs, 333-A E. 2nd, Los Angeles 12.

WHY Job Worry? Start Electroplating, Metal Finishing Business. Free Booklet, Trade Secrets, S. Hyde, 327 West 120th Street, Los Angeles 3, California.

YOUR own profitable home business. Preserve live flowers to last forever. Spare or full time. New discovery—simple—fascinating. No experience necessary. Send \$2.00 for working equipment, instructions and valuable sales plans. Satisfaction guaranteed or money refunded. Hermansen, 210 Fifth Ave., Suite 1102, New York 10, N. Y.

WANT a Mailorder business? Avoid mistakes by reading "Mailorder Pitfalls." Send for free circular. Better Sales Co., 2139 Clifton, Cincinnati, Ohio.

NATURAL molding latex. Extra thick. Free sample. W. Wooley, 115-B Donald, Peoria, Illinois.

BIG Money Regraining-Refinishing Automobile Dashboards—Garnish Mouldings. Write Outman, 4323 So. 38th, St. Louis.

MAKE Rubber Stamps. Feather Pictures. Metallize Baby Shoes. Repair Dolls. Make plaster Novelties. Catalogue of "30 Ideas" Free. Universal, Box 1076-B, Peoria, Illinois.

MAKE durable building plastic of waste. Build Attractive home—\$150.00 room. Bays Laboratory, Oklahoma City 9.

ELECTROPLATE on non-metals. Instructions \$1.00. Four ampere plater \$19.95. Eight ampere \$29.95. 30 ampere \$85.00. Kissel Electric Products, 431 Sherman, Galion, Ohio.

MAKE flexible molds! Cast plaques, novelties, bookends! Free sample! H. Tooker, Hamilton 7, Ohio.

MAKE money making new greaseless doughnuts at home on electric machine. Wholesale to grocers, drug stores, cafes, hamburger shops. Send for free recipes and plans. S. Ray Company, 3605 South 15 Ave., Minneapolis 7, Minnesota.

QUICK Money! "Repairing Car Batteries"! At home! Easy too! Batteryman, Grand Junction, Colorado.

LIQUID Rubber, make flexible molds. Free Sample. Chaney, 1130 E. 16th St., Jacksonville 6, Fla.

MILLION Articles wholesale. Supply Source Directory 10c. Publishers, Box 1302, Detroit 31.

"**SELLING** shoes direct brings me good income, lets me be my own boss. Perfect for older men whose income has dropped." Free Selling Outfit. Consolidated Shoe System, Dept. S549, Chippewa Falls, Wis.

PROSPER with plating! Growing Field! Easily learned! Free particulars. Joseph Kushner, Electroplating Engineer, Stroudsburg 17S, Penna.

NATIONALLY advertised kitchen odor killer made with 95% water for 12c pint assures unlimited profits. Big demand repeat item, twenty-two fragrances. Two manufacturing formulas with source of supply \$1. Mike Sauln, 3520 Juniper St., Freeland, Pa.

WOULD you pay 3%—first \$350 made? Book "505 Odd, Successful Enterprises" free! Work home. Expect something odd! Pacific, Oceanside, Calif.

"**LEAR** Mail Business Opportunities". Ed Medved, Dept. J. Yukon, Pennsylvania.

WANT a Business Of Your Own? Make \$20 to \$30 a week extra money at home! Thousands Do! Interesting service cleaning upholstery and rugs. Big Demand. No selling. "Free illustrated folder tells how." Americlean Company, Inc., Dept. H-20, 211 North 7th Street, St. Louis, Missouri.

TIN Cans. Turn them into cash. Nine methods. Instructions 50c. Charles, 12-BAC, Norwood, Ohio.

SAWDUST. Turn it into cash. Six methods. Instructions 25c. Charles, 12-BAE, Norwood, Ohio.

HOW and where to obtain Capital? Free details. Star Service, Wapakoneta, Ohio.

BOOKKEEPERS earn \$100.00 week operating your "Bookkeeping Service". Simplified plan. Information free. Bookkeeping Service, Box 664-P, Springfield, Mo.

MAILING postcards selling repeat merchandise is profitable. Everything supplied. Details free. Gordon Publishers, Box 23, Pawtucket, R. I.

PIANO Tuning—Home Study—(15th year). Empire School, Champaign, Illinois.

BE a Cartoonist. A Fortune may await you. Write for free circular. Chas. J. Sprusil, 97-42 43 Ave., Corona, L. I., N. Y.

DESIGN-Model-Mold new fast sellers from Plastics, Plasters, Compositions. Amazing profits. Quick returns. Free literature. Simplex System, 2925-K Michigan, Kansas City 3, Mo.

NEW. Proved methods get money by mail. Amazing, eye-opening. Details free. Lexington Mail, 5538-B Lexington, Chicago 44.

MAKE Perfume At Home? Write Carey Laboratories, 1914 Chouteau, PS 2, St. Louis 3, Missouri.

GET Into Pleasant Home Operated profitable business, working by mail. Everything furnished! Tremendous possibilities! Get exciting details. National, Box 88-N, Dorchester 22, Mass.

REAL money making opportunity making Interlocking Concrete building blocks. Rex Products Co., Dept. 21, Piqua, Ohio.

\$46 FROM Square Foot Plywood; Jigsaw necessary. Write; Woodart, Bridgewater, Massachusetts.

WHERE to buy 500,000 articles wholesale. Details free. Krueger, 3418B Wolcott, Chicago 13.

BRONZED Baby Shoe Mountings, Equipment and Supplies. We manufacture world's largest assortment of all metal mountings. Wholesale only. Ramyr Selenium Platers \$39.95. Gold and Silver Plating Assemblies low as \$97.50. Write for Free copy of Electroplating Instructions. Sales Division, Hollywood Bronze Supply, 1770 N. Vermont Ave., Hollywood 27, Calif.

DECORATE discarded furniture and tinware for Home or Profit. Free Details. Stewart's Budgetwater, Mass.

NEW Type Filter That Fits Into Hot-Air Register. Easily Installed. Keeps Atmosphere Dust-Free. Ends Halo of Dirt Which Accumulates Around Register. Free Literature. Modern Metal Products, Warren, Ohio. Wholesale Hardware Distributors Wanted.

LIKE to Make Extra Income at Home? Proven Mailorder Plans Show How. Free Details. Perry Publications, Wenatchee 2, Washington.

WATCHES. Elgin, Waltham, other outstanding brands. Expertly reconditioned, priced low for quick, great profits! Send for FREE catalog. Plymouth Jewelry, 163P Canal St., New York 13, N. Y.

METALLIZE Baby Shoes. Excellent profits. New system assures success. Free details. Treasures Forever, 38 Michigan Ave., Lynn, Mass.

MORE Money—Easier! Revolutionary methods make public bookkeeping easy, interesting, profitable. Earn to \$5.00 hourly within short time! Simple, complete instructions. Full-spare time. Success-revealing information free. Auditax Systems, 10775 V Tabor, Los Angeles 34.

\$5,000 YEARLY. Operate Candy Cigar Store. Small investment. Send \$1.00 "Your Store"—Book on retailing. Dept. S 198-09 Hollis Ave., Hollis 7, N. Y.

MAILORDER failure? My simple "Magic Formula" works miracles! Write: President, The Mailord Company, 204-A East 81, New York 28, N. Y.

BEST Source For Nylons. Rich Supply, 215 W. 98, New York 25.

LIQUID Marble—Colorful, glossy! Molded. Brushed, sprayed! Cast Novelties, Statuary, Colored Tiles, Flexible Molds, Composition Floors, Particulars Free. Marbelizing Service, Edwardsville, Ill.

BABY Shoe Mountings: All metal. Latest Design. Photo Frame, Bookends, \$2.50 each. Sample \$2.25. Hampton Enterprises, 135 Clendenny Ave., Jersey City.

BUY Wholesale. Big-Name Items Up To 40% Below Retail. Folks Eagerly Buy Through You To Get Big Savings. Details Free. Young's, Kent 2, Ohio.

57 MONEY MAKING OPPORTUNITIES

DETECTIVES Earn Big Money. Experience unnecessary. Particulars free. Wagoner, P-125, West 86th, N. Y., N. Y.

SCHOOL Seniors—Earn 40% commission selling classmates America's Most Beautiful Graduation Name Cards. Largest selection. Outsell all others. Free sample kit. Printcraft, Dept. M, 1425 E. Elm Street, Scranton 5, Pa.

WANT Notary Public appointment? Official in usually 10 days. Stationers Exchange, Boerne 50, Texas.

SEWING Machine Business Tops. Big money—not crowded. Spare time home set-up. Repair course, new machines, motors, etc., wholesale. Hurry. Taylor Service, PS, Hamilton, Ohio.

RAISE Ginseng. Roots Bring Fortunes. Circular. Fezler Seed Company, Patchogue, New York.

"**URANIUM**—is currently the world's most-prized material. Full particulars Free. Write Sharpe, Prospector, Box 142, North Battleford, Canada."

NEW way. Earn \$50 weekly working at home. We show you how. Ability in simple arithmetic essential. Write for literature. Dollar-a-Month Plan, Box 5236-B, Phila. 26, Pa.

POPULAR SCIENCE OPPORTUNITIES

OPERATE concessions at carnivals, shows, fairs. Free details, Stampico, Detroit 4, Mich.

WIN Contest Money. General Contest Bulletin gives hundreds of tips. Lists current contests and rules. Sample 25c. General Contests, 1609-A East 5th, Duluth, Minnesota.

DELIGHTFUL Plans! Australia, South American. Free Book "372 Unusual Worldwide Business." \$800.00 month reported. Work home (U. S. A.)! Get surprise! Publishers, Carlsbad, Calif.

"OPPORTUNITIES Preferred Magazine" tells how. Sample 25c. Glen, Howel 5, Kentucky.

WOULD You pay 3%—first \$350 made? Book "505 Odd, Successful Enterprises" free. Expect something odd! Pacific, Oceanside, Calif.

ELECTRICALLY Inclined? Make \$100-\$250 weekly installing, maintaining fluorescent lighting. Make beautiful lights for 50c each. Exclusive, inexpensive, illustrated instructions enables you to cash in on this fast growing industry. Request impressive evidence on this proven business opportunity. Wilber Distin "Fluorescent", 401 Foote Bldg., Syracuse 2, N. Y.

"WESTERN Advertiser" offers many worthwhile moneymaking opportunities. Sample copy—3c. Harold E. Edlund, 577 Kensington, Los Angeles 26, Calif.

HAVE your own big-money business! Others are making up to \$500 monthly in waterproofing and cement painting. Let me prove you may do as well! Few dollars starts you. Interesting facts free. Write today! Edgar W. Thomas, Barnesville 1, O.

EARN Money evenings, copying and duplicating comic cartoons for advertisers. Adservice, Argyle (2) Wisconsin.

MEN-Women—"Everybody Likes Candy." Learn to make professionally. Details free. (Our 40th year.) Ragsdale Candies, D10, East Orange, New Jersey.

GET your copy of the new 1950 edition of the official Concessionaires Guidebook. 76 Pages, jam-packed with money making formulas, M.O. ideas, games and equipment for concessions, roadside stands, carnivals, etc. Send \$1.00 to: Concessionaires Guidebook, Station H Zone 13A Toledo 6, Ohio.

58 FORMULAS, PLANS, ETC.

10,000 FORMULAS and trade secrets. Free Literature. Stillmans, 555 Kingston Ave., Brooklyn 3, N. Y.

LABORATORY tested formulas. Lists free. Pont, Box 635-PS, Terre Haute, Ind.

BE Independent. Fifty Valuable Formulas. Only \$1.25 complete. Youngs Productions, St. Helens, Oregon.

FREE Formula Catalog anything analyzed \$20.00. Western Chemical, Salem, Oregon.

59 PLASTICS

PLASTIC supplies, materials, instructions for hobby or business. Send for free catalog. Tells about internal carving. Hays Plastics, 2333 Lincoln Avenue, Alameda, California.

LUCITE. Plexiglas. Any size sheets, masked. Square foot (12 x 12) cost, 1/16", 96c; 1/8", \$1.25; 3/16", \$1.52; 1/4", \$1.80. Colors add 10%. Include 10% postage. Almac Plastics, 230 Fifth Avenue, New York 1, N. Y.

INTERNAL Carvers—guaranteed fast cutting, high speed, tapered drills with sharp points that make carving easier. 1/16", 3/32"—\$.80; 1/8"—\$1.00 each postpaid. Send for literature. Bay Sales, 101 Fifth Ave., N. Y. 3, N. Y.

WHOLESALE Plastics supply catalog, 10c. Lucite, clear, colored. Metallic Acetate, 15 colors. Thick Lucite cutoffs, polished blanks for carving. Metal findings, tools. Ideas, bargains galore. Quantity prices on Casting Plastic, Gem-O'-Lite, Box 686Y, North Hollywood, Calif.

PLASTIC. Sheets, Rods, Tubes, etc. Free List. Plastic Supply Co., 2901 N. Grand Blvd., St. Louis 7, Mo.

NEW Liquid Plastic. Clear, colors. Cast without heat. Embed flowers, insects, coins. Saw, drill, carve. Send 35c for exciting new home project manual showing how to get started. Castolite, Dept. B 102, Woodstock, Illinois.

PLEXIGLAS—Write for Free Price List. The Unique Glass Shop, 309 Cowardin Ave., Richmond, Virginia.

MAGNIFICENTLY carved plexiglas wall plaques 2 1/2" x 3/4" \$3.39 pair postpaid. Free plastics Supplies Catalogue. Craft Plastics, Somerville, New Jersey.

INTERNAL carved roses, orchids, swans, goldfish, butterflies, etc. Jewelry and gifts. Crystal Floral Novelty Co., Bound Brook, New Jersey.

AMAZING! Internal carving drills, high speed steel, super fast cutting, professional type. Double spiral hand finished. 3/32" or 1/8". 75c each postpaid. Special! Any carving drill reconditioned 40c. Send for literature. Plasticrafter's, Dept. P, Box 68, Ft. Hamilton Station, Brooklyn 9, N. Y.

60 CHEMICALS AND APPARATUS

NEW Idea Chemical and Apparatus Outfits for Home Experimenting. Photo-Scales, Microscopes, Chemicals, Biological and Laboratory Supplies in Small Quantities. Catalog 15c. Established 1931. John H. Winn, 124-B West 23rd Street, New York, N. Y.

LUMINOUS Paints will glow in dark. Six colors. Fairmount Chemical Co., 136 Liberty St., New York City 6.

NEW. Used Catalog 10c refundable. Atlantic Laboratory Supply, 21 Wenham, Boston JP, Mass.

NEW catalog: Chemistry, mineralogy, biology, physics 10c. Tracey Laboratories, Evanston, Ill.

SNOOPERSCOPE Tube Permits nighttime vision. Tube and complete instructions \$14.95. Infrared filters 15c. Voltmeter, Oscillator Kit Special \$2.95. Precise, 942 Kings Highway, Brooklyn 23, N. Y.

CHEMICALS and apparatus for industrial, analytical, and private laboratories. Catalog 15c. Dept. M-26, Biological Supply Co., 1176 Mt. Hope Ave., Rochester 7, N. Y.

NEW Laboratory supply catalog of Chemicals and Apparatus. Contains many thousands of items with illustrations. Send 25c. Standard Science Supply Company, 1232 N. Paulina St., Chicago 22.

61 HELP WANTED

IMMEDIATE opening for reliable man with car to call on farmers. No experience necessary. \$15 to \$20 in a day. Permanent. Mc Ness Company, Dept. 214, Freeport, Ill.

FOREIGN Employment. Construction men, building trades mechanics, helpers, office men. Good workers needed for oil projects, mining, pipe lines, dams, power plants, roadways, shipping, etc. Transportation and quarters furnished; high wages. Listings of firms actively working and hiring on projects in South America, Arabia, Asia, Africa, Alaska, Central American, etc. Send \$1.00 for foreign construction compendium and application forms. Foreign Service Bureau, Dept. PS-2 Employment) P. O. Box 295, Metuchen, New Jersey.

INTERESTED in Latin American and Foreign Employment??? \$1.00 Brings 1950 Copyrighted "Foreign Service Directory" with new complete listings in US & Canadian Construction Companies; Worldwide Oil Firms, Mining, Aviation, Steamship, Transportation; Manufacturers; Importers & Exporters; Domestic & Foreign Listings. Special Daily Listing of firms hiring. Tells How-When-Where to apply, application form. Global Reports, P. O. Box 883-S, Hollywood 28, Calif.

ALASKA—The Great American Frontier offers unlimited opportunities. \$1.00 brings 1950 Copyrighted Report & Government Map. Business Directory listing Big Construction Projects: Fishing; Mining; Aviation; Hunting—Fishing-Game rules. Fur-Farming, Lumber; Agriculture; Live Stock Raising; Transportation; Homestead & Highway information. Hot list of firms hiring. Alaska Opportunist, P. O. Box 883-S, Hollywood 28, Calif.

JOB openings. Industries presently hiring. Wages, Housing, Rentals, Living Costs, etc. Complete Information. \$1. Free Map included if sent Today. Opportunities in California, Box 202-S, Los Angeles 34, California.

TAKE orders at home. Spill coffee or ink on 275 sq. inches of Free fabrics, demonstrating sensational tablecloth invention. Not ordinary plastic. Withstands 16 years cleanings. Styleco, Dept. 74, Cincinnati 10, O.

MAKE \$20 a day! Complete line. Door name plates, knockers, numbers. Hub-stamp, 359-B Congress, Boston, Mass.

62 AGENTS WANTED

PHOTO-Salesmen-Agents. Sell beautiful hand-colored plastic enlargements. Collect deposit, we deliver. Profitable sideline. Send card for free sample kit. Novel Portrait Co., 3343-A North Ave., Chicago, Ill.

SEWING Machine electrification kit. Nationally advertised. Has Good Housekeeping Guaranty Seal. Can be demonstrated and sold in 5 minutes. Make at least \$5 per sale. For complete details write today to Brownell Distributors, Inc., Dept. PS, 308 Canal St., New York 13, N. Y.

BE Renewal Headquarters for all magazines. Big profit in Christmas gift sales now. No experience—No capital needed. Free Catalog tells how. Write: McGregor Magazine Agency, Dept. 510A, Mount Morris, Illinois.

NYLON, Poplin, Rayon Uniforms, white and colors. Immediate Delivery, Immediate Profits. Sell to Doctors, Dentists, Nurses, Waitresses, Beauticians, Housewives. Free Sales Kit, Superior Fabrics, Dept. A-1, 3936 Market St., Phila. 4, Pa.

FAST profits—No investment. Send for big, free catalog. Plastic aprons, tablecloths, etc. 150 sure-fire items. We guarantee sales. Write The Halliday Company, Dept. P-2, 347 Broadway, Passaic, N. J.

DRESSES 18c; Men's Overcoats \$1.00; Skirts 50c. Free Catalog. Crown, 164-PS Monroe St., New York 2.

LOOK! Make money all year round selling personal initialed individualized belts, buckles, cap badges, tie holders, complete line Police and Firemen's Badges, 2000 emblems to choose. Big profits, whole or part time. Please write today special outfit offer. Hook-Fast Specialties, Box 1425, Dept. 7, Providence, R. I. Established 1926.

WHERE To Buy 800,000 articles direct from Manufacturers. Save by buying direct. Sent Free. "Your Profits Under the Spotlight." Glass Pub. Co., Ellwood City 3, Pennsylvania.

ADVERTISING book matches—Cash in on big demand—sell Union Label matches. Cuts for all businesses and political parties—Free powerhouse selling kit—low prices—protection guaranteed on repeat orders—Cash commissions. Superior Match Co., Dept. P-250, 7530 Greenwood, Chicago.

GOLD lacquered Window Sign Letters. Large Sizes Penny Each. New Folds. Absolutely Beautiful. Free Samples, Atlas, 544 W. 79th, Chicago 20.

MAKE Money Fast. Sell gorgeous, new Metal and \$1 Plastic Greeting card assortments. 100 other sell-on-sight items. 21 All-Occasion cards for \$1.00. Birthday, Easter, Relative cards, Wrappings, Scented Stationery, Gifts. Amazing profits. Bargain offers. Write for Samples on approval. Hedenkamp, Dept. PS-4, 361 Broadway, New York.

AMAZING Offer—\$40 is yours for selling only 50 boxes. Also entirely different, new Deluxe All-Occasion assortment with television card, Little Pearls, Hankie Gift Greetings, other surprise items. Feature boxes on approval. Free samples imprinted stationery and Rose Scented Notes. Write today. It costs nothing to try. Cheerful Card Co., 1155, White Plains, N. Y.

BETTER way to extra money! Sell outstanding new Plastic, Metallic greeting cards, Gift Wrappings, Scented Stationery. Profits to 100%. Bonus. Request free samples exclusive Name Imprinted and Floral Stationery, free catalog and Feature All-Occasion samples on approval. Special offers. New England Art Publishers, North Abington 203, Mass.

POPULAR SCIENCE OPPORTUNITIES

FREE Nylons given if Kendex hosiery runs or snags. World's only women's hosiery sold with written guarantee amazing everybody. Mere words could not express unbelievable money making opportunity. Fantastic earnings become reality. Armstrong earned \$202 in 9 days. Watkins sent 92 orders in one day. Imagine replacing hosiery free regardless of cause—whether use or abuse! Truly sales dynamite for terrific profits. Even if you never sold before, three magic words: "Guaranteed Against Everything" will open doors for you—make women listen and pour money in your pocket. Nationally advertised in Life, Ladies Home Journal, Saturday Evening Post, McCall's and Woman's Home Companion. Awarded Seal of Approval by Good Housekeeping. 75 million readers will see Kendex advertising to help you make quick sales and big money. Complete line from sheerest 15 denier 51 gauge to heavy 70 denier service. Sizes 8½ to 11½; lengths 28 to 35 inches; latest fashion colors plus white; full fashioned seamed and seamless. No competition because Kendex nylons are not sold in stores. Also complete line men's hosiery actually guaranteed for one full year or replaced free. Nothing like this anywhere. Includes rayon, nylon, lisle, wool, cotton, mixtures, etc. All styles, patterns, colors, prices to please everybody. 200,000 pairs constantly in stock for fast delivery. Thousands shipped daily. Over 30 years in business. You need no money or experience. Nothing to pay now or later. Just show free outfits. Write orders. We deliver and collect. Big advance cash plus huge bonus. Earn money spare or full time—exclusively or as side line. No restrictions. Become manager—appoint others to sell for you—earn steady income on their sales. Man or woman, young or old, experienced or beginner, you can make money and friends writing orders. Everything you need is furnished free, including sales books in color, samples of hosiery materials etc. Simply write your name and address on postcard and make money next week with money-making outfits sent free and prepaid. No obligation. Kendex Company, Babylon 54, New York.

FREE Samples, and amazing plan, giving you Gorgeous Dress without penny cost. Rush name today, with dress size. Harford, Dept. B-335, Cincinnati 25, Ohio.

ABSOLUTELY Free! Big package actual sample fabrics and style presentation of dresses, lingerie, hosiery, etc. Take orders. Commissions big. Send no money. Melville Co., Dept. 5279, Cincinnati 3, Ohio.

MAKE Money Calling on Friends. Show nationally advertised Greeting Card Assortments—16-Card All Occasion Assortment only \$1.00—also Birthday, Gift Wrapping, Plastics, Imported English Napkins, Floral Stationery, Children's Books, many more! Up to 50c profit on each assortment. Experience unnecessary. Samples on approval. Write Wallace Brown, 225 Fifth Avenue, Dept. H4, New York 10.

BE Renewal Headquarters for all magazines. Handle everything at home. Big profits. No experience—no capital needed. Free Catalog tells how. Write: McGregor Magazine Agency, Dept. 510A, Mount Morris, Ill.

SELL DuPont Nylon Uniforms. Complete line famous exclusive Hoover styled nylon uniforms for beauty shops, Nurses, doctors, Waitresses, others. Best quality, splendid values. Exceptional income. Real future. Equipment free. Write fully, Hoover, Dept. B-102, New York 11, N. Y.

FREE Samples. Big profits showing amazing Glow-In-The-Dark Specialties. House numbers, pictures, plastic novelties, ashtrays, keyholders, religious and nursery objects, etc. Madison Plastics, 303 Fourth Ave., New York 10, N. Y.

EXCELLENT Sideline for printing and advertising salesmen. Decalomania name plates in small quantities. Great demand. Also, make money with our line of Automobile Initials and Sign Letters. Free Samples. "Ralco", XL-Roxbury, Boston 19, Mass.

MORE money—so easy! Sell distinctive new greeting cards, stationery. Fast selling Plastic, Metallic, 3-dimension, 21-card \$1.00 All-Occasion assortments. Profits to 100% Exclusive Gift Wraps, Novel "double" cards, Animated Books, Gifts, Bonus. Special offers. Write for free samples exclusive Name Imprinted Decorated Stationery and feature All-Occasion samples on approval. Elmira Greeting Card Co., 2210 Elmira, New York.

NEW! Stainless steel window guard. Foils prowlers! Literature, samples: \$1. Artware Corporation, 11110 Ventura Blvd., North Hollywood, California.

START Your Own Business on Credit. Always your own boss, 1554 Dealers, sold \$5,000 to \$26,500 in 1948; their average \$6,742. We supply stocks, equipment on credit, 200 home necessities. Sales experience not needed to start. Wonderful opportunity to own pleasant, profitable business backed by world-wide industry. Write Rawleigh Co., Dept. B-U-PSC, Freeport, Ill.

FREE! Big box actual full-size packages groceries, home needs, sent Free F.O.B. factory. Try them at home and show friends. World-beating money-making opportunity. Write Zanol, Dept. 8091-B, Richmond St., Cincinnati 3, Ohio.

BIG Bargains for Big profits. Over 100 sensational values. Men's used suits \$2, pants 35c, topcoats \$1.25, overcoats \$2, shoes 20c. Experience unnecessary. Free wholesale catalog. Superior, 1250-B Jefferson, Chicago 7.

NOW we are positive! Pro-Check-Tor—the \$3.95 check protector designed for everyone will be the sensation of 1950. You can make thousands, 23,000,000 waiting prospects. Don't pass up this opportunity. Federal Pro-Check-Tor Co., 627-D Grove, Evanston, Ill.

EXTRA Money! Sell new, different greeting cards. Complete line includes Regal Plastic assortment, metallics, "Stand-Up" and "double" cards. Free samples Exclusive Imprinted and Engraved Stationery. Sales Kit on approval. Regal Greetings, Dept. PS-12, Hazel Park, Mich.

ENJOY earning \$85.00 weekly selling shoes direct. Experience unnecessary. No investment. Advance commissions. Bonus. Free outfit, Samples, Paragon Shoes, 738 Columbus, Boston, Mass.

AGENTS. Sell finest food products direct to homes. Successfully sold for 25 years. Big profits. Powerful combination sale plans make sales easy. Permanent repeat business. Powerful premiums and free door openers for easier sales. Samples furnished. Live territories open to distributors. Mother Hubbard Products Co., 4139 Grand, Dept. S-Z, Chicago.

NEW "Sponge" Wall Cleaner. Erases dirt like magic. Wallpaper, painted walls, ceilings. Saves redecorating. Lightning seller. Samples sent on trial. Kristee 143, Akron, Ohio.

STRANGE "Dry" Window Cleaner. Sells like wild. Replaces messy rags, liquids. Simply glide over glass. Samples sent on trial. Kristee 144, Akron, Ohio.

BE first! Sell this sensational new assortment. Contains everything but the food... The invitations, table cover, napkins, nut baskets, place cards, snapper hats, cups, plates, game booklet and six different games: a complete party for eight. Sample \$1.25. Also America's leading greeting card line featuring personalized stationery, napkins, book matches and exclusive new Wedding invitations. Free Samples. Elmcraft Chicago, 5930 S. Western, Chicago 36, Illinois.

EXCLUSIVE Agency. Power Mowers—\$49.50. Delivered. Modern, 7401-PS, North Kansas City, Mo.

SELL ultra-blue stock signs to stores, 1000 slogans, comedy, general, religious. "7x11" cost 6c—Sells 35c—Make money. 15 samples Ultra-blue signs "7x11"—\$1.00 postpaid. L. Lowy, 8 West Broadway, Dept. 524, New York City.

YOU positively sell our Business Cards By Mail. Successful "Beginners" plan gets you lifetime repeat mail orders, free details. Lynn, 5710-C Bankfield, Culver City, California.

LOOK! Make money all year round selling personal initialed individualized belts, buckles, cap badges, tie holders, complete line Police and Firemen's Badges, 2000 emblems to choose. Big profits, whole or part time. Please write today special outfit offer. Hook-Fast Specialties, Box 1425, Dept. 7, Providence, R. I. Established 1926.

DOUBLE Your Income—Sell wool and Cotton uniforms, Badges, Initial Buckles, Belts, etc. Write Hook-Fast, Box 480PS, Roanoke, Virginia.

SELL Big Money-Maker to men and Women. Easy handwork makes fast-selling useful articles. Sample free. Sunmade Company, Brockton 64, Mass.

SELL Slot Machines, Games, Home Bars. Send for wholesale deal. Webb Distributing Co., 4958 West Chicago Ave., Chicago 51, Ill.

\$1 starts you in business. Sell top quality \$1.00 ties. Now only \$7.20 dozen, your profit \$4.80 dozen. Regular \$1.50 up values. Send \$1.00 for Introductory Offer two ties. Catalog complete line free. Philip's Neckwear, 20 West 22nd St., Dept. P-39, New York 10, New York.

MEXICAN feather pictures. Big Profits! No investment! Details, sample, 10c stamps. Sylvias, Apartado 9036, Mexico City.

MAKE \$50 selling America's leading All-Occasion greeting card assortments. Samples on approval. Complete line fast money makers—free samples imprinted and monogrammed Stationery, Napkins and Guest Towels. Write Lorain Art Studios, Dept. AP, Vermilion, Ohio.

MAKE money selling all-occasion and plastic cards, Stationery, Wrappings, shopping bags, children's books and phone book covers. \$1.00 for samples start you in business. Pascale Greeting Cards, PSJ, Irvington 11, New Jersey.

BUY thousands of nationally advertised products direct from manufacturers and distributors. Write for "Buy Direct and Save". Service Publishing, 218-B Investment Bldg., Pittsburgh 22, Pa.

WOULD you pay 3%—first \$350? Book "505 Odd, Successful Enterprises" free! Work Home. Expect something odd! Pacific, Oceanside, Calif.

BIG Profits—amazing safe-Lock (for cars with center opening doors) locks rear doors; children can't fall out. Dollar item sells on sight! Send 50c for sample and details. Safe-Lock, Box 1071-M (PS2), Pasadena, Calif.

SELL new—used clothing from home, auto. store. Men's suits \$1.25. Leather Jackets 85c. Overcoats 56c. Dresses 18c. Ladies' coats 38c. Other Bargains. Catalog Free. S&N, 565-G Roosevelt, Chicago.

NOT a get-rich-quick-scheme but honest endeavor can build astonishing profitable business. Every home, factory, institution a genuine prospect. Big repeat orders. Ask for details about Proloc, the miracle finish and protector for wood and metal. Protected territory. Own and develop your own business. Write Widger Products Corporation, Route 5, Alexandria, Virginia.

SELL!! Balloons, Combs, Specialty Merchandise. Carleton House Distributors, Texas City, Texas.

SELL \$2 Fire Extinguishers. Locally mailorder. Lorrac Products, Albany 1, N. Y.

FREE Literature—Thousands Wholesale supply sources. Moneymaking Business ideas. Wilkin, Hillsboro 4, Ohio.

EXCELLENT sideline. No selling—easy repeat earnings. Inquire Modern Technical Supply, 55-PS West 42 Street, New York 18.

NEWEST money-making sensation, miniature authentic replicas, police and firemen's badges also pocket pieces, key chains. Write for descriptive folder. Hook-Fast Specialties, Dept. 23, Box 1425, Providence, R. I.

63 HIGHGRADE SALESMEN

BIG Money Taking Orders: Shirts, Ties, Sox, Pants, Jackets, Sweaters, Shoes, Uniforms, etc. Sales equipment free. Experience unnecessary. Nimrod, 4922-AV Lincoln, Chicago.

POPULAR SCIENCE OPPORTUNITIES

SALESMEN. Earn \$50.00 weekly, selling only three pairs shoes daily. Commission and bonus. Wide variety for men, women, children. No investment. Experience unnecessary. Free catalog. Tanners Shoes, 560 Boston, Mass.

START your own business on Credit. Always your own boss, 1554 Dealers, sold \$5,000 to \$26,500 in 1948; their average \$6,742. We supply stocks, equipment on credit, 200 home necessities. Sales experience not needed to start. Wonderful Opportunity to own pleasant, profitable business backed by world-wide industry. Write Rawleigh Co., Dept. B-U-PSC, Freeport, Ill.

SALESMEN—Sell America's finest, biggest line of Adv. Specialties. Sensational sellers to all types of business. Big commissions advanced. Sensational sales plan nets you top earnings. Free Outfit. Charms & Cain, 407-D South Dearborn, Chicago 5.

"SELL New Automatic Floor Waxer." Trigger on Handle. Hands never touch Floors or Wax. Retail \$2.95. Profit 125%. Write Smith, Inc., Greenfield 6, Mass.

SALESMEN—absolutely make \$50.00 a day. New sensational utility item for every food, beverage outlet, etc. Samples furnished. Johnson-Hill, 53-B West Jackson, Chicago 4.

RAT-SNAP 35c, 60c, \$1.00 Sizes. Also Seeded-Ferto-Soil and Ferto-Pots. Allen Company, Pittstown, N. J.

SALESMEN—Put yourself in line for big money, real future. Keep stores supplied with 5c-10c to \$1 counter goods. Nationally advertised. Top profits for you and merchants. Liberal deals boost sales. Side-line or full time. World's Products, Dept. 83-D, Spencer, Ind.

EARN Big Money Fast! Sell finest quality advertising work uniforms to garages, factories, filling stations, etc. Free selling kit. Topps, Dept. B-20, Rochester, Ind.

67 EDUCATIONAL AND INSTRUCTION

BE A real estate broker through home study or classroom instruction. Write for free book. Approved for veterans. Weaver School of Real Estate, 15 E. Pershing Rd., Box PC-11, Kansas City 8, Mo.

WANT a steady Big Pay Job in Diesel? Our approved, easy-to-understand Diesel Training Course qualifies you. Placement advisory service Free. Learn as you earn. Write for free 24 page book today! Interstate Training Service, Dept. 2N, Portland 13, Oregon.

HYPNOTISM. Complete course, 20 illustrated lessons \$1.00, moneyback guarantee. Baltimore School of Hypnotism, Dept. 23-A, 4214 Belmar Ave., Baltimore 6, Md.

BOOKKEEPERS! Increase your earnings! Operate your own simplified "Dollar-A-Week" Bookkeeping and Tax Service. Full or spare time. Details Free. No obligation. Ellis, Box 203, Cedar Grove, North Carolina.

PIANO Tuning Pays. Learn this profitable profession at home. Our Tonometer and mechanical aids make learning easy. No knowledge music necessary. Diploma granted. Largest and oldest school—51st year. G. I. Approved. Write for booklet. Niles Bryant School, 77 Bryant Bldg., Washington 16, D. C.

INCREASE your Poultry Income—thorough knowledge means greater success. Our interesting, practical, home study course has trained thousands during past 29 years. Don't delay—write today for free booklet describing courses, methods, opportunities. National Poultry Institute, Dept. 73, Adams Center, New York

MAKE Up To \$35-\$45 Week as a Trained Practical Nurse! Learn quickly at home. Booklet free. Chicago School of Nursing, Dept. M-2, Chicago.

SELFSTUDY Courses: Triplespeed Nuabc Shorthand, high school, college. Bulletin Free. Capital City College, Washington 5, D. C.

EXPORT! Learn at home from established World Trader. Big paying positions. Your own profitable world-wide business by mail order without capital; or travel abroad. Experience unnecessary. Free booklet. Mellinger, 202 W. Los Angeles 24, California.

LEARN the Collection Agency business. Highly profitable. Easily mastered. Free folder. Cole Associates, Syracuse 2, N. Y.

LEARN Piano Tuning, Repairing—at home in 30 days. Unlimited income. Phonograph recordings, tools and instructions furnished. Write Capitol City Tuning Co., Department C-233, 129 East Michigan, Lansing 16, Michigan.

BECOME a Doctor of Psychology or Metaphysics. Teach secret of contentment, happiness. Win degree of PsD, or MsD. Solve mental worries. Free book. College of Universal Truth, 5153-K N. Clark, Chicago.

LEARN Gunsmithing. Details and copy "Guns and Gunsmithing," 25c. Gunsmith's, Palatine, Illinois.

MEDICAL Laboratory Technicians in great demand. We train you in your own home. Catalogue free. Imperial Technical Institute, Box 973-B, Austin, Texas.

WANT U. S. Government Job? Start high as \$66.35 week. Men-Women! Qualify Now for secure positions. Many openings expected. Experience usually unnecessary. Write for Free 40-page book showing jobs, salaries, sample tests. Franklin Institute, Dept. B-22, Rochester, N. Y.

PHOTOGRAPHIC mind with Super-memory, write Thor Books, S-11, Box 1210, Chicago.

USED Correspondence Courses and Educational Books. Bought, Sold, Rented. Catalog Free. Educational Exchange, Summerville, Georgia.

WATCHMAKING. a dignified, profitable profession. Complete course with necessary tools available under the G. I. Bill. American Academy, Inc., Room 457, 1549 Lawrence Street, Denver 2, Colorado.

YOU For President of your own credit-collection business. Many who answered our ads now have their names on office doors. Franklin Credit, Roanoke 7, Va.

68 DANCE INSTRUCTION

CONQUER Danceritis! Free Aptitude test—lessons. Danceology, 35-W Warren, Youngstown, Ohio.

69 CONTESTS

WIN Cash, Cars In Prize Contests! Write for copy filled with current contests, winning hints and tips. Send only 25c. Wright Contest Digest, Dept. 20-B, P. O. Box 2266, St. Louis 9, Missouri.

70 LANGUAGE OUTFITS

LINGUAPHONE Makes Languages Easy. At home learn to speak Spanish, Portuguese, Italian, French, German, Russian, by quick, easy Linguaphone conversational method. Save time, work, money. Linguaphone Institute, 54 RCA Bldg., New York 20, N. Y.

72 AUTHORS SERVICE

I WANT New Writers to cash checks of \$1 to \$100 offered daily. The easiest way to write for pay. No previous experience necessary. Free Details. Saunders M. Cummings, 468-15 Independence Bldg., Colorado Springs, Colo.

74 CARTOONING, SIGN PAINTING, DRAWING AIDS

"HOW to make money with simple cartoons". A book everyone who likes to draw should have. It is free; no obligation. Simply address Cartoonists' Exchange, Dept. 192-C, Pleasant Hill, Ohio.

CARTOON Your Way To Success! Internationally known instructor, Raye Burns, will personally teach you to create salable, original cartoons at home. Course of 26 lessons only \$2.85. Send remittance with order or write for Free Details and addresses of successful students. Raye Burns School, Box 3583-S, Cleveland 18, Ohio.

SIGN painting taught at home. Test lesson free. Ben Kerns, Box 812-PS, Greenville, S. C.

9 ALPHABET 3 Numeral pattern sets and catalog. \$1.00. Sign Letter Distributors, P. O. Box 101, Mineola, N. Y.

75 CHALK TALK-STUNTS

CHALK Talks. Laugh Producing Program. \$1.00. Illustrated Catalog 10c. Cartoonist Balda, Oshkosh, Wisconsin.

76 TYPEWRITERS AND OFFICE MACHINES

TYPEWRITERS \$17.50; Duplicator \$9.95, adders \$12.50. Typewriters, 118 Spruce, Wichita, Kansas.

77 OFFICE SUPPLIES & EQUIPMENT

MIMEOGRAPH Paper, 68c Ream, samples. Brookman, 56-C West 24th, New York 10.

ABACUS. Loy's. Does work of adding machine and slide rule. \$6.50. Details Free. Loy's, 1317 Rhode Island Ave. N. E., Washington 18, D. C.

78 RUBBER STAMPS

3-LINE Stamp, 90c. S&O Rubber Stamps, 24½ S. Clinton, Iowa City, Iowa.

79 PRINTING OUTFITS, SUPPLIES

PRINTING Presses, type, supplies. Send stamp for details or dime for complete illustrated printer's supply book and samples. Kelsey Corp., J-8, Meriden, Conn.

PRINTING Presses, Type Supplies, Lists 3c. Turnbaugh Service, Loysville, Penna.

MAKE Your Own rubber printing cuts. Self-molding process. Plexirubber, Argyle 2, Wisconsin.

80 PRINTING, MULTIGRAPHING, ETC.

MIMEOGRAPHING; Free samples! Topical Emprise, 1527 Highland, Box 42 B, Louisville 4, Kentucky.

QUALITY Printing—Low prices—Complete line. Everything prepaid. Price list free. Albert Wilcox, Nicholls, Georgia.

1000 BUSINESS Cards \$2.50 Prepaid. Samples free. Reliable Print Shop, 905 East Jefferson, Louisville 6, Ky.

1000 BUSINESS Cards \$1.85. Prepaid. CPR, 914 E. 217 Street, Bronx 67, N. Y.

ENVELOPES; Hammermill Letterheads; 100—\$1.00. Odom Supply, Box 9345, Tampa, Florida.

FREE! Wedding Invitation Samples. Same Day Service. Scholler, 530 Dunloe, Pittsburgh 12, Pa.

500 ¾ x 2¼ PRINTED stickers 50c. 500 2 x 3 Two Color Shipping Labels \$2.25. General Printing, Willis Myers Company, Owasco, Michigan.

1000 8½ x 11 Photo Offset \$7.50. Printing, Mimeographing. Other prices equally reasonable. Send dime (refundable) for Pricelist. Mimic Reproductions, 383P No. Corona, Valley Stream 2, N. Y.

82 PATENT ATTORNEYS

PATENT practice before U. S. Patent Office. Validity and infringement investigations and opinions. Booklet and form "Evidence of Conception" forwarded upon request. Lancaster, Allwine & Rommel, Registered Patent Attorneys, Suite 413, 815—15th St. N.W., Washington 5, D. C.

C. A. Snow & Co.—S-427, Snow Building, Washington 1, D. C. Registered Patent Attorneys. Write for information.

PATENTS—Trade Marks. Patent Lawyer. Gustave Miller, 20-B Warner Building, Washington 4, D. C.

INVENTORS—Patent Laws encourage the development of inventions. The Rules of Practice of the U. S. Patent Office advises—unless an inventor is familiar with such matters—that he employ a competent registered attorney or registered agent, as the value of patents depends largely upon the skilful preparation of the specifications and claims. Write for further particulars as to patent protection and procedure and "Invention Record" form at once. No obligation. McMorro; Berman & Davidson, Registered Patent Attorneys, 143-P Victor Bldg., Washington 1, D. C.

REGISTERED Patent Attorney offers services. Sanders, 6430 Evans, Chicago 37, Illinois.

INVENTORS: Without obligation, write for information explaining the steps you should take to secure a Patent. John N. Randolph, Registered Patent Attorney, 207 Columbian Bldg., Washington 1, D. C.

POPULAR SCIENCE OPPORTUNITIES

INVENTORS: Learn how to protect your invention. Unless the inventor is familiar with patent matters, he should engage a competent registered patent attorney or agent to represent him. We are registered to practice before the U. S. Patent Office and prepared to serve you in handling your patent matters. "Patent Guide for the Inventor" containing detailed information concerning patent protection and procedure with "Record of Invention" form will be forwarded to you upon request—without obligation. Clarence A. O'Brien & Harvey Jacobson, Registered Patent Attorneys, 02B-A District National Building, Washington, D. C.

INVENTORS: When you are satisfied that you have invented something of value write me, without obligation, for information as to what steps you should take to secure a Patent. Write Patrick D. Beavers (Formerly Randolph & Beavers) Registered Patent Atty., 938 Columbian Bldg., Washington 1, D. C.

INVENTORS—If you have a valuable invention, the usual procedure is to authorize a preliminary search through appropriate classes of U. S. patents. This firm is registered to practice before the Patent Office.—is available to make such a search and report to you concerning the probable patentability of your invention. Booklet and convenient "Evidence of Invention" form sent upon request. Victor J. Evans & Co., 541-B Merlin Bldg., Washington 6, D. C.

PATENTS—Trade marks. Irving L. McCathran, 316 McLachlen Bldg., Washington 1, D. C. Registered Patent Attorney.

INVENTOR'S Guide free on request. Frank Ledermann, Registered Patent Attorney, 154 Nassau St., New York 7.

INVENTORS: Write for free brochure "Evidence of Invention." Labiner, World Building, New York 7.

83 FOR INVENTORS

INVENTORS: Without obligation, write for information explaining the steps you should take to secure a Patent on your invention. John N. Randolph, Registered Patent Attorney, 206 Columbian Bldg., Washington 1, D. C.

CASH For your idea, 280 manufacturers need inventions, patented or unpatented. List free. Invention Bureau, 208-S Clinton, Oak Park, Illinois.

INVENTIONS Wanted. Prominent manufacturers and national distributors look to us for new products. You can also benefit by having us assist you with your invention from the idea stage through to the developed product, fully protected. Ask for Booklet "P". Elo Development Co., Chatham Phenix Bldg., L.I. City 1, New York.

INVENTORS—Patent Laws encourage the development of inventions. The Rules of Practice of the U. S. Patent Office advises—unless an inventor is familiar with such matters—that he employ a competent registered attorney or registered agent, as the value of patents depends largely upon the skilful preparation of the specifications and claims. Write for further particulars as to patent protection and procedure and "Invention Record" form at once. No obligation. McMorrow; Berman & Davidson, Registered Patent Attorneys, 143-M Victor Bldg., Washington 1, D. C.

INVENTORS: Learn how to protect your invention. Unless the inventor is familiar with patent matters, he should engage a competent registered patent attorney or agent to represent him. We are registered to practice before the U. S. Patent Office and prepared to serve you in handling your patent matters. "Patent Guide for the Inventor" containing detailed information concerning patent protection and procedure with "Record of Invention" form will be forwarded to you upon request—without obligation. Clarence A. O'Brien & Harvey Jacobson, Registered Patent Attorneys, 02A-A District National Building, Washington, D. C.

INVENTORS: The usual First Step is to have a search of the U.S. Patents conducted, so I can report on Patentability. Write, without obligation. Patrick D. Beavers (Formerly Randolph & Beavers) Registered Patent Atty., 939 Columbian Bldg., Washington (1), D. C.

INVENTORS—If You consider your invention to be something of importance, take steps to protect it with a United States Patent which gives you the right to exclude others from making, using and selling your invention as claimed. "Patent Protection for Inventors" outlines steps to take to secure patent protection. Mailed promptly without obligation. Victor J. Evans & Co., Merlin M. Evans, Registered Patent Attorney, 542-B Merlin Building, Washington 6, D. C.

INVENTORS: If you have an invention for sale, patented or unpatented, write Institute of American Inventors, Dept. 30A, 1926 Eye St. N.W., Washington 6, D. C.

SEARCHES \$5.00, including patent copies. Same reliable search that we conduct for patent attorneys. Free protection forms, 48 hour service. Patent Service Institute, 945-B Pennsylvania Avenue, Washington 4, D. C.

MAKE Money From ideas. Literature Free. Grayland, 5312 Grace, Chicago 41.

"DIRECTORY of Inventor Aids" Drawer 1289-N, Clearwater, Fla. Write for free description.

COMPLETE Services for inventors. Patent searches, including analysis, patent copies. Patent applications prepared. Inventions marketed. Protection forms free. Industrial Patent Reports, Box 1081, Massachusetts Avenue and North Capitol, Washington 13, D. C.

1001 NEEDED inventions. A new bulletin listing 1001 needed inventions with sound commercial value. Put your talent to work on the right problem. Inventors' Idea Guide. Send \$1.00. Satisfaction guaranteed or return in 5 days for refund. C. J. Specialties, Box 5007, Dept. 11, St. Paul, Minnesota.

PATENTED, Unpatented, inventions promoted. M. Joyce Humphries, 1424 Landtitle, Philadelphia 10, Penna.

INVENTORS: Obtain patents without assistance. Details free. International Patent Library, 1420 New York Avenue, Washington 5, D. C.

DEDICATED to More Worthwhile Inventions; Fewer Worthless Patents; Enquire today. Dept. 325. Inventors-For-Industry Inc., 501, 1947 Broadway, N. Y. 23.

INVENTORS - For - Industry. Scientific programme for successful inventing improves quality and quantity of ideas and demonstrates modern salesways. Dept. 325. Inventors-For-Industry Inc. 501, 1947 Broadway, New York 23.

"INVENTOR'S Guide" free on request. Frank Ledermann, Registered Patent Attorney, 154 Nassau St., New York 7.

84 INVENTIONS WANTED

CASH For your idea, 280 manufacturers need inventions, patented or unpatented. List free. Invention Bureau, 208-S Clinton, Oak Park, Illinois.

INVENTORS—What have you, patented, patent pending to offer manufacturers? Booklet, information Free. Market Contacts, 11106-B2 Longwood, Chicago 43, Ill.

INVENTIONS Promoted. Patented or Unpatented. Write Adam Fisher Company, 183-A Enright, St. Louis, Mo.

HIGHEST Royalties—Cash. Request free Booklet "C." Universal Marketing Co., 354 South Spring St., Los Angeles 13, Calif.

INVENTORS: Hundreds of manufacturers have requested our assistance in locating marketable new products. Complete information, free. Institute of American Inventors, Dept. 30C, 1926 Eye St., N.W., Washington 6, D. C.

INVENTIONS Wanted. Patented or Pending only. Inventors Exchange-D, Hartford 1, Conn.

LEVEL-Headed Inventors are invited to discuss their plans with Dept. 325, Inventors-For-Industry Inc., 501, 1947 Broadway, New York 23.

IMAGINEERING: A new name for successful inventing in the World to-day. If you are inventive-minded, learn more about it. Dept. 325, Inventors-For-Industry Inc., 501, 1947 Broadway, New York 23.

89 MODELS, MODEL SUPPLIES

EVERYTHING for Miniature Steam Locomotives. 1/4", 1/2", 3/4", 1 1/2" scales. 64 page catalog 35c. Little Engines, Lomita, California.

SHIP Models—most complete line in New England. Kits, parts, plans, books. Steam and electric power plants. Illustrated catalog 25c. James Bliss & Co., Inc., 220 State St., Boston, Mass.

SHIP Model and yacht supplies, complete large 64 page catalogue, 30c. Wm. Wild, 510 E. 11th St., New York City.

STEAM engines, boilers, castings. Catalog 25c. Anton Bohaboy, 2297 Price, Rahway, New Jersey.

BRASS Gears and model supplies for the inventors. Send 10c for catalog. Pierce Model Works, Tinley Park, Ill.

BUILD Historic Ship Models, complete kits 39c to \$9.00. Catalog 10c. Ideal Models, 21 West 18th, New York 11, N. Y.

READY! Our 1950 catalog of ship model kits and fittings; sail, steam, diesel. Send 25c for catalog. Model Shipways, Folio 41, 476 Main St., Fort Lee, N. J.

91 HOME CRAFTSMEN

JUST Off The Press—8-page folder illustrated 6 beautiful, popular lamps you can make—for yourself, for gifts, or to sell others. It's fun, highly profitable—as hobby, or part or full time basis. 8-page folder, 32-page parts catalog, wholesale price list only 25c—refundable first order. Gearon Company, Dept. 400-A2, 27 South Desplaines, Chicago 6, Ill.

LEATHERCRAFT. Monthly price list guarantees best prices. Catalog free upon request. Tandy Leather Company, Dept. PS20, P. O. Box 397, Tulsa, Oklahoma.

PROFIT with Larson Leathercraft. Belts, purses, 100 other ideas. Largest supply in U. S. Catalog 10c. Larson, Dept. C, 826 S. Tripp, Chicago 24.

LEATHERCRAFT Supplies, Leather & Tools, low prices. Send 10c for catalog. Jonas Handicraft Co. (Dept. P-2) Frankfort St., N. Y. 7.

90 ALL new, full size lawn ornament and novelty patterns, up to 20" high. Only \$1.00. Mastercraft 22S, 7041 Olcott, Chicago 31, Illinois.

TOYS, novelties, furniture, garden figures, lawn chairs etc. 68 popular plans with full size patterns, \$1.00. Mastercraft 21S, 7041 Olcott, Chicago 31, Illinois.

16 NEW lawn chairs, 22 picnic tables, benches, trellises etc. All 38 plans, with necessary full size patterns, \$1.00. Mastercraft 23S, 7041 Olcott, Chicago 31, Illinois.

HOPPERCRAFT Plans to make your child happy. Child's Modernistic Chair .35. Child's Desk-table, .50. Easy construction. Instructions and drawings. Designed for child 2 to 5. Hoppercraft, 224 Mill St., Conneaut, Ohio.

UNUSUAL 8 & 16mm Films. Used by many Art Students. Write for Free Catalogue. Friart, 140 S. Liberty Street, N. Y. 6.

LEATHERCRAFT, Copper tooling, textile painting, Materials, tools, supplies. Free illustrated catalog. Kit Kraft, 7377 Melrose, Los Angeles 46, California.

BANDSAW, Jigsaw owners, let your machine bring extra profits, fun. Free details. Nu-Art, Dept. C, Box 2235, Boston, Massachusetts.

SPECIAL Offer: 80 Full Size Toy, Novelty, and lawn ornament patterns only \$1.00 Postpaid. Lynds, Box 193E, Medway, Massachusetts.

8 BEAUTIFUL Full Size Whatnot patterns 25c. Joanness, P. O. Box 141-S, Omaha 7, Nebraska.

BIG, new, practical, Factful plastics book shows how to make swell things at home with new liquid plastic. Embed real flowers, butterflies, shells, photos, to make handsome wall plaques, coasters, paper weights, trays, etc. Cast unusual book ends, candle holders, desk sets, lamp bases. Plastize baby shoes or make profile silhouette plaques of children, dear ones. Also explains proved 6-point Success plan for starting your own profitable plastics Business. Hundreds successful. Send 25c for "A Success Plan for You". Castolite, Dept. TB102, Woodstock, Ill.

POPULAR SCIENCE OPPORTUNITIES

FREE catalog! Unpainted or painted figurines, lamp bases. C. Katon, 7807—21st Ave., Brooklyn 14, N. Y.

KNOCKDOWN Cedar Chest, Lumber and Veneers. Free Price List. Giles Co., Brownsboro, Alabama.

CATALOG. Patterns: Plywood novelty furniture, lawn ornaments, silhouettes, weathervanes, letters, numerals, Decals. Books, Booklets, Hundreds illustrations, 10c. Wo-Met, Ashburn, Georgia.

BRASS, Aluminum, Steel, in short lengths. Free list, Everson, 6 Franklin Avenue, West Orange, New Jersey.

80 **FULL** sized patterns, toys, novelties, lawn ornaments, \$1.00. Modern Woodcraft, Saginaw, Mich.

LEATHERCRAFTERS: Complete supplies and leather. Free Catalog. Arts Leather, 411 Joseph Ave., Rochester 5, New York.

LEATHERCRAFT Tool Kit (Xacto) complete, Wooden Chest \$6.75. Craft catalog Free, Kale Crafts, 2252 Milwaukee, Chicago 47.

DARRA-JAMES Power Tools pay off! Save money—have fun in your own home workshop. Free illustrated Folder: Dept. P. Tool-Kraft Corp., Waterbury, Conn.

TURN your workshop into cash. Send dime (refunded first order) for catalog describing hundreds modern, saleable items. Craftplans, 1321-B South Michigan, Chicago 5.

HOBBYISTS! Draw Patterns Quickly. Easily. Handy Drawing Sheet 16" x 21" ruled 1/2 inch squares, 12 for \$1.00 Ppd. Brower, 104-46 92nd Ave., Richmond Hill 18, N. Y.

CELLULOID—New, beautiful selection, Mottles, opaques, onyx, pearls. Used by ring makers everywhere. One pound assortment, Pieces approximately 30 sq. in. each. Price \$1.00. Add 10c postage. Craft Service, 337 University Avenue, Rochester 7, New York.

92 BLUEPRINTS AND PLANS

\$600 **BUILDS** Cozy Home, 4 room Concrete Block. Step-by-Step Instructions & Blueprint, \$1.00. L. H. Farrow, G82, Box 645, Columbus 16, Ohio.

BUILD your own farm, home equipment, 180 plans, Catalogue 25c. Dealers wanted, Kimo, Box 307K, New York 19.

PLANS, instructions, for Lake Hunting, Fishing Cabins. Cost less than \$100. Easy Construction! Only \$1.00. R. H. Perron, 4508 E. First Ave., Spokane, Wash.

93 BUILD IT YOURSELF

BUILD Your Own "Tractor." Plans, instructions, Walking, Riding. Send postcard. Free information, Ellsworth Co., D-5, Camptonville, California.

STREAMLINED. Built-in Kitchen cabinets to fit any Kitchen. Illustrated manual describes designing and construction. All for \$1.00. Thombert Company, Newton 11, Iowa.

"**CONCRETE** Block Homes." 32 page booklet on how to build, \$1.00. Other Home Building booklets, \$1.00. H. C. Lightfoot, Civil Engineer, Richboro, Penna.

FREE Handbook, Build sawmills, block machines, freezers, tractors, scooters, 250 shop, farm, home machines, Nichols Co., Dept. C-402, Purvis, Miss.

94 WATCH REPAIRING

WATCHMAKERS Tools, Supplies. Sold—Bought. Catalogue! Bengale Company, Culver City, Calif.

WATCHMAKERS' Journal contains instructive articles for watchmakers. Send 20c for new copy, Dean Co., 116-B Nassau St., New York 7, N. Y.

WATCHMAKER'S Catalogue 20c. deductible. Tinker Kit, instructions, catalogue, \$3.90. Bengal Company, Culver City, Calif.

95 OLD GOLD, WATCHES, ETC.

HIGHEST Cash Paid For old, Broken Jewelry, Gold Teeth, Watches, Silverware, Diamonds, Spectacles, Platinum. Free information, Satisfaction Guaranteed. Government Licensed, Rose Smelting Company, 29-Y East Madison, Chicago.

GOLD \$35.00 Ounce—Mail old gold teeth, jewelry, watches, diamonds—receive cash by return mail. Satisfaction guaranteed. Free information, Dr. Weisberg's Gold Refining Company, 1500-B Hennepin, Minneapolis, Minn.

HIGHEST cash prices paid for old gold, diamonds, coins, gold teeth, rings and watches. Satisfaction guaranteed, Argee, Dept. P.S.2, 2824 S. Claverdale Ave., Los Angeles, Calif.

TOP prices paid for broken jewelry, gold teeth, old watches. Free information, Hammond, 1112 Mahantongo St., Pottsville, Pennsylvania.

96 JEWELRY

JEWELRY Making, Illustrated catalog 20c. George Sassen, 35 Maiden Lane, N. Y. C. 7.

GOLD Plated Jewelry Supplies—Rhinstones—Pearls—Illustrated Catalog 10c. Barry's, 47-B Branford Place, Newark 2, New Jersey.

COSTUME Jewelry Manufacturers: Illustrated parts list 10c. Conner, Box 188, National Park, N. J.

MANUFACTURE costume jewelry. Illustrated literature 10c. Herber, 1360-N Hicks, N. Y. C. 67.

97 TOBACCO & PIPES

GROW your cigarette and pipe tobacco for few cents per pound in back yard. Seeds, instructions sent postpaid \$1.00 check or money order, Liston Malpass, Clinton, N. C.

FREE literature Pipes and pipemakers' supplies, Carvapipe, 2829-K Dixie, Hamilton, Ohio.

98 RAZOR BLADES, SHAVERS

FREE Trial, Try 5 famous, precision, "Don Juan" double-edge Blades. At 100 for \$1. Be satisfied or return balance for full refund. Rush \$1. Leonard Sales, Dept. P, 150 Nassau St., N. Y. C. 10.

100 MISCELLANEOUS

DRESSES 18c; Men's Overcoats \$1.00; Skirts 50c. Free Catalog. Crown, 164-PS, Monroe St., New York 2.

YOUR Leather Jacket renovated by our craftsmen expertly, reasonably. Request Free descriptive circular No. 7; Berlew Mfg. Co., Freeport, N. Y.

BOOKFINDERS! (Scarce, out-of-print, unusual books) Quickly supplied. Send wants. Clifton, Box 1377-PSM, Beverly Hills, Calif.

RECEIVE Mails 10c 3 mos. 25c 1 yr. Zenith, Box 95, South Orange, N. J.

"**INTERESTING** Mails"—25c will keep your mail box full three months. Bentz, Jr., Desk A-84, Chatawa, Mississippi.

TREASURE—Mineral Locators—Geiger Counters can be purchased on monthly payment plan. Free literature. Fisher Research Lab., Inc., Palo Alto, Calif.

MILLION Articles wholesale. Supply Source Directory 10c. Publisher's, Box 1302, Detroit 31.

PANNING Gold—Beginners booklet 36 pages—Catalogue Supplies, Mining Books, Maps "Where To Go" 25c. Old Prospector, B-313, Dutch Flat, Calif.

UNUSUALLY realistic 10" statuette of yourself or loved ones. Inexpensive, desirable lifetime keepsake. Write Ameri-Tech Industries, 1239 West 9th St., Cleveland 13, Ohio.

BIG Mails Three Month, 25c, year Name Listed Directory \$1.00. Harvey Teeple, Decatur, Indiana.

FREE Art Test, State Age, American, Box 8066, Dallas, Texas.

EXTREMELY interesting Golden minutes booklet shows road to success in business job and private life. Booklet plus 3 charming photo cards 40c. Catalog-samples 10c. Persil, 436 N. Y. Ave., Brooklyn 25, New York.

101 FOR SALE—MISCELLANEOUS

STEEL Tool boxes any size 5c lb. N. Y. Salvage, 196 Chambers St., New York.

FREE Catalog! War surplus clothing bargains. N. Y. Clothing Co., N. Y. 29.

"**TOP** Secret" Wallets, Hand Made leather belts, handbags, Bargain list 10c. Sterling Leather Products, St. Joseph 1, Mo.

102 WANTED MISCELLANEOUS

SCRAP Mercury (Quicksilver) Tantalum—Bismuth—Tungsten. Metallurgical Products Co. Established 1909, 35th & Moore Sts., Philadelphia 45, Pa.

103 FOR THE HOME

PLASTIC Wall Tile—Simple to install. Seven beautiful colors. Price 38 cents square foot in 4 1/2" by 4 1/2" blocks. Send 60 cents for set of samples, Davenport Corporation, Box 151, Kent, Ohio.

104 PERSONAL

BORROW by mail. Loans \$50.00 to \$300.00 to employed men and women. Easy, quick. Completely private, confidential. No endorsers. Repay in convenient monthly payments. Details free in plain envelope. Write State Finance Co., 210 State Finance Bldg., Dept. E-14K, Des Moines 9, Iowa.

DETECTIVE'S Opportunities. Particulars free. Write, Wagoner, P-125 West 86th, New York 24.

PSORIASIS Sufferers: Has everything failed to bring even temporary relief from scales, lesions, and itching? Then write today for Free important information. You needn't invest one cent! Pixacol Company, Box 3583-S, Cleveland, Ohio.

BEAR Oil—Best treatment for baldness. You never saw a bald headed Indian. They use it. We can supply you with the genuine product. One dollar prepaid. Swastika Drug Co. Limited, Swastika, Ontario.

ATHLETES Foot discomfort relieved with ATH-O-Derm. A specially prepared ointment. Send only 65c for the one ounce Trial Size—2 ounce size \$1.00. The Jamyr Co., McKeesport, Pa.

LOANS By Mail, \$50 to \$300. Quick, Easy, Confidential to employed men and women. No endorsers. Easy monthly payments. Write for free information sent in plain envelope. Postal Finance Co., Dept. 46, Sioux City, Iowa.

AUSTRALIA! Mail confidentially forwarded anywhere. Send 30c for letter, surface, 50c air. C. Tipping, 56 Cavendish St., St. Stamme N. S. W. Australia.

"**LETTERS** remailed, 25c each. Abraham, 1017 Park Avenue, Richmond 20, Virginia."

RECEIVE Mail, Samplers, Magazines, Outstanding offers galore. Name Listed 10c. Arthur Sibley, Mendon, Mass.

PHOTO Stamps—List, Large assortment of Glamor, Art, Scenics, etc. \$1.00. Reid, 1227 1/2 East VanBuren, Phoenix, Arizona.

BRASS Identification plate with your name & Adr. Stamped 25c. Rudholm, 378 Apple, Muskegon, Mich.

ATHLETE'S Foot! Ringworm! Amazing New Preparation (Dermoring). Sure remedy with one application. Money back guarantee. Send \$1.00. Includes postage. Candido Pharmacy, Box P-1256, Albany, N. Y.

"**HOW** Can I Find Out?" You Can! Information discreetly developed. Any matter, person, problem, anywhere. Worldwide. Officially licensed, bonded service. Established 1922. Reasonable, Confidential. William Herman, 170 Broadway, New York.

INFORMATION for single people by Human Relations Consultant, Dr. B. Long, Box 375, Los Angeles 53, Calif.

MEXICAN Law, General Practice Attorney, 1203 Arizona Street, El Paso, Texas.

HYPNOTISM. Self-hypnosis courses. Free details. Craft Publications W2, 601 S. Vermont, Los Angeles 5, Calif.

PILES? Worrynot. Particulars from relieved sufferer. Heike, PS, 1409 Orange, Berwick, Pa.

PENMANSHIP Corrector! Improves your Penmanship in 3 hours. Proof Free, Ozment, 35e, St. Louis, Mo.

POPULAR SCIENCE OPPORTUNITIES

LETTERS remailed from Paris (France). \$1.00, Airmail \$2.00, Box 4066, San Francisco 1.

STOP Unhappiness, sickness, failure! 50c. self-addressed, stamped envelope. Guaranteed, 8016 Phil. Houston 12, Texas.

IF you Sincerely Desire to improve your position in life. Write us. No charge whatsoever. Dept. SC 2, Self Development System, Box 6370-A, Chicago 80.

106 ADVERTISING

AVOID costly advertising mistakes. Get enlightening Ad-Guide and Ratebook leading newspapers, magazines, mailing lists, 10c Chicago Advertising Agency (Established 1900), Chicago 4.

ADVERTISE: 24 words, 40 Newspapers, \$3.50. Lists Free. Advertising Bureau, 10511-p Springfield, Chicago 43.

ADVERTISING Copy that pulls and follow up that pays off. Gowen Advertising Agency, Gowen, Michigan.

24 WORDS in 50 Weeklies, \$4.96. J. Darnell, 730 Hays, Jackson, Tennessee.

ADVERTISE in 40 weeklies, \$3.50; (24 words). M. Pennebaker, San Marcos, Texas.

116 SURVEYING INSTRUMENTS

GUARANTEED Factory Rebuilt Transits and Levels Sale or Rent with purchase Option. We will Repair. Trade or Buy old instruments. Write for list PS911, Warren Knight Co., Manufacturers of Surveying Instruments, 136 N. 12th St., Philadelphia 7, Pa.

117 TATTOOING SUPPLIES

TATTOOING Outfits, Supplies. Illustrated List Free. Zeiss, 728 Lesley, Rockford, Illinois.

119 SCIENTIFIC SUPPLIES

SNOOPERSCOPE Tube Permits night-time vision. Tube and complete instructions \$14.95. Infrared filters 15c. Voltmeter, Oscillator Kit Special \$2.95. Precise, 942 Kings Highway, Brooklyn 23, N. Y.

120 CANDY MAKING

MEN-Women—"Everybody Likes Candy." Learn to make Professionally at home. Instruction and Outfit furnished. Details free. (Our 40th year). Ragsdale Candies, East Orange, New Jersey.

126 CAMPING

TENTS, canvas & nylon. All styles & sizes. Camping equipment. Catalogue. Morsan, 10-19D 50th Ave., L.I.C. 1, N. Y.

131 TREASURE FINDERS

GEIGER Counters for locating Uranium; Metal Detectors for Gold, Silver and minerals. Lightweight, low cost, ultra-sensitive. None finer at any price. Free information. Detectron Co., 5637 Cahuenga Avenue, Dept. A2, North Hollywood, Calif.

TREASURE—Mineral Locators—Geiger Counters M-Scope Type. Lightweight. Unsurpassed in efficiency. Factory guarantee. Lowest prices. Can be purchased on monthly payment plan. Free Literature. Fisher Research Lab., Inc., Palo Alto, Calif.

TREASURE Hunters! New 11-pound featherweight Model 101 locator for gold, silver and minerals. Money-back guarantee best available. Also Geiger Counters for uranium prospectors. Complete information free. The Goldak Company, 1544 W. Glenoaks Blvd., Glendale 1, Calif.

137 DETECTIVES

DETECTIVES—Work home—Travel. Experience unnecessary. Write Wagoner P-125 West 86th, N. Y., N. Y.

DETECTIVE Training, Phillips Secret Service System, 1917-C North Kenneth, Chicago 39.

CRIMINOLOGY—detective courses. Free Literature. Allied Academy, 14 No. East, Indianapolis, Indiana.

DETECTIVES needed everywhere. New method. Hanna, 3911 Tacon, Tampa, Fla.

142 INFORMATION

AMATEURS—Radio and Electrical Research Engineering. H. Y. Twillmann, R. R. #1, Chesterfield, Mo.

'HARRISON'S Better Memory' will help you win friends and influence people. 33 page pamphlet—\$1.49 postpaid. Guaranteed. Send order or inquiry. Thomas D. Harrison, 726 North 15th, Waco, Texas.

144 MILITARY INSIGNIA

MILITARY Medals, Enameled Orders Bought, Sold. Lee, Security Bldg., Glendale 3, Calif.

145 SOUVENIRS

EMBROIDERED American & Foreign emblems. 30 for 50c including price list. Hobbyguild, 57X Sumner, Brooklyn, N. Y.

COLORFUL oil painting, landscape of Puerto Rico \$5.00. Grace Morales, Mau-nabo, P. R.

World's Largest Stocks of Jeep Parts

Write For Your Special Requirements—We Can Fill Any Order!

The King of Jeeps

LOWEST PRICES IN AMERICA ON GUARANTEED JEEP PARTS!

COMPLETE TRANSFER CASE
A1195-GPW7700 REBUILT (Outright) **\$120.00**
(Exchange) \$95.00

STARTER-Auto Lite
No. MZ4113 A1245-GPW11001 New **\$26.50**
(Replacement Type) \$18.50

DUAL WINDSHIELD WIPER KITS
Complete with 2 motors Trico-SP-2467 **\$5.45**

WINTER SPECIAL USED CANVAS TOPS
Slightly Soiled A3216-GPW1152700 **\$12.50**

WATER PUMPS
639992-GPW8501 Brand New Outright **\$5.75**

BRAND NEW CAPSTAN WINCHES
6000 lb. capacity. Accurately machined gears provide for smooth efficient operation. Suitable for both front or rear mounting. May be used on amphibious jeeps or trucks. All units are brand new and fully guaranteed. **\$17.50** | 6 or more **\$15** ea.

TERMS: Net cash with order. Open account to rated firms only. C.O.D. shipments should have 25% deposit with order. All prices are F.O.B. our yards, Chicago, Illinois

BIG, FREE CATALOG
Write For Your Copy Today
Thousands of other parts and accessories available. SHOP BY MAIL—Order direct from this ad today.

BERG TRUCK & PARTS CO., INC.
603 So. Wabash Avenue, Dept. S-2, Chicago 16, Ill.
Cable Address . . . JEEP KING

ANALYZE Handwriting

Try it FREE, use it—to understand yourself and others in business and social life—more clearly than you ever thought possible. Many use their knowledge of handwriting to make more money full or part time. Simply send your name today for FREE ILLUSTRATED lesson. No obligation. Must be over 21.

INTERNATIONAL GRAPHO ANALYSIS SOCIETY, INC.
304 Witholt Building Springfield 4, Mo.



LEARN HOW TO HYPNOTIZE

COMPLETE—ONLY \$1.95, POSTPAID!
Amazing self-study lessons . . . in simple, easy to understand language. How to select a subject—how to hypnotize by telephone—how to make money from hypnotism—mental telepathy—stage hypnotism—self-hypnosis; how modern hypnotism is used to conquer inferiority complex, fear, battle fatigue, timidity, etc. Clear, helpful pictures show operating positions, movements. Money-back guarantee. Only \$1.95, postpaid—or COD, plus postage. Write today!

Nelson-Hall Co., 1139 S. Wabash Ave., Dept. 2B-1, Chicago 5, Ill.

TRAIN Your VOICE!
RESULTS GUARANTEED
STRENGTHEN your voice this tested, scientific way. Yes—you may now be able to develop the POWER of your speaking and singing voice in the privacy of your own room. Self-training lessons, mostly silent; no music required. Write TODAY for Eugene Feuchtinger's great booklet "How to Strengthen Your Voice." It's absolutely FREE! You must state your age. Booklet mailed in plain wrapper. No salesman will call. Send your name and age RIGHT NOW!

Perfect Voice Studio, 1141 S. Wabash Ave., Studio B-1, Chicago 5, Ill.

ILLUSTRATED COMIC BOOKLETS
THE KIND MEN LIKE!
(VEST POCKET SIZE)
They are loaded with rare cartoons. Full of Fun and Humor. 20 DIFFERENT booklets sent prepaid for \$1 in plain sealed wrapper. No C.O.D.'s.
GRAYKO, Dept. 1808, Box 520, G.P.O., N.Y.C. 1

FUN FOR BOYS FROM 6 TO 60

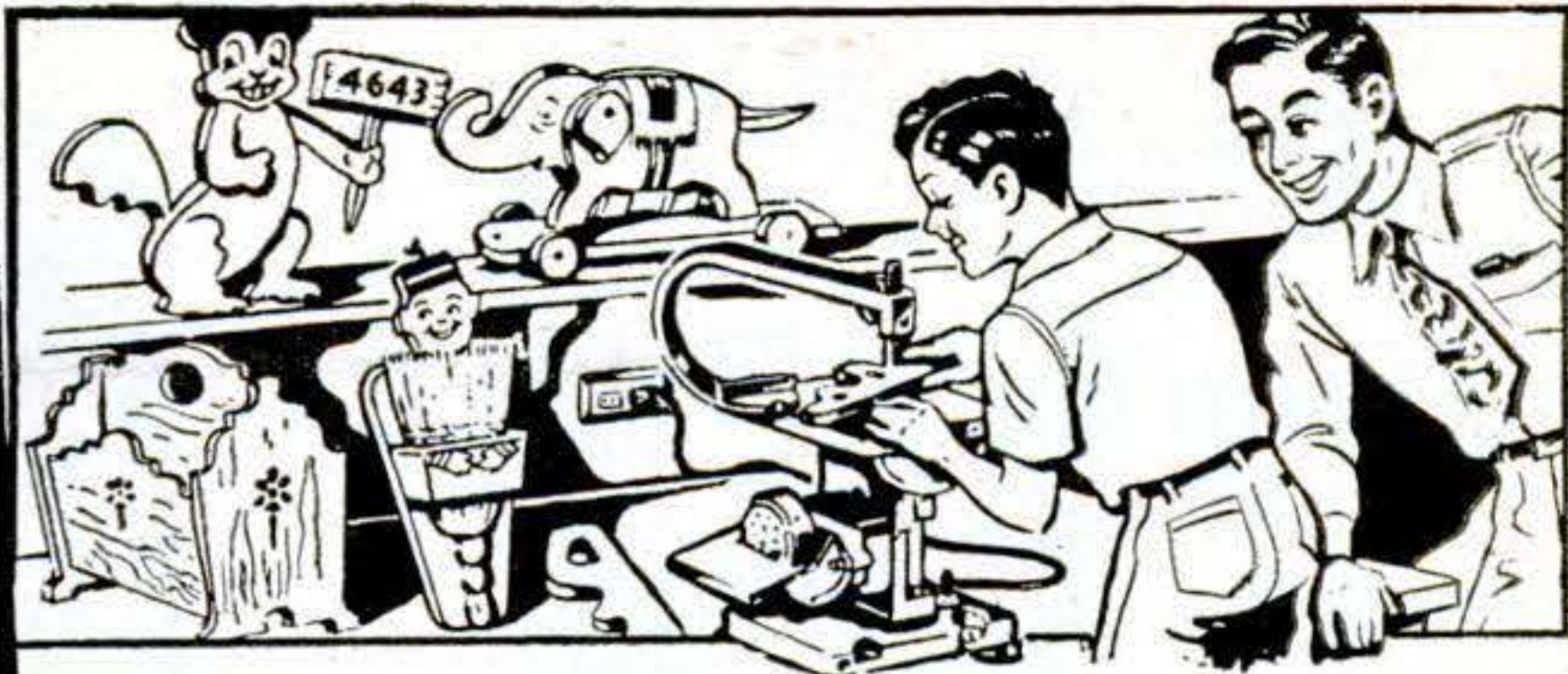

Make Hundreds of Things for the Home and for Sale—Have Fun and Earn Money in Spare Time!

Here's a tool every hobbyist, young or old, dreams about owning. Think of the things you can make in your own home or workshop with a 3-in-1 combination electric JIG SAW, SANDER and FILING MACHINE. Now you can make toys, models, tie racks, book ends, broom holders, shelves, cornices, trays, stands, and hundreds more! Most exciting of all, you can own this amazing power tool at cost far less than you ever dreamed possible!

AMAZING NEW LOW PRICED ELECTRIC

3 in 1 JIG SAW SANDER FILER

Complete with motor

\$11.95

**Not a Toy—
Precision Built!**

This useful, inexpensive 3-in-1 JIG SAW, SANDER, FILER is a real power tool, guaranteed to delight all hobbyists. Makes an ideal gift!

**Absolutely
SAFE**
Foster Products, Inc.
179 Wooster St. NYC.

**COMPLETE with
3,000 RPM
Powerful Electric Motor**

This wonderful combination JIG SAW, SANDER and FILER is made of lightweight aluminum, comes complete with a quiet 3,000 RPM electric motor, with on-off switch. Features self-aligning oilite bearings, ground, polished shaft. SAW cuts soft or hard woods up to 1/2" plywood. 3,000 3-16" saw strokes per minute really make the work fly! Cuts to the center of a 16" circle, may be rotated to any position to cut longer lengths. Saw arm may be removed and sabre-type blade used for sawing longer pieces. 4x6" sanding table tilts and rotates to cut at any angle, and is grooved for protractor guide. Disc sander smooths rough edges, moves at approximately 2,000 sanding feet per second, for fast, easy sanding! Saw blade easily replaced with metal file. Comes complete, ready to plug in—includes three exciting project patterns, package of extra saw blades, two 4"x9" pieces of plywood, 6-foot molded cord and plug. Imagine all that for only \$11.95! SEND NO MONEY—for exciting free trial. Mail the coupon NOW!

**FOSTER PRODUCTS, Inc., Dept. JS-7
179 Wooster St., New York 12, N. Y.**

Please rush your 3-in-1 combination electric JIG SAW, SANDER, FILER for 10-days no risk trial. On arrival I will pay post-man only \$11.95 plus delivery charge.

() Check here if you enclose \$11.95 now. We pay all delivery charges.

NAME.....

ADDRESS.....

City.....Zone...State.....

NOTE: Full purchase price refund guaranteed if returned within 10 days.

SALESMEN!

WRITE
THREE
WORDS
COLLECT
\$9.95

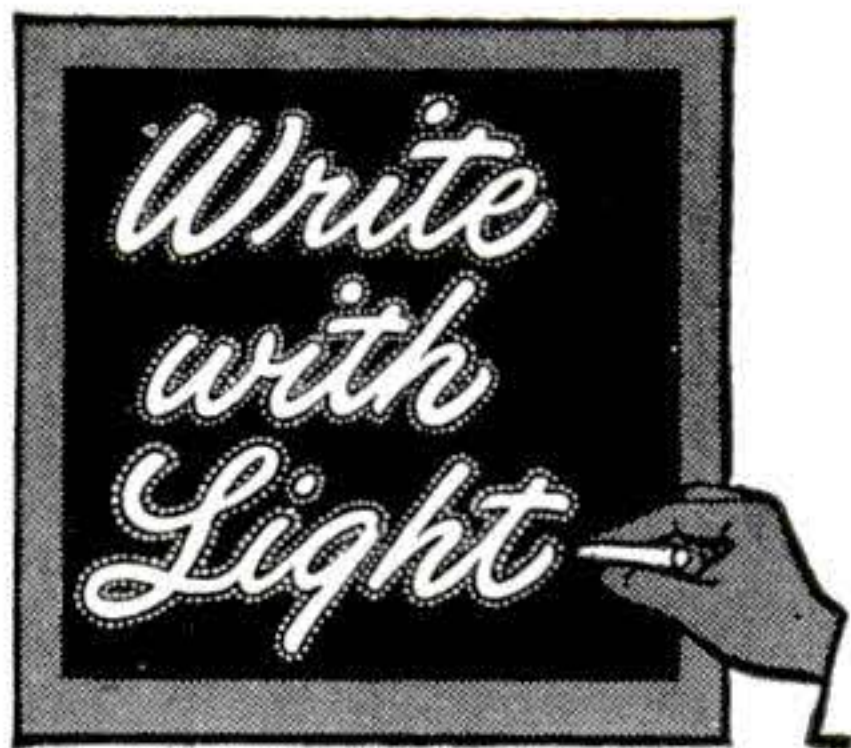

SENSATIONAL NEW ADVERTISING SIGN

YES, MAKE \$9.95 on 10-second demonstration to merchants. Write on glass with amazing magic crayon and presto—a 5-color advertising message takes fire and glows like a brilliant neon sign! Three sales a day and \$29.85 profit is for "lazy" men. Workers can double to triple that amount. FREE SALES KIT. Don't wait. Rush your name and address on a penny postcard for full details and complete sales kit—ALL FREE. Write Today!

**MAXILUME CO., 125 W. Hubbard St.
DEPT. L-92 CHICAGO 10, ILLINOIS**

DEALERS WANTED MAKE BIG MONEY SELLING EYE GLASSES

Send for FREE Literature and Eye Glass Tester!

ADVANCE SPECTACLE COMPANY

540 S. Plymouth Ct.

Chicago 5, Illinois

MEN! WOMEN!
New Car given
as Bonus!



TAKE ORDERS for
Nationally Advertised
NYLONS

GUARANTEED NINE MONTHS

Sensational Guarantee creating a tremendous demand for Wilkmit Nylons! If they run, wear out or even snag from any cause whatever... within NINE MONTHS... depending on quantity... they are replaced FREE OF CHARGE. No wonder it's easy to quickly build up fine, steady, year-round income. Earnings start immediately. Look at these exceptional figures—Ralph Shearer made \$67.11, first week—Mrs. Paul Estes, \$42.92—Mrs. Ivey Gentry, \$43.37. Doris Jensen in addition to making as much as \$17.00 in a single day, earned two cars as EXTRA BONUSSES. Learn how you can make money in your full or spare time without a bit of previous experience.

SEND NO MONEY... Just Hose Size

When you send for Selling Outfit, I also send your choice of Nylons or Socks for your personal use. Don't lose a minute. Rush name on penny postcard for full money-making facts on Sensational Sales Kit. Send hose size, too. **Lowell Wilkin, WILKNIT HOSIERY CO., 322 Midway, Greenfield, Ohio**

**EARNED
\$120.00 in 1 WEEK
Plus 2 NEW CARS**

That's the exceptionally fine record of Chas. Mills with the famous Wilkmit line of men's, women's & children's hosiery—Offer of New Chevrolet as a bonus open to EVERYONE. Send name for facts FREE.

Baby Shoe
Platers...
ATTENTION!

Bookends • Ashtrays • Photoframes
"THEY SELL ON SIGHT"

**SPECIAL
OFFER**

Sample assortment—5 different styles. **\$13.95**

PPD anywhere in USA

**Don't Pass Up
SURE SALES!**
Feature the New
**DOROTHY LANE
MOUNTINGS**

Our new original designs and superbly finished and fully weighted bases are real sales builders. Put quality into your line. This is a tremendous opportunity to raise sales and profits to a level you never anticipated. Write at once for Illustrated Booklet, Sales Aids and Price List.

Dorothy Lane, Inc.
VALLEY STREAM, N.Y.

it's fun to earn
RAISING HAMSTERS

Cash in on the growing demand for SYRIAN GOLDEN HAMSTERS recently introduced into the U. S. Ideal pets... big laboratory demand. Hardy, clean, odorless. Easily and profitably raised anywhere.



AKOPIAN HAMSTERY

the largest in the West write for FREE illustrated booklet
7358-BC Varna • Van Nuys, Calif.

GOOD MONEY IN WEAVING

Earn money at home weaving rugs, carpets, etc., from old rags or new yarn—in your community! No experience necessary. 31,000 doing it with easy running Union Looms costing less than \$50.00! Send for our free booklet today.

UNION LOOM WORKS

27 Factory St. BOONVILLE, N. Y.

**GET THIS SUIT
AS A BONUS!**

YOU PAY 1/2 • WE PAY 1/2

Sell popular Smith tailored-to-measure suits. Make up to \$10-\$15 daily, taking orders from friends. As an extra bonus, get your own suit at HALF wholesale cost. No experience needed. Send for FREE selling kit and sample line. Send no money. Write fully, state age, etc.

**W. D. SMITH & CO., Dept. E
833 W. Jackson Blvd., Chicago 7, Ill.**



NEED MORE? MONEY?

Thousands already earn big, steady profits selling famous Bostonian shirts, rainwear, hosiery, underwear and other everyday needs for men, women and children. Also new line of Hamilton shoes. No selling experience needed—if you're keen and really want to assure yourself of a steady income, Bostonian will back you and set you up in business. You get big profits, immediate cash and big selling kit. Our Company has tripled its business in the last year. Write now—big Spring season ahead. Bostonian Mfg. Co., Dept. 304, 89 Bickford Street, Boston 30, Mass.

Write for
**FREE
Selling
Kit**

DEAF? HEAR BETTER Or Pay Nothing

Don't deny yourself the joys and opportunities of life. Your friends, family, business associates *want* you to hear. Let a home trial of the new, modern sensationally-priced Zenith "Miniature" Radionic Hearing Aid prove you can even hear a whisper. Only \$75.00 complete, ready to wear. Needs no "fitting." Weighs only 6¾ oz. See what you save! If any \$200 Hearing Aid outperforms the Zenith in efficiency or economy, your *money back*—under our 10-Day Return Privilege. For authorized Zenith Hearing Aid Dealer in your locality, consult your classified telephone book; or write for complete coast-to-coast list of dealers. Free descriptive literature and full details on request. Address:

Zenith Radio Corporation, Hearing Aid Division, Dept. 292, 580! W. Dickens Ave., Chicago 39, Ill.

Makers of World Famous Zenith Radio, FM and Television Sets



AMAZING NEW INSTRUMENT

MEASURES DISTANCE AT SIGHT!

INSTANTLY FINDS EXACT FOCUS SETTING FOR SHARPEST, CLEAREST PICTURES FROM YOUR CAMERA.

Just look at the subject through this professional *IDEAL PRECISION RANGEFINDER*. Turn the knob until the double images come together, and read the exact distance on the calibrated dial. *ITS LIKE MAGIC. EVEN A CHILD CAN USE IT.* You get needle-sharp, perfectly-focused pictures from your camera, that can be enlarged without fuzziness or blurring. You will be proud of your professional-looking pictures, and proud, too, of this beautiful, efficient optical instrument in its maroon leatherette box. *FULL INSTRUCTIONS AND THREE YEAR GUARANTEE WITH EACH INSTRUMENT.*



ONLY
\$2.95

Get one today at your dealer's or send only \$3 for immediate prepaid shipment.

FEDERAL INSTRUMENT CORP. Dept P52, 14-02 Broadway, L.I.C. 6, N. Y.



World's Lowest Cost Dependable, Powered Transportation!

The New 1950

Cushman
MOTOR SCOOTER

75
MILES
PER GAL.



Greatest
Scooter
VALUE
Ever
Offered

"My Cushman takes me everywhere — quickly — AT AMAZINGLY LITTLE COST!" Own, maintain and operate it for only ¾c a mile! Cheaper than bus fare—and no long waits. Parks anywhere. Wonderful for getting to work, school or market—making deliveries—or just taking pleasure spins.

New flashy 1950 Cushmans are ruggedly built, beautifully streamlined. You'll be proud to say "I own a genuine Cushman!" And how you'll boast of the economy!

SEE your Cushman dealer for demonstration. Or, **rush card for free folder with full details.**

CUSHMAN MOTOR WORKS
Dept. P2 Lincoln, Nebr.



You Read About it! NOW OWN America's Most Wanted Car Accessory

"Oil-Spy"

AN EVER WATCHFUL EYE
ON YOUR OIL LEVEL

Your Cheapest Insurance
Against Damaged Motors

Measures Oil Level
Accurately & Automatically

Now you can know right away when your oil level goes down too low. This inside-the-car-on-the-dash accessory ends for all time the bothersome, time-consuming chore of having to check your oil with a dip-stick. Every car on the road needs one. The Oil-Spy never lets you down. Flashes on an amber light when oil is 1 qt. low, a warning red light when oil falls 2 qts. low. Easy to install. Installed by replacing plug in crankcase. A factory approved accessory.

Most Valuable Car Accessory
Since the Automatic Transmission

Motorists have long wanted it. You read about it in the Nov. '48 issue of Popular Mechanics. Now it's available for every car. Protect the life of your \$300 or more motor. Not only is it useful but it looks very neat on your dash. Stop guessing about oil level. Be sure. Get an Oil-Spy.

ORDER NOW! FITS ALL CARS

Send cash by registered mail only. When ordering C.O.D. send \$2.50. Pay postman balance on arrival. We pay postage when remittance sent with order. State make, model, year of car. Shipped complete with full directions for installation.

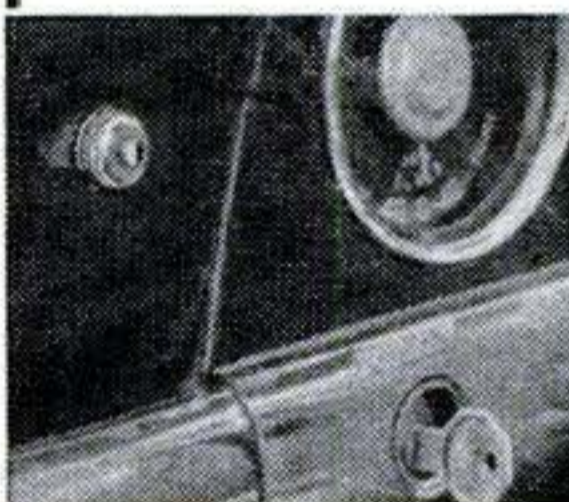

Glow Amber 1 Qt. Low
Glow Red 2 Qts. Low



\$9.95

YOU MUST BE SATISFIED AFTER 10 DAYS TRIAL OR YOUR MONEY BACK.

PARKWOOD MANUFACTURING CO.
605 Williamson Bldg. Cleveland 14, Ohio



SPEED fast boats that take the lead in outboard races. You'll find them in the more than 50 models ruggedly built for speed, for fishing; in fact, there's a "Wolverine" for every boating pleasure. Make your next boat a "Wolverine"! Free literature on request.



WAGEMAKER COMPANY
DEPT. 26 GRAND RAPIDS, MICHIGAN

\$4.95

REAL ENGINE VALUE



A miniature gas engine that really operates. Thousands of Buzz "B" gasoline engines have been sold at twice the price. Now is your chance to buy a real 1/6th H.P. gas engine for only \$4.95. Turns up over 8,000 rpm. For Boats, planes, midget cars, etc. Guaranteed and ready to run. Includes Champion spark plug and tank. Send only \$1.00, engine shipped collect for balance, same day. Write for free catalog or **SEND 10c FOR NEW MAMMOTH ILLUSTRATED CATALOG OF THOUSANDS OF HOBBY ITEMS.**

America's Hobby Center, Inc., Dept. S-20, 156 West 22 St., N.Y. 11

BRAND NEW! 7 JEWELS!

3 Year SERVICE GUARANTEE

- Sweep Second Hand
- Radiant Dial
- Chrome Case
- Leather Band
- Shock, Water Resist

\$5.95

P. Paid Add 60c Tax

Special! Order today! Money Back if not satisfied. Sorry, no C.O.D.'s.

ELCO PRODUCTS CO., 3805 Broadway, K.C. 2 Mo.



Treasure and Mineral LOCATORS GEIGER-COUNTERS

FOR URANIUM-ORES

CREDIT PLAN—FREE LITERATURE

FISHER RESEARCH LABORATORY Inc.,
Palo Alto, Calif.

FREE

parts catalog

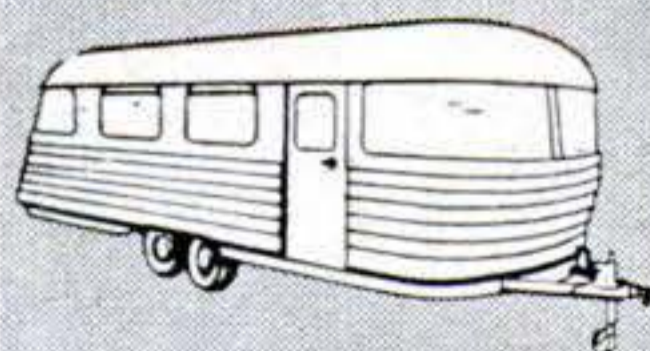

Build Better Trailers with Safety-Engineered

- ★ Torq-less Axles
- ★ Bull Dog Hitches
- ★ Parking Jacks

... Send for your copy TODAY!



HAMMER BLOW TOOL CO.

WAUSAU 14, WISCONSIN

NOW YOU CAN BUY THE ONE AND ONLY HOWALD PROCESS FIBER GLASS

Shakespeare WONDEROD



\$15.00
LIST PRICE

Prices Begin at \$11.25

TRY ITS AMAZING 1-2-3 ZONE ACTION

COMPARE Wonderod at your Sport Store. See what a difference *exclusive* Howald Process Glass Fibers make.

1. The ACTION Zone
With Wonderod's *fast tip action*, you "cast like a bullet" with just a *flick* of your wrist!

2. The POWER Zone
Wonderod has *backbone*—where it's needed—for the power to set the hook.

3. The ACCURACY Zone
Shakespeare's famous *Tru-Aim double offset handle* makes accurate casting as natural and easy as pointing your finger.

BOTH FREE! 1950 Tackle Book and Fishing Calendar—Show best days to fish, best *ways* to fish, best rods, reels, lines, bait. Casting lessons, fishing tips by U.S. Champion Ben Hardesty. Mail coupon.



Shakespeare

Shakespeare Company, Dept. PS-2
Kalamazoo 2, Michigan

Send me your free 1950 Tackle Book and Pocket Fishing Calendar.

Name.....

Address.....

HONOR BUILT SINCE 1897

ACTUAL PHOTO

6

POWER PRISM BINOCULARS

VEST POCKET IN SIZE!

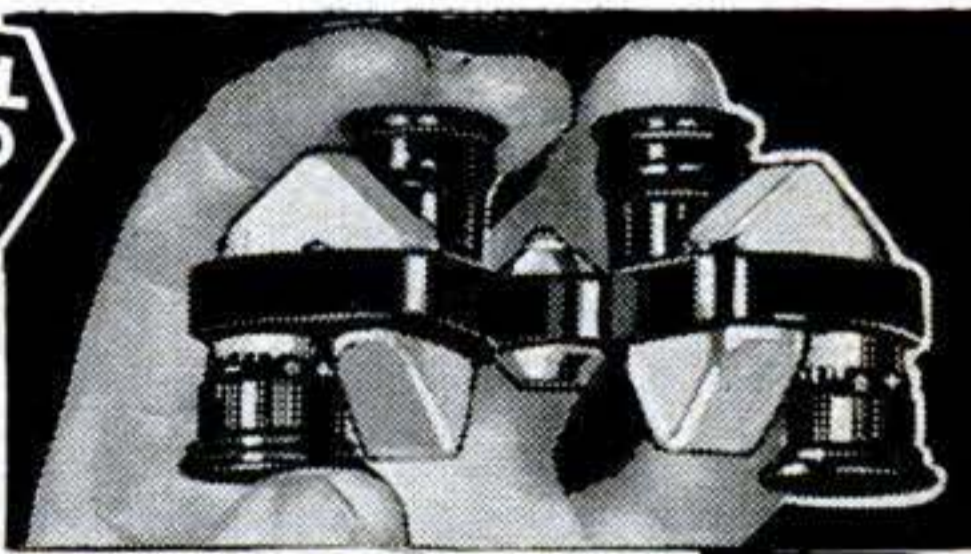

COATED OPTICS! Dynamic in power and range. At 1100 yards has sharp, clear field of 370 feet! Made under military supervision. Moisture-proofed . . . Dust proofed! All metal construction. Individual eye focussing. Adjustable for all eye widths! A compact, durable, all purpose prism binocular. NOT a field glass. **Coated optics means entire optic system is coated!** Economy priced at fraction of what similar glasses sell at retail! Complete with leather case and straps only \$19.50 plus 20% Fed. tax. Cash orders sent postpaid. On C.O.D.'s include \$2 deposit. **Guaranteed. Try 20 days at our risk. United Products Co., 7941 S. Halsted, Dept. ARF-2316, Chicago 20.**

NEW LOWER PRICES ON CROSLLEY CARS!

Reductions up to \$105. And the 1950 Crosley cars have hundreds of improvements, many exclusive features such as Hydradisc (airplane type hydraulic) Brakes and Crosley engine with rugged cast iron block and 8 to 1 compression ratio. Save with a new Crosley—costs less to buy, less to drive—up to 50 miles on a gallon of regular gasoline.

STATION WAGON
Price reduced \$105. Seats 4, or 2 with 1/4 ton load. All steel.



SEDAN DELUXE
Price reduced \$101. Speedline styling. Rich fabric upholstery. Seats 4, plus luggage.

CONVERTIBLE
Price reduced \$101. 4 passenger. Easy-to-handle top. Big luggage space.

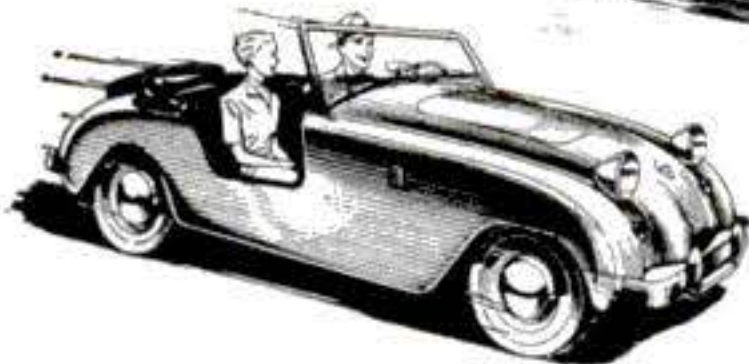

HOTSHOT
Price reduced \$51. A new thrill in motoring. America's own sports car. 2 passenger.

Crosley Trucks, both Panel Delivery and Pick-up have also been reduced—\$83 on each model! Dealers and driver agents wanted!

CROSLLEY
a FINE car

You see them everywhere!

* IT'S FREE! IT'S NEW!
the 1950 CROSLLEY CATALOG. Write Crosley Motors, Inc., 2530-JO, Spring Grove Ave., Cincinnati 14, O.

Make Garden Masonry for Spare-Time Profits

Millions of homes can use these Ornamental products—urns, vases, flower boxes, bird baths, lawn seats, flagstones, etc. Easily made of sand and cement. Permanently glazed in a range of smart colors. Distinctive—attractive—quick selling.

Eye-Appeal Makes for Cash-and-Carry Sales



Selling prices allow 200% to 300% mark-up on basic costs. Only a small investment needed for supply of molds. Easily set up in shed or garage. Write immediately for catalogue OM and price list.

COLORCRETE INDUSTRIES, INC.
711 Ottawa Ave., Holland, Mich.



WAKE UP YOUR Scalp
WITH THE NEW ELECTRIC-AUTOMATIC Vitabrush

BE FAIR TO YOUR HAIR Want better looking hair? Embarrassed by falling dandruff, itching scalp? Get the new VITABRUSH, the electric-automatic brush with built-in brush head motor... gives scalp and hair an invigorating "workout" in just 3 minutes. Cleans scalp, stimulates blood supply, distributes the natural oils. Fun to use—relaxing. Write for satisfaction-guaranteed offer—today. Hershey Mfg. Co., 3799 Field Bldg., Chicago 3.

STOP AUTO ACCIDENTS



with new **STOP LIGHT FLASHER!**
Makes Your Stop Light Flash 115 Times a Min.

FREE OFFER TO YOU! The "Stop-It" warns cars behind—makes your stop light flash on & off, on & off! Completely automatic, acts instantly when you step on foot brake... attaches in 5 minutes to any car or truck. Approved by safety engineers, used by Police & Fire depts. Non-rusting, dust, oil, vapor, waterproof. Write NOW for free introductory offer—no obligation. Get this amazing "Stop-It" for your car at no cost to you! Dealers, salesmen wanted.

MACCHI & CO., Dept. PE, 927 Larkin St., San Francisco 9, Calif.

FANS! FANS!

ALL TYPES — ALL SIZES

Kitchen Ventilators, Exhaust Fans, Attic Fans, Blowers, Heat Boosters, Desk Fans, Window Fans, Blades, Guards, Shutters, Motors, etc.

Send 25c for large illustrated catalogue

EDWARDS BROS. ESTAB. 20 YEARS

WESTERN APPLIANCE CO., INC.
5650 Grand River Ave. Detroit 8, Mich

Weaver SCHOOL OF REAL ESTATE

BE A BROKER - PAYS BIG!

STUDY AT HOME or in our classes in leading cities. **EASY TO START** your own Real Estate business or step into high-paying job. **FREE PLACEMENT SERVICE.** Men, women all ages learn quickly. **MAKE BIG MONEY,** gain lifetime security. Course covers Sales, Property Management, Appraising, Loans, Mortgages related subjects. Diploma awarded. Nationally known. G I. approved. Write for free, illustrated catalog now!

WEAVER SCHOOL OF REAL ESTATE (Established 1936)
15 East Pershing Road Dept. J Kansas City, Mo.

FREE BOOK TELLS HOW

FLASH Your Turns

ELIMINATE HAND SIGNALLING
Enjoy Safe—Comfortable Winter Driving with the

SIMPLEX DIRECTIONAL SWITCH

Here is a safe and comfortable way of signalling your intention to make a left or right turn. Flashes from 60 to 80 times per minute. Kits furnished with all necessary material for perfect installation. No outside mounting of any kind... uses your present parking and tail lights. Either of our two models fit most cars from 1942 to 1949.

\$8.95 Post-paid in U.S. Send check or money order. Postage extra on C.O.D.'s

A PRACTICAL GIFT FOR MOTORISTS!

Specify year and make of car. Money back guarantee. Tested and Approved to meet SAE requirements.

DEALERS INQUIRIES INVITED
Dept. B-4, 1303 W. Jackson Blvd. Chicago 7, Illinois

SIMPLEX SALES COMPANY

PRESTO! ANYONE CAN MASTER GLAZE

LEAVES HARD GLASS-LIKE FINISH
EASY TO APPLY
PROTECTS THE SURFACE
NO SMEAR OR STREAKS AS WITH WAX
LASTS SIX MONTHS TO A YEAR

SEALS THE PORES OF THE SURFACE
WILL NOT FINGER-MARK
NO OILY FILM AS WITH POLISH
SAVES YOU MONEY

Car Owners! Meet Master Glaze—the sensationally different luster for new and used cars! Not a wax—not an oil polish—not a paint!—nothing that “smears” over the surface.

MASTER GLAZE is a unique discovery—a creamy liquid—quick and easy to apply! Gives a hard, glass-like surface. Even gasoline cannot dull it! Lasts six months to a year! Amazing luster—beautiful, sparkling clean and brilliant! Doesn't finger-mark—doesn't smear! A match box full glazes an entire car. Seals the pores—protects! **NOTHING LIKE IT!**

AGENTS
An unusual opportunity!
Quick, flashy demonstrator.
Big profits.
Good territory.
Write today!

FREE SAMPLE

Just send your name and address to

MASTER GLAZE CO., 7720-684 W. Harwood Ave., Milwaukee, Wis.

FLIP THE LEVER—YOU'RE IN NEUTRAL

Now!

NEUTRAL CLUTCH

in the Famous 5.0 h.p.* Johnson Outboard Motor

JOHNSON'S NEW MODEL TN

Johnson Neutral Clutch and Full Pivot Reverse. Alternate Firing. Dual Carburetion. Sure-fire Shock Absorber Drive. Vari-Volume Pump. Synchro-Control. Ready-Pull Starter. S-l-o-w Trolling—24 other features. *No increase in weight or price!*

*OBC Certified Brake H. P. at 4000 r. p. m.

Mister, this is *IT!* Neutral is now yours in the outboard motor that is renowned for its performance, its **DEPENDABILITY**—the famous 5 horsepower* Johnson.

Start in neutral. Flip the lever—you're on your way. Stop, with the motor running. Jockey easily in and out of tight places. *Johnson Neutral Clutch* brings new convenience, new thrills to outboard motoring!

Prices are lower. Get set early for a full season of boating and fishing fun. See your Johnson dealer now. Look for his name under “Outboard Motors” in your classified telephone book.

FREE HANDY CHART

Describes all 5 models for 1950, including the 10 h.p.* Model QD with Gear Shift Control, Mile-Master Fuel Tank... Write today!

JOHNSON MOTORS
500 Pershing Road, Waukegan, Illinois
Johnson Motors of Canada, Peterboro, Canada

Handy Chart 1950

If it's not a Sea-Horse, Johnson did NOT make it

JOHNSON

SEA-HORSES FOR DEPENDABILITY

FOR BIG MEN ONLY!

SIZES **10 to 16** WIDTHS **AAA to EEE**

We specialize in large sizes only—sizes 10 to 16; widths AAA to EEE. Loafers, Wing Tips, Moccasins, Dress Oxfords, House Slippers, High and Low Work Shoes, Rubbers, Sox. Specially designed for large sizes. Satisfaction guaranteed. Sold by mail only. Write Today for FREE Catalog.

Write for **FREE CATALOG**

KING-SIZE, Inc., 267, Brockton, Mass.

New MIRACLE WALL CLEANER

Saves Costly Redecorating!

AMAZING INVENTION. Banishes old-style housecleaning mess and muss. No rags—no sticky “dough”—no red, swollen hands. No more dangerous stepladders. Literally erases dirt like magic from walls, ceilings, window shades, upholstered furniture, etc. *Ends drudgery!* **SAVES REDECORATING!**

SAMPLES FOR AGENTS Sample offer sent immediately to all who send name at once. A penny postal will do. **SEND NO MONEY—just your name.** KRISTEE CO., 713 Bar Street, AKRON, OHIO.

ONAN Portable ELECTRIC PLANTS

FOR CABINS, TRAILERS, CONTRACTORS, BOATS

Light weight, compact, air-cooled engine-driven. Furnish regular city-type A.C. electricity for lights, appliances, radios, etc. Can be carried by hand. Fit trunk of car. Plug-in receptacles on plant. Larger models for farms, homes, businesses beyond highlines. Catalog shows over hundred models. 350 to 55,000 watts.

Gasoline or Diesel Powered

WRITE FOR CATALOG

D. W. ONAN & SONS INC.
2804 Royalston Ave., Minneapolis 5, Minn.



FAST—Old Town Lapstrake Boat

SMOOTH lines of this lapstrake out-board boat help you start in a hurry—and get there fast! She's roomy, too, with wide cross seats (folding backs) and long seats on both sides at the stern. Handles easily, with deep bow to fight stormy waves! Built of handsome woods for strength and service. Upkeep is easy.

FREE CATALOG shows just the model you need. Write for one today! Also rowboats, sailing dinghies, sailboats, canoes. Address: Old Town Canoe Co., 642 Wood Street, Old Town, Maine.

"Old Town Boats"

"BEST SURFACE POPPING LURE IS HULA POPPER"



—SAYS WORLD FAMOUS
OUTDOOR WRITER
ROBERT PAGE LINCOLN

"I took these four bass from Thunder Bay River, Alpena, Mich., on your Hula Popper. Have seen a great number of small and large mouth taken with it here. It's the best surface popping lure made."

Pops, plunks, jerks, twitches with full control. Skirt squirms like

live bug. Drives bass

HULA POPPER

(Casting Size) — **5/8 oz.**

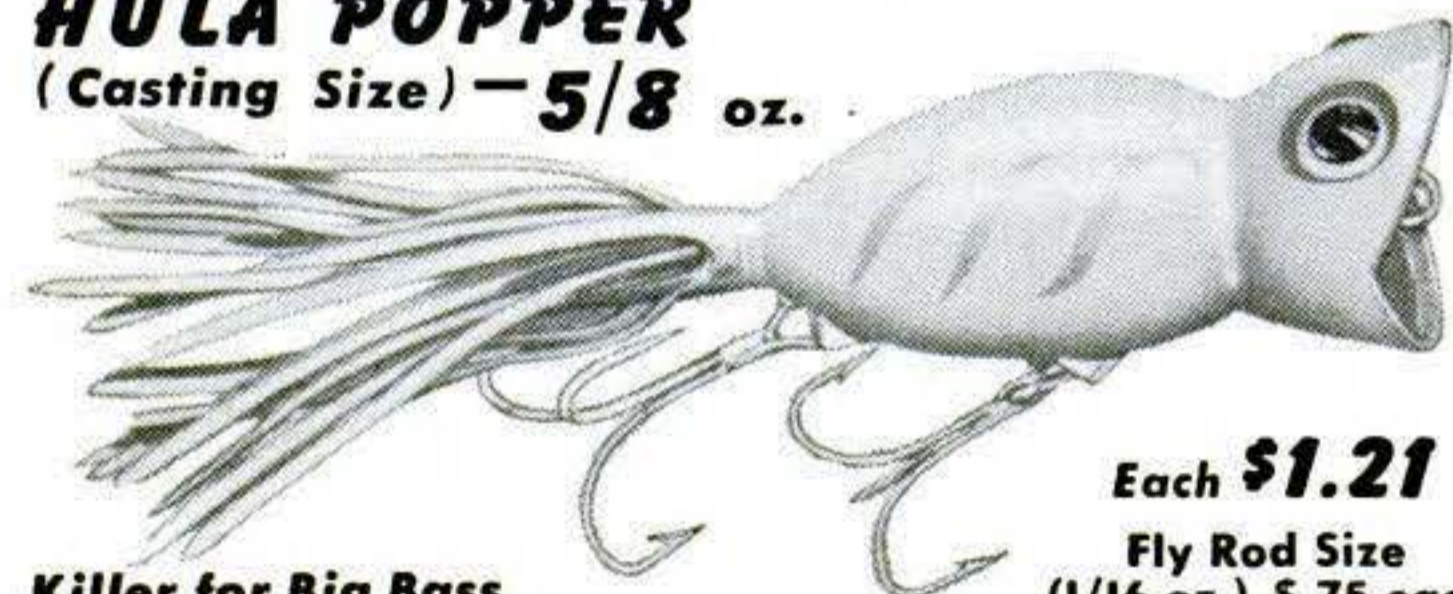

Each **\$1.21**

Fly Rod Size
(1/16 oz.) \$.75 each

Killer for Big Bass

Also in 3 **FIREPLUG® FINISHES** \$1.45 each.

Extra Hula Skirts (small) — Choice 11 Colors — \$.17 each

► **WRITE FOR FREE FULL-COLOR BAIT CATALOG**
FRED ARBOGAST & CO., INC.
1752 WEST NORTH STREET • AKRON 3, OHIO

KING MIDGET HOME ASSEMBLED AUTO



WORLD'S LOWEST PRICED AUTOMOBILE!

80-90 MI. PER GAL.—45-50 MI. PER HR.

Drive for as low as 50c per week. Precision built parts direct from factory with beautiful all steel body. Get the facts on this amazing small auto—send 25c for detailed circular with large picture, 3 view drawings and price of all parts, or send \$1 (refunded first order) for this plus actual assembly book with 42 photos, drawings; blueprints of snow, ice conversions, information on mini-midget racing, etc.

MIDGET MOTORS MFG. CO., Athens 3, Ohio

King Midget is ideal for errands, sports use, to work, short business or pleasure trips, or second-car utility for the whole family. Also tops for mini-midget racing. Room for six footer.

FENDER SKIRTS \$9.95 PER PAIR

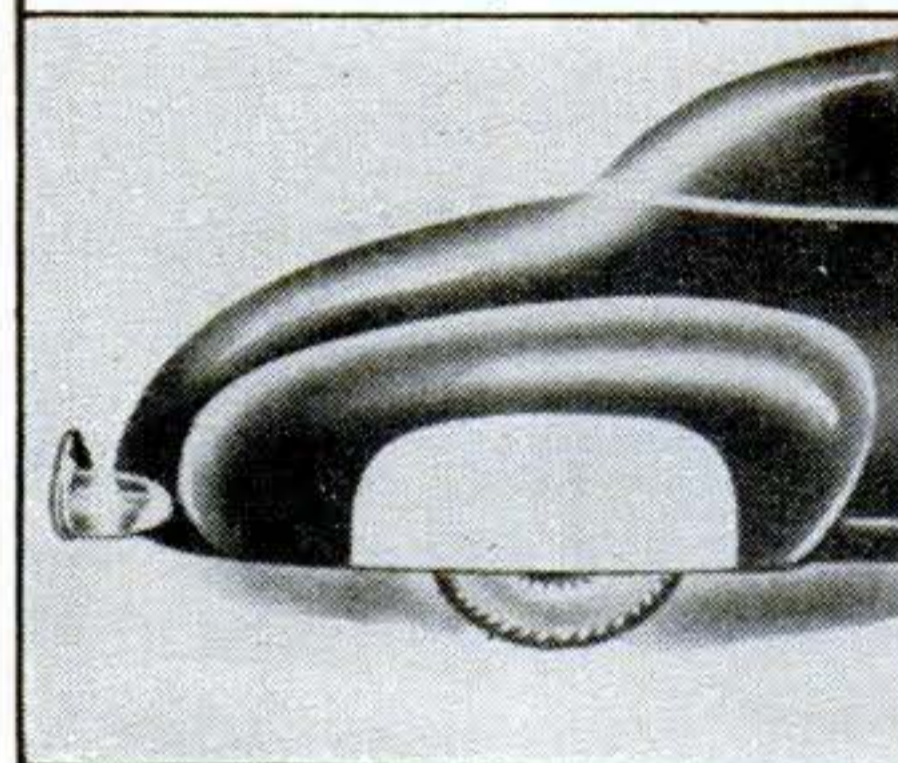

For 95% of all cars. Beautify your car . . . bring out the flowing lines designed in it. Sparkling beauty you'll like. Constructed of heavy gauge body steel, finished in prime. Perfect fit. Prompt delivery.

SANDEE MUFFLER CO.

5643 Corryne Place
Culver City, Calif.

Gentlemen: Please send me one set of Sandee Fender Skirts to fit my

(year and make of car).

Check or M.O. for \$9.95 enclosed. No C.O.D.s at this low price, please.

HULL AUTOMOBILE COMPASS READY ANSWER

WHEN THE QUESTION IS DIRECTION

Beaconlite illuminated, \$5.95; Streamline standard \$3.95. At your dealer's.

Write for literature

HULL MFG. COMPANY, P. O. Box 246-E2, Warren, Ohio



Reduce RADIO NOISES

SIMPLY PLUG Radio or Appliance cord

into Noise Eliminator and plug into wall socket. Enjoy reception FREE from many distracting noises. Send No Money, pay postman \$1 each (2 for \$1.75) plus postage or send cash and we'll mail postpaid. Try 5 days, money back if not delighted. Many hundreds of satisfied users. Send for yours today.

RAND SALES, Dept. PS2 \$1.75
688 LEE STREET DES PLAINES, ILLINOIS

NEW! SPECIAL 18" LEVEL For Home Craftsmen!

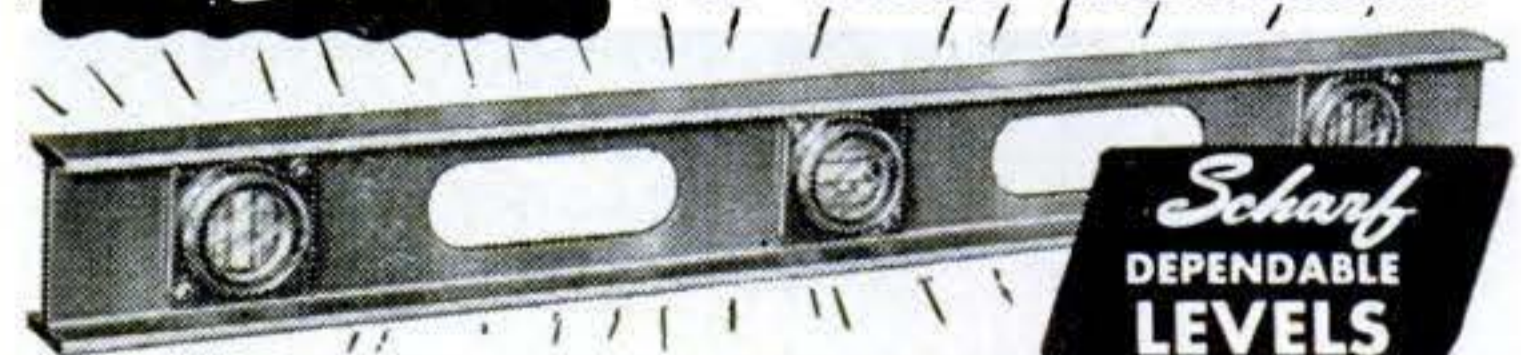

UNBREAKABLE FRAME OF EXTRUDED ALUMINUM ALLOY!

Not cast aluminum! Frame is extruded aluminum alloy. Will not break. This Scharf 18" Level made specially for Home Craftsmen. Straight, parallel, absolutely accurate, large hand-holds, extremely lightweight. Beautifully designed, gracefully streamlined. Has 6 vials. Greatest level ever built!

Adjustable and Replaceable Vial Units

Finest, die cast, vial assembly. Vial units attached to level by screws. Easily adjusted or replaced entirely if damaged by accident.

BIG VALUE!

Get your Scharf 18" Home Craftsmen Level today. **\$4.50**

If your dealer can't supply you, order from us direct, but you must send dealer's name and address. Satisfaction guaranteed. If you send money order or draft, mailing charges will be prepaid. If C.O.D., mailing charges will be added. "We Make All Sizes of Levels"
J. H. SCHARF MFG. CO.
Dept. P.S. 2, Omaha, Nebr.

MIRACLE TOMATO Yields 2 BUSHELS To a Vine



Now—You can grow the world's most amazing Tomato right in your own garden and get from 2 to 3 bushels of delicious, ripe tomatoes from every vine.

BURGESS CLIMBING TRIP-L-CROP

TOMATO grows 16 to 20 feet high. Huge, meaty, solid fruit, wonderful flavor. Some weigh as much as 2 pounds each. Unsurpassed for canning and slicing. Blight free—drought and disease-resistant. Grows in any garden. Outyields all other varieties.

TRIAL PACKET OF PELLETTED BETTER GROWING SEEDS ONLY 10c—3 FOR 25c POSTPAID. ORDER TODAY.

Write for **FREE** complete Catalog listing many unusual Seeds, Plants and Bulbs.

BURGESS SEED & PLANT CO.
207 T. Galesburg, Mich.

NU-WAY LAWN MOWER

Write for
FREE Circular

Price **\$12.50**
Why Pay More

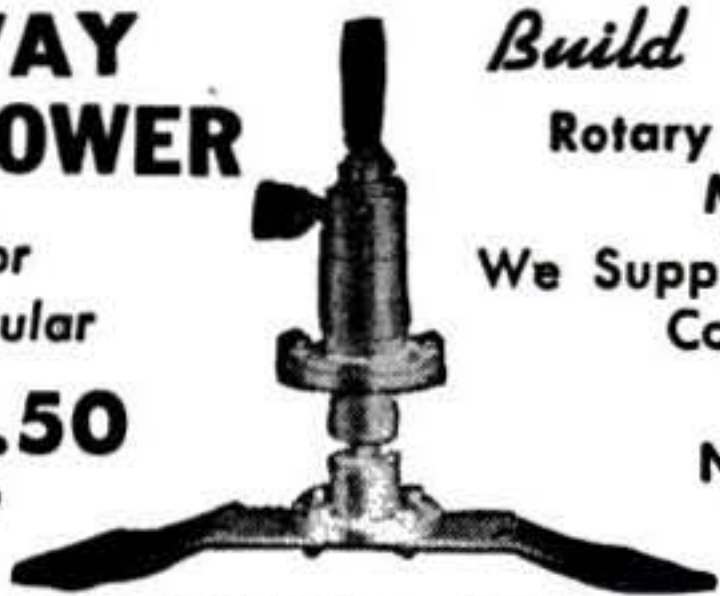

Build Your Own
Rotary Type Lawn
Mower
We Supply Cutting Unit
Complete.

**NO INCREASE
IN PRICE**

TRACTOR-LITE MFG. CO., SPIRIT LAKE, IOWA



LIGHTWEIGHT

Now Only **\$346.30**

9.5 hp. 4-cycle. 3-speed. Foot-shift.
Over 70 miles per gal. Over 60
m.p.h. Write for free circular.

MUSTANG, Dept. GP-28
635 W. Colorado, Glendale 4, Calif.



(Fed. tax paid,
at factory)

SAVE UP TO 50% BINOCULARS DIRECT From IMPORTER



THE WORLD'S GREATEST VALUES

GERMAN ENGINEERED. BRAND NEW, DELUXE LEATHER CASE INCLUDED. Each instrument precision built to rigid military specifications. Buy direct at lowest unheard of prices! **Free Catalog.** Lifetime guarantee. Use at our risk and expense.
6 x 25 \$28.00 with Coated Optics \$30.00
8 x 30 33.00 with Coated Optics 39.50
7 x 50 42.50 with Coated Optics 49.50
10 x 50 52.00 with Coated Optics 62.00
Many other models. Largest Stock in the West.
ORDER TODAY! Send check or money order; \$2.00 Deposit on OOD's. **MONEY-BACK GUARANTEE!** Add 20% Fed. Tax. Postage Included

"HOW TO SELECT BINOCULARS" SIX POWER Pocket Binocular

WITH DELUXE LEATHER CASE. LIGHT • COMPACT • TAKE IT EVERYWHERE • 6x15 with COATED OPTICS. Weighs only 5 ounces! Size, 2 x 3 3/4 inches. A high quality prism binocular (German design) with precision ground achromatic lenses. Field of view; 370 feet at 1000 yards.
MADE TO SELL FOR \$39.95
BUSHNELL Importers

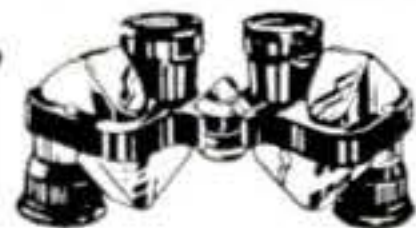

Only **\$18.00** Plus Tax

ORDER TODAY! with Coated Optics \$19.50
Dept.-P52, 43 E. Green,
Pasadena 1, Calif.

Is your Hearing worth a 3¢ Stamp?

Discover a new way to HEAR AGAIN with startling clarity — by spending just 3c for a postage stamp! A way that may help you enjoy normal family and social life again . . . win new success and happiness. A way that's easier than you've dreamed possible.

FREE BOOK Tells How to Overcome Hearing Loss



All you do is mail coupon for valuable **FREE** book. It reveals amazing secrets of how deafness can now be overcome, thanks to a tiny, new electronic miracle.

No Button Shows In Ear

Book tells how to hide deafness. Act now to discover what this new way to hear may do for YOU. Mail coupon today for your **FREE** book. No obligation.



Beltone MONO-PAC One-Unit Hearing Aid

Beltone Hearing Aid Co., Dept. 50PS-2
1450 W. 19th St., Chicago 8, Ill.

MAIL COUPON TODAY

Beltone Hearing Aid Co., Dept. 50PS-2
1450 W. 19th St., Chicago 8, Ill.

Please send me **FREE** book that tells how to overcome hearing loss without a button showing in ear.

Name.....

Address.....

Town.....State.....

Pioneers

Leaders

AIR RIFLES

BENJAMIN

AIR PISTOLS

WITH SAFETY LOCK

SEND FOR FREE FOLDER OF LATEST MODELS TODAY

If you want a **REAL GUN** for **PRACTICAL USE** inside or outdoors, get a **SAFE—CLEAN—ECONOMICAL—BENJAMIN** with Adjustable Power and Amazing Accuracy. Use **BENJAMIN H-C PELLETS** for **BEST RESULTS** in all rifled models. **WRITE AT ONCE.**

BENJAMIN AIR RIFLE CO., 811 MARION ST., ST. LOUIS 4, MO.

FEBRUARY 1950 95

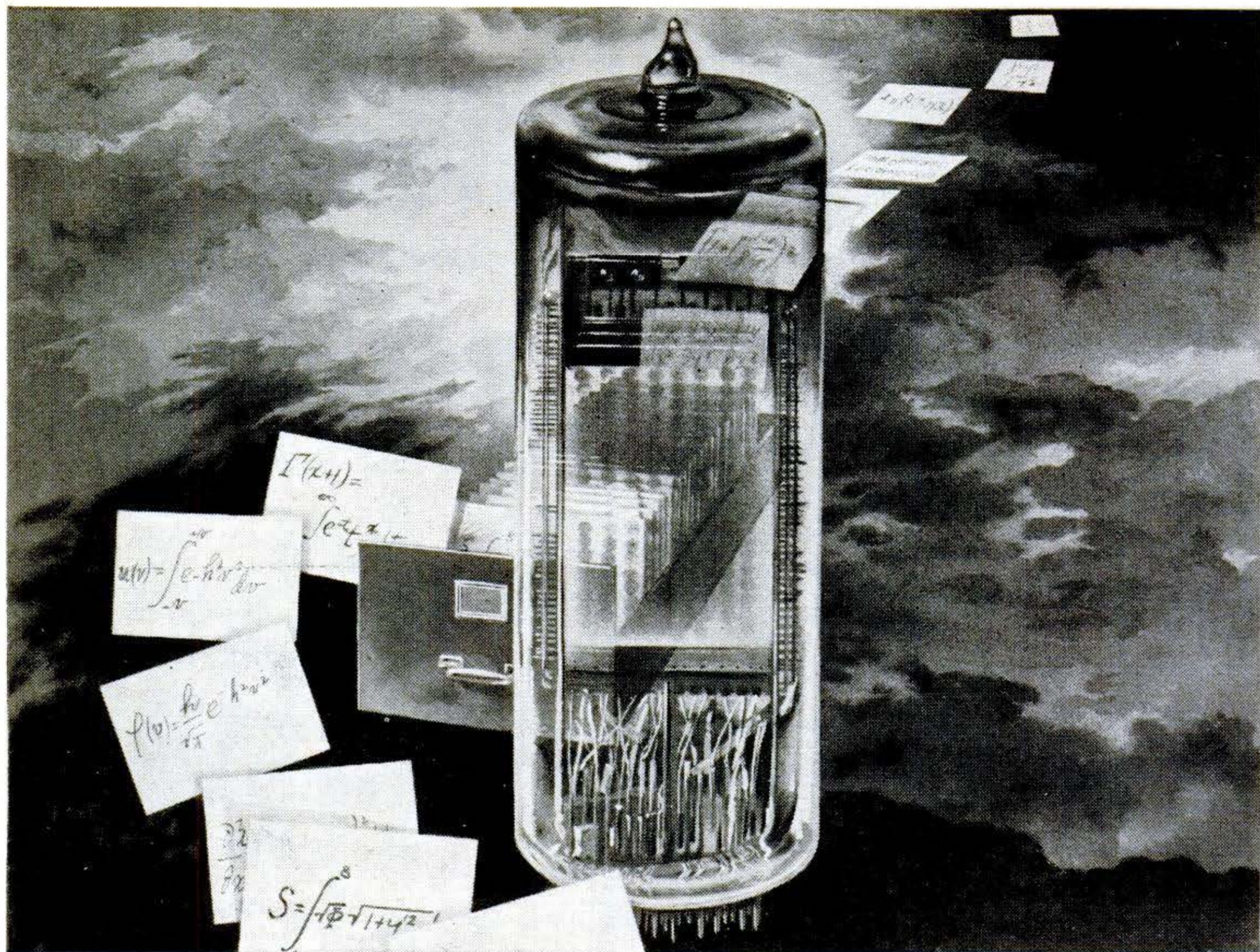

New RCA electron tube gives today's amazing computing machines an indispensable memory.

Tube with a memory keeps answers on file

So complex are present scientific studies—such as in atomic research—that just working out the “arithmetic” could take all of our scientists’ time.

A short cut is found in electronic computers, capable of adding or multiplying numbers as large as one thousand billions in *millionths of a second*. But such speed is valueless unless—with comparable speed—the results of countless computations can be kept “on file” and taken out again.

Such a “file” now exists in a “memory” tube, developed at RCA Laboratories. Electronically it retains figures fed into calculating machines, holds them in storage while it memorizes new ones—speeds intelligent solutions through mazes of mathematics.

Uses of RCA’s “memory” tube are many. It will help atomic scientists acquire new and needed knowledge . . . provide new information on supersonic flight . . . even help make rapid weather predictions! It is an invaluable instrument in the scientist’s campaign to penetrate the unknown.

For your benefit:

Development of the “memory” tube is just one example of the many basic advances pioneered at RCA Laboratories. Continued leadership in science and engineering adds *value beyond price* to any product or service of RCA and RCA Victor.

Examples of the newest advances in radio, television, and electronics—in action—may be seen at RCA Exhibition Hall, 36 West 49th Street, N. Y. Admission is free. Radio Corporation of America, Radio City, N. Y. 20.



RADIO CORPORATION of AMERICA

World Leader in Radio — First in Television

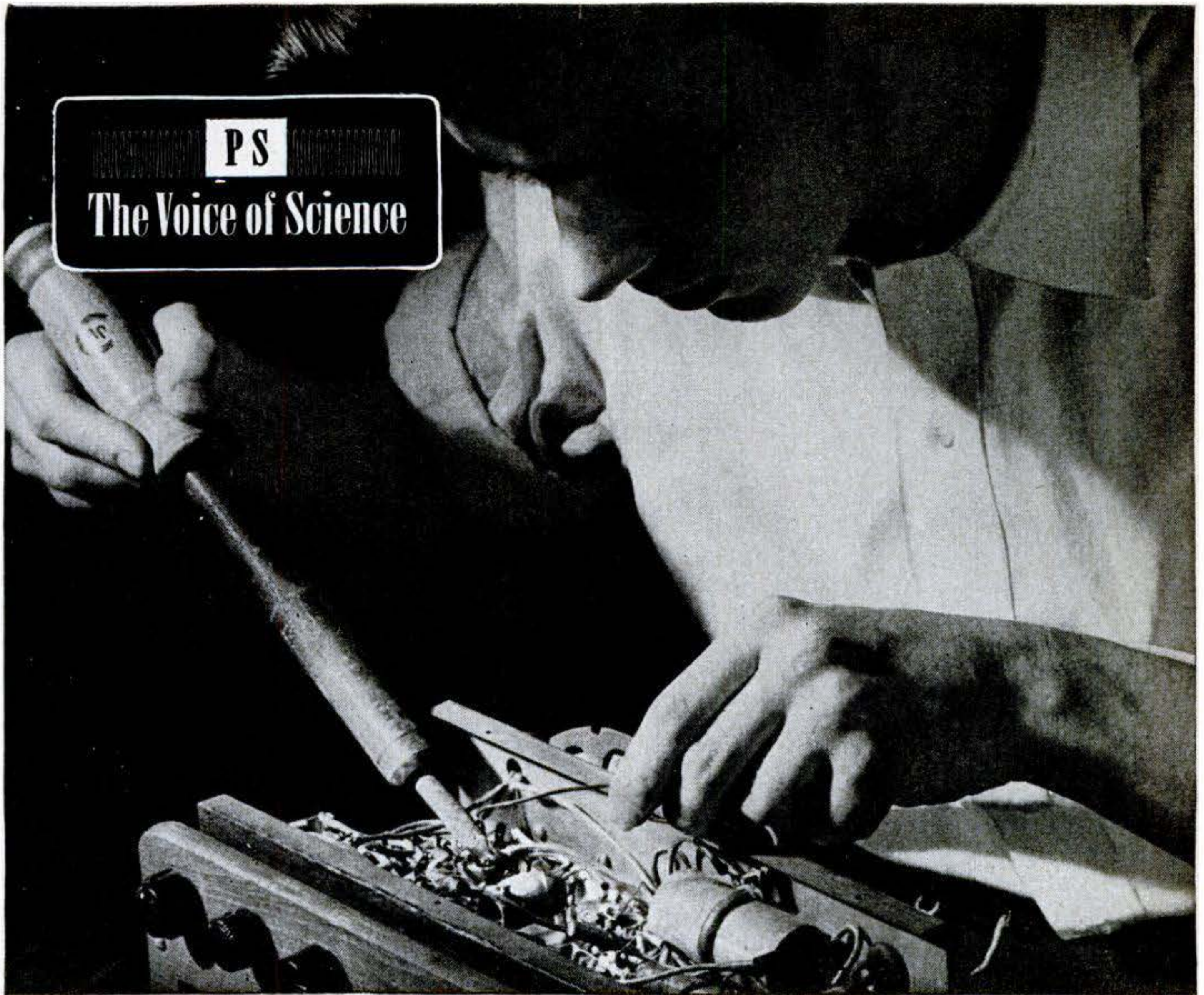

PS
The Voice of Science

The Playing Fields of Science

THE Battle of Waterloo, they say, was won "on the playing fields of Eton." And the athletic field has long been a training ground for the kind of courage and leadership that is vital in visible combat.

But the battle for survival, it seems obvious, will be won on the playing fields of science and engineering. With or without war, the future that projects from the present calls for aptitudes that don't grow on athletic fields.

For two years, the Civil Service Commission has been looking for the answer to the question that is the hinge of the future: where can we find the thousand young men a year who will be needed to run a billion-dollar-a-year program?

The young men with the aptitudes to dream, develop, and operate equipment constantly more complicated aren't dashing

around on high-school football fields. The best place to catch a future physicist, the Commission says, is among those who get through school ahead of schedule.

The best budding engineers and technicians, according to the Commission, come from the high-schoolers who spend their spare time soldering up a radio circuit, or crawling around the innards of an automobile.

In other words, the "playing fields" of science and engineering are the school lab after hours, the Model Garage, and the back room of Joe's Radio & Fixit Shop.

We think that, technically, the future is in good hands.

Perry Githeas

**NOW... LIGHT
WHEN YOU NEED IT!**

**Ray-O-Vac LEAK PROOF batteries
stay fresh for years!**

(because they're sealed in steel!)



© 1949 BY RAY-O-VAC COMPANY, MADISON, WIS. RAY-O-VAC, CANADA LTD., WINNIPEG, MAN.

See how much more you get

in these truly modern batteries. Each Ray-O-Vac Leak Proof starts with a powerful, well made battery. Then . . .

1. Steel bottom is added.
2. And a steel top.
3. Next — Multi-ply insulation. Many layers of protection against corrosion.
4. Last—a steel jacket. This completes an air-tight seal, to stop corrosion and keep the battery fresh and powerful. Only Ray-O-Vac builds batteries with all four of these safeguards.

GUARANTEE on every Ray-O-Vac Leak Proof:
"If your flashlight is damaged by corrosion, leakage or swelling of this battery, send it to us with the batteries and we will give you **FREE** a new, comparable flashlight with batteries."

Ask for Ray-O-Vac Leak Proofs

Buy Spares... they stay fresh

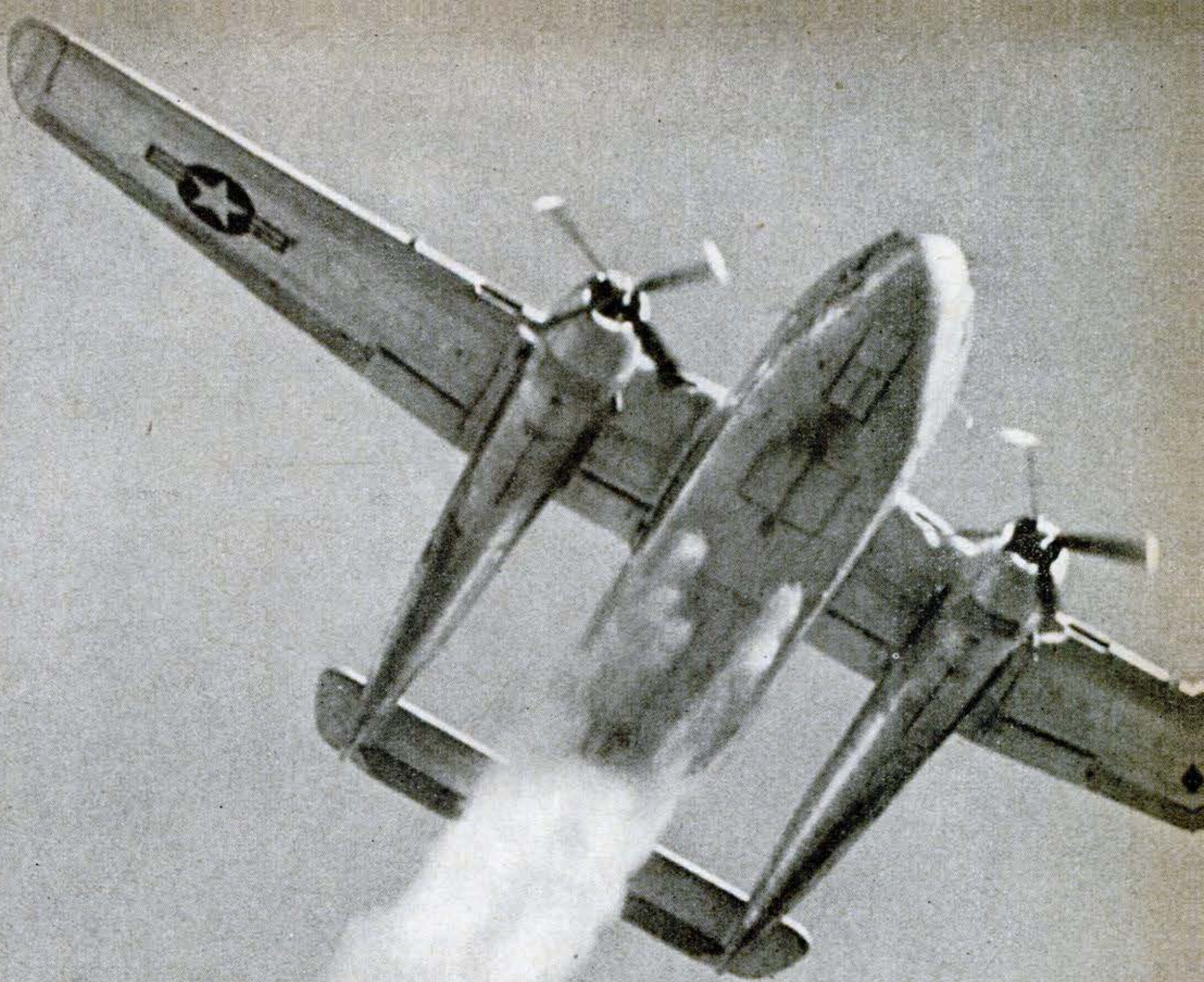

**POPULAR
SCIENCE**
REG. U.S. PAT. OFF. *Monthly*

Water Trails in the Sky . . . This may look like a rocket-assisted take-off. Actually it is a Fairchild C-119 Packet cargo plane dumping water ballast during a test flight. Replacing 25-pound bags of shot used previously as ballast, the water, contained in four 720-gallon aluminum tanks, can be pumped back and forth to duplicate any load distribution. The water ballast is transferred from tank to tank at the rate of 70 gallons a minute. Electrically operated valves in each tank permit the entire liquid load to be jettisoned through 10-inch openings in the plane's floor in 75 seconds.

FEBRUARY 1950 99

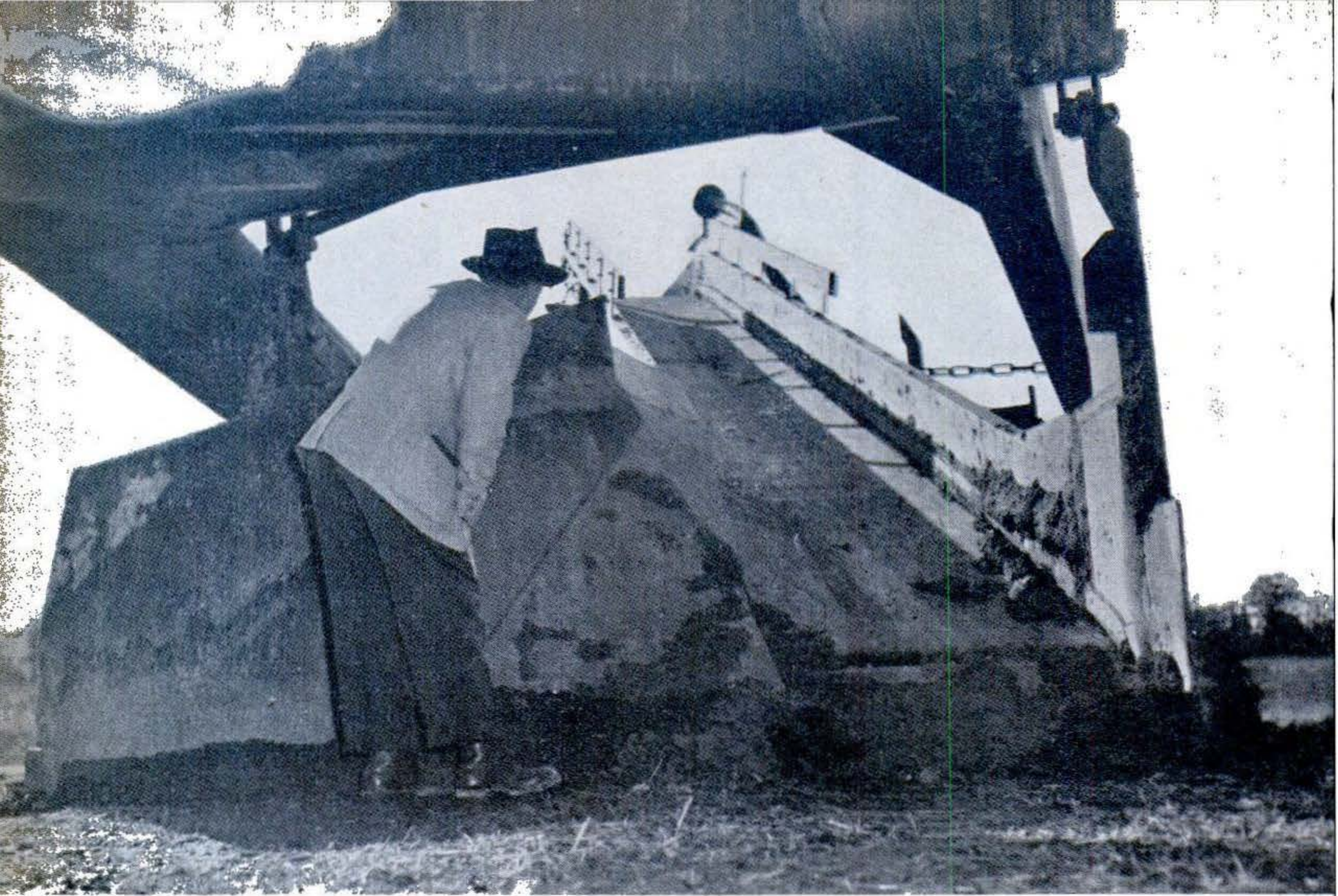

Big mouth of this earth mover can scoop up a ton of dirt a second in a 9½-foot-wide swath.

**POPULAR
SCIENCE**

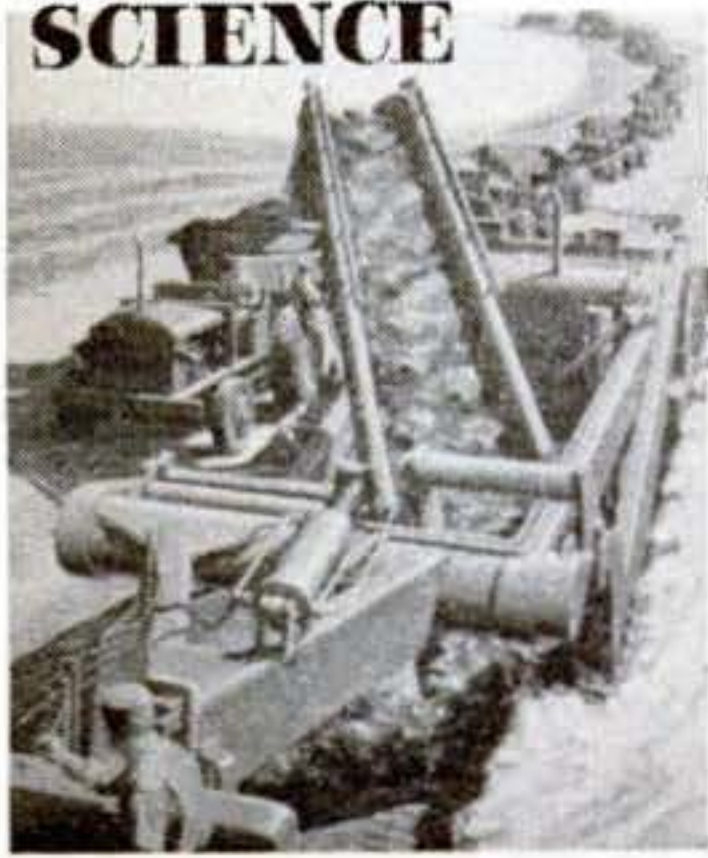

Cover painting by Ray Pioch

Big Mouth Eats a Ton a Second

Trucks follow loader in long procession, each one moving up under the conveyer as the one ahead is filled and moves on. The loader can fill the trucks, each with a 16-cubic-yard capacity,

at a rate of better than one a minute. All out, it can dig a ton a second. The loader itself, not including tractor that pulls it, is 50 feet long and 18 feet high. Conveyer is 4½ feet wide.



Machines that move mountains are helping man literally to change the face of the earth.

By George H. Waltz, Jr.

PS photos by Hubert Lockett

A HALF-DOZEN years ago, a dam or road builder who could handle 300,000 cubic yards of dirt a day was considered a miracle man. Now, more than one large contractor can guarantee to move 1,000,000 cubic yards—the equivalent of a mountain of earth half as tall as the Washington Monument and a seventh of a mile long at its base—in a day without even straining his equipment!

This tremendous increase in our ability to make mole hills out of mountains is made possible by the new and ingenious “big mouths” used in the earth-moving industry. Today, we have mechanical monsters capable of chewing up and transporting prodigious amounts of dirt. We have rugged Diesel engines capable of powering such earth movers. And we have mammoth rubber tires—some taller than a man and costing more than your family car—on which the new earth movers can roll at high speeds.

Right now, a team of one breed of “big mouths”—giant-size conveyer-belt loaders—is chewing through the hills and dales near the town of King of Prussia, Pa., to form the roadbed for the eastern extension of the famous Pennsylvania Turnpike. A few weeks ago, I watched one as it spewed an almost continuous stream of earth into big Diesel-powered trailer trucks, each capable of holding enough dirt to fill the average living room up to its door tops.

Stopwatch in hand, I timed the opera- ➤

Mountain a day. In 24 hours, as drawing below shows, loader can move enough dirt to form hill three times taller than average two-story house and six times wider in diameter at the base.

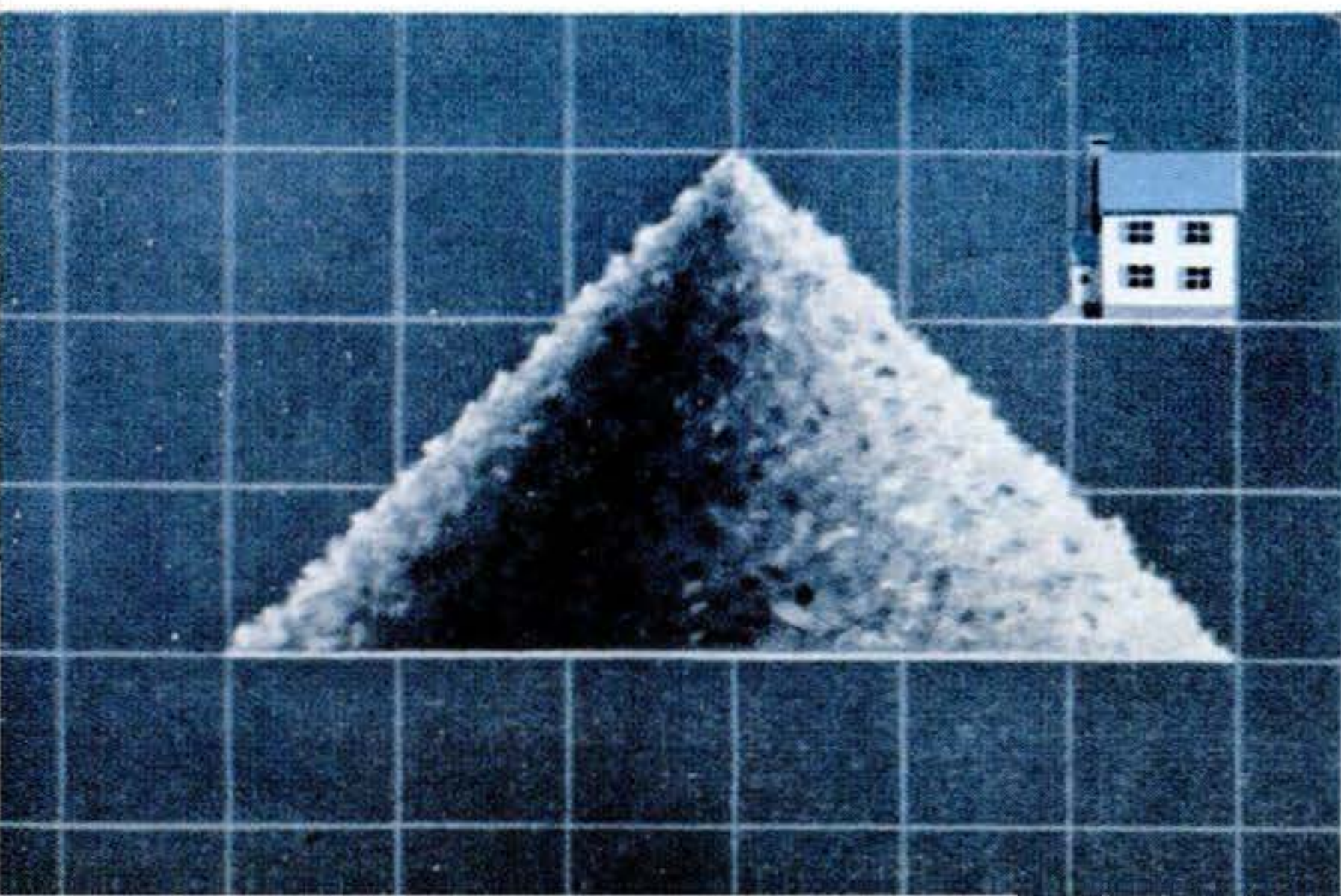

Close-up of big mouth in action shows how dirt sheared off by large, plowlike blade and edge-cutting blade at side is funneled into 35-foot-long rubber conveyer that feeds it to trucks.



Above, tractor pulls loader along at brisk 3-m.p.h. pace when cutting. Note the depth of the cut as shown by the high bank at the right. Below, a General Motors Diesel mounted on the rear end of the loader powers the conveyer. Tiny figure of truck driver shows giant's size.



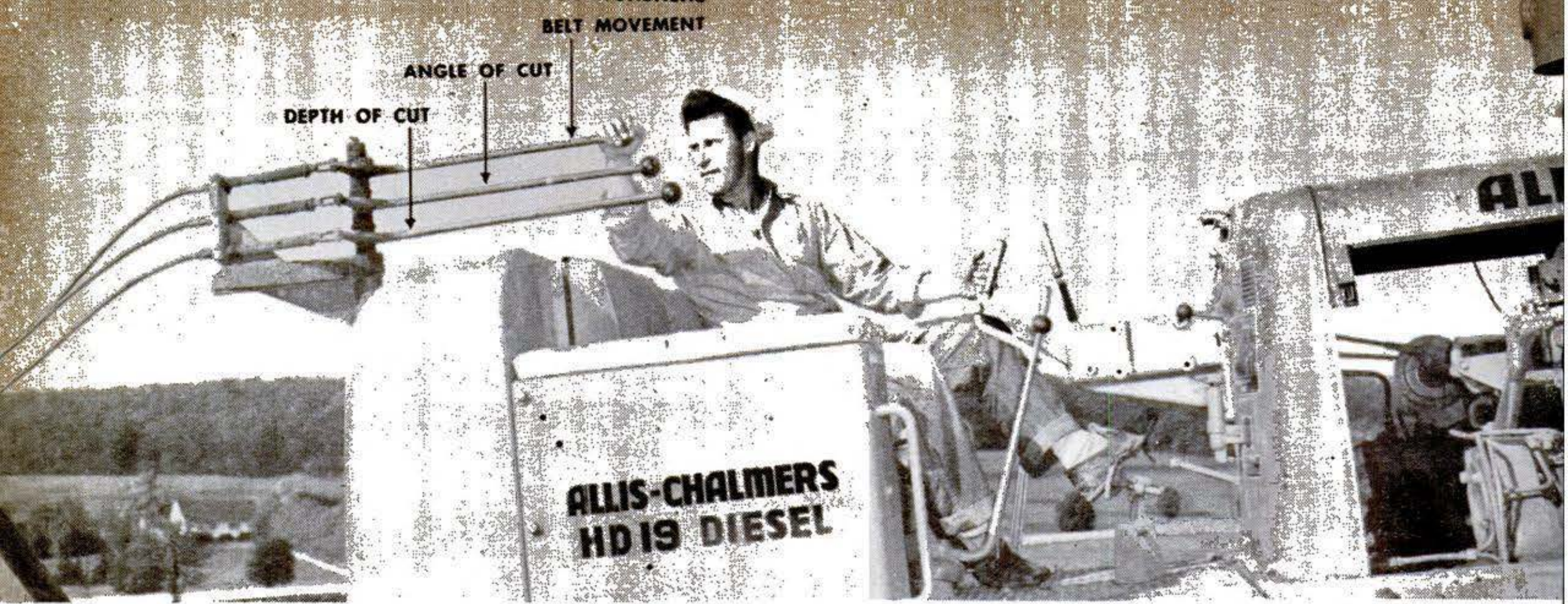

The tractor driver controls the loader with three hydraulic levers mounted just behind his seat. The levers control the movement of the conveyer belt, the angle of the cut, and the

depth of the cut. Looking back, the tractor driver gets directions signaled to him from man on rear end of loader who also signals directions to drivers of trucks moving up under conveyer.

tion as a long procession of the deep-bellied trucks followed the loader as it gouged out the roadbed at a three-mile-an-hour clip. As each truck was filled to heaping, the one directly behind it would pull up under the loader's conveyer and follow at the loader's pace. It took just 50 seconds, on the average, to fill a truck to overflowing and get it on its way.

The big-mouthed loader was gulping up dirt at better than 16 cubic yards a minute, or at a rate of 23,000 cubic yards every 24 hours. If its round-the-clock output were piled in one spot, it could form a hill three times taller than the average two-story house and six times larger in diameter at the base.

Another big mouth, this new twin-engine scraper has one engine in front to pull and another in back to push. Fully loaded, it weighs 122,000 pounds, yet can still scoot over rough

If it were dumped into a block-long city street, it would bury it up to the third-story window sills of the bordering buildings. At the time, the loader was running at less than full speed. All out, the conveyer can deliver as much as a ton a second. That's 36,000 tons in a 10-hour shift.

Mountain a Day

In any terms of comparative measurement, that single machine was moving a heap of dirt. Little wonder then that, by putting to work a large number of "big mouths" like the one I was watching, a well-equipped contractor can literally move a mountain a day!

ground during hauling runs at 30 m.p.h. It can make a round trip from "borrow pit," where it picks up needed dirt, to the dump point several hundred yards away in less than 3 minutes.



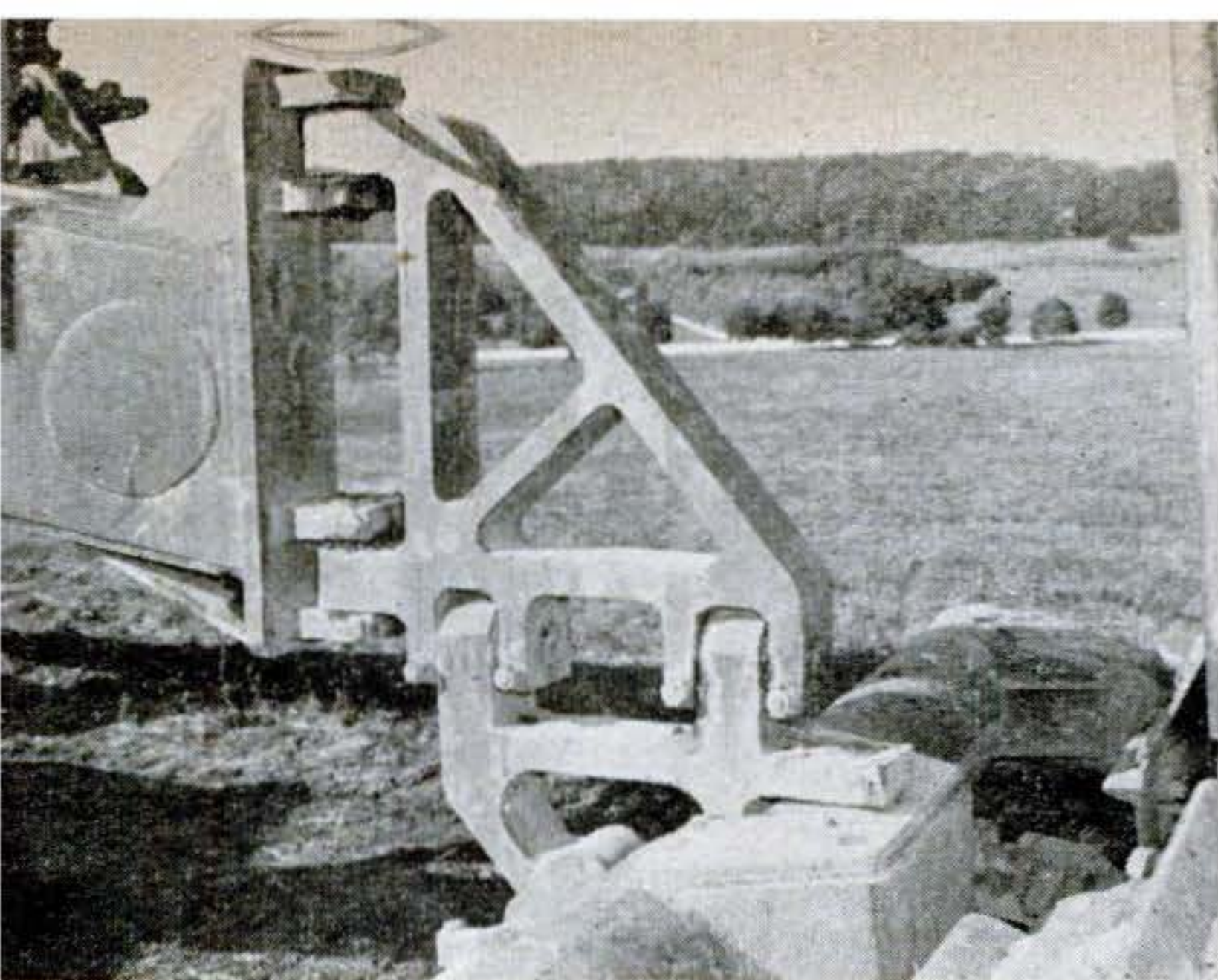

Special bridgelike design of hitch and draw-bar centers loader's 25-ton weight on tractor's track frames. Joint's universal action lets loader pitch and yaw without straining coupling.



Rear end of loader rides on crawler tracks having individual rollers on each shoe. Tracks spread weight over large area, providing good flotation and stability on soft or uneven ground.

Basically, the loader is an overgrown, super-powered belt conveyer riding on twin endless tracks and fitted with a wide cutting blade and deep plow at its forward and lower end. Its 50-foot length and 18-foot height dwarf the tractor that is used to pull it along.

As the loader moves forward, the plow mouth, which can cut a swath nine and a half feet wide, feeds a steady stream of dirt onto a rubber conveyer belt that is four and a half feet wide. At the end of its 35-foot trip up the conveyer, the dirt is dumped into the waiting trucks. A 190-hp. Diesel engine, mounted on the rear of the loader, provides the power for the belt conveyer.

The movement of the belt, as well as the angle and the depth of the cut, all are easily controlled by the tractor driver through three conveniently located hydraulic levers mounted just behind his seat.

As he drives, he looks back and receives hand-sigaled instructions from the "truck guider" who stands on the loader's frame just under the upper end of the conveyer. The "guider" watches the loading of each truck and not only signals to the tractor driver when to start and stop the belt but indicates to each truck driver whether he should pull up or fall back to distribute the dirt evenly in the truck's body. The efficient operation of a loader depends to a

Ground's-eye view shows scraper's giant bowl. Man in center is dwarfed by its massive size. When scraping edge (lower foreground) has scooped up enough dirt to fill bowl, gate (top of

picture) is lowered, and bowl is raised clear of ground for overland travel. Note sharp, near-90° angle of front driving wheels, permitting the scraper to turn on proverbial dime.



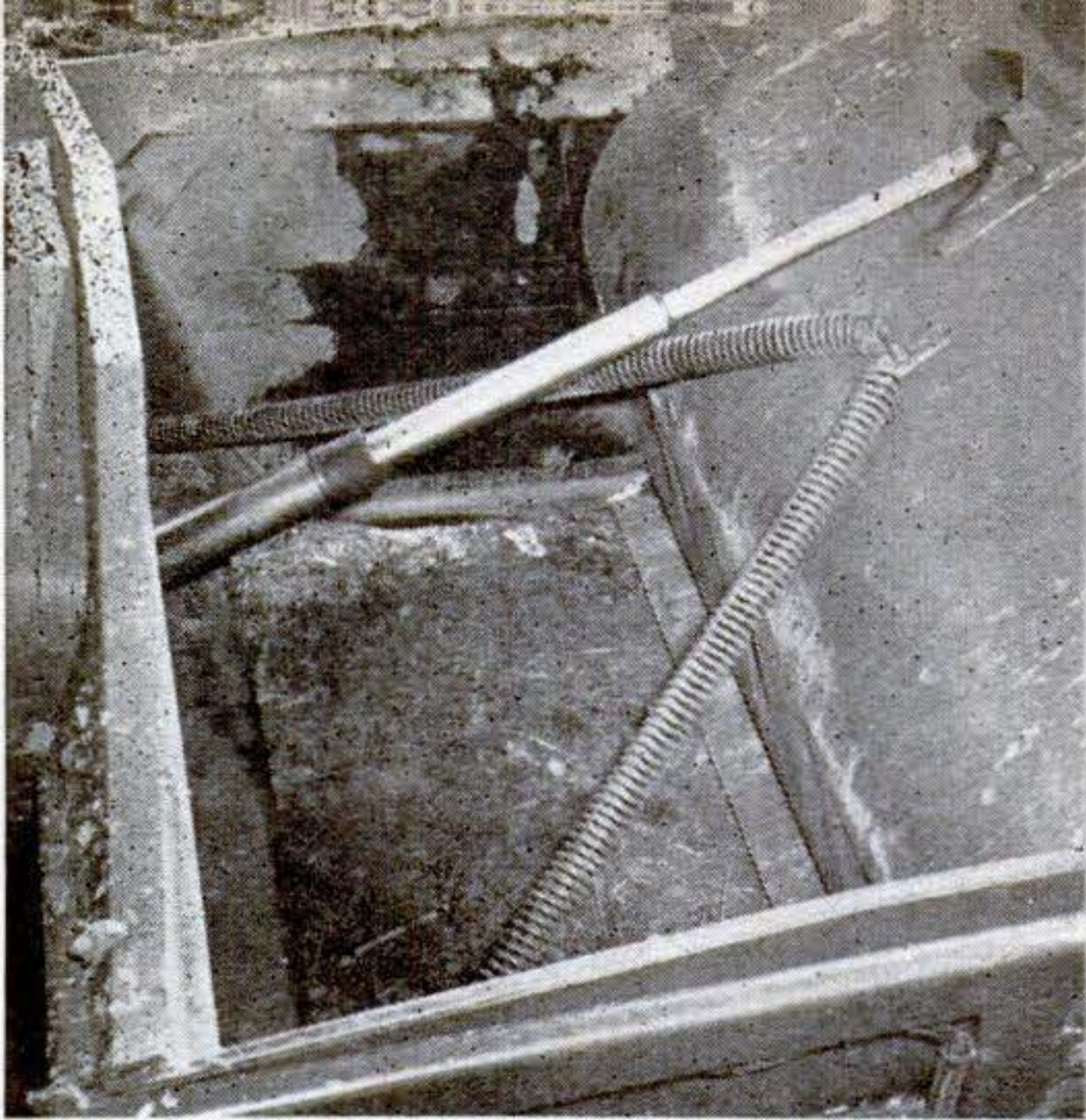

To dump scraper, gate is raised, and telescoping hydraulic piston tips up bowl to spill out dirt. Dumps, like pick-ups, are made on the run, so entire operation is done without stopping.

A 190-hp. GM Diesel powers scraper's rear wheels through Allison torque converter. Good year tires, 87 in. in diameter, each weigh 1,427 lb., cost \$2,400, and take ½ hr. to inflate to 40 lb.



large extent on the teamwork of these three men.

Newest of the "big mouths" that are now speeding the construction of dams and highways is the twin-engined scraper. Manufactured by the Euclid Road Machinery Co., of Cleveland, Ohio, which also makes the loaders I saw in operation, the new earth mover not only loads itself by scraping earth up into its belly at the rate of 24 cubic yards a trip, but it carts its load quickly to where it is needed. It can gather in its full

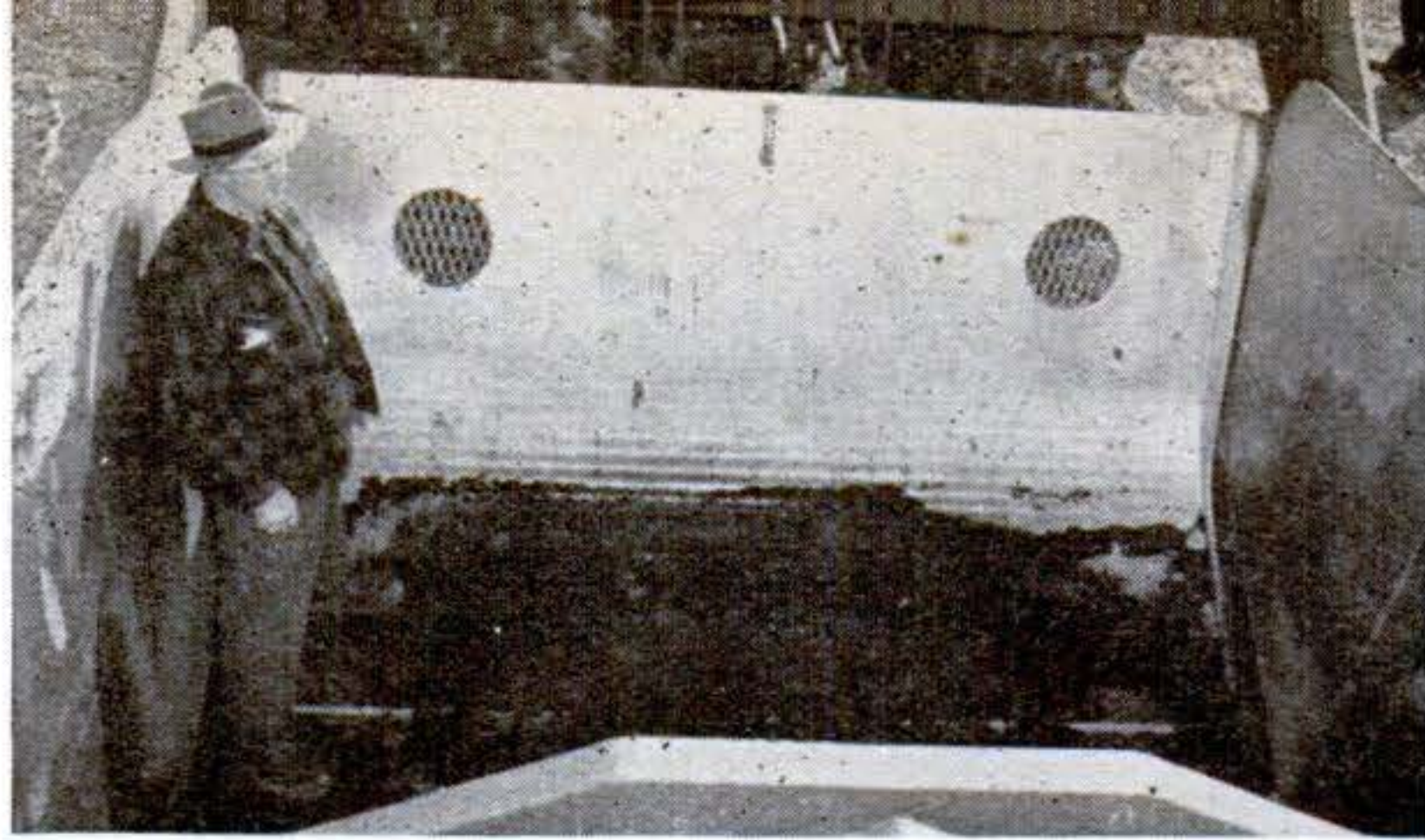

Inside view of scraper's bowl with front gate closed shows its large capacity. Sides are as tall as man standing inside. Scraper can pick up its 24-cubic-yard load in less than a minute.

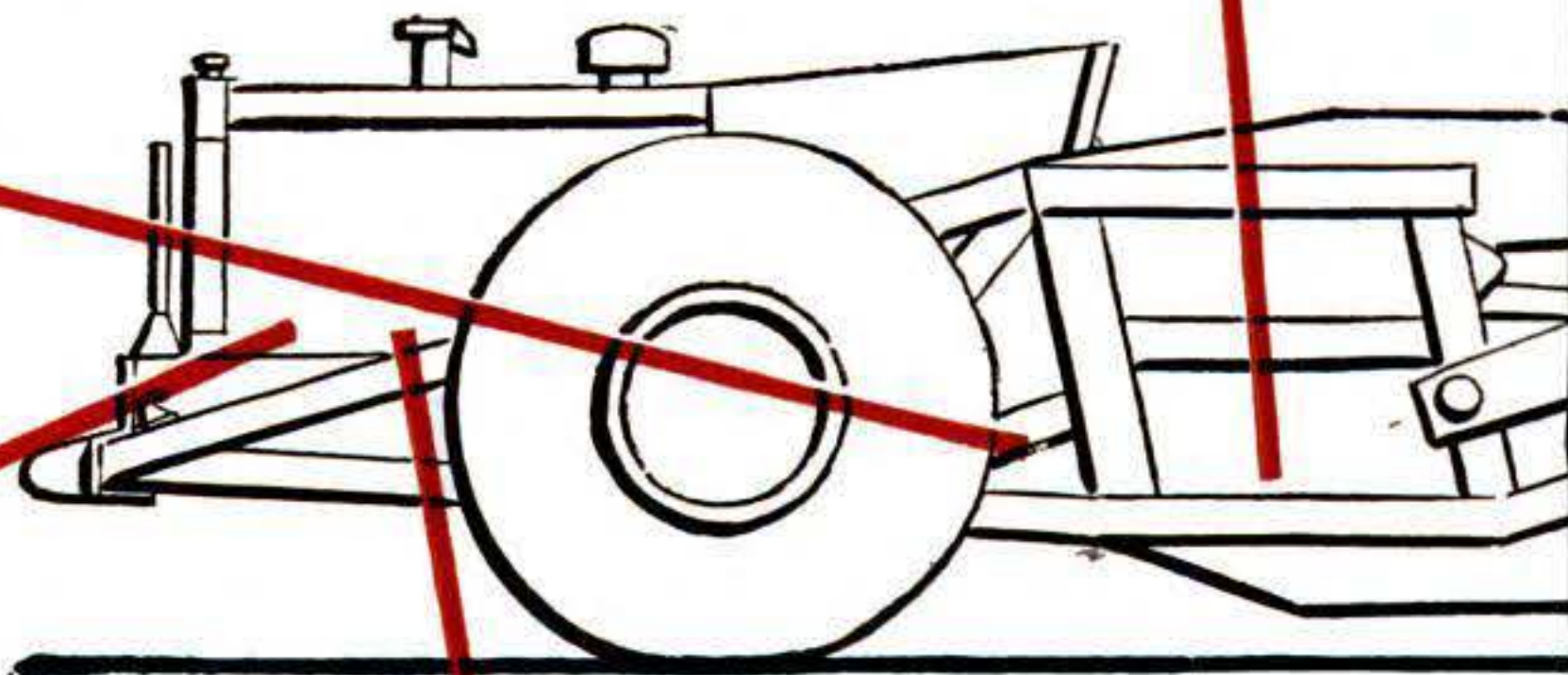

Four solenoids, below, automatically shift the scraper's rear-engine transmission when the operator shifts the front engine. Both engines have three speeds forward and one in reverse.

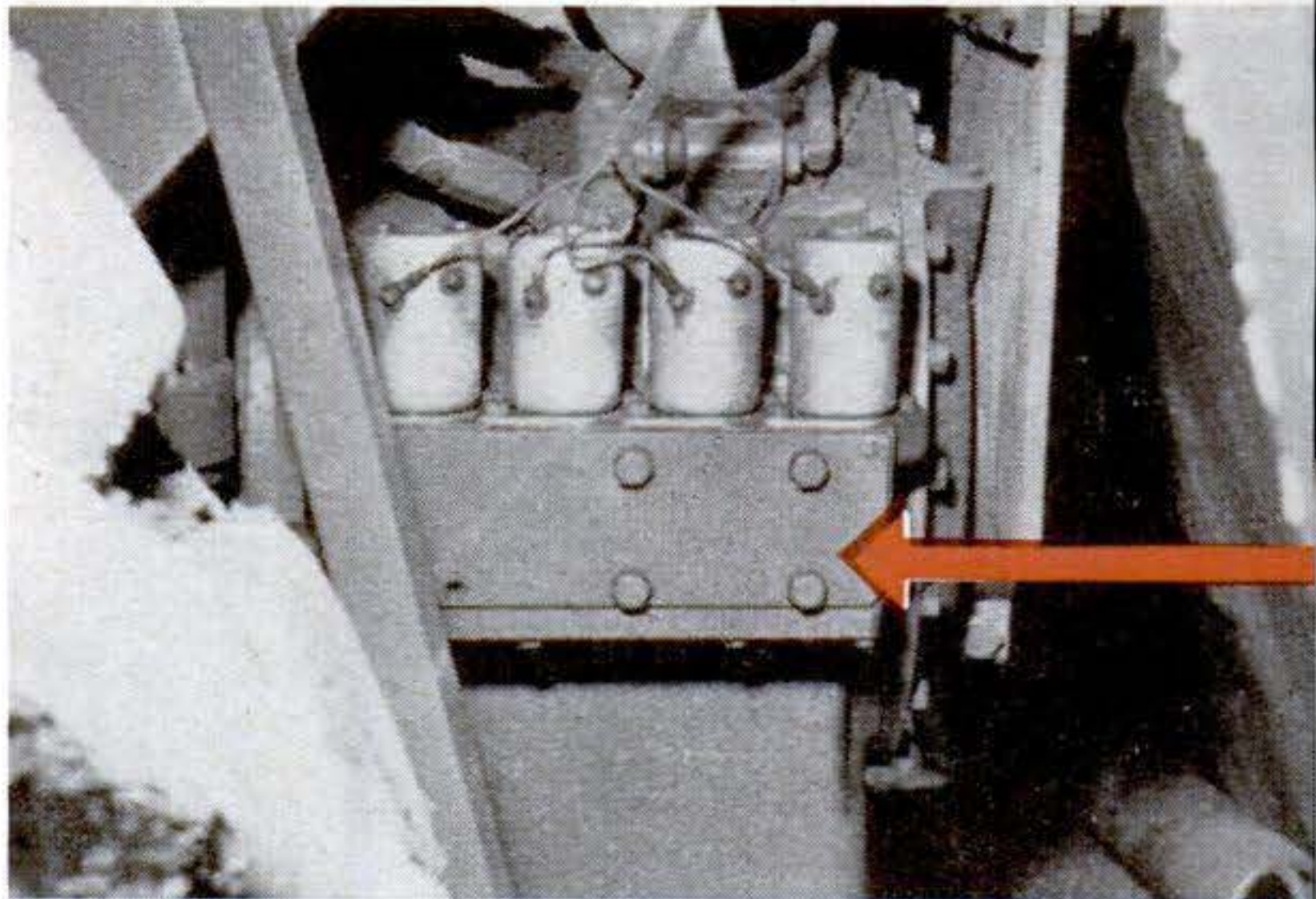

capacity of dirt in less than a minute and be off on its overland haul to the dumping area at a galloping 30-m.p.h. pace.

Pan scrapers are not new in the earth-moving business. Those in general use, however, are of much smaller capacity (14 cubic yards or less), are pulled by a tractor or a two-wheeled traction unit, and normally require a second tractor or 'dozer to push from behind while they are making a cut to fill their bodies. On the overland haul after loading, their speed is limited.

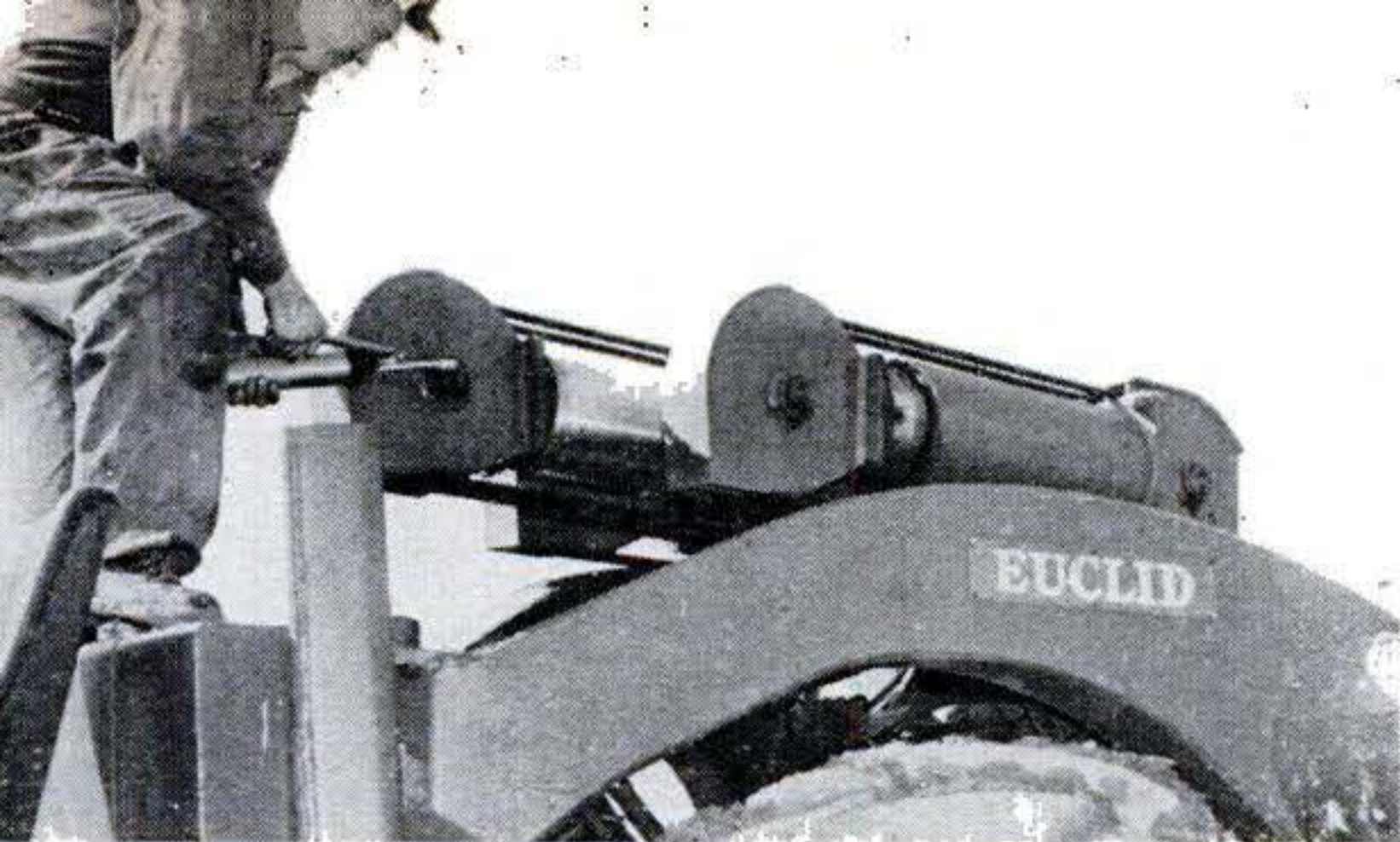

Gate and bowl, like unloading ejector, are hydraulically operated. Three cylinders atop the front end of the scraper body, as shown above, do the job—one for the gate, two for the bowl.

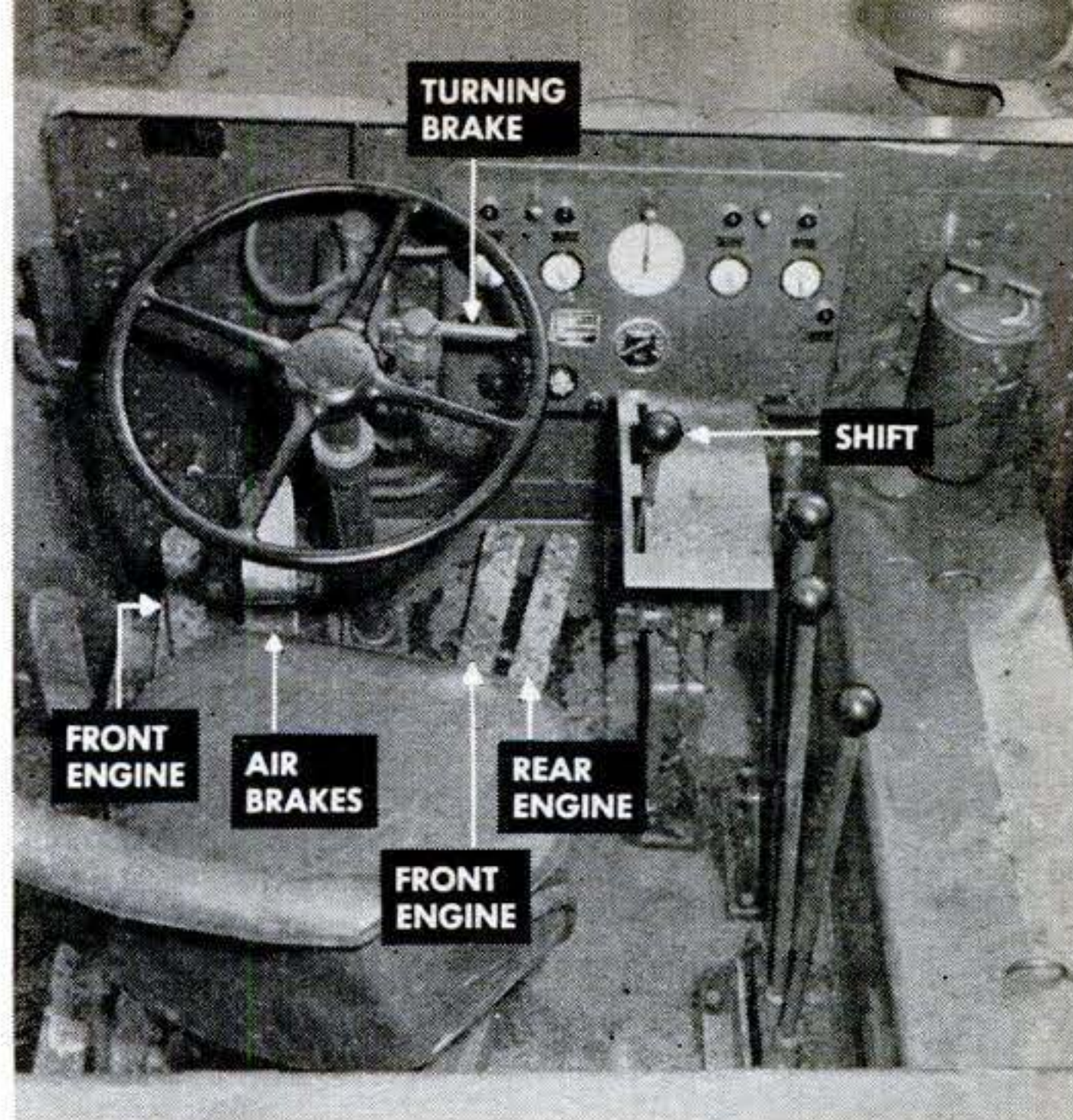
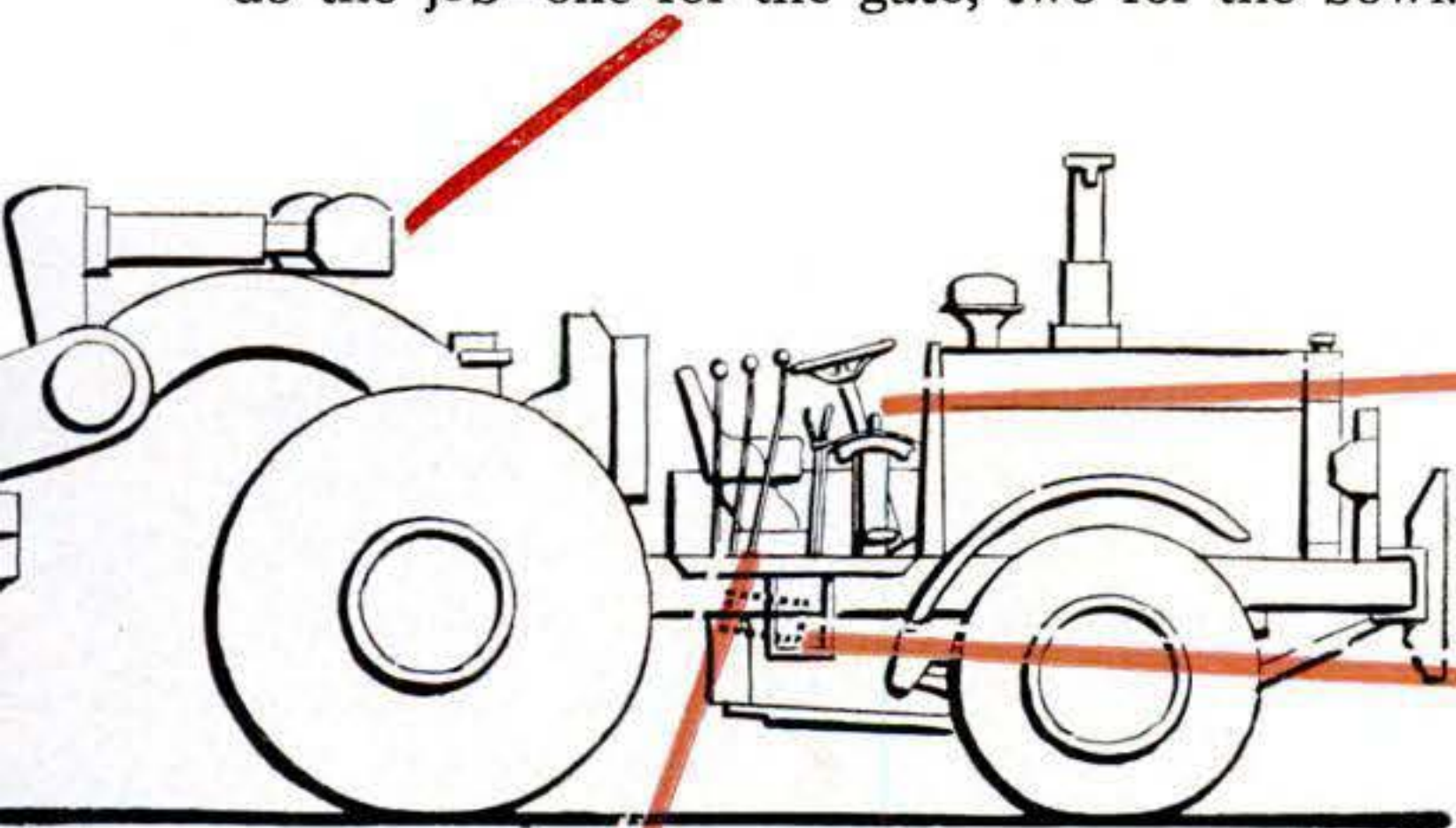

Driver's cockpit has more pedals than you can shake a foot at. Pressed together, dual accelerators at right control front and rear engines simultaneously. Larger pedal at left is air brake.

Air booster on steering mechanism lets driver handle the big machine about as easily as you do the family car. The seat is equipped with hydraulic shock absorbers and spring mountings.

When driver shifts front engine, roller attached to shift lever operates buttons that actuate solenoids to shift rear engine. Three levers in foreground control gate, bowl, and ejector.

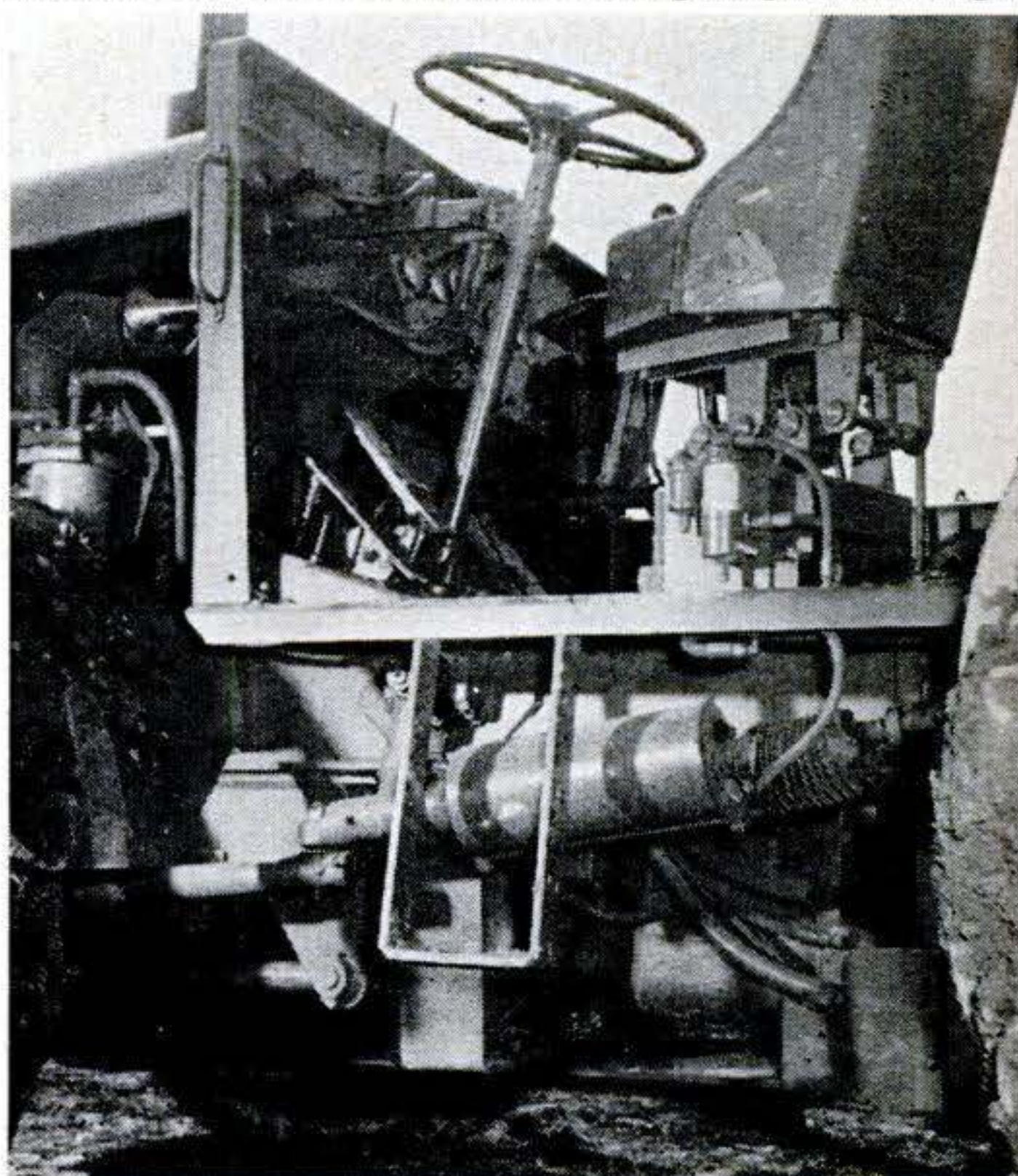
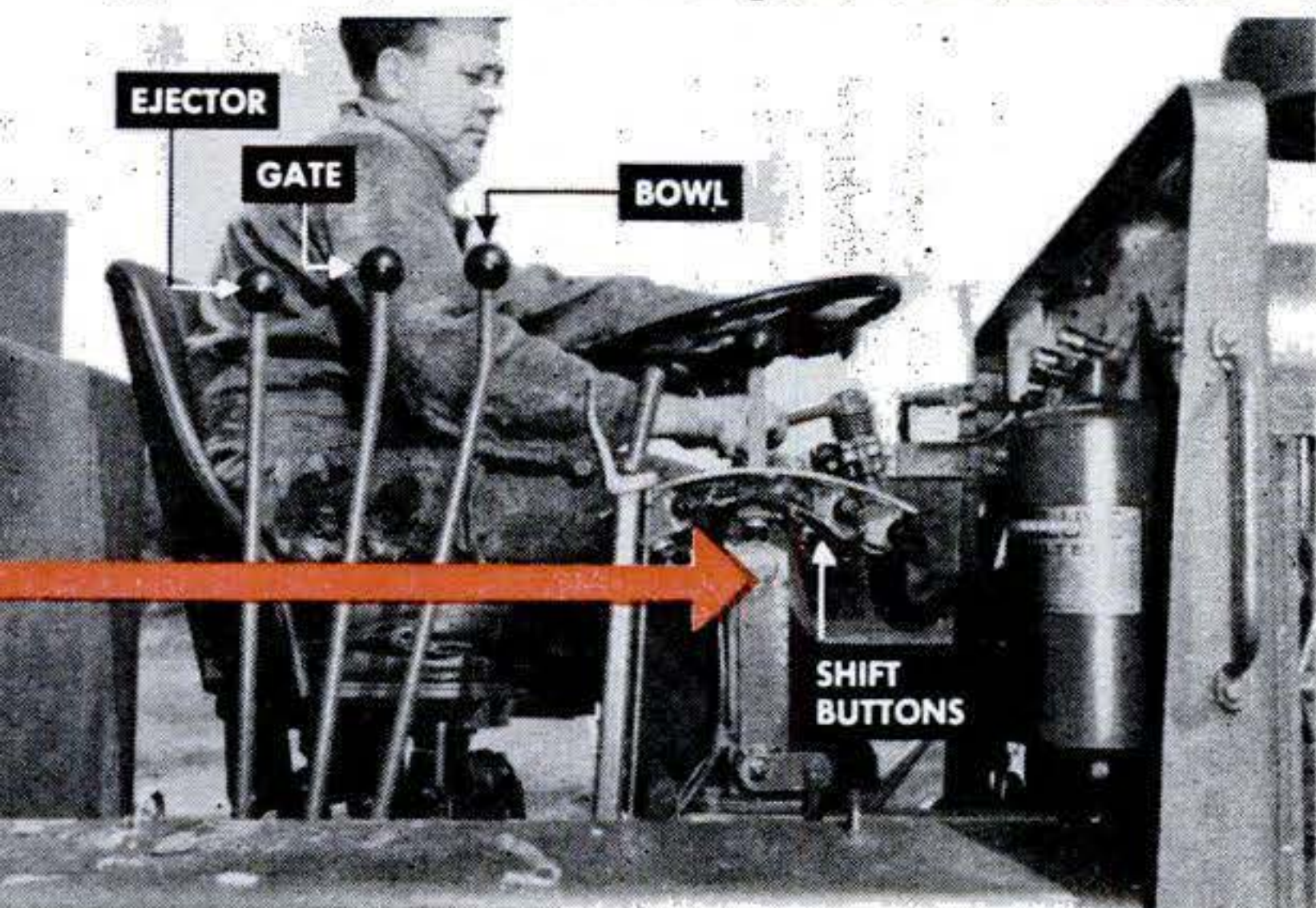

Not so with the new twin-engine scraper. It has its rear-end pushing power built-in in the form of a remotely controlled Diesel engine that drives the rear wheels through a torque converter. The 190-hp. Diesel that powers the two rear wheels of the front-end puller is used for general maneuvering. When power from the rear of the scraper is needed in making a cut, however, the operator presses down on dual accelerators to bring both engines into play. This applies a total of 380 horsepower from the two en-

gines to the four giant rubber driving wheels. The new scraper makes scraping and loading a one-man operation. When the driver shifts gears on the front engine, the gear-shift lever operates buttons that in turn activate solenoids to shift the rear engine simultaneously. The effort necessary to steer the 48-foot behemoth, which weighs approximately 122,000 pounds fully loaded, is no more than that required to drive the average car. An air booster on the steering system takes care of that. As for

brakes, a foot pedal applies air brakes to all four driving wheels, while an auxiliary hand-operated air brake allows the driver to lock either the right or left front driving wheel as an aid in making sharp, right-angle turns. Even the horn is air-operated.

By operating three levers located at his right, the driver has fingertip control of all scraping (loading) and dumping operations. He can lower the pan to scrape and load or raise it to carry. He can open or close the front gate. And he can control the ejector that pushes the dirt out during the unloading operation. In each case, powerful hydraulic plungers provide the lifting, opening, closing, or pushing power.

Working on the Run

Under average conditions, the twin-engined scraper can work continuously without stopping. When a cut is to be made, the bowl, or body of the scraper, is lowered so that its front cutting edge can take its long scooping bite of earth under the power of the four big driving wheels. Then, when the bowl is filled, its front edge is raised, the gate is closed, and the scraper is off at a good clip to the dumping or fill-in grounds. To unload, the driver simply moves the controls to open the gate and move the ejector forward. The dirt spreads out evenly from the forward edge of the raised bowl and the scraper starts its trip back for another cut. On the average overland haul—about 400 or 500 yards—the entire sequence from loading to dumping and back to loading takes less than 3 minutes.

Power, capacity, and speed—those are the watchwords where earth movers are concerned. For they are the three factors that reduce costs and speed construction. And all three are made possible through the development of the Diesel and giant rubber tires.

Visit any big construction job today and you'll see the strongest, the biggest, and the fastest, all the way from the loaders and scrapers to twin-engined Diesel dump trucks that can roll over rough off-the-road terrain with a full 34-ton payload at better than 25 m.p.h.

Watching these machines move mountains, you have to think twice to realize that they are today's version of the dinky mule-drawn "fresno" wagons that not long ago toted the dirt for our roads and dams and even today still help out with the daily chores on many a small farm. END

Automatic 'Chute Safeguards Airmen

THE British airman below is wearing the latest addition to pilots' safety devices—a parachute with a robot ripcord. The automatic release assures that even a wounded or unconscious jumper's 'chute will open at a preset height from the ground. It also delays opening of the 'chute until a jumper has fallen quickly through high-altitude air so rare that he might suffocate. The release works by barometric pressure on the rubber bulb seen attached to the mechanism on his belt. If a flier abandons his aircraft below the altitude for which the release is set, a clockwork opens the 'chute after a delay of five seconds to make sure he is clear of the plane. The robot release, developed by the Irving Parachute Co., of Hertfordshire, England, operates a seat-type 'chute; the chest 'chute here is worn only for emergency use.





What Makes the Water Run?

SPECTATORS were stumped at a science show staged by the Naval Ordnance Laboratory in White Oak, Md.—a faucet hanging in mid-air kept spewing forth water. The explanation: the stream hid a glass tube connecting the faucet with a big pan on a table. A motor pumped water up through the tube, and it ran down the outside.

'Copter Nose Peels Open

OPENING like orange peels, the doors on the nose of this new Air Force helicopter, made by Sikorsky, give ready access to the engine and the big fan necessary to cool it. With seats for 12 or space for eight stretchers, the machine has been flight-tested successfully. The cabin is under the main rotor. The pilots sit above and forward of it.

Jack Speeds Car Loading

AUTOMOBILES are pushed from assembly lines right into waiting freight cars with this new Autow Loader[®] made by the Salsbury

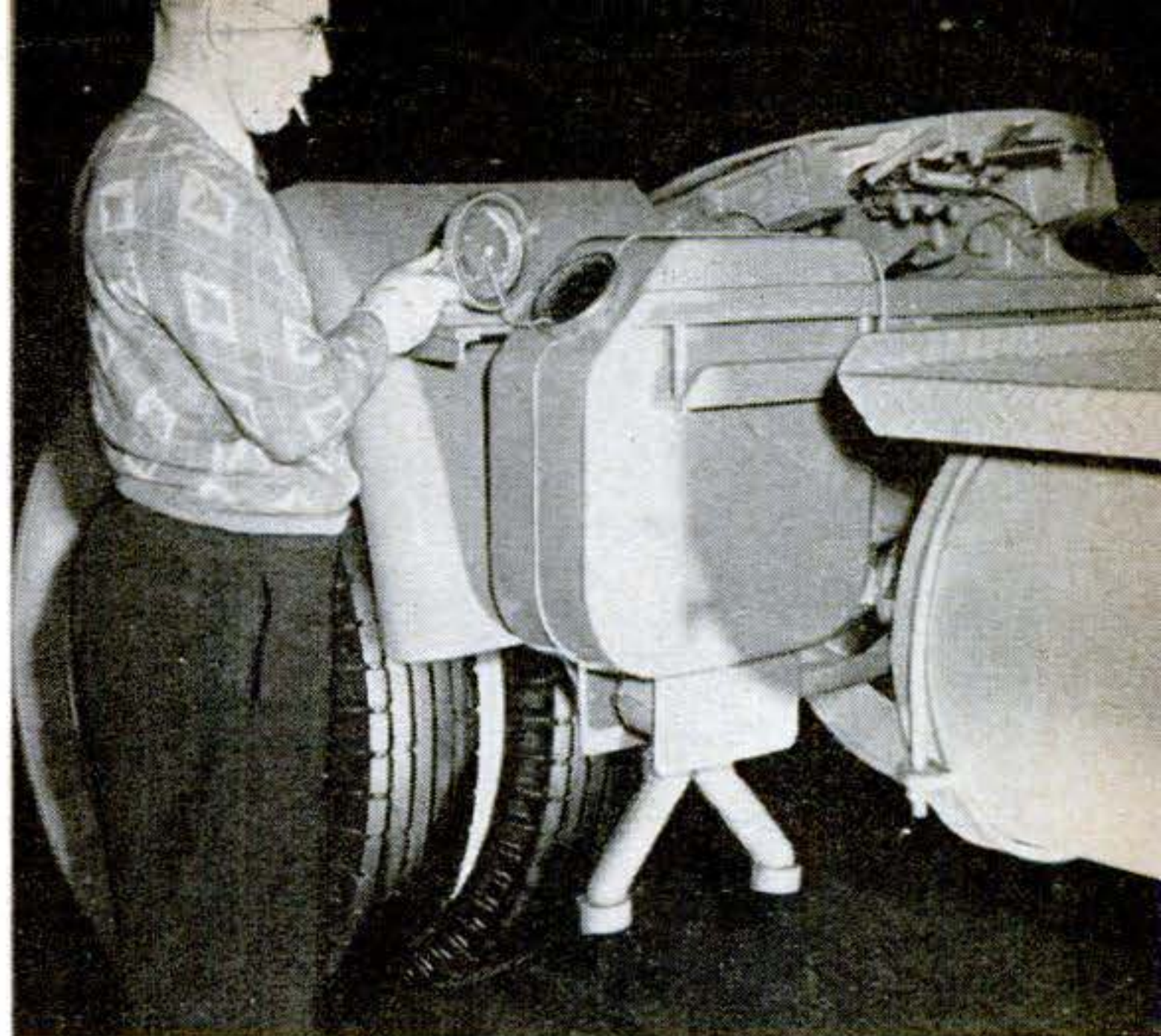

Sander Helps Tires Grip Road

THIS road-sanding unit on a new General Motors truck is operated by a dash-controlled solenoid when tires need more friction. Made by the Elston Electric Sander Co., St. Paul, it holds 70 lb. of sand.



Corp., of Los Angeles. The tug in the foreground lifts the rear end of an automobile with a hydraulic jack and pushes it into the rail car. An assistant at the steering wheel guides the car's front wheels.



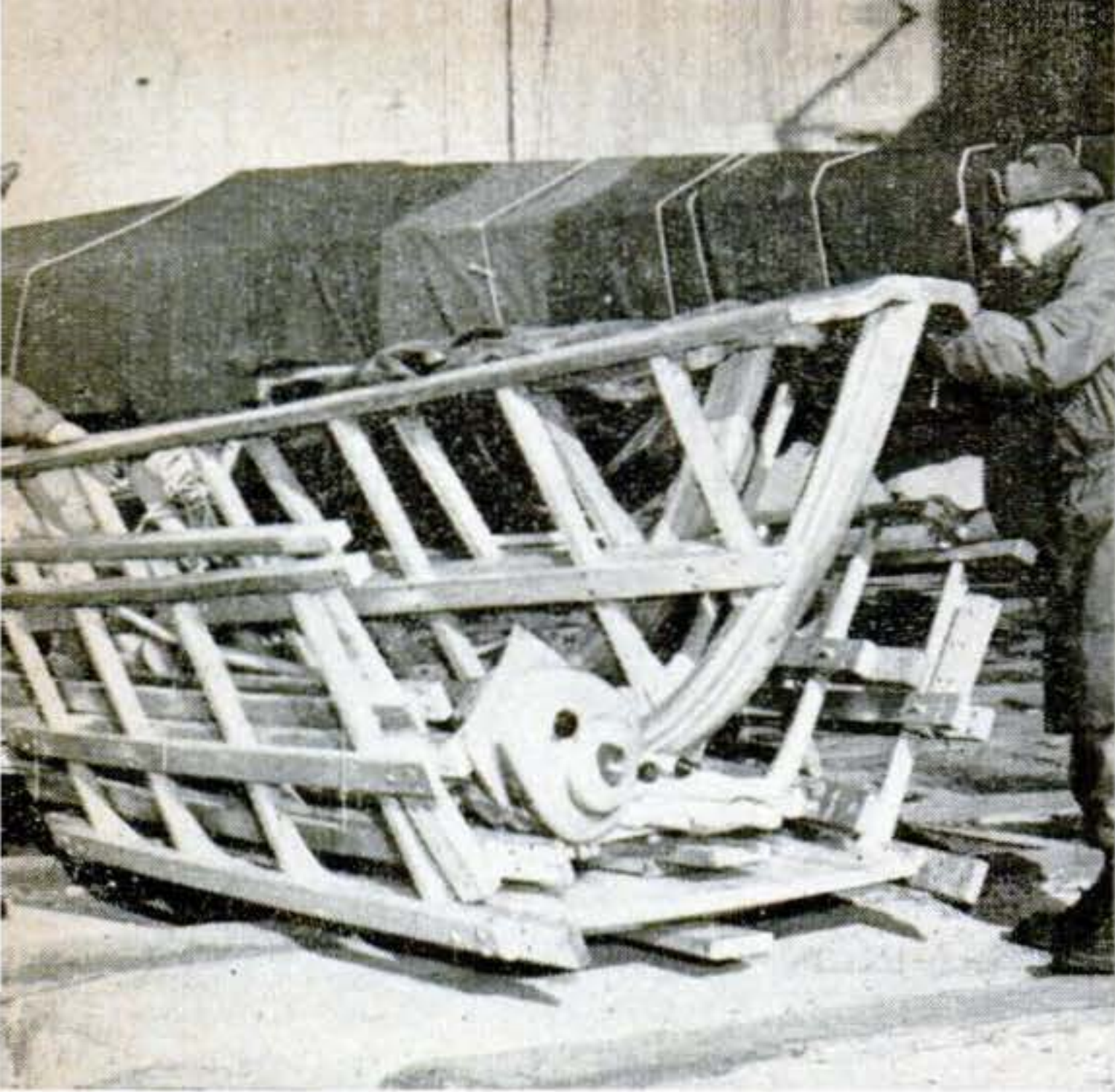

1 Nested sections of Army's Transportation Corps umiak are examined by two soldiers from Fort Banks, Mass. Boat was designed by Corps' Marine Section at Brooklyn Army Base.

Army Improves Eskimo Boat

THE Army's Transportation Corps has taken apart an age-old Eskimo boat, the umiak, and put it together again better.

The umiak is a light, small craft with a wood framework covered with animal skin. The Eskimos, propelling it by paddle, find it ideal for Arctic use.

The new Army version is collapsible. It comes in four wood-framework sections that are fastened together and covered with a rubber-impregnated nylon skin. That makes it portable for long overland hauls. And it can be dropped—in pieces—from an airplane.

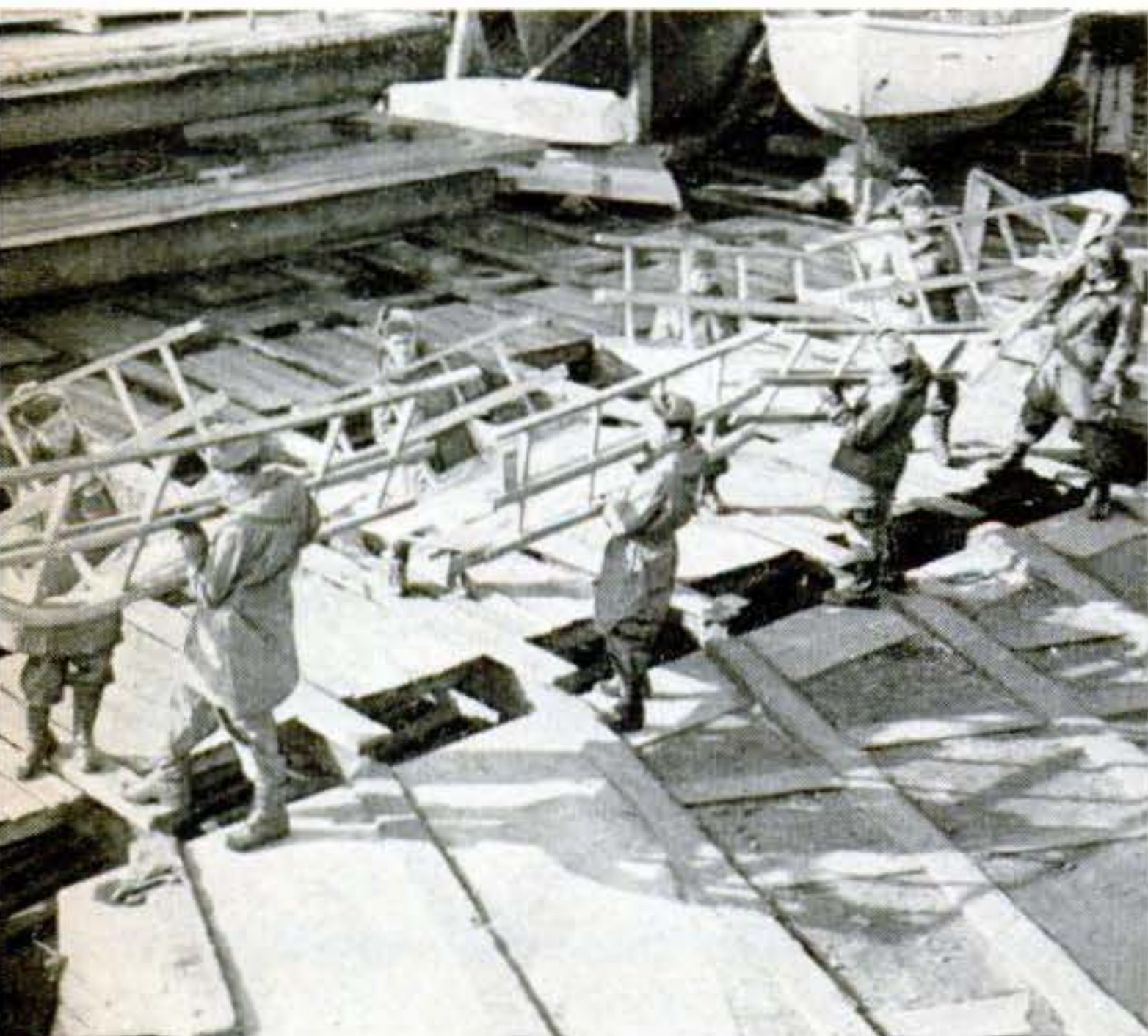

2 Eight soldiers prepare to assemble the sections. Boat, 26 feet long, can carry 11 men or 3,000-lb. cargo. Weighing 500 lb., of which 440 is frame, it can breast fairly rough seas.



3 When sections are bolted together, skin is slipped on. Lashing draws it tight and secures it. Boat was constructed on dory-type lines at Graves boat yard, Marblehead, Mass.

4 Here craft rides icy waters off Marblehead. It can be propelled either by oar or by a

10-hp. outboard motor, which gives it 8-m.p.h. speed. Assembly took only 30 minutes.

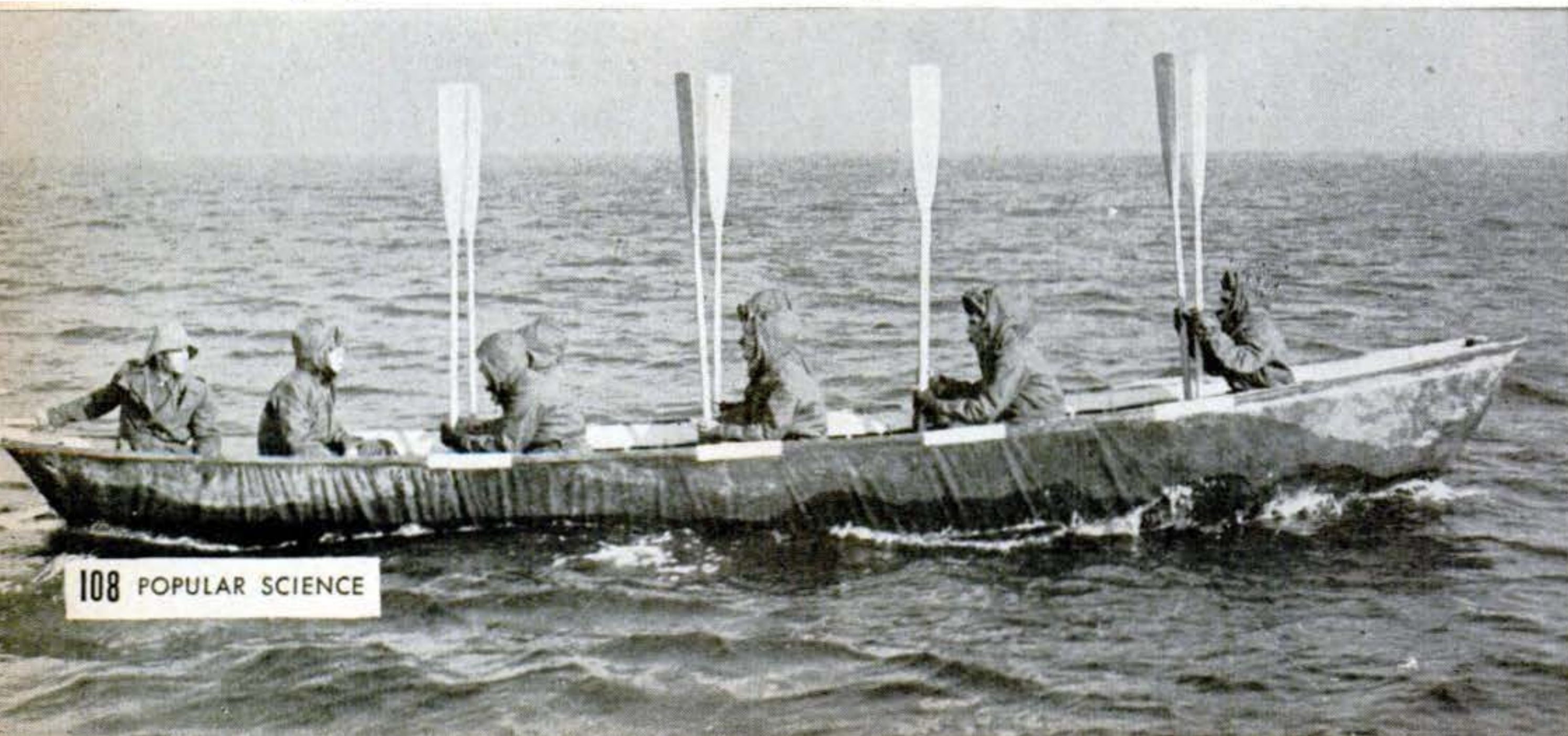

New Ideas from the Inventors

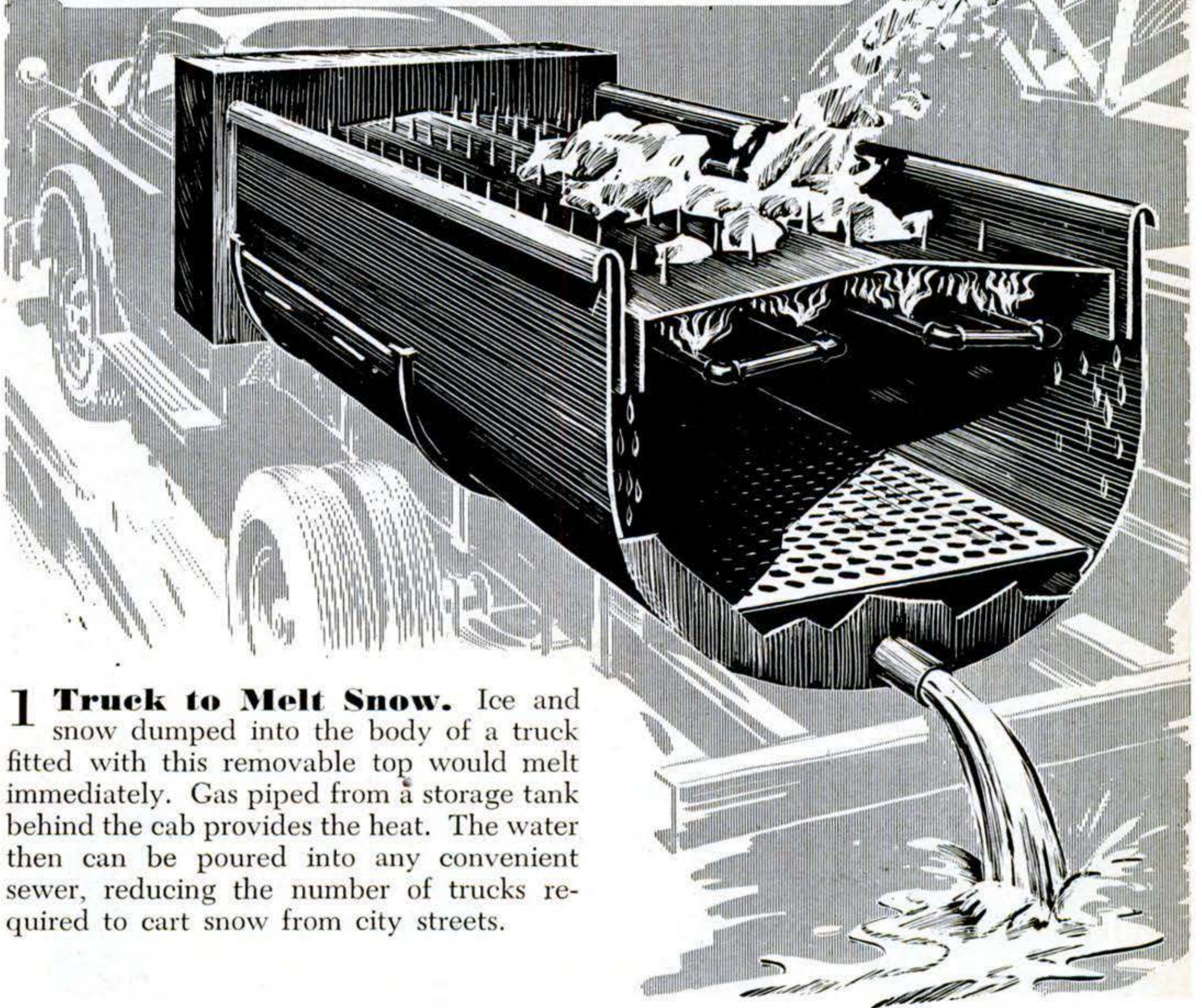

1 Truck to Melt Snow. Ice and snow dumped into the body of a truck fitted with this removable top would melt immediately. Gas piped from a storage tank behind the cab provides the heat. The water then can be poured into any convenient sewer, reducing the number of trucks required to cart snow from city streets.

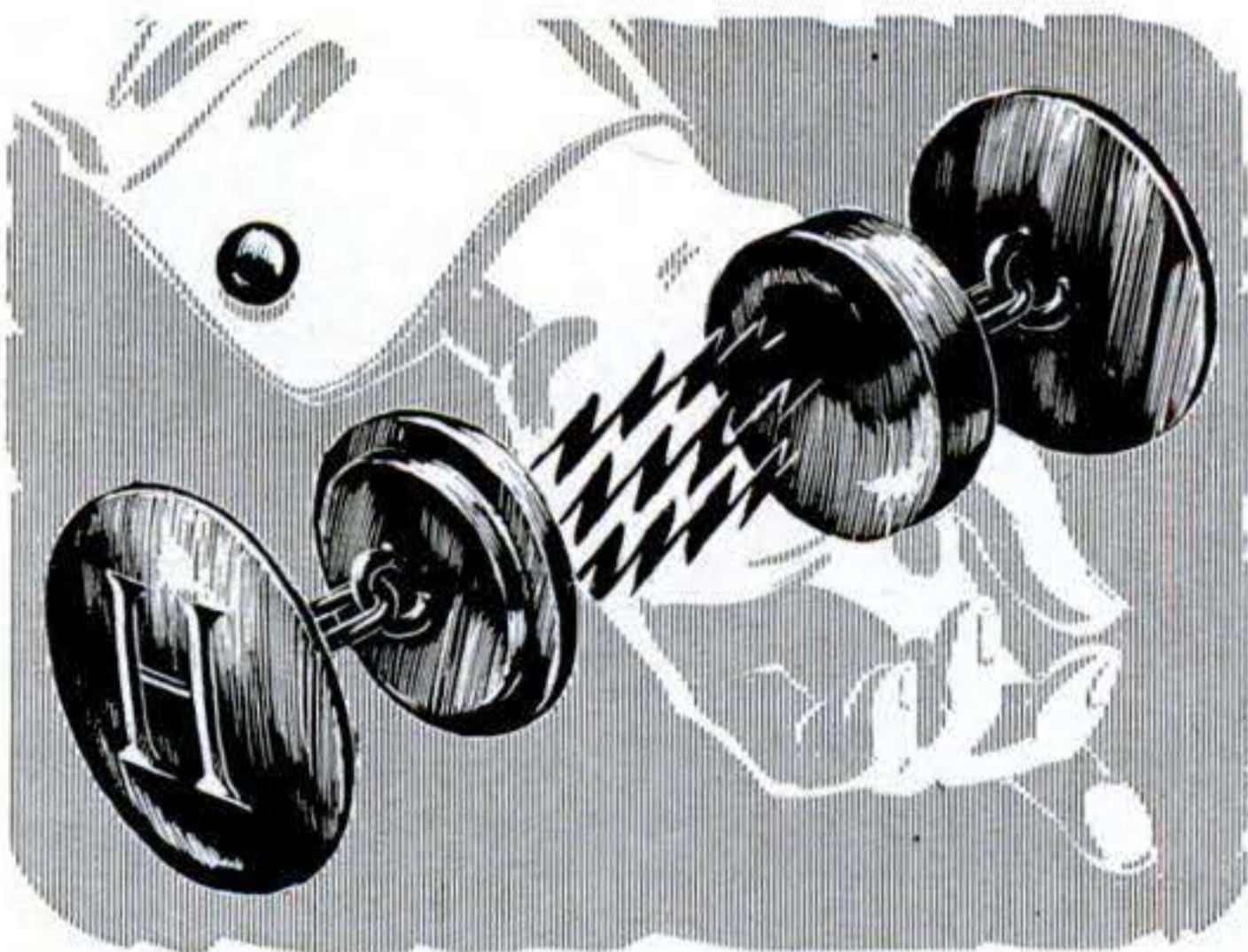

2 Magnets to Hold Cuff Links. There would be no fumbling with the fastenings of these cuff links. A powerful magnet embedded in one half of each link and a soft iron disk embedded in the other form a strong "magnetic latch" to hold them together. The design concentrates the magnetic force so it won't magnetize a wrist watch.

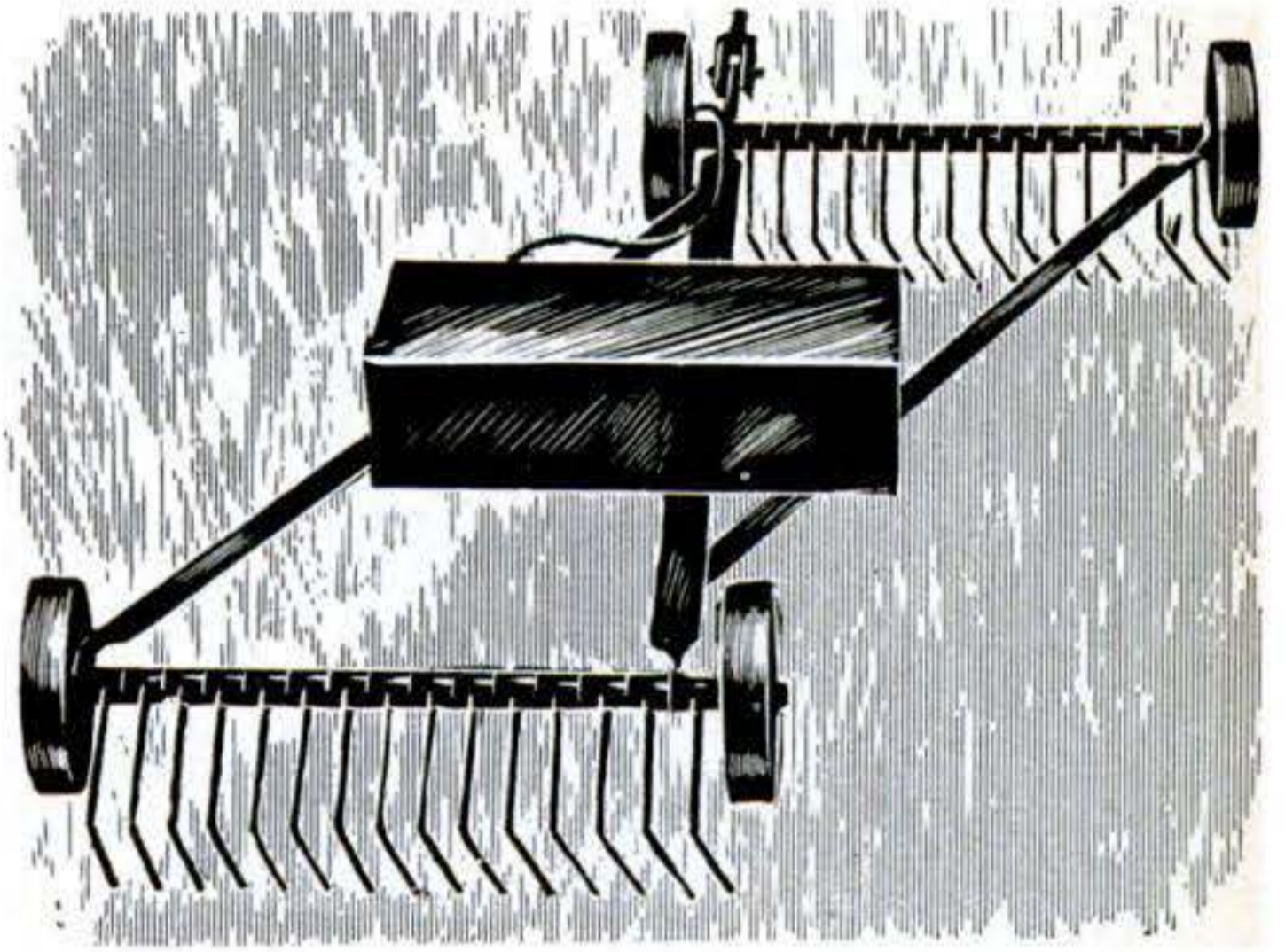

3 Electricity to Kill Weeds. Weeds would be literally shocked to death when this electrical weed killer was pulled over them by a tractor. Multiple electrodes projecting down from the wheeled trailer touch the weed shoots and give them a 12,500-volt-AC jolt that, according to the inventor, will effectively kill their roots.

Turn the page, please, for three more new ideas

FEBRUARY 1950 109

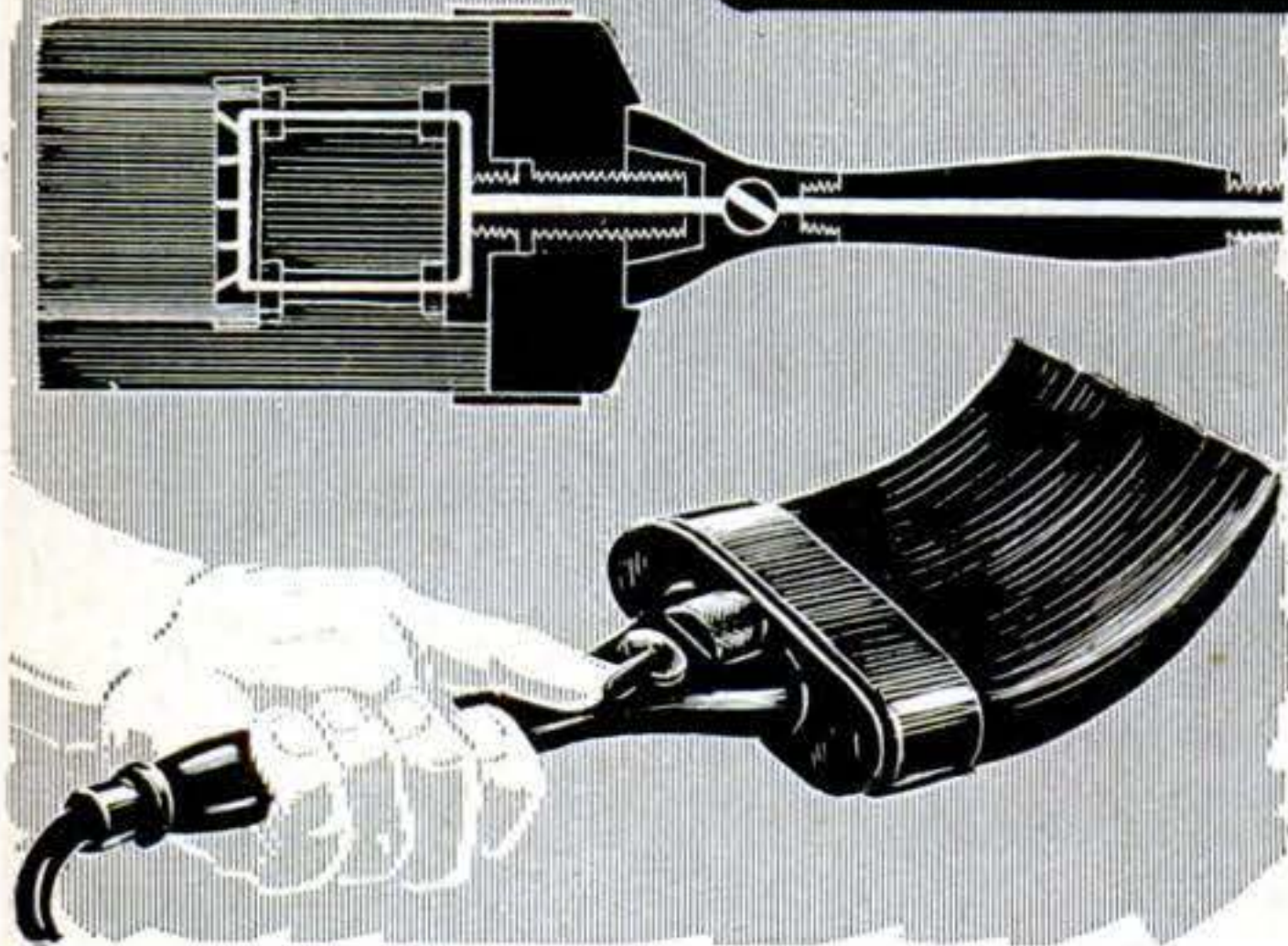

4 Brush to Speed Painting.

Bothersome dipping in a paint can would be out with this brush that is fed by a flexible tube connected to a paint reservoir. The flow of paint to the bristles can be controlled by a handy thumb-operated valve. For ease in cleaning, the brush handle, bristles, and paint feeder can be easily taken apart.

5 Mower to Use Disk Cutters.

A set of rotating elliptical disks would replace the conventional long cutting blades on this lawnmower. Mounted on the driving shaft at an angle, each rotating blade produces a shearing action first against one edge and then the other of a V-shaped tooth. Mower operates when pulled or pushed.

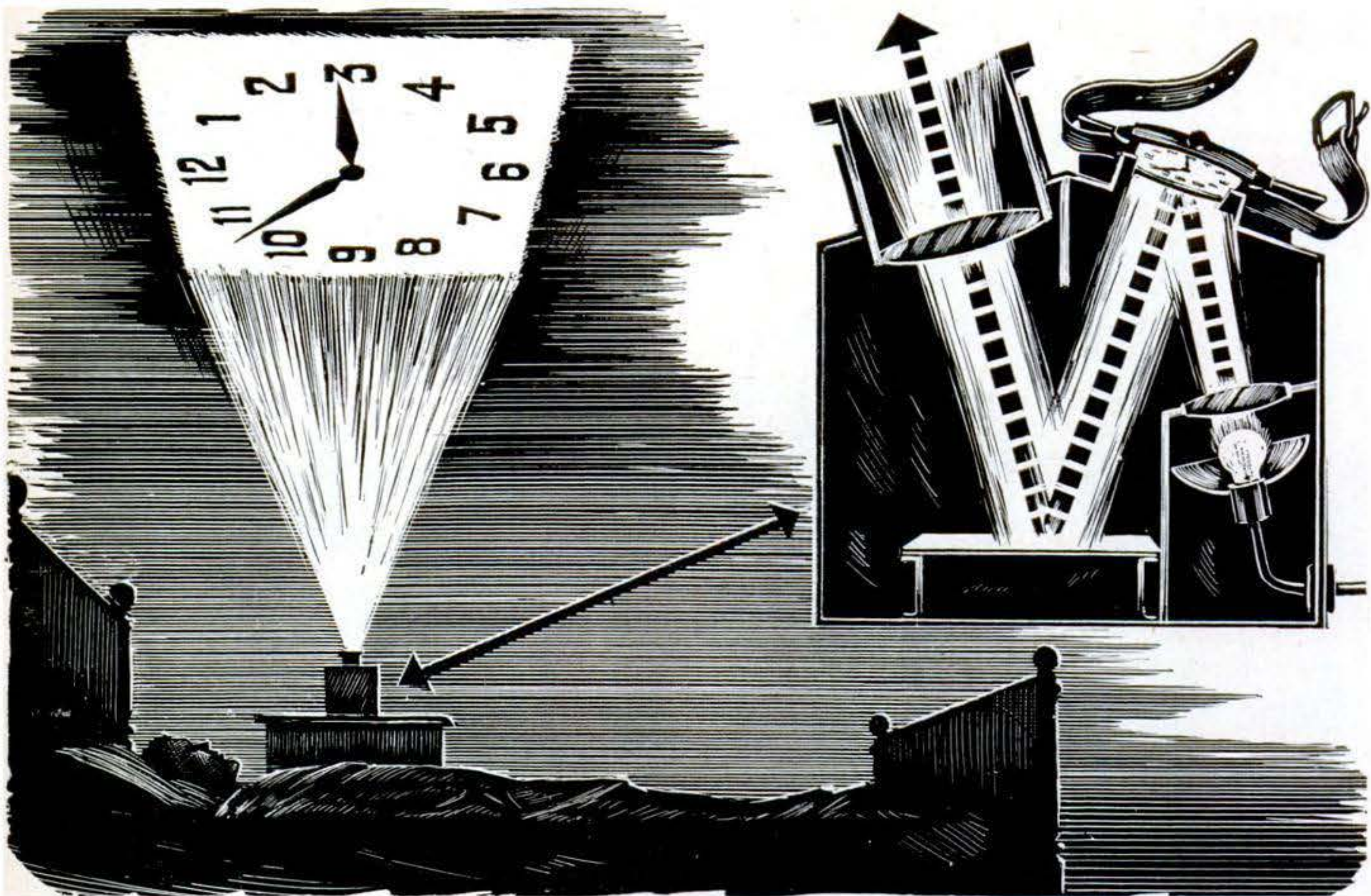

6 Projector to Show Time. You wouldn't need even to lift your head from your pillow to see the time at night with this projector. A push of a convenient bedside switch flashes an image of the dial of your watch on the ceiling. Before retiring

it is necessary only to place your pocket or wrist watch on an aperture on top of the projector housing. A small lamp bulb, two lenses, and two reflectors do the rest when the switch is operated. The projector also can be arranged to project onto a wall.

Patents on these inventions have been granted to: 1. A. J. Cayas, Glendale, Calif.; 2. H. Avedon, New York, N. Y.; 3. G. M. Baker, Los Angeles, Calif.; 4. R. S. Eisner, Red Bank, N. J.; 5. W. Brauer, Ingleside, Tex.; 6. S. Loewe and B. Lowe, Yonkers, N. Y.

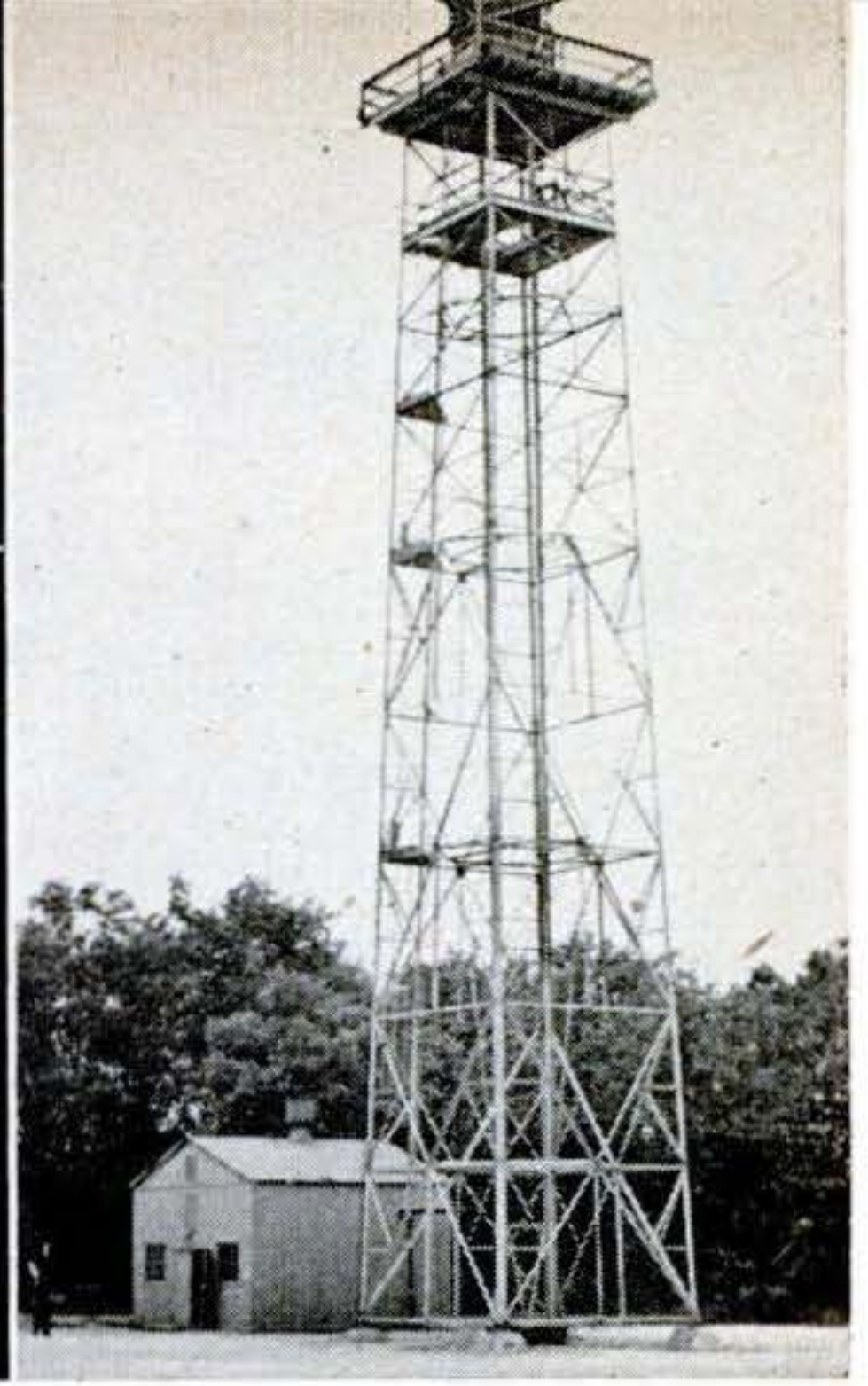
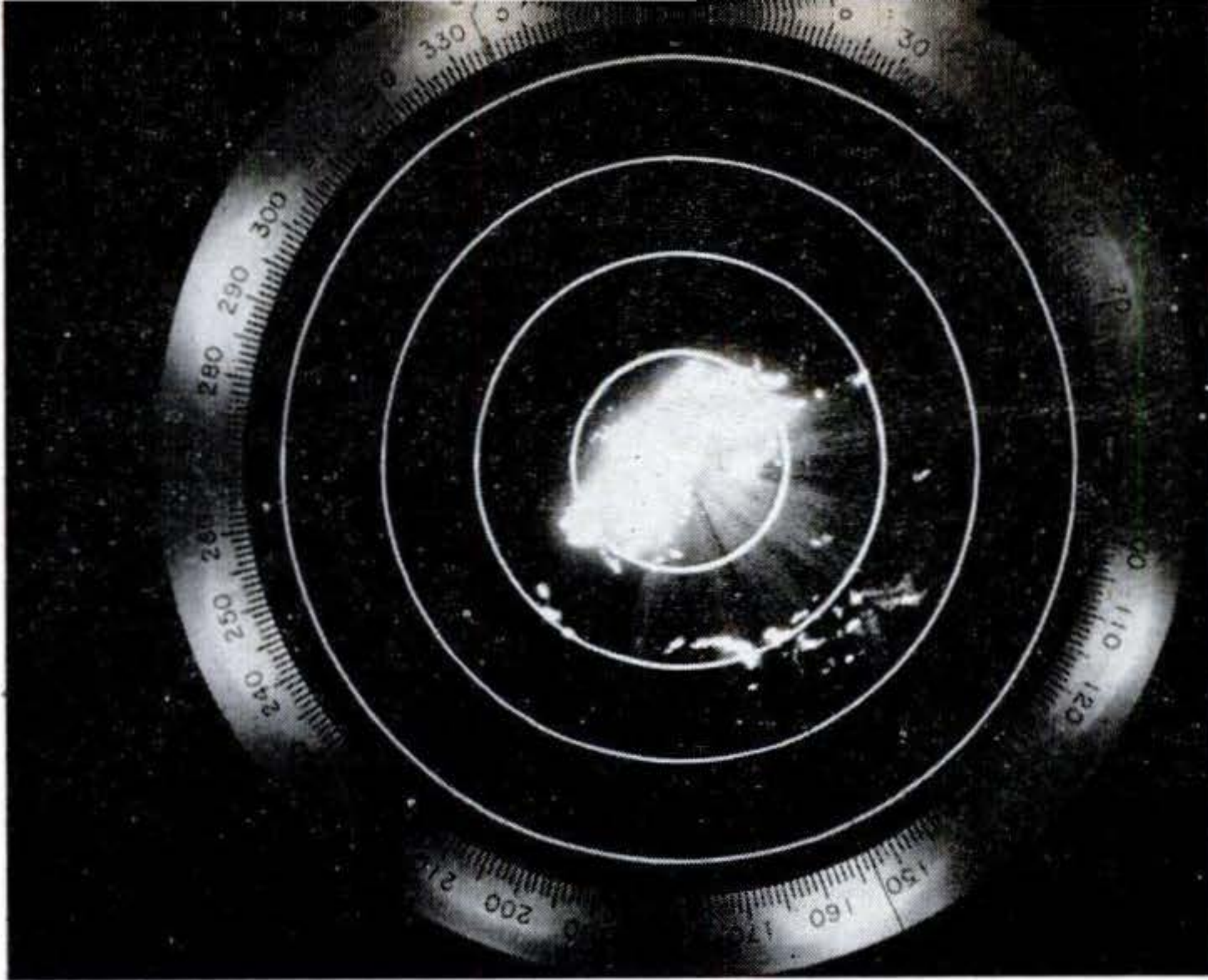

Sensitive Radar Snoops Out Storms in Advance

THE U. S. Signal Corps Engineering Laboratories at Ft. Monmouth, N. J., is forecasting storms by radar six to eight hours away. In the picture of the oscilloscope above, the top represents due north. The hard blotch of light in the center, site of

the station, is made by nearby land and sea targets. The flecks of light within the rings, spaced at 100-mile intervals, are storms from 175 to 275 miles away. Broken light on perimeter is degree scale. Picture at right shows 100-foot storm-detector tower.

Fancy Towboat Has Radar

THIS ultramodern towboat can pull three integrated barges with a capacity of 81,680 barrels of gasoline. It's equipped with radar, radiotelephone, and an automatic pilot. Made for the Sohio Petroleum Co., it is powered by a pair of two-cycle General Motors Diesels of 1,600 hp. each.



'Chute Stops Newest Bomber

TO SAVE brakes and permit use of shorter fields, the newest U. S. bomber, the Air Force three-jet XB-51, can be brought to a fast stop at the pilot's discretion by a ribbon parachute released from above the tailpipe. Main wheels are bicycle style; plane is steadied during taxiing by wing-tip wheels.



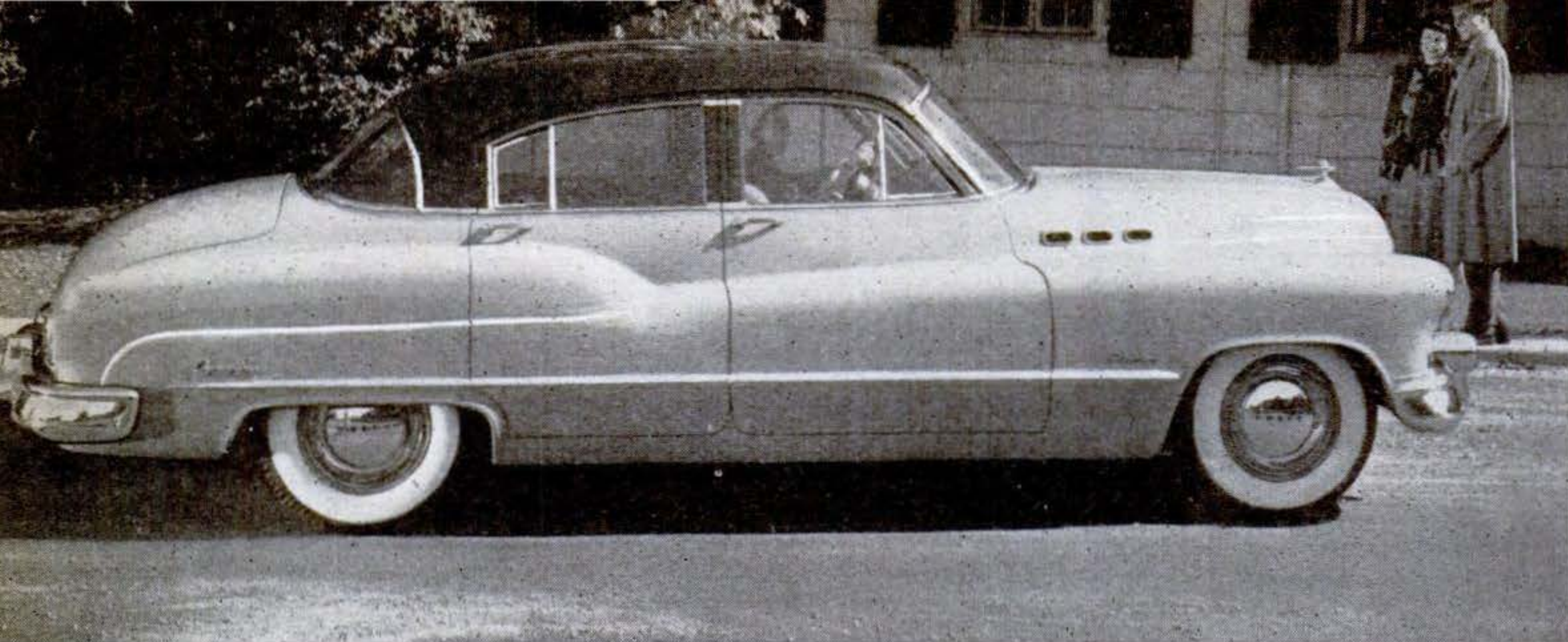

Buick's sleek 1950 Super model 4-door sedan shows added window area, especially in the rear.

Buick Boosts Power, Engine Compression

BUICK unveiled 21 new models at the turn of the new year—with higher compression ratios and resulting higher horsepower. The company's stable of cars boasts seven models for each of its three lines—Roadmasters, Supers, and Specials. The compression ratio for all Dynaflo models has been boosted from 6.9 to 1 to 7.2 to 1. Horsepower ratings are: Roadmaster, 152; Super, 128; and Special, 122. A slight in-

crease in compression ratios for Buicks with standard transmissions also was announced.

Aside from many small engineering refinements, the company's chief accomplishment for 1950 is a new engine for its Supers. It's more powerful without the penalty of a weight increase and, due to a new rear-axle ratio, uses less fuel in normal driving. The compression ratio is 6.9 to 1 with the regular transmission.

Super's new pistons (right below, with older one) are cut $\frac{9}{16}$ in. in length to $3\frac{49}{64}$ in. Bore is boosted $\frac{3}{32}$ to $3\frac{3}{16}$ in. Pencil points to new type of slot to minimize piston slap.

Con rods are $\frac{1}{4}$ in. shorter, or $7\frac{7}{8}$ in. between bearing centers. Stroke remains the same. Power of engine on Super models has been upped to 128 hp. from 120 hp. without weight increase.

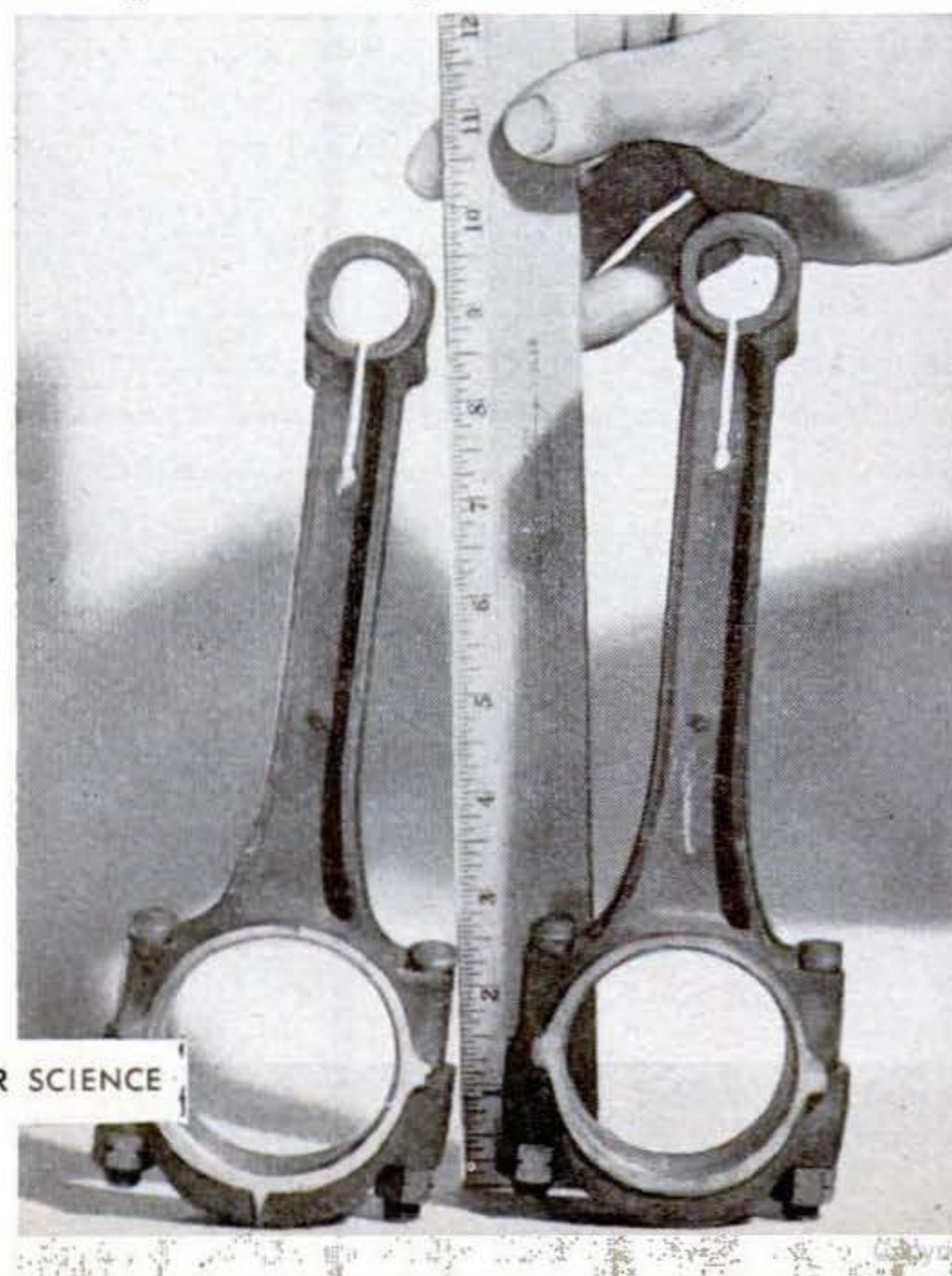
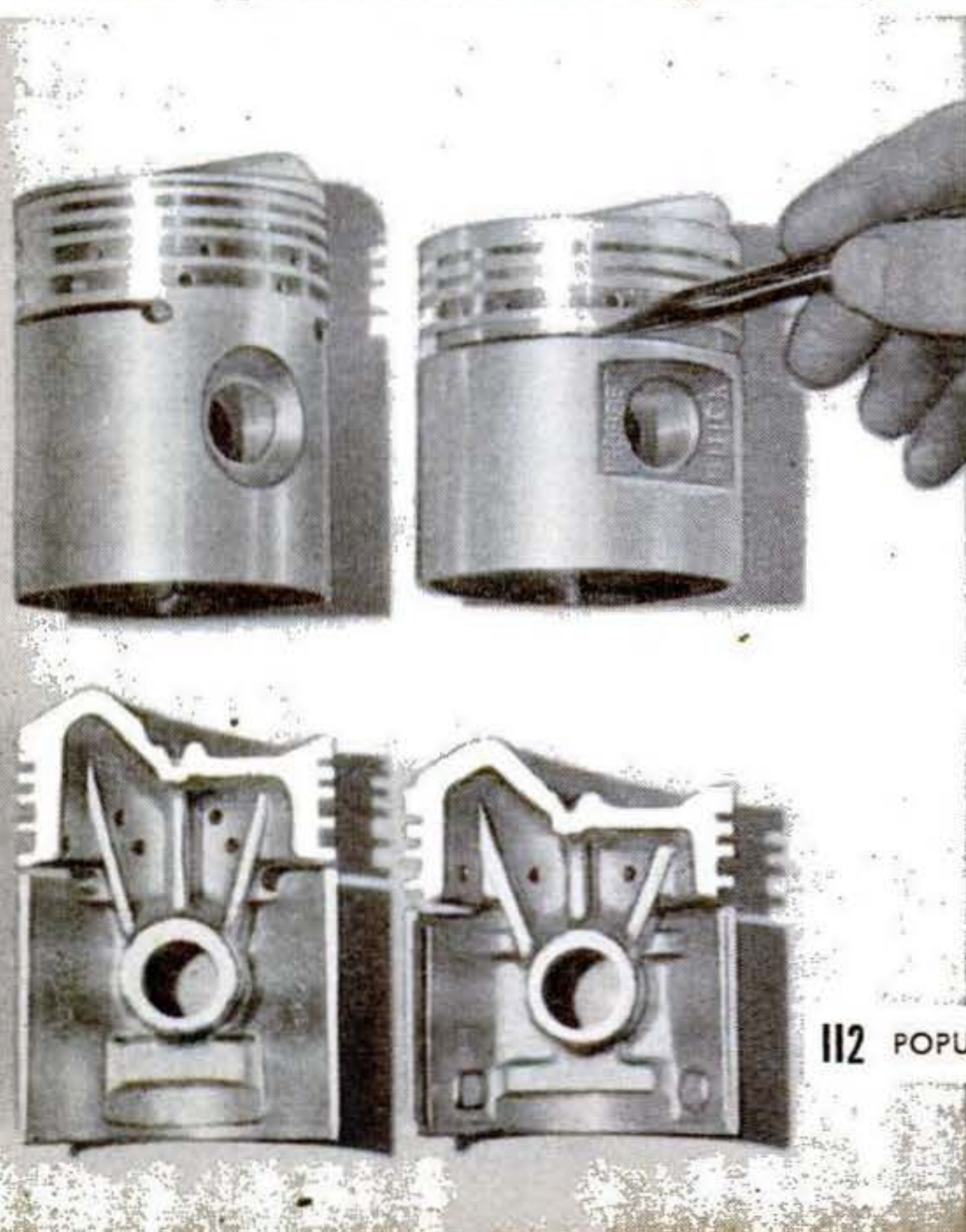

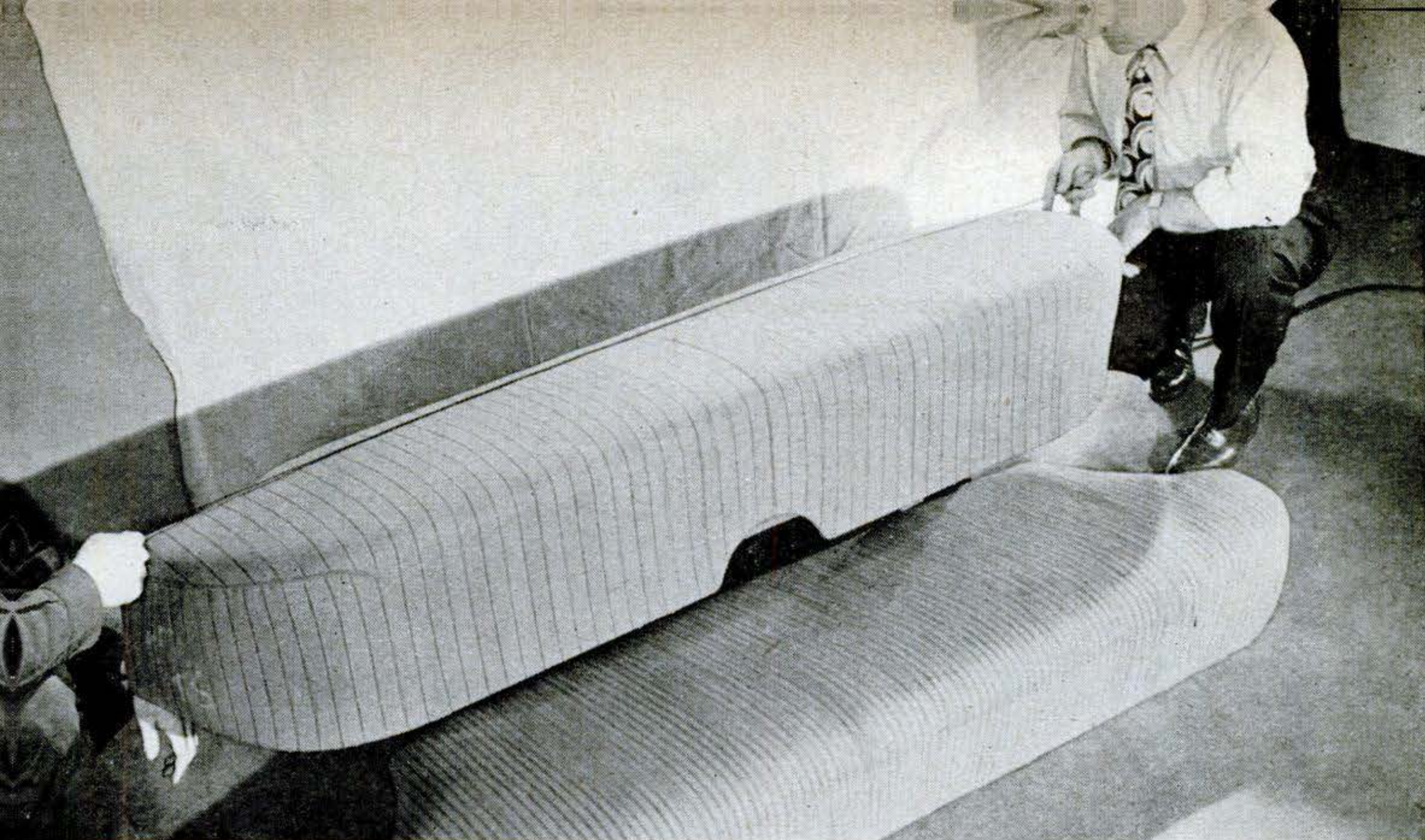

Rear-seat hip room, shown (top) in comparison with last year's, is greater—up to 14½ inches

in some models. The rear seats in the Tourback models are roomier than the front ones.



A contribution to quietness as well as protection of luggage is hair flocking of rear compartment with spray gun. This simulated-cloth covering is good for lifetime of the automobile.



This is the hair flocking as it looks after application. Counterbalanced springs eliminate former lid braces and save space. Turn of key opens lid; locking handle is gone.

Bearing journals on Super engine crankshaft have uniform diameter of 2 9/16 in. in place of five different diameters formerly used. This reduces types of bearing shells from 10 to four.

Main-bearing diameter on Super has been boosted ¼ in. to 2 9/16, and rod-bearing diameter ⅛ in. to 2⅝. Engine displacement is 263 cubic inches. Crankcase height is slightly less.

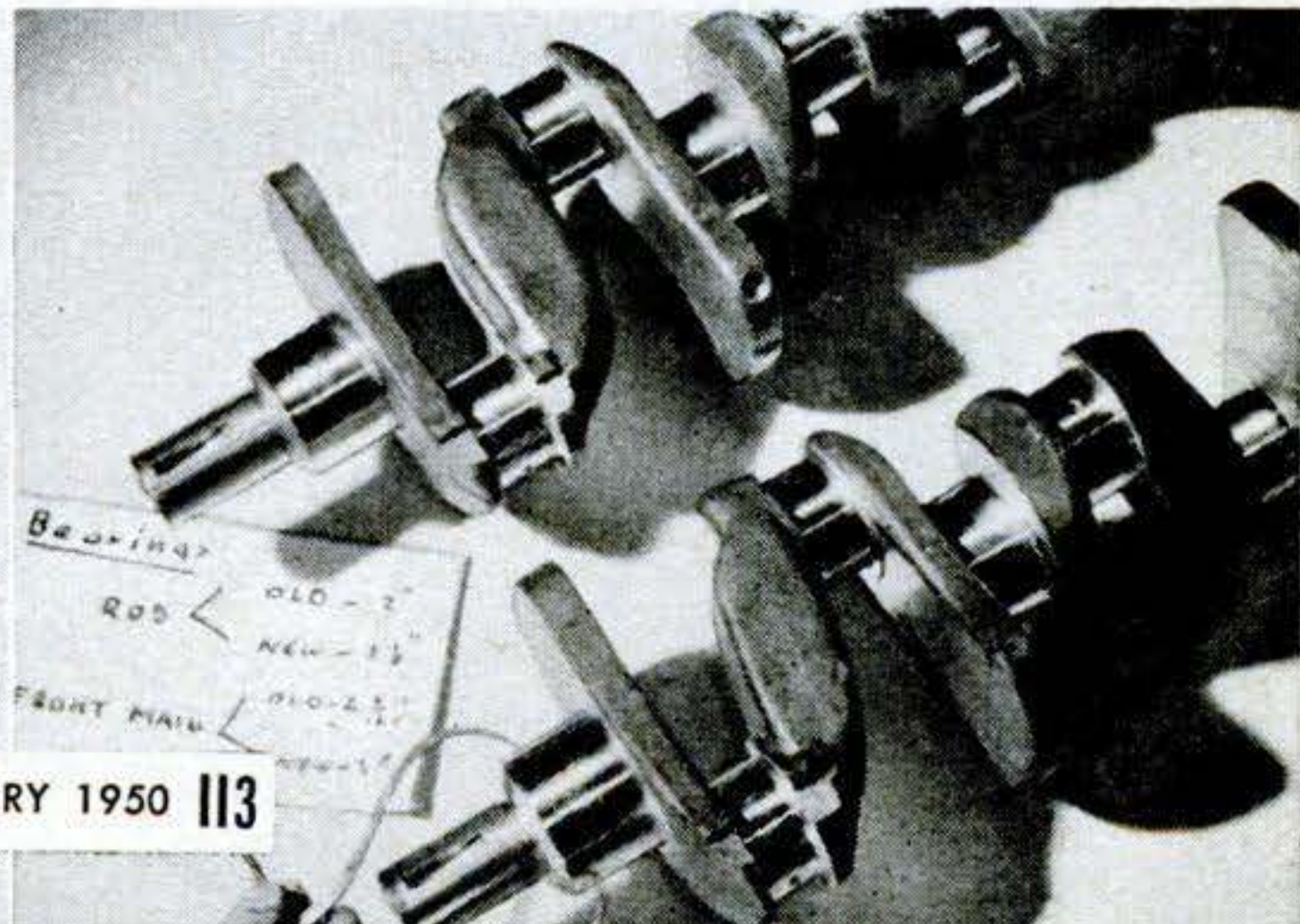
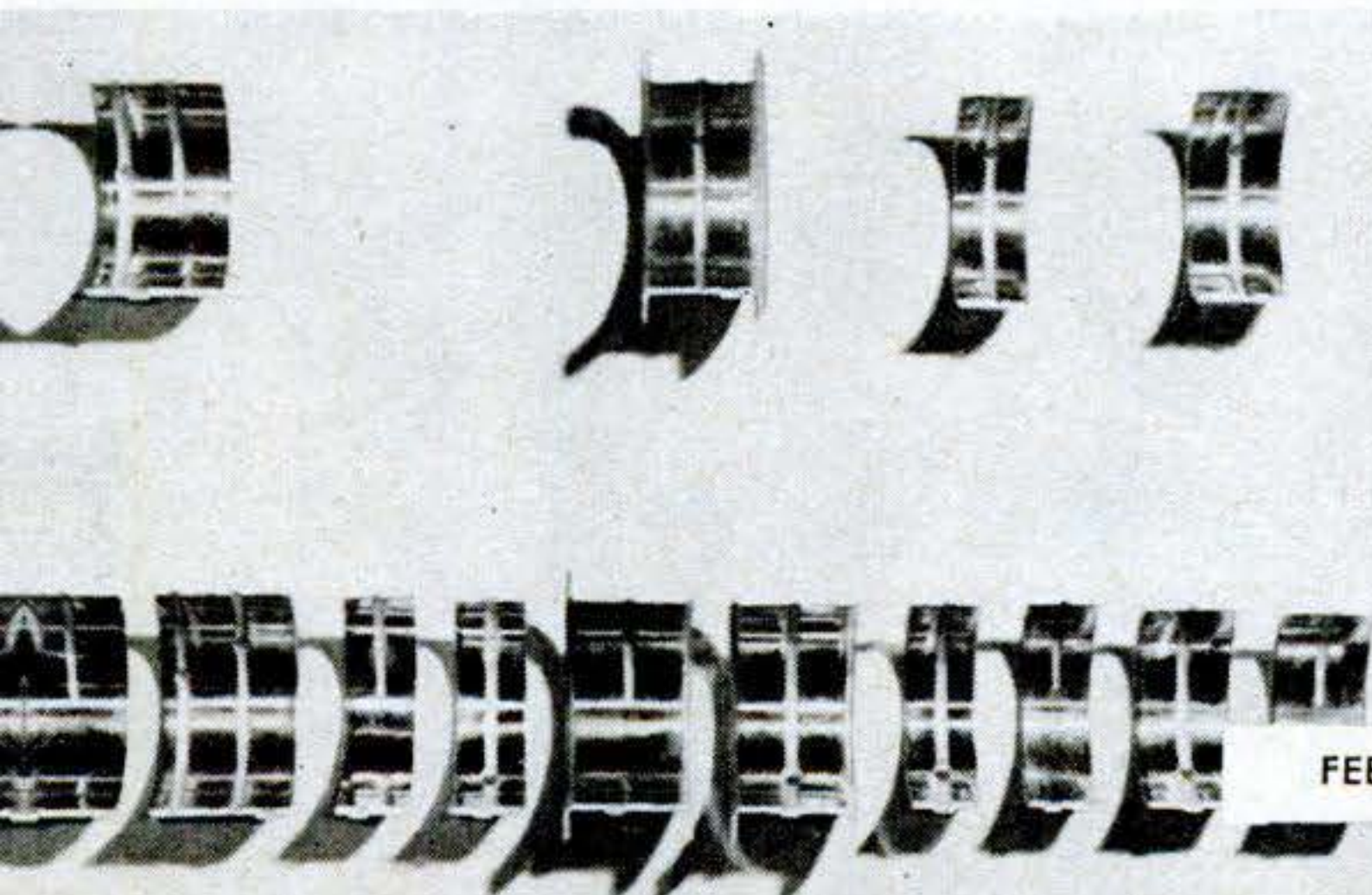

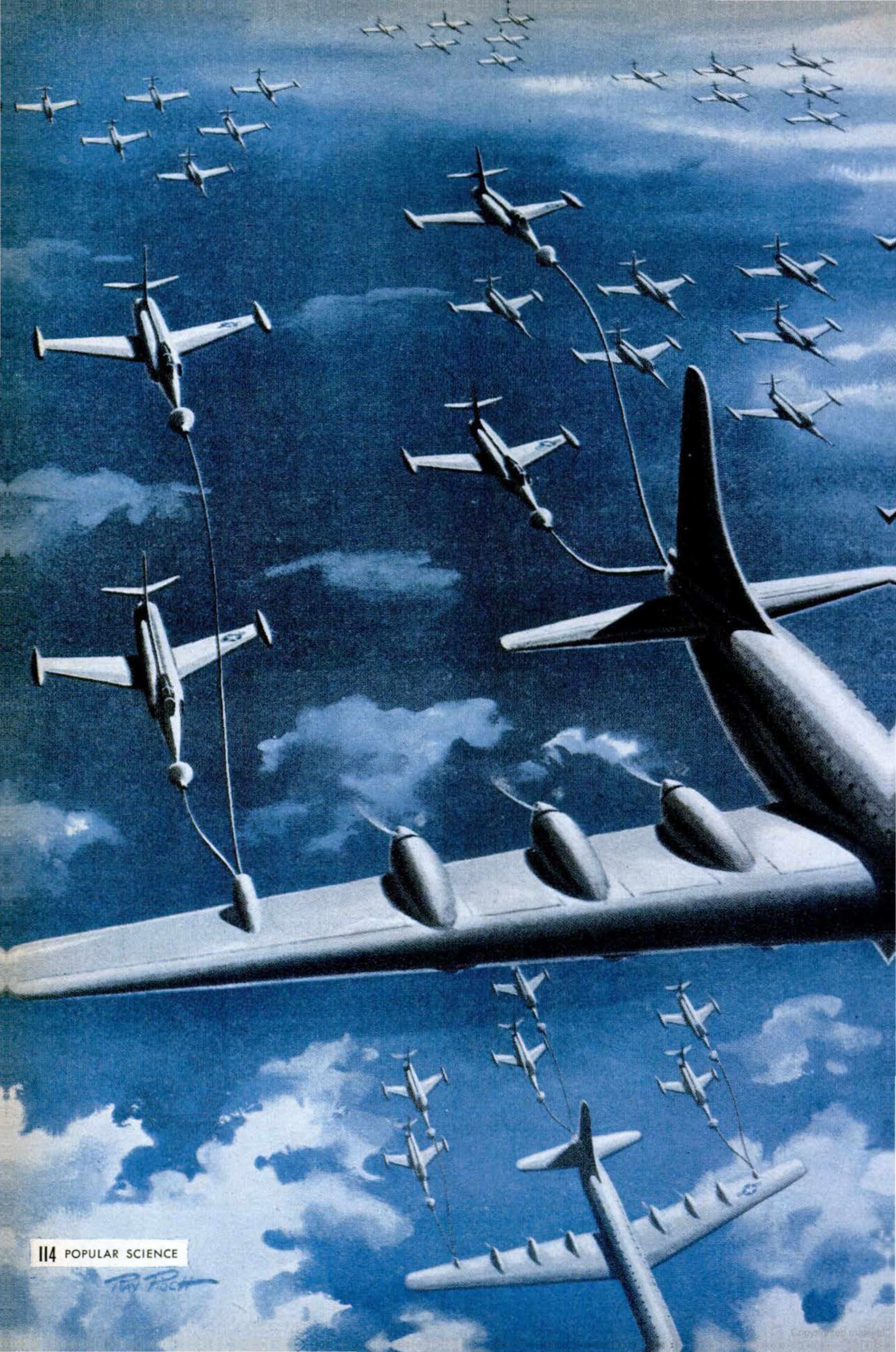

Ray Pech



Air Tankers Fuel Jets for Long Flights

Speedy new system for refueling on the wing opens way for revised air strategy and faster airline trips.

By Deron Francis

Drawings by Ray Pioch

IT LEAKED out last month that the U. S. Air Force had three Republic Thunderjet fighter planes equipped to be completely refueled in mid-air in 90 seconds each—and the way was opened for a fundamental revision in the nation's air defense strategy.

The perfection of a quick in-flight refueling system also promised seven-hour transatlantic schedules by jet-propelled passenger transports, perhaps within a year.

It forecast the probability of ultimate five-hour passenger flights coast-to-coast in jet-propelled aircraft.

It offered the U. S. Navy new versatility and striking power for its carrier fleet.

It solved, finally, the most serious drawback of the airplane—its inability to carry a great load a long distance nonstop.

The fast, automatic transfer of fuel from tanker planes to military and commercial aircraft has been 15 years in the making. Now it is a reality. In-flight refueling will become a commonplace for both bombers and fighters in the next few months. What this means in terms of air defense can be reduced to simple mathematics.

A bomber propelled by reciprocating engines and refueled once in mid-air en route to its target can carry *three times* **▶**

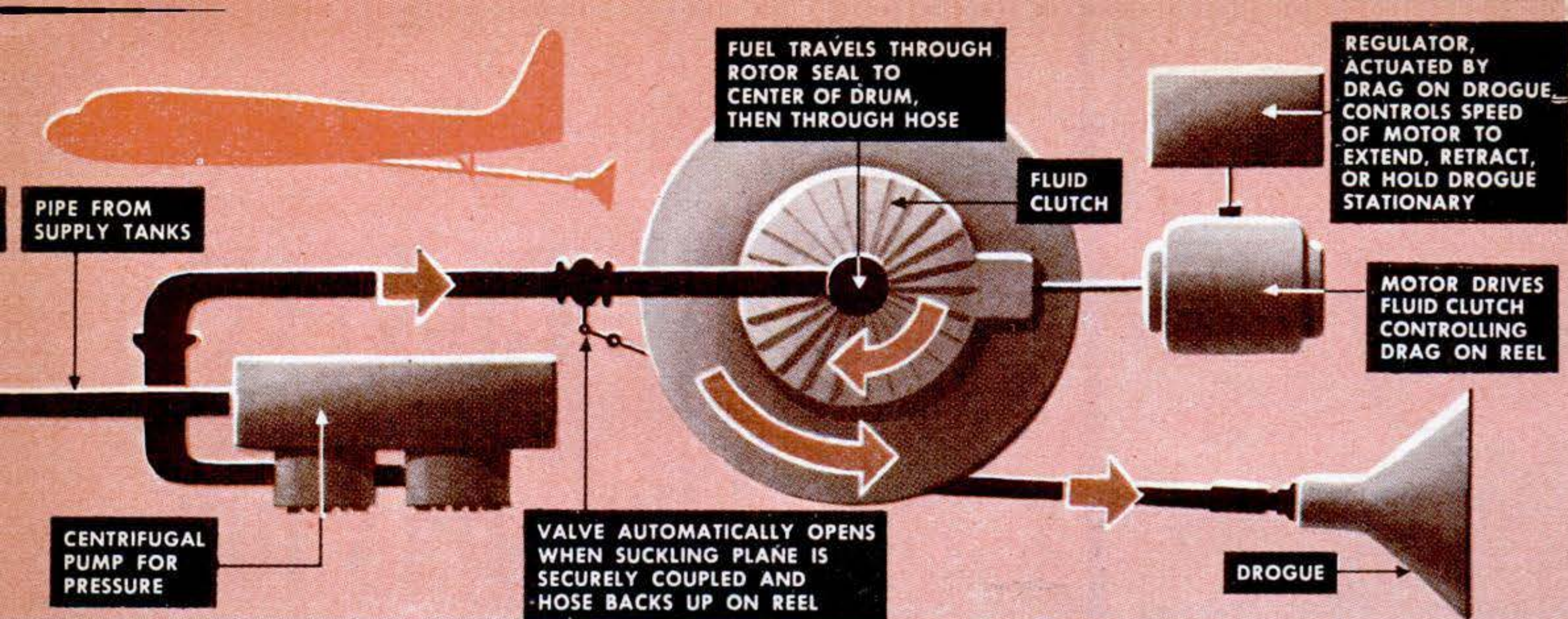

One of two chief components in flight refueling is 70-foot flexible-metal hose. In military

operations, tanker carries it; in commercial refueling, the air liner will unroll it to the tanker.

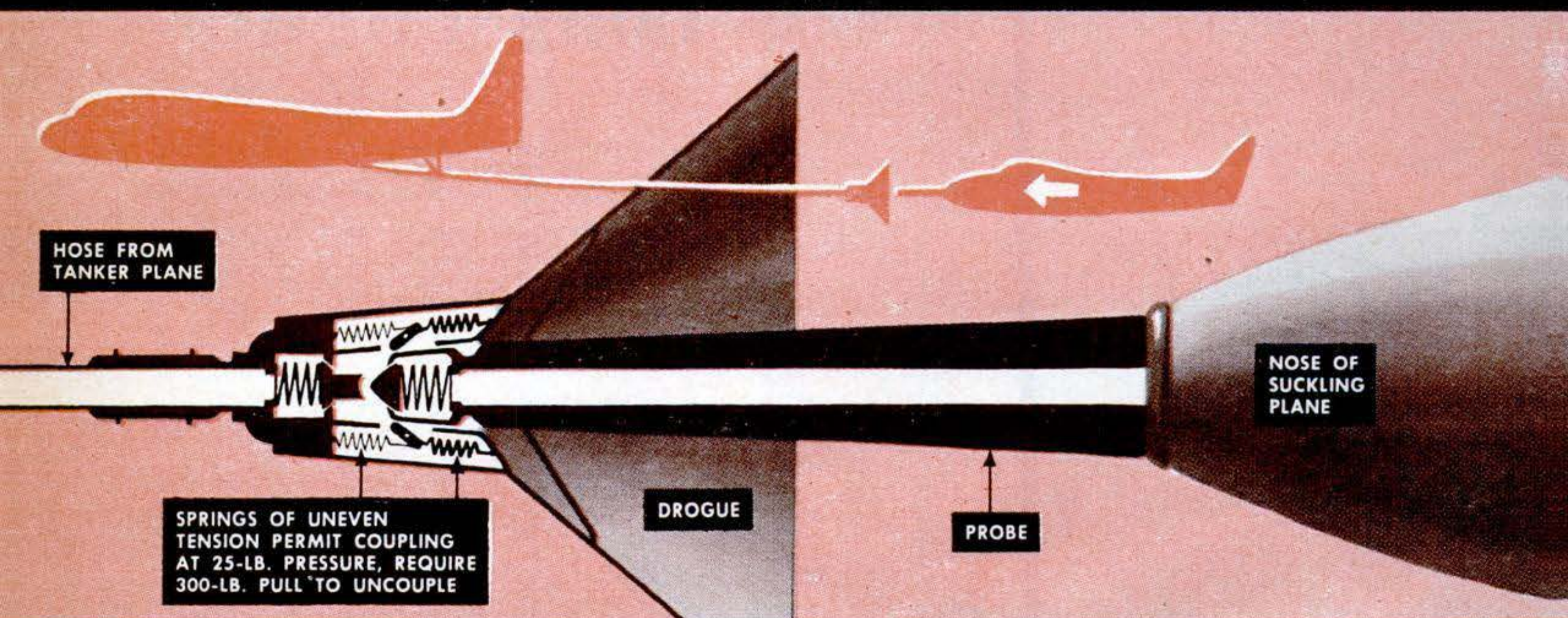

Three toggles in drogue clamp over annular groove in probe. Joint is sealed by synthetic-rub-

ber ring. Plane carrying probe eases forward, and pressure flashes a green light in tanker cockpit.

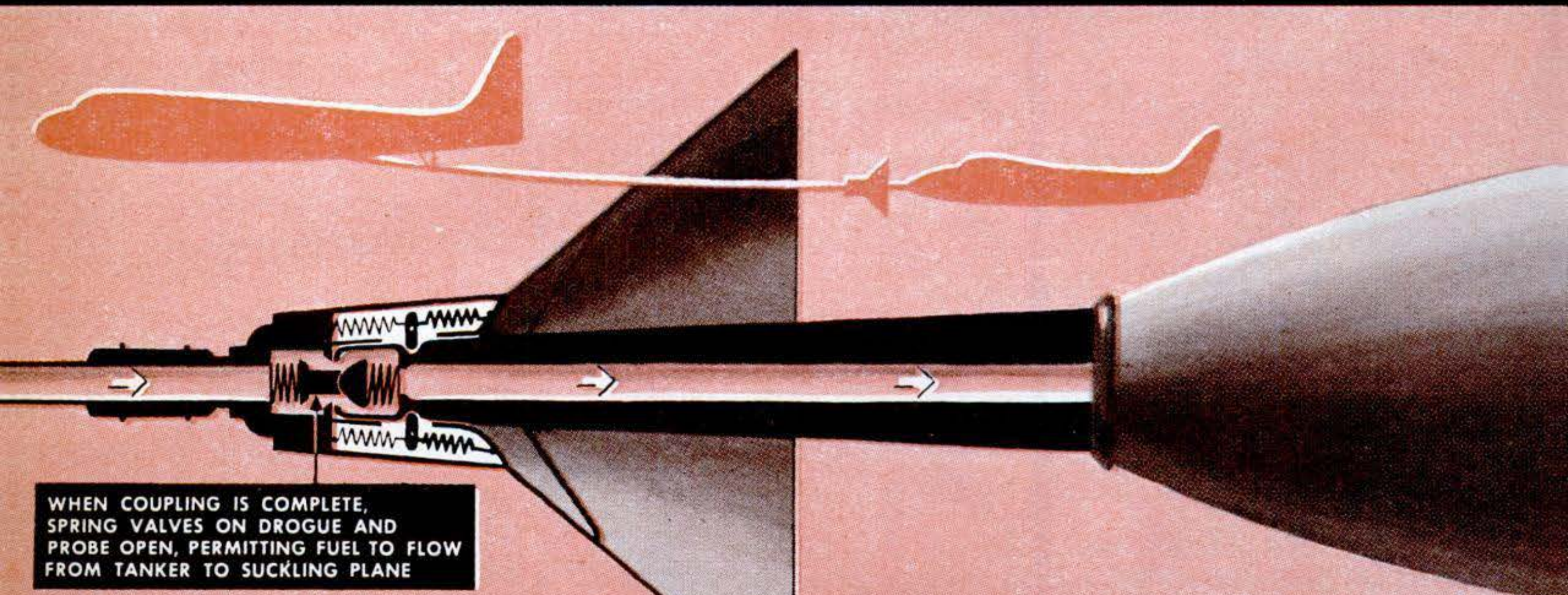

Tanker crew then switches on fuel pumps. Play in drum rotation allowed by fluid clutch enables

two planes to maintain contact if momentary speed differences are not more than 25 m.p.h.

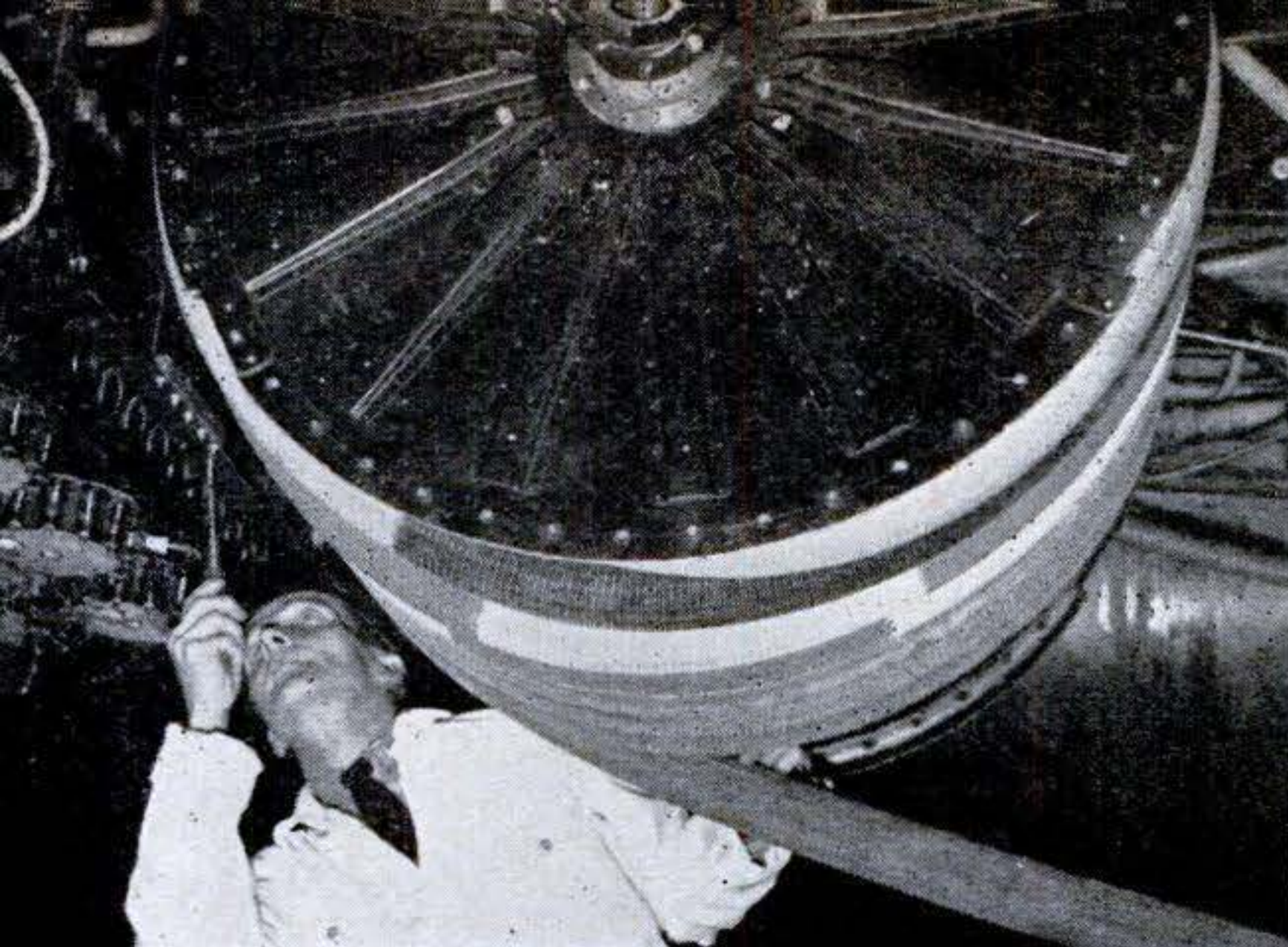

Crewman checks drum amidships in tanker. Same equipment is used for ground refueling.

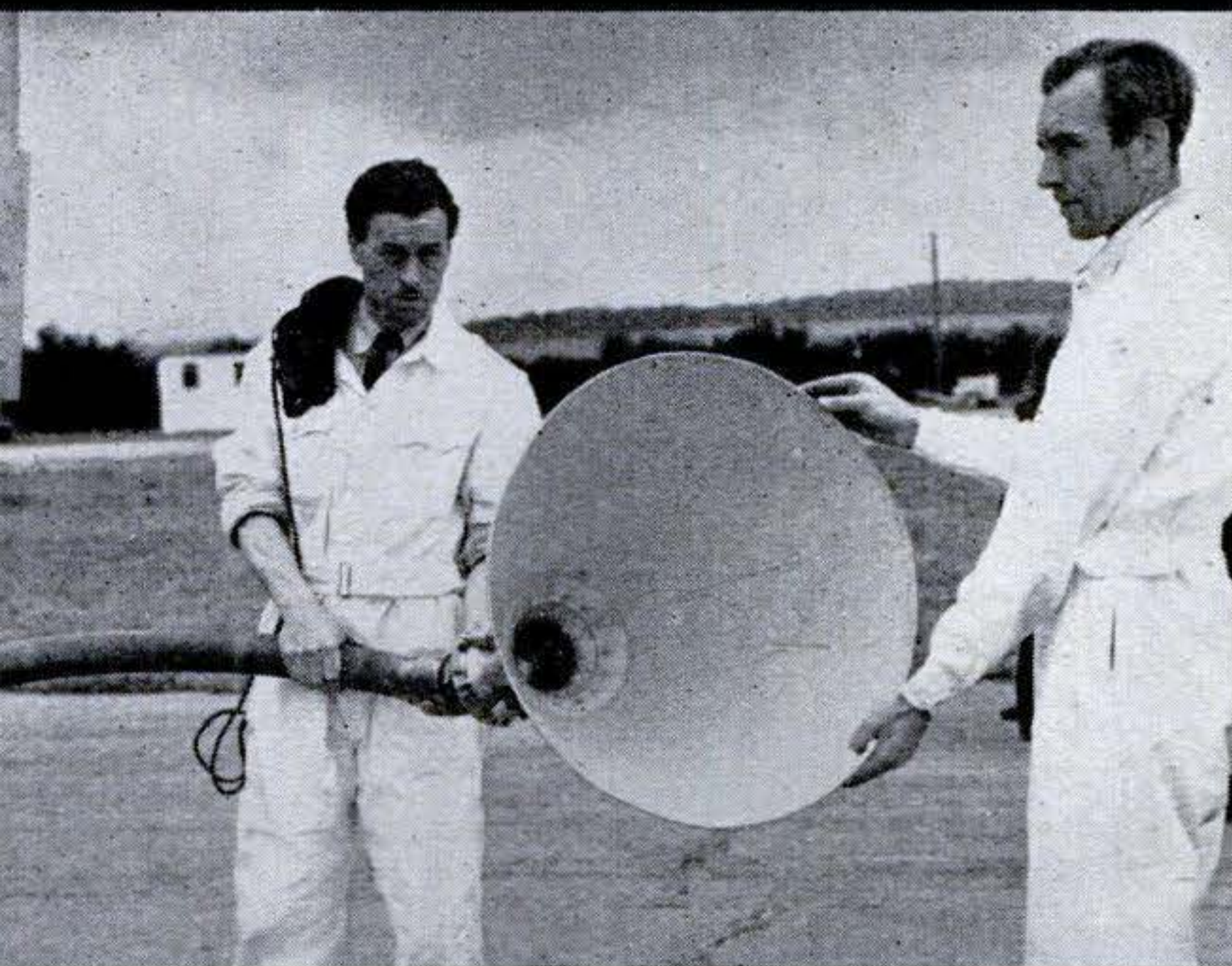

Drogue's shape can be changed so air flow positions it either above or below the tanker.

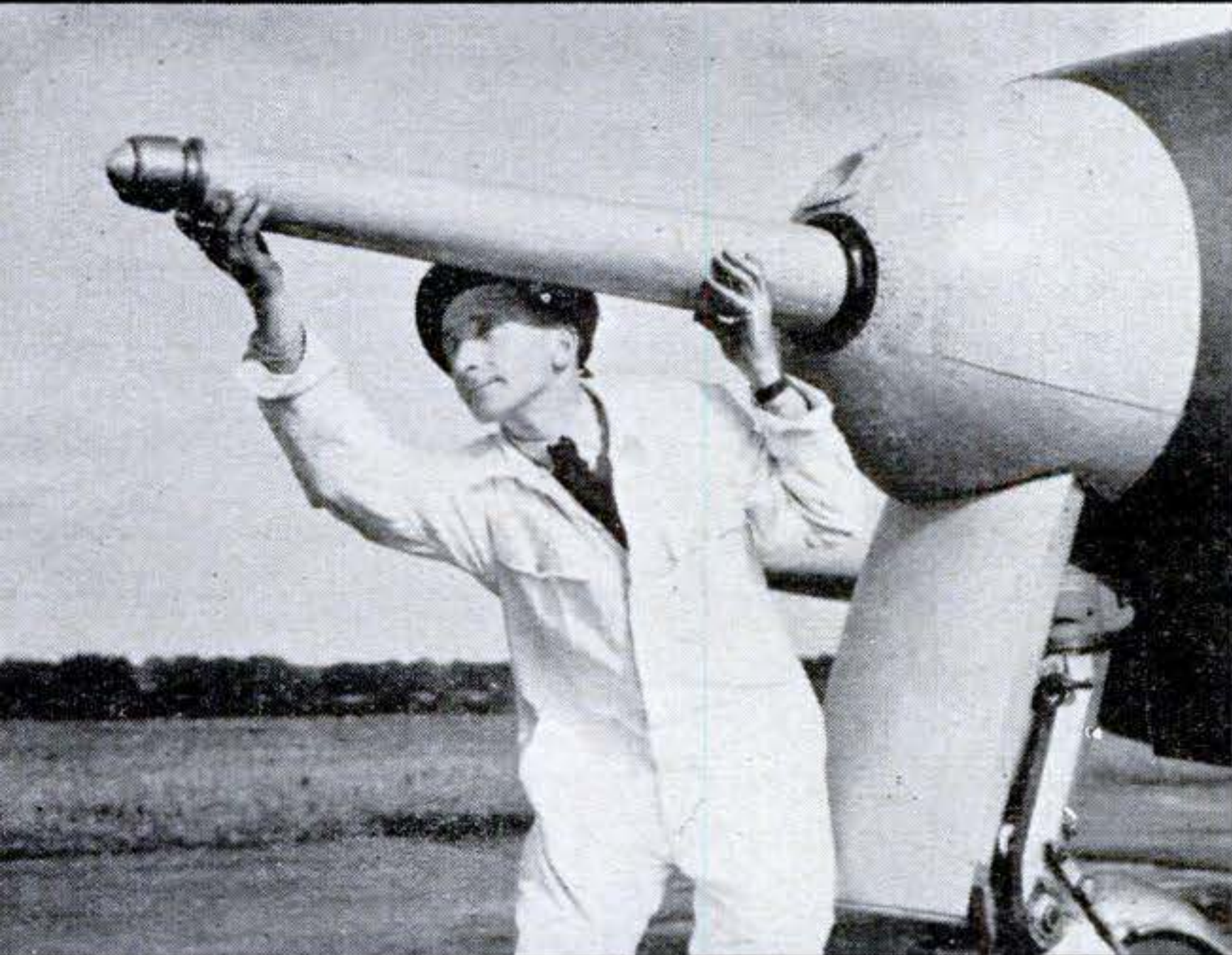

Probe, to be made retractable, feeds fuel to main inlet pipe above receiving plane's tanks.

the weight of bombs over any given distance that an unrefueled bomber can carry. On a round trip of 6,000 miles, a bomber smaller than the Boeing B-50, refueled once on its way to the target and once on its return flight, can carry 20 tons of bombs. (See "What Can Our Bombers Do Now?" PS, Aug. '48, p. 74.) Without refueling, it requires a bomber the size of that Air Force colossus the B-36 to tote the same load on the same operating radius and return to base.

In-flight refueling will also vastly simplify the problem of maintaining screens of air patrols for home defense in the event of war. The Air Force C-99 cargo plane, unarmed version of the Convair B-36, will be able as a tanker to haul aloft enough fuel to replenish the supplies of an entire squadron of 40 jet fighters—this at a pumping rate of at least 600 gallons a minute. The usual routine of take-off, fly, land, refuel, and take-off again will be a thing of the past. The pilot's physical endurance will be the only limit on the duration of a flight.

On the Navy's side of air defense it is proposed that tanker planes be based on its carriers to refuel its swarms of bombers, torpedo planes, and fighters at distances up to several hundred miles away.

Twice as Fast to Come?

So seriously is the Air Force taking mid-air refueling that it is shooting at a fuel-transfer rate of 1,200 gallons a minute. The people who brought flight refueling to its present state say that such a rate is not only possible but highly probable in the near future. A fighter can be refueled in 90 seconds either on the ground or in the air as against 45 minutes on the ground by conventional methods.

Flight refueling isn't new. It was used 20 years ago to hang up flight-endurance records. Cans of gasoline were transferred from one airplane to another, or the fuel was passed down through a hose by gravity feed. As late as last February the Air Force B-50 bomber Lucky Lady II refueled four times by the hose-gravity method in its non-stop flight around the world. The Boeing Airplane Co., of Seattle, recently announced a refueling system based on a collapsible metal boom connecting the tanker plane and the plane being refueled. It worked, but the crew of the receiving plane had to "fly" its boom to the tanker plane to make the connection. That needed a trained crew. ▶

What is new about flight refueling is ▶

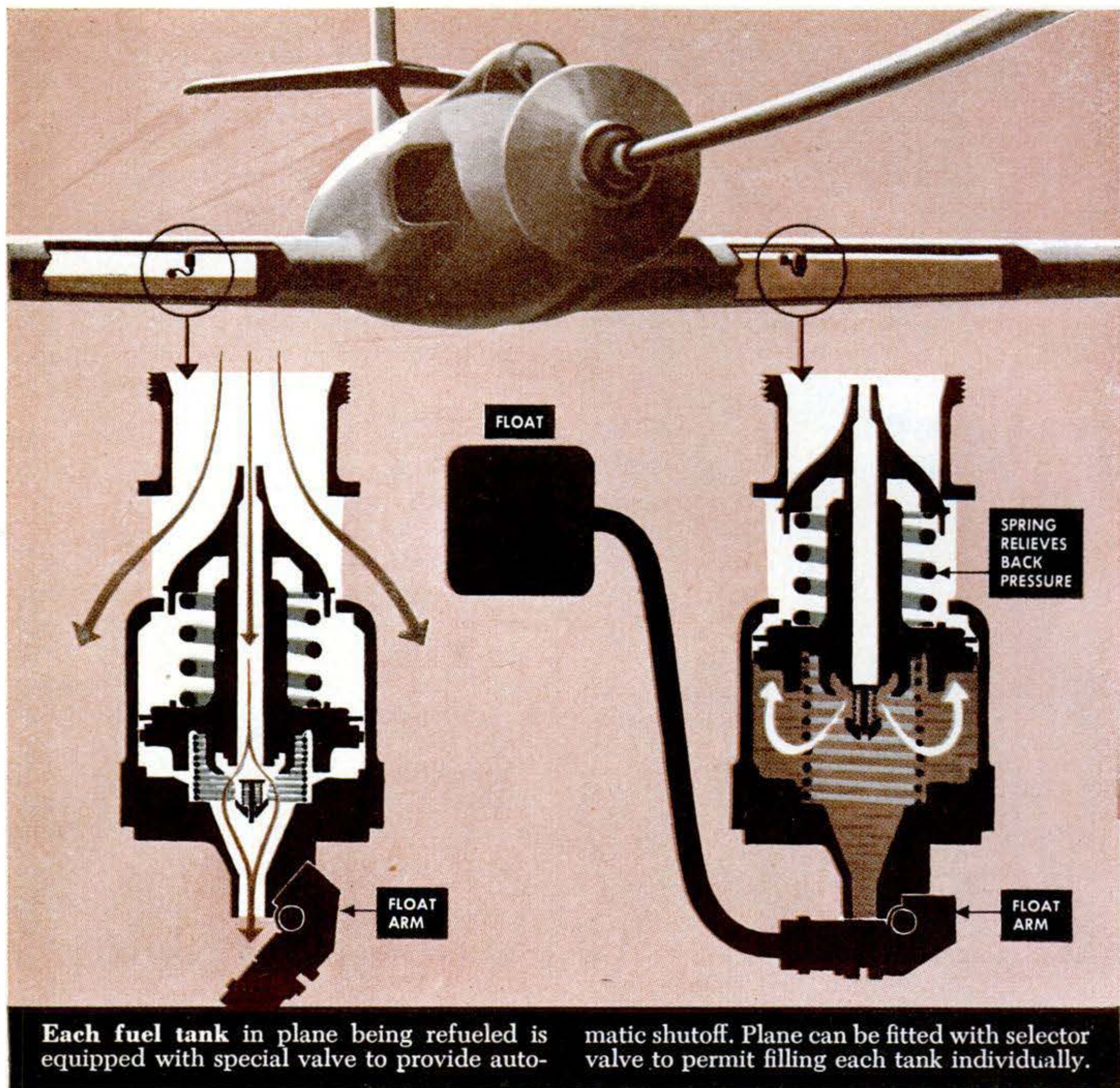

the system developed by Flight Refuelling, Ltd., of England, now being adapted for use by our armed services. Here is why it had to be developed:

Inherently, the airplane is an inefficient vehicle for transporting passengers, goods, or bombs. It eats up too much fuel in the process. Even with reciprocating engines instead of the more voracious jets, it consumes three to four times the weight of fuel required by a motor bus, for instance, and even at that will transport only two-thirds of the bus's payload. Weight for weight, it uses more than twice the fuel of a transatlantic liner and carries only a third the payload, even with stops to gas up.

Big planes capable of carrying enough fuel for nonstop flights of more than 3,000 miles are not only expensive to build and operate, but they also can carry only about 1/25th of their fully loaded weight as "use-

ful" or payload—passengers, cargo, or bombs. Capt. C. H. Latimer-Needham, Flight Refuelling's chief engineer, points out that there is a limit to the distance airplanes can fly nonstop, regardless of size, without dangerous overloading—when *all* the disposable load (passengers, cargo, *and* fuel) takes the form of fuel. In the opinion of some authorities this limitation would prohibit global air warfare—without refueling.

This characteristic of airplanes, in fact, is at the bottom of the hullabaloo between the Air Force and the Navy over the use of the Convair B-36 as an intercontinental defense weapon. The plane can go just so far, so fast, with a given weight of bombs, and it is astronomically expensive to build.

Airplanes have another characteristic that made flight refueling inevitable. Unassisted by Jato (jet-assisted take-off) bottles to augment the thrust of the engines, they can

lift off the ground less total weight than they can actually carry once they are aloft. That old standby, the DC-4, can tote a ton more weight in the air than it can take off the ground. The air liner you board at your local airport cruises on a third to a half the power, once it gets going, than it requires to become unstuck from the runway. A plane designed for flight refueling will save weight on take-off by carrying less fuel and thus will need less take-off power.

Flight refueling means a lot more than the mere transfer of gasoline for reciprocating engines—or kerosene or other high-ignition-point fuels for gas turbines—from a tanker plane to fighters, bombers, and air liners. That sounds simple until you get into the operation itself. Then troubles begin.

In the first place, the transfer of fuel from one airplane to another is dangerous. A way had to be devised to protect highly flammable liquids from ignition by hot exhaust pipes or static electricity. That meant the invention of a “closed system”—one in which not a drop of fuel could escape to the open air while it was being transferred.

A second problem was the designing of automatic cut-off valves to stop the flow of fuel at the split second that the receiving plane's tanks are brimful. Another problem was making an easy and routine physical connection between the tanker plane and the plane to be refueled. Still another was making the fuel flow fast enough to complete the operation within a few minutes, even in the case of big aircraft requiring thousands of gallons. And still an-

other was how to prevent the tanker and the plane being refueled from becoming unhitched if speeds didn't quite match.

And there were lesser questions to be answered. Among them was how to bring together the tanker and the plane to be refueled in the unmarked vastness of space—to avoid a game of hunting for a needle in a haystack. Another was how to make the tanker crews comfortable in sub-freezing temperatures at altitudes of 20,000 to 25,000 feet. Refueling operations had to take place at that height if the airplanes were to get above most of the bad weather and make visual contact. Another problem was how to make mid-air refueling universally practical without the expense of training large numbers of crewmen to use it. And still another was how to prevent “vapor locks” in the refueling lines when the fuel began boiling in the thin air of high altitudes.

All these problems were tackled in 1935 by Sir Alan J. Cobham, noted British flier, aviation engineer, and present chairman and managing director of Flight Refuelling, Ltd. By 1939 his refueling system was being used to supply gasoline to British flying boats plying between the United States and England. Then the war interrupted commercial research work.

Flight refueling became a wartime project in 1943-44 when it was proposed to equip 1,250 British Lancaster bombers and tankers with fuel-transfer systems. The bombers were to be used for attacks against Japan from Burma, 2,500 miles away. The plan was dropped when the United States

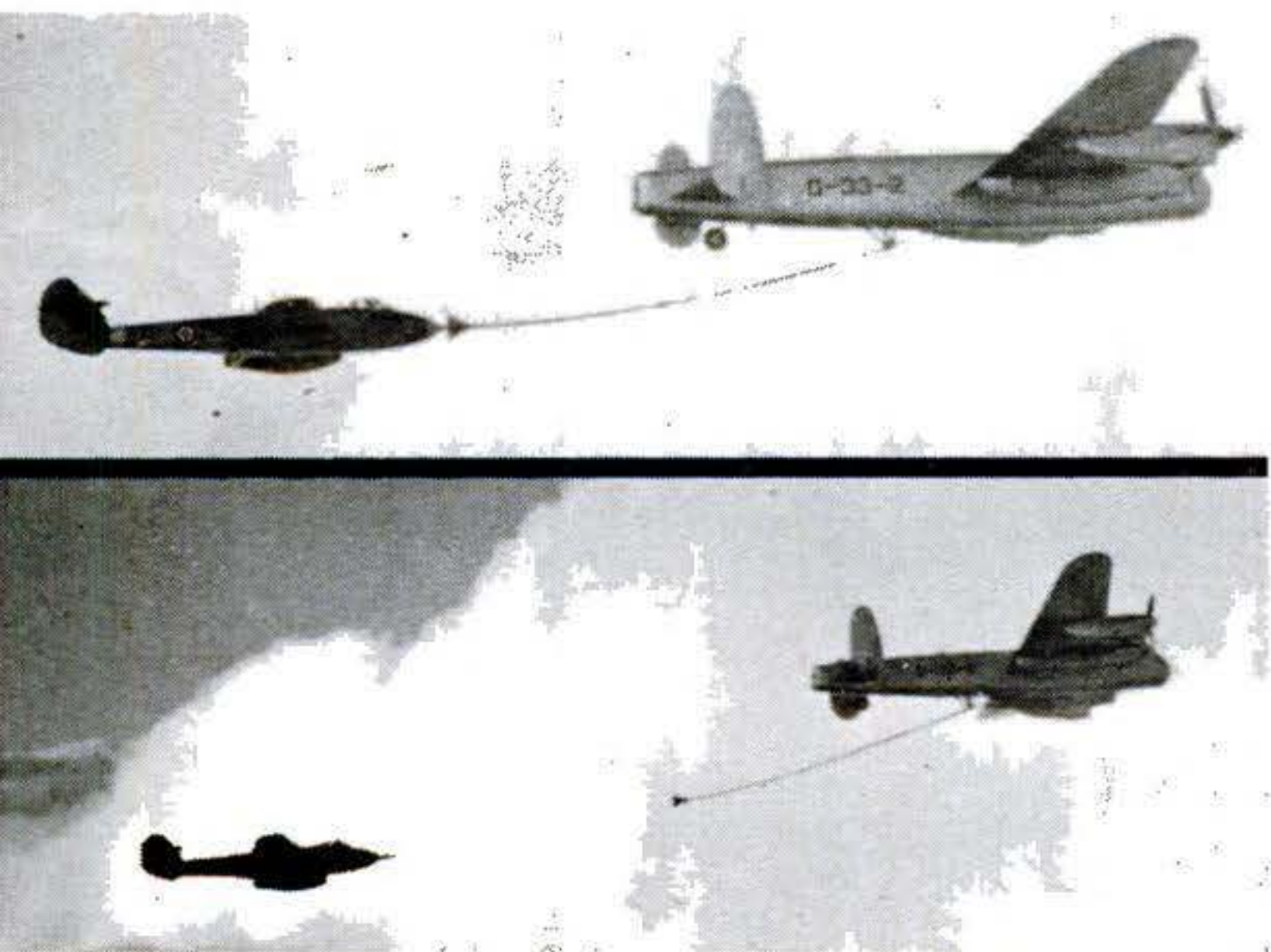

Operation completed, refueled plane eases back until hose is extended to fixed limit. Two pawls lock drum. Further pull by plane disengages probe, automatically shuts off fuel.



In Boeing system for refueling bombers, telescoping pipe or boom is “flown” by controls called rudder-deviators to tanker plane. It requires, however, a trained crew in bomber.

made unexpectedly rapid advances across the Pacific.

With the war over, Sir Alan's company renewed its work on refueling development. Experiments in 1946 included 25 day and night refueling tests over the North Sea and the English Channel. In the first sustained operations with commercial planes, the company based its tankers at Santa Maria in the Azores to refuel nonstop flights of British South American Airways to Bermuda.

Transatlantic Freighters Refueled

Next, Sir Alan decided to try winter refueling over the North Atlantic. He collaborated with British Overseas Airways in refueling nonstop flights by freighter planes between London and Montreal. Tankers based at Shannon, Eire, refueled planes within a radius of 500 miles of that base. Other tankers from Gander and Goose Bay, Newfoundland, performed a second refueling operation east of those bases.

Once radar and cabin heating failed them. Another time the fuel-tank valves failed to open due to an experimental change in positioning the tanker lower and more rearward of the freighter plane. But on no occasion did the tankers fail to take off from their bases despite snow, fog, icing conditions, and temperatures as low as -35° F. On some occasions the freighters made their westward crossings against headwinds that caused the regular transatlantic airline traffic to be diverted to Iceland.

It was in part Flight Refuelling's equipment that was employed by the U. S. Air Force in the globe-girdling trip of the B-50, Lucky Lady II. Recently a jet fighter, the Gloster Meteor Mark IV (PS, Oct. '49, p. 131), having a normal flight time of slightly more than an hour, was kept aloft for 12 hours 3 minutes with ten refuelings.

An American company, Flight Refueling, Inc., of Danbury, Conn., has taken over distribution of the system in this country for its British counterpart. Right now, its customers are only the Navy and the Air Force, but the company is confident that American commercial air liners will soon be taking flight refueling in their stride.

The advantage that flight refueling will afford jet aircraft, requiring some four times the fuel consumed by reciprocating-engine transports, when they begin flying the Atlantic is obvious. To the jets, flight refueling will be more than an advantage. It will be a necessity. END

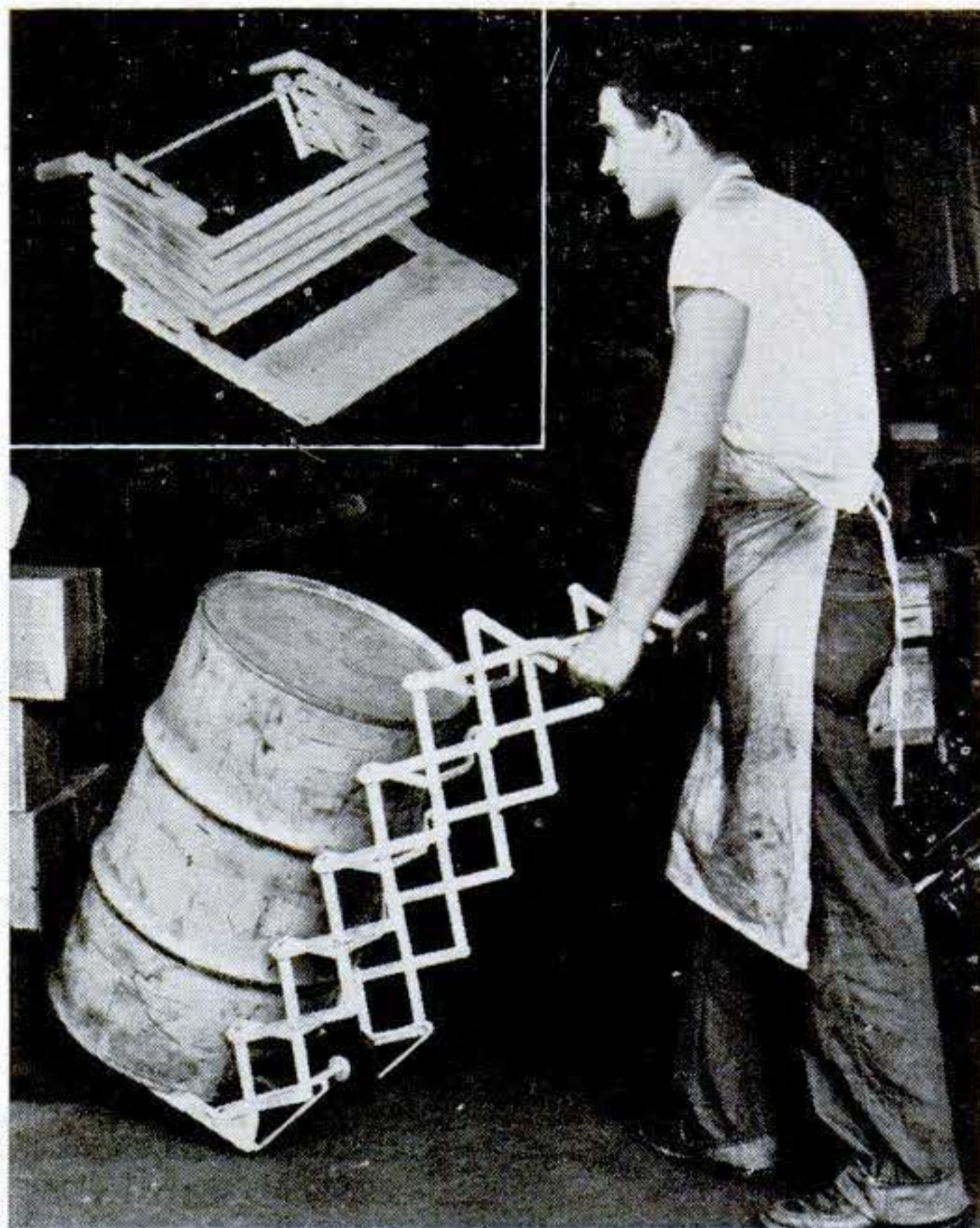

Folding Truck Saves Space

WHERE space is a problem, this new hand truck that folds up can be used to move heavy items. When not in use, it folds down to a height of only nine inches. Called the Fold-A-Way[®] by the distributor, Business Equipment Specialists, of New York City, it weighs only 25 pounds but will take a load of 700 pounds.



"Keymonica" Teaches Music

THIS plastic musical instrument is called a Keymonica[®]—a cross between a clarinet, harmonica, and button accordion. With ten buttons for 20 notes, it can be used in teaching the fundamentals of music. Even the reeds are plastic, and it can be cleaned by washing in warm water. It is made by the Magnus Harmonica Corp., of Newark, N. J.

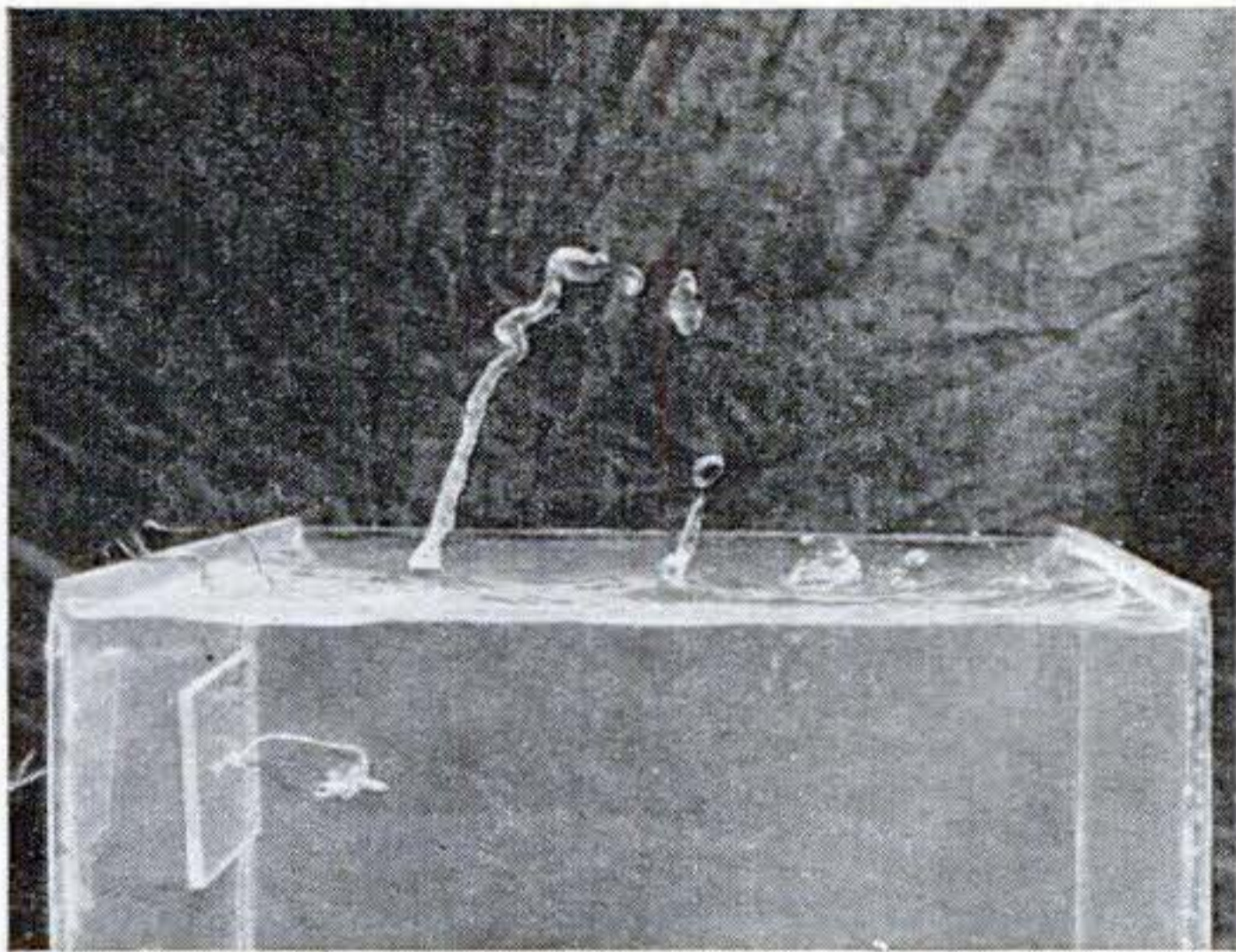

Sound Makes Odd Fountain

JETS of water spurt mysteriously from the surface of the tankful above. They're made when electric voltage vibrates a dime-size, concave disk of barium titanate suspended in the liquid. Oscillating nearly 3,000,000 times a second, the disk produces ultrasonic waves (too high-pitched for human ears to hear) for study by GE engineers.

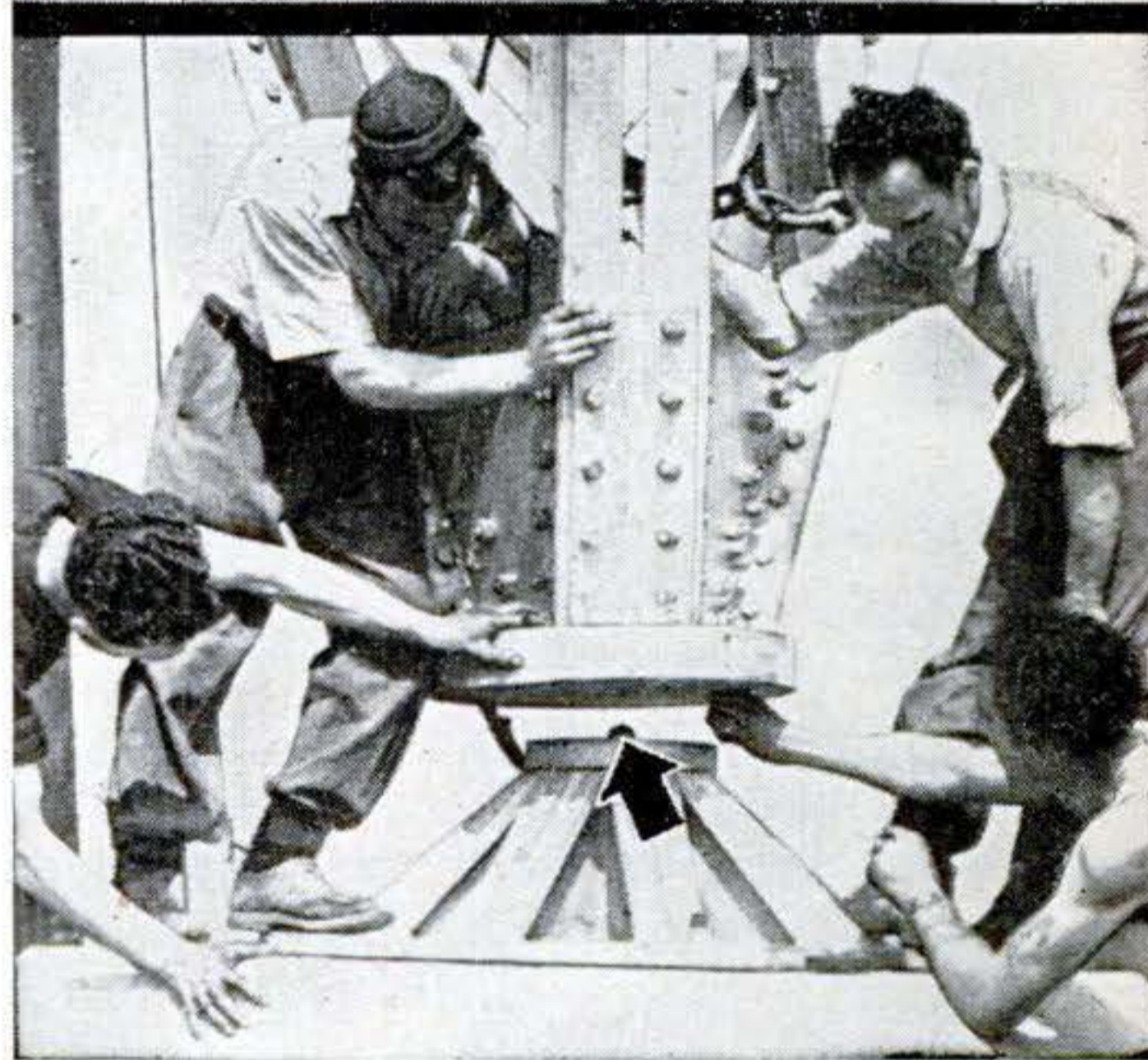
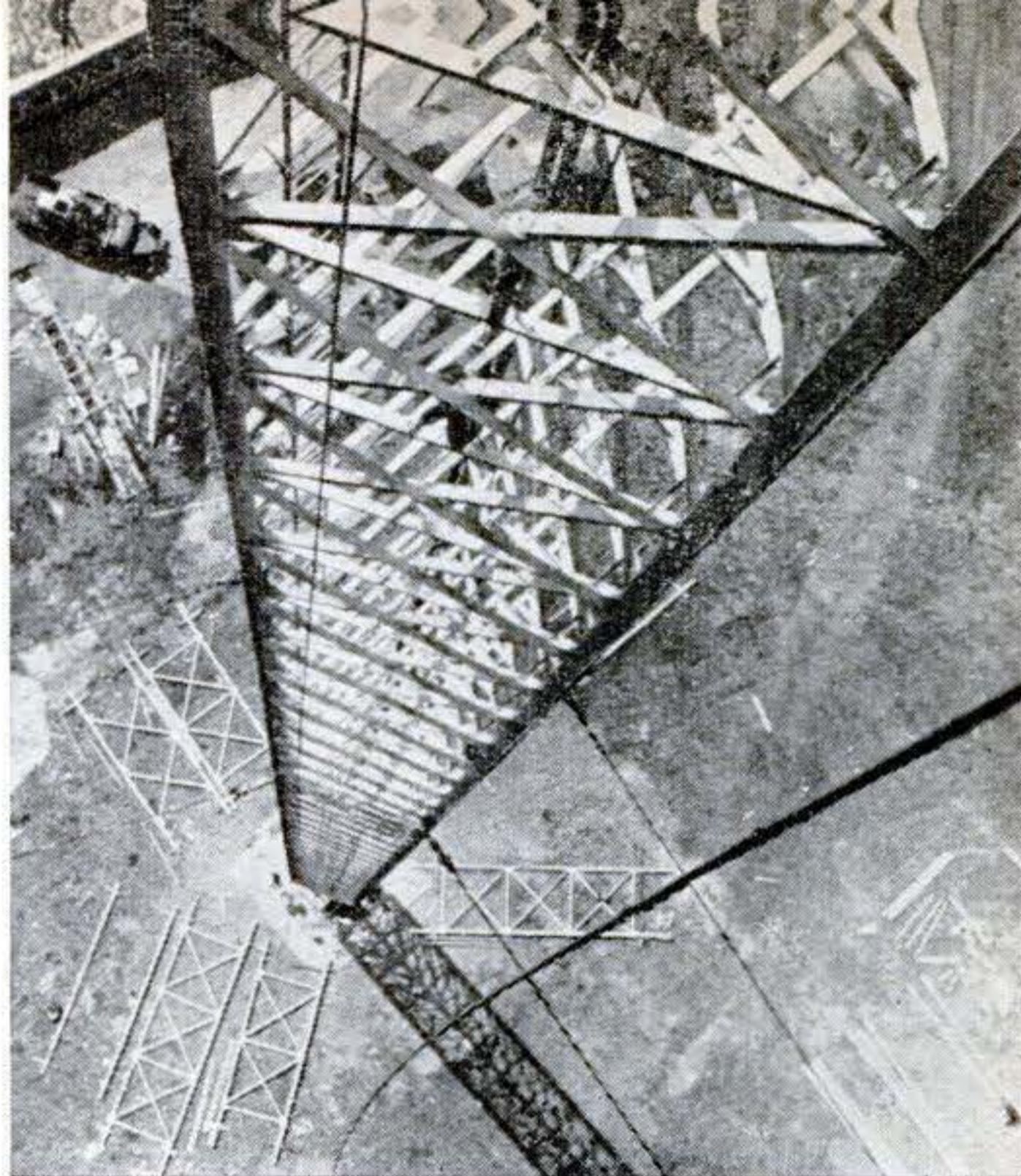

Tiny Ball Supports Tower

A BALL bearing just two inches in diameter supports the weight of Britain's tallest television mast, the 750-foot tower shown under construction in two views above. Held upright by guy wires, the 100-ton mast will pivot on the tiny sphere, seen at the center of its convex base in the lower view, to allow for "give" in a high wind.

Shoptalk:



"I CAN'T KEEP MY SKED WITH THAT VK TONIGHT BECAUSE I'M STILL CHASING BUGS IN THE RIG."

What are they talking about? Answer below.

They're amateur radio operators. He won't be able to keep a pre-arranged radio contact (sked) with an Australian (VK) amateur because he is still trying to eliminate difficulties in the transmitter (rig).

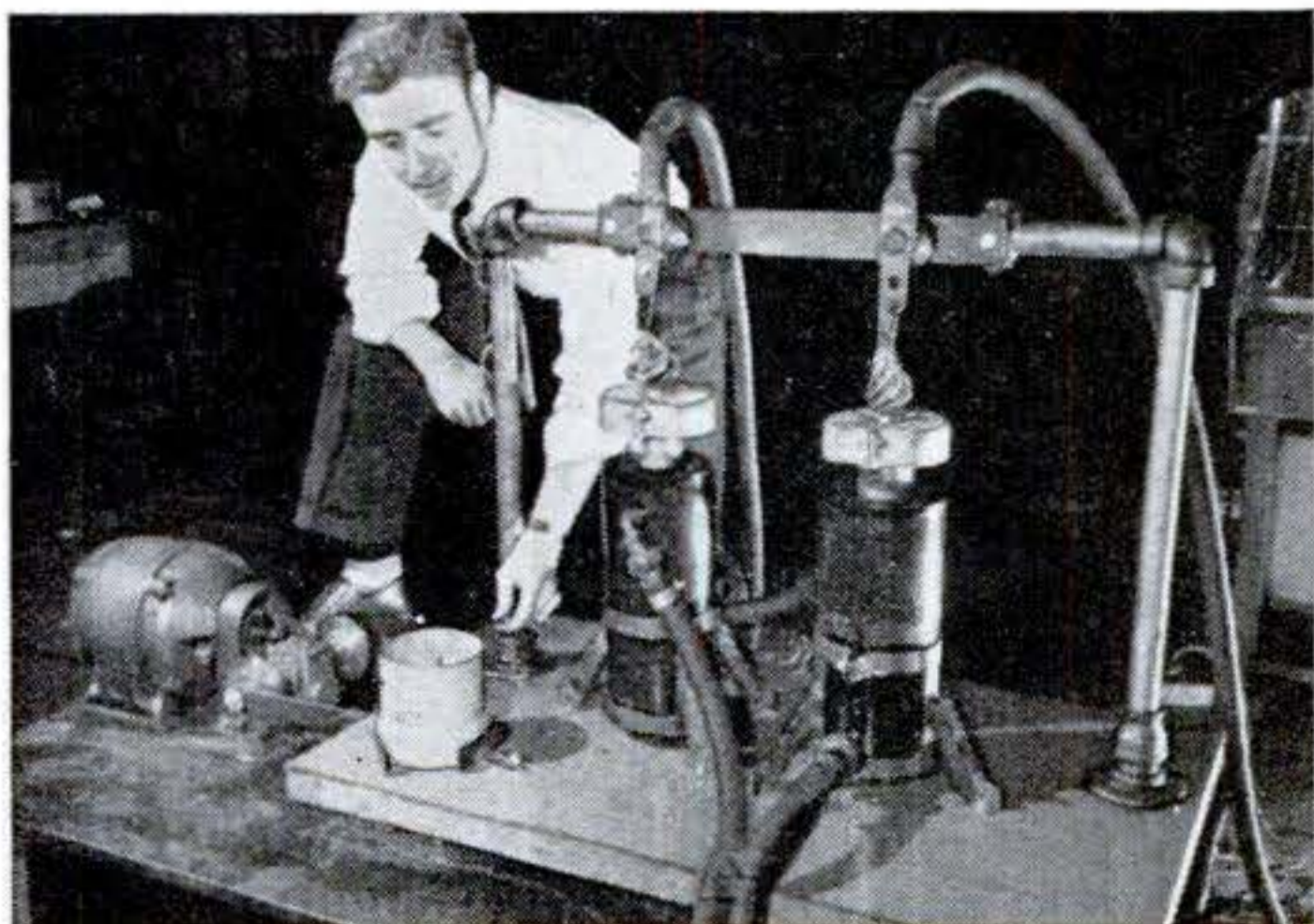

Tubes Get Jitterbug Test

BY CONVERTING alternating to direct current, Westinghouse ignitron tubes at left enable electric locomotives with light and compact DC motors to use power from low-cost AC transmission systems. Fears that jolting the liquid mercury in the tubes might interrupt their power were proved groundless by the "jitterbug" table shown, on which they performed smoothly for a month, although its 180 jiggles a minute emptied a cupful of water in two seconds.

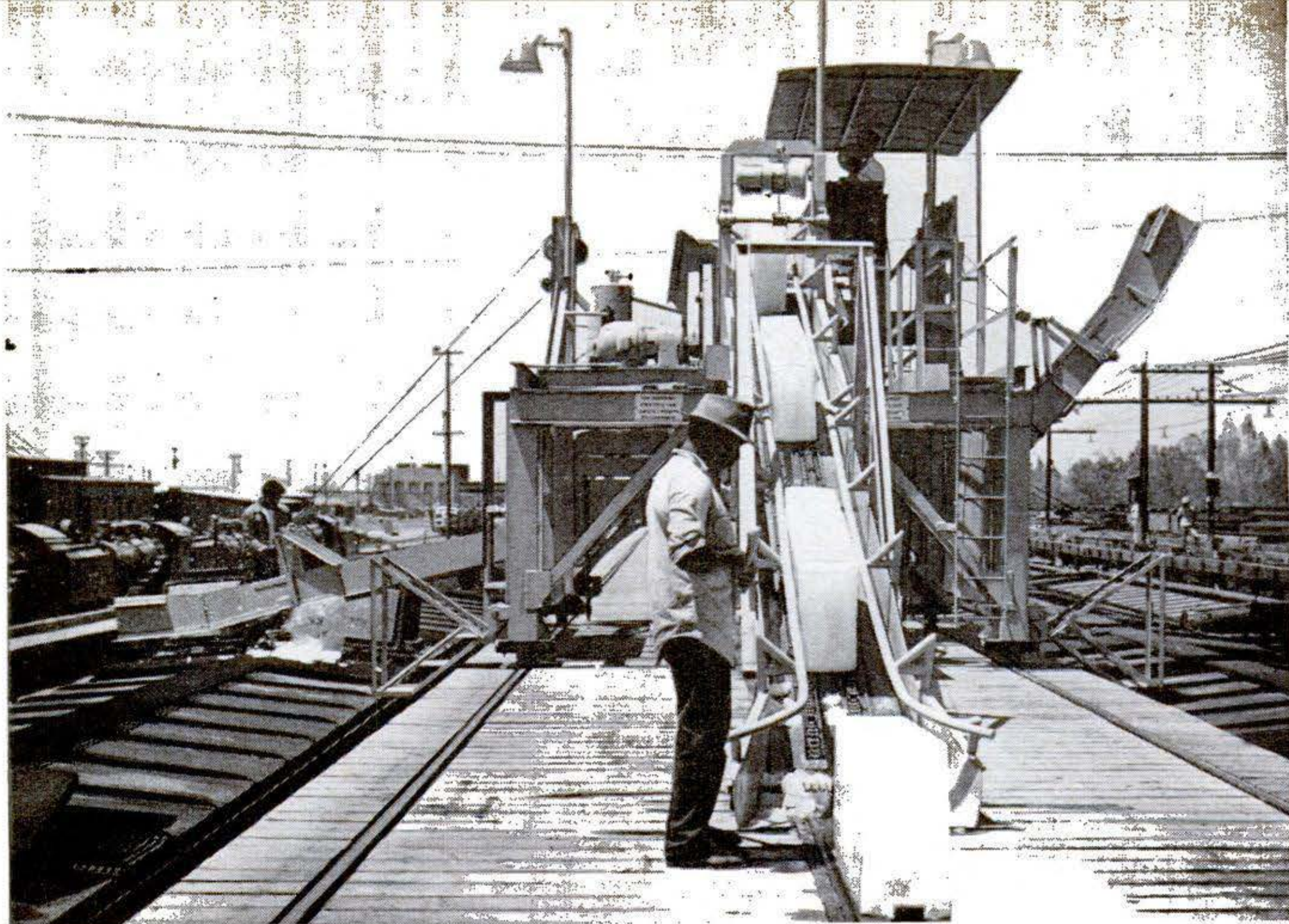

Electronics Ices Freight

REFRIGERATOR cars filled with perishable fruits and vegetables now get quick, push-button icing at Bakersfield, Calif. This huge machine pours five tons of crushed ice into a car's bunkers in 90 seconds. Moving like a giant, antennaed spider along rails on a raised icing dock, the machine straddles a chain conveyer leading from an ice-storage house. As it moves, it scoops up forty 300-

pound blocks of ice a minute, crushes them, and feeds cars on both sides of the dock. The operator on the bridge electronically controls the flow of ice, raises and lowers the chutes, and regulates the crush from coarse to fine, depending on the product being iced. The machine, developed by the Railways Ice Co. and the Santa Fe Railway, is operated by six electric motors powered through a trolley wire running underneath the dock.

Small Air-Gun Shears Lop Big Limbs

LIGHTWEIGHT and fast-acting, the new Limb-Lopper[®] at right below is designed for easy, one-handed pruning of vines, shrubs, or trees. For large-scale vineyard operations, as seen at left below, it can be attached to a mobile rig having as many as eight air lines fed by a single large compressor. Used singly, it requires only a small compressor and thus is also ideal for

pruning in parks and on estates. Weighing only 1¼ pounds, the 14-inch tool will cut limbs up to ¾ of an inch thick by the pressure of a trigger. With a slight rocking motion, it can make bigger cuts. Speed is obtained because the air pressure is used to open the blades as well as close them. The clipper is manufactured by the Miller-Robinson Co., of Los Angeles, Calif.

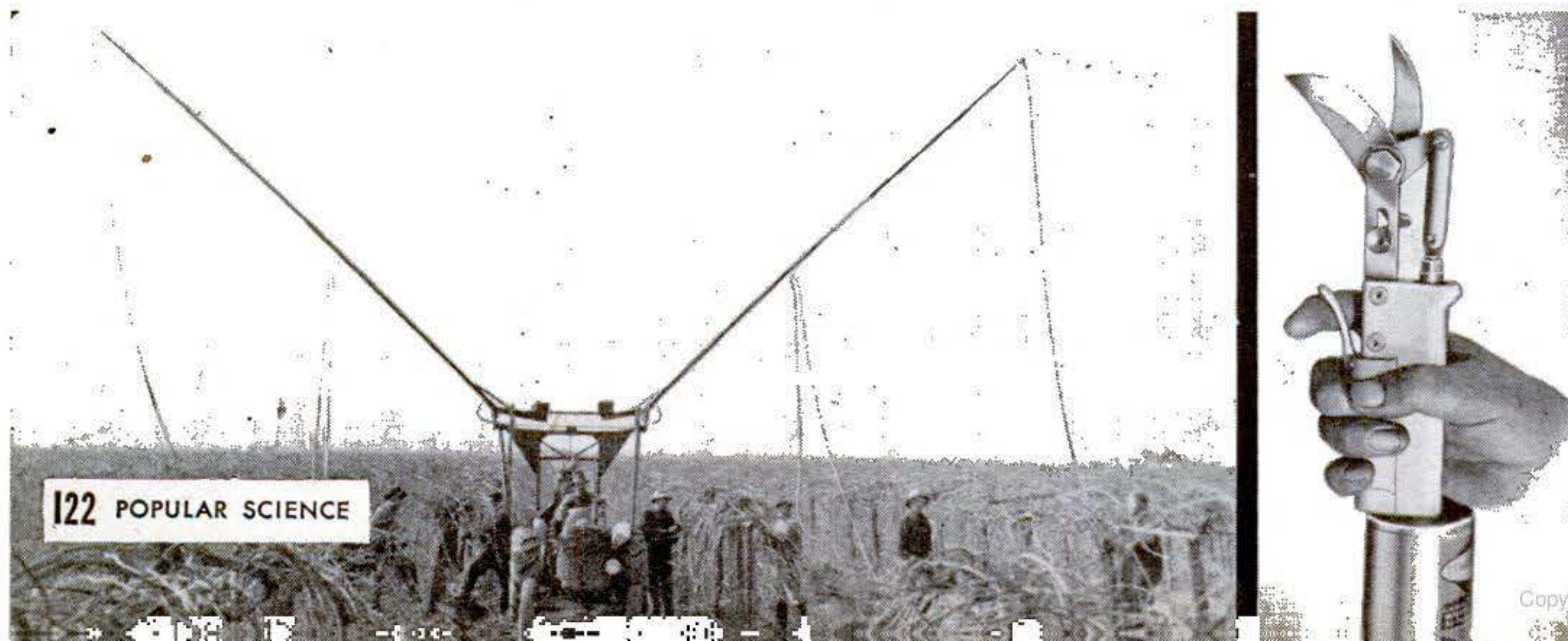

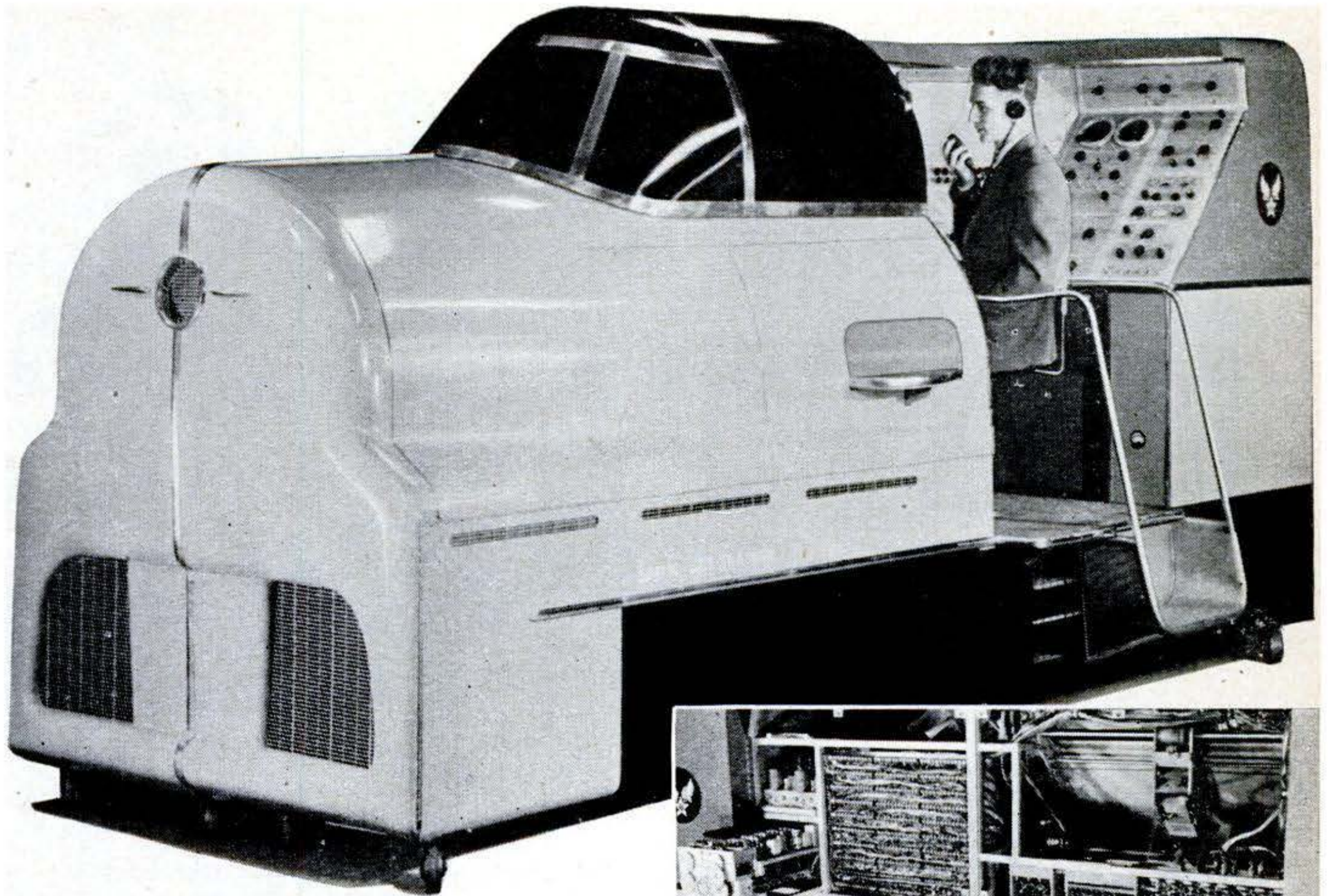

At the base of the new Link Jet Trainer (above) is its brain (right), consisting of 24 electronic computers. Each individual chassis rolls out on casters for inspection and servicing.

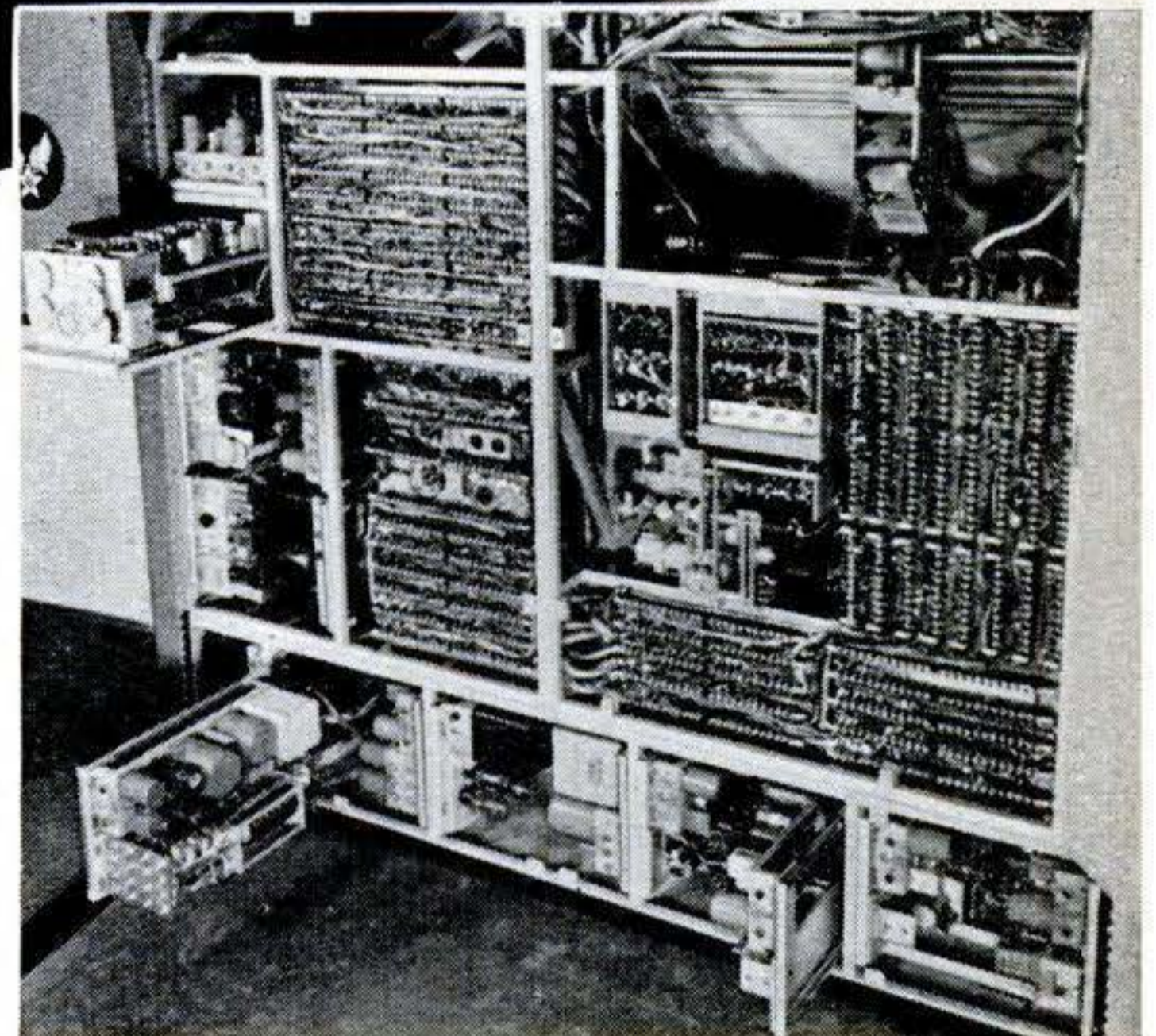

Jet Jockeys

Get Ground Go-Around

By Herbert Johansen

THE speeding F-80 jet fighter's tailpipe is dangerously hot. The pilot doesn't notice the warning signal on his cockpit panel. In a matter of seconds the pipe burns out and his engine is disabled. But in this case he doesn't crash. A check pilot simply pushes a button and the world's first jet instrument trainer gives the pilot a new engine, a new tailpipe, and a new start.

As in conventional Link trainers, the pilot has of course never left the ground. But although the trainer has not moved an inch, he has experienced all the conditions of sub-

sonic flight on his instruments, and the actual "feel" of flight on his rudder pedals and stick.

The new trainer, developed for the Air Force, is more than just an electronic teacher of instrument flying. It also checks the pilot on radio navigation, operation of his engine, proper fuel consumption, and how to deal accurately and swiftly with emergencies.

Since coping promptly with emergencies is vital at jet speeds, the check-pilot instructor, sitting behind the hooded cockpit, has buttons for introducing a variety of operating troubles, ranging from a fuel-tank puncture or a fire to a complete engine failure. For added realism, the instructor can feed

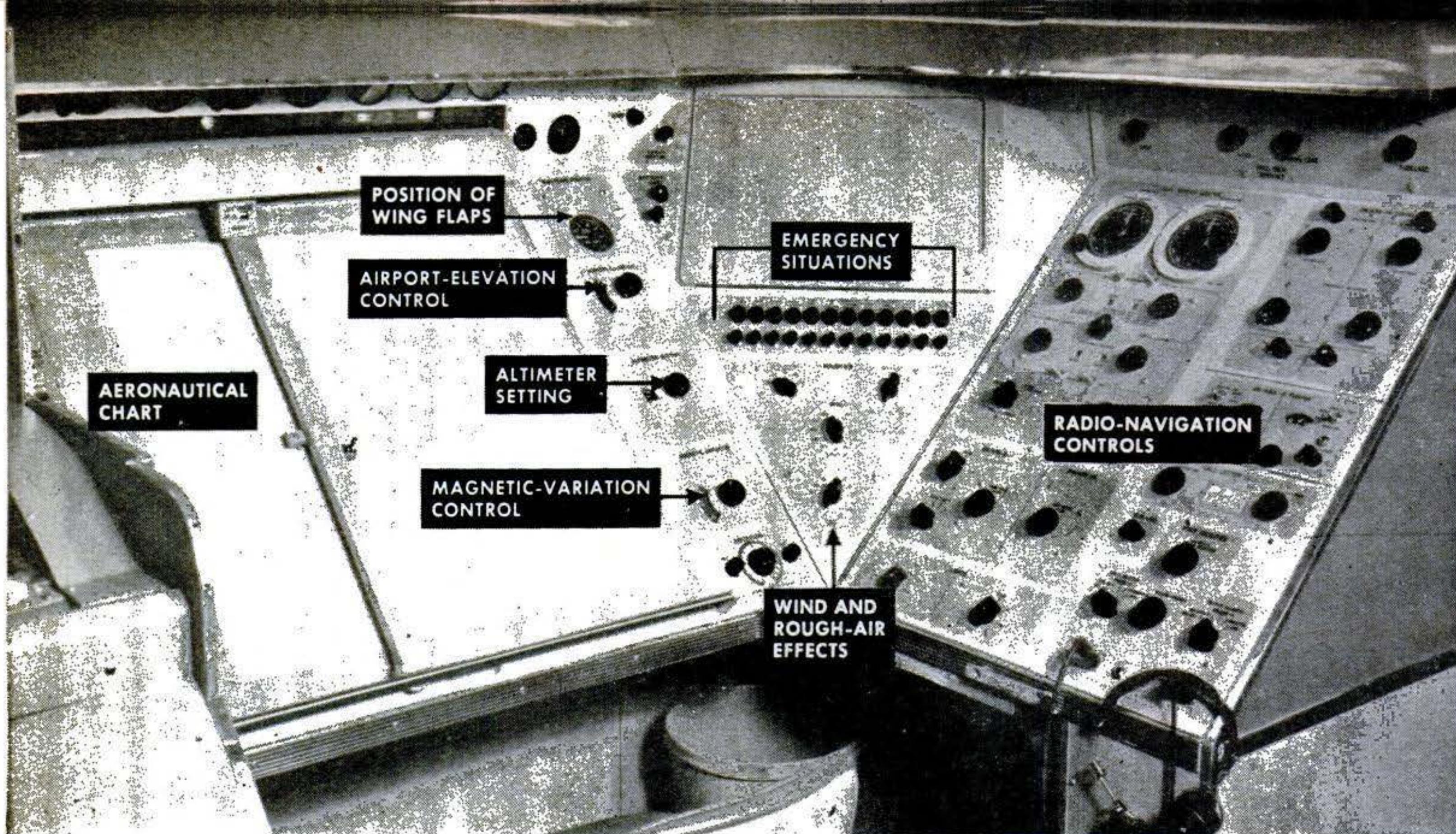

The instructor's console is located immediately to the rear of the hooded student's cockpit. The instructor faces a recorder panel (left) that traces simulated flight on an aeronautical chart.

In the center are push-button controls to feed in emergencies, and (right) fuel and radio controls. A window at far left (not visible) permits observation into cockpit.

in lightning flashes, simulate rough air or high winds, and duplicate wing icing.

While the student is being bedeviled by all sorts of troubles, electronic watchdogs keep tabs on his every action. A set of duplicate instruments tells the instructor exactly how the plane is flying. If the student does not follow engine-operation procedure to the letter, failures occur that are indicated to the instructor through tell-tale lights.

One important feature of the new trainer is the completeness of its radio-navigation instruments. Such devices as a radio magnetic indicator and distance-measuring equipment enable the pilot to determine his position and course by looking at instruments rather than by listening to radio signals. Instrument approaches can be practiced, too.

Station locators permit setting in two radio stations at any geographical location on the chart being used. The location and characteristics of the stations may be changed while the flight progresses. By "leapfrogging" them, always keeping one station ahead of the student, the check pilot can supervise the student as he makes a thousand-mile cross-country "flight."

During such flights, instrument settings can be varied to simulate changes in atmospheric conditions and airport elevations, while an automatic recorder traces the path across an actual aeronautical chart.

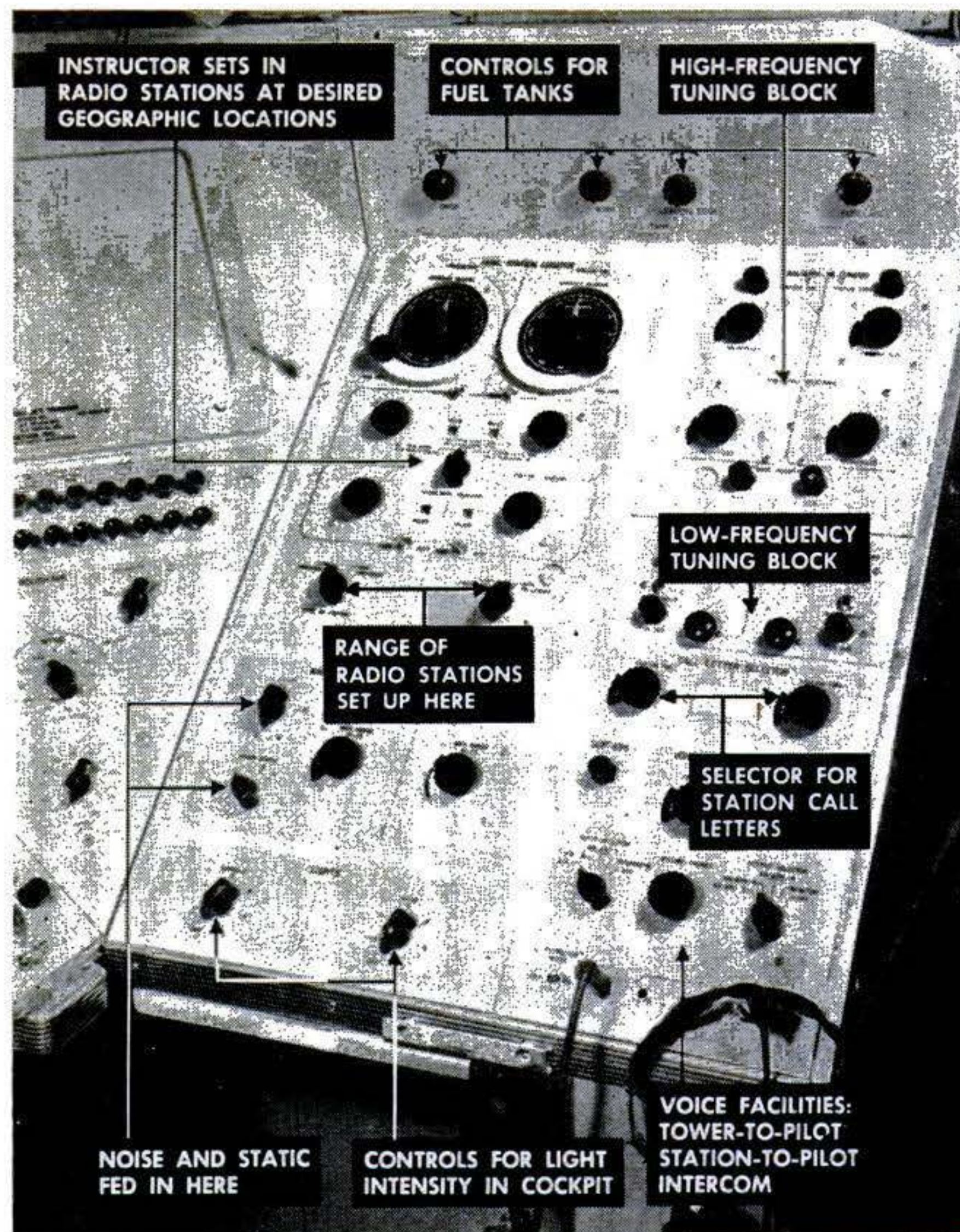

At top of the radio panel are controls for filling the fuel tanks to any desired capacity. Controls below permit the instructor to set up a wide variety of radio-navigation problems.

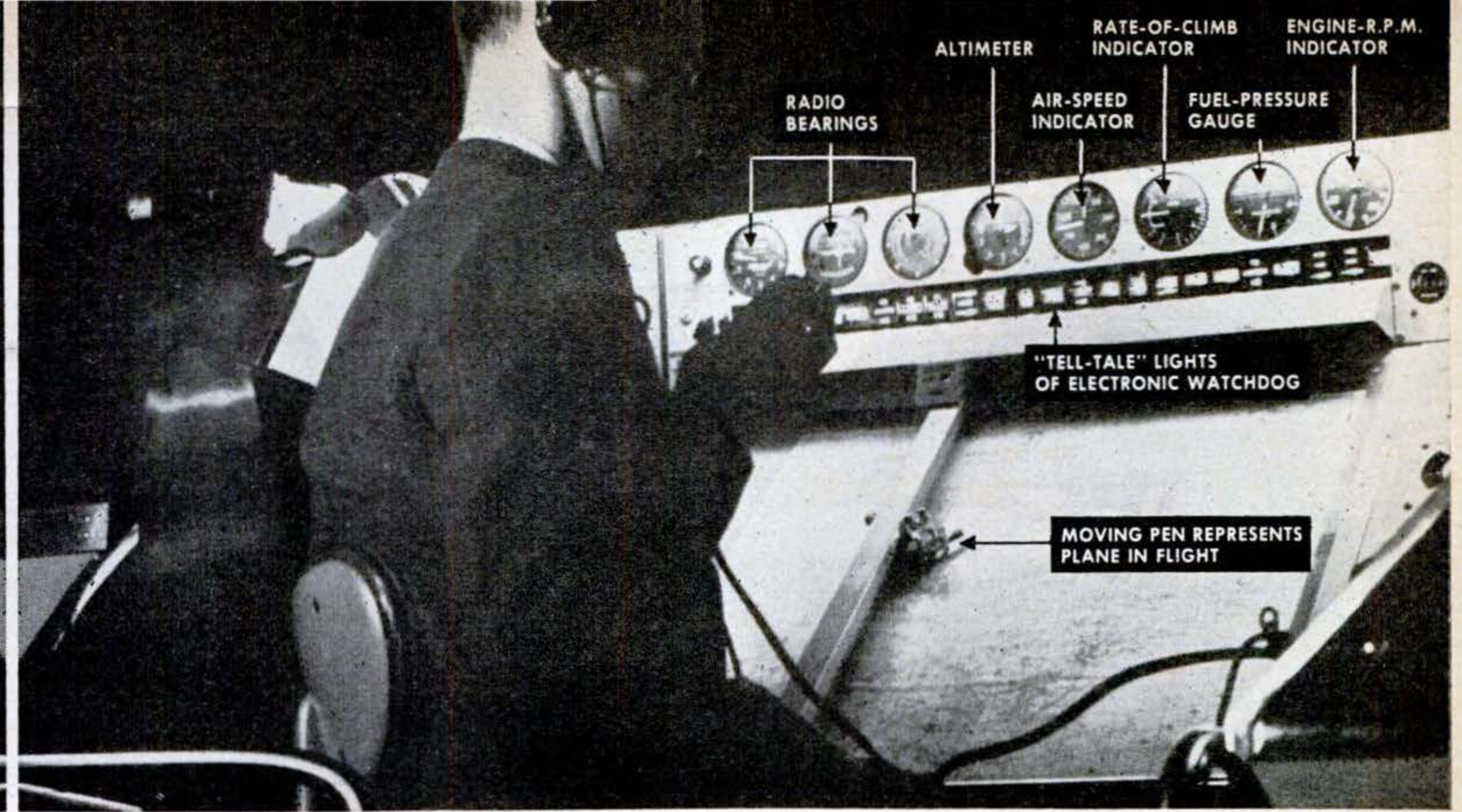

Close-up of the recorder panel shows eight repeater instruments on top that duplicate readings in the pilot's cockpit, enabling the instructor to follow student performance. Directly

below is the row of 32 tell-tale lights that signal pilot errors and their effects on the plane's operation. Next is the flight-recorder pen that moves over an aeronautical chart.

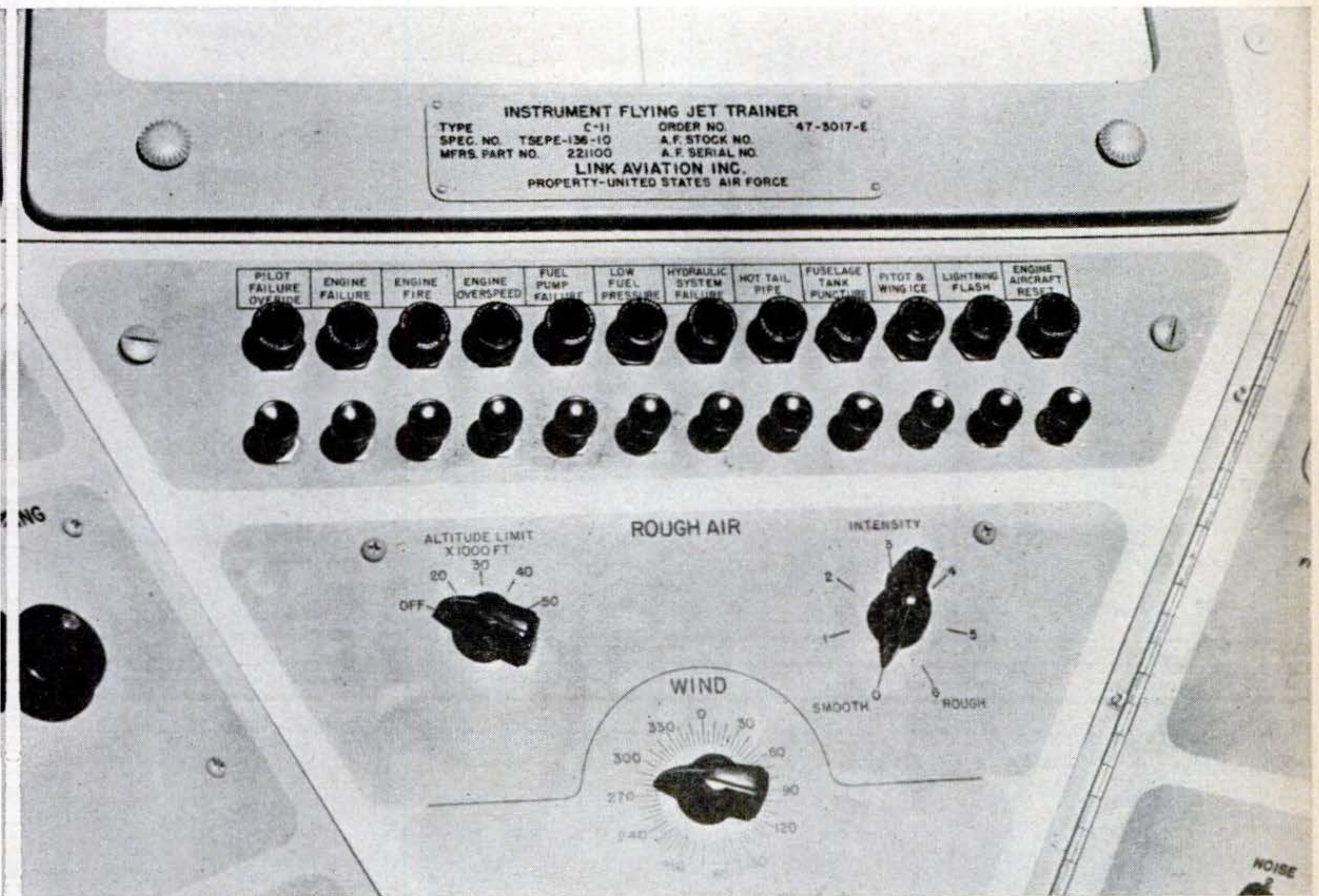

Here's trouble for the student pilot. If his reaction to any of the various emergencies fed in by the instructor is wrong, the error shows up on the row of tell-tale lights. If the student be-

comes hopelessly snafued, the instructor can press the "angelic switch" at far left. The effect of this is to clear all troubles and give the student a fresh start at tackling the problem.

One Hour — Broadway

WHEN a real expert talks rocket ships, the amazing-fiction boys take a back seat. Dr. Hsue-Shen Tsien is a real expert — director of the Guggenheim Jet Propulsion Center at Caltech. Here's his idea of

a rocket ship that could be built right now. The sketches below were adapted from Dr. Tsien's own drawings.

This liner could shoot 20 people coast-to-coast in less than one hour. It would

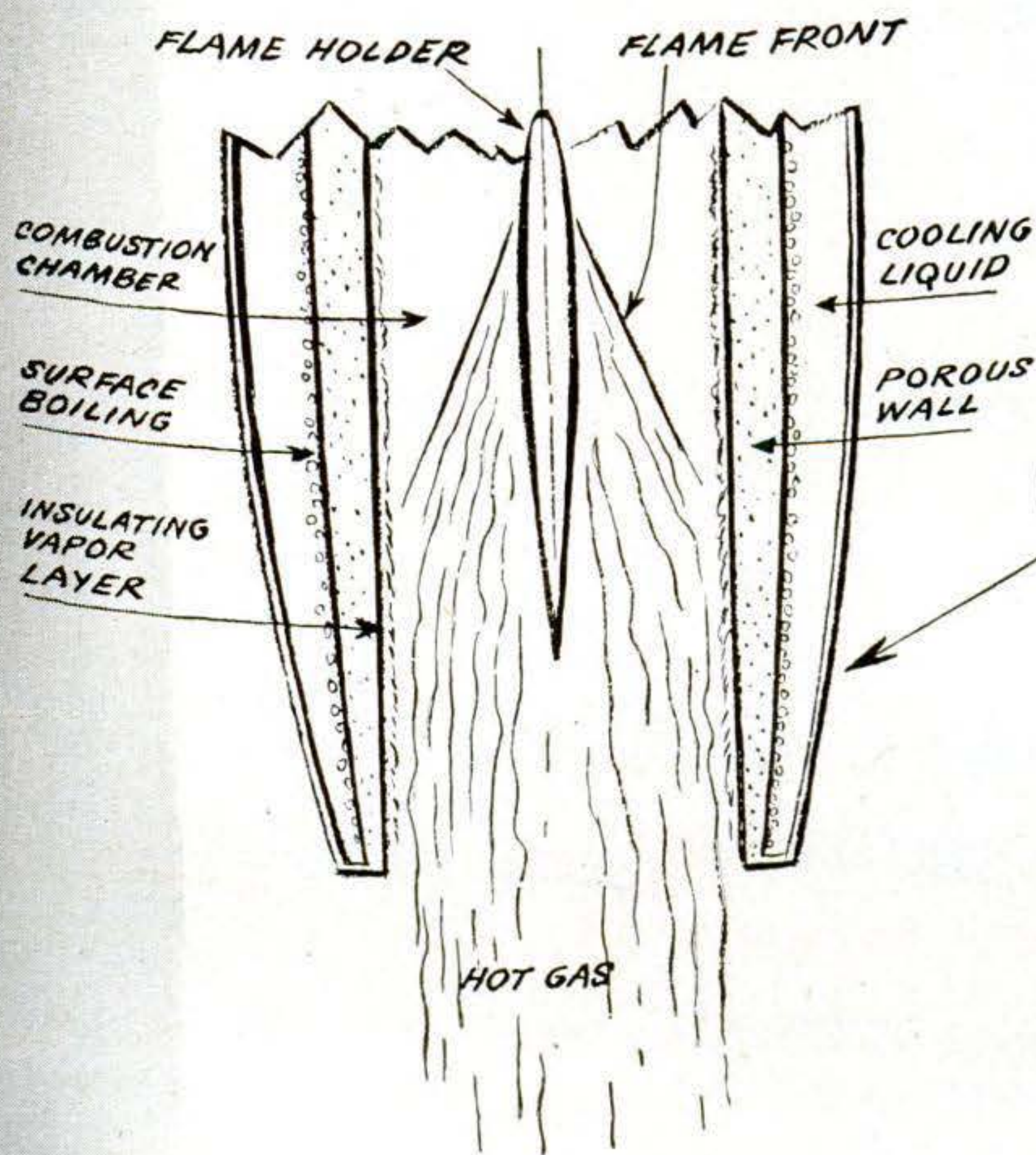

SAME MOTOR IS BOTH ROCKET AND RAM-JET. WHEN USED AS RAM-JET, CIGAR-SHAPED FLAME HOLDER DIRECTS AND HEATS FUEL GASES SO THAT FLAME STAYS IN PROPER POSITION. COOLING LIQUID CIRCULATING AROUND MOTOR IS SEPARATED FROM COMBUSTION CHAMBER BY POROUS WALL. ON "COLD" SIDE OF WALL LIQUID BOILS TO TAKE UP HEAT FROM WALL. VAPOR THEN SWEATS THROUGH WALL TO "HOT" SIDE, FORMING THIN INSULATING LAYER FOR FURTHER HEAT PROTECTION

ALTERNATE METHOD OF COOLING MOTOR, CALLED "FILM COOLING", SQUIRTS LIQUID THROUGH HOLES IN WALL. RUSHING HOT GASES IN MOTOR SPREAD LIQUID ALONG "HOT" WALL, FORMING INSULATING FILM. FOR BEST COOLING, FILM MUST BE ONLY FEW MILLIONTHS OF INCH THICK.

NEW YORK TO LOS ANGELES
LESS THAN ONE HOUR

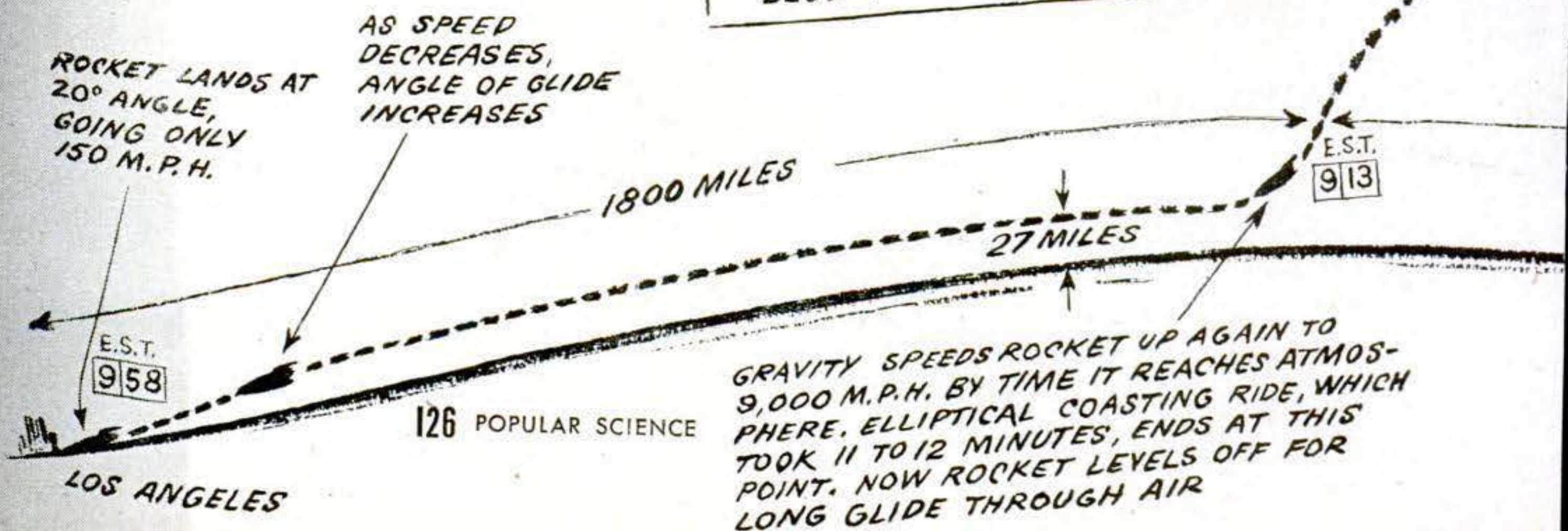

GRAVITY SPEEDS ROCKET UP AGAIN TO 9,000 M.P.H. BY TIME IT REACHES ATMOSPHERE. ELLIPTICAL COASTING RIDE, WHICH TOOK 11 TO 12 MINUTES, ENDS AT THIS POINT. NOW ROCKET LEVELS OFF FOR LONG GLIDE THROUGH AIR

to Hollywood

take off vertically—with passengers flat on their backs—zoom to 9,140 m.p.h. in one minute, coast like an artillery shell for 1,200 miles, then glide on wings for 1,800 miles. Landing? Level, at 150 m.p.h.

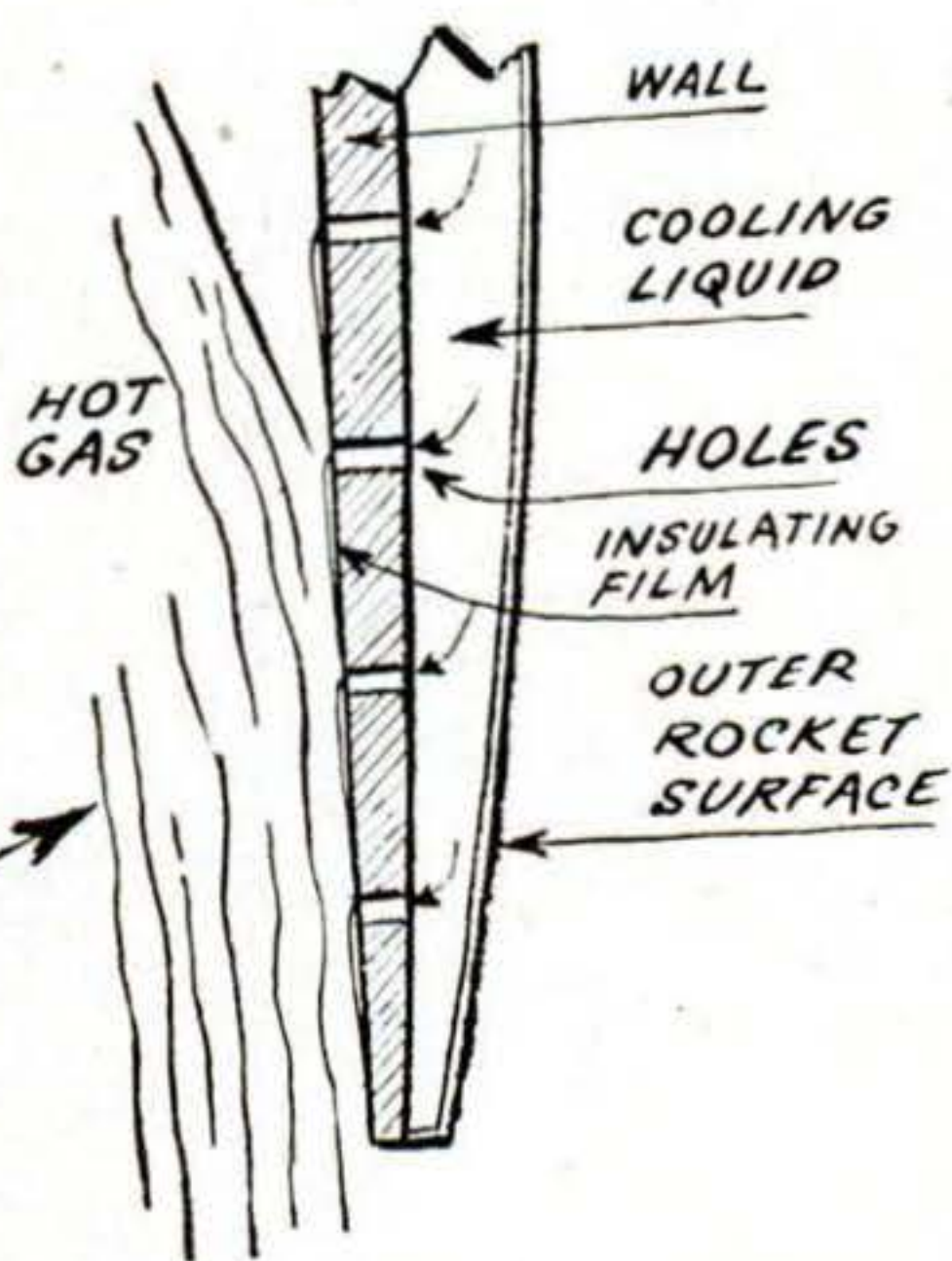

SPEED DROPS TO ABOUT 6,000 M.P.H. WHEN ROCKET REACHES ITS HIGHEST ALTITUDE, 600 MILES ABOVE THE EARTH

AFTER ONE MINUTE'S VERTICAL FLIGHT, ROCKET HAS REACHED 9,140 M.P.H. AND FUEL IS EXHAUSTED. THIS PUSH KEEPS IT COASTING ON ELLIPTICAL PATH

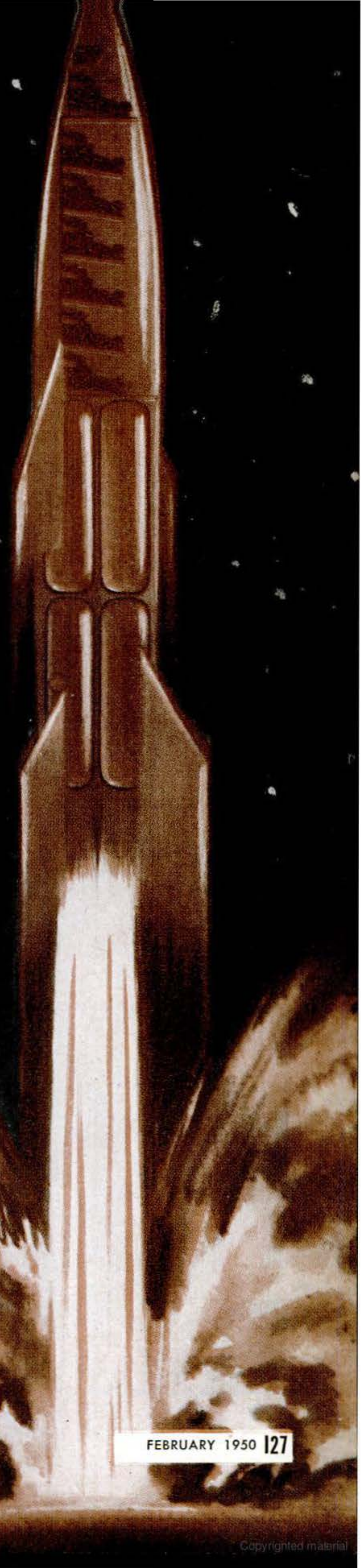
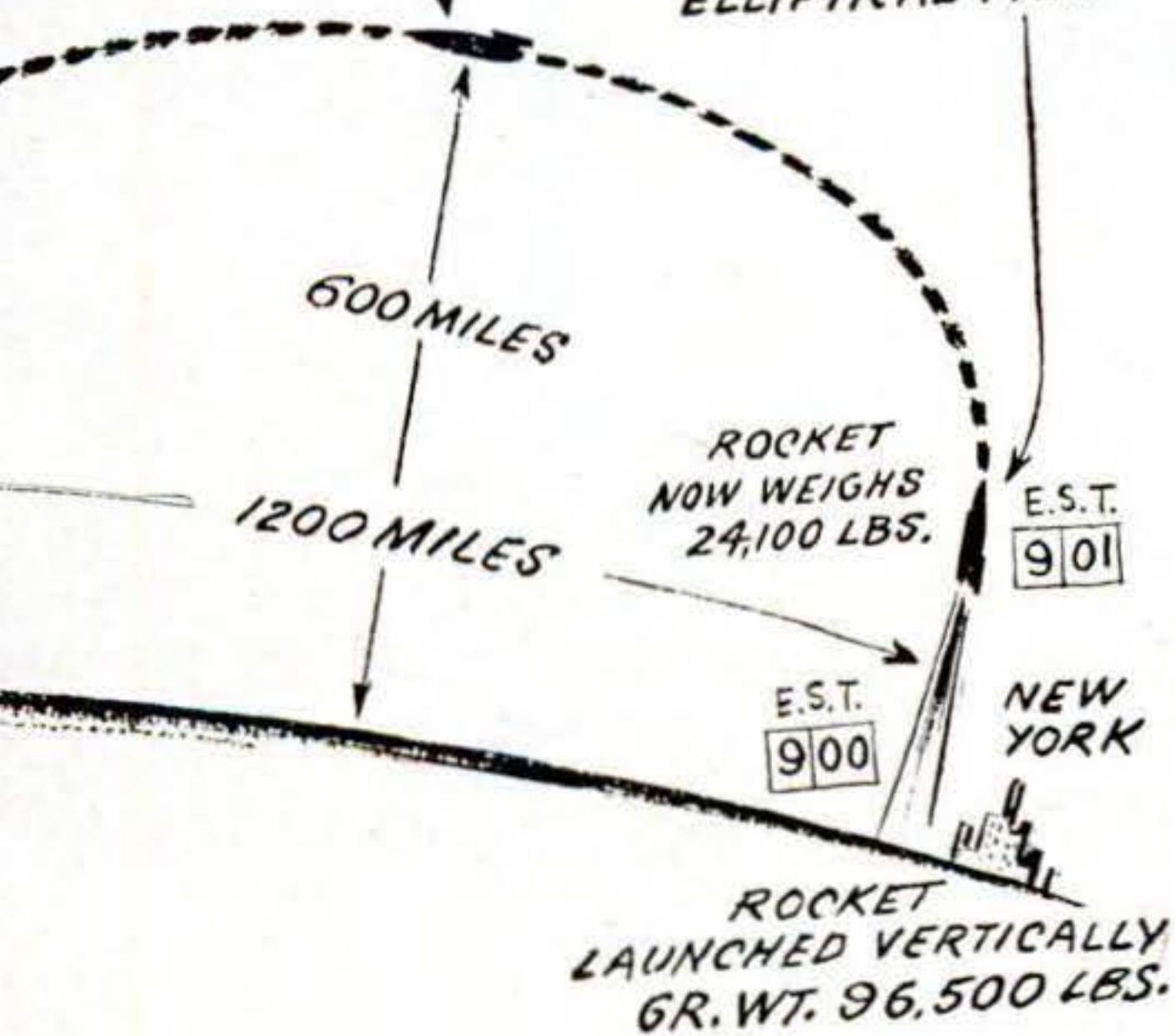

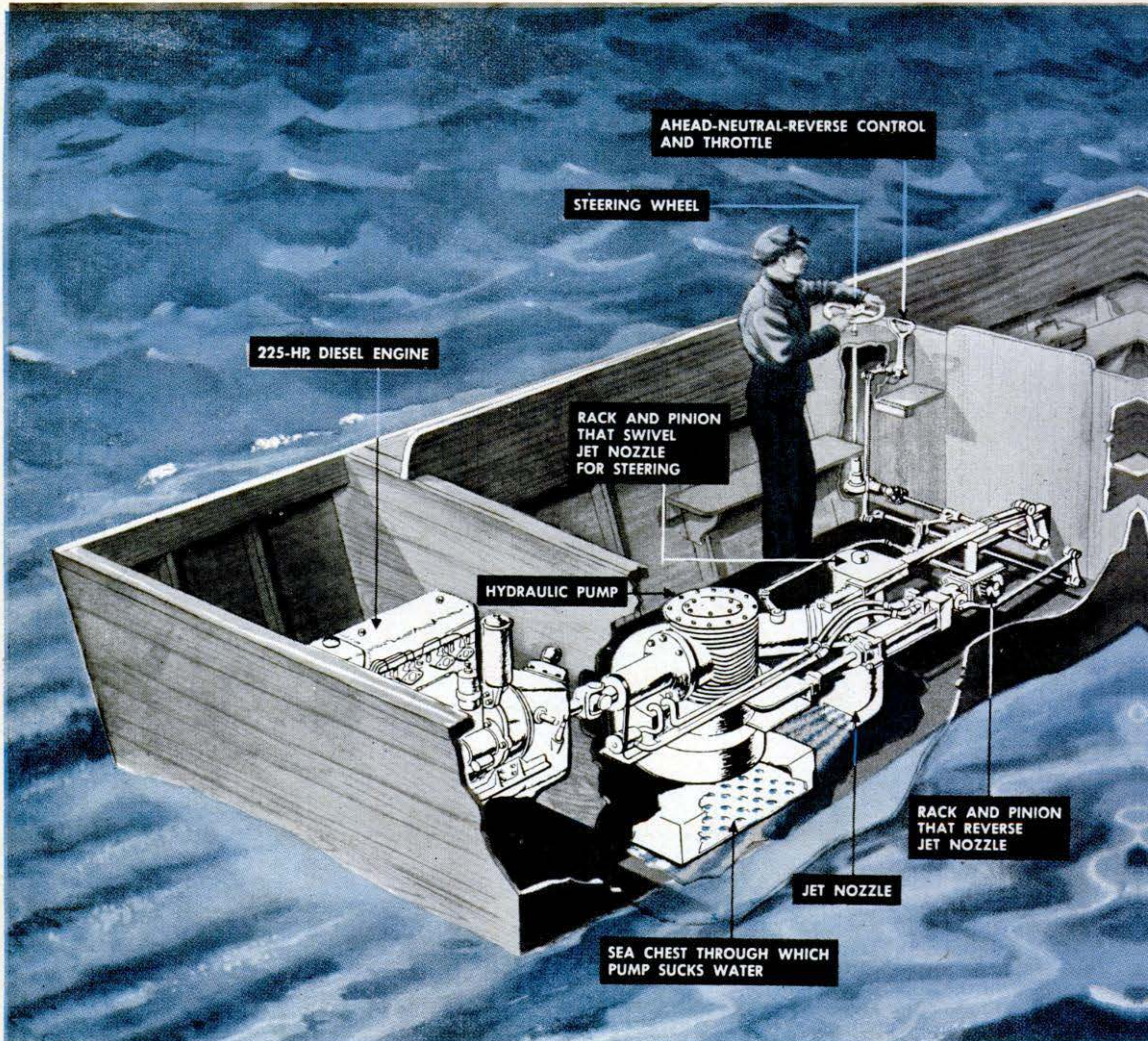

Artist's drawing shows experimental installation of hydrojet propulsion unit in a landing craft.



A 14-foot pleasure boat, propelled by water jet, speeds along at 15 miles an hour in a trial run. The boat draws only $3\frac{1}{2}$ inches of water, and can turn around in its own length.



Attach a hose to the pump unit, and you have a one-man fire department. With the motor going at full speed, a stream of water can be shot 60 feet into the air under 85 pounds pressure.

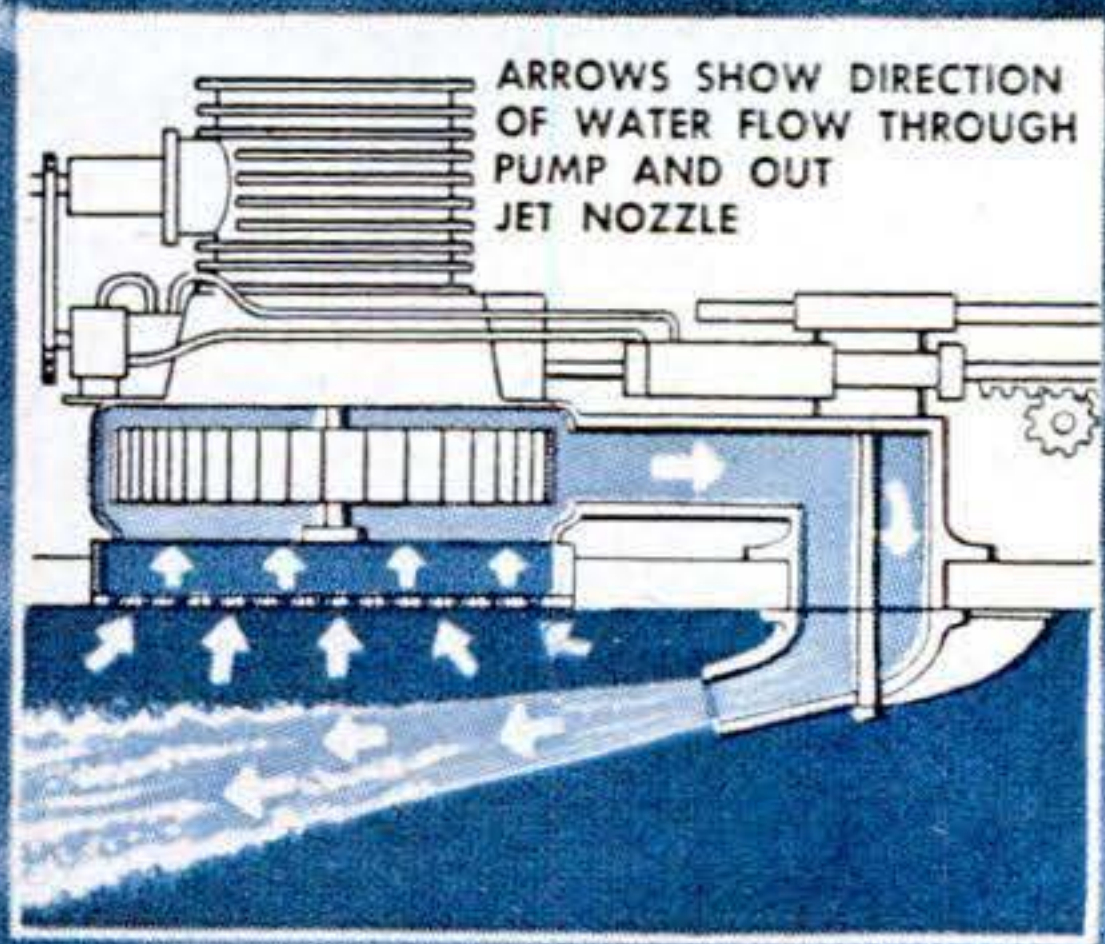
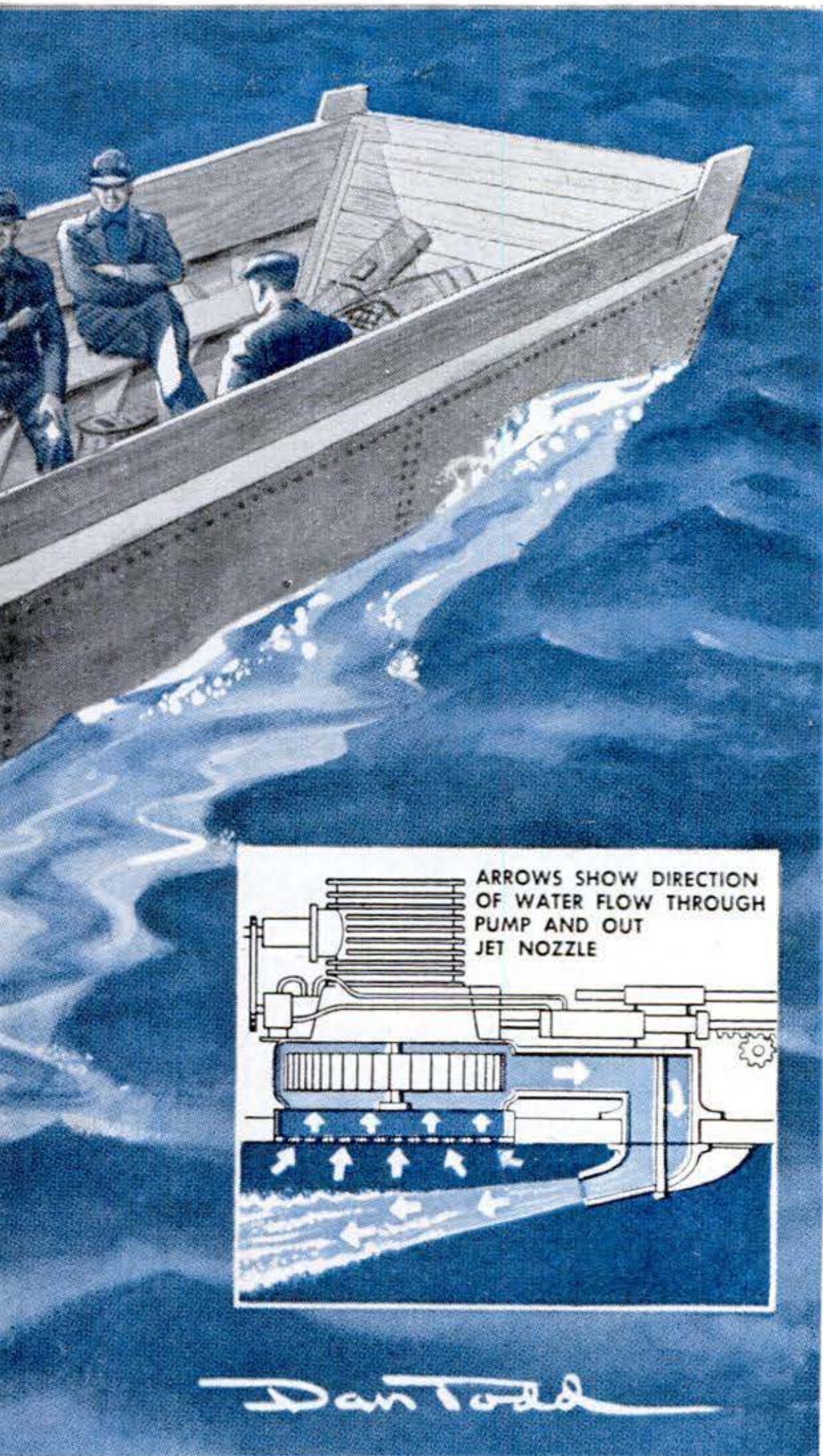

Inset shows details of pump and jet nozzle.

Water Jet Propels Boats

A POWERFUL jet of water replaces the propeller in a new kind of shallow-water craft that's being tried out by the Navy and Air Force. A conventional engine drives a pump that forces more than 7,000 gallons of water a minute out through a nozzle under the hull.

Steering is done by turning the nozzle to the right or left, up to 90 degrees, by a manual control. Reverse motion is obtained by a hydraulic control that swivels the nozzle 180 degrees. Thus the propellerless, rudderless boat can push its way through swamp mud that is 50 percent solids and climb over logs and other obstacles.

Developed by Hanley Hydrojet, Inc., of Prospect, Ohio, jet-propulsion units have been installed experimentally in swamp gliders designed for Air Force rescue work and in a Navy LCVP assault landing craft.

In backing off, the jet nozzle literally eats away the beach or mud bank, as in hydraulic mining. Hydrojet is also adaptable to small pleasure craft and fishing boats.



A Navy LCVP landing craft, using hydrojet propulsion, is shown above being beached at more than eight miles an hour. The boat literally climbed up on the beach to a distance that

probably would have ruined a propeller, while the jet nozzle, protected by a shallow keel, was undamaged. A 225-hp. marine Diesel engine drove the pump of the Hanley Hydrojet unit.



Movement of eyes while reading test passage is photographed in ophthalmograph. Film at

right shows how many times eyes move, how long they stop, and if there's tendency to retrace.

Fliers Learn to Read Fast

IN THE Pentagon building there's an installation sometimes called "the place where they teach Air Force officers to read." This designation isn't quite accurate, of course, but a battery of ingenious gadgets there is helping the fly boys read faster and better. In some cases they double or triple

their reading speed during a 30-hour course.

First the student must get rid of poor reading habits, such as moving his lips, or going back over a line because he didn't get it straight the first time. Then he builds new habits that make his eyes do double duty. That's where the devices below come in.



Tachistoscope is short-range projector with camera-type shutter. It flashes numbers on screen at varying speeds. Idea is to learn to recognize longer series of digits in shorter time.

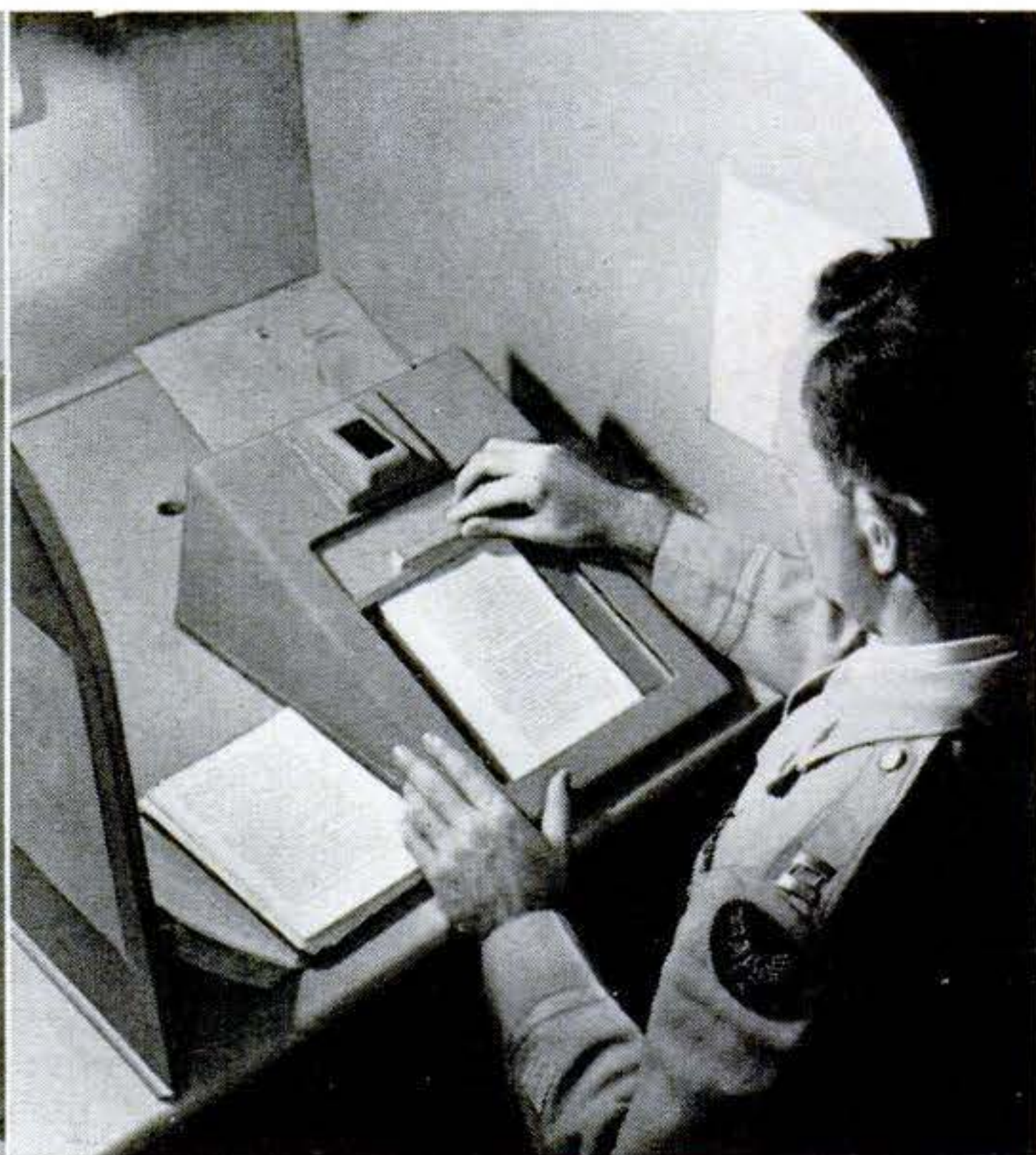

Reading-rate controller has a motor-driven slide that moves down page at predetermined rate. Reader must go fast enough to keep ahead. Afterward he is tested for comprehension.

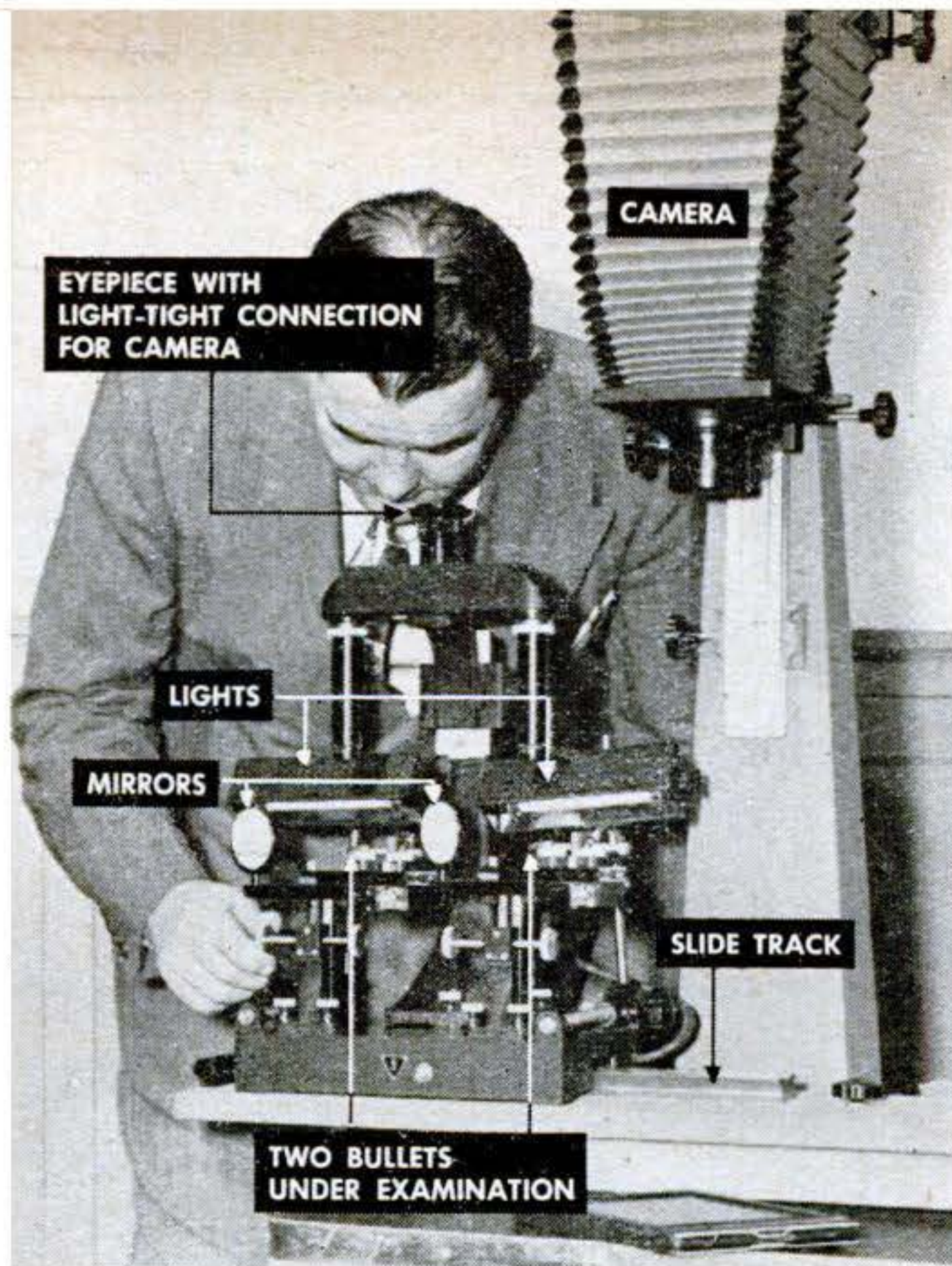

Microscope Compares Bullets

LATEST of scientific police weapons is a new comparison microscope that quickly shows whether two bullets were fired from the same gun—and then takes a photograph of what it sees. Made by Bausch & Lomb with the needs of small cities in mind, it also compares fingerprints, hair, tool marks, and other small objects or markings. A sliding base permits the microscope to be focused visually and then pushed under the camera.



Slots Steer Parachutes

THE Air Force is cutting pieces out of its parachutes now—slits that let a jumper “steer” to a good landing spot. Variations of the “Derry slot,” currently in use by the Air Rescue Service, spill air from underneath the canopy without collapsing the chute. The spilled air causes the parachute to slip in the direction in which the air is escaping. Thus the jumper can head in any direction he wishes, or even turn completely around.

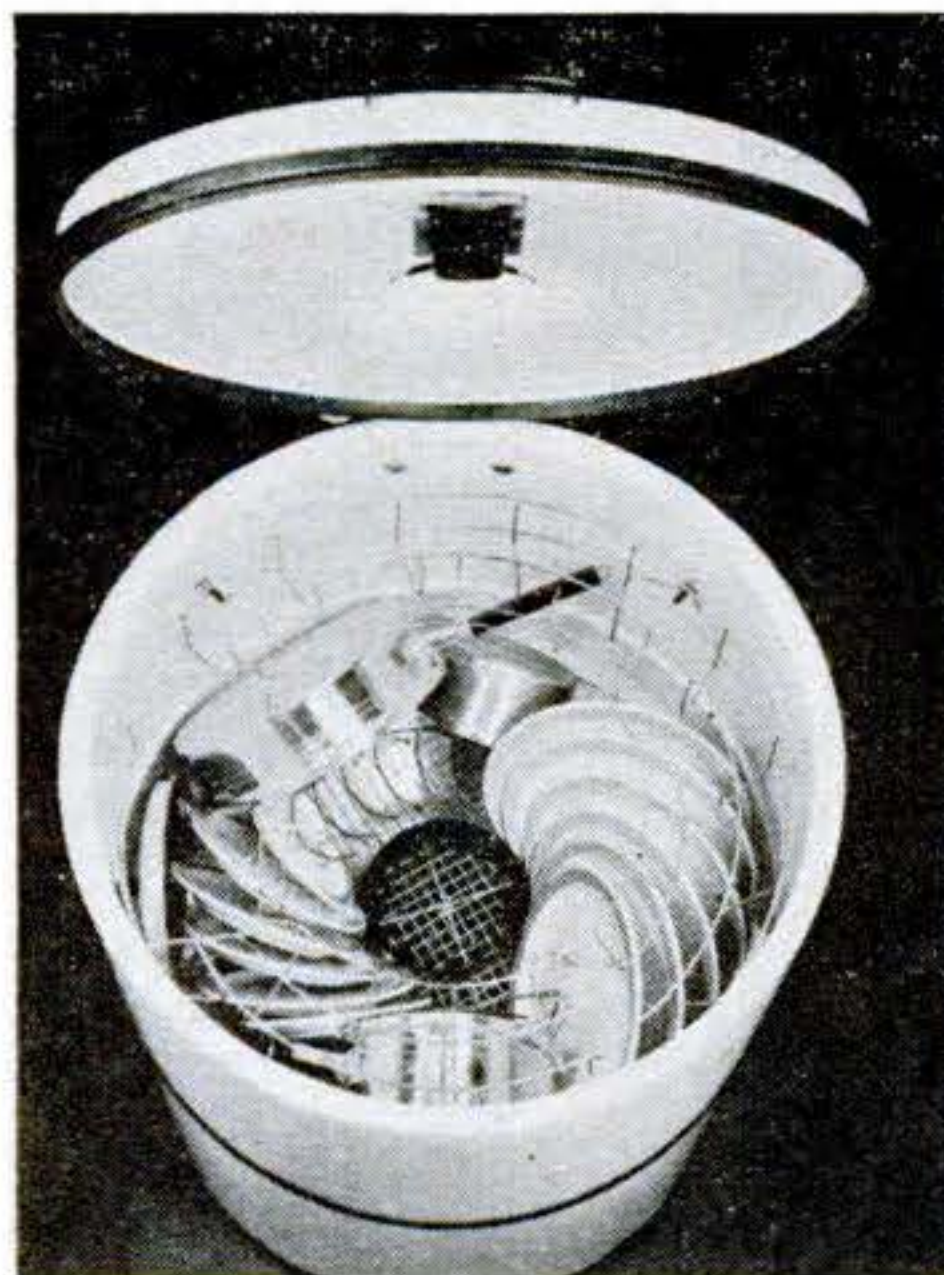

Dishwasher Rolls to Sink

A NEW low-cost dishwasher lightens one of the most tedious of household chores. Priced at around \$170, the manually controlled GE portable washes and rinses up to 100 pieces of table and cooking ware at once, but re-

quires no permanent installation. It is simply pushed to the sink, plugged into an electrical outlet, and hooked to the faucet by a special hose. A high-speed impeller sprays hot water and detergent over the dishes. The drain hose discharges right into the sink without any connection.

Digging Oil out of the Wilderness



This open-pit mine yields oil—but a new kind of plant is needed to separate oil from sand.

ONE of the world's greatest treasure chests was discovered long ago in Canada, but never opened. It is a bed of sand full of oil. Power shovels can scoop it up, but gas pressure does not force this oil into wells—and getting it out of the sand has been prohibitively expensive.

Last summer the Research Council of the Province of Alberta began to extract oil from this rich black sand in a pilot plant at Bitumount, where these pictures were taken. In this new plant, the sand is mixed with hot water and agitated so that the oil rises and can be skimmed off. The sand sinks and is pushed out at the bottom of the separation tank by a screw conveyor.

Dr. Karl A. Clark, of the University of Alberta, believes that this is likely to prove to be the simplest and cheapest of the various methods that engineers have suggested; but difficult engineering problems may have to be solved to keep such a plant going economically. By operating the Bitumount plant, Alberta authorities expect to determine the cost of further efforts to obtain this oil on the earth's surface.

Scores of billions of barrels of oil are locked in sand beds in the vast, cold, and desolate Athabasca River valley of northern Alberta, Canada, shown in the map below.

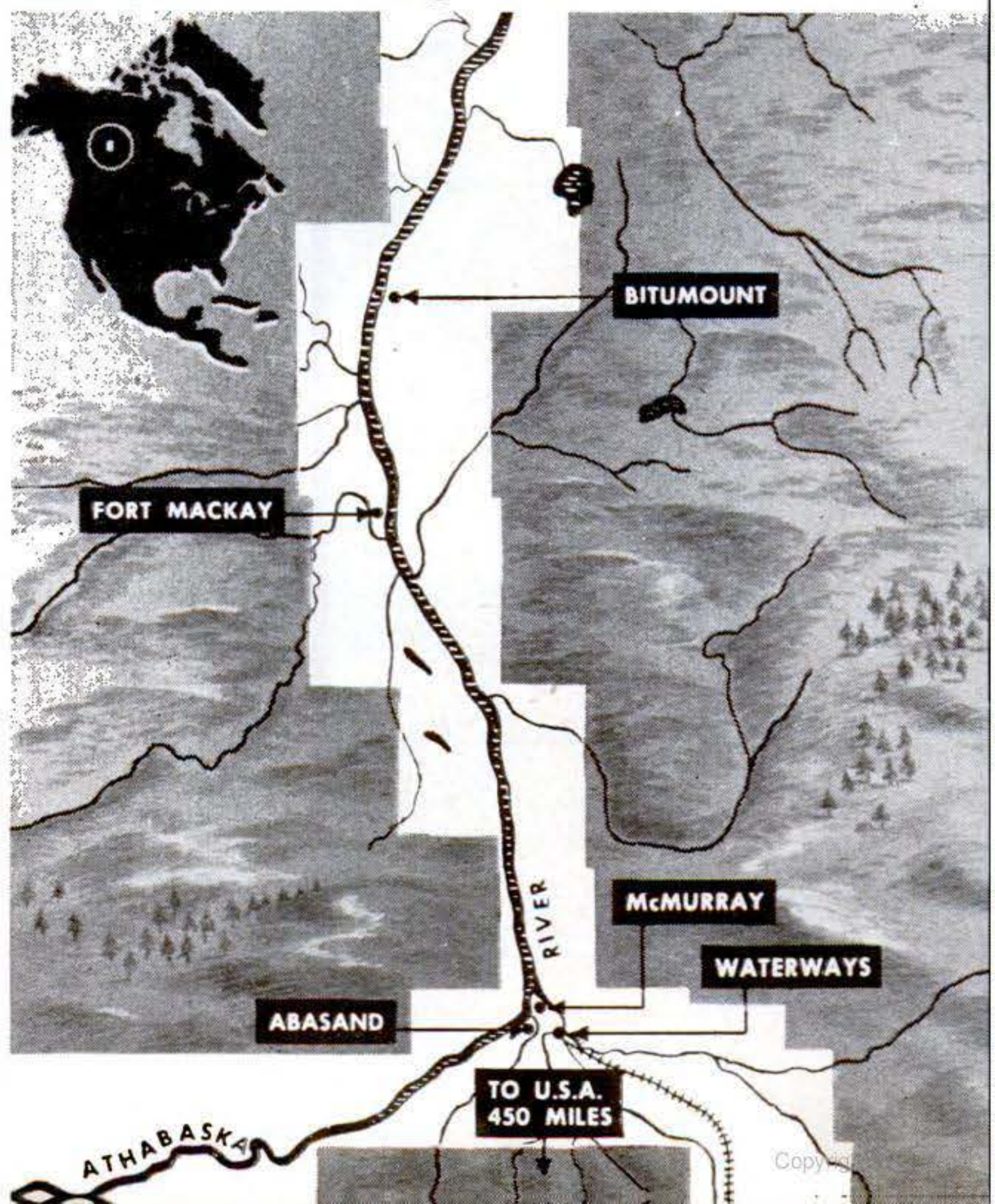

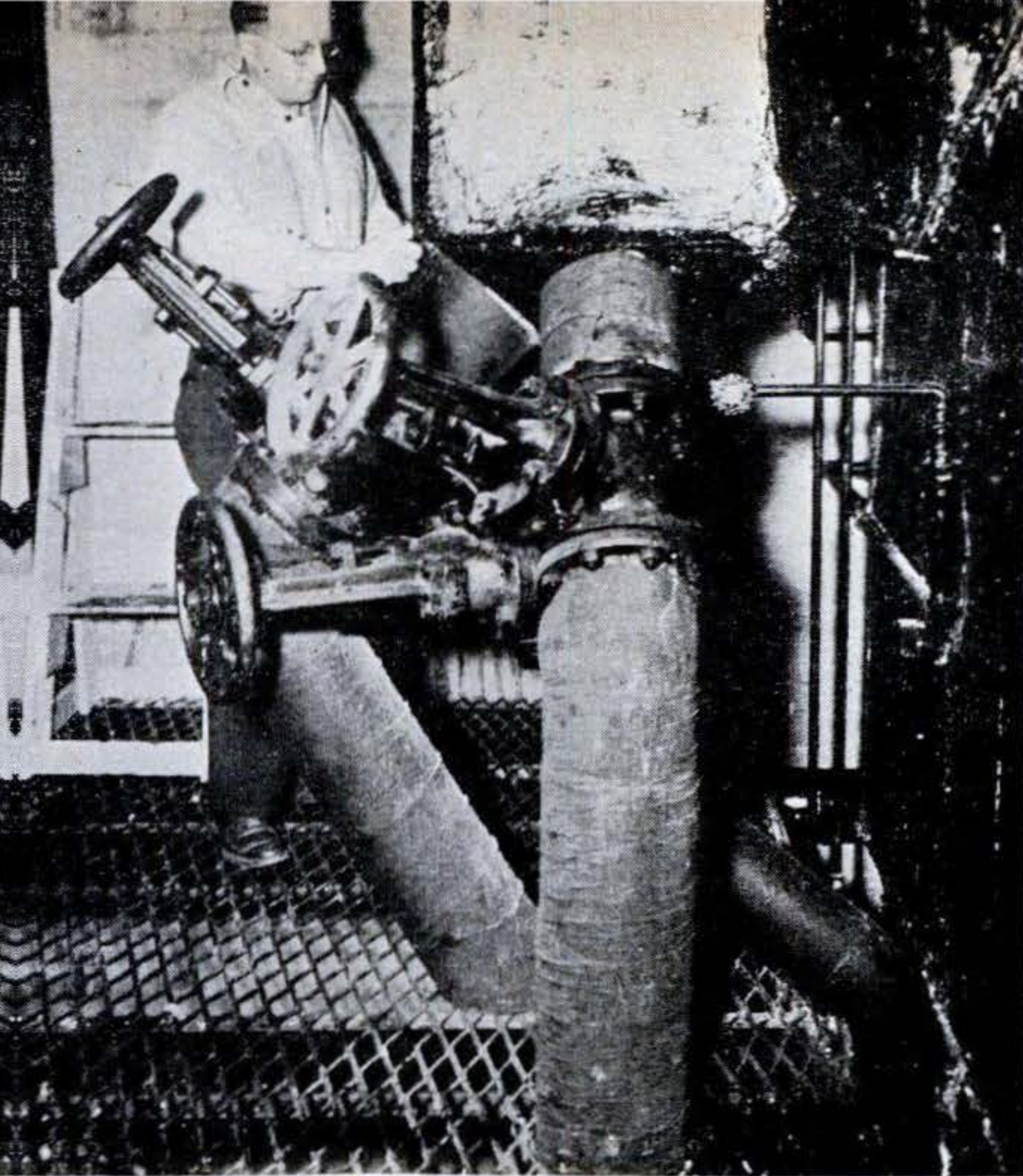

Hot water is used in Alberta government's experiment in extracting oil from sand. The valves shown here control flow. When mixture of water and sand is agitated in a separation cell, sand settles to bottom and air bubbles carry particles of oil to surface.

Experimental plant's capacity is 350 barrels a day—too small to be commercially important but ample for determining costs. Refining unit is shown below. The tower in center is a flash chamber and fractionator for separating crude into various products.

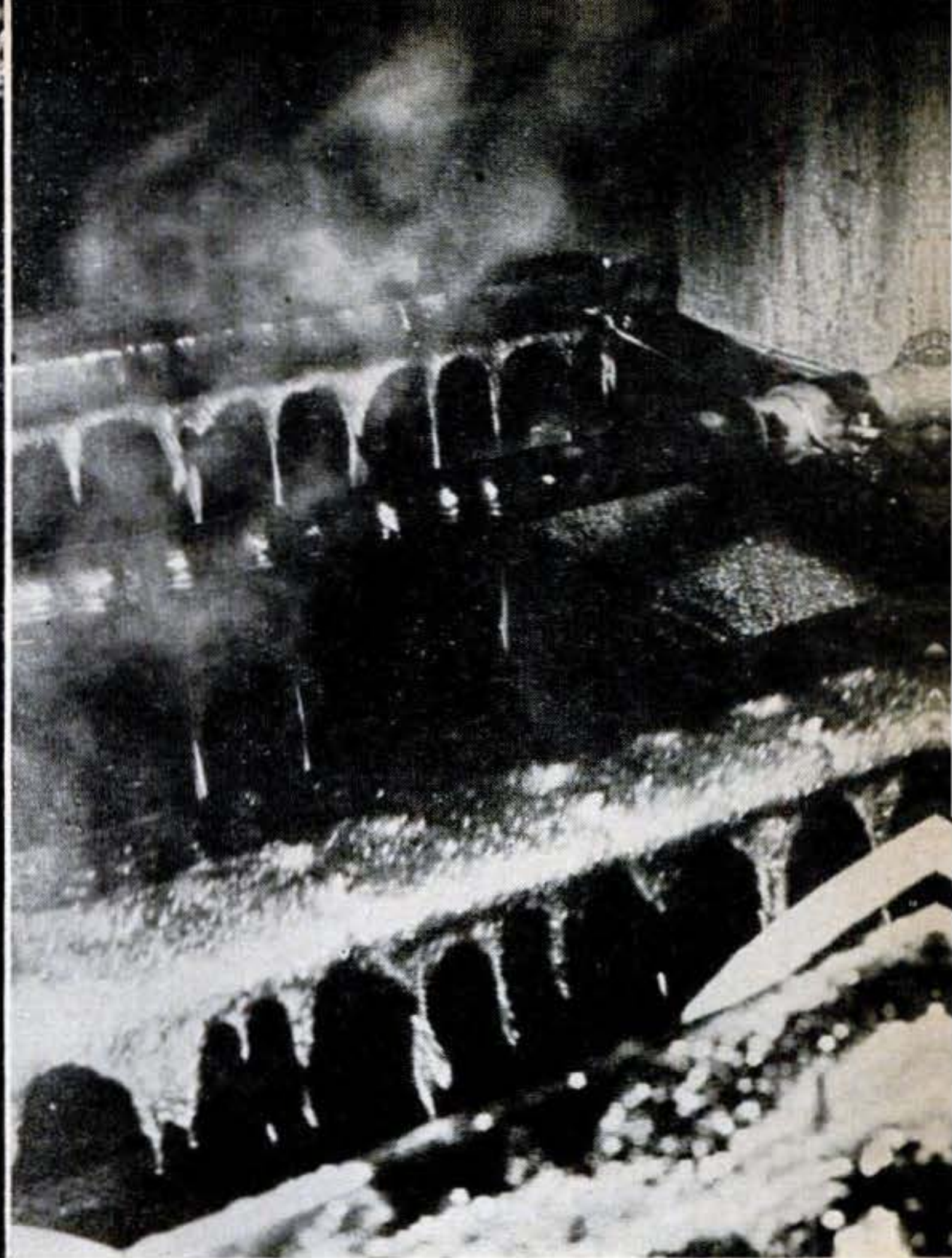

Rotating paddles like this skim the froth that contains oil from surface of hot water, and water is recycled for use again at the rate of 400 gallons per minute. Further treatment of the froth yields crude oil similar to that which comes out of an ordinary well.

Constant laboratory checks are made to determine efficiency of the process. Plant employs from 18 to 60 men, who communicate with civilization by two-way radio. Engineers and scientists of Research Council of Alberta consider the initial findings encouraging.

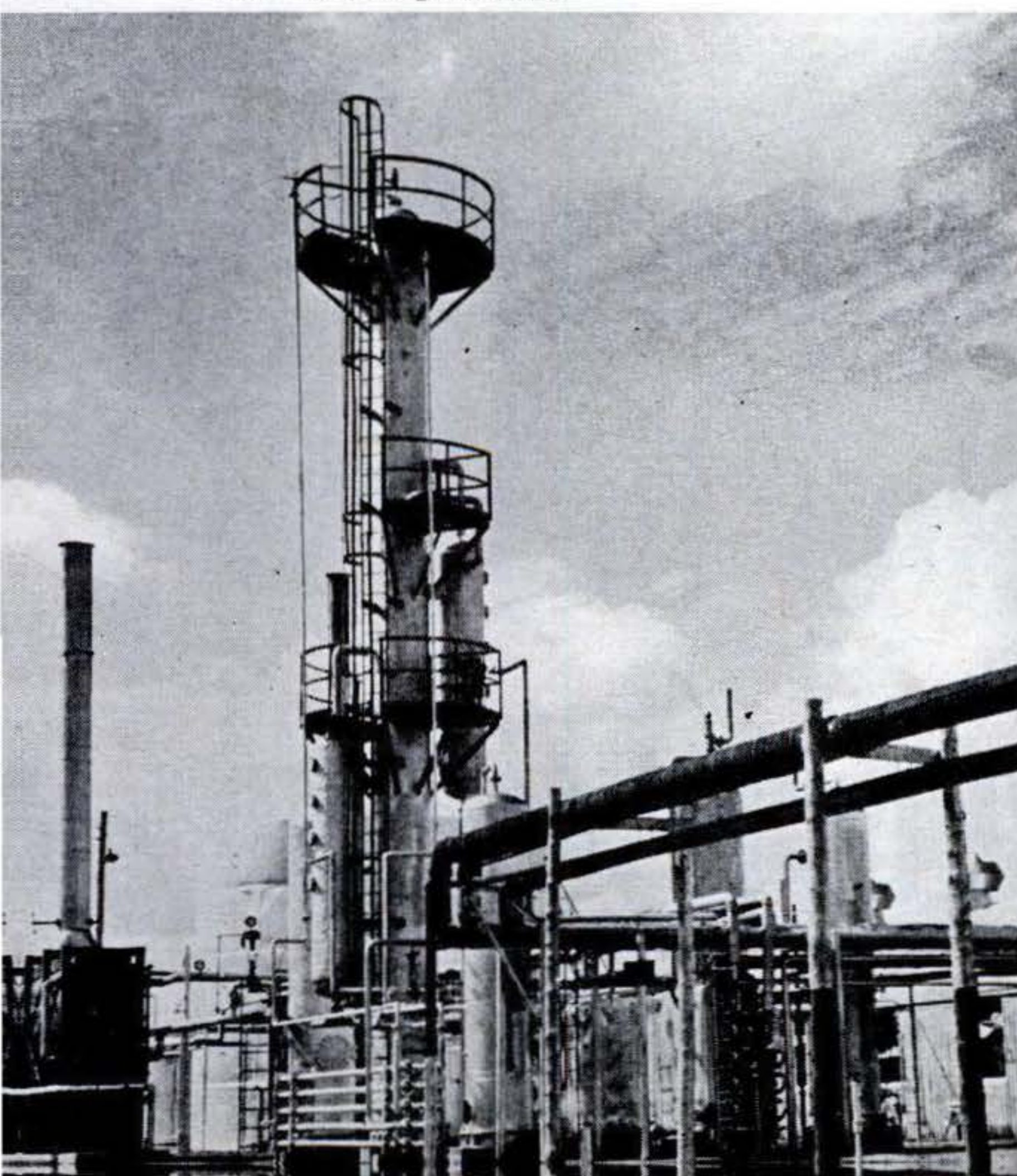

High Vacuum...



Diffusion pumps create the highest vacuum. They use jets of oil vapor to push air molecules from top to bottom of pump and out the valve.



Mechanical pumps have off-center wheel to sweep air from one side of cylinder to other. Sliding vane separates sections.



Steam-jet pumps, producing moderate vacuum in big tanks, work on same principle as diffusion pumps, but use steam instead of oil.

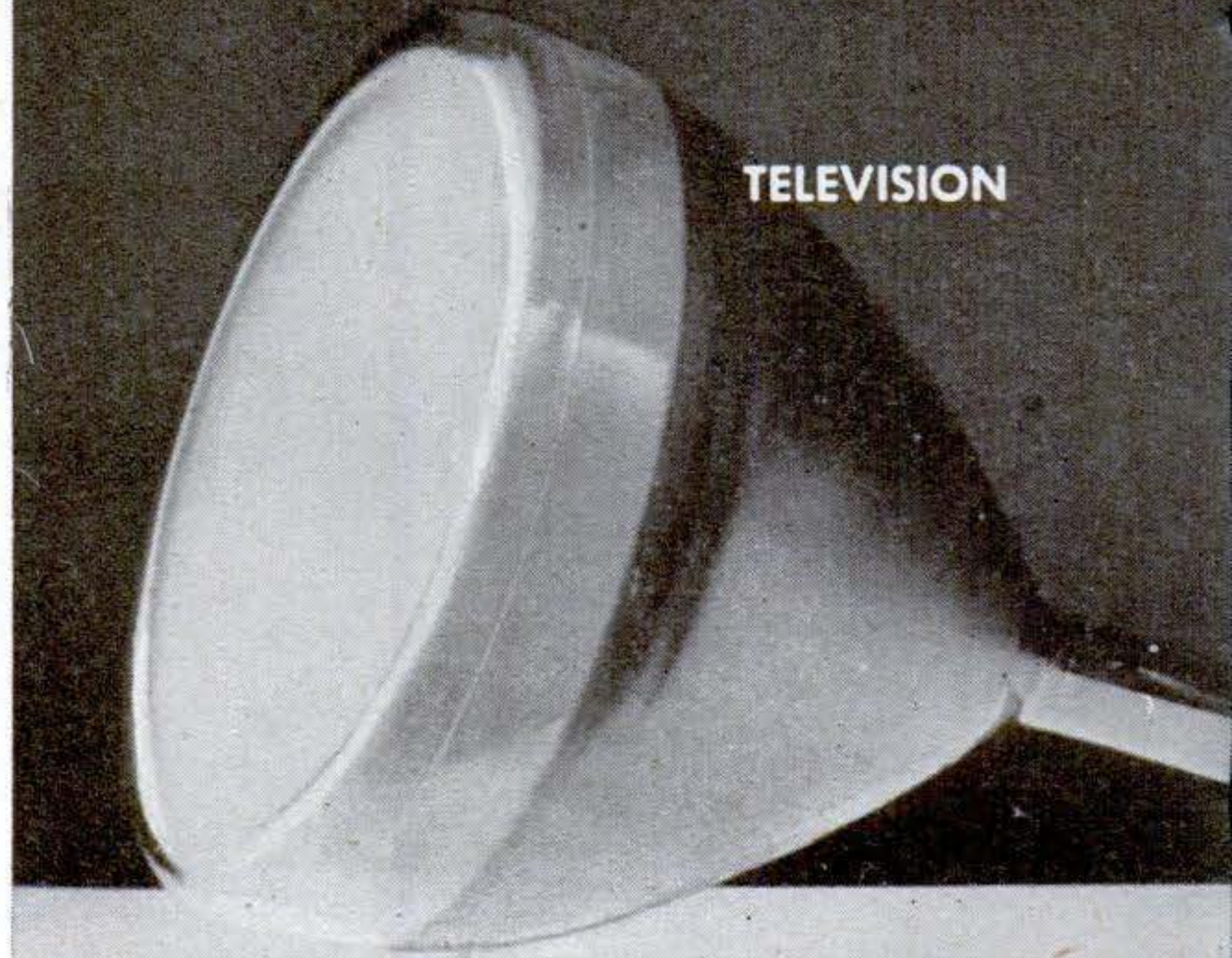
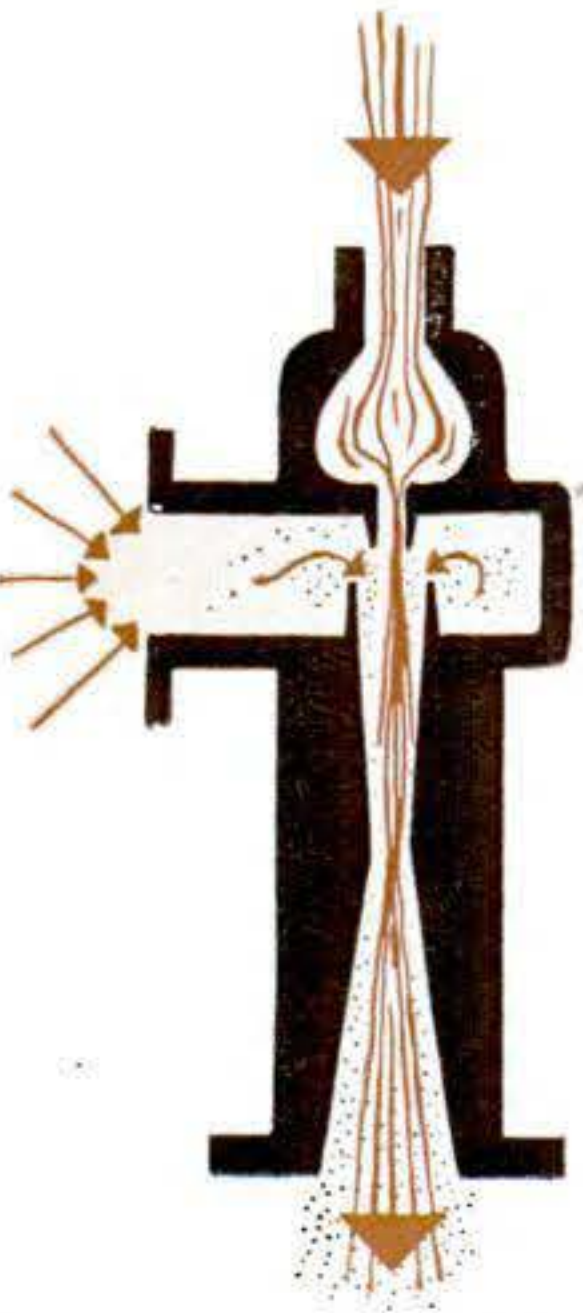

TELEVISION



MEDICINE

Three types of vacuum pumps, shown in drawings at left above, help produce all kinds of new

How to Make A Lot Out of Nothing

...You Use It Every Day

LIGHTING

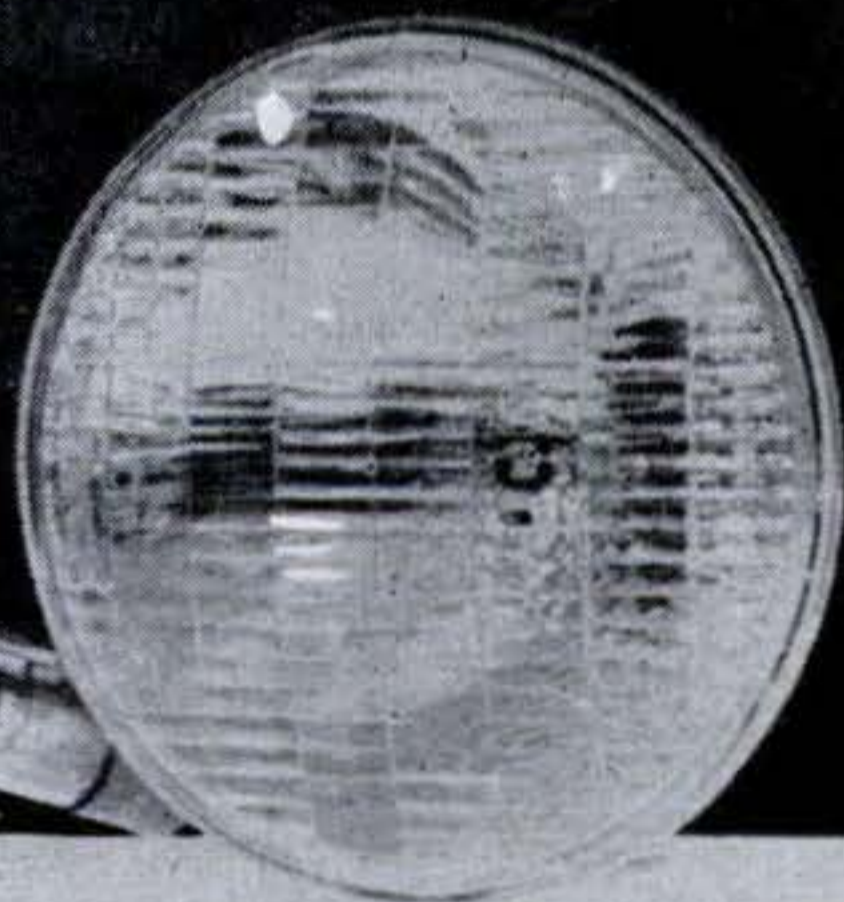

MUSIC



FOOD STORAGE



FOOD PRODUCTS



RADIO



PHOTOGRAPHY



TOYS



DECORATION



and better products—from frozen orange juice and penicillin to TV tubes and auto headlamps.

New uses for high vacuum make empty space one of industry's important raw materials.

By Martin Mann

Drawings by Ray Pioch

YOU'VE got to have air to live. Yet air can be a nuisance, too. Get rid of air—make a vacuum—and you can do a lot of wonderful and very useful things.

In a tank of “nothing” you can make water boil even when it's *cold*. You can dry things that are frozen solid. You can make

electrons and atoms and molecules do your bidding: move from one place to another, taking the straight, short route or twisting around in curves. You can keep gas bubbles out of metal.

All these things are impossible under ordinary air pressure. The 400,000,000,000,000,000,000,000 molecules in every *cubic inch* of air literally get in the way and prevent them. Reduce the air pressure enough—remove enough air molecules—and such accomplishments become possible.

These things are not just tricks—not any more. New and improved vacuum

THREE WAYS VACUUM HELPS YOU

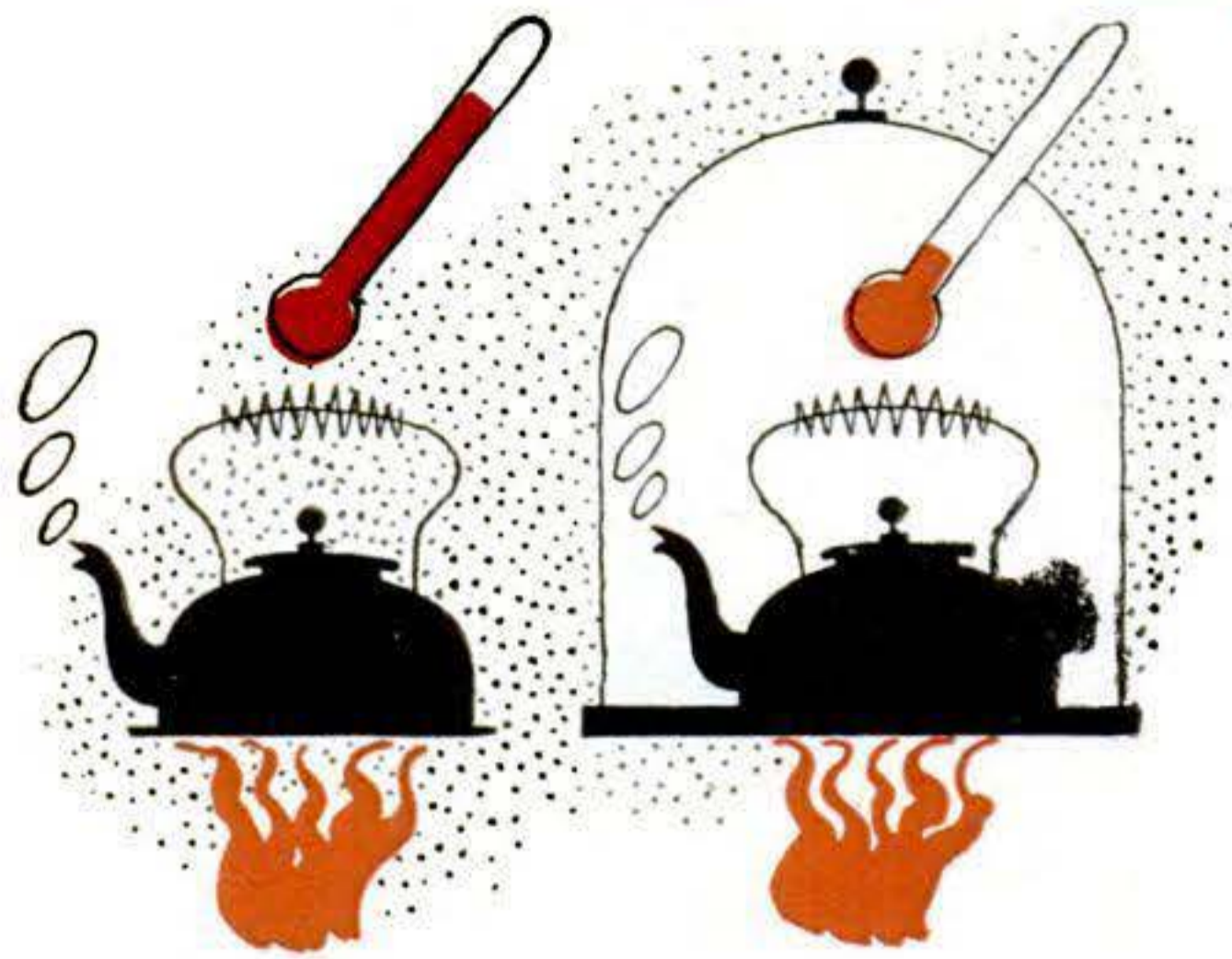

The lower the air pressure, the lower the temperature at which water—or anything else—boils. In fair vacuum, cold water boils.

BOILING THINGS WITHOUT HEAT



“Cold boiling” prevents heat damage in drying orange juice, blood plasma, and coffee, and in distilling some chemicals.

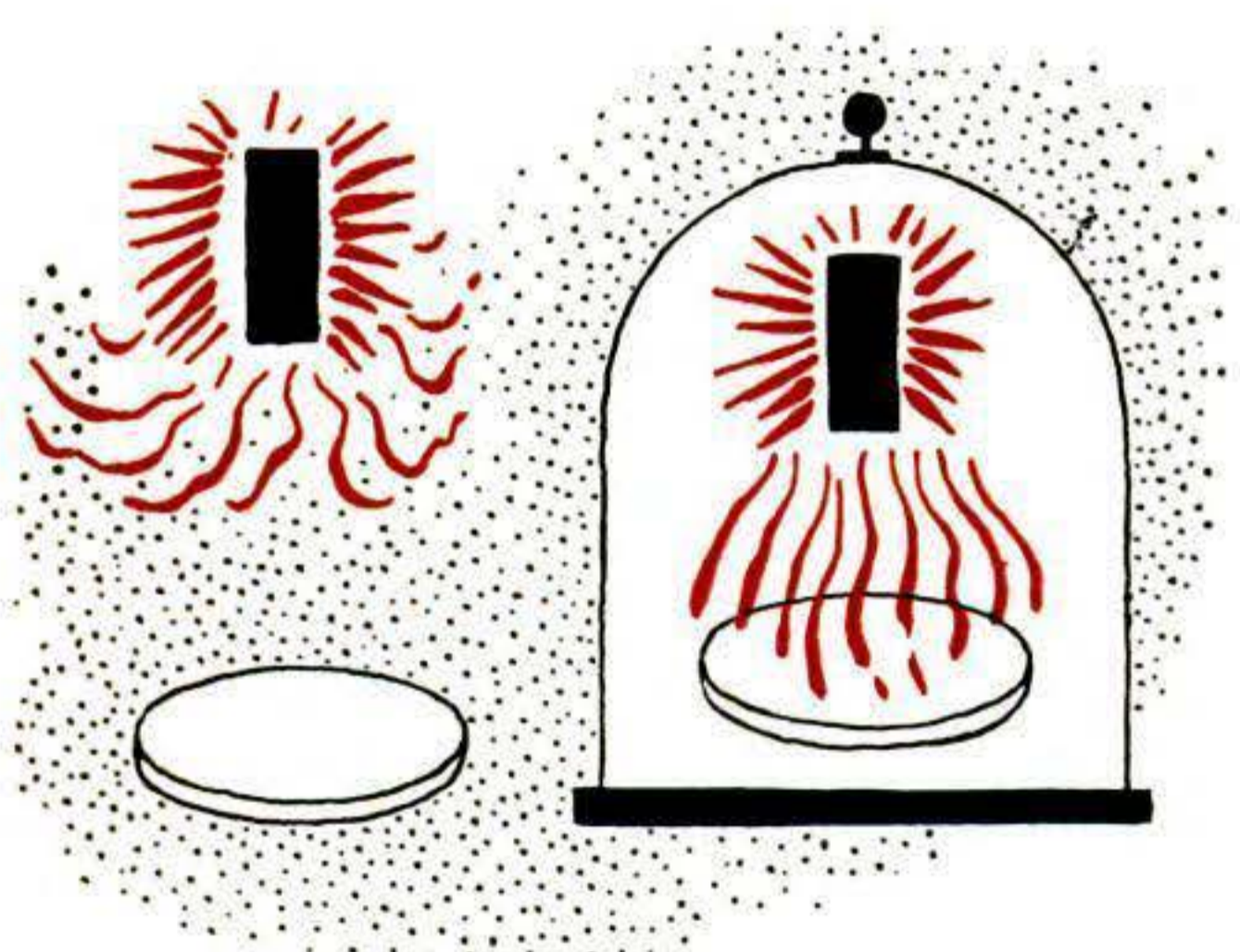

To put thin layer of one material on another, obstructing air molecules must be removed so coating molecules get through.

REMOVING UNWANTED AIR MOLECULES

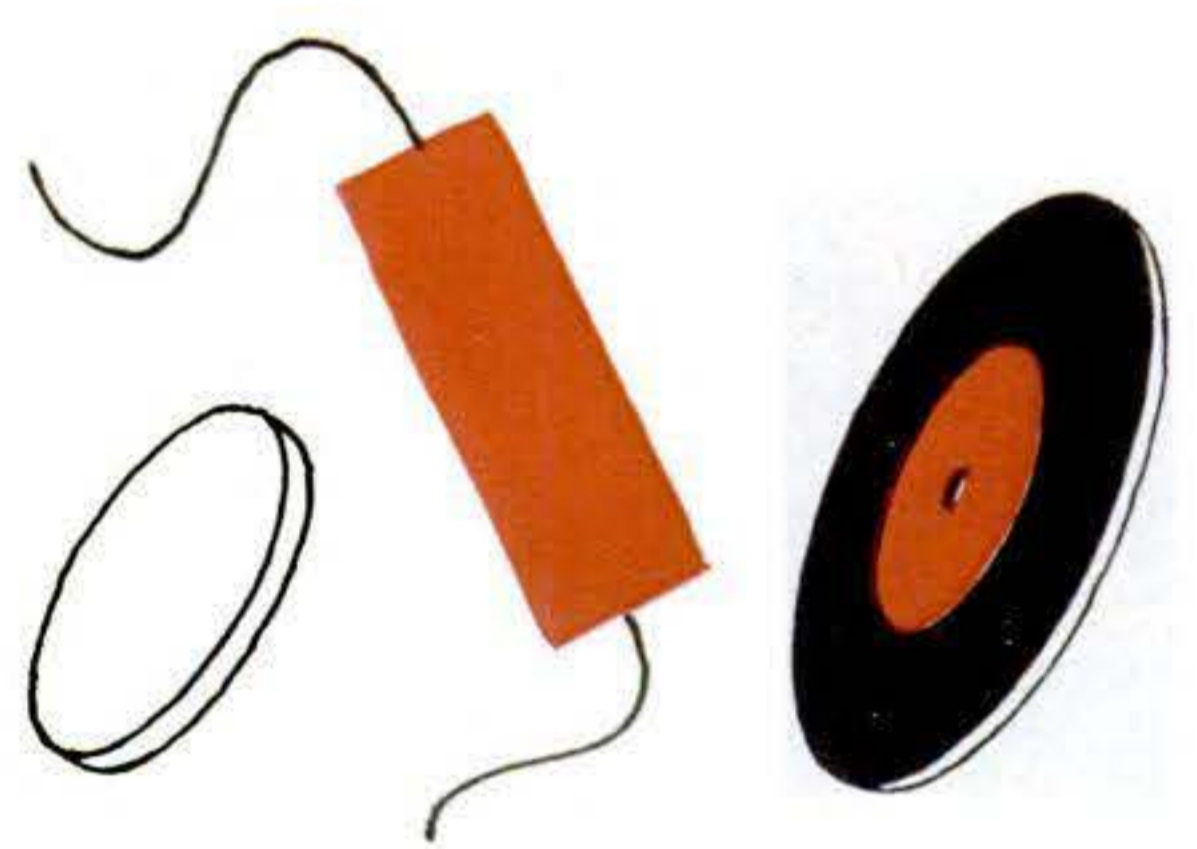

These thin, smooth coatings serve many different purposes on such varied things as lenses, condensers, record “masters.”

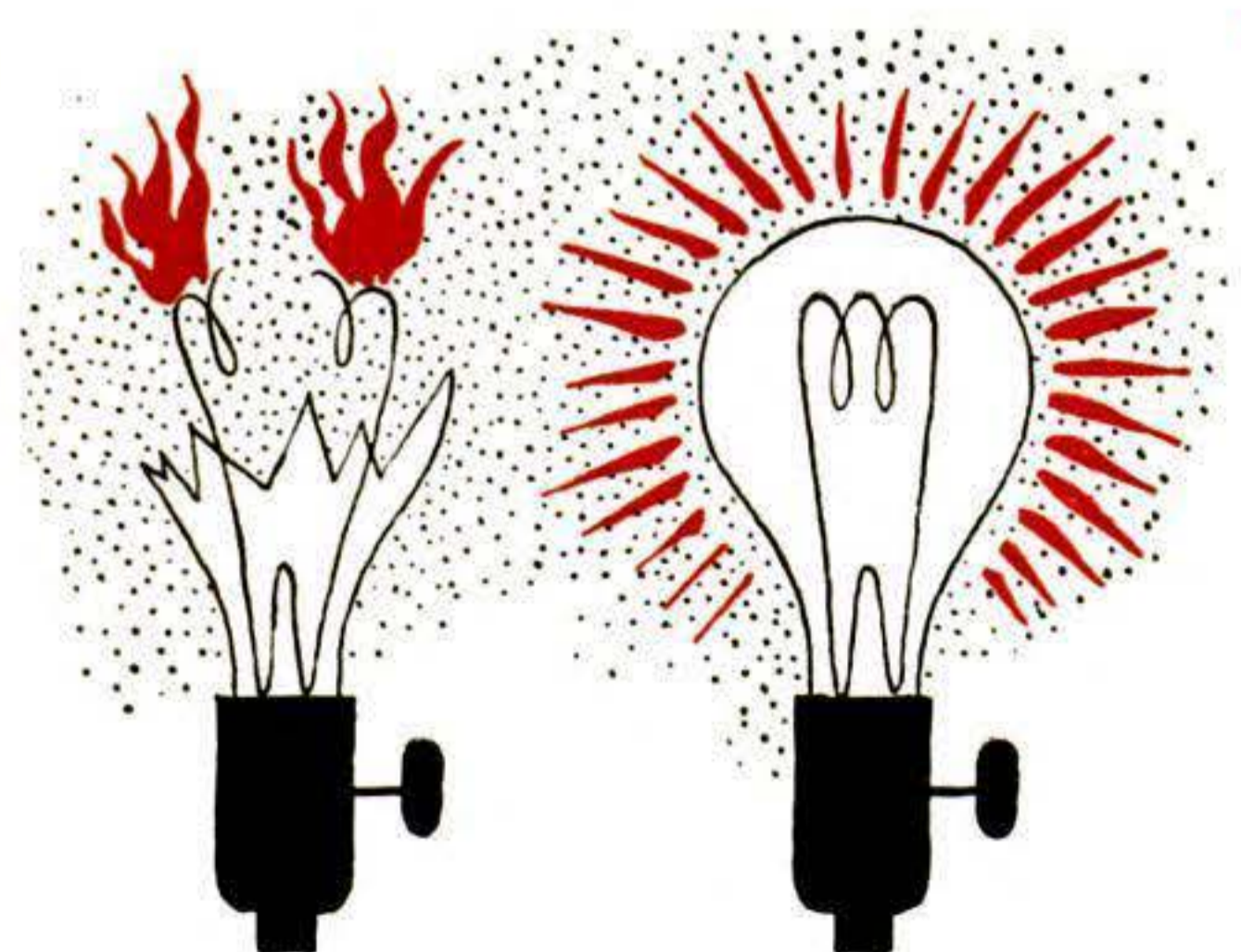

Without vacuum right in the product you buy, some things—like light bulbs—would burn up, or not work at all.

IN A PACKAGE

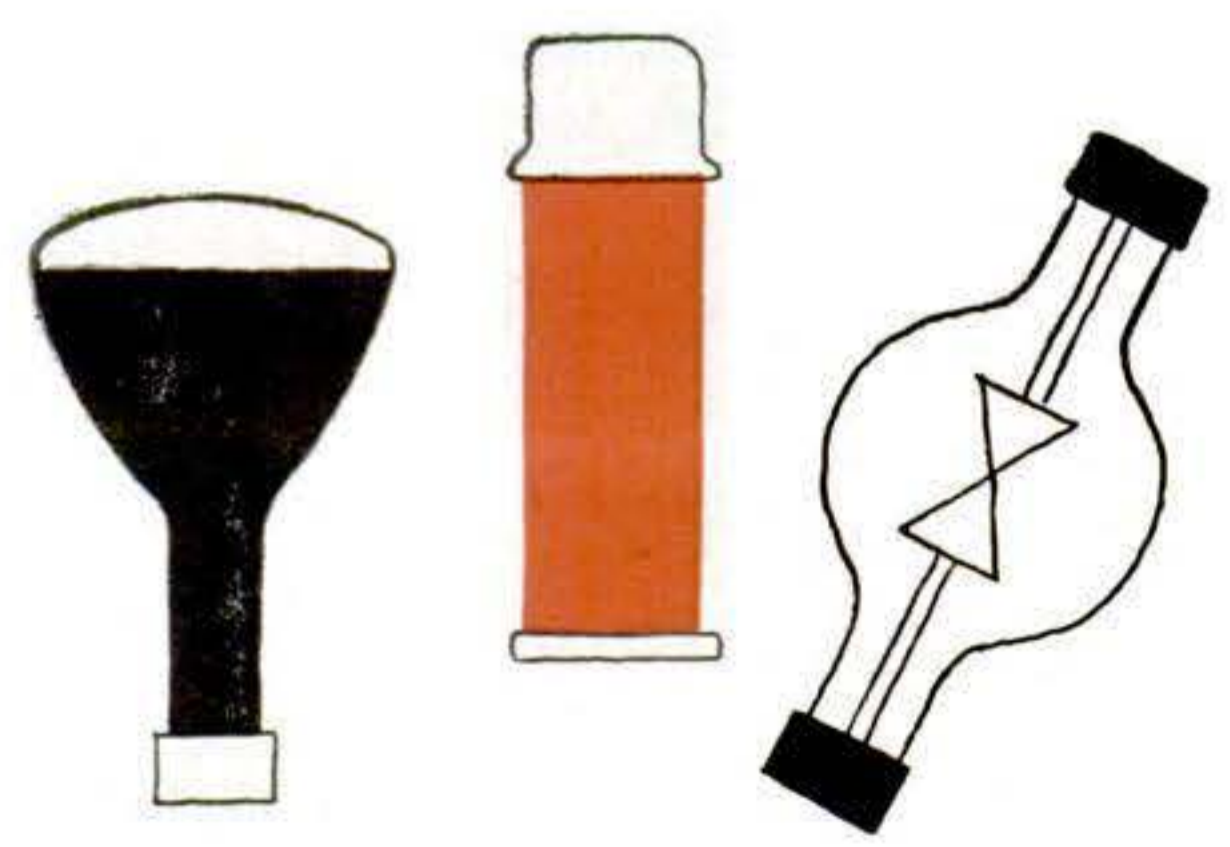

This “packaged vacuum” is put to work in television and radio tubes, food containers, X-ray tubes, and many others.

methods, many developed during the war, have pushed them out of the laboratories and into the factories. The techniques are now used every day to produce dozens of new products everybody is using.

Is your family one of many that make the morning orange juice by diluting a small can of frozen concentrate? One reason it tastes so much like fresh juice is the use of vacuum to make the concentrate. Maybe you have a new camera with a "coated" lens. The coating—which helps get a sharper picture with less light—must be applied in a vacuum. Those shiny, metallic toys you see in the dime store—they're plastic with a thin coating of aluminum, also applied in a vacuum. Or perhaps your doctor has prescribed penicillin, streptomycin, blood plasma, vitamins—they and many other pharmaceuticals can be made only with vacuum.

The new high-vacuum equipment helps make these things in several ways. For many products, it simply lets water boil off at a low temperature. You know that water boils below the ordinary 212°F. temperature when you're on top of a mountain, where atmospheric pressure is lower. If you were on a mountain top 20 miles high, water would boil between 50° and 60°F. The water would boil even though it's actually cold! Orange juice, grapefruit juice, and a

new kind of instant coffee are concentrated just this way. A vacuum equivalent to a 20-mile altitude—about 1/50 of sea-level air pressure—is created in the evaporating tanks, so that the water will boil away at low temperatures. This "cold boiling" is what protects the taste; heating fruit juices and coffee affects their flavor. The same technique is used on blood plasma and germ killers, which heat would completely ruin. In many cases they are dried while actually frozen—the ice changes directly into water vapor without becoming a liquid (this is called *sublimation*). Cold boiling also purifies vitamins and other hard-to-get chemicals. But here the process is distillation without heat—the chemical itself boils, not water.

For some of the other vacuum-made products, the idea is to get rid of air molecules that interfere with other kinds of molecules. A great many "coated" items—lenses, automobile insignia and horn buttons, Sealed-Beam® headlamps, interference color filters, mirrors for astronomical telescopes and projection television sets, electrical condensers, toys, decorative cellophane, phonograph-record "masters"—owe their existence to this technique.

Here, the objects to be coated are simply placed in a vacuum tank, and the ma- ➤

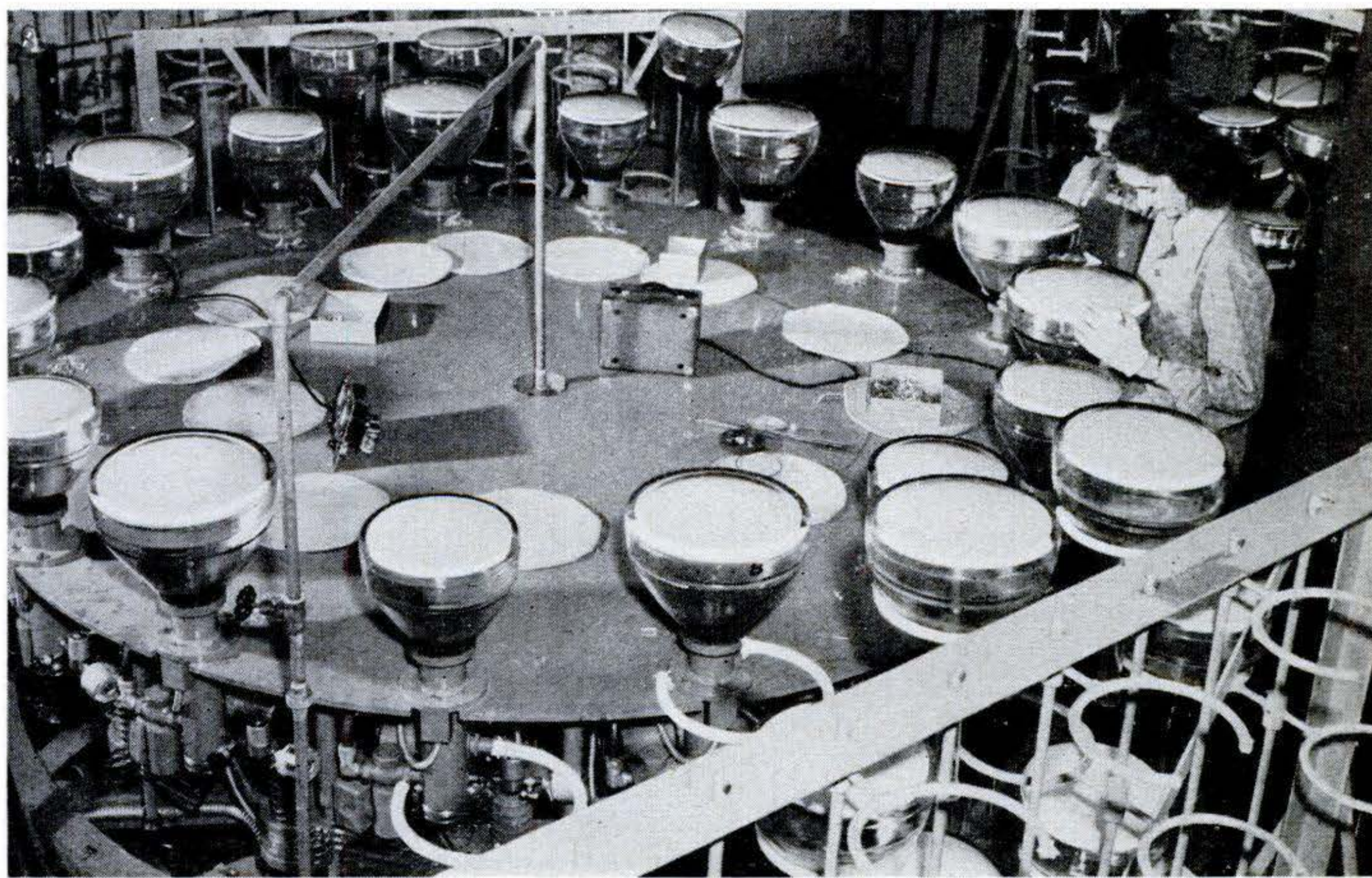

TV tubes need vacuum for several things. At GE, air is pumped out for coating inside with

aluminum (above), then readmitted while working parts are put in, and finally pumped out again.

material that makes up the coating is put in the center of the tank and heated until it vaporizes. The vapor solidifies again when it hits the parts being coated, since they are cold. With no air molecules to get in the way, the molecules of coating material can travel long distances and make a thin, smooth, very even coating. To provide all-around coatings—for three-dimensional items like toys—the pieces are mounted on long racks and rotated by a motor inside the vacuum chamber. This metallizing process requires a fairly high vacuum, about a millionth of sea-level pressure. Once a delicate, expensive laboratory procedure, it has now become so routine that toys are coated for less than a penny apiece.

High vacuum also helps in metallurgy, providing new methods of refining and treating some metals. Lithium, magnesium, and titanium, for instance, react with oxygen when heated to the temperature that will separate them from their ores. But refine them in a vacuum furnace, and there's no oxygen to cause trouble. Thanks to this vacuum technique, titanium—light, noncorroding, and very strong—promises to become an increasingly important metal for all kinds of uses (see PS, Dec. '48, p. 105).

Vacuum Casting Arrives from Germany

Vacuum casting is only now being introduced in the U. S., although a German firm, Heraeus Vacuumschmelze, specialized in this work for many years. When molten metal is poured into a mold, tiny bubbles of gas become trapped in the metal, weakening the product. Cast in a vacuum, however, no bubbles can form and a "sounder" casting results. Vacuum-casting furnaces often involve tricky design—you have to be able to pour the metal into the mold without disturbing the vacuum. One way to do this is to hang the mold on an axle so that it stays level while the whole vacuum-chamber furnace tilts, pouring the metal.

In many things, vacuum is not just involved in the manufacturing process but is a part of the final product. Electric light bulbs work only if the air has been removed from the bulb. Radio, television, and X-ray tubes depend on streams of electrons that would be stopped by air molecules. The atom smashers, like cyclotrons and betatrons, all require vacuum to work. And when you buy a Thermos® bottle, you pay mainly for "nothing"—the vacuum that does such a good job of heat insulation.

The atom-bomb project, perhaps the biggest research job of all time, depended greatly on vacuum. One device for separating uranium 235, which splits, from uranium 238, which doesn't, is a mass spectrometer. It sends mixed uranium atoms into a vacuum tank. A magnet makes the atoms curve as they travel. The lighter U-235 atoms curve more than the heavier U-238 ones, so they go into different collecting bins. The gigantic "Y-12" plant at Oak Ridge refines U-235 this way. It requires vacuum tanks each the size of a room and the biggest high-vacuum pumps ever made. Largely as a result of experience gained on this job, many of the new peacetime uses of vacuum became possible.

It's easy to make a low vacuum. People do it every day with a vacuum coffee pot.

But producing the high vacuum needed for the new things like orange juice and lens coatings—from a fiftieth to a billionth of atmospheric pressure—takes a lot of fancy engineering.

The pump that creates the highest of high vacuums is called a diffusion pump. Basically, it is nothing but a pot of boiling organic oil. (Sometimes mercury is used instead.) The oil vapor shoots out of jets, knocking air molecules away from the vacuum end of the pump. This "sweeping"

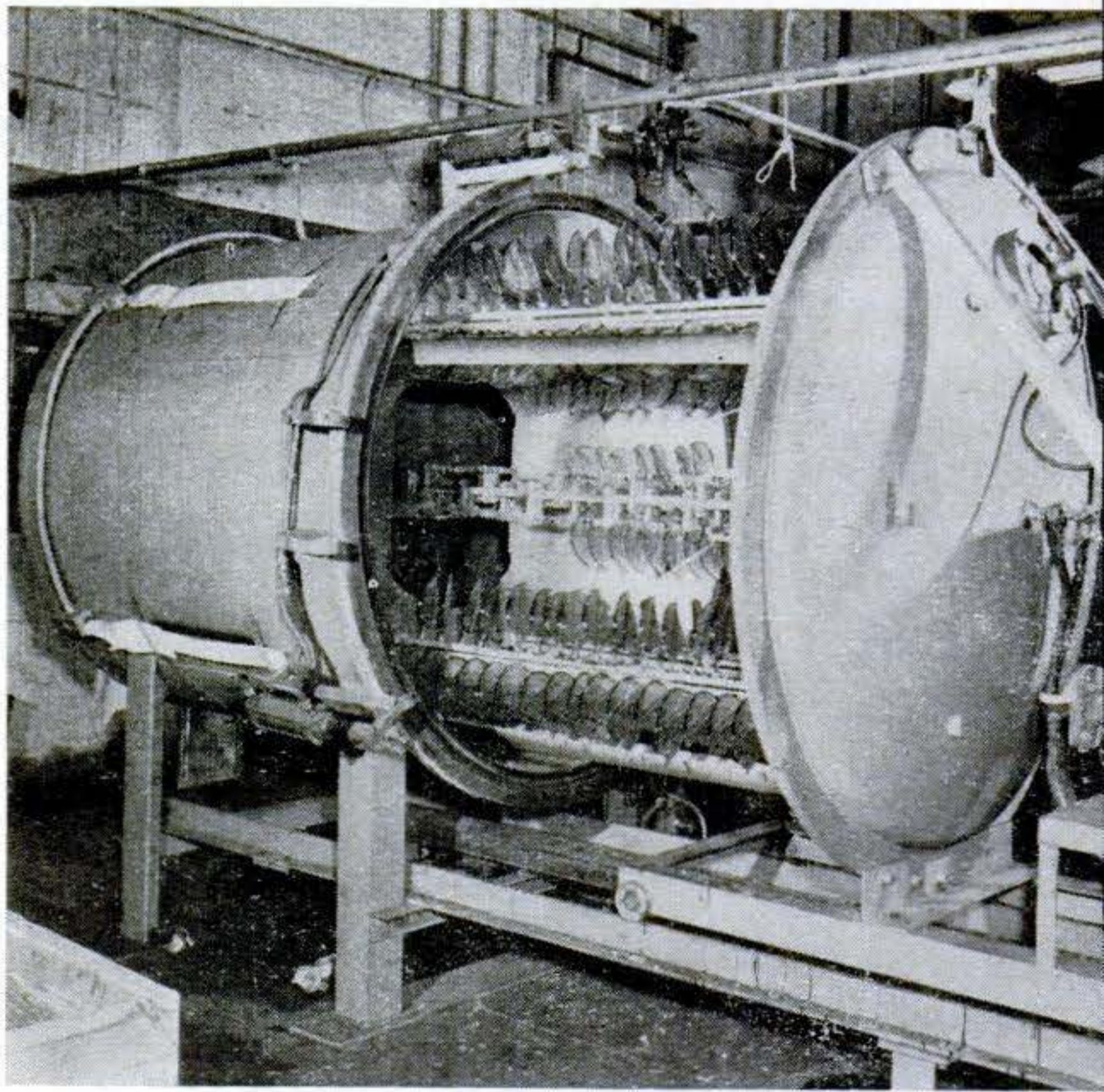

Large vacuum tank originally designed for coating lenses now gives beautiful metallic surface to plastic parts for toys, candy dishes, and other dime-store items. Racks spin inside tank.

action can reduce air pressure to almost 1/100,000,000,000 of its sea-level value.

Mechanical pumps can lower pressure to about 1/100,000 of that at sea-level. A typical model consists of a wheel mounted off center inside a cylinder so that its edge always touches the cylinder wall, sweeping the air out. A sliding vane, one end resting on the wheel, separates the suction and discharge sections.

For pumping out large tanks to only a moderate vacuum, steam jets are used. Able to reach about 1/10,000 of sea-level pressure, they work something like diffusion pumps, but use steam instead of oil vapor to sweep out the air molecules.

Although similar pumps have been available for years, it wasn't until simple ways to create good vacuums in large tanks were found that the present flood of vacuum-made products became possible.

You'd expect a large space to be harder to pump out than a small one. And it is, though not entirely for reasons you'd think. There's more air to handle, of course, but the container itself causes trouble.

There's a lot of gas mixed right in with most materials—metals especially. Days of pumping may be needed before all this gas bubbles through the surface and out. For this same reason, many ordinary greases

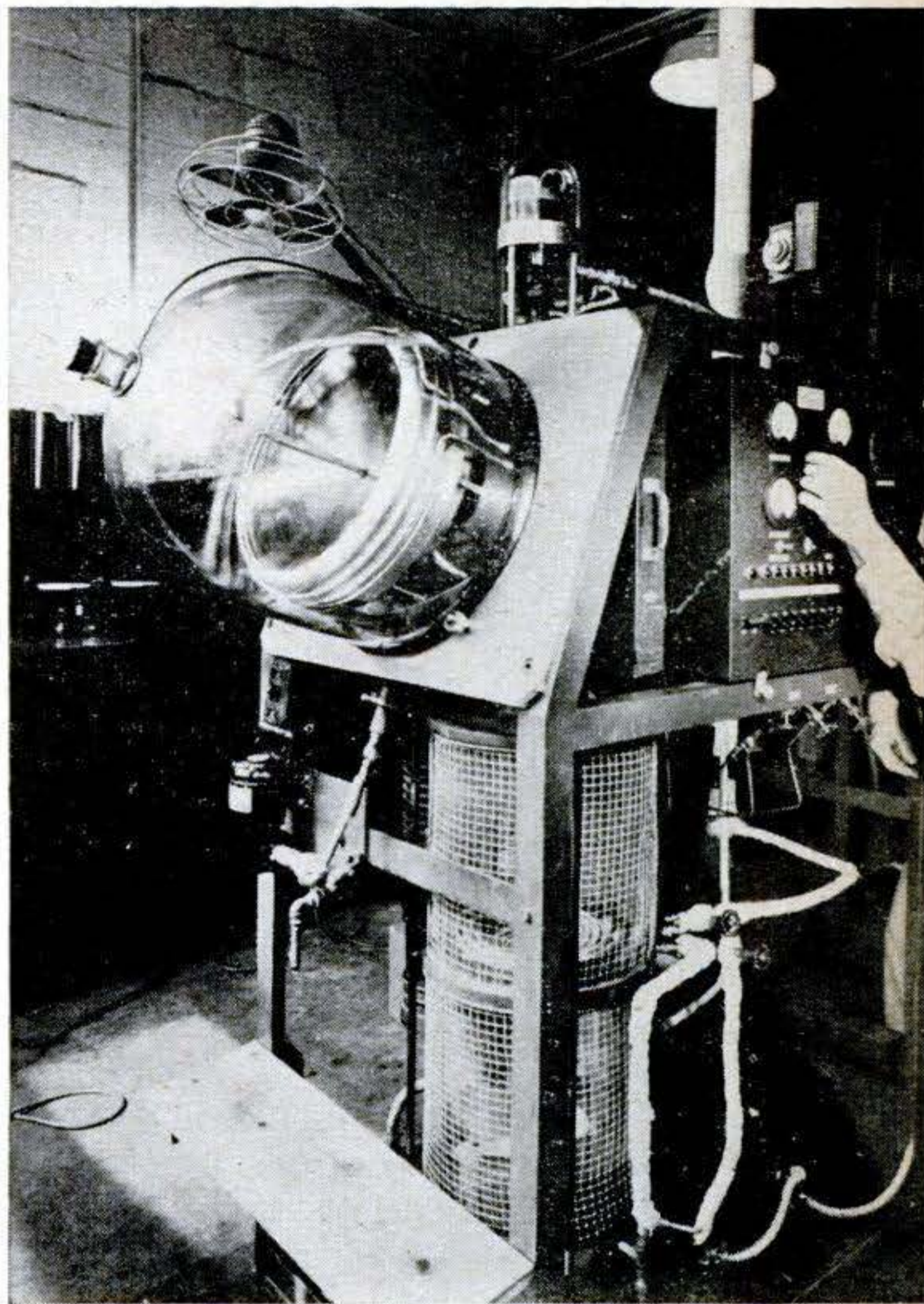

Coating lenses was one of first uses of high vacuum. Photo above shows Kodak technician applying thin layer of magnesium fluoride that increases light transmission of optical parts.

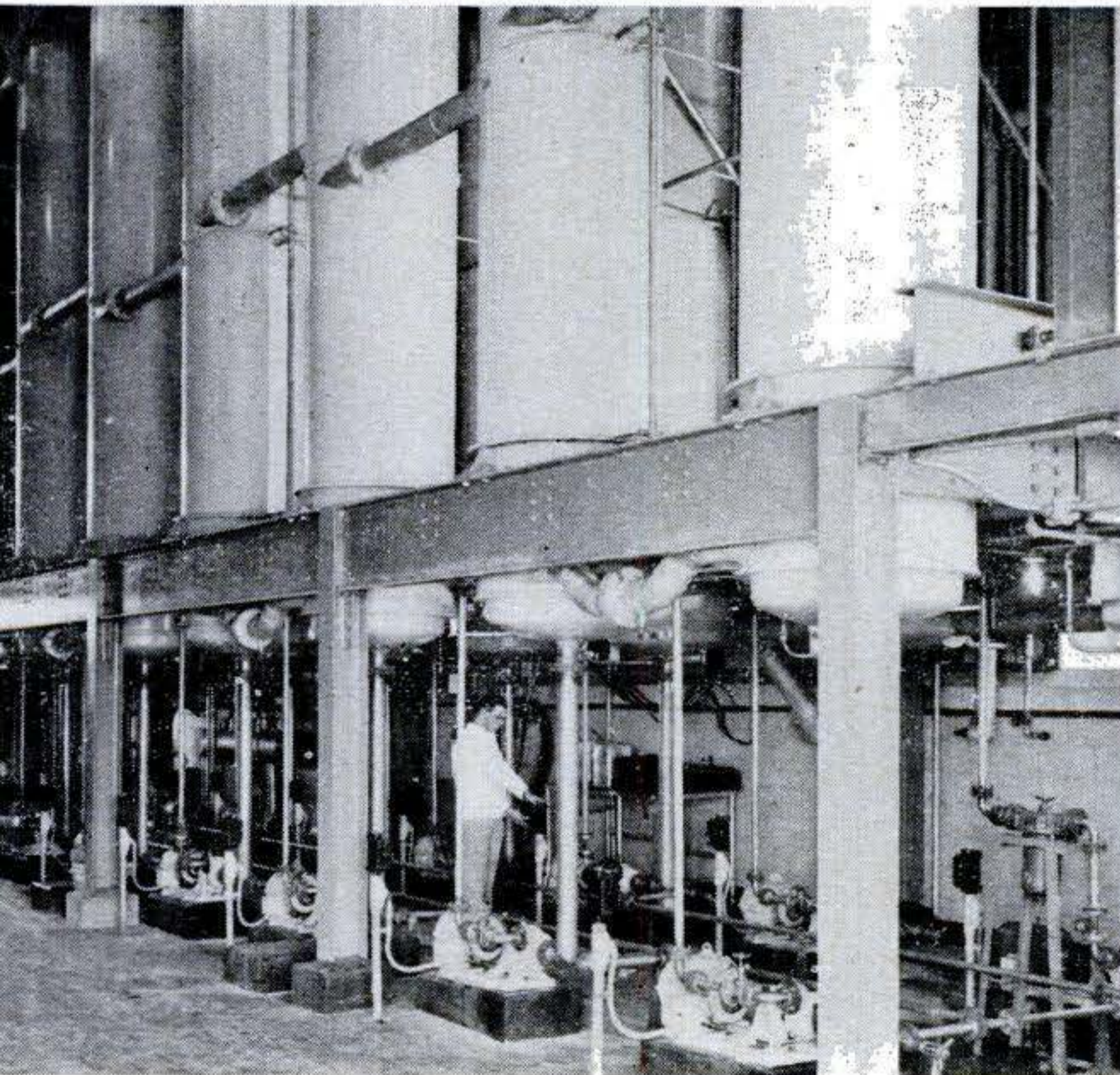

One of most spectacular vacuum-made products is frozen fruit juice. Fresh taste results because water is evaporated at low temperature in vacuum. Picture shows Minute Maid® plant.

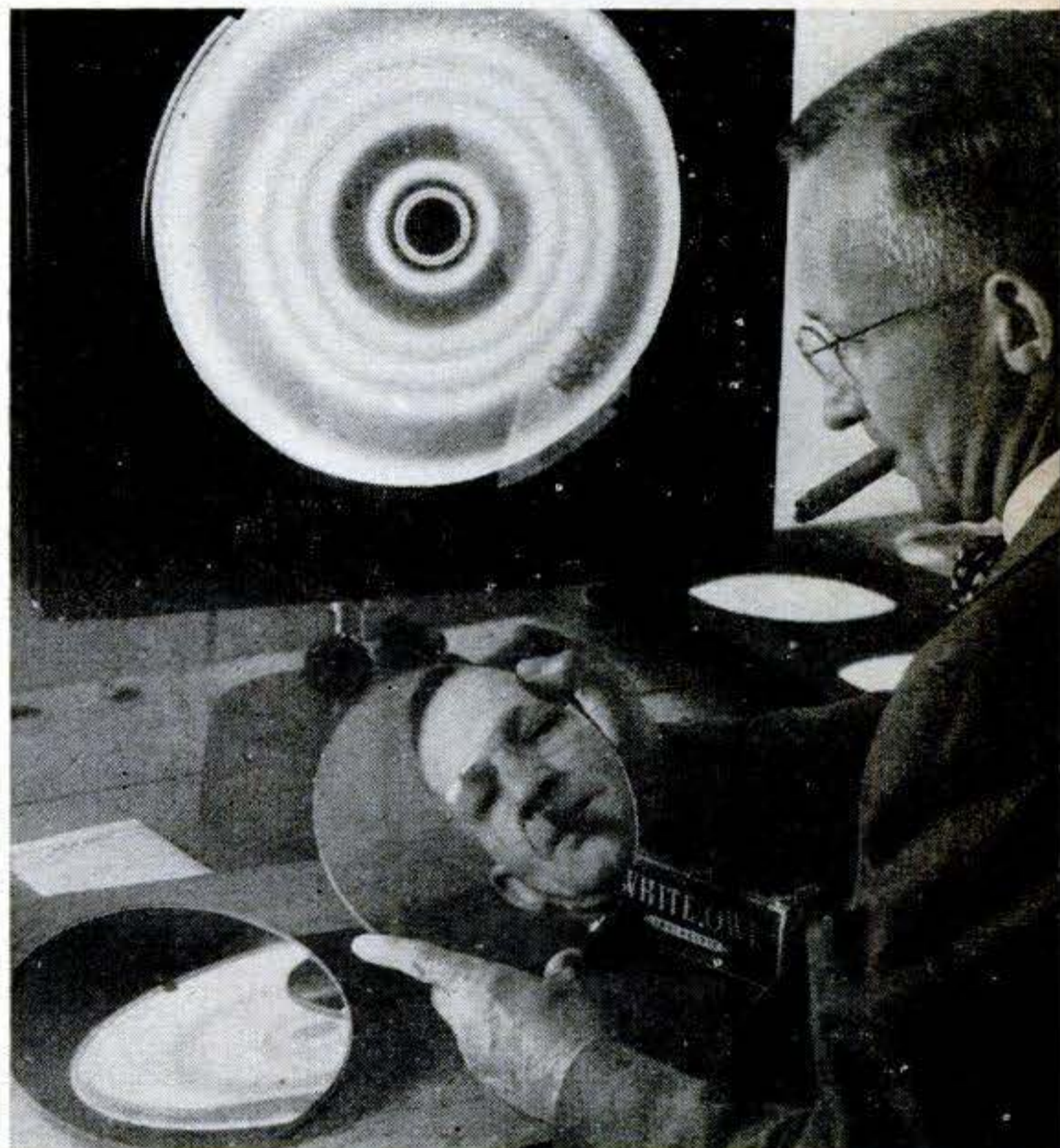

"Mirrors" held by Bausch & Lomb expert really transmit light, as one at upper left proves. They are "interference" color filters—glass vacuum-coated with silver and magnesium fluoride.

and gasket materials can't be used at all: they would never "outgas"—completely give up all of their gas molecules.

Leaks become more important, too. Even a small one can ruin the vacuum. And you can't use soapy water to find them the way you can in checking a leaky tire tube. Instead a mass spectrometer—a smaller edition of the Y-12 units that separated uranium for the atom-bomb project—is hooked up to the vacuum system. Then a jet of helium is sprayed along the vacuum pipes. When the helium hits a leak, the mass spectrometer indicates almost immediately that some helium has entered the system.

These and many other problems of evacuating big tanks were licked during the war, when tremendous quantities of coated optical parts, germ killers, blood plasma, and atomic explosives were needed. After the war, the companies specializing in vacuum equipment—National Research Corp., Distillation Products, Inc., and F. J. Stokes Machine Co.—quickly found peacetime uses for their know-how. Equipment designed to coat lenses, for example, now puts the shiny surface on toys and cellophane.

Disks Mark Traffic Lanes

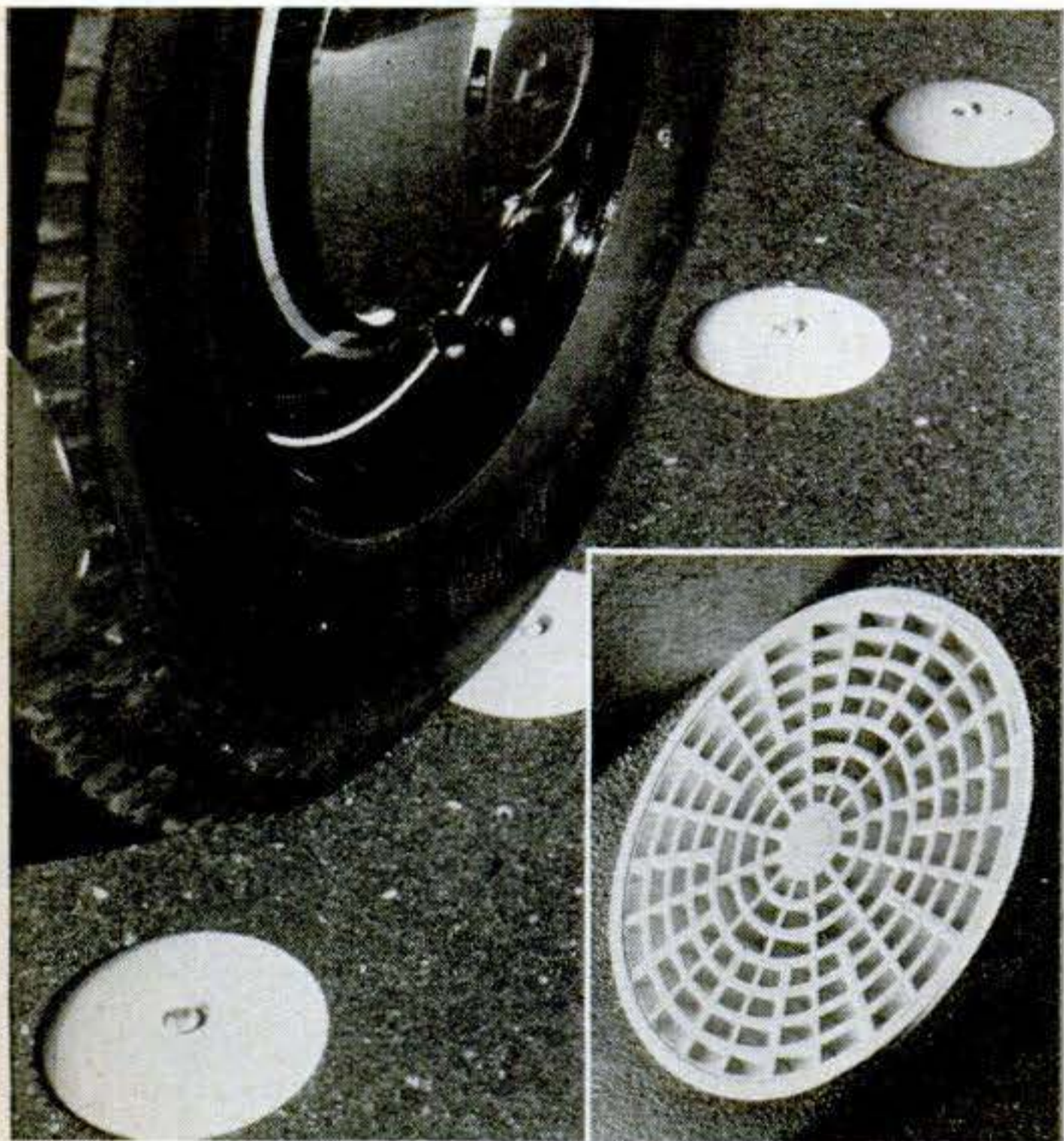

MORE durable and easier to apply than paint to asphalt or concrete, a new traffic-lane marker made of Tenite® plastic has been developed by the Traffic Safety Supply Co., of Portland, Ore. The disks, 4½ inches in diameter, have a convex top and a flat bottom with waffle-type ribbing (inset) for strength. Colors are white and yellow.

This is only the beginning, the vacuum experts say. An instant coffee concentrated the same way as orange juice (but dried to a powder instead of frozen) is already on sale in a few stores. The makers claim it tastes almost exactly the same as fresh coffee. Milk—which is 87 percent water—is another food the researchers are trying to concentrate in this way.

And the drugstore shelves may soon hold a host of new products that owe their existence to high vacuum—vitamin complexes, vaccines, hormones, and a combination of amino-acid chemicals that might be used instead of blood plasma.

Another process is vacuum impregnation, which forces fillers into the pores of materials under vacuum. Already used to eliminate porosity in metal castings, it is being tested for dyeing new synthetic fabrics that don't dye well by ordinary methods and for impregnating leather to resist scuffing.

And still other new things are on the way. More and more industries are discovering what the laboratory people knew years ago—you can really make a lot out of "nothing." END

Making World's Biggest Hose



COPPERIZED ⅝-in. steel wire for reinforcement is shown being wrapped around a 20-foot length of hose weighing more than four tons. Made of 15 plies of rubberized fabric, the hose is 38 inches in diameter. The granddaddy sand-suction and discharge hose, made by the Goodyear Tire and Rubber Co., will be used on Mississippi dredges.

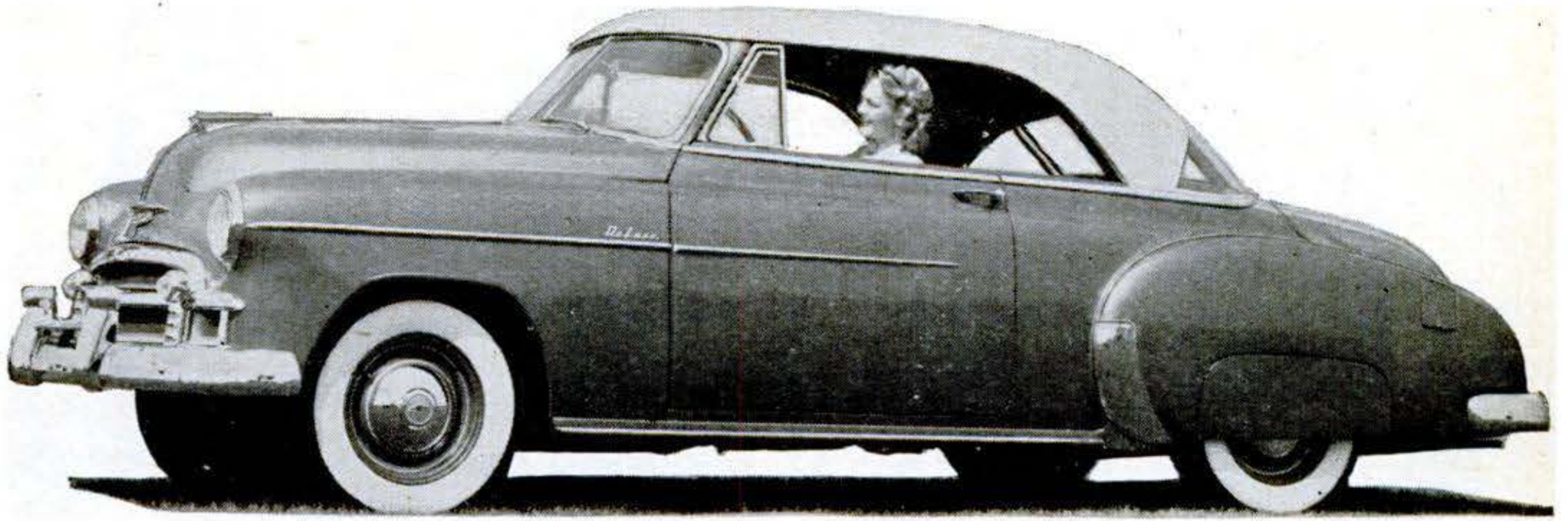

A six-passenger hard-top coupe that looks like a convertible is new on Chevrolet's 1950 line.

Chevy Gets a Torque Converter

LONG-RUMORED in the car industry, a Chevrolet with an automatic transmission as optional equipment was announced last month as the company's bid to retain the car's lead sales position in the low-priced field. An adaptation of Buick's Dynaflo, the Chevrolet torque converter is called "Powerglide." Unlike some simple torque converters, it does not allow the car to free-wheel when the driver takes his foot from the accelerator. Styling for 1950 follows the general pattern laid down last year. Added to the line is the Bel-Air (above), a hard-top job resembling a convertible.

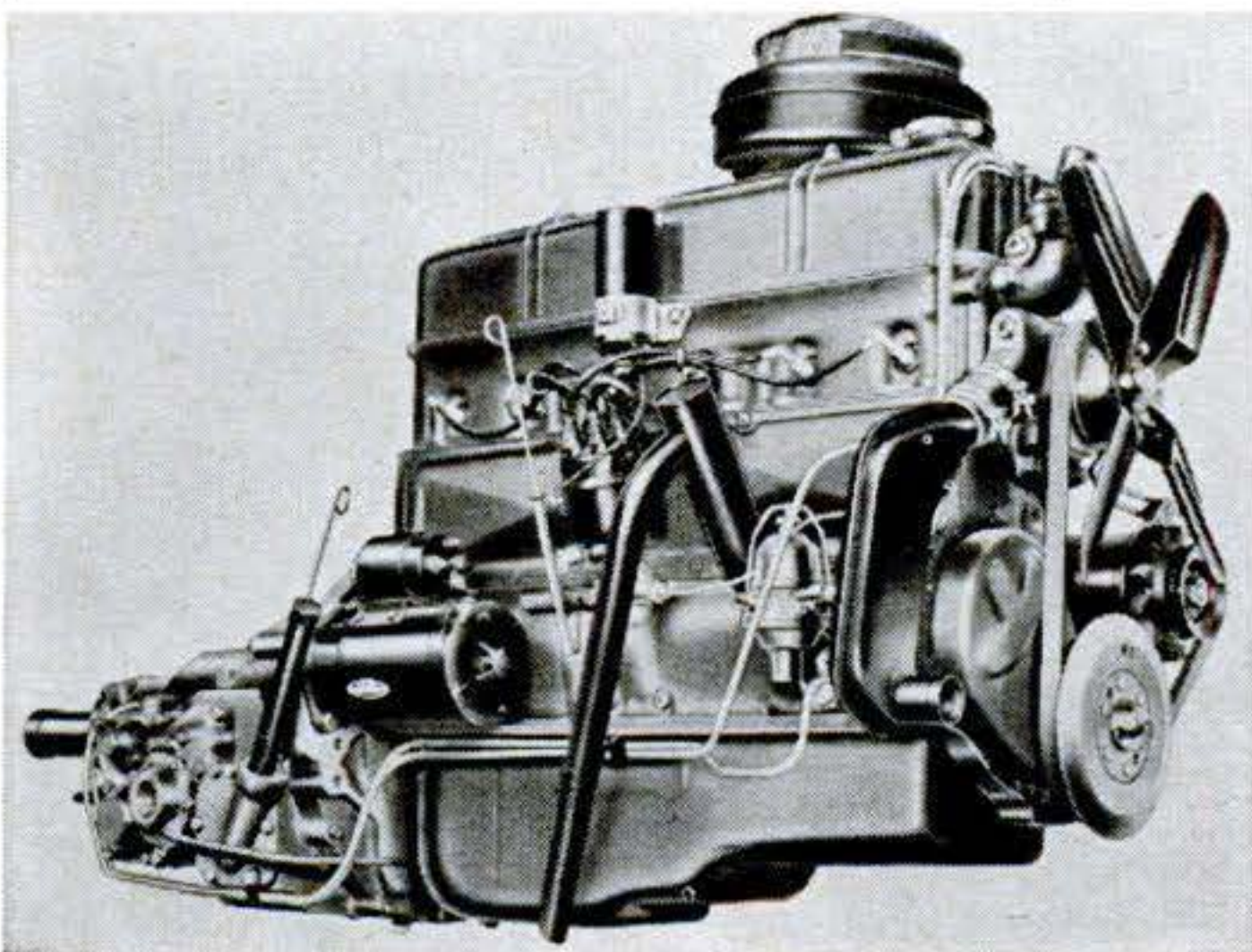

New valve-in-head engine develops 105 hp. for use with Powerglide, 15 hp. more than former engine. Displacement is 235.5 cubic inches; bore, 3 9/16ths; stroke, 3 15/16ths. Smaller engine of 92 hp. is used with gearshift models.

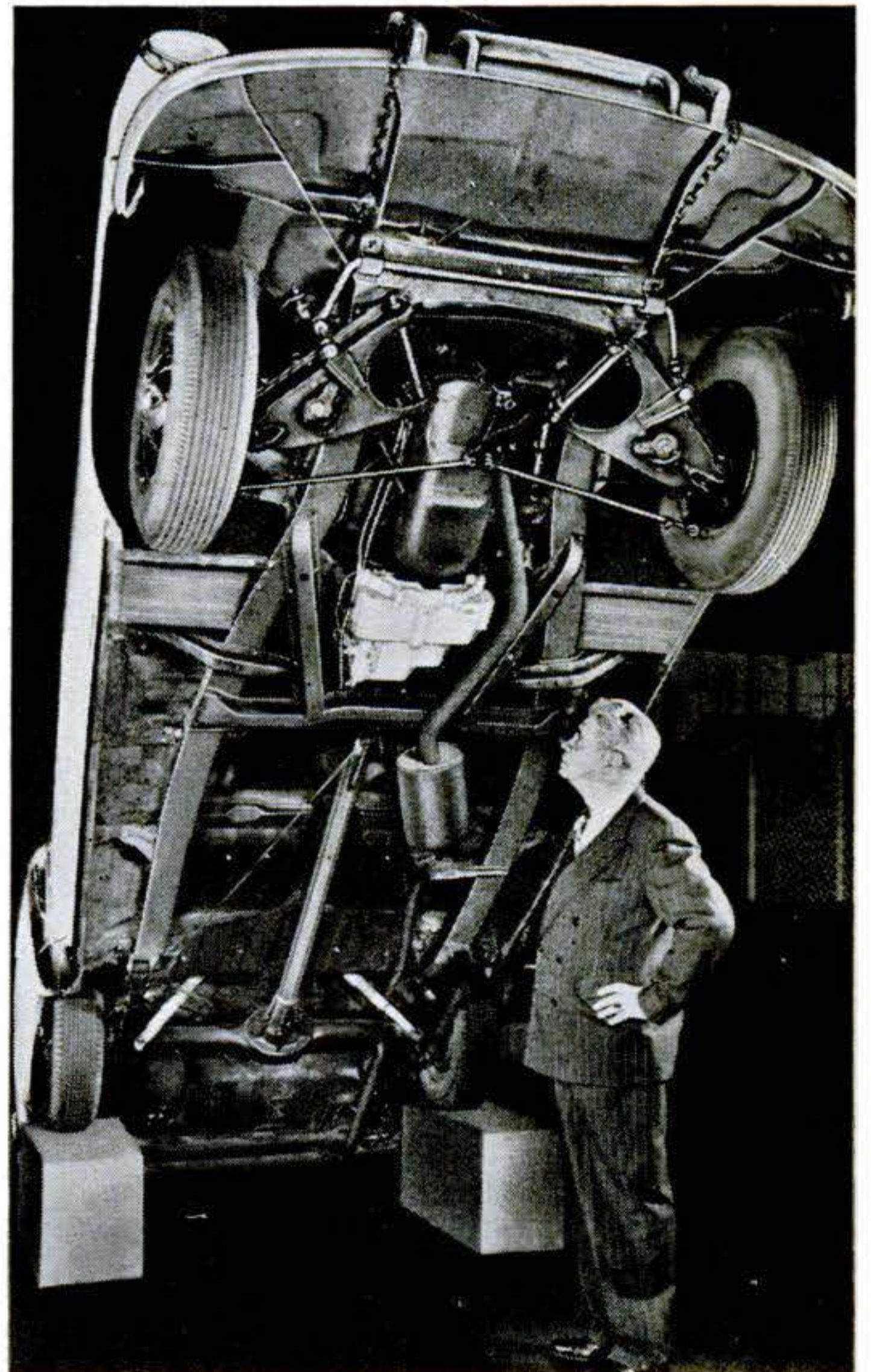

Chief engineer for Chevrolet, Edward H. Kelley, looks at installation of new automatic transmission, shown in white on car's underside. New way of manufacturing torque converter made possible its application to GM's low-priced car.

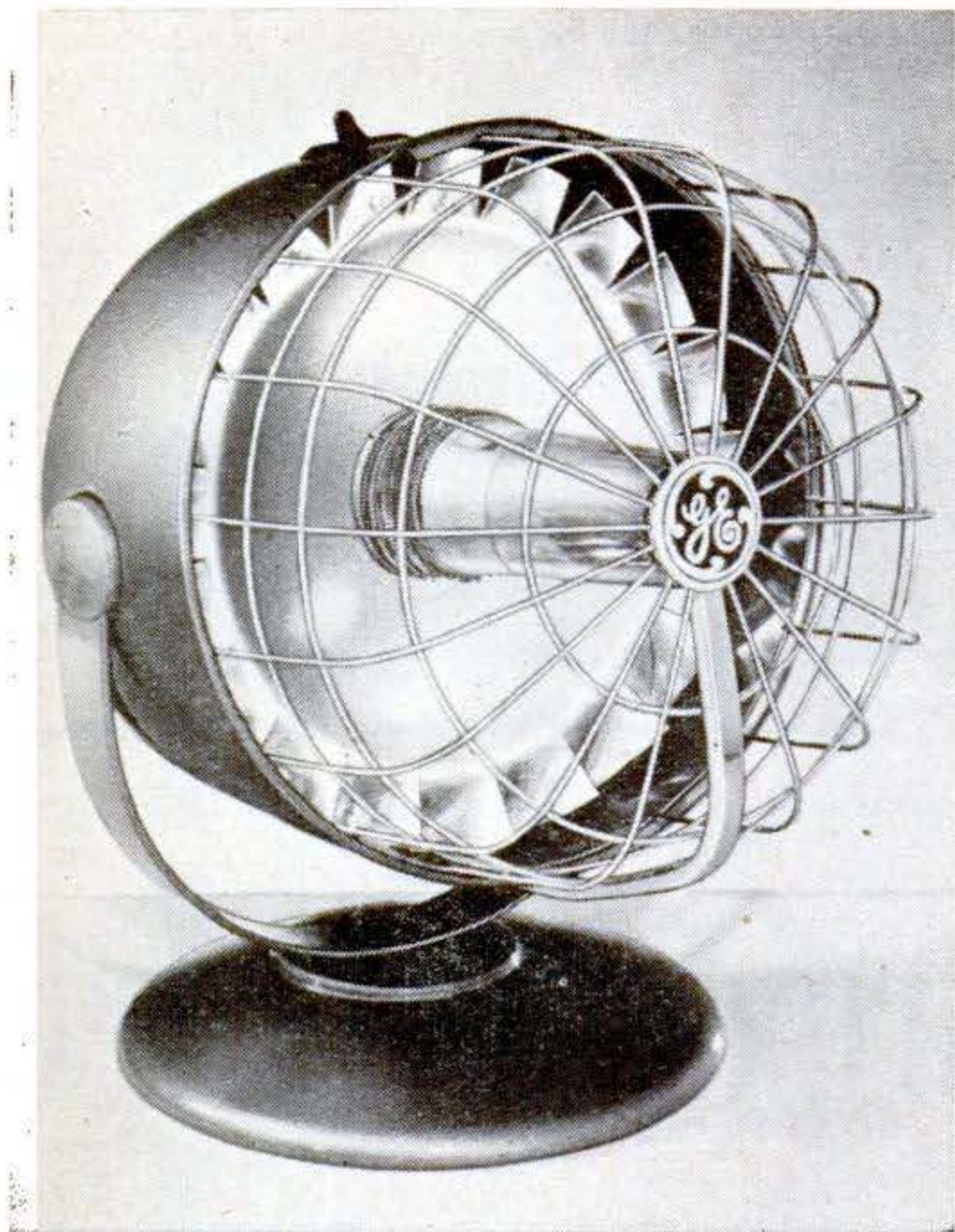

Heater Has Rotating Reflector

THIS portable GE heater has a polished aluminum reflector that doubles as a low-speed fan. A motor switch provides a choice of either radiant or radiant and forced-air heat. Suspended from a U-shaped bracket, the appliance throws heat at any angle from vertical down. For use on 120-volt AC, it is rated at 1,320 watts.

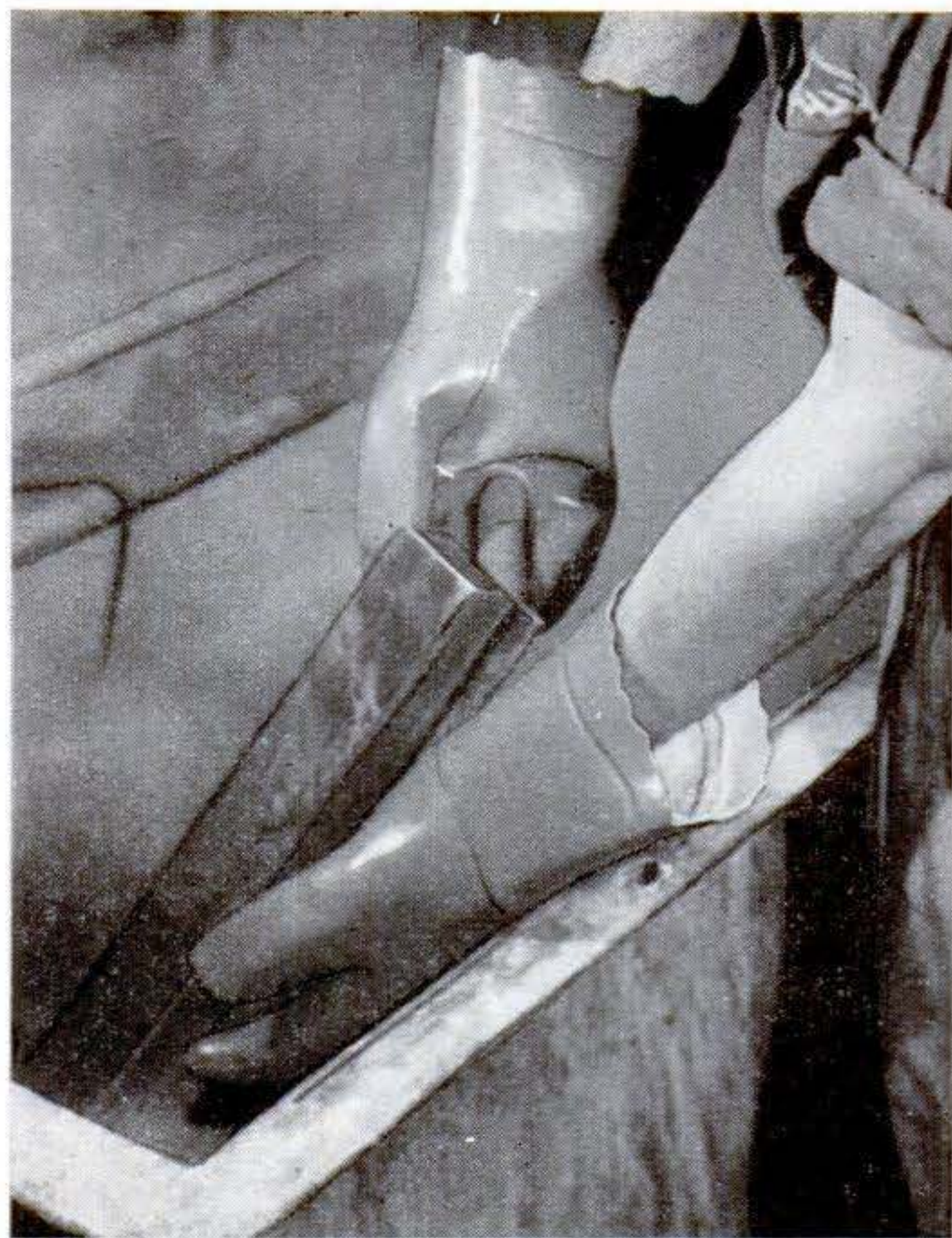

Gloves Stop Heat or Cold

WHEN an industrial worker wears the waterproof gloves above, he can put his hands into liquids as hot as 314° F. and as cold as 85° below zero. Made of red neoprene by the Pioneer Rubber Co., of Willard, O., the hand protectors have curved fingers and cover the wrists. They are insulated with layers of wool fleece.



Plastic Tot Tub Blows Up

A BATHTUB for Junior is only one of the uses for the Koroseal® container above. Convenient also for carrying laundry, or holding the baby in an auto, the basket has three mouth-inflated parallel tubes on its sides. Measuring 6 by 12 by 26 inches, it retails for about \$4 and is made by Ideal Novelty and Toy Co., of Hollis, N. Y.

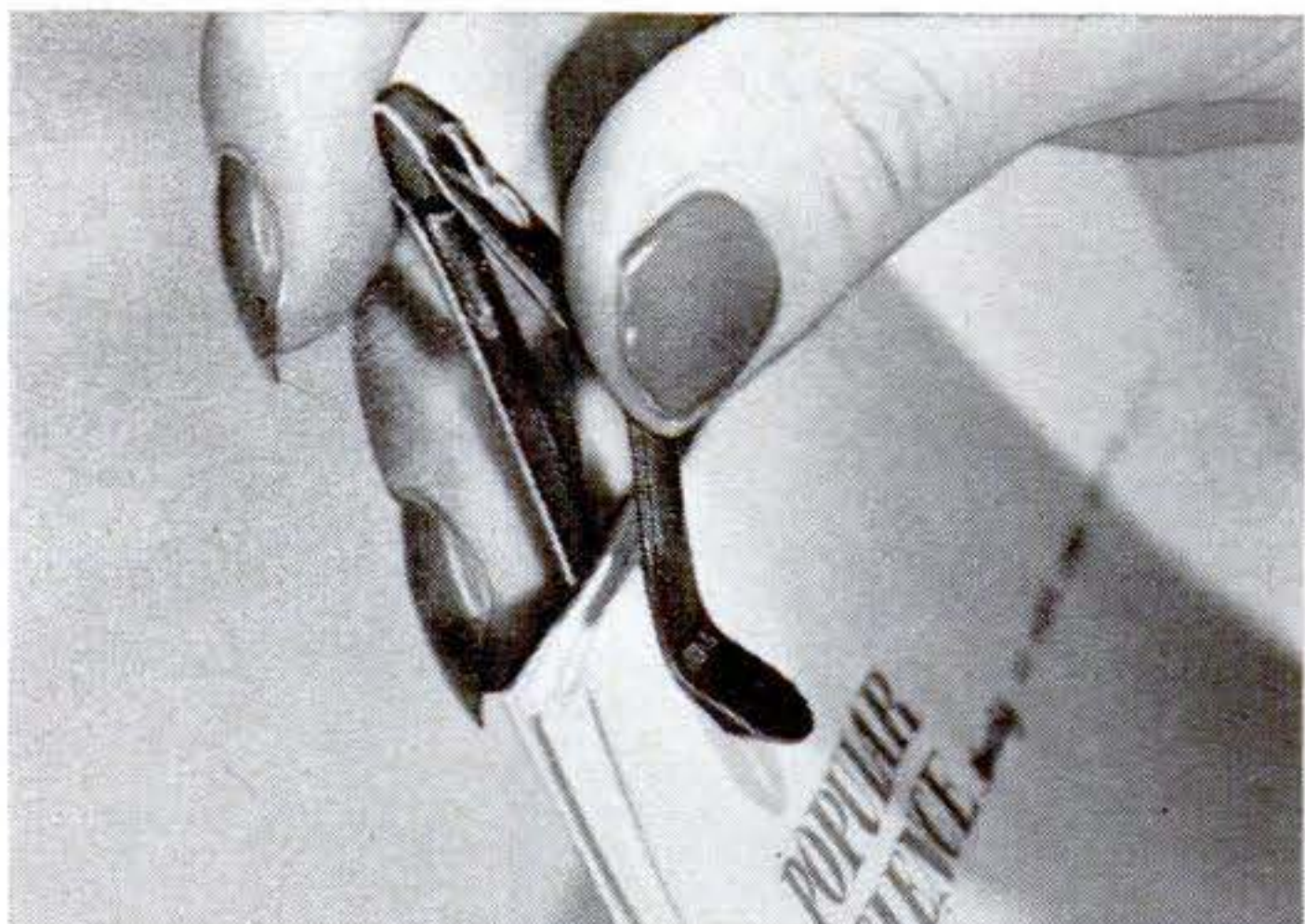

Paper Clip Holds Tight

THE simple but tenacious paper clip above won't let papers slip from a thick pile of correspondence. According to the inventor, Forest J. Neel, of Louisville, Ky., the fastener is grooved and tongued in such a way as to increase its resiliency and give a greater holding surface. It is 2½ inches long and ½ inch wide.

Like jumping beans, atoms of the radioactive families hop about the periodic table of elements as they change spontaneously from one substance into another. Recent discoveries link atom-bomb ingredients and newly discovered elements to these radioactive families—and solve the riddle of what such oddly named members as Uranium X₂ and Radium C' really are.

New Atomic Charts Reveal Secrets of Radio-Elements

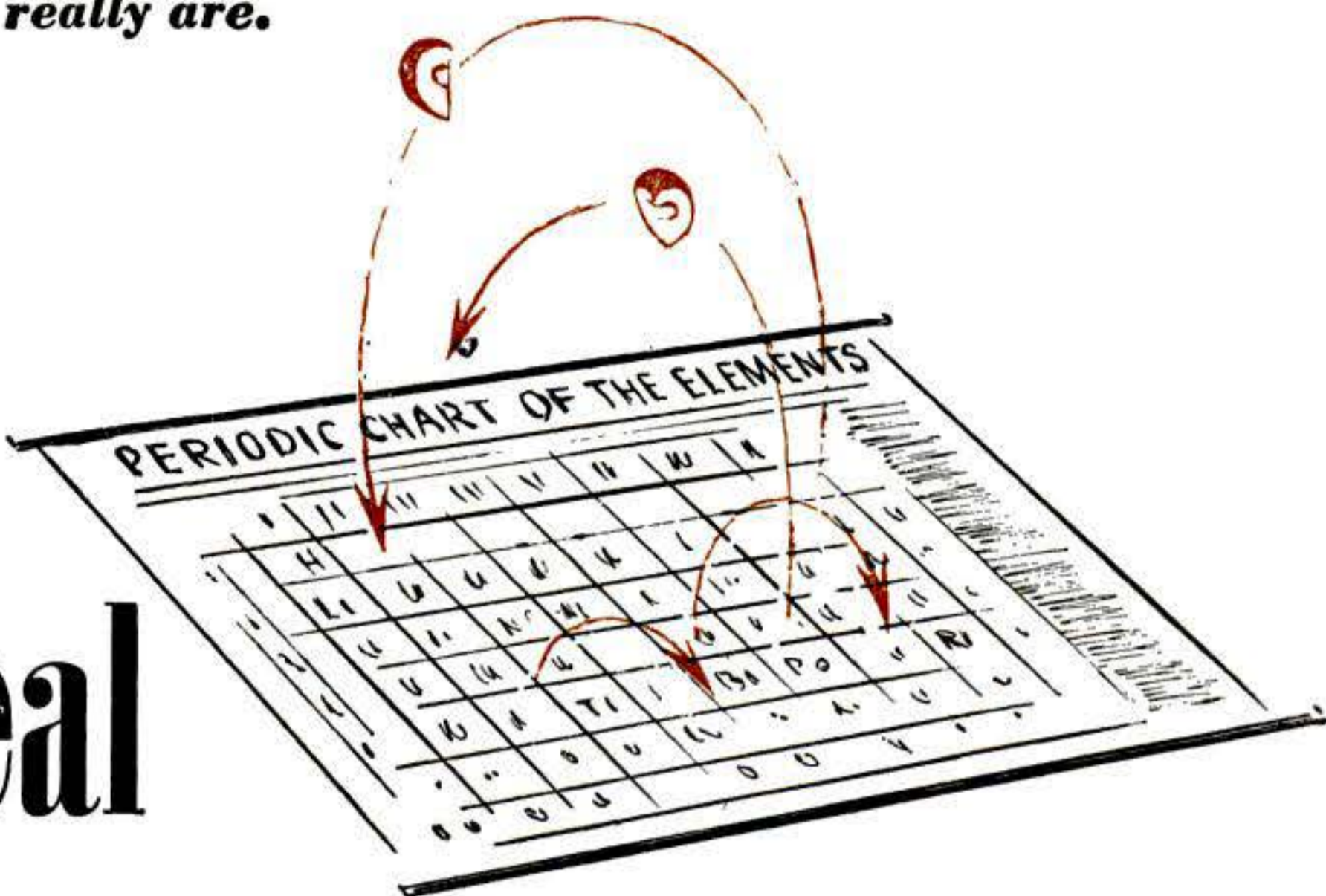

By Alden P. Armagnac

A whole new radioactive series, the Neptunium Family, has been discovered. Important branches, including six newly found elements, have been added to the "family trees" of the three series known before. Practical uses for the new data are as spectacular as in making plutonium for atom bombs—a process to which a formerly unknown branch of the Actinium Family supplied the key.

Atomic-age discoveries described in this article have been happening too fast for the chemistry and physics books to keep up. Radioactive-family charts in standard works of reference are now superseded by new ones from the AEC, summarizing all the latest information, and reproduced here for the first time in popular form.

SOME day soon, a brand-new chemical element seems likely to be added to the 96 now known. Like astronomers training their telescopes on the predicted position of a new planet, chemists seeking it have considerable advance information to go on.

The predicted new element will be radioactive. Its atomic number of 97 will top that of curium, a violently radioactive element that concludes the present list as No. 96. Its isotope or variety of mass 243 will be formed from curium of the same mass,

by natural radioactive transmutation or "decay," and will emit alpha rays. It will change successively into more than a dozen other substances, including uranium 235 of atom-bomb fame, and wind up as stable lead.

This is just one of the revelations of a new set of charts of the radioactive families of elements just released by the U. S. Atomic Energy Commission from its "classified" or secret list. They were compiled by Dr. Karl Z. Morgan, director, Mrs. Virginia K. Patterson, junior physicist, and Dr. Forrest Western, associate director, of the Health Physics Division, Oak Ridge National Laboratory, Oak Ridge, Tenn.

Modernizing the classical "family trees" of uranium, radium, and the rest of the radio-elements, the four atomic-age charts of the AEC set incorporate the latest discoveries. They contain so much new information that they render obsolete all earlier ones in textbooks and encyclopedias.

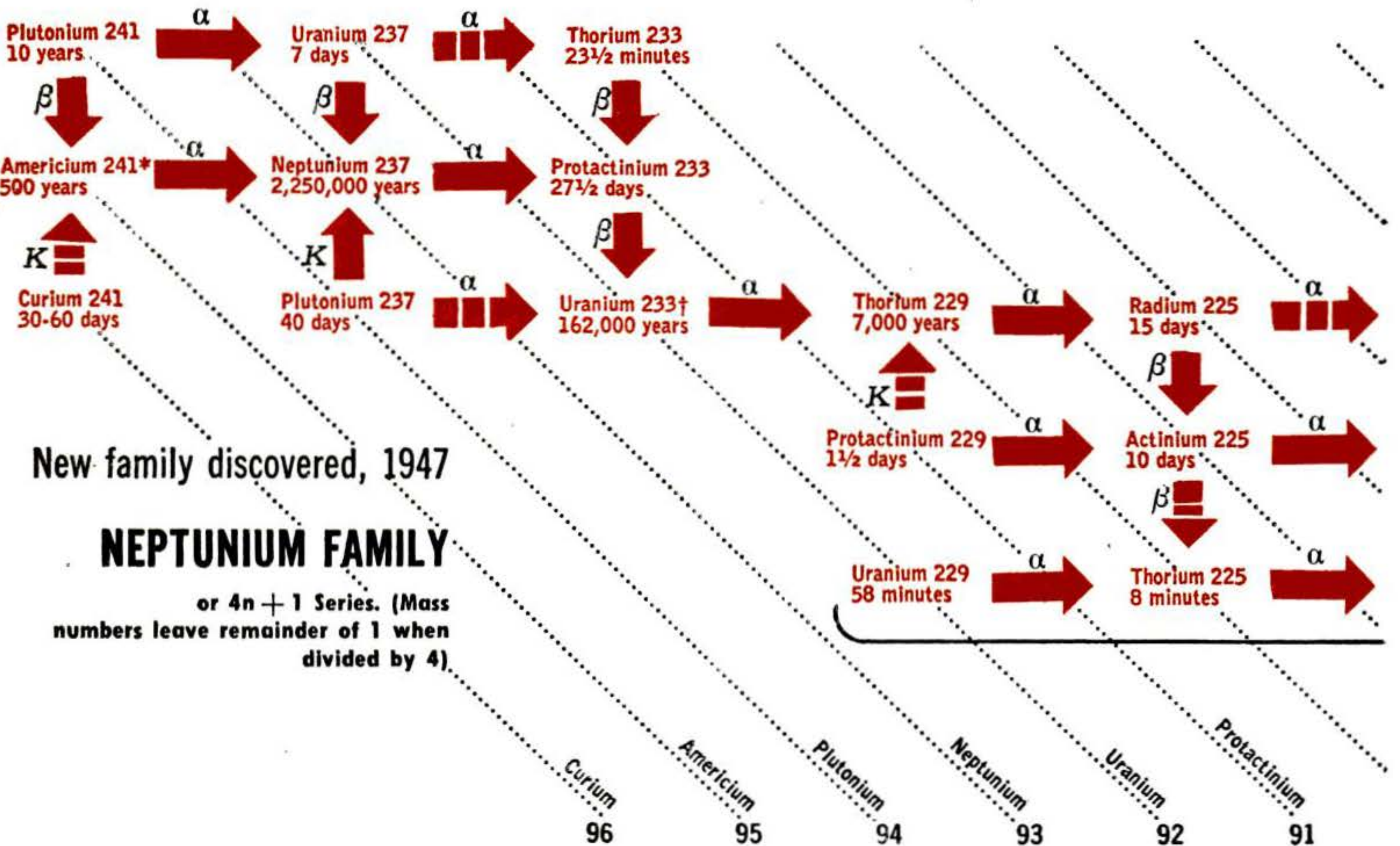
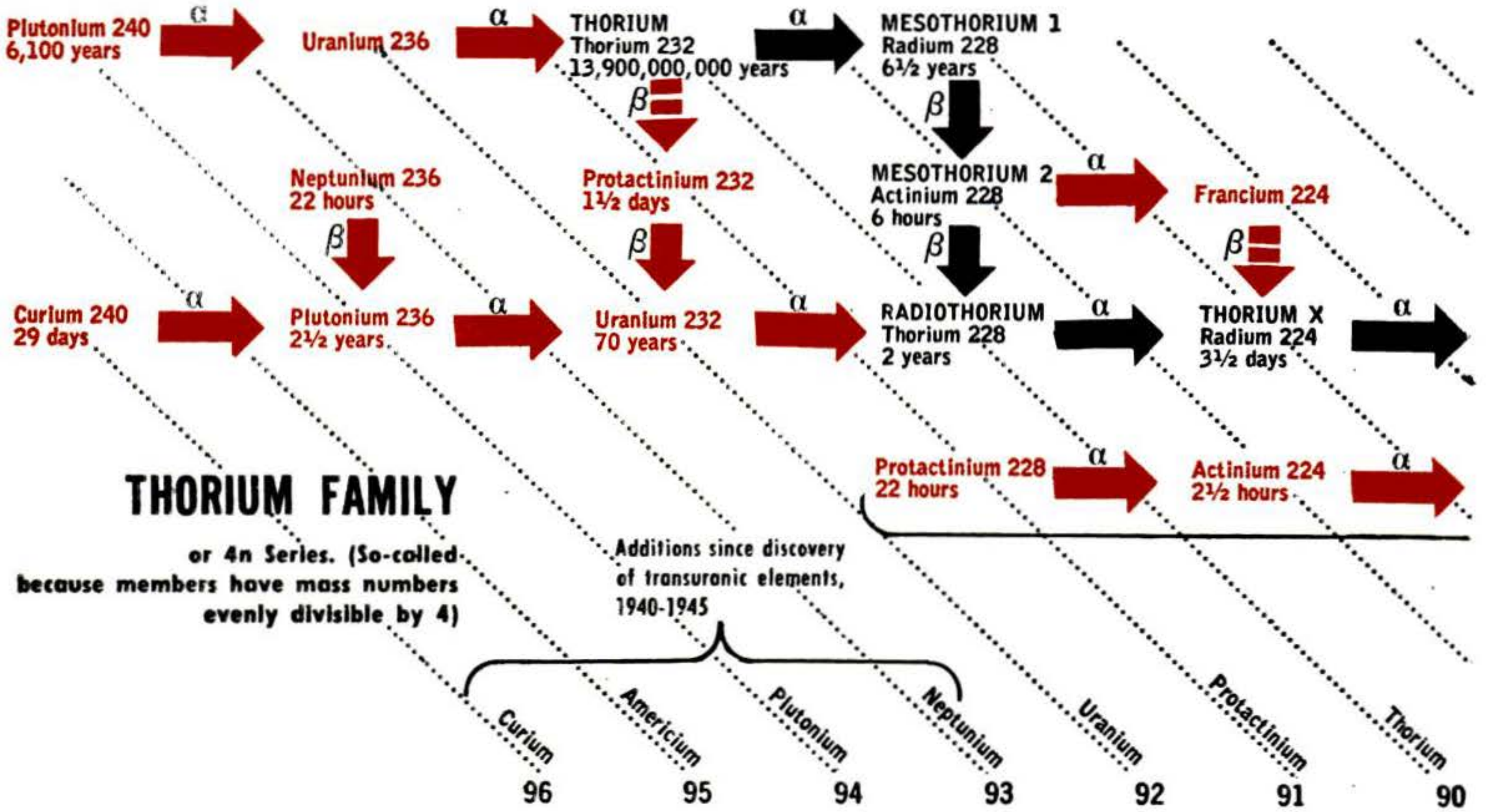

Because of their lively news interest and permanent value for reference, the complete set of AEC charts is reproduced on pages 144-45 and 148-49. POPULAR SCIENCE has rearranged them for convenience in reading, inserted both old and new names in full, and added profuse descriptive notes from the original scientific reports

New Radioactive-Family Charts



Key to All Charts *(New names and data appear in color)*

RADIUM A ... Old name (in capitals)
 Polonium 218... Actual element and isotope
 3 minutes ... Approximate half life, if known

-  **Black arrows** connect members of family formerly known
-  **Colored arrows** connect members of family recently discovered
-  **Broken arrows** connect possible family members, and show possible transformations, awaiting confirmation

- α **Alpha particle** emitted in transformation
- β **Beta particle** (negative) emitted in transformation
- K** **Orbital electron** moves into nucleus in transformation
-  **Atom-bomb ingredients**

Names and atomic numbers of the radio-elements appear below charts. To find any element in chart, follow corresponding **diagonal line**.

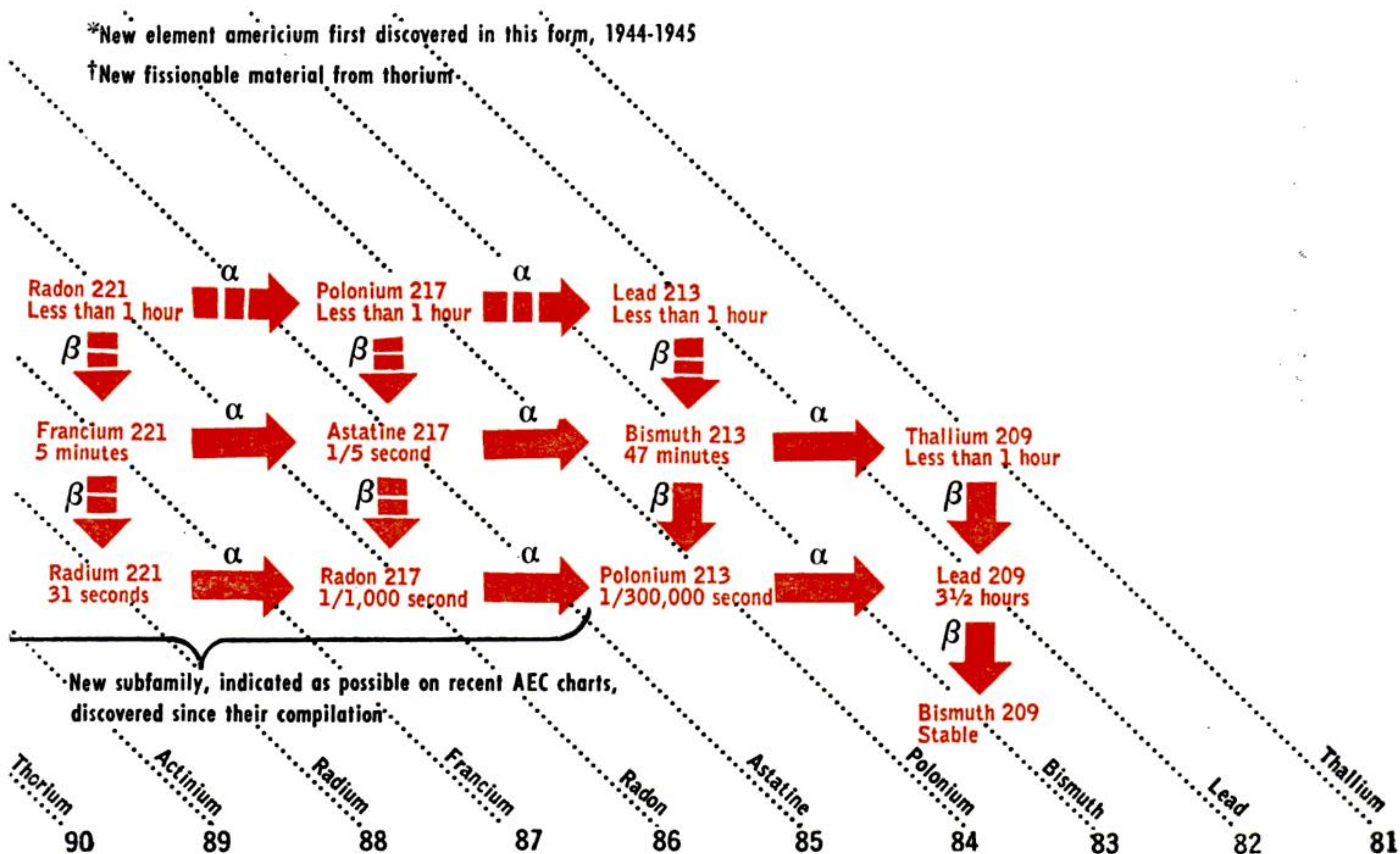
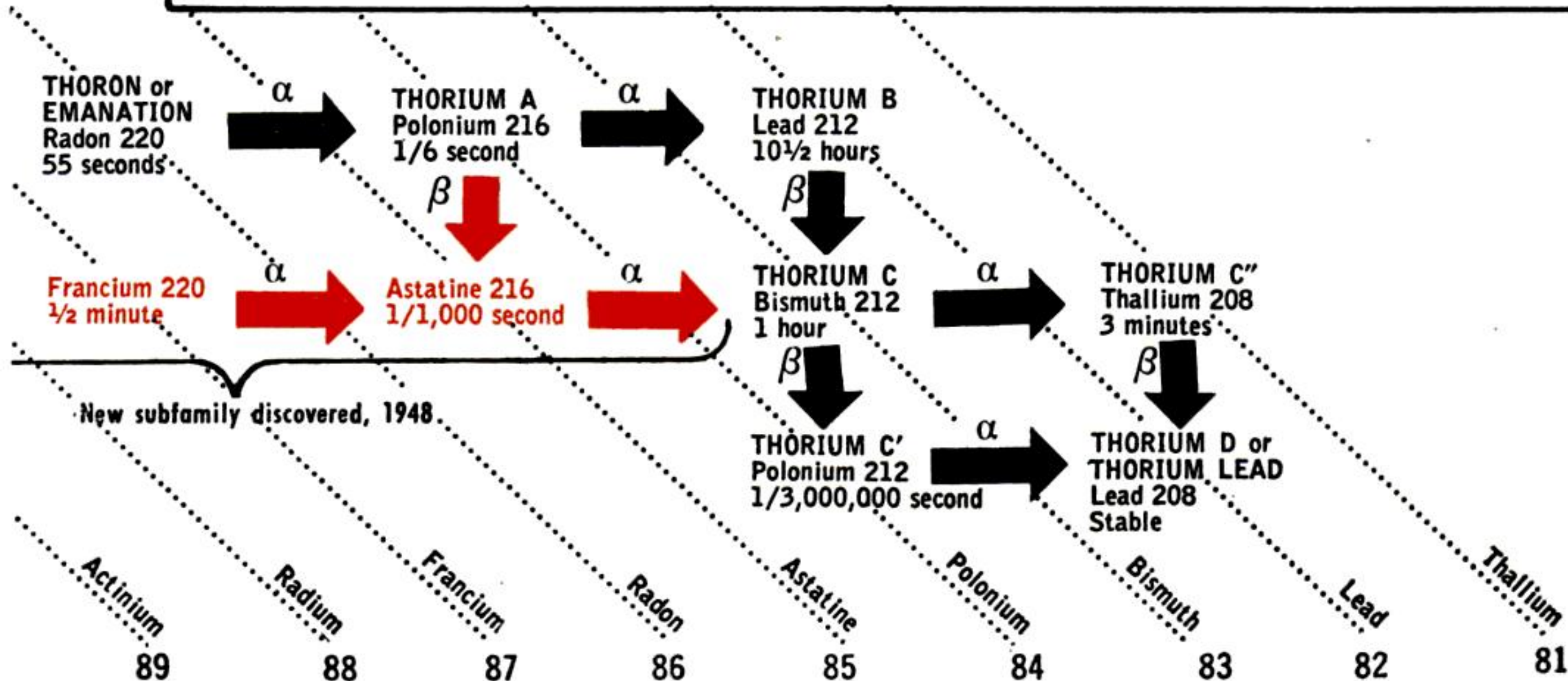

upon which the new AEC charts were based.

Reading left to right and top to bottom, each chart shows the succession of different products into which a substance like radium turns—usually emitting alpha or beta rays as it does so. Thus in the Uranium-Radium Family, radium itself first changes into radon, a heavy radioactive gas, and then into a series of other substances of which the last is nonradioactive and stable lead. Rounded figures show the approximate “half life” of each substance—the time required for half of it to turn into the next.

Three radioactive families have been known in the past—the Thorium Family, the Uranium-Radium Family, and the Actinium Family. As recently as 1947 a whole new one was discovered, the Neptunium Family, which ends in bismuth instead of lead as the other three do. All four families are portrayed by the new charts.

Here are some of their highlights:

Key to Atom Bomb Shown

Making the atom bomb has been the outstanding practical application to date of their new data. The two most celebrated of all radioactive substances both appear on the modernized Actinium Family tree—uranium 235 and plutonium 239, the atom-bomb ingredients.

Earliest known member of this family, for which it was named, was once actinium. Then the family tree was traced farther

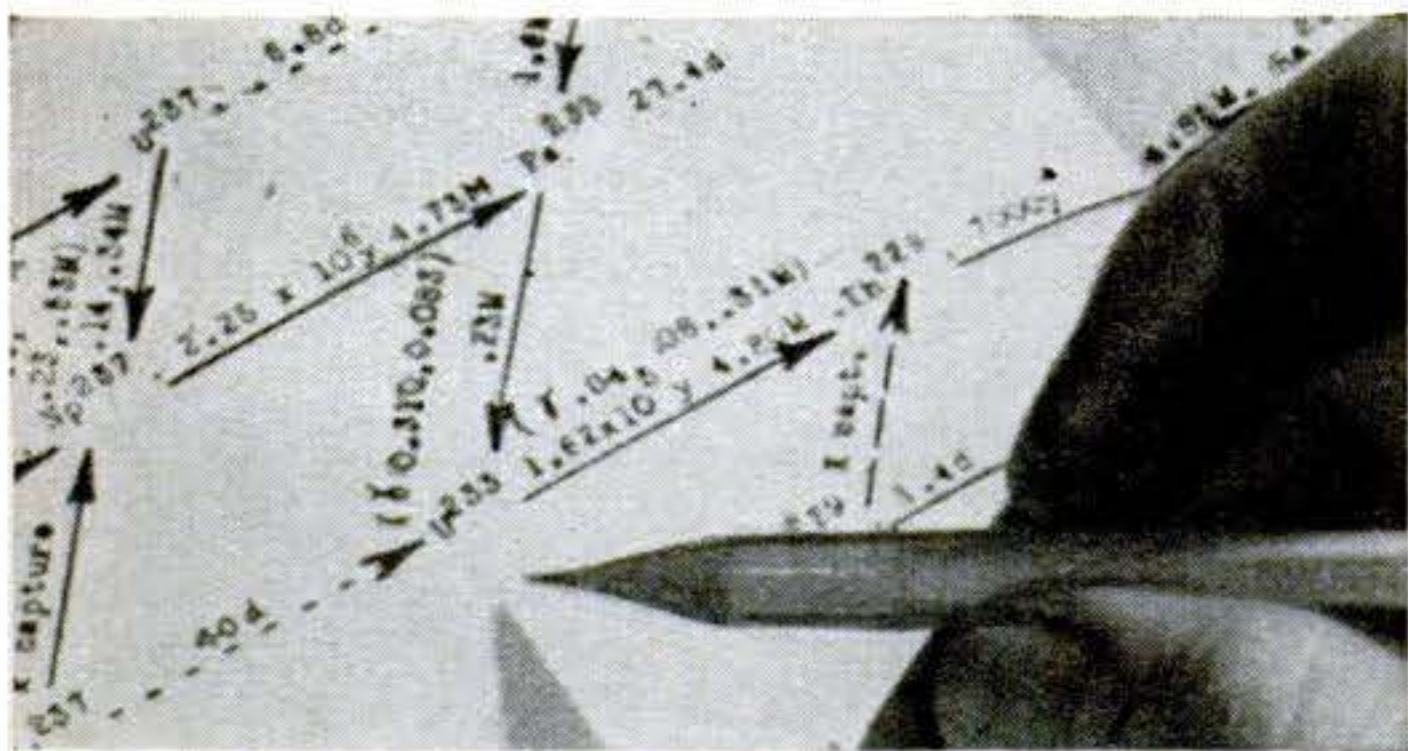

AEC “declassified” document, formerly secret, contains new atomic charts in skeleton form above. Pencil points to new fissionable material, uranium 233, abbreviated as symbol U^{233} .

back to “actino-uranium,” old name for uranium 235. Now plutonium joins the family as a parent of uranium 235. Its own ancestry, as the chart shows, traces back to uranium 239.

This is the key fact applied at the AEC’s great Hanford, Wash., plant to manufacture

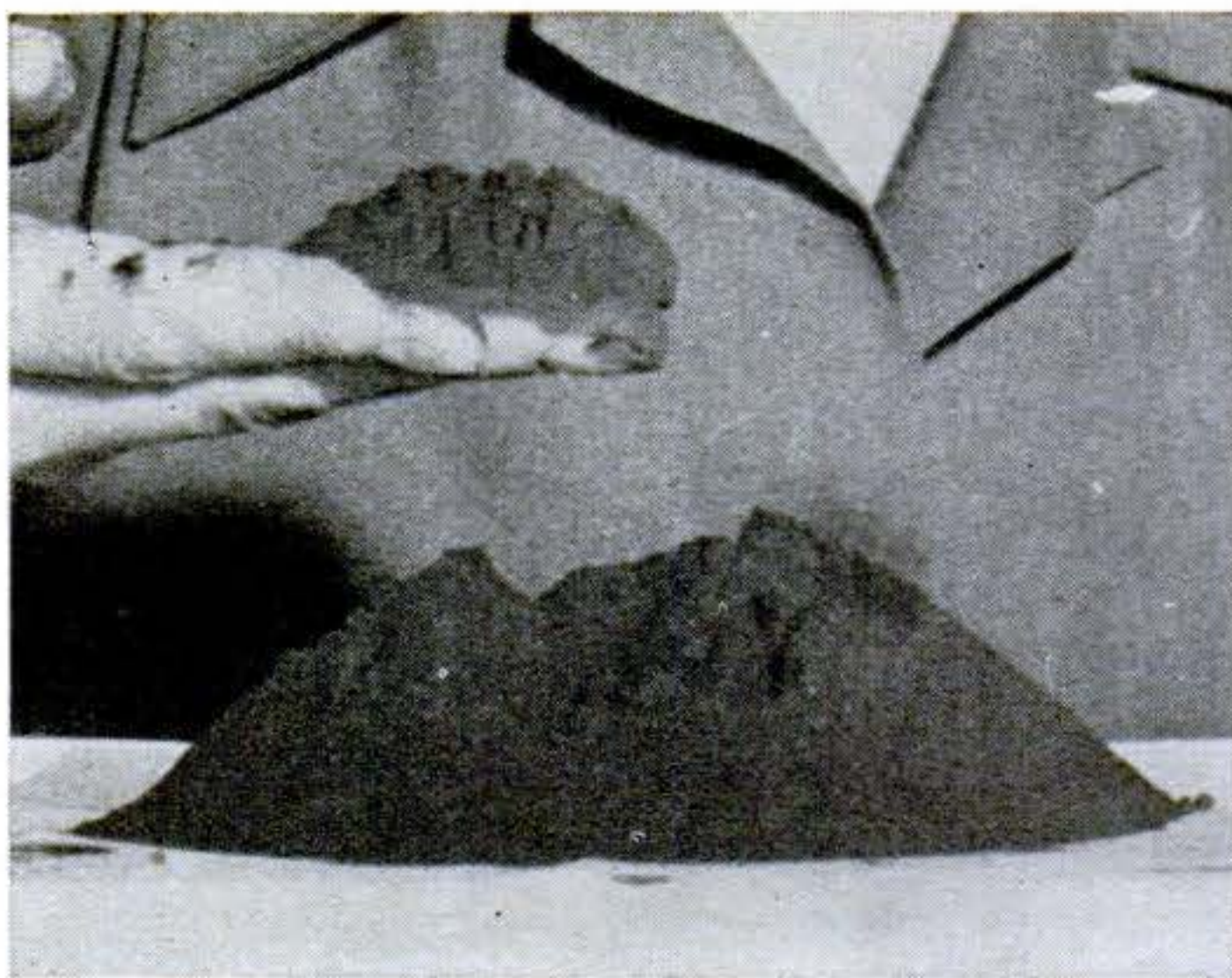

Textbooks saying “Plutonium does not occur in nature” are behind the times. Secret war search, recently revealed, found natural plutonium in concentrate of pitchblende ore, above.

plutonium for atom bombs. In atomic piles there, bombardment with neutrons first converts natural uranium 238 artificially into short-lived uranium 239. Then nature takes its course, and plutonium results.

In April, 1948, the AEC officially classified as “fissionable” a third material, uranium 233 of the new Neptunium Family. Comparative abundance of its raw material, thorium, makes it especially interesting as a possible ingredient of A-bombs and source of atomic power. Its artificial manufacture resembles that of plutonium. Bombarding natural thorium 232 with neutrons converts it to thorium 233, which then turns into uranium 233 by the steps shown on the Neptunium Family chart.

Gather more than a critical quantity of an A-bomb ingredient in one place and a chain reaction produces an atomic explosion, whose atomic debris includes dozens of different elements. This cataclysmic possibility has overshadowed what otherwise and normally happens to plutonium 239 or uranium 235. By natural radioactive decay, over a long period of time, they turn into the products shown on their chart.

Six New Elements Charted

Charts of all the radioactive families get a whole “new look” with discovery of family ancestors earlier than any known before and of new side branches in their lines of descendants. Six newly discovered chemical elements figure prominently in the recent additions.

The four “transuranic” elements discovered in the period 1940-1945—neptunium,

plutonium, americium, and curium—head the revamped family trees.

Other newcomers discovered in 1939-1940 are the elements francium and astatine, given names as recently as 1946 and 1947 respectively. A Frenchwoman, Mlle. Marguerite Perey, found francium to be a hitherto undetected, natural daughter of actinium 227; and it has subsequently been shown to be a member of other radioactive families. Astatine, first made synthetically in the University of California cyclotron, has attracted interest as a possible radioactive medical aid because, like iodine, it becomes concentrated in thyroid tissue.

“Natural” or “Artificial”?

Are “artificial” family-tree members, born in the laboratory and sometimes unknown in nature, entitled to the same standing as old established “natural” members? With former distinctions between “natural” and “artificial” rapidly vanishing in modern science, the answer seems to be yes.

For one thing, modern alchemists with their atom-smashers have synthetically created many bona fide “natural” radioactive substances—among them, Radium E, Ra-

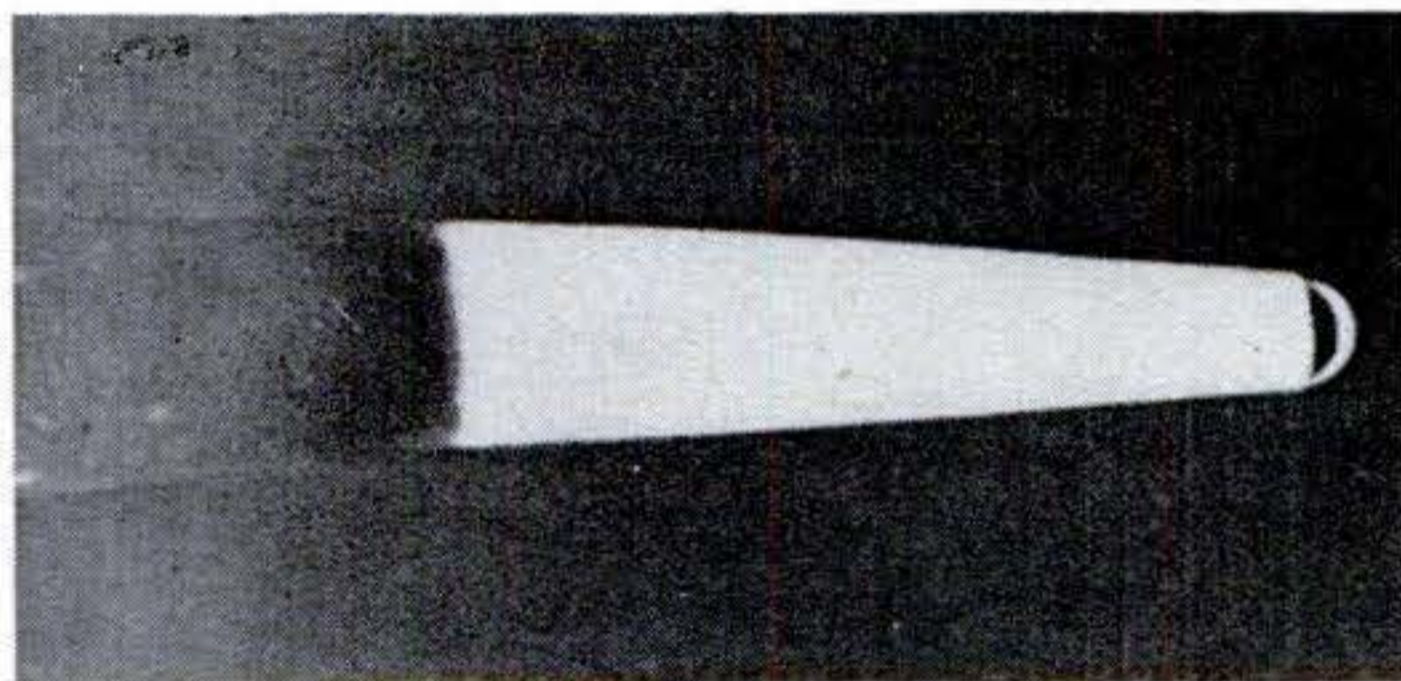

Miniature test tube above holds tiny amount of purified curium, element No. 96. Violently radioactive, it glows with own light, and is most dangerous to handle of all radio-elements.

dium F, Actinium, Actinium X, and Actinium C'—which thereupon go through all their accustomed transformations. A gram of natural radium bombarded with neutrons recently yielded to Argonne National Laboratory experimenters, by artificial transmutation, the first substantial quantity ever available of pure “natural” actinium 227 for study of its chemical compounds.

Conversely, supposedly “artificial” elements have now been found in nature too! One of the most hush-hush projects of World War II was a U.S. search to discover whether there were any ores from which

plutonium for atom bombs could be mined. Although it failed to unearth usable quantities, it revealed that pitchblende and carnotite ores do contain traces of plutonium 239. Contrary to the statement that “plutonium does not occur in nature” in some textbooks published as recently as 1949, it has actually been proved a natural as well as an artificial element. Likewise, the “artificial” element astatine has now been found a natural member of the old radioactive families.

“Prehistoric” Family Re-Created?

Discovery of the synthetic Neptunium Family raises an interesting conjecture along the same lines. Is this a prehistoric natural family, now extinct except in the laboratory? Its longest-lived member known, neptunium 237, has a half life of $2\frac{1}{4}$ million years. This is short by comparison with the half lives of the longest-lived members of other families, and with the estimated two-billion-year age of the earth. Thus all the known Neptunium Family members might have once existed on earth and now vanished.

If this is so, how could natural plutonium 239 survive, with its comparatively short half life of 24,400 years? The proposed answer is that natural uranium in ores bombards itself with neutrons, constantly creating plutonium anew.

Isotopes Solve Old Mystery

What are Uranium X₁, Radium E, and Actinium C'? They're *not* uranium, radium, or actinium. Today, chemists know they're thorium, bismuth, and polonium, of mass 234, 210, and 211 respectively.

These misleading old-fashioned names, adorned with letters from A to Z, subscripts, Roman and Arabic numerals, and primes and double-primes, date from the days before puzzled chemists understood what radioactive-family members were. By such tests as atomic weight, they seemed to differ mysteriously from all known elements.

Modern discovery that they're actually isotopes, or light and heavy varieties, of familiar elements brings order out of chaos. The name of an element and the number of its isotope positively identify 112 of those charted here. The remaining two, easily distinguished by different half lives, are twin forms or “isomers” of the same isotope, protactinium 234. The whole 114 fit like jigsaw-puzzle pieces into a beautifully systematic picture, as will all new ones discovered in the future. 

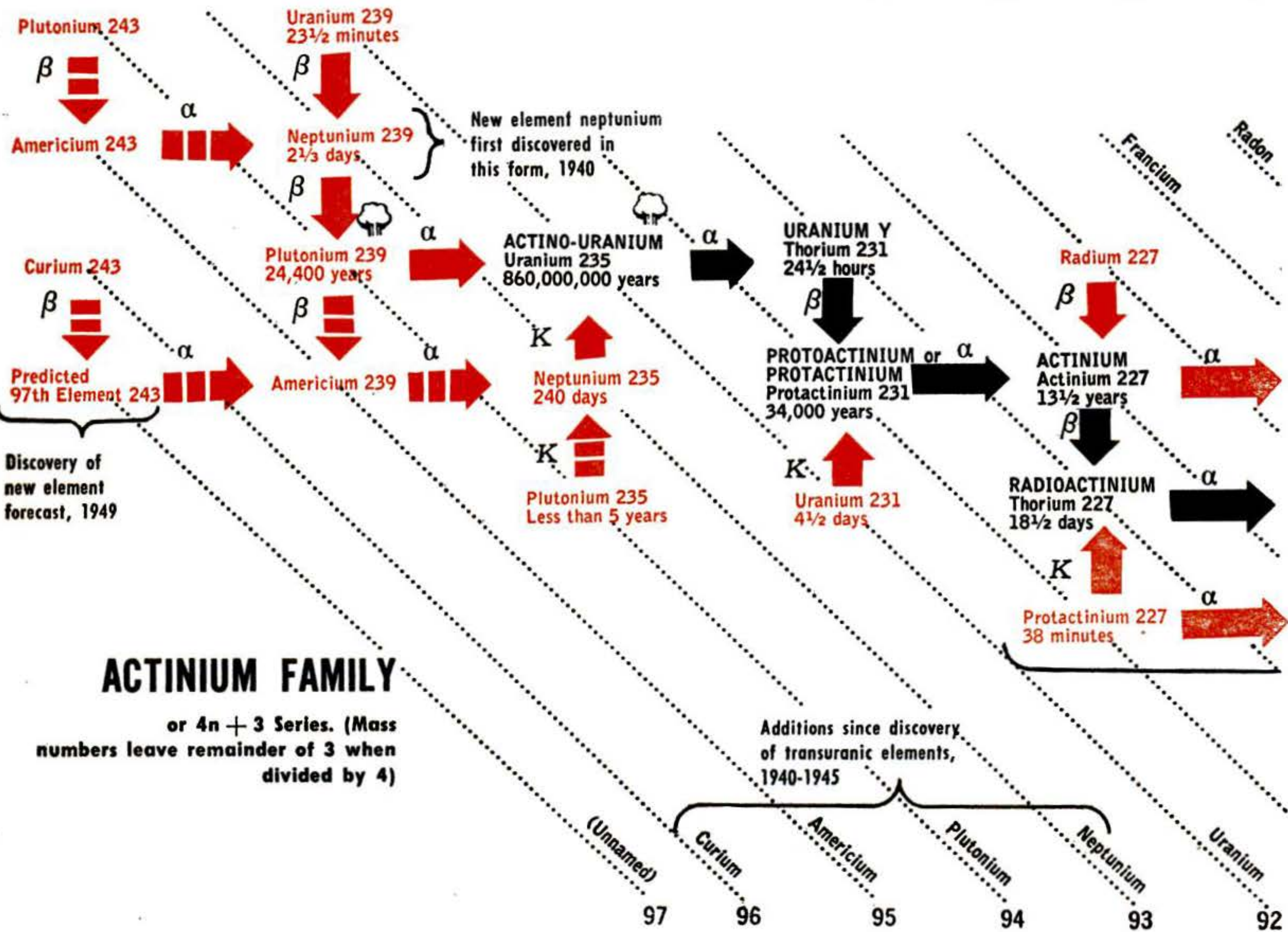
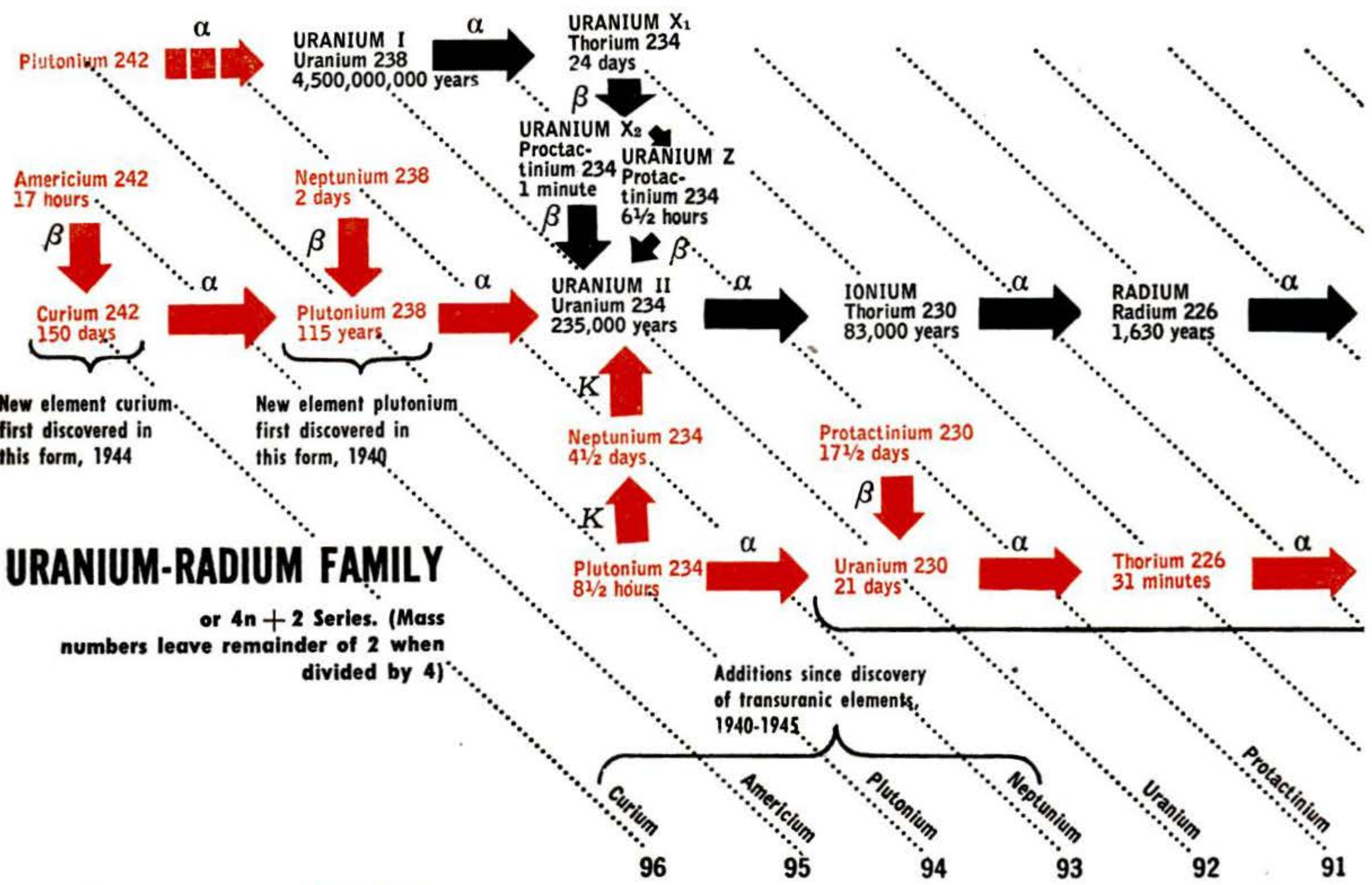

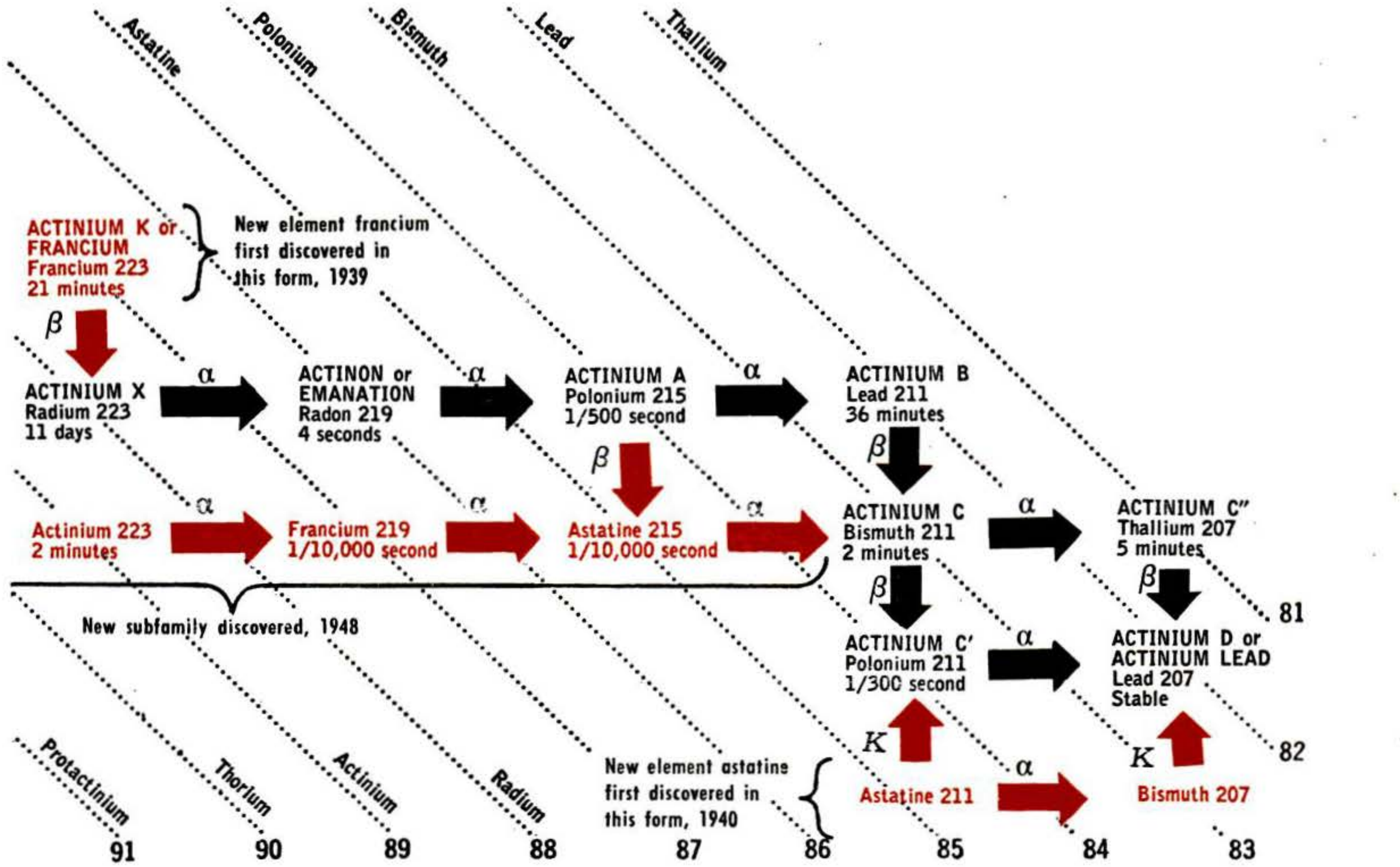
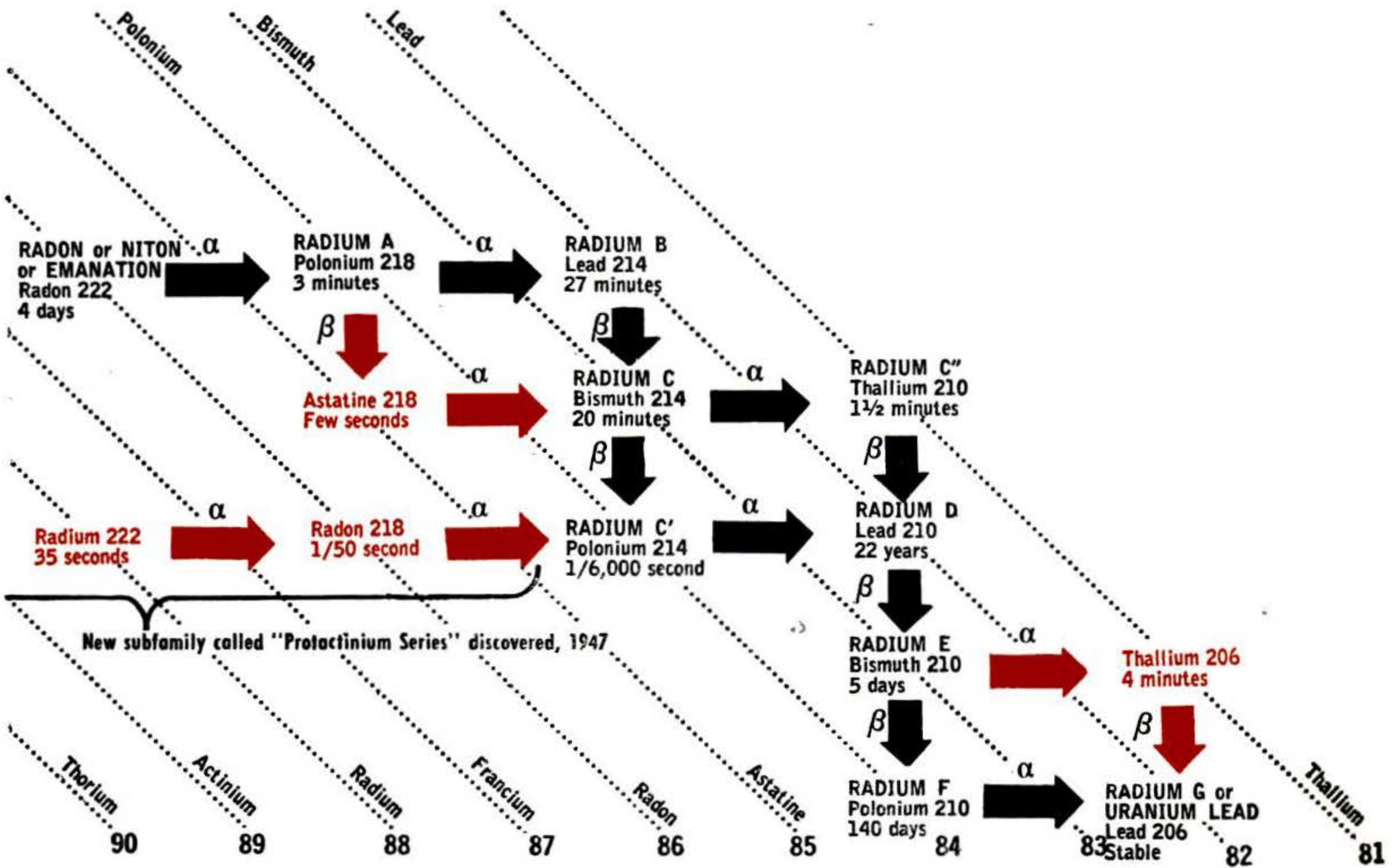

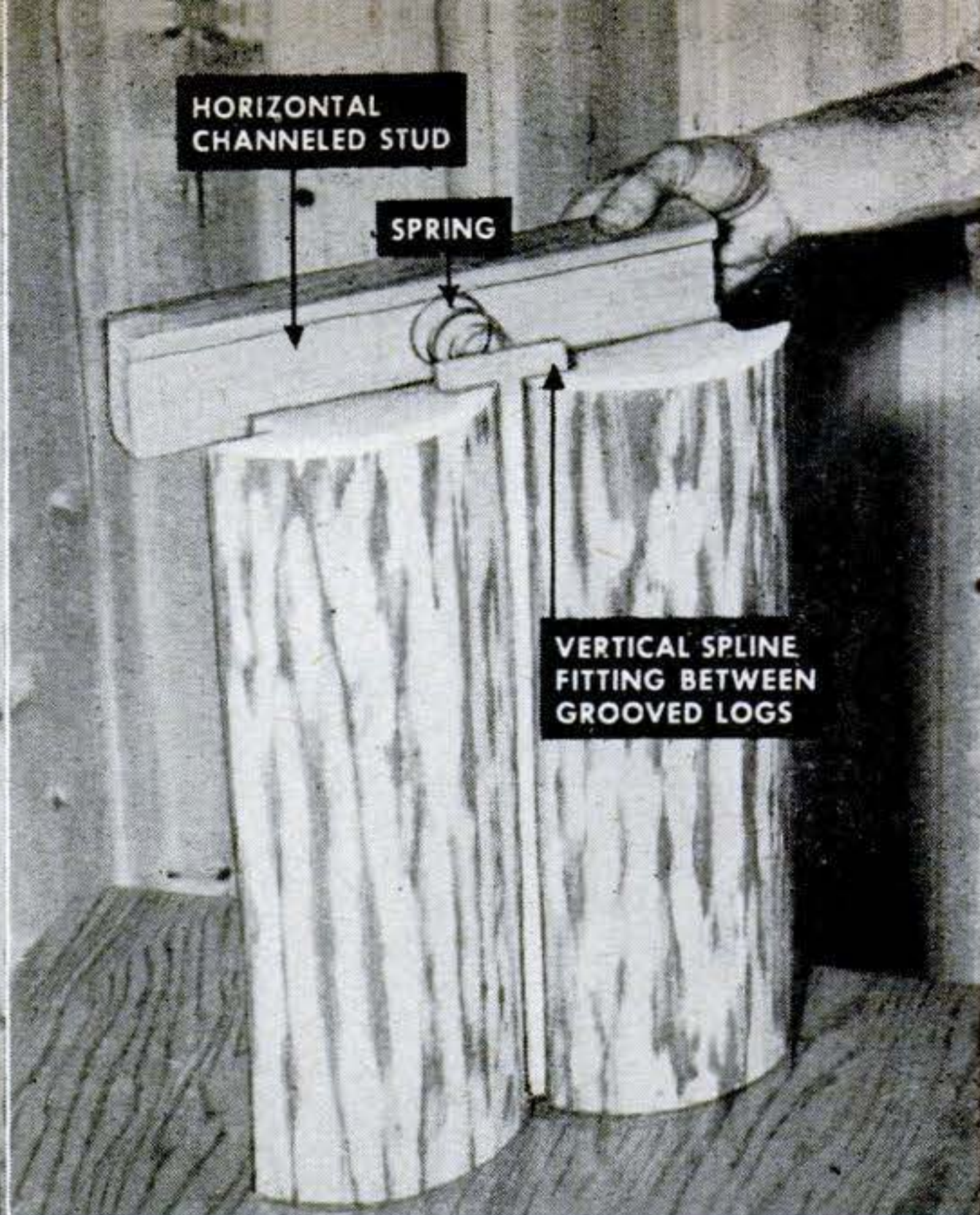

Log Walls Made Weathertight Without Chinking

THE tedious and expensive chinking of log walls that has made them impractical for homes and business structures has been eliminated by a mechanical joint that provides protection against wind, rain, and snow.

In a method developed and patented by Robert Jonsrud of the Jonsrud Log House Co., of Sandy, Oregon, rabbeted half-logs in a vertical position are joined together by splines that take the place of chinking, as

shown in detail in the photo at right above. Instead of conventional studding, the backing on the inside of the wall consists of horizontal studs that are channeled to hold galvanized spiral springs against the splines, pressing them firmly against the rabbets in the logs. The spring action keeps the joints tight, regardless of any shrinking or swelling caused by extremes of weather. The photo at left shows how the walls look outside.



Atomizer Sprays Ice Away

DE-ICING fluid is packaged in a flexible, nonbreakable atomizer bottle to make the clearing of sleet and snow from windshields and car windows easy. Squeezing the bottle with a pulsating action forces the liquid out of the atomizer in a fine spray. The liquid turns snow and ice to a slush the wiper blades can handle. Made by Birma Mfg. Co., Buffalo, the de-icer sells for about \$1.

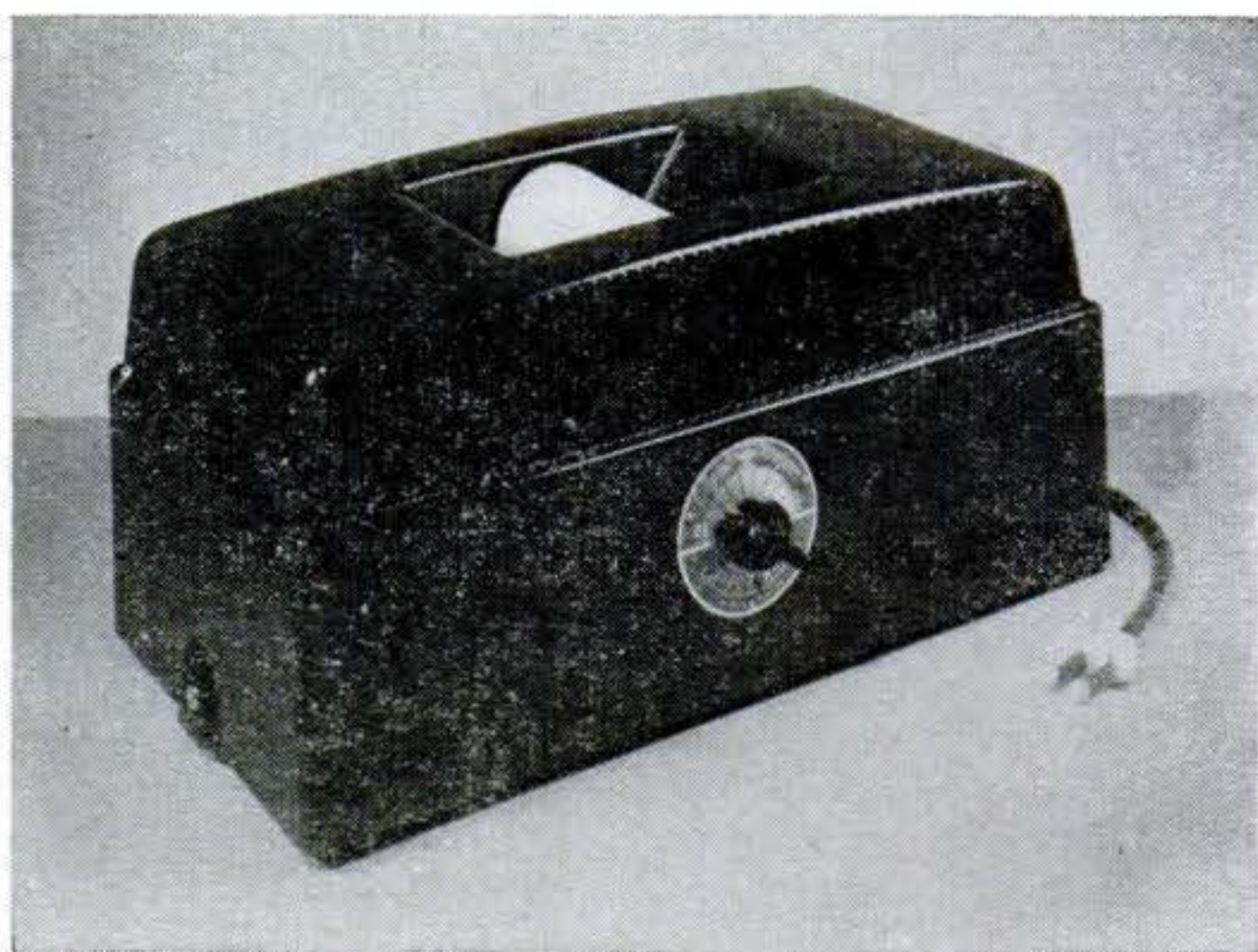

Vapor Machine Kills Viruses

AIR-BORNE diseases in the office, home, or nursery may be cut down by this air purifier that looks like a table radio. As a roll of impregnated paper passes over a heating element, it releases triethylene glycol vapor, destroying viruses that cause respiratory infections. A dial on the plastic cabinet regulates the amount of vapor produced. It is made by Air Purification Service, Newark, N. J.

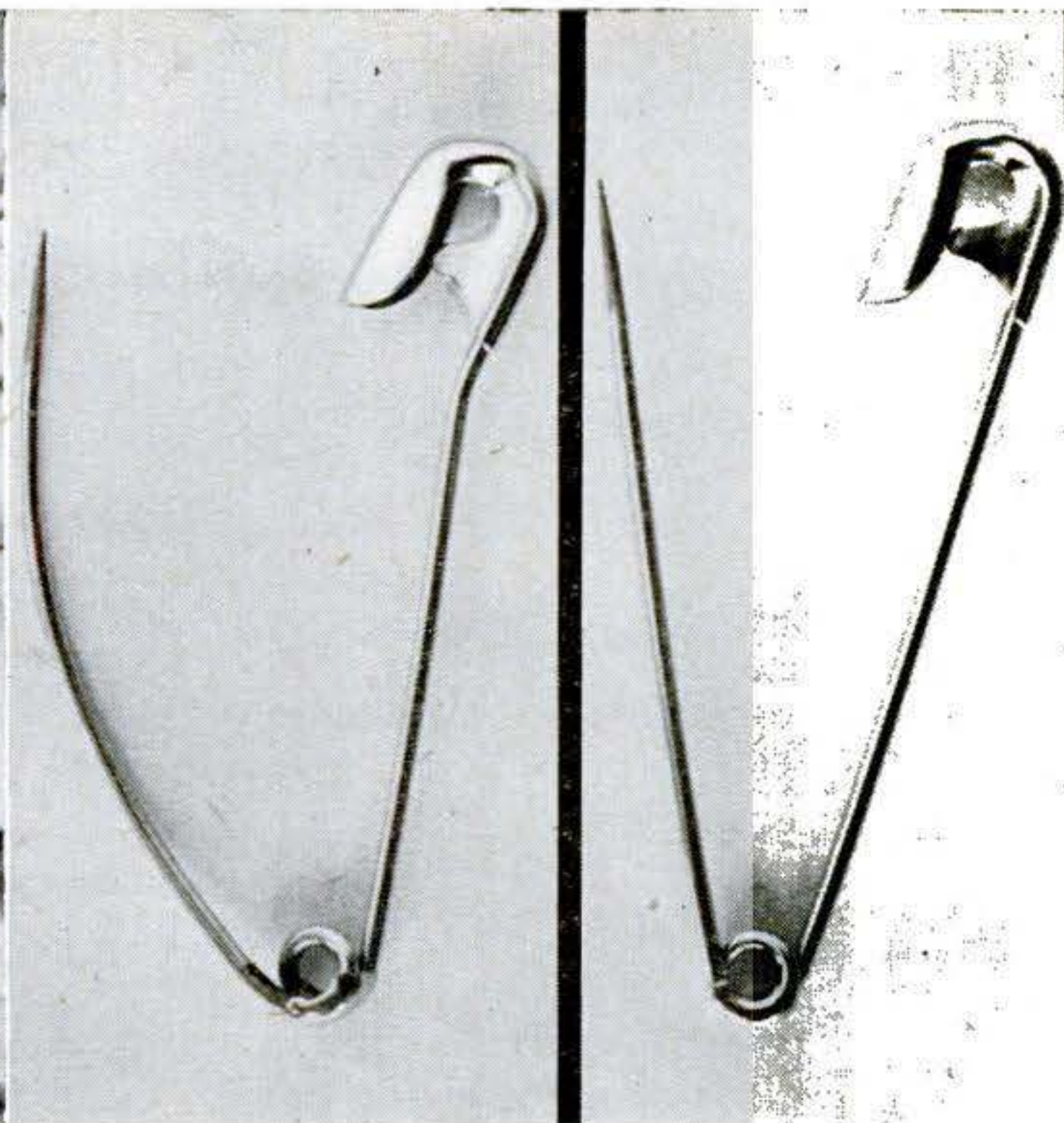
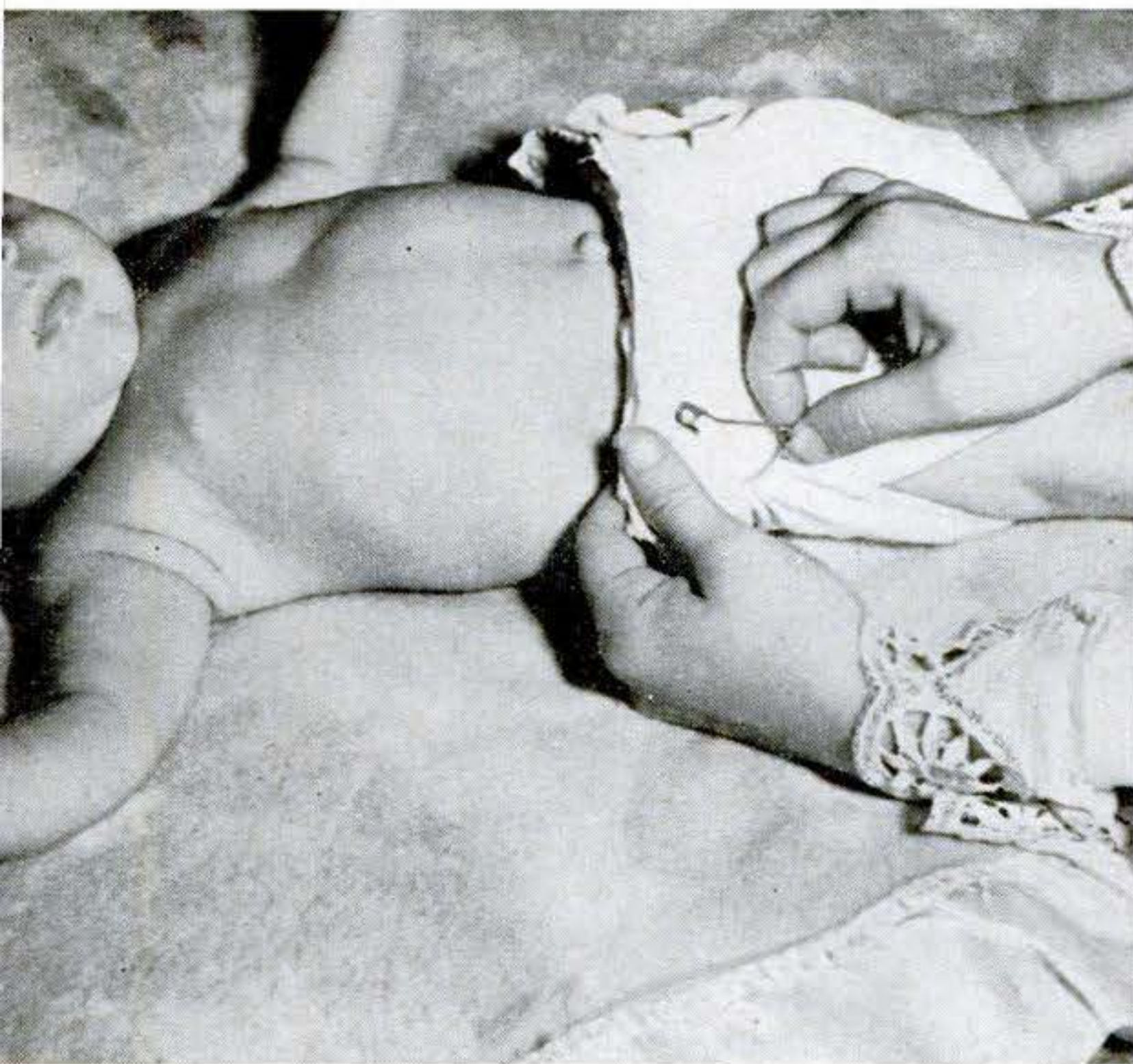

Baby Pinned Painlessly

A DIAPER pin with a safety curve, shown above in use and contrasted with an ordinary safety pin, may reduce anguished cries from

the nursery. Father of the "scoopin," and of a baby girl who inspired it, is Dr. Bruce R. Vent, of Lagrange, Ind. He claims his pin turns the point away from the baby during pinning and holds larger folds of cloth.

Coin Operates Shaver

A QUARTER in the slot of this wall unit, designed for installation in rest rooms, gives you the use of a Norelco electric shaver for six minutes, and a teaspoonful of after-shave lotion when you are through. When the razor is not in use, it fits in a cabinet behind the mirror and is bathed by a germicidal lamp that shines through for display purposes. A burglar alarm discourages razor robbers. The shaver empties and sharpens itself.



Small Ultraviolet Lamps Kill Germs in Phone Handset

THE phone bugs won't get you with this Sterl-A-Fone®, which destroys harmful micro-organisms in both the mouthpiece and earpiece in a few seconds after a phone is cradled. As shown in the photo at left, the device consists of a hollow platform on which the telephone-instrument base is mounted. This contains the electrical connection to light the two 3½-watt germicidal lamps seen at the bottom of the cylindrical shields at each side. When the telephone handset is replaced after use, its weight automatically trips a switch, lighting the ultraviolet lamps that burn for about 30 seconds. The life of the sterilizing lamps is estimated at 20 years in normal use.

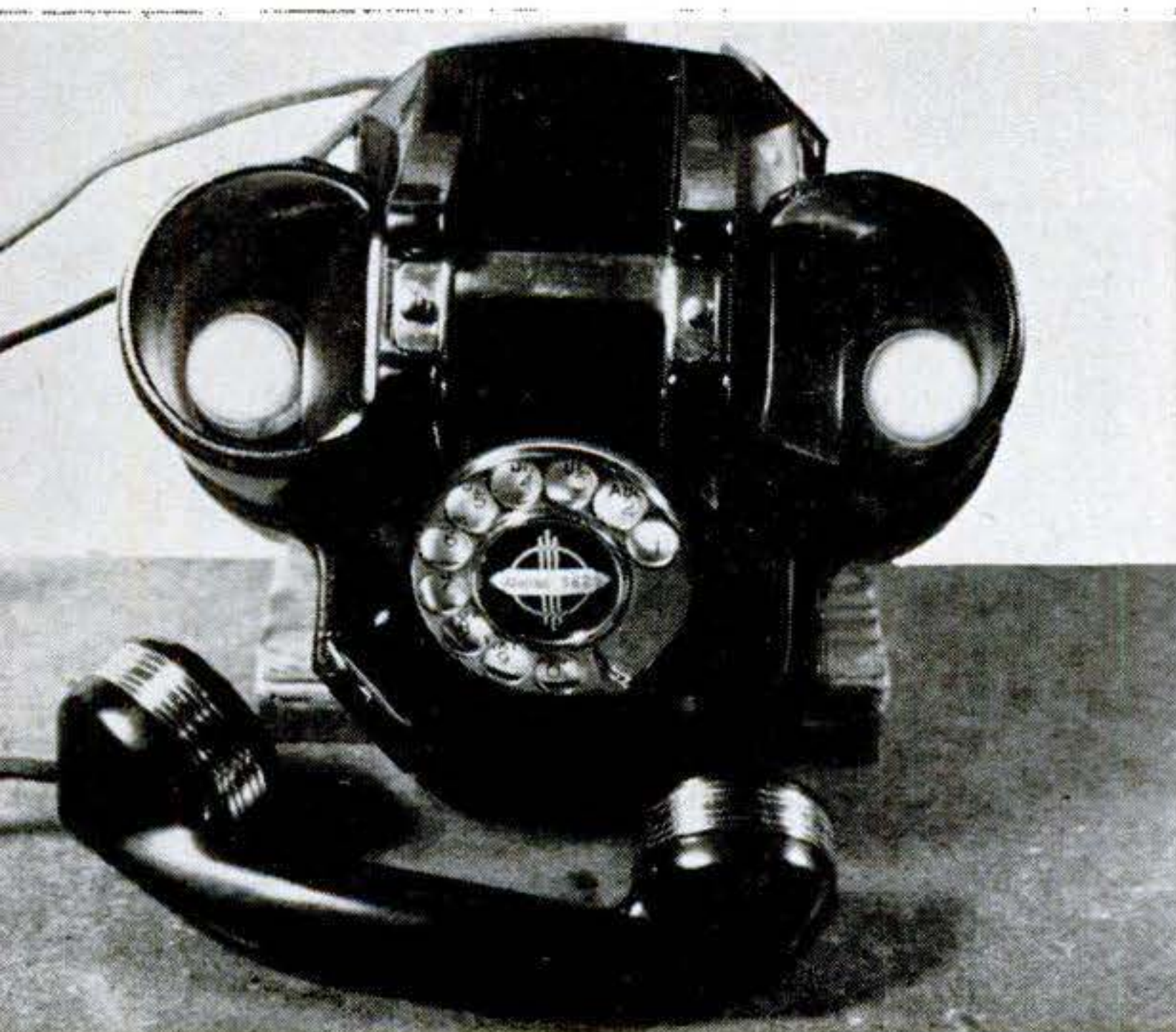



Homes Ride on Housemobile

HOUSES are whisked from one site to another by the self-propelled "housemobile" above. Ernest Hugentobler, a rigger, of Little Ferry, N. J., built it from spare parts of cars, motorcycles, and planes in a year and a half's spare time. Besides saving time and labor, he says, it avoids the risk of damaging a house in pulling it on timbers. It carries a load of 150 to 250 tons at a speed ranging from 90 up to 2,500 feet per hour. A trailer truck easily transports it to a job.

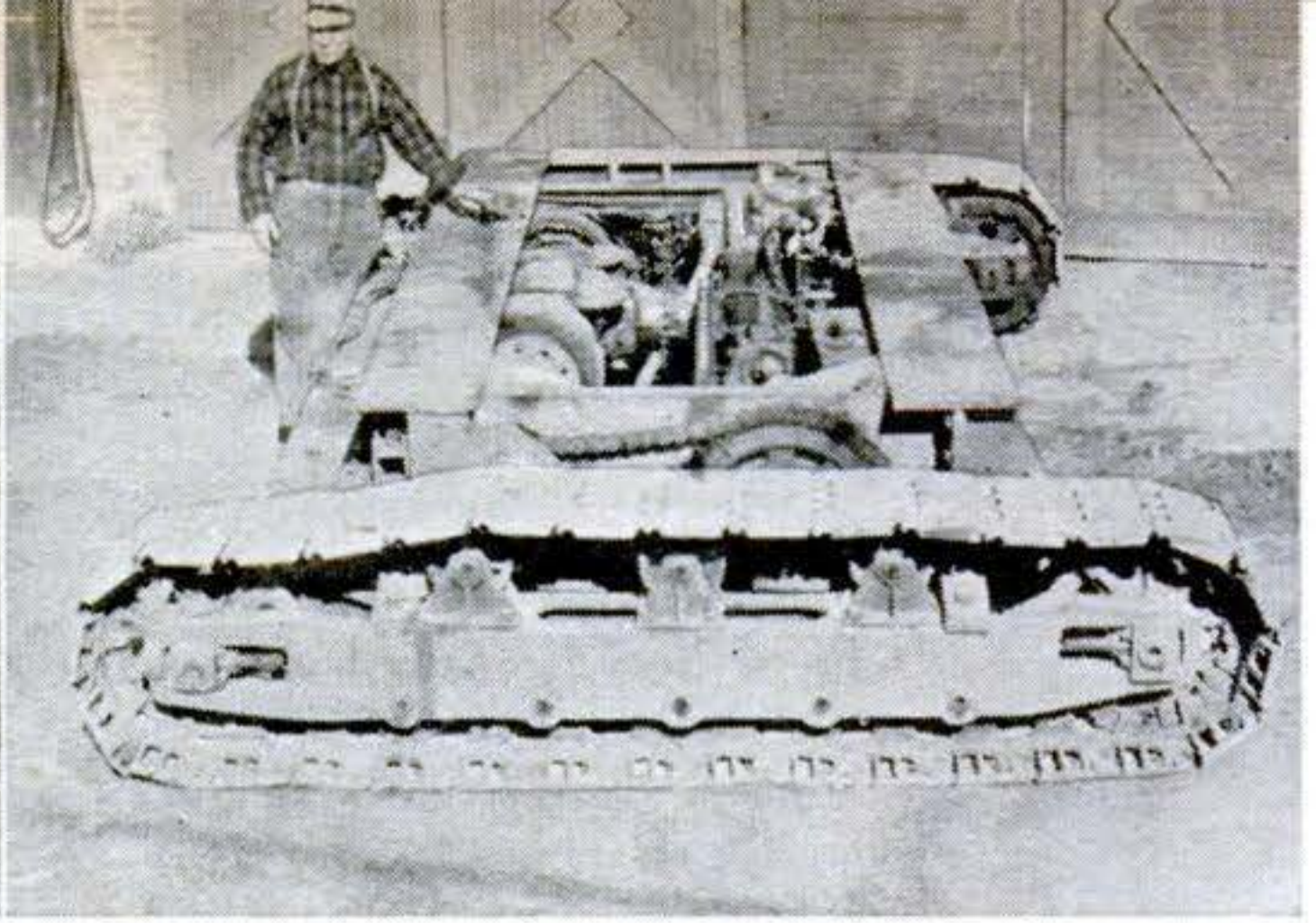

The 15-ton housemobile, pictured at right above, measures 11 feet long and 18 feet wide. Operated by remote control with compressed air hoses and valves, it has a body of steel beams and a 73-hp. marine engine. It runs on 20-inch treads made for a 50-ton crane. Cars furnished its radiator, transmission, and drive shaft. A plane's automatic pilot controls its clutch. At left above, it is moving a Lincoln Park, N. J., bungalow along a highway, where its speed minimizes interference with traffic, under the control of the operator walking alongside.

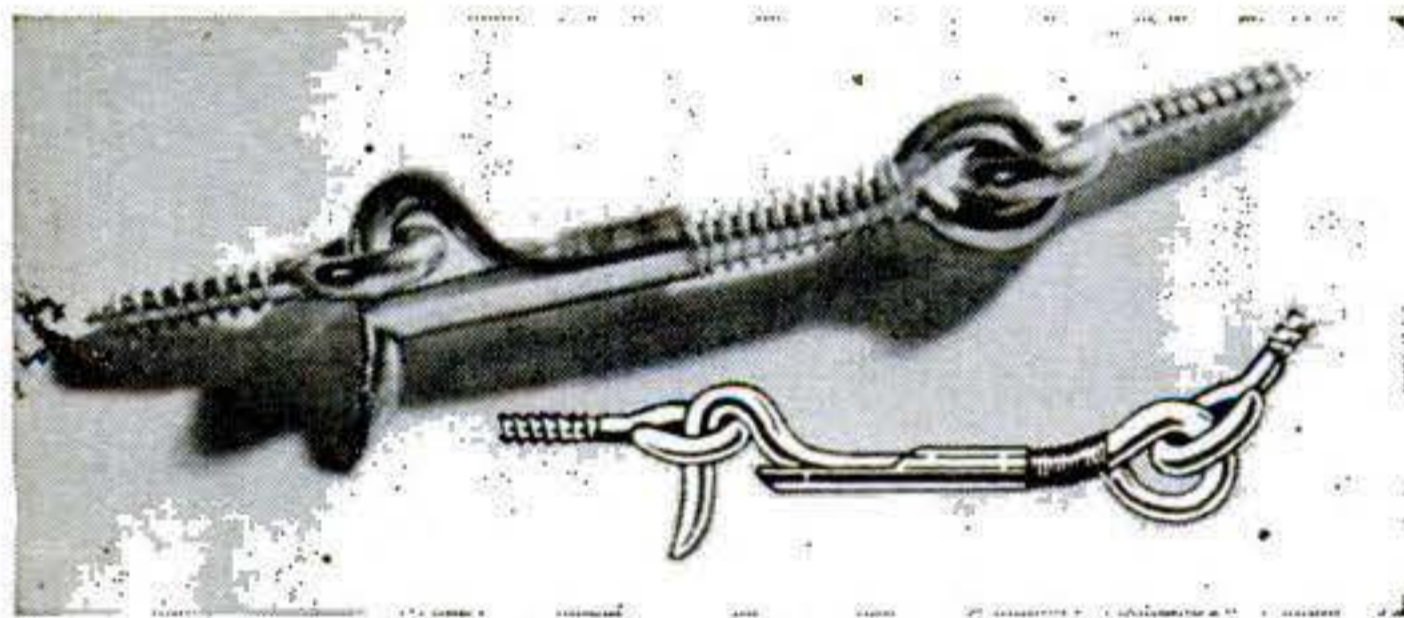

Safety Hook Has Lock

FASTEN a window screen with this Lawler safety hook, and a small child can't unhook it and fall out. It has a locking slide, drawn back against a spring (inset) to release it. Made in two sizes, it also locks stair gates and screen doors.

Ship's Anti-Roll Fins Turn Rough Water to Smooth

EXPECTED to prove a boon to passengers subject to seasickness, stabilizer fins of recent British invention have been fitted to the cross-Channel vessel *Invicta* to keep her on an even keel in heavy weather. Projecting from the hull's sides as at left, below, the movable fins are automatically operated by

the control unit shown in the other view, which works like a plane's gyro-pilot. When the ship starts to roll or pitch, spinning rotors of vertical and horizontal gyros maintain their original positions, and the relative motion of their frames actuates mechanism that tilts the fins just enough to right the vessel.

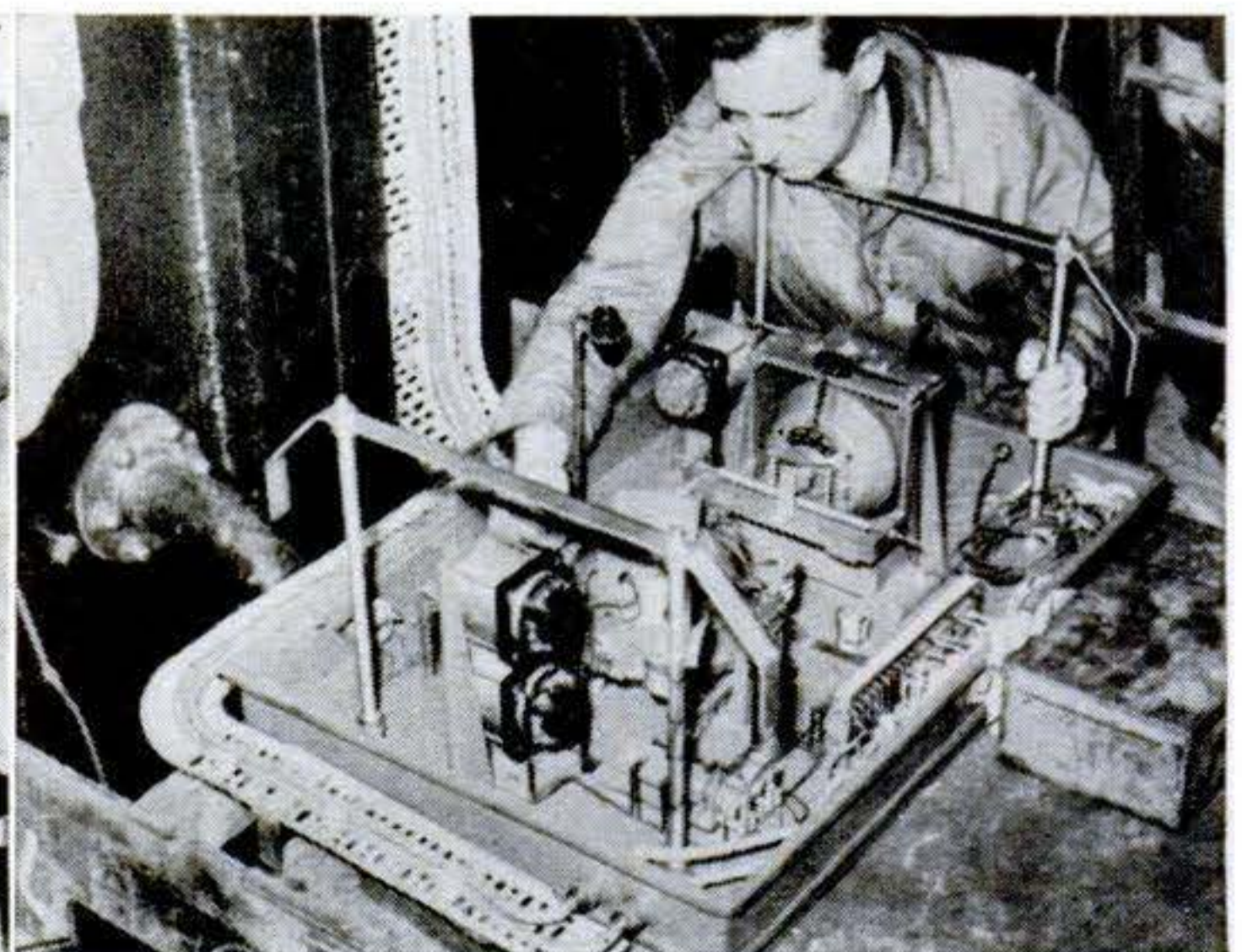

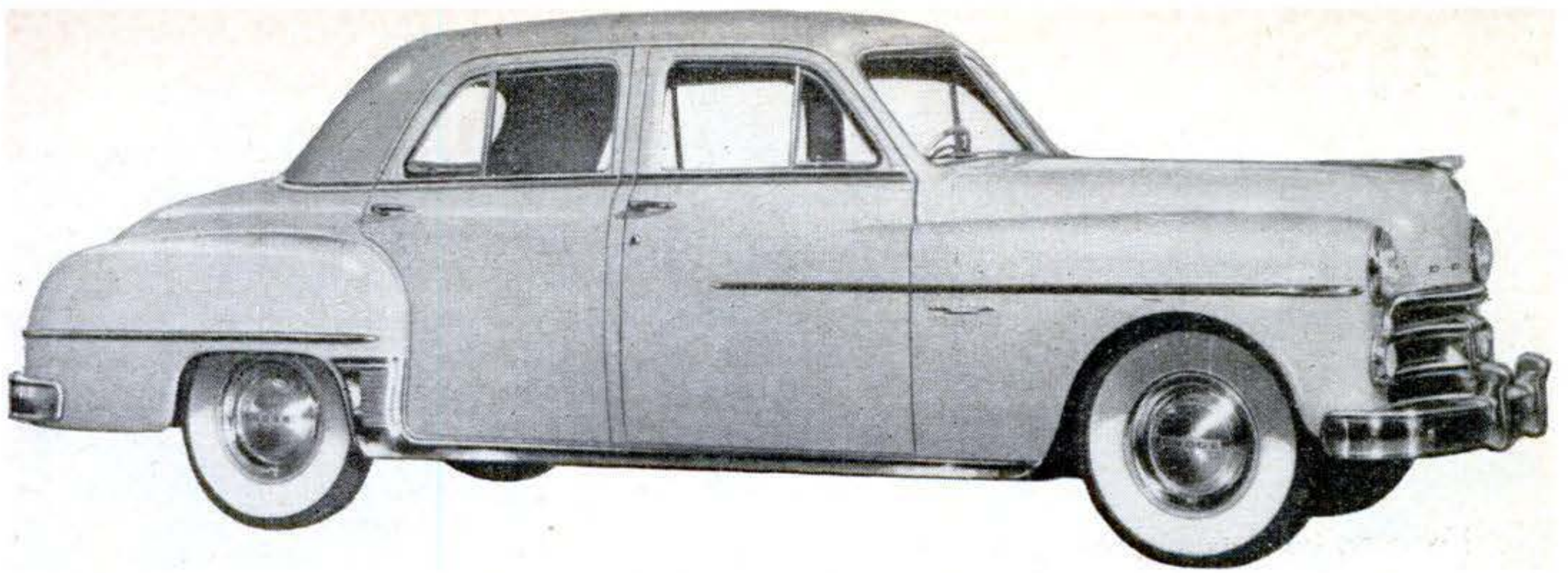

New Dodge Coronet has 123½-inch wheelbase. New cylinder processing cuts break-in time.

Chrysler Lines Get Restyling

NEW lines of De Soto, Plymouth, and Dodge cars, resembling their 1949 predecessors but restyled to give them a longer, lower appearance, were announced by the Chrysler Corp. at the turn of the year. Dodge offered its Gyro-Matic semi-automatic transmission at a cost described as lower than competitive automatic transmissions. Plymouth widened its front and rear treads, has a 97-hp. engine of 7-to-1 compression ratio, and sports huskier bumpers.

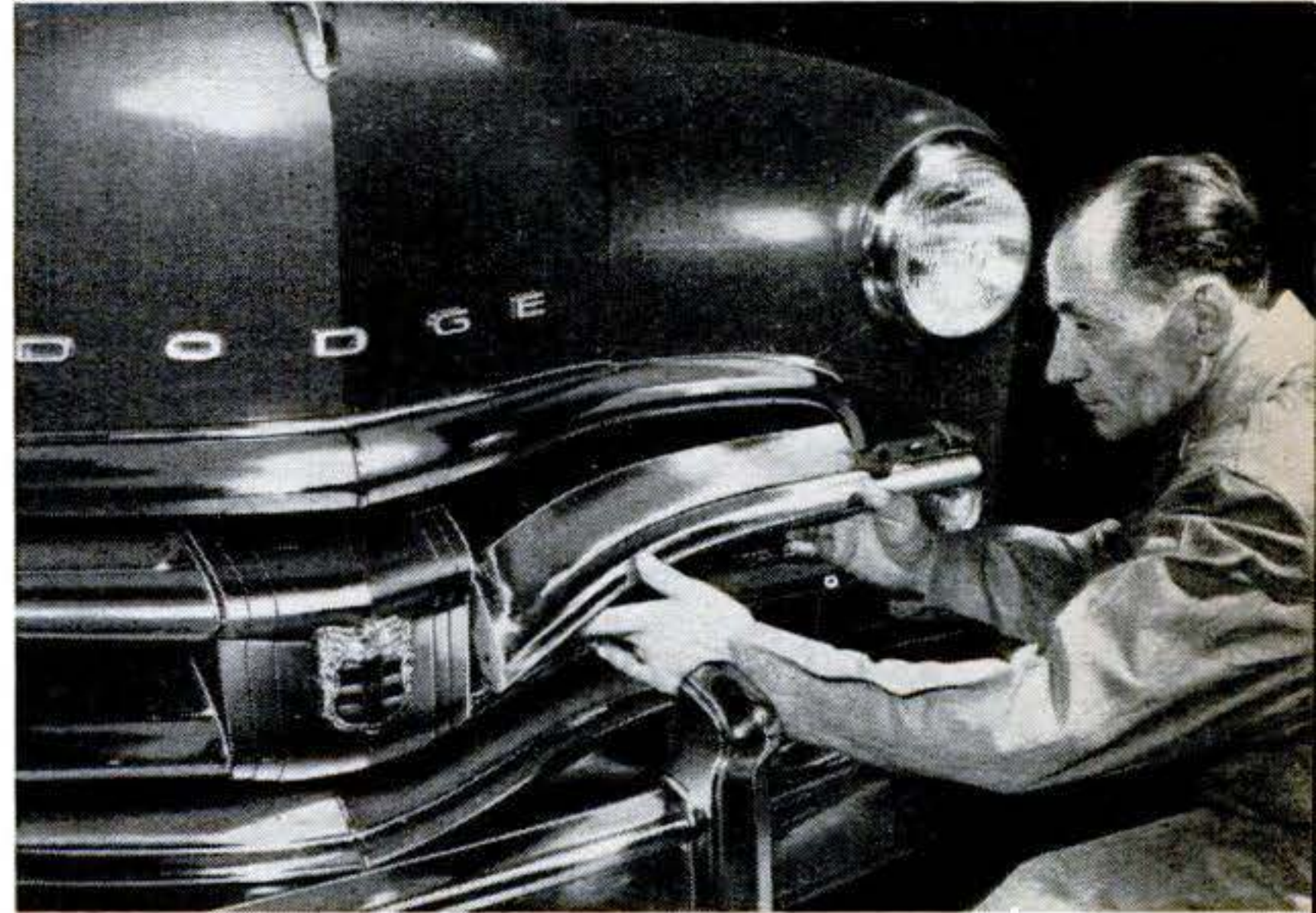

Dodge grille is replaceable in sections. Cowl, side panels are insulated with rubber, jute.

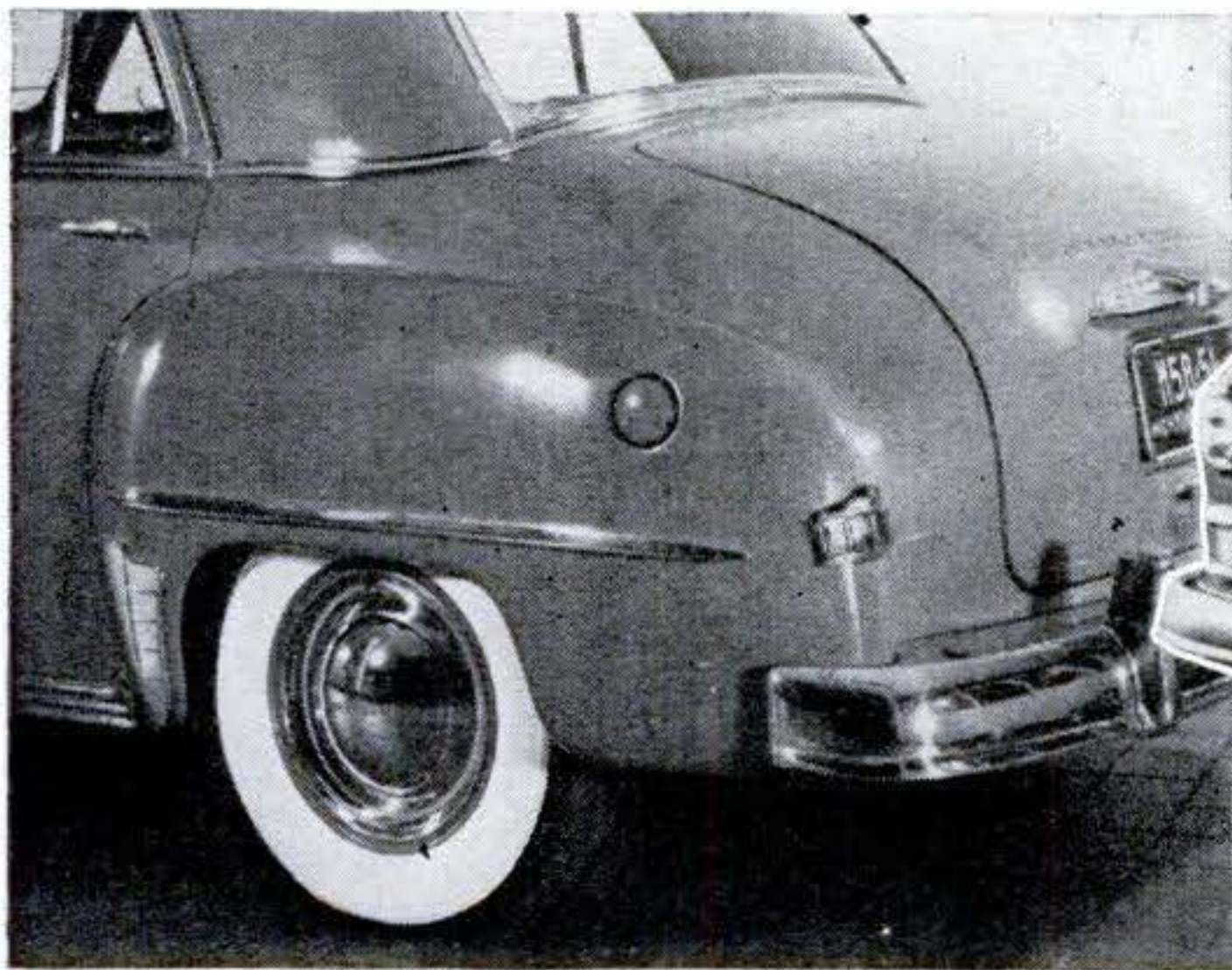

Rear fenders of 1950 Plymouth are longer, have peaked crowns. Below: the new De Soto.



Special DeLuxe Plymouth sedan is one of nine body styles. Rear window has new rubber seal.

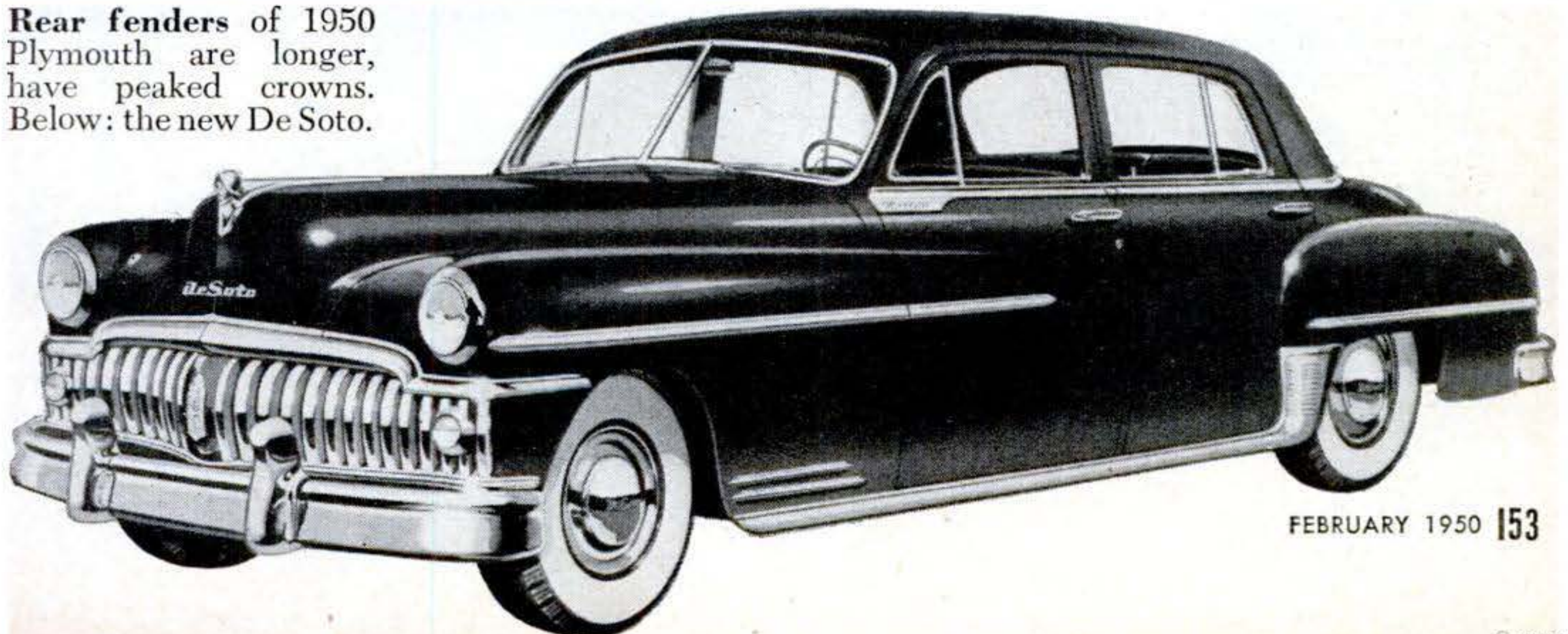



Fog-dispensing truck has 12 nozzles, six to a side under catwalks, that can produce either spray or straight streams. In addition, men on catwalks can fight fire with hand fog guns.

Fire Chief Builds Engine To Fight Brush Fires



Safety belt connected to sturdy rail on top of truck frees fireman's hands so he can use fog gun while truck moves rapidly through fire. Truck's 817-gal. tank can be filled from pond or stream.



Dozen 5-gallon cans equipped with hand pumps are carried on top. These are dispensed to firemen who are dropped off to fight fringe of fire as truck proceeds to fog out head of it.



Fog streams shown above protect crew and equipment if truck becomes encircled by fire—

an ever-present danger—eliminating the possibility that crew might be forced to abandon truck.

PS photos by W. W. Morris

BUILT on the chassis of a 2½-ton war-surplus Army truck, this homemade fire engine can crash right through dense brush and woods to fight runaway fires. High-pressure spray jets along the sides envelop

the truck in a cloud of waterfog to protect its men and equipment while it roars in to attack the head of a fire. A beefed-up, battering-ram bumper permits the six-wheel-drive truck to bowl over five-inch trees. The truck was built by ex-Fire Chief Louis Maas for the Brentwood, N. Y., Fire Dept.



Where hydrant is available, hose coupling in bumper aperture takes standard 4-inch intake hose. Water can be discharged at 200-lb. pressure through one 1½-inch and one 2½-inch nozzles.



Truck's heavy bumper pushed down this 5-inch tree in demonstration. Truck's ten speeds forward and two in reverse let it traverse practically any terrain. Slowest speed is about 2 m.p.h.



With these quickly erected aluminum tanks, surplus grain was saved from weather damage.

Raising the Roof Builds Bins Fast

YOU start from the roof and work down in setting up these midget grain elevators. Made entirely of aluminum, they are assembled by fastening the roof sections to one "tier" of corrugated siding, lifting this unit and fastening another tier under it, and so on until the building is complete.

About 26,000 of the lightweight grain bins—these are at Enterprise, Iowa—were built last year to store surplus grain for the Government's Commodity Credit Corp. Butler Mfg. Co., Kansas City, and Beatrice Steel Tank Co., Beatrice, Neb., did the work.

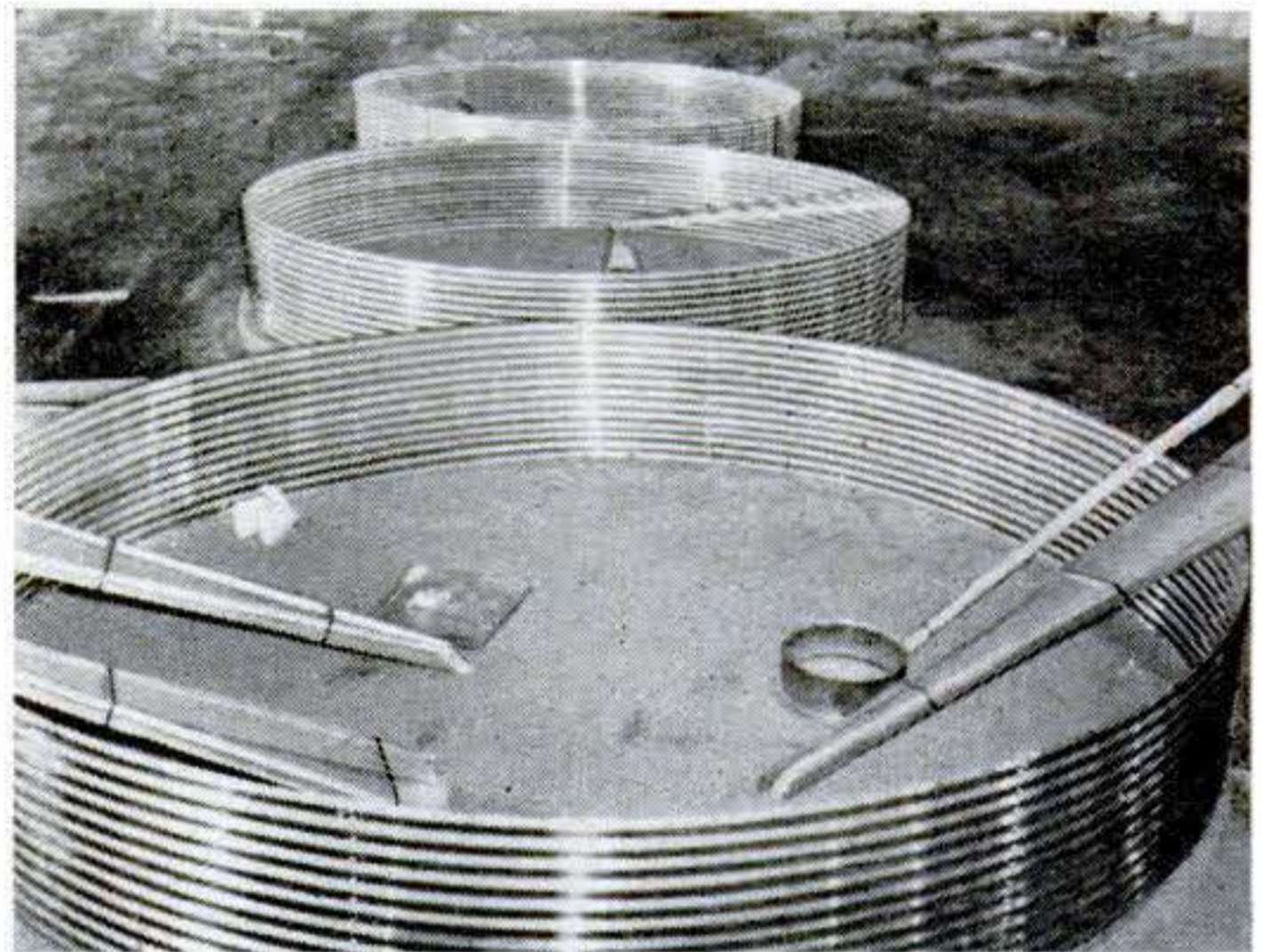

First step in construction is placing of one "tier" on concrete footing that will serve as foundation when last section is in place. Completed, each bin holds 3,250 bushels of grain.



Workmen can put on the roof while standing on the ground. Roof is made up of pie-shaped aluminum wedges that dovetail together. Lightness of aluminum permits this unusual method.

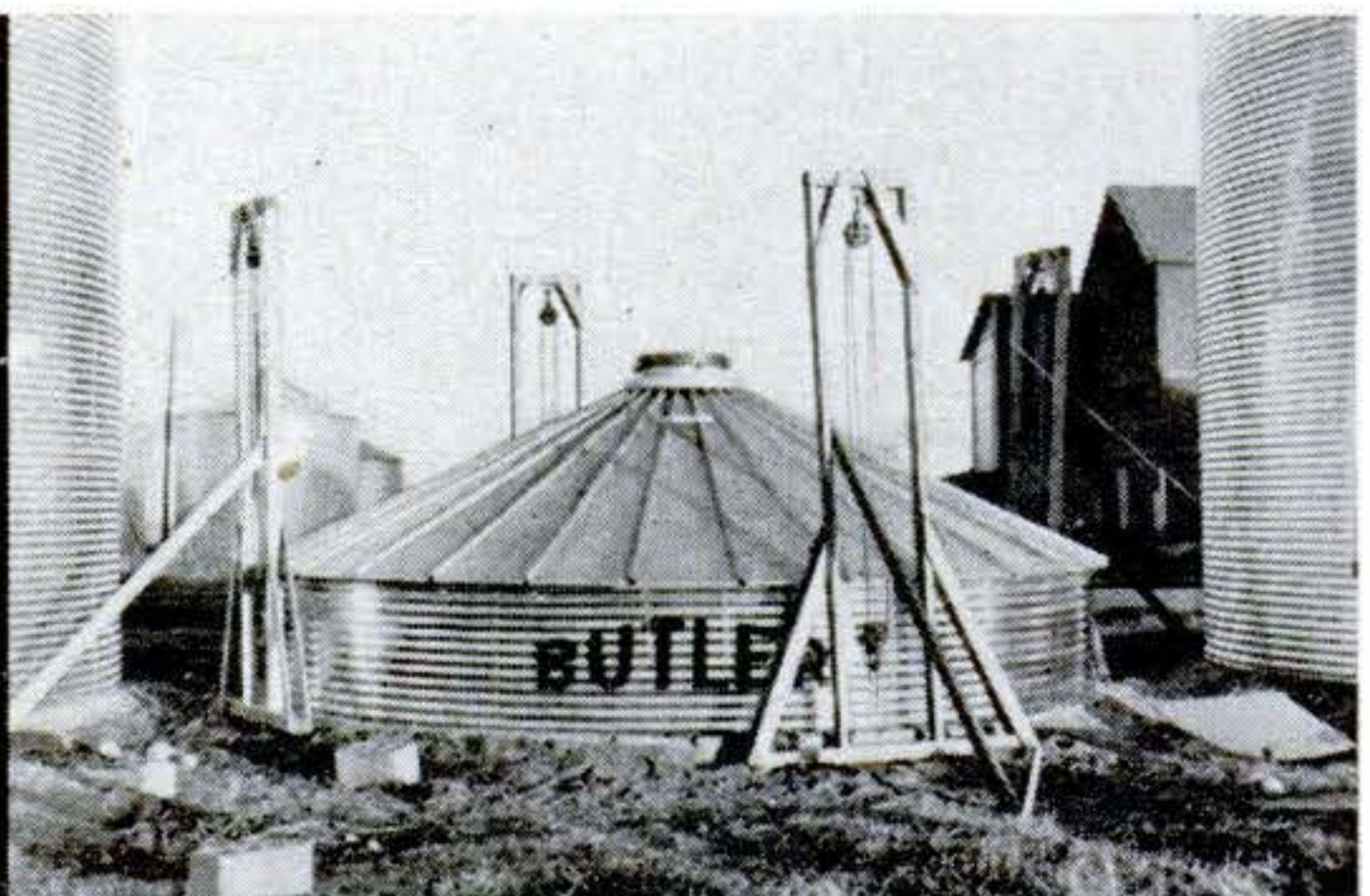

Now block and tackle lift the tier and roof up into the air so that the second tier of siding can be fastened on. Building must be lifted by its bootstraps five times before it is finished.

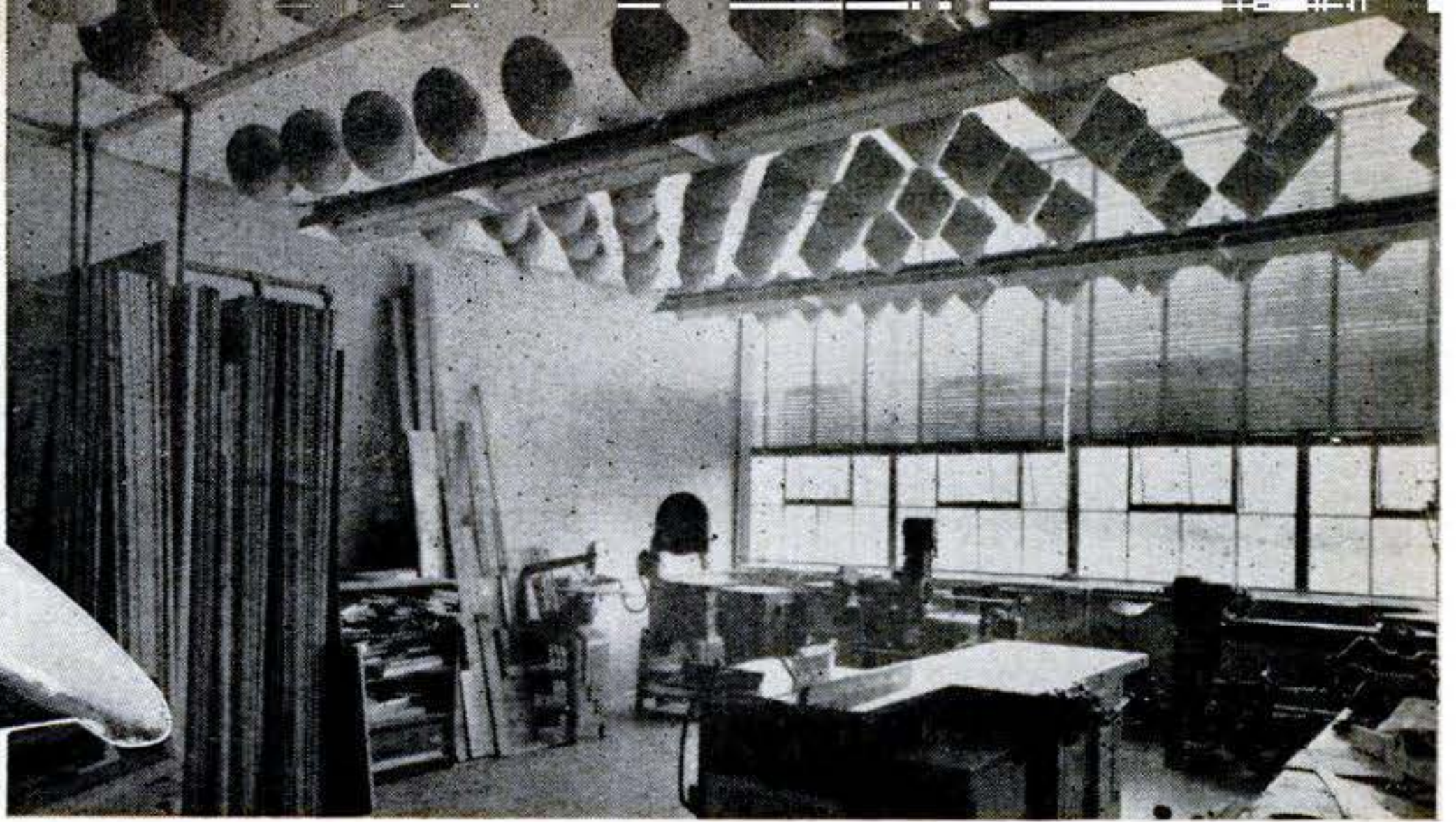
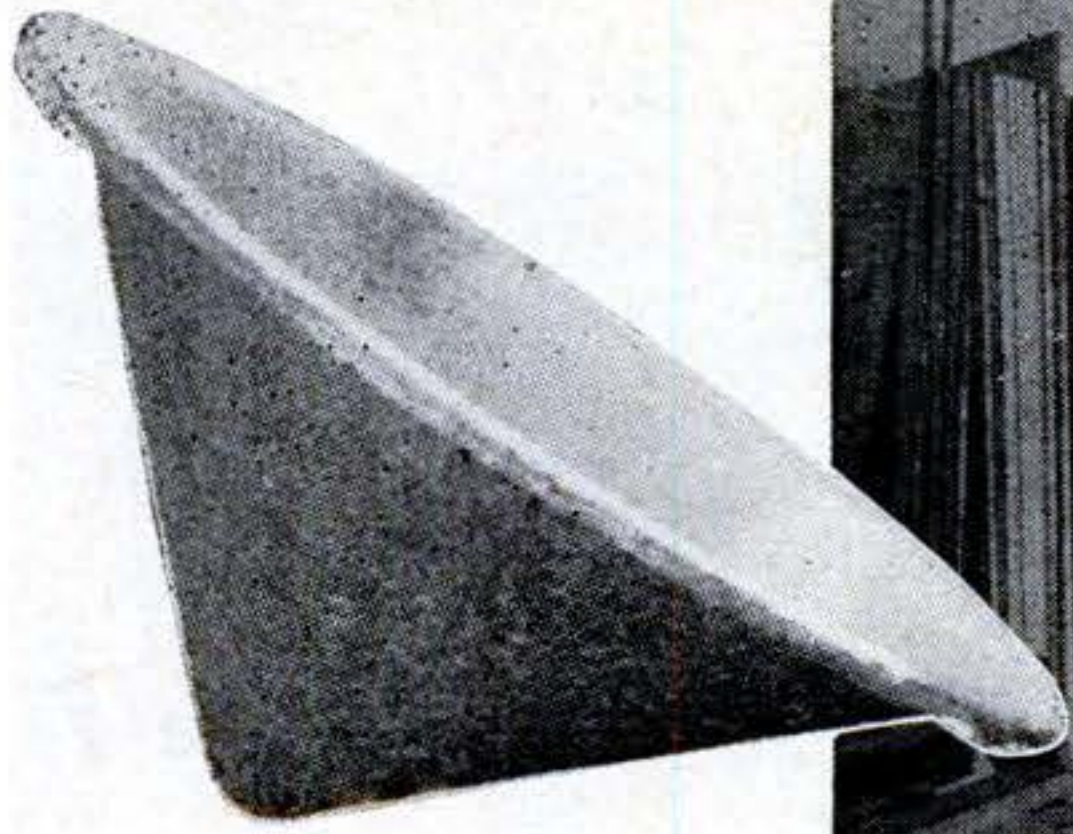

Cones of Silence Soak Up Noise

SOUND absorbers developed at the RCA Laboratories, Princeton, N. J. have proved twice as effective in reducing noise levels as conventional acoustical materials. The photo at right above shows their installation in a woodworking workshop, where noise was reduced by 60 percent. The units, called

“cones of silence,” operate by forcing sound to travel through extremely narrow passages on the fuzzy surface of the cones, converting acoustic energy—noise—into heat energy. Consisting of two 14-inch cones (inset) clamped together, the wood-pulp units are suspended from wires. They can be used where pipes, skylights, crane rails, or lamps prevent conventional sound insulation.



Double Rake Nips Up Trash

THIS double-armed rake is intended to lessen back aches from stooping to pick up trash or leaves. Made of enameled steel, the tonglike device weighs only four pounds yet is strong enough to pick up stones as well as rubbish. The Grab-Rake® is made by L. M. Bussey, of Los Angeles.

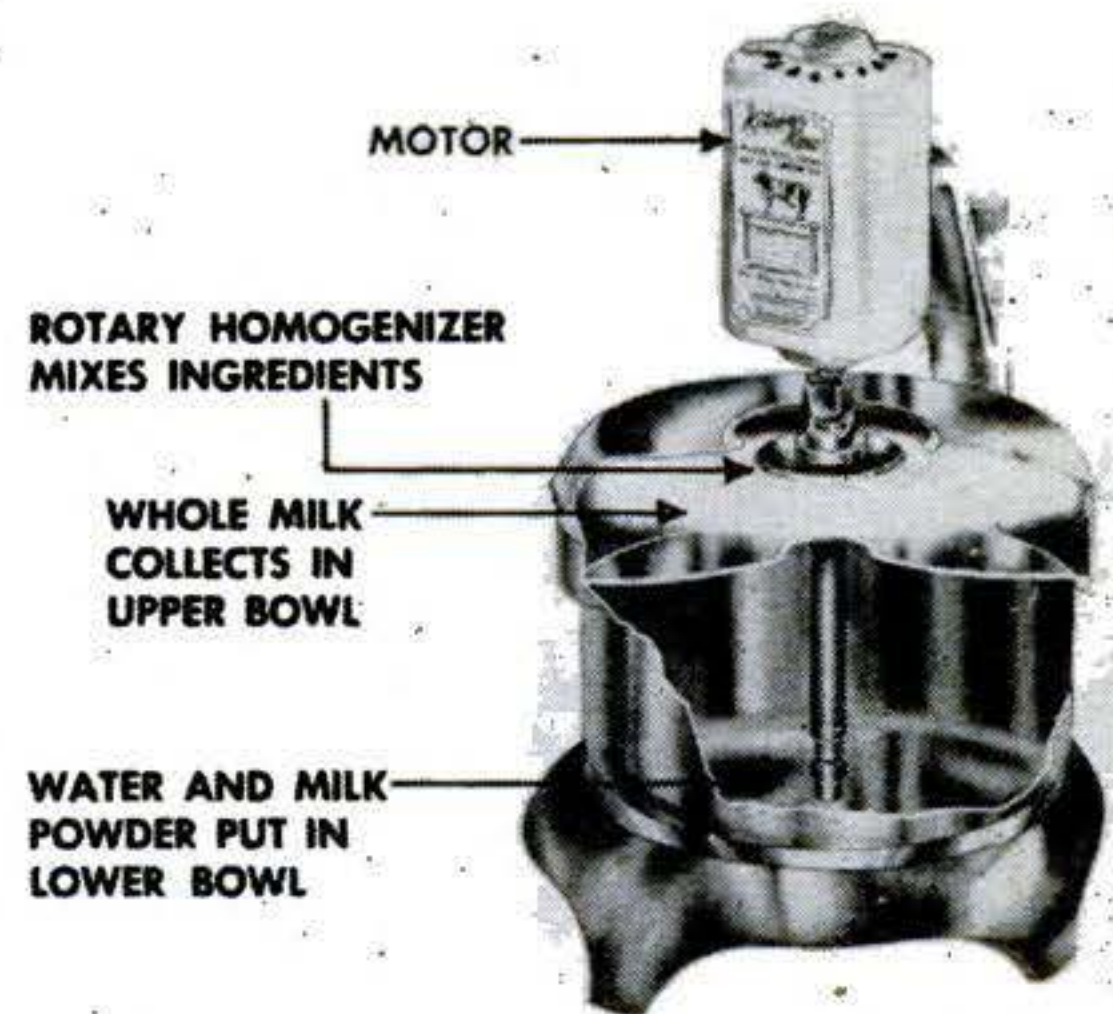

Mechanical Cow Remakes Milk

THE Kitchen Kow®, above, recombines whole-milk powder and water into a beverage closely resembling natural fresh milk. Designed for home use, the small unit rehydrates, aerates, and homogenizes a quart in seven minutes. It uses less current than a 40-watt bulb. The device is made by the Star Metal Mfg. Co., of Philadelphia, Pa.

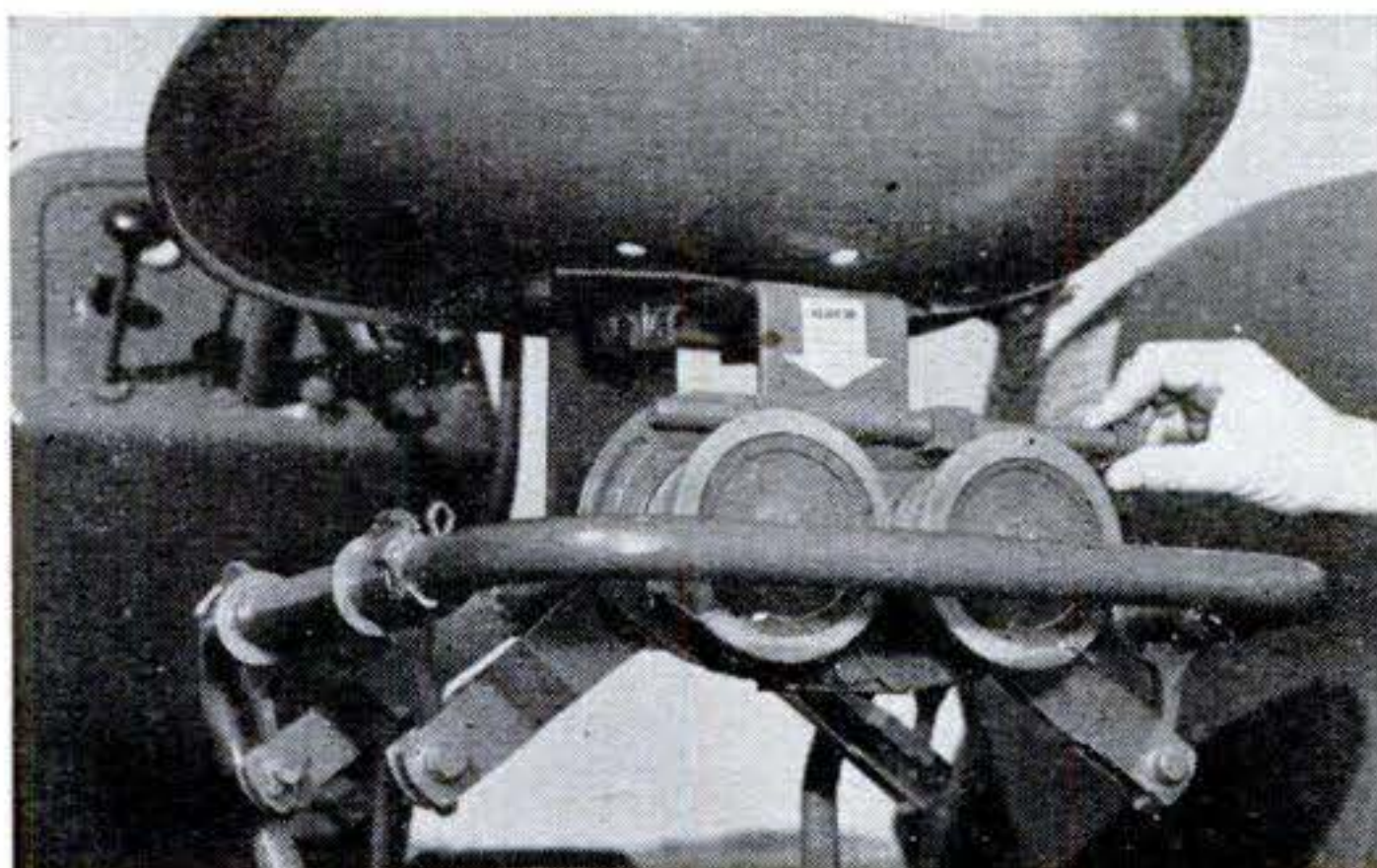

Rubber Springs Soften Bumps

CYLINDRICAL rubber springs mounted as shown at left under a tractor seat are said to lessen driver fatigue and reduce rebound on jounces. Developed by the U. S. Rubber Co., the springs operate on a torsional-shear principle, twisting and turning with bumps. They can be adjusted to driver's weight.

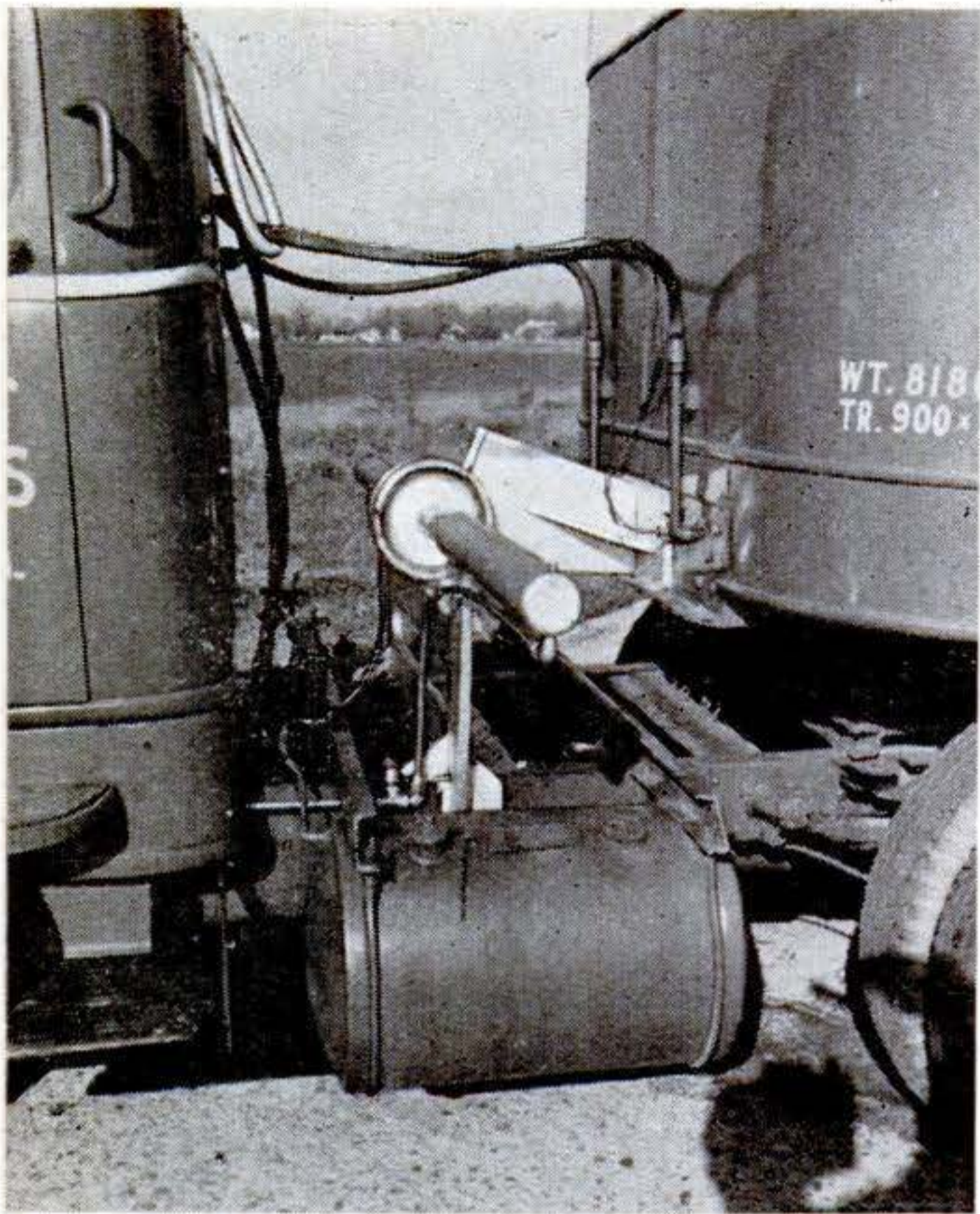

Side view shows tongue on trailer front inserted between two circular plates on tractor. Plates are on ends of plungers in two opposed cylinders. A dash control sets hydraulic pressure.



New Truck Hitch Ends Jackknifing

A NEW hydraulic hinge for the front end of a truck trailer goes a long way toward minimizing that trucker's nightmare—jackknifing. Jackknifing occurs when the brakes are applied too hard on the tractor. The trailer, trying to overrun the tractor, whips off sideways. The Wakeman Stabilizer® shown here works as a damper to permit turning without sudden lash. It also can be used to lock tractor and trailer rigidly together if jackknifing threatens. Maker is Automatic Safety Devices, of Holly, Mich.

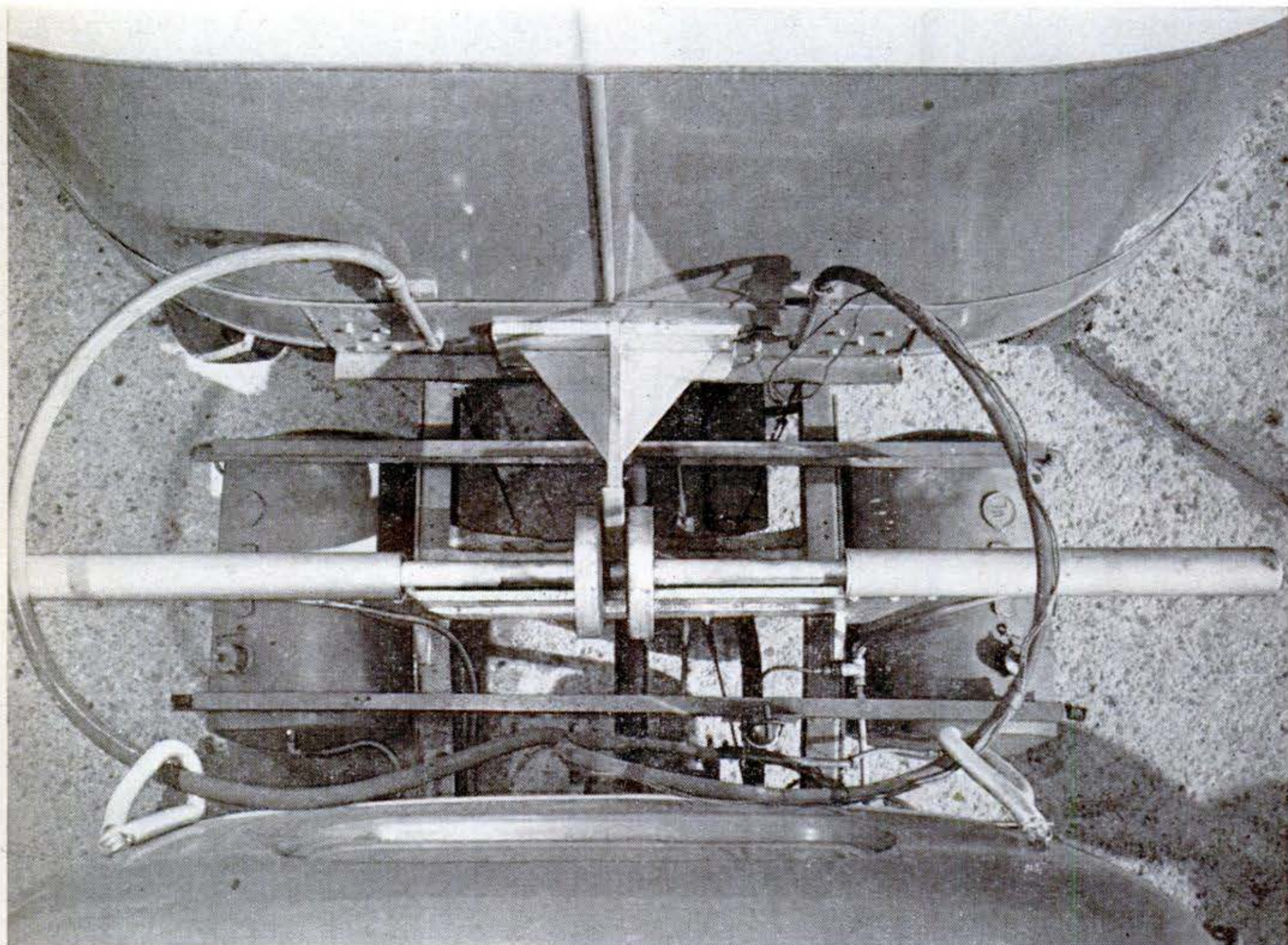

Top view shows how tongue presses against plate in a turn. Hydraulic fluid in cylinders opposes tendency of trailer to overswing on turn.

Driver can lock hydraulic system by floor switch if he feels jackknife start. Normally cylinders allow gradual movement but resist sudden swings.

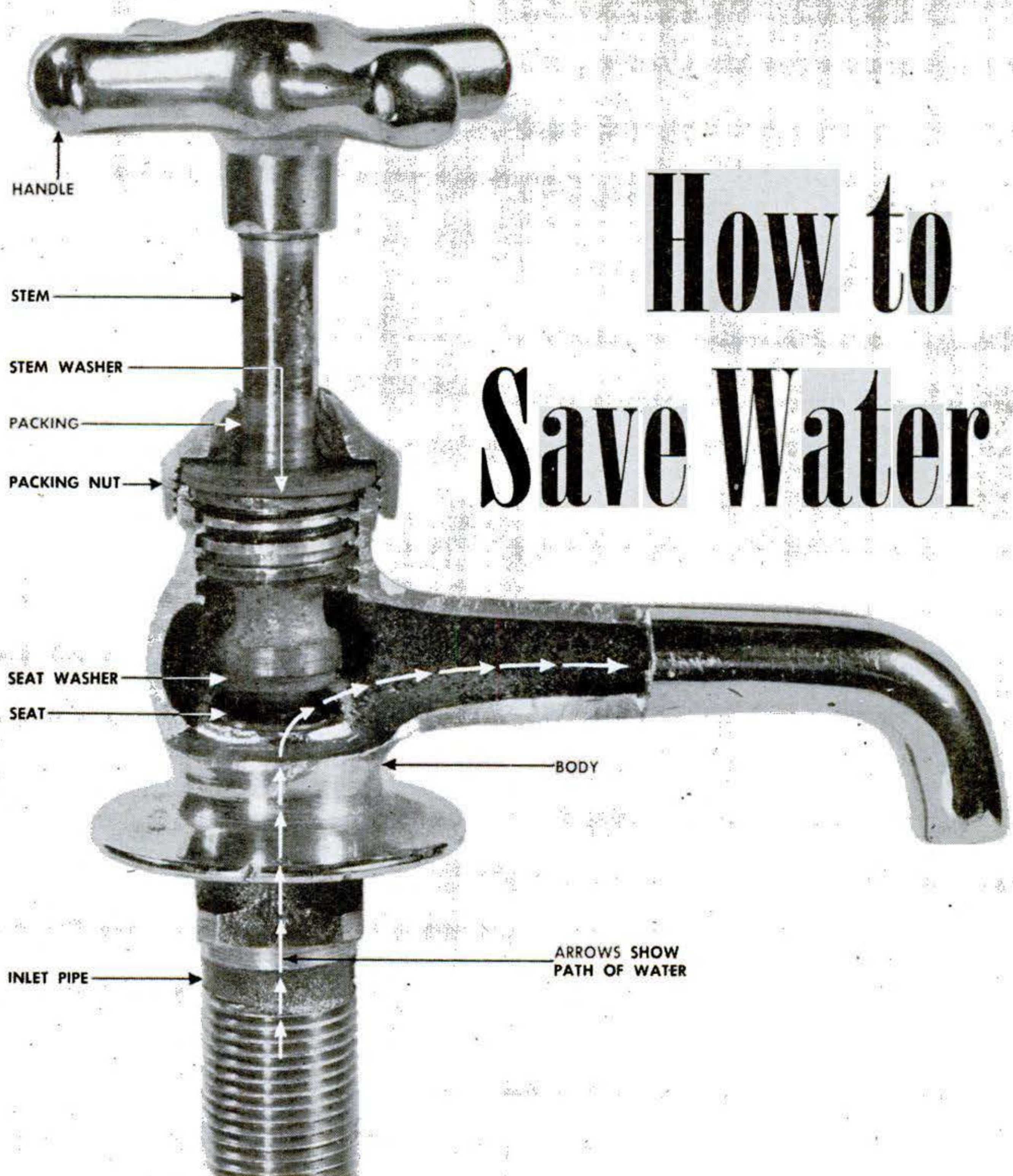

How to Save Water

A wrench, screwdriver, and reamer—those are all the weapons you need to fight water waste on the home front.

By Robert Hertzberg

DRIP, drip, *drip*. From leaking faucets in homes everywhere, millions of dollars of hard-earned tax money are daily going down the drain—literally. Even more important is the grim reality of dangerously low water supplies in many parts of the country as a result of last year's drought.

Water waste can be stopped, very easily,

if every home owner will devote an hour some evening after supper to the various plumbing fixtures in his kitchen and bathroom.

The wastage of water directly traceable to neglected sinks, bathtubs, showers, and toilets is staggering. In New York City, where the normal daily consumption is 1,200,000,000 gallons, the loss from wastage and faulty faucets has been estimated at about 200,000,000 gallons a day. That means a sixth of all the water the city consumes every day goes unused down the sewers!

But there's really not much to the job 

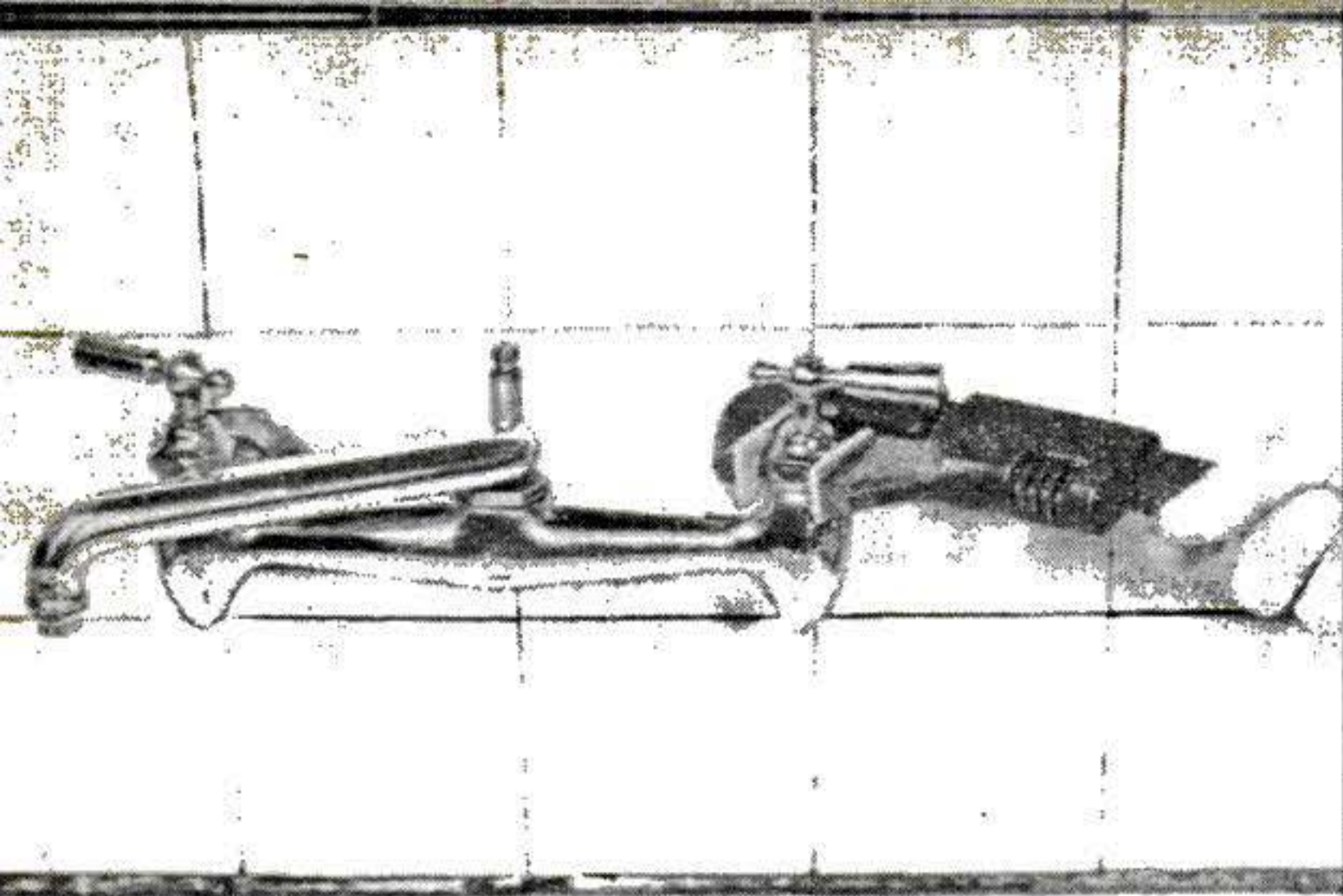

1 First step in repairing a leaky faucet is to remove packing nut with a monkey (not Stillson) wrench. Protect plated finish of the fixture with strips of wood or cardboard.

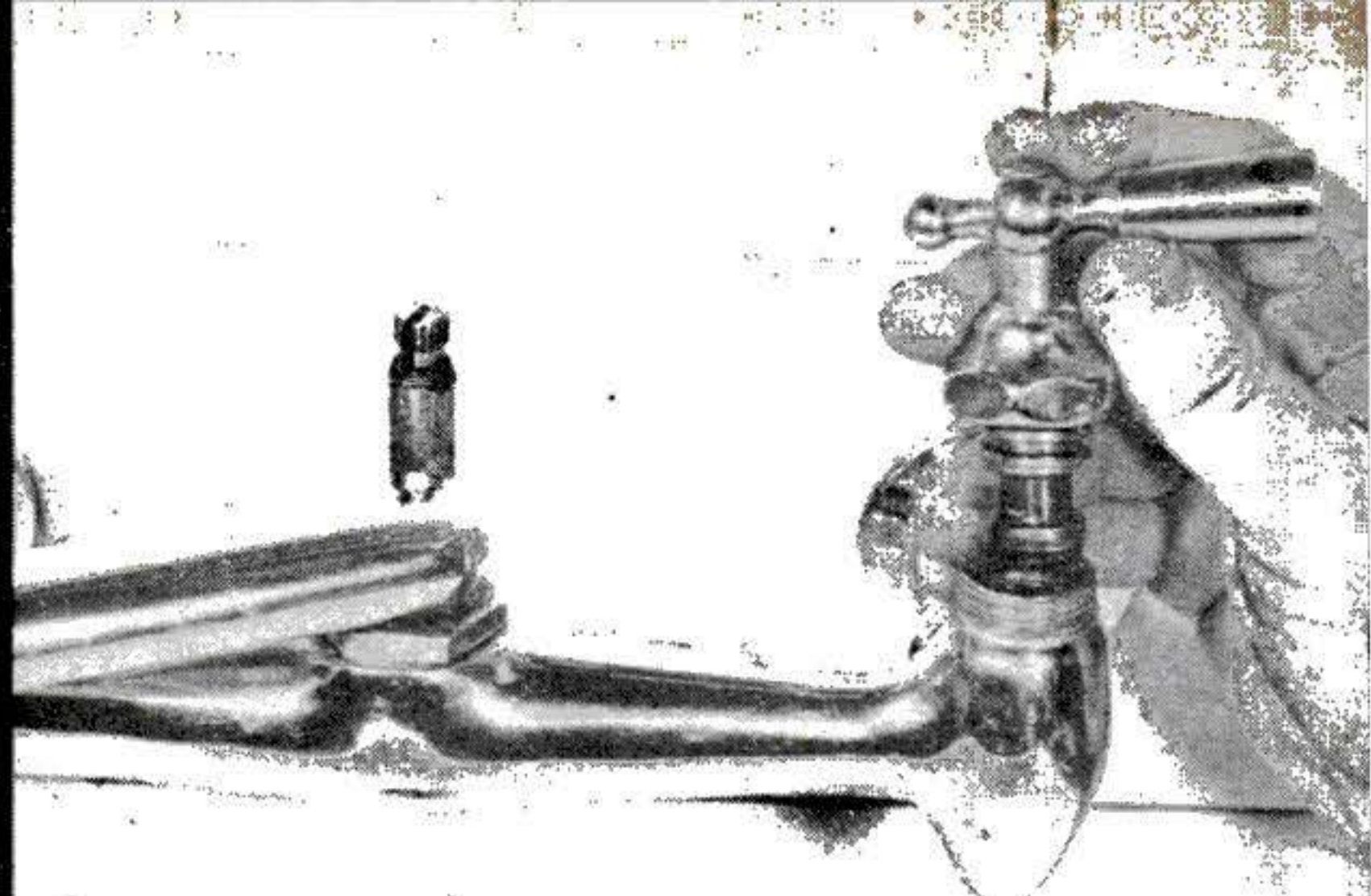

2 Remove packing nut and stem assembly by turning nut with fingers as it comes off the body. Let water from pipes drip out. Then examine seat inside the fixture for roughness.

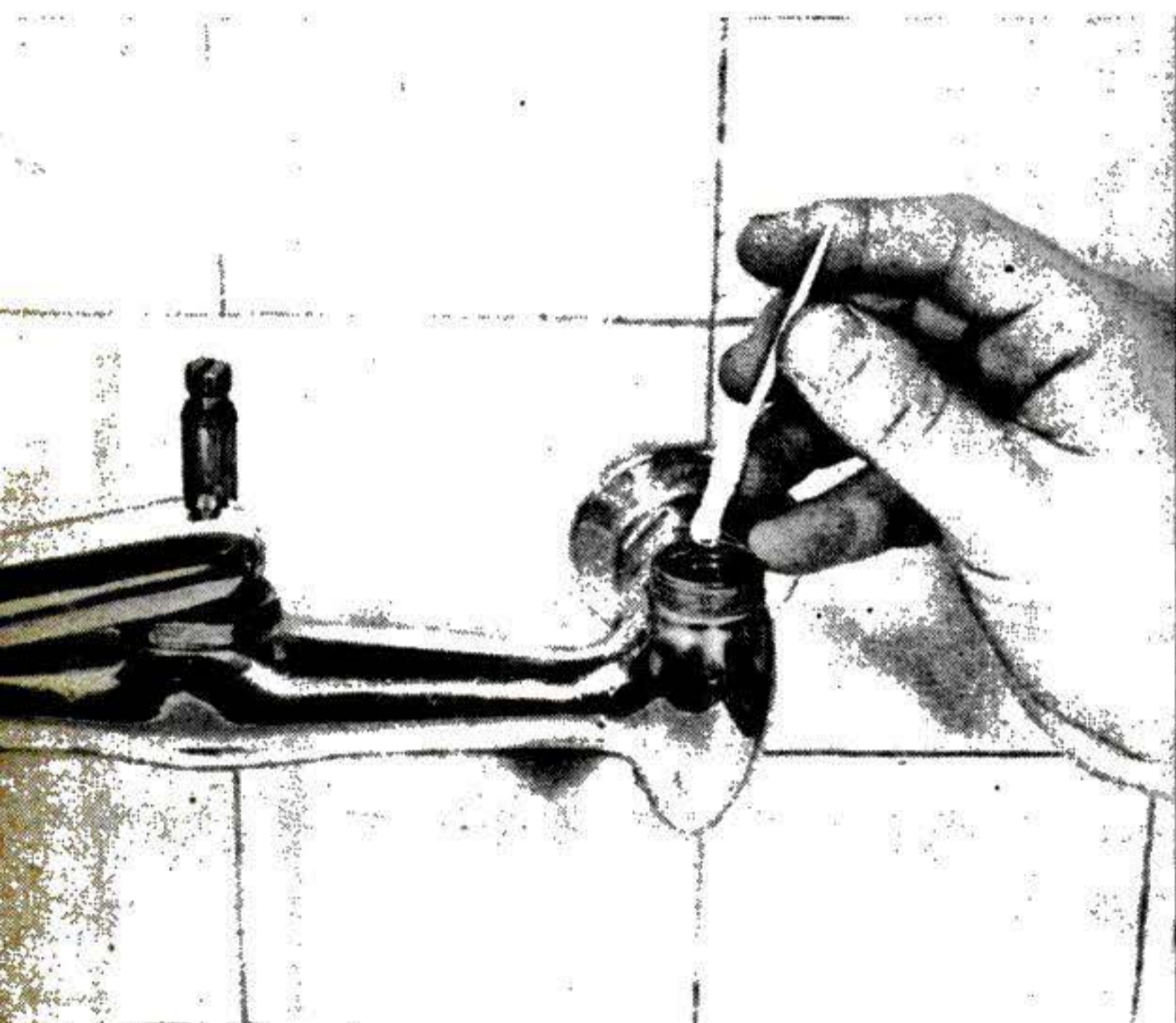

5 After removing seating tool, clean out cuttings inside faucet with cotton-tipped toothpick swab. Neglected brass shavings can shorten life of new washer and cause fresh leaks.

9 Here is the dripless faucet that will save some 30 gallons of water a day from going wasted down the drain. An added dividend: You will get a smoother and more even flow.

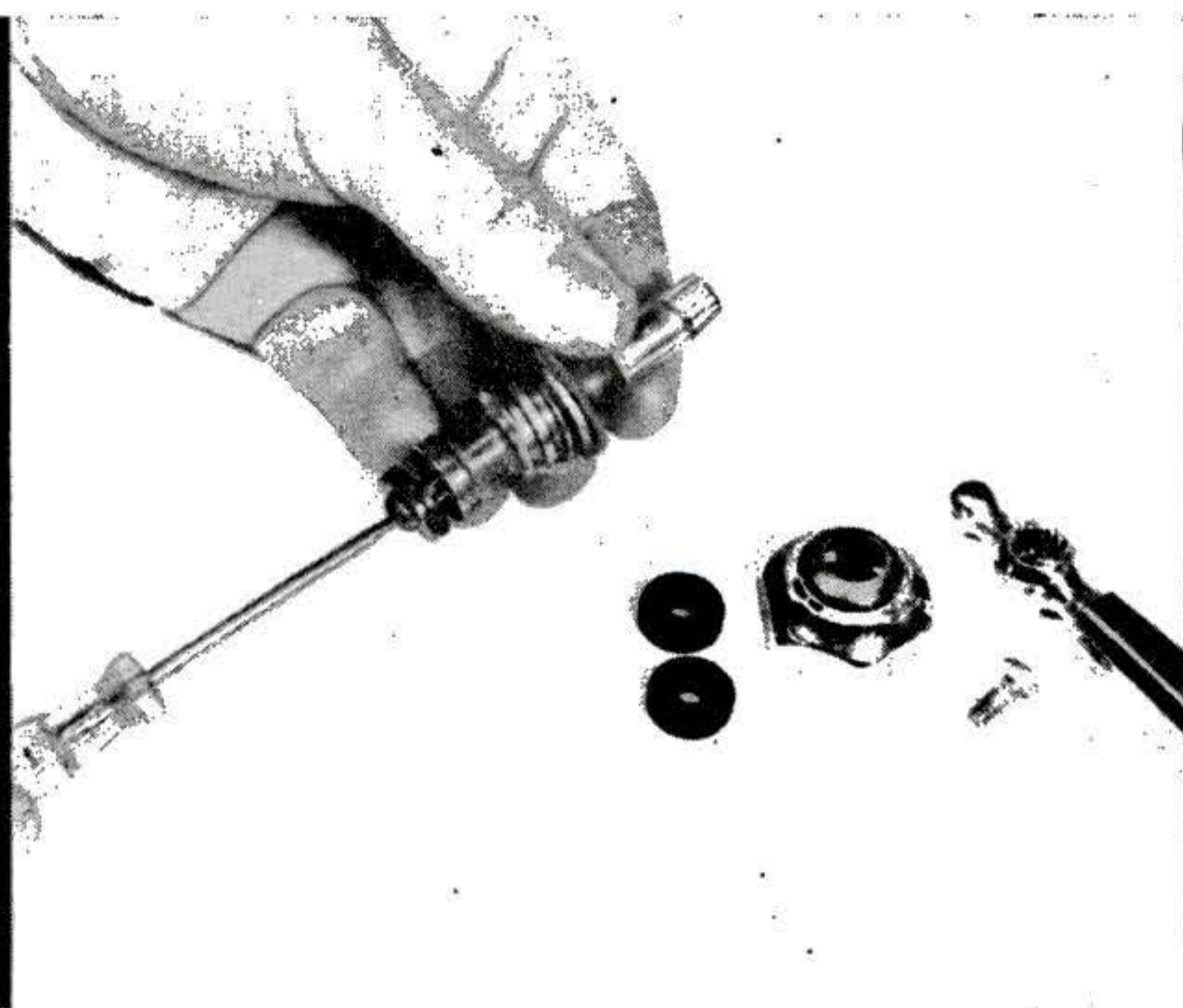

6 New washer must be of right diameter to fit recess in end of stem. Tighten screw just short of causing washer to become distorted. Loose washer can cause hammering noises.

of fixing faucets. In the way of tools you need only a screwdriver, a monkey wrench opening to about two inches, and a little 39-cent reaming gadget, called a valve-seating tool, for smoothing off the washer seats inside the fixtures. Another 25 cents will buy a handful of new washers of assorted sizes.

After shutting off the cut-off valve in the basement, open the basin taps in the bathroom and the taps in the kitchen to drain out the water in the pipes. This precaution will save you from a spurt of water in your face when you start disassembling the fau-

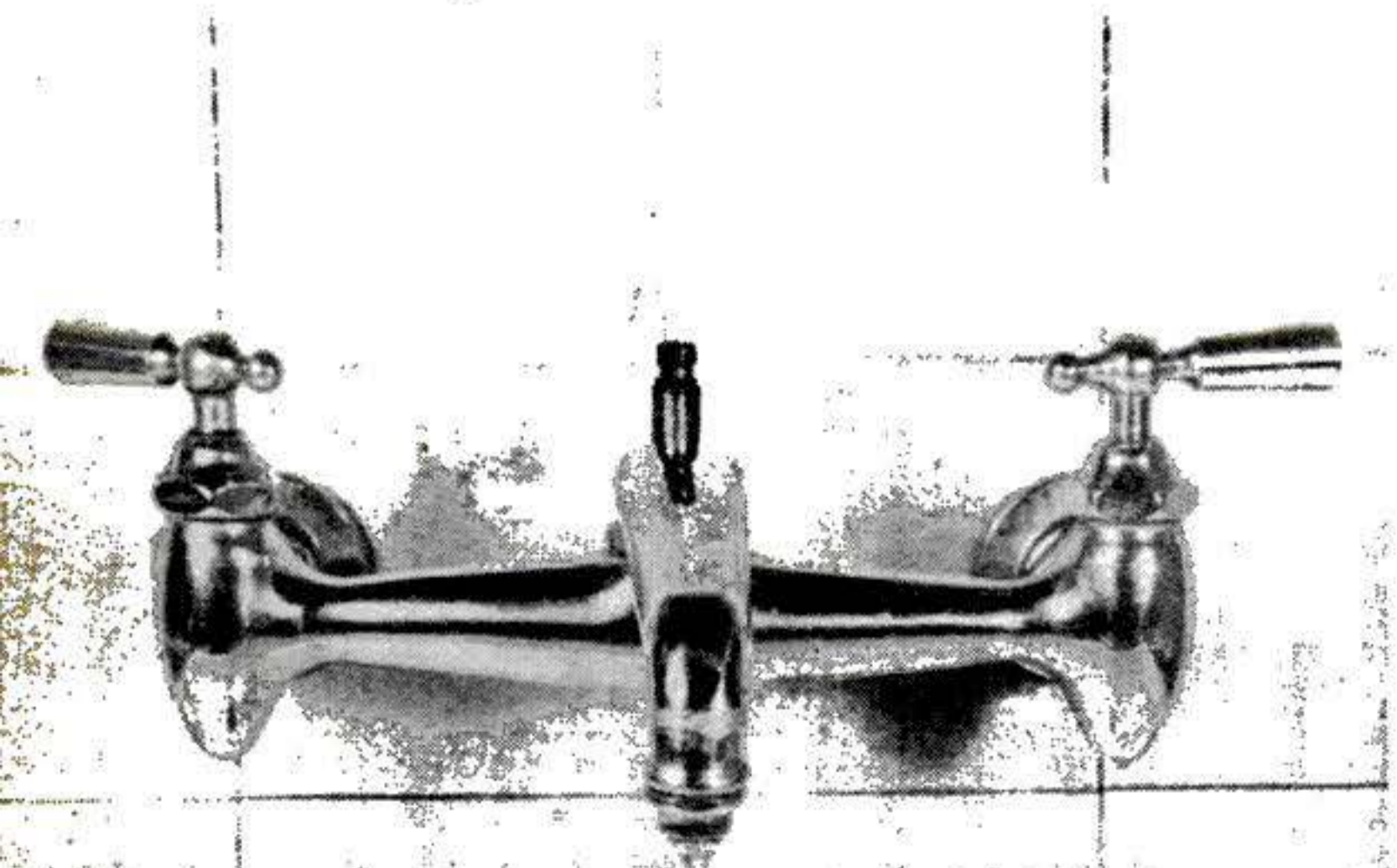

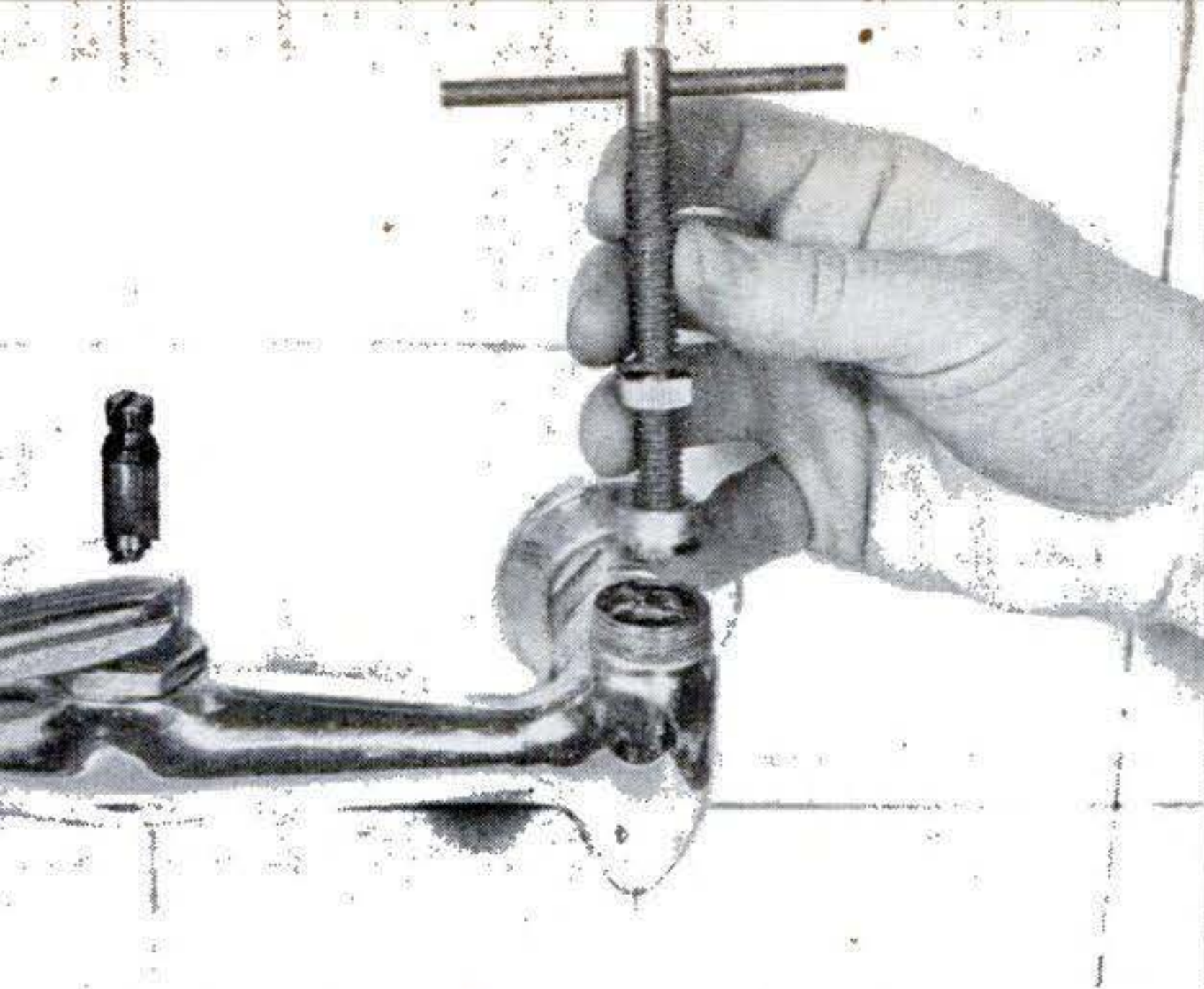

3 Valve-seating tool, with hardened cutter at lower end, fits in faucet in place of the regular stem assembly. It is sold in most hardware stores for less than half a dollar.

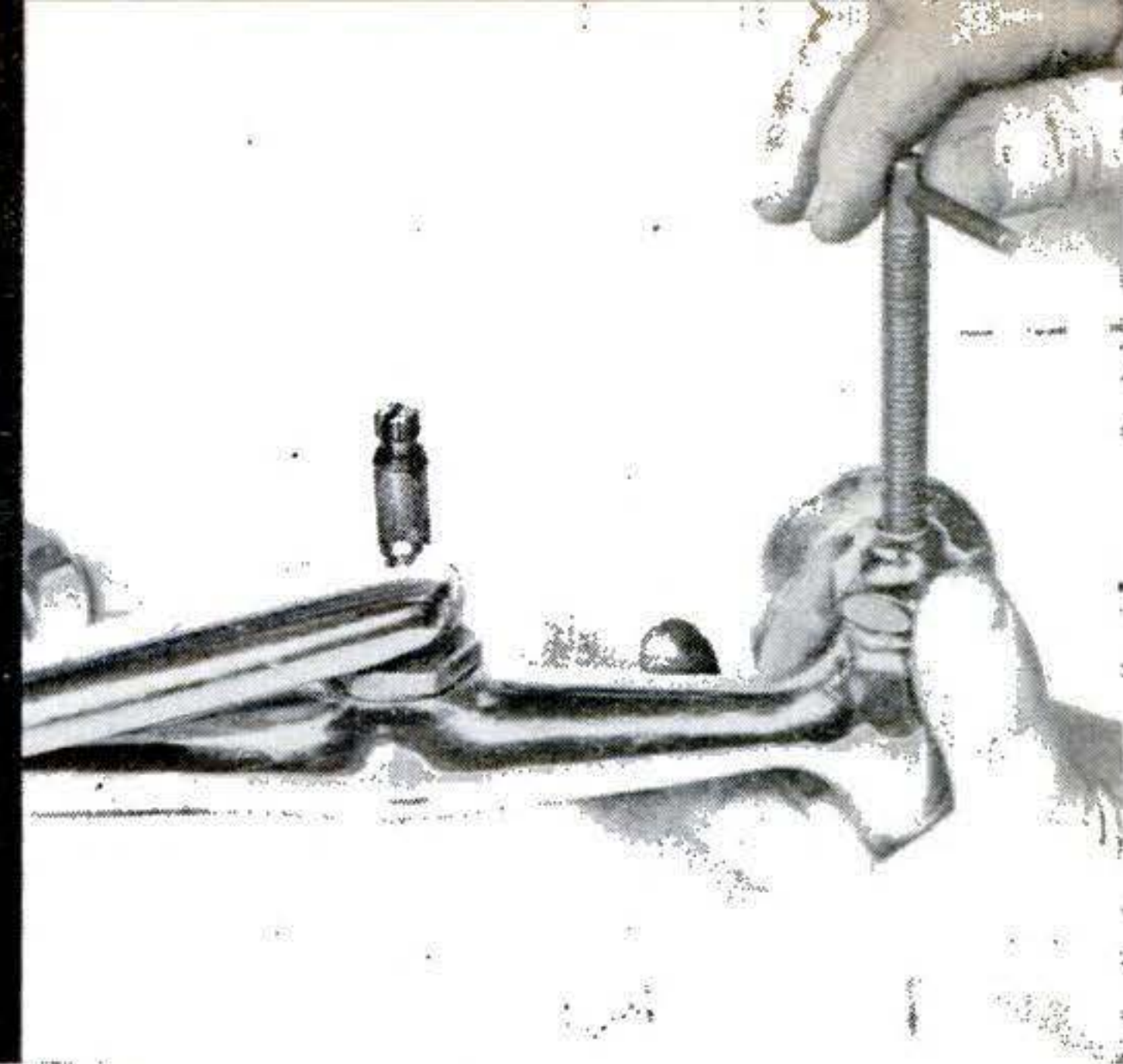

4 Valve-seating tool attached to faucet body with packing nut. Turn handle only two revolutions to loosen scale on the valve seat. Excessive turning may take off the whole seat.

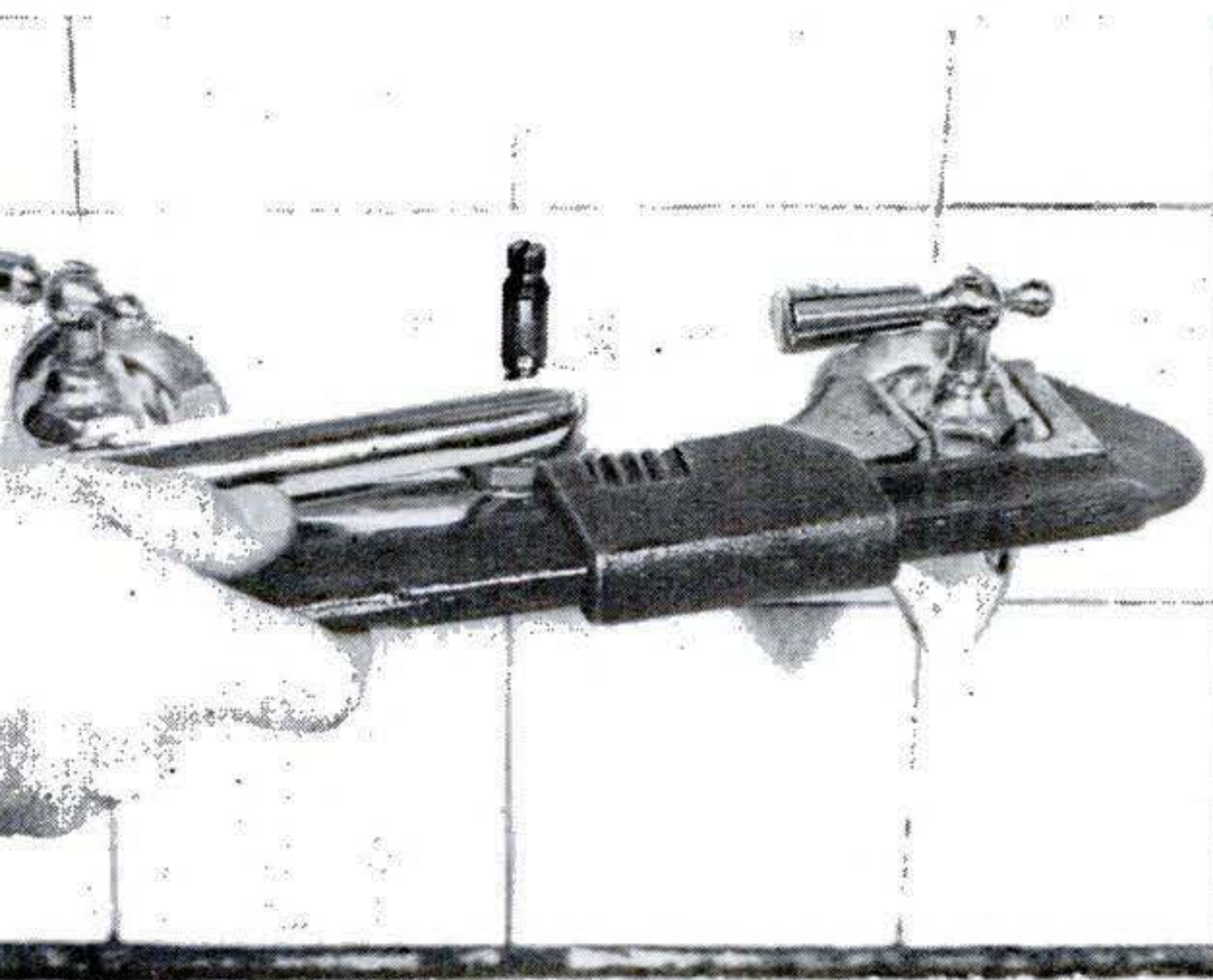

7 Reassemble faucet. Make sure packing nut turns easily before applying wrench. The fine threads are easily upset. Adhesive tape can be used instead of wood to protect plated finish.

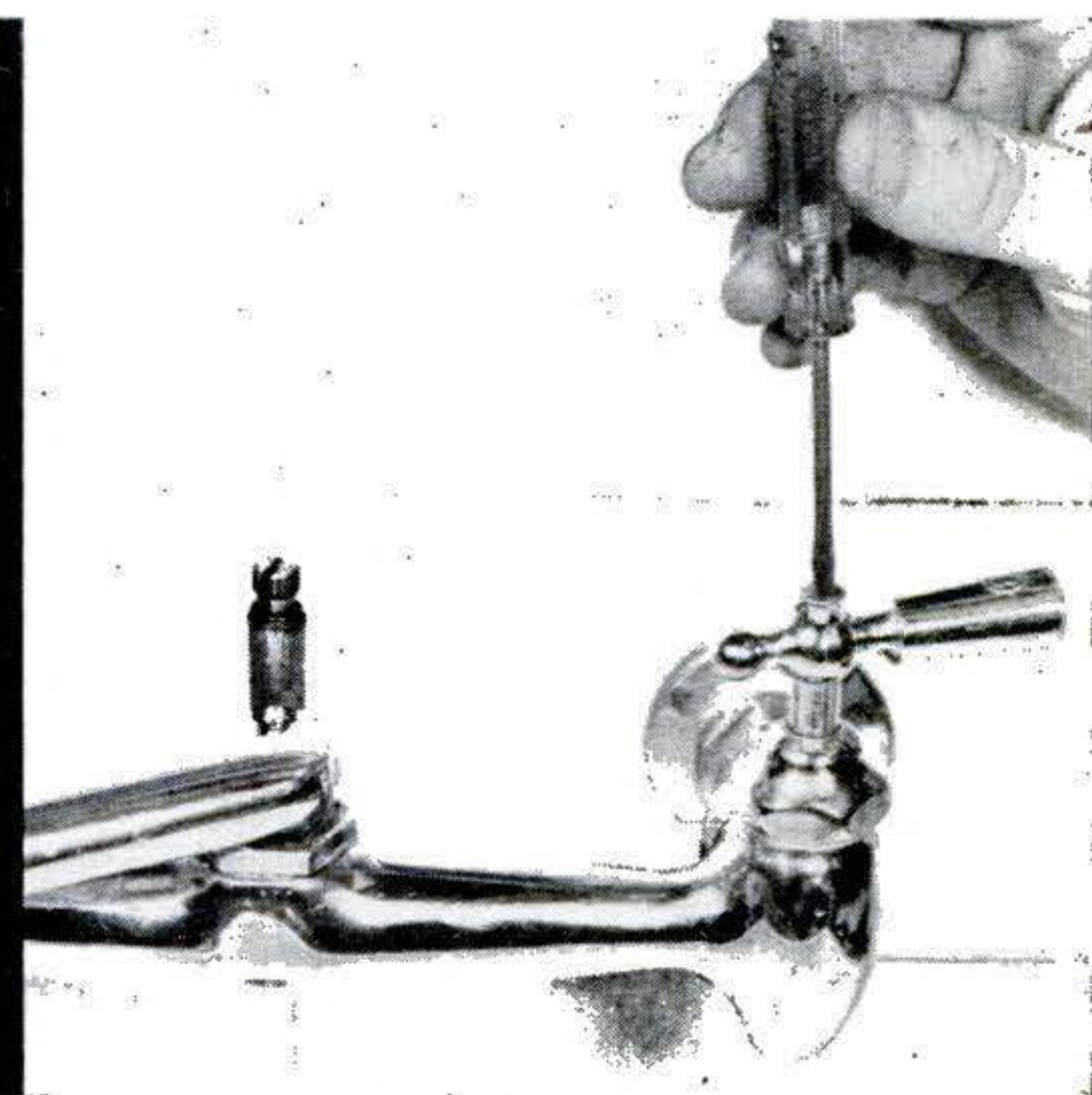

8 New washer will probably make handle of faucet assume different "off" position. Handle fits on splined end of stem and can be adjusted. Tightening of holding screw is last step.

cets in the kitchen or the basement laundry.

Most faucets used in homes are of the compression type. A typical one is shown in the cutaway photo on page 159. When the handle is turned down, a fiber or composition washer, about $\frac{1}{8}$ inch thick, is pressed against the circular seat in the body. If the seat is smooth and the washer flat and pliable, the two make a watertight joint, and there is a feeling of softness or "give" to the handle when the flow of water stops. Since the brass body is hard and the washer soft and soaked, the latter will gradually shred away as the faucet is turned on

The Fuller-type faucet, shown in drawing below, has a cone-shaped washer or ball fastened by a nut on the end of a short plunger rod. It can easily be replaced with a pair of pliers.

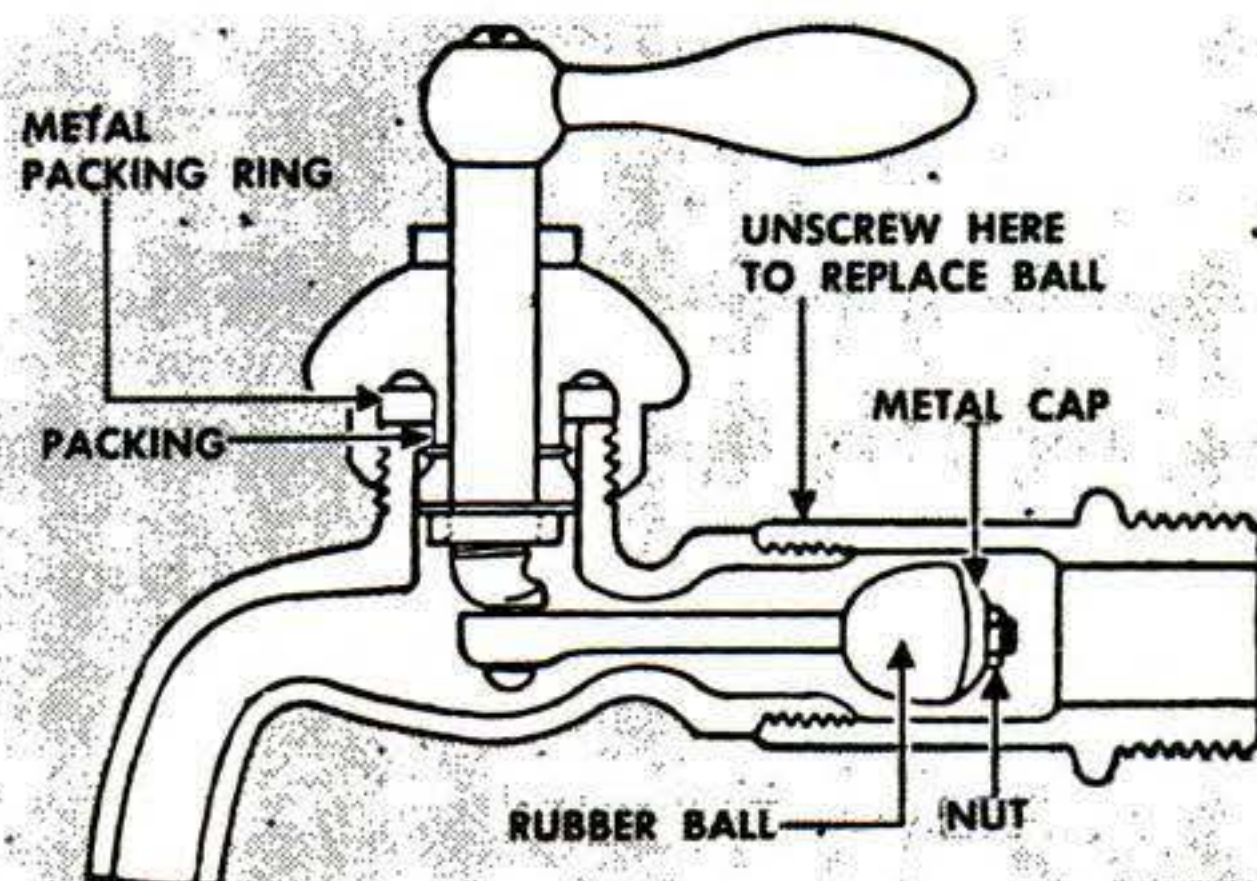

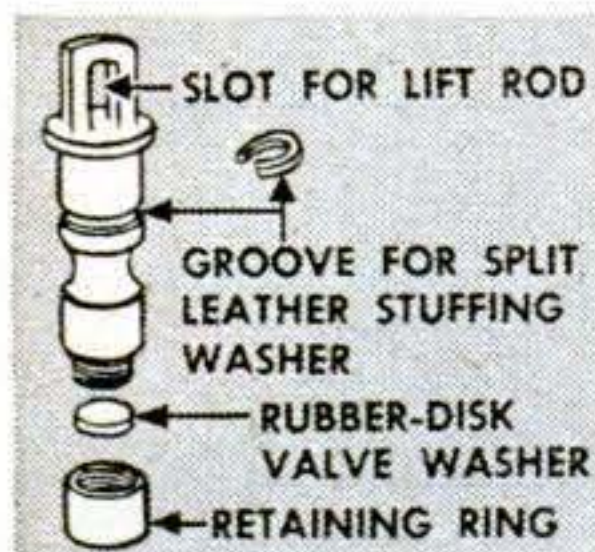
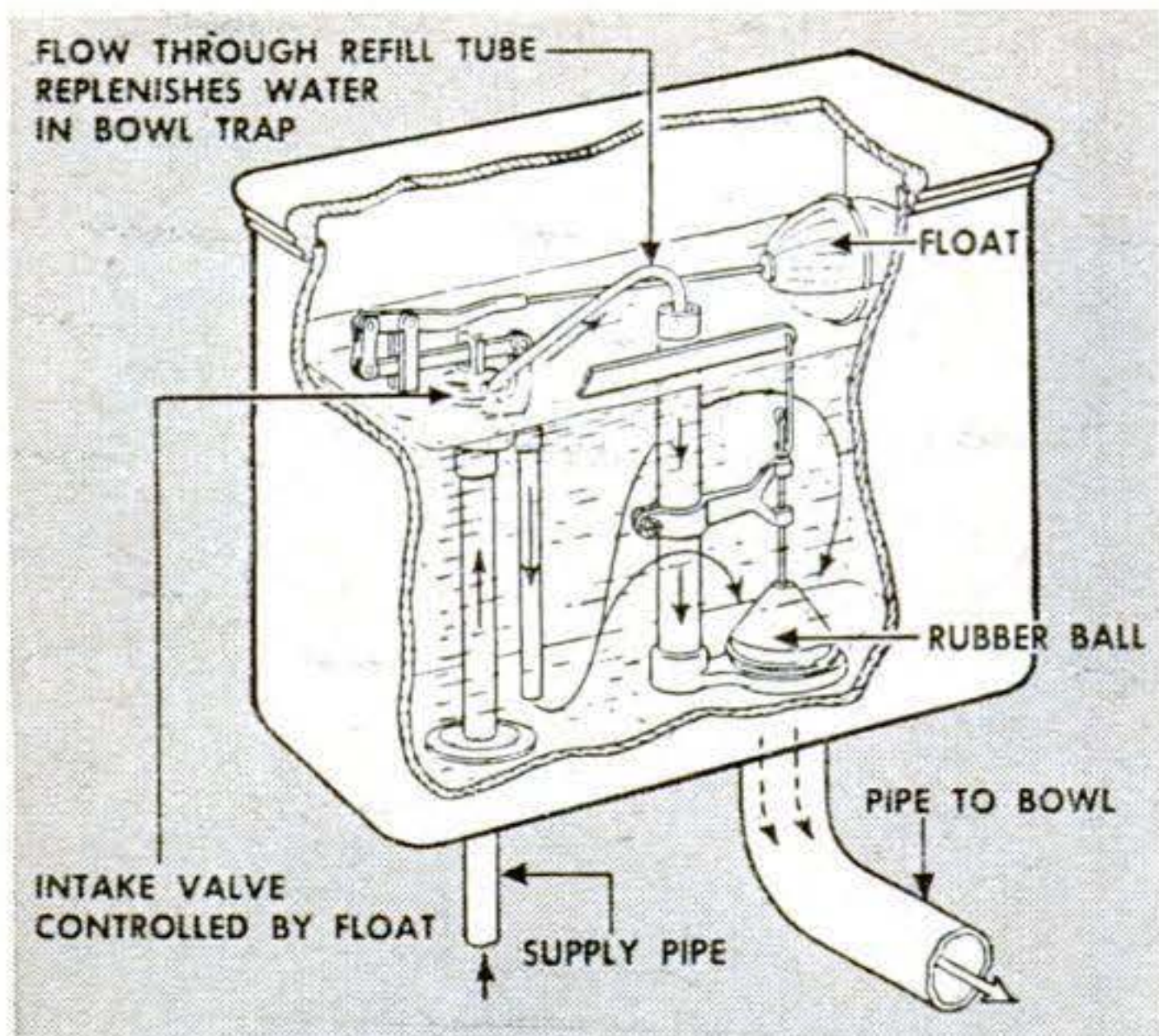

The flush-tank toilet may be a water waster because it has two control valves that can leak. Rubber ball at outlet is easily replaced by a new one. At left are shown the intake-valve parts.

and off. The first sign of danger is a feeling of "hardness" as you turn the handle, indicating that the washer has lost its ability to compress. This is the time to replace the washer.

The accompanying illustrations show the steps in repairing a kitchen faucet of the compression type. The same general procedure applies to bathtub, washtub, and shower fixtures and to old faucets of the "Fuller" type. The latter requires a cone-shaped washer that is fastened by a nut on the end of a short plunger rod.

As long as the water is off anyway, disassemble and examine *all* the water fixtures in the house, not just the leaking ones. Washers are so cheap that you might as well put in a whole round of new ones.

Toilets of the flush-tank variety are notorious water wasters because they use *two* control valves, either or both of which may go bad. Also, because the entire brass mechanism is submerged in water, it accumulates greenish scum and slime through the reaction of the minerals and chemicals in the water on the copper component of the brass. These deposits may prevent the valves from seating tightly. In many cases, just cleaning the mechanism off with a rag and a soft brass brush will stop loss of water.

Of the two valves, the outlet is the likeliest offender. Usual point of trouble is the

large rubber ball that is supposed to sit snugly over the open end of the pipe leading to the bowl. When it hardens or swells with age, it must be replaced. The slightest leak in the inlet valve will cause the water in the tank to overflow continuously through the center overflow pipe, even though the float ball is in its topmost position. The valve comes apart readily for inspection and repair. When it is seated properly, the water level should be about an inch below the top of the overflow pipe. With both valves in good condition, there should be absolutely no dribbling or gurgling of the water in the bowl itself.

In tankless-type toilets, known generally as "flushometers," the flushing cycle is controlled by a leather or rubber diaphragm. Although this diaphragm has a long life, the packing washer on the flushing handle takes considerable mechanical wear. All the necessary washers for a particular make of flushometer are usually sold as a package. It is a good idea to have a set on hand, because they may not be easy to find in an emergency.

Excessive water pressure naturally aggravates leakage problems. If the water shoots out of your faucets like miniature geysers, try closing the main shut-off valve a turn or two at a time. If the house has flush-tank toilets, you will probably find that the only difference with reduced pressure is that the flush tanks take a minute or more to fill up. With flushometer toilets that depend on water pressure alone for their operation, the adjustment of the cut-off may be critical. If you live at the bottom of a valley and are getting a really strong head of water, consult your water company on the advisability of installing a pressure reducer. END

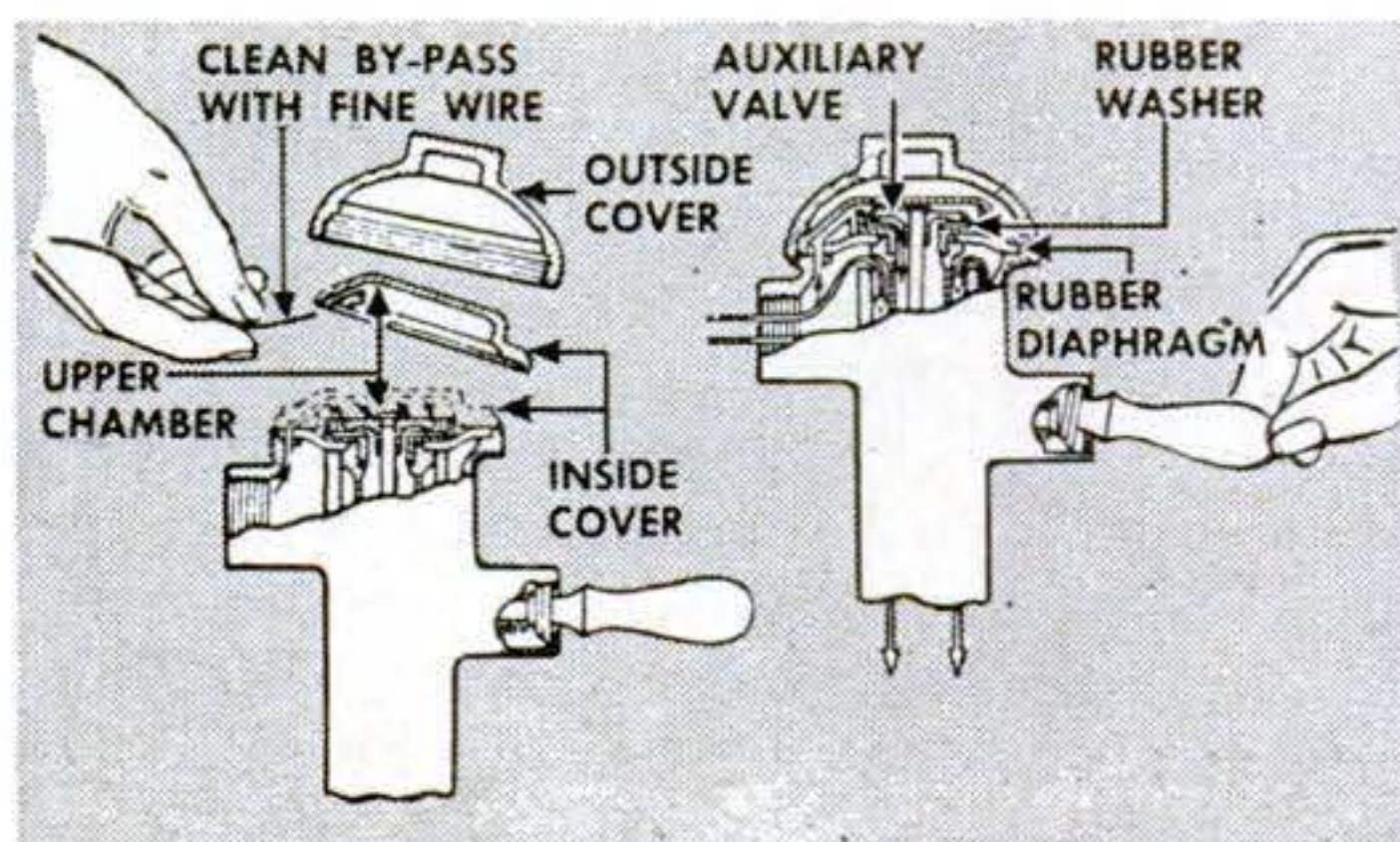

Valve of the tankless-type toilet, shown above, operates by water pressure alone. Moving the handle tilts an auxiliary valve that releases water pressure, starting the flushing cycle.

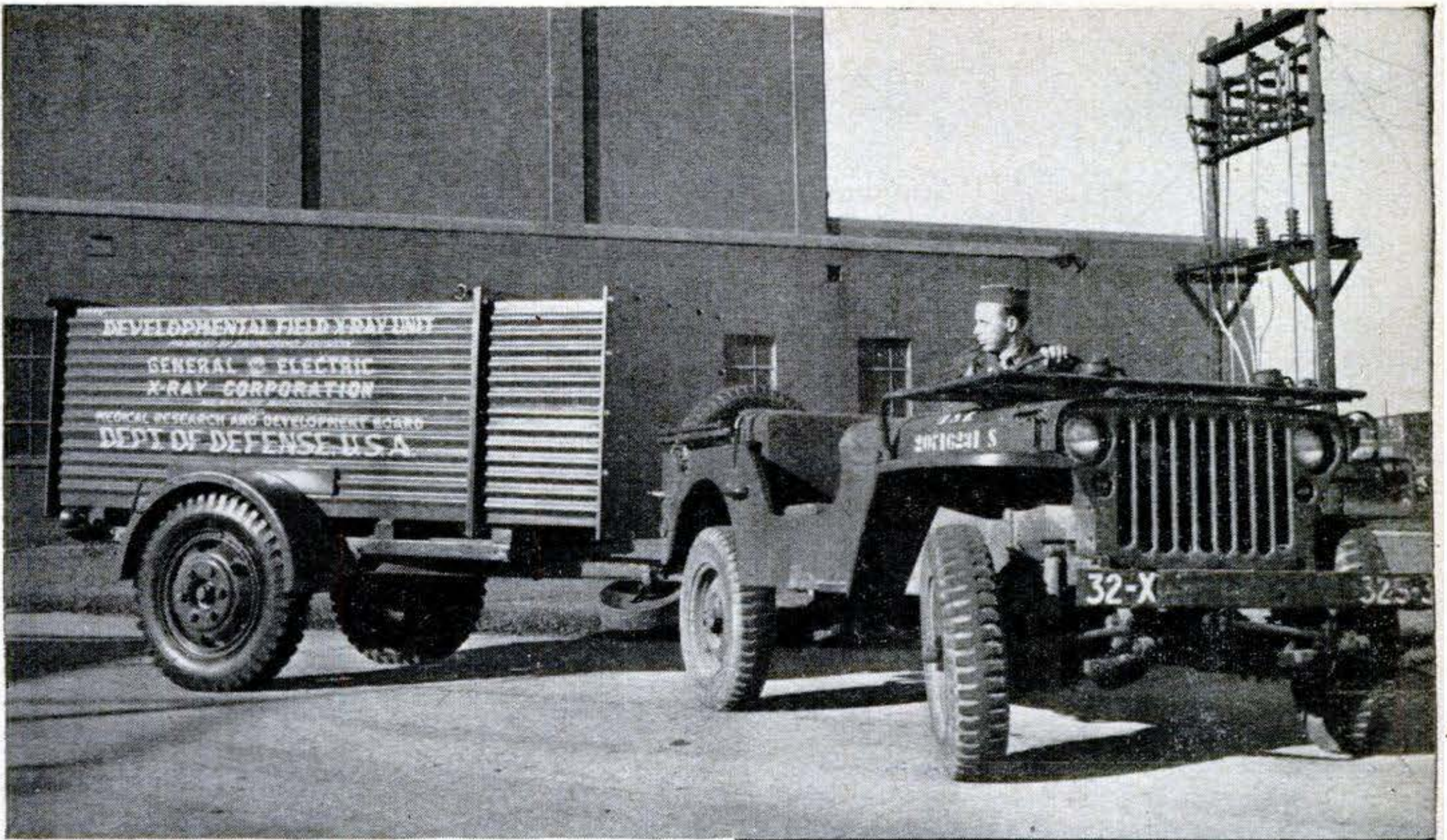

Field X-Ray Unit Weighs Less

DESIGNED for use in combat areas, this portable X-ray machine has all conventional features, but weighs far less. A steel version tips the beam at 2,100 lb. and an aluminum one weighs only 1,600 lb.—compared to 3,000 lb. for comparable conventional models. It has a counterweighted tube assembly, a fluoroscopic unit, and a hydraulic drive that raises, lowers, or tilts the table. At right, a technician raises the table by pressing a foot pedal. The machine, developed by GE, fits in a waterproof, corrugated-metal container, shown above, which is buoyant enough to float. A heavy-duty transformer and rectifier supply 100,000-volt DC.

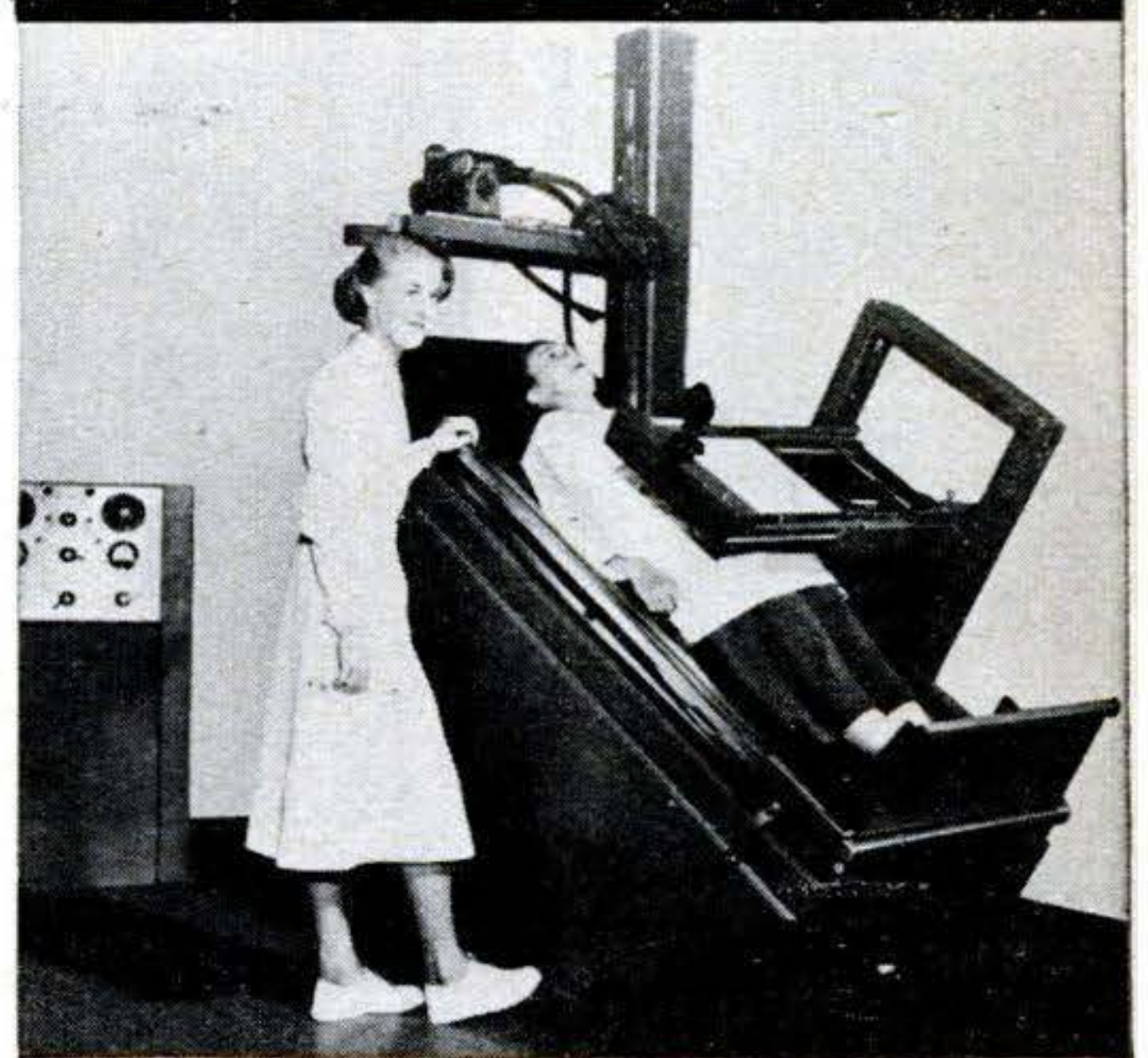

Vacuum Cup Clings to Slippery Surfaces

Now you can permanently install fixtures on any smooth, impervious surface, thanks to a new vacuum cup that several manufacturers are fitting to their appliances. After the diaphragm is flattened against a surface,

a screw threaded to an outer shell draws out a steel disk, giving increased "vacuum tension." At right, below, Screw-Vac® holds a pencil sharpener to a refrigerator. Van Dusen Engineering Co. developed the cup.

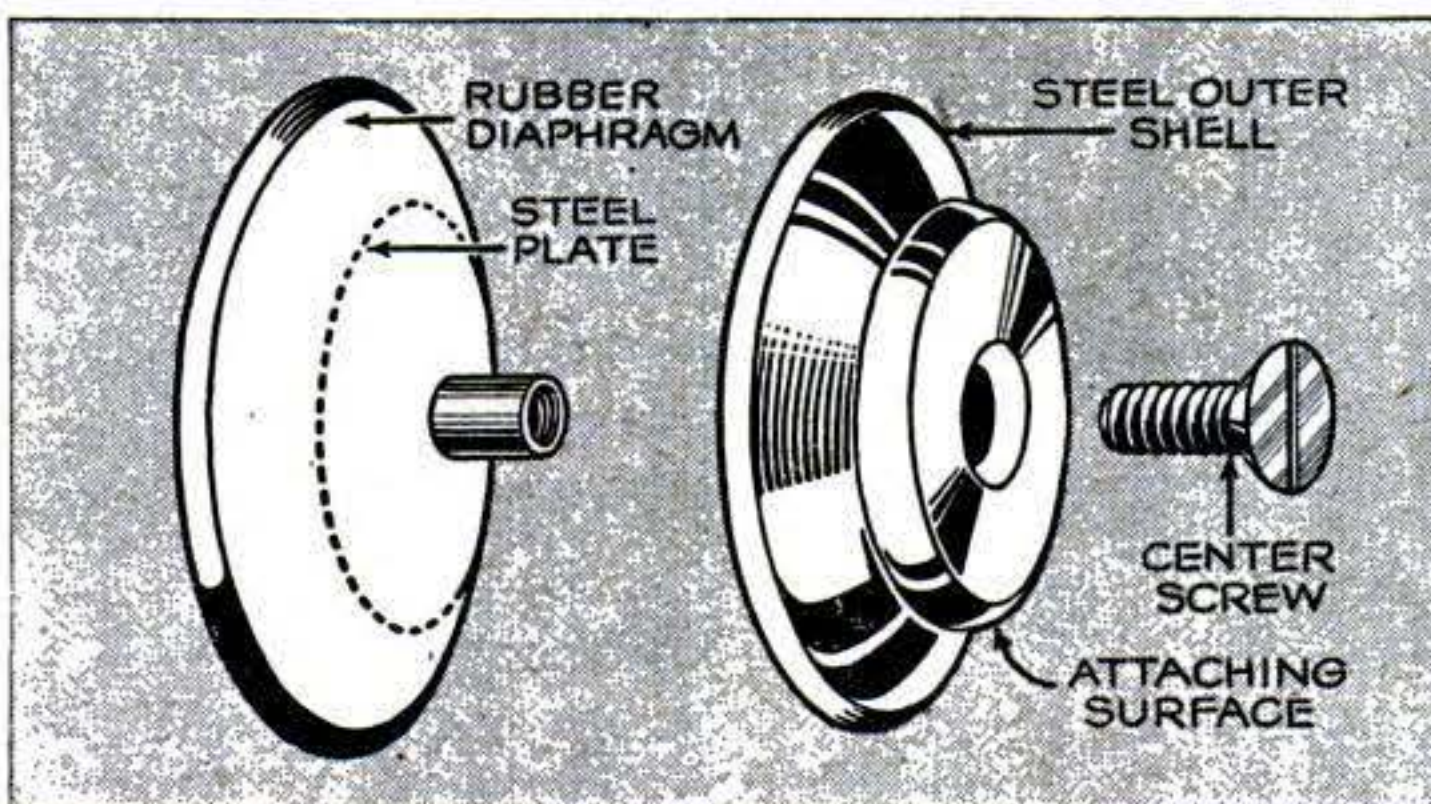

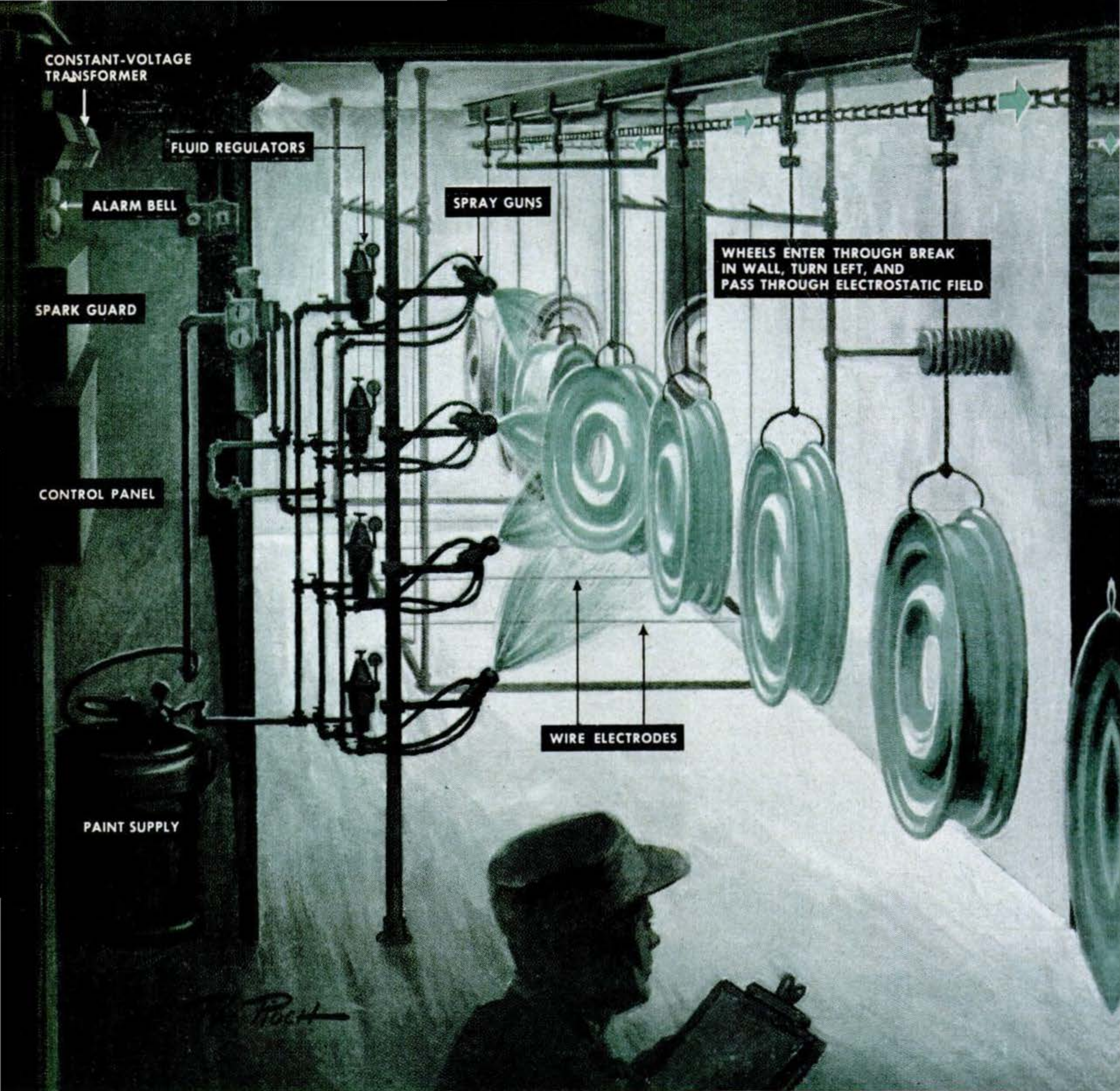

Electrostatic spray-painting, visualized in drawing above, saves paint, requires fewer op-

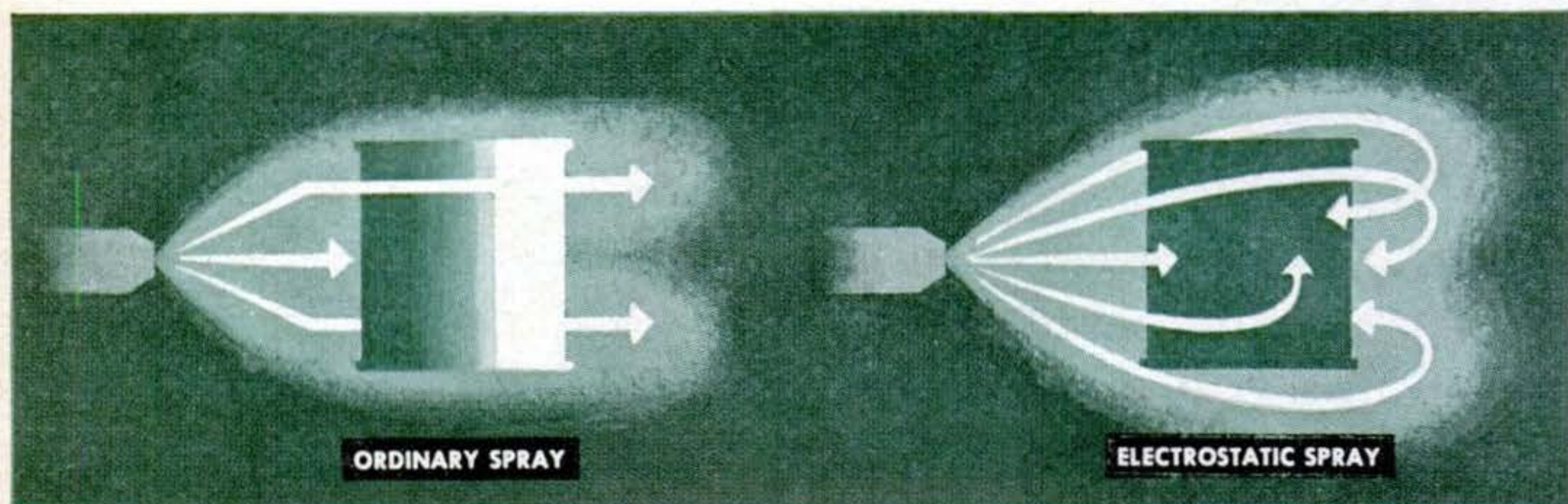

Conventional spray-painting, above, wastes paint through overspray, covers only one side.

Electrostatic spray, right, wraps itself around the object. Relatively little paint is wasted.

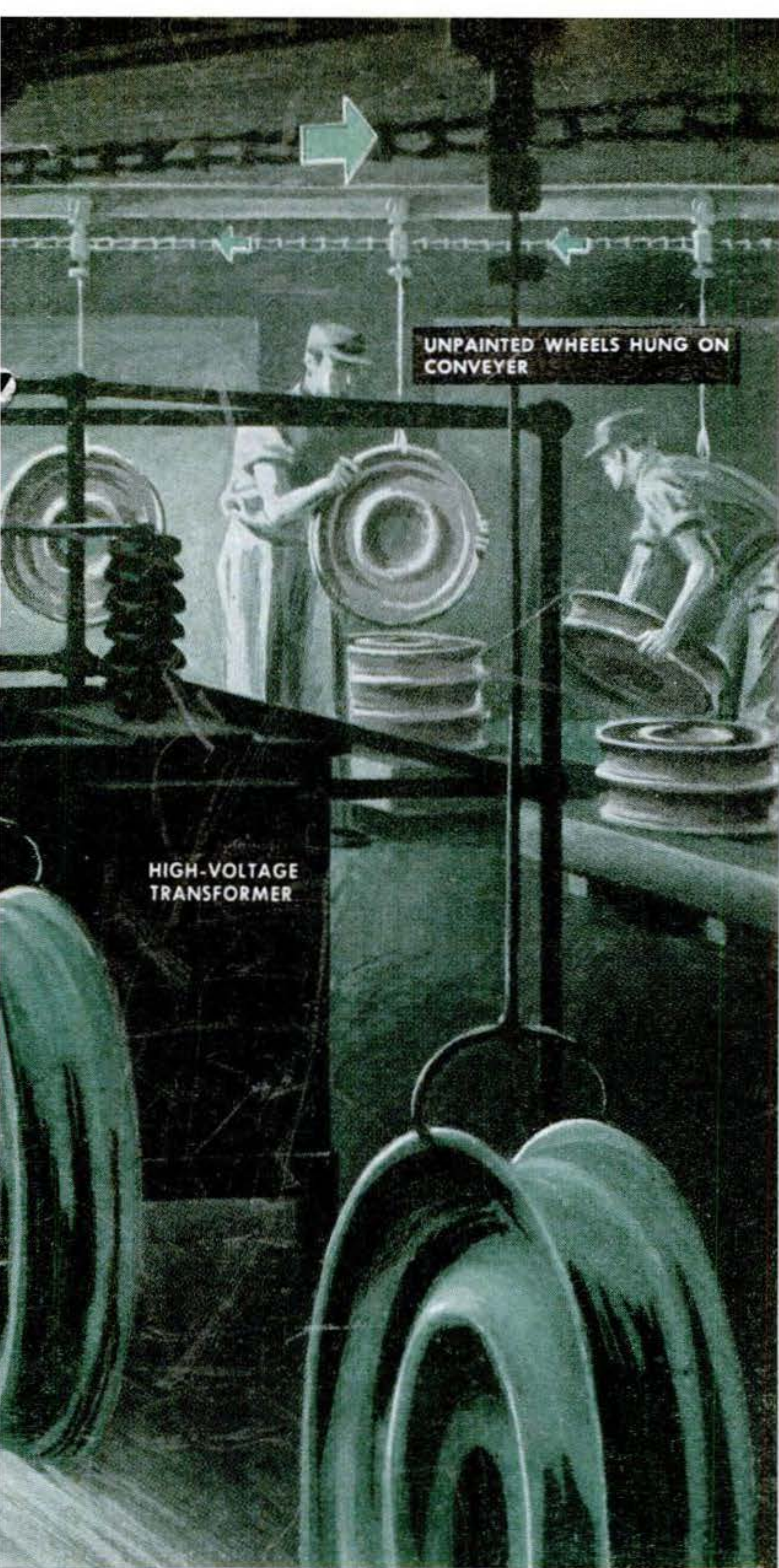

Electricity Aims Paint

By Herbert Johansen

SPRAYING paint through a high-intensity electrostatic field now turns its atomized particles into a barrage of tiny "homing missiles" that literally wraps itself around objects to be painted. The drawing at left shows a setup for the process, called Electro-Spray, developed by the Ransburg Electro-Coating Corp., Indianapolis, during the war (PS, March '45, p. 118) and now used in many industries.

Standard 220-volt AC is fed into a high-voltage transformer, stepped up to approximately 100,000 volts, and changed to DC by a rectifying tube. The high potential charges a wire grid within the spray booth, creating an electrostatic field. Paint particles sprayed at comparatively low pressure into this field also become charged with the same polarity, opposite to that of the articles to be painted, which are grounded by the conveyer. The resultant attraction between paint and work is so great that many paint particles that blow past are pulled back to their target.

A special protective circuit prevents sparks and possible explosions. If excessive field current flows—as when a piece falls from the conveyer, or an electrode wire breaks—a thyatron-triggered "spark guard" cuts the high voltage and rings a bell. **END**

erators, and does a faster, more even job.

"Wrap-around" action makes it possible to hang many small objects, like the film reels be-

low, from each hook in Christmas-tree style. Ordinarily each would be sprayed individually.

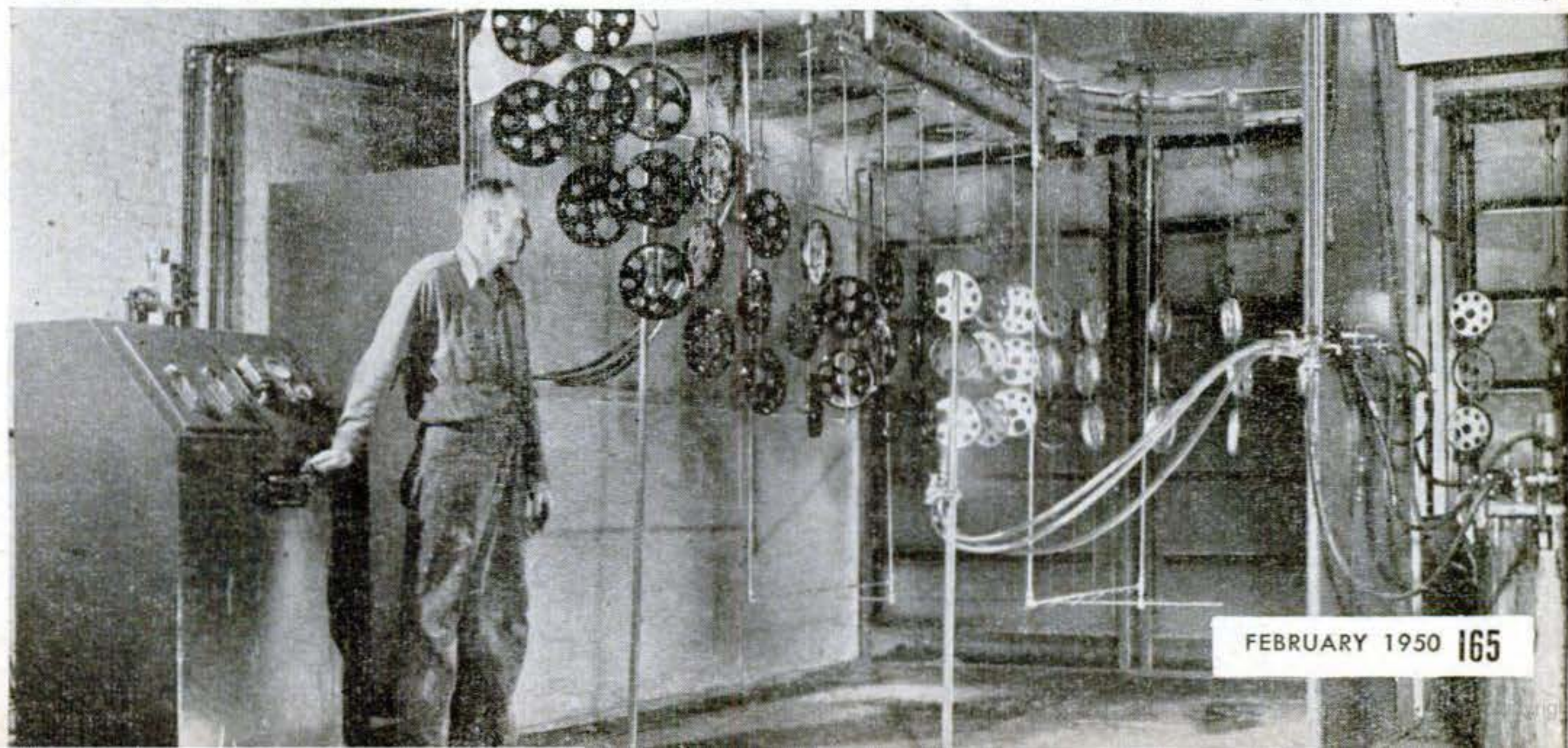



Aids to Modern Living

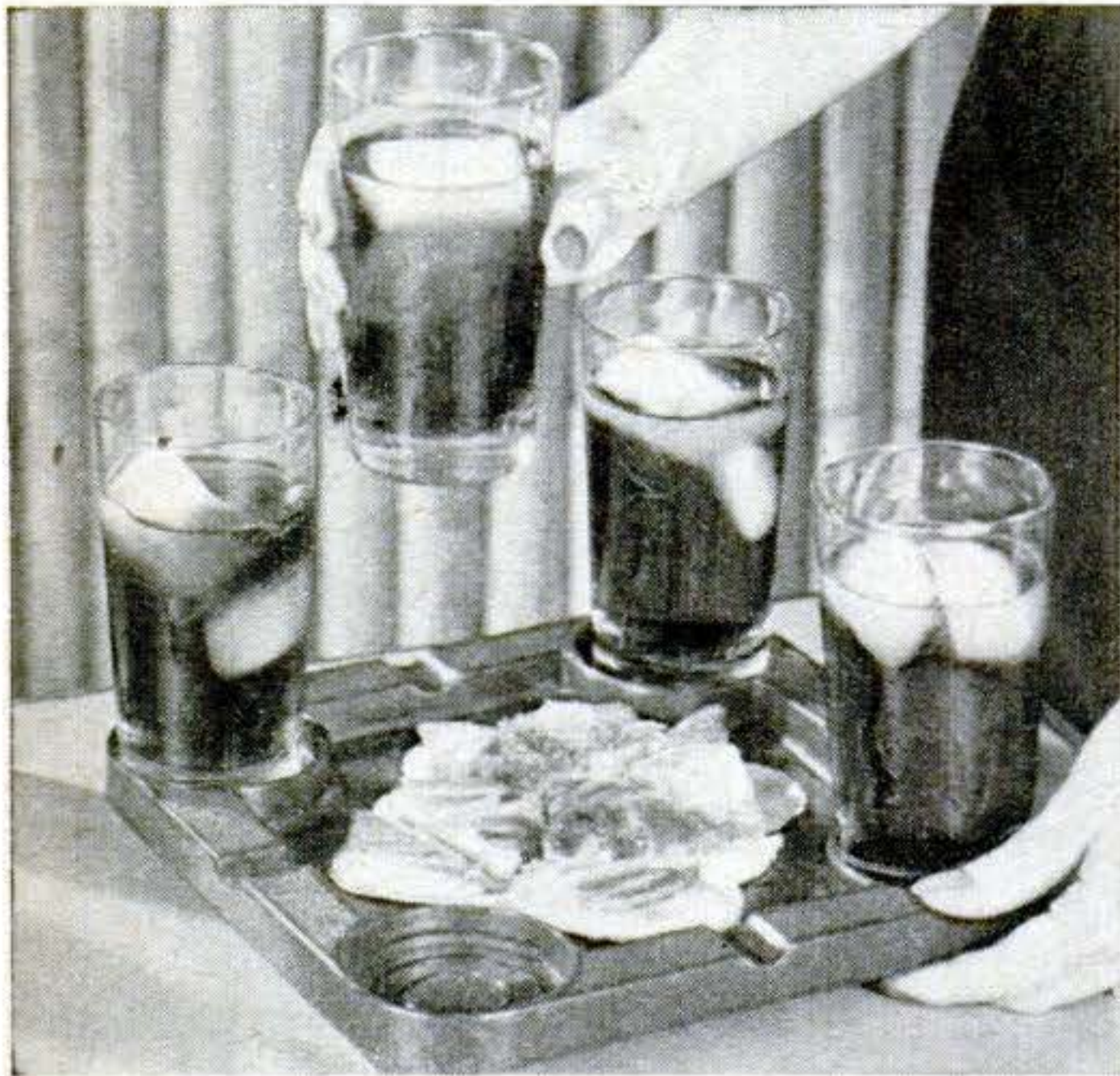

Tray Handles Three Jobs. Molded of Bakelite®, this refreshment tray holds four glasses in non-tipping coasters and has space in the middle for snacks. And when the food's gone, that center space serves as a jumbo ash tray. Made by the Count-Rite Corp., of Cleveland, Ohio, the tray retails for about \$1.50. Easy to clean, it can be rinsed and scrubbed without damaging it. Rubber pegs support the tray.



Scissors Fold Up. One of the first products to be imported from the U. S. zone of Germany, these scissors fold up for easy carrying in pocket or handbag. When closed, the tool is 2¼" long; open it's 4". The blades are made of carbon steel with a highly polished nickel finish. Hoffritz Cutlery, New York City, prices the scissors and case at about \$3. When folded, the points cannot rip clothing or the lining of a purse.

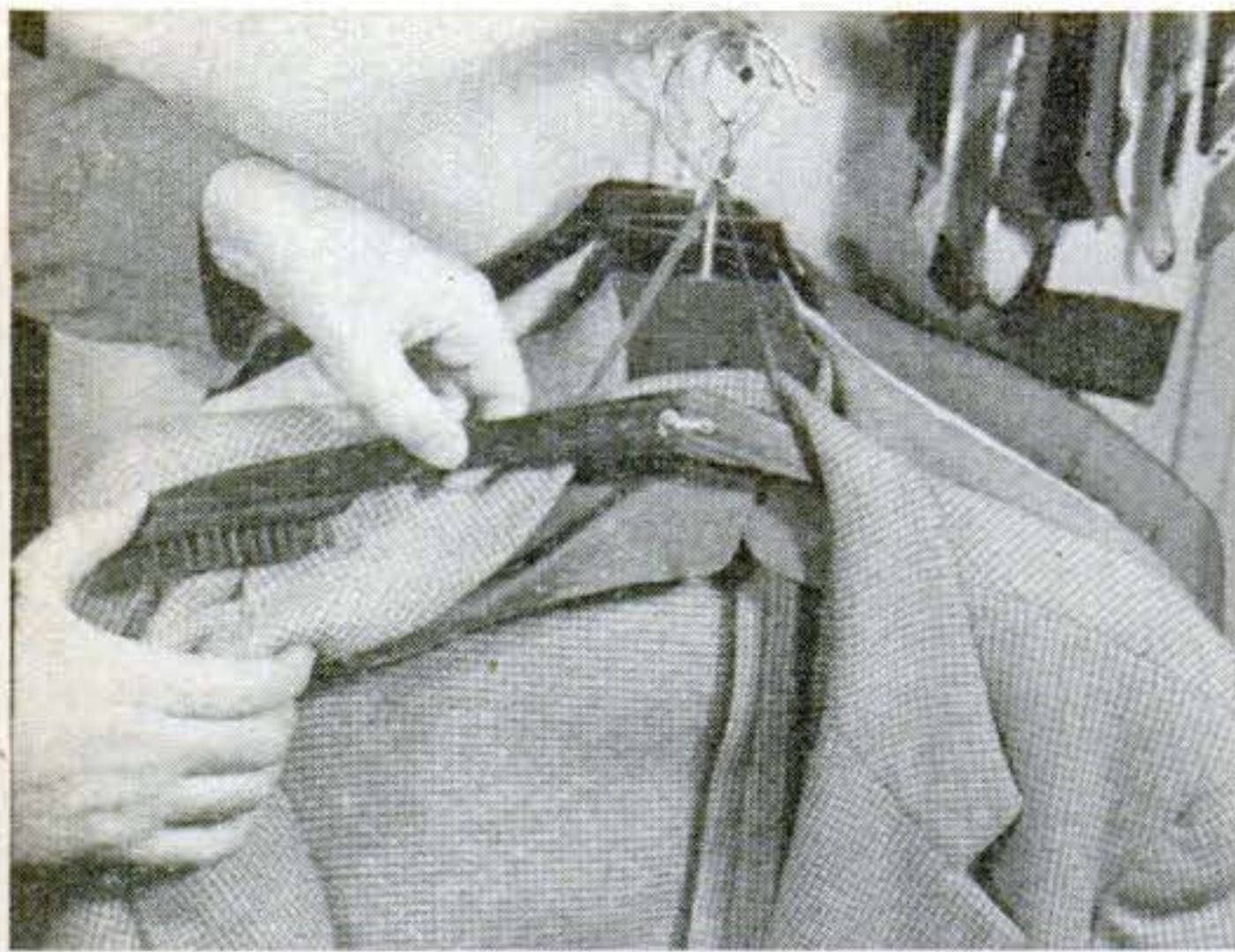

Brush and Hanger Combined. Besides folding up to save space in your suitcase, this coat hanger has a clothes brush at each end. The Rola Novelty Company, of New York City, sells the hanger for about 70 cents. When it's folded, the hanger arms serve as a handle for the brush. When opened as a hanger, a small hook locks it.

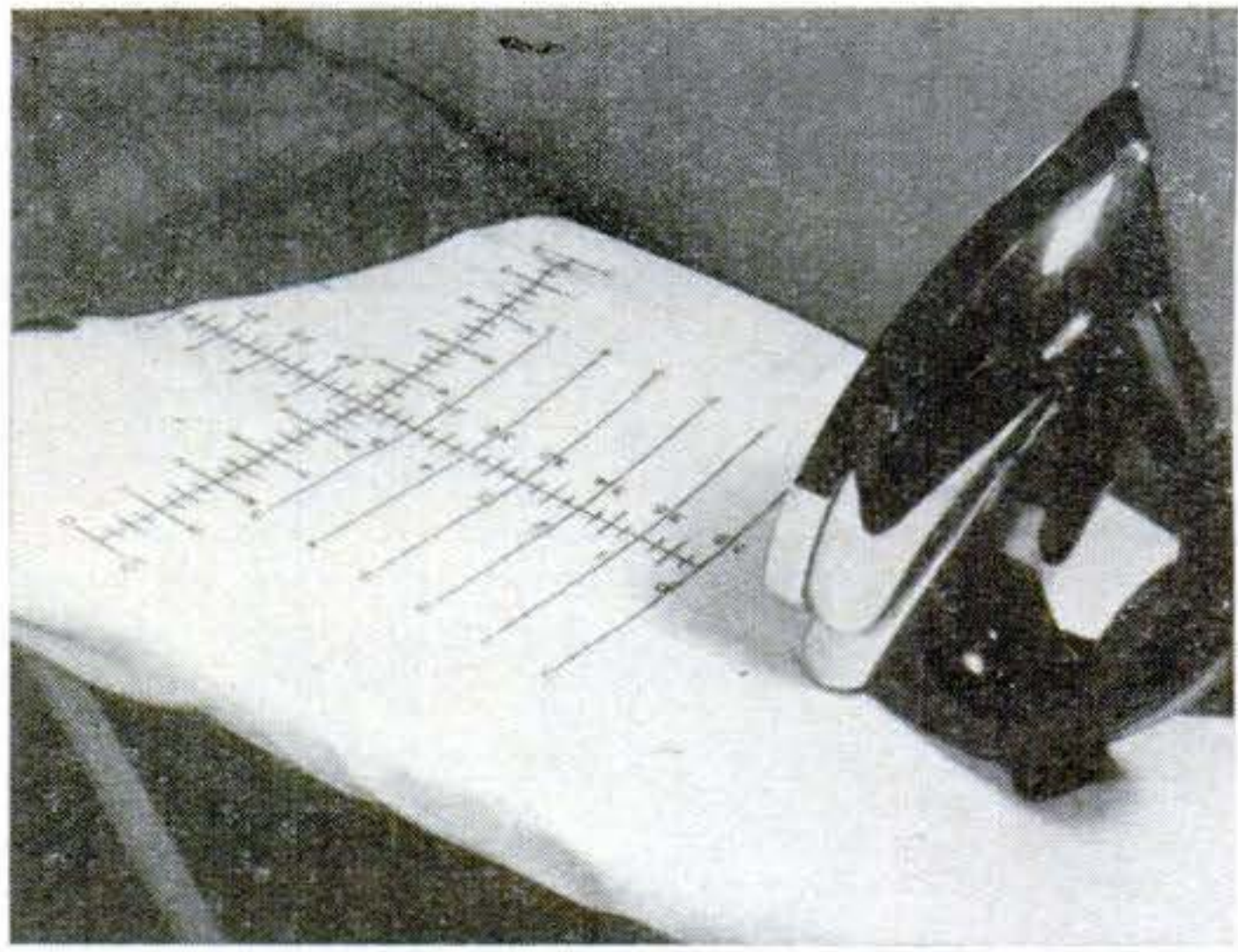

Ironing-Board Cover Is Ruled. With a graduated yardstick printed on this ironing-board cover, the housewife can do a professional job of altering hems, laying pleats, and blocking sweaters or other knitted garments. The figures are printed in ink that won't rub off. The maker is Hart-Beckner Mfg. Co., Versailles, Mo.

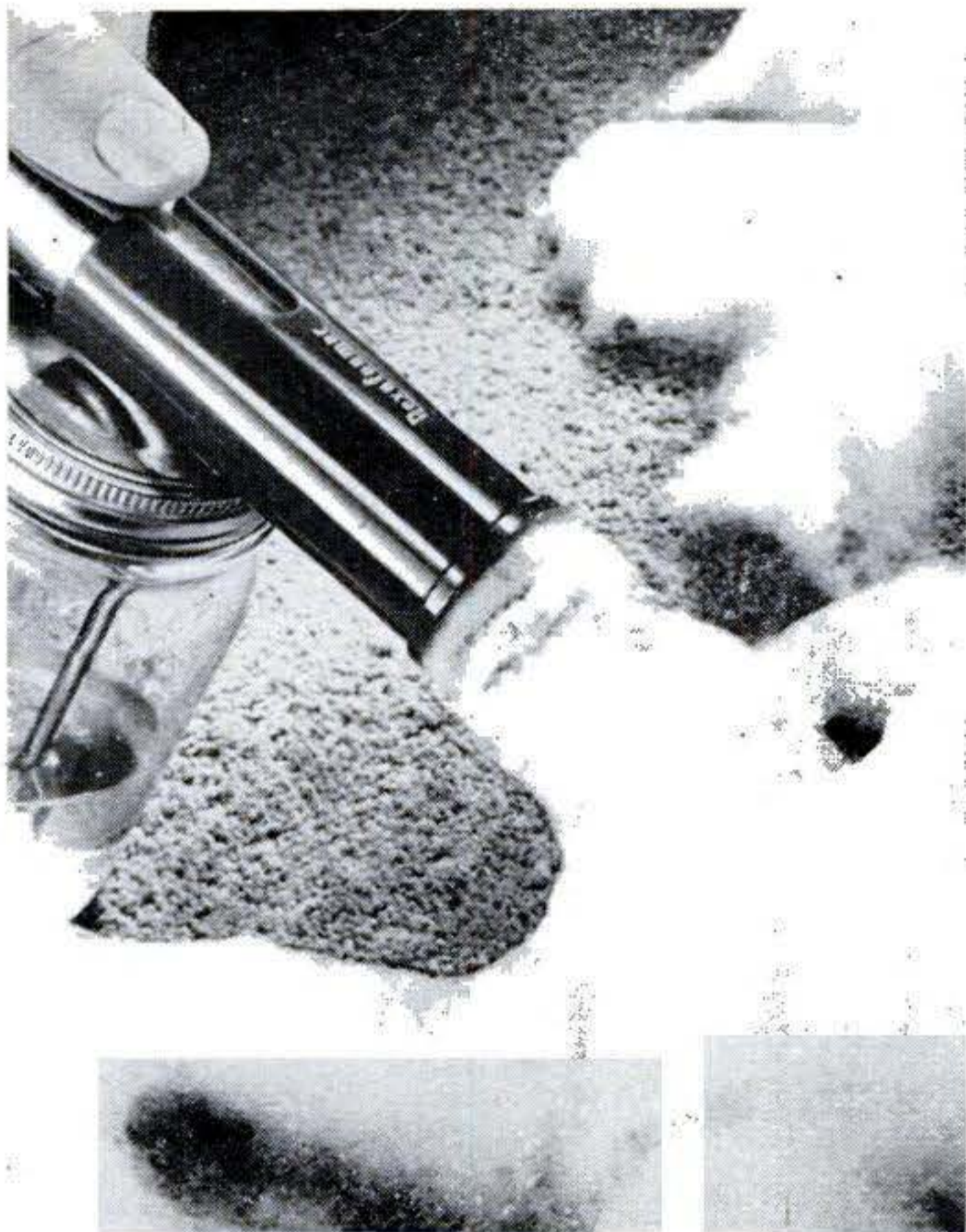

Attachment Shampoos Rugs. The Rexafoamer® shampoo attachment, sold by Martin-Parry Corp., Toledo, Ohio, is molded of Tenite®. It fits the spray-pot attachment of tank-type vacuum cleaners. A wire mesh in the nozzle mixes the liquid soap with air to form suds for washing rugs or upholstery. The plastic attachment is moisture-resistant and corrosion-proof. Its non-porous surface is easy to clean.



New Table Lighter. This lighter, for home or office, has a clear-plastic reservoir so you can always see the amount of fuel in reserve. It's priced at \$7.50 by the Ritepoint Co., of St. Louis, Mo., and is available in four colors. The reservoir is sealed and cannot leak or let fuel evaporate. Fuel is transferred to the wick chamber only as needed by a finger-touch valve. All the metal parts are chrome-plated and polished.



Frying Pan Accessory. The Small Fry® set includes two 3½" aluminum rings that are ¾" deep, two aluminum covers, and a lifter. According to the makers, Benmatt Organization, Chicago, use of the rings to fry or poach eggs saves shortening and reduces cooking time. The rings leave room in the skillet for bacon. Price is \$1.



Rain Leggings. Empire Products, New York City, markets these slip-on plastic leggings for \$1. They fit over the lower part of your trouser legs, protecting them from rain and splashes. A clip slips over the edge of your pocket to hold them up.

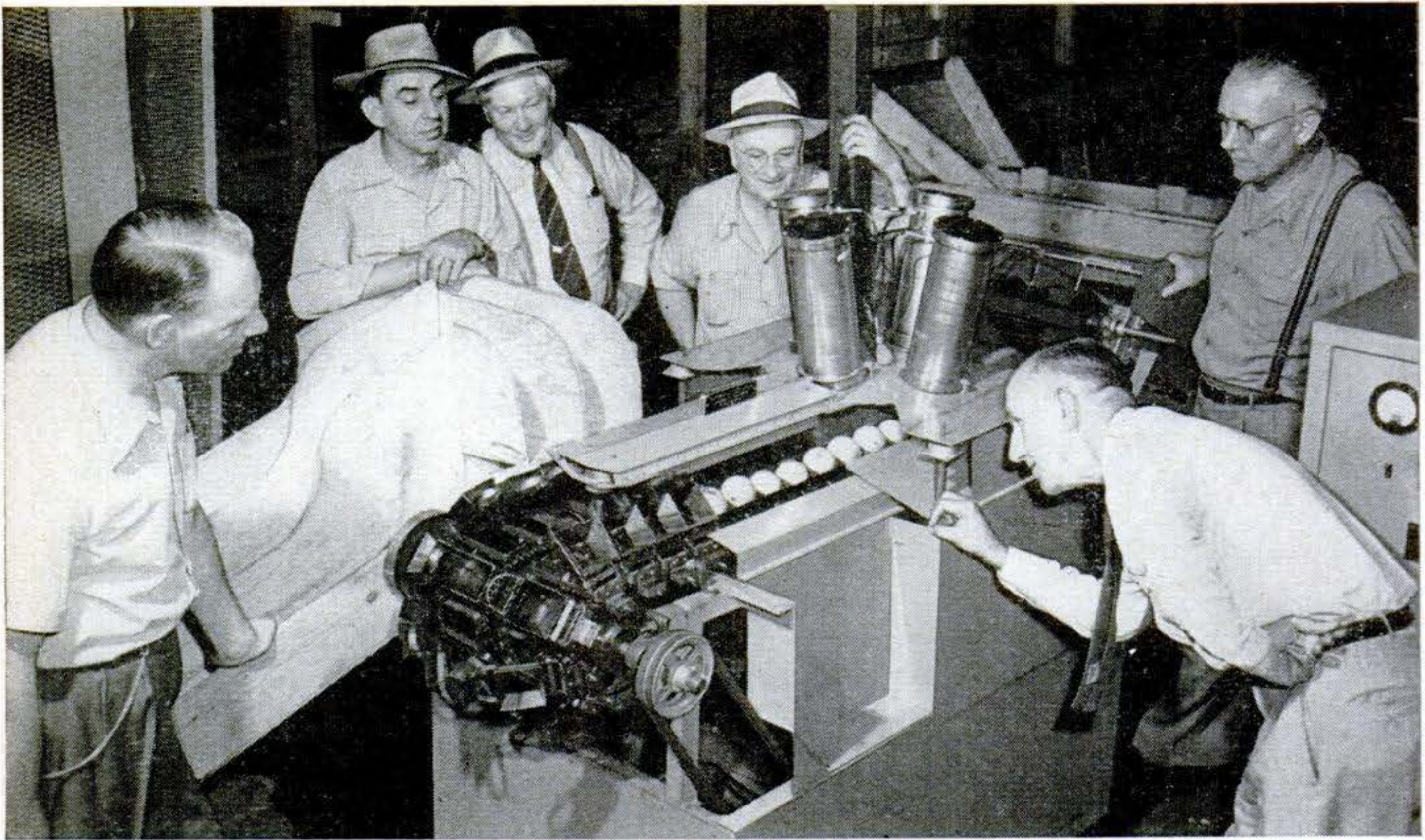

X Rays Spot Orange Frostbite

Now they're X-raying oranges. A new machine uses the rays to spot cold-damaged fruit—the frost-bitten oranges contain less juice and therefore let more rays pass

through. The machine automatically throws out the damaged oranges and separates the good ones into three grades, all at the rate of 35,000 an hour. Developed by the Automatic X Ray Corporation, the first unit is being used by Sunkist at Upland, Calif.



Basket Guards Jet Intake

NORTHROP engineers aren't taking any chances on being sucked into the jet engines they work on. They designed this steel-mesh wheeled basket that can be rolled up to cover the intake port. Without the guard, it's dangerous to walk within 25 feet of the intake when the engine is revved up.

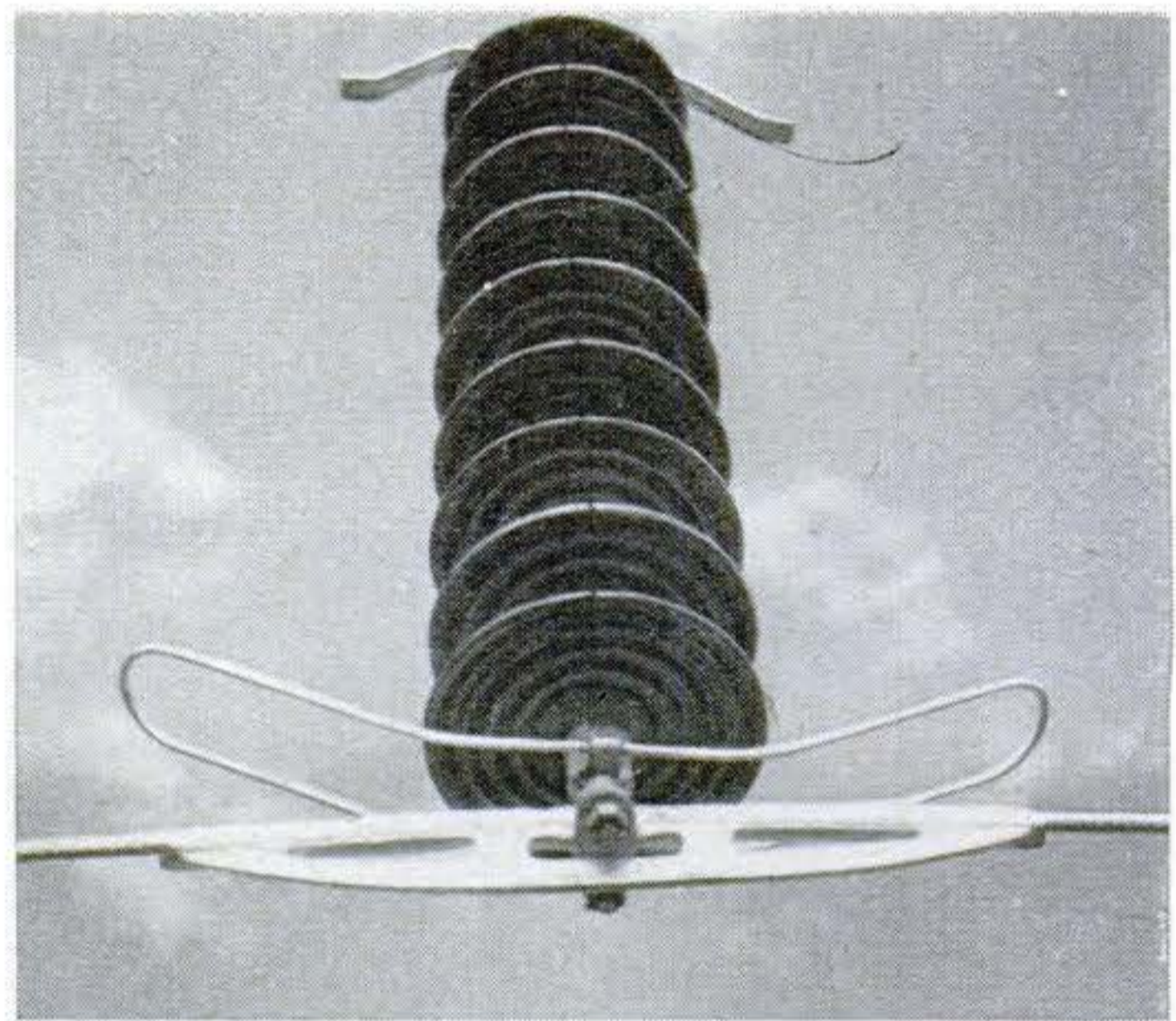

Clamp Ends Power-Line Break

A NEW clamp to keep power lines from breaking and interrupting electric service has been developed in Europe. Wind makes the cables sway, frequently snapping them at the insulator. Ice and vibration also give trouble. Developed by Sverre Sandberg and J. Lindblom, of the Swedish Aluminum Company, the clamp has a shallow, longer bend to reduce stresses. It is in use on power lines in Norway and Sweden.



Faulty asphalt mixture may shed stones as above, leaving potholes, or acquire "washboard" surface by yielding under pressure.

Diamond Tools Sample Roads

ASPHALT roads are being sampled to learn how to build better ones. Boring a hole in the surface, a whirling diamond-edged tube extracts a four-inch-diameter cross-section from top to bottom. Pieces are then squeezed in testing machines until they break. Types of paving that have lasted well or poorly in actual service thus yield their specifications in the Shell Oil Company's Wood River, Ill., research laboratory. Laboratory mixes comparing favorably in similar tests serve as guides in preparing large batches of paving material for new roads.

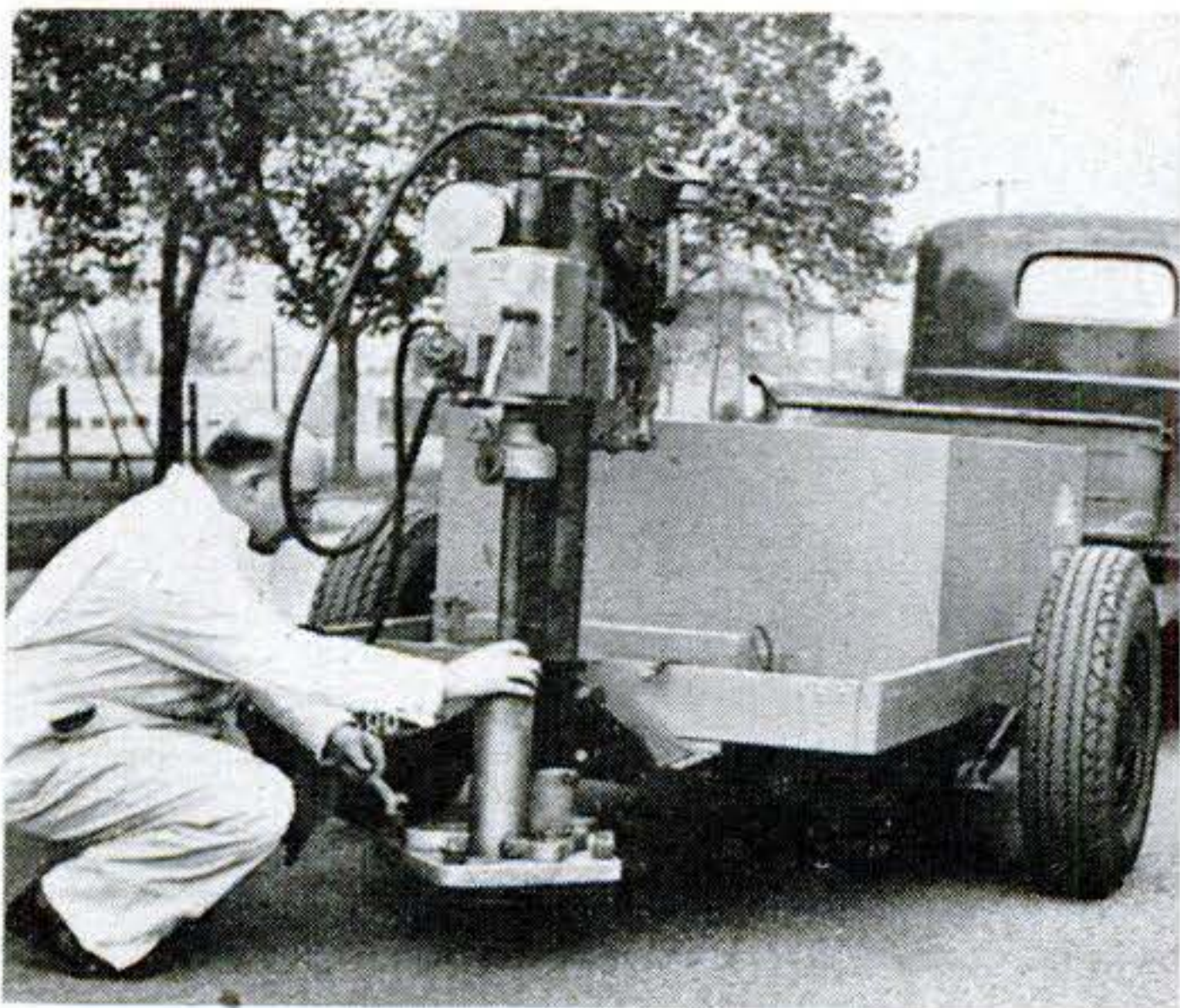

Diamond drill used to obtain sample of asphalt road is mounted with its 3/4-hp. gasoline engine on trailer towed by car or light truck.



Steel tube edged with diamonds, whirling at 150 r.p.m., bites easily through rock, asphalt, and sand. Stream of water lubricates cutting tool.

Road sample cut by drill is lifted out. Hole left will be filled with patching material, tamped into place by drop hammer on same rig.

Testing machine squeezes road sample until it breaks; gauge shows force required. This predicts wearing quality of new paving mixes.

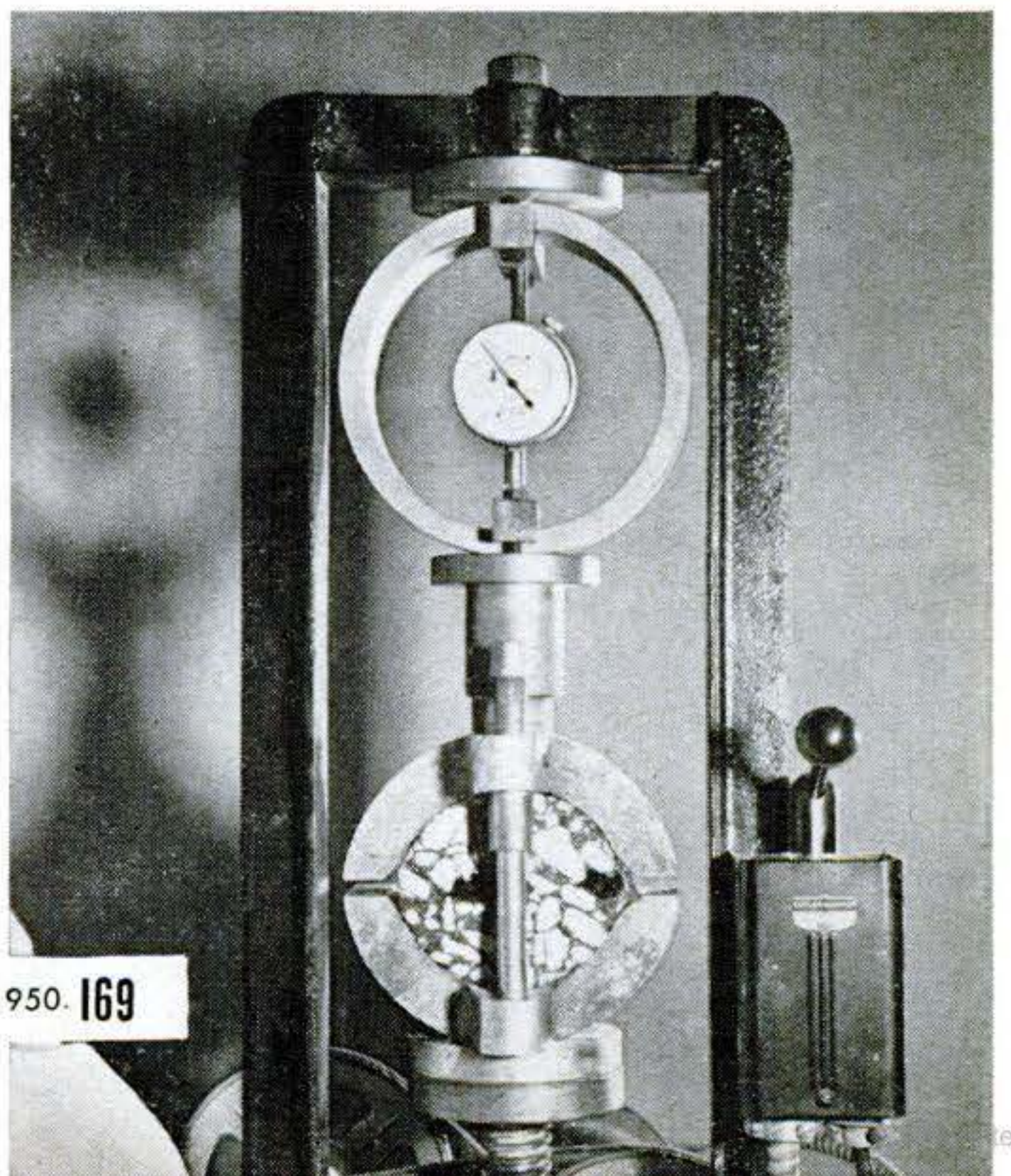
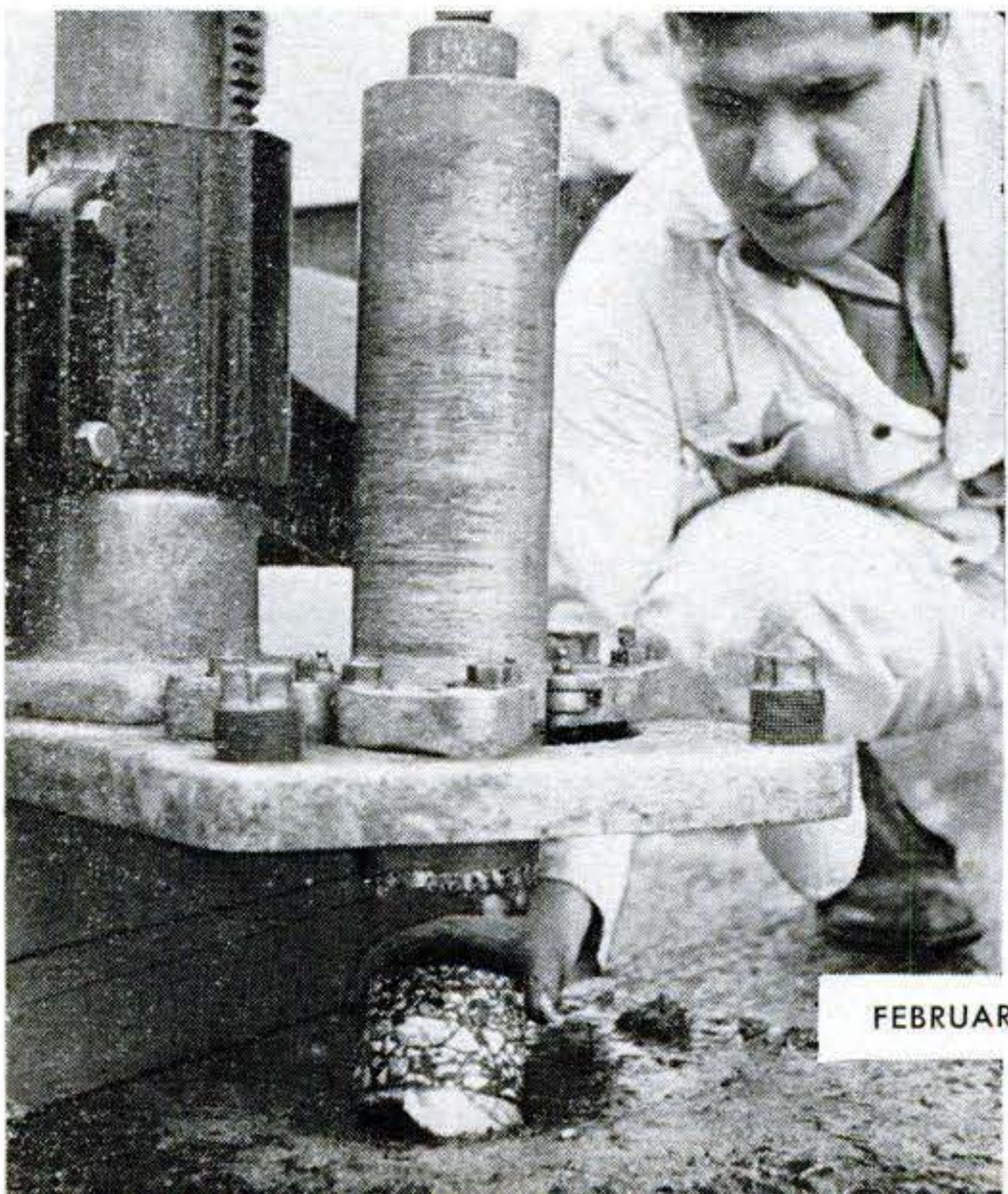

Bird-Chasing Glider Seeks Flight Secrets

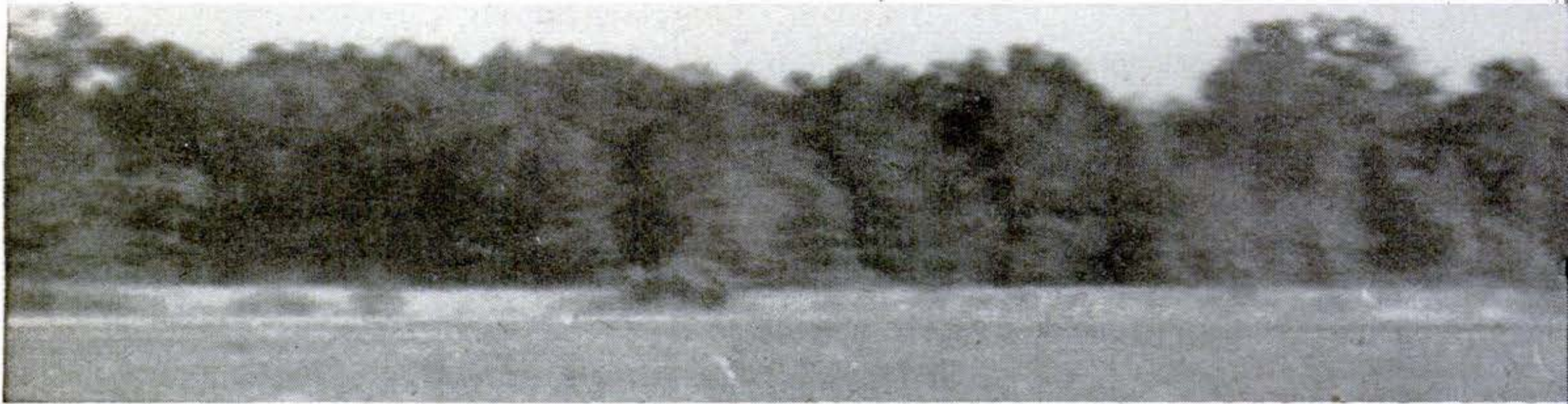

By Ross E. Hutchins

GLIDER pilots are now dogfighting buzzards and gulls to find out how to design airplanes that will fly as easily as the birds do. Flying a camera-carrying, English-built Kirby-Kite® sailplane, they have chased

the soaring birds 15 miles at speeds up to 50 m. p. h., sometimes only 15 feet behind the bird's tail.

The glider is specially equipped for the job. Two-way radio relays instrument readings to the ground, helps the pilot spot birds to chase—and also lets him call for somebody



Nose of glider holds electrically driven movie camera that photographs bird's position once a second. This shows how soaring bird rises, falls.

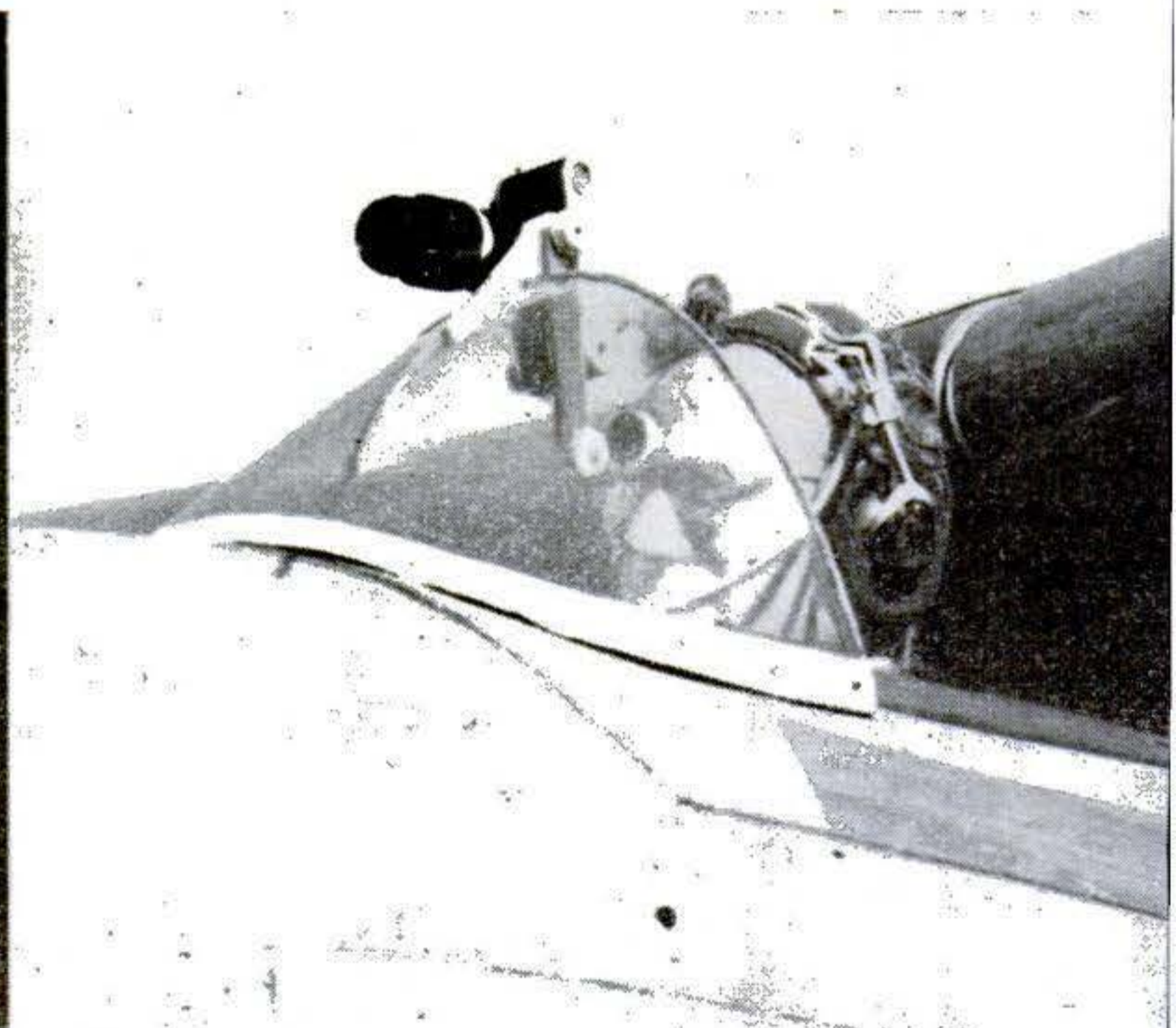

Pilot radios periodic instrument readings to ground operator. Ground crews can spot birds more easily, so they tell pilot where to look.



to come and get him when he must land far from his base. A time-lapse 16-mm. movie camera in the nose makes one picture every second of the bird being followed. This film tells how fast the bird sinks through the air. A 35-mm. still camera on the windshield records wing shapes.

This research, directed by Dr. August Raspet, of Mississippi State College, aims to learn why soaring birds can fly so high and so long with so little effort—particularly what effect wing contour and feather porosity and arrangement have on such aerodynamic characteristics as drag. **END**

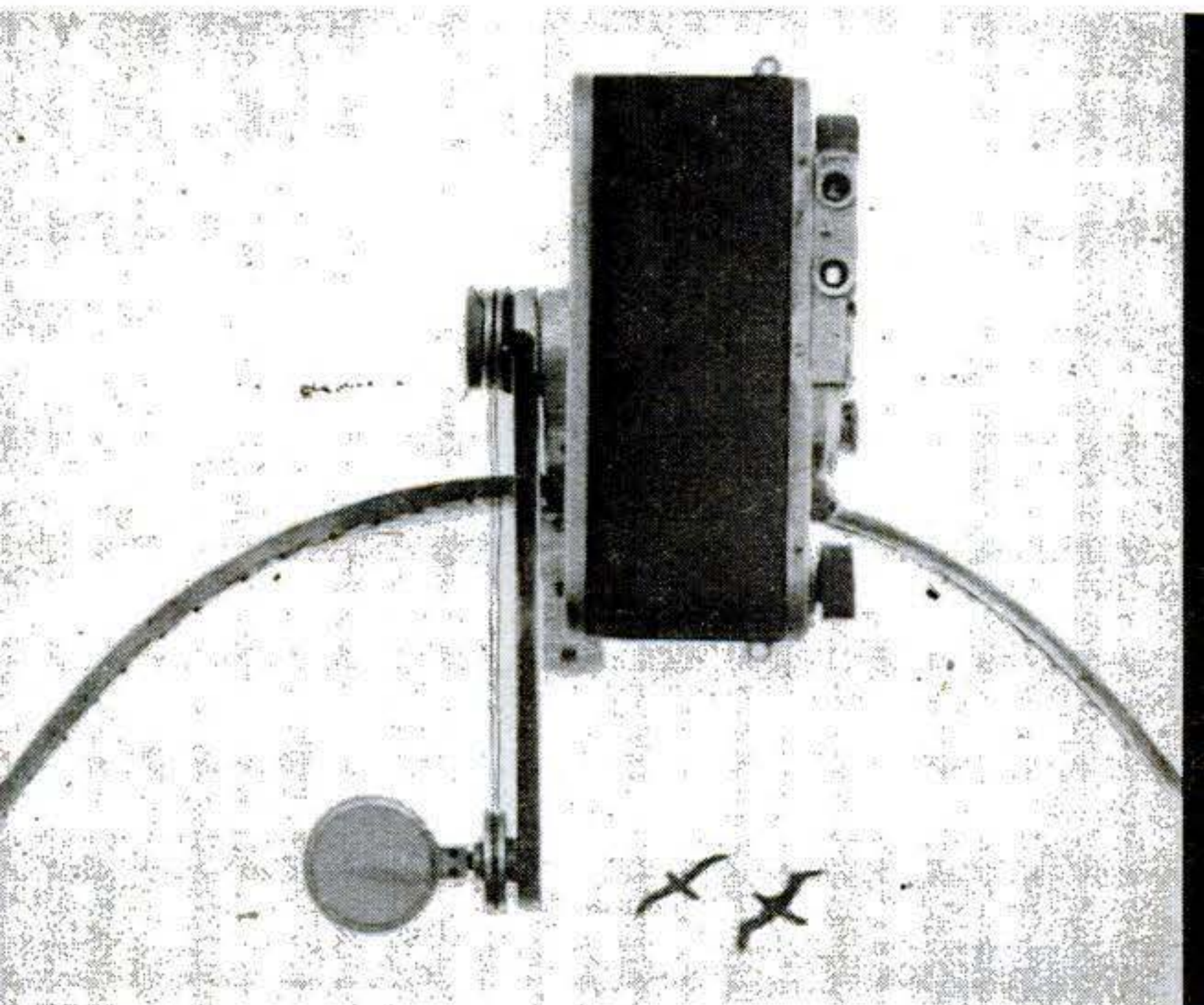

A pair of gulls fly into range. The pilot will pick them up and follow them with the help of the polarizing sight (ring at lower left).

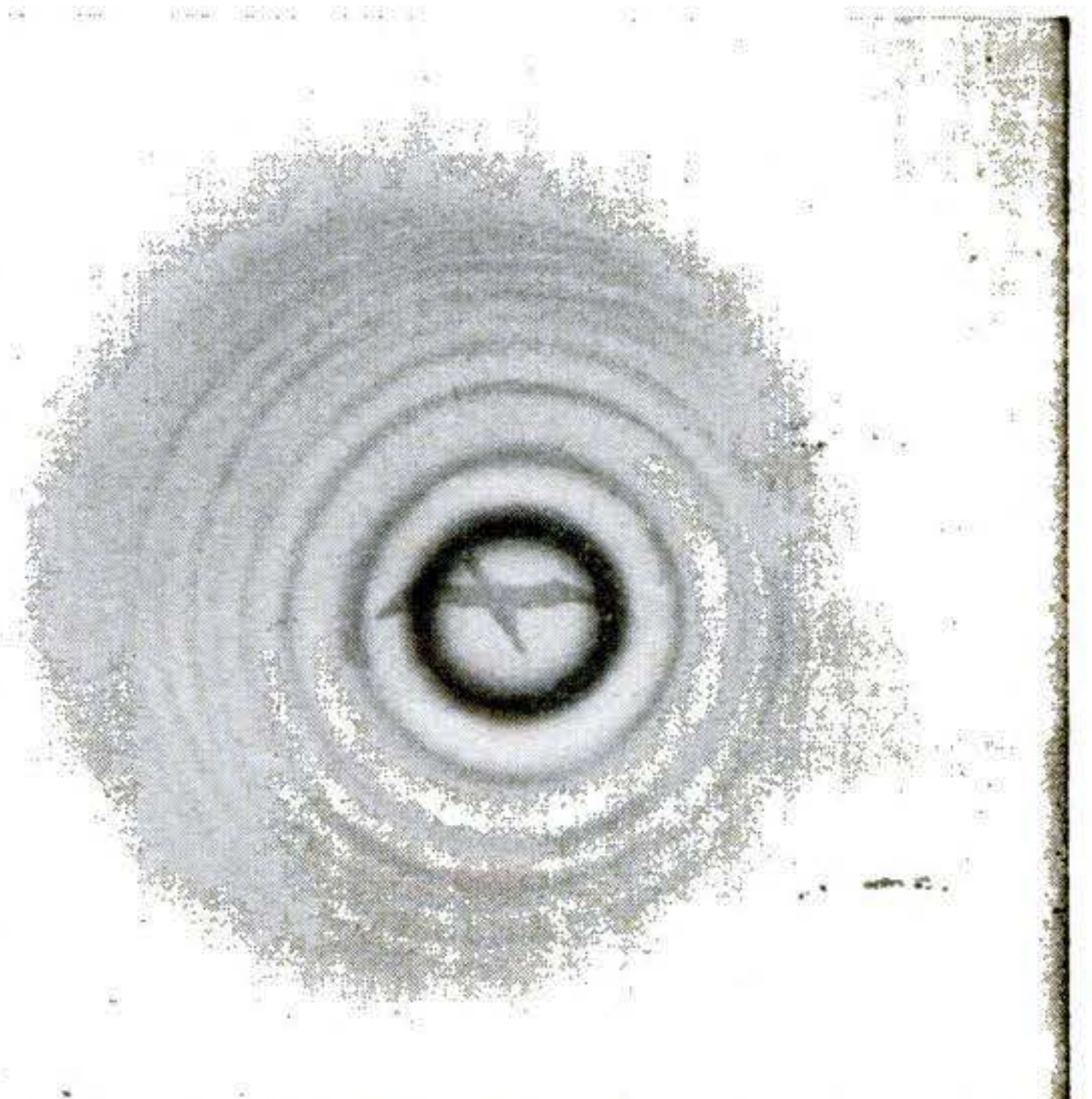

The gull looks like this when seen through the sight. Skilled pilots can follow the birds closely through intricate spiraling maneuvers.



Golfer Prefers Gun to Clubs

WHEN Henry N. Marsh, of Wilmington, Del., shoots a game of golf, he really shoots it—with a golf-gun. A professional trap-shooter, Marsh invented the gun because he was annoyed that he couldn't drive a golf

ball as far and as straight as his opponents. The gun shoots a ball 250 yards right down the middle—even if not quite according to Hoyle. It consists of a sawed-off .38-cal. pistol with a brass tube attached to the muzzle to hold the ball (right above). A blank cartridge supplies the necessary kick.

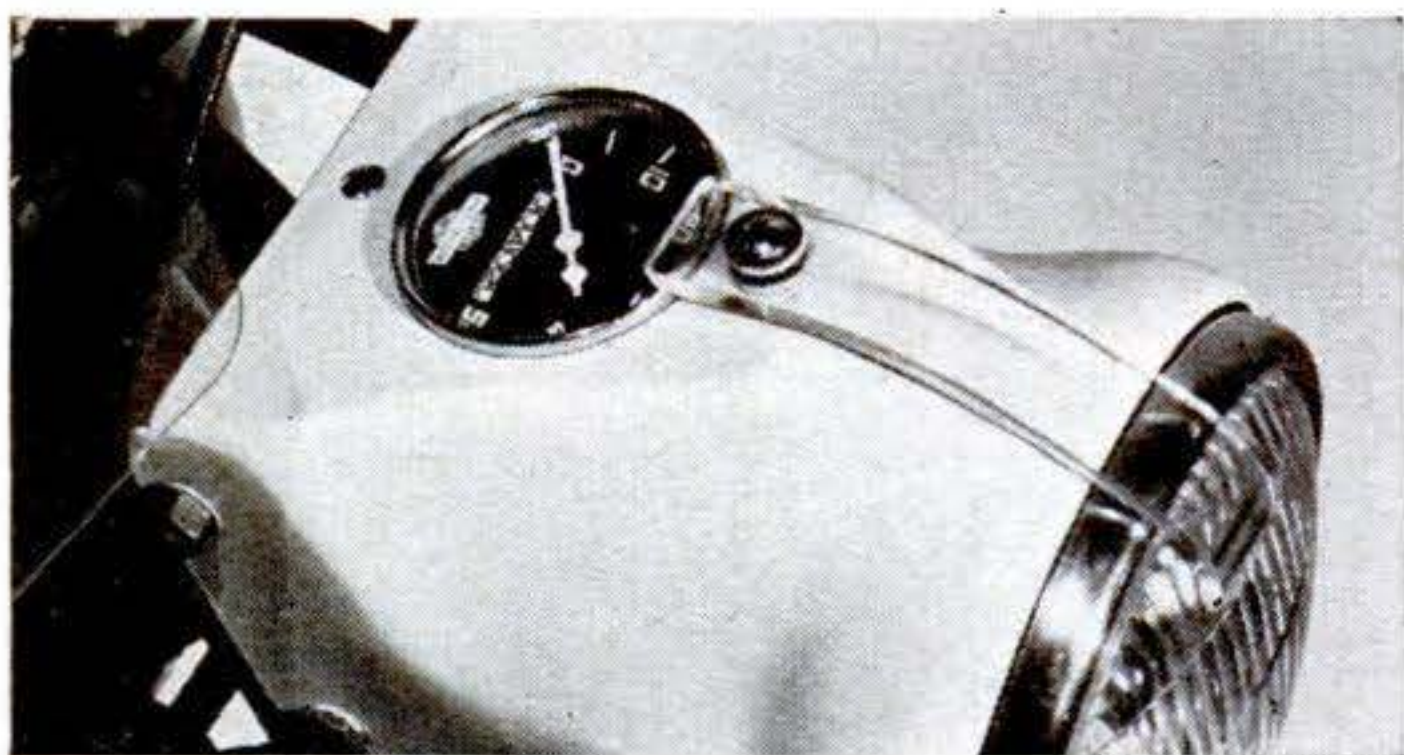

Plastic Lights Speedometer

You can tell how fast you are driving in the dark if this plastic illuminating strip is mounted between the headlamp and speedometer of your motorcycle. A Harley-Davidson accessory, the methyl methacrylate strip channels light to the speedometer.

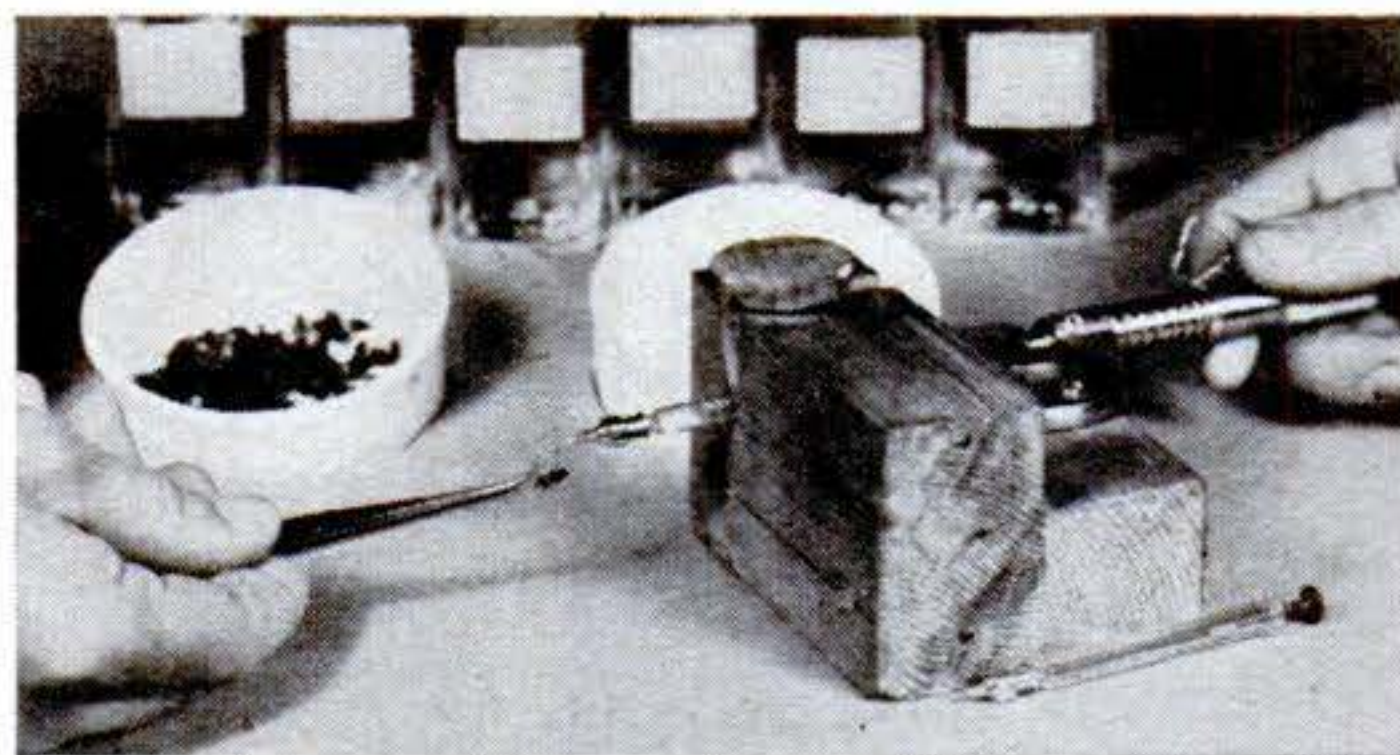

Fly Gets Knock-Out Drops

How much insecticide does it take to knock out a fly? The Citrus Experiment Station in Riverside, Calif., is trying to find out. A fly held by tweezers, above, gets a shot of insecticide from a hypodermic needle working like a miniature medicine dropper.

Wheelbarrow Is Self-Powered

THIS mechanical wheelbarrow, demonstrated recently at Tunbridge Wells, England, has the capacity of five manually operated barrows. Controlled by an operator at right, the vehicle's power unit is mounted on a turntable that turns 360 degrees. The barrow's removable carrier can be replaced with a platform for transporting machinery.

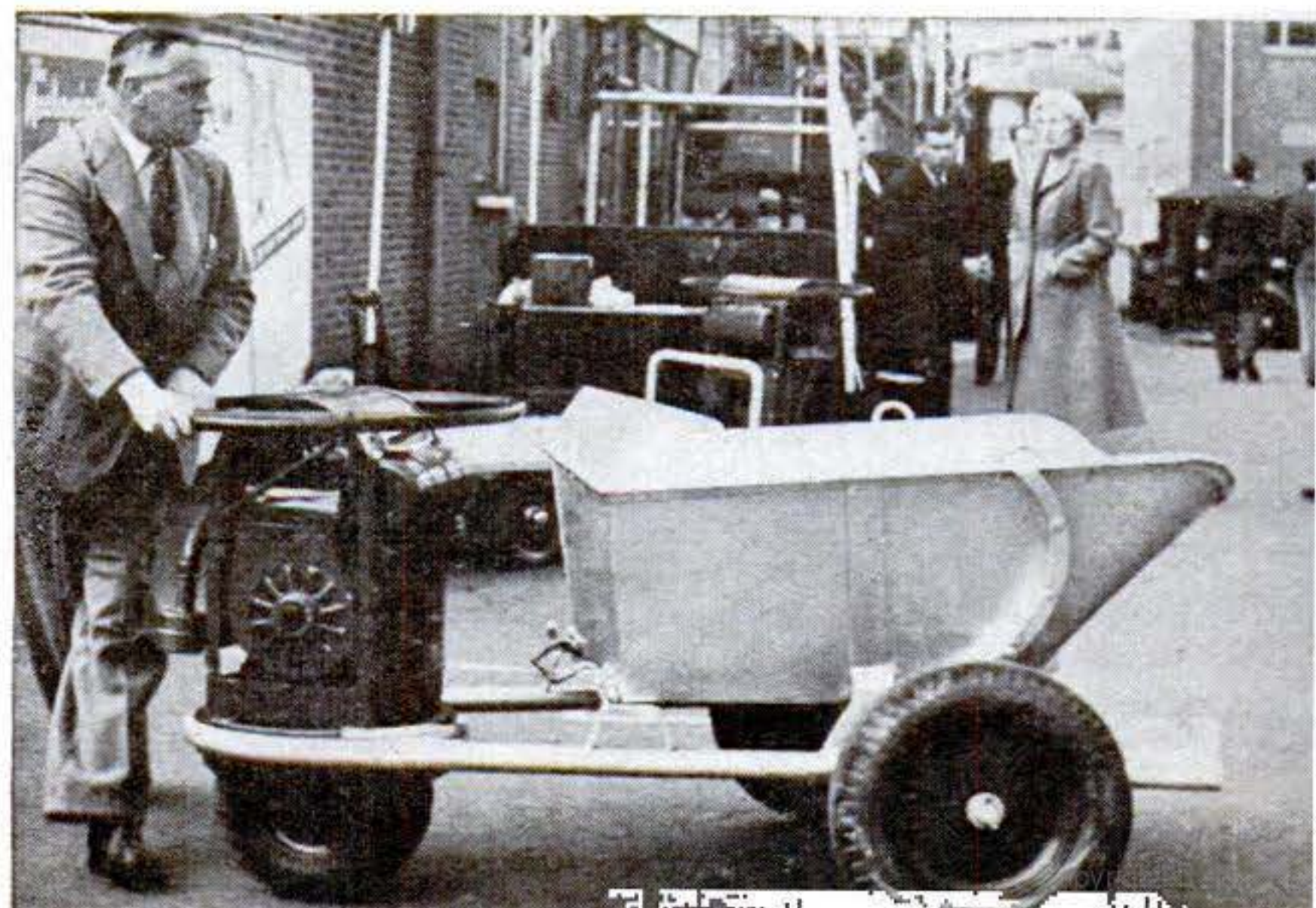

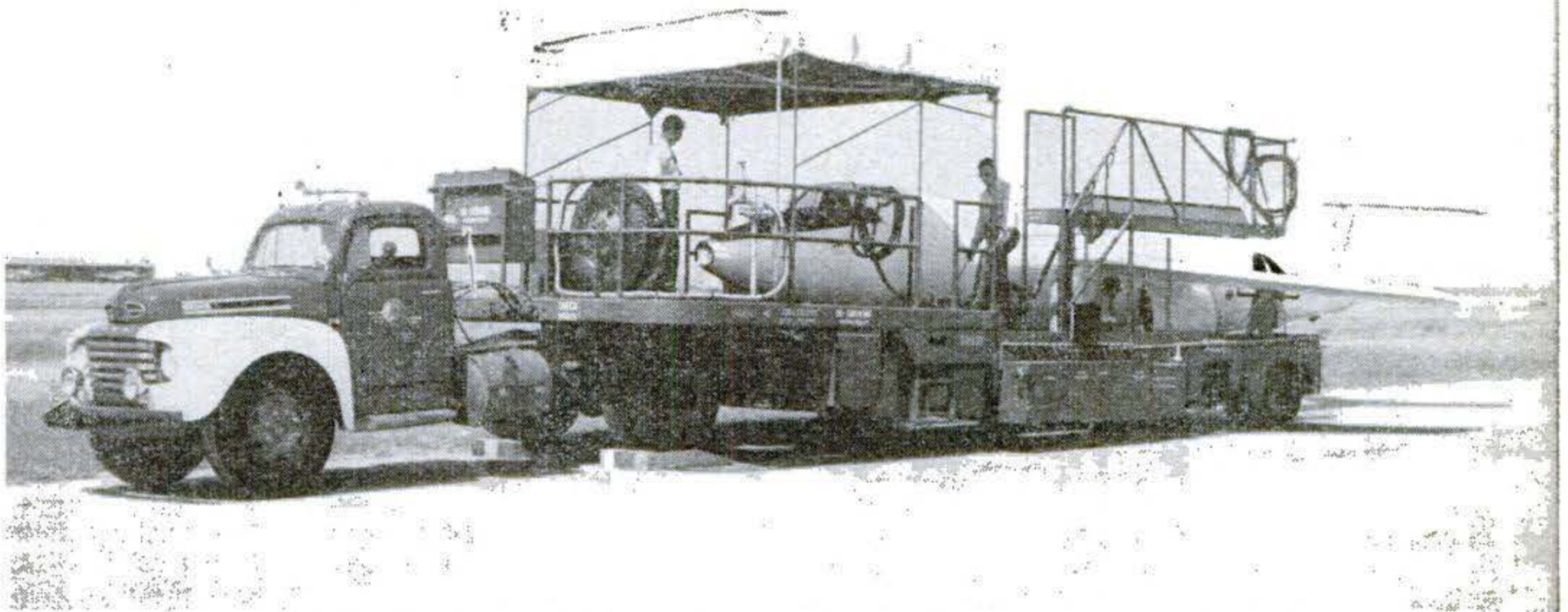

The Skyrocket, high-speed research plane, gets complete service as it is hauled in this special trailer along a California highway to its desert base after a visit to the factory between flights.

Work platforms give crewmen access to all parts of the craft. Forward canopy shields the pilot's compartment so that it will be cool and ready for an immediate take-off on arrival.

Mobile Service Station Mothers Sky Speedster

SOME of the world's fastest research aircraft are kiwis—birds that can't fly—under certain conditions. Because they are highly experimental in the trans- and super-

sonic ranges, these hot-rod planes need exceedingly wide and open areas for their Buck Rogers' flights, such as the vast expanse of California's Muroc Dry Lake

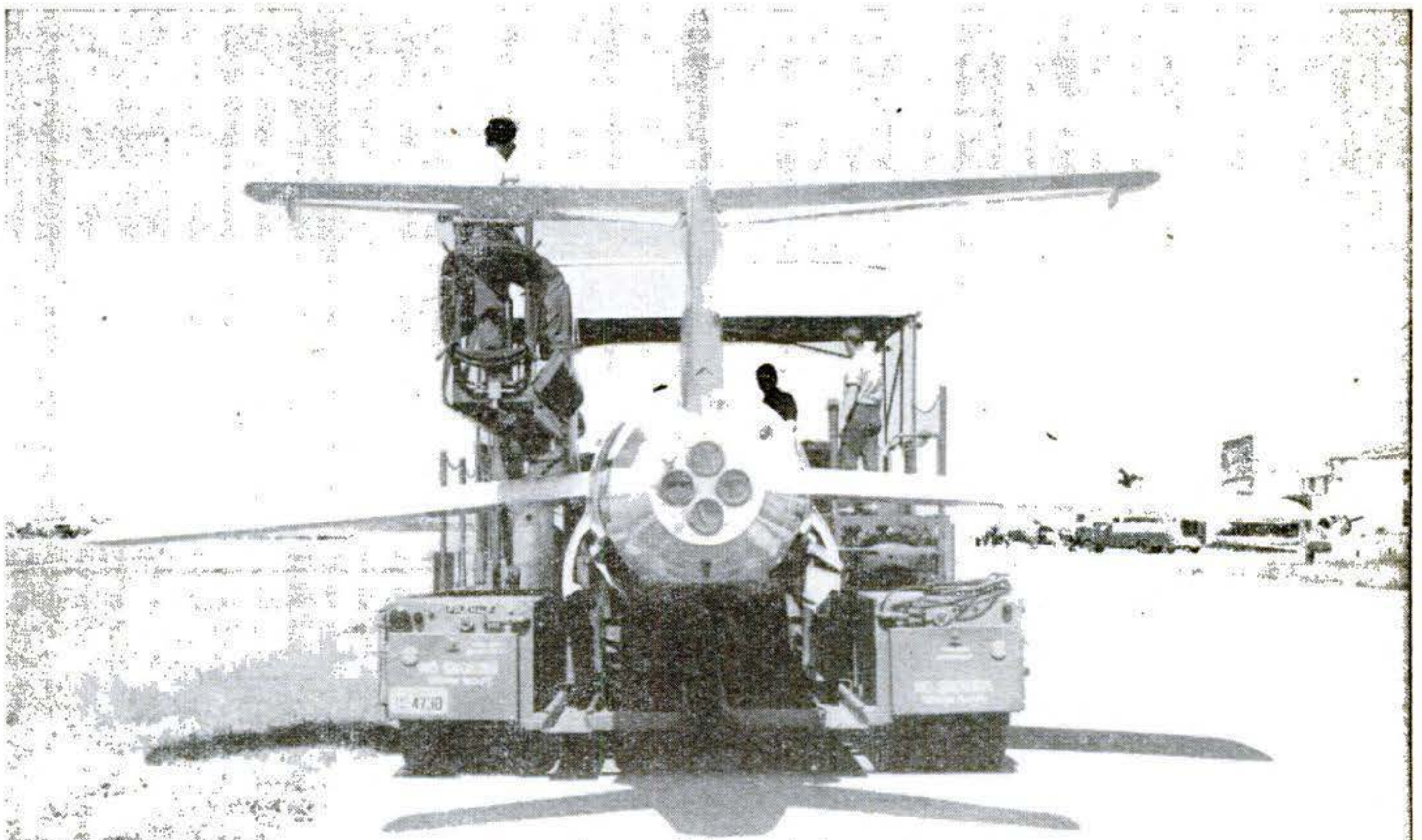

Rear view of the novel plane-trailer built by Fruehauf to Douglas Aircraft specifications.

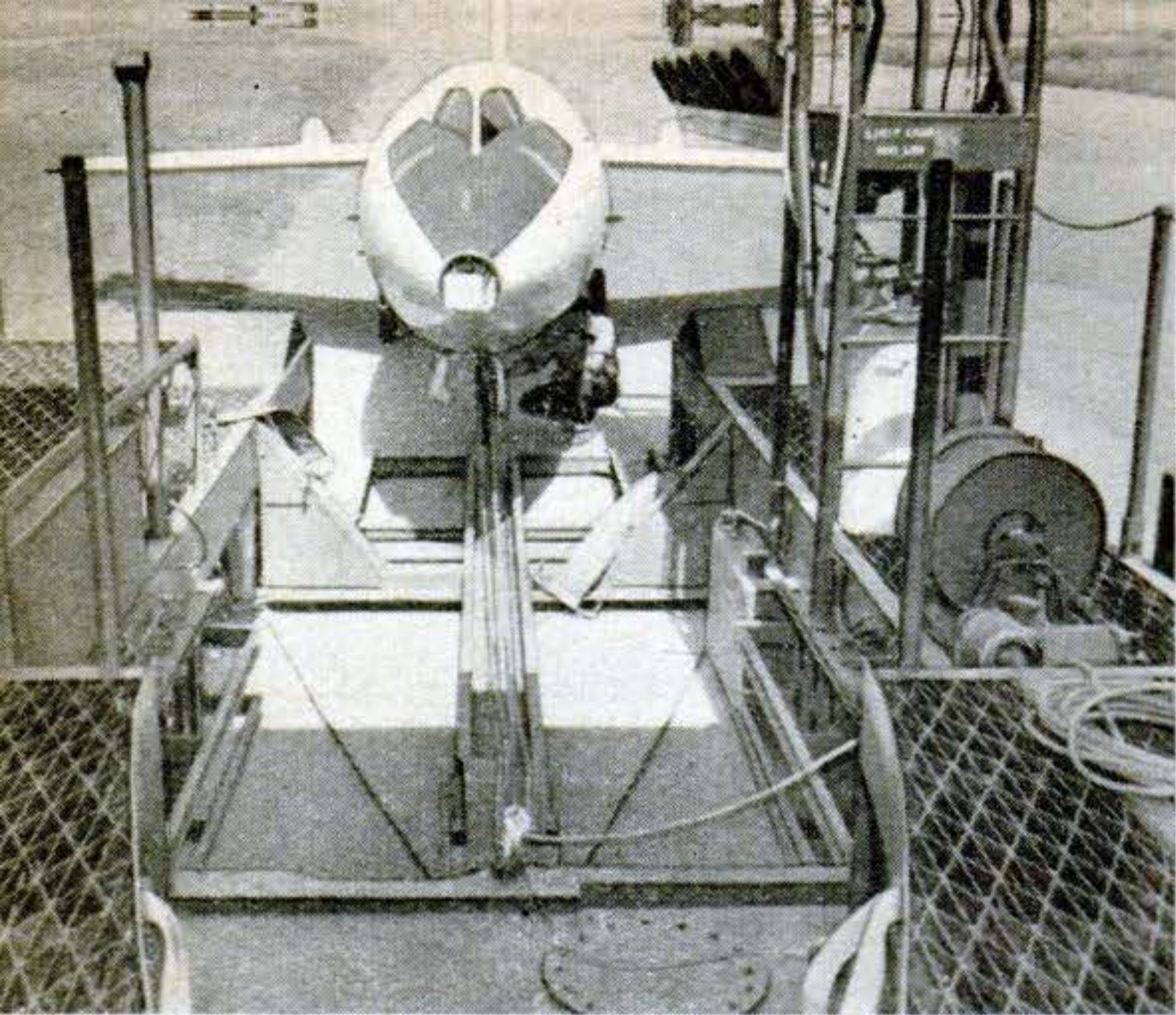

A "kneeling" action that drops the rear end of the trailer permits the 45-foot-long Skyrocket to be rolled up into place on its own running gear. Storage batteries supply power for all services.



When the aircraft is aboard, electric motors return loading gear to place. The plane can be fueled while it is traveling. A portable pump supplies pressure to a pair of fire hoses.



After each flight, fuel tanks are emptied to prevent fire and then flushed out by air pressure, as shown here. The trailer includes a shower for crewmen doused with dangerous liquids.

with a natural runway seven miles long and desert wide. When a speedster of this feather—such as the Navy's Douglas Skyrocket—needs major design changes or a complete overhaul, it can't just fly back to a local airport near the factory. It has to travel the highways. So a special service-enroute trailer was built to ground-ferry the needle-nosed D-558-2 that recently flew faster than the speed of sound. A pure research plane, the Skyrocket, along with such aircraft as the Skystreak and the Air Force's Bell X-1, is exploring the effects on plane and pilot of flight at speeds greater than that of sound. The photo sequence on these pages shows how a fly baby that can crack the sonic barrier must be babied on the ground between flights. END

Jukebox Announces Train Departures

THE uniformed train announcer is out of a job at the Texas & Pacific Railway station at Fort Worth, Texas. His place has been taken over by an automatic, heavy-duty record changer, right below, that plays station names and departure times over the public address system. With the two jukebox-type record selectors shown at left, a

ticket seller can pick any of 38 selections to give a first and last call for each of the 19 passenger trains that arrive at and depart from the station daily. The records were made by a professional radio announcer, so that the announcements are clear and understandable. A similar system is in operation at several large airports.

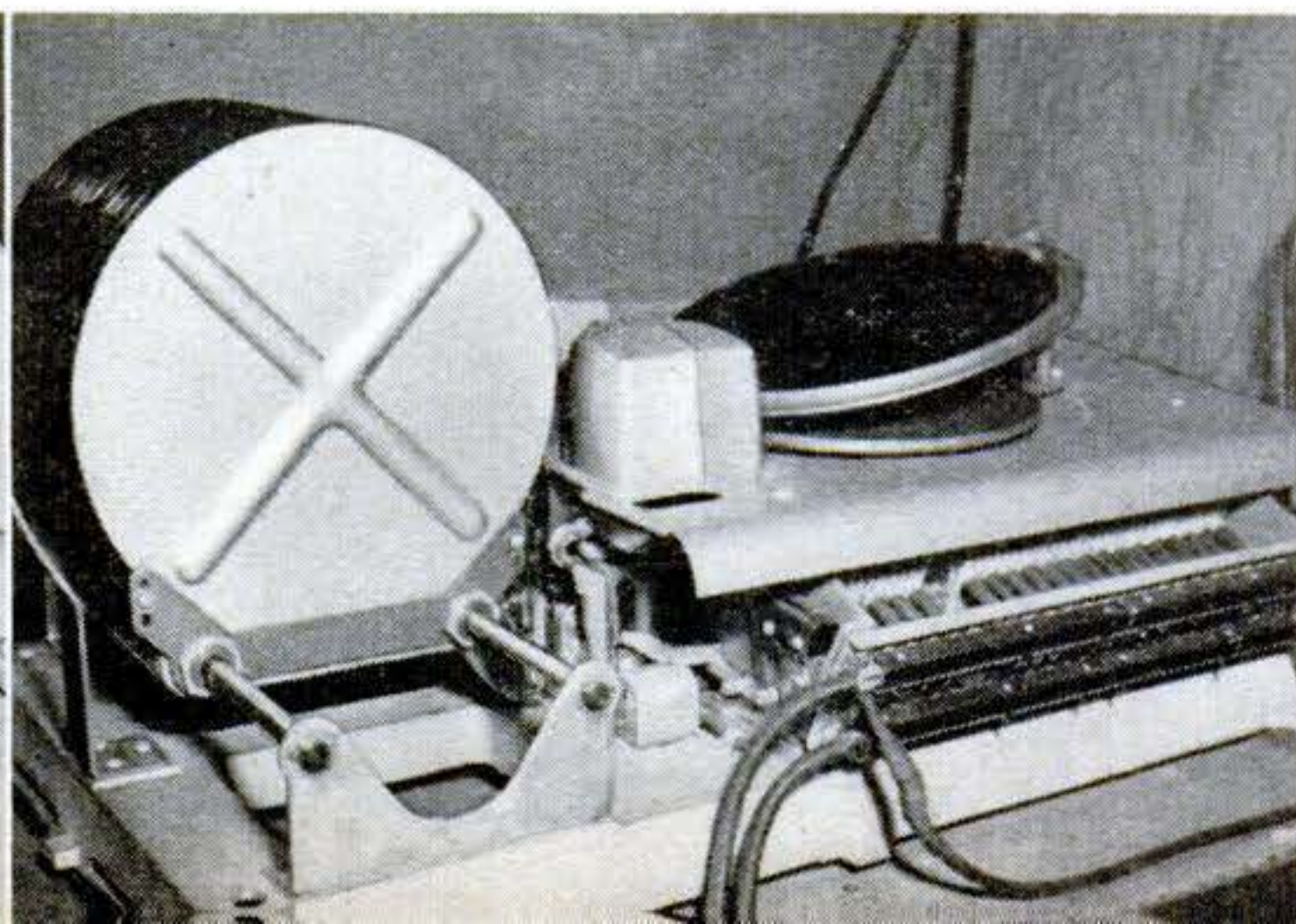

Keeping the Home Shipshape

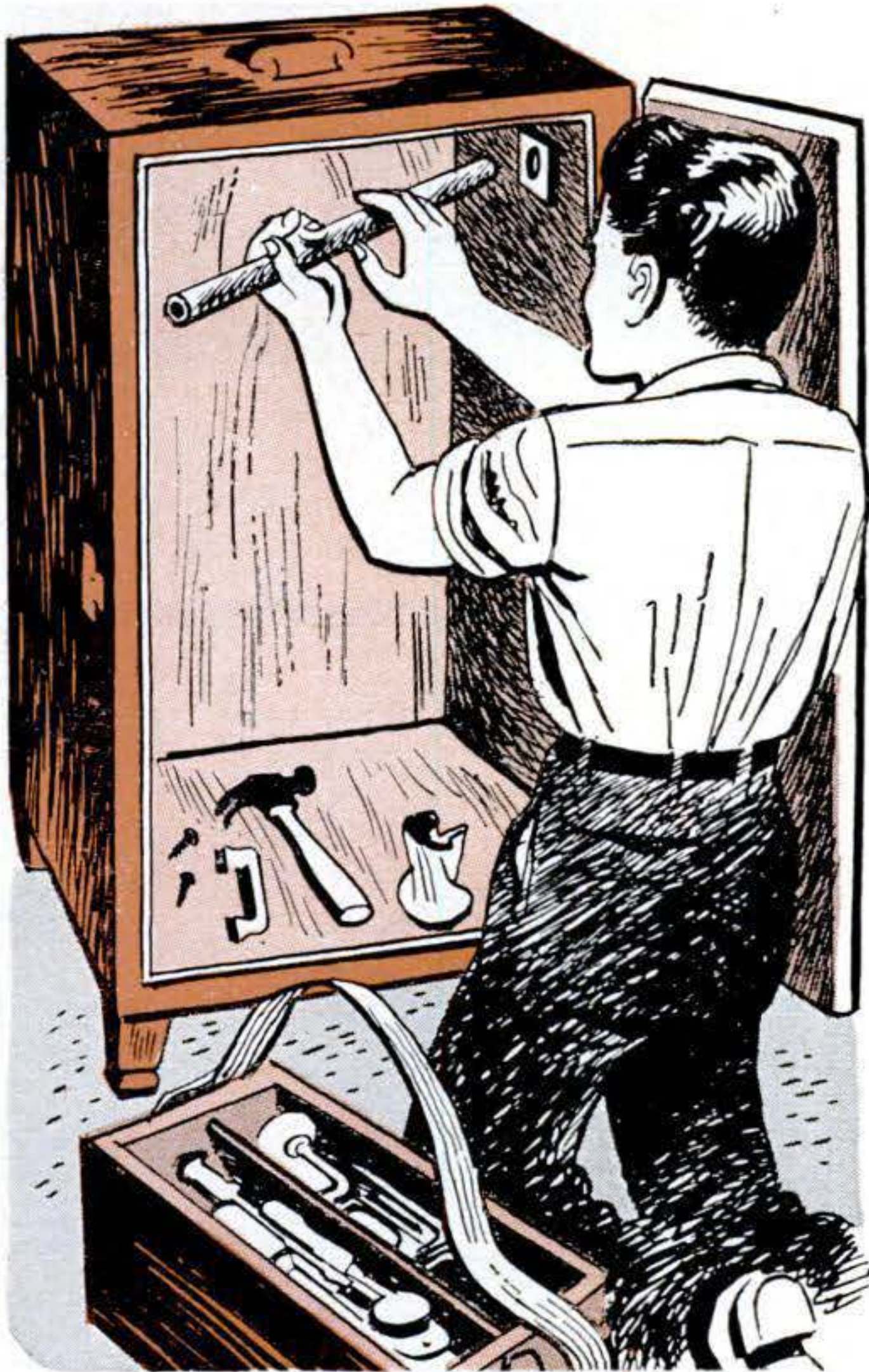

By shifting the legs from the bottom to one end, you can convert an up-ended cedar chest for duty as a cabinet in the attic or storage room. A bar for coat hangers may be added.

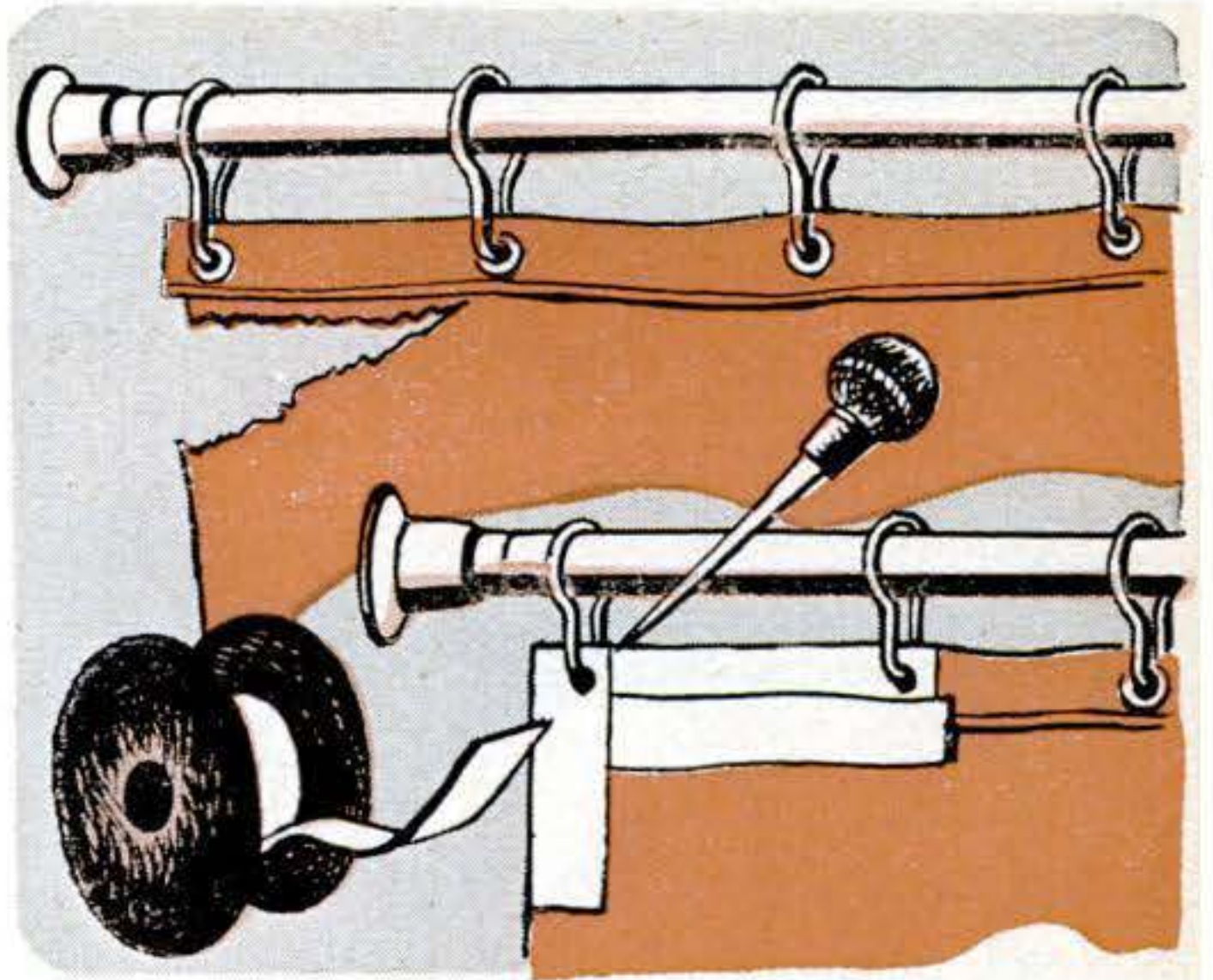

Rips in a shower curtain can be repaired with adhesive tape. Run a horizontal piece of tape along the rip. Then loop a vertical piece over it. Punch holes for the rings.

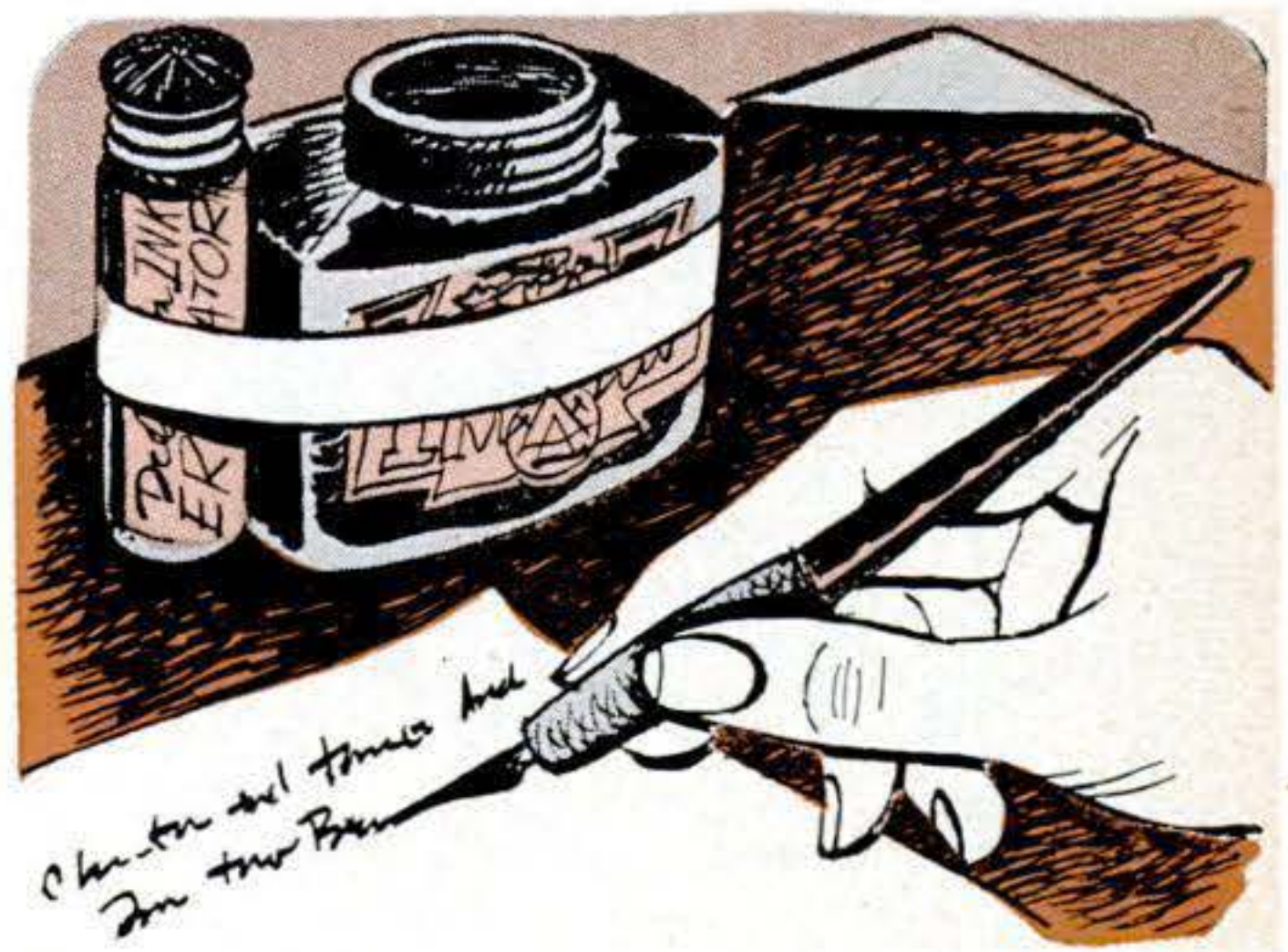

Bind your bottle of ink eradicator tightly to the desk ink bottle with cellulose tape. This makes spilling less likely and keeps the eradicator ready at hand for use.

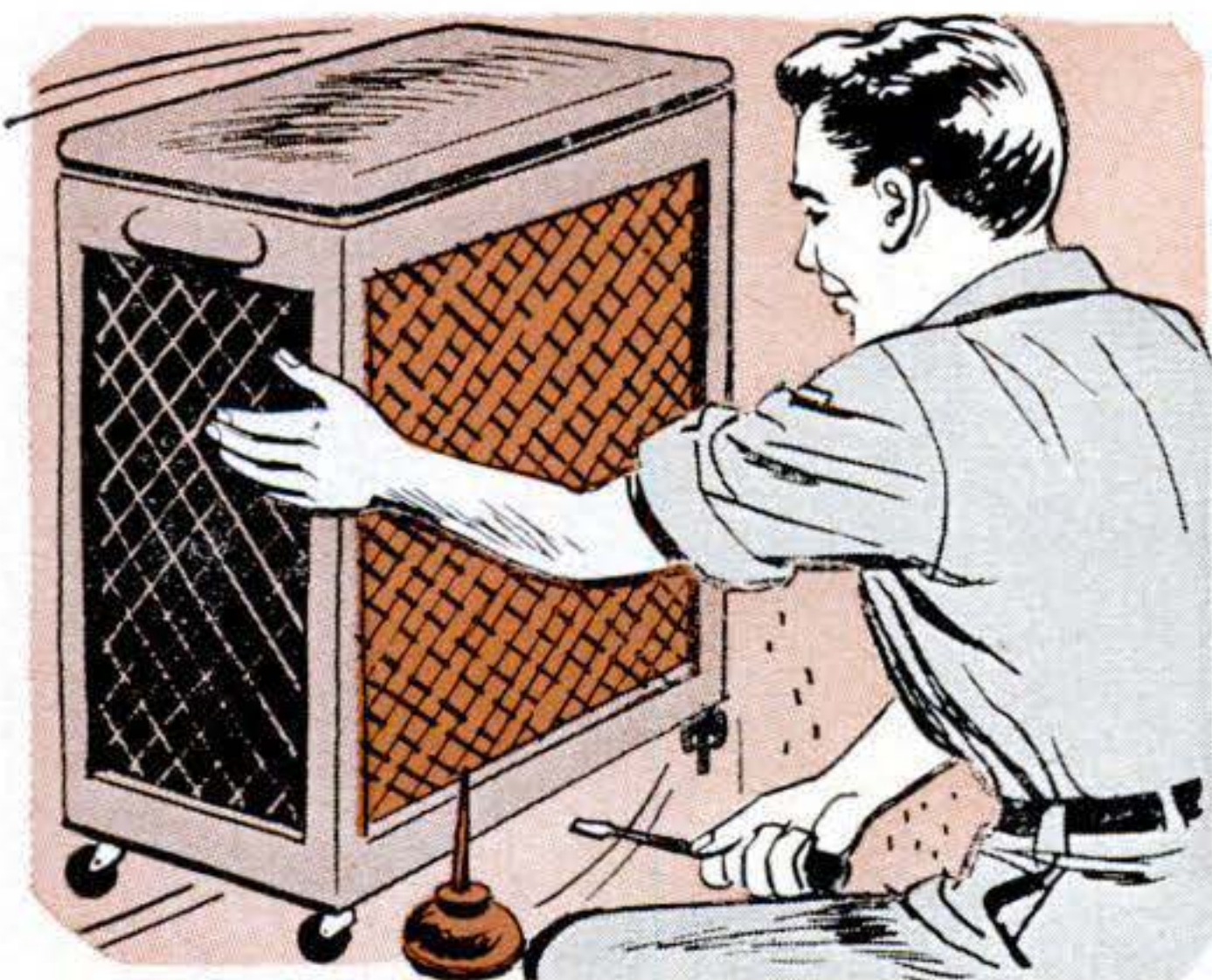

Here's a work saver: Attach a set of casters to the bottom of the clothes hamper. Instead of carrying the clothes, you can roll the hamper right up to the washing machine.

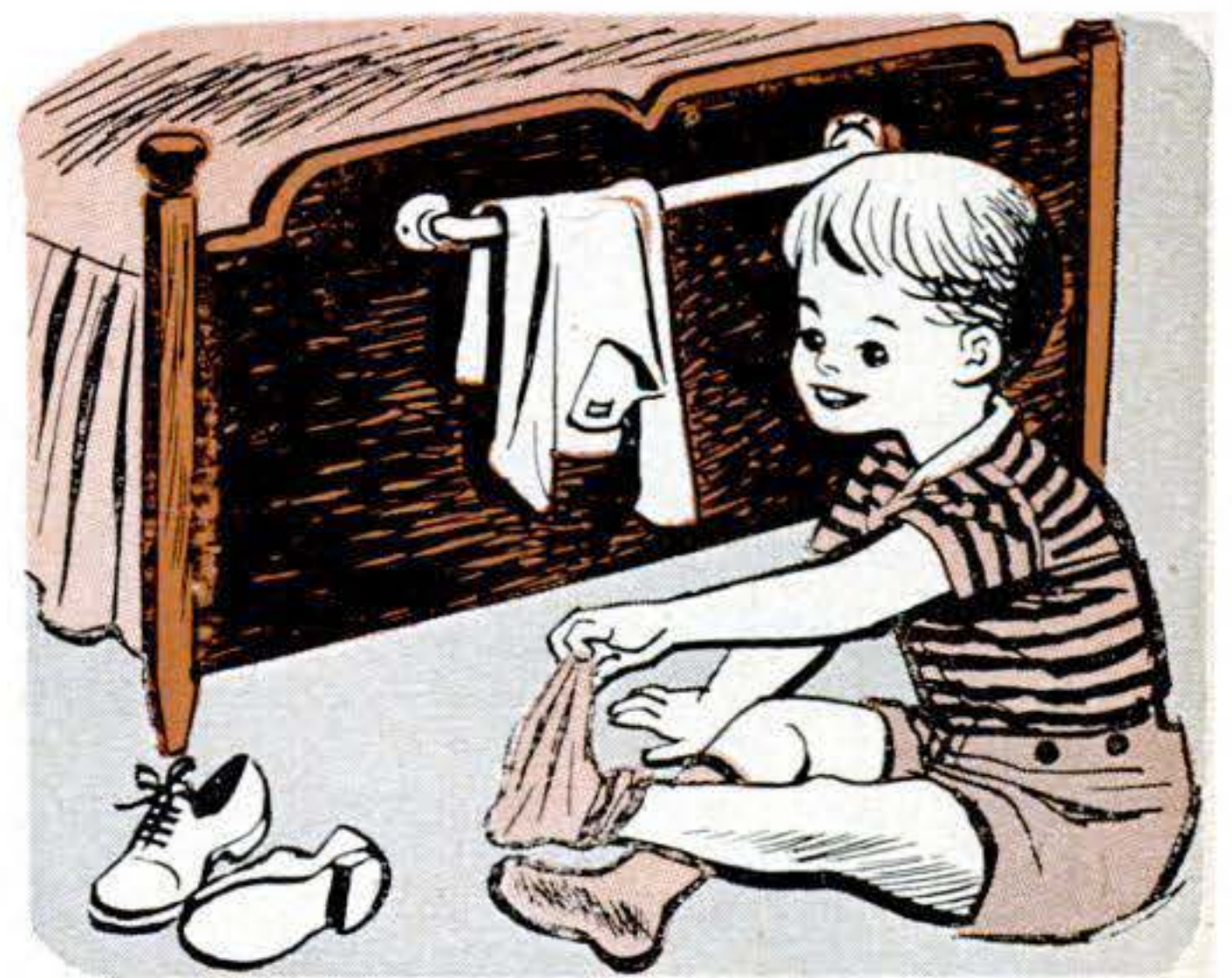

To encourage your child to be tidy and to take care of his clothes, screw a dime-store towel rack to the footboard of his bed. It provides a convenient clothes rack for him.

Please turn the page for five more suggestions

Keeping the Home Shipshape



A level spoonful of sugar, salt, or coffee is easily obtained this way. Glue strips of cloth across the tops of the canisters. The loaded spoon is simply scraped along under the cloth.

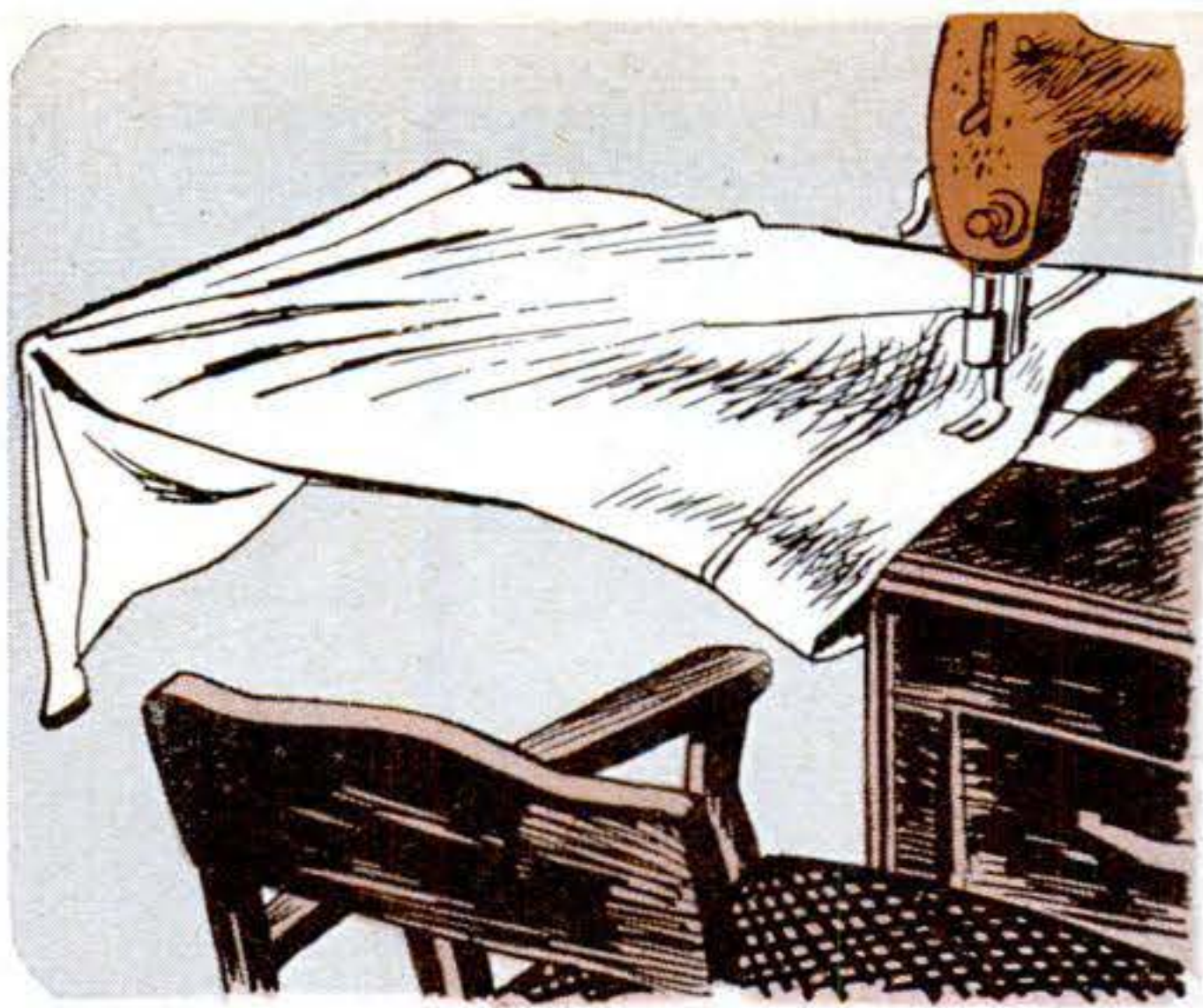

Slip a pillowcase over the leaf of a sewing machine when working on silk or sheer material. It makes snagging unlikely and curbs the tendency of such material to slide off.



White gloves and belts will stay cleaner longer if you store them in sandwich bags. They'll be less likely to pick up dirt and wrinkles when you rummage through a drawer.

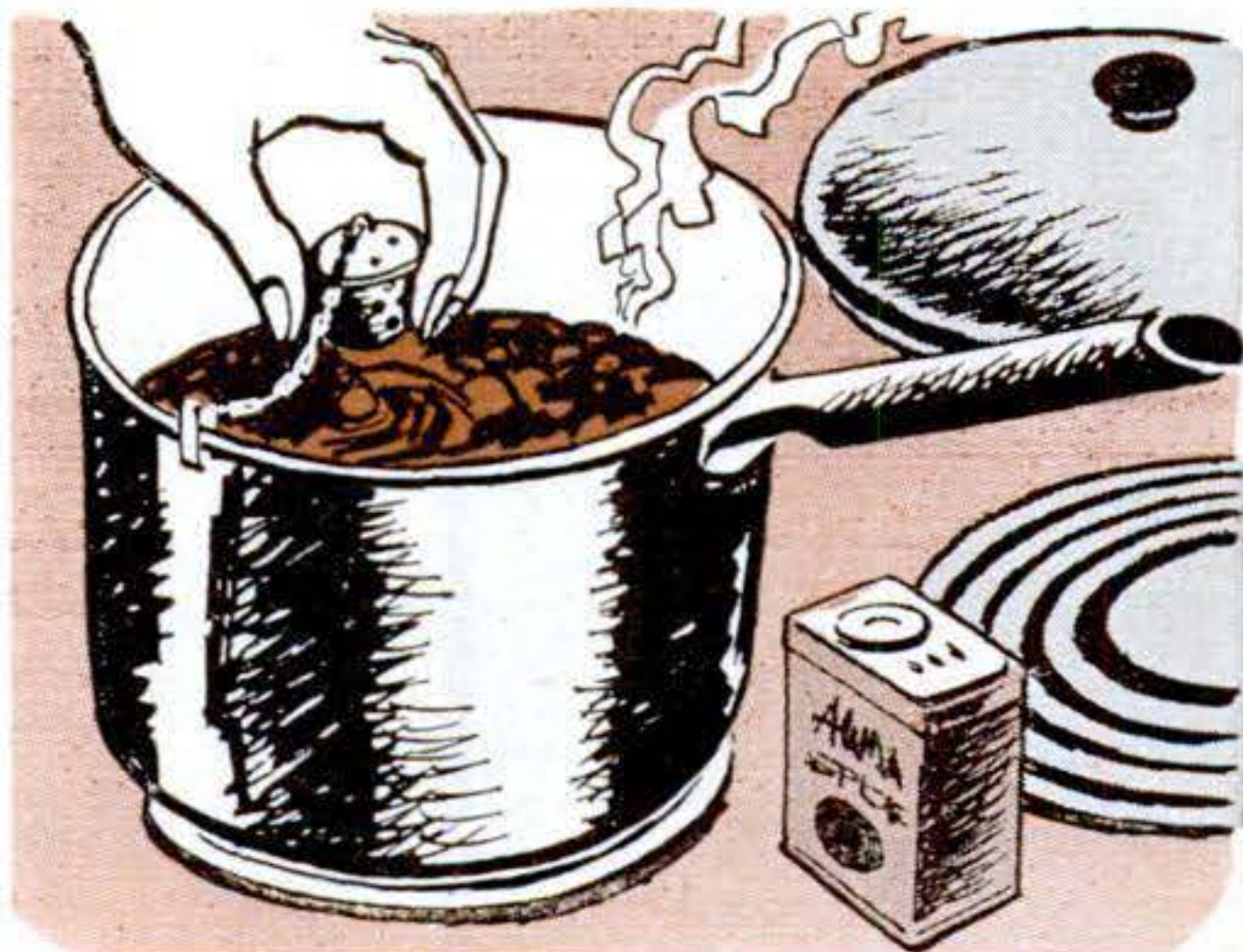

Place spices in a metal tea ball and hang it inside the cooking utensil. It lets the spices flavor the dish but keeps them from mixing with the food that's being cooked.

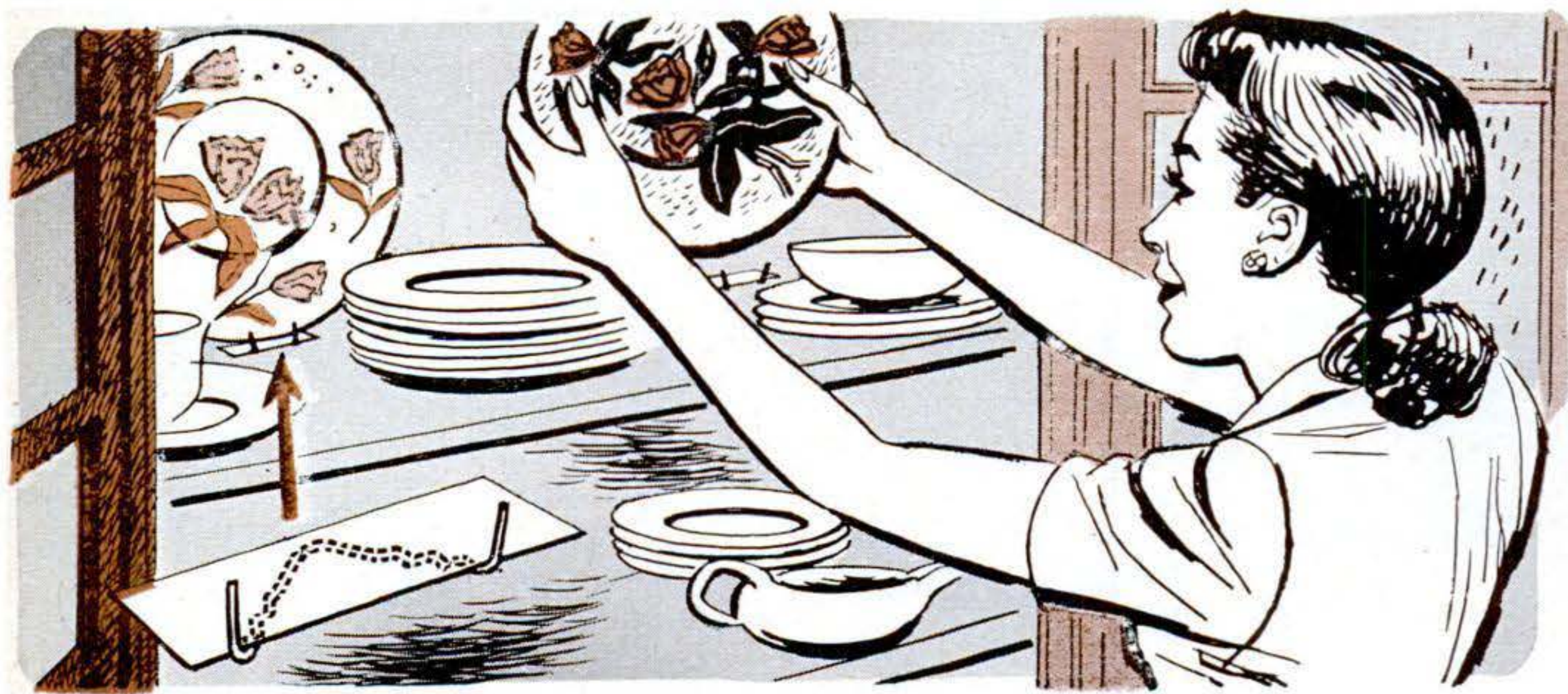

Hairpins and cellulose tape will hold plates on edge against the back of a cupboard. Bend the

legs of the pins to 90° and turn up about $\frac{3}{8}$ " of each end. Tape holds them in place.

Mechanics and Handicraft

REG. U. S. PAT. OFF.

Booster Improves TV Pictures PAGE 187

How's Your Hot Water Supply? PAGE 196

Easily Built Home Accessories PAGE 217

Spot Welding on a Drill Press PAGE 230

Processing Your Own Photos PAGE 234



What Makes This Engine Run? SEE PAGE 206 FEBRUARY 1950 177



Gus and the Flying Keys

By Martin Bunn

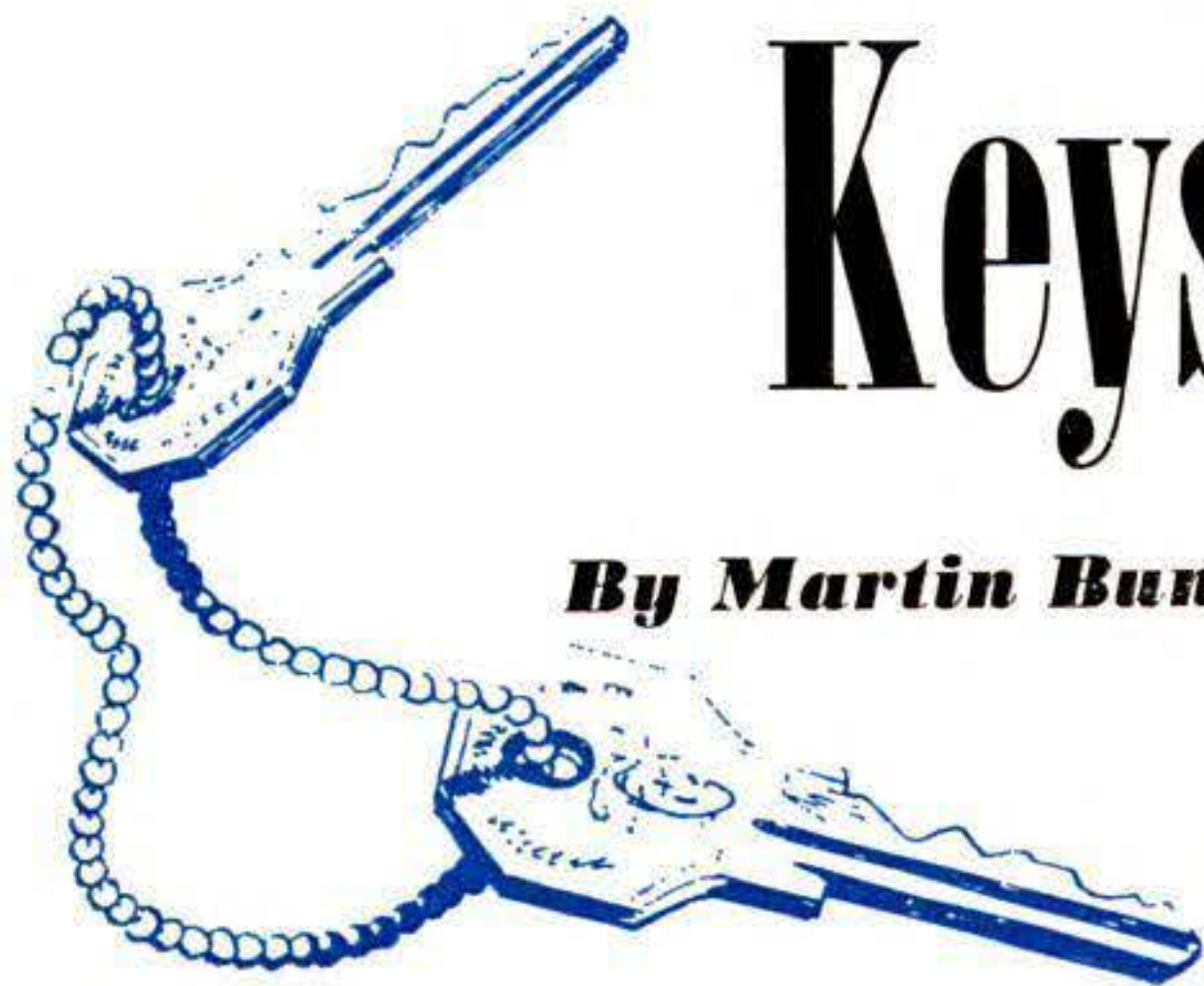

DURING his years in the Model Garage, Gus Wilson has seen a lot of disgruntled motorists. But not one of them was more fed up with a car than Val Murdock the day Officer Cecil O'Toole handed him a ticket for reckless driving at Main and Center Streets.

It was strange, too, about Val. Usually, he is a very careful driver. And it would seem he had every reason to be pleased with the car. It was brand new, a superduper convertible equipped with automatic transmission and all the other modern improvements—a job to take anyone's fancy.

Gus got into the case just by chance. It was late Saturday afternoon. As he stepped from the Men's Shop after buying a couple of shirts, a small object hit the pavement with a metallic clatter. It had come from the midst of a crowd gathered around Val's car—stopped dead in the middle of the intersection.

Gus looked down. A set of car keys. Stooping to pick them up, Gus heard Val's angry voice: "I'll never drive it again! I'm through!"

The situation *must* be bad, Gus decided, if it could cause Val to throw away his keys.

"It's the crazy gadgets on this car!" Val yelled. After listening a moment, Gus worked through the crowd to where O'Toole was writing a ticket.

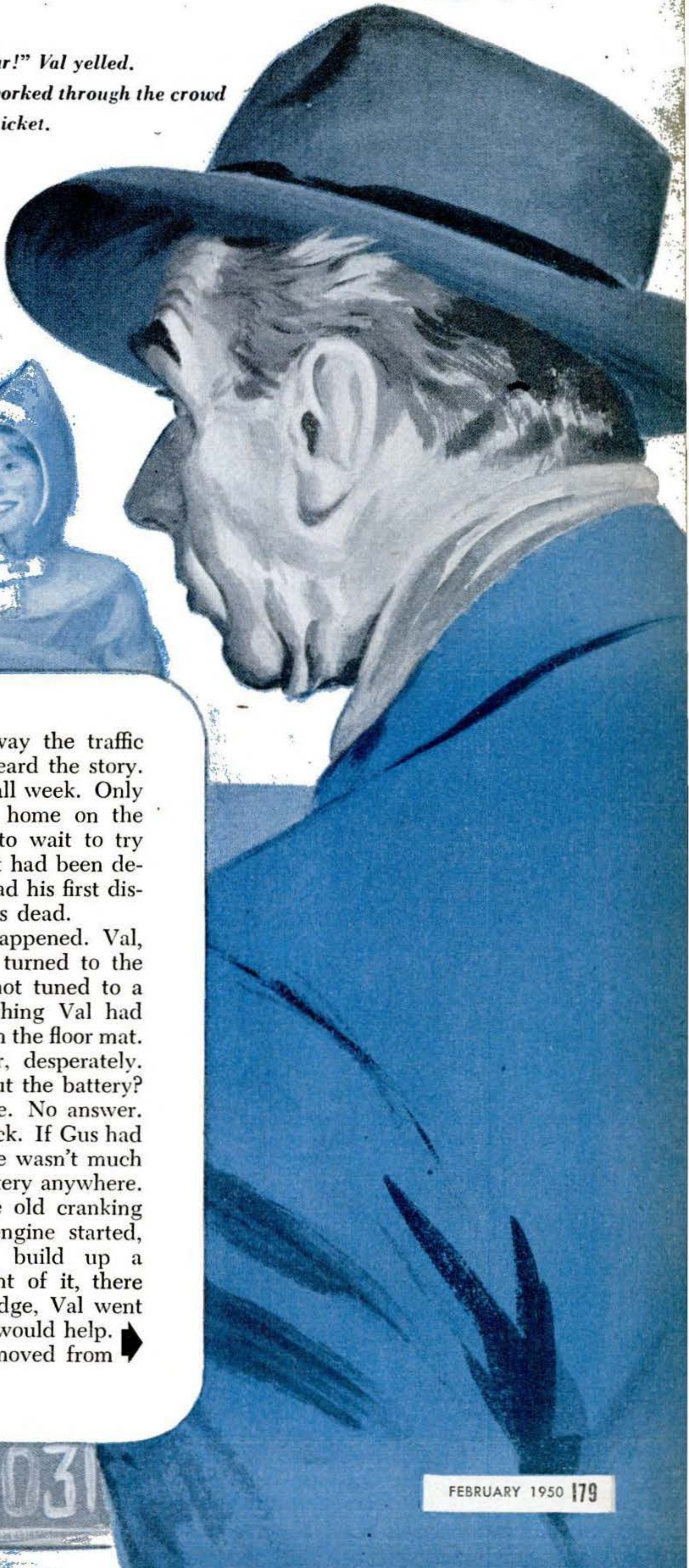

Later, after helping clear away the traffic snarl Val had created, Gus heard the story.

Val had been out of town all week. Only a few minutes after getting home on the afternoon train, barely able to wait to try out the No-Shift-O Eight that had been delivered two days before, he had his first disappointment. The battery was dead.

It was obvious what had happened. Val, Jr. The key in the ignition, turned to the left, and the radio on—but not tuned to a station. That was the first thing Val had found, that and a lot of mud on the floor mat.

Val wanted to try the car, desperately. But what could be done about the battery? He phoned the Model Garage. No answer. It was already after four o'clock. If Gus had closed shop, Val figured there wasn't much chance of finding a rental battery anywhere.

Briefly, Val longed for the old cranking days. If he could get the engine started, the generator would soon build up a charge. Now that he thought of it, there *was* a way. Vaulting the hedge, Val went next door. Yes, his neighbor would help. ➡

The battery was easily removed from ➡



the neighbor's car. Luckily, he was one of those rare individuals who keep the corrosion cleaned away and the terminals coated with petroleum jelly.

Carrying the battery to Val's garage, they hooked it up in parallel with the dead one, pressing into service two lengths of welding cable and four C clamps to make the connections. The engine was soon running smoothly.

Val had returned the borrowed battery and was just straightening down the cleaned floor mat when his wife Marge opened the back door. "Oh, Val," she called, "would you go over and pick up the laundry?"

Traffic was light on the side street, and after driving a couple of blocks Val began to relax and enjoy what the salesman had extolled lyrically as clutch freedom. Automotive engineers really had a lot on the ball, he decided. Gears that shift themselves, and no clutch pedal to bother with!

He overtook an ancient sedan. The street ahead was clear. He sheered out from behind the slow-moving car, and pressed the accelerator all the way to the floor board. The transmission downshifted sweetly, and exultation flooded Val's middle-aged soul at the smooth surge of power that swept him swiftly past the old car. Some bus, this baby!

But the Car Keeps Going

A block ahead a green light blinked to yellow and then to red. Val didn't slow down—maybe it would turn green again before he got to it. It didn't. He took his right foot off the accelerator and braked lightly, while his left foot pawed instinctively for the clutch pedal—which wasn't there. "Dumbell!" he reproached himself, and braked harder.

But the car kept right on going! As the stop line flashed under the front wheels Val really stomped down on the brake. The car slowed, but it was around the corner into Main Street before he could stop it.

He had shifted the selector lever to "Neutral," but the engine was racing. Puzzled, he fiddled with the accelerator. After a few seconds the engine slowed to idling speed. Funny about that, he thought. Must have done something wrong. Better be careful.

Pulling into the parking lot adjoining the laundry, Val eased the car to a halt and, through habit, reached over and turned off the ignition. Back with the package of laundry, he suddenly remembered he had intended to leave the engine running. "Oh, well," he thought resignedly, "there should be enough juice now to start it once."

Will the Engine Start Again?

In the parking space next to his a horse-faced man in a battered sedan was regarding the new car and its owner with an expression that Val classified as sardonic.

A little disconcerted by this inspection, Val forgot he wasn't in the old coupe. He reached his left hand out to where the starter button should have been—but it wasn't there. "Watch what you're doing, you dope!" he chided himself. He located the button and pressed it—but nothing happened. There wasn't a peep from the starter.

Puzzled, Val checked over the controls. There, that was it! He had forgotten to shift the control lever to "Neutral." A neat little safety feature that! No juice could flow through the starter circuit until the car was in neutral.

The engine finally caught, but Val was so badly flustered that he shifted the selector lever from "Neutral" to "Reverse" instead of to "Drive," with the disconcerting consequence that when he released the hand brake and pressed the throttle pedal, the car shot backward. Only his frantic application of the brakes stopped it in time to avert, by inches, a crash with a delivery wagon parked twenty feet behind.

Val mopped the cold sweat off his brow



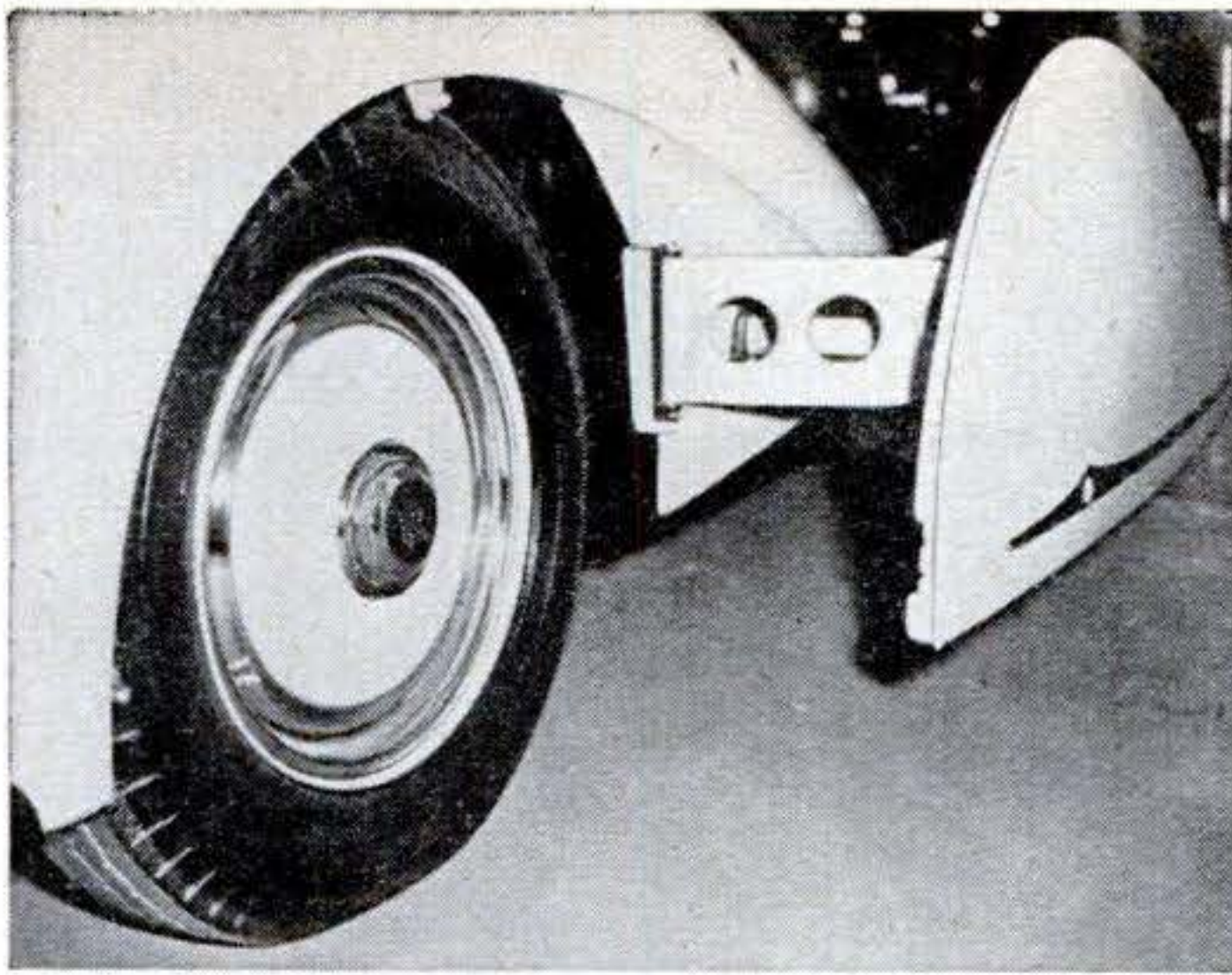

Fender Skirt Swings Outward

WHEELS are fully enclosed on the latest Rolls-Royce Wraith model, but tire changing is made easy. The entire skirt swings out on a hinge, giving ready access to the wheel. Two catches keep the skirt locked in place during normal operation.



Washer Sprays Entire Car

STANDING in one position, an operator can swing this counterbalanced arm back and forth to wash a car from end to end. Fully self-contained, the spray-jet washer even has its own soap supply. It's made by Phillips Pump and Tank Co., Cincinnati, Ohio.

and tried again. This time he manipulated the selector lever according to Hoyle, and went in the direction he expected to go.

The traffic thickened and slowed as he neared the intersection of Main and Center. Out on his little safety island Officer O'Toole, tired, nervous, and short of temper after four straight hours of duty, was controlling the lights manually, and making the most of every chance to keep the cars moving.

When the last automatic light before Center Street turned green, the block between it and the intersection was clear of traffic. Val's car was the first in line, and he took advantage of the break by speeding up to the 25-mile limit. But just before he reached the intersection O'Toole switched the Main Street light to red. In an instant Center Street cars were half-way across the intersection or making right turns into Main, and impatient pedestrians were flooding the street.

Why Val Threw Away the Keys

Val's right foot moved swiftly and surely from the accelerator to the brake pedal. But again his car kept on going! It missed the rear end of a truck by a scant inch, and a fear-paralyzed shopper by half as much. Women screamed. Men cursed. Horns squawked. Val put everything he had onto the brake pedal, and the car came to a grinding stop a yard short of the safety island. Val jumped out.

Officer O'Toole blew a whistle blast that set brakes to whining two blocks away, and switched the Center Street light to red. Then, his face fiery, his jaw out, and his eyes blazing, he stalked over to Val. "What in blazes is th' matter with you?" he roared.

Val Murdock is a peppery sort of citizen. His temper slipped its leash, and he blew his top. "There's nothing the matter with me!" he yelled. "It's the crazy gadgets on this car!"

It was then that Val reached into the No-Shift-O, snatched the ignition keys, and hurled them as far as he could.

By the time Gus got out into the street, the mutual fury of O'Toole and Val had set most of the onlookers to laughing. Gus didn't join in—he has seen too often the tragedy an out-of-control car can cause. After listening a moment, he worked his way through the crowd to where O'Toole was writing out a ticket while Val glared. "Hello, Cecil," he greeted. "Hello, Val—here're your car keys—you might want 'em. Anything I can do?"

O'Toole looked up from his writing. "Mebbe you can get this bus out of the middle of the intersection," he growled. "I wouldn't trust this nut to do it."

Gus and Val got into the car. Gus pressed the starter button, but nothing happened. "Oh, Lord," exclaimed Murdock. "I forgot to tell you. The battery's dead. If it was only the old car, we could get a shove. I don't know if you can push these things." ➤

"You sure can," Gus said, "if you know how. Cecil, ask that lead car over there to give us a fast shove up the street, will you?"

As the other car nudged its bumper against the rear one on Val's car, Gus moved the selector lever to "Neutral." Slowly, the cars picked up speed. When the speedometer registered 20 miles per hour, Gus switched on the ignition and moved the selector lever to "Drive." The engine quickly caught.

"Easy, isn't it?" Gus asked. "You won't do any damage if you do it just as I did. But you should always remember to move the lever to 'Drive,' never 'Low.' And don't push any of these cars faster than 25 miles an hour or more than two miles."

For several blocks the No-Shift-O performed beautifully. Then, when Gus took his foot off the accelerator, the car didn't slacken speed. Quickly he moved the lever to "Neutral" and applied the brake. As the car stopped by the curb, he set the hand brake. "Accelerator's jammed," he said. "Let's take a look. If I can't find the trouble right away, I'll get the wrecker and tow your car in. It's only a few blocks, but I'm not driving a car with a stuck accelerator even that far."

A few minutes later Gus straightened up.

"The trouble is," he told Val, "that the accelerator rod, under the treadle, is jammed by the rubber floor mat. Sometimes it works all right, and sometimes it doesn't—and when it doesn't it holds the throttle open. There's really nothing to fix—someone has taken the mat out and replaced it in the wrong position. I'll put it back so the rod works freely."

Val looked guilty. "I'm the guy who did it," he confessed. "My kid had tracked dirt all over the mat. So I took it out and washed it—you know how a fellow is with a brand-new bus. But say, Gus—I'm not sure I'll ever trust that automatic shift again."

"Of course you will," Gus reassured him. "As soon as you get to understand it. It's an improvement—a big one. In a couple of days you'll wonder how you ever got along without it. And I don't think there's much chance you'll ever be bothered again with a sticking accelerator. But if you should, just remember to move to 'Neutral' in a hurry."

"There's another thing, too. A car with an automatic-shift device has to be driven, just as much as a Model T had to be driven. No one ever has built a human brain into an automobile—and you can take it from me no one ever is going to!"

END

Folding Rack from Old Car Boosts Luggage Space

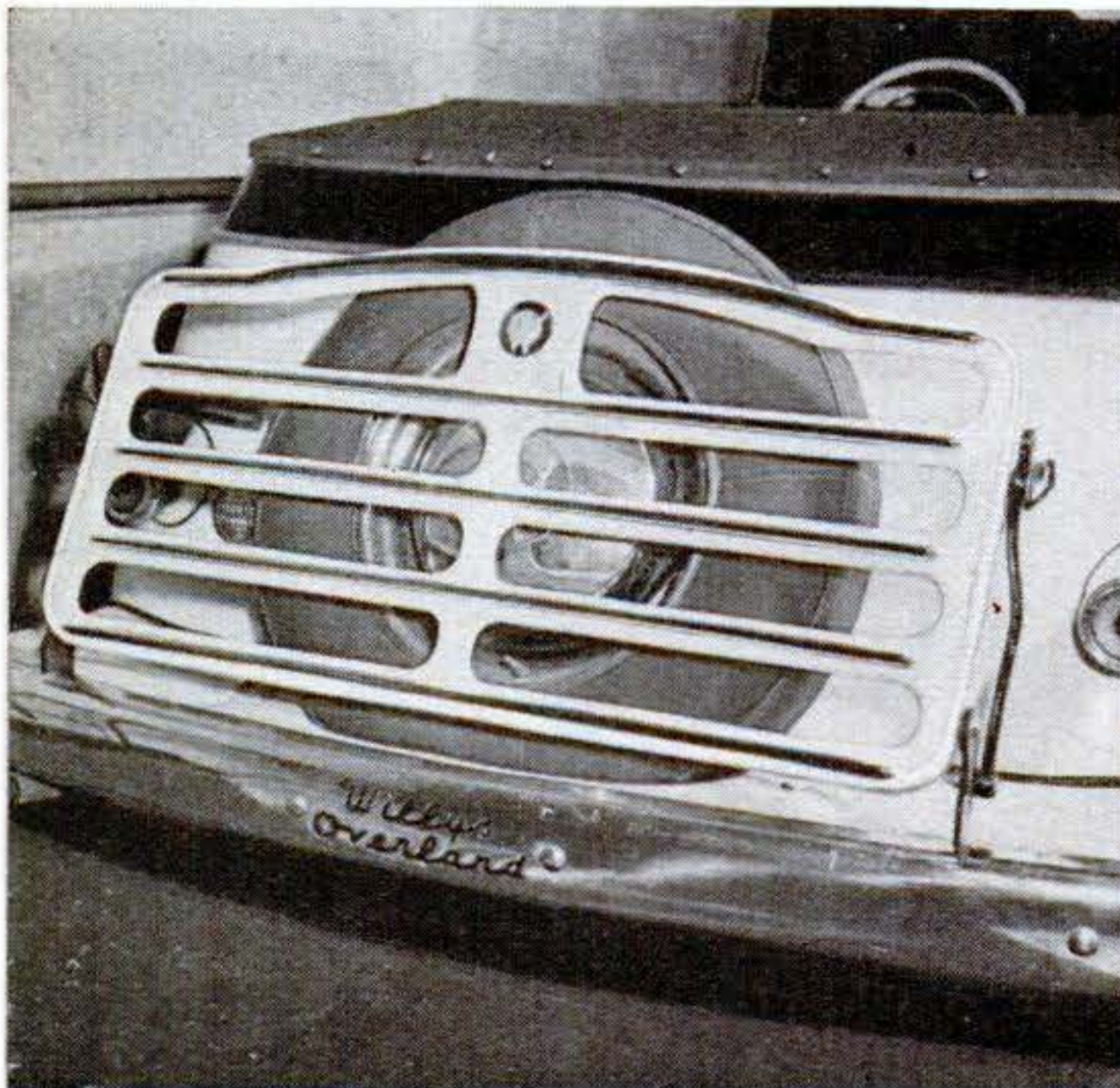

SHORT of luggage space, B. C. Bowker, of Toledo, bought an old-style, outside rack at a junk yard and put it on his Willys Jeepster as shown. For use, it swings down flat.

The rack was mounted by removing the bumper and cutting small holes through the body metal to accommodate brackets made

of $\frac{1}{4}$ " steel strap. Each bracket consists of a vertical member welded to the upper of two clamping pieces located horizontally across the bumper braces.

Before installation, the rack was painted to match the car and its chrome trim reconditioned. Such racks once were widely used.

Here's How I Start My Car in the Morning

By Victor Dettling



Before breakfast I press a switch near the window in the dining room. This closes a circuit leading to my car out in the garage. The object is to start the engine and have it at operating temperature before I set out for my job at an automobile plant in Manchester, Mich. The line leading from house to garage is a heavily insulated, two-conductor electric cord.

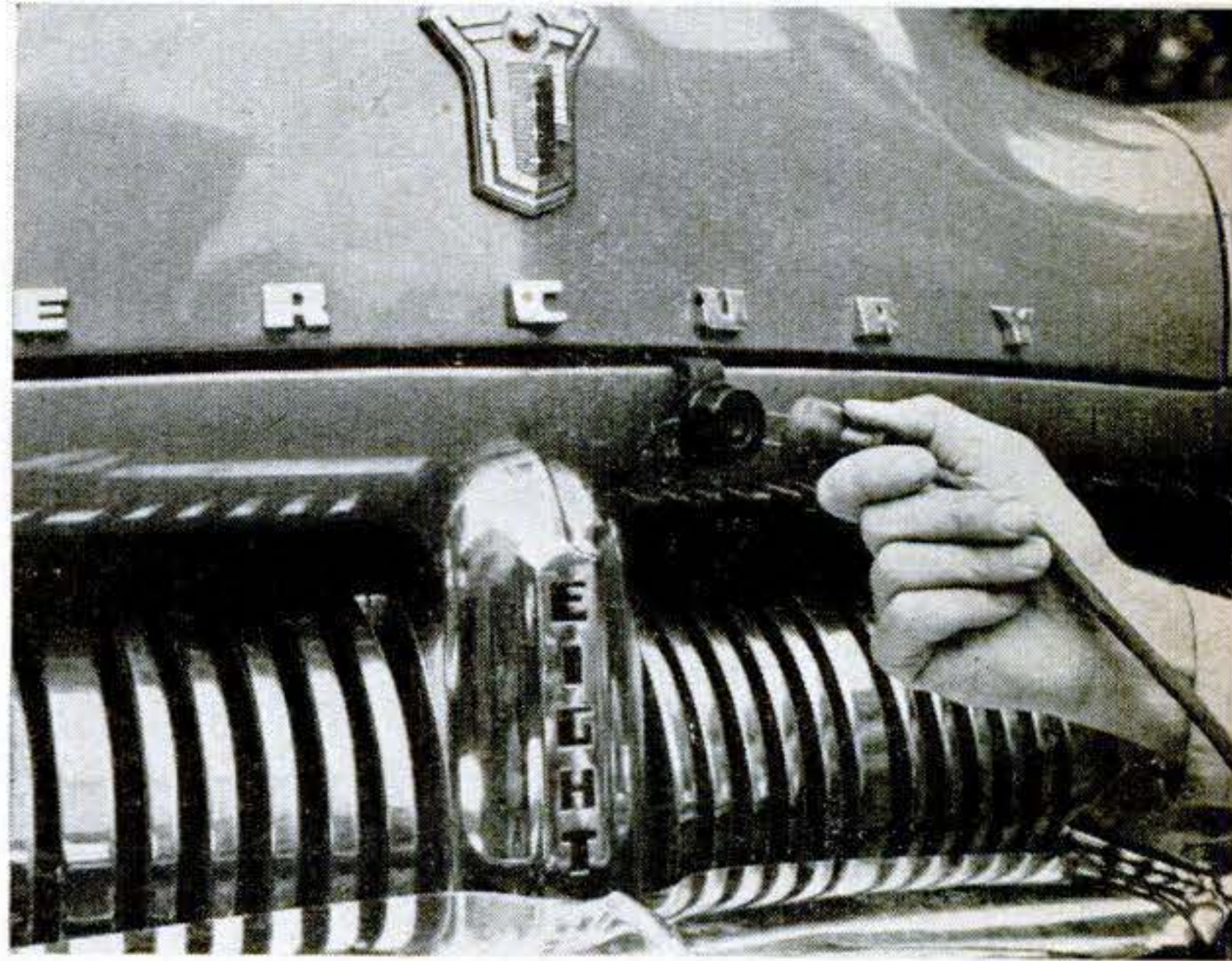

Each night I plug in the cord from the house after putting the car in the garage. The plug and socket are the type you would use in ordinary electrical wiring around the house. The socket is permanently mounted above the grille as shown. One terminal is grounded to the car body. The other is connected to a control box developed especially for my starting system.

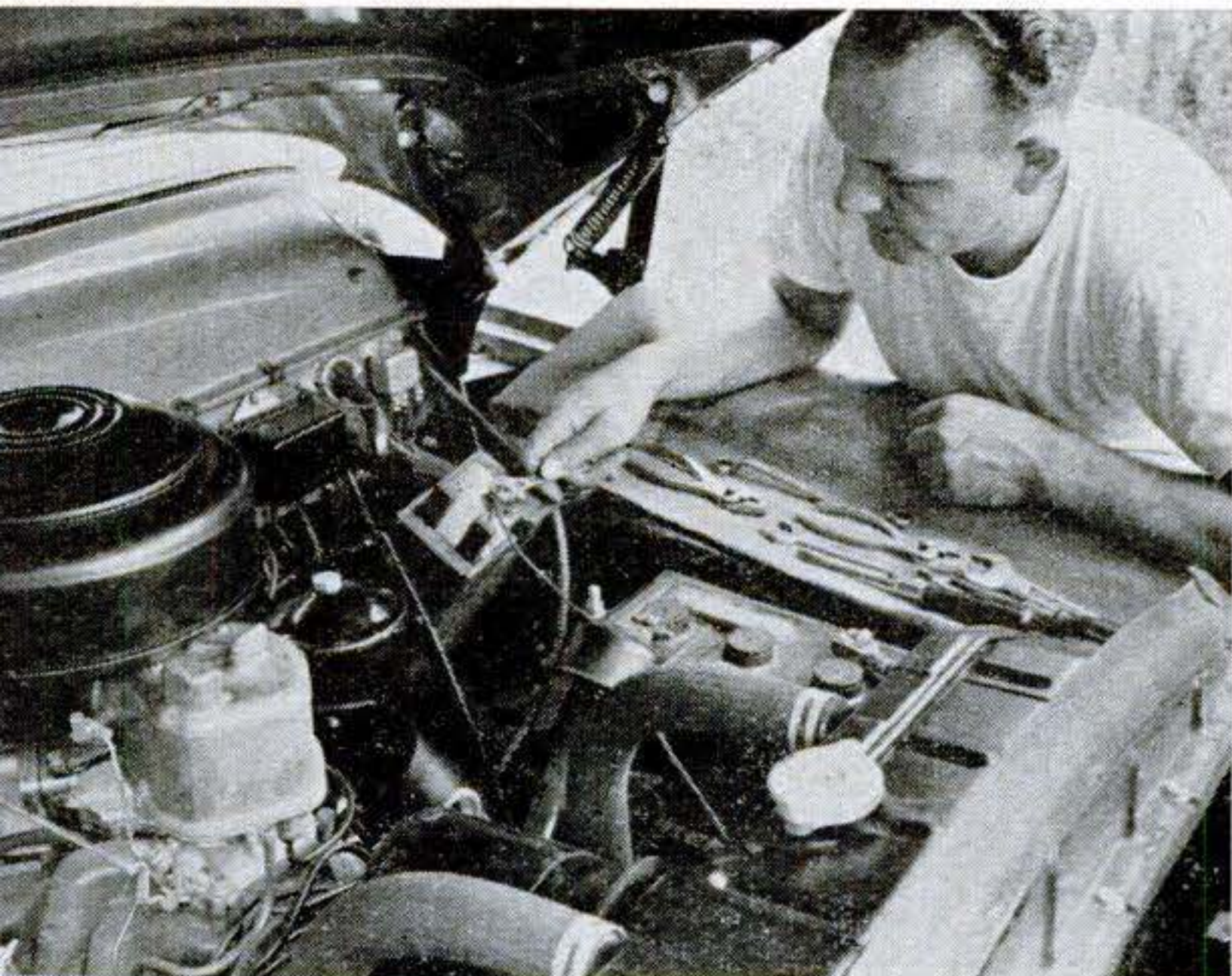

Here's the control box. The two pegs projecting from the end are part of my safety system. Free to move lengthwise through the box, these rest against the gear-shift control rods. The engine can start only if car is in neutral. If a gear is engaged, the bars move, breaking an electrical contact. The box has another job, too, but I'll explain that later. From the box, a wire runs to a powerful solenoid starting switch installed in place of the original one.

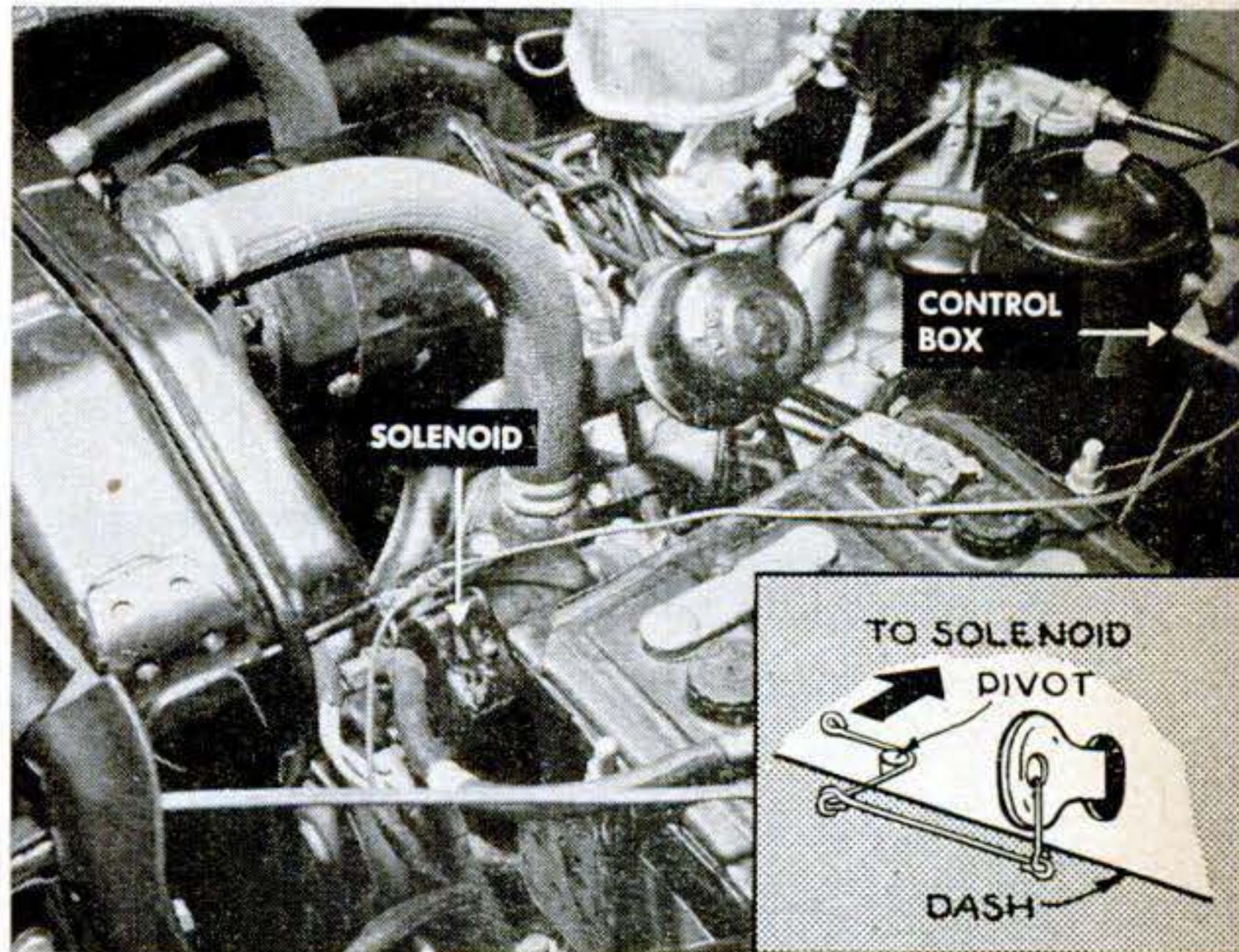

The solenoid does two things. When energized, it completes the starting-motor circuit. At the same time, by magnetic action, it exerts a pull on a wire linked to the ignition key by a bell crank as shown in the drawing. This turns the key. After the engine starts, increasing manifold vacuum acts on a diaphragm in the control box, breaking the starting circuit.

**But that's not all:
Turn the page and see**

Just Before Quitting Time An Alarm Clock Starts Up Engine



During the day I leave the car in an outdoor lot near the plant. After parking, I set my alarm-clock switch, timing it a few minutes before quitting time. When the alarm rings, the engine starts automatically. This gives it a chance to warm up before I start home. I keep the clock switch in the glove compartment.

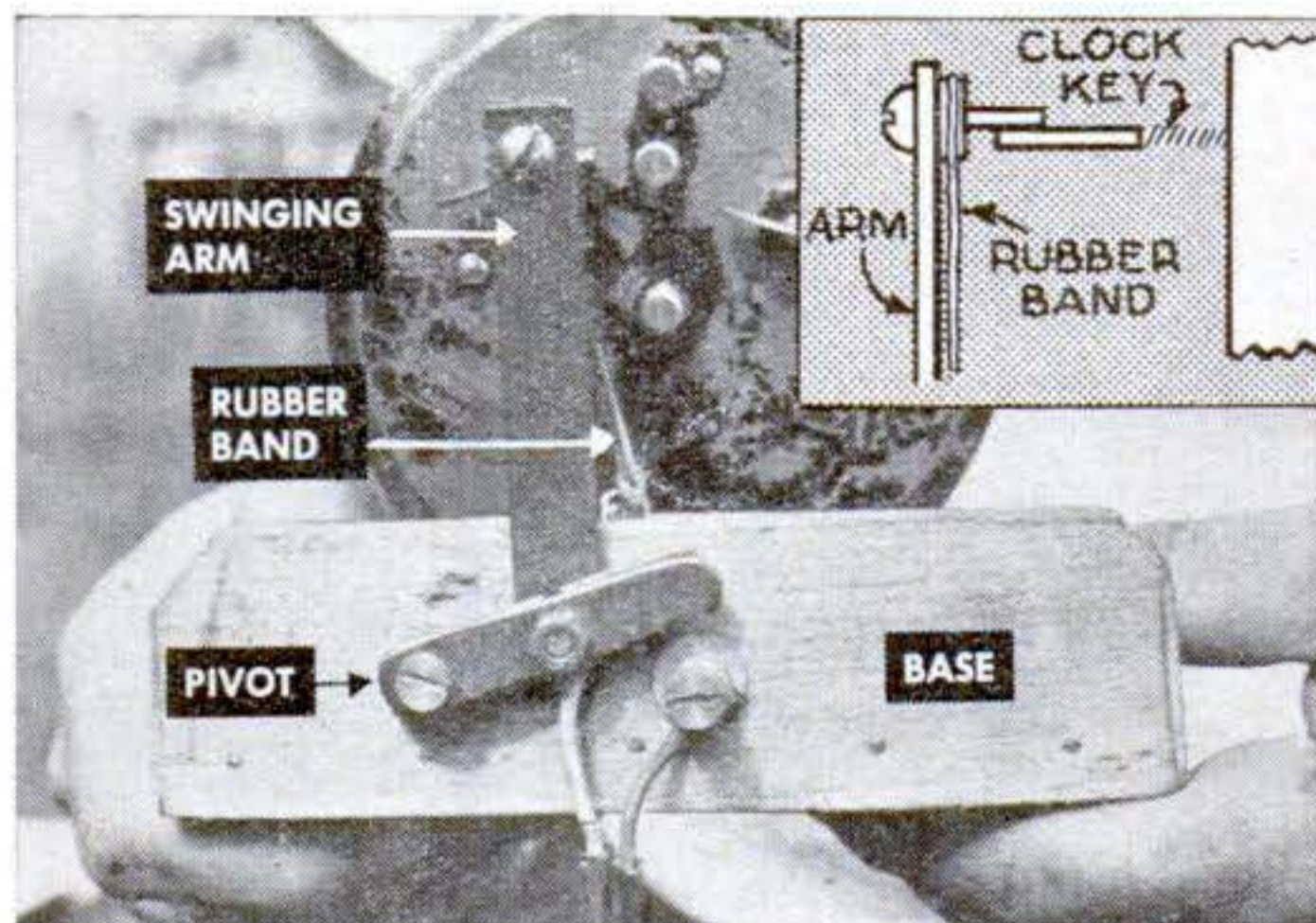

The switch works like this. After the alarm has been wound, a bolt through the swinging arm is hooked over the winding key, as shown in the drawing. When the alarm goes off, the key releases the arm, permitting the rubber band to pull it down and close the circuit. This does the same job as dining-room switch.

Here Are the Details of the System

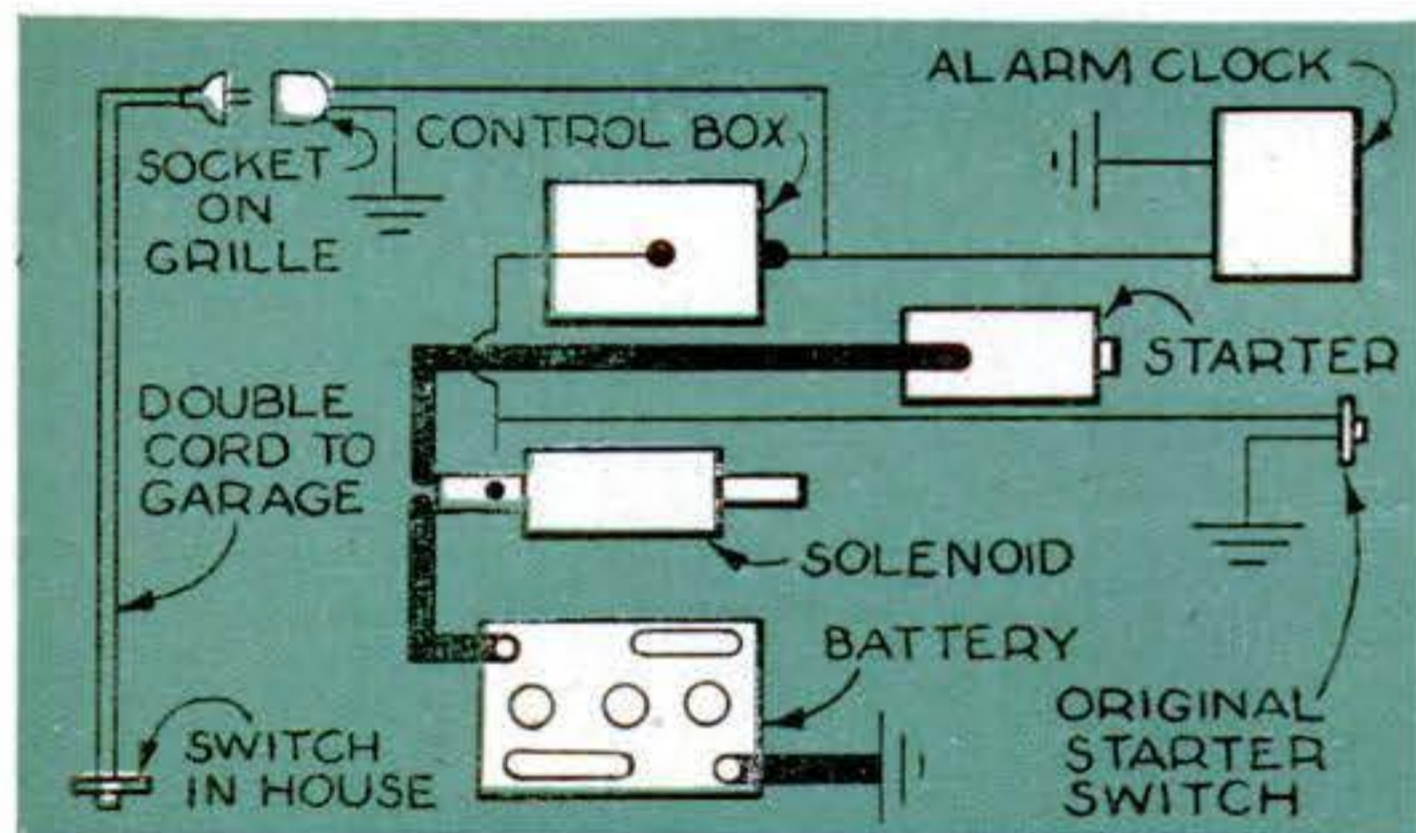

Wiring is simple. Notice that the automatic system operates independently of the original starter switch. The wire and parts required to set up my system cost me about \$23.

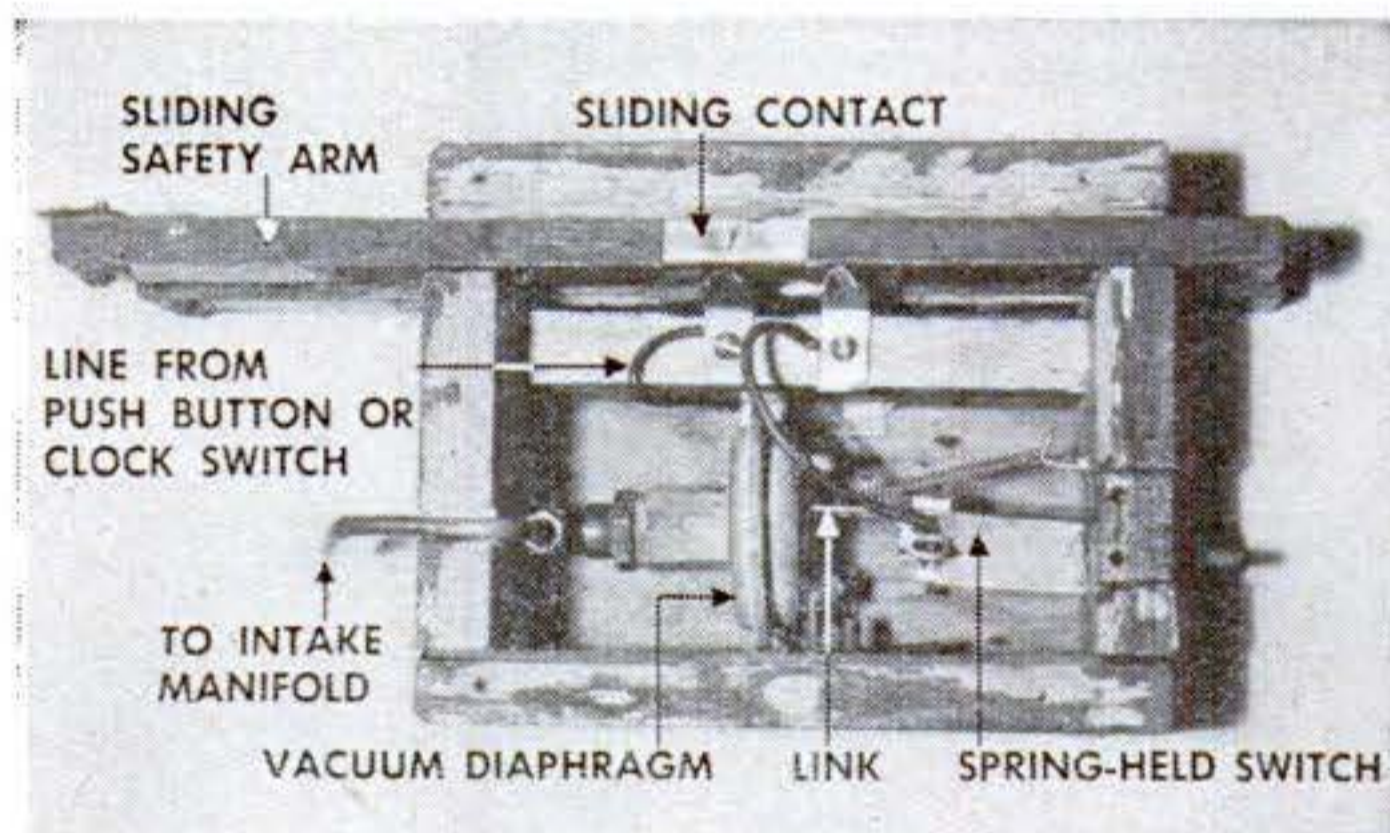

A vacuum diaphragm is an important part of the control box. When the engine starts, rapidly increasing manifold vacuum moves the diaphragm and link, breaking the starting circuit.

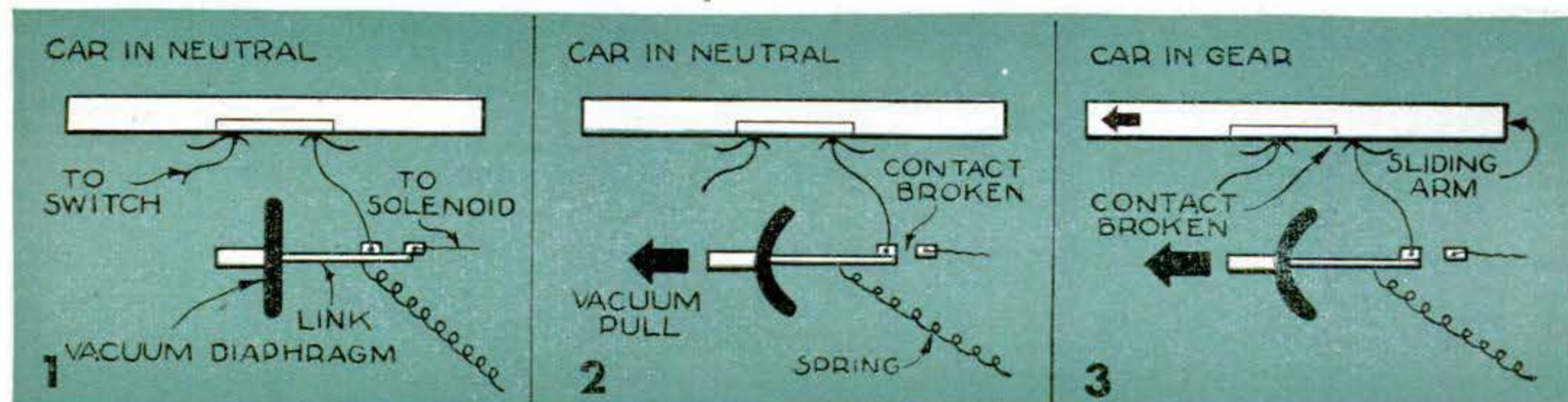

What happens in control box? At the time the alarm clock goes off, or I press the dining-room switch, you have the situation in Fig. 1. Since there's no vacuum, the spring can keep the vacuum switch closed. When engine starts, vacuum overpowers the spring, breaking the circuit as in Fig. 2. This disengages starter. If the engine stalls, the vacuum disappears, per-

mitting the spring to close circuit again. If it's the clock switch that has set off the system, current flows again—and again—until the engine catches or the battery runs down. While I'm driving the car, the vacuum and—when it's in gear—the sliding arm cut out the automatic system (Fig. 3). Moreover, the leads from the clock or the house are disconnected then. **END**

Hints from the Model Garage

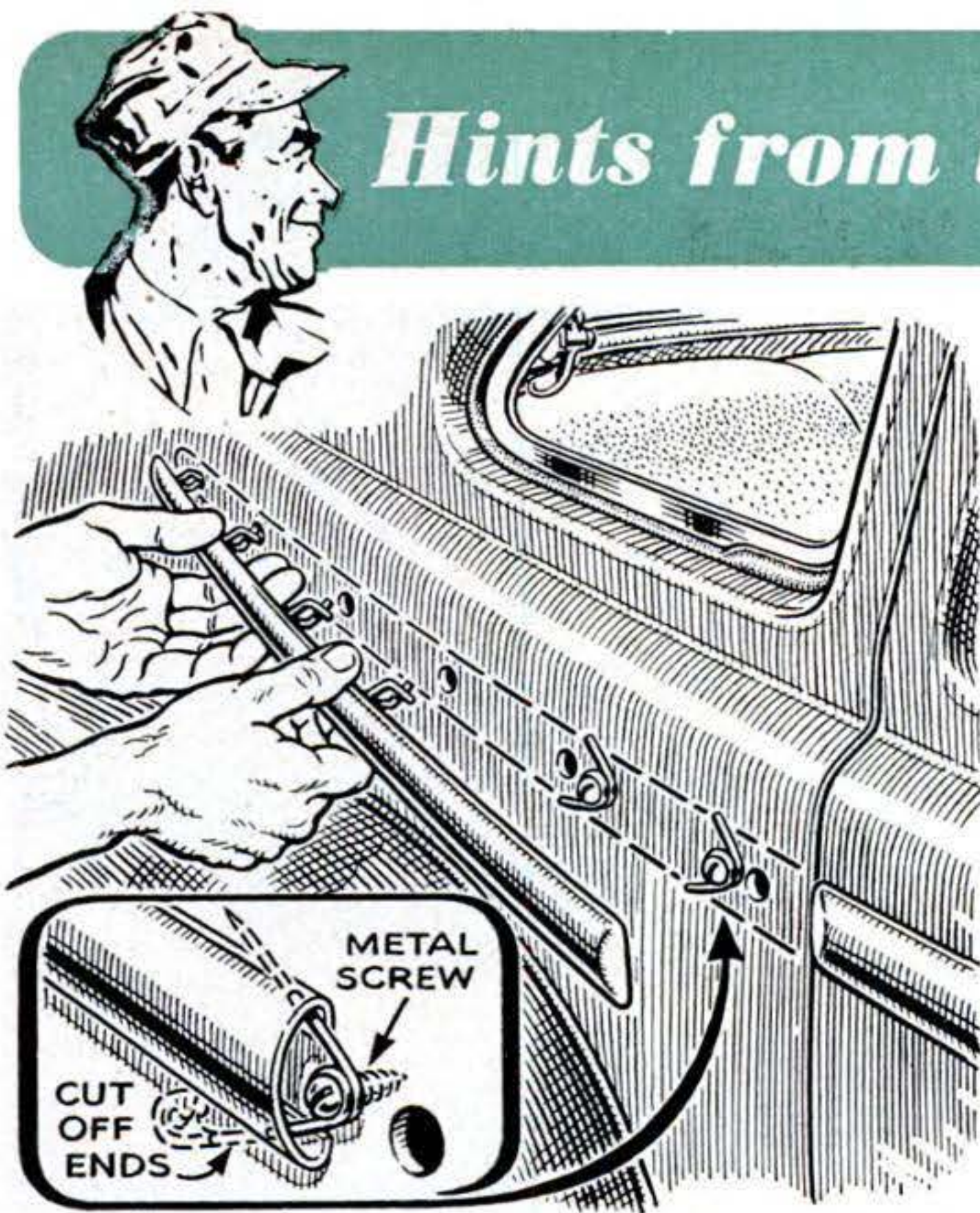

Safety Pins Hold Chrome. If a trim strip on your car has lost any spring clips, safety pins will fasten it down. Cut the ends off each pin as indicated and attach to the body metal with a self-tapping screw through the loop of the pin and into a small drilled hole. Snap the trim strip over the cut ends of the pin.

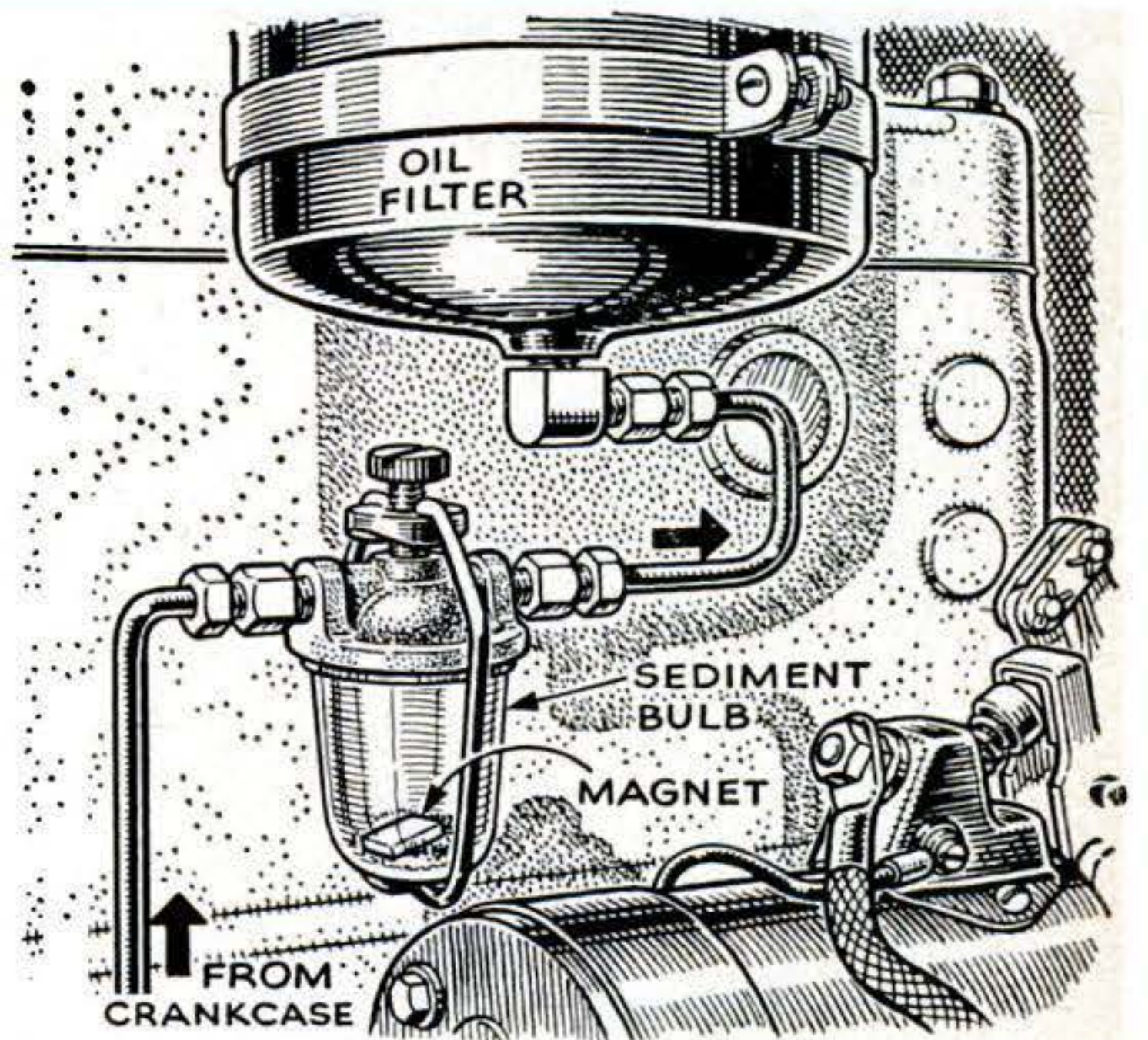

Magnet Helps Filter Oil. B. M. Thomann, of Kenmore, N. Y., finds that this setup gives his oil filter a helping hand and prolongs the life of each cartridge. It consists of a fuel filter with the element removed and a permanent magnet resting in the bowl. Considerable sediment settles out and the magnet holds fine metal particles.



Straightening Hub Cap. A bucket or tub of sand and a rubber mallet are all you need to bump most dents out of a hub cap. Work from the inside of the cap, using light taps and checking frequently to keep from making new outward dents.

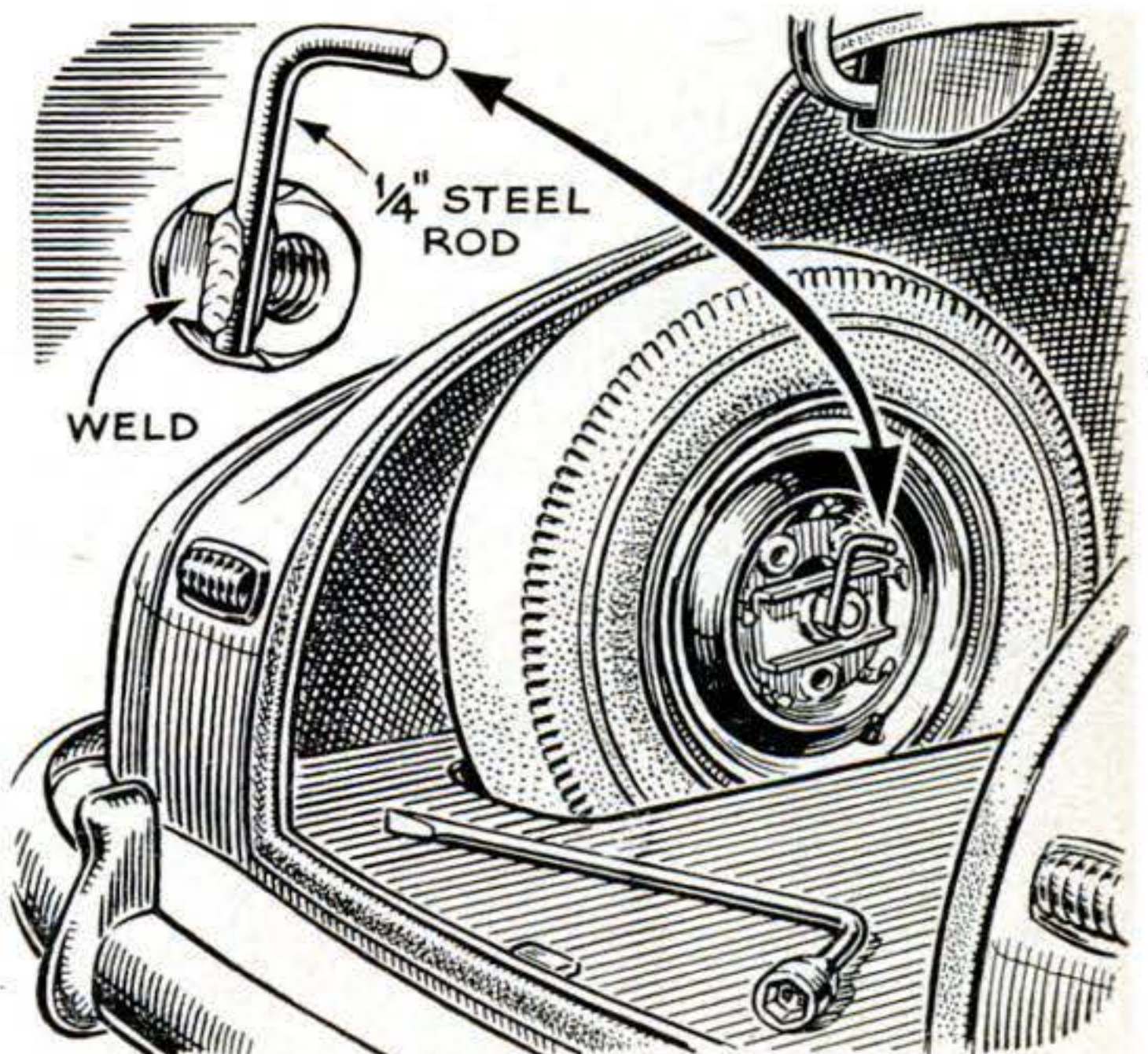

Welded Crank Loosens Spare. In some cars, it's difficult to swing the lug wrench to loosen or tighten the nut that holds the spare. J. W. Rocke, of Globe, Ariz., suggests making the job easier by welding a crank to the nut as shown.

Turn the page, please, for three more auto hints

FEBRUARY 1950 185

MORE Hints from the Model Garage

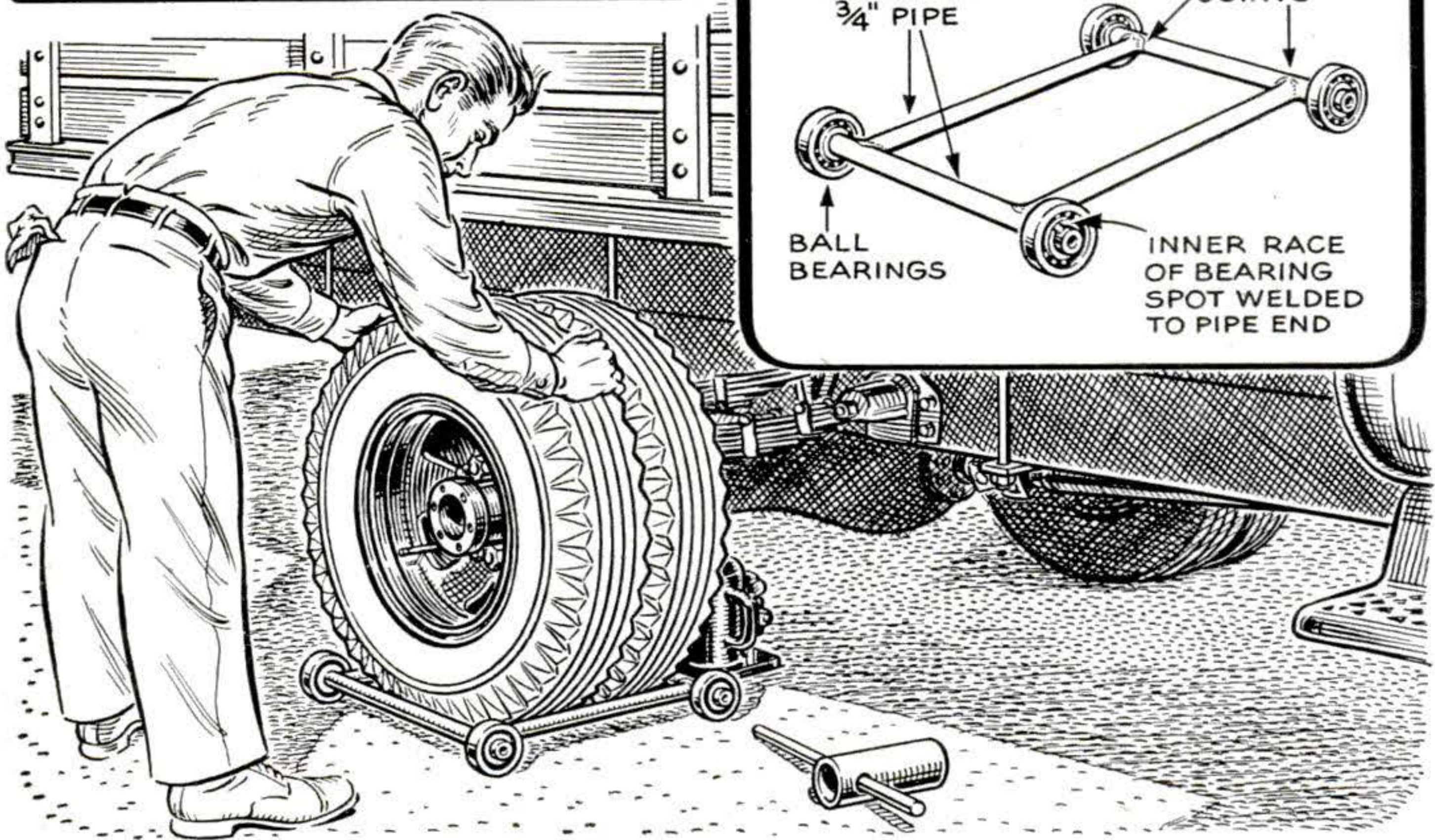

Dolly Handles Dual Tires. For removing and installing dual truck tires as a unit, Charles D. LaRue suggests making up a dolly like this. The original is in use at a shop in Sacramento, Calif. The dolly is inexpensive to make. Four

used ball bearings will serve as the wheels. Adjust the frame dimensions to suit the size of the truck wheels. To use, lower the jacked-up wheels on the dolly. After removing the retaining nut, you can then pull the wheels away on the dolly.

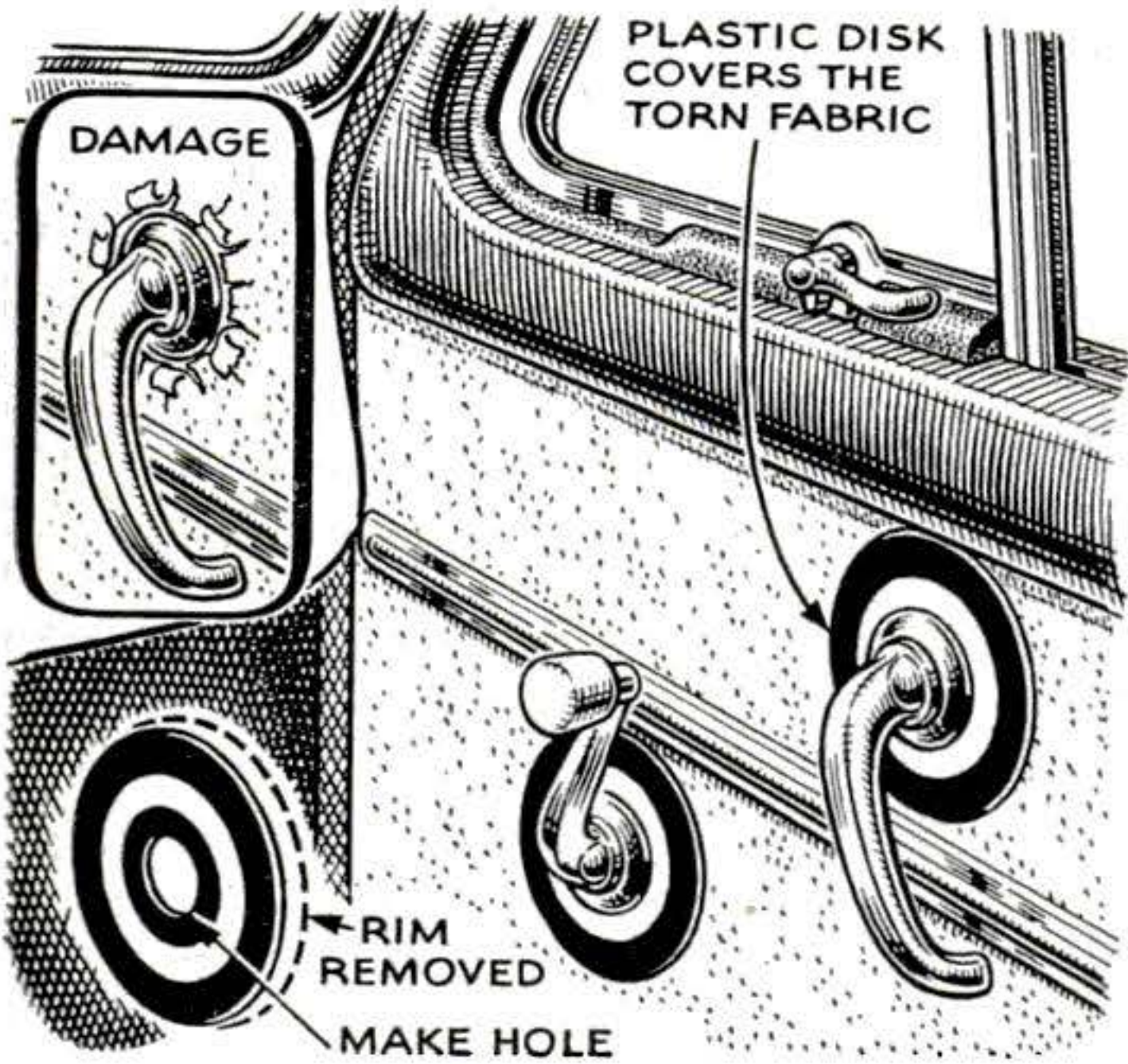

Repairing Handle Wear. Plastic coasters from the dime store can be used to hide torn fabric around a door handle. Cut the rim from the coaster and make a hole large enough to slip over the handle. Clamp in place with the original flange.

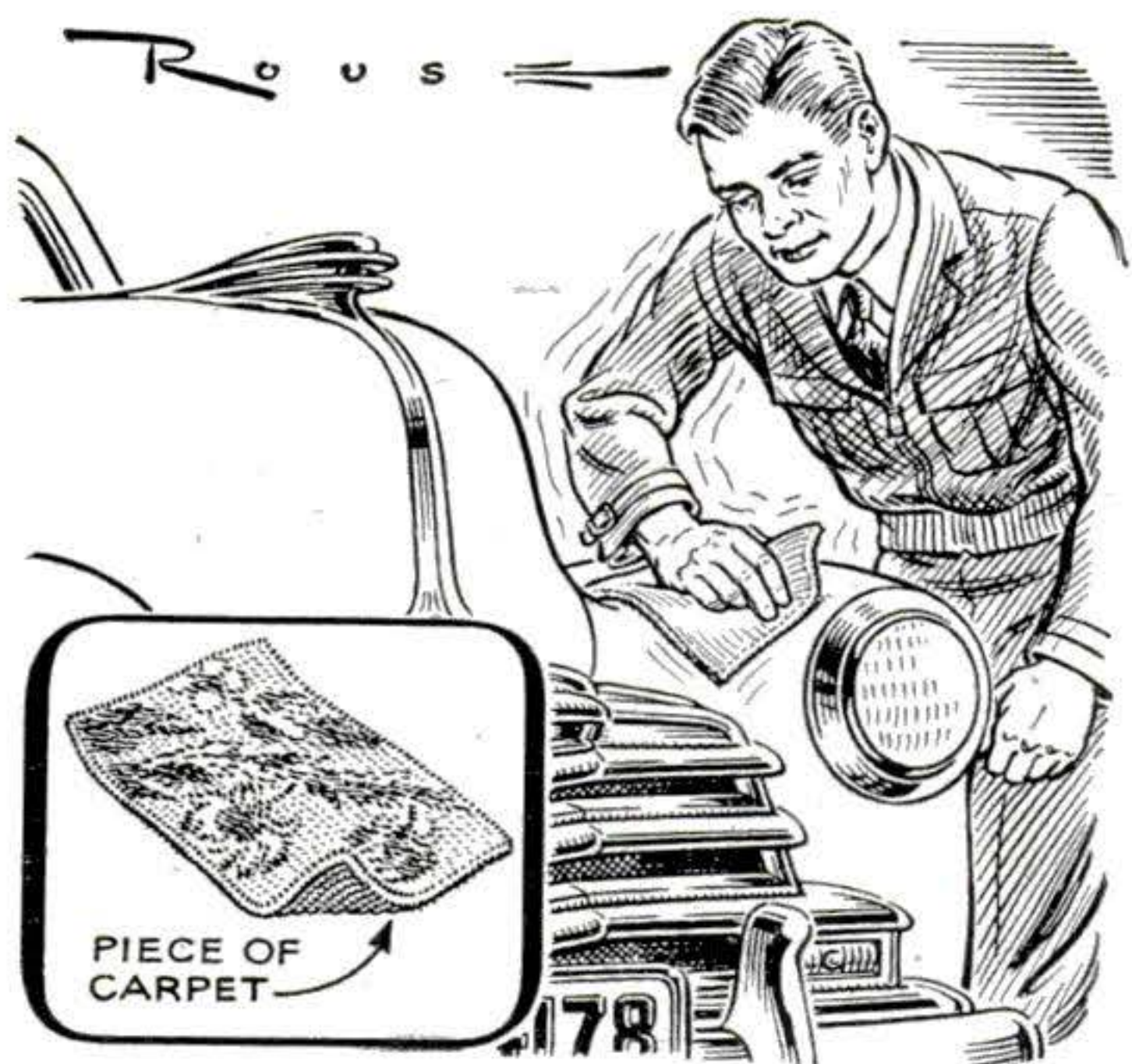

Handy Polishing Pads. Pieces of old carpet run through the washing machine and then dried make convenient pads for polishing cars. If no old carpet is available, your furniture store may be able to supply small remnants.

The \$8 unit at the right "melts" the snow that flakes through weak signals, sharpens and brightens images.

Homemade Booster Improves TV Pictures

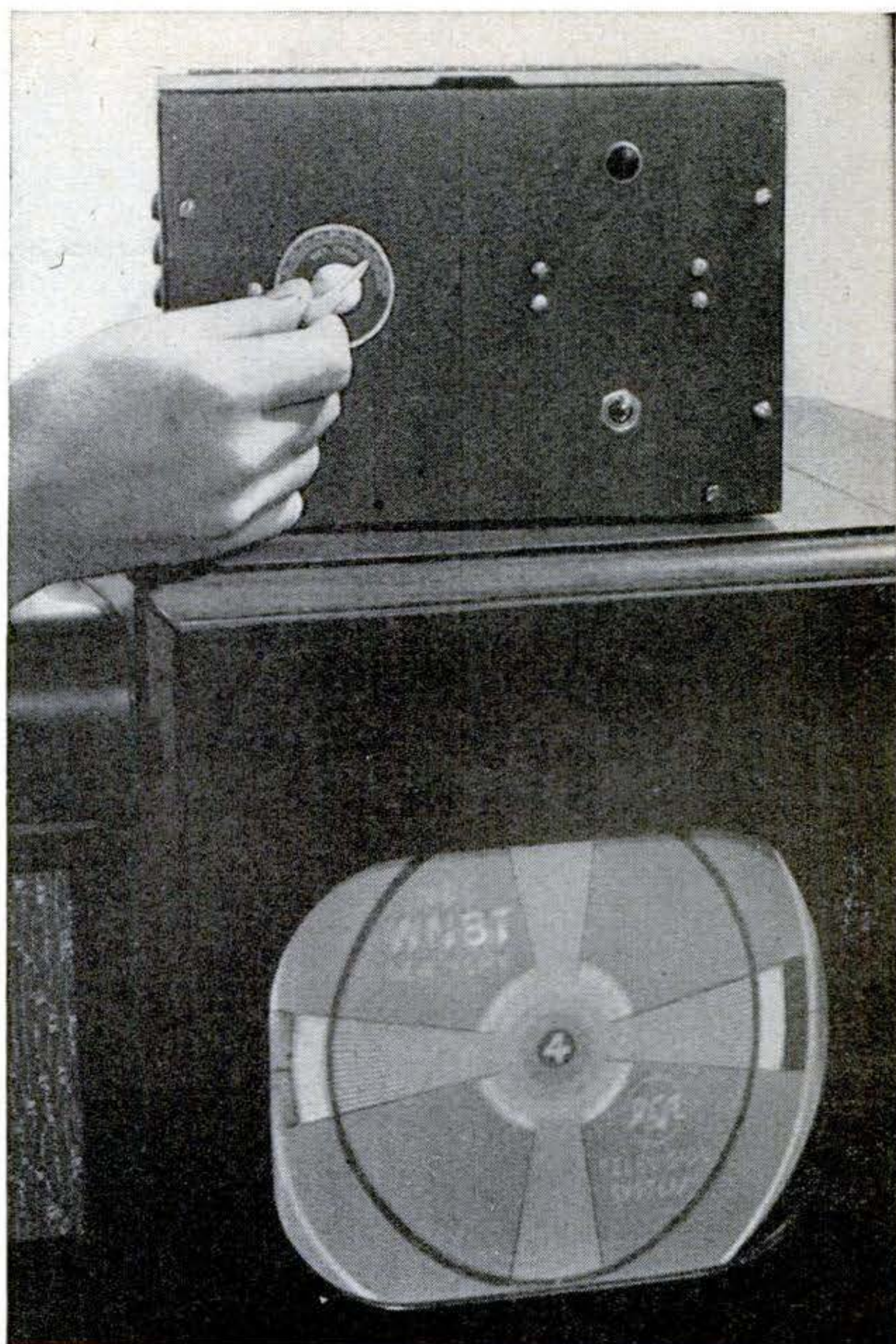

Amplifying distant signals may give you grandstand reception in the bleachers.

ARE your TV pictures as good as they ought to be? If not, you may be able to help yourself to greater video enjoyment with a booster that will strengthen weak signals on the low channels.

"Snow" in a picture is a sure sign of weakness. Not only can a booster cure this condition but it can also sharpen image outlines and improve contrast and clarity.

The unit shown above can be built for about \$8. You can use it with either an indoor or outdoor antenna, but it won't take the place of either. It improves a signal, but doesn't create any where none exists. If you live in a fringe area you will still need your roof-top rig. But whatever your antenna, if you are now getting pictures that are under par, a booster will help.

Though the range of this booster covers only the first five channels, it is so designed as to cause no interference with high-band stations. You can leave it connected even

when you're looking at channels 7 to 13.

Two lengths of 300-ohm flat-ribbon lead-in are wired directly to the coils. One of these (marked "IN" in the diagram on page 189) goes directly to the 300-ohm lead from the antenna. The other goes to the antenna terminals on the receiver. Placed ahead of the receiver input, the booster acts to amplify signals coming in from the antenna. The unit has its own power supply and must be plugged into an AC outlet.

To put the booster in operation, first tune in the station on the set, then tune the booster by varying the tuning condenser. This is the amplifier's only control. For channel 2, set the pointer knob so that the plates are fully in mesh. Find the best setting for each channel and mark the dial accordingly. For high channels set the pointer so that the plates are out of mesh.

Want one? Turn the page for building instructions. ➤

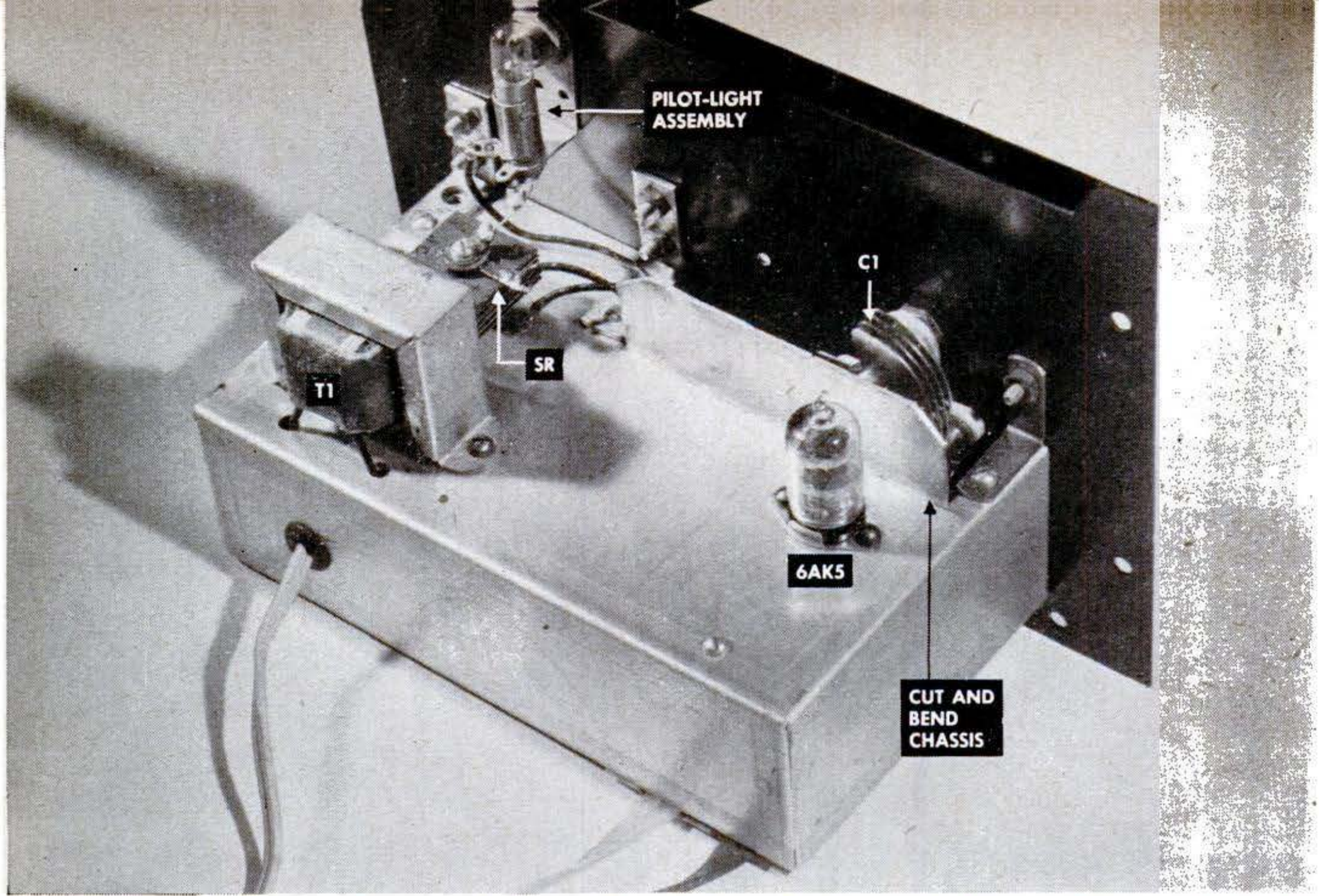

You can use almost any chassis and cabinet for this unit. The transformer, selenium rectifier, and the single tube are on top of the chassis, which is bolted to the front panel with angles.

The switch, pilot-light assembly, and the 50-mmf. variable condenser are on the panel. The tube is directly behind the condenser, but note the 1" ledge bent up on the chassis as a screen.

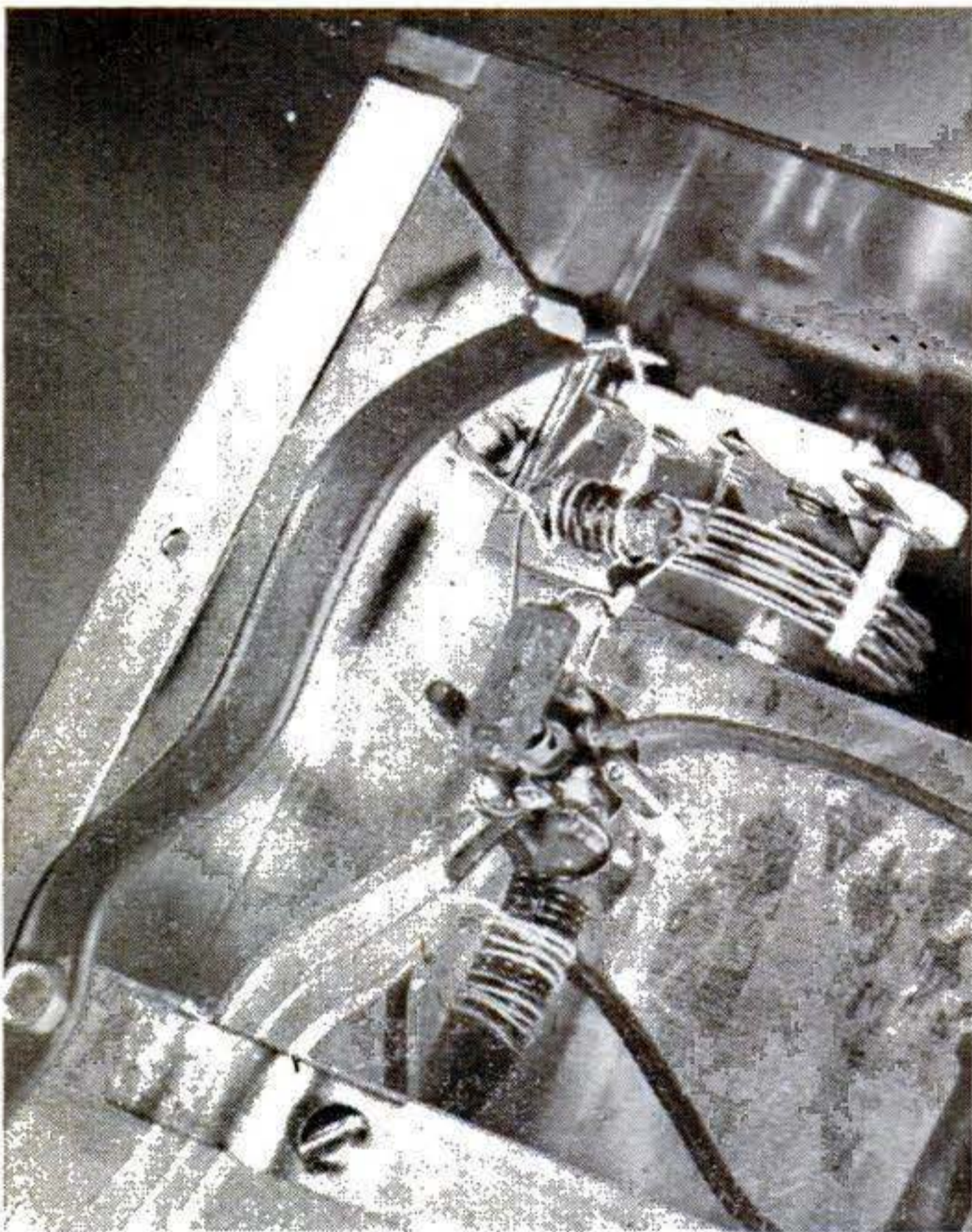

To keep RF losses to a minimum—which is important at television frequencies—make wiring compact. This close-up shows a 7-pin miniature ceramic tube socket with all related parts clustered in a tight huddle around it. Leads are soldered directly to socket-pin lugs. All ground connections are gathered at one point on the chassis near the tube socket.

COIL-WINDING DATA

(Wind L1 on R1 and L2 on R2)

- L1A: 6 turns No. 18 enamel (close wound)
- L1B: 8 turns No. 30 D.C.C. (wound over L1A)
- L2A: 19 turns No. 18 enamel (close wound)
- L2B: 8 turns No. 30 D.C.C. (wound over L2A)

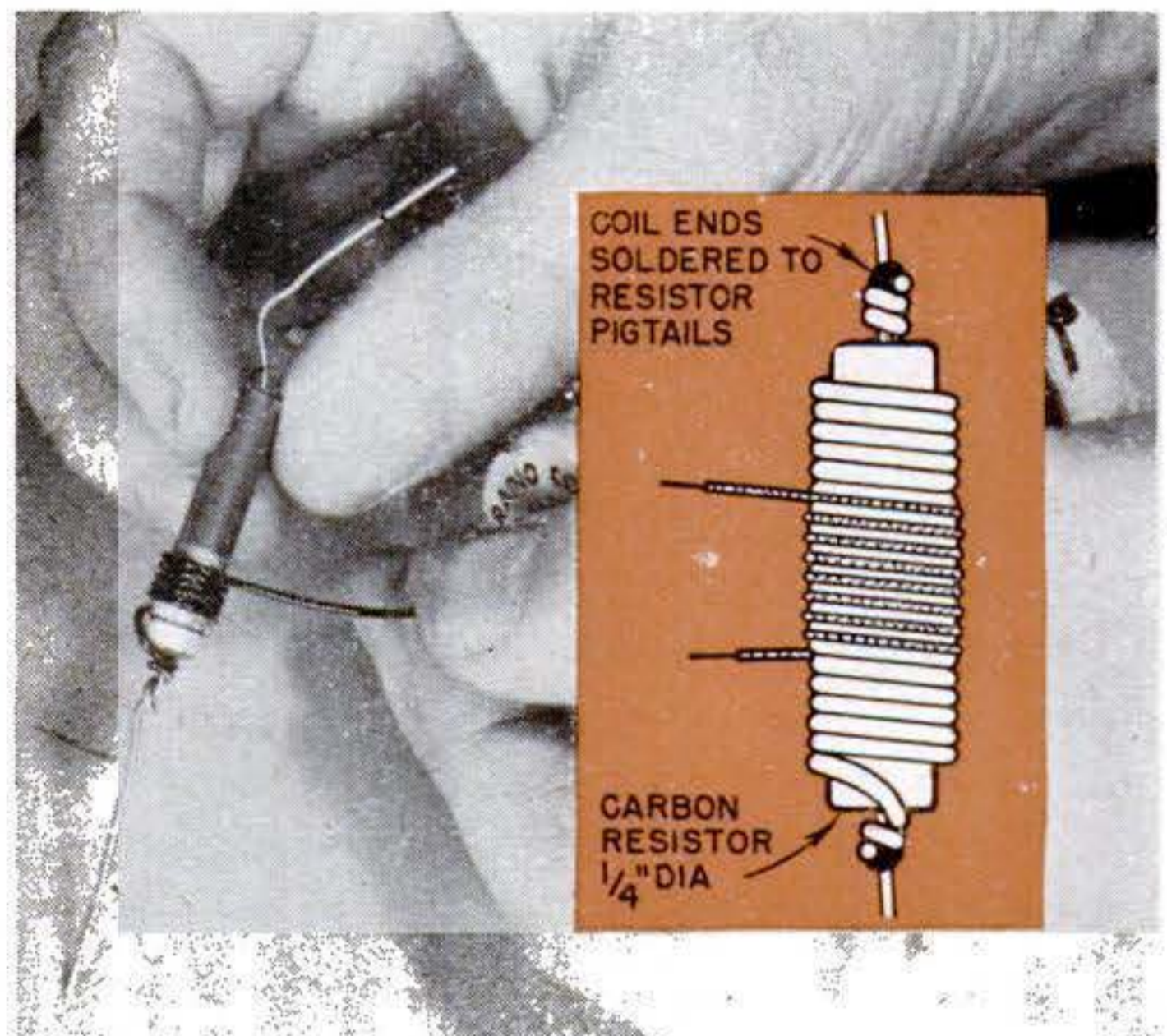

Another dodge for compacting parts is to use resistors R1 and R2 as forms for winding coils L1 and L2. To do this, you should purchase 1-watt resistors with diameters of $\frac{1}{4}$ ". The table specifies the number of turns for each winding, but don't take that for gospel. Your booster may show better results with fewer or more turns. Experiment with both 8-turn windings.

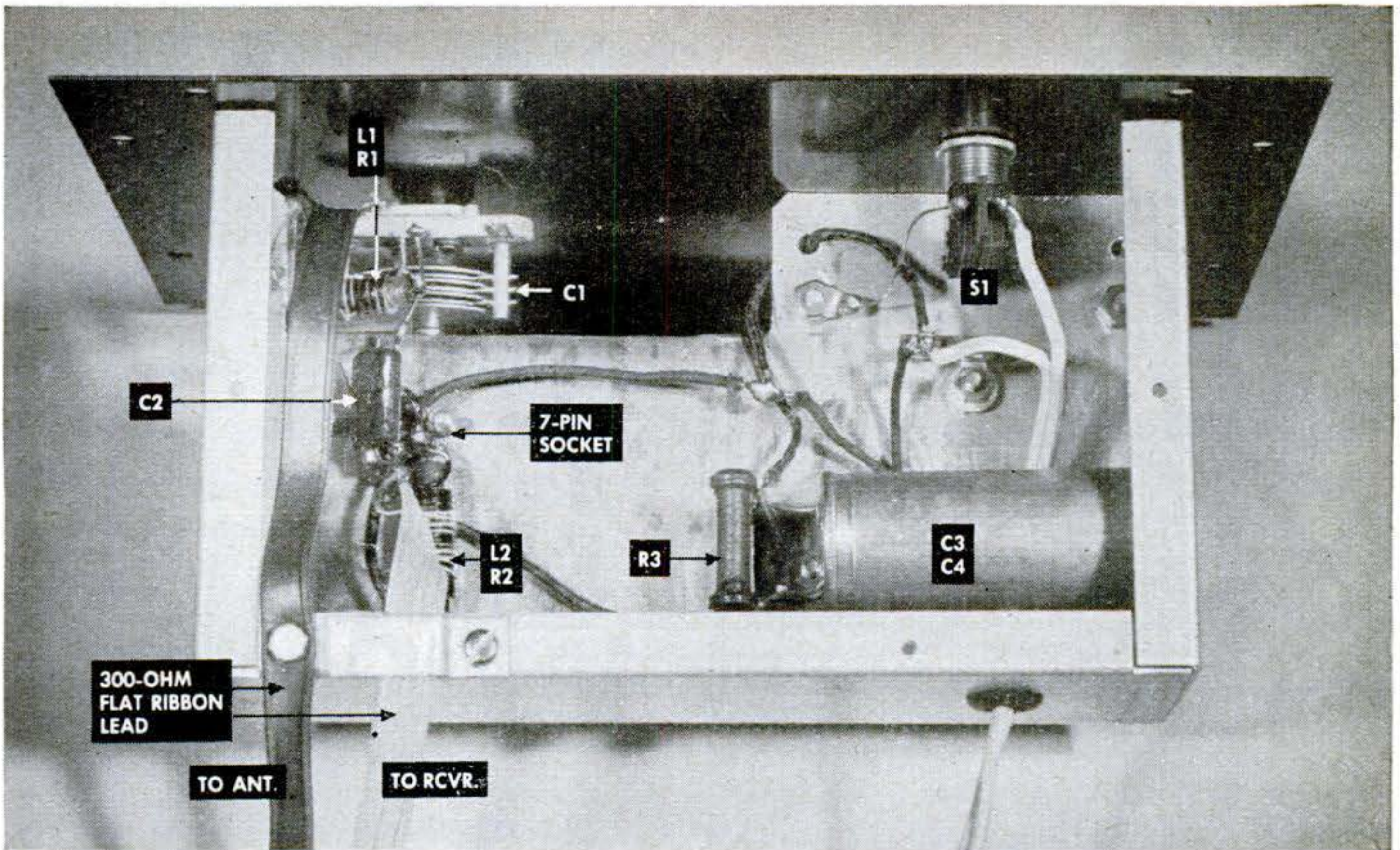

The dotted line dividing the diagram below and the space in the middle of the photo above separate the booster circuit into its two parts. Wiring to the right of the line requires no

special precautions. But all leads to the left with the exception of the 300-ohm ribbon lead must be kept as short as possible. A close-up of this portion is shown on the facing page.

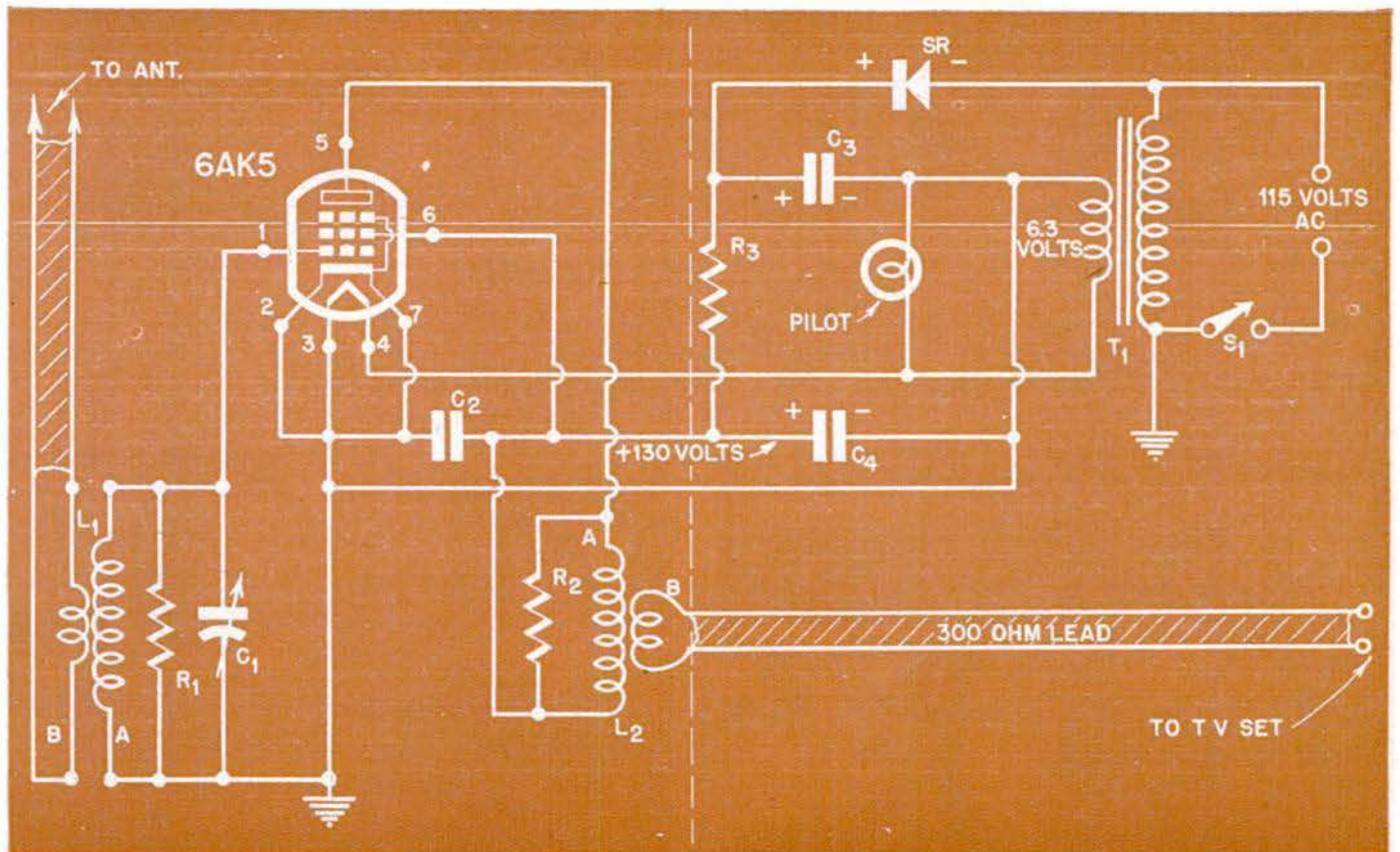

LIST OF PARTS

R1: 5,000-ohm, 1-watt carbon, approx. 1/4" dia. (Use as form for L1)
 R2: 2,000-ohm, 1-watt carbon, approx. 1/4" dia. (Use as form for L2)
 R3: 1,000-ohm, 1-watt carbon.
 C1: 5- to 50-mmf. variable

condenser.
 C2: 150-mmf. mica.
 C3: 40-mfd., 150-volt electrolytic.
 C4: 20-mfd., 150-volt elect. (May be dual unit with C3).
 S1: SPST toggle.
 SR: 75-ma. dry-disk selenium rect.

Pilot-light assembly with 6.3-volt brown-bead bulb, chassis, cabinet, 7-pin miniature ceramic socket, 6AK5 pentode, 300-ohm flat-ribbon lead, set of coils (see text and table), misc. hardware.

I'd like to see them make...

Everybody has his own pet idea of some gadget he would like to see in general use. What is YOURS? Popular Science will pay \$5.00 for each one published. Use government postcards only. Contributions cannot be acknowledged or returned.



Oil cans with weighted bottoms. Oil cans should be built with almost round, weighted bottoms. Then if knocked over accidentally they would automatically right themselves. A small bottom flat would keep them from bobbing.—Don Salmon, Detroit, Mich.



Retractable sun visors. The solid-type visors make it very tough to see an overhead traffic light when you're driving in the city. They could be made so you could crank them in and out of the car top.—D. H. Boyd, Cincinnati, Ohio.

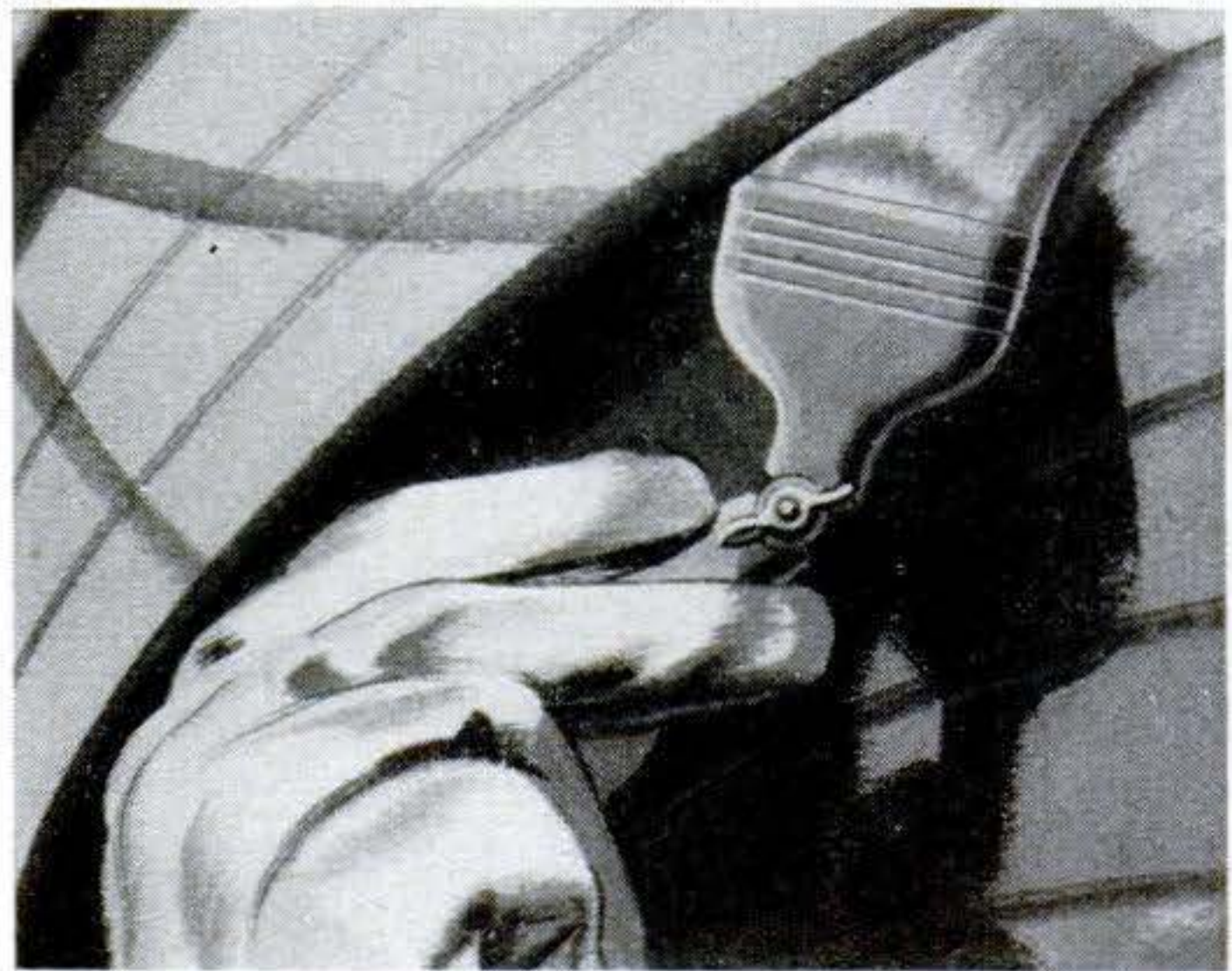

Paint brushes with jointed handles. The handle could be locked at various angles with a thumb nut. It would be handy for painting in cubbyholes such as you find aboard a ship.—M. J. Steppello, S1c, U.S.N.

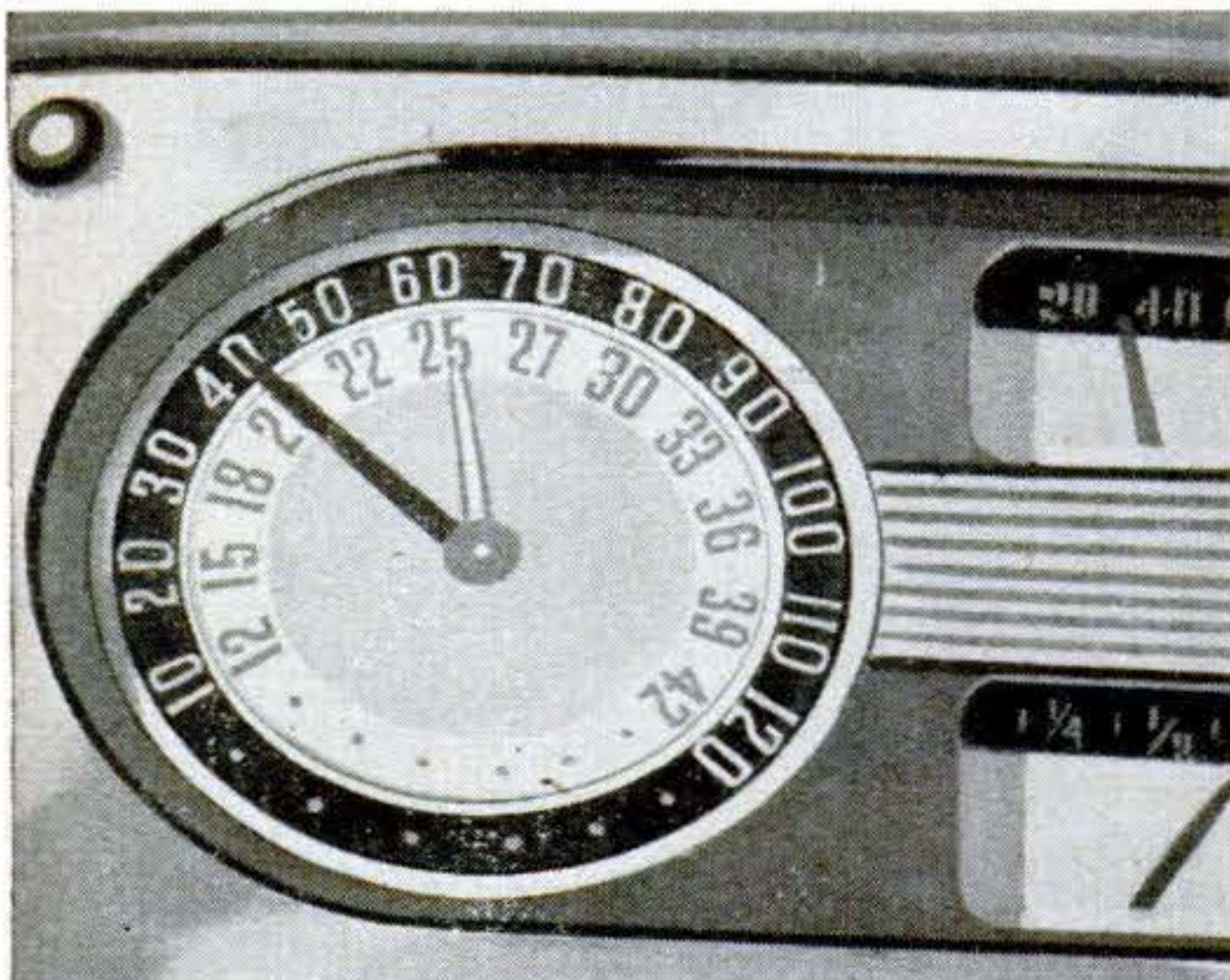

Combined speedometer and tachometer. This instrument could be built with two hands, like a clock. The inner dial would show the engine r.p.m., the outer one would show the speed of the car.—Bernard E. Morris, Belhaven, N. C.



Mixing directions on the lid of paint cans. Instead of putting directions on the sides, where they get smeared with paint, why not put them on the lid? They'd stay clean and be easy to read.—W. A. Rice, Hartford, Conn.

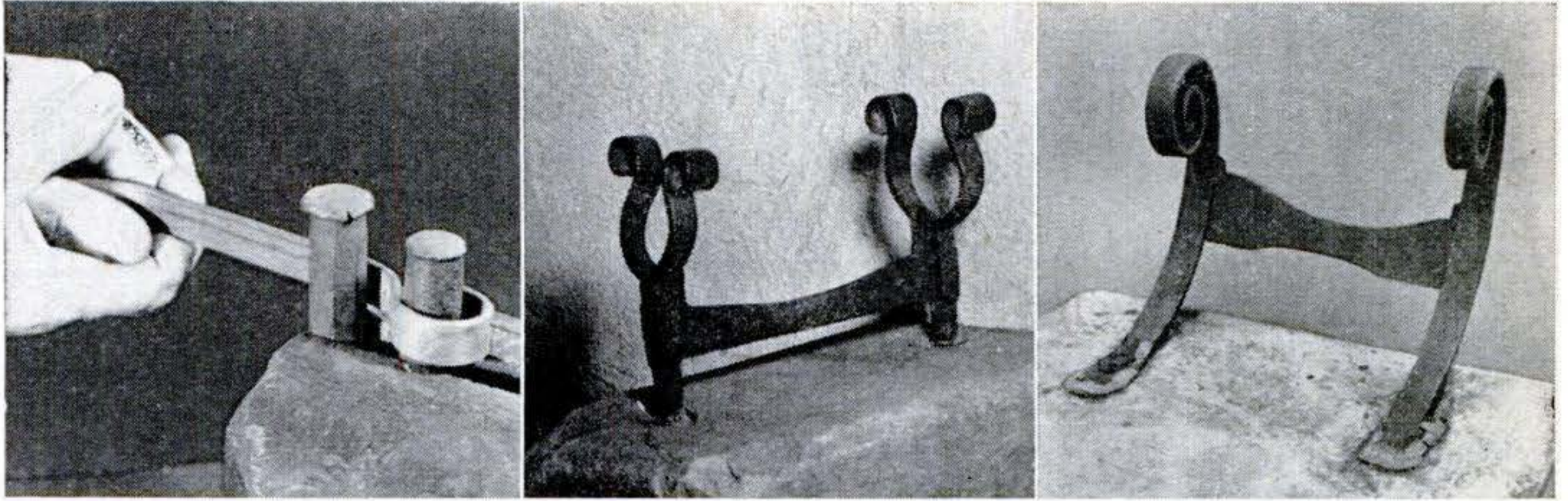

Shanks of two cold chisels are locked in a vise to form a jig for bending scrolls. The split posts (center) were twisted into a tulip design. At

right is another scroll-design scraper. This one was fixed in a block of marble with hot lead. Marble was set in ground near front steps.

Foot Scrapers You Can Make

THE foot scraper is one of the few home accessories that haven't shown much improvement in design down through the years. With that in mind, John P. Arnold, of Doylestown, Pa., went back to the products of Colonial metalworkers for the scrapers pictured here. All of those shown predate 1800. The best reproductions, of course, are made by working hot iron on an anvil. However, some types can be bent from cold metal and the parts riveted. **END**



Supporting bracket for a wall-mounted scraper is twisted to shape with vise and wrench. Length of pipe over wrench handle adds leverage, but



don't treat a good wrench this way. Above, heated scraper blade is formed by bending it around an iron hoop of suitable diameter.

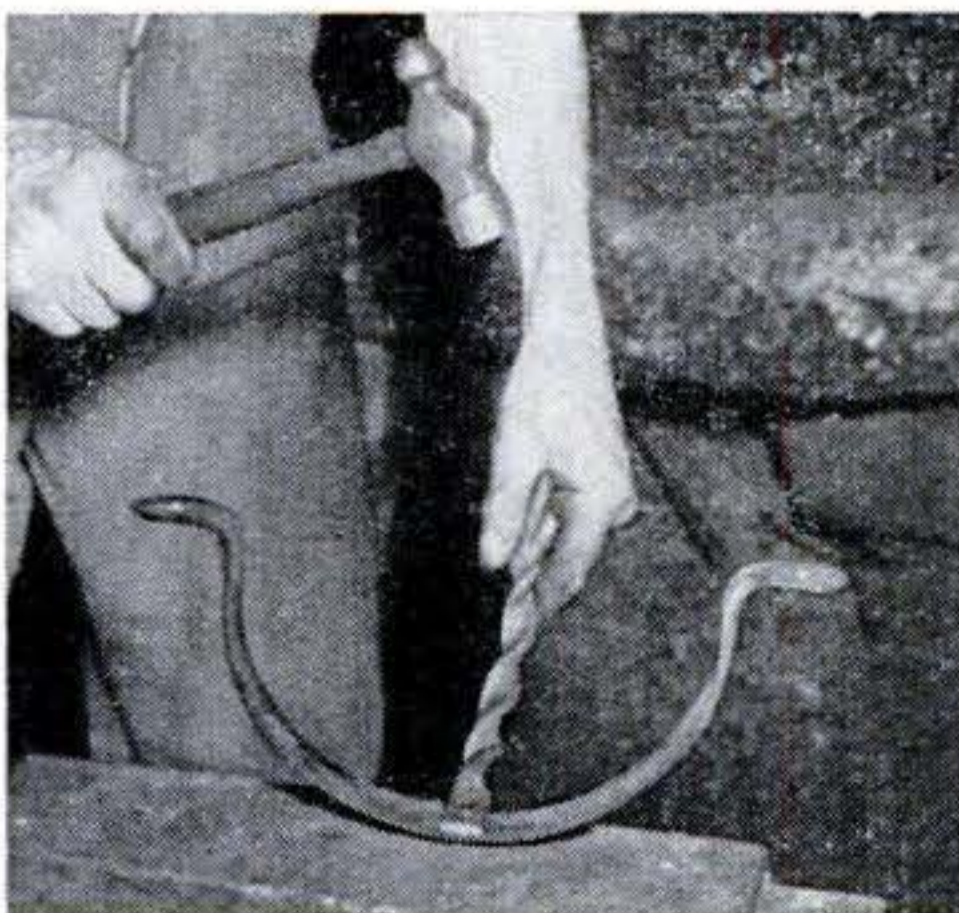

Scraper blade and bracket are assembled with a single rivet. Center photo shows completed unit and the three wrought nails that hold it to

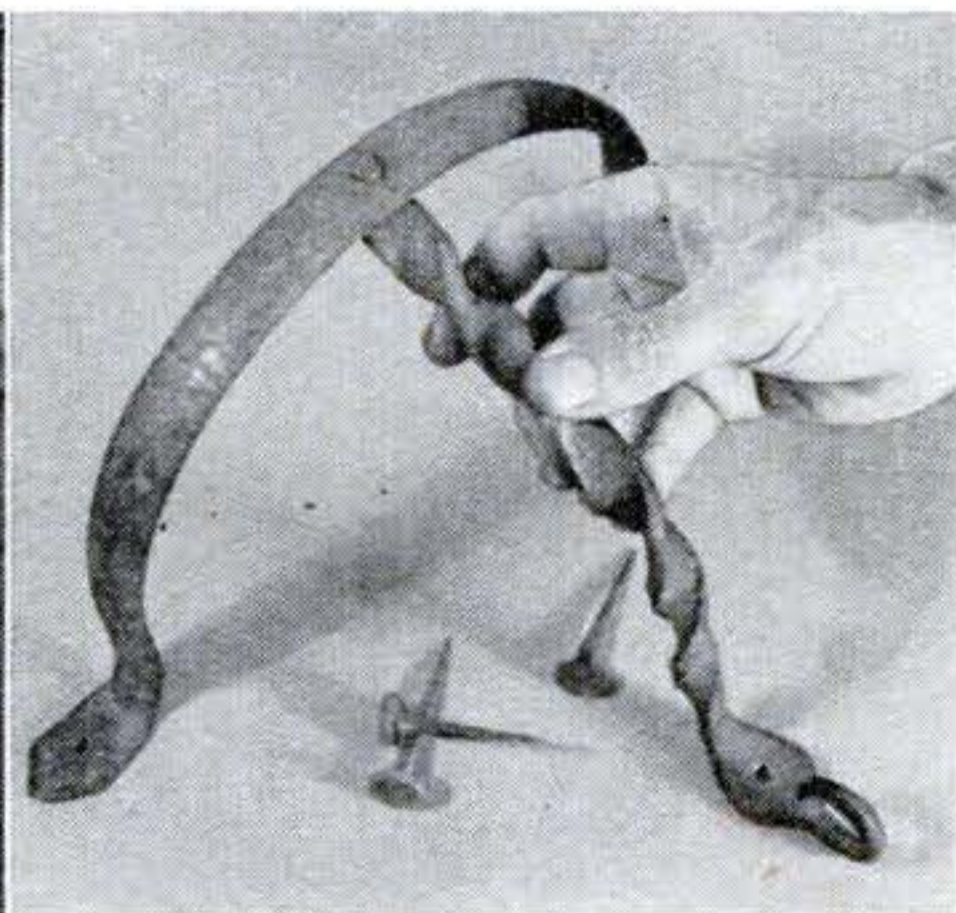

side of the house, mounted as pictured at the right. This kind of Colonial scraper is much less common than those at top of page.



Wood-Turning Tricks

How Did the Rings Get There?



I Too small to slip over the base or bowl, the rings at the left have no practical use—but they'll mystify your friends. They were produced by simple turning. To begin, hollow out the bowl with a narrow skew as seen above. Finish with a round-nose scraper. Leave a stub to hold the dead center, turning it small toward the end of the work. In turning the goblet, you could mount the block on a faceplate, but the setup pictured above is more rigid.

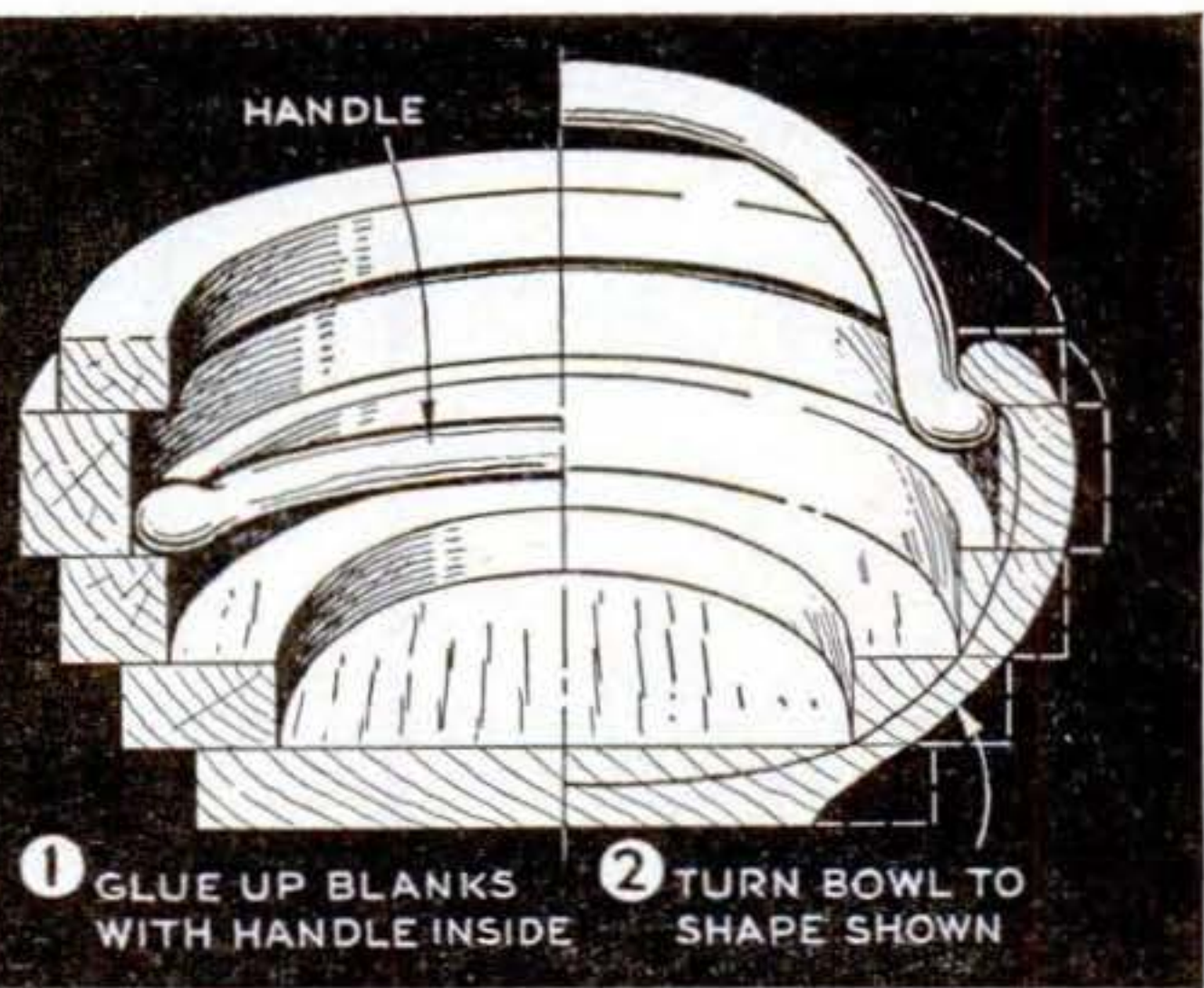
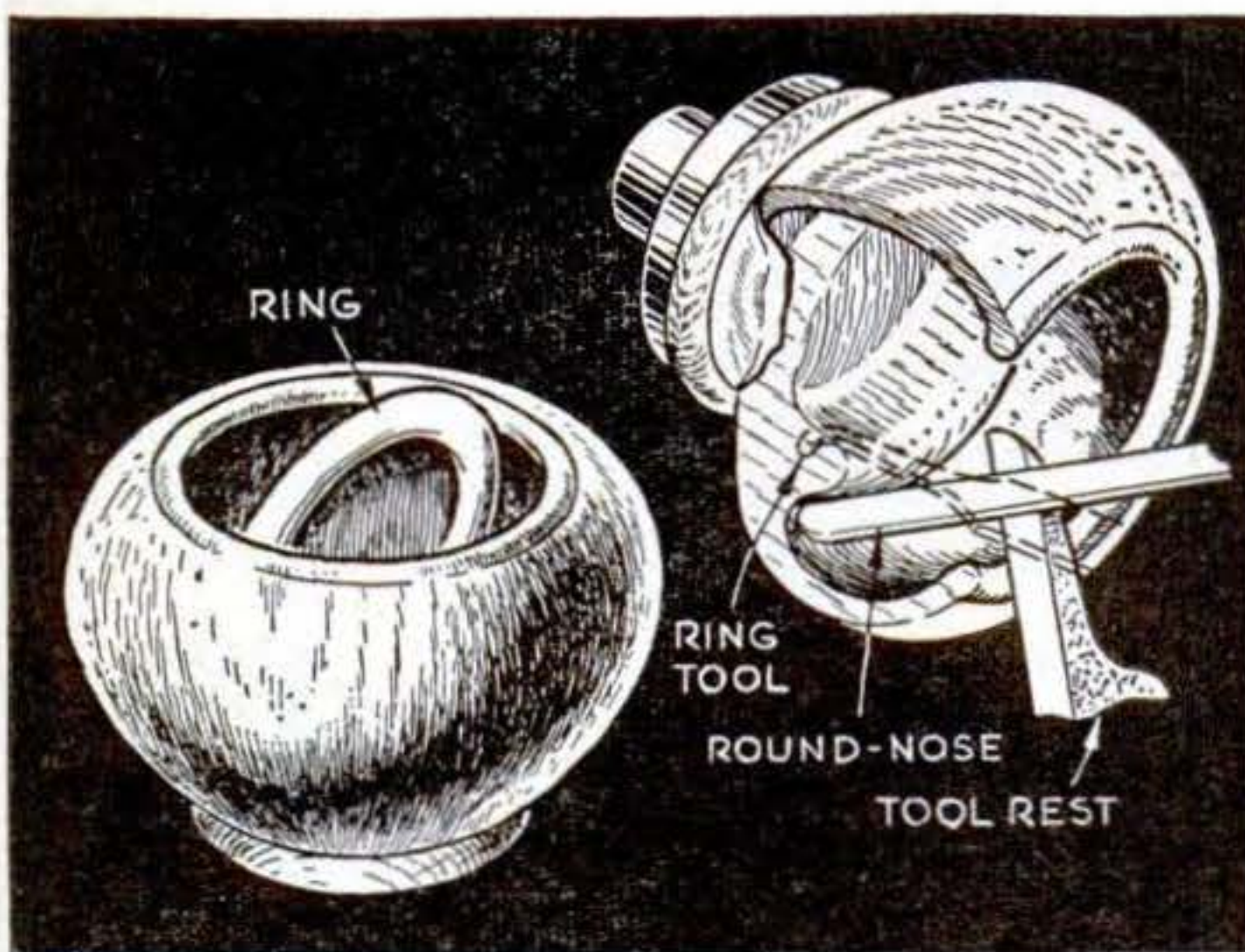

Here the ring's inside. The captive ring above has a practical use. Pulled up, it serves as a handle for the bowl. If the bowl is undercut deeply, you have plenty of waste material for the ring. After turning the outside of bowl, hollow the inside to sufficient depth to permit turning the near face of the ring. Shape the back face of the ring and cut it loose with ring tool you have made from a file.

Glue does the trick here. In this case, the handle is made before the bowl is turned. The trick is to glue up the bowl blanks with the handle trapped inside. If you wish, you can make the handle of some contrasting wood—or of metal or plastic.

In previous issues, Edwin M. Love has told Popular Science readers how to turn spindles, disks, and bowls. Here are some lathe tricks that knowledge of those techniques makes possible

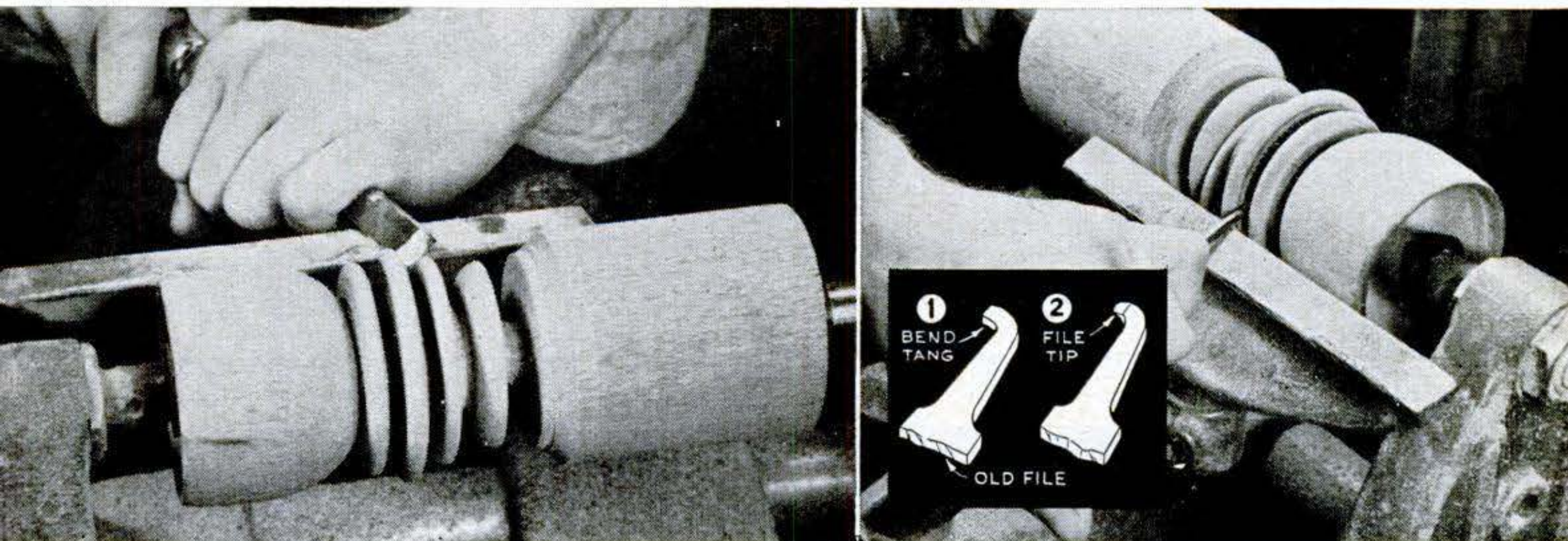

2 Locate the rings with cuts of parting tool and round them on the outside as above. Space the rings as far apart as possible to provide working room. Rough-turn the bowl and base before starting work on the rings.

3 Round the rings on the inside and separate them from the stem with a special tool made from an old file. After bending tang, grind a tiny round-nose chisel on its tip. Sand the outside of the rings before cutting them loose. Sand the inside by hand. After the rings are loose, hold them to one side while giving finishing touches to the stem, bowl, and base.

How Was This Turned?

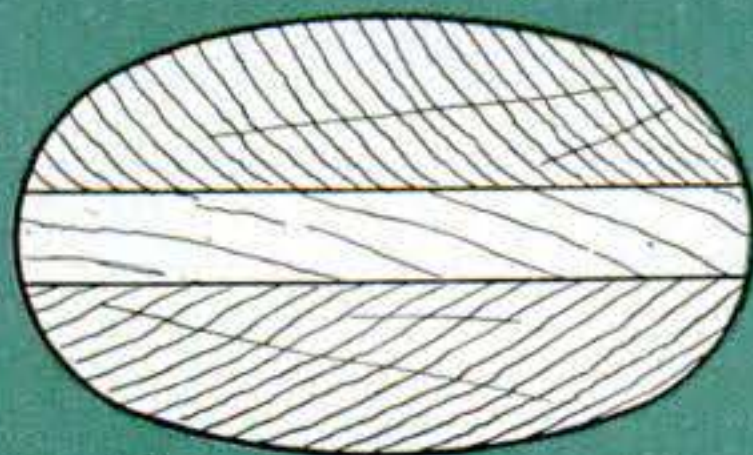

SECTION

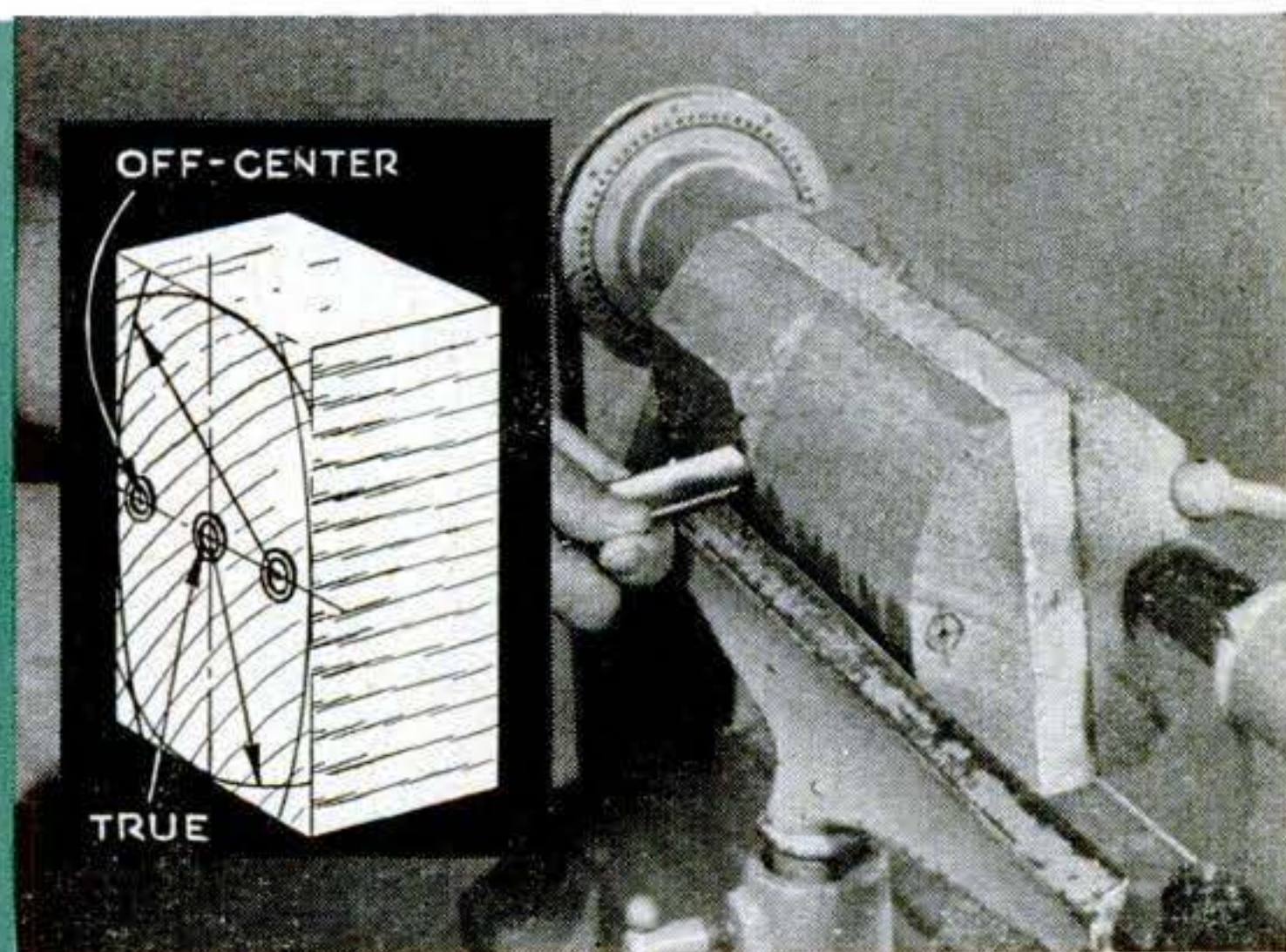

1 Off-center turning does the trick, if you want an oval cross section, as in the jewelry box at the left. (The handles and legs are glued on.) Lay out the job as in the inset drawing above, locating the off-centers on the short centerline near the edges. Run block at low speed on one set of off-centers as above and turn down the opposite face. Shift to the others to turn the second face. After this, continue as shown on next page. ➤

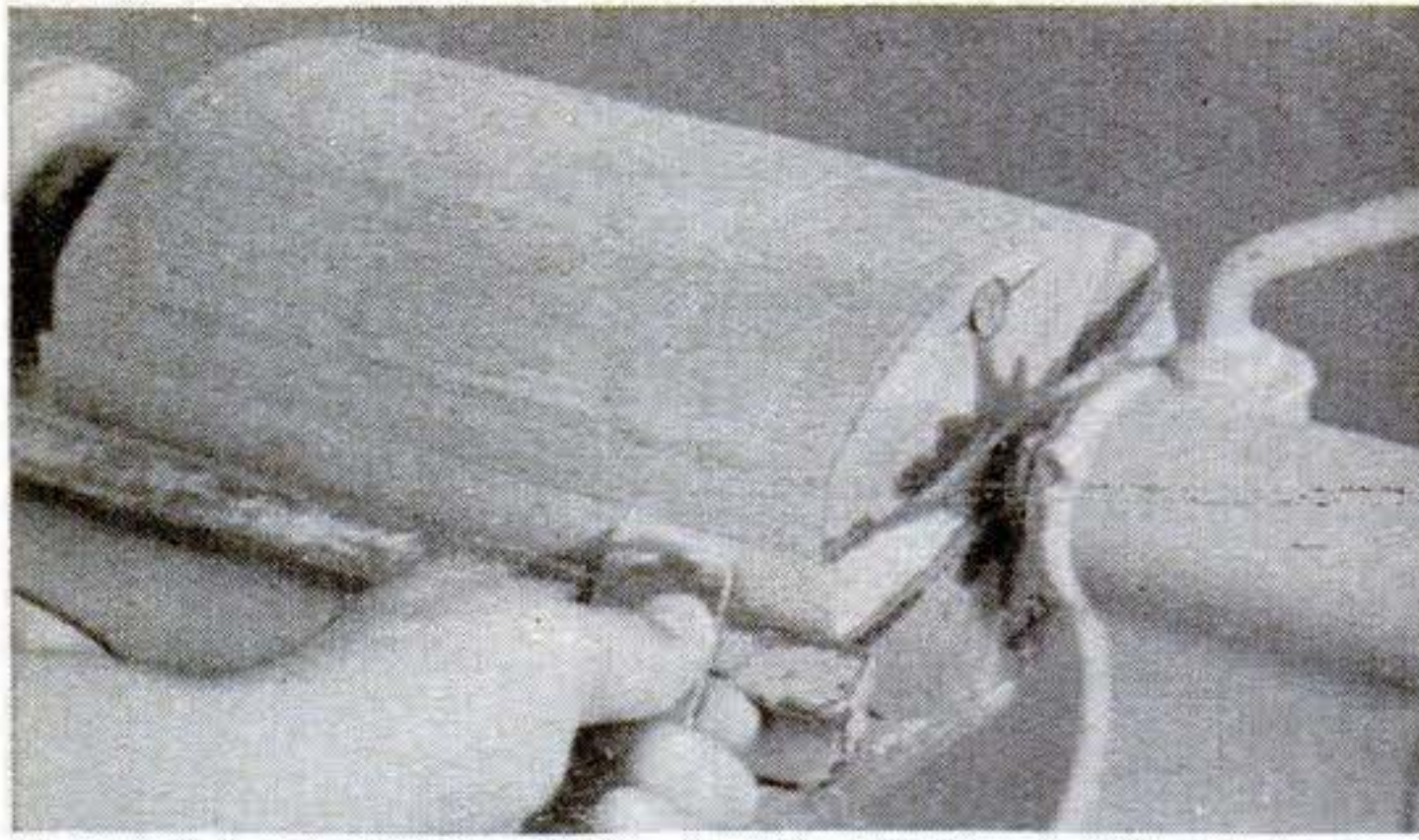

2 A turning on true centers rounds off the two remaining faces of the box. (Hollow out the inside, with a chisel and gouge, before gluing up the block for turning. Gluing paper in the lid-body joint provides clean separation when the cover is split off.)

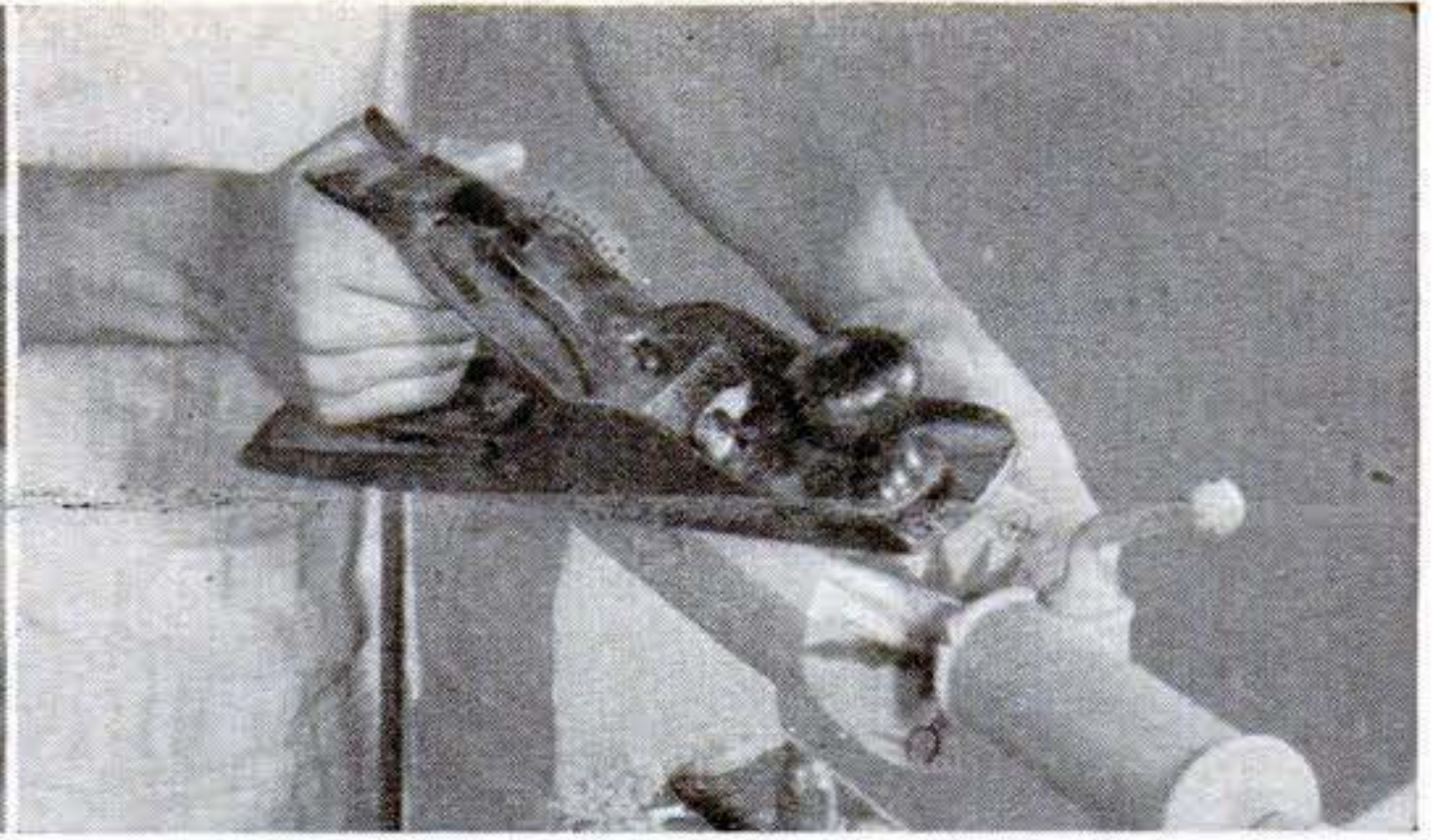

3 Plane off the blunt arrises that are left by the final turning. On smaller work, this can be done by sanding. As the last step before removing the job from the lathe, sand it smooth, using a lathe speed slow enough to enable the hands to follow the cam movement.

This Tray Was Hollowed...

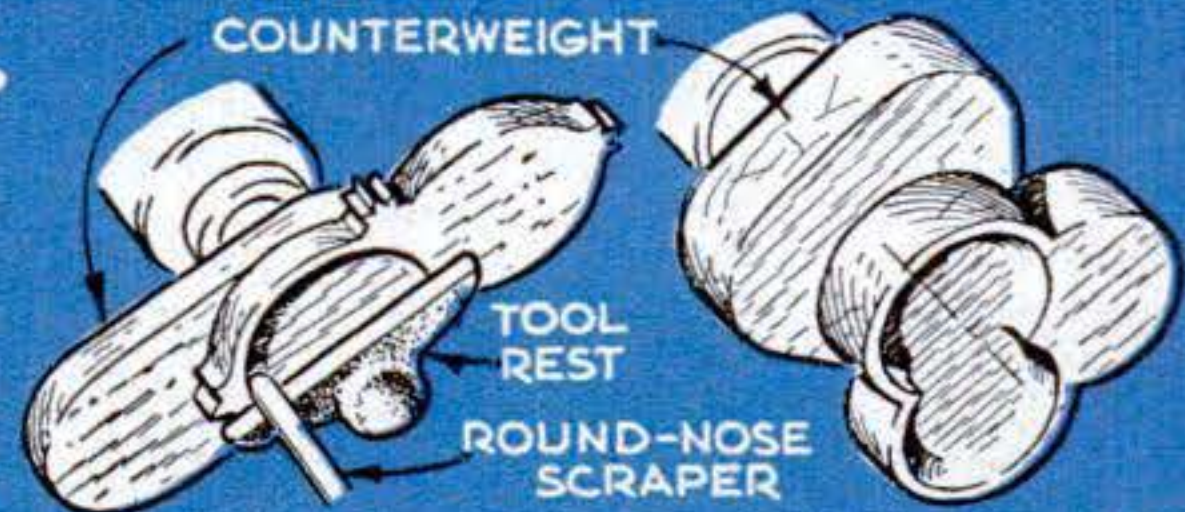

...By Cluster Turning

In cluster turning, you use a variation of the off-center method. To hollow out a tray like that above, mount the blank on a counterweight backing, as shown in Fig. 1. After turning out

one section, reverse the piece and scoop out the second. Cluster turning can also be used as in Fig. 2 to hollow three or more compartments.

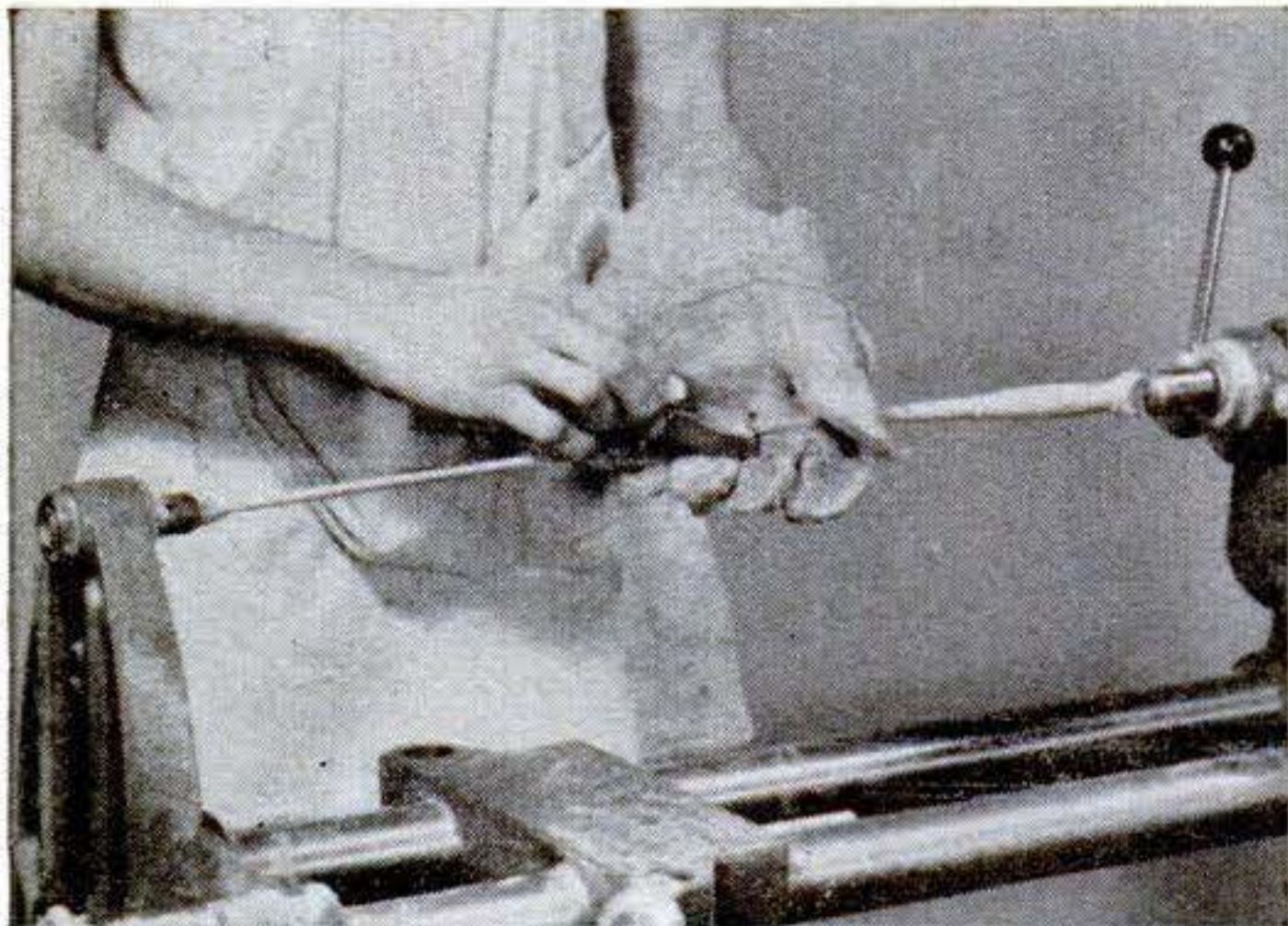

For a slender turning, such as this baton, ordinary methods aren't satisfactory because the stick whips violently. But managed as shown here, there's nothing to it. After roughing it out with chisels, reduce the shaft with a block plane, using the gloved hand to encircle and steady the piece. Steady it while sanding, too.

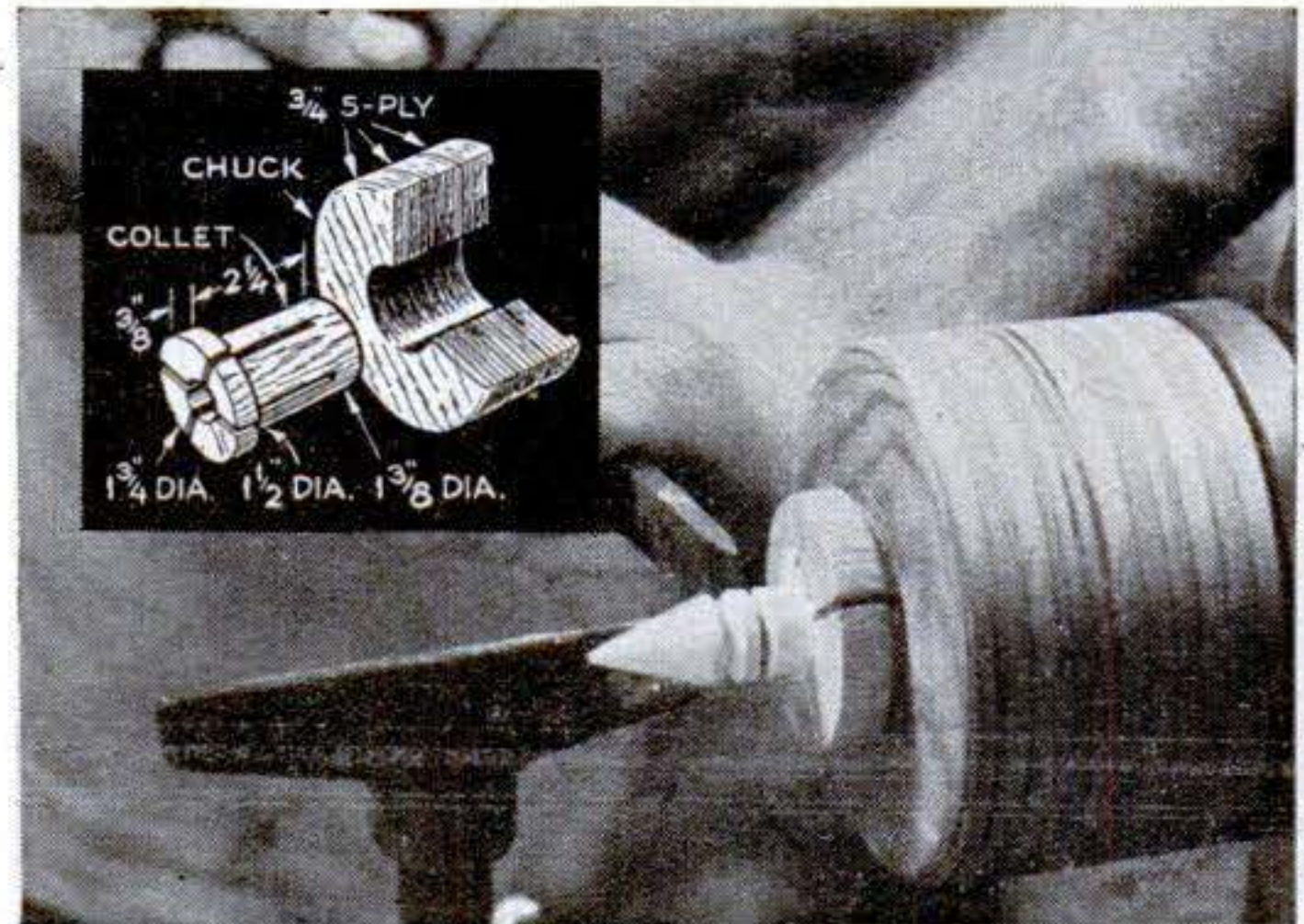

A drive collet like this is useful for turning finials, plugs, and other small objects. Turn the chuck from a glued-up plywood stack. Bore it slightly tapering or bellmouthed. Make the collet of hardwood, tapering it to fit chuck. Bore the collet after driving it into the chuck. Make saw kerfs at right angles. The pinching effect of the jaws when driven into the chuck holds dowel stock firmly. END



Feeler Stops Backing Truck

IF THIS truck backs into anything, its brakes automatically lock. The signal is given by the thin feeler rod shown above. This is pushed out behind the rear bumper by a solenoid that is energized when the reverse gear is engaged. If the feeler hits anything, it flexes enough to actuate another solenoid that sets the brakes. They remain set until a forward gear is engaged. If the rear path is clear, the feeler retracts when the truck goes ahead. Peter and Alfonso Fasolino, of Buffalo, developed it.

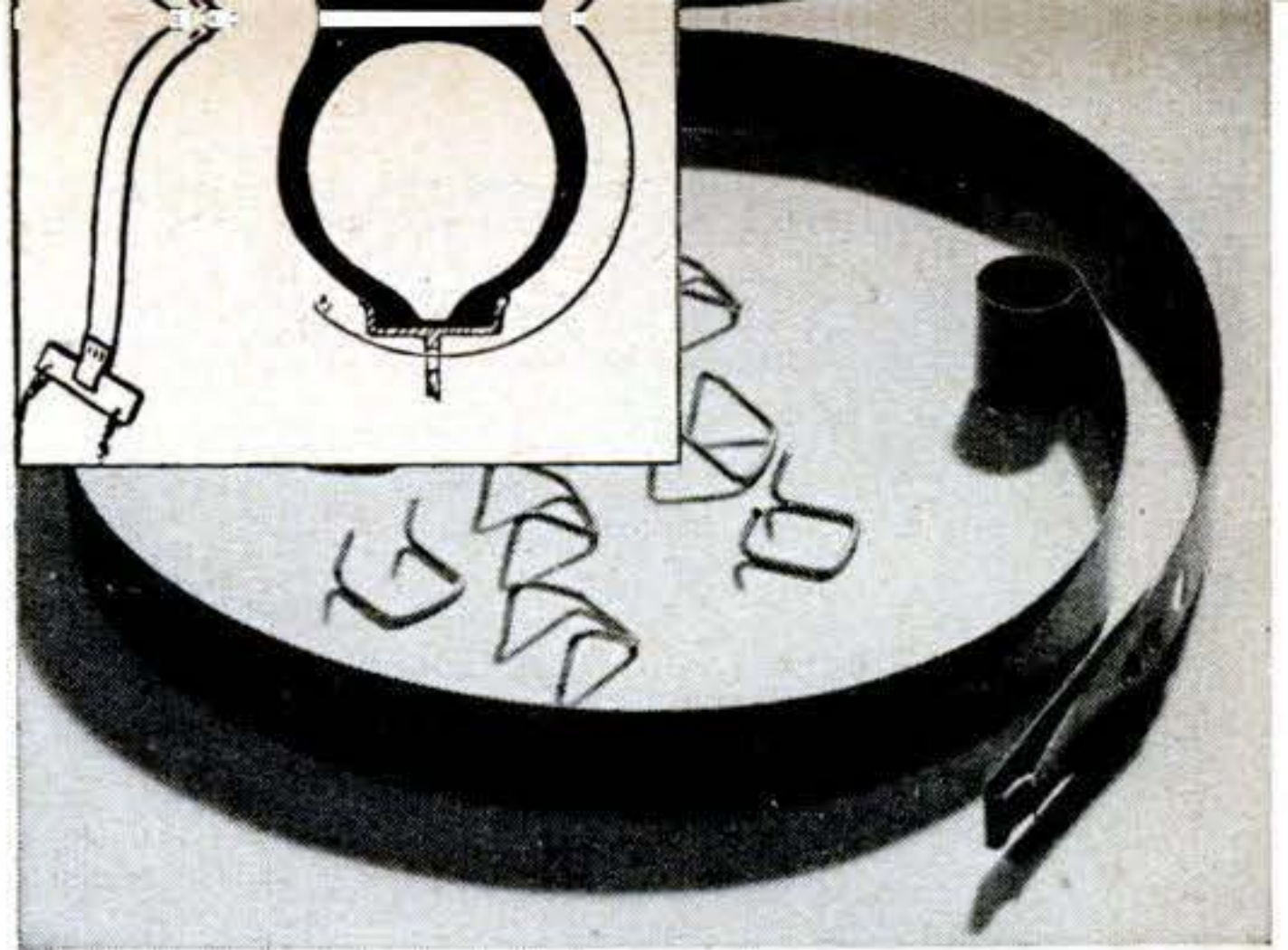

Tool Pulls Chain Around Tire

STRAP chains are reported easier to put on with a new tool marketed by J. Randolph & Co., of Englewood, N. J. You start by crimping one of the wire clips shown in the photo on the end of each strap. To use the tool, push the thin end through the wheel slot. As you continue to push, the tool will curve up around the tire so you can hook on the strap, as seen in the drawing. Then pull the tool back in the opposite direction and the strap will follow through the slot. The tool sells for about \$1.

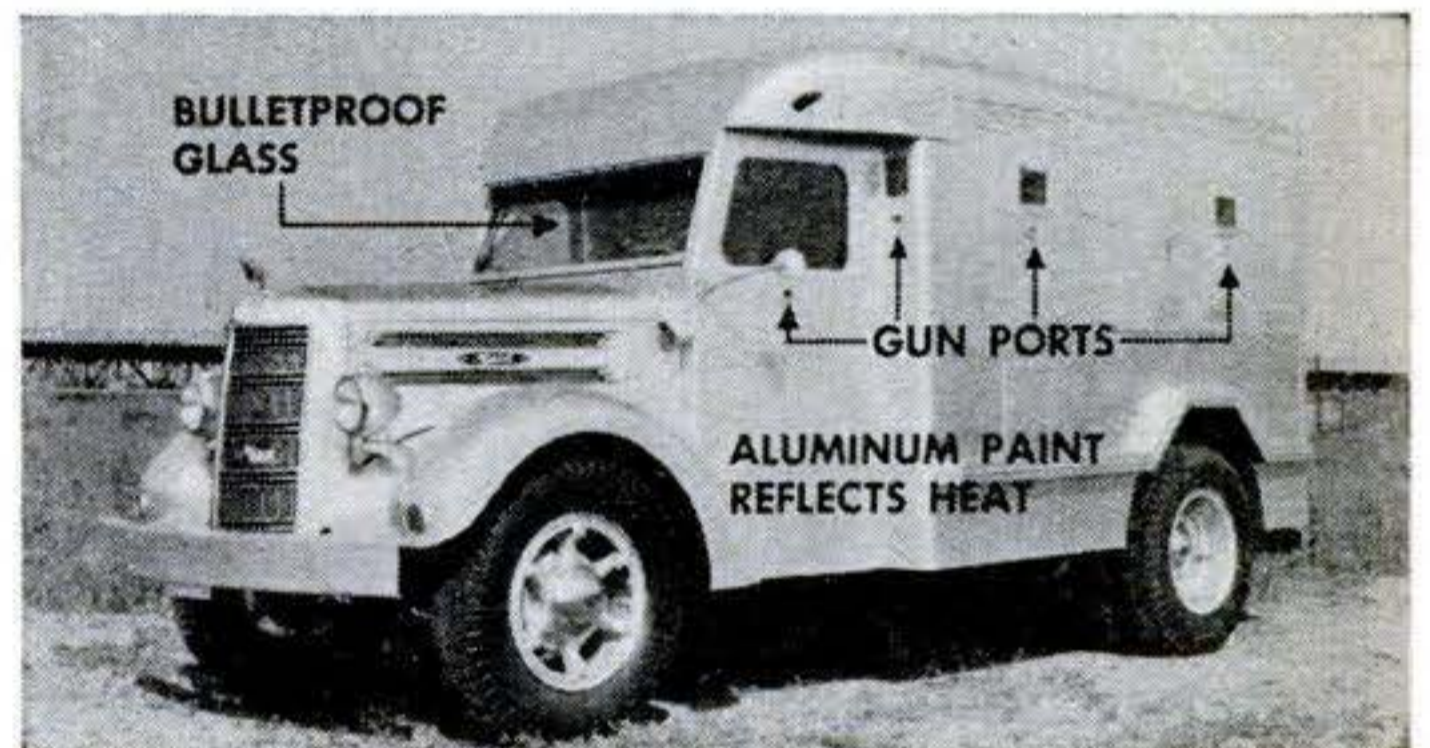

Why Don't Bandits Give Up?

BANDITS who jump this armored truck will get a hot reception from cool guards. Built for Cuba's Treasury Department, the truck body was designed to achieve maximum security plus comfort in a hot climate. Sides and body are lined with 2" of glass insulation, and aluminum paint reflects the sun's rays. The inside body walls are heavy aluminum armor plate. Windshield and windows are bulletproof glass.

Talc Protects Wallpaper

DIRT and natural oils on the hands can spoil a wallpapering job. Next time you hang paper, rub some talcum powder on your hands. It will help keep them clean and dry and thus prevent soiling the paper. Powder that settles on the paper can be easily wiped off.—J. E. Bird, Carrollton, Ill.

The Height of Ingenuity



• Here was my problem. Our house is built so low to the ground that even a junior-size midget couldn't crawl under it. So when a pipe froze, I had to figure some way to thaw it even though I couldn't get to it. What'd I do?

I hooked up my electric soldering iron and wired it loosely to the pipe. With another piece of wire, I slowly moved the iron along the pipe until it was thawed.

How Much Does Hot Water Cost?



COAL:
580 LB. A MONTH

APPROXIMATE CONSUMPTION OF
**FOUR BASIC FUELS NECESSARY
TO PRODUCE 50 GALLONS OF
HOT WATER A DAY.**
BY APPLYING FUEL COSTS IN
**YOUR LOCALITY YOU CAN FIGURE
COMPARATIVE COSTS**

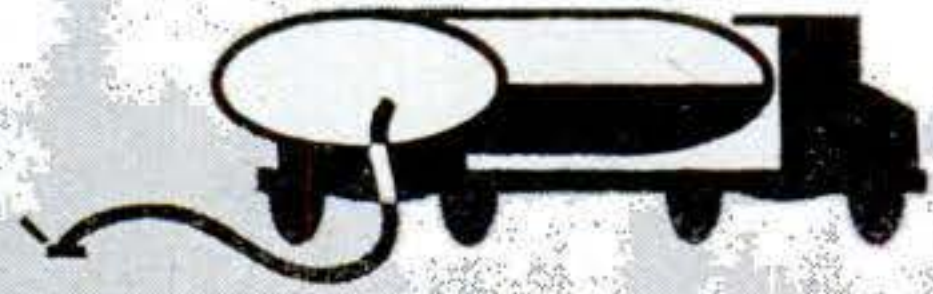

OIL:
50 GALS. A MONTH



GAS:

(MANUFACTURED) 2,800 CU. FT. A MONTH
(NATURAL) 1,400 CU. FT. A MONTH



**50 GAL. OF HOT WATER
A DAY BY DIRECT SYSTEM**

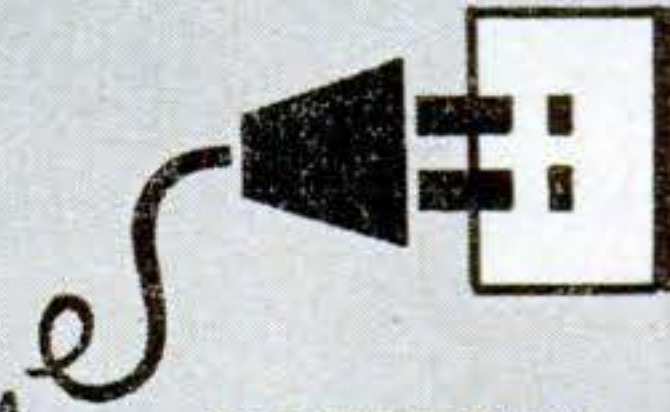

ELECTRICITY:

370 KILOWATT-HOURS A MONTH

Measuring Your Home for Hot Water

By George H. Waltz, Jr.
Drawings by Jere Donovan



**Here's how you can assess a hot-water system in
terms of capacity, demand, and comparative cost.**

Where Your Hot Water Goes



BATH:
10 GALLONS EACH



SHOWER:
8 GALLONS EACH



DISH WASHING:
(MANUAL) 11 GALLONS
(MACHINE) 15 GALLONS



LAUNDRY:
(MANUAL) 12 GALLONS
(MACHINE) 15 GALLONS



DAILY CLEANING:
5 GALLONS



PERSONAL TOILET:
1 GALLON A PERSON

(FIGURES APPROXIMATE)

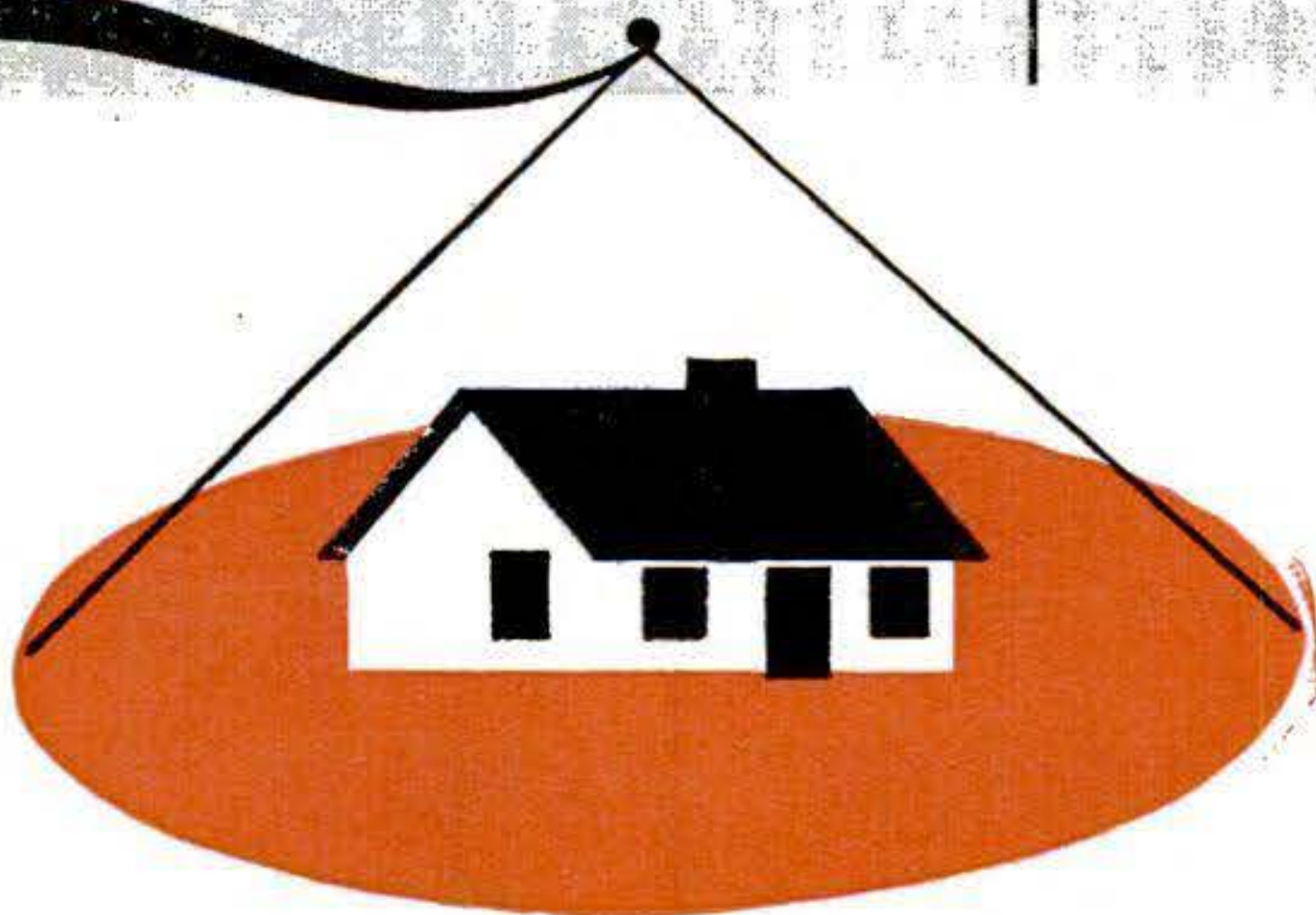

MODERN kitchens and laundry rooms are making old-fashioned water systems obsolete. New robot dish and clothes washers have boosted hot-water consumption in many homes, and at the same time improved new heaters have appeared that generate hot water faster and more efficiently.

You can measure your own home for hot water easily. Then, if your audit indicates a new and better system, you can select a heater from a wide array of types to suit the needs of your own particular household. Three major considerations, however, should govern your choice:

- The total amount of hot water your family needs;
- Your existing home heating system; and









- The relative cost of the various fuels in your locality.

Experts estimate that the average requirement per person is about 15 gallons a day. An automatic dishwasher or a clothes washer is likely to require an additional 15 gallons a day. So, by adding up the gallons, the head of a family of four equipped with an automatic clothes washer will find that he should have about 75 gallons of hot water a day available. With an automatic dishwasher, the same family should have about 90 gallons. Since a hot-water system using a storage tank should be capable of storing at least 20 percent of the normal daily needs, this means a tank with a capacity of at least 20 gallons.

There is, however, another factor that's often overlooked. Just as important as your total *daily* needs are your maximum *hour-by-hour* needs. A heater may turn out the total amount you need, but, because its capacity is barely enough or because it heats slowly (experts would say "it has a slow rate of recovery"), it may be inadequate when your wife decides to do several things requiring hot water at the same time.

Theoretically a 20-gallon storage tank can take care of four persons, a dishwasher and a clothes washer. But an audit of

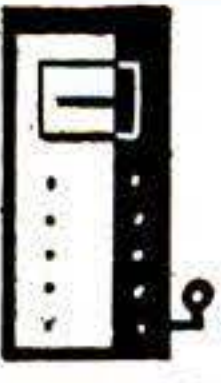
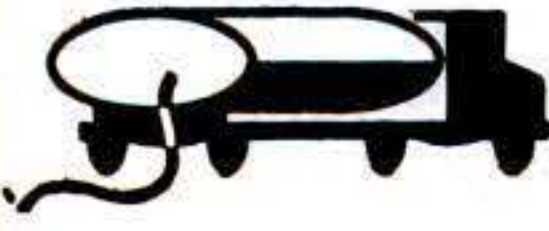
Direct Heaters

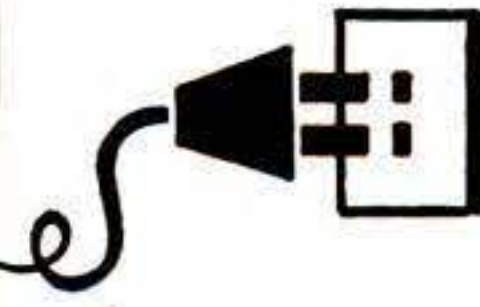
TYPE	FUEL	ADVANTAGES	COMMENTS
 "BUCKET-A-DAY" STOVE	 COAL	LOW INITIAL COST	REQUIRES ROUND-THE-CLOCK ATTENTION REQUIRES FLUE CONNECTION
 INSTANTANEOUS GAS HEATER	 GAS	NO FUEL STORAGE NO ATTENTION NO TANK HOT WATER AT THE TURN OF A FAUCET	HIGH OPERATING COST IN AREAS WHERE GAS RATES ARE HIGH REQUIRES FLUE CONNECTION
 STORAGE-TANK GAS HEATER	 GAS	NO FUEL STORAGE NO ATTENTION	HIGH OPERATING COST IN LOCALITIES WHERE GAS RATES ARE HIGH REQUIRES FLUE CONNECTION
 STORAGE-TANK OIL HEATER	 OIL	NO ATTENTION	REQUIRES FLUE CONNECTION AND OIL-STORAGE TANK
 STORAGE-TANK ELECTRIC HEATER	 ELECTRICITY	NO ATTENTION NO FLUE CONNECTION NECESSARY NO FUEL STORAGE	HIGH OPERATING COST UNLESS AREA HAS LOW RATE OR ENOUGH OTHER ELECTRICAL APPLIANCES ARE USED TO GIVE REDUCED RATES

their hourly needs may show a deficit if Mrs. Jones is in the habit of doing her hair while her automatic kitchen helpers do the clothes and dishes. A hair wash takes about 10 gallons and the automatic washers swallow up another 15 gallons each for a total of 40 gallons within the hour. Forty gallons of hot water must be on tap, and that doesn't mean that a 40-gallon tank will do the trick. It means that 40 gallons must be available and at the right temperature. Under such circumstances, Mr. Jones will be wise to invest in a system that has at least a 50-gallon capacity and a fast rate of recovery.

To play safe, you should gauge your hot-water needs for both the over-all daily total and the greatest hourly demand. Then, the

higher figure should be chosen as the minimum capacity. The supplier of a new heater should be able to tell you if its recovery rate is adequate for your needs.

Kinds of Systems

Hot-water systems can be *direct* or *indirect*. In the direct systems, a separate hot-water heater is used, fueled by coal, gas, oil, or electricity. In the indirect systems, the existing home-heating plant is used to heat the water. Most systems—with the exception of the instantaneous gas water heater (direct) and the tankless take-off heater (indirect)—use storage tanks.

If your house is heated by an oil- or gas-fired steam or hot-water furnace, you can use either a direct or an indirect system to

Indirect Heaters



Internal coils make hot water as by-product to regular furnace operation. A nearby hot-water storage tank is often used.

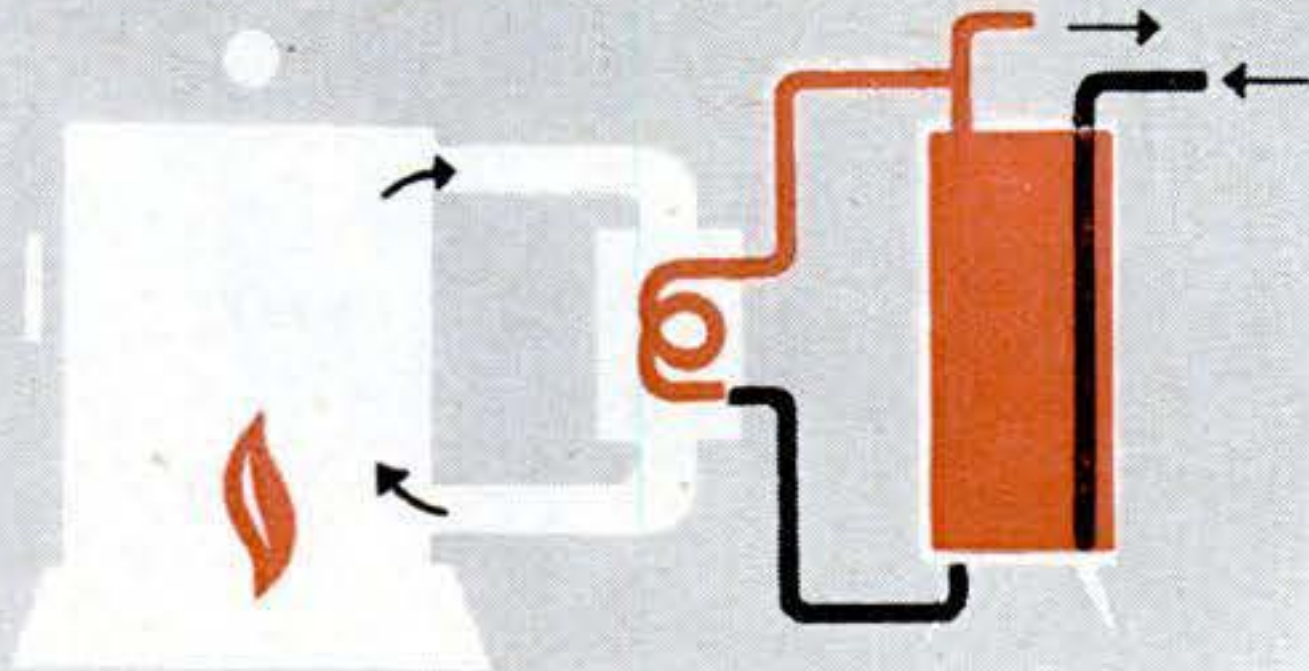

External coils located near furnace may heat water indirectly. Output is almost always fed to a storage tank nearby.

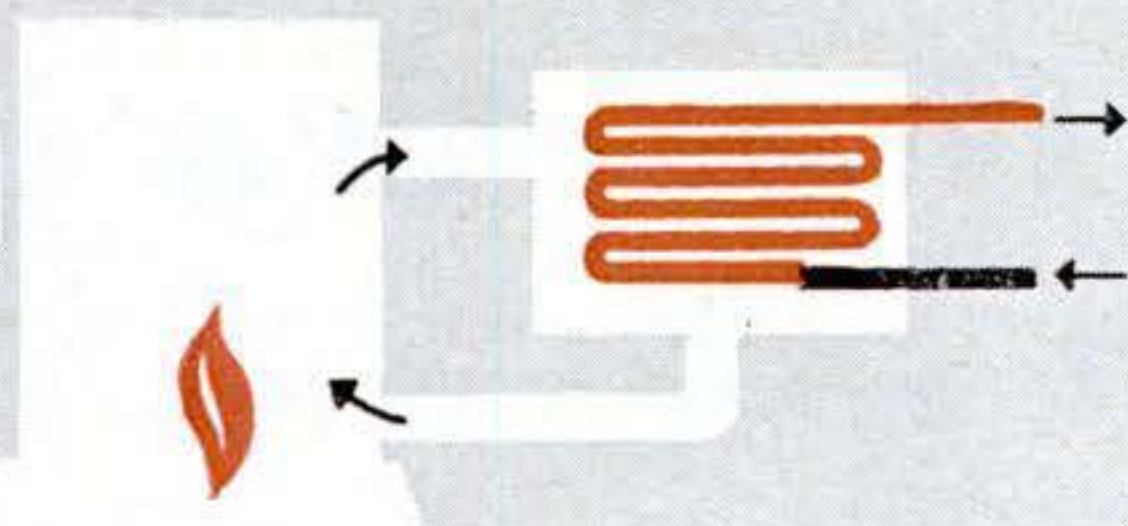

Tankless heat-exchanger type has more extensive coil system, and transfers heat fast enough to eliminate need for a tank.

get hot water both summer and winter. If your furnace does not have a built-in hot-water coil, one can be added externally to service a storage tank, or a tankless heater can be piped into the system. The tankless take-off supplies hot water directly to the faucets without storage. In either case, an over-riding thermostat can be installed to operate the furnace just enough during the summer months to heat the water without heating the house.

If your furnace is not automatic, or is the hot-air type, you have no alternative but to use a water heater that is a complete unit within itself (direct type). Here, your choice extends all the way from the familiar "bucket-a-day" pot or laundry stove and storage tank to automatic oil, gas, or elec-

tric heaters. What you choose will depend on how much you want to spend for the initial installation, how much water you need, and local fuel costs.

Gas and electric hot-water heaters are usually economical only where rates for gas or electricity are low, or in cases where other gas or electric appliances are used sufficiently to put you on a highly reduced cubic-foot or kilowatt-hour rate.

Protecting Against Corrosion

Your best choice of a storage tank also may depend on where you live. Storage tanks are made of galvanized steel, glass-lined steel, copper, and Monel® metal. The best material for your installation will depend on the make-up of the water supply in your locality. If it is excessively hard or soft, it's probably best to avoid galvanized tanks. However, some protection can be had by inserting a magnesium protective rod in a galvanized tank. (The magnesium corrodes and a protective film is formed on the steel tank walls.) Many manufacturers of water heaters now include protective rods in their galvanized tanks. Magnesium rods also can be bought for existing tanks.

Your careful choice of metals should extend beyond your hot-water tank. It is risky, for instance, to attach a copper pipe directly to a galvanized tank. Galvanic action, like that in a battery, will be set up between the two dissimilar metals and will eventually destroy the galvanized metal. If you *must* connect copper piping to a galvanized tank, insert a short length of galvanized pipe between the copper piping and the tank. The worst that can happen then is the eventual breaking down of the galvanized nipple, which can be replaced easily.

High operating temperatures also can shorten your tank's life by stepping up the rate of corrosion. For this reason, it's rarely wise to try to boost your hot-water supply by boosting the temperature. A tank having a larger capacity is a better solution.

Basically, the whole problem selecting a dependable and adequate hot-water system is one of matching and balancing—matching its capacity and recovery rate to your maximum water requirements, balancing your choice against the furnace system you have, and balancing the convenience of various fuels against their costs. Finally, be generous when figuring your family's hot-water needs. No household ever suffered from too much hot water.

END

1.

First model was crude.



Two pieces of pipe welded to a triangular piece of flat steel formed the body. The object was to make an accessory so a wood lathe could be used to cut off $\frac{1}{2}$ " steel bars. It worked fine.

2.

Then it was cast in bronze.



Friends liked it and asked for duplicates. So the inventor made pattern and had bronze body cast. But tool had a weak point. A screw fed in bit, but it had to be pushed back by hand.

Inventor Tells How New Tool Was Born *By Ray Millholland*

Editor's Note: *Ray Millholland of Indianapolis is a well-known writer who invented a tool for home workshoppers. This is his story of its birth and development.*

ONCE there was a basement mechanic who needed a dozen pieces of $\frac{1}{2}$ " cold-rolled steel, all cut off square in 6" lengths. A metal-working lathe would have done the job in jig time, but, as is the case in many home workshops, none was available. So a special self-guiding cutting tool that could be attached to a wood-working lathe, a drill press, or a grinder was devised.

The body consisted of two short pieces of pipe—one to hold the cutting tool; the other, the stock—welded at right angles on a triangular gusset of flat steel. A lathe-tool bit was centered in one pipe and melted babbitt cast around it. This produced a sliding guide for the bit. In-feed pressure for the bit was provided by a strap-iron arm tapped for a $\frac{1}{4}$ "-20 machine screw.

A stock guide was formed in the other pipe by holding a piece of $\frac{1}{2}$ " bar with its centerline even with the cutting edge of the bit and pouring babbitt around it.

To cut the rod, it was fitted into the stock-guide end of the tool, which was slid along it to the six-inch mark. Screwing the bit gradually into the rod then made the desired cut. Two and a half hours after the need arose the 12 steel pieces had been cut.

Because friends liked the tool, an improved model was produced. In this, the holes for stock and tool bit were bored to exact diameter in a cast-bronze body. By inserting the proper bits, you could turn multiple diameters with this version.

More improvements were made in a third model. The tool bit was mounted in a cylindrical slide, with a keyway to keep the slide from turning. A graduated collar provided in and out micrometer adjustment of the bit. A knurled clamp screw locked it.

3.

Action was improved.

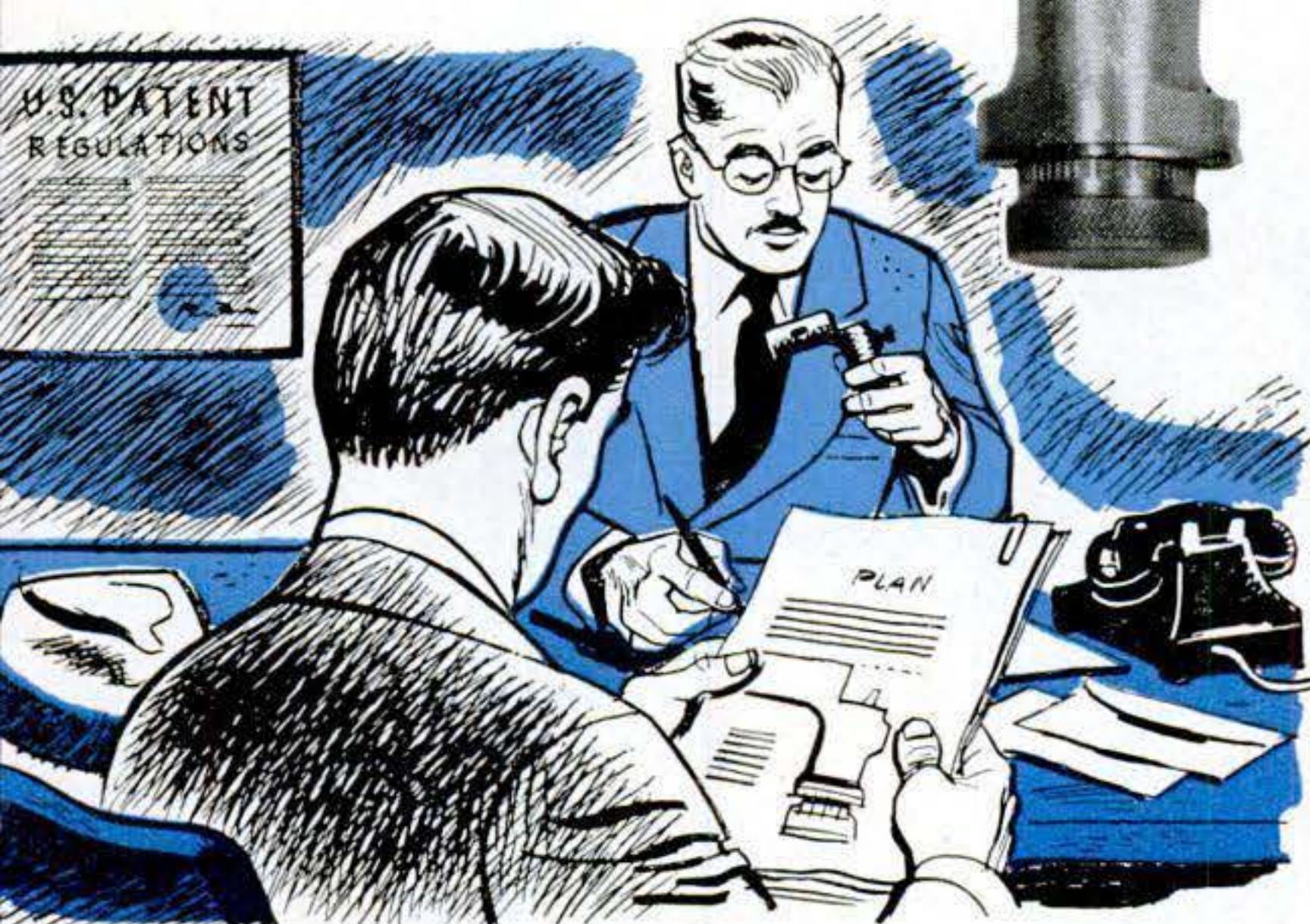

Positive adjustment of the tool bit, both in and out, was achieved in the third version. A cylindrical slide was installed to carry the bit, and a knurled locking screw was added.

4.

Redesigned to sell.



Manufacturer then agreed to take it. But first the body was redesigned for more eye appeal, and adapter bushings were added for taking $\frac{1}{4}$ " and $\frac{3}{8}$ " stock. Thus, at last, it went to market.

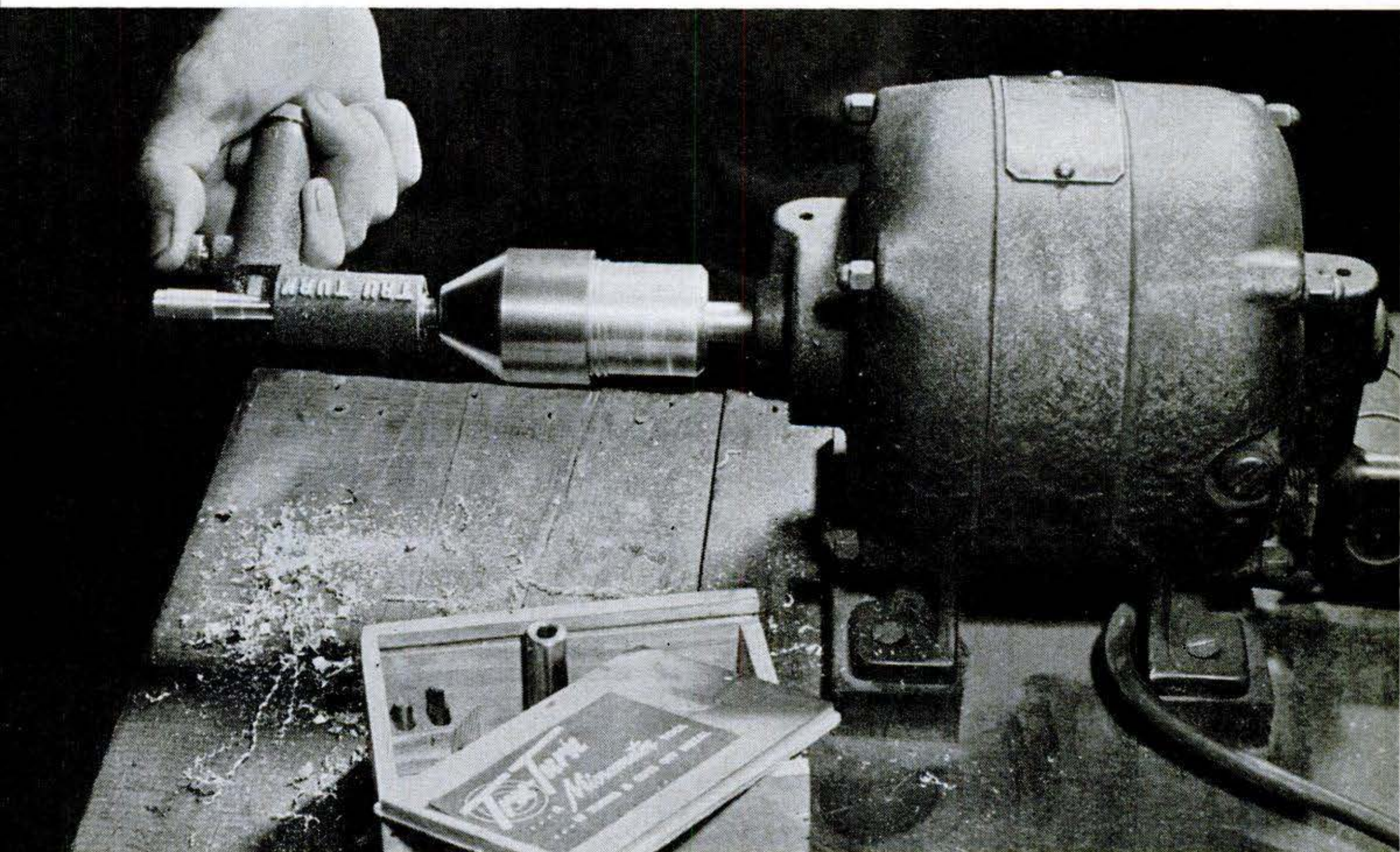

Using the tool, you can machine bar stock with the simplest of equipment. Here, a $\frac{1}{2}$ " bar is held in a chuck locked to a motor shaft. With this, you could either cut off the stock or turn

it down. More often, however, you would probably want to use tool with a drill press or wood lathe. The Tru-Turn®, as the tool is called, was described in PS, Dec. '47, p. 195.

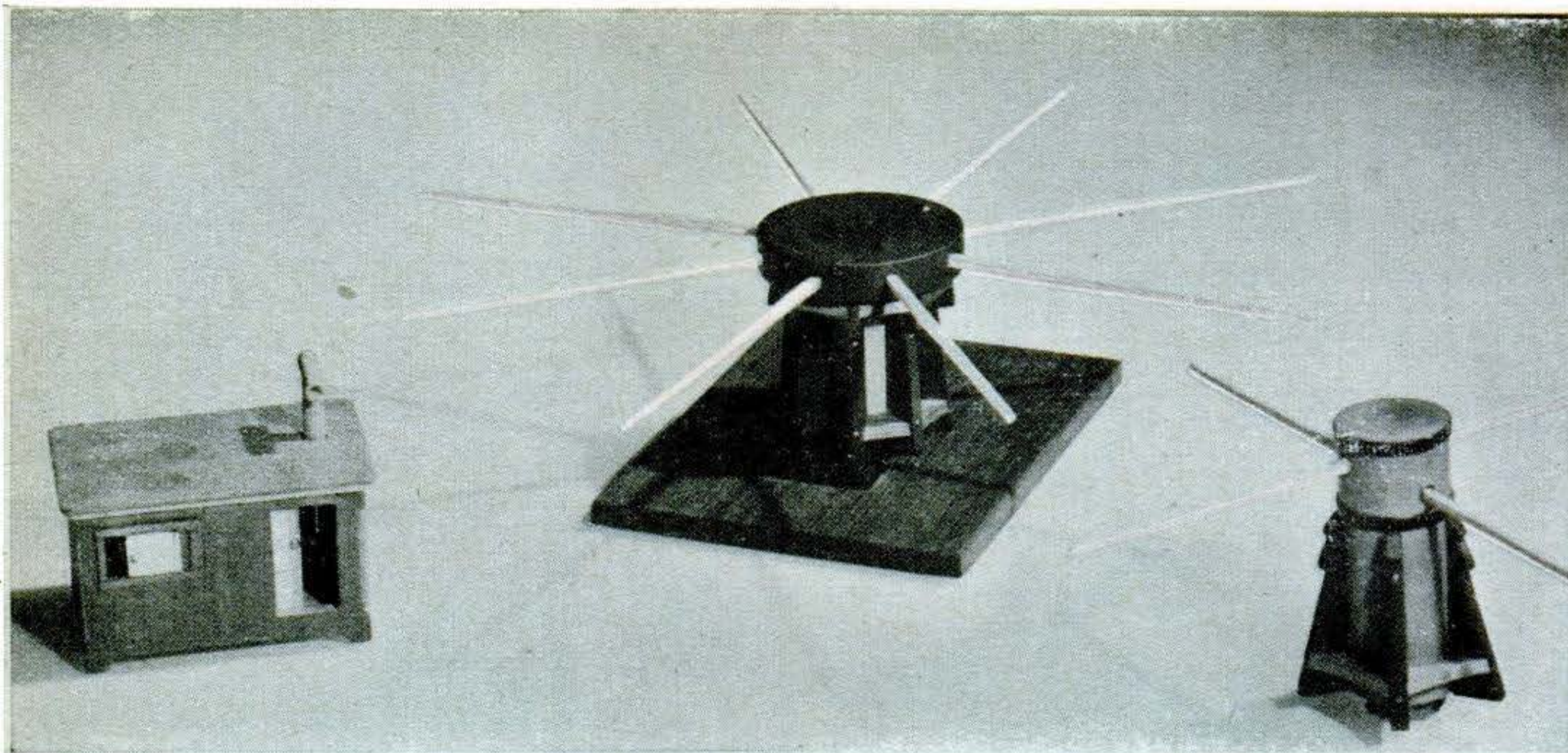

Finished models above are a type of galley (left) that was lashed to deck or hatch of sailing ships, and two kinds of capstans (right).

Deck Fittings for Model Ships

MAKING deck fittings is a tricky job. Here are some hints from Winthrop Pratt, Jr., celebrated model builder of Dorchester, Mass.

Wooden bitts as small as 1/16" square can be made by cutting a slot with a file or saw and dropping in the crosspiece and filler piece. Use glue to hold the parts.

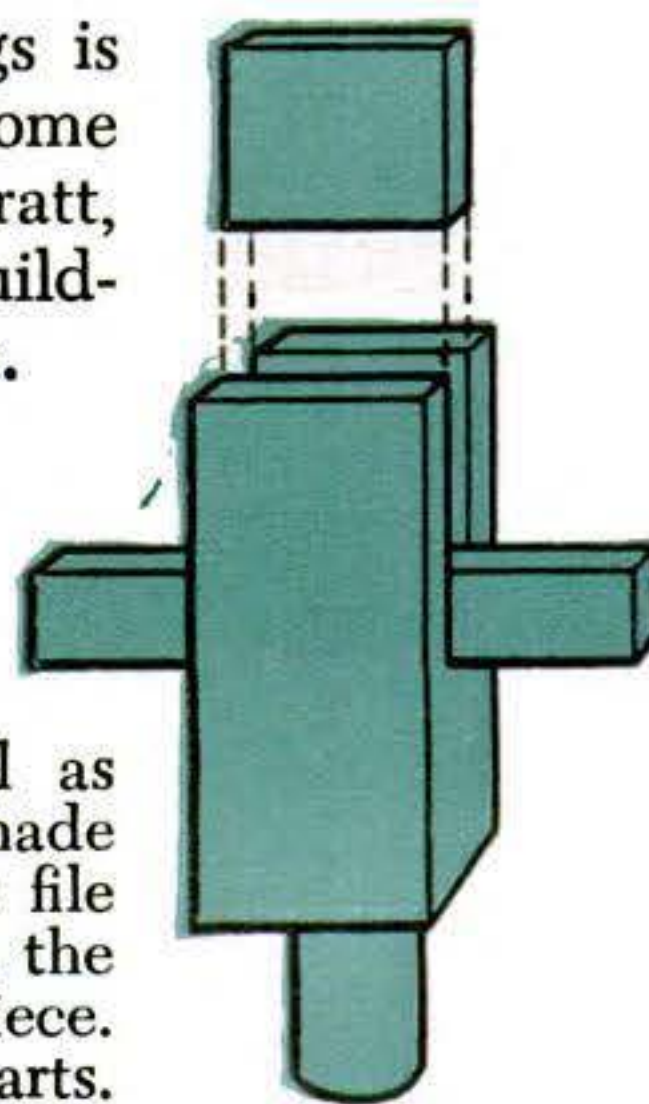

Galleys like one at left, common during 18th and first half of 19th Centuries, were about 6' by 8' or 10', and were lashed to deck or hatch by ringbolts in each corner. To make one, glue corner posts to ends, and glue floor sills, on all four sides, to posts. Cut out door and window openings in both sides. Doors slide in channels inside galley, windows in channels outside. Center drawing shows galley with false top in place. True top overhangs sides. Molding is glued under overhang. Fit chimney but don't put it on until galley is painted.

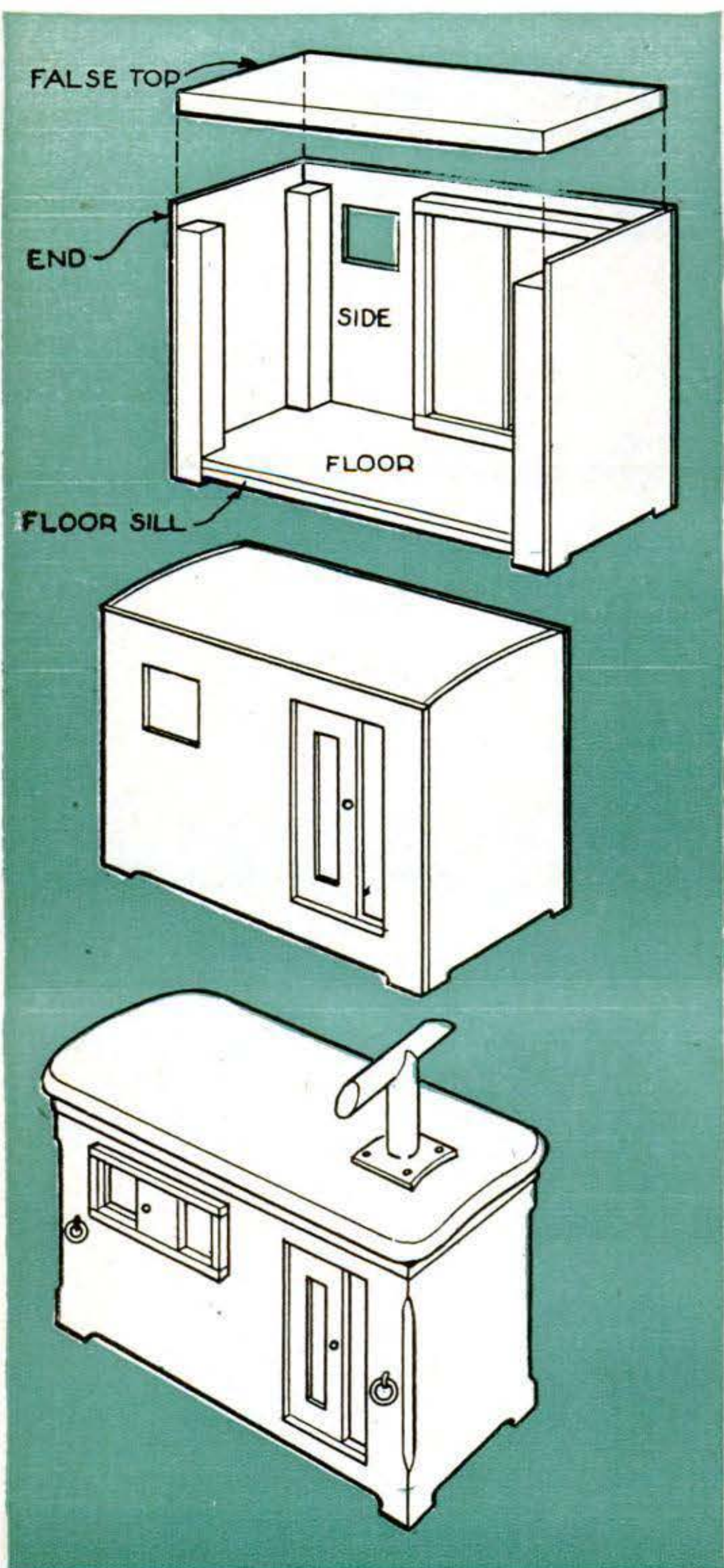

Capstans of the type shown at A were in use during the 17th Century. Note that there is only one row of chocks—at the bottom. The bars go clear through the drumhead as in the 16th and early 17th Century capstan, shown at B. The latter capstan, you'll note, has no whelps.

HOW CAPSTANS BELOW ARE PROPORTIONED

Diameter of the barrel equals $2\frac{1}{2}$ " for each 10' of the ship's keel.

Holes for capstan bars are about 4' above deck.

Drumhead diameter equals capstan height.

Thickness of drumheads on heaviest capstans equals $\frac{1}{3}$ diameter of barrel; on lighter capstans, as little as $\frac{1}{5}$.

Width of whelps (vertical ribs) at bottom and shoulder is $\frac{1}{2}$ diameter of barrel.

Whelp thickness equals $\frac{1}{6}$ barrel diameter.

Thickness of chocks is same as whelps.

Holes for bars scale $2\frac{1}{2}$ " to 3" square.

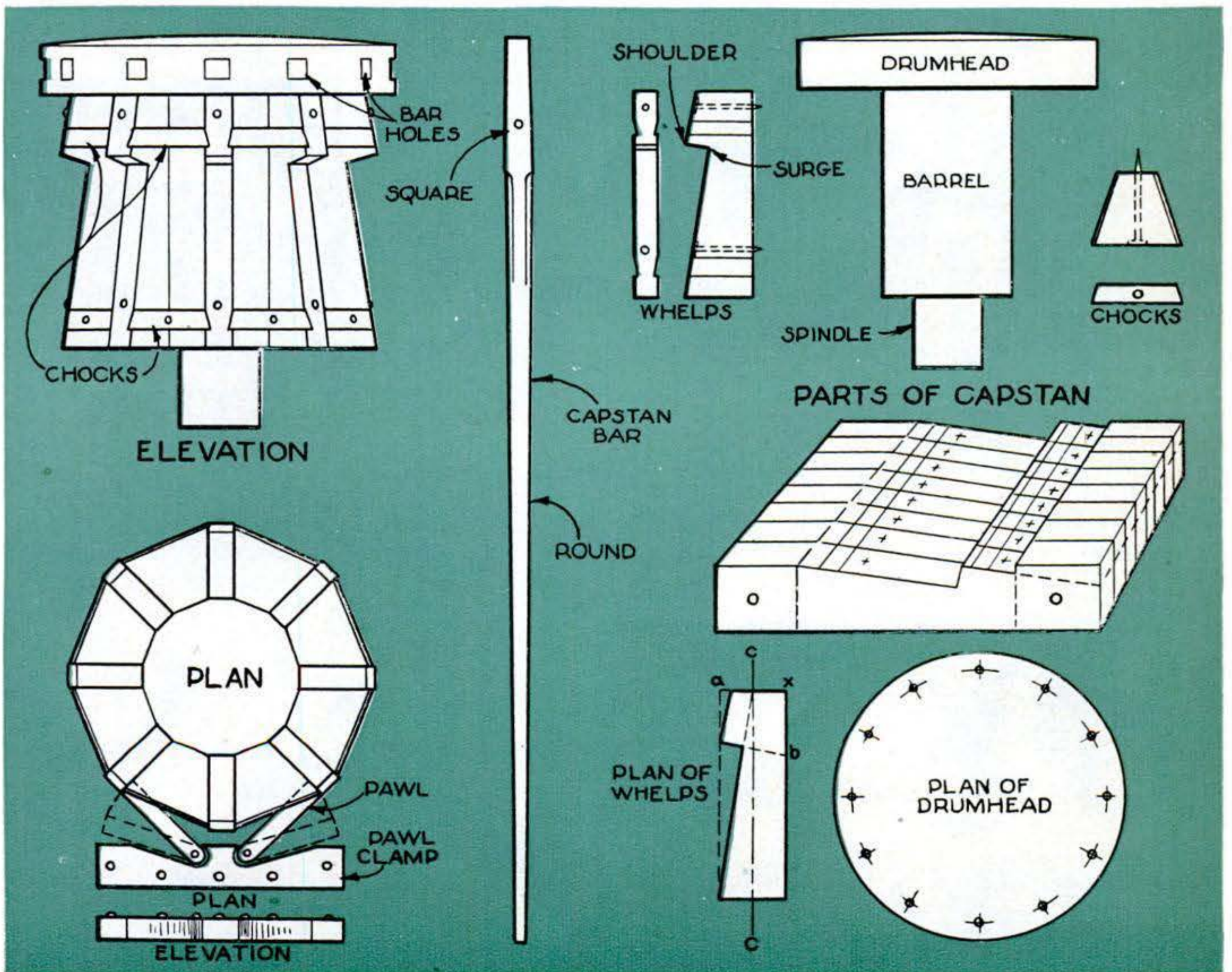
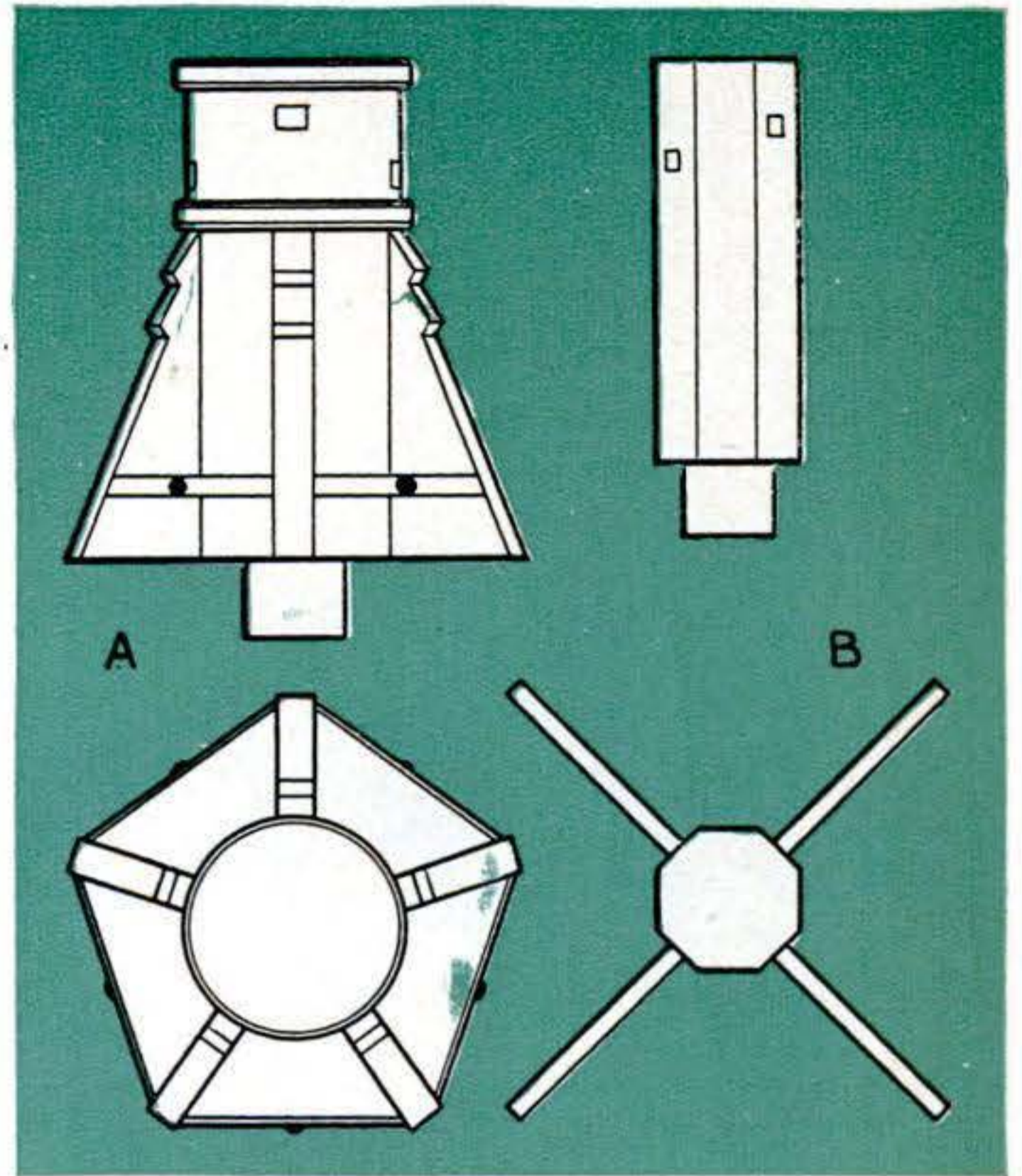

Capstans like this were common from early 18th to middle of 19th Centuries. Turn barrel and drumhead from one piece of hardwood. Leave spindle on bottom to set in deck. Mark locations of bar holes and whelps. Make whelps as shown, cutting on dotted lines. If pieces are

too small to be nailed together, bind with tape and put them in vise for sawing. Rabbet sides of whelps for chocks. Grain of wood for chocks must run from whelp to whelp. Whelps are glued and nailed to barrel. Install chocks singly. It's hard to make them interchangeable.

Hints for Users of Small Motors

INEXPENSIVE small 115-volt shaded-pole induction motors are a convenient source of light power. They'll handle scores of jobs—running working models, action displays, small fans. Sometimes you must adapt the motor to a particular job. Here are ways to do it.—A. C. Porter, South Bend, Ind.

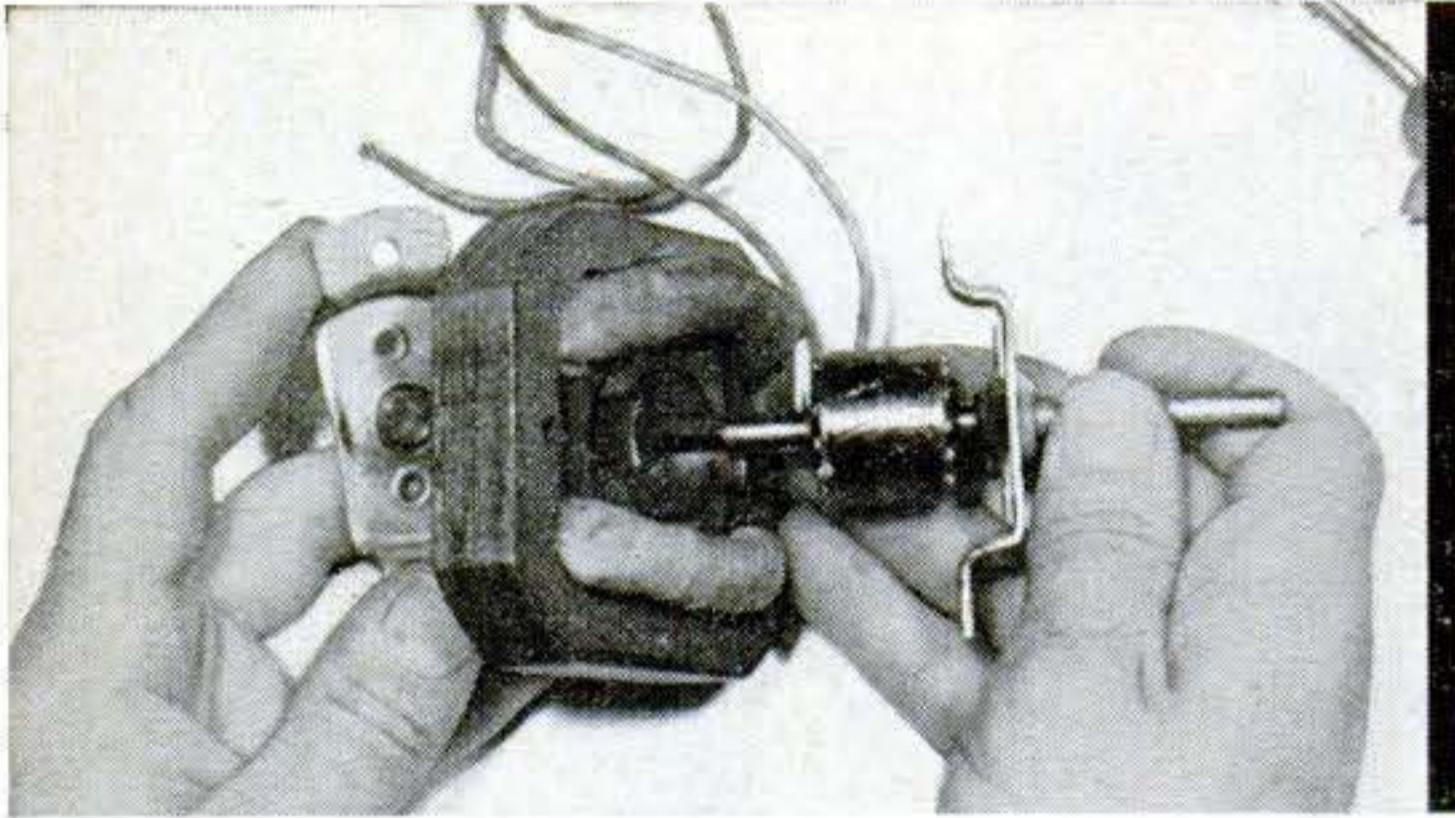

IF it rotates the wrong way, chances are you can simply switch the motor end for end. But if for some reason that isn't feasible, you still aren't licked. Just take the motor apart, as shown above, and insert the rotor with the shaft out the opposite side of the frame.

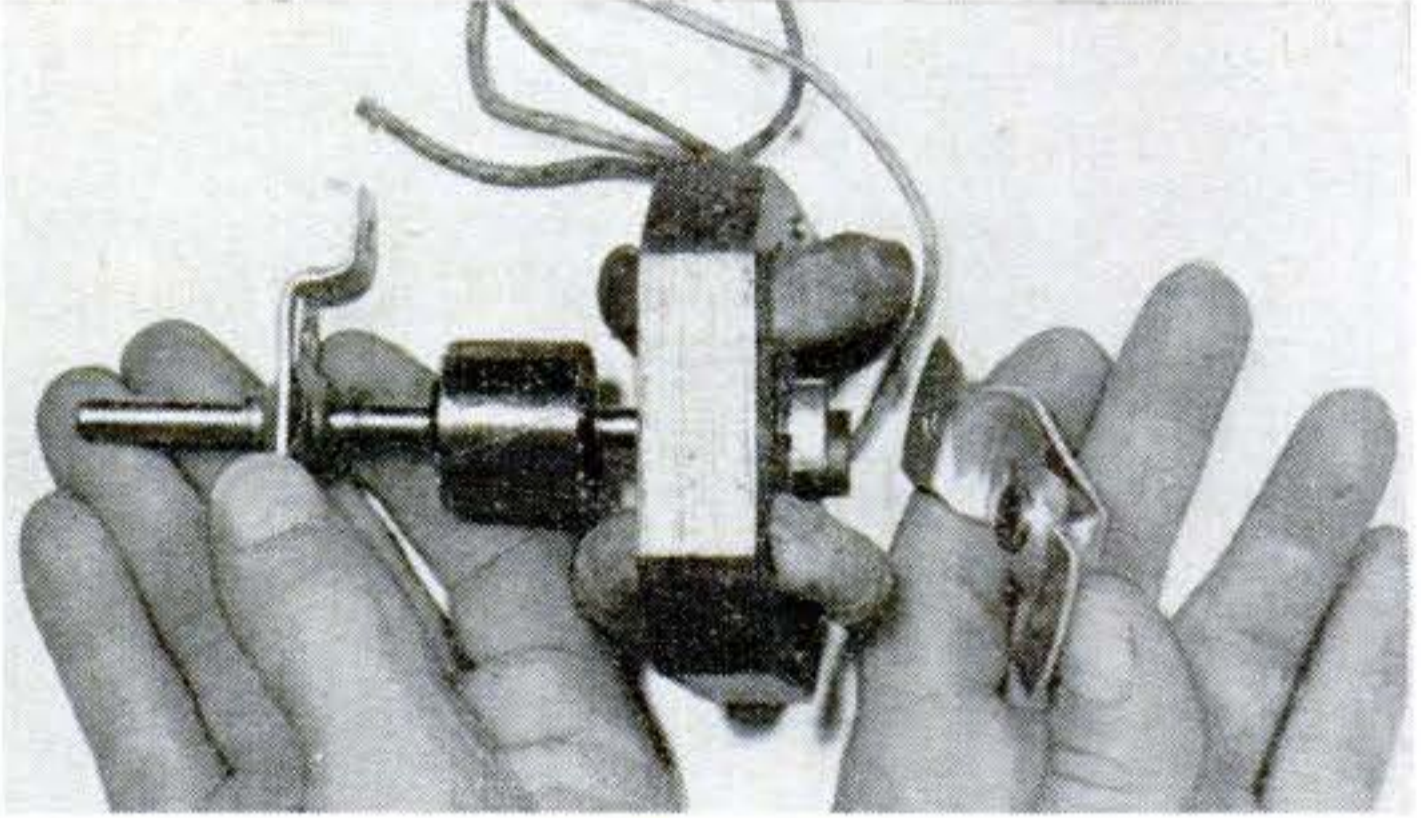

That does the trick. The shaft now rolls in the opposite direction.

In horsepower rating, these motors range between 1/60 and 1/150. A 1/4" shaft is a common diameter and the motor usually runs at about 3,000 r.p.m., depending on the load.

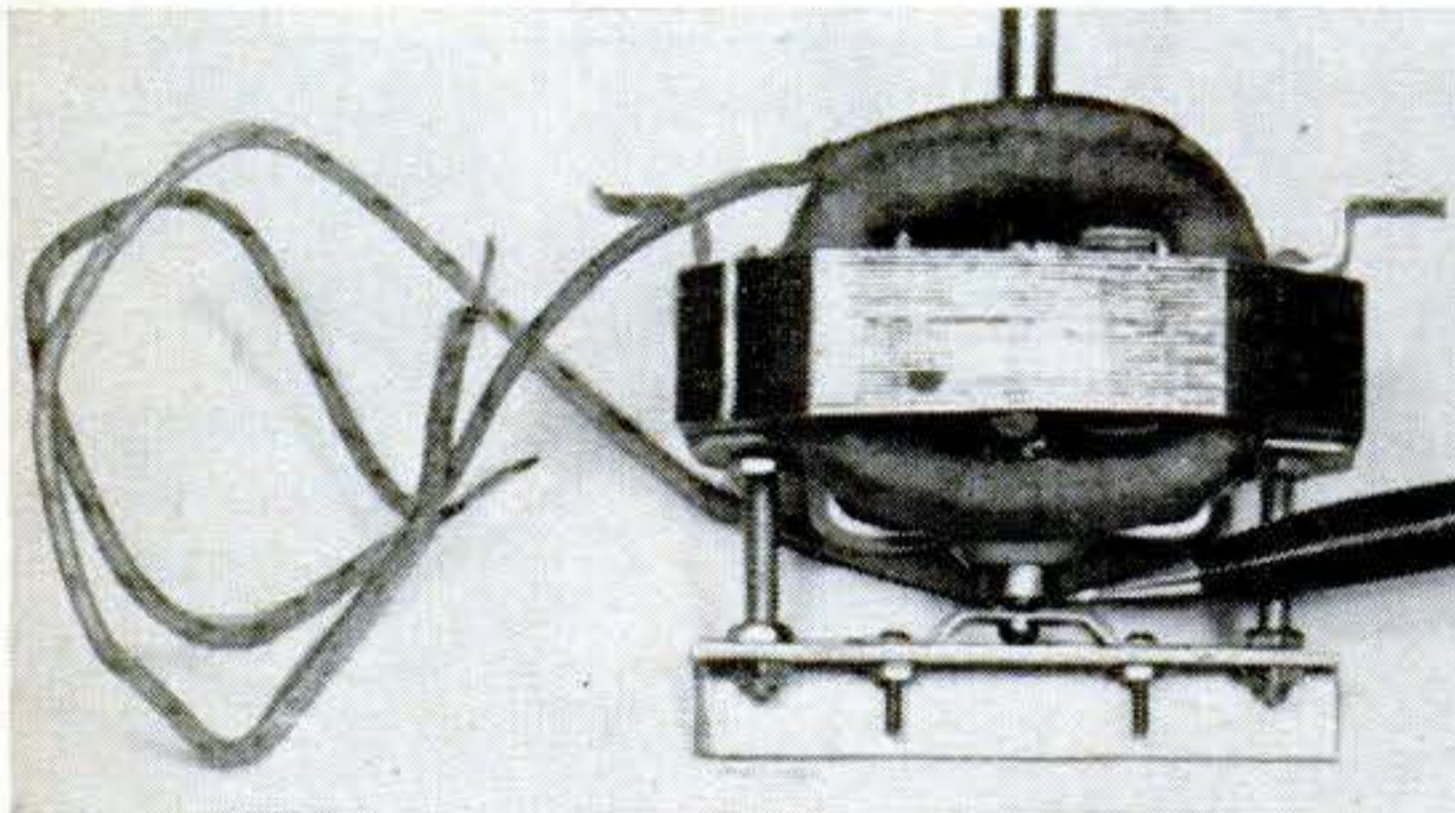

IF mounted vertically, the motor may need a thrust bearing under the end of its shaft. That's easy, too. Start with a small steel ball. Centerdrill the shaft end so it will partially conform to the contour of the ball. Support the bearing with a metal angle, held in place by

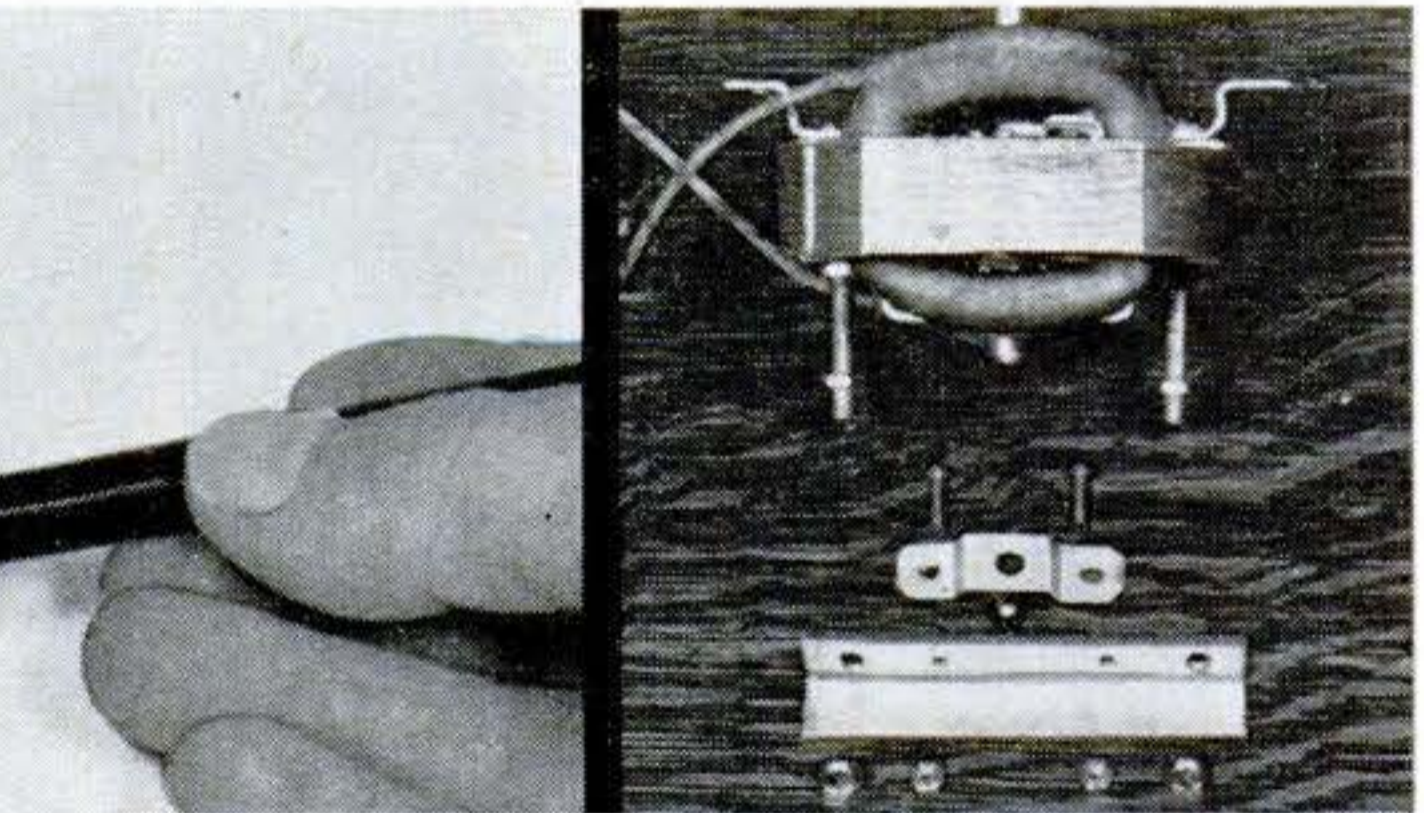

the machine screws that keep the motor together. A thin brass bracket, with a hole in its center, retains the ball. For lubrication, put an oil-soaked felt washer under the ball and against the metal angle. The assembly and parts are shown here.

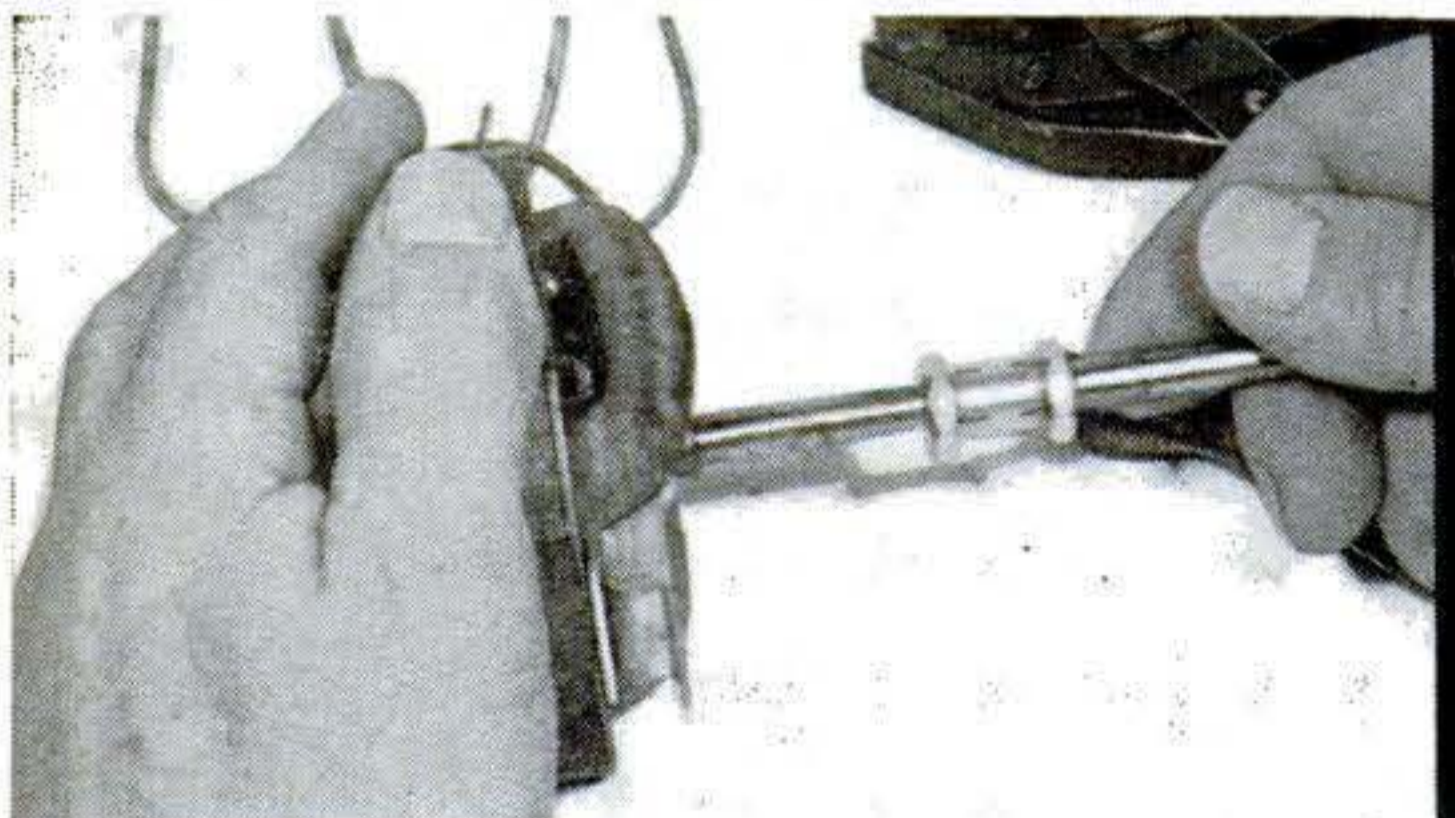

IF the shaft is too short, go to a radio-parts store and get an extension shaft and 1/4" coupling. Select the type of coupling that's made as a split bushing, threaded on each end and fitted with two nuts to clamp the two shafts securely together.

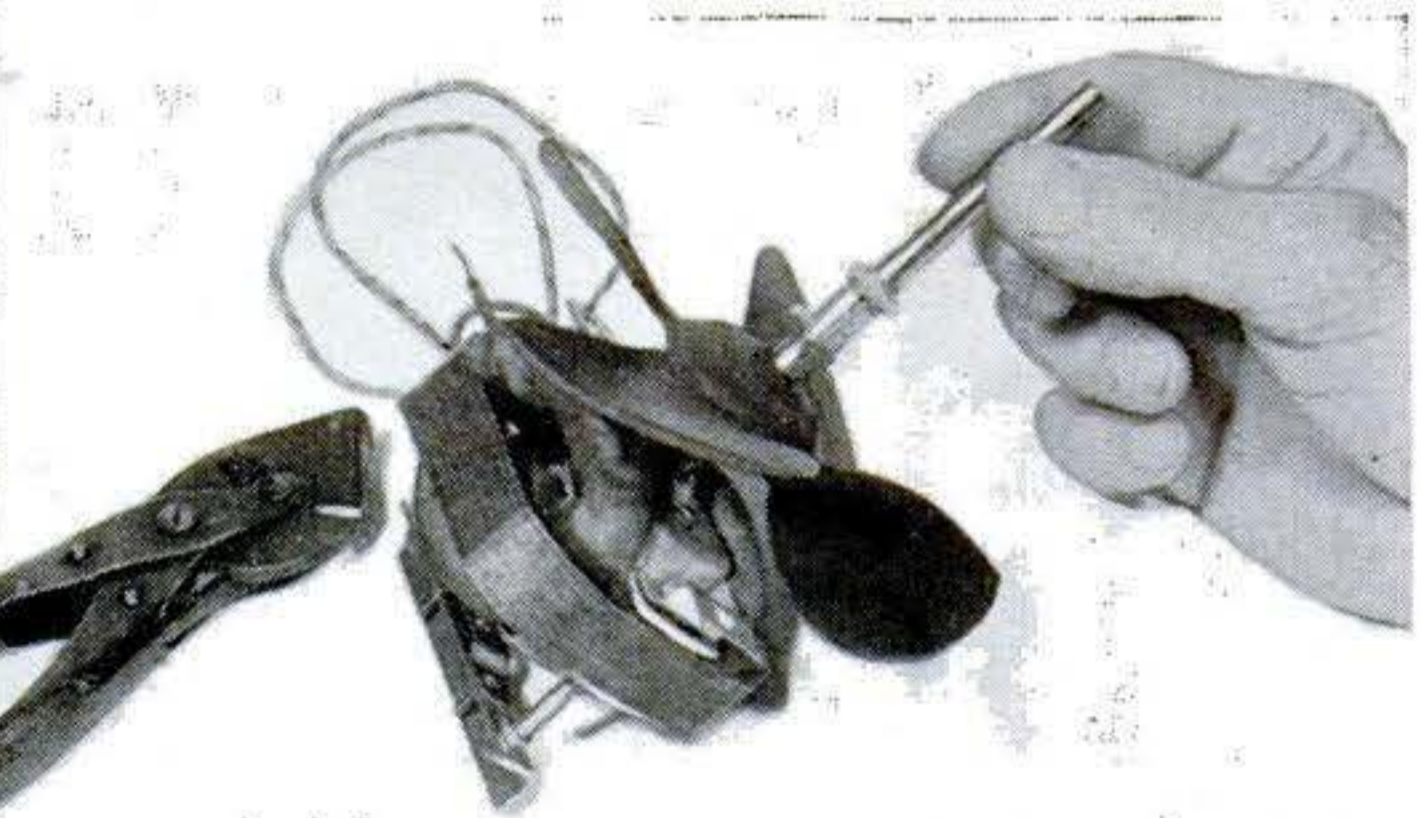

IF it gets too hot, as it probably will if run a long time, mount a cooling fan on the shaft. A windshield-defroster fan is just the thing. Don't skip the fan, for these motors usually are designed for intermittent duty and may overheat in continuous service.

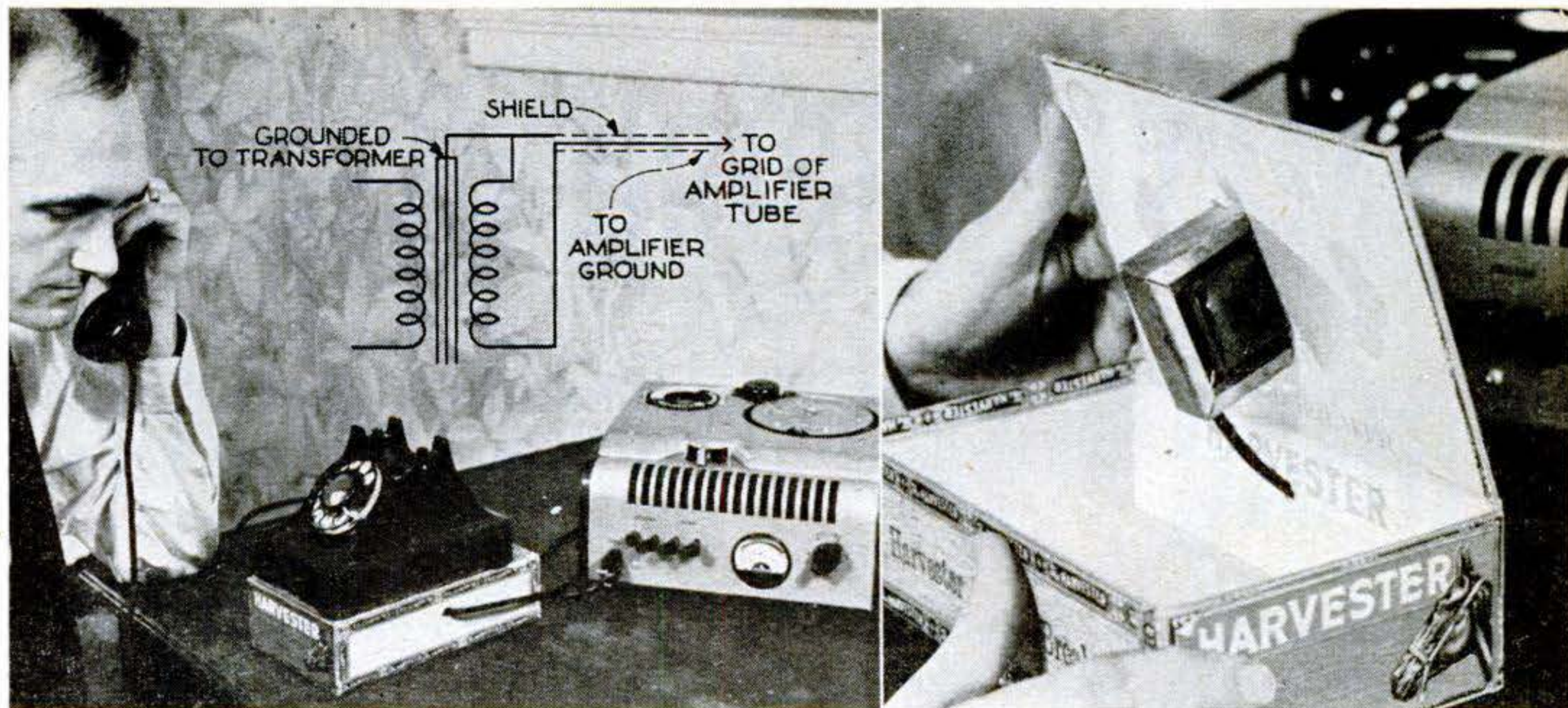

Simple Rig Picks Up Phone Conversation

AN AUDIO or output transformer with a high-impedance winding, a cigar box, and a piece of shielded wire can be made into an inexpensive magnetic telephone pickup. With it and a wire, tape, or disk recorder, you can record both sides of a phone conversation. (Be sure to let the other party know his words are being taken down, for there are strict laws about unauthorized wire tapping.) You can also hook the pickup to a radio or audio amplifier so several people can listen. The device won't make the phone company unhappy, either, because you don't

have to tamper with their instrument, which is also illegal.

Mount the transformer inside the box and connect the shielded wire as shown. Try different transformer windings till you find the best one. One side is connected to the transformer frame and the shield—which acts as the ground conductor; the other side of the winding goes to the amplifier grid. Call up a friend. While he's talking, move the phone over the box until you locate the loudest signal, and mark the position.—*J. A. Rademacher, Fargo, N. D.*

Paint Car Tools to Stop Rust

JACK handles, lug wrenches, and other emergency tools that lie unused in the car for long periods won't be rusty and messy to handle if they are given a coat of paint occasionally.—*C. E. Wilkinson, Peru, Neb.*

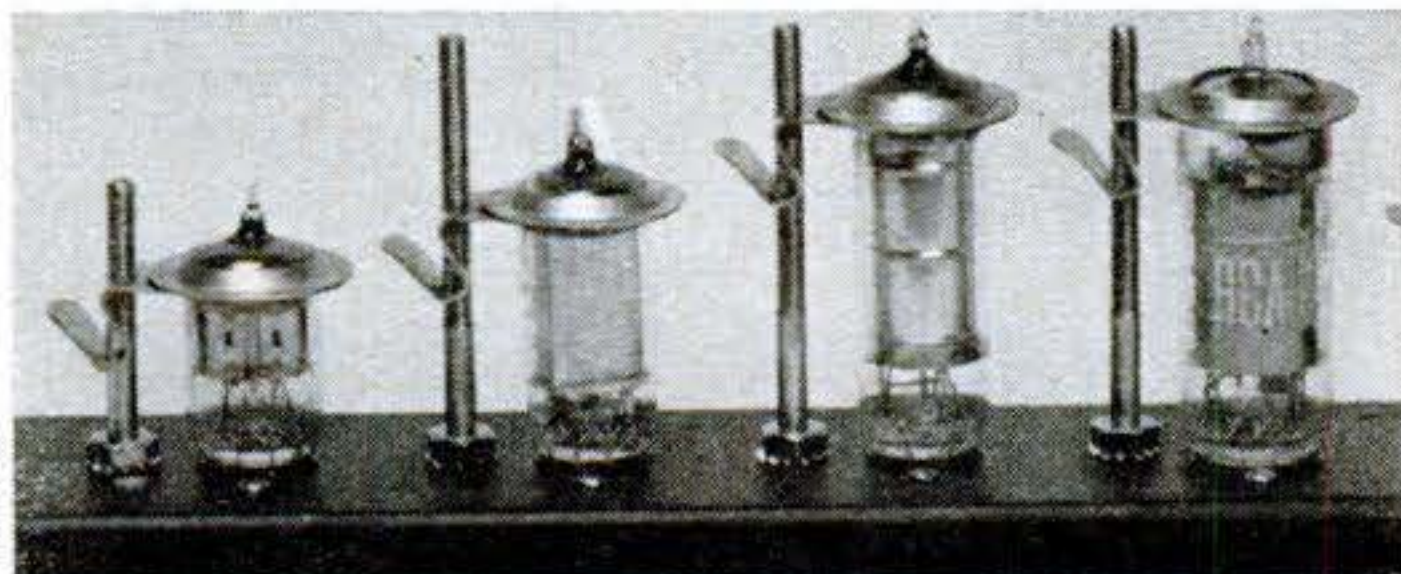

Gripper Keeps Tubes in Place

THE danger of tubes or other plug-in parts shaking loose from portable radio equipment is largely eliminated by the Top Hat[®] retainer pictured above. Made in a variety of sizes, the retainer fastens to the chassis and grips and holds the top of the tube or other component.

Wash Car Often in Winter

MANY owners wash their cars regularly during warm weather, but tend to neglect it when winter comes. Actually, winter washing is much more important. Many communities use salt-abrasive mixtures to melt street ice and snow. Unless this is frequently washed away, it may damage the body paint.

Meter Tests Ear-Aid Batteries

A SIMPLIFIED voltmeter for both A and B batteries used in hearing aids is being made by Telex, Inc., of Minneapolis. Eliminating wire leads makes the meter easier to use; spring contacts on the arms automatically orient the batteries for testing.



Mystery Engine Breathes

Flame

Give yourself a capsule course in machining by building this lively model. Then ask your friends what makes it go. Few of them will know.

By Harry Walton

PS Photos by W. W. Morris

CHANCES are neither you nor your friends ever saw an engine like this. Guesses will run wild when you ask others how it works, and most of them will be dead wrong. Substantial and good looking, it has a lively pop as you turn it over by hand, and it has the staccato roar of a small gas engine when it's running at speed.

It will readily operate light model machinery and toys. Fitted to a turntable as on page 177, it makes a fascinating shop-window display. In tests it has run 40 minutes on one filling of its small lamp. But don't expect it to turn a heavy load or run a model speedboat. Like a gas engine, it delivers full power only at higher speeds, and its weight makes it awkward for use in small model boats.

Not only is this baby engine fun to operate, but it's a top-notch project on which to break in a new lathe and get the hang of basic machining operations, involving as it does layout, boring, turning, facing, simple milling, drilling, and tapping. The photos on these pages show how Floyd McGuckin, of Ridgewood, N. J., did the whole job while PS looked on.

You can make the engine out of scrap, turning the cylinder from solid cast iron, bronze, or dural, and building up a base. However, castings save a lot of shopping and machining time. Those who would rather spend a few bucks than many hours can inquire of Mr. McGuckin.

The whole job can be done on a bench lathe, although a drill press will speed up the job. Only one tap and one die (6-32) are required. In addition to engine stock, you'll need a length of 1 1/16" bar for a mandrel, and a 3 1/2" disk of any metal for

the jig on which the valve cam is turned.

The cylinder casting can be gripped in a three-jaw chuck; but since it's not balanced, lathe speeds must be kept reasonably low. Take a heavy first cut with a husky boring bar, feeding by hand, to get under the hard scale. Light cuts and power feed

IT ROARS AS IT RUNS, the alcohol flame dances furiously, and a lance of fire stabs into the port through the rapidly working valve. This mechanical teaser is an atmospheric engine, also called a vacuum engine.

The first patent on the type was granted to an English inventor in 1823. Pressure generated by a coal-gas explosion in his engine escaped through check valves, which closed as the pressure fell below that of the atmosphere. Then water was injected, cooling the remaining gases and further lowering the pressure, so that atmospheric pressure shoved the piston back.

A few such engines were built, but they were cranky and costly to run. More successful was the Otto and Langen engine, used in large numbers in England and Germany from 1863 to 1876.

In this, a free piston was shot upward in a vertical cylinder by the explosion, which did no other work. But as the gases cooled and atmospheric pressure pushed the piston down, a toothed piston rod turned a pinion, and through it the shaft. A ratchet device let the pinion turn free on the shaft during the upstroke.

The piston of the engine shown sucks in hot gases from the flame. Just before bottom dead center, the sliding valve closes the port. Losing heat to the cylinder walls, the gases contract and leave a partial vacuum. Atmospheric pressure pushes the piston inward. This is the power stroke.—Joseph Tracy, Manhattan, N.Y.

Meet Floyd McGuckin

THE expert who builds the engine in the pictures on the following pages comes by his talents naturally. His father invented the Spintite® wrench and numerous other automotive and optical tools.

Floyd has been running a lathe since he had to stand on a box to reach it. In his neat basement shop in Ridgewood, N. J., he has developed some inventions of his own. Among these are a friction-testing machine, a microscope stage for measuring fine textile threads, a photo-cell gadget to count the particles in colloidal graphite, and a tattooing system that unerringly identifies racehorses. When not inventing something new, he manufactures telescope eyepieces and other optical parts, makes special dies, and builds fixtures for use in his work.

Like every good machinist, he has worked out some shop dodges of his own. PS plans to bring you some of these from time to time.

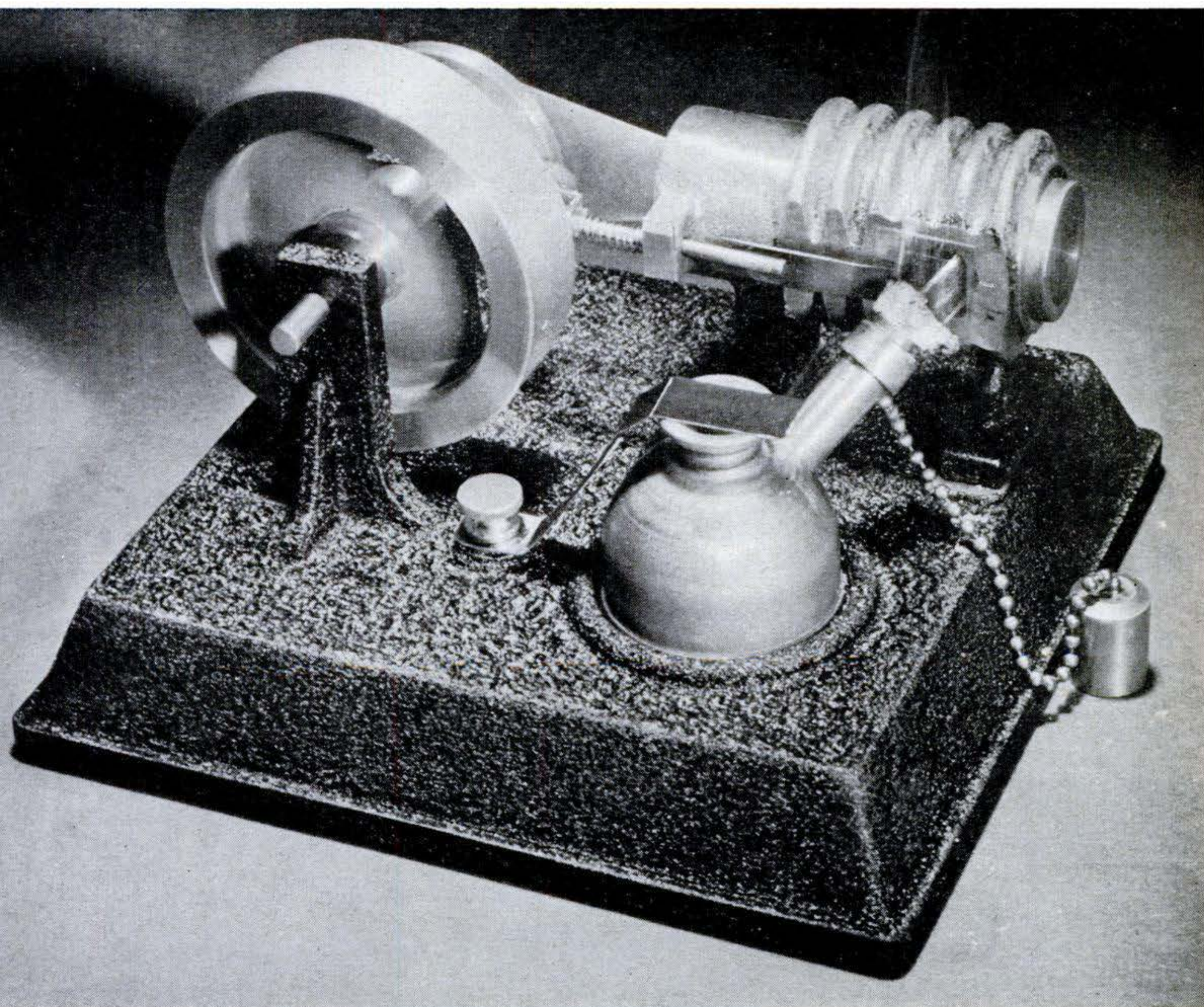

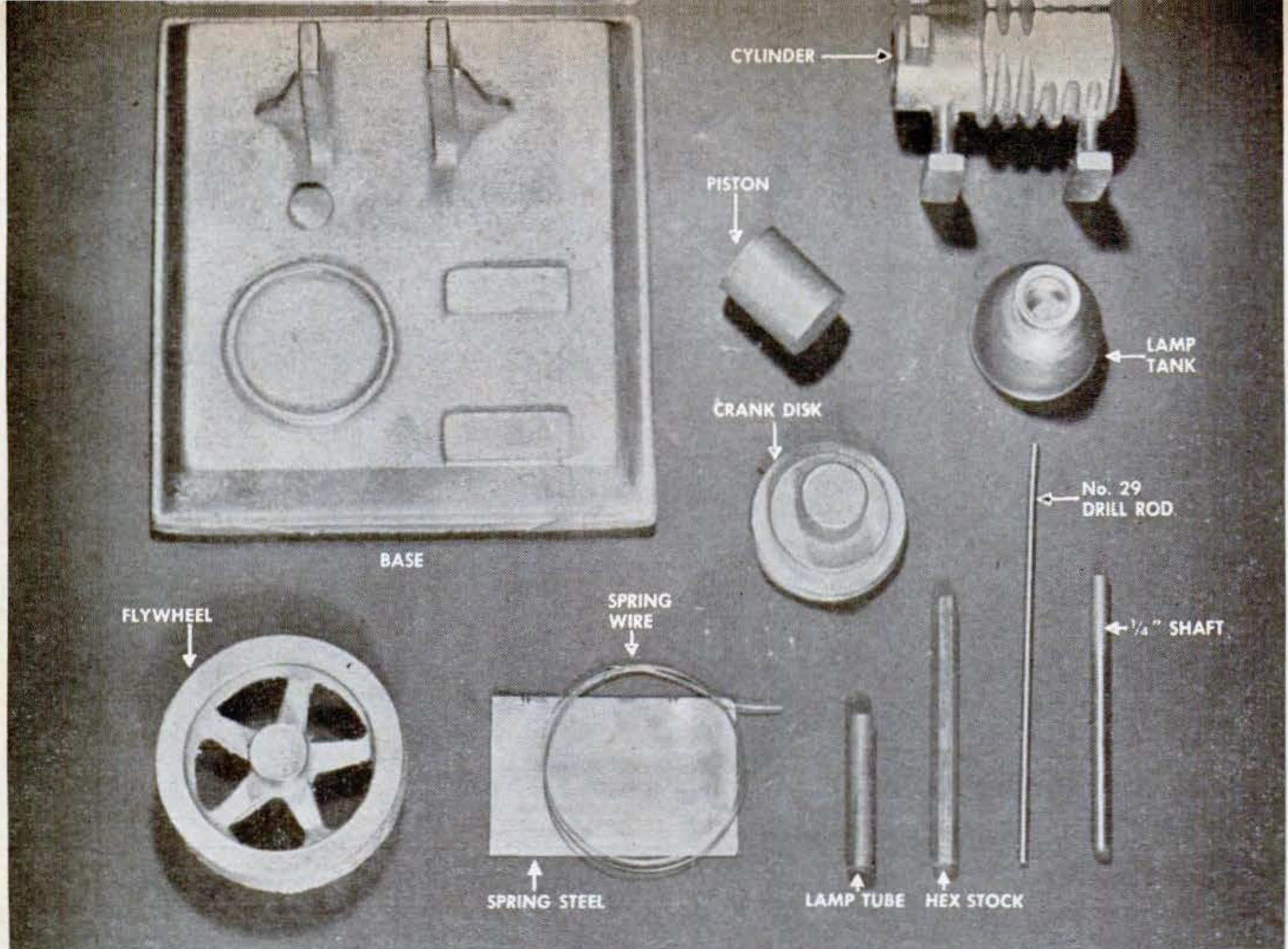

You can build the engine from solid stock, but a set of castings like this saves time and work. The cylinder is cored. Flywheel casting has

should be used to bring the bore to size. A tapered bore, or bellmouth, will be fatal to good performance. It's important to get a free-running but reasonably airtight fit between piston and cylinder. The cast fins require no turning.

If the port face is roughened in filing the port, you should lap it dead smooth. This can be done by rubbing it on a fine oilstone, but be careful not to rock the cylinder and so round the surface.

If you haven't a drill press, spot the bearing holes on both uprights, drill them under-size, and run a $\frac{1}{4}$ " drill or reamer through both at once to bring them into line.

1 Cylinder is firmly chucked like this for boring, with jaws straddling the flat side. Using a husky boring bar, take a deep first cut to get under hard crust of casting. Keep subsequent cuts light to avoid boring a taper.

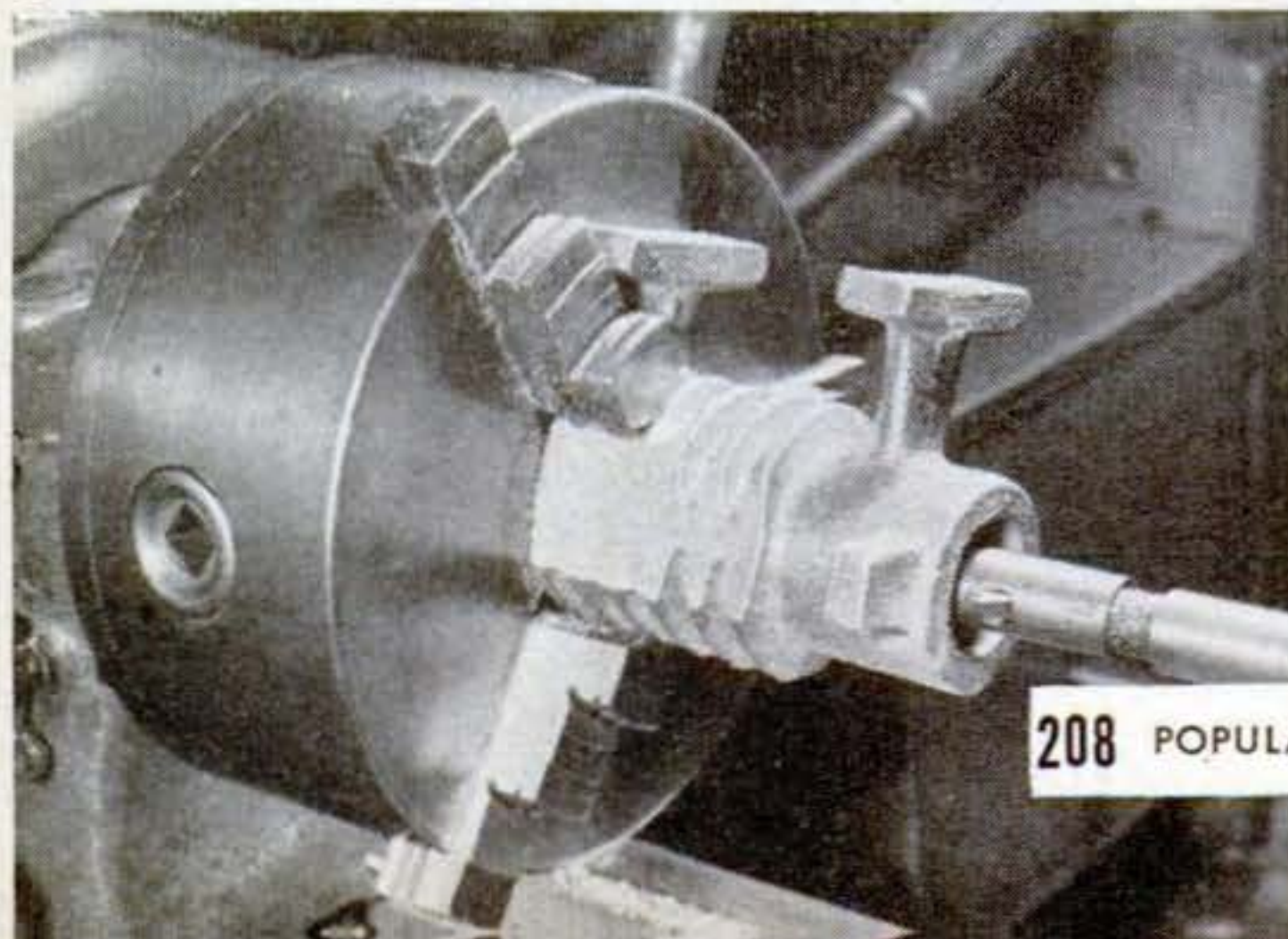

handsome square spokes. Stock for engine parts even includes small oil can from which alcohol lamp to supply heat to run engine is made.

Probably the trickiest piece of work involved is the combined crank disk and cam. Take special care in laying out the $\frac{15}{32}$ " offset center and the 30° angle on the jig, since these determine the valve timing. This part is a press fit on the shaft. After turning the cam profile, round its sharp corners with a file. Then rechuck the piece on the 2" diameter as at the top of page 211. Put the $\frac{1}{4}$ " crankshaft in the tailstock chuck and press it in by advancing the ram with the handwheel. This trick helps you get the disk on square.

Be sure to turn the bottom of the piston cavity flat so that the wrist-pin stud will

2 Make last boring pass without advancing tool, using medium speed and finest power feed. Then face end of cylinder and valve guide. With care, you can also face one side of both feet now, as shown below.

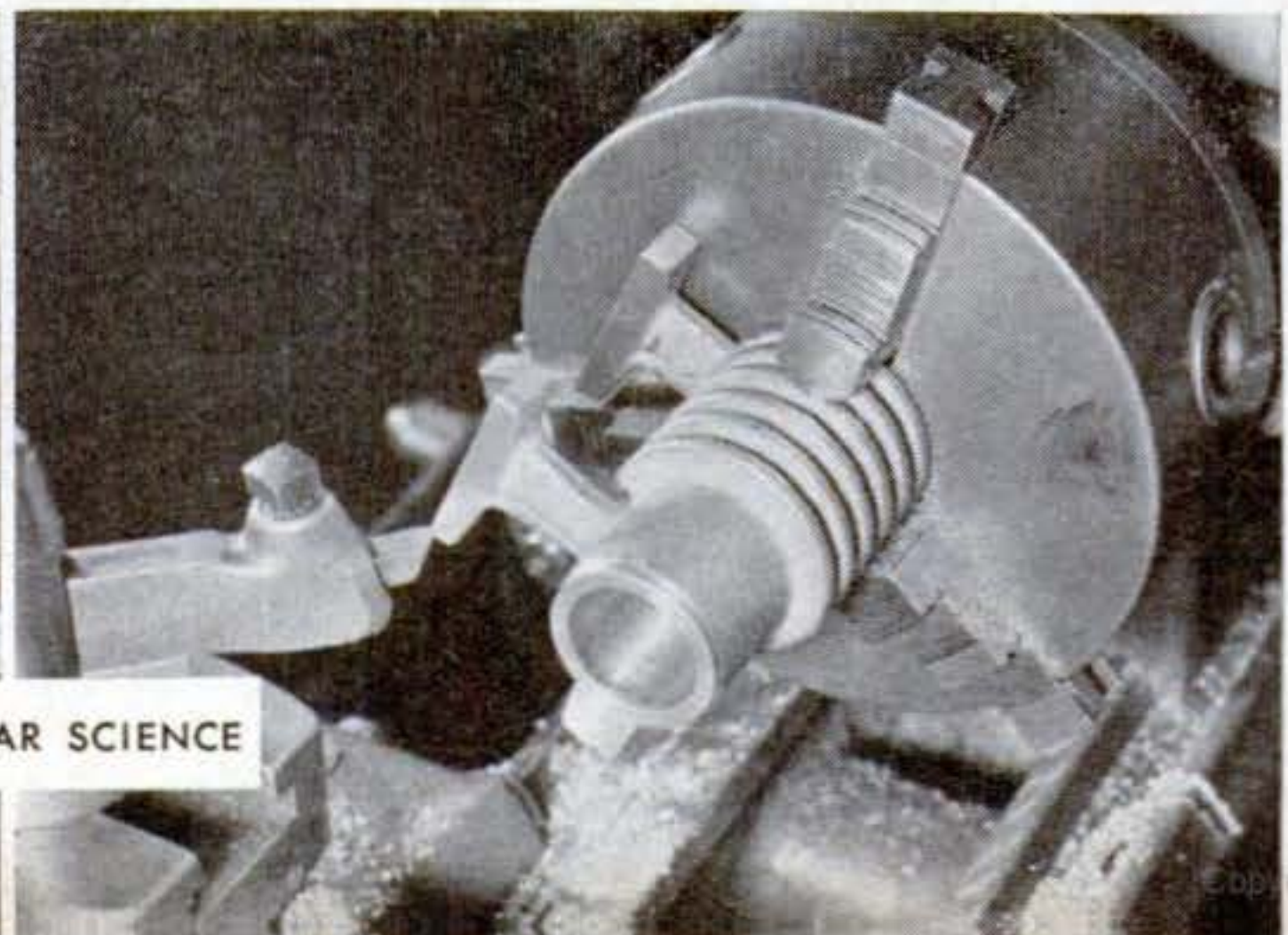

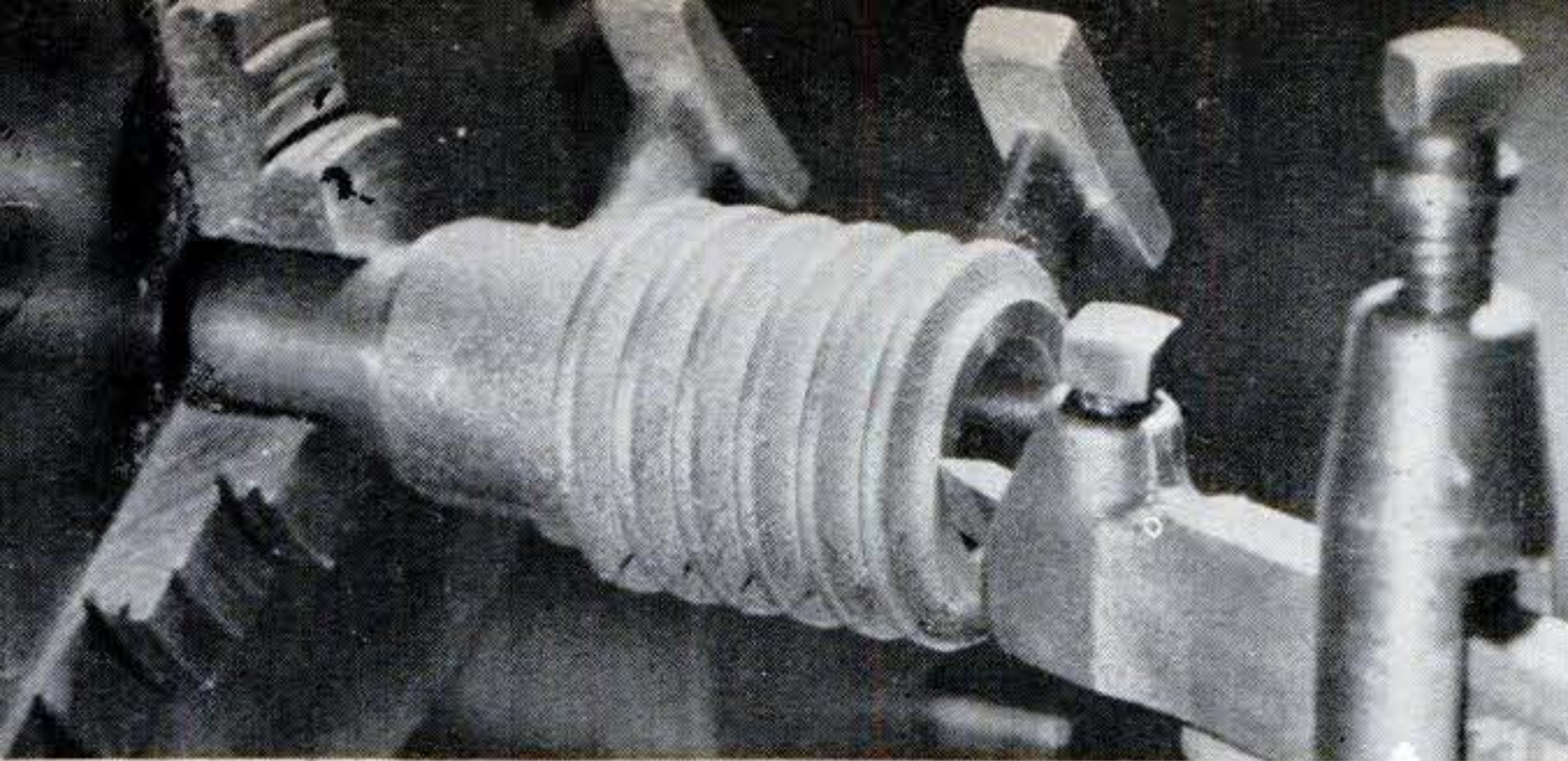

3 Chuck a piece of bar stock, turn to 1", and file enough taper to allow cylinder to be pushed on tightly at least two thirds its length. Face for cylinder plug as shown. Then reset the tool to face other sides of both feet.

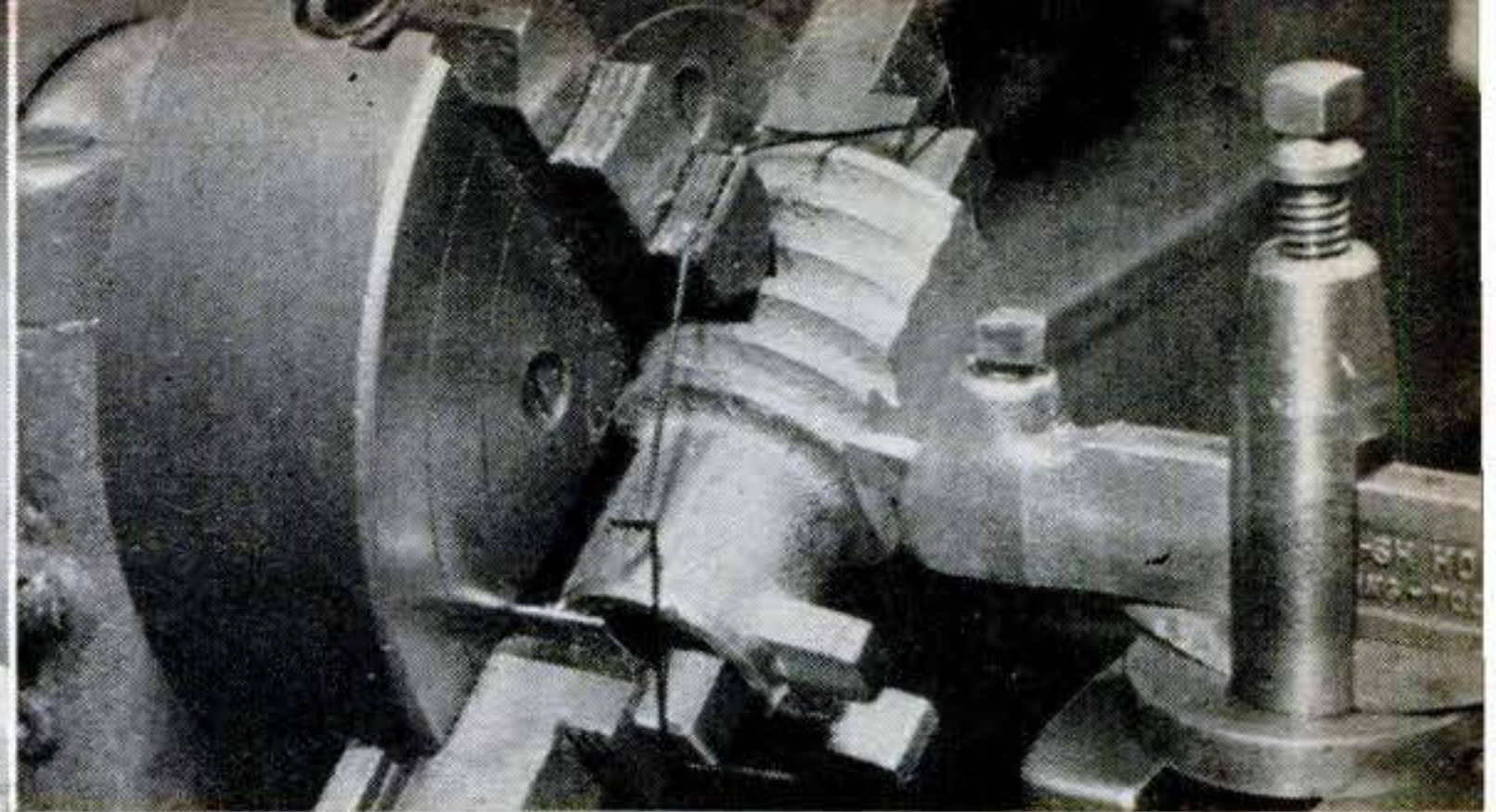

4 Put cylinder in four-jaw chuck, with square bar inside resting on opposite chuck jaws to insure parallelism of port face with bore, and with feet at 90° to chuck face. Wire the bar fast for safety. Turn port face true and smooth.

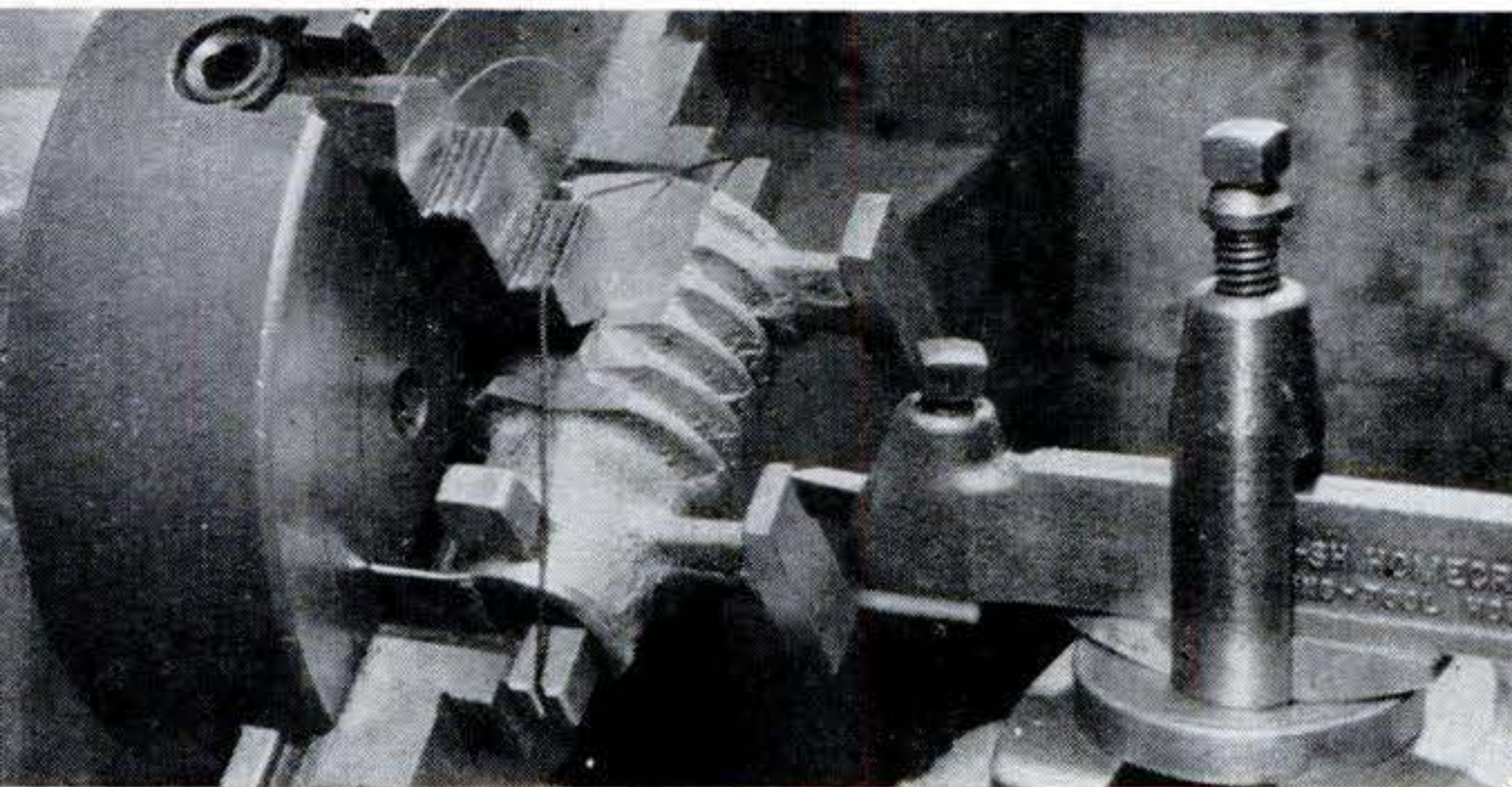

5 Turn cylinder 90° and rechuck with same bar inside and port face under one jaw. Use aluminum, copper, or brass pads under jaws to protect finished surfaces. Again secure bar with wire. Then face bottom of both feet.

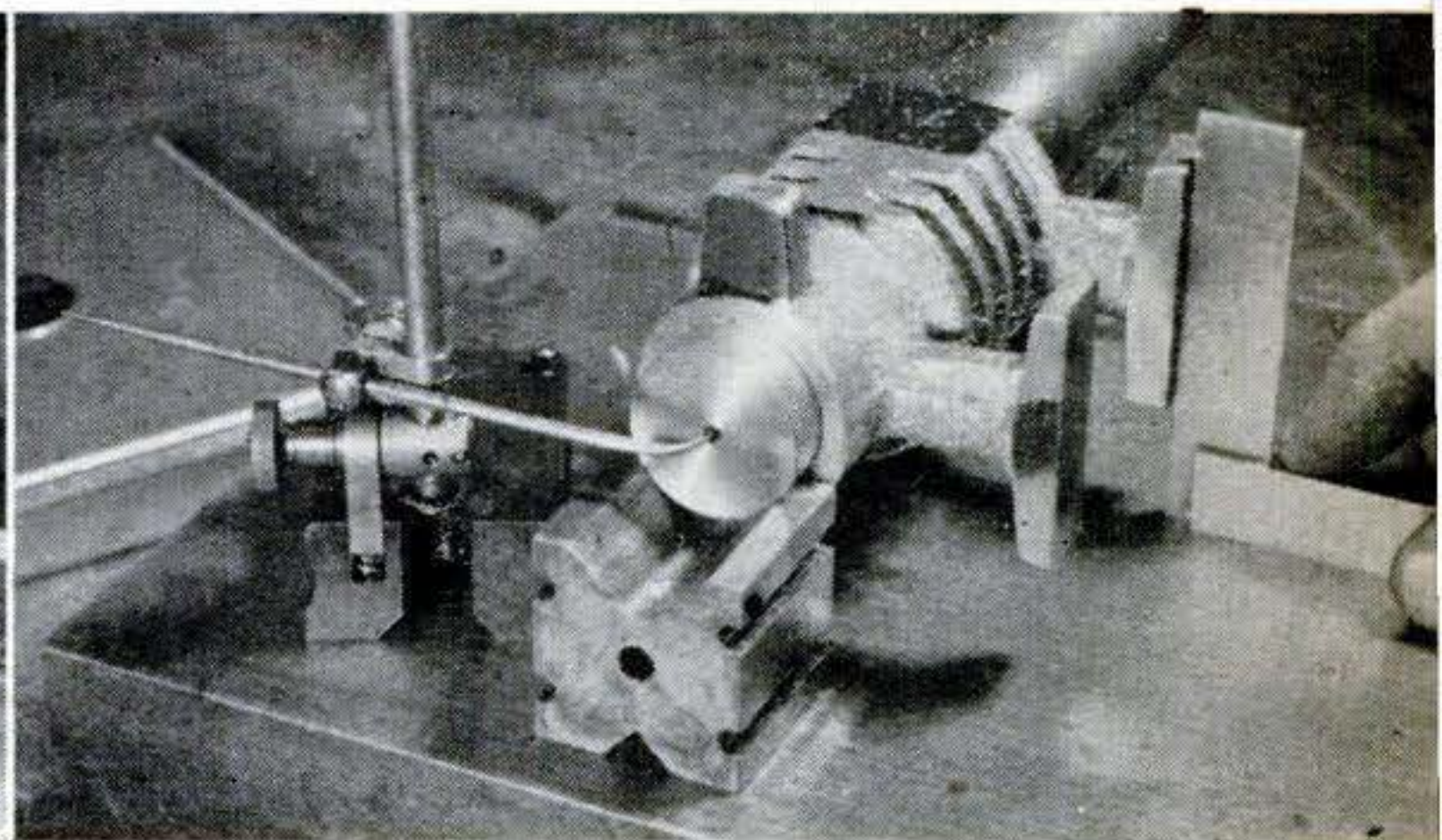

6 Mandrel previously used, centerdrilled and filed to a push fit, supports cylinder on V blocks on a surface plate or piece of plate glass. Set surface-gauge scribe on mandrel center, square feet, scribe centerline on them.

seat squarely for an airtight fit. Since all the engine's power is derived from atmospheric pressure, a good piston fit is vital. But this must be obtained without undue friction. With the cylinder plug in, the port covered, and the cylinder only lightly oiled, the piston should offer real resistance to a pull, and should snap back by itself when released. If you have means of "miking" the cylinder, you can turn the piston about one thousandth undersize. If not, use the cylinder itself as a gauge. A couple of shallow oil grooves can be turned in the piston if you like.

McGuckin uses an impromptu milling set-up for slotting the wrist-pin stud. Turn the stud with a little pip about 1/16" in diameter on the face. Set it up as shown, ▶

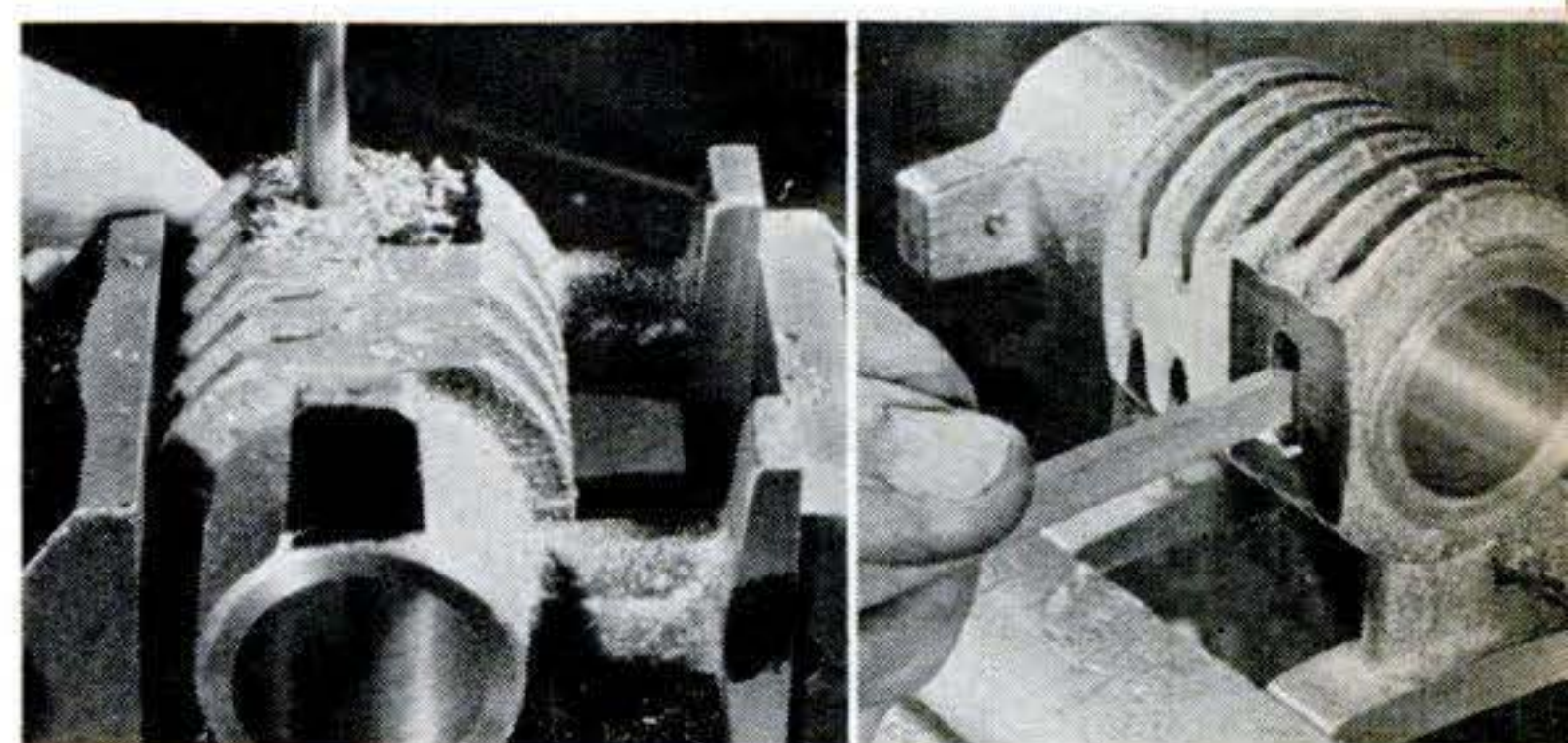

7 To mark centerline of port and valve guide, stand cylinder on its feet and reset surface gauge to mandrel center. Prick-punch and drill two 15/64" holes 1/2" apart as at left above. The intervening metal can then be milled out or simply filed away as shown at right. Be careful to make port to size. Clean up any burrs left inside the bore with a fine file. If port face is rough, lap it perfectly smooth on a fine, flat oilstone.

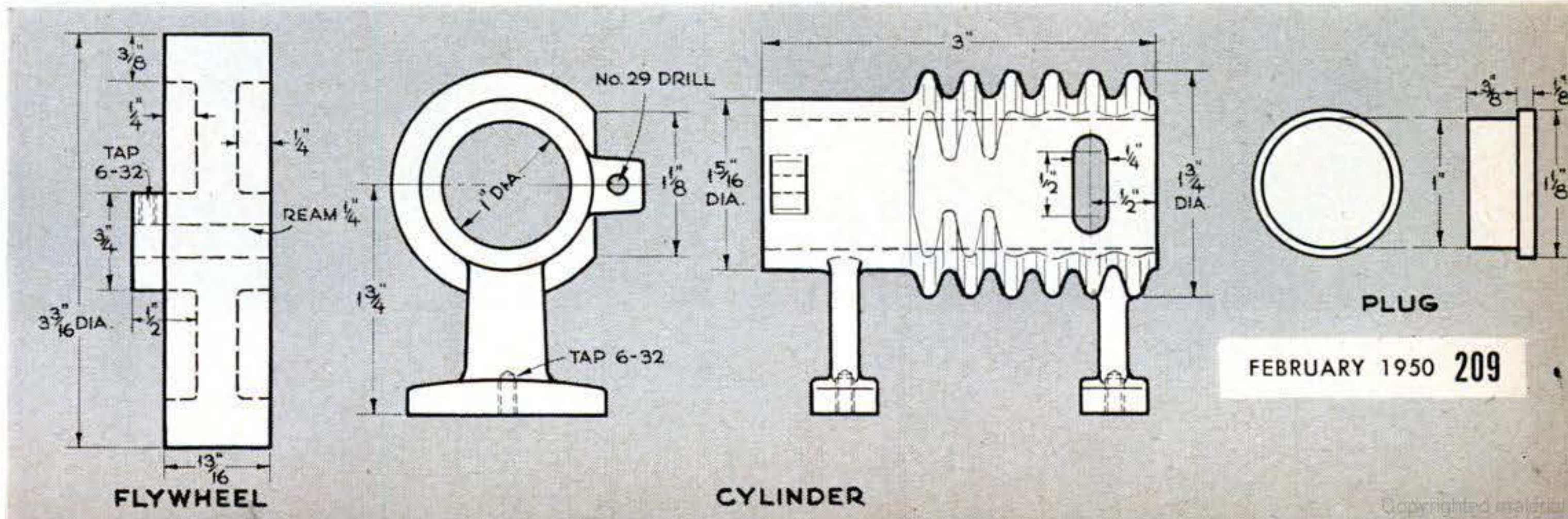

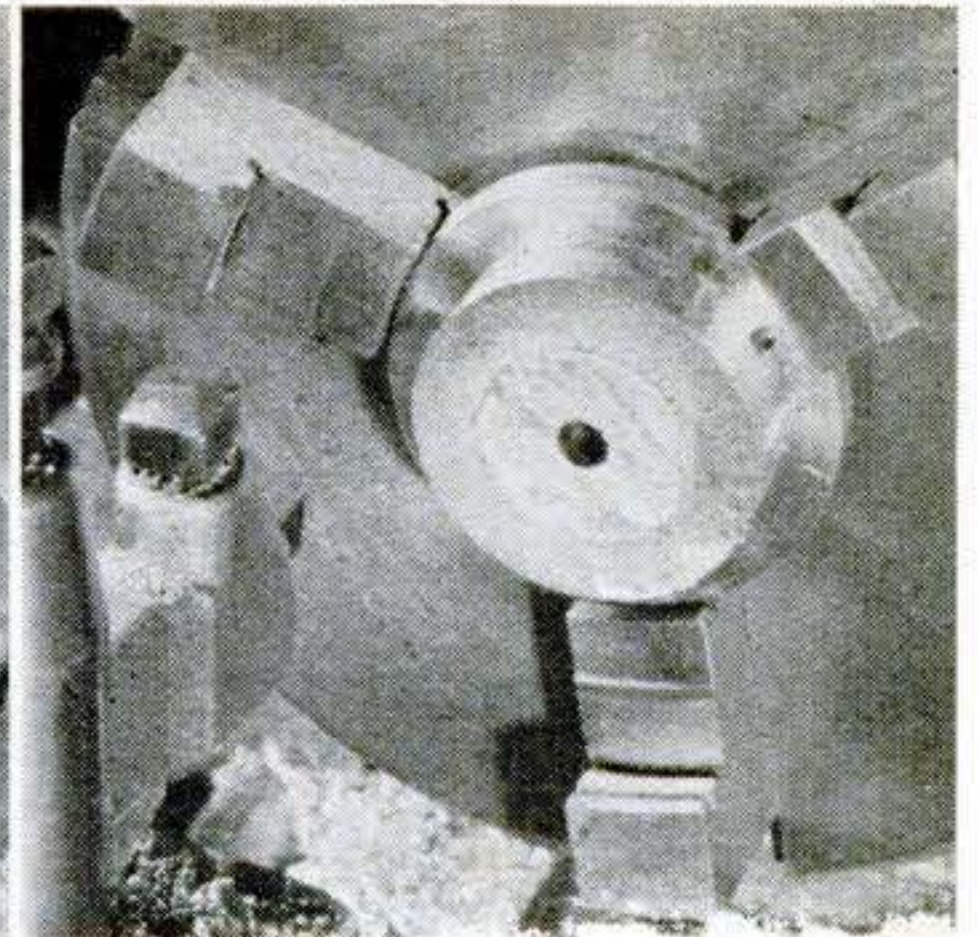
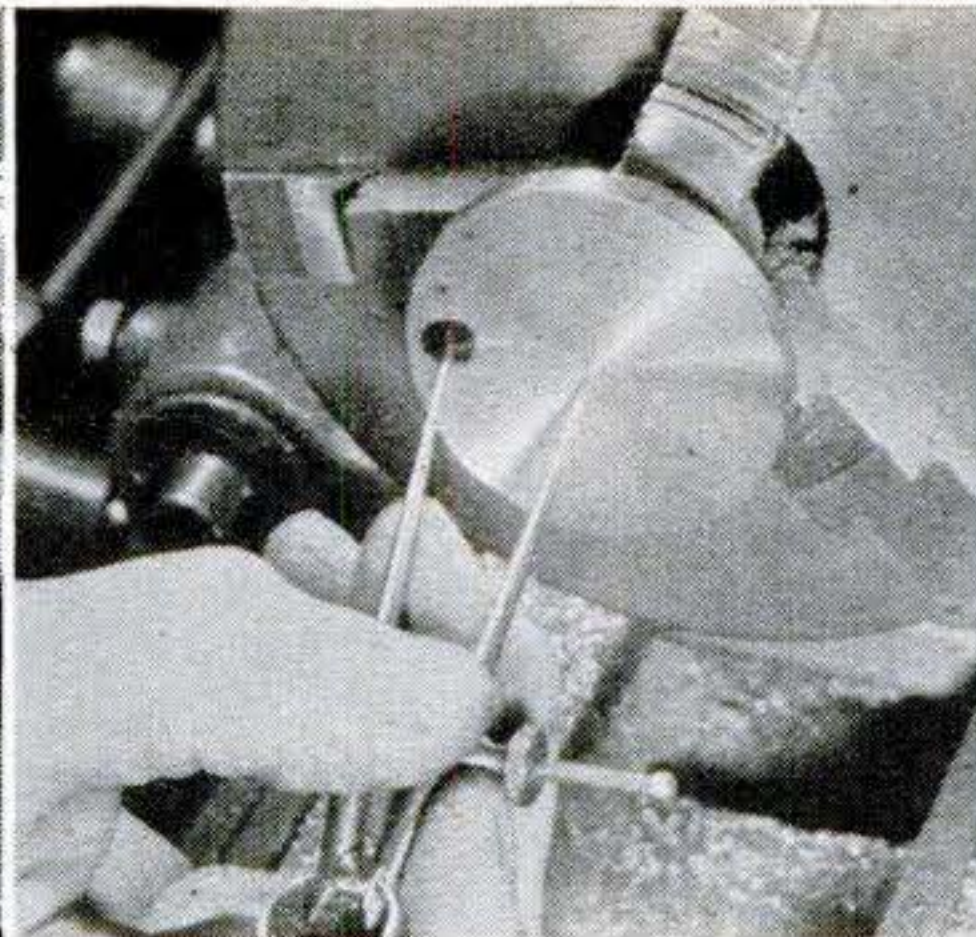
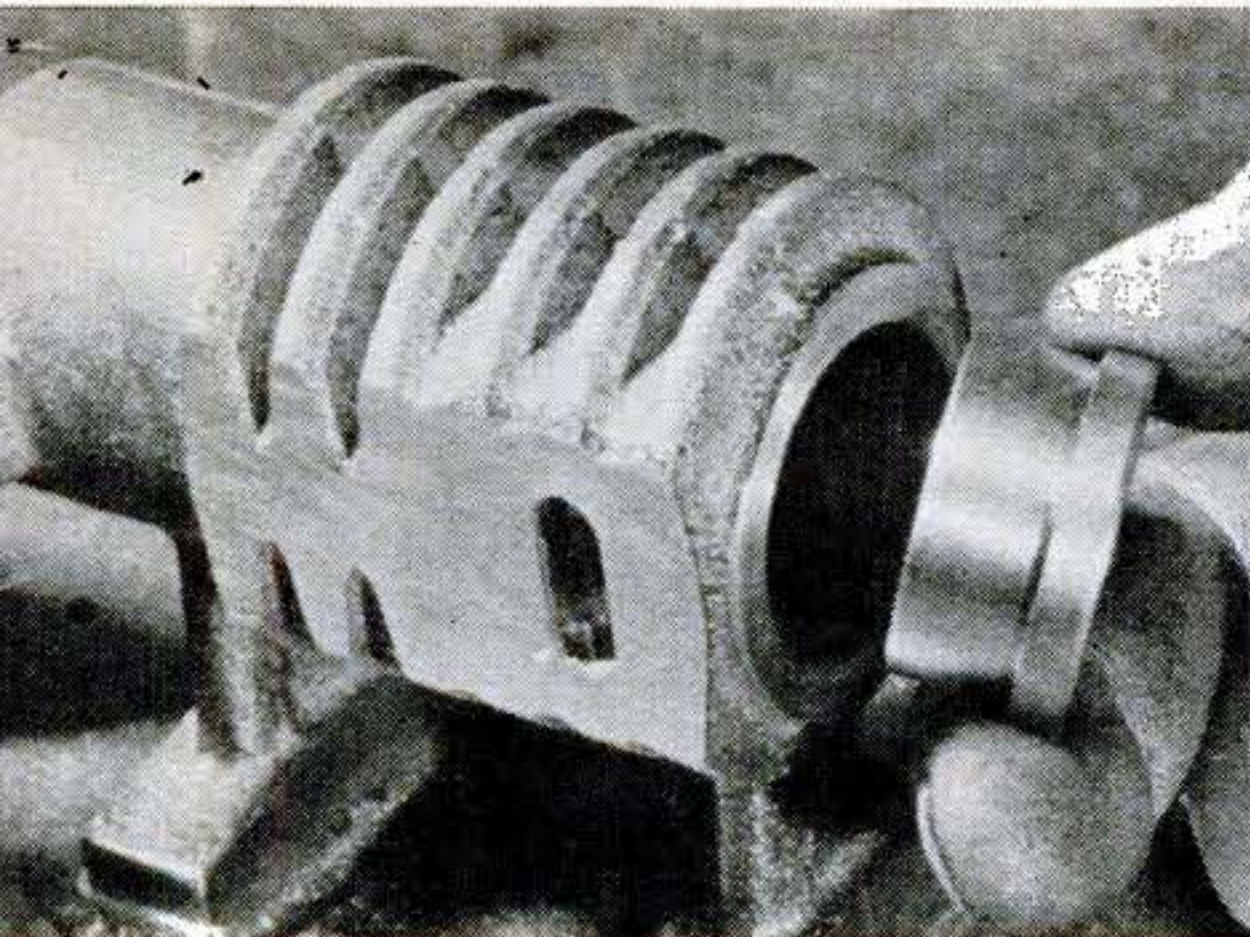

11 Holes are drilled in base bosses and matching holes are drilled and tapped in cylinder feet. A plug turned to a tight fit is filed to a slight taper and driven in (left above). First step in making crank disk and cam is to grip casting by its chucking spigot and face off and turn 2" diameter. Centerdrill lightly to spot crankpin circle at $\frac{3}{4}$ " radius with dividers (cen-

ter photo). At same chucking, turn $1\frac{1}{2}$ " diameter of cam behind and face rear of 2" diameter to $\frac{3}{16}$ " thickness. Centerdrill more deeply and drill to a drive fit on the $\frac{1}{4}$ " crankshaft. Remove from chuck and rest on rear face of crank disk to drill No. 36 crankpin hole. Saw off the spigot. Then rechuck with the cam diameter out (right above) and face off cam to $\frac{1}{4}$ " width.

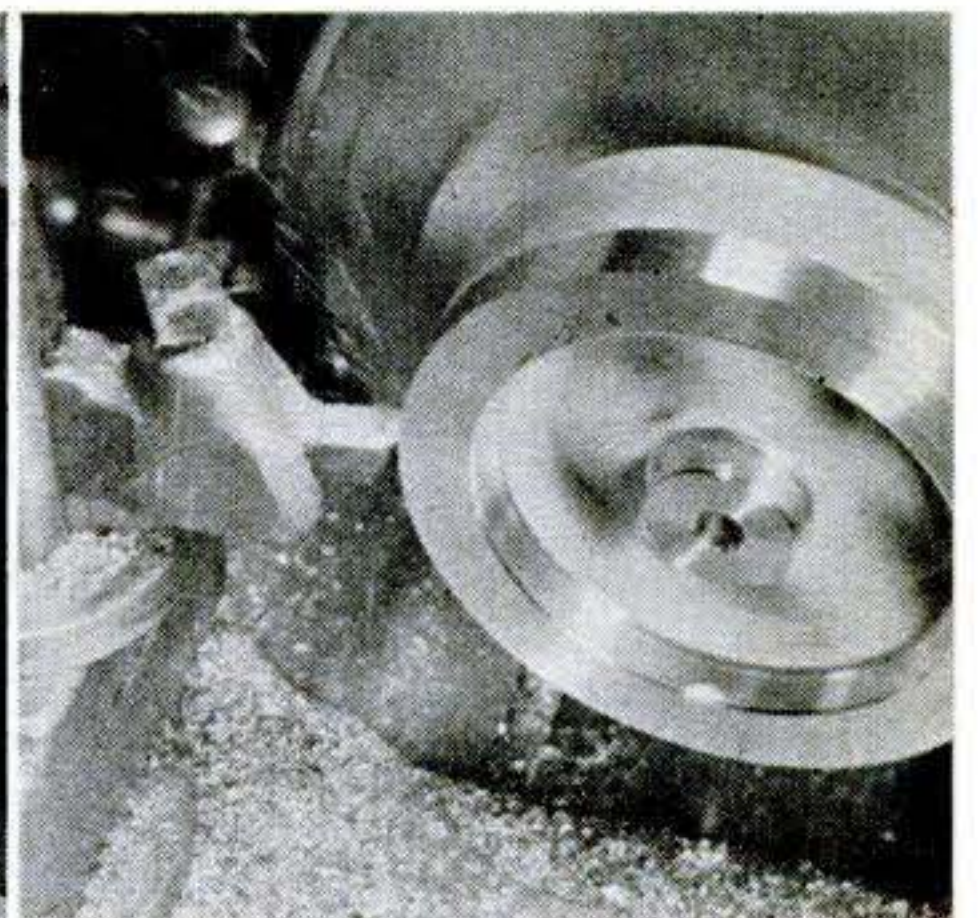
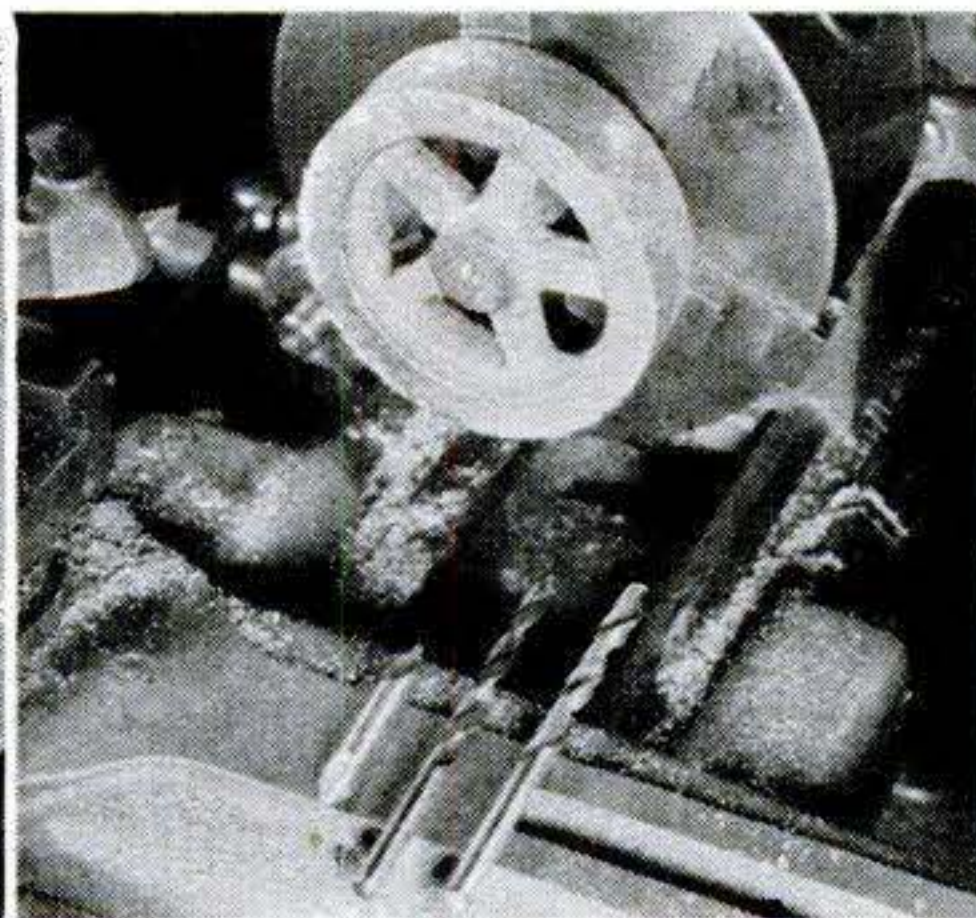

12 Face off a $3\frac{1}{2}$ " disk of brass or other stock and scribe a diameter with a sharp bit. Lay out offset center as in drawing. Mount crank disk with two short pins or small pin and screw threaded into jig. Turn cam to $1\frac{11}{64}$ " width. File sharp corners round. Chuck flywheel by inside of rim, with chuck jaws against the spokes so that rim doesn't touch them. Cen-

terdrill, drill undersize, and finish with $\frac{1}{4}$ " drill or reamer. Next face the hub and rim. Turn outside of hub and inside of rim, and finally outside of rim as at right above. File slight chamfer on corners. Then reverse in chuck, using outside jaws to grip on finished rim. Face other side and turn inside of rim and outside of the hub.

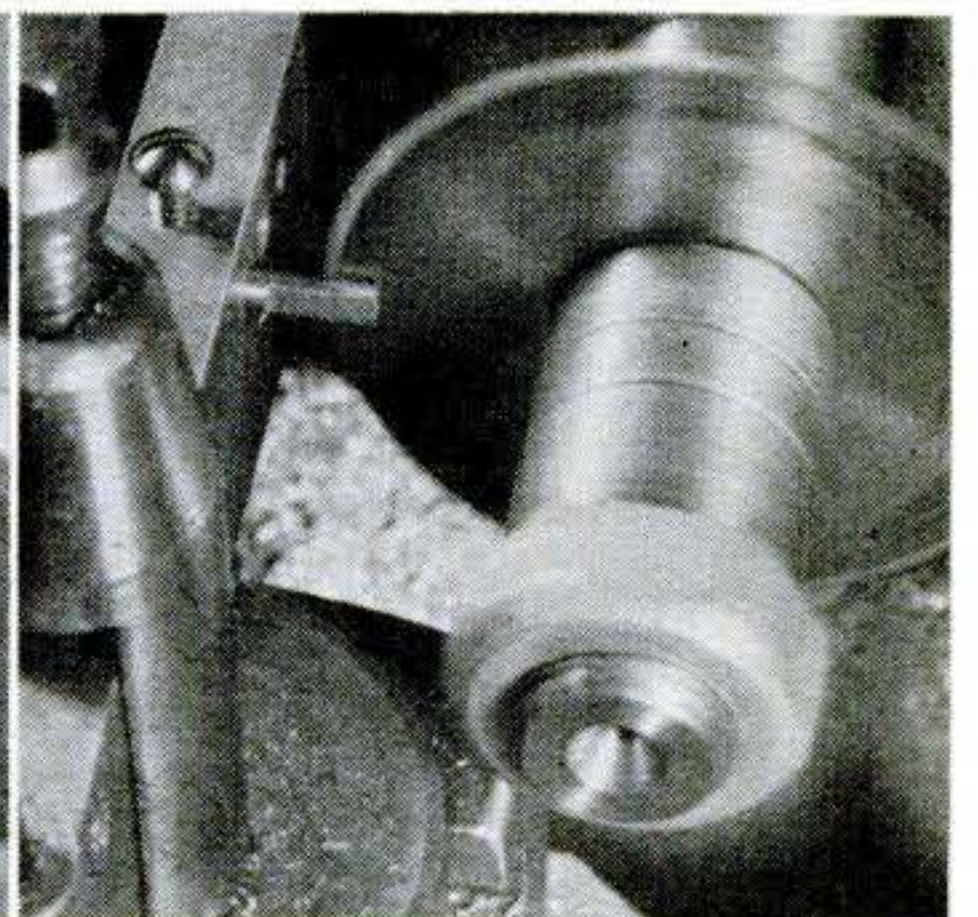
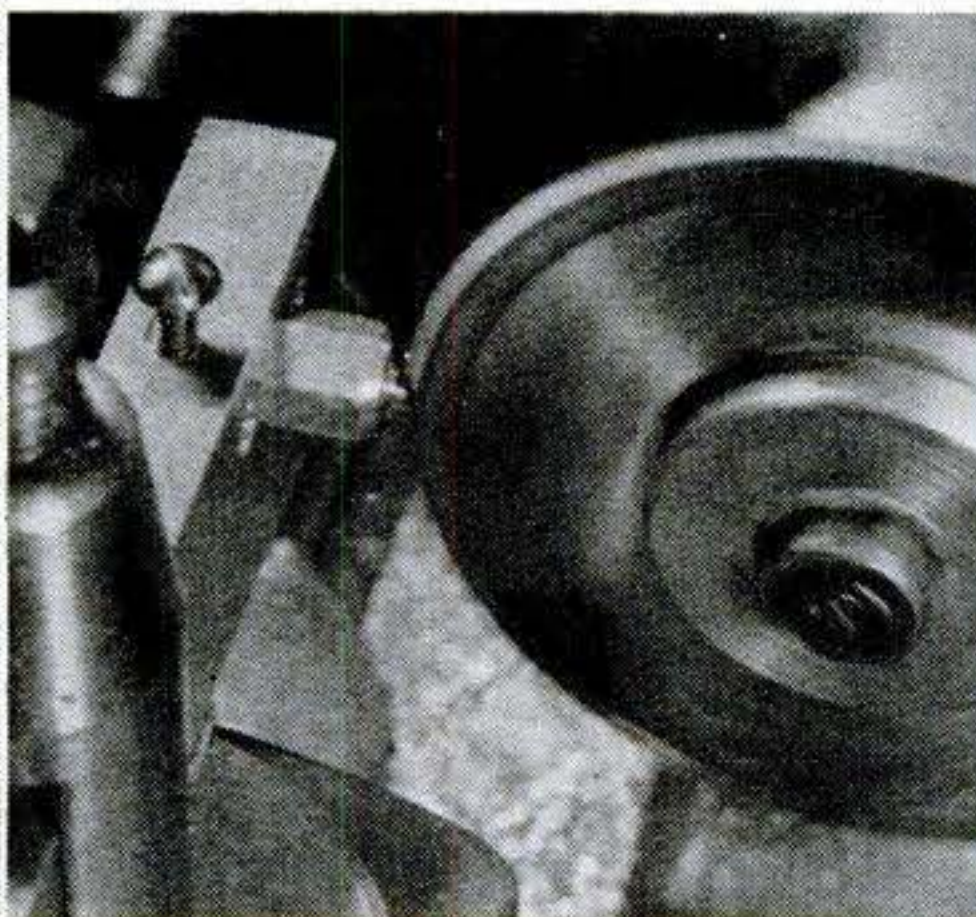
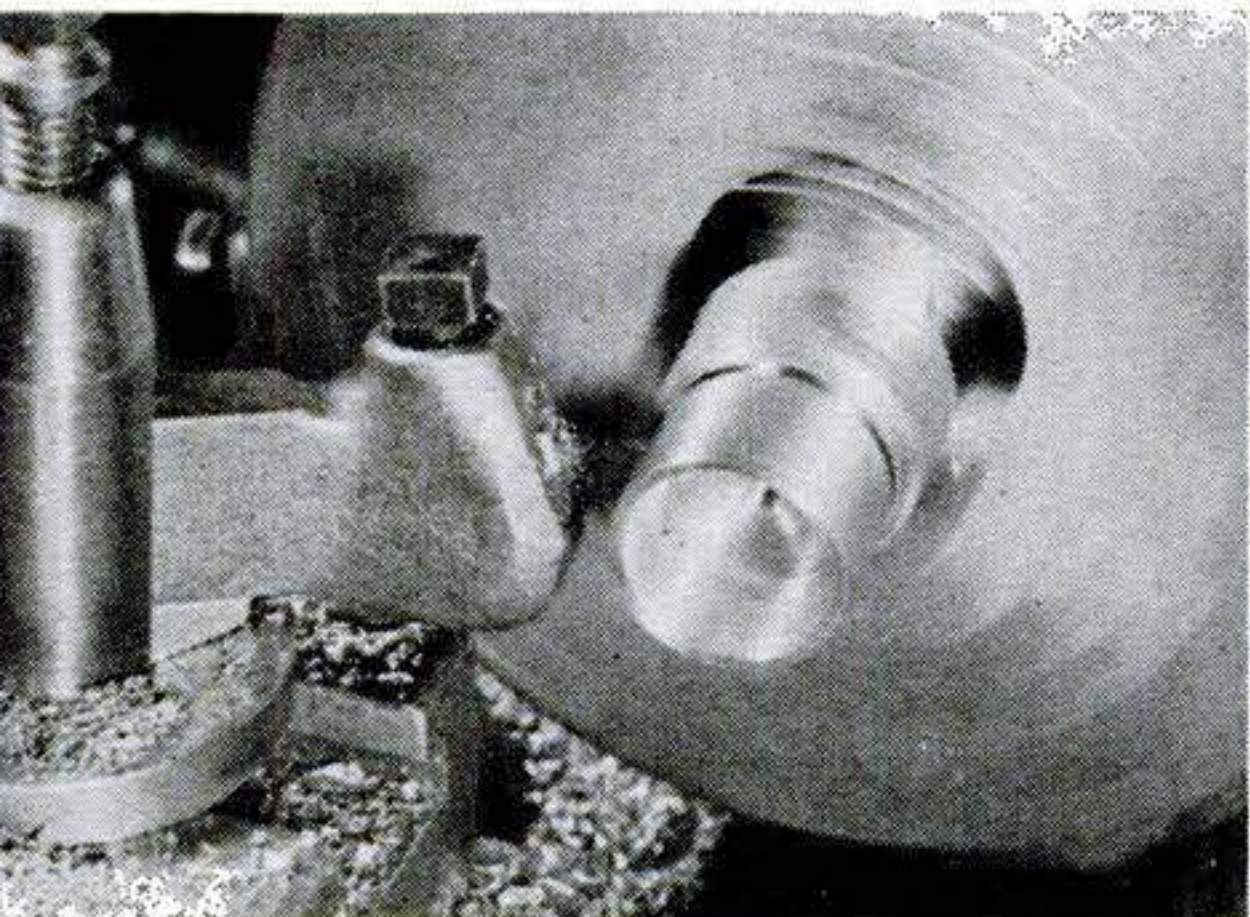

13 Piston is simple, but must be carefully fitted for good performance. Bore out first, forming flat bottom inside. Drill and tap 6-32. Turn outside to a close push fit in cylinder. Lap with crocus or other fine abrasive cloth to a good running fit, without shake. Shoulder down hex stock for wrist-pin stud, thread, and reverse to face off, leaving a tiny pip at center. Screw

stud into bar and clamp into tool post, hex corner up and pip at lathe-center height. Align pip with a $.064$ " slitting saw and feed in to cut slot (center photo). Hold con rod in hole in bar with a setscrew, align parallel to saw by running rod against its side, and mill flat on both sides to $\frac{1}{16}$ " width, as at right. Mill the flat on the valve rod in the same way. 

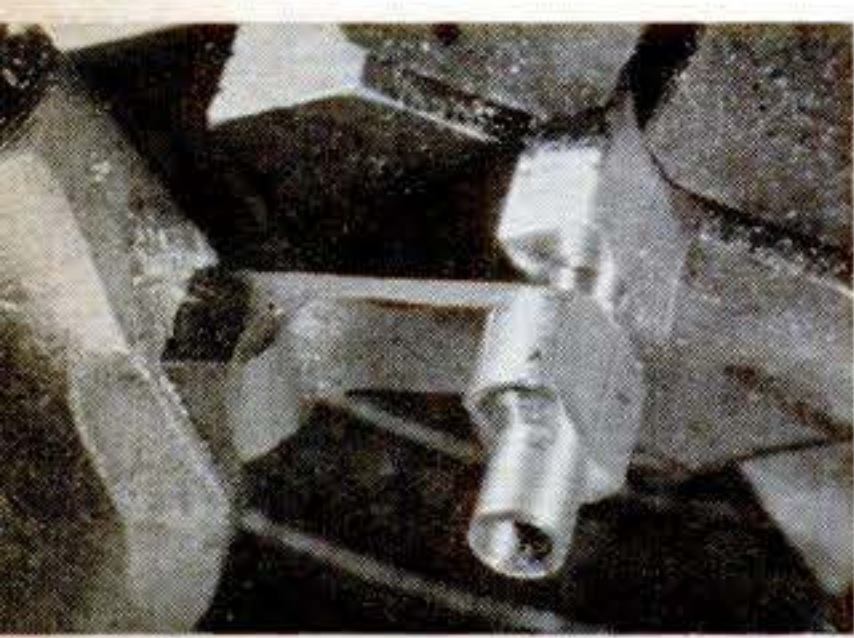
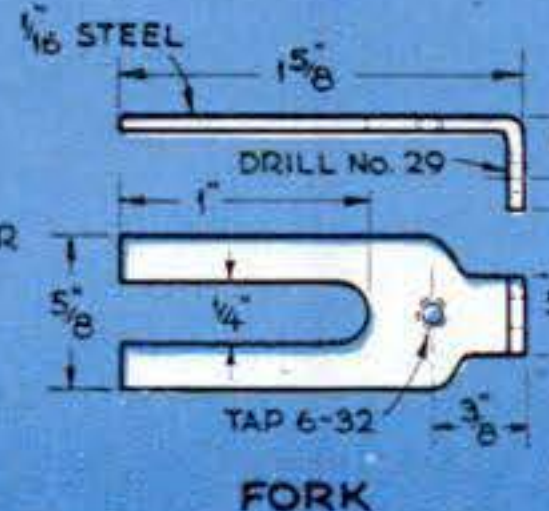
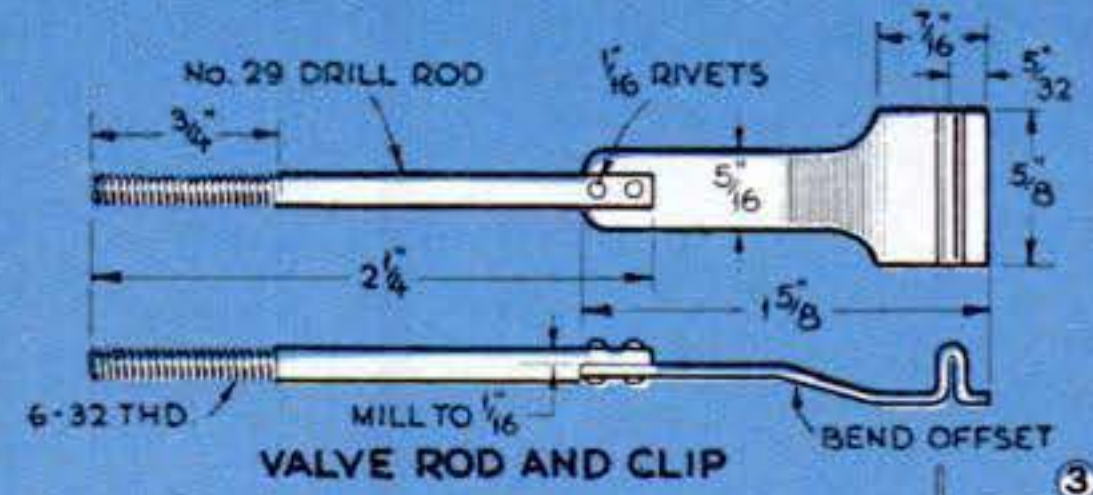
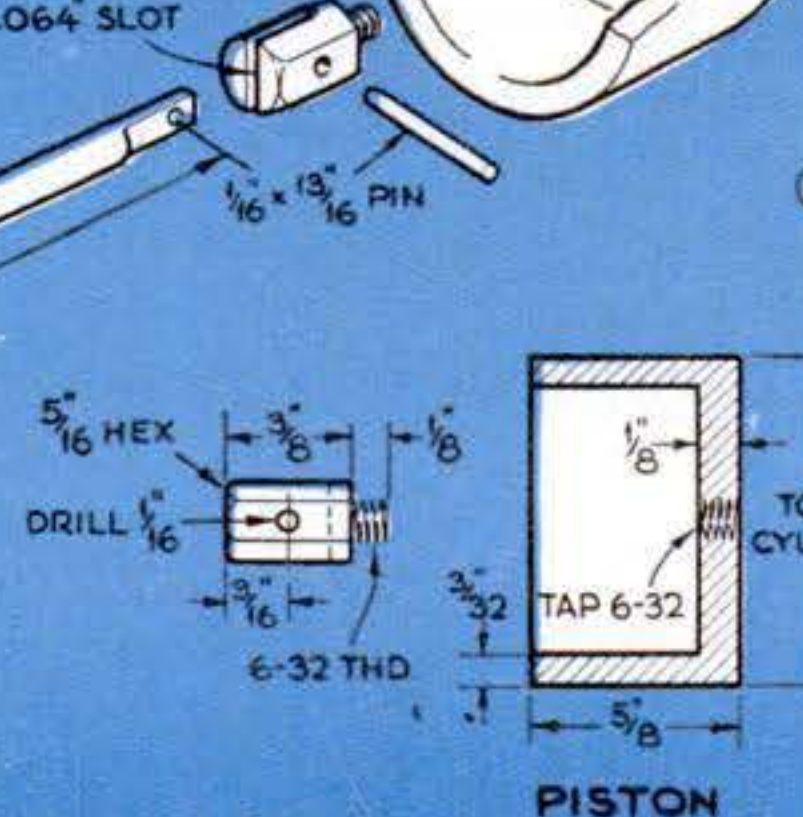
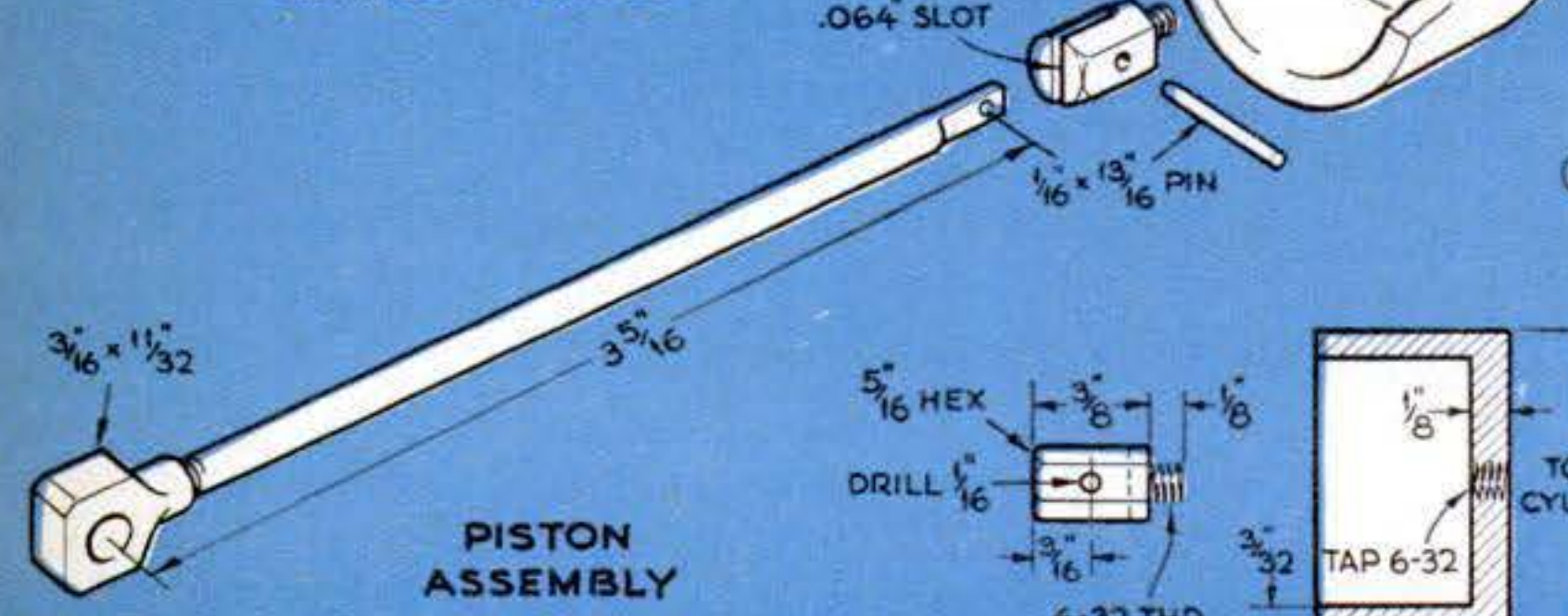
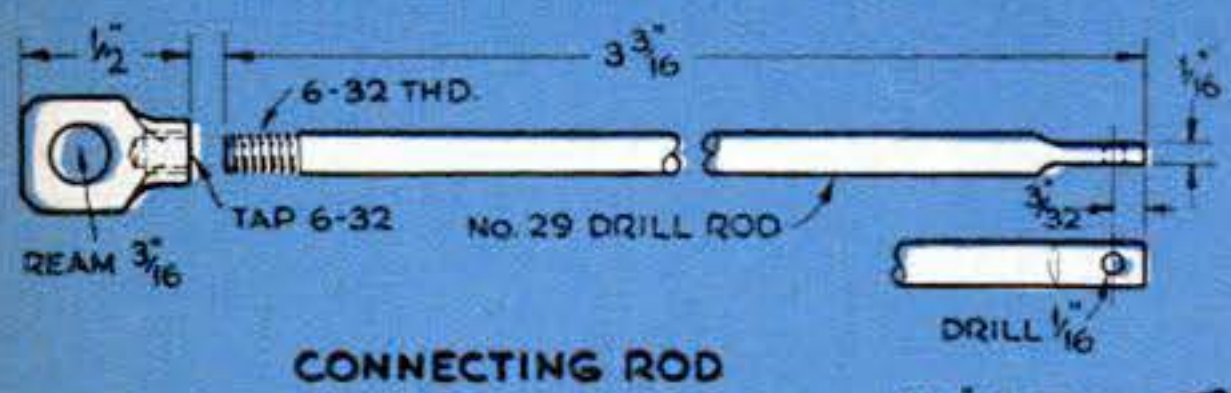

14 Big end of con rod is turned from flat bar or hex stock. Shoulder end, tap 6-32, and cut off. If your 6-32 die is adjustable, open it to cut tight threads on rod, which is best cut a bit long and then trimmed to fit.

When turned backward, the piston should resist and snap the wheel back if released.

Make a hole in a small oil can or similar container and solder in a bit of 3/8" i.d. tubing to hold a soft string wick just below the port opening. Bend a retaining clip from spring stock and mount it on the base with a thumb-screw. Pull out enough wick to give a flame about 1 1/4" high.

To start the engine, turn it to top dead center and give it a hearty spin forward. Turn the lamp in the base ring for best operation; flame position can be critical.

If piston and valve seem reasonably airtight and the engine is mechanically free but won't run, or has little pep, check flame height and valve action. The port should be fully uncovered just past top dead center. If the engine picks up just after the piston is oiled, it's probably leaking air. Lapping the port face, if you haven't done so, may improve operation. Friction must be held to a minimum. The valve should bear very lightly on the port, and valve-spring tension must not be excessive. **END**

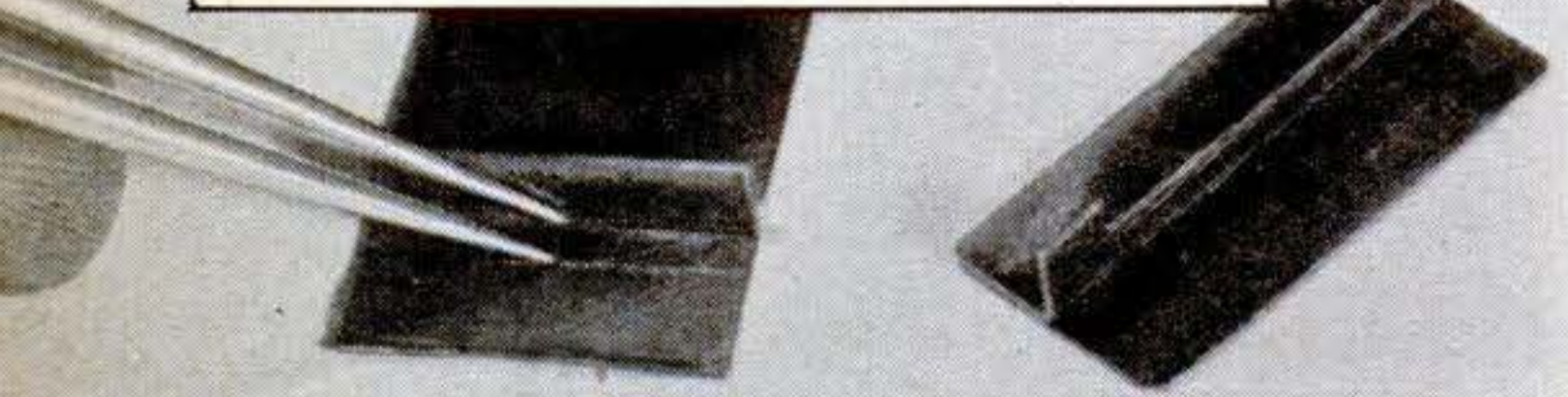
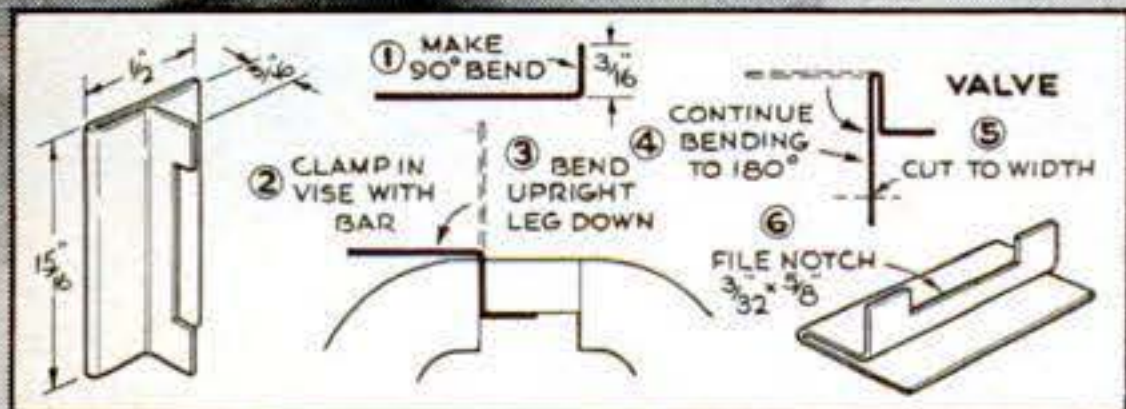

15 Anneal .010" spring steel and bend valve as shown in diagram above. Bend valve clip as in drawing at top of page. Scribe to length alongside bend with dividers, shape narrowed shank, and rivet to valve rod.

16 Lap valve perfectly flat, first on fine emery cloth laid on plate glass, and then on an oilstone. The valve parts are shown below in order of assembly, except for 6-32 adjusting nuts, which clamp the work between them.

17 Adjust valve so that it overlaps the port only 1/32" when fully closed. Clip should exert little pressure on port face. Use washers to align cam with roller if necessary. Engine runs clockwise as seen from crank end of shaft.

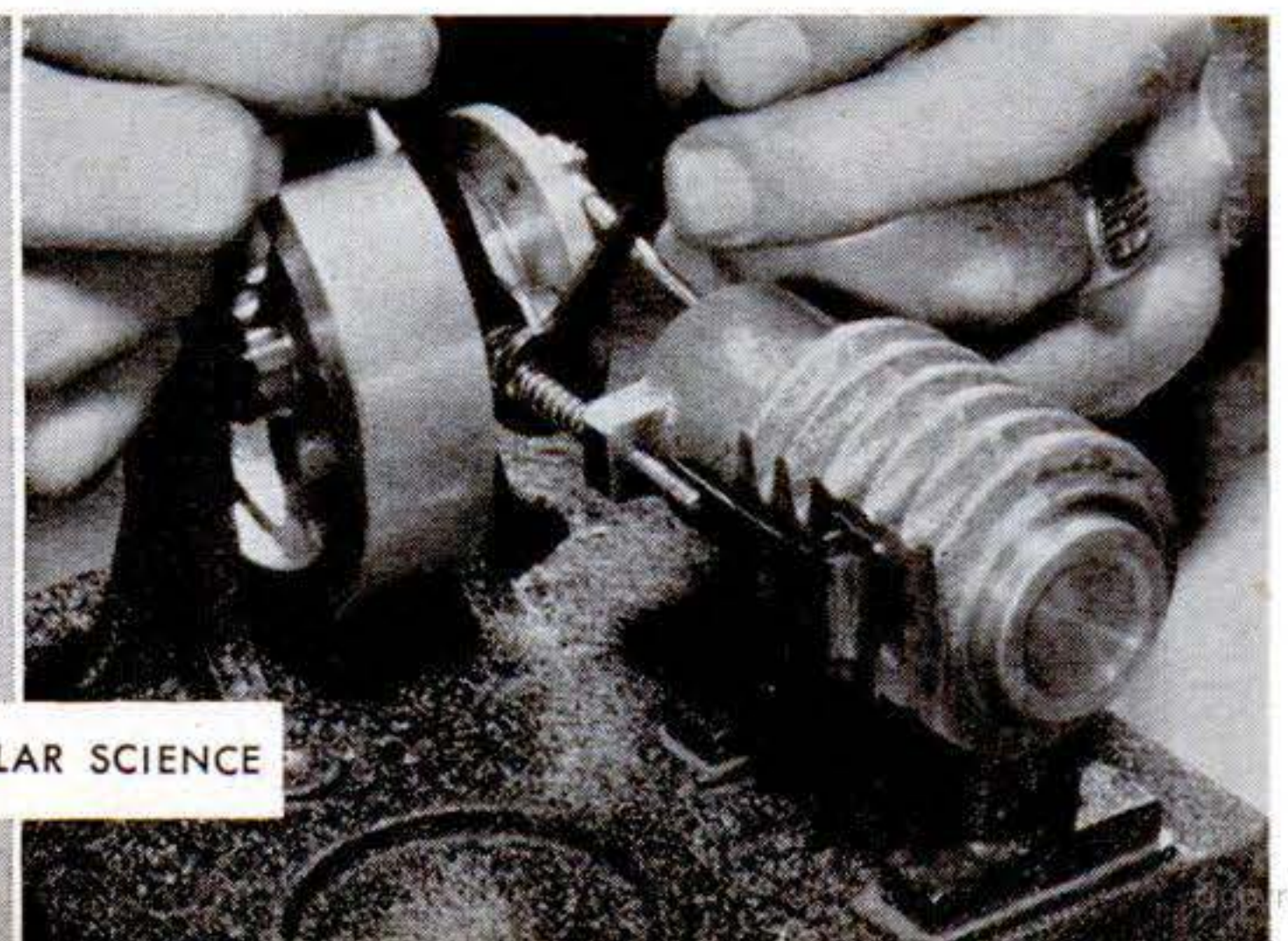
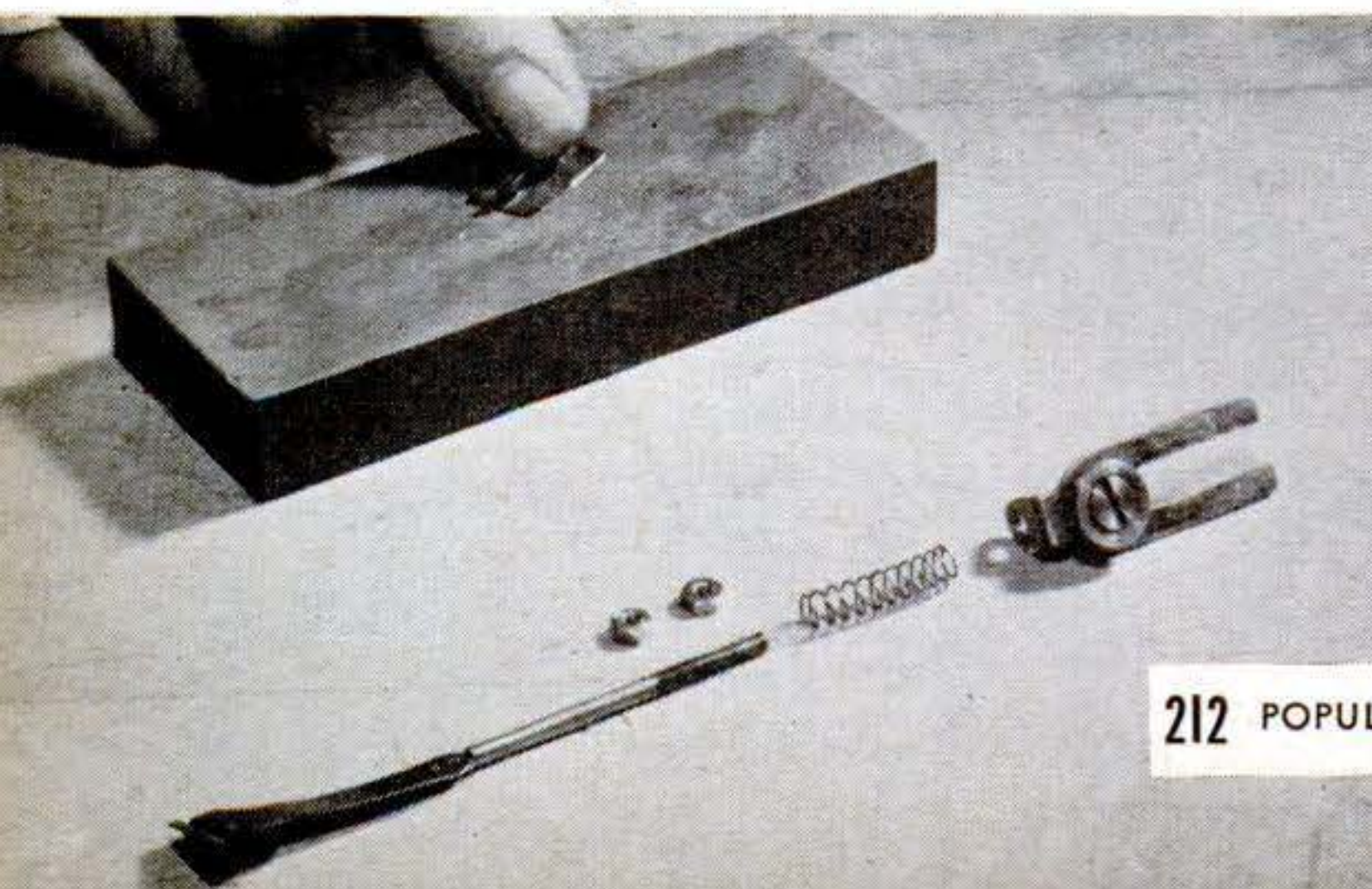

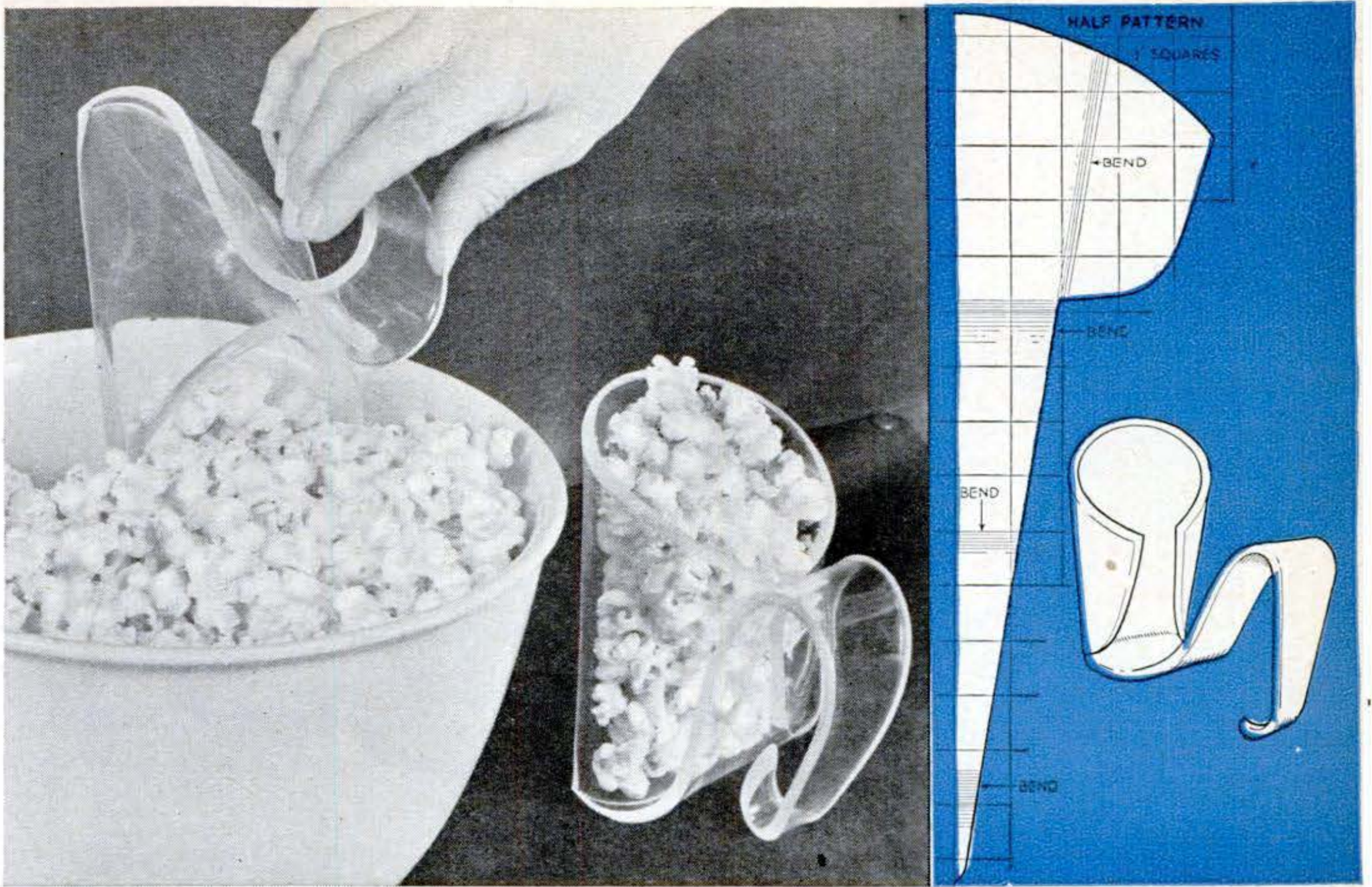

How to Turn Plastic Scraps into Popcorn Scoops

You can make a set of plastic scoops for popcorn from a few scraps of $\frac{1}{8}$ " clear or colored plastic. For each one, enlarge the scaled pattern (only one half is shown) and trace it off on the masking paper of the plastic. Jigsaw to the outline and smooth the entire edge with file and sandpaper.

Strip off the masking paper and put the plastic on a flat surface such as a cookie

sheet. Heat it in the oven at about 275° to 300° F. When the plastic is limp and pliable, remove it from the oven with gloved hands and bend the sides around to form a cup. Bring the long tapered part up to the top edge, then curve it back toward the bottom to form both a handle and a rest. Hold the plastic with both hands while it cools and sets.—*Doris Aller, San Francisco.*

Wire Extends Flashlight

A TROUBLE-SHOOTING light that will get into tight corners can be made by extending the bulb of an ordinary flashlight as shown at the right. Solder a miniature socket to one end of a length of shielded wire, using the conductor and shield for the contacts. Break off the base of a flashlight bulb and solder it to the other end of the wire.—*Milford Ames, Des Plaines, Ill.*

Turning Work to Small Size

IF YOU have to turn a relatively long piece to a small diameter, make the final cut a heavy one. By taking a $\frac{3}{32}$ " cut on a $\frac{5}{16}$ " rod, you can bring it to $\frac{1}{8}$ " diameter in a single pass. The $\frac{5}{16}$ " thickness ahead of the tool is strong enough to withstand the cut, and the $\frac{1}{8}$ " behind is not under strain.

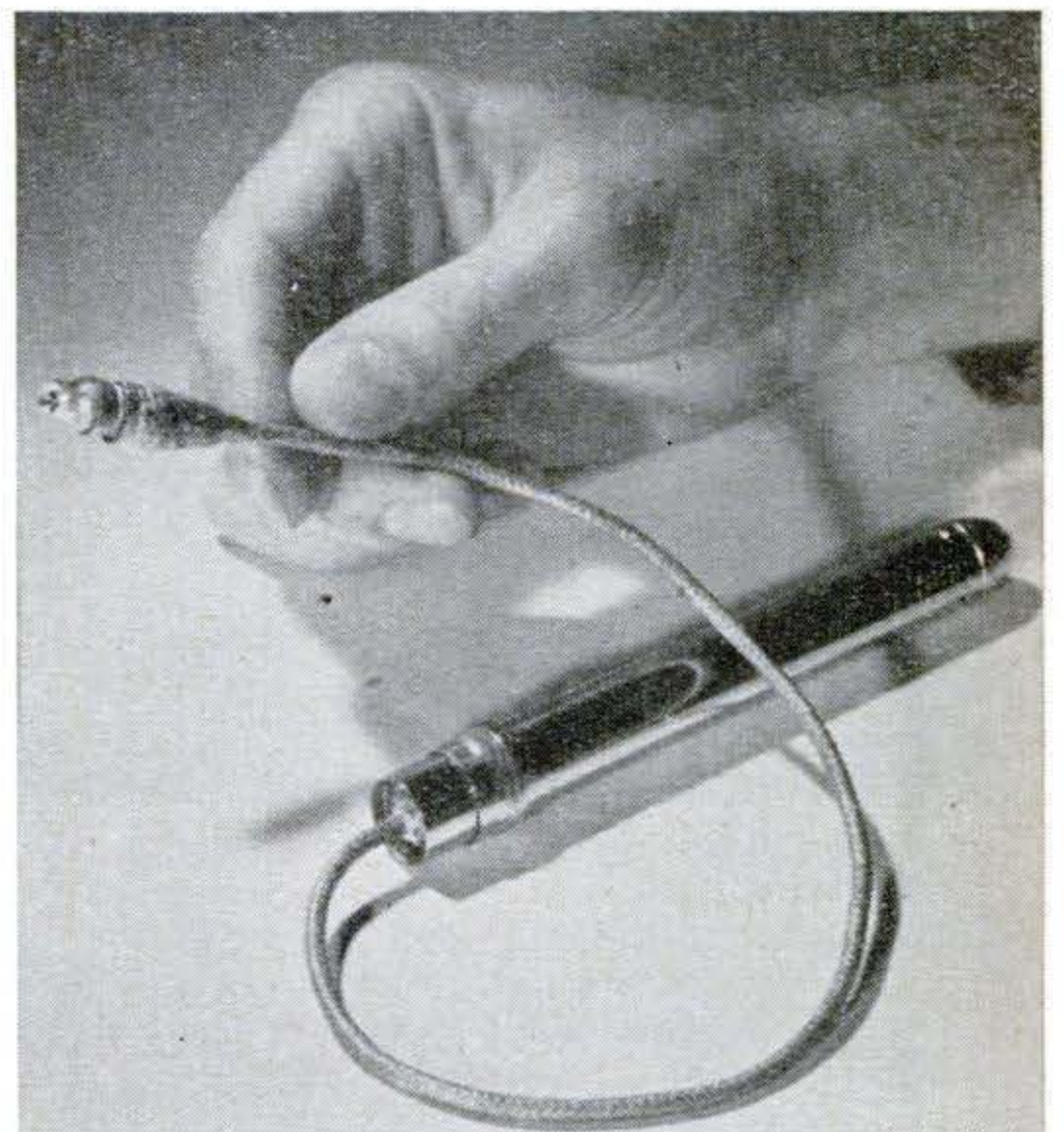

How Your Car's Engine Is Cooled

Three simple home experiments suggested by Kenneth M. Swezey.

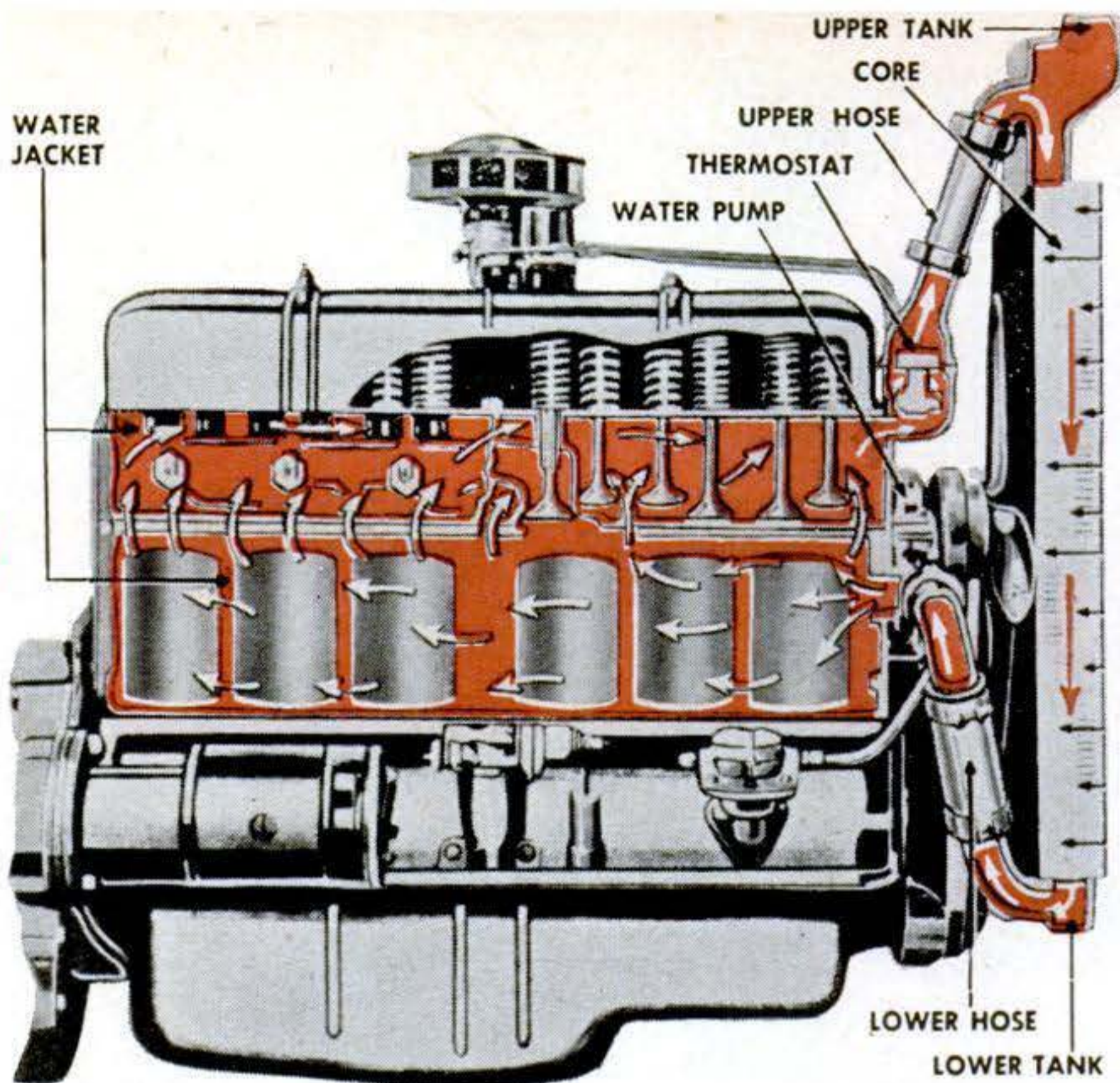

ALTHOUGH heat makes your car go, too much would quickly bring it to a halt. Left unchecked, the intense heat of combustion would soon warp and burn the valves, break down the oil, overheat the bearings, and "freeze" the pistons to the cylinders.

Part of this excess heat passes out the exhaust. The cooling system takes care of the rest. A typical system is shown in the draw-

ing above. Urged on by the pump, water circulates through the jacket, picking up heat from the combustion chambers, valves, and cylinders. Then it carries the heat to the radiator, releases it to the air, and returns again to the water jacket.

To learn at first hand a few more facts about the cooling system of your car, try the simple demonstrations on these pages.



How can plain water keep your engine at a safe working temperature despite much higher temperatures inside the cylinders? Partly for the same reason you can bring water to a boil in a paper cup without setting the cup afire. If you don't believe this can be done, try it. Use a single-bottom cup, about a quarter full of water. Hold it over a candle flame, and the

water will soon boil. Why doesn't the paper burn? Because the hot water keeps it cool. The paper gets hot, it is true, but the water carries off the heat before it rises to kindling temperature. In like manner, water circulating through the engine carries off heat from the working parts, preventing them from being distorted, or even melted, by the combustion heat.

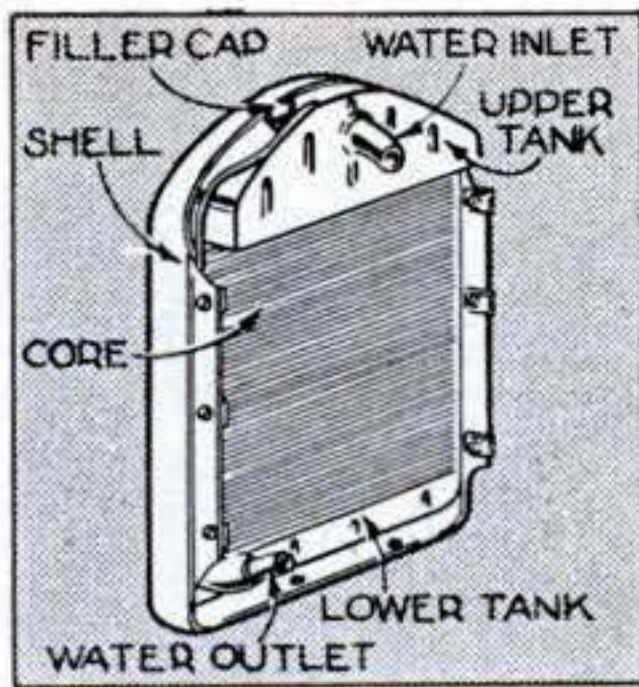

How does the radiator transfer heat to the air? After collecting in the top tank, hot water from the engine passes down through the core. The core's function is to divide the water into many small streams and expose each to air drawn through the radiator by the fan and forward

movement of the car. As the air rushes past copper fins on the water tubes, it takes up heat from the water inside the tubes.

How fins help cool water can be shown with the setup in the photo at right. Attach broad fins of heavy aluminum foil to one of two identical test tubes. Put the same amount of water in each tube and hold them over identical candle flames. The water in the plain tube will soon steam. The other will take longer because it loses heat to the air through the fins.

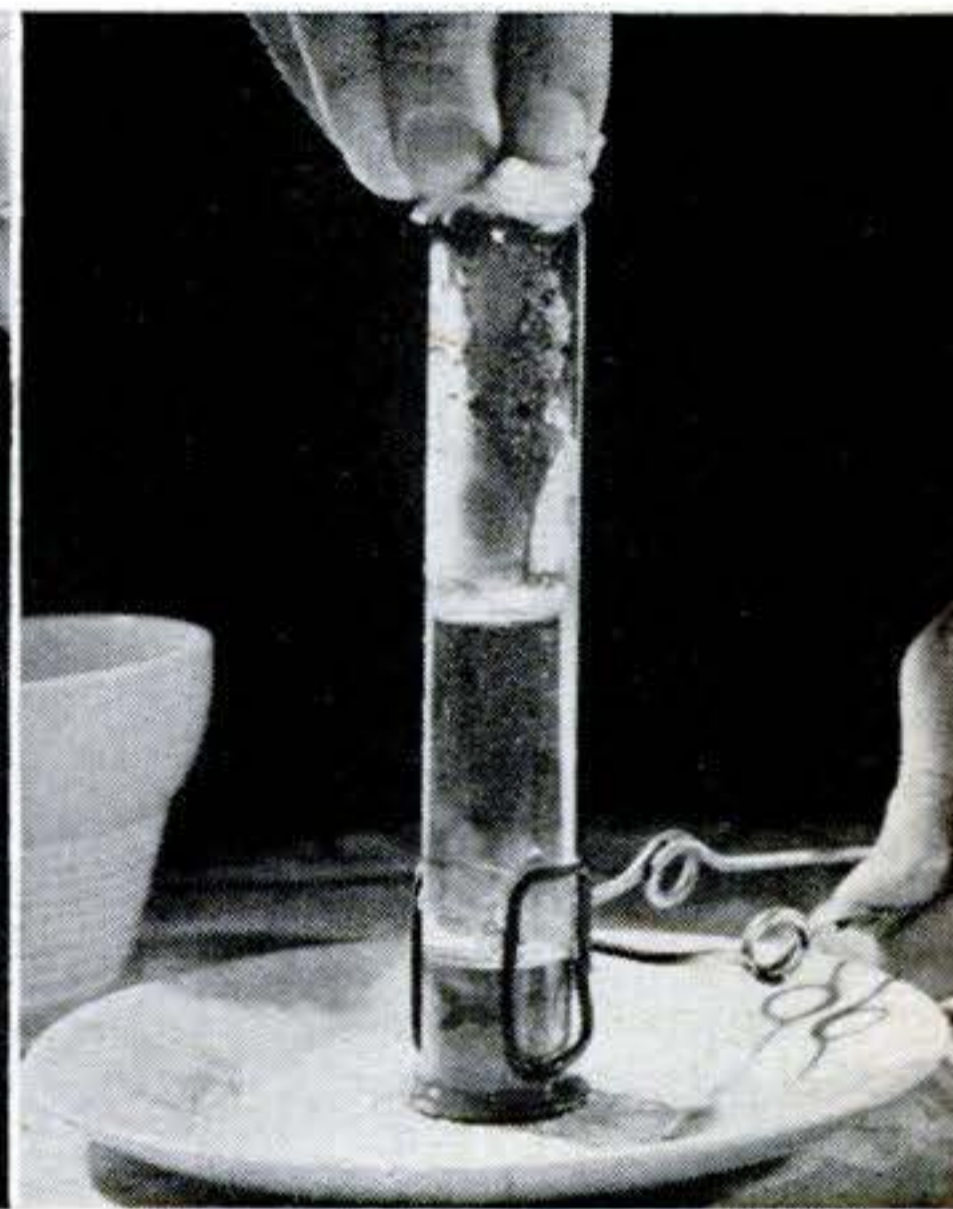
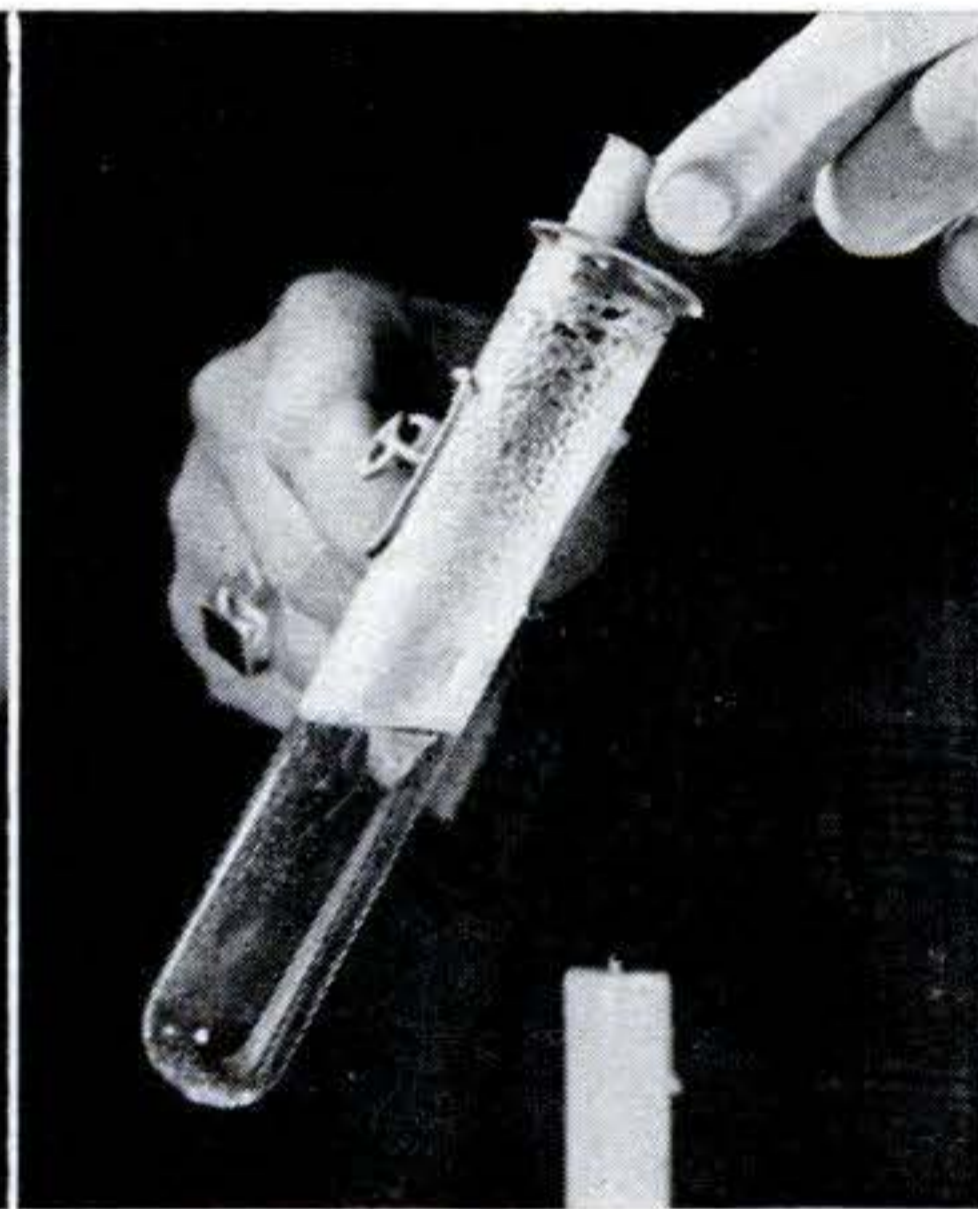
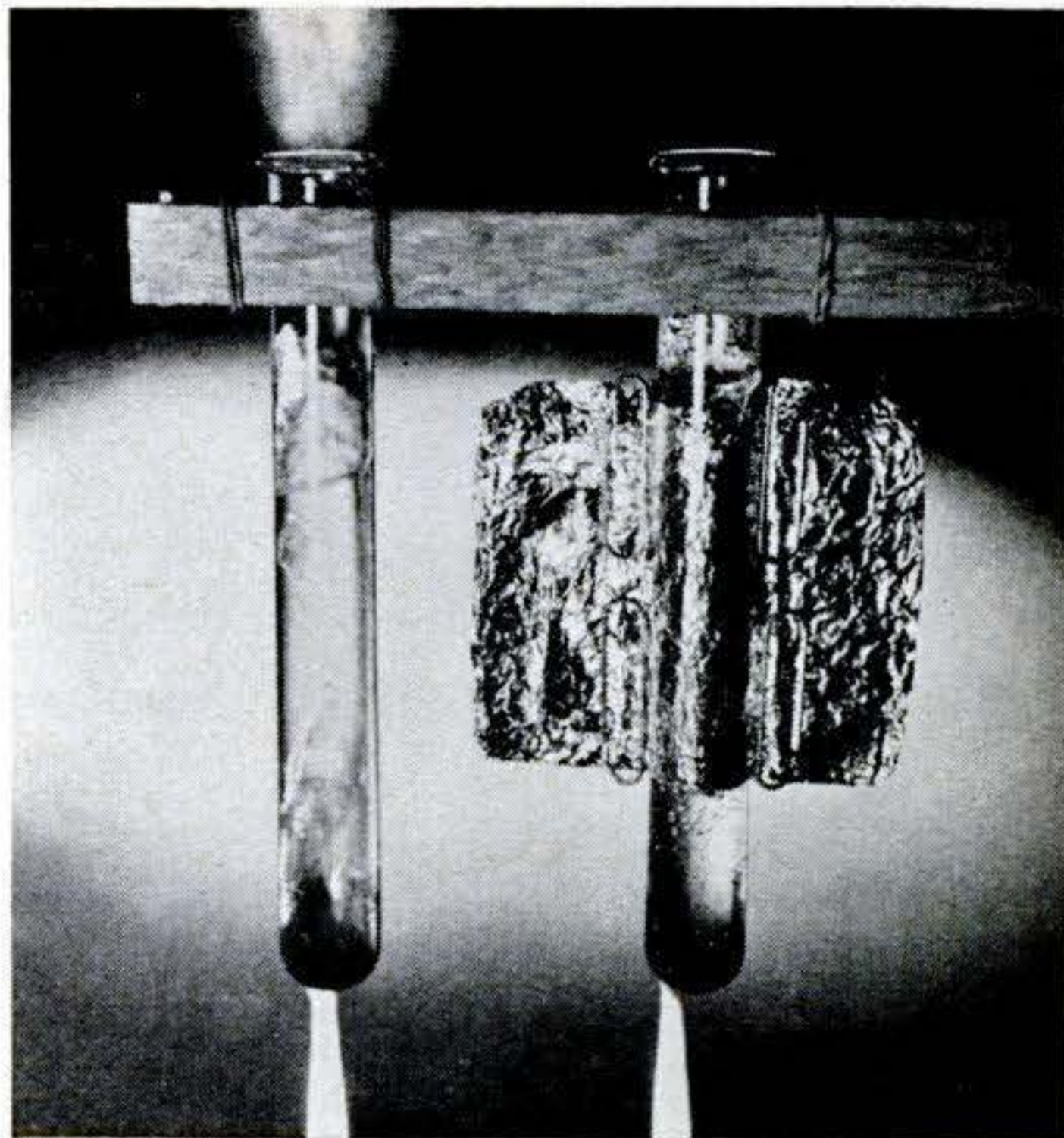

Why are pressure cooling systems now used in most cars? Strangely enough, you can find the reason on a mountaintop. A few years ago, when all cars had nonpressure systems, radiators often boiled at high altitudes. Why? Because of the drop in atmospheric pressure.

At sea level, the boiling point of water is 212° F. When you climb a mountain, atmospheric pressure drops and the boiling point drops. The experiment above shows this.

Fill a test tube half full of water. Bring it

to a vigorous boil, quickly stopper the tube, invert it, and apply cold water with a wad of wet paper. This condenses the steam inside, causing a partial vacuum and reducing the pressure. Although cooled, the water begins boiling again. In a pressure cooling system, this works in reverse. Since the system is airtight, the steam that's generated exerts pressure on the water, raising its boiling point above 212°. This permits the engine to operate at a more efficient higher temperature without boiling.

Waxed Nails Hold Securely

SOME nails that you buy are wax-coated for better holding qualities. Recently, unable to buy a supply, I coated some common nails myself. Dissolving 1½ lb. of rosin in a pint of liquid paint drier, I dumped this solution and two kegs of nails into a tumbler made from an old oil drum. Then I gave the tumbler a few turns and took out the nails.—*John E. Heisson, Fitchburg, Mass.*

White-Lead Putty Won't Bleed

IF YOU have trouble with ordinary putty "bleeding" through your paint and showing up as yellow spots, try a homemade putty that is free of this trouble. Into a small can of white lead stir some powdered whiting. Add a little at a time until the mixture has the consistency of putty. The whiting can be worked in best with a spatula or knife.—*Joseph E. Bird, Carrollton, Ill.*

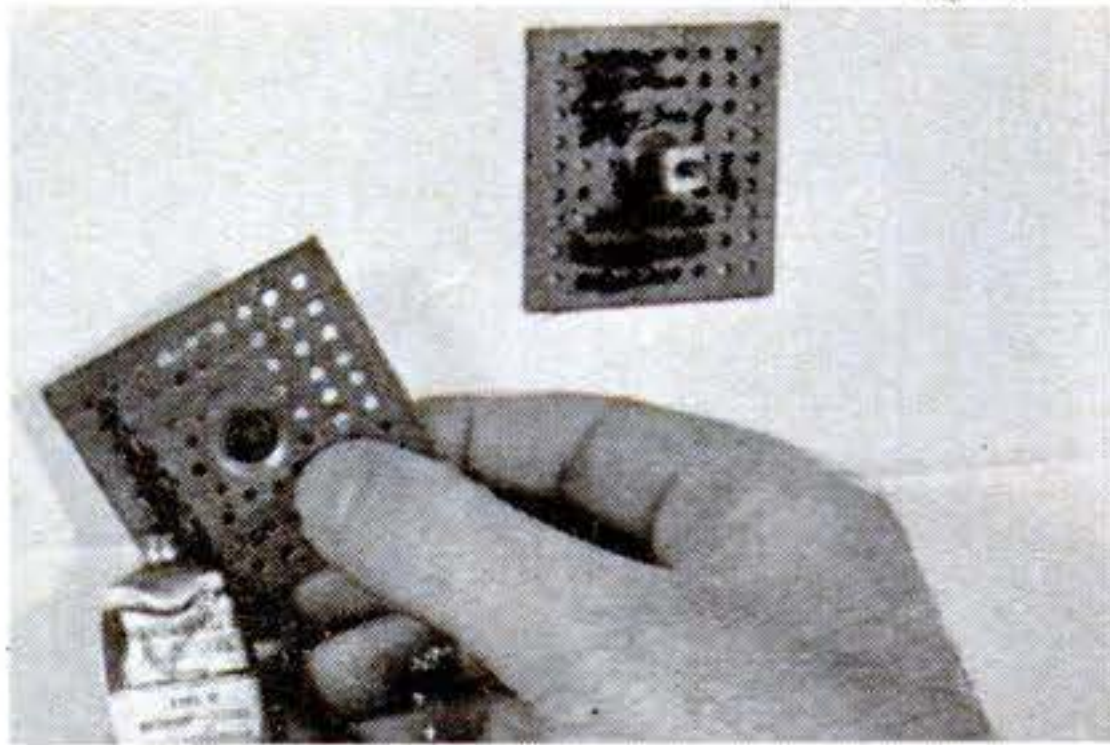

Adhesive Bonds Wall Anchor

BY USING these new anchors, you can mount cabinets, towel racks, or other fixtures on masonry, tile, or other surfaces without drilling holes. The Miracle Surface Anchor®, a perforated metal plate, is attached with a special adhesive. Plates are available with various attachment devices—nails, bolts, spindles, threaded studs. Goodloe E. Moore Co., of Danville, Ill., is the maker.

Triangles Held in Book

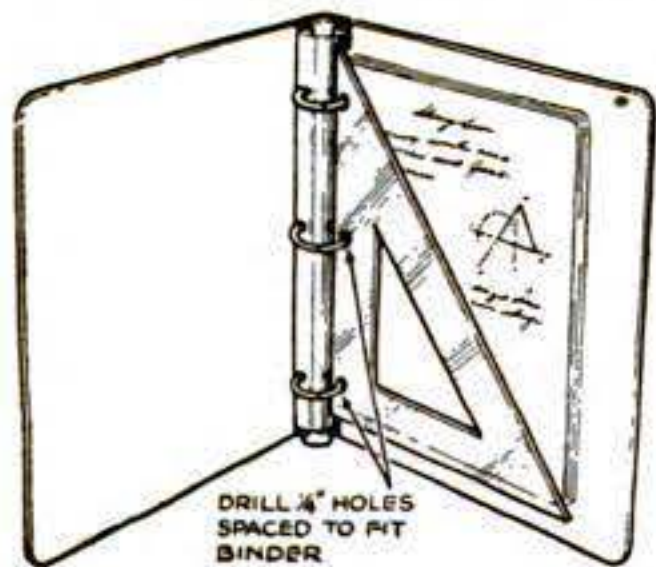

DRAFTING students and others who have occasion to carry plastic triangles may find this tip useful. I insert mine in my looseleaf notebook by drilling holes to fit

the rings. This way the edges are protected and the triangles won't be mislaid.—*H. L. Orwig, Wilkinsburg, Pa.*

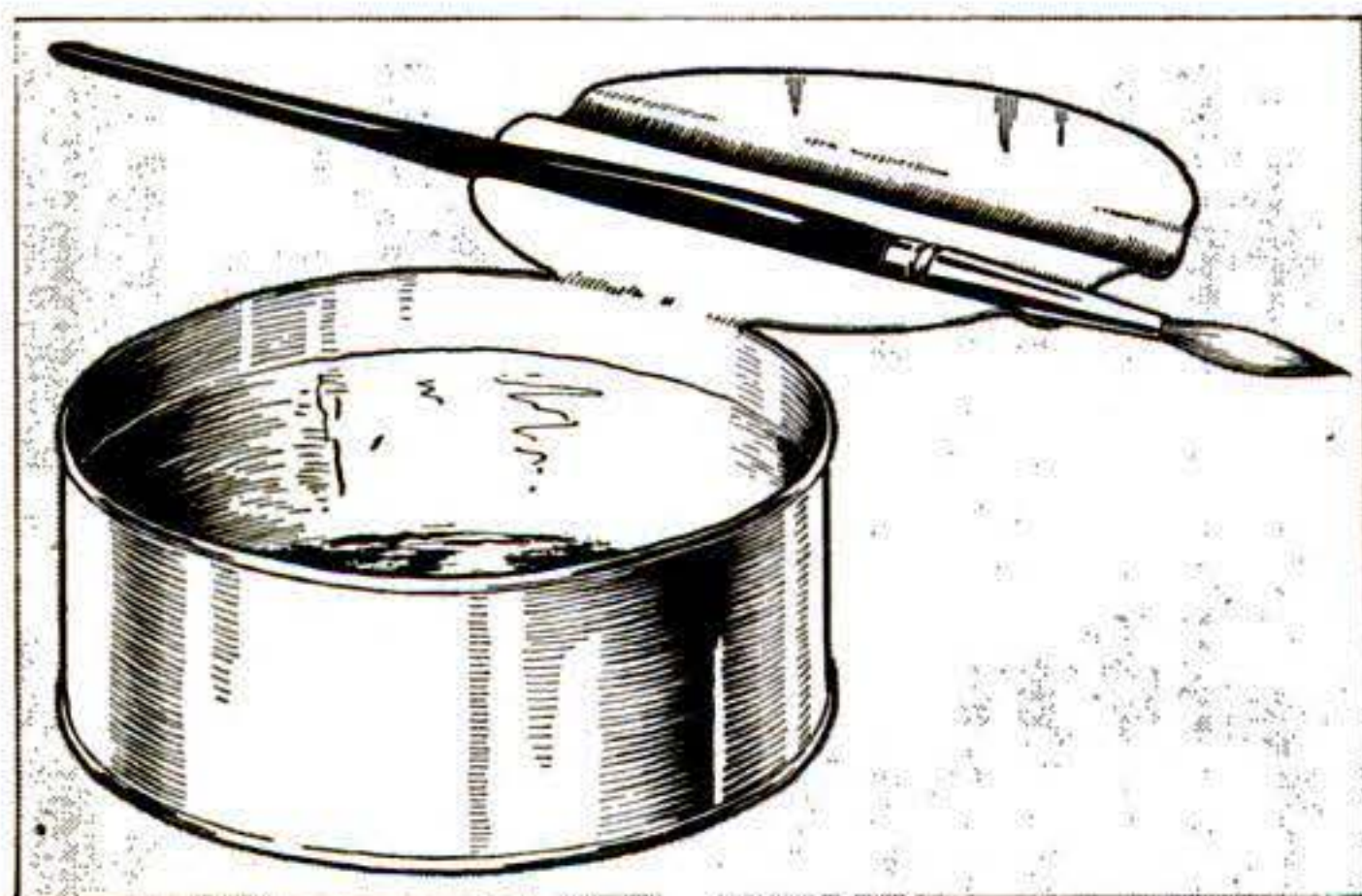

Tin Can Holds Paint Brushes

A TIN can makes an excellent container for washing small brushes, and the lid can be used to hold wet ones. Open the lid with a roll-type opener, leaving a hinge portion. Bend a couple of hollows in the lid with pliers.—*Frank Shore, Manhattan, N. Y.*

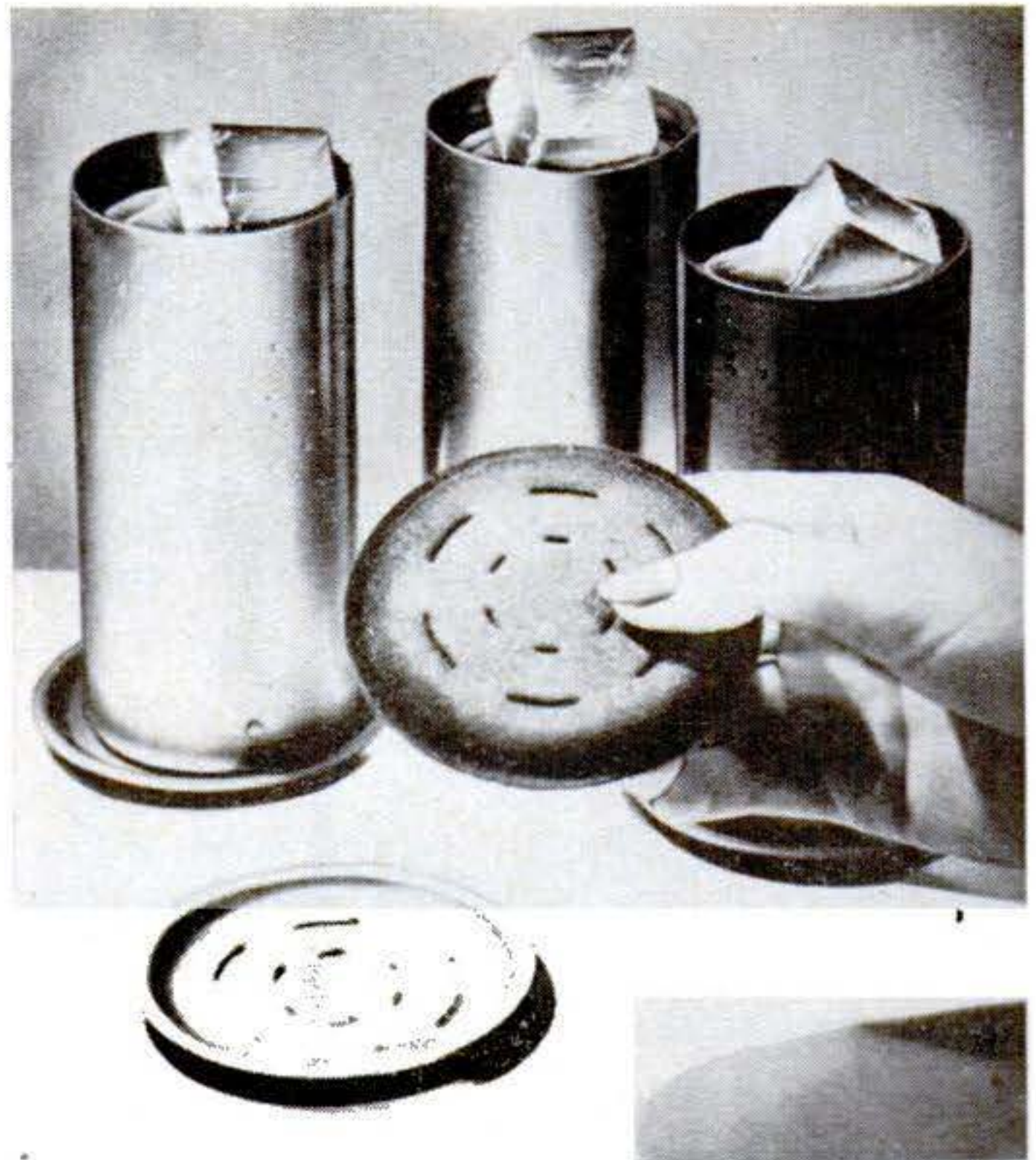

These Coasters Won't Stick

WHEN you pick up a drink, these coasters are guaranteed not to ride along too. Made of metal, the coasters have a felt base to protect your furniture.

A product of the J. H. Cristil Co., of Edgerton, Ohio, the coasters sell for about \$3.50 for a set of eight. They're made in colors to match Perma Hues® aluminum-tumblers, also shown above.

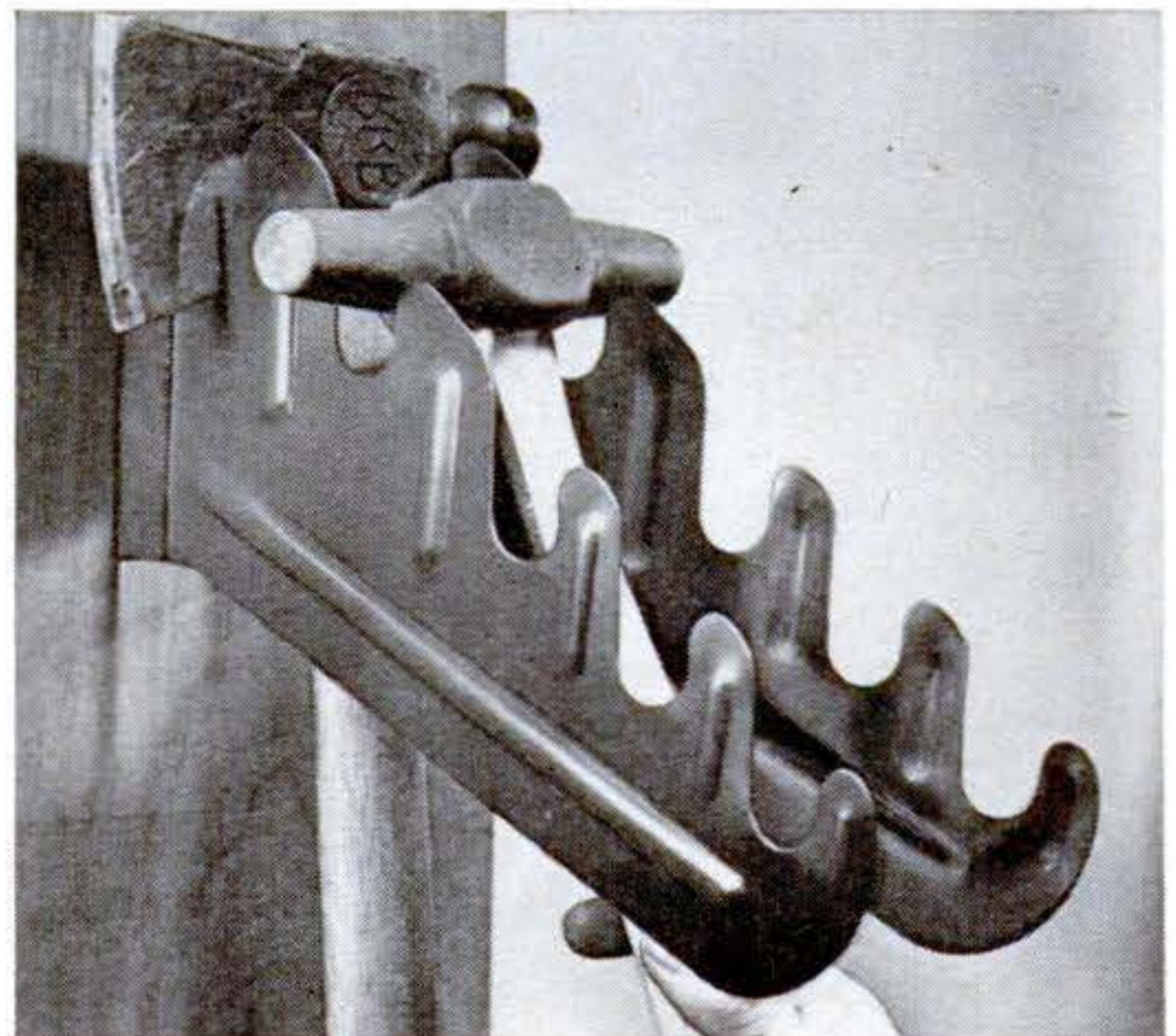

Holds Shop or Garden Tools

FIVE of your household, shop, or garden tools can be hung out of the way on this simple pressed-steel rack. It is priced at about \$1 by the Jim Brown Toy Company, of Akron, Ohio. The rack is mounted by screws in two slotted holes.

Home Accessories You Can Build on Your Kitchen Table

Guest Mirror Assembled with Ready-Made Parts

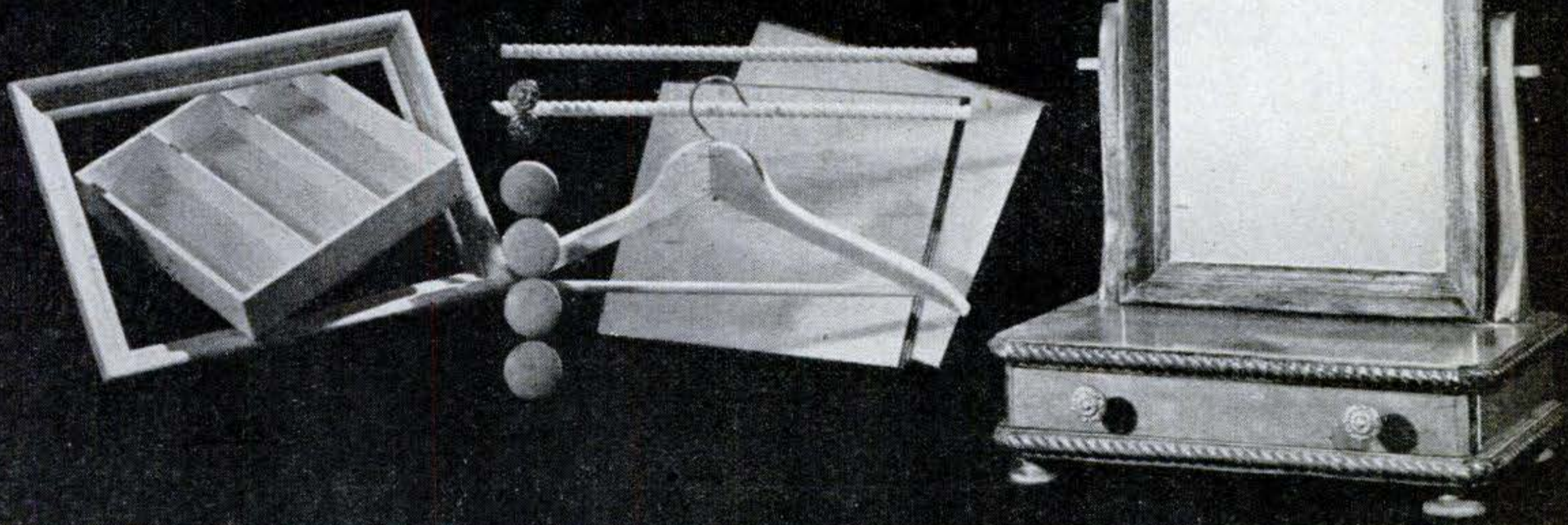

Looks like a power-tool job, but it's not. The parts cost \$6.03.

LOOK for parts instead of finished products the next time you go shopping—and you may discover ways to save money while having fun. Even apartment dwellers without workshops can produce many useful and decorative home accessories by cleverly combining odd items.

On this and the next six pages, Arthur Miller, of New York City, shows you how to put together five attractive pieces—the guest mirror pictured here, a dressing table, a folding wall table, a double-deck sewing stand, and a chandelier.

The guest mirror is handy as well as decorative. Place it on top of a chest of drawers and you've got a temporary dresser with a tilting mirror and a drawer for small articles.

To build it, you'll need:

- Two breadboards.
- Two brass drawer pulls.
- Four wooden drawer pulls.
- Picture frame.
- Cutlery tray.
- Wooden coat hanger.
- Nine feet of $\frac{1}{2}$ " rope molding.
- Scrap stock.

A photo on the next page shows construc-

tion details of the base. Make saw cuts across each corner of the top and bottom pieces (the breadboards). Then round them with sandpaper. Cut the corners of the sides, back, and drawer facing (made from scrap) diagonally as shown in the photo. Before assembling the base, attach the

Wooden coat hanger, hacksawed in two, makes mirror supports. Cut halves as shown below. Mount the supports on the top with dowels.

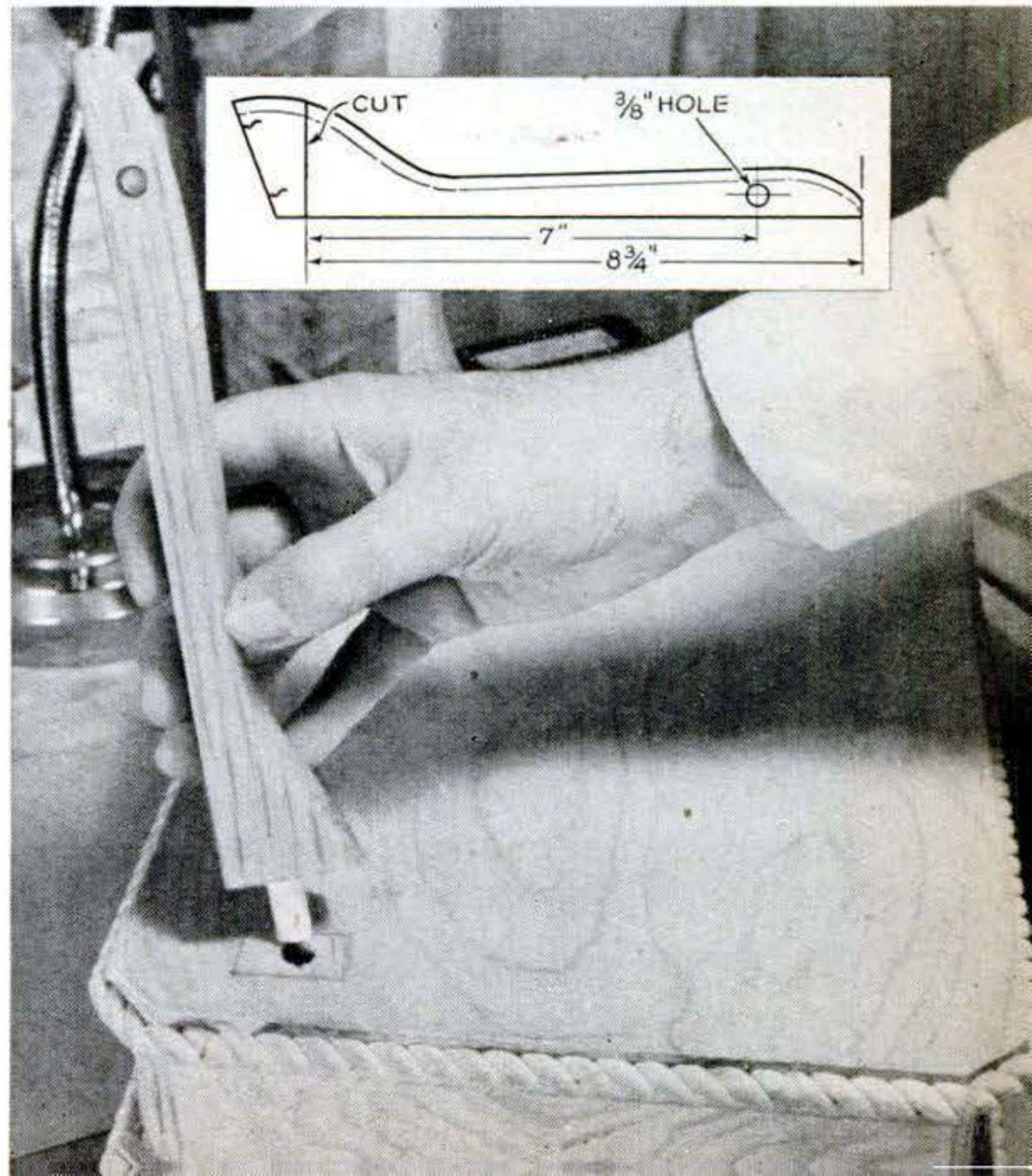

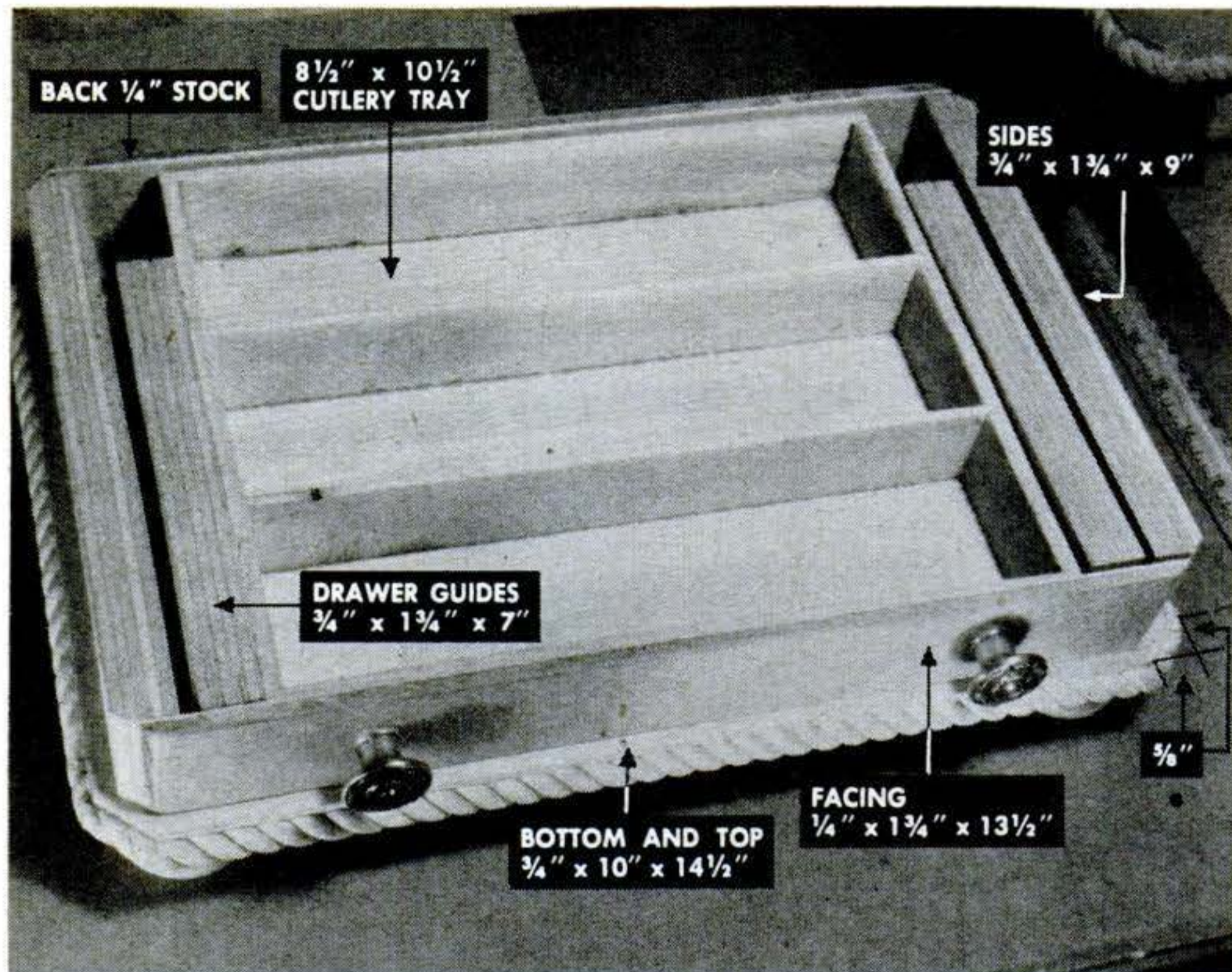

Here the base is assembled except for the top. Dimensions are shown on photo. Brass pulls and glue hold drawer facing to the cutlery box.

drawer pulls that serve as feet. These are held in place by screws driven down through the bottom piece.

Attach the $\frac{1}{2}$ " rope molding with glue and brads. When you come to a corner, saw almost through the molding from the back. Then you can bend it without breaking it. Now assemble the base with glue and nails.

Cut and drill the coat hanger as indicated. You can saw up the hanger's crossbar for dowels to mount the mirror and mirror supports.

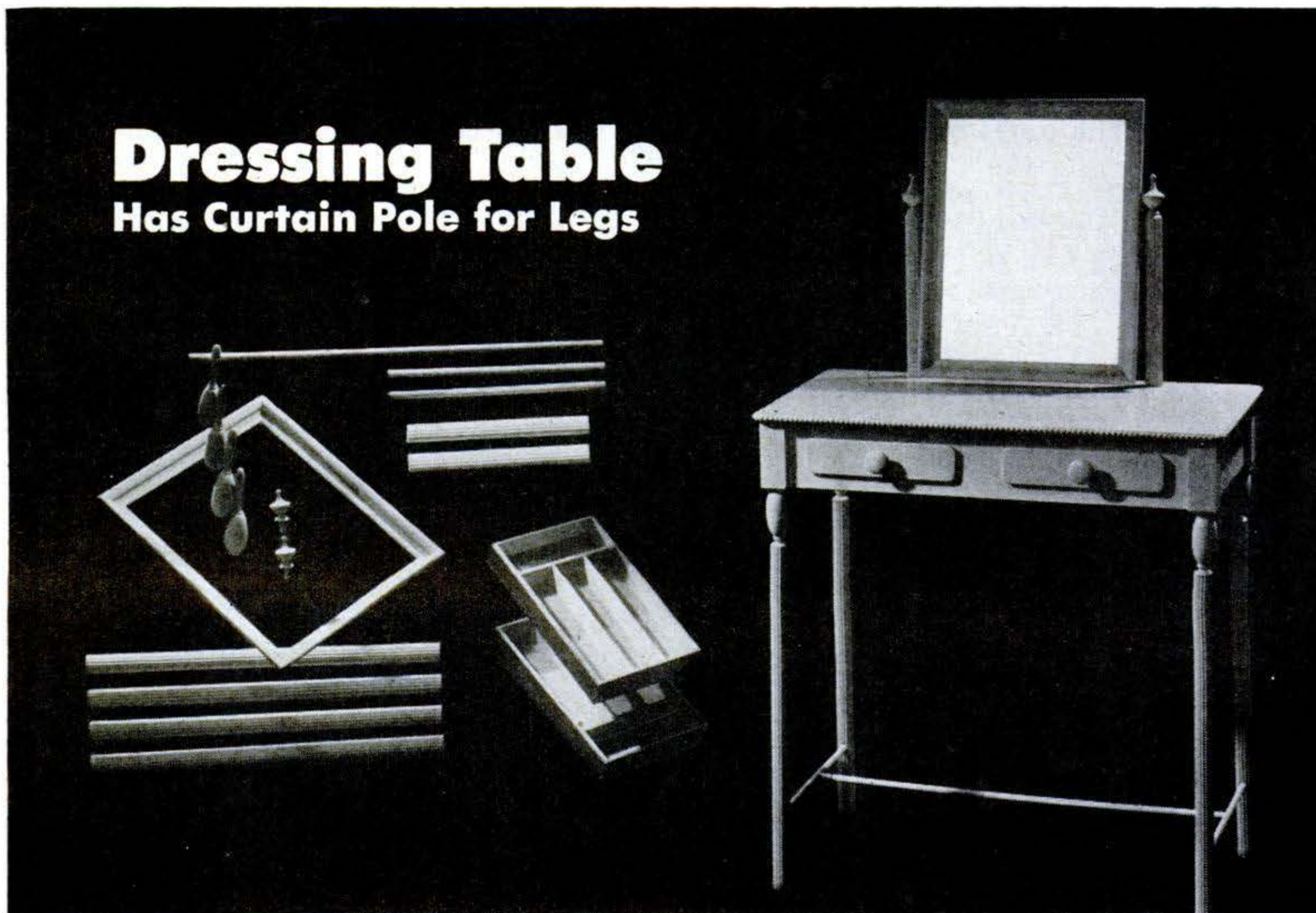

You'll need plywood for the tops and sides of this project, but the table's total cost is only \$10.51.

HERE'S a welcome addition to almost any bedroom. At first glance, construction may look tough, but it's really easy. Dimensions

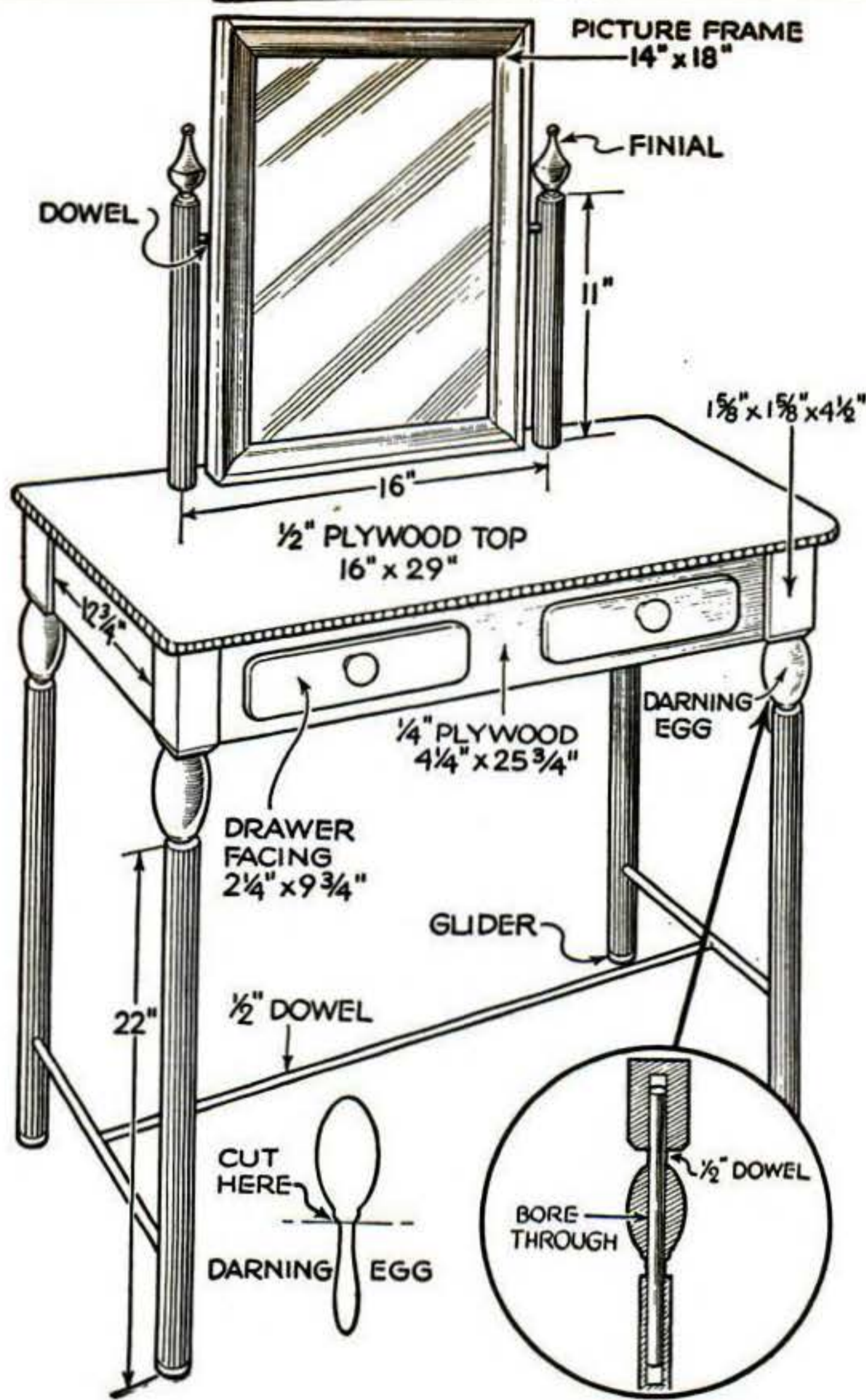

are detailed in the drawing shown at top.

Buy the few dollars' worth of lumber that you'll need at a yard that will cut it to size. The other parts you'll need include:

- Picture frame.
- Two cutlery drawers.
- Two wooden drawer pulls.
- Two fluted curtain poles 11" long.
- Four fluted curtain poles 22" long.
- Two small finials.
- Four darning eggs.
- Eight feet of beaded molding.

Many department stores sell the curtain poles by the foot. They'll cut them to length for you. Start by gluing up the leg assembly. While this is drying, assemble the drawer unit with brads and glue. Use a coping saw to cut the openings for the drawers. The 1/2" by 3/4" slat above each drawer keeps the drawers from tipping when they're pulled out.

You can saw and chisel the grooves in the corner blocks yourself or have the lumber yard cut them. Glue the plywood apron into the grooves. Attach the beaded molding with glue and brads. You may have to alter the dimensions of the mirror. They'll depend on the size of the picture frame you use. Dowel and glue the mirror supports into the top and you're ready to paint. ➡

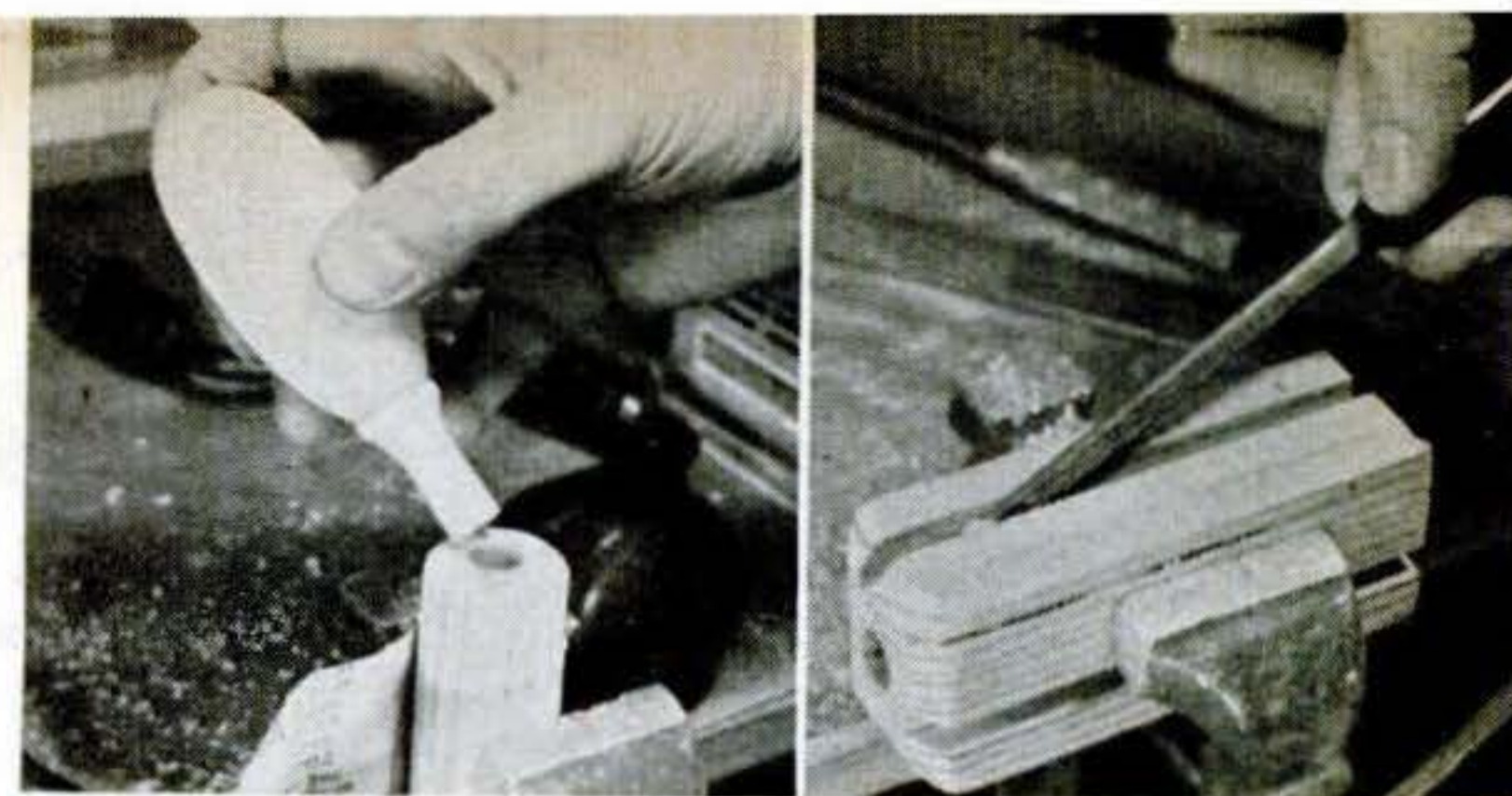

Darning egg can either be drilled all the way through for single dowel (drawing), or handle can be used as one dowel and top drilled for second (left above). Right: grooving a block.

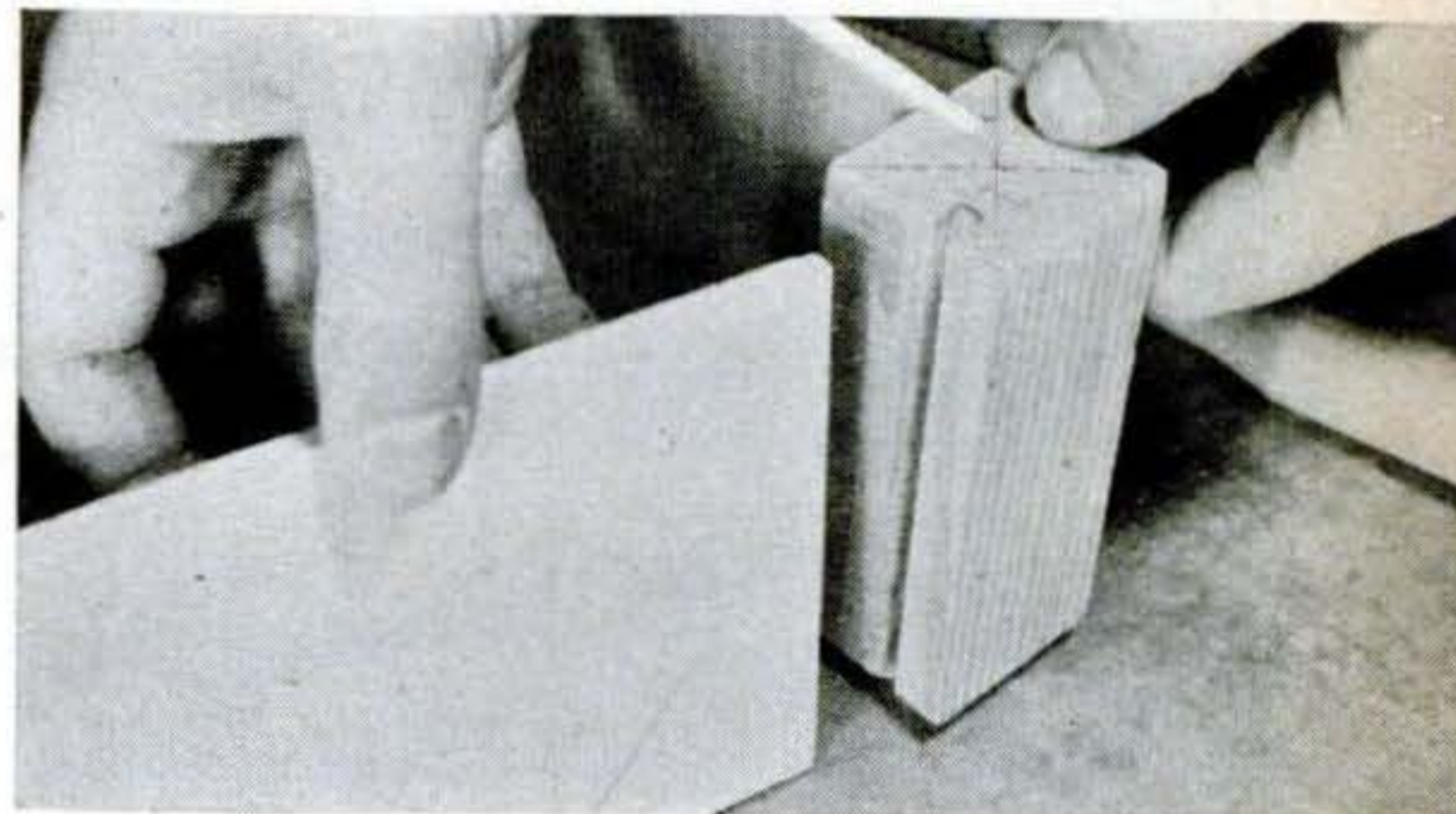

You can groove the corner blocks by making two saw cuts and chiseling out the waste. Secure the plywood aprons in the grooves with glue.

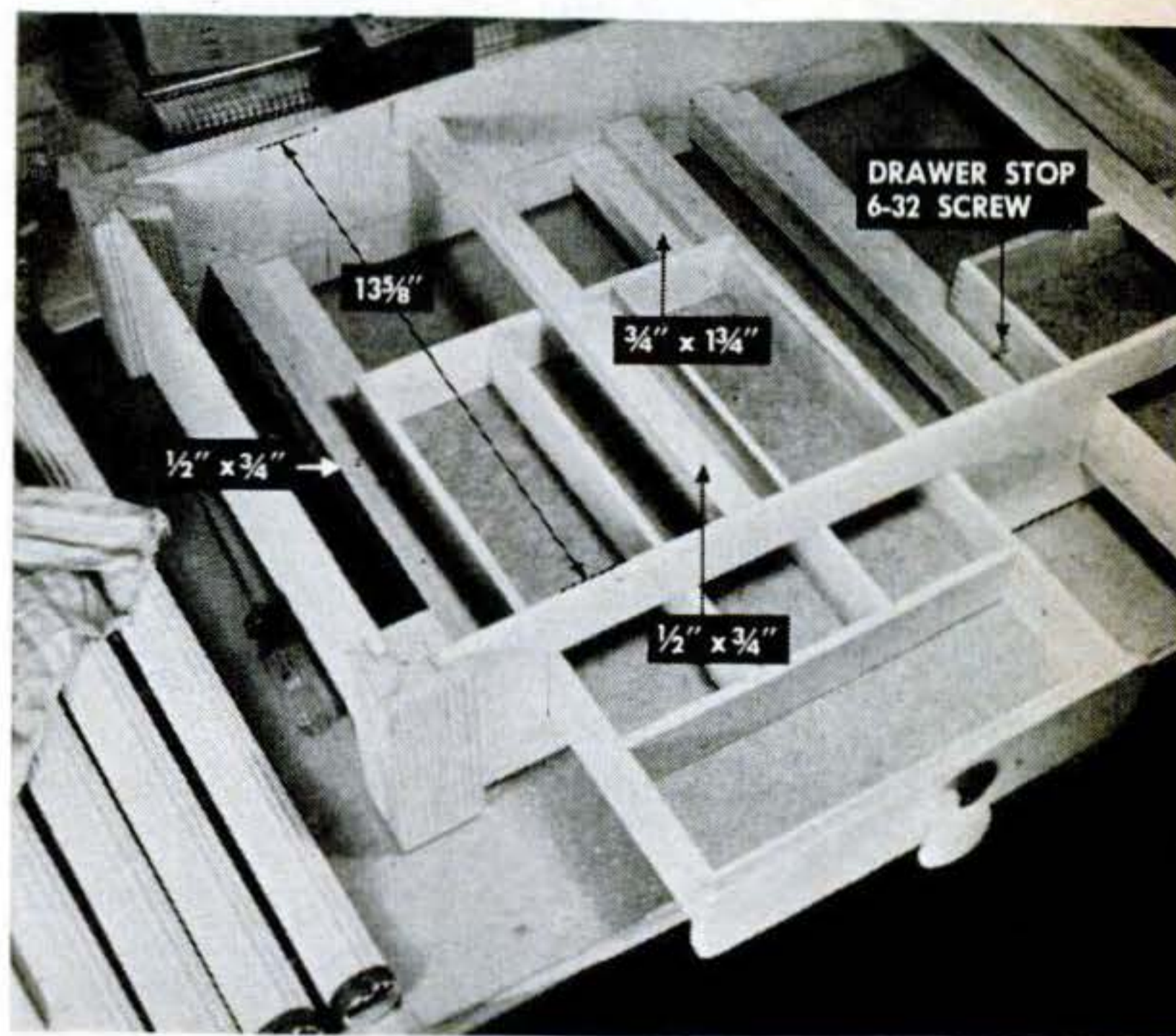

Here are details and dimensions of drawer assembly. Drawer facings are held in place by glue and the screws that hold wooden drawer pulls.

Mirror supports are topped off by small urn-shaped finials. Drill top of support for finial's dowel. Mirror is suspended by 3/8" dowels.

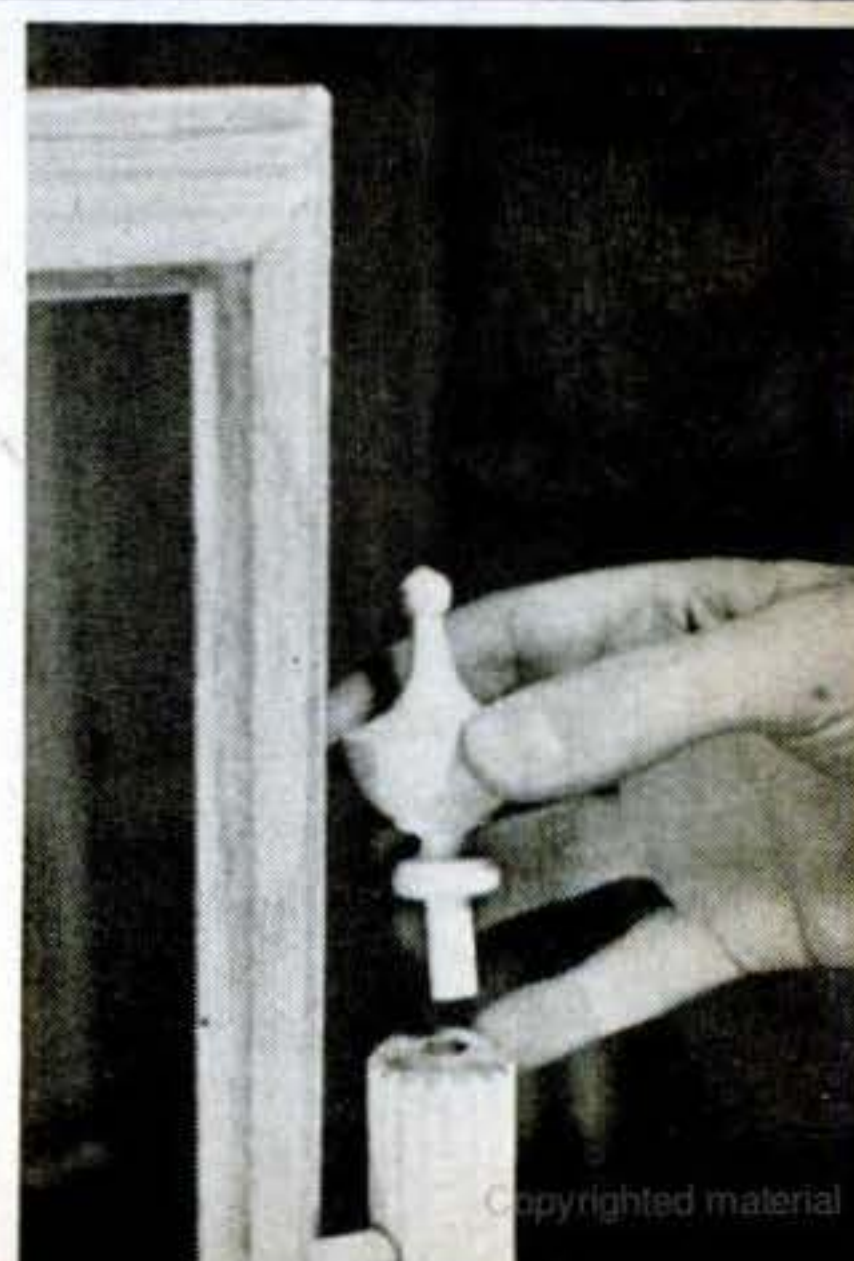



Wall Table Folds Out of Way

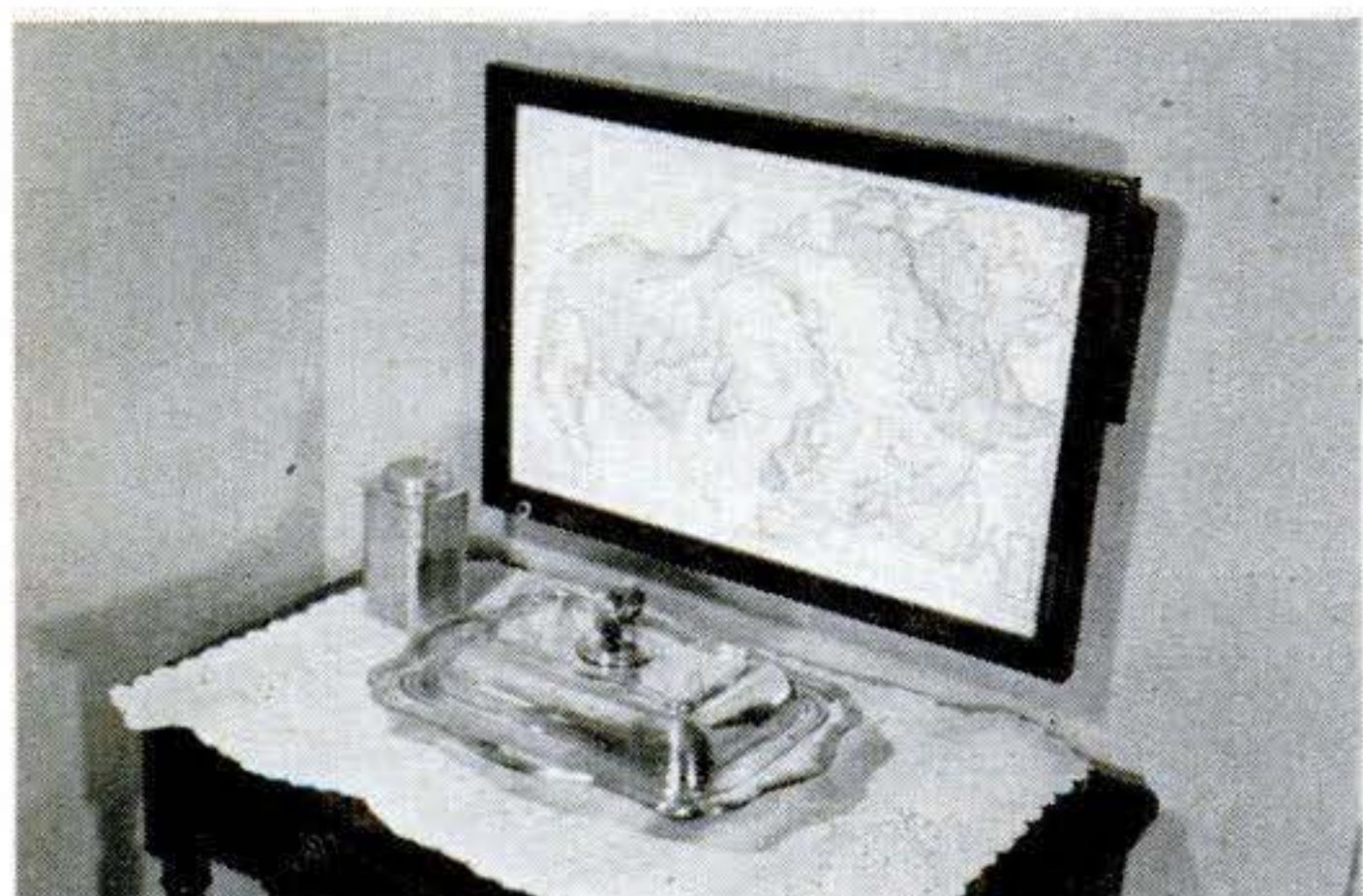

Bracket that supports wall table is hinged in exact center of piece that is screwed to wall.

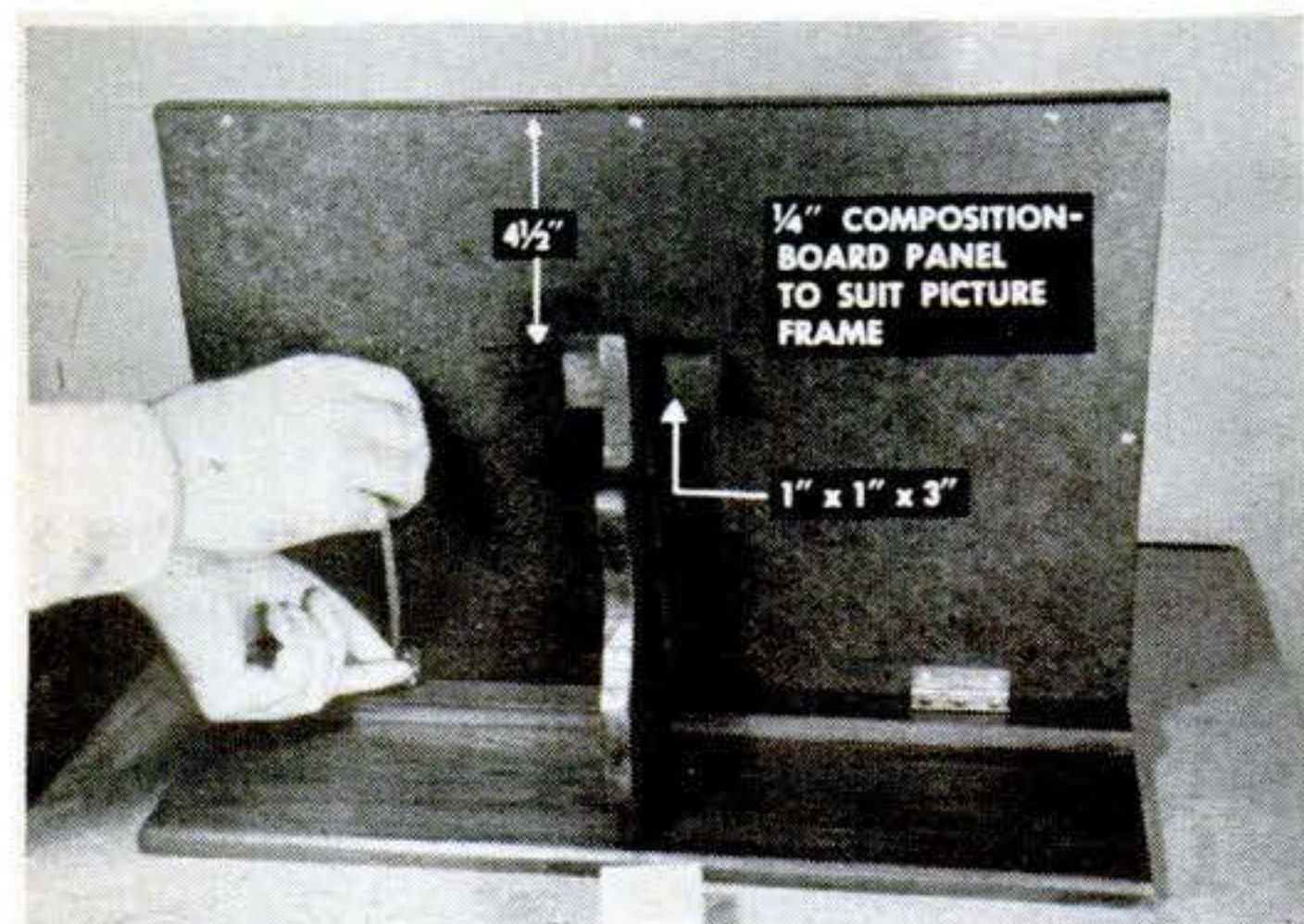

Two assemblies are joined with hinges. Put them on table like this to line them up correctly.

**Up it's a shelf; down it's a picture.
Cost of this quickie job: \$3.75.**

THIS folding wall table can be used in many ways. If you live in a small house or apartment, it can serve as a buffet in your dining alcove. Or you can mount it in an entrance hall as a spot to park parcels or mail. In fact, you'll find a use for this table in almost any room.

Parts list:

- Picture frame.
- Four small pieces of wood.
- Three hinges.
- 3/16" composition board to cover the back of the picture frame.

The frame measures 12" by 18" inside. Other dimensions are given on the photos.

Nail a 1/2" by 1" strip along the top of the piece that screws to the wall. Then cut out and hinge the supporting bracket as shown in the photo. Attach a 1" by 1" block with wood screws through the composition board. Next, put a picture in the frame and brad the composition board to the back of the frame. Then hinge the two assemblies together as shown in the bottom photo.

After sanding all parts well, finish the wall table to match your other furnishings. The one shown here was given a mahogany stain and then rubbed well with wax. In mounting your drop-leaf table, be sure it is well anchored to the wall. If the wall is plaster, drill the holes and then insert wooden plugs to take the mounting screws. Use flathead wood screws at least 1 1/2" long and countersink them. You also can use toggle bolts. They're made especially for plaster walls.

Sewing Stand

Has Two Decks; Costs only \$2.38



Two salad bowls, a rolling pin, and two coat hangers are all you need.

You can build this sewing stand with only three tools—saw, hand drill, and screwdriver.

The salad bowls are 9" and 11" in diameter. When you shop for them, pick out a pair that match in wood grain and color. A rolling pin forms the central shaft on which the two bowls are mounted. The legs are made from halves of wooden coat hangers.

The first thing to work on is the rolling pin. Saw off one of the handles flush with

the end of the roller. Then, on the same end, cut three flat surfaces on the roller. Space these flats equally around the roller. The legs will be screwed on at these points.

Drill a hole in the center of the smaller bowl. Make it just large enough to take the remaining handle of the rolling pin. Four flathead wood screws through the bowl and into the roller hold the smaller bowl in place. Make the hole in the larger bowl a tight fit for the rolling pin. If you don't have an expansive bit for this, drill a circle of overlapping ¼" holes. Then use file and

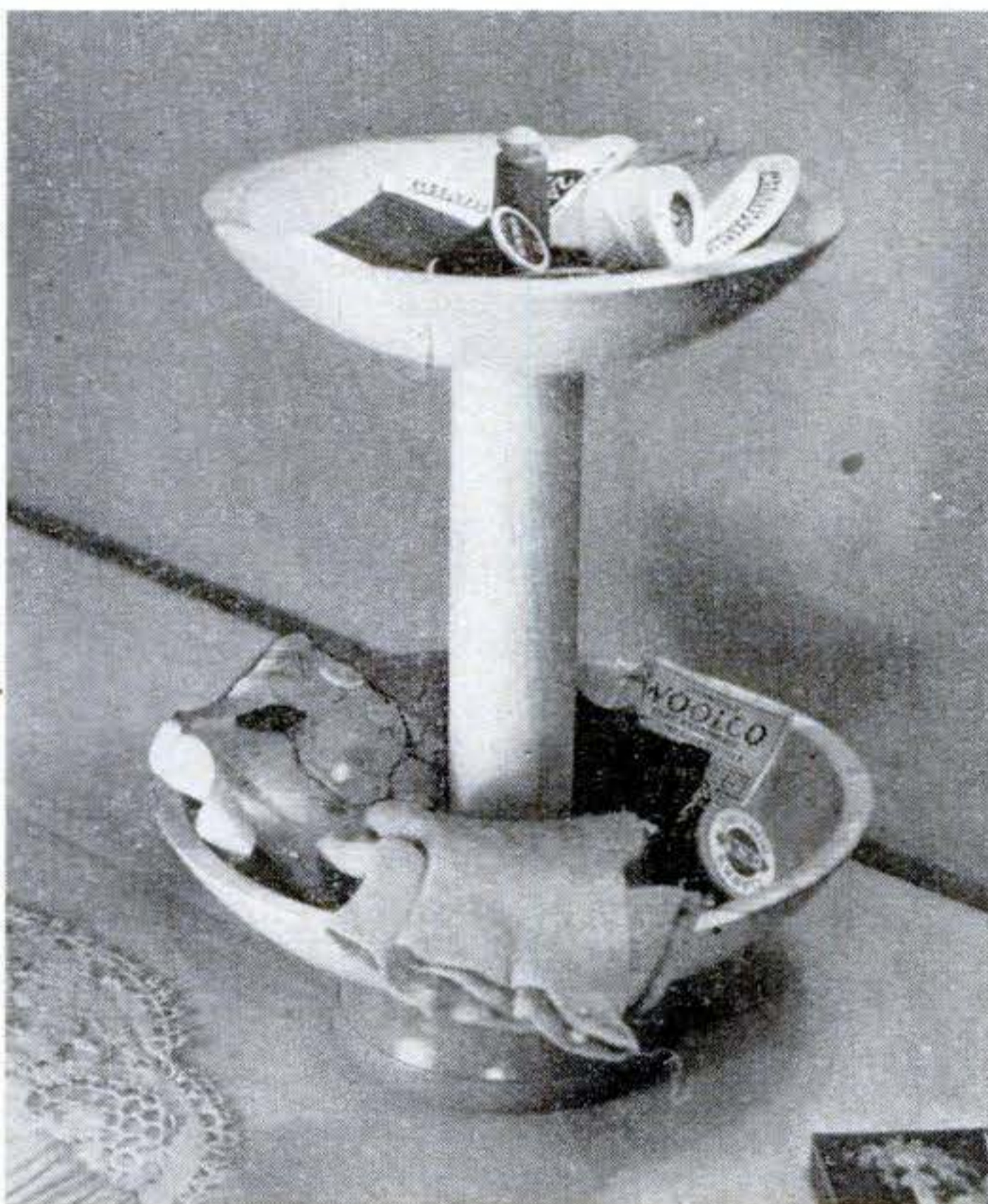

Inverted, a 6½"-diameter wooden bowl can be used instead of legs if you prefer to make this stand low enough to be placed on a table.

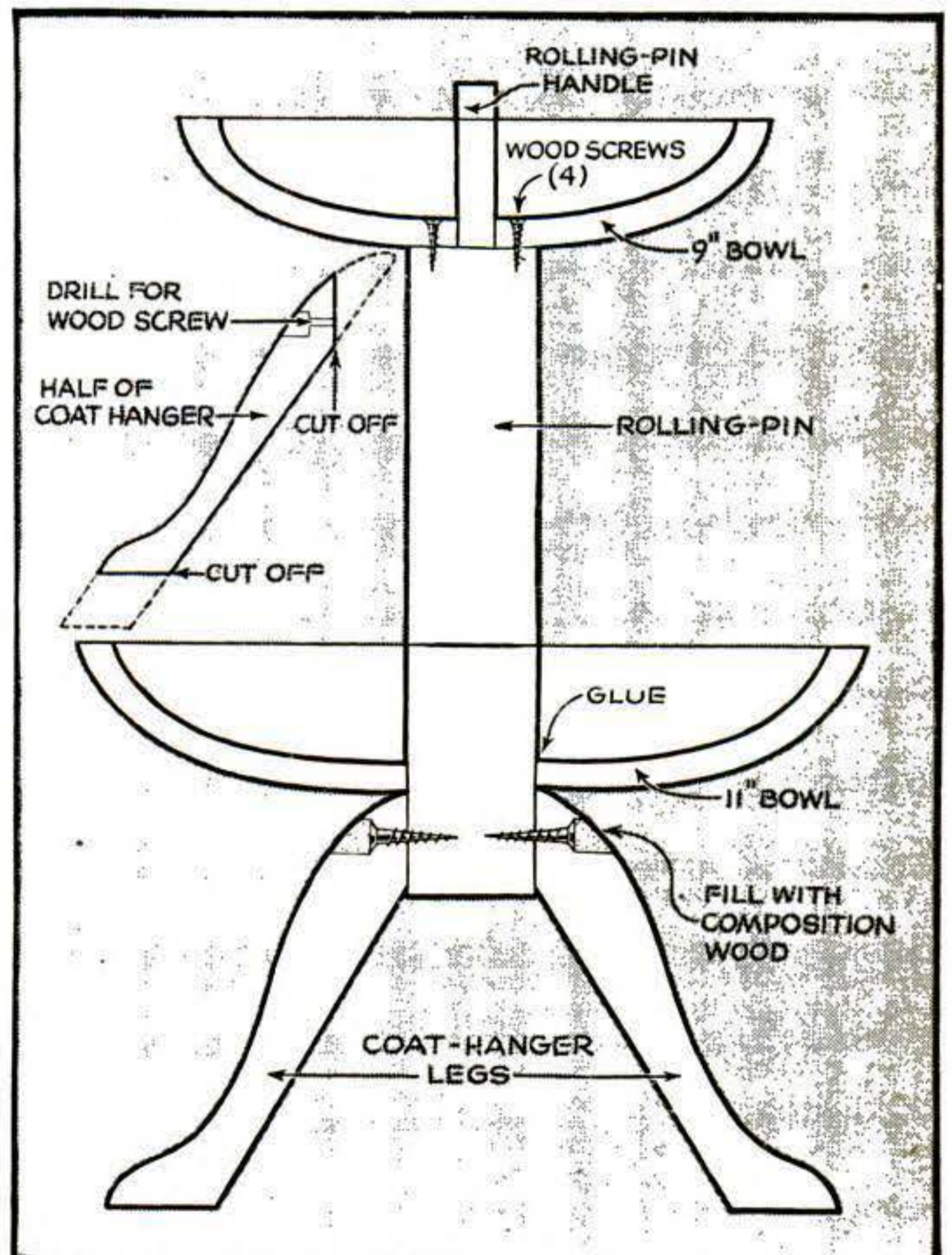

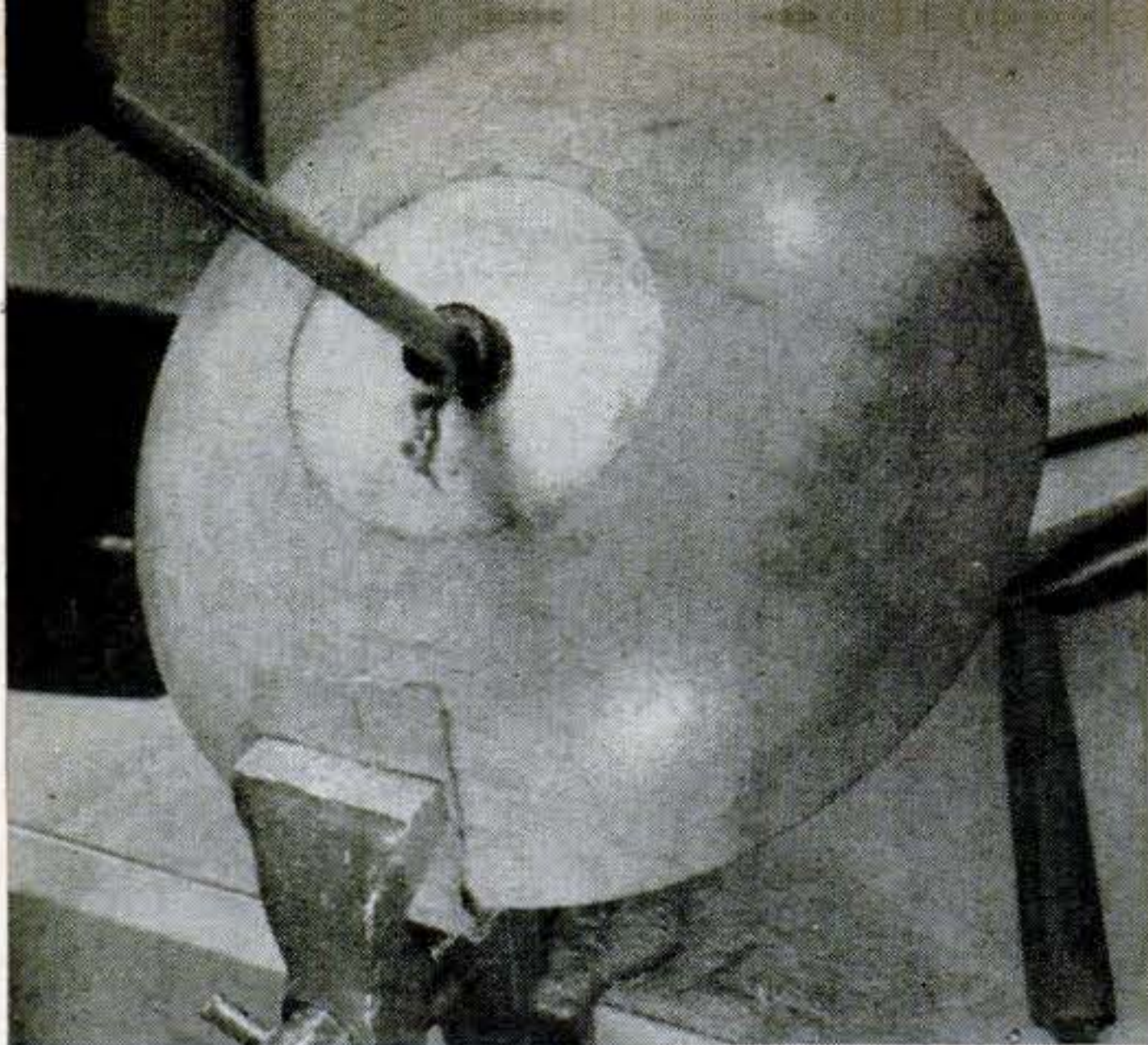

Drilling smaller bowl. Lock it in a vise if you have one, but use cardboard to protect the surfaces. Hole should just clear handle.

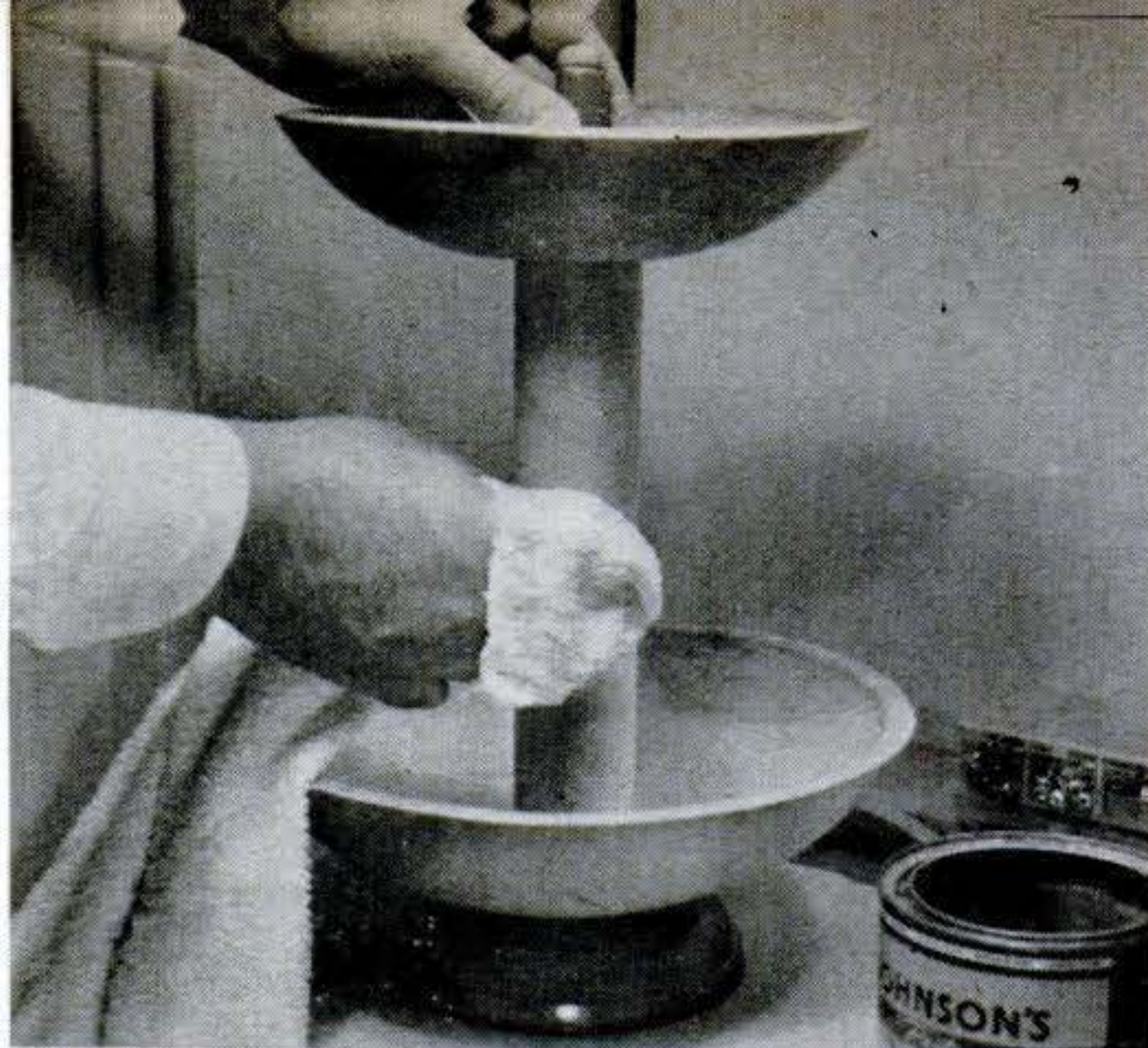

Apply stain to bring bowls, rolling pin, and legs to the same color. Then finish the stand with a couple of well-rubbed coats of wax.

sandpaper to smooth out the jagged edge.

With the bowls on the rolling pin, attach the legs with glue and wood screws as shown in the drawing below. Counterbore for all screws and fill in over the heads with com-

position wood. The lower bowl rests on the three legs. To secure it, use glue.

After the glue and composition wood have dried thoroughly, sand all surfaces and finish the stand with a stain and wax.

Chandelier

Made with Cake and Pie Tins



Here's an Early American design you can make for \$3.40.

IF YOU like to dine by candlelight, this chandelier will serve nicely. And you can buy all the parts in a dime store. Here they are:

- Two 9" cake tins of different depths.

- Three 27" flat curtain rods—the kind that telescope.
- Five 5" pie tins.
- Five 4" individual gelatin molds.
- One adjustable closet pole.

Start by pulling the curtain rods apart. Cut three of the halves exactly in two. Use either the inside pieces or the outside pieces,

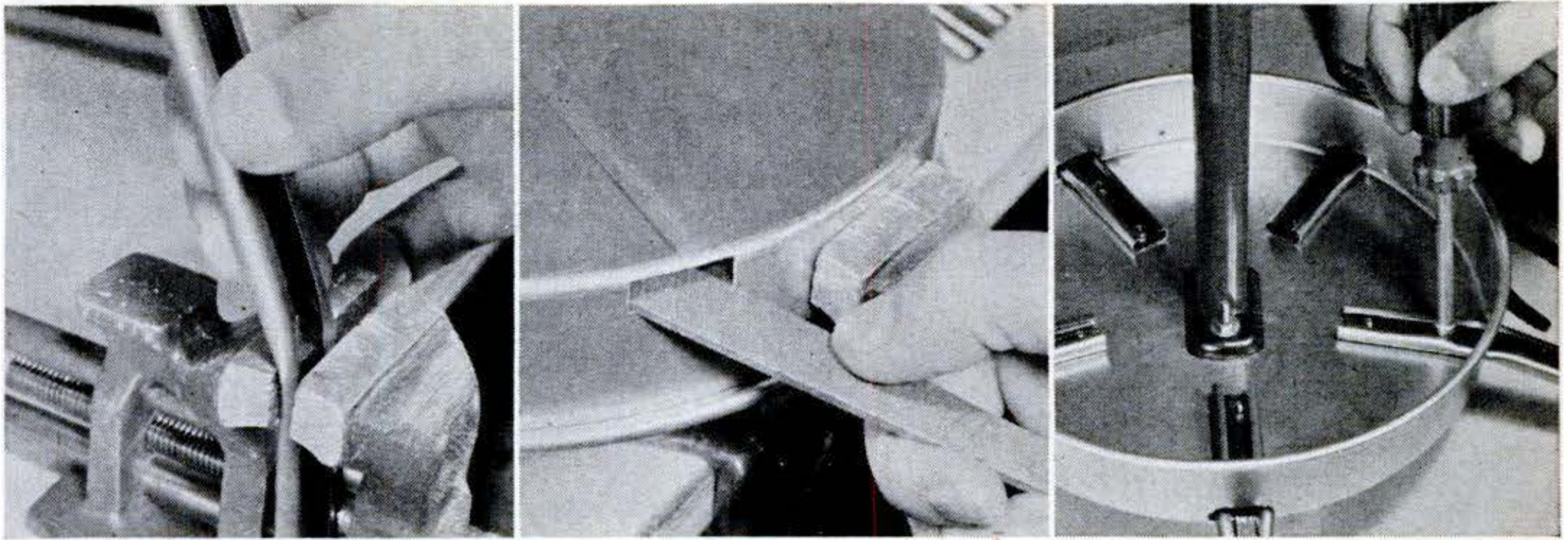

Arms are bent in vise (left). Slots are cut in the side of the deeper cake tin to take the arms. Slot is started by punching or drilling small holes. Then opening is enlarged with file (cen-

ter). Each arm, open side up, is secured inside cake tin by two small bolts and nuts (right). One end of adjustable closet pole is also bolted to the tin. Locate the center exactly for the pole.

but keep them all alike. This gives you the five arms with one left over. Use the sixth to make experimental bends. Then you'll get the feel for the right amount of pressure when you shape the arms. Each arm is bent $2\frac{1}{2}$ " from one end and $3\frac{1}{2}$ " from the other end. Bend the arms to the shape shown in the drawing below.

Mark the bottom of the deeper cake pan into five segments. Where the dividing line of each segment touches the circumference, cut slots in the side for the arms. You can do this by punching or drilling small holes and enlarging them with a file. Then bolt the closet pole to the center of the tin. You can find the center of the tin by cutting a circle of paper to fit inside, folding it in half and then in half again, and then placing it, folded, in the tin again. The apex will be at the center of the tin.

After the arms have been inserted through

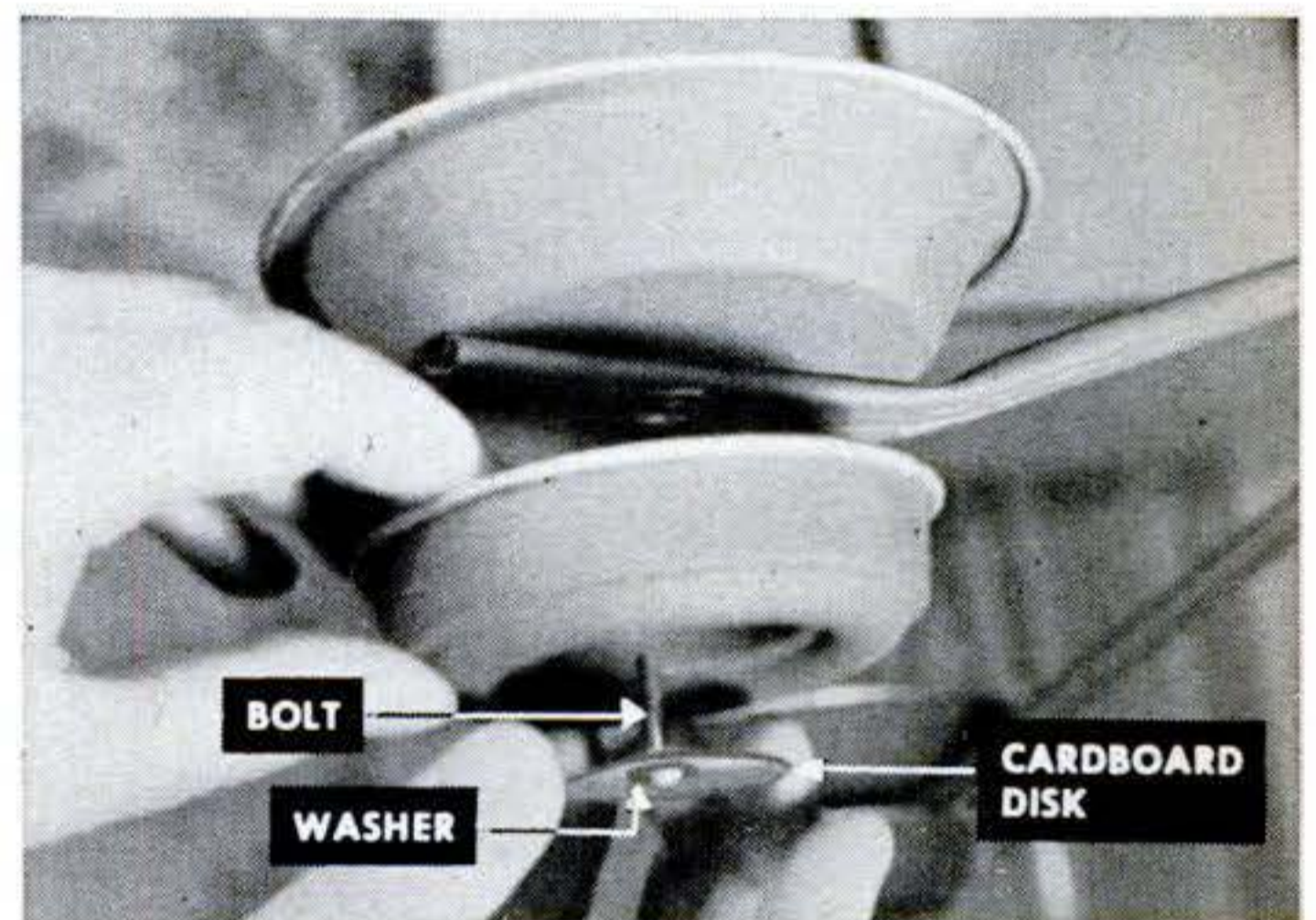

Cardboard disk and washer are slipped over bolt before candle holders are assembled. Disk and washer hold bolt head when nut is tightened.

the slots and bolted down to the first tin, the second cake tin—with a hole cut in the center—is slipped over the closet pole. Place two small pieces of wood inside the tins and screw the tins to the wood. Thickness of the wood, of course, should equal the total depth of the cake tins. The photo above and drawing below show you how to assemble the candle holders. The holders need no candle supports because the candles are pushed down over the tops of the bolt ends. Drill short, blind holes in the candle bases, or make them with a hot nail or wire. END

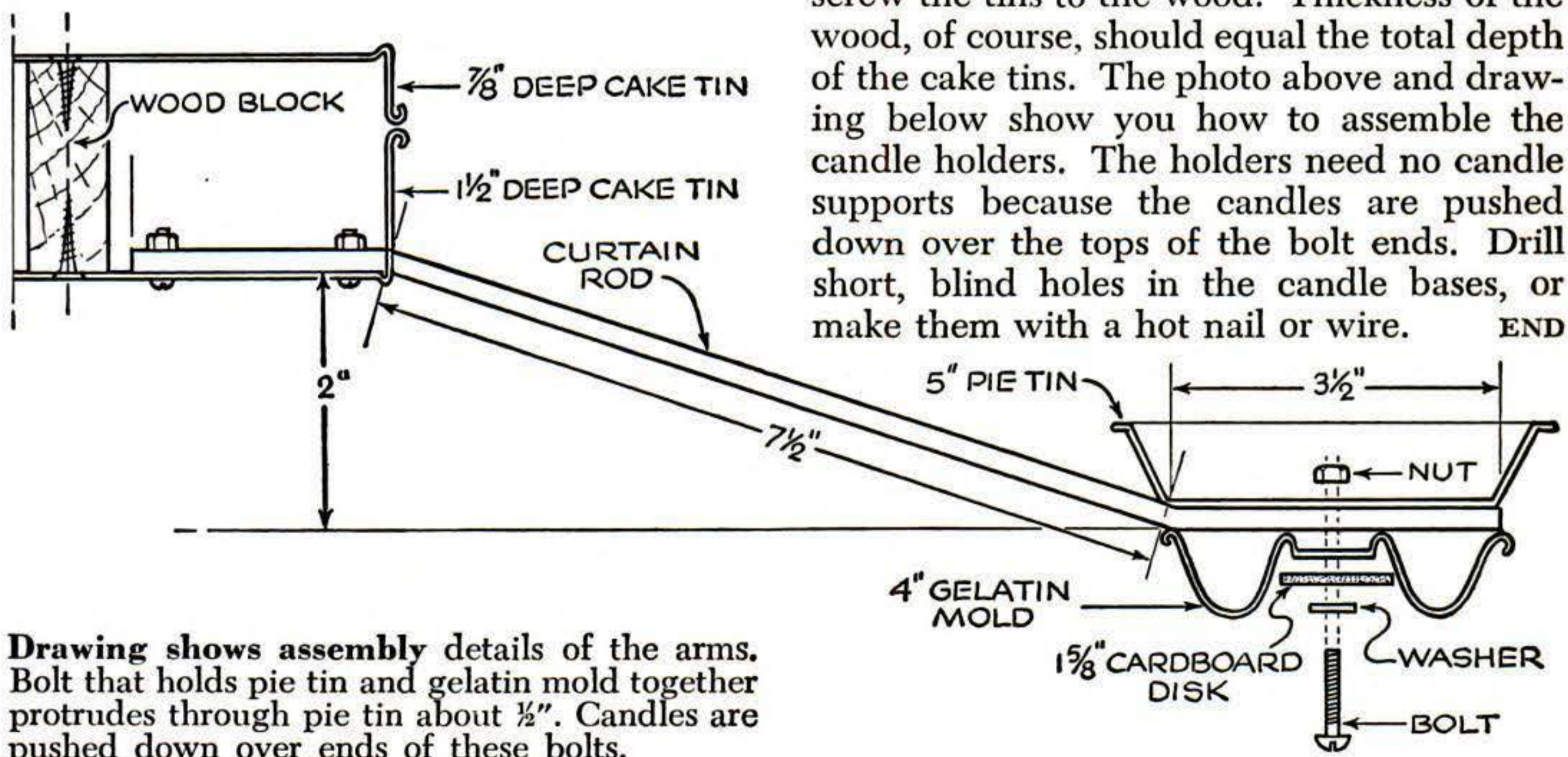

Drawing shows assembly details of the arms. Bolt that holds pie tin and gelatin mold together protrudes through pie tin about $\frac{1}{2}$ ". Candles are pushed down over ends of these bolts.

Waves Serve

As Boat's Engine

Ripples in bathtub propel model of wave-power boat. Fins have flexible rubber hinges.

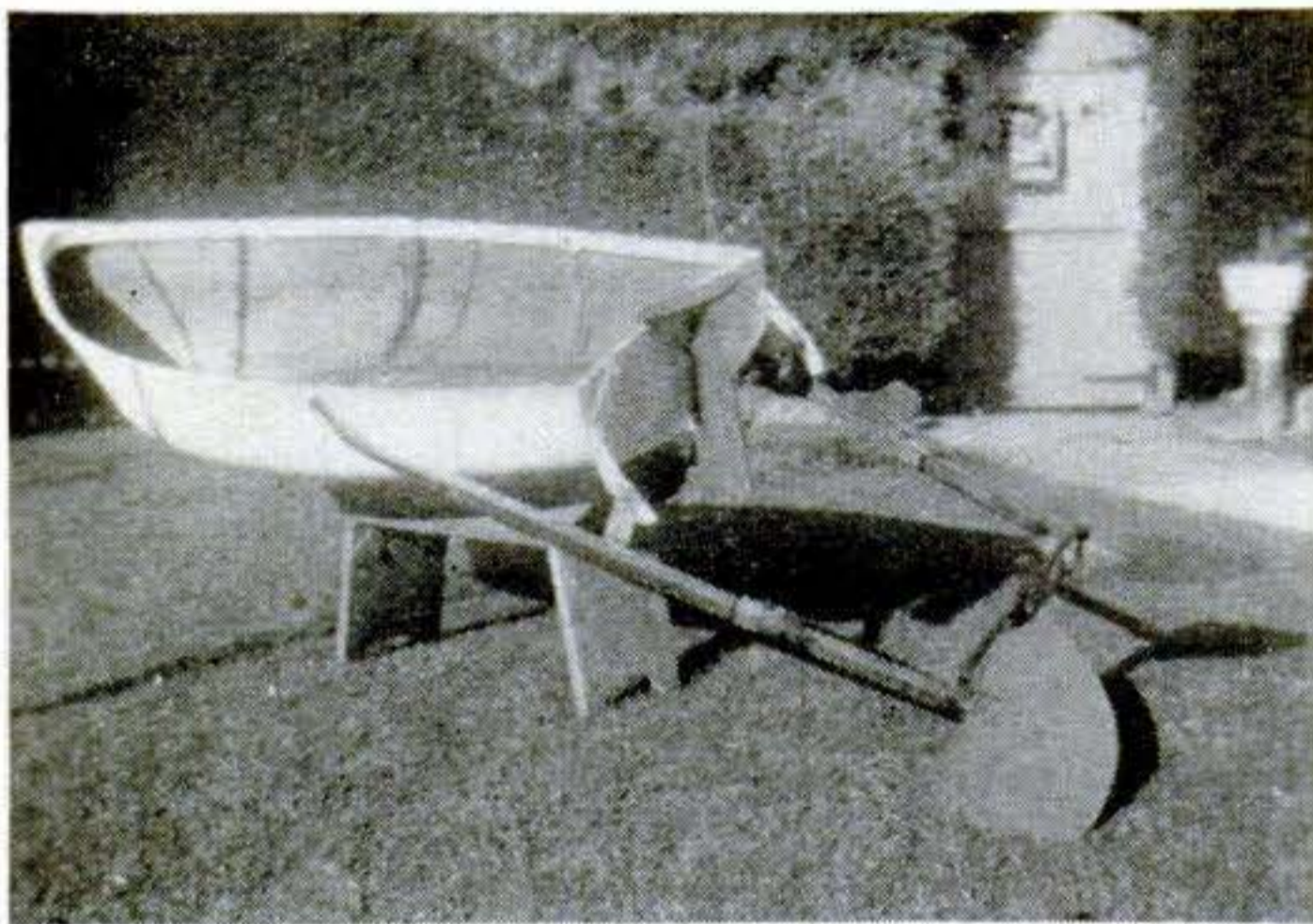

Man-carrying version of engineless boat, designed by John S. McCubbin, of Victoria, Australia, rides sea by harnessing wave power. A conventional rudder steers the odd craft.

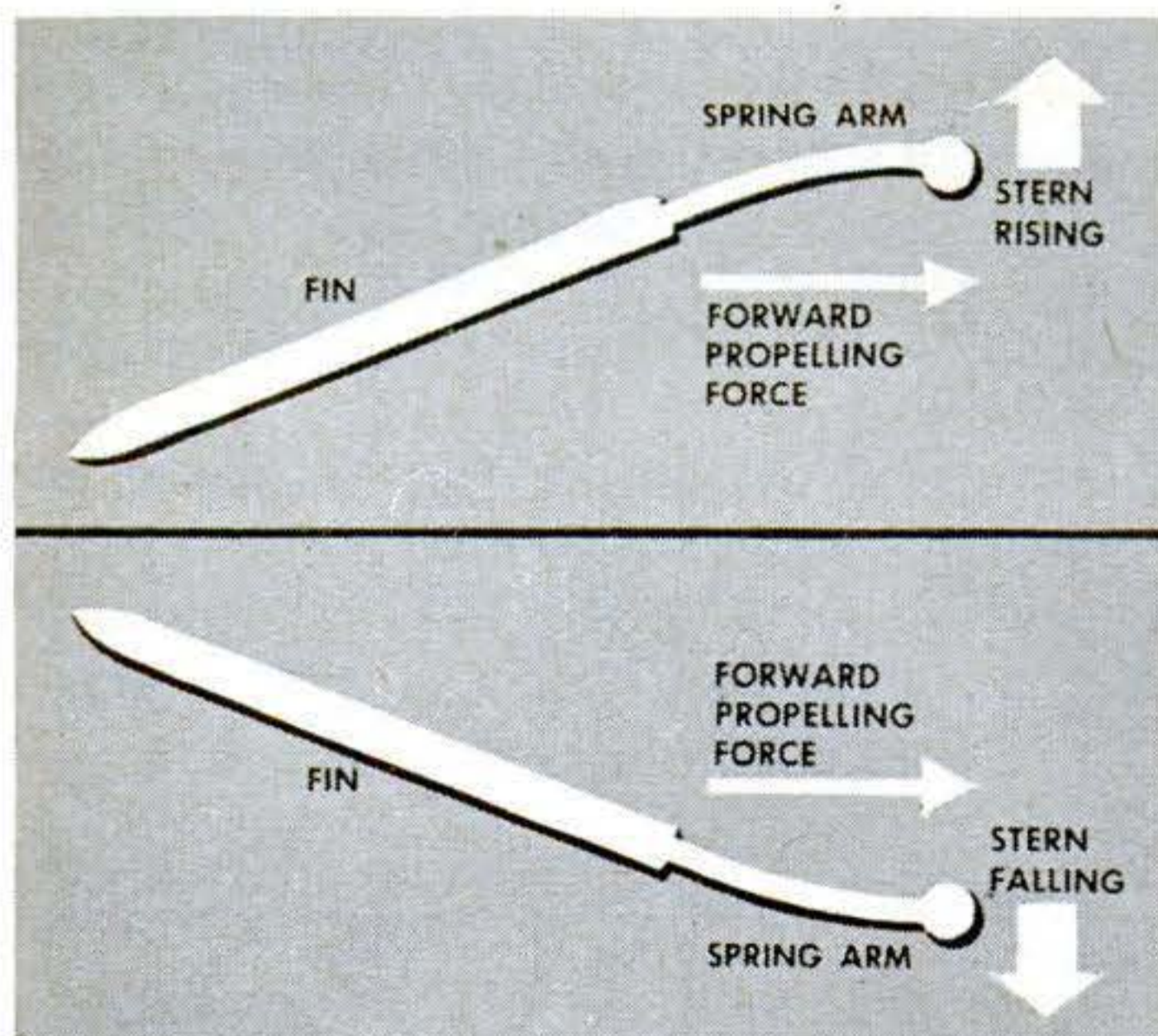

Diagrams show ingeniously simple principle of wave-power boat. Fins are flexibly mounted and exert a forward propelling force, as boat pitches, whether stern is rising or falling.

TRAILING a pair of flippers at its stern, this new boat mysteriously propels itself without apparently receiving power from anywhere. The toy-size model above will sail around a bathtub when the water is only slightly agitated. The man-carrying version at left works in a gentle sea.

Actually, the mystery boat runs by wave power. When passing waves make it pitch even slightly, the flexibly supported fins turn upward or downward, and exert a forward propelling force as their inclined surfaces follow the vertical movement of the stern in either direction.

The inventor of the novel craft, John S. McCubbin, of Victoria, Australia, also envisions a "wave motor" rotated by flexible fins, shown below, that would harness waves to supply power for machinery.

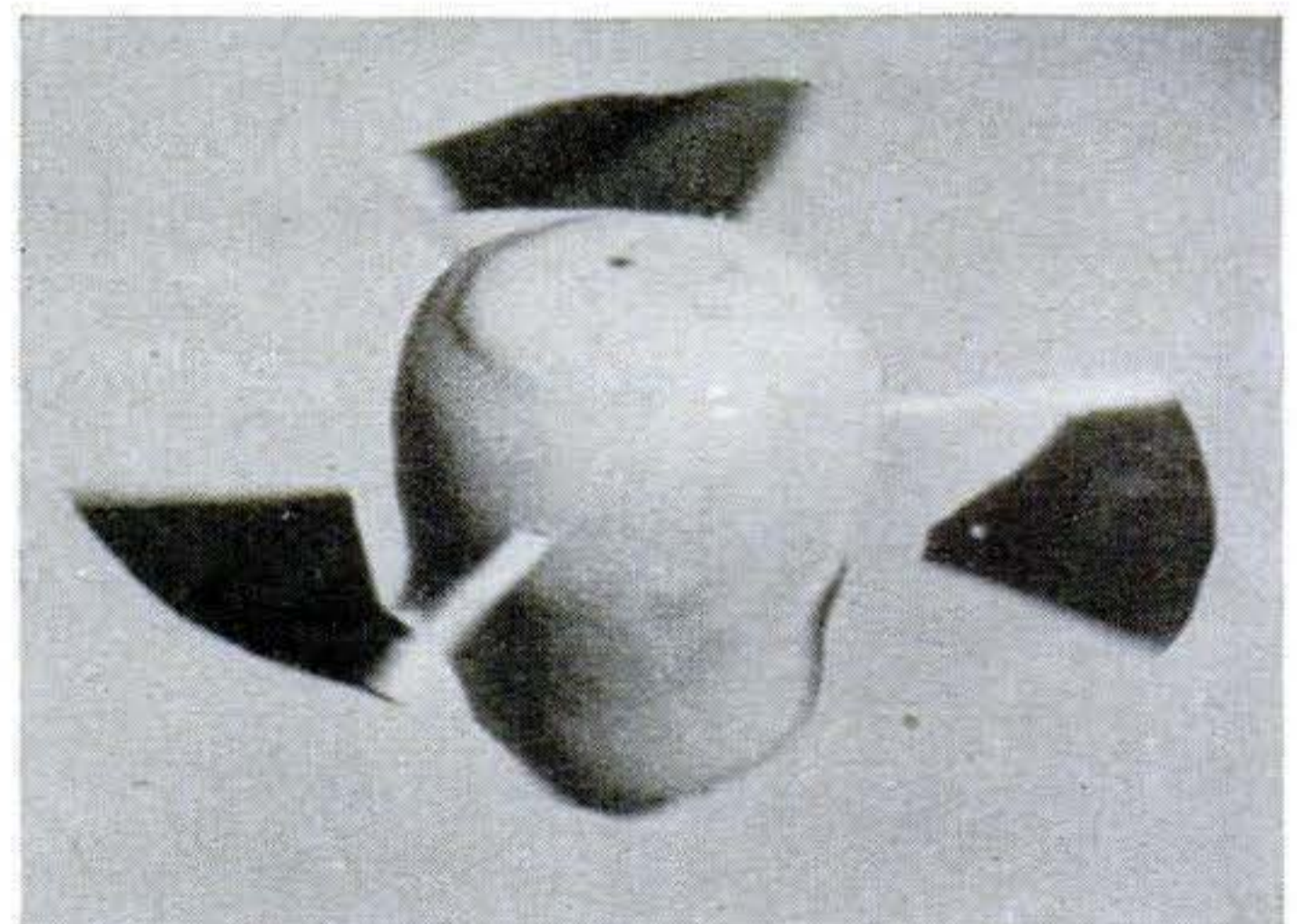

Model of rotating float with flexible fins shows how same principle could be applied in stationary "wave motor." Mounted on shaft, float would supply power to drive machinery.

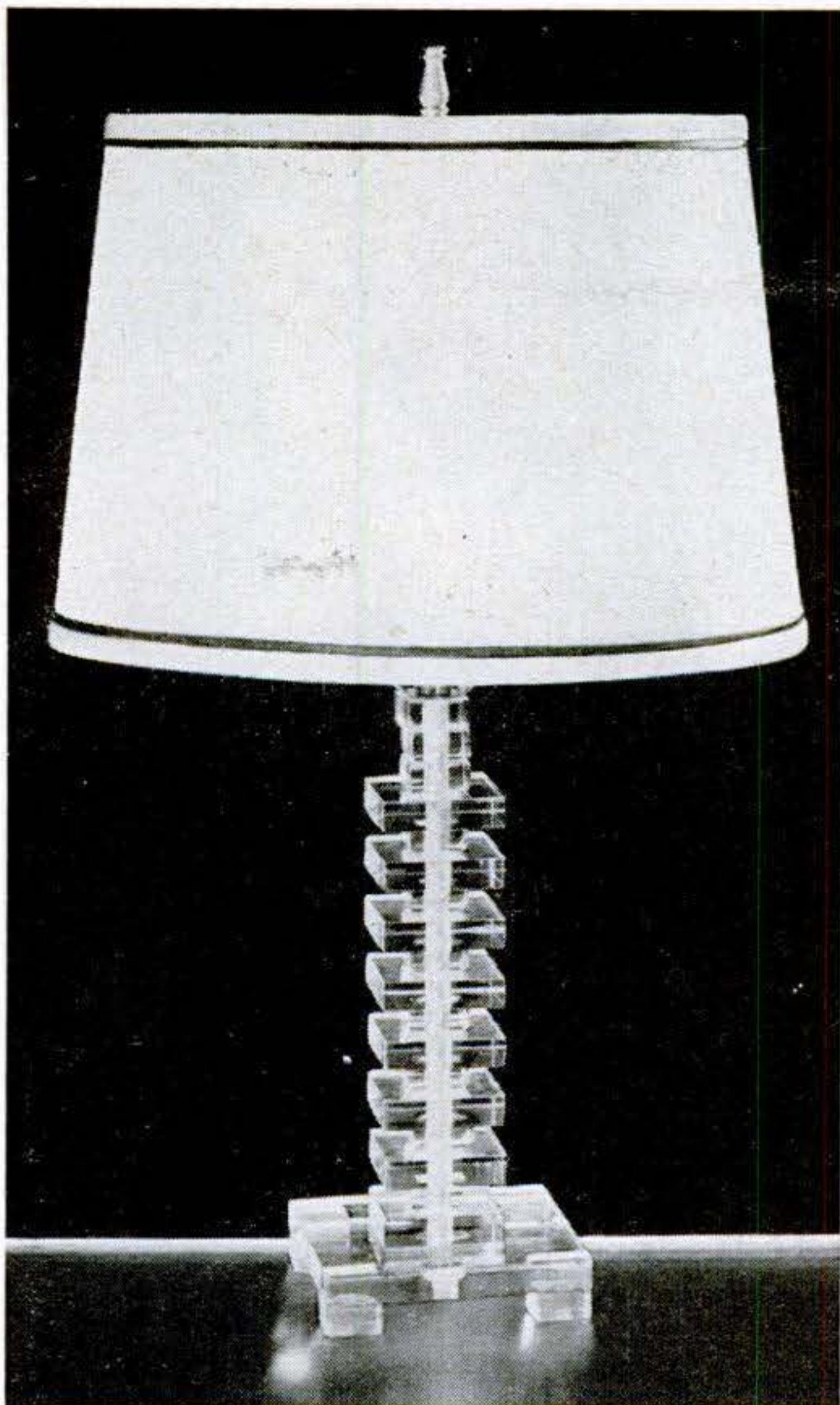

Lamp Base Built Up of Plastic

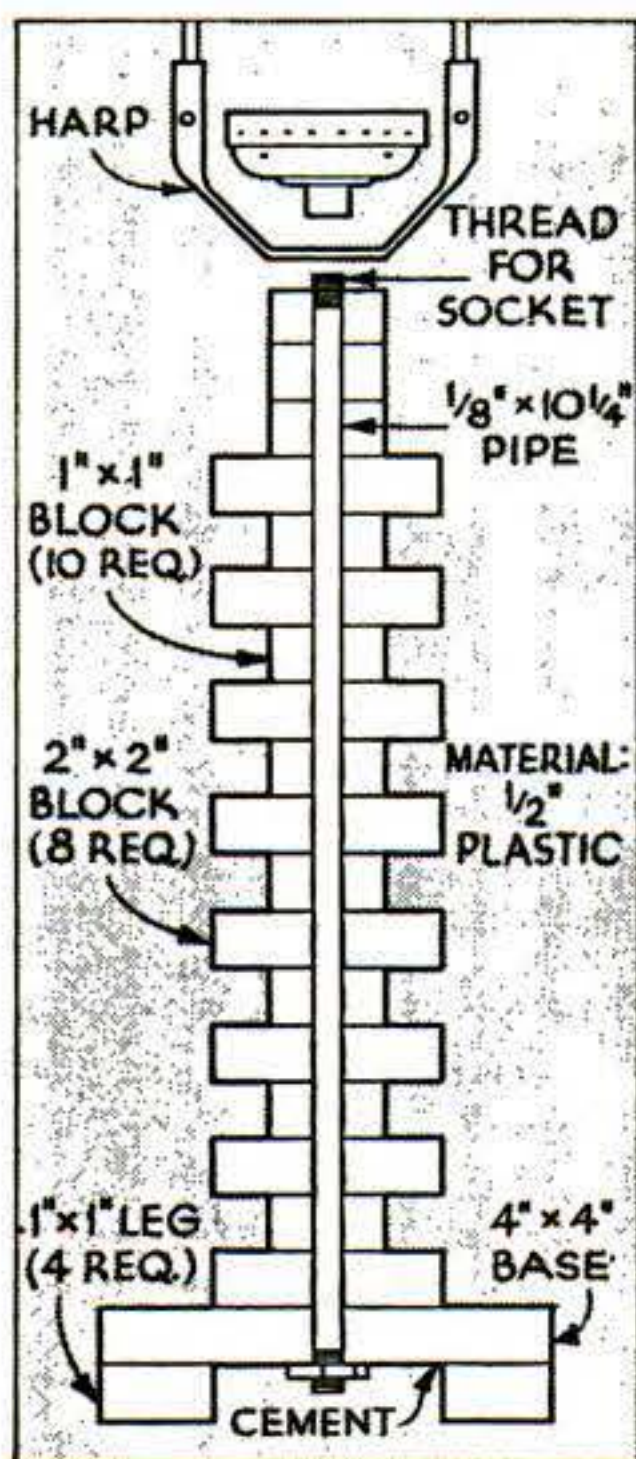

SQUARES of $\frac{1}{2}$ " clear sheet plastic cemented one on top of another make up the base of this homemade lamp. The plastic gleams in a beautiful pattern when the lamp is lit.

One 4" by 4" square, eight 2" by 2" squares, and 14 1" by 1" squares are required. After cutting the squares to size from your sheet stock, sand the edges to a smooth finish, and buff and polish to a high gloss. Drill a $\frac{3}{8}$ " hole in the center of

all pieces except the four 1" leg squares. Cement these to the corners of the 4" base.

Slip all the others over standard lamp pipe (called $\frac{1}{8}$ ", actually $\frac{3}{8}$ " o.d.) and apply cement between. Run the socket leads up through the pipe.—*M. S. Gearon, Chicago.*

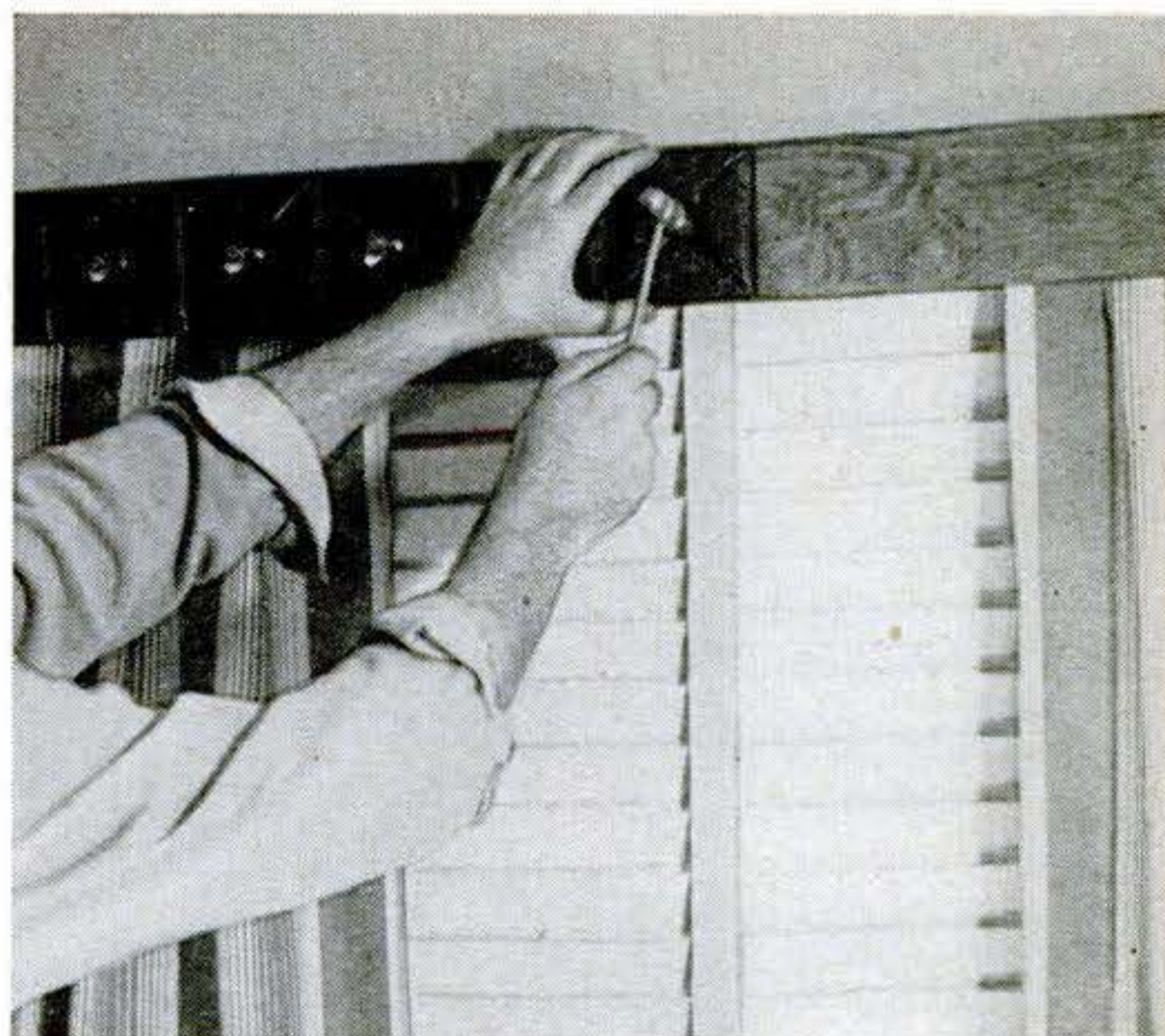

Plastic Squares Bedeck Wood

INSTEAD of painting some wood project you've just completed, you might like to try Deks®. These are 4" by 4" squares of a plastic resembling leather. They come in 10 colors and cost a dime apiece.

Above, Deks cover a valance board. Other uses include bookends, jewel boxes, hassocks, bed headboards, and mirror frames. An upholstery tack holds each square. Deks, Yonkers, N. Y., is the maker.

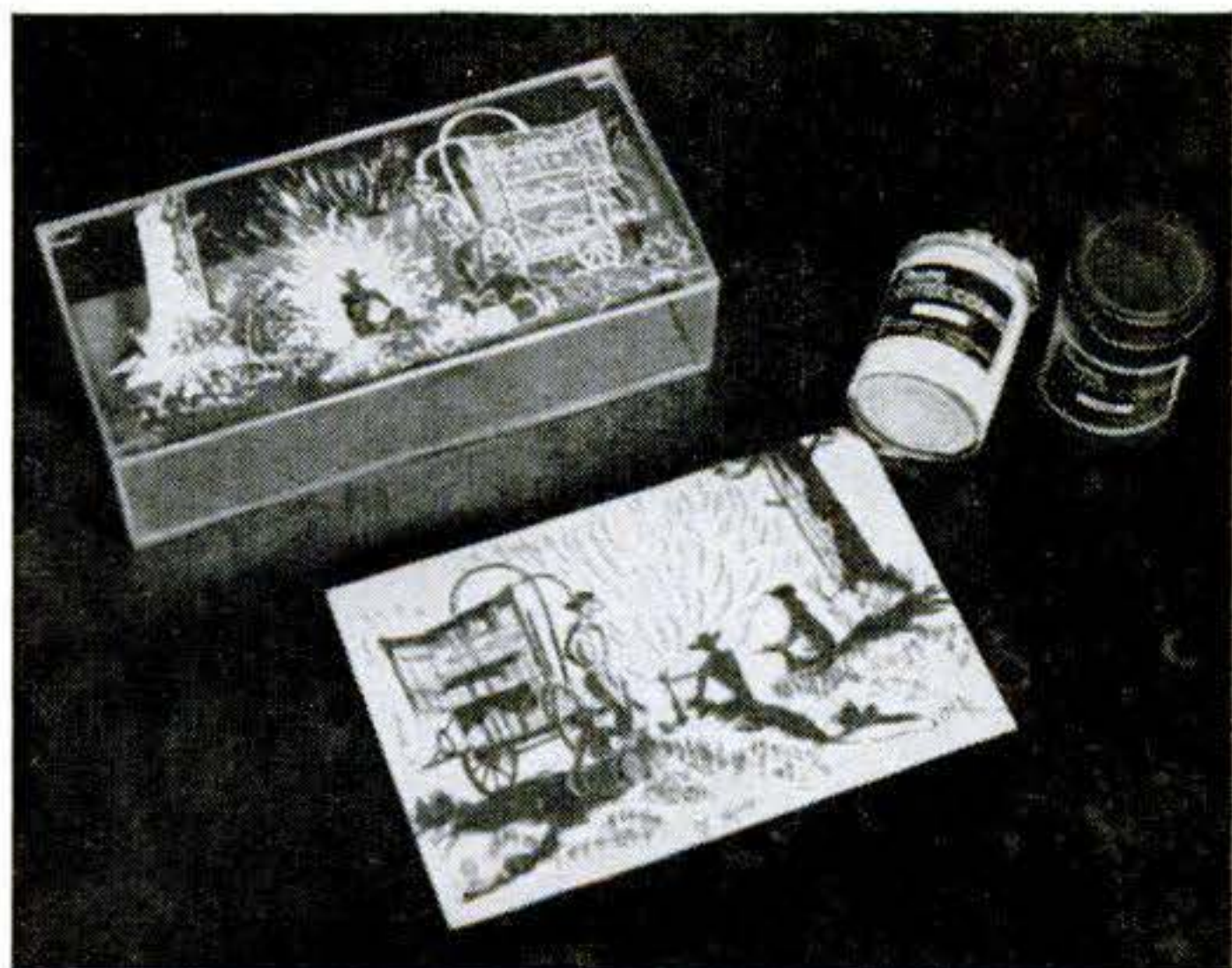

Etched Scene Adorns Plastic

USING a sharp steel needle in a vibrator tool, you can etch decorative scenes on the surface of plastic objects you have made. The plastic box above is an example.

Here, a western scene from a magazine was the pattern. The lid was placed on this, top surface down, and the etching done on the underside. Textile color was rubbed into the etched area with a soft cloth, then cleaned up with a clean cloth. A wax crayon could also be rubbed in for the color.—*O. L. Woolley, Colorado Springs, Colo.*

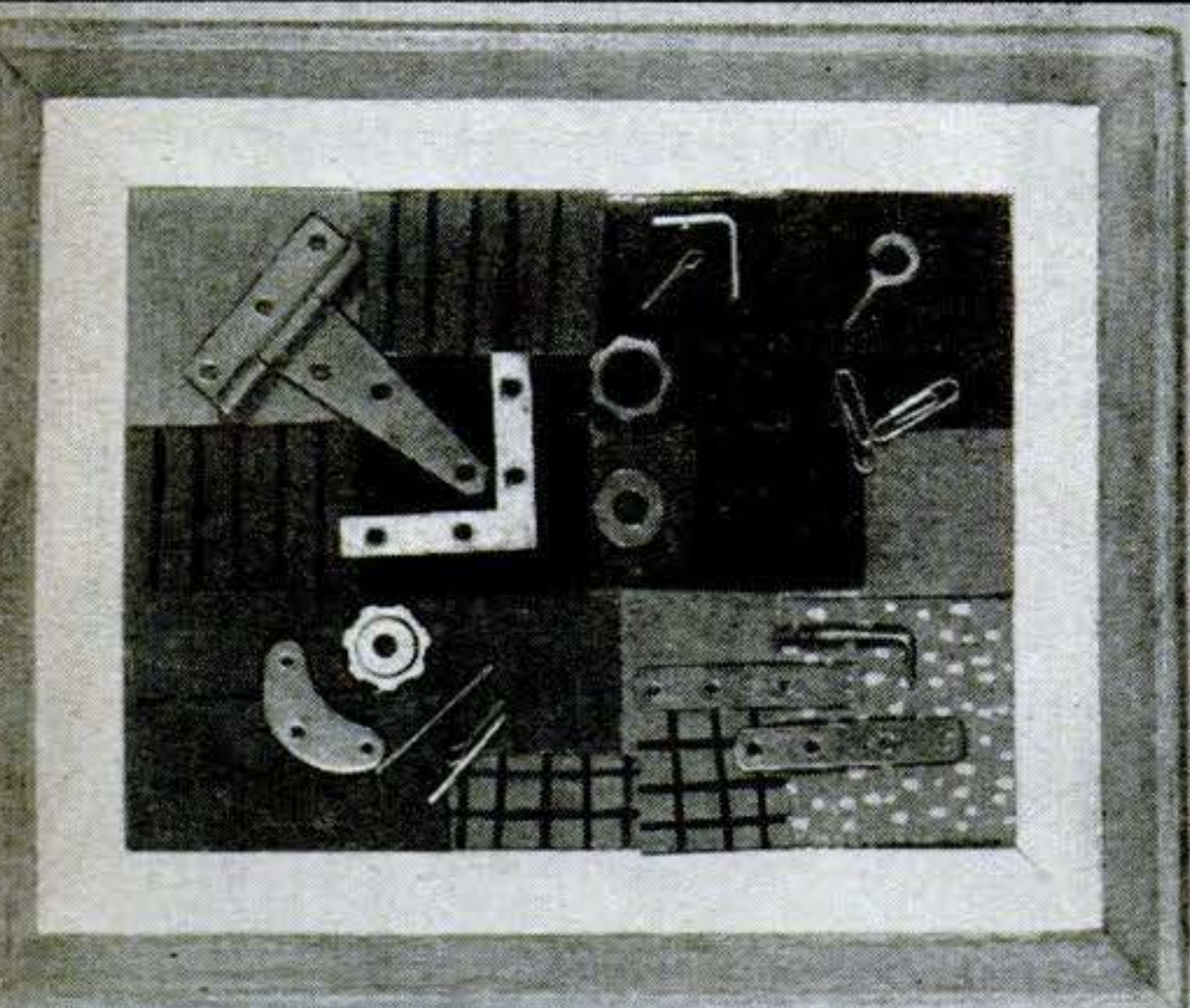
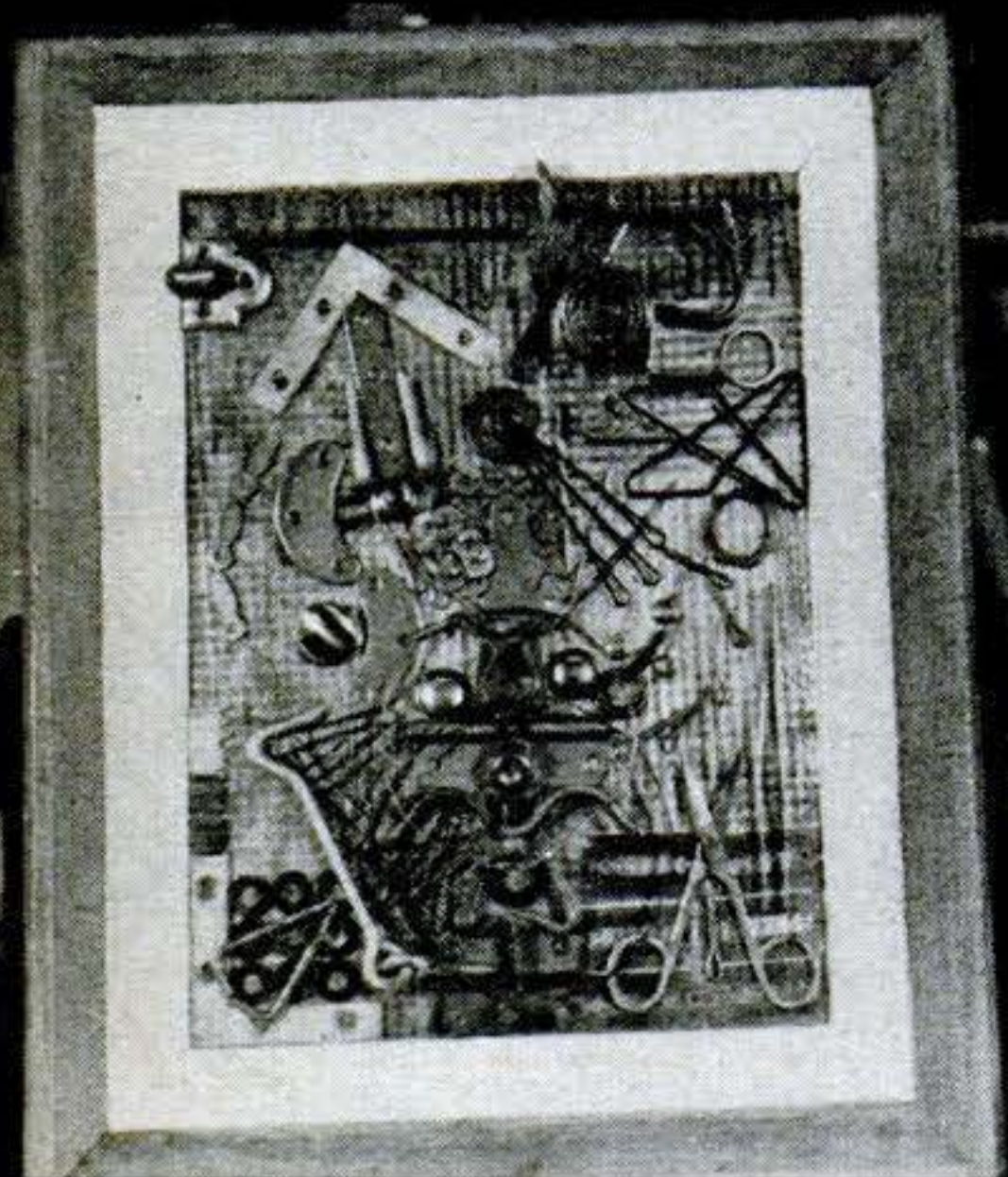
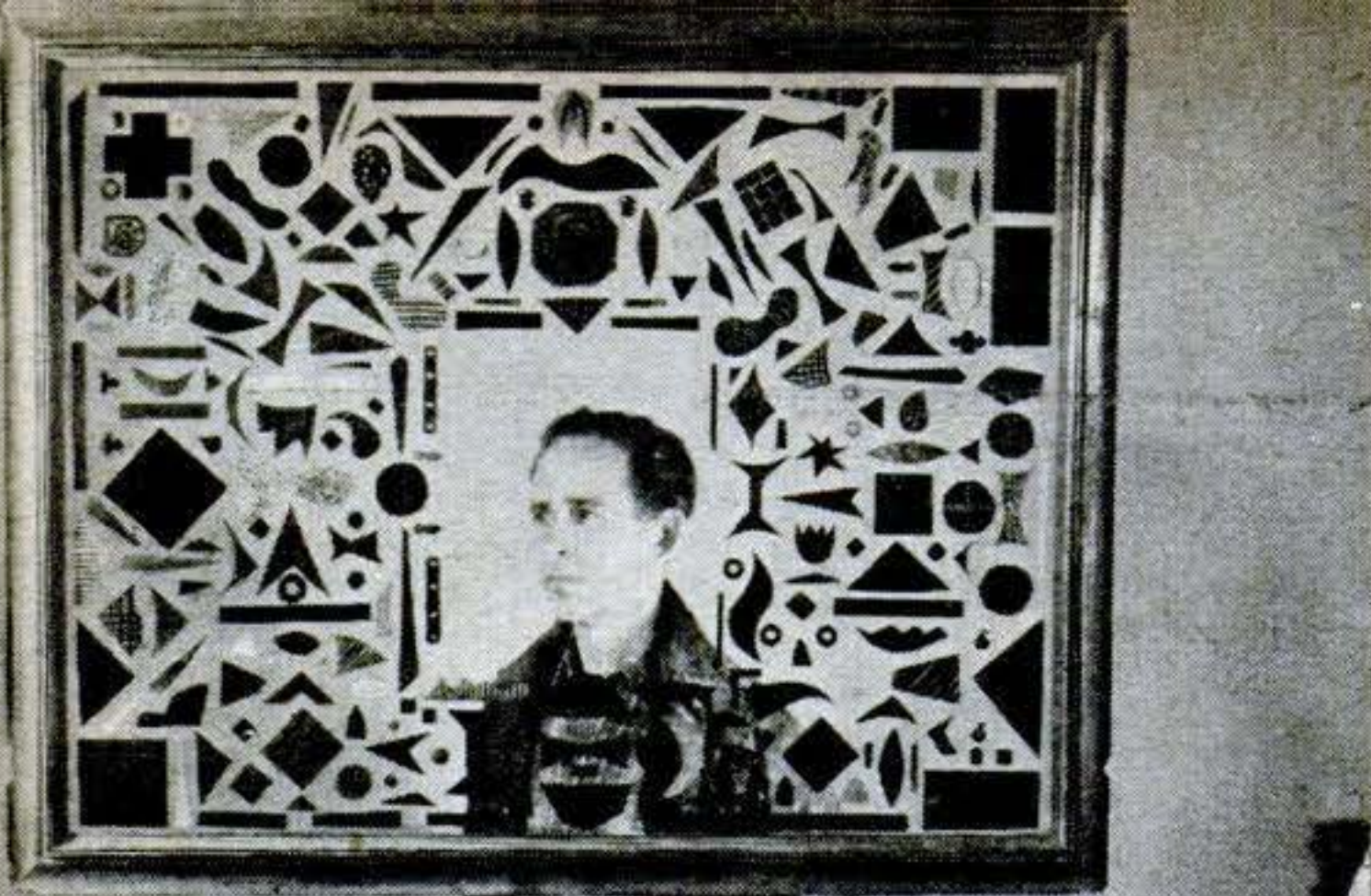

Hardware Serves as Paint

MECHANICAL odds and ends are now being used to teach art. To obtain greater flexibility in non-objective composition, Philadelphia instructor Leonard Nelson developed the "Gismo." It consists of a large picture frame with a metal background and a handful of bar magnets. A large assortment of household objects and variously shaped, brightly painted free forms cut out of sheet iron complete the equipment. The magnets, placed behind the frame, hold the oddly shaped pieces fast to the metal.

Cut-out paper forms have been widely used in teaching non-objective art. But they are likely to be blown around unless pasted down. When the "Gismo" composition is arranged—and rearranged—to the satisfaction of both student and teacher, the final effect is recreated in conventional materials.—Walter Fischman, Manhattan, N. Y.

Splicer Simplifies Editing of Magnetic Tape

QUICK, clean, noiseless splices of magnetic recording tape can be made with the Carson Tape Splicer®, which can be attached right to the recorder. It consists of a metal form with grooves that serve as razor guides. The tape ends are simply clipped to the tool,

slightly overlapping (photo 1), and then razored to a close, clean fit (photo 2). Taping (photo 3) completes the job. Guides along the edges permit easy trimming of the adhesive. Made by Magneccessories, Washington, D. C., the splicer sells for \$2.

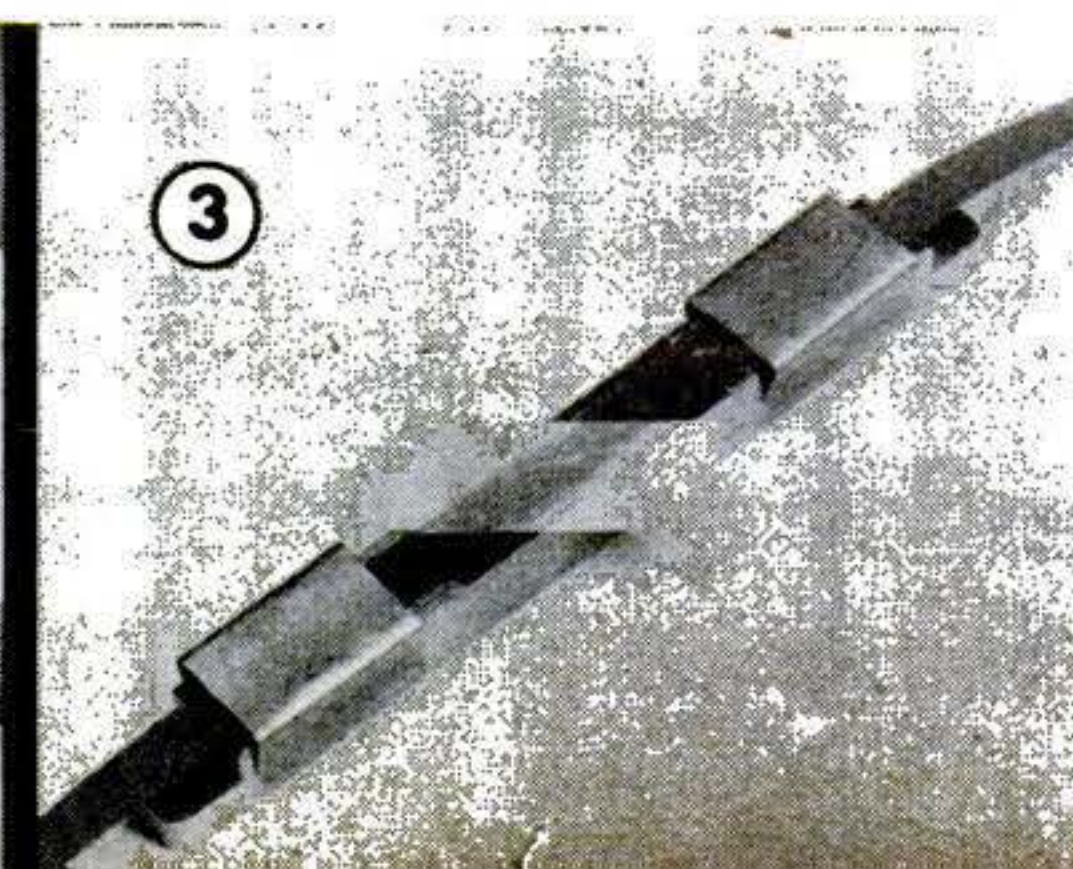
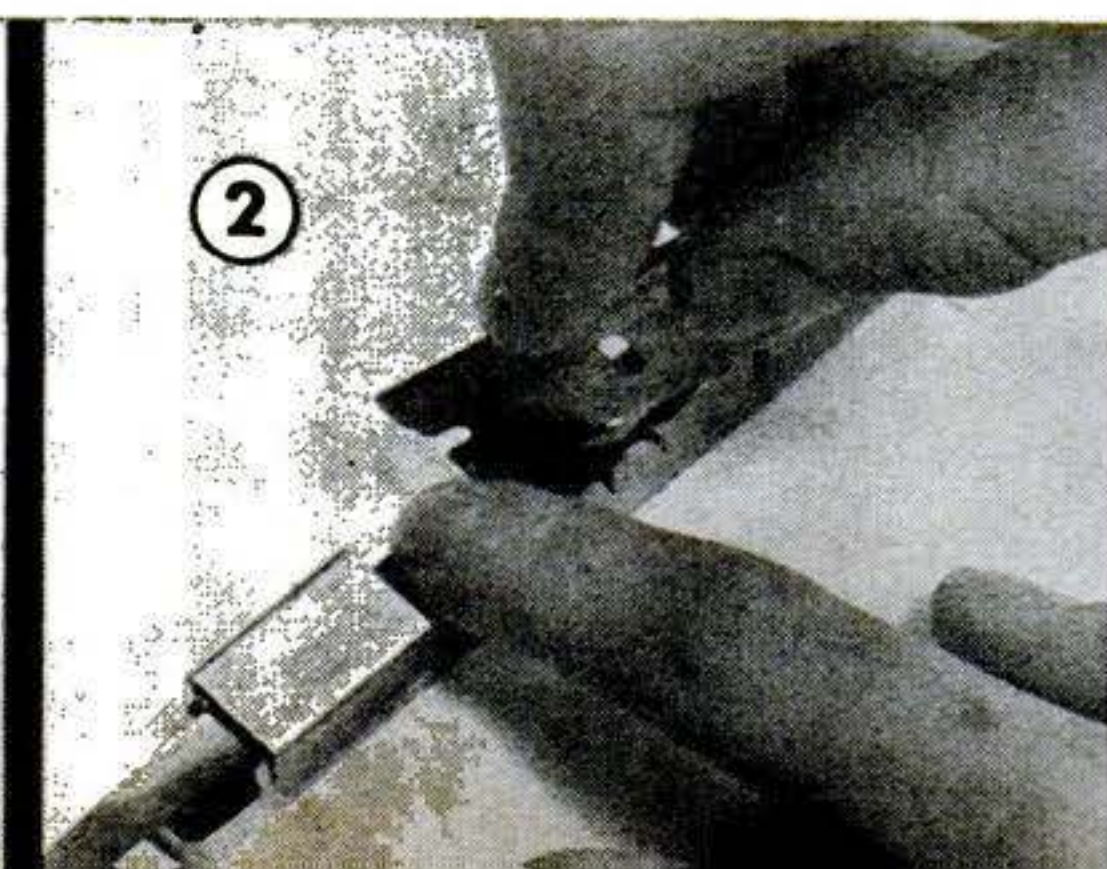
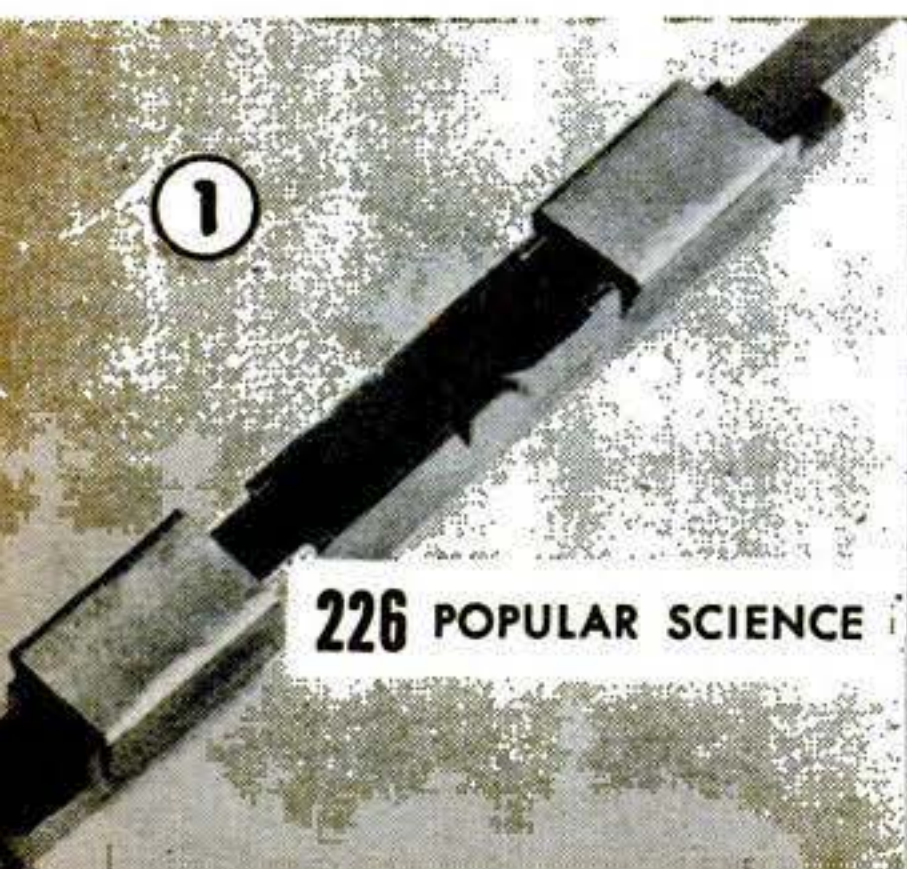

Use a Towel Rack

YOU'LL find many spots where you can put towel racks to work. One over a workbench holds catalogs, magazines, plans, flat or round plastic, or dowels. Ceiling storage also handles table leaves, and a rake and hoe could be stored like the broom.

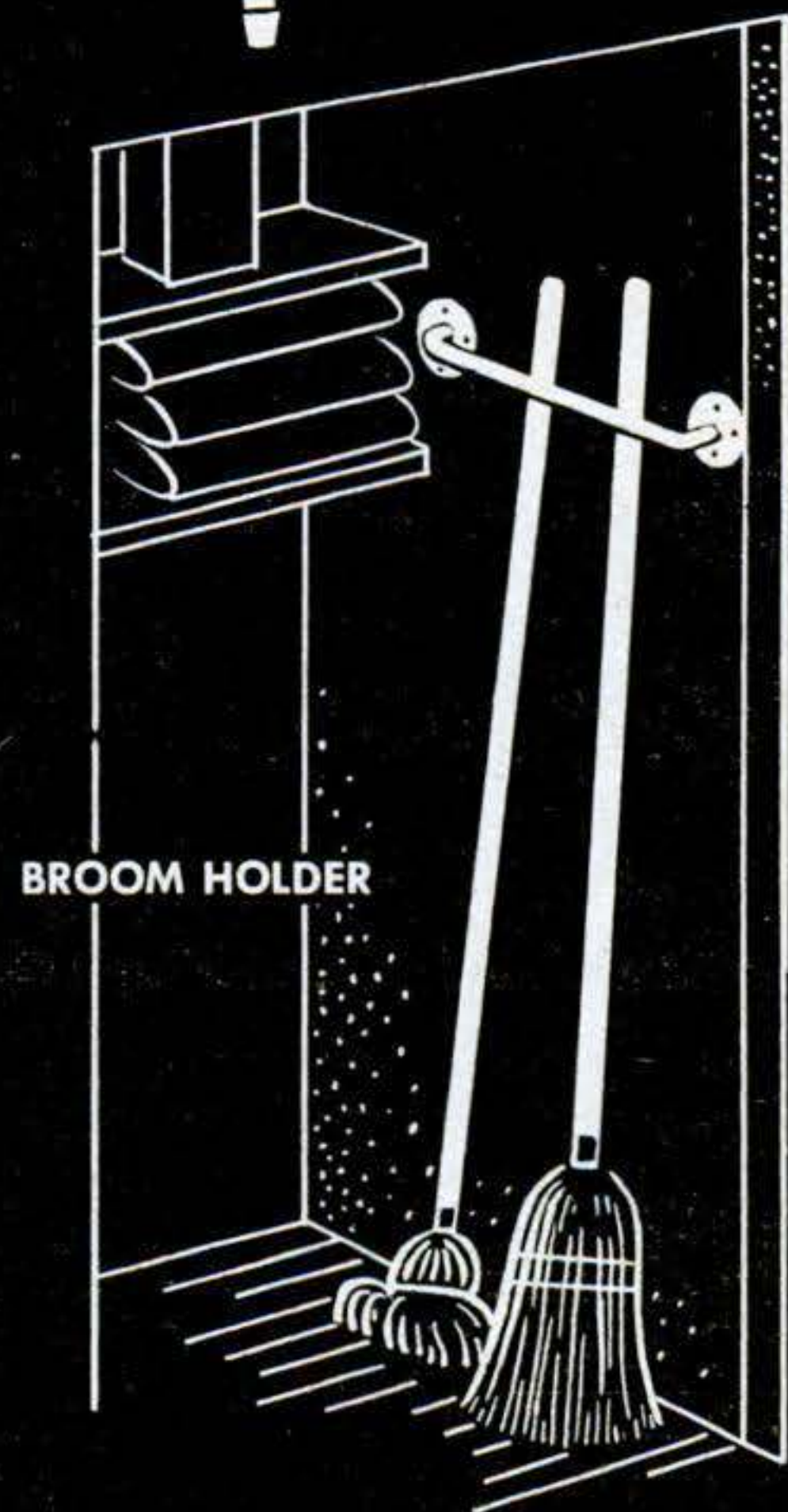
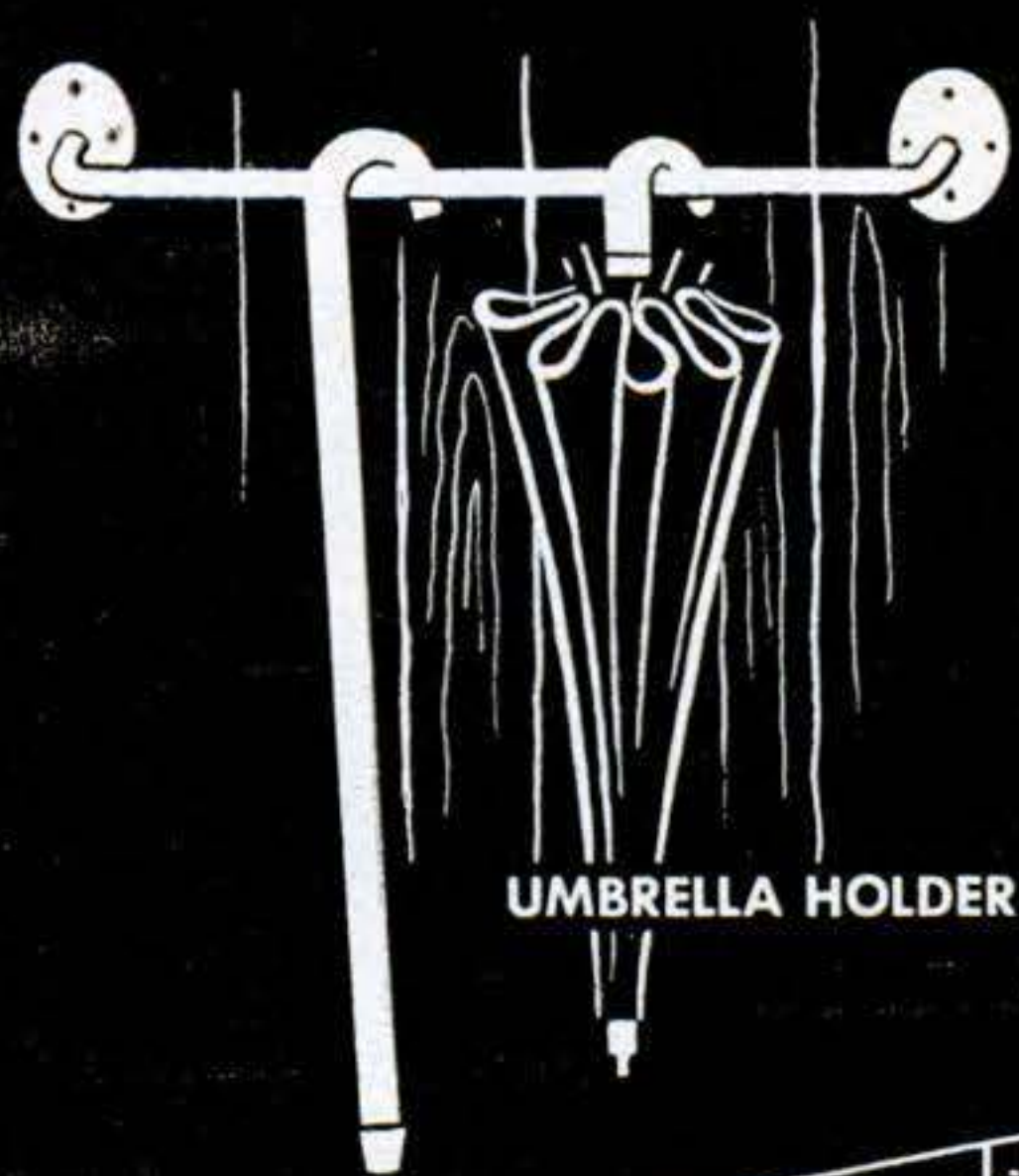
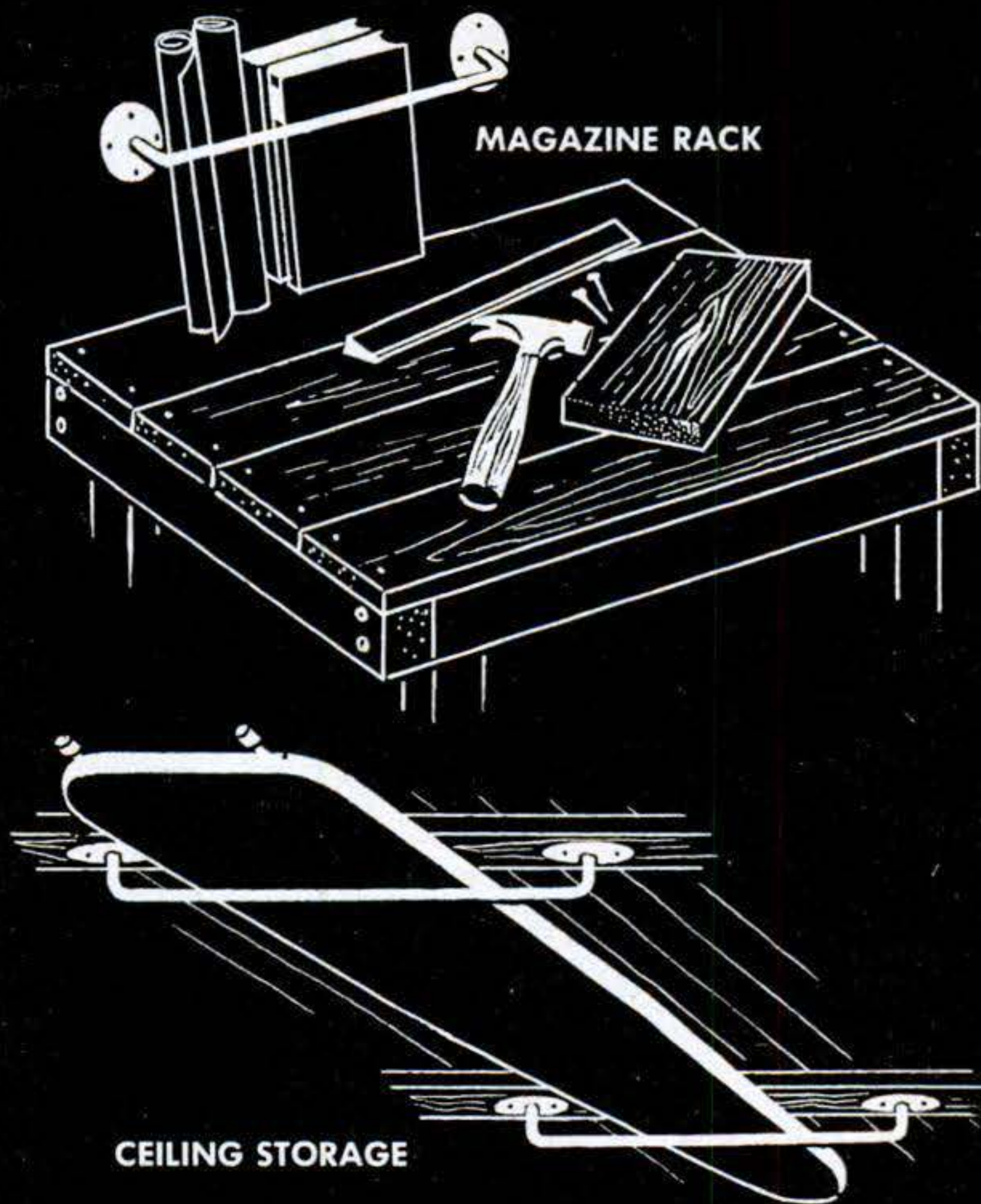

Put Your Walls to Work

WHETHER on a porch or in the house, shelves like those at right make good use of bare wall areas. They are built of stock lumber with nailed butt joints. A $\frac{1}{4}$ " plywood back serves as a brace for the shelves.

You can hang them with screws through the back or you can use shelf brackets underneath with one or two screws through the back near the top to steady the shelves. Before you cut up your lumber, make a scale drawing. Then the compartments will be the right size to handle the objects you want to put in them.—Hi Sibley, Nuevo, Calif.

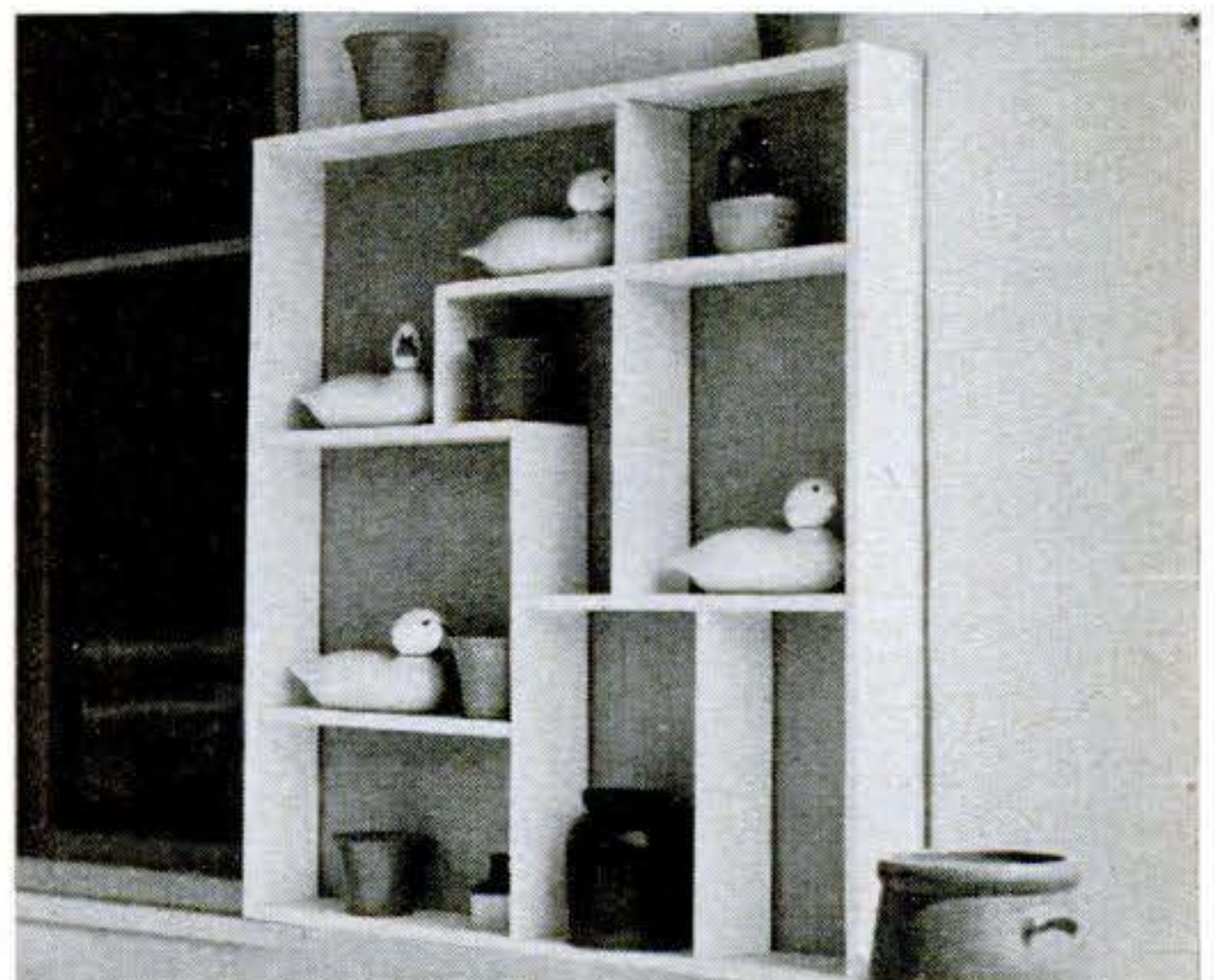

 **NEW SHOP IDEAS**

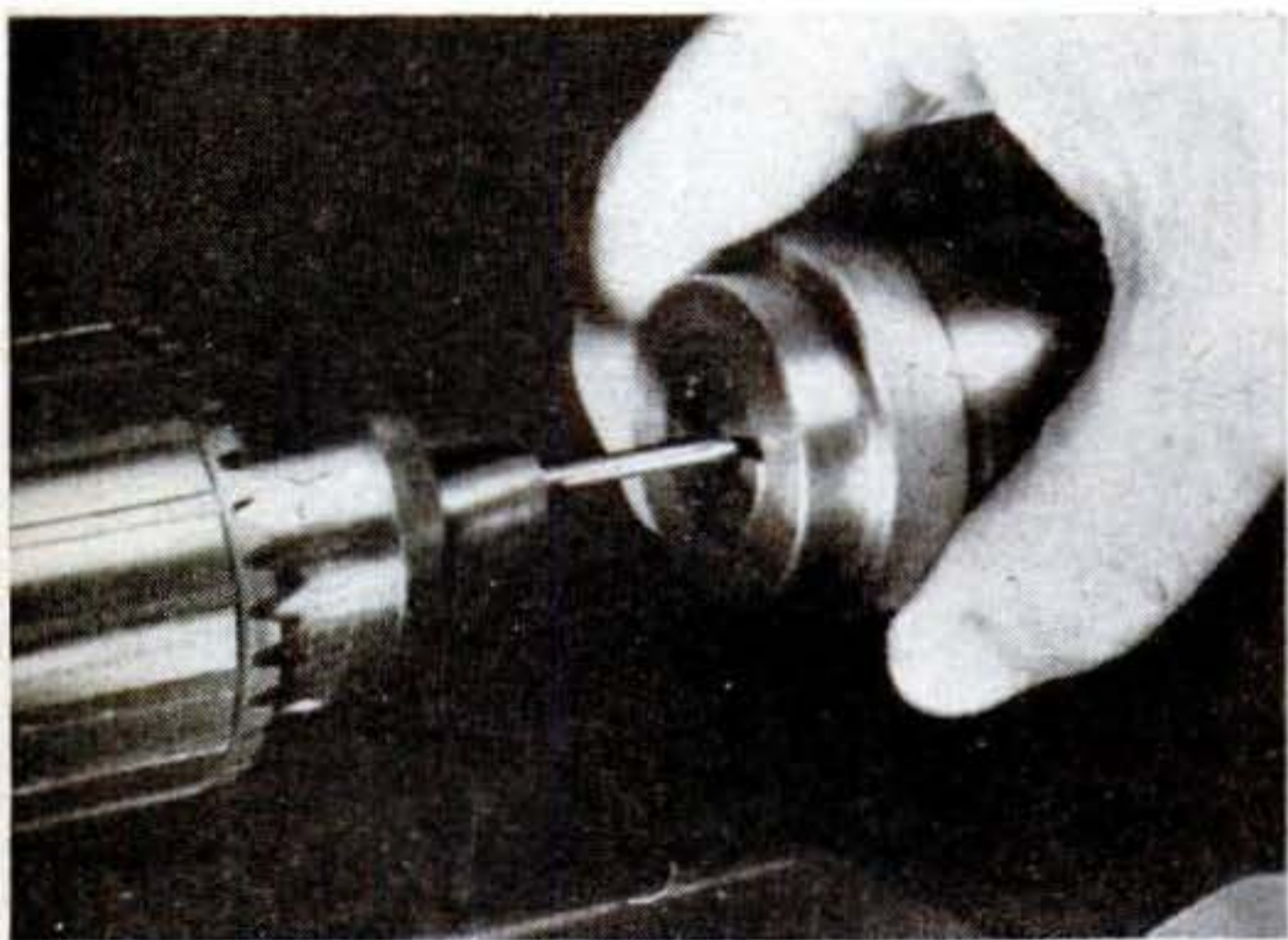
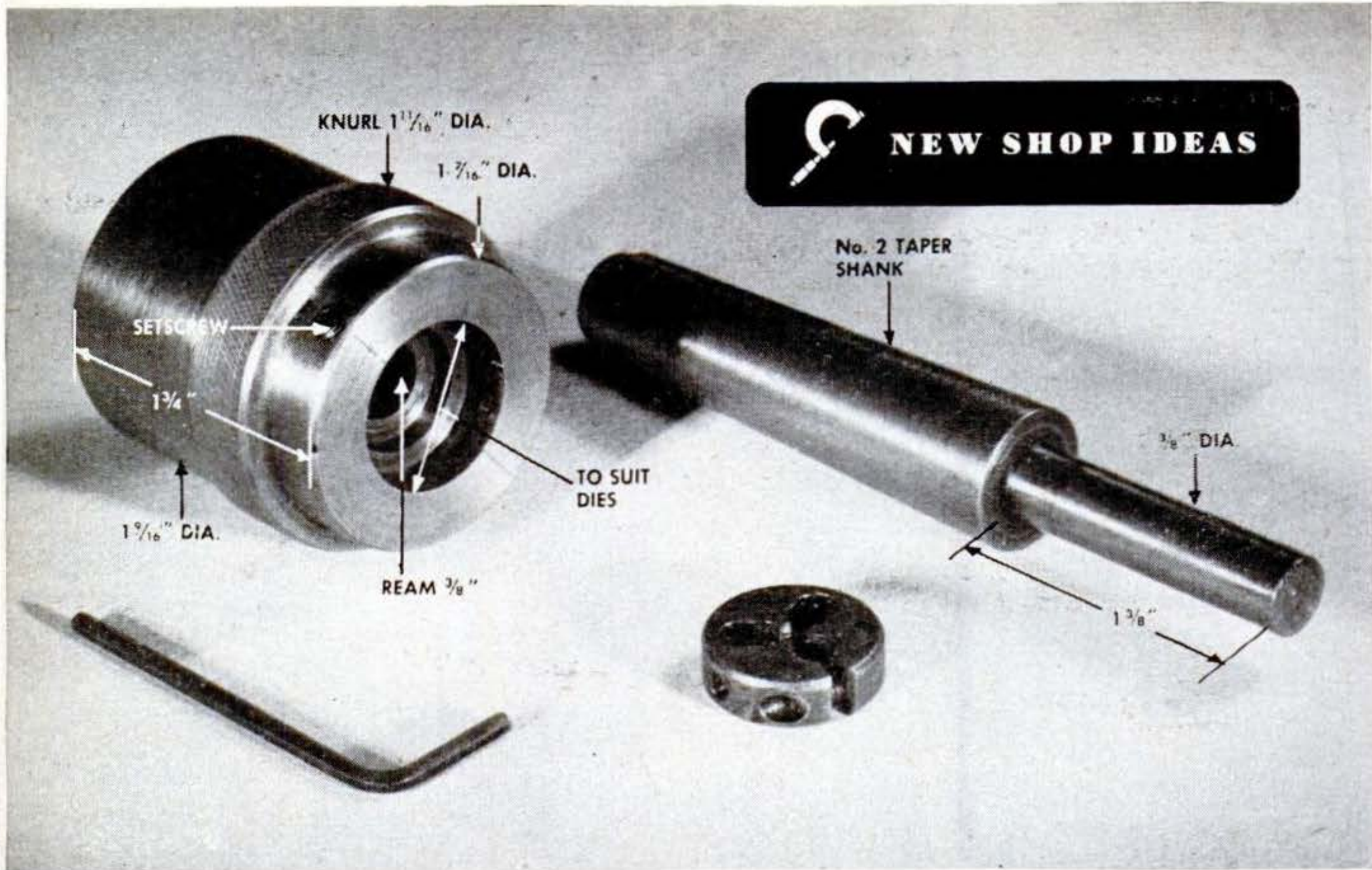

Dies Held Square. For threading work in the lathe, a die is often held against a drill pad while the spindle is turned by hand. Since the rotating parts have a considerable mass, it's hard to tell by feel how the die is cutting or how fast to advance it, so threads are often damaged or not started square.

This tailstock die holder gets them square and leaves the die free to follow the thread. To make it, turn the outside of a piece of 1 3/4" cold-rolled steel; knurl, face, and drill through the 3/8" pilot hole. Bore the die seat to a push fit, using a fully expanded die as a plug gauge. Reverse to face the other end.

Insert a long taper shank in the spindle and turn the pilot a sliding fit in the holder. In use, clamp the tailstock and advance the wheel only to start the die. Then simply turn the holder by hand.—*J. Tracy, New York City.*

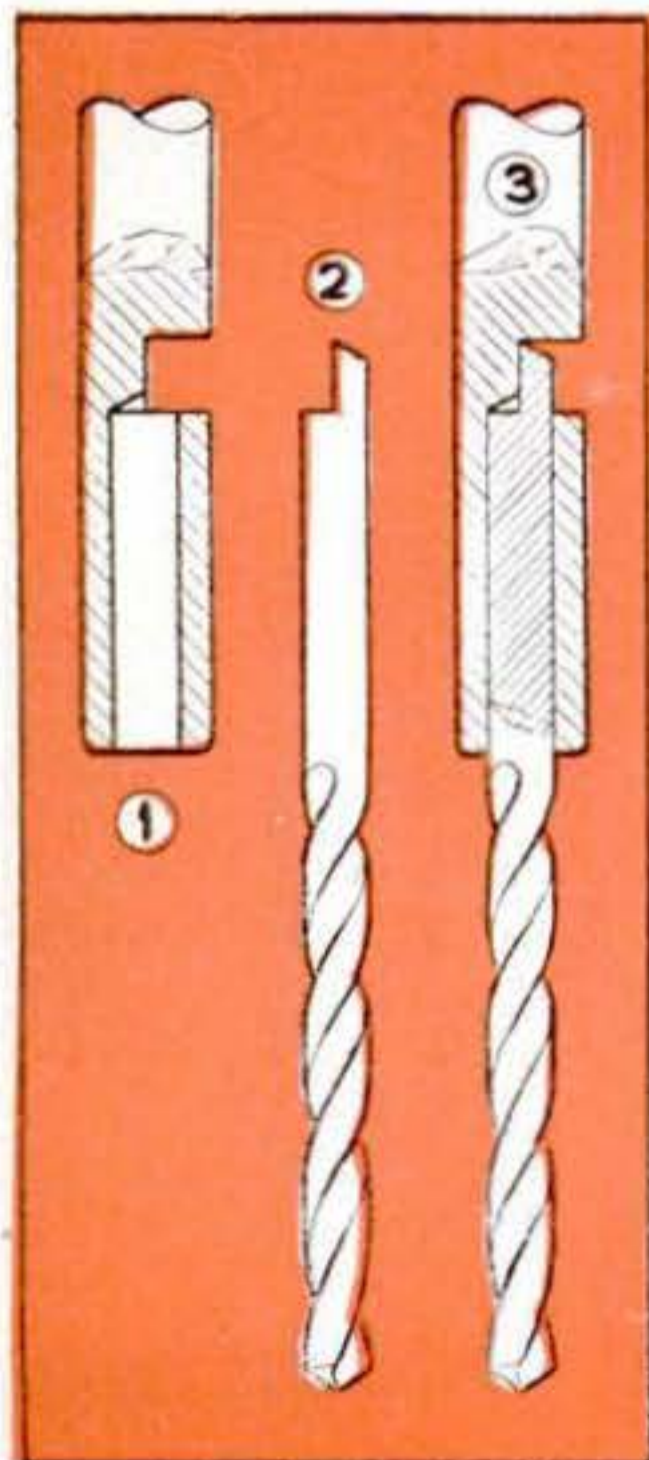

Depth Drill. If you must counterbore a deep hole and the drill won't reach, it can be extended in this way. Drill a piece of round stock with the drill you intend to use for the counterboring. File a slot half through the round stock right at the bottom of this hole (1). Then file down the drill shank (2) to fit the shoulder in the extension (3), and the rig is all ready to go.—*M. L. Dodge, Seattle, Wash.*

Life of Chuck Key Doubled.

If the teeth on a drill-chuck key become worn, allowing it to slip, the key can be given new life by driving out the handle and driving it in through the opposite side of the hole.—*R. Rutledge, Sr., Kansas City, Mo.*

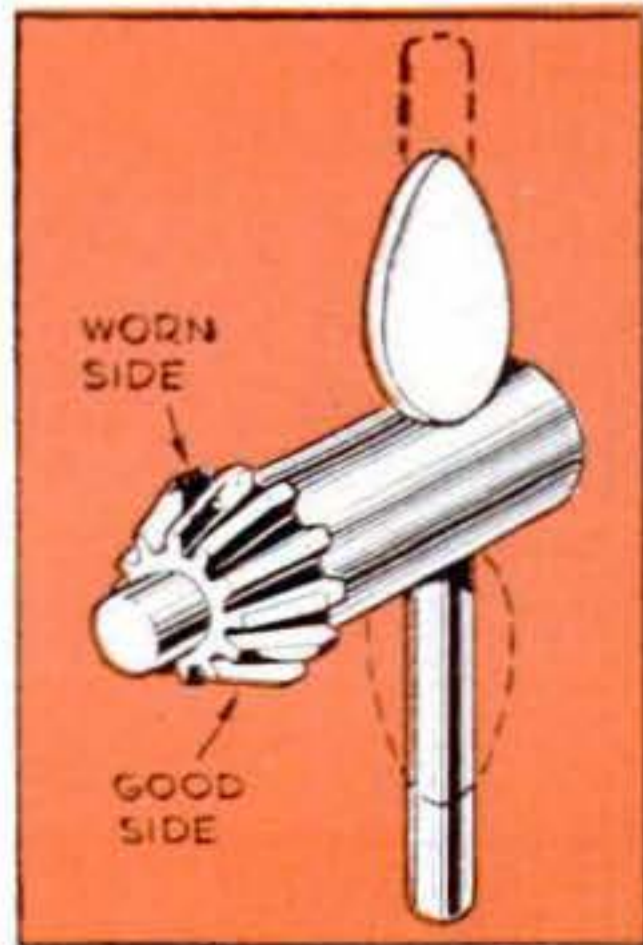

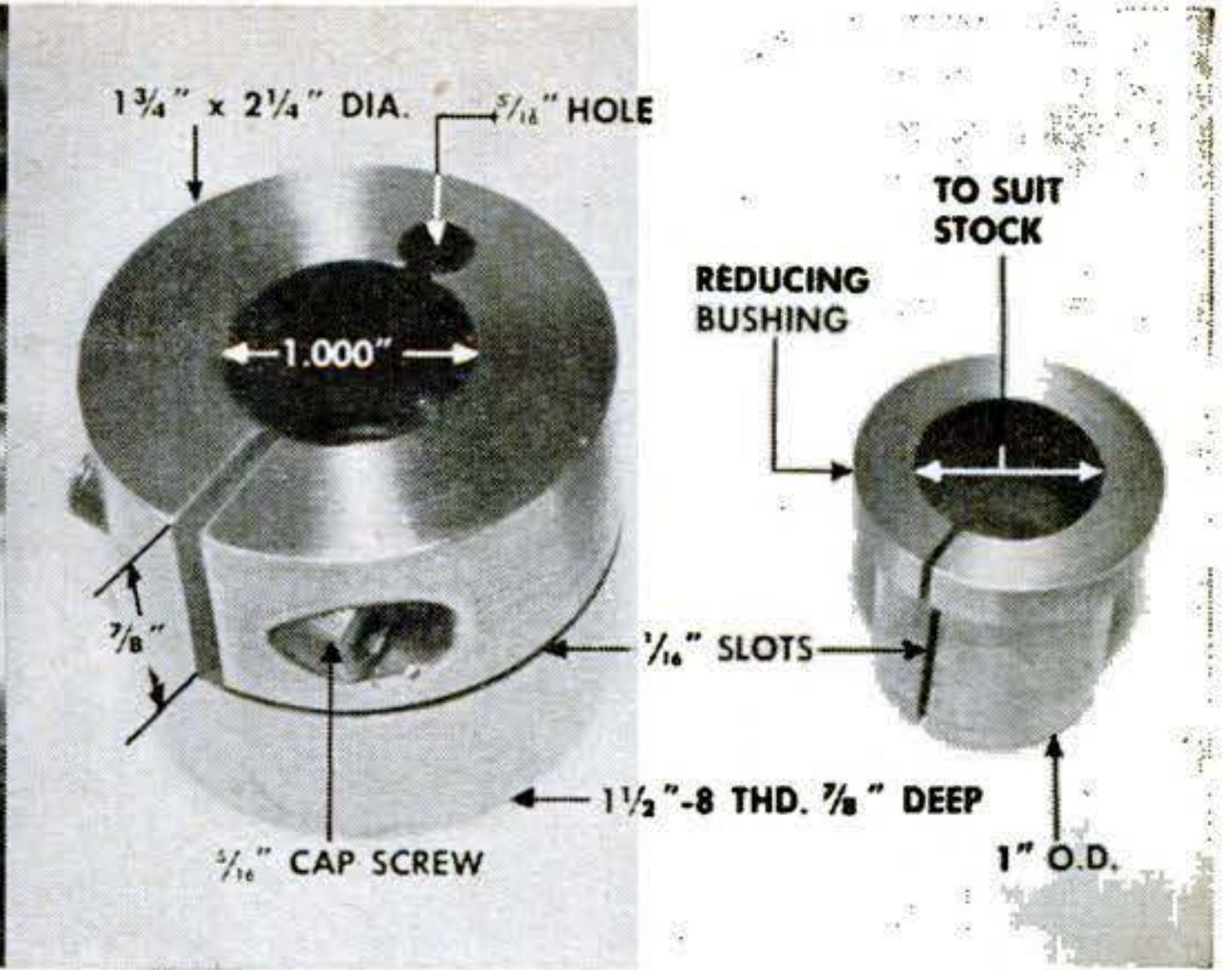
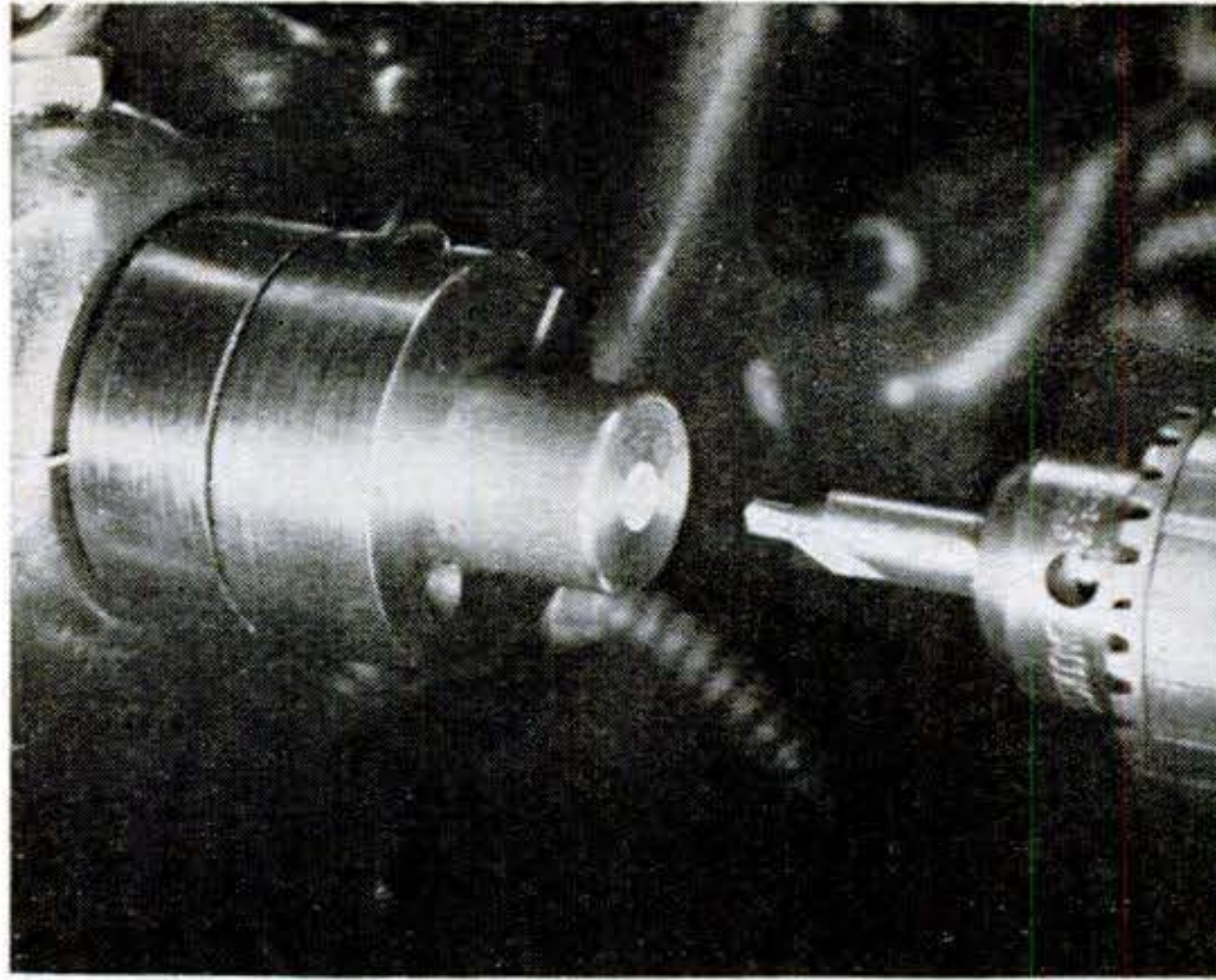

Low-Cost Collet Chuck. If fitted with a variety of collets, a pot chuck like this will center round stock of different sizes quickly and accurately.

Bore a 1 3/4" piece of 2 1/2" rod half its length and thread to fit the lathe spindle. Then bore the stock opening through, about .010" undersize. Drill a 5/16" hole 1" deep and saw or mill a slot 7/8" long directly opposite.

At right angles to this slot, cut another half-way through the diameter. This forms the closing spring jaw.

Drill a hole across the slot, open out half to 5/16", and tap the other side for a 5/16" cap screw. Tighten up the jaw with the screw before boring or reaming the stock opening to finished size.—Wesley O. Walker, Montebello, Calif.

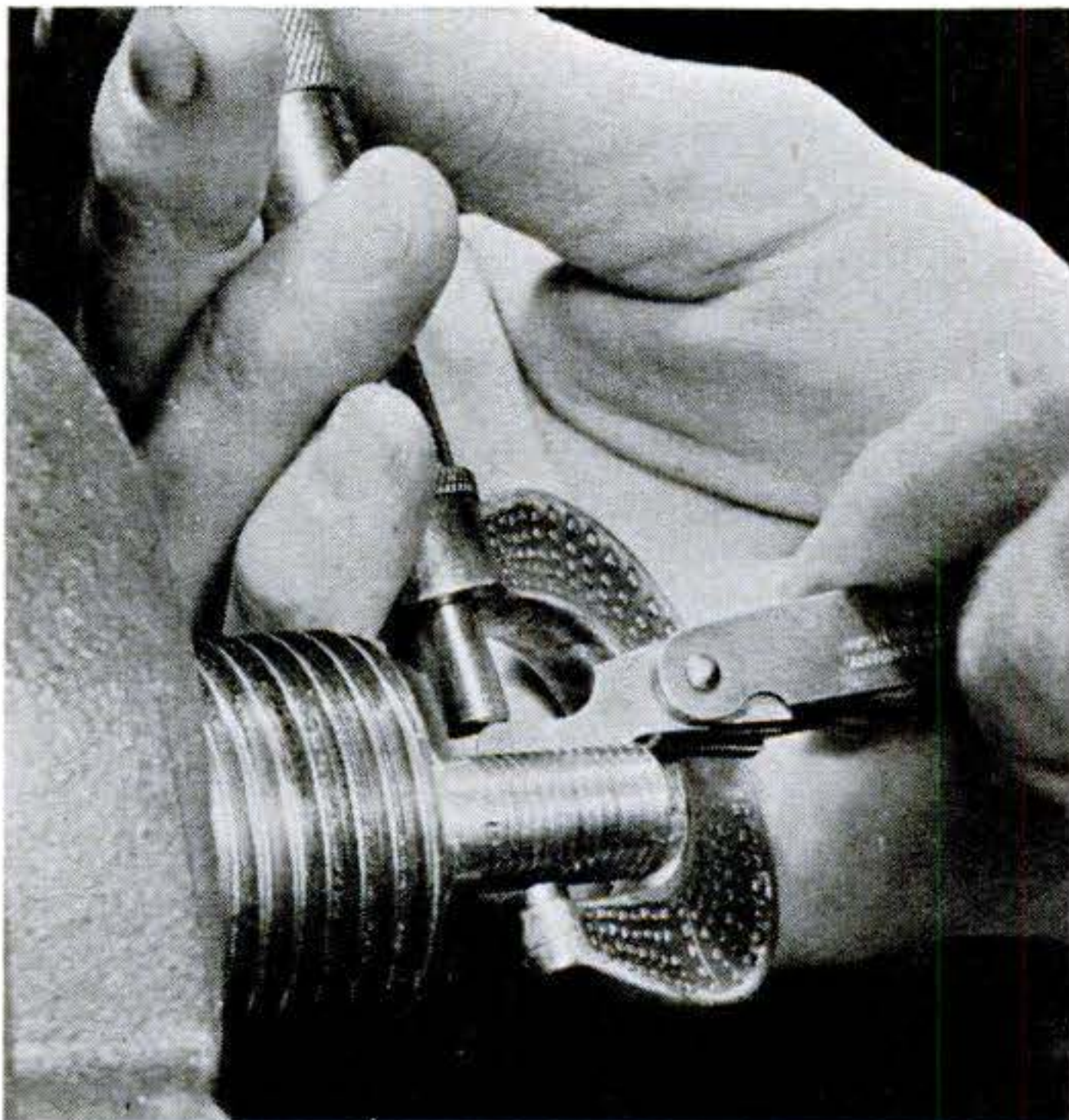

Checking Pitch Diameter. Instead of taking work from the lathe to check thread fit, you can measure pitch diameter within a few thousandths with a screw-pitch gauge and a micrometer. Find the pitch diameter of the thread in a table and mike the width of the gauge leaf. Add, and check the total against the over-all measurement over gauge and thread, made as shown in the photo. This gives the same result as deducting single-thread depth from the major diameter.—R. J. Lemp, Woodhaven, N. Y.

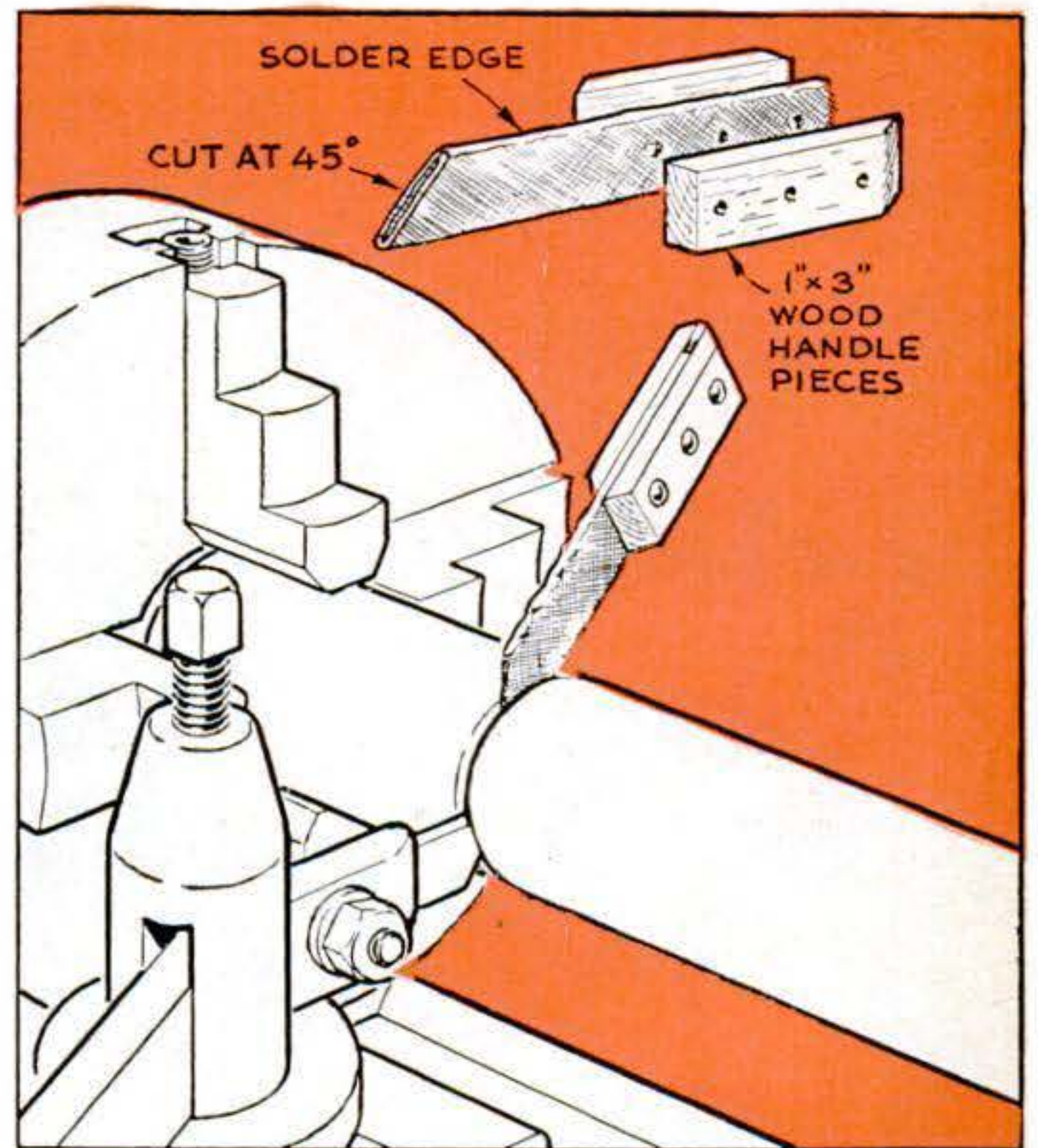

Oiling Cut-Off Operations. A "knife" made from a piece of fine screen or wire mesh will put an even supply of oil at the bottom of the cut. Fold the screening upon itself, pound flat, and solder the edge. Trim one end to a 45° angle. Sandwich the other end between two pieces of wood. To use, dip into oil and apply inside the cut as the work turns.—A. R. Christensen, Lockport, N. Y.

Spot-Welding on Your Drill Press

By J. B. Posner

You can throw away your rivets, and join sheet metal with a welding outfit assembled from surplus items.

BY EQUIPPING your shop for spot-welding, you can seam together two pieces of sheet metal as easily as your wife sews cloth. Made as shown here, the outfit costs very little. Materials are available in radio-parts and electrical shops as war surplus.

A good transformer is the most important item. The continuous-rating filament type that powered ground radar sets during the war will serve well. These deliver 5 volts at 190 amp. and cost between \$15 and \$20. However, any transformer that delivers 2½ to 5 volts at 175 to 300 amp. will do.

Spot-welding requires a means of adjusting electrode pressure on the metal. That's why I use a drill press. It's ready-made for the job.

Preparing the cables. You'll need two 24" lengths of welding cable. Strip the insulation back about 1" on all ends, using a sharp knife. Be careful not to nick any



Mounted in the chuck, the top electrode can be raised or lowered at will to vary pressure on the work.

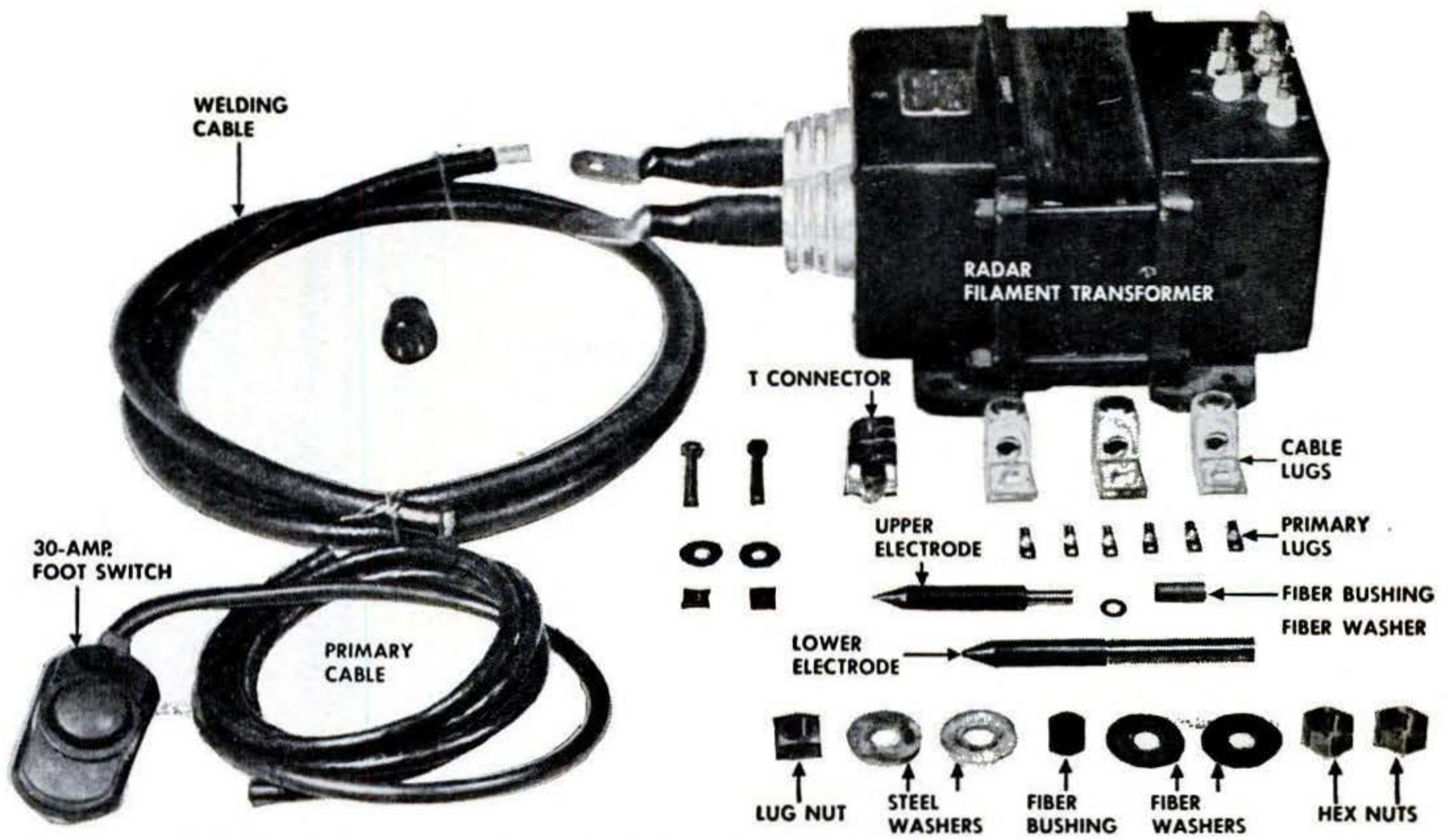

These are the parts I use, but substitutions are often possible. Foot switch is convenient.

strands, or the cable may break when repeatedly flexed. Clean the exposed copper with fine sandpaper.

Attach lugs to three of the four ends. Place each lug in a vise, cup upright, and half fill the cup with plain or rosin-core solder. (Never use acid-core solder on electrical work.) Coat the cable copper with a noncorrosive flux, such as a small piece of rosin dissolved in alcohol. Heat the lug cup with a torch until the solder is molten, push the fluxed cable into it, and hold in position until the solder has hardened. Slide a T connector over the fourth cable end and tighten the setscrews firmly.

Making the electrodes. Use hard-drawn copper or any copper alloy made especially for the purpose. The smallest permissible is $\frac{3}{8}$ " rod. Machine the tips to $\frac{1}{16}$ "-diameter points. Turn down the butt of the upper electrode and thread the butt of the lower one as shown in the drawing on the next page.

Insert the upper electrode into the T connector and tighten the setscrews. Over the small end of the electrode slide an insulating fiber washer and then a bushing. You mount this electrode exactly as you would a drill. Just tighten the chuck jaws over the bushing.

Mounting lower electrode. This goes through the center hole on the drill-press table. First run a hex nut to the end of the thread and slip on a steel washer, fiber washer, and a fiber bushing in that order. Set the electrode in place and slip on

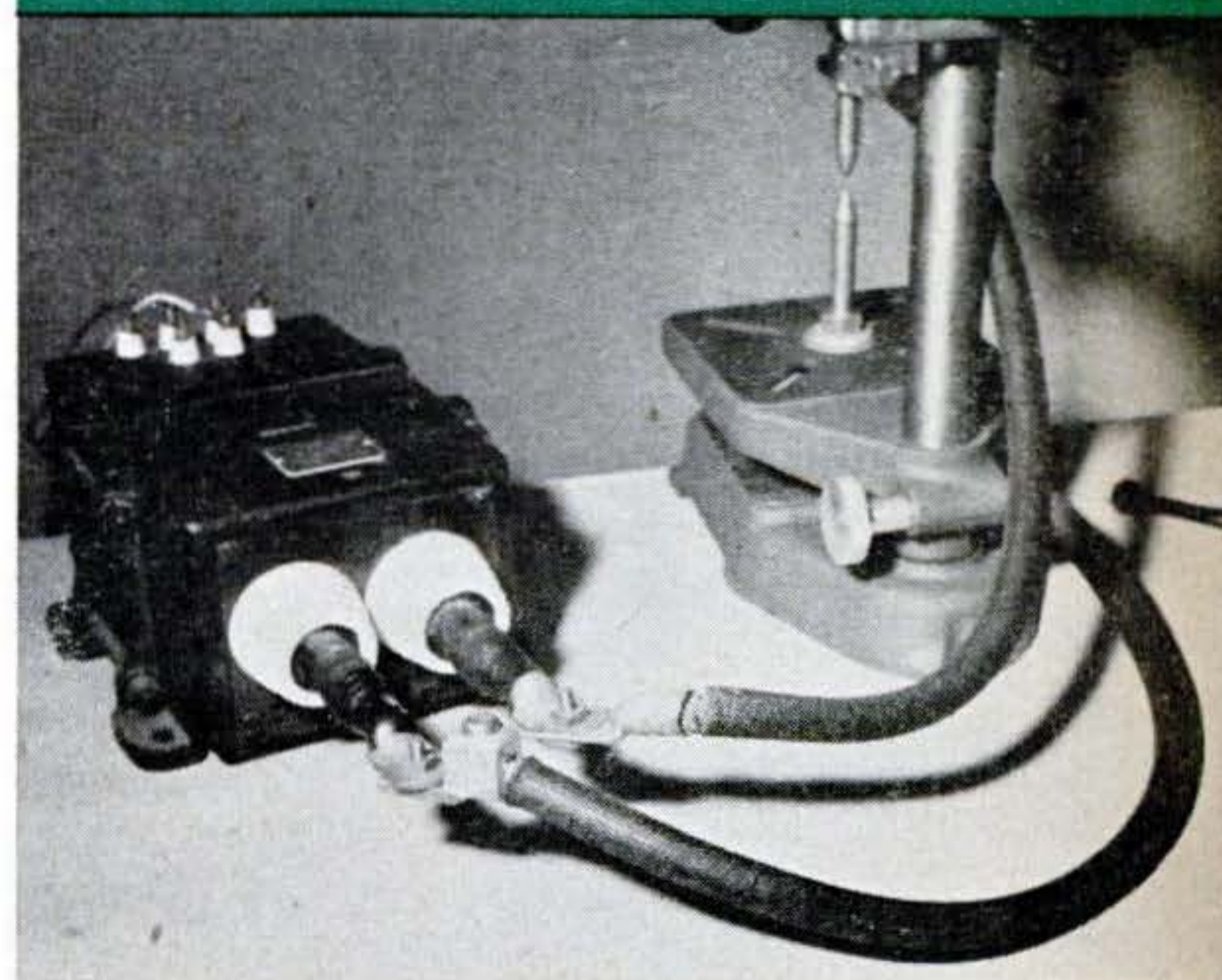
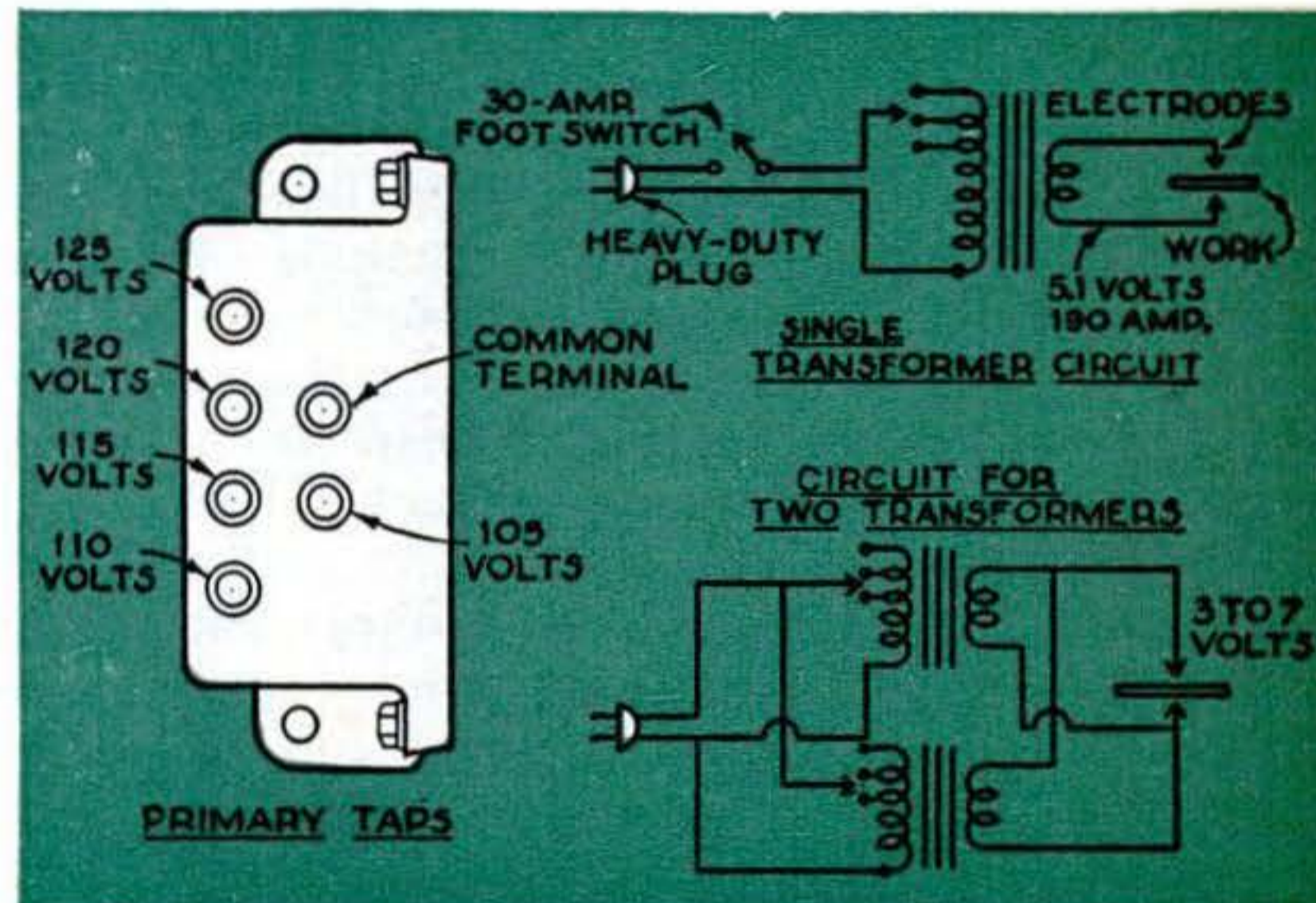

Welding cables 24" long connect transformer and electrodes. It's a good idea to tape the connecting lugs to forestall shorts. Above are wiring diagrams for single and double transformer. Latter is needed for heavy-duty work.

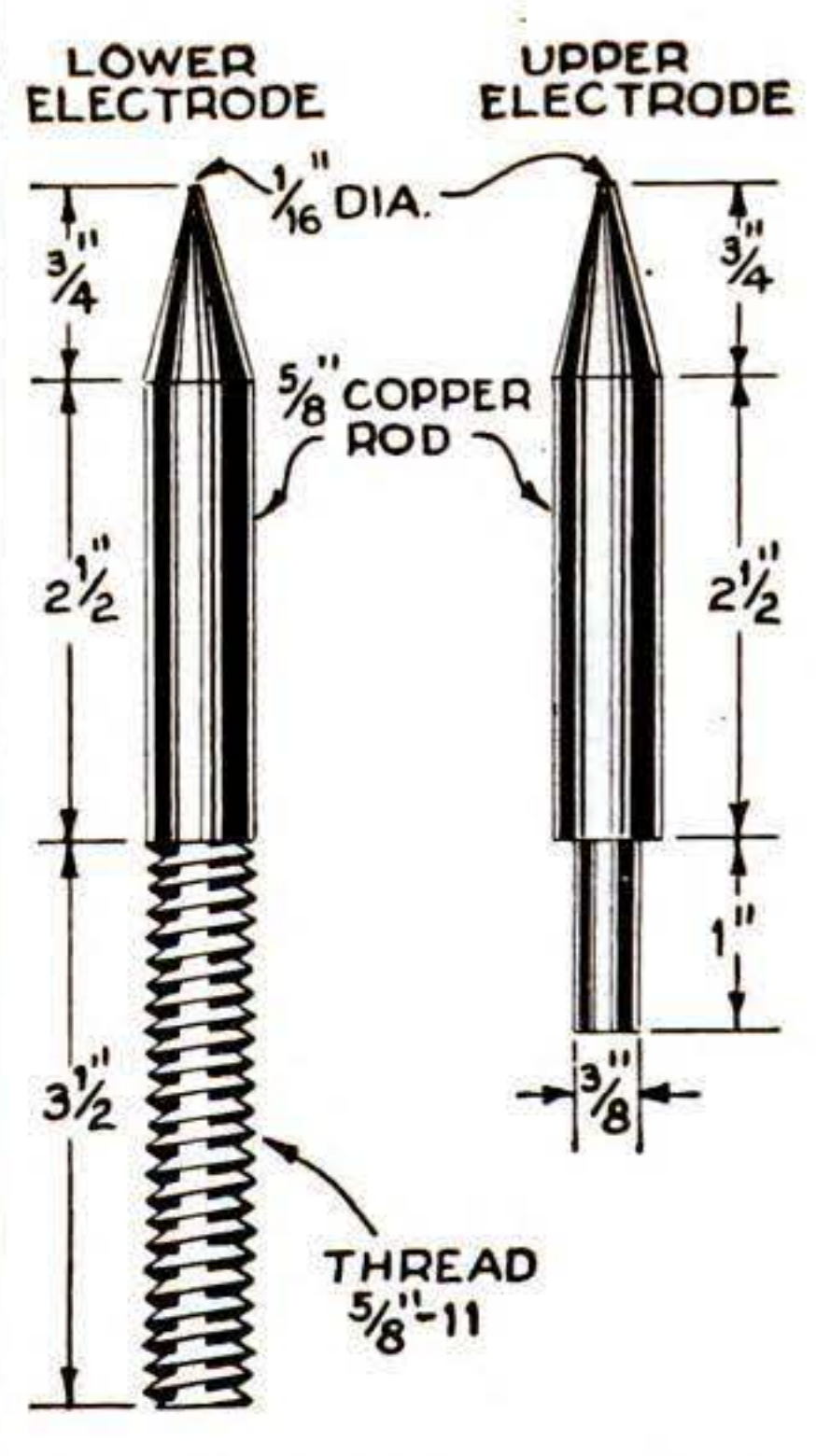
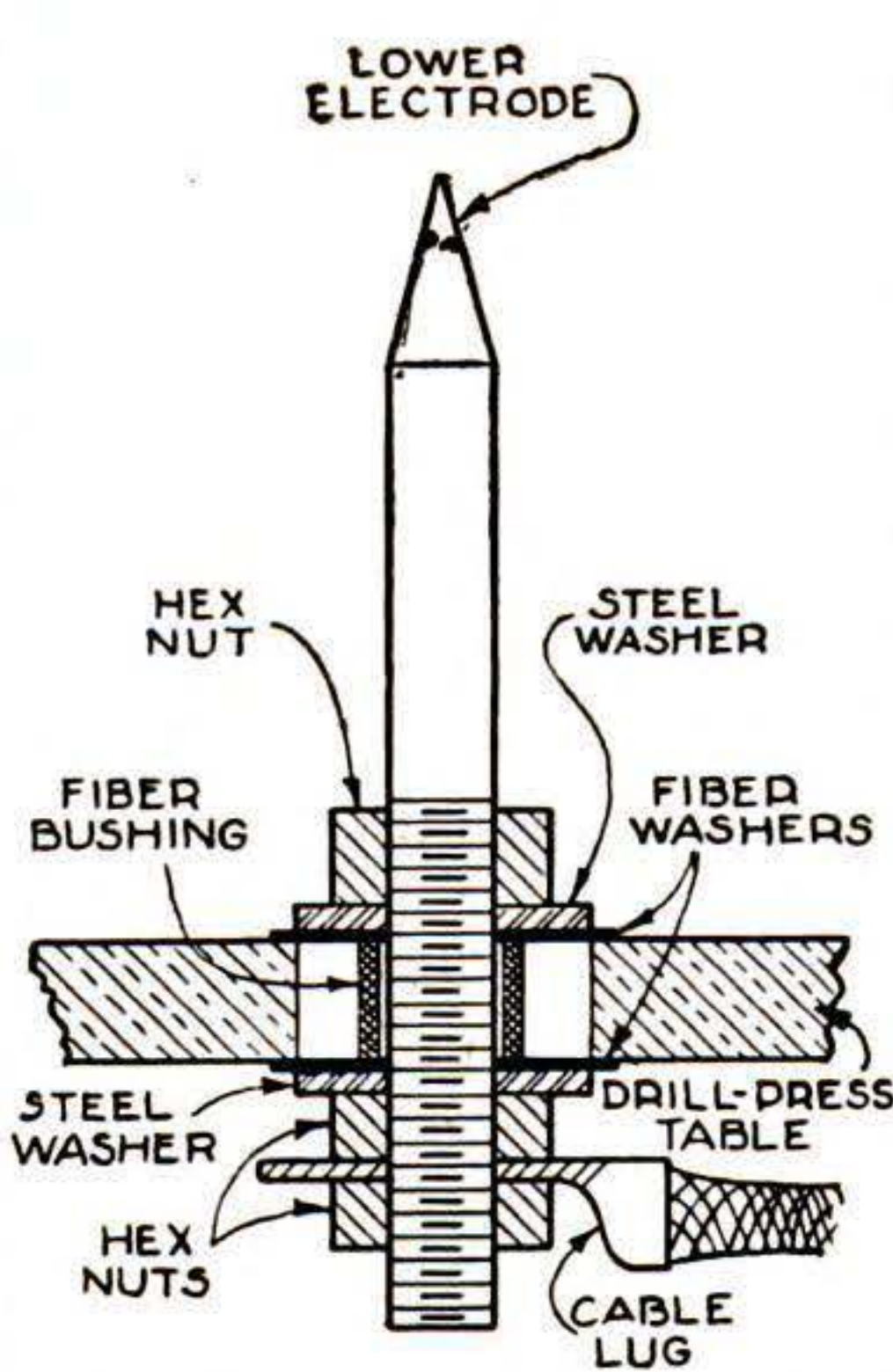
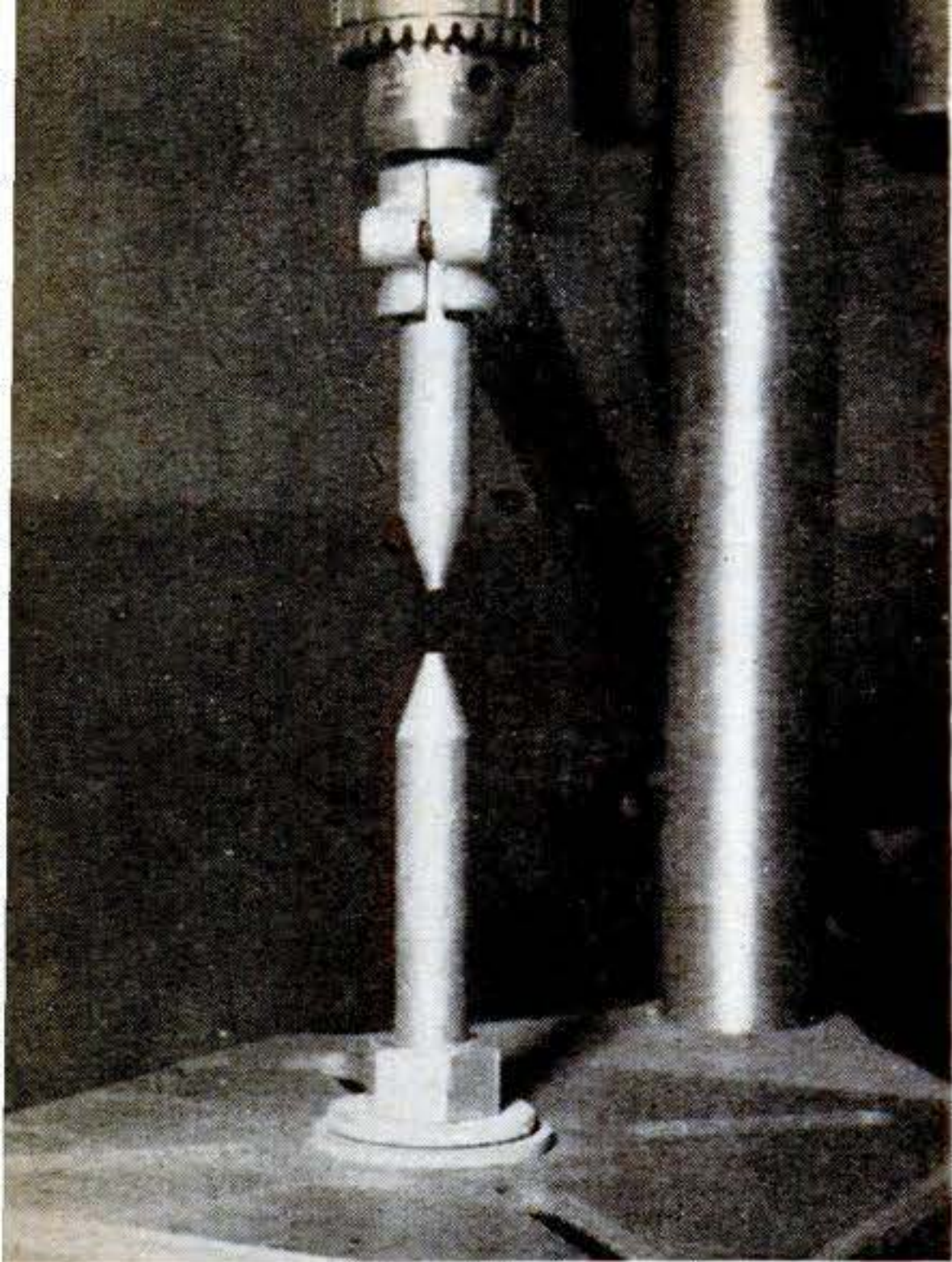

Electrode tips are machined to 1/16"-diameter points. Fiber bushings and washers insulate

electrodes. Tips of the two electrodes must meet squarely in alignment for proper operation.

a fiber washer, steel washer, and a nut. Make the assembly just fingertight.

Next bring down the upper electrode and align the lower one so the two points make square, full contact. When this has been done, tighten the lower-electrode assembly, put the cable lug on the portion projecting under the table, and turn up the final nut.

Hooking up the transformer. Now connect the free ends of both cables to the transformer, using bolts, nuts, and washers. Tape these connections to prevent shorts from metal or tools that may accidentally drop across the terminals. Finally, make certain all connections are tight on the primary cable. Taking such pains with connections may seem unnecessary if you have never worked with high-amperage juice—but it's vital to proper operation.

With all connections checked over, you're now ready to go.

How the outfit works. In spot-welding,

the two electrodes pass a heavy current through the adjoining pieces of sheet metal. Because the metals at this point impose a high resistance, compared to that of the lead lines and electrodes, intense heat develops. This melts the metals and they fuse together.

Spot-welding works best with ordinary carbon steels and stainless steels. Other metals require extremely accurate heat control. For example, the temperature range at which aluminum remains useably molten is very narrow. If you don't apply enough heat, you won't get a weld. If you apply too much, the metal will vaporize, leaving a hole.

Tips on welding. To familiarize yourself with the technique, get several scraps of 20- or 22-gauge cold-rolled steel. Clean in a hot solution of Oakite® or similar degreasing agent. Dry thoroughly.

Place the strips, with about 1" overlap, on the lower electrode and bring down the upper one with light pressure. It's best to wear a glove when handling short pieces.

Close the switch and increase the electrode pressure slightly. Metal around the electrodes should glow red immediately. If the redness is slow in appearing, decrease the pressure slightly. After the red spot appears, increase the pressure slightly. Then shut off the power. But hold the sheets in position for several seconds before releasing the pressure. This allows the metal to set.

Repeat spotting until a seam is complete across the strip. Then just try to pull the pieces apart. If the weld is good, the metal itself may tear, but the seam never will. **END**

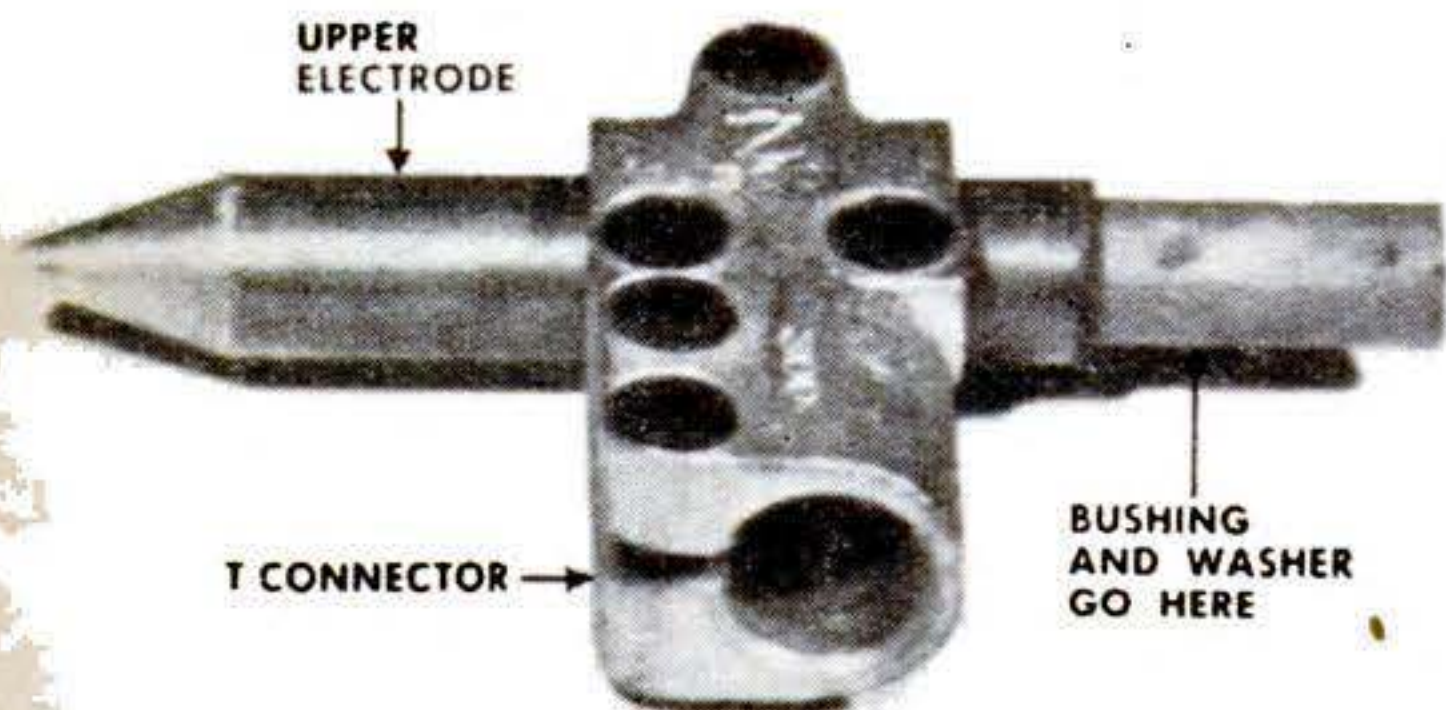

Mount top electrode in T connector. Place the latter 1/4" to 1/2" below the shoulder of the electrode. Connector clamps over end of cable.



Model Airplane Flies While You Sit

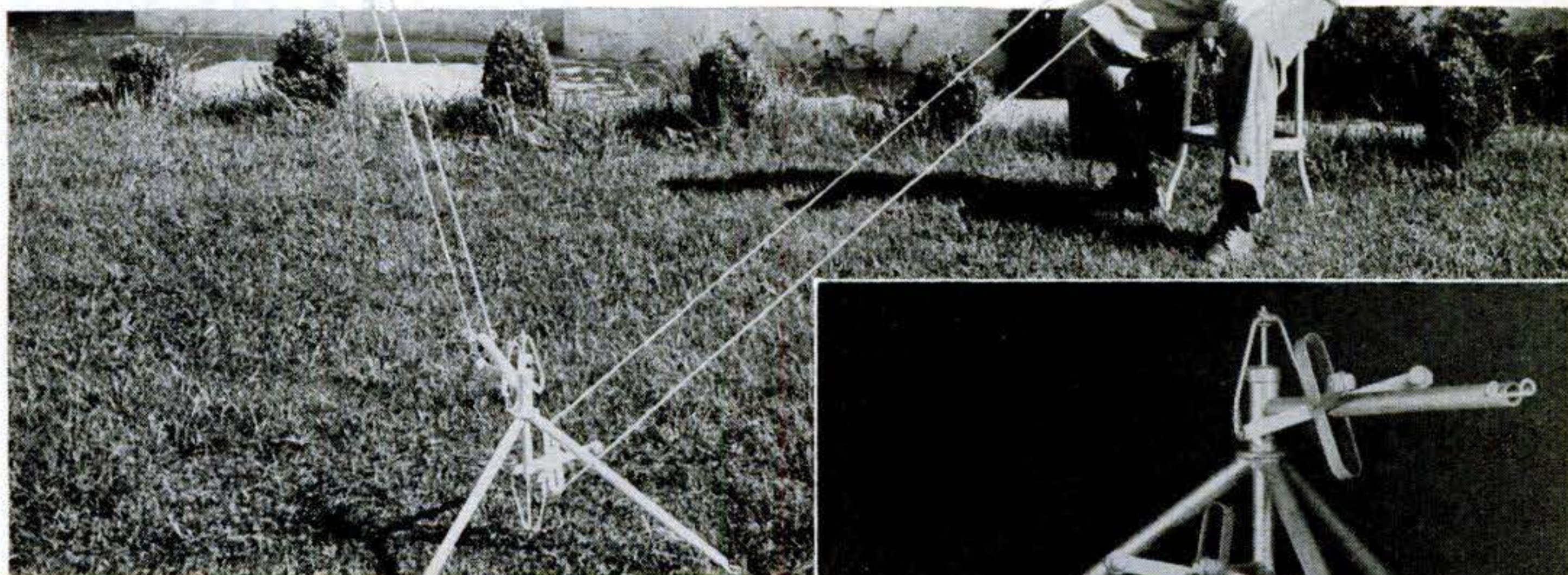

BY USING the De-Dizzer[®], the pilot of a cable-controlled model plane doesn't have to stand up and turn around and around as he guides the ship. The plane can be controlled from a comfortable sitting position.

The plane is attached to the rotating arm by the usual two control wires. Two other wires run from the stand to the operator's control handle. Movements are transmitted through the vertical push rod around which

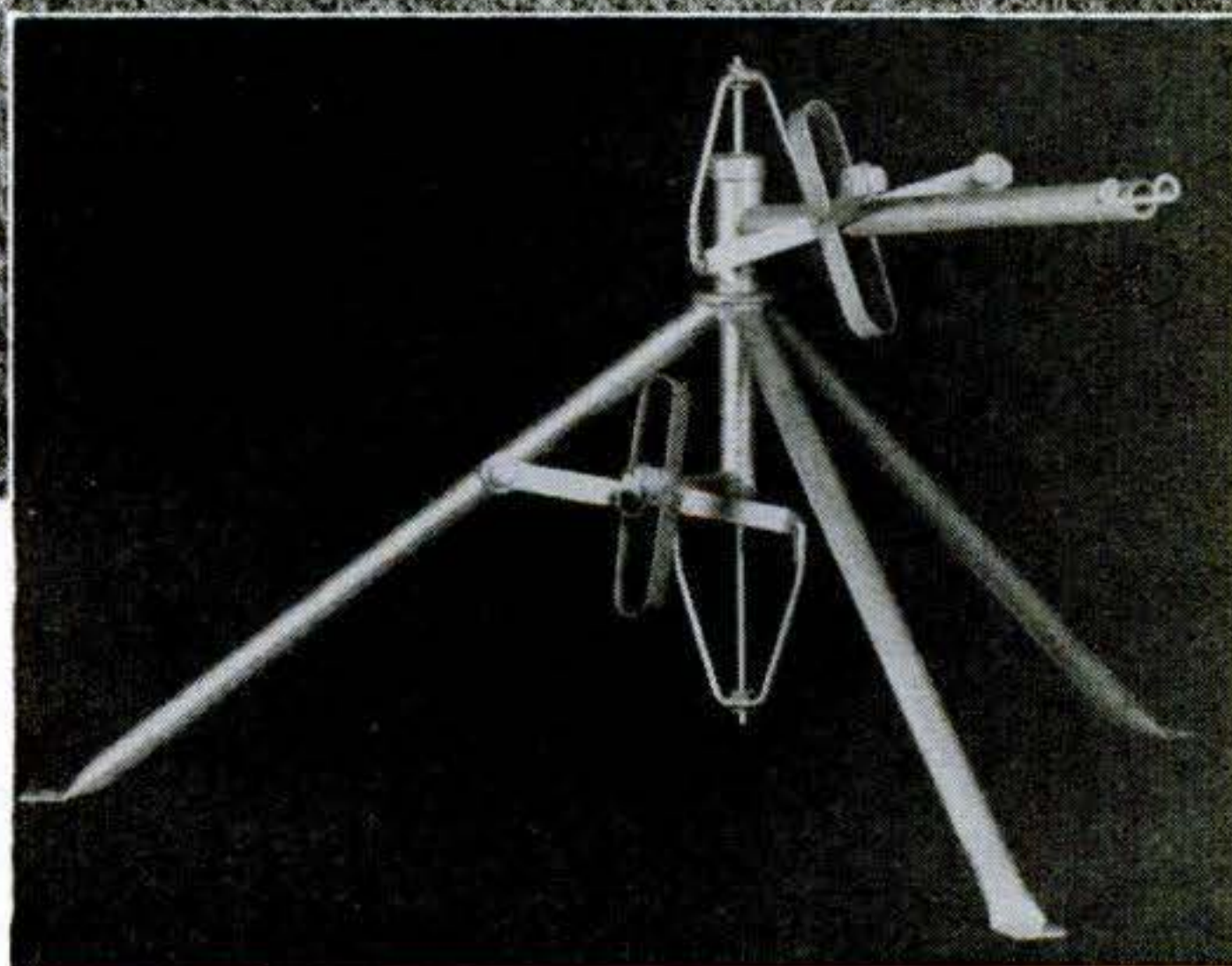

the upper arm travels. Stakes anchor the legs down. The Jarvis Battery & Electric Co., Winston-Salem, N. C., is the maker.

Toy Roof Looks Like Tile

CORRUGATED cardboard can be used to simulate a tile roof on a toy house. Cut it to the size desired and paint it a bright red or orange for realism. The cardboard can also be used to represent corrugated iron.—J. G. Bindas, Arnold, Pa.

Dogs Are Going to the World

RACING greyhounds ride from track to track in style in this de luxe trailer, built by Walter Knight, of St. Petersburg, Fla. Venetian blinds, screens in the windows, electric brakes, drinking-water tanks, an ice box to store the meat supply, and adjustable overhead air vents are features of the trailer. The brakes are designed to go on automatically if the trailer should break away from the tow car.

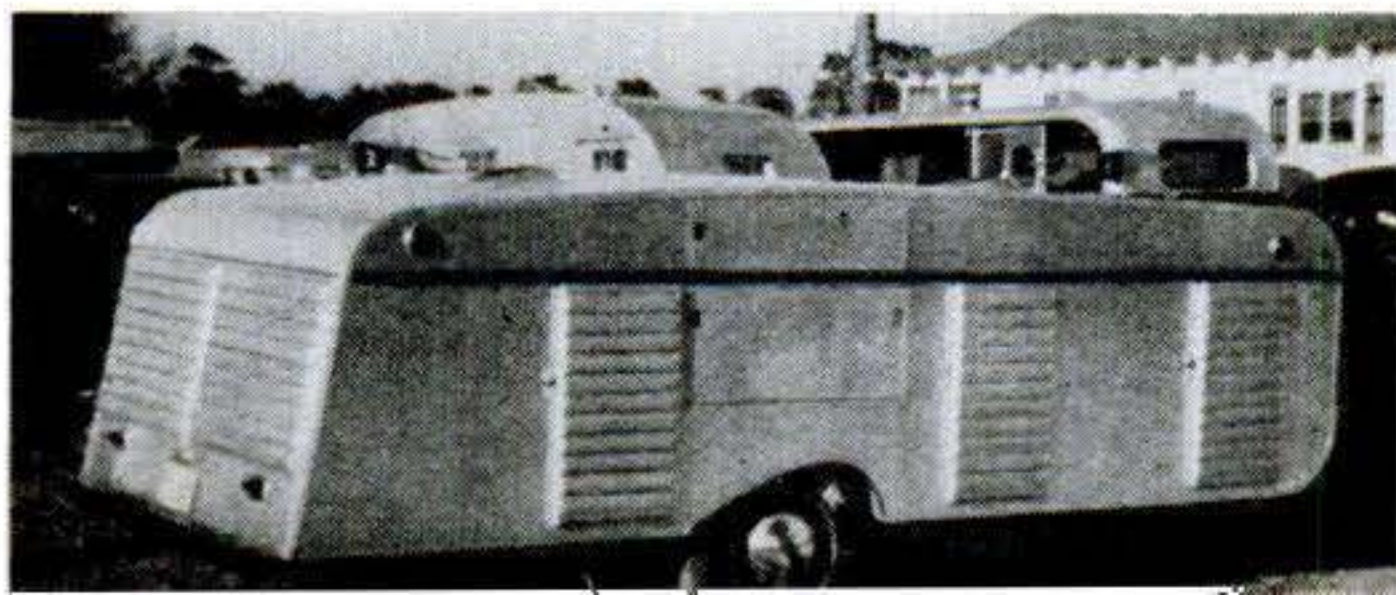

Valve Tool Has Air Inlet

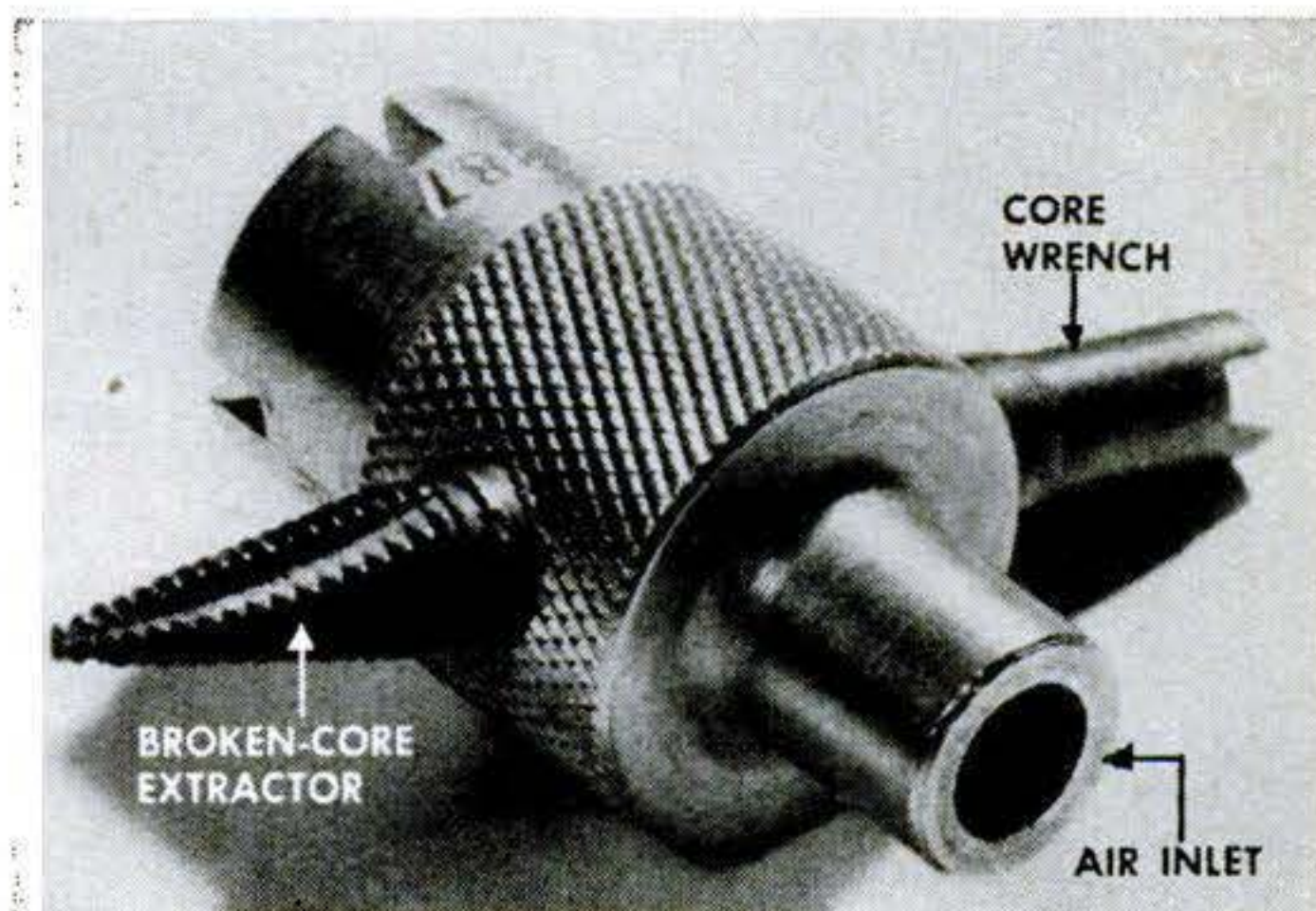

BESIDES keeping a tire valve from slipping back into the casing, this valve holder makes it possible to inflate the tube without removing the tool. All you need do is apply the hose to the air inlet. Rinck-McIlwaine, Inc., of New York City, prices it at 40 cents. The tool can be obtained either with a broken-core extractor, as seen here, or with an inside rethreader.



How to Finish Photos Yourself for 55 Cents

By George S. Cowlam



This is what you need to develop and print a roll of film. Soup plates make trays; glass, cardboard, and clothespins, a printing frame; red cellophane, a safelight. Thermometer helps check developer temperature, but you can do without it. Chemicals, paper are what cost 55¢.

You don't need a lab full of fancy equipment to develop and print your film—just a kitchen.

SAYS you: "I'd like to make my own pictures, but it costs too much to buy the equipment, and it's too technical, and besides, I haven't the time."

Says we: Are you through work for the day, must you go to bed before 10 p.m., and can you get up 55 cents?

If the respective answers are yeah, no, and here it is, let's do a little shopping, and before you hit the hay, you'll have your first print—the picture that will be all yours, from the click of the shutter to the final trimming job with the family scissors.

The 55 cents goes for chemicals and printing paper, on sale at any photographic store. You need *universal developer* and *fixer* (Eastman Kodak makes a Tri-Chem Pack® that includes both of these plus a short-stop rinse for about 20 cents). Buy *glossy, grade 2 (normal contrast)* paper to fit your film—25 sheets of the size for 120 or 620 negatives cost about 35 cents.

The rest of the stuff is almost sure to be around the house—and we don't mean spare parts from a 1922 Cadillac, either. What you do need are: three ordinary soup plates, a drinking glass to measure liquids, a wood stick for stirring, a small piece of glass (take it out of a picture frame or cut from window-glass scrap), very stiff cardboard (we cut ours from a cigar-box lid), a thermometer, a few spring clothespins, string, scissors, some dark-red cellophane or gift paper, a towel.

Of course, you must also have an exposed but undeveloped roll of film. It's best to learn with ortho film (Verichrome® or Plenachrome®), since the panchromatic types must be developed in total darkness. Naturally, this setup isn't intended for the "serious" amateur. But for the guy who wants to try out photography, or who wants to process a few rolls once in a while, it will work perfectly well.

Your darkroom is the kitchen. Protect the drainboard with newspapers and lay out your soup plates. Mix the chemicals in them according to the instructions in the package. The developer goes in the left-hand plate, the short stop (or plain water) in the middle, and the fixer in the right-hand plate.

Put a small bulb in the kitchen fixture and wrap it with the red cellophane—that's your safelight. It should be so dim you can just barely read the clock or watch. Don't worry



1 Hold film by clothespins and seesaw it through developer, moving arms up and down, for time recommended—go by the clock, not appearance of negatives. Then seesaw in rinse a few times, and in fixer for twice time needed to remove milky color (10 minutes).



2 After fixing, wash the film in running cold water for about 20 minutes. If your sink doesn't have a stopper, put the film in a pot and let the faucet run into that. Leave the clothespins on—they'll keep the film from curling up into a spiral and also make it easier to handle. ➤

about bits of light coming through cracks around the door so long as none shines right on your film.

Now you're ready to warn the family not to burst into the kitchen for a glass of water. Unroll your film just enough so that you can clip a clothespin on the end. Now unroll it the rest of the way, tear the other end from the paper, and put a clothespin on that end. Hold the film by the clothespins and keep it stretched out taut. It curls up while dry.

Okay? You've got an armload of film. Now just do what's shown in the pictures on these pages and you'll soon have finished prints to show off.

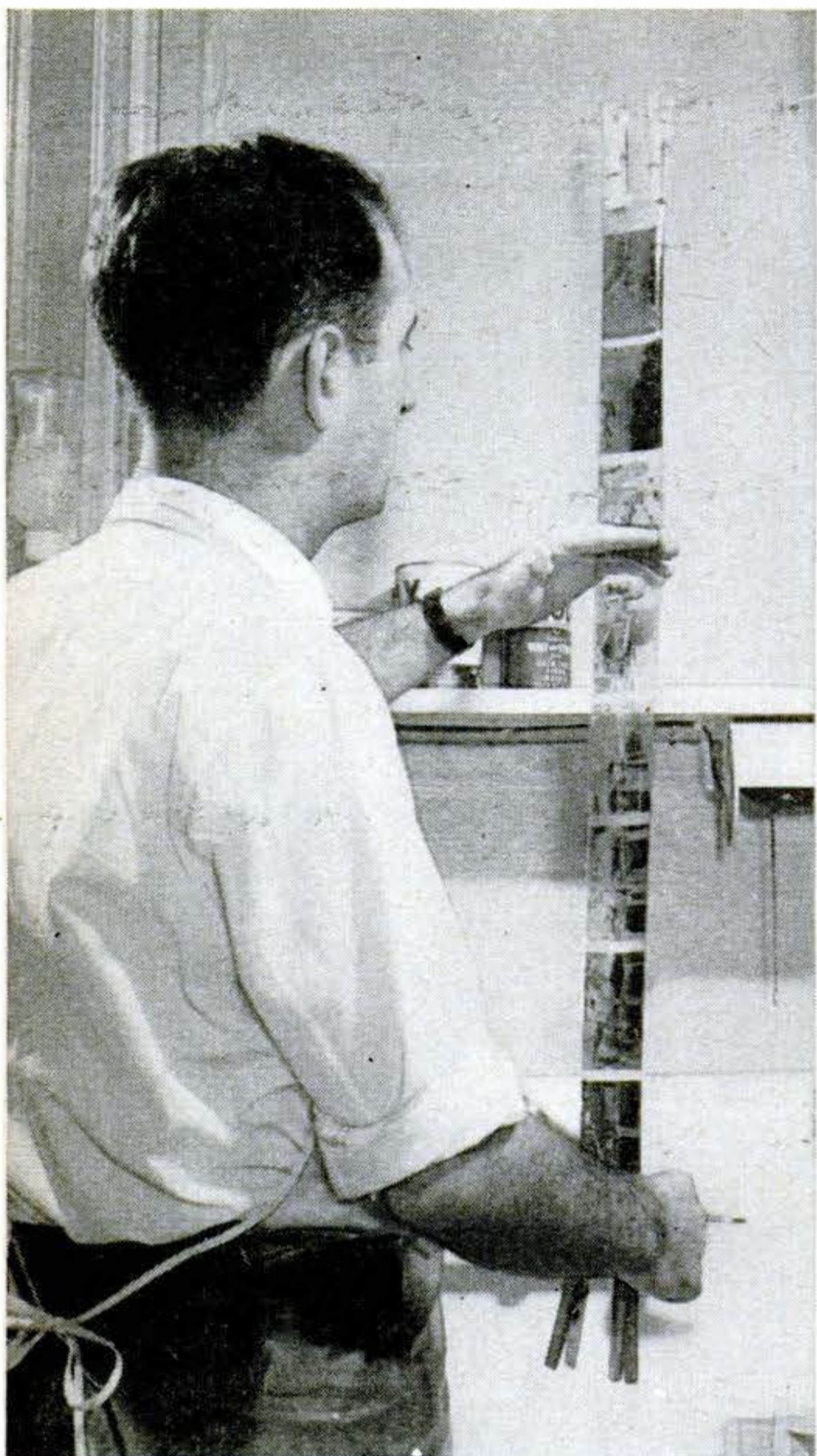

3 The string, threaded through the clothespin springs, holds the film while it dries. Wipe some of the water off with your wet fingers, as shown above. Don't squeeze hard—emulsion scratches easily when wet. It'll be dry in about 45 minutes, unless the weather is very muggy.

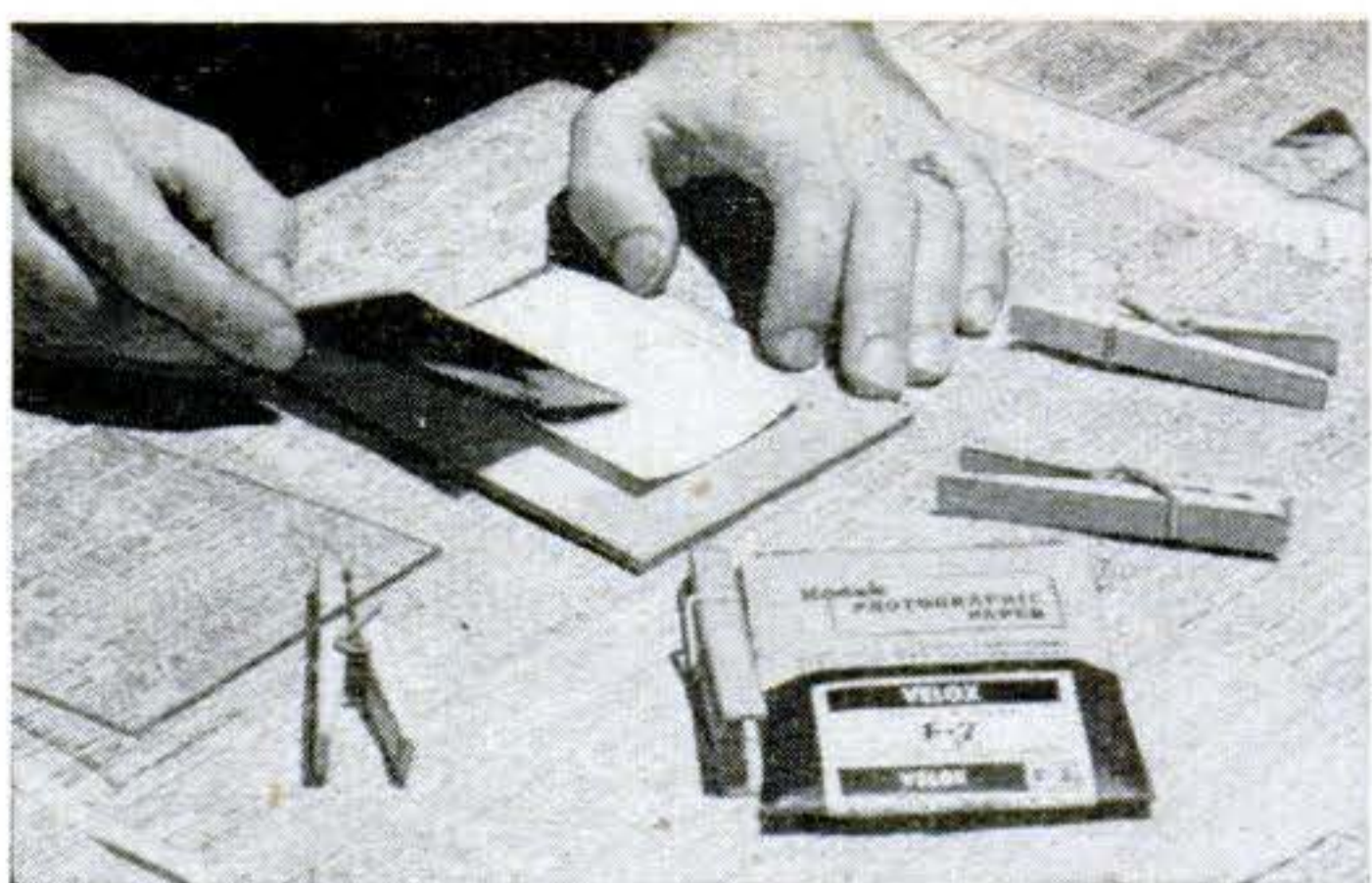

4 Your printing frame is made of the cardboard and glass. Take out *one* sheet of printing paper, lay it glossy side up on the cardboard, then lay the negative glossy side up on top. Slide the glass over, fasten with clothespins. Brighter room light is safe to use when printing.

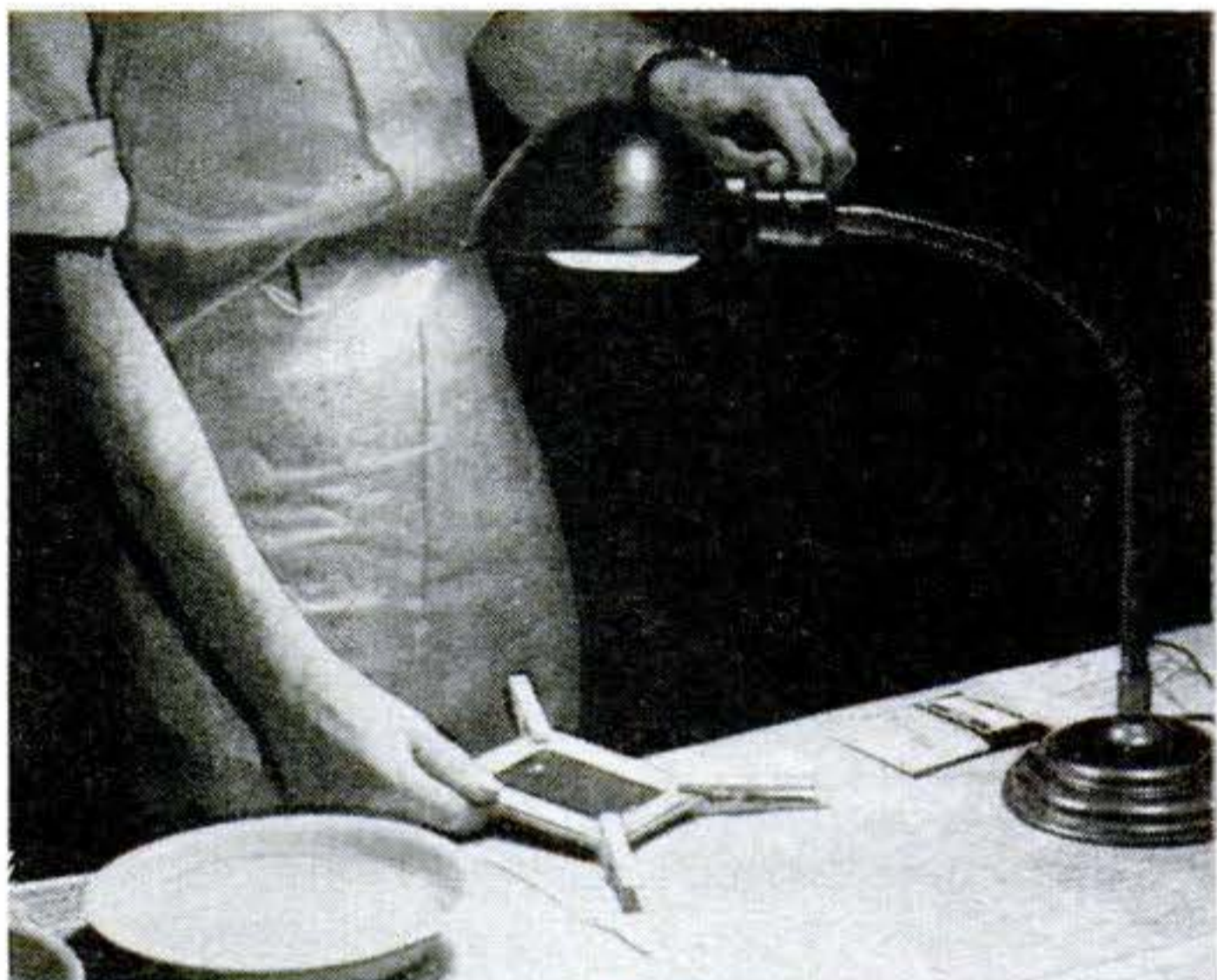

5 A table or desk lamp makes a convenient printing light. Hold the glass side of the printing frame a foot or so from the bulb—but the same distance every time—and turn the light on for five seconds (count "one thousand, two thousand, . . ." to measure seconds).

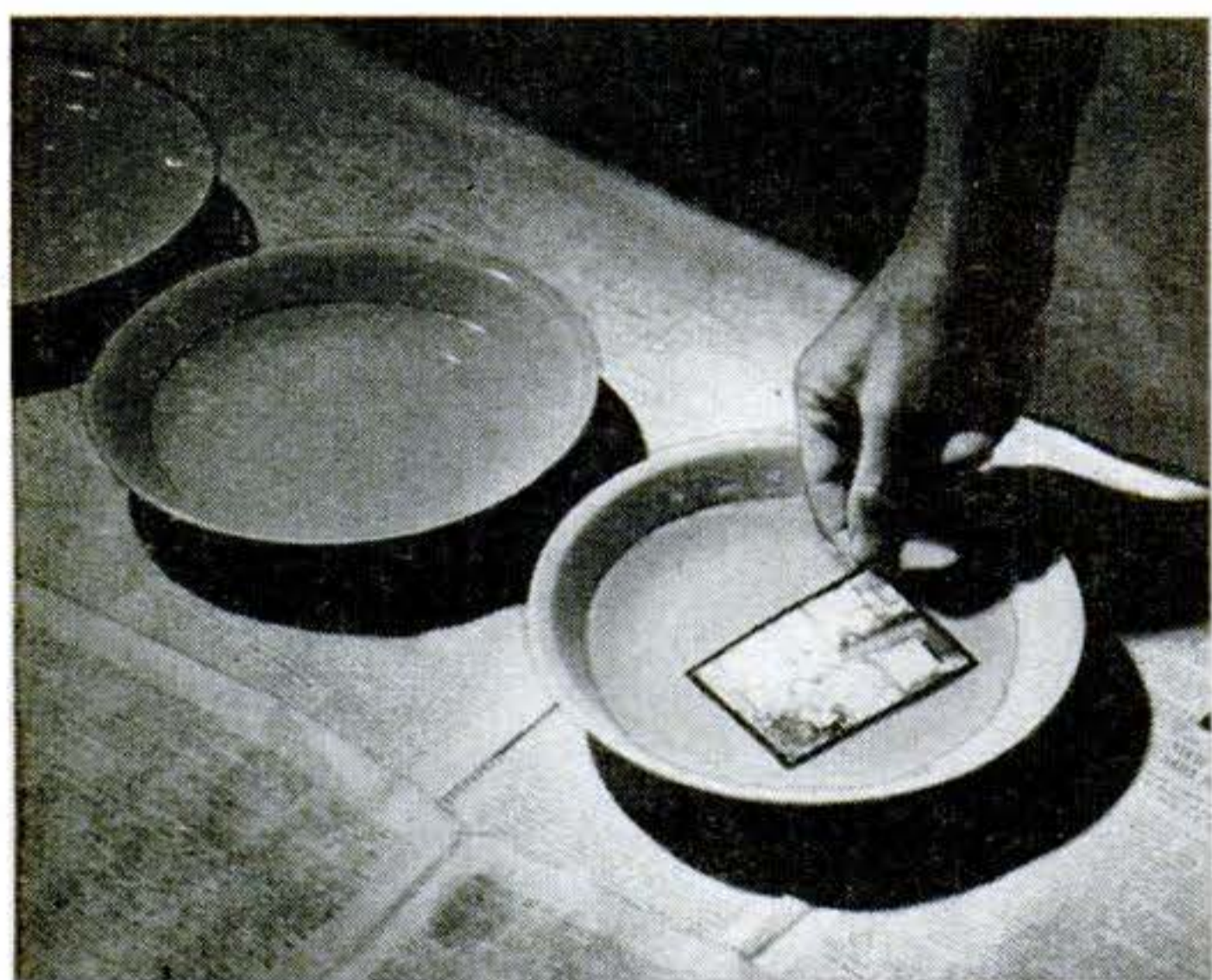

6 Swish the paper around in the developer for the recommended time. Rinse a few seconds, then let it stay in fixer for 15 minutes while you print and develop others. Finally wash in running cold water for *one hour*. If prints are too light or too dark, change exposure time.



7 The easiest way to dry prints is to lay them face down on a towel. And soon you'll have the pictures you made yourself from start to finish. Don't worry about doing all this with ultra-scientific precision—a little bit one way or another won't make very much difference.



Negatives Go Down Drain In New Printing Process

Paper is exposed by enlarging or contact. In first steps, you use a common safelight. Here, 35-mm. color slide is enlarged to 8" by 10".

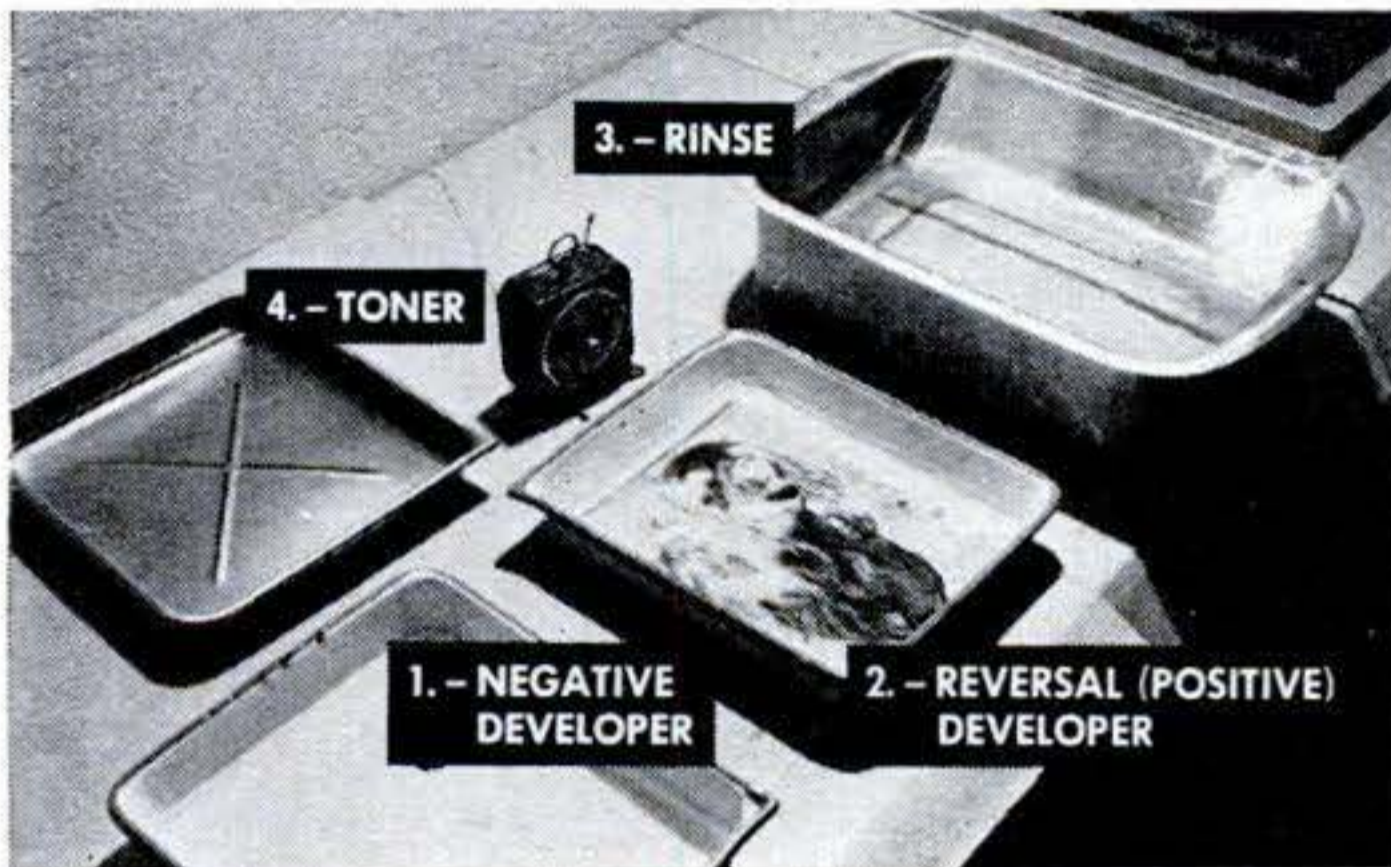

Two developers are used, the first any common paper developer. The negative forms in this. A minute is about right. Then the sheet goes into the reversal bath, as seen above. There it's left, without agitation, for three minutes while the positive image develops in the second coating. After it has been in this bath 30 seconds, you can turn on the white light.

A NEW photo paper coated with two emulsions offers photographers a quick way of making sepia or other single-tone prints from color transparencies. A negative image forms on the top emulsion, a positive on the lower. After the negative layer has done its job, you simply wash it away.

Developed in Belgium by the Gevaert Company, the new paper works by what the company calls reversal-transfer by diffusion. This means that after a negative image has formed in the top coating, the undeveloped silver salts in this layer diffuse downward into the second. There the salts are changed into metallic silver, creating the positive image. The accompanying photos show how the paper is used in making prints from transparencies of any size.

Called Diaversal[®], the paper is distributed in the United States by the Gevaert Company of America, Inc., of New York City. This company also supplies chemicals required for making the reversal solution.



Next the negative washes away, and you begin to see the positive image. This bath is simply plain water. Rested on a sheet of glass for easier handling, the wet print is stroked with a wet pad of cotton. As the negative coating peels off, you notice that the positive image is a weak yellowish color. Toner will cure this.



Toner strengthens image. In this case, a selenium toner was used, the image deepening to a pleasing sepia. Other toners would produce different tones. After being toned for about three minutes, the print is washed for five or 10, and then dried. Like other reversal processes, this one gives a black border.

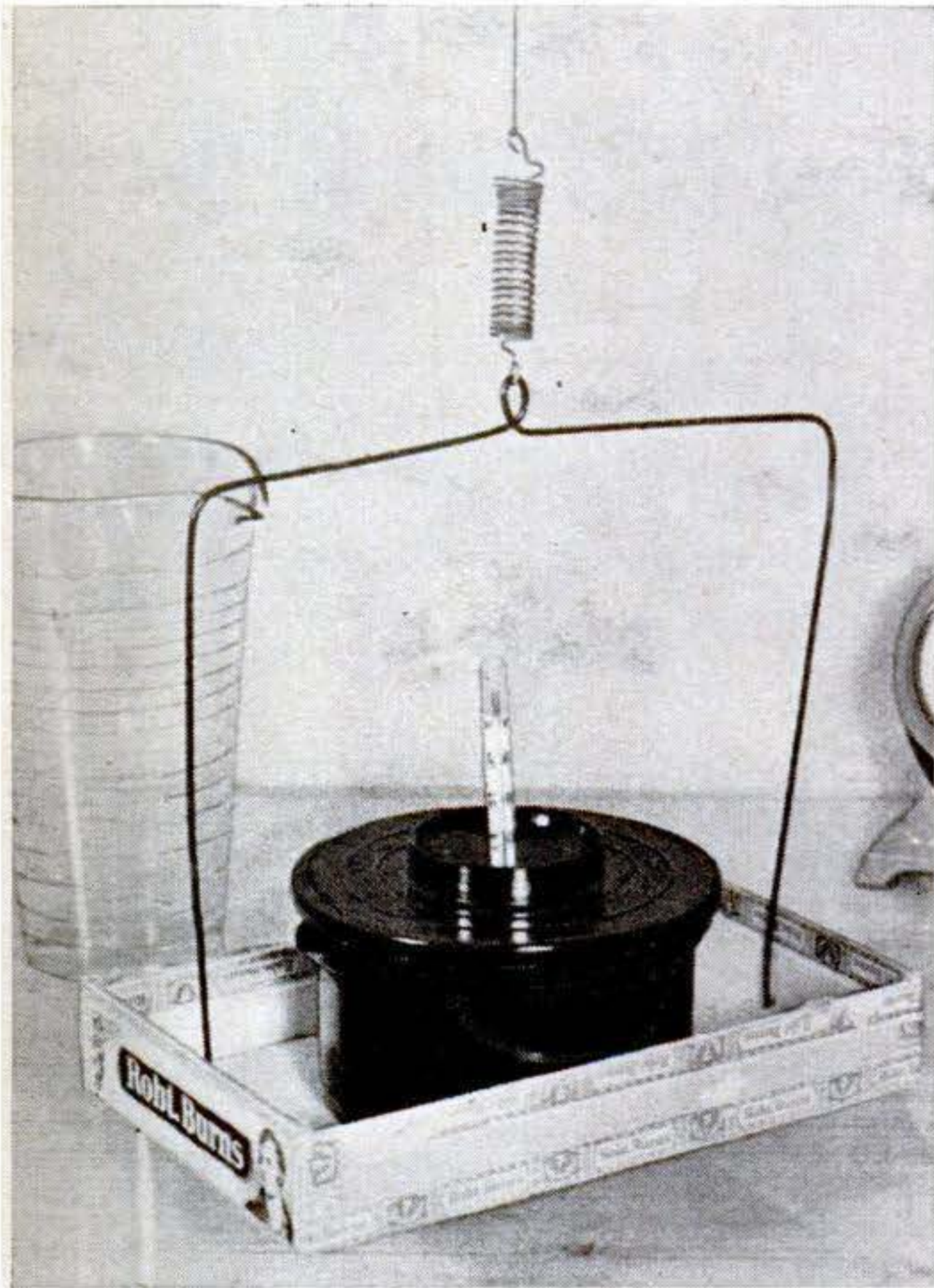

Spring Agitates Tank. A cigar box, wire coat hanger, 48 inches of string, and a spring combine to form an excellent film-tank agitator. Given a good twist, the one shown spins and jounces for 15 minutes.—*J. M. Overstreet, Birkenfeld, Germany.*

Disk Speeds Up Filtering. Ordinary absorbent cotton is an efficient and inexpensive material for filtering photo solutions, but it tends to pack down in the funnel. To hold it back, cut a disk of $\frac{1}{8}$ " plastic, drill several holes in it, and cement the disk inside a one-pint funnel.—*F. T. Sokolik, Chicago.*

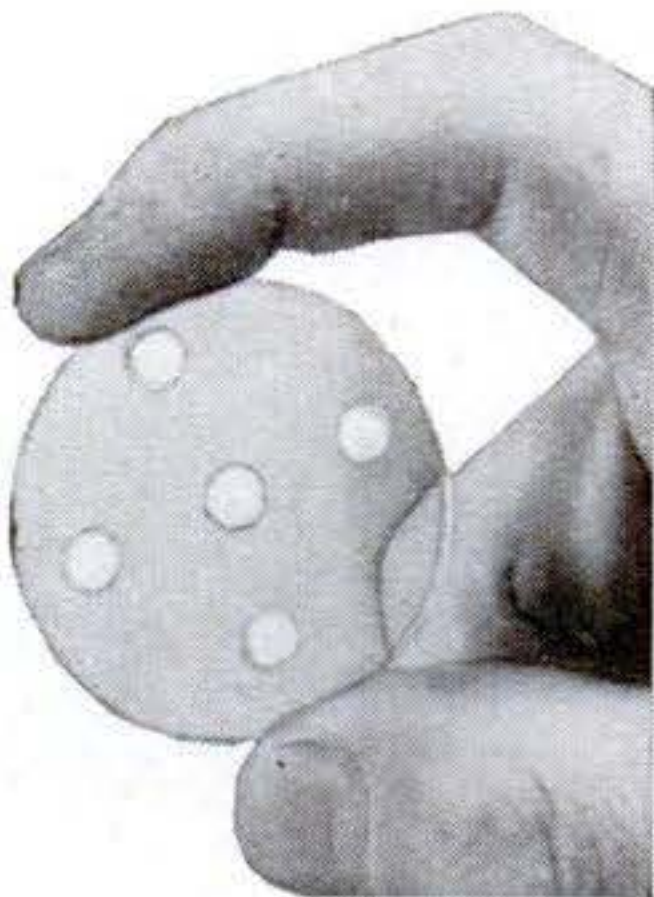

Clothespin Holds Thermometer. Tape a spring clothespin to your photographic thermometer. The unit can then be clipped to the edge of a solution tray.—*R. K. Wahler, Fond du Lac, Wis.*

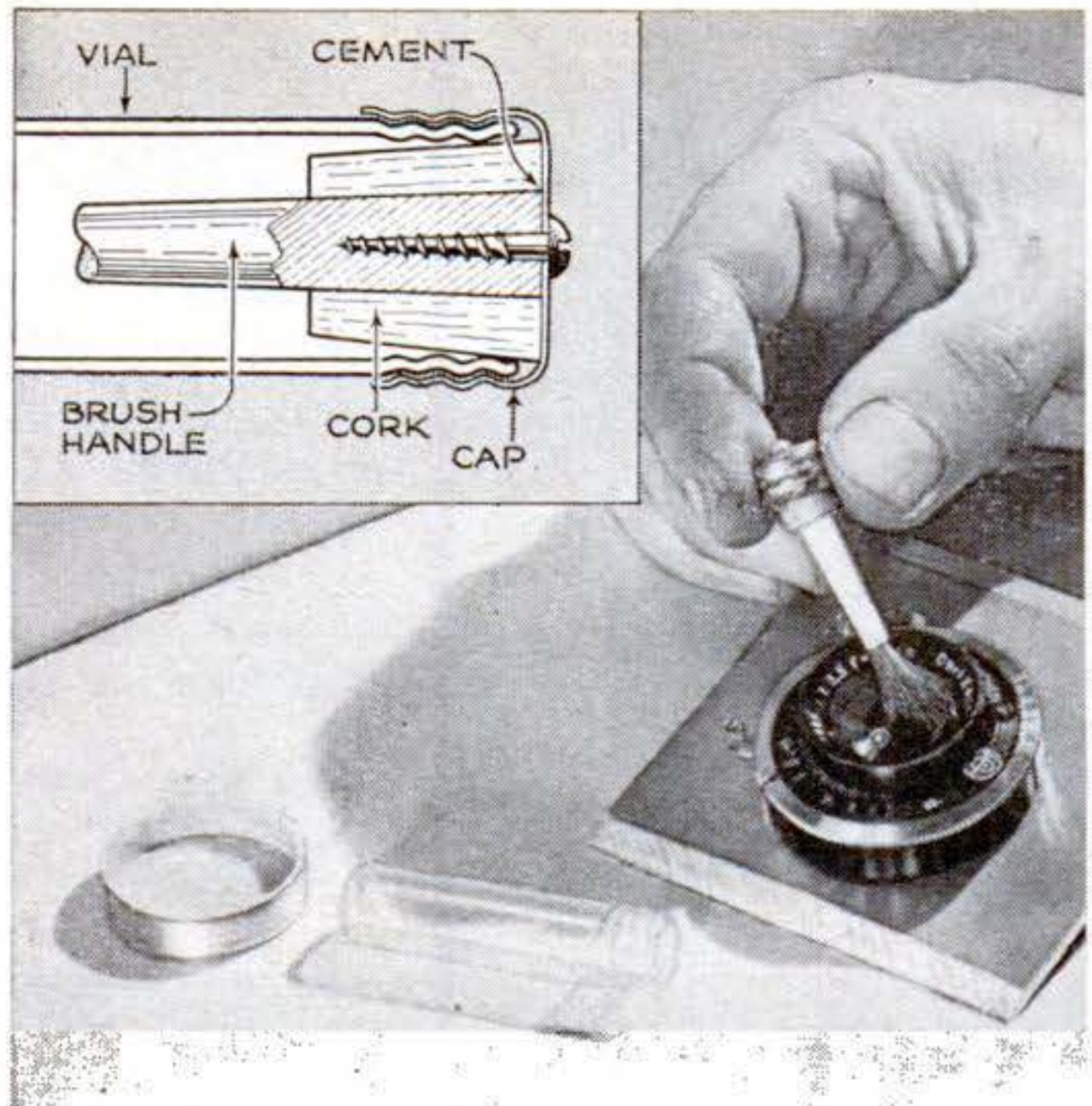

Making a Lens Brush. A small round artist's brush, an empty dental-floss vial, a small cork, and some cement make an excellent lens brush with its own dust-proof case. Total cost: ten cents. Cut the brush handle so the bristles don't quite touch the vial bottom and cement it into a hole in the cork. This in turn is cemented and screwed to the underside of the cap.

Washer Keeps Prints Moving. A print washer that does a thorough job is shown below. Form the parts of the metal box around a wood block cut to the proper size. Solder all joints, making them watertight. Drill $\frac{1}{16}$ " holes in one end and a $\frac{1}{4}$ " hole on top for the 2" length of brass tubing that takes the rubber tubing. Bend the 4" by 4" deflecting plate and the hook to fit the pan. A hose coupling, stub piece of hose, and a cork attach the washer to the faucet.—*J. A. Appelquest, Leonia, N. J.*

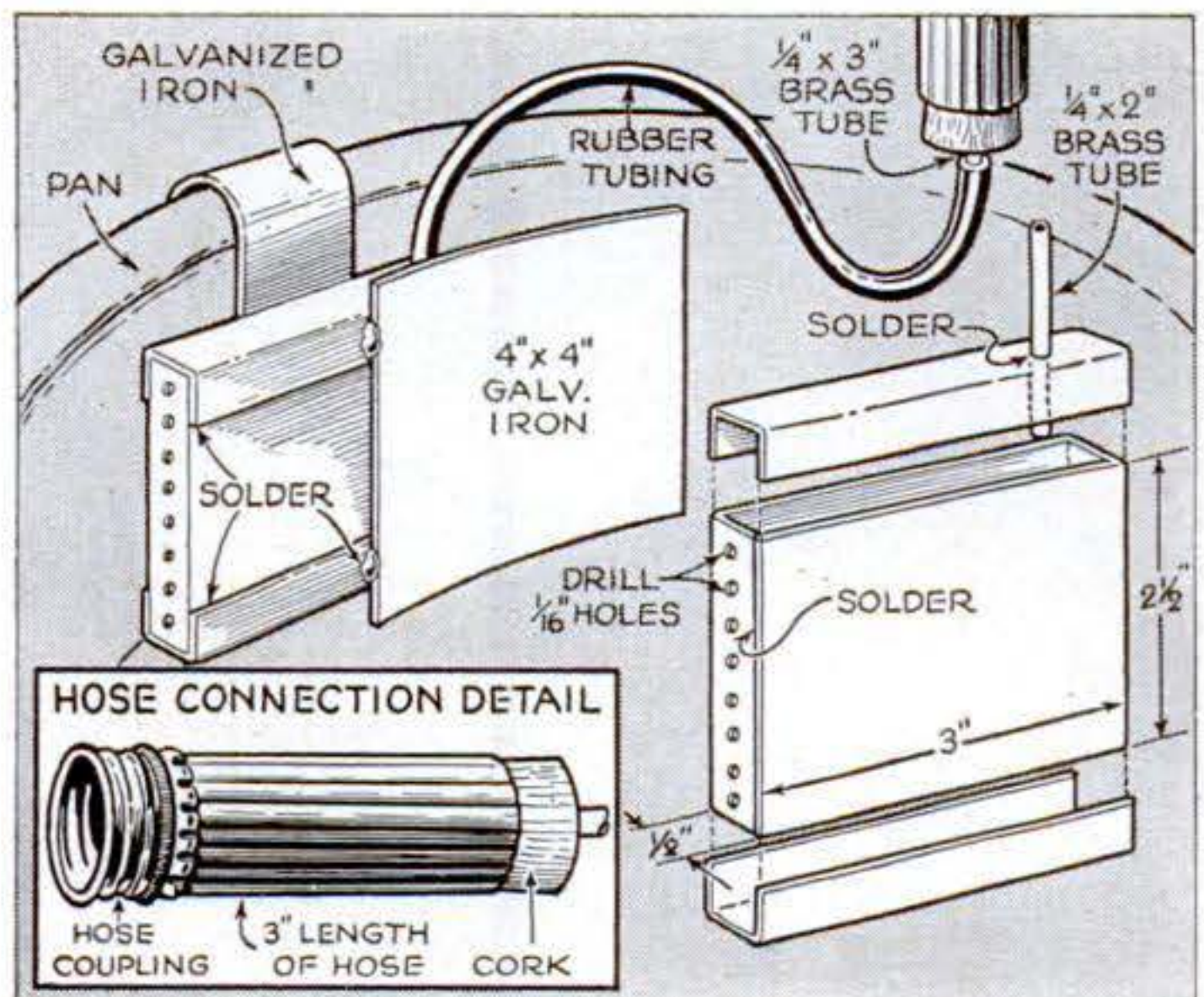

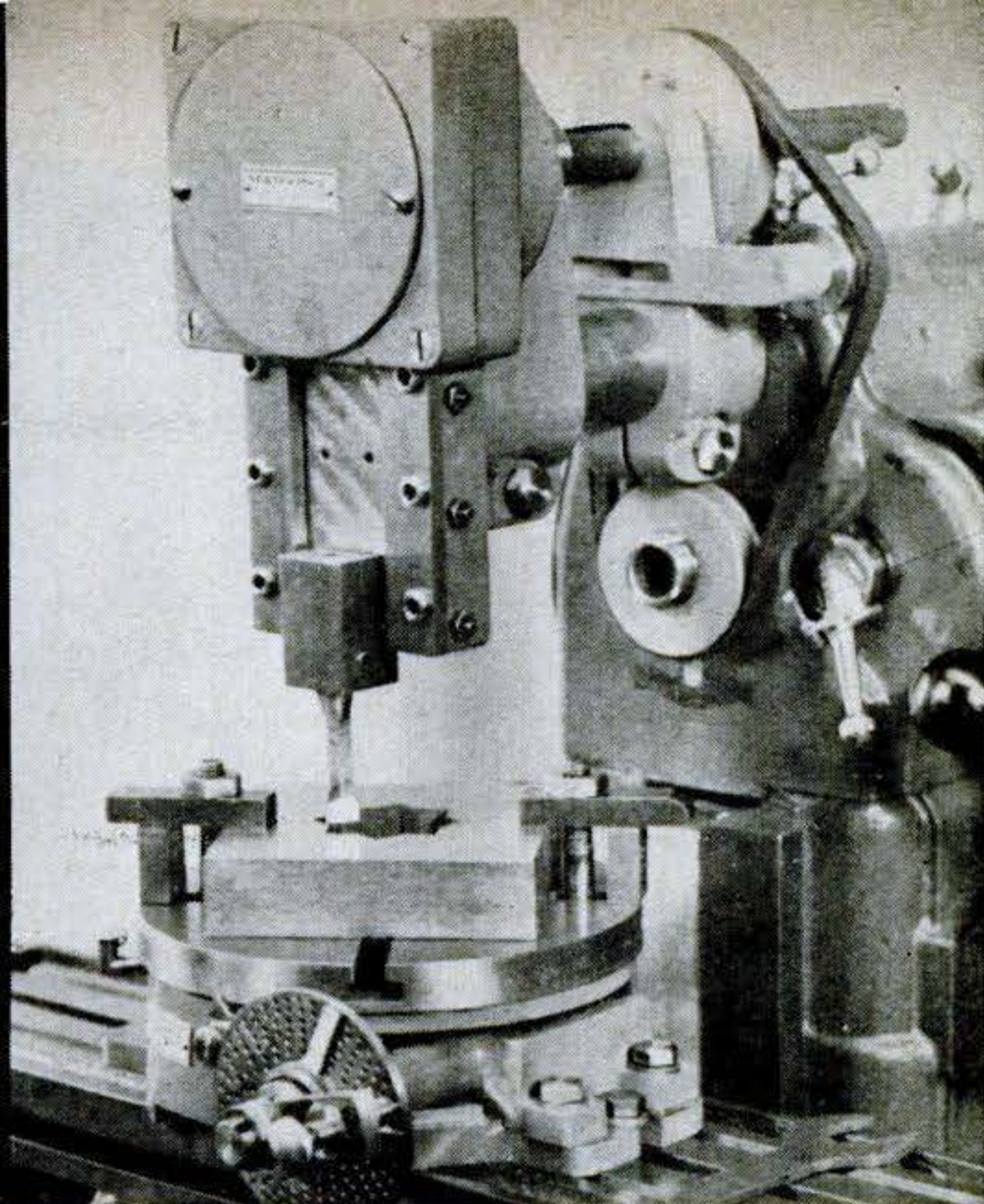
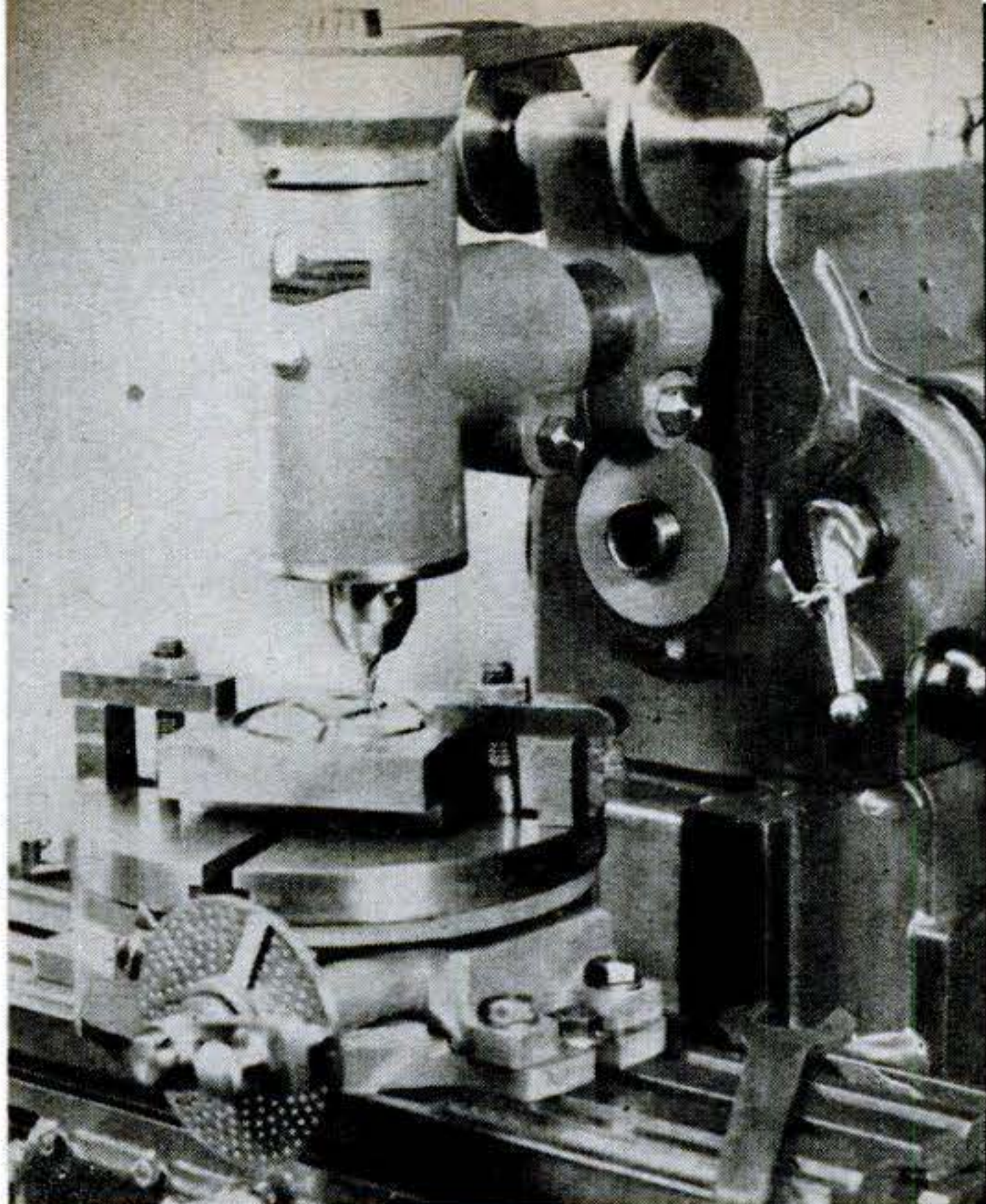

Attachments for Bench Mills

BENCH mills can be used for more jobs with these new attachments. The vertical head (at left) for a horizontal mill can be set at any angle or pulled out past the table for overhanging work.

A slotting attachment, right, allows the

mill to do the work of a small shaper. Its stroke is adjustable from 0 to 2". Both attachments take their power from the machine arbor. A rotary dividing table, a third accessory, is shown in both photos. Marvin Machine Products, Detroit, makes them to fit Atlas millers, but they can be adapted to work on others.

Standard Parts Motorize a "Quickie" Bow Saw

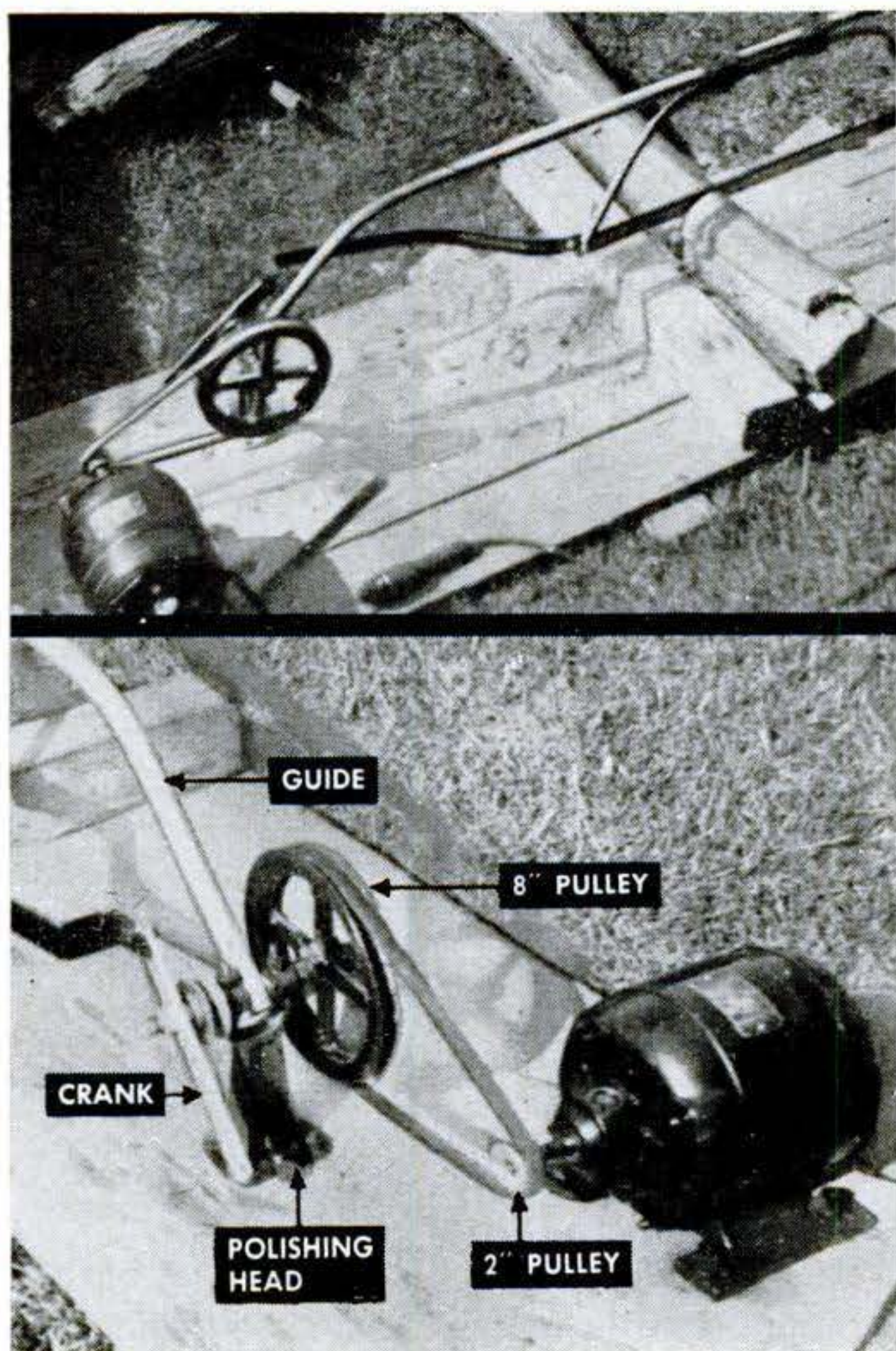

DETERMINED to avoid sawing a pile of logs by hand, I quickly rigged a drag saw by combining my bow saw, a 1/6-hp. motor, and a polishing head in the setup pictured.

A piece of pipe serves as a guide. The saw, mounted on two bent metal clips, slides back and forth on the pipe. One end of the guide pivots on the shaft of the polishing head. The crank is a length of strap iron clamped on the shaft. Another piece of strap stock forms the connecting rod.

Sitting at one end, I operate the switch, push down the saw guide, and hold the log against the stop.—*E. Herzog, Bethlehem, Pa.*

Replacing Teeth in Zippers

SLIDE fasteners that have one or two teeth missing can often be repaired with teeth salvaged from discarded garments. Remove these from the discarded fastener by pulling them firmly with tweezers. Pry open the prongs that grip the cloth, put the tooth in place of the missing one, and press the teeth together. Zipper teeth vary in size, so it's important to select replacements that match.—*Katherine Binder, London, Ont., Canada.*

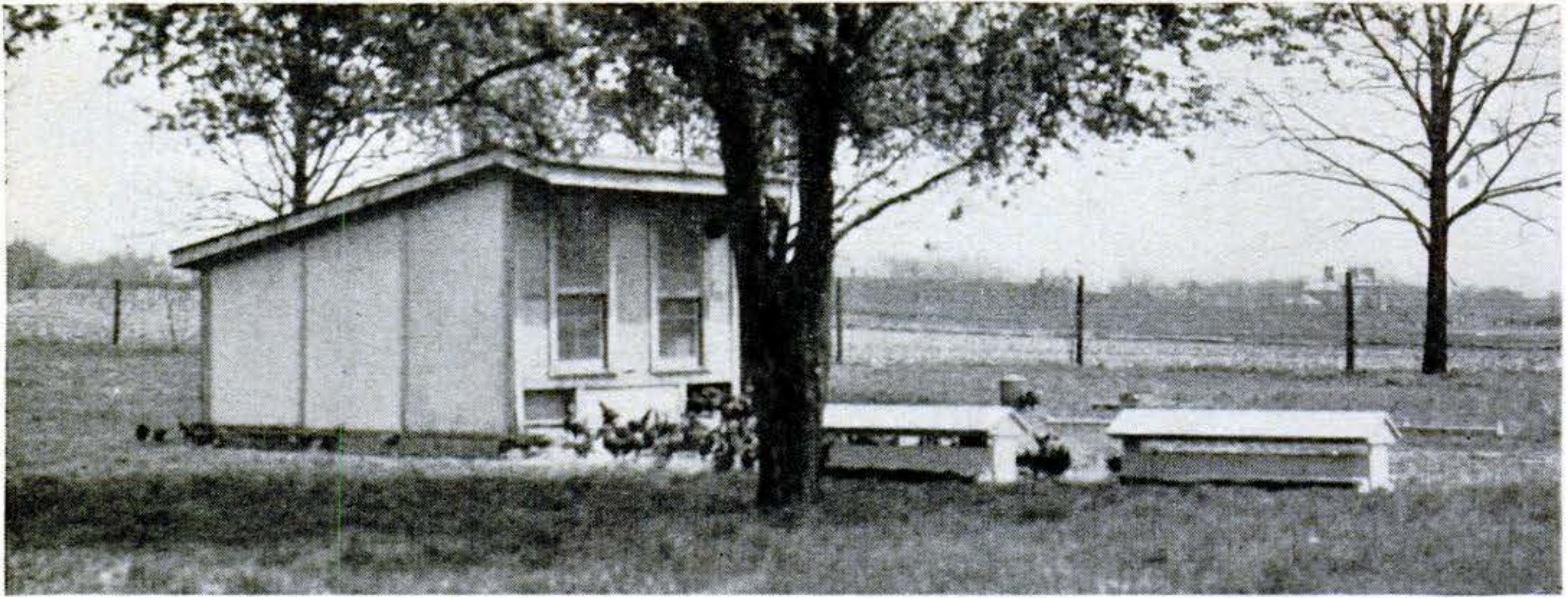

Outdoor feeders need a rainproof cover. The two above will hold enough feed for 200 or 250

pullets for four or five days. Construction details are shown in photo at bottom of page.

Poultry Feeders That You Can Build

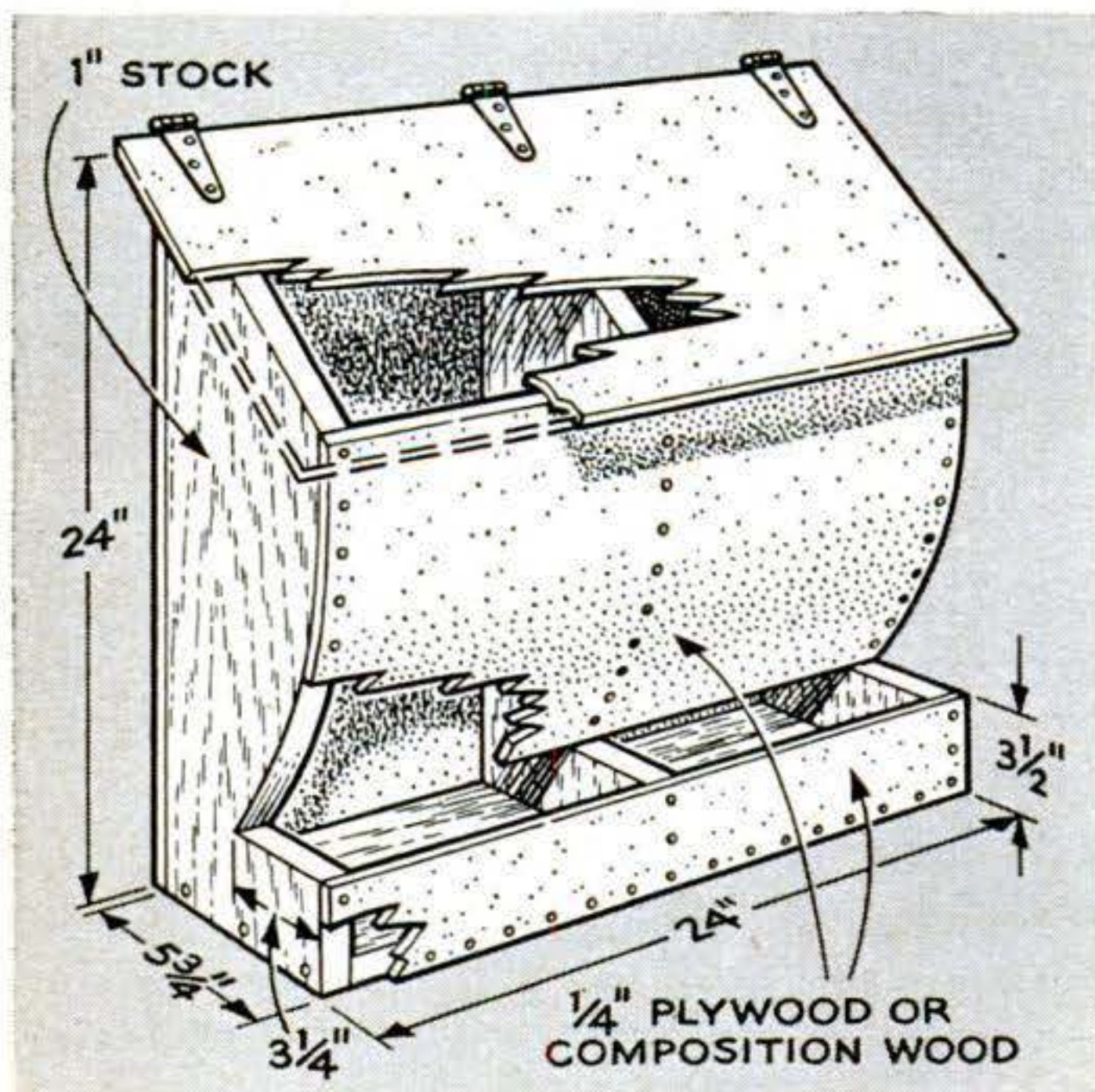

Grit and oyster shell are a requirement for laying hens. This hopper-type feeder will keep your flock supplied for a long period.

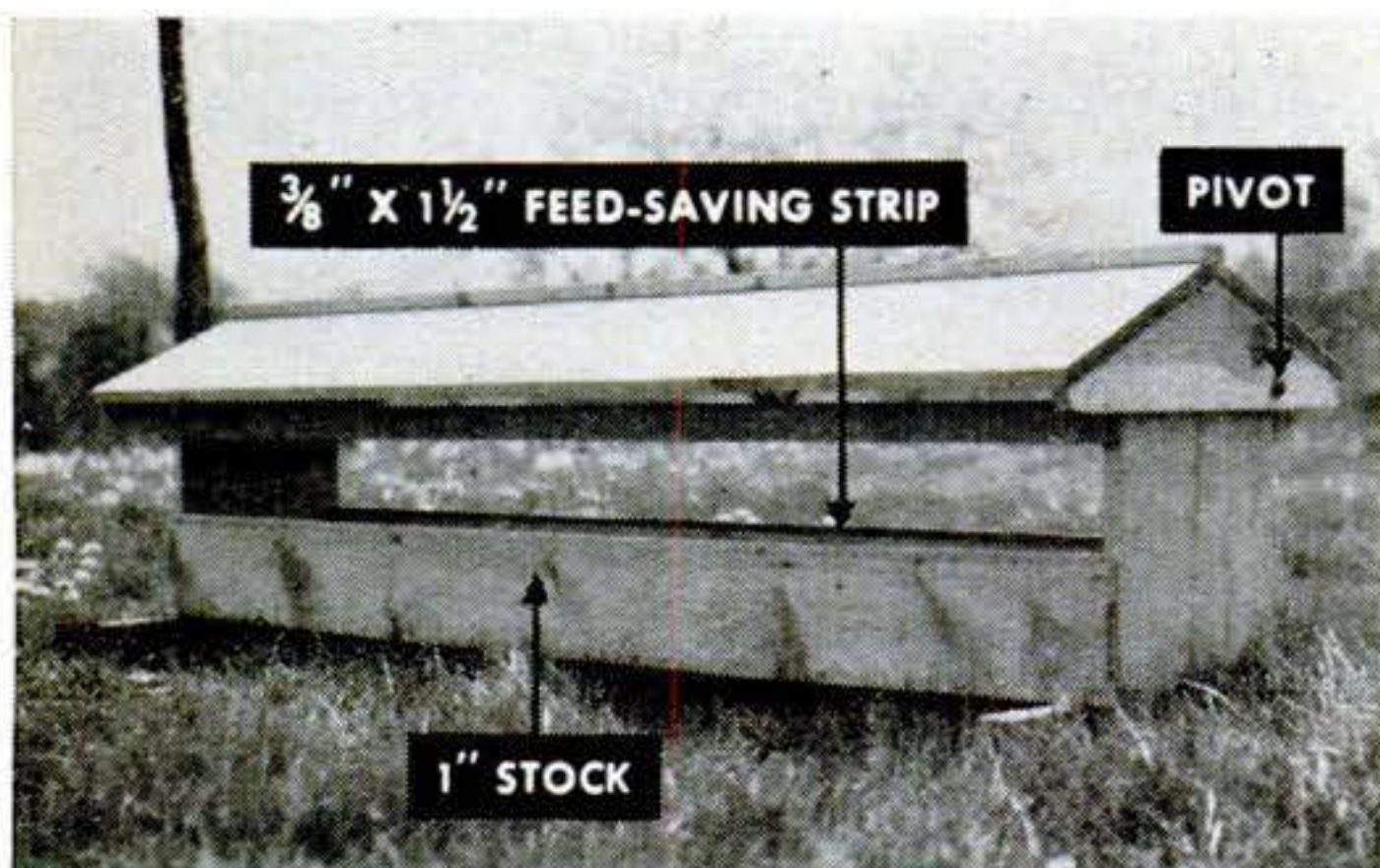

Cover swings up for easy filling. Trough is $3\frac{1}{2}$ " deep, 11" wide, and 6' long. Two-by-fours raise this feeder to right height for turkeys.

BESIDES lightening your chores, these easily built poultry feeders will increase your profits. They reduce feed losses, keep the feed clean, and—by letting the birds eat as much as they want when they want it—cause the chicks to grow faster and the hens to lay more eggs.

Guard rails, or reels, are fitted to all the indoor feeders on the opposite page for two reasons. The rails allow the birds ready access to the feed, but keep them out of the trough. This prevents feed from being wasted and keeps it cleaner. The larger feeders also have feed-saving strips along the edges of the trough.

Capable of being knocked together in only a few minutes, the lath feeder (Fig. 1) will feed about 100 baby chicks during their first two weeks of life. From then until the three-month stage, the wider version (Fig. 2) will take care of about 50. As a final step, the larger feeder (Fig. 3) will carry the chicks through to maturity. As the chicks grow, you can gradually raise the height of the rail of this feeder.

For each 100 laying hens, provide three of the mash feeders shown in Fig. 4. It's a good idea to supply fresh feed in such feeders each day, for this tends to stimulate consumption and increase egg production.

The combination grain and mash trough (Fig. 5) has the advantage of occupying a minimum of floor space. If grain is not to be fed, the lower box can be raised against the bottom of the upper one and held by looping the ropes around the cleats.

5 COMBINATION GRAIN AND MASH TROUGH

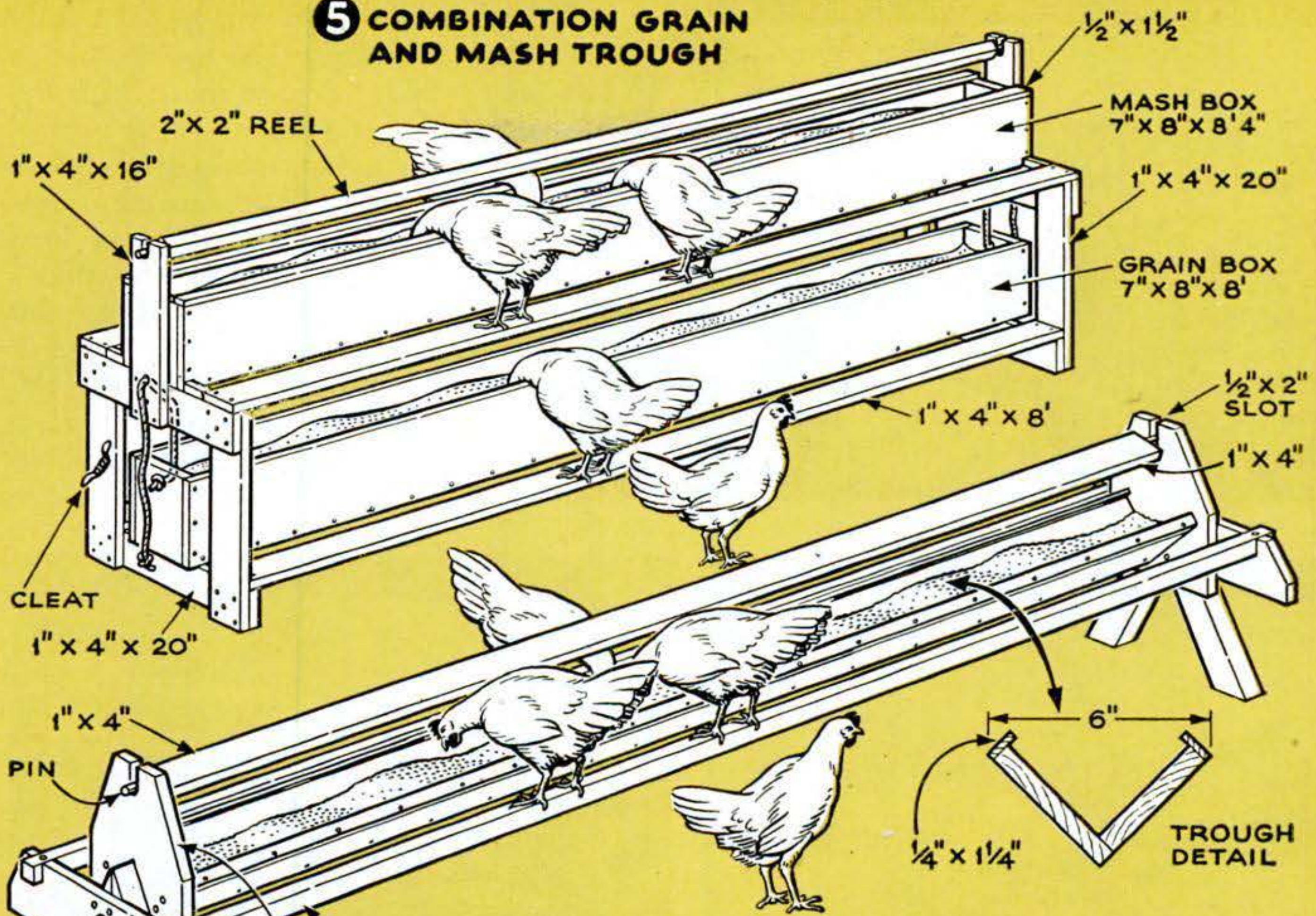

4 INDOOR HEN FEEDER

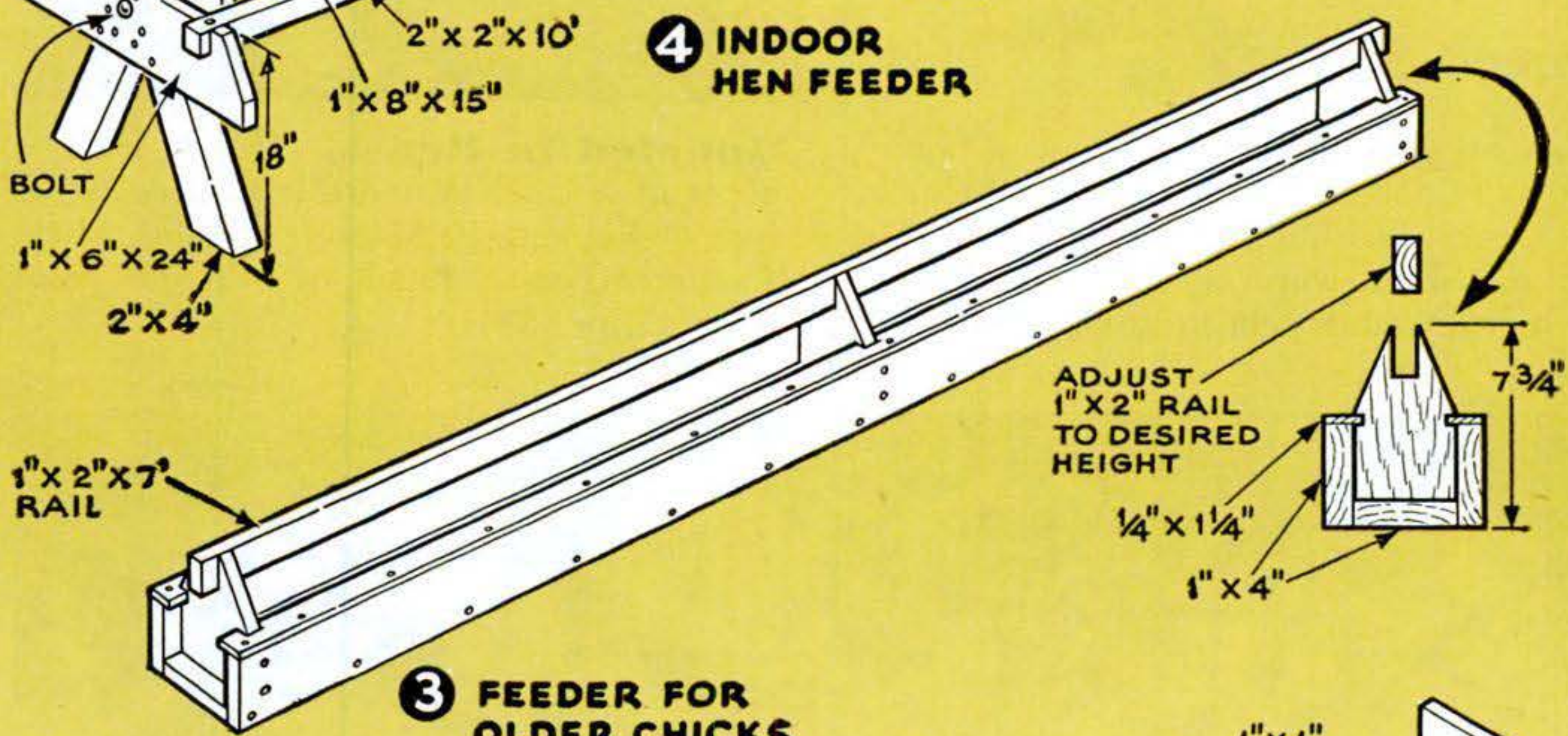

3 FEEDER FOR OLDER CHICKS

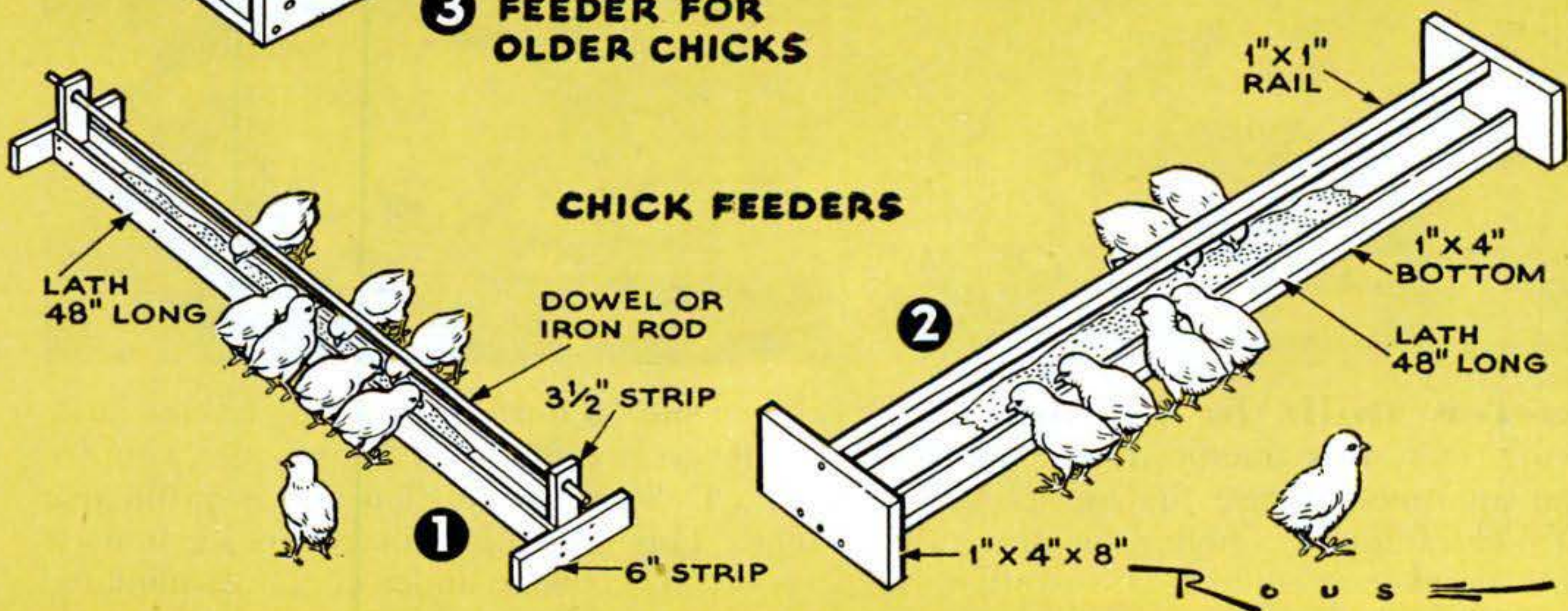

CHICK FEEDERS

CRAFTSMEN AT WORK



Antique Flies on Tether.

A scaled-down version of a Curtiss biplane flown in 1914-15 by Lincoln Beachey, this model has a one-cylinder engine that whips the ship up to 55 m.p.h. on a control line. For flying, the center of balance was moved forward by casting the body of the pilot of lead from the waist down. The pilot's backbone is a coil spring; this permits side-to-side and forward-and-back movement when the elevator controls are worked. Ted Morrison, Oakland, Calif., built it.

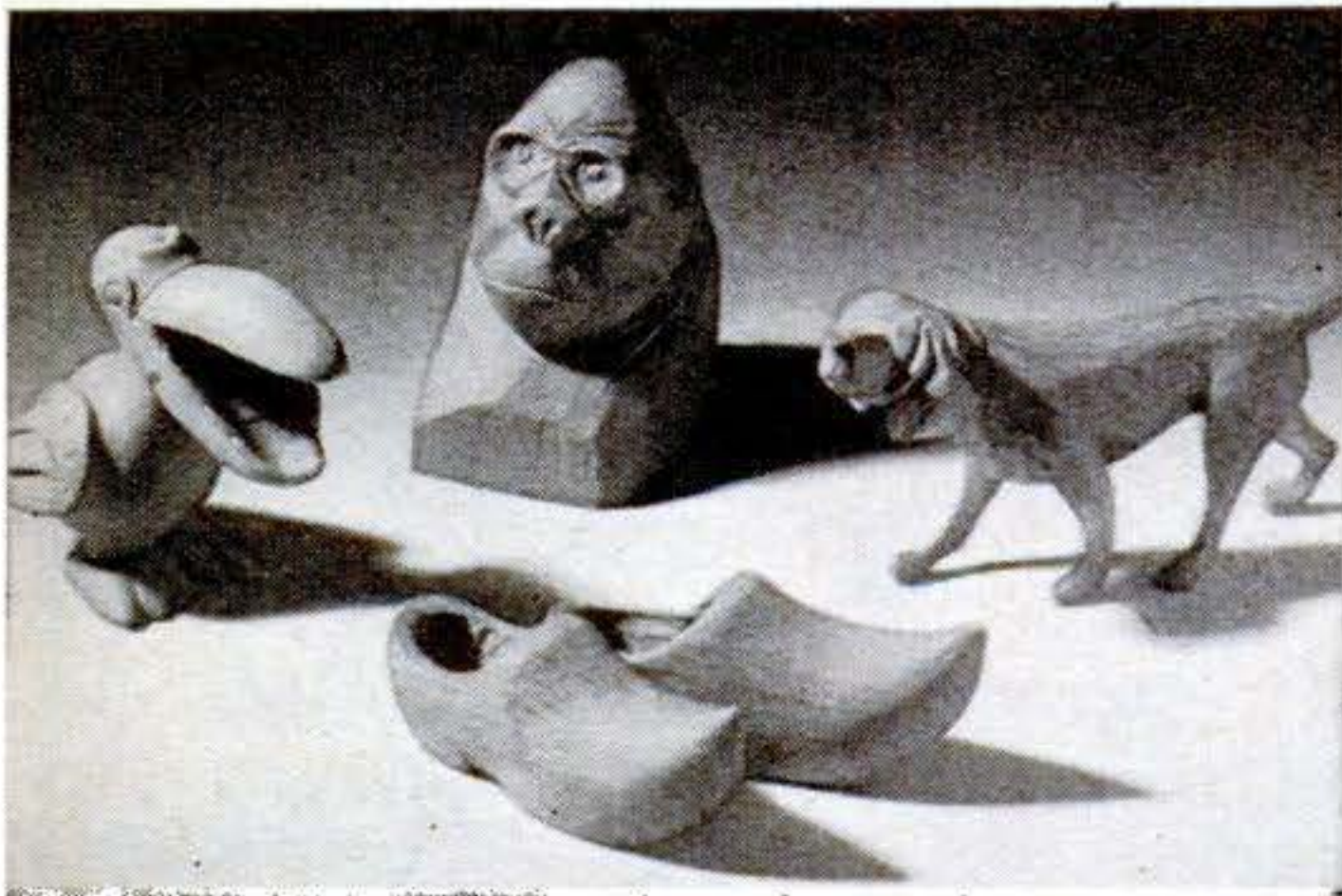

Carves Knickknacks. As a hobby, Leonard Cronk, a cabinetmaker in Valhalla, N. Y., carves oddities like those above. The dog and shoes were cut from white pine, the monkey and pelican from applewood.

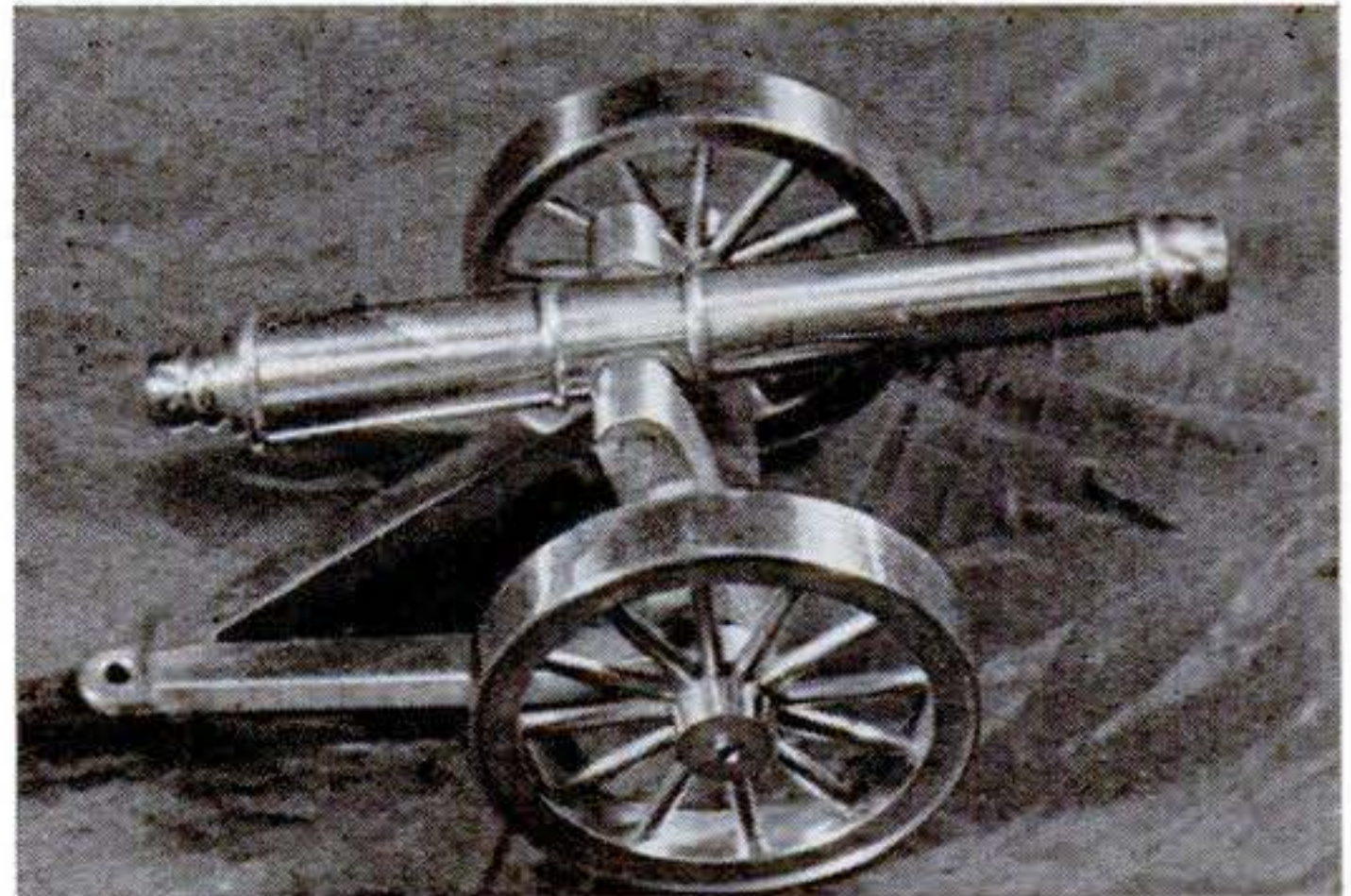

Modeled in Brass. This neat scale model of a Civil War artillery piece is the work of Kenneth E. Maurer, of Flint, Mich. He worked from POPULAR SCIENCE plans (Jan. '47, p. 152).



Tractor Built in Cellar. L. C. Warner built this tractor in the basement of an apartment house in Queens Village, N. Y. The frame was bolted together rather than welded so it could be dismantled. He then hauled the parts in his car to his new

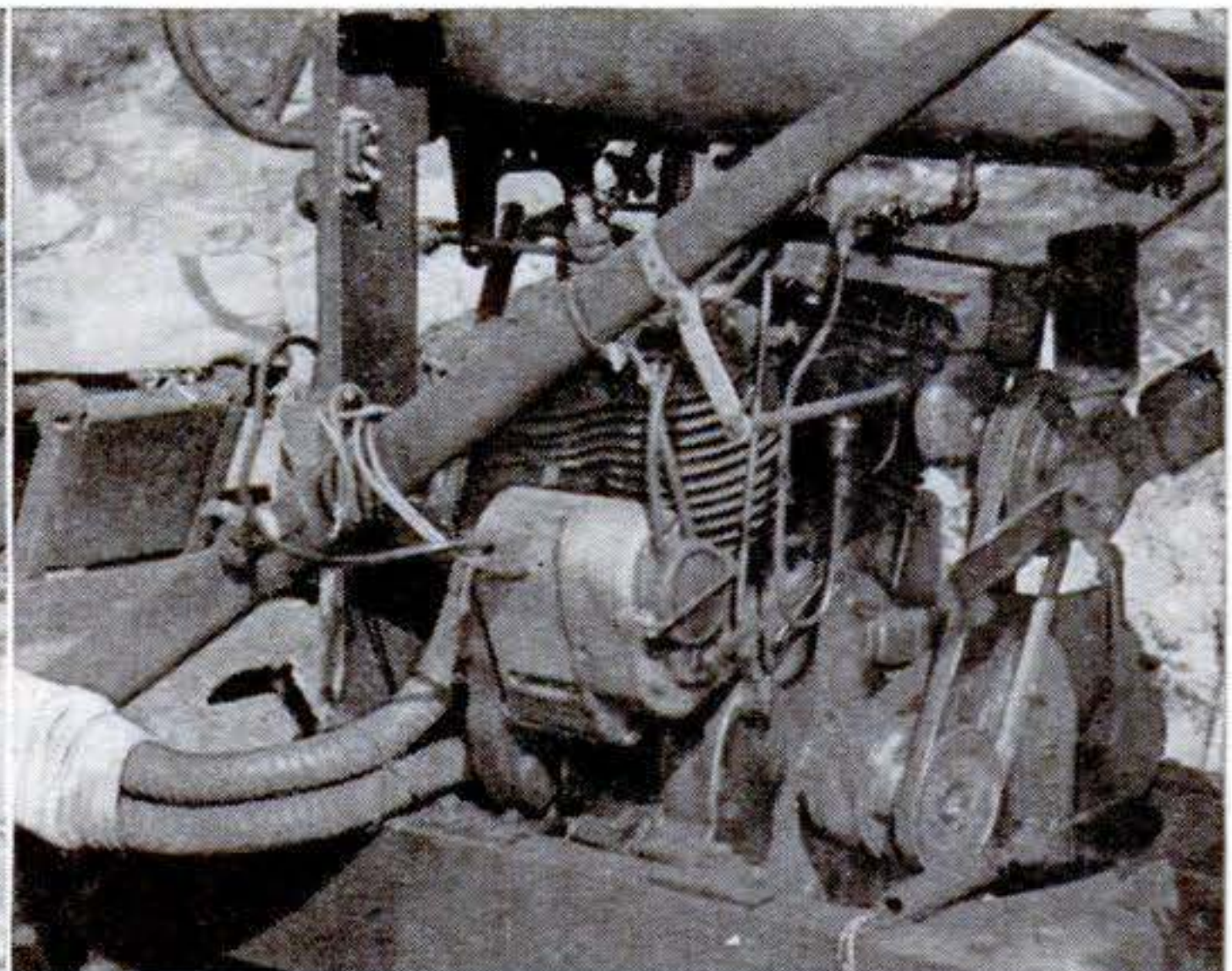

home site 75 miles away. The tractor has a motorcycle engine and transmission coupled to a DeSoto transmission and a Saxon rear end. This gives nine speeds ahead, four reverse. The two-cylinder engine is mounted crosswise and cooled by an auto fan.

Less than \$50...a fine Kodak Enlarger

**THE NEW
KODAK "HOBBYIST"**



"Cold light" protection for your negatives—at the touch of a button, the circline fluorescent lamp flashes on. "Integrating-sphere" type lamp house and its special inside coating give uniform light distribution.



"Squeeze action" control smoothly elevates or lowers the enlarger head. You can enlarge negative areas up to 7 times.



As for focusing, what could be quicker than a turn of the lens. The Kodak Enlarging Ektanon $f/6.3$ 89mm. Lens, with click stops, is velvet-smooth—accurate to a degree.



**ONLY
\$47.50
COMPLETE
WITH LENS
and including
Federal Tax**

Enlarging is swell fun . . . ask anyone who does his own work. So see the new Kodak Hobbyist Enlarger at your Kodak dealer's now. It's a great performer at a modest price.

EASTMAN KODAK COMPANY • ROCHESTER 4, N. Y.



New negative carrier simplifies loading—for negative sizes through $2\frac{1}{4} \times 3\frac{1}{4}$ inches. Kodak Combination Negative Carrier A, masks, and roll-film cups are available accessories.

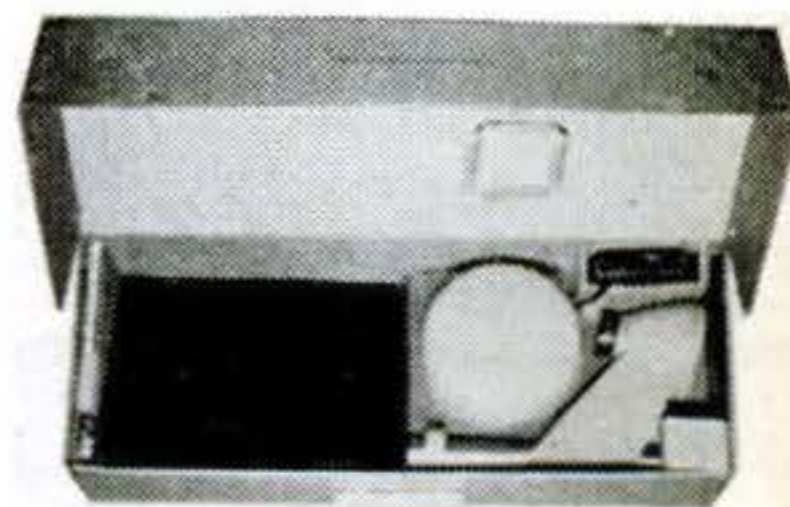

Stows away in its own suitcase-type packing case—ideal for closet storage.

Kodak
TRADE-MARK

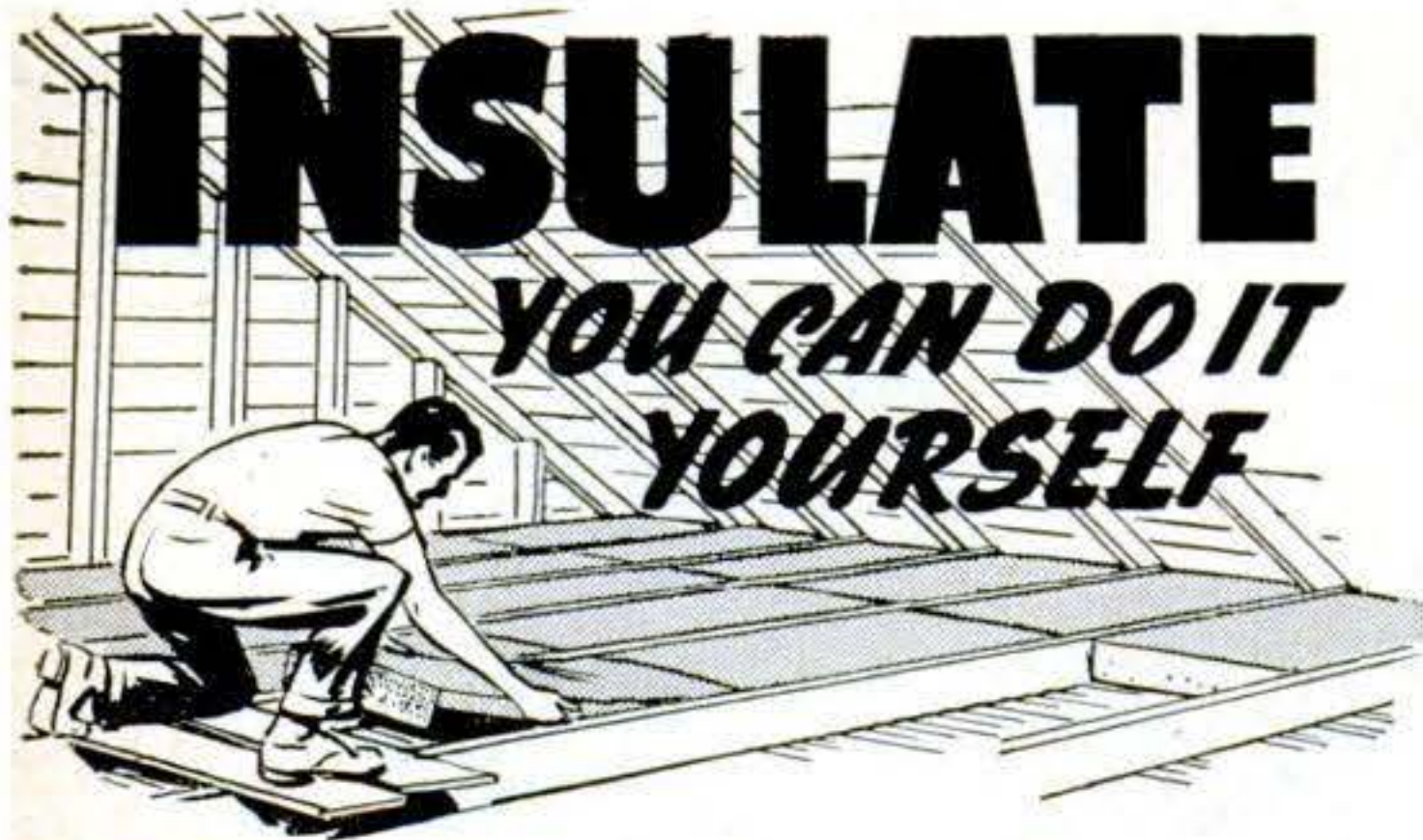

IT'S a cinch to insulate your home with Gold Bond Rock Wool Batts or Blankets. You'll save a lot of money in fuel bills and keep your house warmer in winter, cooler in summer. Light, easy-to-handle batts slide between rafters or attic floor joists. You get extra fire protection too. Gold Bond Rock Wool Batts and Blankets *can't burn*. Batts are 2 and 4 ft. long, Blankets 8 ft. long. Both come in standard widths to exactly fill the space between framing members. Be sure they're "full-thick" and bear the Gold Bond name for maximum insulation and fire protection. For a free booklet giving details, write Division Y, Department PS-2.

Available at your local Gold Bond Lumber and Building Supply Dealer!
NATIONAL GYPSUM COMPANY
 BUFFALO 2, N. Y.

AT LAST! THE BEST OF EVERYTHING IN ONE GREAT MOWER - THE NEW 1950 Worcester 21-INCH SHEAR MASTER

Only \$109.50 f.o.b. factory

Think of it!
 In this one fine mower you get:

1. Quick-starting Briggs & Stratton 4-cycle, 1½ h.p. engine.
2. Famous, long-wearing Timken bearings.
3. Grass guards to prevent clogging of reel.
4. Heavy-duty, tractor-tread, non-skid tires.
5. Clutch and speed controls on handle.
6. Free-floating, shock-reducing handle. Stands upright for small space parking.

Yes... you get all these great features, and many more.
 See Your Dealer—
 or Write Dept. B-13 for Illustrated Literature

WORCESTER LAWN MOWER COMPANY
 Div. Savage Arms Corporation, Chicopee Falls, Mass.



Kit Keeps Thread Tanglefree

THE kit shown above keeps the family sewing box free from the tangle of unwound thread. Its six spools, clearly visible through the package's transparent side wall, feed thread out through portholes as needed, while the kit keeps its contents dustproof. Clear Pak Inc., of Brooklyn, N. Y., makes the kit, which also holds needles.

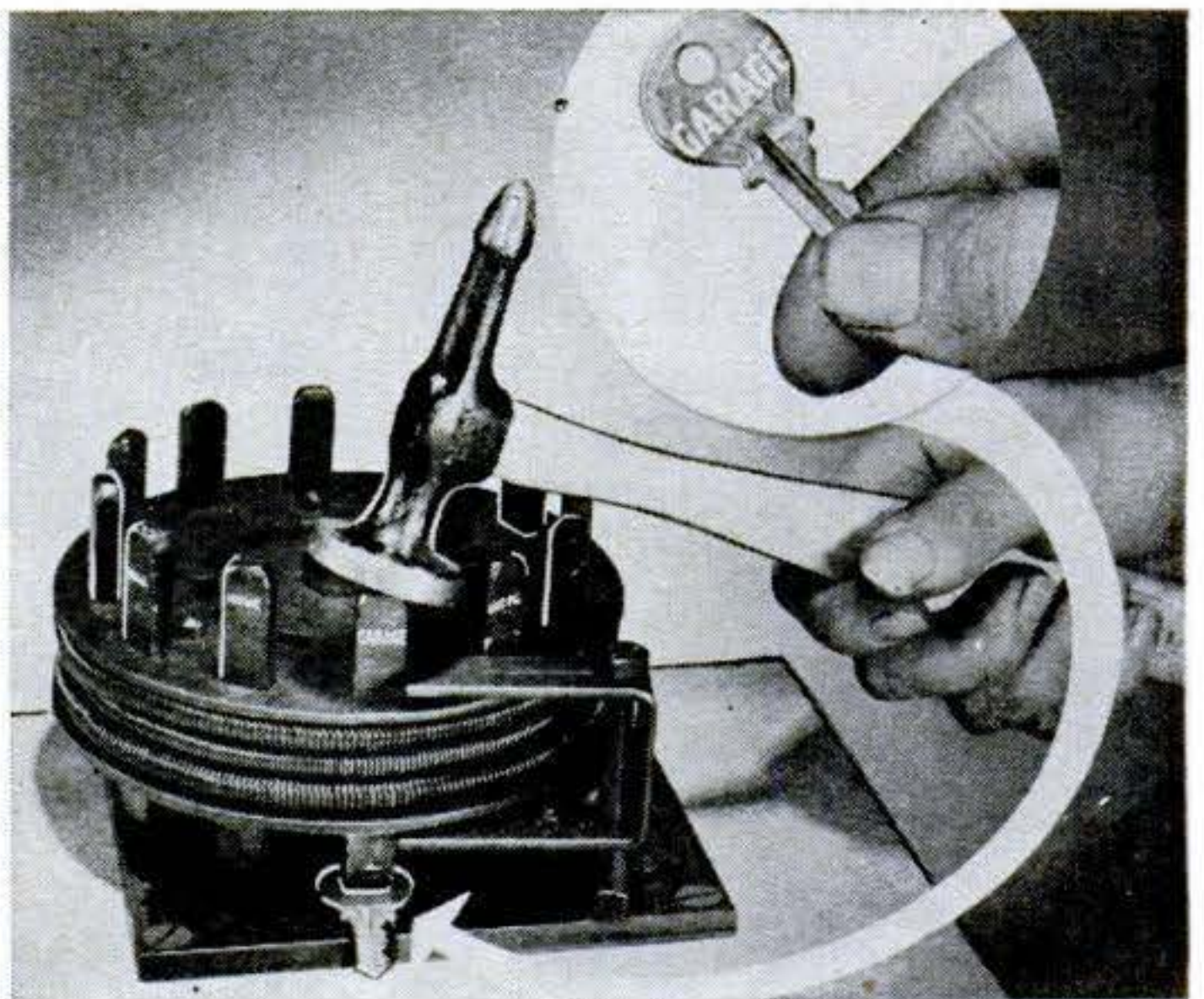

Dies Identify Keys

You won't have to fumble for the right key if it's identified by the device above. Mounted on a metal base, Ident-A-Key Set® consists of a six-inch steel turntable that holds 12 steel marking dies. To imprint a key, the proper die is placed over the key handle and struck with a hammer. Red pencil or white paint can then be rubbed into the letters to make them more legible. Metro Mfg. Co., Chicago, makes it.

TWO NEW MOTORS by **EVINRUDE**

Fleetwin
with
NEUTRAL-FORWARD
and **SAFTI-GRIP DRIVE**

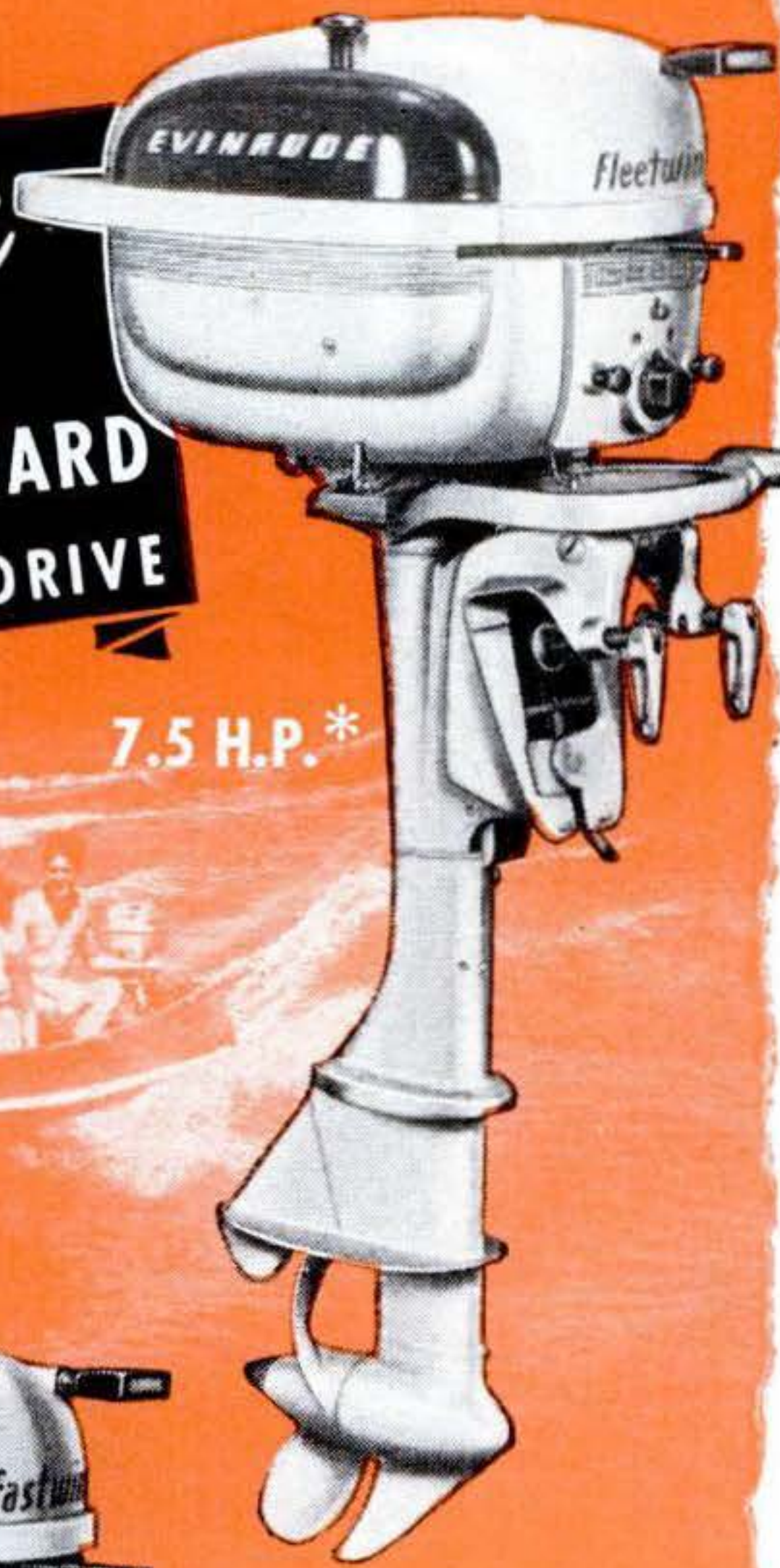

7.5 H.P.*



14 H.P.*

Fastwin
with **GEARSHIFT**
NEUTRAL
FORWARD
REVERSE

... and
CRUIS-A-DAY
TANK

*O.B.C. certified
broke horsepower
at 4000 R.P.M.

• Brawny power under finger-tip control . . . new maneuverability, operating convenience, handling ease . . . sharply advanced performance that brings new thrills to boating . . . with these sparkling new models Evinrude again makes outboard history!

FLEETWIN WITH DUO-CLUTCH: You start the motor in *Neutral* . . . "idle" whenever you like, at dock or fishing spot . . . press the control button and you're in *Forward*. Full Pivot Reverse and 360° steering for complete maneuverability. Safti-Grip Propeller Drive for trouble-free operation in shoal water. 7.5 certified horsepower* . . . low trolling speed . . . and exhilarating top throttle performance that "brings out the best" in typical family and fishing boats!

FASTWIN WITH GEARSHIFT: 14 horsepower* for thrilling speeds, heavy loads . . . with *Gearshift* that lets you reverse, idle and maneuver with motor car ease of control! And to give you broad cruising range the Fastwin comes with separate 6-gallon *Cruis-a-Day Tank*. You stow the tank anywhere in the boat . . . and "hook-up" the fuel line to the motor as easily as plugging in a lamp socket!

SEE YOUR EVINRUDE DEALER: He will gladly show you the complete line of Evinrude models for 1950 . . . the 1.5 H.P.* *Sportsman* and 3.3 H.P.* *Sportwin*, both with exclusive *FISHERMAN DRIVE* that "let's you go anywhere there's water to float your boat." For largest, fastest boats, the 22.5 H.P.* *Speeditwin* and the 33.4 H.P. four-cylinder *Speedifour*. Look for your dealer's name under "Outboard Motors" in the yellow pages of your phone directory.

CATALOG FREE! Write today for full-color catalog of the 1950 Evinrude line.
EVINRUDE MOTORS,
4405 N. 27th Street,
Milwaukee 9, Wis.

In Canada:
Evinrude Motors,
Peterboro, Ontario



EVINRUDE

FIRST IN OUTBOARDS . . . 41st YEAR

FEBRUARY 1950 245

Make \$20 to
\$30 a Week

**EXTRA
MONEY**



MACHINE SAW FILING PAYS UP to \$2 or \$3 an HOUR

• Turn your spare time into CASH—sharpening saws with a Foley Automatic Saw Filer pays up to \$2 or \$3 an hour. You will find you can make \$20 to \$30 a week in your spare time as a starter.

You can work in your basement or garage—no experience necessary. "The first saw I sharpened with my Foley Filer came out 100%"—writes Clarence E. Parsons. No canvassing—"I advertised in our local paper and got in 93 saws"—says M. L. Thompson. The Foley is the only machine with which you can file all hand saws, also band saws and cross-cut circular saws.

SEND FOR FREE BOOK "INDEPENDENCE AFTER 40"!

Shows how you can get business from home owners, farmers, carpenters, schools, factories, etc. With a small investment, no overhead, no stock of goods to carry, you can get right into a cash business,—and possibly later on develop into a full-time repair shop. Send coupon today for Free Book.

"Each saw I filed got me six more and business has been picking up that way since a year ago. If it keeps up I will have to buy another Foley Saw Filer."
William C. Baldwin

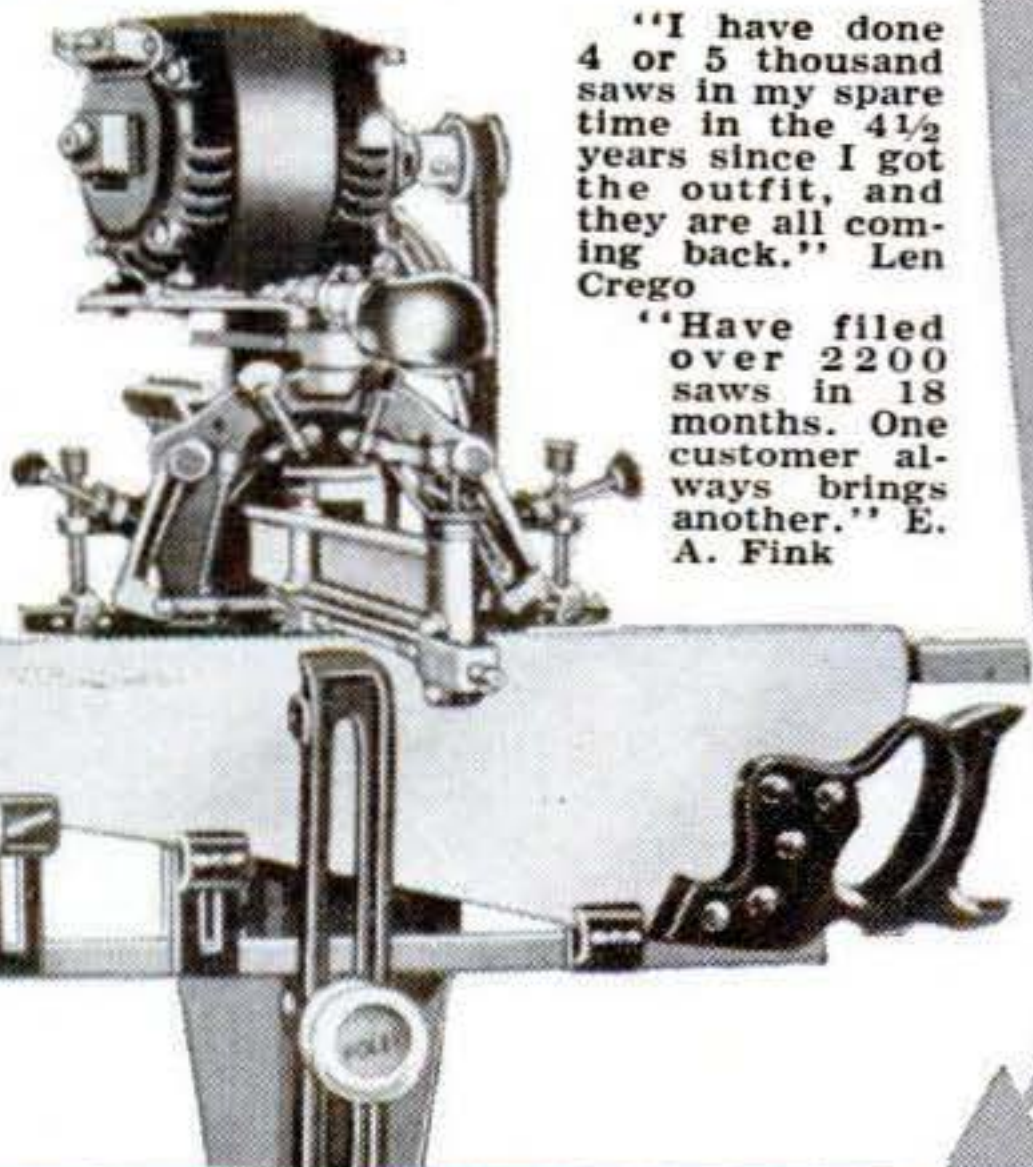

"I have done 4 or 5 thousand saws in my spare time in the 4½ years since I got the outfit, and they are all coming back." Len Crego

"Have filed over 2200 saws in 18 months. One customer always brings another." E. A. Fink



SEND COUPON FOR FREE BOOK

FOLEY MFG. CO., 219-O Foley Bldg.
Minneapolis 18, Minnesota

Send FREE BOOK—
"Independence After 40."

Name.....

Address.....

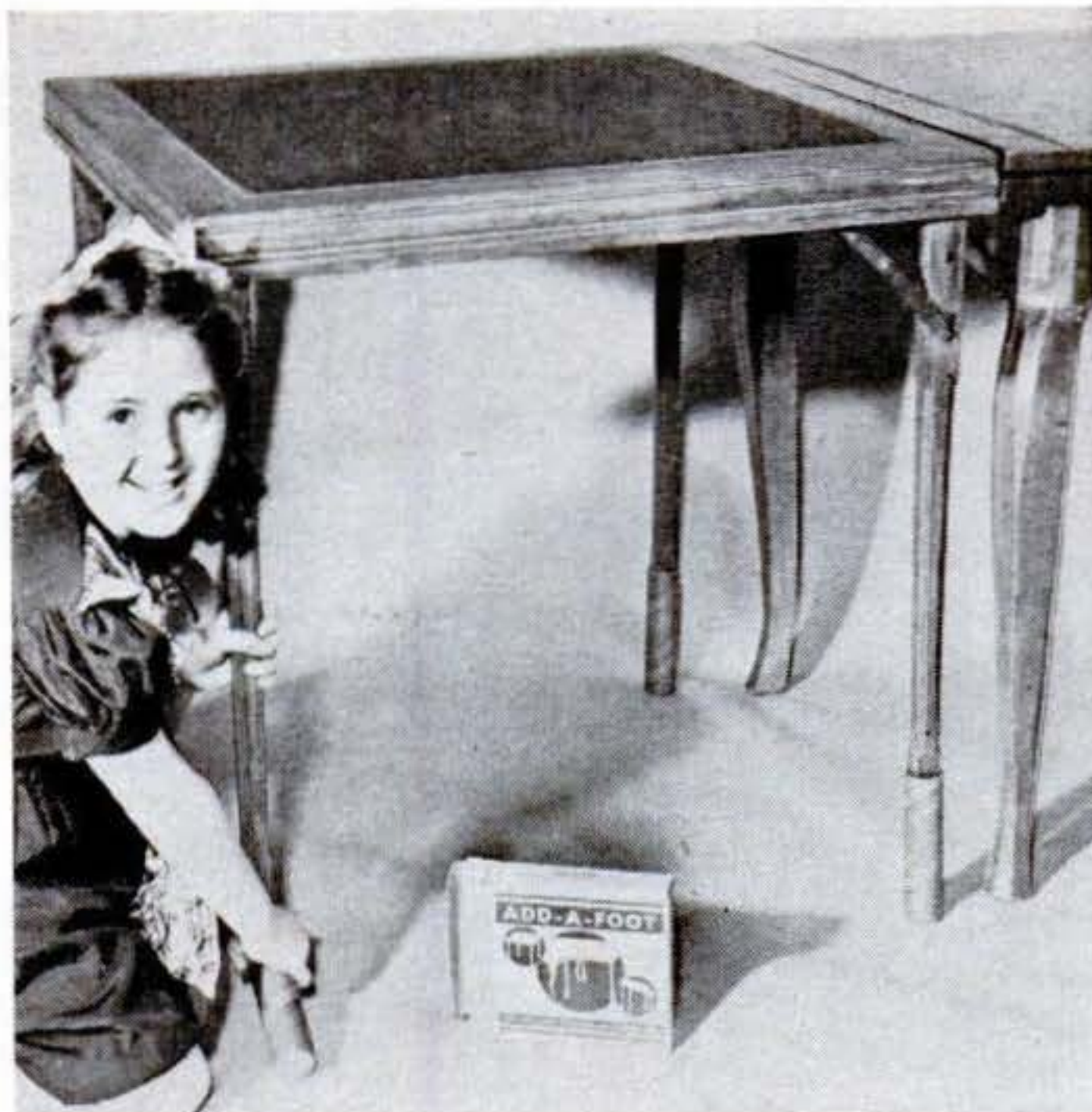

Extension "Legs" Raise Table

AN ORDINARY folding card table can be raised to the level of the dining-room table, for use as an extension when you have more guests than room to seat them, by fitting its legs with tubes having hardwood plugs. Add-A-Foot® comes in one-inch- and 1½-inch-dia. sizes. A set of tubes, made by Syland, of Staten Island, N. Y., sells for \$1.

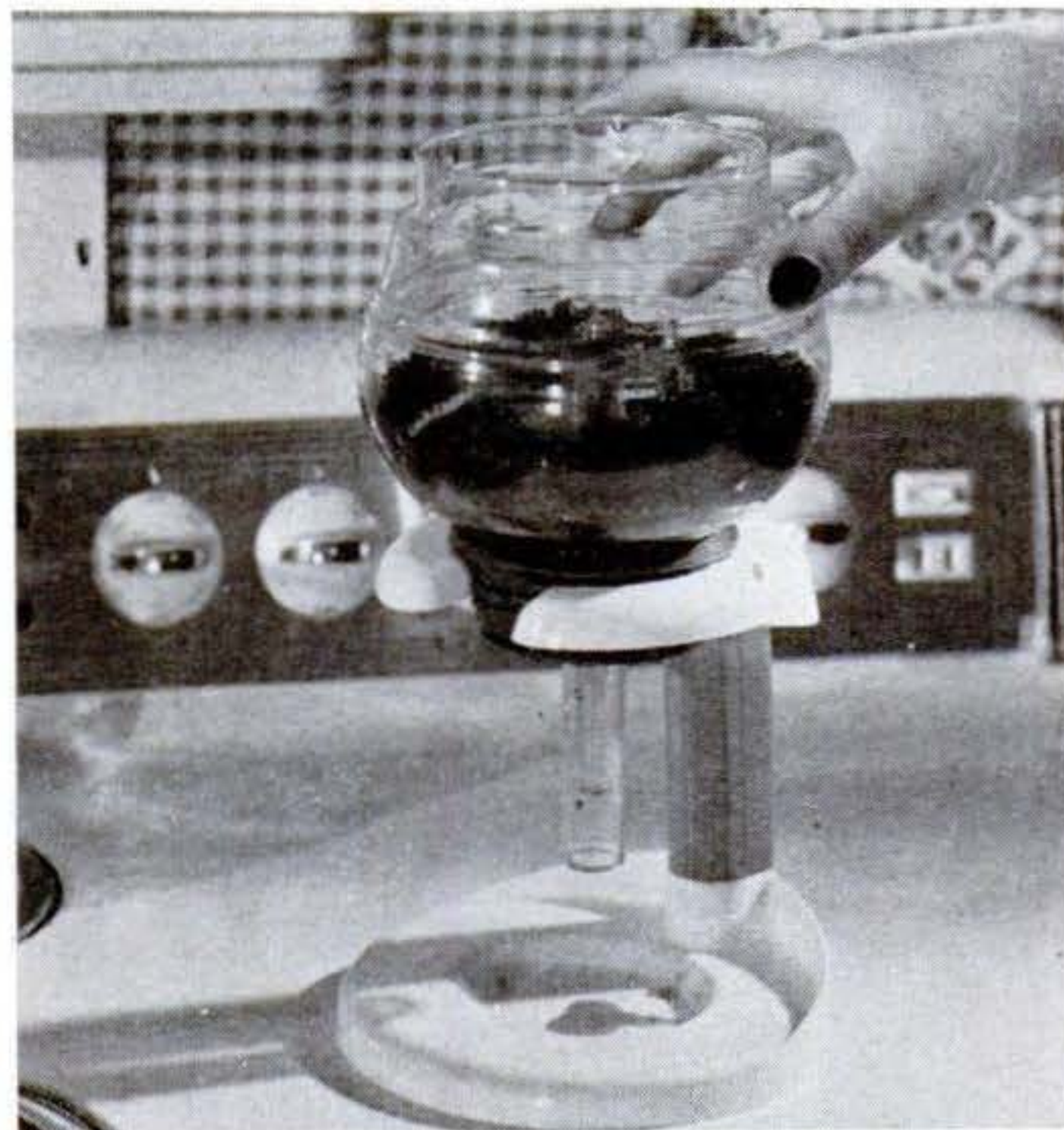

Holder Protects Coffee Maker

THIS Bakelite® holder offers a safe place to put the top of the coffee maker when you have finished making the morning brew. It also catches the drops that run off the grounds. The protector is made by Wolverine Plastics, Inc., of Milan, Michigan.

The one
fine car
 in the
 low-price
 field

'50
 FORD

50

WAYS NEW

Take a GOOD look—
 Take a GOOD ride

AT YOUR
 FORD DEALER'S



NEW box-type frame rails have steel of greater thickness for increased rigidity. Five rugged cross members give torsional strength.

NEW shields on front brakes plus labyrinth seals between backing plate and drum on all wheels protect brakes from dirt and water.



NEW gas filler tube and cover... new non-spill vent tube that allows air to escape freely. Closed cover blends into body.

NEW one-piece torsional stabilizer, rubber mounted on lower control arms, and improved front suspension add to Ford's famous roadability.



NEW front end styling... new parking lights... new smart medallion... new "Air Foil" grille... new stronger bumper guards and bumper support arms.



ENGINEERING ADVANCEMENTS MAKE
FORD'S 100 h.p. V-8
 QUIET AS A WHISPER!



NEW permanent-type lubricant on hand brake shaft assures continued easy operation. Smart new hardware—inside and out—adds new beauty.

NEW "Magic Air" heater control is clearly marked, compact, easy to operate and lighted for after-dark use. ("Magic Air" heater optional at extra cost.)



NEW defroster openings are 44% wider and air flow is 25% greater for wider vision in bad weather... new interior light switch mounted on instrument panel saves groping in the dark.

★ **Dozens of other BIG features!**

There's a *Ford* in your future...
 with a future built in!



FLOODLIGHT LANTERN

*Prices as low as \$9.95 in U. S. A.



"My Coleman Lantern adds more hours of fun, with plenty of good light in camp at night," says **ANDY DEVINE**, sportsman and picture star, and owner of Sportsmen's Tavern, Big Bear Lake.



"I wouldn't be without my Coleman. You need it for a brighter camp light and longer outings," says **JOE GODFREY**, founder of the Sportsman's Club.



"You need adequate light when you haul big ones aboard—that's why I use Coleman," says **JOHN HIGHTOWER**, noted outdoorsman.

Floodlights 100-ft. area—20 times as bright as wick-type lantern. Storm-proof. Safe. Ask your dealer.

GOOD EATS Quick...Anywhere

Cooks like a city gas range. Lights instantly. Folds up; carries like a suitcase. Safe. Prices as low as \$9.95 in U. S. A.



Folding Camp Stove

The Coleman Company, Inc., Wichita 1, Kansas

The Coleman Company, Inc., Dept. 208-PS, Wichita 1, Kansas—Please send me FREE booklet, about Coleman Lanterns and Camp Stoves.

NAME.....

ADDRESS.....

CITY..... STATE.....

Wax Eases Home-Movie Film

IN WARM, humid weather, movie film often sticks in the film-gate channel, causing torn sprocket holes and interrupted showings. This can be corrected by coating the film with paraffin. Such treatment also tends to delay drying out of the film—a condition that makes it brittle and easily damaged.

Clean the film thoroughly by winding it several times through a clean, soft cloth that you have saturated with carbon tetrachloride. Because of rapid evaporation, the carbon tet will disappear almost immediately.

Make your coating solution as follows: Pour about two tablespoons of carbon tet into a glass and shave into it ordinary paraffin wax, stirring with a match stick until the mixture reaches its saturation point. Then add enough carbon tet to triple the volume. The mixture must be fairly thin.

Apply it with a saturated cloth held in contact with one side of the moving film. Do this once to each side of the film. When the wax is dry, run the film through a dry cloth to wipe off any excess.

In splicing waxed film, carefully scrape joining surfaces.—*W. H. Hunter, Tunkhannock, Pa.*

Glue Brush Made of Rattan

RATTAN of about 3/8" diameter taken from discarded porch furniture can be made into excellent glue brushes. Cut it into pieces 10" or 12" long, and carefully scrape off any paint or varnish from 2" at one end. Boil these ends in water for an hour. Then hammer the softened ends on the end grain side of a wood block. For fine work, a single length can be used as a small brush. For bigger jobs, wire several together.—*E. N. Rizzotti, Mt. Vernon, N. Y.*

CHAMPION V-GLOW PLUGS

for model engines only

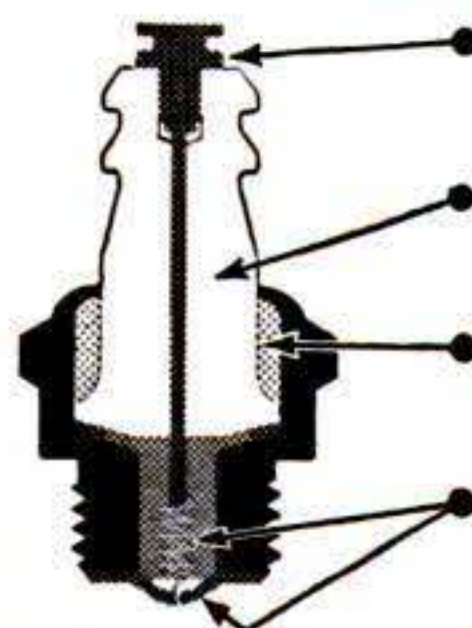

CHAMPION TERMINAL—assures better center electrode seal and provides sturdier electrical connection.

CHAMPION-CERAMIC INSULATORS—proved dependable in millions of Champion Spark Plugs.

CHAMPION SILLMENT SEAL—prevents excessive compression leakage between insulator and shell.

CHAMPION "THERM-O-FLEX" CONSTRUCTION—longer element life, more dependable performance.

Follow recommendations of plug types and fuels approved by engine manufacturer.

CHAMPION SPARK PLUG COMPANY, TOLEDO 1, O.

BE A CHAMPION DRIVER

FOLLOW THESE RULES TO STRETCH GAS MILEAGE

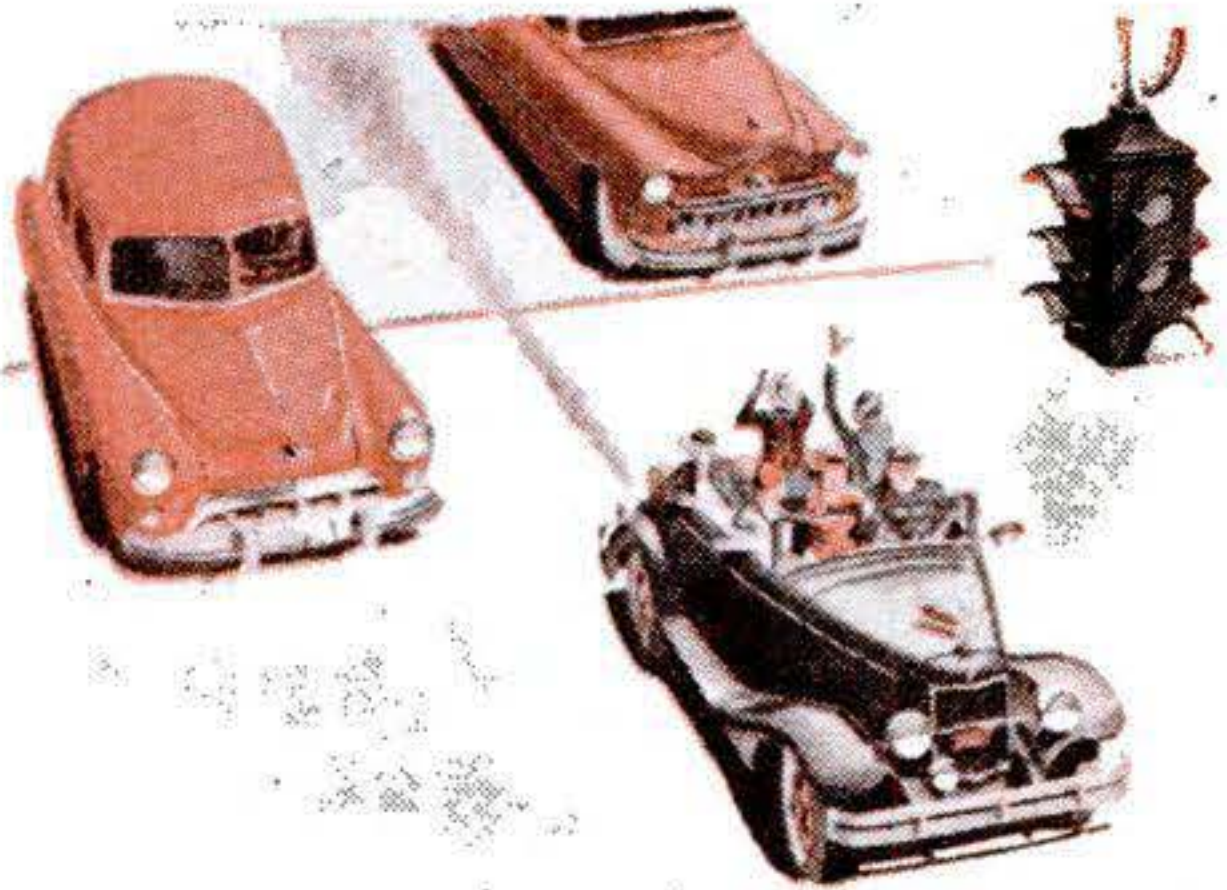

Showoff acceleration proves nothing and is extremely wasteful of gas. Normally this type of driver has to slow down a moment later. Drive steadily—you will arrive at your destination **safe and sound.**

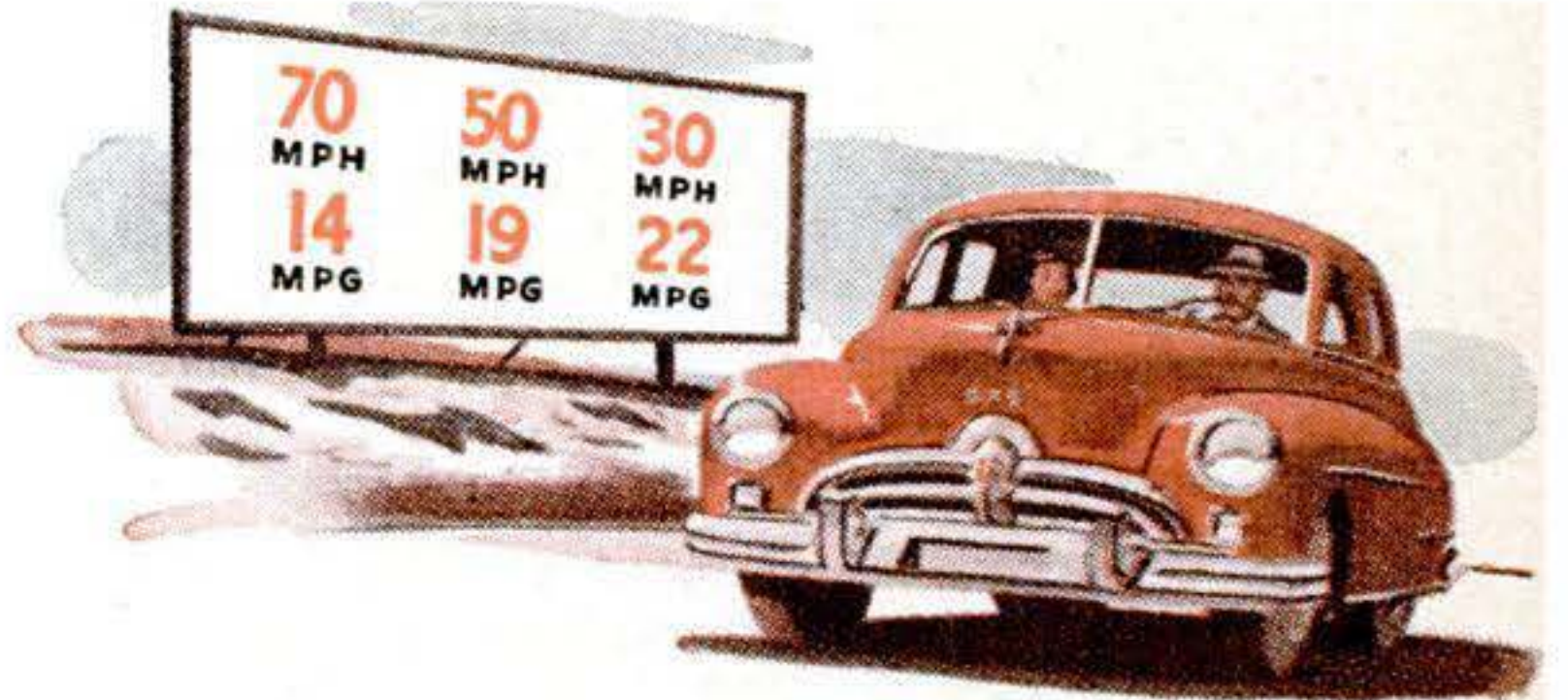

Gas mileage goes down drastically as speeds go up. Table above is based on actual tests of six-cylinder medium-priced cars. Make a habit of driving at conservative legal speeds **because it pays.**



Have your spark plugs tested, cleaned, adjusted regularly, replaced every 10,000 miles. One missing plug in a set of six wastes up to one-sixth of your gas—to say nothing of impairing starting, performance and dependability. You can rely on your Champion dealer **for dependable service.**

A *Champion* driver cultivates driving habits that will increase the pleasure, the performance and the economy of his car throughout its useful life. As one of the most important investments you have, it deserves the best in service and equipment. When you need spark plugs, follow the experts—race drivers, master mechanics, airline and fleet maintenance men, who insist on dependable Champion Spark Plugs . . .

... BE A CHAMPION DRIVER—IT PAYS.

FOLLOW THE EXPERTS—

Guy Lombardo, famous for "the sweetest music this side of Heaven" and equally noted as a motorboat racing champion says, "I always use dependable Champion Spark Plugs to get the sweetest music out of my engines."



Demand

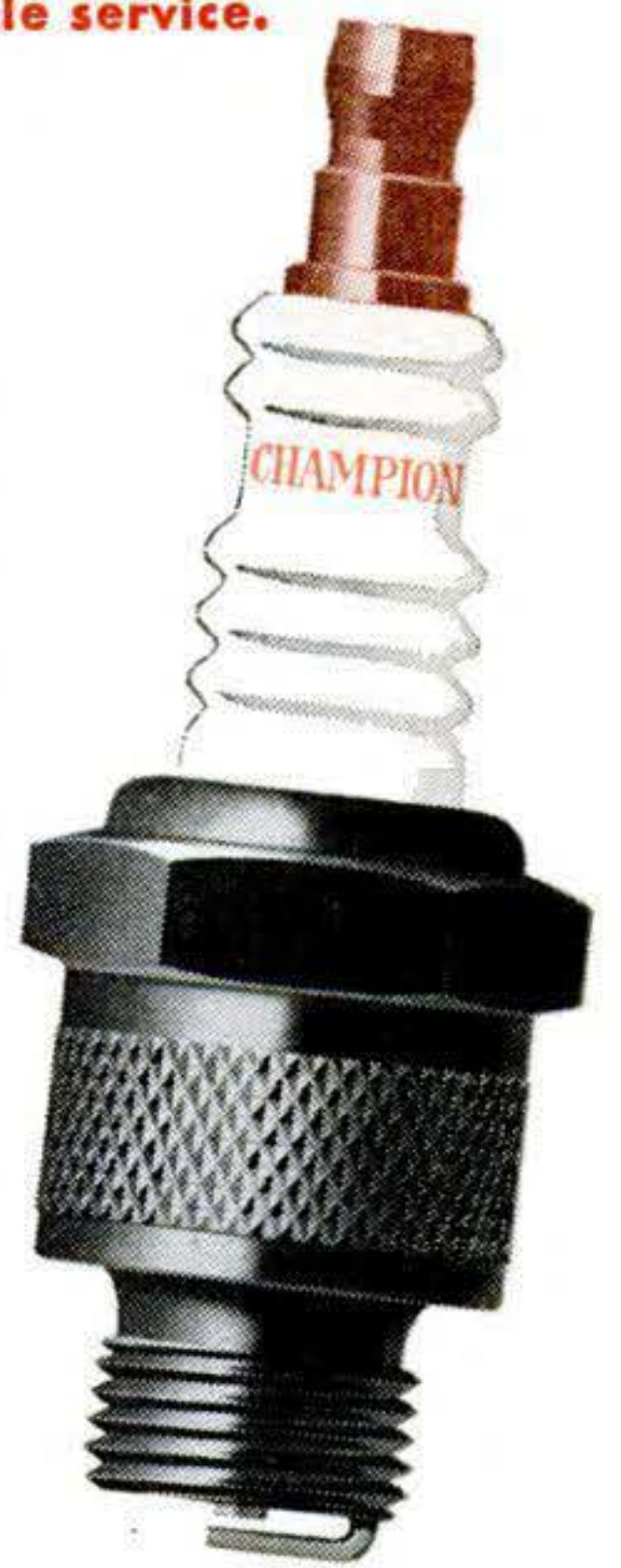

CHAMPION SPARK PLUG COMPANY, TOLEDO 1, OHIO

Listen to the CHAMPION ROLL CALL . . . Harry Wismer's fast sportscast every Friday night, over the ABC network

FEBRUARY 1950 249

Outboard News

About the new Scott-Atwater **SHIFT** motors

WHY ROW?

With a Scott-Atwater Shift motor, you can start in Neutral, while still tied up at the dock. Then Shift to Reverse and back away like a cabin cruiser. The Shift is simple, sturdy, foolproof... adds little to motor weight!

Our motors even turn on their own GAS

All Scott-Atwater Shift models with conventional gas tank (1-14, 1-16, 1-20) have automatic gas line and air vent control. When you move the speed control lever to the "start" position, the gas is turned on, the vent opened. When you stop the motor, gas and vent are closed automatically. Never before have outboards been so simple to run.

• "Now I use Neutral and Reverse like a taxi driver. My Scott-Atwater Shift motor is a honey... don't see how it could be improved!"—Joe Alexander, Madison 5, Wis.

WATER TAXI

SHIFT!

Scott-Atwater announces amazing new Model 1-30... now offers 4 **SHIFT** models

America's most advanced outboard—with 1-to-30 m.p.h. performance, the Shift, more ball-and-roller bearings than any outboard its size, separate 5-gallon "stowaway" gas tank, exclusive steering-handle control of spark and throttle!

1-30 SHIFT
TWIN • OVER 15 HP
(TO BE CERTIFIED)
1 to 30 MPH \$349.50†
With separate gas tank...

1-20 SHIFT
7½ HP* TWIN
1 to 20 MPH \$199.50

1-16 SHIFT
5 HP* TWIN
1 to 16 MPH \$179.50†

1-12 NON-SHIFT
3.6 HP** SINGLE
1 to 12 MPH \$99.50

1-14 SHIFT
4 HP* SINGLE
1 to 14 MPH \$149.50†

†WEST COAST PRICE SLIGHTLY HIGHER

*OBC CERTIFIED @ 4200 RPM **OBC CERTIFIED @ 4000 RPM

SEE FOR YOURSELF...
SHIFT FOR YOURSELF...

SHIFT



to Scott-Atwater

Dept. 36, Scott-Atwater Mfg. Co., Inc., Minneapolis 13, Minn.

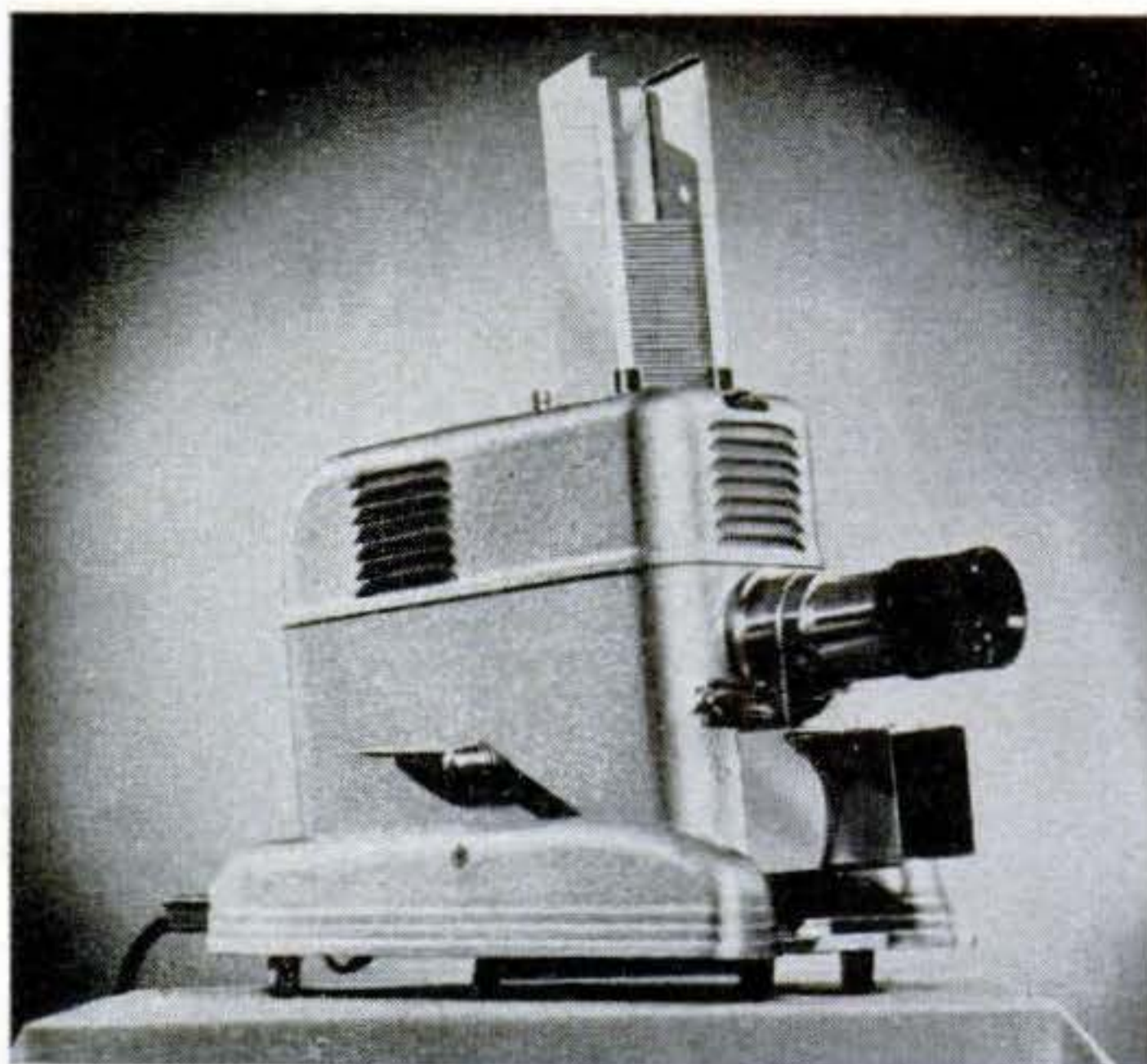

Automatic Slide Projector

REMOTE, push-button control enables the operator of this new projector to change slides while standing in front of his audience. Another feature is that all feeding, changing, and restacking of the slides is completely automatic. Since they are handled only once, when being arranged in sequence, the glass slides or ready mounts remain free from fingerprints. It is made by La Belle Industries, Oconomowoc, Wis.



Regulate Your Own Watch

THIS new Croton Aquamedico® wrist watch can be regulated to split-second accuracy without opening the case. The waterproof and dustproof outside regulator is built into the back, as shown above. It is synchronized with the regulator control in the watch's movement inside. A slot in the outside control permits it to be adjusted with a dime coin, in accordance with "slow-fast" graduations engraved on the case.

ride the champ!



HARLEY-DAVIDSON *HYDRA-GLIDE* MOTORCYCLE

Choose the motorcycle of the champions, the favorite mount of the racing stars! Experience for yourself the unequalled thrills of champion performance . . . acceleration that shoots you ahead like a rocket . . . power that makes steepest hills seem like straight-aways . . . comfort that lets you ride all day without tiring . . . quality that gives you years of service. Fascinating fun and friends are yours at exciting race meets, hillclimbs, gypsy tours, club events and parties. There's no sport like motorcycling, no motorcycle like the world-champion Harley-Davidson! And you can own one on easy terms! See your dealer today. Mail the coupon now.

**Riders of
HARLEY-DAVIDSONS
Won 17 NATIONAL
CHAMPIONSHIPS
Set 7 all-time records
in 1949**

- 100-mile
National Road Race
- 100-mile
National Speedway
Jack-Pine National
Endurance Championship
- 45" and 80"
National Tourist Trophy
Championships
- Five Class "C" National
Hillclimb Championships
- Track Championships**
(One-mile track)
- 10-mile National
- 15-mile National
- 20-mile National
- 25-mile National
- Track Championships**
(Half-mile track)
- 5-mile National
- 7-mile National
- 8-mile National

HARLEY-DAVIDSON MOTOR CO., Dept. PS, Milwaukee 1, Wisconsin

Send me free copy of thrilling ENTHUSIAST Magazine filled with motorcycle action pictures and stories; also literature on new models.

Name.....

Address.....

City..... State.....

DEALERS: Valuable franchises are now available for the full line of famous Big Twins and the 125 Model. This is your opportunity to line up with the greatest name in motorcycles. Write or wire for complete information today.

get the world's greatest RADIO & TELEVISION CATALOG! **FREE**

ALLIED'S
196-PAGE GUIDE
TO EVERYTHING
IN RADIO & TV AT
LOWEST PRICES



**Everything for Experimenters,
Builders, Amateurs, Service-
men, Engineers, Soundmen**

Save money on every radio need! Get the 196-page 1950 ALLIED Catalog featuring the world's largest stocks of top-quality equipment, at low, money-saving prices! Latest TV releases, home radios and radio-phonos, Amateur equipment, PA systems and High-Fidelity Sound, recorders, test instruments, builders' kits—plus thousands of parts, tubes, tools, books and diagrams. Get more for your money from the World's Largest Radio Supply House. Send today for your **FREE** copy of the 1950 ALLIED Radio Buying Guide!



TELEVISION AND HOME RADIOS



SERVICE SUPPLIES BUILDERS' SUPPLIES



AMATEUR GEAR



AMPLIFIERS, P.A. SYSTEMS, RECORDERS

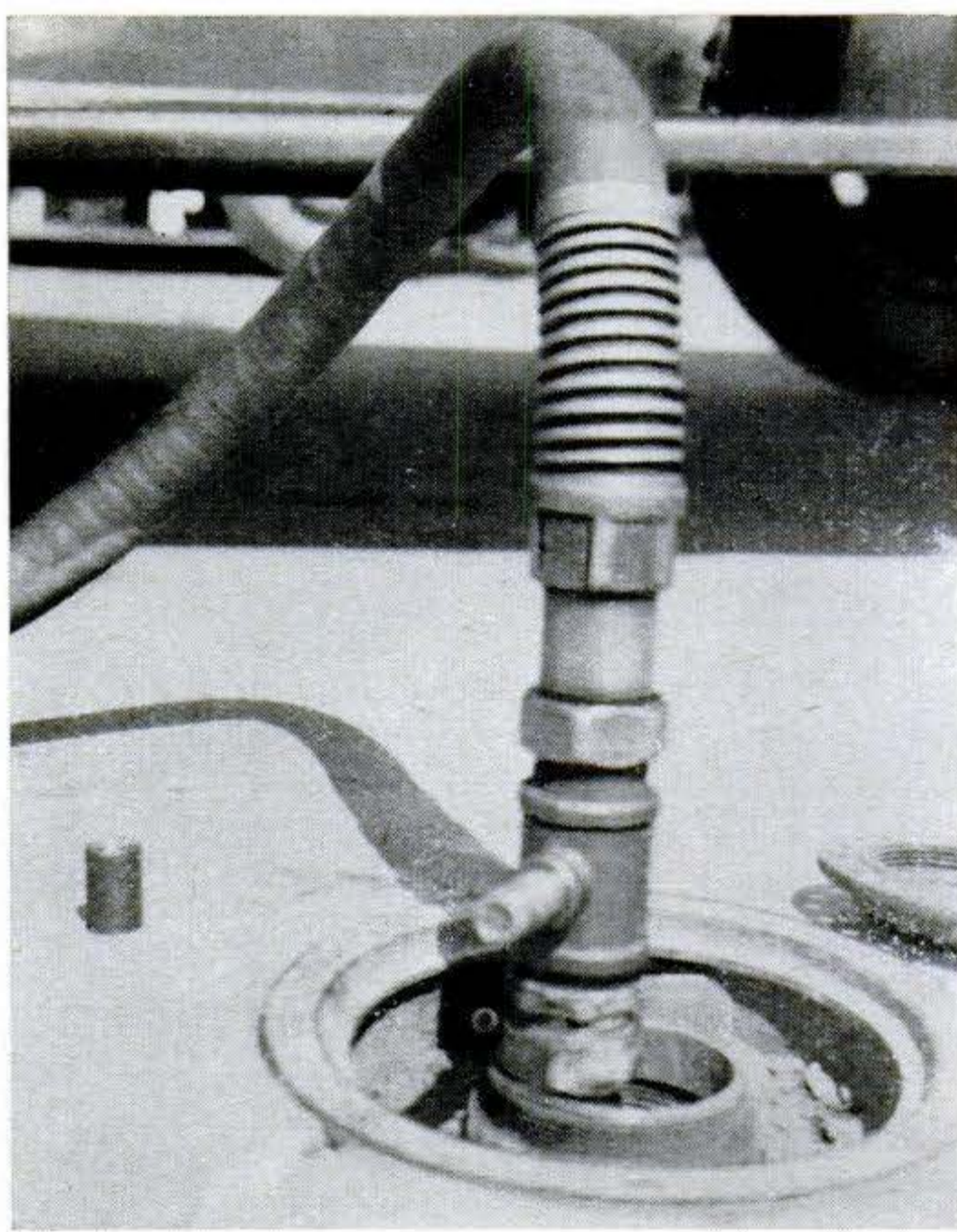

Whistle Sounds Warning

THE tube sticking out from the gasoline-hose coupling above is a small siren that warns nearby smokers of dangerous fumes. It is operated by the vacuum created as the gasoline flows into an underground tank. The Gasiren® also guides the operator by ceasing to blow when the gasoline supply is depleted or the underground tank is overflowing. The Gasiren is made by the P. & M. Mfg. Co., of Escondido, Calif.



Trouble Lamp Made Safe

THE portable extension lamp above has an added device to protect industrial workers from possible electrocution by accidental grounding in damp or wet locations. A step-down transformer—the large, black capsule at top—reduces a 110-volt current to a harmless six volts. The capsule, which weighs only 4¼ pounds, is protected by a waterproof Bakelite® covering that will withstand physical and chemical abuse. Called Saf-T-Lite®, the device is made by the Etraco Mfg. Co., of Flemington, N. J.

ALLIED RADIO ★

ALLIED RADIO CORP.
833 W. Jackson Blvd., Dept. 7-BB-0
Chicago 7, Illinois



Rush FREE 196-Page Catalog

Name.....

Address.....

City.....Zone...State.....



TIME-SAVING TOOLS for SHOP and HOME

The Most Versatile Tool
a Man Can Own

MOTO-TOOL

Grinds, Routs, Drills, Polishes, etc. Moto-Tools, Kits and Accessories should not be confused with "bargain offers". Compare Dremel Products feature for feature, with other similar equipment. If ours are not superior in quality, design and performance, we don't want you to buy.

Look at those **MOTO-TOOL** Features Dynamically balanced armature eliminates vibration. Oilless (oil-sealed) bearings • Patented automatic chuck lock pin • Snap-type sliding switch • Cord protector • Shockproof bakelite housing • Dust-filtered air-cooling system • Weighs 13 oz. • Plugs into any 110-120 V. AC outlet • Backed by over 13 years use in plants of General Electric • Ford • Remington Arms • Nash-Kelvinator • Westinghouse • Douglas Aircraft, etc. . . . plus a money-back Guarantee if not delighted after 5 days' trial.



Approx.
25,000 RPM

PRE-WAR
PRICES STILL
PREVAIL

MOTO-TOOL KIT No. 2, with 23 accessories including high-speed steel cutters and Model 2 Moto-Tool in natural finish hardwood case **\$23.50**
MOTO-TOOL No. 2 with one emery wheel point **\$16.30**

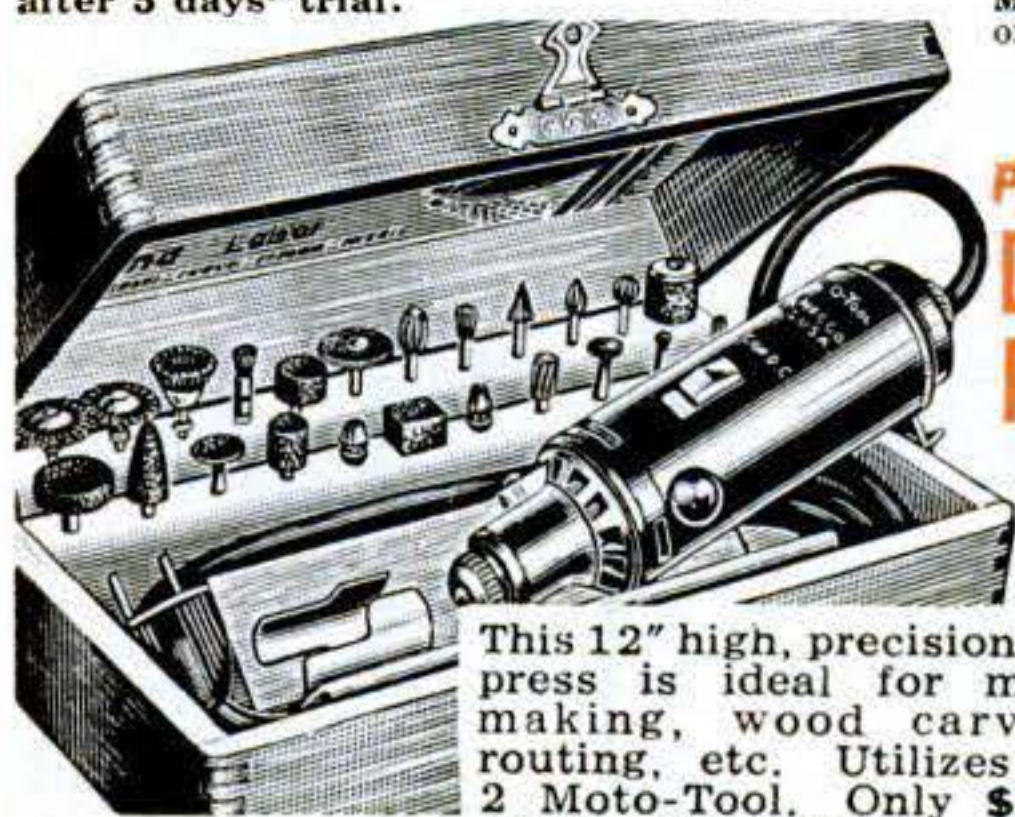

Portable
Drill
Press



This 12" high, precision drill press is ideal for model making, wood carving, routing, etc. Utilizes No. 2 Moto-Tool. Only **\$9.95** (Less Moto-Tool).

Use Coupon to Order—
If your dealer cannot supply you.
DREMEL MFG. CO., DEPT. 120-B, RACINE, WIS.

FUN FOR BOYS FROM 8 TO 80 DREMEL Electric COPING SAW

CUTS SCROLLS LIKE MAGIC—SANDS AS IT SAWS



BLADE
FACES
4 WAYS

SAFE!
AS A
HANDSAW

JUST
GUIDE IT!

Only
\$5.85
with 3 saw
blades

FREE
PROJECT
PLANS

Plans for making six useful, decorative projects packed with each Dremel Electric Coping Saw.

For men who harbor a hobby or do their own repair work . . . for boys who like to make things . . . no other tool will give so much pleasure and satisfaction in the home or workshop for the small amount of money invested as a Dremel Electric Coping Saw. It works in any direction . . . delivers 7,200 strokes per minute . . . so easily, there is no effort . . . so smoothly, work needs no sanding. Saws through 3/4" medium-hard wood at a foot-a-minute speed. Touch-of-the-trigger, foolproof action. Only two moving parts, never needs oiling. Operates on 110-120 V. AC. - Thousands and thousands of satisfied users.

MONEY BACK GUARANTEE. If your dealer cannot supply you, use coupon to order direct from factory for five day trial.

DREMEL MFG. CO., DEPT. 120-B, RACINE, WIS.

3
TOOLS IN ONE



Only
\$14.85
POSTPAID

Patented

Dremel Electric SANDER POLISHER-MASSAGER

Say goodbye to hand sanding and polishing! This miracle machine is so easy to handle, a child can use it. Craftsmen and housewives find (1) **As a sander**, it takes the effort out of sanding walls, woodwork, furniture, workshop projects, etc. Its straight-line (non-rotary), action will not burn or scratch surfaces. (2) **As a polisher**, it does a professional job on waxed surfaces of cars, furniture, etc. (3) **As a massager**, it's ideal for tired or sore muscles.

LOOK AT THESE DREMEL FEATURES

Dremel Sander delivers 14,400 strokes per min., weighs only 2 1/2 lbs.; it's fool-proof (has only two moving parts . . . never needs oiling). Dremel Sander operates on 110-120 Volt, 60 Cycle, AC. Thousands and thousands of satisfied users prove its outstanding value.

SATISFACTION GUARANTEED

Dremel Sander comes complete with 6 sheets assorted grade Garnet Paper for sanding, plus felt pad and sheepskin for polishing. If your dealer cannot supply you, use coupon to order direct from factory. Money back if not delighted after 5 days' trial.

DREMEL MFG. CO., DEPT. 120-B, RACINE, WIS.

**If Your Dealer Cannot Supply You
USE THIS HANDY ORDER FORM**

DREMEL MFG. CO., Dept. 120-B, Racine, Wisconsin

Enclosed find \$ (check or money order) in full payment for items checked below.
Enclosed find \$2. Ship items checked below C.O.D. I'll pay postman balance plus postage and fee.

- Dremel Sander **\$14.85**
- Dremel Coping Saw **\$5.85**
- Moto-Tool Kit No. 2 **\$23.50**
- No. 2 Moto-Tool, **\$16.50**
- Drill Press **\$9.95**

Send FREE Catalog on Moto-Tool
 Dremel Sander Dremel Coping Saw

Name

Address

City Zone State



Works Easily
in Awkward Places



Sands Flat
Surfaces Evenly



Makes Play of
Wax Polishing



Soothes Tired
Muscles

Be Independent! Have your own business. Make \$300.00 to \$500.00 extra profit monthly arc welding

"Pays for Itself" terms puts you in business with but little cash outlay



Why tie yourself down to routine work and limited pay when on-the-job arc welding is in such demand? Contractors, builders, farmers, businessmen gladly pay big money to men who have their own welders. HOBART'S new gas engine driven welders make your services even more valuable with faster, better welding. They run lights, motors, tools besides.

Gas Drive Arc Welder

Generator Only . . .

The same type generator used in HOBART'S complete factory built welders is available if you want to "Build Your Own" portable gas drive welder. Made in all sizes and types. Saves \$\$\$\$ and lets you get started right away with minimum investment.



HOBART builds A.C. and D.C. Welders for shop or field. Write name and address in margin and send today for details.

HOBART BROTHERS CO., Box P-20, Troy, Ohio

"One of the world's largest builders of arc welders"

Hobart Training at Low Cost

Don't turn away from this fine opportunity if you lack welding experience. Let the HOBART Welding School help you become expert in short while. Low tuition, fully approved under G.I. Bill of Rights.



Write for Complete details

HOBART WELDERS

Can You Equal This Home for \$2345

Shipped Direct from Our Mill



Save 30% to 40% on Your New Home.. **Act Now!**

Don't pay several hundred dollars more than necessary when you build a home! Buy direct from our mill at our low factory price. We ship you the lumber cut-to-fit, ready to erect. Paint, glass, hardware, nails, etc.. all included in the price—no extra charges. Plans furnished—also complete building instructions. No wonder our customers write us that we saved them 30% to 40%. Easy terms—monthly payments.

Handsome Big CATALOGUE

Pictures wonderful homes in colors at money-saving prices. Designs to suit everyone. Write for your catalogue today.

LEWIS MANUFACTURING CO.
1302 Lafayette Ave., Bay City, Mich.



Guard Stops Flying Acid

WEARING this lightweight hood, a worker is safe from acid splashes. The window of the Chemgard Acid Hood® is made of replaceable vinyl plastic. The hood itself is made of flexible vinyl plastic, electronically seamed. Snap fasteners attach it to a white-coated vulcanized fiber headgear, adjustable to any head size. Ventilation is supplied through baffled vents. Mine Safety Appliances Co., Pittsburgh, makes the hood.

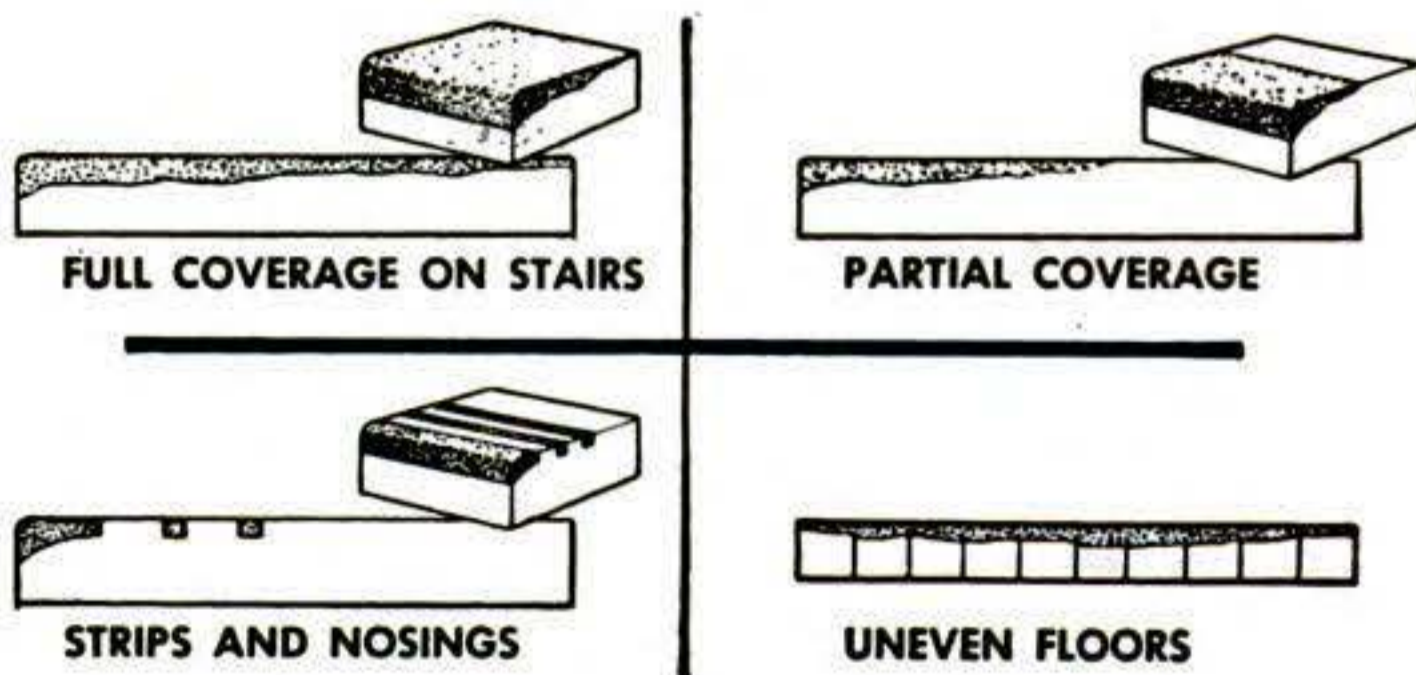

New Cement Is Slip-Proof

WORN and uneven stairs and floors cause many accidents. The drawings above show how a new abrasive cement, Duracite®, is said to cure these tripping hazards, according to the manufacturer, Duane Specialties, of Newark, N. J. The product comes in powder form and is made into mortar by mixing with water. It will form a solid bond with such bases as slate, marble, concrete, or wood in six to eight hours.

NEW POWER FOR YOUR CAR ENGINE!

BY CONSTANT BALANCE OF LUBRICATING OIL SUPPLY

*Give Your Car this Tonic—
Add Power, Pep and Performance*

MARVEL INVERSE OILER



Here's the famous, low cost, auxiliary lubricating system that meters MARVEL MYSTERY OIL to critical upper cylinder engine parts, precisely in accordance with engine load. The compact INVERSE OILER functions inversely to manifold vacuum, retarding feed *visibly* when throttle is closed or at engine idle, an exclusive MARVEL feature! You can keep ring, piston and valve wear down and performance way UP this winter with the sensational MARVEL INVERSE OILER.

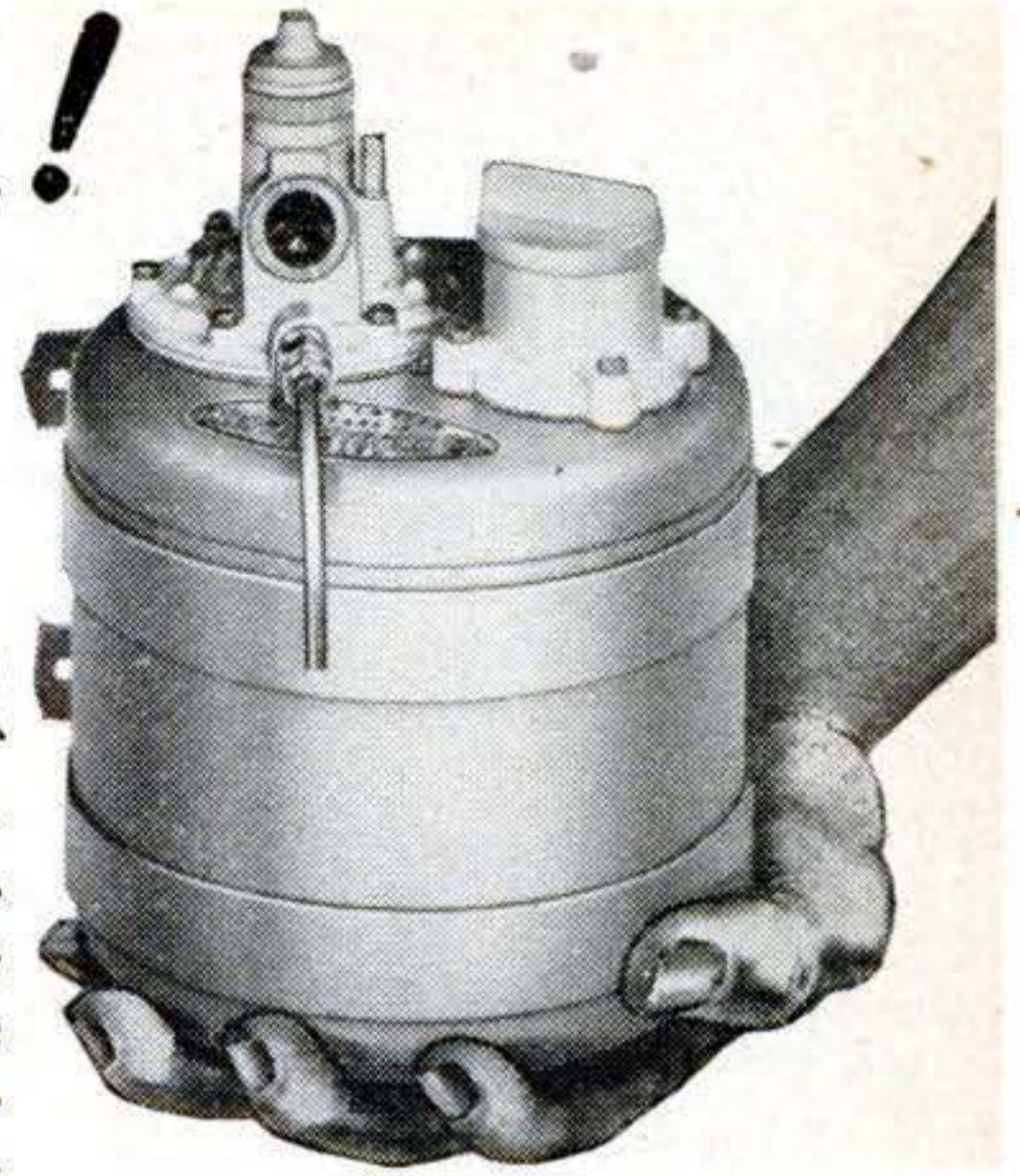

Learn about MARVEL MYSTERY OIL too—the famous oil improving Additive for YOUR motor oil that produces a slow idle, faster engine pick-up and an even, power pull. Thousands of car owners are using it in increased volume this winter for engine protection and to keep starts summer quick in cold weather and in ALL gear greases—it flows at 70° below zero!

The MARVEL INVERSE OILER Is Easily Installed on Most Engines

EMEROL MANUFACTURING COMPANY, INC.
242 West 69th Street (Dept. P.S.) New York 23, N. Y.

WRITE FOR THE FACTS NOW!

INCREASE SAW SHARPENING PROFITS!

Sharpens Saws 5"–30"

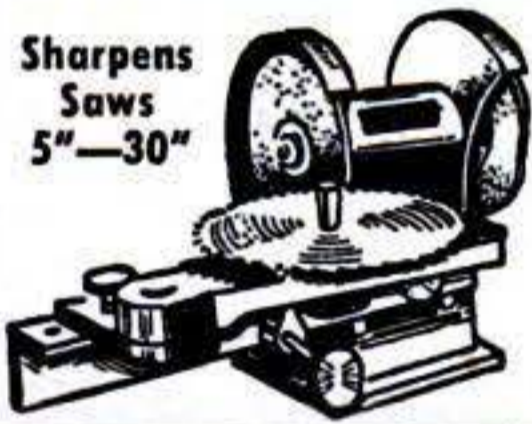

REYNOLDS CIRCULAR SAW GRINDER
Produces top quality results in fraction of time usually necessary for sharpening, jointing, gumming and tooth forming. Any hook or pitch of tooth and depth of cut is quickly adjusted. Both hands are free to control position of saw while grinding. Write now for free circular!

PROVIDENCE SAW & KNIFE COMPANY
303 Eddy Street Providence 3, R. I.



5 big-capacity power tools in 1 rugged, precision-built unit

Write for free, 20-page, profusely illustrated book. SHOPSMTIH, Dept. 109-A, 12819 Coit Rd., Cleveland 8, O.

How To Get MULTIPLE UTILITY When You Buy a SMALL GRINDER

BUY THE FOREDOM MODEL 100 FLEXIBLE SHAFT MACHINE

the choice of tens of thousands because:—Pencil-size handpiece provides positive, sensitive, finger-tip control, works in hard-to-reach places. Your work always well in view. Precision construction and silencer-

equipped flexible shaft assures smooth-running performance. Motor not dwarfed to fit the hand, hence more power, longer motor life. Price only \$16.95. Foot rheostat \$4.85 extra.

Use It to Grind, Polish, Drill, Saw, Sand, Carve, Mill, Clean, Etch, Engrave, Etc. on all metals, wood, plastics, glass, leather, linoleum, etc.

35" FLEXIBLE SHAFT

\$16.95

COMPLETE WITH MOTOR

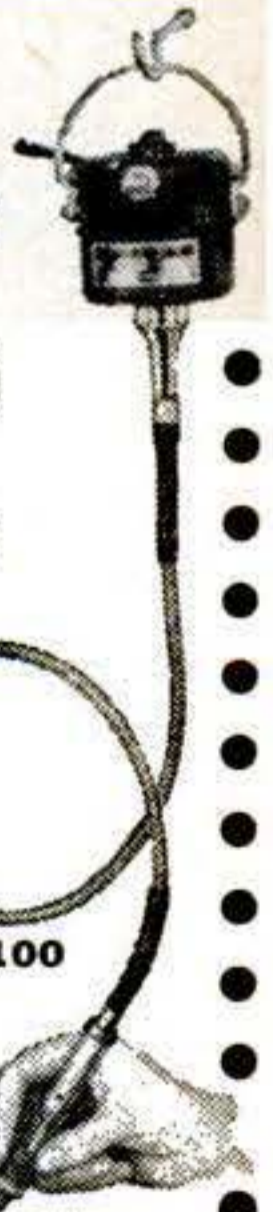

Model 100

BUT THAT'S NOT ALL—

For \$4.95 extra get Foredom's new **Drill Press Attachment**. Magically and quickly converts machine into a power drill press. **AND FOR ONLY \$3.50 EXTRA**, there's Foredom's new **B-R-S Attachment**. Makes machine serve 3 extra functions—

Bench Grinder with angular adjustment, Router with detachable guide for borders, and SHAPER.

Budget your purchase or buy **FOREDOM MULTI-PURPOSE THREESOME** comprising Model 100 Machine, Drill Press Attachment and B-R-S Attachment \$24.95



PRESTO-FLEX \$5.95

AND HERE'S ANOTHER AMAZING FOREDOM PRODUCT

Now turn your old motor, drill press or electric drill into a Flexible Shaft Tool with FOREDOM PRESTO-FLEX with PENCIL SIZE handpiece. Attached or removed in a jiffy! Gets into tight places. Handy 35" overall length. And—only \$5.95 complete! Precision made. For use on motor, specify motor shaft diameter and add 50c for coupling. (Available for 1/4, 5/16, 3/8, and 1/2" shafts.) No. 50 Accessory Set \$1.50 extra.



NEW ACCESSO-RAK. Mount on wall or back of bench and hang up machine. Comes with 40 highly useful accessories, all at your finger tips. Sensational value, only \$4.95.

ORDER TODAY. Send check or money order for items above or sent C.O.D. plus postage. Sold on 10 day money back TRIAL.

Write Today for FREE CATALOG NO. 1026-E

FOREDOM ELECTRIC CO., Dept. 1026-E, 27 Park Place, New York 7, N. Y.

FOREDOM — Used by INDUSTRY — Preferred by HOBBYISTS!

Better, Easier, Quicker GROOVE CUTTING or CABINET-MAKING

with *Warren* DADO SAWING WASHERS

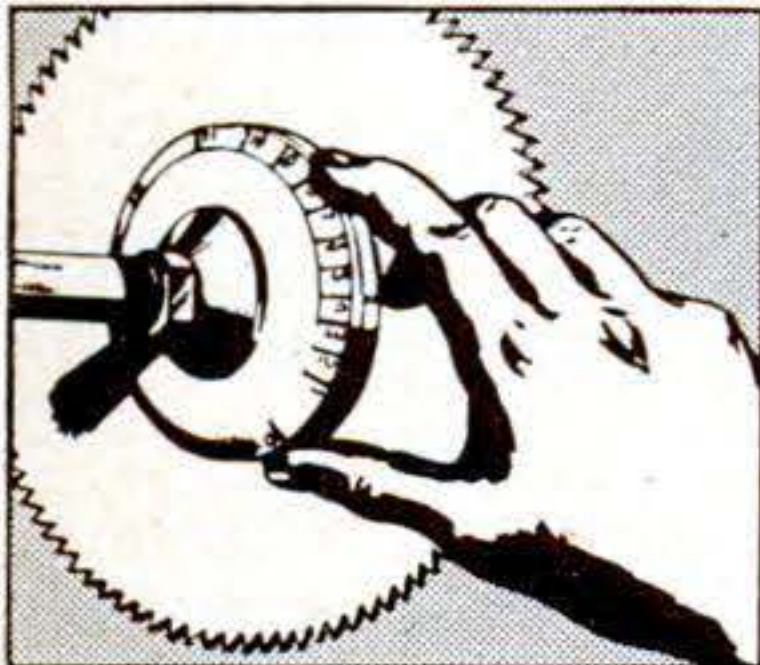

Just dial
DESIRED CUT

Cut accurate, parallel grooves—any width, any angle. Just dial desired width with Micromatic adjustment. Cuts smooth and

clean—no burning or chewing to mar fine wood. Just four simple washers. Available in 5 sizes— $\frac{1}{2}$ " , $\frac{3}{4}$ " , $\frac{5}{8}$ " , 1" , $1\frac{1}{8}$ ". Free booklet on request. See your dealer or write direct. Absolutely guaranteed! In Canada, send money order for \$4.95 (duty and sales tax extra).

\$4.95
A SET

Dealers, Jobbers, Write for Information!

WARREN DADO SAWING WASHERS CO.
70 Medbury, Dept. 42, Detroit 2, Michigan

HUNDREDS OF ITEMS AND IDEAS FOR THE WOODWORKER

A board or carload—Top grade kiln dried Mahogany—Walnut—Wh. Hd. Maple—Cherry—Poplar—Aromatic Red Cedar—Red, White and English Brown Oak—Sapeli—Andiroba—Balsa Wood. **NEW LOW PRICES.**

HARD TO FIND LUMBER

**BIG NEW NO. 17
CATALOG FOR
WOODWORKERS.
144 PAGES
OF HARD-TO-FIND
SUPPLY ITEMS.**

The finest catalog we ever published. Full of unequalled bargains and useful information.

Greatest Selection of Fine Domestic and Imported Woods
Catalog shows in natural color 32 rare and fancy woods, 43 matched veneer designs, multi-colored bandings, inlays, overlays, 275 scroll patterns to choose from, labor-saving machinery and a section for beginner's instruction.

OVER 100 NEW ITEMS

My stocks are gigantic—bigger than ever before. Really **FAST SERVICE** on your orders. My new catalog includes a "gold mine" of hard-to-find hardware items. Whatever Wood Craftsmen need—I HAVE IT.

**MAIL COUPON TODAY for
GIANT NEW CATALOG #17**

Only 15c Refunded on first order.

Harold F. Hunt, President
CRAFTSMAN WOOD SERVICE CO.
2729 S. Mary St., Dept. B-2, Chicago 8, Ill.

I enclose 15c, to be refunded on my first order. Please send me your big new Catalog No. 17.

NAME.....

ADDRESS.....

TOWN.....ZONE.....STATE.....

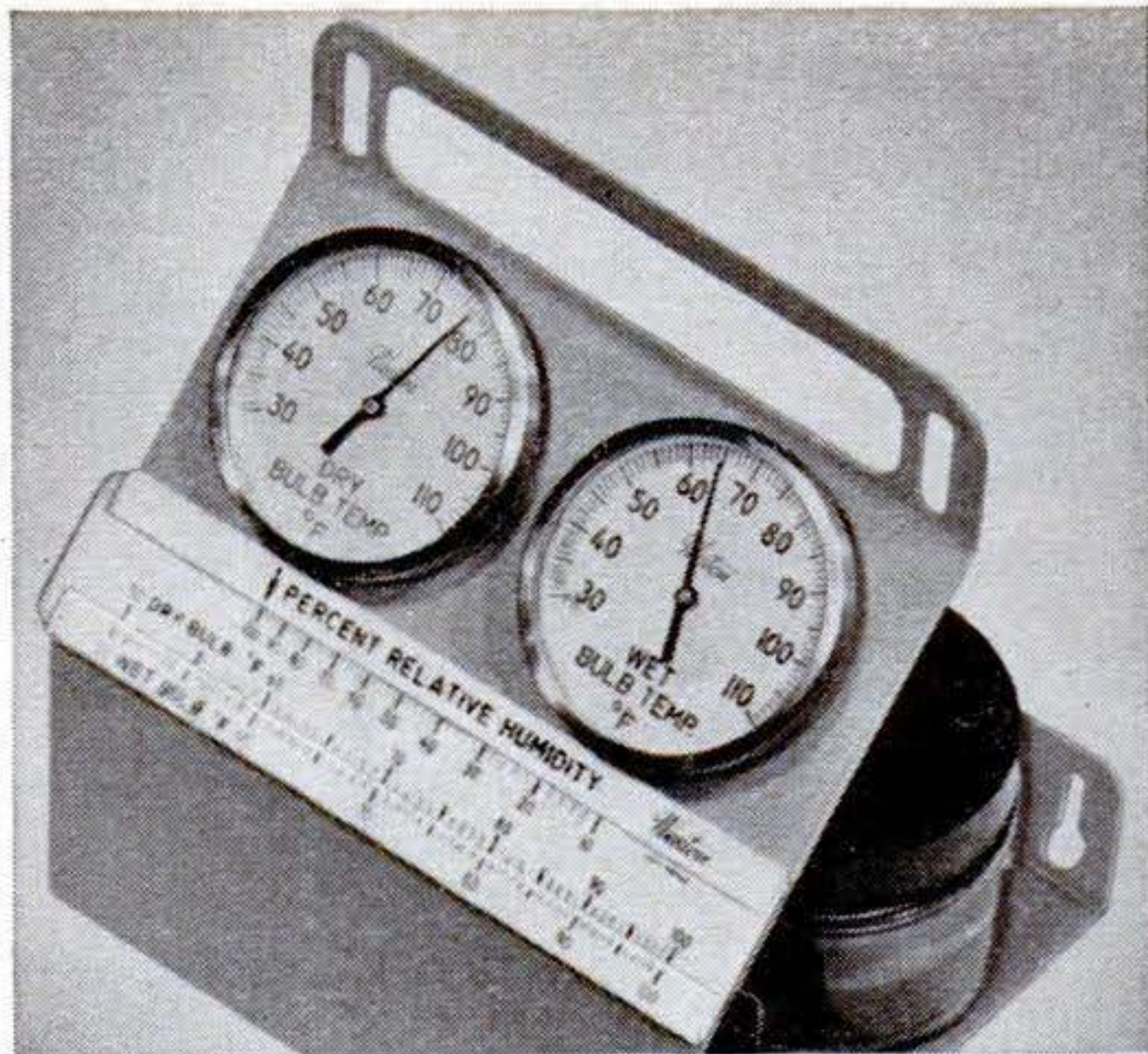

Slide Rule Tells Humidity

You can tell immediately how humid it is by consulting the slide rule mounted at the bottom of this lightweight, wet-and-dry-bulb type of humidity indicator. Just move the ruler until the dial readings for the two thermometers meet on the lower scale: the relative humidity can then be read on the upper scale. Readings are accurate within one percent, report the makers. Designed for industrial use, the instrument can be swung when still air makes it necessary to start evaporation of the wet-bulb wick. Weston Electrical Instrument Corp., of Newark, N. J., makes the device.

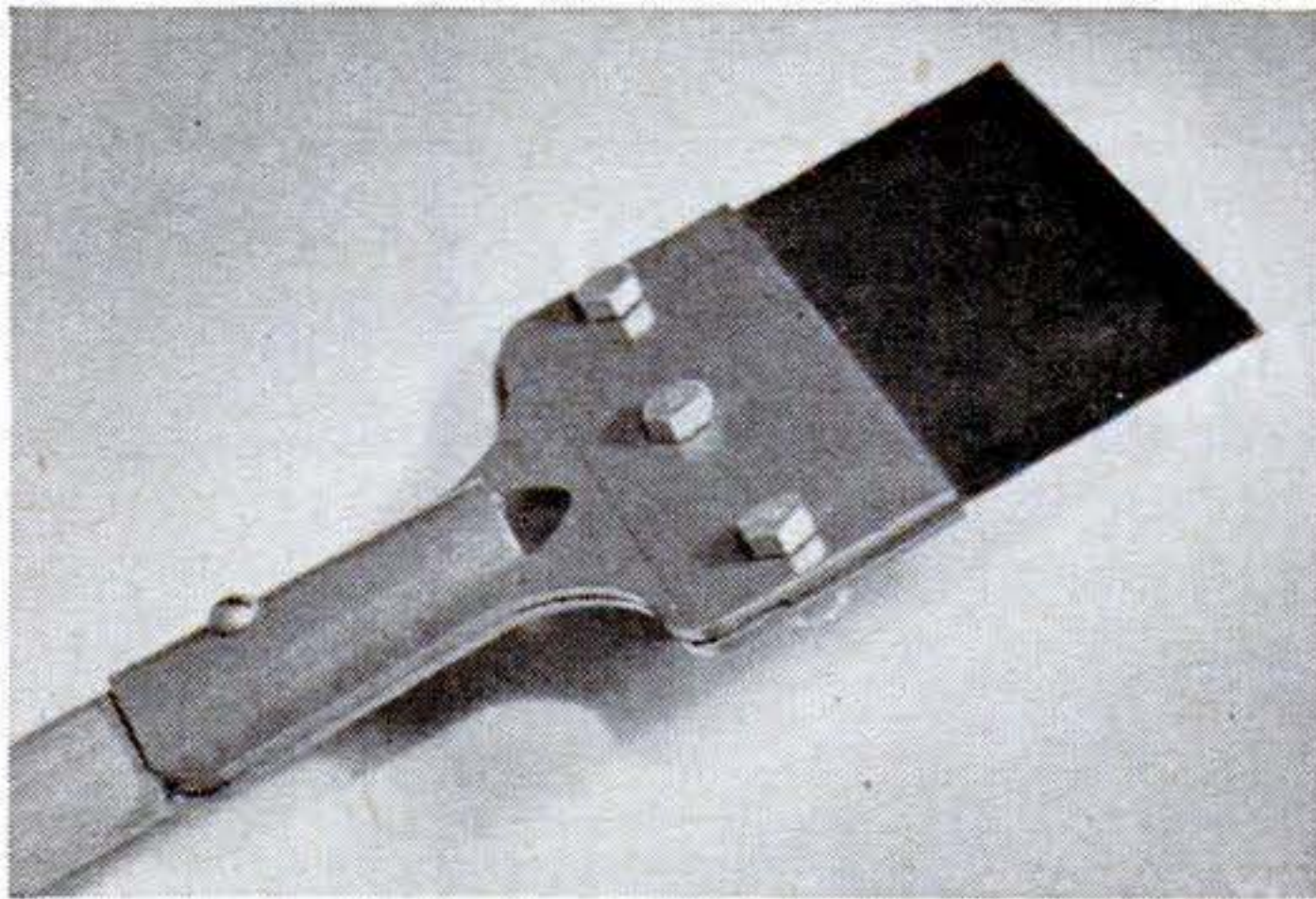

Scraper Blade Is Replaceable

It's easy to change the blade of this all-purpose scraper when it's worn out or you need a different type. Sturdy bolts through slots in its inner edge lock a blade to the handle. Blades come in either tool steel or brass (for jobs where there is danger of friction fires) with double-beveled or square-ground edges. The J K L Manufacturing Co., of Rockford, Ill., is the maker.

I'll Give You **30 DAYS TRIAL**

To Test This Magnificent New 1950

MIDWEST TELEVISION

Console Right In Your Own Home



A. G. Hoffman
President

You are the sole judge of the performance of Midwest Television. You must be satisfied or it is **NO SALE!** Your decision will not be influenced by high-pressure salesmanship but by what your eyes and ears, see and hear.



EASY TERMS

GIANT NEW 16-inch PICTURE

Now In Our 30th Year Of **FACTORY-TO-YOU** Selling



MIDWEST Offers

FACTORY-TO-YOU, A Line of Beautiful Consoles and Complete Chassis TELEVISION MODELS

Here is Television at its finest! Brought to you by Midwest, the world's largest and oldest exclusive Factory-To-You radio and Television manufacturer. Giant new 16-inch Picture Tube receivers with 151 square inches of image . . . clear, steady, bright pictures . . . perfectly synchronized picture and sound that even a child can tune . . . new long distance FM sound circuit . . . big 12" Dynamic Panasonic Speaker. Available in beautiful consoles or complete chassis (not a kit) for custom installation in your own cabinet. Low Factory Prices, Long Easy Terms, and Liberal 30 Days Money-Back Trial. Send for **FREE 32-Page, 4-Color Catalog.**

READ WHAT THESE FOLKS SAY about MIDWEST TELEVISION



"I Am Amazed At The Clearness of The Picture"
Bayonne, N.J.--I am more than satisfied with my new Midwest "Constellation" Television Receiver. I really am amazed at the clearness of the picture, the fine reception, and the general attractiveness of the set. Midwest Television is everything you said it was, plus a whole lot more.
Charles Maraza
661 Avenue "E"

"My Midwest Television and Radio Are The Best I've Seen"
Wilkesburg, Pa.--Recently I bought a Midwest Television Receiver Chassis to supplement my Midwest Series 16 AM-FM Radio and I am well pleased with both. In my estimation, my Midwest Television and Radio are the best I've seen. Please let me know if I can secure one of your large console cabinets to hold my complete outfit.
David M. King
751 Ross Avenue

"My Midwest 'Is Worth Far More Than I Paid For It"
Utica, N.Y.--I am writing you this letter because I feel that the wonderful Midwest Symphony Grand radio-phonograph which I purchased from you several months ago deserves a few words of praise. In my estimation, my Midwest is worth far more than I paid for it. Its performance on all bands is really amazing and its tone is with out equal.
Matthew J. Banash
1410 Francis St.

... also a Magnificent Line of

NEW 1950 RADIOS

featuring the New Long Distance FM Circuit and New 3-SPEED PHONOGRAPH

MIDWEST RADIO & TELEVISION CORP

Dept. X247 909 Broadway Cincinnati 2, Ohio

Send TODAY FOR LOW FACTORY PRICES

Write For **FREE 32-Page, 4-Color Catalog** or Paste This Convenient Coupon on 1c Post Card

Midwest Radio & Television Corp.
Dept. X247, 909 Broadway, Cincinnati 2, Ohio
Please send me your new **FREE 1950 Midwest Catalog**

Name _____

Address _____

City _____ Zone _____ State _____

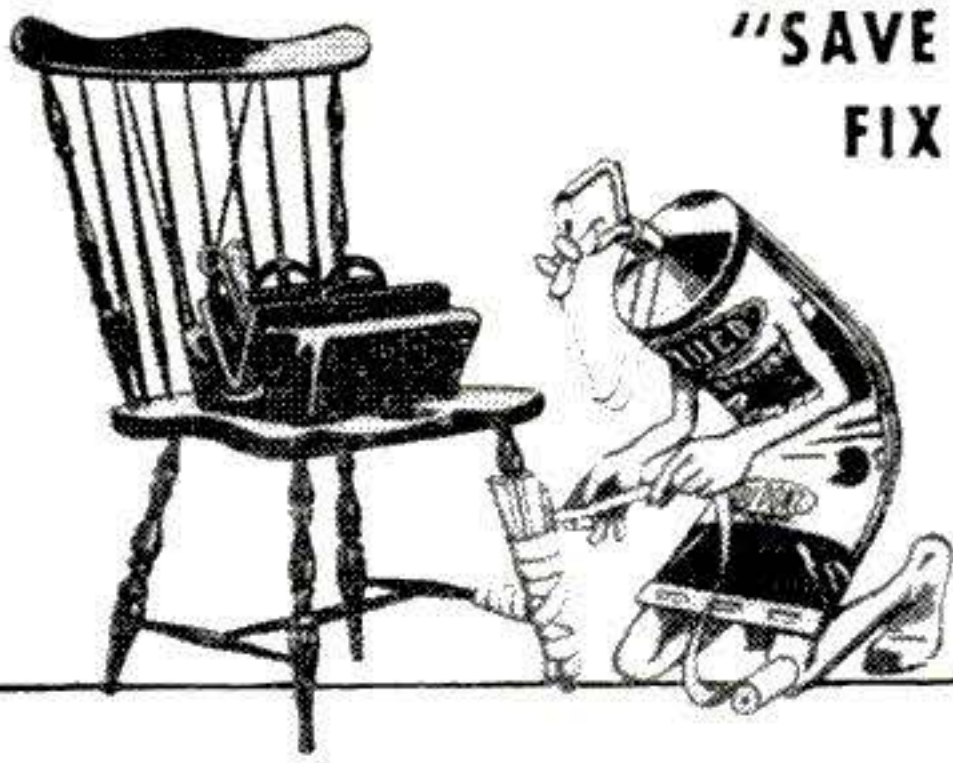

"SAVE IT AND
FIX IT"

FIXES

FURNITURE, DISHES, TOYS
BOOKS AND GLASSWARE

It's transparent, waterproof,
flexible and durable.
Get a tube
today.



DUCO CEMENT

REG. U. S. PAT. OFF.

PALMGREN



No. 000 ANGLE VISE
For MILLING—DRILLING—GRINDING
FITTING—FILING

Solve Difficult Angle Jobs

Quick, accurate set-ups at any angle. End make-shift methods—time loss—rejections. Ideal for tool rooms or home workshop. Accurately machined and graduated. Once set it stays locked. Jaws of steel—plain or grooved. PRICE \$12.05 complete with Swivel Base. Write for other styles and sizes.

DRILL PRESS VISES

For tool room, machine shop, school shop, home shop or repair shop. Accurately machined. Best semi-steel castings. Adjusting screw of hardened steel with fine pitch thread and long bearing. Jaws of steel, grooved or plain. Sizes 1 1/2" — 2 1/2" — 4" Jaws.

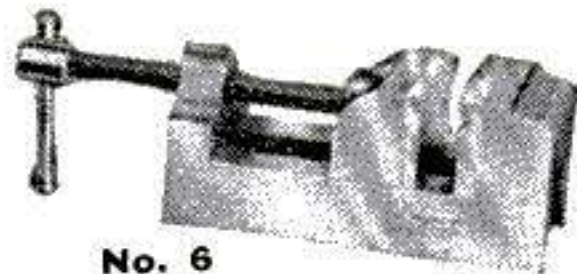

No. 6
1 1/2"-GROOVED STEEL
JAW. \$4.

No. 83 ROTARY TABLE with . . .
DUAL CROSS FEED and
ROTARY FEED



Has 8" Circular Table with full 360° movement and 4" crossfeed travel. Free moving adjusting wheels and dials graduated in degrees. Crossfeed adjusting screws have Acme threads with adjustable dials graduated in thousands. Four slots in base and key slots for bolting to table.
No. 83 Rotary 8" Table . . . \$49.50
No. 82 Dual crossfeed—with-out rotary . . . \$39.75

IMMEDIATE DELIVERY Write for Circular No. 12 — Order from dealer or direct postpaid if he can't supply.

CHICAGO TOOL AND ENGINEERING CO.

8396 South Chicago Avenue Chicago 17, Illinois
Telephone — Saginaw 1-9675

Knowing Auto Noises Can Speed Repairs

EVERY auto mechanic has a lingo all his own to describe trouble noises. One man's "bump" is another's "clunk." A "hiss" may turn up as a "buzz," "wheeze," or "fry."

Hearing the noise, the experienced mechanic usually knows where to locate the trouble. But if you just drive in and ask him to "get rid of the squeal," he may go off on the wrong track.

To avoid misunderstandings between driver and mechanic, General Motors engineers have divided trouble noises into seven classifications. These are:

The Rattle. A series of hard, sharp sounds in rapid succession, like a hard object being shaken around in a metal container. This noise usually indicates a loose or broken part striking against another.

The Thump. A dull sound, generally made when a soft part strikes against a hard part. An example is the noise made by a deflated tire on the road.

The Squeak. A sharp, shrill, piercing noise, generally made by two dry metal parts rubbing together. The sound may be sharp and erratic, or drawn out—a squeal. Lack of lubrication causes many squeaks.

The Grind. This is a continuous crushing sound like a part being crushed between two revolving parts. Such a sound might come from the transmission.

The Knock. This is a sharper and more distinct sound than a thump. It's generally associated with a loose rod or crankshaft bearing. (Not to be confused with the "knock" or ping of a laboring engine.)

The Scrape. A grating or harsh rubbing sound, often made by two pieces of material rubbing together. The sound of a dragging brake could be described as a scrape.

The Hiss. This is like escaping air or steam or the sound of water on a hot metal part.

These definitions are contained in a booklet, "How to Report Trouble," prepared by GMC Truck & Coach Division for distribution to coach drivers. Besides telling *what* the noise is, the driver is expected to report *where* it comes from and *when* it happened. With this report, the mechanic has a good start toward learning *why* it happened.

THIS IS IT! *The saw all America Is Talking About!*

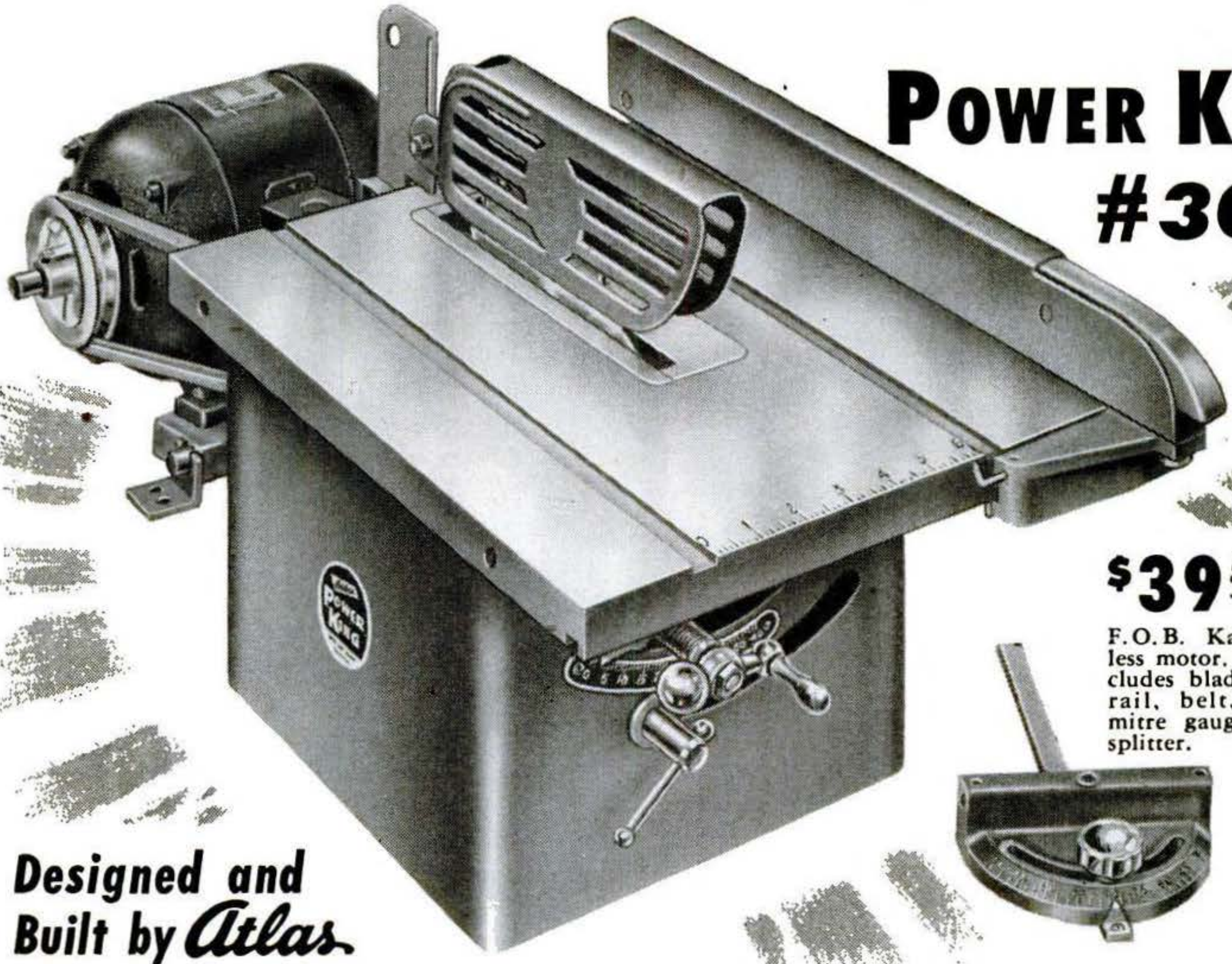

POWER KING #3001

\$39⁵⁰

F.O.B. Kalamazoo, less motor. Price includes blade, motor rail, belt, pulley, mitre gauge, fence, splitter.



Designed and Built by Atlas



#3001
with two
Extensions
\$350 each

It's America's outstanding circular saw value! Look at these quality features — features found only in saws costing much more: tilt/arbor design (your work and table are always flat for greater accuracy and safety), the blade cuts 2¼" deep, sealed ball bearings, precision-ground grey-iron table (25½" wide x 16" with two low-cost extensions), full length double-locking rip fence, convenient controls. For model and furniture building, and home improvements,

there just isn't a better value anyplace! See it at your Power King dealers, or send for catalog. Note special free furniture-making offer.

FREE!

Popular Science, as a public service, has permitted reprint of its December article showing how to make 9 furniture pieces at low cost. Get a copy from your PK dealer, or send this coupon.

ATLAS PRESS COMPANY
242 N. Pitcher St., Kalamazoo, Mich.

Please send the furniture-making booklet and latest PK catalog.

Name _____

Address _____

City, State _____

ATLAS PRESS COMPANY
242 N. Pitcher St., Kalamazoo, Mich.



**MATCHED PRECISION TOOLS FOR
WOODWORKING AND METALWORKING**

A WORKSHOP WONDER
at a wonderful **LOW PRICE**



**LIFE-TIME
PLASTIC
CHEST**

**Improved
CASCO**

ELECTR-O-TOOL KIT

DRILLS • SAWS • ETCHES • POLISHES

Casco's ELECTR-O-TOOL kit is the most complete, practical power-workshop any craftsman or hobbyist can own. Has ALL the accessories you need to drill, cut, etch, carve, grind, buff, polish, sand, engrave, saw, clean and sharpen — metal, wood, glass, leather, plastic and fibre. 1001 year-round money-saving uses. Operates on AC and DC current. Fully GUARANTEED.

Now on sale at Department, Hardware, Appliance, Auto Accessory and Jewelry stores.

Light your way to SAFER CAR SMOKING



WITH A **CASCO**
ILLUMINATED "POP-OUT"
CAR CIGARETTE LIGHTER

Casco's VIS-O-LITE car lighter has an illuminated well that guides the lighter swiftly back. Eliminates fumbling in the dark... prevents scratched dashboard... keeps your eyes on the road. Now on sale at Dealers, Auto Supply Stores and Service Stations, only **\$2.75**

VIS-O-LITE illuminating well-assembly (minus pop-out unit)... **\$1.25**
Replacement pop-out unit... **\$1.25** Replacement element... **\$1.00**

CASCO Products Corp.
Bridgeport 2, Conn.

260 POPULAR SCIENCE

Plastic Cover Protects Top



You can't see it here, but this convertible top has an all-weather protective covering. It's made of thin-gauge, clear plastic, reinforced at the edges and shaped to conform exactly to the contour of the fabric top. Stretched tight, the cover doesn't detract from the appearance of the fabric top, and it can be left on when the top is raised* or lowered. It can be washed with soap and water. The Winterseal Co., of Chicago, makes the cover.

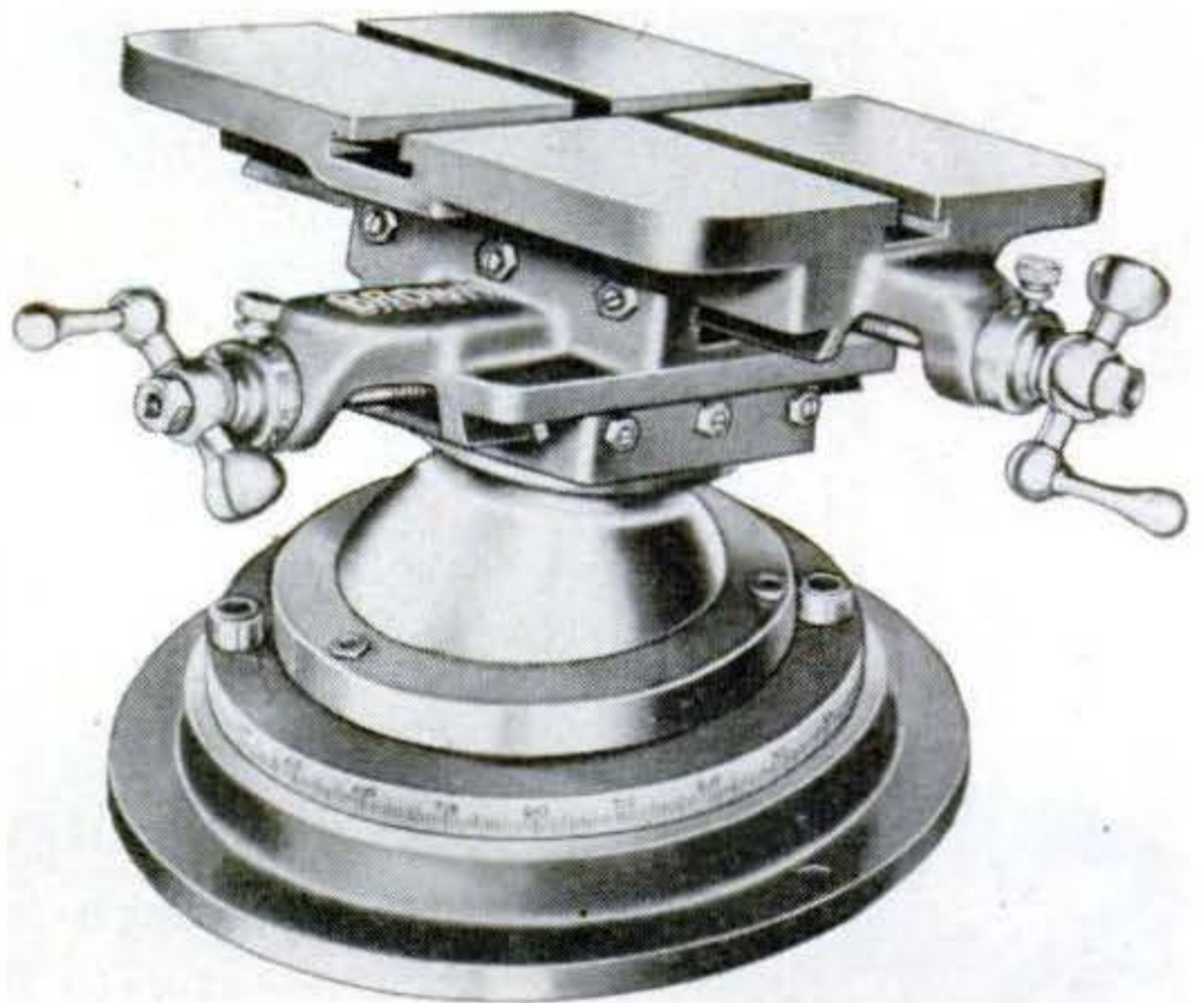

Ball-Tilt Milling Table. The Leo G. Brown Engineering Co., Los Angeles, makes this milling table that'll tilt 30° in any direction. The ball angle adjustment is made by loosening one of the three hollow-head screws. Over-all height of the table, when level, is 6½"; weight is 50 lb. The table is priced at about \$115.

Seal Wood Before Puttying

BEFORE puttying windows, seal the wood frame with a coat or two of paint. Putty applied to raw wood dries out rapidly because the wood absorbs oil from the putty.
—Joseph E. Bird, Carrollton, Ill.

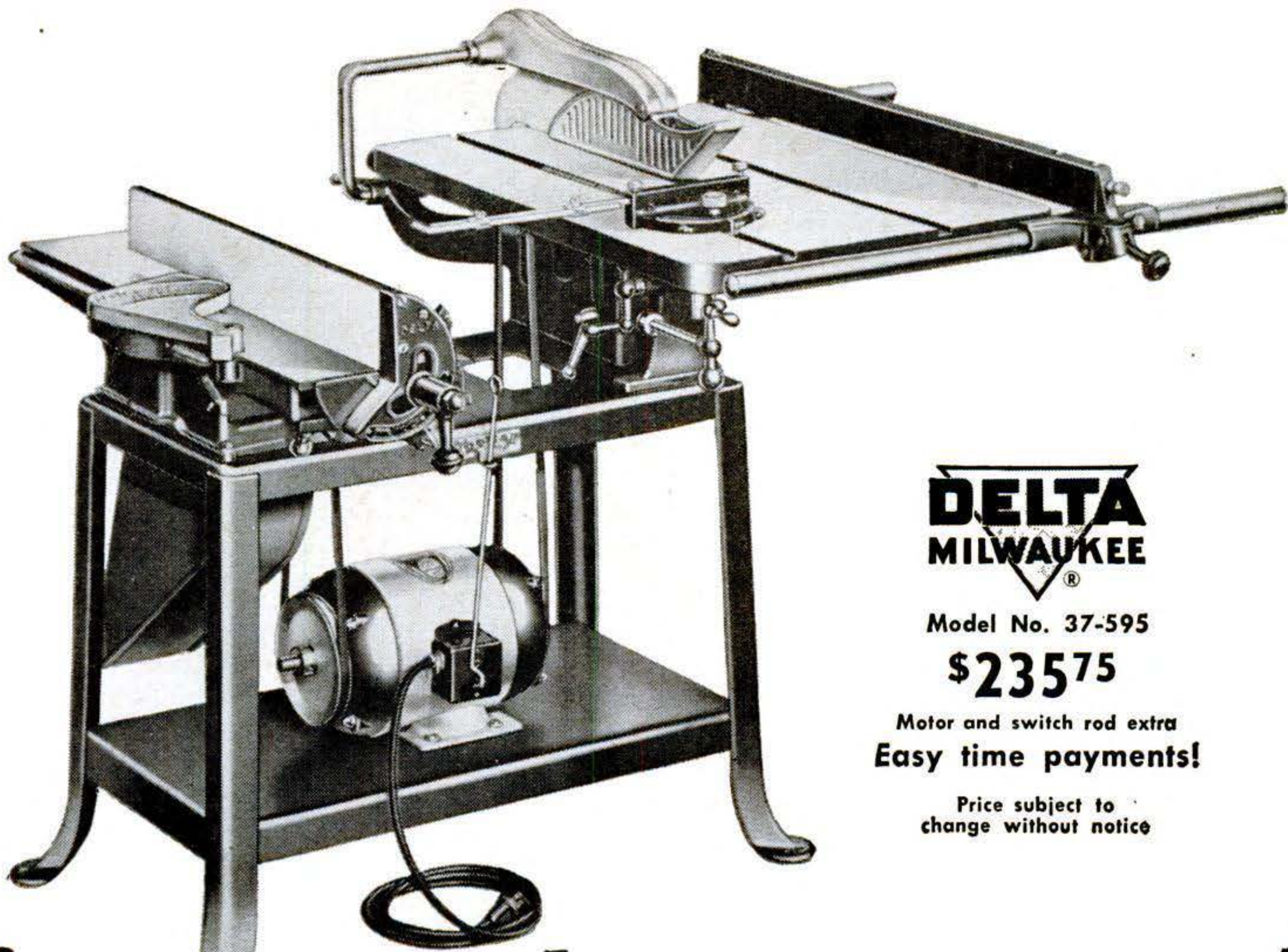

**DELTA
MILWAUKEE**

Model No. 37-595

\$235⁷⁵

Motor and switch rod extra
Easy time payments!

Price subject to
change without notice

Cuts costs, boosts output!

For pattern makers . . .

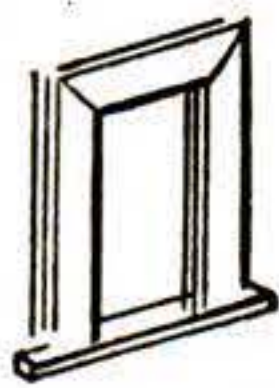
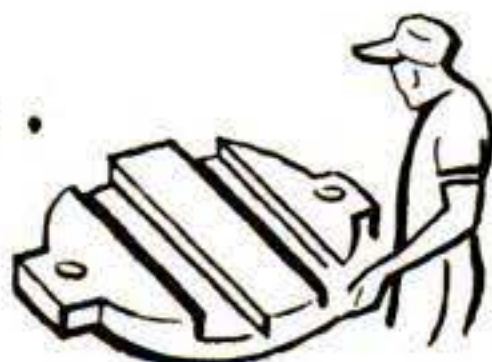

. . . For builders

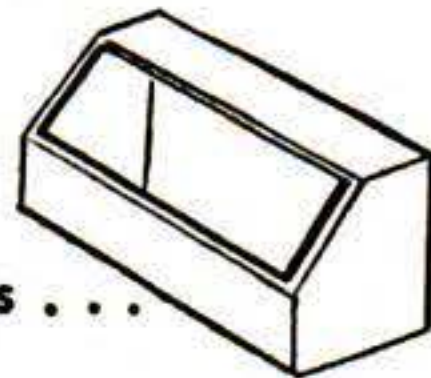

For cabinet makers . . .

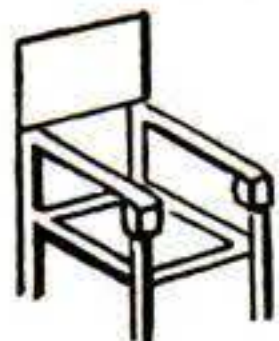

. . . For furniture makers

For sign shops . . .

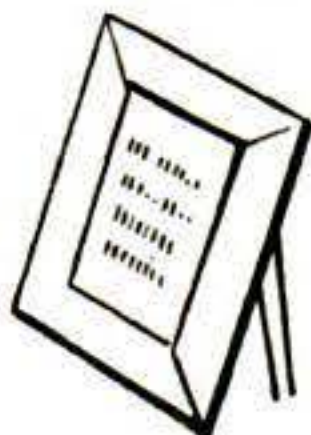

. . . For hobbyists

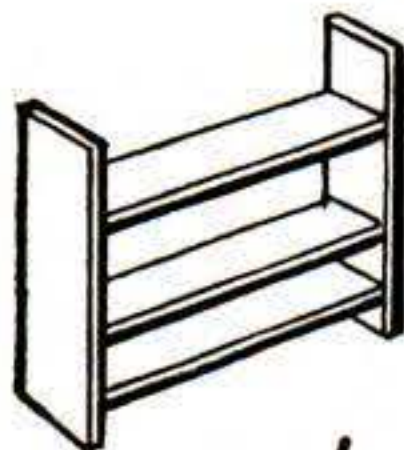

For *everybody* who cuts wood!

Delta[®]-Milwaukee Saw-Jointer Combination

A big-capacity, precision-built unit that's portable! Move it anywhere in your shop — take it right to an outside job. You can easily load it on your truck.

Saves space, both 10" tilting-table saw and 6" jointer mounted on one steel stand and driven by the same motor. Saves the cost of an additional motor. Saves on power costs, too.

Use the machines singly or together — there's no interference between them. Cut 3¼" stock. Rip to center of 50" panel. Surface boards 6" wide. Rabbet ½" deep. Both tools have lubricated-for-life ball bearings. Saw table tilts 45° to right. Jointer fence tilts 45° to right or left.

See at first hand how you save space, time, and money with a Delta-Milwaukee Saw-Jointer Combination. Have your Delta dealer demonstrate it today.

Look for the name of your Delta dealer under "Tools" in the classified section of your telephone directory.



POWER TOOL DIVISION



Rockwell

Manufacturing Company

682B East Vienna Avenue N

MILWAUKEE 1, WISCONSIN

HM-77

FEBRUARY 1950 261

STRIPS PAINT

and all finishes
CLEAN, QUICK, EASY



One coat usually lifts off all paint, varnish, and synthetic finishes. Stays wet longer. Semi-paste — will not run or drip; needs no after-wash. Harmless to hands or surface. Pint 65c, does a large table. Sold where you buy paints.

IT'S ORANGE!

Write for FREE CIRCULAR

SAVOGRAN
DEPT. 29, BOSTON 16, MASS.
STRYPEEZE

Stop Drafts! Save Fuel!
WEATHERPROOF YOUR HOME
WITH **Nu-WAY**
WEATHER STRIP

Easiest strip in the world to put on. Can be used on most any type door or window. Wool felt, reinforced with white metal.

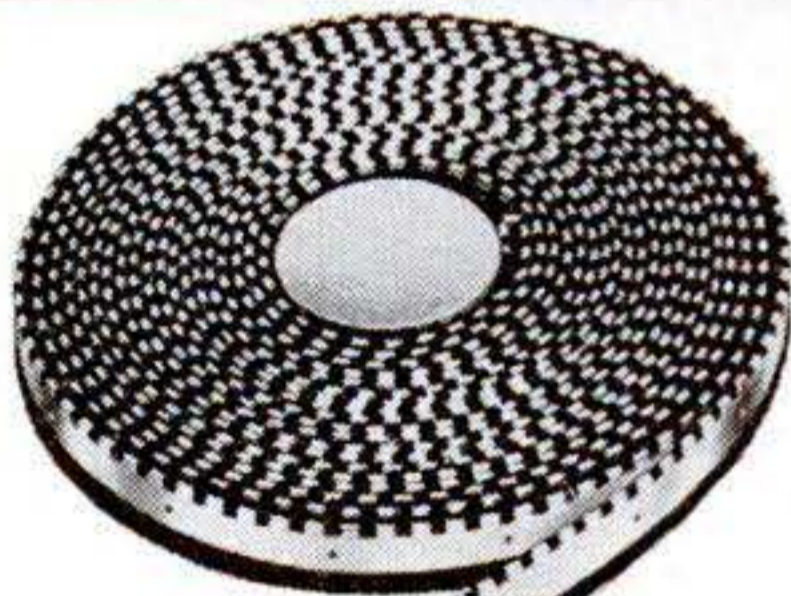

MACKLANBURG-DUNCAN CO.
Oklahoma City 1, Okla.

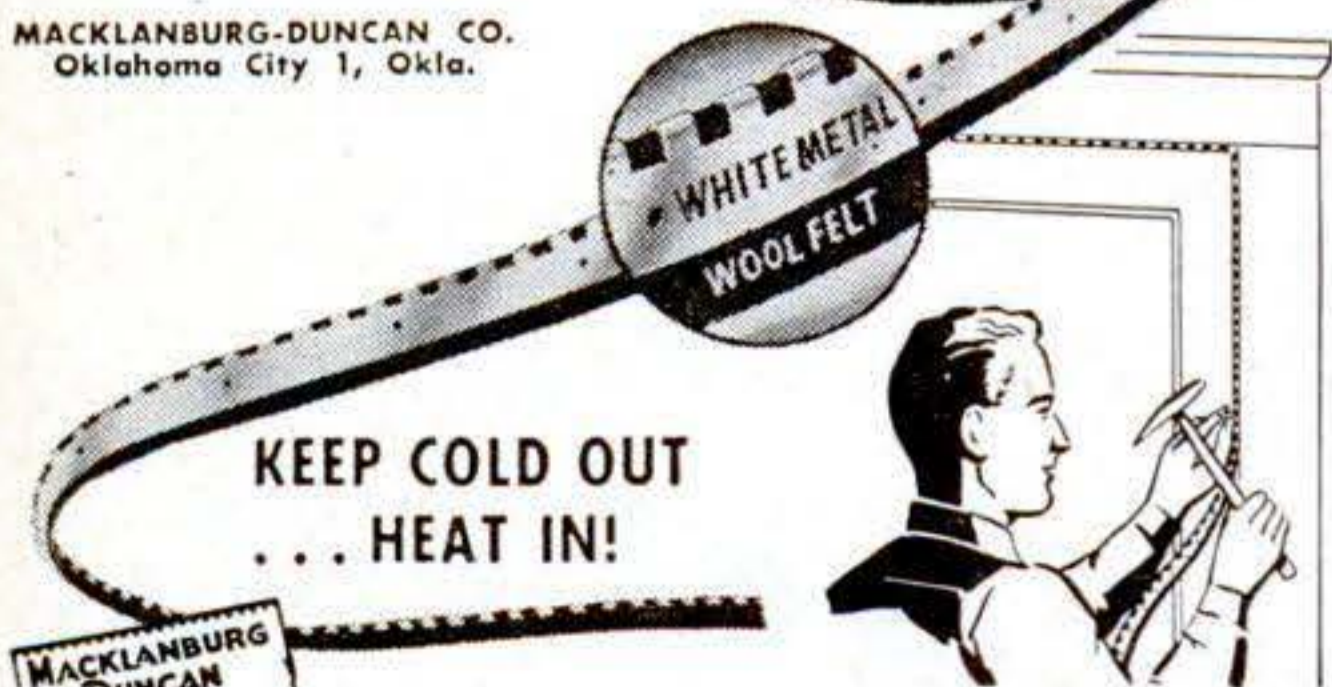

BUY AT YOUR LOCAL HARDWARE STORE, BUILDING SUPPLY DEALER OR LUMBER YARD

SERRATED JAWS FOR POSITIVE GRIP

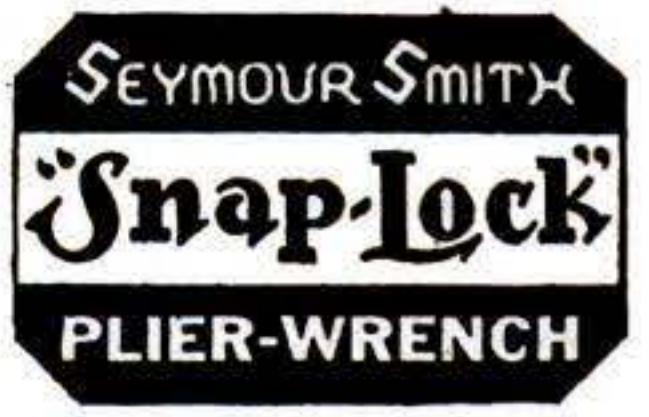

SWIVEL JAW

ALL-NICKEL FINISH

CAPACITY INDICATOR



Only Locking Plier with All These Features

A plier, wrench, clamp; 1000's of uses in garage and home. Heavy pressed steel body, rugged tool steel, replaceable jaws.. 7" size, \$1.75; 10", \$2.25 (10% higher, Denver & West). At dealers everywhere.

INSTANT LOCK RELEASE

SEYMOUR SMITH & SON, Inc.,
900P Main St., Oakville, Conn.
Quality Tools Since 1850

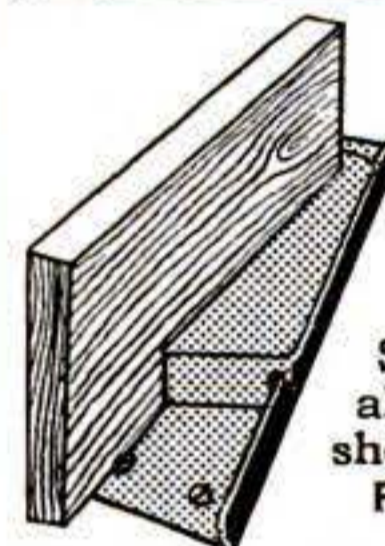

SENSATIONAL BARRON SPEED-VISE!

PERMANENT—PORTABLE

Slickest, handiest, most useful all-metal work bench vise. A workshop "must" for—
PLANING • SAWING • DRILLING •
SANDING • FILING • ETC.

Only \$175
Include 20c for shipping

Won't mar, mark or dent woods, plastics, metals. No piece too small or too large. 10 Day Money Back Guarantee.
BARRON TOOL CO. • DETROIT 1, MICH.

BUILD YOUR OWN POWER TOOLS

Reliable Guarantee

BALL BEARING ARBORS \$6.95



Rugged aluminum alloy housing, heavy duty sealed ball bearings, precision steel shaft 1/2", 5/8" or 3/4". RH or LH thread.
Housing Overall Price
2 1/4 x 4" 7 1/2" \$6.95
2 1/4 x 9" 13" 7.95

BALL BEARING PILLOW BLOCKS \$3.00 ea.



Same bearings as arbors. Sizes 5/8" and 3/4". Shipped immediately postpaid. Write for FREE Catalog or Order today. You will be pleased.
W. R. WEBER TOOL CO., P. O. Box 789, Kalamazoo, Mich.

SAND! MASSAGE! POLISH!

Exclusive
DOUBLE ARC MOTION



14,400 RAPID POWER STROKES A MINUTE

New
SYNGRO
ELECTRIC

only \$14.50
SANDER POLISHER MASSAGER

Amazing new device for light sanding, polishing and body massaging ready! SYNGRO sands, polishes in tight places, corners, around mouldings and on flat, curved or irregular surfaces. Just guide it! Easily adjustable stroke! 60 cycle, 110-120 volt AC. With 10 sheets sandpaper, fabric, lambswool pads, cord, plug. \$14.50 at Dealers! If he hasn't, send \$14.50 to factory, we'll ship Sander postpaid. See other Syngro products pages 270, 282. (Dealers write!)
SYNGRO CORP., DEPT. PM-25, ROCHESTER, MICH., U.S.A.



SAVE UP TO 85%



PALLEY FAMOUS MIXES!!
Here are assortments of Hinges, Springs, Nuts & Bolts, Rivets, Files, Pulleys, etc. Especially prepared for you home-craftsmen and gadgeteers.

GADGET MIX - Rivets, Spacers, Bolts, Screws, Gears, Wheel bearings, Springs and Clamps. No. 106, 5 lbs. **1.19**

BEARING MIX, No. 170A. Approx. 20 needle, Ball & Roller Bearings, New & Used. Sizes: 1/2" to 4". Some of these cost Gov't \$10 a piece. Never such a value! 5 lbs. **ONLY** **1.59**

HINGE MIX, No. 170H. 12 pairs of Strap and butt hinges, Hasps, 1" x 1" to 7/8" x 10" in length and 8" strap. 2 lbs. **1.09**

ABRASIVE AND GRINDING WHEEL MIX - 50 pieces including honing stone, pencil rolls, wheels, etc. A sharp value. No. 170AG **99c**

SPRING MIX, No. 206 - Torsion, Compression & Tension Springs. Ass'd. sizes. A treasure trove for emergencies. 2 lbs. for **ONLY** **89c**

COMBO-MIX - Comb. of all above in one pkg. Special deal. CB-2 **4.95**

FILE MIX - Ten assorted Files, 4" to 12", includes 3 Vixens, half rounds bastards, mills, etc., in seconds and used but in good condition. 1 Vixen alone worth our price for entire mix. F-1 **99c**

PULLEY MIX, No. PM-1 - You'll want this one around. 10 micarta & metal pulleys ranging from 1" to 5" with ball and one piece bearings. These are aircraft pulleys, the best made with 100's of uses. **A WONDERFUL BUY!!! 2.95**

COUNTERSINK MIX, No. 168. Wide assortment. Excellent condition. High speed steel. Assortment of ten 100° and 110° with pilot sizes ranging from 3/32" to 3/16" No. CM-1 **2.69**

SCREW MIX - 5 lbs. incl. 2 1/2 lbs. wood screws & 2 1/2 lbs. machine screws. All sizes. Save dollars and always have plenty of screws on hand. **1.39**

NUT MIX NM-1 - 3 lbs. approx. 500 nuts. Anchor, Lock, Castle, Hex, Elastic Stop Nuts, etc. You'll always have plenty of Nuts in the shop. NM-1 **1.39**

SUPER COMBO MIX - No. SC2. Here's a real bargain. All eleven of a above mixes for **ONLY** **12.95**

REAMER MIX - No. 168. Reamer assortment: Special Taper line finish Reamers. High Speed Steel. Slightly used but in excellent condition. Ten assorted sizes ranging from .168x.165 & .244x.215 to .425x.385 & .432x.403. One alone worth our selling price of ten. For set of ten Reamers **4.49**

PLASTIC Mallet CLEAR PLASTIC with 2" dia. x 4" head & 12" handle. For soft metal or plastic work where non-marking or light tapping is desired. **79c ea.**

15" MONKEY WRENCH Adjustable Jaw - Opens to 4" Drop Forged. Auto Type. Cadmium Plated **89c** Black **79c**

PIANO HINGE
Overall Width Length Price Ea.
1 1/4" (5/8" side) 72" alum. **\$1.00**
1 1/2" (3/4" side) 53" cad. steel **\$0.75**

PALLEY SUPPLY COMPANY
6321 SAN FERNANDO RD.
DEPT. P.S. 2 GLENDALE 1, CALIF

IN WAR SURPLUS from "GADGETEERS" HEAVEN

HEAVY DUTY WINCH
GENUINE U.S. SURPLUS **7 1/2 TON - GAR WOOD**
Here's brute power for all lifting operations in shops, garages, foundries, factories - tow-trucks, etc. The Army used these on their "Cle-tracs". (M-5) Worm gear drive, power driven from 1 1/2" take-off. Cable drum is 15" wide-16" dia. with 6" core. Holds approx. 200 ft. 5/8" cable. Has disengaging clutch & mounting brackets. This winch cost the Gov't many times our price of **Only 139.95**

No. 100 WINCH HOIST
A sturdy, dependable hoist, originally used as bomb hoist in B-29's. Capacity 2500 lbs. with 24 to 1 gear ratio. Has bronze worm gear and drum has 19 ft. of 1/4" flex. steel cable with hook on end, and two speed handle. Ideal for shops, garages - tow-trucks, boats. **\$21.99**

Sperry Aircraft Directional GYRO COMPASS
Dial is 360° swing calibrated 1/10° (6 min). Panel Mount 4 1/2" square with 3" luminous dial. Can be used in autos, planes, or boats by attaching one tube to intake manifold for required vacuum. Complete with reset caging knob. Gov't. overhauled - **ONLY** **\$449**

U.S. NAVY BATTLE LANTERN
A powerful lamp complete with 2 1 1/2 volt dry cell batteries. Size: -" x 7" x 4" **3.29**

AIRCRAFT CABLE
Rust resistant alloyed steel, extra flexible, preformed - 7 x 19 strand-on reels.
1/16" 3¢ ft. 1/4" 8¢ ft.
3/32" 4¢ ft. 9/32" 9¢ ft.
1/8" 4 1/2¢ ft. 3/8" 12¢ ft.
5/32" 5¢ ft. 1/2" 15¢ ft.
3/16" 6¢ ft. 1/4" Bronze 14¢ ft.
1/8" Stainless Steel, per. foot 12¢
Aircraft control cable 18 ft. long, 3/16 in. diam. with turnbuckle ends. **99c ea.**

OXFORD BRG & TOOL SCRAPERS
Complete set of 6 Tools packed in Grained Wood Case.
Contains 1 ea. 8", 10", 12", 14" half round scraper. 1-6" Three square Scraper. 1-12" Double end Scraper. Made of Finest Tool Steel. Forged, Tempered, and Hollow Ground. An Unheard of Price! **SET \$2.49**

NEW PRESSURE TANKS
Stainless Steel, Shatterproof & Rustless. Ideal for painting, cooking, spraying, ocean buoys, underwater fishing, or diving.
G-1-12 1/2 x 24 inches. 2100 Cu. In. capacity **NEW 4.75**
F-1-10 x 18 inches. 1000 Cu. In. capacity **USED 4.19**
F-2-6 x 45 inches. 1000 Cu. In. capacity **NEW 3.95**
D-2-6 1/2 x 24 inches. 500 Cu. In. capacity. Stainless Steel Construction **USED 3.49**
D-2A-Corrosion resistant steel. Same as D-2. **NEW 2.49**
A-6-5 1/2 x 15 inches. 280 Cu. In. capacity **USED 2.25**
A-4-5 x 8 inches. 104 Cu. In. capacity **NEW 1.35**
NOTE: All tanks listed as used are guaranteed serviceable and free from leaks or dents.

FIRE EXTINGUISHER
Kiddie Lux CO2 Type. Built to Gov't spec. Shatter-proof, heavy case. Fully re-charged, with horn
No. 601C-2 lb. wheel control **11.75**
No. 602A-7 1/2 lb. \$35 Value. **19.25**
No. 603 - 10 lb. A \$65 Value. **25.75**
No. 605-A - 15 lb. New. Break disc Type. A \$75 Value **29.75**
No. 605-B - 15 lb. Wheel Control Type **32.95**
No. 605-C - 15 lb. New. Squeeze Grip Type. \$85 Value. **39.95**

TWO HEAT SOLDERING IRON
World's Hottest Iron Value!
Two soldering irons in one with button heat control. Push the button-Select 150 or 300 Watt heat for light or heavy work. Complete with tip, bench holder, 5' asbestos cord. 110V AC. A \$15.00 Value For **3.95**

16mm MOVIE GUN CAMERA. Has semi-telephoto 1 3/8" (35 mm) lens with yellow filter - 3 shutter speeds for normal (16 frames) semi-slow motion (32 frames) and slow motion (64 frames per second). Uses any standard Eastman film magazine or Type 'G' AAF magazine. Takes Black & White or Full color pictures. Operates on 24V (dry cell batteries) & require slight conversion for hand use. Diagram furnished. Cost Gov't \$235.00 - **NOW . . . 24.50**

CONVERTED GUN CAMERA - Fully re-conditioned with start switch on front. Choice of finishes - Gray, Black. Blue **33.95**

VIEW FINDER - Calibrated for above lens **8.75**

FILM - Standard, type "G" magazine - Fits gun camera and many other standard 16mm cameras - Loaded with 50ft. black and white film - Price includes processing. **2.25**

D. C. GENERATORS
Suitable for adaption to home welding units, portable and rural lighting, power plant on boats, etc.
TYPE AMPS VOLTS
P1 200 27 1/2 **17.95**
R1 300 30 **29.75**
ESA 50 12 **14.95**
Used but Guaranteed Condition

D. C. METERS
AMMETERS VOLTMETERS
- 30 - 0 - 30 + 0 - 120 0-30 **\$3.95**
- 60 - 0 - 60 + 0 - 240
- 120 - 0 - 120 + 0 - 300

Your choice 3.95 ea.
COMBINATION VOLT METER - AMMETER
30V - 30 AMP **\$4.95**
30V - 60 AMP
All meters 2" face except 0-300 which is 3" face.
SHUNTS - Required for use with D.C. Ammeters 30-60-120-240 **\$1.00**
SOLD ONLY WITH METERS.

NEW ELECTRIC MOTORS
No. 500 - New 1/2 HP - 27 Volt DC-AC. This motor can be readily adapted to deliver up to 1/2 HP on 110 Volts AC by the simple method of rearranging armature brush-leads. Free diagram with each order. A sensational Value **\$5.95**
No. 500-A - Converted to 110 Volts-AC Equipped with plug and 3/2 ft. Heavy Duty Cord **\$8.49**
No. 502 - 2 HP-24V. DC Motor Used **\$8.95**

OXYGEN & ACETYLENE REGULATORS
OXYGEN REGULATOR - Bottle Press. Gauge - 0-3000 PSI. Regulating Press. Gauge - 0-400 PSI
ACETYLENE REGULATOR - Bottle Press. Gauge - 0-500 PSI. Regulating Pressure Gauge - 0-50 PSI.
AIRCO & Other Popular Makes to fit ALL Standard Bottles - ALL NEW!! **\$12.95**
A Real Buy at each **\$25.00**
or Both for

PNEUMATIC AND AIR TOOLS
10,000 in various popular makes, sizes, types, Cleco, Aro, Ingersol Rand, Chicago, Pneumatic, Buckeye, etc.
#180 RIVET GUNS
Pistol & Gooseneck Type #181 \$55 VALUE **\$8.95** Pistol
Gooseneck SPECIAL ARO PISTOL **\$17.95**
Air Drill or Air Motor with 1/4" Jacobs chuck.
Send for Catalog and List of Other Sizes, Types of Pneumatic Tools.

92 PAGE CATALOG
War Surplus - Tools, Machinery, Raw Materials, Clothing, etc. Illustrated with valuable info., tables, charts & data. Send 25¢ to cover handling & postage.
NEW-HYDRAULIC CYLINDER SPECIAL
Gives 20,000 lb. thrust (push pull) using 1500 PSI line pressure as obtained from our hyd. pumps. Or will produce 40,000 lb. thrust with 3,000 lb. line pressure. CAN ALSO BE OPERATED ON LOW PRESSURE AIR SYSTEMS. 4" Bore, 1 1/2" dia. piston shaft, 18" stroke, length 30 1/2". Equipped with ball bearing loaded clevis type mounting and swivel type high pressure steel pipe bracket for easy use. Ideal for road, farm & shop machinery, presses, etc. Cost Gov't \$390.00 **22.50**

We carry the World's Largest Supply of New Hydraulic Equipment featuring over 20,000 Cylinders in 61 Sizes & Types. Can also supply all accessories such as Pumps, Fittings, Valves, Tanks, Hose Fittings. Let us solve your Hydraulic problems. Write for information.

BENDIX HYDRAULIC HAND PUMP
Provides an instantaneous source of tremendous power for almost any heavy work. Double action stroke. Delivers .30 cu. in. per cycle at 3000 PSI. Max. press. 5000 PSI. Built-in Reservoir cap. 2 1/4 qts. 3/8" pipe outlets. Has Pressure Release Valve. 7 1/2" dia. by 23 3/16" overall ht. Weight 15.2 lbs. A **\$15.95**
\$40.00 Value for **NEW 11.95**
Used - In Good Condition

Vickers Hydraulic Transmission
Self contained, 2 H.P. constant torque at all speeds with variable volume reversible, piston pump (controlled by outside lever) supplying piston hydraulic motor. Automatic pressure, dash pot for smooth control. Power output R.P.M. - 0 to 1/3 input R.P.M. in both directions. Input R.P.M. 1800 continuous 4000 intermittent. Dash pot can be removed for greater R.P.M. Ideal for Lathes, Dupli-cator Setup on Mills, Conveyors, Small Cars, Drives, Gearing, etc. Includes 2-4" Spline Shafts for input & power take-off - Cost Gov't. approx. \$400. **\$27.50**

GEAR BOXES VTG-1 - 90°
Level gear 1 1/2 to 1 reduction, size 7" x 6". A Life-time Value. **\$3.95**
VTG-2 - In-line spur gear 16 to 1 reduction, thru 4 gears. Final take-off 4 1/2" dia, 26 tooth. 1/2" Alum. spur gear. **\$6.49**
Both above gear boxes have lever control for engaging & disengaging positive clutch. Dust proof housing. Pre-lubricated bearings. Both can be adapted to Vickers Transmission.

VALUABLE GEAR BARGAINS!
8 to 1 ratio, spindle drive #110 **\$2.98**
6 to 1 with screw shaft #111 **\$4.98**
85 to 1 (can be used for radio, antennae, etc.) . . #112 . . **\$3.95**
#G-11 - 10-1 gear ratio **\$3.95**

ELECTRONIC TRANSMISSION GEAR TRAIN
GT-1 Containing approx. 50 Bronze Spur & Pinion Gears - ranging from 3/8" to 4" dia., 5 sets of 7 cluster gears, 2 complete worm & worm gear drive sets, 40 N.D. ball bearings from 1/2" to 1 1/2" dia. watch springs, bushings, posts, face plates, housings - Micro Switches, 2 miniature, controlled clutches, etc. 19 lbs Of Pleasure and profit. A Tremendous Gadget Mine. **ONLY \$8.49**
Gears in above train are all in multiple size & sequence with identical teeth ratio giving 100's of ideal gear reduction comb.

Order from this Ad. All sales final. All Prices F.O.B. Los Angeles. Pay by M.O. or Check. P.O.'s Acptd. from D & B. firms. 1/2 deposit with C.O.D.'s.

THE LARGEST FIRM OF ITS TYPE IN THE WORLD

The JIFFY metal CABINET

YOUR ANSWER TO SMALL ITEMS STORAGE at home, office, and shop (IDEAL GIFT, TOO)

So handy to keep nuts, bolts, screws, nails, parts, washers, stamps, hobbyists' needs, etc., at your fingertips.



THIS 32 DRAWER UNIT ONLY \$5.95 POSTPAID

Stop searching, get a 32 or 64 drawer Jiffy to keep those small items that usually get mislaid. Spot welded steel, gray enamel finish, metal drawer guides. Dividers included with aluminum drawers make possible three compartments per drawer. Looks good anywhere. Send check or money order, please—no C. O. D.'s. Prices below. Your money refunded if not satisfied. Dealers write for quantity discount.

SPECIFICATIONS

32 Drawer Unit
6" Deep
12 3/4" Wide
15 1/4" High

64 Drawer Unit
6" Deep
25 1/2" Wide
15 1/4" High

Drawer Size
1 1/4" Deep
2 3/4" Wide
6" Long

WITH ALUMINUM DRAWERS

Dividers and Index Cards Included

One piece rustproof aluminum drawers for heavy service—good for work bench and industry use.

32 drawer - \$8.95
64 drawer - \$15.95

Ohio orders add 3% sales tax. Marproof Rubber Feet included with all cabinets. **POSTAGE PAID**

WITH CARDBOARD DRAWERS

Suitable for most home uses. Heavy board kraft covered. Metal drawer pulls.

32 drawer \$5.95
64 drawer \$9.95

Ohio orders add 3% sales tax. Marproof Rubber Feet included with all cabinets. **POSTAGE PAID**

KAYTEE PRODUCTS, Dept. S, Box 588, Canton, O.

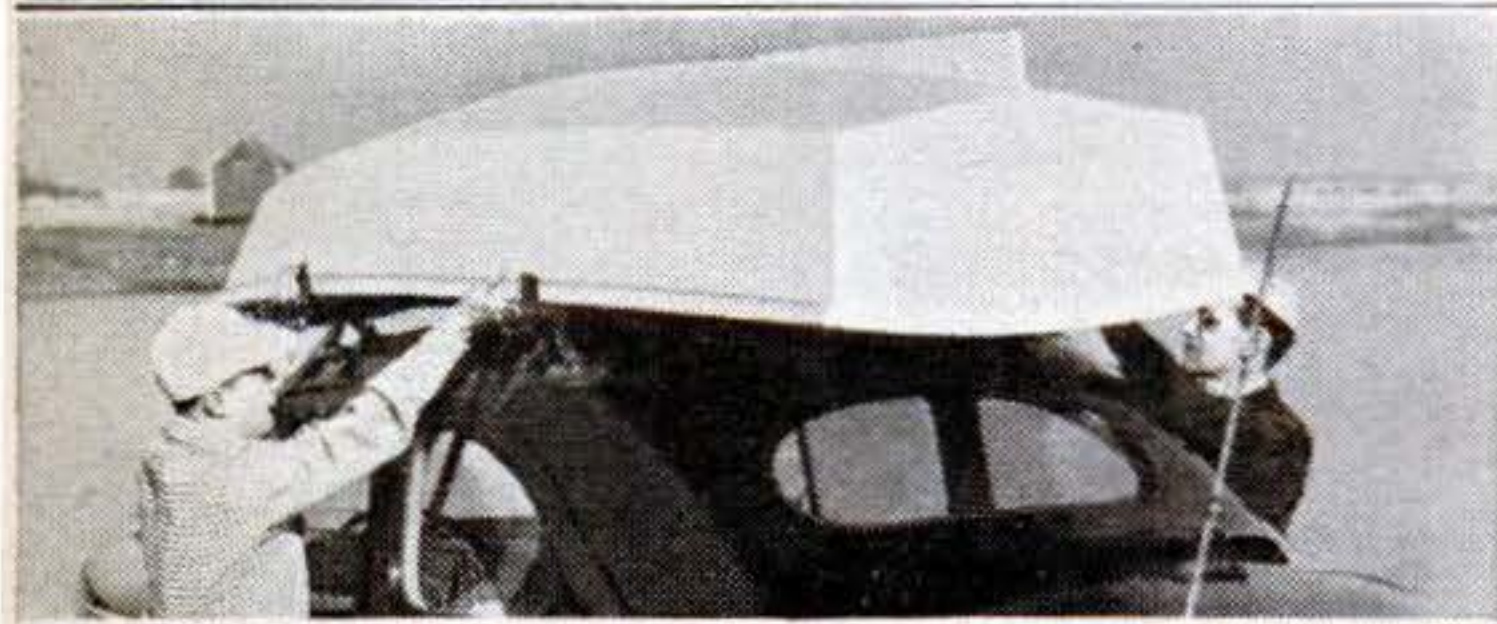

HAGERTY SEA SHELL ONLY \$35

MAKE every week end a real vacation! Take along your HAGERTY SEA SHELL! Handy and light (65 lbs.) for easy carrying, easy rowing. Rugged for years of service. Takes a small outboard. Kit easily assembled in a few pleasant evenings! Holds 3 adults in safety. Ideal for all-around use. Over 15,000 in service. Fully guaranteed.

THIS 8-FOOTER SAVES YOU MONEY

Put the SEA SHELL together and save half the cost of a ready-made rowboat. It's fun! Only ordinary hand tools needed. Kit includes pre-cut waterproof plywood and wood parts, screws, oarlocks, seam compound, full instructions. Beam 4 ft., depth 16 ins. Sailboat conversion kit available.

HAGERTY, 102 Front Street, Cohasset, Mass.

- Please send me FREE booklet, name of nearest dealer.
- Please send SEA SHELL kit, freight collect. Enclosed is \$35.

Name _____
Address _____
City _____ State _____

Every Electric Drill A PORTABLE SAW



CAN BE USED WITH ONE HAND!
Just try it! You won't use a hand saw anymore
FITS ANY 1/4" ELECTRIC DRILL

"ARCO-SAW" **\$9.95**

"ARCO-SAW" is a rugged precision woodcutting tool with right angle gear drive. (No clumsy direct drive with drill sideways.) Works like high priced Portable Saw. **EXCLUSIVE SAFETY YOKE** connects drill and saw. **ABSOLUTELY SAFE TO USE.** All Parts Guaranteed.

Cuts 1 1/8", 2 x 4 BY TURNING OVER

DEALERS: Write for name of nearest wholesaler.

5 DAY MONEY BACK GUARANTEE

ORDER YOURS TODAY at your Dealer or send M.O. or Check for \$9.95 (compl. with 4" "Hycarbon" Blade)
Extra Crosscut Blade, Will Rip & Mitre.....\$1.60

ARROW METAL PRODUCTS CO.

Dept. PS-2, 140 West Broadway

New York 13, N. Y.



Ask Your Hardware Store for **FULLER'S Unbreakable Amber Handle SCREW DRIVERS**

America's most popular line of moderately-priced screw drivers! Wide range of sizes. **FULLER TOOL CO., Inc., 911 Faile St., New York 59**
World's largest maker of Amber-Handle Tools



NOW! FILE YOUR OWN SAWS

Do expert saw filing at home. Precision filing easy without experience. Two simple adjustments. Keeps any hand saw extra sharp and true-cutting. Complete with file. Money back guarantee. Cash with order, prepaid. (COD postage extra.) Order today.

Another Speedcor Tool
THE SPEED CORP., PS-2
512 N.E. 73 Portland 16, Oregon

HIGH POWER TELESCOPE

60 POWER-ALUMINUM TUBES-OPENS TO 33"

Variable Power Eyepiece Adjustable to 15X, 30X and 60X.

4.50 Leather Case Included

5 Sections. 4 Ground & Polished Lenses. Also used as 50X Microscope. Ready to use, only \$4.50 POSTPAID.

BROWNSCOPE CO. NEW YORK 19, N. Y.



Nearest thing to GLASS WALLS

Brighter interiors with amazing **INDORLITE WHITE** Enamel. Whitest White you ever saw... and **STAYS WHITE**... the nearest thing to Glass Walls.

For kitchens, bathrooms, basements, work rooms, etc. Brings in the sunshine, raises spirits, improves efficiency. Washable, long-lasting and always gleaming, pure **WHITE**.

Easy to apply, economical. "Only Indorlite is as white as Indorlite." Accept no substitute. If your dealer can't supply, write us! Descriptive folder **FREE**.

COLONIAL WORKS, INC.
225 NORMAN AVENUE, BROOKLYN 22, N. Y.

WAR SURPLUS BARGAINS

SHOP by MAIL - SAVE at GROBAN'S

LOGAN HEAVY DUTY



Gear Type—All Manganese Bronze INSECTICIDE PUMP

For Spraying D.D.T., 2,4-D, Sulphur Compounds, etc. **BRAND NEW.** Pressures up to 200 lbs. and 14 gallons per minute—at 1200 R.P.M. Will not rust, pit, foul or freeze up. Use rubber hose inlet, 3/4" pipe outlet. Equipped with double mounting bracket. Weight 24 lbs. Dimen. 8"x7"x10". Standard 1" manganese bronze shaft with keyway. U. S. Govt. Acquisition Cost \$62.00. **NOW... 15.00**
FREE—complete instructions and performance data with each pump. **F.O.B. Chicago**



HYDRAULIC CONTROL VALVE

BRAND NEW control valve with built-in adjustable relief valve, will operate one double-acting hydraulic cylinder or two cylinders as one or a reversible hydraulic motor. Valve handle latches in neutral position. Made of rugged cast aluminum alloy. Open center unloads the pump in neutral position. Throttling control allows operator to regulate the speed of movement of the hydraulic cylinder or motor. Has removable mounting brackets with 4 bolt holes, 3/8" pipe thread connections. Overall dimen.: 12 1/2"Hx8 1/2"Dx8"W. Ship. wt. 17 lbs. Govt. Acquisition Cost Over \$100.00. An Excellent Buy **21.95**
F.O.B. Chicago

AIR or OIL HYDRAULICS

Use hydraulics on arbor presses, hydraulic presses, hay lifts, manure loaders, lift trucks—push or pull, tilt or turn, press or squeeze, open or close, lift or lower—and other hydraulic and industrial applications. Use with either air or oil... of finest precision workmanship. **BRAND NEW.**

ITEM #16—Use these cylinders on farm trucks, bulldozers, hay lifts, manure loaders, etc. Double action, 1 1/2" bore, 27" stroke. (Will lift 1760 lbs. in 2 seconds with Logan Pump.) Wt. 8 lbs. A \$55.00 hydraulic cylinder value for only... **postpaid 12.95**

ITEM #17—Double action, 2 3/8" bore, 8" stroke. (Will lift 4400 lbs. in one second with Logan Pump.) Will withstand 1500 P.S.I. against wall. Wt. 7 lbs. A \$65.00 value. **Postpaid 14.50**

ITEM #15—Double action, 3" bore, 8 1/2" stroke. All steel hydraulic cylinder, (will lift up to 7000 lbs. in 3 seconds with Logan Pump) Wt. 12 lbs. A \$78.00 value. **Postpaid 19.50**

ITEM #31. Double action, 3 1/2" bore, 11" stroke. (Will lift 9600 lbs. in 7 seconds using Logan Pump.) Wt. 15 lbs. A \$92.00 value. **postpaid 22.50**

ITEM #42—Double action hydraulic cylinder. 4" bore, 18" stroke. Rated lift capacity with 1000 P.S.I. input is 12,560 lbs. using Logan Pump. Ship. wt. 30 lbs. AN EXCELLENT VALUE for **32.50**
F.O.B. Chicago



NOW... It's Easy to Weld with this handy

ARC WELDER

250 AMP. MODEL 252

Designed for many years of trouble-free service. Handles anything from light gauge sheet metal to 1/2" plate



FOR ANY WELDING JOB, LIGHT OR HEAVY

This precision-engineered direct current ELECTRIC ARC WELDER is offered at but a fraction of its original value. It can be mounted permanently or easily transported for portable use. Does the job instantly, where and when you need it. The War Surplus generators for these Arc Welders were built by General Electric, Westinghouse, and Delco-Remy at a cost of over \$300.00. They are light in weight; have oversized lifetime grease-sealed ball bearings; air-cooled commutator; dial type rheostat for easy pinpoint control; high-low range switch; reactor coil for even arc; handles 1/16 to 1/4" rods. Run welder at 2500 R.P.M. from drive pulley or power take-off of tractor, a 7 1/2 H.P. electric motor or a 10 H.P. gas engine. Use two V-belts, or flat belt (on pulley). Continuous welding rating—200 amps.; intermittent rating—250 amps.; 0-30 volts. Now... **AT A FRACTION OF ITS VALUE.** Price includes double V or flat belt pulley and instruction book. Ship. wt. 107 lbs. Only one or two jobs will pay for entire welder. **F.O.B. Chicago 99.50**
ACCESSORY KIT including welding helmet, electrode holder, two 10 ft. cables with clamp, and 5 lbs. of assorted welding rods. **(ITEM #66) F.O.B. Chicago 10.50**
Remember, Satisfaction is Guaranteed

115 Volt—60 Cycle A.C. LIGHT PLANT GENERATOR

(ITEM #67)



Ideal For: Home Lighting, Hunting Lodges, Stand-by Electricity. Running All AC Electrical Appliances including: Fans, Motors, Electric Razors, Refrigerators, incubators, etc. 750 Watts at 1800 RPM using 1 1/2 HP gasoline engine. 0-150 Voltmeter with Regulator, 1" diameter shaft with keyway for direct or belt drive, carried in two bearings, one bronze and one ball-thrust bearing, and packed separately to prevent damage to generator or shaft while in transit. Protection for emergencies to operate oil burner, stoker, freezer, water pump, and lights. These units, built to exacting Signal Corps specifications, are the answer to your lighting needs. Shipping wt. 60 lbs. **AN OUTSTANDING VALUE 59.50
F.O.B. Chicago**

BRAND NEW HANNA AIR CYLINDER

Used for heavy duty industrial applications on shop air lines or with low pressure systems. With 100 lbs. of air pressure, will deliver 1900 lbs. pressure at the ram shaft. All steel construction. Adjustable cushions at both ends of cylinder. Shaft dia. 1 1/2". Foot mounting with clevis on ram shaft, 2 6 1/2" double-acting stroke; 5" bore, 40 1/2" overall length closed, 7" overall width, 89 1/2 lbs. net wt. Gov't. acq. cost \$101.85. **(ITEM #61) AN EXCELLENT VALUE for 39.50**
F.O.B. Chicago



HALE FIRE and IRRIGATION HIGH VOLUME CENTRIFUGAL PUMP

For Fire Protection, Irrigation, De-Watering, Industrial Uses, Farm Uses, Etc. PUMPS RATED 500 GALLONS PER MINUTE AT 275 FT. HEAD PRESSURE Equipped with 1 1/2" diameter straight splined shaft for direct coupling drive; 4 1/2" threaded suction intake; two 2 1/2" threaded discharge outlets; Hale Pump Co. Model CF volute type; use any 4 or 6 cylinder gas engine direct coupled to pump; dimensions 21" x 24" x 28". Complete with full accessory kit including suction and pressure gauges, priming equipment, and instruction book. Ship. wt. 415 lbs. Gov't. acquisition cost \$425.00. **(ITEM #48) NOW 149.50**
F.O.B. Chicago

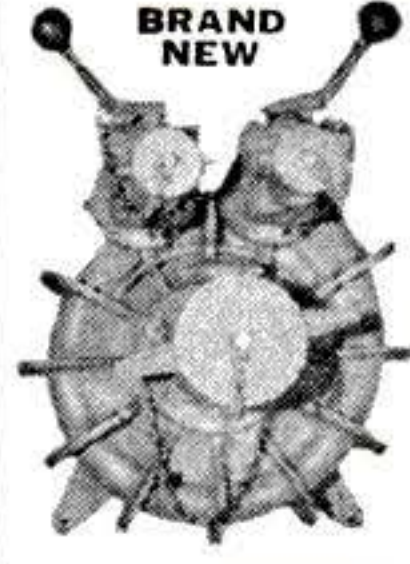

Hydraulic Control Valve

ITEM #24. Four-way control valve with built-in relief valve, for use with one double action hydraulic cylinder, may be used with 1500 P.S.I. hydraulic system to open and close hydraulic cylinders. Brand new. Ship. wt. 8 lbs. A \$38.00 value. **postpaid 7.95**

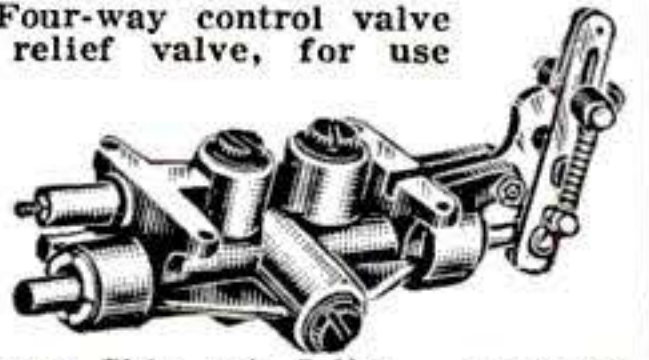

ITEM #26. Four-way control valve for use with two hydraulic double-action cylinders. Each cylinder may be operated independently of the other or in conjunction with the other. Oil may be locked in any of the cylinders to hold the piston at any required position. Brand new. Ship. wt. 6 lbs. A \$60 value **postpaid 10.95**

ITEM #28. A two cylinder double action valve with a unique arrangement, allowing the operator to raise both cylinders simultaneously, to lower them simultaneously or to raise one and lower the other at any predetermined rate and speed. Brand new. Ship. wt. 8 lbs. A \$75.00 value **postpaid 14.95**

VICKERS MF9 HYDRAULIC PUMP or MOTOR

Complete with mounting kit ready to install **Value 75.00 19.90** **post-paid**
 Pump is compact, powerful, rated 1,000 P.S.I., .507 cu. in. per revolution. 8 gal. per min. at 3750 RPM. Change rotation by reversing flow. Delivers up to 6 H.P. Requires 1/3 to 6 H.P. to drive directly or by pulley. **BRAND NEW.** Mounting kit has been especially designed to provide maximum utility and ease of mounting MF Series Vickers Pumps. Brackets are constructed of heavy steel plate; shaft is made of 1/2" steel with one end splined to fit pump; other end of shaft has machined flat for mounting a standard pulley with 1/2" hole. Shaft runs in oilite bronze bearings. Pump only (Item #18) \$14.95 postpaid Mounting Kit only (Item #38) \$4.95 postpaid **BOTH AS COMPLETE UNIT (ITEM #39) \$19.90 postpaid**

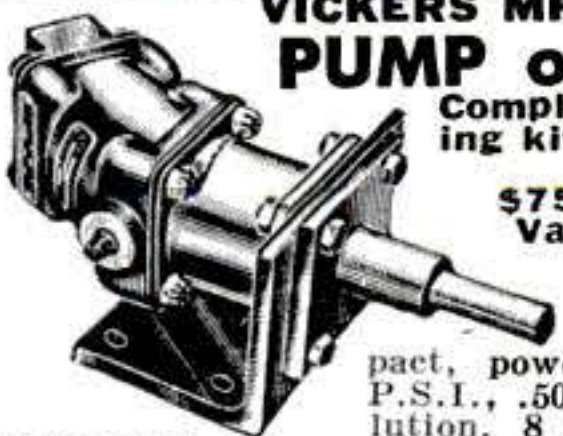

LOGAN 4-Way Foot Operated AIR VALVE

Model 6520
BRAND NEW. For double-acting pneumatic devices. Fine for operating air presses, air machinery of many types. Heavy cast construction. Threaded for 1/2" pipe. Dimensions of valve body 8 1/2" L x 5 3/4" W x 7 1/2" H. Net Wt. 28 lbs. Gov't acquisition cost \$42.00. **AN OUTSTANDING BUY AT 15.00**
(ITEM #59) F.O.B. Chicago



FREE: NEW 1950 CATALOG

WATEROUS PUMP

Rated 500 gallons per minute at 120 P.S.I. This high efficiency pump is designed for front end mounting on General Motors, Dodge, Studebaker and Ford trucks and comes complete with gear box and power take-off for easy mounting and attachment to crank shaft. Net weight of pump 500 lbs. Shipping weight 1200 lbs. **149.50**
F.O.B. Chicago

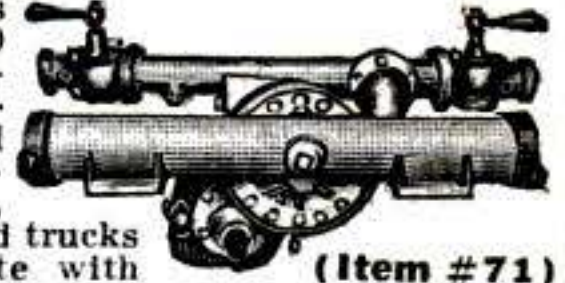

LOGAN HEAVY DUTY

Hydraulic Pump

BRAND NEW
 ... for operating hydraulic cylinders and hydraulic motors on tractors, bulldozers, construction machinery, lift trucks, industrial applications, etc. Delivers 8 GPM at 1200 RPM at 1000 P.S.I. using 5 H.P. Has 1/2" pipe thread inlet, 3/8" pipe thread outlet. 3/4" shaft with flat and keyway for direct or pulley drive. Has flange with 4 bolt holes for convenient mounting. Ship. wt. 22 lbs. Overall dimen.: 7"Lx5 1/2"Hx5 1/2"W. A \$105.00 value. **22.50**
F.O.B. Chicago
FOR ONLY



ORDER DIRECT FROM AD
 Send payment or purchase order today

GROBAN SUPPLY CO. Dept. PS-2
 1507 S. MICHIGAN AVE., Chicago 5, Ill.

ALL ITEMS UNCONDITIONALLY GUARANTEED

Look to **FUTURE** needs

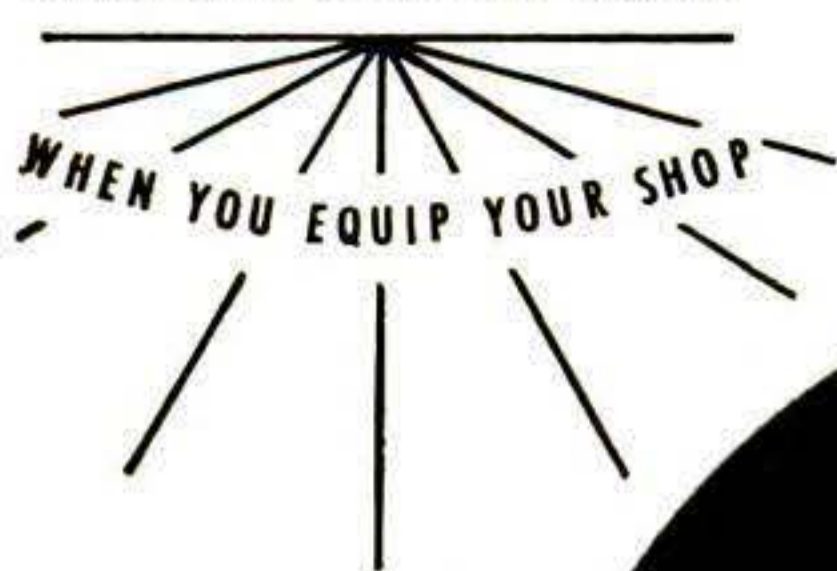

Get
BIG CAPACITY
Atlas **TOOLS**
for Fine
Woodworking

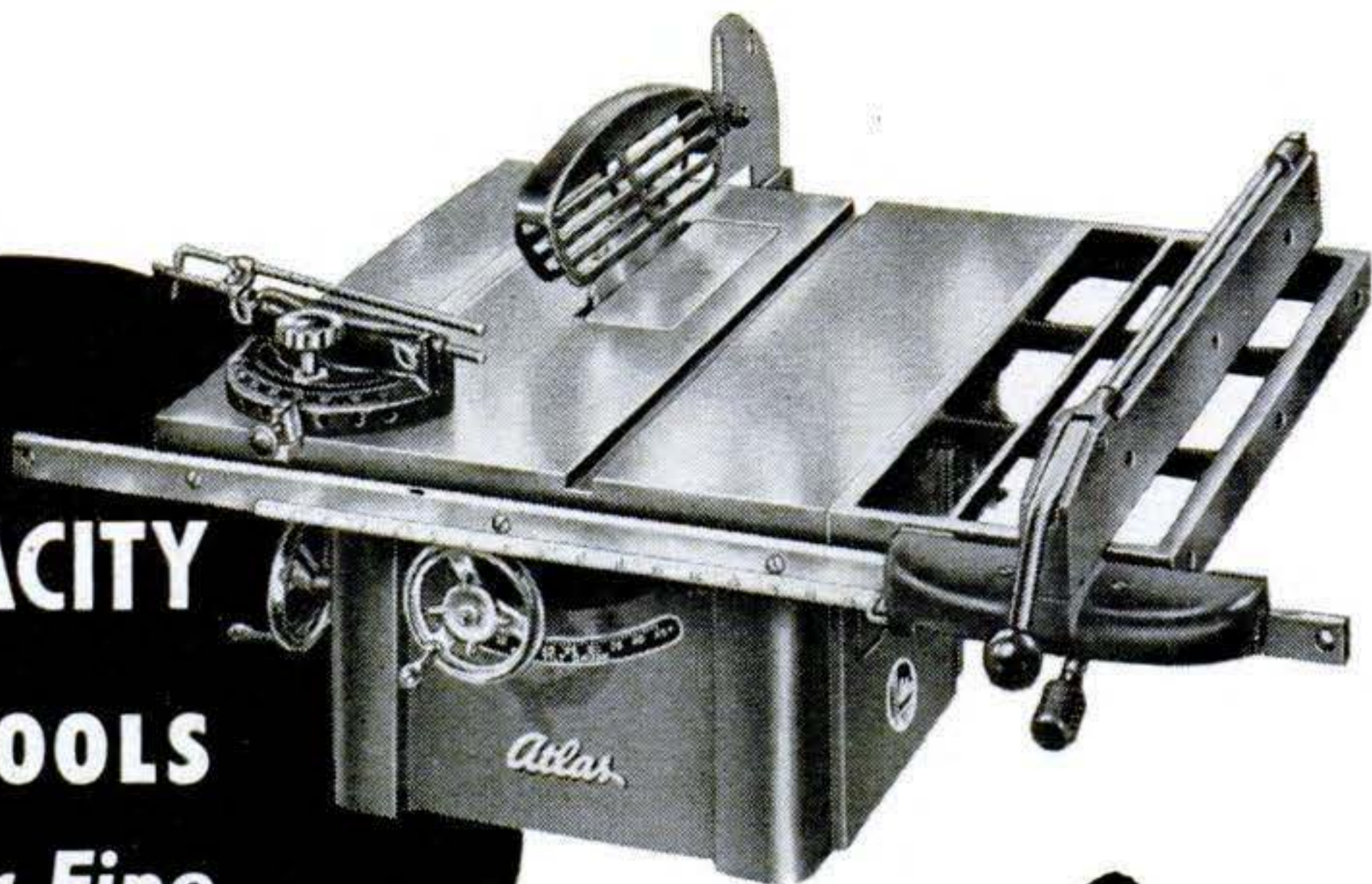

Atlas
8" SAW
(with extensions)

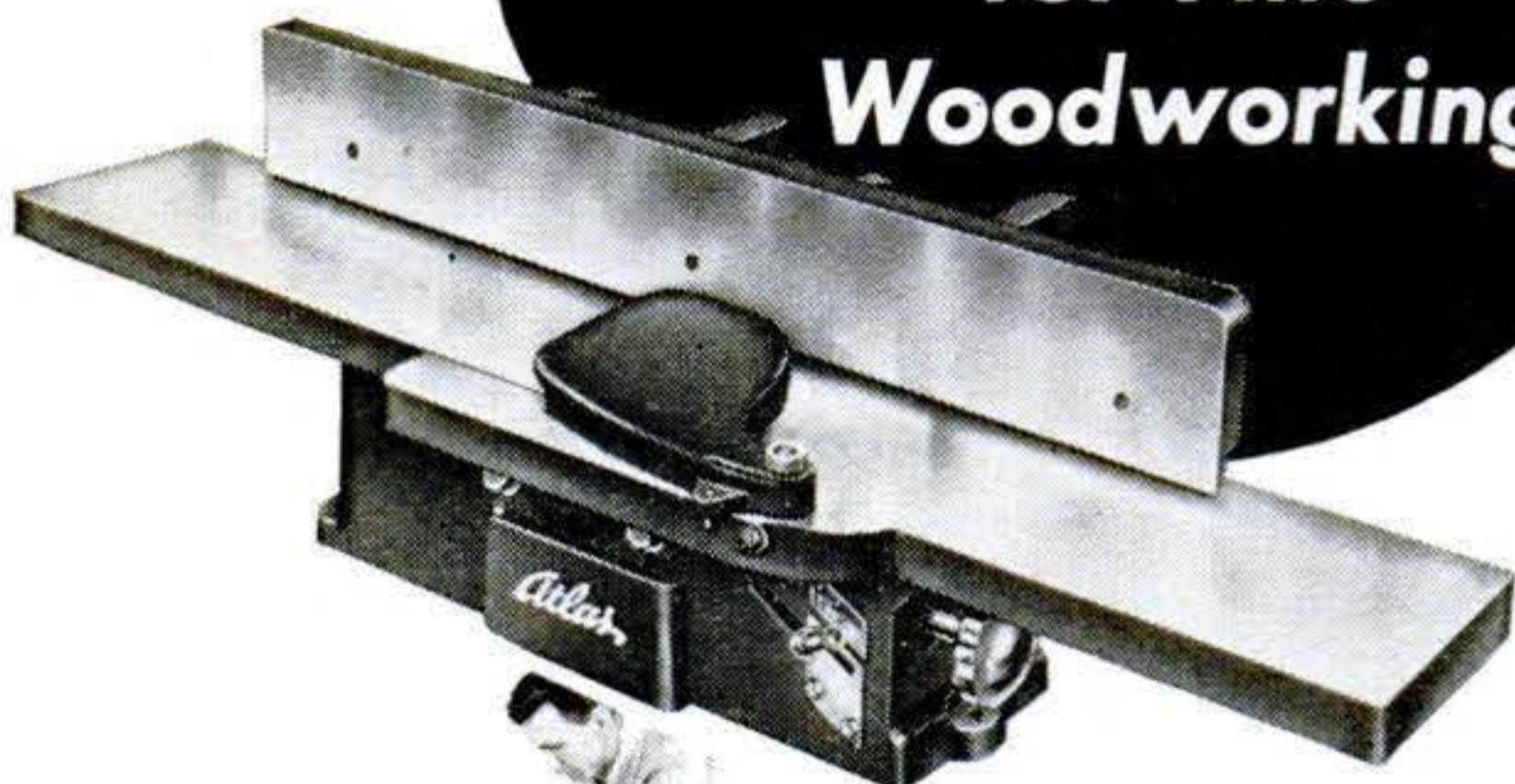
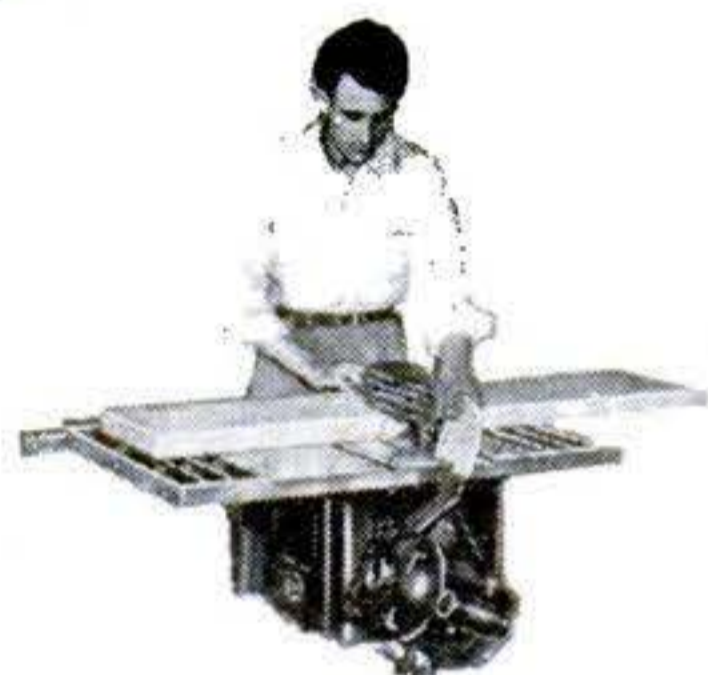

Atlas 6"
Jointer Planer



Your shop can save you hundreds of dollars on cabinet work, furniture, and home improvements of all kinds when your power tools are big and accurate.

These Atlas tools will handle your needs for a lifetime. The Atlas 8" saw gives you an extra large precision-ground table, sealed ball bearings, 45° tilting blade, 2 3/8" depth of cut, quick adjusting rip fence. The new Atlas 6" jointer-planer with 42" precision-ground table and high speed 3-blade cutter gives you "factory smooth" finishes on all your planing, truing, rabbeting work. Get all the facts about these industrial quality tools from your Atlas dealer or send coupon for latest illustrated literature.

FREE CATALOG - Write Today!

Please send literature on
 Atlas Woodworking Tools
 Atlas Metalworking Tools

Name _____

Address _____

City, State _____

255

ATLAS PRESS COMPANY
255 N. PITCHER ST., KALAMAZOO, MICH.



MATCHED PRECISION TOOLS FOR WOODWORKING AND METALWORKING

Precision Metalworking Costs Less with *Atlas* Tools

For repairs on your car and home appliances, developing inventions, making special tools and models Atlas provides the lowest cost precision tools. They are the same high quality tools used in industry — accurate, sturdy, dependable. See them at your Atlas dealer's or send for catalog.



MILLER

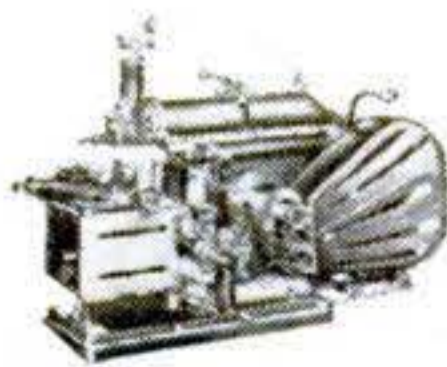

7" SHAPER



DRILL PRESS



"Quick Change"
10" LATHE

PAINTERS' STRIPING TOOL

A TOOL... NOT A BRUSH

NEW, IMPROVED

Modern—streamlined—fits the hand like a fountain pen! Easy to use as a pencil. Draws parallel lines—straight, curve, or circular. Does expert job on autos, furniture, toys, bikes, model planes, signs, bulletins, linoleum. (Makes wall board look like tile.) Every painter and craftsman needs one! Type "M" MASTER Painters' Striping Tool complete with tip for 1/16" stripe, \$1.00. Other tools complete with following tips 1/64", 1/32", 3/64", 5/64", 3/32", 1/8", \$1.50 ea. Extra tips 75c ea. Entire kit with tool and 7 tips, \$5.00. (COD's postage collect) Paint dealers, write!

EASY AS USING A PENCIL!



\$1.00 POST PAID

WENDELL MFG. CO.

4234-A Lincoln Ave., Chicago 18, Illinois



HANDY CALCULATOR FOR WOODWORKERS.. ONLY 10c

Just set dial, quickly solves countless problems. Converts linear to board feet, compares workability of various woods, shows bit sizes, nail specifications. Also tool sharpening tips, etc. 6" diameter heavily varnished cardboard. Send 10c to Greenlee Tool Co., 2122 Columbia Av., Rockford, Ill.

POWER HACKSAW \$47.25

less motor
F.O.B. Benton Harbor

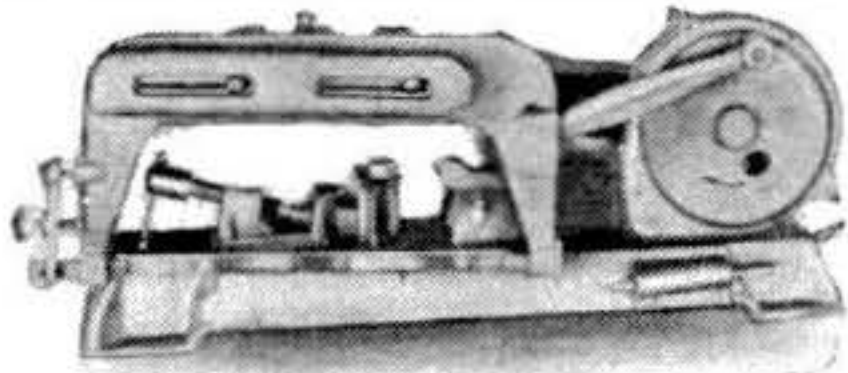

No other saw like it. Rugged cast iron construction. Bronze bearings. Quick action vise—jaws swivel to 45°. Draw cut. Automatic shutoff switch. Capacity 4" x 4". Send for full details and name of nearest dealer.

EXCEL MACHINE TOOLS Dept. PS-20, Benton Harbor, Michigan

Print Your Own



Cards, Stationery, Advertising, labels, circulars, photo and movie titles, church work, tags, etc. Save money. Sold direct from factory only. Raised printing like engraving, too. **Print for Others, Good Profit.** Have a home print shop. Easy rules supplied. Pays for itself in a short time. Write for free catalog of outfits and all details.

KELSEY PRESSES, N-33, Meriden, Ct.

ARC WELDING FOR PROFIT OR PLEASURE

60 LBS. OF READY MADE PARTS

Only \$24.95

BUILD YOUR OWN HEAVY DUTY WELDER

SAVE BUY ONLY NECESSARY PARTS

All parts Ready-Made and easy to assemble. You can do all around welding on steel, cast iron and other metals after only a few hours practice. Illustrated instruction manual included. Sold on 30 Day Money-Back Guarantee!

FREE: Write today for fully illustrated Pamphlet S-2.

ATOMIC ARC WELDER CO.

1039 So. 19th St., OMAHA, NEBR.

Gives 100% penetration. Welds are stronger than original metal. Operates on 110 or 220 AC.

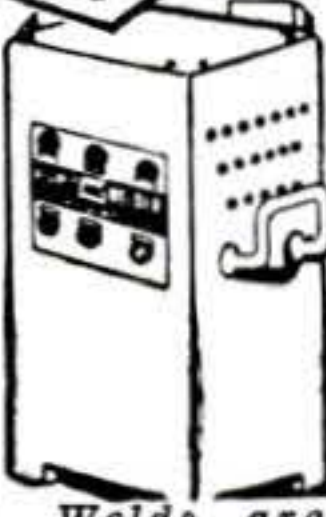

SURPLUS BARGAINS

LEARN OR TEACH CODE

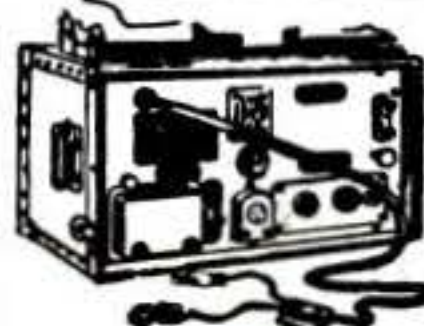

for Boy Scouts, Sea Scouts for Daddy or for Jr. Uses 6-12-24-115 V DC, 115-230 V AC. Can use a hook up of over 20 students. Contains 10 keys, speaker, blinker, frequency control, etc. In fiber trunk 17" x 13" x 10 1/2". Price..... **\$29.50**

VEEDER COUNTER

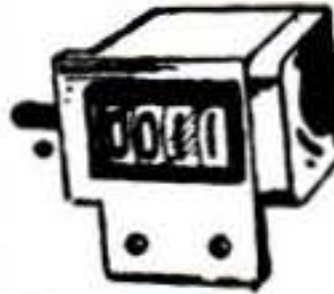

Counts to 9999 and repeats. Many uses 1/4" shaft front meas. 1" x 1/4". Price... **98c**



RIFLE BORE CLEANER

A very good carbon cleaner for cars, motors, tools, etc. A 6 oz. can. **20c** ea. **6 for \$1.00**



BC605 INTERPHONE AMPLIFIER

Easily converted to an ideal inter communications set for office—home—orfactory. With diag. & tubes. **\$4.75**
Brand New.....



ANTENNA MAST

Are you in a dead spot. If you can't get a good T. V. Picture. Here is a Sig. Corp. Ant. mast 30' high of rugged plywood construction to solve your problem. It telescopes into 3 ten ft. sect. for easy stowage. Easy to Mt. Comp. with stakes & rods. Ea. **\$19.95**



WING LIGHT

for planes aqua blue. Mfg. Grimes NAF 1021-12
ea..... **40c**



FRIGIDAIRE THERMOSTATIC EXPANSION VALVE

F 12 Model MX 12 BC Series A-6-5 for Sulphur, Methyl or Freon. Price..... **\$4.95**



200 W Soldering Iron

and Stand. Mfg. Hexacon P200 5/8" tip replaceable. Heavy duty. ea. **\$3.95**



ELECTRIC MOTOR

115 V. 60 cy.. 3500 RPM for experimenters. 3 1/4 x 2 x 1 5/8. Shaft 3/4" long. Price..... **\$1.95**
ea.....



SOUND POWERED PHONES

Complete. No batteries req. Brand new. Leather case. Waterproof with ring-ing CK; operation more than 27 miles. Pair: **\$37.50**
2 Phones.

Real PRIVATE TELEPHONE

WITH ACTUAL SIZE TELEPHONE HANDSETS

Indoor or Outdoor—Nothing to Change, Add, or Buy

Just push buzzer to call. No electrical connections. Comes complete and includes: 2 French type hand-sets, 2 push button boxes with buzzers. 1 50 ft. roll of wire.

Necessary battery also included. These sets come already wired and ready for use. No instructions necessary. Guaranteed to please or your money refunded. Additional wire if needed, may be purchased for 5c per foot.

MOUNT THESE PHONES ANYWHERE YOU LIKE. All that's needed are 2 screws or 2 nails for each box. These are the two telephone boxes with buzzers. Can be mounted on side of desk. Can be mounted on wall. Noise free in noisy areas. No electrical connections. No squeals. No tubes. No hum. **Complete 2 PHONES..... \$14.95**

Write for flyers of hardware, motors, transformers, wire, electronic components, etc. From one of the largest surplus houses in the east. If we haven't got it, it's unavailable. Retail, Wholesale.

ALL MERCHANDISE GUARANTEED. Mail orders promptly filled. All prices F.O.B. New York City. Send Money Order or Check. Shipping charges sent C.O.D.

HIGH RIDGE ELECTRONICS CO.

343 Canal St., Dept. "SC", New York 13, N. Y.

Tel. Canal 6-4882

DELIVERED TO YOUR DOOR POSTAGE PREPAID!

MAIL ORDERS
WE PAY POSTAGE ON ALL ARTICLES



ARMY SURPLUS
 \$8.95 VALUE!

BOOTS

IDEAL ALL WEATHER BOOT FOR WORK—SPORTS

LEATHER UPPERS—RUBBER BOTTOM

- Flexible double chrome, tanned, tough wearing leather uppers!
- Leak-proof gusset tongue!
- Non-skid heavy duty rubber soles.

\$3.45

WE PAY POSTAGE

SIZES
 7-8-9-10
 11-12-13

LOWEST PRICES IN THE COUNTRY
NEW CANVAS COVERS

Made from 10 to 12 inch strips of 12-oz. olive drab Canvas. Waterproof! Double lap seams. Grommets on 4 sides! This multiple seam process gives added strength to small tarp!

ALL ARE FULLY RECONDITIONED

100% WEATHERPROOF—All Purpose FOUL WEATHER SUITS

For • Sportsmen • Hunters • Fishermen • Workmen
 Perfect for Deep Sea and Surf Fishing—Duck and Deer Hunting—Any Outdoor Work, Ranching.



Designed for U. S. Navy for use under toughest conditions. Two-piece . . . parka hooded jacket: overall bib-style pants. O. D. Water repellent, wind-resistant fabric. Pants have zipper fly, button flap, pocket and adjustable shoulder straps. Draw strings on hood, breast, waist, ankles. SIZES: SMALL, MEDIUM, LARGE, EXTRA LARGE.

THIS IS ABOUT A \$6.95 VALUE

USED—GOOD CONDITION! COMPLETE SUIT.

2.49

Delivered to You. We Pay Postage.

NEW SMALLER SIZE MULTIPLE SEAM TARPS

- 5 Ft. x 7 Ft. \$2.89 (\$3.95 Value)
- 6 Ft. x 7 Ft. \$3.49 (\$4.95 Value)
- 6 Ft. x 9 Ft. \$4.39 (\$6.95 Value)
- 7 Ft. x 9 Ft. \$5.10 (\$7.50 Value)
- 8 1/2 Ft. x 10 Ft. \$6.98 (\$8.95 Value)

KILLS ODORS

Just put it in refrigerator or ice box. Absorbs fish, meat, onion, garlic odors. Harmless. 1 YEAR GUARANTEE! POSTAGE PAID



29¢

A MUST for the Handy Man
ALLEN HEAD HEX KEYS

You find Allen screws wherever you turn . . . in cars, appliances, instruments, radio, hobby, farm and workshop equipment. Don't be "stuck" without the right key. Get genuine Allen keys made by the originators of Allen Head screws. Seven popular sizes in a sturdy snap pouch, 75c. at your hardware store.

ALLEN MFG. CO.
 Hartford 2, Conn.

75c



NOW . . . FOR 1/10th THE COST

CONVERT ANY DRILL PRESS INTO A PLANER • SHAPER • JOINTER POWER SANDER • ROUTER

This FREE Book Tells You How

BARRON TOOL COMPANY, INC.
 970 Architects Bldg., Detroit 1, Mich.



Build Your Own POWER MOWER

Make that power lawn mower you "couldn't afford to buy"! New book tells how. 7-day return privilege. Send a quarter today to



ROYAL MFG. CO.

Dept. A25, 1205 Charlotte St.
 Kansas City 6, Missouri

WAR SURPLUS BARGAINS

Substantial Savings on WAR SURPLUS and other MERCHANDISE OVER 200 TIMELY ITEMS

SEND FOR

FREE CIRCULAR

SIoux FALLS SURPLUS STORE
 SIoux FALLS S.D.

See The Wonders of the Heavens!

Amazing value! Wonderful 192-page cloth-bound book, *Everybody's Guide to Astronomy*, now yours for only \$1.00! Contains star charts, tables, telescope-making instructions, how-to-do-it ideas for astronomical equipment you can build, etc. *Supply limited!* Order today! Write:

POPULAR SCIENCE

Dept. 250, 353 4th Ave.

New York 10, N. Y.

Combination FLASHLIGHT and SCREW-DRIVER

Handiest tool invented in many years!

(Dealer Inquiries Invited)

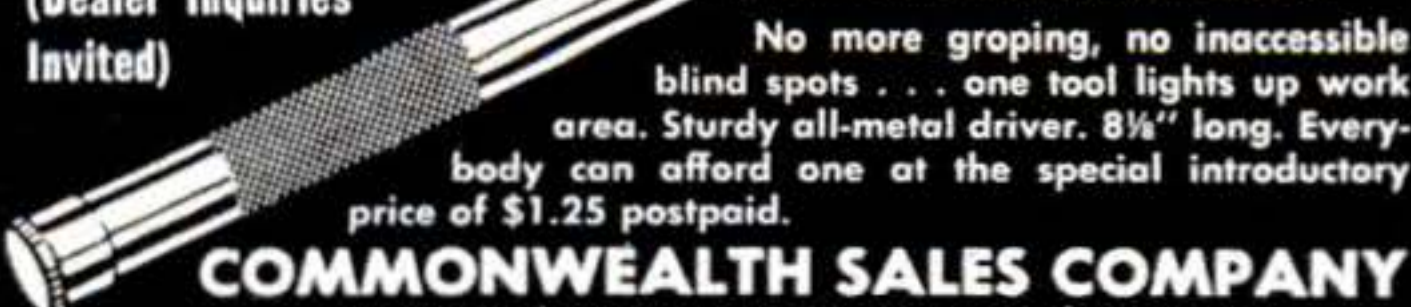

No more groping, no inaccessible blind spots . . . one tool lights up work area. Sturdy all-metal driver. 8 1/2" long. Everybody can afford one at the special introductory price of \$1.25 postpaid.

COMMONWEALTH SALES COMPANY

576 Broadway, Dept. 51, New York 12, N. Y.

PARTS FOR MILITARY TRUCKS

4 or 6 Wheel Drive at a SAVINGS

1/4 ton to 20 ton

Parts List Available on Most Makes

Military Trucks and Jeep Models.

Write stating model of Truck



JEEP TOPS and CURTAINS

Supply Limited (Weatherizing Kit), complete top with back curtain and side curtains with doors. 5 windows. Waterproof O.D. color, shipping weight 40 lbs. Never again at such low price. **\$49.50** Wonderful value. F.O.B. K. C.

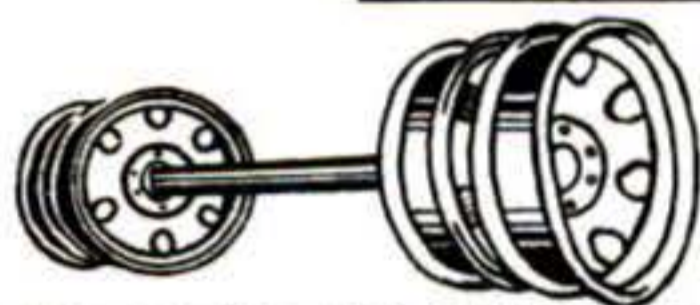

TRAILER AXLE

Heavy duty trailer axle suitable for many types of trailer construction. Also excellent for building of heavy farm trailers and wagons. It is a 12,000 lb. capacity square type straight trailer axle complete with Timken roller bearings, hubs, and 6 hole 750 x 20 Budd Wheels. Without brakes. Axle is 2 inches square and 69 inches between wheel mounting flanges. Std. width. Write for quantity prices, 6 or more.

With Single Wheels **\$59.50** With Dual Wheels **\$69.50**

GAS TANK Utility, 6 qts.—New Surplus. Cylindrical 5 1/2" x 15 1/2", complete **\$2.10**

HYDRAULIC JACKS Walker, 3 ton. Complete, limited supply, ea. **\$9.95**

WINCH CABLE—1/2", 250 ft. **\$30.00**

Hundreds of Other Truck & Jeep Parts and Supplies

All prices quoted good 30 days FOB, Kansas City, 25 % Deposit Required on All Orders.



UNITED AUTO PARTS CO. INC

1901 TROOST-GR.1800-KANSAS CITY, MO.

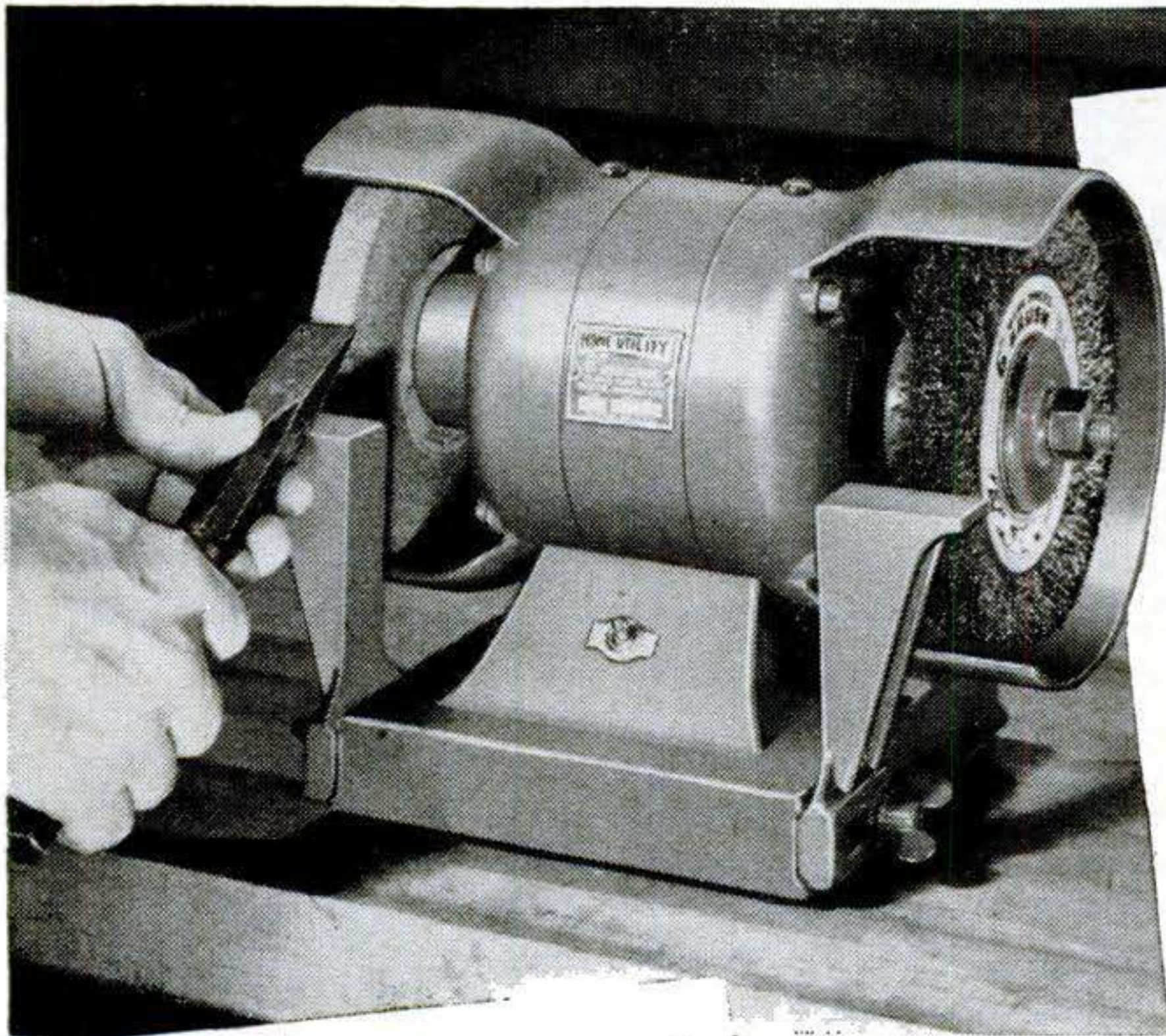

NEW

HOME-UTILITY 6" BENCH GRINDER

\$38⁰⁰

SPEEDS UP

- Tool Sharpening
- Grinding — Cleaning
- Wire Brushing

Compare These Features Before You Buy

- Constant speed Home-Utility 1/4 h.p. motor gives plenty of power.
- Sturdy die-cast housing and wheel guards; substantial base on rubber feet.
- Tool rests locked in base grooves with winged nuts for easy adjustment.
- Full-size ball-bearings on rotor and wheel spindles, protected from dust and grit, for smooth running.
- A quality tool throughout; engineered by BLACK & DECKER, world-famous maker of electric tools for over 39 years!

THE new Home-Utility 6" Bench Grinder is one of the handiest, most useful tools you can buy for your home or farm shop. It does a whole raft of jobs like keeping tools sharp and clean; grinding minor welding jobs; removing rust, old paint, gummy dirt deposits; preparing surfaces for painting; polishing plated metal surfaces. Comes equipped with medium grinding wheel and wire wheel brush; also drives cotton buffing wheels and other attachments, available at slight extra cost.

See the **NEW Home-Utility 6" Bench Grinder** at your **Hardware, Electrical or Implement Dealer.**

WRITE TODAY for your free copy of our helpful "How-To-Do-It" booklet. Gives many useful hints on workshop and repair jobs. Write to: THE BLACK & DECKER MFG. Co., Dept. H2S, Towson 4, Md.



For Home • Farm • Shop • Tool Kit



1/4" DRILLS



1/2" DRILLS

ELECTRIC HOME-UTILITY TOOLS



5" SANDER-POLISHERS



6" SAWS

**THE BIGGEST
VALUE
ON THE MARKET
DIRECT FACTORY TO YOU**

DYNAMIC ARC-WELDER

Super Charged

DOES WELDING, BRAZING, SOLDERING, CUTTING

This is one of the finest scientifically designed and precision-built genuine heavy duty transformer-welders on the market today! Made by an old established firm. High efficiency, heavy-duty output does work you'd expect from costlier machines. It's **EASY TO OPERATE.** Do expert work in a jiffy by following the simplified instructions furnished. Works on iron, steel, brass, bronze, aluminum or other metals. **OPERATES** from any convenient properly wired 110 VOLT A. C. line. **SAVE TIME AND MONEY . . .** build or repair your own auto, home, farm, or shop equipment and appliances, etc. Make big money doing work for others in spare or full time. **OVER 50,000 SATISFIED USERS** all over the country, hobbyists, maintenance and repair men, farmers, tinsmiths, engineers, home and auto owners. Order today on 10-day trial or send coupon for full details.

DYNAMIC WELDER CO., Dept. ATD-25, 13 E. 23rd St., Chicago 16, Ill.

**\$40³⁰ VALUE
Only
\$28⁵⁰ F.O.B.**

GIFT WORTH \$680 INCLUDED

**For Prompt Action
SEND ORDER TODAY**

SEND TODAY FOR FREE DETAILS

Send Free details on Dynamic and Gift offer.
 Send Dynamic and 10 day trial. Enclosed \$28.50, or \$.....deposit send C.O.D. for balance. Include gift offer.

Name.....
 Address.....
 City.....Zone.....State.....

**CUT
HEAT BILLS
WAY DOWN!**

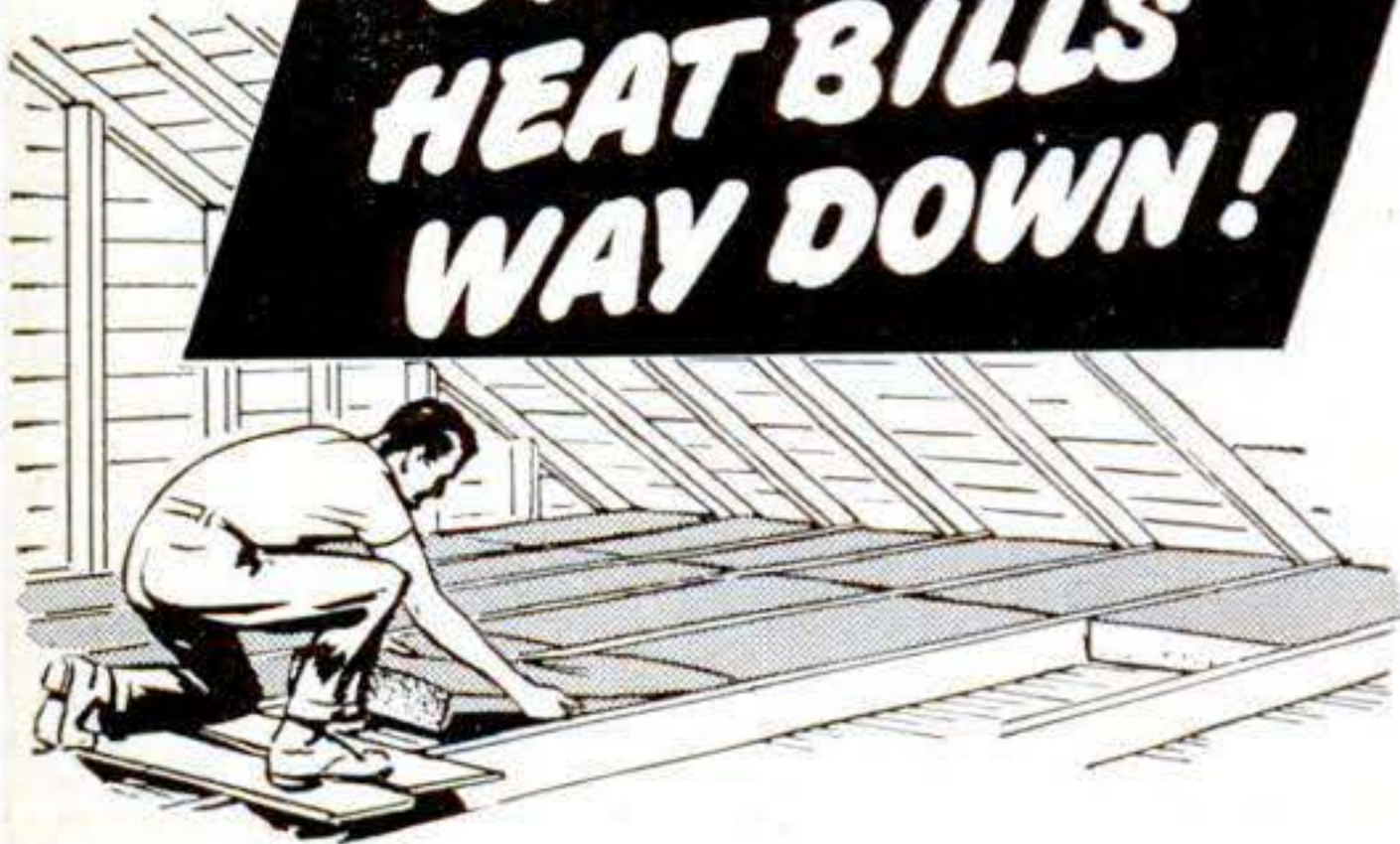

YES, you'll save a lot of money in fuel bills by insulating with new fireproof Gold Bond Rock Wool Batts or Sealed Blankets. Keeps you warmer in winter, cooler in summer. Light, easy-to-handle batts in 2 and 4 ft. lengths, and 8 ft. blankets. Both come in standard widths that slide right in between rafters or attic floor joists. Be sure they're Gold Bond and "full-thick" for maximum heat savings and fire protection. For free booklet on insulation, write Division Y, Dept. PS-2a.

Available at your local Gold Bond Lumber and Building Supply Dealer!

**NATIONAL GYPSUM COMPANY
BUFFALO 2, N. Y.**

**SHARPEN CIRCULAR SAWS
LIKE AN EXPERT**



No experience needed. Two simple adjustments. Gets hollow-ground, cross-cut or combination saw blades true and sharp. Fits 6" to 12" blades with 1/2" to 13/16" centers. Includes file and complete instructions. \$6.95 postpaid. (Check or money order) C.O.D.s postage extra. Guaranteed—Money back if not satisfied after 10 day trial. A money maker for fix-it shops. Soon pays for itself. Order today. Free folder.
**SURE SHARP MFG. CO., Dept. S-20
P. O. Box 24 Santa Ana, Calif.**

\$6.95

**MASTER HOBBY ARBOR TOOL KIT
AT THE GIVE-AWAY PRICE \$5.95**

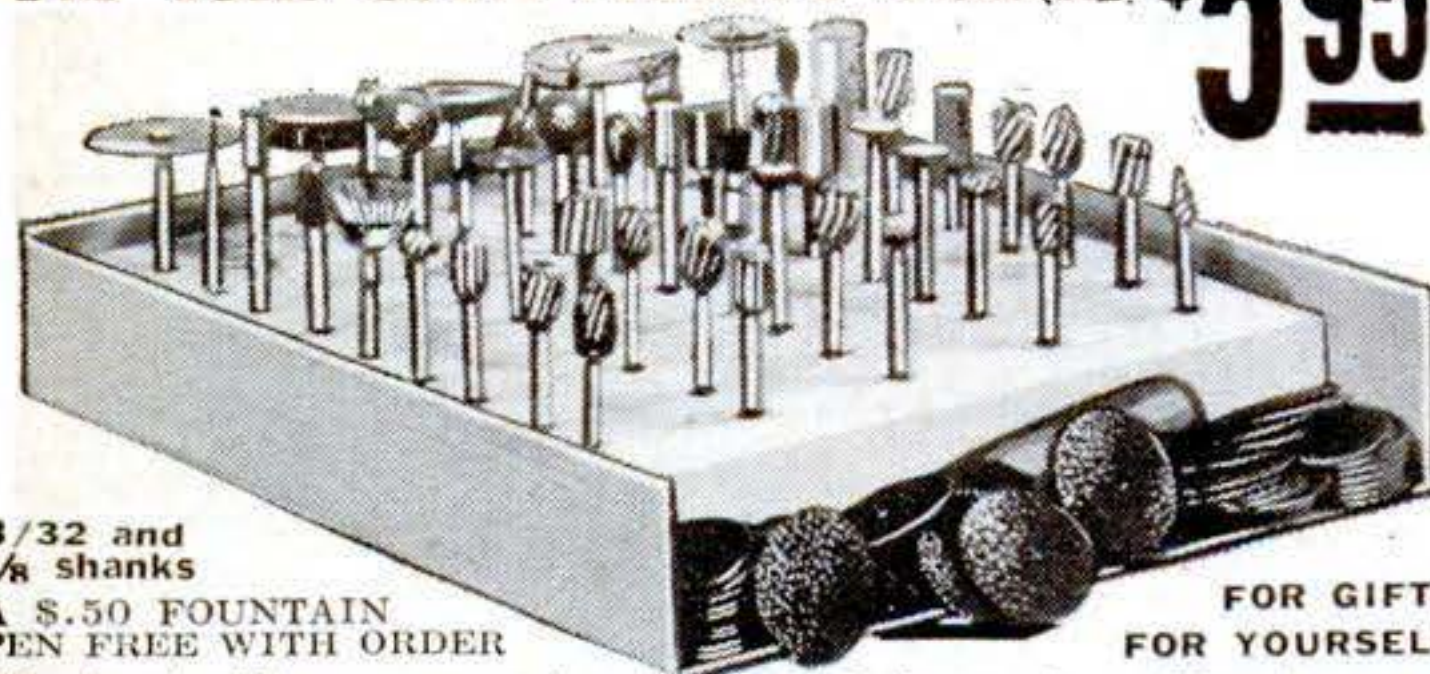

3/32 and 1/8 shanks
A \$.50 FOUNTAIN PEN FREE WITH ORDER

FOR GIFTS
FOR YOURSELF

The best gift you can give to the hobby worker. We give you saws, drills, routers, carvers, emery disks, polishing compound, reamers, borers, shapers, stone points, grinding points. About 150 pieces that we went out and priced in other stores for over \$20.00 for half of what we sell for \$5.95. In addition to the above we are including a dozen saws and a 60c heavy duty mandrel. After receiving set, if you don't think it worth what we say, send it back. Your money refunded.

All orders shipped P.P. prepaid. Send check, Money Order or C.O.D. to Dept. A.

Get our 100 page catalog. Send 25c, money refunded with first order.

GENERAL AIRE CO.

447 W. Norris St.

Phila. 22, Pa.

Get This SAFE Electric Jig Saw

The safe saw for children yet powerful, versatile enough for homeshops. Easily adjustable. Portable. Thousands in use. Plug in any 60 cycle, 110-120 volt AC outlet—and saw! Arm ADJUSTS to permit cutting ANY LENGTH 1/2" wood, 1/4" plywood, thin metal, plastics. Not a "lumber cutter" but for delicate, fine craftsmanship. No belts, gears, wheels. Use for family projects or making money. The BASIC homeshop tool. Get yours now with BUILT-IN MOTOR, 3 blades, cord, plug \$17.50

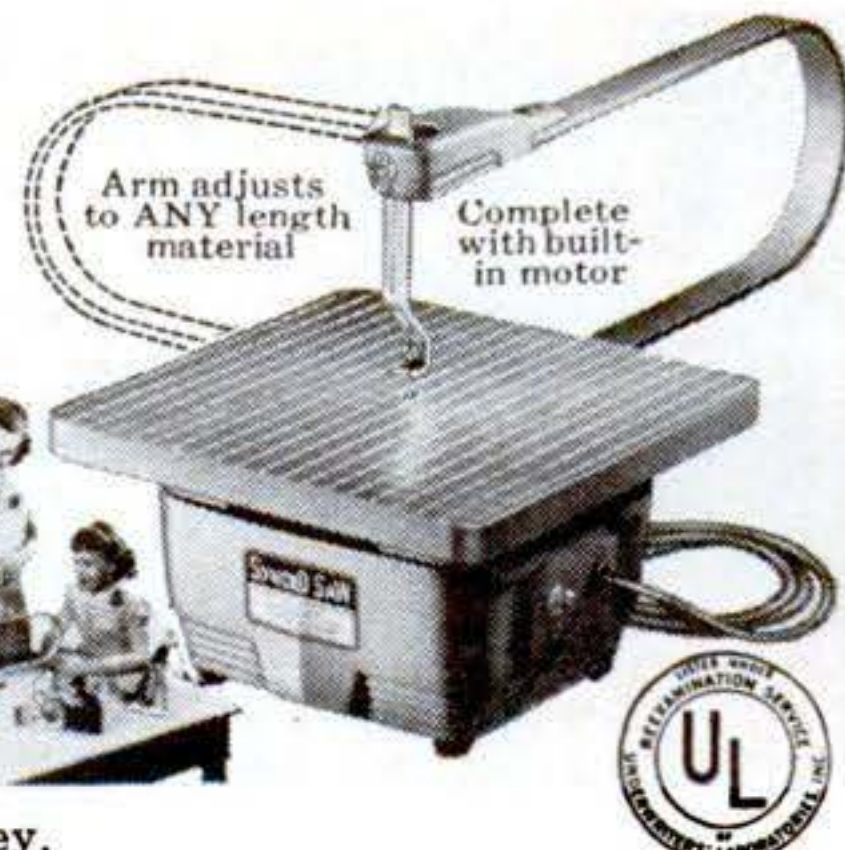

Arm adjusts to ANY length material

Complete with built-in motor



SYNGRO
ELECTRIC JIGSAW

At Dealers! If he hasn't, send \$17.50 to factory, we'll ship saw postpaid. See Syngro products pages 262, 282. (DEALERS WRITE!)
SYNGRO CORP. DEPT. SM-25 ROCHESTER, MICHIGAN, U.S.A.

BUILD YOUR OWN

ARC-WELDER
For Light or Heavy Work

NO REWINDING NECESSARY

We show you how to build this NEW Powerful welder without rewinding. Uses coils taken from old auto generator. Has 20 heats. Operates on either 110 or 220 volts A. C. Learn to weld. Make money welding for others. Complete plan and valuable catalog 35c.



LEJAY MFG. CO., 3323 LeJay Bldg., Minneapolis, Minnesota

**TOILET PAPER FILTERS OIL BETTER...
AT FRACTION OF COST**

An ordinary roll of toilet paper makes an ideal element for any oil filter. Laboratory tests prove it cleans oil faster and better than popular makes of filter elements. With a simple set of adapter plates you can start using toilet paper . . . instead of expensive replacement elements . . . in your present oil filter. Easy to install yourself. For proof and descriptive literature, send name, address, make of car or truck and brand of filter. Retlif Filter Corporation, Dept. PS-2 1237 No. Highland, Los Angeles, Calif.

AMAZING NEW WOOD-TURNING TOOLS

SHARPEN ONCE IN 12-YEARS! (UNDER NORMAL USE)

These remarkable tools tipped with TUNGSTEN CARBIDE will astound you with their performance. They work FREE HAND equally well in wood, plastic or soft metals—and at the same time hold their razor-like edge almost indefinitely. Tests show that they will turn wood or plastic for days and days CONTINUOUSLY without showing any signs of dulling. They are the finest tools available at any price. Beautifully finished 5" blade—flush ground, polished tip—finest brass tube ferrule—9" hardwood handle—over all length 14"—25 tools to choose from: round and square nose from 1/8" to 1/2"; 1/8" cut off; 1/2"x30° skew, spear, r. & l. skews, turning and parting. Amazingly Low Prices! Write at once for free literature.
JOHNS MFG. CO., DUNELLEN 7, N. J.

WESTINGHOUSE AIR COMPRESSORS

Lowest-Ever Closeout Price!

WESTINGHOUSE 1850
Reg. \$60.50 **1850** FOB Pgh.

Model T-1, brand new, complete—Surplus Special at amazing low price. Westinghouse Double-piston type, 6.54 volume. Mount on truck or car engine—or operate with 1/2 HP motor. For farm, home, industry and painters. Full Instructions. Send check or money order. Shipping weight 26 lbs.

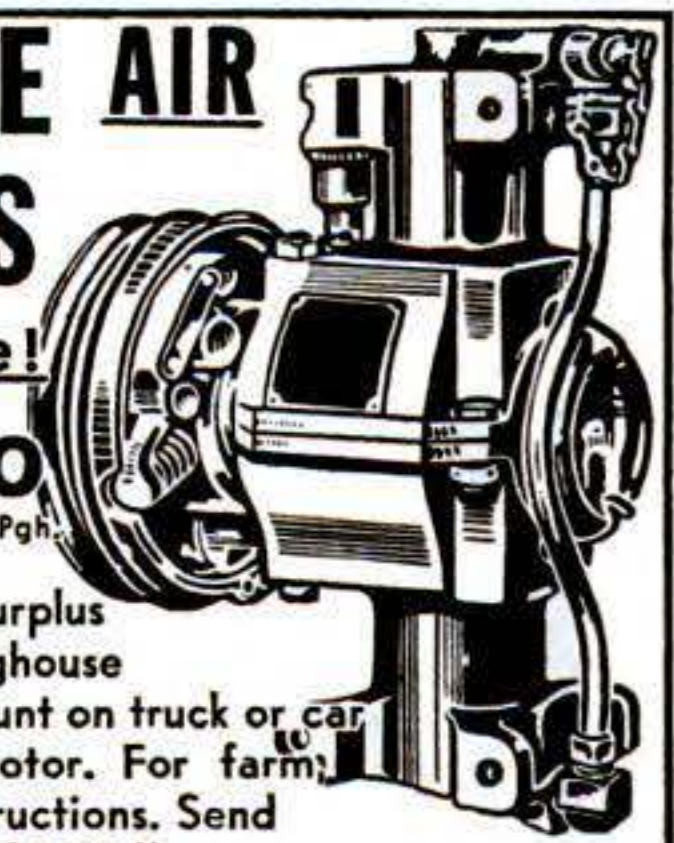

We Carry a Full Line of Spare Parts

**NATIONAL STORES 200 Smithfield St., Dept. 32
PITTSBURGH 22, PENNA.**

YOU CAN'T LOSE!

HAVE A PROFIT MAKING BUSINESS OF YOUR OWN

NATIONALLY ADVERTISED PRODUCTS

NO EXPERIENCE NECESSARY

NO MONEY TO INVEST

FREE SAMPLE OUTFITS

FULL OR PART TIME

A LIFETIME FUTURE

Man or woman—young or old, YOU can earn a steady income in full or spare time as an independent Kendex dealer. Amazing and almost "impossible" earnings can become a reality for you. Herbert Armstrong of Tenn. earned \$202 in 9 days. C. O. Watkins of Oregon sent 92 orders in one day. You have the same opportunity to duplicate these exceptional earnings. Over one million dollars will be earned in 1950 by Kendex dealers—why not let us establish you in your own business and get a share of these wonderful earnings?

KENDEX NYLONS REPLACED FREE . . .

if they run or snag within guarantee period up to three months! Impossible? It's true! No matter what the cause—hard use or deliberate abuse—whether it is fault of the hose or the wearer—Kendex nylons are replaced FREE if they run, snag or become unfit for wear within the guarantee period. How could any woman resist a positive guarantee of satisfaction when she can obtain it without paying any more than other standard advertised brands? Kendex nylons are NOT sold in stores, so you have no competition. Complete line includes everything from heavy 70 denier service weight to gossamer luxurious ultra sheer 15 denier 60 gauge. Proportioned sizes and lengths. Latest colors plus white.

LINGERIE - ROBES - HOUSECOATS - MEN'S HOSE

In addition to the sensational Kendex nylons, you will have a complete line of glamorous lingerie, beautiful robes and housecoats plus a complete line of Kentcraft mens' hosiery guaranteed for one full year. Any pair or pairs of men's hose that does not give satisfactory wear within one year of purchase will be replaced FREE!

NATIONALLY ADVERTISED

Kendex will spend over \$350,000.00 in 1950 to tell millions of readers of the advantages in buying from you. Almost every issue of Good Housekeeping, Saturday Evening Post, McCall's, Women's Home Companion and Ladies' Home Journal carry our advertising in addition to many others. Kendex has advertised in Life, Look, Collier's, etc. Awarded Good Housekeeping Seal. Thousands of orders are shipped daily from coast to coast.

FREE NYLON STOCKING

EVERYTHING GIVEN FREE

Risk nothing! Mail coupon and we will send you, free and prepaid, complete money-making outfits including sample nylon stocking, samples of lingerie, robes, housecoats and men's hose fabrics and everything you need to immediately start making money. Complete outfits become your property even if you don't send any business. Simply write orders, we deliver and collect. Advance cash plus huge bonus. No money or experience needed. Mailing the coupon is all you need to start on the road to a 52-weeks-of-the-year high paying business of your own. You have everything to gain and nothing to lose.

KENDEX COMPANY, BABYLON 649, N.Y.



FOUR MONEY-MAKING LINES

- WOMEN'S NYLON HOSIERY
- GLAMOROUS LINGERIE
- HOUSECOATS — ROBES
- MEN'S HOSIERY

MAIL TODAY

NOTHING TO PAY

NO OBLIGATION

**KENDEX COMPANY
BABYLON 649, N.Y.**

Date.....1950

Send me, free and prepaid, everything I need to make money as a Kendex dealer, including sample stocking etc. There is nothing for me to pay now or later and I am under no obligation in accepting your money-making outfits.

Name.....

Address.....

City..... State.....

NEW 5 lb., 37"
CARBINES
 with
HINGED FOREND

\$21.95 MODEL #142
(Illustrated)
 .22 cal. bolt action,
 7-shot repeater.
 \$22.95 west of Rockies

\$26.95
 MODEL #152
 .22 cal. 7-shot
 automatic.
 \$27.80 west
 of Rockies.

Scope
 extra
 \$9.35

*Insist on a
 Mossberg, at
 your dealer's.*

FREE ... Send for
 catalog with full story
 of Mossberg rifles,
 shotguns, scopes.
 No sales at factory



O.F. Mossberg
 & SONS, INC.

9702 St. John St., New Haven 5, Conn.

**FOR
 FASTER WORK
 IN HOME OR
 SHOP...**

HOLD-E-ZEE
 The Original AUTOMATIC GRIP
SCREWDRIVERS

Pat'd.

See these popular, high-quality
 drivers with the exclusive Gripper
 that holds, starts and sets up
 screws in unhandy places!

New Models FOR RECESSED
 HEAD SCREWS 

At Leading Dealers Everywhere
 UPSON BROS., INC., ROCHESTER 4, N. Y.

Amazing **INSTANT GLOSS**
 Cleans—Waxes with One Application



for Autos, Trucks, Buses, All Painted Surfaces,
 Windows, Mirrors, Venetian Blinds, Ranges

5-OZ. CAN
ONLY \$1

Original all purpose dry cleaner. Just rub it on—let it
 dry—rub it off. Cleans and waxes—leaves a mirror-like
 gloss. Contains no grit or abrasive substance—will not
 harm the most delicate finish. Try it. You'll be amazed!

Enough to clean
 your car 6 times!

POWER SALES CORP. Dept. J, 514-30 S. Green St.
 Chicago 7, Illinois

USE YOUR BENCH SAW
 FOR JOINTING & CUTTING MOULDINGS



With our six inch tool steel cutters
 make mouldings, casings, drop-leaf
 tables, grooves beading and jointing.
 Moulding cutters, A 1 in. wide
 \$1.75. 1 1/2 in. \$2.25. Jointing cut-
 ters, B 1 in. \$1.75. 1 1/2 in. \$2.25.
 E 1 in. for drop-leaf tables, \$1.75.
 E 1 1/2 in. Makes 3/4 in. cove & Quar-
 ter. \$2.25. Postpaid. Guaranteed.
 State size hole. List & Folder free.

JOHN A. SANDSTROM
 Rt. 2-P. Clearwater, Fla.



ARMY SURPLUS BARGAINS
 FOR THE HOME — SHOP — HANDYMAN

Send for our FREE catalog of Surplus Bargains. All
 NEW top-quality merchandise. Buy from Army Surplus
 Sales of Fresno—and save! Also big stock of brand-
 new home utility power hand-tools, drills, saws, etc.
 All products of Black & Decker. Tremendous buying
 power and low overhead means lowest prices.

ARMY SURPLUS SALES OF FRESNO—Dept. 12
 1820 Tulare Street Fresno, California
THE FRESNO HARDWARE COMPANY

**Build
 your own SMITH Compressor**

Operates spray guns, rock drills, tampers, paving breakers,
 sandblasting . . . Uses only 1 gallon of gas an hour!



Save Money—build your own Smith Air
 Compressor! Famous the world over!
 Capacity 60 cu. ft.; pressure up to 100
 lbs. per sq. inch. Just order the Smith
 Compressor Head and Accessories
 with complete instructions for assem-
 bling. All you need is a Ford Motor
 and shop facilities. Head equipped
 with high speed compressor valves;
 automatic unloading and idling.

Write for complete information!
GORDON SMITH & COMPANY, Inc.
 405 College Street • Bowling Green, Ky.

**Snap-on* MAGNETIC
 PICK-UP TOOLS**

- Powerful Lift • Small Size
- Hinged Handles

Perfect for retrieving iron
 and steel objects, such
 as bolts, nuts, wash-
 ers, cotter pins, etc.,
 that fall into small
 places.

9" Size **\$1.00**
 Lifts 8 oz.

16" Size **\$1.95**
 Extends to 27"
 Lifts 24 oz.

DIRECT THRUST HACKSAW
 One-piece steel tube back is
 fitted into a precision-ma-
 chined cast-aluminum han-
 dle. With 10" blade . . . **\$3.95**

* T. M. REG. U. S. PAT. OFF.

**SNAP-ON
 TOOLS**
 CORPORATION
 8060-B
 28th Ave.
 Kenosha,
 Wisconsin

I enclose Check Money Order for
 the following tools:

Pick-up Tool 9", 16"
 Hacksaw Frame, blade
 Add Local Sales Tax

Name.....
 Address.....
 City.....State.....

Portable Automatic Paint Spray Unit

Spray paint your home, car, garage, etc.



Complete Outfit Including Spray Gun

\$150 Value, only **\$89.50**

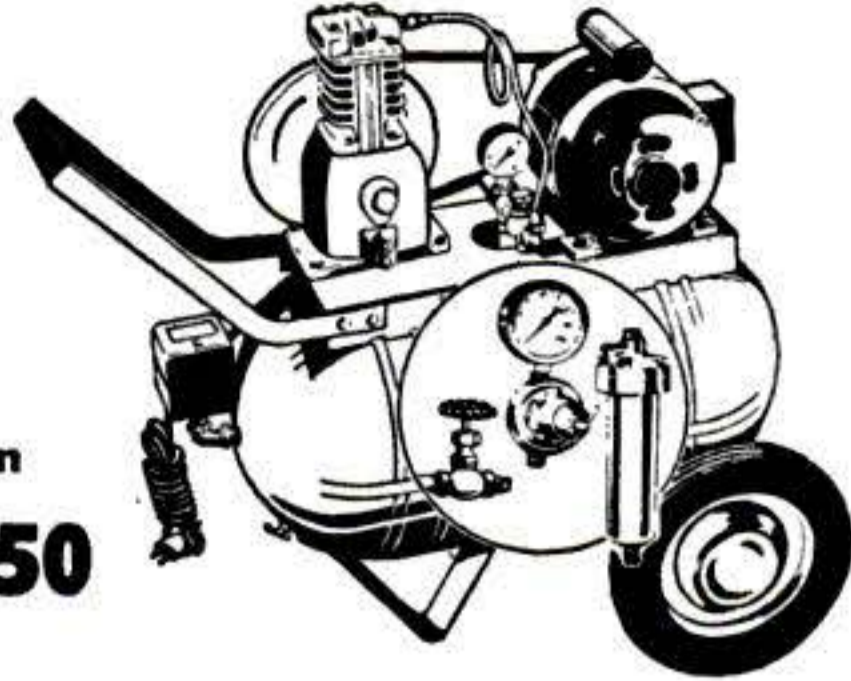

Use also for spraying insecticides on plants and flowers. 1/3 H.P. heavy duty capacitor motor. AC 110/220 volt, 60 cycle. 2 x 1 3/4 inch piston type compressor, splash feed lubrication. 12 x 24 inch tank, automatic pressure switch. CFM 2.8 at 100 lbs. pressure, or 150 lbs. pressure for intermittent duty. Check valve, safety valve, air regulator with gauge and filter, spray gun with 20 ft. air hose and air chuck for inflating tires, V belt drive. Mounted on 2 wheels, ball bearing, with 2" x 10" pneumatic tires. Portable, with handle. Shipping wt. 90 lbs. Regular \$150.00 value. ONE YEAR GUARANTEE.

PARTS SOLD SEPARATELY

Compressor	17.50	wt. 16 lbs.
Automatic pressure switch	7.50	wt. 3 lbs.
Regulator, gauge and filter	8.50	wt. 5 lbs.
Spray gun	9.95	wt. 4 lbs.
Tank, wheels and base	17.50	wt. 32 lbs.
20 ft. hose	2.95	wt. 6 lbs.
1/3 H.P. Cap. motor	22.50	wt. 28 lbs.
Air gauge	1.75	Adjustable pop valve
1/4" check valve	2.75	wt. 2 lbs.

WELLWORTH TRADING CO.

1831 S. STATE ST. DEPT. B-2 CHICAGO 16, ILL.

WRITE FOR FREE Building Instructions

The Rite-Way Mower Attachment



BUILD YOUR OWN POWER LAWN MOWER

WHY PAY MORE FOR FACTORY BUILT MOWERS?

Now anyone can save time and effort mowing field or lawn by building their own whirl type Power Mower. Build it in a short time with parts and instructions we furnish. Requires no special tools.

Write Today for Free Building Instructions

T & H MFG. CO., INC.
Dept. MSB-2, 811 E. 31st St.
Kansas City, Mo.

DRAINS CELLARS, WASH TRAYS CIRCULATES OIL

Pumps 1800 GPH 300 gal. 30' high, uses 1/8 to 1/3 HP motor. Will not clog. **\$6.50**

Postpaid if cash with order. (Add 50c for west of the Mississippi.)

Thousands in use since 1936

LABAWCO PUMPS, BELLE MEAD 3, N. J.

BIG FREE CATALOG of WAR SURPLUS OPTICAL BARGAINS

Build Your Own RIFLESCOPE, BINOCULARS, TELESCOPES, ETC.

We Furnish Optics and Instructions

- LENSES, PRISMS & RETICLES
- EYEPIECES and OBJECTIVES

Send \$1.00 for Stock #2-N 10-Piece Lens Kit and Big Instruction Booklet.

We Have Numerous Types of Assembled Optical Instruments Including BINOCULARS and RIFLESCOPES. CHECK OUR BARGAINS . . . Request CATALOG N

EDMUND SALVAGE COMPANY
BARRINGTON, NEW JERSEY



FREE!
LAFAYETTE'S NEW 164 PAGE CATALOG

The Biggest Bargain Book In Radio and Television

Radio and TV Sets—Parts—Tools—Hi-Fi—Public Address—Kits—Test Equipment—Ham Gear—Record Changers—Records, etc.

164 pages packed with all new, latest-model, famous-make radio and TV equipment at money-saving prices.

Invest a penny postcard and send for this great new 1950 Lafayette Catalog. Then sit down with pencil and paper and make a price comparison test. Check model for model, and see if Lafayette doesn't save you anywhere from a few pennies to a few dollars on most every item.

If you're a service man, experimenter, ham, hi-fi bug, engineer, set-builder, or serious amateur—send for your 1950 Lafayette Catalog now. It's one of the biggest things in America you can get "for free"!

SALE! SALE!

Lafayette famous FM-AM
PRICED AT ONLY HIGH-FIDELITY CHASSIS
\$59.50 with built-in PHONO PRE-AMPLIFIER

INCLUDING WIDE RANGE 12" PM SPEAKER!

Look at these \$300 set features: Latest 11-tube circuit plus rectifier. 10 watts undistorted power output. Phono pre-amplifier permits direct connection of variable reluctance pick-ups. High and low impedance phono input. Tone control. Slide rule dial. Supplied with loop and folded dipole cabinet antenna. 12" PM speaker with Alnico V magnet. 105-125 volts, 60 cycles, AC only. Chassis dimensions: 13x9x9 1/2. Shipping weight: 25 lbs. Complete with tubes \$59.50.

30-day Money-Back Guarantee! If not fully satisfied, return to us within 30 days, and you'll receive full refund, less transportation charges.

NEW YORK:
100 Sixth Avenue and
542 E. Fordham Road
(Bronx)
CHICAGO:
901 W. Jackson Blvd.
ATLANTA:
265 Peachtree Street
BOSTON:
110 Federal Street
NEWARK:
24 Central Avenue

Lafayette
RADIO
OUR 29th YEAR

RUSH COUPON NOW FOR FREE CATALOG

LAFAYETTE RADIO, Dept. KB-50
901 W. Jackson Blvd., Chicago 7, Ill.
or 100 Sixth Avenue, New York 13, N. Y.
Rush me your FREE 1950 164-page Catalog.

Name _____
Address _____
City _____ Zone _____ State _____

PASTE ON PENNY POSTCARD

MODERN LAWN MOWER SHARPENER

PROFITS and SPEED

- FOR LAWN MOWER SHOPS
- FIXIT SHOPS
- LOCKSMITHS
- HARDWARE STORES • GOLF COURSES • SCHOOLS • PARKS
- INSTITUTIONS • CEMETERIES
- AND ALERT INDIVIDUALS!

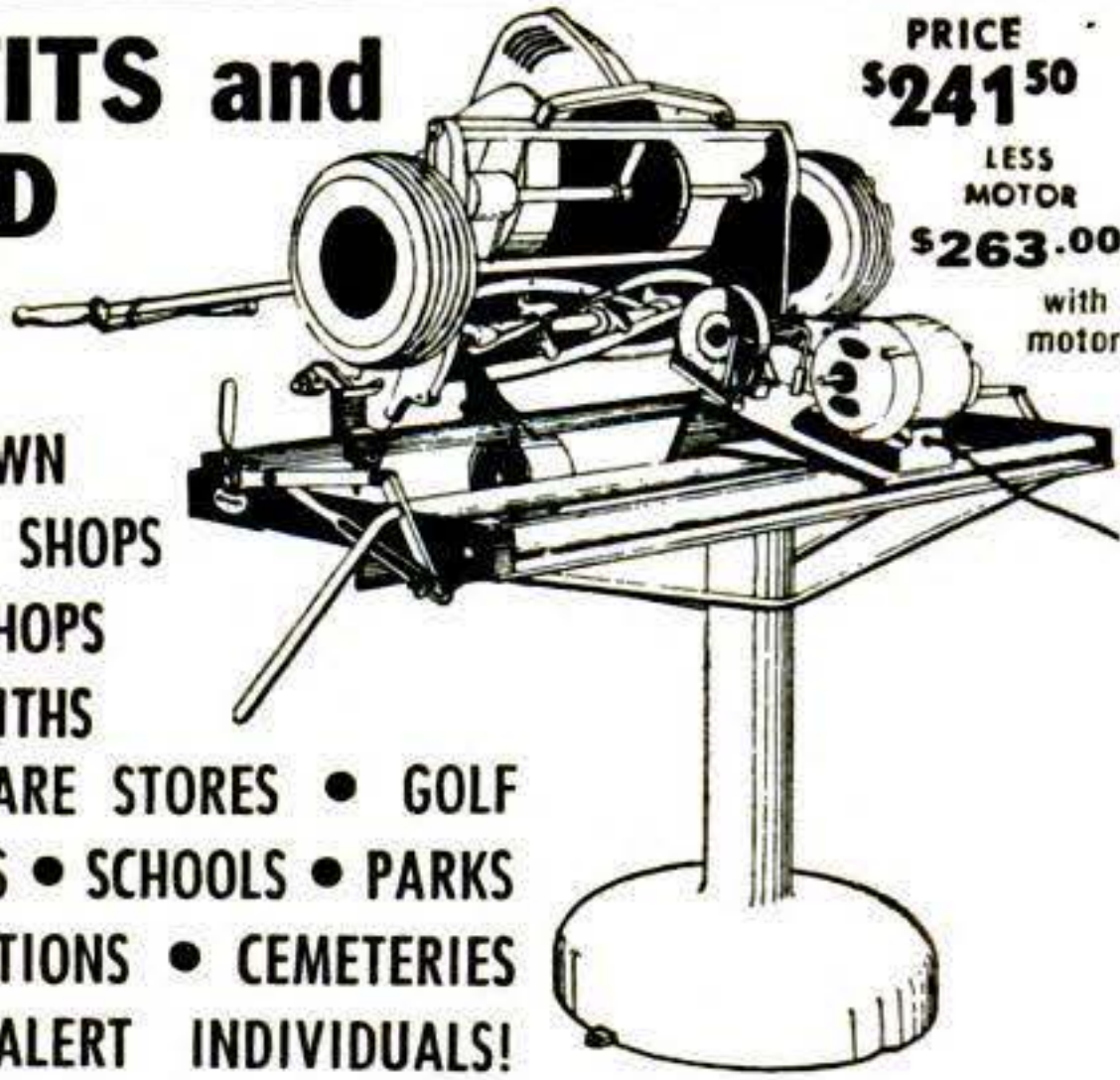

PRICE
\$241.50
LESS MOTOR
\$263.00
with motor

Sharpens All Reel Type Mowers • Hand, Power or Gang • 10 to 20 Minutes • No Dismantling No Extra Attachments Needed

All reel type mowers, from 5-inch edgers to 36-inch power mowers, are quickly sharpened to extreme ends of both left and right twist reel blades. Handle, wheels, roller and motor remain in place when sharpening is in process. Bed knife is sharpened in same brackets that hold mower in grinding position. No extra attachments required. One lever puts mower or bed knife in grinding position. 100% steel construction. Grinding head rides on five ball bearing races. Easy to operate. Sharpens wood chisels, joiner knives and planer blades without extra attachments.

ORDER NOW
Immediate Delivery

Skate Sharpener Attachment Available

Send for FREE ILLUSTRATED BULLETIN No. 11C

MODERN MFG. CO. 160 N. FAIR OAKS AVE
PASADENA 1, CALIFORNIA

AIRPLANE WIRE ROPE

Extra flexible, corrosive resistant.

Size	Strands	App. break lbs.	Per foot
3/32"	7/7	920	.04c
1/8"	7/19	2000	.06c
5/32"	7/19	2800	.08c
3/16"	7/19	4200	.10c
1/4"	7/19	7000	.13c

No CODs. Postage prepaid. Min. order \$2.00. Discount 10% 100 ft. or more.

AIRPLANE GENERATOR, P-1 type, 200 amps, 24V; use for welding, lighting, etc. Good used condition. FOB. Ship. weight app 60±. reduced to \$15.

AERO PARTS SUPPLY

8102 Lockheed Dept. PS-1 Houston 17, Texas

NEW! Motor Driven JIG-SAW

(Not a "Vibrator")

PLUS

★ Power Sander PLUS

★ Filing Machine

ALL
\$11.95

POSTPAID
INCLUDING MOTOR

HOME WORKSHOP In Itself!

Get wonderful NEW precision Saw—Sander—Filer! Own a whole Workshop, power driven! 3000 RPM Electric Motor, A.C. Oilite bearings, ground and polished shaft. Heavy flywheel, 3/16 saw stroke. Cuts to center 16" circle, or rotate table for longer pieces. Saw arm may be removed and stillet type block used on larger work. Slide-guides in table. PRECISE, straight cuts all angles. **SPEED SANDER**: own 45° tilt table. **POWER FILE**. Attach regular files. Fine for precision metal work.

Durable cast aluminum and steel. Unbreakable 6 ft. rubber cord and plug. Complete with several saw blades, 3 patterns, 2 pieces wood. **SEND NO MONEY**. Pay postman plus C.O.D. postage. Or remit \$11.95, we pay postage. Rush order now.

Absolutely Safe. All ages. Special Blade Guard 6x4" Tilt Top, Rotates, too. Saw GUIDES Sanding Table Tilts 45° Power Filer Powerful Motor! Money back guarantee if not satisfied in 5 days.

WALTER WILLIAMS & CO. 2410 N. Lakeview Dept. SF, Chicago 14

274 POPULAR SCIENCE

Handi-Chest

So Handy...



Home-Office-Shop
Stamps-Pins-Buttons-Washers
Bolts-Nuts-Nails-Screws-

• METAL CABINET
ALUMINUM DRAWERS

No Extras To Buy!

48 BINS
16 DRAWERS
\$4.75
CABINET SIZE
6"-8 1/2"-12 1/2"

Money Back Guarantee!

PRICES

96 BINS..... \$8.75
32 DRAWER

192 BINS..... \$15.75
64 DRAWER

WE-PAY-ALL-POSTAGE

WEST OF THE ROCKY MOUNTAINS
AND FOREIGN COUNTRIES ADD 10%
OHIOANS ADD 3% SALES TAX

No C. O. D.'s Please

Send check or money order to:

TIBBITS MFG. CO.

Dept. 2F Alliance, Ohio

SIZES	DESCRIPTION
32 Drawer 6"-12 1/4"-15 1/4"	★ BEAUTIFUL HAMMERED ENAMEL FINISH ★ REMOVABLE DIVIDERS, IN DRAWERS ★ INDEX CARDS ★ SPOT WELDED STEEL CABINET ★ RUBBER FEET WON'T MAR
64 Drawer 6"-24 1/2"-15 1/4"	
Drawer Size (all same) 1 1/4"-2 3/4"-5 3/4"	

FIX IT WITH EASY TO USE KESTER METAL MENDER

GENUINE TIN-LEAD SOLDER



Write for
NEW FREE
20 Page booklet
on **SOLDERING**

KESTER SOLDER COMPANY
4254 Wrightwood Ave.
Chicago 39, Illinois

D.C. ARC WELDER

OVER \$300 VALUE AT LESS THAN 1/3

200 Amperes Continuous Duty. Up to 250 amps, intermittent duty. Easily mounted on your tractor. Welding range from 0-up by dial type control. 1-yr. guarantee with money back 10-day trial period. Write for FREE literature. OR send 35c for PLAN "Build Your Welder from Aircraft Generator" literature included.

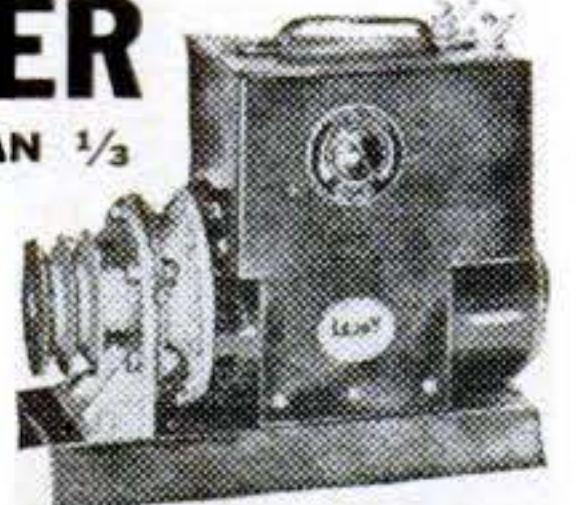

LEJAY MFG., 823 LEJAY Bldg., Minneapolis 8, Minn.

HYDRAULIC Power Transmission

WITH Infinitely VARIABLE SPEEDS, Clutch and INSTANT REVERSE
OUTPUT TORQUE ADJUSTMENT UP TO 180 inch POUNDS

This positive displacement Hydraulic Torque Converter is the ideal fluid drive with thousands of uses. Output Speeds Infinite .0 to 550 R.P.M. in either direction. Change Speeds WHILE RUNNING. Control and Transmit your power this SMOOTH Oil-Way. Will handle 1/4 H.P. to 1 1/2 H.P. Motor. Industrial or Home & Farm Use. Cost Government \$300. High Quality Precision Workmanship. Buy this unit to get the most for your money. Case measures 7 1/2" long 7" high 6 1/2" wide. Input & Output Shafts 5/8" dia. Beautiful Red Crackle Finish Case.

FINGER TIP CONTROL

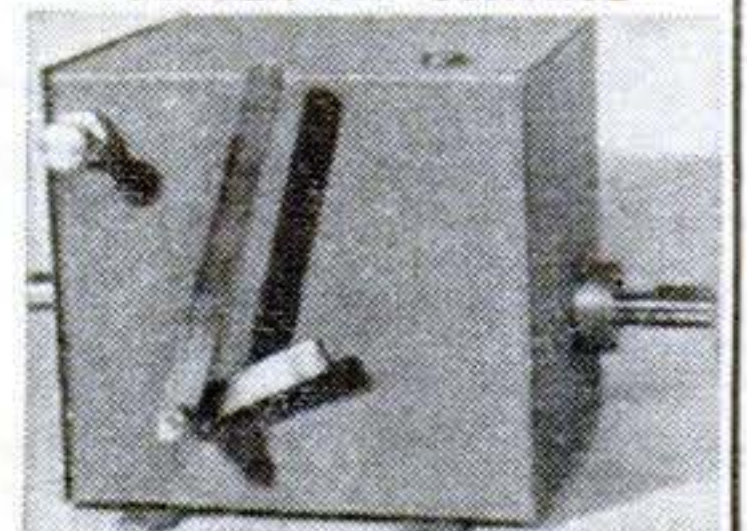

Shipping Wght.
25 pounds

Only
\$54.50

PREPAID
2 quarts oil included FREE

If C.O.D. is requested a 10% Deposit must accompany order and we ship F.O.B. Chicago.

1 1/2"-8 thread Lathe
Chuck Adapter, \$3 extra

DIRZIUS MACHINE SHOP "Y" 1423-25 So. 52nd Ave., Cicero 50, Ill.

Look - ONLY \$39.95
for This 5-in-1 Machine

EQUALS \$200 IN SINGLE UNITS

Become an expert craftsman. Operate profitable business at home. Save money on household repairs. Lifetime pleasure for entire family at few cents per hour, making things from wood, metals, plastics.

HEAVY-DUTY TOOLS AT FACTORY COST

EMRICK is 5 precision power tools in ONE assembly, using ONE Motor. Equals in performance separate units costing up to \$200—yet our price only \$39.95 for everything identified above. Thousands of satisfied customers. Our 52nd year building fine tools.

WRITE FOR FREE Literature on New 1950 features; Reduced Price Specials; and MONEY-BACK, FREE-Trial, Easy Payment Plan. EMRICK, Inc., 1928 Clinton Avenue, Kalamazoo, Michigan.

Sand Casting—Forging—Heat Treating—Case Hardening
BRONZE FOUNDRY



In your own workshop allows you to design and build your own GASOLINE ENGINES, STEAM ENGINES, STATUARY, ART OBJECTS, SPECIAL TOOLS, NEW INVENTIONS, ETC. You can also make forgings and case harden steel. Your shop is not complete without a FOUNDRYETTE. Three sizes are available capable of making bronze castings of 1½, 3 and 6 pounds weight, aluminum, copper, brass, etc., \$22.50, \$29.50, \$42.00 f.o.b. Kansas City. Domestic gas supply energy required for operation. Write for circular.

and 110 volt AC or DC
KANSAS CITY SPECIALTIES CO.
Box 6022, Dept. S-1 Kansas City, Mo.

GARDEN TRACTOR

• 30 ATTACHMENTS • NO BELTS
• NO CHAINS • POWER TURNING
• GEAR DRIVEN

Plows deep furrows. Change attachments in seconds. FREE Instruction Booklet.

Buy Direct • Special Discount
Send Postcard for Big Free 32-page Catalog

RED-E TRACTOR CO., Richfield, Wisconsin
50 Fond du Lac St., Richfield, Wis. 53453



The Modern PLASTIC
for lasting Home Repairs

PERMANENTLY mends cracks or holes in wood, tile, stone or plaster. Sticks and stays put—Does not chip, shrink or fall out. Easy to use. Economical. Mold it, chisel it, polish or paint it. If unobtainable from your lumber, paint or hardware dealer, the big 4-lb. can will be sent you post-paid (in U.S.) for only \$1. Full money-back guarantee, order now.

DONALD DURHAM CO.
Box 804-N, Des Moines, Iowa

OVER 500 WAR SURPLUS BARGAINS!

WAR SURPLUS CATALOG **NEW! GOVT. SURPLUS CATALOG FREE!**

JACKET—SHEEPLINED TYPE AN-J4
Genuine Air Force Issue! The Air Corp's finest jacket. Top grade leathers, trimmed at cuff and waist. Ex. lge. sheeplined collar. Adj. tabs at side, zip front. Reconditioned. \$42.50 value. Med. sizes only. **\$15.95**

New! **\$21.95**

B-2 FLYING CAP. New, all leather cap, square visor, sheeplined, turn-up flaps. \$5.00 value. State size. **\$2.50**

TYPE A-6 FLYING BOOT
Rubber soles, sheeplined for warmth. Zipper closure. Used. \$18.50. Est. **\$6.95**
Brand New **\$9.95**

ALL SIZES

Write for FREE Catalog PM-11 Today!

BE FIRST ON THE LIST
New Spring and Summer Catalog now in preparation. Ready about April 1st. Crammed full of amazing surplus bargains. Write today.

DOWN & FEATHER SLEEPING BAGS
NEW. Mummy style. Filled with mixture of down and chicken feathers. Water repellent poplin cover. Zipper opening. **12.99**

BRAND NEW O. D. ARMY BLANKETS
Right out of orig. govt. cases. Size 68" x 86". 4 lbs. **\$5.88** 2 for 11.50

GENUINE ARMY BLANKETS
Finest 100% wool blankets issued! Soft, soil resistant nap. Olive drab, cleaned, guaranteed perfect. This quality in civilian colors sells for \$12.50.
Wgt. 4 lbs. **\$3.88**

TYPE B-3A FLYING GLOVE
New, fine supple brown leather. Separate rayon liner for extra warmth. Both complete. **2.69**

F-2 High Altitude FLYING GLOVES
New, soft durable brown leather. 100% wool knit lining. Sizes 8-9-10-11 \$6.00 value **\$3.98**

Sportsmen's BRAND NEW! N-1 PANTS
Wool-lined, water-repellent jungle cloth! Rugged and warm! S.m., Med., Lge. sizes. **4.98**

A-9 FLYING GLOVES
\$10.00 wouldn't buy a better mitt. Warm, fleecelined, soft deer-skin. New! Large only. **\$4.98**

AIR FORCE FLYING TROUSERS LEATHER • SHEEP LINED! Brand New! The Navy's finest! Zippers entire length of pant. Suspenders included. All sizes. Government cost over \$20.00. State waist size and length. **\$6.88**

Mail orders add 10% for packing and shipping. Send deposit or check with order. Every item guaranteed as advertised.

AAF ALPACA LINED PANTS
ALPACA LINED THRU-OUT!
Weatherproof poplin outer. Complete with pockets, zippers and suspenders. Warm, light weight. State waist size. **\$5.88**

ship wt. 36 lbs. **PORTABLE GASOLINE HEATER**
Brand new. Complete with 3 gal. steel tank. Automatic float valve prevents flooding. Famous Evans blue flame burner produces 30,000 BTUs per hr. Flexible steel fuel line. Durably made for 'U. S. Air Force! Excellent for tents, barns, hangers, garages, etc \$50 value. No. 58. **\$12.95** ship. exp. col.

FISLER SALES CO. 723 Walnut St. Kansas City 6, Mo.

FIRE EXTINGUISHERS

New Surplus 1 gal. capacity fully charged, ready to use. Carbon-tetrachloride is non-conductor; stored pressure type shoots 40 foot stream; height 23", diameter 5". Ideal for home, garage, workshop, etc. **\$14.95**
Lists approx. \$65.00. Our price...

Price F.O.B., Kansas City, Mo. No C.O.D.'s
Send 10c For New 72 Page Jam Packed Catalog

ATLAS EQUIPMENT CO.
229 S.W. Blvd. Dept. PS2 Kansas City, Mo.

UP TO 80% SAVINGS ON WAR SURPLUS

LT. WT. ALUMINUM PIANO HINGE

Length 72 inches, thickness .040—width 1 1/4"—Operating radius 275 degrees. Made of aluminum alloy, sold in 6 foot lengths only—\$1.14 per length. . . .

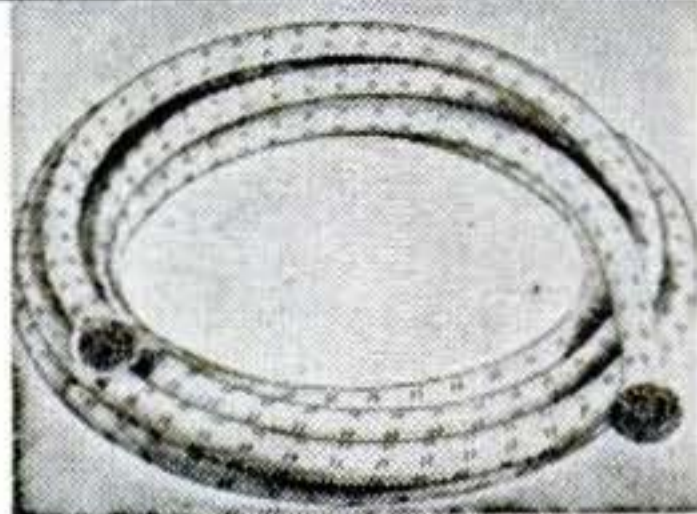

LIVE RUBBER SHOCK CORD

Made in accordance with rigid army specification. Clean fresh stock. 5/8" contains approx. 500 strands of live rubber. 3/8" approx. 100 strands. 1/4" approx. 40 strands. Sold in 25 ft. lengths or more. At about 20% of original cost.

DIA.	PRICE (per 25')	Ship. Wt.
1/4"	\$1.00	2 lbs.
3/8"	\$1.25	2 lbs.
5/8"	\$1.75	3 lbs.

HEAVY DUTY STEEL PIANO HINGE

Length 56"—Thickness 3/32"—Width (open) 3-5/16"—Operating radius 330 degrees—Made of heavy duty steel—Drilled ready for use. Ideal for drop tables, heavy tool boxes, heavy doors, and many other uses where heavy hinges are required. Sold in 56" lengths only. Ship. Wt. 7 lbs. At a fraction of original cost. . . . \$1.45

HEATING ELEMENTS

For home made photo print dryers, chicken brooders, etc. Wiring diagram for use on 110-volt; 50 watts each. Each element 1 1/2"x2 1/4"x3/16". Set of four. . . . 96¢

OIL IMMERSION HEATER



110 volts AC or DC. Three position. High Heat (1250 watts). Medium Heat (625 watts). Low Heat (312 watts). Make winter starting on your car, truck, tractor, or farm equipment, easy. Just plug in your 110V Immersion Heater, insert it into your oil tank through the oil filler hole, and have hot oil in a jiffy. Heating elements 11" long, diameter 1 3/4". At a fraction of original cost. Each. . . . \$7.95

6 VOLT DOUBLE SHAFT MOTOR

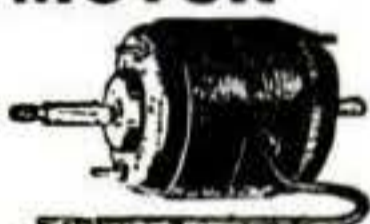

1/30 horse-power motor made by Delco. This is a 6 volt D.C. motor with two 1/4" shafts, used on Auto Heaters, Auto Fans, etc. Ideal for use in the shop, garage, and wherever 6 volt D.C. is available. RPM 3700. Ship. wt. 3 lbs. List price is \$4.20, our price is a real money saving buy. Our price, only \$2.95

Prices F.O.B. Chicago. Include approx. postage on orders paid for in advance. C.O.D. orders enclose 25%, balance sent C.O.D. WRITE FOR FREE ILLUSTRATED CIRCULAR.

U. A. S. Corp. Dept. PS-2 5637 W. 63rd Pl. Chicago, Illinois

ELECTRIC SHEAR SHARPENER

Over 65,000 Sold—It Must Be Good!



Genuine Carborundum wheel ideal for shop or home use. Send remittance with order and shipment will be made at once, prepaid to your door, complete with electrical goods catalogue. Motor driven \$9.75 complete with vise

WILLIAM MARVY COMPANY, Dept. 8
479 St. Peter Street St. Paul 2, Minn.

WORLD'S LOWEST PRICED ADDING MACHINE

VEST POCKET SIZE

IDEAL FOR INCOME TAXI

FREE TRIAL ONLY \$2.95

TOTAL COST SEND NO MONEY

FREE!! Each Baby Calculator in Beautiful, rich-looking Leatherette case—at no extra cost.



Fits vest pocket or purse. Guaranteed accurate. Operated as easily, and as reliable, as machines costing many times as much. Not a toy. Precision made, very durable—guaranteed for life against defects in construction. You positively can't buy a calculator of equal quality for as little money. ACCEPTED AS THE FINEST LOW PRICED CALCULATOR FOR OVER 35 YEARS! Operates with a flick of your finger. Adds, subtracts, multiplies, divides—counts up to one billion. Pays for itself over and over in mistakes avoided, and time saved.

MAKES IDEAL GIFT

Sold on a positive money back guarantee. Send only \$2.95. Calculator sent postpaid, or send name and address and pay postman \$2.95 plus postage. MONEY BACK IN 10 DAYS IF NOT DELIGHTED! (If outside U. S., send \$3.50.)

AGENTS WANTED

CALCULATOR MACHINE CO., (Mfrs.)

Dept. 521, P. O. Box 248, Glenview, Illinois

NEW FALSE TEETH IN ONE DAY

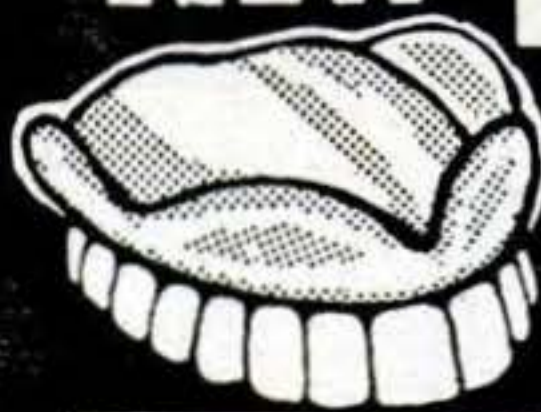

ONLY \$17.00 PER SET

Remake Old, Loose, Cracked or Chipped Plates Into Perfect Fitting Natural Beauty-Pink Dupont PLASTIC PLATES

NEW METHOD—NO IMPRESSION NEEDED

No more loose plate discomfort or danger to health thru improperly chewed food. No more germ-breeding cracks and crevices. Your teeth will be like new — perfect fitting \$100, Dupont beauty-pink plastic plates for only \$17.00. All work is guaranteed. Order direct—save over 50%. SEND NO MONEY—WRITE FOR DETAILS TODAY

BEST DENTAL CO. Dept. S

475 5th AVENUE, NEW YORK 16, N. Y.

\$\$ EXTRA PROFITS! \$\$

Flocks & Sandblasts



Dual Purpose Spray Gun! Uses only 25 lbs. Air Pressure!

Thousands of uses in Home, Shop, Industry: Makes Auto Interiors Clean & New, Lines drawers, Marproofs lamp bases, Refinishes any object. All in colorful Flock. Etch & Frost windows, glassware, etc. Removes Paint & Rust from Autos, Tools. Guaranteed! Send \$19.75 or write for free information. Complete Flocking Supplies!

BLASTO SPRAY GUN MFG.

Dept. PS-2, 7007 Haas Ave., Los Angeles 47, Calif.

WHEELS—WHEELS

- 5" Disc Wheel 5/8" Tire 5/16" or 3/8" sleeve. 30c ea.
- 6" Disc Wheel 5/8" Tire 5/16" or 3/8" sleeve. 35c ea.
- 7" Disc Wheel 3/4" Tire 3/8" sleeve. 45c ea.
- 8" Disc Wheel 1 1/8" Tire 1/2" sleeve. 70c ea.
- 7" Disc Wheel 1" Tire 1/2" ball bearing. 80c ea.
- 8" Disc Wheel 1 1/8" Tire 1/2" ball bearing. \$1.00 ea.
- 8" Disc Wheel 2" semi-pneum. T. 1/2" B.B. \$1.35 ea.
- 10" Disc Wheel 1.75 semi-pneum. T. 1/2" B.B. \$1.50 ea.

Above wheel prices include hub cap.

10" Aluminum Wheel 2 3/4" semi-pneum. T. 1/2" B.B. \$4.50 ea.

Plus Postage, 20% — C.O.D.'s accepted.

UNITED WHEEL STAMPING CO., PS-2

2756 W. 115th STREET CHICAGO 43, ILLINOIS

HAUCK FLAME GUN KILLS WEEDS



KILL WEEDS, crab grass, Canada thistle—stalks, seeds and roots. Destroy brush, caterpillar nests, diseased trees, grasshoppers, chinch bugs, etc. Clear irrigation ditches, split rocks, burn tree stumps. . . Sterilize poultry houses, kennels, barns. Use as portable home forge. Melt ice, thaw pipes. Safe, inexpensive. Burns only 6% kerosene, 94% air! Thousands satisfied users. 7 models. Write for FREE CATALOG.

HAUCK MFG. CO., 80 Tenth St., Brooklyn 15, N. Y.



Puts light where You need it!

Ideal for work bench, repairs, painting. Sturdy aluminum reflector; 10' cord; socket with switch; swiveling device.

#4 with rubber grip spring clamp \$2.35

#42 with 2-section telescopic steel stand, plated. Elevates to 6' 6" \$4.95

Top quality; money-back guarantee. For prepaid shipment, send cash, check, M.O.

J. H. SMITH & SONS CORP. GRIFFITH, IND.

Money Back Guar.



7x50 PRISM BINOCULARS
PRECISION OPTICS—BRAND NEW

\$36*

6x50 Achromatic Field Glasses \$16*

*20% Federal Tax

Send for Free Catalog of Binoculars, Telescopes & Microscopes
BROWNSCOPE CO.
Dept. 2P, 24 W. 45th St., New York 19, N. Y.

7x50 \$36 Illustrated

**FINE TOOLS
NEED
FINE OIL!**



• Lubricates

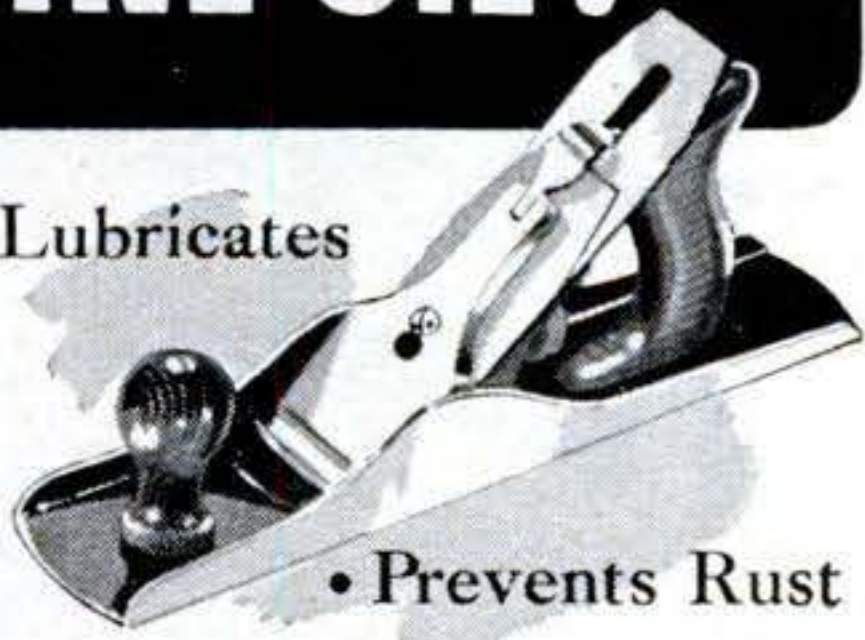

• Prevents Rust

• Cleans • Polishes

SOLD EVERYWHERE

3-IN-ONE Oil

**Convert HAND MOWERS TO
POWER MOWERS**

Takes less than 3 hours
The Handy-Dandy Lawn Mower Kit fits any hand mower from the 16 to the 20 inch size. Complete with all necessary parts. Kits can be purchased separately, complete with engines or complete with Pennsylvania mower.

Also manufacturers of a complete power mower and garden cultivator attachments.



DEALERS
WANTED

LE CLAIRE MFG. CO.
LE CLAIRE 3, IOWA

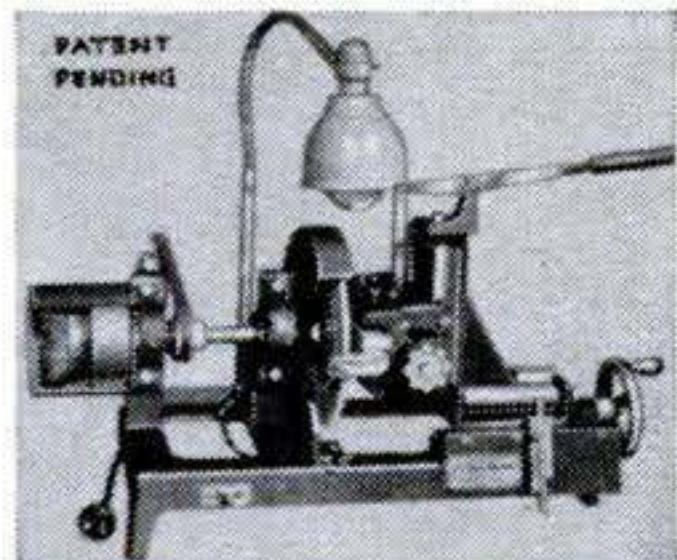

Start a NEW BUSINESS!

or Add to your present
Repair Business

SHARPEN DULL PIPE WRENCHES

PIPE TAPS & DIES
"GUM" CIRCULAR SAWS

Write for Information

J. C. MOORE INDUSTRIES

BOX S 276, Fredonia, Pa.

DELTA MILWAUKEE HOMECRAFT®



Model
No. 37-510
\$8920

motor and
switch rod
extra
Price subject
to change
without notice

**Low down
payment
delivers!**

*Saves space!
Saves money!*

**Delta® Homecraft
Saw-Jointer Combination**

Two precision-built tools on a single stand, using one motor. Takes floor space of only 25 1/4" x 28 1/4". Husky 8" tilting-table saw cuts stock up to 2 1/4" thick. Rip to center of 15" panel, cross-cut, angle-saw, bevel-saw, dado and make mouldings. Jointer planes up to 4" wide, rabbets 1/4" deep. Fence tilts 45° to right or left. See your Delta Homecraft dealer today!

POWER TOOL DIVISION



Rockwell

Manufacturing Company

682B East Vienna Avenue
MILWAUKEE 1, WISCONSIN



Free Book!

"How to Start Your Home Workshop." Write for your copy today.

GOVT. COST
~~\$51.25~~



NOW
\$19.75

CHRONOMETRIC TACHOMETER

U. S. NAVY SURPLUS—ACCURACY—PRECISION—GUARANTEED

For PRECISION timing of all rotating mechanisms. Incomparable GUARANTEED ACCURACY of 1/10 of 1%. An RPM counter and surface speed indicator combined with chronometric operation which AUTOMATICALLY computes period of test in EXACTLY 6 SECONDS. No stop watch or personal equation necessary. UNSURPASSED for cameras, projectors, gen-

erators, motors, sanders, turbines, saws, shafts, looms, fans, lathes, etc. Packed in plush-lined, simulated leather case. UNCONDITIONALLY GUARANTEED subject to your inspection and approval. Manufactured by JAEGER and TOTCO, leaders in field of exacting measuring devices. Only \$19.75 Shipped postpaid in U.S.A. on cash orders.



\$7.95

SOUND POWERED PHONES

No batteries needed. Your voice generates current. O.K. for 25 miles. Perfect intercom for shop, office, farm, darkroom. WAR SURPLUS. Orig. Govt. Cost \$58.00 ea.

**MONEY-BACK
GUARANTEE.**

Order these surplus bargains today. We pay postage on cash orders. Add postage to other items. 20% dep. on C.O.D.'s



WESTON VOLTMETER

Model 433. 0 to 150 volts. Laboratory type precision built. Hair line pointer on mirror scale. 25 to 2400 cycles. Size: 3 1/2" x 5" x 6". Govt. cost \$65. **\$14.95**
Our price

Semlers' ASSOCIATED SURPLUS CO.

5720 WILSHIRE BLVD., LOS ANGELES 36, CALIF.

START A BUSINESS this quick way

with

FOLEY LAWN MOWER SHARPENER

"I have taken in 100 mowers in 5 weeks since I got my Foley,—with no advertising," says George C. Wise. "In two months I have sharpened 155 hand mowers, 6 power mowers and 1 trimmer. My machine has paid for itself and everything I take in now is all profit"—from Otis Zacharia.

Here's a business you can start in spare time, and begin to make a CASH PROFIT right away. The Foley handles up to 3 or 4 mowers per hour, and prices run \$1.50 to \$3.00 for hand mowers, \$5.00 to \$8.00 for power mowers.

FREE BOOK— "HOW TO SHARPEN POWER MOWERS" shows just how to sharpen any make of power lawn mower with the Foley. Low prices, only \$98.50 to \$139.50—easy payments. Mail coupon today—we'll also send FREE PLAN telling how to start your own business without previous experience. No salesman will call.



FOLEY MFG. CO.,
208-O Foley Bldg., Minneapolis 18, Minn.
Send FREE BOOK "How to Sharpen Power Mowers," and FREE PLAN on lawn mower business.

NAME.....
ADDRESS.....

BURR HAND SAW FILER

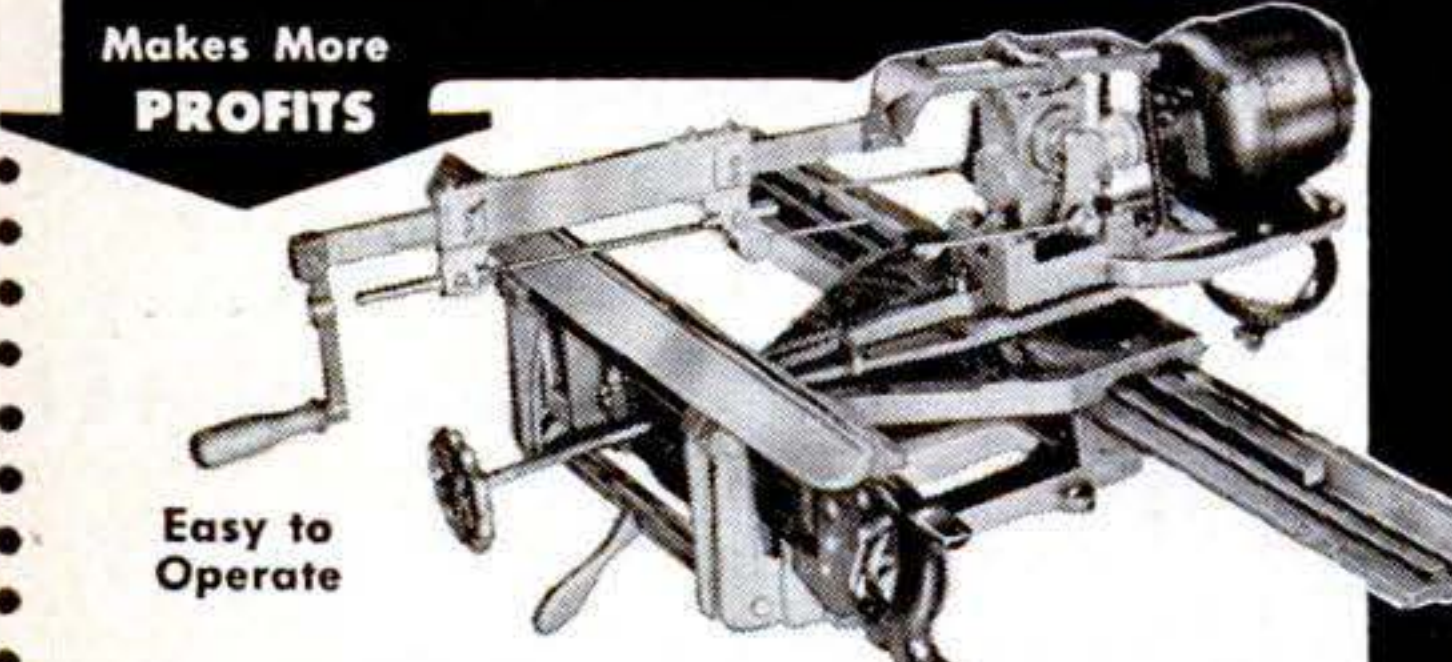

Fast, accurate, will file from both sides. Operator controls file arm. No saw carrier or adjusting screws to fuss with. A money-maker in any shop.

BURR MFG. CO.
8943 Venice Blvd.
Los Angeles 34, Calif. **WRITE TODAY!**



COMPLETE LOCKSMITH SHOP \$99.00

NEW POPULAR STANDARD EQUIPMENT
START YOUR SHOP NOW! At Home, Garage, Basement, or rent a small store, or add a key department to your present business.

- | | | |
|--|--------------------------------------|---|
| 1 Precision key machine complete with three cutters. | 1000 Popular key blanks and cut keys | 1 Assortment of pins and springs |
| 1 Heavy plywood key display board with 100 hooks | 3 Locksmith Instruction books | 1 Assortment of disc tumblers and springs |
| | 1 Automotive lock manual | 1 Misc. set of locksmith tools |

ALL FOR ONLY \$99.00—EASILY WORTH \$130.00!
Slightly higher out of U.S.A. 25% deposit on C.O.D. orders.
Start making money at once! Order your outfit today! Complete satisfaction guaranteed. Write for FREE Catalog today!

REPAIR SHOP SERVICE ● Box 264-B ● Skokie, Illinois

WAR SURPLUS BARGAINS

\$500,000.00 INVENTORY for QUICK LIQUIDATION

Surplus items—hundreds of them for home, shop, factory, farm and outdoor use. New items, used items, reconditioned items—all at tremendous savings—all priced for quick sale.

PAGE AFTER PAGE OF VALUES
This big catalog shows page after page of amazing money saving values. Write for your copy today. Send 10c to cover postage, mailing, etc. Write today!

SEND TODAY FOR YOUR COPY

STARK'S

509 So. State St.
Dept. PS-2
CHICAGO 5, ILL.

10c

OTTAWA Buzz Master

7 MODELS—\$99.00 up
Greatest offer ever made by oldest and largest firm in the business. Made by men with the know-how. A model to fit your needs and your pocketbook. Endorsed by Conservation experts. Send for FREE details. Now in our 46th year.

OTTAWA MFG. CO., 1-001 Brush Ave., Ottawa, Kan.



Look—a 10½x4, 6-ply Tire. Tube, Machined Wheel and Bearing at a "give away" price. Supplied in two types:—

1. With Highspeed TIMKEN BEARING (with Grease Retainer) \$8.95
 2. With Slowspeed NEEDLE BEARING (with Grease Retainer) \$5.95
- Freight Collect (8½ lb.)



Ideal for Handcarts, Bogies, Trailers, Soapbox Racers, etc. A bargain from the world's largest stock of all types of Airplane Tires. Send your check or money order to:

Airplane Tire Co., 99 Hiway, Tulare S., California

NEW! MINIATURE DUST MASK

Wear when sanding, grinding, paint spraying, sweeping, dusting, furnace cleaning, etc. Handy as a pair of glasses. Just keep mouth closed and breathe through nose is all you do to operate. Protects against dusts, lint, coal, cement, grain dust. Has 9 sq. in. filter.

Order today.



JERRY BRYANT, Dept. PS, 919 N. Michigan Ave., Chicago 11, Ill

CRAFTSMEN! MAKE YOUR OWN POWER TOOLS STEEL HOUSING (Not Die-Cast) BALL BEARING ROTATING QUILLS

- NEW DEPARTURE SELF-LUBRICATING BEARINGS!**
- | | |
|--|------------|
| A-51—Plain Spindle..... | \$3.75 pp. |
| A-52—5/8x4 1/2 spindle..... | \$5.25 pp. |
| A-61—1/2x12 1/2 spindle, housing 2x8 | \$7.75 pp. |
| A-62—5/8x12 1/2 spindle, housing 2x8 | \$8.25 pp. |
| A-63—3/4x12 1/2 spindle, housing 2 1/4 x 8 | \$9.00 pp. |
| A-71—1x17 1/2 spindle, hsg., 2 5/8 x 11 | \$16.75 |
- 10,000 r.p.m. 1" BETWEEN WASHER & COLLAR
Enclose check or m.o., Satisfaction Guaranteed!
- ASPEGREN PRODUCTS, 1612 (P-2) Webster Ave., New York 57, N. Y.**
Creators: ASPEN DRIVE-ALL Portable Power Unit (Illus. Circ. on request)

SURPLUS SPECIALS — BRAND NEW — SATISFACTION GUARANTEED

**ONLY \$3.95
BRAND NEW ARMY AIR FORCE
ASTROGRAPHS with case**

New B-29 navigation instrument which can easily be used to make a good contact printer, strip map holder, etc. The plywood case 14½" x 11" x 10" high is perfect as tool kit, camera projector case or for building a portable phonograph, picnic kit, makeup case, etc. Has leather handle, reinforced cover, eight covered compartments in bottom. Cost Gov't \$125.00. Add postage for 20 lbs.



EXTENSION LIGHT

Use on car, boat, dark rooms, workshop, airplanes, etc. Turn of knob gives clear, white, or red light, also pulls out 6 ft. on spring wound internal reel. Quick snap automatically rewinds wire. Fluorescent tipped on-off switch. Takes standard automobile bulb — mounts anywhere. 3" x 3¼" x 4¼". \$12.50 value only FOB B. H.



LIGHT PLANTS

110 volts — 250 watts — Complete Compact Gasoline Self-Contained Generating Set, perfect for camping, trailers, hunting, emergency home power, etc. self-governing output — two outlets for plugging in lights — Brand New — in factory sealed waterproof crates — single cylinder gas engine directly coupled to air cooled generator — rubber shock mounted, complete with spares, tool kit, and carrying case — weight 72 lbs. Measures 22" high x 16" wide x 20" long. FOB B. H.



REMOTE CONTROL THERMOMETER

For milk coolers, brooders, orchard use, refrigerators, automobiles, homes, workshops, etc. Temperature bulb at end of either 5 or 15 ft. flexible tube (state length desired). Dial Thermometer glows in dark — non-electric — very sensitive. Aircraft quality. FOB B. H. — worth many times



Perfect for car, boat, den, or workshop. Fine present for sportsman. Horizontally mounted, large 6½" dial — marked in single degrees. Fluorescent Dial glows in dark — dial rotates for positioning — compensated aperiodic and vibration resistant, \$65.00 value. FOB B. H.



COMPRESSED AIR TANKS

500 cu. in. capacity Steel Tank, can be used for compressed air, oil, gasoline, buoys, emergency air for tires, etc. 5½" x 23", up to 450 lb. pressure — non-shatterable — ¼" pipe fitting on each end. FOB B. H.



HYDRAULIC CYLINDERS — AIR OR OIL

These "Brand New" Double Action, Precision Hydraulic Cylinders have 1000's of applications for use on lifts, presses, actuators, positioners, etc. Use with either air or oil. All use standard pipe fittings.

- Item A — 1" Bore, 1½" Stroke — will lift 770 lbs. using 1,000 lb. pressure. A \$18.65 value — Postpaid **\$4.50**
- Item B — 1½" Bore, 9" Stroke — will lift 1,770 lbs. using 1,000 lb. pressure. A \$45.00 value — Postpaid **\$9.95**
- Item C — 1¾" Bore, 8½" Stroke — will lift 2,400 lbs. at 1,000 lb. pressure. A \$55.00 value — Postpaid **\$12.50**
- Item D — 3" Bore, 8½" Stroke — will lift 7,000 lbs. at 1,000 lb. pressure. A \$78.00 value — Postpaid **\$17.50**
- Item E — 3" Bore, 10" Stroke — will lift 7,000 lbs. at 1,000 lb. pressure. An \$85.00 value — Postpaid **\$20.00**

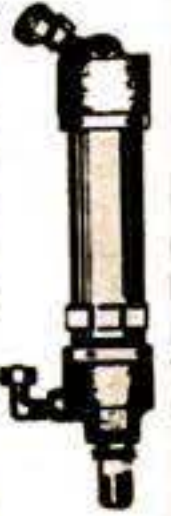

ALTIMETER

Modernize your car. Fine for desk ornament. Shows height above sea level up to 20,000 feet while driving your car, same instrument as used in airplanes. Front adjustment knob sets instrument for your location. Fluorescent Dial glows at night — easily installed — no connections — self-contained — Measures 3¼" x 3¾" x 3". Certified calibration chart included — suitable as a laboratory standard instrument. Cost Gov't many times this price. FOB B.H.



Enclose sufficient postage — Excess will be refunded — No COD's

AIRCRAFT COMPONENTS, Inc. 800 Woodland Avenue Benton Harbor, Michigan

**5 BIG POWER TOOLS
in ONE**

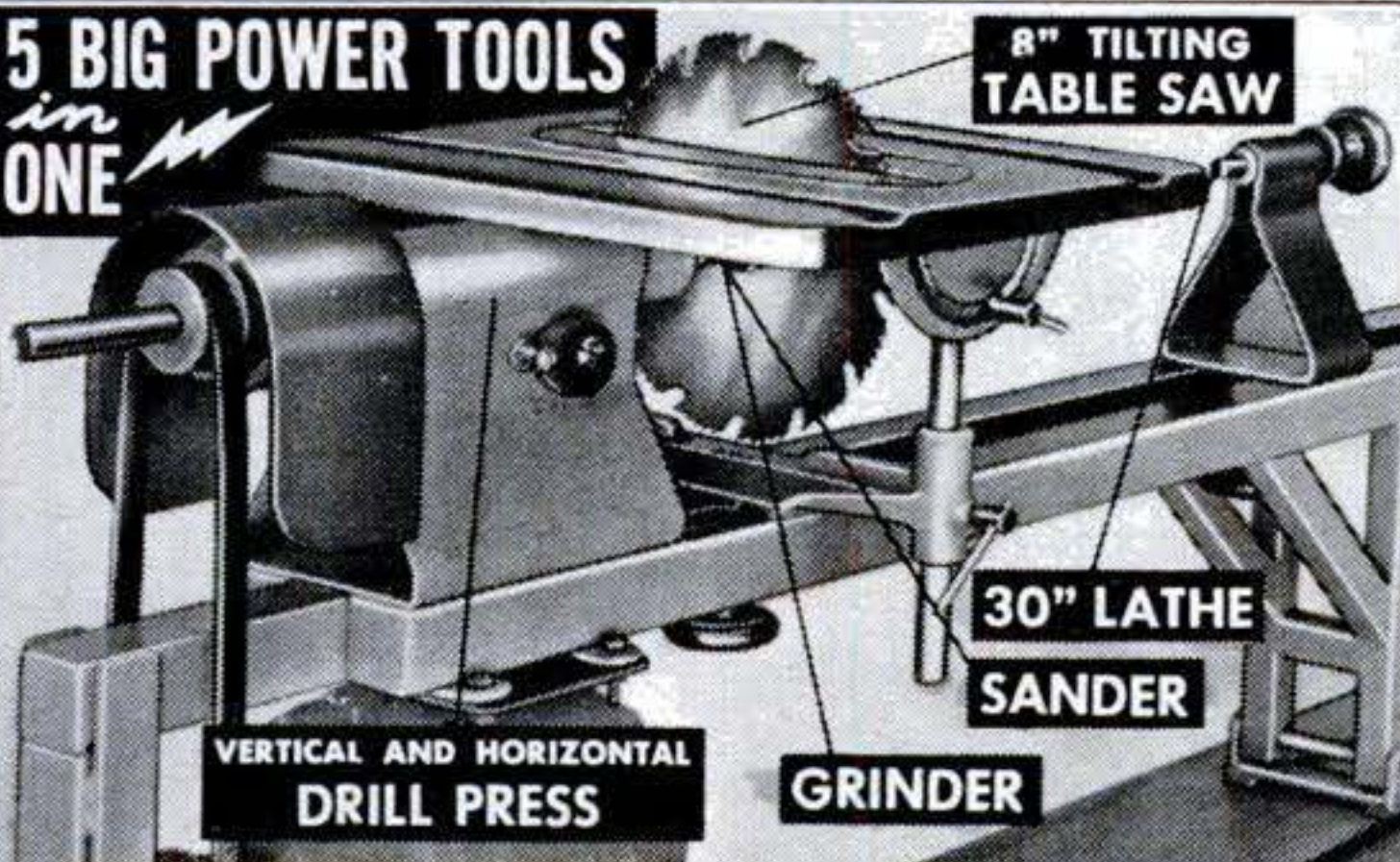

RETAIL PRICE \$125.00
FACTORY TO YOU \$59.95

SUPERSHOP the PRECISION BUILT WORKSHOP. Lifetime lubricated BALL BEARINGS. All running parts precision GROUND. Compare finest production tools. BIG capacity. Amazing VALUE. Write for FREE catalog, full details, trial plan.

POWER TOOLS, INC. 208 Yates Avenue Beloit, Wisconsin



**SURPRISE VALUE
100 Pieces \$1.00**

FOR ELECTRIC GRINDERS
Grinding Wheels, Cut-off Wheels, Sanding Discs, Mounted Stones, Sharpening and Honing Stones, Rotary Cutting Burs, Abrasive Cartridges, and many other items, Rush check or Money Order.



**2 CIRCULAR SAWS
ON 2 MANDRELS — ALL AT ONE LOW PRICE \$1.50**

1" diameter saws on ½" Mandrels. For cutting wood, plastic, or soft metals. Order at once! Send Check or Money Order for this big bargain. U.S.A.



18 ROTARY CUTTERS

\$13.50 Value **\$5.85** Post Paid in U.S.A.

Assorted sizes cutter on ½" or 3/32" shank. Will fit all hand grinders. Ideal for cutting wood, metal, or plastic. Brand new. Send Check or Money Order. ILLUSTRATED BARGAIN CATALOG 10c SCHUPACK SUPPLY CO., 7331 Cottage Grove, Dept. S-2, Chicago 19, Ill.

NEW BOOKLET TELLS HOW GRAVELY POWER EQUIPMENT Solves Upkeep & Gardening Problems

FREE!



Give yourself the leisure to really enjoy country living! This big Free Booklet is chock full of labor-saving ideas—shows how to give your home a lovely setting without long hours, hard work!

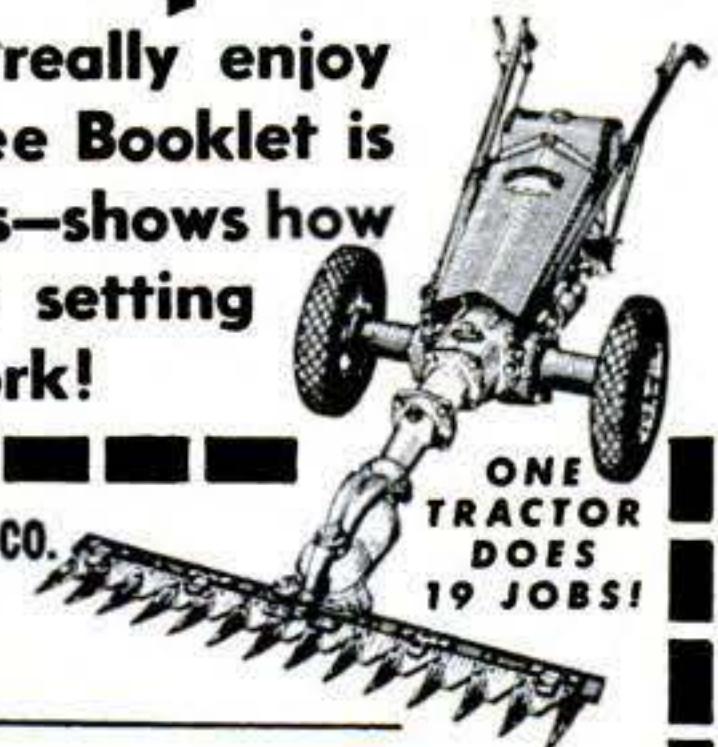

MAIL TODAY!
GRAVELLY MOTOR PLOW & CULTIVATOR CO.

BOX 284, DUNBAR, WEST VA.

NAME _____
ADDRESS _____
CITY _____ STATE _____

ONE TRACTOR DOES 19 JOBS!

GOOD WEAR FOR WORK GOOD LOOKS FOR PLAY



Reeves
ARMY TWILL
MADE TO GOVERNMENT
SPECIFICATIONS
SANFORIZED

REEVES Army Twill is a double duty fabric that's right for work and play. It's highly resistant to wear and tear, and its wide variety of vat dyed colors are fast to sun, water and perspiration. Being Sanforized*, it can take repeated washings and still come up fresh and new. For better looks and longer wear—demand Reeves Army Twill.

*Residual shrinkage less than 1%

REEVES BROTHERS, INC.
54 Worth Street, New York 13, N. Y.



EXPORT PAYS BIG

World Trade firm offers men and women plan for big pay positions or unlimited-profit businesses of their own in Export-Import Mail order World-wide without capital, from home; or travel abroad. Write today for Free Book. State if veteran. Airmail reaches us over night. The Mellinger Co., 1418-AX Westwood, Los Angeles 24, Calif.

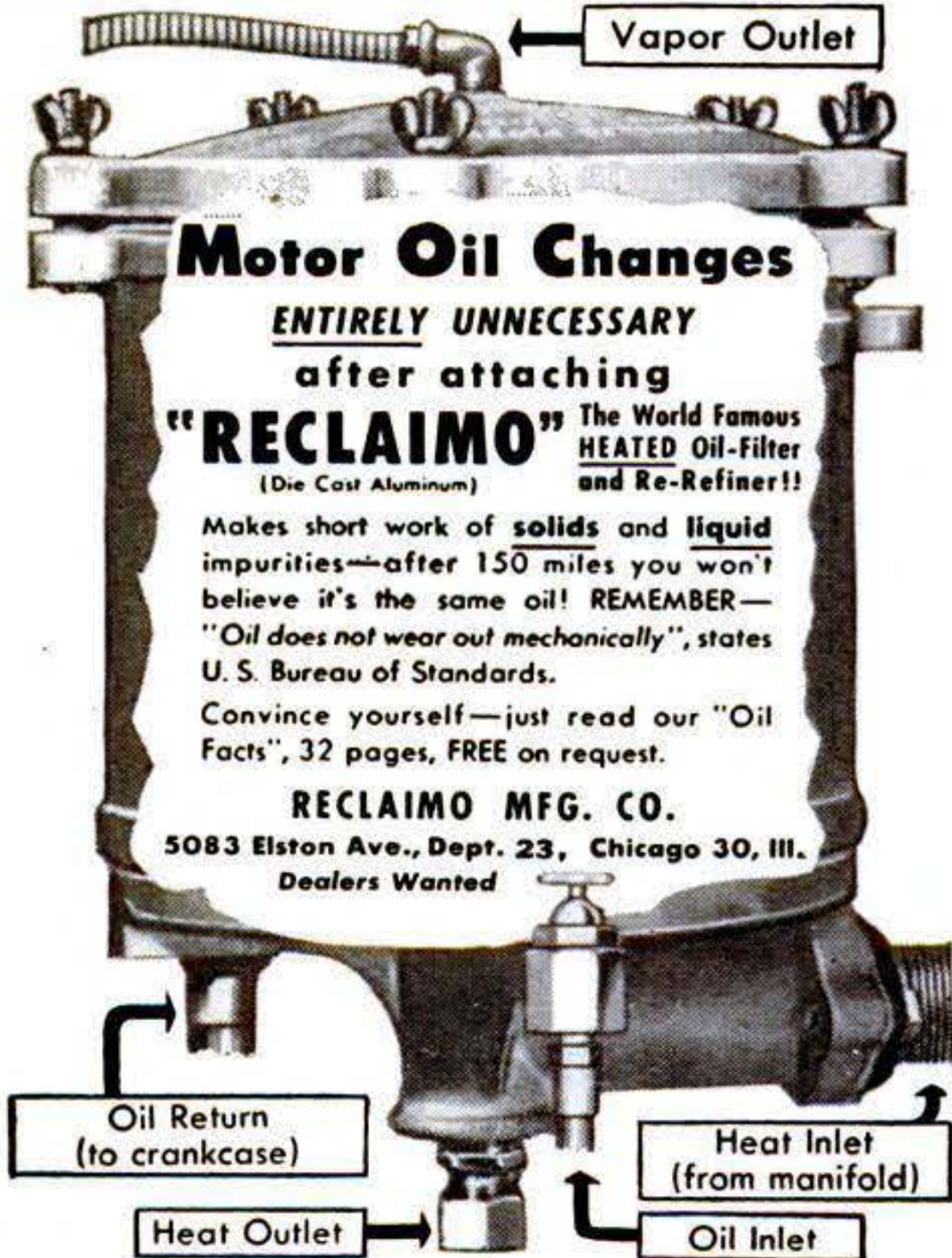

Make Your Electric Drill A CIRCULAR SAW!



Save time...
Save work...
Save money

• Right-angle drive with oversize guards is super-safe, perfectly balanced for one-hand use. Attach it to any drill 1/4" and up, in seconds. Full 1 1/8" cut, handles 2" stock by turning over. Machined cutting guide for extra accuracy.

Oilite bearings, sealed gears for long life. Complete with 4" high speed steel saw blade. Money-back guarantee.....only **\$7.95**

Postpaid—send check or M.O. C.O.D.'s accepted—postage extra.
GLEAM PRODUCTS (Dept. X-2) Whitestone, L. I., N. Y.

War Surplus

BARGAINS

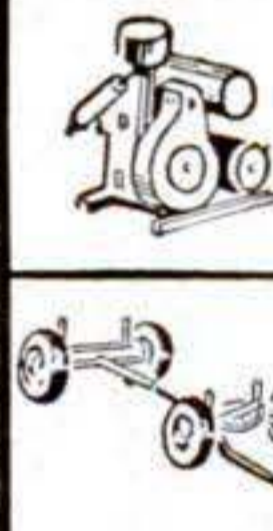

THOUSANDS OF ITEMS IN STOCK

THERE ARE BARGAINS GALORE AT C. & H. Motors, light plants, generators, trailers, home tools, gas engines all at reduced prices. DON'T fail to write for our BIG, NEW FREE catalog. Pictures and full descriptions of most of our items. WRITE TODAY. Don't fail to write today. Many items at lowest prices are moving fast.



C. & H. ELECTRIC COMPANY

436 W. Juneau St.

Milwaukee 3, Wisc.

AIR TANK and ACCESSORIES

Air receiver, stainless steel, 12 1/2"x24". 400 lb. test. Ideal for carrying on trucks, autos and wherever compressed air is needed. Equipped with 500 lb. air gauge, tire chuck, 3 ft. high-test air hose, air inflation valve with core for retaining pressure in tank, and fittings.

Complete outfit **\$6.95**

Shipping wt. 20 lbs.

Same unit but with 6"x24" tank... **\$5.95**

Prices F.O.B. Chicago. Sold on money back guarantee. Send check or money order today. CATALOG FREE.

WELLWORTH TRADING CO.
1831 S. STATE STREET, DEPT. B-2 CHICAGO 16, ILL.

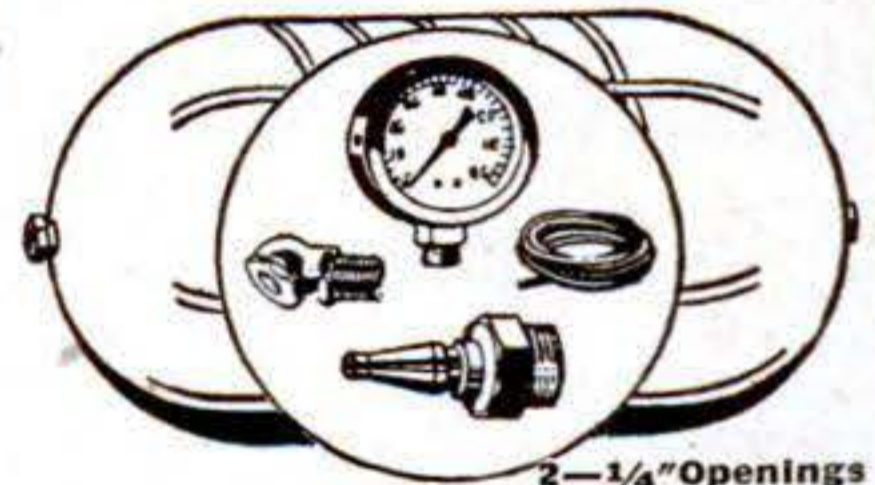

2-1/4" Openings

Sprunger precision built

POWER TOOLS

pay for themselves on just a few jobs. Make your own furniture, home repairs, etc. with these rugged, precision tools.

See them at your dealers.



14" Band Saw \$84.95



6" Jointer-Planer \$79.95



8" Tilt Arbor Saws BL\$74.95; "C"\$49.95



18" Jig Saw \$34.95



10" Gap-Bed Lathe \$49.95

WRITE Dept. PS-25 for latest literature. (Prices subject to change without notice.)

SPRUNGER BROS. INC. TOPEKA, IND.

WAR SURPLUS AND OTHER BARGAINS



PNEUMATIC RIVETER & CHIPPING HAMMER

Mfd by Ingersoll-Rand, Chicago Pneumatic and Thor
Pistol grip. Ideal for fender, brake lining, concrete breaking work. Like new. Six rivet sets and bucking bar included, making a complete combination. Weight 9 lbs. Each **\$6.95**

MICROMETERS



Chrome plated, precision engineered and carefully tool to give long life. All new.
0-1" capacity . . . each **\$2.25**
1-2" capacity . . . each **3.50**
2-3" capacity . . . each **5.50**
3-4" capacity . . . each **6.50**

HIGH SPEED DRILLS



All New. Fractional & numbered. Orig. Vol. \$15. Nationally known brand. Asstd. sizes. Set 30, **\$3.50**



ELECTRIC BELLS—Vibrating type, high pitch. 115 V., 60 Cycle. Ideal for use indoors or outdoors—on ranches, for schools, plant installations, as signal systems, burglar alarm systems, etc. Nationally known Mfr. ALL NEW in original Pkgs. Solid brass clapper and 8 1/2" gong. Weight 8 lbs. Govt. cost about \$67.50. Close out at **\$7.95.**

Send check, money order or cash. 25% deposit required on C.O.D. orders. All prices F.O.B. Culver City, Calif. Send 25c for Illustrated Catalog.

AIRBORNE SALES CO., INC. DEPT. PSM 2-O
CULVER CITY, CALIF.



For Loose Caster Guides

Remove the guide, fill the hole with a putty-like mixture of Smooth-On No. 1 Iron Cement and drive the guide back in. It will stay in place, because Smooth-On, in hardening, expands slightly and takes hold tight. Use Smooth-On for tightening other loose parts and also for stopping leaks in boilers, furnaces, piping, radiators, etc. Buy Smooth-On No. 1 in 1 3/4-oz., 7 oz., 1 lb. or larger sizes at your hardware store. If they haven't it, write us.

FREE Repair Handbook

Shows how to save time and money, making many household repairs. 40 pages. 170 pictures. Clear directions. Send today.

SO-313

SMOOTH-ON MFG. CO., Dept. 58B
570 Communipaw Ave., Jersey City 4, N. J.

Do it with
SMOOTH-ON
THE IRON CEMENT OF 1000 USES



ALL-PURPOSE SMALL MOTORS



D-2 Converts to 110 V AC in ten minutes, diagram included, contains integral gear box having four 1/4" drive shafts turning simultaneously at the following speeds:
4000 RPM—Grinders, buffers, flexible shaft tools, etc. **150 RPM**—Wrapping fishing rods, slow speed tools.
25 RPM—Dev. tray rocker for photo darkroom.
5 RPM—Turning barbecue spits.

Adv. Disp. Beams. A Thousand Other Uses Around the Work Shop. ONLY **\$5.95**
Converted to 110 volts AC **\$7.95**

D-1 Converts to 110 V AC in ten minutes, diagram included, has shaft with squirrel cage blower, also gear reducer with 2 shafts and pulleys at the other end. 1001 uses. Only **\$4.95**

6 V MOTOR A real beauty, removed from aircraft. Type used for auto fan. Many uses. Ea. **\$1.50**

All prices F.O.B. Chicago. 20% deposit required on all C.O.D. Orders. Write for free catalog.

NESCORP ELECTRONICS Dept. PS-2, 2635 W. Grand Ave. Chicago 12, Illinois

A MAN'S BEST FRIEND IS HIS POCKET KNIFE

All CAMILLUS knives have hand honed blades. Many styles at your dealer's.

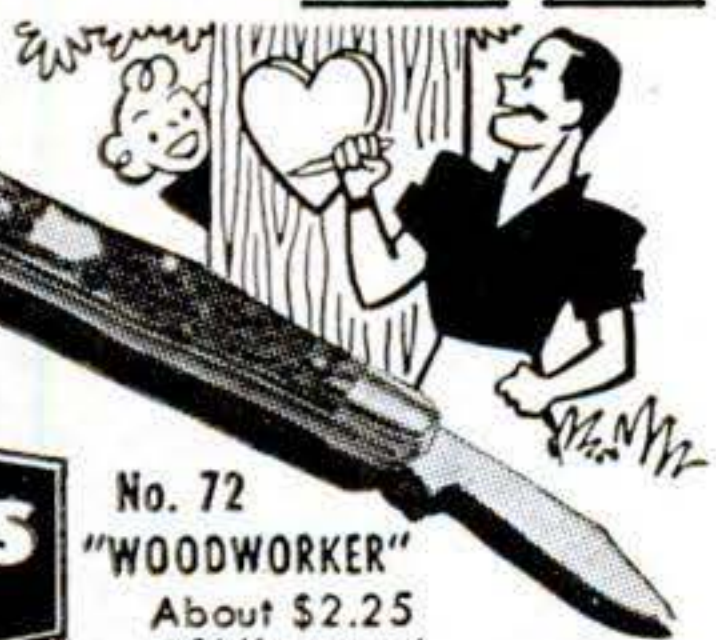

CAMILLUS
has the edge!

No. 72
"WOODWORKER"
About \$2.25
3 3/8" closed

CAMILLUS CUTLERY COMPANY, CAMILLUS, N. Y.

BE A HIGH-PAID MAN IN YOUR COMMUNITY WITH THIS LONG NEEDED INVENTION

Earn up to \$10,000 or more per year! U.S. Pat. D 153853
Nothing to invest! Be your own boss! D 153854

A worldwide product needed by every home, business and farm...priced to sell quickly! Automatic Red Comet goes into action as soon as fire starts... smothers fire without human aid. It's a sales 'natural'!

FREE SALES KIT

Demonstrator units, sales literature, etc., furnished you FREE. Handsome leather-type kit. Tried and proved, it will make you an independent businessman. ACT NOW! Someone in your community will be appointed soon. Write for details, today!

RED COMET, INC.
525 R. C. Bldg., Littleton, Colo.



SOLDER WITH A MATCH

LARGE TUBE

\$1

Postpaid Anywhere in U. S.

Wonderful new All Purpose Solder Paste as described in December '49 Popular Science. Does complete job in one operation. No cleaning, no tinning, no flux. NOT A CEMENT. Simple, just apply paste and heat—any heat will do, even a match for small jobs. Requires no skill to obtain a strong, permanent bond. One paste solders anything but aluminum. Large tube only \$1. Sent anywhere. Full Money Back Guarantee. Send cash, check or money order today.

HOWARD PRODUCTS, Chardon, Ohio

BE YOUR OWN BOSS! Make UP TO **\$50.00** PER WEEK IN YOUR SPARE TIME

Mr. B. of California writes "The lawn mower grinding business, with my Universal Grinder, has been a gold mine these last two years." Mr. J. L. P. of Pennsylvania says "Thank you for getting me started in this wonderful business . . . I averaged \$100.00 per week for the month of May."

ONLY ON THE UNIVERSAL LAWN MOWER GRINDER

. . . can the inside face and edge of the stationary blade, as well as the reel blades, be ground to proper clearance

ALL IN ONE SET-UP

WITHOUT REMOVING ANY BLADE FROM THE MOWER

Users who have tried them all acclaim the UNIVERSAL far above any grinder on the market. Write today for full details of our Proved Success Plan. It's Free.

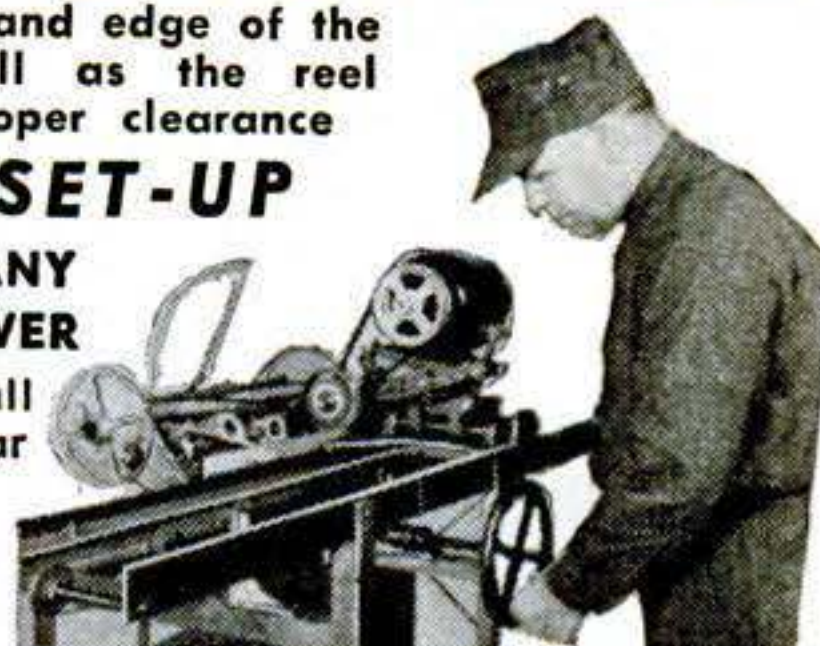

ROGERS MFG. CO., DEPT. P-20, LINDSEY, OHIO

WELD
BRAZE, SOLDER, CUT
quickly...easily

The FOUR-WAY PORTABLE ARC-WELDER

COMPLETE ONLY \$9.95
10 DAY TRIAL

FOB

YOU'LL BE AMAZED by the work you can do on your first job! Plugs into any convenient properly wired 110 volt A.C. or D.C. line. Follow simple directions and work on iron, steel, bronze, brass, aluminum and other metals. Save money doing own repairs. Make money repairing for others. Thousands of enthusiastic users among maintenance and repair men, farmers, tin-smiths, engineers, home and auto owners, etc. Pays for itself over and over. Order now on ten-day trial or send for details.

MAKE OR REPAIR HOME & FARM APPLIANCES FENDERS BICYCLES METAL FURNITURE & 1001 ITEMS

FREE Full Details SEND TODAY

FOUR-WAY WELDER CO., Dept. PS-25/ 2326 So. Michigan Avenue • Chicago 16, Illinois

FOUR-WAY WELDER CO., 2326 So. Michigan Ave., Chicago 16, Dept. PS-25. Please send as checked below.

Four-Way Welder on 10-day trial. I enclose \$9.95, or I enclose \$_____ as a deposit. Ship C.O.D. for balance.

Illustrated and described details on Four-Way Welder.

NAME _____

ADDRESS _____

CITY _____ STATE _____

THE New VISE-GRIP WRENCH

Does jobs no other tool can do. Double-lever action LOCKS jaws with tremendous grip—quickly adjusts to non-locking action. New Involute Jaw Curve holds all shapes—nuts, rounds, irregular shapes, with unbelievable ease. Has Knurled Jaw Tips, Thin Nose and Super Wire Cutter. With cutter—No. 7W, 7-in., \$2.25; No. 10W, 10-in., \$2.50. Without cutter—No. 7C, 7-in., \$1.85; No. 10C, 10-in., \$2.25. If not at your dealers, order direct.

PETERSEN MFG. CO. Dept. M-2 DeWitt, Nebr.

DUST-O-VAC FOR ALL MACHINES

For Home Workshops & Industry. DUST-O-VAC collects & bags wood & plastic chips, wood & metal dust, wood shavings. Free Bag. Attaches to circular saw, planer, band saw, grinder, belt or disc sander, sander, drill press with shaper or sander attachment, spindle shaper, wood lathe, jig-saw, 110 A.C., D.C. Send for mounting instr. for all machines.

\$19.95

Free Ship. east of Miss. West of Miss., add \$1. Check. M.O.

HEAVY CAST ALUMINUM BLOWER—ONLY \$9.75
110V. AC 50-60 cycles, cont. duty motor, deliver app. 100 C.F.M. For workshop, lab. kitchen, cellar, etc. Install yourself. Send for circular.

UNIVERSAL YONKERS CORP., 137 Alexander St., P-2, Yonkers 2, N. Y.

AMAZING NEW PASTE-TYPE SOLDERS

As Reported in Popular Science—December 1949

QUICK • SIMPLE • EASY

No Cleaning—No Flux—No Tinning

FUSION 4 in 1 Alloys make soldering simple as A B C. It's all in the paste. One operation completes the job. Insures a solid, permanent bond. A special alloy for every tough job—Aluminum, stainless steel, pewter, copper, brass, etc. No special skill required. Used in industry for over 10 years. Now available in handy kit form. Famous Super Jet Torch and dry fuel included in each kit. Order today. Full Money Back Guarantee.

ORDER THE KIT YOU NEED

K-7 Complete Craft Kit, 2 ozs. of alloys plus Handy Torch	\$7.25
E-300 Electric Lo Melt	T-500 Stainless Hi Power
G-300 Pewter Lo Melt	A-750 Aluminum Hi Power
D-400 Die Cast Lo Melt	S-4 1050 Silver Braze
G-450 Copper Fit Lo Melt	Super Jet Torch and Fuel
K-6 Same as above without Super Jet Torch & Fuel	\$6.00
K-5 Craftsmans Special Kits, 2 ozs. of alloys plus handy torch	\$5.50
E-300 Electric Lo Melt	A-750 Aluminum Hi Power
G-450 Copper Fit Lo Melt	S-4 1050 Silver Braze
T-500 Stainless Hi Power	Super Jet Torch and Fuel
K-4 Same as above without Super Jet Torch & Fuel	\$4.25
K-3 Craftsmans Junior Kit	\$3.25
E-300 Electric Lo Melt	T-500 Stainless Hi Power
G-450 Copper Fit Lo Melt	Super Jet Torch and Fuel
K-2 Same as above without Super Jet Torch & Fuel	\$2.00

All Kits Postpaid in U.S.
Send Cash—Money Order or Check
Dealers: Send for information and discounts

FUSION ENGINEERING • Dept. M • 4504 Superior Ave. • Cleveland, Ohio

SYNCRON

The Electrified HONE that M-O-V-E-S!

SYNCRON hones sharp hundreds of articles in homes, shops, farms. 14,400 rapid, gentle honing strokes a minute! No belts, wheels, gears. 60 cycle. 110-120 volt AC. Both hands free to hold work. Easily adjustable stroke! Ideal birthday, personal gift. With 3 interchangeable Honing Stones, Cord, Plug, \$10.50 at DEALERS. If he hasn't, send \$10.50 direct to us, we'll ship Sharpener postpaid. Satisfaction Guaranteed. See other Syncro products, pages 262, 270, this issue! (DEALERS WRITE!)

SYNCRON CORPORATION
DEPT. HM-25, ROCHESTER, MICHIGAN, U.S.A.

Easy way to strip paint...

WONDER-PASTE, applied with a paint brush, softens up the toughest paint, varnish, enamel or shellac right down to the surface. Comes off clean at every stroke of your putty knife. Try it. At paint and hardware stores. . . Write for leaflet on Wonder-Paste and advice on your particular removing problem.

Wilson-Imperial Company, 121 Chestnut Street, Newark 5, N. J.

DECORATIVE METAL WORK

A new manual for the amateur. Tells in easy to understand language how to make useful metal articles in your home workshop. You'll be surprised how easy and interesting metal work really is. Fully illustrated with diagrams and step-by-step instructions. Sturdy cloth binding. 253 pages. Send only \$2.00 and your copy will be sent postpaid.

POPULAR SCIENCE MONTHLY—Dept. 250
353-4th Ave. New York 10, N. Y.

WAR EQUIPMENT MAIL SALE!

WE PAY ALL FREIGHT AND MAIL CHARGES

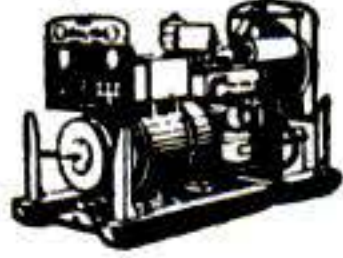

POWER PLANTS

110-V, 60-C, 3,000-W. Remote switch electric self starter. Easily made full automatic. Army's finest plants. Full instructions. Ideal for farmers, sportsmen, contractors. New condition. Fully guaranteed. Get catalog for details. Cost Gov't. \$756. Sale Price \$345

● **GUY CABLE AND TURNBUCKLE.** 12' flexible steel cable with 14" turnbuckle. 100s uses. Fix sagging buildings, guy television antennas. Gov't Cost \$1.10. Sale Price 15 for \$4.39

● **HYDRAULIC CYLINDERS.** 2 1/2" bore, 17" stroke. Excellent for loaders, graders, etc. Gov't. Cost, \$87.50. Sale Price \$11.60

● **WELDER.** 220-volt, 60-c, a-c. Genuine ALLMAND. 0 to 250 amp. Complete with cable, holder, mask, rods, etc. Sale Price \$149.50

● **CENTRIFUGAL PUMP.** Stainless steel shaft. 3/4" outlet. 1" inlet. Dozens of uses. Sale Price \$6.50

● **MALL ELECTRIC CHAIN SAW.** One-man saw zips through big timbers. Operates off home 115-v AC-DC current. Only \$95



INDUSTRIAL ENGINES

New 1-cyl., Briggs 3.5 heavy duty, air cooled. Excellent for boats, garden tractors, weed sprayers, elevators, pumps, scooters, saws, etc. Complete instructions. Cost Gov't. \$130 Sale Price \$75.50



WINCH 3000 Lb.

Low cost power for all kinds of hoisting, loading, etc. Used by leading truck lines for loading. Ideal also for farmers, merchants, factories. Wonderful for use on boats, boat docks, trucks, jeeps. Easily mounted. 12" x 14", 9" high. New finest steel and bronze gears, 80-to-1 power ratio. Drive with old car 6-v. Starting motor, power take-off, fan pulley, etc. Cost Gov't. \$95. Sale Price \$24.95

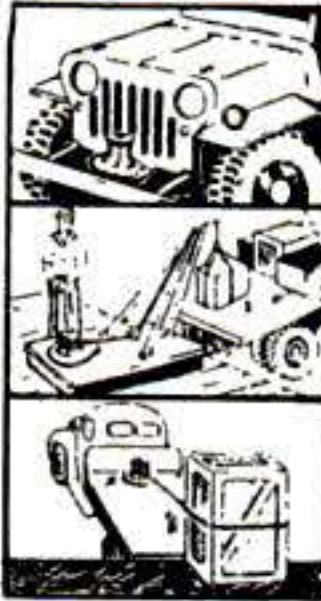

BUY DIRECT BY MAIL AND SAVE!

- A. Utility Clutch, up to 6.5 h.p. \$13.95
- B. Magneto Rural Telephones... 12.40
- C. Burglar Alarm System... 6.99
- D. Fire Alarm System... 9.90
- E. 2000-watt 110-volt Elements... .99
- F. City Wall or Desk Phones... 4.99
- G. Rotary Gear Pumps... 3.95
- H. Briggs 1.5 h.p. Engine... 49.50
- I. Multi-Speed 110-v. 60-c Motor 8.75

● Dozens of electronic, hydraulic, mechanical bargains. Electrical drills, saws, etc.
 ● Bargains in electrical appliances, motors, home workshop tools, etc.
 ● Inventory Closeout, finest electrical appliances—grills, toasters, waffle irons, coffee makers, stoves, irons, etc. Overnight shipment.
 Order direct from this ad. Satisfaction guaranteed. Or, rush card for free catalog today!

BURDEN SALES COMPANY
 824 "O" St. Lincoln, Nebr.



Save Fingers

with Industrial Finger Guards

Hundreds of factories save time and injuries and speed production by protecting workers with Industrial Finger Guards. Used for handling rough or sharp articles, for buffing, grinding, sanding, polishing, punch press work and hundreds of other jobs. Protect fingers or thumb, front or back, from cuts, abrasions or blisters. Made of durable leather with elastic web back for snug, cool, comfortable fit. Easy on and off. One size fits all, men or women. Send 10c each for samples or trial order box of 50 at \$4.50 less 10%.

Catalog of Industrial Safety Apparel free on request
INDUSTRIAL GLOVES CO.
 1427 Garfield, Danville, Illinois
 (In Canada: Safety Supply Co., Toronto)

Famous Industrial Safeguards Since 1910



Only \$498

OTTAWA Mule Team Tractor

Finest low-cost tractor. Costs too little to do without. Engines burn gasoline or kerosene. Starter and lights available. Other larger Models to choose from. Over 4,000 in world-wide use. Time-proved and tested. At low cost they easily mow, plow, disc, harrow, plant, cultivate, etc. Sold only direct to user. Write for FREE details.
OTTAWA MFG. CO., 2-001 Garden St., Ottawa, Kansas

LAWN MOWER SHARPENER

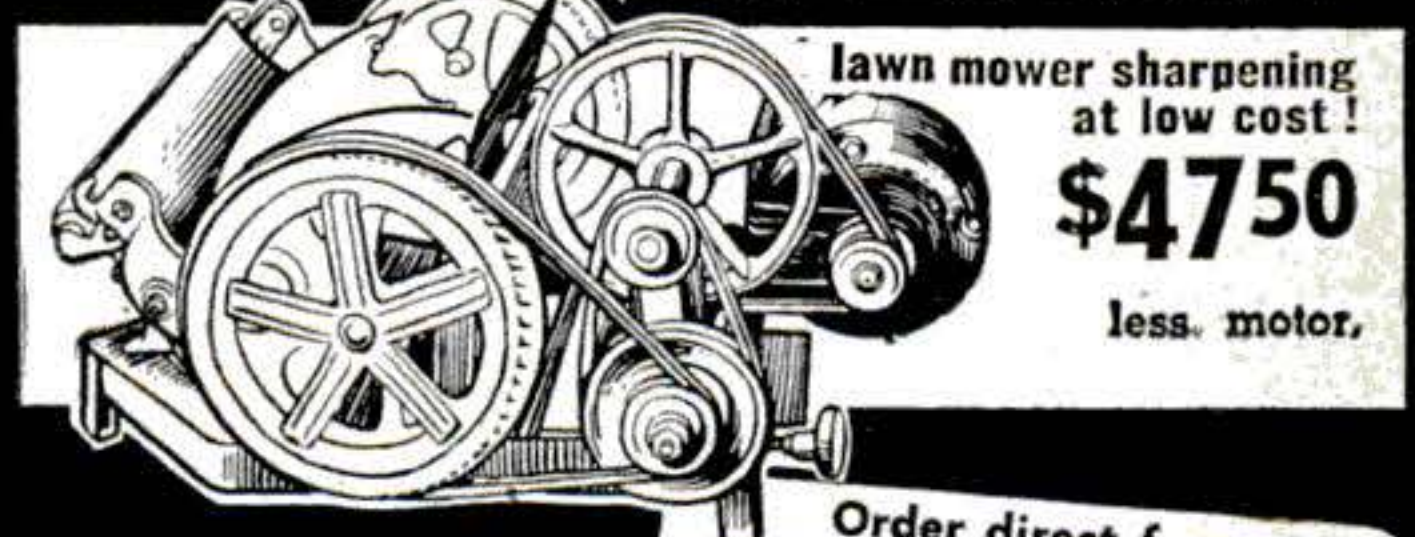

lawn mower sharpening at low cost!
\$4750
 less motor.
 Order direct from **QUAD CITY PRODUCTS Company, Inc.**
 Box 42, Rock Island, Ill.

NEW QUICK-CLAMP 30" BRAKE

Forms angles, flanges, seams. Bends 26 gage steel. Heavier copper and aluminum. Cam locking. Portable, can be clamped to edge of truck. All steel. Wt. 42 lbs. Express collect... \$24.50
 36" size... \$29.00
 12" BRAKE. Fits in vise to form difficult compound bends, up to 20 gage steel. \$12.50 PP.
 CUTTER. Cuts 18 gage steel any length and width. \$12.50 PP.
 SHEET METAL PLIERS. 2 1/4" wide. \$2.00; 5", \$3.00.
 IRON BENDER. Forms hooks, braces, eyelets. Bends 1/4 x 2. \$10.00.
 Immediate delivery. Order cash or C.O.D., or send for folder.
WISE BRAKE MFG. CO., 51116 So. 27th St., Omaha 5, Nebr.

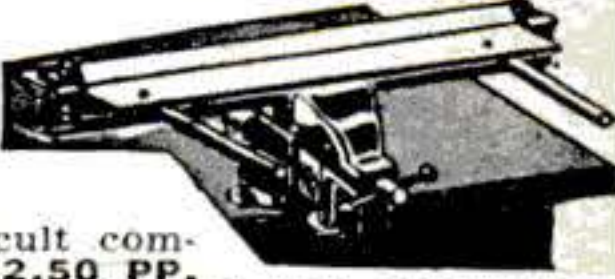

"Wellworth" Sensational Offer! Reg. \$60.50 WESTINGHOUSE AIR COMPRESSOR

Model T-1 Brand New—2 CYLINDER PISTON TYPE. Operates with 1/2 H. P. Motor or equivalent gas engine.

Compressor, pressure tank, air gauge, air chuck, 20-ft. hose, pop valve, copper tubing with 4 brass flared fittings for connecting compressor to tank, 4-way cross and 3 nipples. COMPLETE OUTFIT, wt. 52 lbs. **\$3250**

Equipment less Compressor, \$12.50—Compressor separately, \$21.50
 Compressor has 2" bore, 1 1/2" stroke, ball bearing, 3.27 CFM at 600 R.P.M. Capacity up to 6.54 CFM. Size 9" x 11 7/8" x 6 5/8". Wt. 26 lbs. Ideal for spraying paints, insecticides, etc. inflating tires, operating air tools, and other uses. All new equipment. U. S. government surplus. Replacement parts available. Amazing buy. Don't miss it.

Prices f.o.b. Chicago. Sold on money back guarantee. Send check or money order today. Prompt shipment.

WELLWORTH TRADING CO. 1831 S. STATE ST., Dept. B-2 CHICAGO 16, ILL.

Model T-1 Brand New!

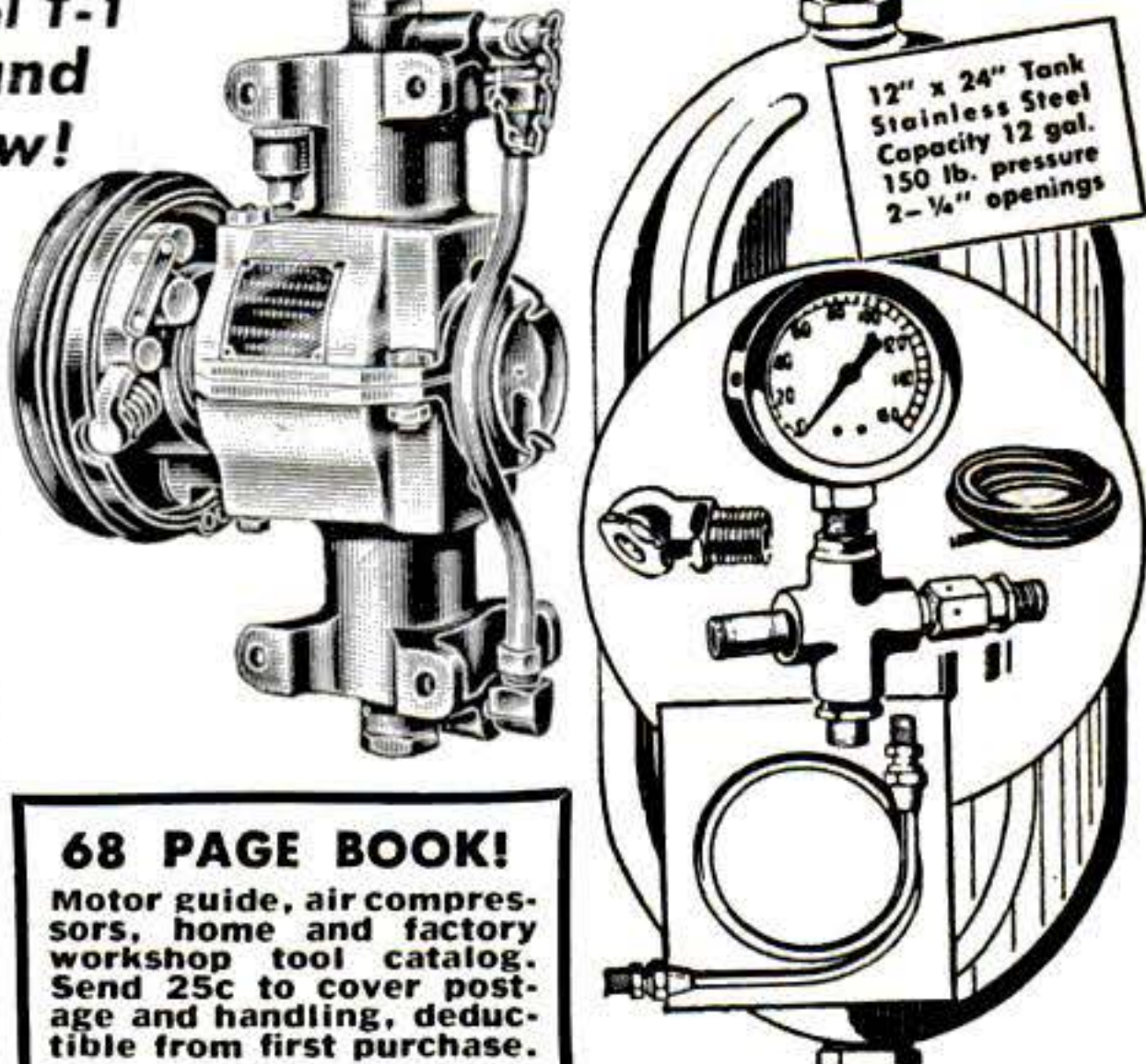

68 PAGE BOOK!
 Motor guide, air compressors, home and factory workshop tool catalog. Send 25c to cover postage and handling, deductible from first purchase.

Snap-on * PRY BAR

FORGED FROM FINEST ALLOY STEEL!
HANDLES A DOZEN DIFFERENT JOBS

Use the point for lining up work
...use the rolling head when
you want to exert great
pressure or leverage
for prying.

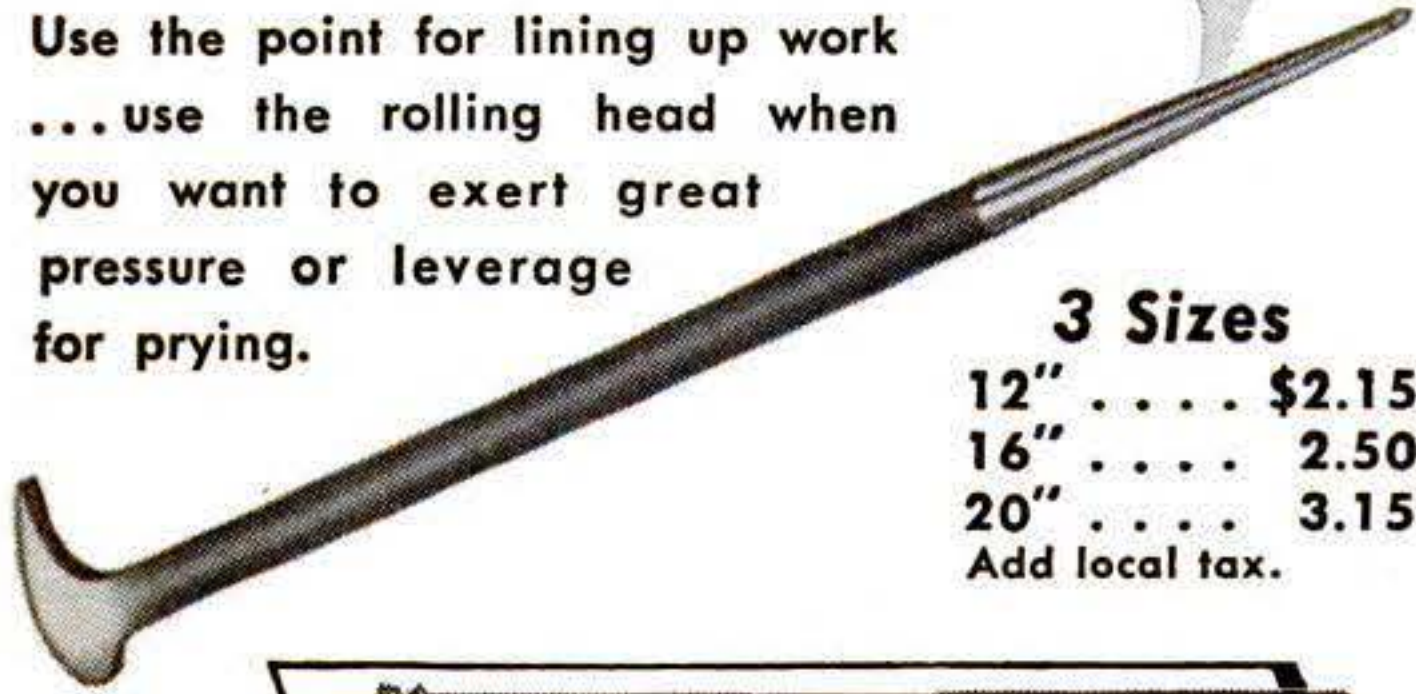

3 Sizes

12" \$2.15
16" 2.50
20" 3.15
Add local tax.

SCREW STARTERS make jobs easy!

End of tool chucks tightly into Set of 3
screw slot. Provides 8 lb. grip. **\$3.50**
Releases automatically. 3 sizes.

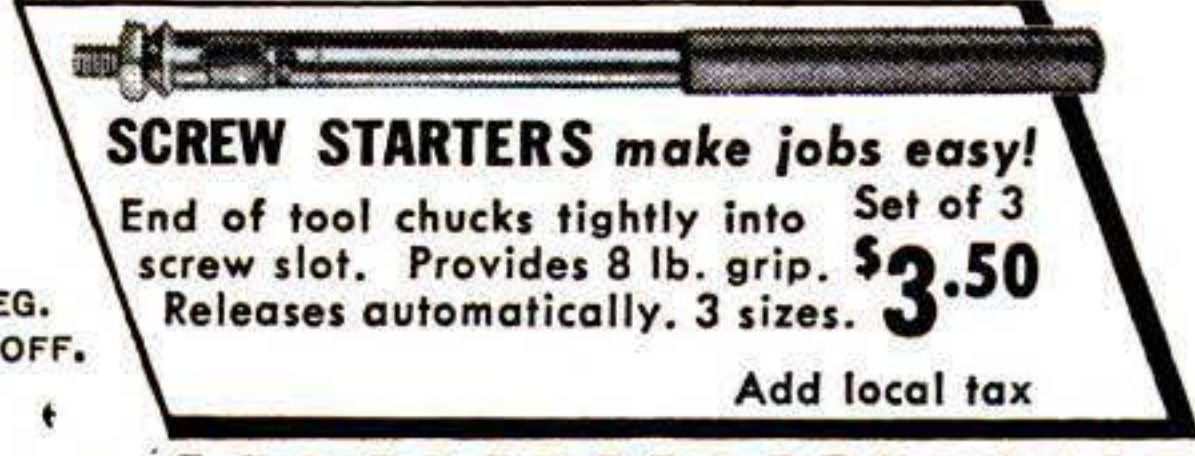

Add local tax

*T. M. REG.
U. S. PAT. OFF.

**SNAP-ON
TOOLS
CORPORATION**
8060-B
28th Ave.
Kenosha,
Wisconsin

I enclose Check Money Order for the
following:

Pry Bar 12", 16", 20"
Set of 3 Screw Starters

Name.....

Address.....

City.....State.....

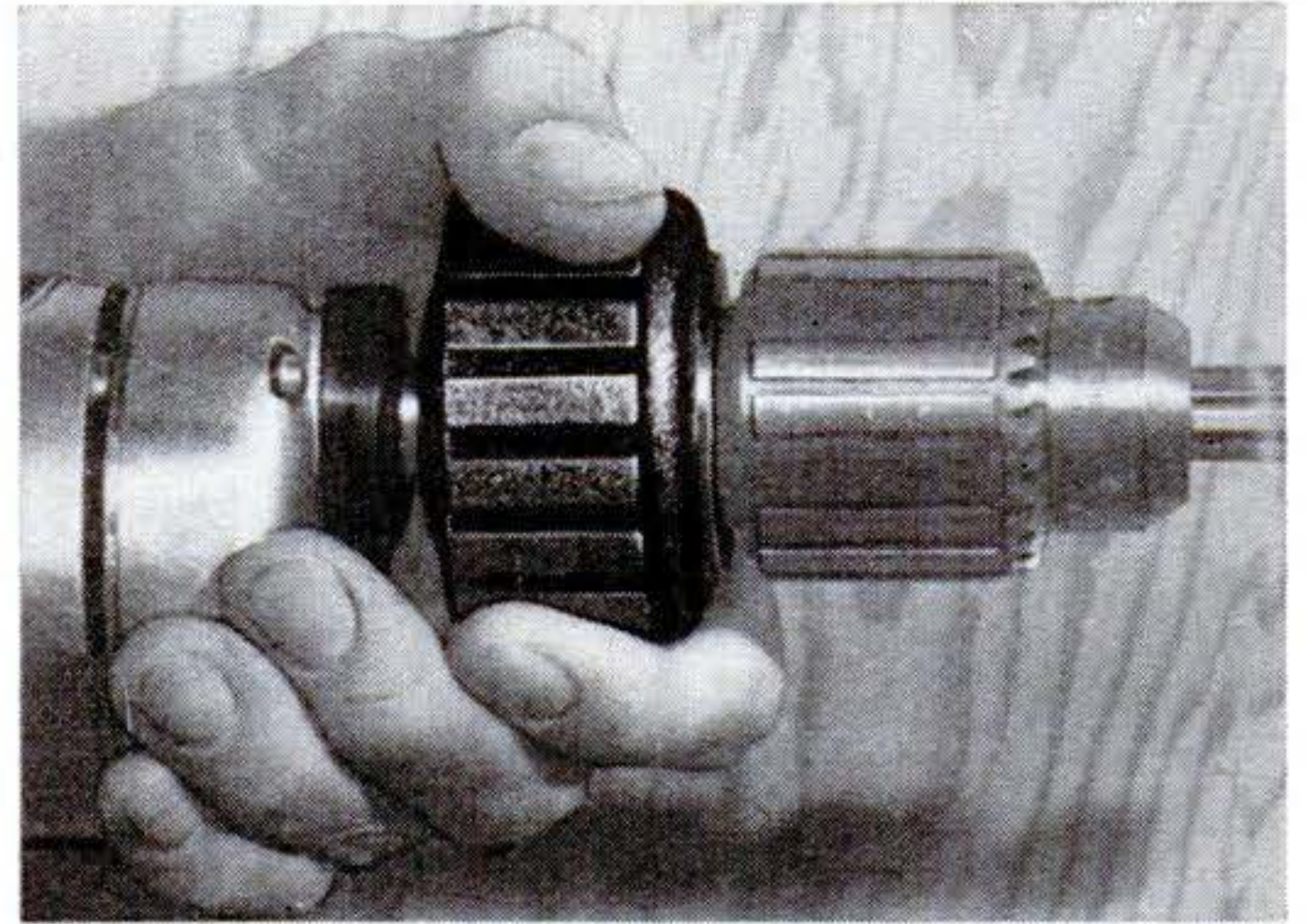
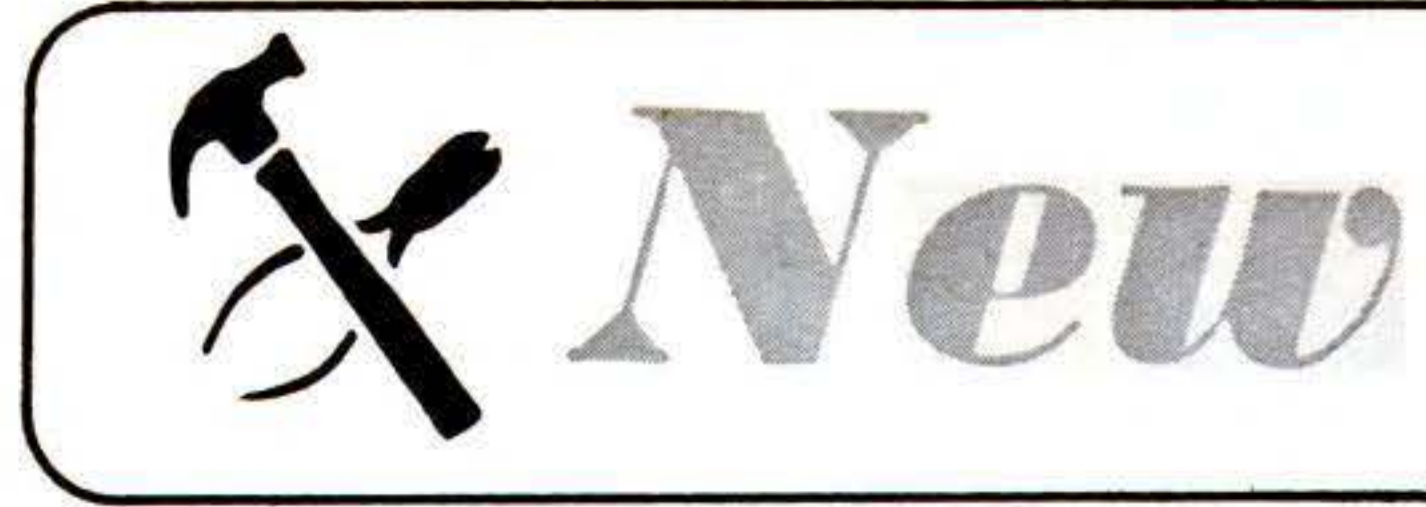

Tool Reduces Drill Speed. With Grip-Torc® attached, any 1/4" drill becomes a multi-purpose tool for heavy-duty boring, drilling, reaming, and other jobs. The geared mechanism increases torque output about 5-to-1. Grip-Torc is controlled by gripping or releasing the body of the unit, starting or stopping the working tool while the drill motor continues to run. McLaughlin & Co., Los Angeles, prices it at about \$15.



Hand Sander Rotates. The pivoted disk of the Rota-Matic® sander is free to rotate at random as you push the tool back and forth. This motion brings into use all facets of the sanding grit. Interchangeable sanding disks—fine, medium, and coarse—are included with the sander, priced at \$2.50 by the Binkley Manufacturing Company, Warrenton, Mo. The disks come with an adhesive coating on them.

Speedway

PORTABLE Bench and Hand GRINDERS

No. 117 Bench Grinder \$14.95

A capable bench grinder for general home and work shop use. Long life, air cooled motor. 1 "coarse" and 1 "fine" 4 1/2" x 3 3/8" wheels in 1-piece cast aluminum housing with sliding switch, rubber feet, cord and plug.

G.A. Kit \$13.95

"16 tools in 1." A No. 129 Electric Hand Grinder with 3/32" and 1/4" collets and 16 mounted stones, cutting burrs, wheels and disks.

No. 128 Bench Grinder \$29.95

Industrial quality 1/4 H.P. shaded pole A.C. motor. Special adjustable rests have formed-in angle guides for correct grinding of drills, bits, chisels, and blades. Two 6" x 3/4" grinding wheels operating at efficient speed. Completely encased in die cast aluminum housing. Plastic eye shields, mounted switch, 3-wire (Underwriter Approved) cord and plug.

Write for Circulars and name of your local dealers.



SPEEDWAY MFG. CO.
1864 South 52nd Ave. CICERO 50, ILLINOIS

Tools

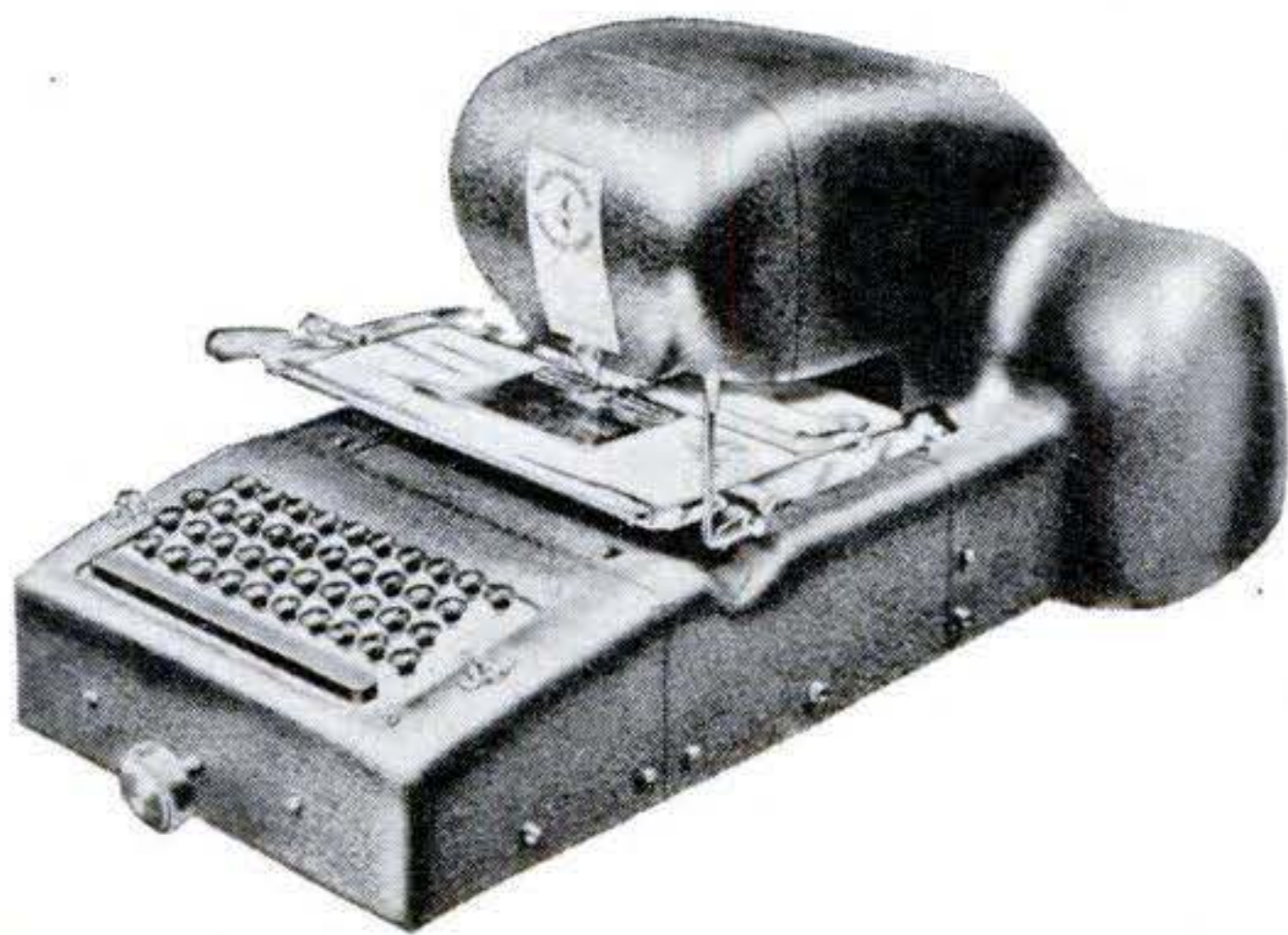

Typewriter Marks Metals. Designed for pressing markings into metal, this electric typewriter can be adjusted to letter wood, leather, or plastics. The interchangeable letter wheels—for various type sizes—are made of tool steel. To operate it, all you do is punch the keys. The machine can be set up to letter unhardened steel $\frac{1}{2}$ " thick. It's distributed by the Cadillac Stamp Company, of Detroit.



3-hp. Saw Weighs 25 lb. The one-cylinder, two-cycle, air-cooled gasoline engine that powers this saw operates in all positions. The tool is available in two straight-bladed models—18" and 24"—and as a 14" bow saw. The throttle is controlled by a trigger in the pistol-grip handle. A manually operated chain oiler is controlled by a button above the throttle. McCulloch Motors Corp., Los Angeles, is the maker.

Your Hands are Handier with

SKIL Home Shop Tools



SKIL Home Shop Sander-Polisher

Most useful tool you'll ever own! Powerful motor speeds a thousand jobs in your basement, garage or home. Drills, sands, buffs, polishes . . . wood, metals, plastics. With other attachments does wire brushing, stirs paint, grinds, sharpens.

**IT DRILLS!
IT SANDS!
IT BUFFS!
IT GRINDS!
IT CLEANS!**

Takes out the work, puts in quality on every job. Why be without this handiest helper when your favorite dealer has SKIL Home Shop Sander-Polisher waiting for you now. See him today!

SKIL Home Shop Saw



Sawing is a cinch with powerful 6 in. SKIL Home Shop Saw . . . very low-priced but fully adjustable for depth of cut and bevel-cutting!

Plugs in anywhere. Rips, cross-cuts, miters 2 in. dressed lumber 10 times faster, easier than by hand. Light, safe, easy-to-use on wood, metals, plastics.

Ask to see SKIL Home Shop Saw today.

See the complete SKIL Home Shop Line!

- DRILLS— $\frac{1}{4}$ in. and $\frac{1}{2}$ in.
- BELT SANDER
- HEDGE TRIMMER
- Bench Drill Stands
- Drill Kits • Saw Tables

**BEVELS!
ADJUSTS FOR
DEPTH!**

SKIL home shop Tools

SKIL Home Shop Tools
Made only by
SKILSAW, INC.
5033 Elston Avenue
Chicago 30, Ill.

SKILSAW, INC.
Home Shop Division, Dept. D-2
5033 Elston Ave., Chicago 30, Ill.
Please send information on SKIL Home Shop Tools and name of my dealer.

Name.....
Address.....
City.....Zone.....State.....

SAVE TIME AND WORK!

MAKE EXTRA MONEY!



EASY TO OPERATE

SHAW "DU-ALL"

and **"PEPPY PAL"**
GARDEN TRACTORS

PLOW



HARROW



CULTIVATE



MOW

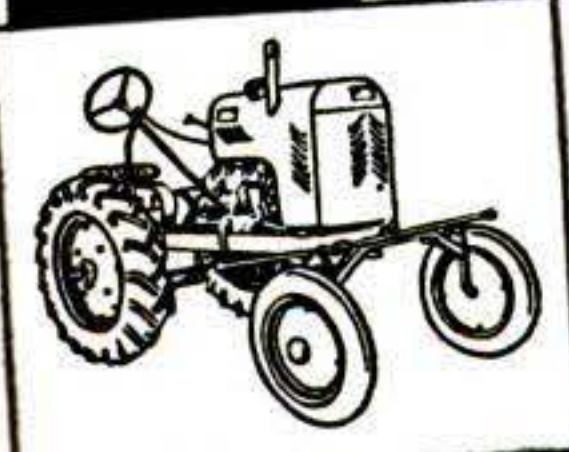

RIDE

RW-2

SHAW MFG. CO.

These sturdy walking and riding tractors ideal for dozens of uses around the farm, orchard, garden, golf course, estate and poultry farm.

DO DOZENS OF JOBS

Shaw Du-All or Peppy-Pal tractors do many jobs quickly and easily. Plow, cultivate, harrow, mow, disk, bulldoze, spray, grind, haul and saw wood. New uses discovered every day.

BUILT FOR RUGGED WORK

Sturdy, extra-strength construction means low upkeep, long life. Patented tool control allows quick shift for crooked rows. Attachments easy to change with new "Jiffy Hitch."

CHEAP TO OPERATE

Operates on few cents an hour. Soon pays for itself in time and labor-saving plus low initial and operating costs.

LOW FACTORY PRICES

Buy direct or through your dealer! Almost anyone who has a garden can afford a Shaw Du-All or Peppy-Pal. Full year's guarantee.

RIDING TRACTORS

Four models, from 5 to 12½ H.P., 58 in. wheelbase, 36 in. wide, 24 in. plant clearance. Hand or electric starter. Improved steering device, brakes enclosed in differential housing shaft. Standard hitch for trailers and wagons. Plow, harrow, cultivator, cutter bar, snow plow, bulldozer available.

PROMPT SHIPMENT

No waiting—order now for immediate delivery.

FREE: Illustrated folders giving complete details and price lists. Write today:

5702 Front St., GALESBURG, KAN.
668PS North 4th St., COLUMBUS, O.

New Tools

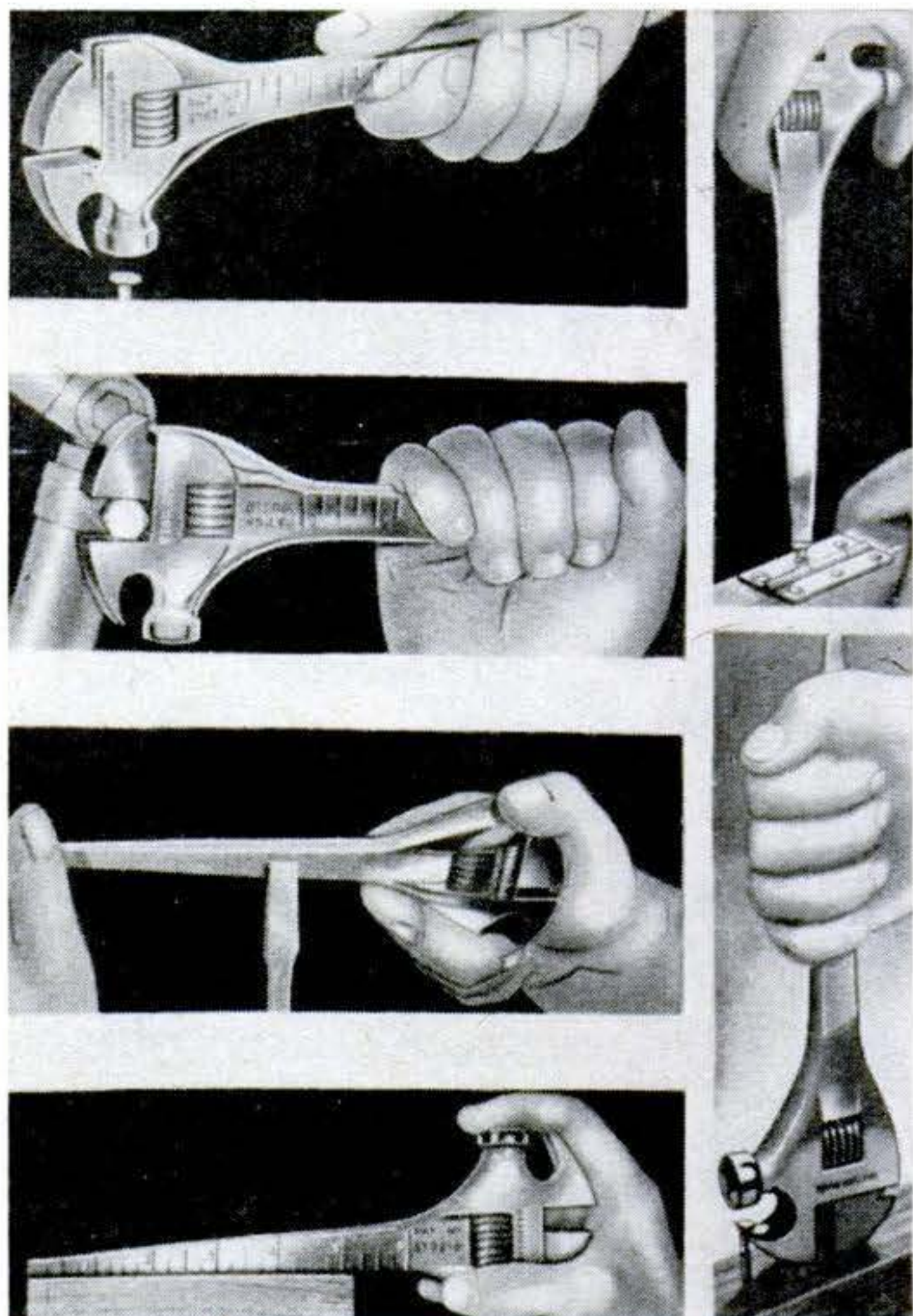

Tool Handles Six Jobs. Made in England and distributed in the United States by the Laster Export-Import Co., New York City, the Utilex® combines six everyday tools in one. It'll serve as a hammer, ¾" adjustable wrench, file, 6" rule, screwdriver, and a claw for pulling nails. It's priced at about \$5. The Utilex is manufactured from forge-hardened steel.

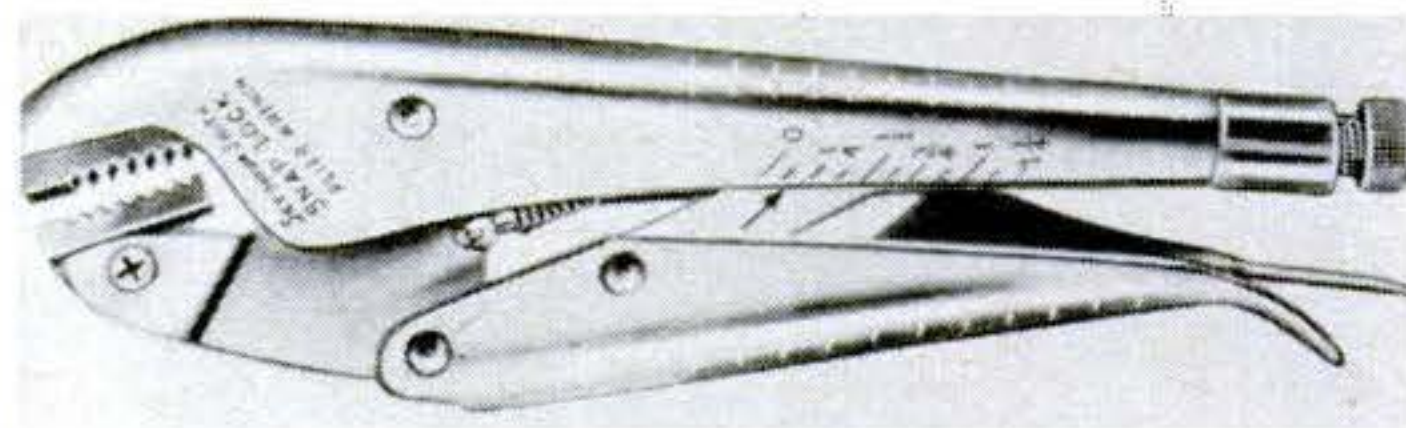

Improved Plier-Wrench. The Snap-Lock® plier wrench, manufactured by Seymour Smith & Son, Inc., of Oakville, Conn., has a finger-tip control that releases the jaws. A capacity indicator on the handle shows the extent of the jaw spread so the tool can be pre-set. The tool serves as pliers, clamp, or vise. With work locked in the jaws, the tool can be clamped in a vise.

New! Lathemaster...

the revolutionary woodturning set every lathe owner needs!



ONLY \$9.95



Now, with LATHEMASTER, you can turn out precision work—even make ornate table legs that match perfectly. And it's easy to use LATHEMASTER—you can make each cut and each bead just exactly the same. Now you can make 12 standard cuts and hundreds of variations with one tool—and 10 times faster too! Handle is stained hardwood, shank is chrome-plated steel. Interchangeable, reversible chisel blades are high-carbon shaper steel. Order yours today, complete with 6 double-ground blades shown above, mounted on wood toolrack, only... **\$9.95**

Send Cash, Check or M. O. for Prepaid shipment
ALADDIN TOOL COMPANY

3121 Main Street Kansas City, Missouri
Dealers write for new 1950 catalog



Drives Nails Automatically. From 40 to 50 nails a minute can be driven with the Azor Portable Pneumatic Nailing Tool, made by Azor Products Co., Los Angeles. The machine weighs about 30 lb., has a hopper capacity of from 400 to 600 nails, and handles 8d, 10d, and 12d nails. Nails may be driven vertically or at an angle. The nail set can be adjusted for depth, and the tool automatically stops driving at the predetermined depth. In a test, the Azor nailed 100 lineal feet of joists in eight minutes.

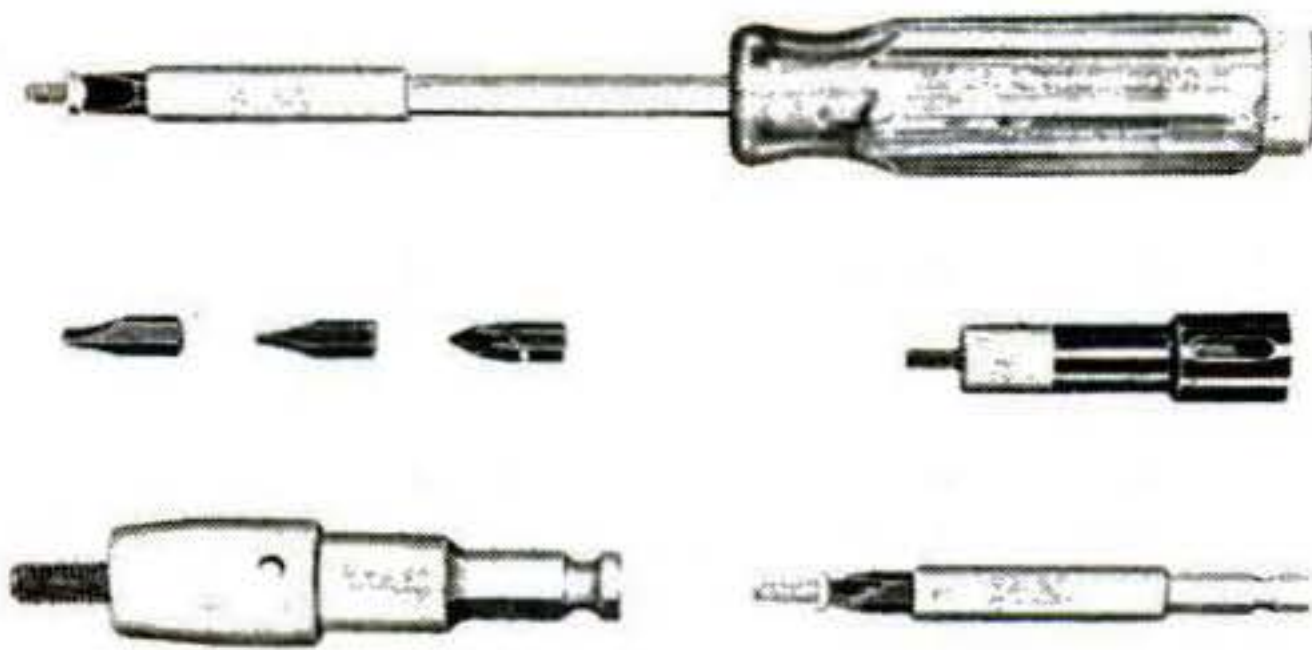

New Magnetic Screwdrivers. Magnetic pull has been stepped up 10 times in these power and hand screwdrivers made by the Magna-Tool Corporation, of Buffalo, N. Y. The power-driven tools include magnetic "finders" that pick up and automatically position the screw. Finders are available for various sizes of flat-head, round-head, oval-head, and filister-head screws. The hand screwdrivers are furnished with a handle compartment for holding an assortment of bits for different screws.

BUILD YOUR OWN POWER TOOLS

EASILY, QUICKLY... AT LOW COST

Exclusive GIL-BILT Build-It-Yourself Features

- No machining—build easily with hand tools only
- No blueprint reading—step-by-step pictorial plans, full scale patterns, actual photographs
- Sturdy wood, aluminum, and steel construction
- Capacity and performance of commercial saws selling for \$60 and up

SAVE \$50 OR MORE

GIL-BILT 10-INCH TILTING ARBOR SAW

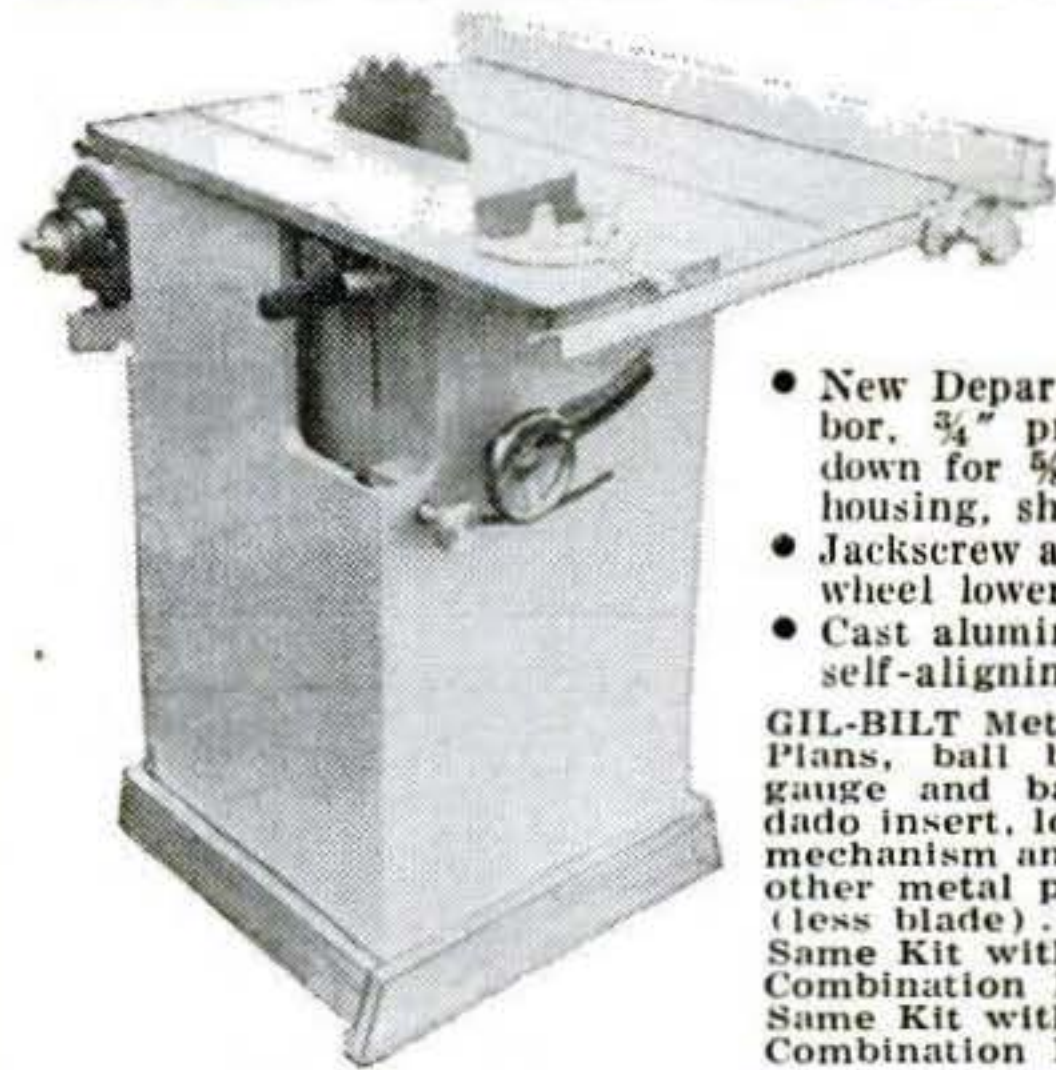

- 27x28 in. table, 13½ in. capacity in front of blade
- 10 in. blade cuts 3¼ in. deep, tilts full 45 degrees
- Floor model 34" high table always stays level

- New Departure ball bearing arbor, ¾" precision shaft turned down for ½" bore blades, alum. housing, shipped ready to run
- Jackscrew and 4½ in. dia. hand-wheel lowers and raises blade
- Cast aluminum miter gauge and self-aligning rip fence guide

GIL-BILT Metal Parts Kit includes Plans, ball bearing arbor, miter gauge and bar, rip fence guide, dado insert, lock knobs, jack screw mechanism and handwheel, and all other metal parts (less blade) **\$20.95**
 Same Kit with 10" Combination Blade **\$24.90**
 Same Kit with 8" Combination Blade **\$23.90**

GIL-BILT 8-INCH TILTING TABLE SAW

- 21x27 in. table tilts full 45 degrees, 13 in. capacity in front of blade
- 8 in. blade cuts from 0 to 2½ in.
- New Departure ball bearing arbor, ⅝" precision shaft turned down for ½" bore blades, alum. housing, ready to run
- Cast aluminum miter gauge and self-align. rip fence guide (same as above)



GIL-BILT Metal Parts Kit includes Plans, Ball Bearing Arbor, Miter Gauge and Bar, Rip Fence Guide, Machined Lock Knobs, Tilt Support Segments, and All Other Metal Parts (less blade) **\$15.95**
 Same Kit with 8" combination blade **\$18.90**

GIL-BILT 12-INCH BAND SAW

- Cuts to center of 24 inch circle
- Handles stock up to 6 inch thick
- 18x18 inch table tilts 45 degrees
- Lower wheel and drive pulley runs on sealed New Departure Ball Bearings; Upper wheel runs on two ⅝" bore Oilite Bronze bearings.
- Upper wheel tension and tilt mechanism of cast aluminum, completely assembled.
- Upper and lower blade guides. Each has ball thrust bearing, self-lub bronze jaws.
- Rubber tired wheels. (Choice of cast aluminum or make-your-own wood wheels on metal hubs.
- Uses standard 78 inch blades up to ¾ inch wide.
- Fully enclosed mechanism for utmost safety.

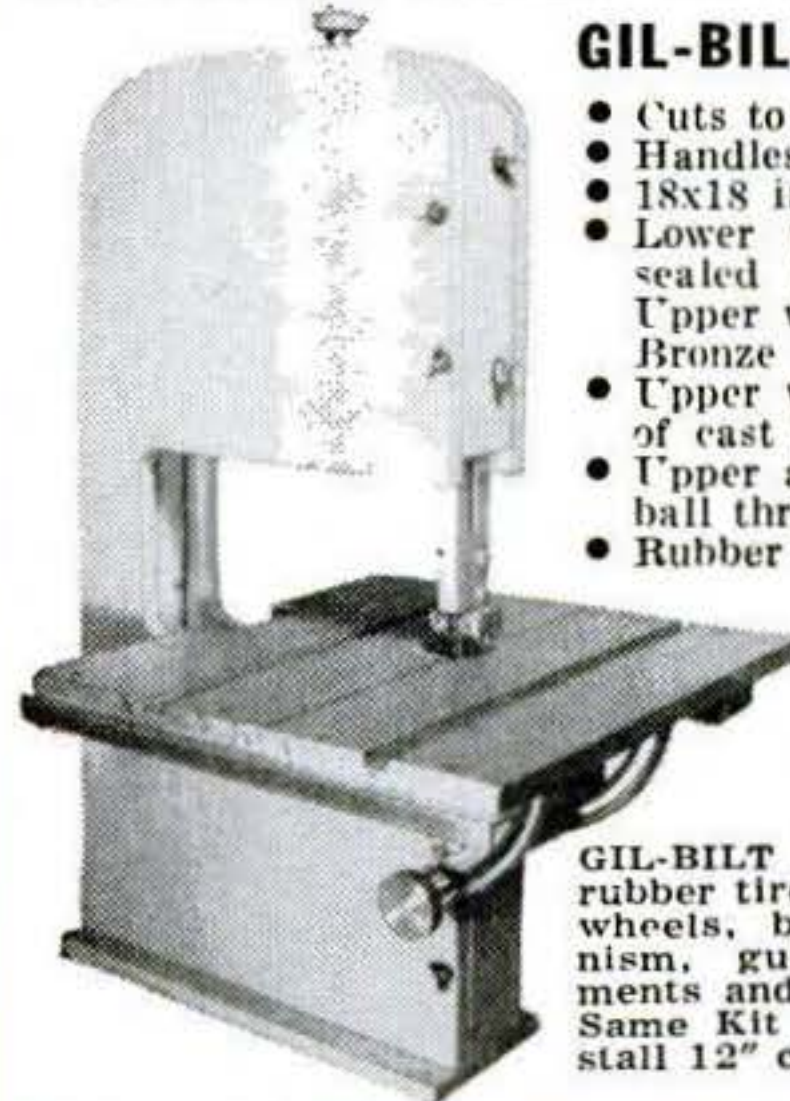

GIL-BILT Metal Parts Kit includes Plans, rubber tires, ¼ inch blade, hubs for wood wheels, ball bearing spindle, tilt mechanism, guides, table tilt segments and all other metal parts **\$16.95**
 Same Kit with two machined ready-to-install 12" cast aluminum wheels **\$20.95**

NO DEALERS—One Low Factory Price!
 Return in 10 days for full refund if not satisfied. Prices include postage within 600 miles. Over 600 miles add 5%. Send cash, check, or money order for parts kit, or send \$1.00 for Step-by-Step Plans and order kit later less cost of Plans. Plans sent postpaid anywhere in the world.

COMPLETE PLANS only \$1.00 EACH

GILLIOM POWER TOOLS
 P. O. Box 1-VB, Lambert Field, St. Louis 21, Missouri

P.S.

Last minute news & notes...

STEAM-DRIVEN CARS are being talked-up again in England--now that financial difficulties have forced Britain to curtail importation of gasoline.

LIGHT ALLOYS instead of steel save three tons in the weight of a Navy motor grader that can travel by air. Built-in boxes carry ballast, if necessary, to hold it down at work. An 80-hp. Diesel drives all six wheels.

RADIOISOTOPES produced by U.S. Atomic Energy Commission are being used now in more than 300 universities, hospitals and research laboratories.

"I FLEW BLIND on One Instrument," a PS story last February (p. 143), won for its author, Associate Editor Herbert O. Johansen, one of TWA's Twelfth Annual Aviation Writing Awards. The award included a flying trip from New York to Phoenix, Ariz.

COMMUNICATIONS equipment now being tried out by the Air Force sends printed messages, including maps, from ground stations to planes in flight.

OF 30 INSECTICIDES, tested by U.S. Public Health Service against adult house flies, best results were shown by a new chemical called Compound

497. Health hazards to sprayers using it are being studied by the scientists now.

A DUST TUNNEL established by the Fram Corp. at Dexter, Mich., may help keep your future car engine cleaner, make it last longer. One objective of the Fram research: to find what filtering elements do the best job in keeping dirt and dust out of the air, oil, and gas an engine uses.

COAL RIDES 10,900 feet - more than two miles - on a new rubber belt near Morgantown, W. Va., which Goodyear reports is the world's longest single conveyor belt.

WESTERN UNION has developed a new kind of paper for facsimile telegraphy. It has a light grey coating of material that turns black when electric current from a wire stylus passes through it.

HOMOGENOUS MEAT, de-boned and minus fat, accompanied by recipes that give frequency setting and time for cooking on a table-side dielectric stove, is among electronic developments now forecast by Westinghouse expert Walter C. Evans.

The Editors



Good News

TRAVELS FAST

PATENTED
CORALOX
INSULATOR

Pleased motorists everywhere are telling their neighbors the good news about *CORALOX*—how it removes the major causes of spark plug troubles in car, truck and tractor engines.

CORALOX is AC's patented Insulator. As compared with the best previous insulators, *CORALOX* is 3 times as strong—has 4 times greater heat conductivity—10 times greater electrical resistance at high temperatures—no affinity for oxide coating.

AC Spark Plugs, with *CORALOX* Insulator, will fire better and last longer in *your* engine.

AC SPARK PLUG DIVISION ◦ GENERAL MOTORS CORPORATION



FEBRUARY 1950 289



Why Struggle with poor equipment? USE

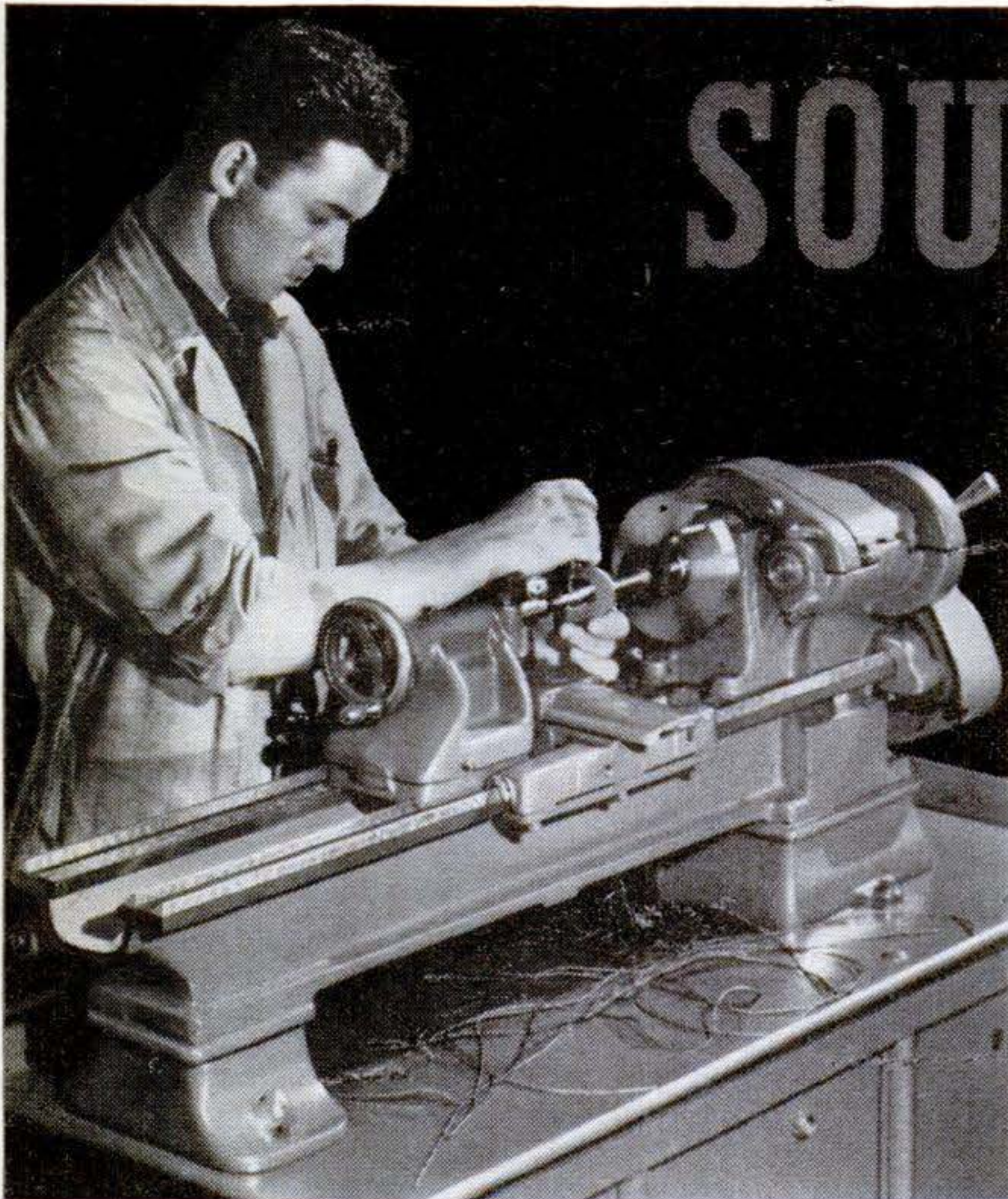

SOUTH BEND

Close tolerances come without a "fight" on a South Bend Lathe. Regardless of the operation you'll find that you can get exact dimensions everytime without slowing up. It's another example of "quality counts." You can always depend on a South Bend to turn out better work. It's built right — it's accurate, versatile and easy to operate. In the long run, it will actually cost you less for you get more and better service. You can't buy a "cheap" machine tool and expect to get satisfactory performance — "cheap" tools are never economical.

10" X 3', 1" COLLET, BENCH LATHE with metal bench; switch and 3 ph., 60 cy., 220 V., 3/4 h. p. motor; f. o. b. factory. **\$99435**
Time Payments: \$249.35 down, \$65.80 for 12 months.

Other lathes from \$160 to \$2496, less electrical equipment.

SOUTH BEND LATHE

SOUTH BEND, INDIANA

Building Better Tools Since 1906



Send for Information

10" BENCH LATHES

LATHE TOOLS AND ATTACHMENTS

TIME PAYMENT PLAN

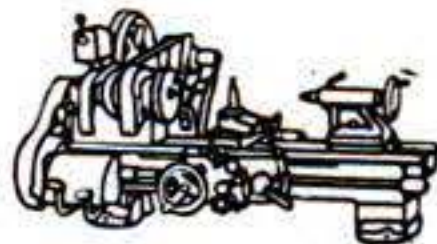

9" BENCH LATHES

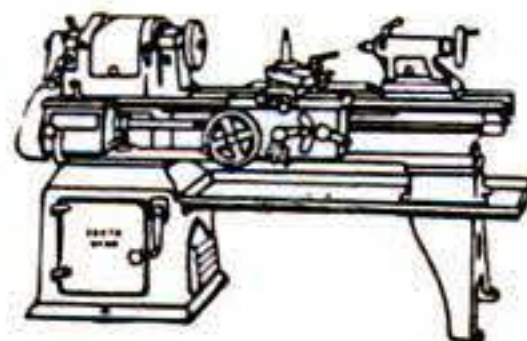

10" TO 16" FLOOR LATHES



14" DRILL PRESSES

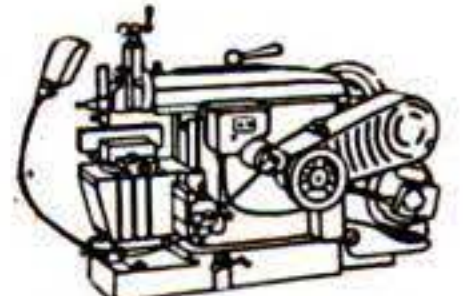

7" BENCH SHARER

Name _____

Street _____

City _____ Zone _____ State _____

TURRET LATHES
1/2" and 1" Collets

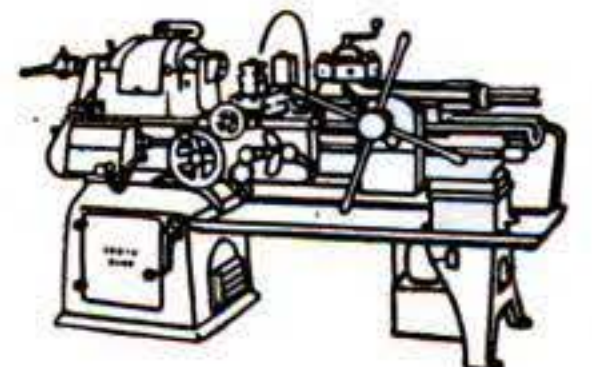

FREE
DAY
TRIAL

NOW!

INCREASE YOUR

\$20 TO \$40 A

with this Spare Time Self-Training

Here in one great practical handbook is step-by-step training with thousands of practical facts and proven methods by which

THE PRENTICE

BUSINESS EXECUTIVE'S HANDBOOK

Now you can learn in spare time—at amazingly low cost—the most effective ways to handle business matters of every description. In this 1600-page Master Volume, you get

Here is just a small fraction of the thousands of items on which the **BUSINESS EXECUTIVE'S HANDBOOK** gives you practical money-making guidance:

THE DOLLARS AND CENTS OF BUSINESS: A real executive knows how to "figure"—knows short-cuts in business mathematics that make him a quick thinker in a business deal. This section of the Handbook shows you: how to calculate simple and compound interest; bank discount; savings through cash discount; trade discounts; averages; markup and selling price; annuities; sinking funds and amortization; depreciation; freight rates; verifying by check numbers; tables of weights, measures and values; miscellaneous tables.

WRITE BETTER LETTERS: Can you put your ideas across "on paper"? This section of the Handbook covers: a plan to improve letters; compiling a correspondence manual; letter-appraisal chart; tone and spirit of the letter; how to answer an inquiry; letters refusing requests; letters to revive inactive accounts; letters that build goodwill; how to answer complaints; legal aspects of business letters; mechanics of the letter; special forms of address; dictionary of correct usage.

HOW TO SELL BY DIRECT MAIL: What products can be sold? What are the steps in planning direct-mail selling? Here is expert guidance on: selecting lists; types of direct mail; self-question chart of direct advertising; testing direct mail; how to record results; how to get and build mailing lists; how to write sales letters.

HELPFUL FACTS ABOUT ADVERTISING: Facts for small advertisers; developing demand; how to work with an advertising agency; fixing the advertising appropriation; selecting the right media; testing your advertising; how to design and register a trade-mark; copyright procedure; printing and typography.

MANAGING SALESMEN: If you are ever required to build and manage a sales force, turn to the Handbook for useful facts on: determining sales territories; sales quotas; recruiting and selecting salesmen; equipping, training and compensating salesmen.

SALES CONTRACTS AND FORMS: Essentials of a contract; when a sales contract must be in writing; forms of contracts for sale of merchandise; conditional sales contracts; lease agreement; miscellaneous clauses in sales contracts; contracts appointing agents for sale of merchandise; miscellaneous clauses in agency agreements; contracts employing salesmen; special provisions in salesmen's contracts; foreign trade definitions.

HINTS ON BUYING MERCHANDISE: Buying the right thing; how to standardize specifications; buying the right amount at the right place, at the right time, at the right price; procedure for handling and analyzing bids; requisitions and purchase orders; receiving and inspecting incoming goods; checking invoices; stores and inventory control.

HOW TO MANAGE AN OFFICE: Do the little details of office routine "throw" you? Here is a commonsense road-map to follow when you need help on: planning and maintaining the offices for efficiency; equipment, files and appliances; making office procedure function smoothly; economies in the use and printing of forms; hiring and training new employees.

HOW TO CHECK CREDITS AND INCREASE COLLECTIONS: Sources of credit information; Dun & Bradstreet reports; special agency reports; credit interchange; salesmen, attorneys and banks as credit references; law relating to checks, notes, drafts or bills of exchange; how to write letters granting or refusing credit; how to write collection letters and reminders; form collection letters.

HOW TO DEAL WITH THOSE WHO OWE YOU MONEY: Collection of a claim by suit on the unpaid obligation; out-of-court agreements; assignment for benefit of creditors; equity receiverships; voluntary or involuntary petition in bankruptcy; corporate reorganizations; wage earners' plans.

FINANCIAL STATEMENTS: Do you know how to read a balance sheet? The Handbook tells you the meaning of: current assets; fixed assets or fixed capital; tangible fixed assets; investments; deferred charges; current liabilities; fixed liabilities; deferred credits; contingent liabilities; reserves; capital stock; surplus.

BUSINESS INSURANCE: How to reduce the cost of ample insurance protection; law governing insurance policies; types of policies; fire, burglary, theft, robbery insurance; fidelity and surety bonds; credit insurance; miscellaneous coverages; business insurance; group insurance.

DIRECTORS, OFFICERS, STOCKHOLDERS: Law relating to directors; removal of director with or without cause; liability of director for acts beyond corporate powers; law relating to officers; liability of an officer for mismanagement; rights, liabilities of stockholders.

CORPORATE MEETINGS, MINUTES AND RESOLUTIONS: Preparations for meetings; stockholders' meetings; directors' meetings and committee meetings; how to keep minutes of meetings; parliamentary procedure.

PARTNERSHIPS: What a partnership agreement should contain; division of profits and losses among partners; liability of a secret partner; power of a partner to borrow money, collect debts, employ assistants, purchase and sell property; liability of an incoming partner; changing to a corporation.

TYPES OF BUSINESS ORGANIZATIONS: Choosing a form of organization for a business; raising of additional capital; power to do business in any state; choosing a name under which to do business.

BUSINESS EXECUTIVE'S HANDBOOK

THIRD EDITION

BROWN and DORIS Editors

17

BOOKS IN ONE

1600 PAGES, 5 x 8 inches, with CHARTS, TABLES, DIAGRAMS, ILLUSTRATIONS, 7700 SEPARATE ITEMS

Fully Indexed for Instant Reference

OVER 120,000 SATISFIED USERS

"mine of information."—C. W. Wall (Kansas)
"book on business I've ever seen. Wouldn't take for my copy."—Stuart Randolph (Georgia)
"exceeds what I expected. I wish I had of your offer sooner."—V. C. Glass (Texas)
"of the finest aids available to an enterprising man today."—J. H. Bailey (Minnesota)

NO MONEY — USE 10 DAYS FREE
send a penny now. Just mail coupon to get this remarkable Handbook for 10 DAYS FREE TRIAL. For yourself how YOU can step up your income this Handbook packed with practical business you can use to cut costs—save time—build—MAKE YOURSELF WORTH MORE MONEY.

MAIL THIS CARD NOW

NOTED THROAT SPECIALISTS REPORT on 30-Day Test of Camel smokers . . .

Not one single case of throat irritation due to smoking **CAMELS!**

Yes, these were the findings of noted throat specialists after a total of 2,470 weekly examinations of the throats of hundreds of men and women who smoked Camels—and only Camels—for 30 consecutive days.



Meet Miss RITA TENNANT, secretary, who recently made the 30-Day Test of Camel MILDNESS under the observation of a noted throat specialist.



Although she's smoked many brands, Rita changes to Camels for her 30-Day Test. Her throat is examined every week by a specialist.



Ah! Saturday—office closed! Rita calls time-out for a Camel and confides: "I am delighted to be making the test. Camels taste so good!"



30th day, final examination! Her doctor reports no throat irritation due to smoking Camels! Rita says: "Smoking is fun with Camels!"

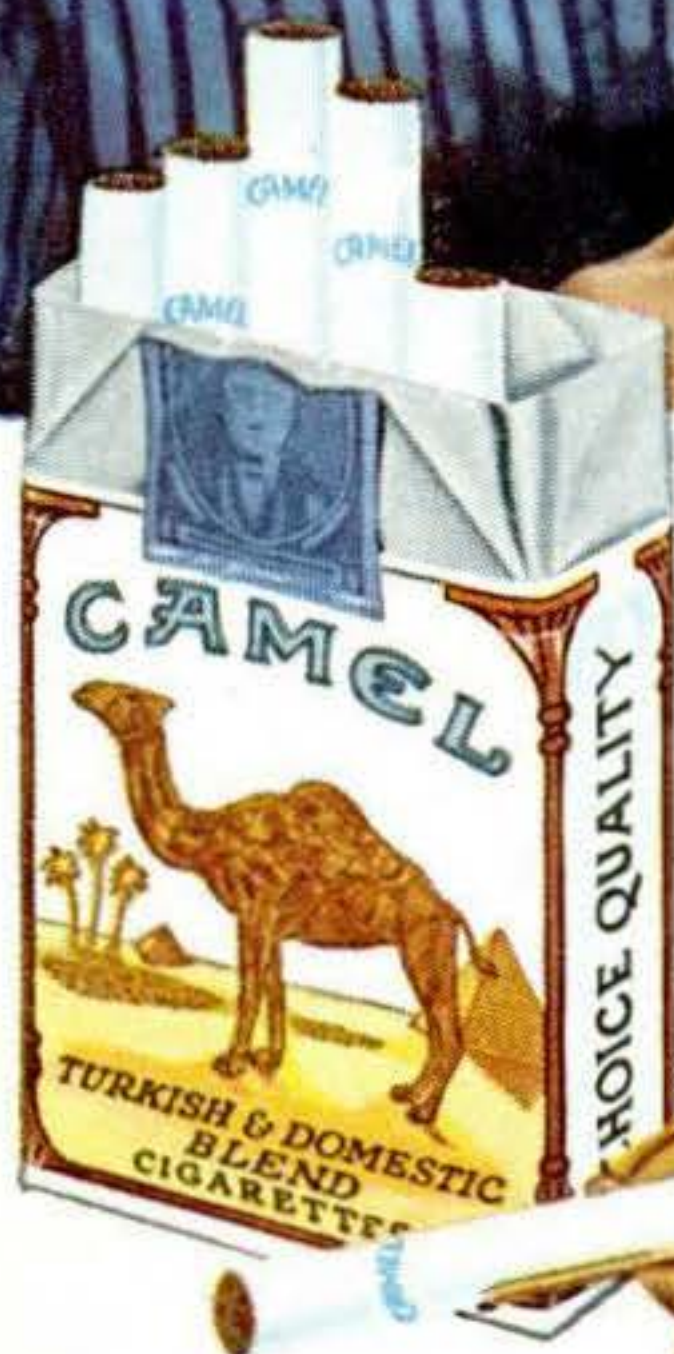

IT'S FUN! Smoke Camels—and only Camels—for 30 days. Let your throat tell you about Camel mildness. Let your taste tell you about Camel's wonderful flavor.

YES, MY DOCTOR'S REPORT JUST PROVED WHAT MY OWN THROAT TOLD ME ABOUT CAMELS—THEY'RE SO **MILD!** AND THEY TASTE SO GOOD!

Rita Tennant

R. J. Reynolds Tobacco Co.,
Winston-Salem, N. C.

Start your own 30-Day Camel MILDNESS Test Today!