

# POPULAR SCIENCE

Mar. 1950

25¢

Monthly

SAH  
5

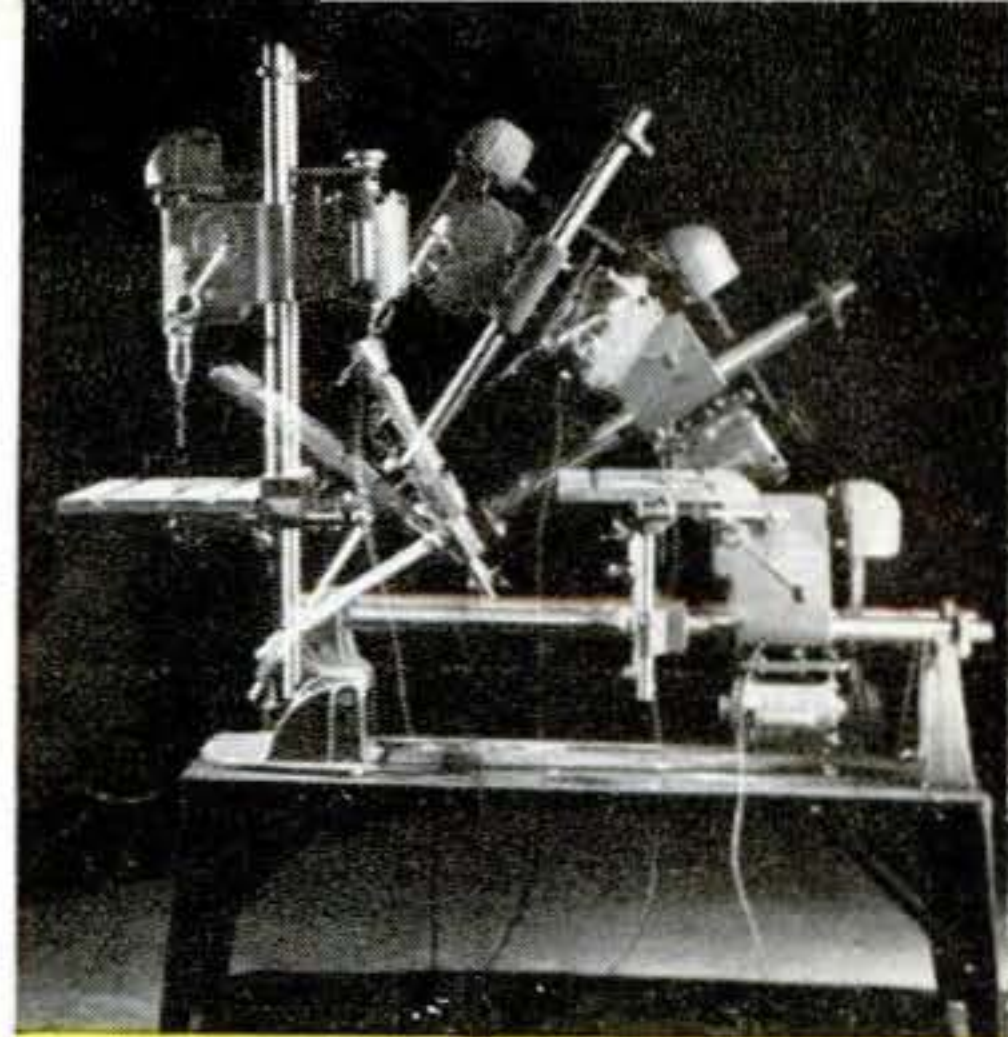

Motorized Tool Kit—page 16



**How Good Is Our  
Anti-Sub Defense?**



"DAD--WE NEED A MONTAMOWER TOO"

"NO MORE LABOR. NEIGHBOR"

DOES NOT ↑  
SHAVE CROWN  
TRIMS AS IT CUTS →

Weight  
only 8 1/4 lbs

MontaMower is a new, efficient kind of lawn mower that literally "sells itself."

This live, 8 1/4 lb. precision machine first gathers then smoothly and easily cuts a full 16" swath through grass, dandelions, spike grass and tall lawn weeds (including those that ordinarily pop back up to cause you extra work).

**AND EVEN MORE IMPORTANT . . .**

MontaMower does what no conventional mower can do! It cuts right up to walls, fences, trees, under foliage, around close quarter borders — it practically eliminates hand trimming!

MontaMower is sturdy, yet so light that even

# MONTA MOWER

**MOWS and TRIMS LAWNS  
in ONE EASY OPERATION**

Trims close to buildings, trees and shrubs.



Cuts clean . . . grass, tall lawn weeds and all.



PASTE THIS  
COUPON  
ON A PENNY  
POSTCARD—  
MAIL TODAY

*Try it*  
**ON YOUR OWN LAWN  
. . . on approval!**

women and children can operate it easily and efficiently. Improved metal handle has special device to adjust cutting height. Self sharpening, tool-steel cutting discs.

Unsolicited testimonials from thousands upon thousands of satisfied owners everywhere have convinced us that, in your own hands — on your own lawn, under most conditions, the MontaMower will prove itself far superior to any other type of hand operated mower.

This is why we can sell you this fine low priced mower with a "Written Guarantee" — on a most liberal "Try on your own lawn . . . on approval" basis. Write today for full details on this amazing offer.

**SOLD DIRECT ONLY NO AGENTS  
NO DEALERS**

MONTAMOWER DISTRIBUTING Co.

Sales and General Offices

P-5 03 KEELER BLDG. • GRAND RAPIDS 2, MICHIGAN

Gentlemen: Without obligation, kindly send me complete descriptive literature, price, guarantee information, and full details of your amazing "Try it on your own lawn" Approval Offer.

NAME \_\_\_\_\_

ADDRESS \_\_\_\_\_

CITY \_\_\_\_\_ ZONE \_\_\_\_\_ STATE \_\_\_\_\_



# HOW TO LIVE LIKE A KING ON AS LITTLE AS ONE ACRE!

YOU don't have to pay a small fortune or buy a large farm to make your dream of a practical country home come true. *All you need is a little land!* The "Have-More" Plan shows you how to transform as little as one acre into the best and happiest living any family could want. And you can make that acre *pay for itself!*

### Modern Inventions Make It Possible!

You'll be amazed what you can do today on a little land—even in your spare time! You can have a bearing orchard with a fruit crop in just 18 months! You can raise a year's supply of tender chickens in 9 weeks—in a 3x4 foot space. You can even raise a pig without buying feed. You can own a small greenhouse—one that anybody can afford—that waters plants and controls heat automatically.

And the best part of it is that you can enjoy this wonderful new way of living on less than \$100 a month. Just a small income—from your Social Security or a part-time job, or a pension—and you can live like a king for the rest of your life!

### Newest Procedures for 1950 Planners

Ed and Carolyn Robinson have spent six years gathering the newest and best knowledge for you, experimenting at their own little place, "trading" methods and ideas with experts and amateurs all over the world. (Perhaps you've seen the stories about their 2-acre "miniature" farm in the *Saturday Evening Post*, *Reader's Digest*, *Better Homes and Gardens*, etc.) Now let their famous "Have-More" Plan show you how to HAVE MORE in every way on YOUR place!

### Everything You'll Ever Need to Know About Successful Country Living!

If you have a garden, farm, or country home, you'll certainly want a copy of this wonder book. *Reader's Digest* calls it "Good news for the millions who have or want a couple of acres in the country." Or, if you're tired of city noise, dirt, and high costs, you'll want to see how easily you can afford a little land in the nearby countryside, where you and your wife and children can really begin to live. The Robinsons did. So can you! The "Have-More" Plan tells you just how—step-by-step!

### Now You Don't Need a BIG Income to Retire

The "Have-More" Plan will show you just how to pick the right place, how to lay out your grounds and design your house, how to raise much of your food, how to stretch your retirement income into the best and happiest life anyone could want!

### There's a Lot to Gain—Act NOW!

Don't hesitate. Make the most of that country place you now have—or expect to have. The "Have-More" Plan will save you endless trouble and expense, solve a thousand problems and answer countless important questions for you. It costs only \$2—BUT FIRST WE WANT YOU TO EXAMINE IT FREE. You get complete satisfaction or DOUBLE your money back! Mail coupon NOW! The Country Bookstore, P. O. Box 2803, Noroton, Conn.



**Examine it FREE!**  
Only \$2.00 if you decide to keep it

43 Chapters! 255 Illustrations! New Spiral-Bound Edition Will Stand Hard Usage. Heavy-Paper Pages Lie Flat When Open. 300,000 Families Already Using It!

### Same Plan You've Read So Much About in:

**SATURDAY EVENING POST:** "To country-minded families with growing children, to couples looking to retirement, the 'Have-More' Plan presents an exciting possibility and a way to achieve it."  
**READER'S DIGEST:** "The 'Have-More' Plan 'a little land . . . a lot of living,' is the slogan of this energetic young couple who have made a suburban farm pay."  
**ESQUIRE:** "Buy the book. Read the 'Have-More' Plan—give your future a break with this practical, sane approach to intelligent living."  
**BETTER HOMES AND GARDENS:** "Live better on two acres . . . the 'Have-More' Plan gives practical details and diagrams."

## ALL THIS EXPERT ADVICE AND MORE—YOURS FOR ONLY \$2.00!

Houses Especially Designed For Country Living

Score Card for Buying Country Property

Your Own Fresh Eggs and Chickens

Scientific Layouts for Small Acreage

Landscaping Your Place

A Better Garden with a Lot Less Work

Quick Freezing is Easy!

Raising Rabbits

Bees for Sugar

Berries and Grapes Money Can't Buy!

Your Miniature Dairy

Keep Pigs On Concrete

Plans For An Ideal Small Barn

Dwarf Fruit Trees

Geese, Turkeys, Ducks

Baby Tractors

Your Own Work Shop

Ham, Bacon, Pork—a Few Cents a Pound

Grow Your Own Fish!

### SEND NO MONEY (Unless You Prefer To)

Mail This Coupon NOW to THE COUNTRY BOOKSTORE, P. O. Box 2803, Noroton, Conn.

Send me the "Have-More" Plan. If I keep it, I'll send two dollars, plus 20 cents for postage, packing, handling. If it doesn't please me, I'll send it back, owe you nothing.

YOUR NAME \_\_\_\_\_

ADDRESS \_\_\_\_\_

CITY \_\_\_\_\_ Zone No. \_\_\_\_\_ STATE \_\_\_\_\_  
(if any)

If you send \$2 now, that will save us record keeping and save YOU the 20 cent shipping charge. We'll give you DOUBLE your money back if you return the plan in 10 days! That's how sure we are you'll like it!



Founded 1872. Vol. 156: No. 3

**POPULAR  
SCIENCE**  
Monthly

Mechanics and Handicraft

Perry Githens, EDITOR

Fred O. Newman, Volta Torrey, MANAGING EDITORS    Howard C. Jensen, ART EDITOR

Harry Walton, MECHANICS & HANDICRAFT EDITOR

Hartley E. Howe, Frank Rowsome, Jr., ASSISTANT MANAGING EDITORS

ASSOCIATE EDITORS: Howard Allaway, Alden P. Armagnac, Devon Francis, Richard Giovine, Robert Gorman, Sheldon Gallager, Herbert Johansen, Martin Mann, Denis Sneigr, Robert P. Stevenson.

ART DIRECTOR: Harry Samuels. ART ASSOCIATES: Herbert Anthony, Eric Karminski, Jr., Richard Meyer, Edward Hallstrom, Frances Cooper (Production).

EDITORIAL ASSISTANTS: Julia Charnif, Carol Ennis, Georgette Sparks, Harriet Trowbridge, Ruth Westphal.

STAFF PHOTOGRAPHERS: W. W. Morris (Chief), Hubert Lockett, Orlando Guerra (Darkroom).

WESTERN EDITOR: Andrew R. Boone (Los Angeles).

WASHINGTON CORRESPONDENT: John F. Loosbrock.

## Highlights FOR MARCH, 1950

### How Good Is Our Sub Defense?....100

Can the dangerous new subs outfox our Navy's defenses? New devices and tactics may counter them.

### Tiniest Glider Hits 250 M.P.H....112

"Unstable Mabel," patterned after the record-breaking X-1 rocket plane, gives air-show crowds a thrill.

### "Overhand Joe" Trains Batters....118

Clever mechanical pitchers throw 12 strikes a minute to give big-league baseball players batting practice.

### Uranium on Sale.....124

The stuff that puts the A in A-bombs is now on sale, along with other rare metals for certain new uses.

### Airmen "Crash" on Rocket Sled..152

Fliers ride a speeding rocket sled into the equivalent of a stone wall to find out how much they can take.

### Dr. G's Motorized Tool Kit.....164

The urge to "invent something" resulted in a power tool that will do nearly everything—and then some.

### Gus and the Popping Filler Cap....178

The parson wasn't polite, but he did bring a lot of excitement to the Model Garage—plus Jerry's stripes.

### Make Your Own Geiger Counter..200

New AEC circuits let you build your own sensitive G-M counter—for experiments or for prospecting.

### Make Your Yard a Playground....205

With summer coming, it's time to make play equipment. Here's everything from slides to swings.

### 16-Inch Tube Converts Small TV..229

Souping up your 10-inch receiver to take a 16-inch tube isn't really tough at all. Here's how to do it.

### Science & Industry

### Health Clinic Takes to Road.....108

### Rescue Radio Fits Pocket.....111

### Ram Jets "Fly" in Tank.....117

### Rectangular TV Tube Cuts Cost.....123

### U. S. to Europe with 50 Tons.....129

### Nash Shows Its "Maybe" \$1,000 Car....130

### Growing Radioactive Food.....132

### New Army Tractors Steer Like Planes....133

### Robot Processes Color Film.....137

### Long Arm Unloads Boxcars.....138

Godfrey Hammond, PUBLISHER · Stephen P. Glennon, ADVERTISING DIRECTOR · Edward Roeder, Jr., ADVERTISING MGR.

EDITORIAL OFFICES: 353 Fourth Avenue, New York 10, N. Y. Manuscripts and illustrations submitted at regular rates should be so marked, addressed to "The Editors" and accompanied by stamped, self-addressed envelope. Popular Science Monthly exercises all possible care but assumes no responsibility for unsolicited material.

TRADE NAMES by which products or materials are commonly known are indicated by the symbol ®. These names may or may not be Registered Trademarks (see

PS, Mar. '49, p. 294). This symbol is used only as a service to readers and Popular Science Monthly assumes no responsibility by use or omission.

ADVERTISING OFFICES: NEW YORK — 353 Fourth Avenue; CHICAGO — 360 North Michigan Avenue; DETROIT — 820 Book Building; SAN FRANCISCO — 1003 TWA Building; PORTLAND (ORE.) — 907 Terminal Sales Building; CLEVELAND — 328 Citizens Building; LOS ANGELES — Granada Building.

Popular Science Monthly is published monthly at 353 Fourth Avenue, New York 10, N. Y., by Popular Science Publishing Co., Inc., Godfrey Hammond, President and Treasurer; R. C. Wilson, Raymond J. Brown, Stephen P. Glennon, Vice-Presidents; F. W. Briggs, Secretary. Entered as second-class matter Dec. 28, 1918, re-entered as second-class matter July 26, 1948, at the Post Office in New York, N. Y., under the act of March 3, 1879; additional entry as second-class matter at Dayton, Ohio. Entered as second-class matter at the Post Office Department, Canada. Printed in U.S.A. Copyright, 1950, by Popular Science Publishing Co., Inc. All rights reserved in the United States, Great Britain, and in all countries participating in the International Copyright Convention and Pan-American Copyright Convention. Yearly subscriptions to United States, its possessions and Canada. \$3.00 (2 years, \$5.50; 3 years, \$7.50); foreign countries \$1 per year extra. Subscribers must notify us of change of address four weeks before next publication date. Be sure to give both old and new addresses, including zone numbers. Vol. 156, No. 3.



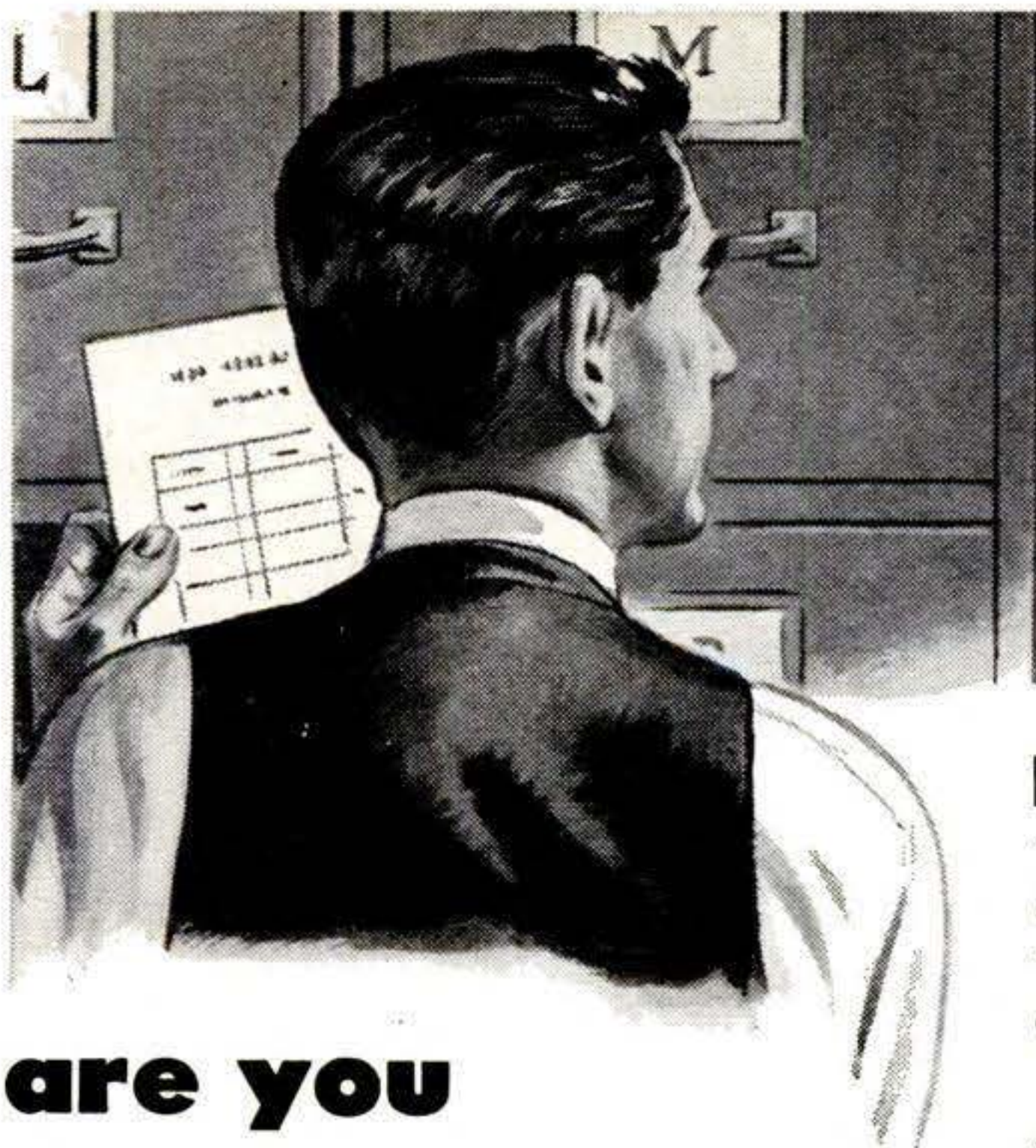

**are you  
SUFFERING  
from  
HIDDEN  
TALENTS?**

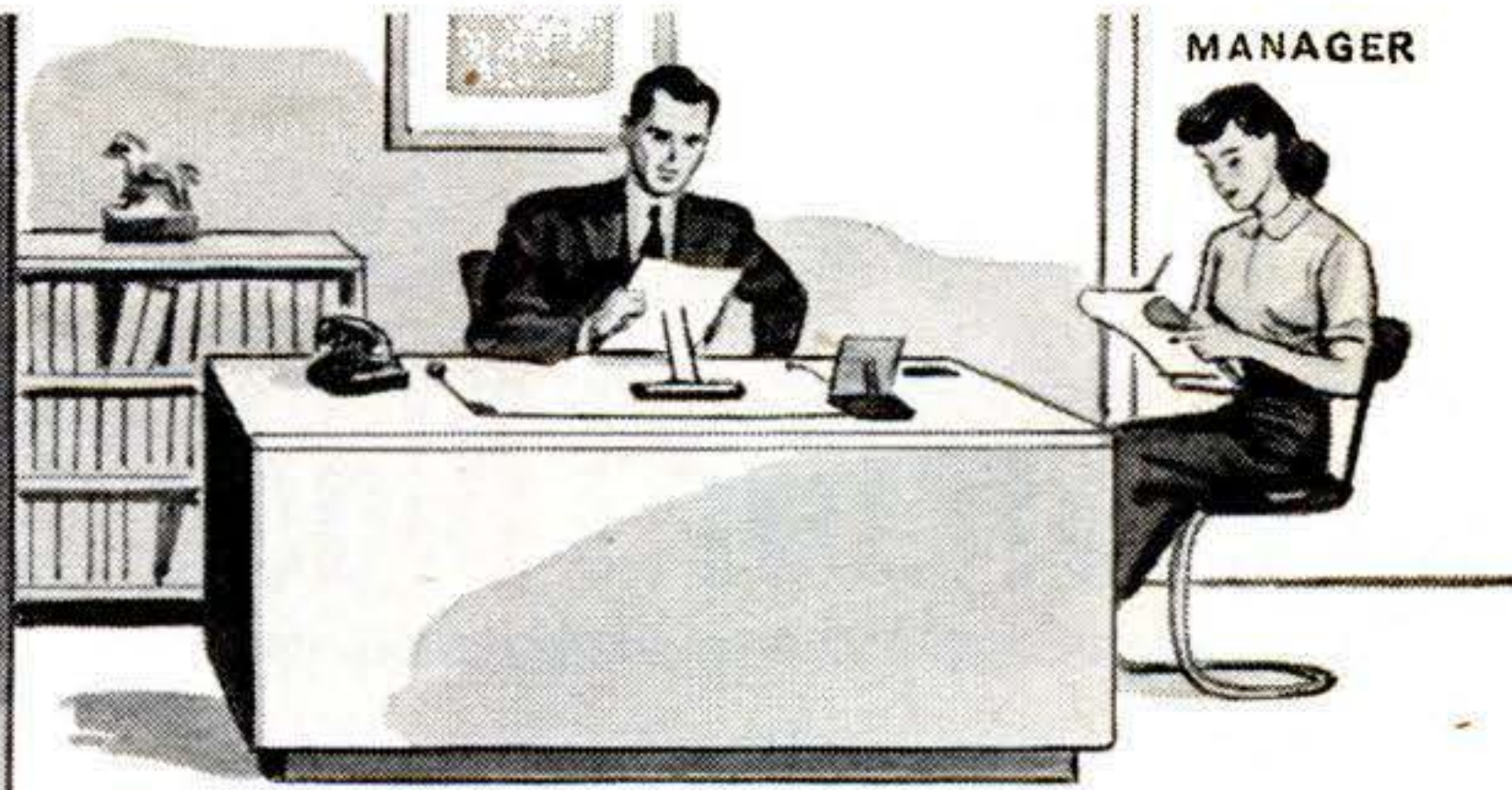

**D**o other people's successes make you feel unimportant? It may be that you've never given yourself a chance. Almost everyone has hidden talents which, when fully developed, open up new and challenging opportunities.

Helping men and women bring out the best that's in them has been the job of I.C.S. for more than 58 years. In every field of industry, you'll find leaders whose skills were developed through study with I.C.S.

They are the ones who sensed a latent ability within themselves—and who proceeded to do something about it. While others (equally gifted, perhaps) plodded along in routine jobs, they mastered I.C.S. courses . . . qualified themselves for rich rewards.

You can develop your hidden talents the same way they did. Start today and be ready for tomorrow's opportunities. Here's the coupon to mail:

**INTERNATIONAL CORRESPONDENCE SCHOOLS**

**APPROVED**  
under the  
**G.I. BILL**

**BOX 7649-M, SCRANTON 9, PENNA.**

Without cost or obligation, please send me full particulars about the course BEFORE which I have marked X:

- |  |   |   |  |
|--|---|---|--|
| <p><b>Business and Academic Courses</b></p> <ul style="list-style-type: none"> <li><input type="checkbox"/> Accounting</li> <li><input type="checkbox"/> App. Psychology</li> <li><input type="checkbox"/> Business Administration</li> <li><input type="checkbox"/> Bus. Correspondence</li> <li><input type="checkbox"/> Certified Public Accounting</li> <li><input type="checkbox"/> Commercial</li> <li><input type="checkbox"/> Commercial Art</li> <li><input type="checkbox"/> Cost Accounting</li> <li><input type="checkbox"/> Federal Tax</li> <li><input type="checkbox"/> First Year College</li> <li><input type="checkbox"/> Foremanship</li> <li><input type="checkbox"/> Good English</li> <li><input type="checkbox"/> Higher Mathematics</li> <li><input type="checkbox"/> Industrial Supervision</li> <li><input type="checkbox"/> Motor Traffic</li> <li><input type="checkbox"/> Retailing</li> <li><input type="checkbox"/> Salesmanship</li> <li><input type="checkbox"/> Sign Lettering</li> <li><input type="checkbox"/> Spanish</li> <li><input type="checkbox"/> Advertising</li> <li><input type="checkbox"/> Bookkeeping</li> <li><input type="checkbox"/> Bus. Law</li> <li><input type="checkbox"/> French</li> <li><input type="checkbox"/> High School</li> <li><input type="checkbox"/> Illustration</li> <li><input type="checkbox"/> Postal Civil Service</li> <li><input type="checkbox"/> Retail Bus. Management</li> <li><input type="checkbox"/> Secretarial</li> <li><input type="checkbox"/> Stenography</li> <li><input type="checkbox"/> Traffic Management</li> </ul> <p><b>Air Conditioning and Plumbing Courses</b></p> <ul style="list-style-type: none"> <li><input type="checkbox"/> Air Conditioning</li> <li><input type="checkbox"/> Heating</li> <li><input type="checkbox"/> Refrigeration</li> <li><input type="checkbox"/> Plumbing</li> <li><input type="checkbox"/> Steam Fitting</li> </ul> | <p><b>Chemical Courses</b></p> <ul style="list-style-type: none"> <li><input type="checkbox"/> Chemical Engineering</li> <li><input type="checkbox"/> Chemistry, Analytical</li> <li><input type="checkbox"/> Chemistry, Industrial</li> <li><input type="checkbox"/> Chemistry, Mfg. Iron &amp; Steel</li> <li><input type="checkbox"/> Petroleum Refining</li> <li><input type="checkbox"/> Pulp and Paper Making</li> <li><input type="checkbox"/> Civil Engineering, Architectural and Mining Courses</li> <li><input type="checkbox"/> Architecture</li> <li><input type="checkbox"/> Building Estimating</li> <li><input type="checkbox"/> Civil Engineering</li> <li><input type="checkbox"/> Contracting and Building</li> <li><input type="checkbox"/> Highway Engineering</li> <li><input type="checkbox"/> Lumber Dealer</li> <li><input type="checkbox"/> Reading Structural Blueprints</li> <li><input type="checkbox"/> Sanitary Engineering</li> <li><input type="checkbox"/> Structural Drafting</li> <li><input type="checkbox"/> Structural Engineering</li> <li><input type="checkbox"/> Surveying and Mapping</li> <li><input type="checkbox"/> Coal Mining</li> </ul> <p><b>Communications Courses</b></p> <ul style="list-style-type: none"> <li><input type="checkbox"/> Electronics</li> <li><input type="checkbox"/> Prac. FM and Television</li> <li><input type="checkbox"/> Prac. Telephony</li> <li><input type="checkbox"/> Radio, General</li> <li><input type="checkbox"/> Telegraph Engineering</li> <li><input type="checkbox"/> Radio Operating</li> <li><input type="checkbox"/> Radio Servicing</li> </ul> | <p><b>Electrical Courses</b></p> <ul style="list-style-type: none"> <li><input type="checkbox"/> Electrical Drafting</li> <li><input type="checkbox"/> Electrical Engineering</li> <li><input type="checkbox"/> Electric Light and Power</li> <li><input type="checkbox"/> Lighting Technician</li> <li><input type="checkbox"/> Practical Electrician</li> <li><input type="checkbox"/> Power House Electric</li> <li><input type="checkbox"/> Ship Electrician</li> <li><input type="checkbox"/> Aviation</li> <li><input type="checkbox"/> Gas Engines</li> </ul> <p><b>Internal Combustion Engines Courses</b></p> <ul style="list-style-type: none"> <li><input type="checkbox"/> Auto Technician</li> <li><input type="checkbox"/> Diesel-Electric</li> <li><input type="checkbox"/> Diesel Engines</li> </ul> <p><b>Mechanical Courses</b></p> <ul style="list-style-type: none"> <li><input type="checkbox"/> Aeronautical Engineer's, Jr.</li> <li><input type="checkbox"/> Aircraft Drafting</li> <li><input type="checkbox"/> Forging</li> <li><input type="checkbox"/> Heat Treatment of Metals</li> <li><input type="checkbox"/> Industrial Engineering</li> <li><input type="checkbox"/> Industrial Instrumentation</li> <li><input type="checkbox"/> Industrial Metallurgy</li> <li><input type="checkbox"/> Machine Shop</li> <li><input type="checkbox"/> Machine Shop Inspection</li> <li><input type="checkbox"/> Mechanical Drafting</li> <li><input type="checkbox"/> Mechanical Engineering</li> <li><input type="checkbox"/> Foundry Work</li> <li><input type="checkbox"/> Flight Engineer</li> </ul> | <ul style="list-style-type: none"> <li><input type="checkbox"/> Mold-Loft Work</li> <li><input type="checkbox"/> Patternmaking—Wood, Metal</li> <li><input type="checkbox"/> Reading Shop Blueprints</li> <li><input type="checkbox"/> Sheet-Metal Drafting</li> <li><input type="checkbox"/> Sheet-Metal Worker</li> <li><input type="checkbox"/> Ship Fitting</li> <li><input type="checkbox"/> Toolmaking</li> <li><input type="checkbox"/> Welding—Gas and Electric</li> <li><input type="checkbox"/> Car Inspector</li> <li><input type="checkbox"/> Diesel Locomotive</li> <li><input type="checkbox"/> Locomotive Engineer</li> <li><input type="checkbox"/> Locomotive Fireman</li> <li><input type="checkbox"/> Locomotive Machinist</li> <li><input type="checkbox"/> Railroad Section Foreman</li> <li><input type="checkbox"/> Steam and Diesel Loco. Eng.</li> <li><input type="checkbox"/> Boilermaking</li> <li><input type="checkbox"/> Combust. Engrg.</li> <li><input type="checkbox"/> Marine Engineering</li> <li><input type="checkbox"/> Power Plant Engr.</li> <li><input type="checkbox"/> Engine Running</li> <li><input type="checkbox"/> Steam Engineer</li> <li><input type="checkbox"/> Loom Fixing</li> <li><input type="checkbox"/> Textile Designing</li> <li><input type="checkbox"/> Woolen Manufacturing</li> </ul> |
|--|---|---|--|

Name \_\_\_\_\_ Age \_\_\_\_\_ Home Address \_\_\_\_\_

City \_\_\_\_\_ State \_\_\_\_\_ Working Hours \_\_\_\_\_ A.M. to \_\_\_\_\_ P.M.

Present Position \_\_\_\_\_ Employed by \_\_\_\_\_

Length of Service in World War II \_\_\_\_\_

Enrollment under G.I. Bill approved for World War II Veterans. Special tuition rates to members of the Armed Forces. Canadian residents send coupon to International Correspondence Schools Canadian, Ltd., Montreal, Canada.



# NOW! *this* FULL WEIGHT Blade in Handy Dispenser

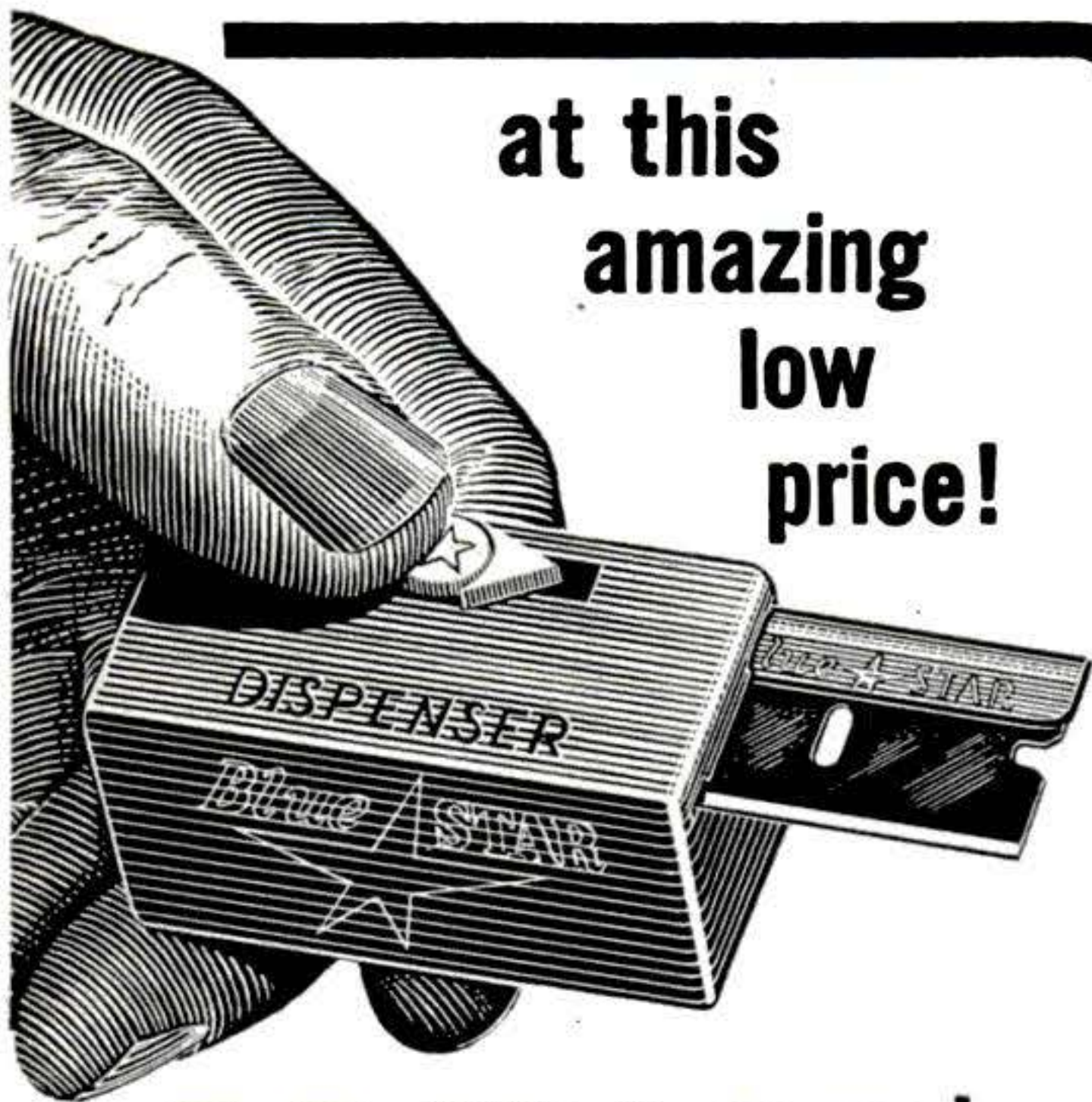

at this  
amazing  
low  
price!

**10** BLADES IN  
DISPENSER **25¢**  
REGULAR PACK 3 for 10¢

Try this sturdy, full-weight Blue Star on those tough, hard-to-shave spots. If *any* blue steel blade, at any price, gives you better shaves than Blue Star, we'll give you double your money back.

## Blue STAR

SINGLE EDGE

DOUBLE EDGE

PRECISION **A-S-R** PRODUCTS

AMERICAN SAFETY RAZOR CORP. BROOKLYN 1. N. Y.

4 POPULAR SCIENCE

Kaiser-Frazer Adds Crash Pads.....	140
Wigwag Signals Direct Movie Scenes.....	142
"Can Opener" Saves Lives.....	144
Plastic Foam Fills Plane Parts.....	145
750 Million Lumps of Sugar Every Day..	146
Trash Won't Clog New Pump.....	150
PS Reader Makes Own TV Color.....	151
How to Know Your Guided Missiles.....	158
Dual Turbine Produces 5,500 Hp.....	159
Machines Lay Biggest Gas Pipe.....	160

### Mechanics & Handicraft

Car Gives Photographer High Eye.....	185
The Laws No Car Can Violate.....	186
Jeep Rig Lifts Heavy Tanks.....	189
How to Build a Station Wagon.....	191
Rack Holds POPULAR SCIENCE Open....	195
Use Your Old Spools.....	196
Flower Bed with Terrace Fits Window..	198
Cozy Corner Costs Only \$17.....	214
Timesaving Tools for Woodworkers.....	216
Inside Mike Converts to Height Gauge....	220
Midget Hot Rod Hits 40 M.P.H.....	221
How to Build a Baby's Service Station..	226
Letters Pop Out of Hot Plastic.....	227
Service Table Folds Away.....	228
Make Your Own TV Cabinet.....	233
Chemical Stretches Kodachromes.....	236
How to Doctor Your Photos.....	238
You Can Do It with Conduit.....	240
Add Power to Your Sailboat.....	242

### Departments

Letters .....	18
Voice of Science.....	96
New Ideas from the Inventors.....	109
Aids to Modern Living.....	172
Keeping the Home Shipshape.....	175
Hints from the Model Garage.....	183
Craftsmen at Work.....	212
New Shop Ideas.....	218
What's Wrong?.....	225
I'd Like to See Them Make.....	234
New Tools.....	294
P.S. Last Minute News and Notes.....	298

### "Perky's" Pal

"PERKY" was a model airplane that Jack Wilson told POPULAR SCIENCE readers how to build last July. Its popularity prompted Wilson to tell you how to build a model car this month. It weighs only 4 ounces but goes 40 m.p.h. You'll find directions for building it on page 221.



**How amazing tube  
discovery seals punctures  
while you ride!**

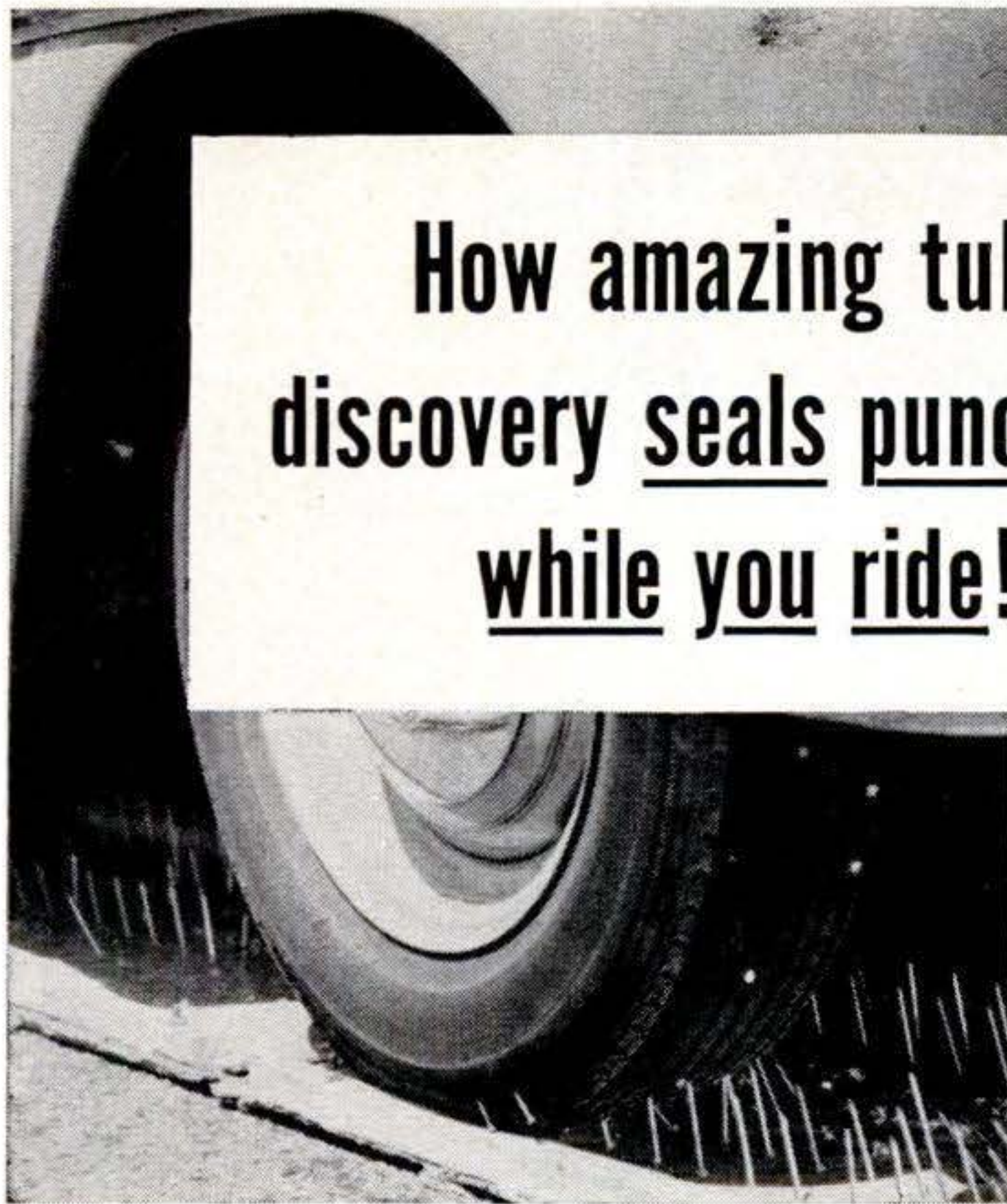

**1.** Sharp nails—*hundreds of them*—pierce deeply into this tire in grueling "Torture Test". What happens? Nothing! The tire does *not* go flat . . . the car keeps right on rolling!

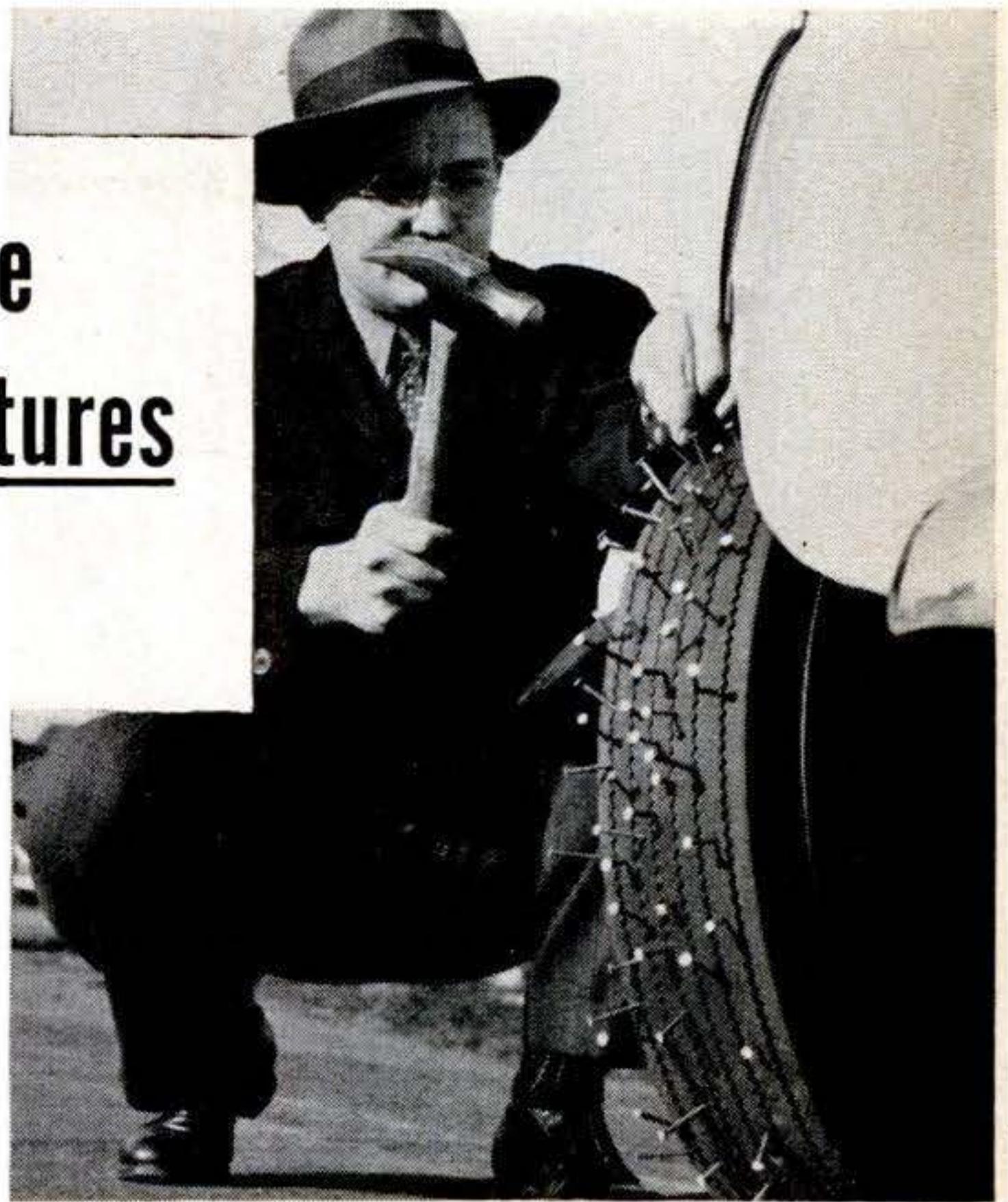

**2.** For good measure, *more* nails are pounded into the tire and through the tube. *Still no flat!* The secret lies in the amazing Sealed-Air Tube with patented Bulkheads perfected by Seiberling.

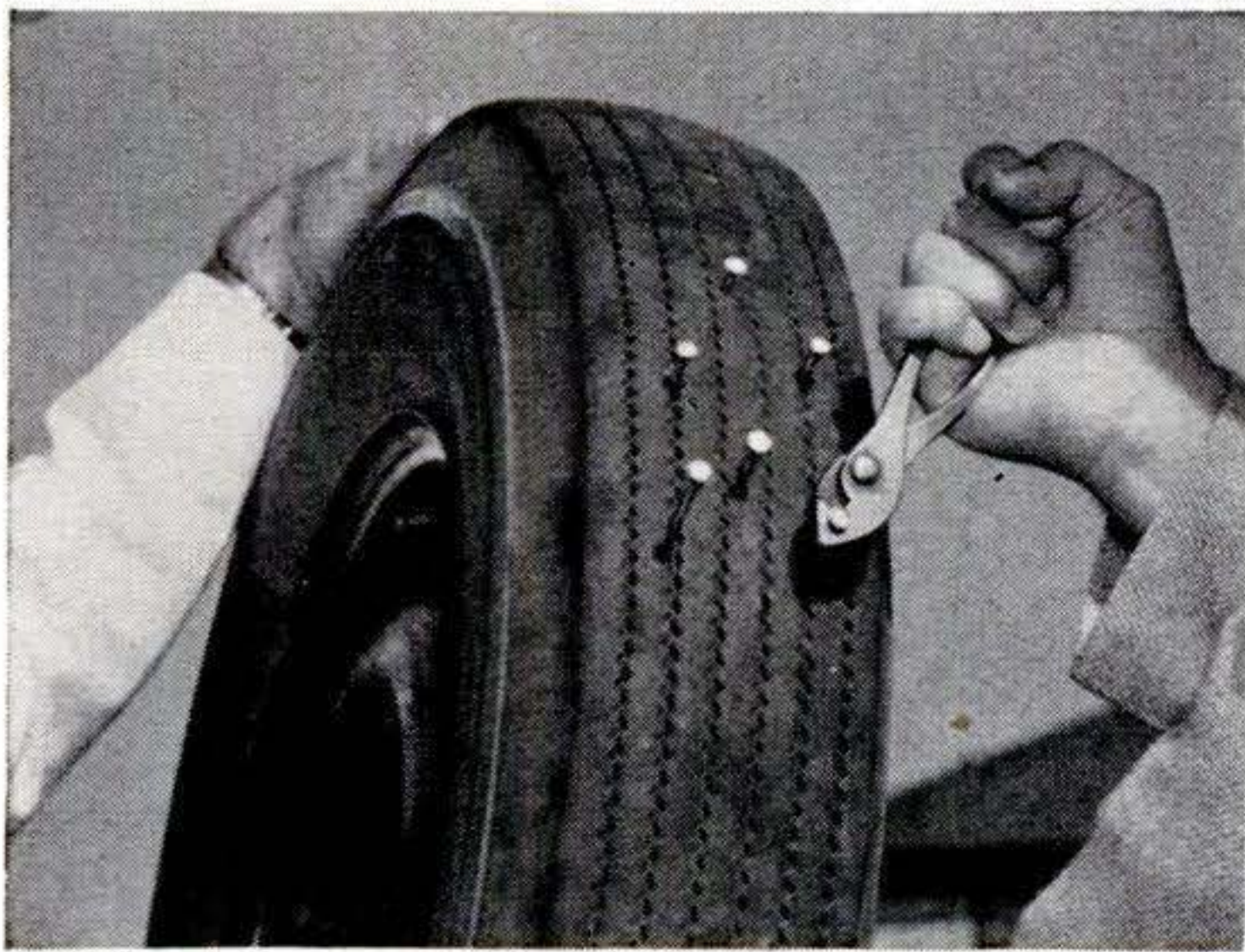

**3.** Here's how you "fix" a puncture when you have Seiberling Sealed-Air Tubes with patented Bulkheads. Just pull out the nail or other sharp object, and the tube seals itself *permanently!* No further repairs necessary!

**How can this tube  
outlast four tires  
WITHOUT GOING FLAT?**

How can this amazing Seiberling Sealed-Air Tube—the tube *no one* can imitate—actually outlast four tires, run as high as 300,000 miles—without even *one* flat? How can it save you many times its purchase price by eliminating the expense of tube repair bills and ruined tubes and tires? How can it make your driving immeasurably safer by protecting you from the dangers of sudden flats and blow-outs, and from the hazards of roadside tire changes? If you drive a car or truck, it will pay you many times over to fill in and mail the coupon below for the amazing story of what the Seiberling Sealed-Air tube can do for you.

**SEIBERLING**

*Sealed-Air* TUBES

WITH PATENTED BULKHEADS

**FREE!** Send coupon before you have another flat!

Learn more about the *only* tube built around the amazing Bulkheading principle. We'll send you, without obligation, our new book "10,189 PUNCTURES—AND NOT ONE FLAT!" Seiberling Rubber Company, Dept. PS-1, Akron 9, Ohio.

Name.....

Address.....

City.....State.....



# Now Look at all 3



## LOW-COST *Marlin* .22 CAL. REPEATERS

Marvels of modern production methods, these sturdy, safe, dependable Marlin Rifles will give you years of sport and utility at nominal cost.

They're man-size, handsome firearms, with selected American Walnut stocks; pre-tested at the factory for performance and accuracy before shipment. Look at all three at your dealer's now!

For "thrifty" shooters—  
a long-lasting load...

### MARLIN MODEL 81-DL

18-25 shots in one load. Pat. non-jamming feed. Shoots .22 short, long, long rifle—regular and high speed. Quick-release trigger—self-cocking—side ejection—Off and On safety—Am. Walnut stock. \$28.90\*

For quick shots on  
fast-moving small game...

### MARLIN MODEL 80-DL

8-shot clip magazine. Quick-release trigger—self-cocking—side ejection—Off and On safety—Am. Walnut stock. Peep or open sights; swivels. A honey for action on vermin or small game. \$24.15\*

Go-getter for "clean-up" of  
vermin or rapid-fire plinking...

### MARLIN MODEL 88C

15-shot semi-automatic, .22 long rifle ammo., greased or waxed, regular & high speed. Fires faster than you can pull trigger. Virtually foul-proof. *Cannot* be disassembled when cocked. Hooded ramp front sight, Rocky Mt. rear. Am. Walnut stock. \$29.95\*

*\*Prices slightly higher west of the Rockies and in Canada*

**THE MARLIN  
FIREARMS COMPANY**  
New Haven, Conn., U. S. A.



YOURS on request, full specifications on all Marlin Guns, with photo-illustrations, in new 80th Anniversary Catalog.\* Enclose 3¢ stamp for postage and handling. Mail coupon to Marlin, Dept. 56, New Haven, Conn.

*\*Sample pack of Marlin Blades included with our compliments*

NAME.....

ADDRESS.....



# Become an EXPERT ACCOUNTANT through LASALLE'S PROBLEM METHOD

WHAT is the LaSalle Problem Method of acquiring Higher Accountancy Training?

Certainly not the dull routine associated with ordinary study—not "book-learning" in the theoretical sense.

Under the Problem Method each week you are given an important accounting principle—then shown how the principle is applied. You are given a problem and its solution. After you fully understand the principle and its application, you are then given a problem which you work out for yourself and send in to LaSalle. Your solution is returned to you with comments. If it has not been properly solved you are shown your error and the correct method.

The entire procedure is practically first-hand personal experience gained by you direct from capable accountancy instructors. These men take an interest in you, check your individual needs and work with you step by step as you progress.

You study and learn under a tested, proven plan built around the Problem Method. You continuously learn by actually handling important accountancy problems, analyzing, working them out and thinking out your own decisions.

Thus you are coached in the practical solving of the very problems you face in a higher accountancy position. Step by step you work mat-



## More Money—A Better Position

ters out for yourself. At the end of your training, you have real ability and practical experience—the kind which fits you for positions that business is glad to reward with real money.

Don't confuse Accountancy with bookkeeping. The Accountant is the executive, the man who makes the big money—the bookkeeper does only the detail routine jobs at low pay.

You can become an expert accountant through the LaSalle Problem Method without any preliminary knowledge of bookkeeping. You will

be given whatever review you need. Mail the coupon now for full information.

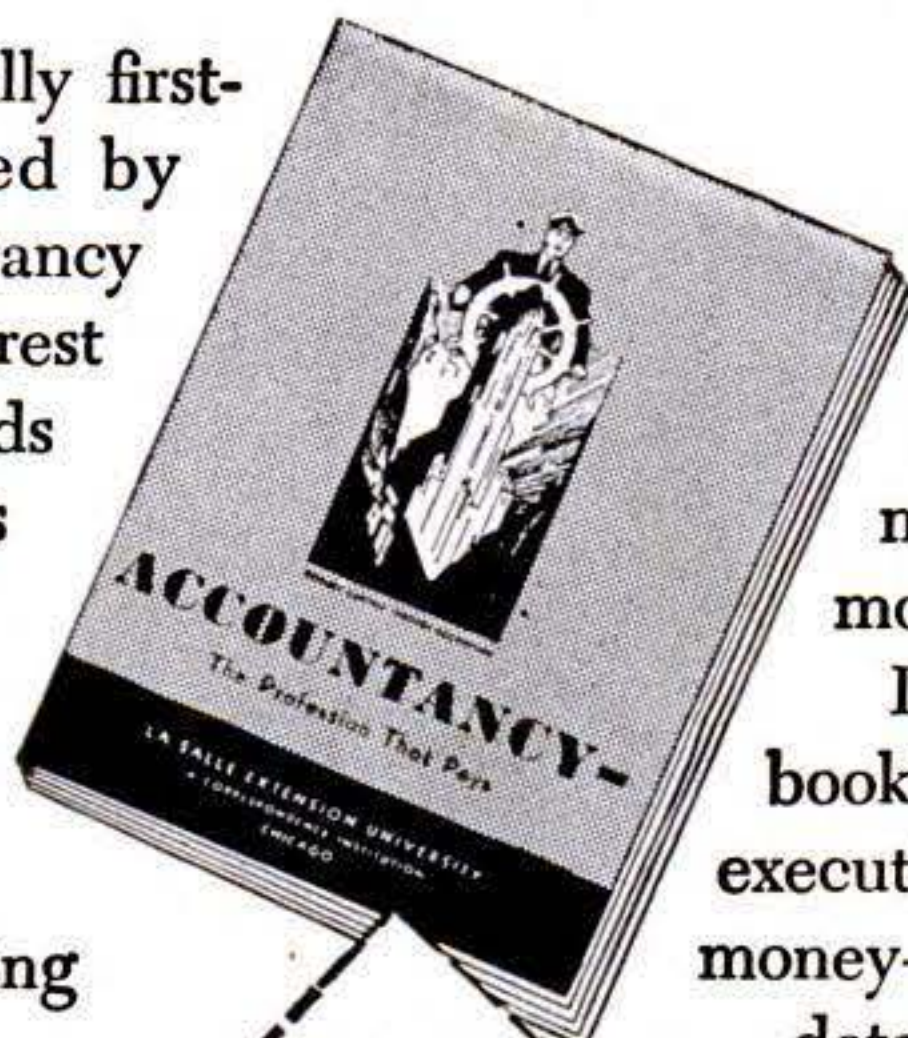

### FREE ACCOUNTING BOOKLET

Send me, without obligation, your 48-page booklet "Accountancy, the Profession that Pays"—plus "Ten Years' Promotion in One" a book which has helped many men.

**GET STARTED NOW**

**Send for the Facts TODAY!**

NAME.....

ADDRESS..... AGE.....

CITY.....ZONE.....STATE.....

**LASALLE EXTENSION UNIVERSITY**  
A Correspondence Institution

**Dept. 383-HR**  
Chicago 5, Ill.

#### OTHER LASALLE OPPORTUNITIES

- |   |   |  |
|---|---|--|
| <input type="checkbox"/> C.P.A. Coaching    | <input type="checkbox"/> Indus'l Management | <input type="checkbox"/> Stenotypy (Machine Shorthand) |
| <input type="checkbox"/> Bookkeeping        | <input type="checkbox"/> Traffic Management |  |
| <input type="checkbox"/> Law: LL.B. Degree  | <input type="checkbox"/> Foremanship        |  |
| <input type="checkbox"/> Business Managem't | <input type="checkbox"/> Salesmanship       |  |



# CHECK YOUR PET AMBITION:



TO SAVE \$100 A MONTH AFTER ALL BILLS ARE PAID.



TO TRADE IN YOUR OLD CAR ON A 1950 MODEL.



TO BUY A HOUSE THAT HAS THREE BED-ROOMS.



TO FLY TO HAWAII FOR YOUR VACATION.



TO HAVE A JOB THAT OFFERS REAL SECURITY.



TO OWN A BUSINESS—AND BE YOUR OWN BOSS.

**IF YOU CHECKED ONE OR MORE — YOU'D BETTER LEARN A TRADE!**

## Learn in months through C.T.I.

Yes, if you wish to realize any of the ambitions shown above, you'd better refer to the coupon below and check a trade that you ought to learn! Many C.T.I. graduates who once followed this simple suggestion now earn good money, enjoy security, and can afford the best things in life!

These comments by C.T.I. men prove that technical skill pays rich rewards: "Since the news got around that I was a student with C.T.I., I was offered three jobs paying over \$85.00 a week." . . . "I have a shop on the north side and have four men working for me." . . . "Since beginning your course I have more than doubled my earnings." . . . "Your course was very satisfactory. I own my own shop now." . . . "Through the efforts of C.T.I. I received a job that I like very much." . . . "I am in partnership with a fellow student from good old C.T.I. Business is very good."

### FILL OUT - CUT OUT - MAIL TODAY

Mr. R. C. Anderson, President  
COMMERCIAL TRADES INSTITUTE, Dept. E1-3  
1400 Greenleaf Ave., Chicago 26

Veteran  
 Non-Veteran

Send free illustrated Brochures and other information about the field I have checked below:

- |   |  |
|---|--|
| <input type="checkbox"/> Automotive Mechanics             | <input type="checkbox"/> Electricity & Electronics |
| <input type="checkbox"/> Body & Fender Rebuilding         | <input type="checkbox"/> Radio & Television        |
| <input type="checkbox"/> Diesel Mechanics                 | <input type="checkbox"/> Building Construction     |
| <input type="checkbox"/> Refrigeration & Air Conditioning | <input type="checkbox"/> Mechanical Drafting       |

Name \_\_\_\_\_ Age \_\_\_\_\_

Address \_\_\_\_\_

City \_\_\_\_\_ State \_\_\_\_\_

If you are mechanically inclined—if you have a strong desire to "be somebody"—to get ahead in life—fill out and mail coupon today!

## CHOOSE YOUR FUTURE NOW!

The list at right tells you what fields offer the best chances for success. Each is a great industry. You can learn any of these trades within months—either through C.T.I. Home Study or at our Resident School. Get the facts! Mail coupon now!

### C.T.I. OFFERS PRACTICAL TRAINING IN

- AUTOMOTIVE MECHANICS
- BODY & FENDER REBUILDING
- DIESEL MECHANICS
- REFRIGERATION & AIR CONDITIONING
- ELECTRICITY & ELECTRONICS
- RADIO & TELEVISION
- BUILDING CONSTRUCTION
- MECHANICAL DRAFTING

**G.I. APPROVED**—All C.T.I. courses, both residential and home study, are fully approved by the Veterans Administration—which means that eligible veterans will have their tuition paid by the government. Remember, there's a time limit on when training must begin—so, act now!

**COMMERCIAL TRADES INSTITUTE, Dept. E1-3**

1400 Greenleaf - Chicago 26





# WHAT Every AUTO MECHANIC Wants to Know

A motor vehicle is a machine of many parts, each part designed and constructed for its own special function.

All good mechanics, like good doctors, should know the working theory and operation of each part and understand what causes trouble and how to remedy it.

## LET AUDELS AUTO GUIDE SOLVE YOUR PROBLEMS

Every auto mechanic, helper, serviceman and operator can use a copy of AUDELS AUTOMOBILE GUIDE. The information it gives saves time, money and worry. Highly indorsed by all users. It presents the whole subject of auto mechanics from A to Z in plain language and simple terms.

This Big Practical Book gives full information with working diagrams covering the principles, construction, ignition, service and repair of modern cars, trucks and buses.

A complete Guide of 1800 pages, with over 1500 illustrations showing inside views of the working parts, with instructions for service jobs. Diesel engines, Fluid and Hydra-matic drives fully explained.

## IT PAYS TO KNOW HOW TO

How to fit pistons—How to locate engine knocks—How to fit connecting rod bearings—How to service main bearings—How to recondition valves—How to time valves—How to adjust fan belts—How to adjust carburetors & chokes—How to rebuild a clutch—How to service automatic transmissions—How to service brakes—How to adjust steering gear—How to cope with ignition troubles—How to service distributors—How to time ignition—How to "tune up" an engine.

## INFORMATION IN A HANDY FORM

73 INTERESTING CHAPTERS—Read this partial list of subjects on which practical information is fully given for quick reference under the headings as shown below. Ready Reference Index.

All Parts of an Automobile—Automotive Physics—The Gas Engine—Gas Engine Principles—Multi-Cylinder Engines—Horse Power—Automobile Engines—Stationary Parts—Moving Parts—Pistons—Piston Rings—Connecting Rods—Crank Shafts—Valves—Valve Gear—Cams and Cam Action—Valve Timing—Cooling Systems—Fuel Feed Systems—Dual Fuel Feed—Mixture—Carburetors—Carburetor Service—Automatic Choke—Super-Chargers—Transmissions—Special Transmissions—Fluid and Hydra-matic Drives—Clutches—Universals and Propeller Shafts

A Ready Reference

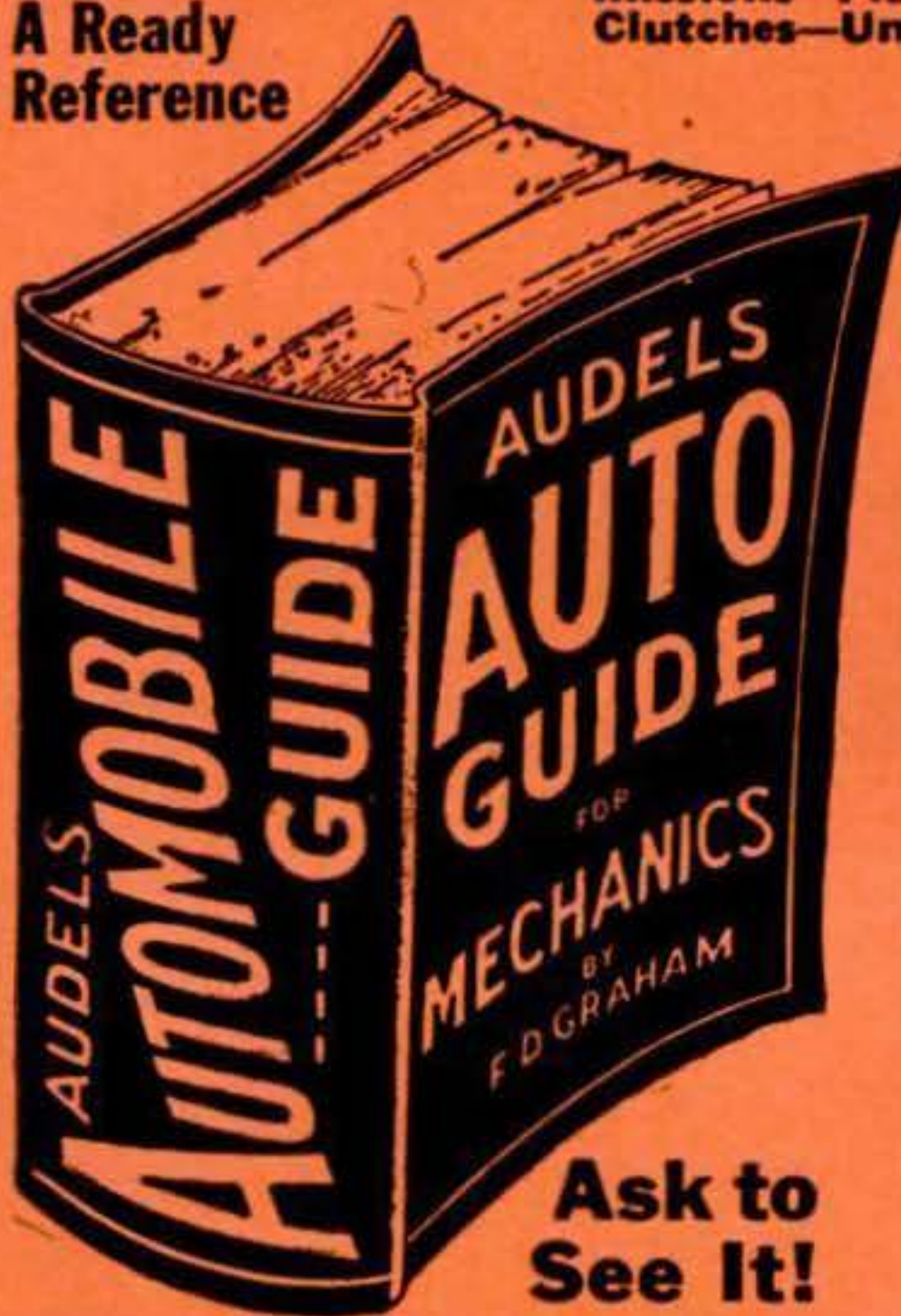

Ask to See It!

—The Differential—Rear Axles—Rear and Front Suspension—Running Gear—Brakes—Wheel Alignment—Knee Action—Steering Gear—Tires—Lubricants and Lubrication—Automotive Electricity—Ignition Systems—Magneto Ignition—Spark Plugs—Ignition Coils—Distributors—Automatic Spark Control—Ignition Timing—Generators—Starters—Generator and Starter Testing—Lighting Systems—Storage Batteries—Charging and Testing—Diesel Engines and Trouble Shooting.

**7 DAYS' FREE TRIAL**  
TO GET THIS ASSISTANCE FOR YOURSELF SIMPLY FILL IN AND MAIL COUPON TODAY.

**\$ 4 COMPLETE PAY \$ 1 A ONLY 1 MO.**



## Sent on 7 Days Approval

Step up your own skill with the facts and figures of your trade. Audels Mechanics Guides contain Practical Inside Trade Information in a handy form. Fully illustrated and Easy to Understand. Highly Endorsed. Check the book you want for 7 DAYS FREE EXAMINATION. Send No Money. Nothing to pay postman.

## ---CUT HERE--- MAIL ORDER

AUDEL, Publishers, 49 W. 23 St., NEW YORK 10, N. Y.

Please send me postpaid for FREE EXAMINATION books marked (x) below. If I decide to keep them I agree to mail \$1 in 7 Days on each book or set ordered and further mail \$1 monthly on each book or set until I have paid price, otherwise I will return them.

- AUTO GUIDE**, 1800 Pages . . . \$4
- DIESEL ENGINE MANUAL, 400 Pages . . . 2
- WELDERS GUIDE, 400 Pages . . . 1
- MACHINISTS Handy Book, 1600 Pages . . . 4
- POWER PLANT ENGINEERS Guide, 1500 Pages. . . 4
- ENGINEERS & FIREMANS EXAMS, 528 Pages. . . 1
- PUMPS, Hydraulics & Air Compressors, 1658 Pgs. . . 4
- MARINE ENGINEERS Handy Book, 1280 Pages . . . 4
- ENGINEERS & Mechanics Guides (8 Book Set). . . 12
- Answers on Practical ENGINEERING, 254 Pages . . . 1
- ELECTRIC WIRING DIAGRAMS, 210 Pages . . . 1
- ELECTRICIANS EXAMINATIONS, 250 Pages. . . 1
- ELECTRICAL DICTIONARY, 9000 Terms . . . 2
- ELECTRIC MOTOR GUIDE, 1000 Pages . . . 4
- HANDY BOOK OF ELECTRICITY, 1440 Pages . . . 4
- ELECTRICAL POWER CALCULATIONS, 425 Pgs. . . 2
- RADIOMANS GUIDE, 914 Pages . . . 4
- ELECTRONIC DEVICES, 216 Pages . . . 2
- ELECTRIC LIBRARY, 7000 Pages (12 Book Set). . . 18
- Vols. I, II, III, IV, V, VI, VII, VIII, IX, X, XI, XII \$1.50 Ea. . . 1
- OIL BURNER GUIDE, 384 Pages . . . 4
- HOUSE HEATING GUIDE, 1000 Pages . . . 4
- CARPENTERS & Builders Guides (4 Book Set). . . 6
- PLUMBERS & Steamfitters Guides (4 Book Set). . . 6
- MASONS & Builders Guides (4 Book Set) . . . 6
- BLUE PRINT READING, 416 Pages . . . 2
- PAINTERS & DECORATORS MANUAL, 450 Pgs. . . 2
- GARDENERS & GROWERS Guides (4 Book Set). . . 6
- REFRIGERATION & Air Conditioning, 1280 Pgs. . . 4
- SHEET METAL WORKERS Handy Book, 388 Pgs. . . 1
- SHEET METAL PATTERN LAYOUTS, 1100 Pgs. . . 4
- AIRCRAFT WORKER, 240 Pages . . . 1
- MECHANICAL DRAWING GUIDE, 160 Pages. . . 1
- MECHANICAL DRAWING & DESIGN, 480 Pgs. . . 2
- MATHEMATICS & CALCULATIONS, 700 Pgs.. . . 2
- MECHANICAL Dictionary, 968 Pages . . . 4
- MILLWRIGHTS & Mechanics Guide, 1200 Pgs. . . 4

Name \_\_\_\_\_

Address \_\_\_\_\_

Occupation \_\_\_\_\_

Employed by \_\_\_\_\_ PSM

AUDEL, Publishers, 49 W. 23 St., New York 10, N. Y.





# BEYOND EARTH

## What Strange Cosmic Power Influences Humans ?

BY WHAT RIGHT does man presume that he is the chosen being of the universe and that the earth alone shapes his existence? In the infinite spaces above, tenanted by vast and magnificent worlds, are Cosmic forces which influence the life of every mortal. As iron filings respond to the attraction of a magnet, so too, your acts are the result of an impelling influence upon your will. Just as the unseen Cosmic rays give the earth form and substance, so too, from the infinite reaches, an invisible subtle energy affects the thought processes of every human. Life itself bows to this strange universal force—why, then, should YOU not understand and COMMAND IT? You are like a pendulum either to be swung forward to happiness and the fulfillment of your dreams, or backward into discouragement and disillusionment. Why remain poised in a state of anxiety, uncertainty, and anticipation? Learn to draw to yourself these Cosmic forces which will give your mind the creative impetus that will assure the end in life you seek.

### For You — A Gift Copy of the Sealed Book

Not for the curious nor the skeptical, but for the modern man and woman the Rosicrucians, a progressive movement of thinking persons, offer a free, Sealed Book, telling how you may acquire the truth about these phenomenal Cosmic powers little understood today and which make for freedom and attainment in life. THIS IS THE DAY AND AGE OF MASTERY. Throw off the age-old custom of—"let life be as it may"—and learn to *create it as you wish it.*

**The ROSICRUCIANS**  
(AMORC)  
SAN JOSE, CALIFORNIA

#### USE THIS GIFT COUPON

Scribe Q.M.L. The Rosicrucians (AMORC)  
Rosicrucian Park, San Jose, California.

Please send me without obligation the free, Sealed Book, which tells how I may obtain the unusual facts about the Cosmic forces which affect my life.

NAME.....

ADDRESS.....

CITY..... STATE.....

✦ *The Rosicrucians are NOT a Religious Organization* ✦





Get  
Into

# RADIO, TELEVISION and ELECTRONICS

## Master ALL Phases

**Get Complete Training. You Receive and Keep All Tubes, Equipment, Parts and Lessons. No Extra Charges.**

**GOOD PAY  
and Unlimited Opportunities  
in JOBS LIKE THESE:**

Business of Your Own  
Radio Manufacturing, Sales, Service  
Broadcasting Telecasting  
Television Manufacturing,  
Sales, Service  
Laboratories: Installation, Maintenance of Electronic Equipment, Electrolysis, Call Systems  
Garages: Auto Radio Sales, Service Sound Systems and Telephone Companies; Oil Well and Drilling Companies; Engineering Firms  
Theatre Sound Systems Police Radio  
And scores of other good jobs  
in many related fields

**YOU CONDUCT MANY  
EXPERIMENTS LIKE THESE!**

Checking action of condensers  
Experiments with AF and RF Amplifiers  
Experiments with resonance  
Producing beat frequencies  
Calibrating oscillators  
Experiments with diode, grid-bias, grid-leak and infinite impedance detectors  
Practical experience in receiver trouble shooting  
Application of visual tester in checking parts and circuits  
Experiments with audio oscillators  
Advanced trouble-shooting  
... and many, many others

**Complete Training by Practical  
Resident Trade School, Est. 1905**

The same highly trained faculty, instruction materials and methods used here in our large, modern resident school, are adapted to your training in your own home. Shop Method Home Training has been proved by hundreds of successful graduates.

**Both Resident and Home Study  
Courses Offered**

**YOU  
LEARN BY  
DOING**

You receive special laboratory experiment lessons to show you how to build with your own hands various experimental units such as those shown at left, and how to conduct many tests.

**YOU  
Build This  
Superheterodyne**

You receive complete standard equipment, including latest type High-Mu Tubes, for building various experimental and test units. You progress step by step until you build a complete Superheterodyne Receiver. It is yours to use and keep.



**YOU RECEIVE THIS  
PROFESSIONAL MULTITESTER!**

You will use this professional instrument to locate trouble or make delicate adjustments—at home—on service calls. You will be proud to own this valuable equipment. Complete with test leads.

**SIGNAL GENERATOR**

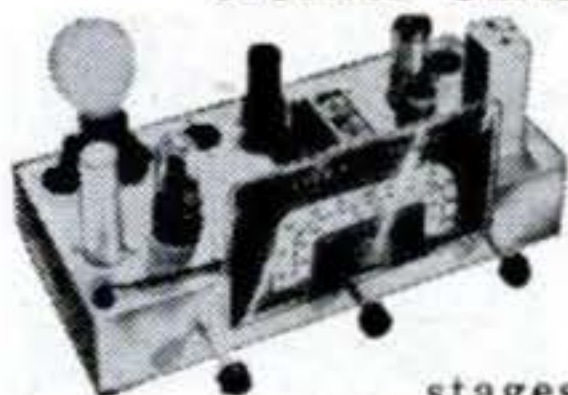

You construct the Transatron Signal Generator shown here, demonstrating Transatron principles in both R.F. and A.F.

stages. You study negative type oscillators at firsthand.

**AUDIO OSCILLATOR:**

An electronic device, which produces audio-frequency signals for modulating R.F. (radio frequency) carrier waves, testing A.F. (audio frequency) amplifiers, speakers, etc.



**T.R.F.  
RECEIVER**

You build several T.R.F. Receivers, one of which, a 4-tube set, is shown here. You learn construction, alignment, make receiver tests, and do trouble shooting.

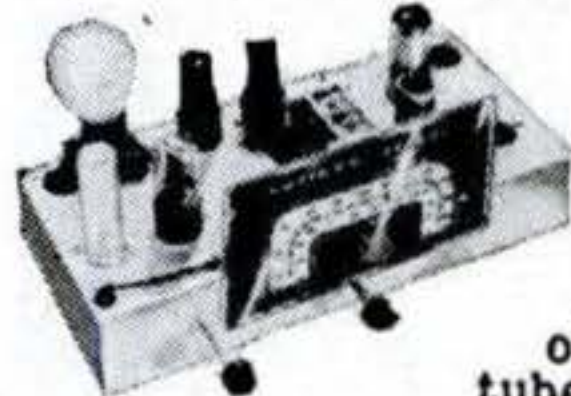

You will find all lessons easy to understand because they are illustrated throughout with clear diagrams and step-by-step examples that you work out yourself. Every piece of the equipment and complete lesson material we send you is yours to keep and enjoy, including the multitester, experimental equipment, all parts of the Superheterodyne, tube manual, radio dictionary, and complete, modern Television texts. All parts are standard equipment.

**Shop Method Home Training . . .  
Earn While You Learn**

With our practical resident Shop Method Home Training, you study in your spare time. You receive Spare Time Work Lessons, which show you how to earn while you learn. Service neighbors' radios and TV receivers, appliances, etc., for extra money and experience. Many National students pay all or part of their training with spare-time earnings!

**DON'T DELAY! The Radio-Television  
Industry needs trained men NOW!**

**APPROVED  
FOR  
VETERANS!**  
Check coupon below!

For quick action,  
mail coupon  
today and we'll  
rush you full information.

**Free!**

NEW, ILLUSTRATED  
OPPORTUNITY  
BOOK AND SAMPLE  
LESSON SHOW YOU  
HOW WE TRAIN  
YOU . . . SEND FOR  
THEM TODAY! NO  
COST. NO  
OBLIGATION.



**NATIONAL SCHOOLS**

LOS ANGELES 37, CALIF. • EST. 1905



**FIND OUT NOW . . . MAIL COUPON TODAY**

National Schools, Dept. PS-3  
4000 South Figueroa Street  
Los Angeles 37, California

Send me your FREE book "Your Future in Radio" and the sample lesson of your course. I understand no salesman will call on me.

NAME..... AGE.....

ADDRESS .....

CITY..... ZONE..... STATE.....

Check here if Veteran of World War II

Mail in envelope  
or paste on  
penny postal.



**FREE**  
7-DAY TRIAL

# HOW TO BUILD A BETTER HOME

If You Are Undecided Whether You Should Build or Buy—  
If You Are Leery of 'Cheap' Building, Shoddy Work or Poor Design—  
If You Are Fed-Up With DREAMING About Your New House and  
Want to Get STARTED—Then This Will Prove a GOD-SEND to YOU!

JUST MAIL COUPON

HERE is the answer to how to build your own home. Here is the WORKS—how to plan, how to construct, how to supervise—simply, clearly explained step-by-step. Jam-packed with everything you need to know about building your own home yourself, or having a contractor build it for you. Hundreds of clear-cut, complete diagrams. You will be able to build a home that will amaze everyone!

Everything You Need to Know to Get Started

**Some of the Things This Book Explains:**

Here at Your Fingertips, the Secrets that Produce Fine Small Homes—Completely Revealed in this Great-Easy-Reference Book! How to Get Started; Deciding Upon Home Ownership; How to Select Professional Service; How to Finance Your Home; How to Select a Building Lot; How to Plan the Home; Where to Get Stock Plans; Taxes, Insurance, Interest, Maintenance, Assessments; How to Choose a Bank, Real Estate Dealer, Contractor; Locating House on Lot, Tax Searches, Comparative Costs, Designs; Prefabricated Houses; How to Fill Out Contract Documents; How to Obtain Good Construction; How to Prevent Termites; How to Prevent Decay; How to Prevent Corrosion; How to Lay Out Building, Excavate, Grade; Monolithic Concrete Construction; Masonry Construction; Footings for Foundation Walls, Chimneys, Piers; How to Build Piers, Foundation Walls; Basement Construction; How to Waterproof Basements and Foundation Walls; How to Build Chimneys and Fireplaces; How to Select the Proper Species and Grades of Wood; House Framing Methods and Details; Finish Carpentry and Millwork; How to Insulate; Sheet-Metal Work, Roofing, Stucco, Lath and Plaster; How to Paint and Finish; Tile Work, Electrical Work, Plumbing, Heating; List of Over 100 Free Publications for the Home Builder; Bungalows, List of Usual Mistakes; Architectural "Don'ts" and over 300 additional paragraphs of important information. QUICK REFERENCE INDEX to SPECIAL PAGE-SIZE PLATES (HUNDREDS OF ILLUSTRATIONS)

Footings—foundation walls—basements; Garage floor, footings, etc.—septic tank—grease trap—area for basement window; Concrete porches, steps, automobile runways and driveways and walks; Brick steps, walks and terraces; Brick, tile and stone wall details—flagstone and stepping stone walks; Masonry dwellings—brick veneer walls; Chimney and fireplace details; Balloon framing details (minimum-shrinkage type; Balloon framing details (box sill type); Roof framing details; Basement columns and girders—framing of openings—bridging; Miscellaneous framing details; Watertables—exterior sidewalls of siding or shingles—cornices—porch columns; Double-hung wood window details; Door frame details—points for millwork—stock doors and windows—sash details; Paneling—stairwork—baseboard details; Termite shields—miscellaneous flashings; Flashing details; Gutters and leaders (downspouts); Roofing details.

Nothing Like It Before! One Simple Fact May Repay you a HUNDRED Times its Small Cost. A Book You Will Refer to for Years to Come!

**Read What Great Building Authorities Say About This Amazing Book (names on request)**

Excerpts from typical letters of praise:  
"... the best book on the subject that has been published to date." "was thrilled" "valuable information for the new home-builder."  
"... an excellent piece of work" "helped us decide our building plans" "well worth price."  
"... very much impressed... an excellent reference book."  
"... the writing is clear and compact... complete and unbiased information."  
"... most interesting and complete." "You are to be congratulated. Contains more information than any volume seen... Everything you said."  
"... One of the best works of its kind I have ever seen. Send me 10 more for presents."  
And from an amateur:  
"From this book, I did the plans myself! Had never done anything like it before... A neighboring architect said I was an up-and-coming designer and he found not one fault with my plans... The building is now finished and everyone says it's beautiful!... I saved \$1900!"

Provides you with all the facts Whether you are going to spend \$2,000 or \$20,000 for your home—whether you are going to employ an architect or use stock plans—or whether you are going to buy a house instead of building, this book will help you. Before you build you should know the difference between good and bad construction. Now—in these days of shortages—just one of the hundreds of diagrams can save you thousands of dollars. You will get a thrill out of being "in the know," being "wise" to the game, being able to talk to building people in their own language. You'll be respected, admired and get better workmanship on your home. You'll get a feeling of pride as your friends admire the home being built. Here, in one clear-cut volume is all the basic information you will need!

**Where to Begin**

No matter what your building problem may be, you will find the answer in this amazing volume. No truth is kept from you. You are told the disadvantages of home ownership as well as the advantages. You are told of the precautions you will need to safeguard your investment. You are shown how to select a lending institution, a lawyer, a real estate dealer, an architect, a contractor. Your questions on methods of buying are fully answered. Just a quick glance at the partial table of contents on this page will show you some of the thousands of facts on building which this complete volume contains. Those who have bought a copy write that they have never seen so thorough a work on this subject for any price, anywhere!

**Hundreds of Construction Details**

Explains all the "mysteries" of permits, contract forms, and construction. Tells you how to build the right kind of home, how to avoid "cheap," cracker-box construction, how to get a house that is suitably located, beautiful to look at and priced within your means—a house you will be proud to call your home.

**How to Build—from Plans to Paint**

Not one important step is missing from this volume. See for yourself. Every conceivable thing you would want to know about building will be found in this wonderful new book!

**SEND NO MONEY**  
Examine It for 7 Days  
**FREE!**

You don't even risk a cent to examine "How to Build a Better Home." Just mail coupon. Study book for a week, FREE! See how easy it is to supervise or build a better home. YOURSELF—even if you know nothing about construction NOW! Then, if you are THRILLED with this amazing volume, send only \$3.98 (plus postage) (split it into two monthly payments if you wish.) If you are not thrilled, return book and pay nothing! This is your chance to build not just a house, but a BETTER HOME! Mail FREE EXAMINATION COUPON NOW, to The Westport Publishing Company, Dept. SP-3, Westport, Conn.

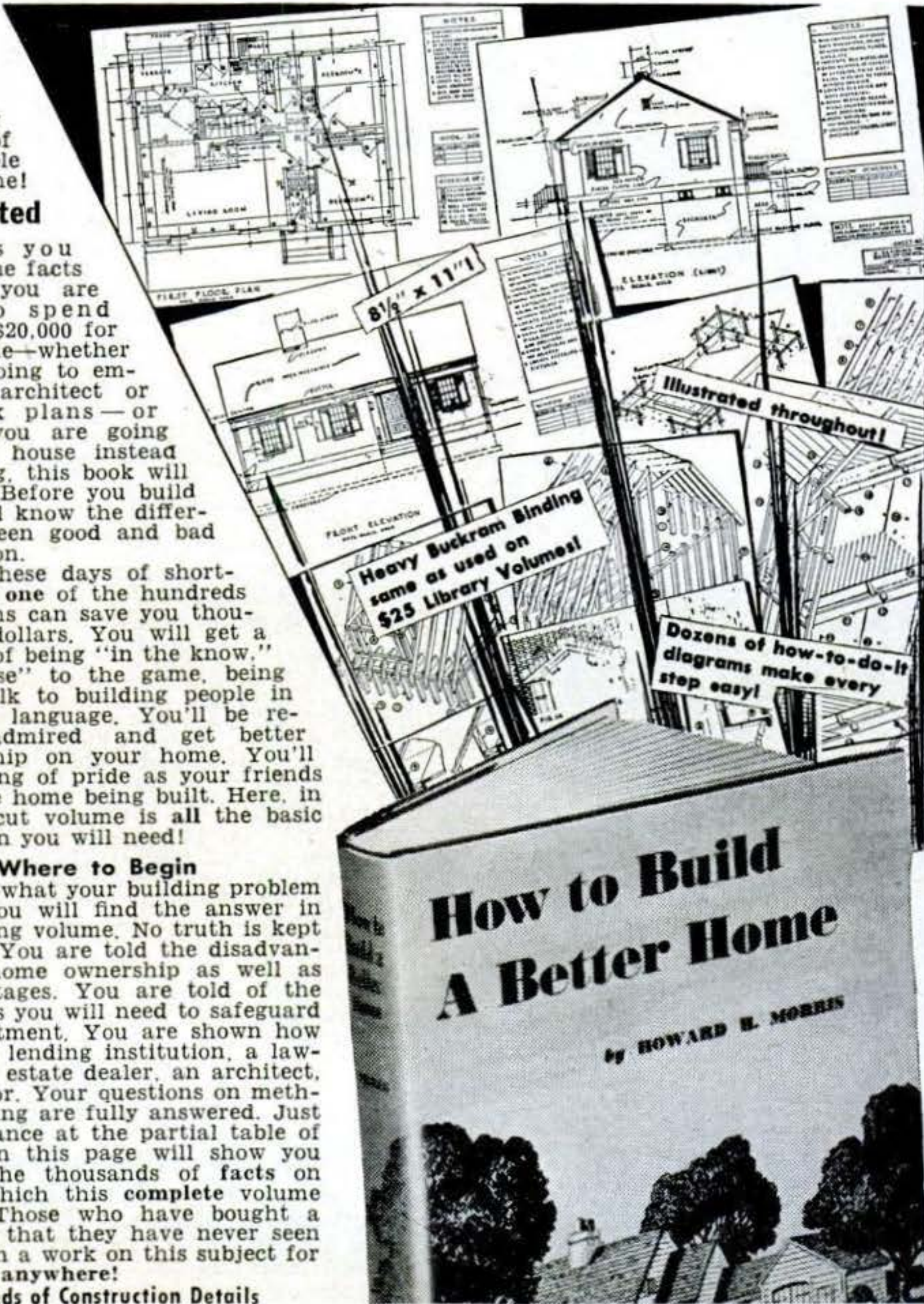

Heavy Buckram Binding same as used on \$25 Library Volumes!

Dozens of how-to-do-it diagrams make every step easy!

How to Build A Better Home  
By HOWARD E. MORRIS

**FREE Examination Coupon—Mail Now**

The Westport Publishing Company, "Books of Merit," Dept. SP-3, Westport, Conn.

Please send me, for one week's FREE EXAMINATION, a new de-luxe edition copy of "How to Build a Better Home." After 7 days I will either return this book and owe nothing, or I will keep it and send you \$3.98 (plus shipping charges). (In two monthly payments, if I wish.)

Name.....Age.....  
(please print)

Address.....

City & Zone.....State.....

Save postage. Check here if you enclose full payment of \$3.98 (check or money order) WITH coupon. WE then pay shipping. If not thrilled return and we will refund your money by AIR MAIL! Foreign Orders \$4.50 Cash with order.



Prepare in our  
Big Training  
Shops for these

# GREAT OPPORTUNITY FIELDS!



## FIVE BIG FLOORS PACKED WITH MASSIVE EQUIPMENT

Thousands of men and young men have come to our big training shops where we have floor upon floor packed with massive equipment to train with, to prepare for good jobs and real futures in the opportunity fields of Electricity and Radio-Television. For many years, these fields have offered great opportunities to trained men. With new developments, including Electronics and Television, they will continue to grow and offer even greater opportunities. Why be satisfied with a "no future" job? Many "one operation" jobs that exist today will not last. Prepare for a good job with a real future for steady pay and advancement by training NOW in the great training shops of COYNE in Chicago.

### NOT "HOME-STUDY" COURSES

Our famous Radio-Television Practical-Technical method gives you practical experience on a massive outlay of equipment. Not by correspondence, but actual shop work plus necessary technical training. You are trained right here in the great Coyne shops that have been training men and young men for over 50 years.

## ELECTRICITY RADIO-TELEVISION

### INCLUDING INDUSTRIAL ELECTRONICS

Big future in Power Plant Work, Motors, Armature Winding, Home and Factory Wiring, Appliances, Refrigeration, Maintenance, Illumination, etc. Electricians are in demand everywhere—lifetime job service to Coyne graduates. Send for BIG FREE BOOK.

A great field now, even greater growth ahead. Here at COYNE you're trained for Construction, Testing, Trouble-Shooting on Radio, Public Address, Sound Units. Training includes FM, Television Servicing, etc. Many Coyne trained men in good jobs or own well paying Radio-Television businesses of their own.

### ELECTRIC REFRIGERATION

This valuable training now included with either course means added opportunities.

### G. I. APPROVED

NON-VETERANS who are short of cash can finance most of their tuition and pay in easy monthly payments after graduation. Many earn while learning.

B. W. COOKE, President

**COYNE** ELECTRICAL AND RADIO-TELEVISION SCHOOL  
500 So. Paulina St., Dept. 30-73H, Chicago 12, ILL.

## LARGEST, OLDEST, BEST EQUIPPED SCHOOL OF ITS KIND IN THE U.S.

### Mail Coupon for Big FREE Book!

Whether you prefer Electricity, or Radio-Television, train on actual equipment at Coyne. We have a big, fully illustrated book on each course, and we'll send you the one you want, or both if you want to consider both fields, without obligation. Mail coupon—TODAY.



B. W. Cooke, President  
COYNE ELECTRICAL AND RADIO-TELEVISION SCHOOL 500 S. Paulina St.,  
Dept. 30-73H, Chicago 12, Ill.

Send me the book, checked below and details of your training offer. This does not obligate me and no salesman will call.

ELECTRICITY  RADIO-TELEVISION

NAME.....

ADDRESS.....

CITY..... STATE.....



# draw me!



COPY THIS GIRL AND TRY FOR  
**\$1200 in PRIZES**

**5 Prizes in this April Contest! 5 Complete \$240  
Art Courses, including Drawing Outfits!**

**Here's your big chance, if you want to become a commercial artist, designer, or illustrator! An easy-to-try way to win FREE art training!**

**Whether you win or not** our instructors send you their comments on your work, if your drawing shows promise! Trained illustrators and artists now making big money. Find out now if YOU have profitable art talent. You've nothing to lose—*everything to gain*. Start your drawing now. Mail it today.

 **ART INSTRUCTION, INC., DEPT. 3140**  
500 S. 4th St., Minneapolis 15, Minn.

Please enter my attached drawing in your April drawing contest.  
(PLEASE PRINT)

Name \_\_\_\_\_ Age \_\_\_\_\_  
Address \_\_\_\_\_ Phone \_\_\_\_\_  
City \_\_\_\_\_ Zone \_\_\_\_\_ County \_\_\_\_\_  
State \_\_\_\_\_ Occupation \_\_\_\_\_

**RULES:** You must be amateur. Our students not eligible. Make copy of girl 5 ins. high. Pencil or pen only. Omit lettering. All drawings must be received by April 30, 1950. None returned. Winners notified. If desired, send stamped, self-addressed envelope for winner list.



Member

*Art Instruction, Inc.*  
MINNEAPOLIS • NEW YORK  
CHICAGO • LOS ANGELES



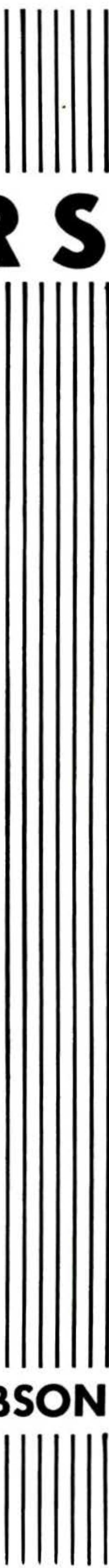

# INVENTORS

Learn how to protect your invention. The U. S. Patent Laws provide that any new and useful art, machine, article of manufacture, or composition of matter, or any new and useful improvement thereof, may be patented if the act of invention is involved. Therefore, every inventor with a valuable invention should take advantage of the Patent Laws and proceed for patent protection in order to safeguard his rights.

A patent gives the inventor the exclusive right to prevent others from making, using, or selling the invention claimed in the patent for a period of seventeen years.

The Patent Laws were enacted for the benefit of the inventor to give him protection for the features of his invention which are patentable. These features must be properly and concisely set forth and claimed in a formal application for patent, in order to comply with the requirements of the Patent Laws. For that reason, unless the inventor is familiar with patent matters, he should engage a competent registered patent attorney or agent to represent him. We are registered to practice before the U. S. Patent Office and are prepared to serve you in the handling of your patent matters.

A specially prepared booklet entitled "Patent Guide for the Inventor", containing detailed information with respect to patent protection and procedure, together with a "Record of Invention" form will be promptly forwarded to you without obligation upon request.

**CLARENCE A. O'BRIEN & HARVEY JACOBSON**

*Registered Patent Attorneys*

02-C DISTRICT NATIONAL BUILDING • WASHINGTON 5, D. C.

*Patents • • Trademarks • • Copyrights*

MARCH 1950 15



**YOU** Need My PRACTICAL Training to Make Money in

# TELEVISION- RADIO and ELECTRONICS!



*I'll Send You*  
**8 BIG KITS of**  
Radio Parts and Equipment

Learn at  
**HOME**  
IN YOUR  
SPARE TIME

Now is the Time to Get Into This Fast  
Growing Industry—Prepare for a Fine  
Paying Job or Your Own Business!

I have trained hundreds of men to become technicians—and I'm ready to do the same for you. Whether your goal is a fine paying job in one of Radio's many branches—or a successful Radio and Television business of your own—you need the kind of training I offer! My training is practical and down to earth. YOU NEED NO PREVIOUS EXPERIENCE. I start you with basic fundamentals and give you plenty of practical shop-bench training with many kits of parts I send you. This is the training that sticks with you and makes money for you on the job!

### GET PAID FOR SPARE TIME WHILE LEARNING

Soon after you start training I send you my famous BUSINESS BUILDERS that show you how to make money in spare time doing interesting Radio jobs. I send you 8 big kits of Radio parts and equipment and help you build step-by-step a powerful 6-tube superhet radio, a 16-range test meter, plus other mighty useful equipment for Radio and Television servicing. You will perform over 175 fascinating experiments while training. You will learn about Television—so that you will be qualified to step into this fast growing, profitable field. I also send you many valuable service manuals, diagrams, and my book telling exactly how to set up your own Television and Radio shop. Clip and mail the coupon below for my two big FREE Radio books. I employ no salesmen—and nobody will call on you.

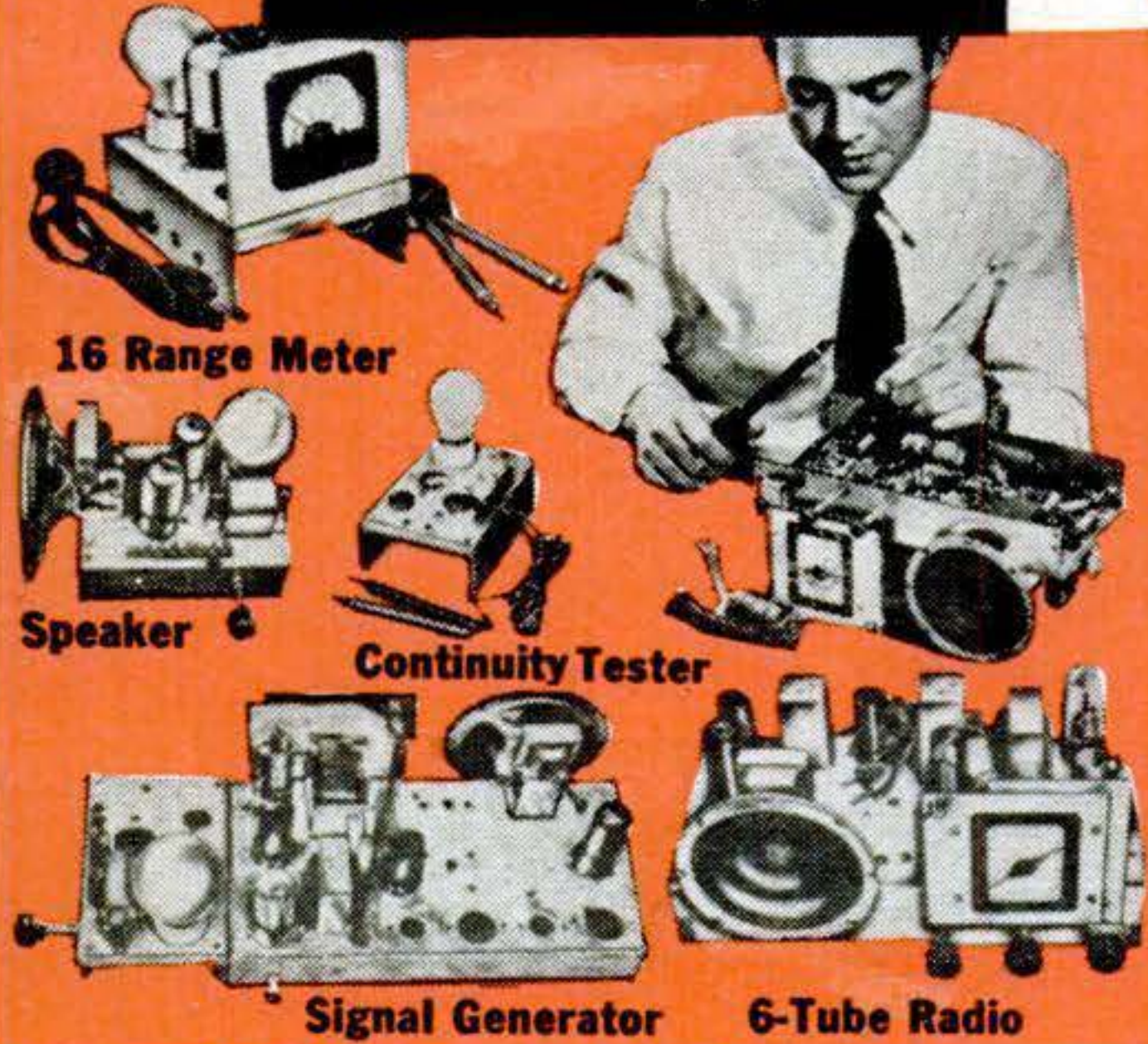

16 Range Meter

Speaker

Continuity Tester

Signal Generator

6-Tube Radio

All Kits Are YOURS TO KEEP

Each of the hundreds of Radio parts and other items I send my students is theirs "for keeps." You may use this equipment in your Radio and Television service work and save many dollars by not having to buy expensive "ready-made" test equipment.



**CALVIN SKINNER** of New Orleans, La. tells us he makes \$5 to \$10 in spare time repairing radios. He is now also working with a Television set.



**LOREN D. SAUCIER** of Coloma, Mich. reports that my training has made it possible for him to repair large numbers of Radio and Television sets.



### HAVE A BUSINESS OF YOUR OWN

A profitable Radio and Television Service Shop may be started with little capital. I will show you how to get started. At left is pictured one of my graduates, Mr. Merrit C. Sperry, Fairmont, Minn. in his own shop.

### Radio and Television Industry Booming

You couldn't pick a better time to get into Radio-Television and Electronics. New Television stations are going on the air to serve every major city—hundreds of new AM and FM Radio broadcasting stations are also on the air. All this creates new and bigger opportunities for the trained man who knows Radio-Television and Electronics.

## VETERANS

**THIS TRAINING AVAILABLE TO YOU UNDER THE G.I. BILL**

## RUSH COUPON Today!

**SPRAYBERRY ACADEMY of RADIO, Dept. 55-G, 111 North Canal Street, Chicago 6, Illinois**

Please rush my FREE copies of "How To Make Money In Radio-Television and Electronics" and "How To Read Radio Diagrams and Symbols."

Name.....Age.....

Address.....

City.....State.....

( ) Check here if you are a Veteran

**My Training Includes . . .  
Television,  
FM (Frequency Modulation),  
Public Address and High Frequency Applications**



### These Two Big FREE! Radio Books

Just mail coupon for a FREE sample Sprayberry Lesson and my big FREE book, "How To Make Money In Radio-Television and Electronics." Learn why my really practical training is best of all for you. Discover what's ahead for you in Radio-Television and Electronics. No obligation. Don't delay! Mail the coupon now—and count on me for fast action.

**SPRAYBERRY ACADEMY OF RADIO**  
111 N. CANAL, DEPT. 55-G, CHICAGO 6, ILL.



# INVENTORS

If you believe that you have an invention, you should find out how to protect it. The first step is to have a search made of the prior pertinent U. S. patents. If a report on this search indicates that the invention appears patentable you can apply for a patent, and the specifications and claims should be prepared.

The firm of McMorrow, Berman & Davidson, with offices in Washington, D. C., is qualified to take the necessary steps for you. We can make a preliminary search on your invention, advise you whether we think it can be patented, and prepare your application for patent.

Unless you are fully familiar with the U. S. Patent Laws, we recommend that you engage the services of a Registered Patent Attorney to protect your interests. The patent laws are *your* laws. A patent gives you the right to prevent others from making, using or selling the invention claimed in your patent for a period of 17 years.

Use these patent laws for your protection. Investigate whether your invention can be patented. If you have what you believe to be an invention, we suggest that you have this firm make a search for you.

*Send for a copy of our Patent Booklet entitled "How To Protect Your Invention," containing information about patent protection and patent procedure. Along with this we will also send you an "Invention Record" form, for your use in writing down and sketching details of your invention. We will mail them promptly. No obligation. They are yours for the asking.*

**McMORROW, BERMAN & DAVIDSON**

*Registered Patent Attorneys*

**PATENTS • TRADE MARKS • COPYRIGHTS**

**1429 VICTOR BUILDING, WASHINGTON 1, D. C.**



# Become an Electrical Engineer

*B. S. Degree in 36 Months*

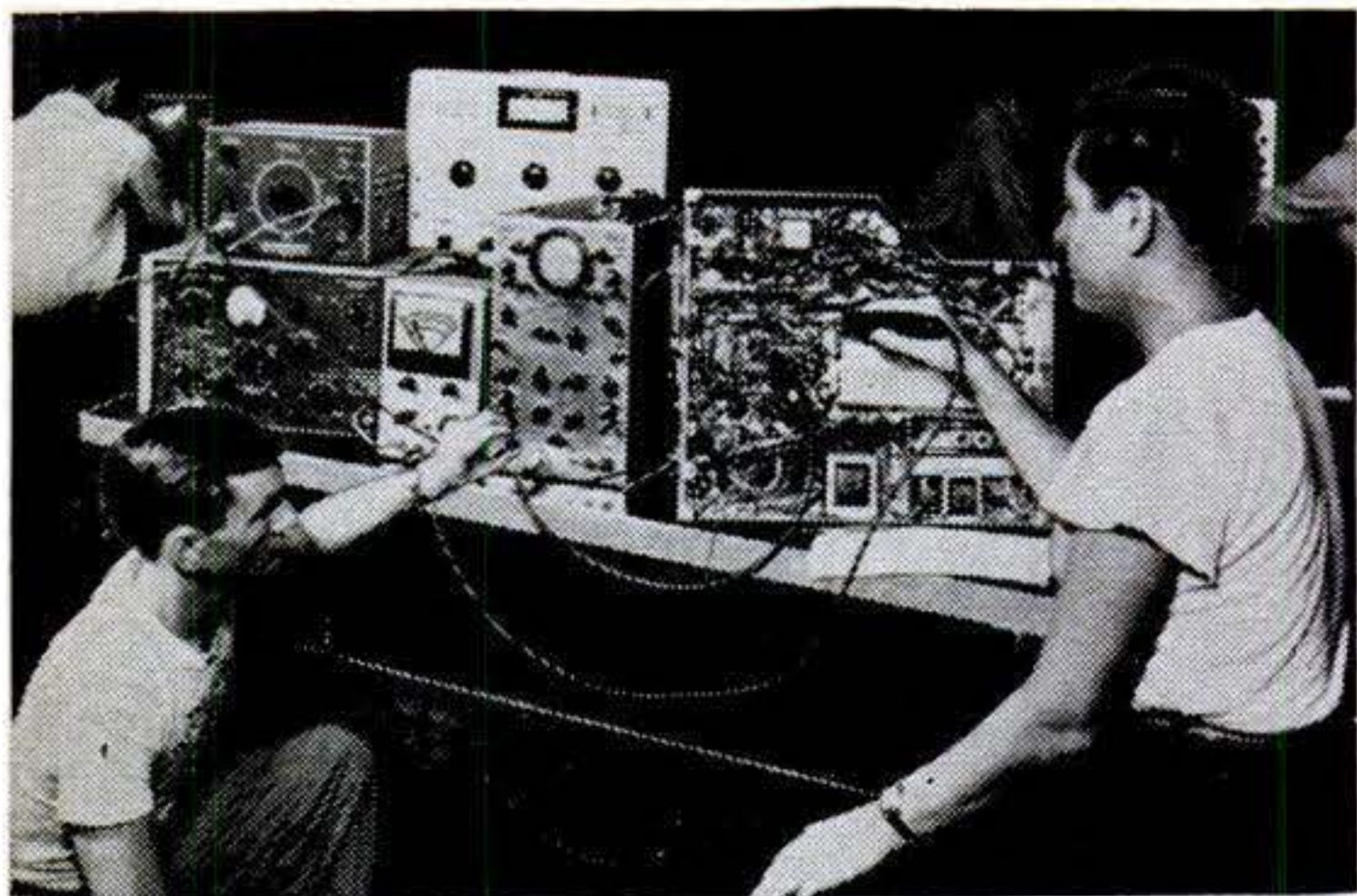

## MAJOR IN ELECTRONICS

Important advantages are yours at this nonprofit Technical Institute and College. A valuable year is saved by gaining your B.S. degree in 36 months of continuous study. You get both practical, specialized training in well-equipped laboratories—and a solid education in Electrical Engineering and related arts.

A *Radio-Television Technician's* certificate can be yours in 18 months. You are then equipped for specific positions in receiver and transmitter testing, servicing, sales and production. This course will be credited toward your B.S. degree in Electrical Engineering.

*Military, Academic or Practical Training* is evaluated for advanced credit. Preparatory courses available.



Faculty of 85 specialists. 1555 currently enrolled from 48 states and 23 foreign countries. Over 35,000 alumni. Terms open April, July, Oct., Jan.

## MILWAUKEE SCHOOL of ENGINEERING

*Founded 1903 by Oscar Werwath*

Write for free 110-page catalog and 48-page pictorial booklet, "Your Career."



### MILWAUKEE SCHOOL OF ENGINEERING

Dept. PS-350, 1020 N. Broadway, Milwaukee, Wis.

Without obligation, send me the 110-page catalog and 48-page "Your Career" booklet.

(Check 6 to 36 month courses which interest you)

<input type="checkbox"/> Electrical Engineering	<input type="checkbox"/> Electronics	<input type="checkbox"/> Power
<input type="checkbox"/> Radio-Television	<input type="checkbox"/> Electricity	<input type="checkbox"/> Welding
<input type="checkbox"/> Air Conditioning	<input type="checkbox"/> Heating	<input type="checkbox"/> Refrigeration

NAME.....AGE.....

ADDRESS.....

CITY.....ZONE...STATE.....

Check if World War II Veteran

## Letters



### Kleberg's First Ranch Car

Sir:

The Buick luxury range car [below] in your January issue [p. 98] is a far cry from the first range car Dick Kleberg had built. I was a boy in high school at the time—around 1920—and was the Delco Light mechanic for that part of Texas after school and week-ends.

The car was a Ford, 1914 or 1915 vintage, and looked rough beside the 12-cylinder Packard touring car next to it.



The hand rails were  $\frac{3}{4}$ " galvanized pipe—not silver plated. And they were there for a purpose: the doors had been removed to let you out quick if the car turned over.

The engine, too, had been altered. The ignition was dual Bosch magnetos. The cylinder head was a "roof" over-head type with two exhaust and two inlet valves in each cylinder. It had two Stromberg carburetors and some kind of a water pump.

My first trip in this car was with the late Matt Cody, the ranch foreman, Dick Kleberg, and two dogs—a mixture of thoroughbred greyhounds from the ranch and anything the hired hands had around the bunkhouse. A driver and I held down the front and kept a close lookout for coyotes. Matt and Dick passed the time by betting quarters which way a steer would run when we came upon one. When a coyote was flushed and run a while, the dogs got to make the kill.

In our chase we bent a radius rod, so the thing wouldn't steer, and one front tire went almost flat. The tires were leather covered with hollow-headed rivets in the tread. A mesquite thorn had gone clear through one, and we had to patch a tube and put in a boot. I also helped to make some extra radius rods out of oak wagon tongues to go between the front and rear axles.

I doubt if Dick has as much fun with his Buick as he did with that old Ford 30 years ago.

ERIC WARREN

Sinton, Tex.



# NOW YOU CAN "Breeze Through" ANY AUTO REPAIR JOB!



Yes—EVERY Auto Repair Job is a "Snap"—with This Big, BRAND-NEW, Time-Saving, Money-Saving Manual. Shows You How to Service and Repair ANY Part of ANY Standard Car, Including 1949 Models!

DON'T waste time and patience trying to "dope out" difficult car repairs! Just look up make, model, and job in MoToR's AUTO REPAIR MANUAL—and you can "whiz" through ANY job in almost no time. Clear, illustrated instructions lead you step by step all the way.

**WORTH BIG MONEY TO:** Mechanics, Handymen, Garagemen, Farmers, Repair Men, Service Station Operators, Taxi Owners.

### See How Much You Get!

This BIG, brand-new 795-page book combines information from over 150 official Factory Shop Manuals. OVER 200,000 service, repair, tune-up facts—35,000 essential dimensions—on all makes and models, 1935 thru 1949! More than 2100 cut-away photos, diagrams show you exactly WHAT to do and HOW to do it. Used by the U. S. Army, tech schools; thousands of auto servicemen.

### Win Prestige! Earn More Money!

MoToR's Manual makes every operation so easy that you'll find yourself tackling jobs you wouldn't think of doing before. And you'll win added prestige and more money in the bargain.

Beginners will find usable helpful guidance on every kind of repair and service job imaginable. Experts will be amazed by the time and labor-saving short cuts they'll discover.

### SEND NO MONEY

Without risk, see for yourself how easily, clearly this book covers every job on every car! Just mail coupon — without money—for FREE 7-Day Trial. Unless you're convinced it's worth many times its cost, return book in 7 days and pay nothing! MoToR Book Dept., Desk 2B, 250 W. 55th Street, New York 19, N. Y.

Published by MoToR, The Leading Automotive Business Magazine.

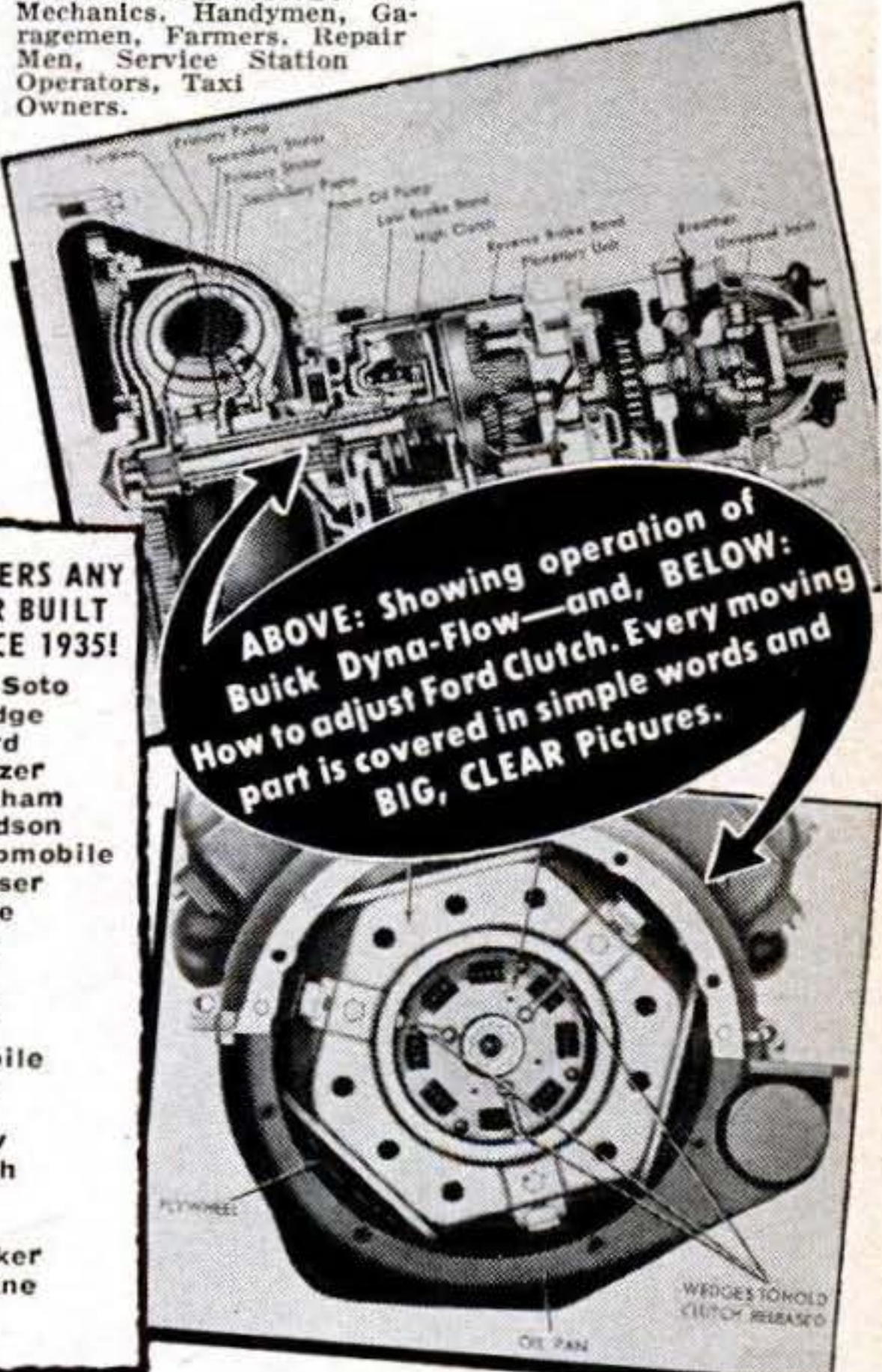

ABOVE: Showing operation of Buick Dyna-Flow—and, BELOW: How to adjust Ford Clutch. Every moving part is covered in simple words and BIG, CLEAR Pictures.

Used by U. S. Army and Navy

### COVERS ANY CAR BUILT SINCE 1935!

- Auburn
- Austin
- Buick
- Cadillac
- Chevrolet
- Chrysler
- Cord
- Crosley
- De Soto
- Dodge
- Ford
- Frazer
- Graham
- Hudson
- Hupmobile
- Kaiser
- Lafayette
- La Salle
- Lincoln
- Mercury
- Nash
- Oldsmobile
- Packard
- Pierce Arrow
- Plymouth
- Pontiac
- Reo
- Studebaker
- Terraplane
- Willys



### Just 2 of the Many Letters of Praise

"MoToR's Manual paid for itself on the first 2 jobs, and saved me valuable time eliminating guess-work."—W. SCHROP, Ohio



"Instructions so clear have no trouble learning anything about any car. Now working as mechanic in big plant."—SAM ORDÓÑEZ, Cal.

### MAIL COUPON NOW FOR 7-DAY FREE TRIAL

MoToR BOOK DEPT.  
Desk 2B, 250 W. 55th St., New York 19, N. Y.

Rush to me at once (check box opposite book you want):  
 MoToR's New AUTO REPAIR MANUAL. If O.K., I will remit \$1 in 7 days (plus 35c delivery charges), \$2 monthly for 2 months and a final payment of 95c one month after that. Otherwise I will return the book postpaid in 7 days. (Foreign price, remit \$8 cash with order.)  
 MoToR's TRUCK REPAIR MANUAL. (Described at left.) If O.K., I will remit \$2 in 7 days, and \$2 monthly for 3 months, plus 35c delivery charges with final payment. Otherwise I will return book postpaid in 7 days. (Foreign price, remit \$10 cash with order.)

Print Name..... Age.....

Print Address.....

City..... State.....

Check box and save 35c delivery charge by enclosing WITH coupon entire payment of \$5.95 for Auto Repair Manual (or \$8 for Truck Repair Manual). Same 7-day return-refund privilege applies.

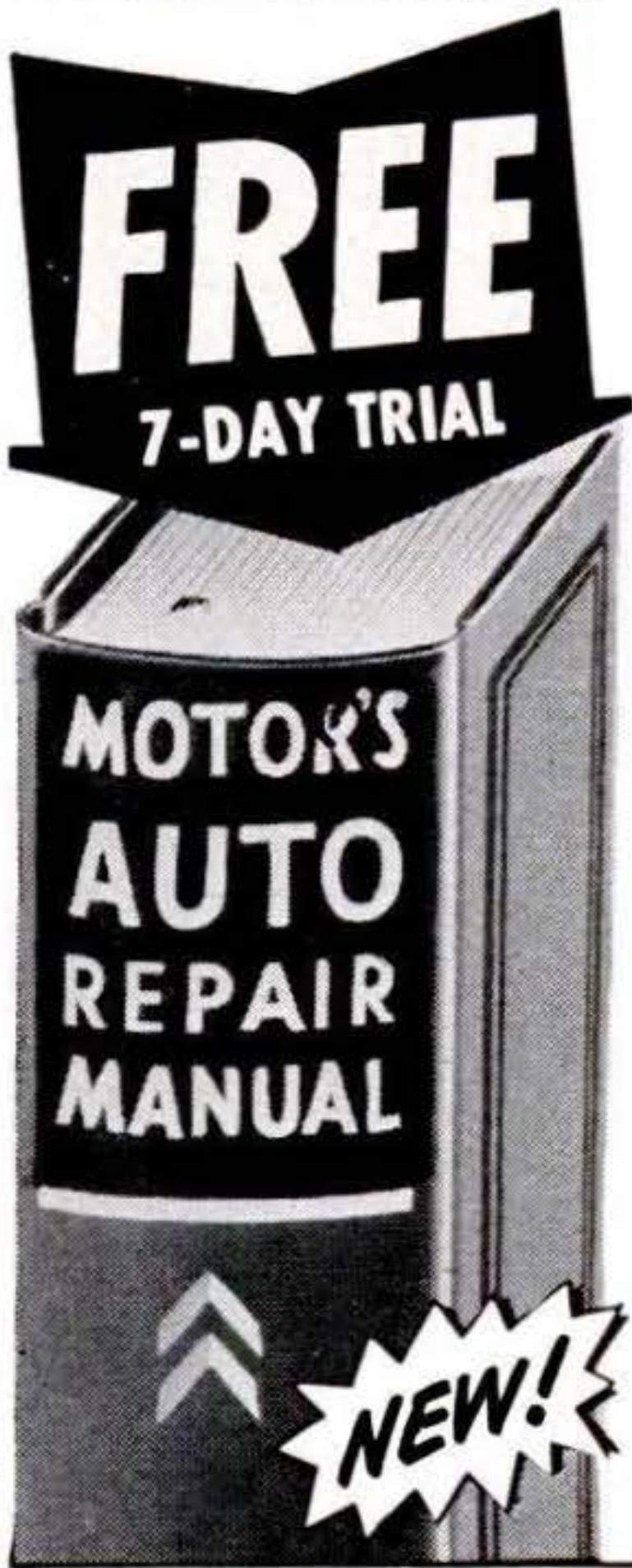

## Same FREE Offer on MoToR's TRUCK MANUAL

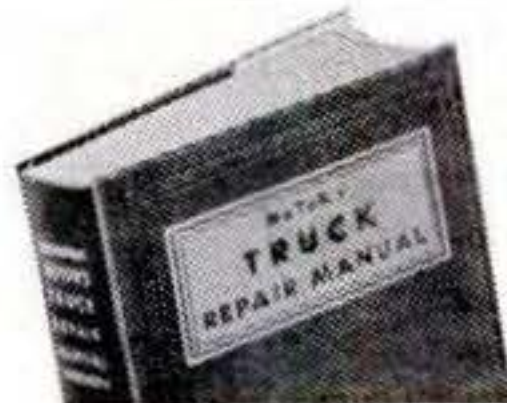

Covers EVERY job on EVERY truck made from 1936 thru 1946! 1400 pictures, 952 pages, 300,000 facts. All types Gasoline Engines, Truck Diesels, Hesselmanns, Fuel Systems, Governors, Lubrication, Ignition, Starters, Clutches, Axles, Brakes, etc., etc.

ALSO covers many buses, tractors, contractor and road building equipment, stationary power machinery. Check box in coupon.



# Lots of DIESEL

IN THE PACIFIC NORTHWEST



Yes, DIESEL is BIG business in Oregon, Washington, and adjoining states where industries and populations are growing so incredibly fast.

**DIESEL IS THE KING OF POWER** . . . on our railroads, highways, waterways and in our industries.



L. L. ADCOX, President

**I PRODUCE DIESEL MEN IN 3 SHORT MONTHS**

**MEN WHO ARE** equipped with the thorough training they get at the ADCOX SCHOOL, are prepared for a splendid future in the great Northwest. A fine place to live and enjoy life.

**NEWEST FACILITIES AND EQUIPMENT**, Advanced Instruction Methods by highly paid, Expert Instructors, combined with my 40 YEARS of trade school experience, enable me to turn out **REAL DIESEL ENGINE TROUBLE SHOOTERS**. When you receive your Adcox Diploma you are ready to begin your career in Diesel.

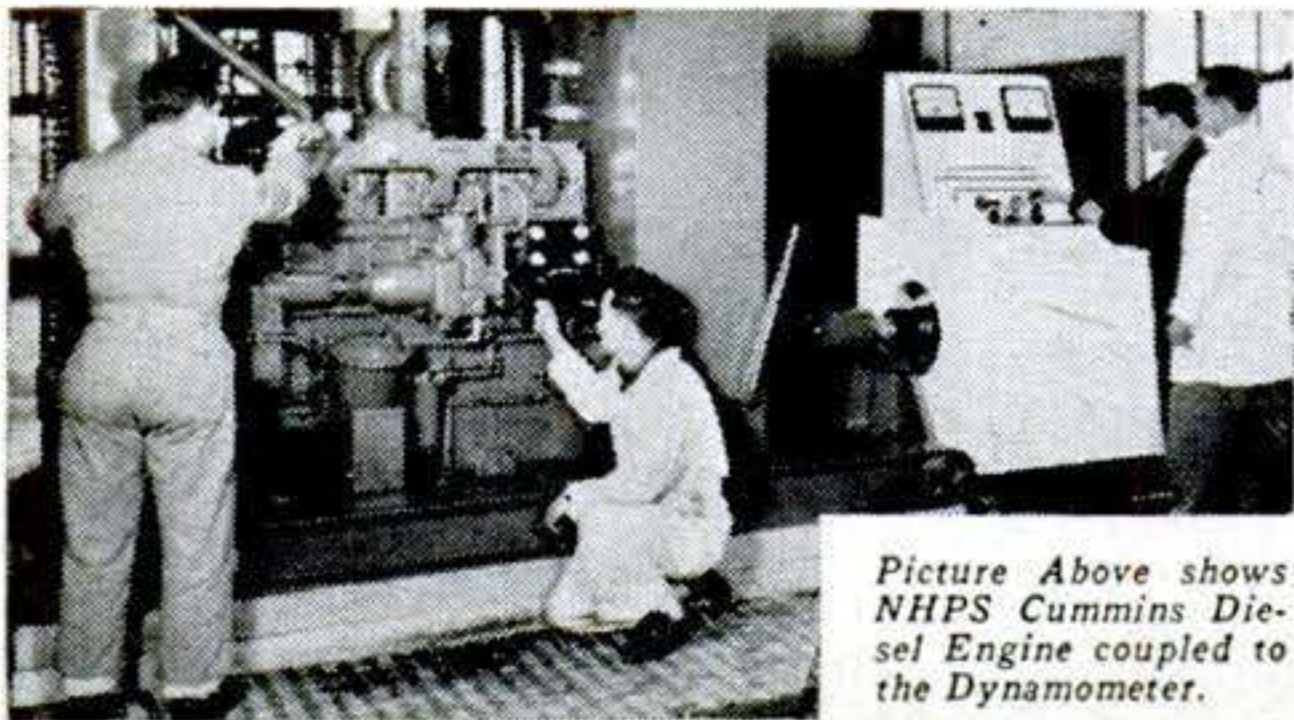

Picture Above shows NHPS Cummins Diesel Engine coupled to the Dynamometer.

**YOU LEARN ENGINE CONSTRUCTION FROM THE GROUND UP.** Special laboratory for Injection, Fuel Pumps, Nozzles and Governors. Trouble Shooting under full Dynamometer Load (as shown in picture).

*This kind of training puts ADCOX out in front!*

**CLASSES LIMITED** — Latest type equipment (no obsolete engines). Skilled Instructors — combine to insure best possible training. You learn Diesel **RIGHT**, and you learn it **FAST** . . . in this Nationally Famous School!

**DIESEL SCHOOL CATALOG FREE**

APPROVED FOR VETERANS



L. L. ADCOX, President  
**ADCOX SCHOOL**  
237 N. E. Broadway, Portland 12, Oregon  
Without obligation, send FREE Catalog No. PS.

Name.....  
Address.....  
Town..... State.....  
If World War II Veteran, Check Here

## Why Not Co-ed Bikes?

Sir:

About that suggestion from R. H. Hemfelt [Dec., p. 92] for a boy's bike with a removable crossbar for easy conversion to a girl's bike: Why, in the name of common sense, ARE there "male" and "female" bicycles? Since a sturdy bicycle can be made without that leg-obstructing crossbar, why not make all bikes that way, so the machine would be equally "proper" for use by girls and boys? Why have *gender* in bicycles?

ANDREW VENA

Philadelphia

## Chuck Trick

Sir:

A while back you showed how to open or tighten a chuck, when the key has been lost, by using a maple dowel, a leather thong, and a steel rod [Sept., p. 213]. There's a much simpler way: just use a screwdriver as a pry against the chuck teeth, bracing it over a rod that fits into the hole in the chuck.

JOHN L. FREY  
Cincinnati, Ohio

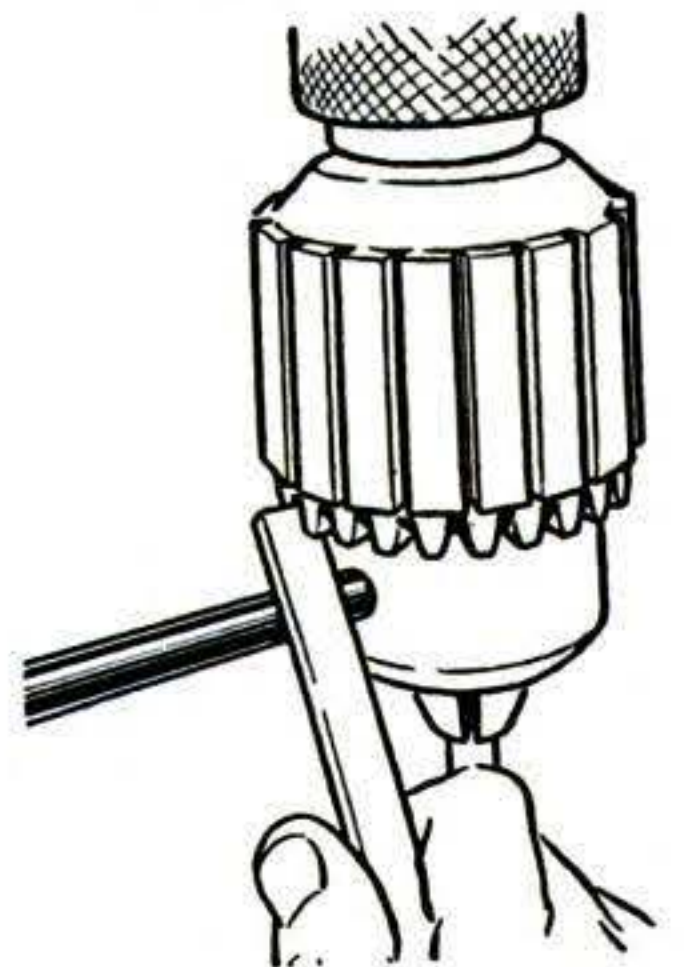

*That'll work, too. But prying isn't a legitimate job for a screwdriver; we'd suggest a brass bar (see sketch), which couldn't hurt the teeth.*

## The Great Debate

Sir:

I am fed up with the complaints from some of your other readers against the styling of our new cars. The Cord and Duesenberg were beautiful cars in their time, but times have changed. Today's cars are far more comfortable, more roomy, easier to handle, offer better visibility to help in making driving easier, and are far more economical to run.

HAROLD SCHUMAN, JR.

Wanamaker, Ind.

Sir:

As to the old Cord being expensive to run, mine never used any oil at 102,000 miles and still had the original pistons. Gas mile-



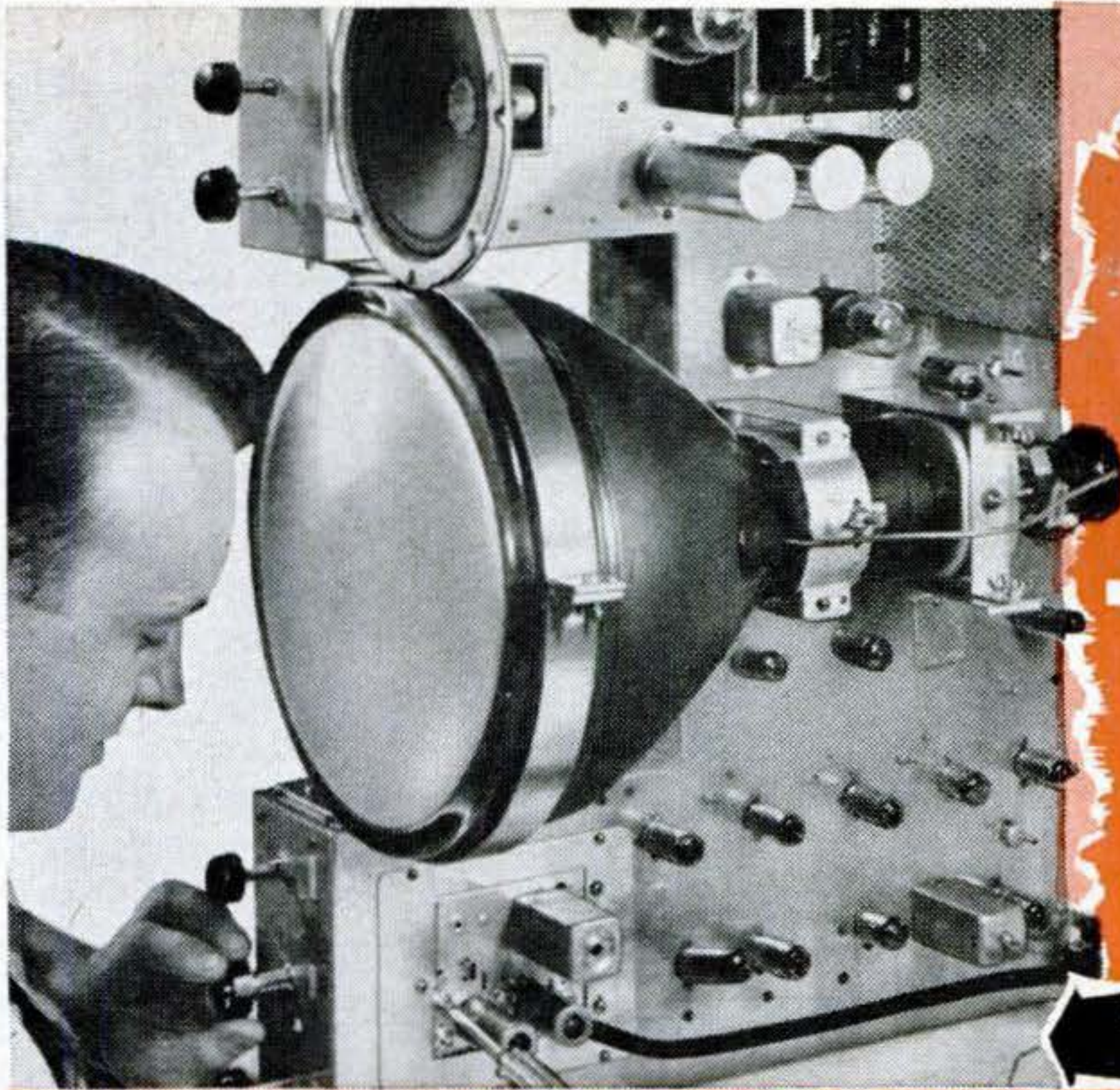

Only D.T.I.  
offers you the  
**"BIG 5"**  
**TELEVISION**  
RADIO-ELECTRONICS  
Laboratory Type  
**HOME TRAINING**

Build and Keep 10, 12½ or 16 inch Picture Tube Quality TELEVISION RECEIVER as you prepare for a Profitable Future



R-F Signal Generator

Here is everything you need to prepare you at home for FASCINATING WORK, GOOD MONEY and a THRILLING FUTURE in one of America's most promising fields.

This includes the opportunity to build and keep the top quality Television Receiver shown above—with choice of a 10, 12½ or 16 inch picture tube that gives big, bright, sharp, steady pictures. This is an optional feature—available when you complete your training described below. Get the complete facts. See how D.T.I.'s wonderfully practical "BIG 5" method meets industry's needs. No previous experience needed. Mail coupon today!

**16 Big Shipments of Parts — Plus Lessons**

Work over 300 electronic experiments and projects from 16 big shipments of parts. This includes building and keeping all test equipment and radio set shown at left side of page. Modern easy-to-read lessons with handy fold-out diagrams simplifies your entire training.

**You Also Use Home Movies**

D.T.I., alone, includes the modern, visual training aid . . . MOVIES to help you learn faster, easier at home. See electrons on the march and other fascinating "hidden action"—a remarkable home training advantage that speeds your progress.

**EMPLOYMENT SERVICE**

When you complete your training, our effective Employment Service helps you get started toward a real future in Television-Radio-Electronics.

**Modern Laboratories**

If you prefer, you can get ALL your preparation in our new, Chicago training laboratories . . .

6 Tube  
Radio  
Receiver

one of the finest of its kind. Ample instructors . . . modern equipment. Write for details!



Multimeter



Oscilloscope



**DeFOREST'S TRAINING, INC.**

Chicago 14, Illinois  
A DeVry Institution

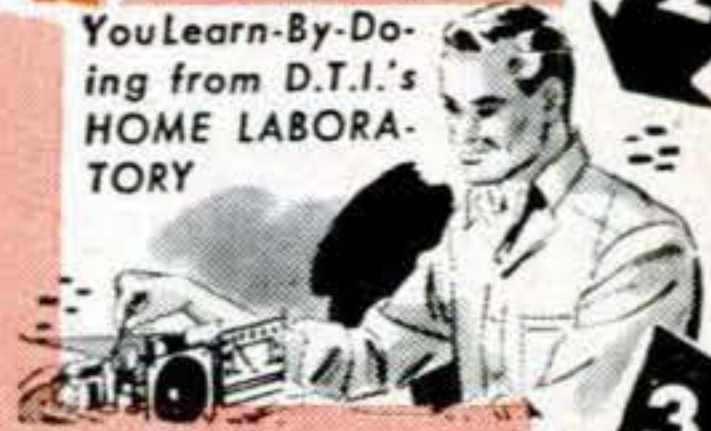

You Learn-By-Doing from D.T.I.'s HOME LABORATORY

You Learn-by-Reading from D.T.I.'s MODERN LESSONS



You Learn-by-Seeing from D.T.I.'s HOME MOVIES

**MAIL THIS COUPON TODAY!**

DeFOREST'S TRAINING, INC. P.S.-G-3  
2533 North Ashland Avenue,  
Chicago 14, Illinois.

Without obligation, give me complete facts showing how I may make my start in Television-Radio-Electronics.

Name \_\_\_\_\_ Age \_\_\_\_\_

Street \_\_\_\_\_ Apt. \_\_\_\_\_

City \_\_\_\_\_ Zone \_\_\_\_\_ State \_\_\_\_\_



# One Step AHEAD!



with  
**EMBRY-RIDDLE**  
Training

## AIRCRAFT & ENGINE MECHANICS

An urgent need exists for properly trained A & E Mechanics throughout commercial aviation. Our C. A. A. approved school with a quarter-century of experience assures your quickest advancement. Embry-Riddle students learn fast with modern equipment...working on live aircraft in airline-size hangars.

## ENGINEERING

Embry-Riddle's Design Engineering and Maintenance Course offers you A & E certification eligibility plus basic engineering knowledge necessary to fill such positions as Field Service, Project or Maintenance Engineer.

## A & E COMBINED \* WITH COMMERCIAL

Airmen with dual pilot-engineering ability are needed by aviation companies and operators. Embry-Riddle combination training offers you the most in your aviation career.

\*Not available to veterans, but combined courses may be taken consecutively with proper justification.

## COMMERCIAL PILOT

Embry-Riddle trained pilots benefit from our years of experience with 30,000 students...the best instructors, up-to-date aircraft, superb year-round flying weather... qualifications unexcelled anywhere. Instrument and instructor's ratings also available.

Never has there been such opportunity for properly trained men in commercial aviation. Put yourself one step ahead of the crowd. Start your career now at Embry-Riddle -- dormitories directly on the airport. For full information fill in the coupon below and mail today!

**Embry Riddle**

International  
SCHOOL OF AVIATION  
MIAMI 30, FLORIDA

Dean of Enrollments - Dept. 91  
Embry-Riddle School of Aviation  
Miami 30, Florida

Please Print

NAME \_\_\_\_\_

ADDRESS \_\_\_\_\_

City \_\_\_\_\_

State \_\_\_\_\_ Age \_\_\_\_\_

I am interested in...

- A.&E. Mechanic
- Commercial Pilot
- Engineering
- A.&E. Combined with Commercial Pilot \*
- Flying Mechanic \*
- Drafting & Design

Check One  Veteran  Non-Veteran

**TRAIN IN MIAMI--AIR CAPITAL OF THE WORLD**

age averaged around 18 on the highway at 70 to 80 m.p.h. and with careful driving would go up to 21.

To really appreciate one of those truly fine cars, you had to drive it at 60 m.p.h. over glare ice and feel it grab the road like a leech and dig in.

LYMAN E. GREENLEE

Anderson, Ind.

Sir:

I should like to add a personal report to the great debate about the styling of the new cars that has been raging in your Letters column.

Recently I was involved in an argument between my '34 Ford and a '49 car at an intersection. Each got a front fender stove in. Repairs cost about \$5 for my car and \$200 for the '49.

HUGH B. McNICHOLS

Boise, Ida.

## PS Flagged Down

Sir:

In the December issue [p. 201] you prominently illustrate a model race car being sent on its way by an interesting device actuated by a current of air from the starter's flag.

Equally captivating is the "starter's flag" itself! It is customary in racing events to use a solid green flag for starting. The checkerboard flag pictured in your illustration is always used at the *finish line*.

HARRY G. WALTER and  
GEORGE E. FARRIS

Lawrence, Kan.

*The car, fortunately, doesn't care what color of flag is waved at it. PS's editors should have been more discriminating.*

## Marshall Plan for Hobbyists?

Sir:

Every month when I get a new copy of POPULAR SCIENCE, I must envy my lucky American co-hobbyist. Lucky, because he can afford to buy those beautiful machines I see on many a page each time.

Considering the difference in wages, those saws, shapers, and drill presses would cost me proportionately *four times* as much. That puts them practically out of the question for the common man over here.

I can only hope that, one day, some U. S.



**YOU BUILD THIS  
23-TUBE  
TELEVISION  
RECEIVER**

**NOW!**

FOR THE FIRST TIME YOU CAN GET  
Real Practical HOME TRAINING In

# TELEVISION

## RADIO AND ELECTRONICS

**RTS LEADS THE WAY**

WE GIVE YOU

**11 BIG  
TELEVISION  
AND RADIO KITS  
AT NO EXTRA COST**

**YOU BUILD THIS  
6-TUBE STANDARD  
SUPER HETERODYNE  
RADIO SET with  
SHORT WAVE  
CONVERTER**

**YOU  
KEEP ALL  
EQUIPMENT  
-it's Yours!**

**★  
SEND  
FOR THIS  
30-PAGE  
FREE  
BOOK!  
★**

to earn WELCOME EXTRA CASH, even BEFORE FINISHING YOUR TRAINING! In fact, when friends and neighbors know you are studying Radio-Television you may - like many RTS students - actually get MORE REPAIR WORK THAN YOU CAN HANDLE.

**27 YEAR  
SUCCESS RECORD**

Backed by over a quarter-century of experience in home training, RTS (formerly Radio Training Association of America) offers practical "Learn-by-doing" methods, assuring you quick step-by-step progress. Begin preparing for your future in Radio-Television now while the time is ripe. If you are at all mechanically inclined - and have a grammar school education, RTS can teach you how to MAKE GOOD in Radio-Television.

**GET THE FACTS**

Send for FREE BOOK which tells you all about the RTS "time-tested" home-training plan, developed by technicians in the heart of the Radio-Television field. Fill out the coupon now - TODAY! and your FREE BOOK entitled "How To Make Good in Radio-Television" will go out to you AT ONCE. No Obligation. No salesman will call. ACT NOW!

**OPPORTUNITIES NOW  
WIDE OPEN FOR  
Properly Trained Men**

Latest reports estimate 400 MILLION new television and radio sets will be built in the next 10 years . . . more than 72 million dollars is being spent RIGHT NOW just for radio repairs ALONE! When you are thoroughly trained by RTS Experts - who have their fingers on the pulse of the Radio-Television industry - a field of unlimited opportunities will open up for you in Your Own Radio-Television Sales & Service Business, F.M., Equipment Manufacturing, Communications and allied fields.

**EARN EXTRA MONEY  
while learning at HOME**

Under the RTS amazingly easy, practical home-training plan there is no need for you to quit your present job. You study in SPARE TIME ONLY! RTS Experts show you how

**RADIO-TELEVISION TRAINING SCHOOL**  
5100 SO. VERMONT AVE., LOS ANGELES 37, CALIF., U.S.A.  
ESTABLISHED 1922 - 27 YEARS AGO

**RADIO-TELEVISION TRAINING SCHOOL, DEPT. PS-3  
5100 South Vermont Avenue, Los Angeles 37, Calif., U.S.A.**

Send FREE Illustrated Book showing how I can make good in TELEVISION and Radio through training under the guidance of expert RTS Technicians. No obligation. (No Salesman will call).

NAME \_\_\_\_\_ AGE \_\_\_\_\_  
ST. & No. \_\_\_\_\_  
CITY \_\_\_\_\_ ZONE \_\_\_\_\_  
STATE \_\_\_\_\_



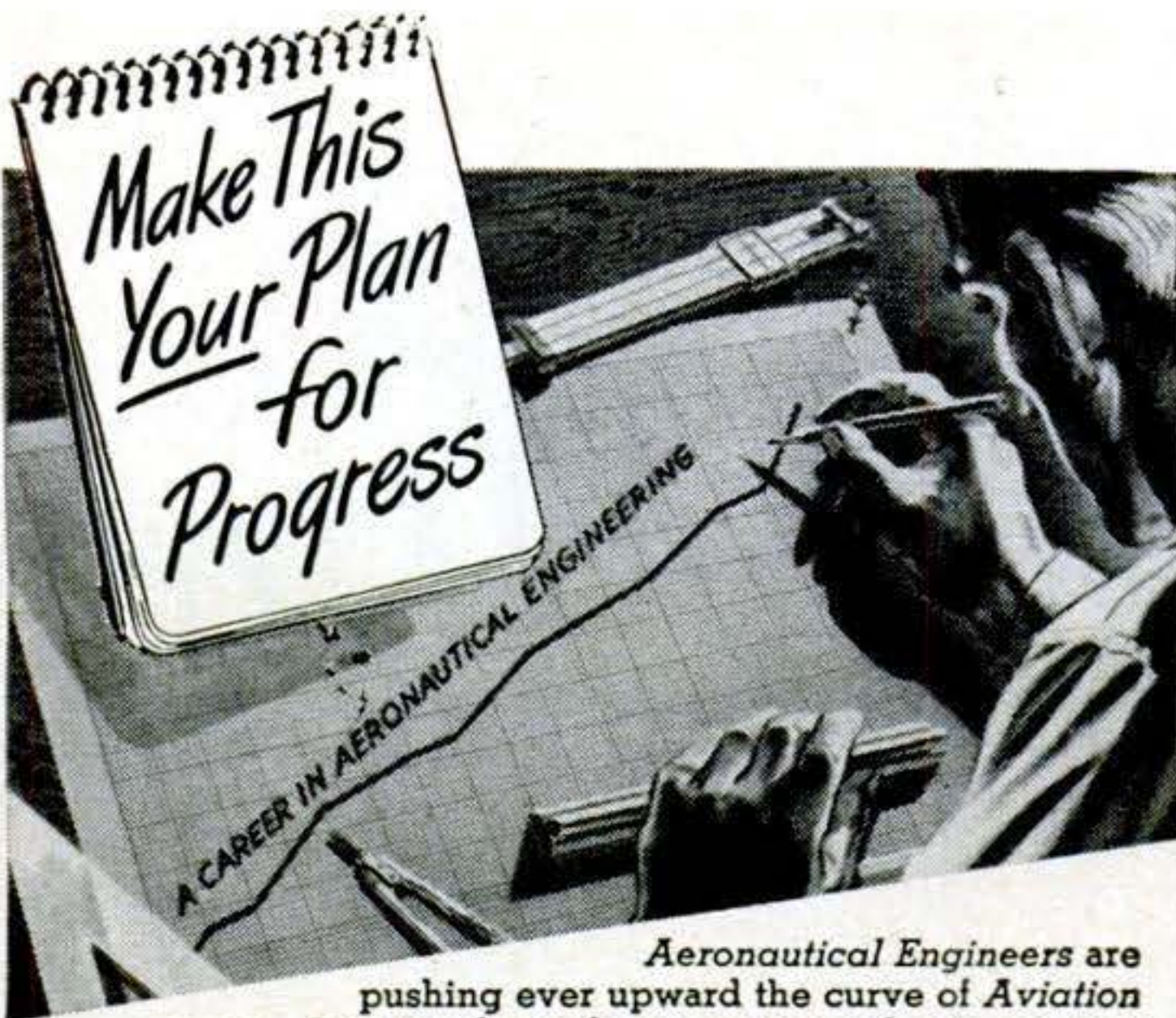

Aeronautical Engineers are pushing ever upward the curve of Aviation progress. Aviation depends on engineers for its constant and amazing achievements and growth. A career in this key division of Aviation can be YOUR personal plan for progress.

Here is a career with security and a lifetime of opportunity—for YOU. Besides fascinating work, you enjoy these rich rewards—good pay from the start, wide-open opportunity for advancement, the security of a big, growing industry. Whether you are creative or practical, there is a place for YOUR talents and ability.

Start the upward "curve" of YOUR plan for progress—with Northrop training. You are already IN Aviation when you train at Northrop. You get actual experience in every-day engineering duties—like the students shown here testing a nose wheel installation for braking effect. In the other photograph you see three pulse-jet engines designed and built as a typical practical project in studying the latest types of aircraft power plants.

Northrop training gives you big advantages... advantages that have won choice jobs for graduates with ALL leading aircraft manufacturers and airlines. Get the whole story, in the big illustrated Institute catalog. Classes start every 8 weeks—you can start YOUR training soon.

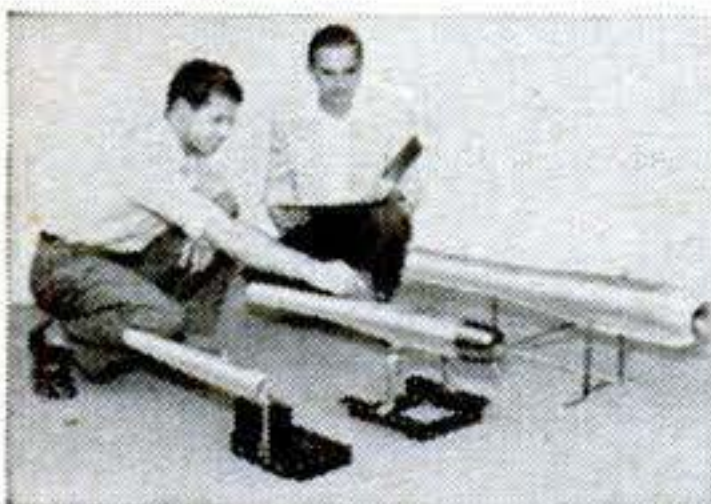
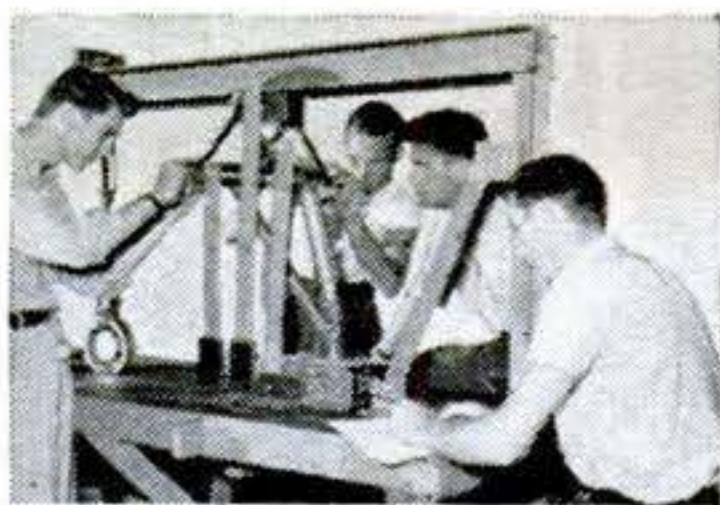

**Send Coupon for this Catalog NOW**

**APPROVED FOR VETERANS**



**Northrop Aeronautical Institute**  
 Division of Northrop Aircraft, Inc.  
 1525 EAST BROADWAY, HAWTHORNE,  
 LOS ANGELES COUNTY, CALIFORNIA

**NORTHROP AERONAUTICAL INSTITUTE**  
 1525 East Broadway, Hawthorne, Los Angeles County, Calif.  
 Please send information on opportunities in Aeronautical Engineering, your catalog, and starting dates of classes. I am interested in:  
 Aeronautical Engineering •  Aircraft & Engine Mechanics

Name \_\_\_\_\_ Age \_\_\_\_\_

Address \_\_\_\_\_

City \_\_\_\_\_ Zone \_\_\_\_\_ State \_\_\_\_\_

Check one:  Veteran  Non-Veteran

Santa Claus will put up a private Marshall Plan for hobbyists. Till then, I'll go on reading PS while day-dreaming.

ERNEST E. VAN HERCK

Antwerp, Belgium

**Sound Idea**

Sir:

Your "telephone of the future" [Oct., p. 170], with the user speaking into its sound-focusing lens from several feet away without using a handset, looks *unsound* to me. Wouldn't it also pick up other sounds and be difficult to use in a room where there were noises like typewriting?

LEO D. KELLER

Rochester, N. Y.

*The gadgets developed by Dr. Winston E. Kock, of Bell Telephone Labs, are lenses that focus sound just the way glass lenses focus light. The lens on the transmitter works like a telescope—it is focused on the user and picks up only sounds from that spot. It would no more "hear" noises from anywhere else in the room than a telescope aimed at the user would "see" other objects.*

**1,500 Percent Wrong**

Sir:

I note in your December issue, p. 119, that the British have gone to the trouble of rigging up eight parachutes for the purpose of air-dropping a jeep and a "6-mm. gun." I can see dropping a jeep, but why a jeep to carry a 6-mm. gun? Six millimeters, according to my calculations, is equal to 0.23622 inches—a gun a little larger than a .22 rifle!

JEROME E. SALNY

Morristown, N. J.

*PS carelessly repeated an error from an official British picture caption. The gun is, of course, a British "six pounder"—which has a bore of 3.67 in. and thus is somewhat larger than a U. S. 75-mm. gun.*

**Dissatisfied Reader**

Sir:

As far as I know, there is only one thing wrong with PS: you carry a hot-rod article only about twice a year. Why not one every month?

PHIL MICHMERSHUIZEN

Holland, Mich.



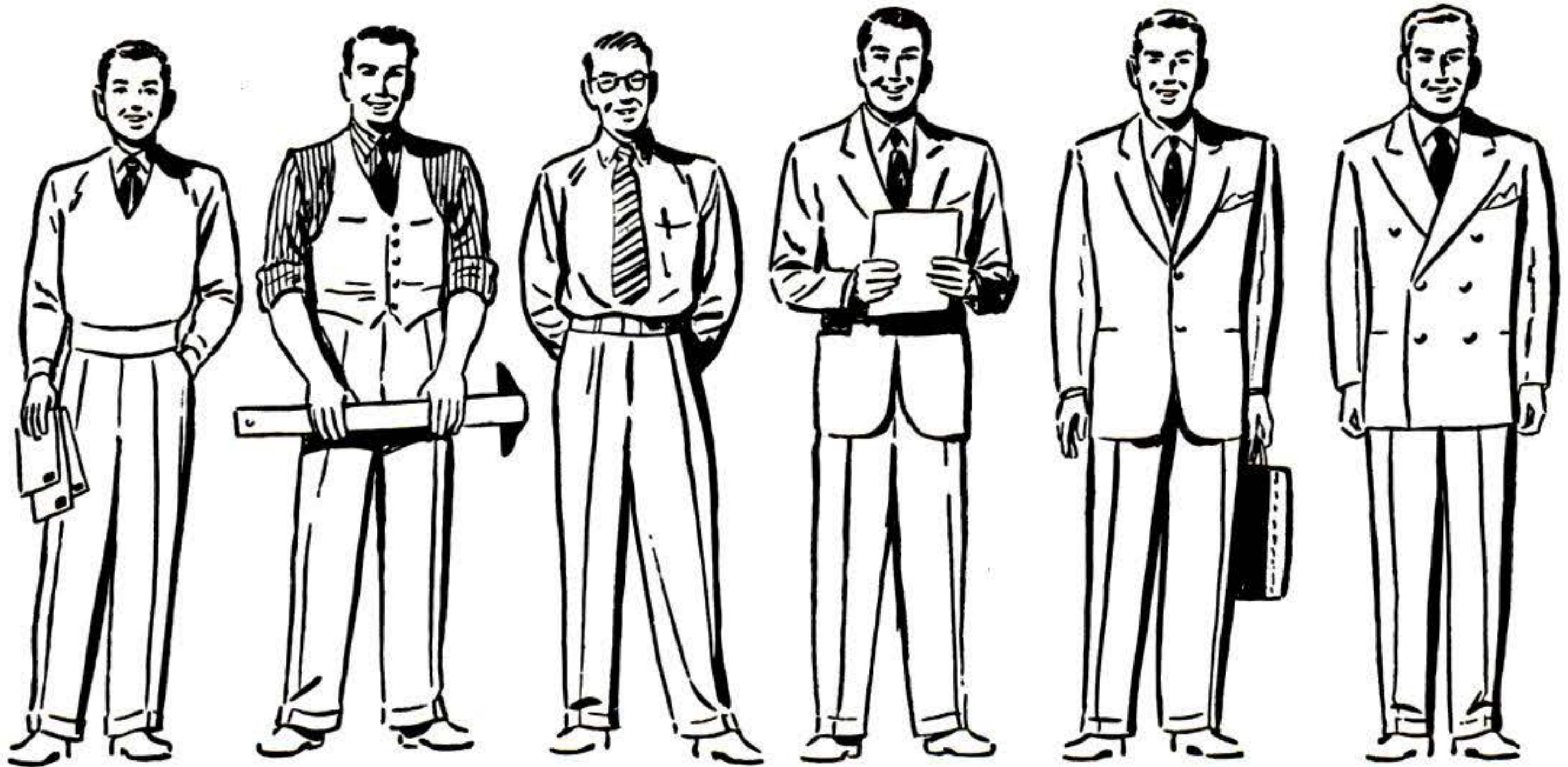

*How do you  
rank in your  
new outfit?*

You've been in civvies for some time now. How are you doing? Are you moving ahead as fast as you want? Or have you struck a snag? You may have found that there are things you have to know — training you have to have — before you can move up.

You can get that training — without leaving your job — from I.C.S. When you study with I.C.S. you study at home in your spare time — with the world's largest educational institution.

I.C.S. training has put others at the top. How about you? If you want to matter in your new outfit, start by filling in the coupon and mailing it, *today!*

## INTERNATIONAL CORRESPONDENCE SCHOOLS

APPROVED  
under the  
G.I. BILL

BOX 7650-M, SCRANTON 9, PENNA.

Without cost or obligation, please send me full particulars about the course BEFORE which I have marked X:

- |   |   |   |   |
|---|---|---|---|
| <p><b>Air Conditioning and Plumbing Courses</b></p> <p><input type="checkbox"/> Air Conditioning<br/><input type="checkbox"/> Heating<br/><input type="checkbox"/> Refrigeration</p> <p><input type="checkbox"/> Plumbing<br/><input type="checkbox"/> Steam Fitting</p> <p><b>Chemical Courses</b></p> <p><input type="checkbox"/> Chemical Engineering<br/><input type="checkbox"/> Chemistry, Analytical<br/><input type="checkbox"/> Chemistry, Industrial<br/><input type="checkbox"/> Chemistry, Mfg. Iron &amp; Steel<br/><input type="checkbox"/> Petroleum Refining<br/><input type="checkbox"/> Pulp and Paper Making</p> <p><input type="checkbox"/> Plastics</p> <p><b>Civil Engineering, Architectural and Mining Courses</b></p> <p><input type="checkbox"/> Architecture<br/><input type="checkbox"/> Architectural Drafting<br/><input type="checkbox"/> Bridge and Building Foreman<br/><input type="checkbox"/> Building Estimating<br/><input type="checkbox"/> Civil Engineering<br/><input type="checkbox"/> Coal Mining<br/><input type="checkbox"/> Contracting and Building<br/><input type="checkbox"/> Highway Engineering<br/><input type="checkbox"/> Lumber Dealer<br/><input type="checkbox"/> Reading Structural Blueprints<br/><input type="checkbox"/> Sanitary Engineering<br/><input type="checkbox"/> Structural Drafting</p> | <p><input type="checkbox"/> Structural Engineering<br/><input type="checkbox"/> Surveying and Mapping</p> <p><b>Communications Courses</b></p> <p><input type="checkbox"/> Electronics<br/><input type="checkbox"/> Practical Telephony<br/><input type="checkbox"/> Radio, General<br/><input type="checkbox"/> Radio Servicing<br/><input type="checkbox"/> Telegraph Engineering</p> <p><input type="checkbox"/> Radio Operating<br/><input type="checkbox"/> Television</p> <p><b>Electrical Courses</b></p> <p><input type="checkbox"/> Electrical Drafting<br/><input type="checkbox"/> Electrical Engineering<br/><input type="checkbox"/> Electric Light and Power<br/><input type="checkbox"/> Lighting Technician<br/><input type="checkbox"/> Practical Electrician</p> <p><b>Internal Combustion Engines Courses</b></p> <p><input type="checkbox"/> Auto Technician<br/><input type="checkbox"/> Diesel-Electric<br/><input type="checkbox"/> Diesel Engines<br/><input type="checkbox"/> Gas Engines</p> <p><input type="checkbox"/> Aviation</p> <p><b>Mechanical Courses</b></p> <p><input type="checkbox"/> Aeronautical Engineer's, Jr.<br/><input type="checkbox"/> Aircraft Drafting<br/><input type="checkbox"/> Forging<br/><input type="checkbox"/> Heat Treatment of Metals<br/><input type="checkbox"/> Industrial Engineering<br/><input type="checkbox"/> Industrial Instrumentation</p> | <p><input type="checkbox"/> Industrial Metallurgy<br/><input type="checkbox"/> Machine Shop<br/><input type="checkbox"/> Mechanical Engineering<br/><input type="checkbox"/> Mold-Loft Work<br/><input type="checkbox"/> Patternmaking—Wood, Metal<br/><input type="checkbox"/> Reading Shop Blueprints<br/><input type="checkbox"/> Sheet-Metal Drafting<br/><input type="checkbox"/> Sheet-Metal Worker<br/><input type="checkbox"/> Ship Drafting<br/><input type="checkbox"/> Tool Designing<br/><input type="checkbox"/> Welding Engineering<br/><input type="checkbox"/> Welding—Gas and Electric</p> <p><input type="checkbox"/> Mech. Drafting</p> <p><b>Railroad Courses</b></p> <p><input type="checkbox"/> Air Brake<br/><input type="checkbox"/> Diesel Locomotive<br/><input type="checkbox"/> Locomotive Engineer<br/><input type="checkbox"/> Locomotive Fireman<br/><input type="checkbox"/> Locomotive Machinist<br/><input type="checkbox"/> Railroad Section Foreman<br/><input type="checkbox"/> Steam-Diesel Loco. Eng.</p> <p><input type="checkbox"/> Car Inspector</p> <p><b>Stationary Eng'r's Courses</b></p> <p><input type="checkbox"/> Boilermaking<br/><input type="checkbox"/> Combustion Engineering<br/><input type="checkbox"/> Engine Running<br/><input type="checkbox"/> Marine Engineering<br/><input type="checkbox"/> Power Plant Eng'r's</p> | <p><b>Textile Courses</b></p> <p><input type="checkbox"/> Cotton Manufacturing<br/><input type="checkbox"/> Loom Fixing<br/><input type="checkbox"/> Textile Designing<br/><input type="checkbox"/> Woolen Manufacturing</p> <p><input type="checkbox"/> Rayon Weaving</p> <p><b>Business and Academic Courses</b></p> <p><input type="checkbox"/> Accounting<br/><input type="checkbox"/> App. Psychology<br/><input type="checkbox"/> Business Administration<br/><input type="checkbox"/> Bus. Correspondence<br/><input type="checkbox"/> Certified Public Accounting<br/><input type="checkbox"/> Commercial<br/><input type="checkbox"/> Cost Accounting<br/><input type="checkbox"/> Federal Tax<br/><input type="checkbox"/> Foremanship<br/><input type="checkbox"/> Good English<br/><input type="checkbox"/> Higher Mathematics<br/><input type="checkbox"/> Industrial Supervision<br/><input type="checkbox"/> Motor Traffic<br/><input type="checkbox"/> Retailing<br/><input type="checkbox"/> Retail Bus. Management<br/><input type="checkbox"/> Salesmanship<br/><input type="checkbox"/> Sign Lettering<br/><input type="checkbox"/> Spanish<br/><input type="checkbox"/> Traffic Management</p> <p><input type="checkbox"/> Advertising<br/><input type="checkbox"/> Bookkeeping<br/><input type="checkbox"/> Bus. Law<br/><input type="checkbox"/> Commercial Art<br/><input type="checkbox"/> First Year College<br/><input type="checkbox"/> French<br/><input type="checkbox"/> High School<br/><input type="checkbox"/> Illustration<br/><input type="checkbox"/> Postal Civil Service<br/><input type="checkbox"/> Retail Bus. Management<br/><input type="checkbox"/> Secretarial<br/><input type="checkbox"/> Stenography</p> |
|---|---|---|---|

Name \_\_\_\_\_ Age \_\_\_\_\_ Home Address \_\_\_\_\_

City \_\_\_\_\_ State \_\_\_\_\_ Working Hours \_\_\_\_\_ A.M. to \_\_\_\_\_ P.M.

Present Position \_\_\_\_\_ Employed by \_\_\_\_\_

Length of Service in World War II \_\_\_\_\_ Enrollment under G.I. Bill approved for World War II Veterans. Special tuition rates to members of the Armed Forces.  
Canadian residents send coupon to International Correspondence Schools Canadian, Ltd., Montreal, Canada.



# EARN MORE IN DRAFTING



**STEADY  
EMPLOYMENT**  
●  
**MORE OPPORTUNITIES  
FOR PROMOTION**

"Here I am at work making good money as a draftsman. I'm glad I sent the coupon to Chicago Tech for that Free Trial Lesson and found out how easy it is to learn Drafting in spare time at home. Today I feel secure in my job because the draftsman's work comes first on any new project. And, in addition, draftsmen can't be replaced with machines. What's more, I feel I'm slated for promotion and more pay, because I see so many draftsmen advancing to high-pay jobs."

## LEARN IN SPARE TIME—AT HOME!

(or at the College in Chicago)

A few hours of pleasant home study every week—that's all. No interference with your present job. All the tools you need; drawing outfit included. With Chicago Tech's help, you train yourself step by step. This tested method—developed over 45 years of C.T.C. progress—prepares men quickly for good positions in industry.



### FREE INFORMATION—SEND COUPON

To prove to you how easy it is to learn Drafting at home by the Chicago Tech method, we will send you this FREE TRIAL LESSON. No charge for this lesson, now or later. Fill out and mail coupon, or send post card today.

## CHICAGO TECHNICAL COLLEGE

C-227 Tech Bldg., 2000 So. Michigan Ave.,  
Chicago 16, Illinois

Mail me FREE Lesson with information about big opportunities in DRAFTING.

Name.....Age.....

Address.....

City.....Zone...State.....

# INVENTORS

Whether an invention is patentable can be substantially determined by a search of the U. S. Patent records. Without obligation, write for information explaining the steps you should take to secure a patent.

## JOHN N. RANDOLPH

Registered Patent Attorney

205 Columbian Building Washington 1, D. C.

## Tells How You Can Learn to



### Learn At Home

Men, Boys, Hunters, Fishermen, mount and save your lovely wild-game trophies. Be a Taxidermist. Mount Birds, Animals, Heads, Fish, Tan skins. YOU learn easily, quickly in spare time. Have a grand home-museum. The finest and the greatest hobby known, for sportsmen. Fun, real profits.

## FREE BOOK

Yes, FREE. Beautiful strange, valuable Book, telling all about Taxidermy. Contains over 100 beautiful game-pictures. And it's yours FREE, if you rush your request. You can mount all kinds of wild-game, and common specimens too. We can positively TEACH YOU. So GRASP this opportunity. RUSH letter or postal for this amazing FREE BOOK. Don't delay. State your AGE. N. W. SCHOOL OF TAXIDERMY, 2603 Elwood Bldg., Omaha 2, Neb.

# INVENTORS

Before you make any effort to market your invention, you should take the first steps toward proceeding for patent protection.

The usual first step is to have a search of the U. S. patent records conducted, so that I can report to you on the question of patentability.

I shall be pleased to furnish you with information relative to patent procedure and also on the matter of trademark registration, upon request from you, and this will be without any obligation on your part.

## PATRICK D. BEAVERS

(Formerly RANDOLPH & BEAVERS)

Registered Patent Attorney

937 Columbian Building, Washington 1, D. C.

# PATENTS PATENT LAWYER

## TRADE MARKS

## GUSTAVE MILLER

30 PS WARNER BLDG.  
WASHINGTON 4, D. C.

ASSOCIATE EXAMINER  
U. S. PATENT OFFICE 1922-1929  
PATENT ATTORNEY AND ADVISOR  
U. S. NAVY DEPT. 1930-1947  
REGISTERED PATENT ATTORNEY

Send for PATENT INFORMATION  
Book and "INVENTOR'S RECORD"  
without obligation.

# HELP FOR INVENTORS

Hundreds of manufacturers have requested our assistance in locating marketable new products.

Complete information, free.

## INSTITUTE of AMERICAN INVENTORS

Dept. 3, 631-E St., N.W., Washington 4, D. C.



# PATENTS

## AND TRADE MARKS

# C. A. SNOW & CO.

REGISTERED PATENT ATTORNEYS

WRITE FOR INFORMATION TO

246 SNOW BUILDING, WASHINGTON 1, D. C.



# INVENTORS

IF YOU WISH TO PROTECT YOUR INVENTION, You should take steps to protect it by a U. S. Patent. Write me for "RECORD OF INVENTION" form.

## CARL MILLER REGISTERED PATENT ATTORNEY

WOOLWORTH BLDG., 35th FLOOR, 30C,  
NEW YORK CITY





**I MADE  
\$14 PER DAY**  
While still learning!

T. E. H.—WEST VIRGINIA



**I MADE  
\$800 IN 3 MONTHS**  
While taking your course!

F. V.—NEW YORK

*Get into the*

# **ELECTRIC APPLIANCE REPAIR & SERVICE BUSINESS**

**SPARE OR FULL TIME.** Want a good-paying business—a job in a fast-growing industry? Learn electrical appliance repair and service. I will teach you this interesting, good-paying business. The **EASY** step-by-step home study method, taught by PTS, prepares you **NOW** to reap lush profits to be made in this unlimited field. Have **YOUR OWN BUSINESS**—spare or full time—prepare for one of the many openings for trained men.

**ACT NOW.** Millions of new appliances in homes—millions of new homes being wired for electricity assures hundreds of customers in nearly every neighborhood.

**EASY TO LEARN.** Men of all ages, yes, even the man of 69 can get into this ever expanding field—a business well suited to men who like to use their hands—a **REAL OPPORTUNITY** for the practical man who is not happy in his present job. Get started **NOW**—send for **FREE BOOK** giving all details.

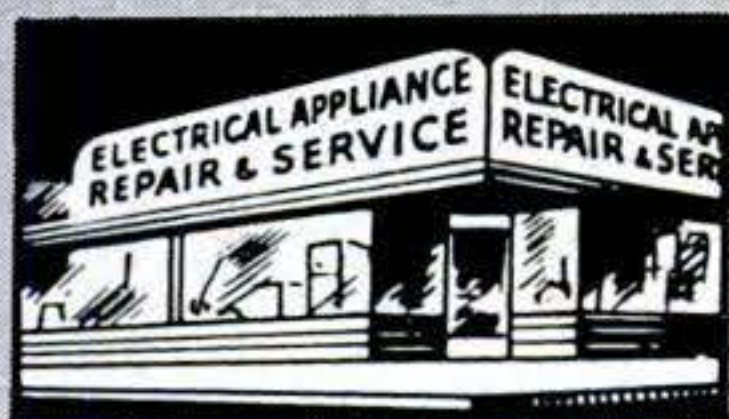

## **OPEN YOUR OWN SHOP**

As soon as you enroll, I send you my New Book "How To Open Your Own Business" at no extra cost. PTS training is more than a home study course in electric appliance repair and service. It gives you the "know

how" on the operation of your shop from a business standpoint: What to charge, how to get customers. Everything possible is done to start you on the road to success.

**EARN WHILE YOU LEARN.** You can actually start earning before your course is finished. I send you your first lesson showing you easy jobs that can be done in your **SPARE TIME AT HOME**. Remember, one good repair job will pay for the cost of your course. **NO BIG OVER-HEAD** needed. Start in your garage, basement, attic or spare room. When you are ready to expand, I will give you the benefit of my advice and experience.

**I SEND  
YOU A  
BIG KIT  
of TOOLS  
at No  
Extra  
Cost**



H. T. ARMSTRONG

**HERE'S MY  
PLAN FOR  
YOUR  
SUCCESS**

Big Book  
Containing  
All The  
Details of My Plan  
For Your Success.

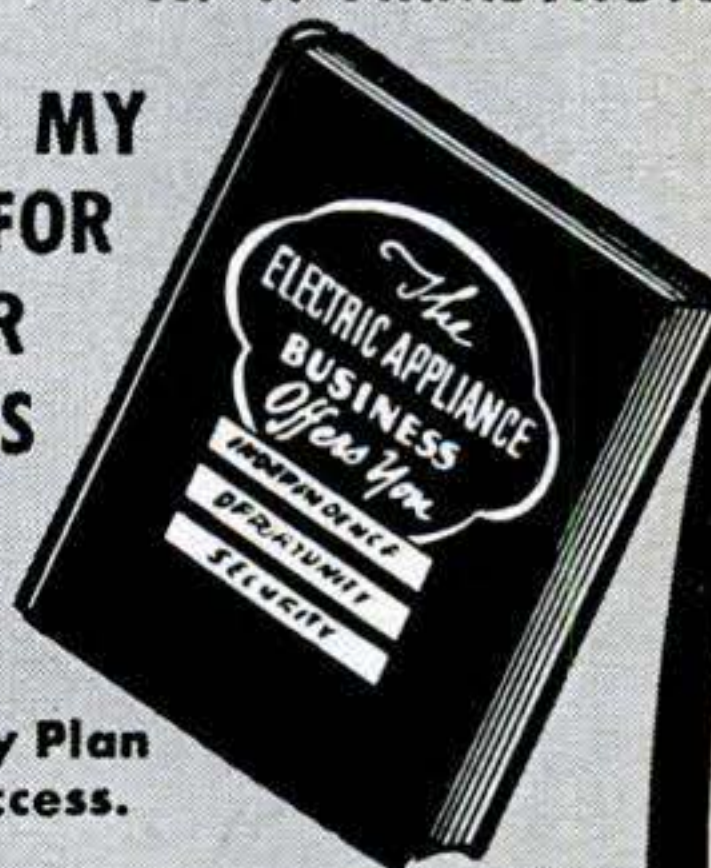

**SEND FOR  
THIS  
FREE BOOK**

## **WE TEACH YOU:**

How to repair:  
Washing Machines, Vacuum  
Cleaners, Ranges (gas and  
electric), Auto electricity, Irons,  
Motors, Garbage Disposal  
Units, Fluorescent Lights, Elec-  
tric Shavers, Refrigeration,  
House Wiring.

**AT HOME IN YOUR  
SPARE TIME OR FULL TIME**

## **MAIL THIS COUPON TODAY**

**H. T. ARMSTRONG  
PACIFIC TRAINING SCHOOLS**

7219 So. Broadway, Dept. S-503, Los Angeles 3, Calif.  
Dear Sirs: Please send me, without obligation, your free  
booklet and complete details.

Name \_\_\_\_\_

Address \_\_\_\_\_

City \_\_\_\_\_ Zone \_\_\_\_\_ State \_\_\_\_\_



# INVENTORS

If you consider your invention to be something of importance—if you have invented any new and useful art, machine, manufacture or composition of matter or improvement thereof—you are advised to protect your invention by applying for a U. S. patent.

A patent is a valuable right. It grants you a monopoly—the right to exclude others from making, using or selling your invention as claimed for a term of seventeen years.

The specification and claims of a patent, particularly if the invention be at all complicated, constitute one of the most difficult legal instruments to draw with accuracy. Therefore, unless you are thoroughly familiar with such matters, you are advised to employ a competent registered patent attorney or agent.

This firm is registered to practice before the U. S. Patent Office and is available to assist in the preparation and prosecution of your patent application.

The "Evidence of Invention" form mentioned below is offered as a convenience to you in making your disclosure to us for search purposes.

You should date and sign your disclosure and have it witnessed by two or more persons who are capable of understanding your invention.

Your disclosure should be mailed to us together with a letter authorizing us to conduct a preliminary

search among previously granted U. S. patents for similar types of invention.

We then make this search and prepare a report of the probable patentability of your invention. If such report is favorable, we recommend the further course for you to take.

The "Evidence of Invention" form and booklet are suggested as conveniences to you and us in starting action on your invention.

**VICTOR J. EVANS & Co.** *Merlin M. Evans*  
REGISTERED PATENT ATTORNEY  
540-C MERLIN BUILDING, WASHINGTON 6, D. C.

We shall be glad to send you promptly and without obligation, an instructive booklet, "Patent Protection for Inventors", which was prepared to give inventors detailed information and steps to take toward patent protection—also our convenient "Evidence of Invention" form. Use address Victor J. Evans & Co., 540-C Merlin Building, Washington 6, D. C.

PATENTS      COPYRIGHTS      TRADEMARKS

## OVER 1100 CUBIC INCHES OF PLANNED DRAWER SPACE

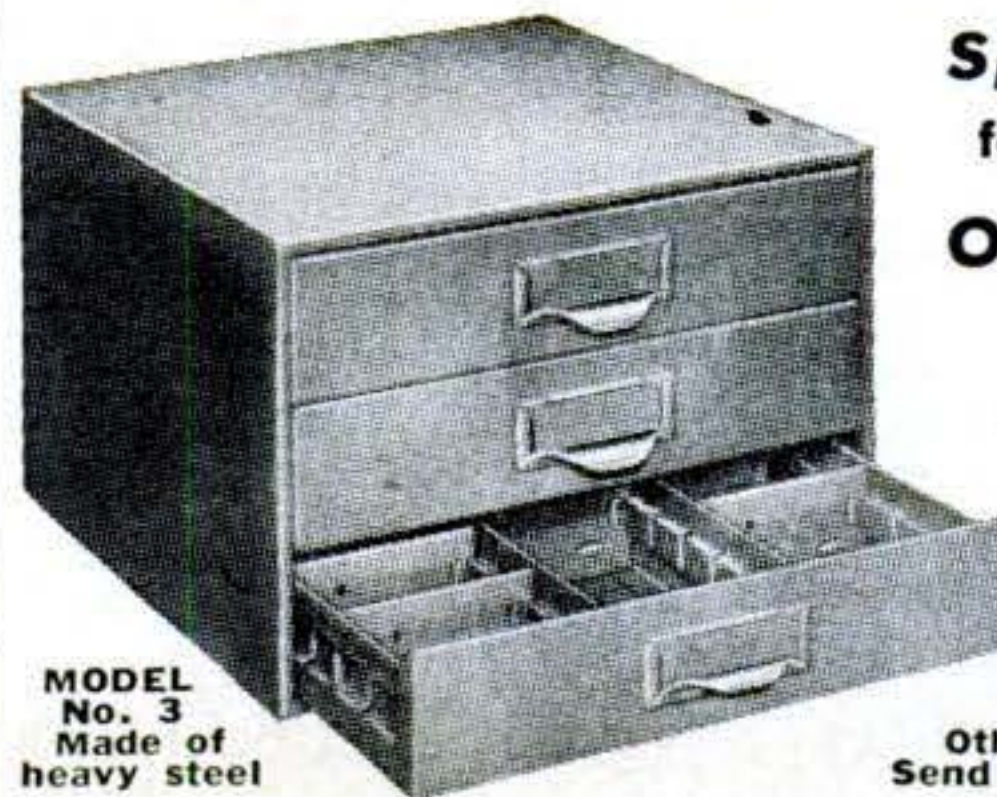

MODEL No. 3  
Made of heavy steel

**Special Price**  
for limited time

**ONLY \$5.95**  
F.O.B.

Chicago, Ill.

11 3/4" wide,  
11 7/8" deep, 7 3/4" high. Drawers approximately 2 1/2" high. Extra dividers available.

Other sizes available. Send for free catalogue.

The ideal cabinet for your shop or workbench, to keep tools, parts, nuts, bolts, screws, nails, and other needs, etc. Drawers fitted with combination pull and labelholder. Each drawer is separated into 3 compartments with 3 adjustable dividers each. Dividers and back of each compartment punched to hold label. Stops prevent drawers from being pulled out and spilled. Green baked-on enamel.

Send check or money order.

**SUPERIOR STEEL PRODUCTS**

8553 S. Carpenter St.

Chicago 20, Illinois

## LEARN TO HYPNOTIZE



Yes, anyone. Modern speed hypnotism. Methods revealed. You are told exactly what to say and do. Many interesting experiments. Self-hypnosis fully explained. Private & class instruction available.

Send for **Hypnotism Revealed \$1**

12" Hypnotism Record Inducing Self-Hypnosis plus Individual & Group-Hypnotism... **\$5**

MELVIN POWERS, Professional Hypnotist, 1324 Wilshire, Dept. 65, Hollywood 14, Calif.

## LEARN IN SPARE TIME— by Easy PICTURE CARTOONING CHART METHOD!

Same Simplified Method that has helped train creators of "Steve Canyon," "Winnie Winkle," "Out Our Way," "Secret Agent X-9," "The Neighbors," "Reg'lar Fellers," "Strange As It Seems," and many others. Send 10c for Picture Chart (to test your ability), and full details. (State age.)

**LANDON SCHOOL OF CARTOONING**  
5023 Cleve. Transit Bldg., Cleveland 14, Ohio



## See The Wonders of the Heavens!

Amazing value! Wonderful 193-page cloth-bound book, *Everybody's Guide to Astronomy* now yours for \$1.00! Contains star charts, tables, telescope-making instructions, how-to-do-it ideas for astronomical equipment you can build, etc. *Supply limited!* Order today! Write:

POPULAR SCIENCE

Dept. 350, 353 4th Ave.

New York 10, N. Y.

## SPEED AND POWER Handbook

50 CHAPTER LIBRARY EDITION

Build Fast Stock Cars! California Roadsters! 160 MPH Rods! Covers Crosleys to Cadillacs—all makes. Breathtaking Methods. Authentic—Direct from California!

SAVE MANY DOLLARS

Build your own Dual Manifolds! Superchargers! Hot Cams! Water Injectors! Hi-Compression Heads! Mileage Devices! Get up to ten more miles per gallon! Get racing speed, lightning acceleration, dynamic power increases from any make passenger automobile! Get construction drawings! Tuning techniques! Speed tricks! Economy secrets! Ingenious formulas! Covers "Racing Frames"—"Reciprocating Masses"—"Jet Engines"—"Braking Characteristics"—"Dynamometers"—"Dual Pipes, Gears, Fuels, Manifolds, Porting, Relieving, Lowering! Balancing. Including 1950 Racing Equipment Catalogues!



SPEED SHOP  
METHODS

Includes "CALIFORNIA AUTOMOBILE CUSTOMIZING"—Drawings! Photographs! Diagrams! Newest Ideas! Conversions! Carson Tops! Restyling all makes! Streamlining! Chopping! Channelling! Complete—\$1.98 Postpaid.

**NEWHOUSE AUTOMOTIVE INDUSTRIES**  
5805 East Beverly Blvd., Dept. A4, Los Angeles 22, Calif.



GET INTO

# DIESEL-AUTO MECHANICS

Master All Phases

**JOBS LIKE THESE ARE AVAILABLE TO TRAINED MECHANICS. CHOOSE THE FIELD YOU LIKE BEST**

**Get Complete Training**

- Diesel Fuel Injection
- Automotive Motor Tune-up
- Diesel Engine Rebuilding
- General Garage Mechanic
- Agricultural Implements
- Auto Engine Rebuilding
- Auto Elec. Service
- Public Utilities
- Parts Dealers
- Bus & Truck Lines
- Industrial Maintenance
- Contracting & Excavating
- Business of Your Own
- AND MANY other similar openings.

As a National Schools graduate, you are trained for ALL opportunities in the Diesel & Auto Industries.

**EARN WHILE YOU LEARN**

With our practical Master Shop-Method Home Training, you study at home in your spare time. You receive Spare Time Work Lessons, which show you how to earn while you Learn... for extra money and experience. You Learn by DOING.

**TOOLS AND EQUIPMENT**

To make your training complete, we give you selected mechanic's tools and equipment, illustrated below, including all-metal tool-box—as a regular part of your instruction.

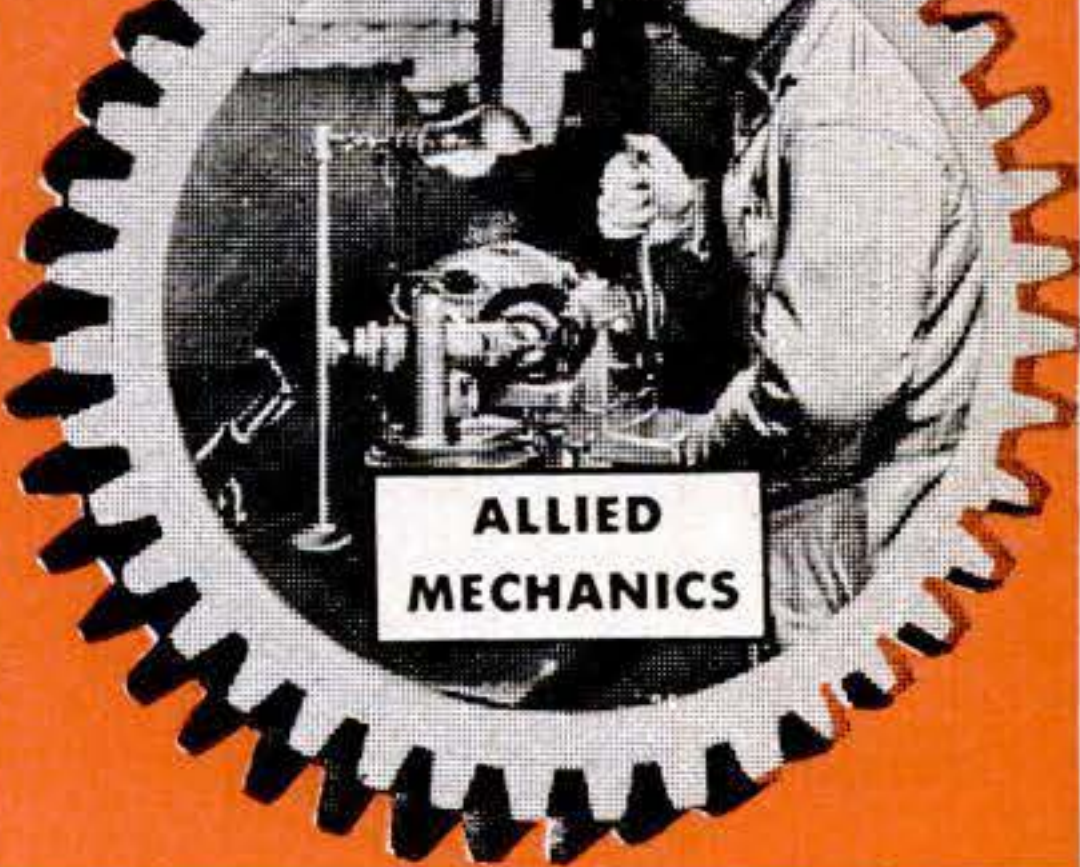
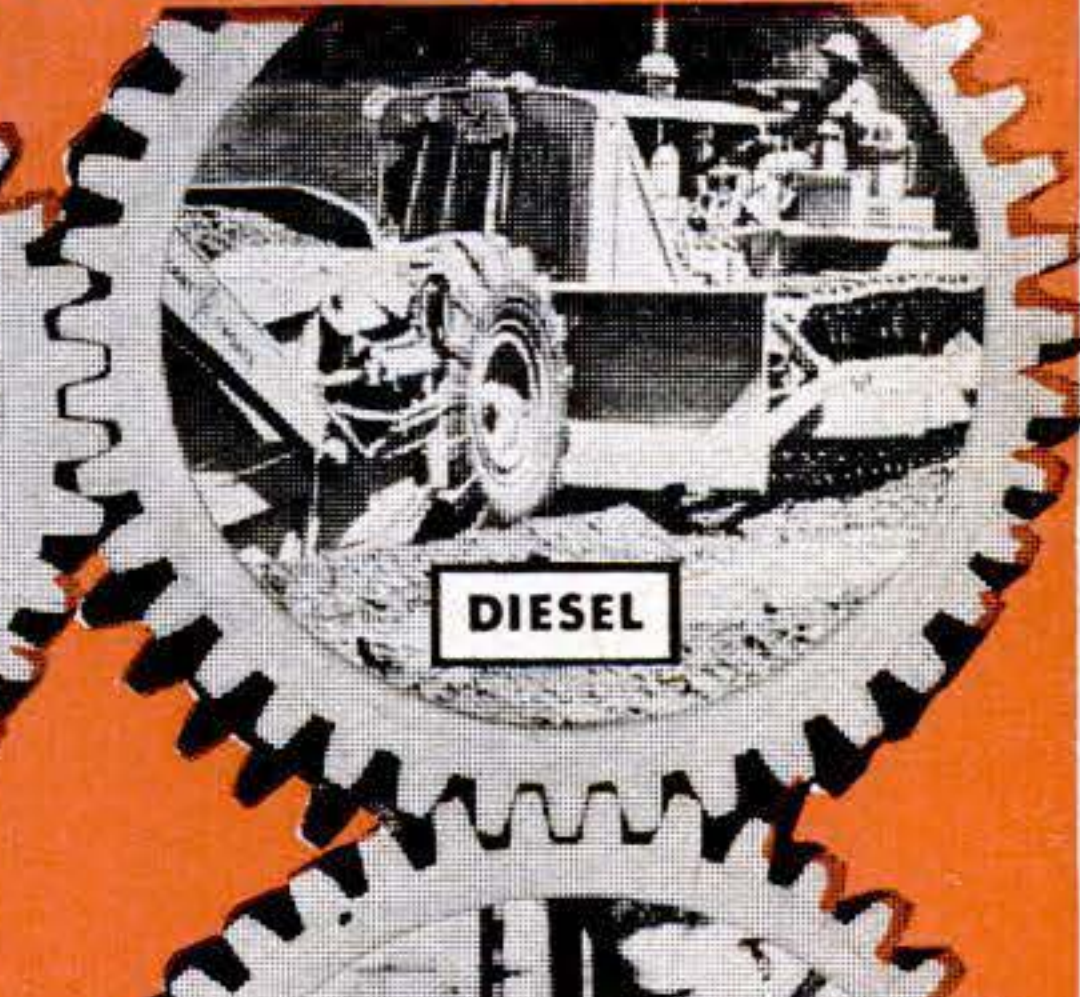

**Shop-Method Home Training by an Established Resident School Prepares you for Many Good Jobs**

Opportunity is everywhere for the trained Diesel - Auto Mechanic. Highways throng with cars, busses, trucks tractors. Garages and Service Stations are kept busy. Factories, ships, farms, railroads, general industry, are dependent upon engine power. Here's a dynamic, fast - growing field that needs trained men who know ALL phases: installation, operation, maintenance and repair. Now—National Schools offers you a practical, all-embracing Diesel-Auto Mechanic's Course, including all of these advantages:

**Complete training, covering—Diesels, High Speed and Heavy Duty; Semi-Diesels, Gasoline and Special Fuel Engines AND Allied Mechanics.**

- Basic Lesson Texts
- Diesel Installation
- Operation—Maintenance
- Diesel Chart Manual
- Spare Time Lessons
- Engine Service Manuals
- Engine Repair
- Drive Systems
- Diesel Electric Power
- Thermodynamics

**TOOLS AND EQUIPMENT INVESTIGATE**

Secure Full Information

**NEW, ILLUSTRATED BOOK & SAMPLE LESSON SHOW HOW WE TRAIN YOU... SEND FOR THEM TODAY!**

**NO COST NO OBLIGATION**

**APPROVED FOR VETERANS**

Check coupon below

**WE GIVE YOU TOOLS OF YOUR TRADE**

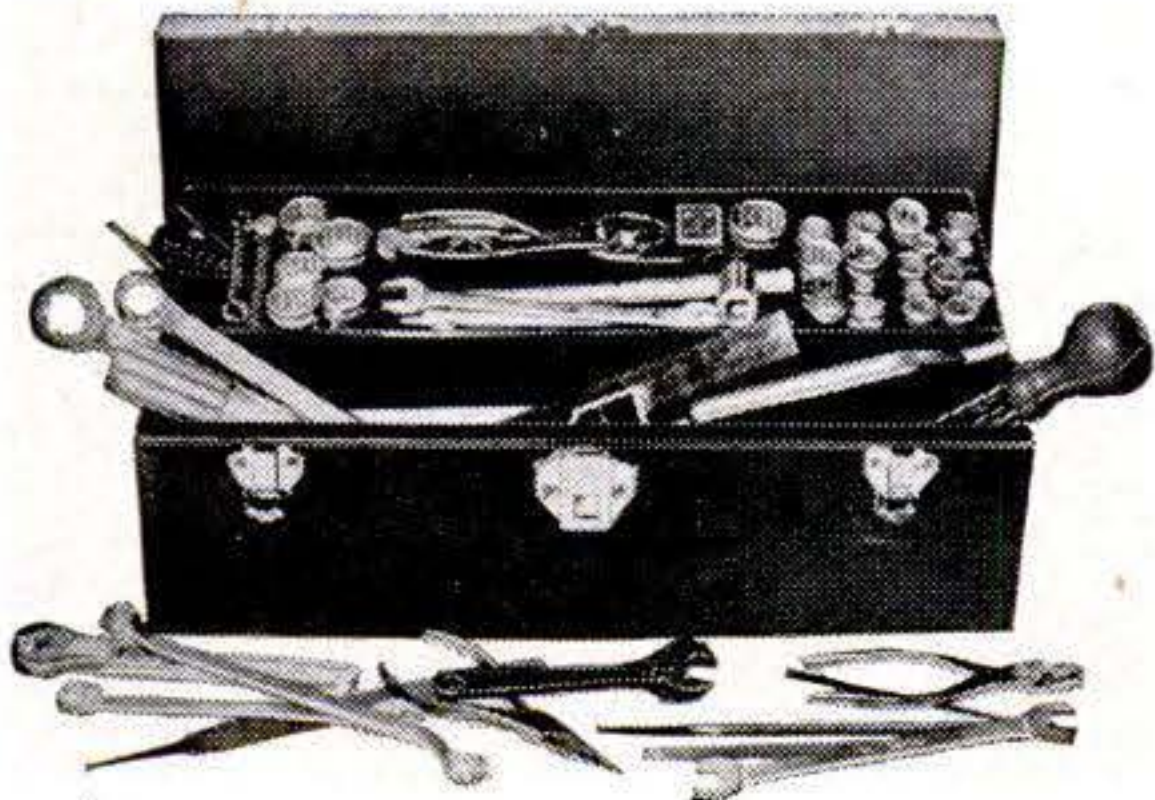

**NATIONAL SCHOOLS**

LOS ANGELES 37, CALIF. • EST. 1905



**FIND OUT NOW... MAIL COUPON TODAY**

NATIONAL SCHOOLS, Dept. PSD-3  
4000 South Figueroa Street  
Los Angeles 37, California

(Mail in envelope or paste on penny postcard)

Mail me FREE the book, YOUR FUTURE IN DIESEL-AUTO MECHANICS, together with the Sample Lesson. I understand I may keep and use the information with no obligation.

Name..... Age.....

Address.....

City..... Zone... State.....

Check here if Veteran of World War II



# WHAT YOU CAN DO ABOUT PIMPLES

## Acne, Blackheads, and other externally caused Skin Blemishes

**W**HEN pimply skin is your problem, the first thing to get straight is that you *can* and *should* do something about it. To develop the attractiveness of your face is not mere vanity. It is an "open sesame" towards bringing the real YOU closer to other people and giving your personality the poise and confidence it needs. Your good qualities—intelligence, character, dignity—all go to naught... are completely cancelled out by a skin that "nobody loves to touch." Remember, the YOU that people see first is your face.

### SKIN PROBLEMS

#### DEMAND IMMEDIATE CARE

Medical statistics tell us that blemished skin usually occurs from adolescence on through adult life. The problem at the adolescent stage is serious enough to deserve attentive care as a family matter. In adulthood, when life's responsibilities are so much weightier, it is doubly important to exert great effort to eliminate these blemishes. And, there is no better time to get pimples under control than *now*.

### DON'T ABUSE SKIN

The first instinctive reaction to pimples and blackheads is to squeeze them out with your fingers.

A bit of experimentation along these lines soon provides convincing proof that this succeeds only in inflaming your skin and spreading the infection.

Under no circumstances should pimples and blackheads ever be squeezed.



Copyright 1949 by Dornol Products, Inc.

### MICROSCOPE SHOWS IMPORTANT BASIS FOR EXTERNALLY CAUSED PIMPLES AND BLACKHEADS

Let's take a look through the microscope to see what's behind those unsightly pimples. The high-powered lenses show your skin coated with a covering which originated from two sources—one, internally and the other, externally.

The internal substances on your skin include dead cells, residue from the sweat glands, and a high quantity of oil excreted by the sebaceous glands. A most important factor in skin disorders occurs when thousands of these tiny sebaceous glands discharge more oil than the skin can use for lubrication. Unless special care is given, the oil forms a heavy film which attracts foreign matter to your skin much as any oil mop picks up dust. These infectious external substances may be classified into three general groups:

1. Airborne materials such as dust, pollens, condensation products of smoke, vapors, etc.
2. Materials brought in contact with the skin, such as tiny fragments of clothing, bedding, cosmetics.
3. Micro-organisms such as bacteria and fungi.

See the difference between a healthy skin and a pimply skin in the microscopic reproductions below.



A.  
Normal skin

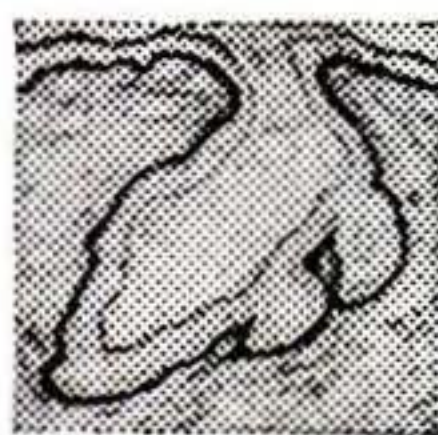

B.  
Sick, pimply skin

Diagram A shows a normal-size, smoothly functioning sebaceous gland. Diagram B pictures sick, pimply skin. Notice that the sebaceous gland is a swollen mass of trapped oil, waste and infectious bacteria.

### TRY THIS SENSIBLE WAY

Two sensible aims to achieve in controlling this skin condition are: to clear the pores of clogging matter, and to inhibit the excessive oiliness of the skin. Toward these ends, Dornol Products' research makes available two formulas. One is to aid in thorough cleansing by highly detergent penetration which simplifies the removal of waste and foreign matter. The other is to discourage oiliness with clinically-proved ingredients, and to kill infec-

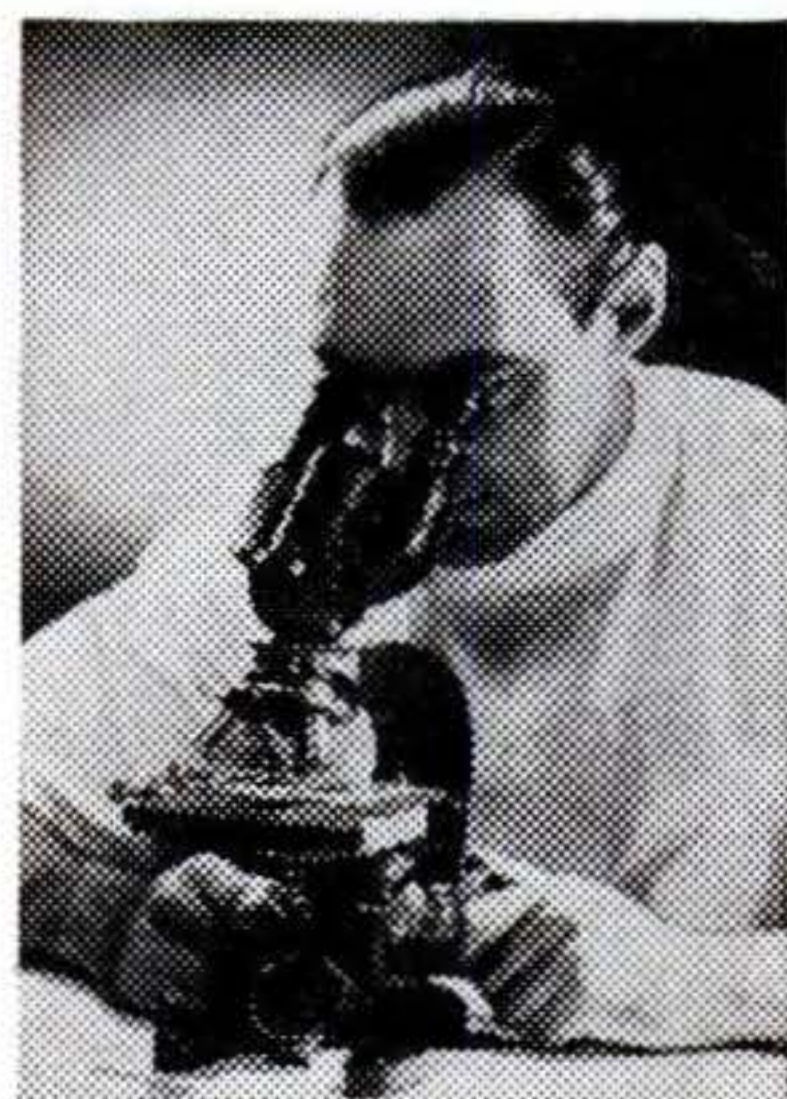

tious bacteria often associated with externally caused pimples and blackheads.

### BLEMISHES COVERED UP

To remove the distressing embarrassment of these skin blemishes, the second Dornol formula exerts a "cover-up" action on your broken out skin while the medication does its work. This, plus its pleasant odor, will spare you the mental distress which is associated with unsightly, malodorous, medicated preparations. Imagine! You can apply this Dornol formula to your skin by day and face the immediate present with greater confidence in your appearance, while secure in the knowledge that medication is acting to remove old blemishes and keep away new ones. What this "cover-up" action alone is worth in peace of mind is beyond calculation. No longer need prying eyes make you wince with humiliation and misery. Now because of this wonderful feature of the Dornol treatment, you can put your best foot forward... at once!

### SATISFACTION GUARANTEED

OR

### DOUBLE YOUR MONEY BACK

We know what the Dornol treatment has done for others, so we want you to try it at *our* risk. A few minutes a day invested in our treatment can yield more gratifying results than you ever dared hope for. This is what we say to you: If you are not delighted in every way by the improved condition and general appearance of your skin in just 10 days, simply return the unused portion and we will refund not only the price you paid—but **DOUBLE YOUR MONEY BACK!** Can anything be fairer than that? You have everything to gain... and we take all the risk!

### How to get the Dornol Treatment immediately:

Just send your name and address to DORNOL PRODUCTS, INC., Dept. 4515, 4257 Katonah Ave. New York 66, N. Y. Be sure to print clearly. By return mail we will ship the Dornol treatment to you in a plain package. When postman delivers the package, pay only \$1.98 plus postage. Or, if you wish to save postal fee, send \$2 now and we will pay postage. Which ever way you order, the **DOUBLE REFUND GUARANTEE** still prevails. Don't delay another minute, send for the Dornol Medicated Skin treatment with "cover-up" feature... at once! Sorry, no Canadian C.O.D.'s.



# BUILDERS

## TRADE GUIDES



### AUDELS CARPENTERS AND BUILDERS GUIDES—4 VOLS. \$6

Inside Information for Carpenters, Builders, Joiners, Building Mechanics—all Woodworkers. 1600 pages; 3700 diagrams; flexible; pocket size. Short-cut instructions, new methods, ideas, solutions, plans, systems—money saving suggestions. An easy progressive course for the apprentice. A practical daily helper and Quick Reference for the master worker. A Helping Hand to Easier and Better Work and Better Pay. To get this aid for yourself, simply fill in and mail the FREE COUPON below.

#### INSIDE TRADE INFORMATION ON:

How to use steel square; How to file and set saws; How to build furniture; How to use mitre box; How to use chalk line; How to use rules; How to make joints; Carpenters' arithmetic; Mensuration problems; Estimating

strength of timbers; How to set girders and sills; How to frame houses and roofs; How to estimate costs; How to build houses, barns, garages, bungalows, etc.; How to read and draw plans; Drawing up specifications; How

to excavate; How to use settings 12, 13 and 17 on the steel square; How to build hoists and scaffolds—skylights; How to build stairs; How to put on interior trim; How to hang doors; How to lath—lay floors; How to paint.

"Audels Guides worth four times their price—handy too as I carry them in pocket for reference." W. J. Bates, Knoxville, Pa.



### AUDELS PLUMBERS AND STEAMFITTERS GUIDES—4 VOLS. \$6

A new edition—just out! A practical, illustrated, Reference Library and Study-Course for Master Plumbers, Journeymen and Apprentice Steamfitters, Gas Fitters and Helpers, Sheet Metal Workers, Draughtsmen, Master Builders, Engineers and all Building Trade Students. 1670 pages; 3642 diagrams; flexible; pocket size. Guides explain all the principles, advances and short cuts of the Plumbing and Heating trade. Contains instructions on how to figure and estimate jobs. Use FREE COUPON below to examine, without obligation, this valuable work.

#### INSIDE TRADE INFORMATION ON:

Air Conditioning. Soldering, tinning. Joint wiping, bending, beating. Pipe—iron—steel, threading. Mathematics, tables, physics. Materials—iron, steel, copper, brass, lead, tin, antimony. Sheet metal—galvanized—plate. Sanita-

tion, syphonage, tanks. Drainage, sewage, purification. Fixtures—bath—kitchen. Pipe fittings, soil pipe, tools. Laying out work. Roughing. Screwed fittings, flanges, joints. Pipe bending, examples. Elbows. Heating, ven-

tilation, refrigeration. Water supply, mains, wells, tanks. Gas-fittings. Underwriters. Sheet metal work, problems, methods, Brazing, heating, lead burning. Welding, various welds, methods. Blacksmithing, forges, tools.

"Audels Guides are practical, easy to understand, reliable. Cover the field in plain language." W. F. Arminger, Annapolis, Md.

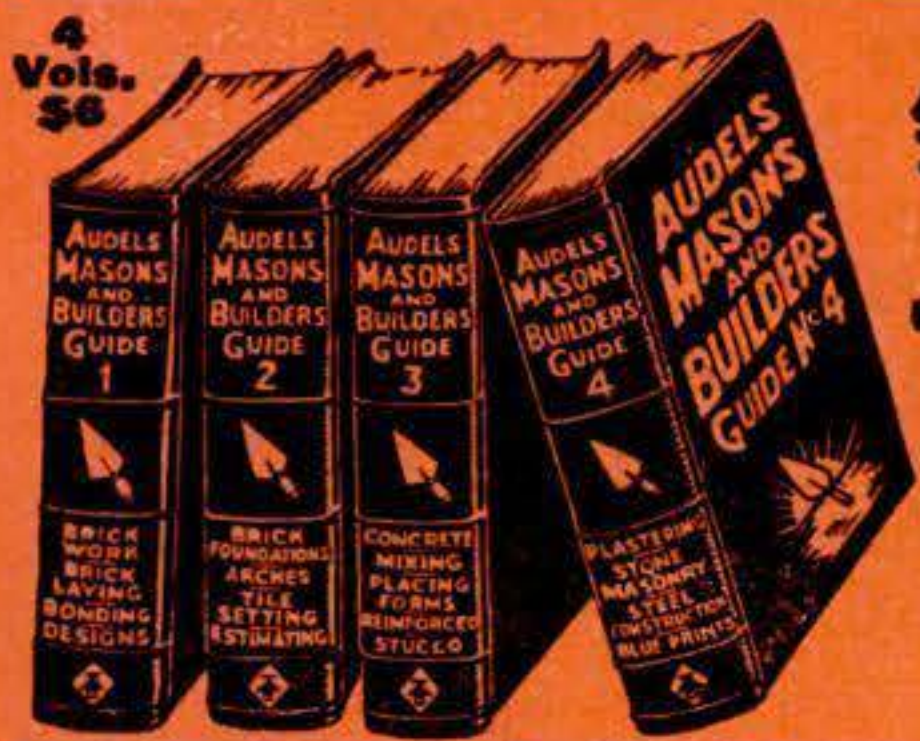

### AUDELS MASONS AND BUILDERS GUIDES—4 VOLS. \$6

A complete, illustrated trade reference library, for Bricklayers, Cement Workers, Plasterers, Tile Setters and Stone Masons, including a practical outline of Steel Construction. 1100 pages; 2067 diagrams; flexible; pocket size. A practical Trade Assistant explaining modern methods of masonry construction. Easy to understand and apply. A reliable and authentic reference work and study-course for Master Journeyman and Young Mechanic. Use FREE COUPON below and find out for yourself, without obligation, whether this set will benefit you.

#### INSIDE TRADE INFORMATION ON:

Bricklaying, tools, materials; Brick designs, patterns, bonds; Setting frames and foundations; Mortars, scaffolds, estimating; Mortars and mortar mixing; Tile setting, mosaic, hollow tile; Straight edge test, trow-

eling; How to figure brick work; Safe loads, piers, chimneys; Boiler settings, anchors, fire stops; Labor tables; Concrete, forms; How to figure concrete work; Stucco—on old and new buildings; Plastering—wood lath—metal;

Plasterers agreement; Plastering on various surfaces; Stone masonry; Cutting, finishing, estimating stone; Derricks, rigging; Steel construction; Fire proof; How to read blue prints.

"Audels Masons Guides are the best books on the subject. Have laid brick 12 years and am able to judge." H. A. Sonnett, Corliss, Pa.



### PRACTICAL ELECTRICITY—1 VOL. \$4

Audels Handy Book of Practical Electricity is a simplified Ready Reference and Study Course in one pocket size volume—for Engineers, Professional Electricians and Students. 1040 pages; 2600 diagrams; flexible bound. A reliable authority and handy helper for every electrical worker. Contains important and valuable wiring diagrams, calculations, machine sketches, helps on maintenance and repair. Use this FREE COUPON today and find out, without obligation, how this handy book will help you in your daily work.

Complete in one handy, red leather bound volume

#### INSIDE TRADE INFORMATION ON:

Electro-Therapeutics, X-Rays, Shocks, Welding, Brazing, Radio Hook-ups, Motion Pictures, Telephone, Telegraph, Cranes, Bells, Elevators, Pumps, Tools, Ship Drive, Railways, Vehicles, Automobile Electric Systems, Ignition, Generation, Lighting, Plant Management, Power Plans, Armature Winding, Repairing, A. C. Motors and Apparatus, D. C. Motors and Apparatus, Alternator Construction, Dynamos, Wiring, Diagrams, Sign Flashers, Cable Splicing, Power Wiring, Outside Wiring, Switches, Lightning, Rectifiers, Converters, Transformers, Fuses, Circuit Breakers, Rheostats, Electro Plating, Electrolysis, Storage Batteries, Magnetism, Electrical Energy, Conductors, Inductors, Static, Dynamic, Radio Electricity, Applications, Ready Reference and Index

Covering the entire field of Modern Electricity.

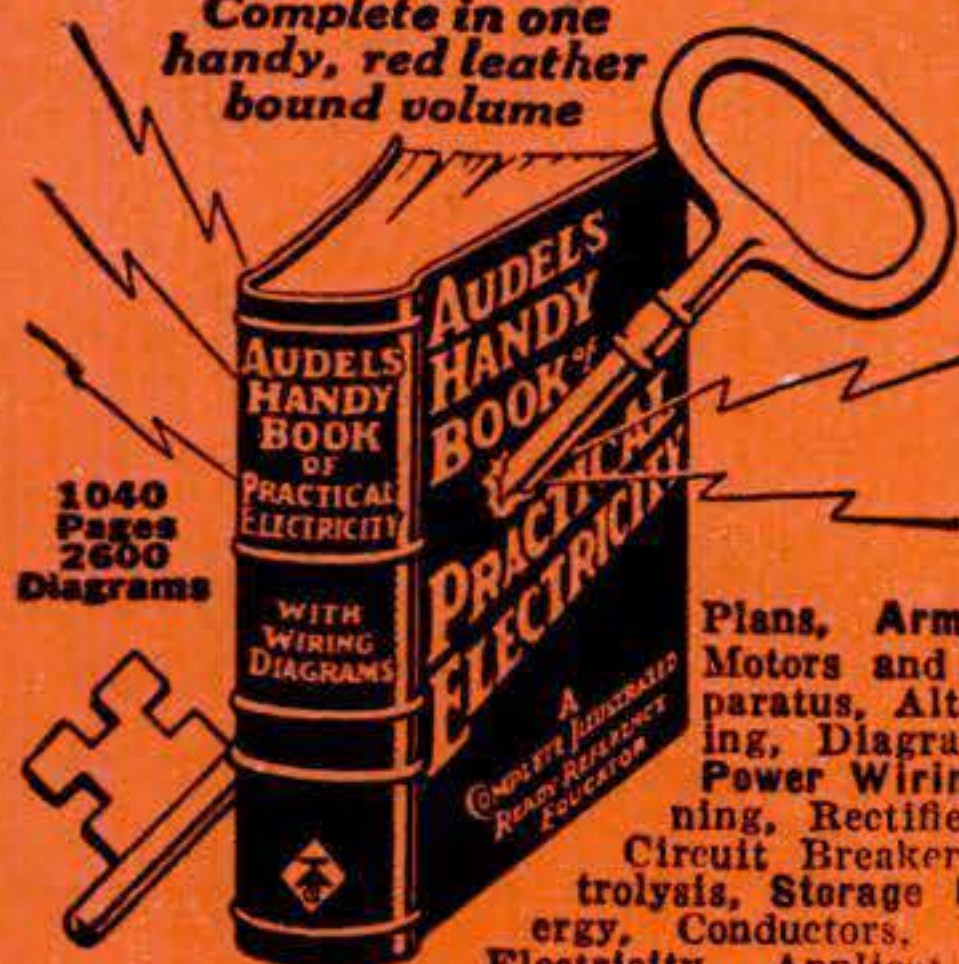

### Learn More and You Will Earn More!

Know your job and you'll never be without one. The skilled man is always in demand. Knowledge is power. Learn your trade thoroughly by easy reading. This coupon is your opportunity for advancement and better pay. You risk nothing in sending for Audels Guides for free examination. Send it NOW!

FREE EXAMINATION COUPON

#### THEO. AUDEL & CO.

49 W. 23 ST., NEW YORK CITY

Please mail me for free examination the books marked (x) below. If I find them satisfactory, I agree to mail \$1 in 7 days, on each set ordered, and to further mail \$1 monthly on each set until I have paid the purchase price.

- 4 CARPENTERS GUIDES \$6 |  4 PLUMBERS GUIDES \$6  
 4 MASONS GUIDES \$6 |  1 ELECTRICIANS HANDY BOOK \$4

NAME.....

ADDRESS.....

OCCUPATION.....

EMPLOYED BY..... PSM



# YES!

# HERE IT IS!

# YOUR BOOK

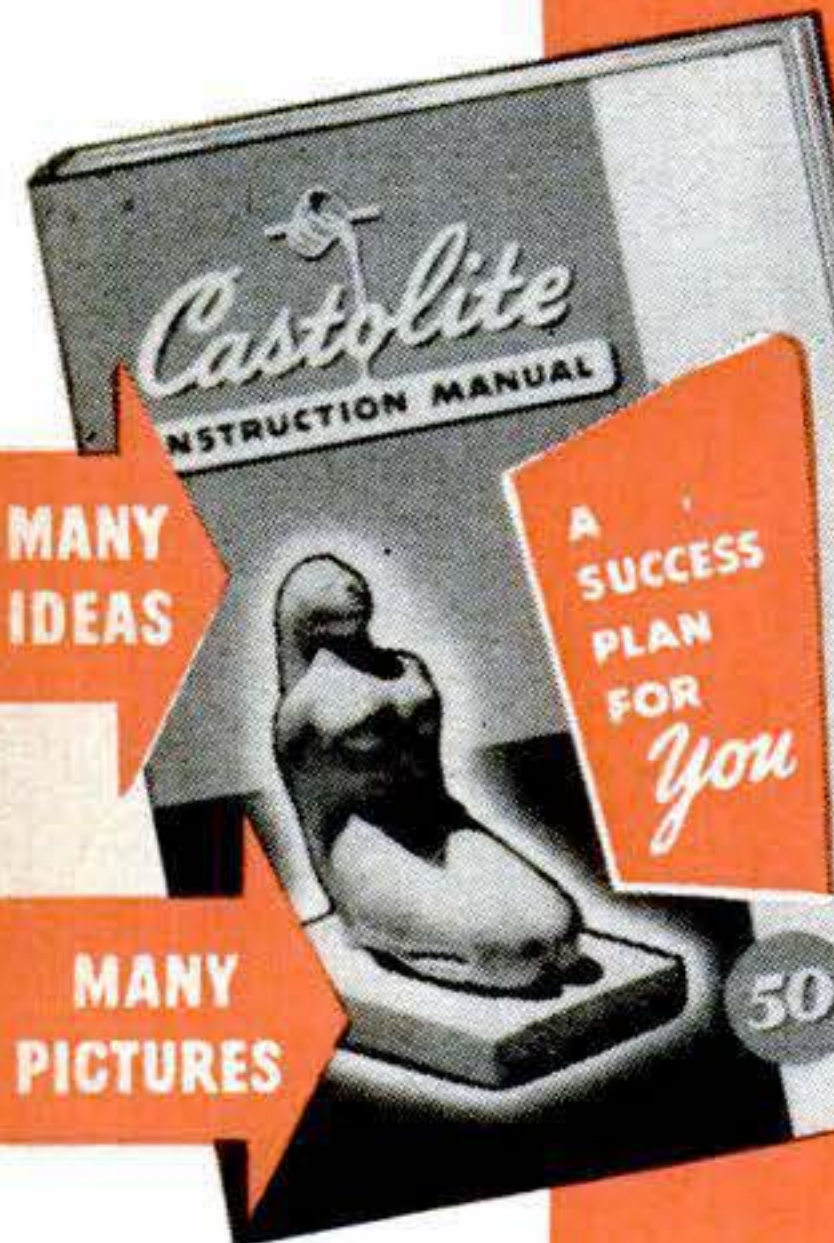

MANY IDEAS

MANY PICTURES



## A BIGGER BETTER

# PLASTIC MANUAL

### combined with NEW SUCCESS PLAN!

**G**REAT news at last for people who want to make all kinds of fine things with Plastic! Now, just released, is a great new Plastic Book—bigger, better, more complete than anything ever before published in this field. This Book not only tells you how to make valuable articles at home, but also gives proved Success Methods for having a business of your own. Positively new—startling—different—100% Practical—for those who want to make things—and make money, besides.

## GREAT NEW MONEY-MAKING IDEAS



New, Modern developments are explained. Think of producing gorgeous baby shoe mementoes with the very latest "plastizing" process, instead of old, slow, costly electroplating methods. Just treat shoes with Castolite, new, magic liquid plastic, and get any desired color-finish. Or create striking plastic profile silhouette wall plaques of children, family, friends. Have the time of your life, also get the extra money you've been wanting.

### NEW LIQUID PLASTIC

With new Liquid Castolite it's easy to make swell things like costume jewelry, fancy buttons, lamp bases, candle holders, coasters, wall plaques, desk sets, clock cases, other valuable articles.

### EASY TO START

Begin making things very first day. But first get this handsome book giving complete instructions and Success Secrets. Tells what you can do; what others are doing in this fascinating field. Send 25c today for your copy of "A Success Plan for You".

## New Advertising Machine



# Prints & Illustrates 1¢ Post Cards

**FREE** Learn how thousands of business men, in every line, are boosting sales in spite of conditions—with 1¢ messages—printed and illustrated in a few minutes on gov't post cards—with amazing new patented **CARDMASTER**. Your "today's" ideas, read by your prospects next morning. Not a toy, but a sturdy advertising machine, built to last for years. Low price, sold direct. Guaranteed for five years. Send name today. **SEND NAME** We'll send **FREE** illustrated book of money-making **IDEAS** for your business and complete, unique advertising plans. **RUSH YOUR NAME TODAY.**  
**CARDMASTER COMPANY**  
1920 SUNNYSIDE, Dept. 163, CHICAGO 40, ILL.

# Learn WATCH REPAIRING

*Earn while AT HOME you Learn*

Learn this fascinating and profitable trade in your spare time at Home through our Correspondence Department. Each individual student receives individual attention! Post-Graduate course at resident school optional for correspondence students. **OUR MOTTO:** Not how quickly, **OR** but how thoroughly we can train you.

## AT OUR RESIDENT SCHOOL

APPROVED FOR G. I. TRAINING

Our school is set up on an individual basis where every student receives individual attention from our competent instructors in a home-like and cheerful atmosphere.

**Write TODAY FOR FREE INFORMATION:** Depts JOHN VAN PUFFELEN, Director American Institute of Specialized Watch Repair 270-276 East Bldg., Grand Rapids 6, Michigan

## Save HALF! Slight Factory Imperfect Dress PANTS

**Genuine GABARDINE** Imperfections very slight—hardly affect wear. Ideal for dress, school, play, work. Firm hard finish. Virgin wool and rayon blended. Wrinkle and shine resistant. Retains neat press. Zipper front. Roomy pockets. Blue, Tan, Sand, Lt. Brown, Dk. Brown & Blue-Gray. Waist 28 to 42.

**SEND NO MONEY** Send name, waist size, 1st, 2nd & 3rd color choice, light or dark. Pay postman only \$4.95 plus small postage. Or send money and save postage. Money-Back Guarantee.

**LINCOLN TAILORS, Dept. PS-4, Lincoln, Nebr.**

Worth \$10

**\$4.95**

### Train for one of these Big Fields in the Largest & Best Equipped School of its Kind

#### HAT CLEANING AND BLOCKING

Learn by doing in modern training shops under experts. Fine opportunities for good jobs or your own successful business. Have the advantage of going to a big, well established school. **COMPLETE HAT CLEANING AND BLOCKING TRAINING IN ONLY 12 WEEKS.**

**G. I. APPROVED**

**CHICAGO SCHOOL OF SHOE REBUILDING**  
124 E. 26th Street Dpt. PS-3 Chicago 16, Illinois

#### Shoe Repairing

Look to the future with confidence. Get into these great fields which are among mankind's oldest and most essential. Trained men—needed in practically every locality the year around. No previous experience or advanced education necessary.

**Write for Free Booklet Today**

## DEALERS

Financially responsible dealers have excellent opportunity handling Castolite products. Send for this new Manual and complete information about our Dealer Plan.

## The CASTOLITE Co.

Dept. C-2

WOODSTOCK,

ILLINOIS



# "Give Me Your Measure and Let Me Prove I Can Make You a NEW MAN!"

**I** DON'T care how old or young you are, or how ashamed of your present physical condition you may be. If you can simply raise your arm and flex it I can add **SOLID MUSCLE** to your biceps—yes, on each arm—in double-quick time! Only 15 minutes a day—right in your own home—is all the time I ask of you! And there's no cost if I fail.

I can broaden your shoulders, strengthen your back, develop your whole muscular system **INSIDE** and **OUTSIDE**! I can add inches to your chest, give you a vise-like grip, make those legs of yours lithe and powerful. I can shoot new strength into your old backbone, exercise those inner organs, help you cram your body so full of pep, vigor and red-blooded vitality that you won't feel there's even "standing room" left for weakness and that lazy feeling! Before I get through with you I'll have your whole frame "measured" to a nice, new, beautiful suit of muscle!

## I Was a 97 lb. Weakling

I know, myself, what it means to have the kind of body that people pity! Of course, you wouldn't know it to look at me now, but I was once a skinny weakling who weighed only 97 lbs. I was ashamed to strip for sports or undress for a swim. I was such a poor specimen of physical development that I was constantly self-conscious and embarrassed. And I felt only **HALF-ALIVE**.

Then I discovered "*Dynamic Tension*." It gave me a body that

won for me the title "World's Most Perfectly Developed Man."

When I say I can make you over into a man of giant power and energy, I know what I'm talking about. I've seen my new system, "*Dynamic Tension*" transform hundreds of weak, puny men into Atlas Champions.

## What Only 15 Minutes a Day Can Do for You

Do you want big, broad shoulders—a fine, powerful chest—biceps like steel—arms and legs rippling with muscular strength—a stomach, ridged with bands of sinewy muscle—and a build you can be proud of? Then just give me the opportunity to prove that "*Dynamic Tension*" is what you need.

No "ifs," "ands," or "maybes." Just tell me where you want handsome, powerful muscles. Are you fat and flabby? Or skinny, and gawky? Are you short-winded, pepless? Do you hold back and let others walk off with the prettiest girls, best jobs, etc. Then write for details about "*Dynamic Tension*" and learn how I can make you a healthy, confident, powerful **HE-MAN**.

"*Dynamic Tension*" is an entirely **NATURAL** method. Only 15 minutes of your spare time daily is enough to show amazing results—and it's actually fun! "*Dynamic Tension*" does the work.



**CHARLES ATLAS**

Twice winner and holder of title, "The World's Most Perfectly Developed Man."

## My Illustrated Book is Yours **FREE** —Not for \$1.00 or 10c—But **FREE**

Send **NOW** for my famous book, "Everlasting Health and Strength." 48 pages, packed from cover to cover with actual photographs and valuable advice. It shows what "*Dynamic Tension*" can do, answers many vital questions.

This book is a **real prize** for any fellow who wants a better build. Yet I'll send you a copy absolutely **FREE**. Just glancing through it may mean the turning point in your whole life! So send the coupon to me personally: **Charles Atlas, Dept. 13, 115 East 23rd St., New York 10, N. Y.**



**CHARLES ATLAS, Dept. 13,  
115 East 23rd St., New York 10, N. Y.**

Send me—absolutely **FREE**—a copy of your famous book, "Everlasting Health and Strength"—48 pages, crammed with actual photographs, answers to vital health questions, and valuable advice to every man who wants a better build. I understand this book is mine to keep, and sending for it does not obligate me in any way.

Name.....Age.....  
(Please print or write plainly)

Address.....

City.....State.....





## YOU CAN HAVE THIS KIND OF BUSINESS..

A big business where there is a constantly growing demand . . . all of the time. **ELECTRICAL APPLIANCE SERVICING!** Millions of new appliances are sold annually. All will eventually need repair.

### •• IF YOU ARE AMBITIOUS

Want Financial Security... want Independence . . . a profitable business of your own, full or part time... or just extra spare time earnings. Learn **ELECTRICAL APPLIANCE SERVICING**. Age is no barrier.

### •• IF YOU ARE WILLING TO DEVOTE SPARE TIME

Our New Shop Method Home Training Program will bring practical and technical Electrical training right into your home! You learn by working with your hands... Building, Testing, Repairing.

### •• IF YOU ARE MECHANICALLY INCLINED

Like to "tinker" with tools... CTS will send you their big FREE Illustrated Book, "Electrical Appliance Servicing" and special form for getting their Electronic Kit, training kits, etc., on a "Pay from earnings while learning" plan.

### •• IF YOU MAIL THIS COUPON TODAY!

**CHRISTY TRADES SCHOOL, Dept. D-8801  
4432 N. Kedzie Ave., Chicago 25**

Please rush me FREE BOOK, Facts about **ELECTRONIC KIT**, Special form for paying from "Earnings While Learning."

Name \_\_\_\_\_ Age \_\_\_\_\_

Address \_\_\_\_\_

City \_\_\_\_\_ Zone \_\_\_\_\_ State \_\_\_\_\_

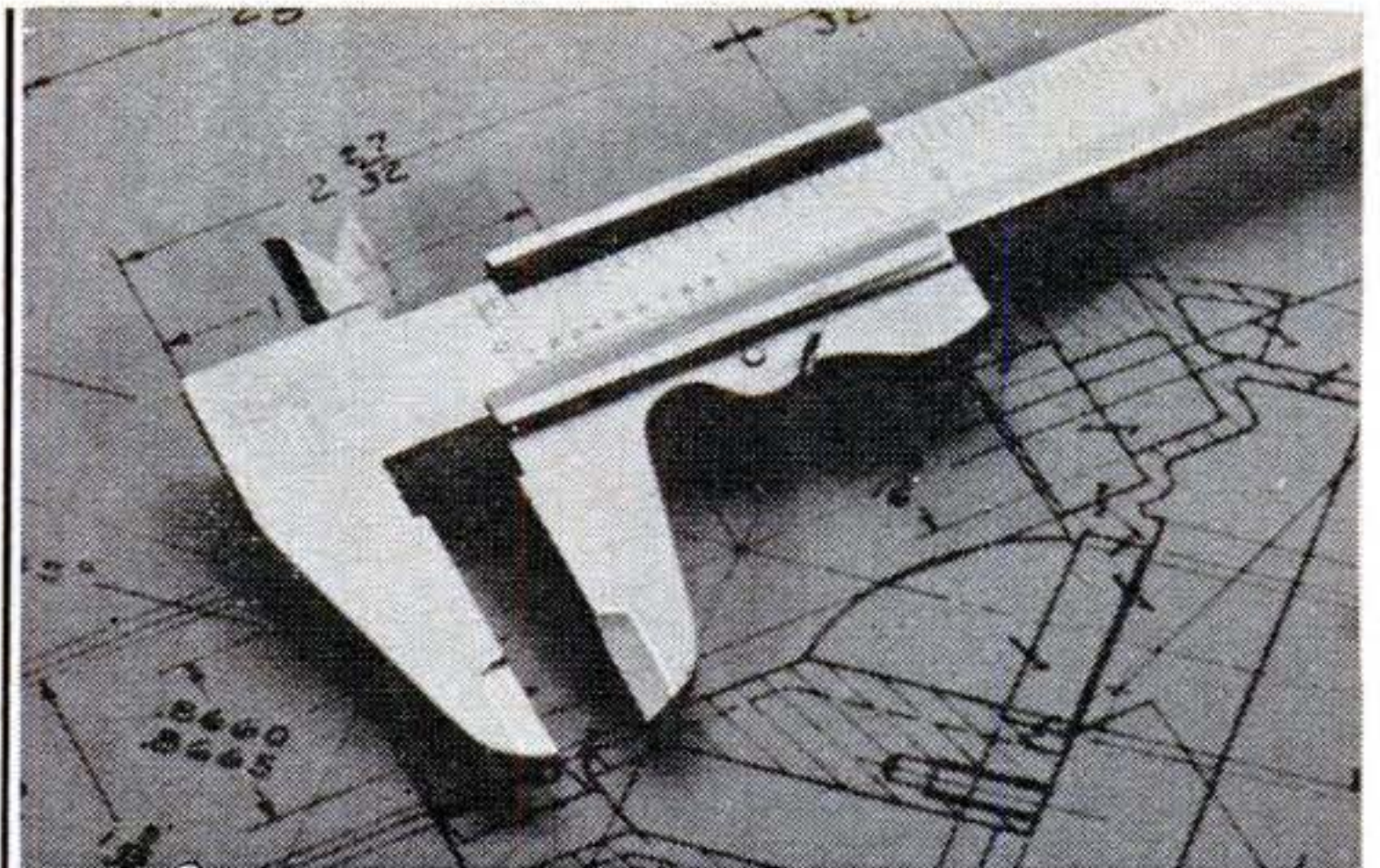

## Elmag VERNIER CALIPER

A quality precision instrument offered at an unusually low price. For inside, outside and depth measurement. Made of stainless steel with hardened jaws and blades. Vernier 1/1000ths and 1/128ths. Comes packed in deluxe leatherette case for only \$18. Full satisfaction guaranteed or money refunded after 10-Day Trial. Order direct (either C. O. D. or remit with order) from

**PTI, Incorporated** 401 BROADWAY, DEPT. 20  
NEW YORK 13, NEW YORK

### WAR EQUIPMENT MAIL SALE!

Buy Direct By Mail—SAVE!

SAVE 50% to 75% on gigantic closeout sale of 100s of guaranteed items. All shipping charges prepaid.

- A. Utility Clutch, up to 6.5 h.p. \$13.95
- B. Magneto Rural Telephones... 12.40
- C. Burglar Alarm System... 6.99
- Fire Alarm System... 9.90
- D. 2000-watt 110-volt Elements... .99
- E. City Wall or Desk Phones... 4.99
- Rotary Gear Pumps... 3.95
- Briggs 1.5 h.p. Engine... 44.90
- Multi-Speed 110-v. 60-c Motor 8.75

Order direct from ad. Satisfaction guar. Or, rush card for sensational mail-sale bargain catalog!

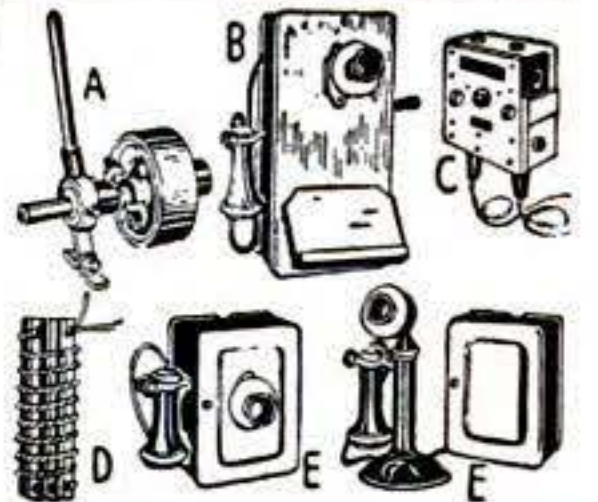

### DOZENS BARGAINS

in electronic, hydraulic, mechanical items. Electrical drills, saws, etc. **SEND FOR CATALOG!**

FREE CAT ALDG

**BURDEN SALES COMPANY**

825 "O" St.

Lincoln, Nebr.

## SHORTHAND in 6 Weeks at Home

Famous Speedwriting system. No signs; no symbols; no machines; uses ABC's. Easy to learn; easy to write and transcribe. Low cost. 100,000 taught by mail. For business and Civil Service. Also typing. 27th year. Write for free booklet to:

# Speedwriting

Dept. 2603-A, 55 W. 42 St., New York 18

## BUILD YOUR FUTURE IN WATCHMAKING and JEWELRY



Avoid dime-a-dozen trades—learn Watchmaking, today's top mechanical profession, at the world's largest and best equipped school of its kind. Work for established jewelers or build your own business. Veteran-training approved courses are offered in watch, clock, chronograph and jewelry repair and engraving. Enroll any time, day or evening classes. Send now for free 116-page illustrated information packet.

**WESTERN PENNSYLVANIA HOROLOGICAL INSTITUTE**  
DESK 39, FIRST FLOOR CHAMBER OF COMMERCE BLDG.  
PITTSBURGH 22, PENNA.

World's Largest Watchmaking School



# AMAZING NEW OFFER!

LEARN HOW TO MAKE REAL MONEY IN

# TELEVISION

RADIO & ELECTRONICS



**YOURS TO KEEP AND ENJOY**

**AT NO EXTRA COST!**  
**YOU GET A ROUND TRIP TO NEW YORK CITY**

After you have completed the home study section of your course, your transportation to *New York City*—both ways—from any point in the United States or Canada will be paid by RTTA. At our affiliated training shops in New York City you'll get *2 solid weeks*—50 hours of intensive laboratory work—on the most modern and scientific equipment. You'll live in New York City, the heart of the television industry, where the headquarters of the National Broadcasting Company, American Broadcasting Company, Columbia Broadcasting System, Mutual Broadcasting System and many large television and radio companies are located.

**FREE EMPLOYMENT HELP**

Upon completing your laboratory resident course, you will *personally be recommended* for a position by our placement director, who will help you get started toward a money-making future in television, radio and electronics.

**YOU BUILD THIS LARGE SCREEN TELEVISION RECEIVER**

**YOUR CHOICE** OF 10, 12½ OR 16 INCH PICTURE TELEVISION TUBE

**CAN BE CONVERTED FOR COLOR TELEVISION**



R.F. SIGNAL GENERATOR

**YOU KEEP ALL EQUIPMENT**

**IN DOUBLE QUICK TIME EARN BIG PAY,**

**OWN YOUR OWN BUSINESS**

Now—you can qualify for a money-making career, through RTTA's sensational plan. In addition to becoming a **CERTIFIED TELEVISION TECHNICIAN**, you build yourself a complete large screen television set of the finest commercial quality, for your own use. You get **15 BIG KITS** to enable you to get practical experience, build the equipment illustrated, plus a **6 TUBE STANDARD SUPER-HETERODYNE** radio set, and many other testing units.

No matter where you live, no matter what you do, RTTA's effective methods can help you toward a **FAT PAY CHECK OF YOUR OWN BUSINESS**. Previous experience is unnecessary.

**ALL EQUIPMENT FURNISHED**

The kits you will receive contain all the necessary **TUBES and BATTERIES**... a complete set of tubes for your **TELEVISION RECEIVER** including the **PICTURE TUBE**. In addition, you'll receive everything needed to build a complete TV set, and many more testing units.

**EARN WHILE YOU LEARN**

You will learn how to *earn money in your spare time*, without interfering with the work you are now doing. From the very beginning, the **RADIO TELEVISION TRAINING ASSOCIATION's** plan is a practical **MONEY-MAKING COURSE**. We will show you how to cash in on your new knowledge, even while you are learning. Act *now* by clipping the coupon to find out how you can become a **CERTIFIED TELEVISION TECHNICIAN** and *earn extra money*.

**YOU GET YOUR FCC LICENSE**

RTTA prepares you to qualify for your FCC license. *Pay is higher* for the FCC license holder because only a comparative few of the thousands of men in radio-television today hold FCC tickets.

**FREE!**

Get the new career book **"HOW TO MAKE MONEY IN TELEVISION"**, and sample lesson to show you how easily you can train for a money-making job. *Send for them today*. Absolutely no cost, no obligation. **RADIO TELEVISION TRAINING ASSOCIATION**, Newark, N. J.

**YOU GET 15 BIG TELEVISION-RADIO KITS AT NO EXTRA COST. YOU BUILD THESE ILLUSTRATED UNITS**



MULTITESTER

**STUDY AT HOME IN YOUR SPARE TIME**



AUDIO OSCILLATOR

**MAIL COUPON NOW!**

**RADIO-TELEVISION TRAINING ASSOCIATION, DEPT. 2-VS**  
 972 Broad Street, Newark, N. J.

Send me, absolutely free, your book, **"HOW TO MAKE MONEY IN TELEVISION"** and the sample lesson of your course. I understand no salesman will call on me.

NAME \_\_\_\_\_ AGE \_\_\_\_\_  
 St. & No. \_\_\_\_\_ CITY \_\_\_\_\_  
 STATE \_\_\_\_\_ ZONE \_\_\_\_\_

**RADIO TELEVISION TRAINING ASSOCIATION**  
 972 BROAD STREET  
 NEWARK 2, NEW JERSEY



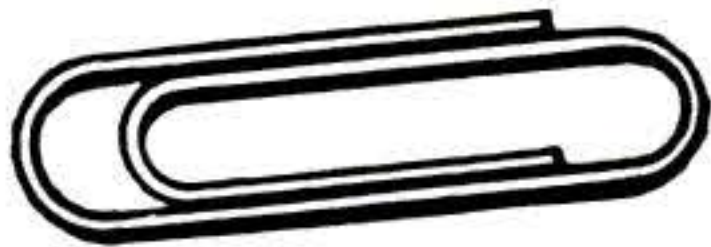

# \$250,000

## FOR THIS!

### 2100 Other Inventions Badly Needed— Big Cash Waiting for Your Little Ideas

IT'S OFTEN the *simplest* ideas that make the *most* money! The Kiddie Kar brought its inventor a cool MILLION dollars. A 70-year-old grandmother made \$350,000 on an improved overall buckle. The paper clip, the hair-pin, the rubber pencil tip all made fortunes for the people who "dreamed" them up.

You can cash in, too—if you concentrate on the inventions that are really needed!

### The EASY Way to Get Started

Don't waste time and brain-work on something nobody wants! Find out WHAT to invent. A valuable book by Raymond F. Yates, noted science editor and inventor, lists and describes over 2100 PRACTICAL, money-making ideas that are crying aloud to be invented!

These 2100 ideas are the things most needed and surest to make money. They are listed under 34 different headings for quick reference: Electrical, Radio, Automotive, Agricultural, Building, Household, Clothing, Toys, Timesavers, etc.

This book ALSO tells how to think inventively; how to PROTECT your ideas; how to develop an invention STEP-BY-STEP, etc.

### FREE EXAMINATION OFFER SEND NO MONEY

Wouldn't you like a slice of the \$280,000,000 that American inventors get each year in royalties? Get started now! You don't risk a penny. Simply mail coupon below WITHOUT MONEY—and get "2100 Needed Inventions," by Raymond F. Yates, for 5 days FREE TRIAL. If, even in that short time, you are not convinced that this book can help you make money—just return it and owe nothing. Otherwise, send only \$2.50 plus few cents postage, as payment in full.

Any one of the 2100 ideas in this book can bring somebody a fortune. Maybe it can be YOU! Mail coupon at once! Wilfred Funk, Inc., Dept. T593, 227 East 44th Street, New York 17, N. Y.



### FREE 5-DAY EXAMINATION

**WILFRED FUNK, Inc.**  
Publishers, Dept. T593,  
227 East 44 Street, New York 17, N. Y.

Please send me 2100 NEEDED INVENTIONS, for FREE EXAMINATION. If I keep the book I will send you \$2.50 plus few cents postage. Otherwise I will return it within 5 days, without further obligation.

Name.....

Address.....

City..... Zone No. (if any)..... State.....

Check here if enclosing \$2.50 WITH this coupon, and we will pay all postage charges. Same 5-day return privilege, for full refund, applies. (Canadian Orders—25c extra for carrying charges. Only U.S. currency accepted.)

## TERRIFIC Surplus BARGAINS

### Officers PINKS

Yes, they are the same type that the officers wore. Beautifully tailored of 18 oz. elastique material. Sizes 29 to 42. Add 15c postage.

**9<sup>99</sup>**

### OFFICERS SHOES

New low price. Best quality uppers, Goodyear welt, oak bend sole. Add 22c postage.



### 16,000 U.S. ARMY all wool serge SHIRTS-PANTS

JUST THINK OF IT! These 100% all wool serge shirts and pants at less than the price of the cheapest work garment. They are used but in perfect wearing condition. Some have slight repairs. True, the sizes are limited, but they are ideal for growing boys and for smaller and medium-sized men. Add 12c per garment postage.



SHIRTS PANTS  
SIZES SIZES  
13-15 27 to 32

**\$1.66 \$1.99**



### SURPLUS SADDLES

**12<sup>99</sup>**

COMPLETE

BRAND NEW. \$60.00 value. Best quality russet leather. Complete with cinch and stirrups. Add \$1.00 postage.

### SURPLUS ALL-WOOL 20-oz. MELTON PANTS

BRAND NEW. Regular \$12.00 value. 100% 20 oz. all wool Melton. O.D. trousers. Sizes 28 to 34 only. Add 18c postage.

**4<sup>99</sup>**



### Extra SPECIAL!

GEN. NYLON 50 FT. PARACHUTE CORD

550 lb. tensile strength, 3/16" diameter. Ideal for clotheslines, venetian blinds and drapery cords. Many other uses. Add 5c postage.

### 50% WOOL SOX

Khaki and natural. Medium weight. A real bargain. Add 3c postage.

**39c**

10 PAIR

**3.79**



### PARATROOPERS BOOTS

Full grain elk or retan uppers. Brown. Goodyear stitch, leather and extra comp. tap sole. 10" high. Add 27c postage.

**8.88**

### COMBAT BOOTS

Rugged and comfortable. Reversed uppers. Full oak sole with extra composition outer top. 10" high. Add 27c postage.

**6.33**

### MAIL ORDERS

Please send remittance with order. Be sure to include postage. Satisfaction or money back. FREE CIRCULAR ON REQUEST

**Sioux Falls SURPLUS STORE**  
SIOUX FALLS, S.D.

TRAIN NOW FOR AN

## AVIATION CAREER

IN SUNNY SOUTHERN CALIFORNIA

### MAXIMUM TRAINING IN MINIMUM TIME

Specializing in AERONAUTICAL ENGINEERING and MASTER AVIATION MECHANICS since 1929... America's Finest Aeronautical Institute... 7000 successful graduates... MAKE MORE MONEY... MAIL COUPON TODAY. APPROVED FOR VETERANS. Board and Room now available.

Without obligation, send free catalogue with full information.

NAME..... AGE..... PS-3

ADDRESS.....

CITY..... ZONE..... STATE.....

**CAL-AERO TECHNICAL INSTITUTE**  
GRAND CENTRAL AIR TERMINAL • GLENDALE 1, CALIFORNIA





*What's the matter...*  
**NOT SATISFIED WITH  
 YOUR PAY CHECK?**

Home study training, in spare time, can increase your earnings!

*For 52 years we've been training men for BETTER JOBS AT BIGGER PAY*

The successes of thousands of today's money-makers started in a coupon similar to the one below, which they checked, signed and mailed to AMERICAN SCHOOL. The information they received opened doors of real opportunity, and steps upward which brought promotions and better living through bigger pay checks.

● Who earns promotions — more money — security? It's the ambitious man with know-how and the self-confidence that comes from training. It's the man who looks far beyond the next pay day and sets his goal. He is determined to merit responsibility and its rewards, and is willing to devote some of his spare time to acquiring the knowledge that will give him the power to climb. For over half a century American School has provided specialized training for commercial and technical advancement. It has enabled men to *earn* more while they *learned* more and win promotions. In almost every business field you'll find highly paid leaders whose success began with American School training.

**IT COSTS SO LITTLE — PROVIDES SO MUCH**

At a cost you can afford and in hours you might otherwise waste you can prepare to climb in the field of work you prefer. American School, an educational institution *not for profit*, offers you a wide choice of training opportunities. Give serious thought to the list in the coupon, then check one or more subjects, add your name and address and mail it. You will receive full information, without obligation of any kind. Do it now. You'll be glad you did.

PRACTICAL, EFFECTIVE HOME

— STUDY TRAINING SINCE 1897

**Take This First Easy Step**

**CHECK, CLIP AND MAIL COUPON NOW**

**AMERICAN SCHOOL, Dept. G-346, Drexel at 58th, Chicago 37, Ill.**

*Without obligation, please send me FREE information on training course checked below.*

- |   |  |   |
|---|--|---|
| <input type="checkbox"/> Accounting                 | <input type="checkbox"/> Business Management     | <input type="checkbox"/> Plastics Engineering         |
| <input type="checkbox"/> Air Conditioning           | <input type="checkbox"/> Contracting             | <input type="checkbox"/> Plumbing—Practical           |
| <input type="checkbox"/> Architecture & Building    | <input type="checkbox"/> Diesel Engineering      | <input type="checkbox"/> Private Secretary            |
| <input type="checkbox"/> Automotive Engineering     | <input type="checkbox"/> Drafting & Design       | <input type="checkbox"/> Radio Operating & Servicing  |
| <input type="checkbox"/> Aviation—Practical         | <input type="checkbox"/> Electrical Engineering  | <input type="checkbox"/> Railway Training             |
| <input type="checkbox"/> Aviation Drafting & Design | <input type="checkbox"/> Electricity—Practical   | <input type="checkbox"/> Refrigeration                |
| <input type="checkbox"/> Better Foremanship         | <input type="checkbox"/> Electronics, Industrial | <input type="checkbox"/> Sheet Metal Pattern Drafting |
| <input type="checkbox"/> Bookkeeping                | <input type="checkbox"/> High School Courses     | <input type="checkbox"/> Shop Management              |
|   | <input type="checkbox"/> Machine Shop Operations | <input type="checkbox"/> Tool Making                  |
|   | <input type="checkbox"/> Mechanical Engineering  |   |

Name \_\_\_\_\_ Occupation \_\_\_\_\_

Address \_\_\_\_\_ Age \_\_\_\_\_

City & Zone \_\_\_\_\_ State \_\_\_\_\_

**AMERICAN SCHOOL**

Dept. G-346, Drexel at 58th Street, Chicago 37



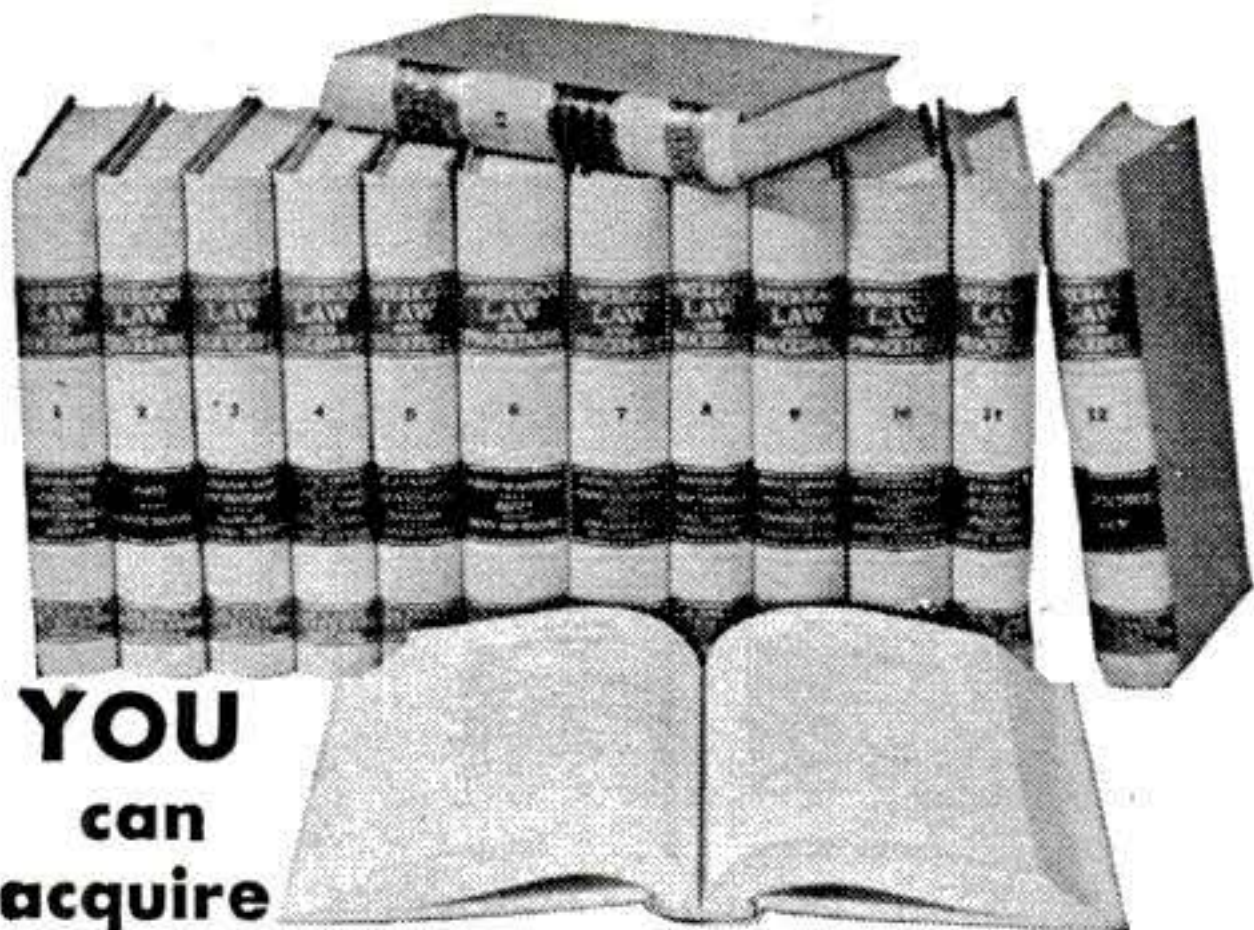

**YOU  
can  
acquire**

**LAW NIGHTS AT HOME!  
L L.B. DEGREE**

LaSalle's famous Law Library—used as reference in many Law libraries and Law offices—has enabled thousands to master Law surprisingly fast, in spare hours at home, for business and professional advancement.

These 14 remarkable volumes, compiled by leading professors and lawyers, cover the whole basic field of Law in condensed, orderly, simplified manner.

You advance rapidly with this great library, plus special lectures furnished. We guide you step-by-step with personalized Problem Method of instruction . . . you *learn by doing*—handling legal problems—not by memorizing rules.

Send for two FREE 48-page booklets, "Law Training for Leadership," and "Evidence," answering questions about Law and its value to you, and telling how LaSalle Law graduates are winning rapid advancement in business and public life. Mail coupon below. No obligation.

**LA SALLE EXTENSION UNIVERSITY  
A Correspondence Institution**

417 S. Dearborn St. Dept. 383-L Chicago 5. Ill.

Send me your two FREE booklets described above, without obligation.

Name..... Age.....

Street.....

City, Zone & State.....

**SANDEE**

Mufflers—All Ford, Chev., Ply....\$4.45

All Buick, Pont., Olds., Chrys.,  
Dodge, Hudson, K.F., Pack., etc....\$5.45

V-8 and Merc. Duals  
(32-49 incl.)  
**\$15.95**

**SPORTONE**  
(Reg. U. S. Pat. Off.)  
**MUFFLERS**

DURABILITY

Beautiful  
SANDEE  
Fender Skirts  
**\$9.95**

DEALERS  
WANTED

A SANDEE Sportone will outlast two ordinary mufflers and give More Power! More Speed! More Mileage!—plus a tone quality unsurpassed.

Please ship (item): \_\_\_\_\_ Price \_\_\_\_\_  
Car and Year \_\_\_\_\_ Name \_\_\_\_\_  
Address \_\_\_\_\_

**SANDEE MUFFLER CO. 5643 Corryne Pl. Culver City, Calif.**

**FULLY GUARANTEED  
TIRES COST LESS!**

Nationally famous **FIRESTONE, GOODRICH, U.S. ROYAL, GOODYEAR,** and other makes. Every tire selected and inspected for your safety.

<b>Military New Tread</b>	<b>New Tread Tires Guaranteed 24 Months</b>		
Guaranteed 24 months	550x16 5.95	700x16 8.95	700x15 8.95
600x16 7.98	600x16 6.95	550x17 6.95	670x15 7.95
750x20 19.98	650x16 7.95	650x15 7.95	710x15 8.95
			760x15 9.95

**Military All Purpose Treads Guaranteed 12 Months**

900x20 13.98	1000x20 14.98	1100x20 16.98	1000x22 14.98
--------------	---------------	---------------	---------------

**Good Used Tires. Guaranteed 12 Months. Tube Free with These Tires.**

600x16 3.58	700x16 4.98	32x6(8) 8.98	825x20 11.48
650x16 3.78	750x16 6.88	32x6(10) 10.88	900x20 11.78
650x15 3.68	650x20 7.58	750x20(8) 8.18	1000x20 12.78
700x15 3.88	700x20(8) 8.98	750x20(10) 9.98	1100x20 13.78

**AAA PREMIUM GRADE GUARANTEED 18 MONTHS  
TUBE FREE WITH THESE TIRES**

600x16 5.18	750x16 7.58	650x20 9.88	825x20 15.68
650x16 5.38	600x16(6) 6.48	700x20 10.88	900x20 14.98
650x15 5.28	650x16(6) 6.98	32x6(8) 10.48	1000x20 16.48
700x15 7.00	700x17 8.88	32x6(10) 12.48	1100x20 11.50
820x15 6.98	750x17 10.88	750x20(8) 10.68	1100x22 18.78
700x16 6.18	600x20 9.18	750x20(10) 12.80	1400x20 22.98

**MILITARY SPECIAL**

900x16 8.98	750x20 8.98
-------------	-------------

Largest stock of used tires in the East. Thousands of satisfied customers. Write for sizes not listed.  
**SEND MONEY ORDER OR CHECK WITH ORDER.**

**PYRAMID TIRE CO.**  
1333-35 North 5th St.  
Dept. S, Phila. 22, Pa.

**"LEARN-BY-DOING"**

**NATION'S LARGEST EXCLUSIVE ELECTRICAL SCHOOL**

**ELECTRICITY**

**PRACTICAL TRAINING NOT "HOME STUDY"**

**G.I. APPROVED** Get actual experience in great shops of M.T.I. Learn all phases Practical Electricity; Housewiring, Motors, Const., Maintenance, etc. Living arrangements, Part-time jobs, etc. A post card brings the story.

**MICHIGAN TECHNICAL INSTITUTE, Dept. PS-2  
2281 W. Fort St., Detroit 16, Michigan**

**WHAM-O SPORTSMAN** **\$1.00 postpaid**

HITS LIKE A .22 RIFLE — KILLS RABBITS, SQUIRRELS. For Hunting, Target, Routing Pests.

**HUNTING SLINGSHOT**

Powerful, silent, accurate. Complete with 40 pellets and extra rubber straps. Send \$1.00 today to — Wham-O Mfg. Co., Box 25 South Pasadena, Calif. PROFESSIONAL MODEL OF THE NAT'L SLINGSHOT ASSN.

**HEAVY DUTY STOCK**

**HOW TO BUILD 78 RADIOS!**

Giant book, *Radio For The Millions* tells you how to build 78 radios—an 8-tube FM set, a 2-way radio station, bicycle radio, vest pocket portable, floor lamp set, all-wave receiver, home recorder, etc. 192 pages, 648 pictures! **Order today!** When book arrives, pay postman only \$1.49 plus postage for handsome cloth bound, Regular edition. If after 7 days' *free trial* you aren't delighted, return it for full refund. Write for it today, to:—

**POPULAR SCIENCE, Dept. 350, 353 4th Ave., N. Y. 10, N. Y.**

**AIR COMPRESSORS**

Lowest-Ever Closeout Price!

**WESTINGHOUSE**

Reg. \$60.50 **18.50** FOR PGM.

Model T-1 Complete

Brand New Surplus Special at an amazing low price. Westinghouse Double-piston type, 6.54 CFM volume. Mounts on truck or car engine—or operate with 1/2 HP motor. For farm, home, industry, painters. Instructions and spare parts kit included. Send check or money order. Weight 26 lbs. We carry a complete line of spare parts.

**AIR HOSE—to fit, 25-ft. length with fittings & chuck.....\$2**

**NATIONAL STORES** 200 SMITHFIELD ST., DEPT. 37 PITTSBURGH 22, PA.



**SALESMEN!**

# SALES GOING CRAZY!

Work hard for 7 months  
...then LOAF the rest of the year!

## AMAZING *Underground* SPRINKLER SYSTEM -

Retails for ONLY... \$49<sup>50</sup>

...SWEEPING SALESMEN INTO THE BIGGEST MONEY OF THEIR LIVES! "GOLD MINE" FOR DISTRIBUTORS!

Last year, EVERSPRAY created a nationwide sensation — poured spectacular profits into the laps of salesmen everywhere.

This year, the NEW, Improved EVERSPRAY is going to make last year's earnings look like small change! Because *this year*, we offer Salesmen TWO spectacular order getters until now unheard of in the history of Direct Selling.

1. A COMPLETE DEMONSTRATOR you carry right in your pocket.
2. An Everspray SYSTEM complete in every detail that you can

spread out on a prospect's lawn and have in full operation IN LESS THAN 10 MINUTES!

This year—right before a prospect's very eyes—you can show him exactly how his Everspray Underground Sprinkler System is going to work *when it's installed in his lawn!*

With *either one* of these two amazing demonstrations you clinch a sale 9 times out of 10. Every home owner who takes a speck of pride in his lawn will want to install an Everspray as quick as it can be delivered to his door!



Everspray installed at North Acres Gardens, Anderson, Indiana

**"People Tell Me I Have the Finest Lawn They've Seen in Years"**

—L. G. Johnson

"When my Everspray is in operation, people actually stop their cars to watch it and to admire the smooth, velvety green texture of my lawn. I never saw anything like Everspray in all my life."

And R. C. Freeman, Chicago, says: "It's amazing how EVERSPRAY keeps our lawn in tip-top condition all season long. Best of all, I don't have to waste hours of time sprinkling with a garden hose."

**CUSTOMER INSTALLS IN FEW HOURS without damage to lawn!**

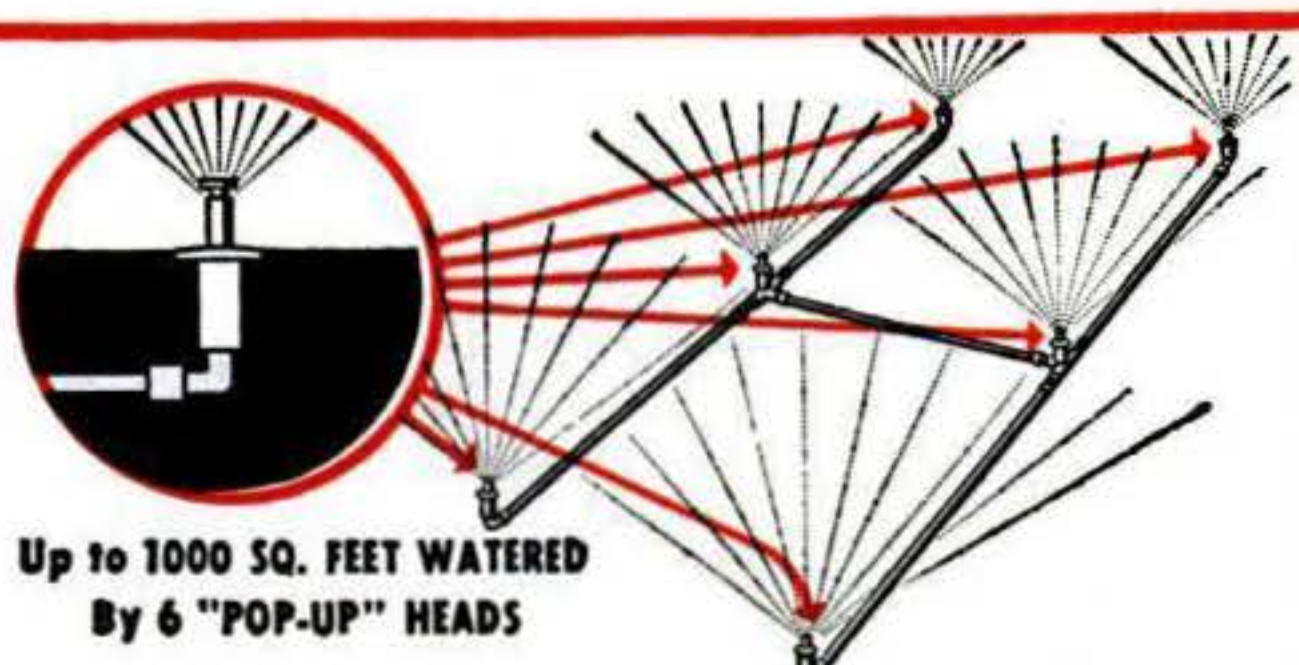

Now, for the first time in history, any home owner—anywhere—can get an Underground Sprinkler System at a price he can afford. Now his lawn can be sprinkled like a million-dollar estate. And look! Everspray is all solid brass and copper. Nothing to rust or wear out. No pipe fitting to do. No plumber's bills to pay. No repairs. No inspection. No maintenance. No freezing

because Everspray *drains itself*—automatically—every time it's shut off. No wonder home owners by the thousands are rushing to buy Everspray!

No wonder Ray J. Eckenrode says: "EVERSPRAY works like a charm. On the strength of this installation, a neighbor asked me to purchase the same layout for him."

**DON'T CALL YOURSELF A SALESMAN IF YOU CAN'T MAKE**

### How to get an EVERSPRAY for your own use

If you want an Everspray for your own use, ask about Special User-Agent Plan that shows how you can get a complete system without a penny's cost to you. Ask for "Confidential User-Agent Plan" when you write or mail coupon.

**\$60<sup>00</sup> A DAY!**

In the NEW Improved EVERSPRAY you've got your hands on the biggest summer seller ever invented. When most lines are dead or dying, *Everspray is just coming to life!* Our sure-fire "Jack-Pot" Pyramid Sales Plan turns your *first* sale into TEN or more. Then *EXTRA* orders start pouring into your hands *automatically—without a bit of effort on your part!*

**FREE! SEND NAME**

This very minute, send your name on the coupon or penny postcard for beautiful Illustrated Folder that shows pictures of *actual Everspray* installations, Demonstrator Offer and Details of sure-fire "Jack-Pot" Pyramid Sales Plan. Everything is FREE. No charge now or ever. Time is precious. Send name today.

**CARRY COMPLETE DEMONSTRATOR RIGHT IN YOUR POCKET!**

You can't believe it until you see it. We show you how to use this amazing "POP-UP" Sprinkler Head to make a Demonstration, right before your prospect's very eyes! Special Demonstrator Offer sent FREE. Just mail postcard or handy coupon.



John Oakman, Sales Mgr.  
EVERHOT PRODUCTS CO., (Everspray Division) Dept. 7-C  
2001 Carroll Ave., Chicago 12, Ill.

- Rush Illustrated Folder, Demonstrator Offer and details of your "Jack-Pot" Pyramid Sales Plan that offers me an opportunity to make \$59.40 a day on only 3 sales. Everything is FREE and costs nothing now or any other time.
- I am not a salesman. I am interested in Everspray for my own use. Send details of user-agency plan.

Name.....  
Address.....  
City.....Zone....State.....

**EVERHOT PRODUCTS CO.**  
(Everspray Division)

2001 Carroll Avenue, Dept. 7-C Chicago 12, Illinois



# YOU CAN BUILD A KIT-CRAFT BOAT

**SAVE  
over  
50%**



Complete for  
Easy Home  
Assembly

**No Experience Necessary**

EASY TO FOLLOW PHOTO DIRECTIONS WITH EVERY KIT!

Kit-Craft boats are easier for you to build. All difficult boat carpentry, framing, standard-beveling and transom assemblies are completed at the factory for you. All Kit-Craft boat kits are complete—there is nothing extra for you to buy! All wooden parts have been pre-cut for you at the factory, only finest marine plywood panels and hardwood parts are used.



**12' SKIFF** — a large 3 seater still in the car-top class.....Kit **\$53.80**

**14' SKIFF** — comfortable 4 seater, strongly reinforced to carry heavy loads.....Kit **\$59.95**

Send 10¢ for fully illustrated catalog and step-by-step photo direction for building Kit-Craft. Convince yourself — see before you buy. Address Dept. P



## 10' SKIFF

—3 seat model—ideal as car-top boat. Easy to transport to your favorite fishing spot.

Kit **\$49.50**

## 8' PRAM

—ideal for Yacht use. Easy-to-tow. Will not dry out on davits.

Kit **\$32.35**

**Roberts INDUSTRIES INC. Durham, Conn.**

# Fistula is Real Threat

**FREE BOOK—Explains Other Related Ailments**

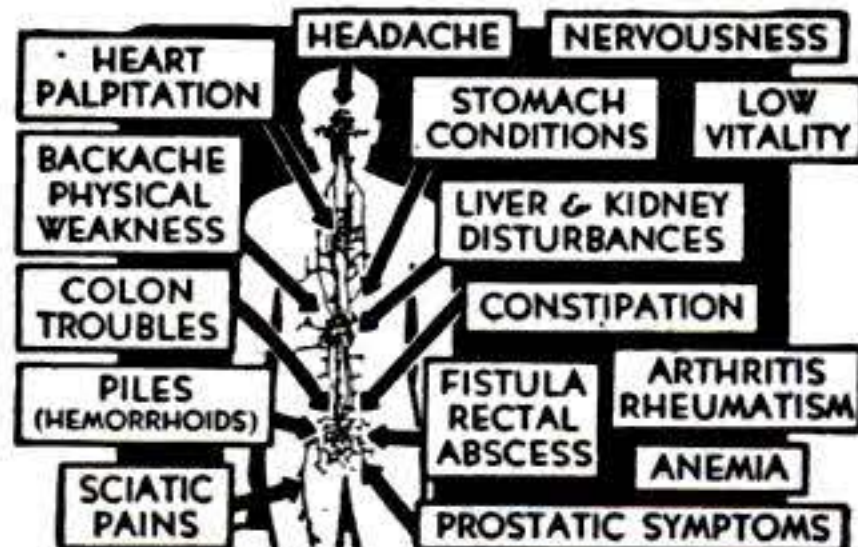

40-page FREE BOOK—tells facts about Fistula, Rectal Abscess, Piles and other rectal and colon disorders; also related ailments and latest corrective treatments. Thornton & Minor Clinic, Suite 349, 911 E. Linwood, Kansas City 3, Mo.

## TRI-STATE COLLEGE

**B. S.  
DEGREE IN  
27 MONTHS**  
Founded 1884  
WORLD-WIDE  
ENROLLMENT

Civil, Elect., Mech., Chem., Aero, Radio and Telev. Engineering; Bus. Adm., Acct. Visit campus, see well equipped labs. Low cost. Prep. courses. Personalized instruction. Grads. successful. Enter March, June, Sept., Jan. Catalog. **530 College Ave., Angola, Ind.**



## ILLUSTRATED COMIC BOOKLETS

**THE KIND MEN LIKE!**  
(VEST POCKET SIZE)

They are loaded with rare cartoons. Full of Fun and Humor. **20 DIFFERENT** booklets sent prepaid for \$1 in plain sealed wrapper. No C. O. D.'s.

**GRAYKO, Dept. 1873, Box 520, G.P.O., N.Y.C. 1**



**TRAIN**

# Your VOICE!

**RESULTS GUARANTEED**

STRENGTHEN your voice this tested, scientific way. Yes—you may now be able to develop the POWER of your speaking and singing voice in the privacy of your own room. Self-training lessons, mostly silent; no music required. Write TODAY for Eugene Feuchtinger's great booklet "How to Strengthen Your Voice." It's absolutely FREE! You must state your age. Booklet mailed in plain wrapper. No salesman will call. Send your name and age RIGHT NOW!

**Perfect Voice Institute, 1141 S. Wabash Ave., Studio C-1, Chicago 5, Ill.**

# BLISS Electrical Training

**BLISS ELECTRICAL SCHOOL**  
Intensive 32 weeks' residence course in fundamentals of industrial electrical engineering, including radio and electronics. Extensive laboratory, shop work, drafting. Prepares for electrical technician and engineering aides in

communications, power, manufacturing, business machines, sales, service. G.I. approved. 57th year. Enter March 6, Sept. 5. Catalog. **7604 TAKOMA AVENUE, WASHINGTON 12, D. C.**

# NEON SIGN SCHOOL

**G.I. APPROVED**

Learn Neon. Interesting, clean work, BIG PAY—\$1.50 to \$2.00 an hour to start. Our 12½ week Job-Practice Course gives you practical training in Glass Blowing, Neon Tube Bending, Color Gassing, other branches. No home study. No text books. No mathematics. FREE FOLDER explains. Write today.

**ACME NEON INSTITUTE, Dept. C-2  
330 South Paulina St. Chicago 12, Ill.**

**LEARN  
IN 12½  
WEEKS**



# Prepare Now for Big-Pay TV Job—Or Your Own Service Business

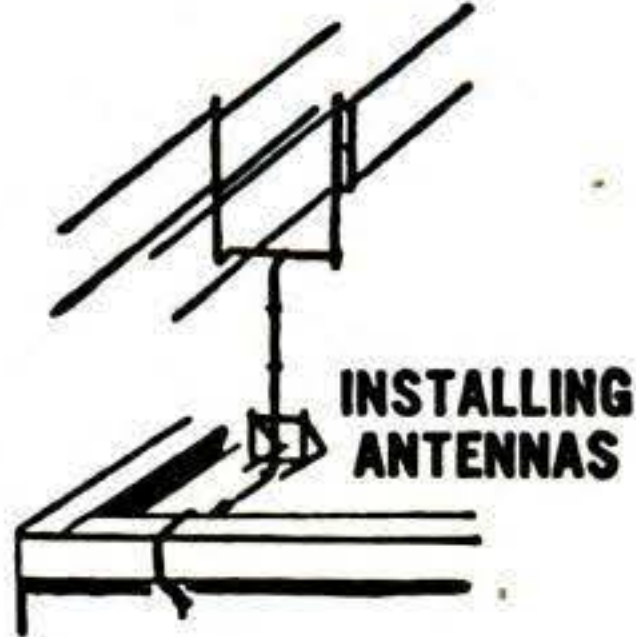

"TAKING THE TUBE APART"



AT LAST!

# The ABC's of TELEVISION

all in one big book!



**Complete Self-Teaching Course in TELEVISION Prepared by Famous RCA Institutes Instructor — Starts From Scratch, Takes You Step-by-Step From Elements of Set Design To Advanced Problems and Color Television**

Now, you can do ANY TV installation, service, or repair job like an expert; operate field testing equipment; understand problems of TV broadcasting.

Bernard Grob, instructor at the famous RCA Institutes has taught hundreds of men just like you to become TV experts. He knows the questions that come up in a student's mind . . . and how to answer these questions *simply and clearly!* Now, he gives you everything you want to know about TV theory, broadcasting, repairs, installations . . . a complete TV course in one GIANT manual—so that you can become a TV "whiz" at home . . . in your spare time!

and expertly. At-a-glance trouble-shooting charts identify the symptoms, tell step-by-step how to "clear the picture."

**Prepares You For The Future**

This book will pay for itself the first time you use it on a job. Contains more than enough material to qualify you for FCC's added FM and TV requirements for 1st Class License Test. Qualifies beginner for big-pay jobs — or own service business! Gives experienced technician more confidence, shows him new tricks!

**At-A-Glance Charts Trace Trouble In A Jiffy, Show How To Fix It**



How to "cure" poor pictures. Over 50 common troubles fixed step-by-step.

**TRY BOOK Free FOR 10 DAYS!**

Get ready now for a prosperous career in America's fastest growing industry. Be the TV expert of your neighborhood.

SEND NO MONEY! Mail coupon below to try "Basic Television" FREE for 10 days. No obligation whatsoever. Mail it NOW.

*Offer applies in U. S. A. only.*

**Qualifies You for FCC's New FM, TV 1st Class License Test!**

"A 'must' for the video service technician."  
—RADIO NEWS  
"Exceptionally thorough explanation of TV and FM. Makes every detail perfectly clear."  
—RADIOFILE  
"As a comprehensive self-study course in television receiver servicing, this book can help anyone interested in knowing more about Television."  
—PRODUCT ENGINEERING

**PARTIAL CONTENTS**

- Installation Made Easy
- Repair of Circuit Troubles
- Testing Equipment
- Making the Switch To Color TV
- Control Adjustments
- Portable Field Equipment
- Short Cuts to Proper Tuning
- Trouble Shooting Transmissions
- Amplifier Installation, Repair
- Receiver Alignment
- Tube Troubles and Their Cure
- How To Get Rid of "Shadows," "Clouds," "Snow," "Bars," "Sound Signals," and "Hums"
- Televising Motion Picture Film
- Solving Scanning Troubles
- Synchronizing Sight and Sound
- Brightness Control and D-C Reinsertion
- The Video Signal from Camera Pickup to Image Reproduction
- Techniques of Camera Pickup
- Projection TV
- AND MUCH, MUCH MORE!

**Almost 600 Pages—400 Pictures**

In 592 big pages, 401 pictures, diagrams, 14 tables, charts—he shows you how to install and service TV receivers expertly . . . how the video AM and audio FM signals originate . . . how each is transmitted . . . how each is received. Full directions for servicing each circuit block of receiver. How to read oscilloscope patterns in voltage, amplitude, frequency.

No matter what the repair problem is—this book shows you how to "lick" it quickly

**Same 10-Day FREE TRIAL OFFER on "Elements of RADIO SERVICING"**

A basic book on the principles and practice of radio servicing. Covers the super-heterodyne A-M receiver, phonograph combination problems, push-button equipment, the auto radio, designs for your radio workshop. 475 pages, almost 400 illustrations. Only \$4.50 on easy terms. But examine it first without cost or obligation!



**CHECK PROPER BOX IN COUPON**

McGRAW-HILL BOOK CO., Inc., Dept. PSF-3, 327 West 41st St., New York 18, N. Y.

Please send me for 10 days' FREE EXAMINATION:

"Basic Television". If not satisfied, I will return it, pay nothing. Otherwise I will keep it and send only \$2 then (plus postage) and \$2.25 monthly for 2 months.

"Elements of Radio Servicing". If not satisfied, I will return it, pay nothing. Otherwise, I will keep it and send \$1.50 then (plus postage) and \$1.50 monthly for 2 months.

Name .....

Address .....

PSF-3

City..... State.....

WE'LL PAY POSTAGE if you enclose full payment WITH coupon. "Basic Television", \$6.50. "Elements of Radio Servicing", \$4.50. Same 10-Day Return Privilege. for full refund.



# FREE Book . . . If you really want to Learn

# How to Write

## Short Stories, Mysteries, Articles

New Opportunities Now. Learn at Home For Part-Time or Full-Time Income



A. E. Van Vogt

Have you ever had an urge to write? Have you or friends had interesting experiences or ideas about people, places, hobbies, sports, business or social activities that might make interesting stories or articles for general magazines, technical journals, fraternal publications, etc.?

Editors agree: the demand for new writers is greater than ever, and you don't have to be a genius to make money. Many Palmer beginners earn while learning, receiving welcome checks for material that may be turned out quickly once you acquire the technique. And now it's easier to learn than you may imagine, through Palmer's unique method of training—for not just one field of writing, but for all: Fiction, Article, Radio. Endorsed by famous authors—including Rupert Hughes, J. Graham Doar, Keith Monroe, and by hundreds of successful graduates. For example: A. E. Van Vogt, leading science fiction writer, says: "Your course is excellent. It was a milestone in my career."

You get practical writing assignments to do at home, saving time, effort and money. Your work is individually handled by professional writers.

FREE book shows how you may earn extra income or make writing a full-time career; tells what to write about for markets most easily sold by beginners. Be independent—work where, when, how you please. Send today! Palmer Institute of Authorship, Since 1917, Desk U-30, 1680 N. Sycamore, Hollywood 28, Calif.

APPROVED FOR VETERANS

**FREE** Palmer Institute of Authorship, Since 1917  
1680 No. Sycamore, Desk U-30, Hollywood 28, Calif.

Please send me free illustrated book "The Art of Writing Salable Stories", explaining how your training helps new writers get started. This is confidential. No salesman will call.

Mr. \_\_\_\_\_  
Mrs. \_\_\_\_\_  
Miss \_\_\_\_\_  
Address \_\_\_\_\_  
City \_\_\_\_\_ Zone \_\_\_\_\_ State \_\_\_\_\_

Please print clearly. Veterans: Check here ( )

Remember it's dangerous to pay less if you want safe, balanced matched tires. WE REPEAT—Consider your family's safety, not just PRICE. You see our adv. every month. Positively not recaps. We serve ambulances, fire trucks, school buses, trucks and cars. "Out-of-Town folks" buy now and take 10% discount.

**GOOD YEAR** **Firestone**  
**Goodrich** **U. S. ROYAL**

& others. Original good tread. Slightly worn. Extra fine traction

<b>FREE Tube with each tire</b>	<b>20 MONTHS GOLDEN RULE GUARANTEE BOND</b>			
	These are genuine "Many Purpose" "AAA" Tires			
	Read that top line again! You'll save MORE than \$.			
600-16 \$5.35	650-16 \$5.45	700-15 \$5.55	475-19 \$5.95	
600-16 (6) 6.50	700-17 9.99	650-15 5.45	525-18 5.95	
700-16 6.85	750-16 7.95	550-17 6.90	550-16 5.55	

America's great Lo-Price Value. 10 Months Guar. Limited Supply.

600-16 \$3.65	650-16 \$3.85	700-16 \$5.50	650-15 \$3.95
	700-15 3.95	750-16 6.50	550-17 5.85

Lo-Price Truck Tires—10 Months Guarantee.

32x6 (8) \$8.95	750-20 (10) \$9.25	1100-20 \$13.95	650-20 \$7.95
32x6 (10) 10.95	825-20 11.25	700-20 9.25	900-20 11.95
			1000-20 12.95

**SUPERCUSHION TIRES (24 lb. air) to fit your present wheels**

670-15 (650-15) \$6.25	760-15 (650-15) \$7.45	670-16 (600-16) \$6.66
710-15 (650-15) 6.85	820-15 (700-15) 6.25	760-16 (650-16) 7.50

**WE ARE TRUCK-TIRE EXPERTS**  
Matched Tires. Truck-owners the world over, depend on us to keep their trucks rolling ON TIME. A few cents more means 1000's of extra miles.

6-8-10-12-14-16 ply. "Many Purpose" "AAAA" Grade

**GOLDEN RULE 20 MONTHS REPLACEMENT GUARANTEED BOND**

600-20 \$9.95	32x6 (8) \$10.70	900-20 \$15.55	1000-22 \$17.25
650-20 9.59	32x6 (10) 13.33	1000-20 16.65	1100-22 18.45
700-20 10.85	34x7 12.75	1100-20 17.77	1100-24 19.99
750-20 10.50	825-20 15.95	750-15 11.45	700-17 13.00

**MILITARY "AAAA" Guar. 20 Mos. (Supers 10 Mos.)**  
900-16 Super Quality \$8.60 750-20 Super Quality \$8.95  
900-16 AAAA 10.90 750-20 AAAA 12.95  
Fits 750-16 Wheels also Fits 650-20, 700-20, 32-6, 34-7

**750-20 Military Rugged Deluxe Guar. 30 Months \$16**

Girard & Lancaster Aves., Dept. PS  
**BLATT BLATT BUILDING PHILADELPHIA 31, PA.**  
Send ck. or money order and this ad for rush shipment. We won't ship a tire we wouldn't use ourselves. Instant shipment down South, Far West and the world over. The name to trust in rubber.

## BUILD SOLID MODELS for display



Bonanza Kit, 59¢  
Wingspread, 8-1/4"; length, 6-1/2".

Planes—trains—ships!  
Accurate scale models to decorate home or office, display on mantel, desk, or in collector's groups. All parts ready-shaped for easy assembly. Wide range of subjects, including newest ships, planes, and historic trains.

Also solid model cars for HO layouts. See them at your Hobby Dealer.



Send for free circular describing all models  
**STROMBECK-BECKER MFG. CO., Dept. PS-3, Moline, Illinois**

# REAL ESTATE

## BE A BROKER

**PAYS BIG! SEND FOR FREE, BIG, ILLUSTRATED CATALOG NOW!** No obligation. Graduates report making substantial incomes. Start and run your own business quickly. Men, women of all ages, learn easily. Course covers Sales, Property Management, Appraising, Loans, Mortgages, and related subjects. **STUDY AT HOME** or in our classrooms in big cities. Diploma awarded. G.I. approved. Nationally known.

FREE BOOK TELLS HOW

**WEAVER SCHOOL OF REAL ESTATE (Est. 1936)**  
15 E. Pershing Road, Dept. PS, Kansas City, Mo.

*Utilities Engineering Institute*  
★  
Founded 1927

## Diesel • Auto Body & Fender REFRIGERATION • AIR CONDITIONING

Practical training in these big pay trades covers overhauling, troubleshooting, installation, maintenance techniques. Proved, easy-to-follow method prepares you at home in spare time, follows with actual shop practice. Also G. I. approved resident courses.

Full information **FREE!** Write today  
2525 Sheffield Ave., Dept. M-3, Chicago 14, Ill.

**LEARN MOVIE PROJECTION THEATRE MANAGEMENT**

The Motion Picture Theatre Business offers big opportunities for trained men. Get into a fascinating field with a promising future. Train at home in spare time. Free Catalog. Established 22 years.

**THEATRE INSTITUTE, 385 Washington St., Elmira, New York**

*Save Money—Make Money with LARSON Leathercraft*

For gifts, or for sale—make easy-to-assemble leather items. Complete stock leathers, tools, accessories. Send ten cents for new catalog of 101 money-making ideas.

**J. C. LARSON CO.** 826 S. Tripp Ave. Chicago 24, Illinois

**MONEY for MEN ALL DATA FREE**

THE PLASTEX Industry needs manufacturers on small scale and for big production of Lamp and Clock Stands, Art Goods and Novelties in Plastex and Marble imitation. Experience unnecessary. 1/2c material makes regular 10c store sellers. Rubber moulds furnished for speed production. Small investment brings good returns. Big chain store orders now being placed. Ambitious men have chance for real prosperity. Our Free booklet will interest and benefit you.

**PLASTEX INDUSTRIES, Dept. 2, 3400 Third Ave., New York 56, N. Y.**



# IMAGINE THEIR JOY

## WHEN THEY FOUND THEY COULD PLAY

### This easy as A.B.C. way!



#### PLAYS ON RADIO

"As a proud student I can't keep from telling you that as a result of my course I have a good position playing from KTHS, Hot Springs, Ark., every morning."

\*J. S., Okla.



#### LEARNED QUICKLY AT HOME

"I didn't dream I could actually learn to play without a teacher. Now, when I play for people they hardly believe that I learned to play so well in so short a time."

\*H. C. S., Calif.



#### INVESTMENT PAID BACK A THOUSAND FOLD

"Anyone with musical ability should make good with your course. My little investment paid back a thousand fold. I have been playing for 4 years now. Today I play in one of our top bands."

\*J. M., San Juan, P. R.



#### PLAYS AT DANCES

"I have completed your course and your lessons have been most satisfactory. I can play all of the popular songs. I have also earned money playing at dances."

\*E. N. J.  
New York.

#### INVITED TO PARTIES

"I enjoyed taking this course and I get a lot of pleasure out of it. I have made much progress and have many invitations to play at parties. I owe you much for making this possible."

\*K. U., N. Y.

## Thousands Have Learned to Play Quickly, Easily At Home

**W**HAT instrument would you like to play? We'll show you how you can learn to play it—quickly, easily, in spare time at home for only a FEW CENTS A DAY! Never mind if you don't know one note of music from another—don't worry about "special talent." The truth of the matter is that thousands now play who never thought they could! Yes, men and women everywhere are enjoying the thrilling satisfaction of playing the piano, violin, guitar, saxophone or other favorite instrument. Some of them are playing in orchestras and over the radio; others are teaching music, making money in spare or full time. And thousands are playing for their own enjoyment

and the entertainment of their friends.

It all came about when they wrote to the U. S. School of Music for the Free Booklet that shows you how EASY it is to learn music at home this modern way. No tedious scales, no tiresome exercises. You learn to play by playing—start right in almost at once with the melody of a simple tune! It takes only a few minutes a day and the cost is trifling; you save the expense of a private teacher. Does it sound too good to be true? Mail the coupon and get the FREE PROOF! (Our fifty-second year—Est. 1898.) U. S. School of Music, 83 Brunswick Bldg., New York 10, N. Y.

### NOTICE

Please don't confuse our method with any systems claiming to teach "without music" or "by ear." We teach you easily and quickly to play real music, any music, by standard notes . . . not by any trick or number system.

### SEND TODAY → FOR COMPLETE DETAILS

• You'll open your eyes when you find how quickly and easily you can learn to play your favorite instrument. Don't doubt; don't hesitate. Send for the fascinating illustrated booklet that answers all your questions; let the free Print and Picture Sample show you how this method actually works. If interested, mail the coupon NOW.

\*Actual pupils' names on request.  
Pictures by professional models.

### FREE PRINT AND PICTURE SAMPLE

#### U. S. SCHOOL OF MUSIC

83 Brunswick Bldg., New York 10, N. Y.

I am interested in music study, particularly in the instrument checked below. Please send me your free illustrated booklet, "How to Learn Music at Home."

Piano	Saxophone	Modern Elementary
Guitar	Trumpet, Cornet	Harmony
Hawaiian Guitar	Pipe, Reed Organ	Clarinet
Violin	Tenor Banjo	Practical Finger
Piano Accordion	Mandolin	Control
		Other Instrument

Have you instrument? \_\_\_\_\_  
Mr. \_\_\_\_\_  
Miss \_\_\_\_\_  
Mrs. \_\_\_\_\_  
(Please Print)

Address \_\_\_\_\_

City \_\_\_\_\_ State \_\_\_\_\_

NOTE: If you are under 16 years parent must sign coupon.

Save 2c—Stick coupon on penny postcard.



NO SHOP  
NEEDED

## Operate YOUR OWN Business



### Clean and Mothproof Rugs and Upholstery

SEE OUR COLUMN "AD" IN APRIL HOUSE & GARDEN

Can you qualify? . . . If you are dependable, honest and willing to work, send for FREE Booklet explaining how you can become "your own boss" in a growing business of your own. You'll use proven successful methods of established DURACLEAN Dealers. Service rendered "in the home," offices and public buildings. Easy to learn. No experience necessary.

DURACLEAN cleans by absorption! No scrubbing. No soaking or shrinkage. Fabrics dry in just a few hours. Dirt, grease and many unsightly spots vanish as if by magic . . . colors revive. Upholstery and floor coverings last longer.

DURAPROOF kills moths and carpet beetles. Makes material resistant to both! Another year 'round service. DURAPROOF, to our knowledge, is the only moth proof service backed by a National Money Back, 4 YEAR WARRANTY of protection. Also rendered "In the Home," at your customer's convenience.

These services are Nationally Advertised! Leading furniture and department stores recommend DURACLEAN Dealer's service. Almost every building in your territory houses a potential customer. Even auto dealers buy your service to revive upholstery in used cars. You get many voluntary and repeat orders.

Some dealers establish a shop or an office after business has grown. Others continue to operate from their own home. Profits up to \$15 and \$20 for a day's service on EACH of your service men. Territories are limited! Write now for FREE Booklet explaining details of these Nationally Advertised services.

Duraclean Co., 0-183 Duraclean Bldg., Deerfield, Ill.

## The New MOTOR TUNE-UP MANUAL

Gives you ALL the information you need in order to understand THOROUGHLY the modern automobile engine and how to keep it in top running order.



ALL principles as well as detailed practical instruction

Explains all electrical and engine principles; the function of EVERY part in batteries, ignition system, distributor, spark plugs, fuel and accelerator pumps, carburetor, choke system, valves, power jet, bearings, manifold, cooling system, starter motor, generator, voltage regulator, etc. Shows step by step how to test each part, make sure meter readings are accurate, locate all types of trouble, make all adjustments. Full information on fuels included.

ONLY \$5.50

Handy lists of trouble symptoms and all possible causes.

Complete summaries of each step in all tune-up jobs.

190 diag., il.

SEE IT ON APPROVAL

The Macmillan Co., 60 Fifth Ave., New York 11

Please send me Motor Tune-Up Manual on approval. I will either remit \$5.50 or return the book in 10 days.

Signed.....

Address.....

P

## New ARMY MINE DETECTOR

An/PRS-1 is a portable device for detecting metallic and non metallic objects, Metals, Buried Cables and sewer Tile.

Our Special Price **\$26.40** with battery  
\$17.50 without battery

By lengthening dipole rods operator will be able to increase the depth sensitivity. This unit comes complete with spare tubes, antenna dipole and reflector, and instructions manual, in wooden chest 9 1/2" height x 28 1/4" length x 15 1/2" depth. Weight in operation is only 22 lbs. LESS Batteries. Power supply: Three 45 volt and one 6 volt batteries. Uses standard batteries. Original COST \$364.00. Shipping weight appr. 80 lbs. F.O.B. New York. No C.O.D.'s. Send Order to:

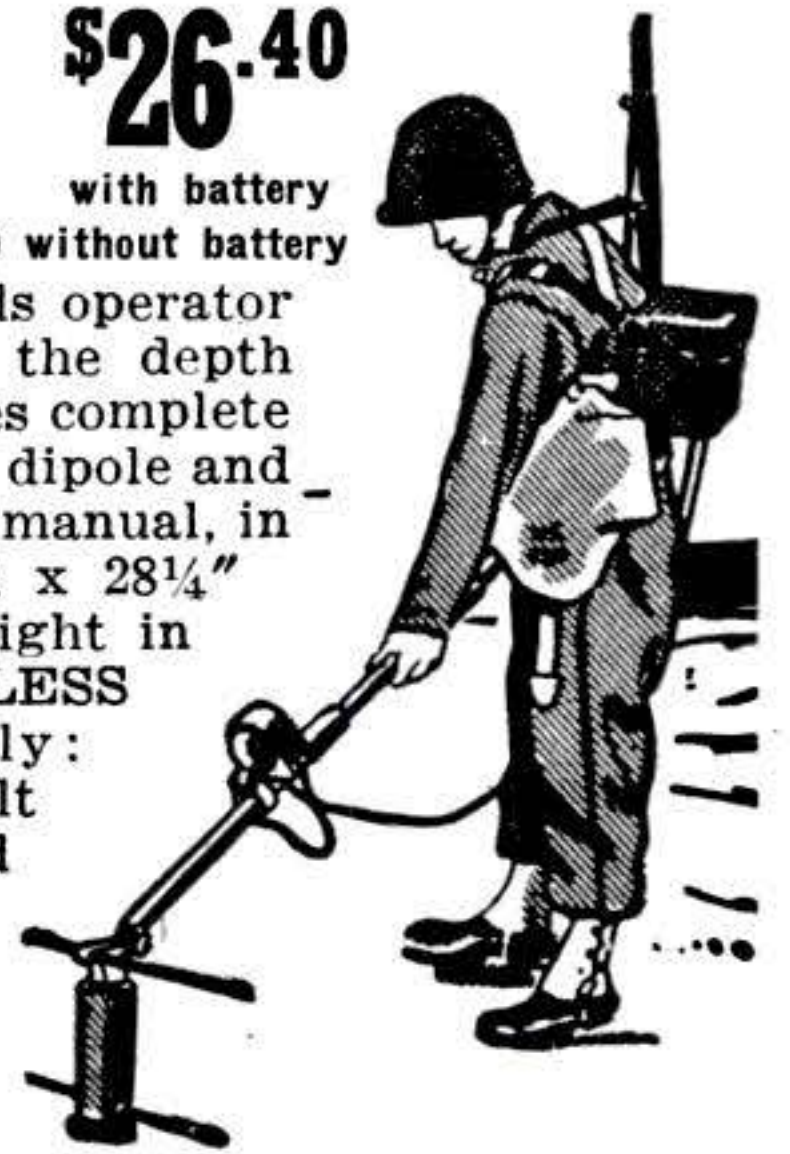

COLUMBO TRADING CO., INC.

304 CANAL ST. DEPT. P.S. NEW YORK 13, N. Y.



## MASTER MIND!

Learn Short-Cut Mathematics

Juggle figures, do baffling number tricks. Make people gasp at your marvelous *lightning-quick* mind. Multiply 4 figures by 4 figures without using old-fashioned multiplication! Big cloth-bound volume; fully illustrated course. Includes worked-out problems, answers, etc. Sensational bargain, only \$1.49, postpaid — or COD plus postage. Satisfaction guaranteed or refund. Order this amazing "Short-Cut Mathematics" today!

NELSON-HALL CO., 1139 S. Wabash Ave. **\$1.49**  
Dept. 4C-1 Chicago 5, Ill. Complete

## ENORMOUS PROFITS CASTING AT HOME

Write today for NEW FREE CATALOG

Learn to cast thousands of perfect figurines, plaques, book ends, ash trays, etc. Start NOW—NO EXPERIENCE. LITTLE CAPITAL needed. Earn GREAT PROFITS with X.L. RUBBER MOLDS. X.L. Rubber, Pts. \$2.00; Qts. \$3.50; Gallons \$8.95; Models and enough rubber for 3 molds . . . \$1.30 postpaid.

PLASTIC ARTS STUDIO 3403 S. Madison St. Dept. 3 MUNCIE, IND.



## Learn BAKING at home

Baking is one of America's high industries in wages. Not seasonable, but year 'round good field for trained and experienced men. Thorough basic spare time home study course lays solid foundation. If you have the aptitude for this type of work, send for FREE Booklet, "Opportunities in Commercial Baking."

NATIONAL BAKING SCHOOL  
1315 S. Michigan Ave., Dept. 1363, Chicago 5, Ill.



## UP TO 80% SAVINGS ON WAR SURPLUS



### HEATING ELEMENTS

For home made photo print dryers, chicken brooders, etc. Wiring diagram for use on 110-volt; 50 watts each. Each element 1 1/2" x 2 1/4" x 3/16". Set of four . . . **96c**

### OIL IMMERSION HEATER



110 volts AC or DC. Three position. High Heat (1250 watts). Medium Heat (625 watts). Low Heat (312 watts). Make winter starting on your car, truck, tractor, or farm equipment, easy. Just plug in your 110v Immersion Heater, insert it into your oil tank through the oil filler hole, and have hot oil in a jiffy. Heating elements 11" long, diameter 1 3/4". At a fraction of original cost. Each **\$7.95**

Prices F.O.B. Chicago. Include approx. postage on orders paid for in advance. C.O.D. orders enclose 25%, balance sent C.O.D. WRITE FOR FREE ILLUSTRATED CIRCULAR.

U. A. S. Corp. Dept. PS-3 5637 W. 63rd Pl. Chicago, Illinois



A DOUBLE-BARRELED OPPORTUNITY TO

# MAKE MONEY!



**NEW HOMES**



**OLD HOMES**



**No Schooling —  
Steady Work**

## Be Your Own Boss!

Another booming year is ahead in the building industry—and here's a double-barreled way for *you* to CASH IN!

Start your own business as a floor surfacing contractor with American Machines—and you will find hundreds of new and old homes are year 'round prospects for your services! No special schooling needed. No long waiting to get going in a business of your own. You can start sanding floors and make money as your own boss *the very first day* your machines arrive! Earnings of \$25 and more a day are not uncommon among men like yourself who have become floormen.

You'll be proud to be a floor surfacing contractor and take your place alongside the plumber, the electrician, the painter and other building craftsmen as an important cog in the construction industry. In new construction you work as a sub-contractor and when resurfacing older homes you will usually operate as a separate businessman.

The investment in floor sanding equipment is small. The overhead is low and you need no elaborate offices, workshop, storeroom or heavy trucking equipment. Many men operate from their own homes and use a regular passenger car to transport their equipment from job to job. Pleasant indoor work... steady the year 'round... prospects everywhere... and *you are your own boss*... a real opportunity for a man with ambition to get ahead and **MAKE MONEY!**

Send for "money-making" booklet entitled "Opportunities in Floor Surfacing"—use coupon and enclose 25c in coin or stamps to cover handling.

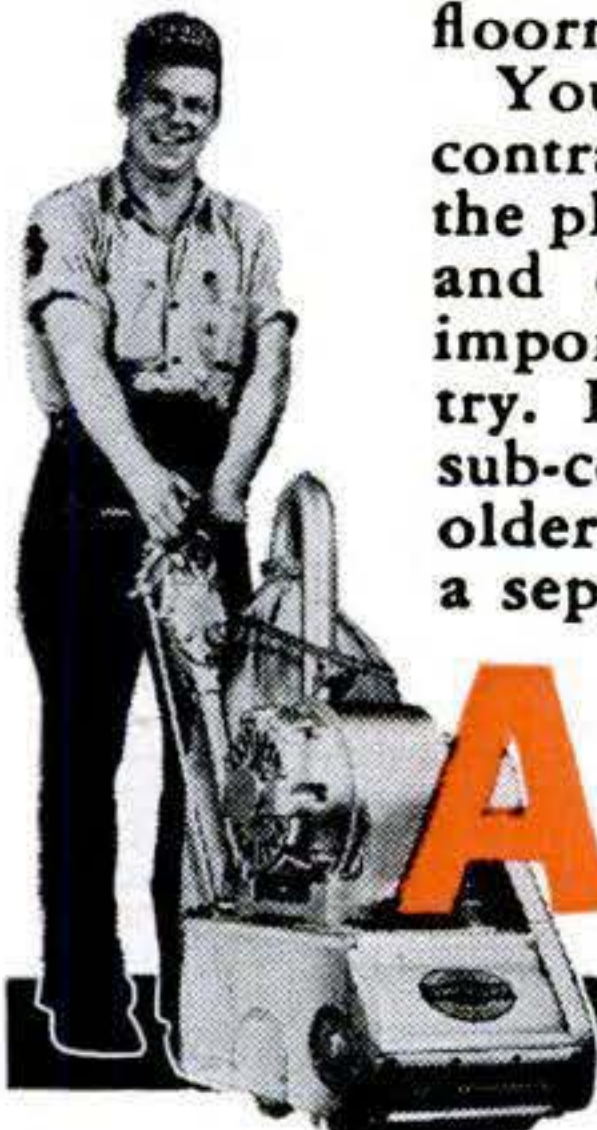

# AMERICAN

**FLOOR MACHINES**

**SEND COUPON TODAY!**



The American Floor Surfacing Machine Co., 532 So. St. Clair St., Toledo, Ohio,

Enclosed find 25c in stamps or coin for booklet "Opportunities in Floor Surfacing" telling me how I can start my own floor sanding business.

Name \_\_\_\_\_

Street \_\_\_\_\_

City \_\_\_\_\_ State \_\_\_\_\_





# FREE!

## LAFAYETTE'S NEW 164 PAGE CATALOG

The Biggest Bargain Book  
In Radio and Television

**Radio and TV Sets—Parts—Tools—Hi-Fi—Public Address—Kits—Test Equipment—Ham Gear—Record Changers—Records, etc.**

**164 pages packed with all new, latest-model, famous-make radio and TV equipment at money-saving prices.**

Invest a penny postcard and send for this great new 1950 Lafayette Catalog. Then sit down with pencil and paper and make a price comparison test. Check model for model, and see if Lafayette doesn't save you anywhere from a few pennies to a few dollars on most every item.

If you're a service man, experimenter, ham, hi-fi bug, engineer, set-builder, or serious amateur—send for your 1950 Lafayette Catalog now. It's one of the biggest things in America you can get "for free"!



# SALE!

## Lafayette

famous FM-AM  
**HIGH-FIDELITY CHASSIS**  
with built-in  
**PHONO PRE-AMPLIFIER**  
INCLUDING WIDE RANGE  
**12" PM SPEAKER!**

PRICED AT ONLY **\$59<sup>50</sup>**

Look at these \$300 set features: Latest 11-tube circuit plus rectifier. 10 watts undistorted power output. Phono pre-amplifier permits direct connection of variable reluctance pick-ups. High and low impedance phono input. Tone control. Slide rule dial. Supplied with loop and folded dipole cabinet antenna. 12" PM speaker with Alnico V magnet. 105-125 volts, 60 cycles, AC only. Chassis dimensions: 13x9x9½. Shipping weight: 25 lbs. Complete with tubes \$59.50. 30-day Money-Back Guarantee! If not fully satisfied, return to us within 30 days, and you'll receive full refund, less transportation charges.

**NEW YORK:**  
100 Sixth Avenue and  
542 E. Fordham Road  
(Bronx)  
**CHICAGO:**  
901 W. Jackson Blvd.  
**ATLANTA:**  
265 Peachtree Street  
**BOSTON:**  
110 Federal Street  
**NEWARK:**  
24 Central Avenue

# Lafayette

RADIO

## OUR 29th YEAR

**RUSH COUPON NOW FOR FREE CATALOG**  
LAFAYETTE RADIO, Dept. KC-50  
901 W. Jackson Blvd., Chicago 7, Ill.  
or 100 Sixth Avenue, New York 13, N. Y.  
Rush me your FREE 1950 164-page Catalog.

Name \_\_\_\_\_  
Address \_\_\_\_\_  
City \_\_\_\_\_ Zone \_\_\_\_\_ State \_\_\_\_\_

PASTE ON PENNY POSTCARD

# BOOK WORTH \$3,500

## FREE! A YEAR TO YOU!

### FREE! READING OFFER

#### HIGH SCHOOL SUBJECTS SELF TAUGHT

### Big Pay Jobs Waiting for HIGH SCHOOL GRADUATES

Big 1250 page book shows you how to qualify quickly in only 15 minutes a day spare time reading! Records prove High School Graduates average \$3500 a year more than untrained men and women. High School Subjects Self Taught makes it easy to learn more and earn more. No tedious study, but fascinating reading. No class room examinations. You "Pass" yourself! Write now! Get Book that can mean a small fortune to you. **SEND NO MONEY.** Pay postman \$9.95 plus postage, or send money order or check and book will be sent postpaid. Read book for 5 days. Show friends, High School Teachers, Students. If you don't agree this Book is best investment you ever made, return for full refund by next mail.

Mail order today and we'll include FREE 150-page book of study material to help you take and pass test for a **HIGH SCHOOL EQUIVALENCY DIPLOMA** (legally equivalent of diploma issued upon graduation after four years high school), now possible without high school attendance, in practically every State. Don't delay. Send order now to: **NATIONAL HOME-STUDY INSTITUTE, INC., 90-61 Sutphin Boulevard, Jamaica 2, N. Y.**



# MAGNETS

## LIFT 125-lb.

**AMAZING PERMANENT MAGNETS — WILL NOT WEAKEN! NON-ELECTRIC.** Retrieve guns, tackle, tools and other steel items from lake, river, plating tanks, drains or other hard-to-reach spots. Recover drills, taps, etc. from floor sweepings. Clear alley of harmful tacks, nails. Many other uses listed. Pays for itself quickly. **GUARANTEED: Try any magnet one week. Money refunded if you are not well-pleased.**

Cat. #P430 (Has a pull of 125 lbs. on a flat steel block) . . . \$7.50  
Cat. #P410 (40 lb. pull) \$2.50 Cat. #P528 (10 lb. pull) \$1.00  
Cat. #P500 Hobbyists assortment of seven small magnets. \$1.10

**RONALD EYRICH, 2566 N. 49th St., MILWAUKEE 10, WIS.**



# GENUINE DIAMOND SCRIBER!

Writes on glass, metals, plastics. Hex. Aluminum 6". Money back guarantee. Agent inquiries invited.

**\$2.00** Postpaid

**CLIPPER DIAMOND TOOL CO., INC. 21-A W. 46 St., N.Y. 19**

# LEARN MEAT CUTTING

through actual practice. Profitable Meat Cutting and Self Service Meats taught easily, quickly. **LEARN BY DOING** at Toledo in just eight short weeks under actual market conditions. For beginners or men with experience. All subjects taught thoroughly and completely. Diploma. Job help. Get store of own. People must eat. School in operation over 25 years. Approved for GI training. Send today for FREE illustrated catalog. No obligation.

**NATIONAL SCHOOL OF MEAT CUTTING, Dept. 51-C, Toledo 4, Ohio**

# GET THIS SUIT AS A BONUS!

YOU PAY 1/2 • WE PAY 1/2

Sell popular Smith tailored-to-measure suits. Make up to \$10-\$15 daily, taking orders from friends. As an extra bonus, get your own suit at HALF wholesale cost. No experience needed. Send for FREE selling kit and sample line. Send no money. Write fully, state age, etc.

**W. D. SMITH & CO., Dept. E  
833 W. Jackson Blvd., Chicago 7, Ill.**



# CARBURETOR TOO RICH MAKES MOTORIST TOO POOR



Car owners who are wasting money and not getting proper gas mileage due to over-rich mixtures will be pleased to learn how to save gasoline by **VACU-MATING** over-rich mixtures. **VACU-MATIC** fits all cars, trucks and tractors. It is automatic and operates on the supercharge principle. Easily installed in a few minutes.

**SALESMEN WANTED! Big Profits!** Send name, address on penny postcard for free particulars and how to get yours for introducing.

**VACU - MATIC CO., 7617 - 1568 W. State St., WAUWATOSA, WIS.**



# Put Your Future in Your Own Hands Be an **ARTIST**

HERE'S THE AMAZING WAY WE TEACH YOU STEP BY STEP TO DRAW AT HOME IN SPARE TIME

**LEARN TO DRAW FOR MONEY**

## TWO BIG ART OUTFITS GIVEN

As soon as you enroll, we send you the first of the TWO complete Artists' Outfits, including all the material you need to start the course. Later in the course you receive the second, advanced outfit . . . all at no extra cost.

### Read What These Graduates Say:

**TRAINING PAYS OFF**—Fred B. Chott of Cicero, Illinois, says: "I have turned your teaching into profit very quickly." (1-49)

**STAFF ARTIST AND CARTOONIST**—G. W. Thomas, Los Angeles newspaper artist says: "W.S.A. is Number One School in U.S.A." (1-48)

### WRITE FOR FREE BOOK

#### ART

#### for Pleasure & Profit

Tells about our course of instruction and commercial opportunities for you . . . also about W.S.A. students, reproductions of their art work, and results enjoyed by our graduates.

**APPROVED FOR EST. 1914  
VETERANS**

Prepare yourself for a pleasant, profitable Art career. **COMMERCIAL ART, DESIGNING, CARTOONING**—all in one richly illustrated, modern home study course. Good art positions available in this great field. You can become your own boss—work at home on your own time. Many students earn extra money while learning by designing posters, rendering simple artwork, lettering, etc. W.S.A. is now in its 36th successful year of training men and women. No previous Art experience necessary, we teach you from the beginning for professional art jobs in advertising, television, newspaper and magazine publishing, department stores, printing, art studios, etc. Get the facts now. Low cost—only \$5 monthly.

### FREE BOOK gives details!

WASHINGTON SCHOOL OF ART, STUDIO 133W

1115—15th St., N.W., Washington 5, D. C.

Please send me full information and your Free Book.

"Art for Pleasure and Profit." (Please print).

Name.....Age.....

Street.....

City.....Zone.....State.....

I am entitled to training under the G.I. Bill.



## WASHINGTON SCHOOL OF ART

## 5 YEAR WRITTEN GUARANTEE 17 JEWEL CHRONOGRAPH 2 PUSH BUTTON

ORIGINALLY \$71.50

- POST-WAR SURPLUS
- WRISTWATCH
- STOPWATCH
- TELEMETER
- TACHOMETER

Precision 4-in-1 Timepiece. Incabloc shock resistant feature. Sweep Second hand. Anti-magnetic. Radium Dial, Stainless steel back.

Our Price Now Only

**\$21.95** Plus \$2.20 Tax

Perfect for physicians, scientists, technicians, engineers, aviators, photographers, broadcasters, navigators, sportsmen, servicemen, etc. Thousands sold at \$71.50. Order now while they last at this record breaking low price.



## 5 YEAR WRITTEN GUARANTEE 17-JEWEL WRIST WATCH \$16.95 PLUS \$1.70 TAX

ORIGINAL PRICE \$59  
INCABLOC SHOCK PROTECTED WATER REPELLENT

Sacrificed Because They're POST-War Surplus. Luminous dial . . . Sweep second hand . . . Super Accurate . . . Imported Swiss precision movement and case. You get these Men's New 5 Year Guaranteed Watches now for a small fraction of the original price. Don't delay! Order now . . . while they last.

**TRIAL OFFER! Wear at our risk!**

Money back in 5 days if not delighted.

SEND ONLY \$1 down payment with order.

Pay balance to postman on arrival plus postage.

Or we pay postage if you include full payment plus tax with your order.

**FREE! Handsome Expansion Band Included. ORDER NOW!**

**MARYLAND DISTRIBUTORS, Dept. 36**

501 East Baltimore St.

Baltimore 2. Md.



## Do you want

- .. to go to College?
- .. or to enter a Profession?
- (Such as Accounting, Architecture, Nursing, Dentistry, Teaching, Social Work, Osteopathy, Beauty Culture, Optometry, Embalming, Chiropody, Law, Medicine, etc.)
- .. or get an Office Position?

To get anywhere, you practically **MUST** finish High School **FIRST**. You can complete our simplified High School Course in **SPARE** time at home, as **FAST** as your time and abilities permit. Equivalent to resident school work—prepares you for college, pre-professional examinations, business, industry. Standard texts furnished. Diploma. Credit for H.S. subjects already completed. Single subjects if desired. Low tuition, easy terms. American School, Chicago, est. 1897—endorsed by educators. Finish your high school education **NOW**. Write **TODAY!**

## High School Course at Home

Many Finish in 2 Years

American School, Dept. H-346, Drexel Ave. at 58th St., Chicago 37

Gentlemen: Send me **FREE** information covering special training in subjects checked below. No obligation on my part.

- |  |  |
|--|--|
| <input type="checkbox"/> High School Course          | <input type="checkbox"/> Diesel Engineering                    |
| <input type="checkbox"/> Electronics, Industrial     | <input type="checkbox"/> Drafting and Design for Men and Women |
| <input type="checkbox"/> Architecture and Building   | <input type="checkbox"/> Plastics                              |
| <input type="checkbox"/> Automotive Engineering      | <input type="checkbox"/> Private Secretary                     |
| <input type="checkbox"/> Business Management         | <input type="checkbox"/> Mechanical Engineering                |
| <input type="checkbox"/> Electrical Engineering      | <input type="checkbox"/> Aviation                              |
| <input type="checkbox"/> Elec. and Gas Refrigeration | <input type="checkbox"/> Salesmanship                          |
| <input type="checkbox"/> Air Conditioning            | <input type="checkbox"/> Radio                                 |
| <input type="checkbox"/> Railway Training            |  |

Name.....

Address.....



# PLASTICS EVERYTHING YOU NEED UNDER ONE ROOF

**CLARO-CAST** A clear liquid casting plastic for imbedding insects, flowers, coins, etc. Tops for casting novelties.  
 Price—1 pt. \$1.95, 1 qt. \$3.75, 1 gal. \$16.00. Instruction book—\$.20.

**METALLIC ACETATE** Newest thing in plastics. Craft material. Make costume jewelry, flowers, book covers, etc. Colors—Aquamarine, orchid, pink, copper, chartreuse, black, purple, ice blue, gold, silver, red, blue, green, fuchsia, lime, iris, rose pink, white, multi-color. Sheets 10" x 25"—Price \$.85, 20" x 50"—Price \$3.00

**CRYST-L-CRAZE** Newest decorative coating. Easily applied by brush. Gives beautiful crystallized pattern—White or colors—to plastics, glass, copper and ceramics. Colors—Red, Blue, Green, Black, Violet, Orange, Yellow, Clear and Fluorescent Pink.  
 Price—4 oz. \$.75, 1 pt. \$1.75, 1 qt. 3.10

**FOR PLASTICS "KNOW-HOW"** Latest book by Cherry. Recommended for all-round "how-to-do-it." Price—\$1.50

**COMPLETE CATALOG—FREE!** A catalog of plastic supplies for the hobbyist. Everything in plastics under one roof—at prices you can afford. GET YOURS NOW!

**FRY PLASTICS CO. Dept. 13**  
 7604 So. Vermont—Los Angeles 44, Calif.

**DYE** Deep, rich colors blend beautifully, dropper cap. Red, Old Rose, Fuchsia, Yellow, Green, Blue, Orchid, Black, Brown, Fluorescent Red.  
 Price—1 oz. . . . . \$3.30  
 4 oz. \$1.00 1 pt. \$2.75

**PRACTICE BLOCKS** Plexiglas and Lucite. Special price—\$1.00 lb., 5 lb.—\$4.75, 10 lb.—\$9.00

**DRILLS** Special precision, machine made, tapered drills ground to perfect points, sharp cutting edges.  
 PRICE  
 Diameter Ea. Doz.  
 1/16" . . . . . \$ .95 \$10.45  
 3/32" . . . . . .95 10.45  
 1/8" . . . . . 1.00 11.00

**"INTERNAL CARVING IN PLASTICS"** A COMPLETE course of instructions by an expert, H. A. Zoback. Price—Only \$1.50

**PL-1 PLEXIGLASS LUCITE CEMENT** Apply with brush, eye dropper or hypodermic needle. 30-second action. Permanent bond, no discoloration. Price—4 oz. \$.60, 1 pt. \$1.50

**PLASTIC JEWEL BOX** Size 3 1/2" x 3 3/4" x 1 1/4". Modern style jewelry boxes add richness, charm to any merchandise. Price—Each \$.15 Dozen . . . . . \$1.50

**TO ORDER**—send check or money order. Add 15% of order to cover postage. (Any postage overpayment will be refunded). Send 25% deposit with C.O.D. orders.

## OVER 500 WAR SURPLUS BARGAINS!



**Genuine U.S. Army TENTS**  
 Weather proof  
 Water proof  
 Fire proof  
 Mildew resistant

9'x9' New Wall Tents	\$29.50
Poles for above	2.50
9'x9' used Wall Tents	19.95
Poles for above	2.50
16'x32' Squad Tents New	49.50
Poles	8.75

Tents & Poles Shipped Frt. Chgs. Collect

**GENUINE G. E. 2 H.P. 4-CYCLE GASOLINE ENGINES**  
 Brand new! In original factory cartons. Complete with oil air filter, dustproof magneto, gas tank, shaft pulley, throttle control, etc. Excellent for mowers, boats, saws, etc. Ship. wt., 37 lbs. Shipped express collect. \$69.50 value. **\$34.95** new

**JEEP CANS** - 5 Gal. Brand New! . . . . . \$2.98  
 New Flexible Spout For Cans .79¢ (Express Collect)  
**Sun Glasses**—Air Force Type. Lifetime guarantee . . . \$1.98  
**New Sprayer**—4-gal. cap. Complete with pump and hose. Wt. 15 lbs. postpaid . . . . . \$3.98  
 Mail orders add sufficient postage unless otherwise noted

**Write for Big FREE CATALOG Today!**  
**FISLER SALES CO.** 723 Walnut St. Kansas City 6, Mo.

# \$ UPHOLSTERY \$

**DO YOU WANT a money-making business of your own and a highly paid trade?**

Investigate the opportunities open to trained men in the Upholstering Industry.  
 In towns and cities all over the U. S. A., homes, theaters, hotels, restaurants, offices, etc., are potential customers, for the trained Upholsterer!

## YOU CAN BE THAT MAN!

Practical shop training at G. T. S. will give you the knowledge and skills needed to enter this uncrowded field.  
 Write for pamphlet "Proof That G. T. S. Training Pays."

Approved School • Home-Study training also available • Payment Plan

**GENERAL TRADES SCHOOLS**  
 3810 BROADWAY • CHICAGO 13, III.

**Start Quickly** BIG MONEY ROLLING WITH **LIFE CHARGE**

**MAKE PLEASANT, DIGNIFIED CONTACTS**

The **MIRACLE Chemical** that helps Batteries stay **AUTOMATICALLY** charged. Adds Months of useful service. Eliminates freezing, overheating and cable corrosion. Revives old Batteries. Saves time and money for user. **EAGER BUYERS EVERYWHERE!** Fleet owners, garages, service stations and individuals all buy. **FOUR EASY SALES A DAY NETS YOU \$144.00 WEEKLY!** Advertising and Promotional Material free. Sold on satisfaction guaranteed or money back plan. Send \$1.00 for special sample offer enough for two batteries, or write for free details. **GET IN THE BIG MONEY FIELD! DO IT NOW. DON'T DELAY...WRITE TODAY!**

**BATTERY CHARGE PRODUCTS COMPANY**  
 728 W. Peachtree Street, Dept. A Atlanta, Georgia

## FOR YOUR BETTER FUTURE

### Learn AIRCRAFT-PRECISION Instruments

Be a specialist in a great industry. Trained men in demand now. Short, intensive training appvd. for Vets, non-vets. Employment and housing assistance. Visit school or write for free information.

**WEST COAST UNIVERSITY**  
 School of Aircraft Instruments  
 5145 San Fernando Rd. West Los Angeles 39, Calif.

## Learn CARPENTRY BRICK LAYING

Big money in the Building Trades. Learn now while opportunities are greatest. Train in our completely equipped shops under expert instructors, or by Home Study. Vets attending school entitled to G.I. Benefits. Write for FREE catalog.

**MIDWEST SCHOOL OF BUILDING TRADES, Dept. PS-3**  
 411 N. Center St. Bloomington, Ill.

## World's Leading AUTO BOOK

**DYKE'S AUTOMOBILE and GASOLINE ENGINE ENCYCLOPEDIA**

Indispensable Help for Mechanics, Beginners, Car Owners, Classrooms

Dyke's is more than a book on automobiles. It is a complete course in Auto Mechanics with special emphasis on trouble shooting, testing, adjusting and repairing. Tells HOW to do things as well as WHY. 1481 pages, 4600 illus. Clip this ad. and mail with \$7.50 check or money order today. Money back if not satisfied.

**GOODHEART-WILLCOX CO., Dept. 114**  
 1321 S. Michigan Ave. Chicago 5



## ROCKET PERFORMANCE FOR ANY CAR

The revolutionary new VAPOJET is designed on the war developed principle of WATER INJECTION. It offers an ideal, INEXPENSIVE way to gain superior performance from any car. For the owners of new cars with HIGH COMPRESSION engines, VAPOJET gives extra power with low octane gas. Thousands of VAPOJETs are now in use and users report better pick-up, smoother running power and BIG mileage increases on regular gas.

Complete, easily installed kit fits all cars, boats and stationary engines and is backed with a 30 day money back GUARANTEE.



U.S. Patent  
2,188,175

**VAPOJET  
MFG. CO.**

11424 Biona Dr., Dept. PSC-3 Los Angeles 34, California  
AGENTS WANTED

Designed to give

- More Speed
- More Mileage
- More Power
- Eliminates Carbon & "Ping"
- Reduces Wear

Order Today

only **\$9.75**  
Postpaid

Send check or money order and save postage. \$1 deposit on C.O.D. List car, year, and no. of cylinders.

## Don't Envy The PLUMBER-Be One

**Make \$15 to \$50 a Day**  
(and work every day)

Every skilled workman will tell you Plumbers have the best of it. WINTER and SUMMER the Plumber is busy at top wages. No skilled Plumber is ever out of a job . . . compare his opportunities with any trade, and decide where your opportunity is.



The Plumber Protects The Health of the Nation

### Own Your Own PLUMBING BUSINESS

No other business offers you the opportunity of starting in your own business, and making good profits, with little other investment than Universal's training and a kit of tools.

### JOURNEYMAN PLUMBER

**Gets Good Salary**

Master Plumbers own their own shop. A Journeyman works for a Master. With Universal's training a journeyman can depend on high wages from the start.

## FREE

DETAILS SHOW YOU HOW TO START

You can start now to success as a plumber by simply filling out the coupon and mailing it . . . or just write Universal Plumbing School, 800 Holmes, Kansas City, Mo. FREE details showing how will be sent by return mail.

Plumbing, to the man with know how, means profit. Investigate Universal's unique "Shop Method" system . . . This system, developed over a quarter century ago by a master plumber, offers you the opportunity to quickly get into the plumbing business. This is not a "war born school" . . . but a plumbing school developed and operated by plumbers since 1923.

### BE A PLUMBER In Just 32 Weeks

Now, just 32 weeks of intensive training equips you to be a plumber. No need ever serve an apprenticeship. Don't envy the plumber's big profits . . . enjoy them.

**System Shows How With Tools . . . Not Books**

Universal's highly developed method makes plumbers by a special developed system showing how to use plumbing tools . . . not books. Every instructor is a Licensed Master Plumber capable of showing every trick of the trade . . . Lead Work . . . Blueprint for plan reading, etc. This offers a wonderful opportunity for the man who likes to work with tools.

**Over 7,000 Successful Plumbers Recommend This School**

This system has made more than 7000 plumbers. Each will testify it was the Universal Plumbing School that started him on the road to profits. Investigate our past performance . . . then decide. Universal is the largest and only school in America devoted exclusively to plumbing. It was established in 1923 under a system developed by a plumber and is owned and operated by licensed plumbers.

Don't waste your time looking over "war born schools" . . . investigate this system . . . then get into the profitable plumbing business.

## JUST MAIL COUPON

Send me FREE details about the plumbing business and tell me how to make profits as a plumber . . . I understand there is no obligation.

Name.....

Address.....

City.....State.....

G. I. Approved. Established 1923

**UNIVERSAL PLUMBING SCHOOL**  
800 HOLMES KANSAS CITY, MO.

## Learn PHOTOGRAPHY at Home

Splendid Hobby or Vocation

Prepare in spare time. Practical basic training. Long-established school. Send for free booklet, "Opportunities in Modern Photography" and particulars. Sent postage prepaid. No obligation.

**AMERICAN SCHOOL OF PHOTOGRAPHY**

1315 S. Michigan Avenue, Dept. 1363 Chicago 5, Illinois

### Trained Men Get the Better Jobs PRACTICAL SHOP TRAINING in AUTOMOTIVE MECHANICS BODY and FENDER REBUILDING

If interested write or wire

**ATLANTA MOTIVE TRADES INSTITUTE**  
Dept. C 254 IVY St., N.E. Atlanta, Georgia

Member of the Southern Association of Private Trade Schools

Veterans ask about G I Training

## WATCHMAKING

### Be a Watchmaker—Be Independent

Get practical training at the only school in Chicago, accredited by the Horological Institute of America and U.H.A.A. Day and Evening Classes—Approved for Veterans

Write today for free information

**CHICAGO INSTITUTE OF WATCHMAKING**

6 East Lake Street Dept. 430 Chicago, Illinois

## LEARN TO MOUNT BIRDS

**ANIMALS, FISH, PETS**  
Be a Taxidermist. Save your hunting TROPHIES. Have a fine home-museum. Hunters, save and MOUNT your beautiful DUCKS, QUAIL, DEER, TAN skins, FURS. Great Fun. Spare-time PROFITS. **FREE BOOK** Tells ALL about it. 100 fine wild-game pictures, 48 pages. SEND TODAY, don't delay. Get this WONDERFUL FREE BOOK, MEN AND BOYS. Learn Taxidermy. Double your hunting pleasure. Rush letter or POSTAL today. STATE YOUR AGE. N. W. SCHOOL OF TAXIDERM, Dept. 2663, Omaha, Neb.

## Learn CRIME Detection!

Learn Scientific Criminology AT HOME. Opportunities in Investigation and Detective work—Identification—Finger Printing—Homicide Investigation—Infrared Photography—Photo-micrography for law enforcement. Send for FREE Book.

Institute of Scientific Criminology  
310 So. Robertson Blvd., Los Angeles 48, Calif. Dept. PS-3

Name.....Age.....

Address.....



# BE A CLERK all my life? **NOT ME!!**



Of course you say you won't. But you may be unless you do something about it.

Hoping and wishing won't get you a better job and more money.

You must prepare for that step ahead—be ready to make promotion come.

We have helped thousands of ambitious men and women get ahead in the business world—perhaps we can help you.

At least you should investigate. It may be the turning point in your life to a better job and more money. So send the coupon without delay. Check the field of your choice and we'll send you without obligation the requirements and opportunities in that field—plus "Ten Years' Promotion in One"—a book which has helped many men.

## LASALLE Extension University A Correspondence Institution

417 S. Dearborn St., Dept. 383-R, Chicago 5, Ill.

I want to know whether you can help me get ahead in the field I have checked below. Send free 48-page booklet and full information about your home-study training—plus "Ten Years' Promotion in One."

- |  |   |
|--|---|
| <input type="checkbox"/> Higher Accountancy  | <input type="checkbox"/> Salesmanship                     |
| <input type="checkbox"/> C.P.A. Coaching     | <input type="checkbox"/> Traffic Management               |
| <input type="checkbox"/> Bookkeeping         | <input type="checkbox"/> Foremanship                      |
| <input type="checkbox"/> Law: LL.B. Degree   | <input type="checkbox"/> Industrial Management            |
| <input type="checkbox"/> Business Management | <input type="checkbox"/> Stenotypy<br>(Machine Shorthand) |

Name..... Age.....

Address.....

City..... Zone..... State.....

## ENGINEERING DEGREE IN 27 MONTHS

### Big Demand for Graduates

AERONAUTICAL, CHEMICAL, CIVIL, ELECTRICAL, MECHANICAL and RADIO ENGINEERING (including Television).

Hundreds of young men are earning engineering degrees in this recognized institution each year—continuous operation. New terms start quarterly. Many students earn a major part of their college expenses in this large industrial center.

Low tuition. Competent instruction. Thorough intense practical program. Modern laboratory facilities including new physics lab. and modernized wind tunnel. Individualized instruction emphasized.

Approved for Veterans. Engineering preparatory courses. Students from 48 states and 21 foreign countries. Enter March, June, September, December. Send coupon for free catalog and full information. Enroll now.

SEND COUPON TODAY

## INDIANA TECHNICAL COLLEGE

630 E. Washington Boulevard  
Fort Wayne 2, Indiana

Please send me free information on B. S. Engineering Degree in 27 months as checked.

- |  |                                      |  |
|--|--------------------------------------|--|
| <input type="checkbox"/> Aeronautical, | <input type="checkbox"/> Chemical,   | <input type="checkbox"/> Civil,            |
| <input type="checkbox"/> Electrical,   | <input type="checkbox"/> Mechanical, | <input type="checkbox"/> Radio-Television. |

Name.....

Address.....

## Piles May Lead to Associated Ailments

### FREE BOOK Explains Causes, Effects and Treatment

If you have Piles, Fistula, rectal abscess, or any rectal or colon disorder—here is good news.



Write today—McCleary Clinic and Hospital, 371 Elms Blvd., Excelsior Springs, Mo.—for your FREE copy of their 160-page, illustrated book.

## HEY GUYS - LOOK!



### THE FINEST SLING-SHOT MADE! STURDY—POWERFUL—ACCURATE

only  
**49¢**  
postpaid

Here it is—the slingshot with the punch and killing power of a .22 cal. rifle. Heavy aluminum yoke. Slings are tough, powerful, red-tempered rubber. Chrome cured leather thongs. 6 extra slings, 2 extra thongs included. When ordering ask for details special offer. Sling-Shot Co., Box 1029-A, Pittsburg, Calif.



## WOOD CARVING

9" TALL FIGURINE Postpaid in U.S.A. **\$1.85**

This beauty is easily carved in white pine with a mahogany and velvet base. Complete kit includes Material, Tru-Form templates and instructions. For more new and unusual projects send 10c for latest catalog.

**BRAUN-CRAFT** 1232 ETOWAH, DEPT. PS-8A ROYAL OAK, MICHIGAN

## MAKE MONEY IN LANDSCAPING

Thorough training by Internationally known Landscape Architect to start your own business, improve your home or advance in this well paid field. Many Opportunities. Approved for Veterans. Send for FREE BOOK.



**NATIONAL LANDSCAPE INSTITUTE**  
310 So. Robertson Dept. PS-3 Los Angeles 48, Calif.



## DO IT YOURSELF with FOAM RUBBER

COVER YOUR FAVORITE CHAIR ... CAR SEAT ... KITCHEN AND DINING ROOM CHAIRS ... IT'S EASY WITH FOAM RUBBER. MANY OTHER USES ... **LOWEST PRICES.**

Auto Seat Topper Pads  
24"x60"x1 1/2" .. \$5.00  
24"x60"x2" .... 7.50  
Kitchen Chair Pads  
12"x12"x1 1/2" in sets  
of 4 ..... \$3.00 a set

WRITE FOR  
**FREE**  
GOV'T  
SURPLUS  
CATALOGUE  
AND  
FOAM RUBBER  
PRICE LIST

Other Sizes  
Each  
15"x15"x1 1/2" .. \$1.25  
18"x24"x2" .... 2.00  
24"x24"x1 1/2" .. 2.50  
sizes are approximate  
SEND 10c FOR SAMPLE

ORDER FROM THIS AD ... SHIPPED PREPAID UNLESS C.O.D.

## BEN'S SURPLUS

901 KLEIMAN BUILDING

GRAND RAPIDS, MICHIGAN



# Norman Rockwell

WORLD'S MOST FAMOUS COVER ARTIST SAYS . . .

## "you can be a successful artist!"



Every famous artist was once an amateur. The difference between "doodling" and a well-paid art job is *professional training*. Now, you can get that know-how quickly, at home, in your spare time. I have worked with America's 11 most famous artists to perfect new and faster methods of teaching you our secrets and short cuts. Get started today. Write for our big illustrated brochure. It's FREE!

### FAMOUS ARTISTS COURSE

.....

**FREE** Institute of Commercial Art, Inc.  
Dept. C-11, Westport, Conn.

Mr., Mrs., Please send book about Famous Artists Course.

Miss \_\_\_\_\_ Age \_\_\_\_\_

Street \_\_\_\_\_ Phone \_\_\_\_\_

City, Zone, State \_\_\_\_\_

### America's 12 Most Famous Artists Teach You

Norman Rockwell • Al Parker  
Jon Whitcomb • Ben Stahl • Stevan Dohanos  
Robert Fawcett • Harold von Schmidt  
Peter Helck • Austin Briggs • John Atherton  
Fred Ludekens • Albert Dorne

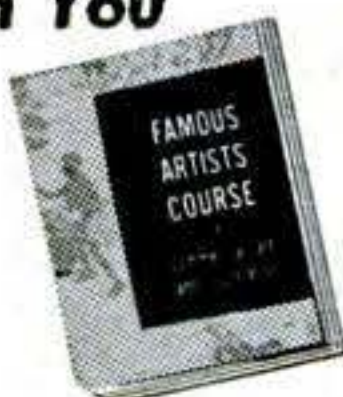

### SHOE REPAIR OFFERS BIG INCOME • Learn in 12 Short Weeks!

Own your own shop. Earn big income. Get into business in this depression-proof work. Hard times only make shoe repairing thrive. 12 short weeks. Packed with practical training on actual shoes and professional machinery. No book studies. No educational or age requirements. Anyone can be a successful shoe repairman—from 18 to 80. Our fast "Learn By Doing Method" is easy, complete. Three modern schools, Chicago, Los Angeles, Oakland, 150 million customers for shoe repairs in U.S. alone. Get the facts on this big paying skilled trade today. Write for free booklet.

**MODERN SHOE REBUILDING SCHOOL, Dept. PS-30**  
2937 Belmont Ave., Chicago; 361—12th St., Oakland, Calif.  
Established 1927 806 So. Figueroa St., Los Angeles 14, Calif.

**FREE!** Big 20-page Illustrated Book tells how you can get into this big paying skilled trade Today! Complete details. No obligation. Fill in coupon Now!

Gentlemen: Please rush me the facts on how I can learn shoe repairing and get into my own business.  
Non-vets check here.... Vets check here....

Name.....  
Street.....  
City.....State.....

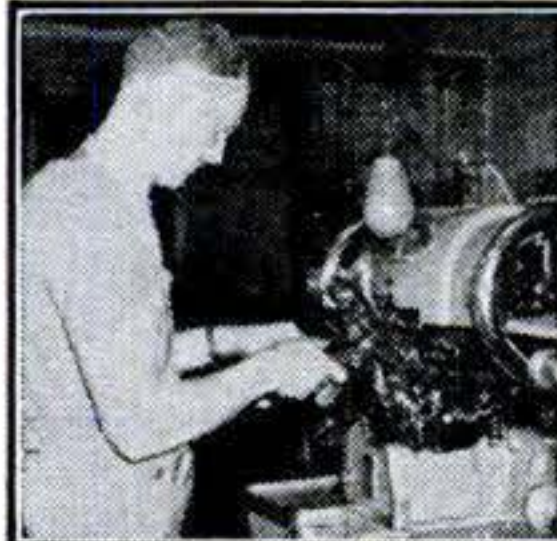

SEND FOR THIS **FREE!**

Make money. Know how to break and train horses. Write today for this book **FREE**, together with special offer of a course in Animal Breeding. If you are interested in Gaitting and Riding the saddle horse, check here ( ) Do it today—now.

**BEERY SCHOOL OF HORSEMANSHIP**  
Dept. 583 Pleasant Hill, Ohio



### 80 POWER MICROSCOPE TREMENDOUS VALUE!

• All metal **PRECISION** instrument with 80X magnification. Fully ground and highly polished lenses. Special sensitive adjustment to insure clearest and finest enlargement details. Comes complete with viewing mirror, clamps and slide. Beautifully packaged in wooden chest. Not a toy. Will give comparable results to other microscopes selling for \$100.00. Worth many times our **LOW PRICE**. Order from— **\$7.95**

**MARDO SALES CO.**  
480 Lexington Ave., Dept. MK-11, New York, N. Y.

New Easy Way TO MAKE

### BIG MONEY!

AT HOME FULL OR SPARE TIME

Costs You Only 5¢-You Get \$5.00



Write Now

Now is the time to cash in on this big-paying, easy-to-operate year 'round business, and you need no experience! Metallize Baby Shoes in real **GOLD, SILVER, BRONZE, and PEARL**. Everything furnished so YOU can start earning money at once—up to \$1,000 per month full time, or \$50 to \$75 per week spare time—at \$5 per hour. They will last **FOREVER**, and there are 30 million eager customers every year waiting to buy. **FREE DETAILS**—send no money—a postcard with your name will bring all the facts. Don't pass up this opportunity to start your own business on a shoestring—so **ACT NOW**. Write at once to

**KIKTAVI COMPANY, Dept. PS-3, 2111 W. Manchester Blvd. Los Angeles 44, California**

- Big Income
- Huge Demand
- Sales Plans
- Future Security
- Your Own Boss
- Money Back Guarantee
- Most Successful Name in Metallizing



**FREE!** 3 way inspection profit plan yours to inspect at my risk for 7 days. Includes two actual metallized baby shoes—or a pair of your own metallized at no extra cost.



**MANUFACTURE THIS BEAUTIFUL  
CONCRETE OUTDOOR FIREPLACE**  
Right In Your Own Back Yard

**\$4.00 Worth of  
Sand & Cement  
produces this  
Attractive  
Fireplace.**

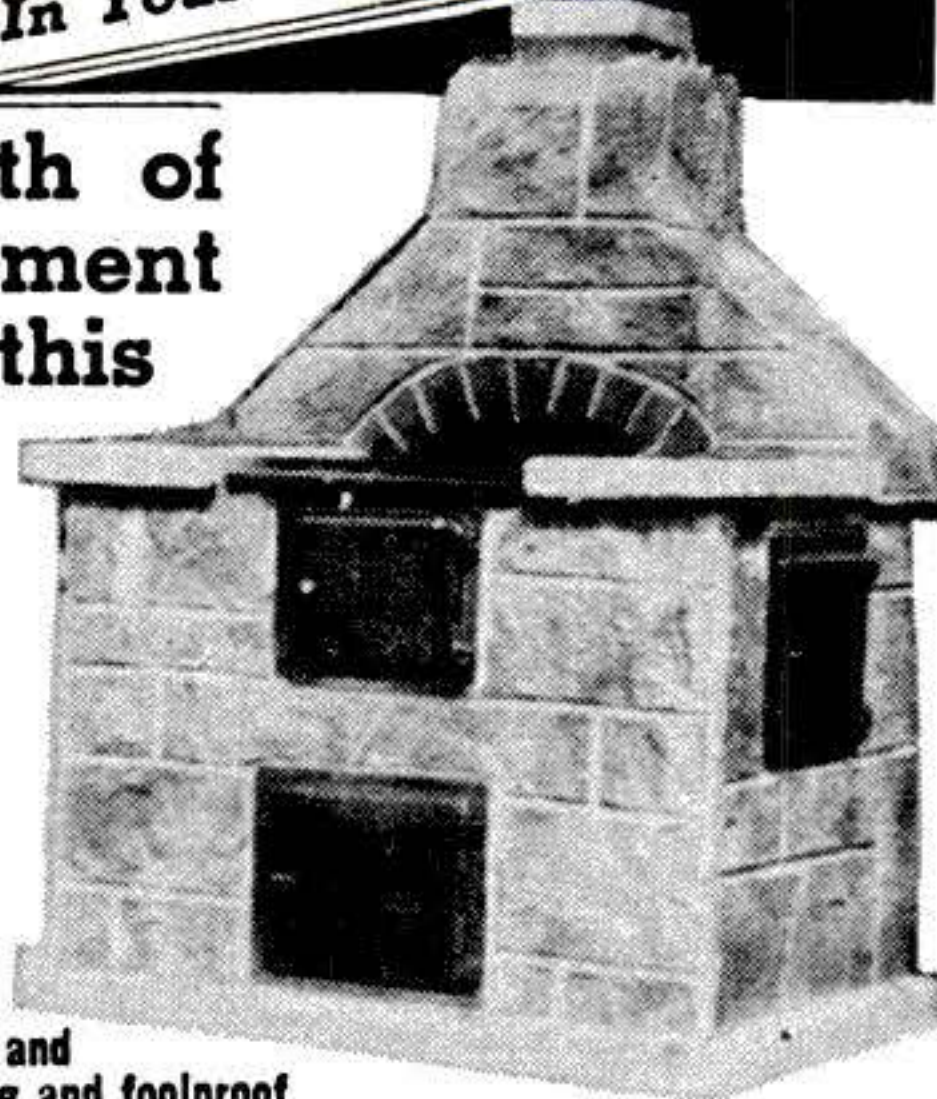

**Sells on Sight  
from \$60. to  
\$80. Easy to  
start your own  
Profitable Bus-  
iness.**

The General Fireplace Molds and Process are the most amazing and foolproof ever invented. Simple to operate, two men can produce five fireplaces a day.

**BIG DEMAND!!**

Sell all you produce to Department Stores, Homeowners, Parks, Nurseries and Picnic Groves. Fireplaces sell on sight. No experience necessary, we supply full operating instructions and equipment plus the know how that spells **BIG PROFITS**. This is an outstanding opportunity for men of vision and small capital to get into a busy rich paying field. Don't delay, be the only exclusive manufacturer in your own home town. Mail coupon at once for full details as to how you can reserve your territory.

**GENERAL ENGINES CO., Inc.**  
307 HUNTER ST. • GLOUCESTER CITY, N. J.

*Mr. Tor of Phila. writes:  
Sold 250 in first 4 months. Selling to  
Sears Roebuck, John Wanamaker &  
Gimbel Bros. in Phila. area.*

Name .....

Address .....

City..... Zone..... State.....

**Home-Study  
COURSES**

*Offered under the  
Faculty Graded System of Training  
Available to Non - Veterans, and also Veterans  
in All States  
under Public Law 16 and 346*

- Practical Business Administration
- Fundamentals of Sales and Advertising
- Production Management
- Bookkeeping and Accounting
- Building, Estimating and Contracting
- Automobile Maintenance and Repair
- Diesel Locomotive Operation
- Diesel Locomotive Maintenance and Repair
- Steam Locomotive and Repair
- Railway Locomotive Maintenance and Repair
- Railway Electrical Maintenance
- Railway-Car Shop Maintenance
- Electrical Courses
- Machine and Allied Courses

*For Further Information and Catalog Check, With-  
out Obligation, Course Interested in and Mail to*

**F. G. S. Training Division  
AMERICAN TECHNICAL SOCIETY**  
Desk PS, 850 East 58th Street  
Chicago 37, Illinois

**ALL-PURPOSE SMALL MOTORS**

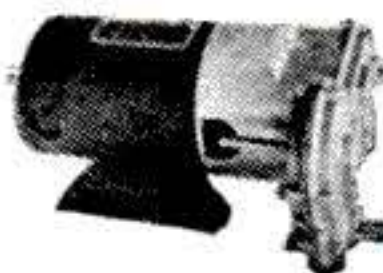

**D-2** Converts to 110 V AC in ten minutes, diagram included, contains integral gear box having four 1/4" drive shafts turning simultaneously at the following speeds:  
4000 RPM—Grinders, buffers, flexible shaft tools, etc. 150 RPM—Wrapping fishing rods, slow speed tools.

25 RPM—Dev. tray rocker for photo darkroom.  
5 RPM—Turning barbecue spits. **\$5.95**  
Adv. Disp. Beams. A Thousand Other Uses Around the Work Shop. ONLY.....

Converted to 110 volts AC..... **\$7.95**

**D-1** Converts to 110 V AC in ten minutes, diagram included, has shaft with squirrel cage blower, also gear reducer with 2 shafts and pulleys at the other end. 1001 uses..... Only **\$4.95**

**6 V MOTOR** A real beauty, removed from aircraft. Type used for auto fan. Many uses. Ea. **98c**

**RM-29 PORTABLE FIELD TELEPHONE**

An ideal portable field telephone. Complete in a rugged steel case for years of wear. Ringer circuit and handset. 5"x6"x9". Simple two wire operation 15 miles distance and upwards. Can be used for television installation, intercom system, construction companies outside and inside work, etc. 13 lbs. As good as new, **\$9.95** 2 for **\$18.95** each.....



All prices F.O.B. Chicago. 20% deposit required on all C.O.D. Orders. Write for free catalog.  
**NESCOP ELECTRONICS** Dept. PS-3, 2635 W. Grand Ave. Chicago 12, Illinois

**Be a DETECTIVE**

**A CHALLENGE FROM WASHINGTON, D. C.!**  
Help Stop Crime! Train at home. Earn big money. Amazing training course from the NATION'S CAPITOL (center of law enforcement) by former U. S. GOVT. AGENT and NAVAL INTELLIGENCE Officer exposes actual methods used by Criminals. Write for FREE BOOK. State age.  
**INTERNATIONAL DETECTIVE TRAINING SCHOOL**  
1701 Monroe St., N.E. Dept. 213 Washington 18, D. C.



**Learn MECHANICAL DENTISTRY**

**A profession offering unlimited opportunities.**  
Most modern and complete course embracing every branch from Plate to Porcelain Work, which prepares you to work for Dentists or start your own business. Individual instruction—practical training in day or night school. No books—no classes. Catalog upon request.

**McCARRIE SCHOOL of Mechanical Dentistry**  
207 N. Broad Dept. 895 Philadelphia



**Bar Bells**

Buy Direct From Factory **\$8.95**  
Write for free booklet and price list **8<sup>up</sup>**

**INDEPENDENT IRON WORKS**  
2416 East 23rd Street, Dept. C  
Los Angeles 11, Calif.

**DESIGNED TO  
SAVE GAS!**

**SPARK - GAP  
RESISTER**



Takes only 6 MINUTES to install. One fits on top of every spark plug. Designed to give your car a "Hotter Spark"—**MORE COMPLETE FUEL COMBUSTION**—therefore, **MORE MILEAGE** and **BETTER ENGINE PERFORMANCE**. Precision made from special heat resistant transparent plastic, so you can **ACTUALLY SEE SPARKS JUMP**—eliminating much "Trouble Shooting" for engine trouble.

**FREE TRIAL  
ON YOUR CAR**

**TRY THEM AT OUR EXPENSE... SEND NO MONEY**  
Just send your name, address, and number of cylinders in your car. Try them for 10 DAYS, then IF SATISFIED, send only 35c for each resistor. If not satisfied, return them—**NO QUESTIONS ASKED**. Send Today—**OFFER LIMITED**.

**TYCO AUTOMOTIVE ENGINEERING CO**  
8070 Lankershim Boulevard • North Hollywood, California





## PLAY GUITAR IN 10 DAYS OR GET YOUR MONEY BACK

LET ED SALE, TOP-RADIO GUITARIST TEACH YOU TO PLAY ANY SONG BY EAR OR NOTE WITH HIS FAMOUS diagram-photo system. THE BIG DELUXE 64 PAGE BOOK WHICH YOU RECEIVE CONTAINS complete easy to learn instructions, 52 photographic chord charts, 47 diagrams, showing just how to place your fingers, enabling you to play harmonious chords in NO TIME AT ALL. Plus 110 Popular songs, words and music. Be in Demand, win new friends, fame and money. Imagine your pride when in two weeks you are playing songs you always dreamed about. ABSOLUTELY NO previous music knowledge needed. Pay Postman \$1.95 plus C.O.D. or to save C.O.D. send \$2 NOW!

**\$1.95**

Also write for attractive Guitar offer on cash or credit.

ED SALE Dept. 1B Point Pleasant, N. J.



Authenticast

SHIP KITS cost-  
from \$6 to \$12.95

EVERY "AUTHENTICAST" KIT A COMPLETE BUY

They include all parts, file, brush, paint, steel wool, duccon cement, detailed plans, complete instructions. EVERY KIT READY-TO-BUILD. SEE YOUR DEALER OR WRITE DIRECT

Send for the new "AUTHENTICAST" catalog now only 25c

COMET METAL PROD. CO., INC. Richmond Hill 18, N. Y.



## BE A LOCKSMITH

Learn Locksmithing and Keymaking from Experts in Your Spare Time at Home!

Locksmiths in big demand! No layoffs, no slow seasons! Age or physical handicap no disadvantage. Year-round, steady income in this permanent, respected field. Full or part time. Practical, illustrated lessons show you how to make money even while learning! All materials and special tools supplied. Send for FREE BOOKLET.

LOCKSMITHING INSTITUTE, Dept. PS-3  
55 Park Ave. Rutherford, N. J.



## LEARN HOW TO HYPNOTIZE

COMPLETE—ONLY \$1.95, POSTPAID!  
Amazing self-study lessons... in simple, easy to understand language. How to select a subject—how to hypnotize by telephone—how to make money from hypnotism—mental telepathy—stage hypnotism—self-hypnosis: how modern hypnotism is used to conquer inferiority complex, fear, battle fatigue, timidity, etc. Clear, helpful pictures show operating positions, movements. Money-back guarantee. Only \$1.95, postpaid—or COD, plus postage. Write today!

Nelson-Hall Co., 1139 S. Wabash Ave., Dept. 3C-1, Chicago 5, Ill.

## AMAZING PROFITS

From Your Workshop!

New, improved Home Craftsman Magazine brings you simple, step-by-step methods used by thousands of successful craftsmen who make their home workshop pay BIG PROFITS—At your fingertips, tested, proved methods, for making a "killing" even in tough times. Tells how to pick projects that sell fastest; how and where to sell. Shows how to actually have fun, yet earn money in spare time.

For the next two years we want to send you Home Craftsman Magazine to show you the hundreds of amazing plans and ideas. Best of all you take it on FREE TRIAL. Also Big Free book "How To Make Money With Your Workshop" yours to keep absolutely Free even if you decide not to continue taking each issue of the magazine—So what have you to lose—a penny postcard? Hurry—Write for details of this amazing free trial offer. Remember—it's free!



The Home Craftsman Magazine, Dep't. S-3  
115 Worth St. New York 13, N. Y.

## PRICES SMASHED!

SAVE Water & Shock Resist  
46% TO  
71%

Wet it! Bang it! Drop it! Special gasket protection against water, dust, grime. Ruby jewels for main bearings. Stainless steel screw back. Sweep-second hand. Luminous. Unbreakable Kleervue Crystal. Thin! Handsome! Formerly \$24.50. Now 9.95, plus 1.00 tax, total: 10.95.



9.95

THORESEN WATCHES GUARANTEED 3 YEARS!

THORESEN'S Chronograph



The Chronograph that Remembers!

THORESEN'S genuine chronograph is a near-miracle of accuracy. Trim, highly functional, the pride and joy of every hobbyist, mechanic, scientist, physician, sportsman, student, aviator.

Over 20 Super-Quality Features  
3 multi-function dials, automatically coupled, 30 min. register. Synchronized for hrs., min., sec., & 1/5th seconds. Anti-magnetic. Luminous. All steel back case, sturdy, yet THIN! Back to zero feature. Built-in Tachometer & Telemeter measure Speed & Distance airplanes, autos, boats, lightning, typing, pulse

beats, etc. Different—it remembers! Precise! A sleek, handsome watch. Directions given. Was \$75.00. Now direct-to-consumers for 22.95, plus 10% tax, total: 25.25.

MONEY BACK IN 10 DAYS IF NOT PLEASED!

AUTOMATIC! 24.95

It winds itself!

The carefree watch! It's AUTOMATIC—it winds itself as you wear it—then forget it! No danger of overwinding. SHOCK and WATER resistant. Patented Incabloc Anti-magnetic. Sweep second, luminous dial. One of the smallest, thinnest made. Extremely accurate and impressively handsome. Save \$46.55 buying the THORESEN DIRECT WAY. Terrific value at \$24.95, plus 10% tax Total \$27.45. 3 year guarantee.



SHOP—COMPARE—APPRAISE



1.98

2.98

2.97

Imitation diamonds! Terrific value! Heavy gold color mounting. Impressive! Wins admiration. Lasting satisfaction guaranteed. Price complete (no extras)—1.98

Distinctive! Extra heavy simulation of a Solid Gold 5 diamond ring. Well made. Rich \$500 appearance. Money back guarantee. Complete price (no extras)—2.98

Extra special! Genuine 14 K Rolled Gold Plate. Your own initial in raised gold effect, flanked by 2 pseudo zircons of sparkling brilliance. Complete, only—2.97

## Men's Famous Brand RHINESTONE WATCH

Accurate, handsome, sturdy! Ruby and Diamond color rhinestones around dial. Genuine Swiss movement. Looks like \$200.00 watch Fully guaranteed. Never a penny for repairs during 3 years. Formerly \$14.95. Now 7.99, plus 80c federal tax, total: 8.79



7.99

## STURDY TARA



1/2 off our former price! Unbreakable crystal, luminous numerals, stainless steel band. Good, dependable, imported Swiss movement. Good time-keeper and only 4.94, plus 49c tax.

4.94

SEND NO MONEY

10 DAY FREE TRIAL

Pay price plus postage on delivery, or send check or money order and SAVE postage. Try, compare, appraise! Money back in 10 days if not pleased. 3 YEAR GUARANTEE—never a penny for repairs, parts or postage. Rush orders NOW!

THORESEN DIRECT SALES

131 West 33rd St., Dept. 7C-200, New York 1, N. Y.



# Owners are making BIG MONEY



## operating this FRANCHISED ROADSIDE STAND

One of the greatest opportunities in America! A business you can start with very little capital . . . and make thousands of dollars if you follow our *proved* methods of stand building and operating. A 28-page folder shows plans, testimonials from owners . . . gives hundreds of other essential facts. Send for your *free* copy!

GO IN  
BUSINESS  
FOR  
YOURSELF!  
FREE  
FOLDER  
TELLS  
HOW

**RICHARDSON**  
CORP.,  
Dept. PS-3  
Rochester 3, N. Y.  
Please send me  
FREE folder on RICHARDSON stand.

Name \_\_\_\_\_  
Address \_\_\_\_\_  
Place \_\_\_\_\_  
Phone \_\_\_\_\_



## EARN MORE MONEY IN ELECTRICITY! with APPLIED PRACTICAL ELECTRICITY



JUST  
OFF  
PRESS

Sent on  
**FREE**  
TRIAL

Coyne's new set helps men get ahead in Electricity. This great Set gives you complete, A to Z know-how. It's all explained in easy-to-follow language, hundreds of charts, examples, pictures. Covers practically all branches of electricity including appliance repairing; AC and DC equipment; electrical refrigeration; industrial electronics and much more. Brings you 10,500 electrical facts; 3,400 subjects; hundreds of wiring diagrams, tables, formulae, shortcut methods. Written and proved in the Coyne shops—backed by 50 years experience in electrical training that has put hundreds of electricians on the road to top earnings. APPLIED PRACTICAL ELECTRICITY IS THE MOST COMPLETE ELECTRICAL SET IN AMERICA.

**USE SET FREE FOR 7 DAYS!**

You have to SEE these books to know how much they'll help you. See them FREE! Just fill out coupon below and mail it in. SEND NO MONEY. Examine the set for 7 days AT OUR RISK!

**150 SHOP PRINTS BOOK FREE—FOR PROMPT ACTION**



Act promptly and we will include FREE, our valuable new book "150 Shop Prints and How to Read Them." If you return the set at our expense in 7 days, you owe nothing. To keep Set, send either \$23.75 in cash or \$3.00 after 7 days and \$3.00 per month until \$25.50 is paid. Either way, you keep the 150 shop Prints Book. It's yours FREE! Coupon below is just a request to see APPLIED ELECTRICITY Set and to get FREE Shop Prints Book for doing so. Mail coupon AT ONCE!

### FREE TRIAL COUPON—MAIL NOW!

Educational Book Publishing Division,  
COYNE ELECTRICAL & RADIO SCHOOL,  
500 S. Paulina St., Dept. 30-38, Chicago 12, Ill.

YES! Send Coyne's new, 8 volume Set, "Applied Practical Electricity" to me, postpaid, for 7 days FREE TRIAL per your offer. Include, FREE of charge, your 150 Shop Prints Book.

Name \_\_\_\_\_ Age \_\_\_\_\_  
Address \_\_\_\_\_  
Town \_\_\_\_\_ Zone \_\_\_\_\_ State \_\_\_\_\_

# TRAINED MEN

win the good jobs in industry

● Prepare for a good-paying job! Franklin Technical Institute will prepare you for an engineering or technical position. More than 50,000 graduates—many are important supervisors.

Practical two-year day courses in industrial electricity and electronics, industrial chemistry, mechanical and machine design, structural design and architectural drafting, automotive service and management, electric wiring and maintenance. One-year professional photography courses. Also preparatory and evening courses. Approved for veterans. Coeducational. Founded by bequest of Benjamin Franklin, 42nd year.



Plan now to acquire the training which you need to get ahead. Write for catalog today!

**FRANKLIN TECHNICAL INSTITUTE**  
39 Berkeley Street Boston 16, Mass.



100% PROTECTION

## TEAR GAS

**A REAL SURE-FIRE SELLER!  
THUGS AND THIEVES BEWARE!**

Here is a tear gas pencil gun which discharges smothering clouds of tear gas to instantly stop, stun and incapacitate the most vicious man or beast. A safe and effective substitute for dangerous firearms. No permanent injury. Needed in Stores, Banks, Autos and Homes, everywhere to protect Life and Property. No skill required. Handle our tear gas as a side line and you'll soon give it full time. For a quick start send \$3.60 for complete demonstrator outfit consisting of an Automatic Pencil Gun with 10 demonstrators and 3 powerful Tear Gas cartridges fully guaranteed. Many thousands now in use. Order your outfit today. Not sold to minors.

Hagen Supply Corp. Dept. D-503 St. Paul 4, Minn.

## EASY TO LEARN CODE

Learn or increase speed with an Instructograph—the Radio-Telegraph Code Teacher that takes the place of an operator-instructor and enables anyone to master code without further assistance. Available tapes from beginners alphabet to typical messages on all subjects. Speed range 5 to 40 WPM. Always ready—no QRM. Thousands have "acquired the code" with the Instructograph System. Write today for convenient rental and purchase plans.

**INSTRUCTOGRAPH COMPANY**  
4701-P Sheridan Road, Chicago 40, Illinois



## Treasure and Mineral LOCATORS GIGER-COUNTERS

**FOR URANIUM-ORES**  
CREDIT PLAN—FREE LITERATURE  
**FISHER RESEARCH LABORATORY Inc.,**  
Palo Alto, Calif.



## MEN WANTED

to Wear Made-to-Measure  
**SAMPLE SUITS**

Pay No Money! Send No Money!

● Men can't resist my sensational values in all-wool, made-to-measure suits. Actual garments clinch sales fast! I make it easy for you to get your own suit to wear and show—and to make money in full or spare time! My plan is amazing! Just take a few orders at my low, money-saving prices—that's

all! Get your own suit without paying one penny and earn up to \$15.00 in a day besides! Rush name and address today for FREE OUTFIT containing more than 150 actual woolen samples, style cards, full instructions. Write now.

**J. C. FIELD & SON, INC., Dept. C-1720**  
Harrison and Throop Sts., Chicago 7, Illinois



**5 YEAR WRITTEN GUARANTEE  
BULOVA 15 JEWEL**

ONLY  
**\$16.95**

Plus \$1.70  
Tax

ORIGINALLY SOLD  
AS HIGH AS  
**\$59.50**

- Also Choice of
- BENRUS
  - LONGINES
  - WALTHAM
  - or ELGIN  
WATCHES

CHOICE  
**\$16.95**



Genuine Bulova, Benrus, Longines, Waltham, Elgin and other famous wrist watches in latest style Yellow Gold Cases. You get these unredeemed 5 year guaranteed lifetime quality famous make watches now at truly enormous savings because we bought out SURPLUS STOCKS of leading New York and Maryland Jewelers. Order now, while they last. State make preferred. Order men's or ladies'.

**TRIAL OFFER! WEAR AT OUR RISK! Money Back in 5 Days If Not Delighted! SEND ONLY \$1** down payment with order. Pay balance to postman on arrival, plus postage. Or we pay postage if you enclose \$16.95, plus \$1.70 tax. Handsome expansion band included with prepaid orders. Order now.

**MARYLAND DISTRIBUTORS, Dept. 28**  
501 E. Baltimore St., Baltimore 2, Md.

**FREE FOLDER:** America's best Watch and Diamond Ring Values. Wholesale prices to user direct.

**15 or 17 JEWEL  
WRIST WATCH**  
Waterproof.  
Shockproof  
with Swiss precision Movement. Originally \$30.  
**OUR PRICE NOW \$9.95**  
plus \$1 tax.

**NEW! SENSATIONAL DEVICE  
ENABLES ANYONE TO TEST  
OWN EYES  
RIGHT AT HOME**



**SAVE up to \$15.00 On Glasses**

Big News to the Millions of Spectacle Wearers and Prospects. Means Freedom from Outrageous Prices. Perfect Satisfaction Guaranteed! No Risk!

**MAKE BIG MONEY QUICK  
FREE SAMPLE KIT!**

Send for Free Sample at once. Show it to friends and others. Let them use it Free and watch their amazement over this new system of Self Testing. Here is a great new opportunity in a tremendous new field of unlimited possibilities. Spare or full time. No experience or capital needed. Act quick!

Clark Optical Co., Dept. A-133, 1148 W. Chicago Ave., Chicago 22, Ill.

**Learn ACCOUNTING  
BOOKKEEPING**

This nationally renowned school has demand for graduates in good salary positions thru Nationwide recognition and placement service. Write Department PSN today for Big 32 page Success Book to be sent to you **FREE**

**Hills BUSINESS UNIVERSITY AND  
EXTENSION SCHOOL**  
619 W. MAIN ST. OKLAHOMA CITY 2, OKLAHOMA

**Enjoy a hobby that's fun!**

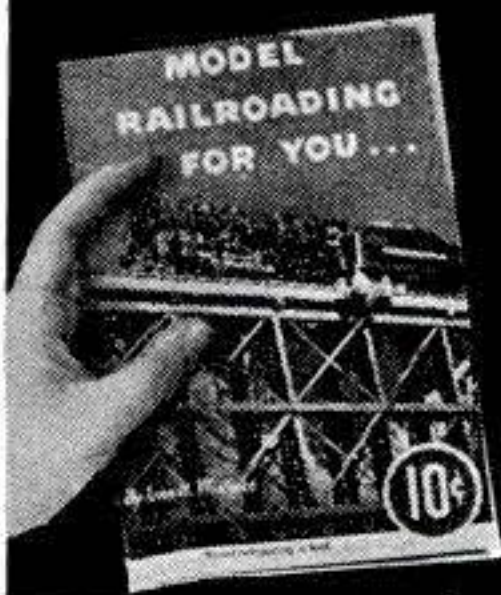

**Get this picture-packed  
book on Model Railroad-  
ing now!**

● It's simple — this book will tell you how you can have your own railroad in your basement, attic, or even a corner. It's inexpensive — surprisingly little money is needed. It's constructive — hobbyists from 17 to 70 spend absorbing hours with the world's fastest-growing hobby.

Fully illustrated — this book explains how you, too, can start. Send 10c today for your copy of "Model Railroading for You," written by a well-known authority. **MODEL RAILROADER MAGAZINE, DEPT. 1639, Milwaukee 3, Wis.**

**NOW** **Week-End  
Painting  
is Fun!**

**NEW, QUICK, EASY WAY TO ENJOY  
AMERICA'S FAST-GROWING HOBBY**

**People Who Never Dreamed  
They Had Any Talent Are  
Now Painting Good Pictures  
—Thanks to This New Guide**



**NEW** guide to OIL PAINTING makes it easy to paint landscapes, trees, shadows, sunlight, reflections on water, etc. Amaze your friends with your artistic ability. Create lovely gifts. Decorate your home with your own paintings. Thousands of readers of the new book, "Week-End Painter" are doing it already—business men, professional people, office workers, craftsmen, technicians, etc. Many of them even make extra money from their new hobby, by letting local stores display and sell their work.

**No Previous Training Needed**

"Week-End Painter" was written by a businessman who took up painting as a hobby years ago, Laurence V. Burton. The author has questioned many famous artists about their secret methods. He has experimented with hundreds of different brushes, paints, canvases, easels—painted hundreds of landscapes. His book is packed with all his accumulated wisdom. It's written especially for people "starting from scratch." No previous training of any kind necessary.

Mr. Burton takes you to the art supply store, helps you choose materials wisely, economically. Then he gives you complete set of simple painting directions, from first brush stroke to framing finished paintings. Tells how to save money on materials. How to use wet and dry paints; mix and use colors, thinners, driers; create moods in pictures; draw compositions before painting; choose subjects; "capture" sunlight, shadows; produce special effects. Shows you so many ingenious short cuts, you'll be amazed at how quickly you learn to paint a good landscape friends will marvel at.

**SEND NO MONEY**

**Examine Book Free 10 Days**

Painting is a wonderful hobby. It develops your artistic ability. It provides a wonderful "escape" from nagging worries and frustrations. You'll be the envy of your friends and neighbors.

But find out for yourself. Examine "Week-End Painter" FREE for 10 days. Simply mail coupon to: **McGRAW-HILL BOOK CO., INC., Dept. PSG-3, 327 West 41st St., New York 18, N. Y.**

**THIS BOOK TELLS  
YOU:**

**The Things You'll Need.** How to choose brushes, easel. Colors.

**A-B-C of Color.** How to "get" any color you see.

**Practical Tips.** Paintbrush magic with different whites, blacks, grays, reds, yellows, blues, greens, browns.

**Brushes.** Kinds. How to use, care for.

**What to Paint.** How to "spot" easy landscapes.

**Working Methods.** Sketching tips. Composition. Putting on the paint. 12 steps.

**Special Tricks.** Capturing sunlight. Painting realistic trees, grass. Secret of "clean color." Cezanne's secret of painting clouds. Hundreds of other hints.

**Same FREE EXAMINATION Offer on "Water-Color Painting is Fun,"**

by Frank A. Staples  
18 different water color landscapes, how to paint them. Chart of 132 color mixtures, when to use them. How to choose materials, create feeling of distance, etc. 100 illustrations. \$3.50 on easy terms.

**McGRAW-HILL BOOK CO., INC., Dept. PSG-3,  
327 West 41st St., New York 18, N. Y.**

Please send me for 10 days' FREE EXAMINATION:

"Week-End Painter" If not satisfied, I will return it—pay nothing. Otherwise I will keep it and send only \$1.95 (plus postage) and \$2 one month later.

"Water-Color Painting is Fun" If not satisfied, I will return it—pay nothing. Otherwise I will keep it and send only \$1.50 plus postage and \$2 one month later.

Name .....

Address .....

City..... Zone No. (if any)..... State.....

**WE'LL PAY POSTAGE** if you enclose full payment WITH coupon. "Week-End Painter," \$3.95. "Water-Color Painting is Fun," \$3.50. Same 10-Day Return Privilege for full refund.



Here it is...

# The HOME MECHANIC'S OUTDOOR HANDBOOK

By R. R. HAWKINS and C. H. ABBE



Complete Step-by-Step Directions for Every Type of Outdoor Construction—from Walks and Fences to Garages and Tennis Courts.

This great new handbook shows you how to mix concrete and mortar, how to build with bricks, tile, concrete blocks, building stone, flagstone, fieldstone, etc. It shows you how to make grills and fireplaces for outdoor cooking; shuffleboards, horse-shoe-pitching grounds, badminton courts, and swimming pools for health and recreation. It covers in complete detail the construction of driveways, walks, steps, curbs and edgings; walls, window wells and stiles; breezeways, arbors, trellises, foot bridges and other small structures; sprinkling systems, garden pools, and outdoor lighting systems.

Examine This Great New Book Free!

Don't send any money, not a penny! Just fill in and mail the coupon below and you will receive a copy of this big, practical, fully illustrated book to examine right in your own home for ten days at our risk, our expense.

-----MAIL THIS COUPON NOW-----

**D. Van Nostrand Company, Inc.** Publishers  
250 Fourth Avenue, New York 3, N. Y. Since 1848

Please send me a copy of "The Home Mechanic's Outdoor Handbook." After 10 days I will either return the book or send you \$1.95, plus a few cents postage, and \$2.00 for two months until the total price of only \$5.95, is paid. (If you send the entire amount of \$5.95 with this coupon we will pay the postage. Same return privilege and refund guarantee.)

Name.....  
Address.....  
City.....Zone.....State.....  
P.S. 3-50

## LEARN TO WRITE *a Good Hand!*

FOR BUSINESS AND SOCIAL SUCCESS!  
Improve your handwriting at home quickly with my new instruction books just off the press. Master all the secrets of better penmanship. Simple and easy, fully illustrated, highly endorsed. Begin today. Write for:  New Free Book, "How to Become a Good Penman", or check books wanted, \$1.00 each.  Business Writing  Artistic Writing  Card Writing  Engrossing Alphabets  Bird and Design Flourishing  Complete Set \$4.50  Enclose 10c for your name beautifully written and shading penpoint. S. A. Ziller, President, TAMBLYN SCHOOL OF PENMANSHIP 439 Ridge Bldg. In Business Over 52 Years Kansas City, Mo., U.S.A.

## GETTING DEAF?

Don't let deafness kill the joys of living. Do as hundreds of thousands have done. Let a home trial prove you can even hear a whisper. Here's Zenith's amazing guarantee—if any \$200.00 hearing aid outperforms Zenith's newest, tiny, 6¾ oz. single-unit "Miniature" Radionic Hearing Aid in efficiency or economy, your money back—under our 10-Day Return Privilege. Only \$75.00 complete, ready to wear. For authorized Zenith Hearing Aid Dealer in your locality, consult your classified telephone book; or write us for complete coast-to-coast dealer list. Free descriptive literature upon request. Address:

Zenith Radio Corporation, Hearing Aid Division  
Dept. 392  
5801 West Dickens Avenue, Chicago 39, Illinois  
Makers of World Famous Zenith Radio,  
FM and Television Sets

SAVE ALMOST HALF!

## PRECISION VERNIER CALIPER

World famous precision, style, workmanship of former Mauser organization of Germany. Made to exacting standards. One-hand operation with positive-action release. Chrome steel throughout, a perfect tool for shop and home. Measures accurately to 1/1000 of an inch and 1/20 mm. Mechanics, tool makers, inspectors, technicians, hobbyists need this excellent instrument. Precise measurements quickly and easily: outside and length, inside, thread, depth measurements. Now, because full scale production is again under way, this beautiful Mauser-type caliper is yours at a price almost half of any comparable tool! Order yours today!

In protective leatherette case.

Dealer inquiries invited.

**GLOGAU & CO., INC.**

1908 Birchwood Avenue,  
Chicago 26, Illinois



Prepaid with your check or money order.

10 day money back guarantee

ONLY  
\$15.00

F.O.B.  
Chicago,  
C.O.D.

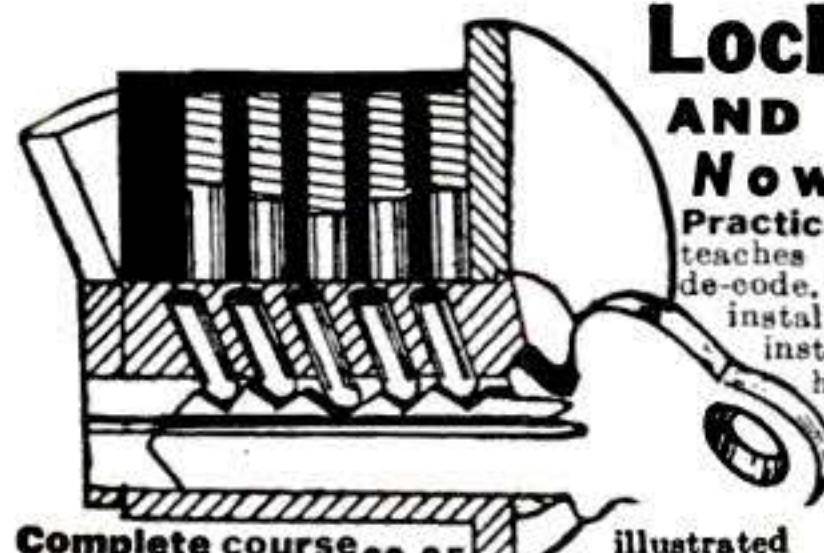

## Locksmithing AND KEY MAKING Now Made Easy!

Practical up-to-date course teaches you how to pick locks, de-code, make master keys, repair, install, service, etc. New self-instruction lessons for every handyman, homeowner, carpenter, mechanic, service station operator, fix-it shop, hardware dealer, gunsmith. 53 easy illustrated lessons. Full price only \$3.95, postpaid; or C.O.D. plus postage. Satisfaction or refund guaranteed. Nelson-Hall Co., 1139 S. Wabash Ave., Dept. 2C-1, Chicago 5, Ill.

Complete course  
now only \$3.95

## LEARN TO PLAY CHECKERS

Send a \$1.00 bill in an envelope with your name and address for the January and February issues of the checker players' magazine.

"THE AMERICAN CHECKERIST"

345C Payne Avenue

North Tonawanda, N. Y.

## WATCHMAKING—JEWELRY REPAIR ENGRAVING—STONE SETTING

Many opportunities for trained men and women in this fascinating, profitable field. Expert instructors. Practical training in modern shops. Professional tools furnished. Nationally approved. No experience necessary. GI approved. Write today for FREE catalog.

JEWELRY TRAINING SERVICE

226 South Wabash Ave.

Chicago, Illinois

## RUPTURE!

An amazing Air-Cushion Invention allows body freedom at work or play. Light, neat, cool, sanitary.



Durable, cheap. Day and night protection helps Nature support weakened muscles gently but surely. No risk. Sent on Trial! Write NOW for free Booklet and Proof of Results. All correspondence confidential.

Brooks Company, 163-G State St., Marshall, Mich.

## STUDY AT HOME

WITH AN EDUCATIONAL INSTITUTION

Courses in **ENGINEERING**: Electrical, Civil, Mechanical, Drafting, Architectural, Automotive, Steam, Diesel, Aeronautical, Radio, Structural, Mining, Industrial, Petroleum, Marine, Refrigeration, Air Conditioning, Chemical.

Courses in **ARTS AND SCIENCES**: Philosophy; Education; Letters; Public Health; Medical Jurisprudence; Psychology; Sociology; Physics; Chemistry; Geology; Pol. Science; Theology; Law; Business and Commerce; Accounting; Mathematics; Statistics; Agriculture.

McKinley-Roosevelt Incorporated, 4610-A3, Sheridan Rd., Chicago 40, Illinois



# NEW POWER FOR YOUR CAR ENGINE !

BY CONSTANT BALANCE OF LUBRICATING OIL SUPPLY

*Give Your Car this Tonic—  
Add Power, Pep and Performance*

## MARVEL INVERSE OILER



Here's the famous, low cost, auxiliary lubricating system that meters MARVEL MYSTERY OIL to critical upper cylinder engine parts, precisely in accordance with engine load. The compact INVERSE OILER functions inversely to manifold vacuum, retarding feed *visibly* when throttle is closed or at engine idle, an exclusive MARVEL feature! You can keep ring, piston and valve wear down and performance way UP with the sensational MARVEL INVERSE OILER.



Learn about MARVEL MYSTERY OIL too—the famous oil improving Additive for YOUR motor oil that produces a slow idle, faster engine pick-up and an even, power pull. Thousands of car owners are using it in increased volume for engine protection. MARVEL lowers oil drag resistance, reducing frictional wear and increasing effective power. Add it to your motor oil!

**WRITE FOR THE FACTS NOW!**

*The MARVEL INVERSE OILER Is Easily Installed on Most Engines*

**EMEROL MANUFACTURING COMPANY, INC.**  
242 West 69th Street (Dept. P.S.) New York 23, N. Y.



## BE A PHOTO-ENGRAVER

We furnish complete equipment and supplies. Learn at home or in our modern, friendly APPROVED school in MISSOURI. Get into this big demand, high profit, high wage field. You can start your own profitable, full time or part time PHOTO-ENGRAVING business right in your own home.

Be independent, be your own boss or pave the way to a high pay job with experience gained in your own shop. TASOPÉ TRAINING and TASOPÉ EQUIPMENT has enjoyed world wide recognition since 1931. Write for descriptive literature today. No obligation.

THE AURORA SCHOOL OF PHOTO-ENGRAVING, DEPT. PS-3 TASOPÉ BLDG., AURORA, MO.

# LEARN MEAT CUTTING EASILY-QUICKLY

At Home-In Spare Time



The steady, dependable trade of Meat Cutting taught easily, quickly by improved HOME METHOD. National School, established over 25 years, has organized its famous "Learn By Doing" Classroom, Cutting room and Retail Market training system into sound, practical HOME STUDY form.

Now, by the miracle of this EXTENSION TRAINING you can prepare in Your Spare Time At Home, for a better job, bigger responsibilities or success and security in a store of your own. Remember, PEOPLE MUST EAT!

Buying, cutting, percentage, pricing, advertising, selling—a complete meat education. For beginner or men with ex-

perience. Thousands of successful graduates. Send coupon for FREE Bulletin NOW!

**MAIL THIS COUPON TODAY FOR FREE BULLETIN**

**National School of Meat Cutting Div. 0-88, Toledo 4, Ohio**

Send me your FREE Bulletin on Meat Cutting and Meat Merchandising. No obligation. No Salesman will call.

Name.....

Street.....

City..... State.....



**Sensational NEW... ELECTRO-MATIC SPRAYER**

**NO MOTOR...NO COMPRESSOR NEEDED**



**ONLY \$9.95**

Postpaid in U.S.  
Postage extra on C.O.D.'s

**HERE'S A SPRAYER THAT REALLY WORKS!**

Just fill this amazingly simple sprayer with enamel, lacquer, varnish, stain, light oil, insecticide, moth or fly spray, plug it in to 110-125 volt AC 60 cycle current, and you are ready to do a professional job of painting furniture, automobiles, shop equipment, farm machinery, bicycles, screens, woodwork, etc. Use it for disinfecting, moth proofing, fly sprays, livestock sprays, rust proofing, too. Precision engineered for long service, fully guaranteed. Replaceable mason jar. Weight 2 1/2 lb.

**The LESTER Co.** 1743 MILWAUKEE AVENUE  
BOX S-3E, CHICAGO 47, ILL.

# Command Bigger Money! STUDY LAW

STUDY AT HOME for BUSINESS SUCCESS and LARGER PERSONAL EARNINGS. 40 years expert instruction—over 114,000 students enrolled. LL.B Degree awarded. All text material furnished. Easy payment plan. Send now for FREE BOOK—"Law and Executive Guidance." It explains the course—how you may enroll and the many ways you may profit from Law Study. Write TODAY to:

**AMERICAN EXTENSION SCHOOL OF LAW**  
Dept. 24-PS, 646 N. Michigan Ave., Chicago 11, Ill.

**COMMERCIAL TRADES' GRADUATES GET THE BETTER JOBS** because they are PROPERLY TRAINED!

Practical Shop Training In  
Air Conditioning—Refrigeration  
and/or

Electricity Major Appliances  
Service, Maintenance & Installation

Write for Catalog PS

**COMMERCIAL TRADES INSTITUTE**  
200 South 20th St. Birmingham, Ala.  
Member: Southern Association of Private Trade Schools  
An approved school to TRAIN Veterans & Non-Veterans

**NEW! BIG FIELD FOR PROFIT AND PLEASURE  
COPPER TOOLING & ETCHING**

**EARN BIG MONEY—SPARE OR FULL TIME**  
No Experience needed—start at once. BIG MONEY waiting in COPPER ART field. Plaques, Bowls, Trays, Gifts, Souvenirs of all kinds. Start on the road to success NOW! Here is an opportunity to get started in your own Big Paying Business—FREE DETAILS don't wait—WRITE NOW!

**HOLLYWOOD COPPER ART STUDIOS**  
4257 Beverly Blvd. Dept. PS-3 Los Angeles 4, Calif.

## Learn A Trade NOW! PRACTICAL SHOP TRAINING!

**In Our Chicago Shops**

- AUTO MECHANICS
- DIESEL MECHANICS
- REFRIGERATION
- BODY-FENDER
- WELDING—ARC and GAS
- MACHINIST
- PIANO TUNING

Above Approved For G. I.'s and Civilians  
One of America's Leading Practical Schools  
7 Floors of Fully Equipped Shops  
Over 48,000 Successful Graduates  
Expert Individual Instruction  
Learn by Doing—Low Living Expense  
Established 1902—Day and Evening Classes

**Also the following Home Study Courses**

- PLASTIC
- REFRIGERATION
- DIESEL

CALL IN PERSON OR MAIL THIS AD TO

**GREER SHOP TRAINING**

(Desk 12) 460 South State St., Chicago 5, Ill.

Please send without obligation free information regarding trade checked above. (Specify whether you are a Veteran  or Civilian )

Name.....Age.....  
Address.....  
City.....State.....

**How to Make Money with Simple Cartoons?**

A book everyone who likes to draw should have. It is free; no obligation. Simply address **FREE BOOK**

**CARTOONISTS' EXCHANGE**  
Dept. 193-D Pleasant Hill, Ohio

**100 ALL STAR MODEL POSES** Only \$1

**GORGEOUS PROFESSIONAL MODELS IN 100 POSES ON 16MM FILM**  
Superb camera studies of 100 thrilling beauties in glamorous poses. Ideal for discriminating sculptors, artists, art students, photography students. Add 10c for postage. Order Now!  
Magnifying viewer for perfect detail..\$1  
**BENEFIT CORP., Dept. A-23**  
3807 Benefit Street Baltimore 24, Md.

# LEARN EXPORT

Buy and sell world-wide without capital. Travel abroad if desired. Export men and women in demand. Your own business — profits unlimited. Salaried jobs in many branches of Export-Import. Practical, low cost **WORLD TRADE COURSE** teaches you quickly at home in spare time. No previous special experience or schooling needed. World Trade Certificate awarded. Write today for **FREE BOOKLET**. No obligation. State if veteran. Air-mail reaches us overnight. **THE MELLINGER CO., Exporters-Importers, 1418-BI Westwood, Los Angeles 24, Calif.**



# \$200 GROSS IN MY FIRST WEEK!



**Some Make More, Some Less . . . Start This Business for YOUR OWN**

Would YOU like to own a permanent, year-round business in which it is possible to take in as much as \$200 gross the first week, as did L. A. Eagles? R. E. Traynor says, "I made \$62 gross in one day." R. R. Newlin reports, "I have averaged \$173 gross per week." Others report gross from \$100 per week to \$12,000 per year.

Surely YOU will want to investigate a golden opportunity like that. You need not have any special skill or experience, but if you are ambitious, honest and courteous, we will help you to start and succeed in YOUR OWN money-making business where net profits are high.

### No Shop Necessary

Our Electric Rug Washer cleans rugs and carpets like new right on the customer's floor. This quick, thorough and highly efficient method removes dirt and grime, thus restoring the natural, fresh beauty of floor coverings. Anyone can run it. Rugs and carpets are not harmed.

There are hundreds of possible customers in YOUR vicinity. Most of them have several rugs needing regular cleaning. To get a quick start,

## FREE BOOK! MAIL COUPON

**VON SCHRADER MFG. CO.**  
311-PL, Racine, Wis.

Send at once (no obligation) your FREE booklet containing information about your Electric Rug Washer and how I can own my own permanent, profitable business.

Name \_\_\_\_\_

Address \_\_\_\_\_

City \_\_\_\_\_ (Zone) \_\_\_\_\_ State \_\_\_\_\_

shampoo a few rugs or carpets. These customers tell their friends and soon you should have an independent, prosperous business, and you should be able to keep it growing. Send the coupon RIGHT NOW for booklet that explains everything.

### Every Machine Guaranteed and Easy to Own

You take no risk. These wonderful, fully guaranteed machines have been used and endorsed by largest hotels, railroads—also used by U. S. Government. Many individuals have built up successful businesses that made big profits. Mail the coupon TODAY and we will send complete information, including how to start and succeed in YOUR business without a large investment. Don't delay your BIG opportunity. Send the coupon AT ONCE.



**MAIL COUPON TO VON SCHRADER MFG. CO., 311 PL, RACINE, WIS.**

## SECURE YOUR FUTURE 3 TRADES in 1 CAREER



**WATCHMAKING**



**JEWELRY—  
STONE SETTING**



**ENGRAVING**

Each Trade can be a full-time job; together they assure numerous high paying opportunities, or a business of your own. Profit by the **Nationally Recognized Training Methods** of the **Kansas City School of Watchmaking**. Enrollments now available.

**CLIP AND MAIL THIS COUPON TODAY**

**KANSAS CITY SCHOOL OF WATCHMAKING**  
Admiral & Tracy, Kansas City 6, Missouri

Please send me, without obligation, complete information on training in the above courses.

Name.....

Street.....

City.....State.....

Check if Veteran.

G.I. Approved

## EARN MORE MONEY!

### Personal Attendance Courses

Be your own boss! Earn more money! Learn photography quickly through our unique LEARN-BY-DOING methods taught by famous photo "aces" at our Resident School. Resident Training is available with subsistence under the G. I. Bill to serious workers.

### Home Study Course

You can train yourself for an action-packed, thrilling, profitable career in photography! N. Y. I.'s INDIVIDUALIZED Home Study Course is a spare time short cut to success. Invest your time in your future—don't waste it!

— Don't delay! Write today for FREE literature —

New York Institute of Photography  
Dept. "5", 10 West 33 Street  
New York 1, New York

Please send me complete information regarding  
 Resident Training  Home Study Course

Name.....  
(Please Print)

Address.....

City.....Zone.....State.....

**NEW YORK INSTITUTE  
OF PHOTOGRAPHY**

10 West 33 Street, New York 1



**40th  
YEAR**



# WORK FOR THE



**GOVERNMENT  
START AS HIGH AS  
\$3,450.00 YEAR**

**Veterans Get Special Preference**

## MEN—WOMEN

Railway Mail Clerks  
Postoffice Clerks, Carriers  
Storekeeper-Gaugers  
Stenographers-Typists  
Meat Inspectors  
Many Other Jobs  
**PREPARE  
IMMEDIATELY  
FOR NEXT EXAMS**  
Common Educa-  
tion Often  
Sufficient

**Franklin Institute**  
Dept. B-80  
**Rochester 4, N. Y.**  
(Not Government Controlled)

Gentlemen: Rush to me,  
FREE of charge, list of U. S.  
Government big pay jobs.  
Send FREE 40-page book de-  
scribing salaries, vacations,  
hours, work. Tell me how to  
qualify for one of these jobs.

COUPON

★ **Mail  
Coupon  
TODAY**

Name.....  
Address..... Vet?.....

## Learn this Profitable Profession



**IN 90 DAYS  
AT HOME**

## Money-Making Career Open to Men and Women, 18 to 50

Hundreds of men and women between 18 and 50 make \$10 to \$20 in a single day giving scientific Swedish Massage and Hydro-Therapy treatments. There is big demand from doctors, hospitals, sanatoriums and clubs. Graduates earn large full time incomes from these or in private practice in their own offices. Others make good money from home treatments given in spare time. Learn this interesting, money-making profession in your own home, through our home study course. Same instructors as in our nationally known resident school. You can win independence and prepare for future security by qualifying for your Diploma. Course can be completed in 3 to 4 months. Many earn while they learn. Begin your training at once.

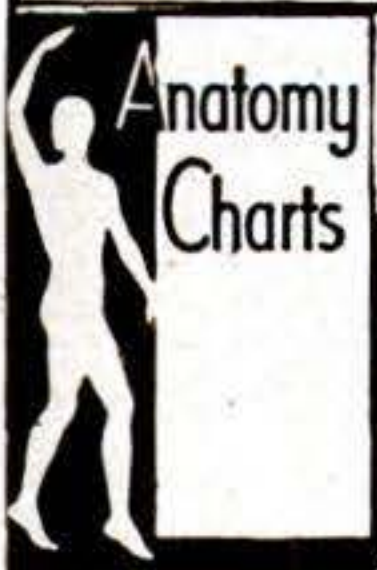

## Anatomy Charts & Booklet FREE

Enroll now and we will include, at no extra cost, many needed supplies. Fit yourself to help meet growing demand for Scientific Swedish Massage. Send the coupon at once for complete details, Anatomy Charts and 32-Page Illustrated Booklet, FREE, postpaid.

**THE COLLEGE OF SWEDISH MASSAGE**  
Dept. 070C, 41 E. Pearson, Chicago 11

Please send me FREE and postpaid, Anatomy Charts, 32-page Booklet and complete details on Home Training.

Name..... Age.....

Address.....

City..... State.....

60 POPULAR SCIENCE

# BE AN AUTO MACHINIST



**Draw Top Pay • No Job Worries**

Earn more money in auto mechanics—Specialize! New FREE booklet tells how to prepare for good jobs with high pay and job security. Our modern equipment and practical instructions make it easy to learn—get experience in:

**ENGINE REBUILDING or  
GENERAL AUTO MECHANICS**

Job  
Placement  
Service  
FREE

**Practical Shop Training**  
Learn to operate the very latest shop machinery. Friendly instructors take a real interest in preparing you for a good job.

**VETERANS**  
American is a G.I. approved school.

**PLANNING  
YOUR FUTURE IN  
AUTO MECHANICS**

**WRITE TODAY FOR  
FREE BOOKLET**

**AMERICAN TRADE SCHOOL**

2407 McGee

Kansas City, Mo.



# BARBELLS



**Finest Quality.....\$8.98 up  
FREE CATALOG**

Send today for big new 4 color fully illustrated free catalog of BARBELLS, Dumbbells and Health equipment. Free—world famous \$15.00 Dan Lurie Barbell and Dumbbell training courses with every purchase.

**DAN LURIE BARBELL CO.**  
Dept. 170 C, 1729-S 1 Rockaway Parkway, Brooklyn 12, N.Y.

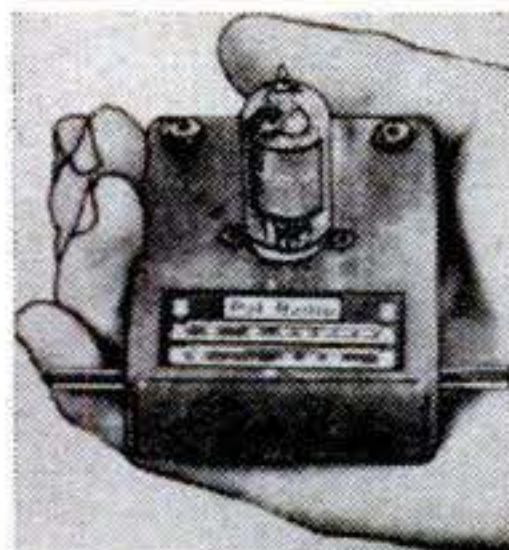

## S-W Pal Radio

Shortwave beginners kit for 19 meter broadcast and 20 meter amateur bands with world-wide coverage. Terrific power from short antenna. Make 8 simple connections from picture plan and kit works. GUARANTEE you can make operate or return with \$1.25 for factory wiring. S-W Pal less phones and batteries, **\$2.98** postpaid

Send only \$1.00, balance C.O.D. plus fee  
Lee Electronics Laboratory, Dept. A-1  
17 E. 48th St., New York 17, New York

## ITALIAN ACCORDIONS



All types, all models, Very best. Hand Made. Fully guaranteed. Buy direct from Factory representative at lowest wholesale prices, and Save Money. Also Button Accordions, Chromatic Accordions and Concertinas. We take any instruments in trade. Send name and Address for FREE catalog.

**ITALIAN ACCORDION MFG. CO.**

7600 Cottage Grove Ave., Dept. PS-3, Chicago 19, Ill.

## HANDBOOK OF AIRPLANE MAINTENANCE & OPERATION

Easy self-study course and up-to-date reference manual in one low-priced book! Covers basic principles and functions, construction, repair and maintenance of every part of the modern airplane. 512 pages, 600 pictures, over 300,000 words! 2,500-item index! Specification data sheets of world's leading types of aircraft. Only \$5.00—refunded if not fully satisfied after week's trial.

**NATIONAL AERONAUTICS COUNCIL, Inc., Dept. 803**  
37 West 47th Street New York 19, N. Y.

## Now CHEAP OIL BURNER FOR HEATING AND COOKING STOVES • FURNACES

**HEAT YOUR HOME, COOK YOUR MEALS  
WITH CHEAP FURNACE OIL**

**NO MORE SHOVELING COAL  
OR ASHES.** Sensational Fuelizer Starter Vaporizing System turns Cheap No. 1 Furnace Oil, also Range, Heater, Tractor Distillate, Kerosene and like oils into oil heat—one of the quickest, hottest fires known. **LIFETIME GUARANTEE. \$1.00 Bonus Offer for Testing.** We will let you try it in your own stove or furnace for one month. Get yours for introducing. Big profits QUICK. Be first. Send in your name today for details and cash in on the tremendous demand for this Amazing Invention.

**NORTHWEST MFG. CO. 731-C Mitchell, S. Dak.**





TAILORING  
22 GREEN ST.  
NEWARK, N. J.  
WRITE FOR  
**FREE**  
BOOKLET . . .

## make your own SLACKS

Send for **FREE INFORMATION** on fascinating new way to learn slack tailoring by mail! Hundreds of illustrated, easy-to-follow directions!

Penny post-card will do!



### PROJECTION SCREEN

HANG it ANYWHERE

Improved screen gives wonderful reproductions. It takes rough treatment—can be cleaned with water. Extra strong steel hanger, roller and tripod. This big value possible through volume production. Roller screen (with fixtures to hang it anywhere) only \$4.79 each postpaid. Tripods: \$2.49 each postpaid. Order yours today satisfaction assured.

SCREEN  
\$4.79  
40" WIDE BY 30"

TRIPODS  
\$2.49 each

CHAS. W. RICE & CO., INC. UNION CITY, IND.

## LOCATE URANIUM



OSSCO Geiger counters are used for locating deposits of radioactive ores. All models light weight but ruggedly built for field use. Very sensitive. Write Dept. P3 for details and prices.

OMAHA SCIENTIFIC SUPPLY CO. 3601 N. 24. OMAHA IO, NEBR.



## New MAGNETIC CENTER PUNCH

Insures Accuracy, Simplifies Work

At last a new Magnetic Center Punch has been perfected that will enable you to do hand center punching within a guaranteed accuracy of .001". The barrel of the Punch encases a Alnico Magnet. The base is square precision ground, and insures perfect concentricity. Used with a parallel, and measuring from one end of the work with gage blocks of vernier calipers, accurate centers are Agents located. Booklet available. **PRICE \$3.85** Wanted

MAGNET-HOLD PERFECT CENTER PUNCH CO.  
837 Central Park Ave. Yonkers 4, New York

## FREE—Amazing Book on RHEUMATISM, ARTHRITIS

If you suffer the aches, pains and discomforts of Rheumatism, as manifested in ARTHRITIS, NEURITIS, SCIATICA or LUMBAGO, send today for the **FREE** Book. It reveals important facts about why drugs and medicine give only temporary relief without removing causes. Explains fully a proven, specialized system of treatment that may save you years of distress. No obligation. Write for this **FREE** Book today!

**BALL CLINIC, Dept. 36, Excelsior Springs, Mo.**

## LEATHER & CRAFT SUPPLIES

### MONEY SAVING OFFER!

GOAT LACING for Leathercraft, our standard full weight, continuous length, BEST QUALITY, full beveled 3/32 Goat Lacing in all popular colors. Regular \$6.00 (100 yard spool) for only \$4.75, and receive **FREE**—6 lacing needles.

Send cash, check or M. O. for plus 10c postage.



WRITE  
**HINKLEY-TANDY LEATHER CO.**  
P. O. BOX 791-R  
FORT WORTH, TEX.  
ESTABLISHED 1919

SEND FOR **FREE** NEW 32 PAGE LEATHERCRAFT CATALOG

## DIESEL MECHANICS NEEDED BIG PAY . . . GOOD FUTURE



If you have no trade or profession that assures you steady employment and top pay through good times or bad, and regardless of whether you want to be a mechanic, technician, salesman, executive — or have your own profitable shop—you should investigate **NOW** this opportunity to enter world-famous Bailey Diesel Schools. Prepare yourself, this proven way, for an important place in the fast growing field of Diesel.

### Why Gamble With Your Future!

Your future success depends largely on the reputation of the school you attend. Don't take chances! Train at Bailey's—America's foremost school of diesel training. Approved by Missouri State Board of Education. Approved, also, for G. I. Training. Full details **FREE**. Return coupon below **NOW**.

### MAIL TODAY FOR FREE CATALOG

**BAILEY DIESEL SCHOOLS**  
1655 So. Grand Blvd., St. Louis, Mo.  
Please Send Me Your **FREE** Catalog.

Name .....

Address .....

Town ..... State .....

Veteran  Non-Veteran

Resident Training  Home Study

## INSTALL YOUR OWN FLOOR

Costs so little . . .  
so easy to do  
yourself!



QUALITY CONTROLLED

**MA-TI-CO**  
ASPHALT TILE  
FLOORING

★  
Guaranteed by  
Good Housekeeping  
IF NOT AS ADVERTISED THEREIN

**SAVE** on today's high labor costs by doing your own floor with MATICO—the beautiful, new asphalt tile. 27 attractive colors, including exclusive decorator-light "Petal Tones," afford unlimited design possibilities. Easy to clean and so durable! Use it in any room; ideal in basements and on concrete slabs in direct contact with the ground.

Send for full instructions on Matico self-installation



**MASTIC TILE CORP. OF AMERICA**  
NEWBURGH, NEW YORK

Please send complete "5-Minute Instruction Kit" showing ease of MATICO installation. I enclose 10c to cover mailing.

NAME .....

ADDRESS .....

CITY ..... STATE .....

P.S. 3-50



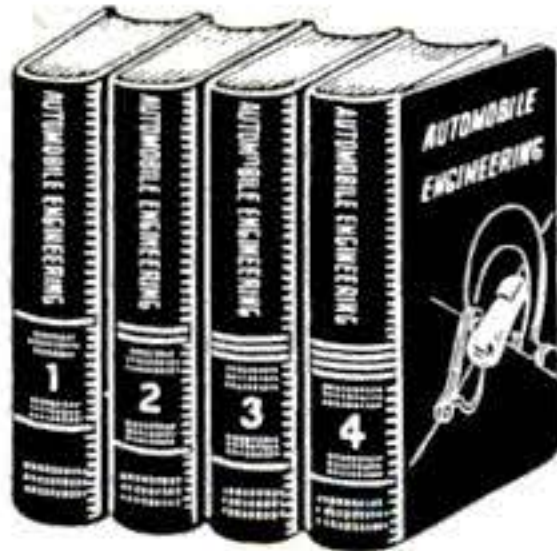

# AUTO BOOKS ON APPROVAL



## CAN YOU FIX IT?

These wonder books tell step by step HOW to make difficult repairs and adjustments, how to keep a car at maximum efficiency, including latest improvements in car design and operation. Engine troubles and how to correct them well covered.

**4 BIG, THICK VOLUMES**  
Over 2700 pages, 2000 illustrations, wiring diagrams, etc. Beautiful modernistic, washable cloth binding.

**SEND NO MONEY.** Just mail the coupon for a complete set of 4 Big, Thick Auto Books. 20th Edition. Over 2700 Pages! Whether you are a mechanic or helper, expert or apprentice, auto owner or driver, take immediate advantage of this **FREE EXAMINATION OFFER.**

### MAKE GOOD MONEY NOW HOLD A PERMANENT JOB

America wants its automobiles kept in good repair. Men with "know how" are in demand, at big pay. These books will help you get and hold an important job, or give you a chance to go into business for yourself now or later. Any man who half tries to improve himself can learn auto servicing and repairing by this quick reference method. Use the **JIFFY INDEX** to find easily understood answer to any auto problem. These wonder books prepared by eleven of America's great automobile engineers. Many hundreds of valuable illustrations. Send the coupon **TODAY.**

**[A year's consulting privileges with our engineers now given with these books without extra charge.]**

*Publishers Since 1898*

**AMERICAN TECHNICAL SOCIETY, Dept. A-320**  
Drexel Ave. at 58th St., Chicago 37, Ill.

I would like to examine your 4 Volume Set of Auto Books. I will pay the delivery charges only, but if I choose I may return them express collect. If after 10 days' use I prefer to keep them, I will send you \$2 and pay the balance at the rate of only \$3 a month until \$24.80 has been paid. Include consulting service as offered above.

Name.....  
Address.....  
City..... State.....  
Please attach letter stating age, occupation, employer's name and address, and name and address of at least one business man as reference. Men in service, also please give home address.

Here's How CREI Prepares You for a  
Professional Career with Industry-Recognized  
Training in a Minimum of Time

# TELEVISION RADIO - ELECTRONICS ENGINEERING

**G**raduates of CREI residence school are preferred by industry because of their *training* and *ability*. This recognition is the reason that CREI men quickly find good jobs. With 23 years of practical teaching experience in these highly technical fields, CREI offers an outstanding faculty, modern and complete laboratories, shops and equipment.

New students are accepted twice monthly and each may advance as rapidly as he is capable. The basic course with one specialized course requires an average of 20 months to complete. CREI is recognized as one of the country's leading technical institutes. Its work is of college level. It prepares the young man for a good job in industry in a minimum of time.

G. I. Approved

## CAPITOL RADIO ENGINEERING INSTITUTE

An Accredited Technical Institute Founded In 1927

### Mail coupon for Free Catalog

Capitol Radio Engineering Institute, Dept. 183B  
16th & Park Road, N.W., Washington 10, D. C.

Please send me your residence school catalog and complete details.  
(If interested in Home Study check below)

Name.....  
Age..... If in school, what term?.....  
Street.....  
City..... Zone..... State.....

I am entitled to training under G.I. Bill  Send information on Home Study Courses

## 14K GOLD PLATED CHRONOGRAPH WRIST WATCH

LOWEST  
MARKET  
PRICE  
**\$7.00**



Sweep Second Hand; Precision Workmanship; Rugged Shock-resistant case; Radium hands and numerals; Leather strap. It measures distance, speed of cars, planes, horses and other moving objects. It's a time keeper, stop watch, telemeter, tachometer. **ONE YEAR WRITTEN GUARANTEE** and full operating instructions enclosed with each watch. **SEND NO MONEY.** Mail your order today. Pay postman \$7.00 plus 10% Federal tax. Total \$7.70 plus postage. Or send cash (money order or check) with your order and save postage charge. Chrome Case Model \$6.50 Plus Tax. Total \$7.10.

**MARDO SALES CO., Dept. 1810**

480 LEXINGTON AVE.

NEW YORK 17, N. Y.

## BURIED TREASURE, MINERALS AMAZING NEW GOLDAK LOCATORS

**SENSATIONAL NEW MODEL!**  
ONLY 11 pounds weight! One hand operation! Money-Back Guarantee of Superiority. Write for full details.

**THE GOLDAK CO.**  
1544 WEST GLENOAKS BLVD.  
GLENDALE 1, CALIFORNIA

World's  
largest  
maker  
of fine  
locators.



## NAVY PHONES

VOICE POWERED  
—NO BATTERIES

Mfg. by RCA. Simple hook-up. Splice 2 wires & talk over 1/2 mile. Complete—no extras to buy. Each phone has headset, adjustable transmitter, chest plate, switch (on mike) PLUS 24' of rubber-covered cable. Navy cost \$99 pr. Brand new—never used. For homeowners, farmers, contractors, mines, mills, television set installers, etc. **Money-back guarantee.** Send check, cash, M.O. **\$13.95** pp. for 2 complete sets C.O.D.'s pay postage.

**GRAND-HAWTHORNE SURPLUS**  
1439 SE Grand, Dept. PS30, Portland, Oregon



## Train for BIGGER PAY in REFRIGERATION AIR CONDITIONING

**GET FREE BOOK!** Prepare yourself for a fine paying job. Trained men find opportunities installing and servicing Refrigeration and Air Conditioning. Get practical training in spare hours at home—plus four full weeks in the great ITI shops. Job Placement Help **FREE BOOK**. Write Industrial Training Institute 2130 Lawrence Avenue Dept. G-2 Chicago 25, Ill.

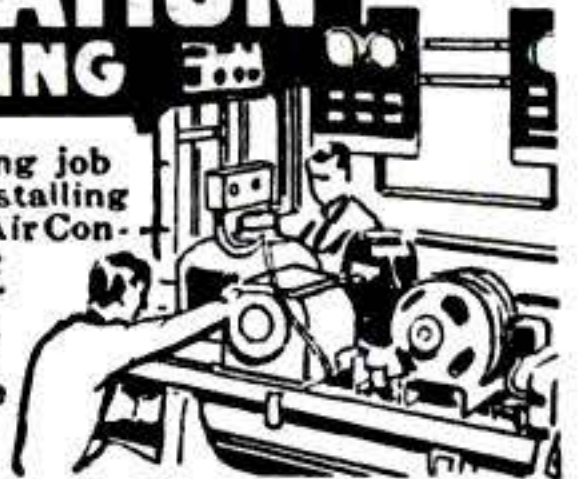

## DEPENDABLE CRAFT SUPPLIES

WRITE  
FOR  
CATALOG  
SINCE 1928

LEATHER CRAFT • POTTERY  
CRAFT • BLOCK PRINTING • BELT CRAFT •  
TEXTILE COLORS • POWER TOOLS • WOOD  
BURNING • INSTRUCTION BOOKS • ETC.

**DWINNELL CRAFT SHOP**  
Dept. PS 503—Wheeling, W. Va.



## LOCKSMITHING & Key Making

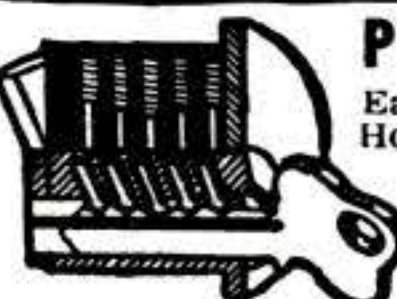

### PRACTICAL UP-TO-DATE COURSE

Easy-to-learn modern information for self-instruction. How to work on locks, pick locks, de-code, make master-keys, repair, install, service, etc. For every handyman, home owner, carpenter, mechanic, service station operator, fix-it shop, hardware dealer, gunsmith. 53 plain illustrated lessons. Full price only \$3.95. **SEND NO MONEY.** Just pay postman plus C.O.D. postage. Or send \$3.95 with order, we'll ship postpaid. Satisfaction guaranteed or refund. Address below.



### WATCH & CLOCK REPAIRING

Learn at Home in Your Spare Time! . . . Prepare for a happy future, with security—and qualify for a good job NOW. A fascinating and thorough self-instruction training in American and Swiss watches and clocks. Special section on alarm clock repairs. Fast-growing field. Satisfaction is guaranteed. Full price only \$4.95, postpaid—C.O.D. plus postage.

**Nelson-Hall Co., 1139 S. Wabash Ave., Dept. C-1, Chicago 5, Ill.**



# Stucco Spraying Can Be Your Opportunity



You can build a profitable, lifetime business with Colorcrete. Large waiting market. Work is easy and interesting. Moderate investment; high return. Large waiting market. Full instructions and liberal co-operation.

## Sprayed-On Beauty

Colorcrete is modern beauty treatment for masonry surfaces—exterior and interior. Fuses to concrete, stucco, etc. Applied by air pressure. Range of many smart colors. Proven by 20 years of use on all kinds of buildings.

Write or wire for Opportunity Book.

**COLORCRETE INDUSTRIES, INC.**  
572 Ottawa Ave.,  
Holland, Mich.



## FREE TO HOME PLANNERS

"Little Red Booklet" of 29 popular plans sent FREE to acquaint you with our MONEY SAVING home planning service which includes 1200 Tested Designs; beautifully illustrated plan books; working drawings; material lists; specifications—all at LOW COST. Write today for FREE RED BOOKLET and complete information. America's pioneer residential plan service.

Your New Home Plans . . . . . 50c  
Modern homes for 1950  
Blue Ribbon Homes . . . . . 50c  
Chosen most popular in sales  
All American Homes . . . . . 50c  
More than 150 styles, all types  
Ranch and Suburban . . . . . 50c  
141 designs, town and country  
Your Home In Brick . . . . . \$1.00  
Excellent selections, all brick

**NEW POPULAR BOOKS SHOWING ALL TYPES OF HOME DESIGNS**  
All 5 Books for Postpaid **\$2.50**  
Many designs in color.

**L. F. GARLINGHOUSE CO., INC., Box PS-6 TOPEKA, KANSAS**

## it's fun to earn RAISING HAMSTERS

Cash in on the growing demand for SYRIAN GOLDEN HAMSTERS recently introduced into the U. S. Ideal pets . . . big laboratory demand. Hardy, clean, odorless. Easily and profitably raised anywhere.

**AKOPIAN HAMSTERY**  
the largest in the West  
7358-BC VARNA AVE • NORTH HOLLYWOOD, CALIF.

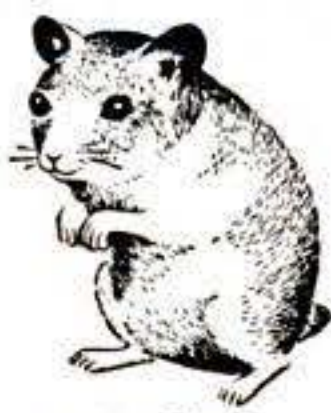

write for FREE booklet

## OIL FILTER ELEMENTS . . 7c



Here's News! Ordinary toilet paper makes an ideal oil filter. Laboratory tests prove it cleans oil faster and better than popular makes of filter elements. All you need is a simple set of Retlif Adapter Plates . . . and you can start using toilet paper rolls (costing about 7 cents) in your present oil filter. For proof and descriptive literature, send name and address to:

**RETLIF OIL FILTER CORPORATION**  
1237 No. Highland Dept. PS-3 Los Angeles, Calif.

## increased "gas" mileage?



## GANE "Air-Flow" NEEDLES

NEW air-bleed idling jet. Replaces present SOLID IDLING ADJUSTMENT SCREW in your carburetor. (8 cyl. cars use 2.) The objective is to lessen the vacuum and thus try to INCREASE YOUR GAS MILEAGE. About 1/2 MILLION NOW IN USE!

Most users who write swear by them and report up to **25% MORE MILEAGE**

and many comment on: **SMOOTHER MOTOR; EASIER STARTING; FASTER PICKUP; BETTER IDLING.** But FRANKLY, some swear at them and curl our hair with "NO improvement" . . . and fire them back AT OUR EXPENSE—proving Ganes CAN sometimes FAIL. Therefore, we invite YOU to TRY the

### "LITTLE STINKERS"

WITHOUT COST to see what they will do for you. Send NO money. Pay postman NOTHING.

### Try Before You Buy — 10 Day Free Trial Offer

Just send us your Name, Address, Make of Your Car, No. of Cyls., and Make of Carburetor by postcard or note. Ganes with literature will be promptly sent you postage paid. ANYONE can install them in ONLY 5 MINUTES.

### USE GANES 10 DAYS

Check for INCREASED "GAS" MILEAGE, which must average 2, OR MORE, EXTRA MILES PER GALLON, or else NEEDLES are NOT worth buying. End of 10 days, send us only \$1.50 per Gane Needle; or you, too, can fire the Little Stinkers back home AT OUR EXPENSE—AND YOU'LL OWE NOTHING—AND WE'LL ASK NO QUESTIONS.

**SEND FOR GANES TODAY**

National Automotive Research Co. 350 W. Washington Blvd. Dept. H-3, Venice, Calif.

## BINOCULARS

BRAND NEW. Made under military supervision. Have precision ground optics, lightweight metal bodies. Moisture—Dust proofed.



7x35 Coated Optics	\$49.50
7x40 Coated Optics	52.50
7x50 Standard Optics	42.50
7x50 Coated Optics	49.50
10x50 Standard Optics	52.00
10x50 Coated	62.00
12x50 Coated	69.50

6x25 Standard Optics	\$26.00
6x30 Standard Optics	31.50
6x30 Coated Optics	37.50
8x30 Standard Optics	33.00
8x30 Coated Optics	39.50
8x40 Standard Optics	49.50
8x40 Coated Optics	55.50



### 6 POWER PRISM BINOCULAR FITS PALM OF HAND

Coated! Dynamic in power

370 ft. field at 1000 yds.! Achromatic lenses. Individual eye focussing. Weighs 4 ozs. All metal construction. Adjusts all eye widths, \$19.50.

### TRY FOR 20 DAYS AT OUR RISK!

If not fully satisfied return for full refund! Cash orders rushed postpaid. On C.O.D.'s include \$2.00 deposit.

All binoculars have individual eye focussing. Prices include genuine leather case and straps.

**UNITED BINOCULAR CO.**  
7941 S. Halsted Dept. ARF-2416

Chicago, 20



# LAW FREE BOOK



Write today for FREE book, "THE LAW-TRAINED MAN," which shows how to learn law for business and the bar easily in spare time at home through the famous Blackstone professional law course compiled by 60 expert law authorities including law college deans, professors, lawyers and Supreme Court judges. We furnish all necessary instruction material including big 18-volume Modern American Law library cited by the courts of last resort as "M.A.L." Many successful attorneys among our graduates. LL.B. degree conferred. Moderate tuition; low monthly terms. Money-back Agreement. Write today.

**BLACKSTONE COLLEGE OF LAW**  
225 N. Michigan Ave., Dept. 123, Chicago 1, Ill.  
A Correspondence Institution Founded in 1890

# RUNNING WATER SYSTEM

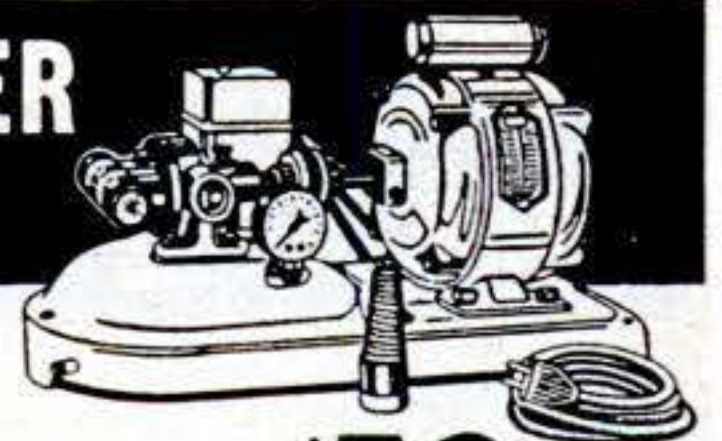

For Shallow Well, Cistern,  
Lake or Stream

Or as Replacement  
or Booster-Pump

**\$59.50**

● Simply connect to water source (22' depth or less)—plug in cord—turn on faucet—have all the sparkling water you want, instantly! Up to 300 gal. per hour! Newest improved jump principle. Motor starts when any faucet opened. Built-in pressure tank insures continuous flow. Pressure gauge. Automatic switch. 110-V. A-C. Amazingly compact. Complete. Anyone can install. Fully Guar. Only \$59.50 prepaid. Order from ad or write for details and for gigantic mail-sale bargain catalog.

**BURDEN SALES COMPANY**  
825 "O" St. Lincoln, Nebr.

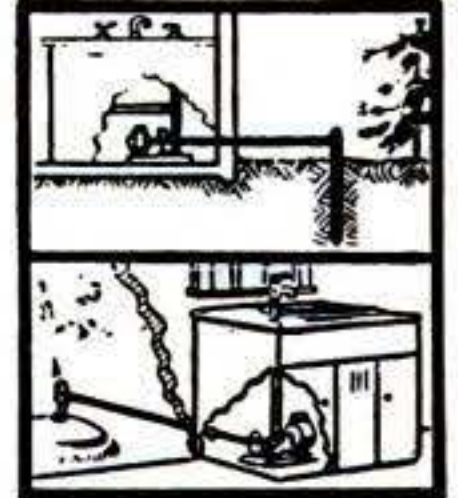

# Thompson BEATS the World on BOATS



**Better Built Lower Prices**



Canoes

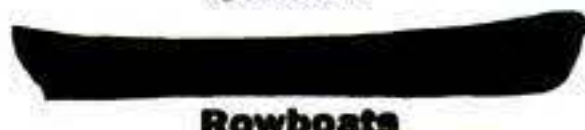

Rowboats



Outboards



Light Boat for Auto

**Safe Boats With Full Length Spray Rails**  
Keep passengers perfectly dry—even at high speeds. Catalog also shows two new models of "Take-Along" Boats. Two big factories—save you freight.

**CATALOG FREE**  
Write for your copy. State kind of boat in which you are interested.

**THOMPSON BROS. BOAT MFG. CO. (151)**  
219 Ann St. PESHTIGO, WIS. (Write to either place) 119 Elm St. CORTLAND, N.Y.

# STOP AUTO ACCIDENTS



with new **STOP LIGHT FLASHER!**

Makes Your Stop Light Flash 115 Times a Min.

**FREE OFFER TO YOU!** The "Stop-It" warns cars behind—makes your stop light flash on & off, on & off! Completely automatic, acts instantly when you step on foot brake . . . attaches in 5 minutes to any car or truck. Approved by safety engineers, used by Police & Fire depts. Non-rusting, dust, oil, vapor, waterproof. Write NOW for free introductory offer—no obligation. Get this amazing "Stop-It" for your car at no cost to you! Dealers, salesmen wanted.

MACCHI & CO., Dept. PF, 927 Larkin St., San Francisco 9, Calif.

# New DIRECTION SIGNAL

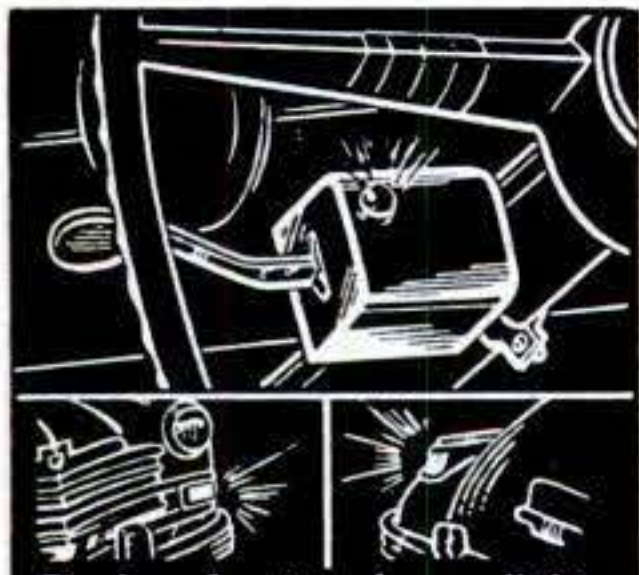

Flashes front and rear lights

Durable, attractive brown or chromium case. Specify finish.

**\$10.95** Postpaid in U.S. Send check or money order. Postage extra on C.O.D.'s.

**The LESTER Company**

**Flashes Your Turns Electrically**

No more winter window cranking for arm signals. The new **AUTO-TURN DIRECTION SIGNAL** fits any car, flashes parking and tail lights 60-80 times a minute. No interference with regular lights, no extra lights to mount for most late cars. Smoothly operating, featherlight control lever. Works similar to factory installed models. All parts furnished—install it yourself. **SPECIFY MAKE AND YEAR.** For cars earlier than 1942, write for price.

**MONEY BACK GUARANTEE**

Box S-3, 1743 North Milwaukee Ave. Chicago 47, Illinois

# New MIRACLE WALL CLEANER



**Saves Costly Redecorating!**

**AMAZING INVENTION.** Banishes old-style housecleaning mess and muss. No rags—no sticky "dough"—no red, swollen hands. No more dangerous stepladders. Literally erases dirt like magic from walls, ceilings, window shades, upholstered furniture, etc. **Ends drudgery! SAVES REDECORATING!**

**SAMPLES FOR AGENTS** Sample offer sent immediately to all who send name at once. A penny postal will do. **SEND NO MONEY—just your name.** KRISTEE CO., 715 Bar Street, AKRON, OHIO.

# WATCH REPAIRING

**be a master watchmaker!**

● Graduates earn big money—many in business for themselves. The famous Sweazey System of Instruction teaches you quickly and easily. Our 42nd year. Write today for free book about watchmaking, gem setting and engraving.

**CHICAGO SCHOOL OF WATCHMAKING**  
Dept. 430, 1608 Milwaukee Avenue, Chicago 47, Illinois

# Convert KITCHEN MIXER to POWER TOOL in Just 10 Seconds

**Sand, Wax, Polish, etc. Amazing new attachment Adapts Mixers to wide variety of Workshop Uses**

**TOOLZON**—Amazing new attachment converts any kitchen mixer into a lightweight portable sanding, waxing, buffing unit. **TOOLZON** is a simple attachment which slips on and off mixer drive shaft in a jiffy. Thousands in use! Gives the hobbyist and workshop fan a whole battery of power tools he didn't know existed. **Money back guarantee.** Enables you to sand wood, metal, plastics, ceramics, polish silver, glass, brass or other metals; wax and

polish autos, furniture, floors, etc. Pays for itself. You'll find a 101 uses around the home and workshop with your **TOOLZON** converter kit. Comes complete with simple instructions. **TOOLZON** unit includes lamb's wool buffer and three sanding discs and adapter. Sent postpaid for **\$3 only** . . . . .

Extra lamb's wool buffers . . . \$1  
Extra sanding discs, per doz. . . \$1

**TOOLZON** also fits 1/4" hand power drills.

**TOWLE MFG. CO. Dept. PS-30 Walnut Creek, California**

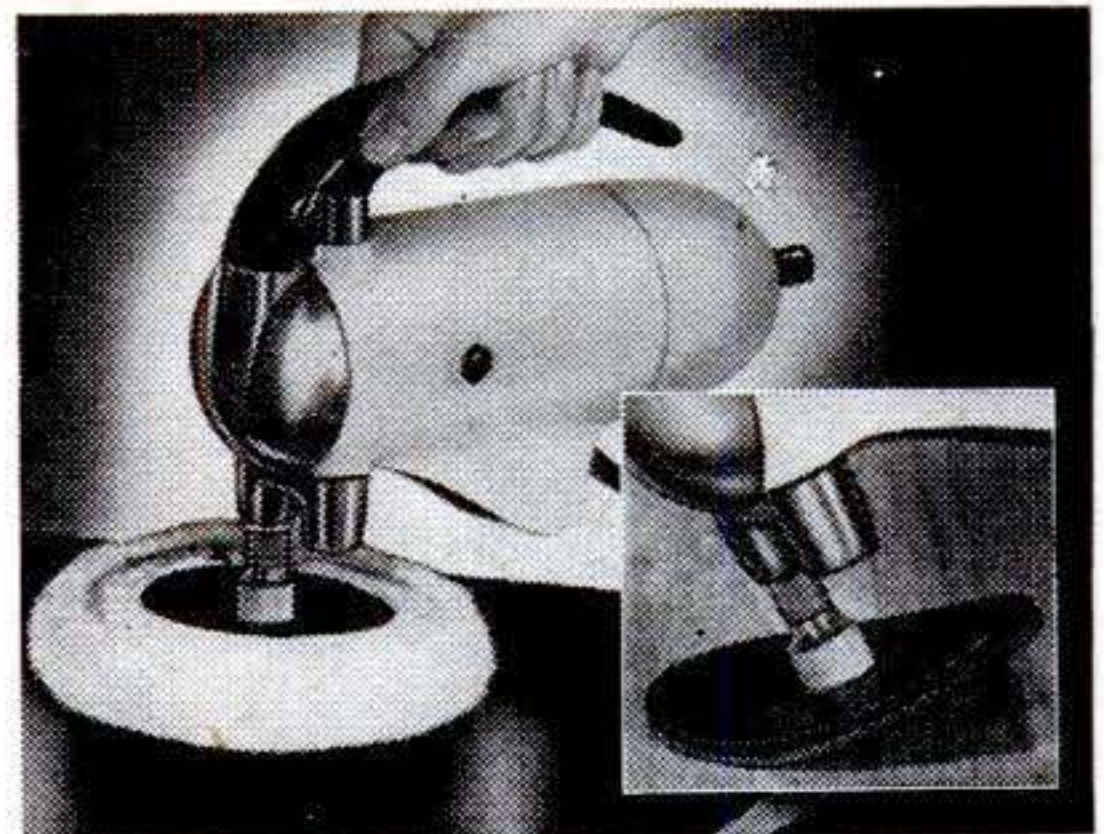



# CORTINAPHONE Makes it EASY To: Speak FRENCH-SPANISH GERMAN-ITALIAN



Count Cortina

BIG OPPORTUNITIES await Americans who speak languages. Learn as a child learns—"by listening" to these CORTINA recordings.



Listen to this Record!

The CORTINAPHONE METHOD, famous for 68 years, teaches you right at home to speak FRENCH, SPANISH, GERMAN, or ITALIAN as a NATIVE speaks!

**VETS**  
FRENCH or SPANISH course available under G. I. Bill State if Veteran

**Sent on 5 Days' Approval**  
Write today for free book which describes the amazing "Cortina Short-Cut" Method. State language interested in.  
**FREE BOOK** | **Cortina Academy**  
Dept. 123, 105 W. 40 Street, N. Y. C.

## ELECTRIFY your SEWING MACHINE



**NEW LOW PRICE!**  
**\$11.50** 1 YR. GUARANTEE

Buy direct from manufacturer and save! Kit comes fully wired, installed in a jiffy. Fits all machines! You get these all-new parts!

- Motor & Bracket
- AC-DC 115v 60c
- Steel pulley & belt
- Carbon-type foot control
- Cord set & block
- Easy instructions

**FREE**, reg. \$2.95 Chrome SEWLITE given with kit.  
**10 DAY FREE TRIAL—ORDER NOW!**

Send no money, pay C.O.D. or send money order and we'll pay postage. Please state whether wheel on your machine turns toward you or away from you. Shipping wt. 6 lbs.  
Dealer inquiries invited

**CONTINENTAL SALES CO.**  
83 Graham Avenue Dept. PS9 Brooklyn 6, N. Y.

## BUILD YOUR OWN 5-ROOM HOUSE \$2500



Price includes lumber, millwork, doors, windows, glass, hardware, roofing, etc. Immediate shipment. Build it yourself and save up to \$3000 or more. Simple step-by-step building instructions furnished. SEND 50c TODAY for Plan Book 149 showing 21

MODERN HOMES—38 FLOOR PLANS with estimates for pre-cut or custom-assembled materials.  
**SUPERIOR HOMES, INC.**  
221 GALE BLDG. JACKSON, MISS.

## FENDER SKIRTS ..... \$9.95 PER PAIR



For 95% of all cars. Beautify your car... bring out the flowing lines designed in it. Sparkling beauty you'll like. Constructed of heavy gauge body steel, finished in prime. Perfect fit. Prompt delivery.

**SANDEE MUFFLER CO.**  
5643 Corryne Place  
Culver City, Calif.  
Gentlemen: Please send me one set of Sandee Fender Skirts to fit my..... (year and make of car).  
 Check or M.O. for \$9.95 enclosed. No C.O.D.s at this low price, please.

**MAKE UP TO \$40 CASH A DAY**  
NO SALES TALK NEEDED



**JOHN B. GORDON**

Put. Pending.

**YOUR CUSTOMER'S NAME MOULDED IN BIG LETTERS**

Lay this colorful giant size mat on the door step and pick up \$1.95 cash deposit for yourself. We deliver and collect balance. No competition—fast seller. Any name to 12 letters—Red, Blue, Green, Black—2¼ ft. long x 1½ ft. wide—7,000 live rubber fingers.

**HAVE YOUR OWN BUSINESS NOW**—no investment, no stock, no deliveries. **BIG PROFITS!**  
**YOUR SAMPLE MAT & SALES BOOK—ONLY \$2.00 PREPAID.** (Sample mats carry stock name.) Make **BIG CASH** first day. Every door a prospect—homes, office bldgs., motels, apts., stores, factories, etc.  
**MONEY BACK GUARANTEE. ACT NOW!**

Established 25 Years in Southern California  
**R. L. MITCHELL RUBBER COMPANY Dept. P-3**  
2124 SAN FERNANDO RD. • LOS ANGELES 65, CALIF.

## PROFIT from PEARL FINISHING



### BIG MONEY RIGHT AT HOME

#### AMAZING NEW PEARL FINISH

Simple method starts you on the road to success in your own lifetime business—new, BIG PROFIT field. Beautiful PEARL finish applied to ANY article—leather, wood, plastic, plaster, paper, glass, metal, etc. Beautify baby shoes, statuettes, figurines, picture frames, book ends, jewel boxes, radio cabinets. Goes on new objects or renews and beautifies old, worn objects. Make unusual costume jewelry. Make things for sale in quantity to stores. All this at big profits for you.

**BABY SHOES**  
Big - New - Tremendous Demand. Baby Shoes are so much more precious when finished with Pearl Kote in baby's own colors. Baby Pink, Baby Blue and Ivory.

**HELP FILL HUGE DEMAND!**  
Start small and grow big. Spare or full time. NO COURSE OF INSTRUCTIONS TO BUY. Complete, step-by-step instructions included with materials. NO EXTRA COST! BIG demand—help us fill it.

**FREE DETAILS**

Fantastic profits waiting if you act NOW — it pays to BE FIRST... It costs you nothing to get the free facts. Scoop the market with this quick, easy way to big money overnight. Mail coupon today.  
**PEARL-KOTE COMPANY, Dept. PS-3,**  
2111 W. Manchester Blvd.,  
Los Angeles 47, California.

**PEARL-KOTE CO. Dept. PS-3**  
**2111 W. Manchester Ave., Los Angeles 47, Calif.**

Okay! RUSH me FREE FACTS at once. I understand there is NO INSTRUCTION COURSE TO BUY!

Name \_\_\_\_\_  
Address \_\_\_\_\_  
City \_\_\_\_\_ Zone \_\_\_\_\_ State \_\_\_\_\_



**Make 100% to 150% Profit!**

**MANUFACTURE BUILDING BLOCKS**  
In Your Own Back Yard

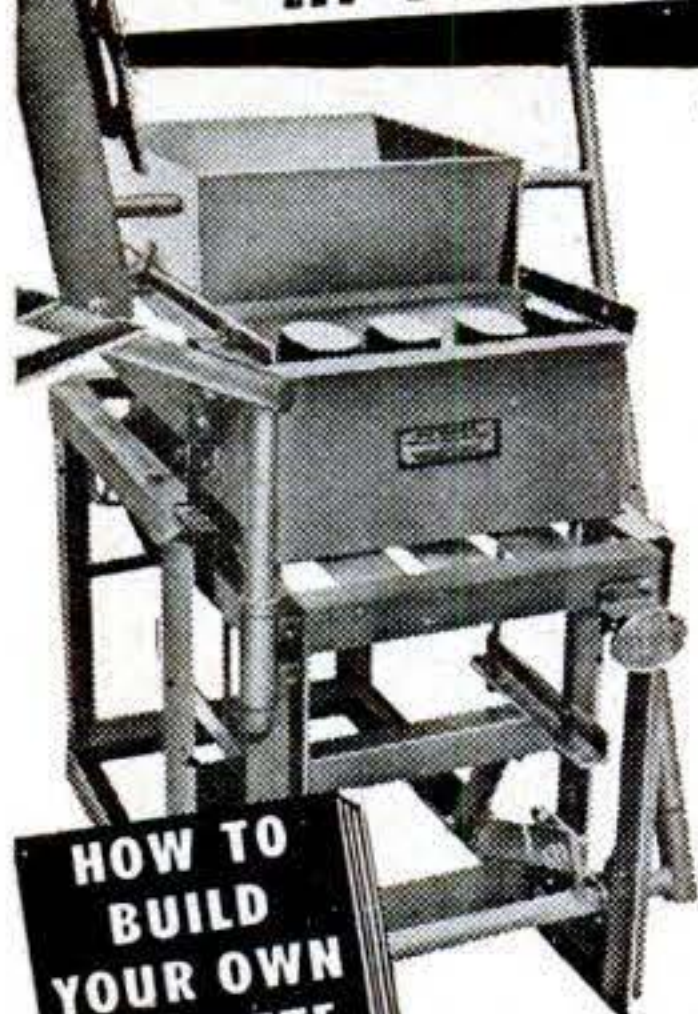

**HOW TO BUILD YOUR OWN CONCRETE BLOCK HOME**  
Only \$1 Prepaid

*Wonderful Book Written & Illustrated by Experts*

**AMAZING GENERAL BLOCK MACHINE**

CAPACITY 1000 BLOCKS PER DAY

Only \$199 LESS MOTOR F.O.B. PLANT

SHIPPING WEIGHT 400 lbs.

Here is an outstanding opportunity for men of vision and small capital. Cinder and concrete blocks are in great demand. Millions used for homes, factories, public buildings. Sell all you produce at 100% to 150% mark-up.

**PEAK BUILDING DEMAND!**

The General Block Machine is amazingly practical, foolproof. Simple to operate indoors or outdoors. Rugged all steel construction. Vibrator mounted in sealed ball bearings. Produces up to 1,000 blocks per day. Superior 3 Core Type that meets all building code requirements. Can produce 4 x 8 x 16, 8 x 8 x 16, 12 x 8 x 16 blocks. All materials obtainable anywhere. All operating instructions and mixing formulas supplied. Full details FREE without obligation.

**GENERAL ENGINES CO.**

DEPT. S6 • 307 HUNTER ST. • GLOUCESTER, N. J.

Includes floor plans for 6 beautiful, easy to build concrete block bungalows. Shows ways to save money. How to lay blocks, lay out building lines, mix concrete, build steps, porches and concrete floors. Mail coupon at once with \$1.

Name.....  
Address.....  
City.....Zone.....State.....

**EARN MORE**

\$\$\$\$\$



**SEND FOR THIS FREE BOOK NOW!**

● Increase your earning power. Become thoroughly trained in a well-paid profession. Without obligation, find out about the opportunities in Electrical, Mechanical, Plastics, Civil, Mining and other engineering fields. Our free 118-page handbook, lists details of home study courses, compiled by world authorities. See for yourself how you can soon earn more dollars. Write today, to: Canadian Institute of Science and Technology, Ltd., 496 Century Building, 412, 5th Street, N.W., Washington, D.C.

*Special discounts for Servicemen*

**MAIL THIS COUPON NOW**

Canadian Institute of Science & Technology, Ltd.,  
496 Century Building, 412, 5th Street N.W.,  
Washington, D.C.

Please forward free of cost or obligation of any kind your 118-page handbook "Engineering Opportunities".

Name..... Age.....

Address .....

CANADIAN ENQUIRIES: 263 Adelaide St. West, Toronto

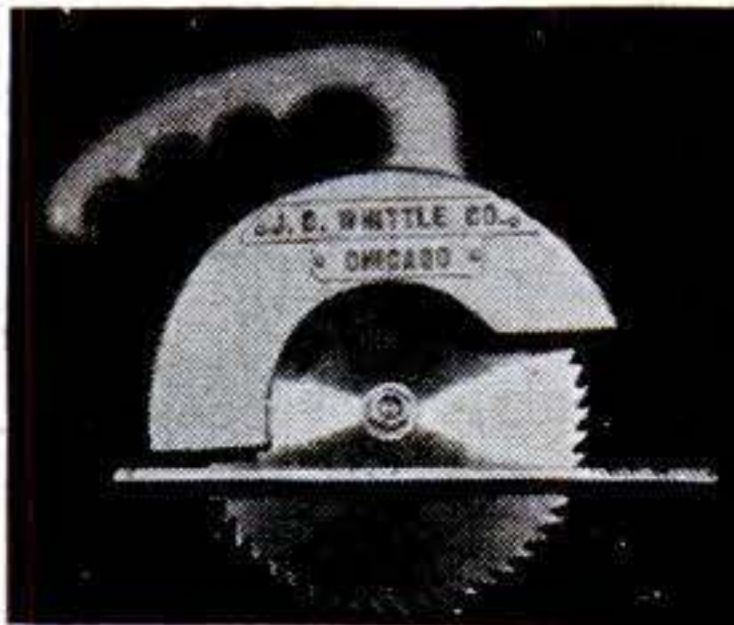

**WHITTLE CIRCULAR SAW**

CHUCKS INTO ANY ELECTRIC DRILL

ONLY \$895 postpaid

Makes up to 1 3/4" cut. Will cut dressed 2 x 4. Has adjustable depth gauge. No oiling necessary. Handle fits hand and fingers. As powerful as the drill behind it. Includes 5" combination cross cut and rip saw blade made of high quality chrome-nickel saw steel. Extra blades \$2.50 ea.

ORDER THROUGH LOCAL DEALER OR DIRECT FROM

**J. D. WHITTLE CO.**

Dept. P-3

1056 Wellington Ave., Chicago 3, Ill.

**NERVOUS STOMACH**

ALLIMIN relieves distressing symptoms of "nervous stomach"—heaviness after meals, belching, bloating and colic due to gas. ALLIMIN has been scientifically tested by doctors and found highly effective. World famous—more than a 1/4 billion sold to date. At all drug stores.

**ALLIMIN Garlic Tablets**

**URANIUM DETECTOR!**



**Lowest Price in Field GEIGER COUNTER**

For Radioactive Mineral Prospecting

Ready to Operate \$49.50

Write for complete information

**ALPHA NUCLEAR LABORATORIES**  
Box 649-A, Asbury Park, N. J.

**WOODWORKERS ... Get this CONSTANTINE MASTER MANUAL**

**Get the Most Fun From Your Hobby**

Indispensable to woodworkers. Newest, biggest edition, more pages, more color, helpful how-to-do-it articles, pre-war and new items, more bargains. Send 25c today and we will include **FREE! FULL YRS. SUBSCRIPTION** to Chips and Chats, published bi-monthly. Keeps you up-to-date on everything in woodworking, offers big money-saving bargains. Send now. **ALBERT CONSTANTINE & SON, Inc. Dept. PS-3 797 East 135th Street, New York 54, N. Y.**



**GUITAR VALUES**

(Cash or Credit Plan)

Have your choice of the finest in Guitars at lowest cost. Each Beautiful Model Hand Picked by Ed Sale Top Radio Guitarist. Send name and address for **FREE Folder** with full information today—Each Instrument sold on a money back guarantee.

**ED SALE GUITAR CO.**

Dept. G1

Point Pleasant, N. J.

**PLYWOOD BOAT KITS**

**\$87.50**  
(Freight Included)



Build this 12-ft. sport runabout from ready-cut parts. Kits include all hardware, paint, etc., to complete the boat shown. Send for free folders of all models as low as \$29.95 freight included.

**TAFT MARINE WOODCRAFT**

Dept. S, 636 39th Ave., N. E., Minneapolis 21, Minn.



# WAR SURPLUS - U.S. SIGNAL CORPS

Genuine EE 8 Portable Telephones  
Telephone Wire - Equipment



## Big Annual Money-Saving SALE

Amazingly simple to install your own private telephone system with portable telephones and wire. All you do is string wire, attach phones to each end and you are ready to ring and talk up to 17 miles! Add up to 6 phones on main line for dependable 2-way communication around Home, Farm, Shop, Construction Projects, Factories, etc. Powered by standard flashlight batteries. Phones checked for perfect operation. Fully guaranteed.

**BRAND NEW EE8 Phones (Formerly \$21.50) NOW.....\$17.50 ea. LIKE NEW.** Each phone thoroughly reconditioned like new. Ea. phone \$12.95—SPECIAL: 2 for.....\$24.50  
**USED.** Reconditioned. Excellent. Ea. \$9.95—SPECIAL: 2 for \$18.50  
**BRAND NEW EE99A TELEPHONE REPEATERS EA.....\$14.50**

**TELEPHONE WIRE.** Prices slashed to near wholesale cost.

**W110B Grade I** unused, new, stored in open. Weatherproof, durable, 2-conductor, twisted telephone wire, insulated. Many extra uses for this handy item.

**ONE MILE REELS,** formerly \$27.50 mile.....SPECIAL \$21.00

**1/2 MILE REELS,** formerly \$14.25 ea.....SPECIAL \$11.00

**500 FOOT COILS,** formerly \$3.95.....SPECIAL \$ 3.00

**1,000 FOOT COILS,** formerly \$7.25.....SPECIAL \$ 5.75

**W110B Grade II,** unused, outer layer wire stained, weathered, but when removed inside layers perfect. Good for years of service.

**ONE MILE REELS,** formerly \$27.50 mile.....SPECIAL \$17.50

**1/2 MILE REELS,** formerly \$14.25 ea.....SPECIAL \$ 9.00

**BRAND NEW W-130 Lightweight,** 2 conductor. 1/2 MILE REELS. Wt. 16 lbs. Formerly \$15.....SPECIAL \$12.95

**1/4 MILE REELS** slightly weathered, unused NEW.....\$ 4.95

Write for Free Folder. Sale on Field Telephone parts. Other specials!

All prices F.O.B. Sacramento. No C.O.D. California residents add 3% for sales tax. Small orders sent postage collect plus small handling charge.

SEND CHECK OR MONEY ORDER **LORIS SALES**

P. O. Box 1896-A-3 Sacramento, California

# 500 Pages, 7000 Novelties

Send 10c for mammoth, amazing catalog of 7000 novelties. 1-inch thick, roto picture section, 6-color cover. Carnival, circus, world's fair & science exhibit rolled into one! Includes live animals & pets, scientific supplies, hobbies, funmakers, planes & boats, looms, magic tricks, joke articles, unusual seeds, gadget timesavers, cameras, optical goods, projectors, movies, lucky jewelry, religious novelties, telegraph sets, disguises, musical instruments, stamps, coins, puzzles, fortune tellers, radios, experimental sets, auto & bike accessories, Western wear, telescopes, magnifiers, compasses, banks, smokers' gadgets, artists' supplies, printing sets, engines, motors, shockers, knives, billfolds, fireworks, guns, rifles, sports, money makers, swimming helps, 1000 fascinating books, games, locks, live chameleons, rings, exercisers, curious plants, etc., etc. (DeLuxe Hard Bound Library Edition 25c Postpaid.) Regular paper covered edition 10c. (Stamps accepted.) Sent Air Mail, \$1.00.

10c

# make your own Gems 29.50 F.O.B.

All necessary lapidary equipment is furnished, including a super-charged diamond blade for sawing, and all wheels for grinding, shaping and polishing; also complete instructions. The complete equipment as shown, less motor and belt, for only \$29.50, f.o.b., Burlington, Wisconsin. Write today for information and literature.

**B&I MANUFACTURING CO.**  
Dept. M Burlington, Wis.



# PLASTICAST

THE GREATEST THING IN PLASTICS!

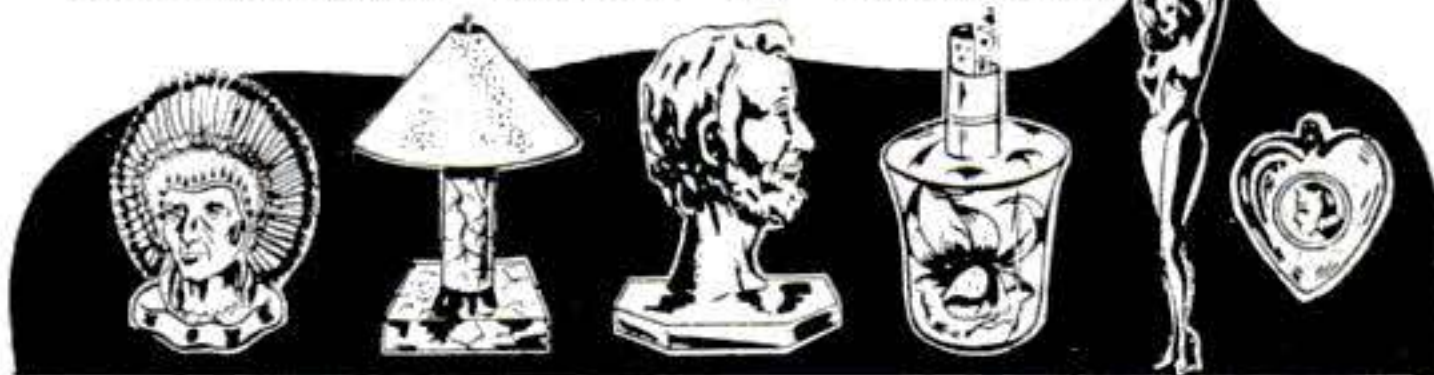

## A NEW HOME INDUSTRY AND HOBBY!

The following materials are just a few of the hundreds of items for **CASTING, MOLD MAKING, manufacturing,** etc. that you will find in our new Catalog No. 10. **CASTING is as easy as pouring water out of a glass!** No tools or machinery required. Everything is supplied.

**PLASTICAST** . . . a transparent liquid plastic; clearer than glass, hard as steel. Ideal for imbedding flowers, butterflies, insects, photos, souvenirs, cigarette lighters, pen sets, jewelry, etc. See 4th and 6th illust. above. **PLASTICAST OUTFIT, 1 lb. plastic, hardener, 3 molds, dye; imbed. materials, complete with accessories & INSTR. BOOK . . . . . POSTPD., \$3.50**  
**ONE POUND PLASTICAST, Hardener and MOLD . . . . . POSTPD. \$2.25**

**LIQUID IVORY** . . . anything can easily be cast out of this beautiful material. Very strong. Ideal for novelties, jewelry, toys, tools, dies, forms, handles, statues, knobs, etc. See 1st & 3rd illust. above.

**LIQUID IVORY OUTFIT, 1 lb. plastic, hardener, 8 molds, dye, jewelry accessories, INSTR. BOOK, complete, POSTPD., \$4.95**  
**ONE lb. IVORY PLASTIC, hardener, 1 MOLD, POSTPD., \$2.25**

**LIQUID MARBLE** makes very beautiful things. See 2nd illust. above. Make lamps, bookends, vases, statues and countless similar items. *As hard and as beautiful as real marble!*

**LIQUID MARBLE OUTFIT, 1 lb. material, hardener, 3 molds, pigments, complete with instructions . . . . . POSTPAID, \$3.95**  
**ONE lb. LIQUID MARBLE, hardener, 1 MOLD, POSTPD., \$1.75**

**CASTEX** . . . a remarkable plastic that makes hollow but very strong practically unbreakable castings! Possesses soft skin-like surface. Ideal for DOLLS and TOYS. See 5th illust. above.  
**CASTEX, one pound . . . . . POSTPAID, \$1.75**  
**CASTEX, one pound and 1 MOLD . . . . . POSTPAID, \$3.50**

**MULTIPLEX** . . . THE IDEAL MOLD MATERIAL. Flexible, takes deep undercuts easily. Any material may be cast in this mold; gives faithful reproductions of original model. Can be re-melted and used over endlessly.

**MULTIPLEX, one pound . . . . . POSTPAID, \$2.25**  
**Quart . . . . . POSTPAID, \$4.00**

HUNDREDS OF OTHER ITEMS AND ACCESSORIES FOR CASTING AND MOLD MAKING IN OUR BIG CATALOG. See Below.  
**TERMS:** We pay the postage (U.S.A. only) if full cash accompanies order. C.O.D. accepted (U.S.A. only) if \$1.00 deposit included for each item ordered.

**DEALERS: WRITE FOR CATALOG, DISCOUNTS & PROMOTIONAL MATERIAL**

# FREE!



Let us show you how extremely easy it is to make beautiful and useful things out of LIQUID PLASTICS, LIQUID MARBLE, LIQUID IVORY, LIQUID GLASS, CERAMICS, ETC. . . . as easy as pouring water out of a glass! Make novelties, jewelry, gifts, artware, gadgets, toys, ceramics . . . a million useful things! We supply everything—**MATERIALS, INSTRUCTIONS AND BUYERS!** Send only 25c for 1. Big catalog of 300 casting materials, molds, and accessories. 2. A beautiful casting free (to show you what you can do), and 3. Actual **INSTRUCTIONS** on how to cast and start in the **CASTING BUSINESS!** Send 25c today—this may be the lucky coin that will start the most fascinating and profitable phase of your life! (Catalog only—10c)

4637 N. Kedzie Ave. **PLASTICAST CO.** P. O. Box 987  
Chicago 25, Ill. **(DEPT. A)** Palo Alto, Calif.

(Write to nearest address)

**CANADIAN CUSTOMERS,** please order directly from: **CANADIAN INDUSTRIAL PLASTICS, LTD., 1056 1/2 Pender West, Vancouver, B. C.**

# Your Car STARTS INSTANTLY

## WITH A Stewart-Warner Electric Fuel Pump



Save Your Battery with instant starts—every time! Stewart-Warner's *Electric* Fuel Pump fits any car or truck. Feeds a steady, even flow of fuel into your engine as soon as you switch on the ignition. Thousands now in use!

Easy to Install. Complete fittings supplied. Do it yourself or see your local Carburetor Shop or Service Garage.

**FREE**—Illustrated Booklet on request  
Stewart-Warner Corp., Dept. J30  
1840 Diversey Pkwy., Chicago 14, Ill.  
Please send **FREE** Illustrated Booklet on the dependable new Stewart-Warner *Electric* Fuel Pumps.

Name.....

Address.....

City..... Zone..... State.....

For Cars  For Trucks



**Your BLUEPRINT FOR PROFIT**

**NELS IRWIN**  
Will help you start your own successful, lifetime business.

**AMAZING NEW Miracle Finish**  
MEANS \$\$\$ TO YOU

**BIG PROFITS**  
Rich profits are waiting to be tapped in this new field. New MIRACLE finish gives a velvety, luxurious surface to radios, lamps, toys, signs, store displays, figurines, auto dashboards, and hundreds of other items. Make old objects beautiful and salable—make new things worth much more with this soft, rich covering that can be applied to any surface, even if old and worn.

**FREE! A PLAN FOR YOUR SUCCESS**

**START RIGHT AWAY**  
Yes, you can learn in a few days to start MAKING MONEY! Everything you need is furnished, including fully detailed, illustrated instructions that are complete and easy to understand. Every point is explained, to show you how to start on the road to big money, full or spare time, right in your own home.

**EVERYTHING COMPLETE**  
In addition to full instructions you get a complete set of materials that enables you to start at once. A few cents worth of materials can mean many dollars in return to you—you can earn up to \$5 per hour and more spare or full time. Add to your income from your present job or start a profitable business of your own. Our Business is Booming. Help us fill HUGE DEMAND.

**ACT NOW**  
Grasp this opportunity TODAY—Start your own business. It's too good to miss! SEND NO MONEY—fill out the coupon and stick it on a post card or in an envelope and mail today for full details. FREE samples of FLOK-KRAFT covered material, and hundreds of useful and profitable IDEAS. Do it NOW—be first!

**COVERS WOOD, FABRIC, METAL, GLASS, PLASTER, PLASTIC OR ANY SURFACE**

**USE COUPON FOR FREE SAMPLE**  
**COAST INDUSTRIES Dept. 13**  
1004 S. Los Angeles St., Los Angeles 15, Calif.  
Gentlemen: Please rush me all the details.

NAME \_\_\_\_\_  
STREET \_\_\_\_\_  
CITY \_\_\_\_\_ STATE \_\_\_\_\_

**9 BIG BUILDING BOOKS**

12th Edition for  
**EXAMINATION**  
SEND NO MONEY

Learn to draw plans, estimate, be a live-wire builder, do remodeling, contracting. These 9 practical, profusely illustrated books cover subjects that will help you to get more work and make more money. Masonry, concrete forms, carpentry, steel square, roof framing, construction, plumbing, heating, painting, decorating and many other subjects. More than 4000 pages—2750 illustrations.

**BETTER JOBS—BETTER PAY UP-TO-DATE EDITION**

A nationwide building boom is in full swing and trained men are needed. Big opportunities are always open for MEN WHO KNOW HOW. These books supply quick, easily understood training and handy, permanent reference information that helps solve building problems.

These books are the most up-to-date and complete we have ever published on these many subjects.

**Coupon Brings Nine Big Books For Examination**

**AMERICAN TECHNICAL SOCIETY — Publishers since 1899**  
Dept. G320 Drexel at 58th Street Chicago 37, Ill.

You may ship me the Up-to-Date edition of your nine big books, "Building, Estimating and Contracting," without any obligation to buy. I will pay the delivery charges only, and if fully satisfied in ten days, I will send you \$2.00, and after that only \$3.00 a month, until the total price of only \$34.80 is paid. I am not obligated in any way unless I keep the books.

Name.....  
Address.....  
City..... State.....

Please attach a letter stating your age, occupation, employer's name and address, and name and address of at least one business man as a reference. Men in service, also please give home address.

**Embed Real Flowers In New MAGIC PLASTIC**

Now create lovely things like the unusual pansy coaster shown—made by embedding real pansies in Castolite, the "Magic" liquid casting plastic. Comes crystal clear or may be colored. Produce gorgeous effects. Make jewelry, book ends, candle holders, picture frames, figurines. Embed real flowers, butterflies, coins, photos for novel plaques, paper weights, tiles, other objects. Use only home tools.

**New Book SHOWS HOW**  
Big, new book explains simple methods to get started. Also gives proved Success Plan for making extra money. Hundreds succeeding. Send 25c today for "A Way to Success" The Castolite Co., Dept. TC-2, Wood stock, Ill.

**Rupture Troubles Ended**

Advanced method has healed thousands. No leg straps, no elastic, no plasters. No pressure on hips or spine. Flexo-pad. Entirely different. Endorsed by doctors, mechanics, clerks. Very light. **INEXPENSIVE. GUARANTEED.** Write for information and trial.

**SMITH MANUFACTURING COMPANY**  
EST'D 1893 Dept. PS, Preston, Ont. Can.

**AMERICA'S BIGGEST KAYAK VALUES!**  
**BUILD Your Own** Light • Strong • Safe • Speedy

Complete easy-to-assemble kit with instructions, pre-cut parts, canvas, dope, trim and hardware. Nothing else to buy. No steaming or bending.

Easy to handle on car or thru woods. Lowest possible center of gravity.

Ideal father and son project—for hunting and fishing. Models today as low as \$16.75.

Send for catalog today! Dept. PS1.

**DEDHAM KAYAKS DEDHAM, MASSACHUSETTS**

**"PLASTICS"**  
**FABRICATING MANUAL AND CATALOGUE**

Work in a fascinating and profitable hobby. Just out—our latest fabricating manual. Tells you how to work with Plastics. Our new Catalogue provides all needed materials: Plexiglas—Lucite—Tenite—Catalin—Acetate—all in sheets, rods, and tubes. Complete line of cements, dyes, accessories and supplies. Send 20c today for 1950 Catalogue and Handbook.

**HOUSE OF PLASTICS**  
8648 Linwood Avenue Dept. MO-3 Detroit 6, Michigan

**ELECTRO MAGNET**

110 volts AC or DC. Will separate ferrous from non-ferrous metal. Will lift 30 to 40 lb. load flat surface. Will also magnetize screw driver, hammer or other tools. Made of highest quality Government surplus parts. Satisfaction guaranteed, or money refunded if returned within 1 week. Send check or money order.

**\$3.95** Post paid

**MACKLEY, 25G Park Place, New York 7, N. Y.**

**MOTOR TUNE-UP GAUGE**  
**new—Simple to Use**

Aluminum case cast bronze movement—Guaranteed. Checks entire motor—Plugs, Points, Rings—Valves—Muffler—Fuel Pump—Carburetor, etc.  
Dial in 4 colors—Instruct. chart included—4" — \$8.50; 8" — \$18.75; 12" — \$27.50 Postpaid. Works on vacuum. Attach to windshield wiper. Over 1,000,000 in use. Tune your own motor.

**GALE HALL ENGINEERING**  
BOSTON 18, MASS.

**WORLD'S LARGEST MFR. OF AUTO GAUGES**





**NEW**

IMPROVED...AMERICANIZED

# JUDO

TWO BIG BOOKS FULLY ILLUSTRATED  
1220 SHOW-HOW PHOTOS. 71 LESSONS  
MANY NEW HOLDS

Protect yourself and others. Size and strength mean nothing. Knowledge and skill enable you to master any situation even against biggest bullies or armed thugs. Written and illustrated by one of the world's great Judo experts. Volume 1, basic and advanced holds. Volume 2, very advanced. . . each volume \$1 50.

**BOTH BOOKS \$2.50 POSTPAID**  
OR C.O.D. PLUS POSTAGE  
5-day Money Back Offer. ACT NOW!

Big Combination Offer!  
**SAVE...**

DEPT. PS-3  
**IMPROVED JUDO, INC.** P.O. Box 7355, Stn. 1, Los Angeles, Calif.

## FOAM RUBBER

For Experimenters, Home Craftsmen, Hobbyists

Lowest Prices—SAVE 50 %

16 x 16 x 1 1/4".....ea. \$1.25  
16 x 22 x 1 1/4".....ea. 1.55  
18 x 24 x 2".....ea. 2.00  
24 x 24 x 2".....ea. 2.75

**AUTO SEAT TOPPER PADS**

Place on seat cushion and cover with your seat cover.  
24" x 60" x 1 1/4".....ea. \$5.00  
24" x 60" x 2".....ea. 7.50

Use for furniture cushion fillers, mattresses, Mattress pads, cushions. Foam Rubber is available in any size or thickness. Send For Free Price List. Immediate delivery. No C.O.D.'s.

**RIOR RUBBER COMPANY, Dept. S-4**  
50 East 22nd St. Chicago 16, Ill.

## ANALYZE HANDWRITING

**NEW**, uncrowded, fascinating field. Gratifying earnings reported by graduates in Employment, Credit, Social Service, Police and Entertainment fields. Others have developed profitable private practice, full or spare time, as Personal and vocational Counselors. Send for 3,000-word test lesson and proof book free. Write today!

I.G.A.S., Inc., 304 Wilhoit Bldg., Springfield 4, Mo.



### YOUR BEST YEAR YET!

Make 1950 more than "just another year" by learning the laws of your own being. Bring your hidden talents to light; arouse, awaken your creative forces for greater happiness and success NOW! Send name and address for FREE booklet.

**WAY TO LIFE, INC.** 3227 INDIANA AVE. • DEPT. A1  
ST. LOUIS 18, MISSOURI

## YOUR CHEAPEST INSURANCE AGAINST A DAMAGED MOTOR

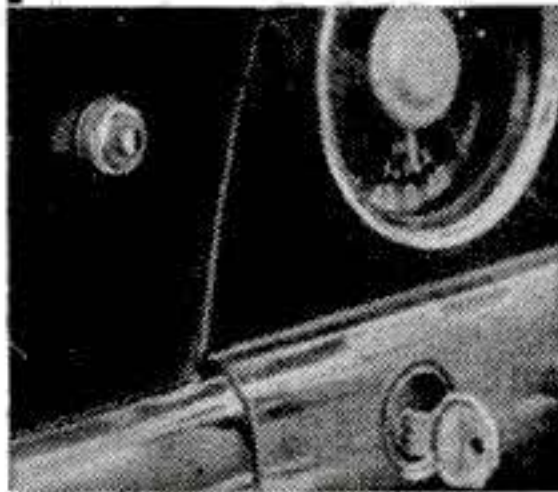

Amber Light—1 qt. low  
Red Light—2 qts. low

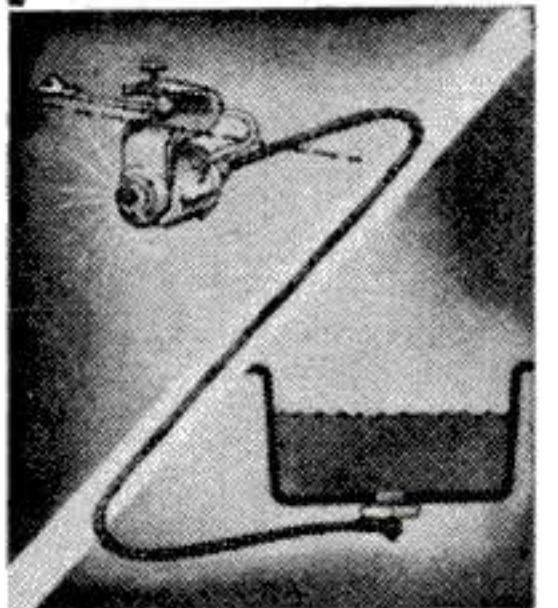

**\$9.95**

YOU MUST BE SATISFIED AFTER 10 DAYS TRIAL OR YOUR MONEY BACK.

**PARKWOOD MANUFACTURING CO.**  
606-S-3 Williamson Bldg. Cleveland 14, Ohio

## "OIL-SPY"

YOUR "PRIVATE EYE" ON YOUR OIL SUPPLY

Measures Oil Level Accurately & Automatically

Your car needs one. **OIL-SPY**, the only inside-the-car-on-the-dash automatic oil level checker, ends for all time the bothersome, time-consuming chore of checking your oil level with a dipstick. You know when your oil level goes down too low. The **OIL-SPY** never lets you down. An amber light flashes when oil is 1 qt. low and a warning red light when oil falls 2 qts. low. A factory approved accessory, **OIL-SPY** was thoroughly tested on the proving grounds of five leading automobile manufacturers.

**Most Valuable Car Accessory Since Automatic Transmissions**

FOUR EASY STEPS FOR INSTALLATION

1. Replace original crankcase drain plug with **OIL-SPY** plug unit. 2. Install **OIL-SPY** light unit in instrument panel. 3. Connect lead line to ignition switch. 4. Thread cable through fire wall and connect to **OIL-SPY** plug unit.

**ORDER NOW! FITS ALL CARS**

State MAKE, MODEL, YEAR of CAR

We pay postage when check, cash, or money order is sent with order. Send cash by registered mail only. When ordering C.O.D. send \$2.50 with order. Pay postman balance on arrival. Shipped complete with full directions for installation.

## Learn REFRIGERATION



Make Top Profits

SERVICE SEALED UNITS AND HOME FREEZERS

Ambitious refrigerator service men with experience will find this book is just what they need to specialize in servicing Sealed Units and Home Freezers. Beginners will find it the best means of getting started on pleasant, profitable career. Non-technical. Covers theory, practical application of refrigeration in all branches. Diagrams in eight colors. 928 pages, 408 illus. Clip this ad. and mail with \$5.00 bill or check today. Money back if not satisfied.

**GOODHEART-WILLCOX CO., Dept. 116**  
1321 S. Michigan Ave. Chicago 5

# HIGHEST ROYALTIES and CASH

## FOR YOUR INVENTIONS

Write for FREE booklet without obligation

**UNIVERSAL MARKETING CO.**

354 S. SPRING ST. (Suite C)

LOS ANGELES 13, CALIF.





## START AS HIGH AS \$3,450.00 YEAR

Many early Examinations Expected. Prepare NOW! Veterans Get Special Preference! 40-Page Civil Service Book FREE

Mail Coupon Today SURE

**Franklin Institute**  
Dept. B-81  
Rochester 4, N. Y.

(Not Gov't Controlled)

Gentlemen: Rush to me FREE of charge, list of U. S. government big pay jobs. Send FREE 40-page book describing salaries, vacations, hours, work, etc. Tell me how to qualify for one of these jobs.

Name.....

Address..... Vet?.....

THE NEW WAY TO

**ELECTRIFY**

TREADLE SEWING MACHINES



1 YEAR GUARANTEE

Terrific! Amazing! Changes any treadle sewing machine, regardless of age, into a modern electric! A child can do it in 5 minutes! Kit comes complete with Universal motor, foot control, belt, pulley, brackets. Completely wired — just clamp on and plug it in!

**MAKE BIG MONEY!**

**FREE!**  
\$2.95 Sewlight with each Kit.

Start now! Make \$5.20 on every kit you sell. Millions of women who can't afford new electric machines are waiting for it! Easy to sell over 10 per day! And Brant's back you with a complete line,

from needles to new machines — for BIG profits without any investment! Sell from our catalog and collect commissions in advance! Send for your kit and free literature, today!

RETAILS FOR \$16.95 YOU PAY

**\$11.75**

**BRANT SEWING MACHINE CO.**

Department AW2, Cincinnati 10, Ohio

- Rush motor kit C.O.D. I'll pay \$11.75 plus postage.
- I enclose \$11.75 — Ship postpaid.
- I want to be an agent! Send complete sales plan.

My machine is a.....

Hand wheel turns  toward me.  away from me.

Name.....

Address.....

City..... Zone..... State.....

## SPEED & MILEAGE MANUAL

140 Illustrations



Easily Get Super Speed, Acceleration, Mileage—Top Racing Performance From Any Automobile!

Famous New Book shows simplified Soup-up Methods—Speed Tuning—Economy Secrets—“Customizing Plans”—Latest Track Proven Methods

ods for all cars! Tells how to build your own SPEED EQUIPMENT! FAST SPORT CARS! “CALIFORNIA HOT RODS”! 200 H.P. ROAD & TRACK CONVERSIONS! Complete Instructions on building inexpensive Superchargers! Dual Manifolds! “Water Injectors”! High Compression Heads! Twin Mufflers! Economizers! All about—Fast Engines, Gas Saving, Restyling, “Cam Secrets,” Multiple Carburetion, Fuels, Porting, Ratios, Frames, “Offys”! BRAND NEW METHODS, Plans, Formulas, “Racing Tricks”—“STOCK CAR SPEED SECRETS”! Reveals 100 ways to save gas! Shows latest “HOLLYWOOD CUSTOM STYLING”! Streamlining! Sport Changes! Lowering! Speed Conversions! Including—California Roadster Plans! Racer Diagrams! Working Drawings! Performance Charts! Graphs! Beautiful Photographs! Etc.!

Large manual (plus) “California Equipment Catalog” and Racing Handbook. **ALL THREE \$1.98** Post paid

ALMQUIST AUTOMOTIVE ENGINEERING, Milford 85, Pa.

## WALKIE TALKIES \$3.99 PER SET OF 2

POCKET SIZE

—ELECTRONIC VOICE POWERED



No tubes, batteries, adjustments, license or permit needed! Should last for years. Guaranteed to work anywhere up to 1/4 mile with extra wire. Clear tone. Swell for room to room—garage to house, etc! Your own private, talk-listen phone. Not war surplus. Brand new. Solid Aluminum Case. Guaranteed. Two absolutely complete units with wire—READY TO USE! DeLuxe model has phone and mike in each unit.

SEND ONLY \$1.00 deposit and pay postman \$2.99 plus postage charges on arrival. Ideal gifts for boys—girls. Order Now! Today!

THE MIDWAY COMPANY, Dept. WPS-3, KEARNEY, NEBRASKA



## FOOT-SWITCH

**Frees Both Hands for Job!**

Handle work easier, get instant stop-and start-control of drill press, power saw, etc. with famous Smith FOOT-SWITCH. Now complete with cord and plug. No soldering or wiring. Heavy duty tungsten points, bronze spring. Just \$3.00 postpaid or send \$1.00 for C.O.D. plus fee. (Foreign \$4.00). Money back guar. In Calif. include 3% Sales Tax

FREE - folder showing uses of Smith-Switch in workshop, office, plant.

NATHAN R. SMITH MFG. CO.

105 P Pasadena Ave. South Pasadena, Calif.

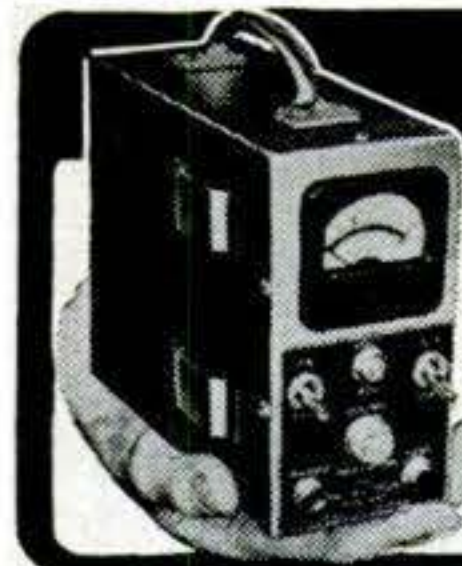

## Find HIDDEN TREASURES

GEIGER COUNTERS for uranium ore detection. TREASURE DETECTORS for Gold, Silver, other metals and minerals. Light weight, highly sensitive. None finer at ANY PRICE.

Detectron Co. Dept. 3-A  
5637 Cahuenga, No. Hollywood, Calif.

## RUPTURE



RELIEF...OR YOUR MONEY BACK

A simple... sturdy truss support built nature's way by old surgical appliance manufacturer. You risk nothing... relief or your money back. Send now for free booklet.

WEB TRUSS CO. Dept. S-3 Hagerstown, Md.

## FOR BIG MEN ONLY!



SIZES

WIDTHS

10 to 16 AAA to EEE

We specialize in large sizes only — sizes 10 to 16; widths AAA to EEE. Loafers, Wing Tips, Moccasins, Dress Oxfords, House Slippers, High and Low Work Shoes, Rubbers, Sox. Specially designed for large sizes. Satisfaction guaranteed. Sold by mail only. Write Today for FREE Catalog.

Write For FREE CATALOG

KING-SIZE, 268 Brockton, Mass.



# YOU CAN'T LOSE!

## HAVE A PROFIT MAKING BUSINESS OF YOUR OWN

NATIONALLY ADVERTISED PRODUCTS

NO EXPERIENCE NECESSARY

NO MONEY TO INVEST

FREE SAMPLE OUTFITS

FULL OR PART TIME

### A LIFETIME FUTURE

Man or woman—young or old, YOU can earn a steady income in full or spare time as an independent Kendex dealer. Amazing and almost "impossible" earnings can become a reality for you. Herbert Armstrong of Tenn. earned \$202 in 9 days. C. O. Watkins of Oregon sent 92 orders in one day. You have the same opportunity to duplicate these exceptional earnings. Over one million dollars will be earned in 1950 by Kendex dealers—why not let us establish you in your own business and get a share of these wonderful earnings?

### KENDEX NYLONS REPLACED FREE . . .

if they run or snag within guarantee period up to three months! Impossible? It's true! No matter what the cause—hard use or deliberate abuse—whether it is fault of the hose or the wearer—Kendex nylons are replaced FREE if they run, snag or become unfit for wear within the guarantee period. How could any woman resist a positive guarantee of satisfaction when she can obtain it without paying any more than other standard advertised brands? Kendex nylons are NOT sold in stores, so you have no competition. Complete line includes everything from heavy 70 denier service weight to gossamer luxurious ultra sheer 15 denier 60 gauge. Proportioned sizes and lengths. Latest colors plus white.

### LINGERIE - ROBES - HOUSECOATS - MEN'S HOSE

In addition to the sensational Kendex nylons, you will have a complete line of glamorous lingerie, beautiful robes and housecoats plus a complete line of Kentcraft mens' hosiery guaranteed for one full year. Any pair or pairs of men's hose that does not give satisfactory wear within one year of purchase will be replaced FREE!

### NATIONALLY ADVERTISED

Kendex will spend over \$350,000.00 in 1950 to tell millions of readers of the advantages in buying from you. Almost every issue of Good Housekeeping, Saturday Evening Post, McCall's, Women's Home Companion and Ladies' Home Journal carry our advertising in addition to many others. Kendex has advertised in Life, Look, Collier's, etc. Awarded Good Housekeeping Seal. Thousands of orders are shipped daily from coast to coast.



### FOUR MONEY-MAKING LINES

- WOMEN'S NYLON HOSIERY
- GLAMOROUS LINGERIE
- HOUSECOATS - ROBES
- MEN'S HOSIERY

MAIL TODAY

NOTHING TO PAY

NO OBLIGATION

**FREE NYLON STOCKING**

### EVERYTHING GIVEN FREE

Risk nothing! Mail coupon and we will send you, free and prepaid, complete money-making outfits including sample nylon stocking, samples of lingerie, robes, housecoats and men's hose fabrics and everything you need to immediately start making money. Complete outfits become your property even if you don't send any business. Simply write orders, we deliver and collect. Advance cash plus huge bonus. No money or experience needed. Mailing the coupon is all you need to start on the road to a 52-weeks-of-the-year high paying business of your own. You have everything to gain and nothing to lose.

**KENDEX COMPANY  
BABYLON 749 N.Y.**

Date.....1950

Send me, free and prepaid, everything I need to make money as a Kendex dealer, including sample stocking etc. There is nothing for me to pay now or later and I am under no obligation in accepting your money-making outfits.

Name.....

Address.....

City..... State.....

**KENDEX COMPANY, BABYLON 749, N. Y.**



# NOW AT MY RISK!

I want you to read the  
**WARNER SUCCESS PLAN**



## It shows you how to... **METALIZE BABY SHOES** AND OTHER KEEPSAKES

- how you can start in spare time with your home as headquarters.
- how to build—step by step—to big profits and personal independence.

This is the famous Warner Success Plan—the Plan for Personal Success in your own fascinating business that many men, married couples credit with freeing them from the limits of a pay check and from the drudgery of a time clock.

It gives the exact step by step instructions for starting a business in spare time—without risking the job or steady pay. It shows with pictures, photographs, and drawings exactly how to Metalize Baby Shoes and other keepsakes. It shows how to get the orders coming in—how to expand—how to get others working for you—how to be SURE of at least twice your present pay before you give up your job for a life of personal independence.

### 15 Million Prospects

There are 15 MILLION pair of Baby Shoes in the country right now ready to be Metalized. Last year alone, more than THREE MILLION more babies were born.

There's not one of these mothers who doesn't want her baby's first shoes preserved forever. The Business is tremendous... and never ending.

The Warner Success Plan shows you how to turn this exciting opportunity into cash. Shows exactly how to prepare the shoes, how to put on them a coating of genuine *gold, silver, or bronze metal* by simple Warner Electroplating process. Shows how to get the business coming in, how to start in spare time, how to pyramid profits. Shows you how the whole family can have fun while building for an independent future. My own Shop here in Chicago does a Big Business by the very secrets I will now unfold to you.

### Read The True Facts

Don't say "Yes" now. You must have ALL THE FACTS. Then decide. First, I want you to read the entire Plan—at my risk. After investigating—after discussing it with your family—then and only then do you decide whether to use the plan and make the small investment necessary to start.

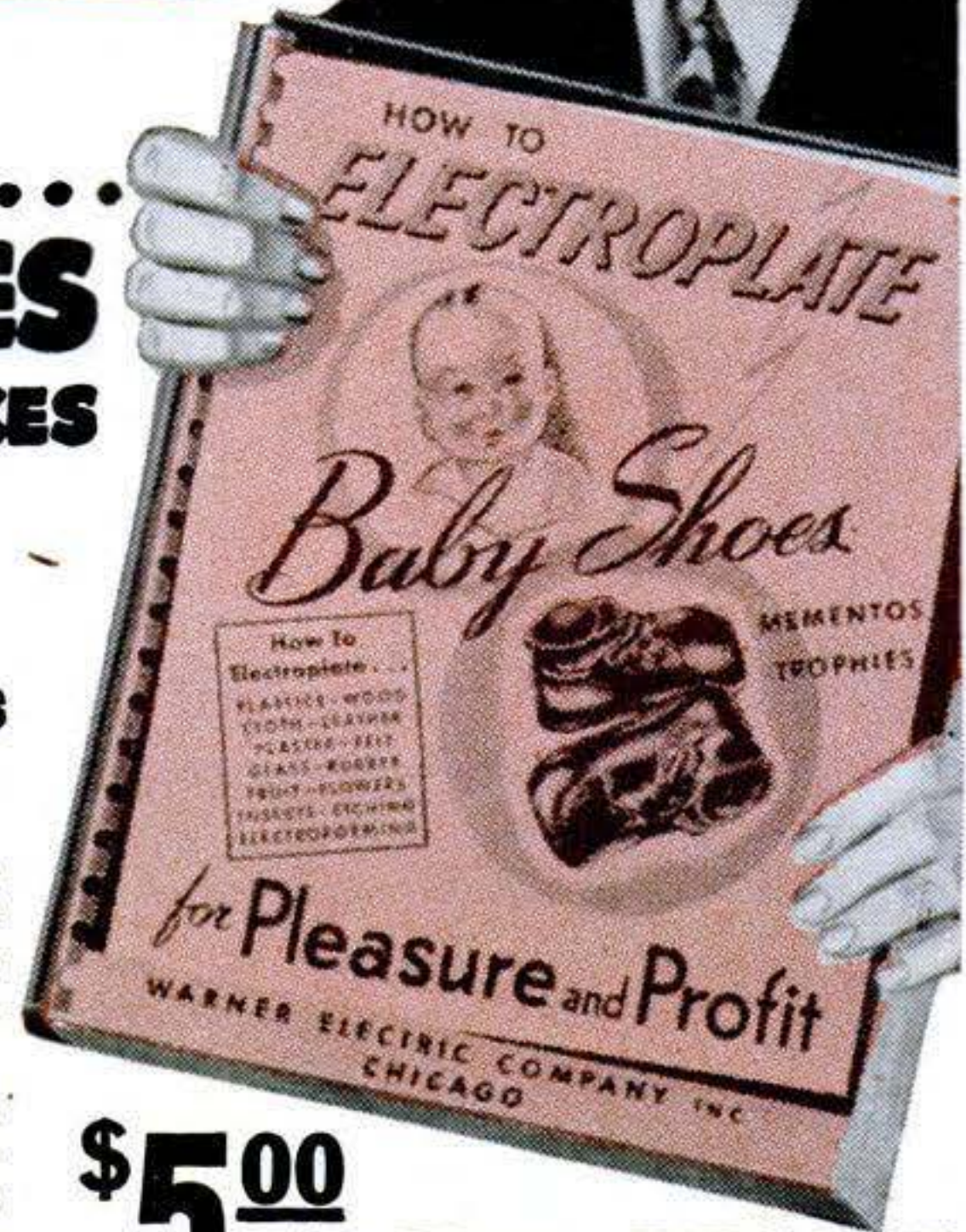

**\$5<sup>00</sup>** An Hour **PROFIT**

Yes, even in spare time it is possible for a man to finish enough work to pay \$5.00 an hour for his time. Think what this can pyramid into when the family helps.

### 3c MAY START A FORTUNE

Today I want you to do only one thing. Send the coupon. Let me give you all the facts. Remember, what I send you does not cost you a cent beyond the postage you put on your letter to me. With an opportunity like this, a man who has a serious interest in his future MUST investigate. MAIL the COUPON TODAY and see for yourself why so many families have called the WARNER SUCCESS PLAN a "godsend".

**DON'T SEND A PENNY  
JUST MAIL THIS COUPON TODAY!**

Raymond E. Brandell, Mgr., WARNER ELECTRIC CO.  
1512 Jarvis Ave., Dept. 23, Chicago 26, Ill.

As long as it doesn't cost me a cent, I am willing to read the facts, investigate, then give you my decision. Send the facts by next mail. Everything you send now is FREE!

NAME \_\_\_\_\_

ADDRESS \_\_\_\_\_

CITY \_\_\_\_\_ Zone \_\_\_\_\_ STATE \_\_\_\_\_

### MAKE 12 TIMES YOUR MATERIAL COSTS

Remember, the Warner Process is not a cheap imitation "PAINT" process. It is the genuine METALIZING through real Electroplating. And in spite of being the best, your materials cost so little that your profits are 12 Times your material cost. Then, when mothers order the shoes mounted as book-ends, as pictures, as ash-trays or pen sets, you make the BIG EXTRA PROFITS on the beautiful mounts.

**WARNER-ELECTRIC CO.**  
1512 Jarvis Avenue  
DEPT. 23  
Chicago 26, Illinois



### WE SUPPLY ALL MATERIALS

You don't have to go "hunting" when Warner is behind you. We supply all materials, all mounts, chemicals, and metals. And you get the low prices made possible by our big quantity purchases and our own manufacture. You send for just what you need and never have any big investment tied up in stock.



Classified Ads only 80c per word per insertion, payable in advance. Minimum ad 10 words. To be included in May issue, copy should be in our office by March 22nd. May issue on sale May 1st.

# CLASSIFIED OPPORTUNITIES

POPULAR SCIENCE MONTHLY-351 FOURTH AVE.-NEW YORK CITY 10

## 1 AUTOMOBILES

**BUICK Parts.** Enjoy new-car pep and power in your old Buick. Same day service from World's largest stock of new (not rebuilt) Buick parts and engines. Ship anywhere. Write today. Robertson Buick Co., 1002 S. Wabash Ave., Chicago 5, Ill.

**"IF You Want To Go Let Us Know"** Complete Line of Sport's Car, Stock Car, Road Car Equipment. Illustrated Catalog 15c. Dealer's Wanted, Hi-Speed Power Equipment, 228-20 Merrick Road, Laurelton L. I., N. Y. La-5-9535.

**BOOKS on Hot-Rods, Stock Cars, Customizing, Engines, Race Car Building.** Descriptive Illustrated Literature Including Catalog Listing 1500 Race Drivers, Cars, 25c. Frank Smith, 17 Watson St., Paterson, New Jersey.

**ENJOY new-car pep and power in your old Buick.** Same day service from World's largest stock of new (not rebuilt) Buick parts and engines. Ship anywhere. Dime brings catalog. Write today. Robertson Buick Co., 1002 S. Wabash Ave., Chicago 5, Illinois.

**"NEW Big Catalog"**—Over 500 Racing, Hot Rod, Speed Equipment, Auto Parts and Hollywood Accessories! Pictures! Speed Data! Customizing Tips! Lowest prices! Illustrated Catalog 25c. Almqvist Engineering & Mfg., Milford 85, Pennsylvania.

**SPEED & Mileage Manual**—"New edition!" 140 Illustrations, Drawings, Charts, Photographs! "Guaranteed finest, most Authoritative book"! Easy, inexpensive ways to build Speed Equipment—California Hot Rods—Beautiful Custom Cars—200 H.P. Road, Track Conversions—Superchargers—Dual Manifolds—Racing Heads—Twin Mufflers—Water Injectors—Economizers! "Get super speed, mileage, acceleration—top racing performance from any car!" Complete instructions with working diagrams on Fast Engines, Speed Tuning, Restyling, "Customizing", Gas Saving, "Racing Tricks", Cams, Fuels, Balancing, Porting, Ratios, Frames, "Offys!"—"Learn 100 ways to save gas!" Reveals "Stock Car Speed Secrets"! California Speed Shop Methods! "Custom Styling Information"! Streamlining! Lowering! Sport Changes! "Hollywood Roadster Plans"! Speed Conversions! (Covers All Cars)—"Large Manual" Plus Equipment Catalog plus "Racing Handbook"—all three only \$1.98. Almqvist Engineering, Milford 84, Pennsylvania.

**"SPEED Equipment"** bargains—California mufflers \$4.50, V-8 Duals \$15.90, Chrome carburetor stacks 98c, Dual manifolds \$9.95, Chrome echo cans \$1.65, Racing camshafts \$29.95 exchange, Water Injectors \$12.95, Hi-Compression heads \$19.75. All popular brands—Big illustrated catalog 25c (dealers wanted). Almqvist Engineering & Mfg., Milford 84, Penna.

**YOUR car burn oil? Poor compression? Slow starting? Excessive cylinder wear? Need overhauling?** Holt's Piston Seal will restore compression! Cuts oil consumption! Checks piston slap! Lasts 10,000 miles! This amazing British product forms self-expanding pliable lubrication seal around pistons. Compensates for wear! Cannot harm finest engine. Easily installed: full directions enclosed. \$3.98 tube for 6-cylinders; two tubes required for 8-cylinders. Details free on request. Treglown Co., Dept. B, 200 W 7th, Plainfield, N. J.

**CALIFORNIA Custom accessory headquarters.** Buy direct from original designers and save. Solid hood sides, grille panels, lowering kits, fender skirts, dual pipes, chrome motor accessories, speed equipment, push button door conversions. Revised catalog, 34 illustrated pages, new low prices—25c. Eastern Auto Supply, 3319-D South Grand, Los Angeles 7, Calif.

**DIRECT From California—Dual Manifolds for Willys Jeeps to Oldsmobile Rockets—Pinned Heads—Three Carburetor Manifolds—over 150 different makes and models. Speed and Dress-up Equipment for passenger automobiles—Magneto Ignitions, Aluminum Flywheels, Racing Camshafts, Water Injectors, Crash Helmets, Exhaust Headers, New 1950 Illustrated Speed Catalogue—25c. (Dealers, request Wholesale Catalogue.) Newhouse Automotive Industries, 5805-A 7 East Beverly, Los Angeles 22.**

**"SPEED & Power" Handbook—50 chapter Library Edition! Diagrams! Breathtaking methods—Authentic—Direct from California. Covers Crosleys to Cadillacs—All makes. Build your own Dual Manifolds, Superchargers, Hot Cams, Water Injectors, Hi-Compression Heads, Mileage Devices. Save many dollars! Get racing speed, lightning acceleration, dynamic power increases from any make passenger automobile! Build fast Stock Cars, California Roadsters, 160 M.P.H. Rods! Get construction drawings! Tuning Techniques! Speed Tricks! Economy secrets! Ingenious formulas! Covers "Racing Frames"—"Reciprocating Masses"—"Jet Engines"—"Braking Characteristics"—"Dynamometers". Also—Dual Pipes—Gears—Fuels—Porting—Relieving—Lowering—Balancing! Includes 1950 Speed Equipment Catalogues! Also "California Automobile Customizing"—Photographs, Drawings, (Newest ideas.) Conversions, Carson Tops, Restyling all makes, Streamlining, Chopping, Channeling, Complete—\$1.98 postpaid. Newhouse Automotive Industries, 5805-A2 East Beverly, Los Angeles 22. (See page 28, Display Advertisement.)**

**FROM Speedway to Roadway! Track-proved Hi-Speed Heads and Manifolds now available for your passenger car! No special tools needed! Increase horsepower 25%! Astounding Getaway! Free Illustrated Catalog, Speedsport, 6215-F Diversey, Chicago 39, Ill.**

**FREE Trial . . . On Ford "Speed and Power" manual!** We will send you on approval this 128 page manual with cutaway construction drawings, photos, understandable technical data. Learn how to install a V-8 motor in a Model "A" chassis and install hydraulic brakes on any Ford. How to rework V-8, Mercury, Ford 6, Zephyr and Model "A" engines for terrific speed. If you don't agree this is the finest hot rod manual you've ever seen—just send it back within 15 days. If satisfied, send \$2.00 to California Bill, Box PSX, Eagle Rock, Los Angeles 41.

**WATER Injection, Also—Speed—Power—Economy—Methods! Free descriptive, illustrated, information, Neher Industries, La Verne 6; California.**

**JUST Published! Clymer's No. 6 Motor Scrapbook.** Latest and best. Heretofore unlisted antique cars, motorcycles, \$2.00. History Motorized Vehicles, data on early gasoline, steam, electric cars, steam engines and motorcycles, \$2.00. Clymer, Dept. 3B, 1268 S. Alvarado, Los Angeles 6, Calif.

**HORSELESS Carriage Caravan Book, Information Harrah's Club Reno 1949 Tour with 50 antique cars through historical mining districts of Nevada. Descriptions every entrant. Photos participating cars. Interesting, educational. \$2.00 postpaid. Clymer, Dept. 3B, 1268 S. Alvarado, Los Angeles 6, Calif.**

**LATEST Ford Speed Manual, 128 pages full of cutaway construction drawings, photos, and understandable technical data. Includes complete data on installing V-8 motor in Model A chassis, hydraulic brakes for any Ford, roadster and fast car into. How to rework these engines for speed: V-8, Merc., Ford 6, Zephyr, Model A. Finest Ford manual published! \$2.00 postpaid. California Bill, Box PSC-3, Eaglerock, Los Angeles 41, Calif.**

**NEW Clymer Books, National Air Race Sketch and History Book, 190 sketches, charts, drawings. Information all National Air Races 1930-1949 inclusive, \$2.00—Pictorial Grand Prix Racing with 48 action photos \$1.00—Catalog of 1949 Automobiles, 120 Photos every American Car with complete specifications compares all cars in one book, \$2.00—Catalog '49-'50 All British Cars, \$2.00—'49 Chevrolet Test Report and Survey \$1.50—Ford Owner's Handbook gives complete servicing information Manual all Fords 1932 to 1950, \$1.50—Complete Service Manual Model "A" Ford \$1.00, Model "T" \$1.50—Life of Ted Horn, three-time American Automobile Racing Champion, \$2.00—Complete Outboard Service Manual covers all makes, \$3.50—Revised Hot Rod Book 1946, 1947, 1948 records, \$1.50—Steam Traction Engines Album, 160 pages, describes, illustrates 105 historical steam vehicles, \$2.50—How to Build Racing Automobiles, \$2.00. All Postpaid. Specify Books Wanted, Clymer Motorbooks, Dept. 3B, 1268 S. Alvarado, Los Angeles 6, Calif.**

**SAVE Gasoline! Sensational Gane needles. Free Trial—See page 63.**

**AUTOMOBILE Nuts—New national all-hobby automobile club mobilizing forces for amateur mechanics, collectors and talk-auto enthusiasts, offers automobile dealer materials, books, data books, motor magazines, dope on old and new cars, engineering manuals. Read about other car crazes. Write Auto Maniacs, Stockbridge, Mich. to get name on free mailing lists.**

**JUNIOR Midget racing, America's newest and most exciting sport. Kits and complete cars now available. Also 2 passenger midget highway cars, 6 H. P. engines. All steel precision-built cars. We manufacture the lowest priced, finest constructed, and most complete line of midget cars in the world. Sold direct at low factory prices. Send 25c for illustrated literature. National Manufacturing & Supply Co., 215 24th Street, Sacramento 16, California.**

## 2 AUTO SUPPLIES & EQUIPMENT

**BRUSH Plating Outfits connect to a battery. No tanks or shop required. Free particulars, Gunmetal Co., Avenue K, Decatur, Illinois.**

**DOUBLESEAL stops drafts under overhead doors, Edwards Industries, Dept. 302, 4268 Shenandoah Ave., St. Louis 10, Mo.**

**CHEVROLET Parts, Scarce motor, body, sheet metal parts, Grossman Chevrolet, Minneapolis, Minnesota.**

**JETRAM, \$3.00, uses air, Saves Gas, Hartman, 3218 Hawthorn, Alton, Illinois.**

**EXCLUSIVE Information—auto efficiency—"soup-up" Methods!! Avoid costly mistakes! Enjoy super performance, inexpensively! \$2.00 Manual, Only \$1.20 PP. Limited Time. D. W. Hartman, Box 128, Batavia, N. Y.**

**USE Toilet paper for Oil Filter Cartridges. See ad on Page 63.**

**MOTORISTS save gasoline by Vacuumating overrich mixtures. Fits all cars. For Free particulars write Vacuumatic, Dept. 1563, Wauwatosa, Wis.**

**"AIR Scoops" air-condition your car wonderfully. Trimmed, most effective car ventilators on market. Merely clamp them to your front small windows. Polished stainless steel. Send \$1.00 now to New Canaan Engineering, New Canaan, Conn.**

**"AIRFLOW Needles." Save gasoline! Free trial! If Satisfactory, \$1.50. Specify Car, Carburetor, Neher Industries, La Verne 6, California.**

**"JEEP" Parts for Military and Civilian Jeeps, Fast, efficient service. Phone and wire orders given immediate attention. Retail Supply Co., Box 906, Dept. 3B, Steubenville, Ohio, Phone, 4-0854.**



# POPULAR SCIENCE OPPORTUNITIES

SAVE Gasoline! Sensational Gane needles. Free Trial—See page 63.

JUST out! Get largest auto accessory and parts catalog in world. Over 15,000 items, including Hollywood accessories, hi-speed equipment rebuilt engines; all parts and accessories for all cars, trucks. New, used, rebuilt! We have that hard to get part! Completely illustrated, Jam-Packed with bargains. Send 25c. J. C. Whitney Co., 1919-T Archer Ave., Chicago 16.

BIG Bargains! Fender skirts for most cars \$10.95 pair. 6 volt Electric Siren with push button \$10.95. Send Deposit. Send 25c for new Illustrated Catalog. J. C. Whitney & Co., 1919-DB Archer, Chicago 16.

SENSATIONAL new accessory for cars with overdrive! Free Details. Signalite, 3908-B Bertheau, Chicago.

## 3 AUTO TRAILERS

BUILD Your own trailer! Save money! Have every feature you want! Plans for house, sport, camp and utility trailers. Catalog describing 9 models 10c. 15c in Canada and overseas. Jim Dandy, Box 125-B, Wausau, Wisconsin.

WIN at poker; experts tips \$1.00. Max Quinn, Jericho 22, Vermont.

WILL license manufacturers: Revolutionary patented tubular safety chassis; Utility, boat, farm, camp and House Trailers. Charles Nelson, 2908 Washington Ave., Santa Monica, California.

## 4 MOTORCYCLES BICYCLES, SUPPLIES

SUPPLIES for Older Harleys Complete. One Stop Sales Service, 813 Ohio, Wichita Falls, Texas.

MOTORCYCLE Magazine — Worldwide Coverage. Yearly Subscription \$1.00. Sample 15c. Motorcycle News, 5424-H Sawyer, Chicago 25.

KNEE ACTION motorbike \$15; Midget car (steel frame) \$25; Moto-Scout \$15; Whizzer motorbike with all attachments \$25; Indian motorcycle \$30. Other motor-scooters \$8 up. motors \$3 up. Send 25c for new catalog #944 listing many other sensational bargains in used motors, motor-scooters, motorcycles, parts, etc. Associated, Box 1764-CS, Toledo, Ohio.

WHIZZERS \$20 each; Cushman motor-scooter \$15; Shaw bicycle motor \$15; Midget car \$15; 1946 motorscooter \$22.50 (needs painting); complete motorbike \$30. Rush 25c for new Spring catalog #16 listing many other amazing bargains in wheels, motors, motorscooters, midget cars, motor-wheels, monocycles, motorettes, etc. Gail, 538 Erie, Toledo, Ohio.

REBUILT and Tested 1½ to 3 H. P. Engines For Motorbikes, Motorscooters, small autos, etc. \$9.00 to \$30.00. Send for Catalogue. Cauffiel Motor Industries, Dept. 119 Temperance Michigan.

## 5 AVIATION

JET Engine \$3.00; Plans \$1.00; Literature 10c; M.E.W., 387 University, St. Paul, Minn.

PROPELLERS-2-3 Blade, for sleds air-drive boats. Catalog. Standard Aero Craft, Box 387, Ft. Worth, Texas.

GENERATORS, Aircraft P-1 200 amps, 28V, good to make welders, etc. Good used condition. \$15.00 cash, FOB. Aero Parts Supply, 8102 Lockheed, Houston, Texas.

PROPELLERS, plans, skis, engines for snow sleighs, air boats. Literature 20c. Banks-Maxwell, Box 3301G, Ft. Worth, Tex.

## 7 ELECTRICAL SUPPLIES & EQUIPMENT

BUY Lamp Parts Wholesale. Parts you need for building, repairing, or assembling. Save money on large or small orders. New catalog for 10c. Gearon Company, Dept. 300-A2, 27 South Desplaines, Chicago, Illinois.

ELECTRIC Pencil: Engraves all Metals \$1.25. Beyer Mfg., 10511-C Springfield, Chicago 43, Illinois.

ELECTRIC Pencil: Engraves all metals, \$1.00 postpaid. Guaranteed. Reiss, 3017-M Ocean Parkway, Brooklyn 24, N. Y.

FREE Catalog — Motors, Generators, Welders from aircraft generators, Water Softeners, many other electrical bargains. LeJay Company, Minneapolis, Minnesota.

LAMP Parts—Extra money modernizing, converting, repairing lamps at home. 3c stamp for illustrated folder. Lamp Shop, 1348 Richmond, Des Moines, Iowa.

APPLIANCE Parts catalog—repair handbook, \$1.00. See-Us Supply, 2512 Prevost, Ft. Worth 7, Texas.

ULTRA-Violet kit—adaptable for sun-lamp, mineral detector, including tube, \$1.25. Ultraco, Suite 904, 1472 Broadway, New York 19, N. Y.

32 VOLT appliances — World's largest line. Catalog Free. Haines Corporation, Dept. P, Minneapolis, Minn.

WATTHOUR Meters. Reconditioned, guaranteed. Ideal for cabins, shops, \$2.95. T. Price, 310—14th, Raymond, Wash.

ELECTRIC Motors. Free Bargain list. Plenge 9, Stuyvesant Oval, New York 9, N. Y.

## 8 WELDING, SOLDERING, PLATING

BIG profits in welding business with a Hobart "Build-Your-Own" Portable. Catalog free. Hobart Brothers Company, Box P-304, Troy, Ohio.

110 V. PORTABLE Transformer Welders, \$29.50. Morris, 1850B State, Schenectady 4, N. Y.

RADIATOR Repairing Books, Supplies, Equipment, Gasoline Torch. Write for circular. Curfman Mfg. Co., Maryville, Mo.

LOWEST Prices on A. C. Welders—Power Mowers. Holgerson Co., Canton, Kans.

LIQUID Silver silverplates, brass, copper, silverware. Cloth applied. Guaranteed. \$1.00 bottle. Fox Specialties, Fordham Box 13, New York 58, N. Y.

BUILD D.C. Arcwelder without rewinding armature. Plans \$1.00 each. 25 to 600 amperes from automotive D.C. motors, Light plant generators, Automobile starter-generators. Welders Club, AS-3432, Chicago 54. Also 100, 200, 300 ampere A.C. Welder Plans \$1.00 each.

## 10 MACHINERY, TOOLS, SUPPLIES

DRILL GRINDER for twist drills, \$2.95. See ad on page 265.

POKITOOLS! 263 Practical Tool Combinations \$3.95. Factory-to-you. Other Super-tools from 89c. Free literature. Box 1451A, Joliet, Ill.

BARGAINS. Welders. Alternating or Direct Current. Gas or Electric Drive, Portable or Stationary. Advise us your needs. William Harrison Company, Box P-305, Troy, Ohio.

POWER Tools. Big savings when you build your own with Lewis castings, 23 wood and metal working tools with blueprints. Most can be completed with lathe and drillpress. Commercial quality. Ideal for home shops, schools, small manufacturing. Catalog 10c. Lewis Machine Tool Co., 3217 Union Pacific Ave., Dept. S, Los Angeles.

POWER tools, equipment wholesale prices. Free Bulletin. Homcrafters Cooperative, Grand Rapids 6, Michigan.

## 13 BATTERIES, GENERATORS, ETC.

SAVE your Battery. Use Nulife Battery Preserver. Proven Product. Guaranteed Harmless. Inexpensive. Write for Particulars. Nulife, 879 Bridge Drive, San Leandro, California.

EDISON Nickel Batteries, 37 to 600 ampere. Also Kits with Edison Plates; make your own. Interesting literature. Hawley Smith Co., Croton Falls 2, N. Y.

## 14 BOATS, OUTBOARD MOTORS, ETC.

STEERING Wheels, windshield brackets, from \$6.95. Modern fittings at lowest prices. Complete pre-cut plywood boats. Bargains galore. Folder 10c. Marine, Box 681, Mendota, Minnesota.

NEW, used, rebuilt marine motors. Marine conversions, fittings. Free Catalog. Stokes Marine Supply, Dept. 23, Coldwater, Mich.

SHIP Modelers—are you looking for authentic, precision-made kits? Send 35c for richly illustrated catalog describing more than 30 models retailing from \$3.95—Clipper ships to modern cruisers—also decorative authentic Naval and Field Gun Kits from \$4. Address Marine Model Co., Dept. A, Halesite, Long Island, N. Y.

SAVE 2/3 cost. Assemble your own boat. Complete plans and boat parts machined ready for assembly. No experience necessary. Rowboats to cruisers. Illustrated catalog 25c. Midwest Boat Company, Menomonee Falls, Wisconsin.

MARINE conversions for Ford and Jeep engines. Catalog 10c. Lehman Manufacturing Company, Department A, Newark 2, N. J.

GET Our Big 224 Page Low-Price 1950 Marine Hardware and Boat Equipment Catalog! Send \$1.00 for packing and Mailing—refunded with first order. Garland Frasher Marine Sales, Dept. J, 540—31st Street, Huntington, W. Va.

FREE! World's most complete catalog listing. Boat kits, plans, patterns, marine engines, conversions, boat building lumber, plywood, marine hardware. Trailer parts. Marine Mart, Buffalo 7A, New York.

KNOCK-Down Boat Kits; Outboards, Inboards, Hydroplanes, Sail, Easy to assemble, costs less. Send 25c for literature, specifications, prices. Brooks Boat Company, Dept. PS, Carrollton, Michigan.

FULL size, cut to shape boat patterns, blueprints, 7½-38 feet. Illustrated "Build a Boat" catalog, 25c (coin). "How to Build Boats" book, \$1.00. PolyWog Houseboat Plans \$10. Marine Catalog \$1.00. Cleveland Boat Blueprint Co., Dept. A-77, Cleveland 13, Ohio.

BUY our conversion parts to change your auto engine into a high-grade marine engine. Marine manifolds, transmissions changed to high speed reverse. Marine bronze pumps, propellers, shafts, couplings, stuffing boxes, struts, fudders, etc. Buy direct from the factory and keep the dealers profit for yourself. Money back guarantee. Conversion Parts Co., 277 Adams Street, Boston 22, Mass., U.S.A.

MARINE Conversions for the auto engines, water cooled manifolds and Transmission conversions for all makes, Ford, Willys and Chevrolet conversion kits and reverse gears. Barr Marine products Co., Dept. A 2700 Castor Ave., Phila. 34, Penna.

## 15 ENGINES, MOTORS, ETC.

"HOBBYMOTOR" — 1/100-hp., 110-AC, 3400 RPM, 3/16" shaft, \$1.95 postpaid. Guaranteed. Specialty Co. 309, Lebanon, Missouri.

WELDING Generator 150 ampere \$47.50. Motors ½ horse \$15. 1 horse \$30. Water pumps \$12.50. Butler, 1885 Milwaukee, Chicago 47.

HOTTEST surplus list in the country. Electronics, Hydraulics, Aircraft, Gadgets. Dick Rose, Everett, Washington.

MOTOR Winders, send for testing and winding bulletins. Motor Industries, Quincy, Illinois.

REBUILT & Tested 1½ to 3 H. P. Engines for Lawnmowers, Farm use, etc. \$9.00 to \$30.00. Send for Catalogue. Cauffiel Motor Industries, Dept. 120, Temperance, Michigan.

## 16 AMERICAN POLICE JIU JITSU

DEADLY Judo—Fiercest fighting technique, Trick knockouts. (Over 200 illustrated pictures.) Expert instructions—Three volumes Complete \$2.25. Variety House, Box 46-A, Wall Station, New York 5.

TWENTY-lesson professional jujitsu course, specially written for beginners. Clear instructions, easily learned. Postpaid. Send only \$1.00 to R. Schillinger, 72 Pine St., Rutland, Vt.

## 18 BODY-BUILDING COURSES

BARBELLS—finest quality \$7.98 up. Catalog Free. Lurie Barbell Co., 1729-S3 Rockaway Parkway, Brooklyn, New York.

BARBELLS, Dumbbells, Exercise equipment. Courses. Free booklet. Good Barbell Co., Reading, Penna.



# POPULAR SCIENCE OPPORTUNITIES

## 19 SPORTING GOODS, GUNS, FISHING TACKLE, ARCHERY

190 PROFUSELY illustrated pages antique and modern pistol, sword, etc. values, 50c. Robert Abels, PS860 Lexington Ave., New York 21.

5,000 BARGAINS, firearms, binoculars, war relics, catalog 40c. Smith Museum, Runnemede, N. J.

FISH line, 1500 ft. Dupont 2 ply Nylon 25 lb. test, \$1.98 postpaid. Allender & Co., Chicago 16.

SEND now for this fascinating, new, free, Richardson 32-page booklet containing 357 fishing tips, compiled by the expert fishermen who make Richardson Rods—the fishing rods that are tagged with the "Sign of the Fish!" For your copy, sent without cost or obligation, Print Your Name And Address On A Penny Post Card and mail to Richardson Rod & Reel Co., 3179 N. Sawyer Ave., Chicago 18, Ill.

SHOTGUNS, Rifles, Revolvers, Over 500 Modern, Obsolete, Also Cartridges. List 10 coin. Ed Howe, 26 Main Street, Coopers Mills, Maine.

25 INDIANHEADS \$1.98—Tomahawks \$3.44—Violin Wood \$6.65—Bayonet \$1.98—Sword \$7.65—8 arrowheads \$1.44—Powderhorn \$7.40—Blunderbuss \$68.00—Agate \$.48—Fossil \$.48. Heike, Wenona 42, Ill.

## 20 FIELD GLASSES, TELESCOPES, ETC.

TELESCOPES, Binoculars, Microscopes—big bargain catalog free. Brownscope Company, 24 West 45th Street, New York.

WAR Surplus Bargains, Binoculars, Telescopes, Sextants, Millions of Lenses, Prisms, Reticles, Eyepieces, Objectives, etc. Request Free "Catalog CN." Send \$1.00 for Stock CN—10-piece Lens Kit and Big Instruction Booklet, Edmund Salvage Co., Barrington, N. J.

REFLECTING Telescopes, completely assembled, 60X, \$25.00. Guaranteed Observatory clearness. Free information. Skyscope, 475 Fifth Avenue, New York 17.

TELESCOPES 30 power, extends 36"; precision lenses. Satisfaction guaranteed or money refunded \$2.95 postpaid. Criterion, Dept. PSC 4, 438 Asylum, Hartford 3, Conn.

6" ALUMINIZED mirrors for reflecting telescopes. Performance guaranteed, \$25.00. James Bray, 860 Walnut, Burlingame, Calif.

SAVE 50% On New Binoculars! Free Catalog, Free Book, "How to Select Binoculars." Write Today! Bushnell Importers, 43-P3, East Green, Pasadena 1, Calif.

"FREE" Catalog! Thousand war surplus optical bargains. Lenses, Prisms, Telescopes, Binoculars, etc. Send \$1.00 for 10 Lens Hobbyist Set and Project booklet, G. Jaegers, 93-08—95th Avenue, Ozone Park 16, N. Y.

GIANT, 100 power astronomical telescope with 6 ft. tripod (10,000 area magnification) Clear Vision, full power guaranteed, \$15.00 F. O. B. factory. Suffolk Science Service, Dept. TC, Riverhead, N. Y.

ASTRONOMICAL telescopes, binoculars, microscopes; Bought, sold, repaired. Books, Lists 10c. Rasmussen-Reece, Amsterdam, New York.

WAR Surplus Bargains, Binoculars, Telescopes, Sextants, Millions of Lenses, Prisms, Reticles, Eyepieces, Objectives, etc. Request Free "Catalog CN." Send \$1.00 for stock CN—10-Piece Lens Kit and Big Instruction Booklet, Edmund Salvage Co., Barrington, N. J.

BINOCULARS—Guaranteed repairs Free estimates. Dealers invited, Tele-Optics, 5514 Lawrence, Chicago 30, Illinois.

## 22 BABY CHICKS

BABY Chicks, Champion Mated, 52 varieties, 7 Grosses, licensed inspected, bloodtested, Rush postal, large colored book Free, low prices. Berry's Farm, Route 11, Clarinda, Iowa.

## 24 DOGS, BIRDS, PETS, RABBITS

MAKE Money! Raise Chinchilla Rabbits. Experience unnecessary. Valuable Breeders. Extra profits from meat, furs, laboratories. Pleasant hobby. Write today! Rockhill Ranch, Sellersville 16, Pa.

RAISE Mink. Amazingly profitable. Free booklet gives inside "secrets." Molgard, Brigham City, Utah.

GOLDEN Hamsters—Novel Pets. \$5 brings breeding age pair including two metal cages, instructions, Hathaway Hamstery, 609 Deerfield, Silver Spring, Md.

\$400 MONTHLY Raising Angora Rabbits. No experience required. Details free. White's Rabbitry, Newark, Ohio.

RABBITS: New Zealands, Ringland Rabbitry, 1726-30th, Des Moines 2, Iowa.

RAISE Guinea pigs. Make extra cash. Booklet free. Taylor, Box 426B, Hapeville, Georgia.

MAKE Money Raising Angoras, Circular free. Vaughn's Rabbitry, Otley, Iowa.

HOBBY Catalog 10c. Reptile Bulletin 5c. Hamsters \$2.75 pair. Chameleon 35c. Quivira Specialties, Topeka 10, Kansas.

\$50 WEEKLY Raising Angoras, Free Illustrated Booklet tells How. Wilson's, Stanton 18, Calif.

MAGILL'S Hamsters, Wonderful pets! Clean, easy to raise anywhere. Splendid profit opportunities. We furnish finest stock, supplies, everything needed. Write today for free illustrated literature. Magill's Hamstery, Drawer 430-ps, Springfield, Missouri.

## 25 FROG RAISING

"RAISE FROGS!" New book tells how! Illustrated Literature Free, Marlboro-B, Box 7002, New Orleans 19, Louisiana.

## 30 FARMS, OTHER REAL ESTATE

FARMS, Ranches, lodges, resorts, Big selection, Milwaukee Road territory, Washington, Idaho, Montana, Dakotas, Minnesota, Iowa, Missouri, Michigan, Wisconsin, Illinois, Indiana. Free colorful descriptive folders, price lists, L. H. Robbins, 738K Union Station, Chicago 6, Ill.

OZARK Lands for All purposes, Actual river frontages, 5 acres \$90.00 and upwards. Free list and literature, Hubbard, 424-H, Minnesota Ave., Kansas City 4, Kans.

STROUT'S Golden Anniversary Farm Catalog Over 2800 outstanding Bargains! Coast-to-Coast; 32 states. Mailed Free! Strout Realty, 255-ZB-4th Ave., New York 10, N. Y.

GOOD Farms—Ranches, Washington, Minnesota, Montana, Idaho, Oregon, North Dakota, Dependable crops, favorable climate. Write for literature, Lists describing typical farm opportunities, Specify which state, J. W. Haw, 120 Northern Pacific Ry., St. Paul 1, Minn.

BIG Free Spring Catalog! Farm and country real estate bargains, good pictures, many states, easy terms, many equipped, feed included. For special Service, State requirements, desired location, United Farm Agency, 428-PS BMA Bldg., Kansas City 8, Mo.

## 31 POULTRY AND SUPPLIES

RAISE Turkeys the new way. Write for free information explaining how to make up to \$3,000 in your own backyard. Address National Turkey Institute, Dept. 57, Columbus, Kansas.

## 32 PROFITABLE OCCUPATIONS

BE Independent, Be Secure, have your own profitable business—earn \$10.00 and more a day making beautiful, fast-selling lamps at home. No equipment needed. Illustrated course teaches you quickly. Course, parts catalog, wholesale price list—only \$2.00. Gearon Company, Dept. 200-A2, 27 South Desplaines, Chicago 6, Ill.

\$5000 FROM half acre growing Ginseng, crop bought, Particulars 10c. Associated Growers, 1169 Corydon, Winnipeg, Canada.

RAISE Fishworms, Easy, Profitable. Send 25c in coin for complete instructions. Huffman's Worm Ranch, Rives Junction, Michigan.

\$400 MONTHLY Raising Angora Rabbits. No experience required. Details free. White's Rabbitry, Newark, Ohio.

\$40.00 WEEKLY, Made growing mushrooms, Fresh, Dried, Dominion Patent 331.583, free spawn, North American, 169Y Yonge, Toronto, Canada.

"ELECTROPLATING-Know-How" includes baby shoe metallizing, other lucrative fields. Learn easily. Free illustrated booklet, Joseph B. Kushner, Electroplating Engineer, Stroudsburg 62S, Penna.

LOCKSMITHING Secrets! Key fitting, Lock repairing, opening; prices, sources. Illustrated book \$1.00. Wexler, 7 West 36, New York City.

LEARN Watch—Clock Repairing at home, our easy way! Free information. Modern Technical Supply, 55-PS West 42nd Street, New York 18.

HAVE Fun! Make Money! "Working with Leather"—64-page booklet tells how. Send 25c for copy. Free catalog and valuable information included, Wilder-Craft, 1038 Crosby, Chicago 10.

DRESDEN-Craft new profitable business any one can enter, small investment assures large income, from home, complete instruction making plastic molds, casting, decorating, Including figurines, paints, glazes, mold compound, all for only \$35.00. Royal Dresden, 186 No. Syndicate, St. Paul 4, Minnesota.

MAKE Money At Home—Casting fast-selling plastex novelties and metallizing baby shoes. Tremendous possibilities—full, spare time. No experience needed—full instructions given. Write: Leonard and Moese, 161-B Madison Avenue, New York 16, N. Y.

## 33 BOOKS, PERIODICALS, ETC.

USED Correspondence Courses and Books bought, sold, rented and exchanged. Catalog Free, Lee Mountain, Pisgah, Ala.

MODEL Tells All, Rackets, Traps, Foul Play of Photographers, Agents, \$1.00—Hold-It, 41 W. 52nd St., N. Y. C.

BOOKHUNTERS! All Subjects, Send Wants! Jaher Book Service, 620-K East 178 Street, New York 57.

ADULT Books—Unusual—Revealing—illustrated, Five \$1.00, Catalogs 10c. Kogan, 1032-DP, Church Annex, New York 8.

POCKET Books! Send six plus 50c. We'll Return Six different, Bookmart, 919 Ingeron St., San Francisco.

KNOW the unusual—copy 20c—Freeland, 4701-13 Sheridan—Chicago 40, Ill.

BIG Cartoon Booklet, Ten Illustrated Comic Cards, 25c. K. Harris, Box 550, Palm Springs, California.

QUICK profits taking magazine subscriptions, handling greeting cards, Cassell Publishers Service, Westfield, N. J.

NATIONAL Geographic Magazines 1888-1949, any issue, Periodical Service, Box 327-PS, Swarthmore, Pa.

BACK-date Magazines, Specific issues; years, Arkell's, Tarzana 2, Calif.

## 35 MAGIC TRICKS, PUZZLES, ETC.

200 ELECTRIC stunts, 110 volts, \$1.00. Cutting Sons, Los Altos 2, Calif.

WE supply every noted magician, Large professional catalog 50c. Holden's, P220 West 42nd Street, New York.

LATEST And Best Tricks Described in our New Large Catalog, Send 25c to Jeffries Magic Company, 17 North Hudson Street, Oklahoma City, Okla.

500 TRICKS you can do! Send 10c for Douglas famous Catalog, best in magic at lowest prices. Unequaled service to magicians for 30 years, Douglas Magicland, Dept. 2, Dallas, Texas.

VANISHING Quarter trick and catalog 25c. Sterling Magic Co., Royal Oak, Mich.

VENTRILOQUISM Taught, 3c stamp brings particulars, Smith, 801 Bigelow, Peoria 5, Ill.

WE supply every noted magician, Large professional catalog 50c. Holden's, P220 West 42nd Street, New York.

BE a Magician, Large professional magic catalog of latest tricks, 35c. Ireland, F-109 North Dearborn, Chicago.

500-PAGE Catalogue of 2500 Tricks, pocket, parlor, stage, World's Finest Magic, Catalogue Price, \$1.50, Kanter's, S-1311 Walnut, Philadelphia 7.

VENTRILOQUIST Dummies, Catalogue 10c. Be a ventriloquist, Free Particulars, State age, Maher, Box 36-S25, Kensington Station, Detroit 24, Michigan.



# POPULAR SCIENCE OPPORTUNITIES

SEND 25c for 6 Latest Tricks Jokers catalog & Circulars. Laramie Sales, 4800 S. Laramie Ave., Chicago, Ill.

**SPECIAL Magic Offer Free.** Write "Marean" Magic Shop, Hopewell, Virginia.

500 TRICKS. Douglas famous Catalog 27 now only 10c. Unequaled Service to magicians for 30 years. Send 10c today. Douglas Magicland, Dept. 2, Dallas, Texas.

**GIGANTIC Magic-Joker catalog.** samples—10c. Mammoth Fun Kit—50c. Funland, 6419 San Vicente, Los Angeles 48-B, California.

## 37 COIN COLLECTING

**FREE!** Foreign coin, banknote and Coin Collectors' Illustrated Catalog to approval service applicants. Send 3c postage. Tatham Coin Co., Springfield-D50, Mass.

**GET Profit and Pleasure** in collecting old coins. Send 10c for 56-page illustrated coin catalog. You'll be delighted with it. Send for it now. B. Max Mehl, 374 Mehl Building, Fort Worth, Texas. Largest rare coin establishment in U. S. Established 50 years.

**OLD Money Wanted.** Will pay \$100.00 for 1894 Dime, S. Mint, \$50.00 for 1913 Liberty Head Nickel (not Buffalo). Big premiums paid for all rare coins. Send 4c for Large Coin Folder. May mean much profit to you. Numismatic Co., Dept. 30, Fort Worth, Texas.

**WORLD'S greatest magazine** for coin collectors, and wooden nickel 10c. Lawrence Bros., Anamosa, Iowa.

**COMMEMORATIVE \$1/2** — Columbus, Washington, Cleveland, Stone Mountain, \$1.50 ea. Illustrated Catalogue 25c. Norman Schultz, Salt Lake 9, Utah.

**WE Pay \$2 to \$500 Each** for hundreds of old or odd coins. Indianhead, Lincoln and foreign coins wanted. You may have valuable coins. Keep all until posted. Send 20c for new Ill. Coin Value Book, 4x6 Buying and selling prices. 44 years in business. Coin Exchange, Le Roy 1, N. Y.

**U.S. coins lowest prices.** Send stamp for lists. Hutchinson, 3463 I Street, Philadelphia 34, Penna.

**INDIAN, Lincoln cents** bought, sold. Send 25c Today for bargain list and Indian cent. Dept. SC 5 Guarantee Coin Company, Box 6370 A, Chicago 80.

43 MIXED Indian cents \$1.00. 33 diff. Foreign coins \$1.00. Chelsea, 40 West 18, New York City 11.

**LOOK at your change!** Wanted—1901-S Quarter, Pay \$5.00-\$150.00. 1913 Liberty Head Nickel \$1,000.00. 1909-S V.D.B. Cent \$5.00. 1894-S Dime \$500.00 and Hundreds of others. Know their True Value. Send \$1.00 for complete illustrated catalog together with Coin Samples of Conditions. Catalogue alone 25c. Worthycoin Corporation, 294 Washington (D-507) Boston 8, Mass.

## 40 STAMP COLLECTING

\$5.00 CATALOG Price For 10c. (1) Big collection 112 all different stamps from Africa, South America, South Sea Islands. (2) Four desirable unused U. S. cataloging 40c. (3) Fine packet 25 British Colonies—Burma, Solomon Islands, etc. (4) U. S. \$5.00 high value. Everything (all four items) only 10c with approvals. Crystal, Littleton 40, N. H.

200 DIFFERENT, including Roosevelt triangle, 5c to approval applicants. S. Avalon Stamp Co., Springfield, Mass.

**WOW! \$10.00 Worth Of Fun 10c!** What a treasure hunt! Big package 500 Foreign Stamps, including airmails, pictorials and others from the world over; stamps worth up to 25c each. This offer sent for 10c to Approval Applicants Only. Jamestown Stamp Co., Dept. 5, Jamestown, New York.

**POSITIVELY Greatest Free Offer!** Latest Scott's International \$6.00 stamp album—covering entire world, contains 36,000 illustrated descriptive spaces; Scott's 1950 Standard \$7.00 catalogues "Philately's Encyclopedia"—absolutely Free to applicants for foreign approvals becoming customers. Approval Service, P. O. Box 1700, San Francisco, California.

**FREE!** Powerful magnifying Glass—to approval applicants; also big bargain lists. Jamestown Stamp Co., Dept. 202, Jamestown, New York.

**FREE—Illustrated Catalog!** Kenmore Stamps, Arlington 74-C8, Mass.

**FREE!** 100 Worldwide different stamps to approval buyers. Big U.S. and illustrated bargain lists sent with approvals. Bookman, Maplewood 1, N.J.

**FIFTY Different Countries Abyssinia-Zanzibar** 3c to approval applicants. Mohawk, Box 141S, West Springfield, Mass.

**UNITED States stamps** nearly 100 years old. Roosevelt set, others, 40c value—only 6c to applicants United States approvals. Wakonda, 140F Nassau, New York 7.

**WORLD'S Largest Stamp** (7 1/2 x 14 inches). A real curiosity! Retail for 50c, only 3c to approval applicants. Tatham Stamp Co., Springfield 50, Mass.

**FREE Catalog!** Illustrated. Forty pages. United States, Foreign, Albums, Supplies. "How to Collect," etc. Harrisco, 204 Transit Bldg., Boston 17, Mass.

**\$1—\$2—\$5 UNITED States**, commemoratives, airmail, high values in large collection United States stamps only 5c to applicants United States approvals. Metropolitan, 140A Nassau, New York 7.

**FREE—Famous Americans Set, Flag Set, National Parks Set, and Presidential Set** to \$5.00. A total of 90 Stamps Free to Customers for our unsurpassed U. S. and foreign selections. Send 3c for 15 of the above Stamps and full particulars. Triboro Stamp Co., 145 Nassau St., Dept. 202, N. Y.

300 DIFFERENT given free with approvals. Postage 3c. Windsor Stamps, 1435 E. 67th Place, Chicago 37.

25 U. S. Commemoratives—All Different from 1893 Columbian to present day issues. This U. S. commemorative collection only 5c to approval applicants. S. L. Engel & Co., 38 Park Row, New York 7, N. Y.

**EXCHANGE!** Send 25 U. S. Commemorative duplicates. Receive 200 different world. Sundman, Littleton 2, N. H.

**FREE \$25.00 Outfit Latest Large Scott album,** valuable collection of 1050 all different beautiful stamps, airmails, triangles, diamonds, high values, etc. Plus watermark detector, tongs, "Stamp Finder" Magnifying glass, perforation gauge, hinges—actual value over \$25.00—but all absolutely free when you become a customer. Write for our foreign stamps on approval now. Americas' Stamp Service, Riverside, California.

**UNITED States Commemorative Collection** 37 different unused Columbians to 1943 issues only. Price \$1. Request approvals. "Stamps" 987, Albany, N. Y.

**RARE Bargain—Six Mint German Sets** —50c Value—Only 10c to Approval Applicants. Stamp Mart, 1412 Great Northern Bldg., Chicago 4.

**"HOW To Recognize Rare Stamps"**—Free Book, Illustrated! Kenmore, Arlington 74-H9, Mass.

200 BRITISH Empire Stamps plus valuable publications Only 3c. Kenmore Stamps, Arlington 74-B 18, Mass.

**FREE!** Liberia Triangle Airmail Set. Package Hinges, approvals. Greenwood, 441 Washington, Miami Beach, Fla.

**FLAG Stamp Free,** if you request my U. S. approvals. E. Wenigman, 1933 Paterson, Chicago.

**FREE United States Price List.** Mark Hanna, 335 Fifth Avenue, Pittsburgh 22, Pa.

**WORLDWIDE Stamps.** All Different, 200-25c; 500-50c; 1000-\$1.00; 2000-\$2.75; 5000-\$13.50. Beacon Sales, Northboro 3, Massachusetts.

**TRIANGLE—Diamond Packet!** Free! Approvals. Colonial, Box 326 B, Passaic, N. J.

**FREE!** Big Packet! With Catalog! Stampmart, Box 2071, Hartford 1, Conn.

**FREE.** Scott's International Album, valuable colorful collection, hinges, other big premiums. Full particulars with approvals. Raymax, 123-X William St., N. Y. C. 7.

**"ROOSEVELT with six fingers: Unique Stamp** free to approval applicants. Apex Stamps, Box 2188, Miami 13, Florida."

1c EACH and Less! Thousands of Bargains! Cole, 43-G Rinewalt, Buffalo 21, N. Y.

**FIVE Triangles Free** to Approval Applicants. Caribbean, Box 498, Miami 42, Fla.

U. S., Canada, Newfoundland, Mexico: "Gold Nugget approvals." Nothing like them! Write today. 312 mixed U. S. only 10c. Kessel's, Folsom, California.

1050 DIFFERENT Stamps given to approval applicants becoming customers. Send 3c for particulars, lists and approvals. Bryson Stamp Company, Drawer F-30, Rossford, Ohio.

**FREE Gigantic, Beautiful, Mint U. S. George Rogers Clark commemorative stamp** to approval applicants, Mohawk, Box 524, Albany, N. Y.

**FREE 6 Ionian Island Stamps** request approvals. WBPS, Box 28, Wilkes Barre, Penna.

35 UNUSED U. S. commemoratives, including Bicentennials, Famous Americans, Roosevelts, and others: \$1.00 to approval applicants. Milton Skinner, 438 Locust, Long Beach 12, California.

**FREE!** Tiny Chinese "Midget" War set. Approvals. Seminole, Leeds 10, Ala.

**FREE!** Complete Balkan aviation set with approvals. Beaman, Leeds 10, Ala.

**OLD, scarce U. S. seconds** on approval. Slightly defective bargain prices. Hearnfeld, Clintonhill Station, Newark 8, N. J.

**BIG Bargain Stock!** General Approvals. Peterson, Box 31, St. Paul 2, Minn.

**WHOLESALE lists** to dealers, 3c postage. Grossman, 106 West 42nd, New York 18.

45 DIFFERENT Netherlands 5c to approval applicants. Howard Laquerre, Camden 3, New York.

**FREE "Stamp Finder"**. Tells instantly country to which any stamp belongs, 36 pages profusely illustrated. Garcelon, Calais 18, Maine.

**ATOMIC Bomb Airmail!** and 100 different from War-torn China! 10c to approval applicants. Star Stamps, Jamestown, N. Y.

**PACKETS!** Free list. Colony Stamp Service, 126-C North Main, Waterbury, Connecticut.

**PENNY Approval Bargains!** (.....) Write Department PSM, 126 7 Tutwiler, Memphis 7, Tennessee.

100 DIFFERENT World-Wide, 5c. Approvals. Stearns, 26970-C Princeton, Inkster, Michigan.

**ABSOLUTELY Free** — Gilbert, Ellice, Cook Islands, Tonga, Seychelles, Ascensions—free to approval applicants. Viking, 130-P Clinton St., Brooklyn, N. Y.

**GENUINE "Goya Nude"** set (Catalogs 55c) 15c. Approvals. Royal Stamp Company, Tamaqua 2, Penna.

307 ALL Different 10c. Beautiful collection of commemoratives, Triangles, High Values, Bicolored Stamps, etc., only 10c. Garcelon, Box 418, Calais, Maine.

**WONDERFUL Offer** 7 complete Mint Sets Manchukuo, Bohemia & Moravia for only 10c with approvals. Reich Stamp Co., 4647 Kenmore, Chicago 40, Ill., Dept. S23.

**A REAL Roosevelt bargain.** No stamps are more attractive, none are more popular than the famous Roosevelt issues by 17 different countries. We have them all for approvals and will send the complete Roosevelt issue of Honduras, the complete Roosevelt issue of Cuba, The Nicaragua bi-colored Roosevelt, and the Monaco Roosevelt triangle, all for only 10c to approval applicants. Please state whether approvals shall consist of U. S. or foreign stamps or both. Globus Stamp Company, 266 Fourth Avenue, New York 10, N. Y., Dept. 224.

**TASMANIA included!** Stamps from forty countries 10c. No approvals. Elzea, Bowling Green, Ohio.

**SCARCE Bahawalpur Jubilee Set** free to approval buyers. Plymouth F3, Bell, Calif.

110 DIFFERENT Hitlers, Roosevelt, Liberia, Vatican, Etc. 10c. Buckey, PS-208 Ludlow Bldg., Dayton 2, Ohio.

25 DIFF. 19th Century, given to approval applicants. Rossom, 218 West 59th St., Chicago 21, Ill.

**ALBUM, 100 Stamps, Premiums—20c.** Box 6618, Northeast, Kansas City, Mo.

50 DIFFERENT U. S. 10c. No approvals. Price list free. Seidenberg, Cassopolis, Mich.



# POPULAR SCIENCE OPPORTUNITIES

500 Mixed Stamps and Surprise Packet for 10c. with approvals. Fahsing, Dept. PS. Topanga, California.

U. S. 797 SPA Sheet only 5c to applicants for U. S. approvals. M. Haycock, 333-86th St., Brooklyn, N. Y.

STAMP Magazine! Copy free! "Stamp Post." South Catalina, Pasadena 1, Calif.

UNITED STATES approvals complete coverage fine quality, attractive prices. Seminole Stamps, Box 1138-S, Coral Gables, Florida.

1000 World Wide 67c; Pacific, P. O. Box 5704, Los Angeles, Cal.

PAYING High Prices for Approvals? If your collection numbers under 15,000 try our 1c and 2c approvals. In books of 1,000 different. Lots to choose from at lowest prices. Also special offer to customers. Clark, Box 544-U, Muskegon, Michigan.

51 DIFFERENT Greece and Albania 10c. Jumbo. approvals. Chase, 1026 Walker Ave., Oakland 10, Calif.

25 DIFFERENT stamps 10c. F. Tunis, Wakeman Ave., Newark 4, N. J.

DJIBOUTI Steam Locomotive, Chinese Hunger Stamps, Angola, Seychelles. 100 fascinating others. 10c. Approvals. Atlas Stamps, 4220 West 16th, Little Rock, Ark.

INTERESTING Premium Free with approvals. Niagara Stamps, Niagara-On-Lake 12, Canada.

AMAZING "Queer Countries" Packet—Free with approvals! Saxon, Escondido, California.

FREE Sample Interesting Stamp collectors weekly. Southern Philatelist, Miami 35, Florida.

FREE! U. S. Lincoln Memorial to approval applicants. Litten, 318A North Fifth Avenue, Maywood, Illinois.

LIBERIAN Triangulars, 10c with approvals. Vargo Stamps, 6044 South Fairfield, Chicago 29, Illinois.

WORLDWIDE, 500 different 25c. Unique approvals. Niagara Stamps, Niagara-On-Lake 13, Canada.

TRY My Approvals by countries once. Henry Bardsley, Roslyn, Penna.

FREE Watermark Detector and Perforation Gauge with U. S. Approvals. Manning, 3259 Decatur Ave., New York 67, N. Y.

FREE Stamps, U. S. Foreign Lists. Schneider, Route 3, Box 555, McHenry, Ill.

PENNY Pictorials, Airs, commemoratives. Also advanced material. Sunny South Stamps, 1267 Tutwiler, Memphis 7, Tennessee.

NEED help in your hobby? Trade ideas with fellow hobbyists. Big mailing list, \$1.00. State your hobby. Hobby Clearinghouse, P. O. Box 541, Indianapolis, Ind.

U. S. Catalogue Free. S. Stone, Box 52-S, Dorchester, Boston 24, Mass.

## 42 HOBBIES, COLLECTIONS

50 DIFFERENT army embroidered patches \$1. Other bargains. Insignia Mart, 703B Broadway, New York 3, New York.

WANTED Old cigarette cards. Write Charles Bray, East Bangor, Penn.

UNPAINTED plaster ornaments. Loxite for moulds. Free literature. Midwest Novelty, Box 788-B, Anaconda, Montana.

UNUSED matchbook covers—100 different \$1.00—Catalog 10c—Charles Edelman, 1311P East 84, Cleveland 3, Ohio.

DRUM Majorettes, 10 Different 3x5 Inch Glossy Snapshots \$1.00. Frederick Forman, 868 Lorimer, Brooklyn 22, N. Y.

POSTCARDS Your Hobby? Lists, Samples Quarter, Wilkins, 417 Hill, London, Canada.

## 44 ANTIQUES, RELICS, INDIAN GOODS

ANTIQUA Guns—Pistols and Revolvers for beginning collectors. 10c for list. Hi-Fulton Gun Corner, 413 S. High Street, Dept. 9, Columbus, Ohio.

SELLING 400 Historical Firearms. 20,000 Indian Relics, Coins, Confederate Currency, Gold Dollars, Collectors Cartridges, Kentucky Rifles, Civilwar Muskets, Carbines, Swords, Bayonets, Ramrods, Powder flasks, Pistols, Holsters, Percussion Caps, Flintlocks, Bullet molds, Stagecoach Carbines, Powderhorns, Blunderbusses, Steerhorns, Blo-horns, Bo-Wood, Mounted Pheasants, Owls, Squirrels.—Agates, Minerals, Fossils.—Arrowheads, Tomahawks, Gempoints, Spearheads, Bannerstones, Wampum. Profusely Illustrated catalog 35c. Heike, Wenona 42, Ill.

## 46 MINERALS & PRECIOUS STONES

"GENUINE" deep red Arizona Rubies (Garnets). Send quarter for packet. Bitners, Box 2651, Phoenix, Arizona.

FOUR one inch Mineral Specimens, Labeled, Mo., Kans., Okla. mines. Post Paid, Dollar Bill, Boodle, Galena, Kansas.

AUSTRALIAN Opals Worlds Best Multi-Colored Gems. 8 x 10mm \$1.00, 12 x 16mm \$3.00, 14 x 24mm \$10.00. Woodrow Oldfield, 11 Cherry Road, Balwyn, Victoria, Australia.

GEMSTONES, Mineral specimens, Every variety. Lowest prices. Postcard brings free booklet. Plummer's, 2183D Bacon, San Diego 7, Calif.

GEMS, precious and semi-precious, all genuine from world wide sources. Deal direct, no overhead, save money. Catalog 10c. Hill Co., Route 7-K, Salem, Oregon.

## 47 CAMERAS, PHOTO SUPPLIES

BASS Says: Bargaingram 257 ready and waiting for you. The book which tells all the finest in new and used camera equipment, a veritable encyclopedia. Write, phone or call the sign of the old "Horse Trader". 39th year of satisfaction or your money back dealing. Bass buys, sells and trades. Bass Camera Company, Dept. AG, 179 W. Madison St., Chicago 2.

FREE Photographic Bargain Book packed with hundreds of sensational values in still and movie cameras, lenses and latest accessories. Super savings for you in new and used equipment. Liberal trade-in allowances, too, on your equipment. Write now for your free copy to Central Camera Company, Dept. 11-C, 230 S. Wabash Ave., Chicago 4 (Photographic Headquarters Since 1899).

ENLARGERS, all sizes, lowest prices. Booklet "B" Free. J. B. Photo, 41-09 19th Ave., L. I. City, N. Y.

KODACHROME Slides On Approval. Death Valley, Yellowstone, Glacier, Grand Canyon, Etc. Douglas Whiteside, Yosemite, Calif.

MESTONS Travels Color Slides, eight only \$1.95. Free List. 2818 N. Piedras, El Paso, Texas.

## 48 PHOTO FINISHING

YOUR 8 exp. roll with 3 prints each good negative 45c. 2 each good negative 35c. One each good negative 25c. Reprints 3c. A few cents postage appreciated. L. A. Eastman, Bode, Iowa.

OIL coloring photographs can be a fascinating hobby or profitable sideline for those with artistic talent. Learn at home. Easy simplified method. Send for free booklet. National Photo Coloring School, 1315 Michigan, Dept. 1722, Chicago 5, Ill.

EKTACHROME, Ansco Color—expert processing from Hollywood. For money saving offer write: Atkinson Laboratory, 7273 Santa Monica Blvd., Dept. PS-2, Hollywood, Calif.

THE Photo Mill. Immediate service! No delay! Eight exposure roll developed and printed for 30c plus valuable coupon for eight reprints, four jumbos or two 5x7 enlargements for a slight additional charge. Film developed and jumbo prints 35c. The Photo Mill, Dept. O, 1511 Hannepin, Minneapolis, Minnesota.

ENLARGEMENTS 5x7 double weight, silk finish. 6 for \$1.00. Rudy Leefama, 375 Riverside Drive, New York 25.

8 BEAUTIFUL Double Size pictures and roll developed 30c. 8 hour service. Free Mailers. Pacific Photo Service, Box 666, San Francisco, Calif.

"SPECIAL"! Five quality 8x10 Enlargements \$1.00. Surgals, 3300 Beach, Chicago, Ill.

## 50 PHOTOPRINTS, PHOTOCOPIES

PHOTOCOPY anything yourself, Papers, books. No darkroom. 8½ x 11" complete. \$6.95. Fotoflek, 4801 Yarmouth Place, Cincinnati 29, Ohio.

GIRL Photos Set \$2.00. Sample 25c. Box 216, Herkimer, N. Y.

## 51 MOTION PICTURES, SOUND EQUIPMENT

BASS Says: 39 years of leadership guarantees satisfaction. Finest Cine equipment. 8mm., 16mm., and 35mm., silent and sound. Write the old "Horse Trader". Satisfaction or your money back always! Bass Camera Company, Dept. A., 179 W. Madison St., Chicago 2.

ORIGINAL Party Films and Records. Adult Entertainment. Details, interesting offers dime. Alberts, Dept. P, 6369 De Longpre Ave., Hollywood 28, Calif.

MOVIES—Black and White, Color, Sound or Silent; \$1.00 up. Large selection includes famous Disney Cartoons. Write laboratory for Free catalog. (State 8mm, 16mm or Sound). Hollywood Films, 6060-L Sunset Boulevard, Hollywood 28, California.

8-16MM. Silent-sound films. Complete rental library. All latest subjects. Free catalogue, (sample film 10c). Garden Film, 317 West 50th, New York 19.

SPECIAL movies for your private showings. 100 ft. 8mm \$5.50; 16mm \$6.00, sound available. Free list. Tasco Supply Co., P. O. Box 6, North Station, Providence, Rhode Island.

PARTY Films! 100 ft. 8mm \$5.50; 16mm \$6.00, sound available. Free list. Helene Dist. Co., 182 Peace St., Providence, R. I.

BETTER 8mm and 16mm Movie Camera Film. Free Equipment Catalog. Better Films, 742 New Lots, Brooklyn 7, N. Y.

GUARANTEED fresh anti-halo outdoor movie film! Weston 16! Daylight loading! Processing free! Three spools double 8mm, \$4.50! Six single 8mm for Univex, \$4.60! Postpaid! Catalog. Filmcraft, 47th Holly, Kansas City 2, Missouri.

RENT 16 mm, sound films 50c reel. Large selection; free catalog. U. C. Film Service, 128 Chestnut St., Roselle Park, N. J.

SUNSHINE and health Films available in 8mm and 16mm. Tel-A-Film Co., 935 Cincinnati St., Dayton, Ohio.

EXCLUSIVE listings free! Over 200 exciting 8-16mm party subjects. Bargain priced! Airmail stamp brings it! Lenscraft Corp., Dept. PS, 3105 Oakland Avenue, Dallas, Texas.

LEARN movie projection management. Free Catalog. Theatre School, Elmira, N. Y.

BIGGEST 16mm, sound film bargain! Twelve good used 100' "Soundies" musicals, \$9.95 plus postage. Hundreds of titles available at \$1.49 each. Write for our big list. Blackhawk Films, Davenport, Iowa.

BETTER 8mm and 16mm Movie Camera Film. Free Equipment Catalog. Better Films, 742 New Lots, Brooklyn 7, N. Y.

FILMS for you used or new. Free catalog. Pix, 6411S Hollywood Blvd., Hollywood 28, California.

ADULT entertainment, new. (Catalogue E). Trophy, #27 Valley Village Station, North Hollywood, California.

ART model films 16mm rentals exclusively, adults list. Enclose stamp. Revere Films, Box 1051, Detroit 31, Mich.

16MM Sound \$3.95 reel up. Waverly, 5707-P So. Christiana, Chicago 29.

FILM—Free processing 100 ft. 16mm Weston 12 \$3.25. Weston 24 \$4.90. Weston 64 \$4.95. 25 ft. double 8mm Weston 12 \$1.50. Weston 24 \$1.89. Weston 64 \$1.99. Free circulars. Fromader Genera, Davenport 1, Iowa.

"GLAMOROUS Exciting Stars." Five gorgeous Model Stars. For this wonderful movie (and Free List) send only \$1.00. State if projector 8-16mm, Sound or Silent. Virginia Rounds, 5423 Lexington Ave., Hollywood, California.



"OUT of This World"! Most Thrilling dances ever filmed. State if projector 8-16mm. Silent, Sound, and send just one dollar for this rare subject to Fred Garcia, 12061 Neenach St., Sun Valley, California.

**SUPER** Special Hollywood Glamour Movies for the connoisseur of the unusual. "Happy New Year", "Snow Girl", "Fighting Females", each 8mm \$2.75, 16mm \$6.00. Two-color brochure of unique 8-16mm silent-sound subjects, plus sample film strip, 10c. Film strip viewer, \$1.00. Camera Corner, 391 Bridge Street, Room 126, Brooklyn 1, N. Y. (Tel. Main 5-3553).

**PROCESS** Your Own Movie Film. Easy Instructions. Formulae, 25c. Superior Bulk Film Co., 103 S. Wells St., Chicago 6, Ill.

**LUSCIOUS** Art Models! Roaring Westerns! Hilarious comedies! Mammoth 8-16mm catalog, samples—10c. Fabulous Films, 6419 San Vicente, Los Angeles 48-B, California.

**MOVIES** for your gay gatherings, 8mm-16mm, color, black and white. Send self addressed stamped envelope. Cornell Enterprises, 7070B Hollywood Blvd., Hollywood 28, California.

**FREE** Movie Catalog; samples 10c. Films Now half price. Goodwill Company, Jackson, Tennessee.

**16MM** Film Duplicating Machines \$76.50; copy favorite films. Electric cameras (16mm) \$49.50. MK Photo, 451 Continental, Detroit 14, Mich.

## 52 MUSIC, MUSICAL INSTRUMENTS

**HILLBILLY**, Polka, Popular Records—12c up. Guaranteed. Collectors. Giant catalog 3c. F. L., Box 19-S, N. Y. 35, N. Y.

**PHONOGRAPH** Records 15c. Catalogue. Paramount, TF-313 East Market, Wilkes-Barre, Pa.

**\$1.00 RECORDS** your song! Send music. Urab-E, 245 West 34th, N. Y. 1.

## 53 SONG WRITERS

**SONGWRITERS**—Honest, Outstanding Music writing offer. Len-Tex Studios, Leonard, Texas.

**POEMS** Wanted. Splendid offer! Rush! Radio Composers, WPSJ, Clinton, N. C.

**SONG** Poems set to music. For details send poems and inquiries to Dept. P, Broadway Music Service, 1674 Broadway, New York 19, N. Y.

**SONGWRITERS!** Outstanding ethical offer. Hibbeler, C-15, 2157 N. Avers, Chicago 47.

**SONGS** arranged for piano, orchestra. Music, lyrics composed. Free information "Songstylings," 52 So. First St., Meriden, Conn.

## 54 RADIOS, SUPPLIES & EQUIPMENT

**MAKE** Simple. Tubeless. Batteryless. Distance-Getting Crystal Radios. Crystal and illustrated instructions 25c postpaid. Allen, 427-s, Clinton, Mo.

**MAKE** your own tubeless, batteryless Crystal Radios. Crystal and instructions for two sets, 25c postpaid. J. Banas, R. 3, Skaneateles, N. Y.

**X-TRA** Long Distance Radio Crystals. Reception of hundreds of miles. Guaranteed. Complete with instructions, 25c. D-X500, Box 201, Marshall, Mo.

**FIX** any radio. Amazing new instrument locates radio troubles double quick. Simple instructions show you how. Thousands now in use. Free—Write today for 32-page illustrated technical manual, "The Inside Story". Feiler Engineering Co., Dept. 3PS5, 1601 S. Federal St., Chicago 16, Ill.

**24 PAGE** plans "18 Crystal Sets" (SW Record 5800 miles). "Radiobuilder" and catalog—25c. Laboratories, 578-T, San Carlos, California.

**FREE** Radio Parts Dictionary. Telegraph Code Instructions and catalog of kits priced from 90c. Build your own receivers, transmitters, test equipment with our easy-to-assemble Pict-O-Graph instructions. Write today! Electronic Kit Co., 326B Park Row Bldg., N. Y. 7.

## 56 BUSINESS OPPORTUNITIES

**CASH** For your idea. 280 manufacturers need inventions, patented or unpatented. List free. Invention Bureau, 208-S Clinton, Oak Park, Illinois.

**RECAST** old batteries into new. Latest achievements. Battery Laboratories, Minneapolis.

**MAKE** Money spare or full time, casting Metal Toys and Novelties. Big Wholesale and chain store demand for cast Metal Autos, Soldiers, Ashtrays, Bands, etc. Keeps manufacturers busy. Production moulds furnished for up to 100 and more casting per hour. No experience or special place necessary. Write for full information and illustrations of patterns needed. Metal Cast Products Co., Dept. E, 1696 Boston Road, New York 60, N. Y.

**GOOD** Paying Business Silvering mirrors, plating autoparts, reflectors, bicycles, bathroom fixtures, etc., by late methods. No tanks or shop required, outfit furnished. Free Booklet. Gunmetal Co., Ave. E, Decatur, Illinois.

**MAKE** money addressing envelopes. Our instructions reveal how. Glen Glenway, 5713 Euclid, Cleveland 3, Ohio.

**EXTRA** Money—No selling—operate vendors. Amazing profits, details Free. Silver King, Suite 282, 622 Diversey, Chicago 14.

**OPERATE** profitable mail order business. Write Walter Service, 4159-B East 112th, Cleveland 5, Ohio.

**A FACTORY** in your home garage! Mfg. and sales rights, mechanics' waterless hand cleaner, \$500-\$800 monthly. No special equipment necessary. Formula free. Western Aircraft Mfg., Dept. G, Los Angeles 6, Calif.

**I MAKE** big money in the mail-order business. You can do the same at home with copyrighted system. Write me. I'll tell you how. F. Little, RD # 1, Glenshaw, Pa.

**ENVELOPES** addressed accurately, reasonably. Fast Service. We have capable addressers in your city. Glenway System, 5713-Z Euclid, Cleveland 3, Ohio.

**EARN** Money At Home With Your Typewriter! Spare time! Details free. Edwards, Publisher, 3915-PS, 12th, Des Moines 13, Iowa.

**BIG** money. Spare or full time in your home. No Selling! Spray New Miracle Finishes. Plush and Suede, on signs, radios, automobiles, figurines, lamps, toys, etc. Our business is booming. Help us fill huge demand. Cash in now on Big Christmas orders. New easy Flok-Kraft methods. Material costs few pennies. You get dollars. Free samples, complete powerful money making plan free. Write now! Coast, 1008 S. Los Angeles St., Los Angeles 15.

**POPCORN** Equipment, Potato Chip Outfits, Long Eakins Company, 5063 High, Springfield 99, Ohio.

**\$25 WEEKLY** working two hours daily. No canvassing. No Manufacturing. Lycke, Box 2471-B, Cleveland 12, Ohio.

**EXPERIENCE** Unnecessary. Earn \$300 month spare time sales and rental America's leading small tractor. Protected territory. Write Tiger Tractor, Fort Lee 2, N. J.

**EARN** at home, casting novelties. Free course using latex molds. Major Chemical Co., 164 Portland St., Cambridge 39, Mass.

"How to start a successful mail order Business." The guide to sound, profitable mail merchandising. 25c. Manhattan House, 126-R Lexington, New York 16.

**MANUFACTURE** Camera at home. Experience unnecessary. Taylor, 4015 Oketo, Chicago 34.

**YOUR** own profitable home business. Preserve live flowers to last forever. Spare or full time. New discovery—simple—fascinating. No experience necessary. Send \$2.00 for working equipment, instructions and valuable sales plans. Satisfaction guaranteed or money refunded. Hermansen, 210 Fifth Ave., Suite 1102, New York 10, N. Y.

**DECORATE** discarded furniture and tinware for Home or Profit. Free Details. Stewart's Budgetwater, Mass.

**MAKE** flexible molds! Cast plaques, novelties, bookends! Free sample! H. Tooker, Hamilton 7, Ohio.

**MOLDING** Rubber for Hobbyists, Industry. Classroom Projects! Flexible Molds easily made from the best Quick-Drying White Liquid Rubber! (Gallon—\$7.95; Quart—\$2.95; Sample Half-Pint \$1.00) Prepaid Parcel Post! Plastercraft Supply Co., 3051 St. Clair Ave., Cleveland 14, Ohio.

**LIQUID** Rubber, make flexible molds. Free Sample. Chaney, 1130 E. 16th St., Jacksonville 6, Fla.

**WANT** a Mailorder business? Avoid mistakes by reading "Mailorder Pitfalls." Send for free circular. Better Sales Co., 2139 Clifton, Cincinnati, Ohio.

**ELECTRICALLY** Inclined? Make \$100-250 weekly installing, maintaining fluorescent lighting. Make beautiful lights for 50c each. Exclusive, inexpensive, illustrated instructions enables you to cash in on this fast growing industry. Request impressive evidence on this proven business opportunity. Wilber Distin "Fluorescent" 712-B, State Tower Bldg., Syracuse 2, N. Y.

**TRADE** Magazines help you get ahead. Latest copies. More than 1150 covering every trade, business or interest available through our easy-to-get-acquainted service. Full particulars and price-list free. Commercial Engraving Publishing Co., 34S North Ritter, Indianapolis 19, Indiana.

**COLOR** Concrete with chemicals. Glazed cement pottery. Garden ornaments. Stucco—rock walls. Dime brings sample pictures. Hollywood Cementcraft, 8527-B Wonderland, Hollywood 46, California.

**HOW** To Set Up and Run a Mirror Shop! Resilver Mirrors. Make chipped glass nameplates. Electroplating Salts and Rectifiers. John Sprinkle, V 90, Marion, Indiana.

**MAKE** Rich Profits selling by mail. "Natural" money-makers revealed! Edward Lay, 3819 Kenmore, Chicago 13.

**MAKE** money making new greaseless doughnuts at home on electric machine. Wholesale to grocers, drug stores, cafes, hamburger shops. Send for free recipes and plans. S. Ray Company, 3605 South 15 Ave., Minneapolis 7, Minnesota.

**BOOKKEEPERS** earn \$100.00 week operating your "Bookkeeping Service". Simplified plan. Information free. Bookkeeping Service, Box 664-P, Springfield, Mo.

**BIG** Money Regraining-Refinishing Automobile Dashboards—Garnish Mouldings. Write Outman, 4323 So. 38th, St. Louis.

**AGENCY** Available! Big Profits—Steady repeats! "Getzol" Hand Cleanser. Instantly removes all types dirt without water. Merely rub on—wipe off! Free sample, sales plan, proposition. Goetz Petro-Chemical Co., Buffalo 14, N. Y.

**PROFITABLE** Importing, Exporting. Hundreds overseas Manufacturers seeking United States representatives, experience unnecessary, list \$1. Stout 35E, Pasadena 8, California.

**LIKE** to Make Extra Income at Home? Proven Mailorder Plans Show How. Free Details. Perry Publications, Wenatchee 2, Washington.

**ELECTROPLATE** on non-metallics. Instructions \$1.00. Four ampere plater \$19.95. Eight ampere \$29.95. 30 ampere \$85.00. Kissel Electric Products, 431 Sherman, Galion, Ohio.

**EARN** Money by mail with my plan. Free details. Satterfield, Box 345-D, Mansfield, Arkansas.

**BRONZED** Baby Shoe mountings, equipment and supplies. We manufacture world's largest assortment of all metal mountings. Wholesale only. Ramyr selenium platers \$49.50. Complete baby shoe plating assemblies low as \$59.50. Write for Free copy of electroplating instructions. Sales Dept., Hollywood Bronze Supply, 1766-70 N. Vermont Ave., Hollywood 27, Calif.

**EARN** money at home: full, part time. Publ. Box 2160, Seattle 11, Wash.

**FIX** Typewriters, full or part time. Inexpensive copyrighted home study course quickly trains you for high earnings. Factory methods cover all phases with drawings and illustrations. No curiosity seekers. Typewriter Repair, Building One, Tarentum, Pennsylvania.

**CANDLEMAKING** is profitable! Detailed instruction manual \$1.00. Particulars free. Robins, 88 Sylvan Lake, Mundelein, Illinois.

**\$4,000.00 PROFIT** in two months. No investment. Instructions 50c. Charles, 12-BAK, Norwood, Ohio.

**SAWDUST**. Turn it into cash. Six methods. Instructions 25c. Charles, 12-BAF, Norwood, Ohio.

**CLINTON** powered mowers, 40% Mark-Up. Delivered. World's cheapest. Rotacut, R-2031, Excelsior Springs, Missouri.

**TRAVEL** and Earn. Travel any where, any time. Earn as you go. Get book, 10 ways to travel and make money. \$1.00 postpaid. Vail Publication, LaGrange 1, Ind.



MILLION Articles Wholesale. "Supply Source Directory" 10c. Publisher's, Box 1302, Detroit 31.

RAISE tadpoles and frogs for pleasure, profit. Free booklet. Specialties, Whiting 4, Indiana.

MAKE Perfume, Men, Women Write Carey Laboratories, 1914 Chouteau PS 3, St. Louis 3, Missouri.

START Mailorder Bookshop—Everything furnished. 25c brings booklet, samples, exciting ideas. General Publications, Ossining 1, New York.

HOW and where to obtain Capital? Free details. Star Service, Wapakoneta, Ohio.

COLORGLAZED Concrete Pottery made without molds. Patented method. Cemetery products, novelties, tiles. Basement leak-sealing. Money-making projects. Booklet, details free. Men only. National Potteries, Grand Rapids, Mich.

PIANO Tuning—Home Study—(15th year). Empire School, Champaign, Illinois.

LEATHER Carving. Fascinating, highly-paid art; age-old secrets now taught by first time in home study course. For hobby, profession or profitable business, write; Baird School of Leather Carving, Box 1367-K, Manitou Springs, Colo.

WHERE to buy 500,000 articles wholesale. Details free. Krueger, 3418B Wolcott, Chicago 13.

WOULD you pay 3%—first \$350 made? Booklet "505 Odd, Successful Enterprises" free! Work home. Expect something odd! Pacific B, Oceanside, Calif.

\$46 FROM Square Foot Plywood; Jigsaw necessary. Write; Woodart, Bridgewater, Massachusetts.

NEW. Proved methods get money by mail. Amazing, eye-opening. Details free. Lexington Mail, 5538-B Lexington, Chicago 44.

MAILING postcards selling repeat merchandise is profitable. Everything supplied. Details free. Gordon Publishers, Box 23, Pawtucket, R. I.

REAL money making opportunity making Interlocking Concrete building blocks. Rex Products Co., Dept. 21, Piqua, Ohio.

HOME Book Shop Opportunity—Get orders by mail. New! Different plan!—Big profits. Everything furnished. National, Box 88-J, Dorchester, Mass.

BE an invisible Re-Weaver—learn profitable trade—earn over \$20 daily, full or part time—repair cuts, tears, burns in clothing or any fabric so damage can not be seen. Big demand, big profit, uncrowded field. Complete low-cost home-study course includes lifetime equipment. Easy-to-learn, pay as you earn, can mean income for rest of your life. Details free. Fabricon, Dept. K, 8342 S. Prairie Ave., Chicago 19, Ill.

AMAZING new book "The Real Truth About The Mail Order Business" exposes the crooks, the petty schemes, tells you how to start. Free information. Ralph A. Long, 208 W. Broad St., Tamaqua 8, Penna.

MEN have succeeded selling shoes who believed they could not sell. Free Selling Outfit puts you in secure business. Consolidated Shoe System, Dept. S-550, Chipewala Falls, Wis.

MAKE Men's and Ladies' plastic wallets. Earn Sparetime profits. Details free. Lakeshore Supply, Dept. PS 3, 534 Surf St., Chicago 14, Ill.

SPIN Angora Wool into beautiful yarn at home. Easy enjoyable work. House of Angora, PSM, Springfield, Illinois.

YOUR own Plastic Business at home. Produce costume jewelry, novelties, statuettes. Liquid plastic, liquid marble. Flexible molds. Write for free book. American Trades, Box 1473-R, Cincinnati 1, Ohio.

SELL by Mail. Right from your home. Everything furnished. Free circular. Write Chas. J. Sprusil, 97-42 43 Ave., Corona, L. I. N. Y.

PIANO Tuning taught by mail. Write Piano Technician, 708 Rawlings, Carbondale, Illinois.

ELECTRICALLY inclined men. Average \$45 weekly for few hours spare-time work. Many opportunities. Write Manhattan, Box 6, New York 35, New York, Dept. PS.

NEW patented screw-holding drivers! Remove, insert screws inaccessible places; factories, garages, stores buy quantities; big profits, exclusive distributor: Toolco, 409 Summit, Brookline, Mass.

SLOT Machines, Punchboards. Wholesale Catalog. Webb Distributing Co., 4966 West Chicago Ave., Chicago 51, Ill.

"HOW to build your own Mail Order business" Idea booklet for beginners. Mail Dealers tells how to use tested, workable, profitable plans. Send 25c and "Know How." Satisfaction guaranteed. Ludecke, 5809-A Franklin Ave., Hollywood, Calif.

SENSATIONAL nylons guaranteed against runs. Nationally advertised. Not sold in stores. No experience or money needed. Also lingerie, robes, men's hosiery, Outfit, samples, etc. free. Wonderful opportunity earn big money spare or full time. See our full page advertisement on page 71. Kendex Co., Babylon 749, N. Y.

RUBACREAM! Natural latex cream! Makes molds quicker! Thicker! Free sample convinces! Castcraft Studios, 2027-S Fulton Street, Brooklyn 33, N. Y.

ASSEMBLE Swiss musical churches. Complete kit \$3.95. Piltzecker Swiss Imports, Wood-Ridge, N. J.

BUY Wholesale, Big-Name Items Up To 40% Below Retail. Folks Eagerly Buy Through You To Get Big Savings. Details Free. Young's, Kent 2, Ohio.

## 57 MONEY MAKING OPPORTUNITIES

DETECTIVES Earn Big Money. Experience unnecessary. Particulars free. Waggoner, P-125, West 86th, N. Y., N. Y.

SCHOOL Seniors—Earn 40% commission selling classmates America's Most Beautiful Graduation Name Cards. Largest selection. Outsells all others. Free sample kit. Printcraft, Dept. M, 1425 E. Elm Street, Scranton 5, Pa.

SEWING Machine Business Tops. Big money—not crowded. Spare time home set-up. Repair course, new machines, motors, etc. wholesale. Hurry. Taylor Service, PS, Hamilton, Ohio.

RAISE Ginseng. Roots Bring Fortunes. Circular. Fezler Seed Company, Patchogue, New York.

OPERATE concessions at carnivals, shows, fairs. Free details. Stampico, Detroit 4, Mich.

"OPPORTUNITIES Preferred Magazine" tells how. Sample 25c. Glen, Howel 5, Kentucky.

GET your copy of the new 1950 edition of the official Concessionaires Guidebook. 76 Pages, jam-packed with money making formulas, M.O. ideas, games and equipment for concessions, roadside stands, carnivals, etc. Send \$1.00 to: Concessionaires Guidebook, Station H Zone 13A Toledo 6, Ohio.

WIN Contest Money. General Contest Bulletin gives hundreds of tips. Lists current contests and rules. Sample 25c. General Contests, 1609-A East 5th, Duluth, Minnesota.

ALASKA Highway offers thousands jobs—opportunities. Complete information 15,000 fact-packed words. Postpaid \$1.00 cash. Guide, Box 142, North Battleford, Canada.

URANIUM: What, where, when, how. An exhaustive bibliography including most recent publications covering entire field for the prospector. \$2.00. Source Research, 2006 4th, San Fernando, Calif.

IT'S smart to have two incomes. Start a coin machine business. Spare time. Big proven, profitable field. Few dollars starts you. Folder Free. Kenneth Fleck, Columbia City 3, Indiana.

CHURCHES Women's Clubs organizations \$130.00 Free. Plus card table. Easy No investments. You sell advertisements. Unique Gift Club Plan, Pine Hill, N. J.

NEW way. Earn \$50 weekly at home. Free literature. "Dollar-a-Month Plan," 5236-B, Phila. 26, Pa.

WOULD You pay 3%—first \$350 made? Booklet "505 Odd, Successful Enterprises" free. Expect something odd! Pacific B, Oceanside, Calif.

HAVE your own big-money business! Others are making up to \$500 monthly in waterproofing and cement painting. Let me prove you may do as well! Few dollars starts you. Interesting facts free. Write today! Edgar W. Thomas, Barnesville 1, O.

WANT Notary Public appointment? Official in usually 10 days. Stationers Exchange, Boerne 50, Texas.

A \$100-A-Month hobby at home! No soliciting, no mail order, no meeting people. Easy enjoyable pastime. Details. 25c (Refundable). Laura Dickson, 1006-PS Elizabeth Street, Anderson, S. C.

MEN-Women—"Everybody Likes Candy." Learn to make professionally. Details free. (Our 40th year.) Ragsdale Candies, D10, East Orange, New Jersey.

ADDRESS. Mail circulars for advertisers. Complete instructions—list of firms—25c. Imperial, PS-3, Wilmington, N. Car.

EARN money at Home! Amazing lesson tells how. Sample 25c. Write Income Builders, Hollywood 508, Calif.

EARN money evenings, copying and duplicating comic cartoons for advertisers. Adservice, Aigyle 2, Wisconsin.

"URANIUM—is currently the world's most-prized material. Full particulars Free. Write Sharpe, Prospector, Box 142, North Battleford, Canada."

SEND Postcard for "1001 Ways to Make Money." 1001 Opportunities Club, Dept. "S." 1495 Westchester Ave., New York 59.

MALE Help Wanted! Everywhere! Earn \$4.00 for 10 minutes work! "Amazing." Send Dime for details. Stephens, 901 South Avenue, Grand Junction, Colorado.

MAKE \$4 to \$6 an hour filing Saws indoor or outdoor. Entirely new method. Instructions how to file saws free. A. Zaport, 586 Manhattan Avenue, Brooklyn 22, N. Y.

## 58 FORMULAS, PLANS, ETC.

NEW method of joining elements such as wood, metal, plastics, glass, etc. Eliminates nails, bolts, screws, glue and other fastening devices. Send \$1.00 cash for complete information. Satisfaction guaranteed. W. I. Evans Co., 24 California St., San Francisco, California.

10,000 FORMULAS and trade secrets. Free Literature. Stillmans, 555 Kingston Ave., Brooklyn 3, N. Y.

LABORATORY tested formulas. Lists free. Pont, Box 635-PS, Terre Haute, Ind.

## 59 PLASTICS

PLASTIC supplies, materials, instructions for hobby or business. Send for free catalog. Tells about internal carving. Hays Plastics, 2333 Lincoln Avenue, Alameda, California.

PLASTIC, Sheets, Rods, Tubes, etc. Free List. Plastic Supply Co., 2901 N. Grand Blvd., St. Louis 7, Mo.

LUCITE, Plexiglas. Any size sheets, masked. Square foot (12 x 12) cost, 1/16", 96c; 1/8", \$1.25; 3/16", \$1.52; 1/4", \$1.80. Colors add 10%. Include 10% postage. Almac Plastics, 230 Fifth Avenue, New York 1, N. Y.

INTERNAL Carvers—guaranteed fast cutting, high speed, tapered drills with sharp points that make carving easier. 1/6", 3/32"—\$.80; 1/8"—\$1.00 each postpaid. Send for literature. Bay Sales, Dept. A, 101 Fifth Ave., N. Y. 3, N. Y.

INTERNAL carved roses, orchids, swans, goldfish, butterflies, etc. Jewelry and gifts. Crystal Floral Novelty Co., Bound Brook, New Jersey.

SPECIAL 3 prime Mashed 6" x 12" Plexiglas sheets \$1.25 Postpaid. Carving Drills 1/16" 75c, 1/8" 85c each postpaid. Free Catalogue. Craft Plastics, Somerville, N. J.

EMBED real flowers, butterflies, shells, photos, to make unusual coasters, plaques, tiles, jewelry, buttons, other objects with new liquid plastic. Crystal clear or colors. Saw, Carve, Turn, Drill. Use only home tools. Big, picture-packed manual shows how to make things very first day. Book also explains proved 6-point Success Plan for starting your own profitable Plastics Business. Send 25c for "A Success Plan For You". Castolite, Dept. C-102, Woodstock, Illinois.

WHOLESALE Plastics supply catalog, 10c. Lucite, clear, colored. Metallic Acetate, 15 colors. Thick Lucite cutoffs, polished blanks for carving. Metal findings, tools. Ideas, bargains galore. Quantity prices on Casting Plastic. Gem-O'-Lite, Box 686Y, North Hollywood, Calif.



**PLEXIGLAS**—Write for Free Price List. The Unique Glass Shop, 309 Cowardin Ave., Richmond, Virginia.

**PLASTIC'S** Low Prices, catalog, instruction booklet 25c. Plastic's, Box 1415, Salt Lake City 11, Utah.

## 60 CHEMICALS AND APPARATUS

**NEW Idea Chemical and Apparatus** Outfits for Home Experimenting. Photo-Scales, Microscopes, Chemicals, Biological and Laboratory Supplies in Small Quantities. Catalog 15c. Established 1931. John H. Winn, 124-B West 23rd Street, New York 20, N. Y.

**LUMINOUS** Paints will glow in dark. Six colors. Fairmount Chemical Co., 136 Liberty St., New York City 6.

**NEW Laboratory supply catalog** of Chemicals and Apparatus. Contains many thousands of items with illustrations. Send 25c. Standard Science Supply Company, 1232 N. Paulina St., Chicago 22.

**USEFUL Laboratory item, catalog** of chemicals, laboratory apparatus, 10c. Rex Laboratories, 2849B Birchwood, Chicago 45, Illinois.

**NEW, Used Catalog 10c refundable.** Atlantic Laboratory Supply, 21 Wenham, Boston JP, Mass.

**ILLUSTRATED Catalog:** Chemistry, mineralogy, biology, 10c. Tracey Laboratories, Evanston, Illinois.

**CHEMICALS and apparatus** for industrial, analytical, and private laboratories. Catalog 15c. Dept. M-26, Biological Supply Co., 1176 Mt. Hope Ave., Rochester 7, N. Y.

## 61 HELP WANTED

**IMMEDIATE opening** for reliable man with car to call on farmers. No experience necessary. \$15 to \$20 in a day. Permanent. McNess Company, Dept. 214, Freeport, Ill.

**INTERESTED in Latin American and Foreign Employment???** \$1.00 Brings 1950 Copyrighted "Foreign Service Directory" with new complete listings in US & Canadian Construction Companies; Worldwide Oil Firms, Mining, Aviation, Steamship, Transportation; Manufacturers; Importers & Exporters; Domestic & Foreign Listings. Special Daily Listing of firms hiring. Tells How-When-Where to apply. Application form. Global Reports, P. O. Box 883-S, Hollywood 28, Calif.

**ALASKA—The Great American Frontier** offers unlimited opportunities. \$1.00 brings 1950 Copyrighted Report & Government Map, Business Directory listing Big Construction Projects: Fishing; Mining; Aviation; Hunting—Fishing-Game rules, Fur-Farming, Lumber; Agriculture; Live Stock Raising; Transportation; Homestead & Highway information. Hot list of firms hiring. Alaska Opportunist, P. O. Box 883-S, Hollywood 28, Calif.

**MAKE \$20 a day!** Complete line. Door name plates, knockers, numbers. Hubstamp, 359-B Congress, Boston, Mass.

**JOB Opportunities, Anywhere, U.S.A.** Many vacancies. Housing information. Free particulars. Business Press Services, Baldwinsville, N. Y.

**\$1,000,000 CONSTRUCTION Job Project Report.** \$1.00 brings Monthly News Bulletin giving authentic projects starting "world wide." U.S.A., Alaska, Canada, Pacific, Arabia, Latin America, India, Mexico, Africa, Europe. Tells How-When-Where to apply. Global Reports, P. O. Box 883-PX, Hollywood 28, Calif.

## 62 AGENTS WANTED

**PHOTO-Salesmen-Agents.** Sell beautiful hand-colored plastic enlargements. Collect deposit, we deliver. Profitable sideline. Send card for free sample kit. Novel Portrait Co., 3343-A North Ave., Chicago, Ill.

**SEWING Machine electrification kit.** Nationally advertised. Has Good Housekeeping Guaranty Seal. Can be demonstrated and sold in 5 minutes. Make at least \$5 per sale. For complete details write today to Brownell Distributors, Inc., Dept. PS, 308 Canal St., New York 13, N. Y.

**NYLON, Poplin, Rayon Uniforms, white and colors.** Immediate Delivery, Immediate Profits. Sell to Doctors, Dentists, Nurses, Waitresses, Beauticians, Housewives. Free Sales Kit, Superior Fabrics, Dept. A-1, 3936 Market St., Phila. 4, Pa.

**WHERE To Buy 800,000 articles** direct from Manufacturers. Save by buying direct. Sent Free. "Your Profits Under the Spotlight." Glass Pub. Co., Ellwood City 3, Pennsylvania.

**LOOK! Make money all year round** selling personal initialed individualized belts, buckles, cap badges, tie holders, complete line Police and Firemen's Badges, 2000 emblems to choose. Big profits, whole or part time. Please write today special outfit offer. Hook-Fast Specialties, Box 1425, Dept. 7, Providence, R. I. Established 1926.

**ADVERTISING book matches—Cash in** on big demand—sell Union Label matches. Cuts for all businesses and political parties—Free powerhouse selling kit—low prices—protection guaranteed on repeat orders—Cash commissions. Superior Match Co., Dept. P-250, 7530 Greenwood, Chicago.

**FREE Samples, and amazing plan, giving** you Gorgeous Dress without penny cost. Rush name today, with dress size. Harford, Dept. B-435, Cincinnati 25, Ohio.

**ABSOLUTELY Free! Big package actual** sample fabrics and style presentation of dresses, lingerie, hosiery, etc. Take orders. Commissions big. Send no money. Melville Co., Dept. 5280, Cincinnati 3, Ohio.

**MAKE Money Calling on Friends.** Show nationally advertised Greeting Card Assortments—16-Card All Occasion Assortment only \$1.00—also Birthday, Gift Wrapping, Plastics, Imported English Napkins, Floral Stationery, Children's Books, many more! Up to 50c profit on each assortment. Experience unnecessary. Samples on approval. Write Wallace Brown, 225 Fifth Avenue, Dept. J4, New York 10.

**FREE Samples. Big profits showing** amazing Glow-In-The-Dark Specialties. House numbers, pictures, plastic novelties, ashtrays, keyholders, religious and nursery objects, etc. Madison Plastics, 303 Fourth Ave., New York 10, N. Y.

**EXCELLENT Sideline** for printing and advertising salesmen. Decalcomania name plates in small quantities. Great demand. Also, make money with our line of Automobile Initials and Sign Letters. Free Samples. "Ralco", XL-Roxbury, Boston 19, Mass.

**START Your Own Business on Credit.** Always your own boss, 1554 Dealers, sold \$5,000 to \$26,500 in 1948; their average \$6,742. We supply stocks, equipment on credit, 200 home necessities. Sales experience not needed to start. Wonderful opportunity to own pleasant, profitable business backed by world-wide industry. Write Rawleigh Co., Dept. 192-PSC, Freeport, Ill.

**FREE! Big box actual full-size packages** groceries, home needs, sent Free F.O.B. factory. Try them at home and show friends. World-beating money-making opportunity. Write Zanol, Dept. 8091-C, Richmond St., Cincinnati 3, Ohio.

**BE first! Sell this sensational new assortment.** Contains everything but the food... The invitations, table cover, napkins, nut baskets, place cards, snapper hats, cups, plates, game booklet and six different games: a complete party for eight. Sample \$1.25. Also America's leading greeting card line featuring personalized stationery, napkins, book matches and exclusive new Wedding invitations. Free Samples. Elmcraft Chicago, 5930 S. Western, Chicago 36, Illinois.

**LOOK! Make money all year round** selling personal initialed individualized belts, buckles, cap badges, tie holders, complete line Police and Firemen's Badges, 2000 emblems to choose. Big profits, whole or part time. Please write today special outfit offer. Hook-Fast Specialties, Box 1425, Dept. 7, Providence, R. I. Established 1926.

**DOUBLE Your Income—Sell wool and** Cotton uniforms, Badges, Initial Buckles, Belts, etc. Write Hook-Fast, Box 480PS, Roanoke, Virginia.

**NEWEST money-making sensation, mini-**ature authentic replicas, police and firemen's badges also pocket pieces, key chains. Write for descriptive folder. Hook-Fast Specialties, Dept. 23, Box 1425, Providence, R. I.

**SELL Slot Machines, Games, Home Bars.** Send for wholesale deal. Webb Distributing Co., 4958 West Chicago Ave., Chicago 51, Ill.

**GOLD lacquered Window Sign Letters.** Large Sizes Penny Each. New Folds. Absolutely Beautiful. Free Samples. Atlas, 544 W. 79th, Chicago 20.

**"SUCTION" Auto Washer.** New invention. Mirror finish. Banishes autowashing drudgery. Lightning seller. Samples sent on trial. Kristee 145, Akron, Ohio.

**MAKE \$50 selling America's leading** All-Occasion greeting card assortments. Samples on approval. Complete line fast money makers—free samples imprinted and monogrammed Stationery, Napkins and Guest Towels. Write Lorain Art Studios, Dept. AP, Vermilion, Ohio.

**STRANGE "dry" Window Cleaner.** Sells like wild. Replaces messy rags, liquids. Simply glide over glass. Samples sent on trial. Kristee 146, Akron, Ohio.

**SELL Big Money-Maker to men and** Women. Easy handwork makes fast-selling useful articles. Sample free. Sunmade Company, Brockton 64, Mass.

**EXTRA Money! Sell new, different** greeting cards. Complete line includes Regal Plastic assortment, metallics, "Stand-Up" and "double" cards. Free samples Exclusive Imprinted and Engraved Stationery. Sales Kit on approval. Regal Greetings, Dept. PS-13, Hazel Park, Mich.

**AMAZING Offer—\$40 is yours for sell-**ing only 50 boxes. Also entirely different, new Deluxe All-Occasion assortment with television card, Little Pearls, Hankie Gift Greetings, other surprise items. Feature boxes on approval. Free samples imprinted stationery and Rose Scented Notes. Write today. It costs nothing to try. Cheerful Card Co., 1227, White Plains, N. Y.

**BIG Bargains for Big profits.** Over 100 sensational values. Men's used suits \$2, pants 35c, topcoats \$1.25, overcoats \$2, shoes 20c. Experience unnecessary. Free wholesale catalog. Superior, 1250-B Jefferson, Chicago 7.

**SELL Ultra-blue stock signs to stores.** 1000 slogans, comedy, general, religious. "7 x 11" cost 6c, sells 35c. Make money. 15 samples \$1.00 postpaid. Lowy, 8 West Broadway, Dept. 512, New York 7.

**EASY dollars even for beginners! Sell** friends Plastic greeting cards. Scented Stationery. Profits to 100%. Bonus. Glamorous Metal Foil, Little Pearls, Hankie Gift Greetings. Irresistible novelties. Free samples imprinted, Decorated Stationery. Deluxe All-Occasion samples on approval. Special offers. Write Pilgrim Greetings, 111 Summer, Dept. AO-3, Boston, Mass.

**JEWELRY For Salesmen Distributors** Direct Factory. Catalog Free. Pickcraft (c 19) Bank St., Attleboro, Mass.

**MEXICAN feather pictures. Big profits!** No investment! Free details. Sample 10c stamps. Sylvia-S, Apartado 9036, Mexico City.

**\$85.00 WEEKLY selling 4 pair shoes** daily direct. Free Outfit. Samples. No investment. Experience unnecessary. Advance commissions, bonus. Paragon Shoes, 738 Columbus, Boston, Mass.

**YOU positively sell our business cards** by Mail. Successful "Beginners" plan gets lifetime repeat orders mailed you. Free Details. Lynn, 5710-C Bankfield, Culver City, California.

**CANVASSERS! Crew Managers! A Penny** post card brings you full details on how you can become a direct factory dealer in your area without any risks, with our beautiful, popular priced, fast selling stainless Tableware. Guaranteed for Lifetime! Enormous Profits! Dept. PS, John Hull Cutlers Corp., 1239 Broadway, New York City, N. Y.

**EARNINGS of \$25 to \$100 weekly** possible selling established family shoe line direct to consumer. 70 styles. Amazing comfort features. Samples to producers. Experience unnecessary. Mench Shoes, MH-26, Brockton, Mass.

**COLLECT easy profits to 100%.** Sell biggest line greeting cards. Plastic Everyday, Comics, Gift Wrappings, Scented Floral Stationery, Hankie Gifties, Plastic tablecloths, novelties bring money galore. Bonus. Write today for Deluxe All-Occasion, Little Pearls assortments on approval and Special offer. Tom-Wat Studios, Dept. PS, Bridgeport, Conn.

**FREE samples Personalized Stationery.** Napkins, Coaster, Matches bring you extra money! Customers buy on sight. Profits to 100% selling sensational new Plastic Greeting Cards, Gift Wrappings, Children's Books. Big demand. Experience unnecessary. Write today. Senrab Co., 129 North Warren St., Syracuse, N. Y.

**SELL Ultra-blue stock signs to stores.** 1000 slogans, comedy, general, religious. "7x11" cost 6c, sells 55c. Make money. 15 samples \$1.00, postpaid. Lowy, 8 West Broadway, Dept. 53-1, New York.



**BIG** money in decals—entirely new line of name plates—tremendous demand—also terrific new monogram display set ups to retail stores. Sells on sight. Constant repeats—Excellent side line printing and advertising salesmen—Free Samples—Enco, 817 W. Cumberland—Phila. 33, Pa.

**HOT Special!** Power Mowers—\$59.50. Delivered. World's cheapest. Modern, 7401-BC North Kansas City, Mo.

**HOUSE Paint**—Your name on label. Agents wanted. Experience unnecessary. Free sample. Certified Products, Louisville, Kentucky.

**FREE Literature**—Thousands Wholesale supply sources. Money-making Business ideas. Wilkin, Hillsboro 2, Ohio.

**\$1** starts you in business. Sell top quality \$1.00 ties. Now only \$7.20 dozen, your profit \$4.80 dozen. Regular \$1.50 up values. Send \$1.00 for Introductory Offer two ties. Catalog complete line free. Philip's Neckwear, 20 West 22nd St., Dept. P-40, New York 10, New York.

**FAST profits**—No investment. Send for big, free catalog. Plastic aprons, tablecloths, etc. 150 sure-fire items. We guarantee sales. Write The Halliday Company, Dept. P-3, 347 Broadway, Passaic, N. J.

**SELL \$2 Fire Extinguishers.** Locally mailorder. Lorrac Products, Albany 1, N. Y.

**WOULD** you pay 3%—first \$350? Booklet "505 Odd, Successful Enterprises" free! Work Home. Expect something odd! Pacific B. Oceanside, Calif.

**AGENTS.** Sell finest food products direct to homes. Successfully sold for 25 years. Big profits. Powerful combination sale plans make sales easy. Permanent repeat business. Powerful premiums and free door openers for easier sales. Samples furnished. Live territories open to distributors. Mother Hubbard Products Co., 4139 Grand, Dept. S-Z, Chicago.

**50% COMMISSION,** steady repeat orders. Lifetime income, free outfit. Nichols Company, Purvis, Miss.

**AT last!** Something New and Sensational in Everyday Cards. Make Extra Money Fast! Show Gorgeous Satin Velour Metallic Cards. Get orders easy. Scented Stationery, Charmettes, Napkins, Kiddie Cards, 25 other Assts. Retail 60c to \$1.25. Samples on Approval. Puro Co., 2801 Locust, Dept. 000, St. Louis 3, Mo.

**SELL!!** Balloons, Combs, Specialty Merchandise. Carleton House Distributors, Texas City, Texas.

**MAKE** money fast selling biggest line greeting cards—21 for \$1.00 All-Occasion, Birthday, Easter, Mother's Day, Friendship, Anniversary, Comics, Relative, Catholic, New Metal and \$1.00 Plastic Cards, Little Pearls, Twice as Nice, Lustre Beauty, Bright Spots, Nifty Gifties, Scented Stationery, Children's Books, Gift Wrappings, Ribbons, Gifts, Plastic Thread Box, Draperies, Handkerchiefs, Imported Napkins, Eversharp Pen Sets. Everyone a prospective customer. Amazing profits for agents. Church groups, clubs. Extra cash bonus plan. Experience unnecessary. Write Today for Samples on approval and special offer. Hedernkamp, 361 Broadway, Dept. PS-5, New York.

**BUY** Thousands of Nationally advertised products direct from manufacturers and distributors. Write for "Buy direct and Save." Service Publishing, 218-B Investment Bldg., Pittsburgh 22, Pa.

**LEN'S Glo.** Amazing new eye glass lens cleaner. Sell individuals and wholesale to stores. Whirlwind repeat seller. Big profits. Carhoff, 9321 Buckeye, Cleveland, Ohio.

**PROFIT** Making Novelties—Two for samples \$1.50—Folder free. Roger Enterprises, Waverly Place, Tuckahoe, N. Y.

**AGENTS—300%** profit selling genuine gold window letters; stores and offices. Free samples. Metallic Letter Co., 437 N. Clark, Chicago.

**SENSATIONAL** nylons guaranteed against runs. Nationally advertised. Not sold in stores. No experience or money needed. Also lingerie, robes, men's hosiery. Outfit, sample, etc. free. Wonderful opportunity earn big money spare or full time. See our full page advertisement on page 71. Kendex Co., Babylon 749, N. Y.

**NEW Duplex Ball Point Pens.** Cost 50c—sell \$1.00. Sample \$1.00. Amhar Industries, Plant 3B, Huntington, New York.

**AGENTS—300%** Profit selling genuine gold window letters; stores and offices. Free samples. Metallic Letter Co., 437 N. Clark, Chicago.

**CASH** in on tremendous demand for new low priced burglar alarm for Cars, Homes and Buildings. Nothing like it. Everybody wants one. 286% Profit. Unique sample offer. Northwest Electric Company, Dept. C-20, Pukwana, South Dakota.

**MAKE** over \$100.00 a week. Each sale you make \$10.00 Selling on Installments. Watches: Bulova, Longines, Elgin, Benrus, at \$2.00 weekly. Easy to sell. We supply samples. Car necessary, for new open territories. Furnish References. Ergim Co., Inc., (Wholesalers), 992 Columbus Ave., New York City.

**\$18 AN Evening** for you! Spend just two hours showing housewives Exclusive D-Frost-O-Matic Refrigerator control. Saves Time . . . Food . . . Money. Sure-Fire Sales plan. Write today. No obligation. D-Frost-O-Matic, 6 N. Michigan Ave., Chicago 2.

**SELL** Household Air-Freshener, cosmetics, etc. Amhar Industries, Plant 3C, Huntington, N. Y.

### 63 HIGHGRADE SALESMEN

**BIG Money Taking Orders:** Shirts, Ties, Sox, Pants, Jackets, Sweaters, Shoes, Uniforms, etc. Sales equipment free. Experience unnecessary. Nimrod, 4922-AV Lincoln, Chicago.

**START** your own business on Credit. Always your own boss. 1554 Dealers, sold \$5,000 to \$26,500 in 1948; their average \$6,742. We supply stocks, equipment on credit. 200 home necessities. Sales experience not needed to start. Wonderful Opportunity to own pleasant, profitable business backed by world-wide industry. Write Raleigh Co., Dept. C-U-PSC, Freeport, Ill.

**EARN Big Money Fast!** Sell finest quality advertising work uniforms to garages, factories, filling stations, etc. Free selling kit. Topps, Dept. B-20, Rochester, Ind.

**SALESMEN,** Earn \$50.00 weekly, selling only three pairs shoes daily. Commission and bonus. Wide variety for men, women, children. No investment. Experience unnecessary. Free catalog. Tanners Shoes, 560 Boston, Mass.

**SALESMAN-Sideline.** Earn \$3,000 next 5 months selling calendars, advertising specialties. Buyers everywhere. Big Comm. Advanced. Samples Free. Continental Calendar, 542-B South Dearborn, Chicago.

**"BIG Pay—Travel** South America Pacific—Europe—Alaska. Construction, Oil, Mining, Manufacturing firms hire clerks, Engineers, pilots, many trades—pay bonuses. We can help you make connection. Dollar brings advice where, how apply. Personnel Services, Box 785, Sacramento, California \$1.00".

**SALESMEN—Put yourself** in line for big money, real future. Keep stores supplied with 5c-10c to \$1 counter goods. Nationally advertised. Top profits for you and merchants. Liberal deals boost sales. Sideline or full time. World's Products, Dept. 83-D, Spencer, Ind.

**BIG Cash Profits** for men and women introducing Flexiclogs, sensational new flexible footwear. Experience unnecessary. Nationally advertised styles for women, children, men. Excellent sideline, no investment. Easy to average hundreds of dollars weekly. Free sales helps and sample offer. Get details now! Flexiclogs, Dept. B14246, New Holstein, Wisconsin.

**SENSATIONAL Nylons** guaranteed against runs. Nationally advertised. Not sold in stores. No experience or money needed. Also lingerie, robes, men's hosiery. Outfit, samples, etc. Free. Wonderful opportunity earn big money spare or full time. See our full page advertisement on page 71. Kendex Co., Babylon 749, N. Y.

### 67 EDUCATIONAL AND INSTRUCTION

**BE A** real estate broker through home study or classroom instruction. Write for free book. Approved for veterans. Weaver School of Real Estate, 15 E. Pershing Rd., Box PC-11, Kansas City 8, Mo.

**WANT** a steady Big Pay Job in Diesel? Our approved, easy-to-understand Diesel Training Course qualifies you. Placement advisory service Free. Learn as you earn. Write for free 24 page book today! Interstate Training Service, Dept. 2N, Portland 13, Oregon.

**BOOKKEEPERS!** Increase your earnings! Operate your own simplified "Dollar-A-Week" Bookkeeping and Tax Service. Full or spare time. Details Free. No obligation. Ellis, Box 203, Cedar Grove, North Carolina.

**PIANO Tuning Pays.** Learn this profitable profession at home. Our Tonometer and mechanical aids make learning easy. No knowledge music necessary. Diploma granted. Largest and oldest school—51st year. G. I. Approved. Write for booklet. Niles Bryant School, 77 Bryant Bldg., Washington 16, D. C.

**INCREASE** your Poultry Income—thorough knowledge means greater success. Our interesting, practical, home study course has trained thousands during past 29 years. Don't delay—write today for free booklet describing courses, methods, opportunities. National Poultry Institute, Dept. 73, Adams Center, New York

**MAKE Up To \$35-\$45 Week** as a Trained Practical Nurse! Learn quickly at home. Booklet free. Chicago School of Nursing, Dept. M-3, Chicago.

**EXPORT!** Learn at home from established World Trader. Big paying positions. Your own profitable world-wide business by mail order without capital; or travel abroad. Experience unnecessary. Free booklet. Mellinger, 203-W, Los Angeles 24, California.

**HYPNOTISM.** Complete course, 20 illustrated lessons \$1.00, moneyback guarantee. Baltimore School of Hypnotism, Dept. 23-A, 4214 Belmar Ave., Baltimore 6, Md.

**LEARN** the Collection Agency business. Highly profitable. Easily mastered. Free folder. Cole Associates, Syracuse 2, N. Y.

**YOU** For President of your own credit-collection business. Many who answered our ads now have their names on office doors. Franklin Credit, Roanoke 7, Va.

**LEARN** Gunsmithing! Details, copy "Guns and Gunsmithing" 25c. Gunsmith, Palatine 3, Illinois.

**USED** Correspondence Courses. Bought, Sold, Rented. Free Literature. Baker, 5509-A Winthrop, Chicago 40.

**LOCKSMITH** Course. Lock-Picking, key-fitting, etc. \$1.00 prepaid. Miller, Holdrege, Nebraska.

**BECOME** a Doctor of Psychology or Metaphysics. Teach secret of contentment, happiness. Win degree of PsD. or MsD. Solve mental worries. Free book. College of Universal Truth, 5153-K N. Clark, Chicago.

**MEDICAL** Laboratory Technicians in great demand. We train you in your own home. Catalogue free. Imperial Technical Institute, Box 973-B, Austin, Texas.

**LEARN** Piano Tuning, Repairing—at home in 30 days. Unlimited income. Phonograph recordings, tools and instructions furnished. Write Capitol City Tuning Co., Department C-233, 129 East Michigan, Lansing 16, Michigan.

**AUTOWELD** training pays. G. I. Approved School. Free Catalog. Hobart Welding School, Box P-303, Troy, Ohio.

**ARC** Welding frames, bodies, fenders. Pays with Hobart Welders. Easy terms. Catalog free. Box P-302, Troy, Ohio.

**WANT \$66.34 A Week?** U. S. Civil Service Jobs. Men-Women. You can qualify Now for secure positions. Many openings expected soon. Write today for Free 40-page book showing jobs, salaries, sample tests. Franklin Institute, Dept. C-22, Rochester, N. Y.

**USED** Correspondence Courses and Educational Books Bought, Sold, Rented, Catalog Free. Educational Exchange, Summerville, Ga.

**PHOTOGRAPHIC** mind with Super-memory, write Thor Books, S-11, Box 1210, Chicago.

**FASTER** Mind! Try "Thinking-Alphabet." Write Frank Tibolt, 17A, Phila. 20.

### 68 DANCE INSTRUCTION

**CONQUER "Danceritis"** (Fear of Dancing) Scientifically. Free Aptitude Tests—Lessons. Psycho-Danceology, 35-W, Warren, Youngstown 7, Ohio.

### 69 CONTESTS

**WIN** Cash, Cars In Prize Contests! Write for copy filled with current contests, winning hints and tips. Send only 25c. Wright Contest Digest, Dept. 20-B, P. O. Box 2266, St. Louis 9, Missouri.

**PRIZE** Contests! How and Where to Win your Share! 25c coin (refundable). National Contest Bulletin, Box 2685-C, Miami 16, Florida.



**70 LANGUAGE OUTFITS**

LINGUAPHONE Makes Languages Easy. At home learn to speak Spanish, Portuguese, Italian, French, German, Russian, by quick, easy Linguaphone conversational method. Save time, work, money. Linguaphone Institute, 54 RCA Bldg., New York 20, N. Y.

**72 AUTHORS SERVICE**

I WANT New Writers to cash checks of \$1 to \$100 offered daily. The easiest way to write for pay. No previous experience necessary. Free Details, Saunders M. Cummings, 468-15 Independence Bldg., Colorado Springs, Colo.

NEW Writers Wanted! Easiest way to write for pay—receive checks for \$3 to \$100, offered daily. No previous experience necessary. Write for Free details and how to get Free Writer's Market Guide! Comfort Writer's Service, Dept. I-J, 200 S. 7th St., St. Louis, Mo.

**74 CARTOONING, SIGN PAINTING, DRAWING AIDS**

"HOW to make money with simple cartoons". A book everyone who likes to draw should have. It is free; no obligation. Simply address Cartoonists' Exchange, Dept. 193-C, Pleasant Hill, Ohio.

CARTOON Your Way To Success! Internationally known instructor, Raye Burns, will personally teach you to create salable, original cartoons at home. Course of 26 lessons only \$2.85. Send remittance with order or write for Free Details and addresses of successful students. Raye Burns School, Box 2583-S, Cleveland 18, Ohio.

SIGN painting taught at home. Test lesson free. Ben Kerns, Box 812-PS, Greenville, S. C.

FIVE Art Books. Hundred pictures. Postpaid. Guaranteed. Send \$1.00. Artistry, 3606 Amesbury, Los Angeles 27, Calif.

MICALITE Sign Letters! Reflect Light! Sample 25c. Harwell, Byrdstown, Tenn.

LEARN Professional Lettering. Amazing Mechanical Process. Instruction Manual Illustrating 75 alphabets, 250 designs, \$1.00. Major-Art Studios, 3510-W Palmer, Chicago 47.

EXCLUSIVE Booklet Offer—"200 places to sell your cartoons"—only \$1.00. Bob Knapp, Gas City, Indiana.

**75 CHALK TALK-STUNTS**

CHALK Talks. Laugh Producing Program. \$1.00. Illustrated Catalog 10c. Cartoonist Balda, Oshkosh, Wisconsin.

**76 TYPEWRITERS AND OFFICE MACHINES**

STANDARD Typewriters \$17.50 up, Duplicators \$9.50, Adders \$12.50. "Typewriters." 118 Spruce, Wichita, Kans.

**77 OFFICE SUPPLIES & EQUIPMENT**

MIMEOGRAPH Paper, 68c Ream, samples. Brookman, 56-C West 24th, New York 10.

FAST figuring secrets in "How to Use the Chinese Abacus." \$1.00. Low-cost fast adding-calculators available. Free circulars. W. D. Loy, 1317 R. I. Ave., N.E., Washington 18, D. C.

OFFICE supply catalog—latest items. 10c refunded first order. Eddy Co., Southington 12, Conn.

**79 PRINTING OUTFITS, SUPPLIES**

PRINTING Presses. Type Supplies. Lists 3c. Turnbaugh Service, Loysville, Penna.

HOBBY Printers—Join American Amateur Press Association, 822 South Orleans, Tampa, Florida.

NEW precolaminating press half price. Nichols Photo, Bristol, Pa.

MAKE your own rubber printing cuts. Self molding process. Plexirubber, Argyle 2, Wisconsin.

**80 PRINTING, MULTIGRAPHING, ETC.**

MIMEOGRAPHING; Free samples! Topical Emprise, 1527 Highland, Box 42 B, Louisville 4, Kentucky.

1000 BUSINESS Cards \$2.50 Prepaid. Samples free. Reliable Print Shop, 905 East Jefferson, Louisville 6, Ky.

**82 POPULAR SCIENCE**

500 3/4 x 2 1/4 PRINTED stickers 50c. 500 2 x 3 Two Color Shipping Labels \$2.25. General Printing, Willis Myers Company, Grosse, Michigan.

MIMEOGRAPHING; Free samples! Topical Emprise, 1527 Highland, Box 42 B, Louisville 4, Kentucky.

ECONOMICAL printing, state requirements. Odom Supply, Box 9345, Tampa, Fla.

QUALITY Printing—Low prices—Complete line. Everything prepaid. Price list free. Albert Wilcox, Nicholls, Georgia.

1000 BUSINESS Cards \$1.75; 500—\$1.35 Prepaid. S&W Printing Co., 32 Grand Street, New York City.

**82 PATENT ATTORNEYS**

PATENT practice before U. S. Patent Office. Validity and infringement investigations and opinions. Booklet and form "Evidence of Conception" forwarded upon request. Lancaster, Allwine & Rommel, Registered Patent Attorneys, Suite 413, 815—15th St. N.W., Washington 5, D. C.

C. A. Snow & Co.—S-427, Snow Building, Washington 1, D. C. Registered Patent Attorneys. Write for information.

PATENTS—Trade Marks. Patent Lawyer, Gustave Miller, 30-B Warner Building, Washington 4, D. C.

REGISTERED Patent Attorney offers services. Sanders, 6430 Evans, Chicago 37, Illinois.

INVENTORS: Without obligation, write for information explaining the steps you should take to secure a Patent, John N. Randolph, Registered Patent Attorney, 207 Columbian Bldg., Washington 1, D. C.

INVENTORS: Learn how to protect your invention. Unless the inventor is familiar with patent matters, he should engage a competent registered patent attorney or agent to represent him. We are registered to practice before the U. S. Patent Office and prepared to serve you in handling your patent matters. "Patent Guide for the Inventor" containing detailed information concerning patent protection and procedure with "Record of Invention" form will be forwarded to you upon request—without obligation. Clarence A. O'Brien & Harvey Jacobson, Registered Patent Attorneys, 02B-A District National Building, Washington, D. C.

INVENTORS: When you are satisfied that you have invented something of value write me, without obligation, for information as to what steps you should take to secure a Patent. Write Patrick D. Beavers (Formerly Randolph & Beavers) Registered Patent Atty., 938 Columbian Bldg., Washington 1, D. C.

INVENTOR'S Guide free on request. Frank Ledermann, Registered Patent Attorney, 154 Nassau St., New York 7.

INVENTORS: Write for free brochure "Evidence of Invention." Labiner, World Building, New York 7.

INVENTORS—If you believe you have an invention, you should find out how to protect it. The firm of McMorro, Berman & Davidson with offices in Washington, D. C., is qualified to take the necessary steps for you. Send for copy of our Patent Booklet "How to Protect Your Invention." We will also send you an "Invention Record" form. No obligation. They are yours for the asking. McMorro, Berman & Davidson, Registered Patent Attorneys, 143-R Victor Building, Washington 1, D. C.

INVENTORS—If you consider your invention to be something of importance, take steps to protect it with a United States Patent which gives you the right to exclude others from making, using and selling your invention as claimed. "Patent Protection for Inventors" outlines steps to take to secure patent protection. Mailed promptly without obligation. Victor J. Evans Co., Merlin M. Evans, Registered Patent Attorney, 541-C Merlin Building, Washington 6, D. C.

PATENTS—Trade marks. Irving L. McCathran, 316 McLachlen Bldg., Washington 1, D. C. Registered Patent Attorney.

PATENTS. "Proof of Invention" folder mailed without obligation. E. E. Vrooman, Registered Patent Attorney, 512 McKim Bldg., Washington 5, D. C.

INVENTORS. For "Record of Invention" form, contact Carl Miller, Registered Patent Attorney, Woolworth Building, New York.

**83 FOR INVENTORS**

INVENTORS: Without obligation, write for information explaining the steps you should take to secure a Patent on your invention. John N. Randolph, Registered Patent Attorney, 206 Columbian Bldg., Washington 1, D. C.

CASH For your idea. 280 manufacturers need inventions, patented or unpatented. List free. Invention Bureau, 208-S Clinton, Oak Park, Illinois.

INVENTIONS Wanted. Prominent manufacturers and national distributors look to us for new products. You can also benefit by having us assist you with your invention from the idea stage through to the developed product, fully protected. Ask for Booklet "P". Elo Development Co., Chatham Phenix Bldg., L.I. City 1, New York.

INVENTORS: The usual First Step is to have a search of the U.S. Patents conducted, so I can report on Patentability. Write, without obligation, Patrick D. Beavers (Formerly Randolph & Beavers) Registered Patent Atty., 939 Columbian Bldg., Washington (1), D. C.

INVENTORS: If you have an invention for sale, patented or unpatented, write Institute of American Inventors, Dept. 30A, 1926 Eye St. N.W., Washington 6, D. C.

COMPLETE Services for inventors. Patent searches, including analysis, patent copies. Patent applications prepared. Inventions marketed. Protection forms free. Industrial Patent Reports, Box 1081, Massachusetts Avenue and North Capitol, Washington 13, D. C.

"INVENTOR'S Guide" free on request. Frank Ledermann, Registered Patent Attorney, 154 Nassau St., New York 7.

1001 NEEDED inventions. A new bulletin listing 1001 needed inventions with sound commercial value. Put your talent to work on the right problem. Inventors' Idea Guide. Send \$1.00. Satisfaction guaranteed or return in 5 days for refund. C. J. Specialties, Box 5007, Dept. 11, St. Paul, Minnesota.

INVENTORS—If you believe you have an invention, you should find out how to protect it. The firm of McMorro, Berman & Davidson with offices in Washington, D. C., is qualified to take the necessary steps for you. Send for copy of our Patent Booklet "How to Protect your Invention". We will also send you an "Invention Record" form. No obligation. They are yours for the asking. McMorro, Berman, & Davidson, Registered Patent Attorneys, 143S Victor Building, Washington 1, D. C.

INVENTORS—This firm is registered to practice before the United States Patent Office and is available to assist you in the preparation and prosecution of your patent application. "Patent Protection for Inventors" booklet containing detailed information and steps to take toward patent protection will be sent upon request. No obligation. Victor J. Evans & Co., 542-C Merlin Building, Washington 6, D. C.

INVENTIONS, Gadgets, Patented, Unpatented. Free offer. Grayland, 5312A, Grace, Chicago 41.

PATENT Searches \$5.00. Includes patent copies. Same reliable search as conducted for attorneys, 48 hour service. Free protection forms. Patent Service Institute, 945-B Pennsylvania Avenue, Washington 4, D. C.

I. F. I. Creative Co-operation includes: Super-scope patent searches; commercial prospects analysis; pre-patent priority protection; invention-improving; finding backers; invention-styling for sales-leadership, plus the Promoting, Marketing, and Selling of inventions for Maximum Cash and Royalties. Write today for free information. Inventors-For-Industry, Inc., Dept. PS3, 501, 1947 Broadway, New York 23.

INVENTORS: Obtain patents without assistance. Details free. International Patent Library, 1420 New York Avenue, Washington 5, D. C.

INVENTORS. For "Record of Invention" form, contact Carl Miller, Registered Patent Attorney, Woolworth Building, New York.

PATENT searches conducted for you personally in the U. S. Patent Office. \$5. Prompt action is wise. Patent copies included. Write Patent Search Bureau, 7614BF, Washington 4, D. C.

MANUFACTURE your invention at home, free information. Craftsman, 2018 Grand River, Detroit 26, Mich.



## 84 INVENTIONS WANTED

**CASH** For your idea. 280 manufacturers need inventions, patented or unpatented. List free. Invention Bureau, 208-S Clinton, Oak Park, Illinois.

**INVENTORS**—What have you, patented, patent pending to offer manufacturers? Booklet, information Free. Market Contacts, 11106-B2 Longwood, Chicago 43, Ill.

**INVENTIONS Promoted, Patented or Unpatented.** Write Adam Fisher Company, 183-A Enright, St. Louis, Mo.

**INVENTORS:** Hundreds of manufacturers have requested our assistance in locating marketable new products. Complete information, free. Institute of American Inventors, Dept. 30C, 631—E Street, N.W., Washington 4, D. C.

**HIGHEST Royalties—Cash.** Request free Booklet "C." Universal Marketing Co., 354 South Spring St., Los Angeles 13, Calif.

**INVENTIONS Wanted, Patented or Pending only.** Inventors Exchange-D, Hartford 1, Conn.

## 85 PATENTS

**THE U. S. Patent System** does Not compel inventors into rash "Patent (S)pending." The intent of the Patent Law is to give you the chance of making a Pre-patent test of the worth of your ideas. And high-character Priority Protection for this purpose can be obtained through: Inventors-For-Industry Inc., Dept. PS3, 501, 1947 Broadway, New York 23.

## 89 MODELS, MODEL SUPPLIES

**SHIP Models**—most complete line in New England. Kits, parts, plans, books. Steam and electric power plants. Illustrated catalog 25c. James Bliss & Co., Inc., 220 State St., Boston, Mass.

**SHIP Model and yacht supplies,** complete large 64 page catalogue, 30c. Wm. Wild, 510 E. 11th St., New York City.

**BUILD Historic Ship Models,** complete kits 39c to \$9.00. Catalog 10c. Ideal Models, 21 West 18th, New York 11, N. Y.

**READY!** Our 1950 catalog of ship model kits and fittings; sail, steam, diesel. Send 25c for catalog, Model Shipways, Folio 41, 476 Main St., Fort Lee, N. J.

**STEAM engines, boilers, castings.** Catalog 25c. Anton Bohaboy, 2297 Price, Rahway, New Jersey.

**MINIATURE engines, castings and drawings.** Catalog world's largest selection 25c. Miniature Engine Laboratories, 200-B Cement Ave., Ohio.

**BRASS Gears and model supplies** for the inventors. Send 10c for catalog, Pierce Model Works, Tinley Park, Ill.

**SHIP and Yacht model fittings; blueprints.** Send 25c for illustrated catalog No. 25—Listing hundreds of items. A. J. Fisher, 1002-2 Etowah, Royal Oak, Mich.

## 91 HOME CRAFTSMEN

**JUST OFF The Press**—8-page folder illustrated 6 beautiful, popular lamps you can make—for yourself, for gifts, or to sell others. It's fun, highly profitable—as hobby, or part or full time basis. 8-page folder, 32-page parts catalog, wholesale price list only 25c—refundable first order. Gearon Company, Dept. 400-A2, 27 South Desplaines, Chicago 6, Ill.

**PROFIT with Larson Leathercraft.** Belts, purses, 100 other ideas. Largest supply in U. S. Catalog 10c. Larson, Dept. C, 826 S. Tripp, Chicago 24.

**FREE catalog!** Unpainted or painted figurines, lamp bases. C. Katon, 7807—21st Ave., Brooklyn 14, N. Y.

**HOPPERCRAFT Plans** to make your child happy. Child's Modernistic Chair .35. Child's Desk-table, .50. Easy construction. Instructions and drawings. Designed for child 2 to 5. Hoppercraft, 224 Mill St., Conneaut, Ohio.

**SPECIAL Offer:** 80 Full Size Toy, Novelty, and lawn ornament patterns only \$1.00 Postpaid. Lynds, Box 193E, Medway, Massachusetts.

**90 ALL new, full size lawn ornament and novelty patterns,** up to 20" high, \$1.00. 68 popular plans with necessary full size patterns of toys, novelties, furniture, lawn chairs, garden figures, etc. \$1.00. 16 new lawn chairs, 22 picnic tables, benches, trellises, etc. All 38 plans, with necessary full size patterns, \$1.00. Mastercraft 34S, 7041 Alcott, Chicago 31, Ill.

**BANDSAW, Jigsaw owners,** let your machine bring extra profits, fun. Free details. Nu-Art, Dept. C, Box 2235, Boston, Massachusetts.

**ATTENTION Manufacturers:** Home Shop: Operators; Hobbyist; Salesmen. Let us show you where you can buy everything you want, have parts made, sources of supplies, machinery, materials, etc. This is not a mailing list. We choose reliable manufacturers, suppliers, importers that can furnish exactly what you want. Save time and money by buying direct. List of five for only \$1.00. Additional 15c each. Minimum order \$1.00. Guaranteed prompt service. Tell us what you want—we'll furnish names and addresses of reliable sources or refund your money. John Allis, Box 214, Mount Clemens, Michigan.

**LEATHERCRAFT Supplies, Leather & tools,** low prices. Send 10c for catalog. Jonas Handicraft Co., (Dept. P-3), 32 Frankfort St., N. Y. 7.

**LONG narrow woolen strips** assorted colors, for rugs, five pounds \$3.00. Long gabardine strips, five pounds \$3.00. Leather Scraps for hobbyists five pounds \$3.00. Wool Cotton Co., Sheboygan, Wis.

**SHELLCRAFT! Make seashell Jewelry, Novelties, Supplies, Instructions.** "Buy Direct." Pace's, Bradenton 1, Fla.

**CORKBOARD Sheets,** 1/4", 1/8", 1/16", 36"x36". Cork Brick Flooring. Granulated Cork. Priced Right. Radigan Distributors, 9758 So. Harding, Chicago 42, Ill.

**LEATHERCRAFTERS:** Complete supplies and leather. Free Catalog. Arts Leather, 411 Joseph Ave., Rochester 5, New York.

**8 BEAUTIFUL Full Size Whatnot patterns** 25c. Joanness, P. O. Box 141-S, Omaha 7, Nebraska.

**JIGSAW owners attention!** Start earning money at home cutting out wooden novelties and souvenirs. Write H. Cook, 4407 S. Normal Ave., Chicago 9, Ill.

**EMBED real flowers, butterflies, shells, photos,** to make unusual coasters, plaques, tiles, jewelry, buttons, other objects with new liquid plastic. Crystal clear or colors. Saw, Carve, Turn, Drill. Use only home tools. Big, picture-packed manual shows how to make things very first day. Book also explains proved 6-point Success Plan for starting your own profitable plastics Business. Send 25c for "A Success Plan for you". Castolite, Dept. TC-102, Woodstock, Illinois.

**HOME building at lowest possible cost; stronger; warmer, practicable guide.** "Air-Insulated Concrete Economy Homes". \$3.00. Roberts, 1204 Bill Holt, Great Falls, Montana.

**INCREASE Your Earnings—Learn watch repairing at home.** Ten easy lessons. We furnish free watches and all tools. A licensed school. Large percentage of students make up to \$40 a week in spare time while learning. Write today for free information. Illinois School of Watch Repairing—Dept. CPS-3, 2870 Elston Ave., Chicago 18, Illinois.

**LEATHERCRAFT, Copper tooling, textile painting, Materials, tools, supplies.** Free illustrated catalog. Kit Kraft, 7377 Melrose, Los Angeles 46, California.

**KNOCKDOWN Cedar Chest, Lumber and Veneers.** Free Price List. Giles Co., Brownsboro, Alabama.

**80 FULL sized patterns, toys, novelties, lawn ornaments,** \$1.00. Modern Woodcraft, Saginaw, Mich.

**TURN your workshop into cash.** Send dime (refunded first order) for catalog describing hundreds of things to make for fun or profit. Craftplans, 1321-F South Michigan, Chicago 5.

**CRAFTSMAN'S Market.** You make it. We help sell it, or trade it. Send 10 word description and price of your product plus photo if possible, with 25c to Craftsman's Registry, Box 827, New Canaan, Conn.

**ELECTROPLATING Units,** \$2.00 and up. Send 10c for instructions. Regency Sales, 5316 Justine, Dept. S, Chicago 9, Ill.

**LEATHERCRAFT Tool Kit (Xacto) complete,** Wooden Chest \$6.75. Craft catalog Free. Kale Crafts, 2252 Milwaukee, Chicago 47.

**BRASS and Copper Materials,** 24 page catalog 10 cents. Groundmaster Company, Div. B, Boulder, Colorado.

## 92 BLUEPRINTS AND PLANS

**MAKE own home, farm devices and equipment.** Booklet describing plans 25c. Kimo, Box 307K, New York 19.

**\$600 BUILDS Cozy home,** 4 room concrete block. Step-by-step Instructions and blueprint, \$1.00. L. H. Farrow, G82, Box 645, Columbus 16, Ohio.

## 93 BUILD IT YOURSELF

**STREAMLINED.** Built-in Kitchen cabinets to fit any Kitchen. Illustrated manual describes designing and construction. All for \$1.00. Thornbert Company, Newton 11, Iowa.

**50% COMMISSION,** steady repeat orders, lifetime income, free outfit. Nichols Company, Purvis, Miss.

**"CONCRETE Block Homes."** 32 page booklet on how to build, \$1.00. Other Home Building booklets, \$1.00. H. C. Lightfoot, Civil Engineer, Richboro, Penna.

**FREE Handbook, Build sawmills, block machines, freezers, tractors, scooters,** 250 shop, farm, home machines. Nichols Co., Dept. C-502, Purvis, Miss.

**BUILD Concrete Blockmaker,** Inexpensive. Practical. Motor—hand. Write, Clyde Lee, Mountain View 1, Oklahoma.

**KNOCKDOWN chests,** made of Tennessee Aromatic cedar. Write Craftman Cedar Works, Fayetteville, Tennessee.

**STEAM Cleaner,** build your own from our plans, low cost—easy to build, steam pressure in 90 seconds, plans and instructions only \$1.50. Connery Mfg. Co., Adrian, N. Dakota.

**URANIUM prospecting.** Make your low cost counter. Special Geiger Tube and Circuit \$10.00. Circuit \$1.00. E. S. Hevelone, Agent, 808 Market St., Beatrice, Nebraska.

**BUILD Your Own "Tractor,"** Plans, instructions. Walking, riding. Farming-Gardening Books. Send Postcard. Free information. Ellsworth Tractor Co., D-5, Camptonville, California.

**PING Pong Table;** Save to \$30. Easily Assembled. Free information. Kay-Bilt, 195 Richards St., Brooklyn 31, N. Y.

## 94 WATCH REPAIRING

**WATCHMAKERS' Journal** contains instructive articles for watchmakers. Send 20c for new copy. Dean Co., 116-B Nassau St., New York 7, N. Y.

**WATCHMAKERS' Tools, Materials, Sold—Bought.** Catalogue! Bengale Company, Culver City, California.

## 95 OLD GOLD, WATCHES, ETC.

**HIGHEST Cash Paid For old, Broken Jewelry, Gold Teeth, Watches, Silverware, Diamonds, Spectacles, Platinum.** Free information, Satisfaction Guaranteed. Government Licensed, Rose Smelting Company, 29-Y East Madison, Chicago.

**GOLD \$35.00 Ounce—Mail old gold teeth, jewelry, watches, diamonds—receive cash by return mail.** Satisfaction guaranteed. Free information. Dr. Weisberg's Gold Refining Company, 1500-B Hennepin, Minneapolis, Minn.

## 96 JEWELRY

**JEWELRY Making.** Illustrated catalog 20c. George Sassen, 35 Maiden Lane, N. Y. C. 7.

**MANUFACTURE costume jewelry.** Illustrated literature 10c. Herber, 1360-N Hicks, N. Y. C. 67.

## 97 TOBACCO & PIPES

**FREE literature Pipes and pipemakers' supplies.** Carvapipe, 2829-K Dixie, Hamilton, Ohio.

**PIPE making kits 75c.** Instructions, Gadgets, Smoker's supplies. Literature Free. Buildapipe, Dep't. PS3, Ivoryton, Conn.

## 100 MISCELLANEOUS

**DRESSES 18c; Men's Overcoats \$1.00; Skirts 50c.** Free Catalog. Crown, 164-PS, Monroe St., New York 2.

**BOOKFINDERS!** (Scarce, out-of-print, unusual books) Quickly supplied. Send wants. Clifton, Box 1377-PSM, Beverly Hills, Calif.

**PLEASING Personality.** To be really Happy. Liked by everyone. Successful in Business. Job. Private life. Golden Booklet plus charming photo cards 40cts. Catalog, Samples 10cts. Persil, 436 N. Y. Ave., Brooklyn 25, N. Y.



"INTERESTING Mails"—25c will keep your mail box full three months. Bentz, Jr., Desk A-98. Ghatawa, Mississippi.

WANT your product marketed? Send full detail about your product to Williams, Wholesale Specialty Co., Box 2106, Ft. Worth, Texas.

TRADE Neckties. Mail 6 neckties you are tired of for 6 different handsomely cleaned ties like new. Pay postman \$1.00. Tietown, Box 5463-S, Chicago 80.

YOUR Leather Jacket renovated by our craftsmen expertly, reasonably. Request Free descriptive circular No. 7; Berlew Mfg. Co., Freeport, N. Y.

SMALL Mailing Cartons, Shipping Labels, Postal Scales, List, Fountainhead, 1049 Bluff Street, Beloit, Wisconsin.

WINE—make wine yourself from any fruit or berry. Booklet with complete instructions—\$1.00. Powers, 4141 46th Street, Long Island, New York.

HOME Envelope Addressers! Latest Issue: "How to contact 100 Mail Order Houses." \$1.00. Tralst, Box 2160, Seattle 11, Wash.

SOAP from kitchen fats. Profitable swap with housewives. Circular Free. Cater, 638-B West Colfax, Denver 4, Colorado.

OUTDOOR Toilets, Cesspools, Septic Tanks cleaned, deodorized with amazing new product. Just mix dry powder with water; pour into toilet. Safe, no poisons. Save digging and pumping costs. Postcard brings free details. Burson Laboratories, Dept. T-38, 955 Willard St., Chicago 22, Ill.

\$3.75 per acre Missouri-Oklahoma Land. Cash or Terms, Free List, Maps, Frederick Calvert (Owner), Winter Haven, Florida.

MILLION Articles Wholesale. "Supply Source Directory" 10c. Publisher's, Box 1302, Detroit 31.

G.I. COVER Cloth—Plasticated, lightweight, pliable. Use for dust cover, storage, wrapping, painter's drop cloth, lawn furniture, machinery, beach blanket or shelter, and 1001 other uses. Send \$1.49 for 8 ft. x 8 ft. cloth or \$2.79 for 9 ft. x 15 ft. size. C.O.D.'s accepted. Quantity discounts. Sax-On, Dept. N-2, 3840 Fullerton Avenue, Chicago 47.

WHY Don't You Write? Writing short stories, articles, etc., will enable you to earn extra money. In your spare time we teach you to write the way newspaper men learn—by writing. Free "Writing Aptitude Test" tells whether you possess the fundamental qualities essential to successful writing. Veterans! This Course Approved for Veterans' Training. Write today! Newspaper Institute of America, Suite 5660-C, One Park Ave., New York 16, N. Y.

FREE Art Test, State Age, American, Box 8066, Dallas, Texas.

BIG Mails Three Month, 25c, year Name Listed Directory \$1.00. Harvey Teeple, Decatur, Indiana.

TREASURE—Mineral Locators—Geiger Counters can be purchased on monthly payment plan. Free literature. Fisher Research Lab., Inc., Palo Alto, Calif.

STOP Smoking Easily—Safely. No drugs. Satisfaction Guaranteed. Complete brochure \$1.00. Turner's Service, Box 619-P, Berkeley 1, California.

FUN hours of fun for children, adults—new sensational automatic bubble gun—actually shoots colorful bubbles—\$1.00 postpaid or order C.O.D. E. De Santis, Box 55, Harper, Detroit 13, Michigan.

SURPLUS Circular saw blades; 8" diameter, 5/8" hole, \$2.00 each. Satisfaction guaranteed. Harry Van Dick, Little Falls, New Jersey.

HAPPY? Healthy? 50c (coin). Guaranteed! Success, 8016 Phil, Houston 12, Texas.

STOMACH ulcers? Send \$1.50 for bottle Gialine tablets, postpaid. Used by physicians. Sterling Laboratory, 143 Sterling, Jersey City 5, N. J.

#### 101 FOR SALE—MISCELLANEOUS

FREE catalog! Save money; Surplus Clothing Bargains. N. Y. Clothing Co., New York 29.

#### 102 WANTED MISCELLANEOUS

SCRAP Mercury (Quicksilver) Tantalum—Bismuth—Tungsten. Metallurgical Products Co. Established 1909, 35th & Moore Sts., Philadelphia 45, Pa.

#### 103 FOR THE HOME

FIRE Alarm! Protect your home against overheated furnace. Automatic Alarm Switch \$1.00. E. W. Lutz, 182 W. Como Ave., Columbus 2, Ohio.

#### 104 PERSONAL

DETECTIVE'S Opportunities. Particulars free. Write, Wagoner, P-125 West 86th, New York 24.

BEAR Oil—Best treatment for baldness. You never saw a bald headed Indian. They use it. We can supply you with the genuine product. One dollar prepaid. Swastika Drug Co. Limited, Swastika, Ontario.

LOANS By Mail. \$50 to \$300. Quick. Easy. Confidential to employed men and women. No endorsers. Easy monthly payments. Write for free information sent in plain envelope. Postal Finance Co., Dept. 46A Sioux City, Iowa.

"HOW Can I Find Out?" You Can! Information discreetly developed. Any matter, person, problem, anywhere. Worldwide. Officially licensed, bonded service. Established 1922. Reasonable. Confidential. William Herman, 170 Broadway, New York.

PSORIASIS Sufferers: Has everything failed to bring even temporary relief from scales, lesions, and itching? Then write today for Free important information. You needn't invest one cent! Pixacol Company, Box 3583-S, Cleveland, Ohio.

BORROW by mail. Loans \$50 to \$300 to employed men and women. Easy, quick. Completely confidential. No endorsers. Repay in convenient monthly payments. Details free in plain envelope. Give occupation. State Finance Co., 210 State Finance Bldg., Dept. F-14, Des Moines 9, Iowa.

GALL Bladder sufferers! Write for free literature. Barlet Co., 6432-A Cass, Detroit 2, Mich.

MEDICAL Prescriptions accurately filled with finest ingredients by registered men. Promptly filled and returned prepaid. Ask for prices on Drug, Vitamin and Sick Room Supplies. Blatt Prescription Pharmacy, 54th and Chestnut Streets, Philadelphia 39, Penna.

STOP forgetting! Win friends! Win promotion! Write Harrison Books, W726 North Fifteenth, Waco, Texas.

PILES? Worry not Particulars from relieved sufferer. Write: PS, 1409 Orange, Berwick, Pa.

MEXICAN Law, General Practice Attorney, 1203 Arizona Street, El Paso, Texas.

INFORMATION for single people by Human Relations Consultant, Dr. B. Long, Box 375, Los Angeles 53, Calif.

HYPNOTISM, Self-hypnosis courses. Free details. Craft Publications W2, 601 S. Vermont, Los Angeles 5, Calif.

HAVE Profitable Home Business—Full-spacetime. Start small—grow big. Tremendous possibilities. Get interesting facts. Box 4066, San Francisco.

DANDRUFF?—Falling Hair? Write Royal Research, 6709 Merwin, Cincinnati 27, Ohio.

#### 106 ADVERTISING

AVOID costly advertising mistakes. Get enlightening Ad-Guide and Ratebook leading newspapers, magazines, mailing lists, 10c. Chicago Advertising Agency (Established 1900), Chicago 4.

ADVERTISE: 24 words, 40 Newspapers, \$3.50. Lists Free. Advertising Bureau, 10511-p Springfield, Chicago 43.

24 WORDS in 50 Weeklies, \$4.96. J. Darnell, 730 Hays, Jackson, Tennessee.

EVERYTHING you need in Advertising Sales Aids for the Bronzed Baby Shoe Business. Free Booklet "3 Ways to Successful Selling." National Ad-Aid Service, 4646 Melbourne Ave., Los Angeles 27, Dept. PS.

RICH Southwest—24 words in 40 weeklies, \$3.50. M. Pennebaker, San Marcos, Texas.

#### 115 DRAWING & ART SUPPLIES

DRAW Beautiful human figures, 20 lessons, 147 pictures, \$1.00 complete. Aldcroft Studios, 1206 Maple, Los Angeles 15.

#### 116 SURVEYING INSTRUMENTS

GUARANTEED Factory Rebuilt Transits and Levels Sale or Rent with purchase Option. We will Repair, Trade or Buy old instruments. Write for list PS911, Warren Knight Co., Manufacturers of Surveying Instruments, 136 N. 12th St., Philadelphia 7, Pa.

#### 117 TATTOOING SUPPLIES

TATTOOING Outfits, Supplies. Illustrated List Free. Zeiss, 728 Lesley, Rockford, Illinois.

#### 118 SCIENTIFIC EQUIPMENT

WATER testing. Do it yourself at home. Test wells, springs. Kit \$4.00. Free details. Powers, 4141 46th St., Long Island, N. Y.

#### 120 CANDY MAKING

MEN-Women—"Everybody Likes Candy." Learn to make Professionally at home. Instruction and Outfit furnished. Details free. (Our 40th year). Ragsdale Candies, East Orange, New Jersey.

#### 126 CAMPING

TENTS, all types & sizes, vast selection, camping equipment; war surplus. Lowest prices. Free catalogue. Morsan, 10-19D 50th Ave., L.I.C. 1, N. Y.

#### 128 HUNTING

MAY hunts, grizzly, Guaranteed, hides sold. Munro Furriers, Kingsway, Vancouver.

#### 131 TREASURE FINDERS

TREASURE Hunters! New 11-pound featherweight Model 101 locator for gold, silver and minerals. Money-back guarantee best available. Also Geiger Counters for uranium prospectors. Complete information free. The Goldak Company, 1540 W. Glenoaks Blvd., Glendale 1, Calif.

SEEK Uranium, minerals, buried treasure! Free literature describing latest low cost, supersensitive equipment. Glen Scientific, Box 151-D, Glen Ellyn, Ill.

SENSATIONAL new line of Geiger Counters for uranium detection. All types, all prices. No finer selection. Also new gold, silver and mineral detector available. Complete information free. Detectron Co., 5637 Cahuenga, Dept. A-3, North Hollywood, California.

MINERAL-Box-of-The-Month Club brings you a different box of labeled minerals every month—240 minerals in all! You also get the new Alphascope Ultra-violet Light for examining fluorescent minerals, etc. Club membership saves you over 25% cost only \$3.00 per month, may be cancelled. For full details, write: Atomic Research Corporation, Colorado Springs 3, Colo.

TREASURE—Mineral Locators—Geiger Counters M-Scope Type, Lightweight. Unsurpassed in efficiency. Factory guarantee. Lowest prices. Can be purchased on monthly payment plan. Free literature. Fisher Research Lab., Inc., Palo Alto, Calif.

BUILD Geiger Counter, Circuit and instructions \$1.25. Nucleonic Corp., Brooklyn 31, N. Y.

#### 137 DETECTIVES

DETECTIVES—Work home—Travel. Experience unnecessary. Write Wagoner P-125 West 86th, N. Y., N. Y.

DETECTIVES needed everywhere, New method, Hanna, 3911 Tacon, Tampa, Fla.

DETECTIVE—Investigator courses, Free literature. Allied Academy, 14 No. East, Indianapolis.

#### 142 INFORMATION

STOP forgetting! Win friends! Win promotion! Write Harrison Books, W726 North Fifteenth, Waco, Texas.

PATENT Pending Inventions; From household, sport, toy, hardware items. Royalty. Leo H. Wirsig, Deepwater, Mo.

AMATEURS—Radio and Electrical Research Engineering. H. Y. Twillmann, R. R. #1, Chesterfield, Mo.

#### 143 NAME LISTS

PROSPEROUS rural customers; Guaranteed complete 1,000—\$3.00. Hickorydell, Glenbeulah, Wisconsin.

#### 144 MILITARY INSIGNIA

MILITARY Medals, Enameled Orders Bought, Sold, Lee, Security Bldg., Glendale 3, Calif.

#### 145 SOUVENIRS

"100 DIFFERENT military emblems—\$1.00. Prices free. Hobbyguild, 57x Sumner Ave., Brooklyn, N. Y."



# GET THE FACTS—

## the all-new IDEAL LAWNMOWER SHARPENER



Model 300 — the result of 48 years experience  
CATALOG FREE!

**A Complete Lawnmower Shop  
in One Machine**

Here it is, after four years of research and development, the **COMPLETELY NEW IDEAL LAWNMOWER SHARPENER**. Designed and built to sharpen post-war and pre-war hand and power lawnmowers with precision and speed, the **NEW IDEAL SHARPENER** includes a tapered-cup grinding wheel for sharpening bed knives and a "lapping-in" reconditioner as standard equipment. *Power mowers need not be dis-assembled, engines and handles remain in place during sharpening.* Chain hoists or ropes are not needed to support heavy mowers, the **IDEAL** supports the entire weight of the mower within its rugged cast-iron frame. The **IDEAL SHARPENER** is a complete lawnmower shop all in one machine. Send for the **IDEAL CATALOG** describing the new **Model 300 IDEAL LAWNMOWER SHARPENER** and the other machines we manufacture for the lawnmower serviceman.

**THE FATE-ROOT-HEATH CO.**

DEPT. G-4

PLYMOUTH, OHIO

**THERE'S GOLD in  
GOOD IDEAS!**



• Rochester, New York, with its nationally known industries and progressive business community, is constantly seeking new ideas which can be converted into profitable products or enterprises. If you have something worth talking about,—something for which there is a market at a minimum price,—then write for details to Division of Public Relations, Rochester Department of Commerce, 54 Court St., Rochester 4, N. Y.

**IN ROCHESTER, GOVERNMENT HELPS BUSINESS**

**THOUSANDS BUILD AT 1/2 THE PRICE**

**20 MODELS  
U-MAK-IT BOAT KITS**

**EASY  
TO BUILD**

**ROWBOATS**

8 TO 14 FT.  
Special Models  
For Fishermen



**PRAMS**

**OUTBOARDS**

Fast Round or V Bottoms  
12 TO 16 FT. Newest  
Assembly Methods

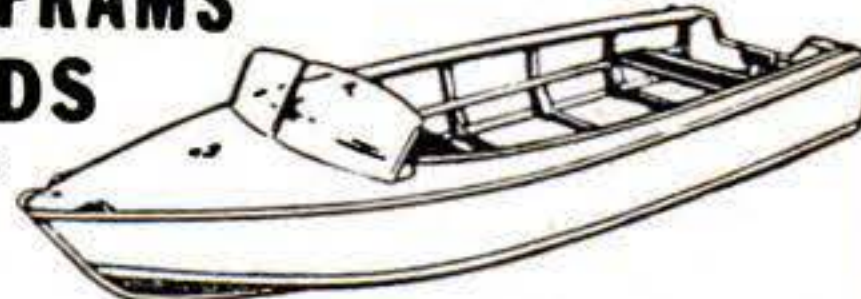

**INBOARDS &  
CABIN CRUISERS**

For Fishing, Racing or  
Cruising 16 TO 23 FT.

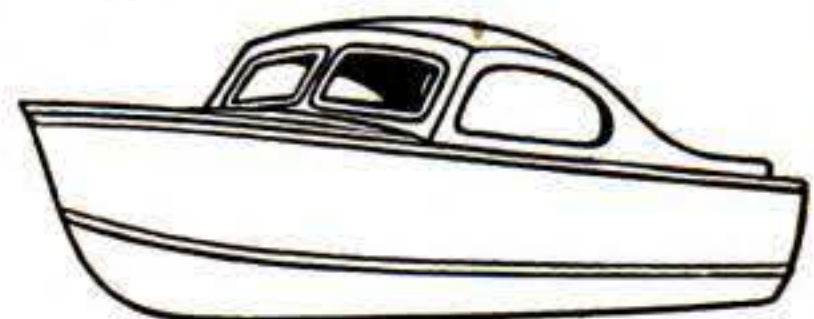

**SEND 25c (coin)  
ORDER YOUR  
CATALOG TODAY**

**U-MAK-IT PRODUCTS**

703R-WHITTIER ST.  
New York 59, N. Y.



# SALESMEN!

WRITE  
THREE  
WORDS  
COLLECT  
\$9.95

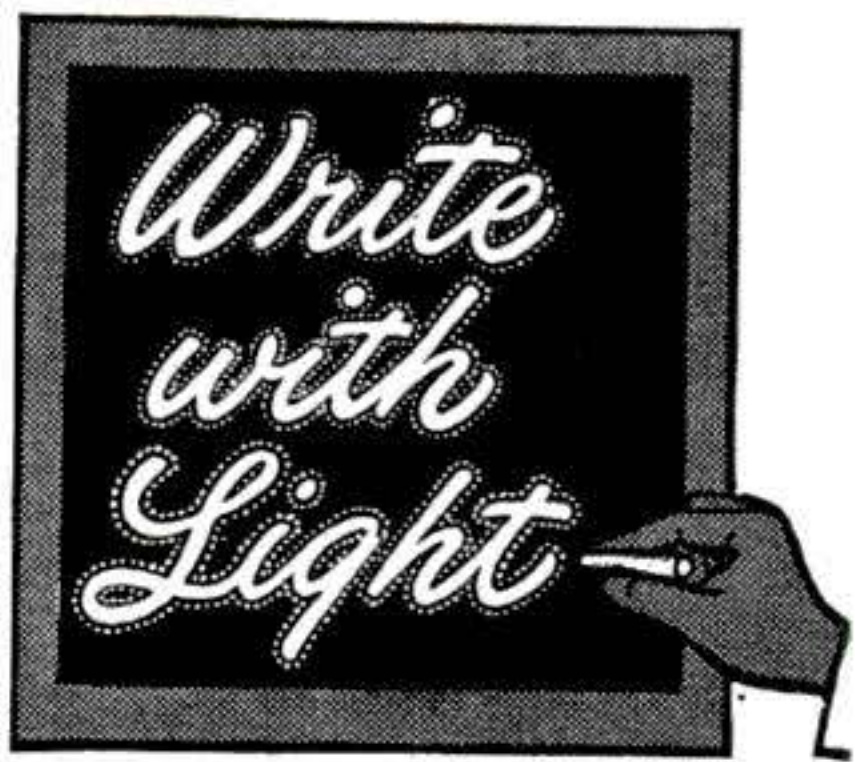

## SENSATIONAL NEW ADVERTISING SIGN

YES, MAKE \$9.95 on 10-second demonstration to merchants. Write on glass with amazing magic crayon and presto—a 5-color advertising message takes fire and glows like a brilliant neon sign! Three sales a day and \$29.85 profit is for "lazy" men. Workers can double to triple that amount. FREE SALES KIT. Don't wait. Rush your name and address on a penny postcard for full details and complete sales kit—ALL FREE.

**MAXILUME CO., 125 W. Hubbard  
DEPT. L-93 CHICAGO 10, ILLINOIS**

EYE-  
GLASSES  
BY MAIL  
16 Days Trial

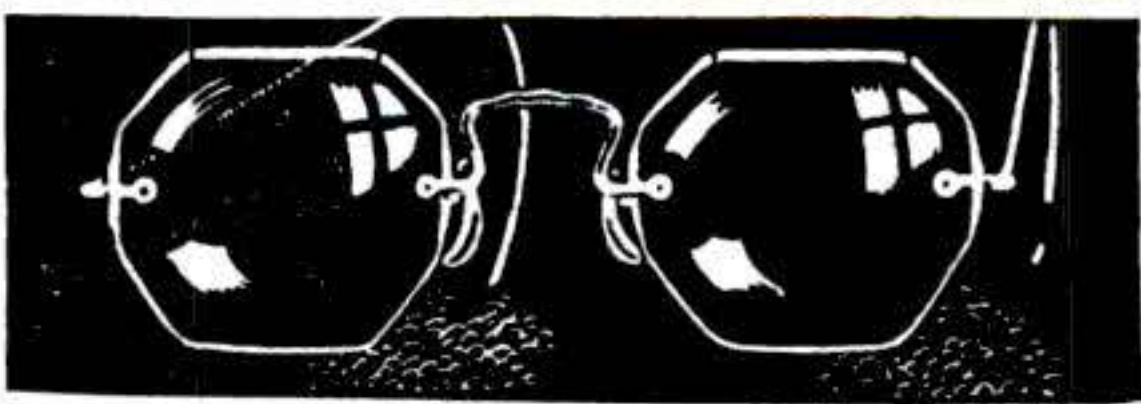

Write Today for Free Catalog. Send no Money  
**ADVANCE SPECTACLE COMPANY**  
537 South Dearborn Street, Dept. SP-3, Chicago, Illinois

## How many men will answer this ad



and **MAKE** up to  
**\$1500** in a **DAY**

HERE'S an amazing offer to a limited number of men who *act fast!* Rush your name and address—that's all—and we'll send you **Big Demonstration Outfit**, absolutely FREE, and show you how to make up to \$15 in a day... even in spare time... taking orders for our wonder-value made-to-measure suits and overcoats. No experience necessary. More than 150 actual samples to pick from. Sensational money-saving values. Send for details!

### SAMPLE SUITS without 1c cost!

Our plan makes it easy for you to get your own fine suits and overcoats *without paying 1c*—in addition to big cash earnings. Hurry! This offer is limited. Rush your name, address today. **PIONEER TAILORING COMPANY**  
Congress & Throop Sts., Dept. C-1120, Chicago 7, Ill.

## PRESTO! ANYONE CAN MASTER GLAZE



Car Owners! Meet Master Glaze—the sensationally different luster for new and used cars! Not a wax—not an oil polish—not a paint!—nothing that "smears" over the surface.

**MASTER GLAZE** is a unique discovery—a creamy liquid—quick and easy to apply! Gives a hard, glass-like surface. Even gasoline cannot dull it! Lasts six months to a year! Amazing luster—beautiful, sparkling clean and brilliant! Doesn't finger-mark—doesn't smear! A match box full glazes an entire car. Seals the pores—protects! **NOTHING LIKE IT!**

### AGENTS

An unusual opportunity! Quick, flashy demonstrator. Big profits. Good territory. Write today!

### FREE SAMPLE

Just send your name and address to  
**MASTER GLAZE CO., 7720-685 W. Harwood Ave., Milwaukee, Wis.**

## NEED MORE? MONEY?

Thousands already earn big, steady profits selling famous Bostonian shirts, rainwear, hosiery, underwear and other everyday needs for men, women and children. Also new line of Hamilton shoes. No selling experience needed—if you're keen and really want to assure yourself of a steady income, Bostonian will back you and set you up in business. You get big profits, immediate cash and big selling kit. Our Company has tripled its business in the last year. Write now—big Spring season ahead. Bostonian Mfg. Co., Dept. 340, 89 Bickford Street, Boston 30, Mass.

Write for  
**FREE  
Selling  
Kit**



## FREE SAMPLES! GLOW IN THE DARK!

**BIG PROFITS** showing amazing Luminous Specialties—house numbers, pictures, plastic novelties, religious and nursery objects, ash trays, key-holders, etc. Large manufacturer. Enormous demand. Sell on sight. **WRITE AT ONCE** for FREE samples. **Madison Mills, 303 4th Ave., Dept. G-5, New York 10, N.Y.**

## BE A HIGH-PAID MAN IN YOUR COMMUNITY WITH THIS LONG NEEDED INVENTION

Earn up to \$10,000 or more per year! U.S. Pat. D 153853  
Nothing to invest! Be your own boss! D 153854

A worldwide product needed by every home, business and farm...priced to sell quickly! Automatic Red Comet goes into action as soon as fire starts... smothers fire without human aid. It's a sales 'natural'!

### FREE SALES KIT

Demonstrator units, sales literature, etc., furnished you FREE. Handsome leather-type kit. Tried and proved, it will make you an independent businessman. **ACT NOW!** Someone in your community will be appointed soon. Write for details, today!

### RED COMET, INC.

587 R. C. Bldg., Littleton, Colo.





## PRINT YOUR OWN POST CARDS

COMPLETE OUTFIT  
only

**\$7.50**

Amazing results in sales, inquiries and contacts... saves time and money... very easy to use GEM STENCIL DUPLICATOR is ideal for Advertising, Announcements, Notices, Labels, Forms, Price Lists—hundreds of uses for every type of business and organization. Comes complete with all supplies, instructions and 60-page Book of Ideas.

**FREE TRIAL OFFER:** Try it before you buy it! Write and a GEM OUTFIT will be sent you postpaid. After 10 days, send only \$7.50 or return the GEM, no questions asked. The GEM must sell itself; you be the judge.

**BOND EQUIPMENT CO. • Dept. 151**  
6633 Enright • St. Louis 5, Mo.

SEND NO MONEY • FREE TRIAL OFFER

Free Book



## RAISE HAMSTERS

The new wonder animals from Syria. Often called Toy Bears. Delightful pets. Everyone wants them. Laboratories need thousands. Clean, odorless. Raise anywhere. A profitable and interesting hobby or business. We furnish breeders and instructions. Write today for free book.

**GULF HAMSTERY, 1540 BASIL ST., MOBILE, ALA.**



95 lb. SET  
**\$10.80**

Extra plates 10c lb.

## BARBELLS

Save Money—Buy the finest barbell equipment direct from our foundry—No other company can match our low price or value!

Send to-day for our FREE Barbell Catalog

**BUR BARBELL CO.**  
Lyndhurst 3, New Jersey

**FREE**  
Bargain Book

Packed with hundreds of sensational bargains—new and used—in still and movie photo equipment and accessories.

Write for your free copy today to

**Central Camera Co.**

Dept. 10-C, 2305. Wabash, Chicago 4, Ill.

Photographic Headquarters Since 1899

## MANY NEVER SUSPECT CAUSE OF BACKACHES

As we get older, stress and strain, over-exertion, excessive smoking or exposure to cold sometimes slows down kidney function. This may lead many folks to complain of nagging backache, loss of pep and energy, headaches and dizziness. Getting up nights or frequent passages may result from minor bladder irritations due to cold, dampness or dietary indiscretions.

If your discomforts are due to these causes, don't wait, try Doan's Pills, a mild diuretic. Used successfully by millions for over 50 years. While these symptoms may often otherwise occur, it's amazing how many times Doan's give happy relief—help the 15 miles of kidney tubes and filters flush out waste. Get Doan's Pills today!

# FACTORY-TO-YOU MIDWEST RADIO and TELEVISION



**EASY TERMS**

**30 DAYS TRIAL**

NEW GIANT  
**16"**  
PICTURE TUBE

**MIDWEST Model CX-26**  
A Complete 16-Inch TELEVISION Chassis

Here is Television at its best!... brought to you by Midwest, the world's oldest and largest Exclusive Factory-To-You radio and television manufacturer. For 1950 Midwest offers a complete line of Television Consoles and complete, ready-to-operate chassis (not kits) featuring the new giant 16-inch tube, clear, steady pictures, synchronized sound and pictures that a child can tune perfectly. Buy your Television direct from Midwest at Low Factory Prices, on Long EASY TERMS and 30 DAYS TRIAL. Send coupon for FREE 32 - page, 4 - color catalog TODAY.

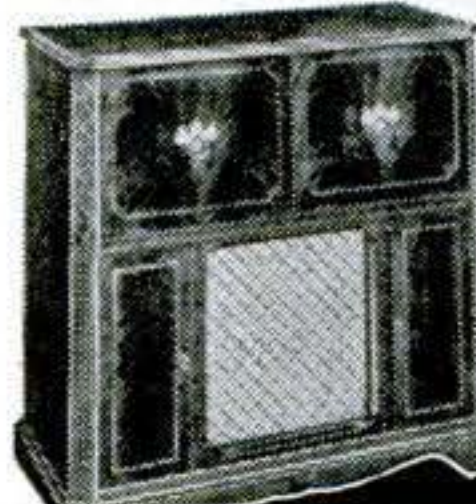

... Also a Complete New 1950 Line of  
**MIDWEST RADIOS**  
with new long distance FM Circuit and new 3-Speed Phonograph.

Write for FREE 32-Page, 4-Color Catalog or Paste This Coupon on 1c Post Card

**Midwest Radio & Television Corp.**  
Dept. X248, 909 Broadway, Cincinnati 2, Ohio  
Please send me your new FREE 1950 Midwest Catalog

Name \_\_\_\_\_  
Address \_\_\_\_\_  
City \_\_\_\_\_ Zone \_\_\_\_\_ State \_\_\_\_\_



# How to give QUICK REST to tired eyes

MAKE THIS SIMPLE TEST TODAY



**EYES OVERWORKED?** Put two drops of gentle, safe Murine in each eye. Then feel that refreshing, soothing sensation that comes instantly. You get—



**QUICK RELIEF** from the discomfort of tired eyes. Murine's seven important ingredients are scientifically blended to cleanse and refresh overworked, tired eyes. Use Murine morning and night and whenever your eyes tell you to.

## MURINE FOR YOUR EYES



A MUST FOR EVERY CAR & BOAT OWNER

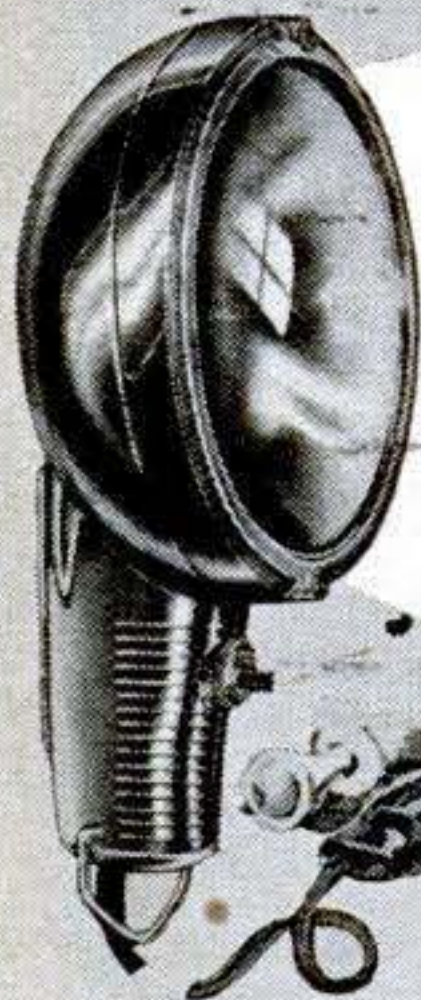

G.E. SEALED BEAM  
PISTOL GRIP  
**HAND SPOT-LITE**  
AND  
TROUBLE SHOOTING LIGHT

PLUGS INTO CIGARETTE LIGHTER OF YOUR CAR • BOAT

**\$5.40** BAKED PEARL GREY FINISH All Chrome \$6.50 Shipped Post Paid

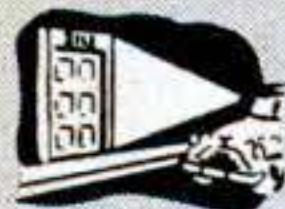

Looking for a number



Fixing a flat tire

- Ideal for motorists, truckers, taxis, hunting and fishing. Perfect spotlight for boats.
- Perfect for finding road signs and house numbers without getting out of car.
- Throws 57,000 beam candle power for a distance of 250 yds. Uses less current than one headlight.
- 11' cord allows use as trouble light anywhere around car.
- Adjustable arm to prop light up on ground at different angles.
- Fits into glove compartment or can hang from dash.

Dealer Inquiries Invited.

Send check or money order to  
**LOYAL ELECTRIC CORP.**  
217 P Centre Street, New York 13, N. Y.

## NEW PACKAGED BOATS 1950 KITS



17 New models. Improved design, skiffs, outboards, inboards, sail boats. Tredronic racers, cruisers. 8 to 16 ft., exclusive features. Preassembled frames, Tri-Keel construction, Tredronic bottom, full length spray rails, widest beam, simplified construction, easy to build. World's best boat buy! Send 25¢ for new 1950 literature, or send \$1.00 for literature, plus booklet "Plywood Boats."

### BOAT PATTERNS-BLUE PRINTS



1950 Catalog—over 100 modern designs by famous naval architects. Racing classes, cruisers, inboard, outboard, sail, 6 to 35 ft. Plywood—Steel—Plank. Construction plans, full-size patterns. Send 35¢ for catalog or \$1.00 for catalog and helpful booklet on "Boat Building."

MARINE MART-DEPT. 23-BUFFALO 7, N. Y.

## SPECIAL OFFER! LOCK-STITCH SEWING AWL

**\$1.** Postpaid

Famous, patented lock-stitch sewing awl complete with needles, waxed thread and direction folder. Hundred uses — sewing, repairing leather goods, canvas, belting, harness, saddles, gun cases, awnings, golf bags. Extra needles and thread available. Satisfaction guaranteed or money back. Send currency, check or money order. Yates Mfg. Co., 611-K Main St., Lake Geneva, Wisconsin

## GOOD MONEY IN WEAVING

Earn money at home weaving rugs, carpets, etc., from old rags or new yarn—in your community! No experience necessary. 31,000 doing it with easy running Union Looms costing less than \$50.00! Send for our free booklet today.

UNION LOOM WORKS

27 Factory St.

BOONVILLE, N. Y.

**Look** — a 10½x4, 6-ply Tire. Tube. Machined Wheel and Bearing at a "give away" price. Supplied in two types:—  
1. With Highspeed **TIMKEN BEARING** (with Grease Retainer) **\$8.95**  
2. With Slowspeed **NEEDLE BEARING** (with Grease Retainer) **\$5.95**  
Freight Collect (8½ lb.)

Ideal for Handcarts, Bogies, Trailers, Soapbox Racers, etc. A bargain from the world's largest stock of all types of Airplane Tires. Send your check or money order to:

Airplane Tire Co., 99 Hiway, Tulare S., California

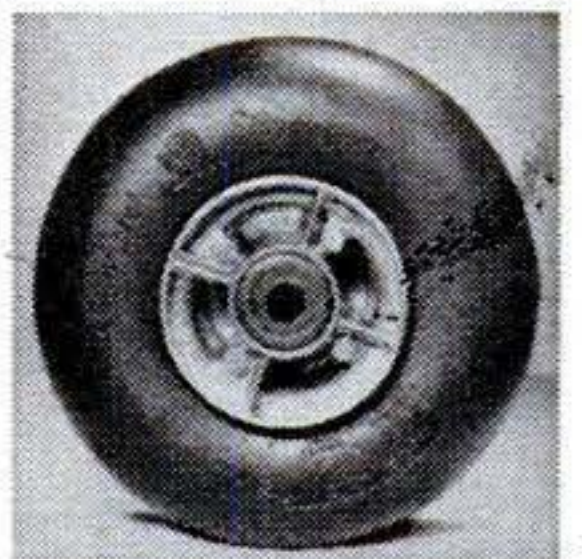

## TAKE 3-DIMENSIONAL PICTURES WITH YOUR OWN 35MM CAMERA

NEW REDUCED PRICE (Outfit No. 101, was \$22.50)

**STEREO-TACH \$17.70** Plus \$2.09 Fed. Tax

and 3-D Slide Viewer complete. Make marvelous stereo color slides. Get Stereo-Tach from your dealer or direct. Money back guarantee. Dept. PS3.

ADVERTISING DISPLAYS, INC.



Covington, Ky.

## Free for Asthma

If you suffer with attacks of Asthma and choke and gasp for breath, if restful sleep is difficult because of the struggle to breathe, don't fail to send at once to the Frontier Asthma Company for a FREE trial of the FRONTIER ASTHMA MEDICINE, a preparation for temporary symptomatic relief of paroxysms of Bronchial Asthma. No matter where you live or whether you have faith in any medicine under the sun, send today for this free trial. It will cost you nothing.

FRONTIER ASTHMA Co.  
462 NIAGARA ST.

434-D FRONTIER BLDG.  
BUFFALO 1, N. Y.



# MAKE YOUR OWN!

WITH

## Griffin READYCUT LEATHER PROJECTS

Over 100 KITS in every kind of Tooling and Carving Leather, accurately cut, all parts included. Only Top Grade Leathers used. You do the choosing. You do the tooling, carving, stamping, the punching and assembling.



SEND FOR COMPLETE CATALOG  
Please send 10c to cover mailing.

SINCE 1924

OUT OF THE WEST, THE HOME OF LEATHER CARVING  
**Griffin Craft Supplies**

5626-B TELEGRAPH AVE.  
OAKLAND 9, CALIFORNIA

### EVERYTHING FOR THE LEATHER WORKER

Largest, most complete stock of *Leathercraft Tools and Accessories* in U. S. A.



HIDES AND SKINS of Craft Leathers of every kind if you prefer to cut your own.

### SANDEE CHROME SILENTIP®

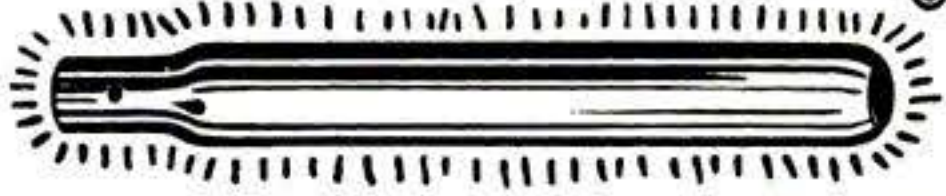

**\$2.95** EACH

FOR QUIETER PERFORMANCE

An exhaust tailpipe extension that is actually a small muffler. Chrome plated. Will make a sport muffler or dual set quieter and still give straight thru performance.

SANDEE MUFFLER CO., 5643 Corryne Pl., Culver City, Calif.

### SHIP MODELS FOR EVERYONE

Authentic kits for both novice and experienced builders

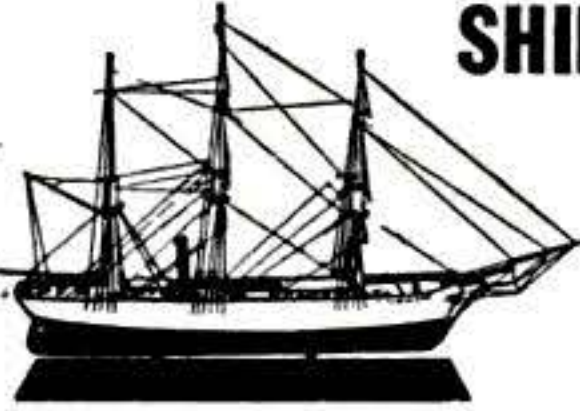

New "Clipper-Bilt" Kits at only \$3.95 each, have carved balsa hulls, die-cut wood parts, tapered masts, finished fittings and simple plans. Send for your kit today. Select Schooner, Clipper, Barque or all three. Each **\$3.95**

Big catalog describes over 30 beautiful models and several authentic, fascinating gun

ship models, 600 fittings and several authentic, fascinating gun models. Only 35c. Send for yours at once.

MARINE MODEL CO., Dept. F4, Halesite, Long Island, N. Y.

### ACCORDION MART

Offers Outstanding Bargains



Buy outright or on rental plan. New and used accordions at lowest prices. Full credit for every dollar you pay when you want to turn in used accordion purchased from us for new one. Instruction course included at no extra cost. Complete, guaranteed repair service. Write today for FREE catalog.

ACCORDION MART, IMPORTERS  
1736 W. 18th Street, Dept. PS-3, Chicago, Ill.

### NEW! Trash Disposal Unit Burns Refuse Safely



● A new type outdoor dispose-all unit safely and quickly burns garbage and trash in any weather. All refuse, damp, green or dry is fully consumed. Scientific draft design completely eliminates fire hazard of flying ash, sparks, burning, blowing bits of paper. Intense combustion removes neighbor-annoying nuisance of flying scraps, smoke, smell.

Sturdily built to last for years. Nothing to get out of order. Needs no watching. Will not blow over. Will not destroy grass or shrubs. Ends refuse hauling and fire hazards to quickly pay for itself. Measures 23" square at base by 40" high. Weighs 23 lbs. Over 2 bu. capacity. Recommended by Bureaus of Fire Prevention. Full price \$9.95—nothing else to buy. Sent F.O.B. Cleveland. Money back guarantee. Send check, cash, or money order to:

ALSTO COMPANY, Engineers Bldg., Dept. PS-3, Cleveland, Ohio



I Discovered  
How To  
**HEAR  
AGAIN**  
IN 20 SECONDS

I was in despair when I began to lose my hearing. Then one day—in just 20 seconds—I discovered how to hear again. Thanks to the new Beltone Phantomold—a transparent, almost invisible device—NO BUTTON SHOWS IN MY EAR. Discover how you, too, may hear again. Mail coupon for FREE booklet—tells all the facts.

**Beltone**

Symphonette  
One-Unit Hearing Aid



Beltone Hearing Aid Company, Dept. PS-3  
1450 West 19th St., Chicago 8, Ill.

MAIL THIS COUPON TODAY

Beltone Hearing Aid Company, Dept. PS-3  
1450 West 19th Street, Chicago 8, Ill.

Please send me in a plain wrapper, without obligation, FREE booklet that tells how deaf can hear again without a button showing in the ear.

Name.....

Address.....

Town..... State.....

Pioneers

Leaders

AIR RIFLES

**BENJAMIN**

AIR PISTOLS

WITH SAFETY LOCK

SEND FOR FREE FOLDER OF LATEST MODELS TODAY  
If you want a REAL GUN for PRACTICAL USE inside or outdoors, get a SAFE—CLEAN—ECONOMICAL—BENJAMIN with Adjustable Power and Amazing Accuracy. Use BENJAMIN H-C PELLETS for BEST RESULTS in all rifled models. WRITE AT ONCE.  
BENJAMIN AIR RIFLE CO., 811 MARION ST., ST. LOUIS 4, MO.





**IT'S MORE  
FUN  
in an Old Town**

**GLIDE** swiftly to your favorite fishing or hunting spot. Your Old Town Canoe responds to a touch, is light for easy portaging, rugged for dependable service. A favorite with guides for fifty years.

**FREE CATALOG** shows all kinds of canoes for paddling, for sailing, for outboards. Also sailboats, outboard boats, dinghies, rowboats.

## OLD TOWN CANOES

643 Wood Street, Old Town, Maine  
PLEASE SEND ME FREE CATALOG

Name \_\_\_\_\_

Address \_\_\_\_\_

City \_\_\_\_\_ State \_\_\_\_\_

## AMAZING NEW BIG CAPACITY

### PORTABLE



# Pik-nik ICE BOX

- Keeps Foods Hot or Cold for over 24 Hours
- Holds More than 4 Liquid Gallons
- Easy to Carry—Weights Under 6 lbs.
- Fully Insulated—Airtight—Leakproof
- Odorproof—Stain-proof
- Cleans in Seconds
- Ideal for Family Picnics, Camping, Vacations, Hunting, Fishing Trips, etc.
- Excellent for Hotels, Industrial Caterers, Ice Cube Manufacturers

**WANT** your food to be just right on your next picnic, camping or fishing trip? Just pack this new portable Pik-nik Ice Box with anything hot or cold. Retains heat or cold for over 24 hours! Special coating keeps food pure and fresh. Has separate leakproof ice chamber. Big capacity, 14" high, 11 $\frac{3}{4}$ " diameter. Handsome ice-blue finish, contrasting lemon-yellow cover. Price, \$5.95, C.O.D. plus mailing charges. Or, enclose \$5.95 and save postage. Money-back guarantee.

**\$5.95**



**FOSTER PRODUCTS, Inc.**

Dept. PN-5

659 Main St. New Rochelle, N. Y.

## SENSATIONAL NEW

# GUMFINGER RAKE

**CLEAN-UP**

**TOUGH, SPRINGY RUBBER TEETH**



**16"  
SIZE  
\$2.50**  
Postpaid

DEALERS  
WANTED

Live, resilient rubber teeth are stiff enough to rake clean, yet won't root up or tear grass or harm tender plants. Flexible teeth adjust themselves to all roughness and irregularity. Will not clog. Amazing for raking grass, leaves, twigs, trash and smoothing gravel drives, walks, beaches, golf greens and sand traps. Light and easy to handle—a pleasure for those who enjoy garden work. Safe, can't injure if stepped on. Tough and long wearing, won't rust or break. Guaranteed for three years. 8" width \$2.00; 12" \$2.25; 16" \$2.50; 20" \$2.75; 24" \$3.00; 30" \$4.00; postpaid anywhere in U. S. Send check, cash or money order now. Ohio orders add 3% sales tax.

**SATISFACTION GUARANTEED**

**MOORE PRODUCTS CO.**

4817 Superior Ave.

Cleveland 3, Ohio



## SOLID OAK \$27 CHESTS

Ship. Incl

Roomy 36" chests. Well built of select oak. Smoothly sanded. Unfinished. All inside fastenings. 30" high—14" deep. Dismantled for ship. Order direct or write for free literature. \$9 dep. on C.O.D.

**JAUNTY MFG. CO.**

11504 Lyndale So.

Minneapolis 20, Minn.

OVER  
1000

RARE ITEMS FOR  
**Fishing**  
Get Yours Now!

### EVERYTHING FOR FISHING

Hard to find fishing specialties for every kind of fishing—sport or commercial. Standard tackle and many make-it-yourself kits.

Netcraft Co., Dept. P3, Toledo 13, O.

FISHING  
CATALOG

**Free**

### "BIG SHOT" SLINGSHOT

NOT a toy. Kills crows, squirrels, rabbits, etc. No noise. Get extra shots at game. Get high scores on your target. Packed with pellets and spare bands. Start your fun today. See your dealer, or send \$1 now to:

**BOND PRODUCTS CO., Dept. P3**  
13139 Hamilton Ave., Detroit 3, Mich.

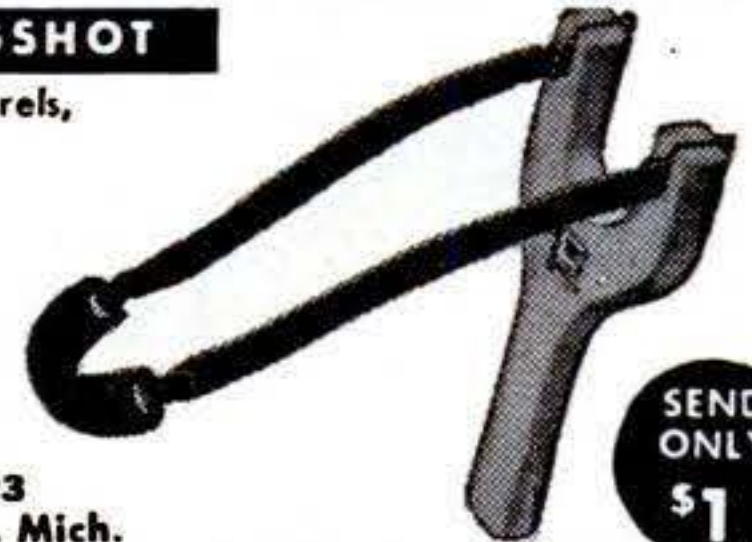

SEND ONLY  
**\$1**

## SMOOTHER WOOD



### Yours with a WOOD IMP

Drill press to rotary planer in 60 seconds—Fits any half-inch chuck—High speed steel blades—Preferred by pattern and cabinet shops—Try one on our 10 day money back guarantee and be convinced. . . .

**\$3.95**  
Post-paid

**Ordermart**

Dept. 11, 3744 E. Colorado Street  
PASADENA 8, CALIFORNIA

## NEW! AMAZING!

FULLY AUTOMATIC

**METRO  
ADDING  
MACHINE**

only  
**\$19.95**  
Including  
Fed. Exc. Tax



Adds, subtracts, multiplies—works like \$100 machine. Over 30,000 in use. Guaranteed for life.

4 $\frac{3}{4}$ "  
high,  
4 $\frac{1}{2}$ " x  
7" base.  
Weights under  
5 lbs.

**WRITE TODAY FOR FREE CIRCULAR**

**METROGRAPH CORP.** 2518 Montrose Avenue  
Dept. 150, Chicago 18, Ill.



# READY CUT HOMES

**\$1885 AND UP SAVE UP TO 1/3**

Build your own home. SAVE labor costs and builders' profits. All lumber marked and cut-to-fit. Everything furnished, doors, windows, floors, trim, roofing, hardware, nails, glass, paint, etc. Complete building plans ready for filing at low cost. Sold separately if desired. Buy Direct from Mill.

## NEW COLOR CATALOG

**SAVE UP TO \$1264**

**25c**

Send 25c IN COIN. Shows 57 modern low-priced designs and floor plans.



**INTERNATIONAL**  
Mill and Timber Co.  
Bay City, Michigan  
Dept. P.S. 350

**STERLING HOMES** Since 1910

## HULL AUTOMOBILE COMPASS

**Best Friend in the World WHEN YOU NEED IT**

Beaconlite illuminated **\$5.95** Streamline standard **\$3.95**

At your dealer's. Write for literature.



**HULL MFG. COMPANY, P. O. Box 246-E3, Warren, Ohio**

*Weaver*  
**SCHOOL OF REAL ESTATE**

**BE A BROKER--PAYS BIG!**

**STUDY AT HOME** or in our classes in leading cities. EASY TO START your own Real Estate business or step into high-paying job. **FREE PLACEMENT SERVICE.** Men, women all ages learn quickly. **MAKE BIG MONEY,** gain life-time security. Course covers Sales, Property Management, Appraising, Loans, Mortgages related subjects. Diplomas awarded. Nationally known. G. I. approved. Write for free, illustrated catalog now!

**WEAVER SCHOOL OF REAL ESTATE** (Established 1936)  
15 East Pershing Road Dept. J Kansas City, Mo.

**FREE BOOK TELLS HOW**

**LAWN ORNAMENT-NOVELTY PATTERNS**

28 Lawn Ornament Patterns, 25c. Other patterns: 15-20" high; Dutch Girl, Dutch Boy, Pirate, Bull Terrier, Mexican Girl, Mexican Boy, Dwarf, Penguin, Flower Girl, 10c each. 25 Novelty Patterns, 30c. All 62 Full Size Patterns, \$1.00 Postpaid.

**FLYING DUCK**

Wind revolves wings. Realistic appearance. Pattern, Instructions and wing Pinion Kit; brass bearing, steel shaft, wing lugs, bolts, nuts and washers. 50c. Pattern and Instructions without kit. 25c. Postpaid.

**STROTHER PATTERN SERVICE**  
Dept. 7-BG Box 128 Belington, W. Va.

## Save UP TO 25% ON QUALITY BALL-BEARING WHEELS



**Bilt-Rite Guarantee**  
No better wheels are made regardless of price; 10 day return privilege.

Bilt-Rite wheels roll smoothly and easily, are semi-pneumatic, ball-bearing, painted red; guaranteed top quality—and you save up to 25%! Compare Bilt-Rite's quality and price; then get your order in today! Dealer inquiries invited.

Ball-Bearing Wheels at Bargain Prices			
(For 1/2" axles)			
6 x 1.00	\$1.30	10 x 1.25	\$1.95
8 x 1.25	1.65	10 x 1.75	2.15
8 x 1.75	1.80	10 x 2.00	2.45
(For 5/8" axles)			
6 x 1.50	\$1.50		
6 x 2.00	\$3.95	8 x 2.50	\$4.45
10 x 2.75	Only \$4.65!		

If size you need isn't listed, write for Folio A. Order Today—Send cash, check, or M. O.—Pay postage on arrival.

## BILT-RITE WHEEL COMPANY

520 East Missouri Ave. Dept. 73 Kansas City 6, Missouri

# Protect your car

## ROUND-THE-CLOCK

# with PYROIL

• Every time you add Pyroil to your car, you're improving lubrication. No matter what kind of gas or oil you use, Pyroil gives oil the added property of clinging to cylinder walls and piston rings, protecting these vital parts against exposure to condensation, and metal-to-metal friction. Pyroil prevents clogging due to gummy deposits. Pyroil prevents damaging dry starts—because that constant clinging film of oil is a round-the-clock protector whether your car is rolling along or parked for the night.

Ask your gas station attendant to "add Pyroil"—and add miles of carefree driving.

### Pyroil for Aircraft Engines

Use Aircraft Pyroil B for lubricating oil, Aircraft Pyroil A for gasoline.

**GIVEN!** An attractive Pyroil metal savings bank—takes coins up to 50c pieces. **MOTORISTS,** it's yours for the asking—sent postage paid.

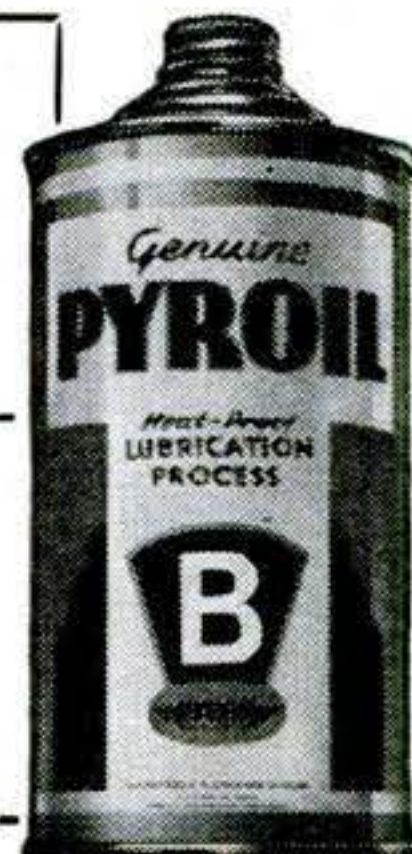

Manufactured and Guaranteed by  
**PYROIL COMPANY,**  
471 Main Street  
La Crosse, Wisconsin.

Canadian Distributors:  
Central Purchasing Agencies, Ltd.  
Toronto, Ontario

**PYROIL COMPANY**  
471 Main Street, La Crosse, Wisconsin

I want my car to last and run properly. Please tell me more about Pyroil and how it can accomplish this for me.

Name.....

Address.....

City or Town.....State.....









*New Star of the Lightweights*



**WHIZZER**  
*Sportsman*

A completely new  
Motor Bike

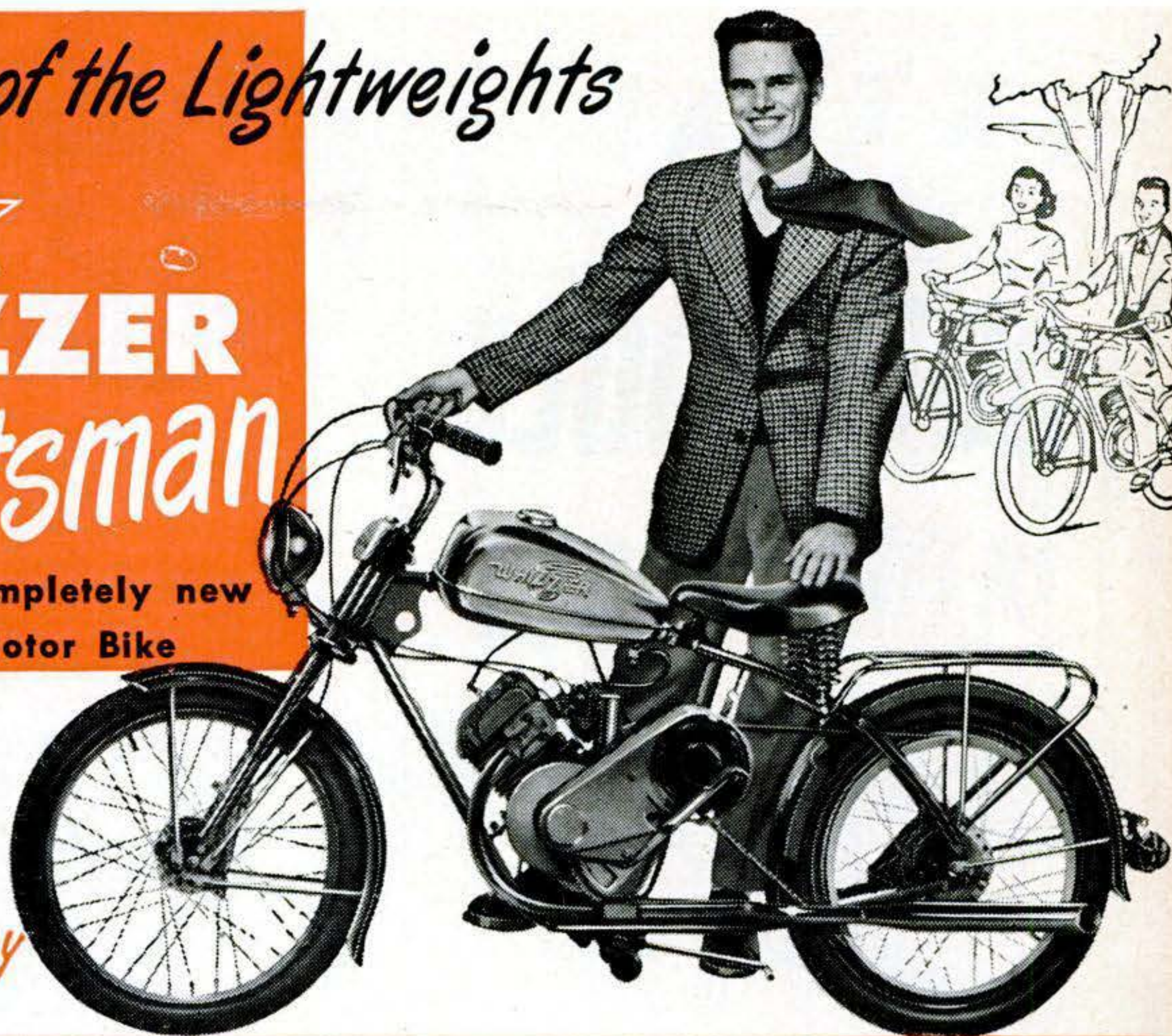

*NEW beauty*  
*NEW power*  
*NEW economy*

★ Big new 3 horsepower motor, 138 c.c.

★ Kick starter

★ Extra-large drum brakes, front and rear

★ 2-speed transmission; automatic shifting

★ 5 to 40 m.p.h.; over 100 miles per gallon of gas

★ Built-in generator, Sealed Beam headlight

**RIDE ONE and you'll BUY ONE!**

Pleasure's *built into* Whizzer's new Sportsman! Powered by rugged, 3-horsepower, 138 c.c. motor, 4-cycle, precision-built. Automatic 2-speed transmission has low gear to conquer hills, give quick starts. Low center of gravity with full-size frame

on 20" heavy-duty wheels. Long wheel-base. Extra-large front and rear drum-type expander brakes, rear brake pedal-controlled. Folding footrests, chrome echo-tube exhaust. For work, low-cost travel and pleasure-riding, you'll want Whizzer **\$239<sup>50</sup>** SPORTSMAN!

complete, plus Fed. tax  
F. O. B. Pontiac, Mich.

*Power Package*  
**FOR YOUR BIKE!**



Famous WHIZZER, America's Finest Bike Motor

**Now 3 Big Horsepower!**

4-cycle, 138 c.c.! 5 to 40 m.p.h. on your bike! For low-cost travel, fun! Motor, complete **\$109<sup>97</sup>** with attachments. F.O.B. Pontiac, Mich.

**SEE YOUR WHIZZER DEALER TODAY!**

WHIZZER MOTOR CO., DEPT. 312, Pontiac 15, Mich.

Please send me, by return mail, *free* illustrated catalog on Whizzer motor bikes.

Name \_\_\_\_\_

Address \_\_\_\_\_

City \_\_\_\_\_ State \_\_\_\_\_



# EXTRA!

a different name for your old friends:

# PROTO TOOLS

-formerly

# PLOMB TOOLS



Here is the biggest news in the tool industry

today. The leading hand service tools are now named PROTO tools—formerly Plomb tools. All PROTO tools are of the very finest quality. That's why they have been the favorites of professionals since 1907. Remember the name — PROTO tools—formerly Plomb tools, when you want the best.

Buy the ones you need from your dealer *today*.

Write for catalog to

**PLOMB TOOL COMPANY**

2257-M Santa Fe Ave., Los Angeles 54, Calif.

4985



# FREE

## NEW BOOK ON FISHING!



You need new "Fishing—What Tackle and When"—nearly 100 pages of helpful fishing tips, casting instructions, fish pictures, tackle, etc. Write for it today. **FREE!**

**SOUTH BEND GLASS CASTING ROD**

New! Hundreds of thousands of glass fibers scientifically bonded for perfect action — strength — durability. Won't "set," rot or corrode. **\$15.75**  
No. 2800. 3 lengths—5, 5-1/2 or 6 ft.

South Bend Bait Co., 892 High St., South Bend 23, Ind.

# SOUTH BEND

**A NAME FAMOUS IN FISHING**

# WALKIE TALKIES

**A Complete 2-Way Electro-Magnetic COMMUNICATION SYSTEM**

Don't let the unbelievable low price fool you! A genuine two way system operating on new Electro-Magnetic principles. Set includes wire, and simple instructions. Amazing clarity makes it effective for all types of operation.

(2 complete units included)

Nothing to build—Nothing to buy—Guaranteed to work indoors—outdoors—anywhere.

C.O.D.'s, send \$1.00 deposit, pay \$2.95 postman balance plus postage.

**NORTH EAST SALES CO.**  
314 MARKET ST. Dept. PS 7, NEWARK, N. J.



## Wrist ALARM Watch

The Latest Development in Swiss Watchmaking Arts. A **WRIST WATCH** combined with **ALARM CLOCK** elements. Set the alarm and listen to the pleasant buzzing sounds and gentle tingling on your wrist. Wonderful way to remind yourself of dates, appointments, schedule, train or radio program. 7 Jewel Movement. Chrome and Stainless Steel back. Only \$14.95 plus tax (total \$16.45). Send check or Money Order.



**MARDO SALES CO., 480 Lexington Ave., Dept. P.W.A., New York, N.Y.**



# ONAN Portable ELECTRIC PLANTS

**FOR CABINS, TRAILERS, CONTRACTORS, BOATS**

Light weight, compact, air-cooled engine-driven. Furnish regular city-type A.C. electricity for lights, appliances, radios, etc. Can be carried by hand. Fit trunk of car. Plug-in receptacles on plant. Larger models for farms, homes, businesses beyond highlines. Catalog shows over hundred models. 350 to 55,000 watts.

*Gasoline or Diesel Powered*

**WRITE FOR CATALOG**

**D. W. ONAN & SONS INC.**  
2805 Royalston Ave., Minneapolis 5, Minn.





Only wide-gap Auto-Lite Resistor Spark Plugs give you

# SMOOTHER PERFORMANCE DOUBLE LIFE and GREATER GAS SAVINGS

Cut-away view shows the 10,000 ohm Resistor which permits wider initial gap settings and makes these advantages possible. Double life under equal conditions as compared with regular type spark plugs.

MILLIONS of car owners from coast to coast are switching from narrow-gap spark plugs to the sensational new wide-gap Auto-Lite Resistor Spark Plug. They want smoother performance—money-saving gas economy—improved starting in extreme cold weather. They want the *Built-in Resistor* that doubles spark plug life and reduces interference with radio and television reception.



To get these remarkable benefits for your car, see your Auto-Lite Spark Plug Dealer today. You're always right . . . with Auto-Lite.

Tune in "Suspense!"... CBS Radio Thursdays... CBS Television Tuesdays



Auto-Lite  
Spark Plugs  
Patented  
U.S.A.

# AUTO-LITE *Resistor* SPARK PLUGS

RESISTOR, REGULAR AND TRANSPORT TYPES

MARCH 1950 95



# What Happened to Atomic Secrecy?

**I**T WAS no surprise to the scientists that the Russians got the bomb. The men who split the atom had long warned that *the basic science* from which came nuclear fission could not be kept secret.

The engineering know-how could be cut up into tons of tables and blueprints, and hidden in the crannies of a thousand minds. But the "secret" could no more be bundled up and locked in a safe than the wind could be held in the hand.

For a time the scientists hoped, with everyone else, that the sheer quantity of know-how and money could buy delay. Yet again they warned that our ways were not the only methods to manufacture hell on earth.

Then came the whirlwind of threatened horror already nicknamed the "H-bomb." Locked doors and armed guards could not stop the talk. Even while it could not be officially admitted, it could not be denied.

Who blabbed? Nobody. The facts of science were on the record.



Only five or six years ago, anyone who said "atom" out loud was in trouble. This time, the even bigger "secret" burst into print. Speculation—scientific, political, and moral—reaches new heights, complete with learned comments by columnists and cutaway drawings. Here we go again!

But let's not go through the whole routine of "just another weapon." Let's not kid ourselves again by saying, "Ah, but we've got the secret of the *Hydrogen* bomb!"

In the present low state of the world, we will have to get into the H-bomb business. But let's not maintain the slowdown of secrecy. Let's admit the only *real* secret we've got is the secret of the soap business and the automobile business: how to make *more* of them *quicker* and *cheaper* than the competition.

Maybe enough murderous weapons that guarantee suicide will stop the shooting and start the thinking.

*Perry Githens*



# NEW PLYMOUTH

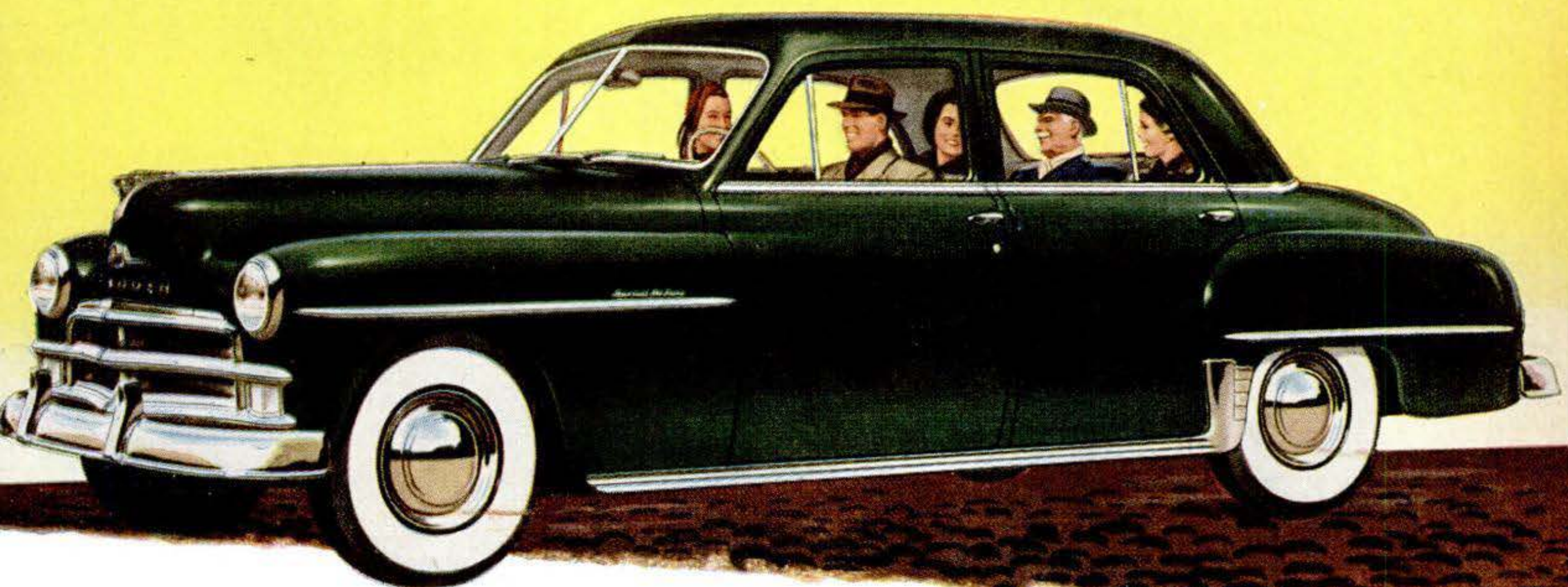

***packed with value and ready to prove it!***

Here's the sensational new standard for excellence in the low-priced car field—the brilliant new, value-packed Plymouth!

No other car at the price gives you anything like the new Plymouth's great engineering advantages. The speed and ease of Ignition Key starting . . . the thrilling performance of the 7.0 to 1 high compression en-

gine . . . the swift, smooth stops of big Safe-Guard Hydraulic Brakes . . . the positive blowout protection of Safety-Rim Wheels.

The new Plymouth rides like a heavy, high-priced limousine yet handles with amazing ease! No wonder this fine car of great value is now—more than ever—the car that likes to be compared! No wonder this

new American Beauty is now—more than ever—the low-priced car most like high-priced cars!

Plan to visit your nearby Plymouth dealer now. He'll gladly arrange for a demonstration drive. Then you can test this car and see for yourself that the new Plymouth is the most car value you can possibly buy at Plymouth's low price!



**PLYMOUTH**  
BUILDS GREAT CARS

**NOW**—more than ever—the car that likes to be compared

PLYMOUTH Division of CHRYSLER CORPORATION, Detroit 31, Michigan



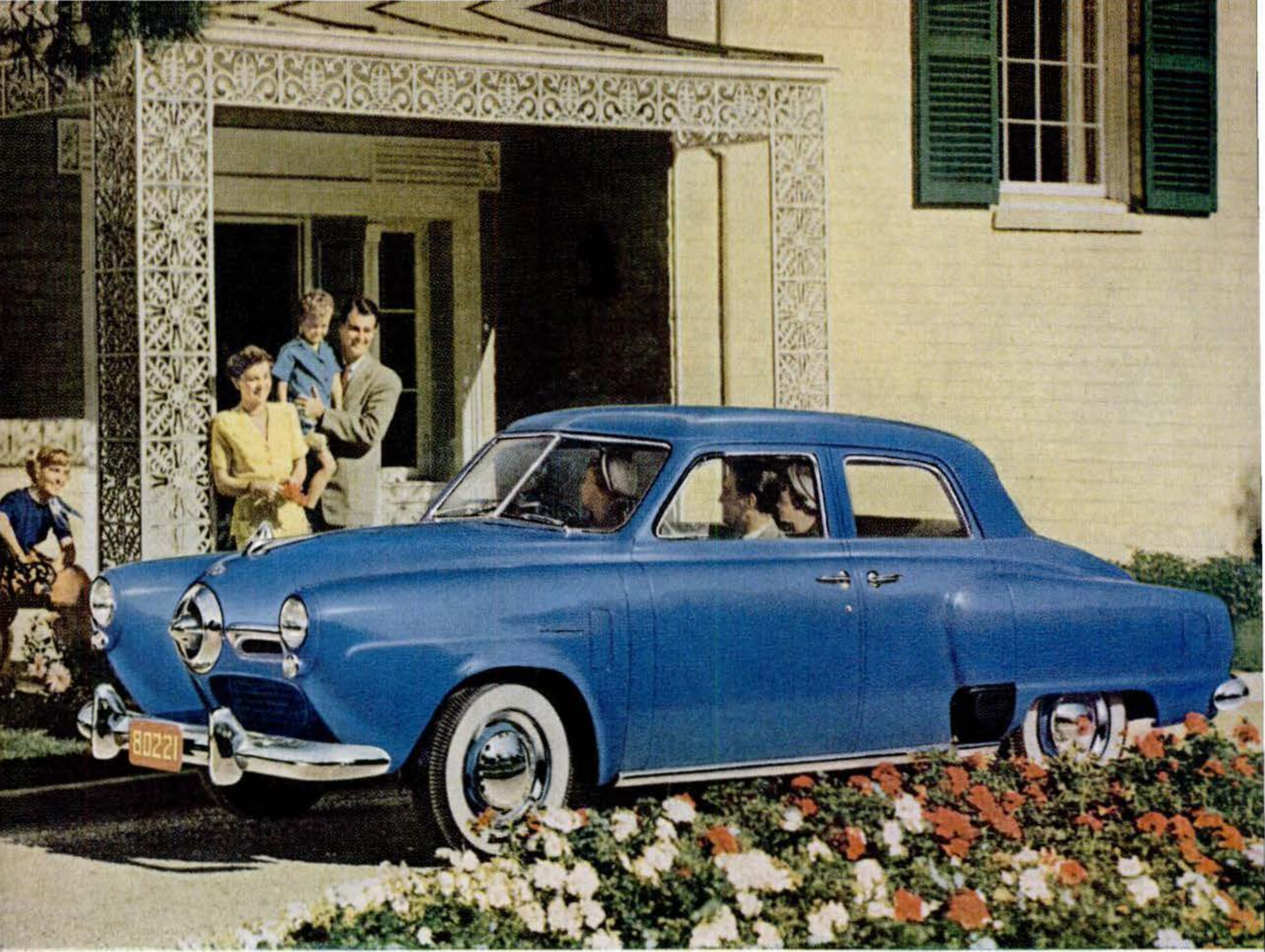

Studebaker Champion 4-door sedan

## Smart 1950 buy — this Studebaker's thrift and value!

JUST a look at the low, long, alluring new 1950 Studebaker tells you that it's a car with the right build for real money saving.

You see no bulging excess bulk that would hitch a ride at your expense—no surplus poundage to squander your gasoline needlessly.

You get welcome protection against unexpected repair bills, too.

The whole structure of this refreshingly different new car has the solid durability of top-quality materials and wear-resisting craftsmanship.

Take the logical next step in getting the most for your new-car money.

Try out the amazing "next ride" of this distinctive "next look" Studebaker.

Stop in at a nearby Studebaker dealer's showroom and go out for a convincing drive in a low-price Champion—a value-packed Commander—a special extra-long-wheelbase Land Cruiser.

## NEW 1950 STUDEBAKER

*Styled ahead and engineered ahead!*

White sidewall tires and wheel trim rings optional at extra cost



You ride in deep-bedded comfort—New balance of design and a brand new kind of coil spring front-end suspension! Regal de luxe Champion has foam rubber seat cushioning.



You're money ahead on gas with a 1950 Studebaker because it has trim, sleek, aerodynamic lines—and the whole car has the right build for thrift in every detail of its structure.



You don't roll back on upgrades—Automatic hill holder is standard on Commanders and Land Cruisers—extra cost on Champions. Overdrive is available too at extra cost.



You get trustworthy craftsmanship that's the pride of numerous Studebaker father and son teams. It's your assurance of top trade-in value. Studebaker, South Bend, Indiana, U.S.A.





***Punctured cloud . . .*** Here's how a man-made hole in a cloud looks from topside, 15,000 feet up. The racetrack-shaped opening, 20 miles long on the sides, five miles across on the ends, was formed by seeding a stratus cloud with dry ice. The ice acts as a trigger on the supercooled water droplets in the cloud. They condense into snow or sleet, fall out of the cloud and, bingo, there's a hole. The cloudbusting is part of Project Cirrus, a joint research program of the Army Signal Corps and the Office of Naval Research. Drs. Irving Langmuir and Vincent J. Schaefer, of General Electric, who originated the seeding technique, insist it can make rain. The Army and Navy, interested in military applications, just won't say.



# How Good Is Our Anti-



Cover by Ray Quigley

**By Phil Gustafson**

*Drawings by Ray Quigley*

**Y**OU are standing on the cramped bridge of a light carrier. Crowded around you are the Skipper, the watch officers, talkers, air officers, the Admiral commanding this Hunter-Killer Force, and some of his staff.

On the flight deck, a couple of narrow ladders below you, plane pushers are re-spotting aircraft at once familiar and

“The importance of undersea warfare from our standpoint as a nation is fully as great as that of air warfare. . . . the scales have recently tipped in favor of the attack as far as undersea warfare is concerned.”

—VANNEVAR BUSH, in *Modern Arms and Free Men*

strange: torpedo-bombers like the faithful old Grumman, but looking like bullfrogs with grossly swollen housings for search gear.

Down another ladder, men in the constant twilight of the information center watch their scopes and plot their dope. Topside, it is a bright tropical day, but your eyes are heavy from the strain of round-the-clock operations. In ASW—Anti-Submarine Warfare—the hounds share the nerve-wracking jumpiness of the fox.

Off the beams and the bows, the destroy-



# Submarine Defense?



A radar-nosed, long-range Martin patrol bomber, left, meets a Hunter-Killer Force at sea.

ers weave their wakes. Overhead, planes drone across, flags whip in the wind, the radar rotates monotonously. And under you, somewhere in all that water, is an "enemy" submarine. A modern submarine, equipped with the batteries to shove it along under water about as fast as you can go on the surface. With a snorkel to let it breathe for recharging without surfacing.

At your elbow, a squawk box begins to blat. One of the search planes, patterning the endless ocean, has caught a scent. A

blimp swoops over to investigate with surprising agility: 70 knots is very fast a few feet off the water. Then comes the call for a killer, and a destroyer closes in like a cowboy. Up comes the sub, a sleek steel shark, and you realize how near it was to getting your carrier, nerve center and home base of the whole H-K force.

That's the way it is in the maneuvers—sometimes. The deadly guppy-snork *can* be caught and killed—when weather and water favor the hunter-killers. But find- ➤



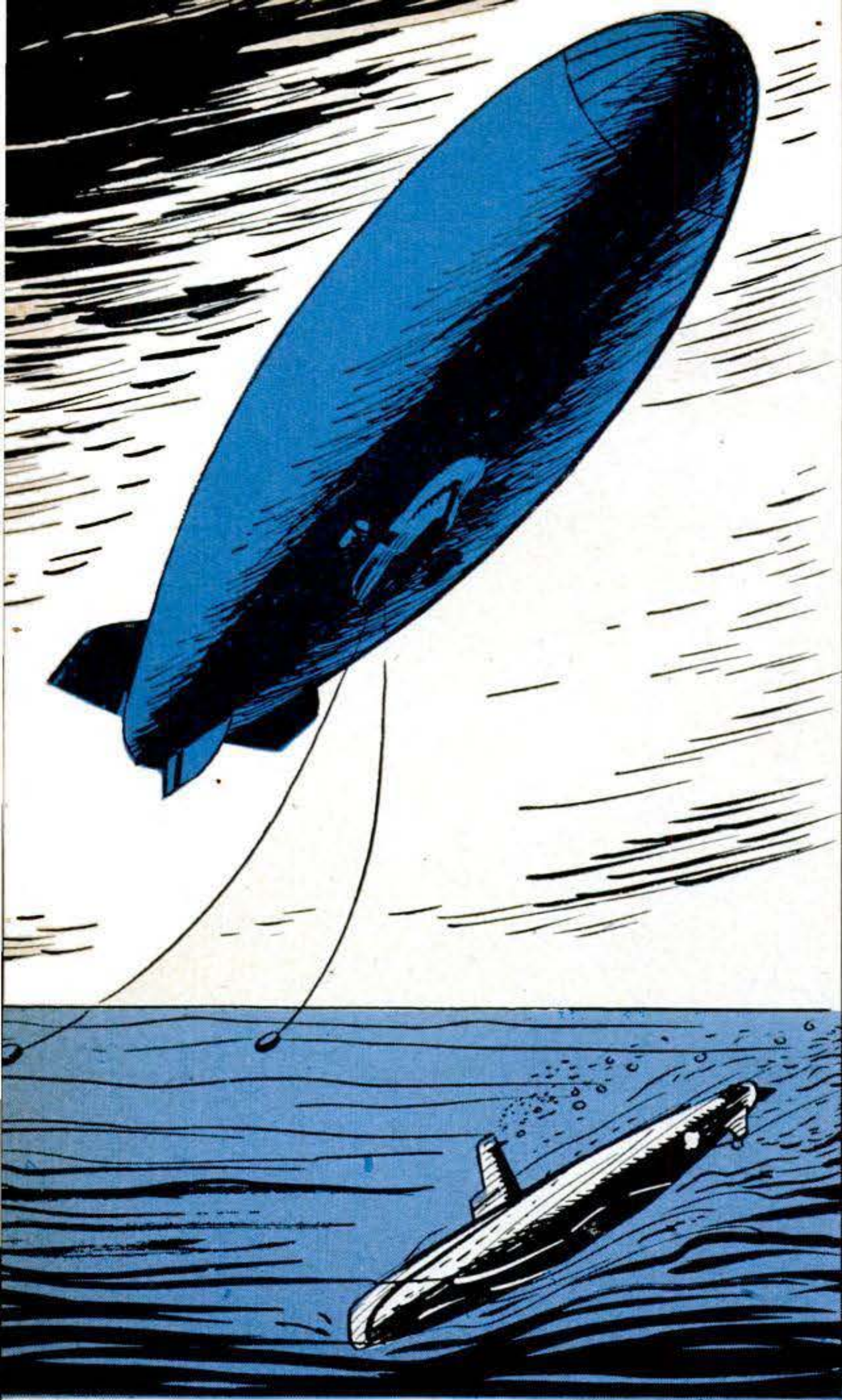

**How H-K Force works:** Ship- and shore-based planes and blimps, sweeping with radar, have outlined suspicious waters and forced subs down. Here, a carrier-based blimp fine-combs the sea with radar, sonar, and magnetic-detection equipment. Flying slowly and close to water, blimp puts the finger on a submerged "target."

ing and fighting the modern submarine is as difficult as it is important in the face of the facts.

ASW is as darkly secret a business as the deep, black sea itself. Security is as tight as a sub rigged for dive. But it is a very public secret that:

- 1) ship for ship, in the brutal economics of undersea warfare the odds are again with the subs;
- 2) the latest German subs could have operated successfully against the detection and killing devices that had swept the old types from the seas;
- 3) the latest German torpedoes had range and speed beyond the capacity of detection equipment; and

4) Russia thus has the makings of a potent undersea navy.

The modern submarine (PS, June '49, p. 98) can travel far, lug missiles and maybe A-bombs. Dr. Vannevar Bush calls it "one of our greatest potential enemies" because it can "cut the world apart." The Navy knows it as a devil's wager at such unhappy odds in men, money, and materiel that it cannot be won head-on.

So it is proper to ask, "How good is our anti-sub defense?"

The honest answer to this simple question is not simple. It is big and complicated. It might be fairly summarized, as of now, by saying, "only fairly good—but getting better."

That represents an improvement. A while back, the answer could have been a grim, "Oh, brother!" Today there is not only a new *attitude* toward the importance of the problem in the Pentagon. In the Navy itself, there is a *broader approach*, planned to draw on the best in civilian science as well as operational experience.

Of course, you should know that to ask, "How good is our anti-sub defense?" is a little like asking, "How much is an automobile?" The answer must carry such question marks as, "How much automobile, and how much money?"

#### *What Will You Pay for a Dead Sub?*

Want to kill a submarine? Sure! Can do. But how much are you willing to spend? Want to swap a carrier with 700 men for a sub with 70? Remember that a sub can bite, too. In fact, today's torpedoes go so far so fast that *the first anti-sub alarm might be a sinking ship*.

Killing the sub, furthermore, is just part of ASW. It begins, like the recipe for hunter's stew, with, "First catch your rabbit . . ."

Today's sub-hunting still centers around the nervy little Hunter-Killer Force that broomed the seas in World War II. It is composed of a carrier, several destroyers, and assorted aircraft.

*The carrier* is not the tin jeep used for ASW in the war, but a tougher, faster flat-top. The kind they first adapted from tanker hulls, like the *Mindoro*, *Siboney*, and *Sicily*. Or it may be on a cruiser hull, like the *Saipan*. Whatever the hull, it is stripped and streamlined for speed, with



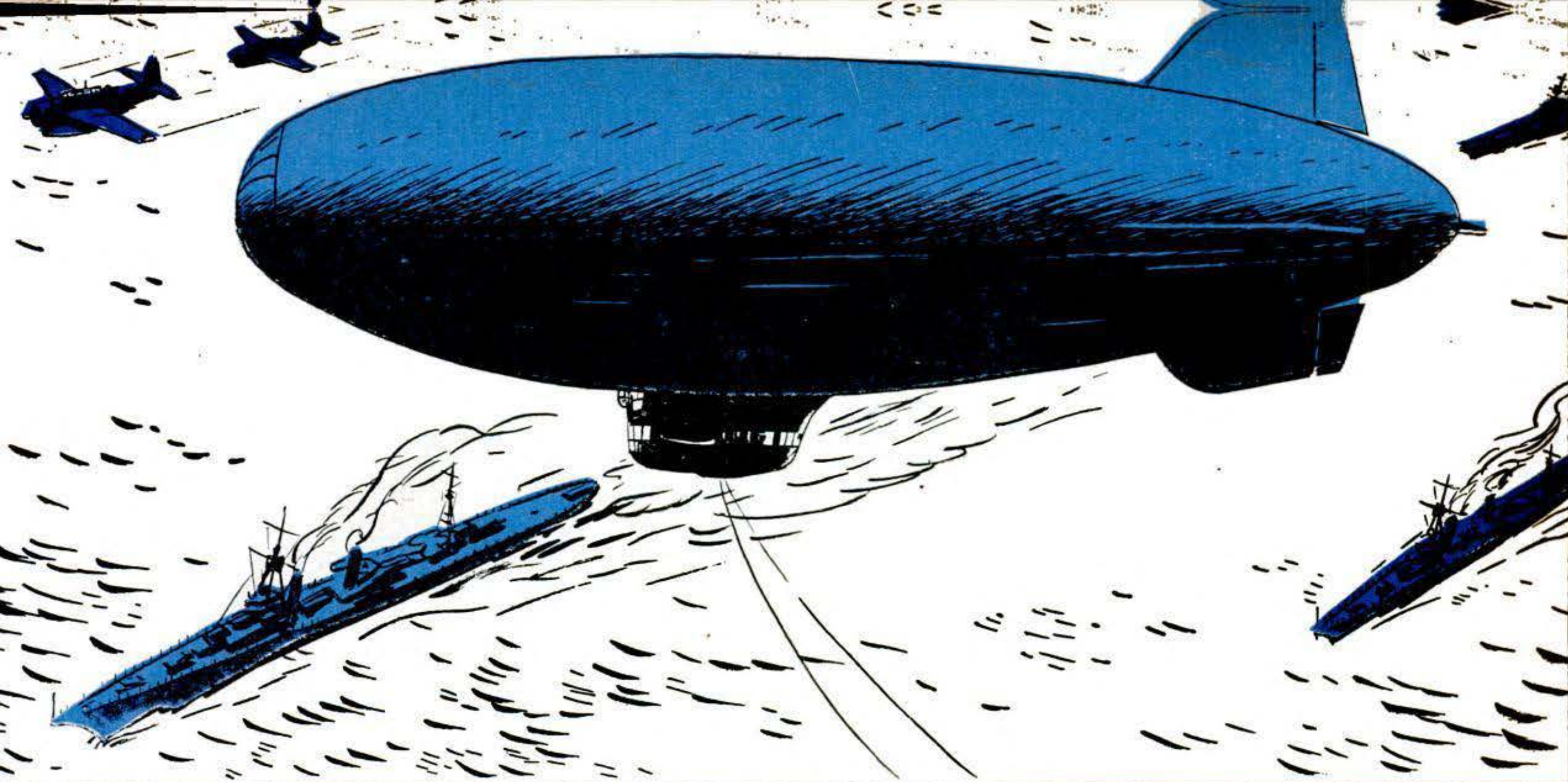

**Yelling for the Hunter-Killer** ships and planes, the blimp fences the suspect seas with sonobuoys and marks the general position of the deep-speeding guppy. Hunter destroyers take up the chase with sonar, and pin-point the

a Combat Information Center specialized for sub-hunting and fighting, and the latest thing in radar.

*The destroyers* are faster and lighter on their feet. Off with some topside armament; on with aluminum superstructure to cut weight. New hunter and killer DDs are being built from scratch, led off by the *Carpenter* and the *Owens*. The light cruiser *Norfolk* has been converted into the first HK of cruiser size and speed. These are the specialized snorkel hounds.

*The aircraft*, too, are becoming more

**The pack closes in.** Killer ships—destroyers with extra weapons and speed—maneuver to bring their deadly hedgehogs to bear with sonar targeting gear. Killer planes drop homing torpedoes and circle to fire rockets if sub surfaces. The blimps stand clear. The carrier zigzags

target. Telltale “pings” of sonar warn the sub that the hounds are hot on his trail. He twists and dives to keep the upcoming killers from drawing a bead—which in war would lead to a shower of deadly depth charges.

specialized. Some have the emphasis on search; others on weapons for killing. TBMs and Douglas Skyraiders, bloated with radar or bristling with rockets, depth charges, and torpedoes, are carrier-based.

Often the HK Force may collaborate with such land-based, long-search big planes as the P2V Neptune. A possible new helper may be the Martin P5M-1, the heavy-hulled flying boat designed for ASW operation. A legitimate guess is that this aircraft would be able to squat on the wet almost anywhere and listen for subs. ▶

warily into the background: the H-K Force cannot afford to swap a carrier for even the most dangerous sub. Finally, a special weapon or a hedgehog missile connects. Sonar plot reports the under-noise of a hit. The surface breaks in a widening boil: “Heard sub; sank same.”





The blimps have a bigger job in the Hunter-Killer Force (PS, July '49, p. 124). Now carrier-based, they can fly out with full detection equipment to extend the fleet's ears. And fly low and slow enough to use fine-tooth search gear at peak efficiency.

The helicopter is a logical candidate for HK membership. It might be used for fine-combing much like the blimps. And its ability to hover could come in handy for putting down advance listening posts.

The anti-sub sub (SSK) is one of the best shots in the Navy's ASW locker. You can set a sub to catch a sub quite successfully, as proved by the record of Jap subs sunk by ours. A sub quietly listening can hear farther than a moving enemy sub



**Douglas Skyraider (AD3W)** is carrier-based search plane. The huge plastic radome underneath houses the radar antenna. Possibly teamed up with specialized killer plane with emphasis on weapons.

whose speed clouds his own sonar. Our new guppies are getting high-power detection equipment to let them go on the prowl. And new killer subs are being built. But the SSK will hardly dare work too intimately with the HK force until somebody finds a way for a friendly sub to identify itself without exposing itself. With no way to yell, "Don't shoot, Joe, it's me!" the SSK will have to keep away from the local area of the Hunter-Killers.

These are the craft the Navy uses—under, on, and over the sea—to find and fight the new-type subs that have changed the shape of undersea warfare. The German Type 21,

you remember, had at least doubled the eight-to-ten knot submerged speed of the old subs. This meant it could make more than one swift pass at a convoy, or walk away from hunters that had to slow down to hear better. The German 45-knot torpedo could be fired from five or six miles, far beyond sonar range under the best conditions even today. So what about sonar?

Sonar equipment comes in two main types: what might be called "passive" sonar, which simply *listens* for underwater noise and indicates direction; and "active" sonar, which sends out a supersonic pulse called a "ping." The ping bounces off a target much like radar, and the newest type presents information on a screen.

Since sonar protection is outranged by existing torpedoes, the Navy has met the problem differently. As Rear Admiral C. B. Momsen, head of the working party whose chore it has been to plan undersea warfare, puts it:

"If we cannot project our *detection* out to the new torpedo range, then we must project the *platform*, just as the airplane projected the gun platform."

The platform from which detection works can be pushed out with the sonobuoy, the blimp, probably the helicopter, and the anti-sub sub that can range discreetly ahead of the Hunter-Killers as a forward listening post.

#### **Buoy Buggy Whip Blabs on Subs**

The sonobuoy is an expendable, battery-powered baby broadcasting station. Dropped into suspect waters by plane or blimp, it lowers a microphone, snaps up a little buggy-whip antenna, and blabs what it hears. Monitored by aircraft, a pattern of sonobuoys can keep a sub under surveillance until surface craft can carry on the chase with sonar.

Pinging sonar is the most accurate close-in detection method. The trouble is that it's too close. But the blimp promises a valuable projection of the platform. The blimp also carries another detection gimmick: MAD—Magnetic Airborne Detection—that can point the finger at a submerged sub by its distortion of the earth's magnetic field.

MAD gear is still pretty delicate laboratory equipment to be tossed around in mid-air, but it works when it works. During the war, it was the only detection gear that could smell a German sub trying to float with the tide, quietly submerged, through



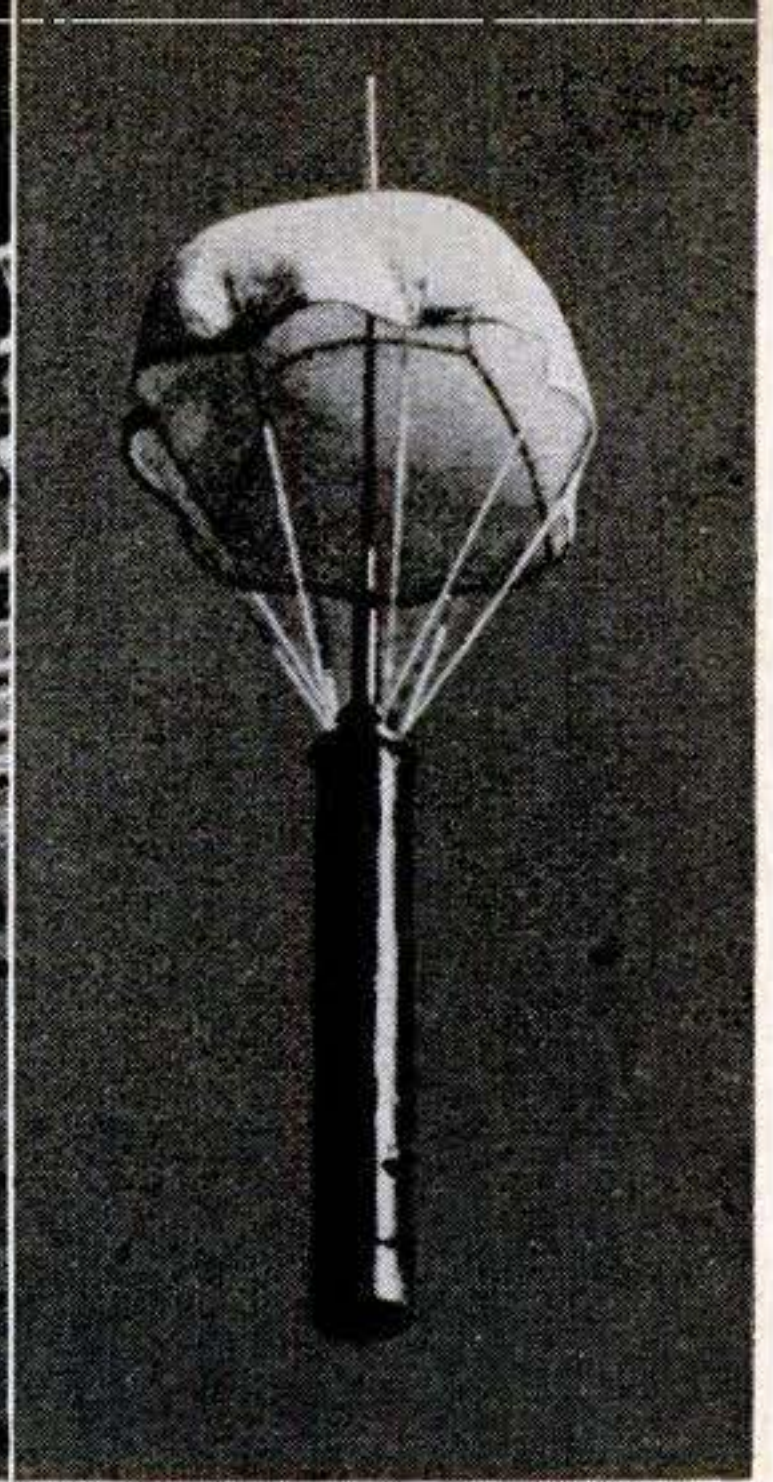
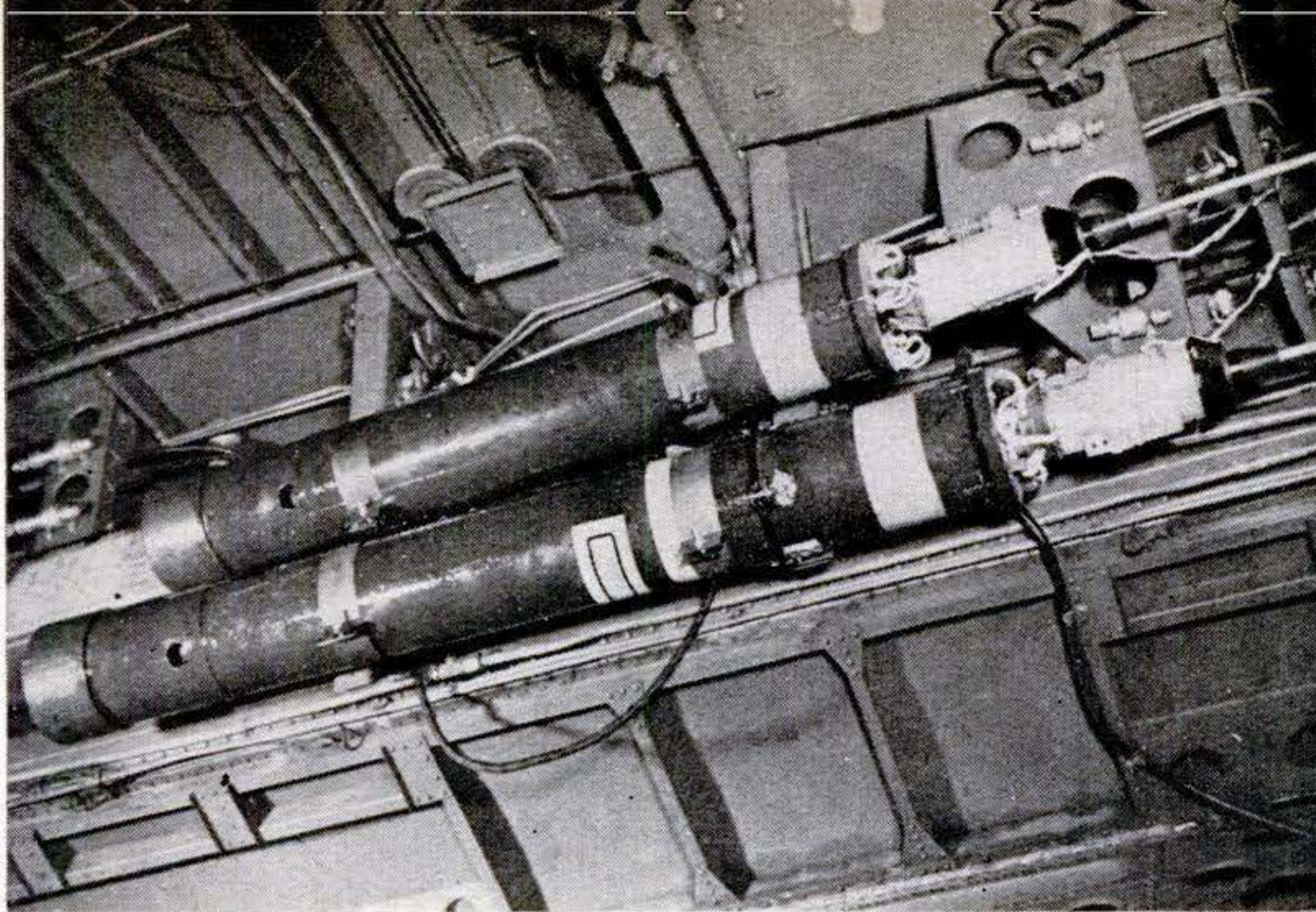

**Sonobuoys** are simply floating radio stations the size of fence posts. Parachuted into the water, they let down a listening hydrophone, pop up an antenna, and broadcast what they hear under water. Dropped in a definite order to ring an area where enemy submarine activity

is suspected or to protect an operational zone, sonobuoys identify their positions by their individual transmission frequencies. Dye markers, spotting the buoys in the water, show aircraft patrolling a sonobuoy fence in daylight where there are any gaps that must be plugged up.

the Straits of Gibraltar. A sharp eye can see the MAD "birds" perched forward on the bag of a blimp, like ears.

The sub-hunters also rely heavily on radar. Improved models in ships and aircraft can catch even the small target of a snorkel. A snorkeling sub presumably has its radar detector going, too, so the very presence of ship and airborne radar over an area is a fine way to keep the subs down or out.

These are the main detection devices that can find the elusive and powerful new subs. But once you've scented your rabbit (and remember, it's a man-eating rabbit!) how do you kill it?

The "hedgehog"—so named in wartime code for its many deadly bristles—is one of your weapons. Once a sub has been pinpointed by search, and pinned down by killer planes, the destroyers can start shooting with hedgehogs.

#### *Hunting with Rocket Shotguns*

These forward-throwing weapons shoot a shotgun pattern of rocket-propelled charges ahead of or alongside the killer ship while it still has the running fox on sonar plotting. The many high-powered charges sink swiftly, and when one hits a sub it hits hard. If you know your weapons, you can wonder about the possibility of more and bigger hedgehog projectiles fixed up with noses like a VT fuse (see cover).

The acoustical torpedo, fitted with homing nose, is known to have existed. ➡

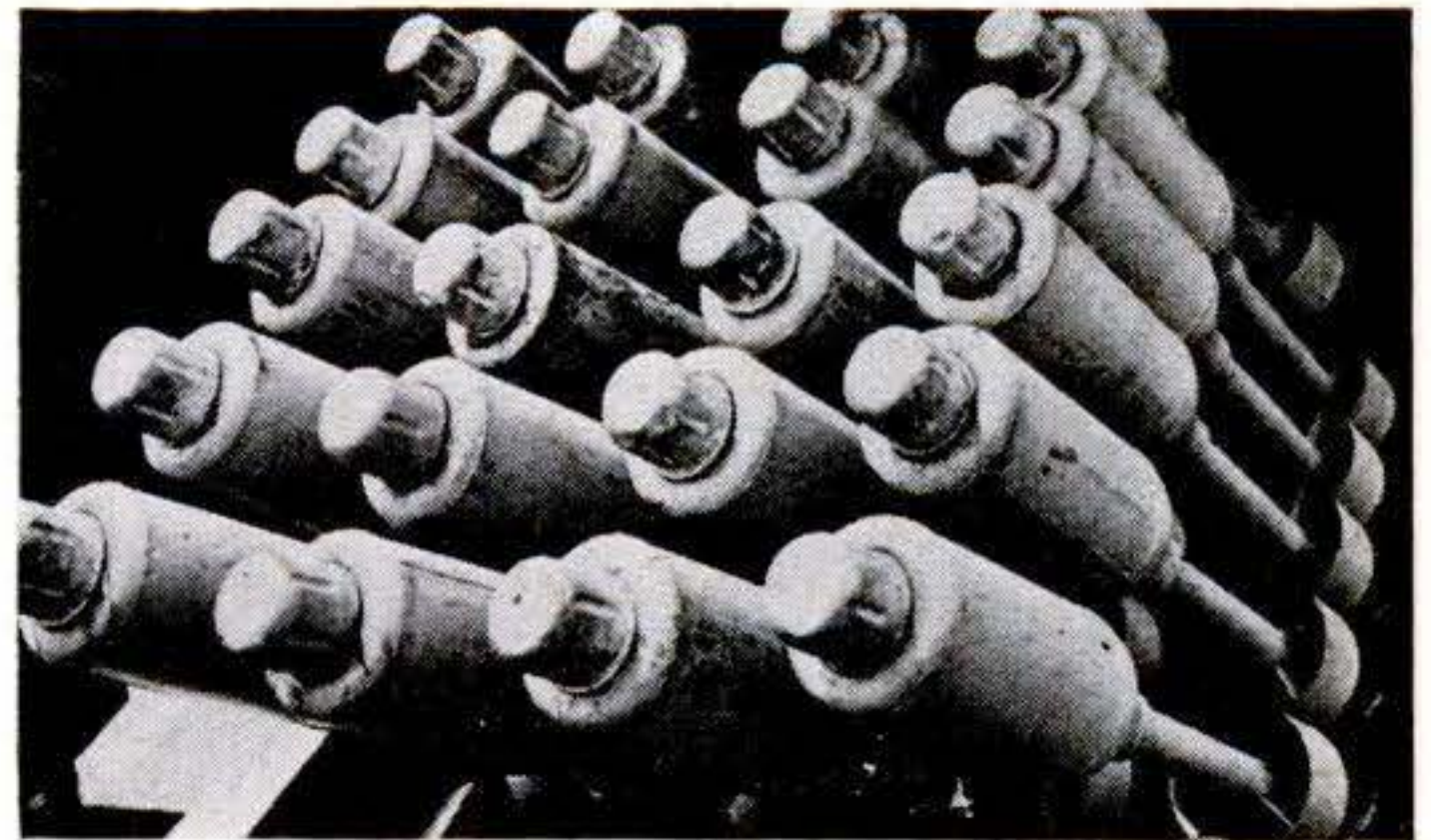

**Hedgehog** is multiple-projectile weapon, firing many contact charges simultaneously, ahead of killer ship making sonar attack on sub. The rocket bombs, shown here on spigots, are set at slightly different angles so that they land in a pattern like shotgun pellets.

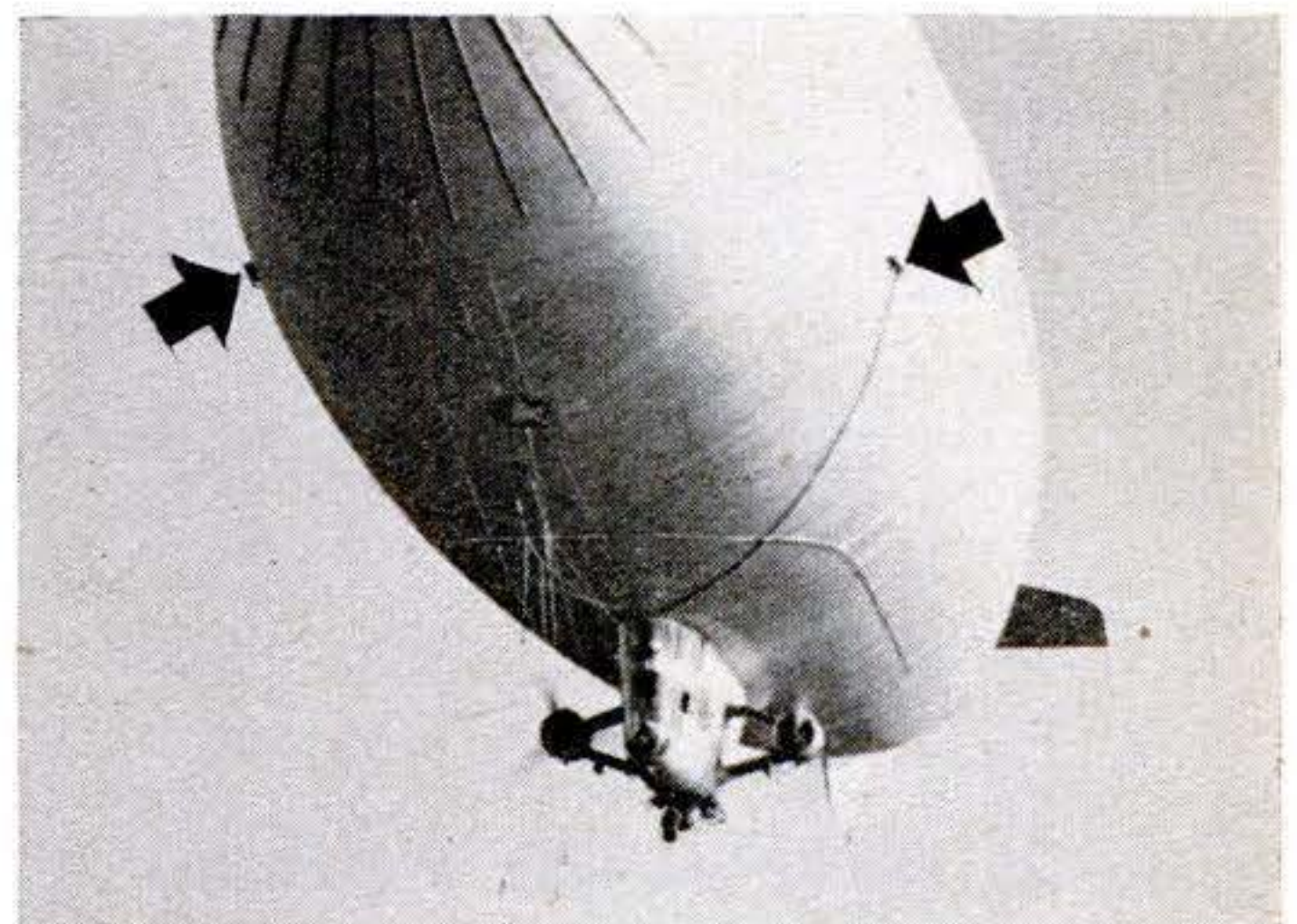

"MAD ears" are high and forward (arrows) on gas bag of blimp. Working just off the water at any speed from a slow swim to double a destroyer's best, blimps can use several kinds of detection gear effectively, since the streamlined guppy-snork submarines have no deck guns with which to shoot them down.



Released by destroyer, aircraft, or SSK, it avoids its friends by a pressure switch set to explode it only between a predetermined underwater floor and ceiling.

Airborne rockets, with a solid steel head that can slam through one side of a sub and out the other, can take care of any guppy-snork that might have to surface.

Even with all this search and shooting gear, the Hunter-Killer Force is not likely to be the final answer to the ASW phase of undersea warfare. It risks so much in that "devil's wager." A carrier, at least six destroyers, two to four blimps (too far from shore to fly home if their carrier goes down), maybe 20 or 30 airplanes also dependent on the carrier.

More and more, shore-based planes and tough new seaplanes will probably take up the task of general search-and-kill. The Hunter-Killer Force, however, will have to take on the risky job of guarding the big, slow convoys that must always move the huge supplies for global war.

One hard conclusion is visible: no single gadget like sonar, which made us overconfident at the outset of World War II, will again be the obvious answer to ASW. From now on, our anti-sub defense depends on broad development rather than simple discovery.

### ***Killing Only Part of Problem***

In this process, constant and continuing, the actual hunting and killing of the modern submarine becomes only one part of the total problem. Also involved are the survey and selection of convoy routes where weather and water conditions are more favorable to the hunters than to the subs. Any future ASW operations must take the offensive by mining the waters enemy subs must use, and by blasting the sub pens and construction yards.

Even such seemingly extraneous factors as our own cargo-ship construction must be taken into account. You might ask yourself why cargo ships should carry masts and booms and donkey engines for loading, when more modern materials-handling equipment is already available. Stripping off such cumbersome gear would lighten and speed up ships. And cutting down turn-around time would be the quick equivalent of a vastly larger merchant marine. Dock-side cranes and loading of whole freight cars, lifted bodily from their wheels, would create more shipping space overnight than

could be constructed in many weeks—or sunk by an enemy in a frightful fraction of construction time.

This is only a flash of the total scope of the problem of getting a lot of tonnage across a lot of water. Direct huntin', shoot-in' anti-sub defense will of course continue as a part of the deal, calling for the best scientific and military thinking in the nation. Warns Dr. Bush, "We need a vigorous program in the hands of a virile and generously supported Navy, in closest cooperation with science and technology throughout the nation."

### ***Thinking Must Come Before Fighting***

As evidence of its own grasp of the situation, the Navy recently called in Vice Admiral Francis S. Low, ASW chief in World War II, to evaluate needs. There's now talk of a new committee of working scientists to project the *thinking* platform.

As an example of what is needed in the dreaming stage of detection equipment, consider the single problem of thinking out sonar equipment that will mechanize the *peak* performance of the *best* human operators. The way things stand now, even the best operator is wearied by the monotony of listening to the sweeping pings to the point where he loses his sense of audio-discrimination, and may make a fatal mistake.

For the sub-hunters, as well as the submariners, must now lean most heavily on the human factor. And as one ASW expert puts it, "Any future undersea war may be won by the nation with the most rugged musicians." END



*They're aviation mechanics. The speaker means he found one of the ribs in a wing broken when he removed the fabric covering.*



## Stilts Boost Tractor's Grip

THE spoked attachment mounted on the rear wheel of the tractor in the photos at right is a British device for giving the tires greater traction when needed. When two nuts at the hub are loosened and the tractor driven forward, 10 spokes are thrust outward to project beyond the tire, as shown in lower photo, becoming ground grippers. Tightening the nuts locks them in position. To retract the cleats, the nuts are loosened, and the tractor backed up. Stanhay Ltd., of Ashford, Kent, England, is the maker.

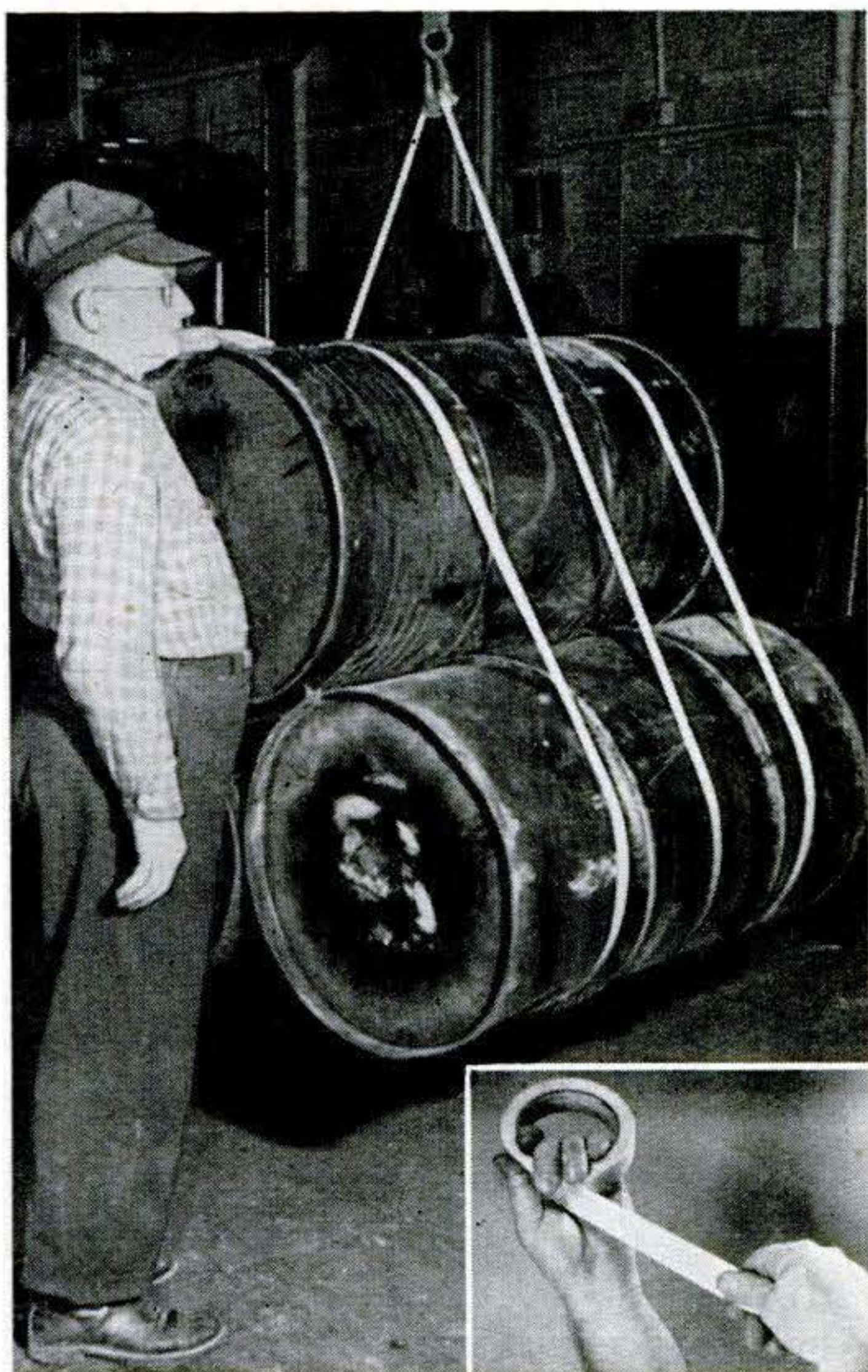

## Tape Has Tarzan Strength

A SINGLE, inch-wide strand of a new tape is holding up these three barrels of oil weighing almost 500 pounds. Similar in appearance to Scotch tape®, the new product is made of acetate film. Its tensile strength of 500 pounds for each inch of width is gained from thousands of continuous glass fibers embedded lengthwise in an adhesive backing. The inset shows a roll of the new tape, which comes in 72-yard lengths, and in standard widths of  $\frac{1}{2}$ ,  $\frac{3}{4}$ , and 1 inch. Minnesota Mining and Mfg. Co., makes it.

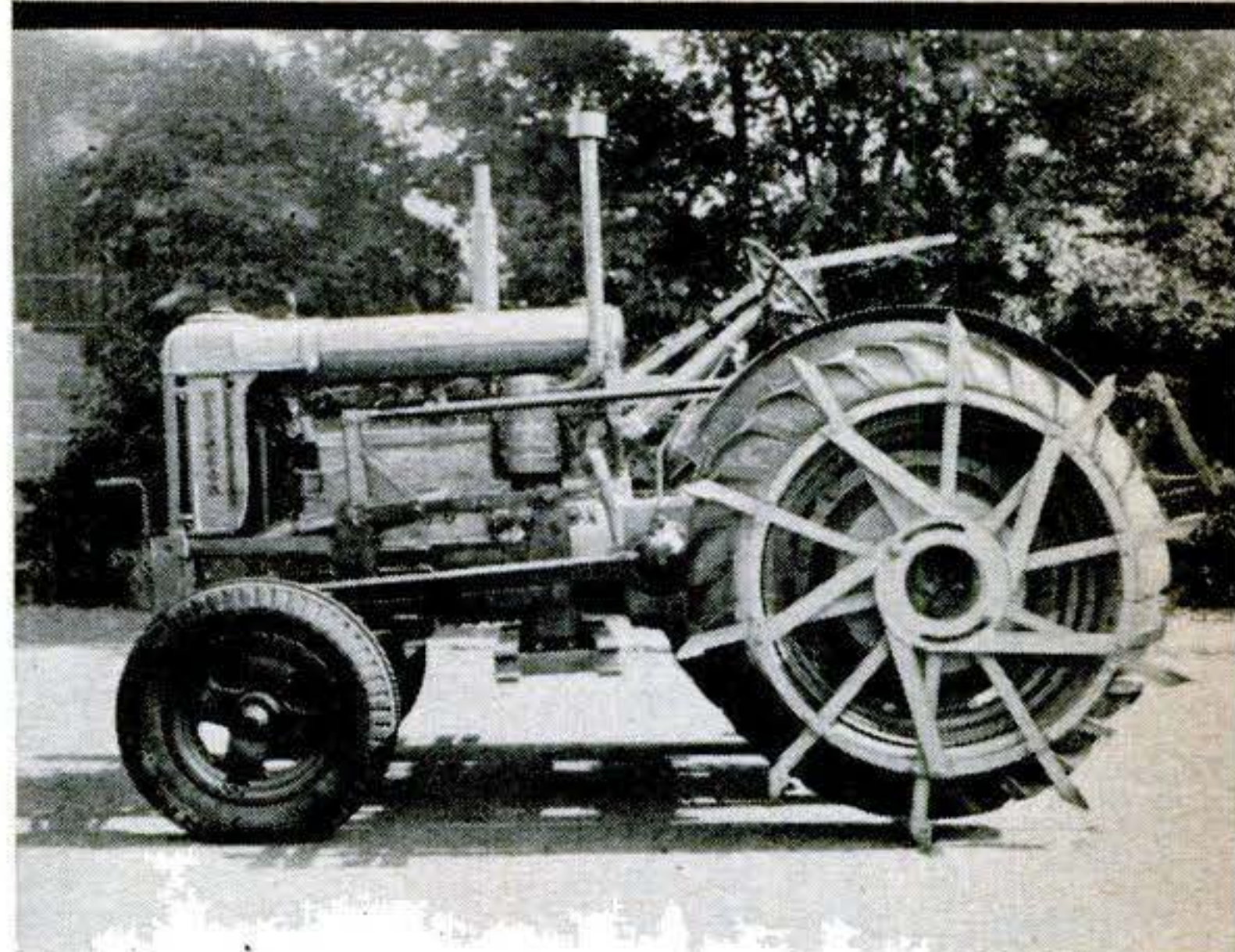
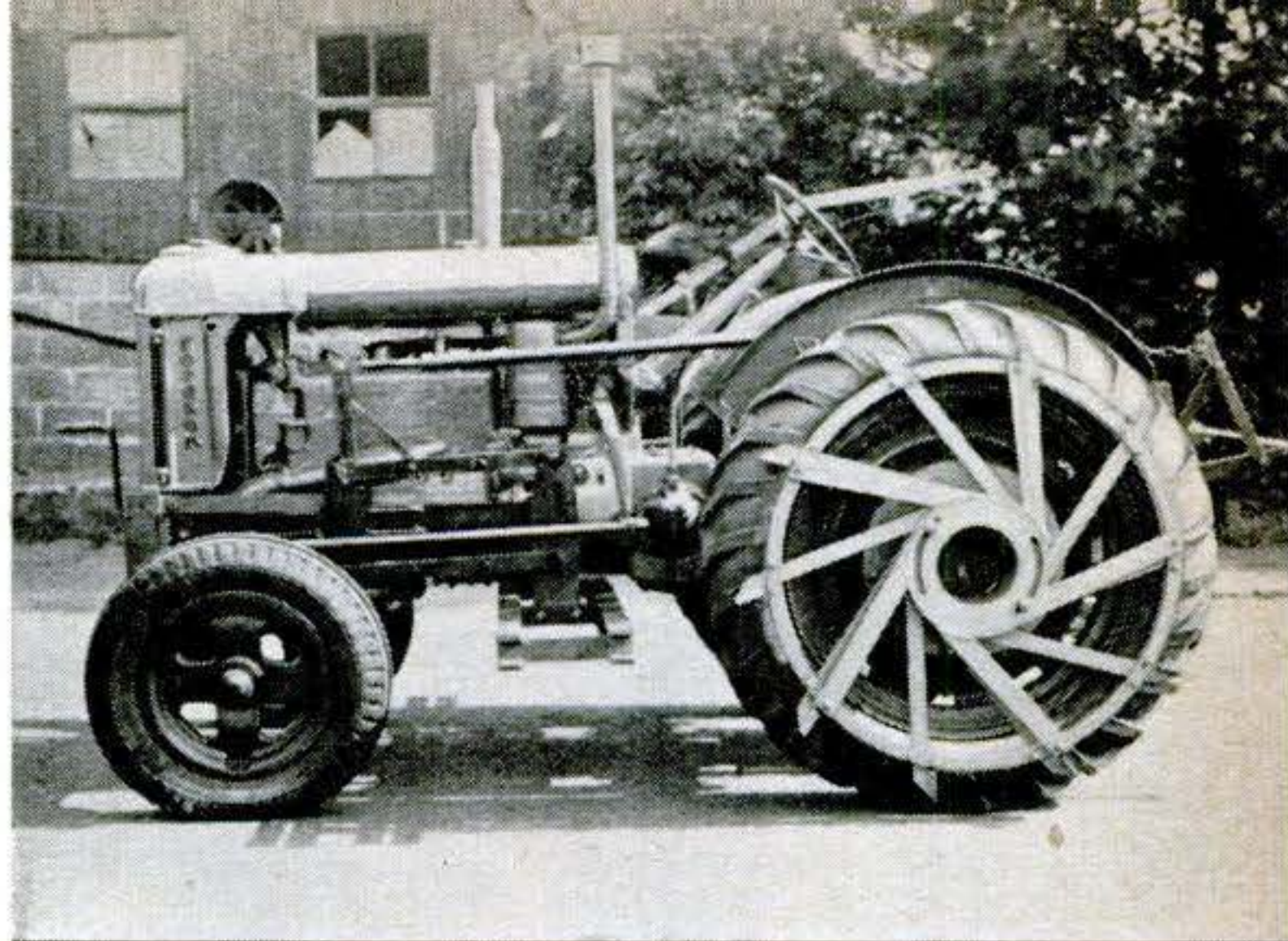

Like the leaves in a camera iris diaphragm, the lugs on the wheel expand or retract with a partial turn of the hub plate. Models are made to fit most U. S. and British farm tractors.

## Lantern Plugs into Oarlock

HERE'S a boon to night fishermen—an aluminum bracket that clamps around a lantern base, as shown below, with a finger that fits the oarlock socket of a rowboat. A thumbscrew holds it fast. When the lantern is used on flat surfaces the finger can be folded up. Made by Timcor, Inc., Cleveland, the bracket fits all gasoline lanterns.

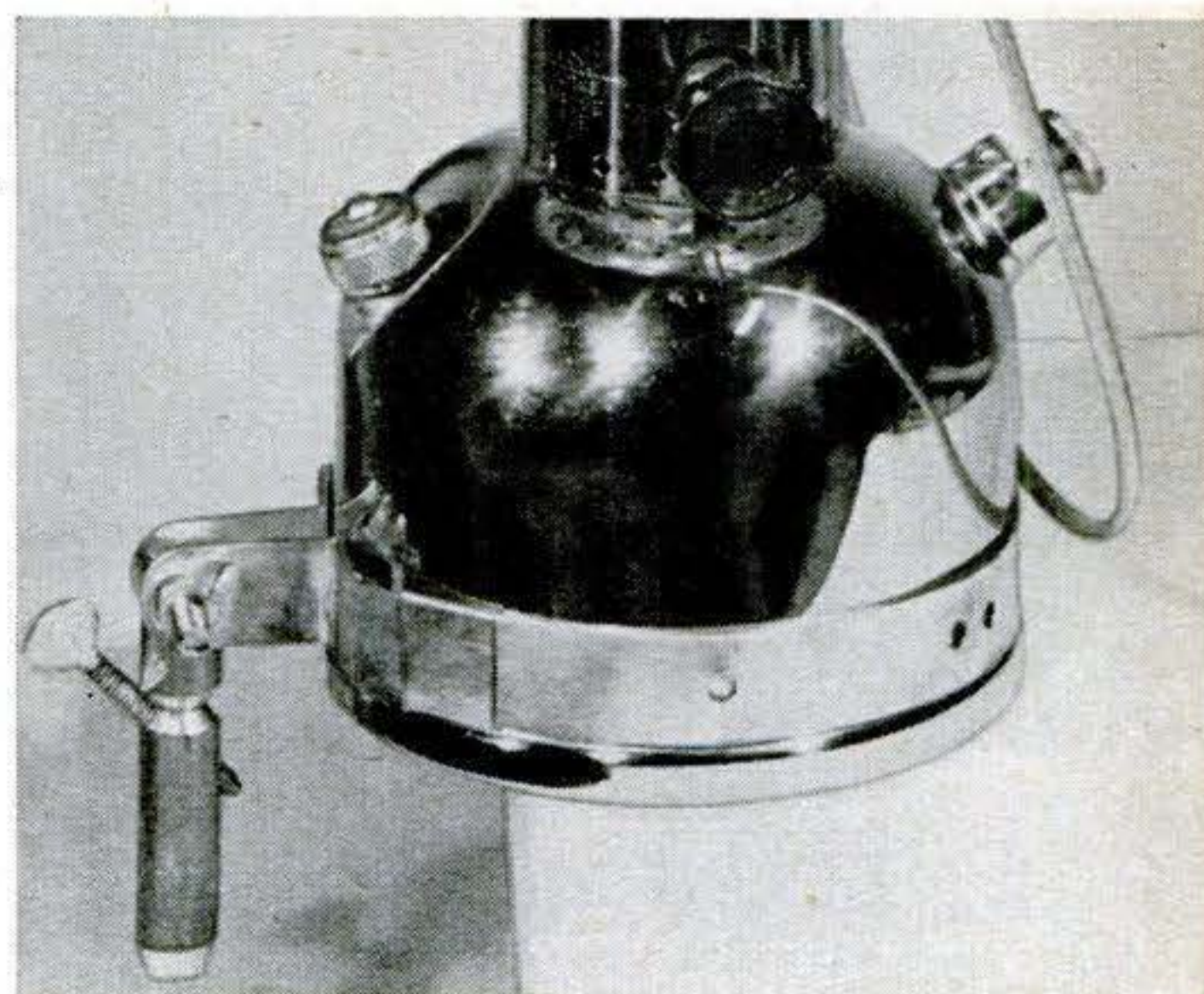





### Health Clinic Takes to Road

THIS special coach is one of 10 clinics on wheels that will bring modern medical and dental facilities to remote rural regions of Cuba. The trailer houses a motor-generator to power the medical equipment. Built by the Linn Division of Great American Industries, the units each contain complete X-ray apparatus, a darkroom, a dental office (shown at left), and a clinical laboratory. A team of six physicians, dentists, and technicians mans each unit and has living quarters in another coach.

### Giant Radiator Cools Big Wind

WHEN more than a million and a half cubic feet of air are blasted through a 6-by 6-foot wind tunnel at 1,500 miles an hour, the inside gets mighty hot. That's the reason for this huge radiator (below) at the Ames Aeronautical Laboratory, Moffett Field, Calif. Through its 10 miles of bronze tubing circulate some 10,200 gallons of water every minute. With its fins, it has nearly 117,000 square feet of cooling surface. The man gives an idea of its size.

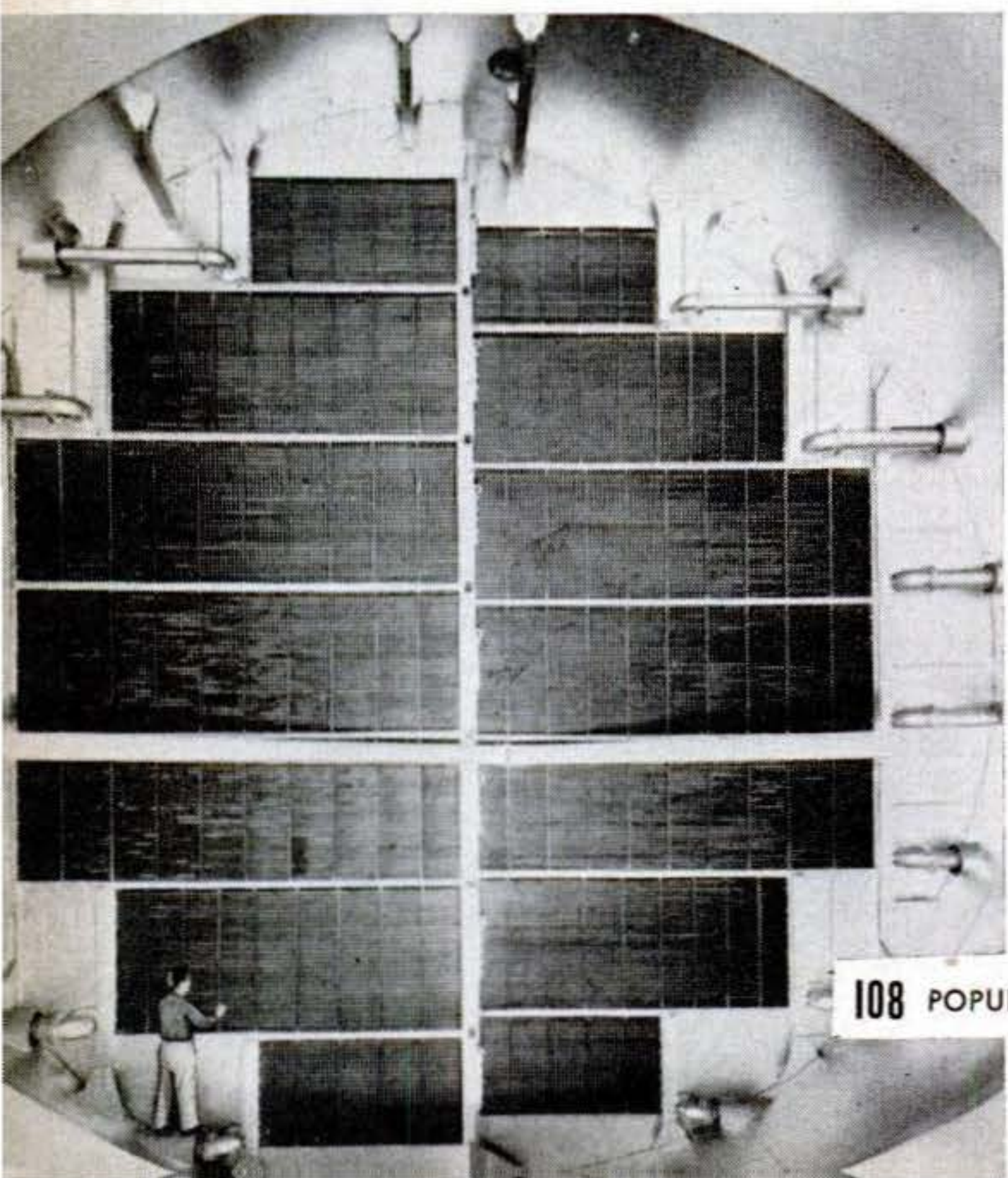

### Tin Can Protects Geiger Tube

SAFE shipping is assured the sensitive tubes that are the heart of Geiger counters when they are packaged in a new tin can developed by the American Can Co. The tube is first wrapped in cotton batting, as shown below, and then placed in the can, which is hermetically sealed. This not only protects the tube from rough handling, but, since the can is airtight, keeps its thin mica window from being affected by pressure changes during shipments by air.





## *New Ideas from the Inventors*

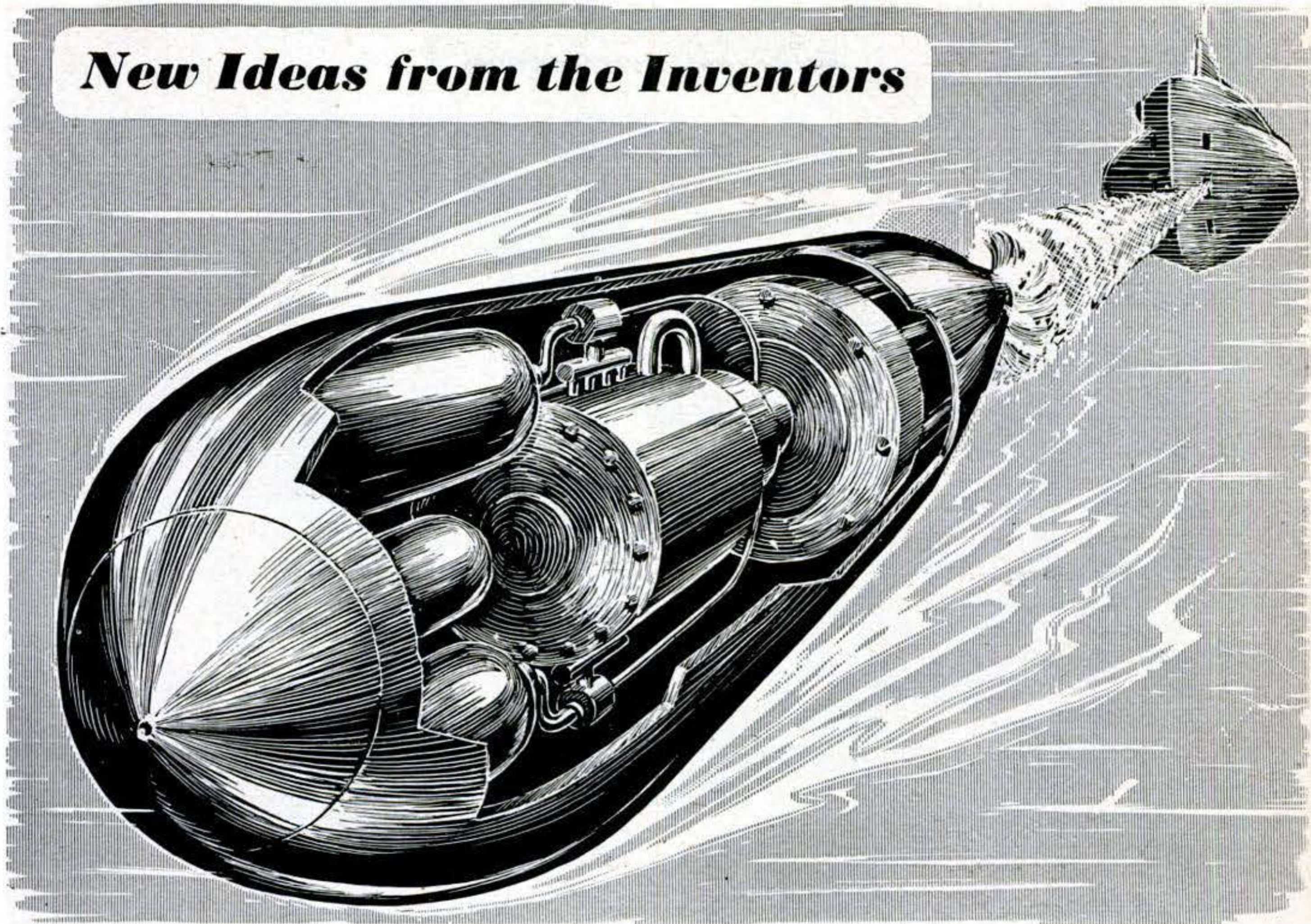

### **1 Steam to Drive Torpedo.**

Steam generated by the heat of chemical reactions would power a turbine to drive this naval torpedo. Hydrochloric acid and water are fed into a reaction boiler contain-

ing pellets of magnesium. Both the acid and the water react with the magnesium, producing heat that vaporizes additional water to form steam. The steam in turn drives a turbine connected to the propeller shaft.

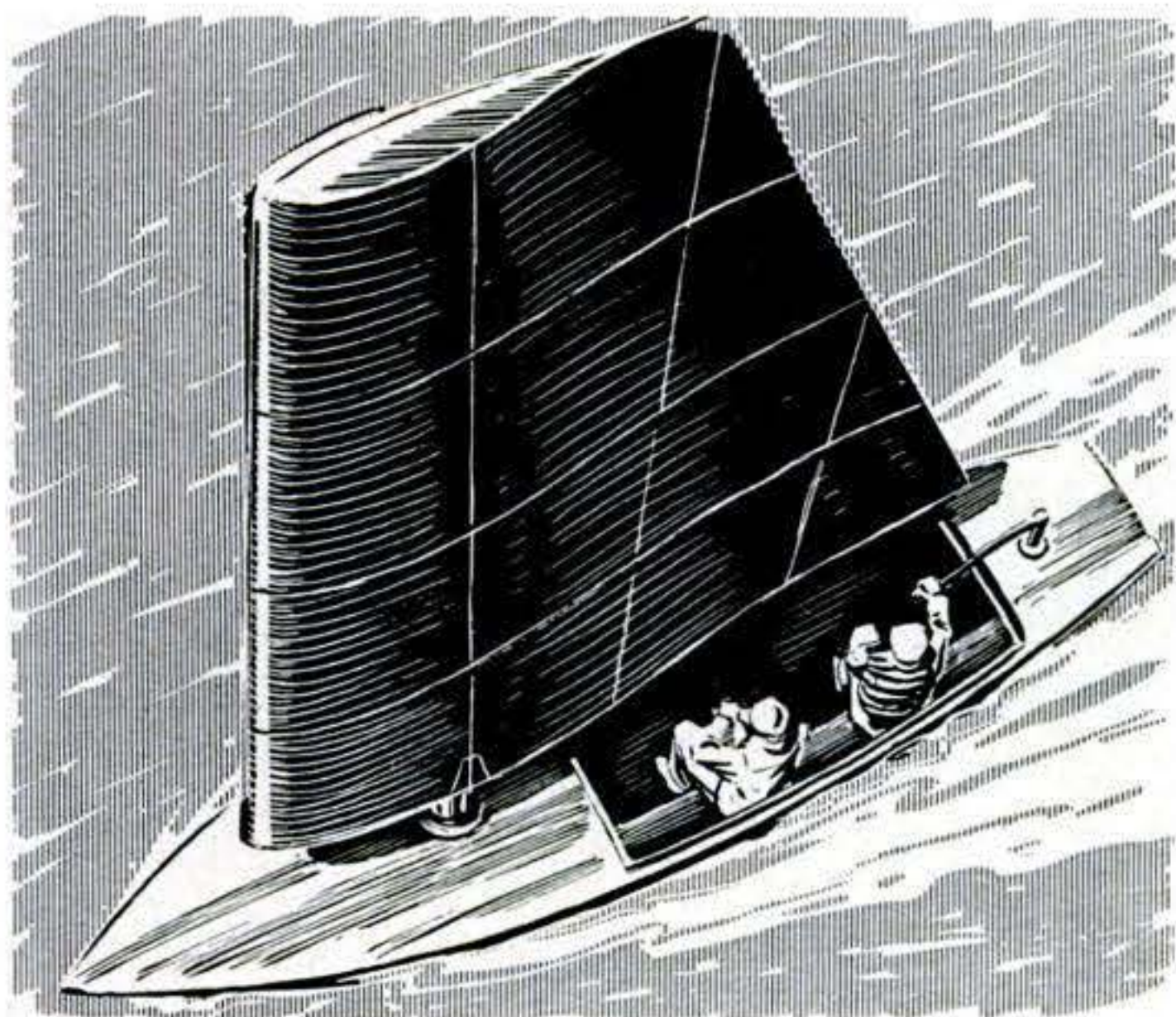

### **2 Rigid Sail to Propel Boat.**

This rigid sail shaped like an airplane wing is designed to give a sailboat the more efficient aerodynamic characteristics of a true airfoil. Being rigid, it also eliminates "flutter" and provides greater area. The trailing edge is flexible and can be turned to change the airfoil shape as desired.

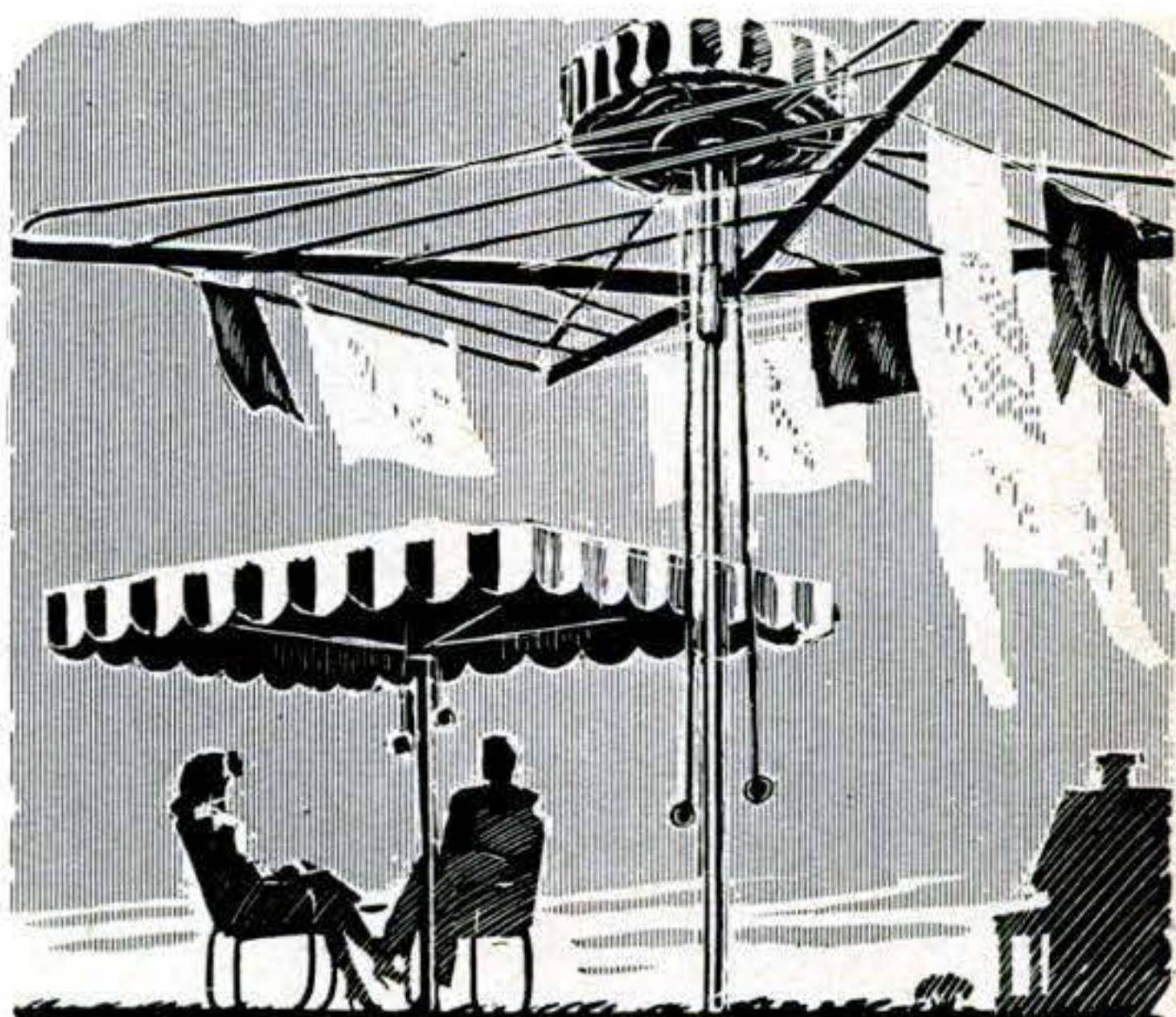

### **3 Drier to Shade Terrace.**

This back-yard clothes drier could also double as a king-size garden umbrella. A canopy fastened by means of rings to four rods on top of the drier arms is controlled by two pull cords. Pulling one cord lowers the canopy down over the drier frame; pulling the other cord folds the canopy back up.



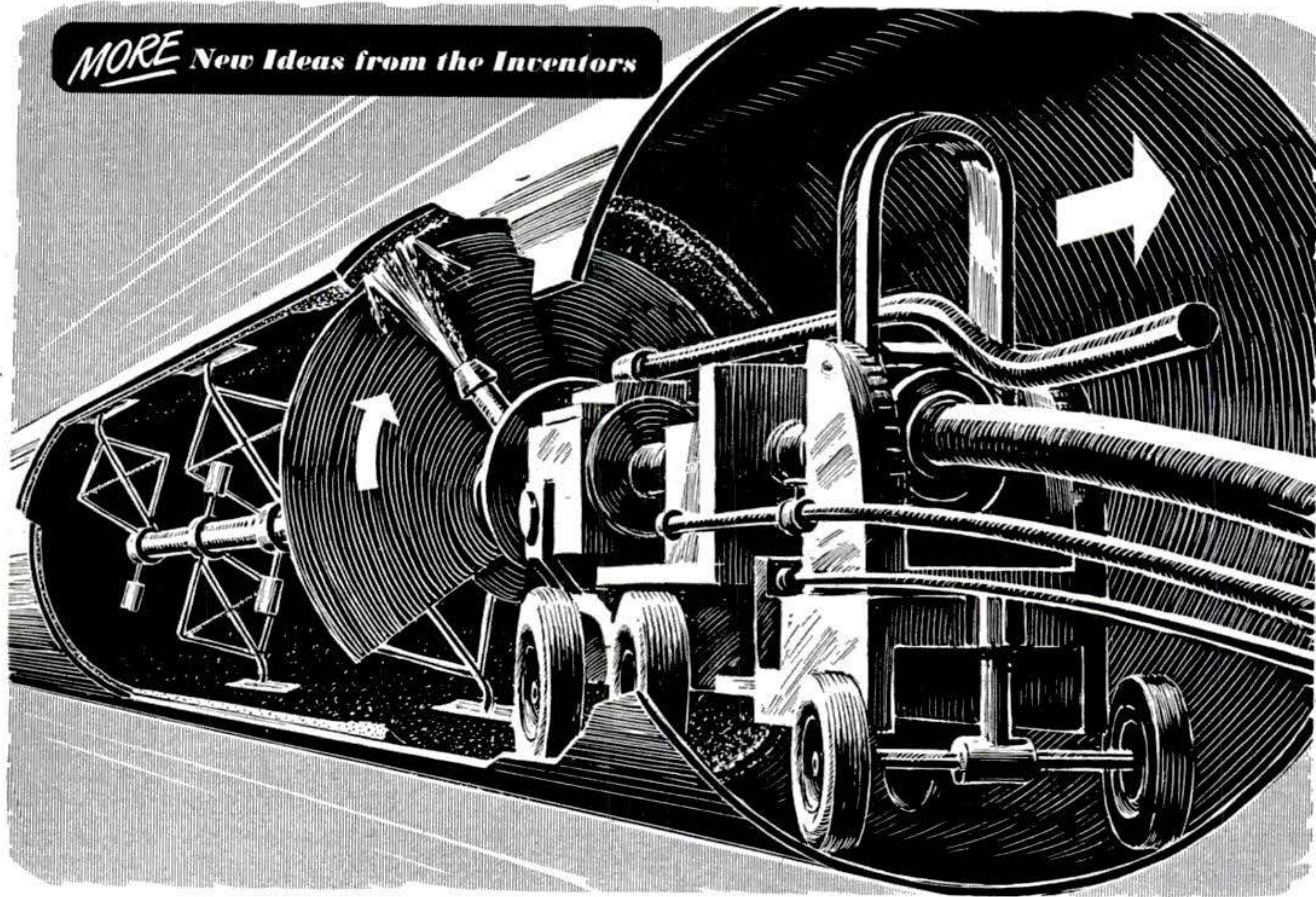

**4 Machine to Line Pipes.** Large pipes for liquids could easily be given a protective lining with this robot sprayer. It not only sprays on the coating as it progresses through the pipe, but smooths it to

just the right thickness with a series of rotating trowels. An electric motor drives the robot's wheels and rotates the spray nozzle. Power is supplied by a cable; the mixture and compressed air are fed through hoses.

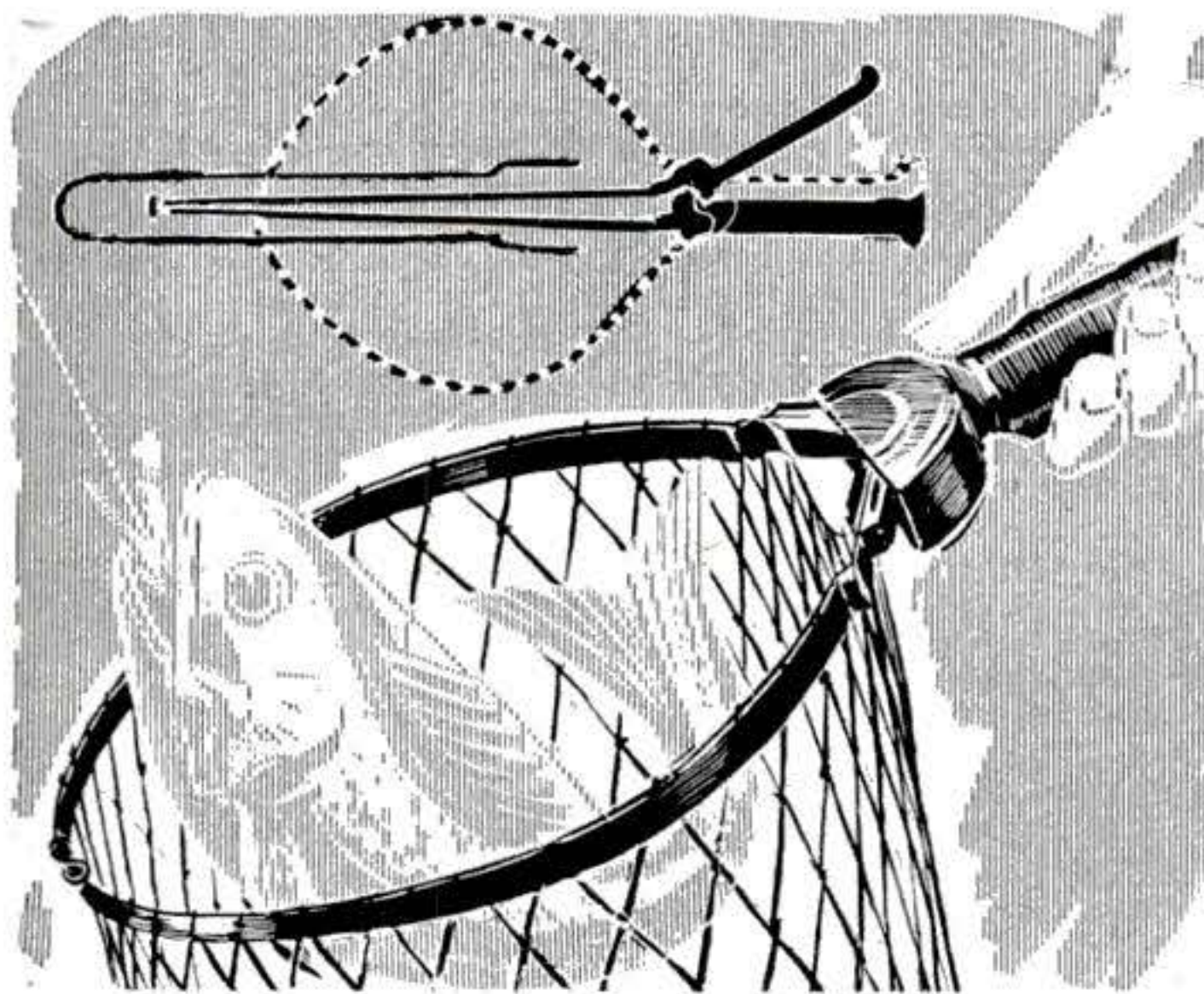

**5 Net to Close on Fish.** That big one couldn't get away once you bagged him in this hand net. Releasing a lever on the handle causes the spring-steel loop supporting the net to collapse flat, closing over the fish. When not in use, the closed net can be stowed in a scabbard fastened to an angler's belt.

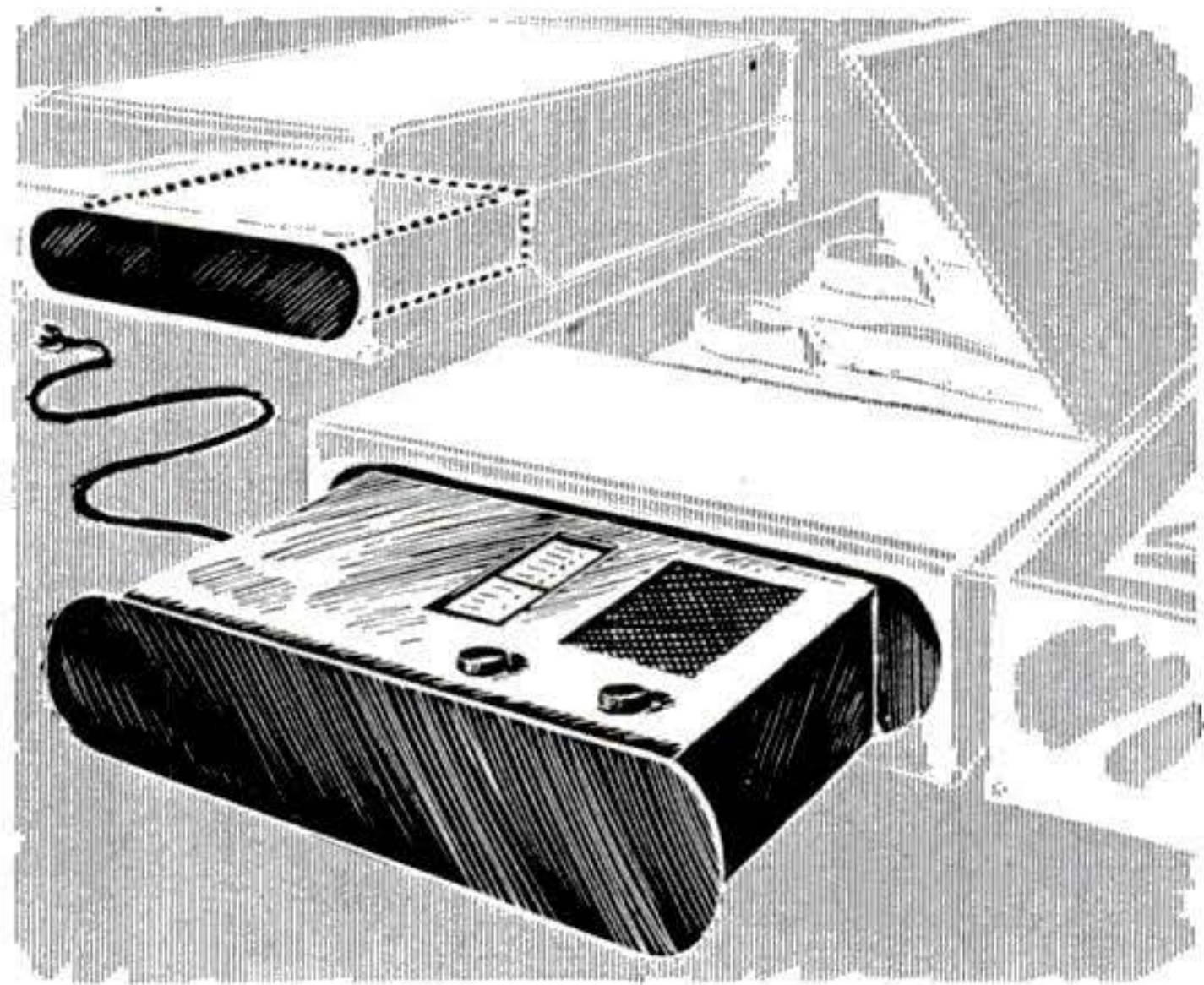

**6 Suitcase to Hold Radio.** A traveler who likes a radio would always have a portable with him when he carried this suitcase. An AC-DC radio pulls out of a compartment in the side of the bag like a drawer. Its antenna is concealed in the dividing board that separates the bag's two clothes compartments.

*Patents on these inventions have been granted to: 1. E. Gulbransen, Pittsburgh, Pa.; 2. W. Carl, Jr., Hampton, Va.; 3. H. Lewis, Los Angeles, Calif.; 4. J. Crom, Washington, D. C.; 5. A. Crot, Topango, Calif.; 6. A. Olson, Niles, Ill.*



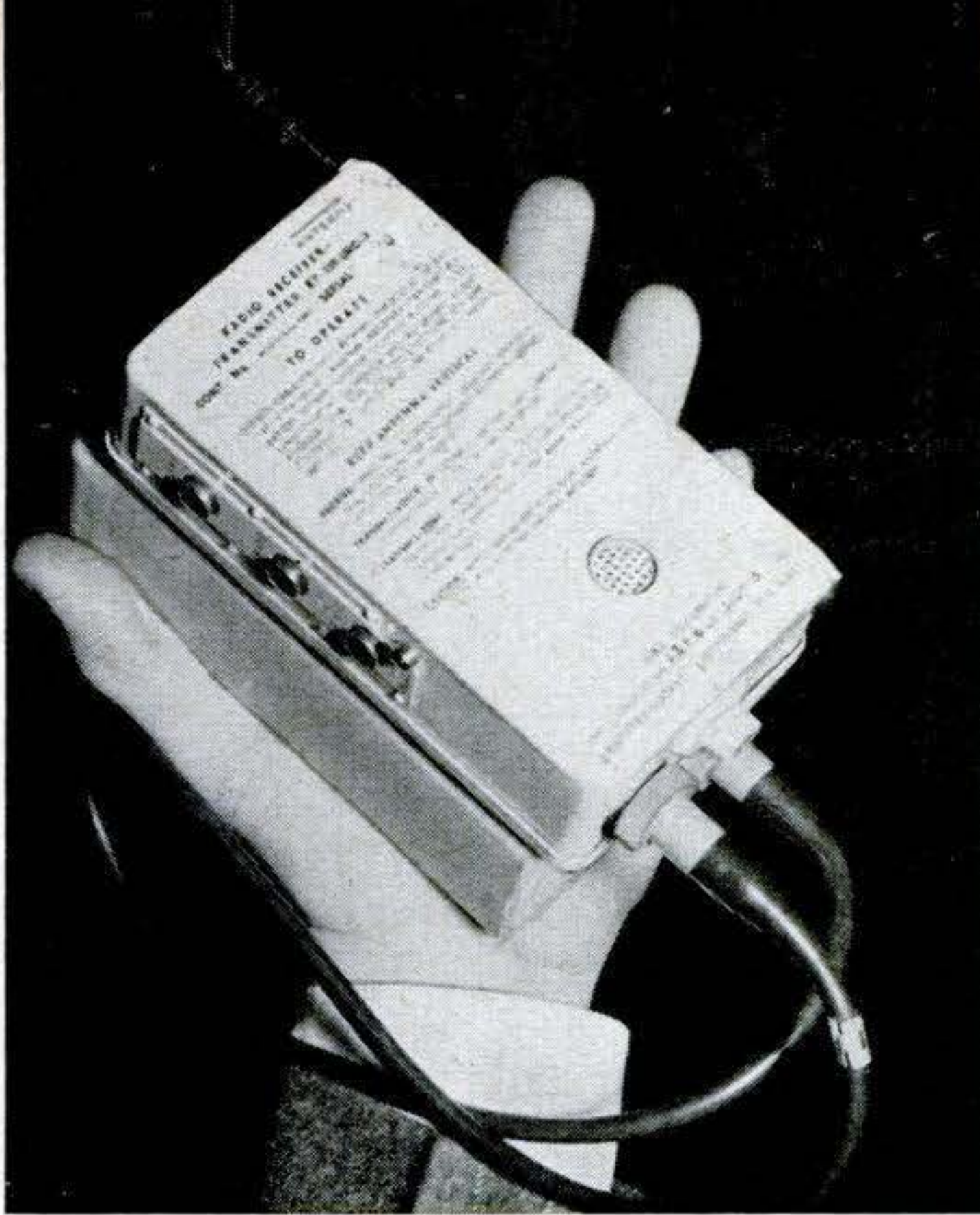

### Rescue Radio Fits Pocket

SURVIVORS of a ditched bomber who recently drifted in the ocean for 79 hours might have been rescued in two hours if they'd had the new miniature transmitter-receiver illustrated above, according to the Air Force. Hardly larger than an emergency ration kit, the radio consists of a transmitter-receiver and a mercury-type battery that

slips into the pocket of a flying suit. It operates on both very-high and ultra-high frequencies, and its messages can be picked up at a distance of 80 miles. Soon to become standard equipment, the new air-sea rescue radio will replace the older "Gibson Girl" that weighs 40 pounds, operates on medium frequency, and requires yards of antenna that must be lifted up into the air by a kite or balloon.

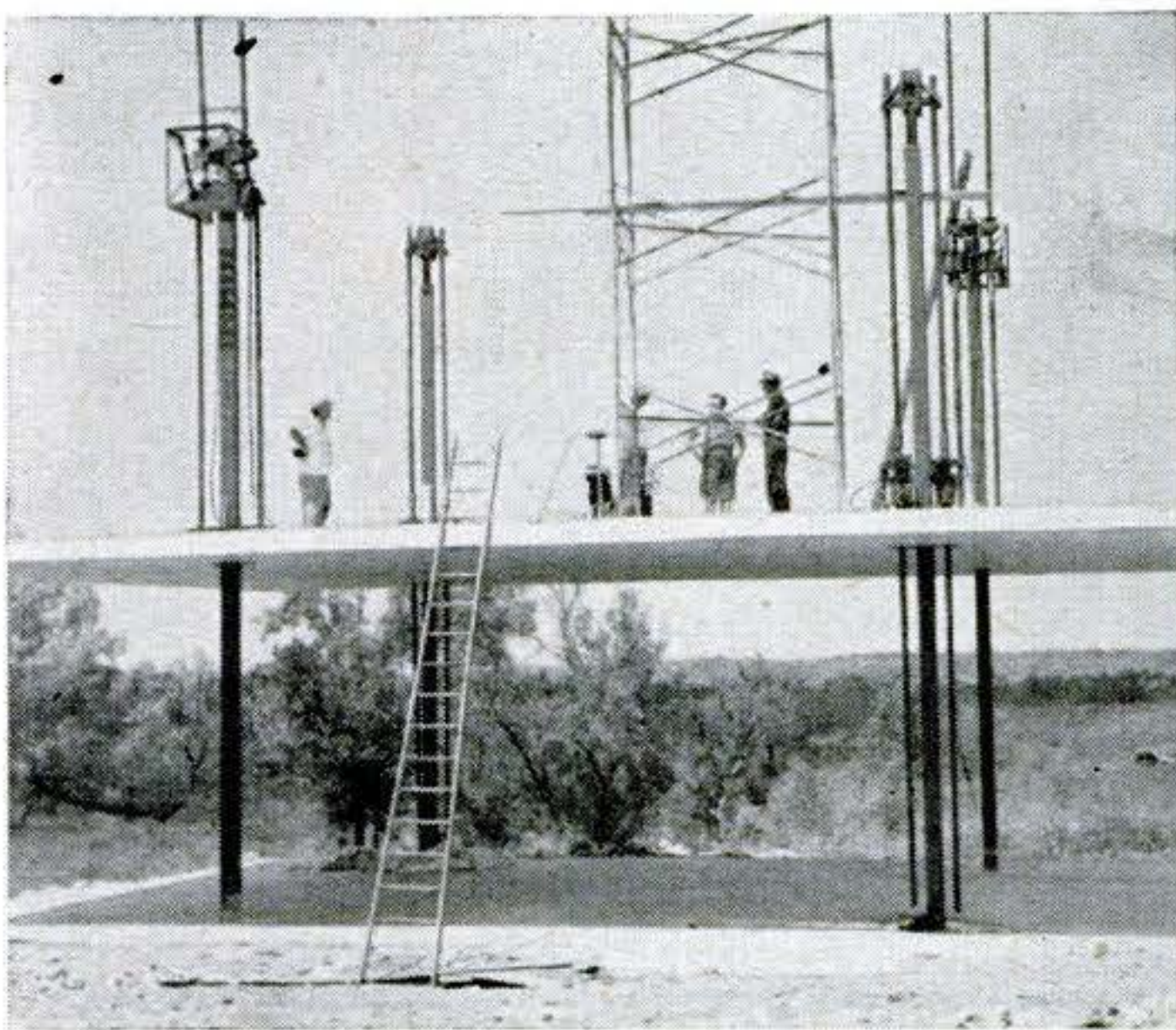

### Raising Roof Speeds Building

A REVOLUTIONARY new construction technique consists of casting roof and floor slabs over the ground floor and then raising them to their permanent positions with automatic lifting equipment. Called the Youtz-Slick method, it was developed at the Institute of Inventive Research, San Antonio, Texas. In the photo above, a concrete slab that was poured on the foundation over a separating medium has been raised on columns.



### Wood Chopped to Mulch

Good farmers may not burn brush or fruit-tree prunings any more. They'll chop it up and use it for bedding or mulch, returning valuable organic material to the soil.

The machine above, custom-built for the U. S. Soil Conservation Service by the Fitchburg Engineering Corp., Fitchburg, Mass., has four blades that make 900 strokes a minute. It cuts limbs up to six inches in diameter and sprays the chips on the soil.





# "Unstable Mabel," Tiniest Glider, Hits 250 M.P.H.

Vest-pocket glider Unstable Mabel flies over rugged terrain of California's Lucerne Valley.

**War veteran thrills air-show crowds by stunting sturdy 305-pound craft patterned on supersonic rocket plane.**

**By Andrew R. Boone**

**A** TINY, stunting glider that looks like—and, in fact, was modeled after—the first U. S. airplane to fly faster than sound is the latest addition to the air-show business. Piloted by Roy Cusick, a 52-year-old veteran of the wartime Ferry Command, it builds up far higher speeds than most gliders will stand. In a dive Cusick's speed often hits 250 m.p.h. He says the wing of his 305-lb. craft, dubbed Unstable Mabel, is strong enough to take 400 m.p.h.

Towed aloft by plane, Cusick cuts loose at an altitude of several thousand feet to loop, roll, and do fast pull-outs. During the past winter he practiced Immelman turns for introduction at this year's shows. That's a half-loop, half-roll maneuver devised by a

German in World War I for quick reversal of direction. Cusick's practice area is California desert air. He lands on dry-lake beds.

Unstable Mabel is one of the few gliders that have ever been towed all the way across the continent. Cusick had a close call on that trip. He was scheduled to stunt his glider over Long Island, N. Y., and gave himself nine days to make the tow. Unstable Mabel sailed along nicely at the end of a 600-foot nylon rope attached to a 450-hp. biplane until she was four miles east of El Paso. There, the rope, frayed by scuffing during a cross-wind take-off, parted. Cusick had only 500 feet of altitude. Almost as bad, the wind was directly on his tail. He had to make a 180° turn to land against it. Whipping around, he put his wheels on a winding dirt road, slipped between two cuts in among some sand dunes, and rolled down a gentle slope into a gravel pit. Not so much as a scratch on the plane marred his landing. Unstable Mabel was on hand



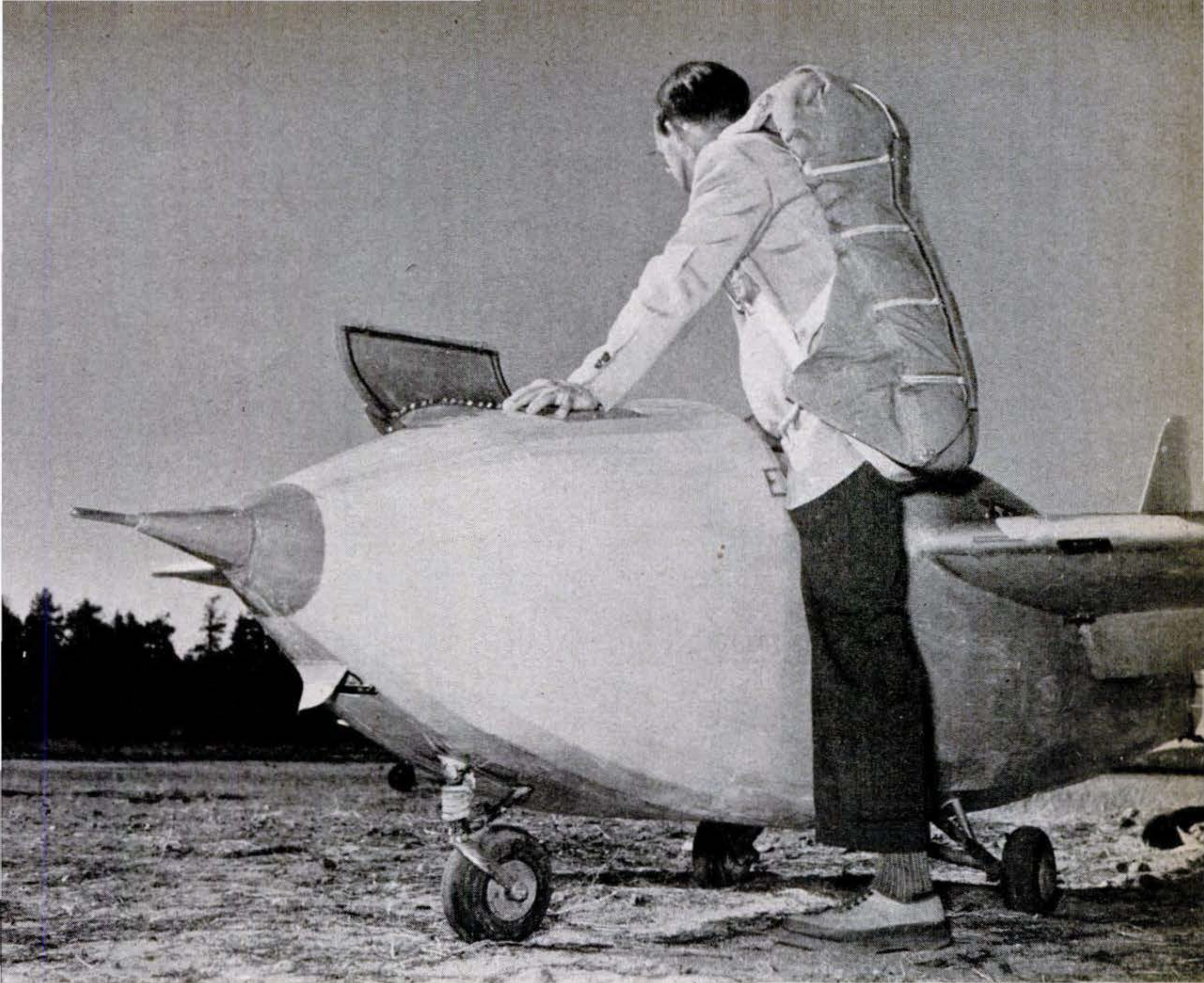

**Wearing 'chute, Mabel's 125-lb. pilot enters cockpit, which is only 20 in. wide at shoulders.**

for her performance in the east three hours before show time.

Mabel is well-named. She comes in hot, and occasionally Cusick has to make a change in her to temper her behavior. Once he found himself in an accidental snap roll. He cured that tendency by installing small blisters under the leading edges of the wingtips. That prevented the tips from losing their lift at critical moments.

Brackets for jet-assisted take-off have been designed for Mabel's wing. Cusick may use them at his 1950 shows.

Cusick patterned his glider after the X-1, the Bell supersonic rocket-driven plane. Its first sketch was drawn on a hangar floor and incorporated the X-1's pointed nose and fat fuselage.

Though Mabel is a tiny vehicle as flying machines go, Cusick wants one even smaller. He hopes to build a glider that, boosted by a ram-jet engine, will clip off 400 m.p.h. Its wing area would be a third less.



**In cockpit, Cusick holds cardboard against plastic canopy with his head for protection against sun. Plane becomes airborne at 100 m.p.h. in take-off from field 6,850 feet high.**



**Mabel's wing and elevator support glider when it is stood up on edge. Used on powered plane, same wing once flew in National Air Races.**

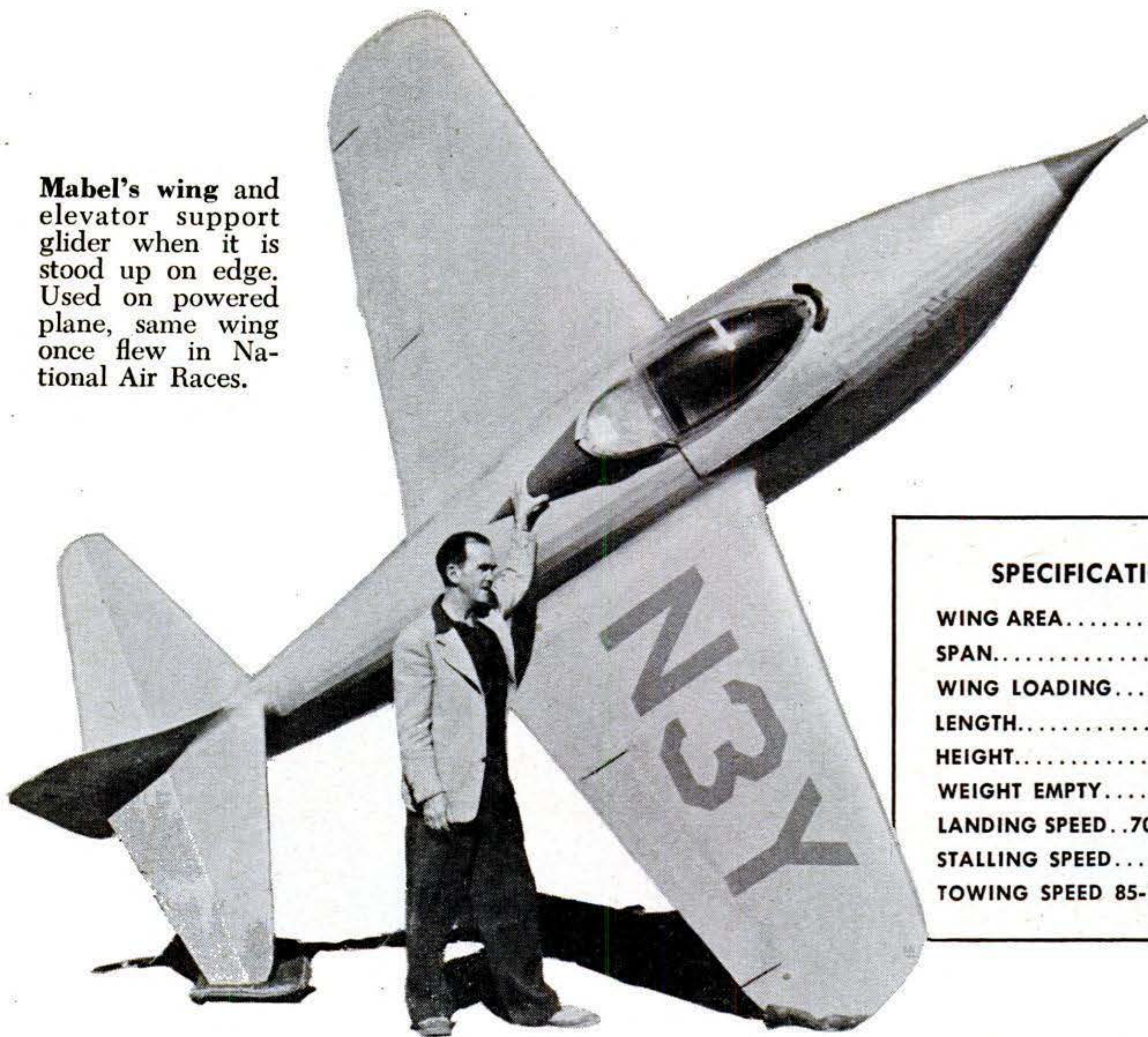

SPECIFICATIONS	
WING AREA.....	43 SQ. FT.
SPAN.....	14 FT.
WING LOADING.....	10½ LB.
LENGTH.....	15½ FT.
HEIGHT.....	43 IN.
WEIGHT EMPTY.....	305 LB.
LANDING SPEED..	70-90 M.P.H.
STALLING SPEED...	60 M.P.H.
TOWING SPEED	85-105 M.P.H.

**Wing strength** is demonstrated by its support of two men weighing total of 300 lb. It is cov-

ered with 3/16-in. plywood. Photo was taken after 120-m.p.h. downwind landing on dry lake.

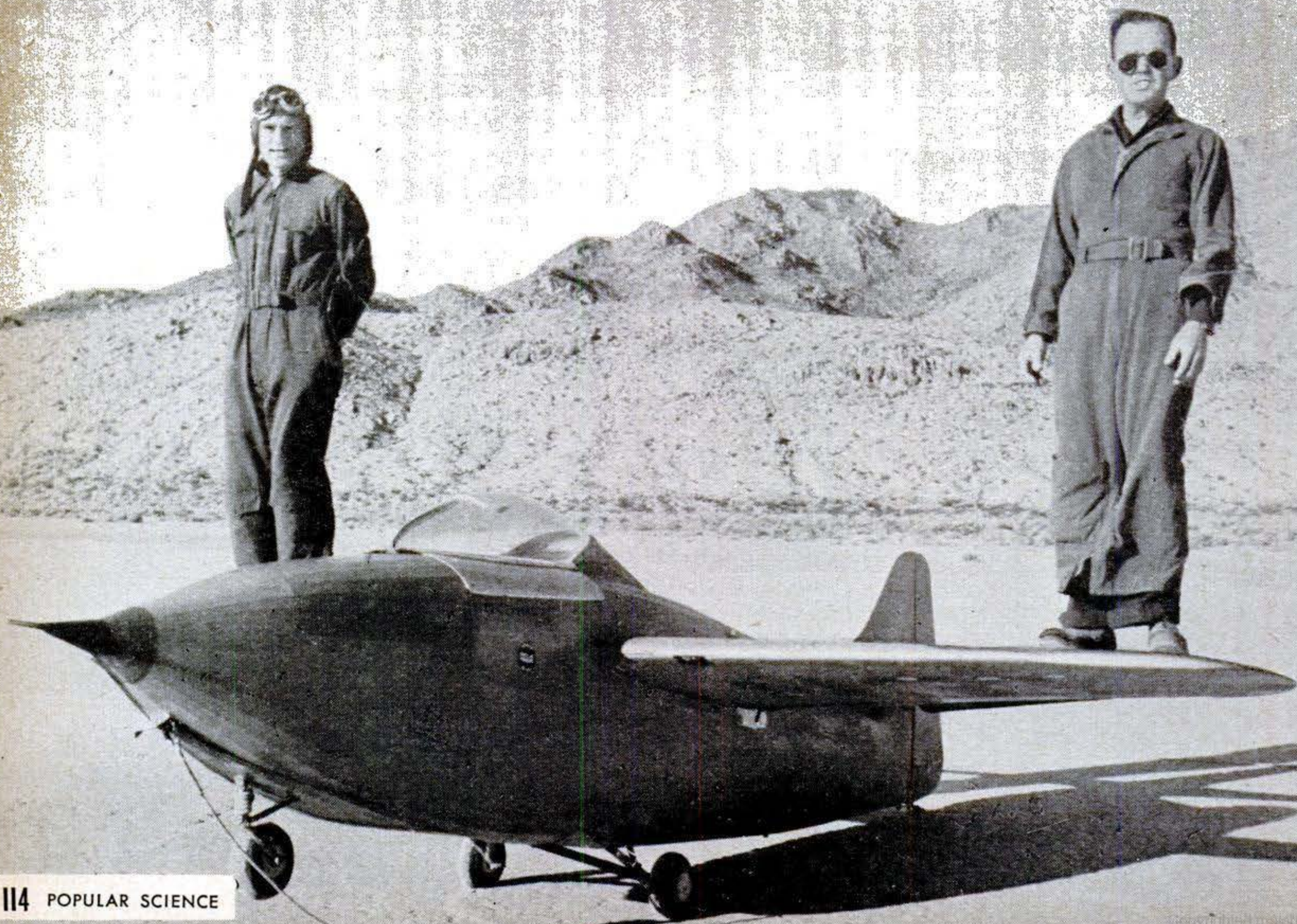





**Steerable nose wheel** can be retracted manually after take-off. Five-inch tires are normally used on airplane tail wheels. Mabel's pilot performs with air show called Hollywood Hawks.

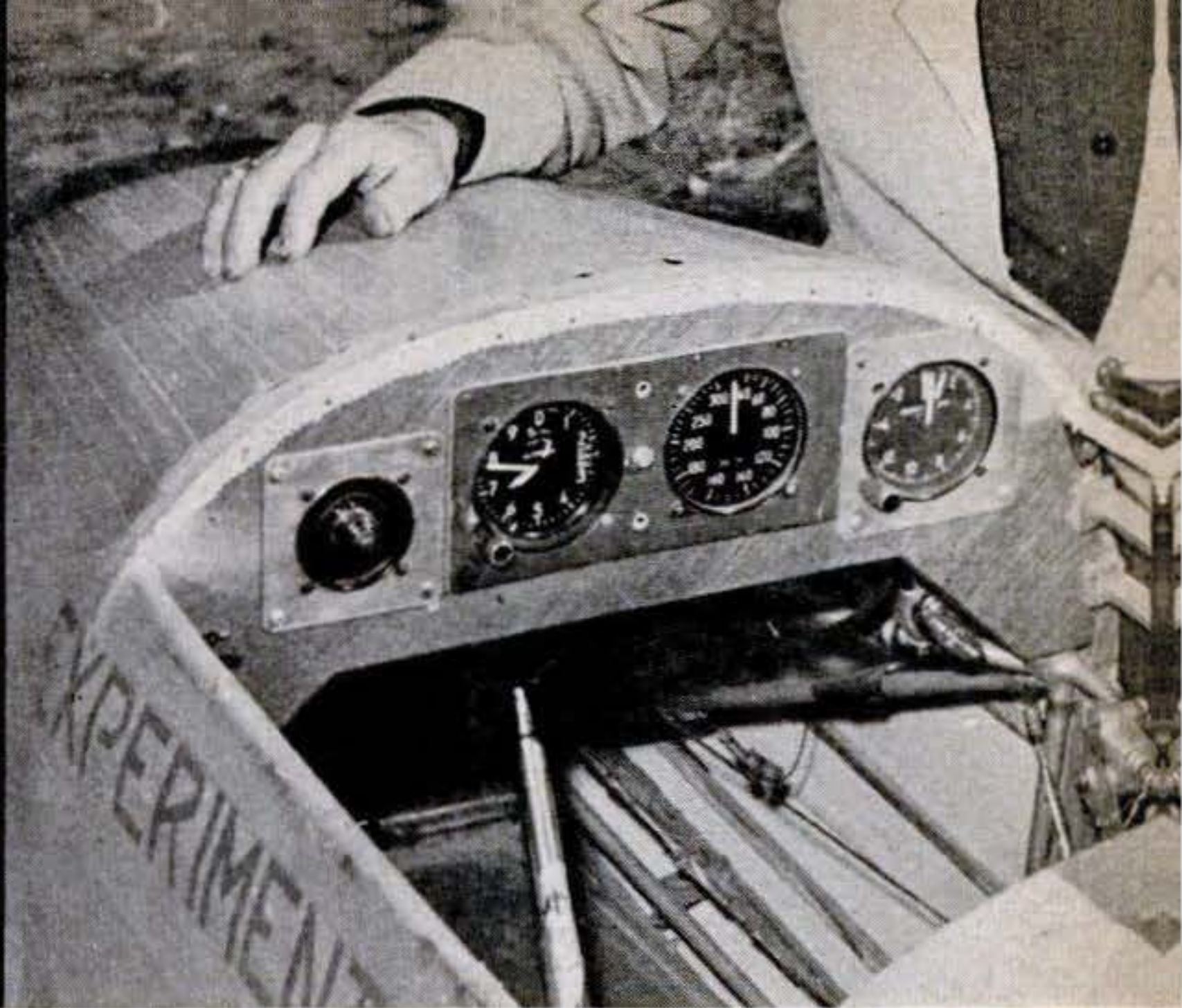

**Only small man** can shoe-horn himself into cockpit. Four instruments provide all flight information: stall and air-speed indicators, altimeter, accelerometer to measure stresses.

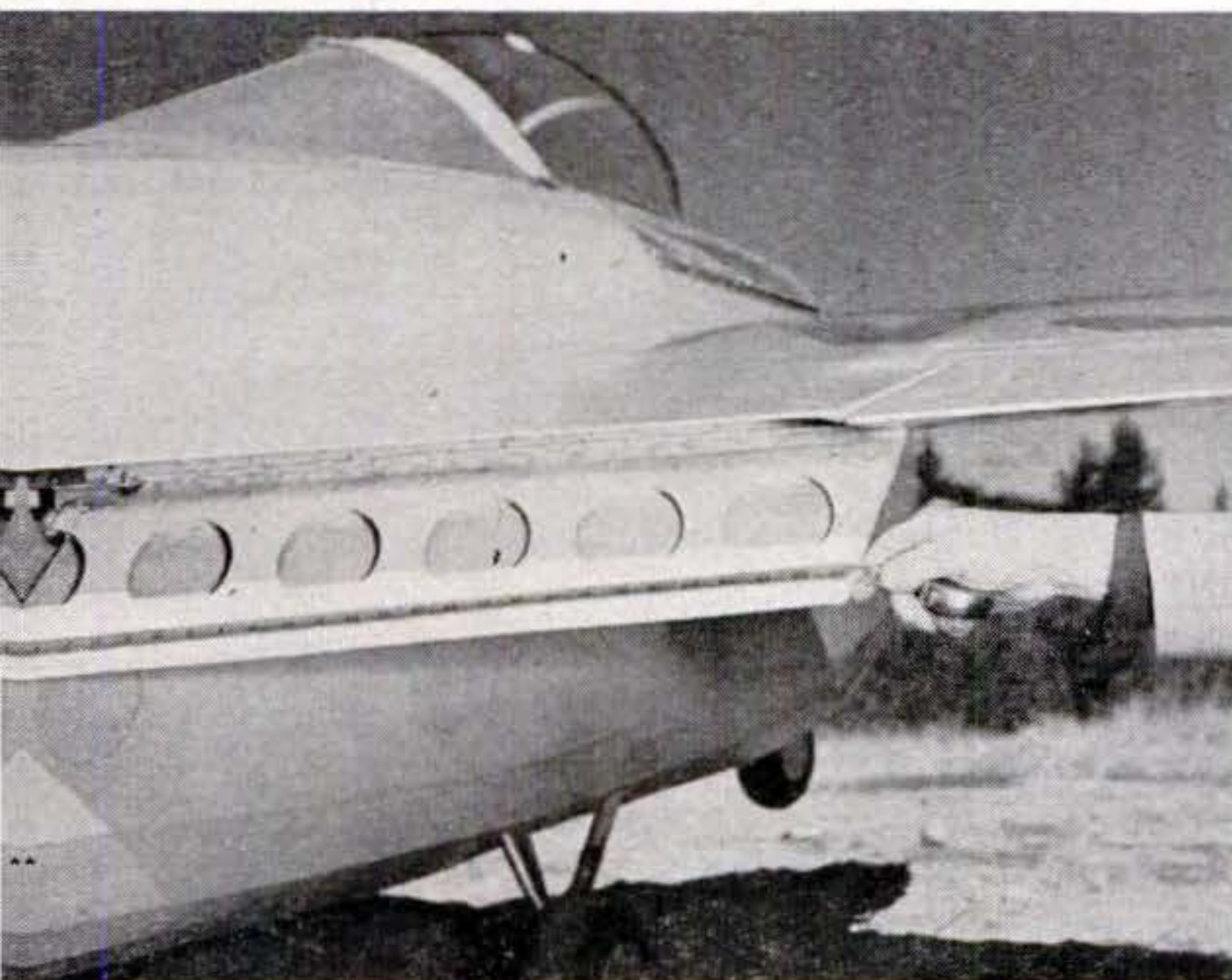

**Manually operated flaps** having area of 130 sq. in. slow glider down from normal cruising speed of 100 m.p.h. to 70 for landing. In stunting, glider loses height at 1,000 ft. per minute.

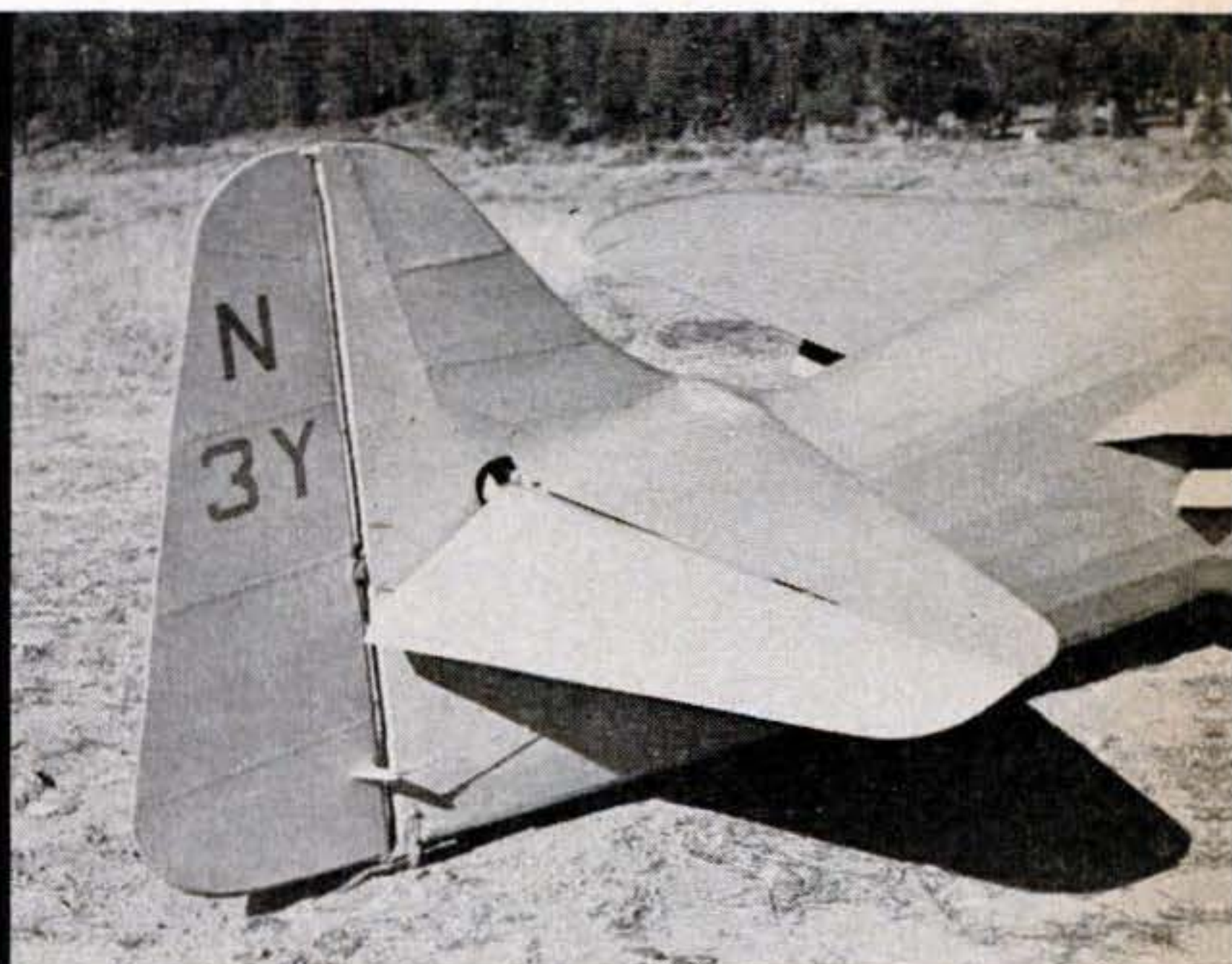

**Unusually large tail group** in relation to glider's size is necessary because aircraft is so short-coupled. During last winter, training flights were made from Big Bear City, Calif.

**Head-on view of Unstable Mabel** shows close resemblance to X-1. Needle-like projection from

nose is pitot tube for speed indicator. Spring shock struts connect main wheels to main spar.





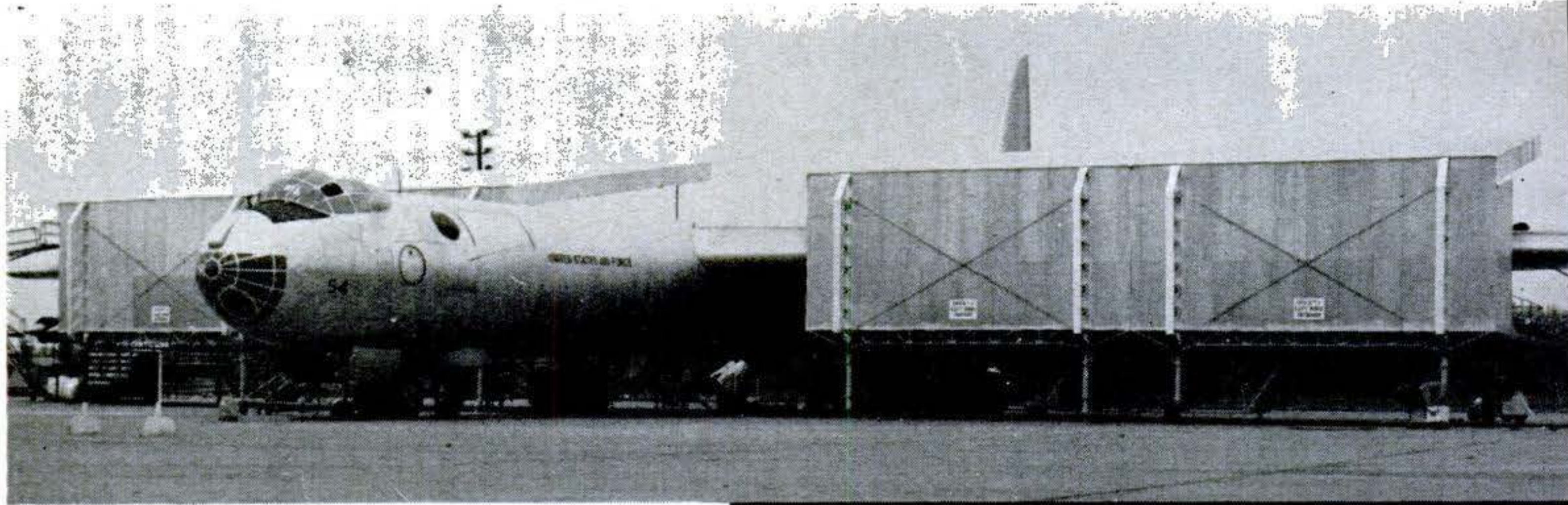

## Service Sheds Shield B-36

ALTHOUGH the world's biggest bomber can fly in all kinds of weather, workers putting the finishing touches on a B-36 at Convair's Fort Worth plant are not immune to Texas temperatures and elements. Above are shown two all-weather service docks that enclose the three engines mounted on each wing of the huge Air Force bomber. Sixty feet long and 36 feet deep, they shade the workers from summer sun and can be heated to ward off winter chills. Photo at right shows a mobile dock rolled into place over a wing. A removable panel closes the front, protecting mechanics from wind, dust, and rain. Piped and wired for compressed air and electricity, the sheds need only be connected to an external outlet for complete construction facilities, including built-in

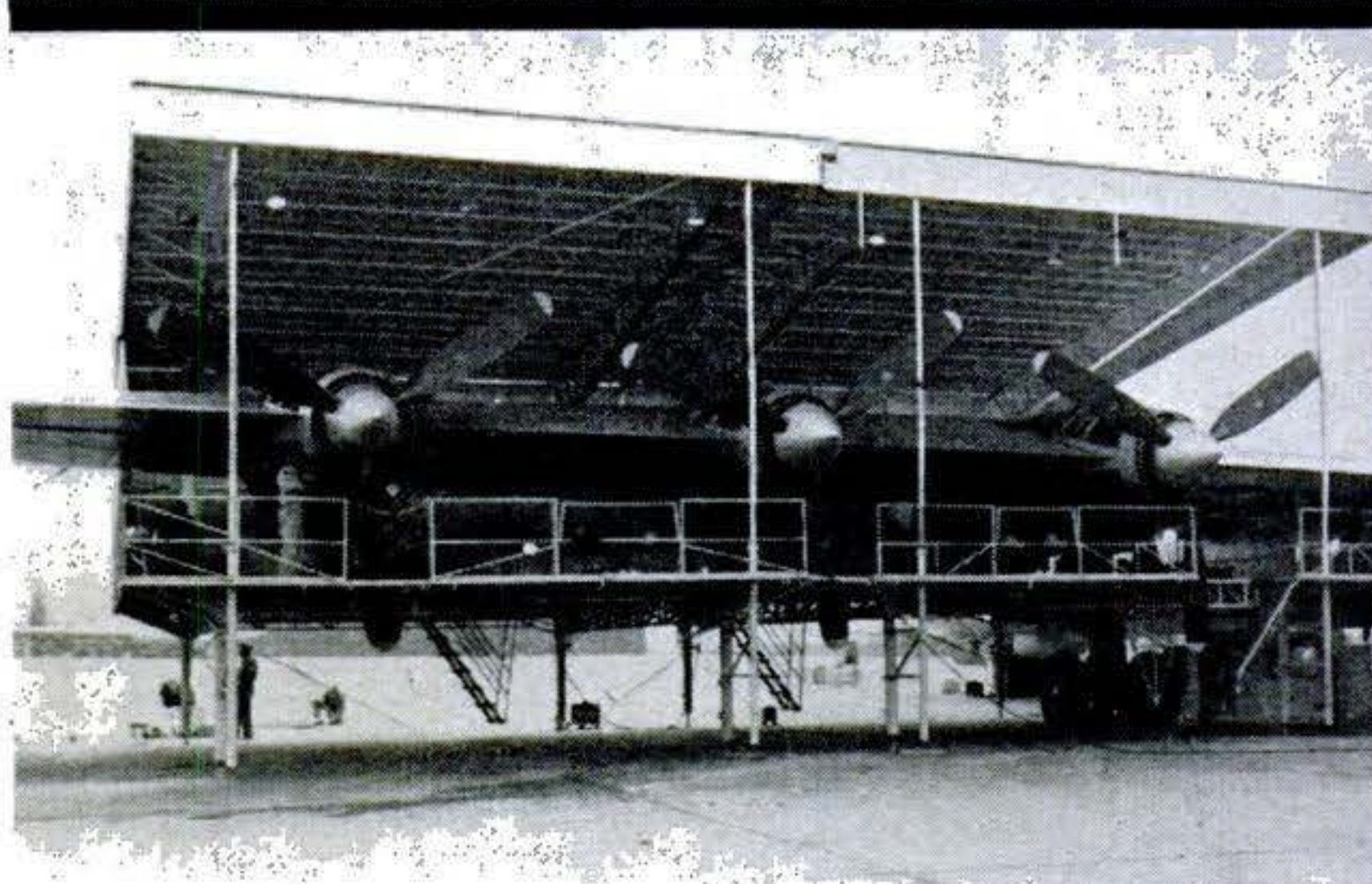

floodlights. One type of dock will be of permanent construction to receive the bombers as they roll out of the factory; others will be mounted on dollies so that they can be moved from plane to plane as needed.

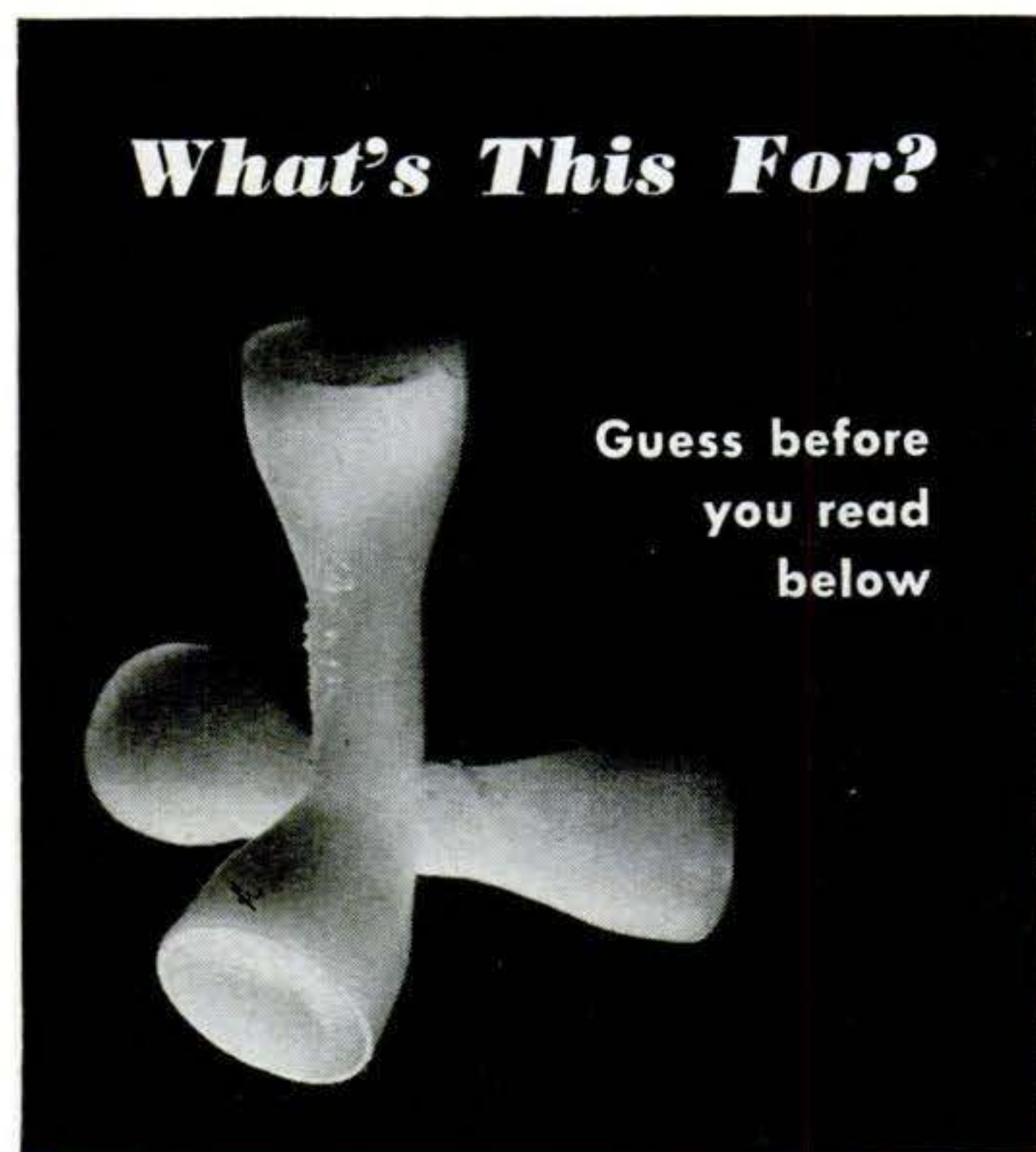

## What's This For?

Guess before  
you read  
below

*It's a new golf tee with four stems of different lengths to give a player a choice of heights. In any position, one stem stands vertically while the other three serve as tripod legs. Four-Up-Tee Co., of Mount Vernon, N. Y., makes it, in various colors, of a resilient plastic that won't damage club heads.*

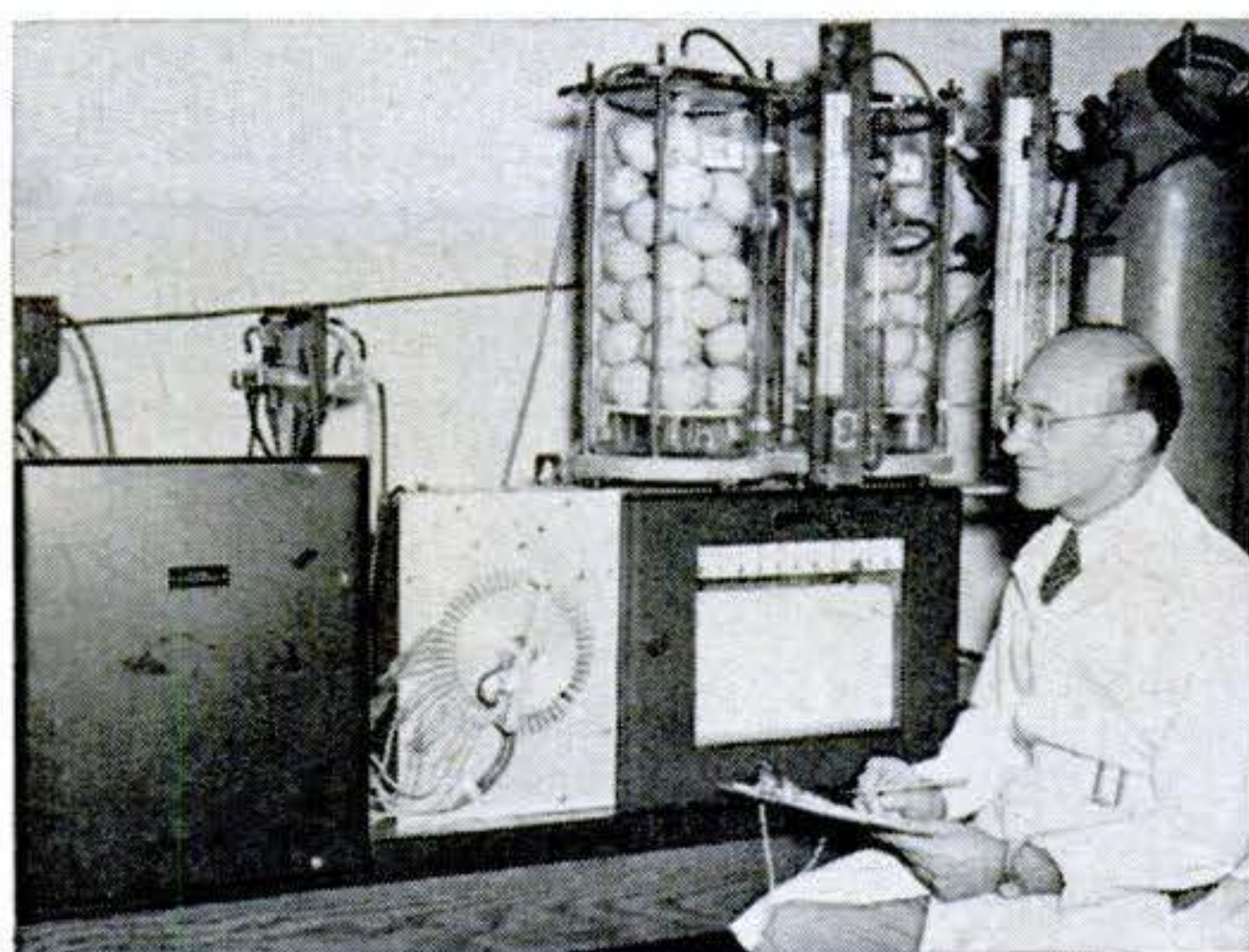

## Breathe Deeply, Please

LEMONS, oranges, and grapefruit "breathe" like humans, taking in oxygen and giving off carbon dioxide. Using the oxygen analyzer above, Dr. Jacob Biale of the University of California at Los Angeles checks their respiration at different temperatures and in various gas mixtures. Results may show how to keep fruit longer in storage.



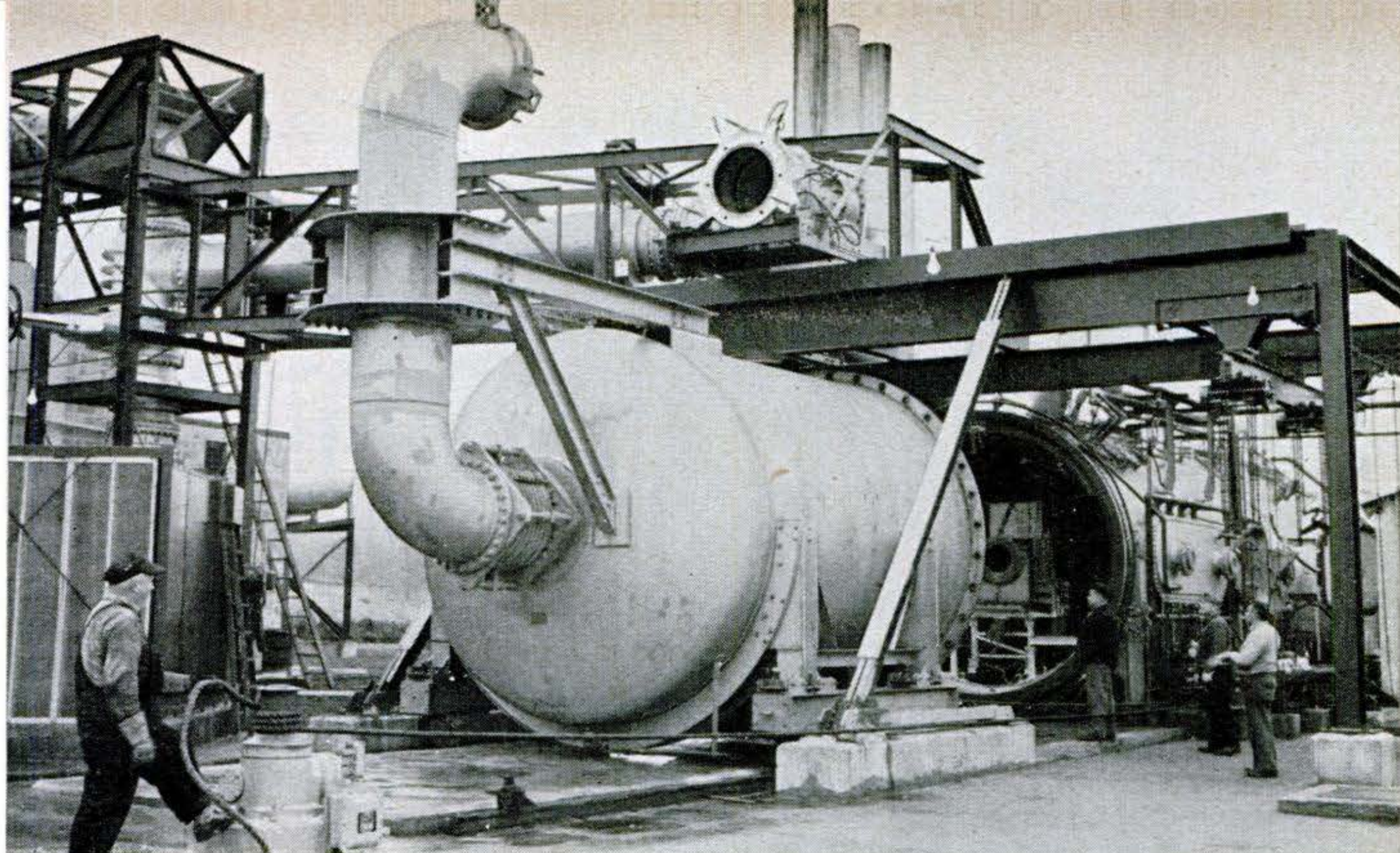

Capstan (left) pulls tank section on rails so that ram-jet engine can be installed for test.

## ***Ram Jets "Fly" Inside Huge Tank***

**A** BIG tank that splits in two now helps engineers design faster, higher-flying ram-jet engines. It tests the jets at "speeds" up to 2,600 m.p.h and "altitudes" up to 15 miles. The tank holds the engine, air-supply pipes and exhaust, and instruments. One section slides back so the engine can be put in. Giant fans blow the 2,600-m.p.h. wind, while steam jets vary exhaust-end pressure.

Since the noise of a smaller setup broke dishes eight miles away, the Wright Aeronautical Corp. engineers who designed this one were worried about its effect in thickly settled Wood-Ridge, N. J. So they floated the tank on springs on a 200-ton concrete slab six feet thick and provided 45-foot-high exhaust mufflers. It doesn't even shake the instruments next door. **END**



Engine under test is mounted just beyond flaring section of exhaust pipe (center) in big tank.



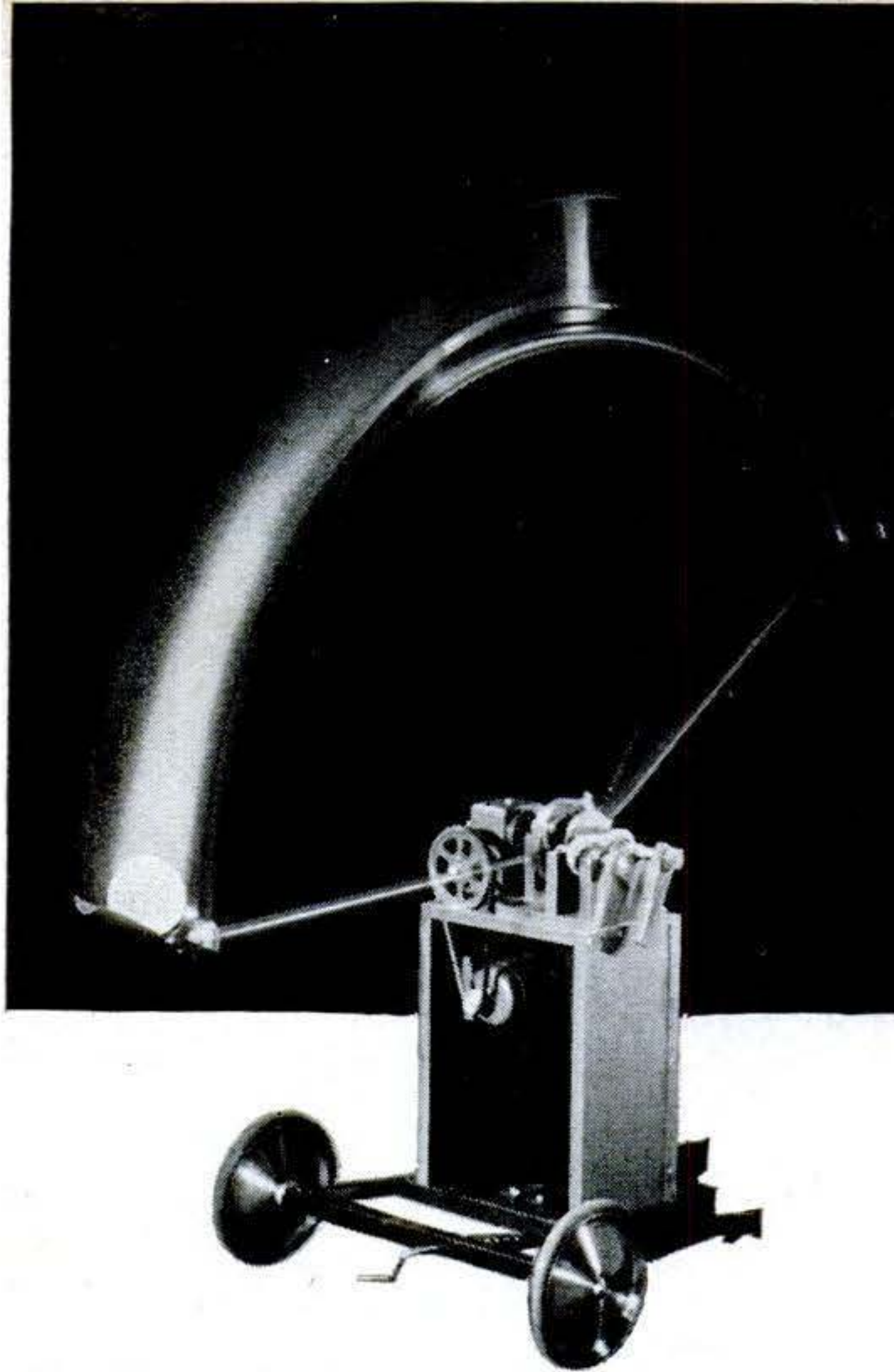

# "Overhand Joe"

*Clever mechanical pitchers*

**By Harold Rosenthal**

**H**E ISN'T nearly as handsome as some of those matinee idols who fill the ball parks on Ladies' Day with shrieking, swooning females, but Overhand Joe has all the looks the nation's baseball magnates think he'll ever need. What's more, they don't have to slip him a staggering bonus to coax him to sign his initial contract, don't have to sweat through a yearly contract wrangle

with him, don't get ulcers okaying fantastic meal checks for him, and don't have to worry about what he's doing after midnight.

Not Overhand Joe. That's because he's a machine, not a man—a pitching machine, the most popular developed in the history of the game. A weird-looking customer, he will be seen in a half-dozen major-league training camps this spring. He costs about \$1,000, which is only a fifth of the first-year salary of the rawest rookie in the majors. And he'll pitch a dozen balls a minute, from sunrise to sunset, year after year and never complain of a sore arm.

Last year the Brooklyn Dodgers installed three batting-practice machines at Vero



**Pitching machines** at Brooklyn Dodgers' production-line training camp at Vero Beach, Fla., are literally a stone's throw from barracks where players eat and sleep. Shown in action there

last year are "Iron Mike," at left, and early model of "Overhand Joe." They throw through openings in wire fencing that protects machines and operators from batted balls.



# Reports for Spring Training

*hurl strikes down the middle for big-league batters.*

Beach—and won the National League pennant. Overhand Joe, a product of the Foster-Porter Enterprises, Inc., of Baltimore, caught the club's fancy. After the World Series, the club brought a machine to Ebbets Field for further experimentation. Out of it came a vastly improved model, of which eight have been sold to five major-league clubs. Meanwhile in Brooklyn's production-line training camp at Vero Beach Overhand Joe and two of his younger and newer brothers are tirelessly "getting them across" for the personnel of the Dodgers and their twenty-odd farm teams.

Pitching machines aren't new. As far back as the middle eighties there were at-

tempts to get a batting pitch across by mechanical means. Just about every principle has been tried, from a bow-and-arrow contrivance to one operated by gunpowder.

Today there are three machines produced commercially. Overhand Joe whips a ball across off an arm traveling forward in a vertical arc; the Bazooka, another Foster-Porter development, fires the ball by compressed air; and Iron Mike, a St. Louis development, utilizes a claw and heavy-rubber-band arrangement. The Bazooka and Iron Mike have additional roles; they can also elevate their barrels and spray the outfield with a variety of long fly balls, keeping the fielders running around



**Other training apparatus** includes this pitching target to help hurlers correct early-spring wildness. Strike zone over home plate is outlined with white twine tied between two posts.



**Gravity system** for returning balls from outfield saves work for fly-chasers. Attendant gathers balls and drops them into pipeline back to pitching machine aimed high for long range.



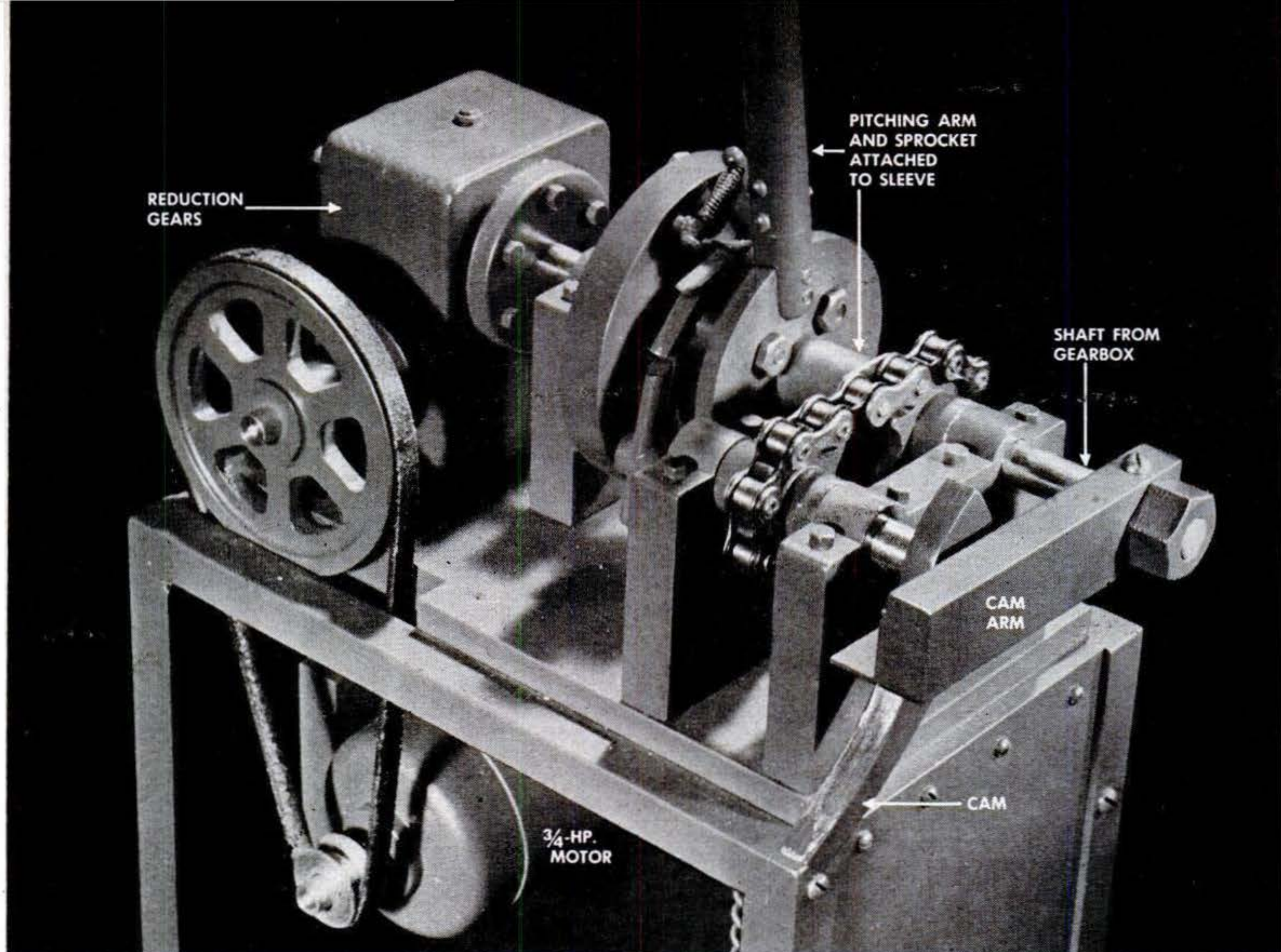

**I** How Overhand Joe burns 'em over is shown in these photos of PS-built model. Motor is belted to reduction gears, turning main shaft and cam arm at constant 11.6 r.p.m. Pitch-

ing arm, ratchet, and sprocket are mounted on a sleeve that fits free on this shaft. Here the cam arm, turning counterclockwise, has struck cam and is pulling it downward and backward.

until they trip over their own tongues.

All of today's baseball machines require only one operator, and all can usually deliver a dozen pitches a minute. They are adjustable for speed, and can pitch for hours at a pace that would tear a top major leaguer's arm right out of its socket.

Ballplayers are super-enthusiastic about Overhand Joe. They say you can "see his pitch coming." His straight up-and-over motion is almost human and simulates the delivery of a number of major-league hurlers like Warren Spahn of the Braves and Ewell Blackwell of the Cincinnati Reds.

There is nothing complicated about Overhand Joe, not even his nickname. He has a long arm sticking up from an encased base. A 3/4-hp. electric motor furnishes a complete cycle of operation at the rate of 11.6 a minute. Tension on a heavy spring determines the speed of the pitch and a V-shaped trough near the top of the throwing arm provides the spin for a "live" throw.

Of today's three commercial machines only Overhand Joe is not equipped to throw a curve. The Bazooka and Iron Mike can

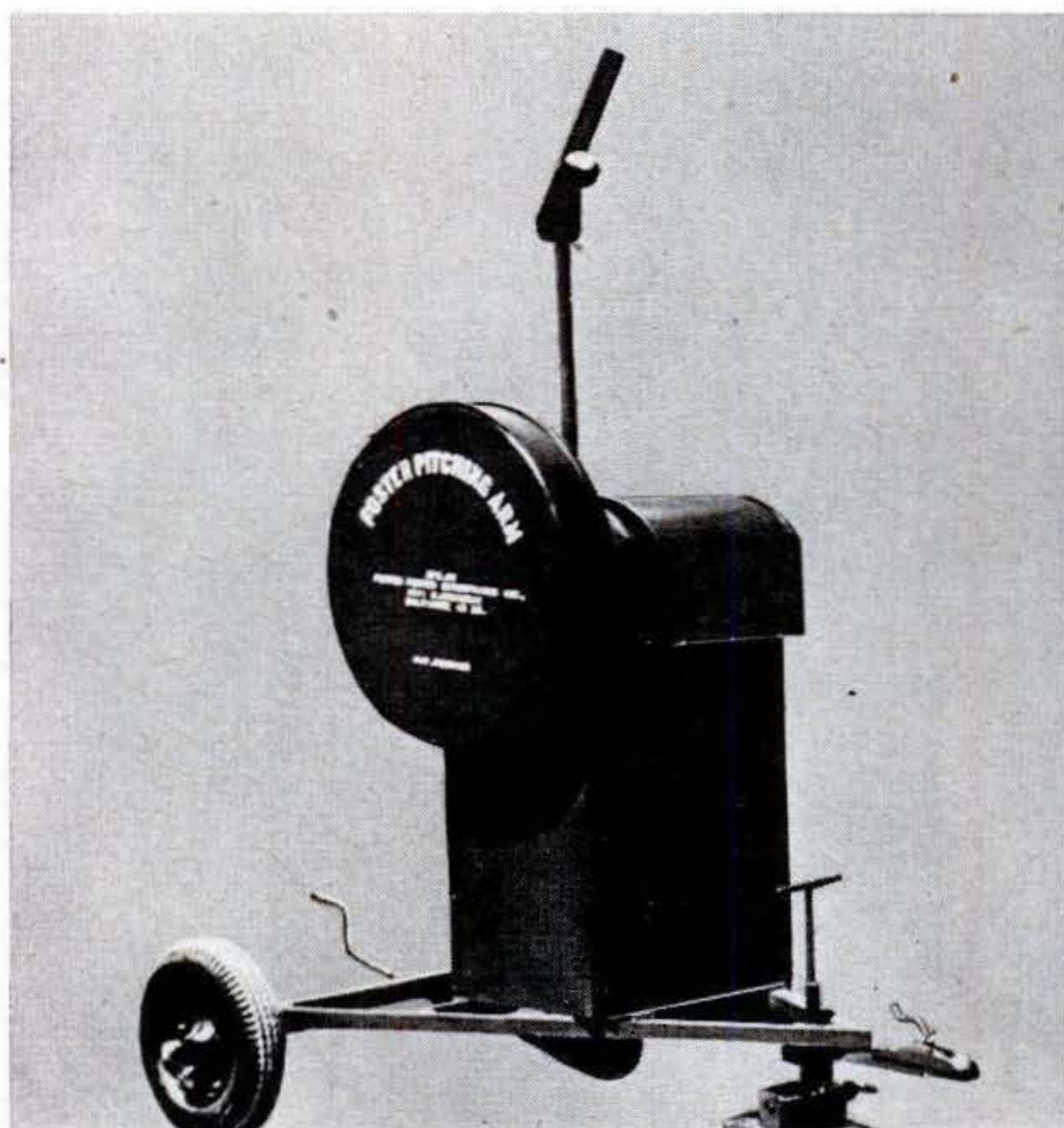

Auto hitch in front allows 400-lb., rubber-tired machine to be towed anywhere. The leveling screw in front helps adjust trajectory of the pitches. This is latest production model.



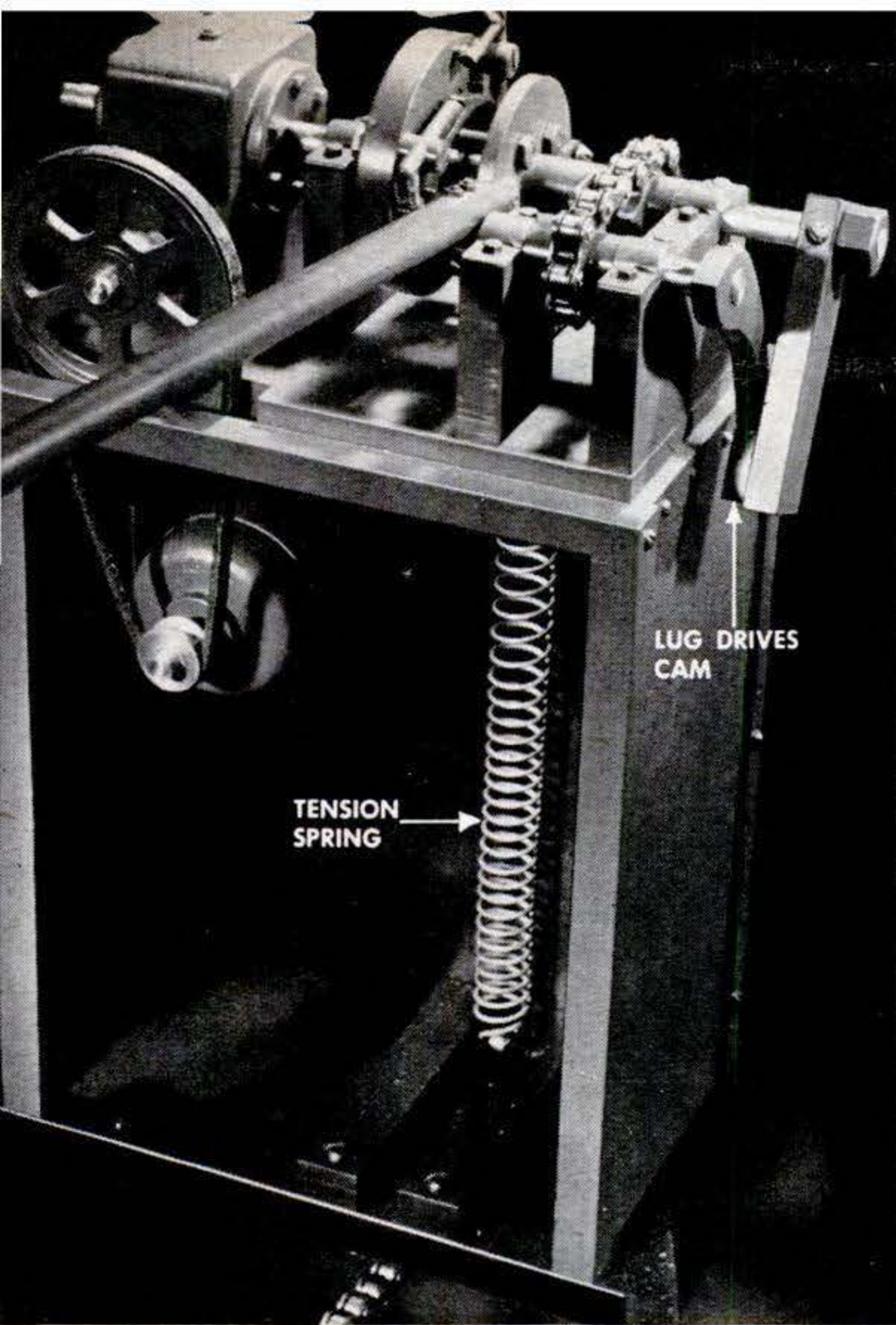

**2** Pitching arm is drawn back by movement of cam. Chain linked to arm pulls tension spring underneath. Cam is about to slip off cam arm, letting spring whip pitching arm over.

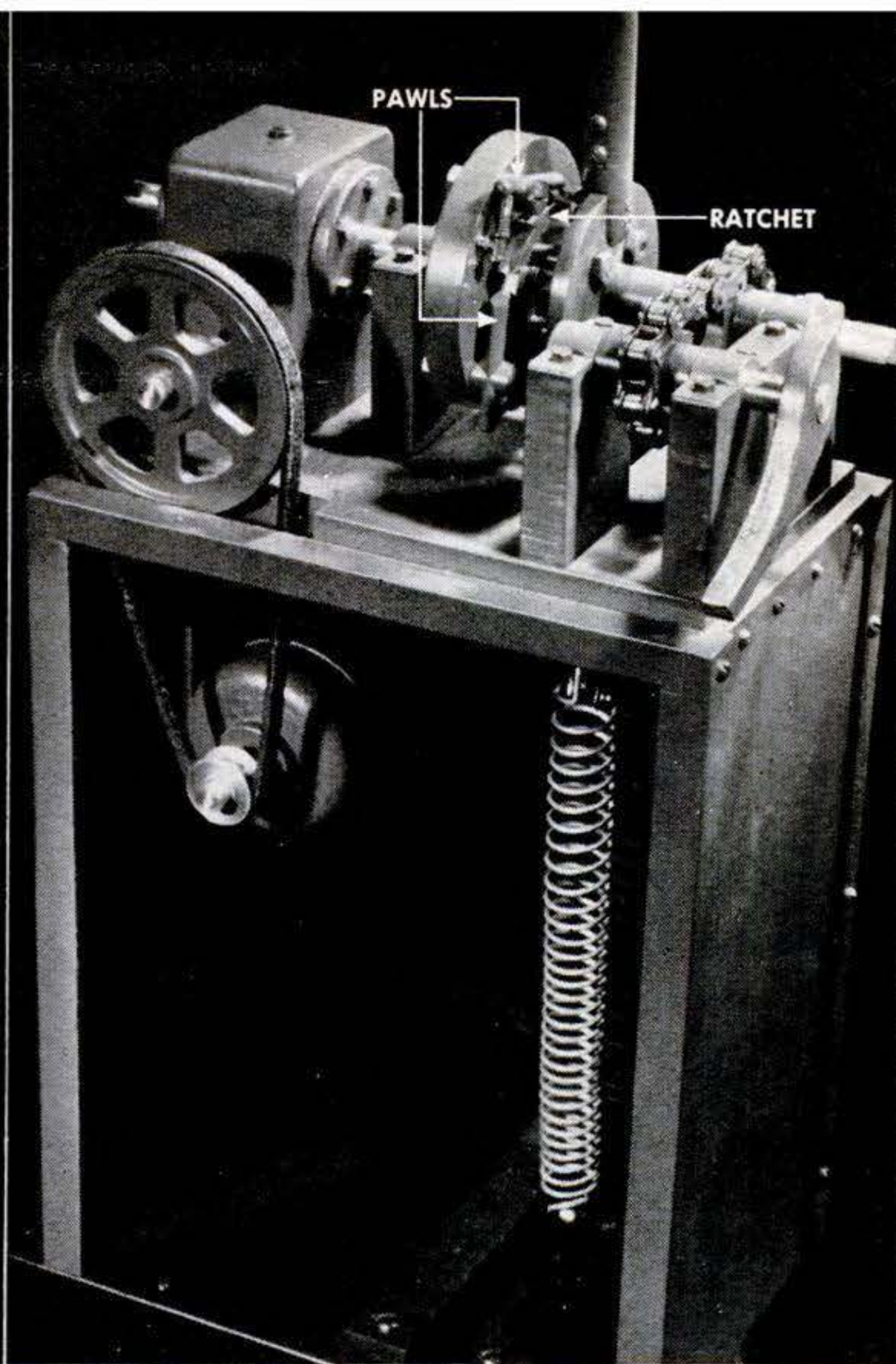

**3** Snapped over and then damped by re-applied spring tension, pitching arm is now kept from oscillating wildly as pawls on the main shaft engage ratchet secured to pitching arm.

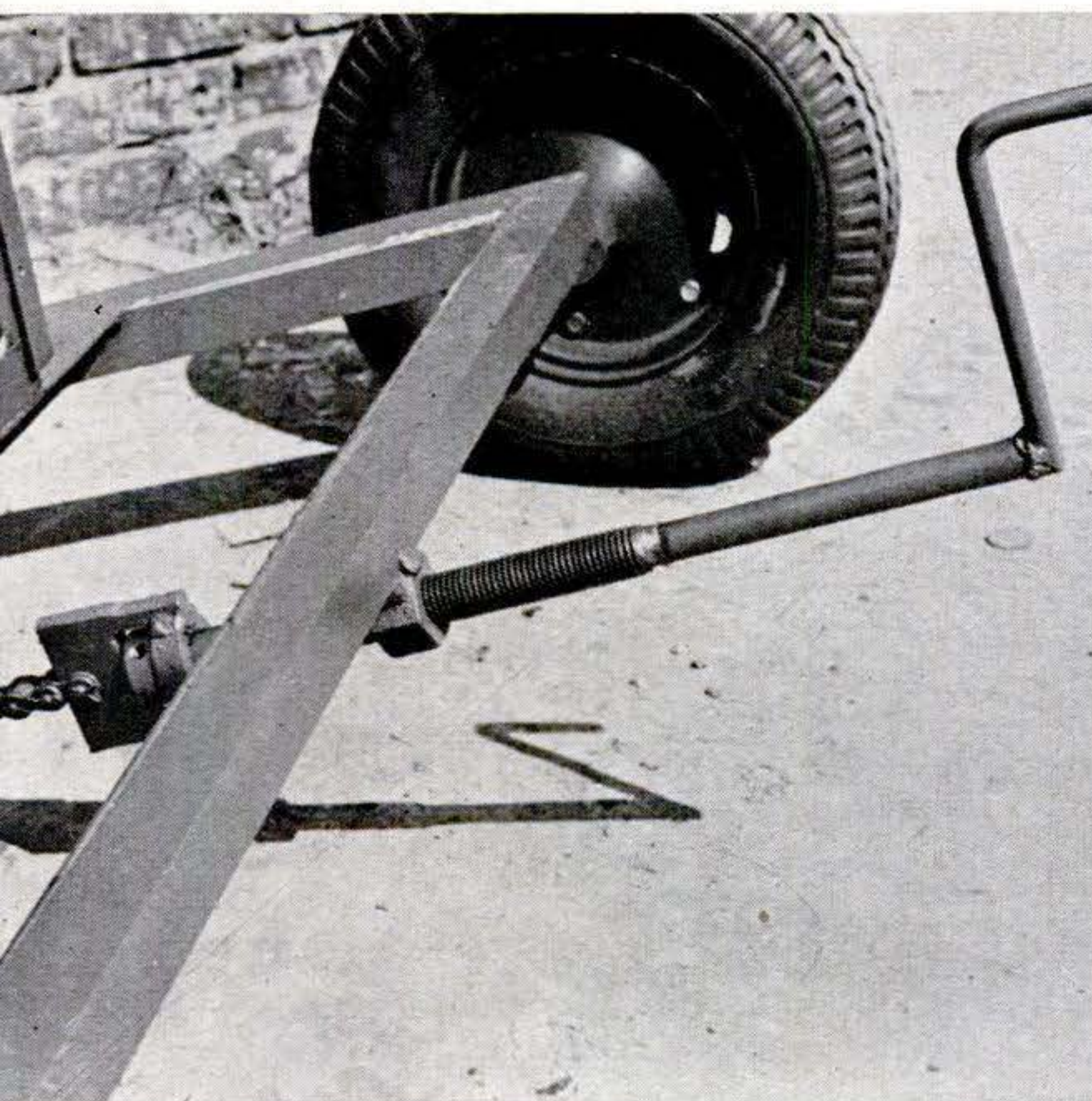

Crank in back permits operator to vary the tension of the power spring. This adjusts speed of the pitches up to a maximum of 90 m.p.h. Machine can throw a pitch every five seconds.

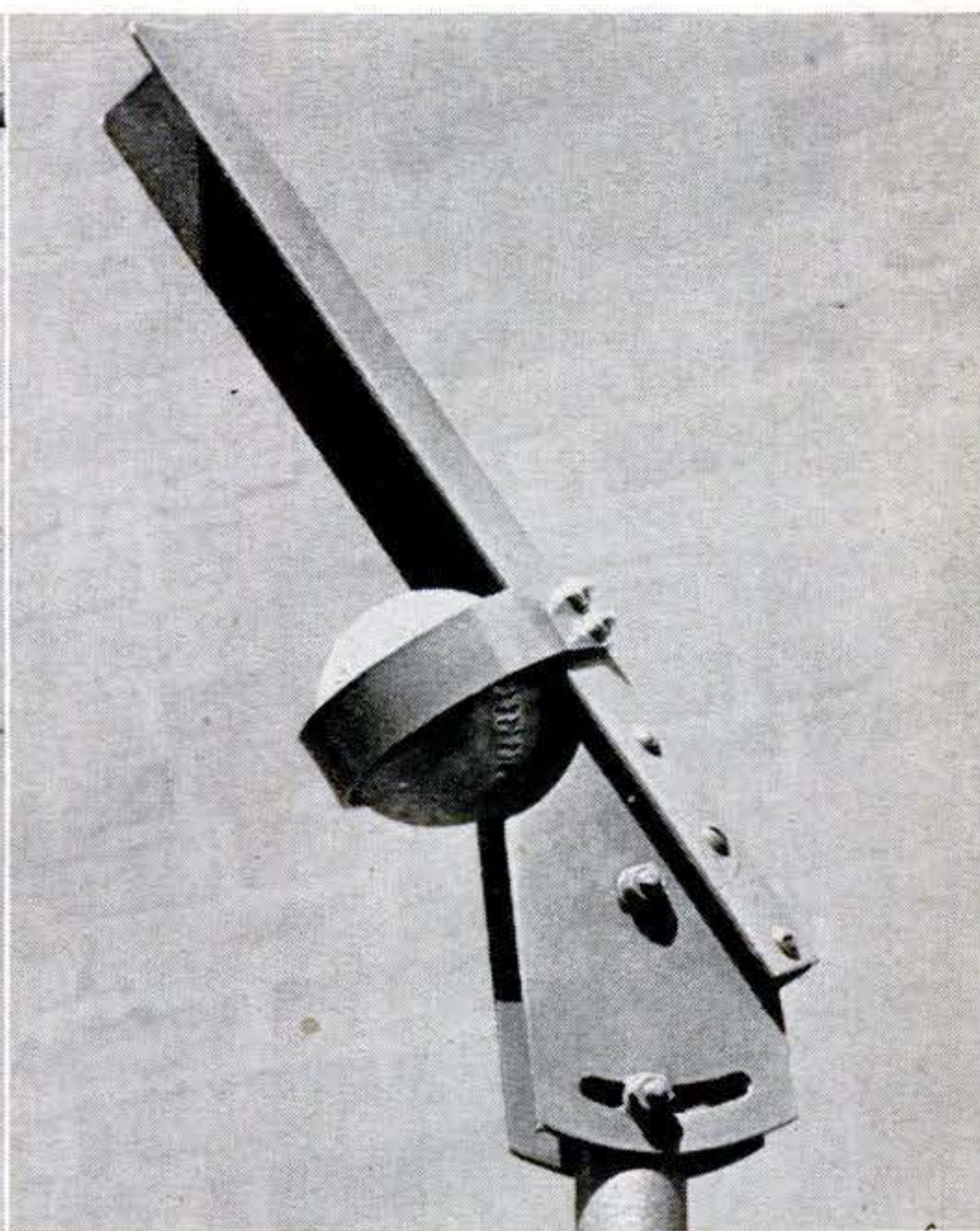

Ball is placed in loose-fitting rubber ring when arm is upright. When arm whips over, centrifugal force rolls ball down short length of angle iron, putting spin on pitch. 



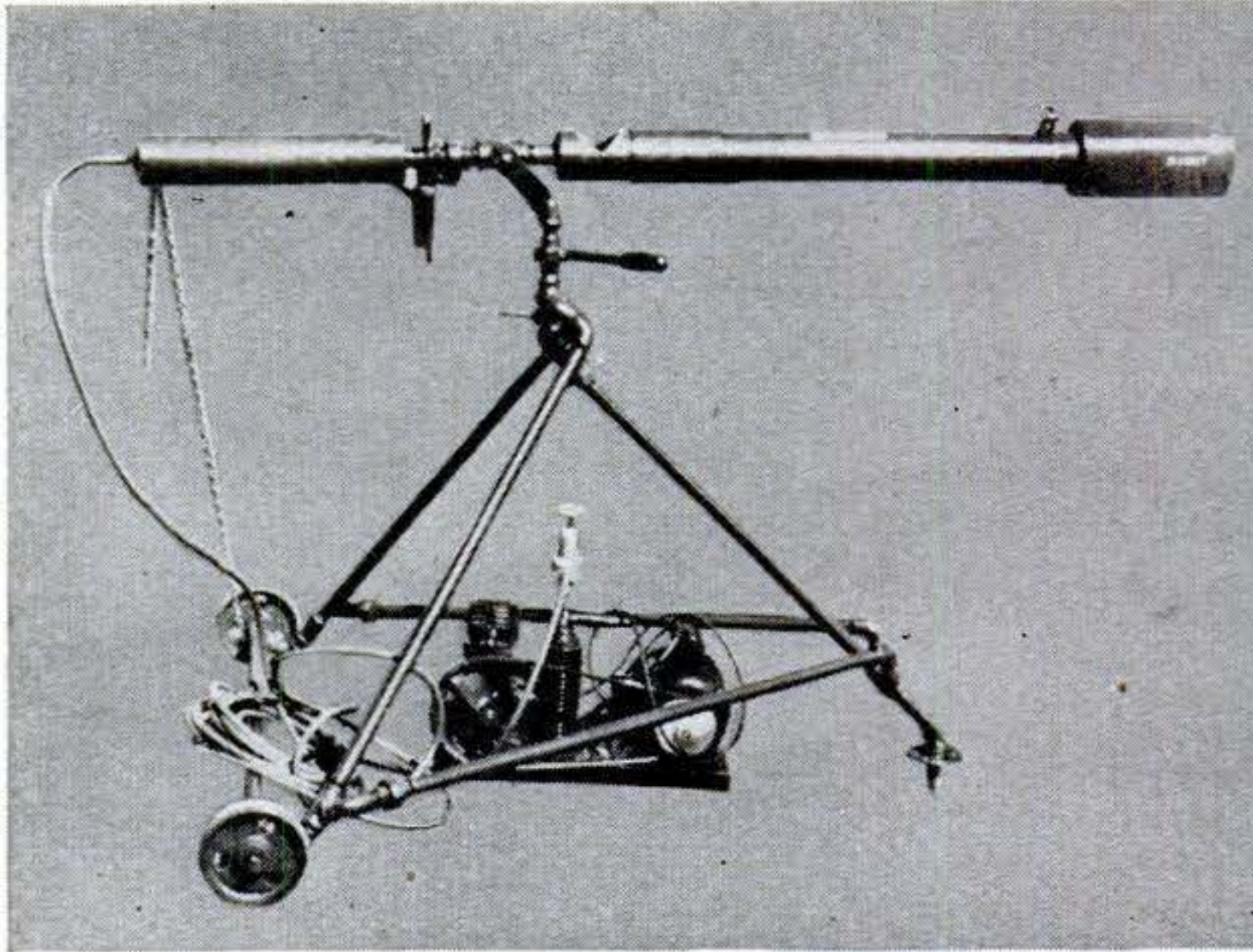

**"Bazooka,"** another pitching machine, is really a compressed-air gun. Compressor delivers air to tank at left end of gun, ball is dropped in breech, and trigger valve struck. Velocity can



be set from a slow pitch to a 400-foot drive. Rubber fingers at end of barrel adjust to give any curve desired. Less accurate than Overhand Joe, it is fine for fielding practice.

give it the old dipsy-doodle by means of mechanical-finger arrangements. Managers, however, have found that it's tough enough getting their players to hit an ordinary pitch early in the spring without worrying about "breaking stuff." They've given hearty endorsement to Overhand Joe, whose dozen-per-minute performance gives ball players all the batting practice they can handle.

This year, in addition to use in the Dodgers' camp, Overhand Joe will make an appearance in the camps of the St. Louis

Cards, the New York Yankees, the St. Louis Browns, and the Pittsburgh Pirates.

Iron Mike, invented and manufactured by a St. Louis banking official, operates somewhat on the principal of a giant sling shot. A claw arrangement holds the ball and a short, heavy rubber band speeds it on its way. The rubber bands are good for between two and three thousand pitches. After that, a replacement, costing \$2.50, must be made.

The Dodgers, who have pioneered in mechanical aids, gradually have dotted their training-camp landscape with various gadgets—all calculated not only to save wear and tear but develop better ballplayers. They have, for example, rigged up a gravity-return system of pipes enabling fly balls to be brought first to a central collection point, and then delivered by pipeline back to the pitching machines.

The Dodgers also use stationary batting tees and strike zones outlined by strings drawn taut between uprights. (The former can be constructed for small change from a portion of broom handle and a piece of automobile-radiator hose, mounted upright on a pedestal.)

Naturally, all these devices are butts for good-natured kidding in camp. "I guess," cracked one observer to a Dodger coach, "you'll be getting a few more machines next year and a few more the year after. Do you think you'll eventually wind up by taking the machines South and leaving the players home?"

END

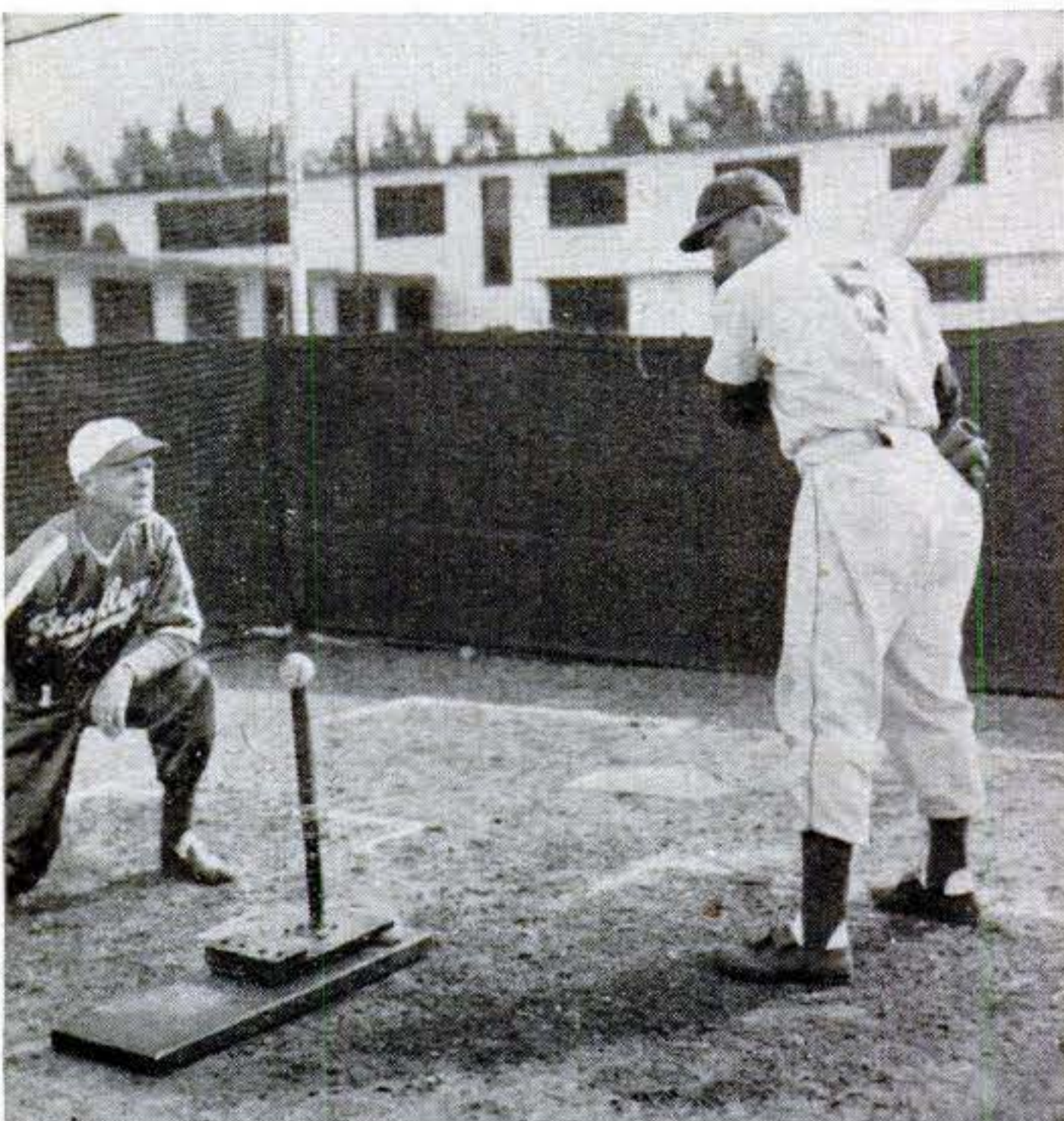

**Batting tee** is a comparatively simple gadget that lets hitter concentrate on improving his form. It consists of auto-radiator hose, adjustable in height and mounted on a weighted base.



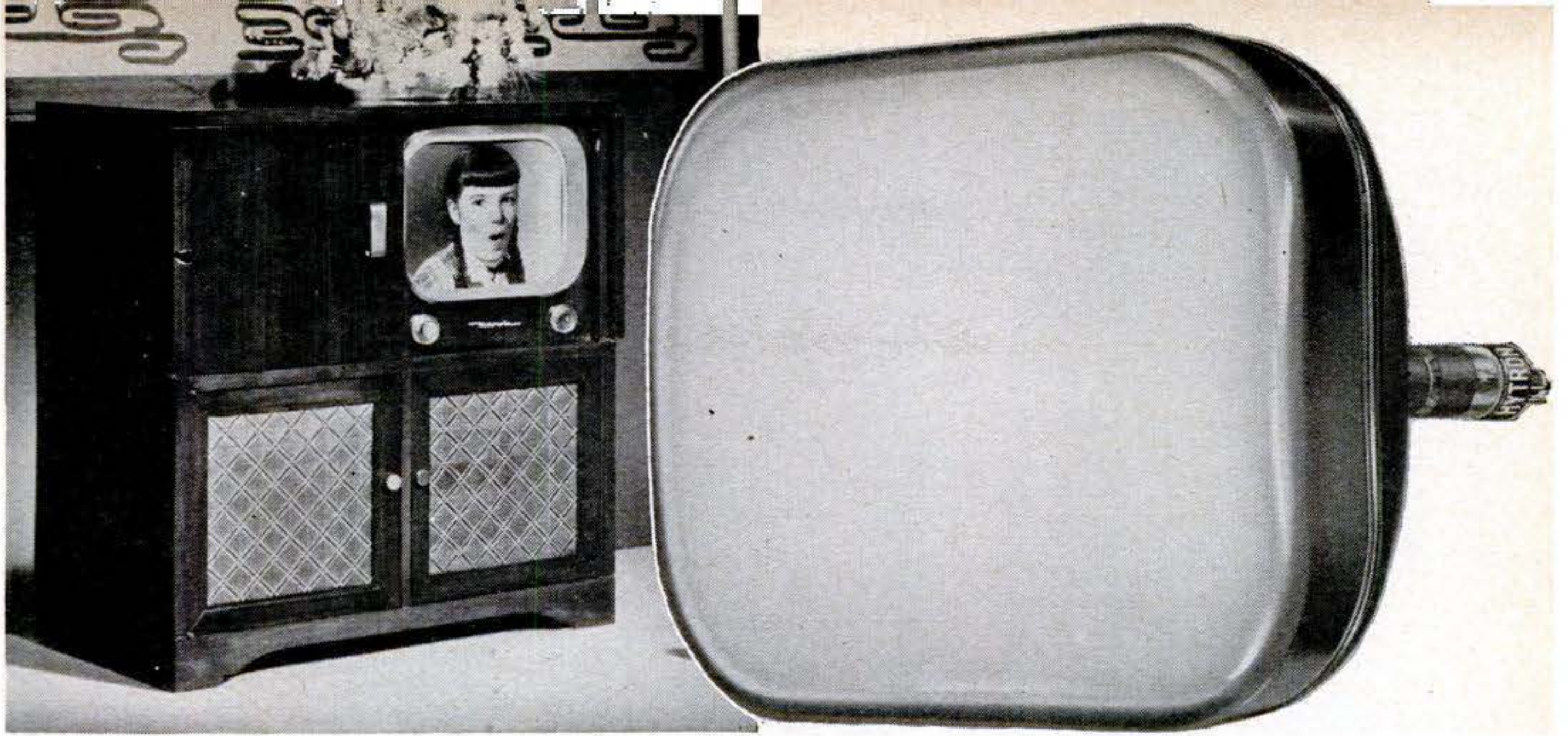

## ***Rectangular TV Tube Cuts Cost***

AFTER years of trying to squeeze a rectangular television picture into a round tube, TV manufacturers have come up with the obvious solution—a rectangular tube.

The new tubes, such as the Hytron shown at right above, are much smaller, making

possible more compact, cheaper sets. Typical of the large-screen receivers now being marketed by several makers is the Motorola combination console above, which shows a 16-inch picture and sells for about \$400. A 16-inch table model is less than \$300.

## **New Austin Is Faster**

A NEW gear ratio to provide a cruising speed of up to 70 miles an hour is announced for the 1950 four-passenger British Austin car (right), being marketed in the U. S. The new ratio is 5.14-to-1. The old ratio was 5.43-to-1. Motorists can get up to 35 miles on a gallon of gasoline.

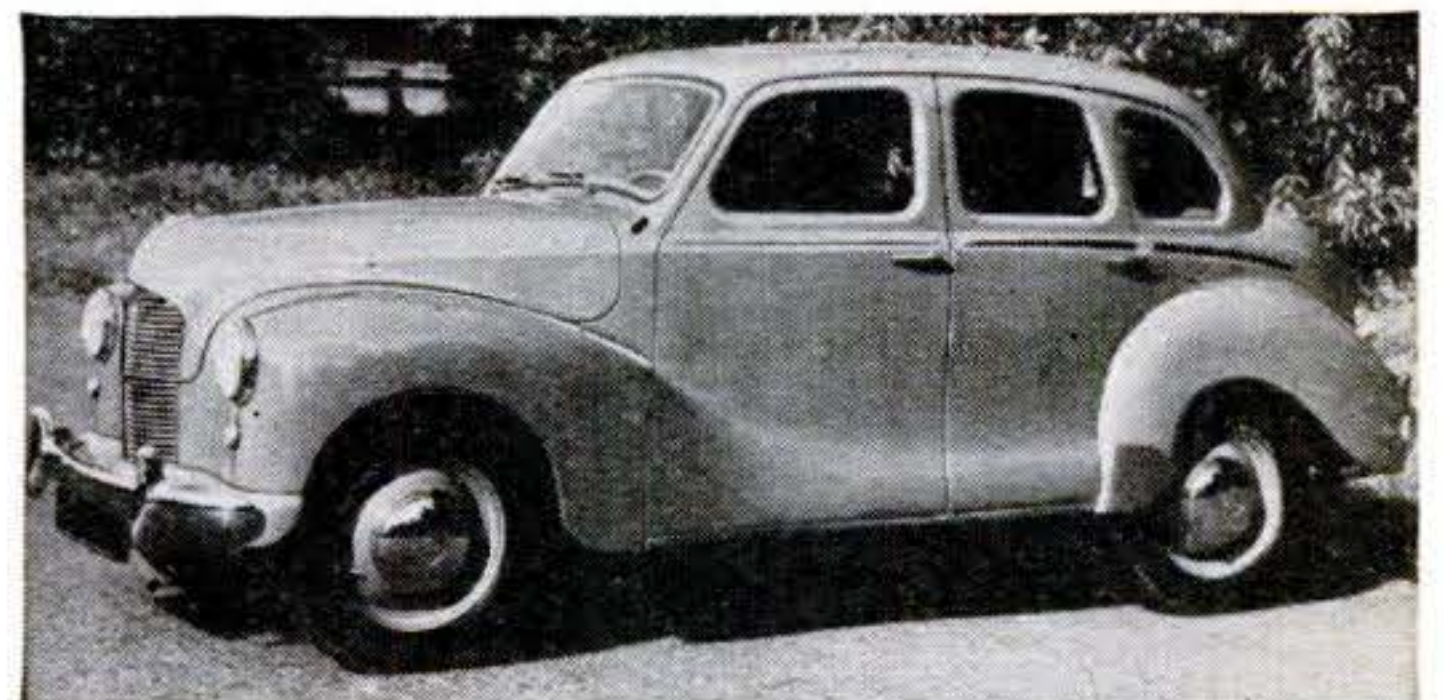

## **1950 Caddy Gets Lower Look**

THE 1950 Cadillacs are lower—as much as four inches in some models. The Series-62 sedan above is five inches longer over-all. This enables the rear seat to be well forward of the wheel housings, providing extra hip

room. Wheel bases, however, are three to four inches shorter, except in limousines. Engines warm up faster because exhaust gas is ducted past the carburetor's idle jet. A valve cuts off the extra heat when the engine warms up. Press-fitting piston pins boost bearing area, eliminate bushings.





**Uranium  
For Sale**

Here are two quarter-pound sticks of the \$50-a-pound uranium metal now on sale. Though it's radioactive, its rays are so mild that you can hold it in your hand without slightest danger.

***A-metal goes on market, and other odd metals find new uses, as they step out of chemistry books into everyday living.***

**By Alden P. Armagnac**

**W**ANT to buy some uranium? You can, now, for the A-metal's on the market. Just explain to the New York licensing division of the U. S. Atomic Energy Commission what you want it for, satisfy them that you're a reputable researcher, and you'll get a license entitling you to send in an order.

To meet legitimate needs, the AEC has authorized the sale of 200 pounds of uranium through normal commercial chemical channels. That's news, because in recent years every available ounce of the silvery metal has been earmarked as a source of fissionable material for A-bombs and chain-reacting piles.

Uranium metal is definitely in the luxury class, several times as expensive as silver, for it sells at about \$50 a pound. But it's still a bargain. The price would have been \$1,000 eight years ago—if available at all

The postman will bring the precious metal in an ordinary screw-cap cardboard mailing tube. It may come from the Mallinckrodt Chemical Works of St. Louis, Mo., which produces uranium from ore mined in the Colorado area, or from other chemical dealers supplied with it by this firm.

One or more black sticks of solid uranium metal, four inches long and a little thicker than a lead pencil, will be in the package. (Although uranium resembles steel at first, it soon turns bronze, and then black, as exposure to air coats it with oxide.) Since uranium is one of the heaviest of metals, 18.7 times as dense as water, even those little rods weigh a quarter of a pound apiece.

Uranium is radioactive, emitting alpha and beta rays. So the sticks come wrapped in ray-stopping lead foil to avoid any chance of fogging photographic film in the same mail. The rays from an unwrapped stick will make a shadowgraph of a key laid on film in a darkroom, and will swing a Geiger counter's needle across its dial. But they are so mild and harmless that you can hold uranium in your hand with perfect safety.





**Needle of ray-detecting Geiger counter swings across dial when probe connected to counter is held beside uranium metal. Meter is set for low sensitivity, or needle would go off dial.**



**Rays from uranium rod, laid over key on photo film in darkroom, took this picture of key. Rod itself made the glow extending across picture. This is a print from developed negative.**

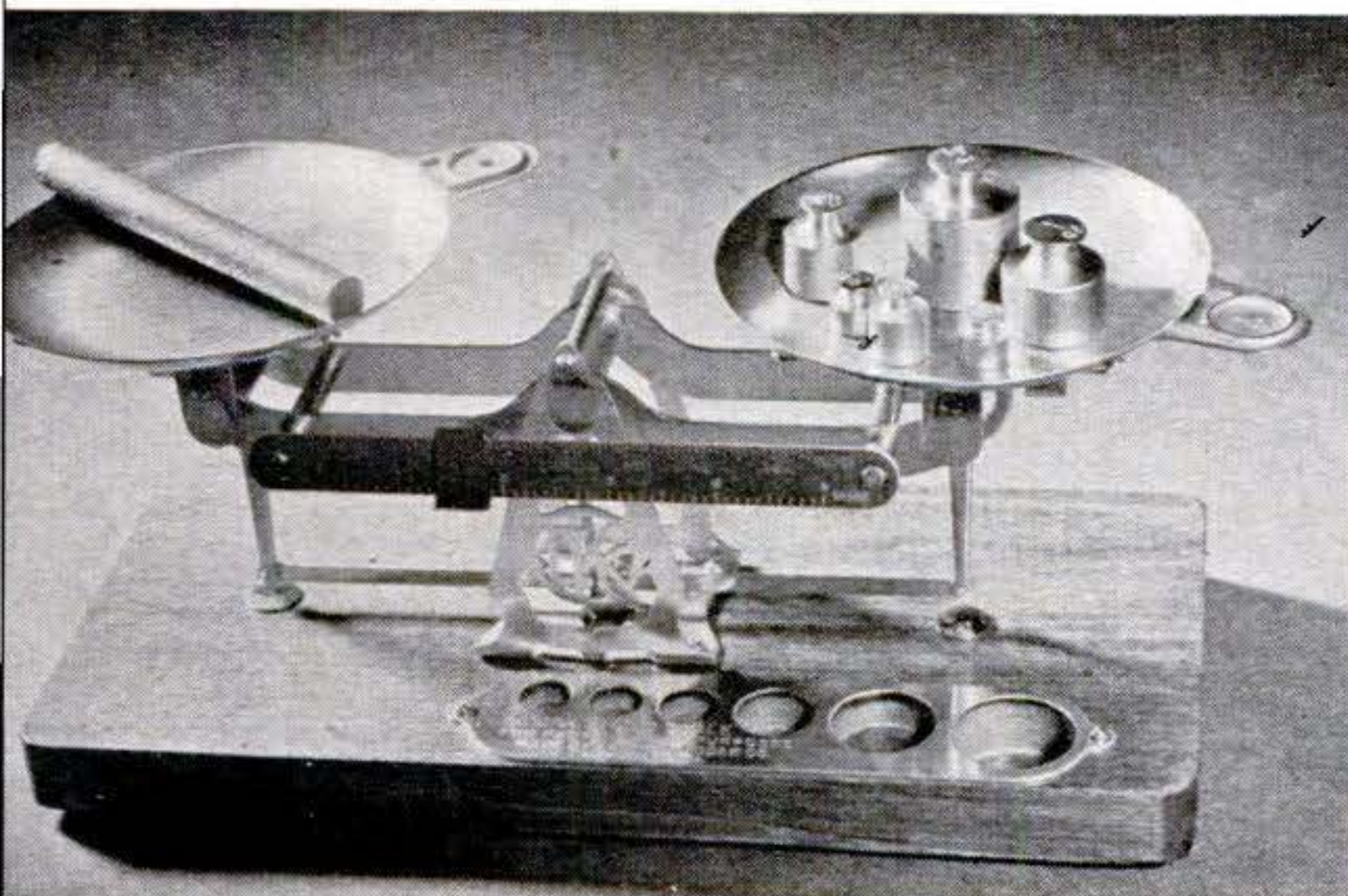

**Heaviness of uranium metal is shown by weights needed to balance small rod of it. Total on scale pan and slide is a shade over four ounces. Rods average a quarter-pound apiece.**

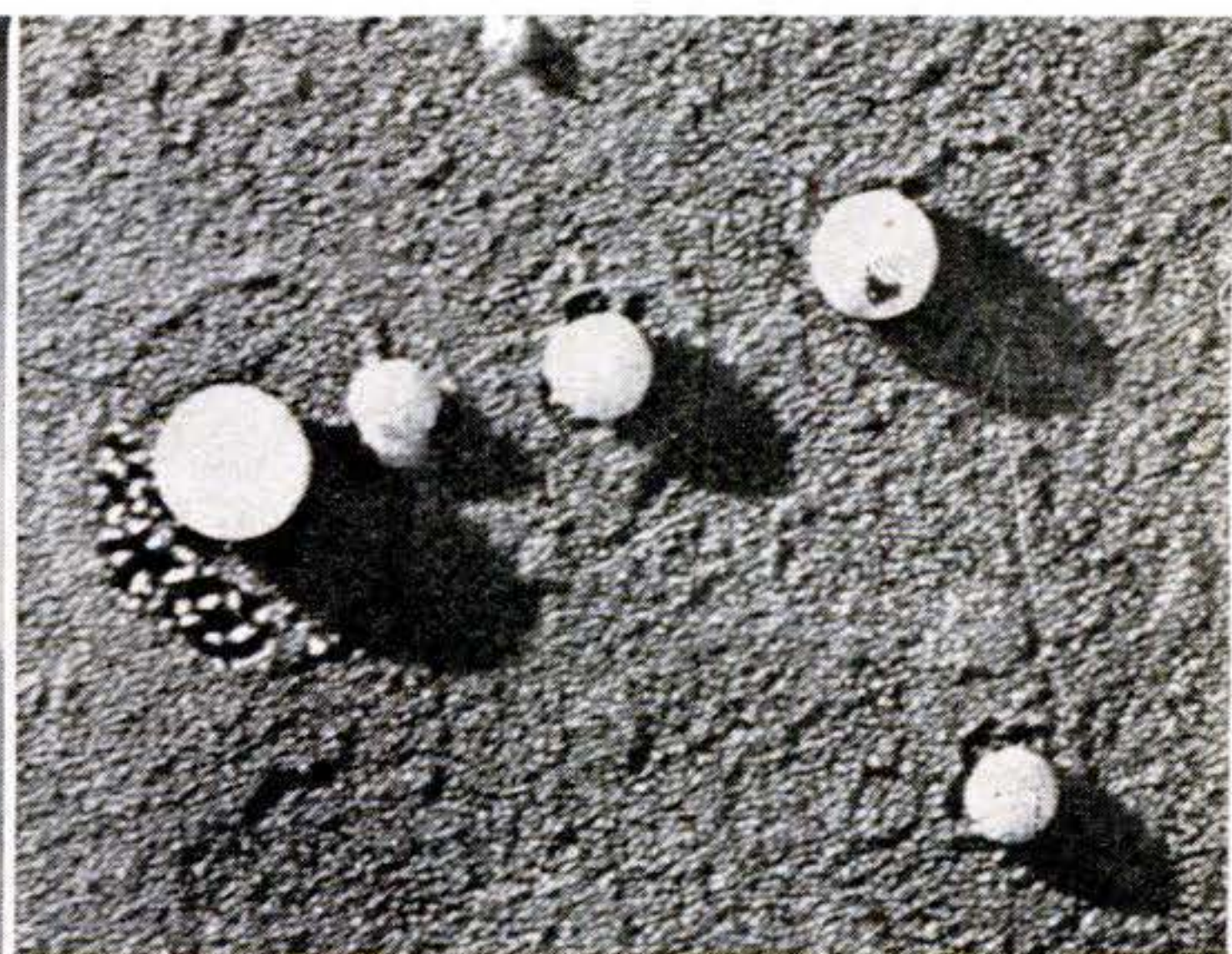

**Form-revealing shadows in this electron-microscope picture, believed to show actual molecules of polystyrene latex, were made with gold. Uranium metal will help get even better views.**

And in contrast with some radioactive materials, you needn't hurry to use uranium while it lasts—for its half life is a generous four and a half billion years!

The uranium you get won't be quite pure enough to use in an atomic pile, nor will it be artificially enriched in U-235 as an atom bomb requires. But that won't matter to you, for Uncle Sam would frown on your running a private pile or making a bomb anyway. By ordinary standards it will be highly refined and suitable for whatever else you want to do with it.

Several of the purchasers whose orders have already been filled, usually for a pound, or four sticks, of uranium metal, will use it to "shadow-cast" specimens for study with electron microscopes. Germs and equally tiny objects stand out clearly in relief under the microscope, with their true form em-

phasized by apparent shadows, after a thin film of a heavy metal is deposited obliquely on them in a vacuum. Of the metals tried to date—which include chromium, manganese, palladium, and gold—uranium works best.

Ostensibly for making steel alloys, Russia obtained 500 pounds of uranium-containing oxide from Canada in 1943, it was recently revealed. Whether that's what they did with it, the record doesn't show—but it's another possible application of uranium. According to the U. S. Bureau of Mines "Minerals Yearbook" for 1941, "Uranium imparts desirable properties to tool steels. The metal is introduced as ferro-uranium, or as a master alloy containing 66 percent uranium and 33 percent nickel." More recently, properties of uranium alloys with aluminum, tungsten, tantalum, manganese, and copper have been investigated and made the subject



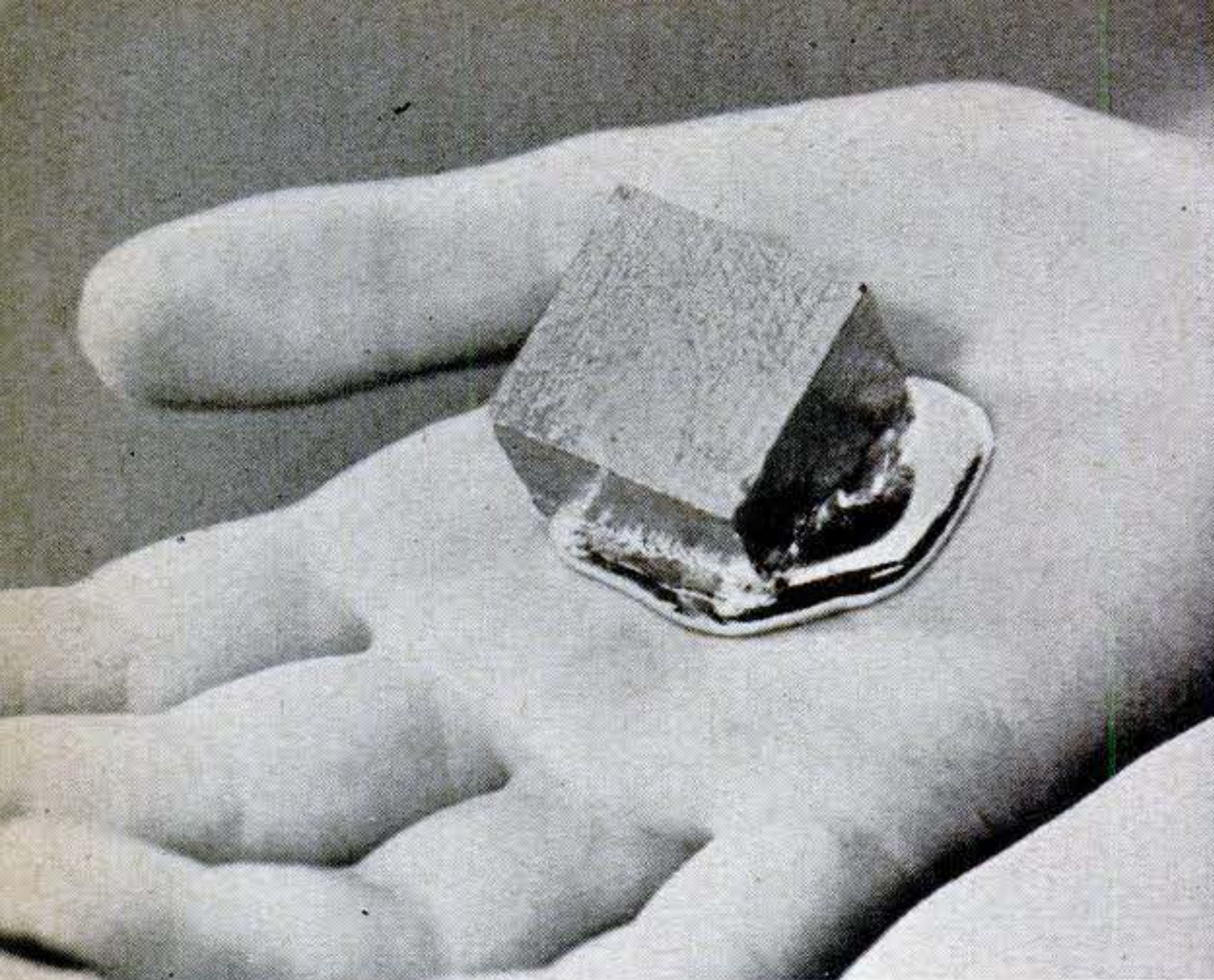

**Gallium metal** is strange new by-product of extracting aluminum from bauxite ore. Above, a cube of gallium is melted by body heat when it's held in the hand. It liquefies at only 86° F.

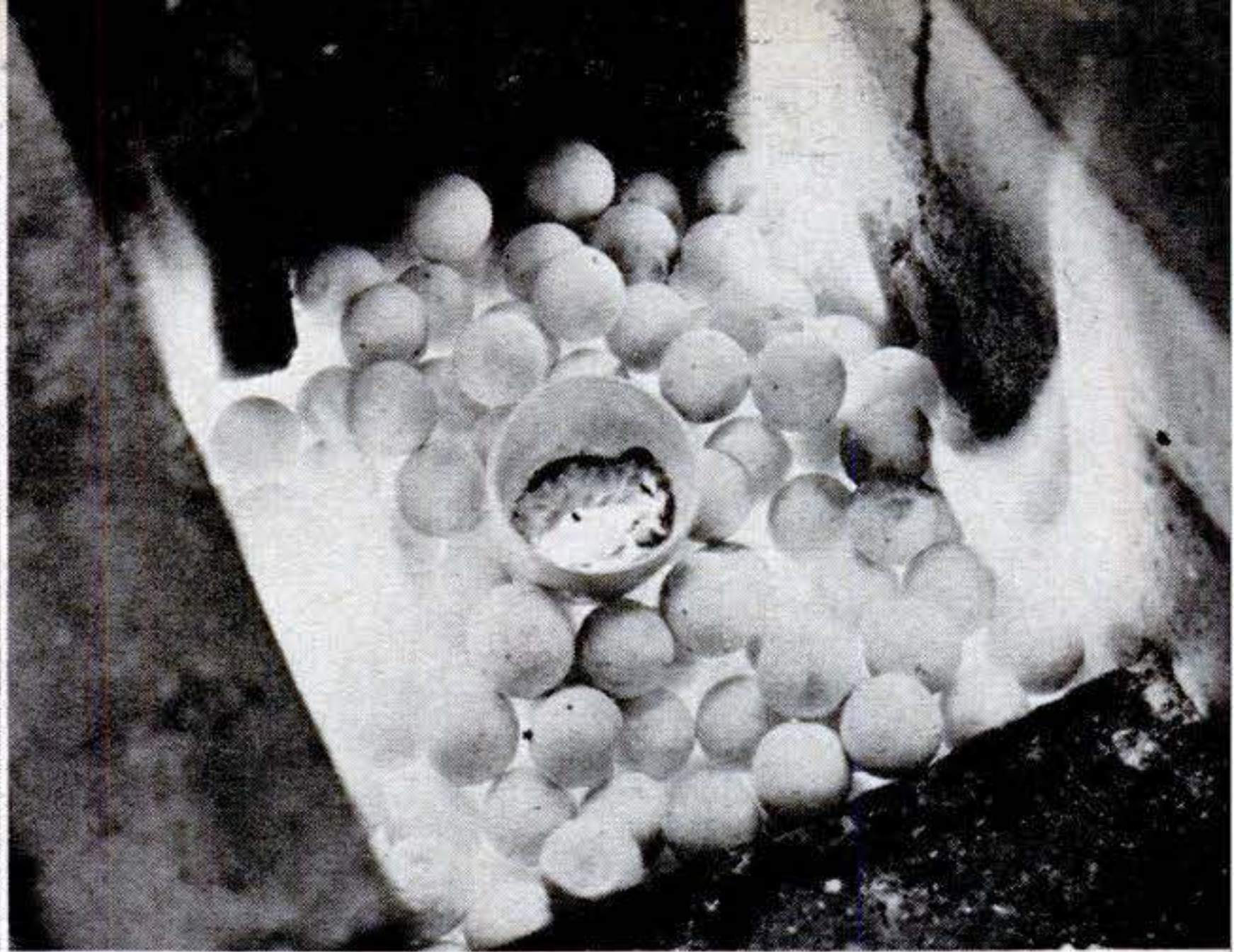

**Crucible of liquid gallium**, resting on balls of white-hot alumina in furnace above, can be heated to 3,600° F. before metal boils. It replaces mercury in high-range thermometers.

of several AEC reports. The uranium now for sale will permit wider studies of this kind.

Physicists should find uranium metal a useful tool, the AEC suggests, to study the strange behavior of substances at extremely low temperatures, where their electrical resistance mysteriously vanishes.

Formerly about the only known use for uranium and its chemical compounds was as a coloring agent for amber signal glass, yellowish-green "uranium glass," and red and orange tile. Said the 1940 pre-atomic-era edition of the yearbook already quoted: "Increased output of radium has raised again the question of disposing of the jointly recoverable uranium." It's come a long way, uranium has, since people wondered what to do with it!

So have quite a few other rare or unfamiliar metals that until recently were only names in chemistry books. One of these days, if you haven't already, you'll be making the acquaintance of such up-and-coming metals as beryllium, gallium, germanium, lithium, molybdenum, rhodium, sodium, and titanium.

#### ***Odd Metal Melts in Hand***

Pick up a piece of silvery gallium metal, and it melts in your hand! Like mercury, it liquefies at a temperature below body heat, 86° F. to be exact. Since it boils at a temperature far higher than mercury does, the queer metal has been used as a liquid in thermometers that register up to more than 1,800° F. New uses are expected to result from its recovery, just begun by the Aluminum Company of America, as a by-product from the aluminum-bearing ore

bauxite. One is in an extremely strong new dental alloy for fillings that won't fall out.

Did you ever see any molybdenum, not mixed in alloys like chrome-moly steel, but the pure stuff itself? Not long ago, Westinghouse learned how to produce the first 250-pound ingots. In contrast to gallium, molybdenum melts at the toplofty temperature of 4,750° F., nearly 2,000° above the melting point of iron. Hence engineers foresee molybdenum nozzles for rockets and blades for gas turbines—and, perhaps, firewalls to protect jet fliers from fire.

Mirrors now get a coating of rhodium metal, better for "silvering" than silver. Called "poor man's platinum" because it's a less expensive member of the platinum group of metals, rhodium also gives a handsome plated finish to cigarette lighters and safety razors of well-known makes.

Titanium's the talk of the town when engineers get together. Although it's heavier than lightweight magnesium alloys, it's so much stronger that aircraft parts of half the weight can be made from it. Silver-white and ductile, it's even more corrosion-resistant than stainless steel, report interested experimenters of the Remington Arms Company. The ore is the fourth most plentiful of any structural metal's, but how to get the metal out has been the \$64 question, until National Bureau of Standards metallurgists recently hit the jackpot with a new method.

Unusual metals mean unusual processes. One modern engineering stunt is to use liquid metal, like the water in your car's cooling system, for cooling and heat transfer. The new atomic pile of the Knolls Atomic Power Laboratory near Schenectady,



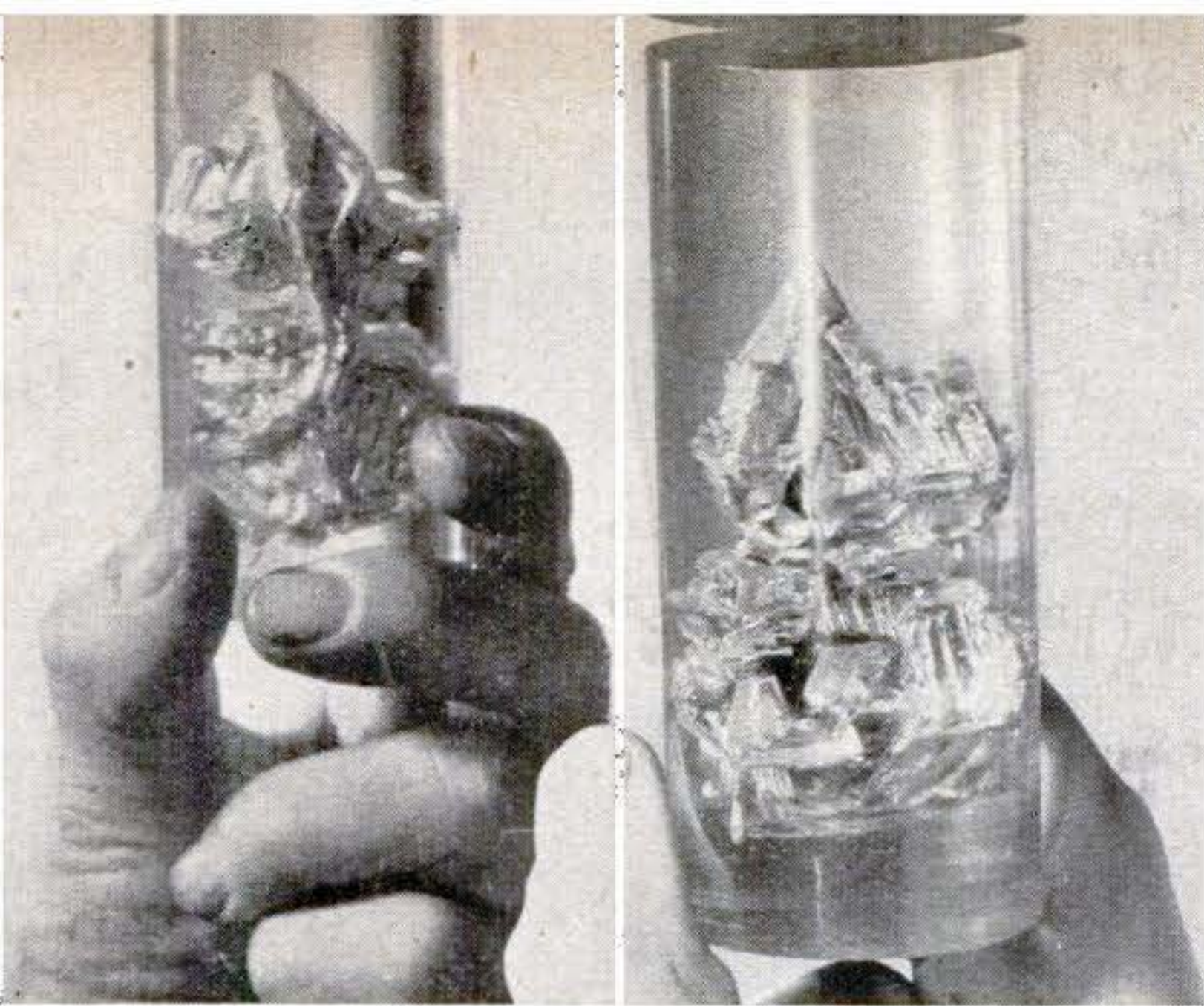

**Crystal of gallium**, in exhibit, is embedded in plastic cylinder so handling won't melt it. Reflection (left) is in glass coated with liquid gallium, which adheres as mirrorlike surface.



**Expanding as it freezes**, gallium cracks bottle at left and exudes from its neck, just like frozen milk in bottle at right. Rubber syringe bulbs make unbreakable containers for shipping.

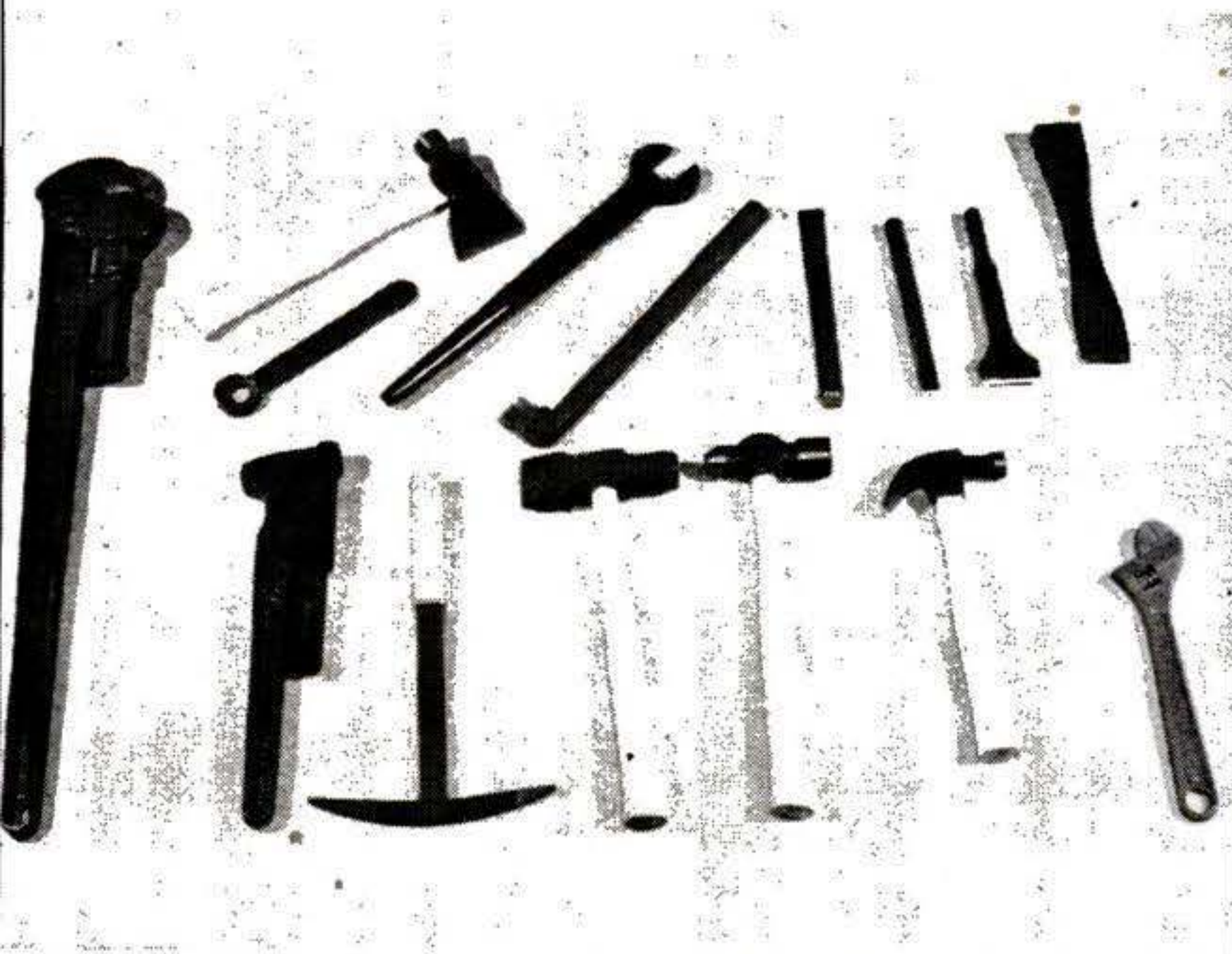

**Non-magnetic tools** of beryllium copper like these are used by workers in Oak Ridge atomic plant, where powerful electromagnets would jerk steel ones out of men's hands.

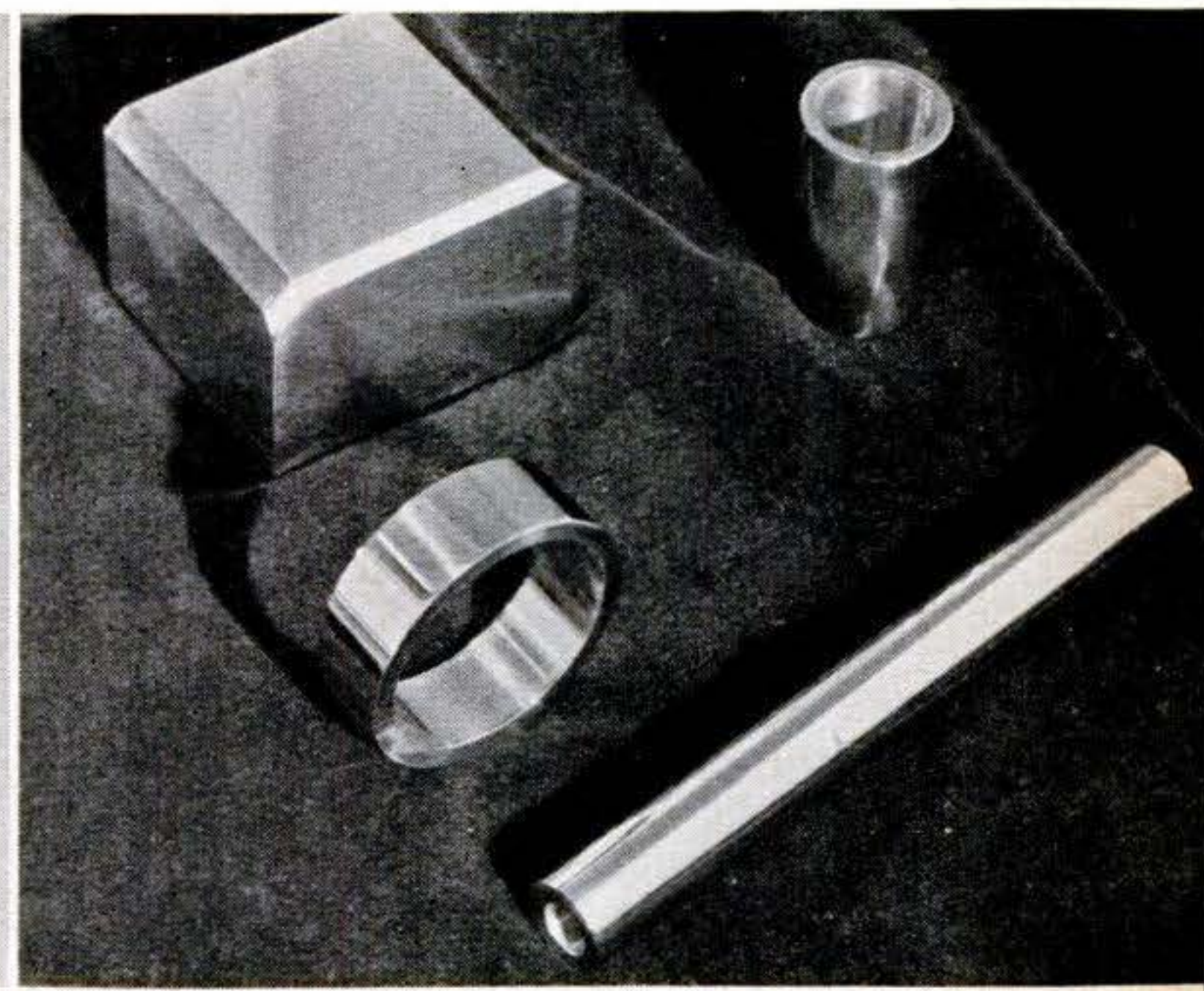

**Pure molybdenum metal** melts at high temperature of 4,750° F., and use is foreseen in rockets and gas turbines. Silvery metal acquires high luster from buffing, as these samples show.

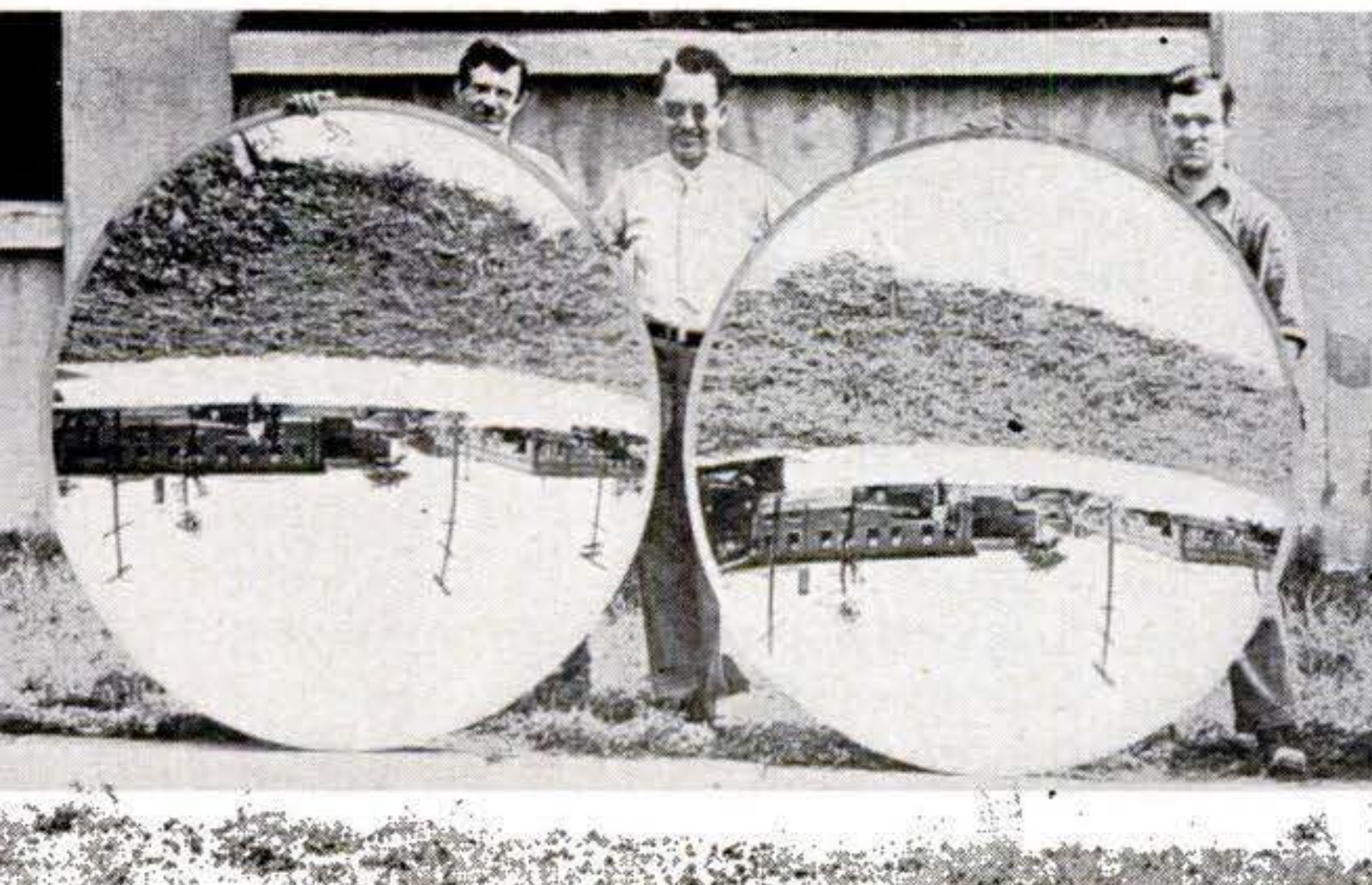

**Rhodium metal** now makes mirrors, above, for searchlight reflectors and optical instruments. Front-surface coating of rhodium, eliminating double reflection, doesn't tarnish as silver does.

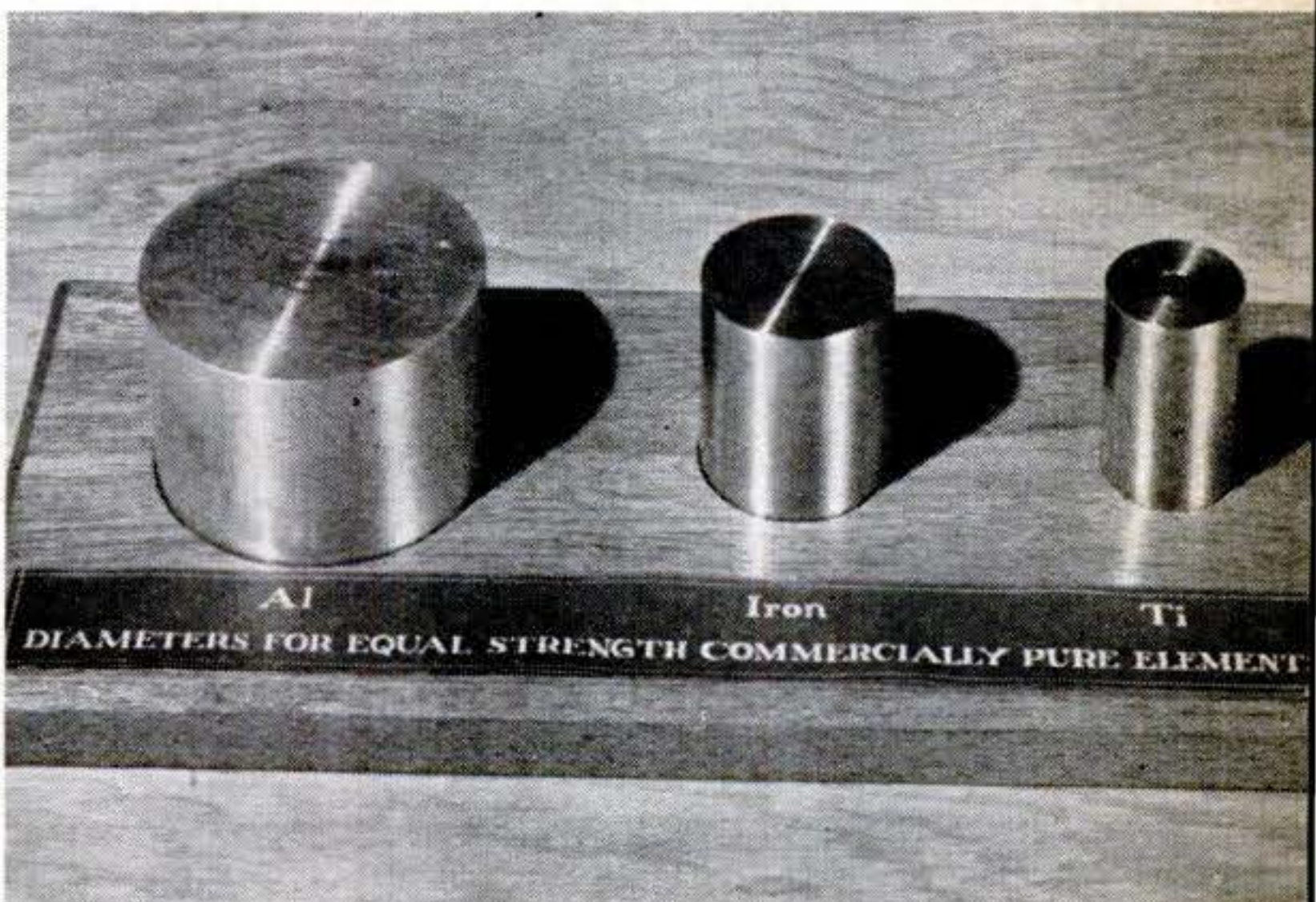

**Titanium is light** and strong new structural metal. Titanium sample at right shows amount required to give same strength as aluminum, left, and iron, center. Du Pont produces it. ▶



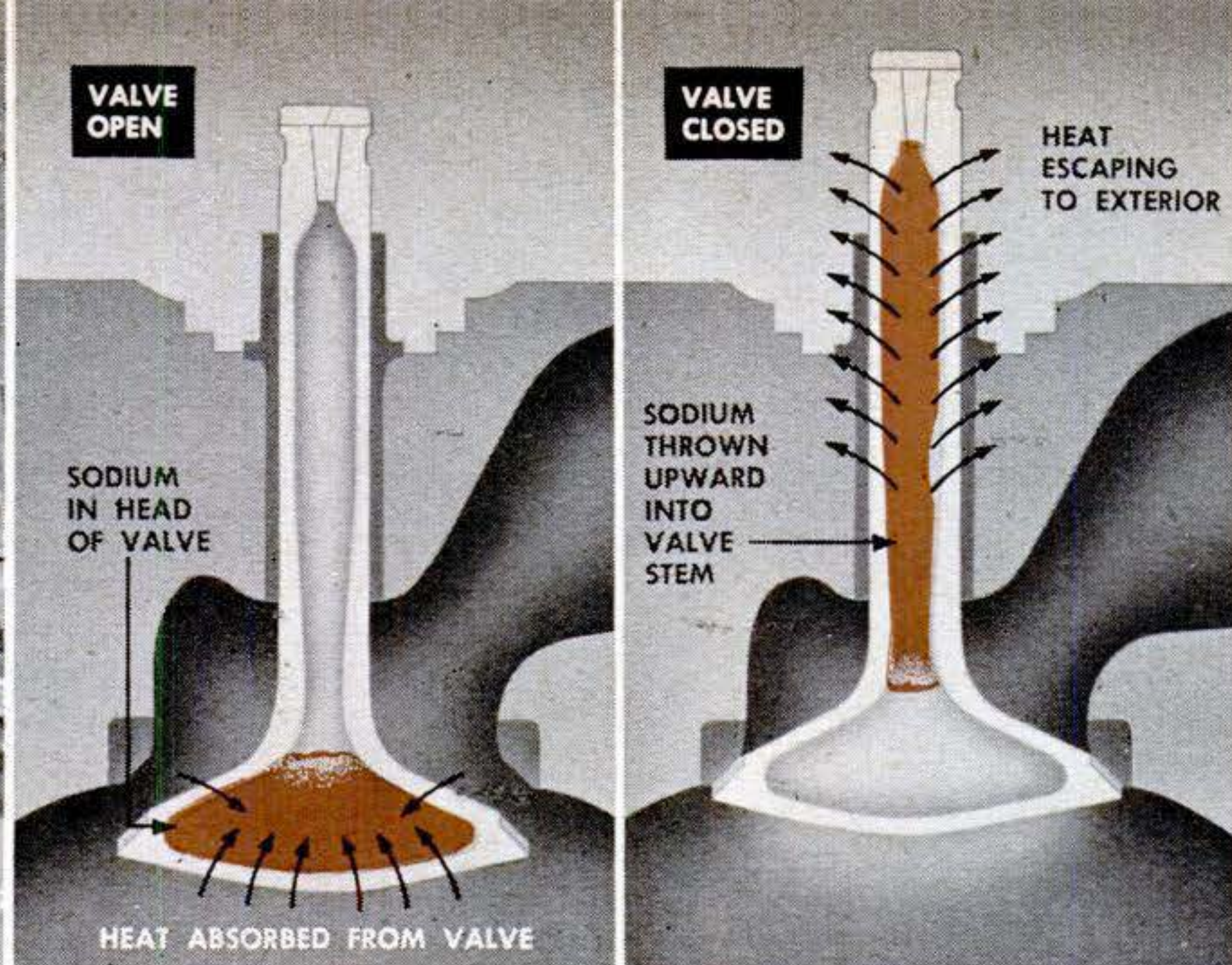

**Cooling with sodium metal** protects valves of aircraft engines from corrosion and distortion by heat. Sodium snipped from rod (left) is sealed in hollow valve. Engine heat melts it. When

valve is open (center), sodium at bottom absorbs heat. Closing of valve throws sodium upward into stem (right) and heat escapes through metal to cooling system.

N. Y., will employ a "liquid-metal coolant." The particular metal or metals haven't been revealed. But at Oak Ridge National Laboratory, they've tried out an experimental cooling system using an alloy of two rarely seen metals, sodium and potassium, in nearly equal parts. The odd alloy is liquid at ordinary room temperature, melting at about 59° F. Sodium-cooled valves, using sodium metal alone (melting point, 175½° F.), have made possible high-power airplane engines.

Because ordinary hammers and wrenches would be jerked right out of workers' hands by the tremendously powerful electromagnets of the U-235 separation plant at Oak Ridge, Tenn., the men there use tools of beryllium copper. This non-magnetic, reddish-gold alloy of beryllium metal and copper is also non-sparking, so that the tools can be used safely in places like powder plants where sparks could cause an explosion. Production of pure beryllium metal, formerly a rare laboratory curiosity, has meanwhile been spurred on by its desirable properties as a structural material for atomic piles—although its dust is so toxic that it has to be machined within a ventilated glass box to protect the operator outside.

"No use at all has been found for germanium," said a book on metals 10 years ago. One of the latest and most promising metals to make headlines, germanium is now the key material that rectifies electric current in radio and radar circuits and in "transistors," which may replace vacuum tubes.

Lenses of germanium metal and of silicon metal, opaque to visible light but transmitting infrared or "black" light, have just been

produced by a Purdue University group headed by Dr. Karl Lark-Horowitz. They promise spectacular advances in infrared equipment and possibly improved designs for military devices like the World War II "sniperscope," used to see and aim guns in the dark with the aid of these rays. Incidentally, silicon is one of the commonest (in sand) but most rarely seen elements.

#### ***Lithium Saves Lives***

About half as heavy as water, lithium is the lightest metal known. Lithium hydride, a grayish-blue to white crystalline compound of lithium and hydrogen, is correspondingly light. Carried in airplanes' emergency equipment, the chemical helped save many lives in the last war. By reacting with water, it liberated hydrogen to fill balloons that carried radio antennas aloft from life rafts of fliers forced down at sea. The silver-white metal itself, hardly known outside the laboratory 10 years ago, now hardens lead and aluminum alloys. Its vapor, produced by heating a cartridge of lithium, protects sheet metal and machine parts undergoing heat treatment in furnaces.

History will almost certainly repeat itself with other odd metals still awaiting use. Unmindful of immediate reward, the chemists and physicists carefully explore and catalog the properties of each one. Years or decades may go by. Then, one day, along comes an application requiring just such-and-such a melting temperature, density, or manner of chemical behavior—and another element steps out of the chemistry books into everyday living. END



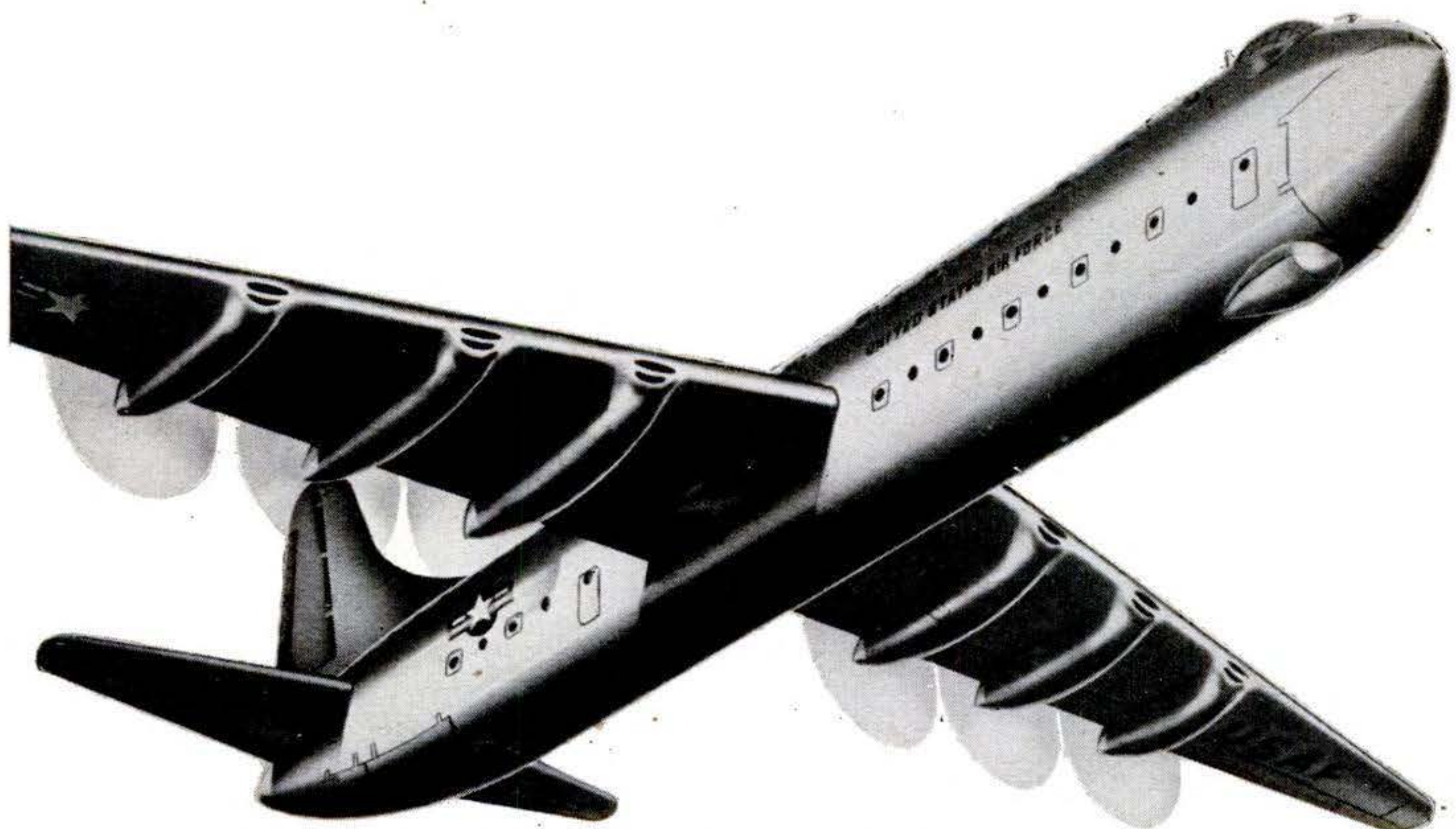

Proposed cargo version of B-36 bomber could carry a medium tank and 30 equipped troops.

## *U.S. to Europe with 50 Tons*

**T**HIS cargo version of the Consolidated-Vultee B-36 six-engine bomber, submitted as a design proposal to the U. S. Air Force, would carry a record load of 400 fully equipped troops or 50 tons of materiel across the Atlantic at over 300 m.p.h.

The double-decked C-99, as the plane has been labeled, is an outgrowth of the XC-99 experimental transport. It could take off from U. S. bases with a full load and fly nonstop to any point in England or western Europe. One version of it could tote 343 litter patients and 33 attendants. Its 21,715 cubic feet of usable space is an increase of more than half again as much as the XC-99 contains. Forty-four of the airplanes could transport an entire air-borne division.

The entire upper deck, including crew's compartment, would be pressurized. **END**

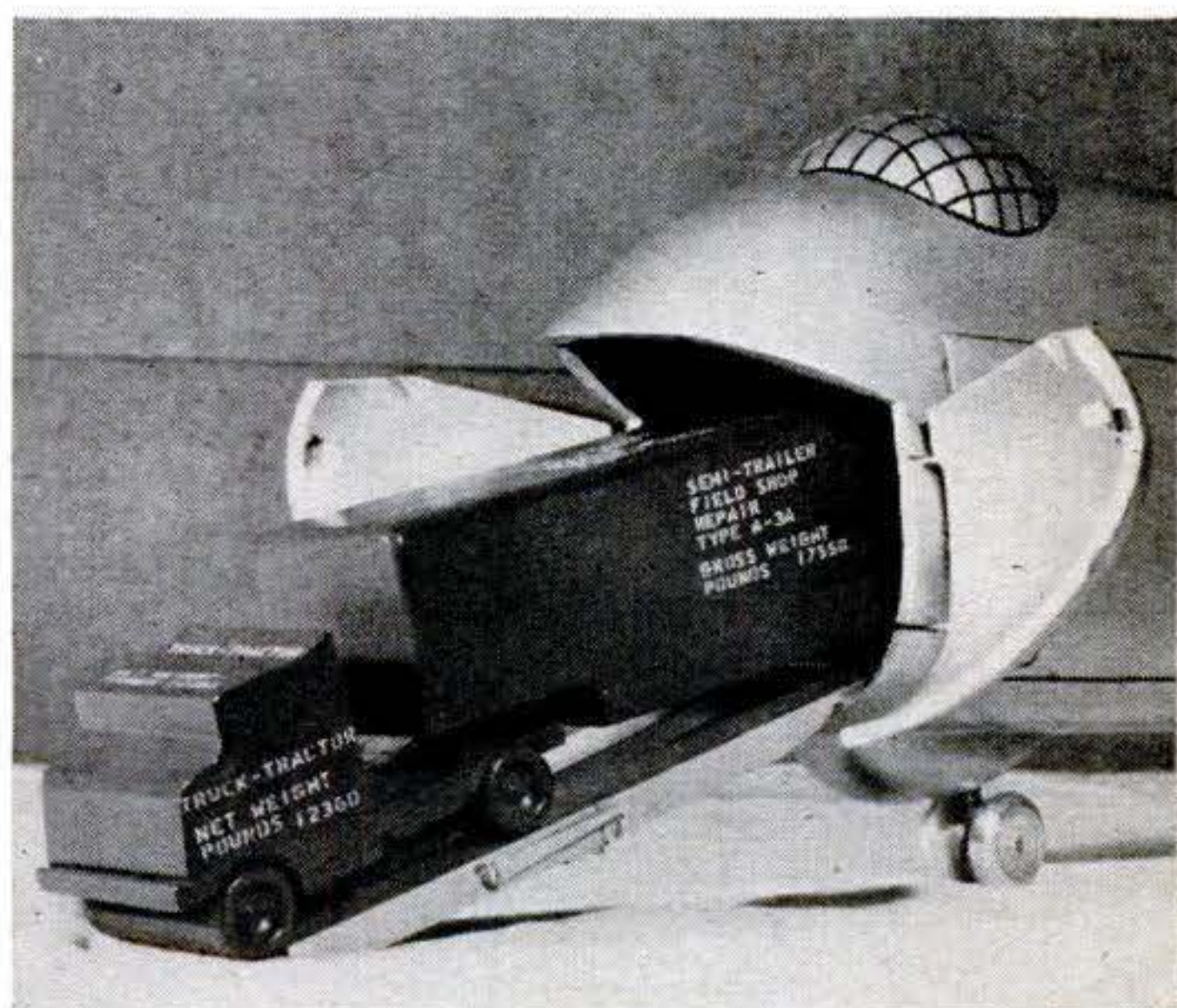

Clamshell doors at front and rear of fuselage would provide entrances measuring almost 12 by 13 feet, sufficient for trucks and trailers. Upper deck alone could accommodate 183 troops.

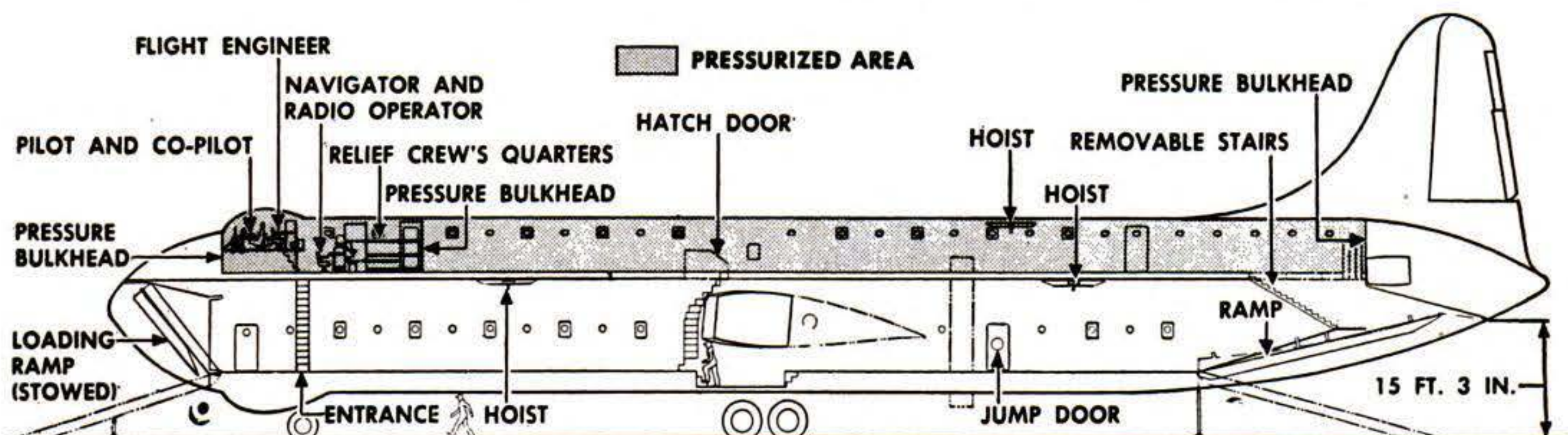

Profile drawing of proposed transport shows pressurized area, hoists for lifting, stowing cargo.





In proposed \$1,000 Nash, drop-center hood is below fender line to give maximum vision.

## ***Nash Shows Its "Maybe" \$1,000 Car***

**W**HAT a \$1,000 automobile might look like—if the public ever gets a chance to buy it—is being demonstrated by Nash Motors with a hand-built, two-passenger convertible now on a tour of key U. S. cities.

Exhibiting it strictly as a "maybe" vehicle, Nash is asking people who come to look: "Do you like this car? Would you buy it if we built it?" Whether the company will turn it out for sale at any time in the future remains a question.

Only one of the cars is in existence. It has styling features designed to take advantage of cost-shaving short cuts in manufacture.

Using relatively inexpensive, low-horsepower foreign engines and transmissions avoids a lot of initial tooling-up expense. European manufacturers already are making engines for their own market and could make them for Nash. The display model has a Nash-built body on an Italian Fiat chassis, with an 18-hp. engine. The production model would have a Nash Airflyte chassis in which the frame is an integral part of the

body. An optional power plant might be a British Standard or a larger Fiat engine, both developing 36 hp.

Body costs would be sliced by peeling away excess chrome and gingerbread ornamentation. Dual-purpose dies would be used where possible. On the display model, front and rear bumpers are identical castings. The left front and right rear fenders can be stamped from the same set of dies. The same is true of the right front and left rear fenders. The hood and the turtleback are identical stampings, as are the two doors.

The trunk lid is eliminated. This means no hinges or lock mechanism, cutting down assembly time. The luggage compartment behind the seat can be reached only from inside the car. Windows are raised by a strap. You push them down.

The big question is the market for such a car. Who would buy it? Nash has stated that if the survey indicates a sale of 200 cars a day with an eventual demand for 300 to 400 a day, the company *might* build it.





**Except for break at door,** fender line is carried through from front to back to give appearance of length. Spare tire is stowed ahead of rear bumper below lidless luggage compartment.

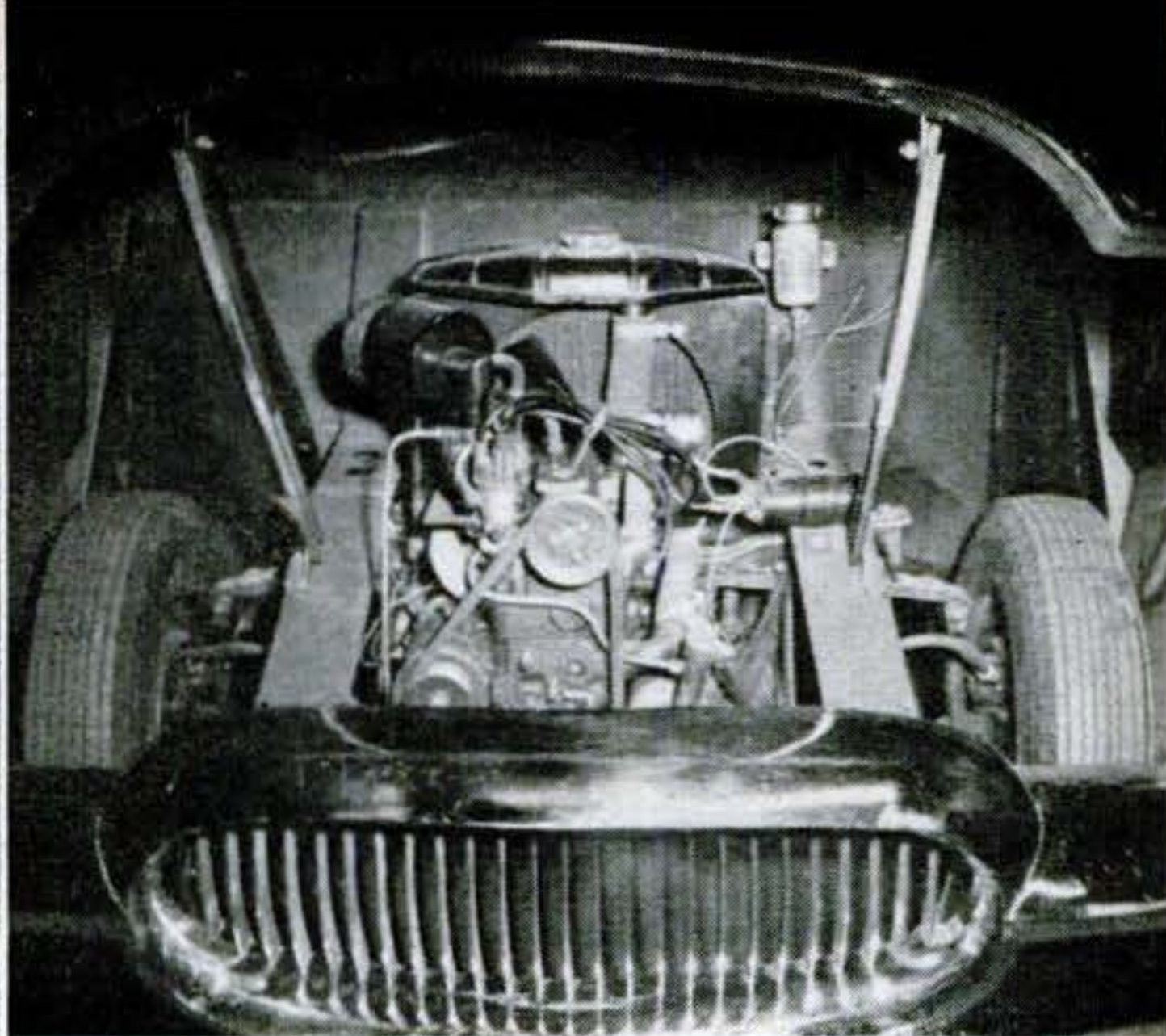

**Entire front end—hood, fenders, headlights—**lifts as unit to give easy access to engine. Shown is 18-hp. Italian-built Fiat engine. Note that the radiator and fan are behind motor.



**Luggage compartment behind seat** is roomy considering car's smallness. Wheelbase on production model would be 84 inches, some 30 inches shorter than on today's "low-price" cars.

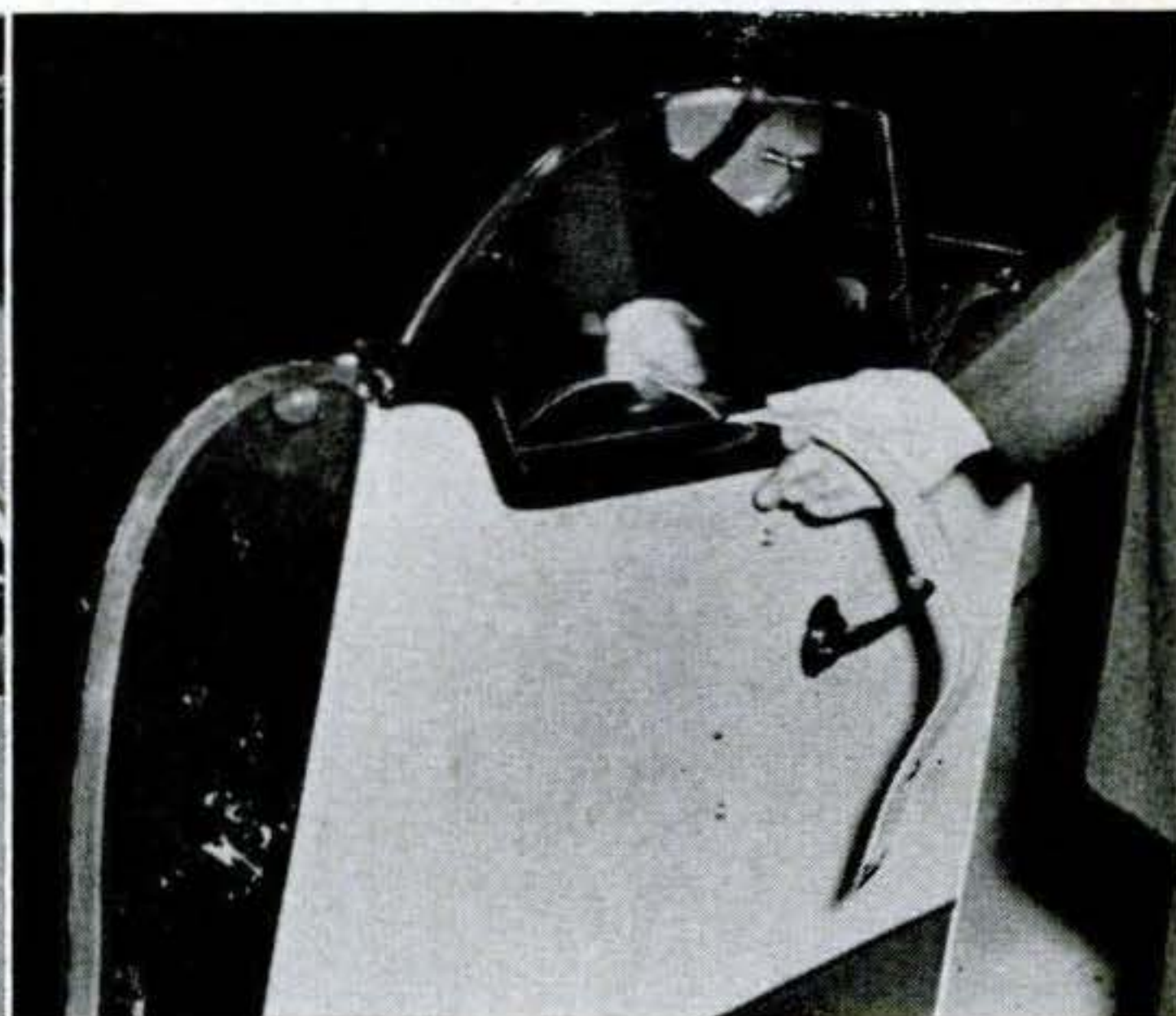

**Plastic strap to raise window** is snap-anchored to door at desired height. Nash proposes 145-inch over-all length as against U. S. average of 188. Height is 53 inches and width is 62.



**Accelerator between clutch and brake** is Fiat design, but could be modified. Weight with 18-hp. engine is 1,350 lb.; with 36 hp., 1,450 lb. Small engine gives 50 miles per gallon.

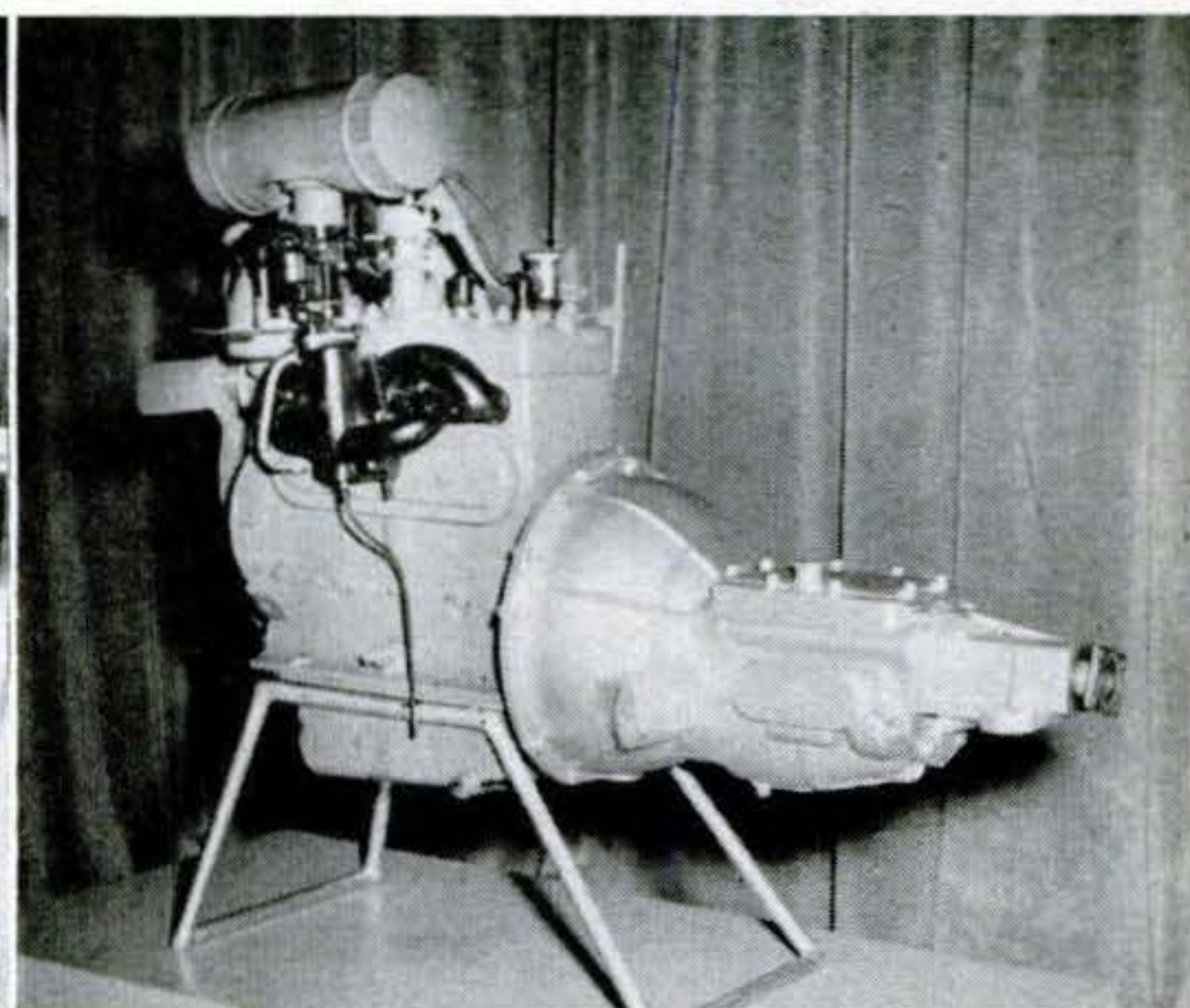

**Possible alternate engine** is this 36-hp. British Standard. Production car would have 47-inch tread, and a top speed of about 65 m. p. h. Nash says doubling power would add \$50 to cost.



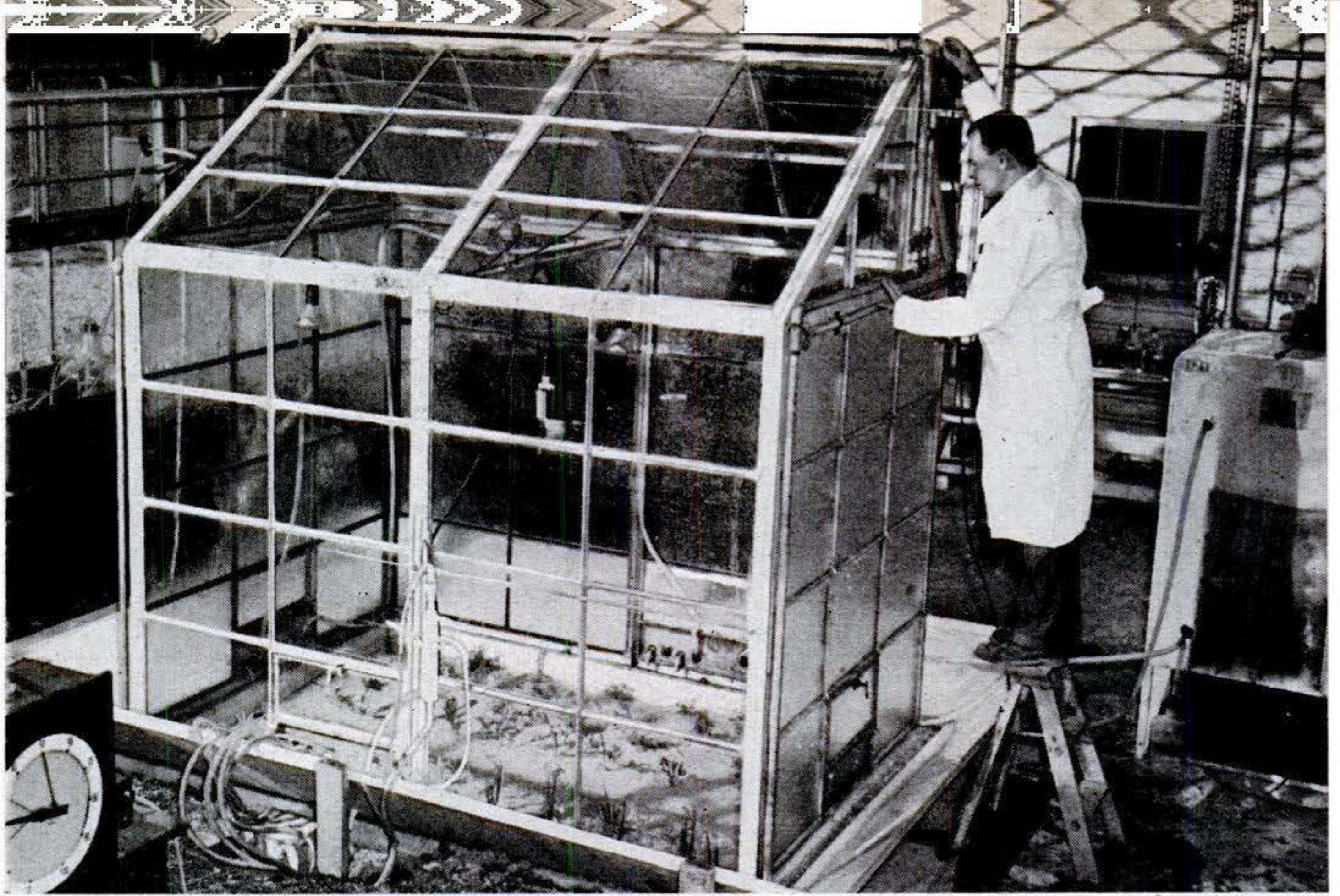

### Growing Radioactive Food

BUCKWHEAT, sugar beets, tobacco, foxglove, and opium poppies grow in an atomic garden at Argonne National Laboratory, Chicago. Breathing radioactive carbon di-

oxide gas in a sealed chamber, above, they yield ray-emitting foods, vitamins, and other drugs. Substances that chemists cannot duplicate synthetically are thus tagged with radioactive carbon for tracer experiments on what happens to them in the body.

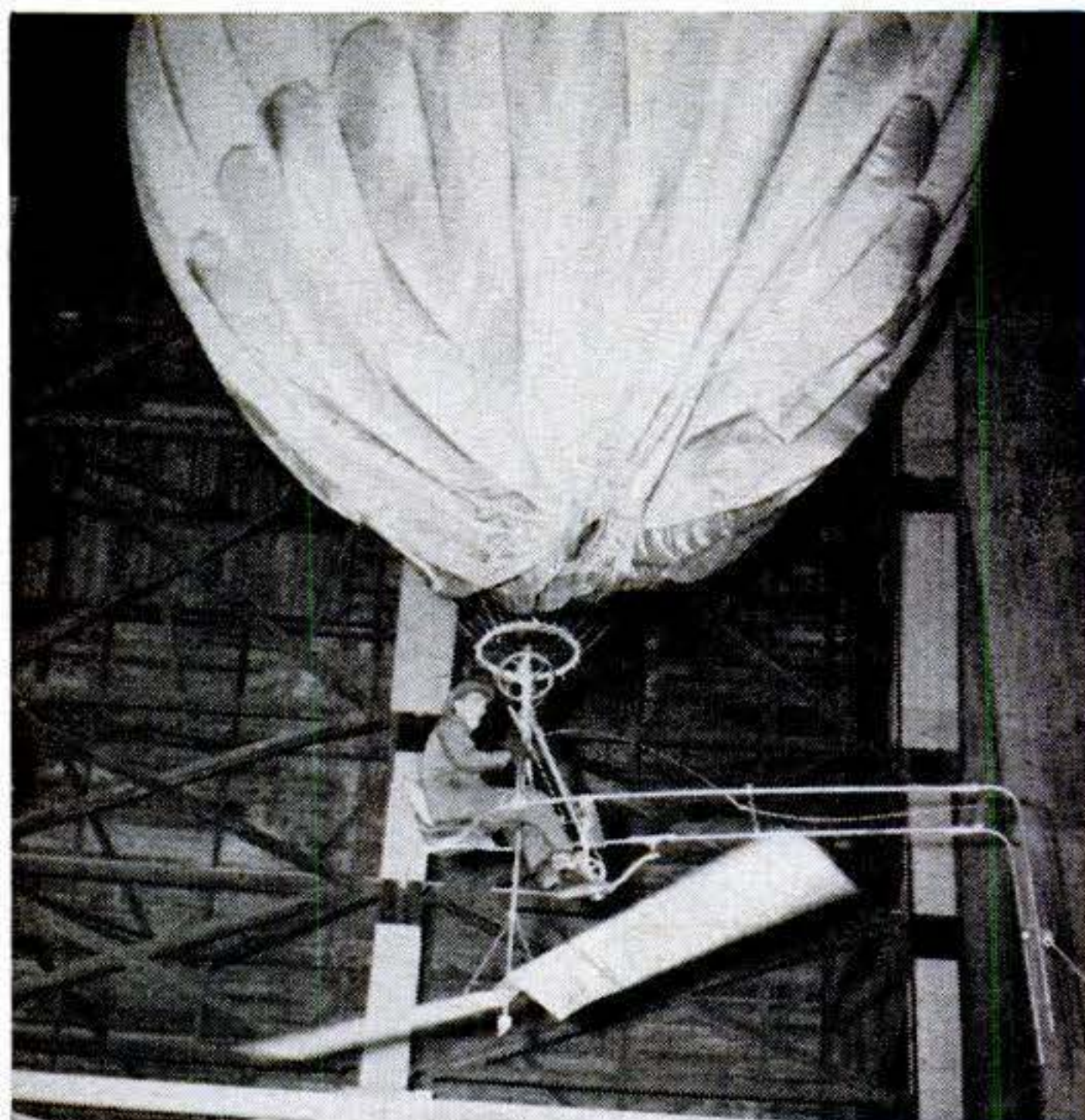

### Pedals Drive Balloon Props

FROM \$400 worth of bicycle parts, Charles K. Paul of Woodbridge, N. J., built the "pedalcopter" seen in flight above. Helium in its gas bag gives it almost enough lift to rise. He supplies the rest by pedaling a sprocket that turns a horizontal propeller. A control stick varies blade pitch to maneuver forward, backward, or sidewise.

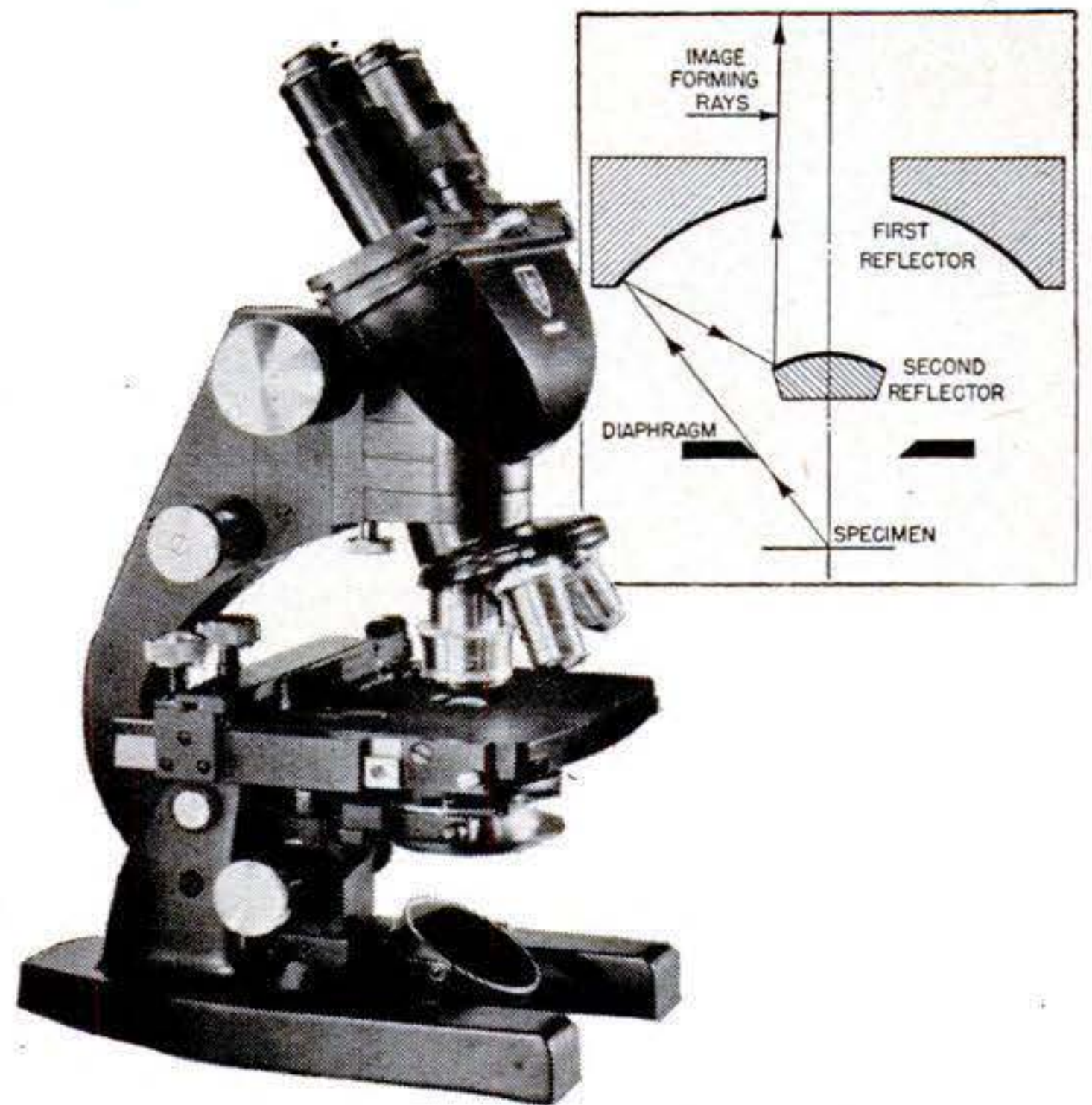

### Microscopes Use Mirrors

MIRRORS replace objective lenses, bringing light of all wavelengths to one focus, in new microscopes. Ultraviolet photos follow visual observation without change of setting. A turret may mount several mirror objectives of different magnification. An American Optical Co. mirror microscope and its optical system are shown above.



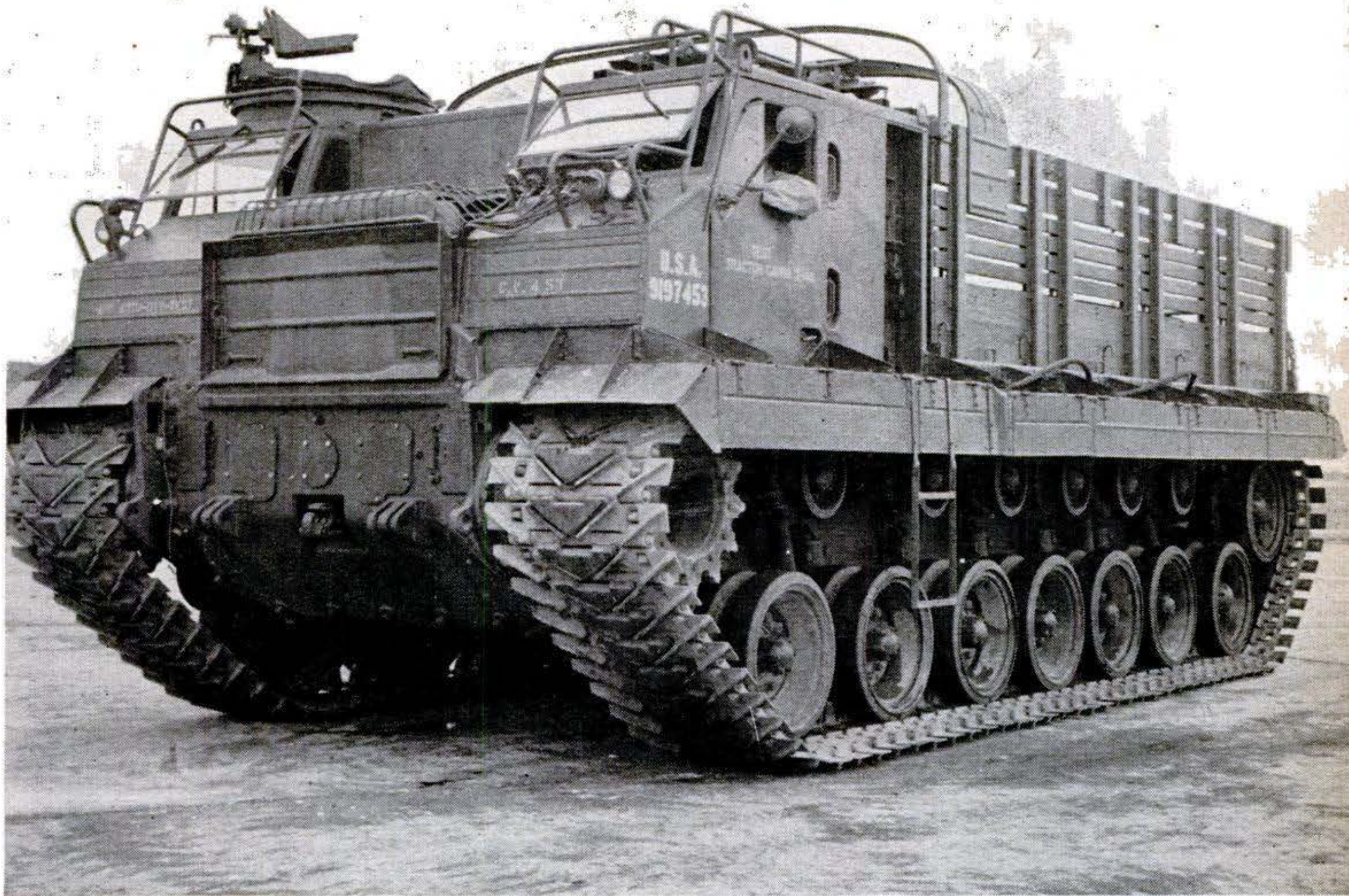

This Army cargo carrier packs a 30,000-lb. payload. It has a V-12, air-cooled, 810-hp. engine.

# *New Army Tractors Steer Like Planes*

**Cross-drive transmission and “wobble-stick” control make these tracked jobs easier to steer than a truck.**

**By John F. Loosbrock**

*PS photos by W. W. Morris*

**H**ERE'S a combat tractor that steers like an airplane. A single “wobble stick,” combining the functions of gear-shifting and steering, controls all movement—forward, backward, and turning. To shift from lower speeds to higher, just pull back on the stick. All the way back is reverse. You can shift directly from high to reverse without stopping or even going into neutral. To turn left, shove the stick to the left; for a right turn, shove the stick to the right.

The secret is a new cross-drive transmission that Army Ordnance is building into its latest tanks and cargo carriers, like the 15-ton T-44 pictured above.

This uses a “split-torque” power train, part mechanical and part hydraulic torque converter. This divides the power delivered to the two tracks in the proper proportions for accurate steering. For a left turn, the right driving sprocket gets the lion's share of the power and vice versa. Sharpness of a turn depends partly on the speed of the vehicle. At zero speed, a tank can be pivoted literally on a dime, with one sprocket driving forward and the other in reverse.

The new tracked jobs, like the Army's new trucks, are getting a workout at Ordnance's Aberdeen Proving Ground, Md. (PS, Nov. '49, p. 121, and Jan. '50, p. 168). To check on their performance, the Aberdeen experts use the world's largest mobile dynamometer (PS, Aug. '49, p. 144). This 60-ton monster, shown in detail on the next page, is pulled by the test vehicle and accurately measures its performance. 



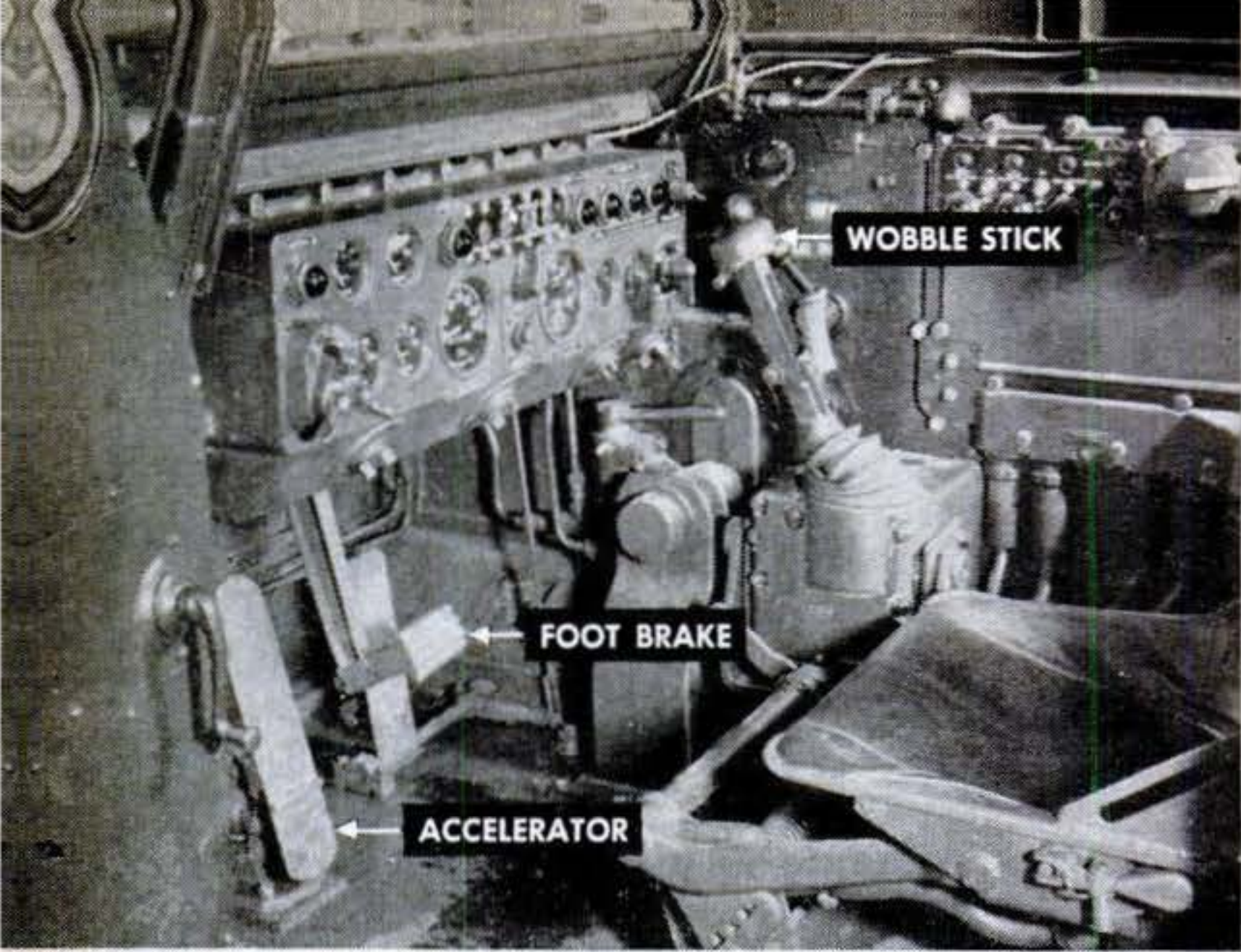

**Cab interior** of cargo tractor shows simplified "wobble-stick" steering and gear-shifting arrangement. Steering and shifting are done with one control stick. There's no clutch pedal.

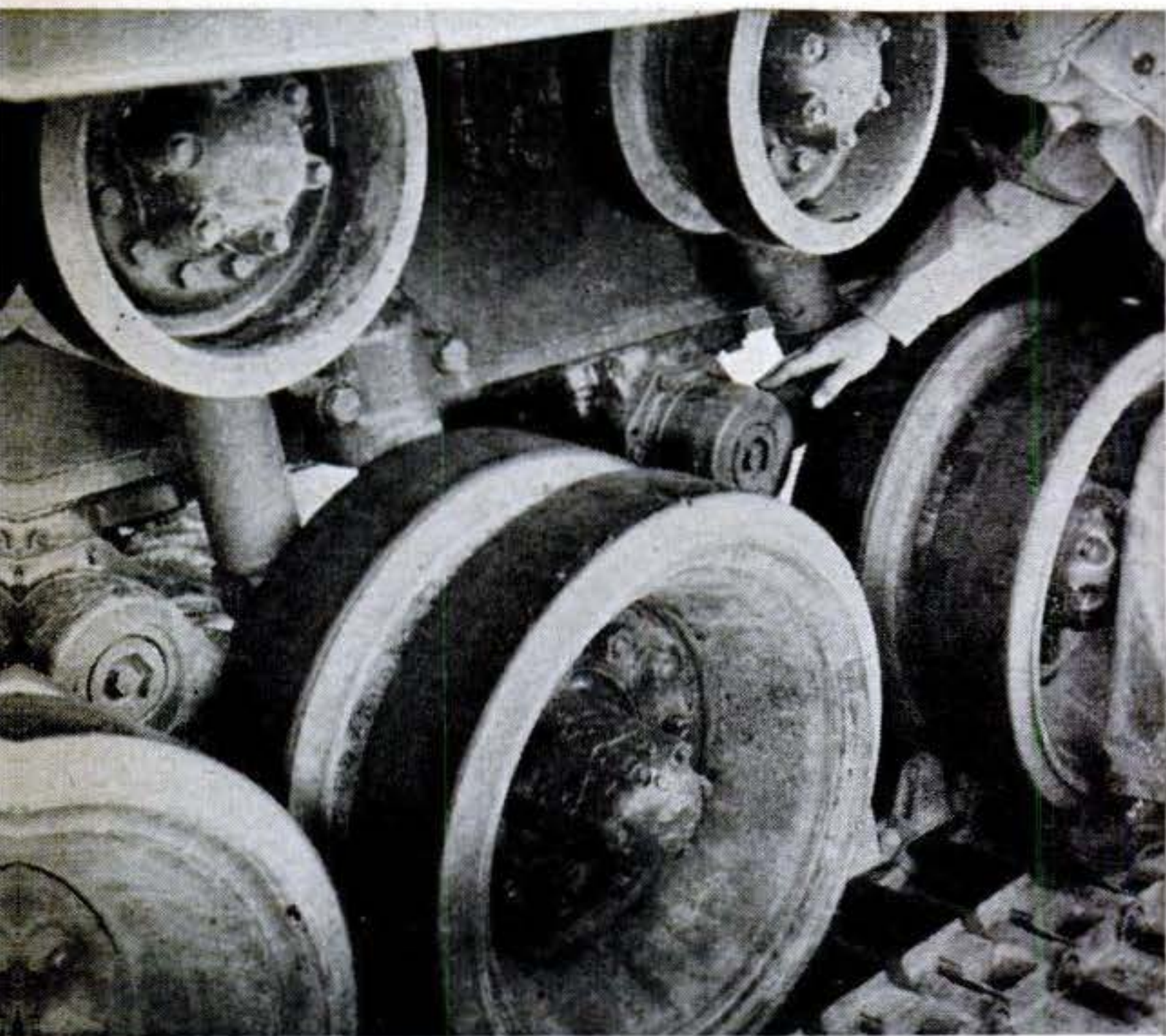

**Bogies** use torsion-bar suspension, similar in theory, though not in design, to that on new Army trucks. On tracked vehicles, bar that twists to take up shocks runs across vehicle.

**Raised hood** shows two huge air cleaners that feed the carburetor. Front plate below cleaners can be unbolted and entire engine and transmission slid out for repair or replacement.

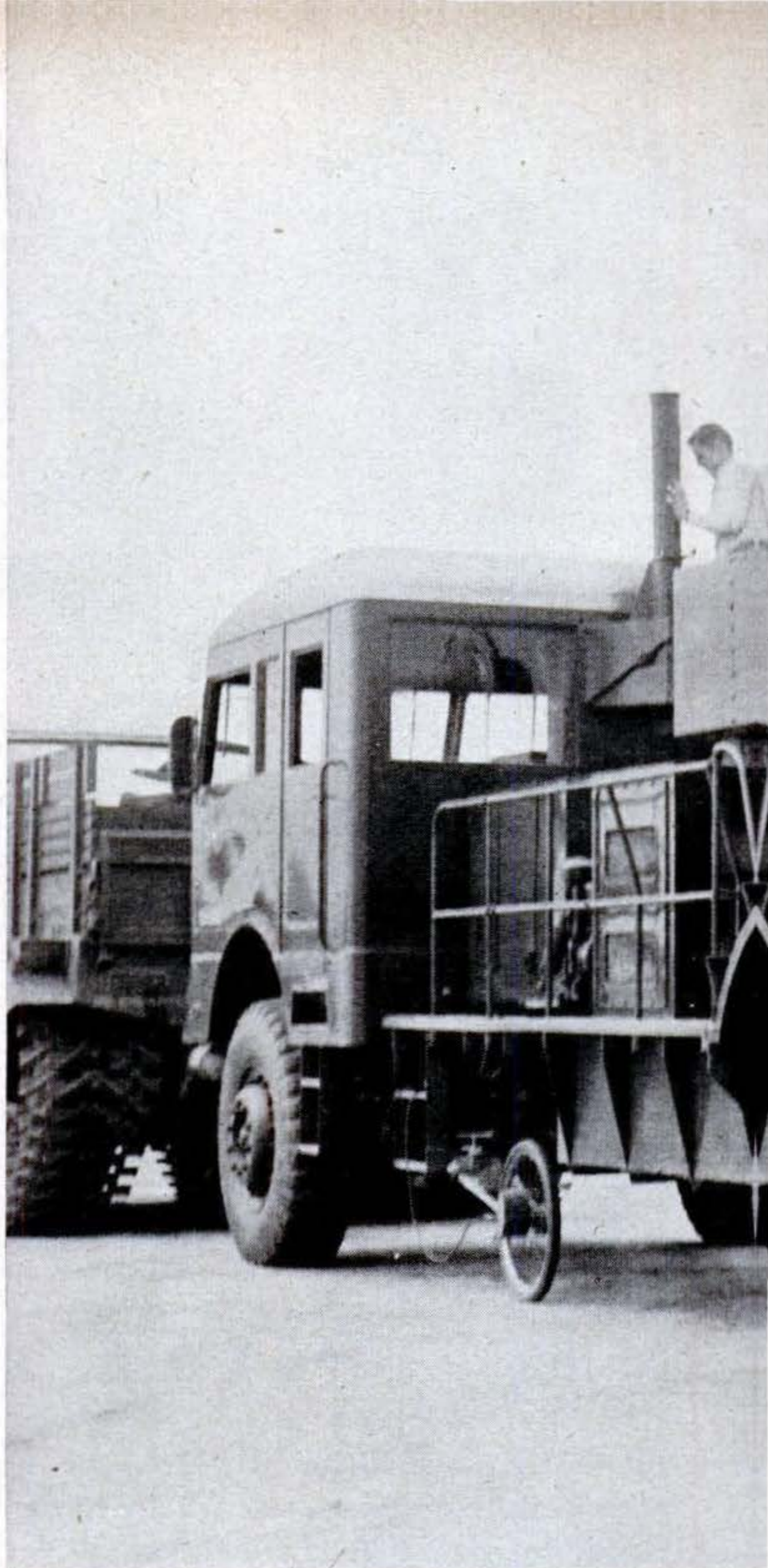
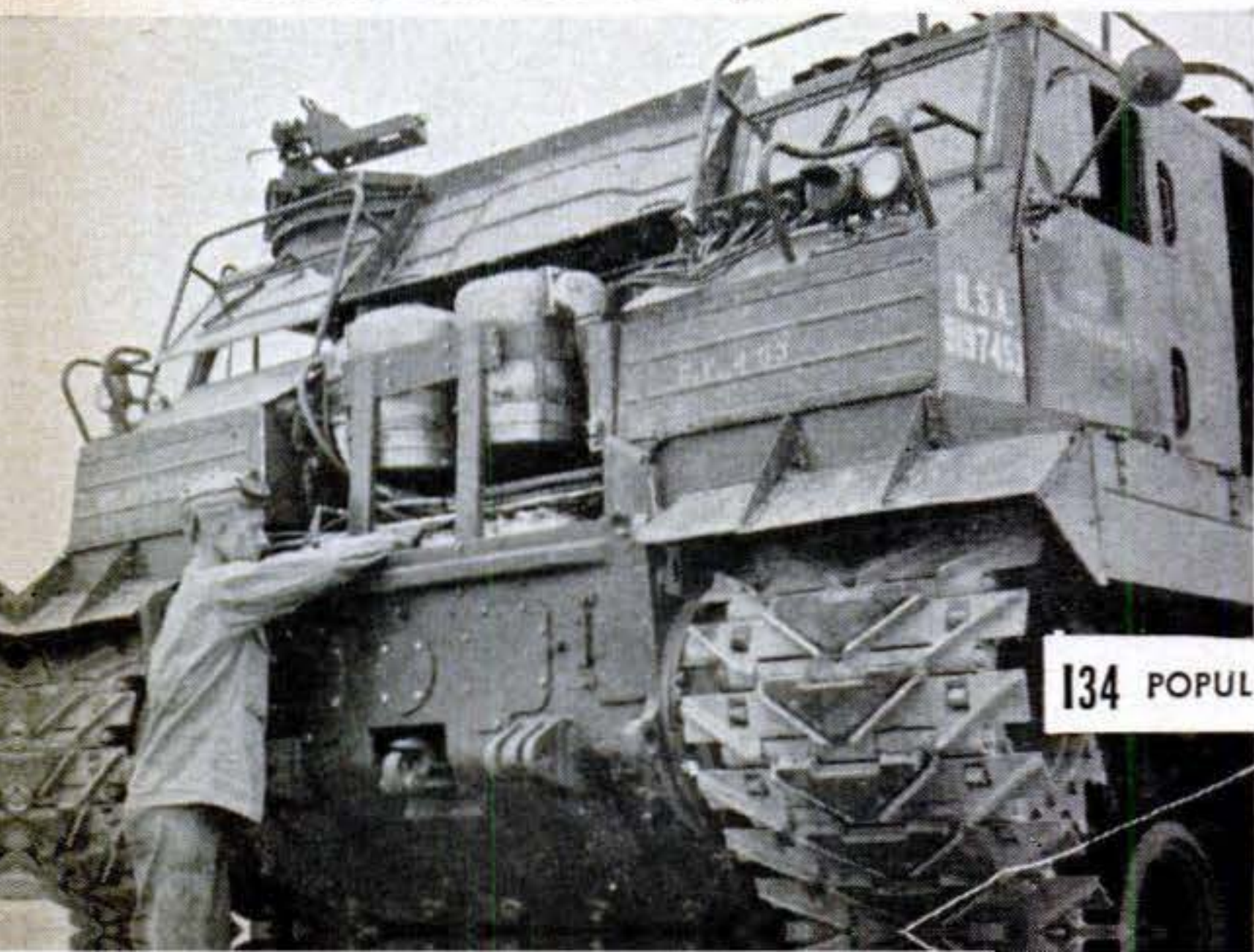

**Dynamometer is 44½ feet long. Power**

**In field tests** vehicle is coupled to dynamometer by strain-gauge drawbar. This can carry tension or compression loads of 400,000 lb.

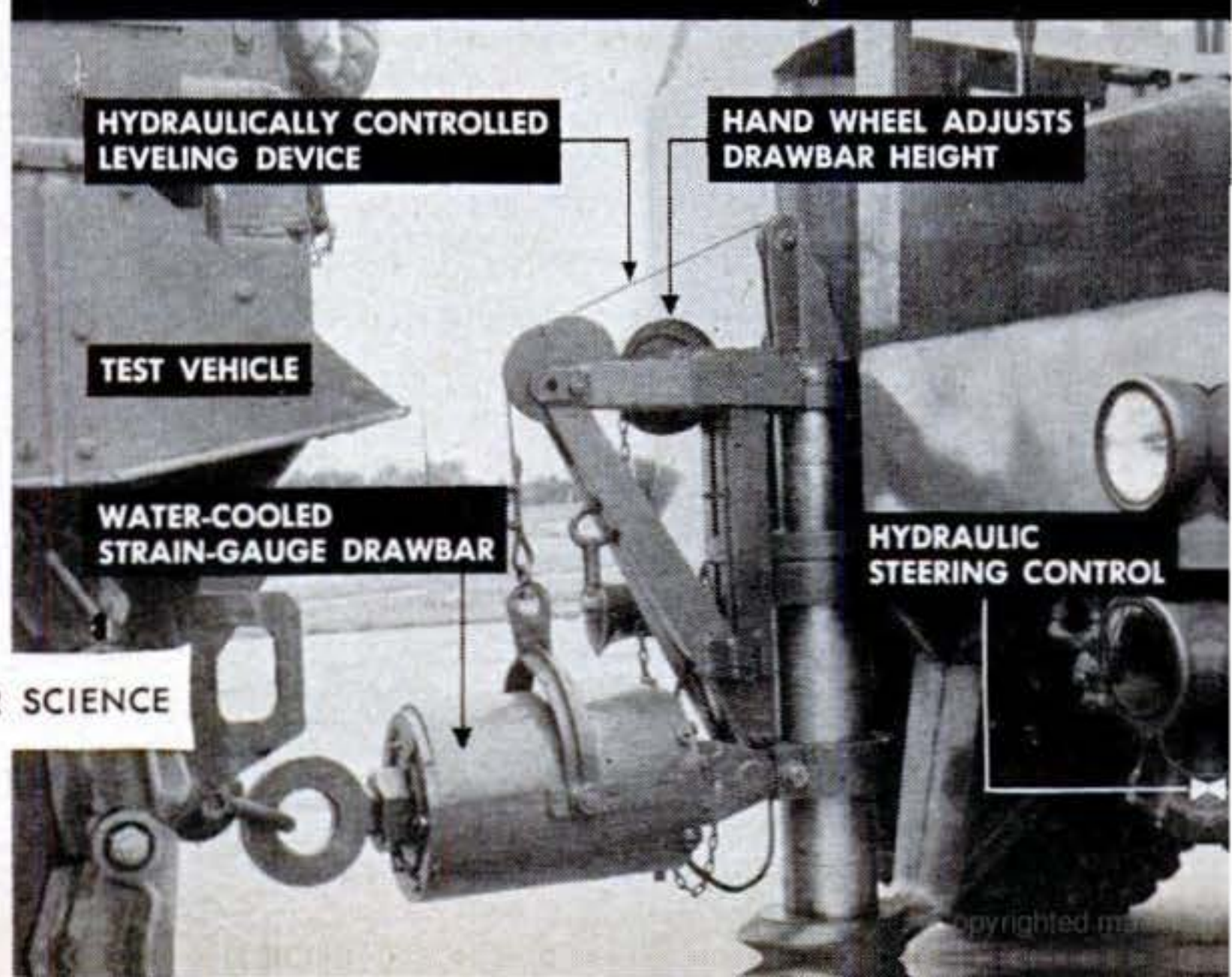





train has two 500-hp. engines driving generators that run four motors that drive wheels.

Complicated instrument panel tells operator just what goes on during test run. A permanent record is made with a 35-mm. movie camera.

Raised panel gives idea of maze of electronic tubes and wiring needed to transcribe data. Instruments are indicators or electronic counters.

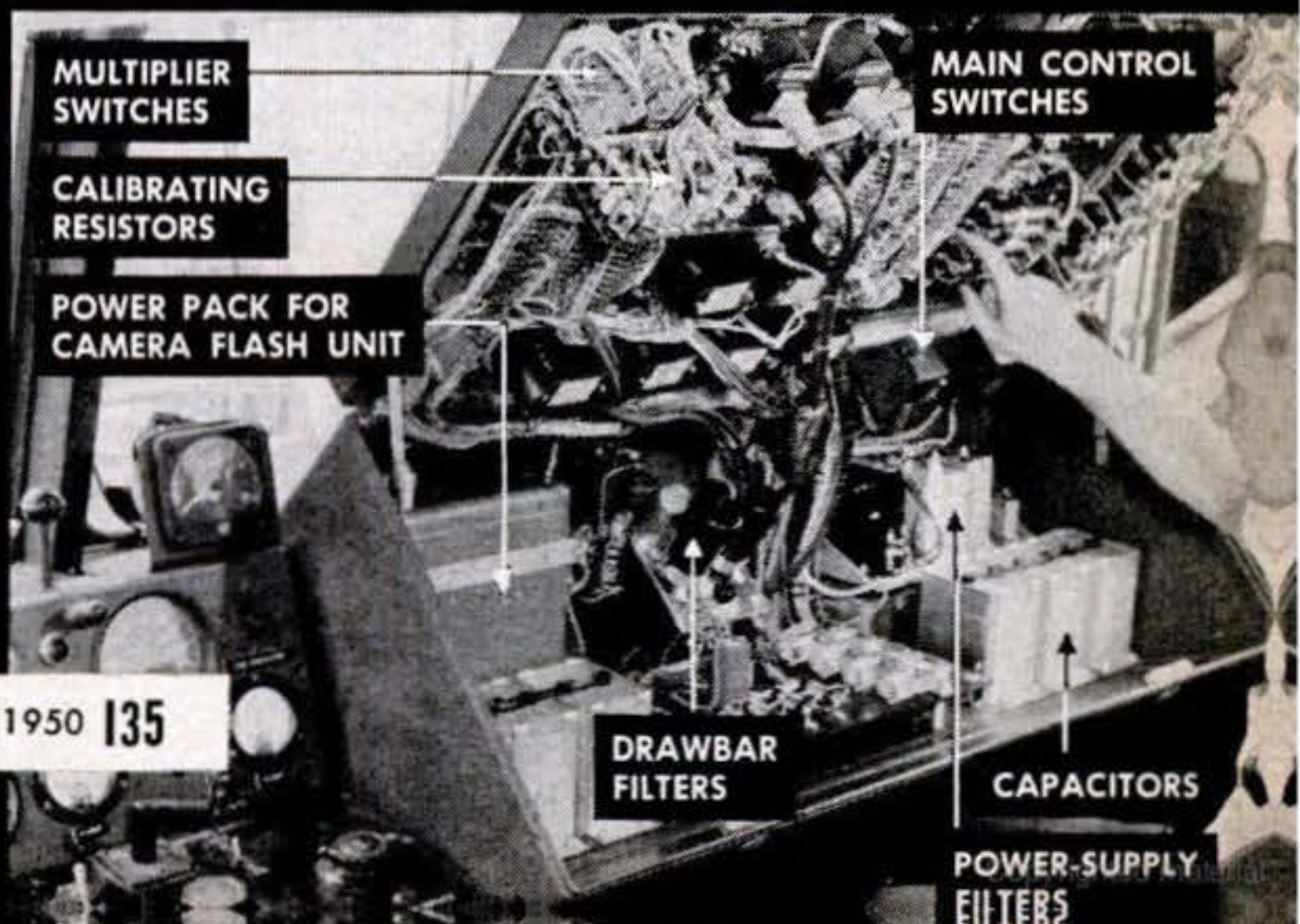
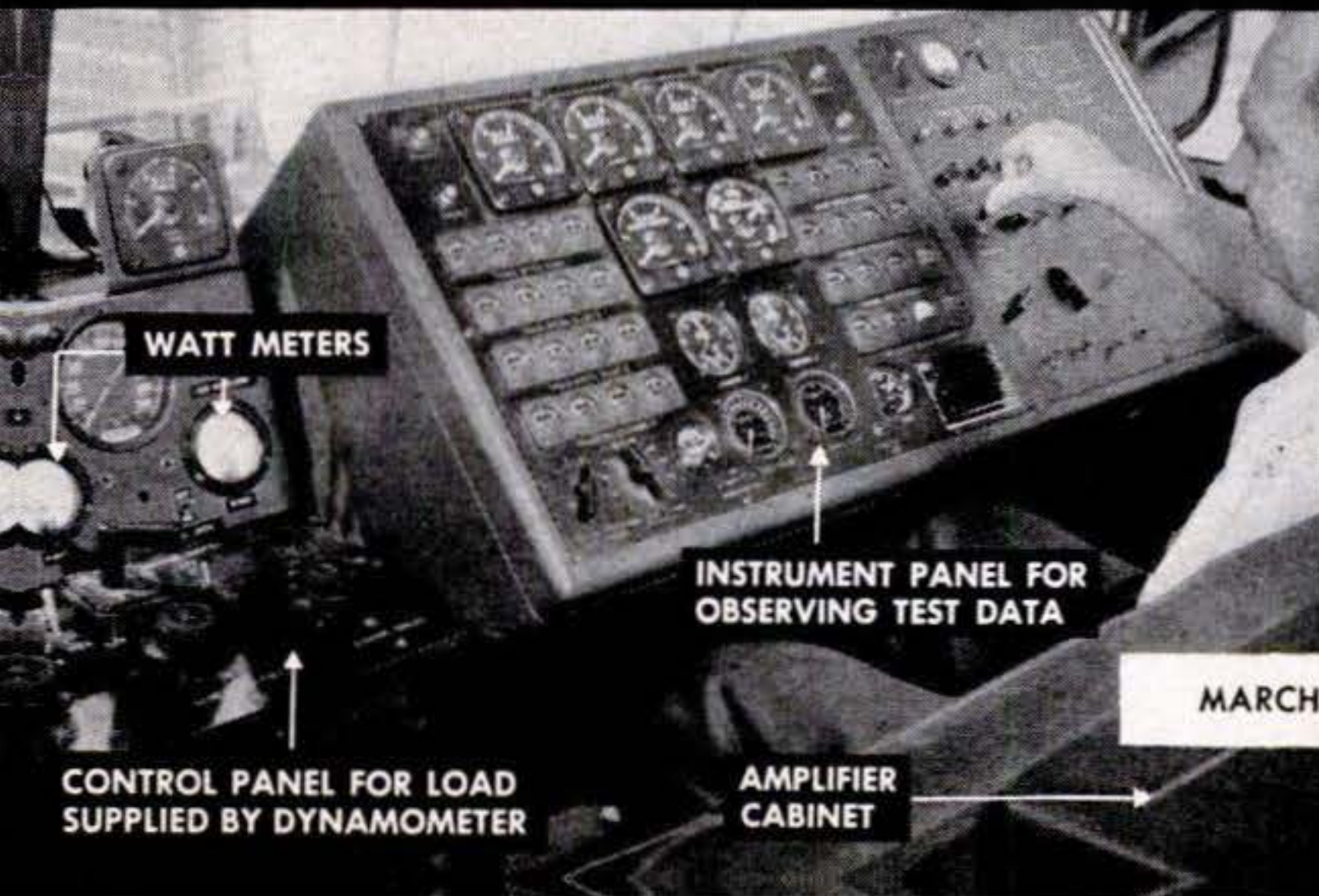

WATT METERS

INSTRUMENT PANEL FOR OBSERVING TEST DATA

CONTROL PANEL FOR LOAD SUPPLIED BY DYNAMOMETER

AMPLIFIER CABINET

MULTIPLIER SWITCHES

CALIBRATING RESISTORS

POWER PACK FOR CAMERA FLASH UNIT

MAIN CONTROL SWITCHES

DRAWBAR FILTERS

CAPACITORS

POWER-SUPPLY FILTERS

MARCH 1950 135



## Flash Lasts 2/1,000,000 Sec.

AFTER smashing through a glass jar, a .22-caliber bullet broke the electrical conductor at left, setting off a new high-speed photographic light. Its flash illuminated the action for two-millionths of a second while an ordinary camera took the picture. The new light, developed by General Electric, makes possible the photographing of objects moving at speeds far beyond the capabilities of the fastest camera shutters. The photographs are used for research into the behavior of high-speed missiles and supersonic aircraft, revealing air-flow patterns around wind-tunnel models.

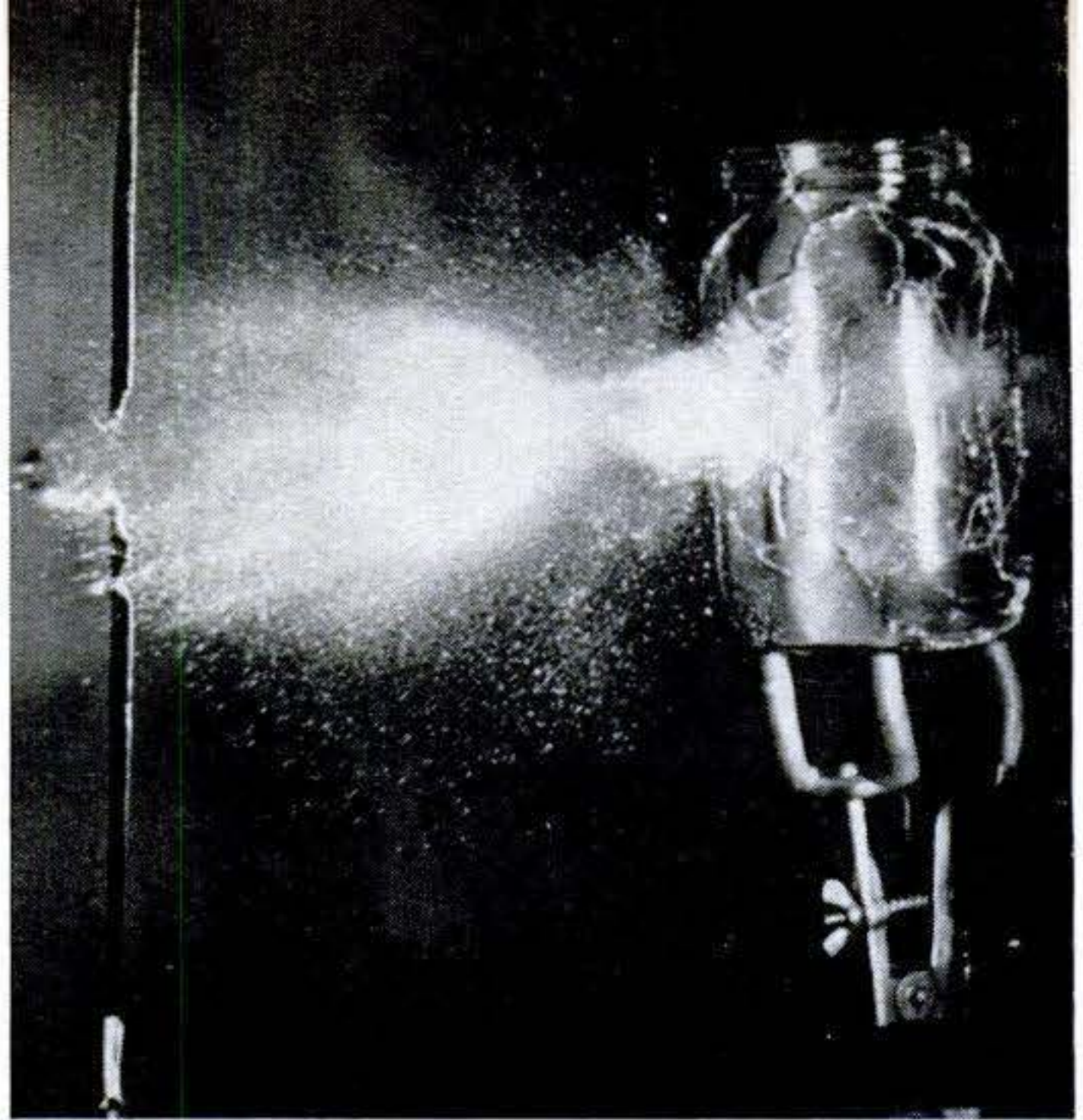

## Mitt Makes Car Shine

THE spaghetti-like tentacles of this mitten for car washing are made of cotton yarn covered with Du Pont cellulose sponge. The manufacturer of the new Spo-Cham® wash mitt, the Zelinkoff Co., of Wichita, Kansas, claims that it wears three to five times longer than ordinary cotton mop yarn, is two to three times more water-absorbent, and leaves no lint. When the car is done, the mitt can be used for washing windows or scrubbing floors.

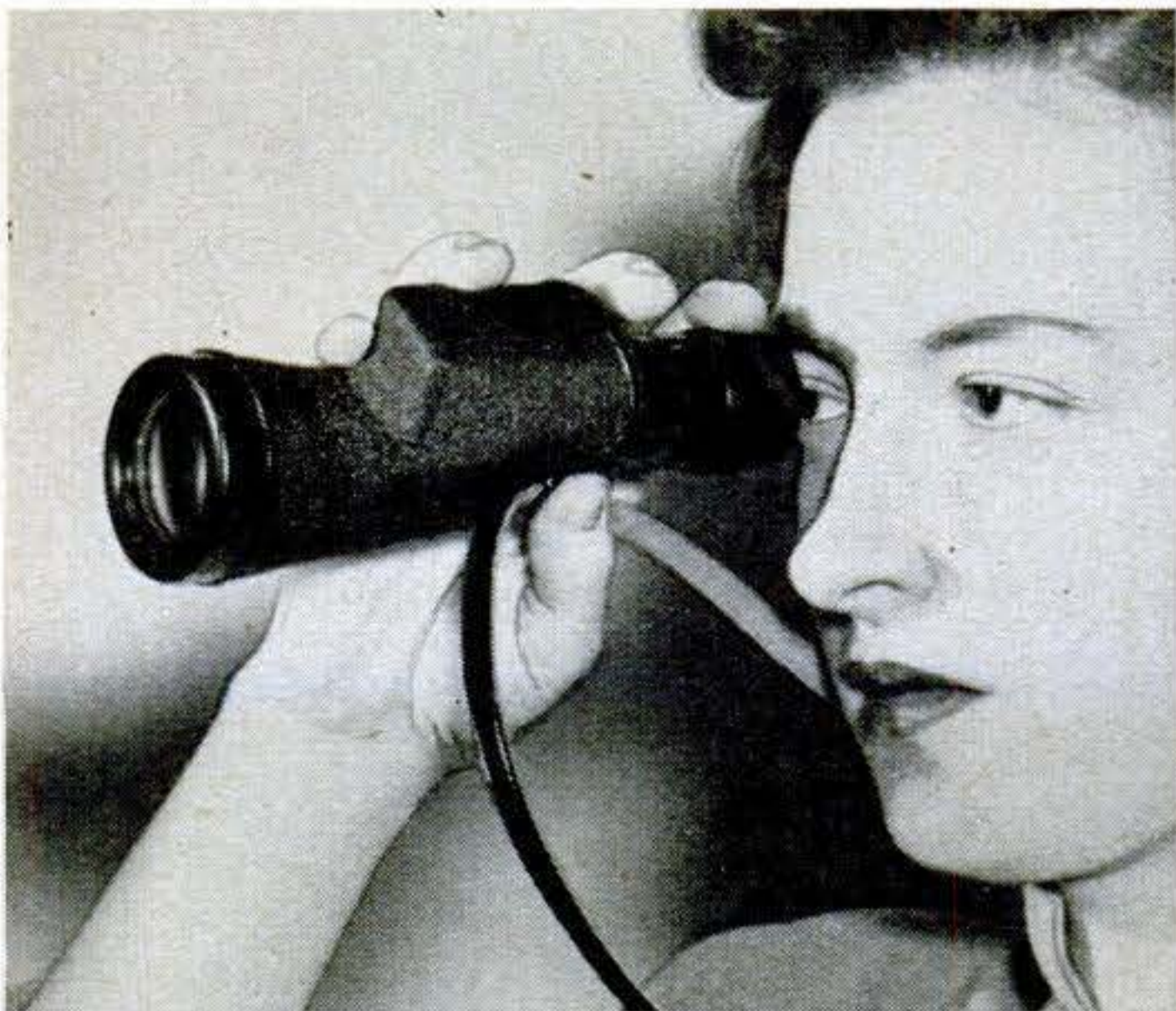

## Monocular Gives an Eyeful

THE new single-tube, seven-power monocular being used by the girl above gives the same field of view as the 7 x 50 binocular used extensively by the Navy during the war. Light in weight, it's small enough to fit in a suit-coat pocket. Designed by Bausch & Lomb, the instrument has a 35-mm. objective and focusing eyepiece. Optical parts are coated for maximum light transmission. It sells for \$77.50 with carrying case.

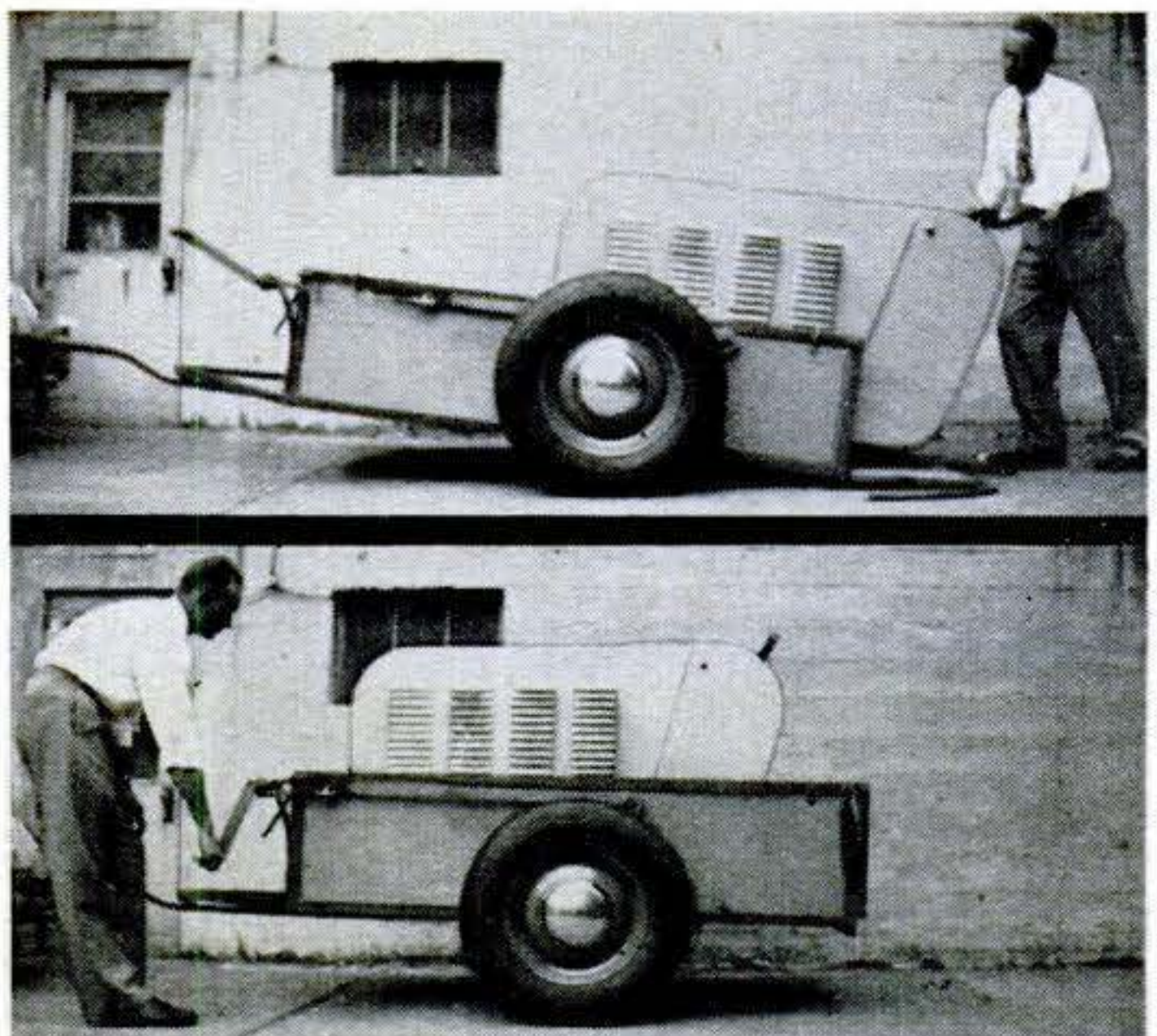

## Trailer Kneels for Loading

THIS Hercu-Lift® trailer can be lowered to street or curb level for easier loading, as shown in the upper photo just above. It is then raised to traveling position by a crank, as demonstrated in the lower picture. The trailer, measuring 24 by 48 by 72 inches, is made of waterproof plywood on a welded angle-iron frame, and sells for \$225. It-Ro Industries, of Portland, Ore., makes it.



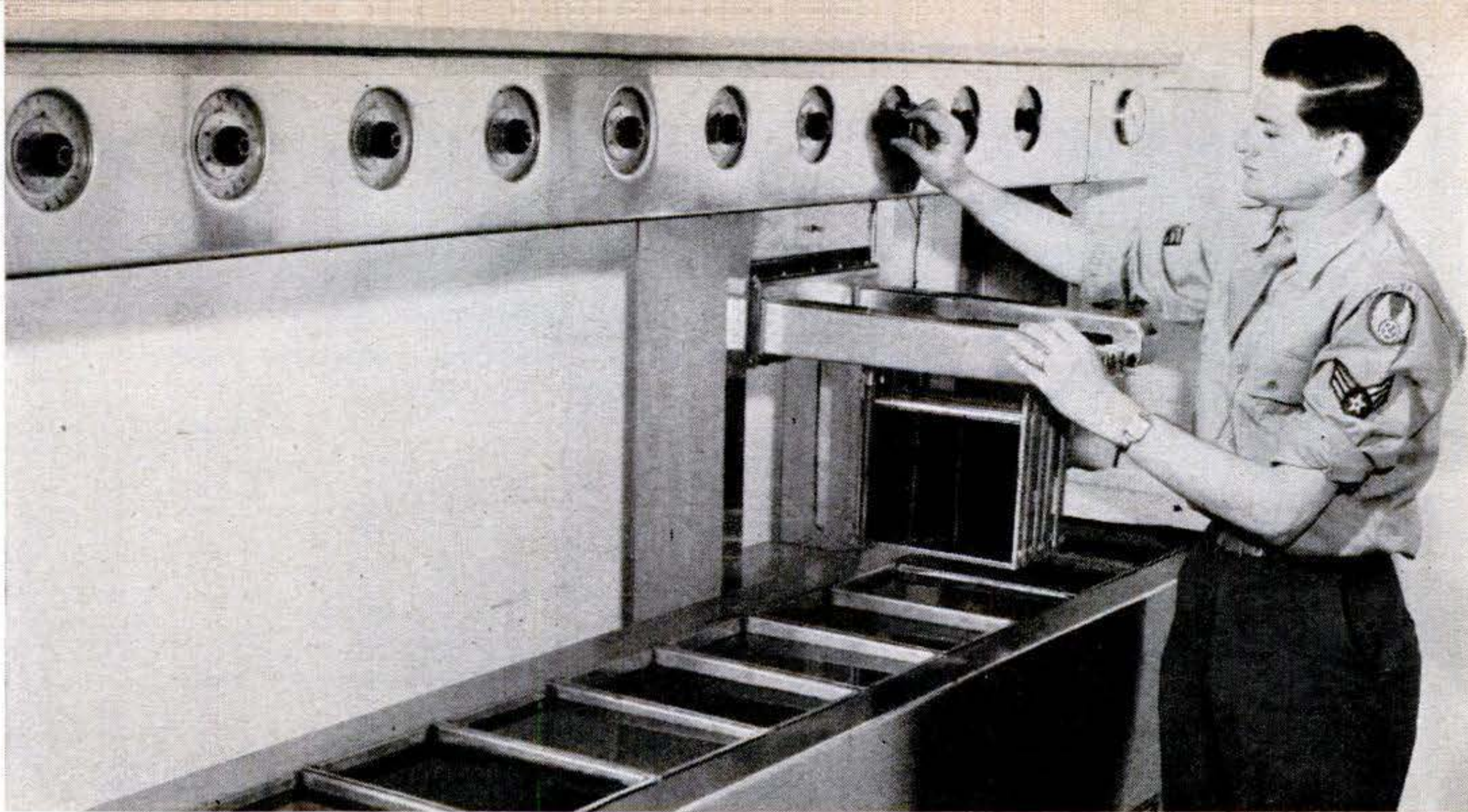

### Robot Processes Color Film

THE Air Force sergeant above is starting a rack of ten 8-by-10 color films on a 90-minute automatic journey through 12 stainless-steel tanks filled with processing solutions. All he has to do is set the timers above each tank and start the machine. The rack

of films will be dunked into the first tank, then lifted out automatically at exactly the right moment and moved along to the next tank. Because it insures absolute uniformity in processing, the new device is being used by the Air Materiel Command to measure accurately the capabilities of various types of color film available.

### Sinker Ends Tangles

TWISTED fishing lines are reported a thing of the past with the Eze-Way® lead sinker shown at right. When the cutaway section is bent shut, the sinker is thrown off center. This restricts spinning action to the bait end of the line, beyond the sinker. Line is looped through eyelets, the loops are then caught over cutaway points, and the gap pressed shut. The Paul Bunyan Bait Co., of Minneapolis, offers nine sizes from 1/8 oz. to 2 1/2 oz.

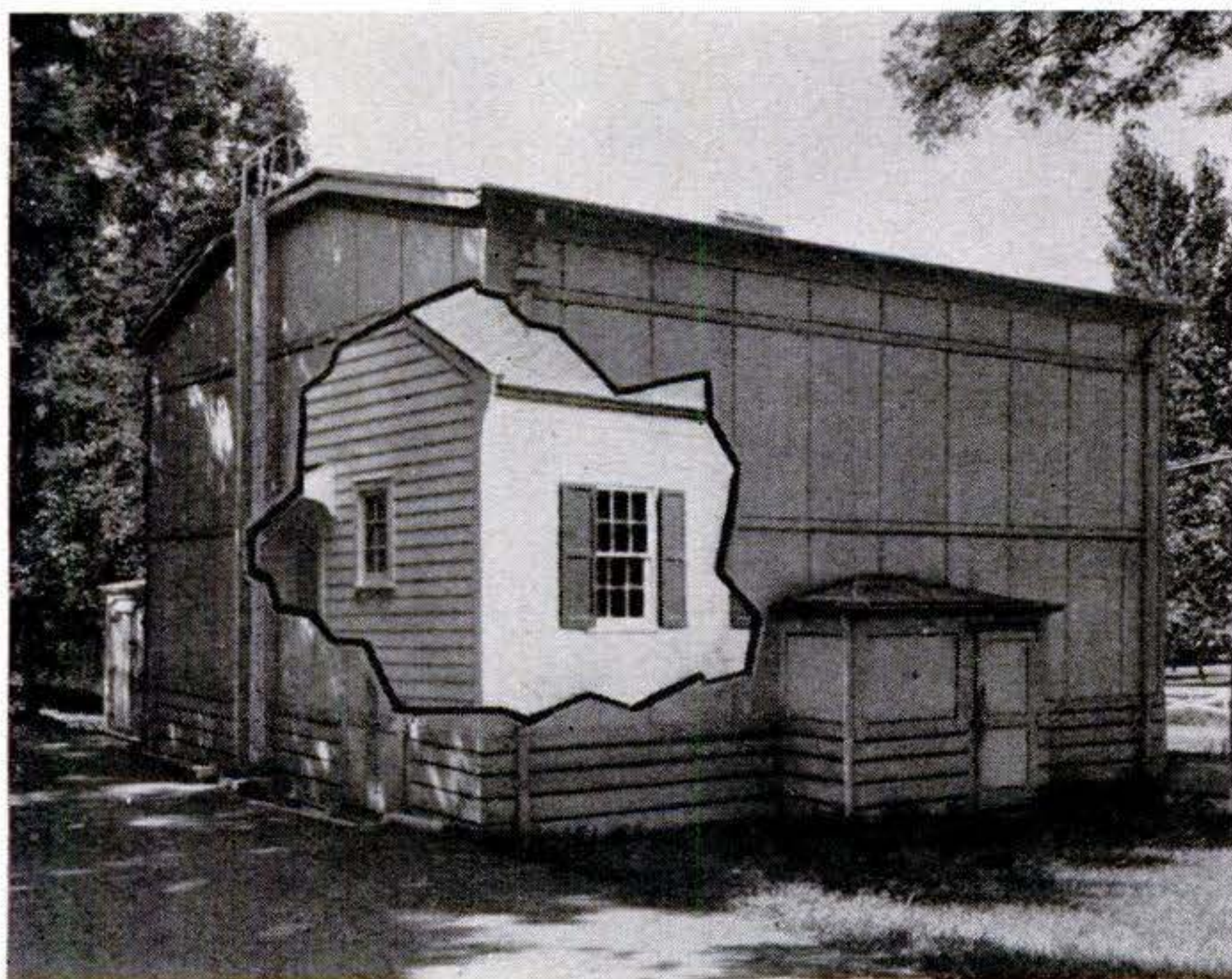
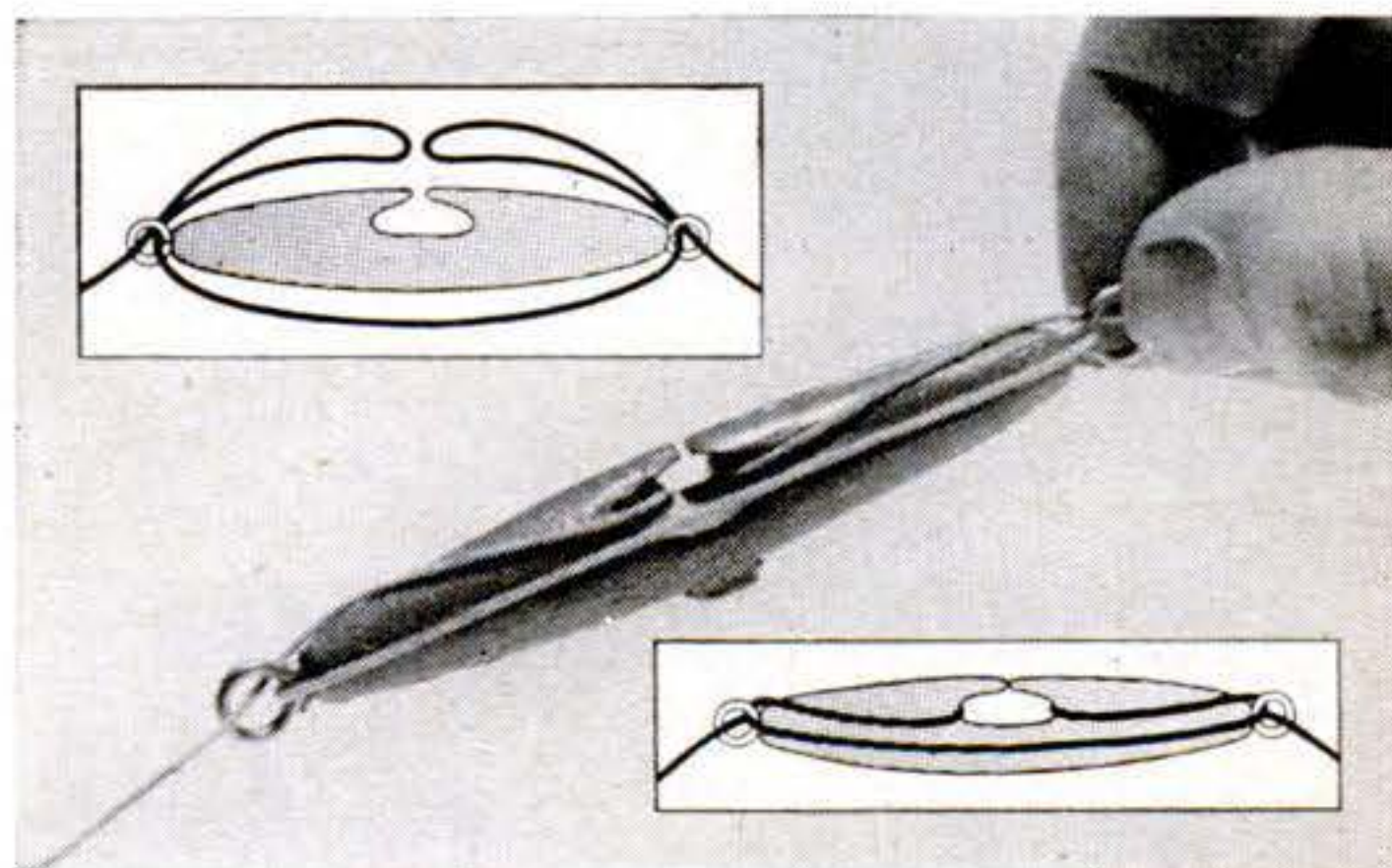

### House Goes Under Cover

TO TEST various types of heating systems, the National Bureau of Standards built a typical low-cost bungalow. Then they covered it completely with an outer insulating shell, shown left with bungalow visible through cut-away section, so that temperature conditions of any place in the United States can be duplicated. All rooms of the house, except the bath, have movable ceilings that can be adjusted two feet by overhead screw jacks.



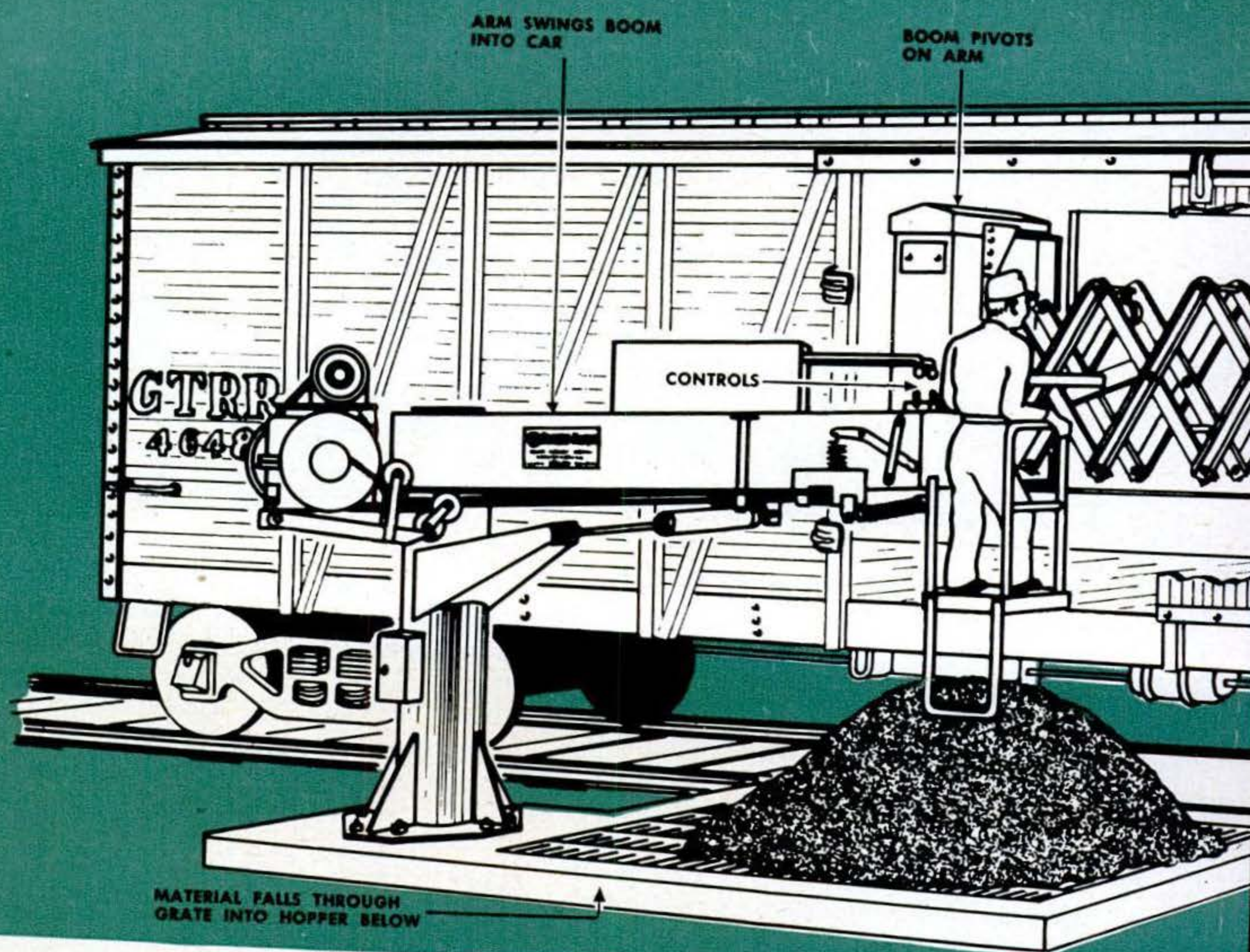

Pivoted beside track, unloading scoop is swung in through boxcar doors so accordion boom

## Long Arm Unloads Boxcars

**T**HIS giant mechanical arm reaches right into a boxcar and scoops out its cargo. Designed to speed the unloading of grain, sand, dry chemicals, and similar cargoes, it can empty an average-size boxcar—even sweep the floor clean—in 30 minutes.

The lazy-tongs arm needs only to be started in the right direction. Then it “feels” its own way, pushing ahead until it meets a wall or part of the cargo and builds up pressure. When this pressure reaches 200 pounds, the scoop automatically lowers, digs into the pile, and then retracts. At the door, it pushes out the load, lifts up, and goes back for another bite.



Single operator, riding arm on platform, need only aim scoop toward desired part of car. After this, its extend-dig-retract cycle is automatic. It is made by Stephens-Adamson Co., Los Angeles.



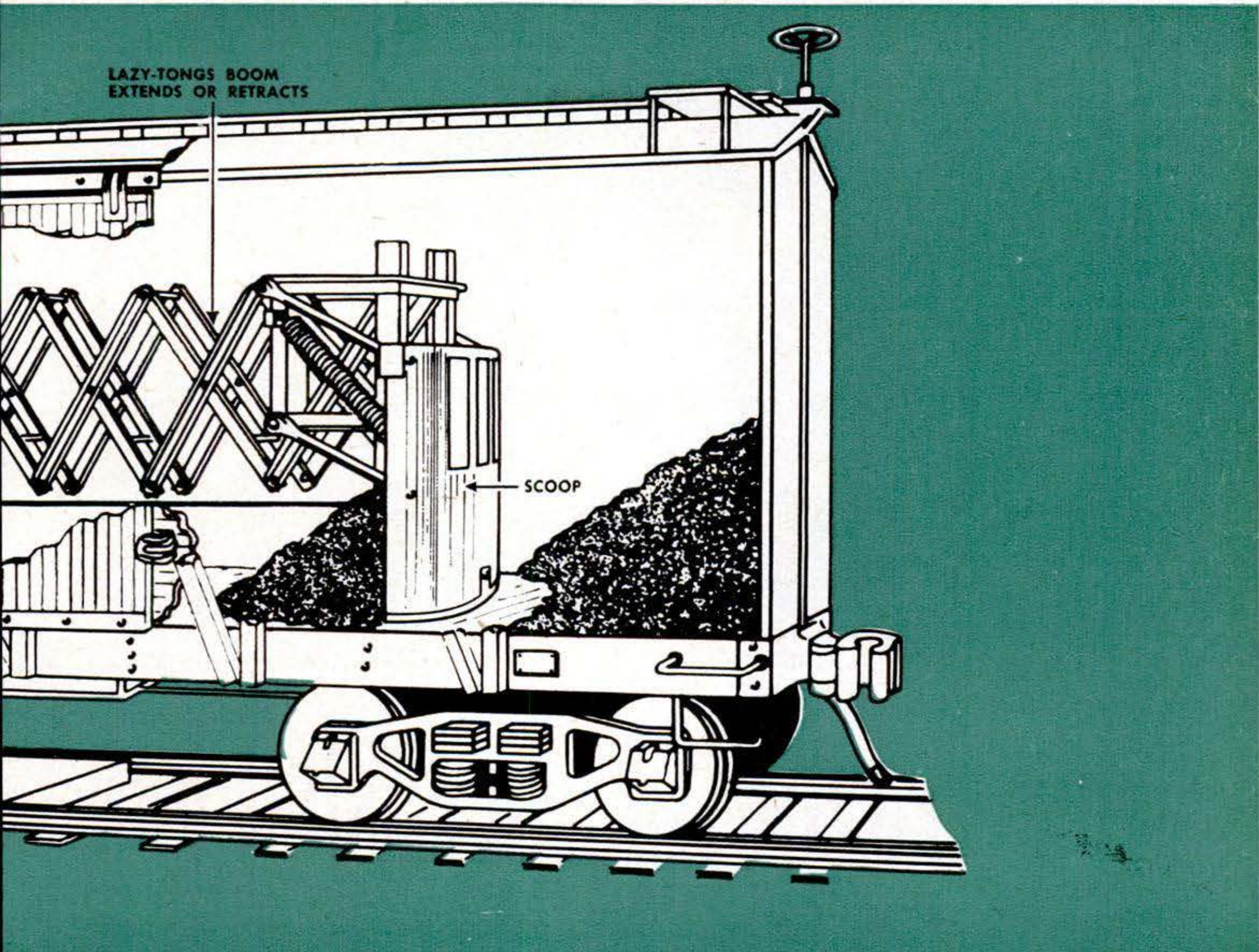

reaches all parts of car. Cargo, pulled out door, falls down through grate into collecting pit.

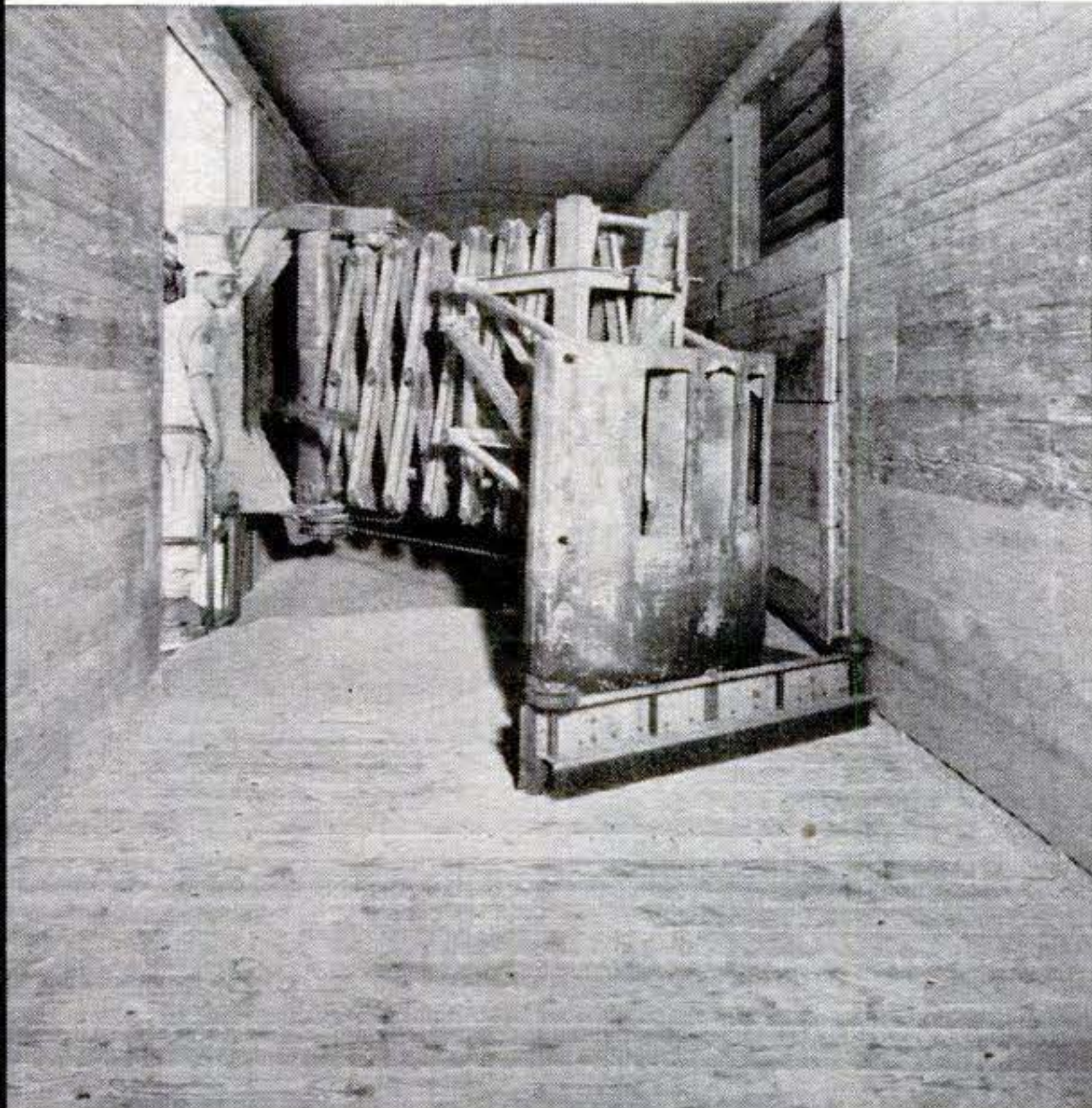

Brush on scoop sweeps floor almost clean, leaving only few grains to be removed by hand, as rollers guide arm along walls. Attaching brush to complete job is only manual operation.

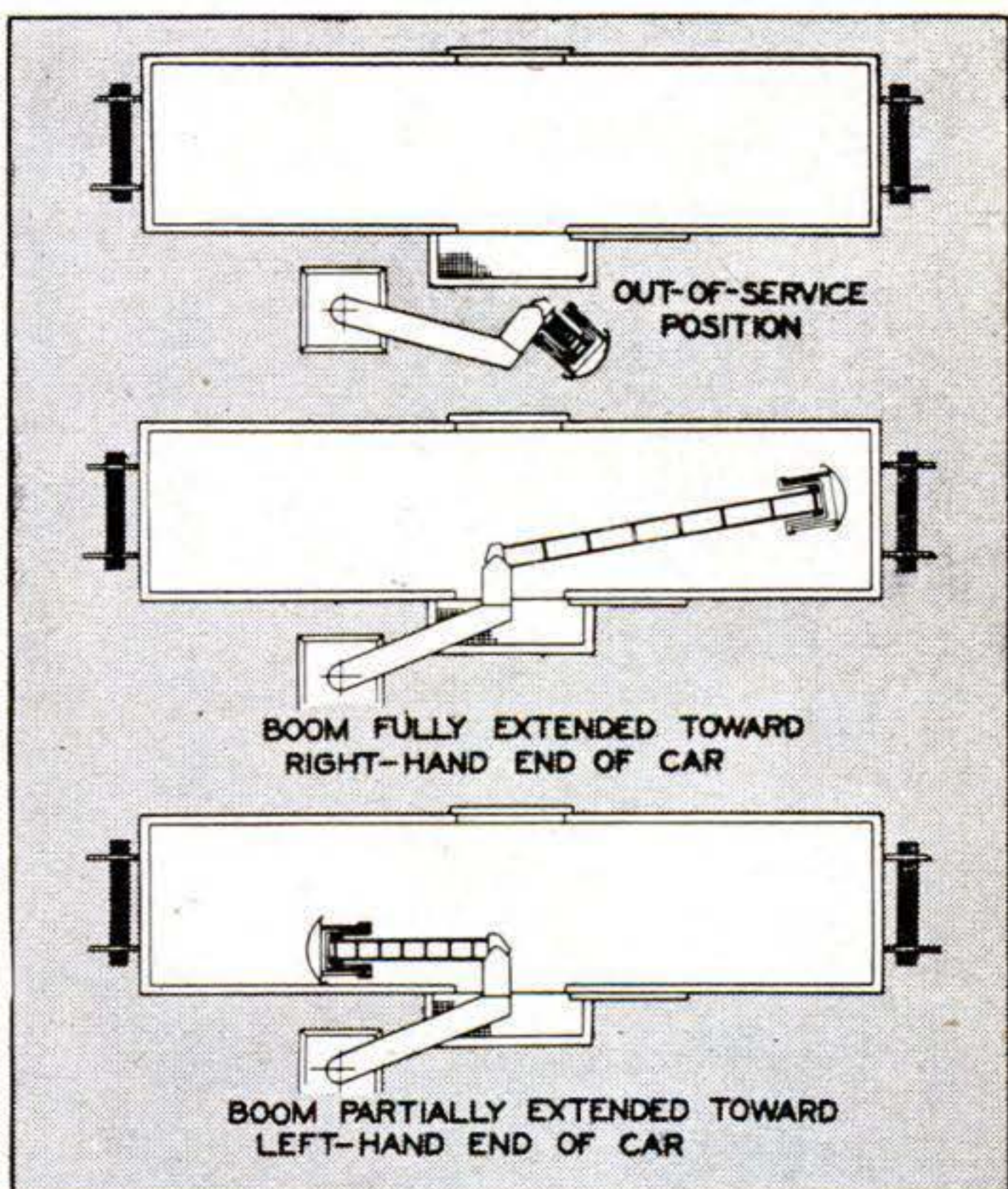

Top drawing above shows how unloading arm can be retracted and swung aside when not in use. Lower views show how elbow joint near door permits arm to be swung toward either end.





Restyled Frazer line of cars is available with standard transmission, overdrive, or Hydra-Matic.

# Kaiser-Frazer Adds Crash Pads

**K**AISER-FRAZER has announced the first major changes in their automobiles since their introduction after the war. The results of the company's two-and-a-half-month shutdown last fall and winter are evident in new styling, lower profiles, greater vision, and—in the case of the Kaisers—more power.

Both lines have what the company calls the industry's first full-padded, crash-absorbing instrument panel. Crash pads have been tried before by other car manufacturers, but one company abandoned them in mid-season. That particular automobile

maker apparently shied away from the implication that people might crack their noggins in sudden stops or collisions.

The snappy styling includes mounting the side glass nearly flush with the exterior body panels both for looks and to reduce wind noise. A "radiator" ornament breaking the curve of the hood to the grille at the front of the car is now standard equipment.

The Kaiser is offered in six body types, including 2- and 4-door Traveler utility sedans (PS, Apr. '49, p. 106). Among the five body styles in the Frazer is a hard-top model that resembles a convertible.

**New Kaiser chassis** is 60 lb. lighter than predecessor and is designed to place greatest body

load on strongest members. Frame is double-channeled around motor and in rear-wheel area.

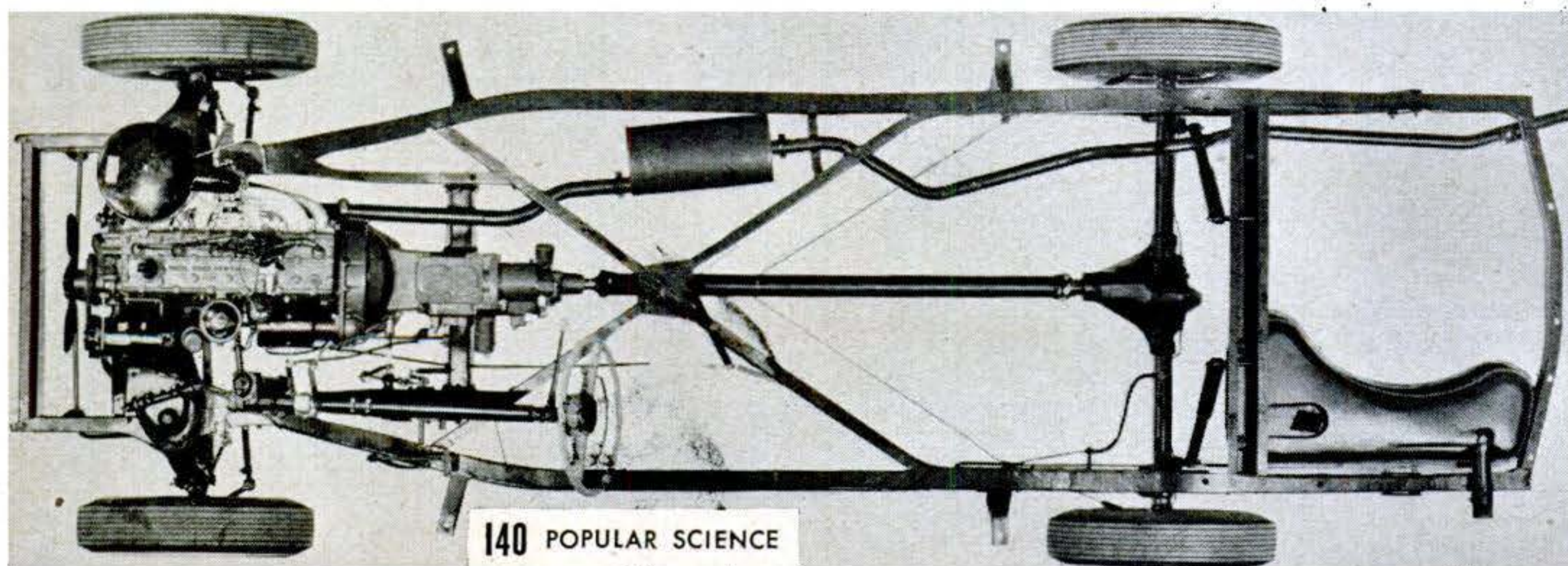



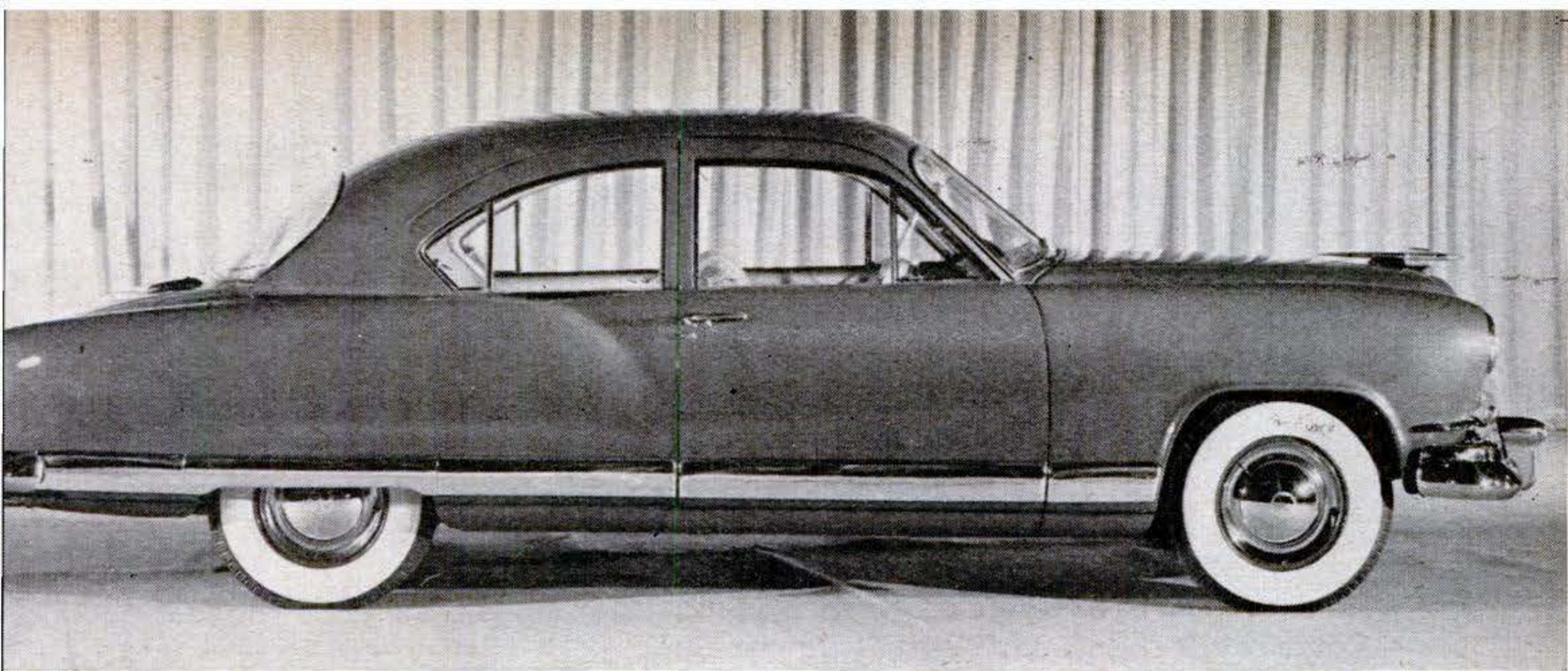

**1950 Kaiser** is 60 inches high, with center of gravity cradled below tire line. Company will

announce another type of car, built for Ford-Plymouth-Chevrolet price range, in late spring.

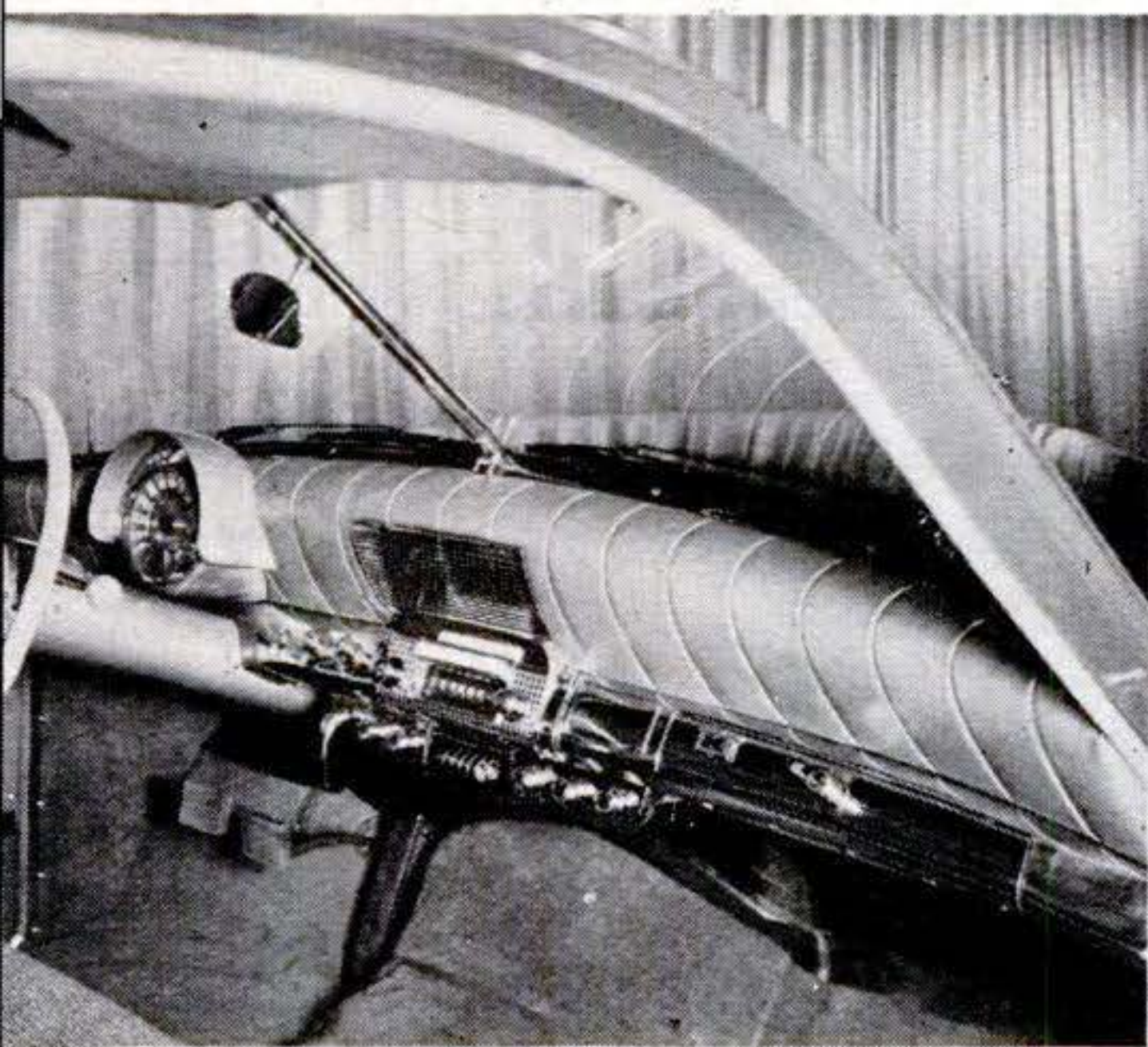

**Kaiser crash pad** extends full width of instrument panel. Speedometer is hooded to prevent glare on windshield at night. Wheelbase is reduced 5 in.; over-all length is boosted 1 1/4 in.

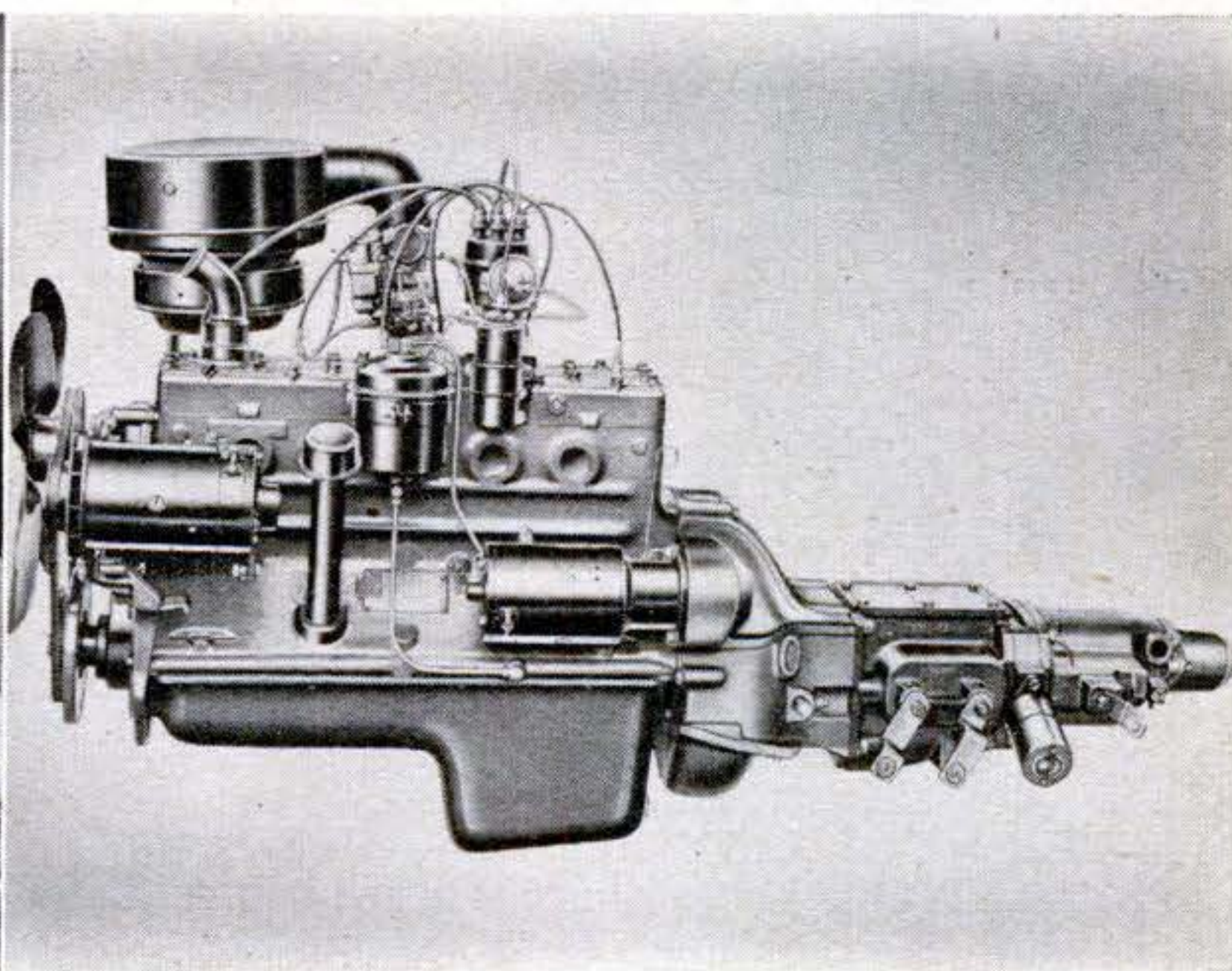

**Refinements** increase horsepower of 6-cylinder L-head engine from 100 to 115 without any change in bore, stroke, or 7.3-to-1 compression. Redesigned crankshaft is 100% counterbalanced.



**Slim windshield pillar** contributes to what company claims is larger passenger-car glass area than that of any other U. S. automobile. Safety-glass windshield has area of 3,541 sq. in.



**Recessing spare wheel** under luggage-compartment floor is a new wrinkle in K-F cars. Both front and rear seats are wider. Ignition key operates all locks, including that on trunk.



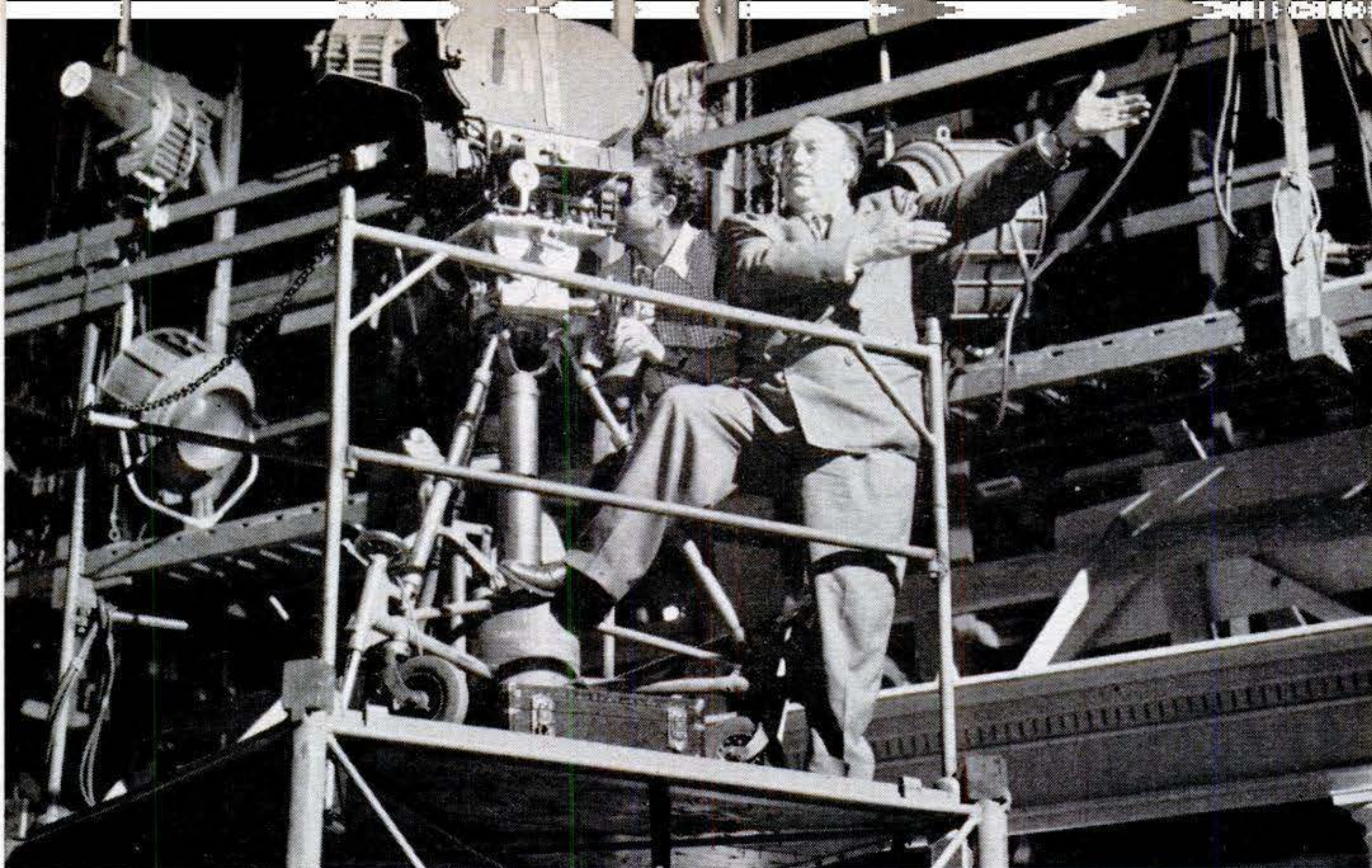

Using new Hollywood semaphore system, a director of photography signals that a scene just

filmed is okay. Photos on these pages were taken for POPULAR SCIENCE at the Goldwyn Studios.

## *New Wigwag Signals Direct Movie Scenes*

**H**OLLYWOOD has borrowed a trick from the landing officer on aircraft carriers. The result is a new system of arm signals for giving orders during the shooting of scenes on big sets and outdoors. They take the place of haphazard "high signs"

and shouted orders that are often drowned out by the wind or garbled by echoes.

The code, cooked up by assistant director Bill McGarry and cameraman Harry Webb, has been submitted to the Academy of Motion Picture Arts and Sciences for adoption.



**5 "Once more."** The trouble has been corrected and the director takes over again by holding one arm horizontal and the other bent upward at the elbow. Then the cameras roll.

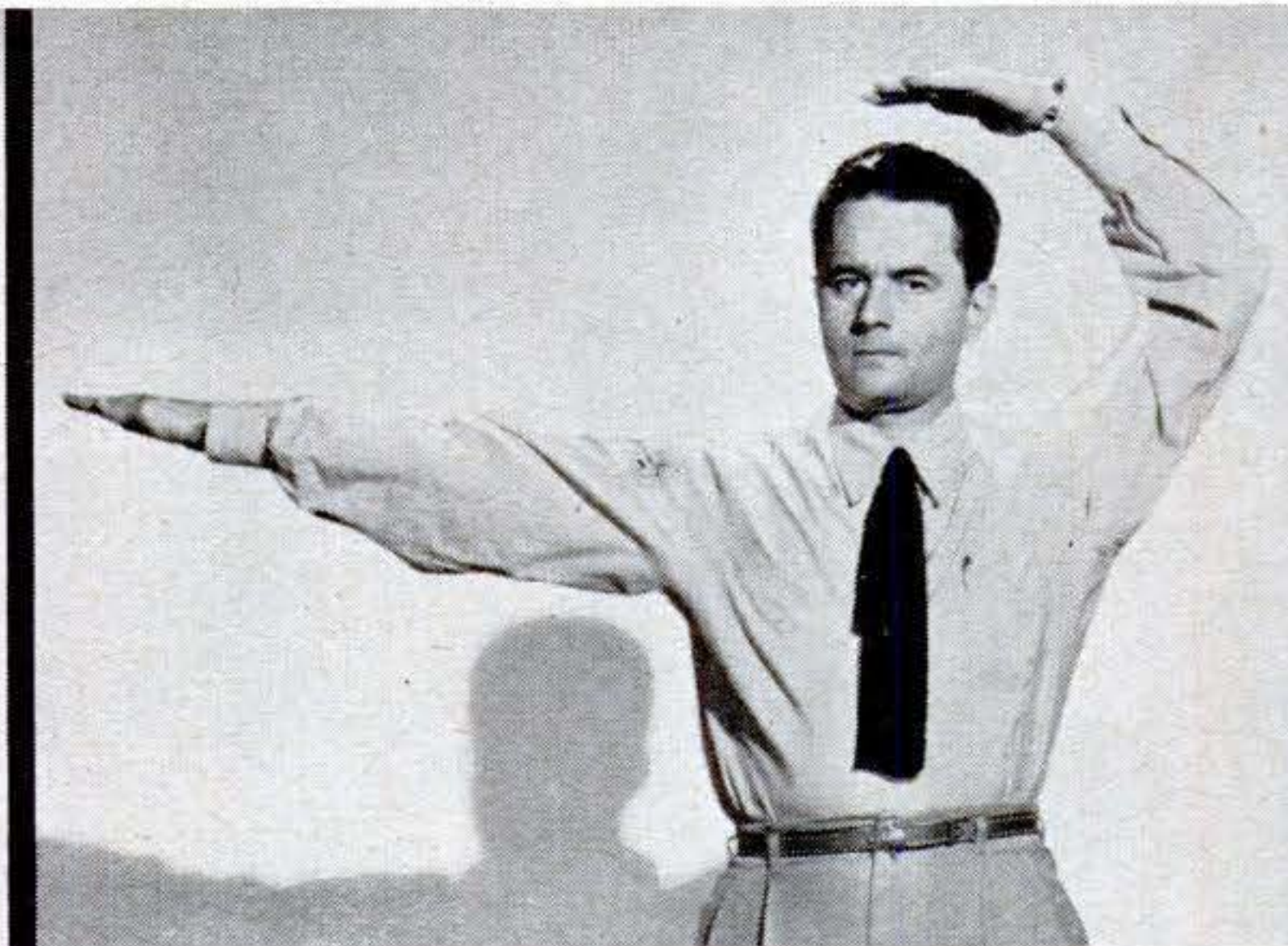

**6 "Camera right."** The director conveys this order to the camera crew by holding his right arm out horizontally from the body and his left arm bent to place hand over the head.





**1 "Upstage."** This signal to the cast indicates that some actors have come in too close and must move back. Hand on hip and arm down at same angle orders cast to move in closer.



**2 "Roll camera."** When scene is ready, director gives this order by holding arms slanted in a straight line. Advantage of signals is that they can be understood from front or rear.



**3 "Cameras rolling,"** signals back the cameraman by holding arms straight out as above. Then director, with arms held same way, but rotating one or both, orders "Action."



**4 "No good,"** signals the soundman, holding both arms down at a 45-degree angle. This signal stops cameras and action. Some noise, such as a passing plane, may have been heard.

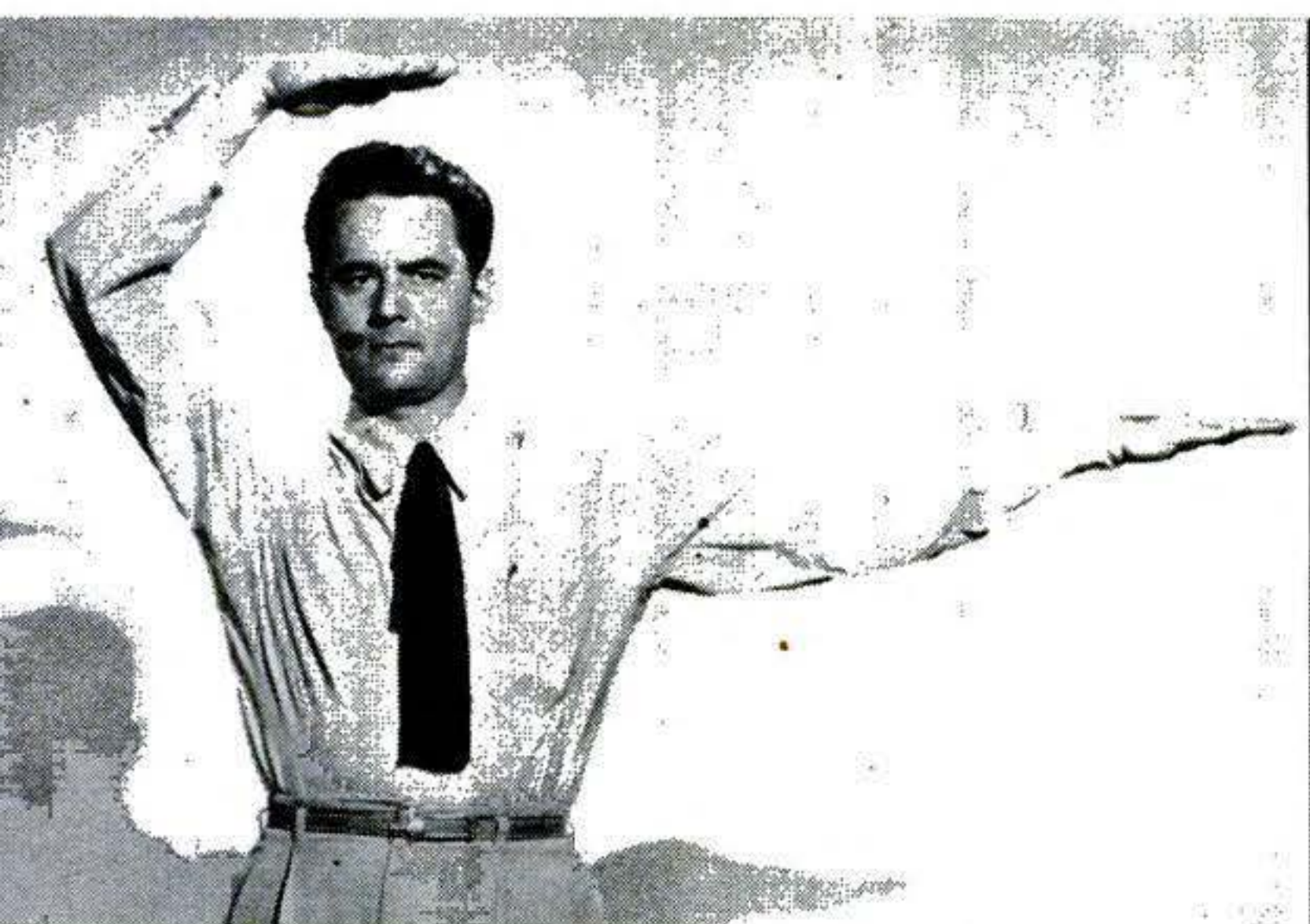

**7 "Camera left."** To give this order, the director simply reverses the previous arm positions. Another signal, arms crossed overhead (not shown in these photos), indicates a rehearsal.



**8 "Okay, cut!"** By holding one arm out horizontal and the other folded across his chest, the director indicates: Action, good; sound, satisfactory. Only director ever uses this sign.





### “Can Opener” Saves Lives

THIS motorized “can opener” chops apart an airplane fuselage to give air-crash victims a better chance to escape. Made of sheets of razor-edged steel eight feet high, it is mounted on an armored car. The Melbourne, Australia, Department of Works and Housing designed and built the life-saving device. In a recent demonstration it was tested on an old RAAF Liberator, cutting the tail right off (left and above).



### Chrysler Gets Bigger Brakes

FANCIEST of the Chrysler Corp. line, the 1950 cars bearing the company name have been souped up in styling and engineering. Wider brakes require less pedal pressure, and a rear window with 27-percent greater area improves vision. An automatic switch keeps the stop light off on the side a turn signal is flashing. You can choose from 19 body styles—ranging from coupes to hard-top convertibles and eight-passenger sedans.

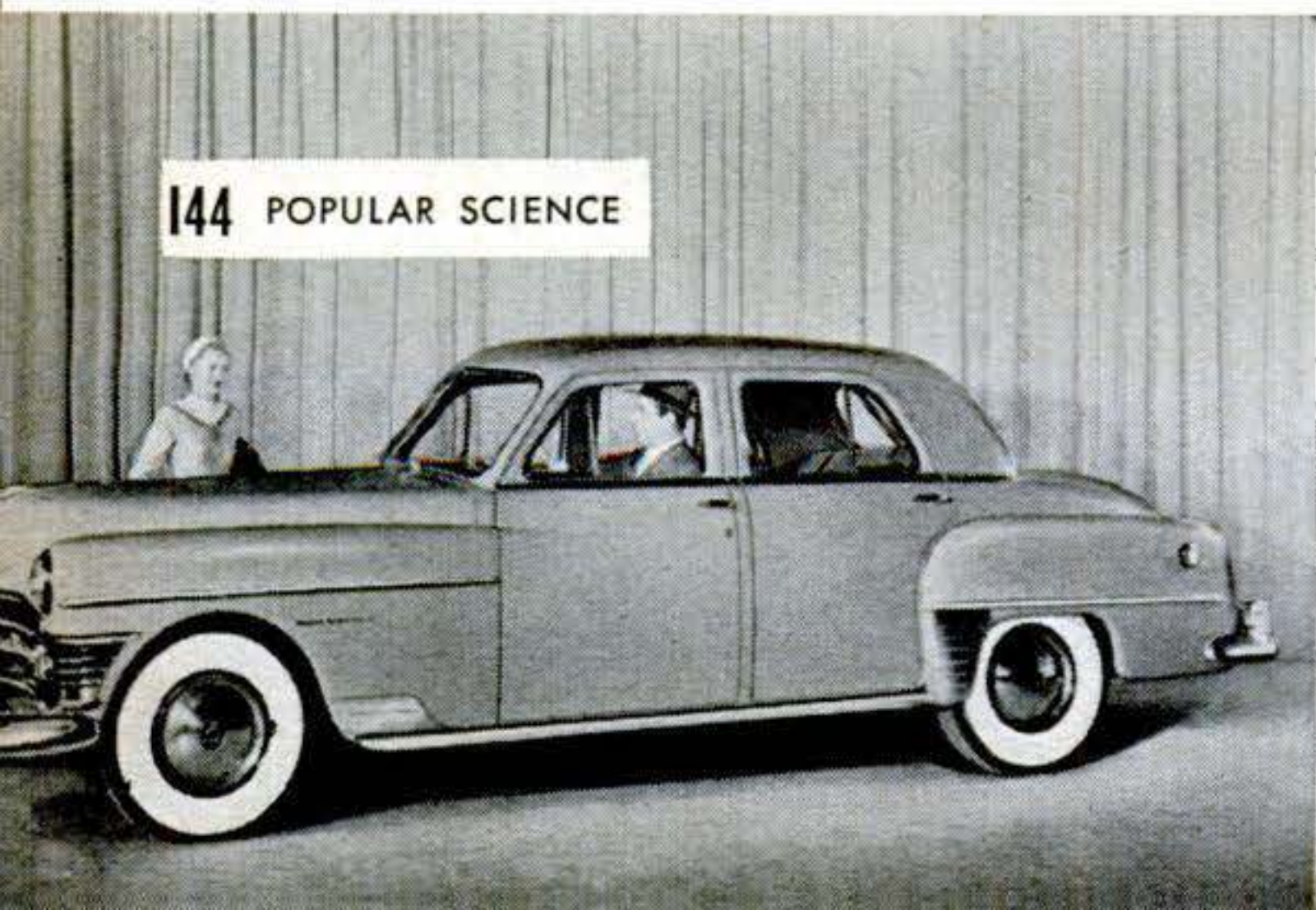

### Plastic Ball Tells Weather

PEOPLE in Minneapolis learn the weather forecasts now by watching this ball of light atop a local bank (below). Neon tubing inside the plastic sphere glows red when the forecast is warmer, white for colder, green for no change. The lights flicker for rain or snow. The big letters “NW” don’t indicate wind direction—they stand for Northwestern National Bank. The weather ball is set manually to agree with official forecasts.





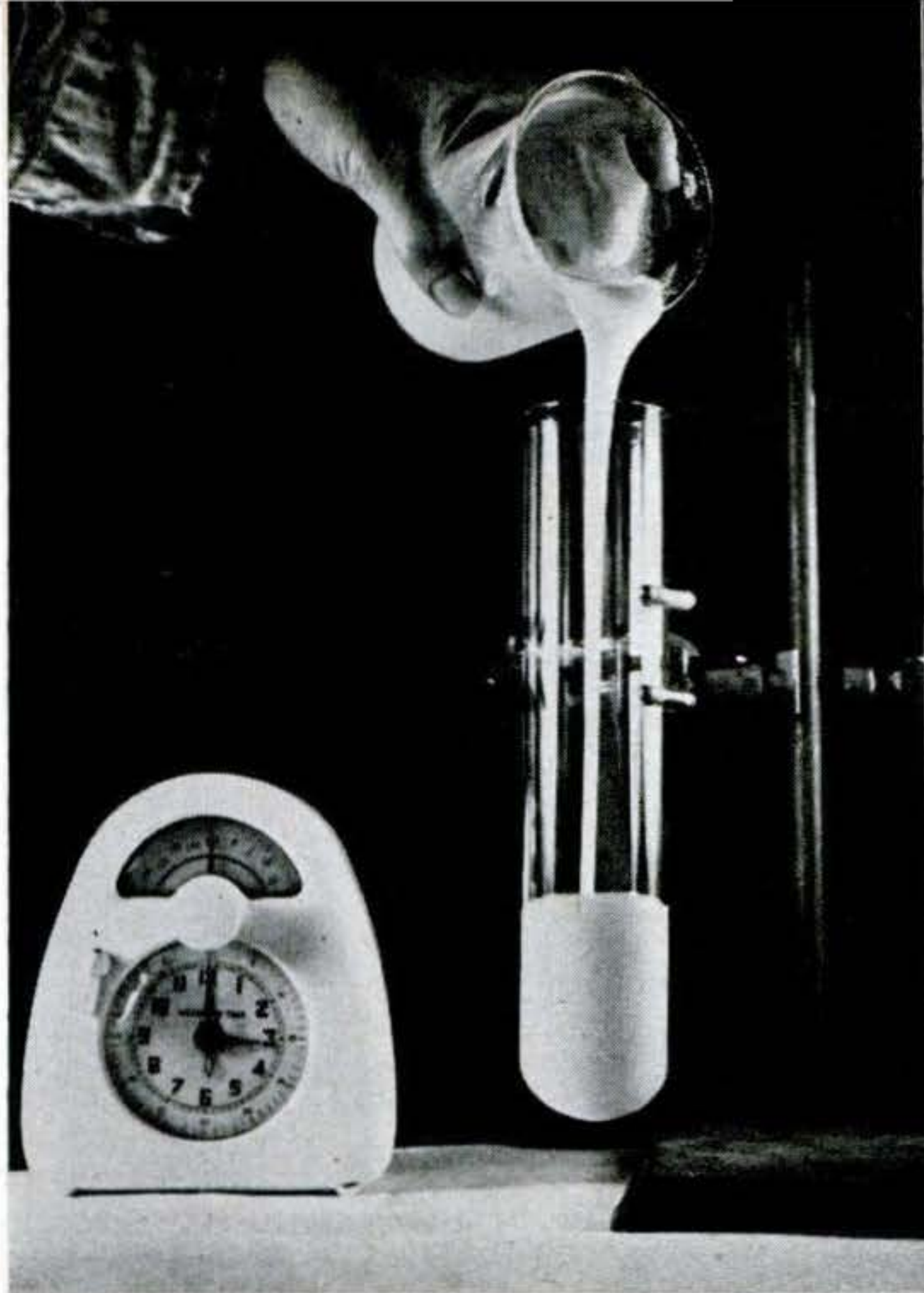

Liquid plastics are mixed in test tube to demonstrate new material's expansion qualities. Mixture heats up to 300° F. and begins to foam.

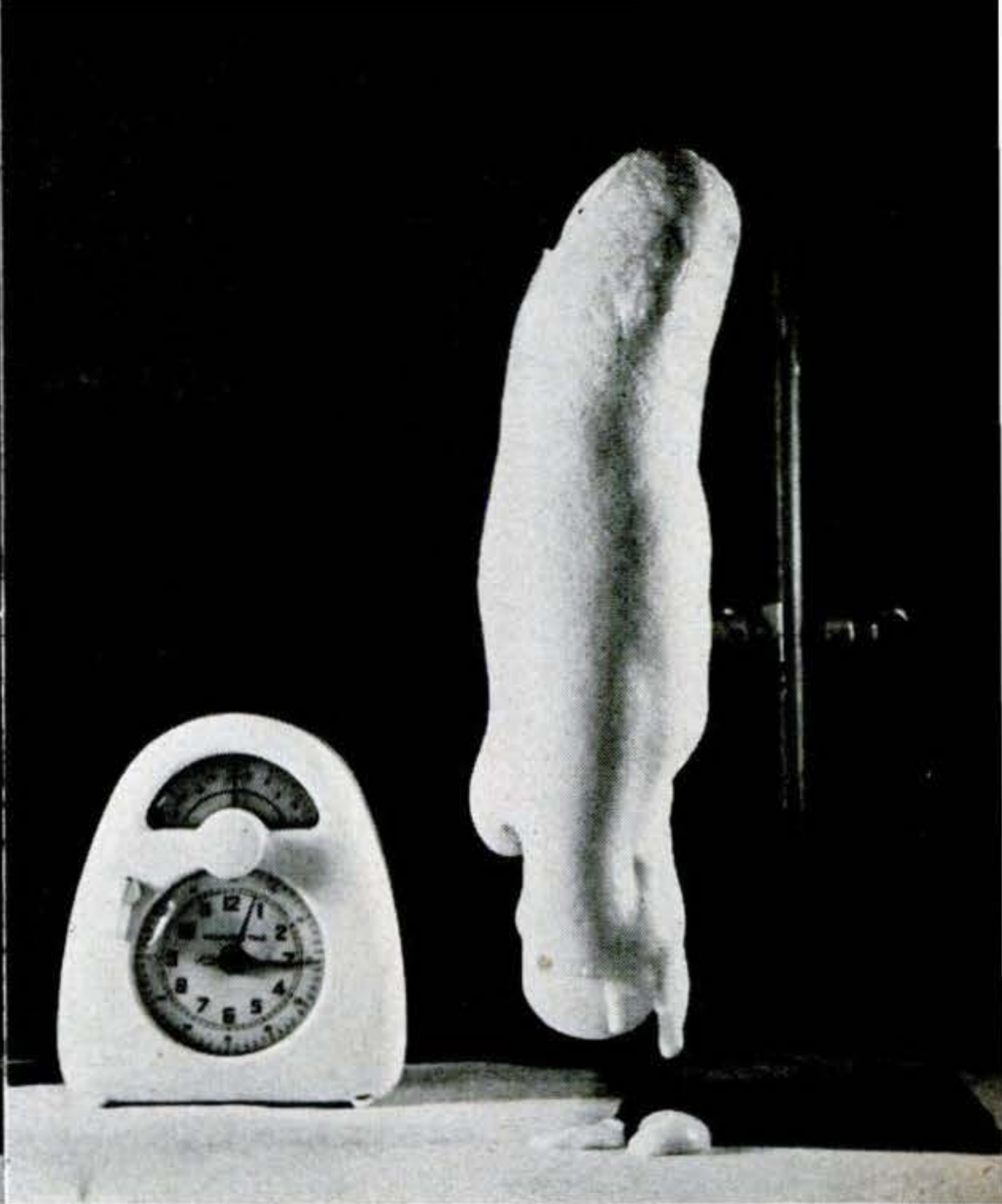

Three minutes and 15 seconds later compound has foamed to this size. As many as 1,100 combinations of varying densities are possible.

### Plastic Foam Fills Plane Parts

CHEMISTS of the Lockheed Aircraft Corp. combine many chemicals and organic plastics to make a feather-light but tough new material called Lockfoam®. When mixed in liquid form, the plastics heat and swell to as much as 25 times their original volume. The foamy mass then hardens into a porous material that weighs only four pounds per cubic foot, which is three times lighter than cork. Lockheed uses Lockfoam to fill ailerons, trim tabs, and elevators on aircraft, replacing many internal parts.

### Machine Vacuums Streets

THIS mechanical street sweeper works like a vacuum cleaner. An agitator loosens debris, while an 1,800-r.p.m. fan blows leaves, stones, and even bottles into a wire-mesh hopper. The hopper dumps hydraulically into a truck. Tractor-mounted, the sweeper can be operated by one man. Harry Clemens, La Porte, Ind., is the inventor.

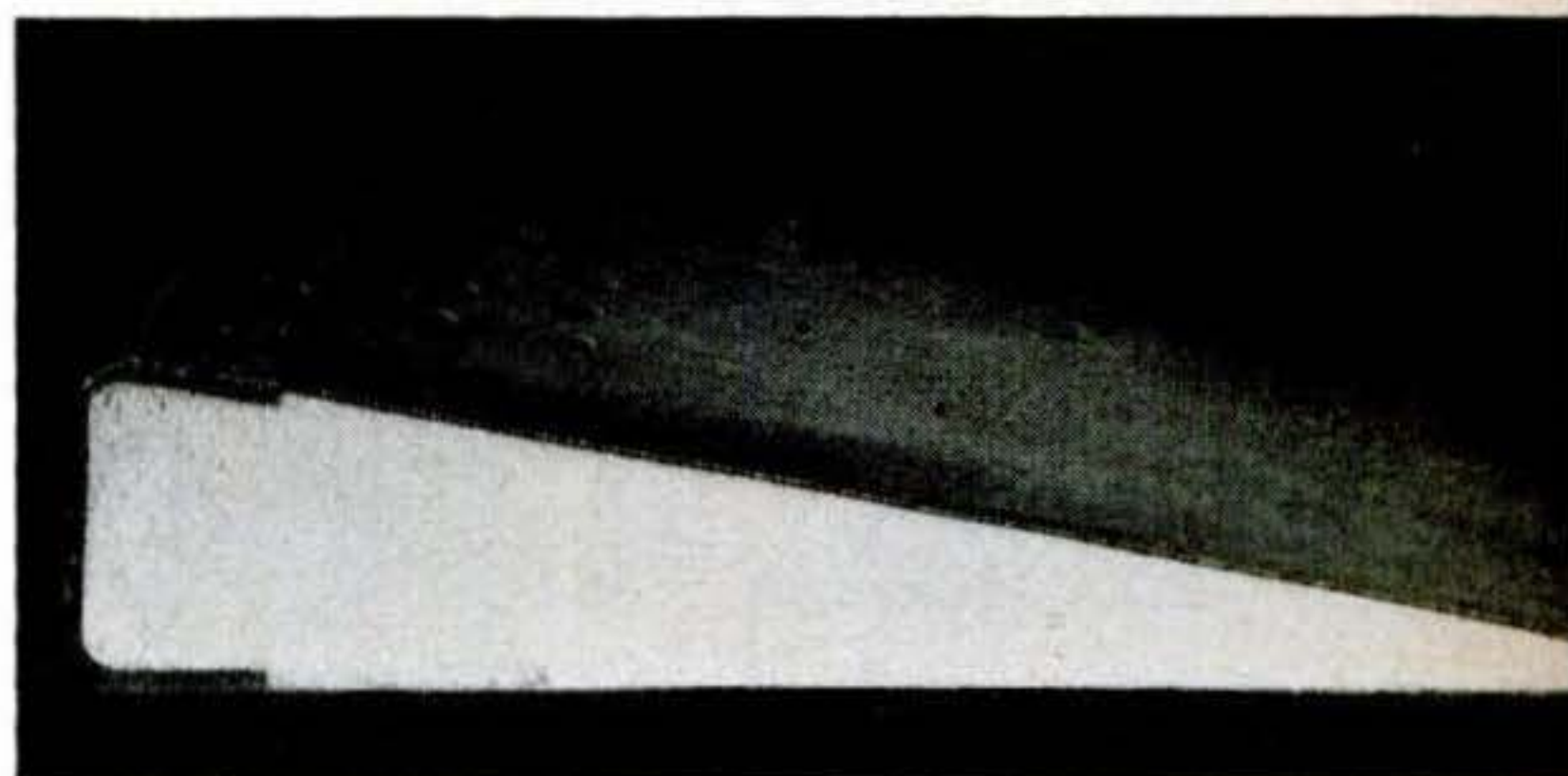
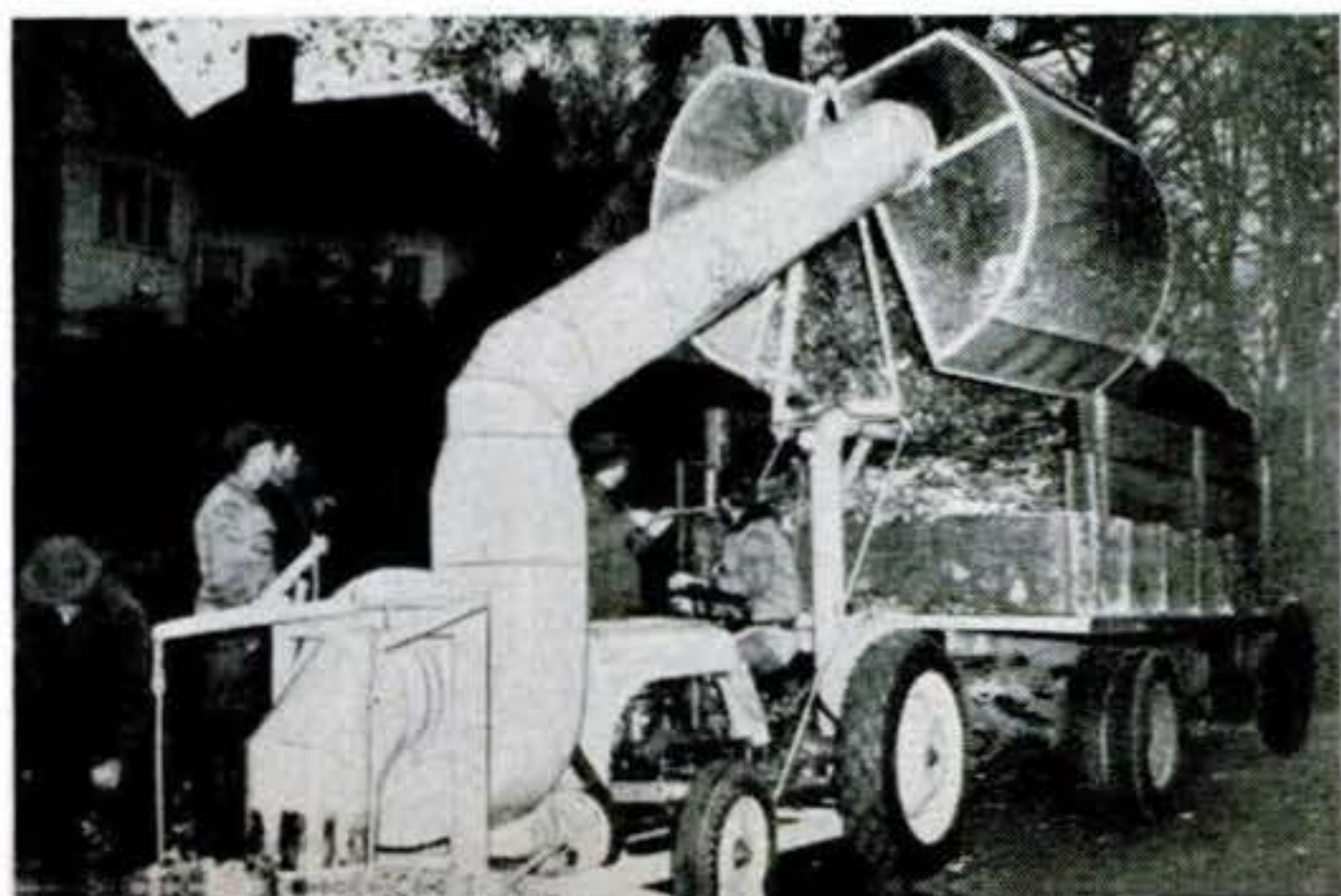

Lockfoam can be cast in any shape. Here it fills an aircraft aileron tab, giving greater rigidity with fewer internal metal parts.

### Flying Banana Gets New Skin

THE Navy's latest transport helicopter, the Piasecki HRP-2, has an aluminum fuselage, instead of fabric covering, to cut down drag and vibration. Its new cockpit has side-by-side pilot seating, dual controls, central instrument location, and improved vision. Designed for rescue work, it has eight seats plus space for nine litters.





# 750 Million Lumps of Sugar Every Day

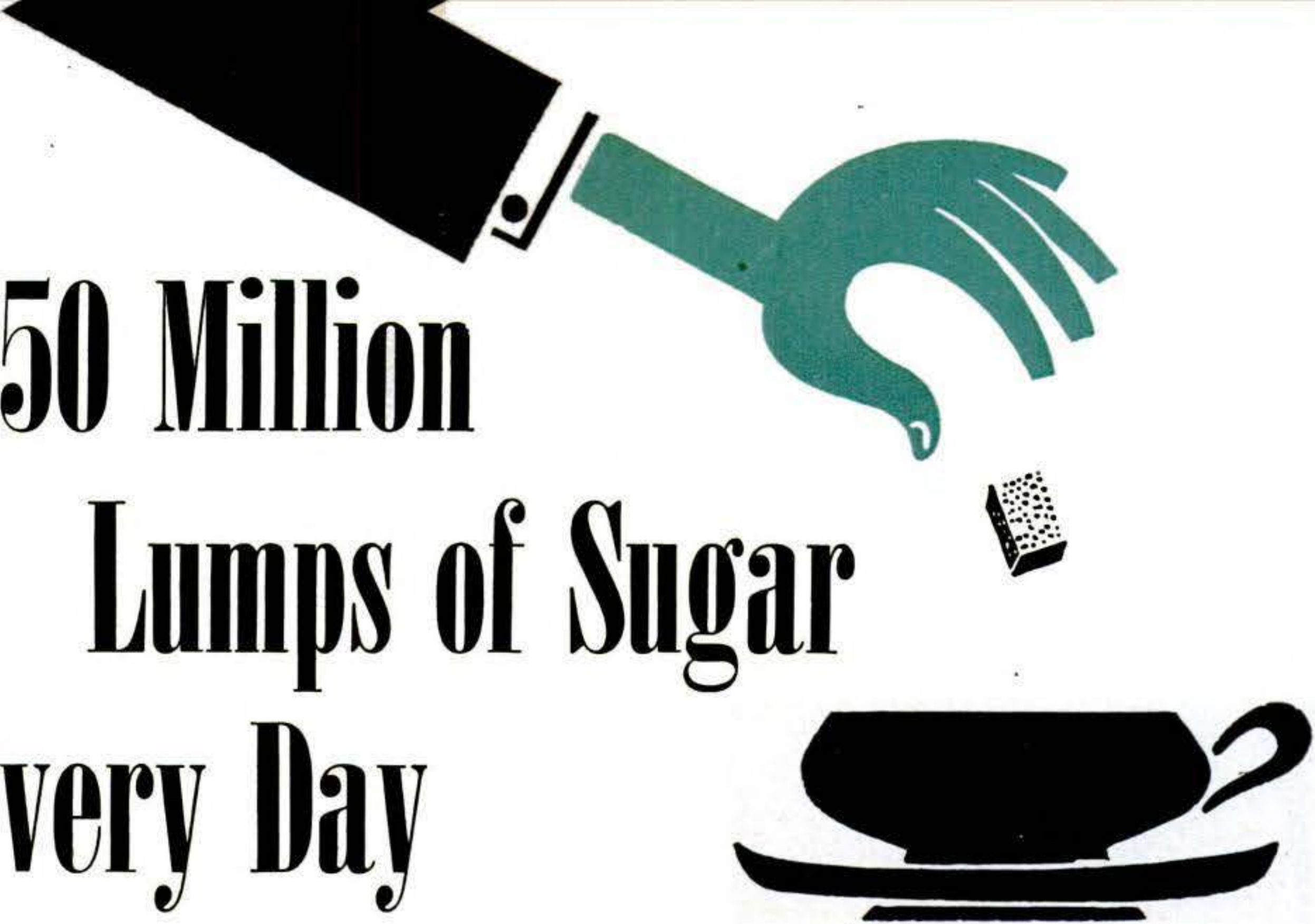

**By Andrew R. Boone**

THE drawing here and the photographs on the next three pages tell the story behind the lump of sugar you dropped into your coffee this morning. They show how the world's largest cane-sugar refinery turns brownish, gummy raw sugar into sparkling, crystalline grains and cubes.

This plant, at Crockett, Calif., supplies a tenth of the 7,500,000 tons of sugar Americans eat each year. Its production would provide five lumps a day for every man, woman, and child in the country. The huge refinery is operated by the California and Hawaiian Sugar Refining Corp., Ltd.

Raw sugar, boiled down from the juice squeezed from cane stalks, arrives by ship in bulk and in bags. The refined product leaves for grocers' shelves as white, brown, confectioner's and lump sugar. All are basically the same: practically pure sucrose, whose complex chemical structure is indicated by its formula,  $C_{12}H_{22}O_{11}$ .

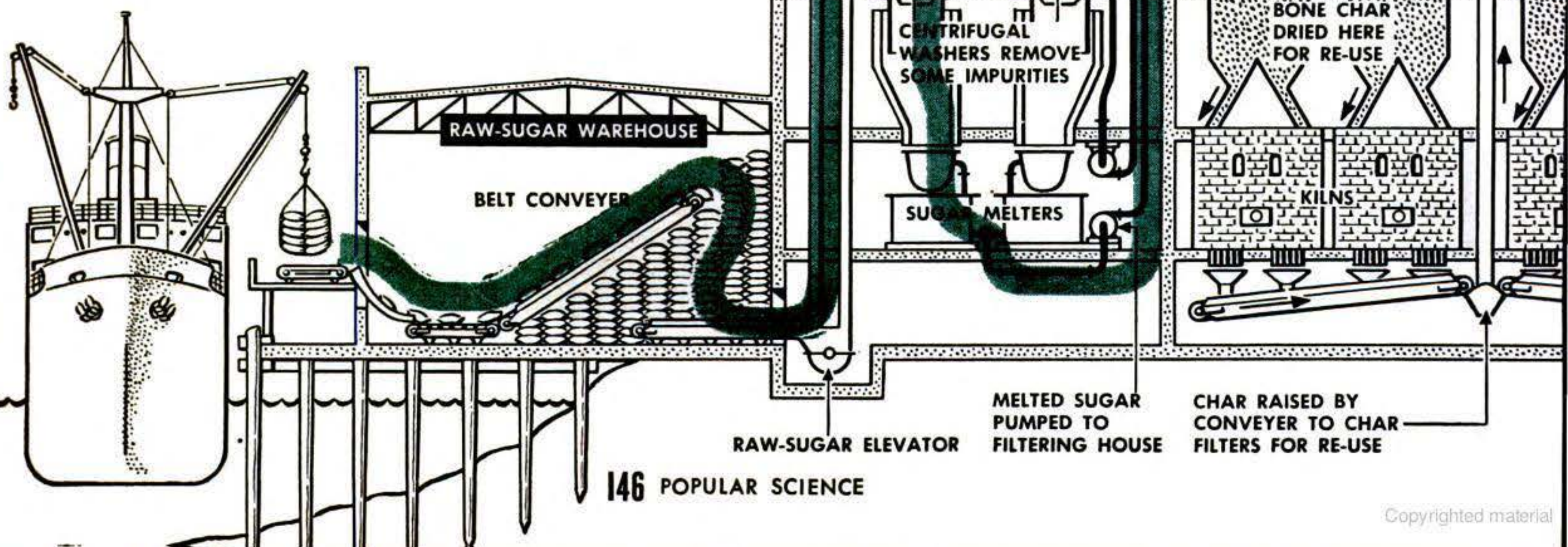





When ship with cargo of raw sugar docks at refinery above, a crane moves into place over the ship's hold, lowering its bucket conveyor to unload the sugar. The bucket lifts sugar onto conveyer belts that carry it to silos in refinery. ➤

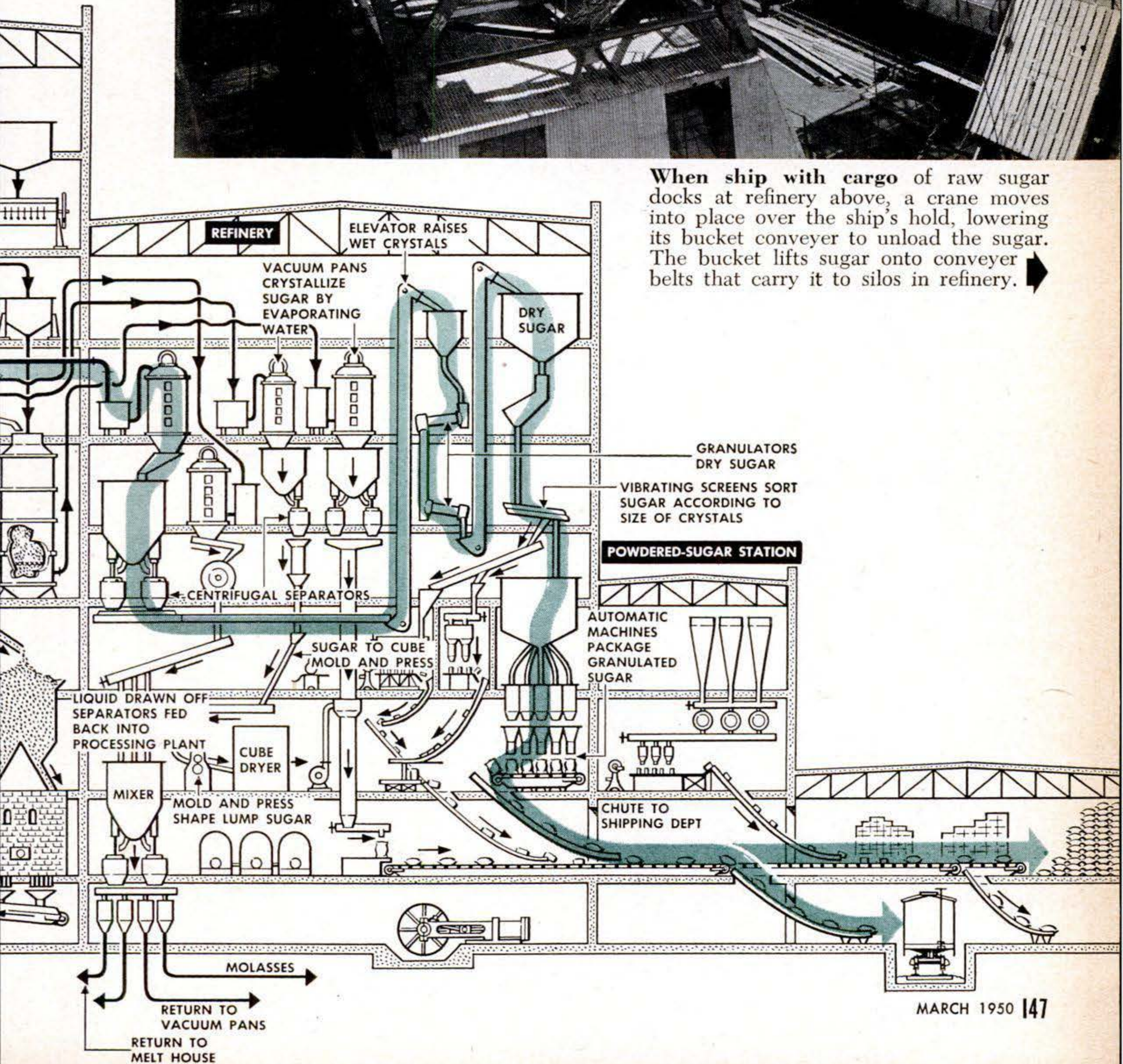





**1** This is one of nine steel silos, each having a capacity of 10,000 tons, for storing raw sugar. Light brown and coarse in appearance, the sugar is unloaded from the silo by the

clamshell bucket above. Positioned by a traveling overhead crane, the bucket drops the sugar down the large tube in the center of the silo. From here sugar travels to refining machinery.

**4** Boiling the syrup under vacuum to evaporate the water is the next step. The huge steam-heated vacuum pan below, 24 feet high and 14 feet across, is used for this operation.

**5** Operator pours sugar crystals into the vacuum pan to induce crystallization of the syrup. Forty tons of crystal-syrup mixture, called massecuite, results from one cooking.

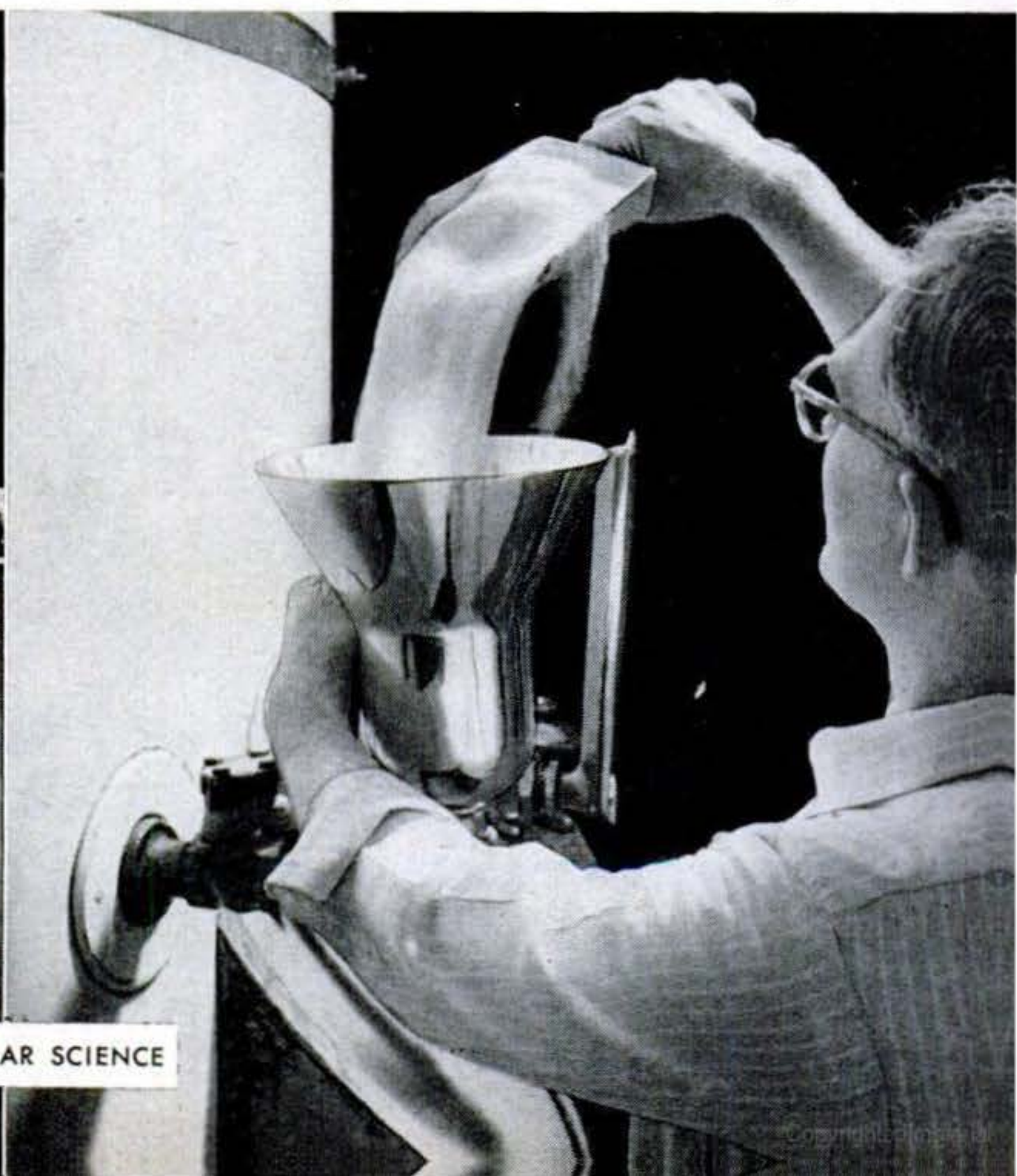
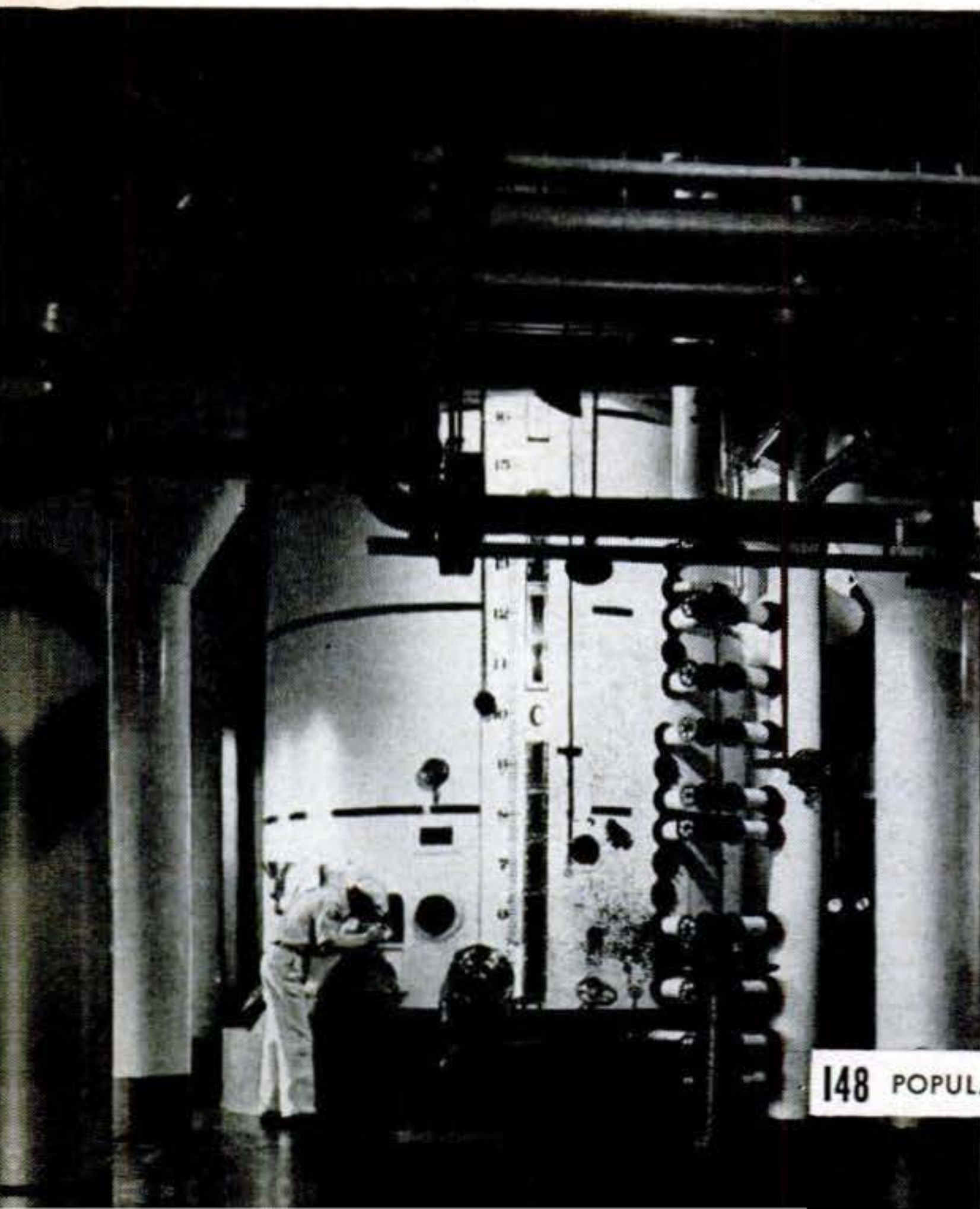





**2** After molasses coating on raw sugar is softened with a heavy sugar-and-water syrup, mixture is washed and whirled in centrifugal machine above to remove some impurities.

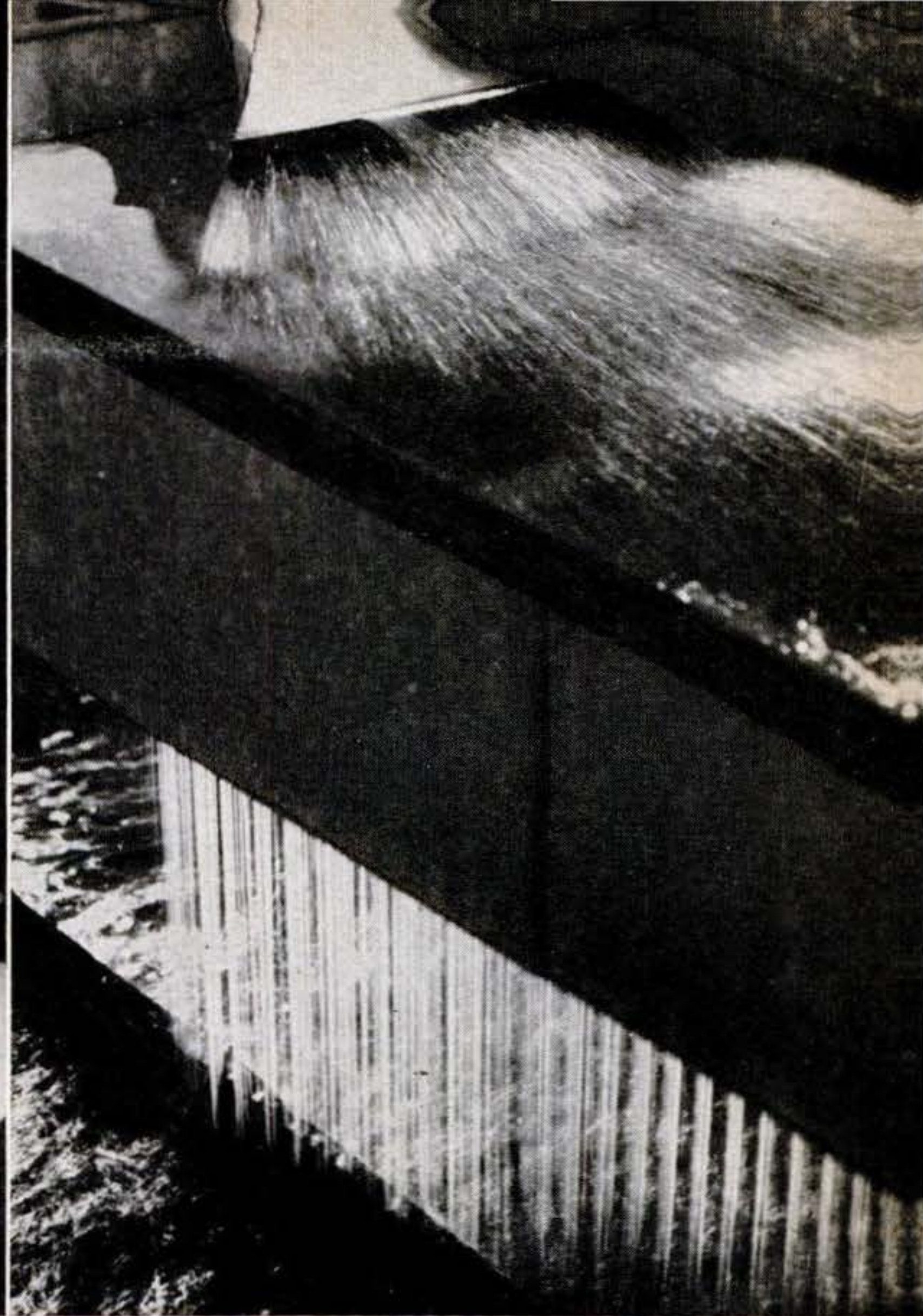

**3** Melted sugar mixture, now a clear amber syrup, strains through fine-mesh screening above in final filtering step. Before this, mixture passes through about 100 other filters.

**6** To obtain granulated sugar, crystals are separated from syrup, dried in a rotating cylinder, then shot down tubes to machines, below, that sort grains according to size.

**7** Lump sugar is made by pouring melted sugar into rectangular forms, cutting them in cubes, and molding with a cylinder. Cubes below move into drying oven as final step.

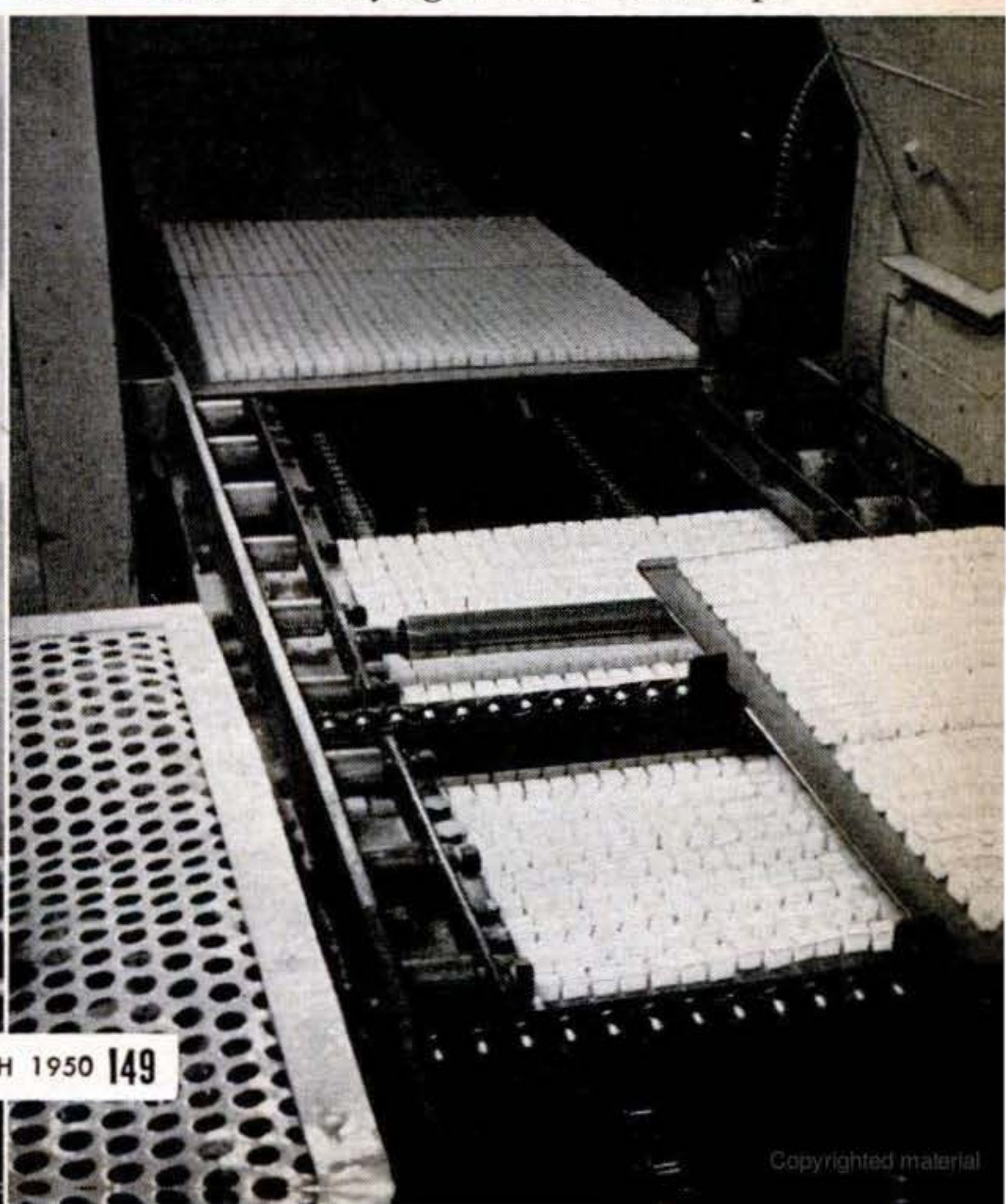
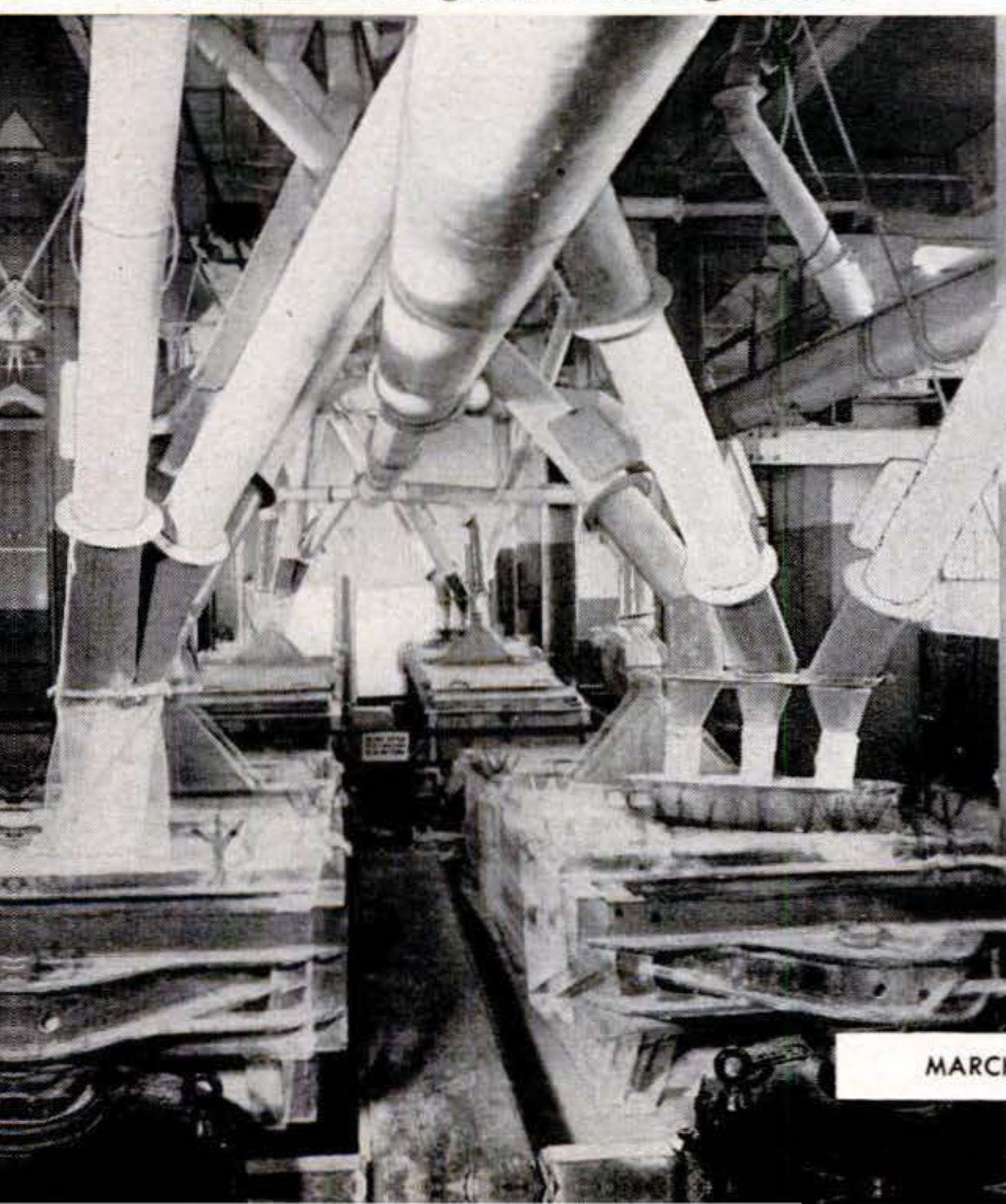



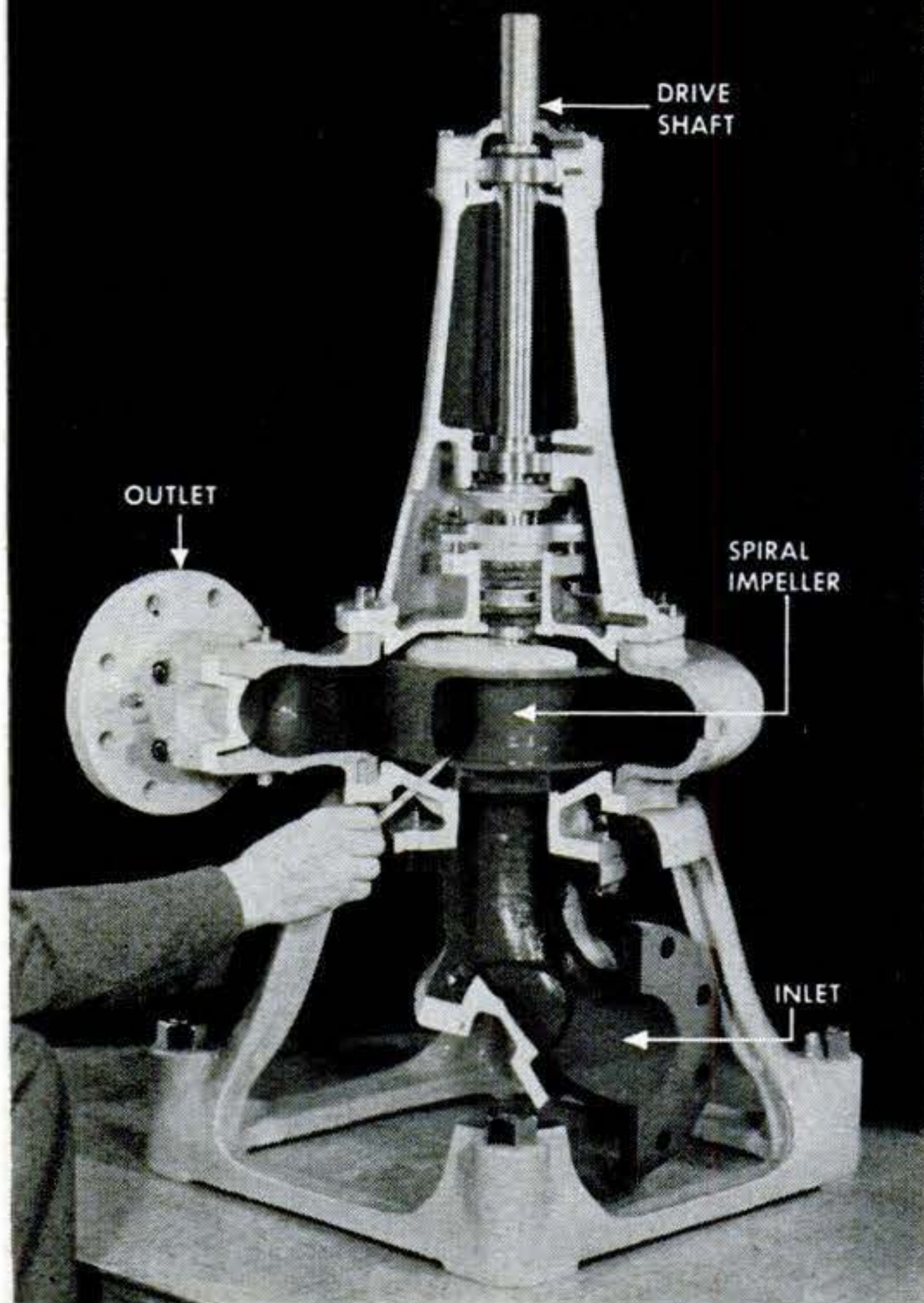

### Trash Won't Clog New Pump

RAGS and other trash sometimes clog the pumps in sewage-disposal systems, making frequent cleaning necessary. To overcome this obstacle, Fairbanks, Morse & Co., of

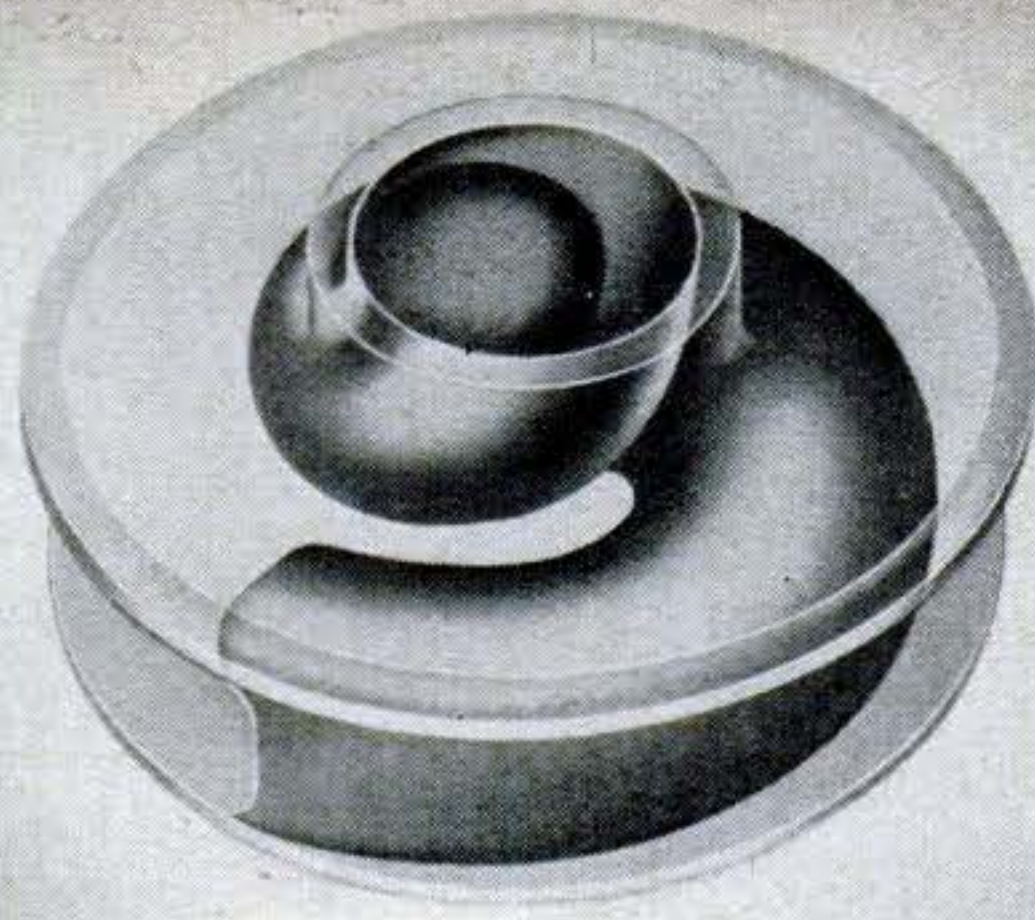

Chicago, has designed a pump that eliminates the trash-catching impeller blade of conventional centrifugal pumps.

Instead, the new pump has a single, coiled-up tube (above), big enough to let both liquids and solids pass through without catching, that rotates on a central axis. Entering at the center, the fluid spirals outward as the tube spins. This speeds up the fluid and shoots it out through the tube's discharge end at the outside of the spiral. The new pump will handle trash 25 times as large as that passed by a conventional pump with its narrow impeller blades.

Because of its gentle action, the bladeless pump may also be useful in food-processing industries. In a recent test, oranges and apples passed through it without being damaged at all.

### Oil Derrick Wears "Overcoat"

THE odd-looking structure towering skyward below is a covered oil derrick. Erected at the Naval oil field in Point Barrow, Alaska, the derrick's framework wears an "overcoat" to protect men and equipment from wintry Arctic blasts.

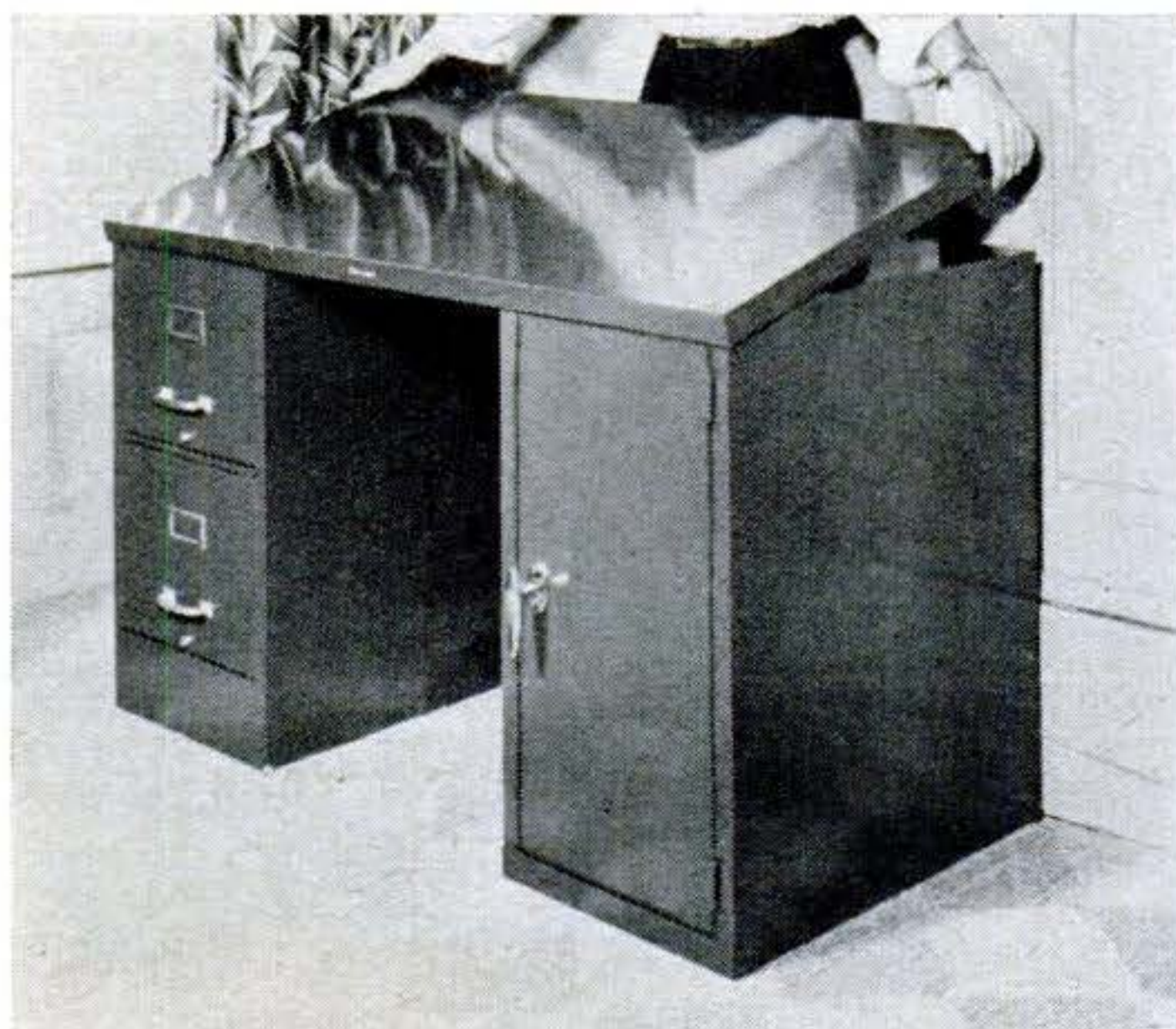
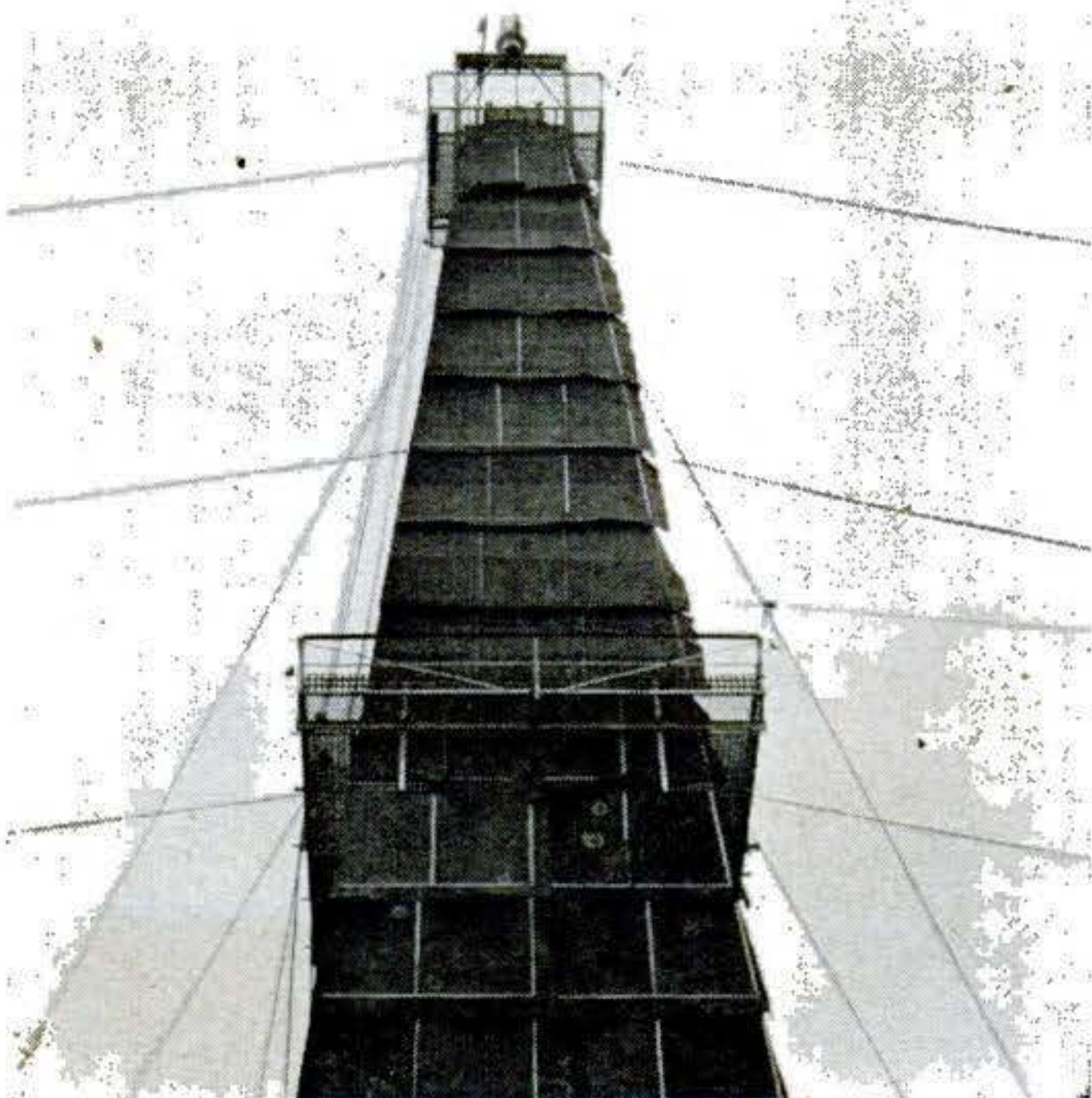

### File Cabinets Become Desk

IF YOU place this snug-fitting metal top over a couple of file cabinets, as shown above, you have a desk. Measuring 24½ by 50 inches, the desk top is easily removed for rearranging an office. The Sect-o-desk® cabinets measure 30 by 24 by 15 inches, come with drawers or a door. Made of heavy-gauge steel by Kalmus-Golden, Inc., New York City, the complete unit sells for \$49.50. Cabinets may be bought separately.



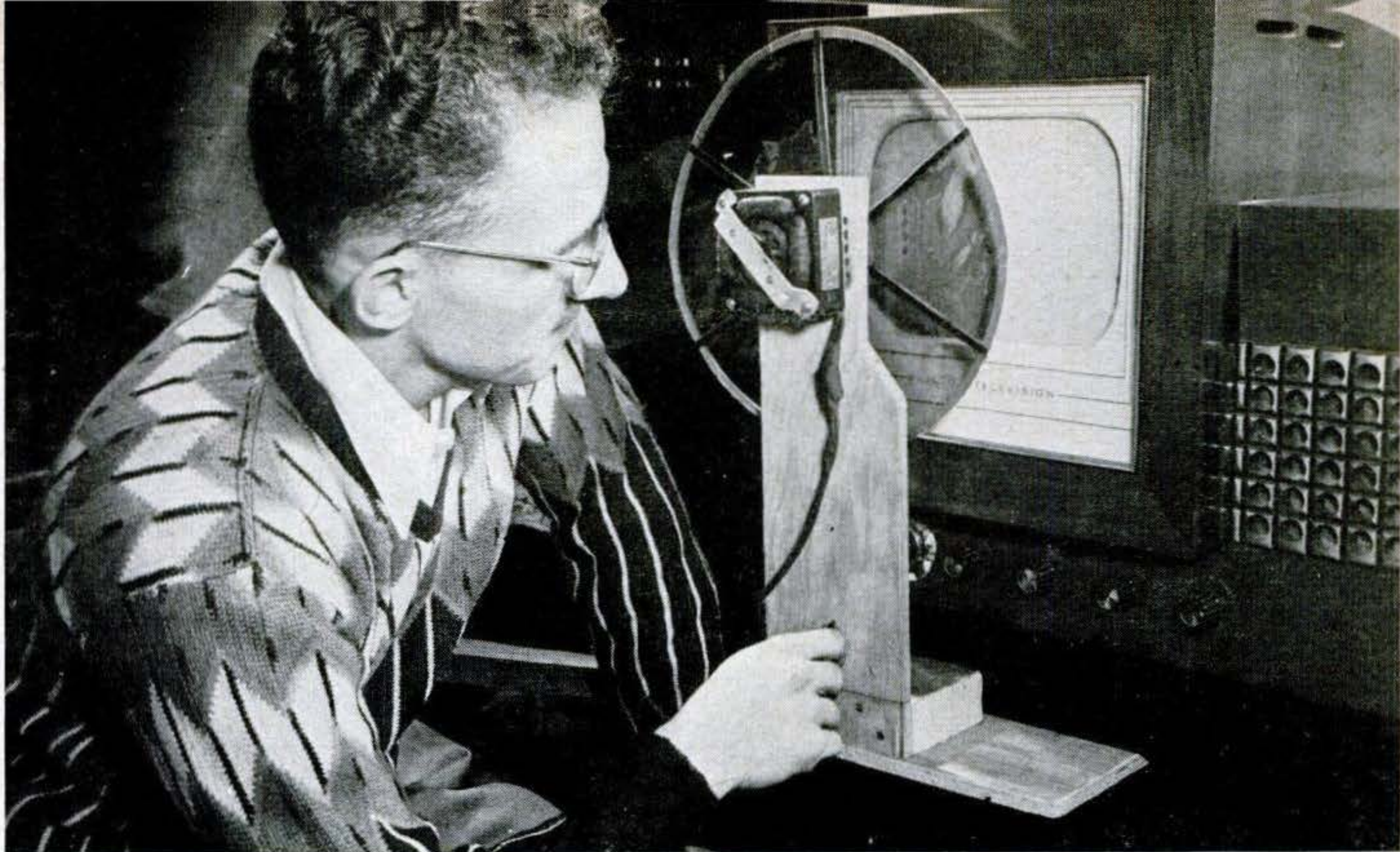

Color TV is no mystery to Forrest Killy—he watches test broadcasts with this homemade rig.

## ***PS Reader Makes Own TV Color***

**W**HILE experts haggled over how difficult it was to put color television into an ordinary set, a POPULAR SCIENCE reader went ahead and did it. Total cost: 30 cents.

Forrest W. Killy, a young electrician of Roselle, N. J., thought it would be fun to peek while the Columbia Broadcasting System broadcast color-television tests. So he picked a phonograph motor, condenser, switch, and rheostat from his junk box and spent the 30 cents for some red, blue, and green cellophane. He cut the cellophane into wedges and pasted them on cardboard and wire to make a color wheel. The phonograph motor, its speed controlled by the rheostat, spins the wheel. The condenser and switch, wired into the horizontal sweep circuit of Killy's standard black-and-white TV receiver, change the picture from the 525-line basis ordinarily used to the 405 lines of Columbia's color system. (This line conversion, simple on the particular model Killy has, would be complicated on others.)

Upon spotting a color telecast (until recently tests were transmitted at irregular "off" hours), Killy slid the color wheel in front of his set, plugged the motor in, and switched the set to the 405-line color scan. The rheostat must be adjusted until the color wheel rotates exactly in time with the color wheel in the studio camera. This is a

little tricky with Killy's rig—the colors may change back and forth until the adjustment is just right. Yet Killy's simple converter can show the colors quite accurately. And so far as CBS knows, he has been the only private citizen in the country to see even that much color on his own set. **END**

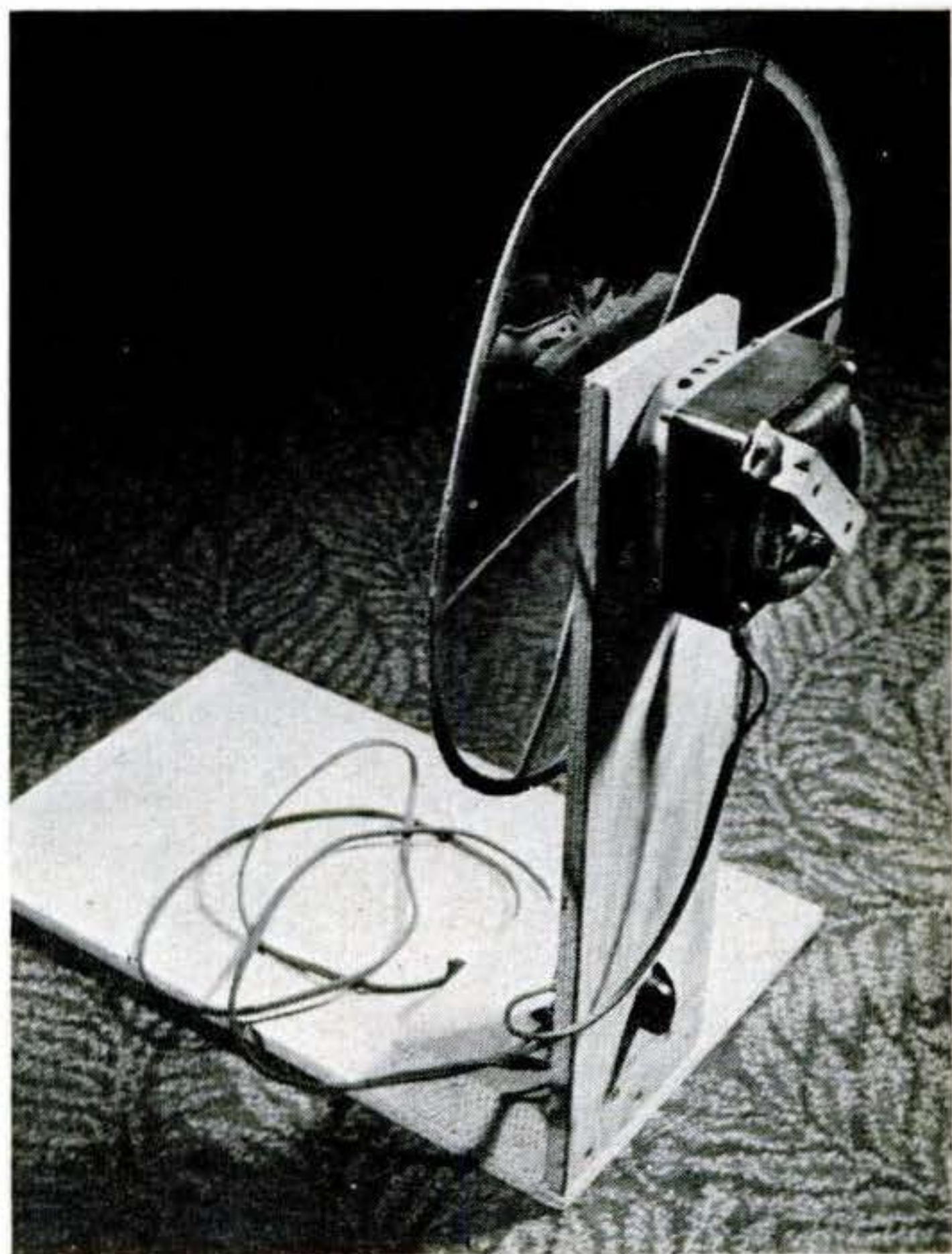

**Except for a condenser and switch in the horizontal sweep circuit of the set, this is all there is to the converter: a color wheel of cellophane, a phonograph motor, and a rheostat.**



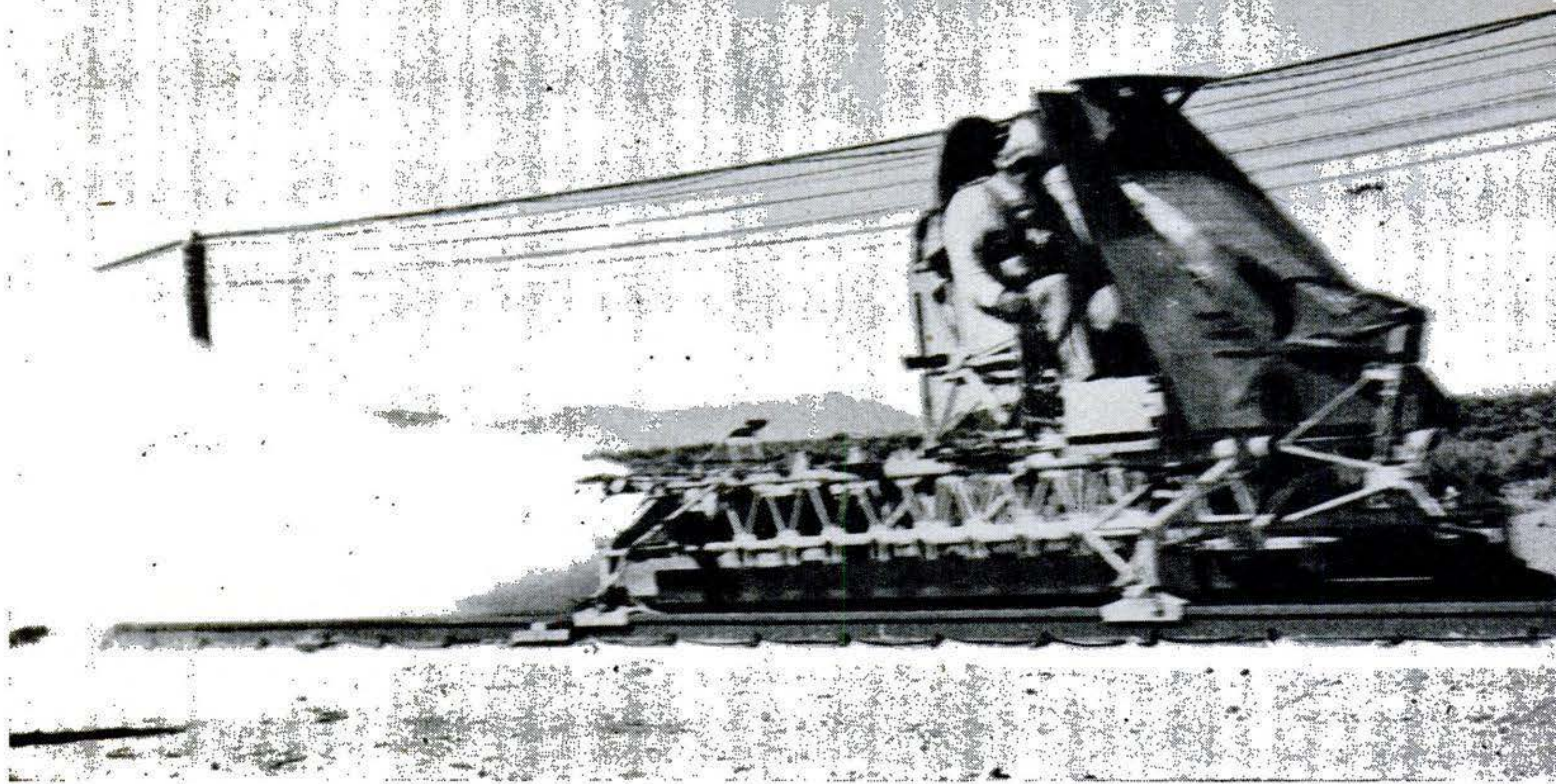

# *Airmen "Crash"* *On Rocket Sled*

**W**HEN the first man-carrying rocket takes off on its "25-G" climb into the void surrounding the globe, the medical boys will know in advance exactly what acceleration the passengers can withstand.

They're finding out now with Hot Rod No. 1, a rocket sled that grinds to a slow-down 70 times as fast as an auto can, simulating the death-dealing forces of air crashes.

Eight Air Force volunteers at Edwards Air Base, Calif., have taken 47 bone-shaking rides on the fire-spouting vehicle. Parts of their bodies have been momentarily subjected to as much as 57 G of force—57 times the pull of gravity.

Object of the speed dashes and quick stops is to learn how many G the human body can take during acceleration or deceleration—negative acceleration, as in a crash—and to develop equipment to safeguard airmen and passengers in crashes.

Riding backward, with the seat to cushion your body, you can easily take 35 G, trials show. It's more rugged if you face forward. For airmen who must, the experiments have already yielded a life-saving develop-

ment—a 250-square-inch harness of double nylon straps fastened to a lightweight aluminum seat strong enough to withstand 150 G. This may enable many a pilot to walk away from a crack-up.

Four modified Jato rockets propel Hot Rod No. 1, designed by Northrop Aircraft, Inc., along a 2,000-foot desert track. Its chrome-moly chassis mounts a passenger seat, a windshield, and telemetering equipment to transmit the readings of G-force gauges. Instead of wheels, it glides on aluminum-alloy slippers shaped to hold it to the rails. A slight aerodynamic lift as the sled gains speed reduces friction and eliminates the need for lubrication.

### *World's Most Powerful Brake*

Racing at 150 m.p.h. or more, the 1,500-pound sled hits the most powerful brake in the world. Twice, eight sets of four brake shoes each clamp hard on two keel-like, armorplate runners under the sled. (In all there are 45 sets of four shoes that can be actuated.) They slow the sled in eight feet to a mere 70 m.p.h.



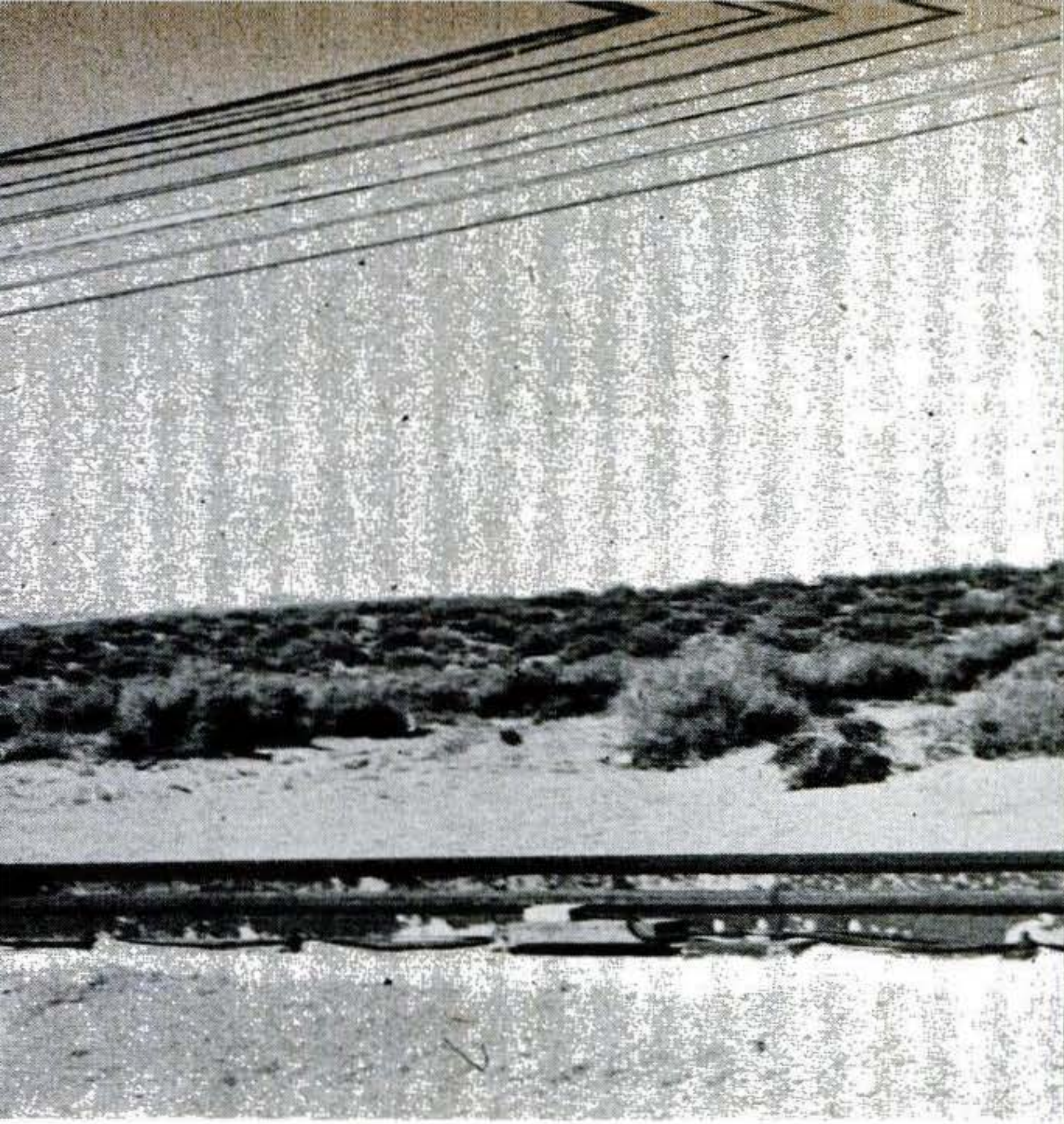

**Rockets boost man-carrying sled to 150 m.p.h. for crash against world's most powerful brake. At right, automatic movie camera aboard tells story of how rider feels about it. From top to bottom, he's shown awaiting start; thrust backward by car's rocket-powered acceleration of 2.37 G; thrown forward as whole car quivers under 35-G impact of brake; straightening up as jolt ends and strain against straps eases; and grinning at end of the run, as he removes rubber mouth guard he wore to protect teeth.**

The result is the same as crashing a car at 75 m.p.h. into a barrier that stops it dead in nine feet! Then the sled coasts on, slowing more gradually. If it doesn't stop in the next 550 feet, it smacks a wire arresting cable that halts it near the end of the track.

How does it feel to take the ride? Says one volunteer: "Ever seen a man strapped in a chair waiting for a firing squad? Then you're off. You get a moderately good thump, and it's all over. Sweating out the start is worse than riding."

None of the volunteers has ridden with the brake set up really high. Captain G. tried it, though. Dashing Capt. G (G for gravity) is a 180-pound dummy shaped like a man. He was the rider when the sled plunged against the brake at 177 m.p.h. It got the whammy from 15 sets of brake shoes. The carriage ground to a dead stop in the next eight feet. But Capt. G. didn't. He carried away the windshield, hit the concrete 90 feet away, and skipped in a cloud of alkali 789 feet across the desert. That was 50 G of deceleration in action. ▶

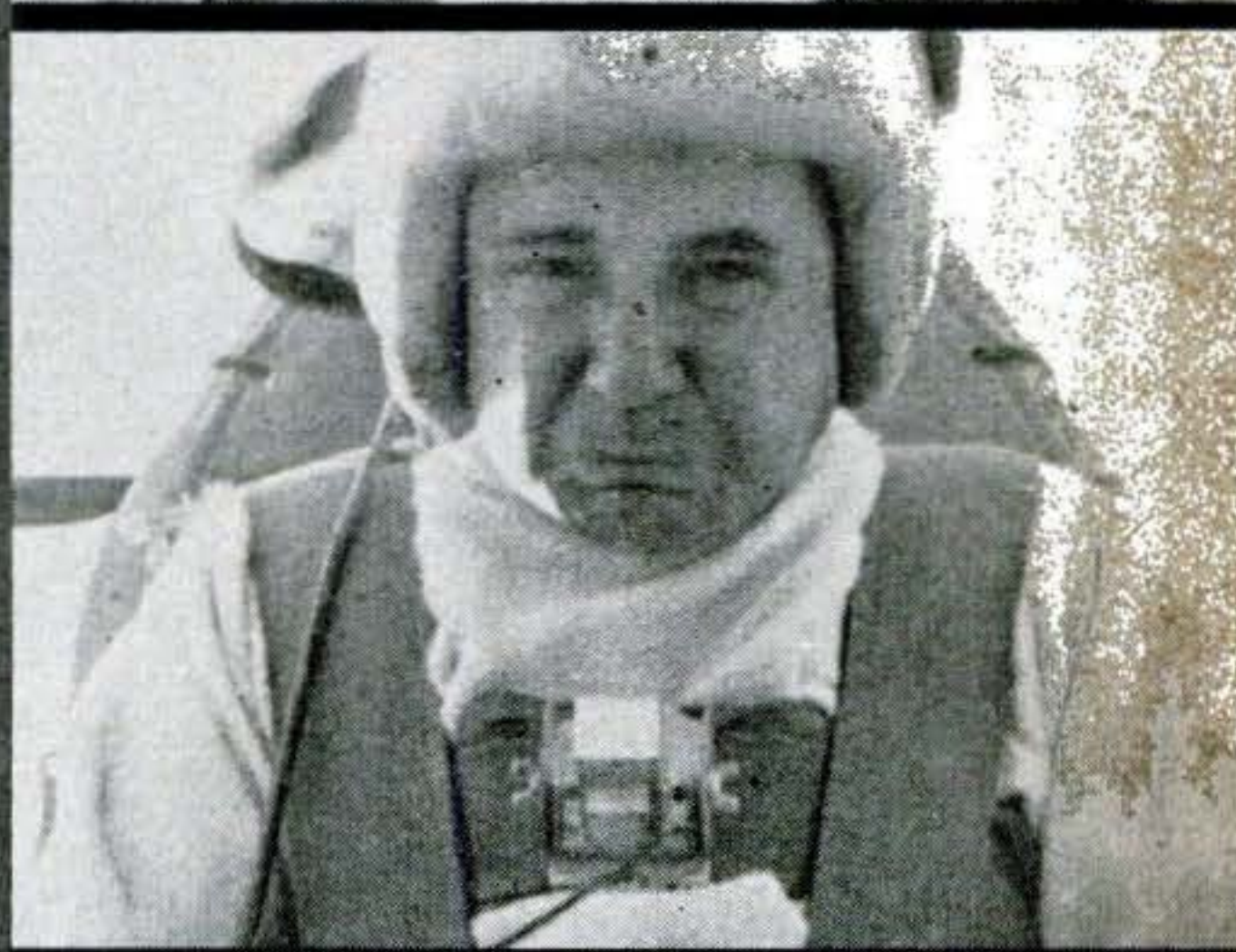



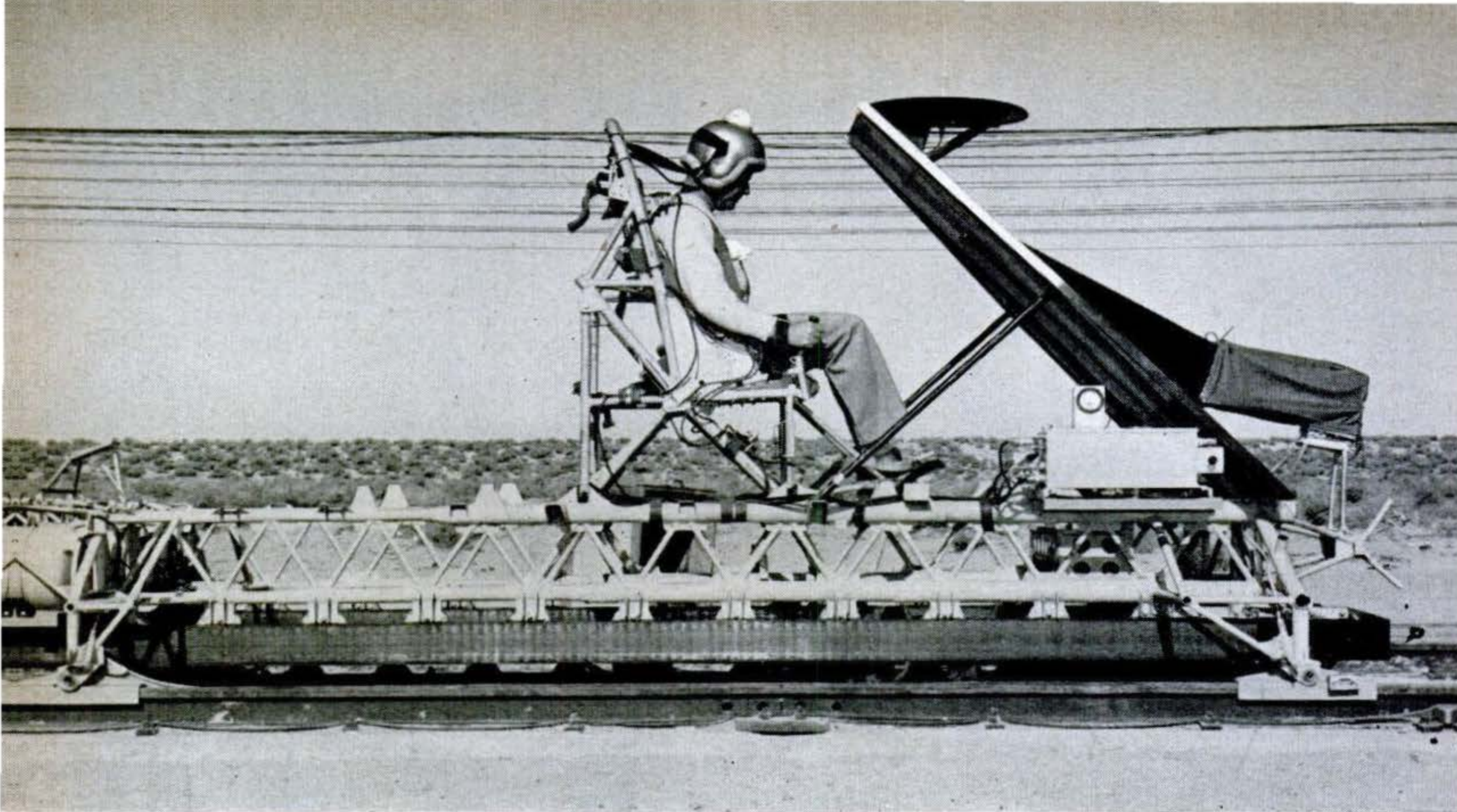

**Muscles tense,** Air Force volunteer awaits impact of rocket blast that will send car screaming down track. Circular platform atop windshield carries radio antenna that transmits data to

trackside receiver. Camera within covering at right records subject's reactions. Track brake will grasp runner of armor plate seen along side of car just above rail of track.

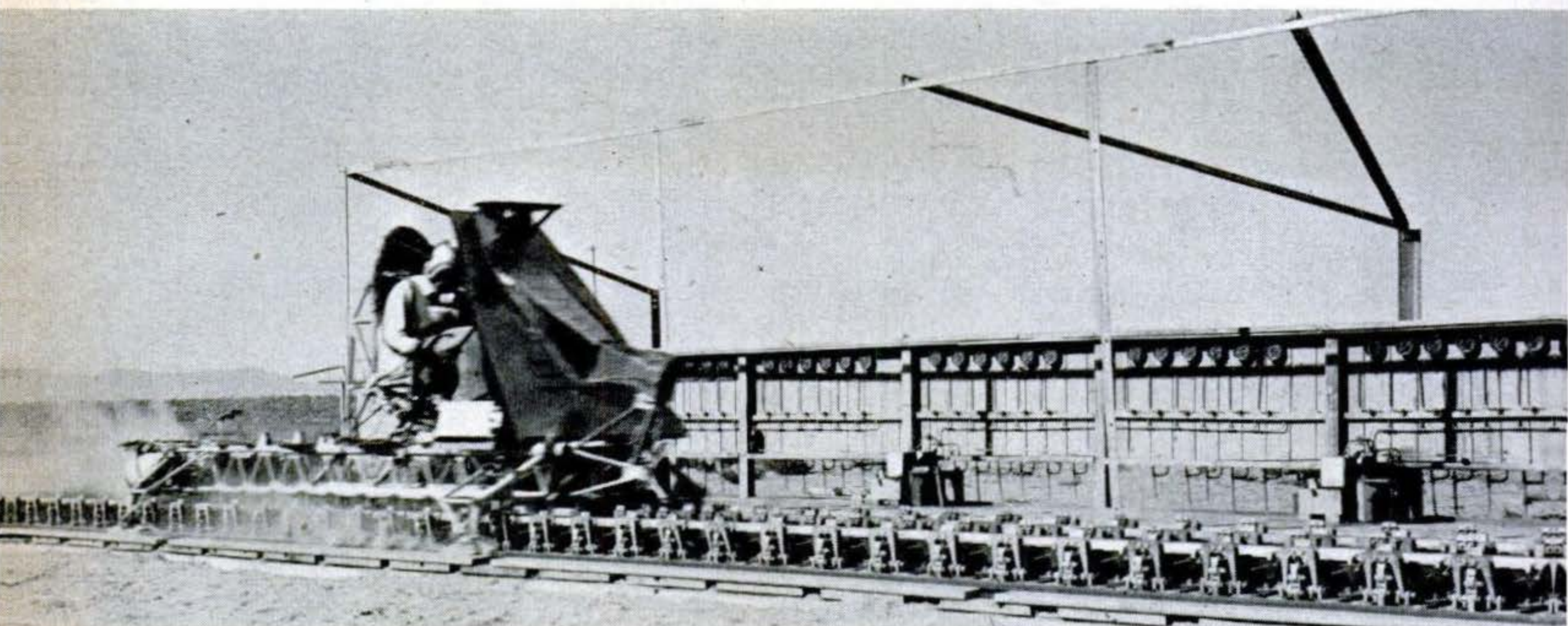

**Sled has reached full speed** and coasts with rockets burned out as it hits braking section

of track, above. World's most powerful brake slows it from 150 to 70 m.p.h. in 1/6 second.

**Brake works like row of mousetraps.** When cams on car hit U-shaped triggers, preset mecha-

nism clamps brake shoes on runner. Shoes (below) are cast iron molded on steel.

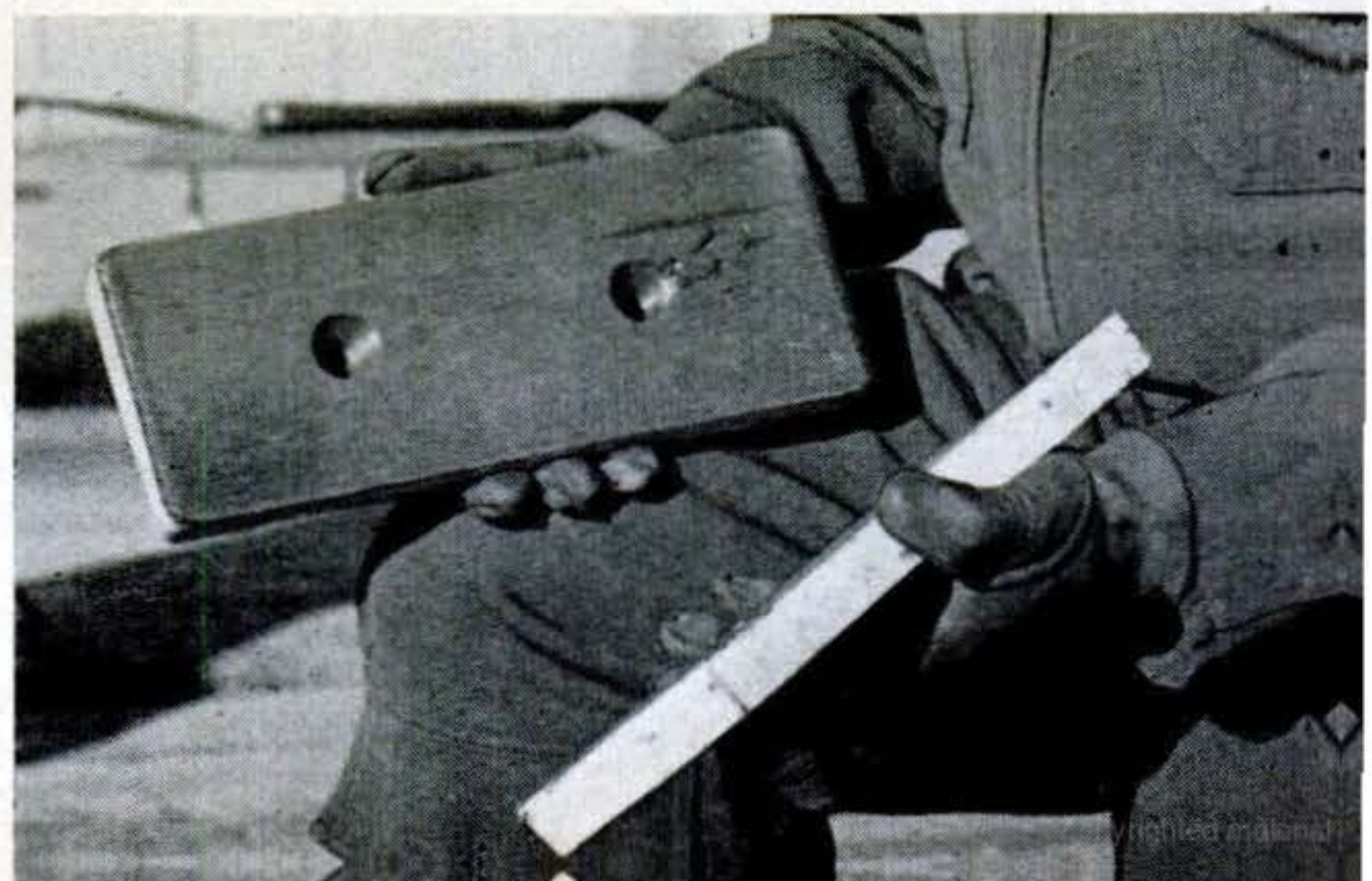
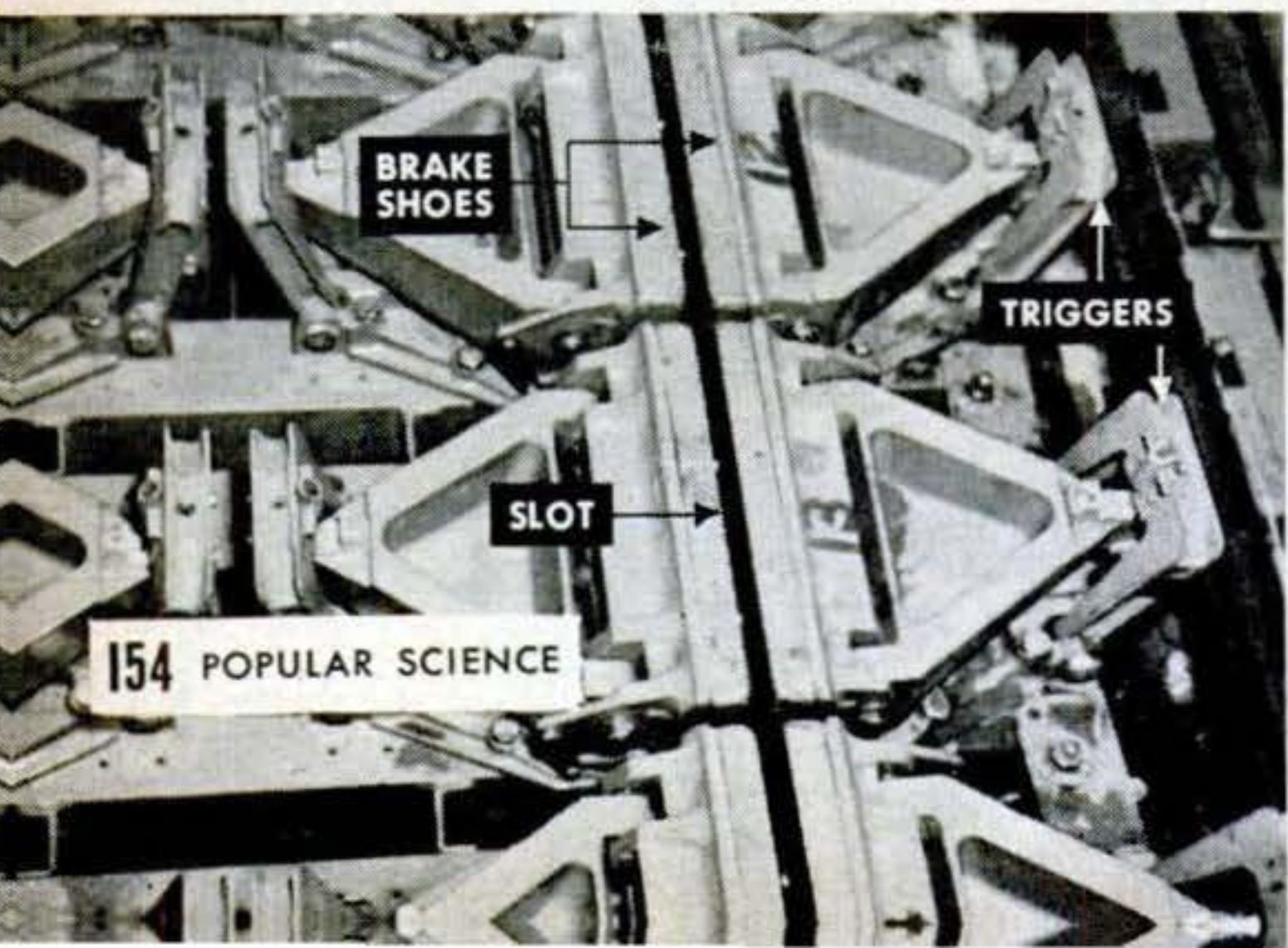





**Helpers strap rider** in seat and adjust his crash helmet in preparation for a run. Gauges attached to his chest strap and helmet register the G-forces to which his body is subjected.



**Last step** before run is arming rockets. Electric igniter resembling spark plug fires rocket by touching off highly active pelleted powder. Its flames ignite solid-fuel propellant.



**Braking section** of track begins 1,250 feet from starting point of sled's run and is about 50 feet long. Slots of inner rails guide sled's braking runners between pairs of brakes.

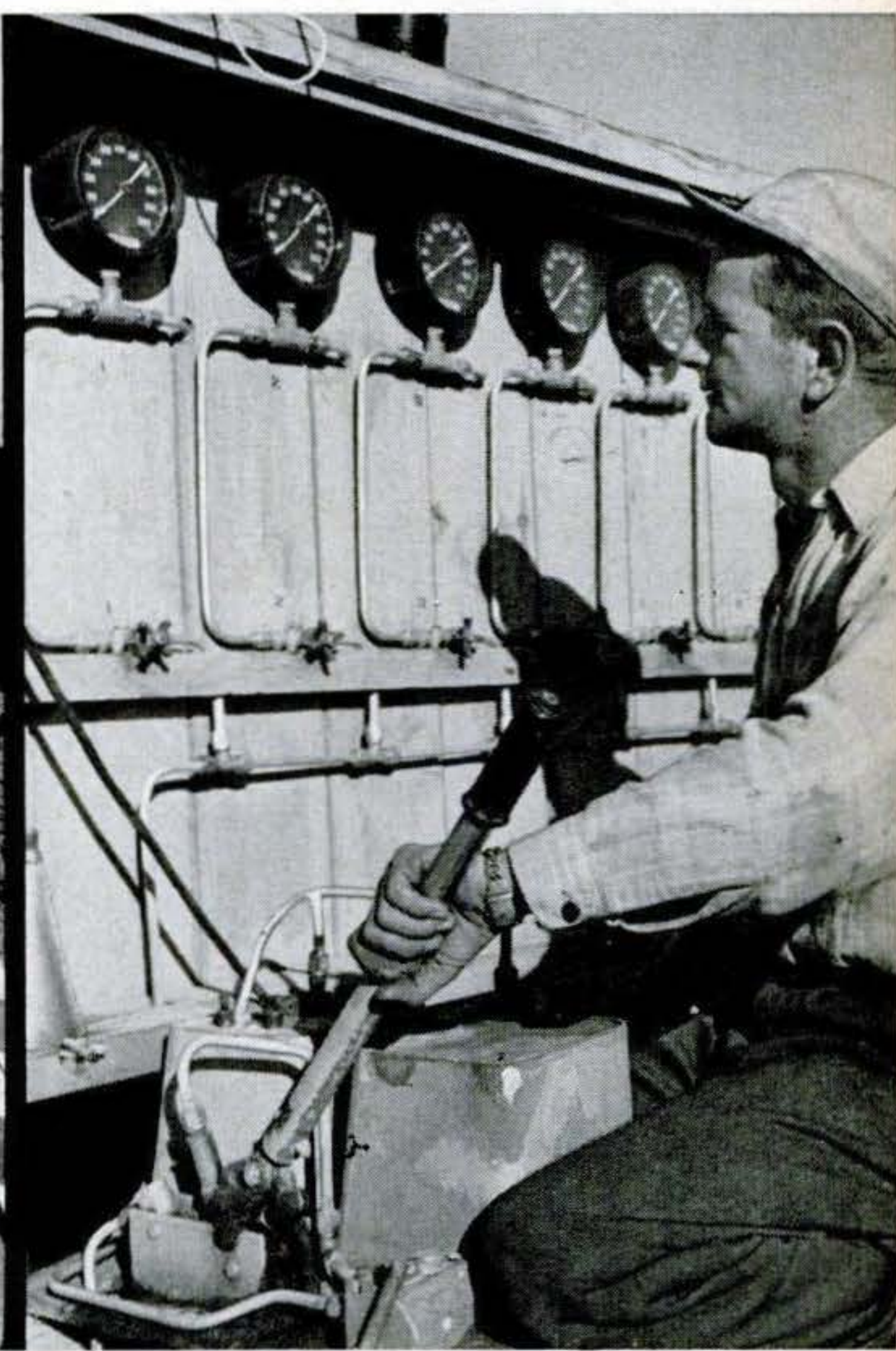

**Aircraft-type hydraulic pump** supplies pressure used to actuate brake shoes. When all is ready, dials at top of picture will show pressure of 800-850 pounds per square inch. ▶



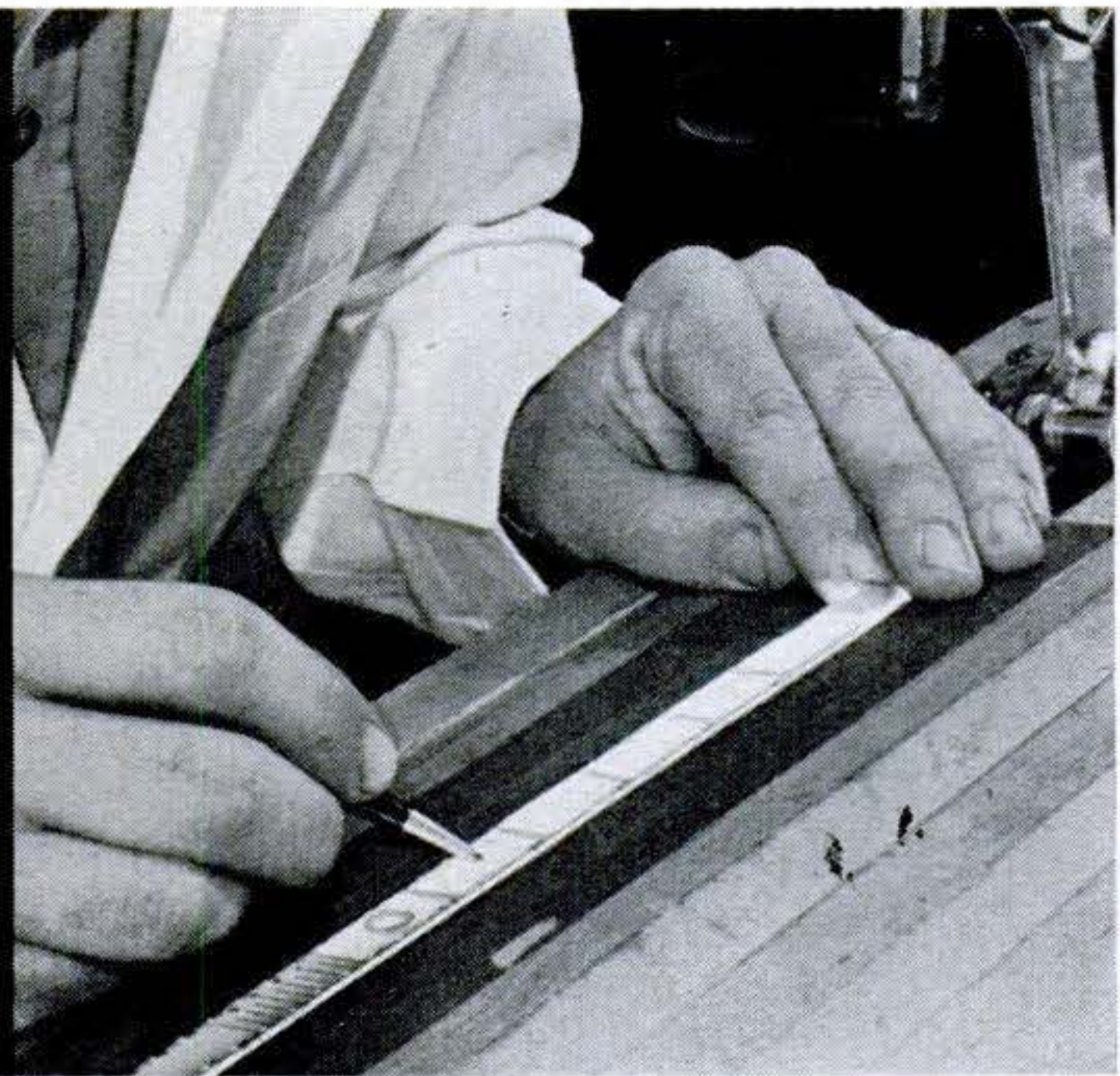
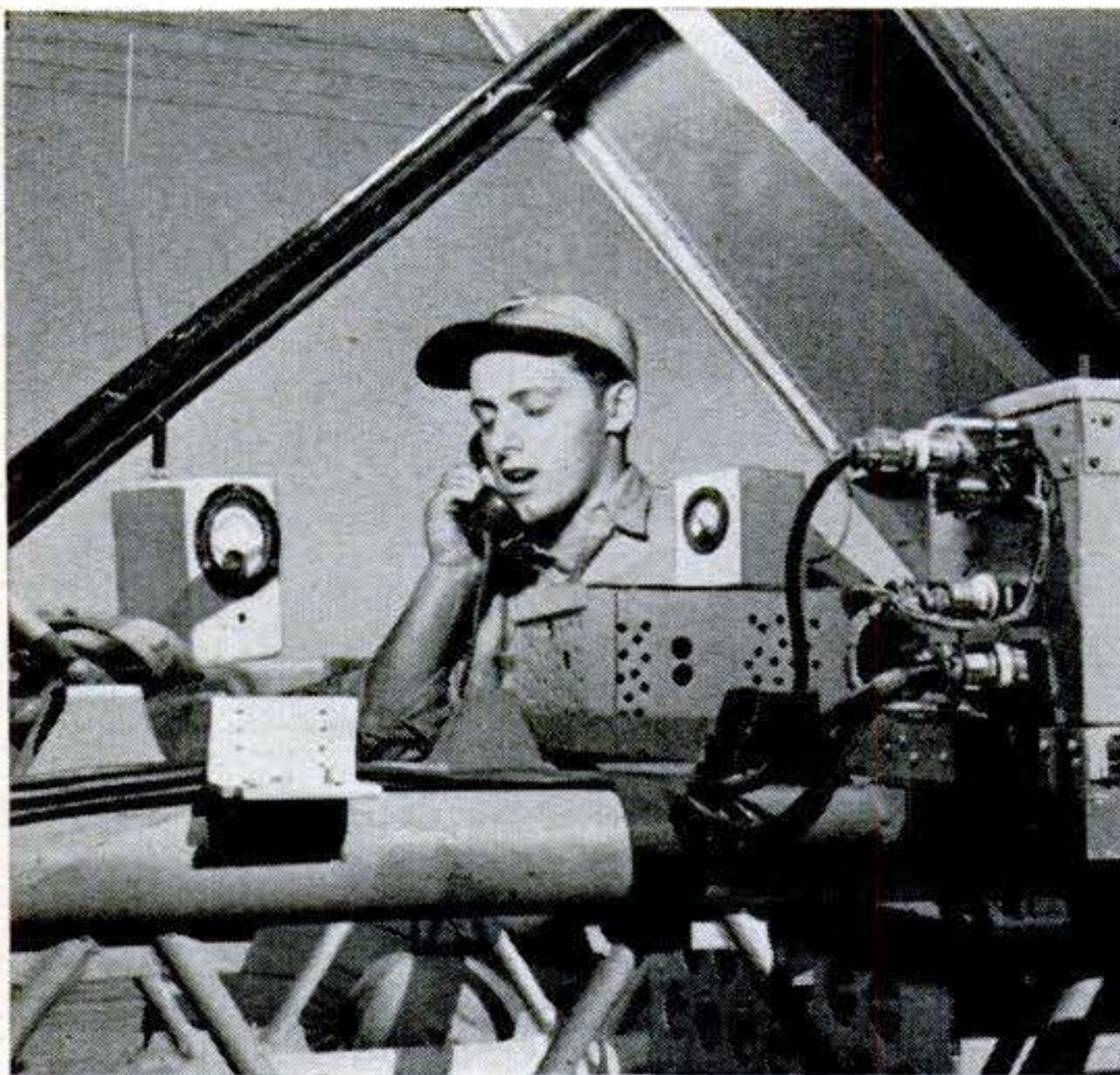

**Shockproof teletiming equipment** on sled transmits four radio signals simultaneously during run. It is so rugged that it would keep right on working if kicked about like a football.

**Film record,** timing each part of run, is made by camera in trackside control room. Camera photographs signal lamps that light up as sled flashes past magnetic coils laid along track.

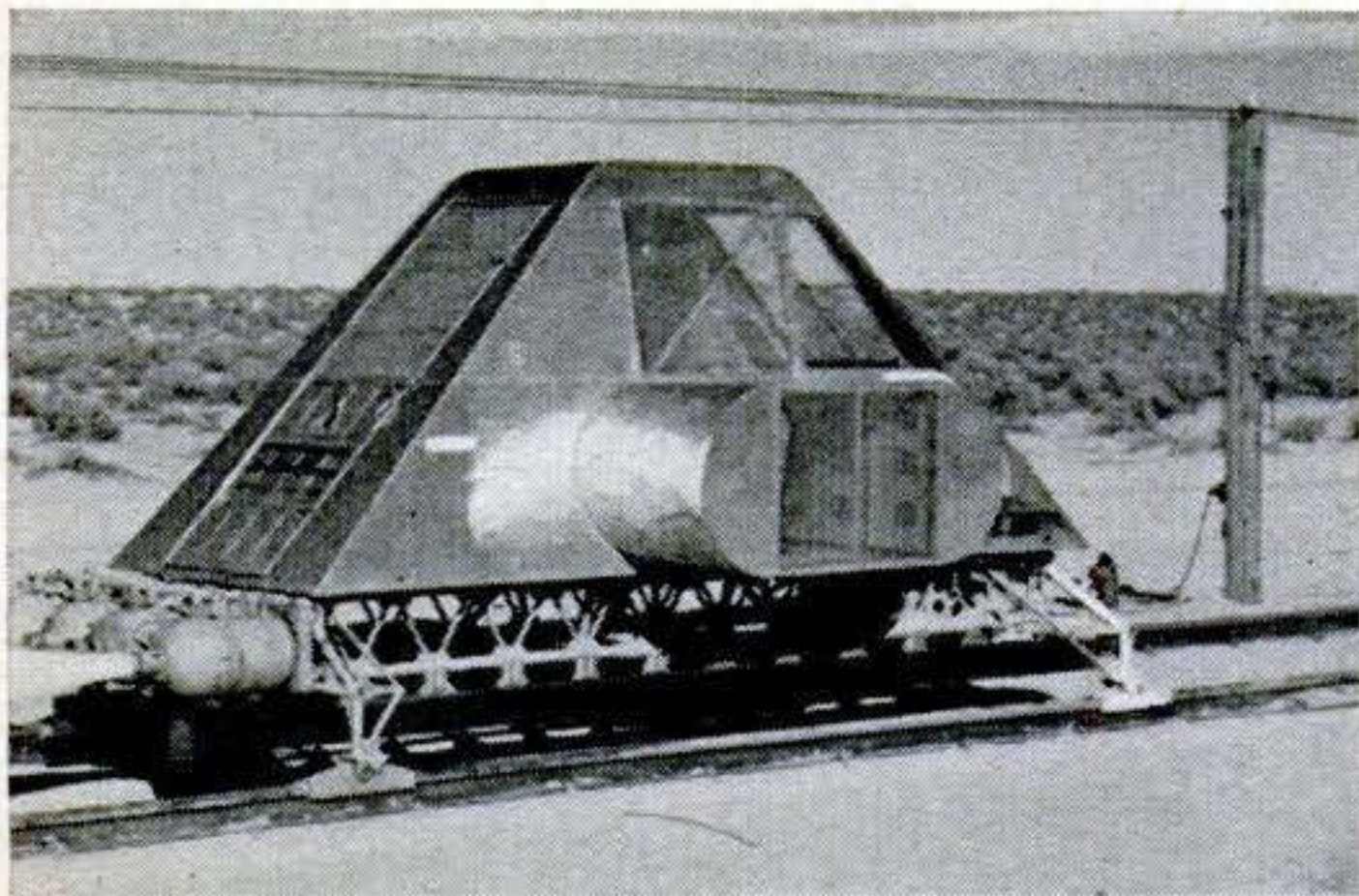

**When first built,** rocket sled had enclosed body as above and was called the "Gee Whiz." Experimenters later remodeled it to present open design, with windshield for passenger.

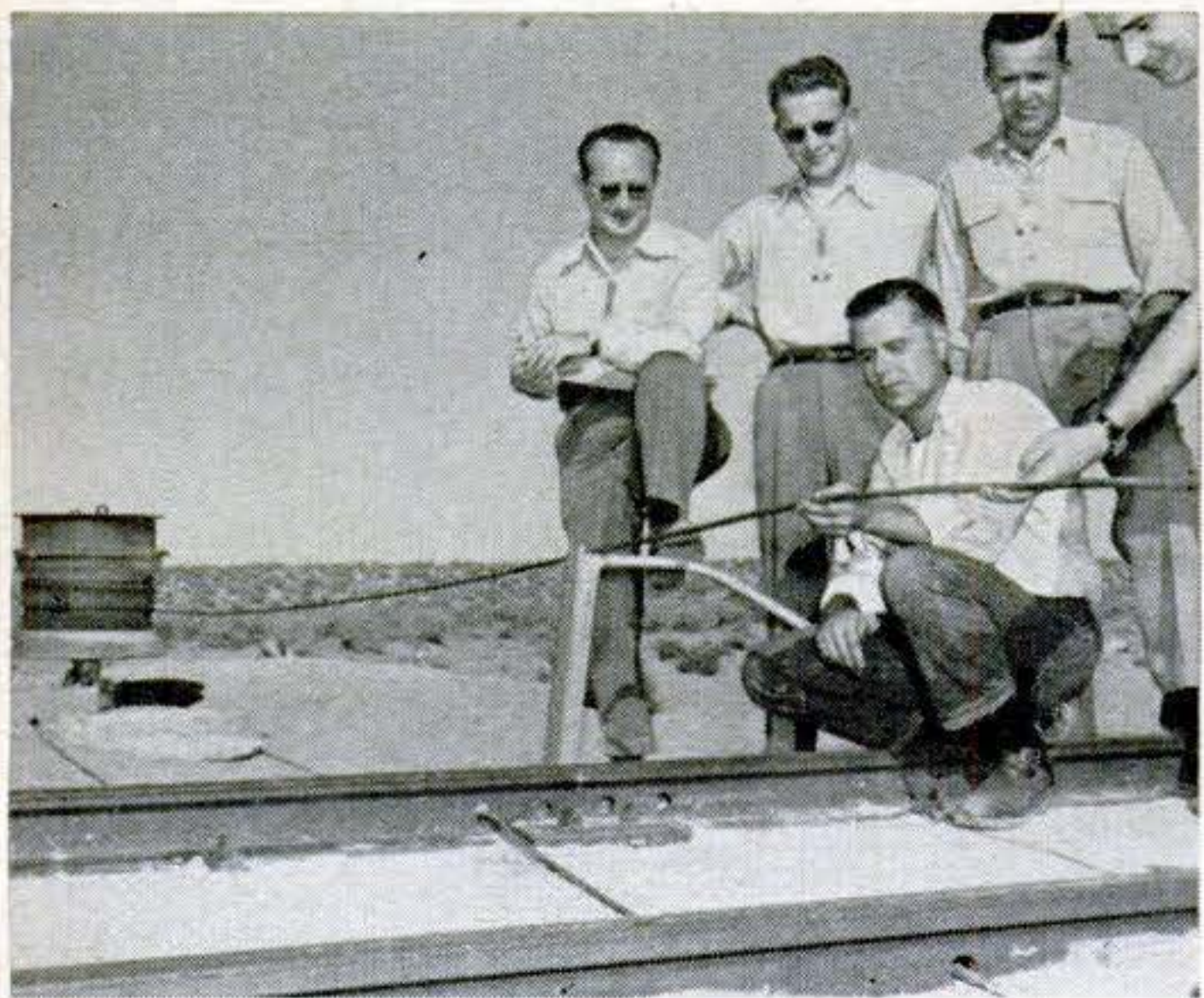
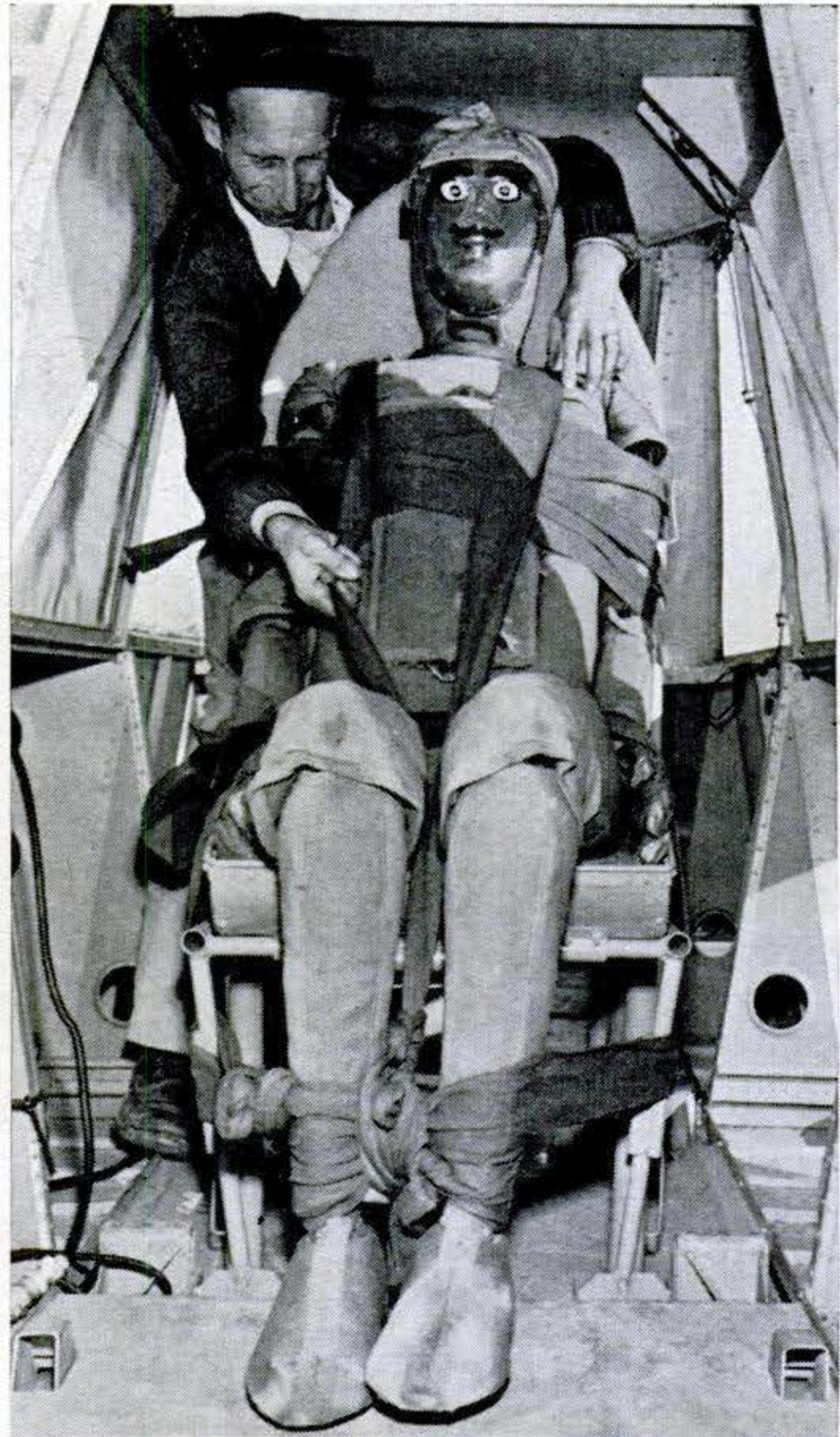

**Arresting cable,** near track's end, stops sled coasting into it after running past brake. Cable unreels from pair of hydraulically braked drums so as to provide shock-absorbing "give."

**Capt. G.,** 180-pound dummy, had wildest ride of all on rocket sled. They gave him the works by braking sled from 177 m.p.h. to dead stop—and he took off on a solo flight all his own.



## Curved Scaffold Fits Capitol Dome

THIS hanging scaffold (right) makes easy work of the previously awkward job of repainting the inside of the dome over the rotunda of the National Capitol in Washington, D. C. The new aluminum structure, specially designed for the Capitol, is suspended from the balcony railing, and curves to follow the contour of the dome. At the base are wheels that roll around a ledge 50 feet below the balcony. Fixed platforms spaced two to six feet apart, depending on the curvature of the dome, serve both as steps and working floors for the painters. The scaffold, designed by the Washington Aluminum Co., weighs less than 1,000 pounds.

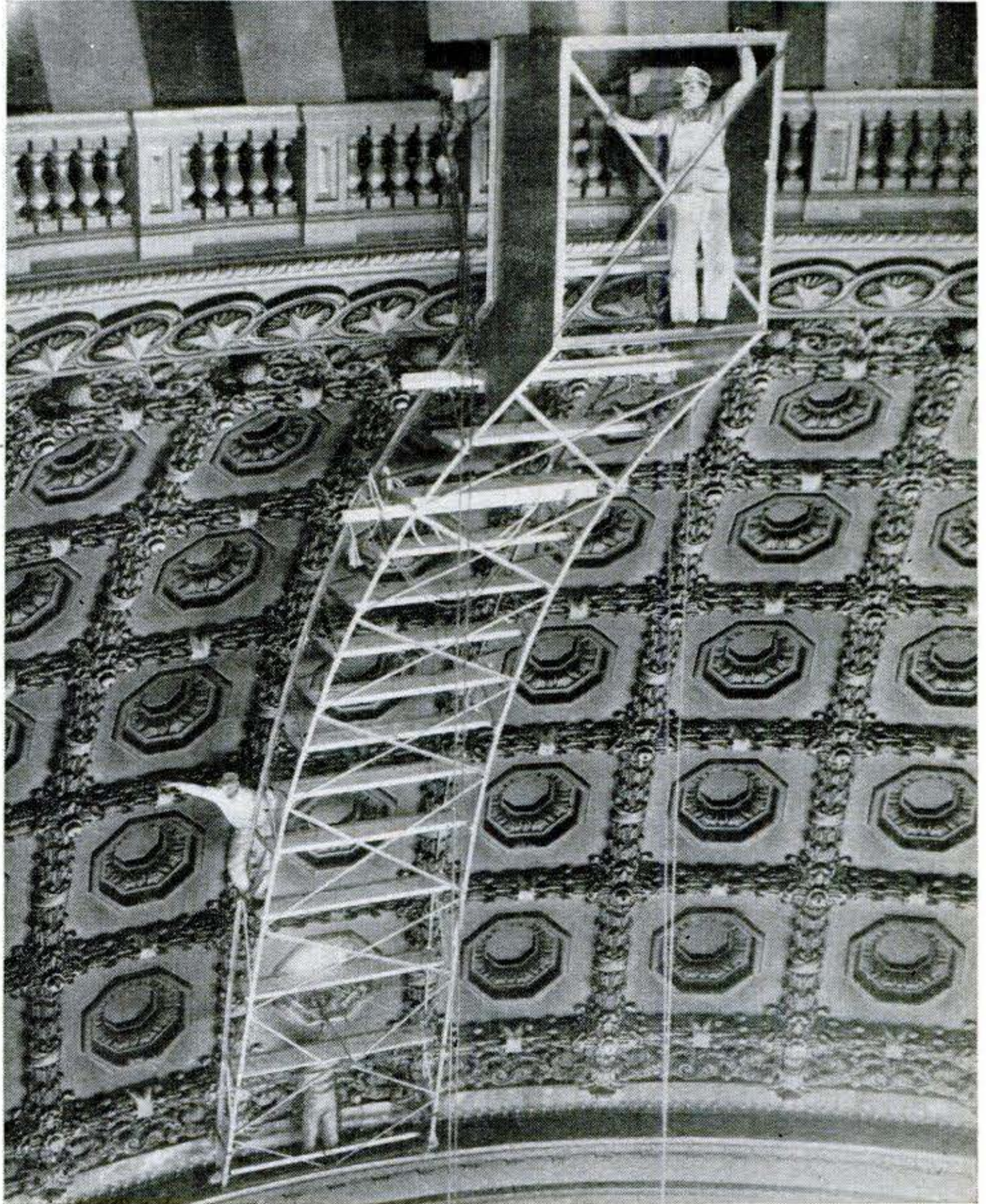

## Grass Seed Sprayed from Hose

ROLLING along Virginia highways, the truck shown above easily and quickly covers the steepest embankments with a spray of grass seed, water, and fertilizer. Using a

tank from an old watering truck, an ancient ferryboat motor to power the pump, and an asphalt spreader for spraying, the unit, with a crew of three, can do a better job than 25 hand sowers. Grass sowing not only beautifies the highways, but prevents erosion.





# How to Know Your Guided Missiles

**U.S.** GUIDED missiles have been given a new designation scheme by the Research and Development Board. With this system the RDB indicated the development of two interesting new types of missile: air-borne projectiles fired from beneath the ocean against ships, and similar ones directed against aerial targets.

In the new identification scheme, shown above, the first two letters are used to indicate the origin and destination. AAM is thus Air to Air. The M stands for Missile. These three letters would be followed by an additional service letter: A for Air Force, N for Navy, G for Army. Then comes a model number and a modification letter.

If the missile is an experimental type, the designation is preceded by an X or Y.

Pilotless aircraft used as explosive-laden drones retain their own designations preceded by the letter M, meaning Missile Aircraft. Planes used as "mother" craft for the control of these drones or other kinds of missiles are prefixed by the letter D, for Director Aircraft.

Guided Missiles for research carry the designation TV for Test Vehicle. One of four prefix letters indicates the type of testing: L for Launching, C for Control, P for Propulsion, R for Research. The service letters and model numbers follow.—James L. H. Peck.





## *Dual Turbine Produces 5,500 Hp.*

**T**HE first real challenge given the British in the race for more powerful gas turbines for aircraft is pictured above—two engines mated to drive one contra-rotating-prop unit. The manufacturer, General Motors' Allison division, says the combination produces 5,500 hp. This is better than two horsepower for each pound of weight—roughly twice the power per pound of piston engines.

The power units, known as the T-40 series, were developed for the U. S. Navy. They will be used in a Douglas carrier-based attack plane, a Convair flying boat expected to have a top speed of 390 m.p.h., and a North American attack plane. Either engine in a pair can be run independently and each drives both props. This will permit full power for take-off and single-engine operation for maximum fuel economy.

The new American twin turbines are also adaptable for transport use. END

Extension shafts, above, run from paired gas turbines to reduction gearing for contra-rotating props. Below, note compactness of twin unit on stand compared to predecessor J-35 on hoist.

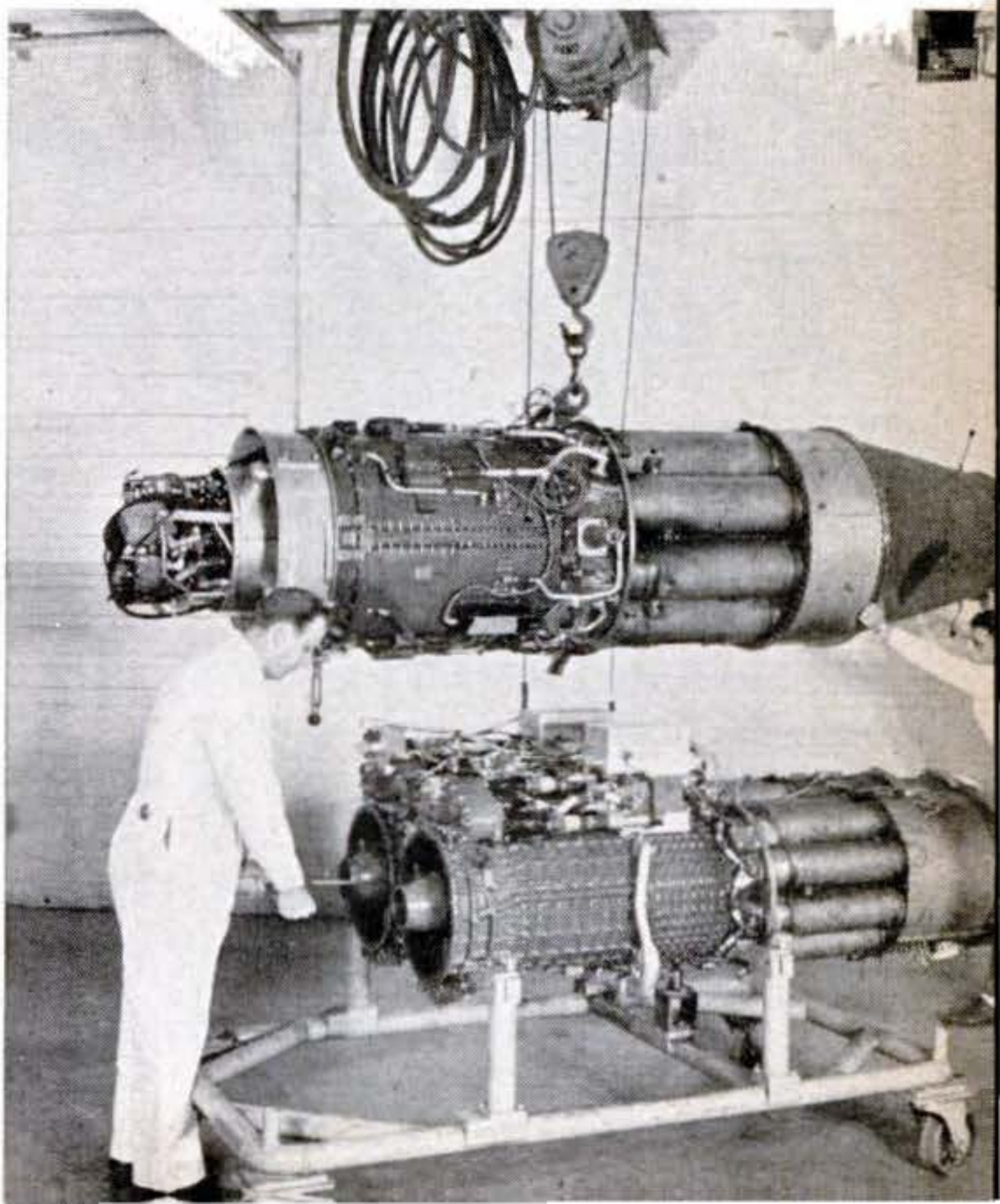



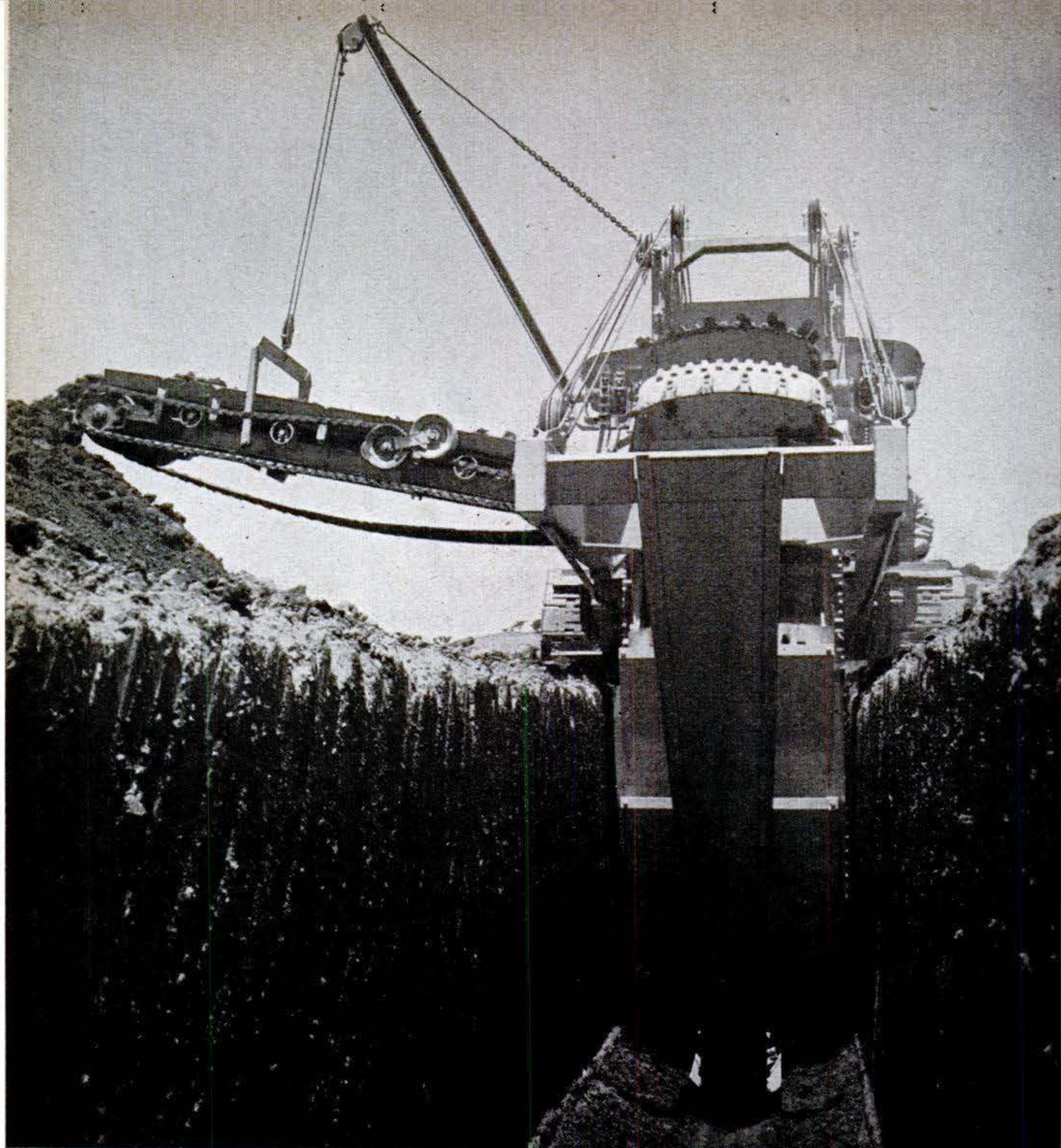

Rear view of 50-foot, wheel-type trencher shows size of bite taken by its steel jaws as it digs a

mile of trench a day. Belt conveyer piles excavated earth along side of trench.

## ***Mechanized Plumbers Lay Biggest Gas Pipe***

**T**HE giant machines seen in action here are making short work of laying a 34-inch pipe, the biggest ever fabricated for natural gas.

The 506-mile, \$63,000,000 welded-steel tube forms California's new Super Inch pipeline, part of a 1,600-mile system that will go into service early next year. Its job will be carrying natural gas from Texas to northern California, where it will serve customers

of the Pacific Gas and Electric Company.

Many of the machines were built to order for the record job. Others were rebuilt to make them big and powerful enough. Mightiest are a pair of trenching machines. Every day, each of these 50-foot, 32½-ton monsters digs a mile of trench 44 inches wide and 5½ feet deep. Then mechanical equipment applies a preservative wrapping to the pipe and lowers it gently into place.



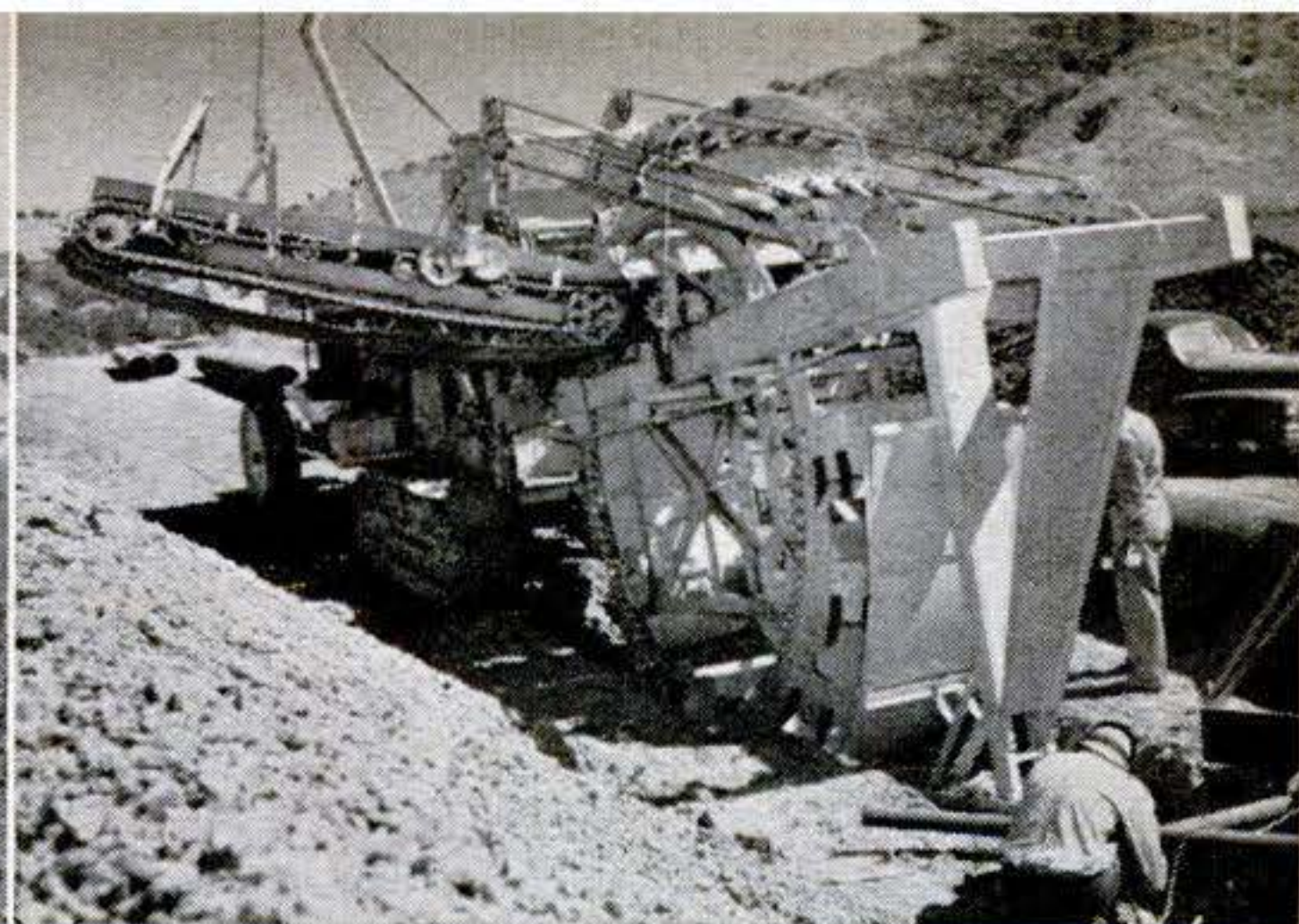

**Above-ground part of trencher** is seen in these front and rear views. The 32½-ton, self-propelled machine travels on crawler treads at any one of 32 different speeds, obtained by various

combinations of gearing. Normal 5½-foot depth of trench dug can be varied by raising or lowering wheel with cutting jaws. Maximum depth, attainable whenever wanted, is 8½ feet.

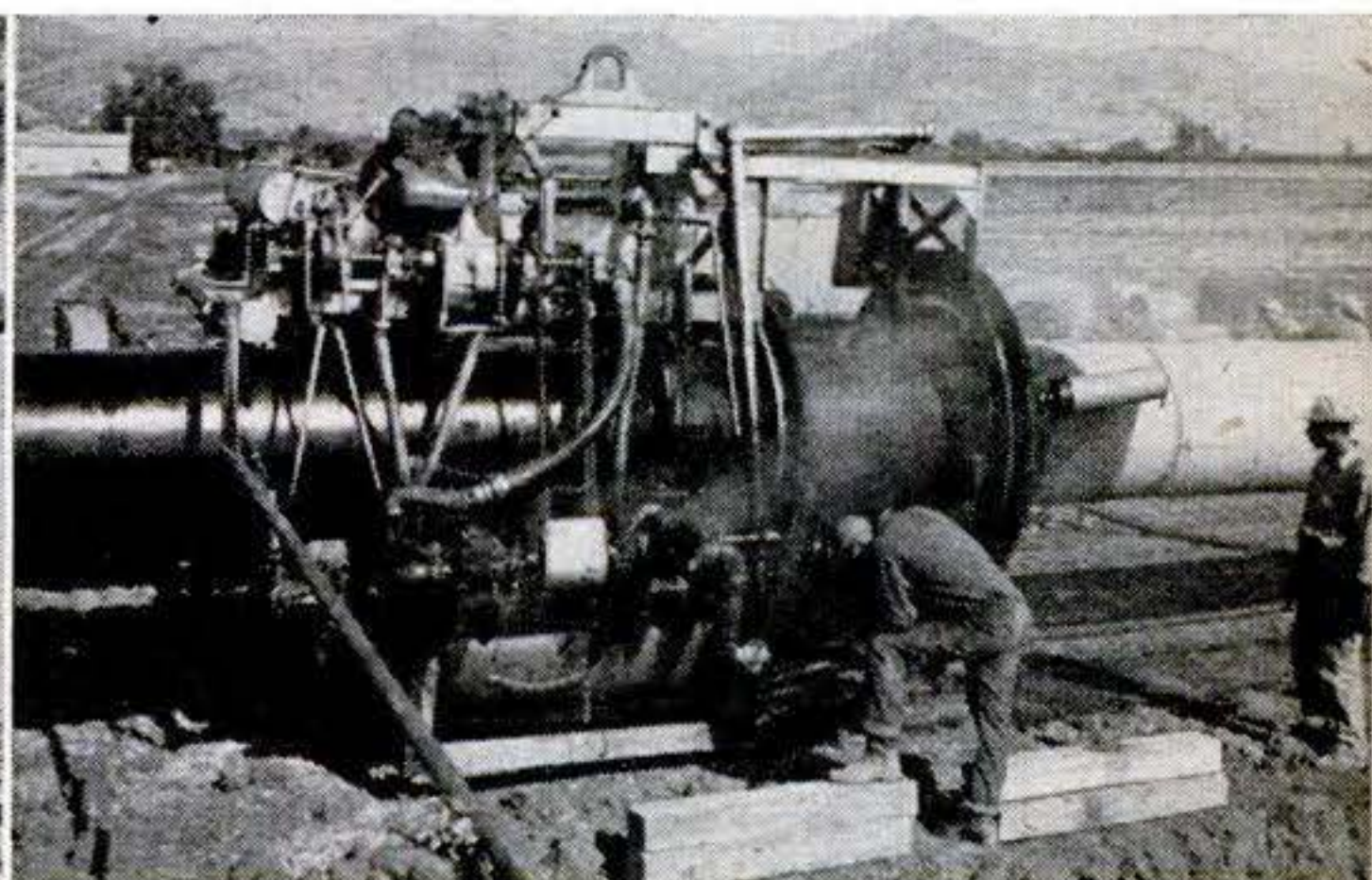
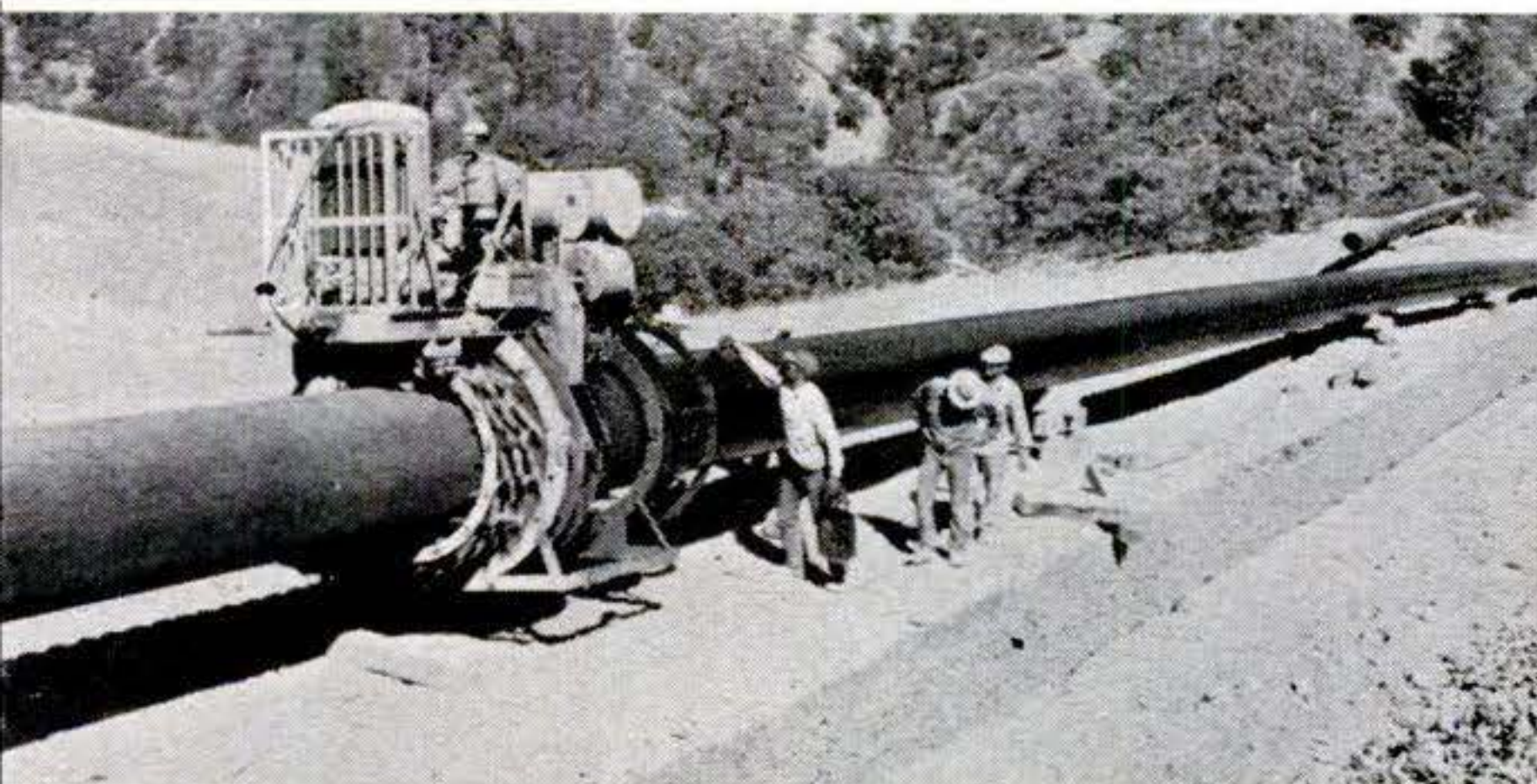

**Self-propelled cleaning and priming machine** rids pipe of scale and dust with contra-rotating steel brushes, then applies asphalt-base priming compound with revolving swabs.

**Wrapping machine**, also self-propelled, now coats pipe in turn with asphalt, asphalt-impregnated paper, more asphalt, and final wrapping of kraft paper in a continuous operation.



**Side-boom tractors** gently lower big pipe, with its preservative coating of asphalt and paper,

into trench. Pipe will begin delivering natural gas to northern California in January, 1951.





### Biggest Blasts Peel Mountains

WHEN Tennessee Valley Authority engineers needed rock for two new dams, they just blew the sides off nearby mountains. One explosion—the largest construction blast on record—used 1,362,095 lb. of Nitramon.

The big blows were made by drilling many short “coyote tunnels” into the mountain face and filling each tunnel with explosive (right). Then the whole thing was set off at once.

Scientists took advantage of the explosions to measure how tremors travel through the earth’s crust. Some of them were picked up by seismographs as far away as Ottawa, Ont.



### Stick-On Letters Make Signs

ANYBODY can make neat signs with these plastic letters. Backed with adhesive, they stick to any smooth surface—but can be pulled off and used over and over again. Faulkner Laboratories, of Bradenton, Fla., makes them in several colors.



### Weeds Plague Crystal Farmers



THE technicians who “grow” synthetic crystals for telephone filters have weed troubles a little different from those of dirt farmers. The photo at left shows a typical “weed”—useless because it contains unwanted water molecules—that grew from an idle solution at Bell Telephone Labs.

### Coated Gloves Won't Slip

A NEW type of work glove has a coating with a special Grip-tite® finish that helps prevent slipping. The Surety Rubber Co., Canton, Ohio, claims the new finish holds effectively even in lubricants, yet won't hurt metals or machinery.







### Dressing Room in Fire Engine

THESE British firemen don't have to stop to dress before starting for a fire—they dress on the way. Their new streamlined fire

engine has a cabin behind the driver's seat large enough to accommodate the six-man crew. Shown above during tests at Ilford, London, the vehicle is powered by a 160-hp. engine and carries a 50-foot extension ladder.



### Grinder Chews Up Light Bulbs

You can't just throw away a burned-out fluorescent light tube the way you do an ordinary bulb—the toxic beryllium powder remaining inside the tube, especially in the large quantity present when many tubes must be disposed of at the same time, is highly poisonous. For safe disposal, this grinder breaks the used glass tubes into small fragments that drop into a porous bag where a stream of water washes the dangerous chemical down a drain. The fragments are packed into tough-walled sacks for protection against cuts. Made by the Standard Equipment Co., of Chicago, the grinder can chew a tube in 10 seconds.

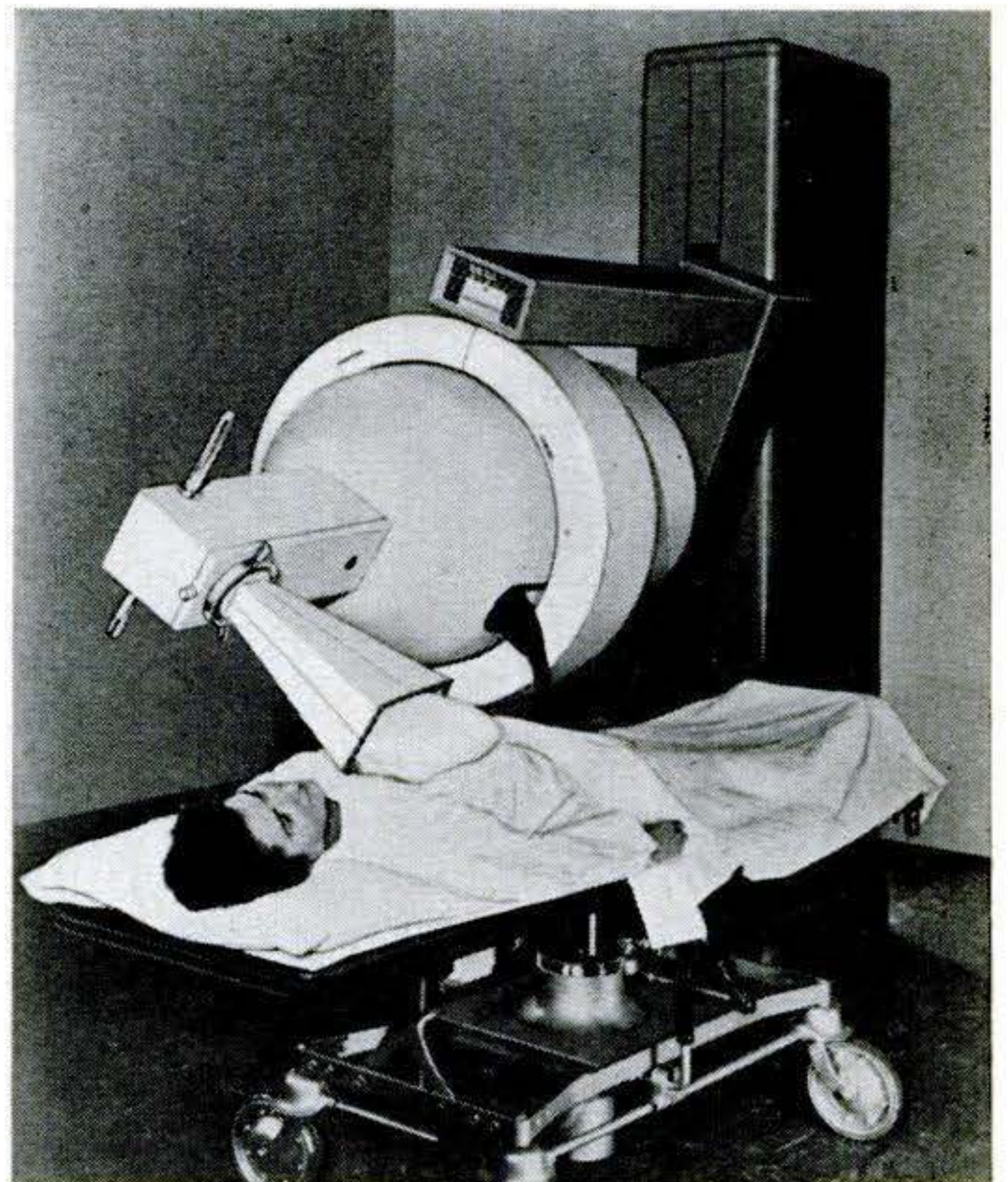

### X-Ray Unit Has Wide Range

WITH this new all-purpose GE X-ray machine, doctors for the first time can treat a wide range of ailments with a single machine. Called the Maxitron 250, the unit can produce all ranges from the softest rays for skin treatments to the most penetrating for deep-seated cancers. Secret of its wide range lies in a new beryllium "window" that permits the same tube to produce both high- and low-intensity radiation. Weight has been reduced more than 700 pounds by use of gas instead of oil as insulation.



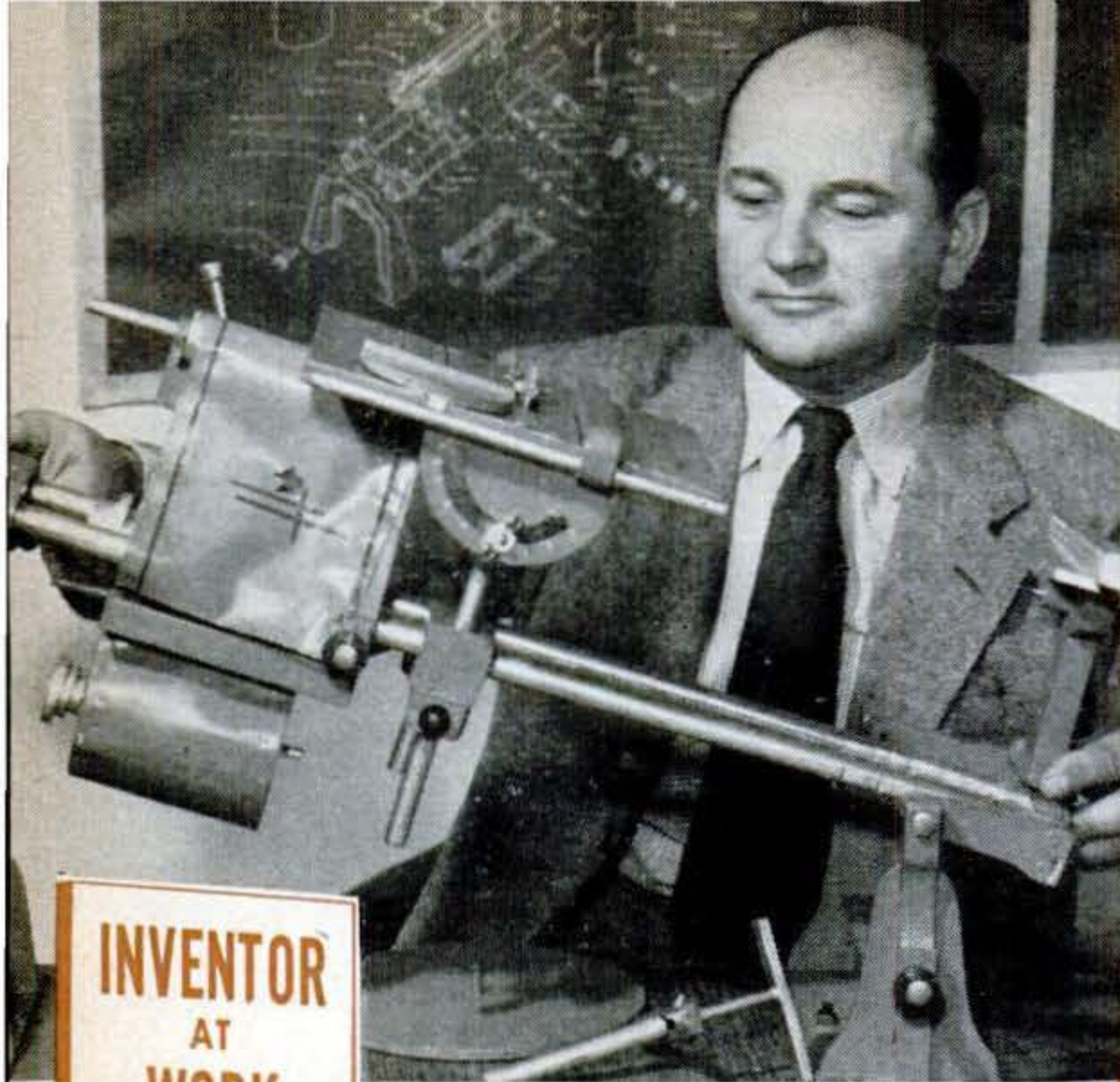

Moulin, San Francisco

**INVENTOR  
AT  
WORK**

**How the Shopsmith was  
"invented on purpose" as  
a work machine that made  
a power tool a household  
utility—and a howling  
sales success.**

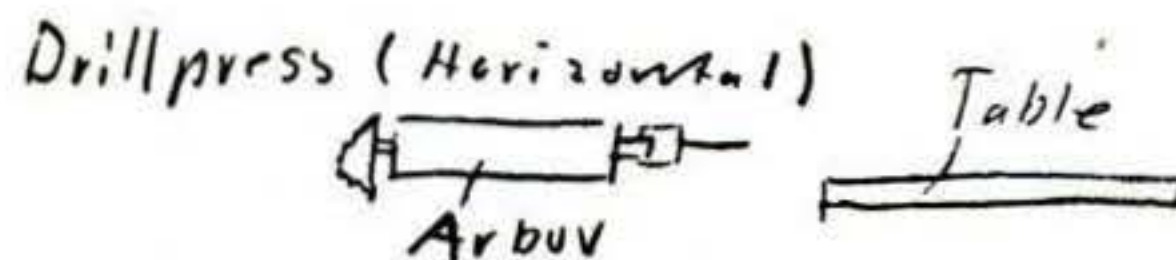
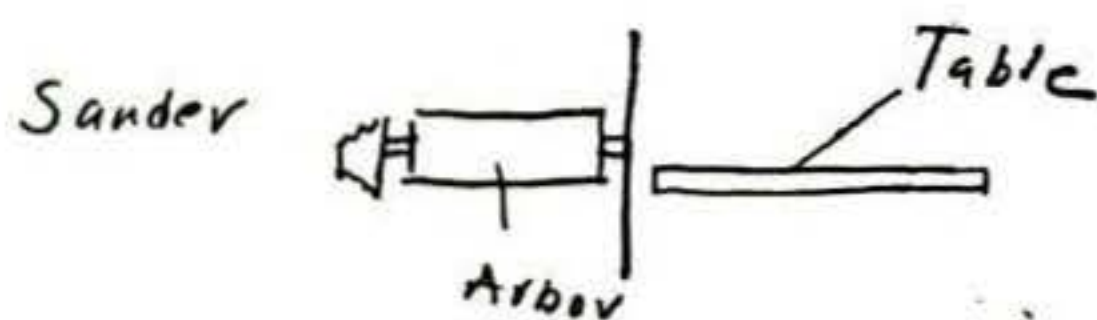
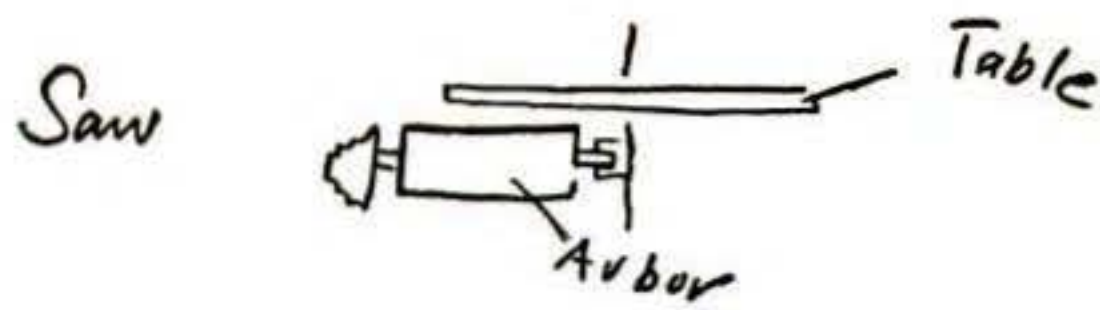

**Goldschmidt's own doodles** show idea's development. Single arbor was saw, sander, drill, but big problem was to get it vertical. At left, inventor holds first crude mockup.

# Dr. G's

# Motorized Tool Kit

**By Andrew R. Boone and Perry Githens**

*PS photos by W. W. Morris and Hubert Lockett*

EVER fingered a safety pin, and said to yourself, "I wish I had invented that!" Or have you ever, by trial and try again, come up with a happy answer to some puzzling mechanical problem? No matter that a hundred other men have found the same solution under the same necessities: you are an inventor, and this is your story.

Or perhaps you simply enjoy invention as a spectator sport. You cheered with Edison as he evolved his electric light, and with Whitney—Eli Whitney—the young Yankee schoolteacher, whose mind swept across a problem like wind around a steeple. Whose first sight of raw cotton mechanized separation of the seeds. And who fathered mass production, with interchangeable musket parts, long before Ford hitched it to power to turn out his automobiles.

Then this is your story, too. For it is one of those rare case histories of invention com-

plete from first gleam to final (and financial) success.

It is reported here, in full and for the first time, by PS Western Editor Boone from the factory in San Francisco, and by Editor Githens from his workshop in Westport, Conn.

**I**NTO Patterson Brothers, famous New York "department store for tools," rushed a man with a shopping list and a train to catch. Fascinated, he joined the crowd around a demonstrator who was putting a Shopsmith® through its paces—and missed his train.

Many a train has been missed, under

**Multi-exposure photo** at right shows how pivot permits quick change from vertical to horizontal. In practice, trick of sliding headstock toward pivot end to lessen weight makes job easy.



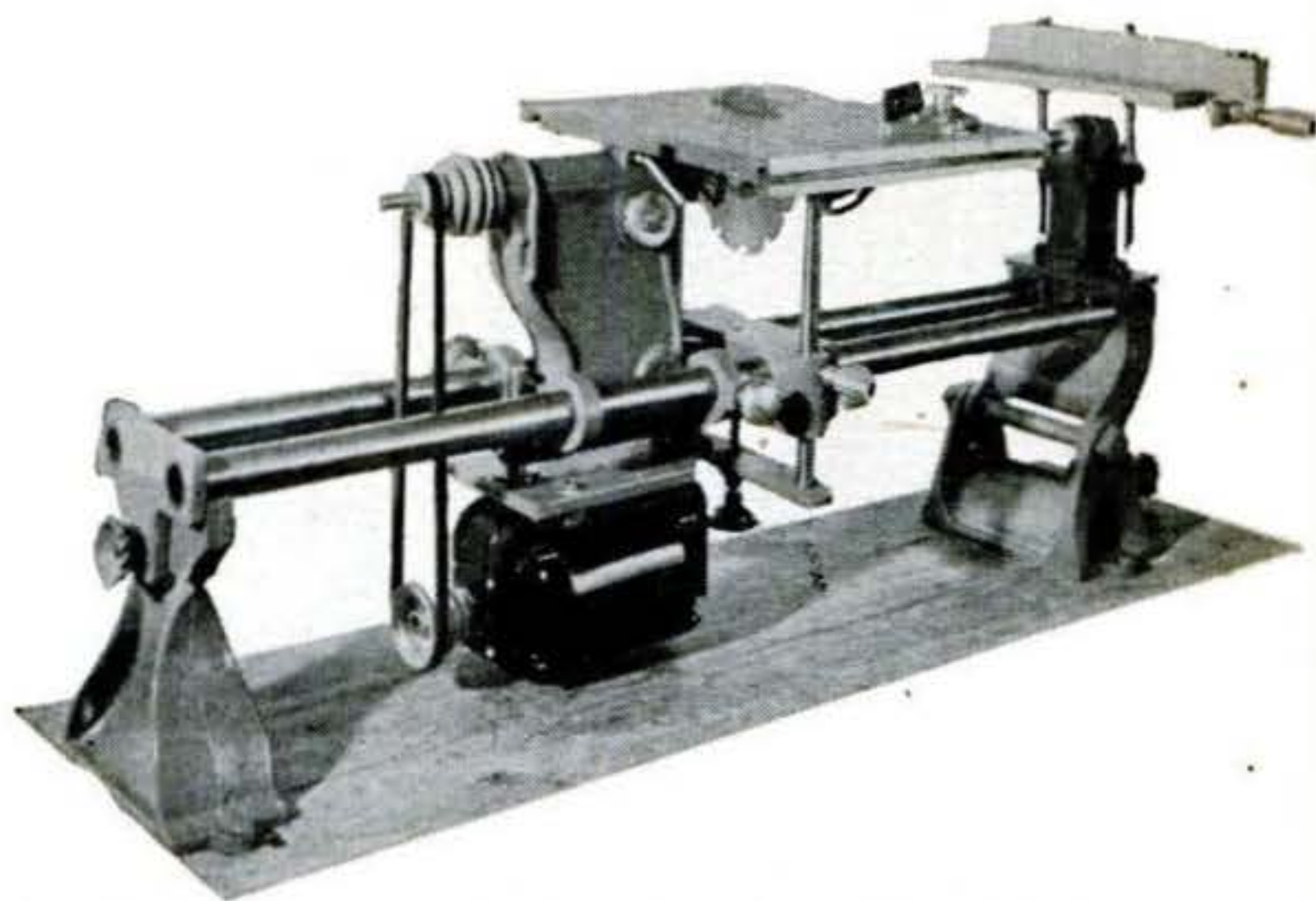
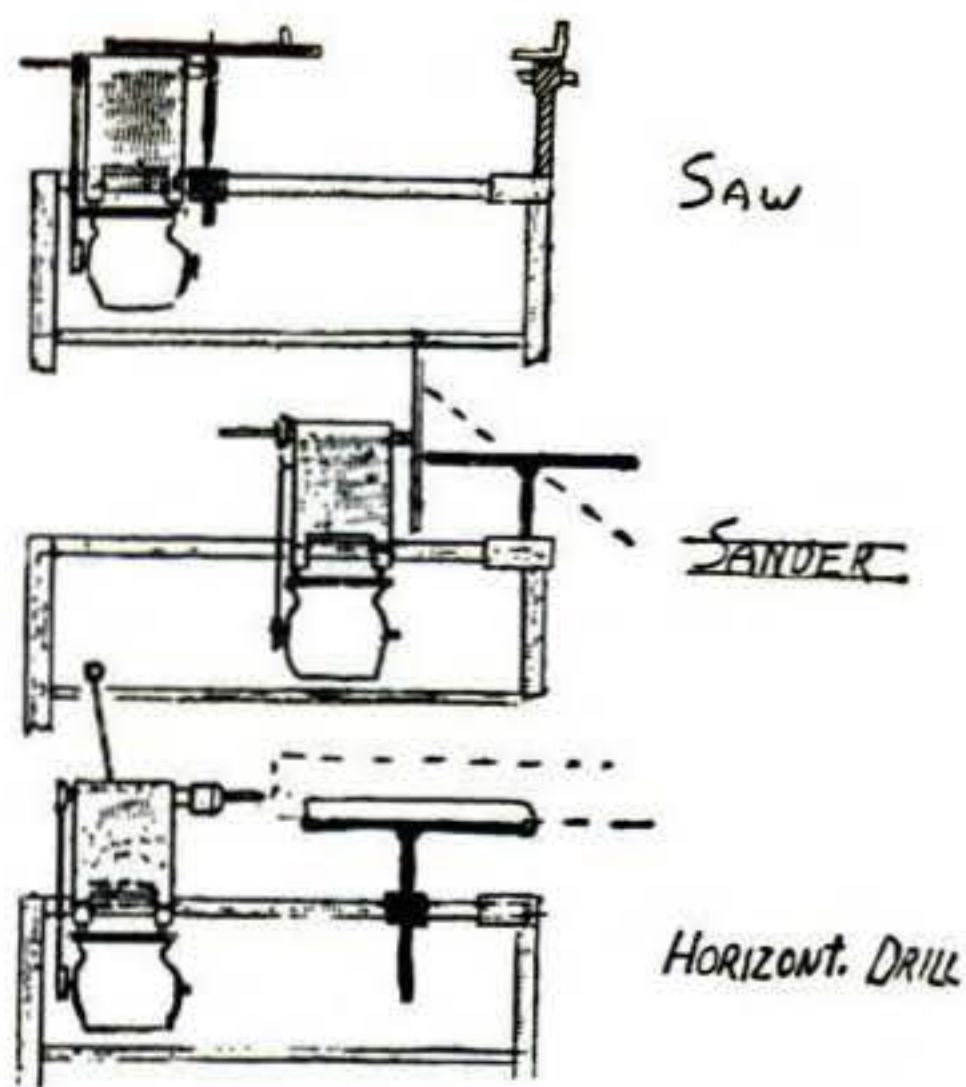

**Turning point** came, as later drawings show, when inventor hit on idea of pivoting end so machine could swing upright. Making headstock move instead of tailstock licked last problem.

**First working model**, assembled from scavenged parts and crude castings, looked like this. Note its close resemblance to final production model below, showing inventor's thoroughness.

### UPRIGHT AS DRILL PRESS

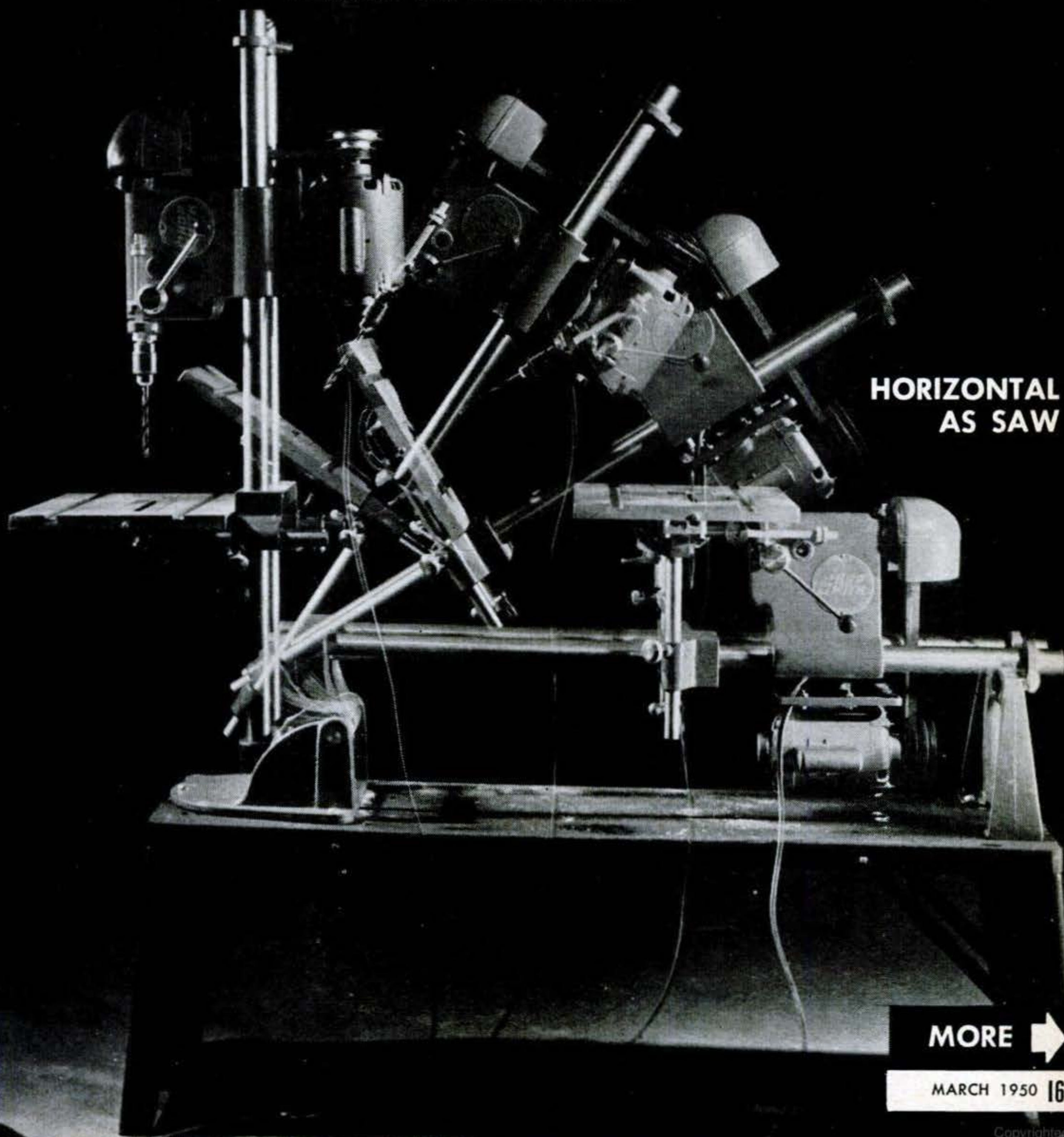

**HORIZONTAL  
AS SAW**

**MORE** ➔

MARCH 1950 165



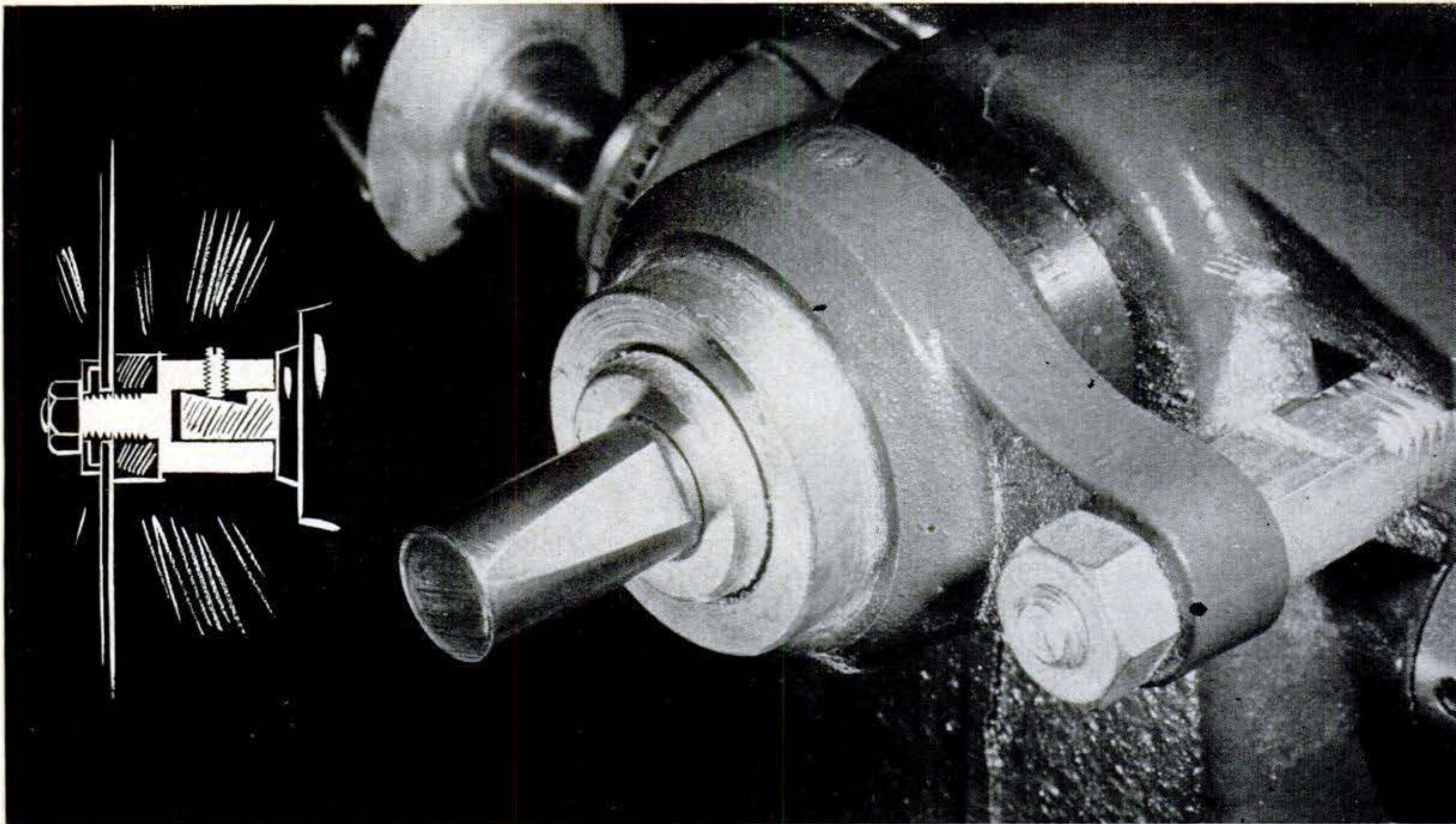

The locking flat on arbor slopes inward, eliminating danger of blade or chuck flying off shaft

at high speed. Even if locking screw loosens, fitting is held on tight, as drawing shows.

similar circumstances, by men whose skill is tried by a tack hammer. And many a spectator at these little Shopsmith shows has the hands that tell of a lifetime with tools. The only unusual thing about this particular man was that he already owned a Shopsmith and simply wanted fresh garnet paper for the sanding disk.

What makes the Shopsmith remarkable is not that it provides anything new in saws or sanders, but that it has wrapped up in one handy package all the most useful power tools. It has provided a basic work machine, adaptable to many tasks, that has become a household utility, like a washing machine or a mixer.

In fact, one husband who had to sell it to his wife in terms of its work, calls it his "mixmister" and uses it to mix dough with a bent rod in the Jacobs chuck. A plumber, building his own home, says it saved its cost in millwork on door and window frames. An airlines pilot, who hoisted a Shopsmith through a second-story window to floor and panel his "expansion attic," has now carried it down—over the stairs it cut—to make built-ins.

The Shopsmith was conceived as a unified power tool combining a bench saw, lathe, horizontal and vertical drill press, disk and drum sander. Attachments make

it a jigsaw, shaper, jointer, mortiser, grinder, buffer, and rabbeter. And these chores it does well.

But its enthusiastic owners, who presumably also use it for woodworking, have gleefully adapted it to such unconventional tasks as cutting firewood (with an oversize saw set outboard), shining the whole family's shoes (with a sheepskin muff on the drum sander), churning butter, freezing ice cream, spinning metal bowls, and cutting sheet steel. Also mixing paint, whipping potatoes, cleaning paint brushes, scouring pots (with flexible-shaft attachment) and running a milking machine. No one has yet reported using it as a washing machine or a dental drill, but one dentist made all the cabinets for his office with it—and the Shopsmith is still young.

#### 50,000 Sold in Two Years

For in a little over two years, this newcomer in the crowded field of power tools for the home workshop has quietly achieved spectacular success. Some 50,000 Shopsmiths have been bought to the tune of a \$10,000,000 total.

To the industry, this is both a shock and a hope. A shock to which some traditional tool manufacturers have already responded with combinations of their own good tools





**Tubular ways** are rugged and rigidly parallel. They went through this strength test unharmed.

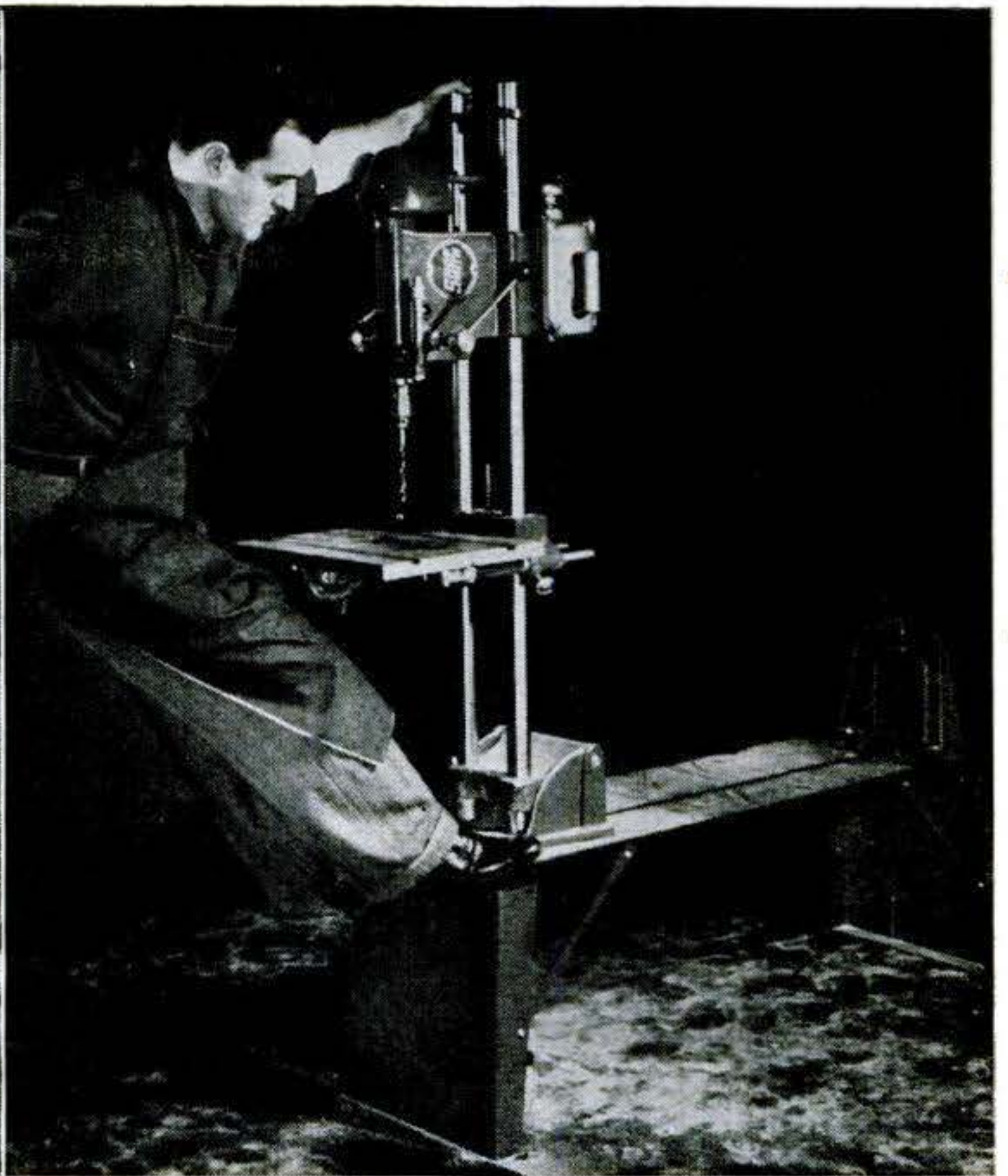

**Well-balanced**, even in upright position, the 200-lb. tool withstands yank of 170-lb. man.

neatly arranged on a bench. A hope, in the realization by the trade that probably most Shopsmith sales represent fresh converts to the home-workshop idea. Logically, few Shopsmith buyers already owned a power saw, lathe, or drill press. In the beginning, the expert amateurs and high-skilled hobbyists were quite cool to the very idea of a

combination power tool. There have been combinations before, and most of them have been like the wondrous jack-of-all-knives that can do anything—and nothing well.

But the Shopsmith was not just a combination: it was conceived, thought out, invented and developed as a *single tool unit* with *multiple-use* in mind. It did not be-



**Four ball bearings** in arbor give tool unusually smooth, quiet operation. Using quill to position saw blade allows fine adjustments, permits dado cutting without special blade or washers.

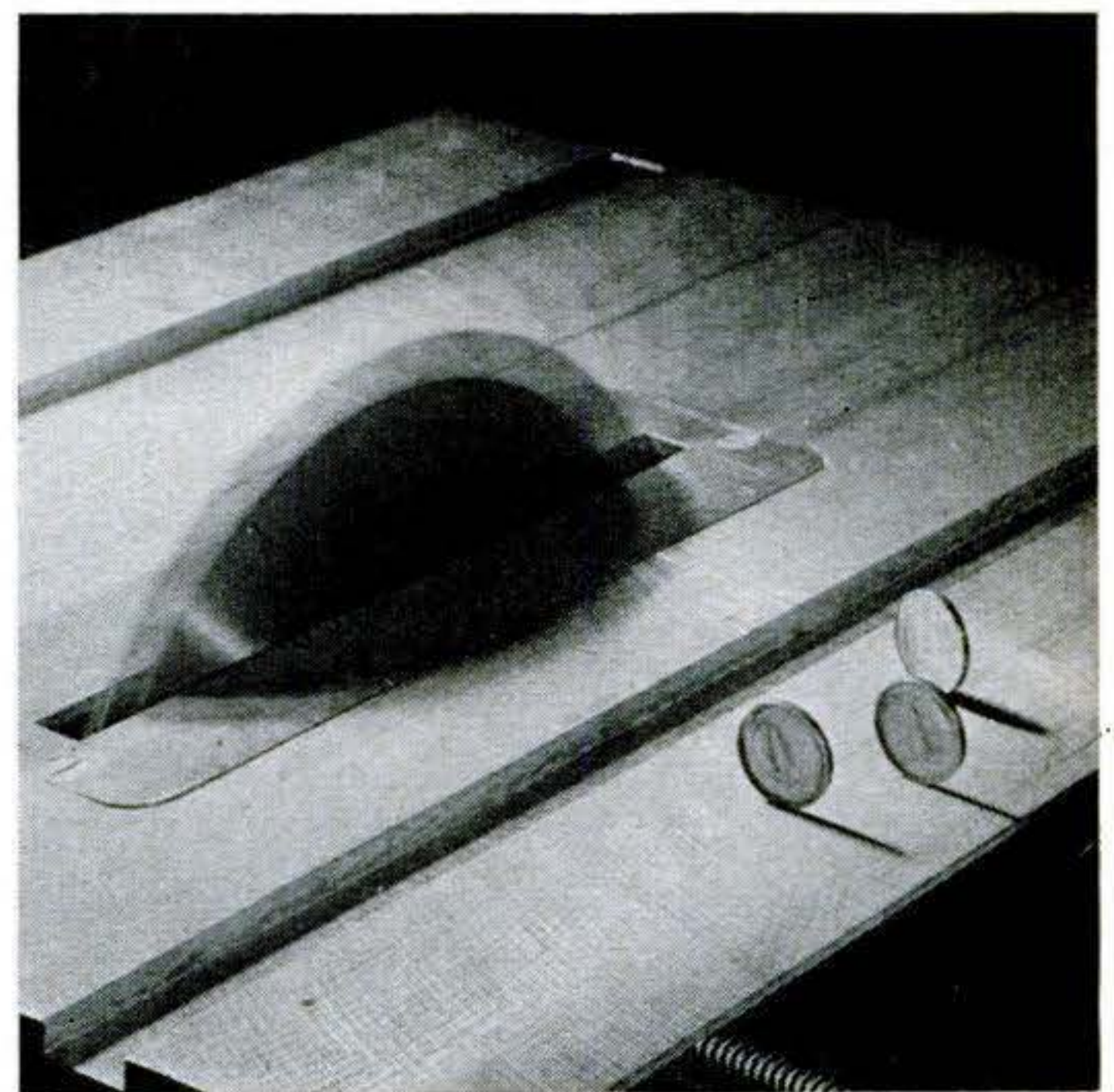

**Coins stand on edge** while blade whirls at full speed, showing tool is virtually vibrationless due to precision construction, ball bearings, and rigidity of ways. Motor is  $\frac{1}{2}$  hp., 1,725 r.p.m.



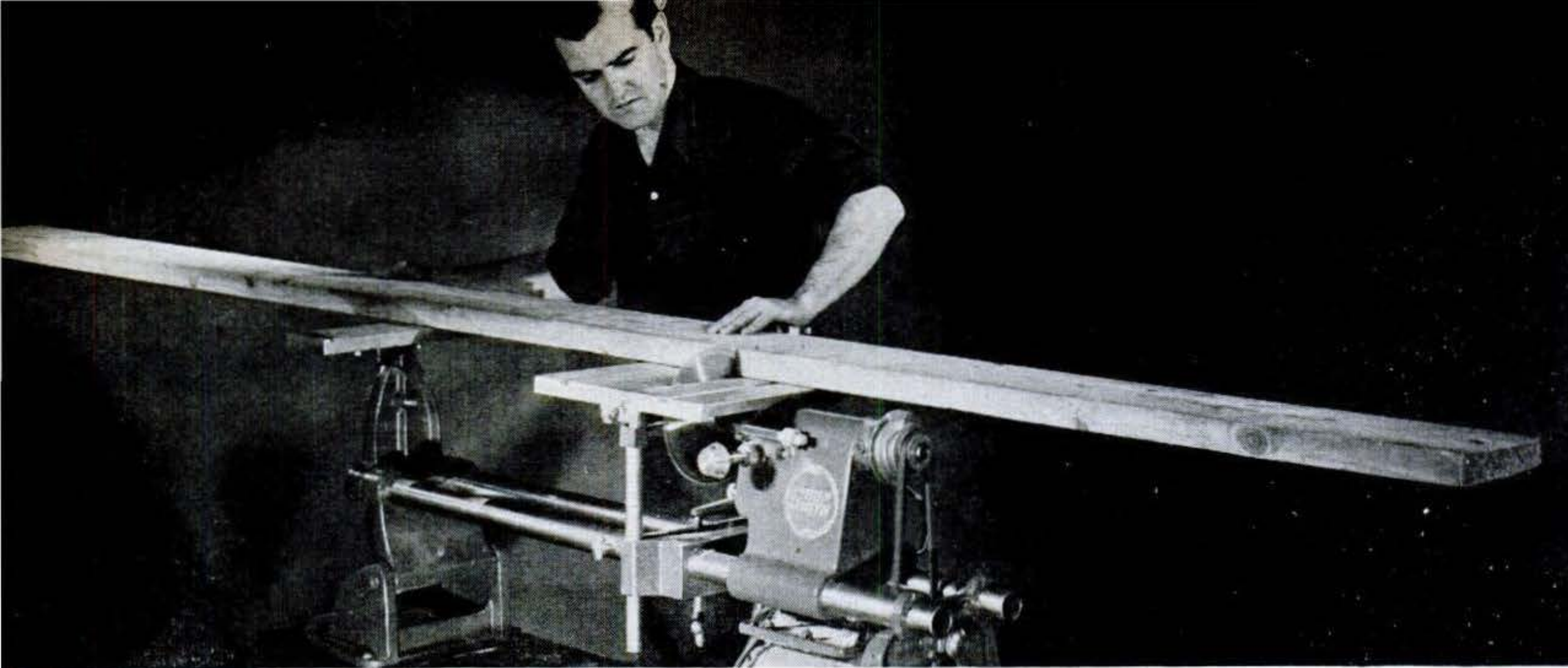

**Sawing long boards** like this 12-footer is no problem with extension table mounted on tail-

stock. Other extensions make table 23" by 55". With 8" blade, maximum depth of cut is 2¼".

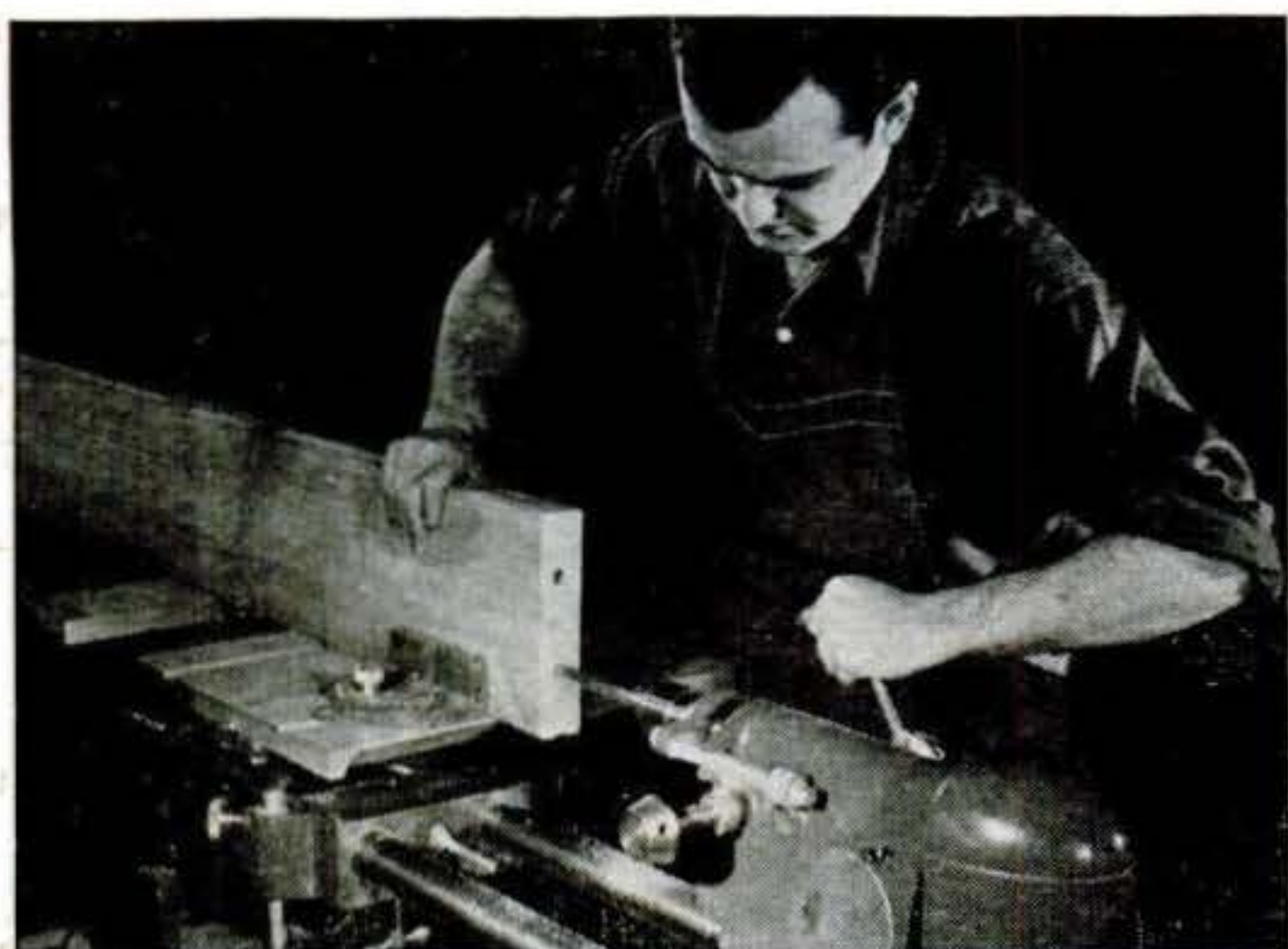

**Horizontal drill-press position** permits drilling of stock far too large for conventional drill press. Note that quill can be operated from either side of tool by simply changing the lever.

gin, like the automobile, as a buggy with an engine to turn existing wheels. It began, like the jet plane, with a fresh concept.

It began with the personal necessity of an industrial engineer who fled his native Germany in 1937, and who found his thoughts could flourish in a land where "Yankee ingenuity" was more a matter of residence than birth.

Hans Goldschmidt is an unspectacular man you would take for granted in a meeting of scientists, in a mechanic's coveralls, or in the smoking car of a suburban train. He is a Ph.D. (he obtained his degree at the University of Berlin) who does not want to be called "Doctor."

#### *Wanted to "Invent Something"*

Hardly five years ago, Hans Goldschmidt was working in the Kaiser yards at Richmond, California, helping to clip the minutes and motions that made Richmond famous for quick ships. With the war all but won, he thought of peace—and the need of a job. This was the necessity that mothered this invention.

For Goldschmidt set out, quite deliberately, to "invent something" that would win him a living in a peacetime world where industrial engineers, however skilled in time and motion studies, would be a dime a dozen. He confided this firm intention to his immediate boss, one Robert L. Chambers, who was equally uninhibited about ideas.

With the war's end, Goldschmidt got himself a job as foreman in a Berkeley wood-working shop. There, watching the men and the machines, he found the answer to



**Need to saw large, heavy pieces?** Just up-end saw and feed work vertically. Guide for bottom edge is plank on floor. Pressing work against table keeps it flat and the cut straight.



what he wanted to invent. He knew nothing of machine design, next to nothing of traditional woodworking methods, and less than nothing of the passionate personal interest of the home workshopper. But he knew production and people. He studied, dispassionately and impersonally, the way of a man with a woodworking machine, and the needs and uses for tools powered to make things easily and quickly.

"I found," he says, "considerable duplication in single-purpose tools. If a multi-purpose tool could use the same parts, I was certain it would be widely accepted."

With that he set out to invent a "multi-purpose tool." He doodled a circular saw first, of course. Now, he sketched to himself, replace the blade with a disk—like this—and there's your sander . . . substitute a chuck and there's your drill press.

He noted that saw, sander, and drill had two things in common: a table to hold the work, and an arbor and clamping device to hold the tool on the revolving shaft. He put aside, for the moment, the problem of the lathe that cuts whirling wood into round bowls and baseball bats.

First, he doodled, try keeping the table stationary and moving the arbor, like this:

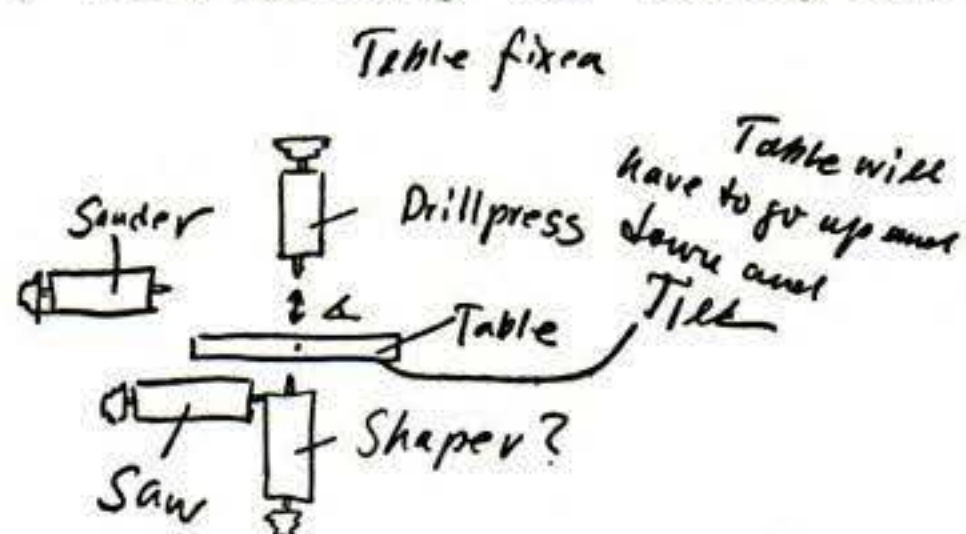

Not so good? Then try a fixed arbor and move the table into position for saw and sander, like this:

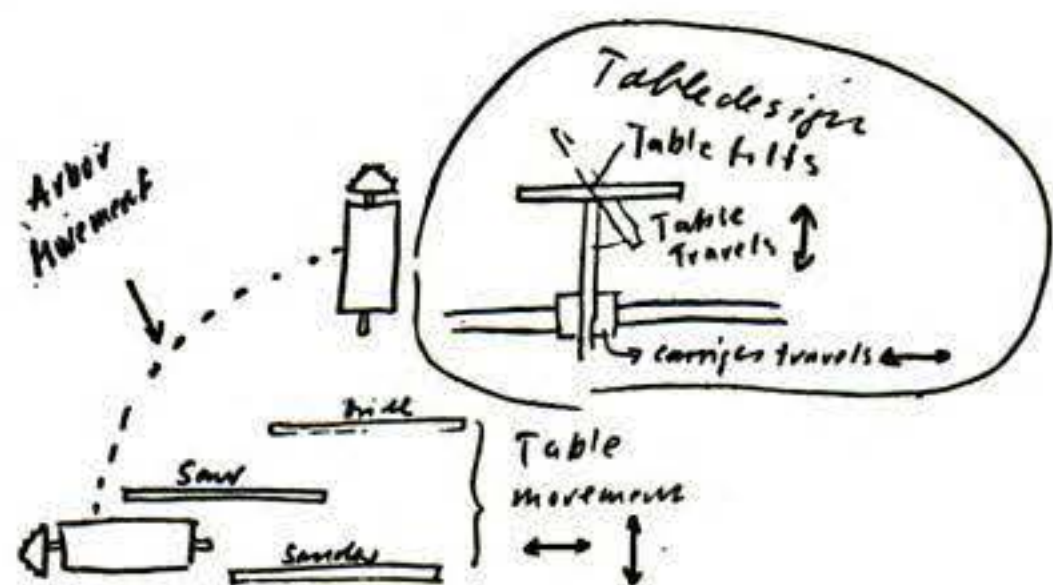

That meant swinging the arbor from horizontal to vertical to make a drill press. But how? Goldschmidt pivoted his pencil on the sketch pad. Slowly the answers came . . . mount the table on a rod . . . set the rod in a carriage . . . move the carriage back and forth on a tube supported at both ends. . .

Now the hounds of the mind were circling for the scent. Why not mount the



With special fence and attachments, tool can be used to shape, as shown above, or joint, rabbet, and mortise. Different-sized table inserts permit various tools to fit through table.

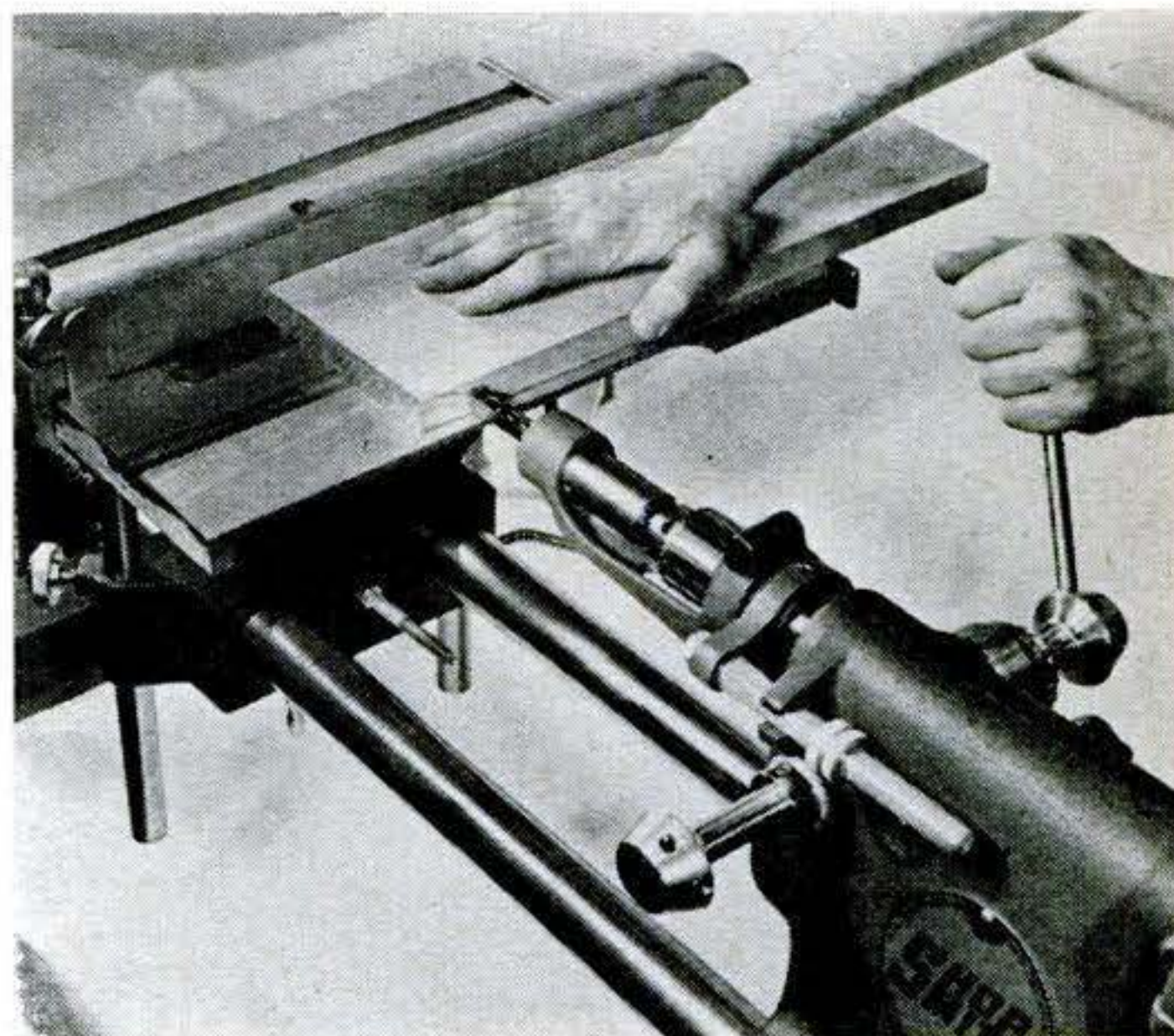

Here tool is rigged to mortise on horizontal with rip fence as stop. Gauge insures accurate depth of cut. Fence has similar gauge for precise sawing. Photos above by Moulin, San Francisco.

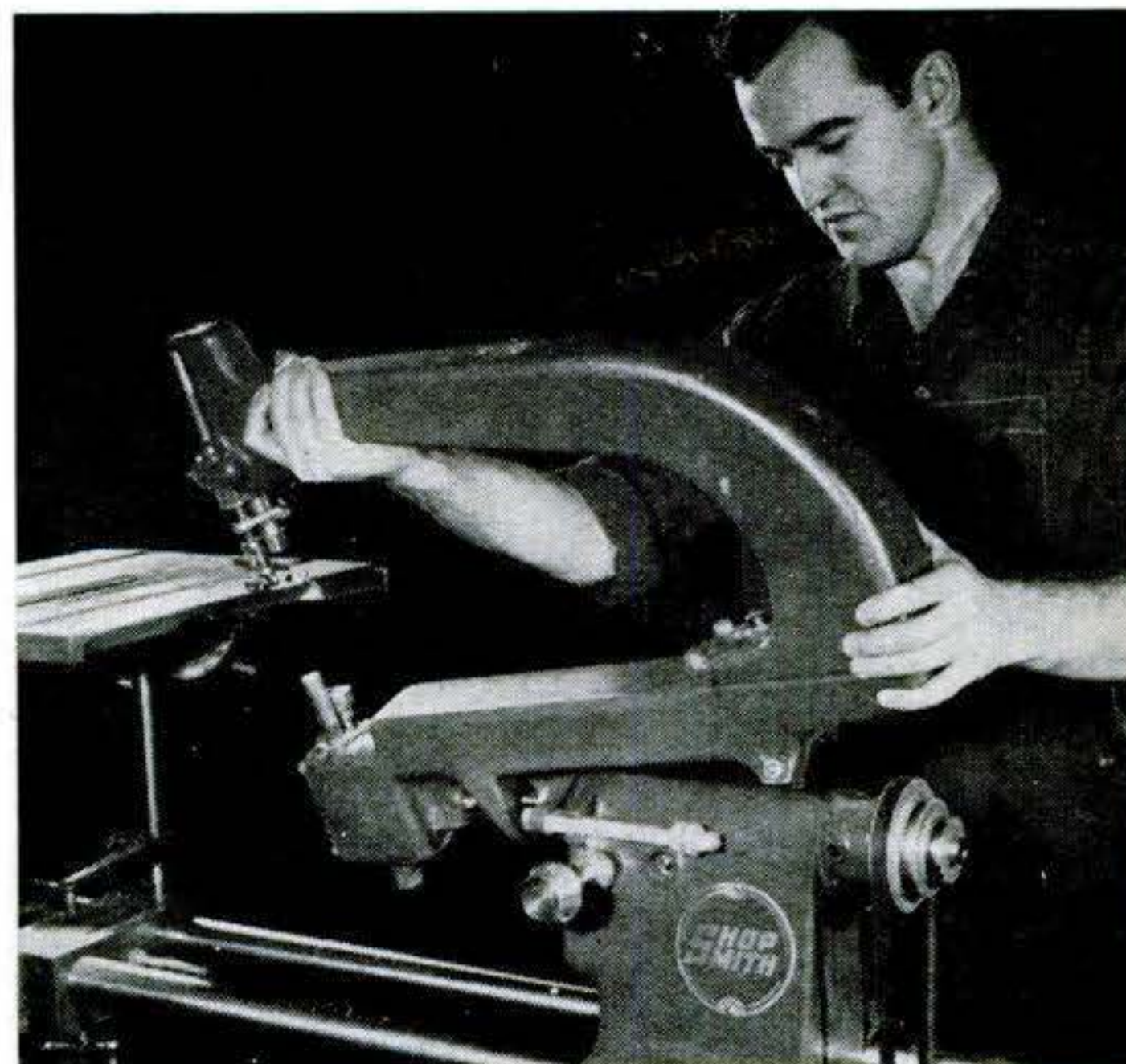

Jigsaw attachment slips over arbor, fastens to headstock with single screw. Aluminum yoke has 18" throat. Two-piece construction lets arm come off for saber-blade work on large pieces.



arbor on the tube, too, and swing the whole business from horizontal to vertical? The hounds gave tongue.

So far, Goldschmidt had dreamed up with pencil and paper a machine with motor and arbor in a headstock mounted on one end of a tubular "way," the other end of which was pivoted on a base plate. The carriage for the table could be locked anywhere along the way. The table could be raised, lowered, and tilted. All that was needed to make a lathe was a tailstock.

But in the vertical drill-press position, the headstock could not be adjusted. The sander worked sideways, but not so you could face the disk. The single tubular way would make it hard to line up carriage, headstock, and tailstock quickly and accurately.

Here the dogs of thought closed in for the kill. Goldschmidt made a succession of important decisions. First, he departed from conventional lathe design and made the tailstock fixed, and the headstock movable.

This let the drill-press height be adjustable, like this:

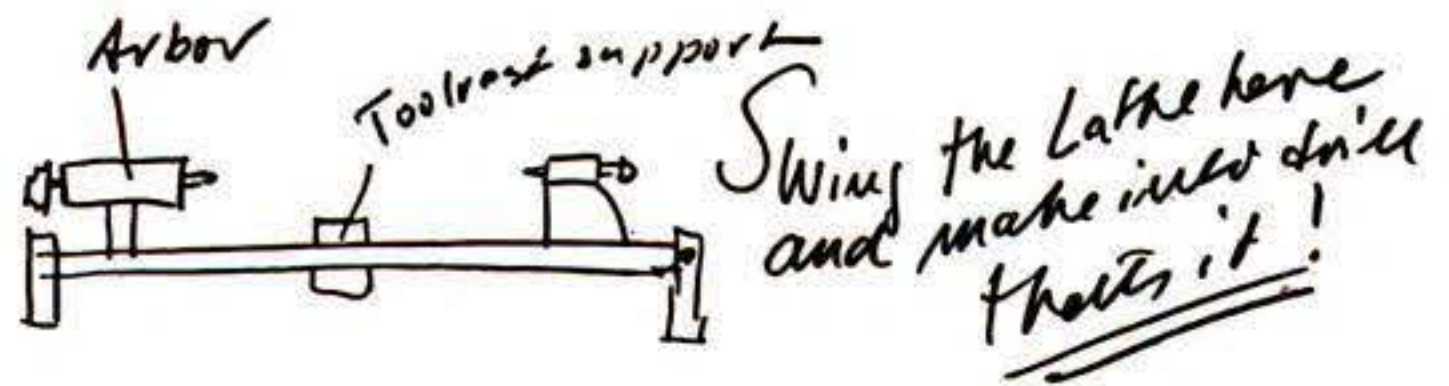

Next, he decided on using *two* tubular ways for maximum rigidity, ease of use, and production economy. The rest was details . . . the arbor designed to feed out as in conventional drill-press design . . . the table rethought to provide miter gauge and rip fence . . . the tailstock made removable, and adjustable to hold a table extension.

Up to now, Goldschmidt had been doing mental inventing, testing problem and approach only with pencil and paper. By late 1946, the Ph.D. with the thinking pencil was ready to turn tool designer.

With wood, cloth, and paper, he made a

**Basic \$199.50 package** includes everything for sawing, sanding, drilling, turning. Jigsaw, speed

changer, and tools for jointing, shaping, and mortising are some of extras available.

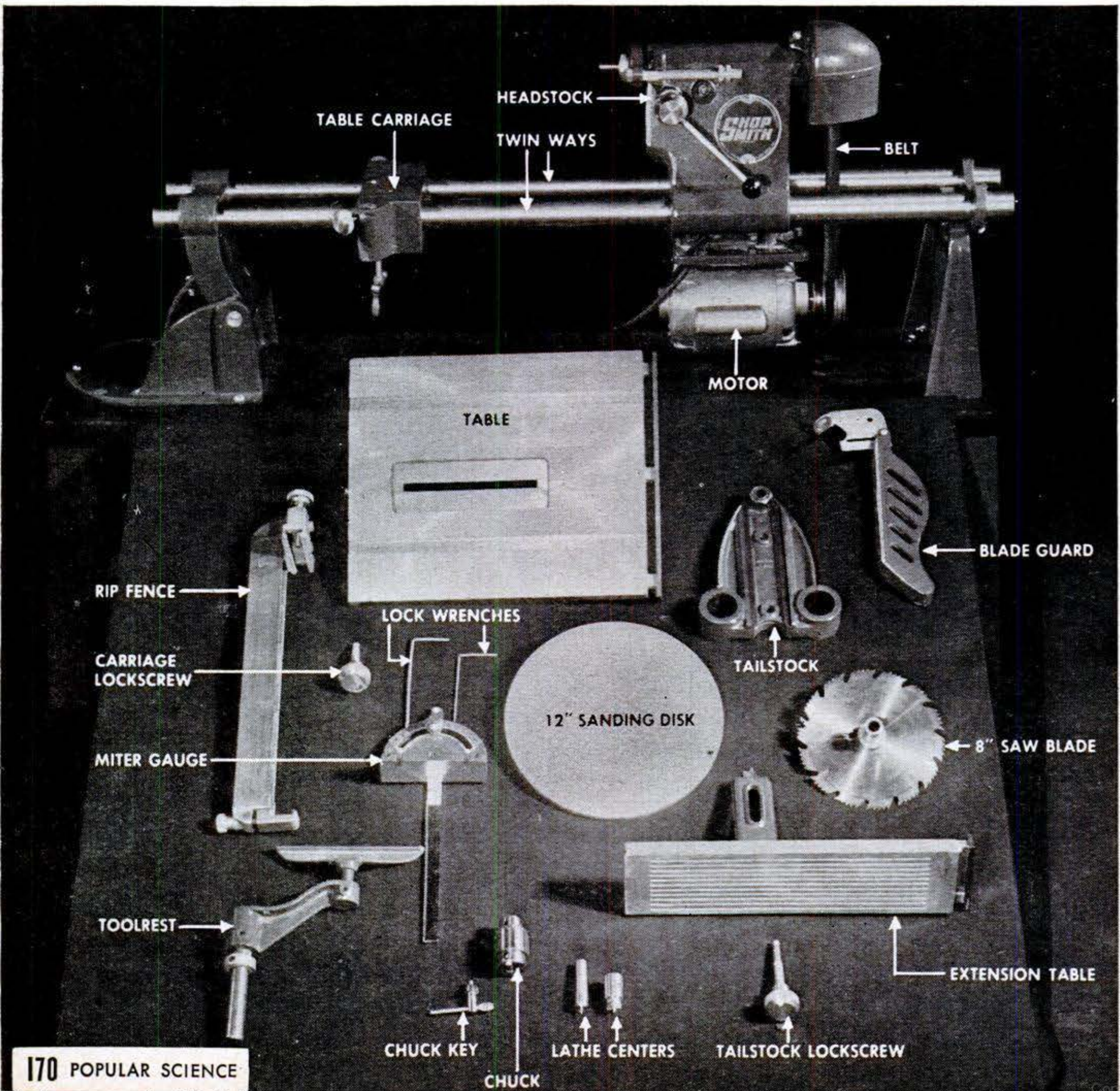





**Lock a bent rod** in drill chuck and you've got a powerful mixer that will mash potatoes, churn butter, beat heavy batter. Inserted through paint-can lid, rod does fine job of mixing paint.

half-scale mockup to try operating principles in simulated uses. The proof of this simulated pudding is that the mockup looks remarkably like the actual Shopsmith as finally produced in steel and aluminum.

Then came a working model, a lash-up of scavenged parts, a couple of crude castings, and plenty of whittled wood. But it worked as Goldschmidt's pencil said it would. His invention was invented, and it was time to tell his friend Chambers.

Chambers took one look and sent for his brother Frank, a Harvard Business graduate who got his merchandising training at Macy's. At their second meeting with Hans Goldschmidt, Bob and Frank Chambers agreed to finance the Shopsmith.



**For super-large turnings**, slide headstock off ways, reverse direction, and put it back so arbor overhangs end of bench. This way, distance from spindle to floor is only limit on diameter.

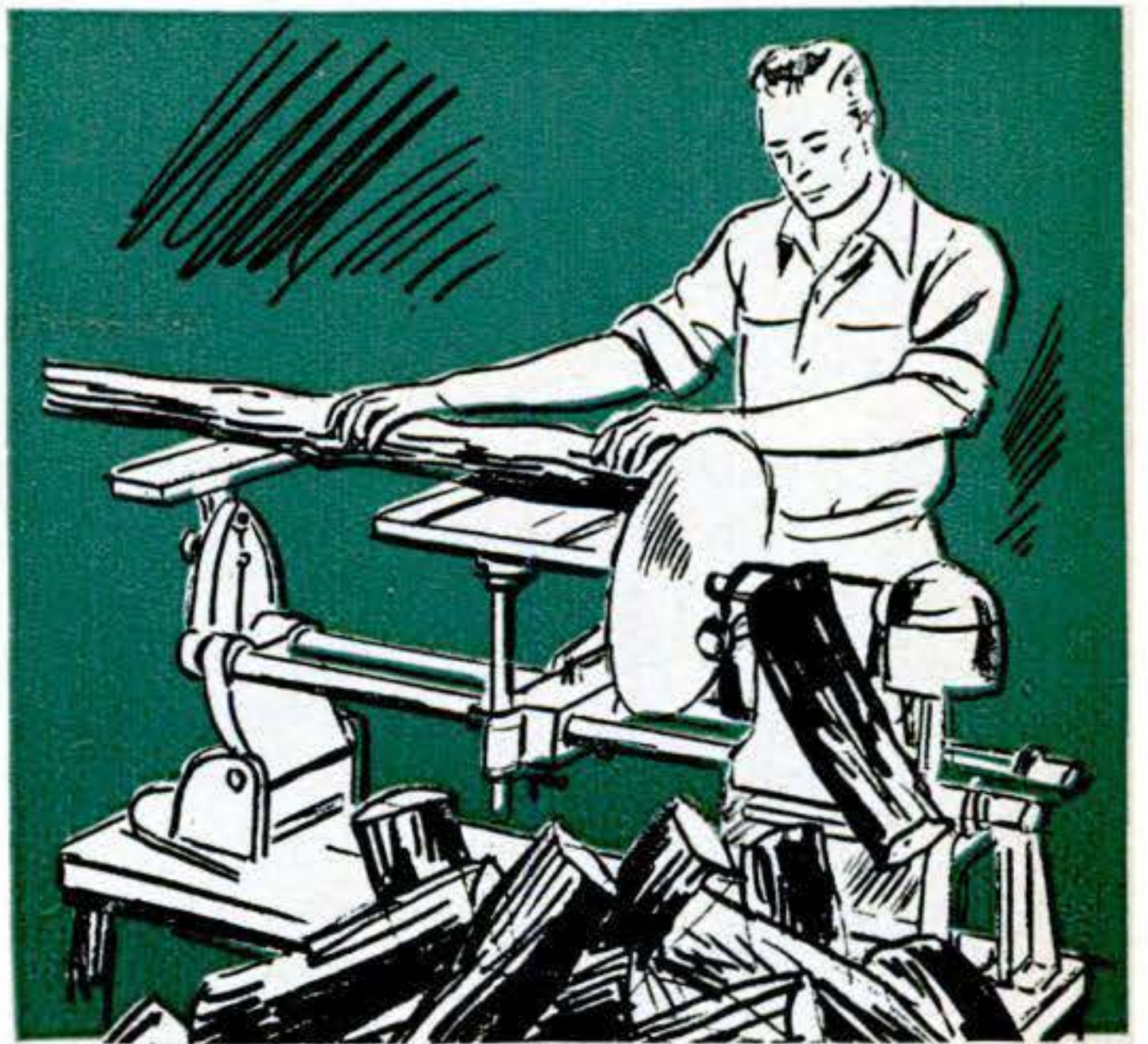

**Cutting firewood**, or other thick stock, is simple with this setup. With saw outside table, blades up to 15" can be used. One owner devised a cradle for greater safety and convenience.

The prototype, gleaming with real steel, was ready in July 1947, almost before the blueprints were dry. The Chambers brothers had raised the money, formed a company called Magna Engineering Corporation, and christened the product Shopsmith. They had also applied their sharpest pencils to manufacturing costs, and had made their first big sale: 250 units to Montgomery Ward, to be delivered by November 15th.

Today, the three men own the company. They are proud of the success of Shopsmith, and busy with ideas for accessories and new products still unnamed. Perhaps the happiest is Hans Goldschmidt who sat down to "invent something" that would make him a living—and did both very well. **END**

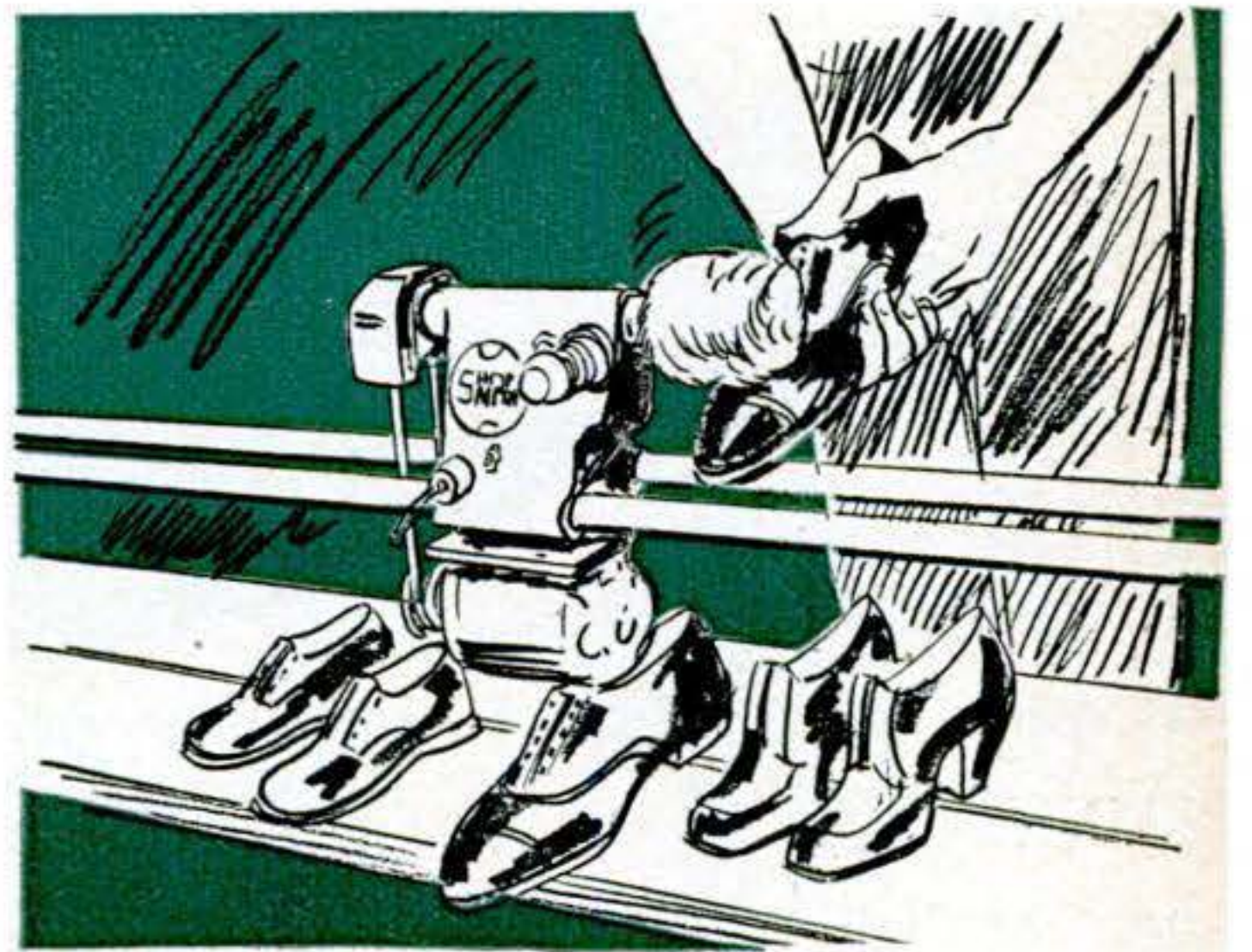

**Shining family's shoes** with fleece muff is one of many tricks Shopsmith will do. For delicate or hard-to-reach jobs, flexible shaft can be attached to take grinders, buffers, brushes, drills.





## Aids to Modern Living

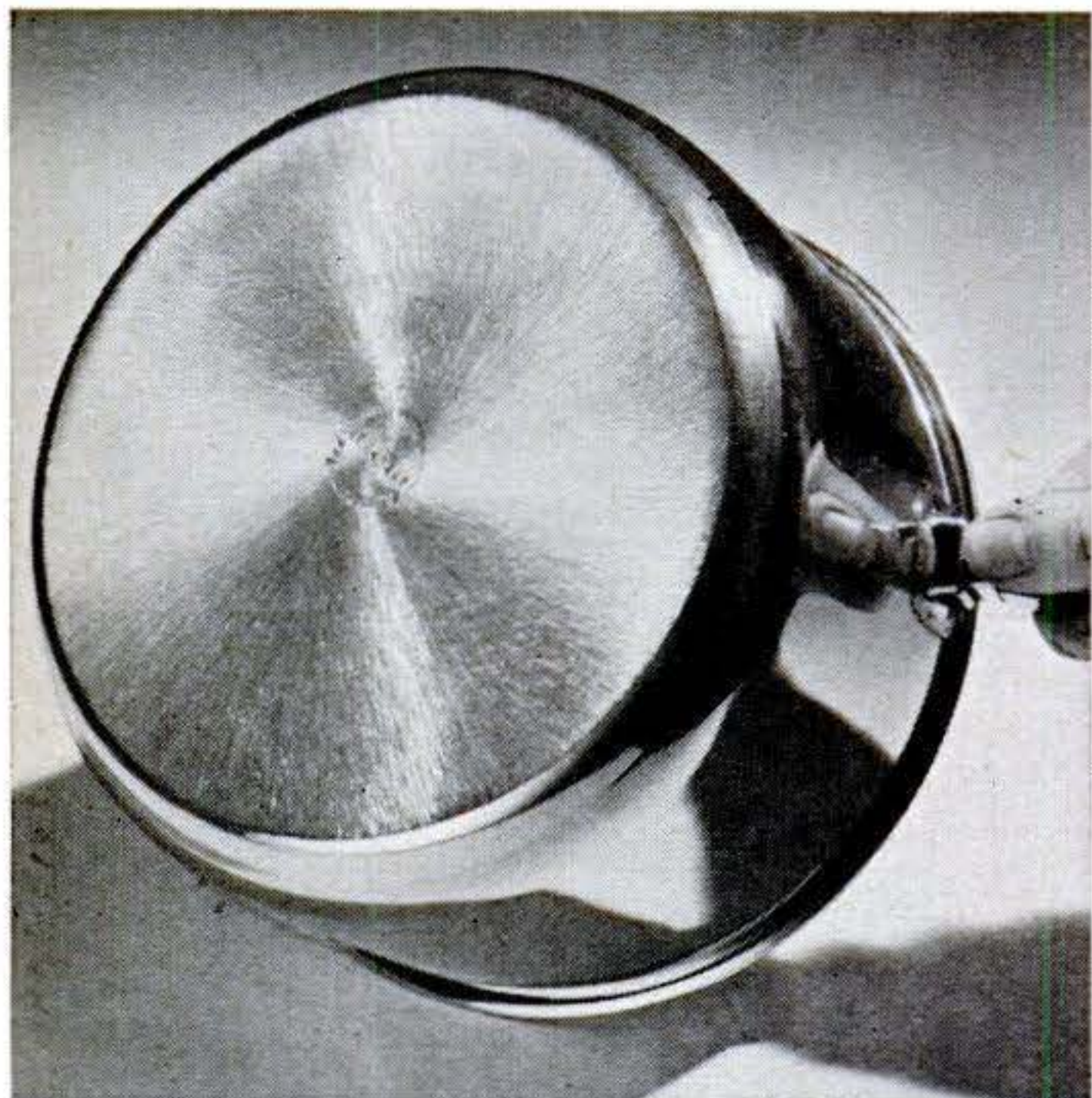

**Steel Pan Has Aluminum Bottom.** A  $\frac{1}{8}$ -inch aluminum bottom bonded to this stainless-steel saucepan is said to lessen scorching of food by eliminating "hot spots" in the pan. Stainless steel is used because it retains heat and is easy to clean. The price is \$4 to \$12, depending on the piece, from S. W. Farber, New York City.

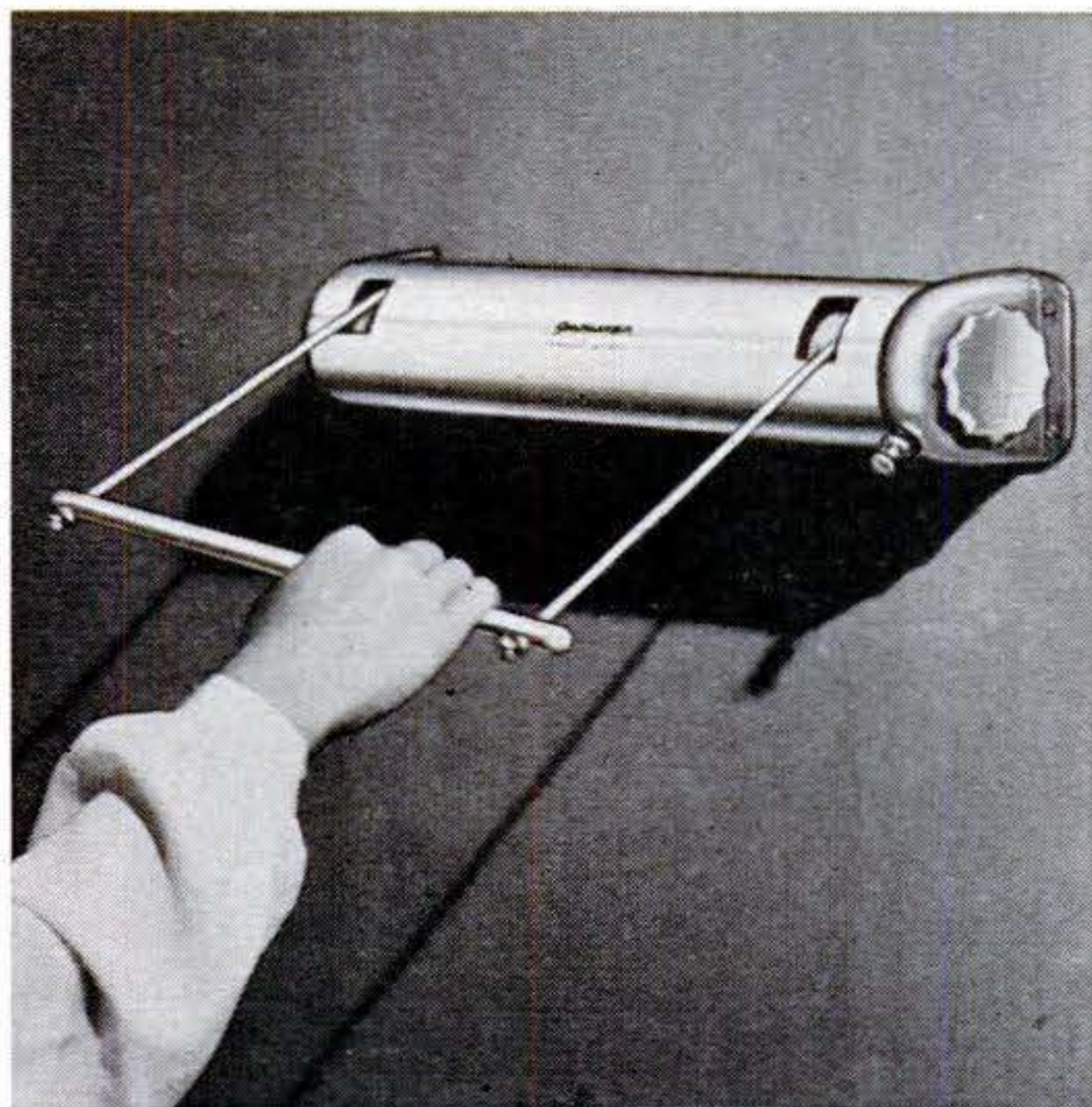

**Wash Line Rolls Up.** When not in use this double clothesline rolls out of sight into a metal holder attached to the wall. When wash is to be hung up, the line can be pulled out and hooked to an opposite wall. A turn of a plastic knob tightens and locks it. The device is sold by Hoge and Grenn, New York City, for \$5.25.



**Bacon and Egg Fryer.** A new skillet keeps cooked bacon strips hot on a special warming apron while eggs are cooking. During bacon-frying, a cover grill holds strips flat, cooking both sides at once. A ring drain around the pan's frying surface catches fat. The skillet is available from the Everedy Co., Frederick, Md., for about \$3.

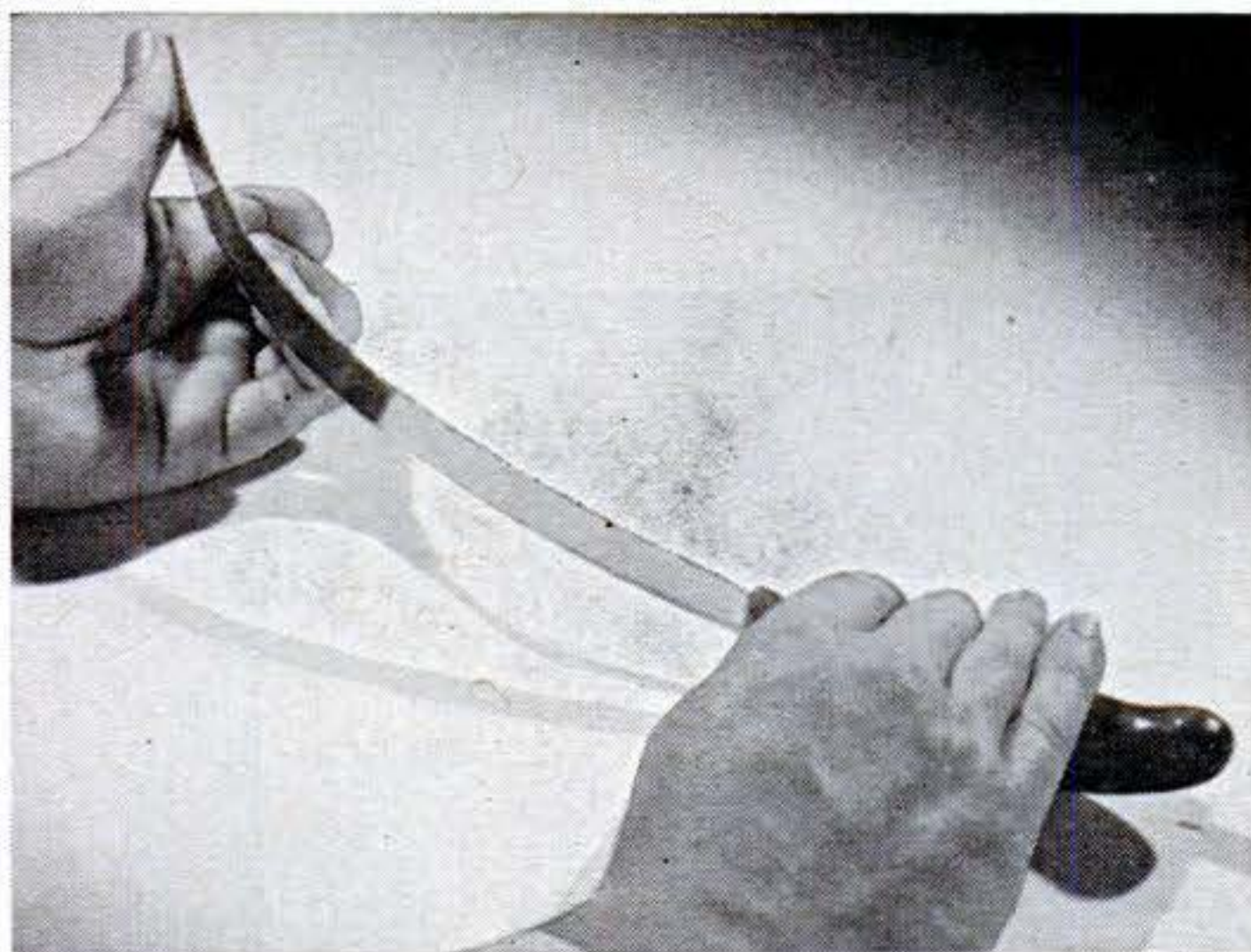

**Flexible Kitchen Knife.** Designed as a kitchen tool, this flexible knife lets you saw frozen foods, bones, or bread. Being made of tempered bandsaw-blade steel, it can also be used to cut plaster, wood, and metals. Priced at 89 cents, the rustproof knife is distributed by Walter Drake, of Colorado Springs, Colo.





**Humidifier Holds Plants.** This decorative plant bowl is also a humidifier that keeps room air moist. Water poured into the base rises by capillary action to the top of two porous evaporators, which are made of specially compounded ceramic materials. Mois'n-Air® is sold by the Puritan Sales Co., of Atlanta, Ga., for about \$5.



**Clothes Rack Saves Space.** If you hook a rack like this over your closet door, you will have more clothes-hanging space. Extended, the rack holds 10 garments; folded flat against the door, it occupies the space of only two. A suction cup holds on the lower part. Nu-Products Co., of New York City, sells it for \$1.50.

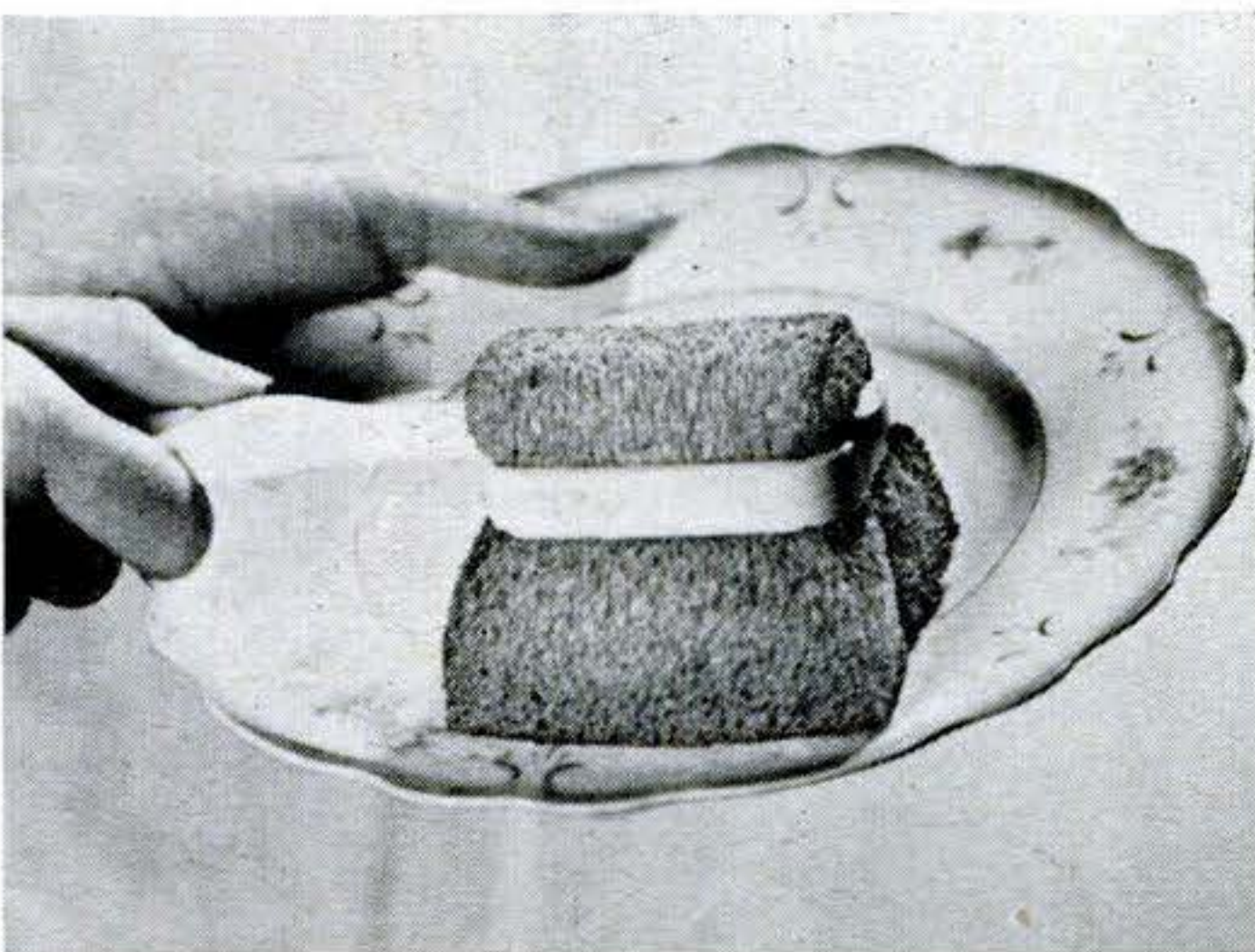

**Sponge Is Brush.** The brush above can be used on clothes, dishes, or in the bath. Unlike fiber brushes, it can be wrung out like a cloth. Available in three sizes, it costs from 89 cents to \$1.69. The device has a plastic handle that is removable for cleaning. Moser-Keenan Co., of Portland, Ore., is the manufacturer.



**Washboard Fits Hand.** Stubborn dirt stains can be rubbed out of small laundry items when you use this pint-size sheet-aluminum washboard, which can be held comfortably in the hand. Tied to the washing machine, the board serves as an auxiliary aid on washday. Vic Products, Inc., of Fenton, Mo., sells it for 25 cents.



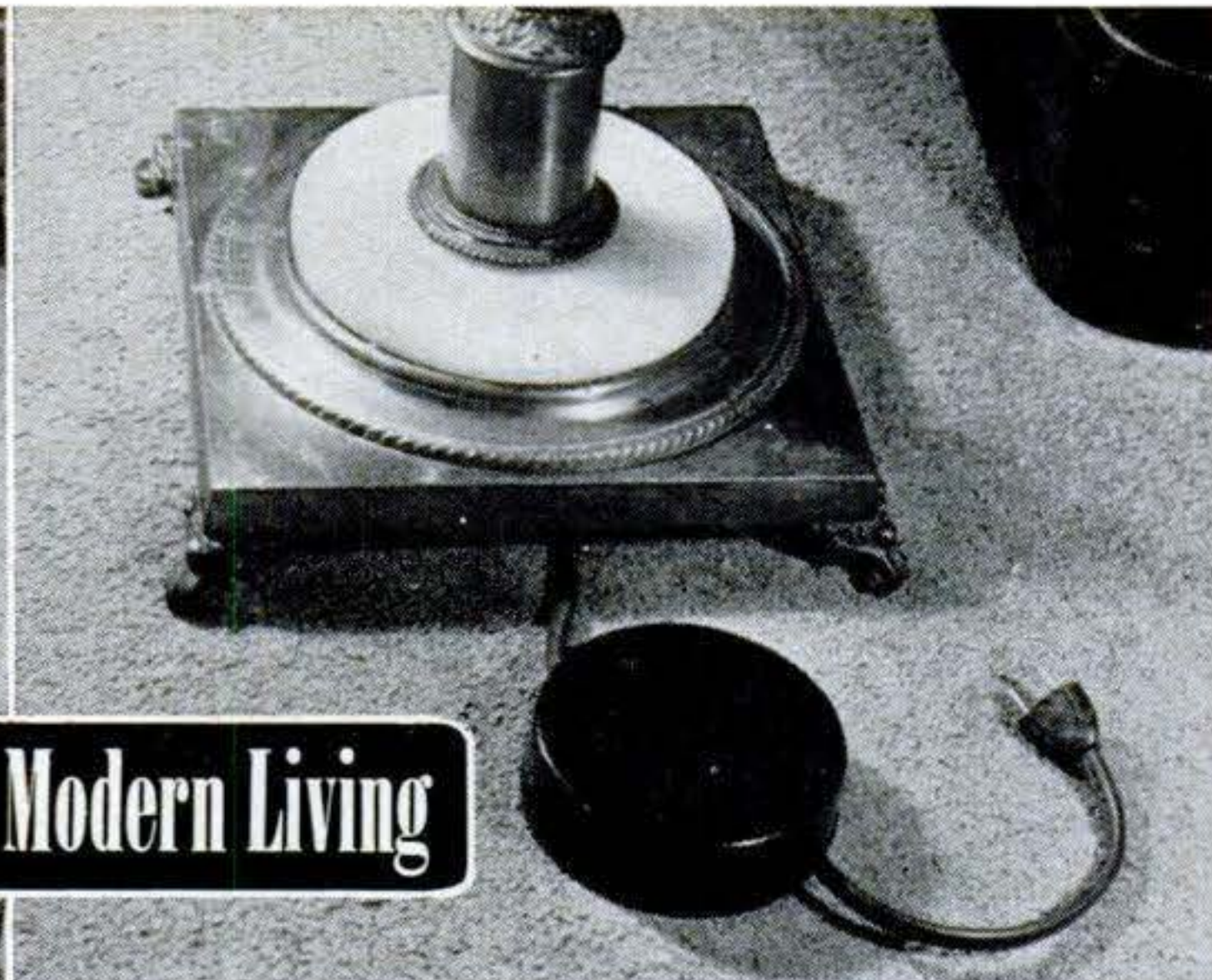

 **Aids to Modern Living**

**Box Holds Outlet Cord.** If stored in this container, excess lamp and fixture cord won't clutter the floor. You remove the top of the circular plastic box, place the

cord across the bottom section, as at left above, screw on the top, and twist to wind in the cord. Made by Eypper & Co., of New York City, Reel-Away® costs 69 cents.

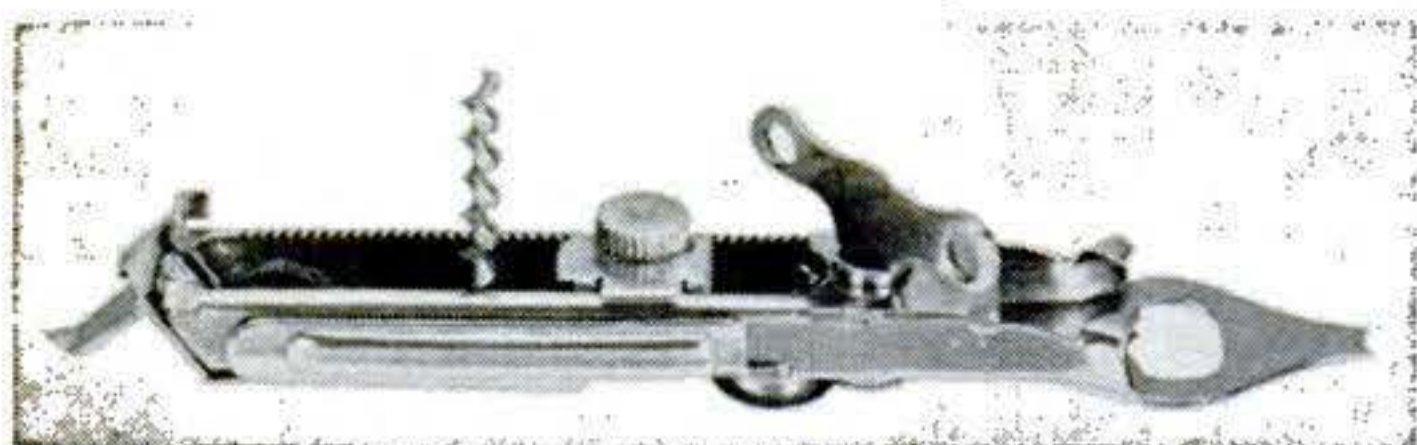

**Can Opener Does Eight Jobs.** Bristling with attachments, this new gadget is armament for assault on eight different kinds of containers. It pries off caps and lids; it helps turn stubborn screw caps of all sizes; it shears off can tops; and it punches milk and beer cans. Priced at \$2.95 by Pretorius Approved Products, of Glendale, Calif.

**Plastic Holds Hook to Wall.** To attach this hook to a wall, the spongy pad on its back is dampened with carbon tetrachloride, contained in a special capsule. This dissolves the polystyrene plastic resin impregnated in the pad, causing the device to stick wherever fastened. It is made by Household Aids, Inc., Rochelle Park, N. J.



**Spatula Grips Food.** Stainless-steel jaws on this spatula hold fish, meat, or pancakes firm while they are turned in the frying pan, preventing grease from spattering. Pressing a thumb plate (arrow) on the handle opens the clamp. The spatula is available from Buckley Culinary Products, of Chicago, for \$1.

**Clock Keeps Running.** If house current is cut off, a clutch inside this electric clock instantly activates a spring-driven balance wheel. The clockwork drive will run it for 30 hours. When current is restored, energized magnets stop the balance wheel, and the motor runs it. Eunice Novelties, Inc., New York City, prices it at \$15.



## Keeping the Home Shipshape



A tie rack for a closet door can be made from a length of flat curtain rod—the kind that telescopes. Bend the rod as shown and tack or screw it inside the closet door.

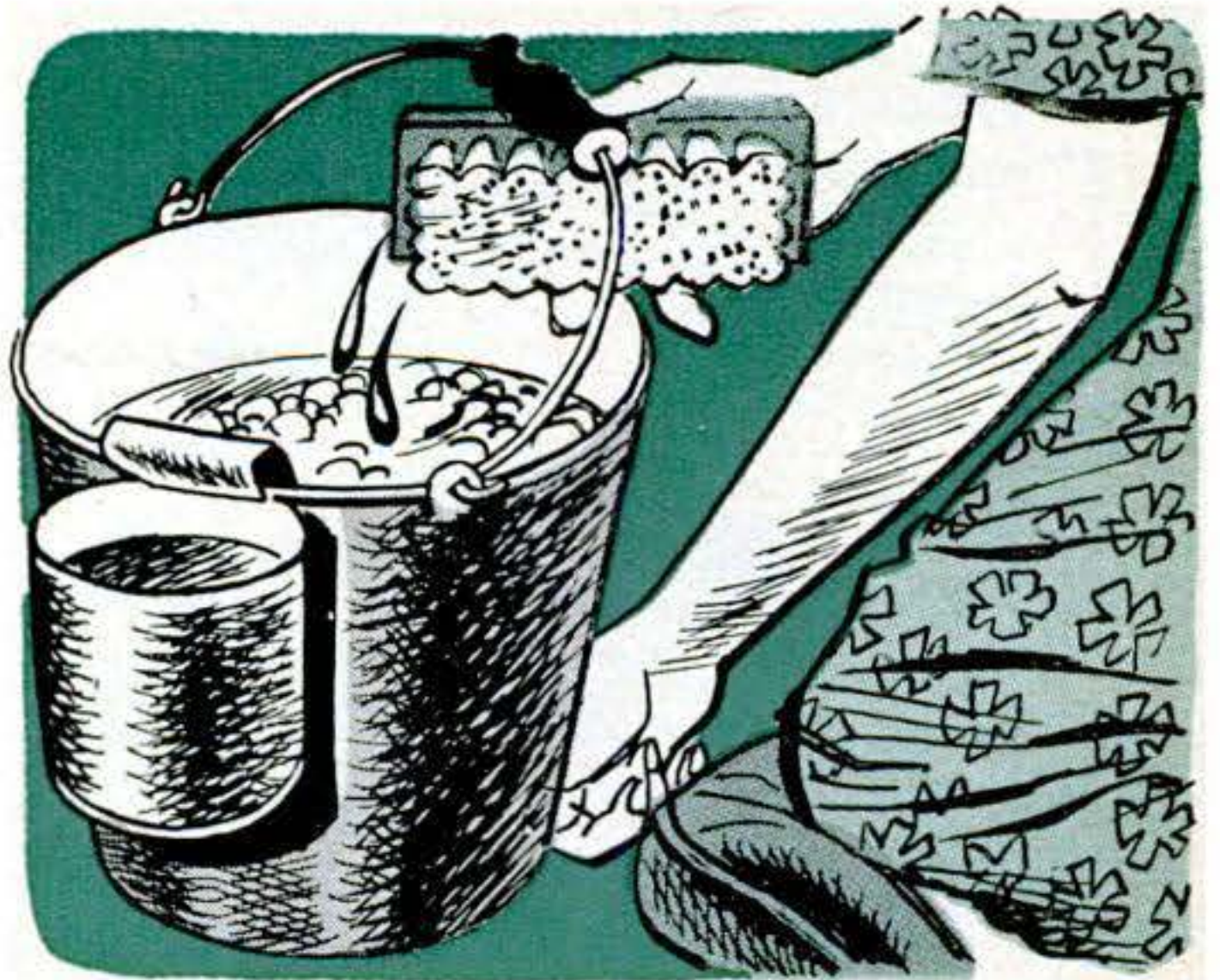

**For cleaning:** Leave part of the lid of a No. 3 can uncut. Bend the lid so the can will hang on the side of a scrub pail. It will carry cleaner to wipe off door frames and window sills.

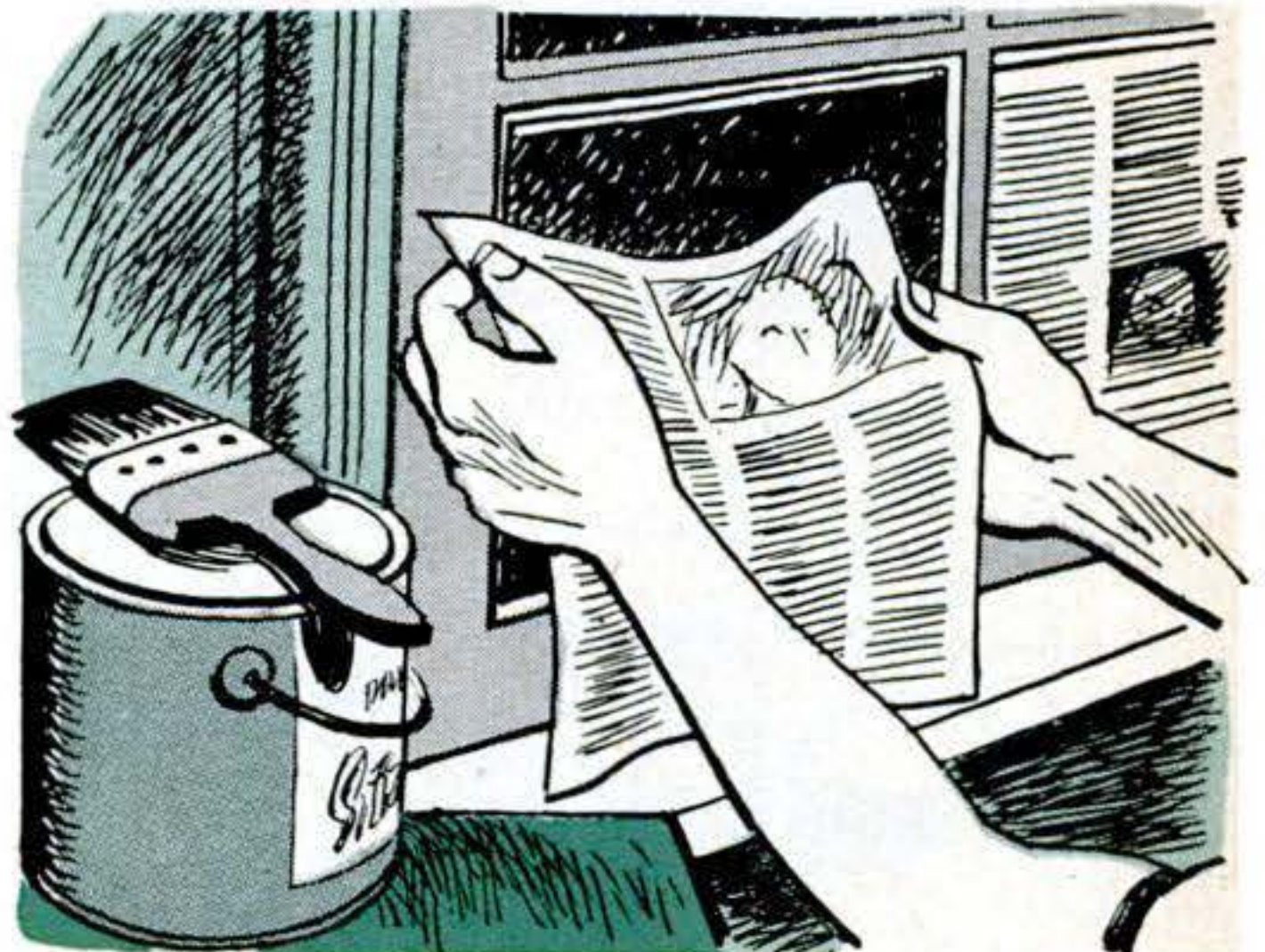

**When painting window woodwork,** use wet newspaper to keep drips off the panes. Cut newspaper to exact size, soak it in water for a few seconds, and smooth it onto the glass.



It's easy to dress up an old iron bedstead. Make slip covers to fit over the head and foot. Patch pockets on the headpiece are handy. They'll hold magazines, a watch, or glasses.

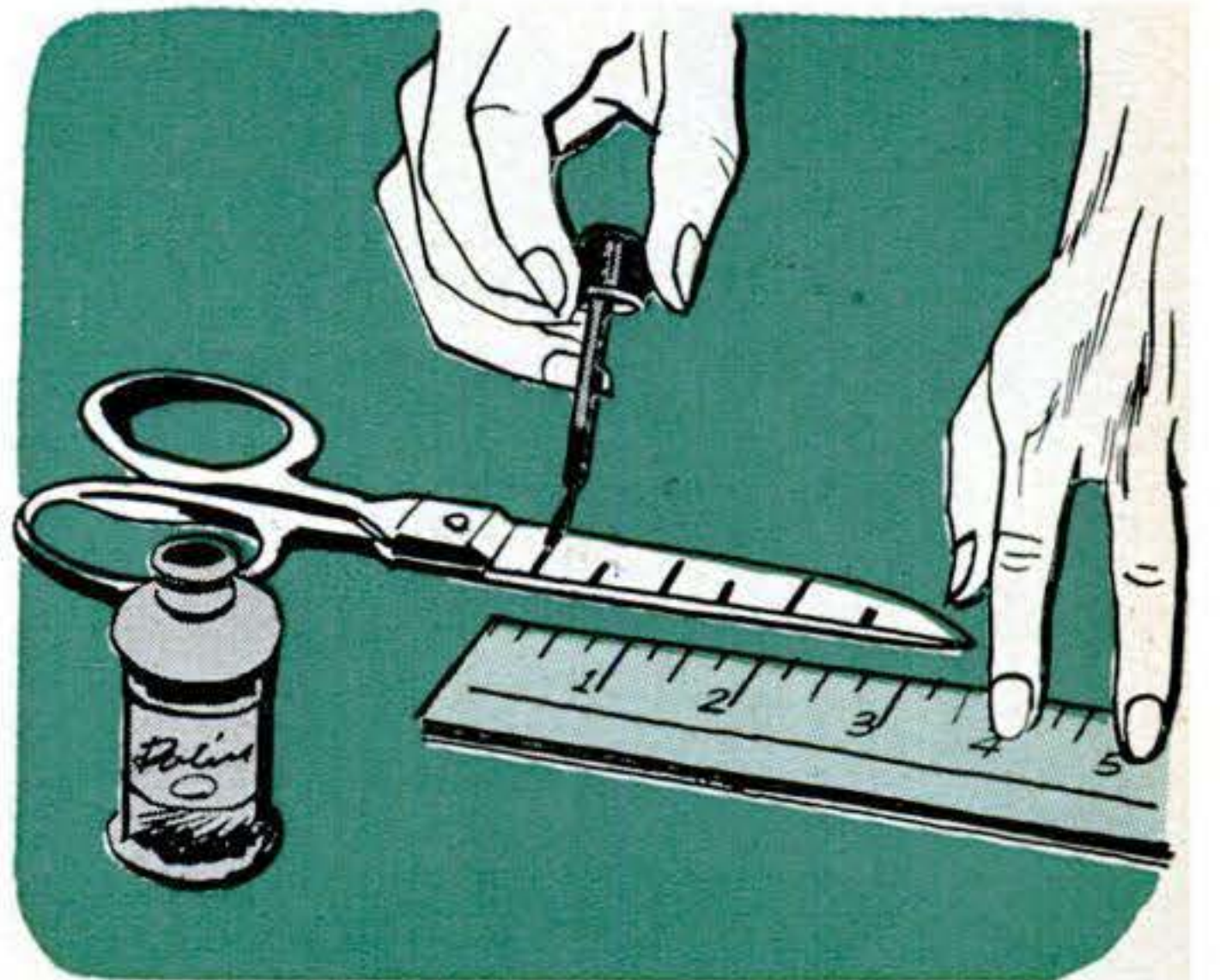

**For the housewife who sews,** a ruler on the blades of scissors is a real help. Using a ruler, mark on the inch and half-inch marks with bright-colored nail polish as shown.

**Please turn the page for five more suggestions**

MARCH 1950 175



## Keeping the Home Shipshape



Aluminum foil placed under ice-cube trays keeps them from sticking. Unlike wax paper, which can also be used for this purpose, aluminum foil can be used over and over again.



Coat the bottom of your kitchen garbage pail with melted beeswax to prevent rusting. The wax melts at about 145° F. Washing the pail with fairly warm water won't soften the wax.

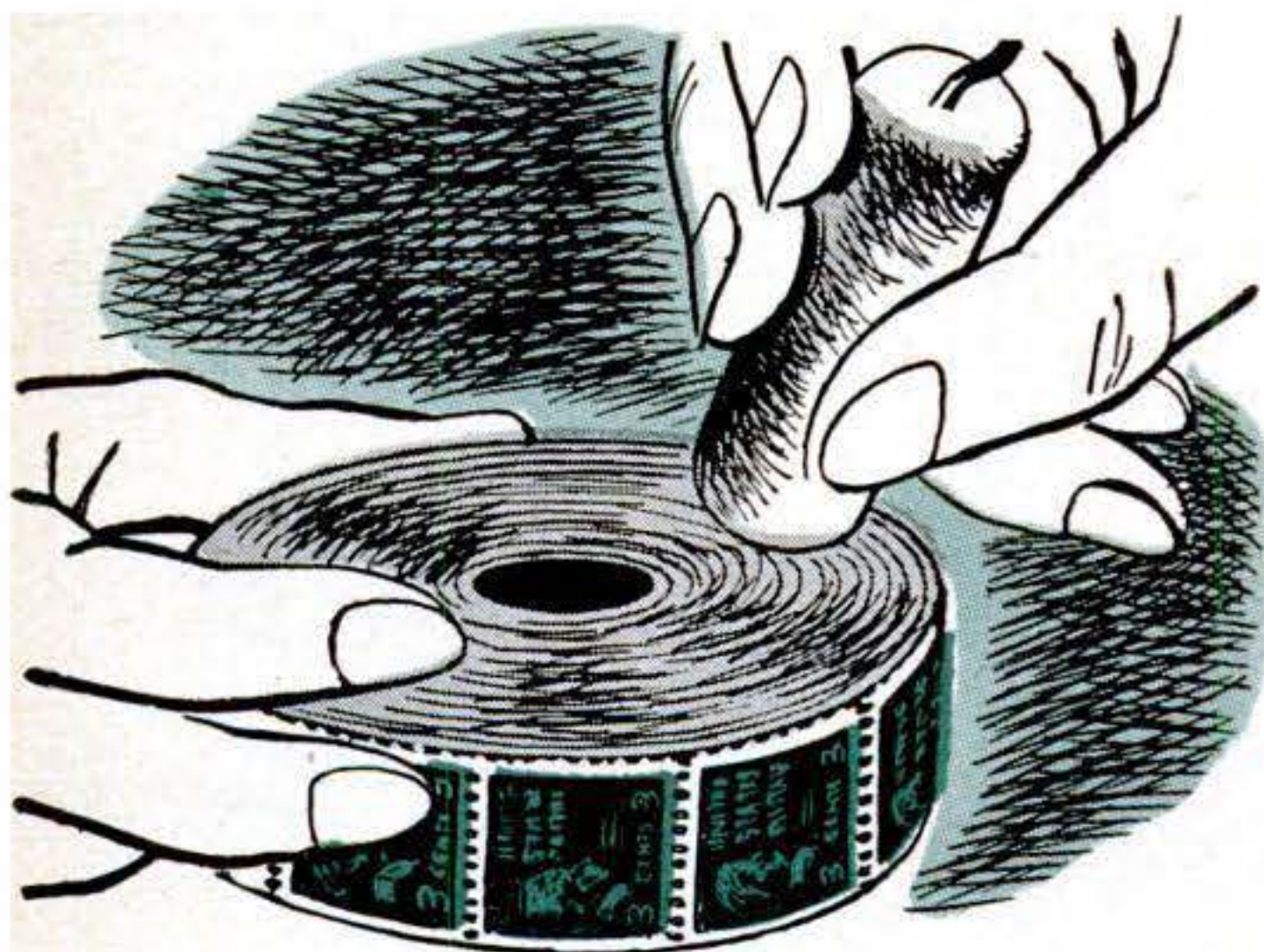

To prevent moisture from entering a roll of stamps, labels, or gummed paper and causing sticking, rub a candle on both sides of the roll. This will help make the roll moistureproof.

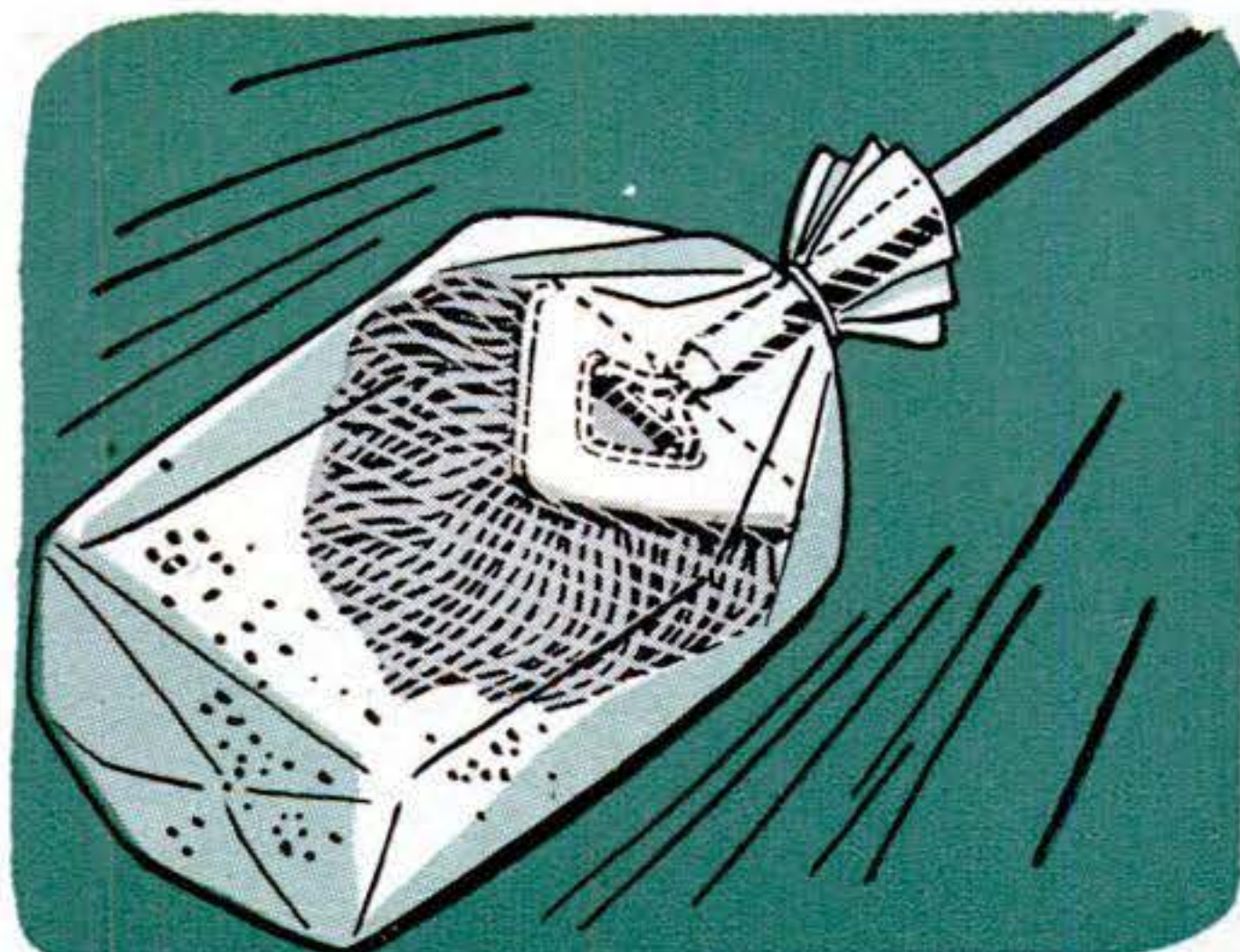

Use a large paper bag as a dust trap when shaking out an oil mop. Put the mop head in the bag, tie the bag's neck with string, and shake. Then you can discard bag and dust.



A small playpen with a detachable bottom can be used as an emergency crib. Place the pen on

a bed after removing the bottom. Anchor it with strong tapes pinned or tied to the bed.



# Mechanics and Handicraft

REG. U. S. PAT. OFF.

*How to Build a Station Wagon*

PAGE 191

*Make Your Yard a Playground*

PAGE 205

*Time-Savers for Woodworkers*

PAGE 216

*Plans for a Midget Hot Rod*

PAGE 221

*Installing a 16-Inch TV Tube*

PAGE 229



**How to Make an AEC  
Geiger Counter in Your  
Kitchen. Page 200.**





# Gus and





# the Popping Filler Cap

Police Sergeant Corcoran, hunting a thug whose dark sedan left a scarred track in the mud, gets an unexpected lift at the Model Garage. *By Martin Bunn*

GUS WILSON looked up from the dismantled fuel pump on his workbench as Jerry Corcoran strode briskly into the Model Garage, came to a heel-clicking stop, and saluted smartly. "Hello, Jerry," Gus greeted. "Practicing for a pee-rade?"

"Jerry be darned," the state policeman said. He cocked his head down toward the brand-new chevrons on his sleeve and grinned. "Sergeant Corcoran, to you!"

Gus stuck out a cordial hand. "They look swell!" he said. "You had them coming."

"Took me long enough to get 'em," Jerry said. "Now they're apt to have 'em off me before I have a chance to get used to 'em!"

Gus laughed. "What's biting you?"

Jerry pushed his broad-brimmed felt hat back on his head and pawed in the breast pocket of his tunic for cigarettes. There wasn't any smile on his brown face now, nor in his keen gray eyes. "Hear about Jim Zugsmith?" he demanded.

"Fellow who runs the gas station at Four Corners?" Gus asked. "What about him?"

"Fractured skull," Jerry stated. "The docs figure he has a fifty-fifty chance—no better. Stick-up job last night, around ten o'clock. The guy got away with about fifty bucks."

"Not much to risk the chair for," Gus said. "I'm sorry about Zugsmith. Got a line on who did it? Or shouldn't I ask, now you're up there with the big brass?"

"Look out—there's a man under there!" Gus shouted, as the customer started to back out.



Jerry didn't smile. "This is my first case as a sergeant," he said, "and I need to get results. You know how the newspapers will ride us. Probably call it a wave of rural crime . . . No, we haven't got much of a line. Jim was alone, and didn't see the guy who slugged him. He had dozed off in the office. Horn woke him up, and he saw a car standing at the pump—all he noticed was it was a dark sedan. Soon as he stepped out of the door someone conked him. When he came to half an hour later he managed to make it to the phone. Then we got on the job."

"But couldn't get anything?" Gus asked.

"Well," Jerry told him, "we did manage to turn up something—not that it's likely to help much. It rained about eight o'clock last night. Jim figured it would freeze, so he sprinkled sand on the concrete apron around his gas pumps. It didn't freeze, and we found some tire tracks in the wet sand." He extracted a photograph from an inside pocket. "Here's the only one that counts," he said.

"Tread isn't much worn," Gus commented after he had examined the photograph carefully, "but there's quite a cut across it."

Jerry nodded. "You and Stan keep your eyes open for a tire with a cut like that on its tread, will you?" he asked. "If you should spot one, get the license number and give us a quick call . . . Oh, there's one other thing. You know where Zugsmith's station is—where the dirt road to Springvale crosses the hard-surface road? Well, we picked up that tire track in the mud of the dirt road

and followed it. The guy drove about a mile toward Springvale, and then turned around—backed into the ditch doing it—and came back to the hard-top. I figure he lost his way—probably doesn't know much about this part of the world."

Gus handed the print back. "Okay, Jerry," he agreed. "We'll keep an eye out for a tire with a big cut across its tread, on a car driven by someone who is a stranger around here. But it doesn't look very hopeful."

"You're telling me!" Jerry growled.

Most of a week went by without Jerry showing up again at the Model Garage. Gus could guess why—the new sergeant was too busy. Jim Zugsmith had turned a sharp corner, was on the road back, and had been pretty well forgotten by the newspapers, which were playing up later exploits of the same thug. Never seen by his victims, he'd already slugged and robbed the operators of three other isolated filling stations within a ten-mile radius of town.

#### *Wilson & Hicks, Private Eyes*

Gus and Stan Hicks between them managed to get a close look at the tires of every car driven by a stranger that had been brought into the shop or even had stopped at the pump for gas. But not one of the tires they'd seen had carried a scar anything like the one in the photograph.

Late one morning, while Gus was in the office talking to his partner, Joe, Stan rushed in. "This one's sort of funny, boss," Stan said, indicating a car that had just entered the shop. "The feller claims the cap on his

## **Pontiac Eases Tappet Repair, Stops Tool Rattle**

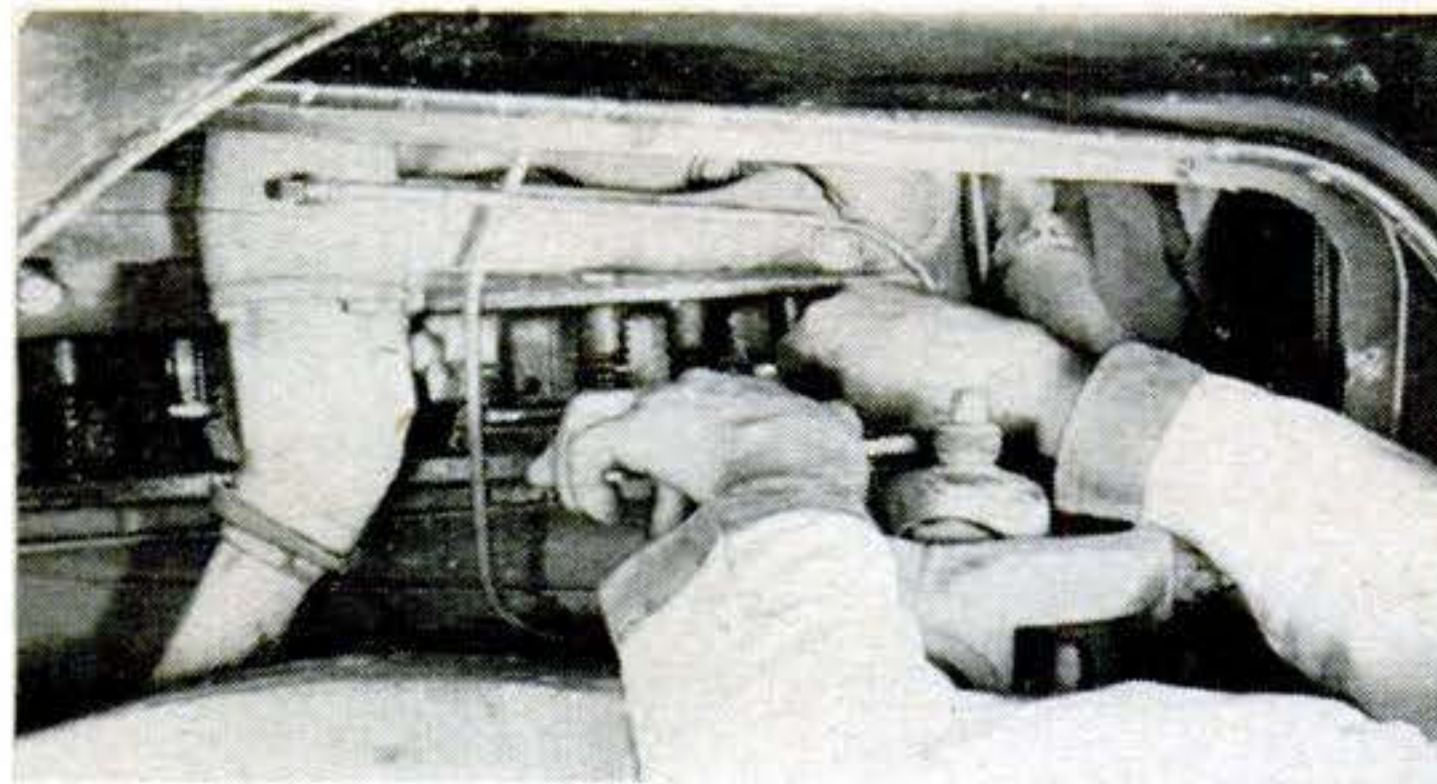

MECHANICS who have had to feel blindly for the tappets of an L-head engine with their wrenches while adjusting for lash will welcome an innovation by Pontiac. Remove the right front wheel, open an access door on the inside of the fender, and tappets can be fixed in plain sight and more accurately.

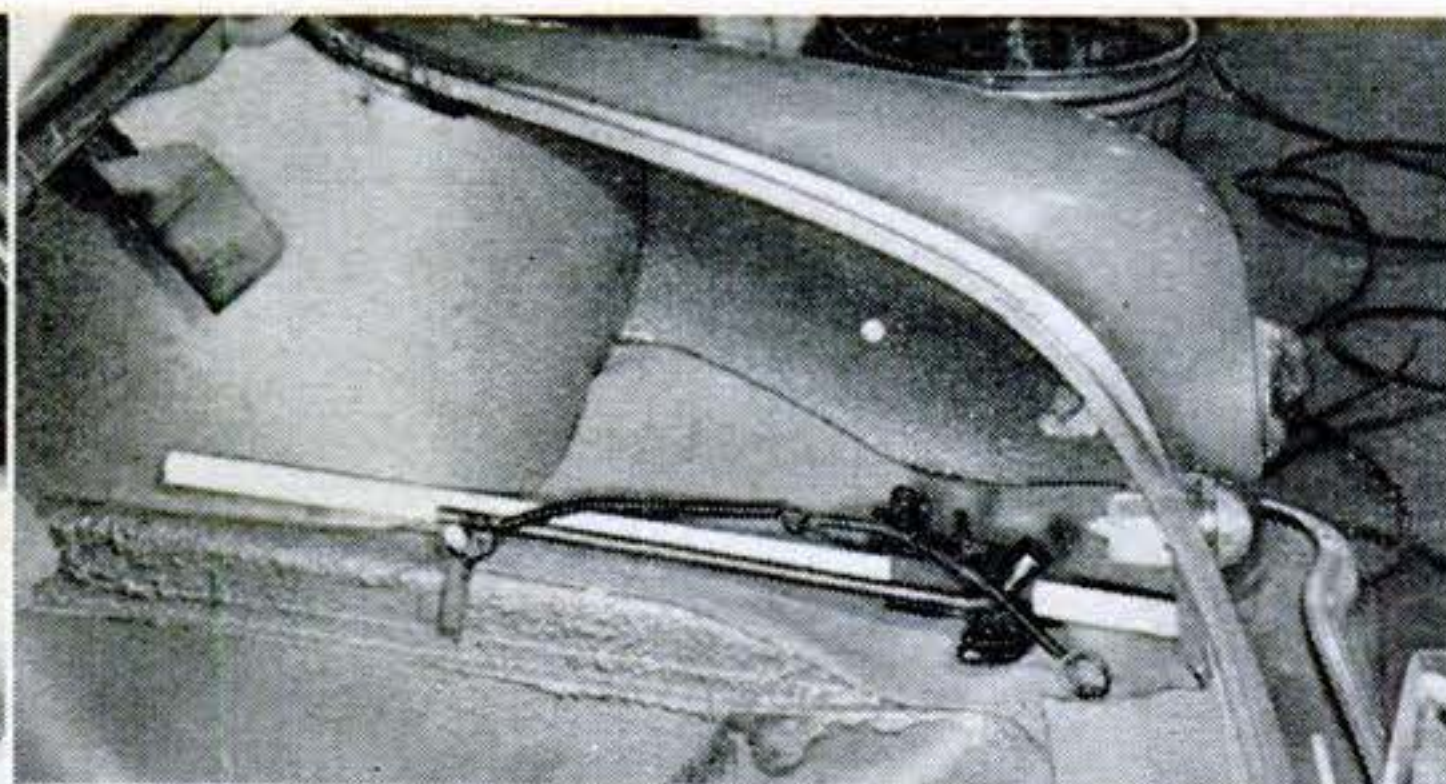

Pontiac also has done something about that noise in the luggage compartment of the family car as the jack, lug wrench, and assorted other tools bounce around with each bump on the road. This year's models have coil-spring tool holders that help stop the clatter of all such accessories.





oil-filler tube keeps poppin' off. I never ran into that one before. You better take a look."

"Did you sleuth his tires?" Joe Clark demanded. He'd been kidding Stan and Gus about their futile detective work.

Stan grinned. "Yes—but this time I didn't need to," he said. "The feller's a minister."

In the shop Gus found a stubby man, wearing a dark-gray suit, a soft black hat, and a clerical collar, frowning at a middle-aged sedan.

"The reverend says—" Stan began.

He was stopped by the customer's up-raised hand. "I'm not a clergyman," he said deprecatingly. "Just a humble worker in the vineyard. But my duties demand a considerable degree of mobility, so any trouble with my car is of serious moment to me." He looked at Gus with smouldering dark eyes. "I want it fixed—quick!"

"Oh?" Gus said. Then he smiled. "We'll have to find out what's causing the popping off, before we can stop it." He removed the filler cap and examined it carefully.

"Ever have this thing cleaned?" Gus asked. The customer shook his head. "I thought not," Gus continued. "The job should be done regularly—during a tune-up is a good time. It's pretty nearly as important as cleaning the carburetor air filter."

Gus pointed to the wire mesh visible through the side of the cap. "See, here's what I mean. This filter is so choked up with dust, dirt, and other gook that I doubt if *any* air can get through. Let's see what happens." He replaced the cap, got into the car, and started up the engine. "Sing out if she pops off," he told Stan.

While Stan watched, Gus ran the engine at varying speeds for a few minutes. Then Stan suddenly raised his voice above the engine's noise. "Thar she blows!" he yelled.

Shutting off the engine, Gus got out and picked up the cap. "That's part of the trouble, anyway," he said, handing the cap to Stan. "Wash it out, will you?"

The sedan's owner had been growing increasingly fidgety. "I'm in a hurry!" he snapped. "If you can't find out what's the matter with my car I'll take it—"

Gus didn't hear him. He had slid under the sedan and was examining the back-pointing crankcase ventilator tube that extended down under the car. After a moment he fished a screwdriver out of his coverall pocket, dug something from the mouth of the tube, and rolled it between forefinger and thumb. He whistled softly as he lay on his back for a moment, doing some fast thinking. Then he wriggled out and straightened up.

"I think I've found the cause of your trouble," he told the owner. He stooped down again. "Look here, Stan, will you?" Stan got down beside him. "Get under the car and make a noise as if you were working on the crankcase," Gus whispered. "Don't ask questions—do as I say! Stall until I come back!" He got up again. "It's the crankcase," he told the car's fidgety owner. "I'll have to get a couple of odd-size machine screws out of the stockroom."

### *Red Clay Gives Clue*

He hurried into the office, closed the door behind him, and dialed the State Police substation. "Sergeant Corcoran there?" he asked, his eyes on the office door. "Put him on quick, will you? . . . Hello, Jerry. What color is the mud on the Springvale dirt road—do you know? . . . No, I'm *not* kidding! . . . Red clay, hey! About the only red clay right around here, isn't it? . . . Thought so! Come over here—fast! I think the guy who slugged Jim is in the shop—he's dressed up like a minister. I'm faking a repair job, but he's getting impatient. Step on it!"

He went back into the shop. The clerically dressed customer scowled at him. "Get a move on!" he rasped.

"Okay," Gus said meekly. "I'll have you fixed up in a few minutes." He



reached a hand under the car. "Here are those screws, Stan. Hurry it up, will you?"

Gus started to tell the impatient customer a trumped-up story about what was the matter with his car. He hadn't got far when a siren wailed briefly down the highway. The stubby man started, then jumped into the sedan and stepped on the starter. "Look out—there's a man under there!" Gus shouted.

The driver paid no attention. As Stan scuttled crablike to safety, the customer started to back the car out of the shop.

But he was too late. The door opened and Jerry Corcoran and another state trooper hurried in. The instant Jerry saw the cleric-

ally dressed driver he went for his gun. "Reach 'em up, Parson!" he said. "Quick!"

The sedan's owner hesitated for a split second; then he got out with his hands held shoulder high. "Look him over, Frank," Jerry said, not lowering his gun. "It's Parson Strauss—he's a bad one. No more a parson than I am."

The trooper's practiced hands ran over the man's coat. Then he held up an automatic and a lead-loaded blackjack. "Put the bracelets on him," Jerry ordered. He turned to Gus. "What goes on?"

Gus told him about the popping filler cap. "When I found the screen stopped up, it was plain what was wrong. Normally, air enters through the cap screen, picks up the vapor in the crankcase, and is sucked out through the ventilator tube underneath the car. Since the cap was being kicked off, I figured a lot of back pressure must be building up, probably from blow-by because of bad rings. But back pressure that strong could only build up if the ventilator tube was stopped up, too. So I looked."

#### *Mud Plug Traps Mug*

Gus held out a chunk of red clay. "Here's what I found. Still plenty in there. The mouth of the tube slants to the rear of the car, so the only way I could figure it could have got plugged that way was by the car being backed into a bank of clay, or along a dirt road that had deep ruts in it. Then I remembered what you had said about the guy who had slugged Jim driving toward Springvale and then backing into a ditch. That would account for the clay plug in the ventilator tube—and the Springvale road is the only red-clay one around here."

The prisoner laughed. "That hooley will get you a long way with a jury!"

"Take him out to the car, Frank," Jerry directed. Then he turned to Gus. "He's right," he conceded, "but with that scar on the tire tread to back it up—"

"There isn't any scar on any of his treads," Stan cut in.

Jerry looked blank for a second. "He got wise and changed tires," he guessed. "Hope he didn't get rid of the old one. Let's have his keys." He opened the luggage compartment, and they got out the spare tire. Its tread had a wide cut on the tread.

"That'll do it," he said. He looked down contentedly at his new sergeant's stripes. "Guess they'll leave 'em on me, after all—thanks to you, Gus!"

END

### **Fender Guide Lights Up**

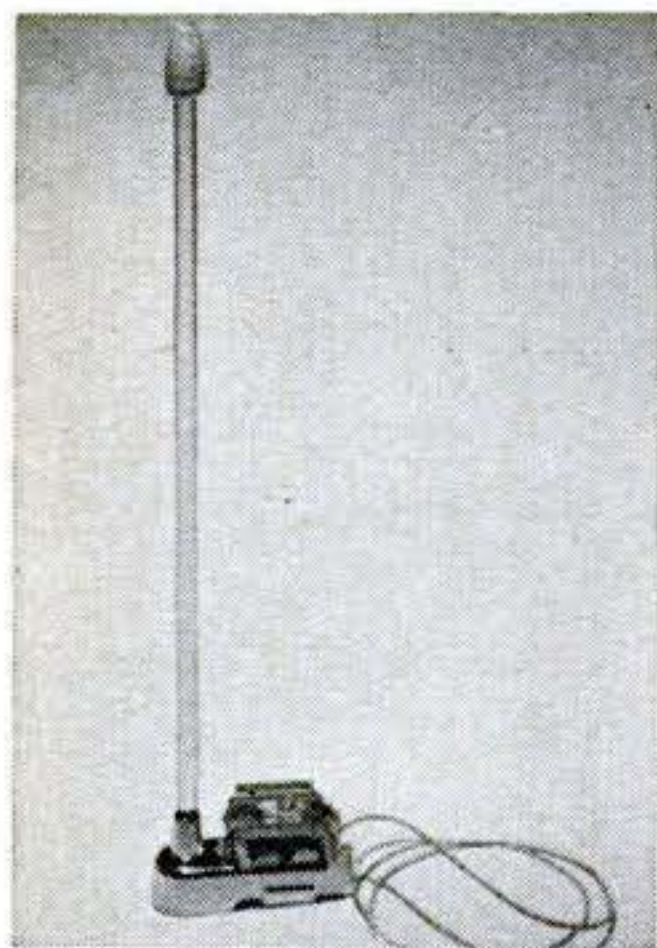

A NEW type of marker, which glows at night, for that invisible right fender is announced by the Santay Corp., Chicago. Called the Flame Tip Fender Guide®, it uses a light-piping Lucite® shaft. A bulb in the base lights up a flamelike upper end.

### **Auto Oven Cooks Hot Dogs**



WANT a hot dog on the road? Just plug this heater into your car's electrical system. It cooks two wieners in three to five minutes. Priced at \$3.95, it also comes in a 115-volt version for the home. It is called the Hot Dog Sizzler® and is made by the Thomas Manufacturing Co., of Chicago.





## Hints from the Model Garage

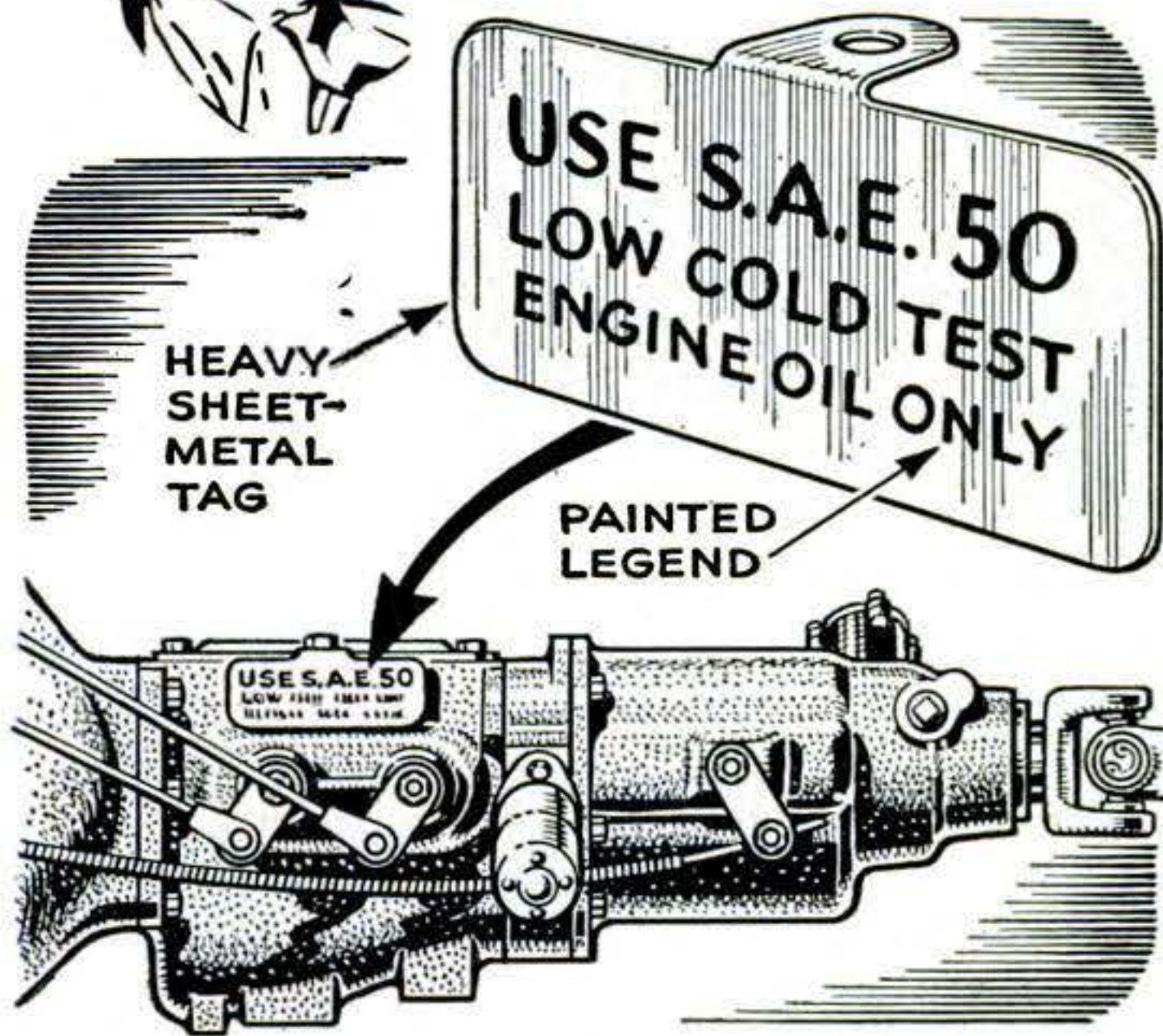

### Tag Shows Proper Lubricant.

In some new cars, a heavy motor oil is specified for the transmission instead of grease. To prevent careless errors, paint the oil recommendation on a metal tag and attach it near the transmission filler plug.

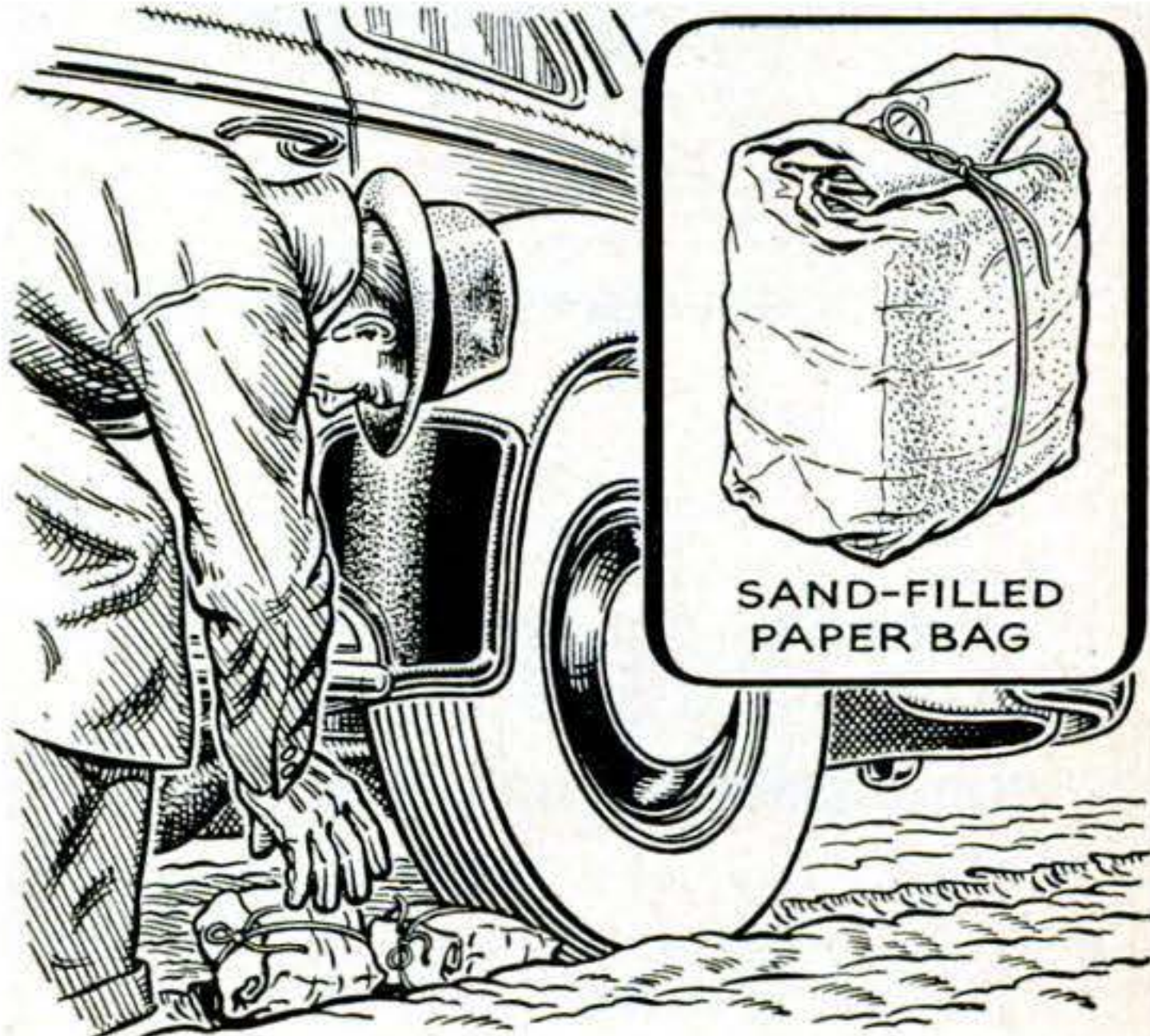

### Sand "Bombs" Overcome Ice.

If you frequently must drive on ice, keep sand in your luggage compartment, packaged in paper bags tied with string. Carry the bags in a cardboard box. Then, when stuck, drop bags under the rear wheels.

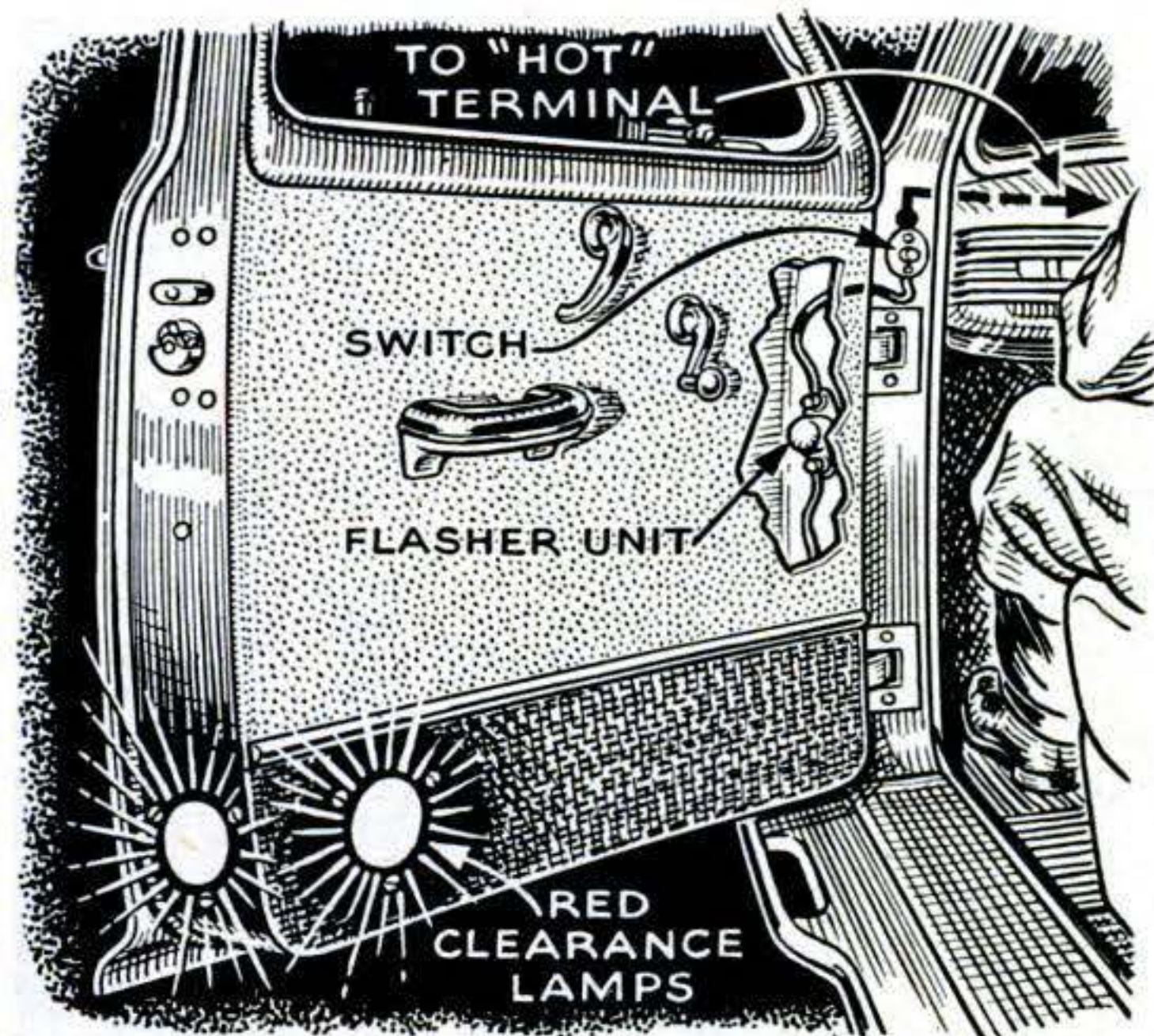

**Door Lights Flash Warning.** Before getting out the driver's door in traffic, it's always a good idea to look both ways. John W. Bell, of Des Moines, Iowa, has provided additional safety with this warning system. When the door is opened, a normally-off push switch in the door jamb shoots current to the flasher unit. An auxiliary switch on the dash cuts off the system if you want to keep the door open.

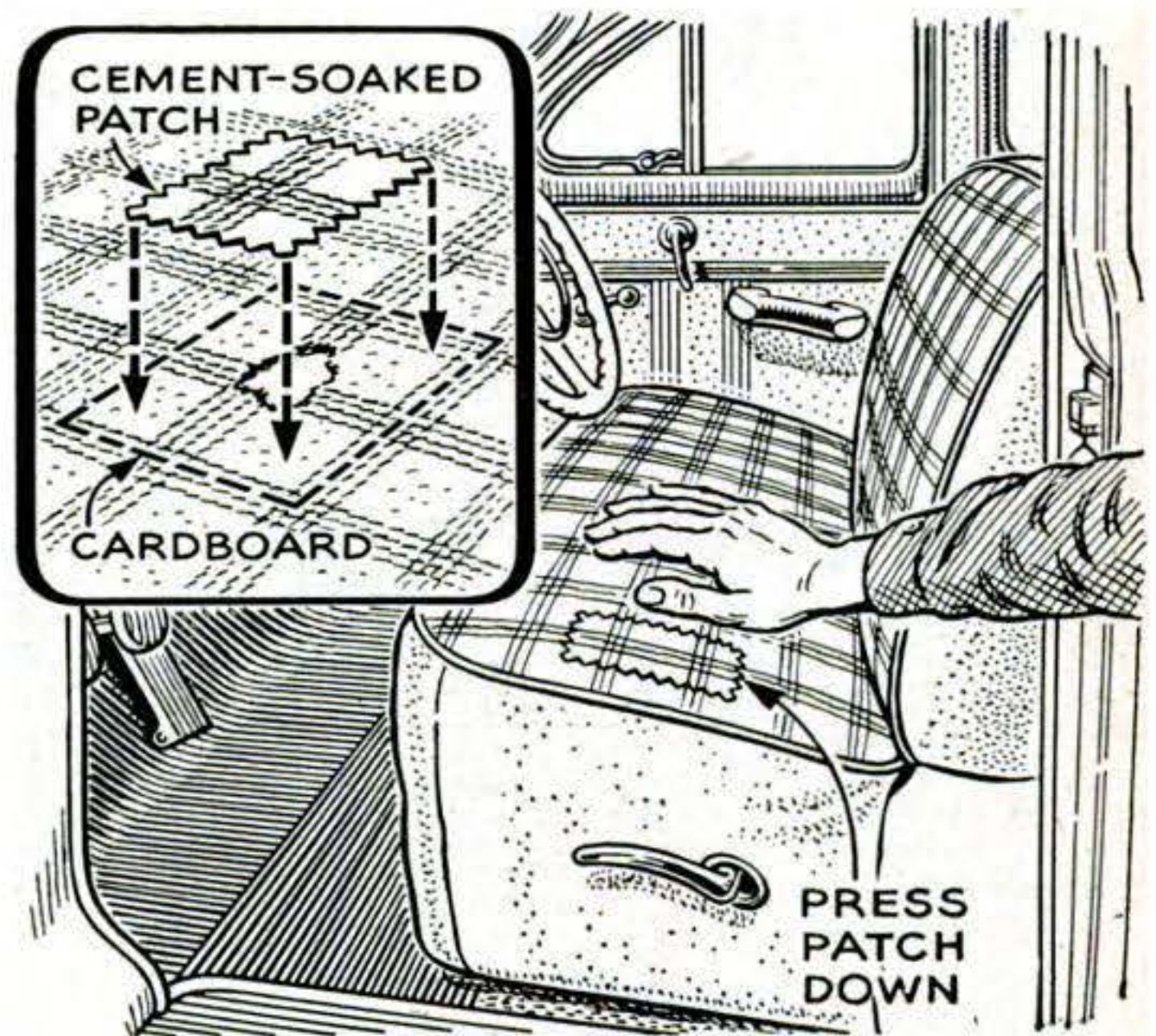

**Patching Seat Covers.** You can repair a worn area or tear in fiber seat covers by cementing on a patch. Cut the patch from a hidden part of the cover, using pink-ing shears if available. Put cardboard between the worn area and the upholstery to protect the latter, saturate the patch with clear model-airplane cement, wait until it is tacky, and press firmly in place. Let the patch dry overnight.



**MORE Hints from the Model Garage**

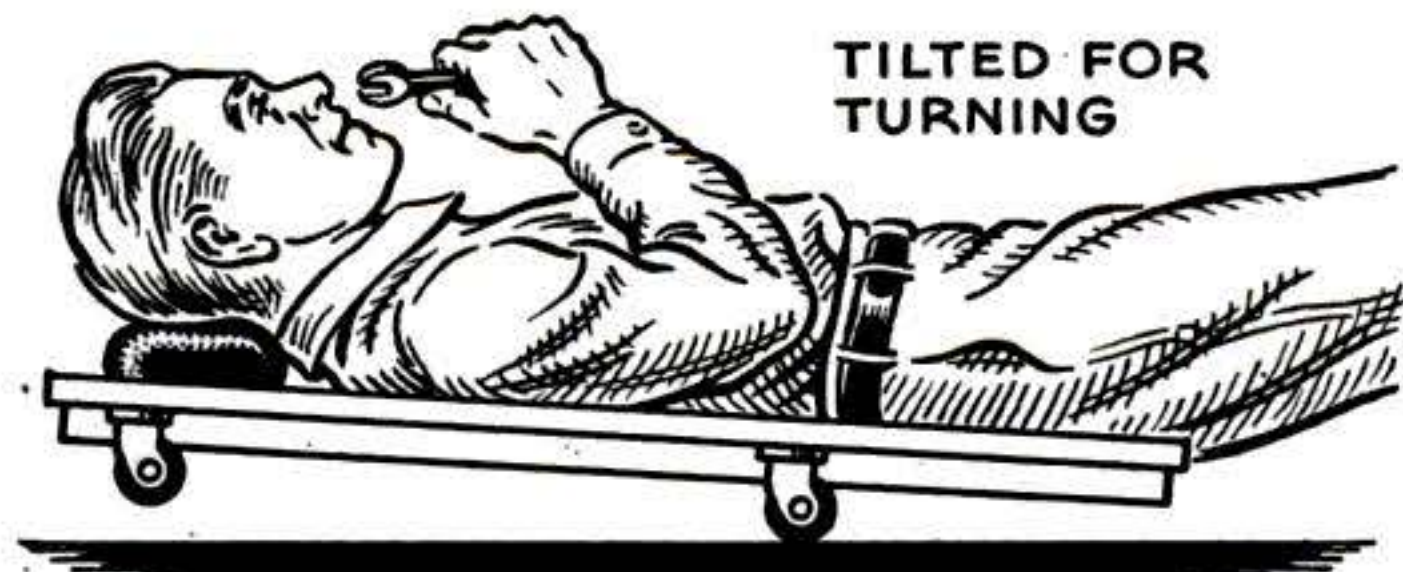

TILTED FOR TURNING

**Turn Creeper by Tilting.** On rough garage floors, it's often difficult to turn the usual shop creeper when you want to move to a new position. The creeper will work better if you set one pair of wheels back 12" or so from the end. Then, by shifting your weight, you can tilt the creeper slightly when you want to turn.

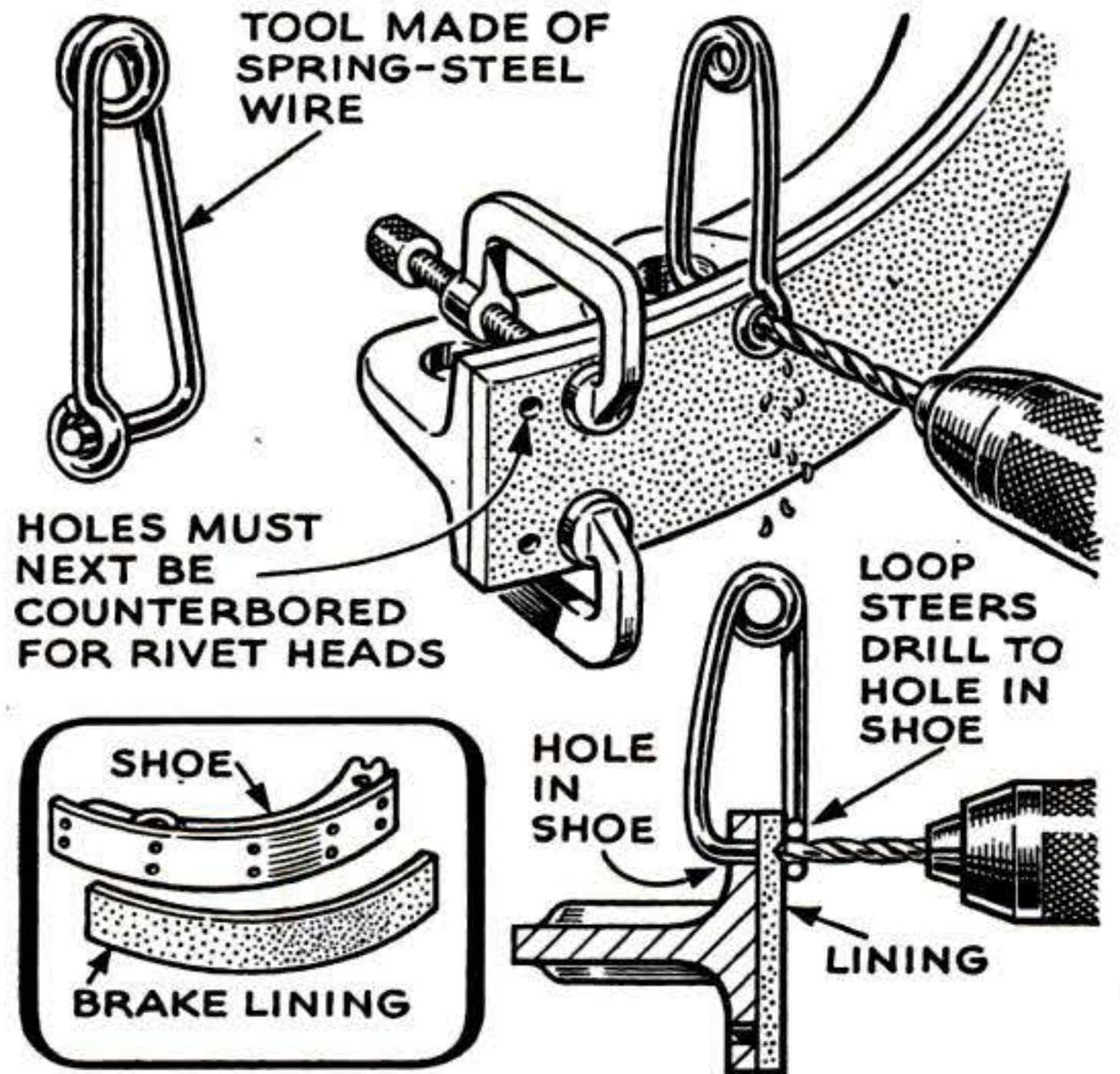

HOLES MUST NEXT BE COUNTERBORED FOR RIVET HEADS



**Aligning Holes in Lining.** If you cut and fit lining to brake shoes, this tool will help you align the rivet holes in the lining. After the lining has been cut, attach it securely to the shoe. Then place the prong of the tool in the shoe rivet hole and drill through the tool eye. Counterbore for the rivet heads.

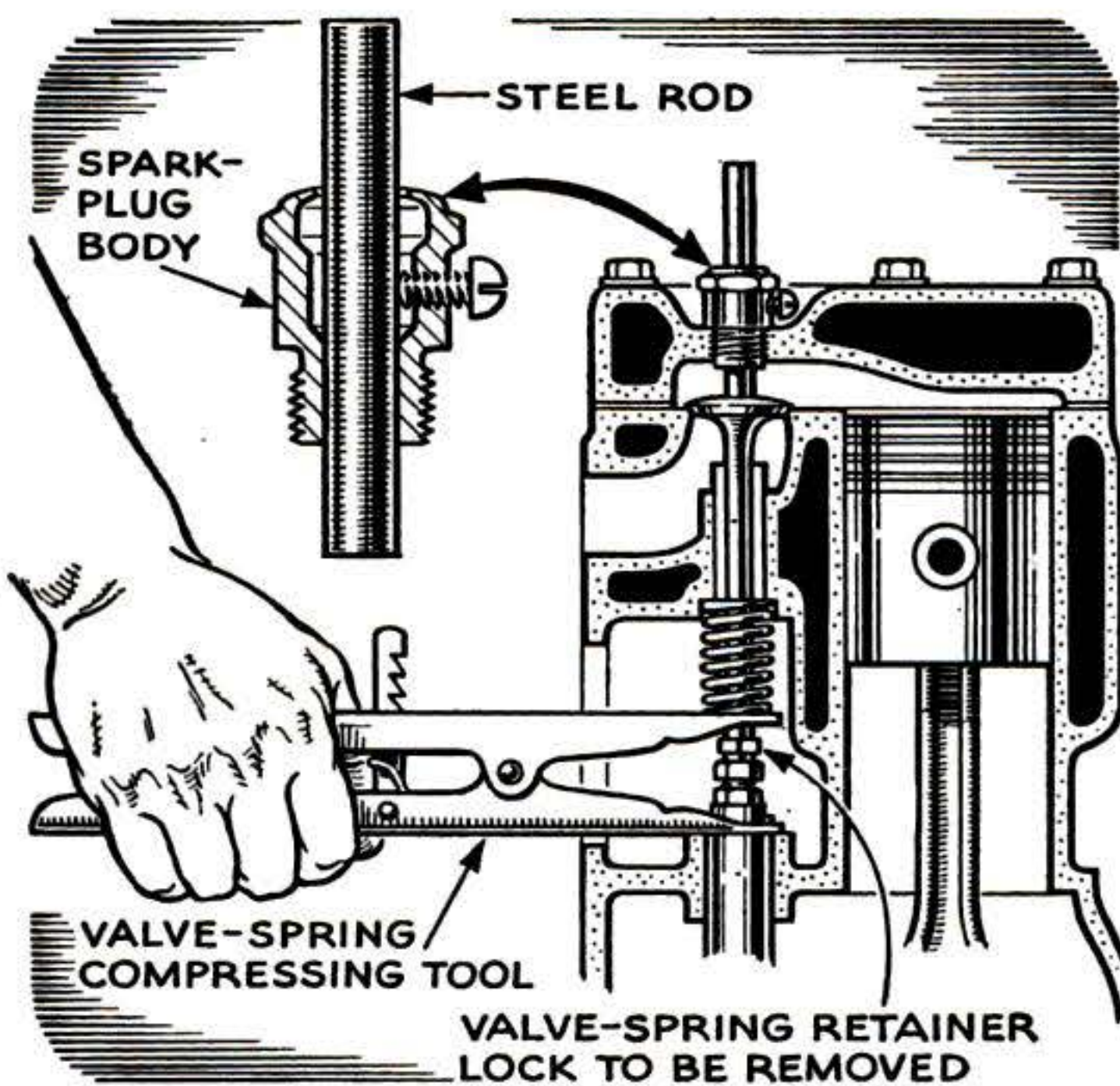

VALVE-SPRING RETAINER LOCK TO BE REMOVED

**Replacing Valve Springs.** This tool makes it easier to replace an intake-valve spring on an L-head engine without removing the head. It's used by adjusting the steel rod until it bears on the head of the closed valve. Turn the body into the spark-plug hole without forcing it. The spring can now be compressed and the retaining key removed. Marion L. Rhodes, Knightstown, Ind., developed the tool.

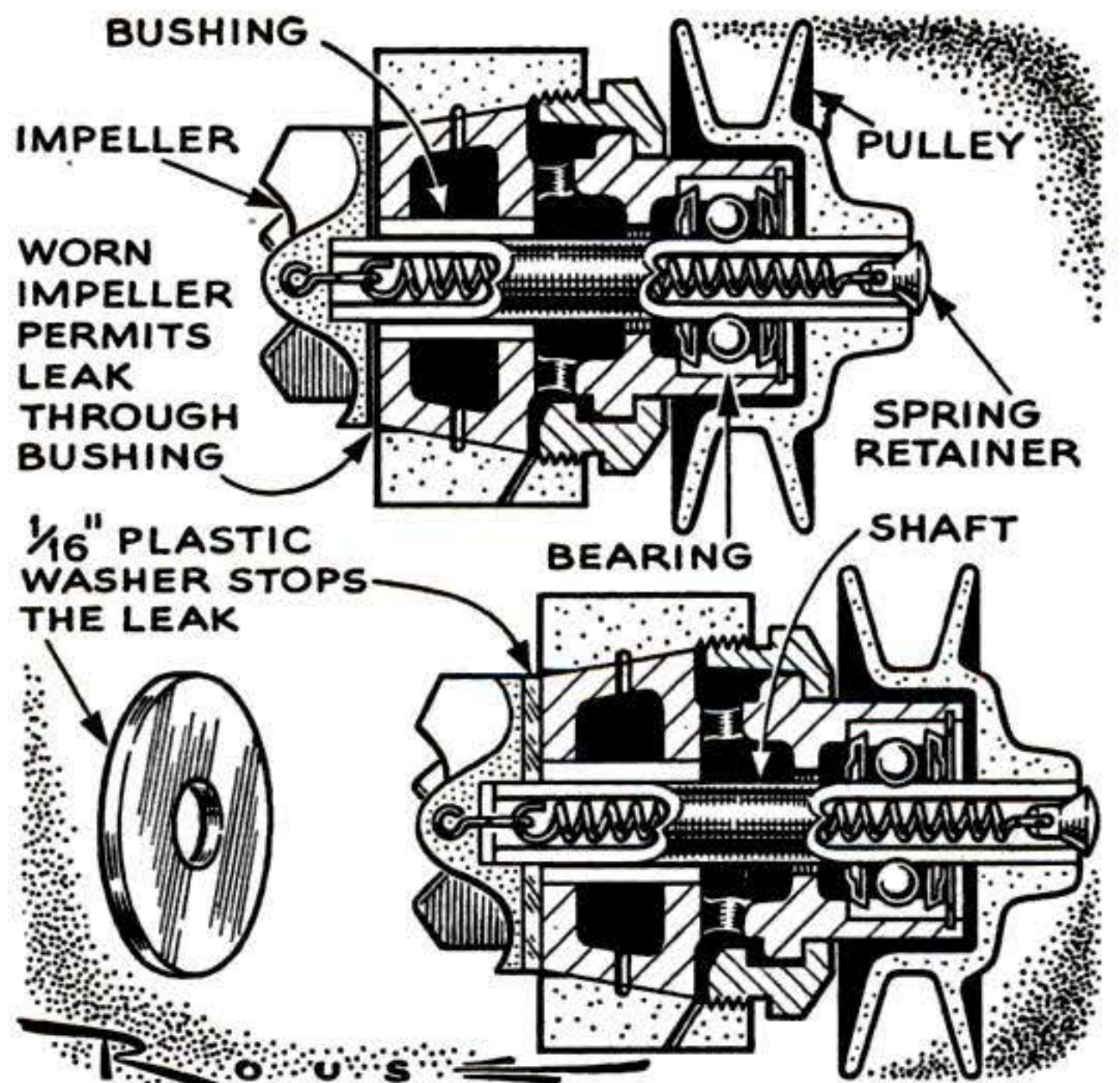

**Washer Tightens Worn Pump.** In overhauling a Ford "60" water pump, John Salzillo, of Brooklyn, N. Y., found that the edge of the plastic impeller had worn so much that the spring couldn't pull it snug against the pump housing. To take up the slack, he removed the impeller, and slipped a plastic washer on the shaft. This had the effect of building up the worn impeller. He cut the washer from 1/16" plastic.





## Car Gives Photographer High Eye

PRESS photographers often have difficulty getting high enough to shoot over crowds and other obstacles. Langston McEachern, of Shreveport, La., has solved this problem by installing a combination platform and equipment cabinet in his Jeepster.

Compartments and drawers in the 30" by 30" by 40" wood cabinet allow plenty

of room for his holders, flash bulbs, tripod, camera, and miscellaneous equipment. A sponge-rubber lining protects the equipment from damage. The hinged cabinet top is covered with a rubber mat. A spotlight with 20-foot cord plugs into the cigar lighter for night work. The Jeepster top can be raised in case of bad weather.

## Sponge-Rubber Padding Protects All Passengers

BRYSON E. HICKMAN hopes he'll never crack up his home-built convertible. But he's well prepared. Sponge-rubber crash padding is fitted to the dash, seats, and doors. Even the rugs are padded.

Using standard parts, Hickman assembled

the car himself at La Canada, Calif. Built on a Lincoln chassis, the car has a 135-hp. V-12 engine, overdrive, and a detachable convertible top. Doors, windows, trunk, and hood are operated through a hydraulic-electric system from a dashboard control.

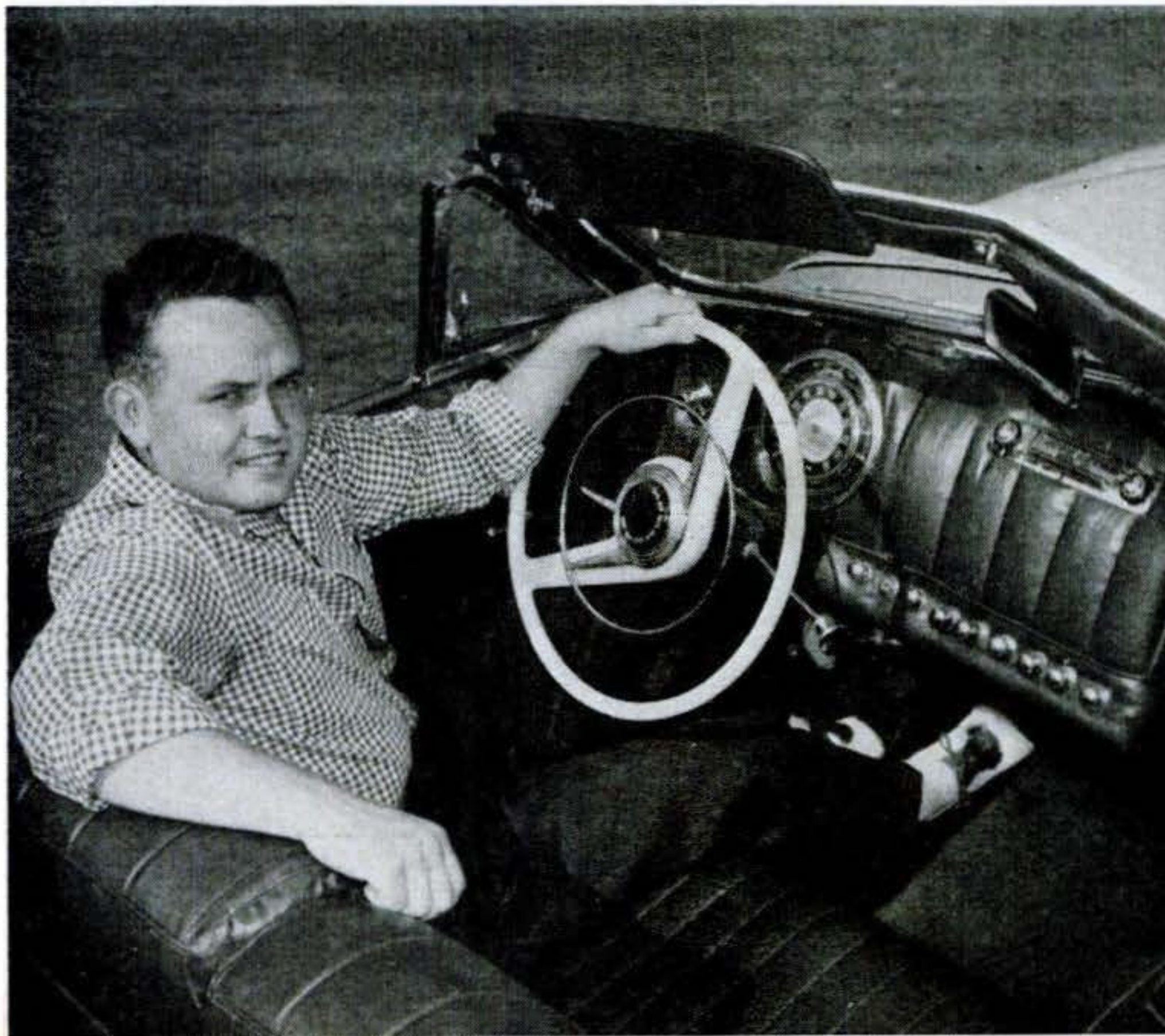



# The Laws No Car Can Violate

These simple home experiments will show you why.

By **Kenneth M. Swezey**

SIR Isaac Newton's First and Second Laws of Motion, set down nearly three centuries ago, are far different from the laws on the local statute books. *You can't*

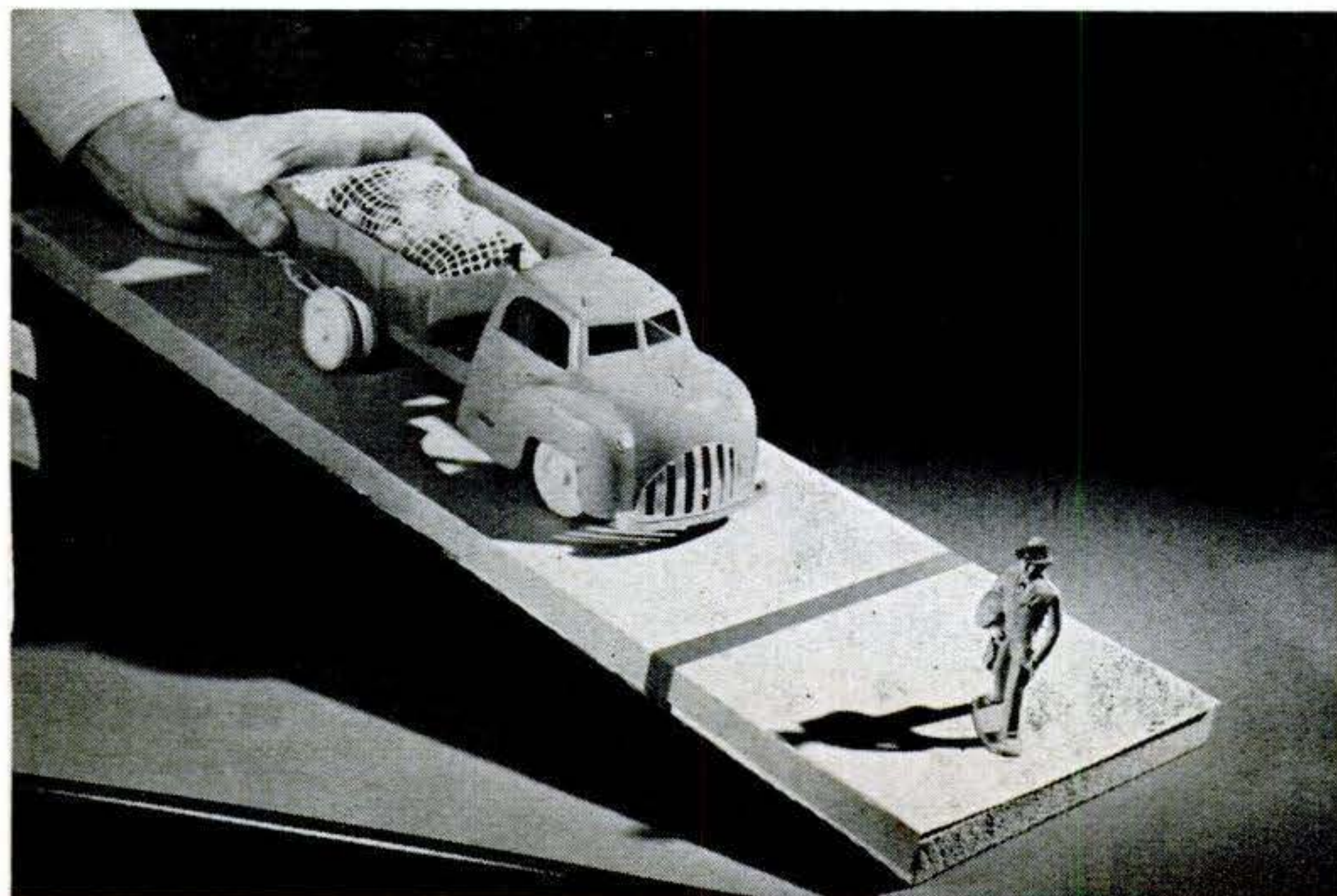

**You can observe** Newton's laws at work with this simple setup. Attach a toy car to the top of an incline by linked rubber bands so that its front bumper normally just reaches a line marked on the slope—the spot at which the driver supposedly applies the brakes. Now pull the car back half-way up the incline, as shown at left, and let it go. At such slow speed, car barely overshoots its mark (below).

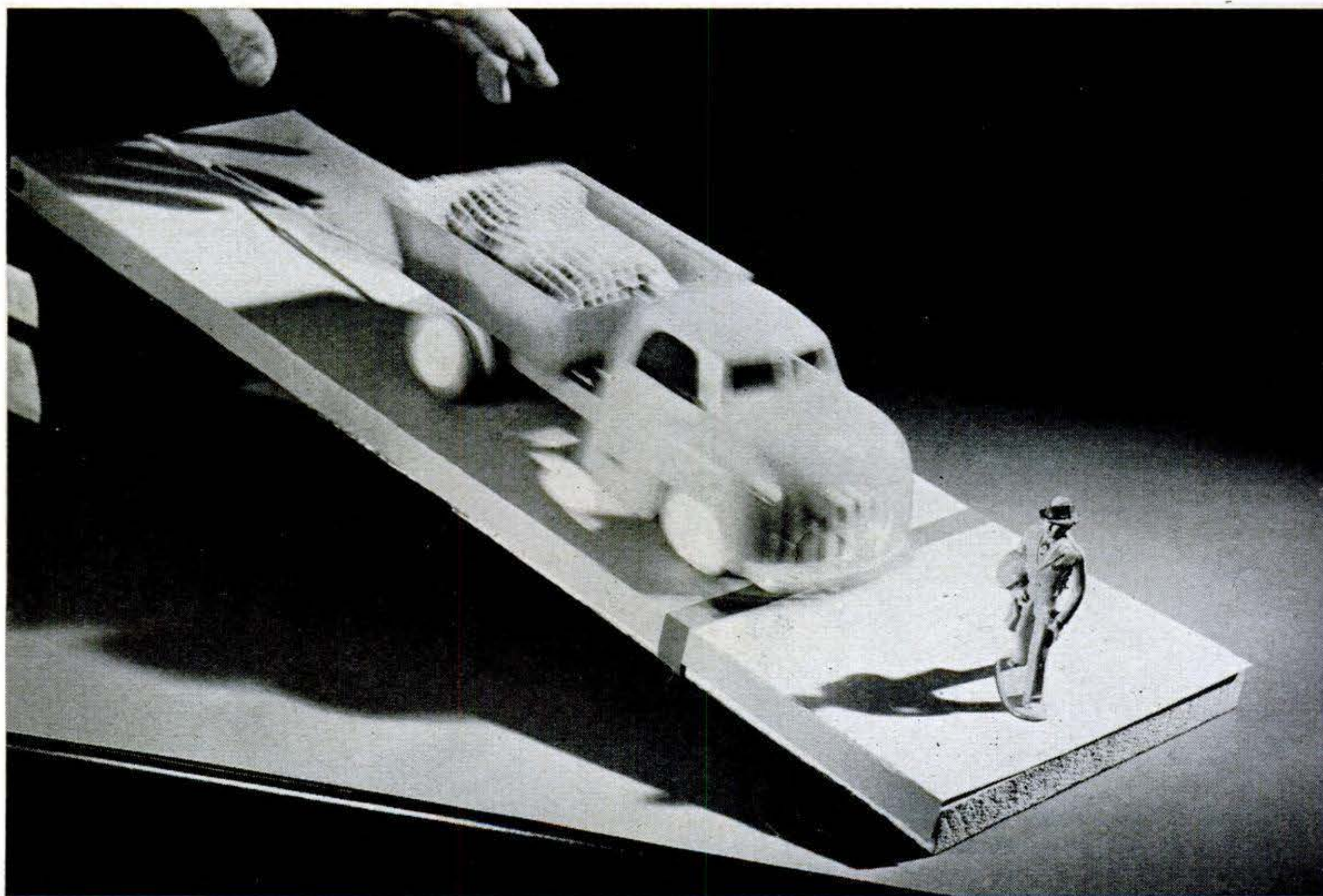





*break them even if you try.* But they can easily break you, causing property damage, personal injury, or even death.

According to these laws, every body remains at rest, or continues to move at constant speed in a straight line, unless acted upon by an outside force. The amount of force required to change the motion of a body depends upon two things: the mass of the body, and the rate at which you must

slow it, speed it up, or change its direction.

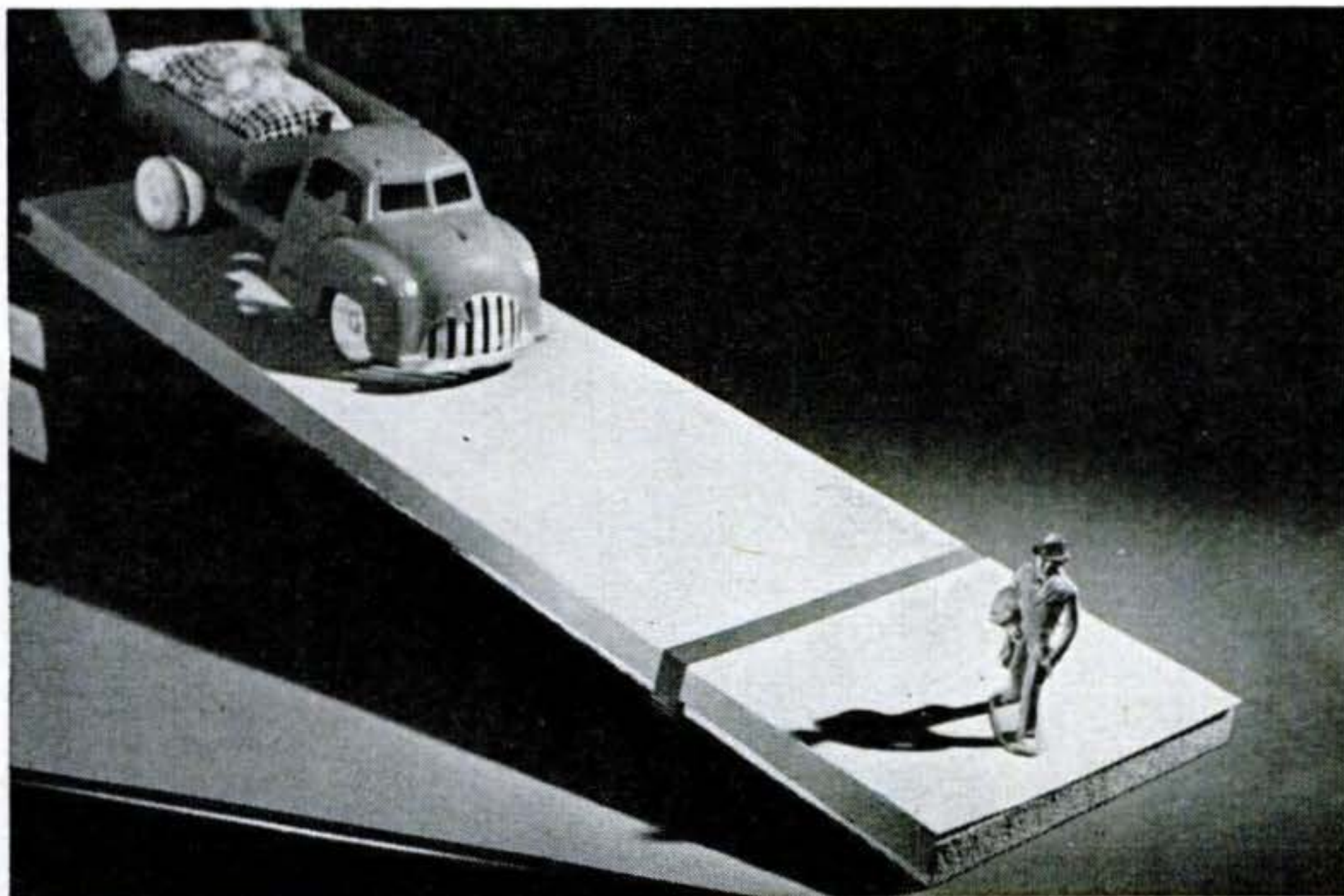
Applied to your car, these scientific axioms explain why you can't stop short at high speed; why you must reduce speed to keep from skidding or turning over on a sharp curve; and why it takes more power to start your car, or to accelerate it, than to keep it moving at a constant speed. The simple experiments shown here and on the next page may help you remember.



**If you double your speed,** the laws say, your stopping distance in a car will not merely be doubled—it will be *four times as great.* To demonstrate this rule dramatically, pull the toy car to the *top* of the incline, as at the left, and let it go. This time the car is rolling so fast when it reaches the braking line that it plunges right ahead and crashes headlong into the man in front of it (below). 

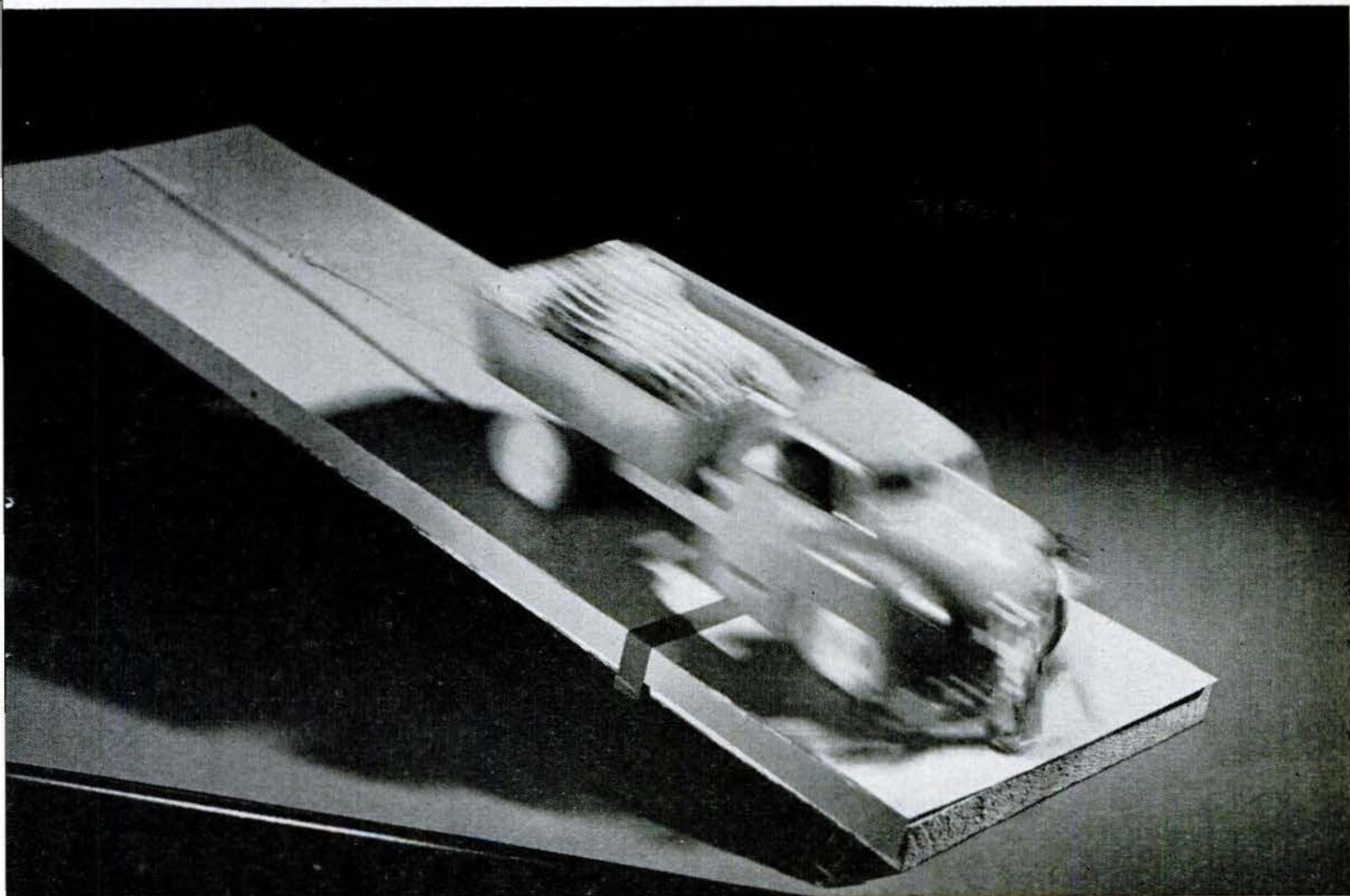



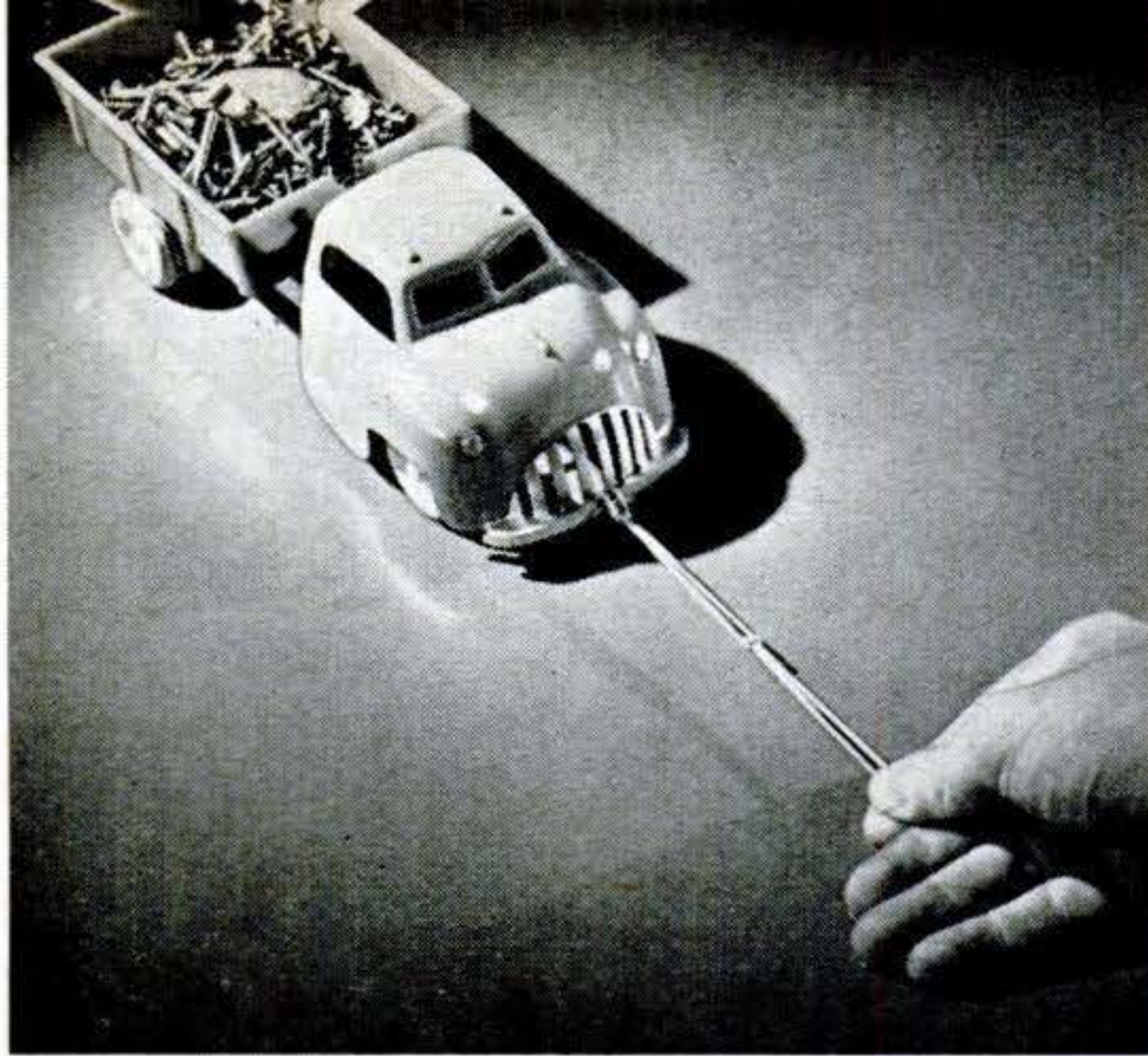

**More power is required** to start your car than to keep it going chiefly because of *inertia*. This can be defined as the inherent sluggishness of matter that causes it to resist any change in its motion. You can test this law on the living-room

floor by pulling a loaded toy car with linked rubber bands. The bands stretch considerably while the car is starting, left above; but they contract a lot when their only work is to keep the car rolling at a steady speed, right above.



**Cars skid or turn over** when rounding curves because their speed is too great for the sharpness of the curve. Both speed and sharpness determine the force that tries to throw them off the road. You can show this with the experi-

ments above. A marble rolled down a cardboard trough into a large pie tin (left) follows the curve. Rolled from same distance onto a small tin (center), marble jumps off. Rolled from halfway (right), it stays on the track.

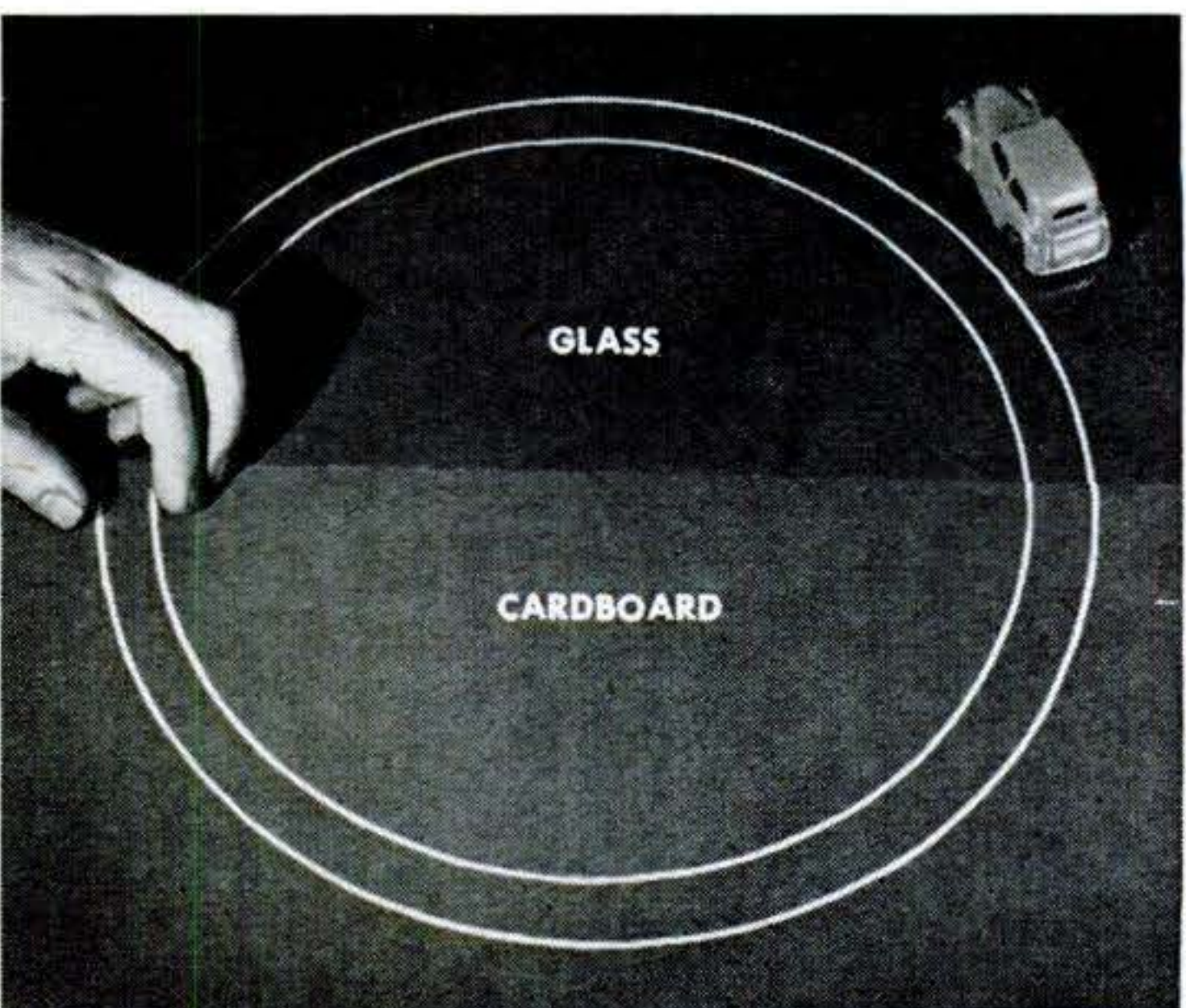
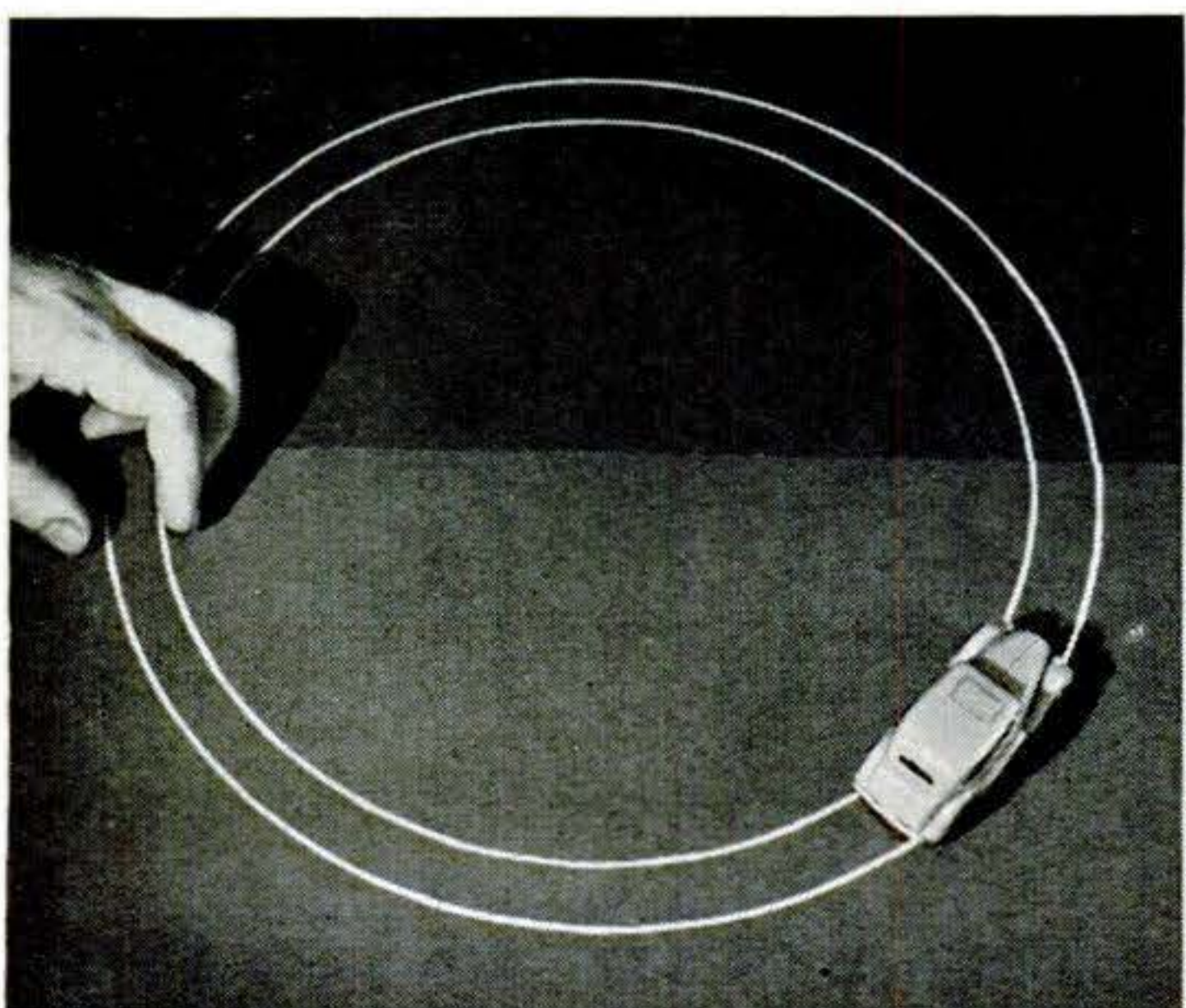

**On unbanked curves**, cars can keep to the curve only because of friction between the tires and road. Reduce this friction with dampness or ice, and cars may skid even at comparatively slow speeds. You can show this by running a

spring-powered toy around a track that is half cardboard and half glass (to represent ice). On the cardboard, the car follows the curve exactly. But as soon as it hits the glass, at right, it swerves sharply off the track.



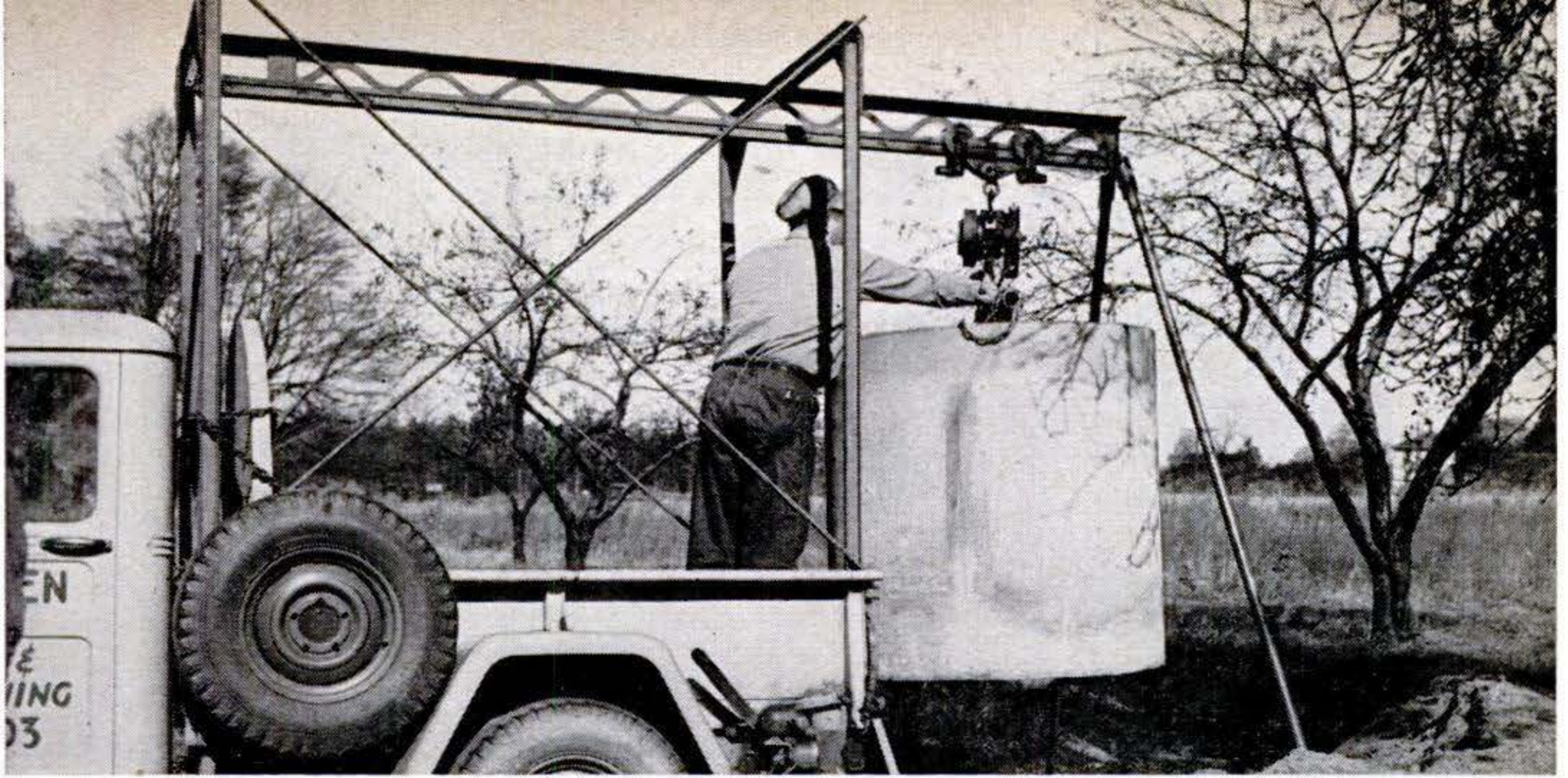

**Down it goes.** Ed Aspden's homemade rig makes short work of setting a 1,400-lb. septic tank in ground. Using a chain hoist, he lifts

tank from truck bed, rolls it along monorail, and lowers it into hole. Telescoping legs brace end of monorail during loading and unloading.

## ***Jeep Rig Lifts Heavy Tanks***

**L**IFTING, hauling, and setting a 1,400-lb. concrete septic tank usually requires several men. But Ed Aspden, of Erie, Pa., has made it a one-man—and a Jeep—job.

He does it with a  $\frac{3}{4}$ -ton Jeep pickup and a special lifting rig he welded together. The main components are a monorail 10 feet long, a four-wheel dolly that travels the

monorail, and a chain hoist for the lifting.

The monorail projects four feet beyond the end of the channel-iron framework. During loading and unloading, telescoping pipe legs support the monorail end. Hooks on the top ends of these legs fit into loops welded on the monorail. The rig cost about \$100, took 25 hours to build. **END**



**Loading** is simply the unloading procedure in reverse, again a one-man job. Corner uprights of the rig are 1" by 2" channel iron about 7' long. I beams to join the uprights were made by welding 1" by 2" channel iron back to back. Structure is reinforced by  $\frac{3}{8}$ " diagonal rods.



**Up in a tree** is where Aspden keeps the rig between jobs. Hooking the hoist over a limb, he drags the entire business up out of the way. Note that 1" angle iron ties the cab-end uprights together. All of the corner posts fit into the stake pockets of the truck body.



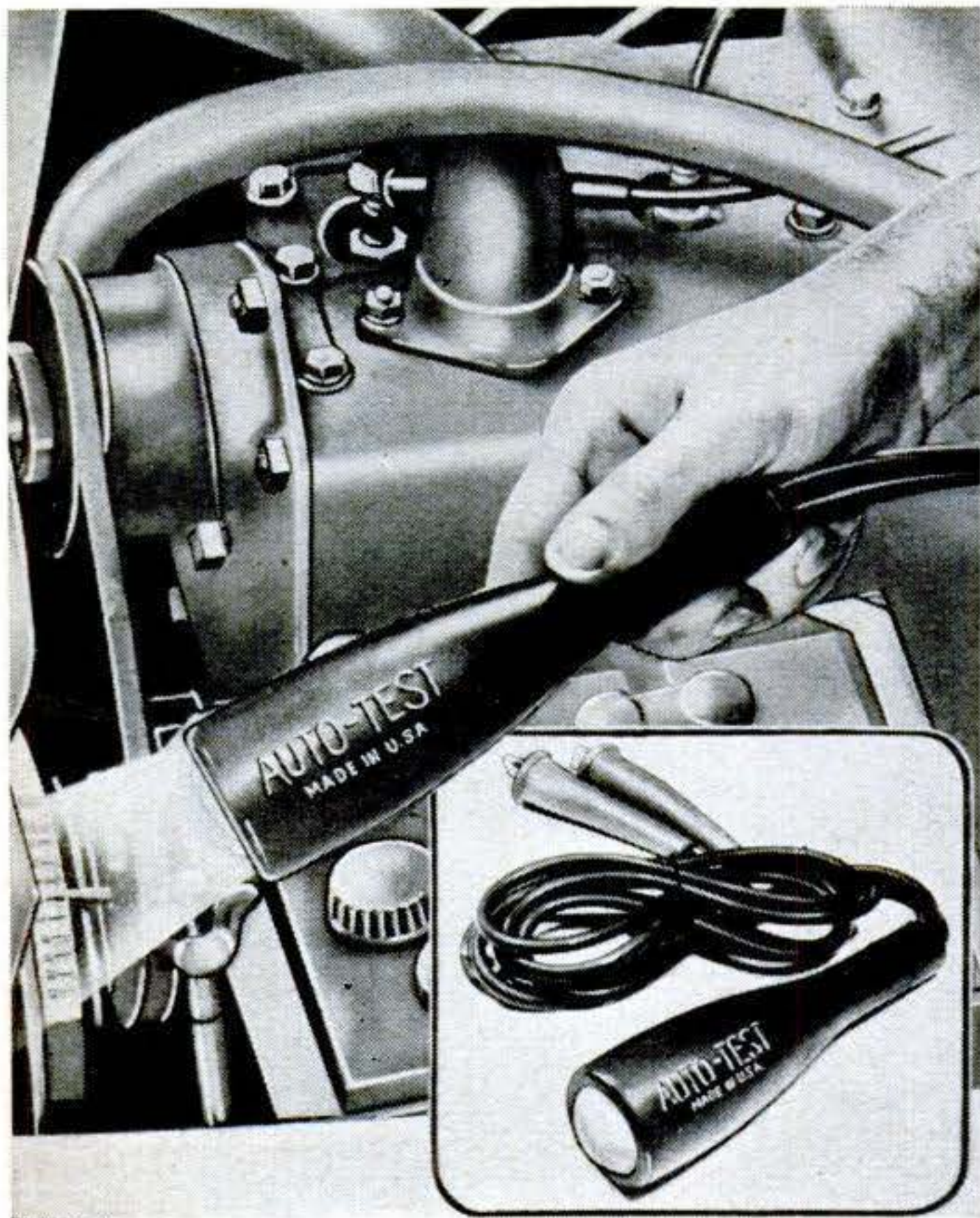

### Rubber Protects Timing Light

THIS low-cost ignition-timing light is cushioned in rubber. Its extra-long handle makes it easy to hold the light close to the timing marks. The neon tube is set in a white reflector. Made by Auto-Test, Inc., of Chicago, Neo-Flash® sells for about \$6.

### Soap Eases Tight Car Window

IF A window in your car begins to work hard, it sometimes can be loosened up by rubbing a little laundry soap along the edges of the glass and in the channel.

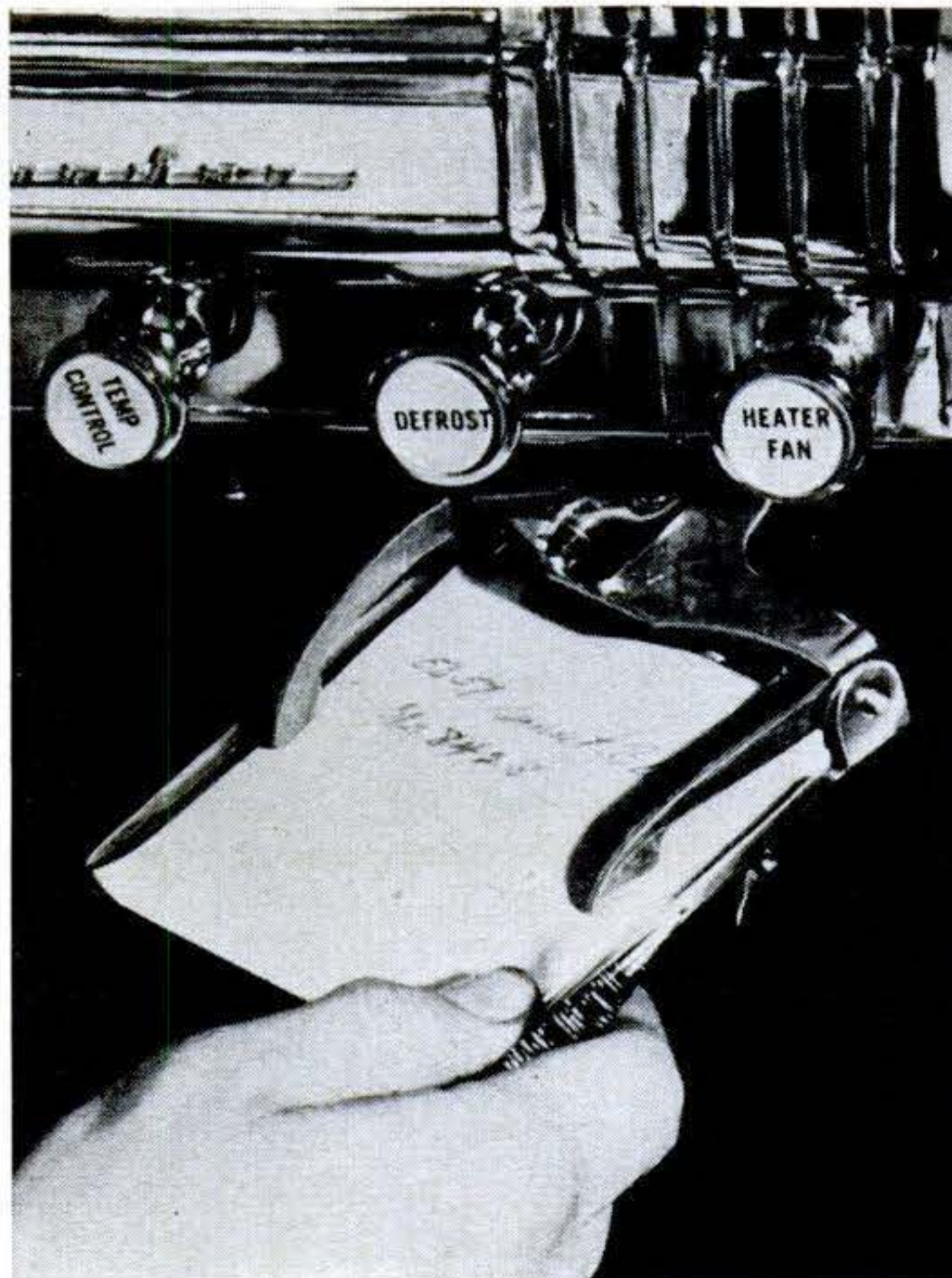

### Miniature Desk for Auto

THIS miniature metal writing desk, for jotting down notes in your car, is easily attached to the dashboard by a single bolt. Complete with pad and pencil, the accessory can be adjusted to any angle for writing and swung back out of the way when not in use. The Auto Desk® is made by the Marsh Mfg. Co., of Santa Monica, Calif.

**Shoptalk:**

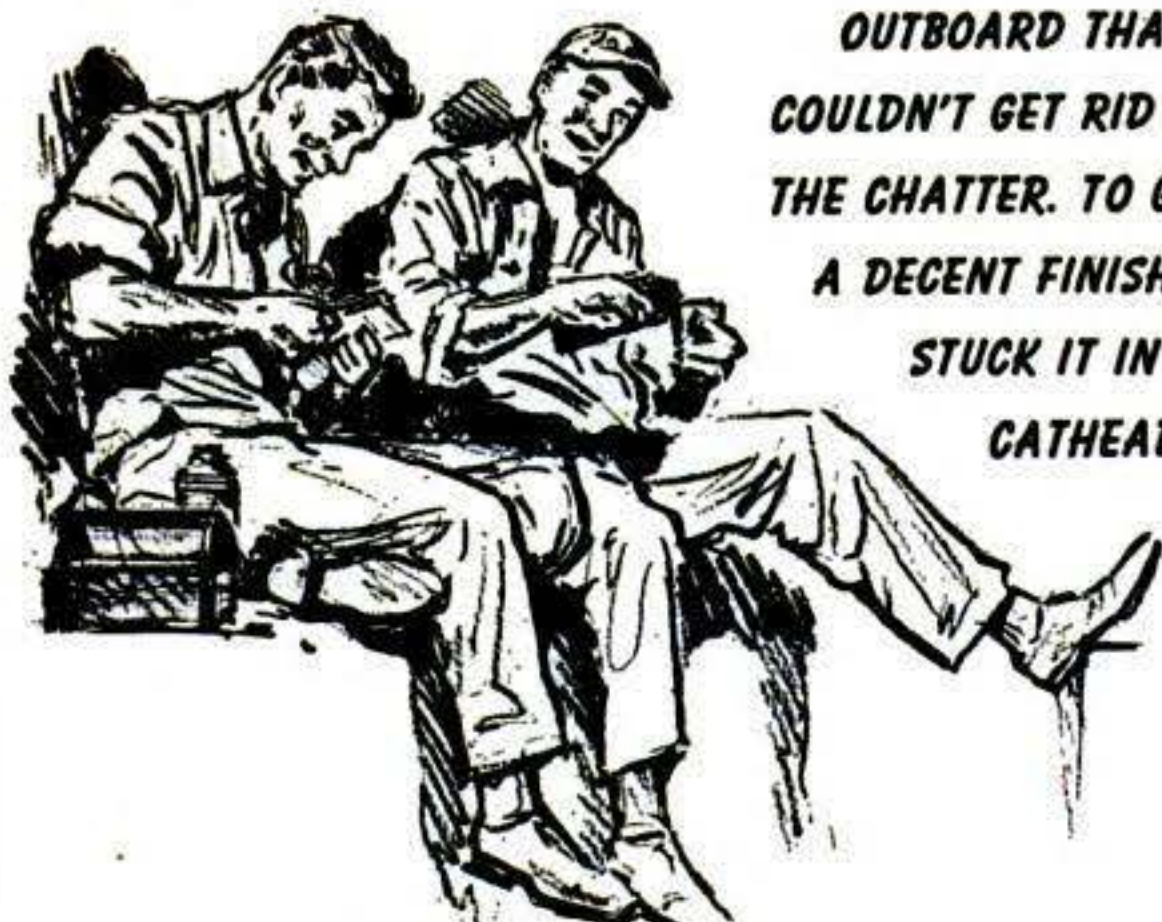

"IT WAS SO FAR OUTBOARD THAT I COULDN'T GET RID OF THE CHATTER. TO GET A DECENT FINISH, I STUCK IT IN A CATHEAD."

What are they talking about?  
Where do they work? Answer below.

*They're machinists. A long, slender piece of work in a lathe was vibrating badly. A cathead is a sleeve that runs in a steady-rest. It steadies the work when it's being turned.*

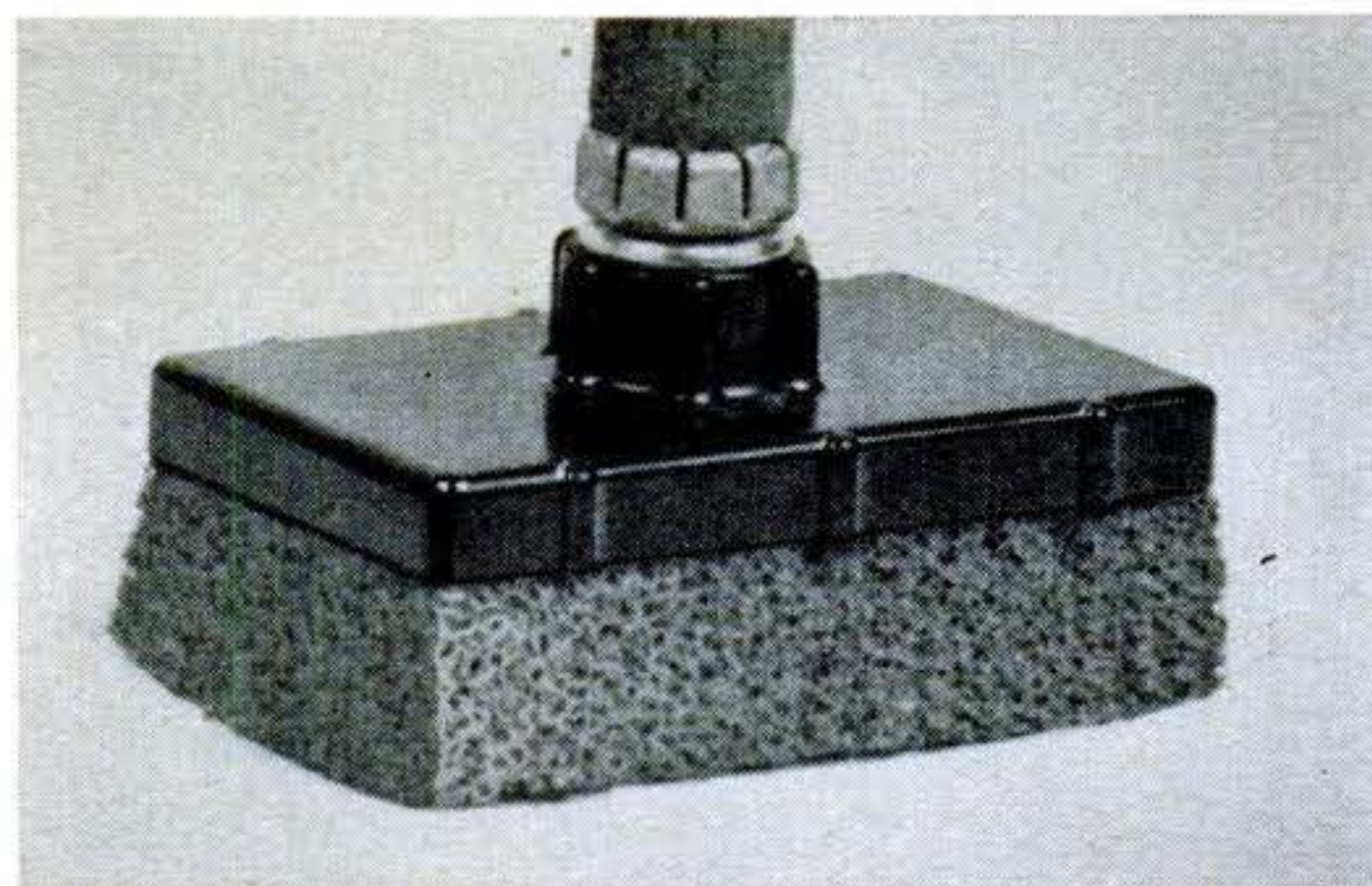

### Sponge Connects to Hose

WHEN connected to your garden hose, this sponge will scrub away the grit and dirt on your car without hurting its finish, according to the maker, Abar Plastics Co., of Pittsburgh, Pa. Set into a plastic holder, the Hand-ee-Sponge® can be gripped without squeezing out the water. It is also useful for household cleaning tasks.



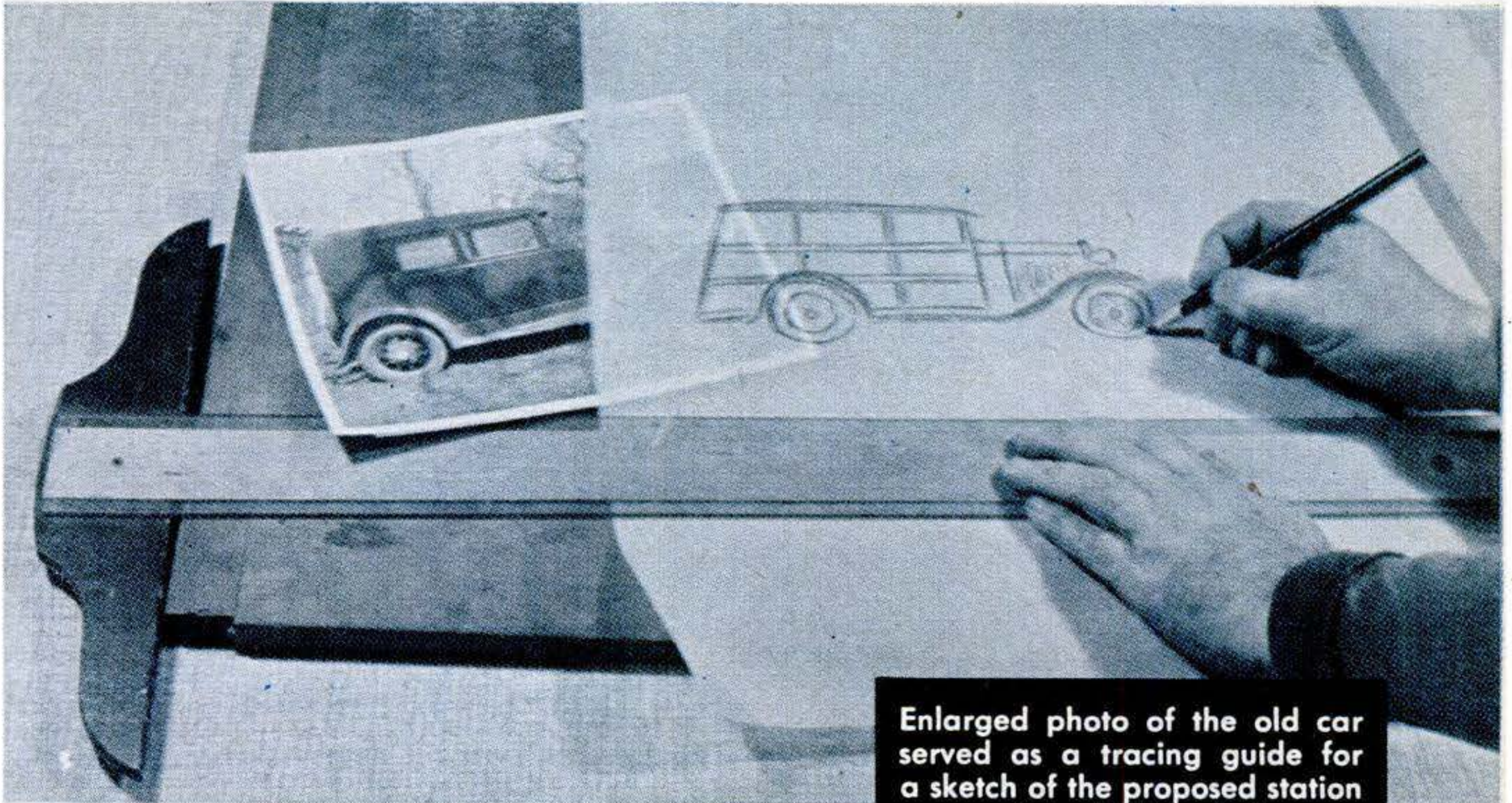

Enlarged photo of the old car served as a tracing guide for a sketch of the proposed station wagon, later built as below.

# How to Build a Station Wagon

**By George Daniels**

A NEW station wagon from the showroom floor was too much of a luxury for my pocketbook. But I now have one—and the amount I spent converting my old bus, a Model-A Ford, to this style of body was only a trifle more than the price of a couple of new tires.

Given an old car in good running order, you can make a similar conversion. There are two ways you can do it—apply plywood panels over the old car body, or remove the body and build a new one from scratch.

If the car dates back to pre-streamline days, the first method is easier and cheaper. You use the old body as the inner framing, cutting out its back end. The flat body panels make it easy to install the plywood.

But if the car has lots of curves, it probably will be best to cut away the body just behind the windshield, leaving the posts in place. In a pinch, you could cut it away with just a pistol-grip keyhole hacksaw.

As the first step in either type of con-

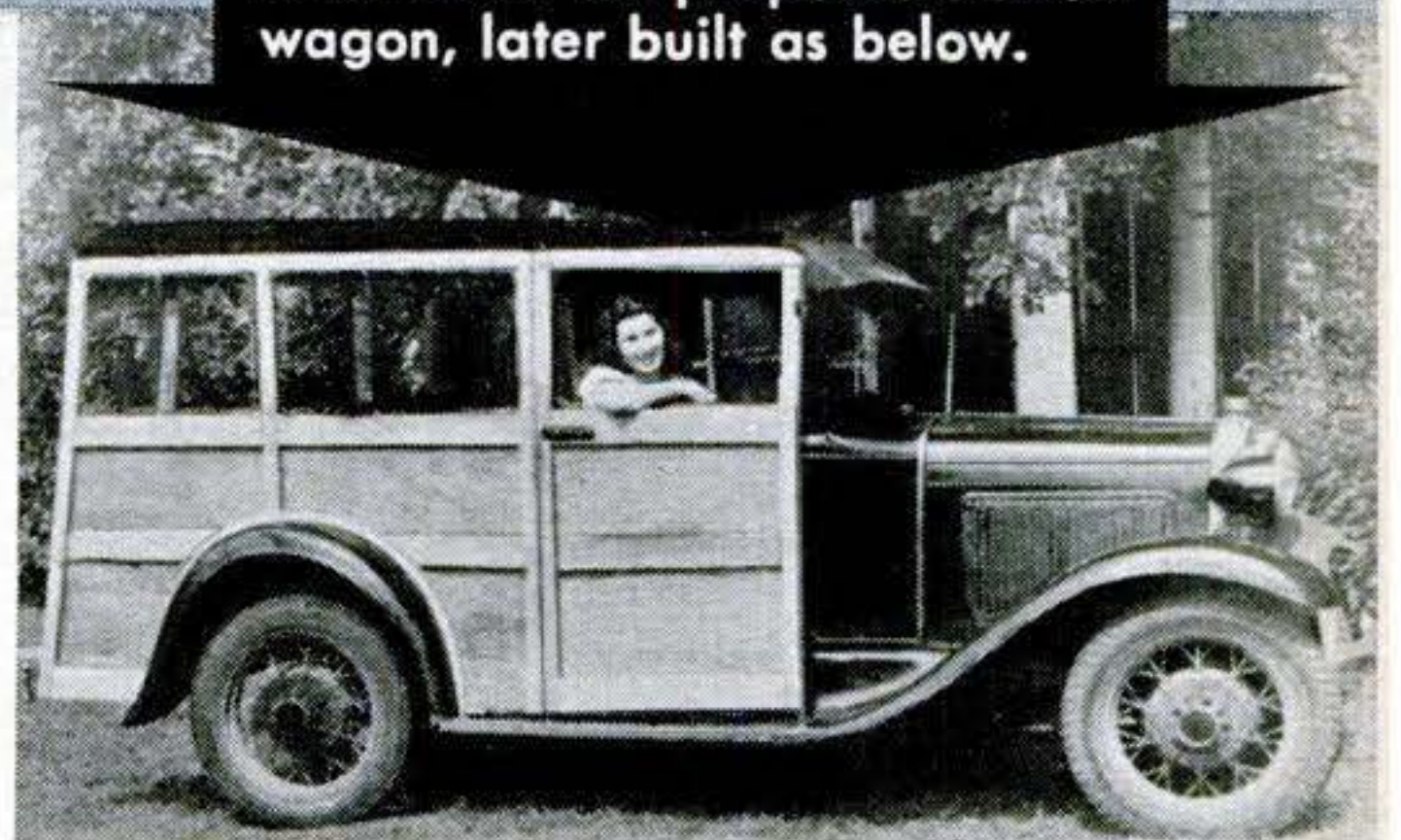

version, take a broadside photograph of the car. Line up the camera at right angles to the wheelbase at its middle point. Have the picture enlarged to 8 by 10 size.

Over this photo, trace the general outlines of your intended station-wagon body, using the roof, windshield, and window posts as guides if you are going to use the old body as an inner frame. In your sketch, extend the body at least as far back as the rear tips of the back fenders. If you wish, it can overhang another foot or so.

This sketch will enable you to visualize the appearance of the completed body. From it, you can also estimate the materials needed. Using a ruler on the sketch, measure the proposed body in units of wheel diameters. Then measure the wheel diameter on the car itself. A little figuring will give you the approximate measurements of the body you plan to build.

You are then ready to start to work. The photos on the next two pages show you how the new body can be built using the old body as the inner framework. ▶



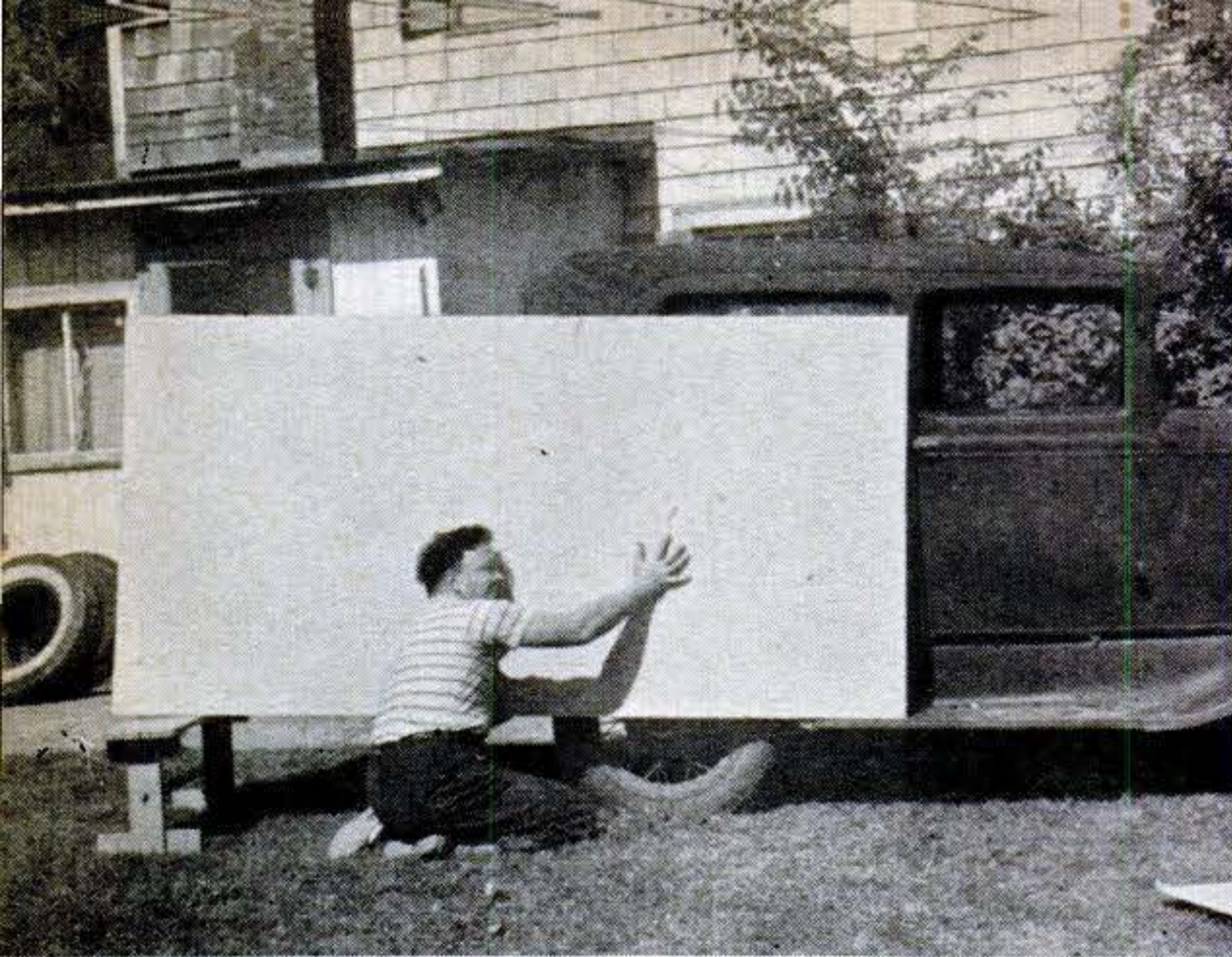

**1** Make patterns of the body panels from fiberboard, using your sketch as a guide. After lining up the pattern sheet, mark it on the inside with a pencil for the fender cutout and for cutting to the lower edge of windows.



**2** Cut the pattern along the waste side of the pencil lines. In addition to this pattern, you'll need another for the door. Patterns for one side are usually all you'll need; you can use them on other side with opposite face against car.

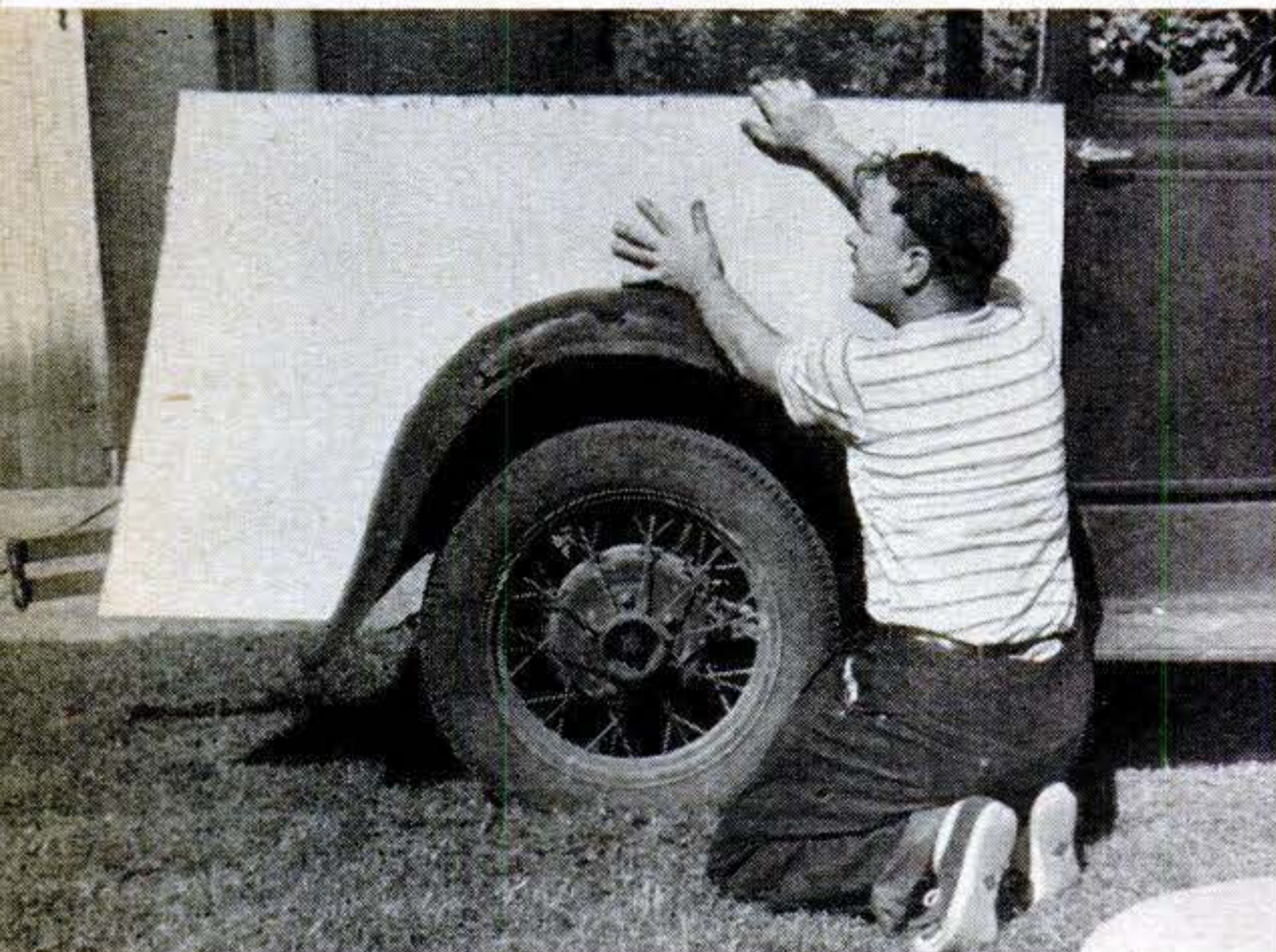

**3** Fit pattern snugly, using a rasp to trim it as needed. Swing back or remove bumper for this. Cut filler-block frames to conform to body contours and fill space between pattern and body. Tack these temporarily to pattern.

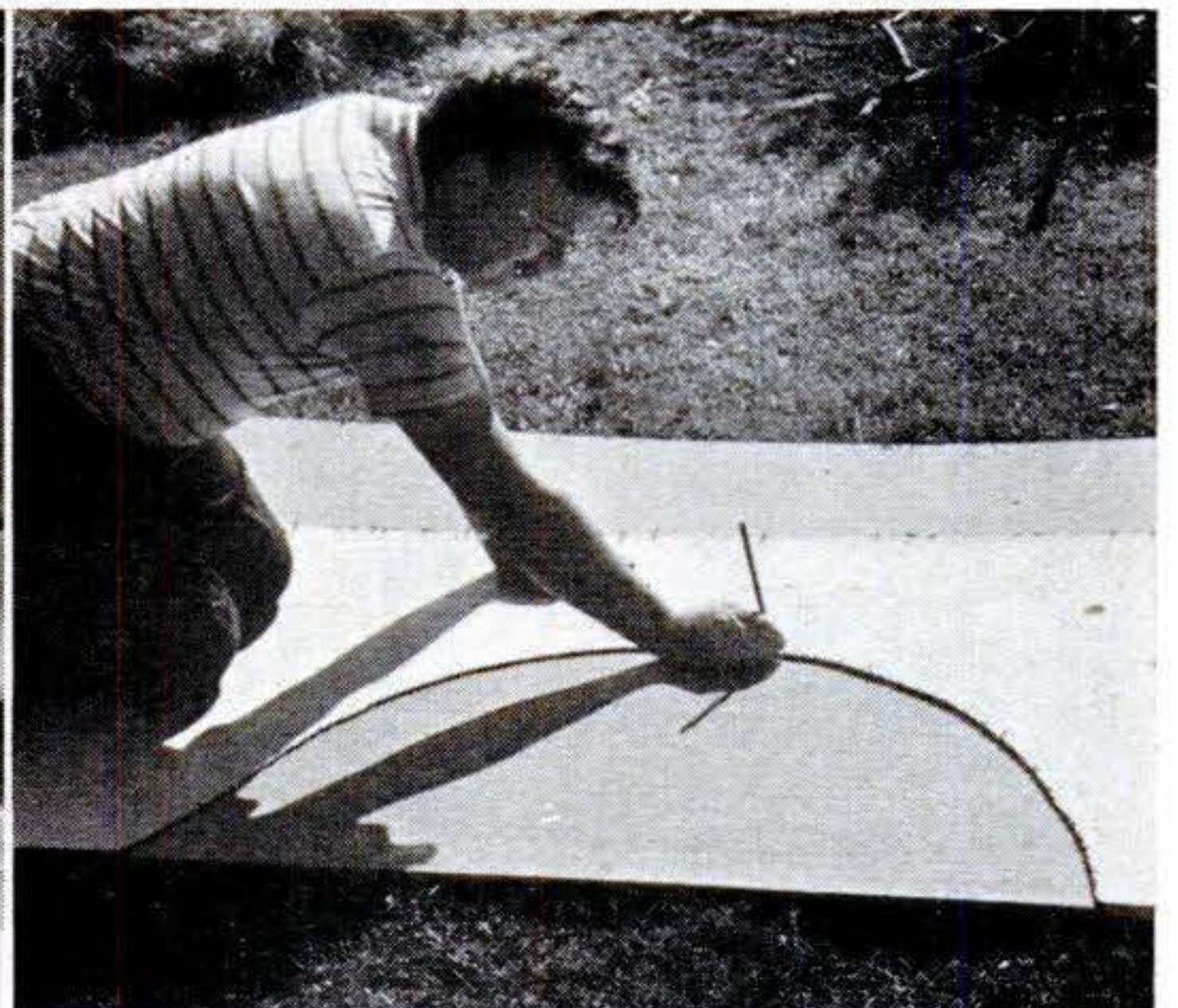

**4** Trace pattern on  $\frac{1}{4}$ " waterproof plywood after you have a good fit. Cut on the lines. Try the panel on both sides of car. If the body has been badly sprung, it may be necessary to make patterns for both sides.



**5** Cap top edges of panels with wood sills, covering space between metal and panels. Mastic in the joints will lessen squeaks. Attach panels with  $\frac{1}{4}$ " rustproof bolts.

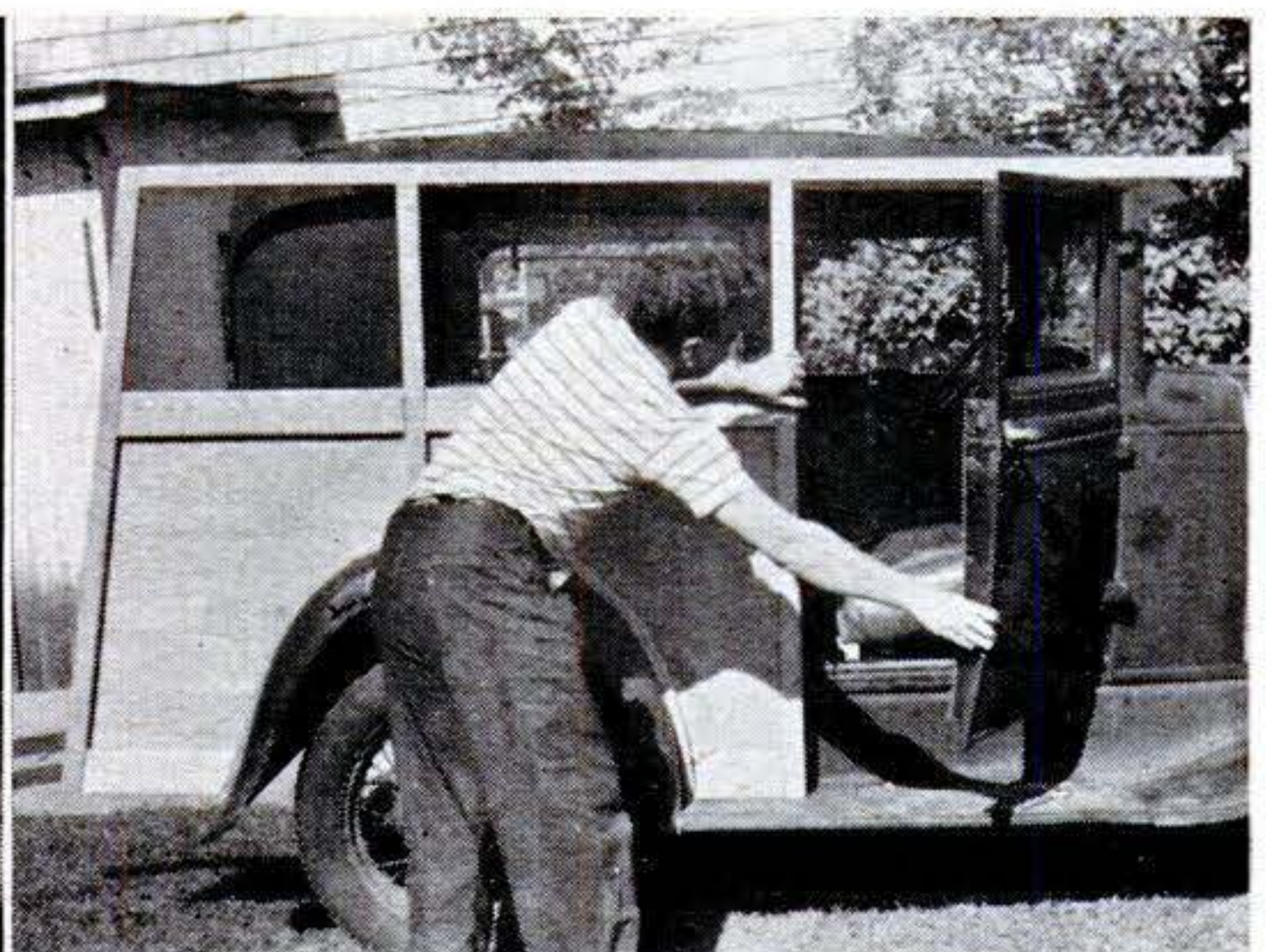

**6** Try door clearance after attaching framing temporarily. After trim fits perfectly, secure it with waterproof glue and screws. You now begin to see how your station wagon will look.



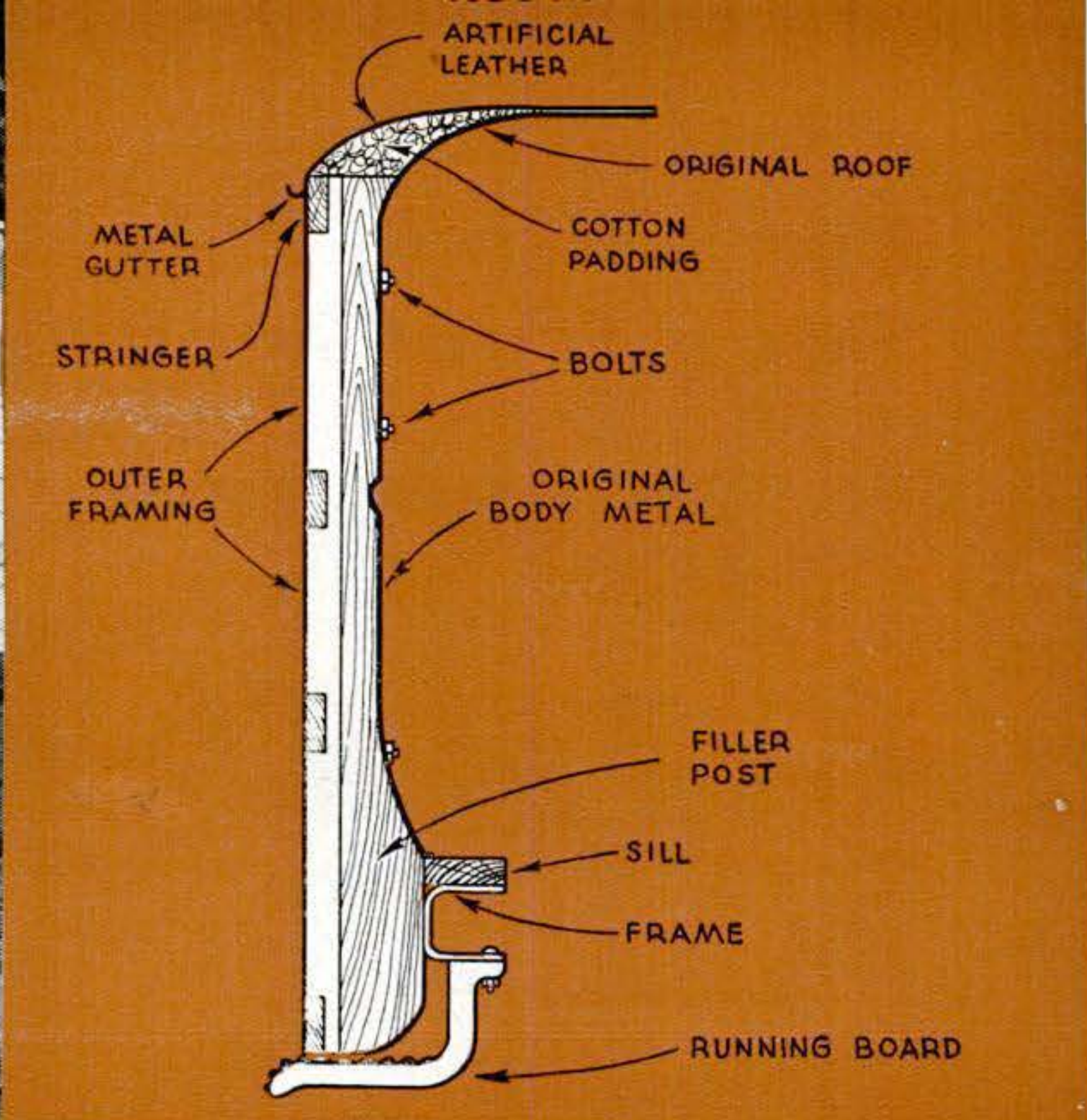
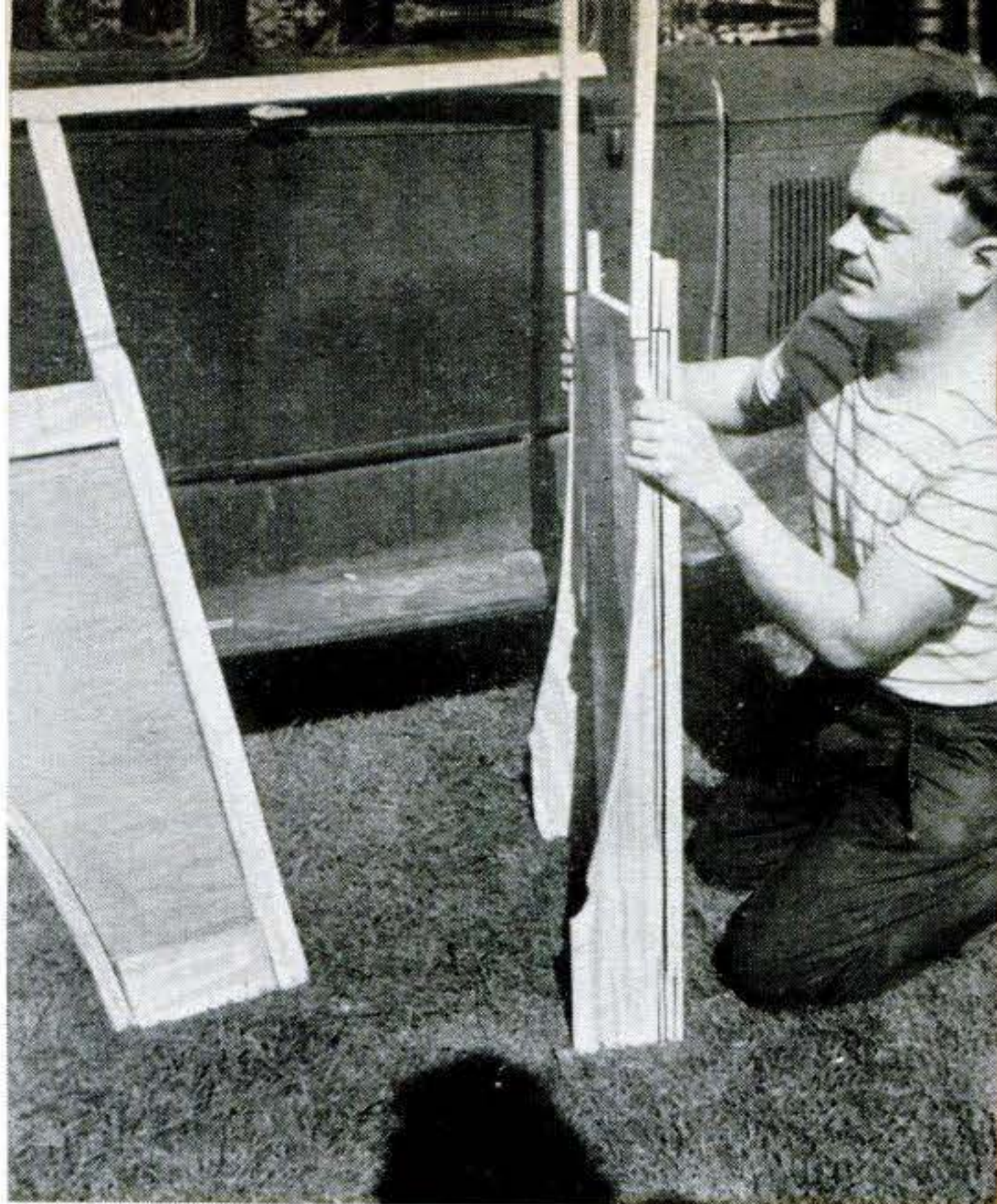

**7** Cut the inside panel frames to follow the contours of original body. Remove handle from door for greater ease in fitting door panel. In stage shown above, rear panel is assembled but has not yet been attached permanently. Be-

fore bolting on the panels remove the upholstery from the inside of car. In drilling for bolts, be careful to locate them so as not to interfere with door or window mechanisms. The drawing above shows how the roof is finished off.

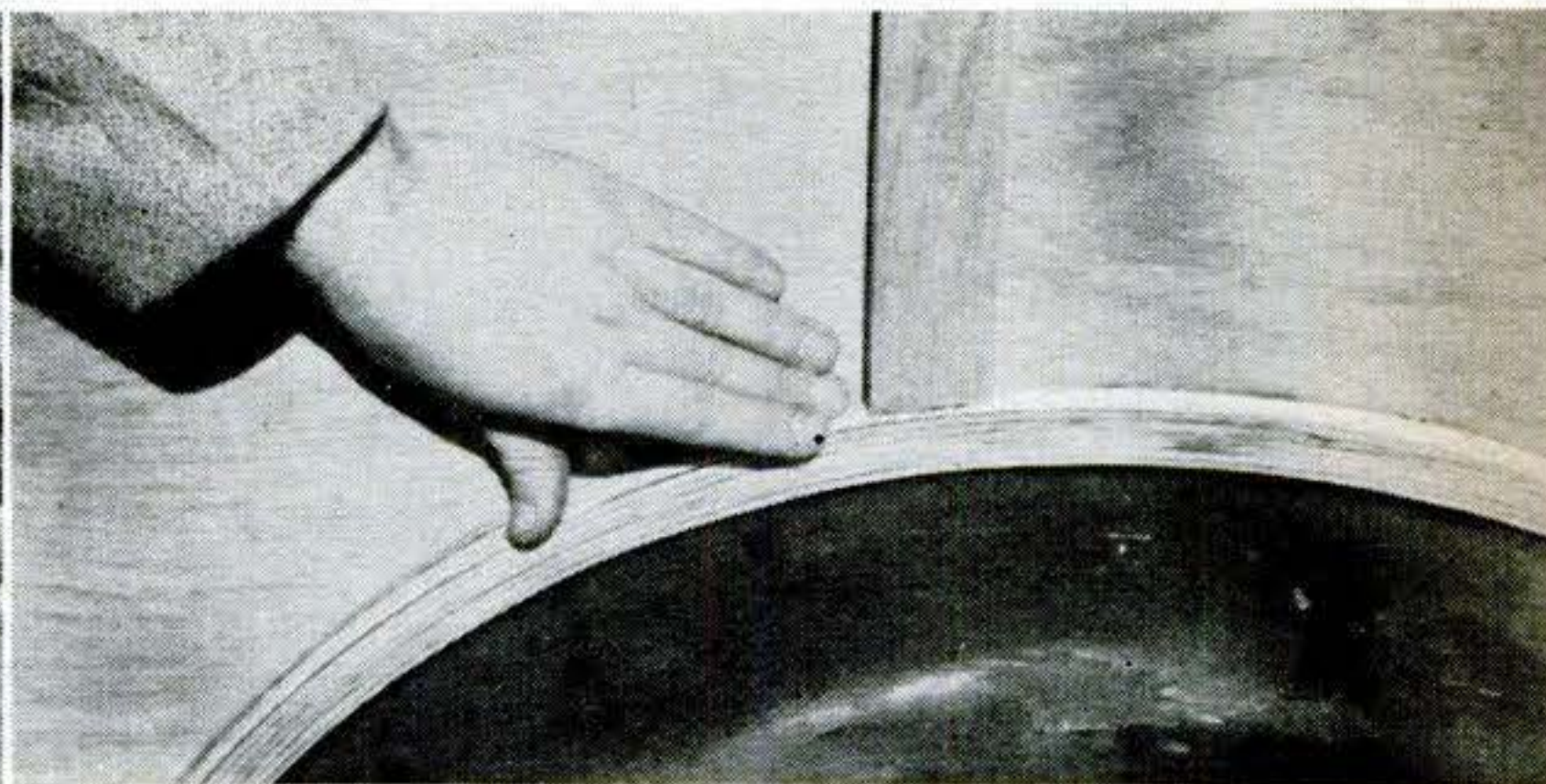
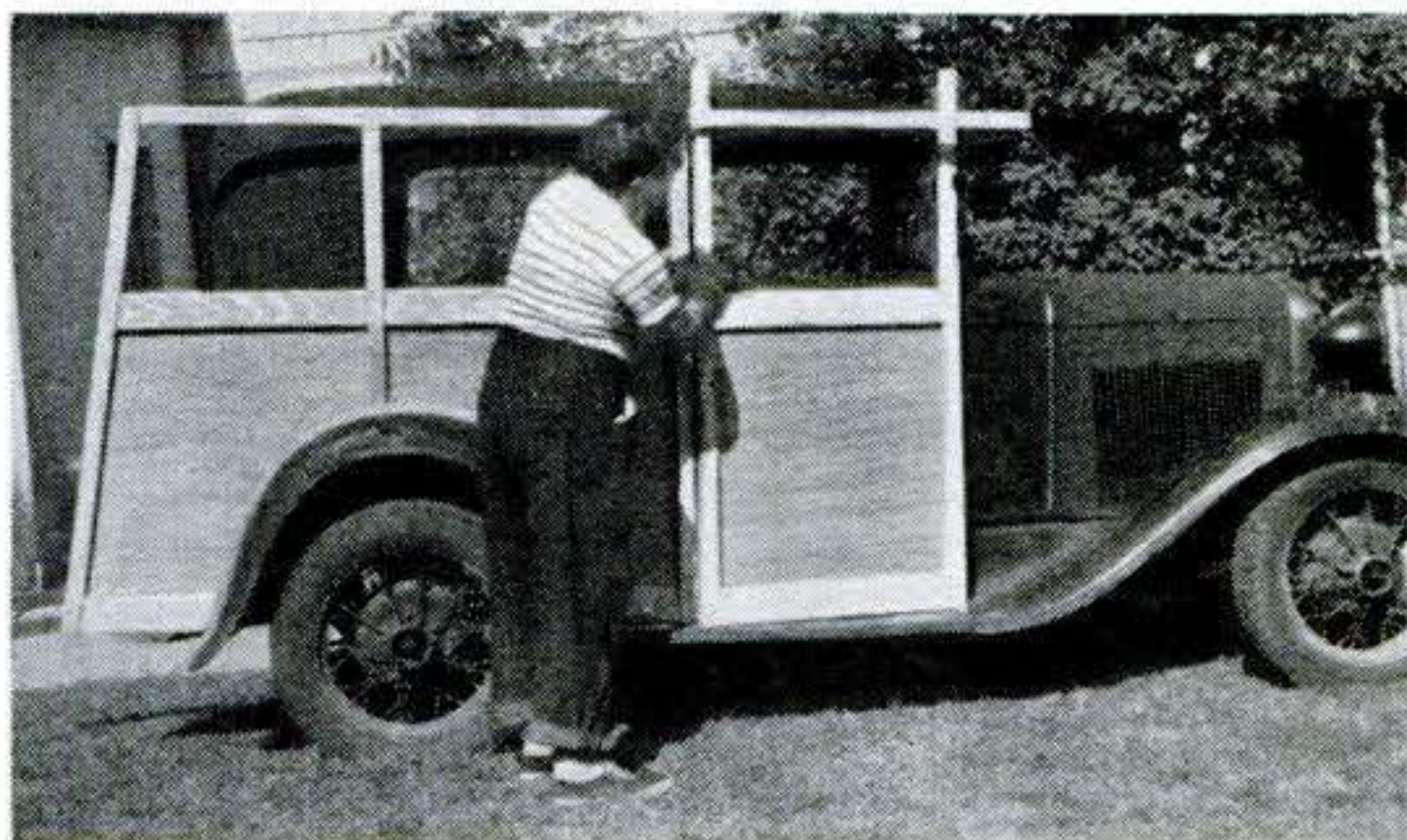

**8** Leave top longitudinal of rear panel over-length to serve as guide in fitting the door panel. Clamp the latter in place to try it. Allow at least  $\frac{1}{2}$ " clearance over the running boards so snow or ice won't jam the doors.

**9** Curved framing over the fender can be laminated with waterproof glue, as this one was. You could also steam-bend it, or glue it up in sections. You will probably want to refinish the fenders and hood on car.

**10** Cut away the rear of body and extend roof to suit new body overhang. If the station wagon is to be just a workhorse, you can install a simple half-height tailboard like the one at right below. You must also extend the

floor back from the rear seat. Place a two-by-four cross beam under its rear edge. You can either remove the rear seat or build a frame of pipe to support it. For details on a curved-body conversion, turn the page.

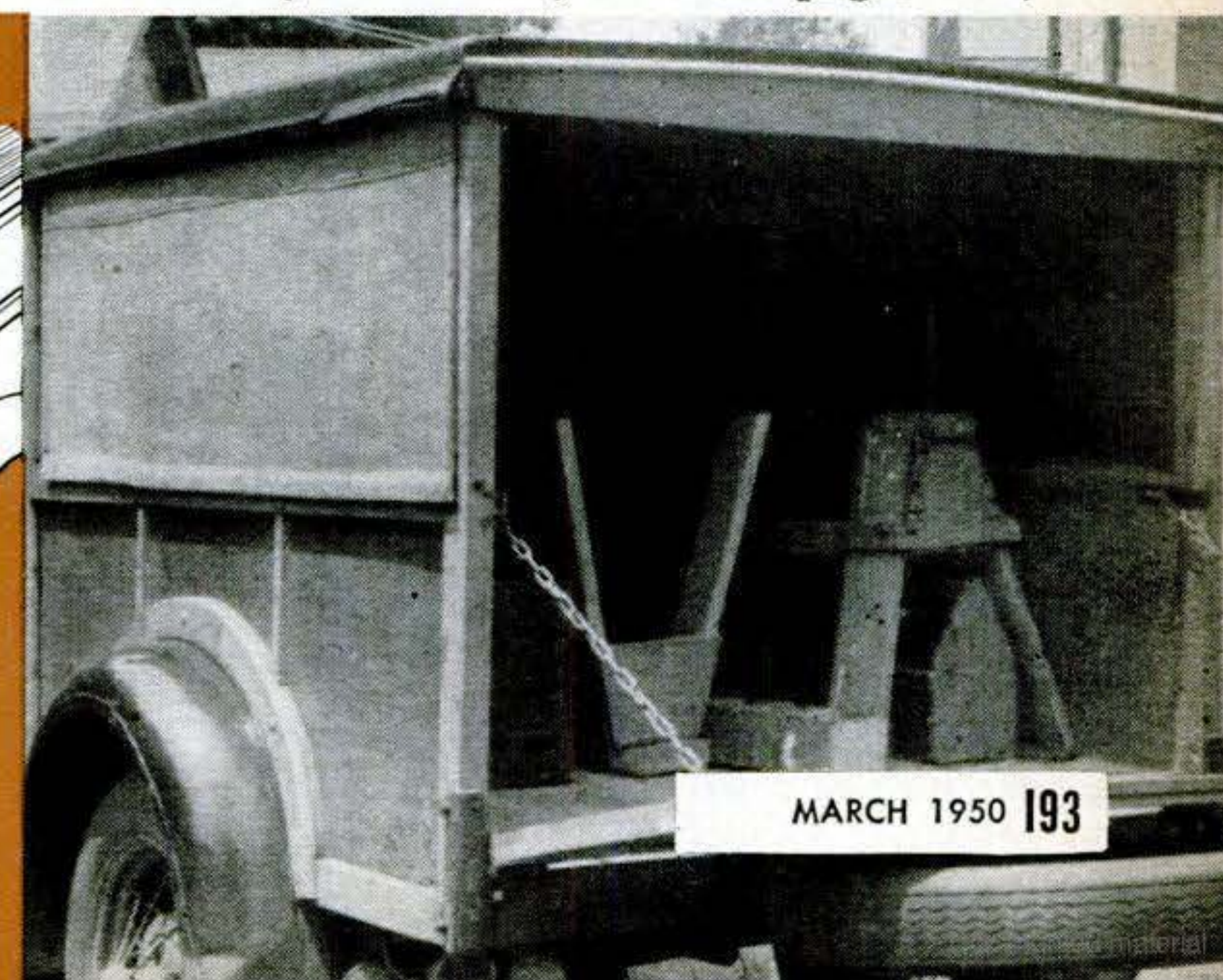
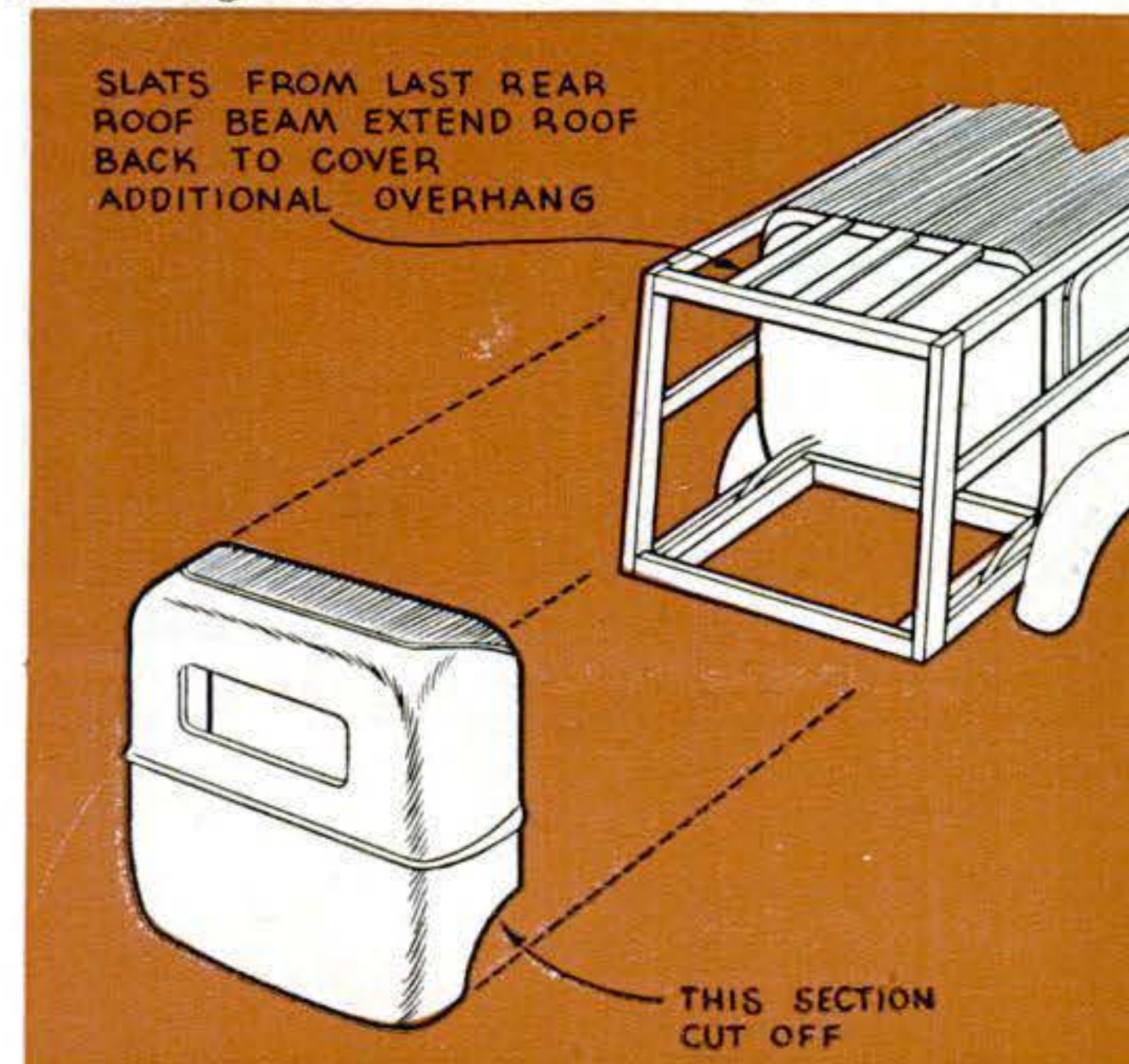



# For a Slicker Job, Build the Body from Scratch



**A showroom model.** That's what the conversion above looks like. A new body was built after the old one had been almost entirely cut away, left. Note that a new floor has already been installed. For this type of conversion, remove fenders and remount them on new body. Rear bumper can be either removed or relocated.

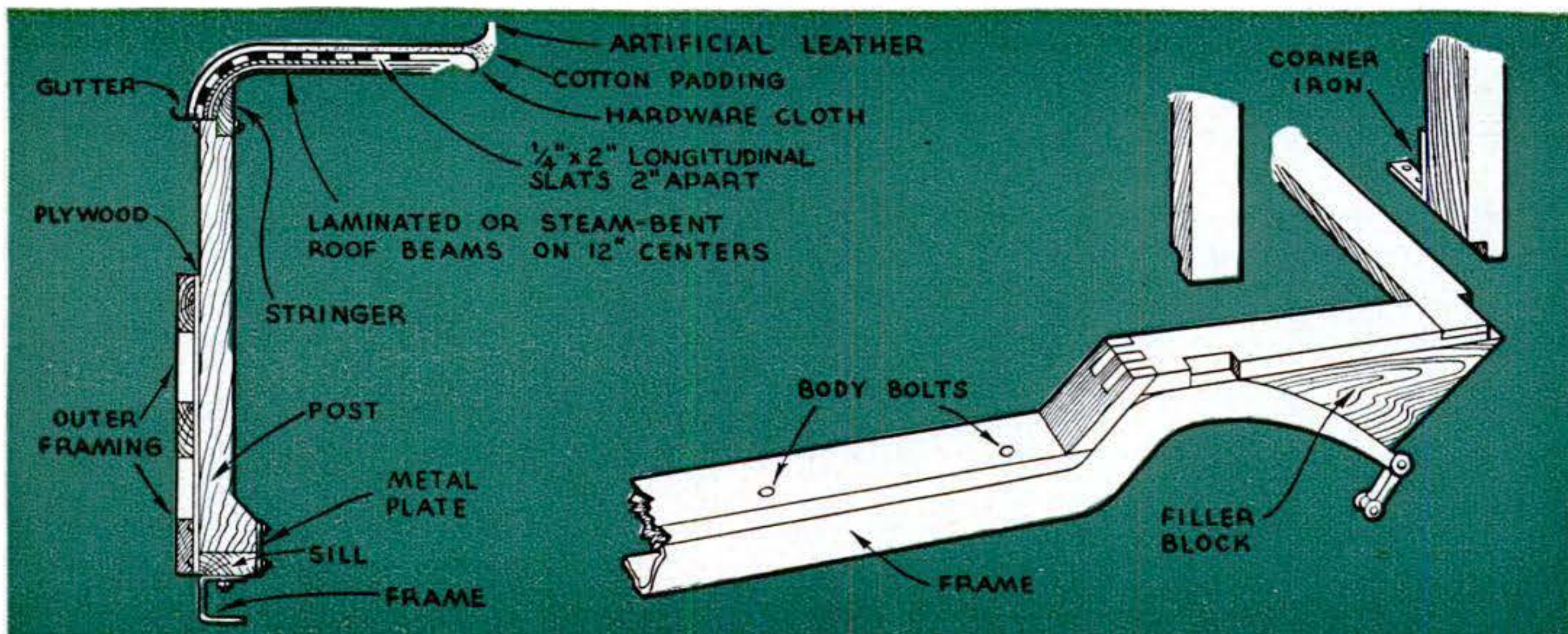

**Construction details** are suggested here. Dimensions should be adjusted to suit the particular car. If the original front doors hinge at front, you can mount new ones on the same

hinges. In any case you can probably use the old hinges, door catches, and window mechanisms. For uprights, glue up hardwood to at least 3" by 3". Assemble with bolts and glue.

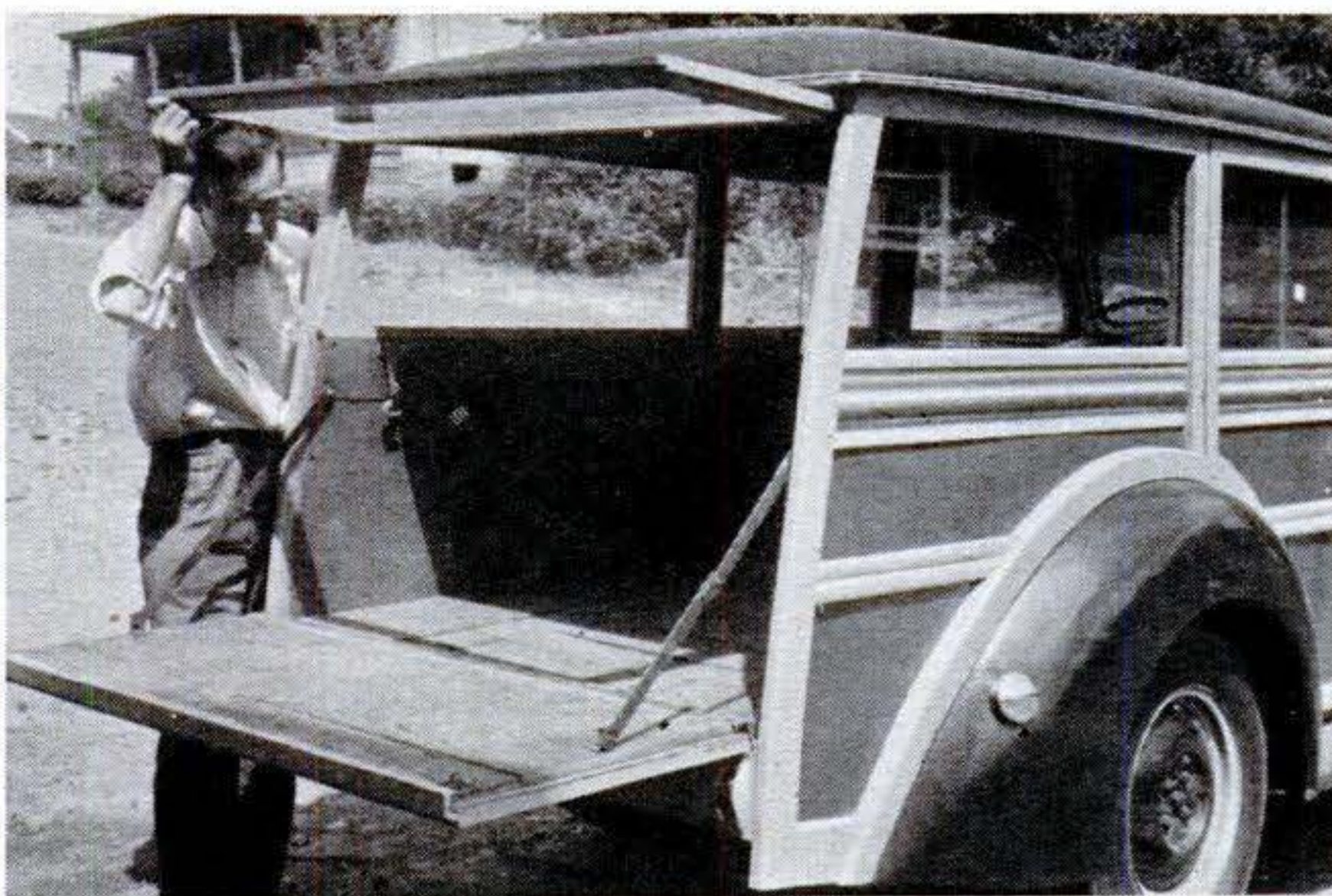

**Fit all joints nicely** and strengthen them with metal angles where possible. For a professional-looking job, use two hinged panels at the rear as above. Three coats of outdoor varnish fol-

lowed by wax will give the body a fine finish. If heavy loads are to be carried, install overload springs. And one final point: notify your state license bureau of the model change.





**Popular Science  
Practical Solution**



# Rack Holds Popular Science Open As You Work

"THERE ought to be some way," pondered the Editor, "to have your favorite mag handy when and where you need it most—in the shop—without getting it dirty. How about a rack that will hold it open at the page you want?"

From this and a sketch was born the versatile holder shown here. Not only does it hold the magazine open and flat, but with an adapter plate it slides onto the ways of a lathe, where you often want to refer to a drawing repeatedly.

Saw the disk for the base from a piece of  $\frac{3}{4}$ " stock, but rip out the dovetail first, while it's still in the square. Use a 1" Forstner® bit, if you have one, to bore the blind holes for the dowel standard in base and block.

The rack proper consists of a  $9\frac{1}{2}$ " by 12" piece with a center dado in which the spine of the magazine lies. Cleats are screwed on at top and bottom, the upper one having gains for small hinges. An 11" by 12" piece of  $\frac{1}{8}$ " plastic is attached with tiny (2-56 or 3-48) flathead bolts and nuts, the latter on the outside. Two wood screws driven in beneath the bottom cleat engage holes in spring-brass clips fastened to the lower edge of the plastic. Attach a knob, such as a tooth-paste-tube cap, between the clips.

Two wood screws running right through the dado fasten the rack to the pivoting block, which is cut at 60° to provide a convenient reading angle. It should pivot freely on the dowel.

END

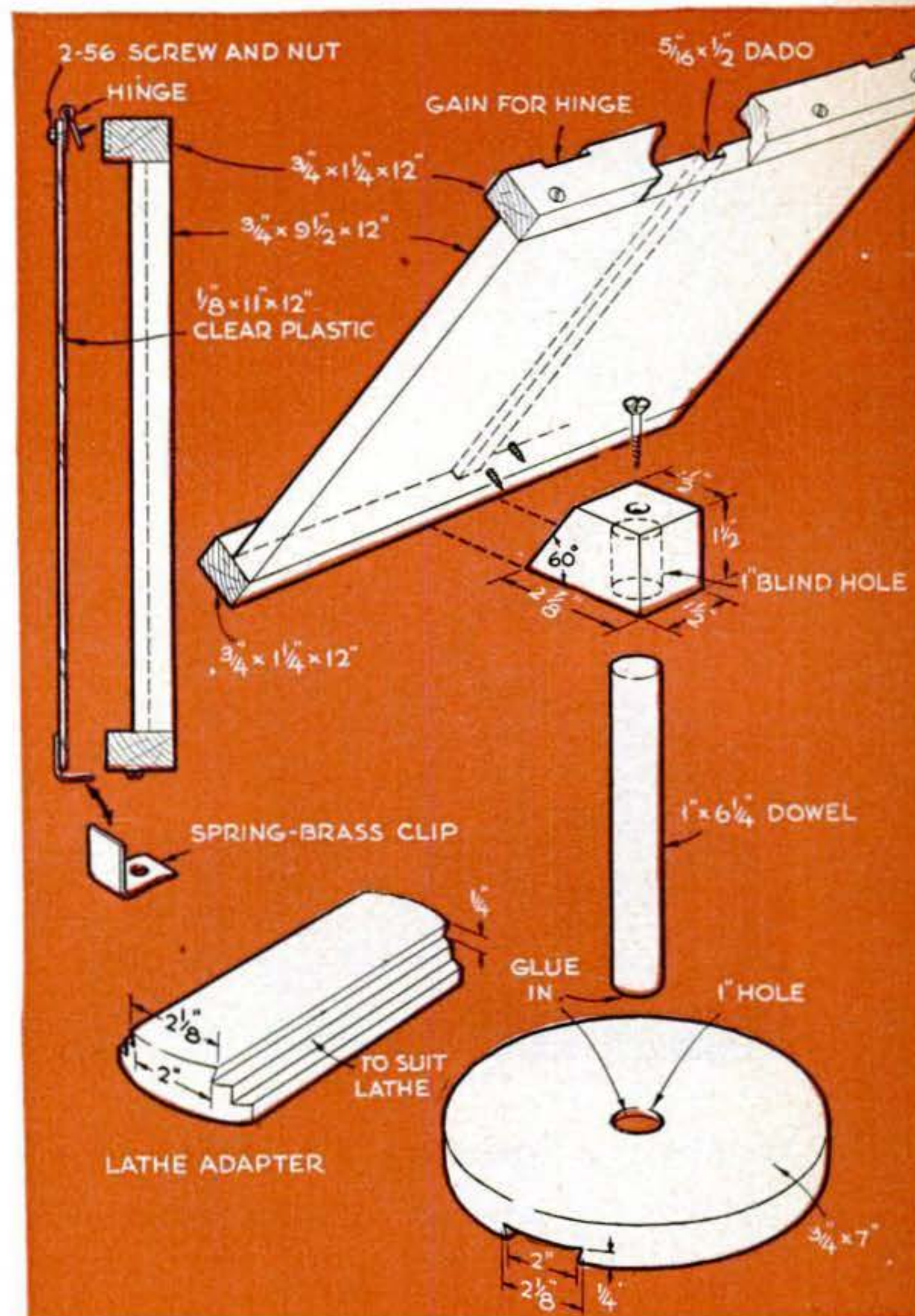

**Information at your elbow.** You could skip the dovetail by bolting the adapter to the base.

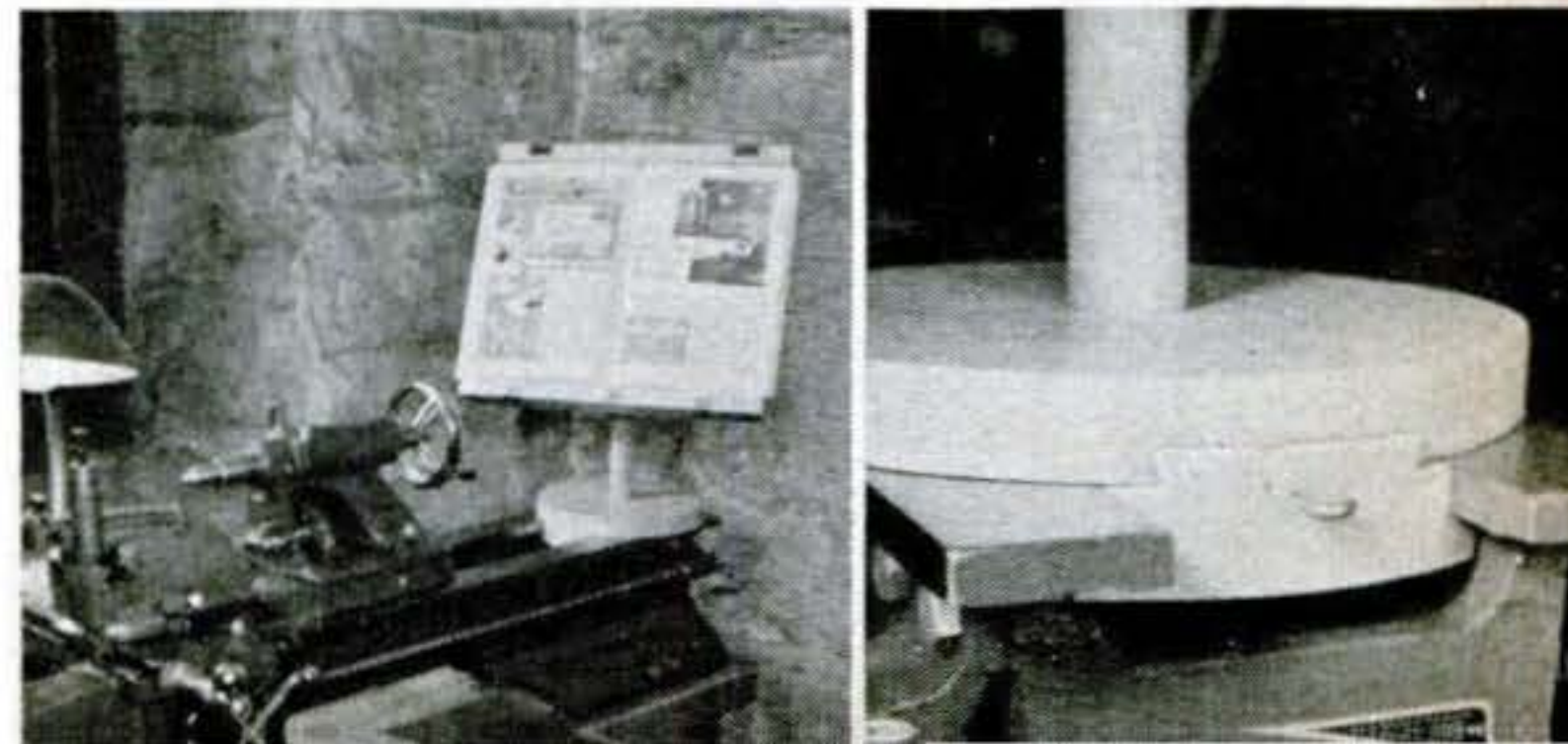



# Use Your Old Spools

**D**ON'T throw away those old spools. They have lots of uses as toys, games, or decorative pieces. For the small fry, an interesting game can be made from a board and a spool. Paint the board as shown. Whittle a spool to make a top. Cut a slice from a spool barrel and start the top spinning in this slice. If the top lands in a square, score 5; in a circle, 10; on a line, 0.—*Elma Waltner, Hurley, S. D.*

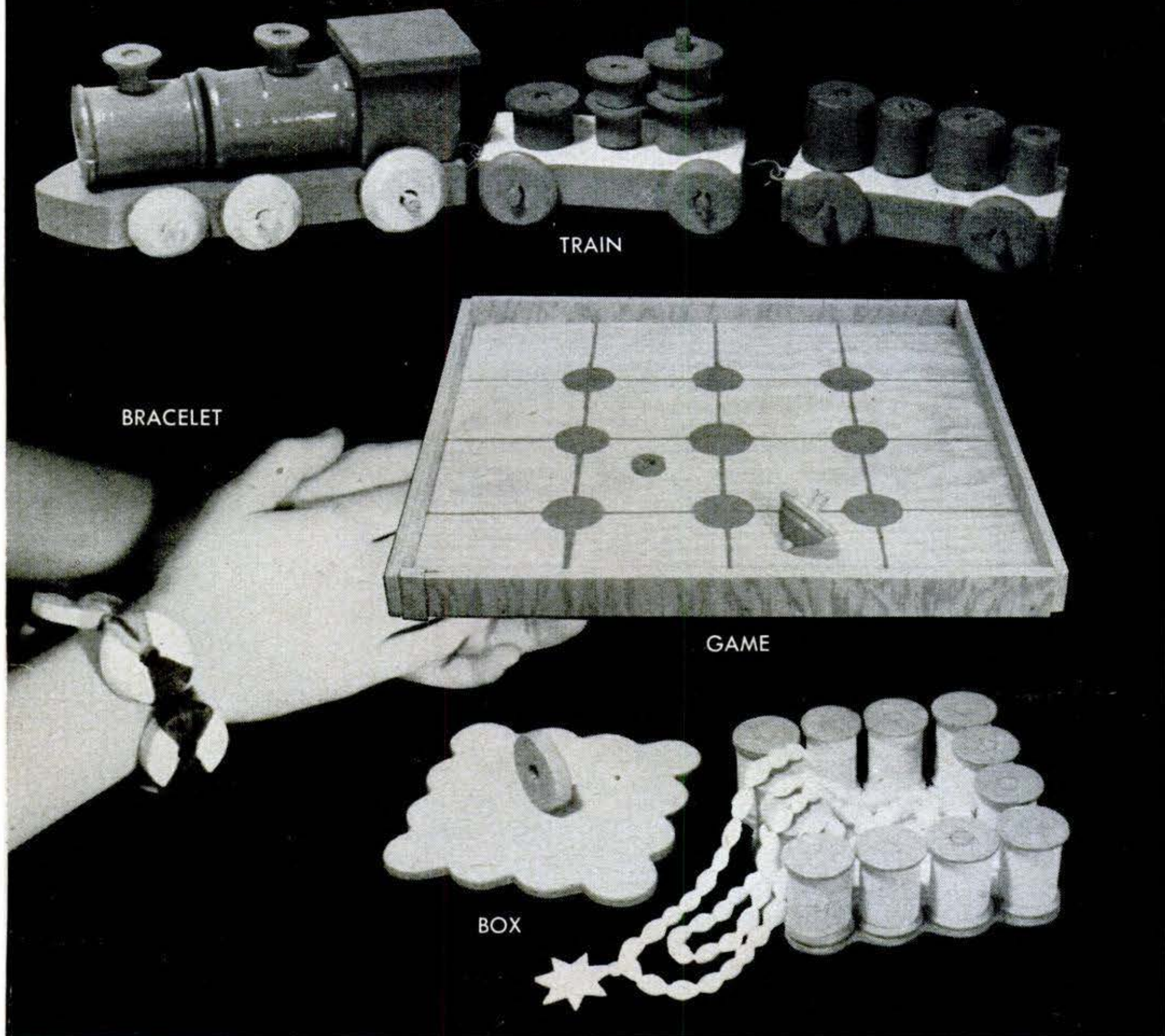

## Resistor Acts as TV Antenna

NOT being satisfied with the results of my indoor television antenna, I tried a novel substitute. I removed the antenna and attached a 250,000-ohm resistor across the two input terminals. Then I hooked one foot of stranded wire to one of the terminals and thumbtacked the other end to the wall behind the set. The results were surprising and excellent. Pictures are actually sharper than those obtained with an indoor antenna. In different locations I have had to change

the length of the wire, starting with a long piece and cutting it off inch by inch.—*Tony Vrlec, Chicago.*

## Punched Can Rim Saves Paint

WHEN you open a new can of paint, punch a few slots in the rim around the top of the can with an old screwdriver. Surplus paint scraped off the brush will then drain back into the can. It will also be easier to replace the cover without splashing paint trapped in the rim.—*Harold R. Terpeny, Marion, Mass.*





### Magnet Holds Auto Tray

HERE'S a utility tray you can set at any convenient spot on your dashboard shelf. A flock-covered magnet on the bottom makes it stay put without screws or suction cups. Polyscope Equipment & Appliance Co., of Brooklyn, N. Y., prices it at about \$1.



### Flashlight Has First-Aid Kit

Two important emergency aids for your home or car—a first-aid kit and a flashlight—are marketed in one compact package for about \$1 by Lewyt Corp., Brooklyn, N. Y. Its size, 1½" by 3" by 6", makes it easy to slip it into the glove compartment.



### Oil Drums Protect Packages

INEXPENSIVE but serviceable package boxes can be made by cutting a rectangular hole in a steel drum and attaching a sheet-iron door. A hasp is used to keep the door closed. Holes in back take bolts that secure the drum to a post so that wind and livestock will not upset it.

### Plastic Belt Fuses Together

PLASTIC belting now on the market can be made into an endless belt by touching together and heating the two ends. Developed in Switzerland, the belting is widely used there to drive watchmaking machinery. It's distributed here by Jules Borel & Company, of Kansas City., Mo. The belting, called Fuse-ite®, is made in flat, V-belt, and round form.

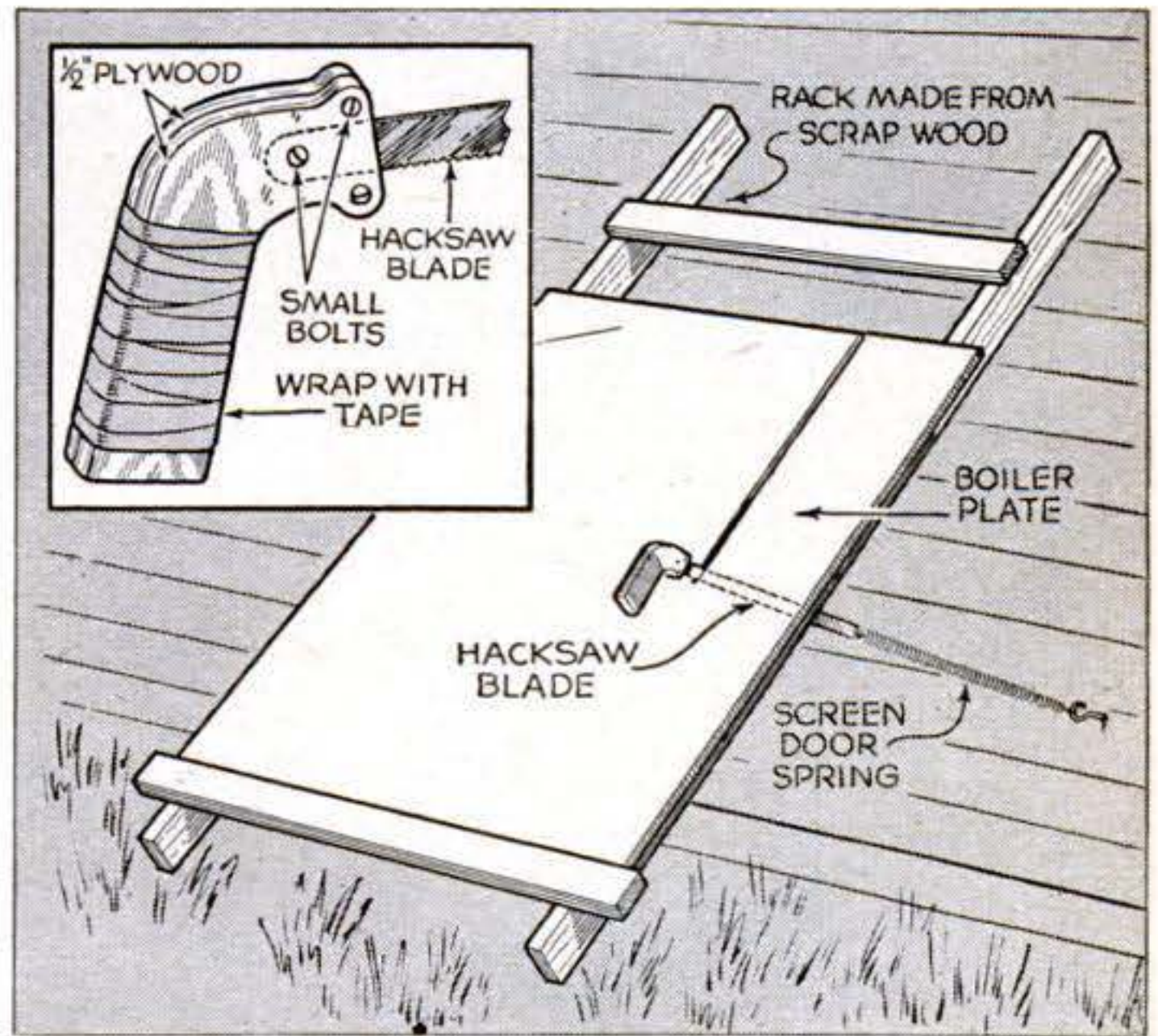

### Spring-Pull Saw Cuts Metal

BECAUSE I don't own a torch, I had to figure out another way of cutting a sheet of boiler plate. Here it is. Holding down the plate with my left hand, I pull the hacksaw blade with the other. The spring pulls the blade back, providing the cutting power. It's slower than a torch but gets the job done without need of later smoothing. —W. M. McKeever, Darwin, Calif.



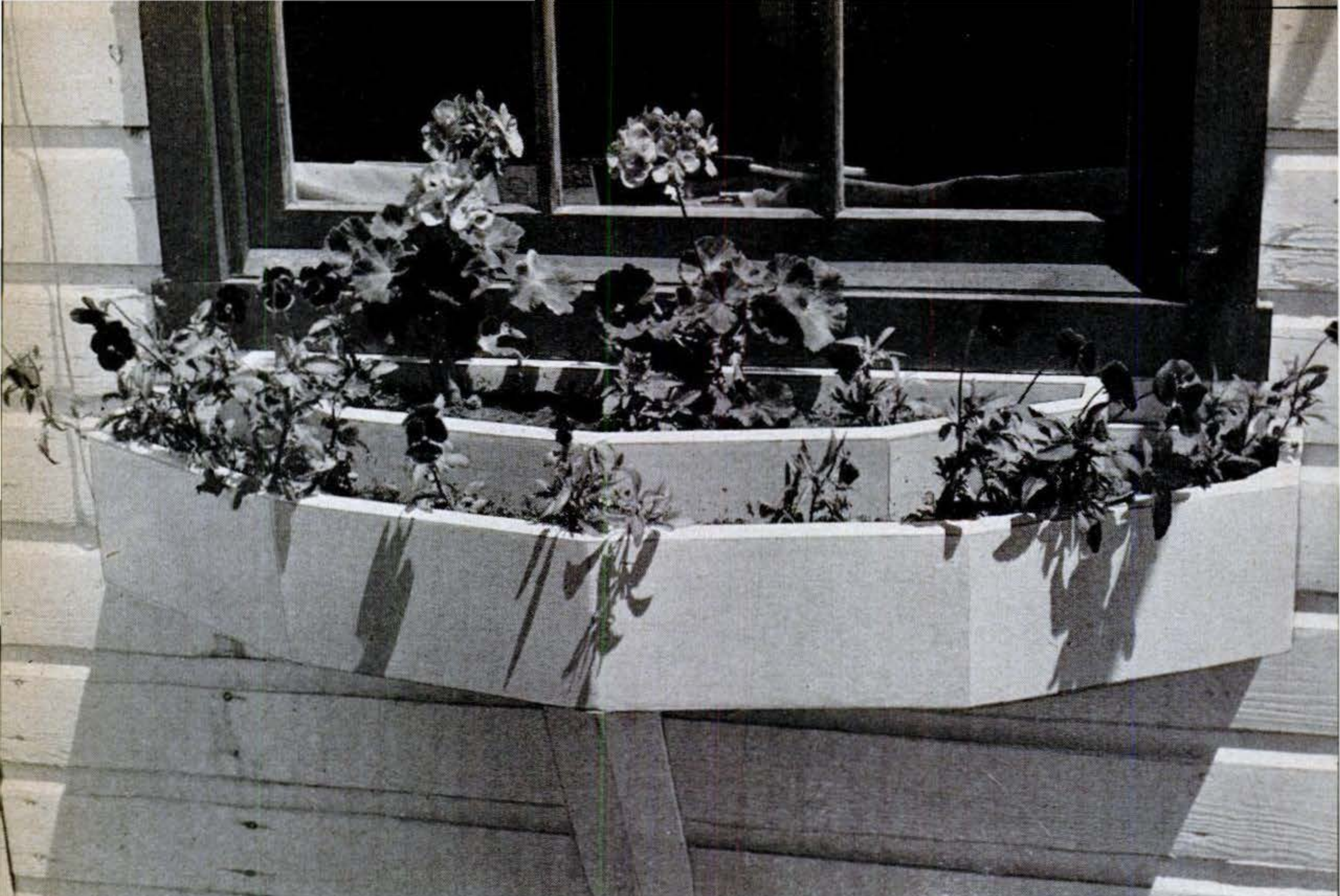

Two levels in this window box are designed to show off both long- and short-stemmed flowers.



After the segments of the outer box are cut to shape and the ends grooved for splines, the pieces are checked for correct joint fit.

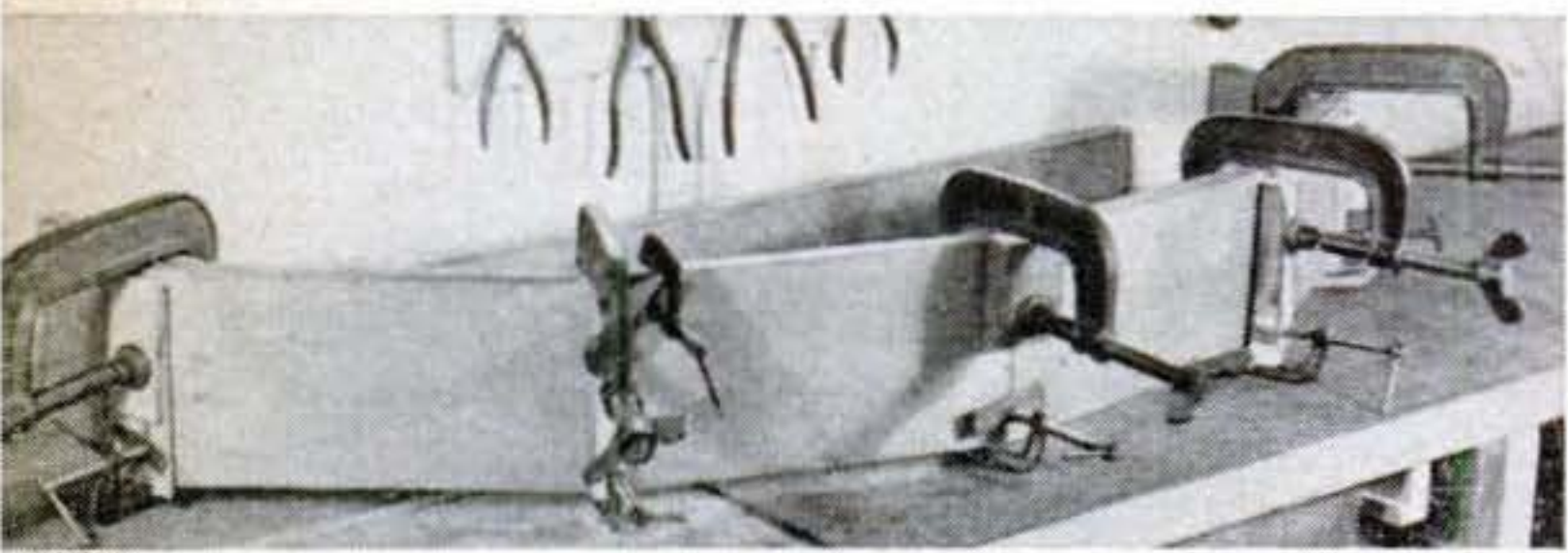

The back of each joint in the outer box is reinforced with a gusset. Splined joints are assembled with waterproof glue and clamps.

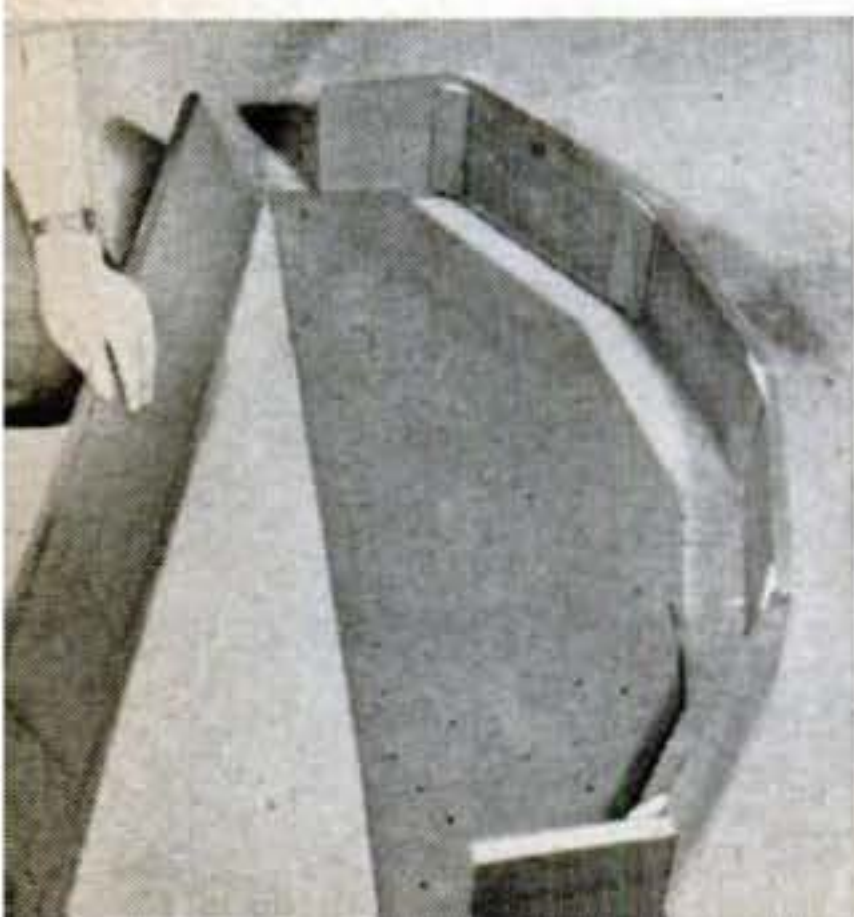

**Bottom** made of waterproof composition board is slipped into grooved front assembly. Back is then attached with nails and waterproof glue. Note small drain holes drilled in bottom.

## *Flower Bed with Terrace Fits Window*

**By Roland Cueva**

**W**ITH Spring taking over this month, now's the time to build window boxes. The box shown above has two sections and was built with redwood, which is light and resists rotting. The three small drawings on the opposite page show you how this box was laid out to fit under a typical window. If you want it larger or smaller, alter the dimensions in proportion. Make a full-scale drawing on a large piece of wrapping paper and let your lines represent the outside edges of the  $\frac{3}{8}$ " stock.

With the drawing as a guide, cut the segments of each box. Then stand them on edge on the drawing to check joint fit and length. Next, groove the outer box segments for  $\frac{3}{16}$ " splines. Cut grooves  $\frac{1}{4}$ " by  $\frac{1}{4}$ " in all segments of the outer box to take the



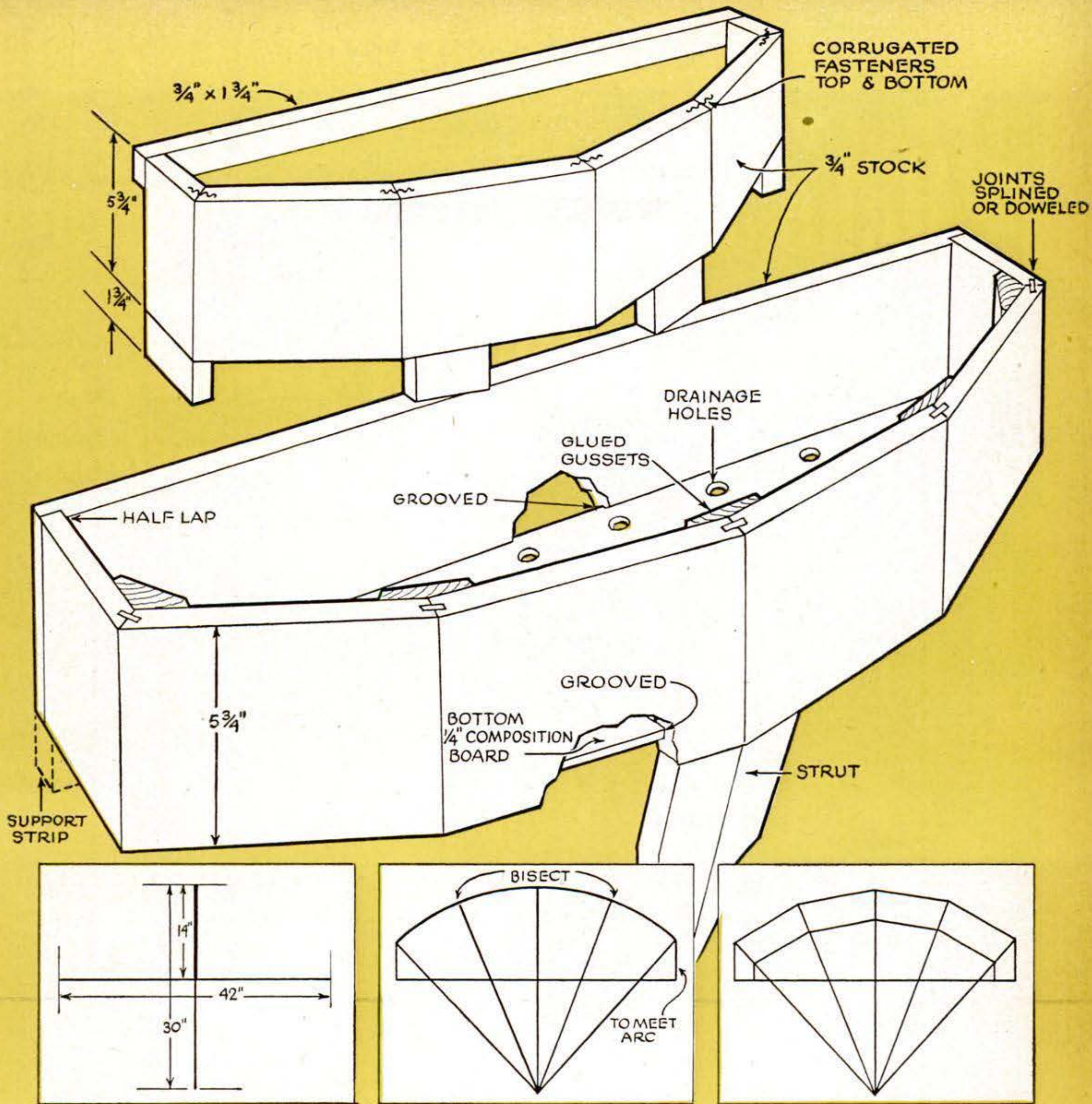

1. Lay out full-scale pattern on a large piece of paper. As the first step; draw the two lines to the dimensions shown.

2. Swing an arc from bottom of 30" line. Draw end lines to meet arc. Bisect arc twice and draw radius lines as shown.

3. Connect points on arc with straight lines. Draw in 3" lines at ends. Lines forming inner box parallel outer ones.

bottom. Make the bottom of 1/4" waterproof composition board. Drill drainage holes in it.

After the bottom is in place, the back is fastened with glue and nails. A 1/4" by 2" batten, screwed along the centerline on the bottom, completes the outer box. The supporting strut is attached to the batten with a strap hinge.

The inner box has no bottom or solid back. It simply rests in the larger box. Paint the unit inside and out and it's ready to mount.

END

Back of outer box is screwed to side of house; strut supports front of box. Inner unit, raised by its block feet, sits inside larger box.





# Make Your Own Geiger Counter

*According to  
AEC Specifications*

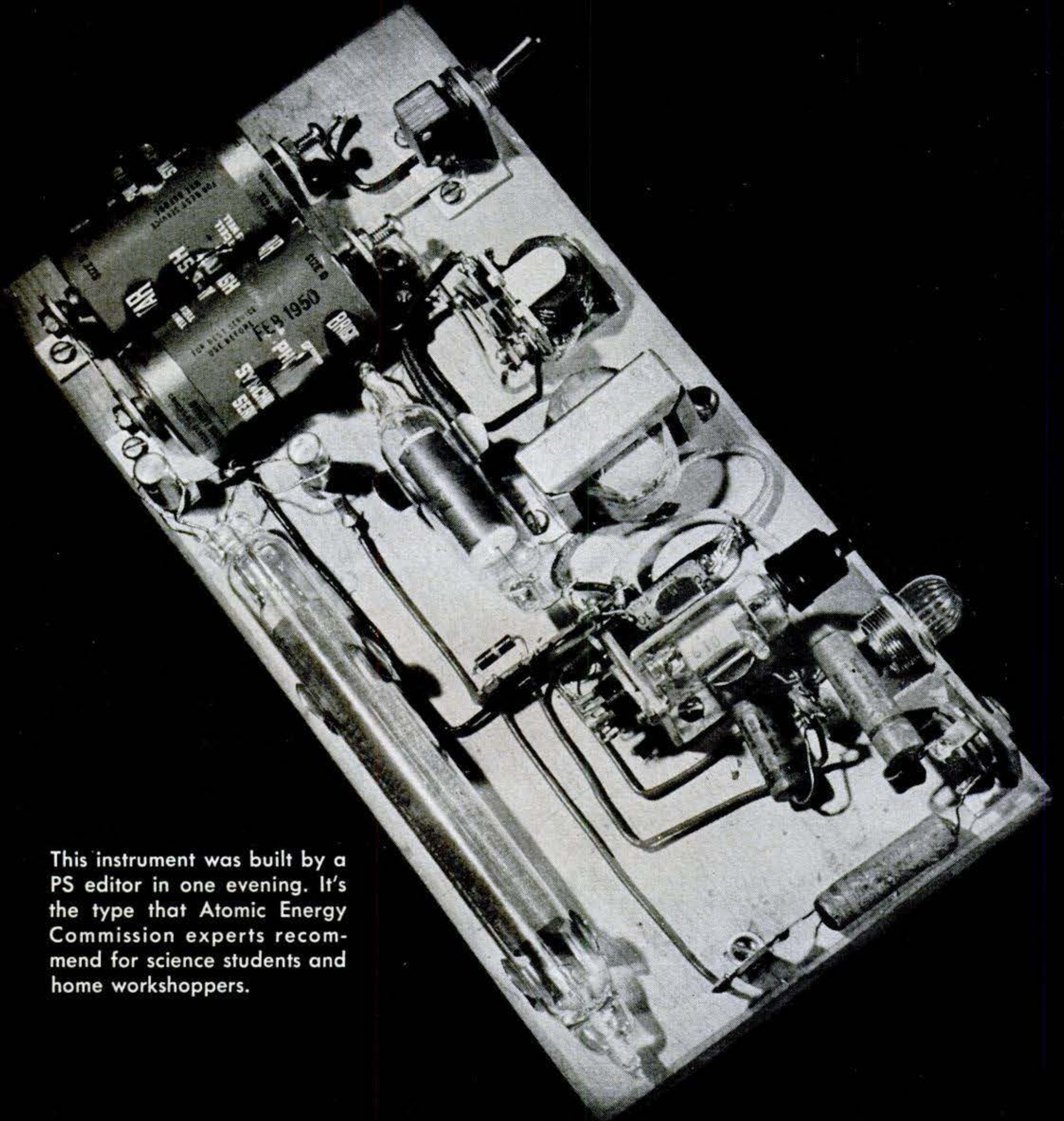

This instrument was built by a PS editor in one evening. It's the type that Atomic Energy Commission experts recommend for science students and home workshopers.



New circuits and parts make it easy and inexpensive to build a good radiation detector or survey meter.

**By Robert Gorman and Hubert Luckett**

NEW circuit designs for Geiger counters, worked out by the Atomic Energy Commission, now make it possible for experimenters to build good instruments for measuring radioactivity. These counters are excellent for school or home laboratories or as survey meters for uranium prospecting.

The model shown here, built by POPULAR SCIENCE in cooperation with the AEC, is the simplest of several types of counters based on the new circuitry. (Others are shown on the next page.) You can duplicate this model on your kitchen table for about \$25.

This cheap and easy-to-build counter was a by-product of efforts to produce better instruments than those now in use. It will clearly detect radiation from the radium-painted dial of a clock or watch, a dentist's X-ray machine, or pre-war bathroom tile that was colored with uranium.

**What a Geiger counter does:** The heart of a Geiger counter is a gas-filled tube containing a cylindrical cathode and a fine-wire anode. A voltage is applied across these electrodes, but no current flows between them because the gas acts as an insulator. When a radioactive particle strikes the tube, however, it sets off an avalanche of ionization, and makes the tube momentarily conductive.

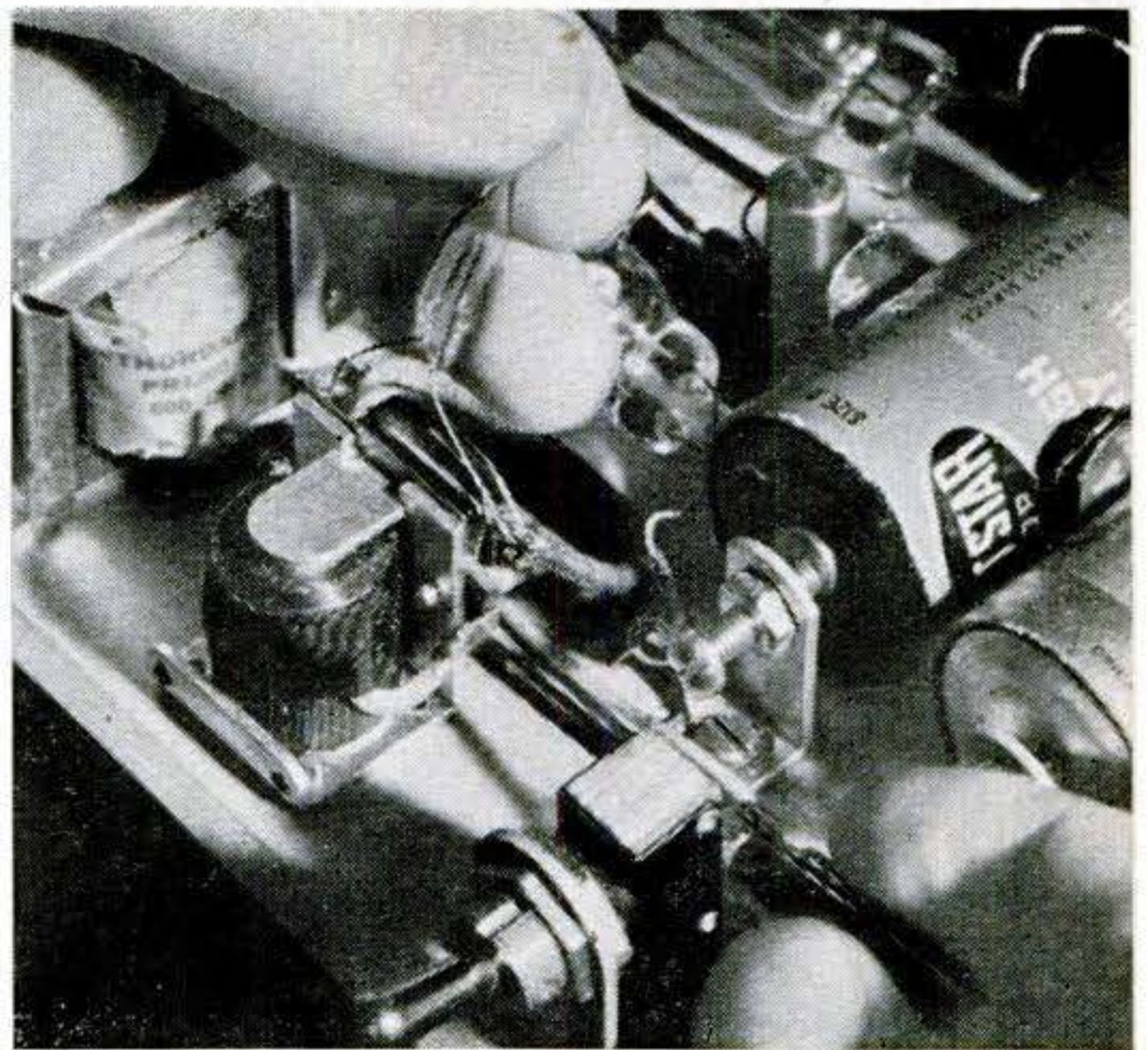

Adjust the relay points for about 30 contacts a second. Connect a 1/25-watt neon bulb across the relay coil and adjust contacts or spring until bulb is just below point of steady glow.

To use such a tube, you need a high-voltage source to make the tube sensitive to radiation. Then you need a metering device to count the pulses of current that flow when it's ionized. Counting can be by earphone clicks, neon flashes, or meter deflection.

In the POPULAR SCIENCE model this associated equipment is simpler than in other counters of comparable quality. One of the developments that made this possible is an ingenious power supply that furnishes all the necessary voltage from *two flashlight cells*. Another is a newly developed counter tube that operates at relatively low voltage (about 350 volts as compared to the 900 to 1,200 volts of earlier tubes). This

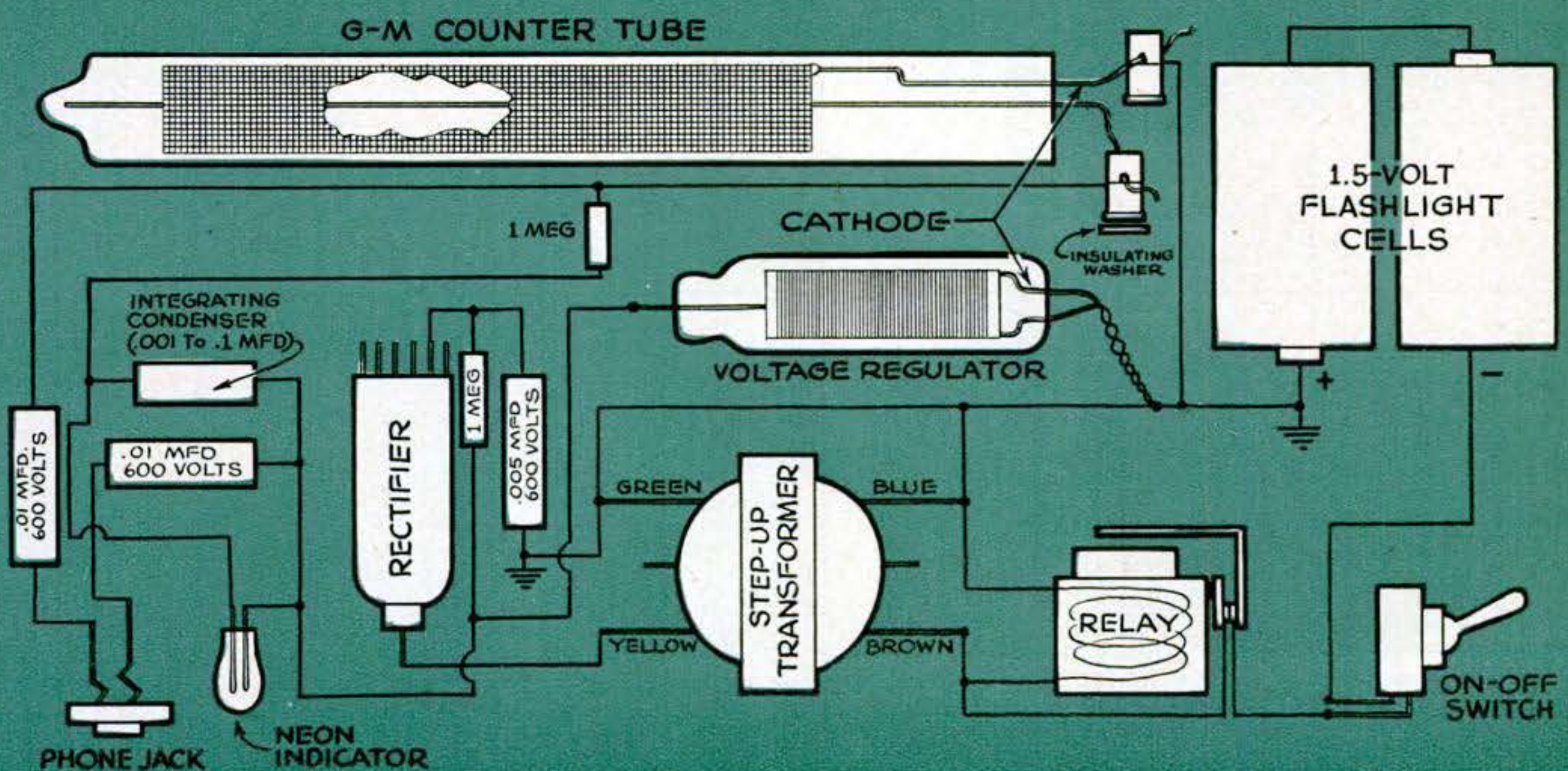



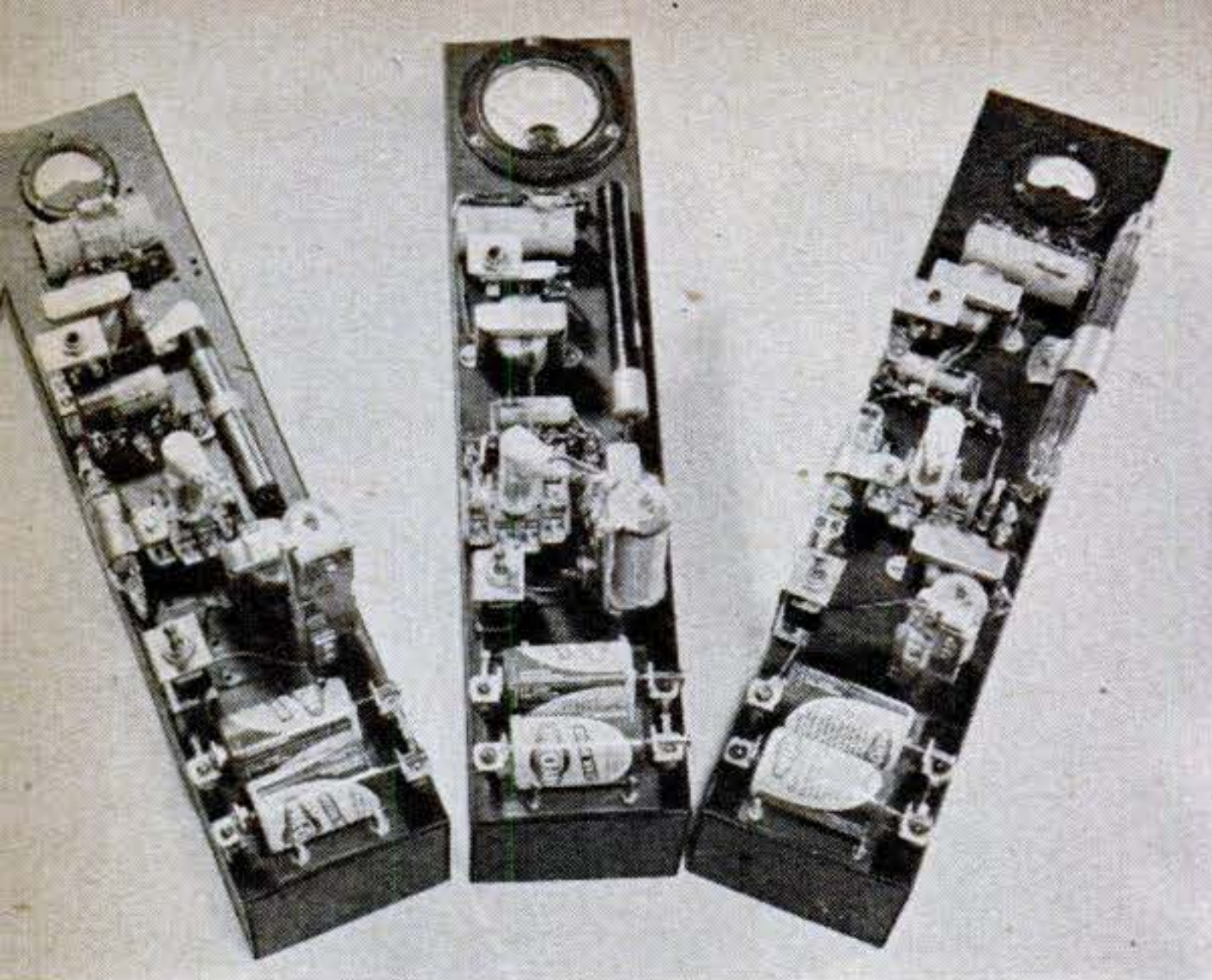

**Laboratory models built by AEC** use metering circuits and 900-volt counter tubes. Basic design is the same as PS model, but components and adjustments are more critical. A 10-cent pamphlet with more information is sold by Document Sales Agency, AEC, Oak Ridge, Tenn.

tube contains new inorganic gas mixtures that make it 10 to 20 times as sensitive as its predecessors. A much larger charge per pulse is obtained. So, when this tube is used, elaborate amplifying and metering devices can be eliminated and the output of the tube can be seen and heard by means of a neon flasher and crystal headphones.

**Power supply:** A standard normally-closed relay is used as a current interrupter. It pulses the current from the batteries and feeds it into the primary of a transformer in short, sharp bursts. This produces an inductive-kickback effect and gives a tremendous voltage boost in the secondary. The three-volt source and a 10-to-1 transformer can put out as much as 1,600 volts.

Current drain from the battery is amazingly small—in the neighborhood of 30 milliamperes. One model was left running continuously for eight days and nights without using up the original pair of flashlight cells.

The high-voltage AC is changed back to DC by the rectifier tube, which is the cold-cathode type requiring no stand-by power. For stable operation, the voltage is filtered

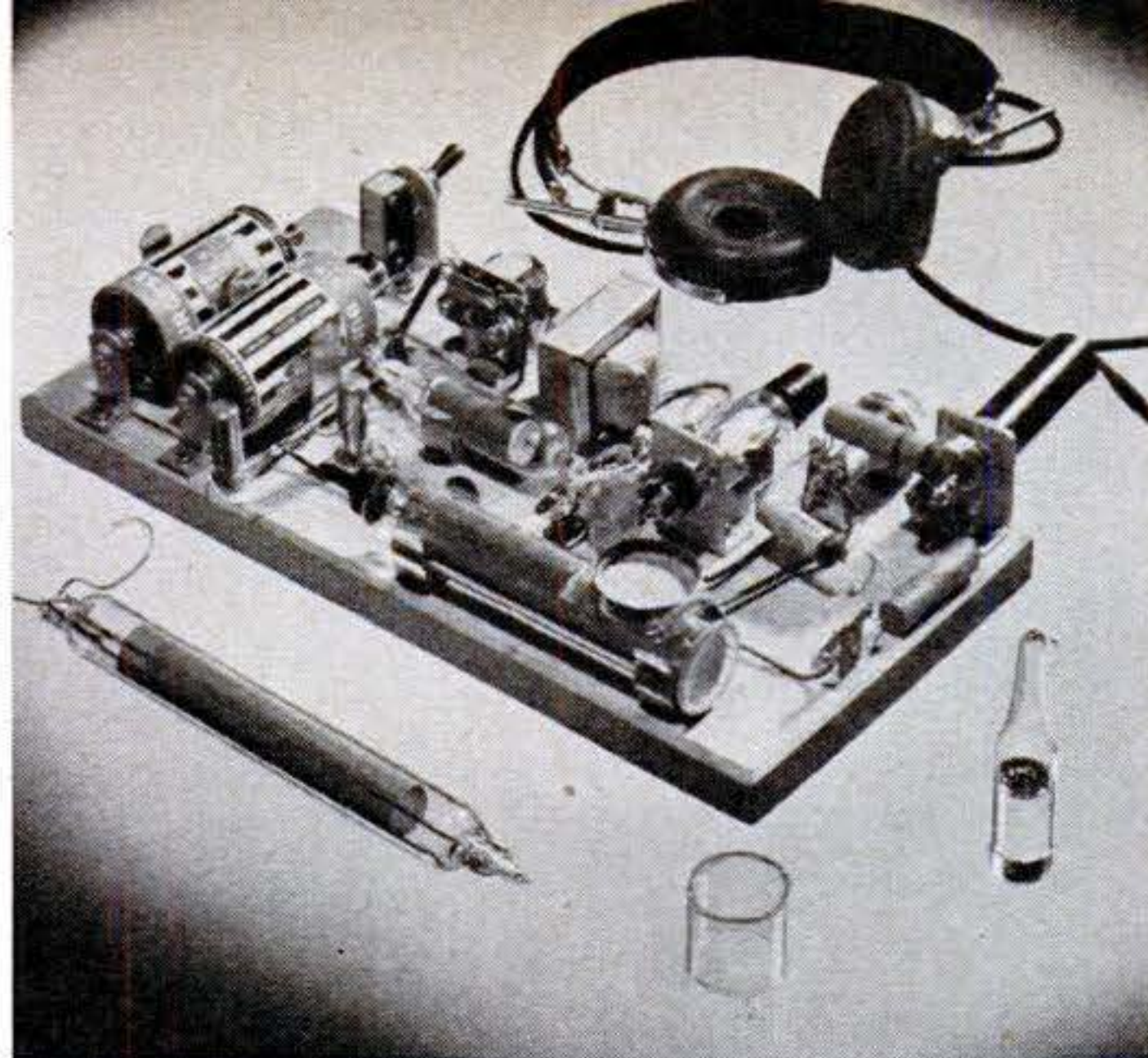

**Here's a complete setup** including mica-window tube (clipped in) and interchangeable gamma tube. The bottle contains a Bureau of Standards radium solution. Crystal headphones have to be used for high counts. The glass ring is uranium-dyed, makes the counter tick.

and then passed through a regulator tube.

**Counter circuit:** When a 1/25-watt neon bulb is wired in series with one of the tube's terminals, the electric charge resulting from ionization causes the lamp to flash. Though multiplied many times in the tube, the charge isn't great enough to give a bright light, so an integrating condenser must be placed across the neon lamp. This gives a brighter flash at longer intervals—making it easier to count individual pulses. The value of this condenser may be varied from .001 to .1 mfd. The higher the value, the brighter and more widely spaced the flashes will be.

The neon flasher isn't satisfactory under all conditions. It can't be seen too well out of doors, and a highly active source will just cause it to glow. An auxiliary jack is therefore provided for use with *high-impedance crystal* headphones. Note that the ordinary magnetic type won't do.

**Construction:** Actual building is simple and straightforward. The POPULAR SCIENCE model is shown spread out on a breadboard. It could equally well be compacted on or

#### LIST OF PARTS

G-M Counter tube: Type EP 30 G (gamma tube) or EP 30 M (mica-window, beta and gamma.)

Voltage Regulator. Type EP 30 RS. (All of above made by Electronic Products Co., Mt. Vernon, N. Y.)

Rectifier: Type CK 1013, Raytheon Mfg. Corp., Newton, Mass.

Relay: SPST, normally closed. The following types have been used successfully:

Advance Relay Co., Los Angeles: Type 5002 or 104 AM-2A, both 15-volt AC coils.

Allied Control Co., New York: Type BG, coil 34, 133 ohms. Type F, coil 32, 47.5 ohms. Type LK, coil 32A, 63 ohms.

C. P. Clare & Co., Chicago: Type C or G, 50-ohm coils.

Step-up transformer: Type 20A00, Thordarson Electric Mfg. Co., Chicago.

Neon lamp: 1/25-watt, any type. Condensers (all 600 volts):

two .01 mfd.

one .005 mfd.

one .001 to .1 mfd. (see text).

Resistors: two 1-megohm, 1-watt.

Switch: SPST toggle.

Flashlight cells, insulated grid cap (for rectifier-tube connection), phone jack and crystal headphone, neon-lamp holder, binding posts, misc. hardware.



inside of a radio chassis. To convert the breadboard model into a portable survey meter, it is only necessary to fit a wooden cover over the board.

The clips that hold the batteries and tubes are ordinary broom holders. There's nothing critical about the wiring or placement of the parts, and shock hazard is so low that no special precautions are needed.

**Adjusting the power supply:** To get the relay to work properly, it may be necessary to adjust the contact points or spring tension slightly. Contacts should make-and-break about 30 times a second, producing a sound that falls just between a tapping and a steady, low-pitched buzz.

It's nearly impossible for a home work-shopper to tell exactly what voltage his power supply is putting out, for an ordinary vacuum-tube voltmeter loads the circuit too much to give an accurate reading.

However, for the POPULAR SCIENCE counter it isn't necessary to know your voltage exactly. The relatively low voltage required by the counter and regulator tubes makes it practically certain that you'll be getting all you need. But you can make a couple of quick checks.

When the wiring is completed, connect a neon lamp across the relay coil (the indicator lamp can be used). With the relay vibrating, the lamp should flash—just between a flicker and a steady glow. Try bending the points until the light is just under maximum brightness.

In a darkened room you should also be

**For precision work** it is important to minimize stray background radiation. A lead block with a hole bored through the center forms a perfect

able to see a dim glow through the top of the rectifier tube. If you can't, the polarity may have been switched somewhere along the line. Color coding of the transformer leads is not uniform in all cases. The remedy is to switch the batteries, putting the shell at ground instead of the positive terminal as in the diagram.

**What parts to use:** The components of the AEC Geiger counter are critical and are therefore specified in detail in the parts list. Most of them are available from radio supply houses. If you have trouble, write to POPULAR SCIENCE for a list of suppliers.

**How to read your G-M counter:** Exact calibration of a Geiger counter is very difficult, but fortunately you don't have to put this instrument on an absolute scale in order to get useful readings.

You can buy radioactive samples from scientific supply houses and from the National Bureau of Standards. The standards sold by the NBS range in price from about \$3 to \$10. By counting the flashes produced by a known sample held at various distances from the counter tube, you can estimate the relative radioactive energy of any unknown sample. Information on available standards can be obtained from Dr. L. F. Curtiss, National Bureau of Standards, Washington, D. C.

The work of developing this counter was done under the direction of Harris D. Le Vine, chief of the Instruments Branch, and Hugo DiGiovanni, chief of the Electronics Section, New York Operations, AEC. END

shield for the mica-window tube. The block is raised on plastic spacers to permit sample trays to slide directly under tube window.

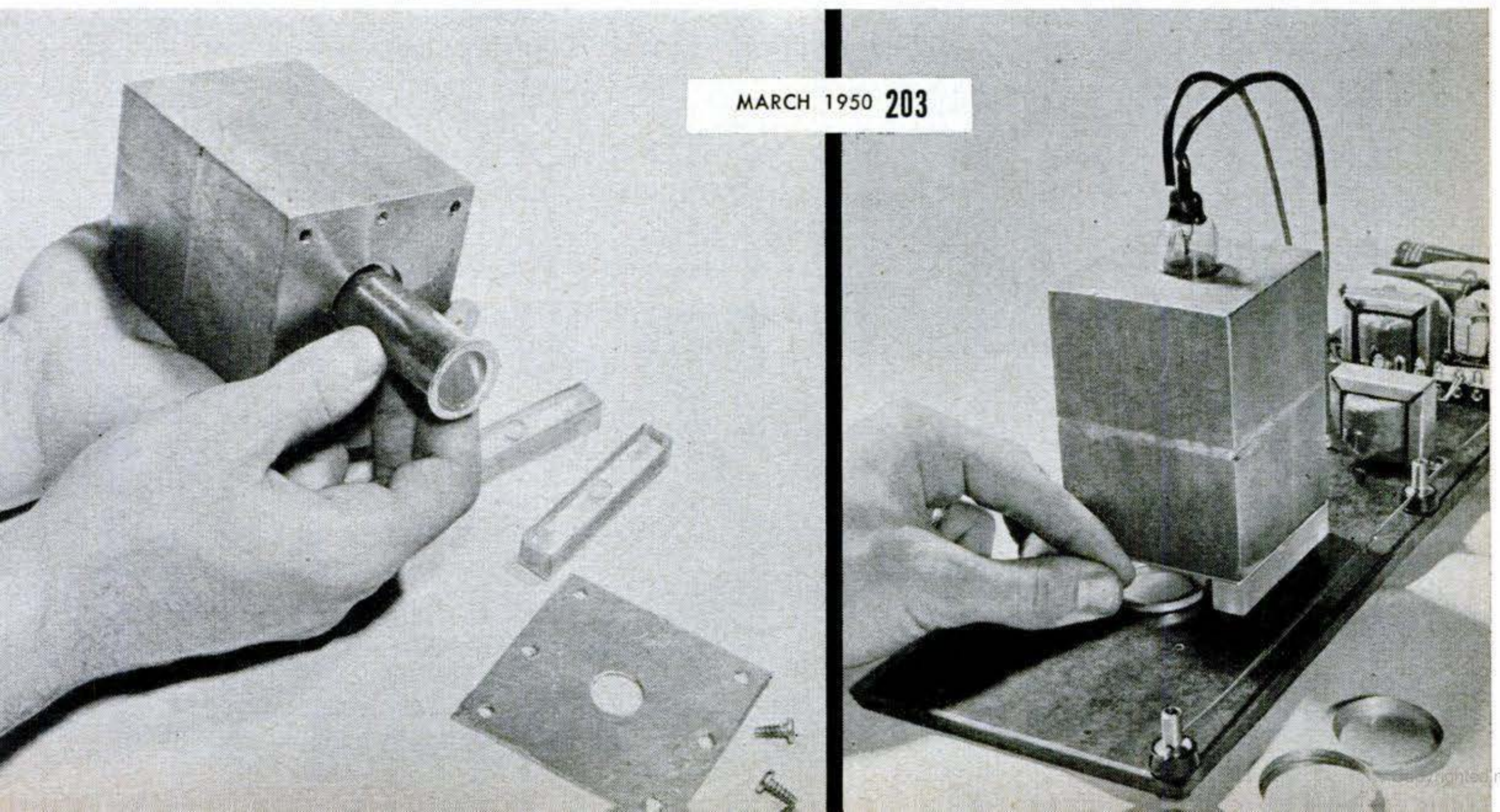



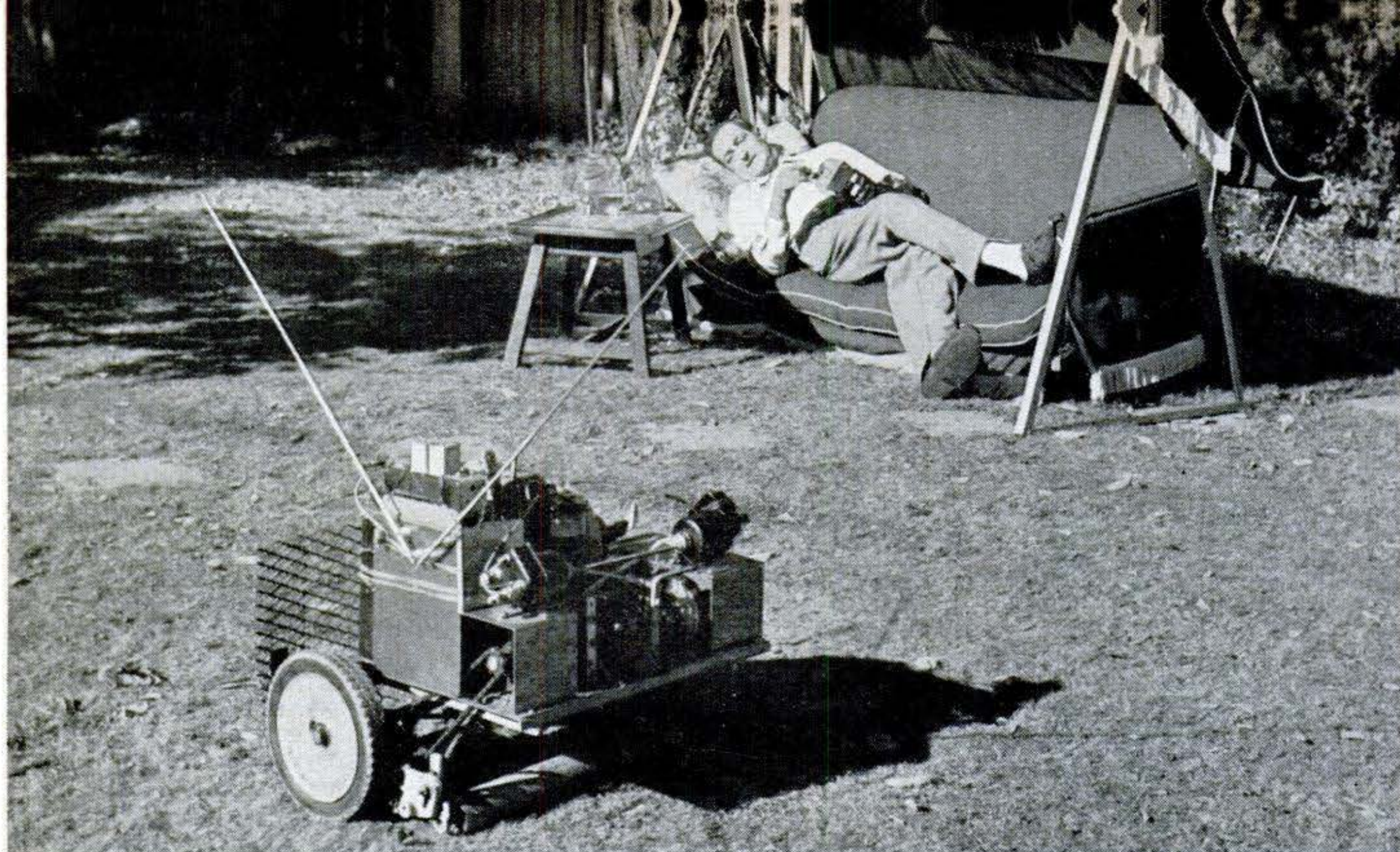

## Mows Lawn by Radio—Pretty Soft!

WHILE his robot lawn mower chugs around the lawn, Jim Walker, of Portland, Ore., takes it easy in his glider, sipping a cool drink and operating the radio controls.

Walker, a radio ham, long-time builder of radio-controlled model planes, and president of a model-airplane company, de-

veloped the robot mower after ninety days of tinkering. He plans to build and sell similar rigs for license-free frequencies.

The mower is a standard job, driven by a one-cylinder gas engine. Separate clutches operated by solenoids control the power to each driving wheel. Normally the mower runs straight ahead, but either wheel may be declutched by radio to steer the robot or turn it around. If you punch one button, it pivots around the disconnected wheel; if you punch both, the mower stops. The engine and cutting reel run at a constant speed. A main clutch is adjusted to slip if the mower jams on an obstruction, and a triggering bar in front shorts out the spark plug if the mower bumps anything.

The radio consists of two small transmitters and receivers, although a single-channel rig with audio discrimination may be used. The transmitters are simple one-tube affairs, powered by hearing-aid and flashlight batteries. Walker says he gets accurate control over a quarter of a mile away.

## Outboard Runs Model Boats

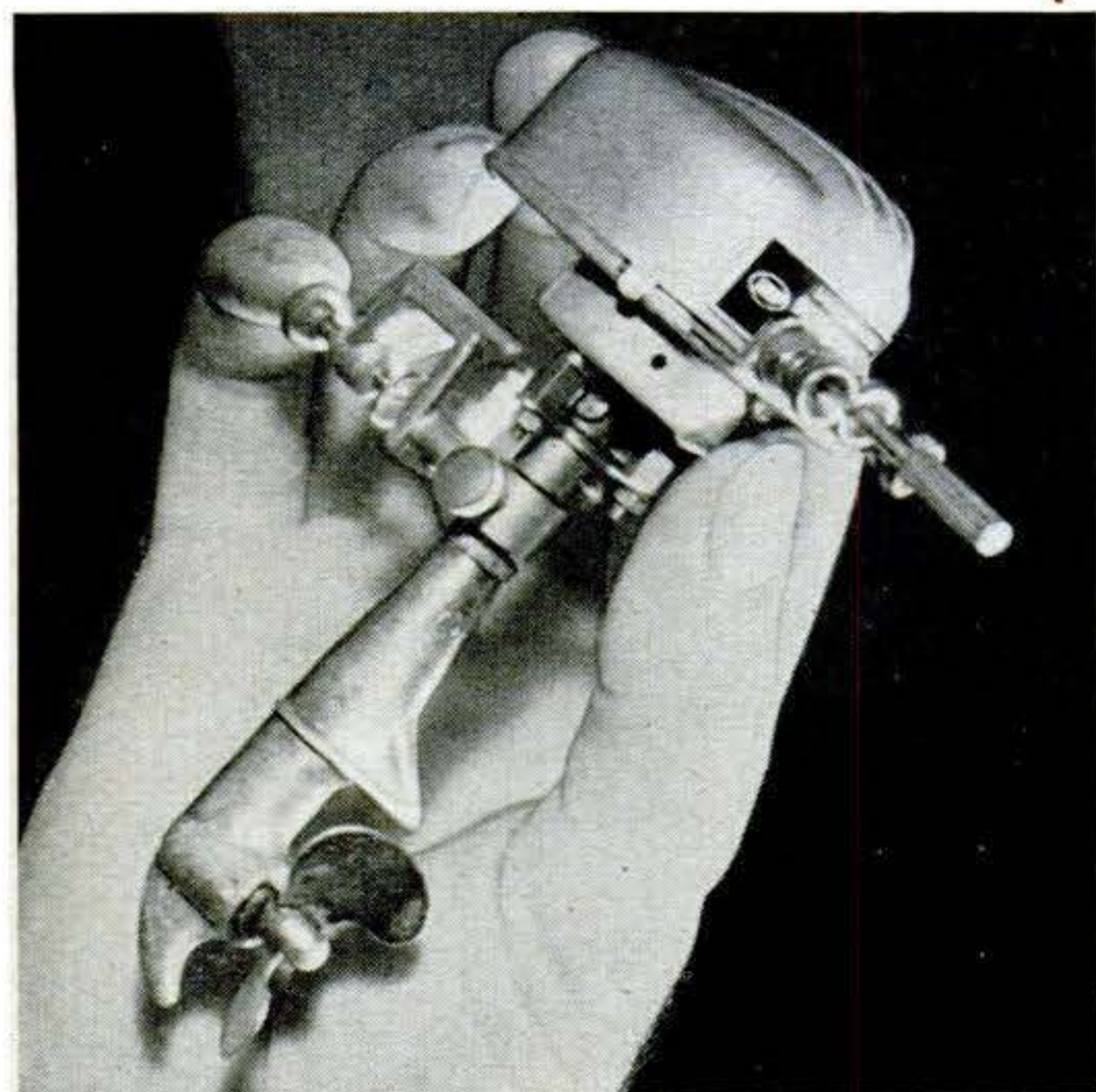

IT LOOKS like a real outboard motor but it fits in the palm of your hand. Hook it up to flashlight batteries—three to nine volts—and it races a model boat over a circular or straight course. At six volts it turns up 1,850 r.p.m. It has a bright silver finish and is sold for about \$4 by International Models, Inc., of New York City.

## Cigarette Pack Is Reminder

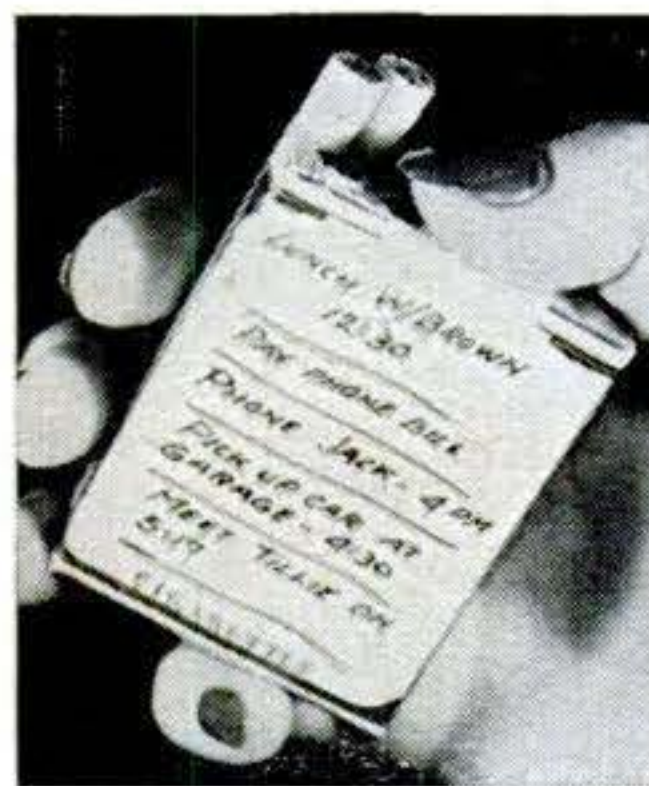

SLIP a note between the cellophane wrapping and your cigarette package. It'll serve as an on-the-spot reminder of engagements and errands.—M/Sgt. John M. Overstreet, Birkensfeld, Germany.



With summer just around the corner, now is the time to build play equipment. Here are six pages of suggestions, from slides to swings.

# Make Your Yard a Playground This Spring

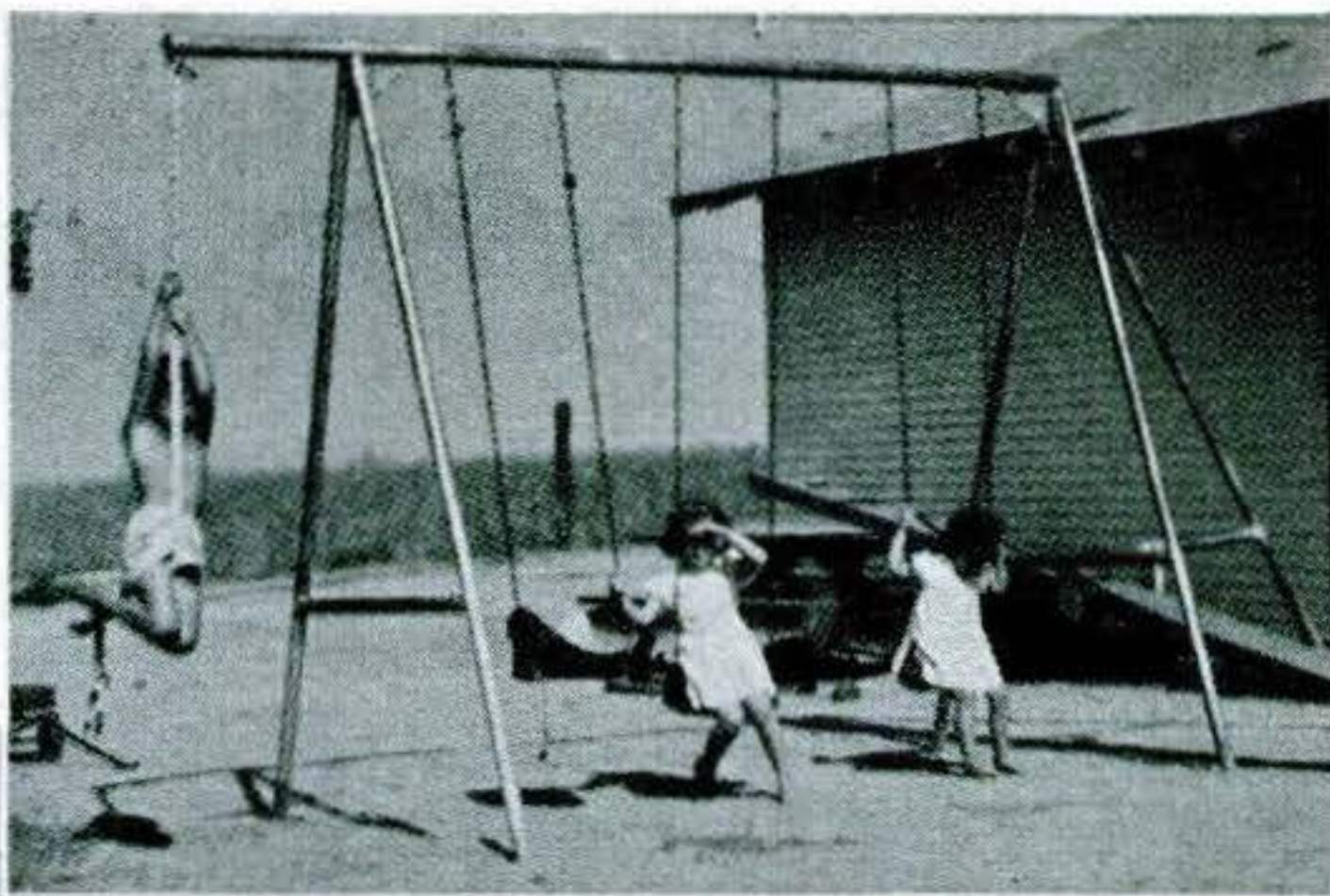

**E**VEN if the area you have for play space is limited, you probably can fit in some of the equipment pictured on these pages. All the pieces are sturdily built. On the heavier units made of pipe—such as the swing and seesaw assembly—you can use either threaded or welded joints. The feet are anchored underground with steel plates.

*This combination job will take care of everyone.*

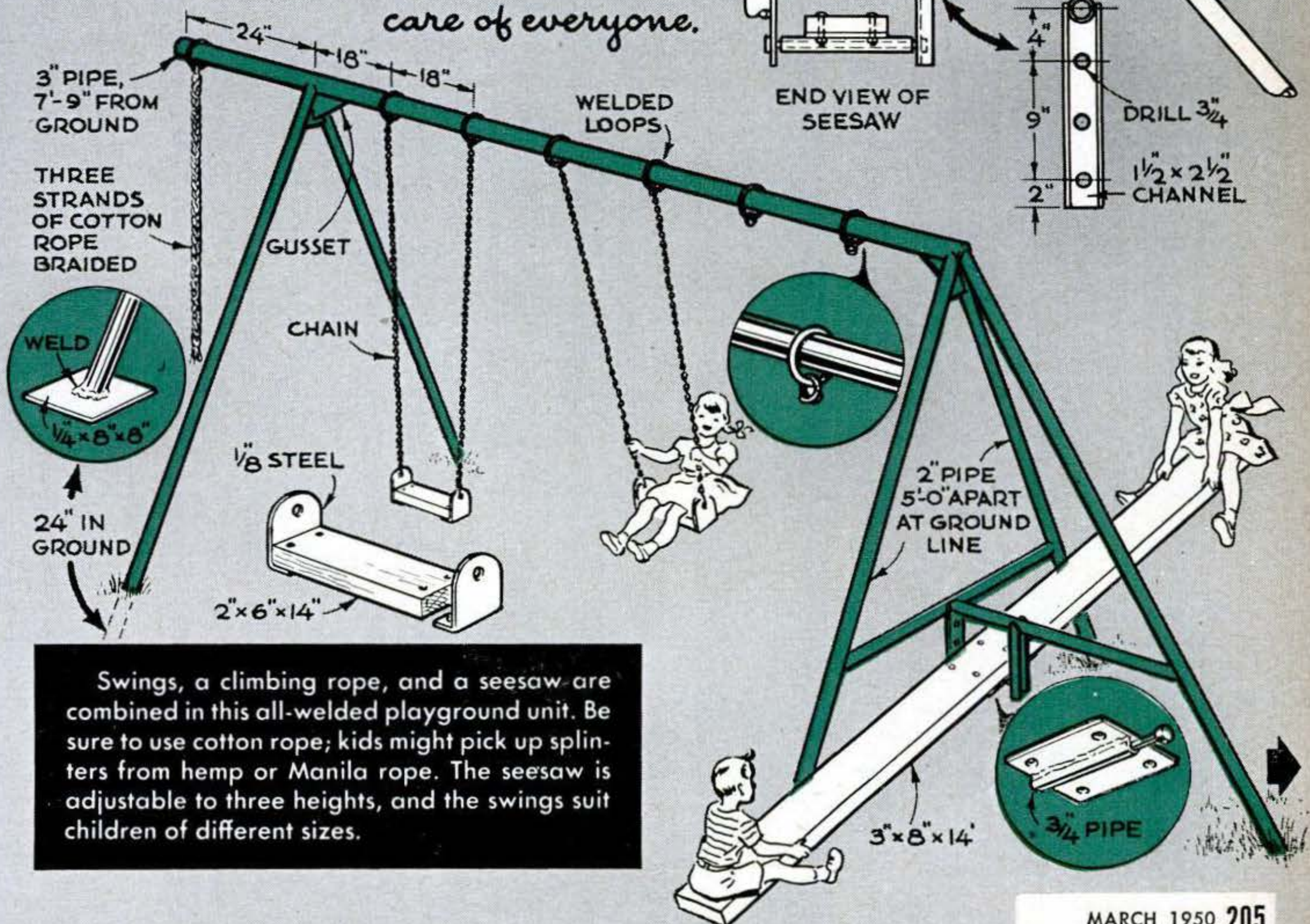

Swings, a climbing rope, and a seesaw are combined in this all-welded playground unit. Be sure to use cotton rope; kids might pick up splinters from hemp or Manila rope. The seesaw is adjustable to three heights, and the swings suit children of different sizes.



You can build this novel merry-go-round in your spare time and at a very low cost.

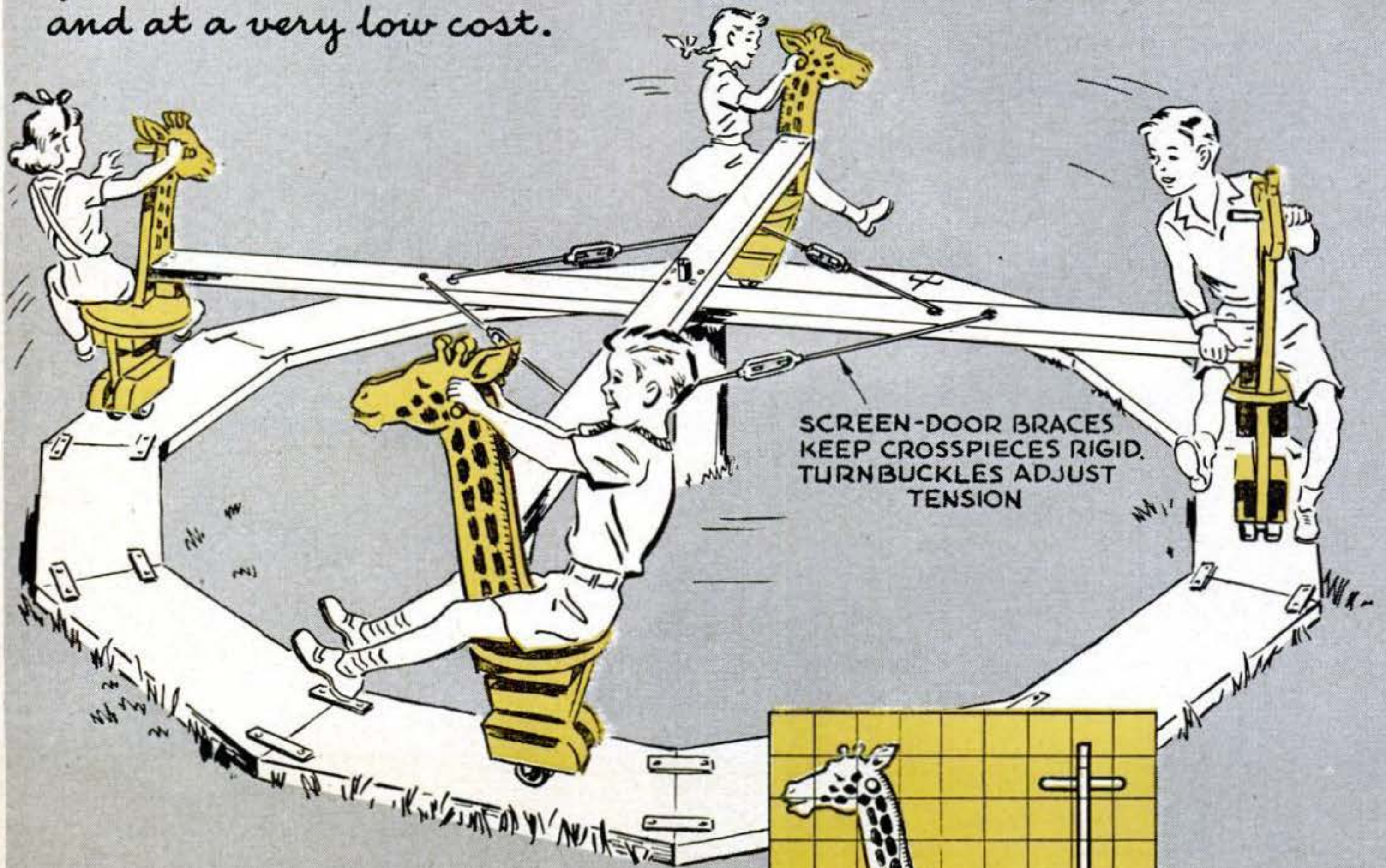

Simple merry-go-round (above) can be made as shown, using half roller skates under each horse. The planks that the wheels roll on are held together with mending plates and screws.

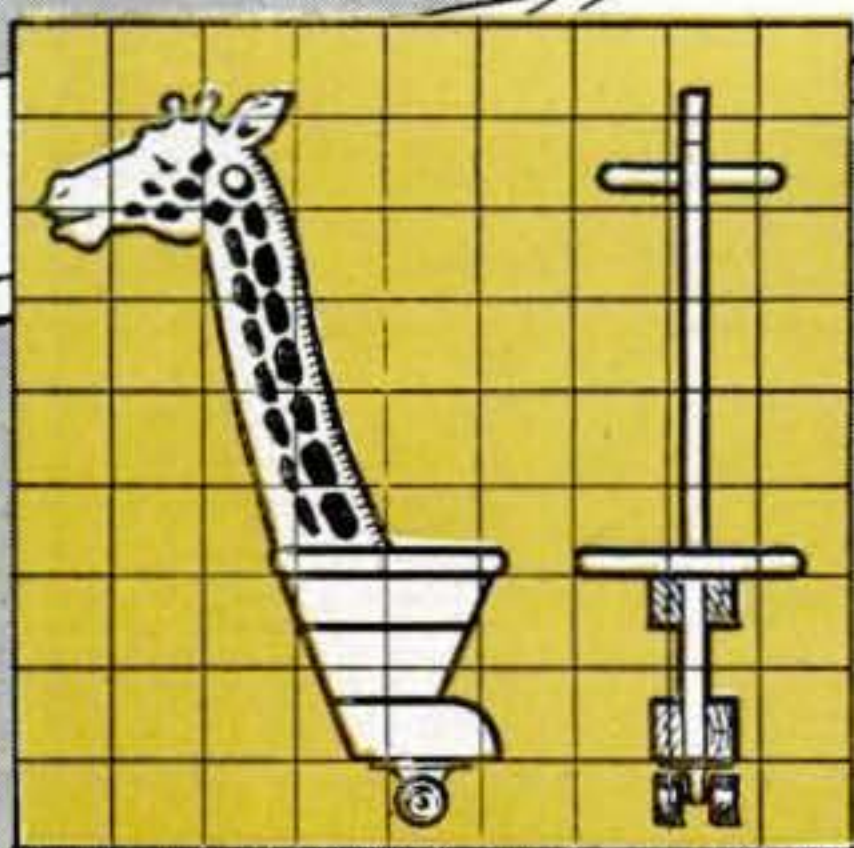

Does your boy need something to hit? Build him this sturdy punching bag.

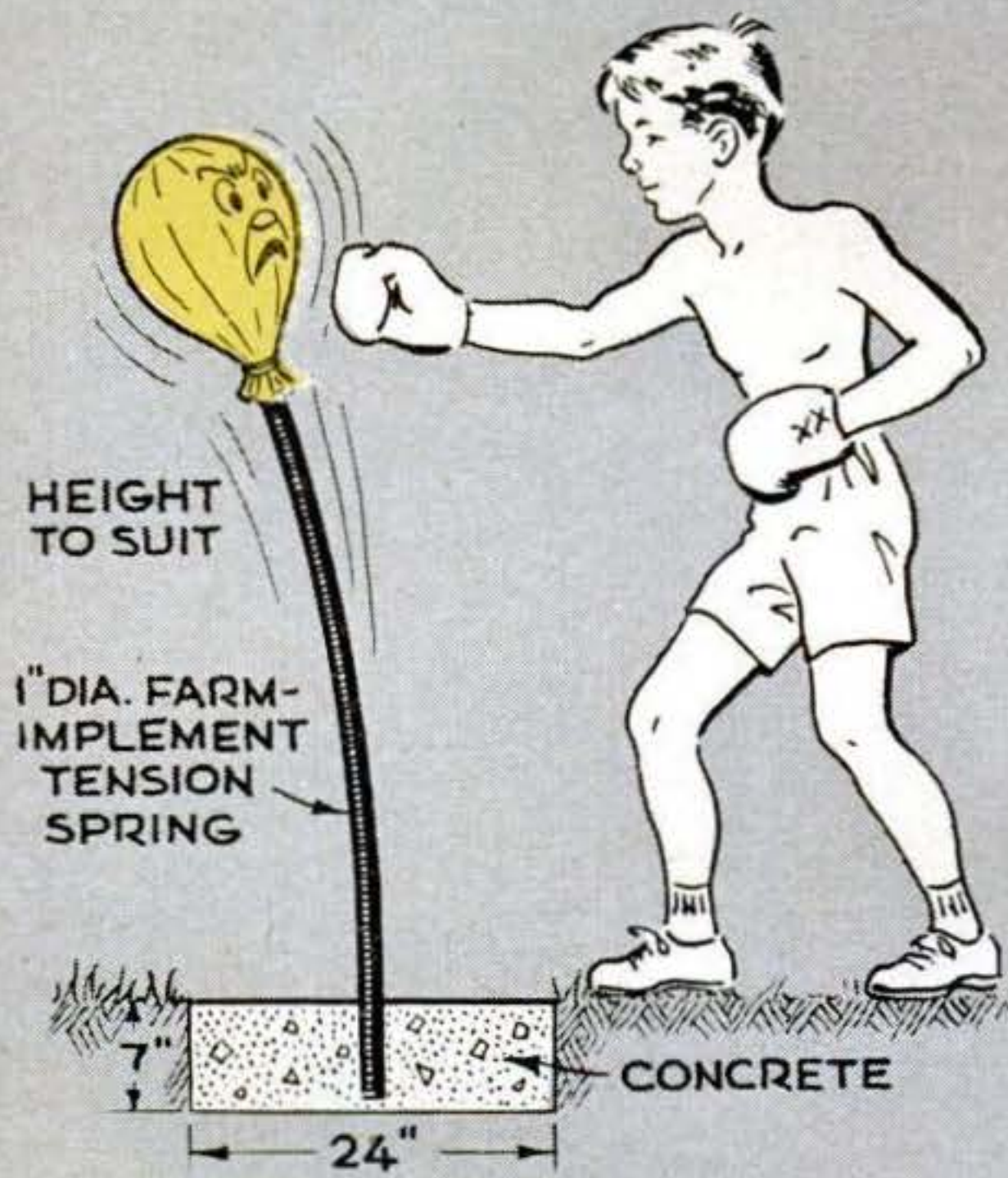

Boys get a bang out of this punching bag. You can buy the spring from a farm-implement dealer. Core of soft pine is made in two halves with a wooden cap screwed on. Canvas cover is made of canoe-shaped pieces stitched together.



Here's another variation of that old playground favorite. Start building it now!

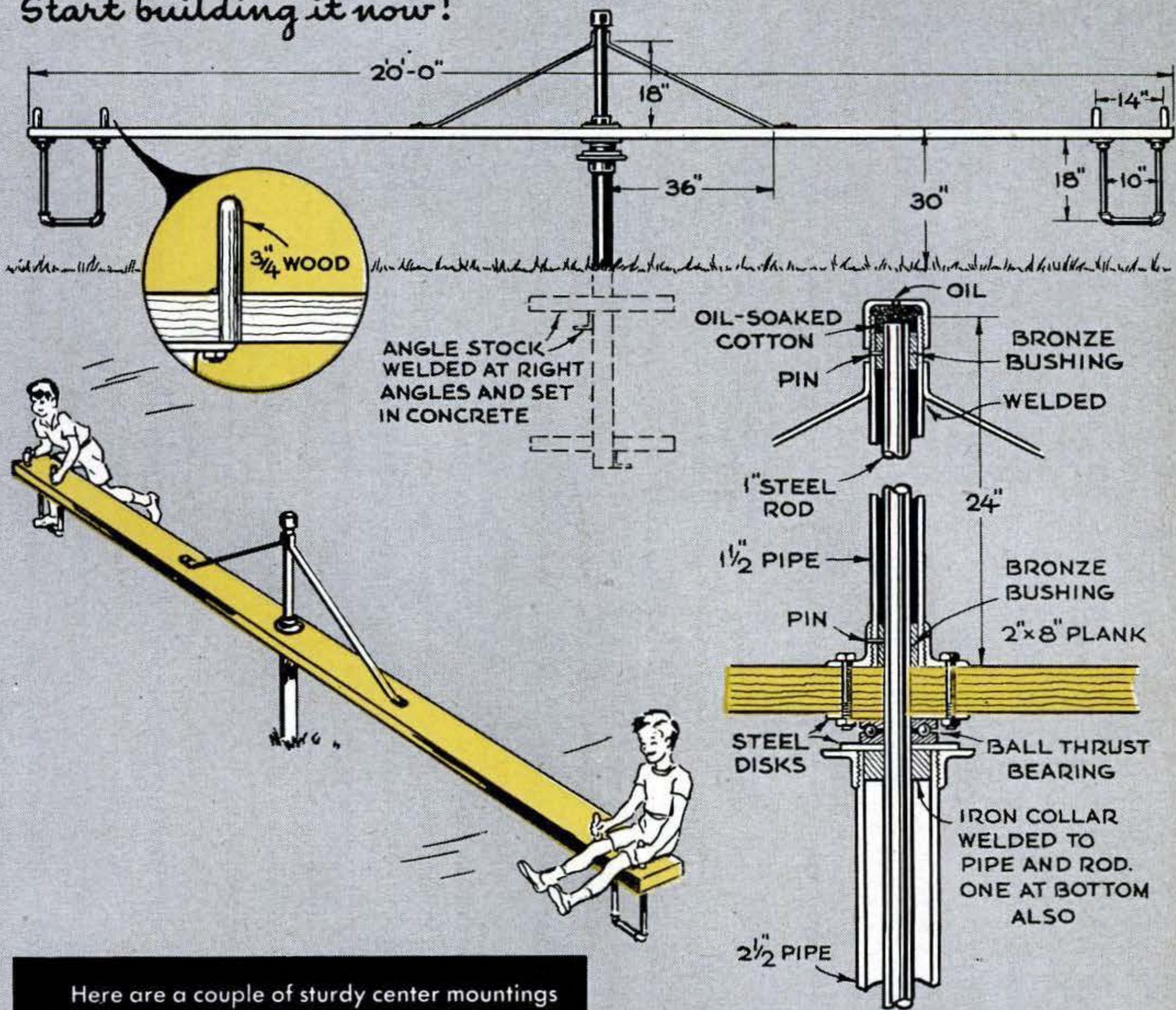

Here are a couple of sturdy center mountings for merry-go-rounds. One above with the ball thrust bearing is self-oiling, will stand up under lots of rough wear. Below is simpler type, oiled at the top of the brass tube. To make a four-passenger merry-go-round, just add another plank and strap-iron braces.

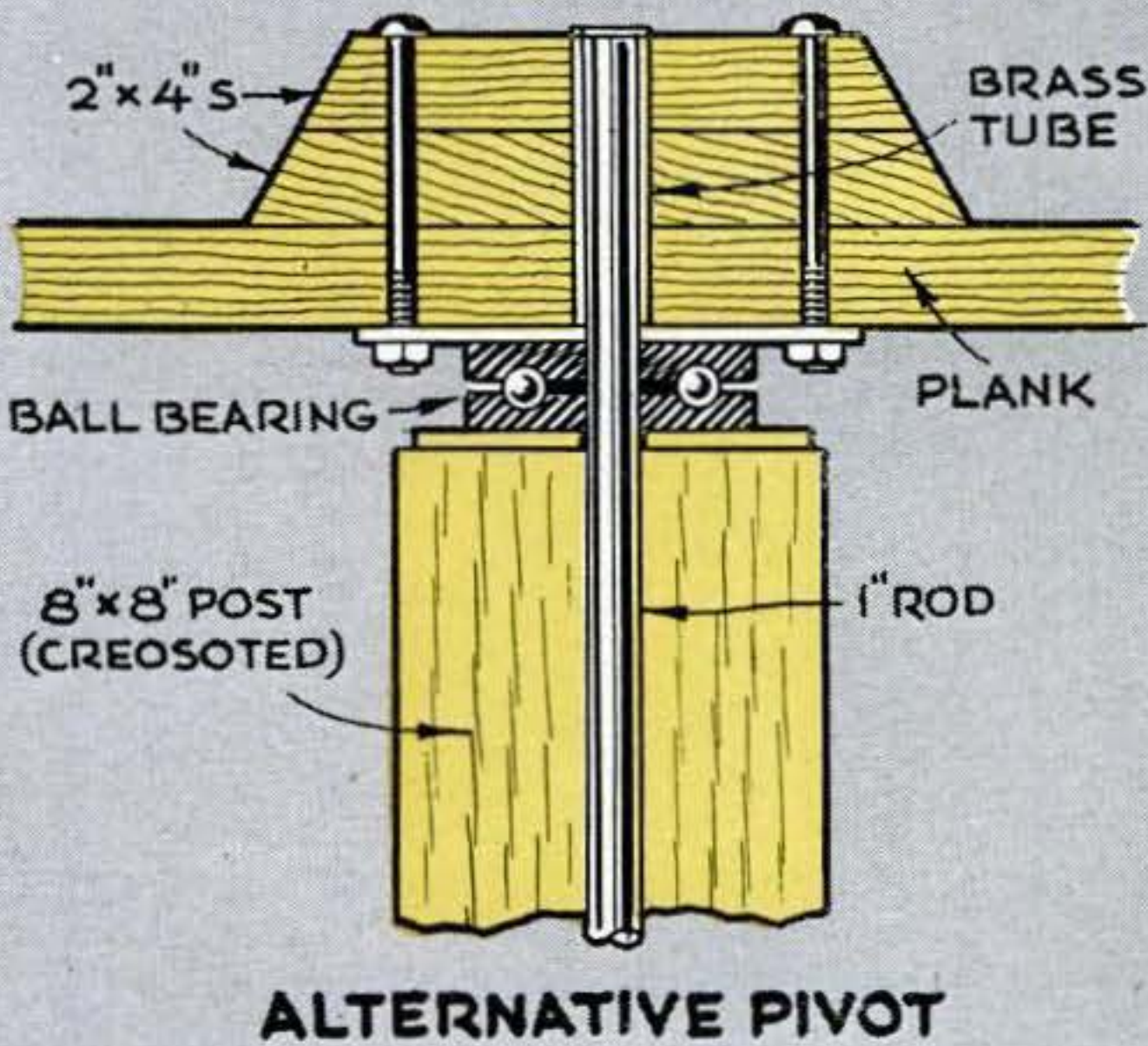

A basketball backboard is a must for every sport-minded boy or girl.

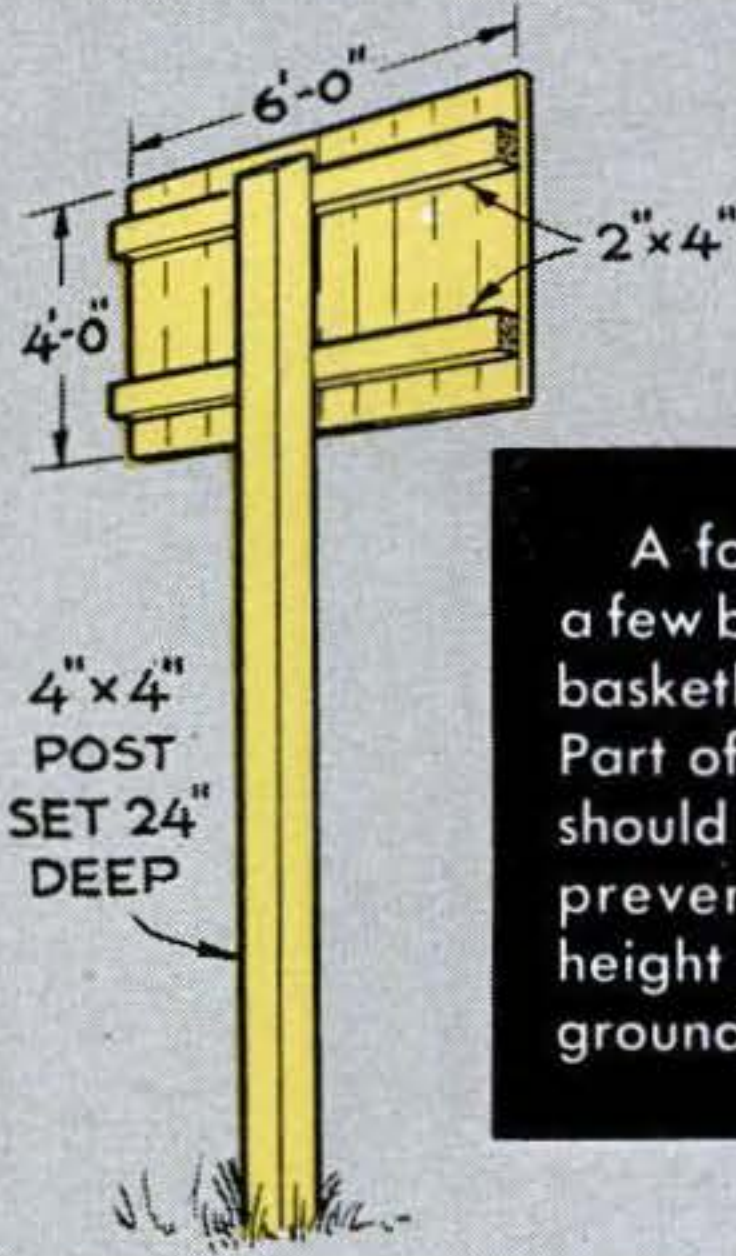

A four-by-four and a few boards make this basketball backboard. Part of post in ground should be creosoted to prevent rot. Official height of basket from ground is 10'.



This climbing unit also serves as a sturdy teepee frame.

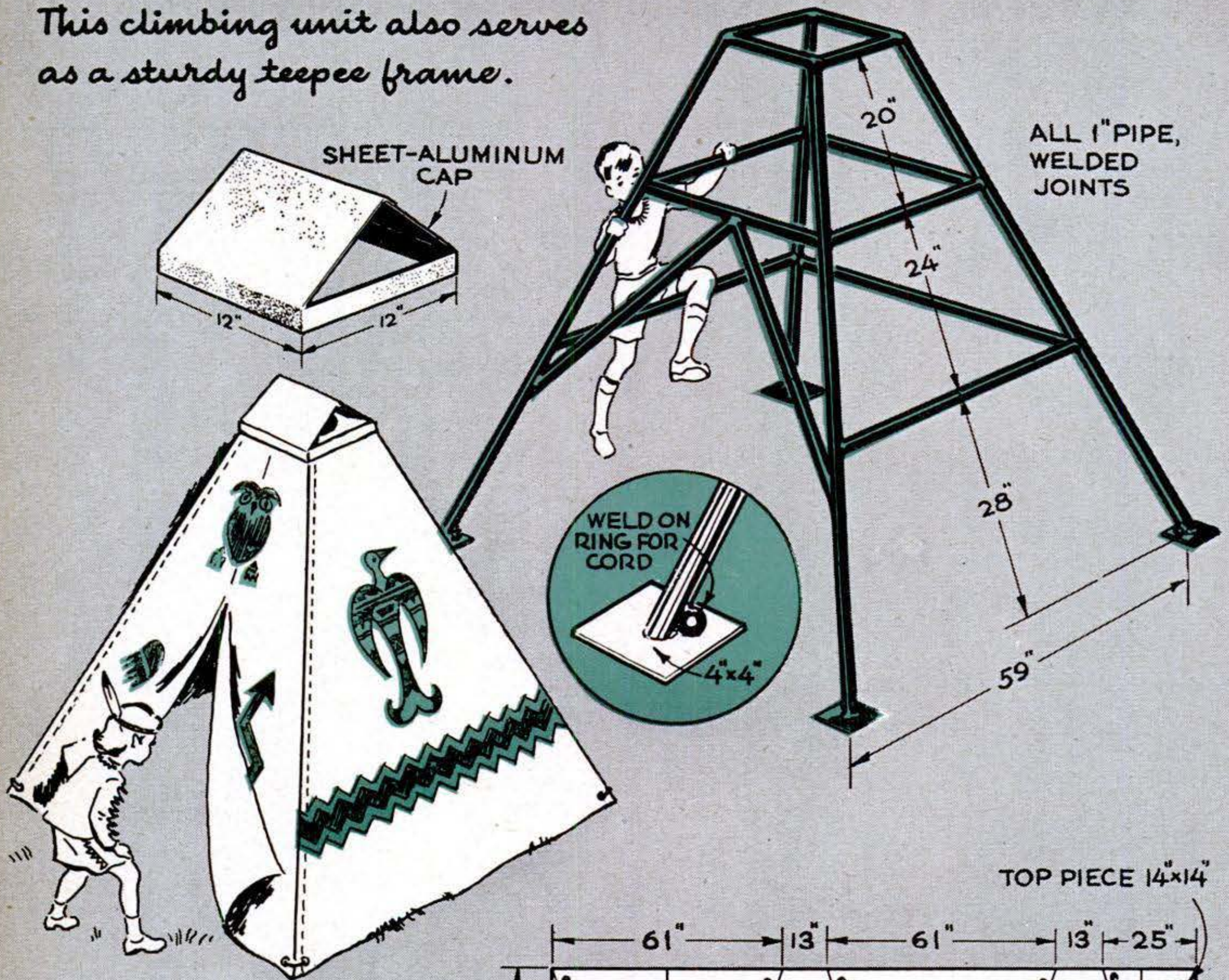

ALL 1" PIPE,  
WELDED  
JOINTS

WELD ON  
RING FOR  
CORD

4"x4"

TOP PIECE 14"x14"

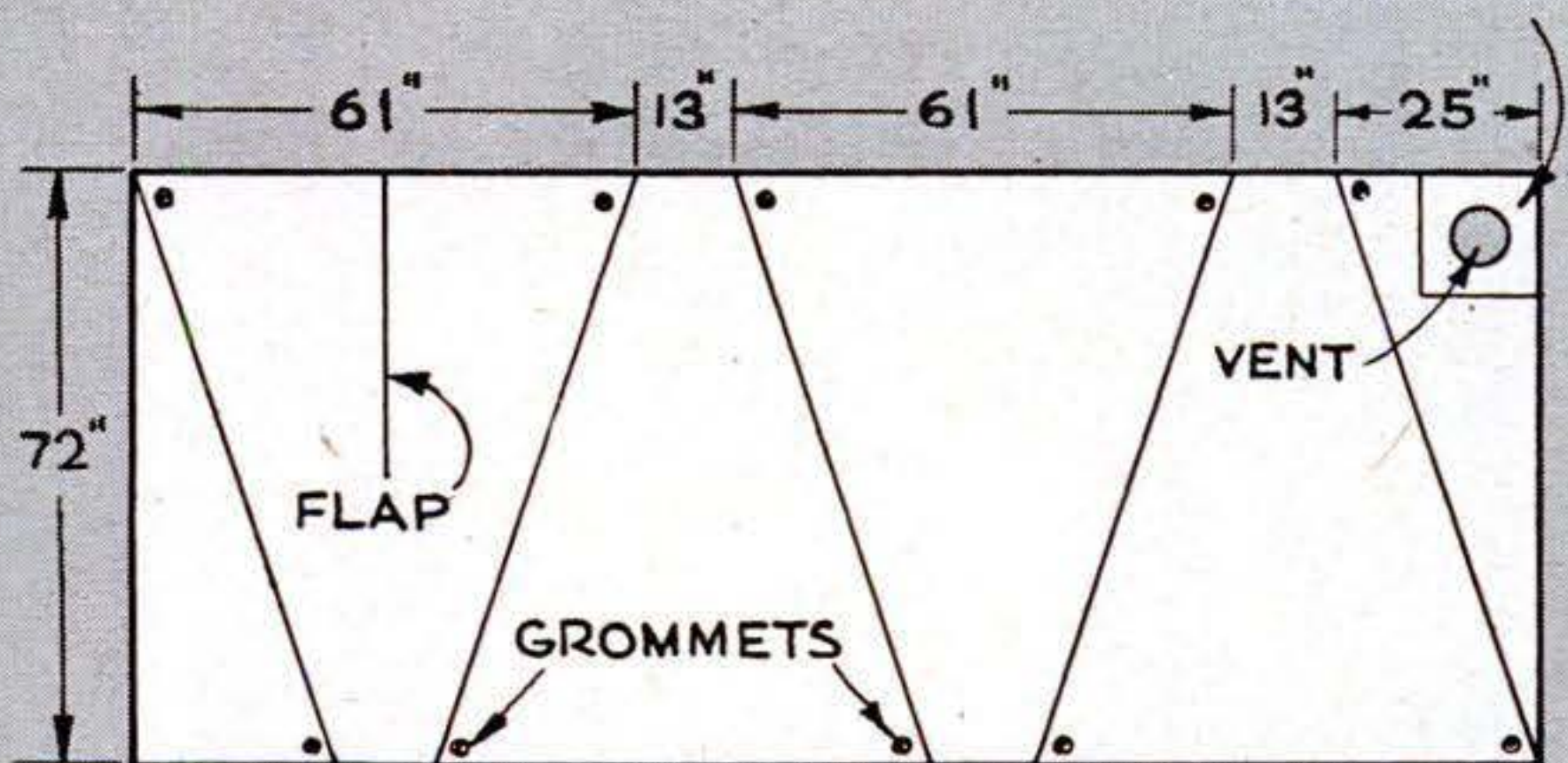

Kids have double fun with this one—as either climbing bars or a tent. Five yards of canvas 72" wide make the tent (right), allowing 1" lap at the seams. Galvanized pipe is used for the framework.



A swing cut from an old truck tire is a lot of fun for kids of all ages.

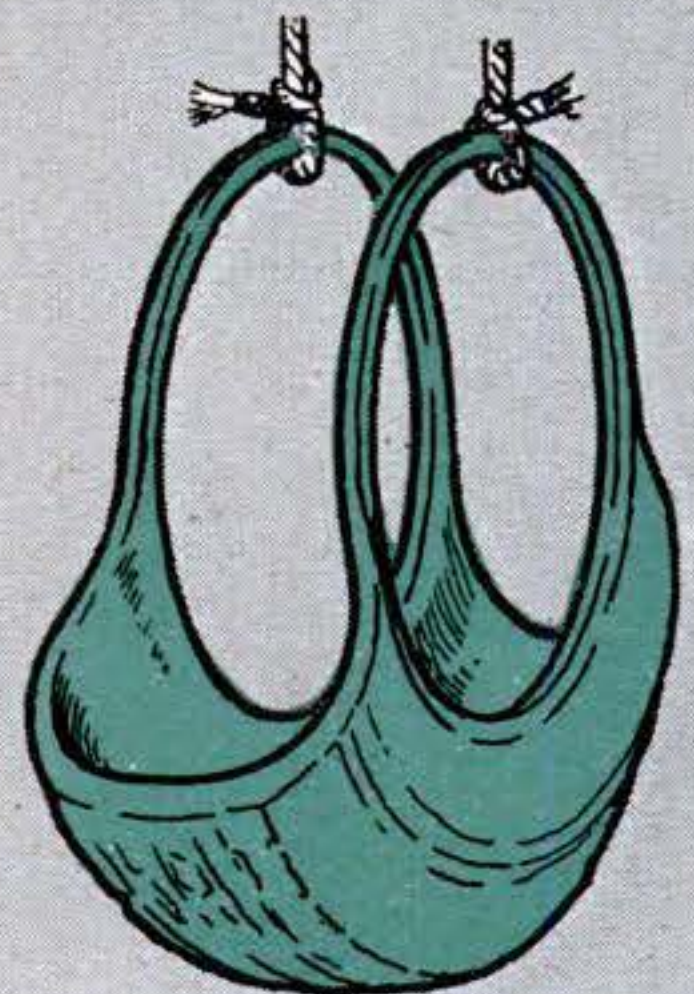

Here's a quickie swing. Cut away all parts of an old truck tire except beads and part of tread to form a seat at the bottom.



Don't forget a sandbox. This one won't fall apart.

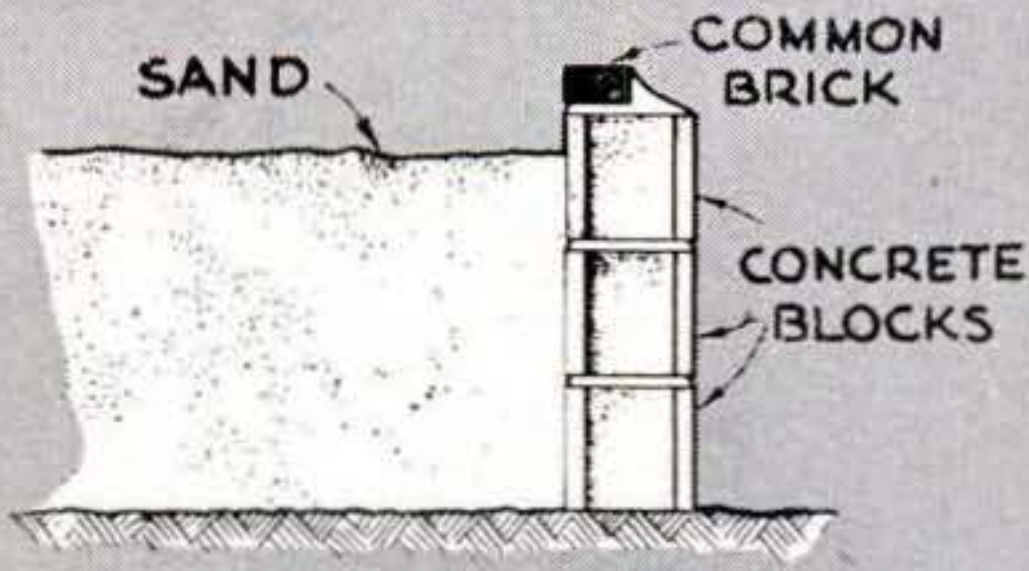

Build sandbox to suit your space. Make it deep enough so children aren't likely to dig down through sand to earth. Walls are concrete blocks topped with red bricks.

Aluminum roofing and a few simple tools will give your child a slide that will be the envy of the neighborhood.

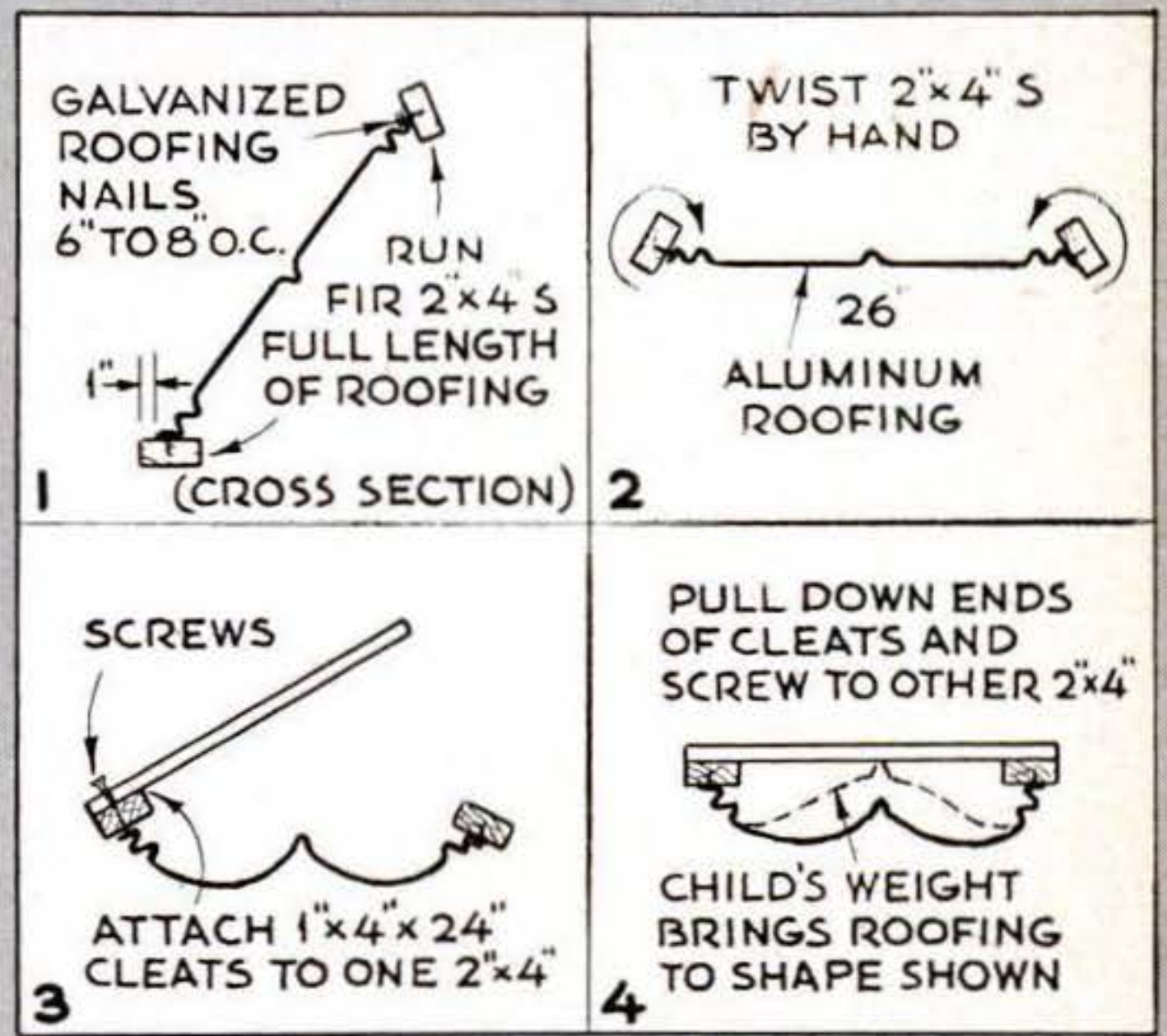
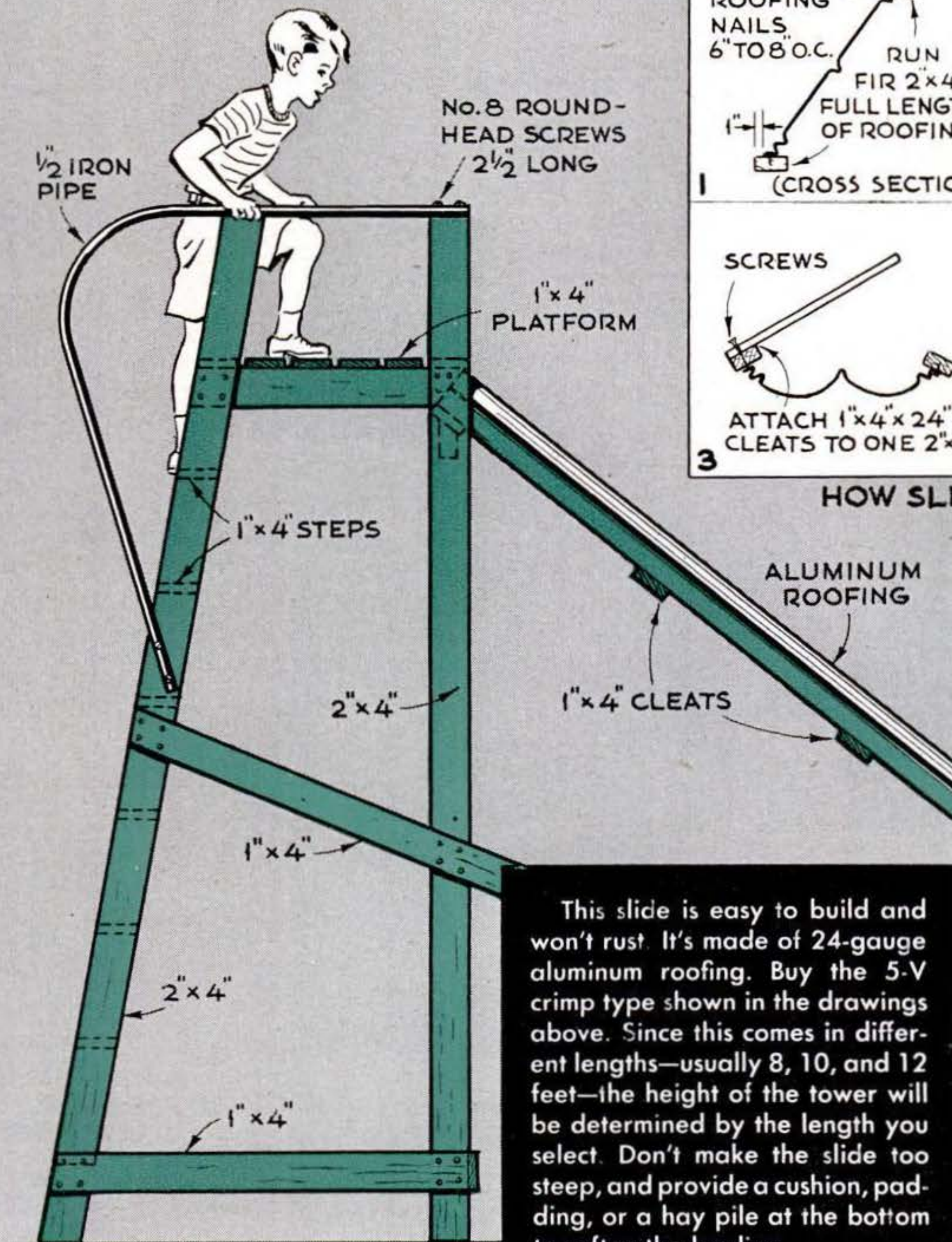

HOW SLIDE IS FORMED



This slide is easy to build and won't rust. It's made of 24-gauge aluminum roofing. Buy the 5-V crimp type shown in the drawings above. Since this comes in different lengths—usually 8, 10, and 12 feet—the height of the tower will be determined by the length you select. Don't make the slide too steep, and provide a cushion, padding, or a hay pile at the bottom to soften the landing.

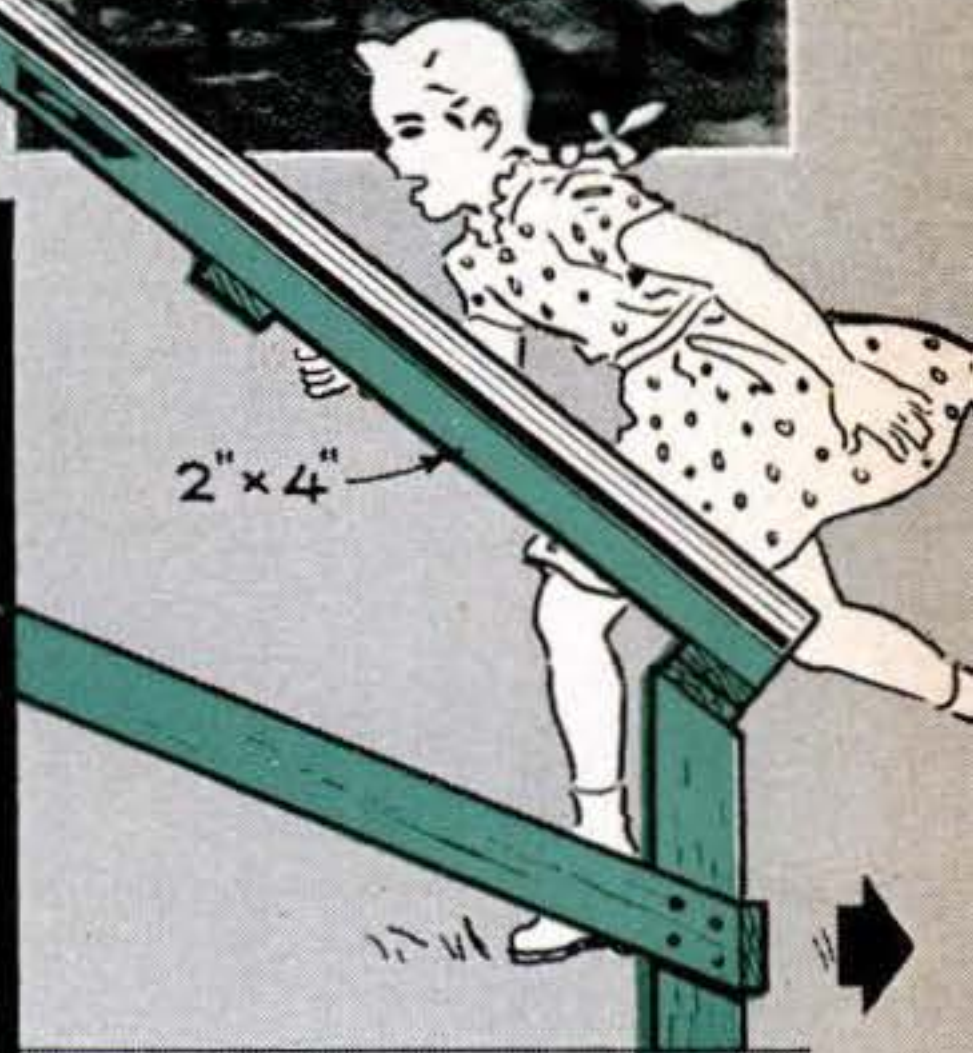



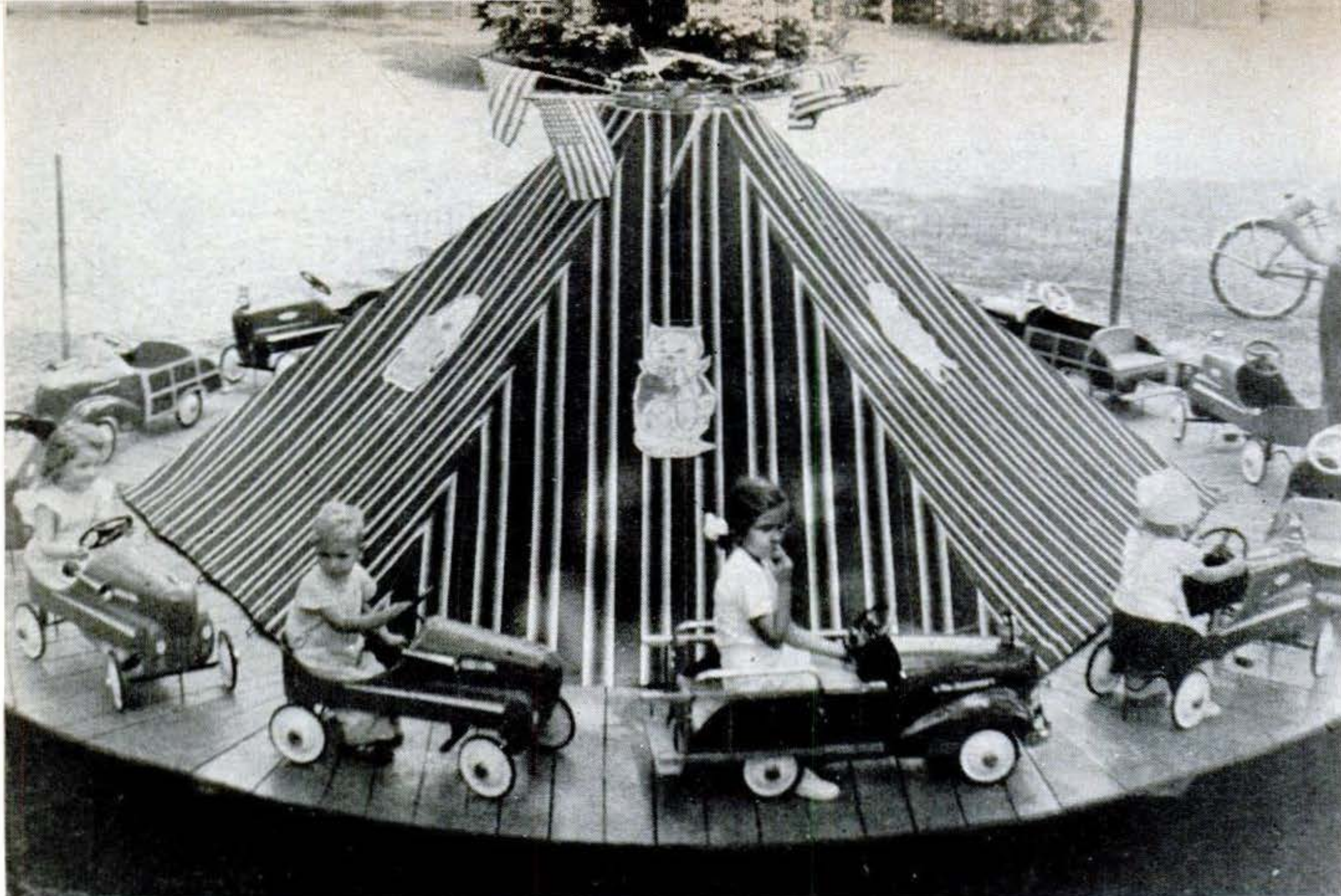

Cars are bolted to wooden platform that rotates. Canvas centerpiece covers the mechanism.

*Here's a merry-go-round a Kiwanis Club built for the children of Columbus, Wis.*

**W**HEN neighborhoods or communities pool their skills, you get a lot more done than if one man tried it. Here's an example of a community project.

In Columbus, Wis., the kids needed play

equipment in the town's park. The Kiwanis Club came up with the answer for less than \$200 plus the combined skills of the membership. One member machined the parts. Others welded, drilled, and bolted the parts together.

The ride is built around a 4" pipe with a ball bearing at the bottom. An old auto tire rim is welded to the center section. V belts connect the rim to a speed reducer and the ½-hp. motor that drives the ride. **END**

Two spare drive belts are in place so ride will not have to be taken apart if the belt breaks.

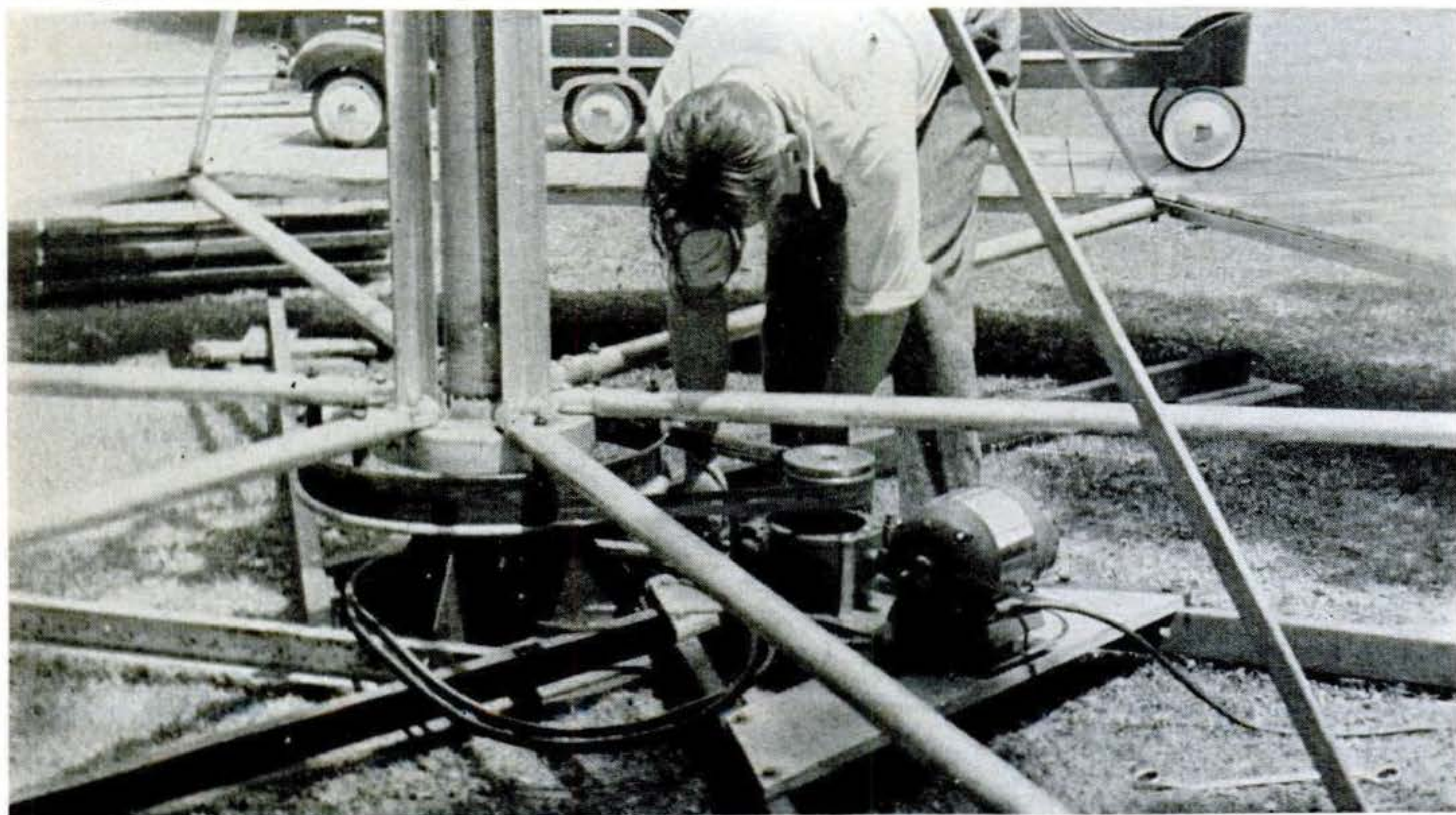



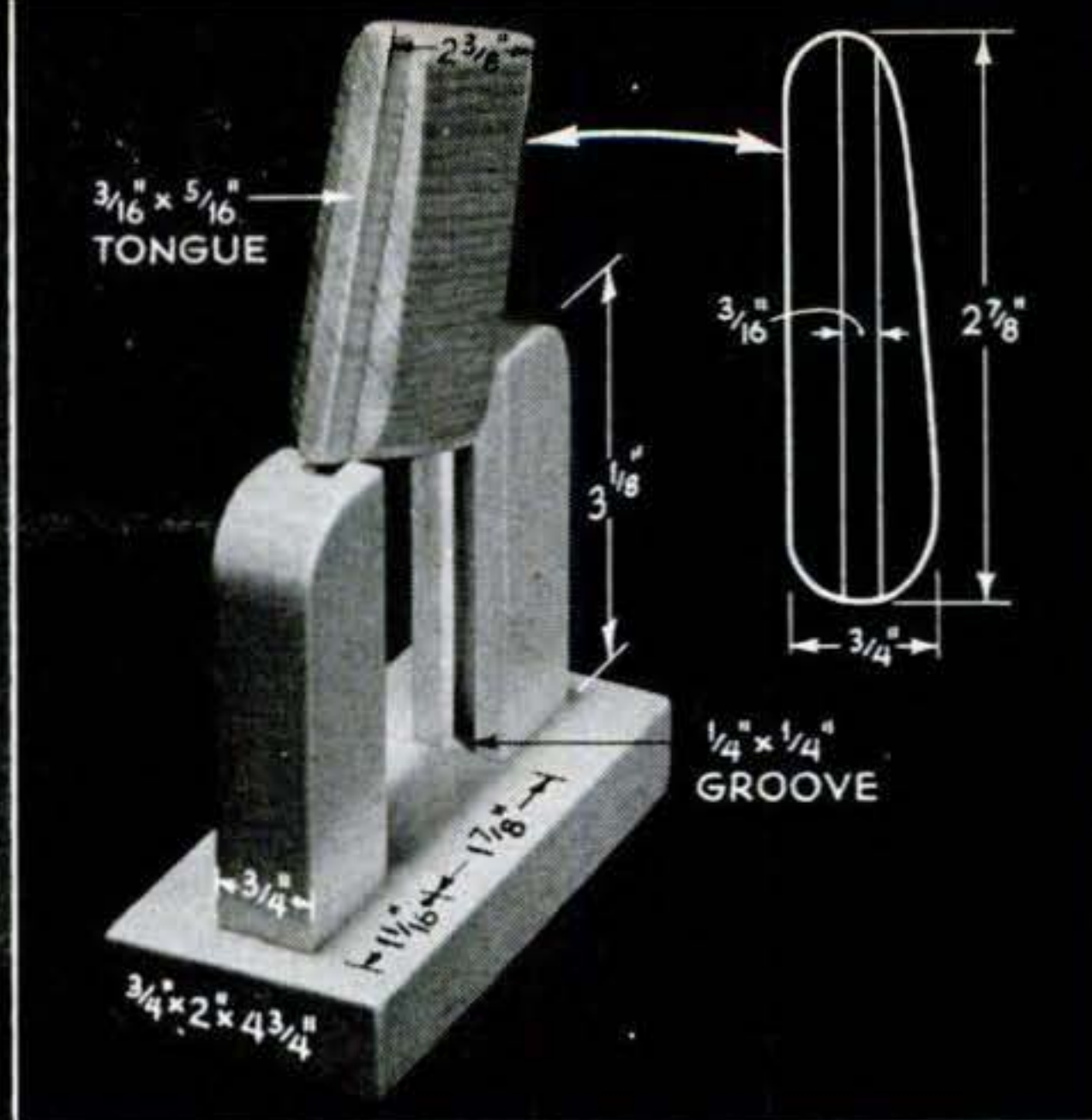

## Stand Holds Wrist Watch Upright

THERE are many times when you want your wrist watch to serve as a stationary timepiece, placed where it can easily be seen. This hardwood stand holds the dial upright so it can be read comfortably, and is fine for a bedside table or desk.

The stand consists of two grooved posts glued and doweled to a base. Matching tongues in the slide block fit the grooves snugly. All stock for the unit is  $\frac{3}{4}$ " thick. Dimensions may be changed to suit materials.—George N. Jones, San Diego, Calif.

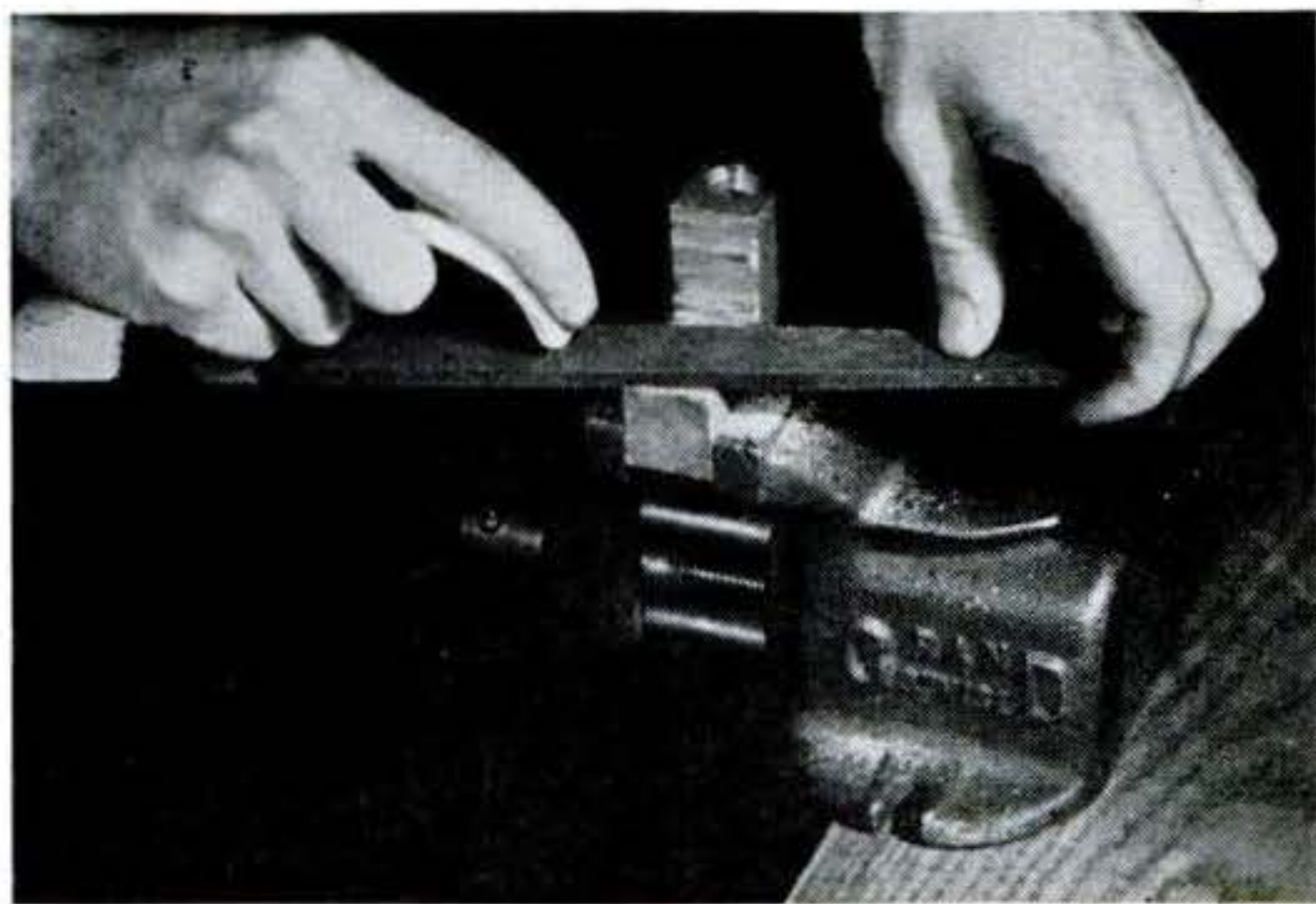

## Handle Improves File Grip

BETTER file control is provided by an interchangeable handle that fits most files. The Handee-Guide® handle moves the grip forward above the file, permitting work to be done with a level, planing motion.

The shank of the file fits a tapered notch in the handle. It can be wedged in or released by a single tap. The sides of the notch are hardened to resist wear. The handle can be used with flat or half-round files and fits all lengths from 8" to 16". It's made by the Riverview Foundry Co., Fall River, Mass., and sells for 49 cents.

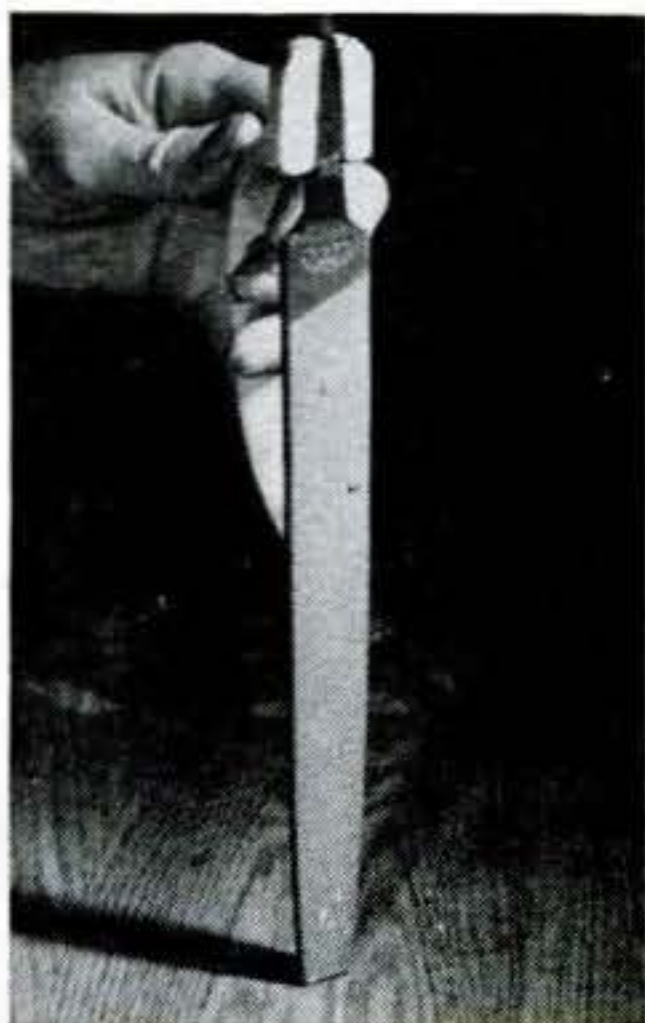

## Tool Speeds Drum Handling

THIS tool for upending barrels and drums uses expanding strap-iron saddles at the points of leverage and lifting. Both saddles spread out as lifting force is applied. This feature insures a positive grip even on wet or greasy drums, according to the D. S. Campbell Company, of Cleveland, manufacturers of the E-Z Up®.



## CRAFTSMAN AT WORK



Arthur Morgan is shown here finishing up one of his caricatures carved from basswood. He also works in walnut, mahogany, and birch. Though harder to carve, these finish beautifully with wax or clear varnish.

SOME years ago, Arthur R. Morgan, of Naugatuck, Conn., saw an article in *POPULAR SCIENCE* on carving a hobby horse from a block of wood. He set to work and ever since has been riding the hobby. His specialty is sculptured cartooning.

The figures are carved from basswood and painted with artists' oil colors thinned enough to get good penetration without danger of the colors running together. Morgan prefers basswood because it is easy to carve, has a close grain, and takes colors well.

What fisherman hasn't entangled his line in something or other? Morgan saw this happen. Result: another carving.

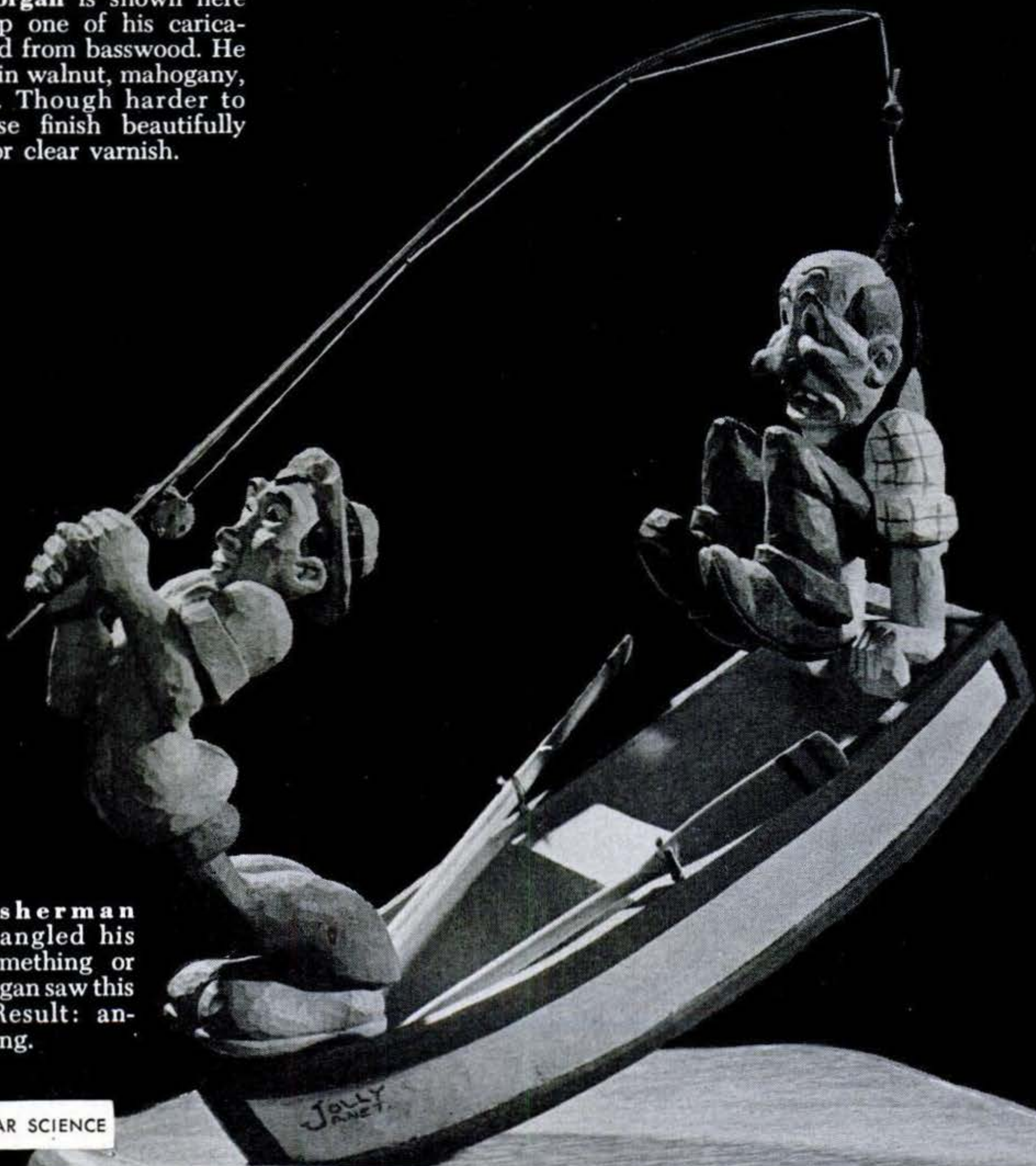





**This jolly Mexican** and his burro were the result of attending a western movie. Morgan keeps on the lookout for likely subjects.



**The Town Crier** was dreamed up after Morgan visited a 200-year-old house and became intrigued with that period.



**This one** is called "The Skating Teacher." Any skating pond will offer ideas for caricatures. Here each figure was carved individually and then attached to the ice-pond base.





Completed unit, left, not only is comfortable but also dresses up corner. Benches are not fastened to wall. If you prefer, you can anchor them to the floor.

With a table in place, below, corner unit becomes breakfast nook. Although benches have both springs and padding, this is not a tough upholstery job.



# Cozy Corner

## Costs Only \$17

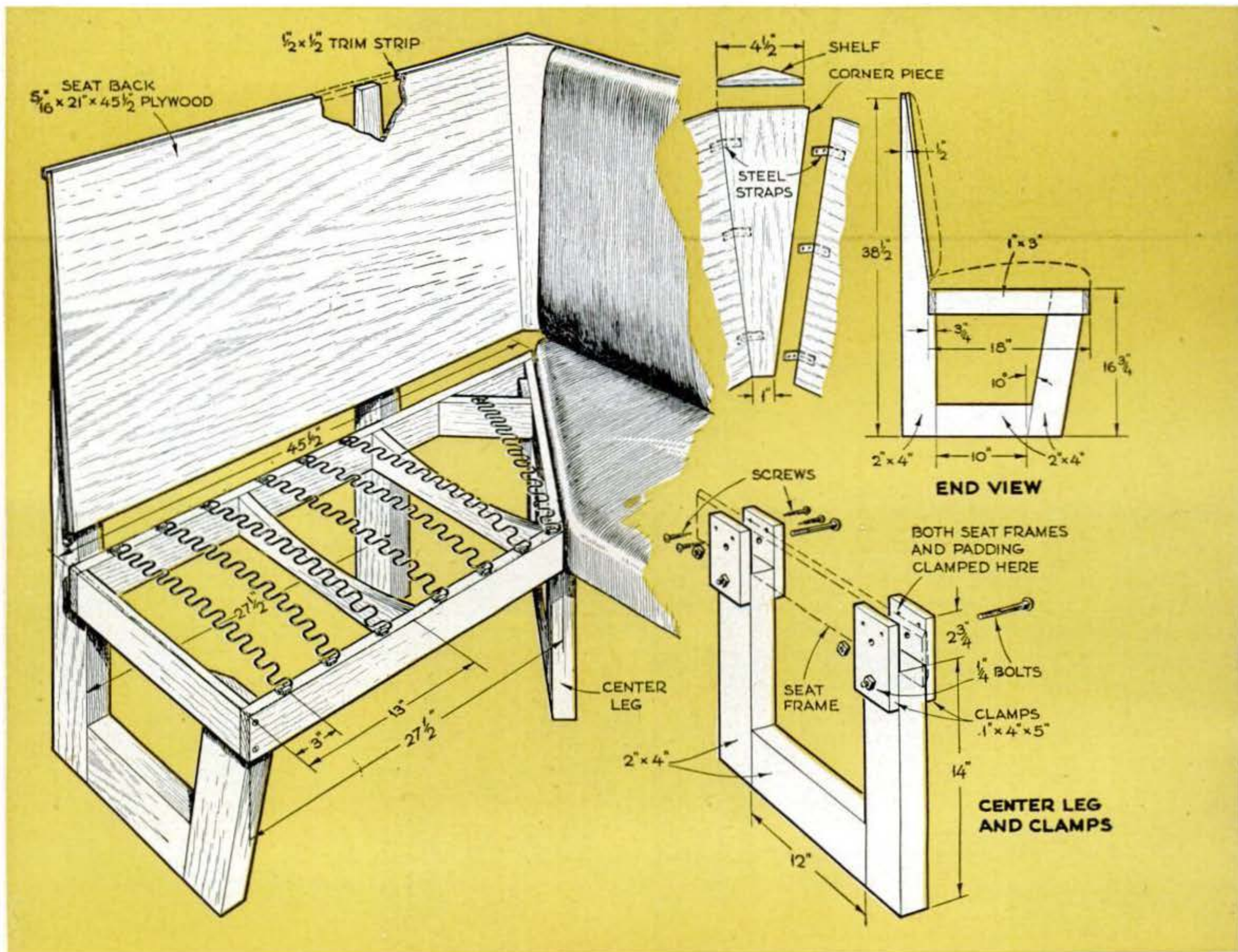



## By W. Arthur Heacock

**B**ESIDES adding to the appearance of a room, this attractive corner unit combines with a table to form a comfortable breakfast nook. The seats have both padding and springs—more than can be said for most breakfast-nook benches. You can build it with hand tools and the cost of materials comes within \$17, including the plastic upholstery cloth.

The drawing on the opposite page gives you dimensions and construction details.

Assemble the frame of each seat with screws. The legs and backs go on after the upholstery. Mark the points where the springs are to be attached. You can buy sinuous springs of the kind shown below—as well as the clips that hold them—at an upholstery-supply house. The springs should be long enough to form a curve  $1\frac{1}{2}$ " to  $2\frac{1}{2}$ " high at the center when the wire is attached to the frame.

The next step is tying the springs. This is important. Broken ties let a spring move

independently when the seat is used. Eventually, the moving spring will work its way through the upholstery. So don't be afraid of overdoing the tying department.

Run the ties 3" apart and at right angles to the springs. Start by knotting one end of the spring twine and stapling it to the frame. Use overhand knots to tie it to each spring. Keep the twine pulled tight. Finish by stapling the twine to the frame.

Cover the springs with canvas or burlap, drawing it tight and tacking it to the underside of the frame. Lay on two layers of sisal fiber and one layer of cotton batting. Then cover the padding with burlap or canvas. After the second canvas is tacked down under the frame, thread a large needle with twine and run it through the whole padded assembly at not less than 3" spacing. This keeps the padding from slipping.

After you've tacked the upholstery cloth in place, attach the legs and backs. You can butt the ends of the backs together, or you can insert a wedge. **END**

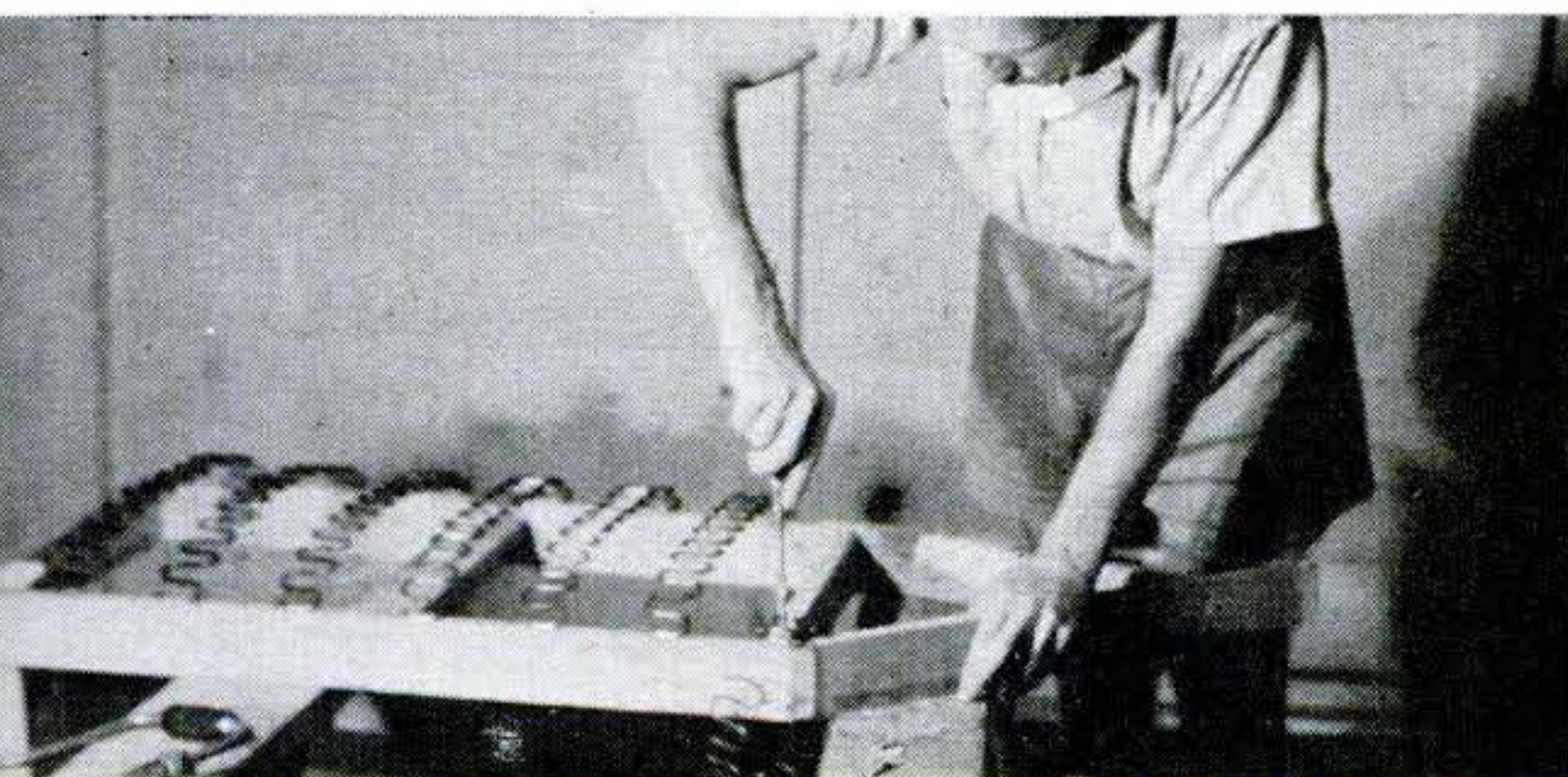

One screw at each end anchors clips for springs. The springs used should be long enough so they form curves  $1\frac{1}{2}$ " to  $2\frac{1}{2}$ " high at the centers.

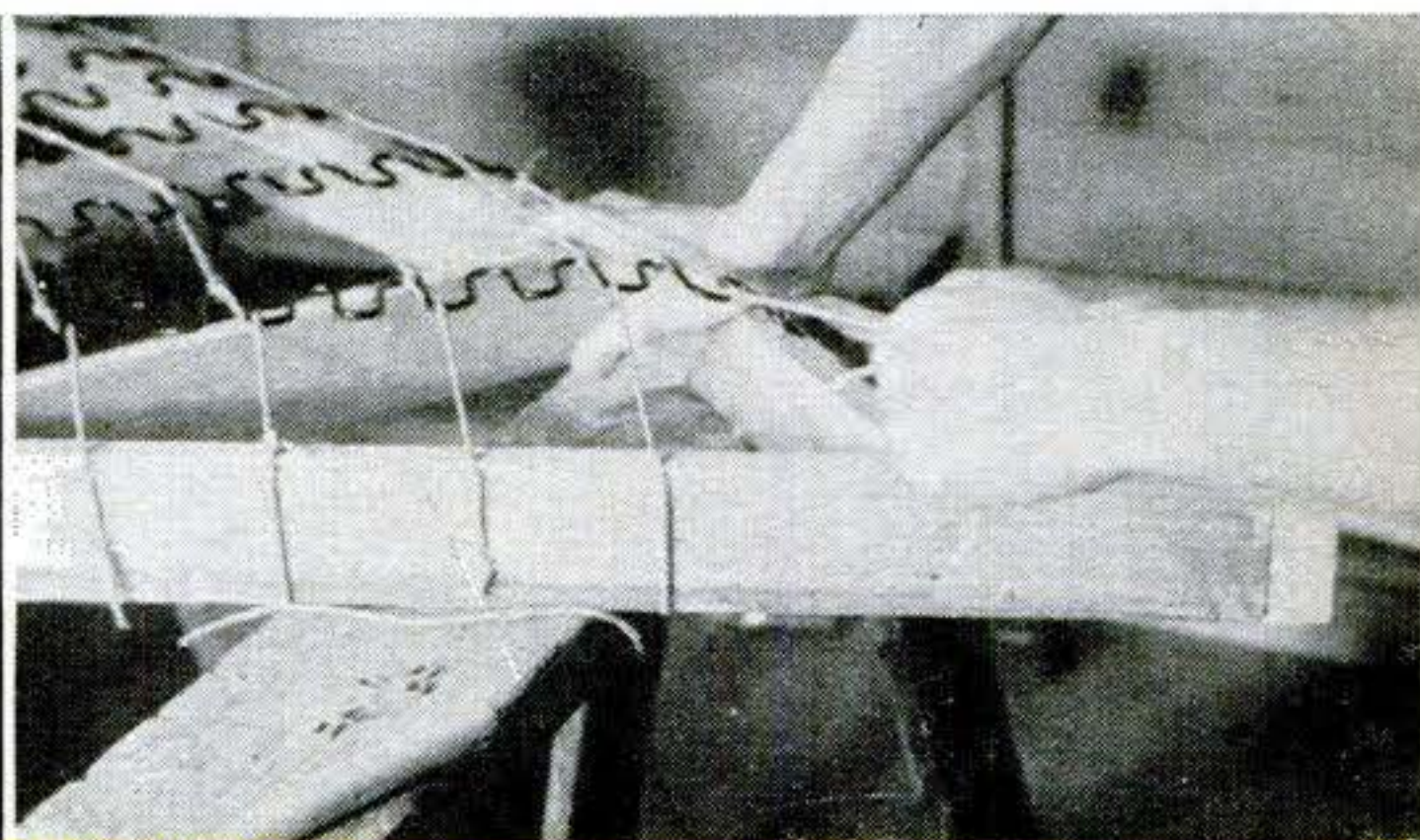

To prevent springs moving from side to side and wearing through padding and upholstery, they must be tied with spring twine.

**Burlap is laid over springs and tacked down under frame. Then come two layers of sisal fiber and one layer of cotton batting. This is covered by burlap tacked to frame. Plywood backs (middle photo below) are covered with two layers of**

**sisal and one of cotton topped with burlap. Cardboard makes smooth ends. Tack through cardboard and material from inside material. Fold down and tack plastic upholstery fabric under frame. Use decorative tacks on corners.**





# Timesaving Tools for Woodworkers

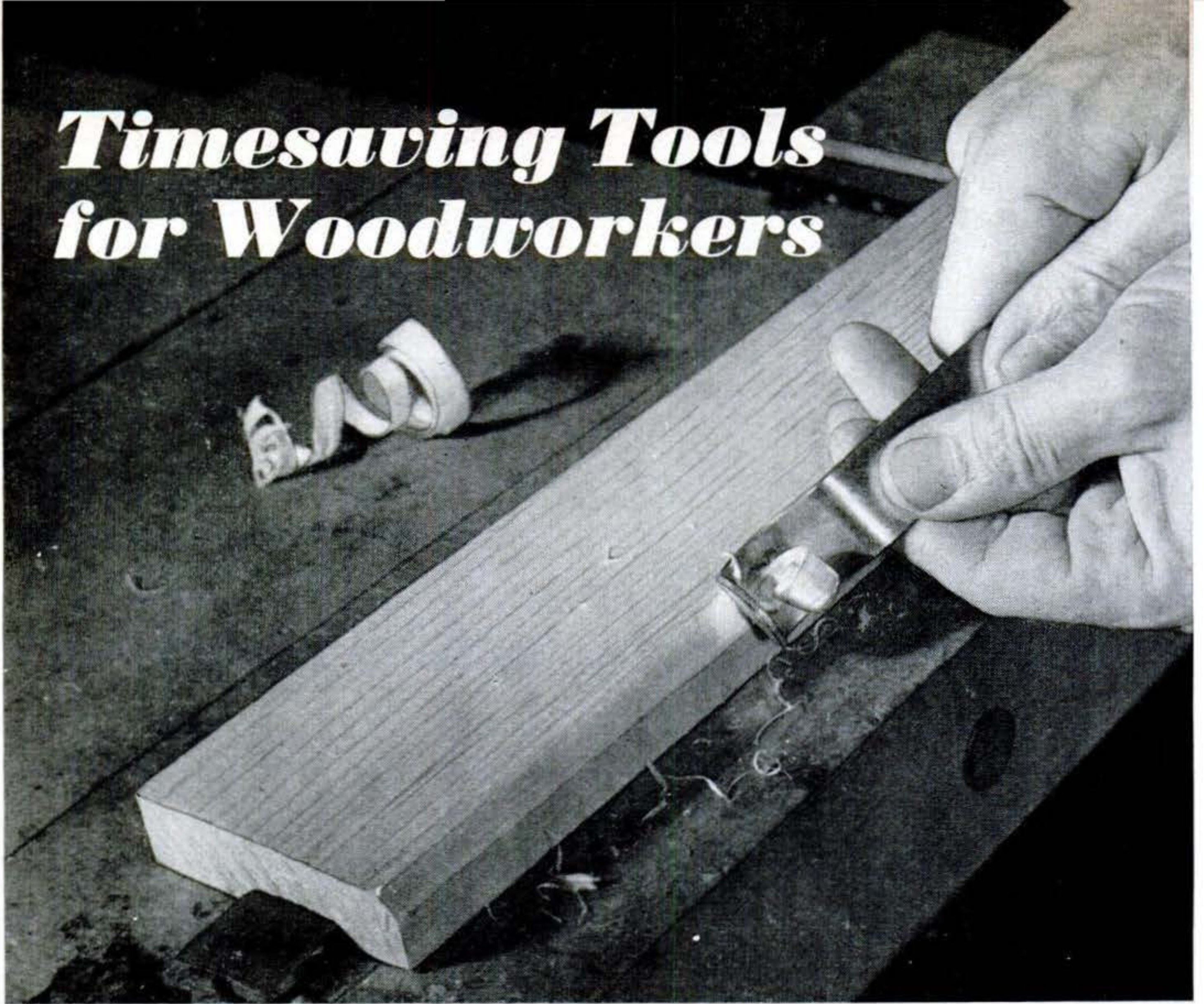

**Corner-rounding tool** comes in several sizes, should be used with the grain. It's good for

rough work since it cuts faster than a plane. The tool can be sharpened with a fine file.

**WHILE** skill and basic tools will often turn the trick in woodworking, there are some comparatively uncommon tools that make difficult operations easier. Seven of them are shown here. Some, like the

scratch stock, have been used for centuries; others, like the magnetic brad setter, are new. The doweling jig is especially useful, since boring accurate dowel holes is a tough job even for experienced workers.



**Nail puller.** Plunger sinks jaws enough to grasp nail head. Arm provides leverage to pull nail straight up, minimizing damage to wood. Small dents made by jaws can be filled.

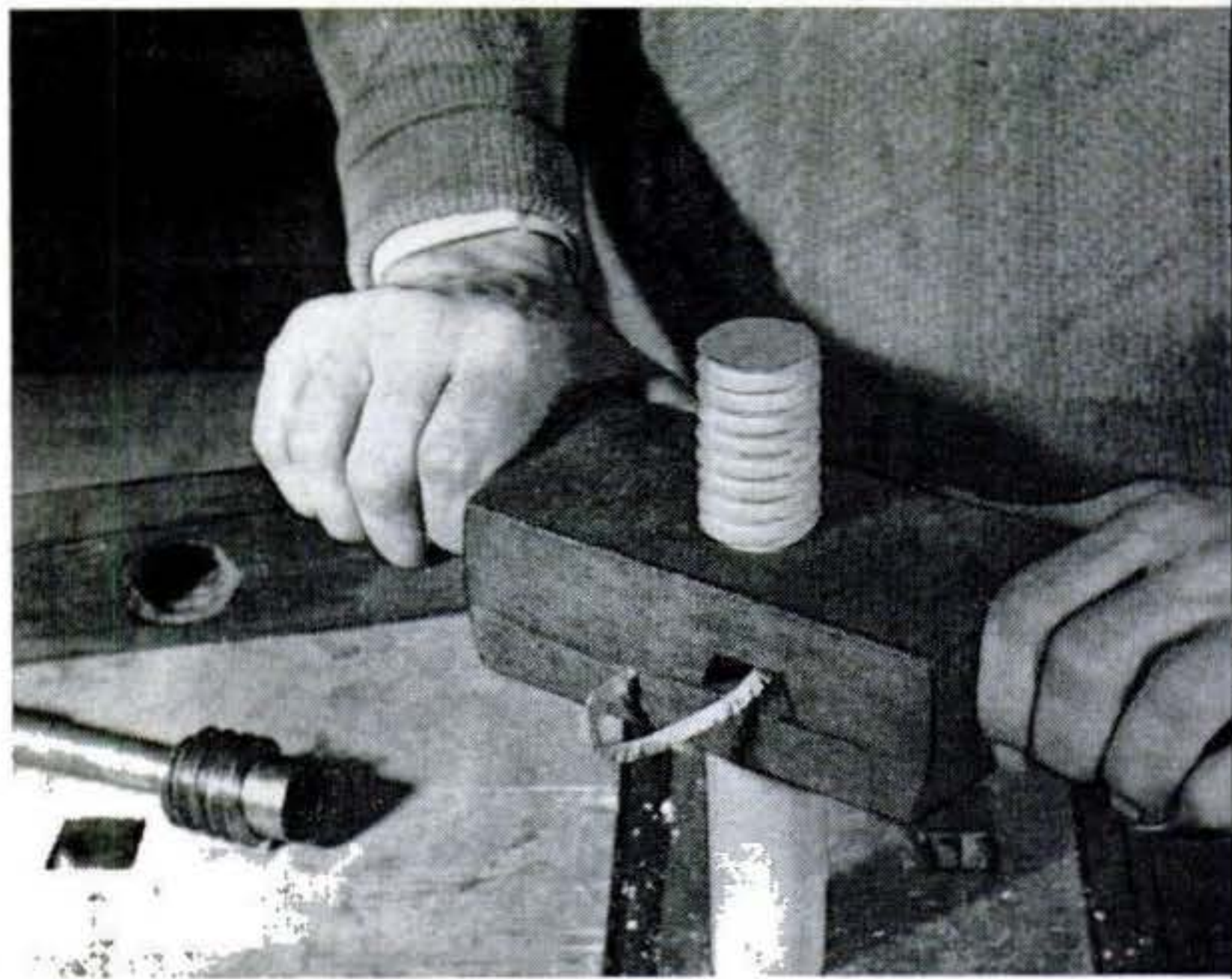

**With wood taps and dies** for cutting threads, you can make adjustable stands, vises, cabinet clamps, and many special fixtures. Tool on bench is a tap for threading holes in wood.



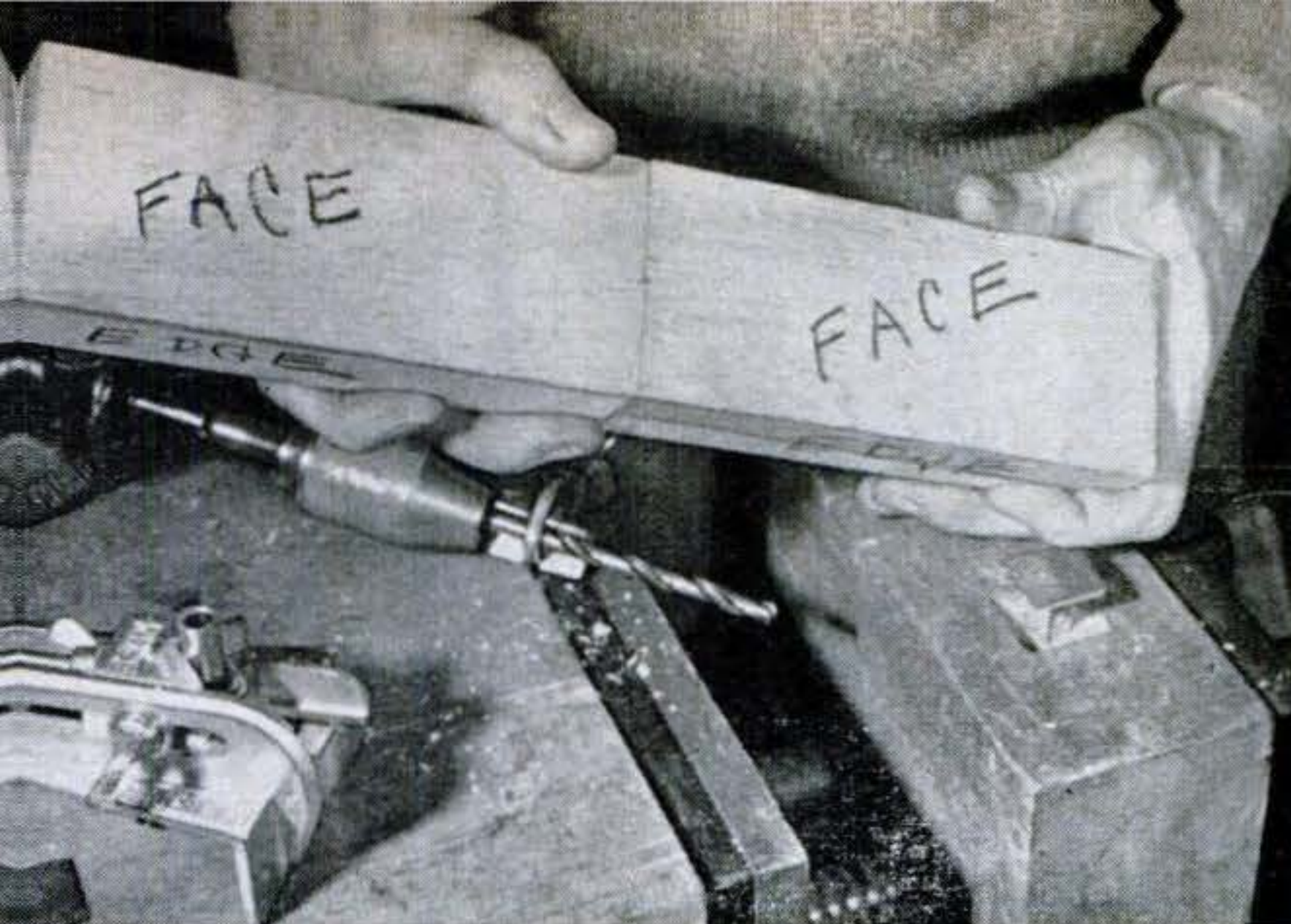

**Boring dowel joints**—a common furniture-making operation—is difficult to do accurately without doweling jig. Only one adjoining face and edge need be marked. Holes are located with

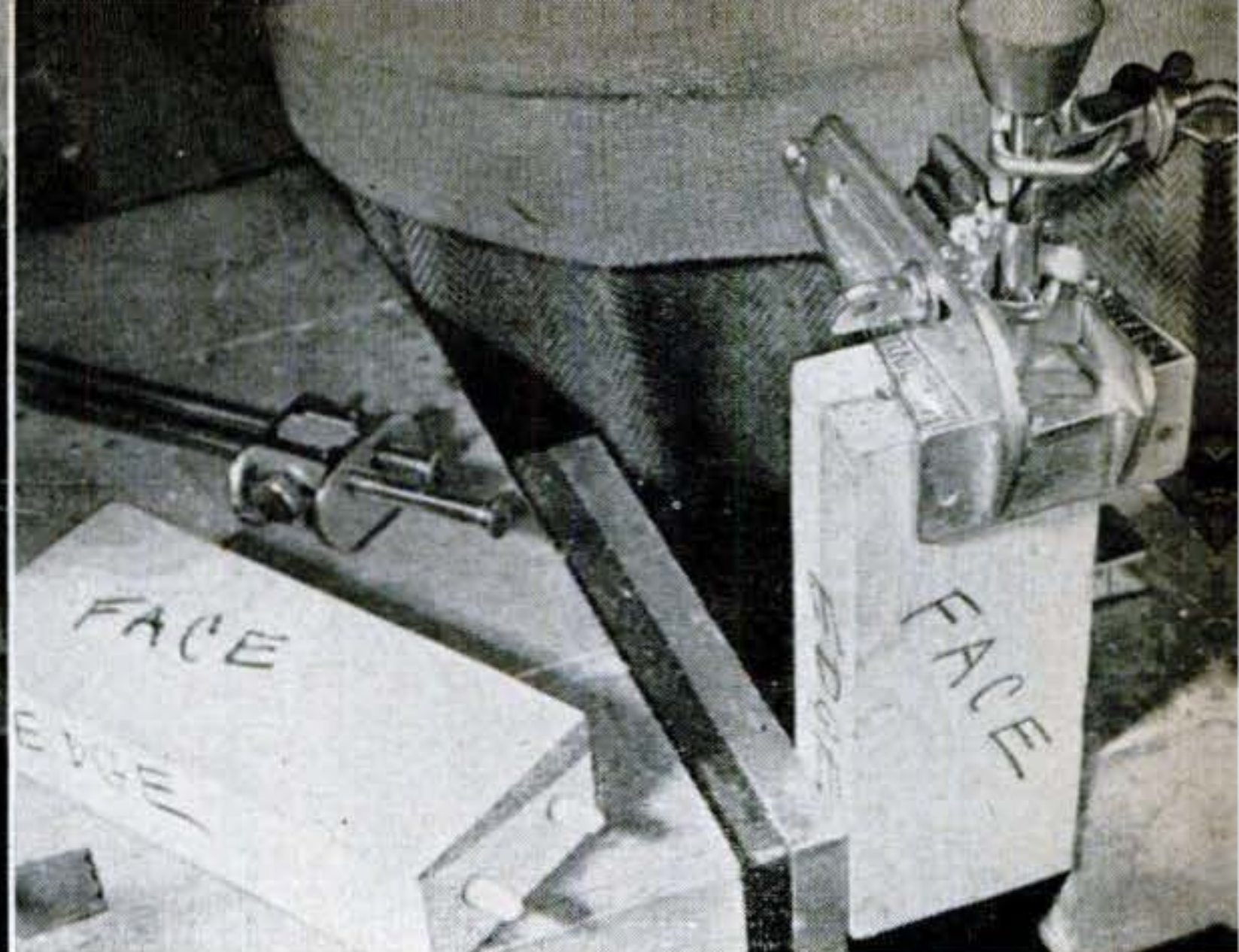

gauge on jig. Then drill guide is set, jig clamped to work, and holes drilled. If you're using dowels of smaller sizes, twist drills are preferred to wood bits since they are less likely to drift.

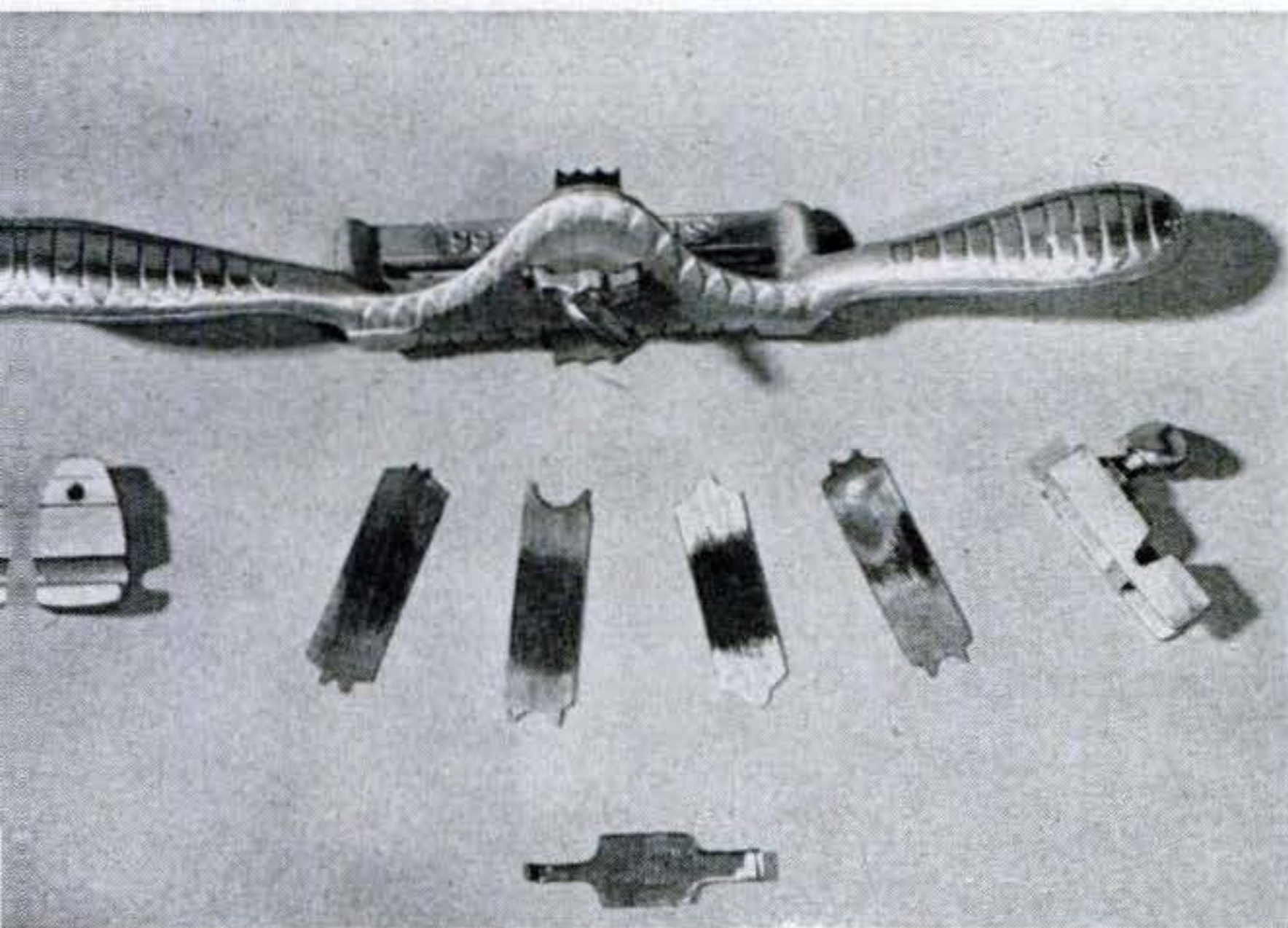

**Scratch stock**—pictured above with blades and straight and curved fences—is a simple tool for making straight or curved moldings. Blade is locked in stock and pulled along in direction of

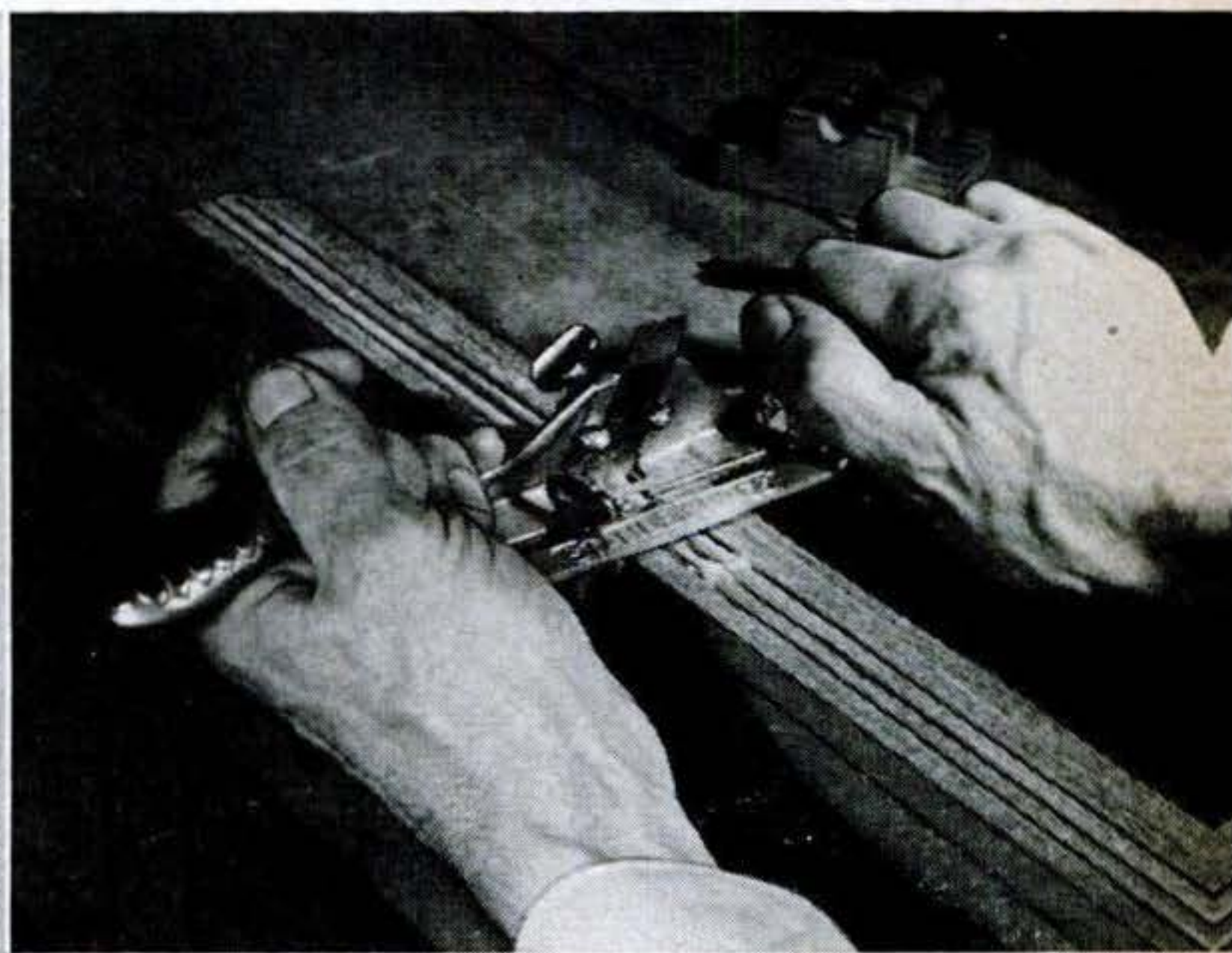

grain. Fence rides against edge of work and guides blade. Successive passes are usually required and it may be necessary to reset blade to make exceptionally deep cuts.

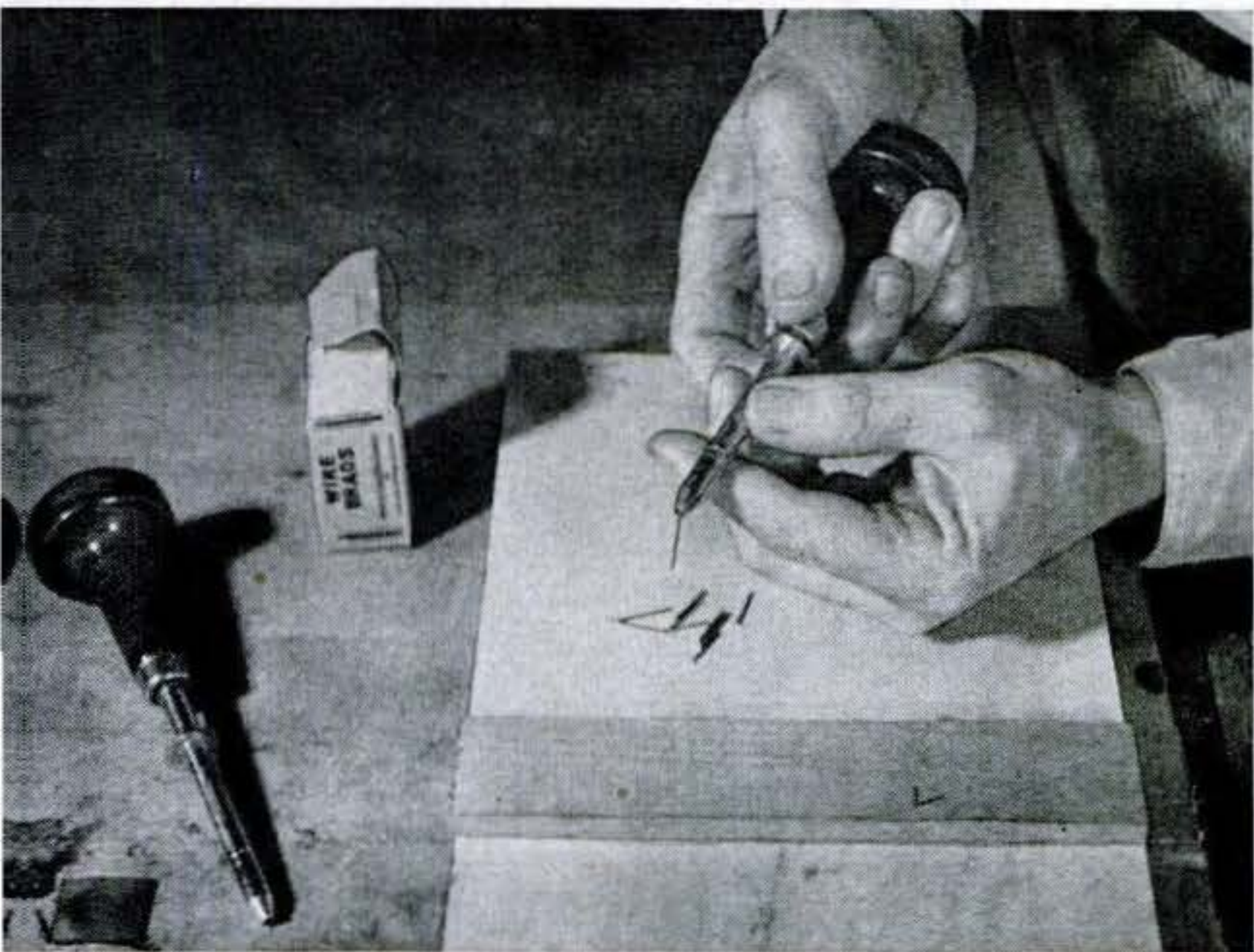

**No need to pound your fingers** if you use a brad setter. Magnetic plunger in a hollow cylinder picks up brad and holds it in tube. Pressure on handle pushes brad into the work.



**Miter vise** has two sets of jaws working at right angles to each other. Mitered pieces are held tightly for nailing or gluing. Doweled miter joints can be held in place while glue sets.



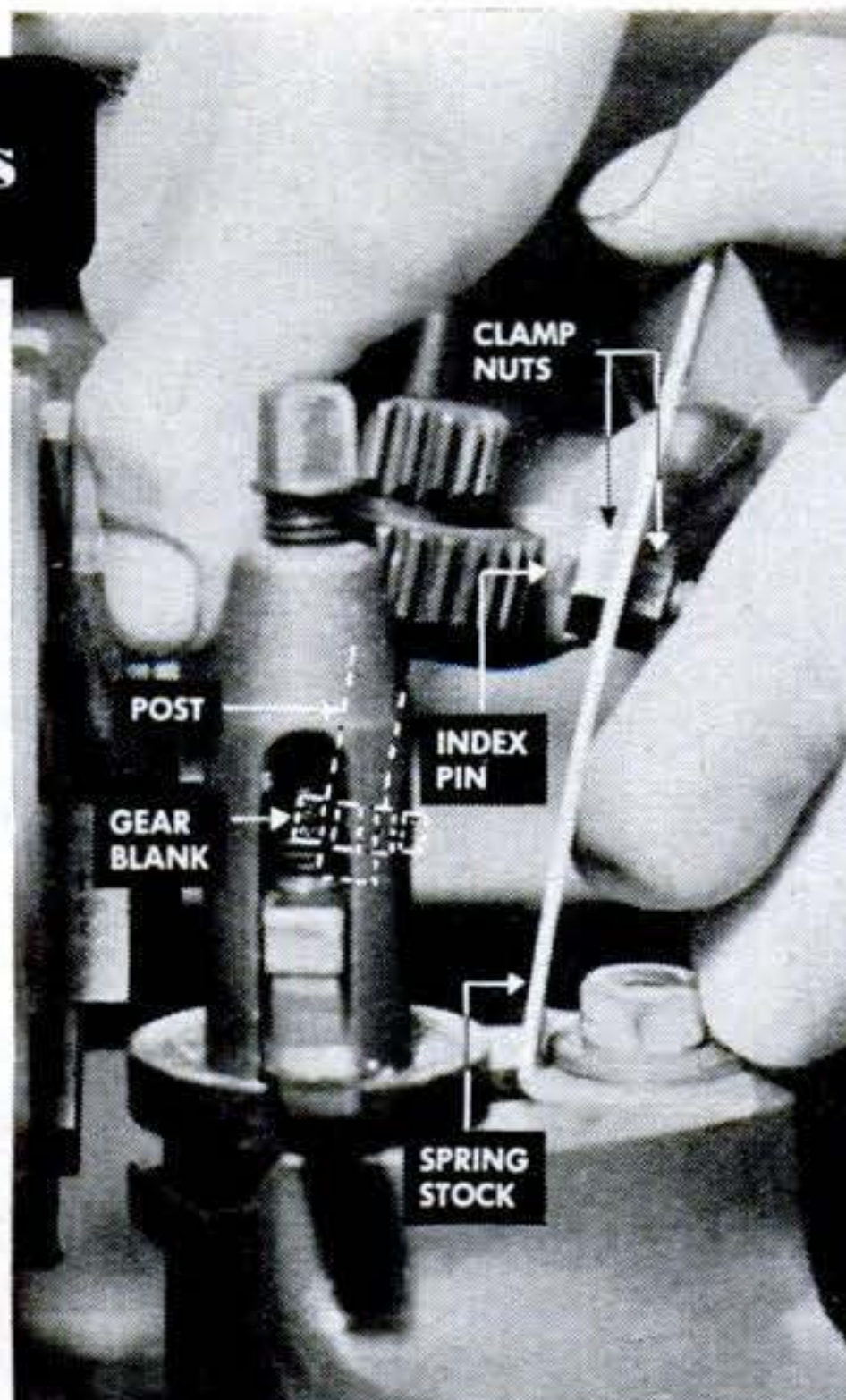
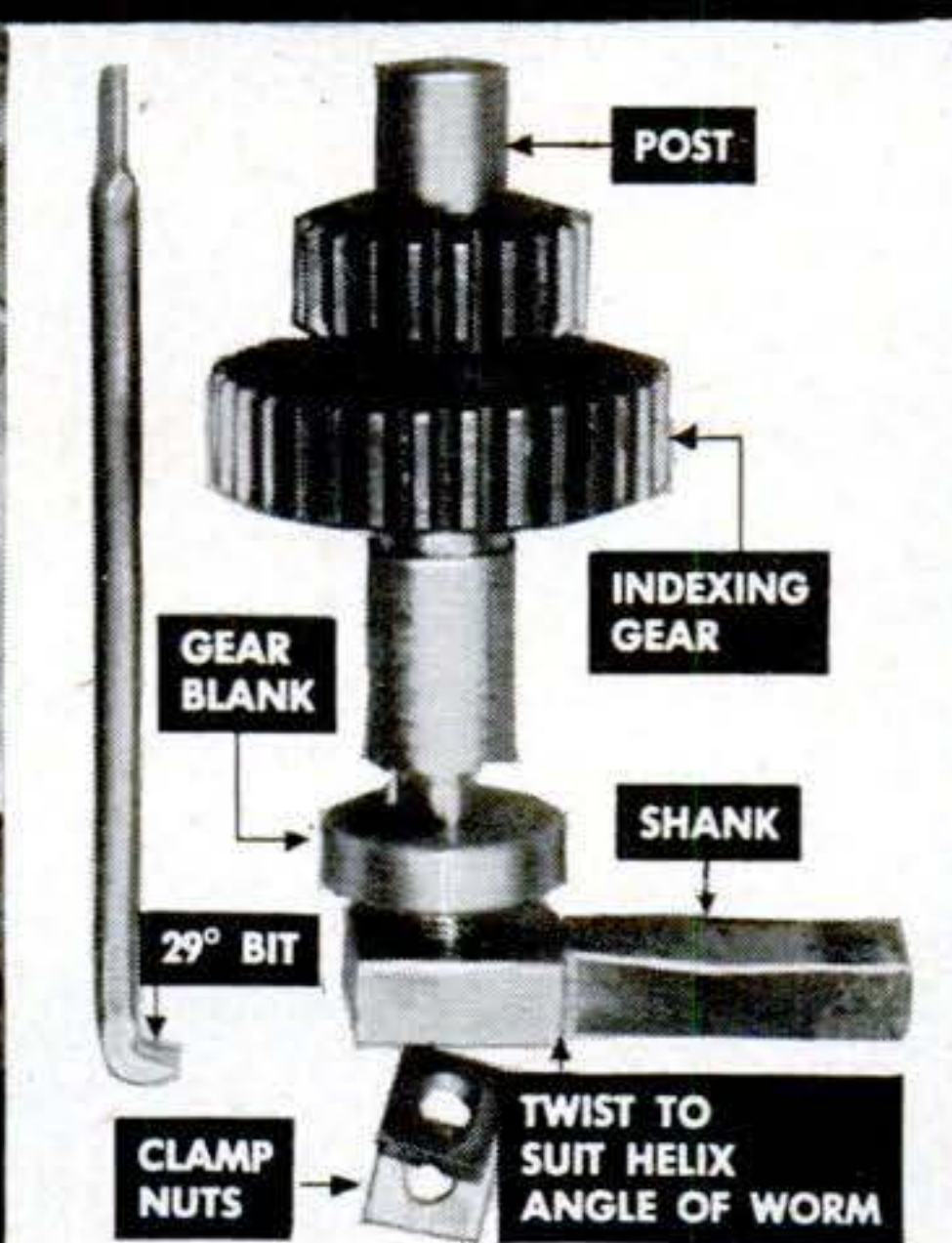
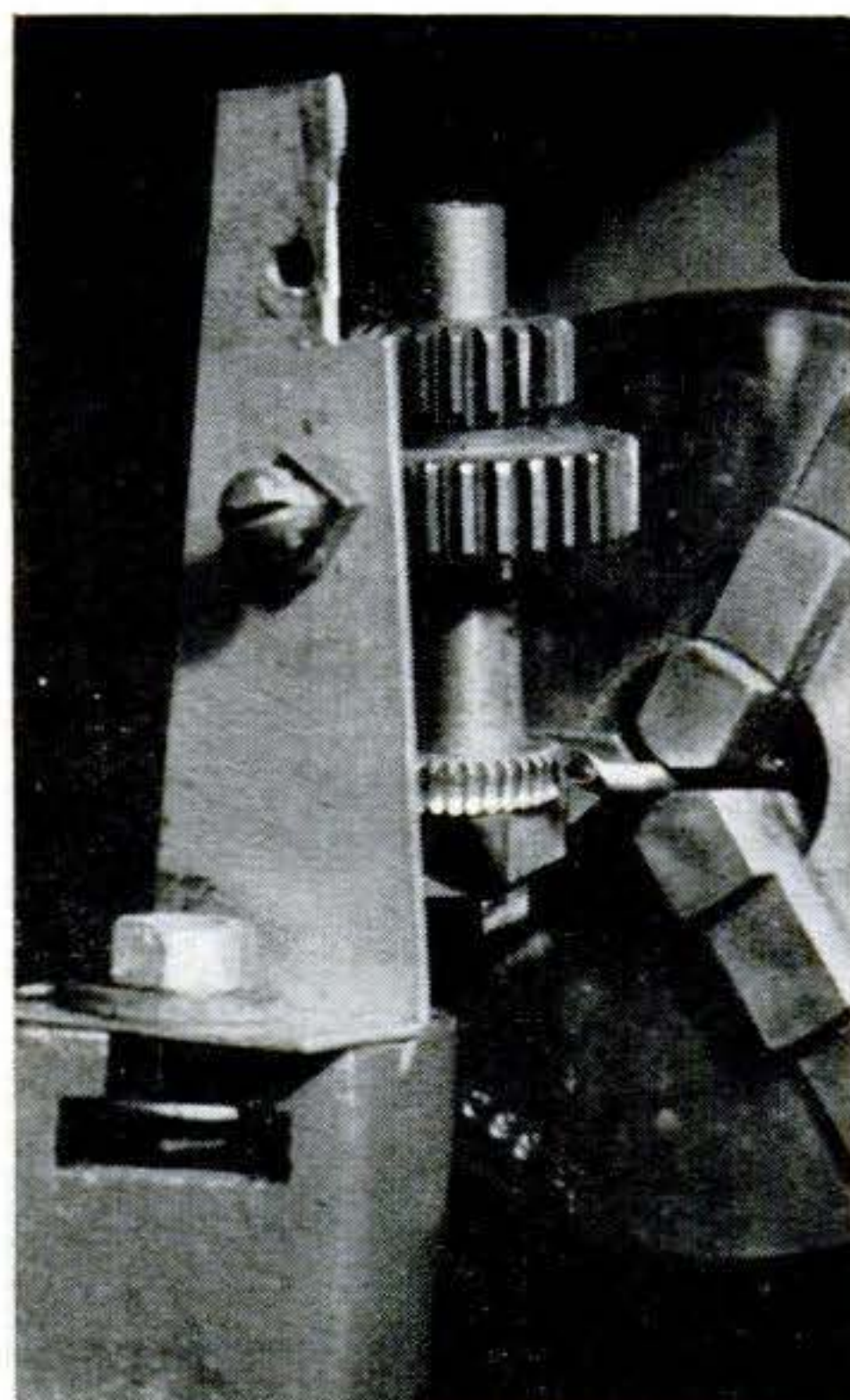

**Lathe Cuts Worm Gears.** Using a lathe to cut special worms is a fairly common operation. I've found that with the setup shown above it's easy to cut matching worm gears, too. I pin a blank on a turned post with a suitable indexing gear keyed on at the other end. The post is mounted with two nuts, so that it can just be turned, on a shank clamped in the tool post and twisted to the worm's helix angle.

I turn the gear blank with a concave throat of the same radius as the worm has at the bottom of its teeth. Multiplying the pitch (distance between teeth) by the number required, dividing by pi, and adding the

tooth depth gives the diameter of the blank across the bottom of the throat.

A screw filed to a taper is mounted as an indexing pin on a piece of flat spring stock clamped in the tool-post slot. Then a boring bar is chucked to swing in a radius equal to that of the outside of the worm teeth. A crossfeed stop helps assure uniform tooth depth. After each tooth is cut, the post is indexed (right above).

For small and medium ratios, use double or triple-thread worms and correspondingly two or three times the ratio number of teeth on the gears.—*Elman Wood, Poulsbo, Wash.*

**Drill Pad Fits Crotch Center.** If you already have a crotch center, it will do double duty as a drill pad when fitted with a detachable cover.



Chuck a suitable piece of stock, face, and turn to diameter. Reverse in the chuck and machine a recess about 3/16" deep to a light drive fit for the crotch center. Press this in, making sure it bottoms squarely.

Make two witness marks on both members for reassembly. Then push the crotch center into the live spindle and face off the pad with a very light skimming cut.

The pad may be detached by striking it with a brass or plastic-faced hammer.—*Joseph Tracy, Manhattan, N. Y.*

**Dodges with Dividers.** Besides their regular uses, dividers are handy for scribing a line parallel to an edge. Let one leg ride outside, against the edge, and scribe with the other. To find a centerline, scribe from both edges with trial settings until the scribed lines coincide.



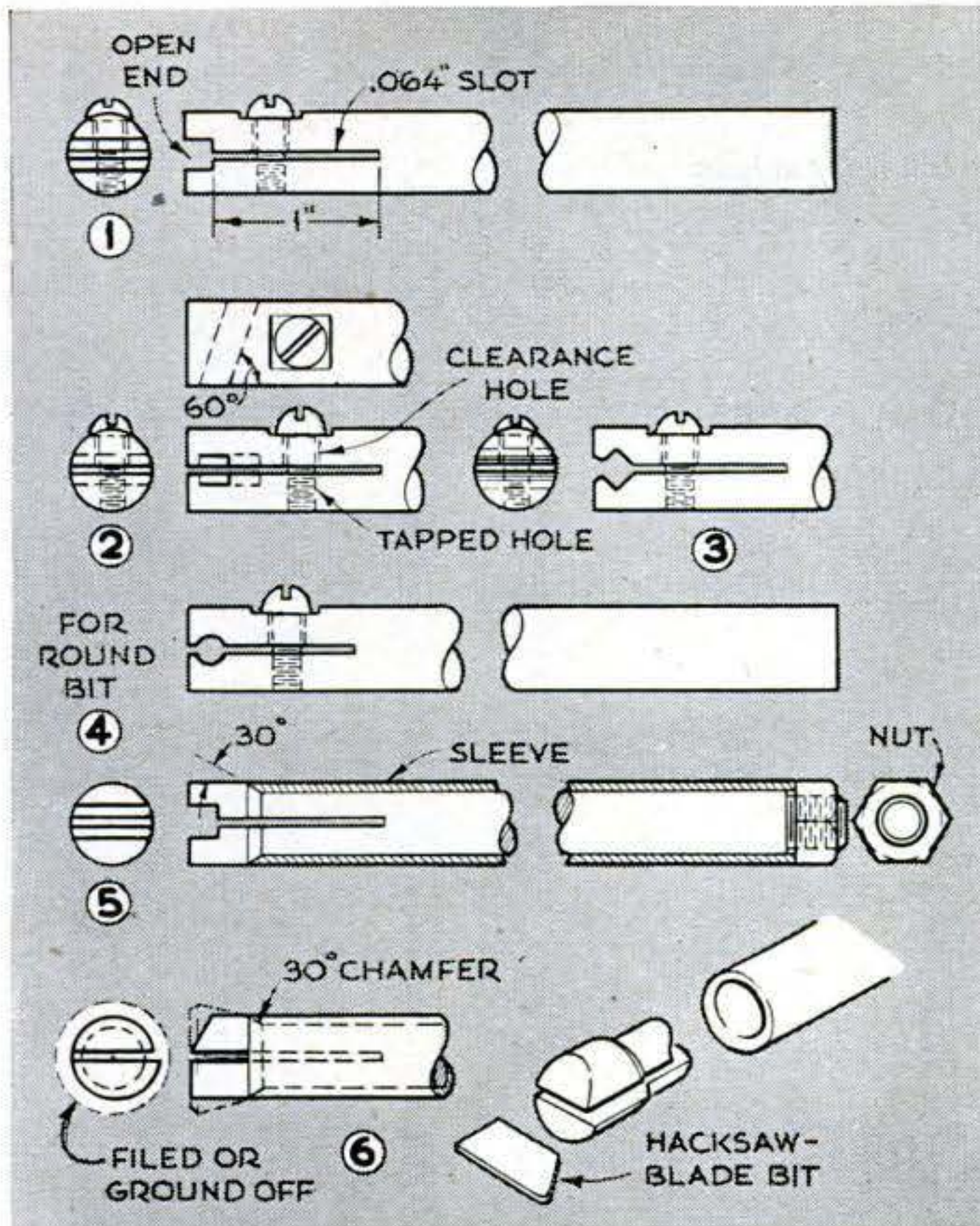

### Small Boring Bars to Order.

These six styles can be made up even in sizes under  $\frac{1}{2}$ "—valuable for delicate instrument and model work. The business ends are slit to grip the bits.

The open-end bit sockets can be sawed and filed. Square bit holes (Figs. 2 and 3) can be drilled and then filed to shape. Bits for the bar in Fig. 4 are ground from old drills as small as  $\frac{1}{16}$ "; the bar can be  $\frac{1}{4}$ ".

A collet action closes the bars in Figs. 5 and 6. As a nut on the far end draws the head into the sleeve, matching chamfers pinch the jaws on the bit. For the bar in Fig. 6, bits are ground from pieces of hacksaw blade. Saw the slot with a similar blade after grinding off all set. Bits shouldn't project more than their own thickness.—*M. Duhamel, St. Hyacinthe, Que.*

**Jig Locates Center Holes.** Useful for centerdrilling a variety of short-run jobs, this simple jig is adjustable and takes the place of several ordinary ones.

The body is a piece of round tool steel, bored out a trifle larger than the biggest work likely to be handled. Three radial holes are drilled and tapped  $120^\circ$  apart. Two of them are occupied by setscrews with lock nuts to retain adjustment, and the third hole is fitted with a T-handle screw for quick clamping. The end of the jig is drilled and reamed to take standard drill bushings.—*Roger Isetts, Kenosha, Wis.*

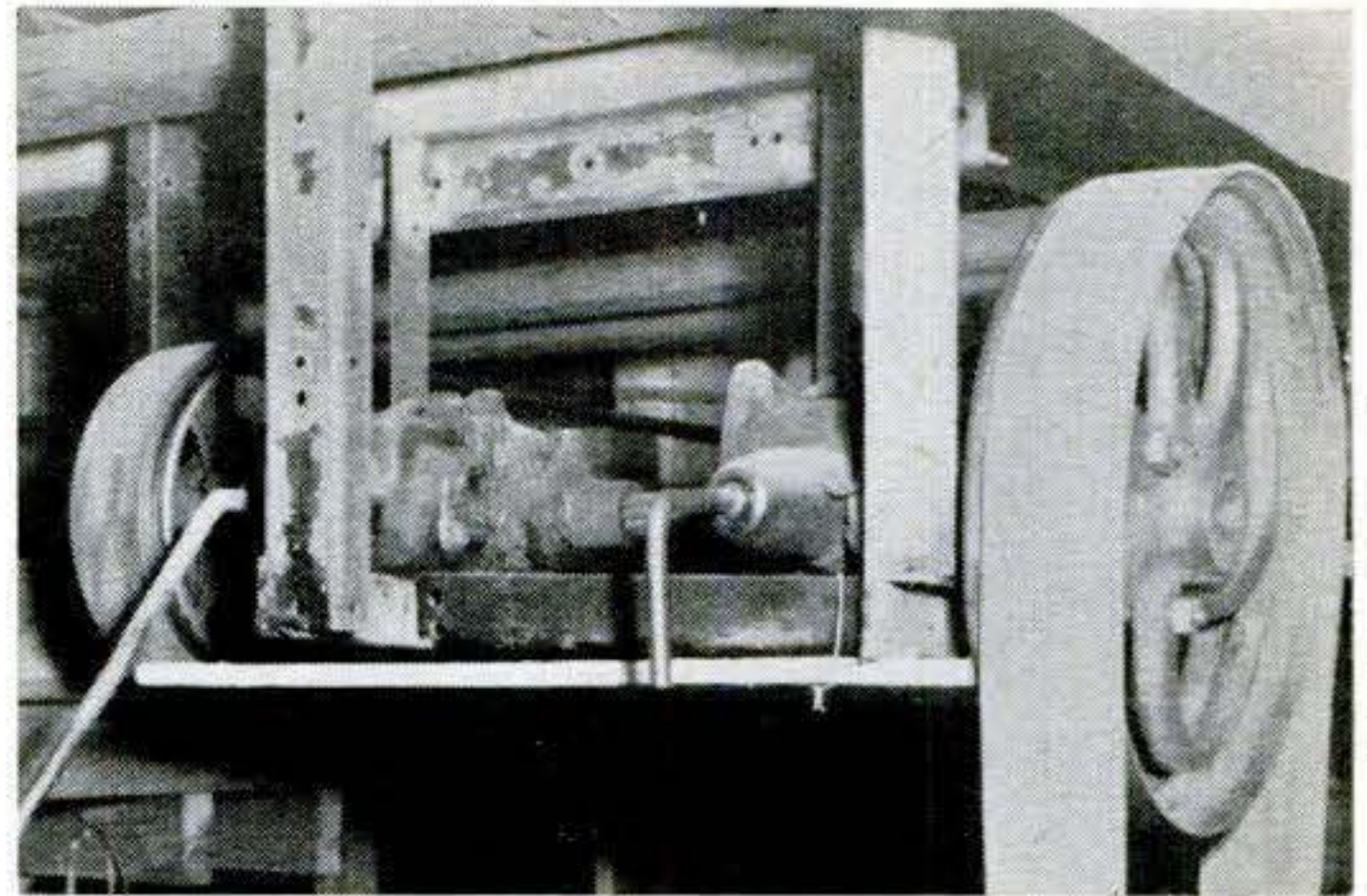

**Drive Has Nine Speeds.** An old dual transmission from a truck, belted as above to the motor driving a milling machine, gives the operator a quick selection of nine forward speeds without belt shifting. Short lengths cut from the frame of the same truck that provided the transmission were used to suspend the assembly under the ceiling.—*R. H. Peters, East Holliston, Mass.*

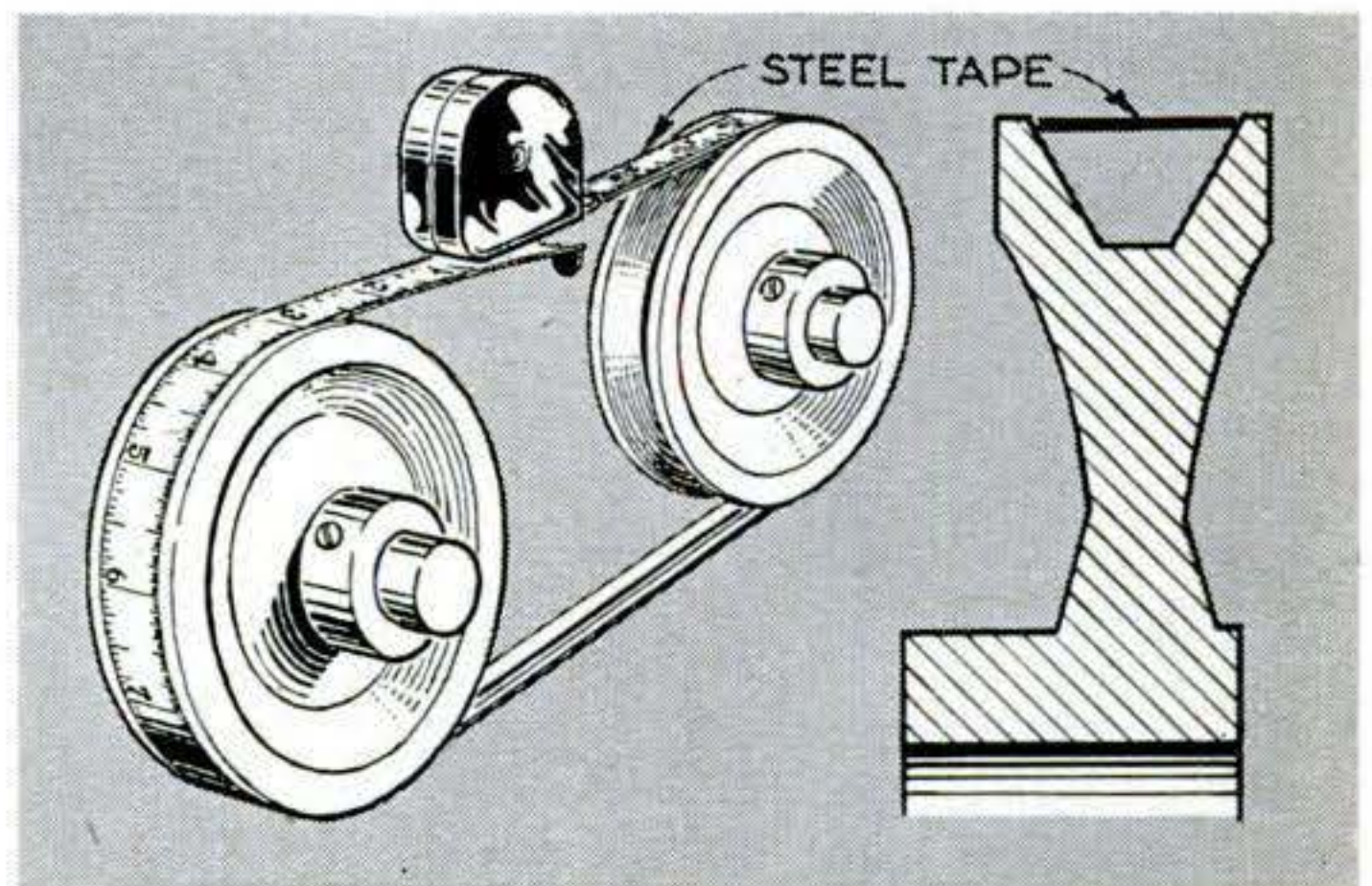

**Measuring for V Belts.** After measuring around two pulleys with a cord and as a result buying too short a V belt, I used a flexible steel tape for the job. Being  $\frac{1}{2}$ " wide, it measured right on that width of the V pulleys, giving the correct length for a  $\frac{1}{2}$ " V belt.—*Art Coberly, Anderson, Ind.*

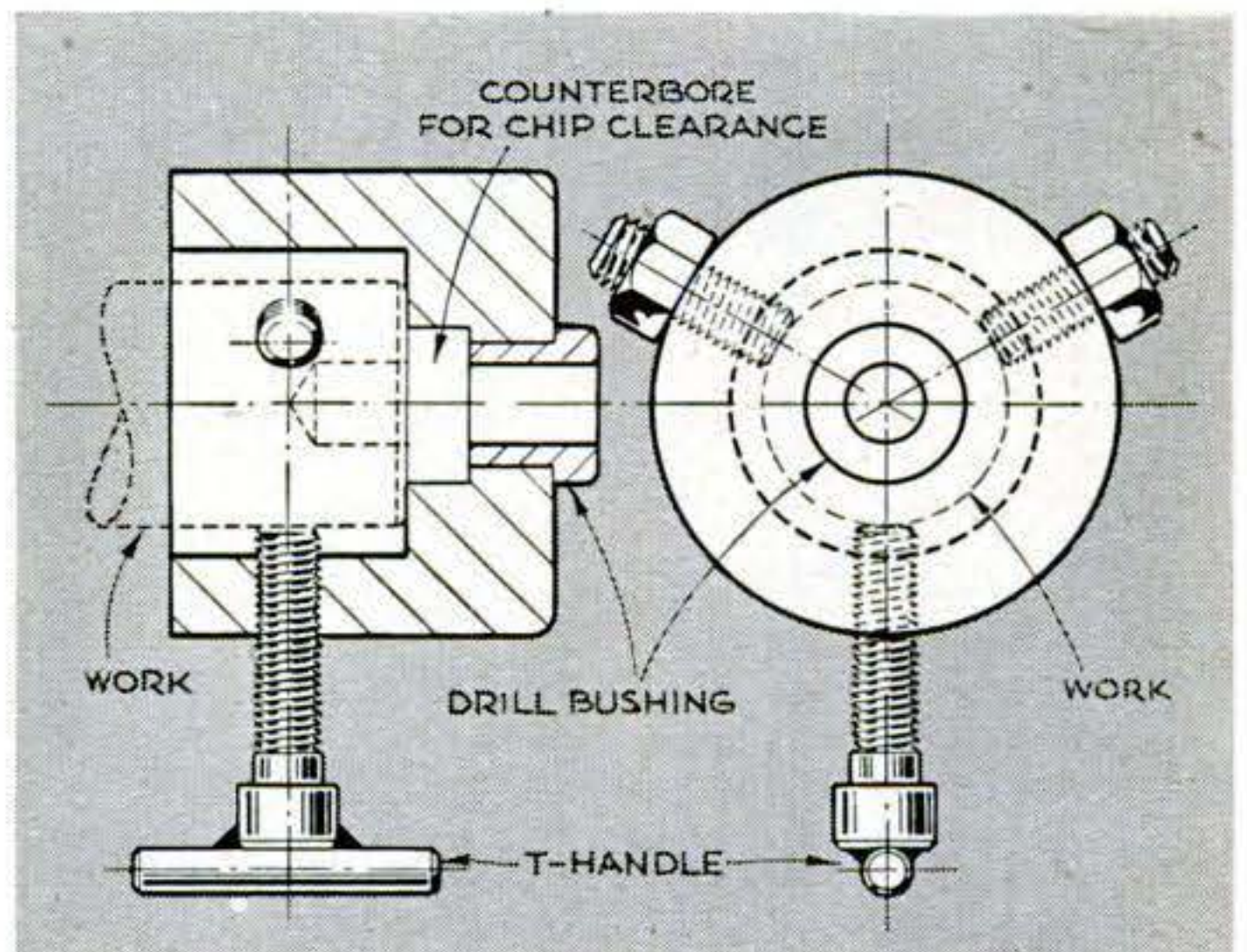



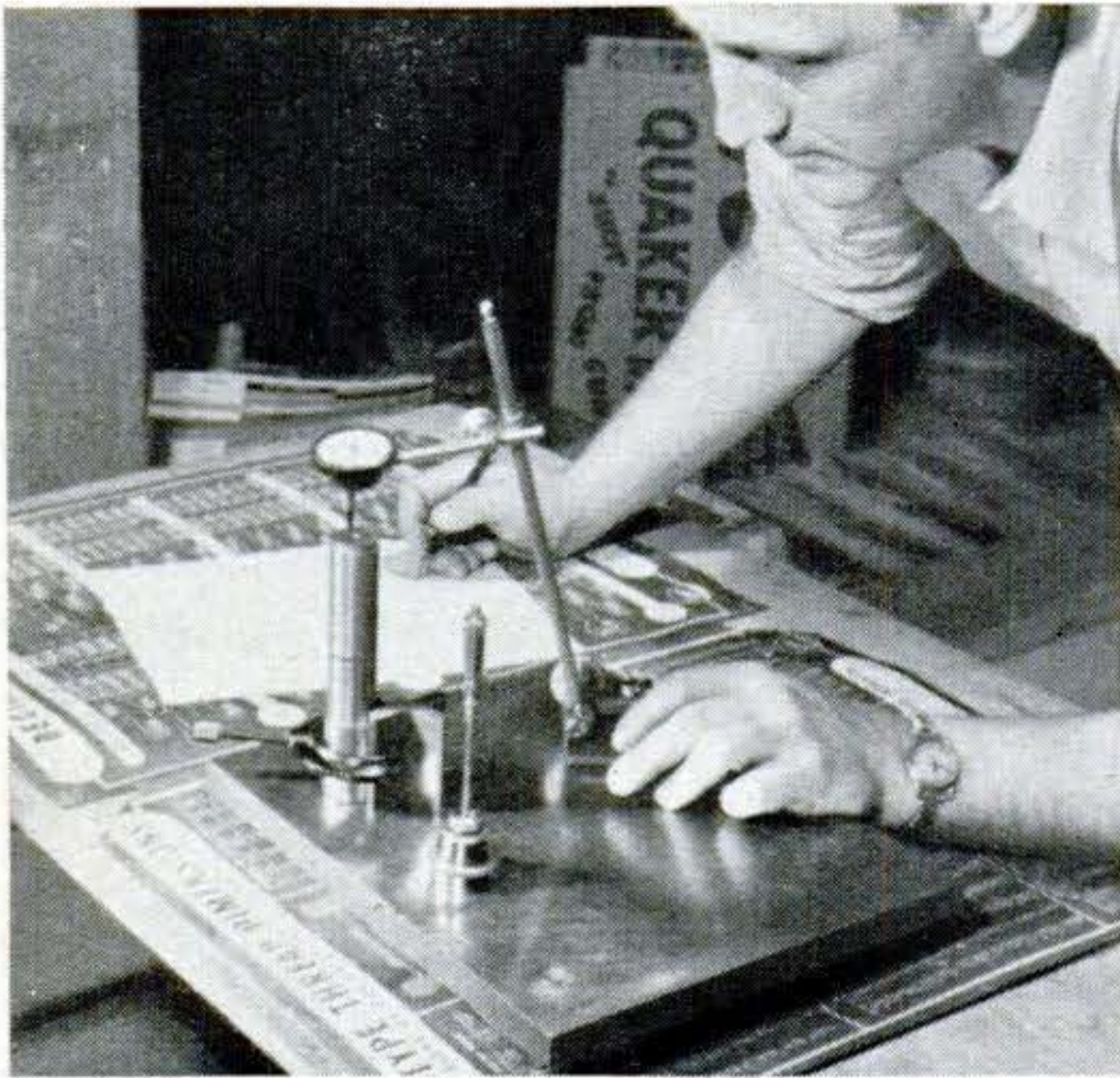

Shaft length is checked by reading indicator on surface gauge. This is then moved over micrometer, which is adjusted for same reading.

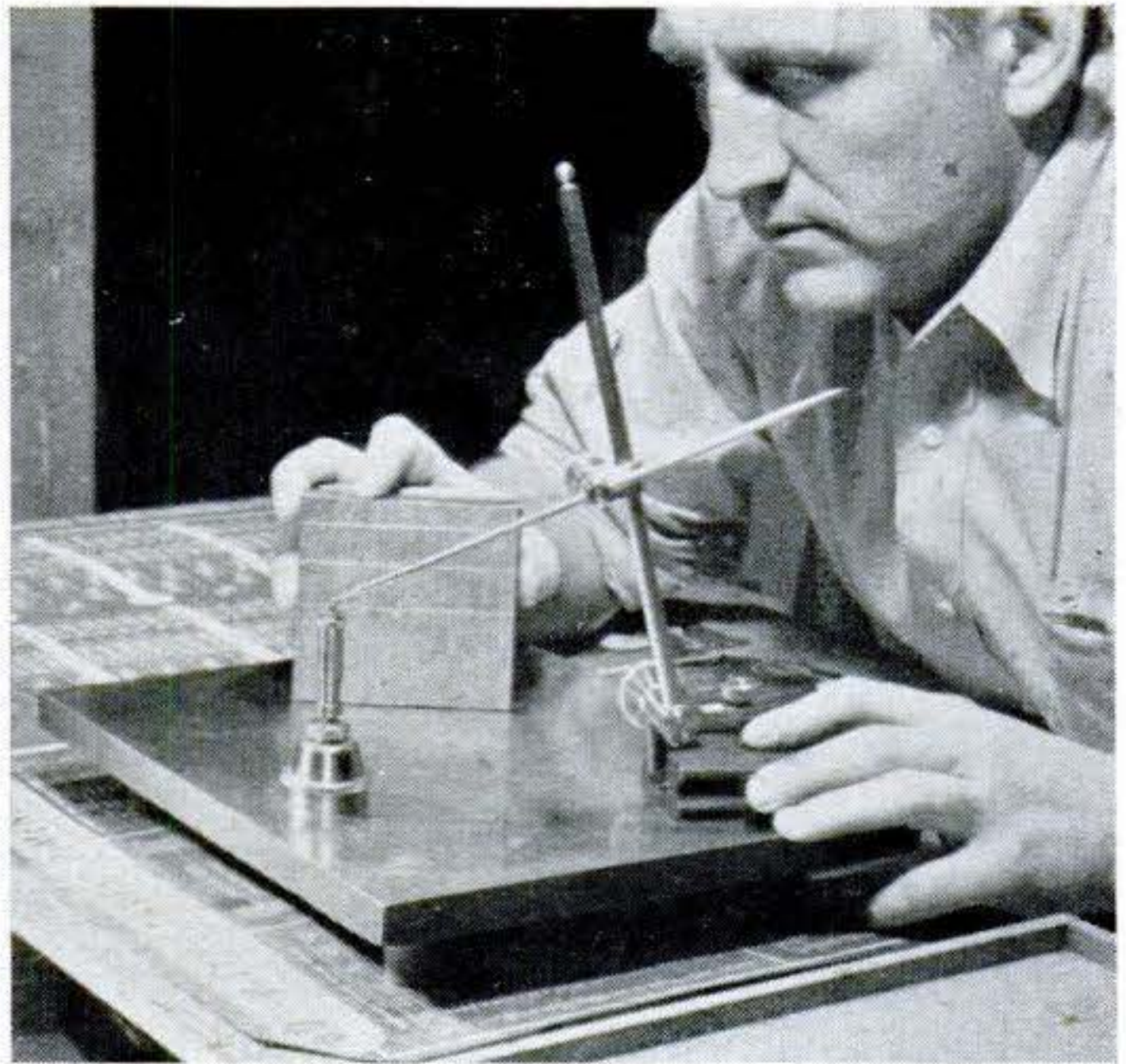

Surface gauge is set with micrometer to scribe precise layout lines. Tilt the scriber downward to insure contact with its extreme point.

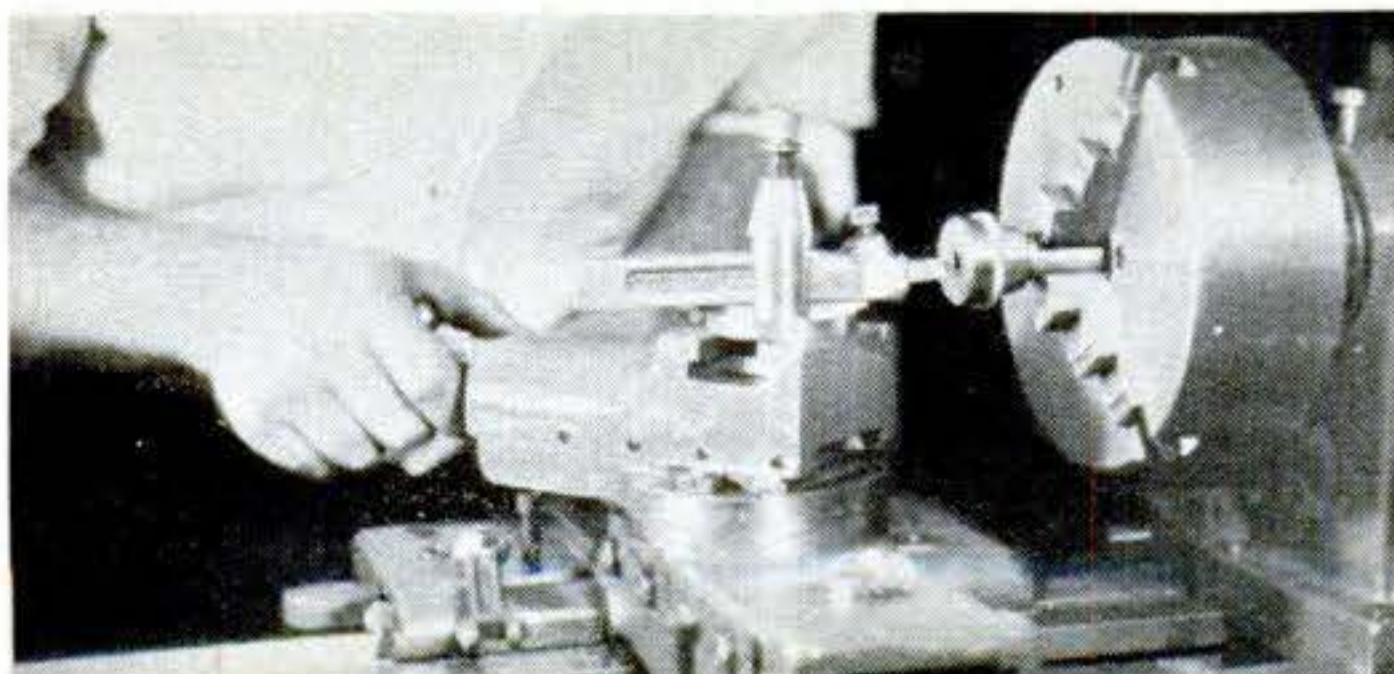
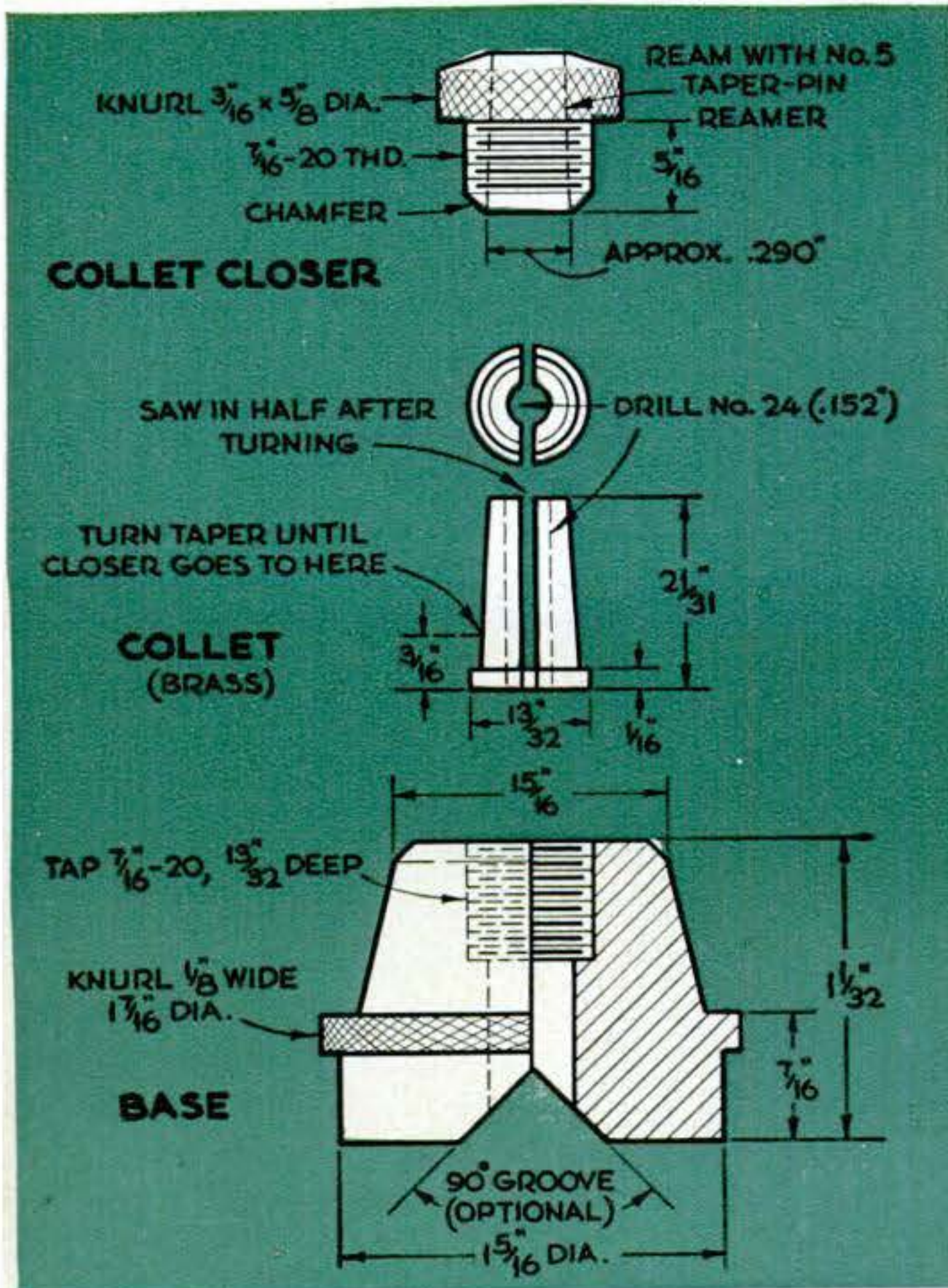

Face the base on a mandrel threaded in the lathe. Base must hold mike absolutely square.

## Fixture Converts Inside Mike to Accurate Height Gauge

YOU may have wanted a vernier height gauge, until you priced them. It's good news, therefore, that you can have the same accuracy at the price of a relatively inexpensive inside micrometer. All you need is a lathe-made fixture to hold the mike upright.

The fixture consists of a base, a collet to grip the micrometer rods in the base, and a collet closer. Machine the base on the end of a piece of bar stock, threaded nose out. Cut it off, and thread a matching mandrel on the lathe. Screw the base on the mandrel to face the bottom square. The groove is for use on round stock but may be omitted.

Knurl, thread, and taper-ream the collet closer. Cut off and reChuck, knurled end out, to crown the top slightly.

Machine the collet from brass. Turn a test taper with the compound, apply marking blue, and twist the closer on over it to try the fit. After drilling through, part off the collet and split it in two with a fine saw.

In using the setup, make sure the micrometer shaft is in contact with the surface from which measurements are being taken.—L. W. Bonnell, San Diego, Calif.



# Midget Hot Rod Hits 40 M.P.H.

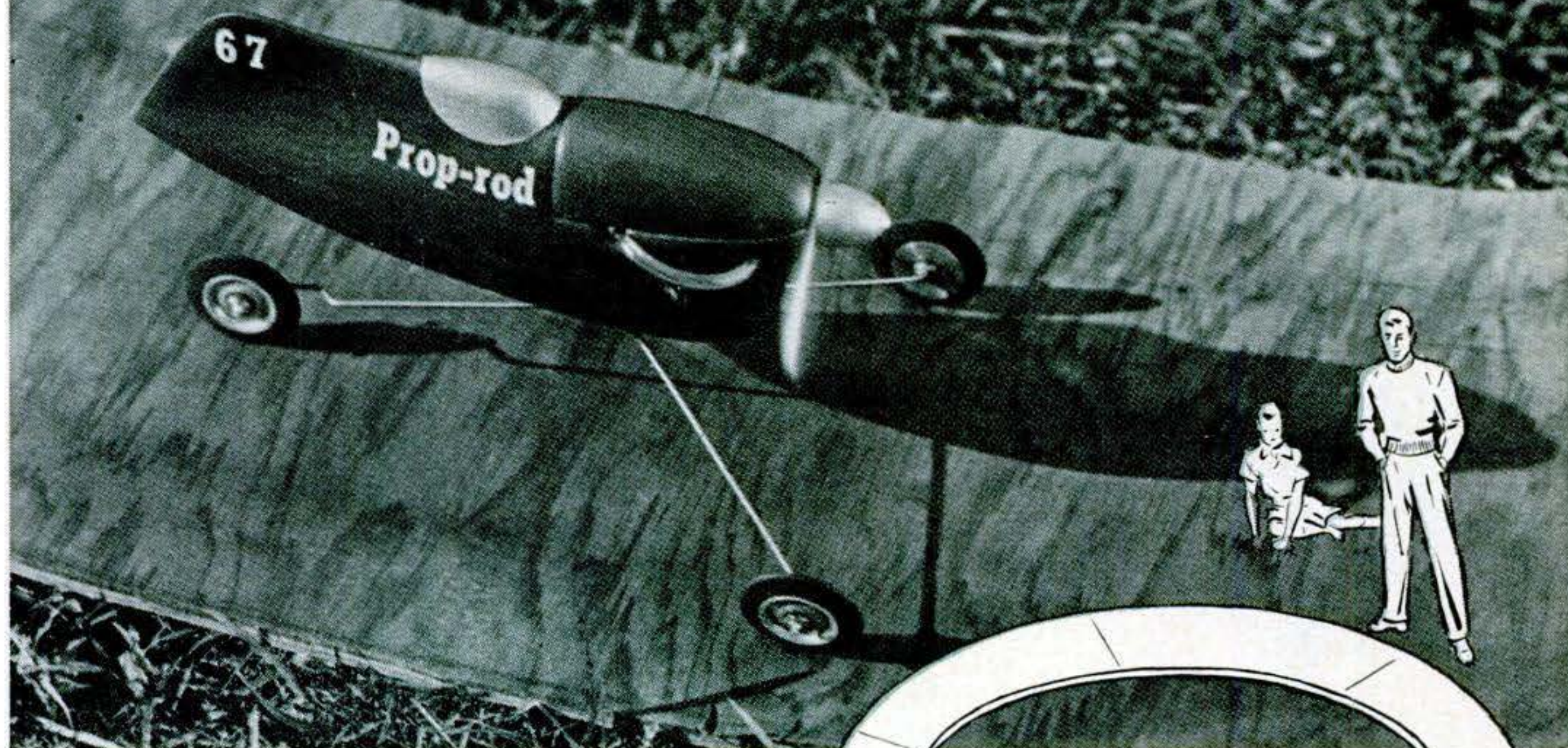

Short, high-revving prop and tapered tread on wheels make it just a blur at the end of its tether line.

**By Jack Wilson**

**I**MAGINE a 4-oz. car, driven by a 1-oz. power plant, clipping off two laps per second on a tether line—and you've got a blurry object that seems to be doing 1,000 m.p.h. It actually does 40 m.p.h., but when it stops, strangers look for wings.

A tiny model-airplane engine powers the Prop-rod. The car is shown above on a plywood track laid out in an 8' 9" circle on the lawn. A longer tether could be used, but by keeping the circle small you can operate the model indoors—perhaps in your garage.

Model-airplane building tools are all you need to make it. Allow an evening for shaping and assembling the parts, and another for painting and finishing.

**What engine to use?** That's your first choice. The accompanying drawings are for the Infant Torpedo®. If you use another engine, check it against the plans and alter them to suit. In the template cross section allow at least  $5/32$ " clearance all around. If necessary, the glow plug can protrude from the bottom of the car body. Differently spaced mounting lugs on some engines

will also require a slight alteration of the firewall design.

After shaping the body from balsa, drill a  $1/2$ " hole in the bottom for a hardwood plug. The axle assembly is bolted to this. Make holes in the sides for the fuel line and the needle-valve knob and another underneath for access to the glow plug. The latter is also the fuel-drain hole.

**Mounting the engine.** Cement nuts for the engine-mounting screws to the back of the firewall. Solder a piece of wire to one nut and run it through a hole in the side of the body. This serves as a ground connection for the starting battery. Connect the other battery clip to the glow plug through the hole in the cowl bottom.

If you are satisfied with speeds up to 25 m.p.h., you can use a stock metal propeller, tank, and wide-tread model wheels. For higher speeds, the prop must be cut down so it will wind up to a screaming 16,000 r.p.m., and tires must be tapered to a smooth, narrow tread to reduce friction. Then the car should reach 35–40 m.p.h. ▶



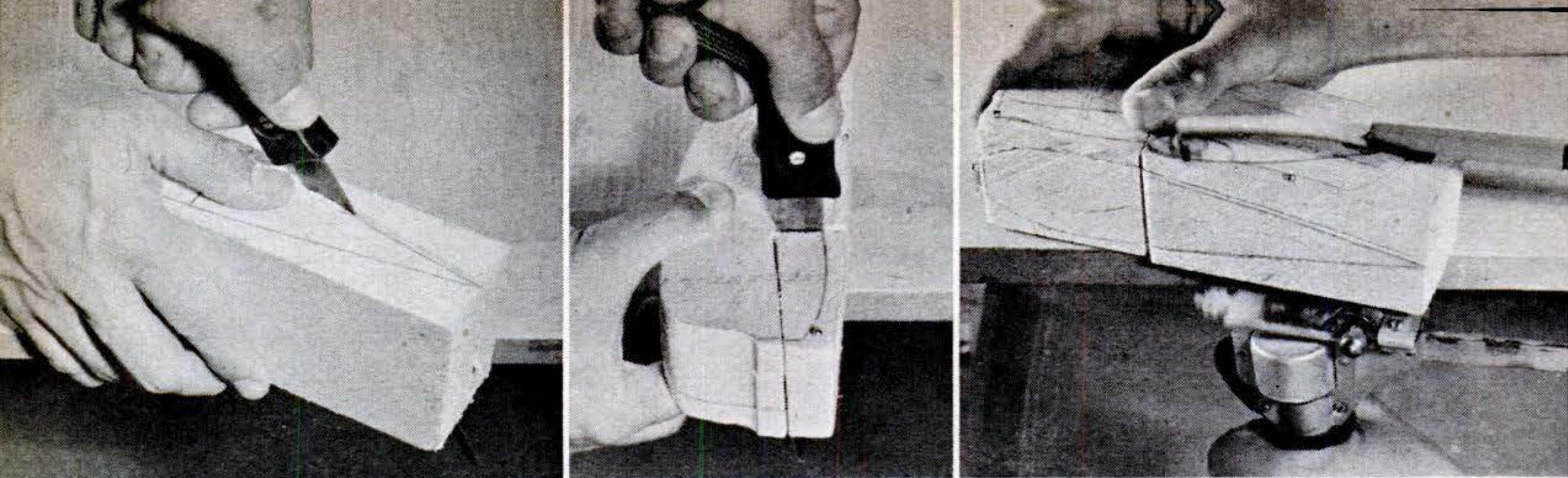

**Saw the body** from a balsa block. Cut top outline first, as at left, sawing just outside line. Trace side outline with side waste pinned or cemented back in place temporarily. Saw away

bottom. Then cut off cowl section (center) and cement it lightly back in place. When cement has set, cut away rest of side (right). Electric jigsaw does a smooth job on balsa.

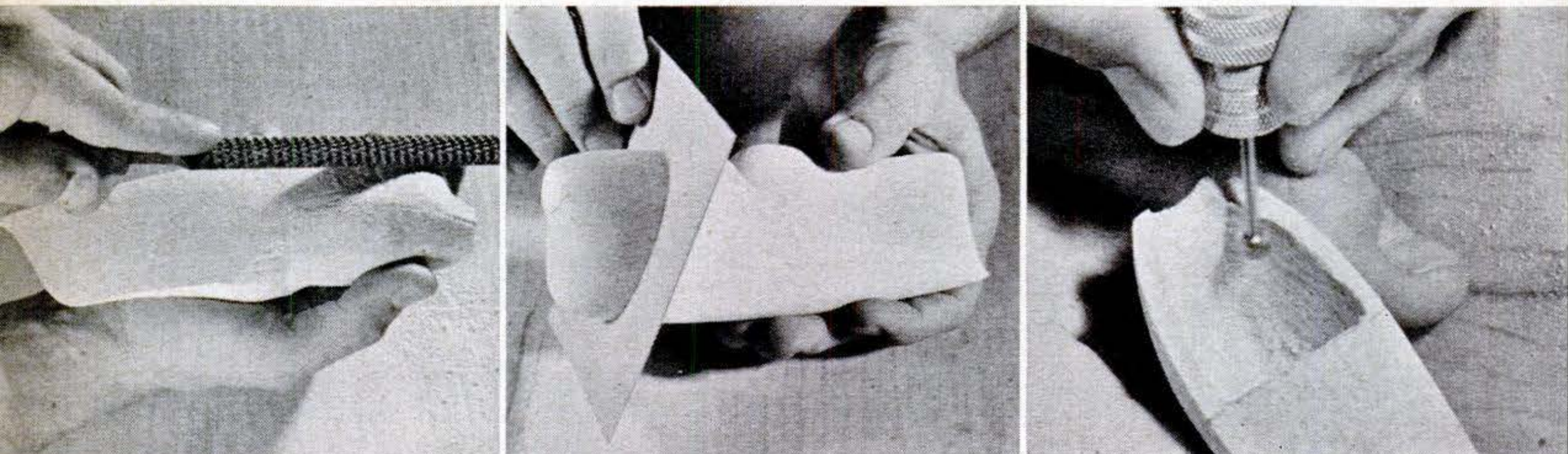

**Rasp or carve the body** to rough shape. Finish with coarse and fine sandpaper. Check at firewall position with a template made from the drawing on facing page. Don't make it too nar-

row or engine won't go in. After removing the cowl top, hollow the body to fit engine. Also hollow lower part of the firewall for gas tank, and drill  $\frac{1}{2}$ " hole for hardwood plug.

**Shaping a high-speed prop.** For tops in speed, Lud Kading, designer of the Infant Torpedo, recommends a  $3\frac{1}{4}$ " propeller of 6" to 7" true pitch. He suggests the following procedure to approximate this with ordinary tools:

Cut the regular  $4\frac{1}{2}$ " metal prop to the  $3\frac{1}{4}$ " shown in the drawing. File the front face to airfoil shape, tapering the trailing edges to knife sharpness. Check the pitch angle by resting the hub on a  $\frac{1}{8}$ " rod on a flat surface. At a point  $\frac{3}{4}$ " from the hub

hole, raise the leading edge  $\frac{3}{16}$ " while the trailing edge touches the work surface. At  $\frac{1}{16}$ " from the tip, raise the leading edge  $\frac{3}{32}$ ", the trailing edge  $\frac{1}{16}$ ". Maximum pitch is near the hub. It flattens out toward the tips. The aluminum spinner shown is a standard model-shop item.

**Cutting the cooling vents.** For the high speeds that such a short prop will give, it is best to cut cooling vents in the sides of the cowl. Those shown are  $\frac{3}{4}$ " high and  $\frac{1}{4}$ " wide at the widest part of the arc. Locate them at the firewall corners.

**Making the fuel tank.** For a longer run, you'll need a larger fuel tank. This can be made from a No. 12 brass thimble, available in a dime store. A spring made by winding No. 28 brass spring wire around a  $\frac{1}{16}$ " rod will keep a long fuel line from kinking. But in the fast model shown, the feed pipe is at such an angle that no anti-kink spring is needed.

**The axle assembly.** Coat the mounting screw with glue and thread it into a  $\frac{1}{2}$ " hardwood plug. Cement the plug into the hole in the bottom of the car body. ➔

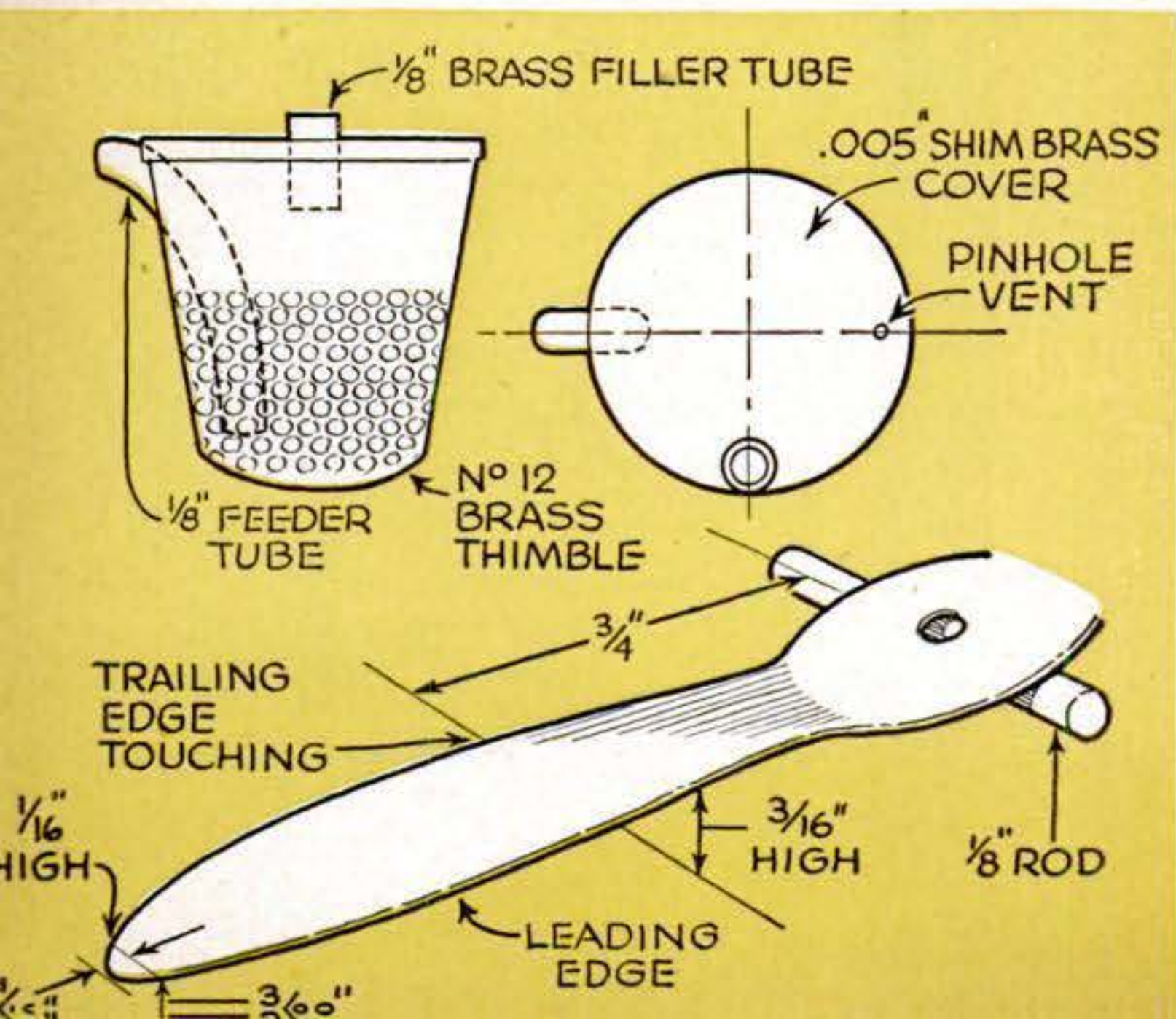



# FULL SIZE PATTERNS

$\frac{1}{16}$ " STEEL WIRE

TOP TEMPLATE

SIDE TEMPLATE

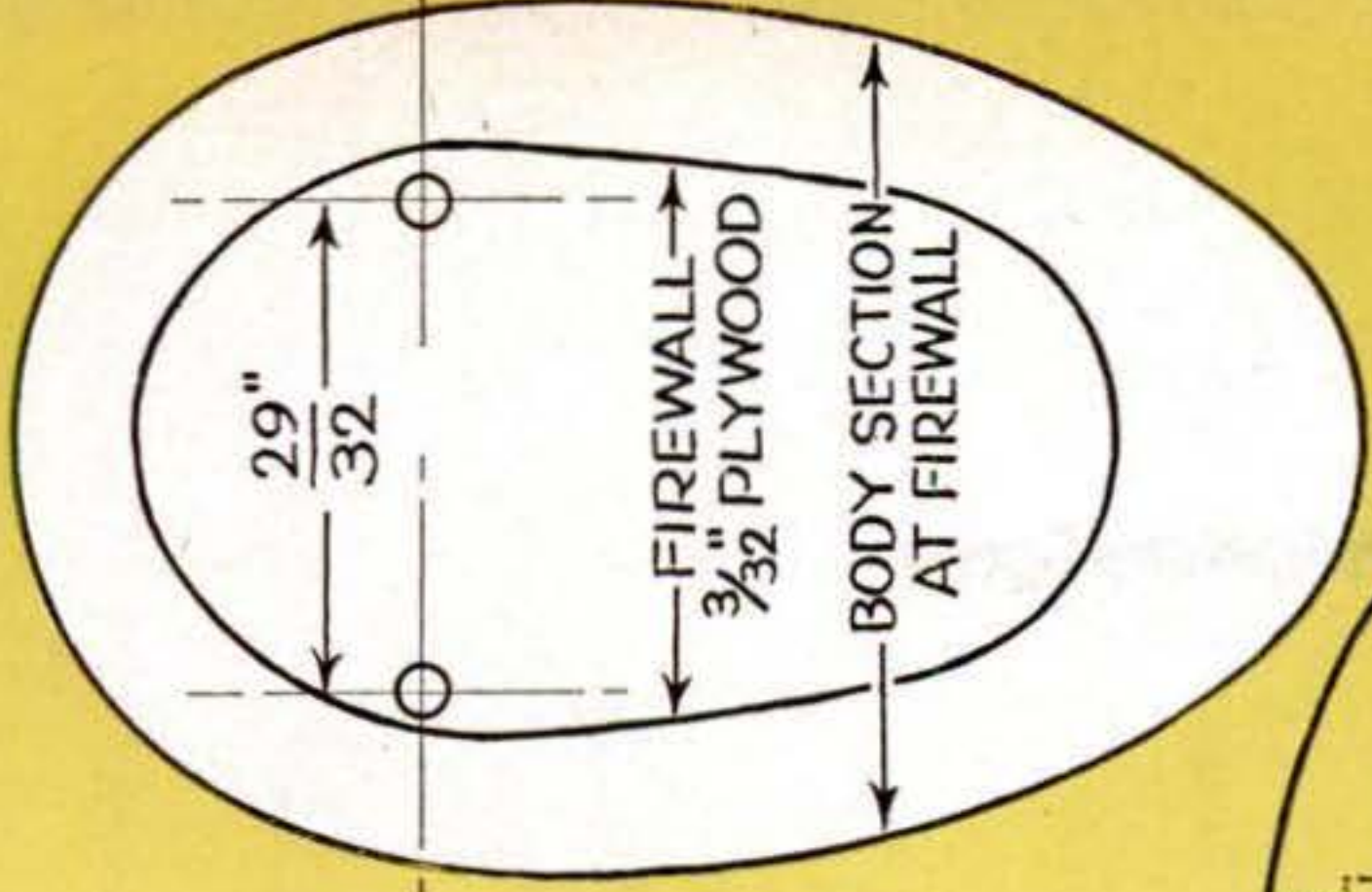

ALUMINUM SPINNER

WASHER

$1\frac{5}{32}$ " DIA. TAPER-TREAD WHEEL FOR SPEED

$5\frac{1}{16}$ " x  $\frac{3}{4}$ " OPENING

$\frac{3}{8}$ " HOLE

WASHER

$1\frac{5}{16}$ " RUBBER TIERED ALUMINUM WHEELS

HOLLOW FOR TANK

$\frac{1}{2}$ " DIA. x  $\frac{3}{4}$ " MAPLE

SOLDERED

$\frac{1}{8}$ " x  $1\frac{1}{8}$ " BOLT

SPEED PROP

TEMPLATE FOR



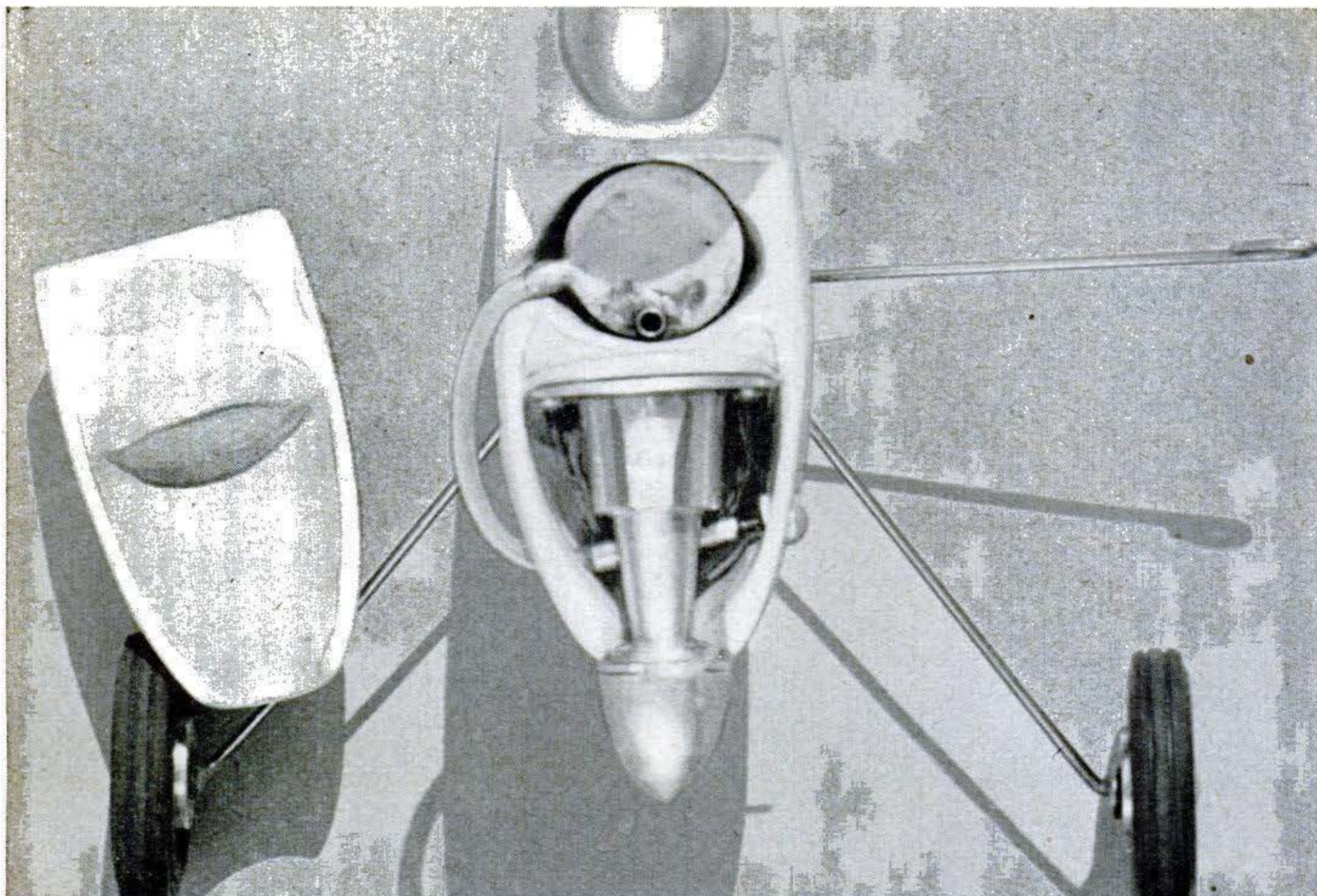

**Brass-thimble tank** holds  $\frac{1}{8}$  oz. of fuel. This is enough for 45 laps. To prime engine, fuel

can be squirted into cylinder through vent in cowl front. Friction keeps cowl top in place.

A nut on the screw secures the axles and the tether anchor. Bend the latter upward so its end is slightly higher than the inside wheel. Washers soldered to the axles on either side of the wheels prevent wobble.

**Applying finish.** Make filler by mixing fuller's earth or talcum powder with clear dope to a thin paste. Apply three coats. Then give the model two coats of clear dope and five of colored dope, apply any decals you wish, a final coat of clear dope, and hot-

fuel proofer. Aluminum dope simulates the cockpit.

**Running the model.** Make the tether of .010" or larger steel wire. For safety, give it a pull test of 20 times the car's weight. A nail will serve as a center pivot.

At top speed, these cars are bound to throw some fuel, leaving an oily ring behind. The fuel will ruin any painted surface. Remember this in picking a spot for your track. END

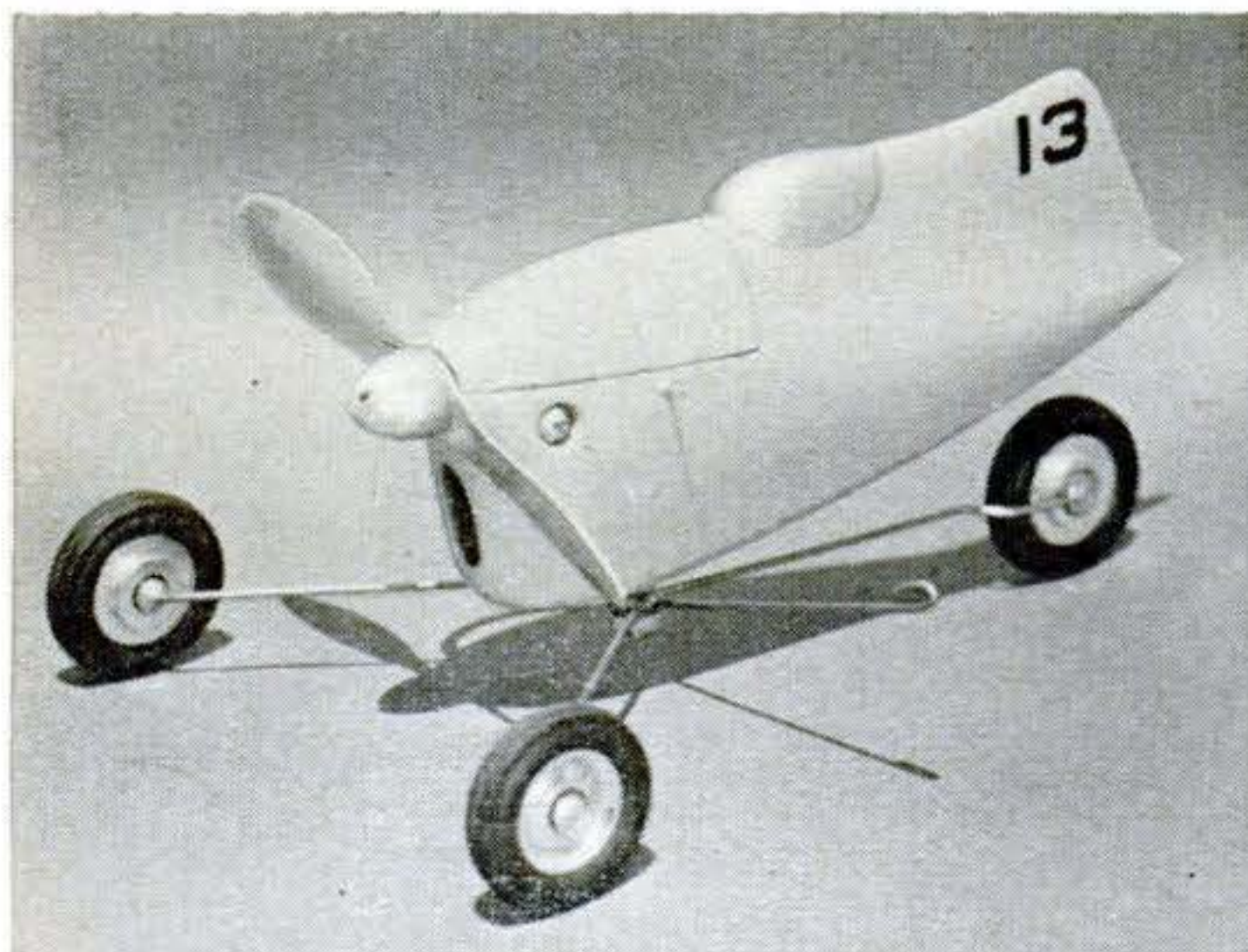

**Slow model** does 25 m.p.h. equipped with standard prop and wheels. Countersunk needle-valve knob is slotted for screwdriver adjustment.

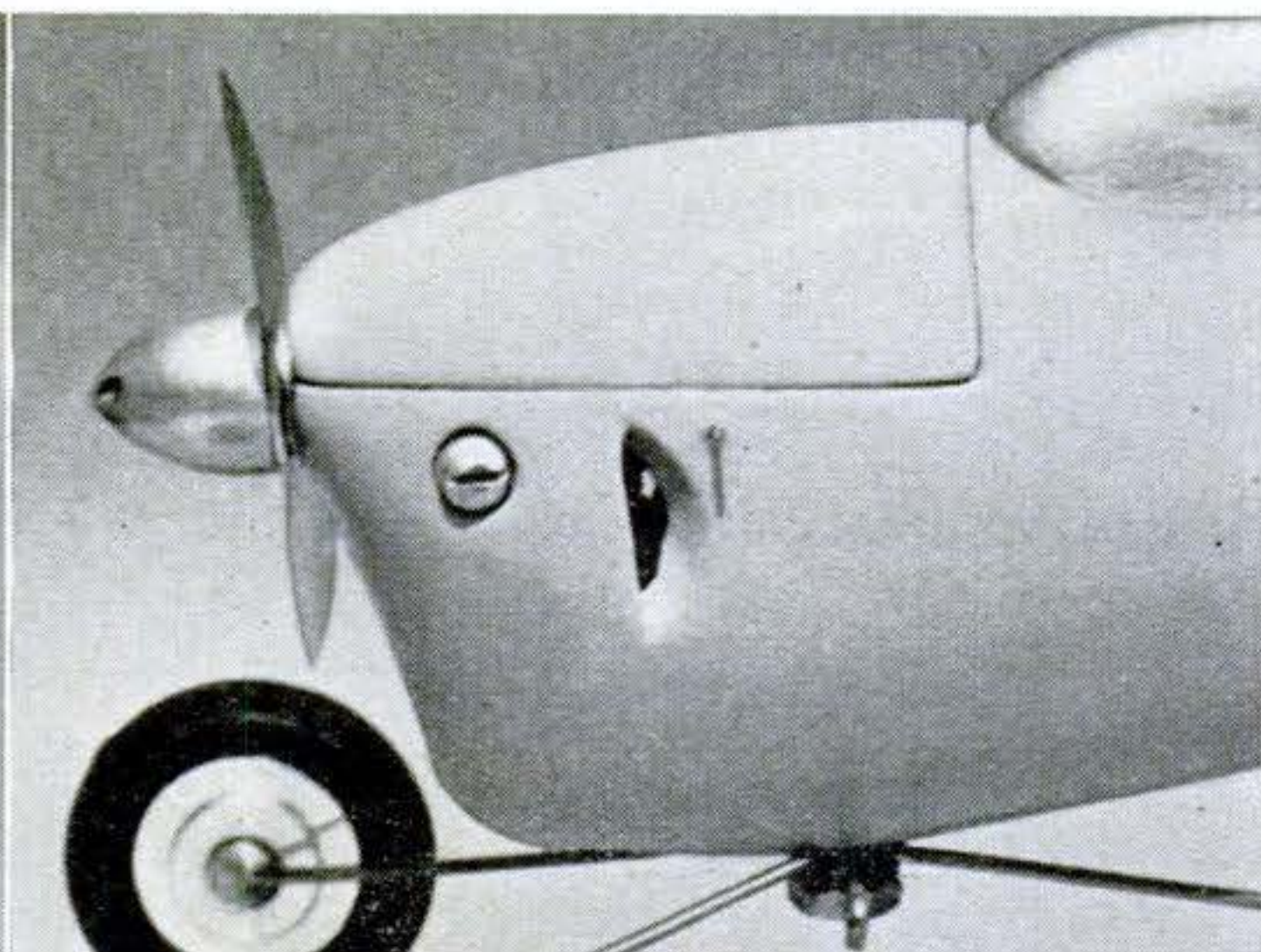

**Fast model** has shorter prop and wheels with narrowed tread to cut friction. Cooling vents in side are advisable for high-speed racing.



## WHAT'S WRONG ?

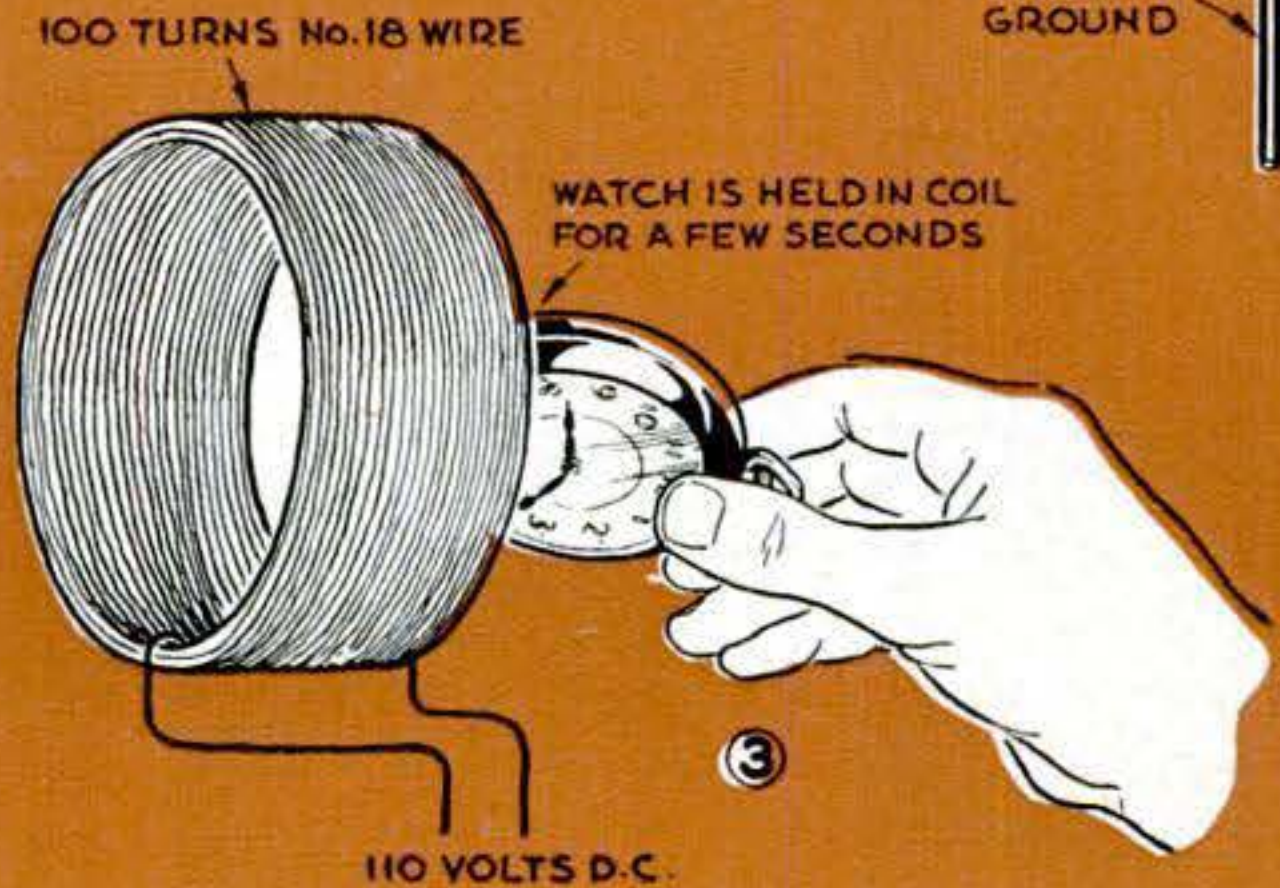
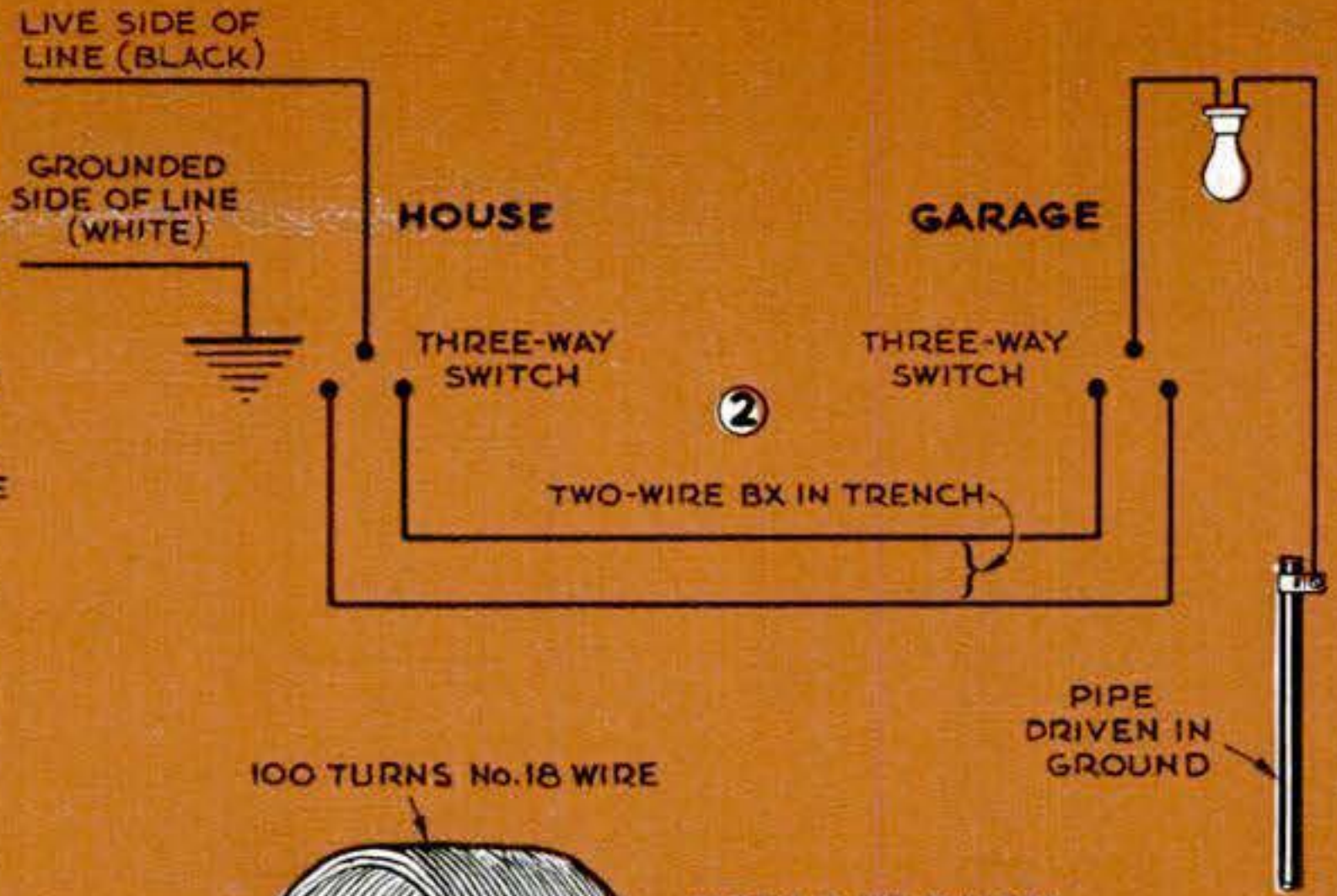
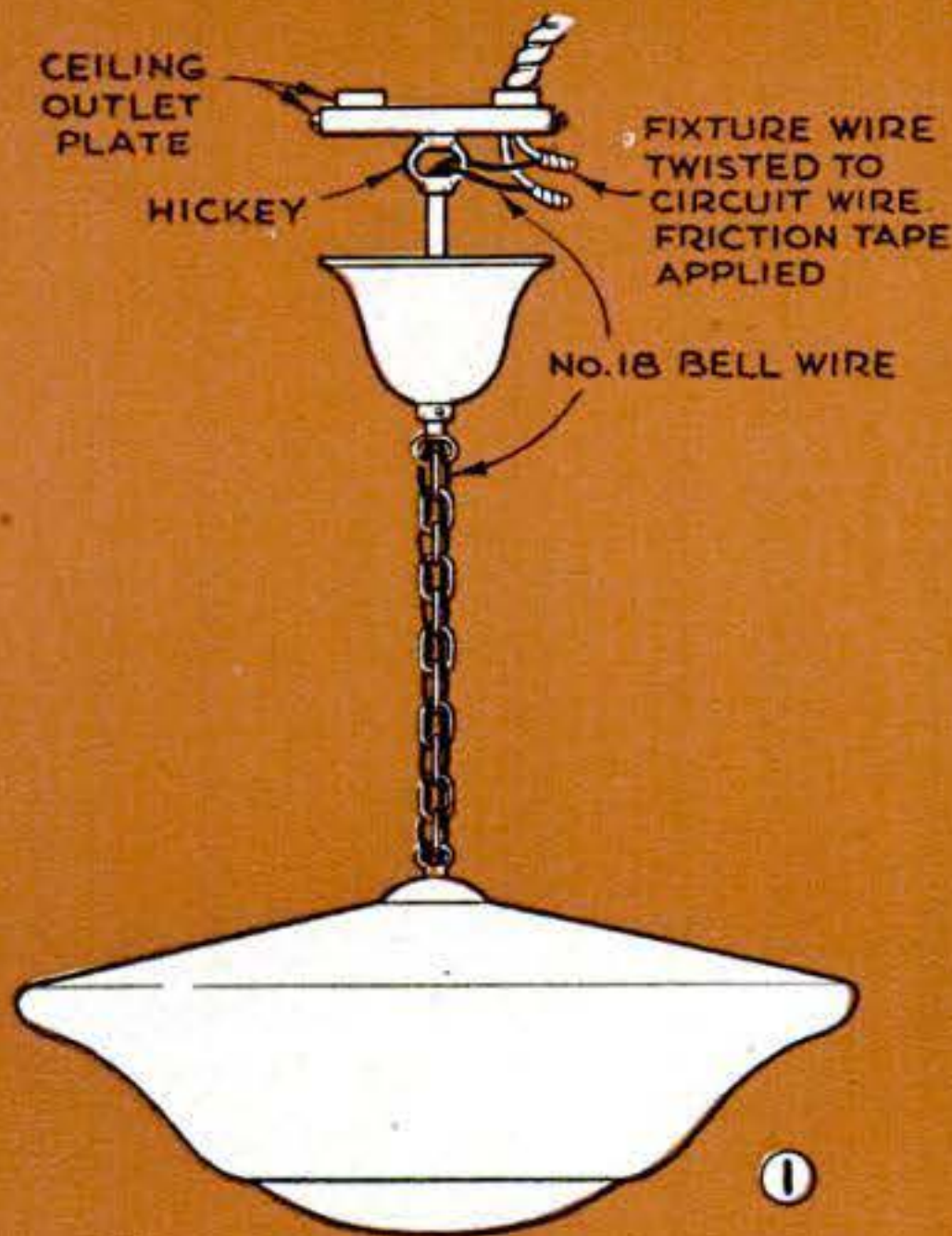

ELECTRICAL errors are often like delayed-action fuses: everything is quiet for a while, then there is a flash and a bang and you know you've made a mistake.

Rewiring the hanging chain fixture (No. 1) made the light work again. The

garage light (No. 2) with switches at both the garage and house also looked good. The builder used material he had, and then improvised a return lead. Number 3 looks familiar, but is this the way you'd demagnetize a watch?

1. For use on 115 volts, bell wire is definitely not approved. Movement of the chain will quickly wear through the waxed cotton insulation. And remember that stranded-wire should always be used where there's motion. Unless solderless connectors are used, joints must be soldered and wrapped with rubber and friction tape. 2. The fellow who wired this setup thought he was clever because he made use of some two-wire BX in a trench he discovered that a third wire is needed for the two-way switching system, so he outdid himself and jabbled use AC and a coil with more turns of finer wire, passing the watch through it.

3. If you come out of this experiment unfried, your watch will still be no better off. Passing 115 volts DC through 100 turns of No. 18 wire will just burn up the wire. Besides, DC doesn't demagnetize. You have to use AC and a coil with more turns of finer wire, passing the watch through it.

### Answers

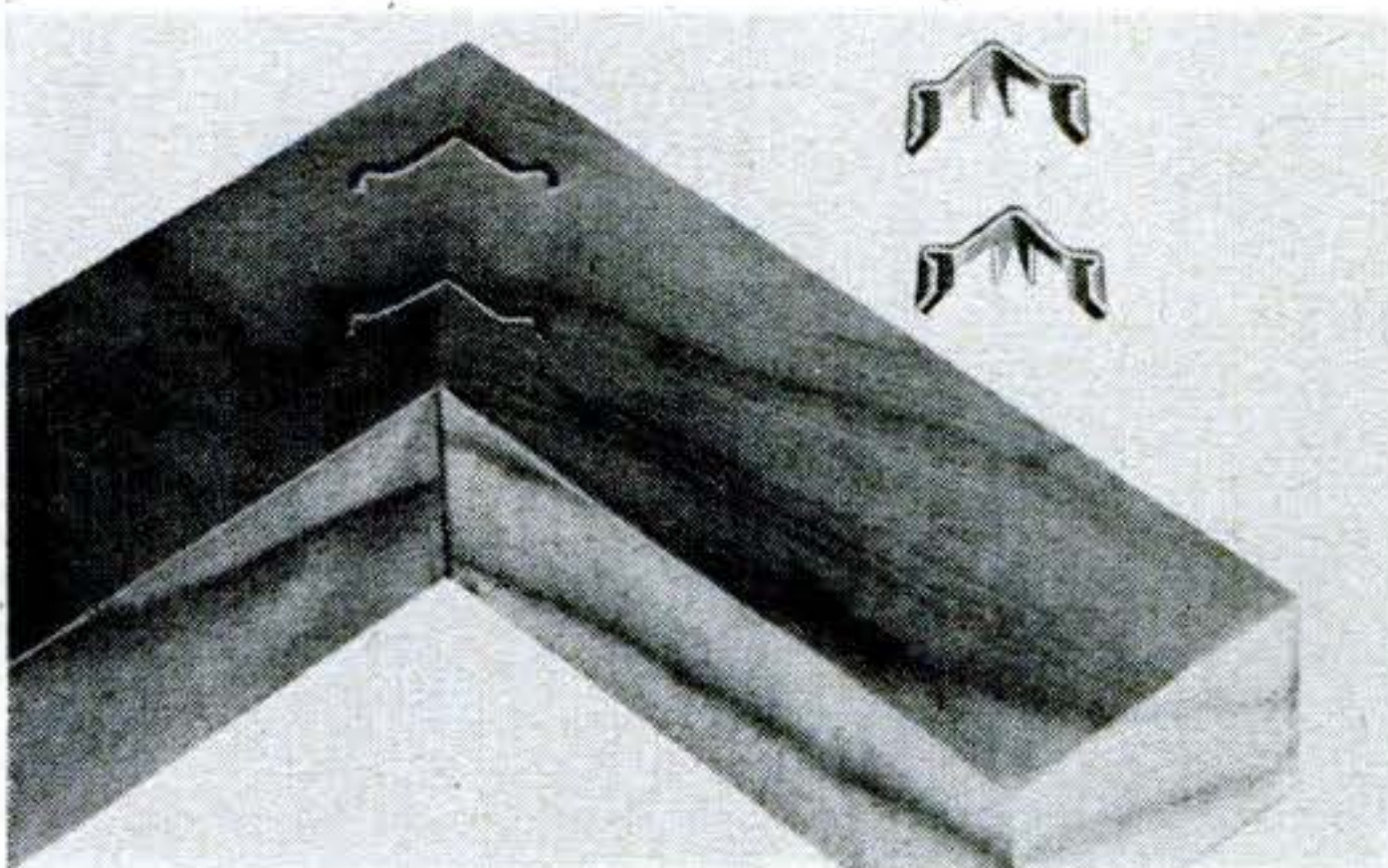

## Fastener Holds Miter Joints

THESE steel fasteners, called Chevrons®, can be hammered into wood to make strong miter joints. They can be countersunk and concealed with composition wood. E. B. Packard Co., Inc., New York City, markets them in four depths: 1/4", 3/8", 1/2", and 5/8". The 3/8" size retails at 25 cents for a box of 30. When driven into a joint, the outside legs of the fastener are anchored across the grain of the wood to hold the fastener firmly.





# How to Build a Baby's Service Station

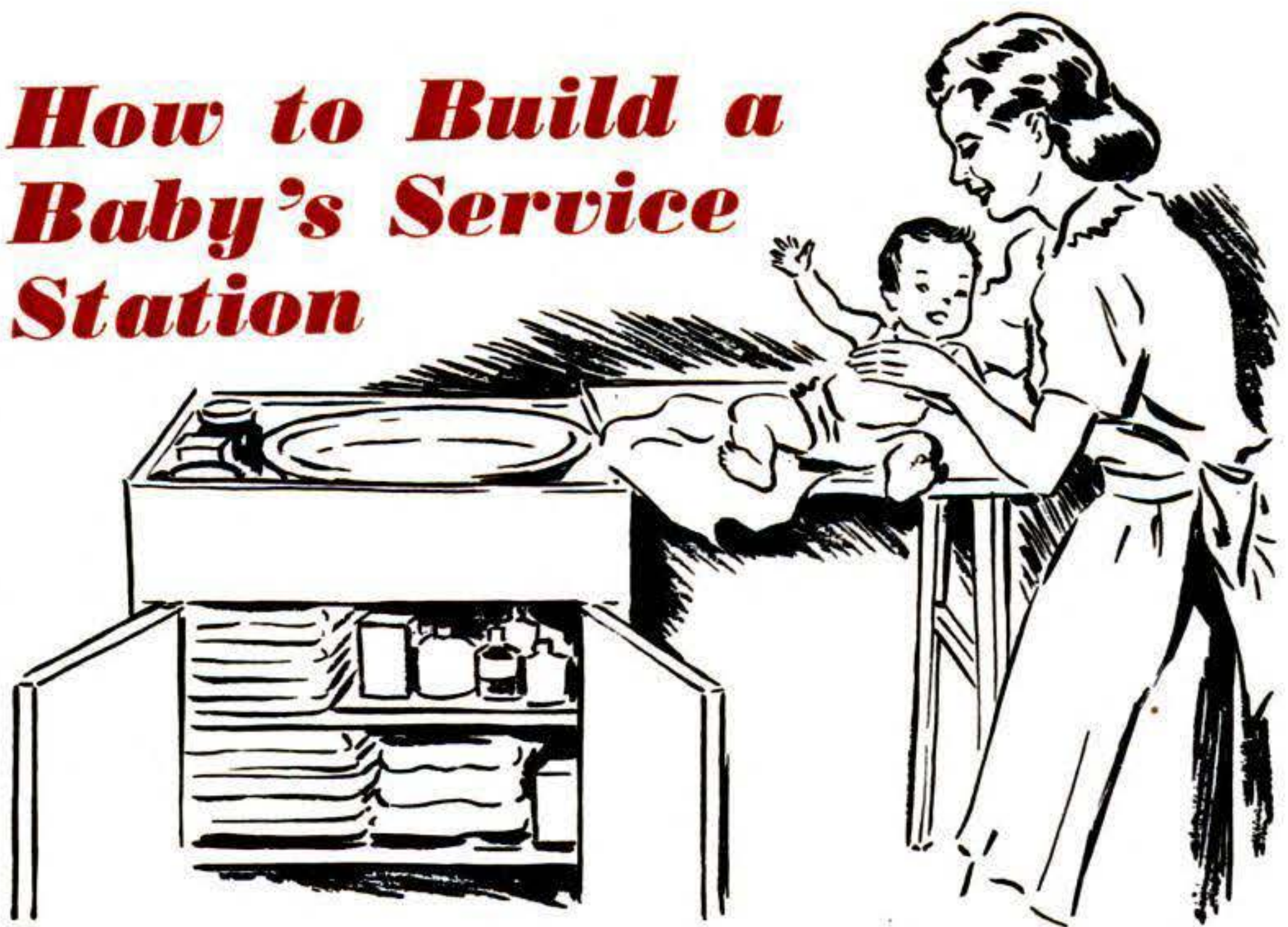

**Construction** of baby's bath station is simple. You don't need any power tools. Unit is compact but has ample space.

**E**VERYTHING mother needs to bathe and dress baby is right at hand in this combination cabinet and table. It provides space for a basin and, when opened, a dressing table beside it to which baby can be easily transferred. Clothing and supplies are within easy reach and the basin is easier to clean than a fabric tub.

Construction details and dimensions are shown in the drawing below. The unit is made of  $\frac{3}{4}$ " pine except for the doors. These are built up of  $\frac{1}{4}$ " plywood as shown. The

linoleum, anchored all around with aluminum angle pieces, keeps any spilled water out of the storage space. Make the openings for the soap dish and jars of cotton and sterile water to suit the ones you have. The front is decorated with decals.

As an added advantage—when Junior graduates to the family bath tub—you can remove the top section and use the cabinet alongside a bed or as a general storage cabinet in the kitchen or cellar.—*Mary A. Bastedo, Washington, D. C.*

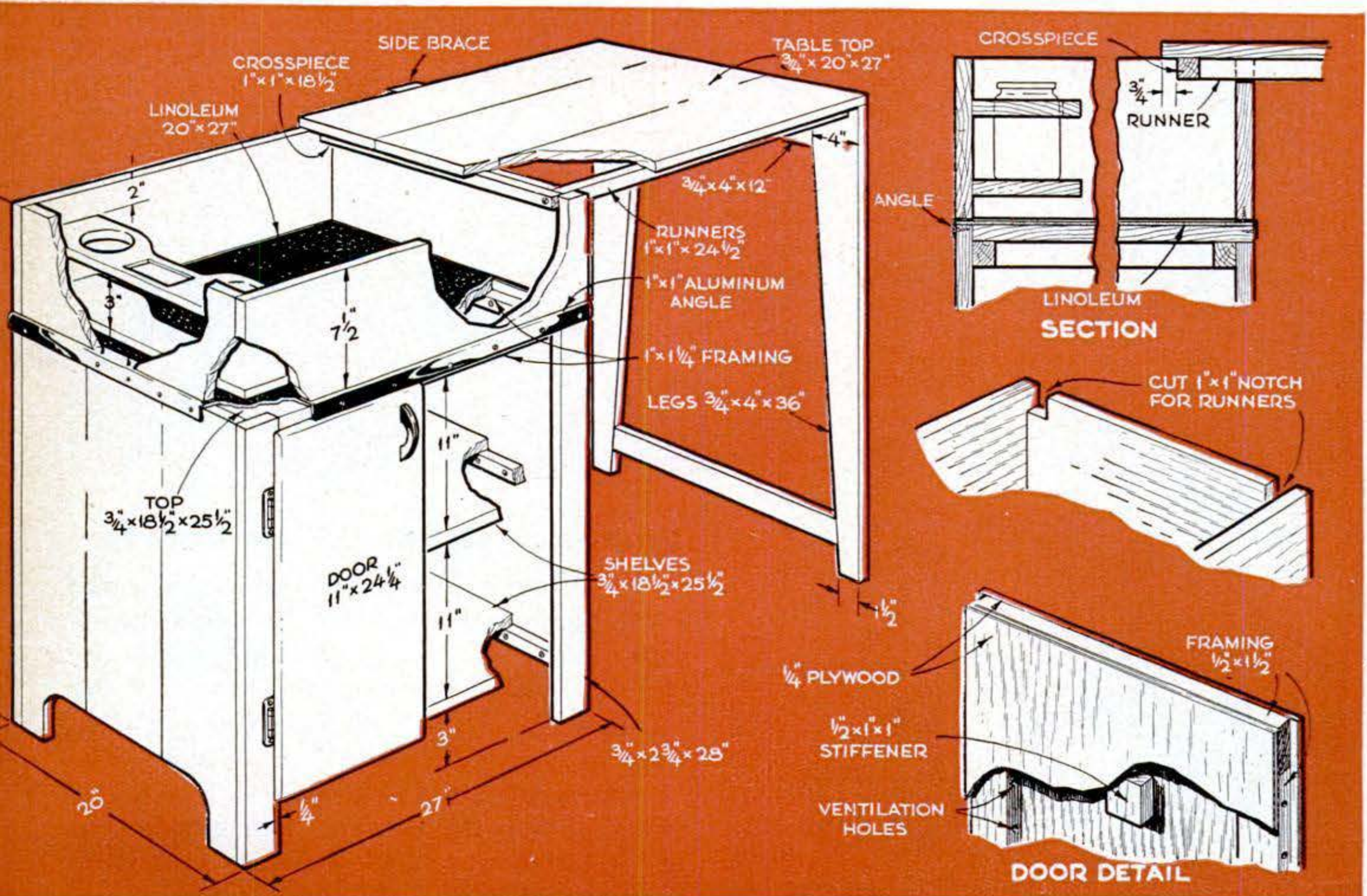



# Letters Pop Out of Hot Plastic

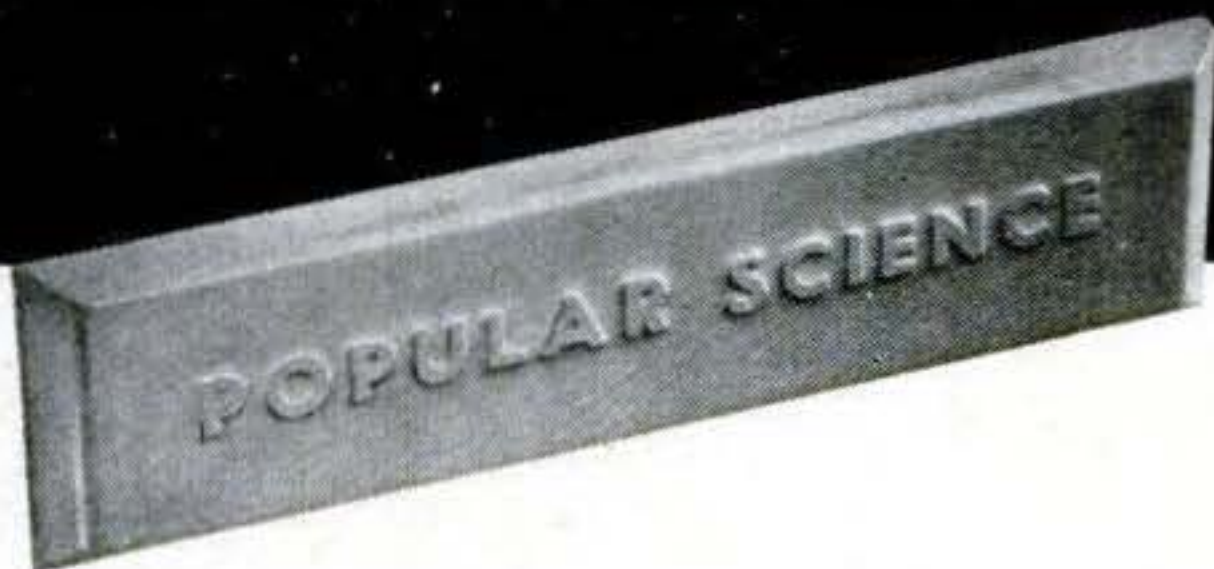

**N**OW you see it, now you don't—and here it comes again. That's the astonishing sequence in which raised printing can be formed on acrylic plastic by a method reminiscent of spies and secret codes, but actually as down-to-earth as your workbench.

You can use this technique to form raised lettering on signs, plaques, displays, ornaments, or other objects made of Lucite® or Plexiglas®. Since the process calls for a Linotype slug, it involves a small investment that may not be worth while for single pieces. Runs of even modest quantities, on the other hand, can be made at low cost, and the craftsman may find it profitable to make raised-letter specialties.

The Linotype slug, which you can have made at a newspaper plant or large printing establishment, is first pressed into the hot acrylic. This compresses the plastic directly under the letters. The surrounding material is then sanded completely away, so that the sunken letters vanish, and the surface is polished. When the piece is again heated, the compressed material expands to its normal height, standing out in relief.

Embossed designs can also be reproduced this way, but the relief must be uniform in height. If it isn't, the more shallow portions will probably be lost.—*M. J. Moch, Queens, N. Y.*

## Oil Smooths Zipper Action

STIFFNESS, locking, and tearing of slide fasteners are sometimes caused by lack of lubrication. Dry cleaning and normal evaporation tend to keep a fastener dry, but this can easily be remedied. Moisten a clean cloth with a few drops of oil and wipe the fastener. The treatment should be repeated after every other dry cleaning.—*John W. Nestler, Tampa, Fla.*



**Slug of type** is pressed into hot plastic so as to form a sharp, uniformly deep impression. A wide vise is best, with wooden blocks for even pressure. Work fast while material is hot—don't try to force type into hard plastic.



**A clean-cut impression** of the type face is required, but it should not be so deep that it shows corners of the slug. Next step is to file or sand entire surface down to bottom of sunken letters. Then polish. Letters no longer show.



**They pop back permanently** as the piece is again heated. Electric hot plate was used for these photos, but in practice an oven is required. A power sander is almost a necessity for quantity work—hand sanding or filing is too slow.

## Glue Fills Plaster Cracks

HAIRLINE cracks that sometimes develop in plastered walls should be filled before painting. For a neat job, mix some glue or glue size with plaster. The glue should be about the consistency of thin syrup before it is mixed. Work the mixture into the crack with the fingers and dress the surface with a putty knife if necessary. It should be left to dry for a day or so before painting.—*Joseph E. Bird, Carrollton, Ill.*





## Service Table Folds Away

THIS English tea table, handy for side service or as an occasional or card table, doesn't know how to get in the way. Top and legs fold up for compact storage.

**Sawed Parts:** Enlarge the grid of squares and trace off the leg profile onto a piece of walnut, maple, or other hardwood. You can save stock by nesting two or more legs in a large board. Thickness is  $\frac{3}{4}$ ".

Cut out the legs, clamp them together, and drill pivot holes through all four pieces at once. Make a  $\frac{3}{16}$ " hole near the top and another about  $13\frac{1}{4}$ " down. Enlarge the center hole to  $\frac{9}{16}$ " on two pieces. These will be the inner legs.

For the top, saw two  $\frac{1}{2}$ " by  $9\frac{3}{8}$ " by 24" boards. Round the corners, ends, and outer edges, but leave the inner edges square.

**Turned Parts:** A lathe is handy for turning the stretcher and rosettes, but it isn't essential. The stretcher may be hand-carved, or a straight dowel with  $\frac{1}{2}$ " by  $\frac{5}{8}$ " tenons at both ends will serve. Rosettes can be almost any disks of proper size. Particularly good ones can be obtained by slicing off the tops of decorative drawer knobs.

**Assembling the Pieces:** Join the squared edges of the table top with three brass hinges. Fasten one in the middle, the others about  $2\frac{1}{2}$ " from the ends.

The understructure is held together by  $2\frac{1}{2}$ " roundhead screws as shown in the sketch. Note that the inside legs (those that go on the stretcher first) come out on the same half of the table.

Rivet a brass bracket of the type shown to the top of each leg. Open the table top, face down, and put the legs in place. Center the assembly lengthwise and screw down the brackets  $4\frac{3}{4}$ " each side of the center.

Its own weight serves to hold the table open, but for extra security, pivot a 10" stiffener strip under one leaf. Turning the strip so that it laps both halves locks the table.—Norbert Engels, South Bend, Ind.



The graceful and familiar style of this table blends with furniture of almost any period. Its understructure shows traces of the Roman folding stool and Gothic English chair.

To fold the table for storage in minimum space, you only have to grasp the two outer edges and press them down. To move the table without folding it, lift it by the same edges.

Photos by Wally Kunkle

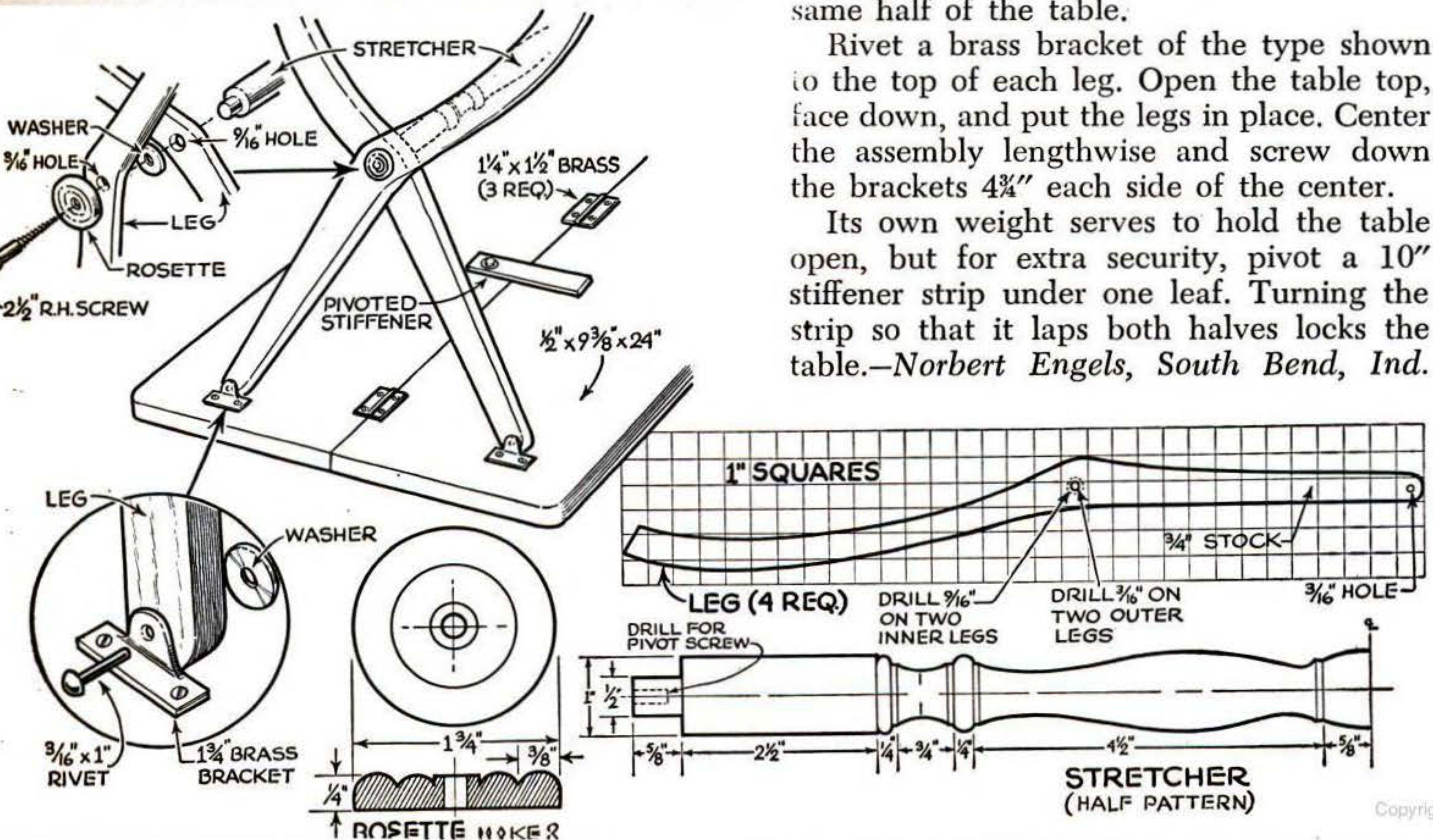



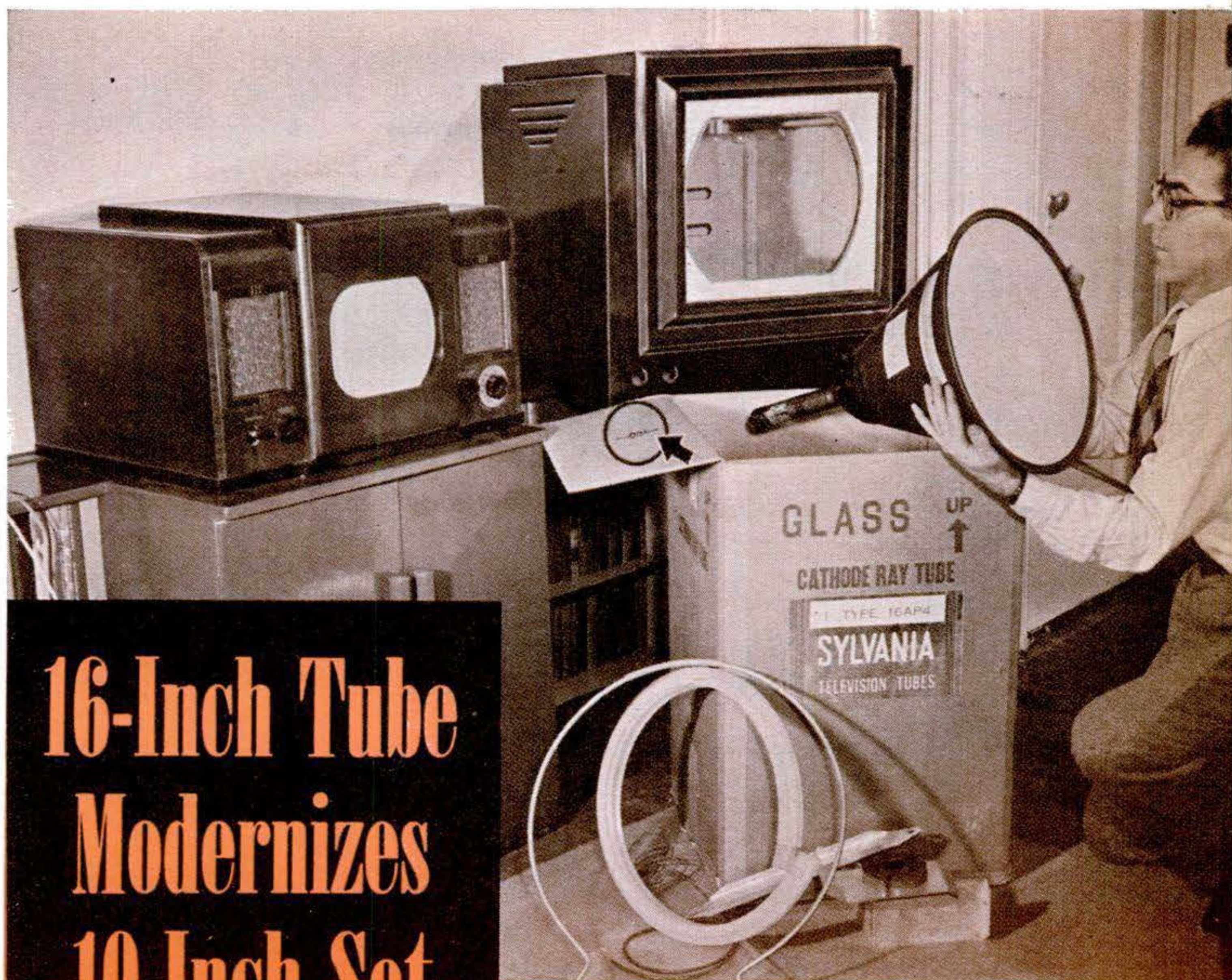

## 16-Inch Tube Modernizes 10-Inch Set

Here are the raw materials of big-screen TV: An old 630-type 10-inch receiver, a larger cabinet, a 16AP4 metal or 15DP4 glass kinescope, mounting hardware, and a 27,000-ohm resistor (arrow).

**Changing one resistor in a small chassis may enable you to enjoy TV pictures that are 2½ times larger.**

**By Robert Gorman**

*PS photos by W. W. Morris*

SEVERAL hundred thousand 10-inch television sets now in use have enough power built into them to drive 16-inch picture tubes. Yours may be one.

It is if it uses the RCA 630-type circuit. Sets of this design were widely distributed from 1946 to 1948 and later. They first appeared under the RCA label and then under a score of other well-known brands. The "6" stands for 1946 and "30" is the number of tubes including rectifiers and kinescope.

I had one of these sets—built from a kit as described in PS of April '49, p. 226. Following the present trend to king-size pic-

tures, I decided to convert my small set for big-screen operation.

But how?

I found the answer in a leading TV lab. Engineers who wouldn't have been afraid to tackle big wiring jobs were making the change I wanted simply *by adding one resistor*.

Electronically it's as simple as that. The resulting performance matches the quality of any 16-inch receiver.

Making the change, however, involves a few fussy mechanical problems that stem from variations in tube size, mounting hardware, and cabinet dimensions.

**Tubes:** Among the picture tubes that can be used are the 16AP4 (metal shell), 15DP4 (glass type) and 12LP4 (12-inch, ▶





**1** I began by taking the old cabinet apart. In most cases the top lifts off or unscrews. Then the front mask and safety glass can be unscrewed from the inside.

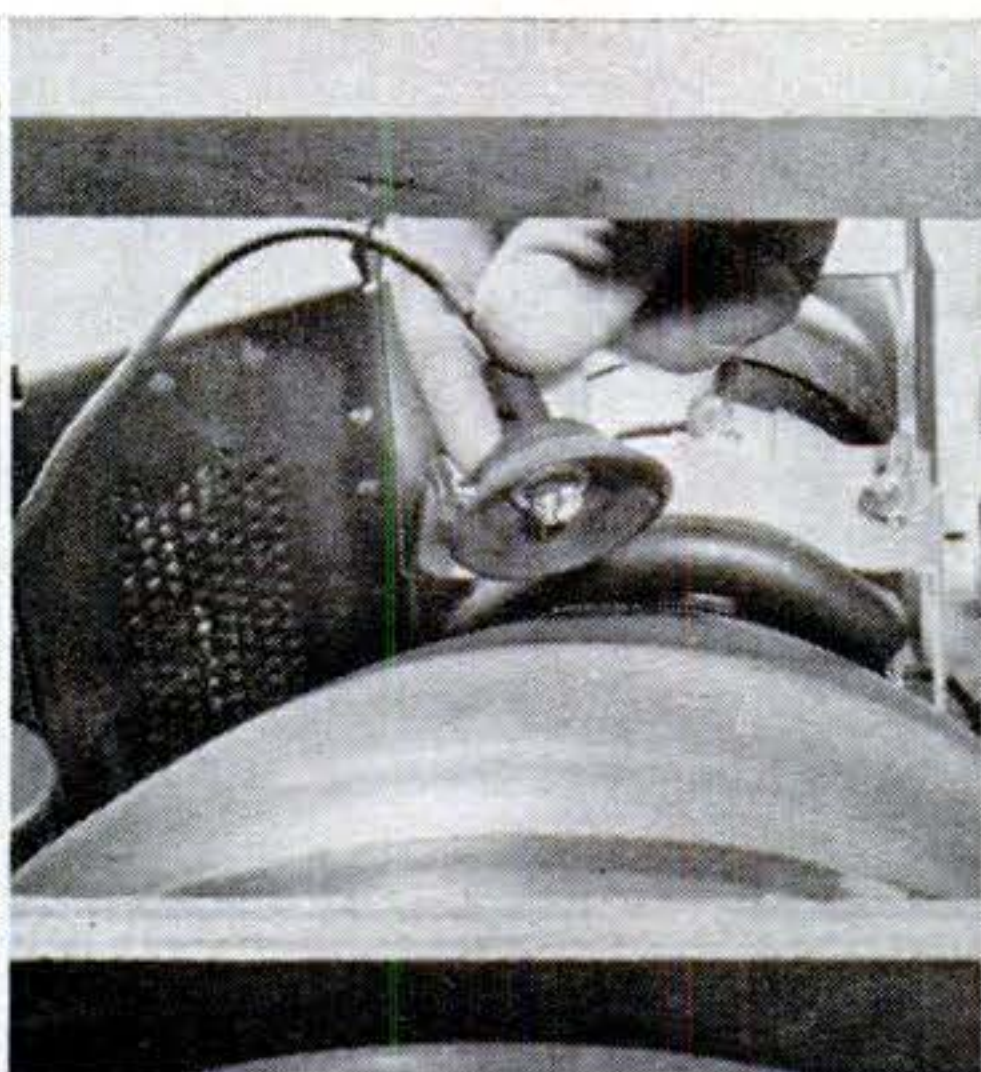

**2** The second-anode connector—the high-voltage cap that plugs into the glass near the bulb end of the picture tube—lifts out. Stored juice is discharged by grounding it.



**3** I slipped the ion trap off the neck of the big tube after removing the tube socket. This trap is of the permanent-magnet type. Some traps are wired into the circuit.

glass). They all have the same socket arrangement as the original 10BP4. Their cost ranges from about \$30 to \$75.

**Brackets:** These are available in different styles in both wood and metal. A set consists of a cradle or ring support for the tube face and a platform for raising the yokes that fit around the neck of the tube.

**Cabinets:** Since mounting hardware isn't uniform it's important to see that the cabinet matches the modified chassis. The height of the tube face must correspond with the picture window. The speaker also has to be moved from its original place. Make sure that the speaker opening isn't in the way of the tube holder.

Another approach is to build a cabinet from scratch. You'll not only get what you want but also save money. The following article gives details on constructing a table-model cabinet to suit your TV chassis.

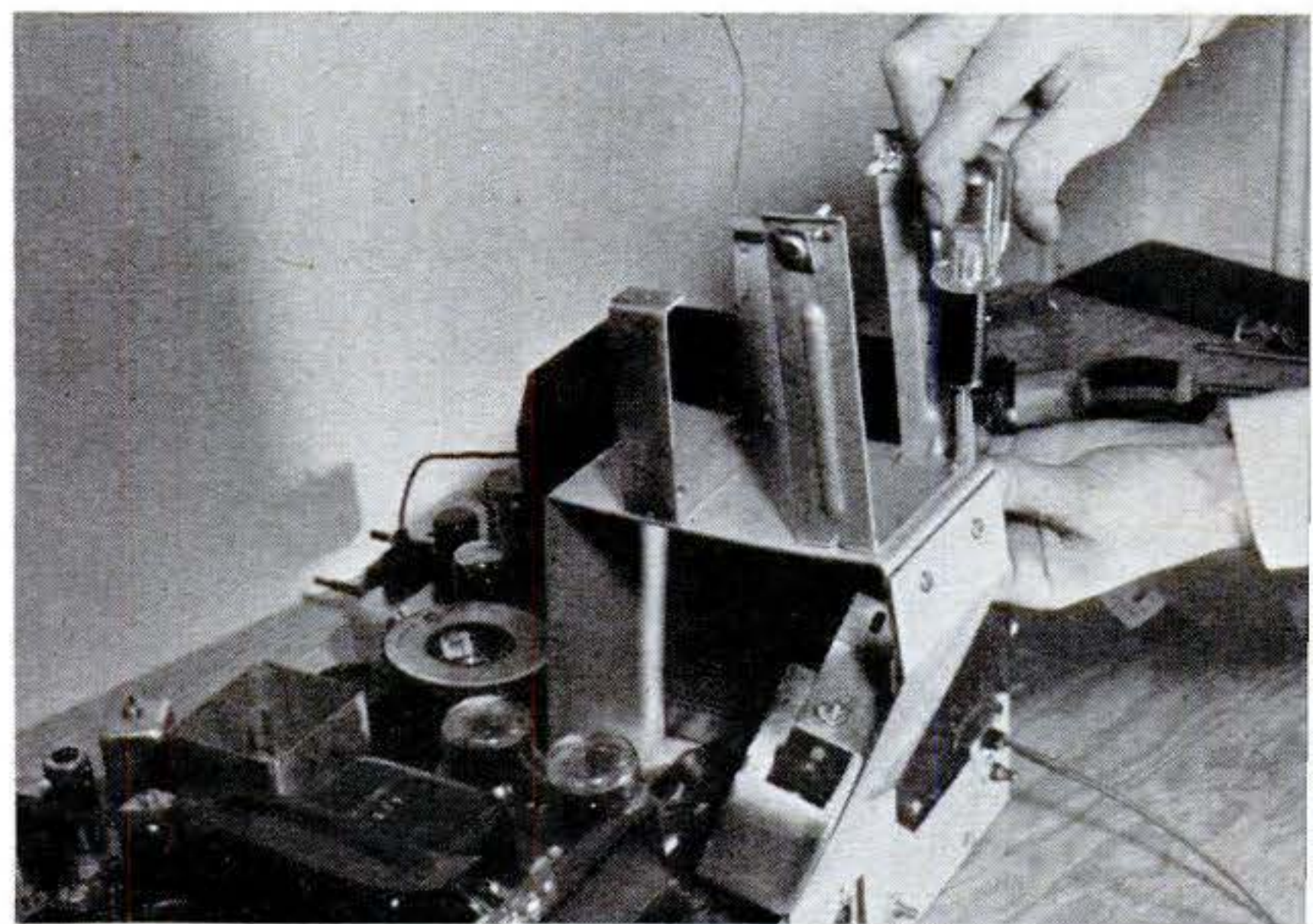

**7** I attached an elevated platform to the chassis and mounted the coil brackets on top of the platform. It's part of the mounting hardware I bought for my conversion.

### Watch Out!

Beware of high voltage and picture-tube breakage.

Pull the power plug before you look inside the cabinet. Also be sure to discharge the capacitors by grounding the second-anode button to the chassis. If you have to extend the second-anode lead, use wire with at least 15,000-volt insulation. For other extensions, use 2,000-volt insulation.

Handle picture tubes by the bulb only, and treat them with respect.

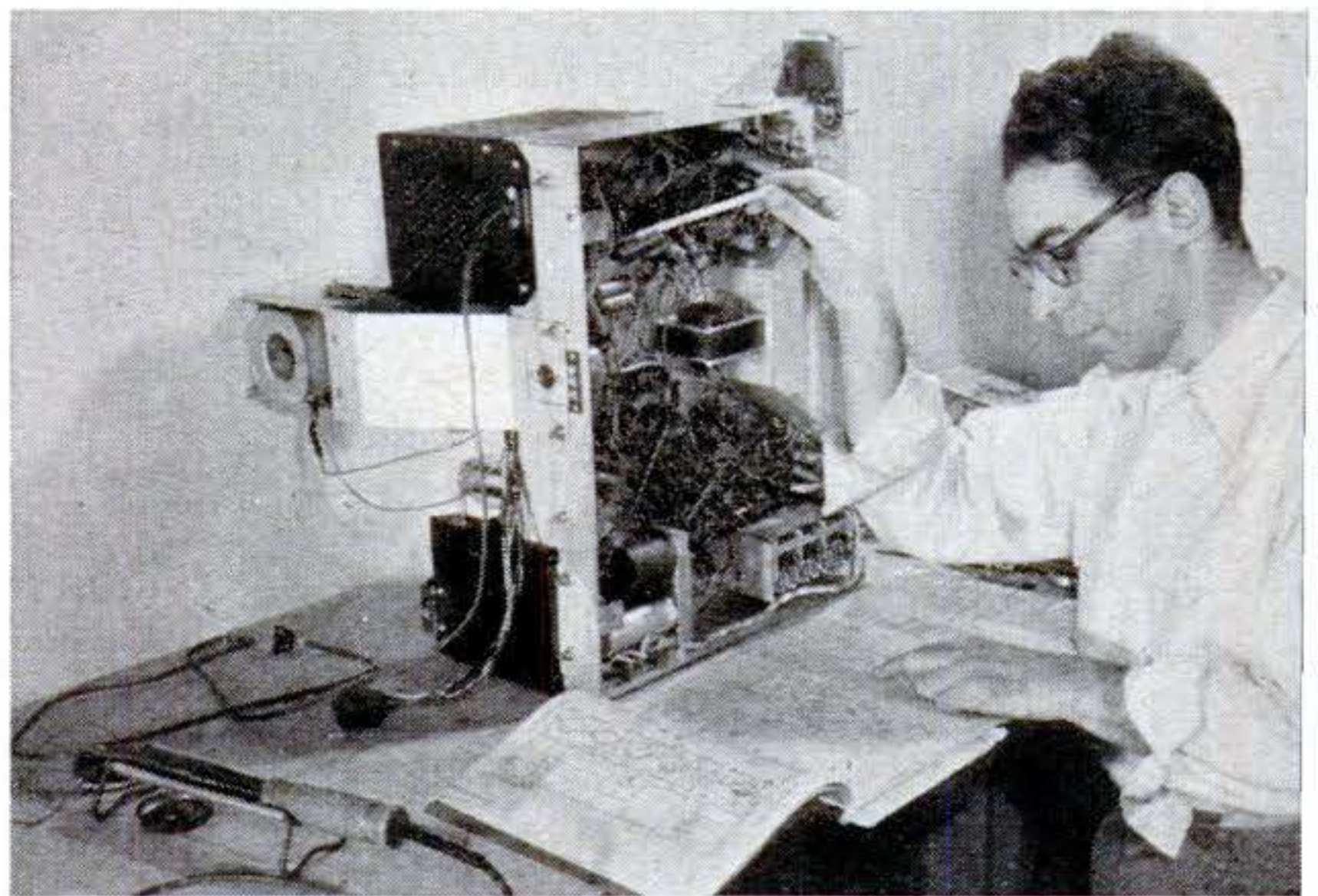

**10** The new resistor is soldered to pin 8 of the 6BG6-G. This is the horizontal sweep output tube and is located inside the high-voltage compartment. Diagram helps to locate tube.





**4** Next, I slipped out the tube and put it away carefully. I then pulled off the knobs, loosened the chassis bolts under the cabinet, and pulled out the chassis.



**5** The focus coil is supported in a metal bracket. The coil is removed from the bracket; then the supporting frame is unbolted from the chassis with a socket wrench.

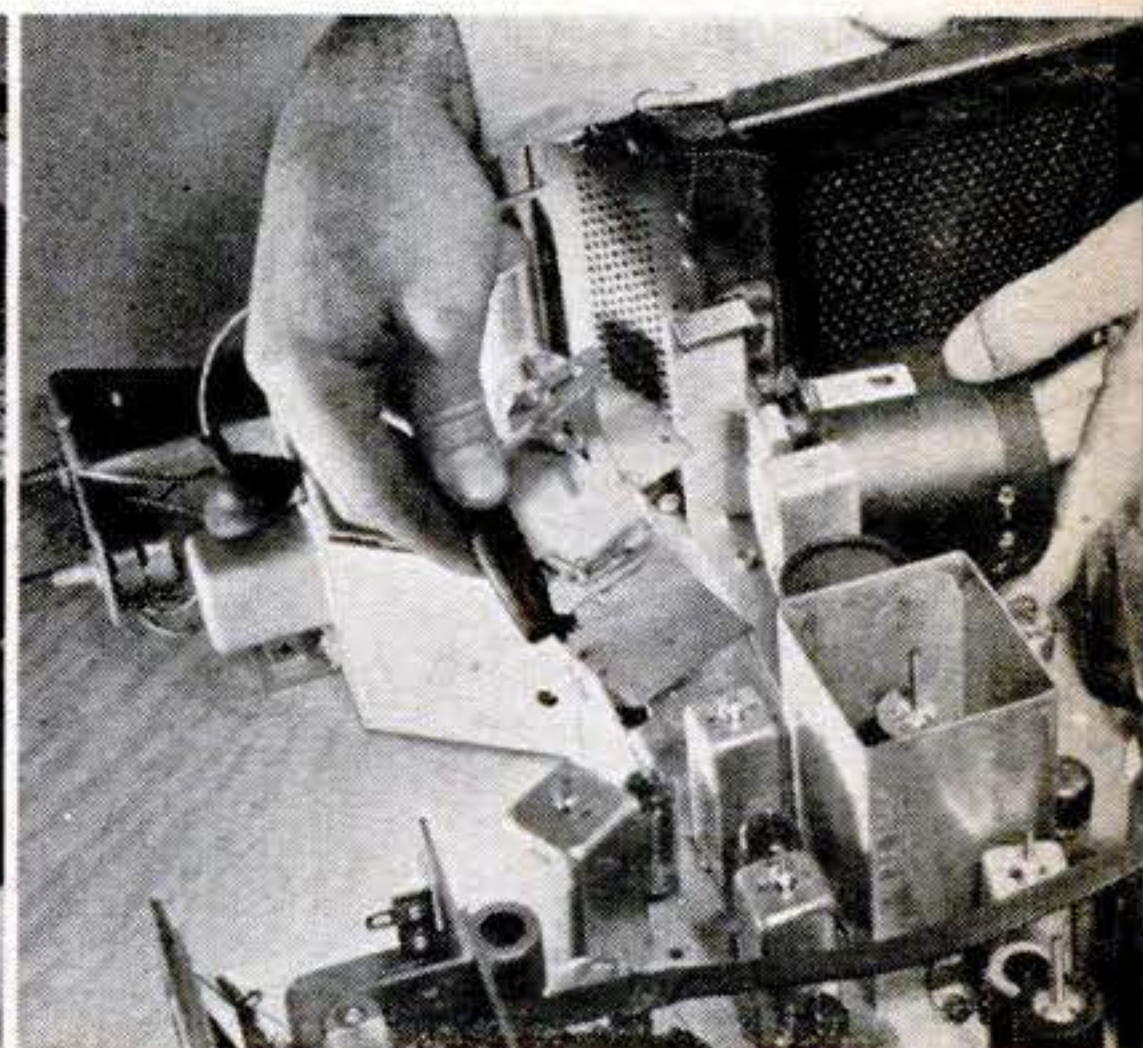

**6** The deflection yoke also has to come off so its bracket can be removed. Loosening three wing nuts frees the yoke from its frame. Wires have to be lengthened.

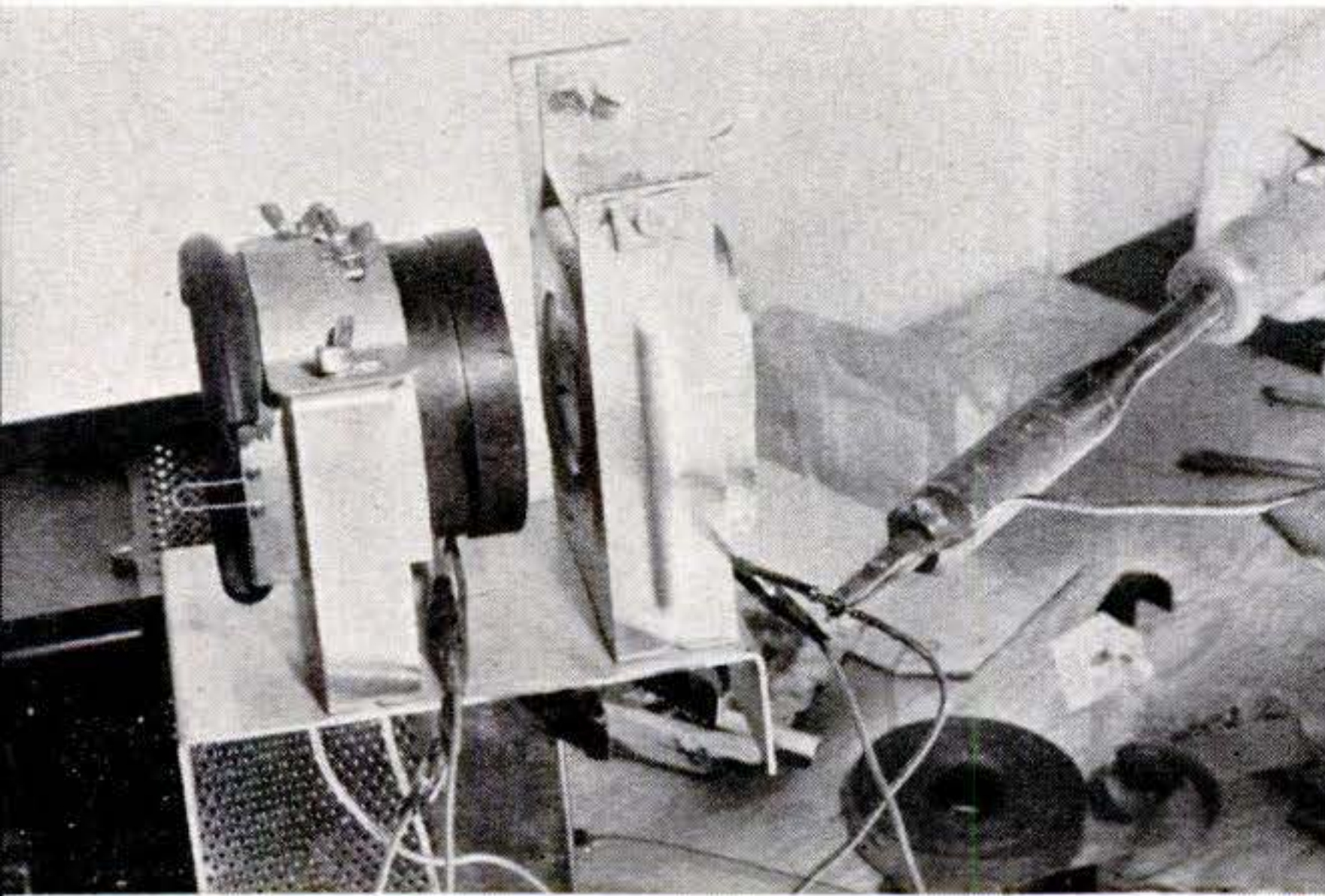

**8** After determining the position of the platform, I removed the rear leg to reach the deflection- and focus-coil wires. These have to be extended to reach the new coil locations.

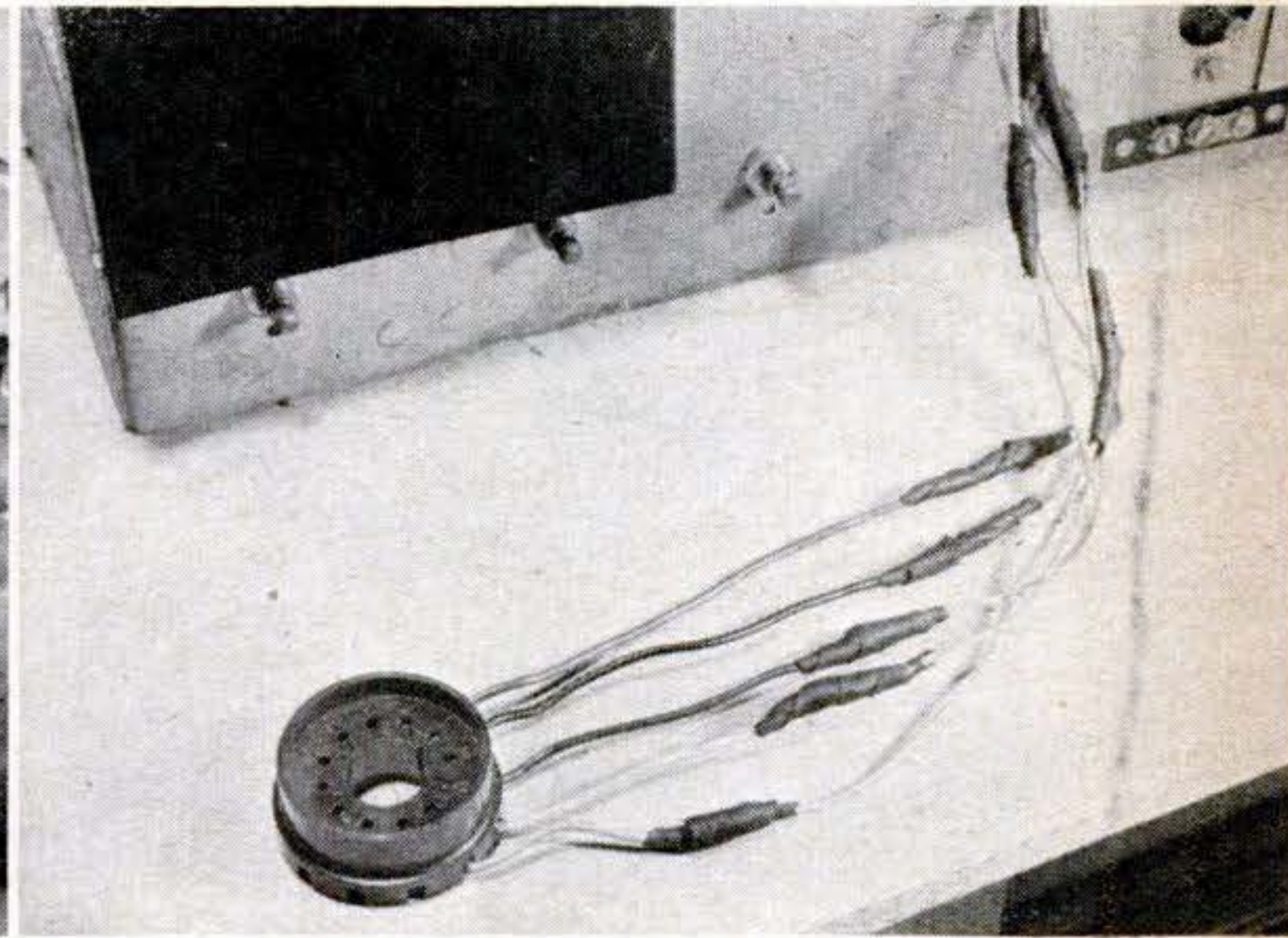

**9** Leads for tube socket also had to be extended. I cut the five wires in staggered steps for increased safety. Even if the tape slips off, the splices aren't likely to short.

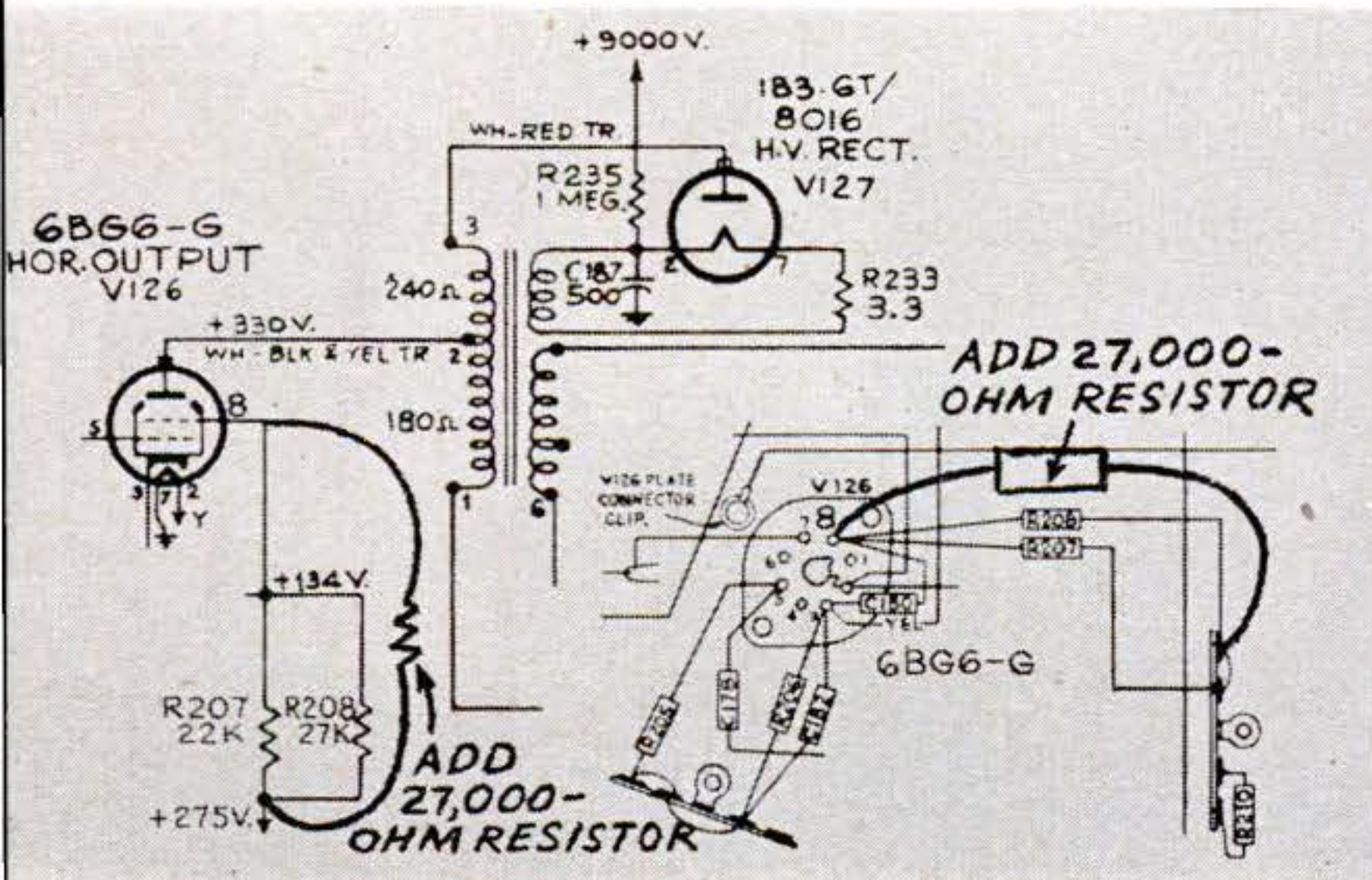

**11** These diagrams of related socket connections are adapted from the RCA service manual. Resistors 207 and 208 are already in parallel. The new unit shunts them both.

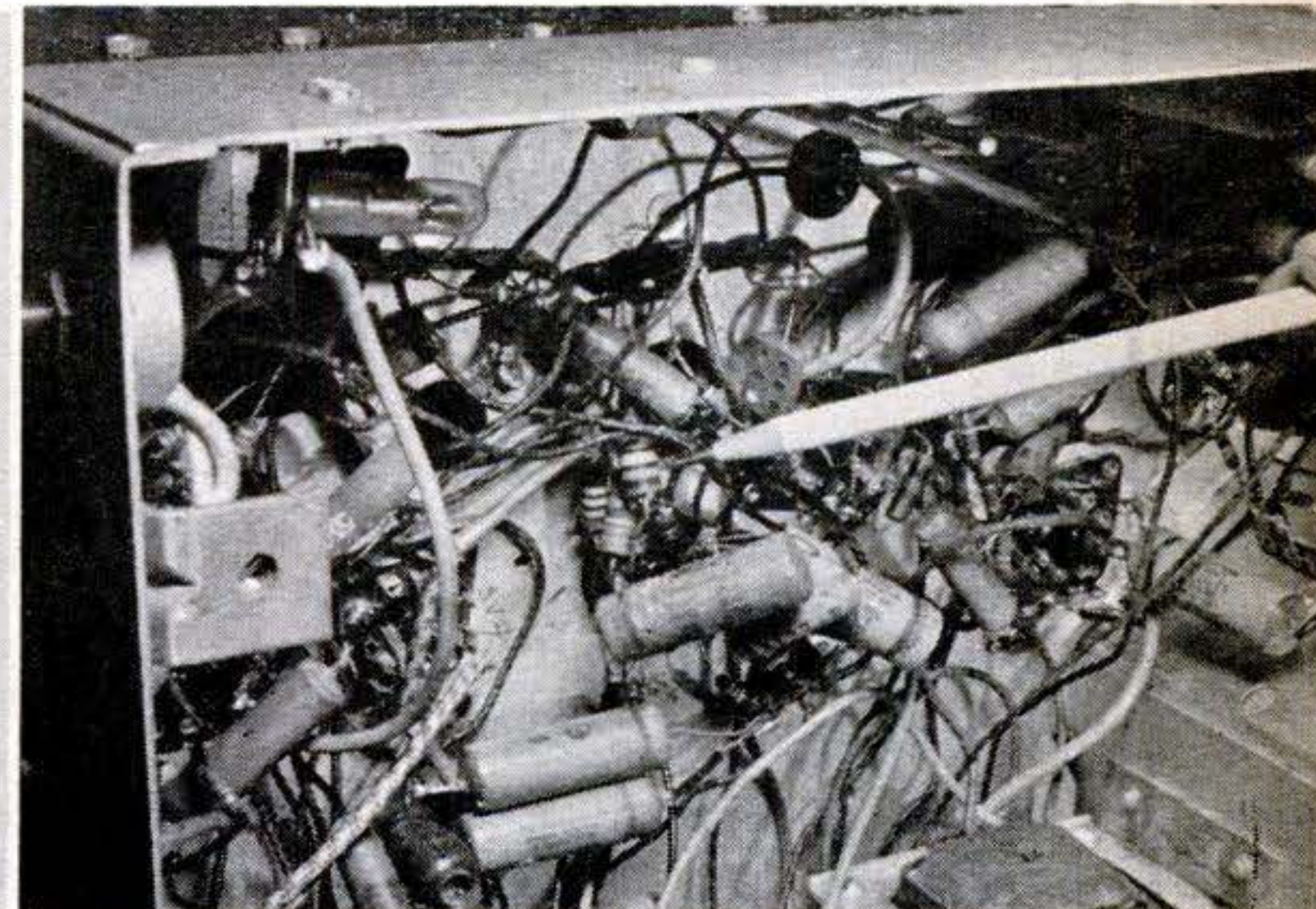

**12** Pencil points to 27,000-ohm, 2-watt resistor added to circuit. Its effect is to decrease screen resistance and increase voltage on primary of high-voltage transformer.





**13** The entire metal shell of the 16AP4 is "hot," so it's wise to cover it with a plastic insulating hood and ring. The brackets I bought had a metal ring support.

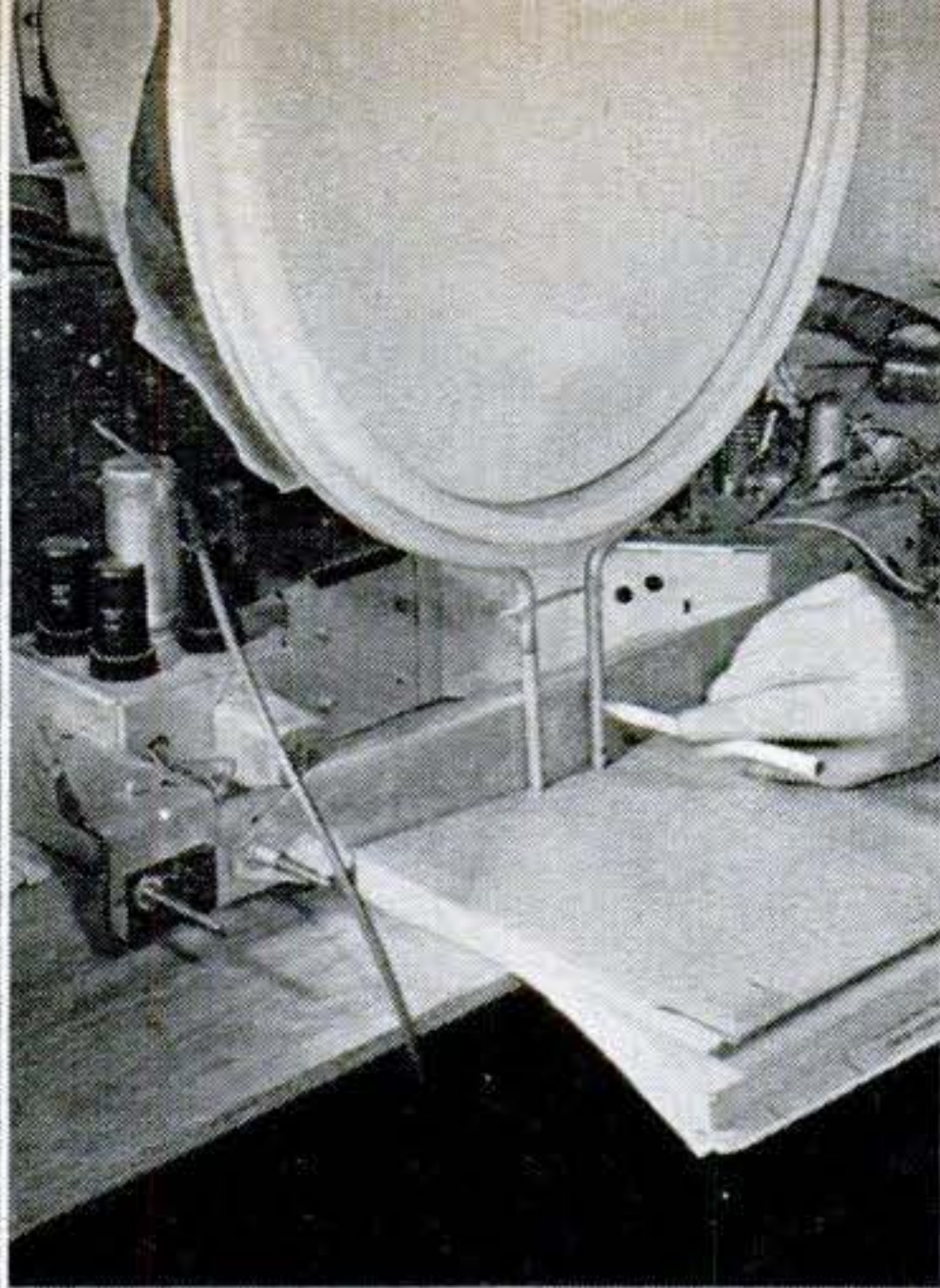

**14** The chassis crossbar that holds the tube mount was drilled for the legs of the supporting ring, but the holes were in the wrong places. I redrilled them to fit.

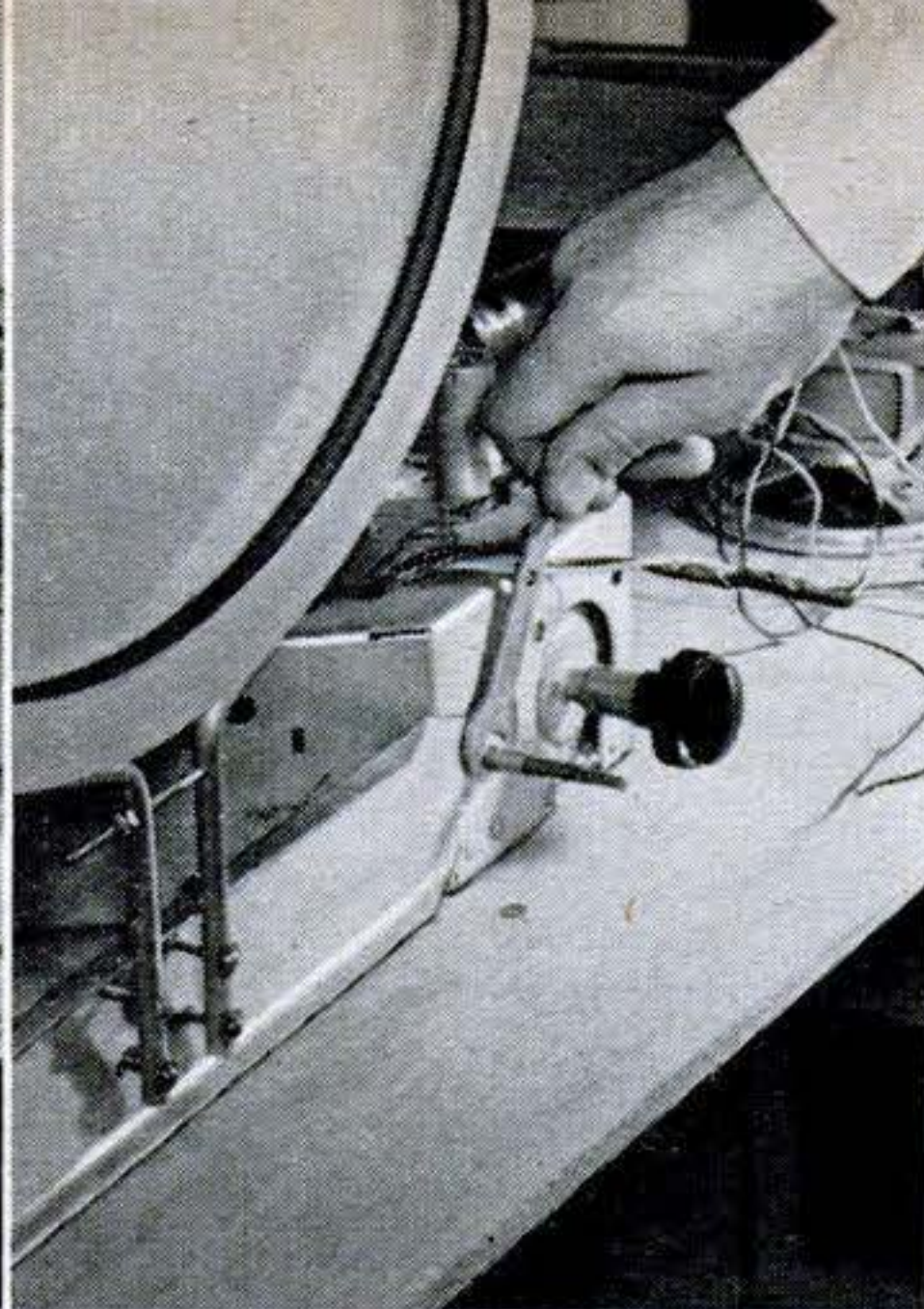

**15** The right way to mount the crossbar is with the flat side to the front. However this made the tube sit too far back, so I reversed the bar. It's held by control nuts.

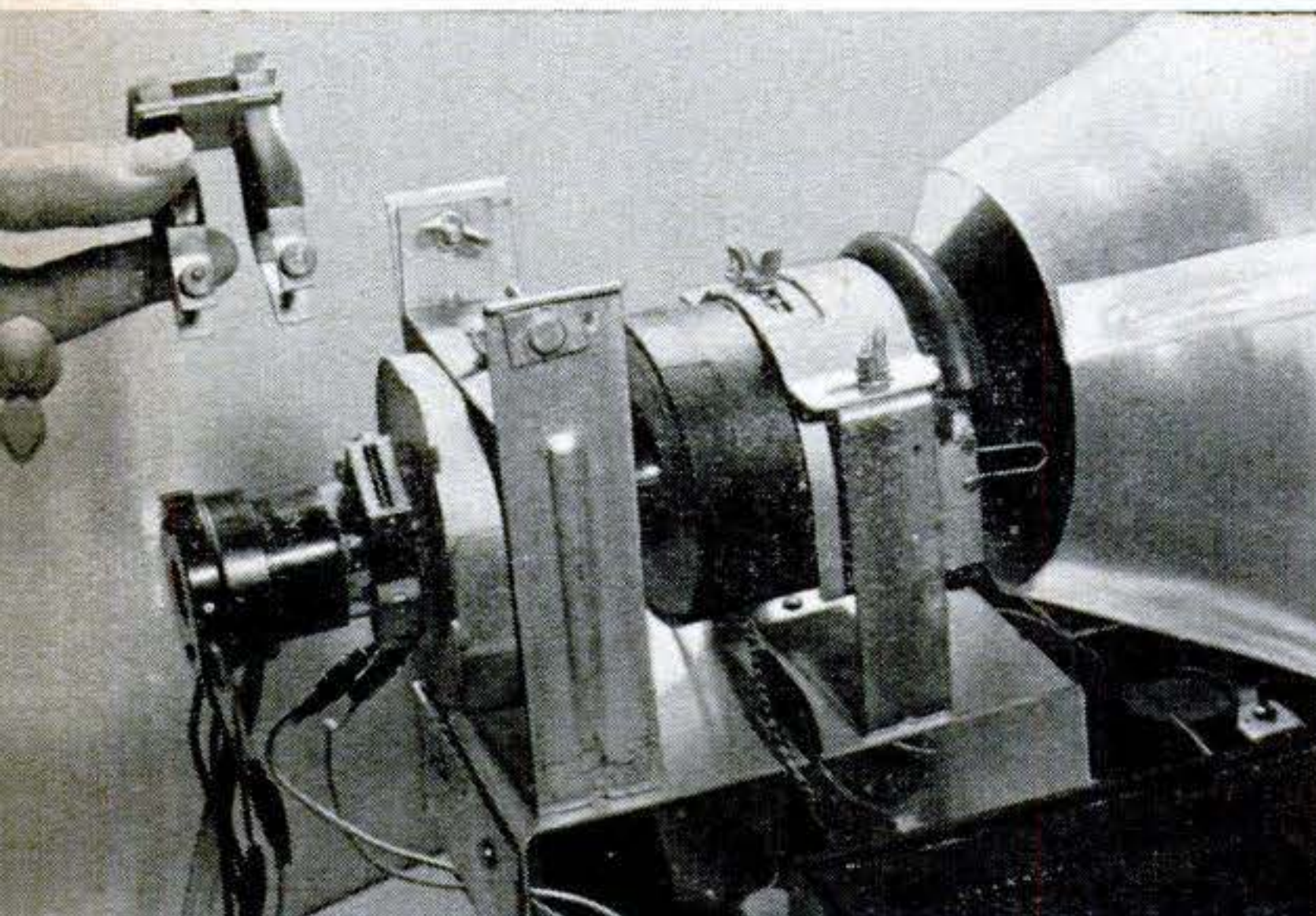

**16** Another change I didn't expect to make concerned the ion trap. The neck of the 16-inch tube is about 1 inch shorter than the old 10 incher, so I substituted a narrower trap.

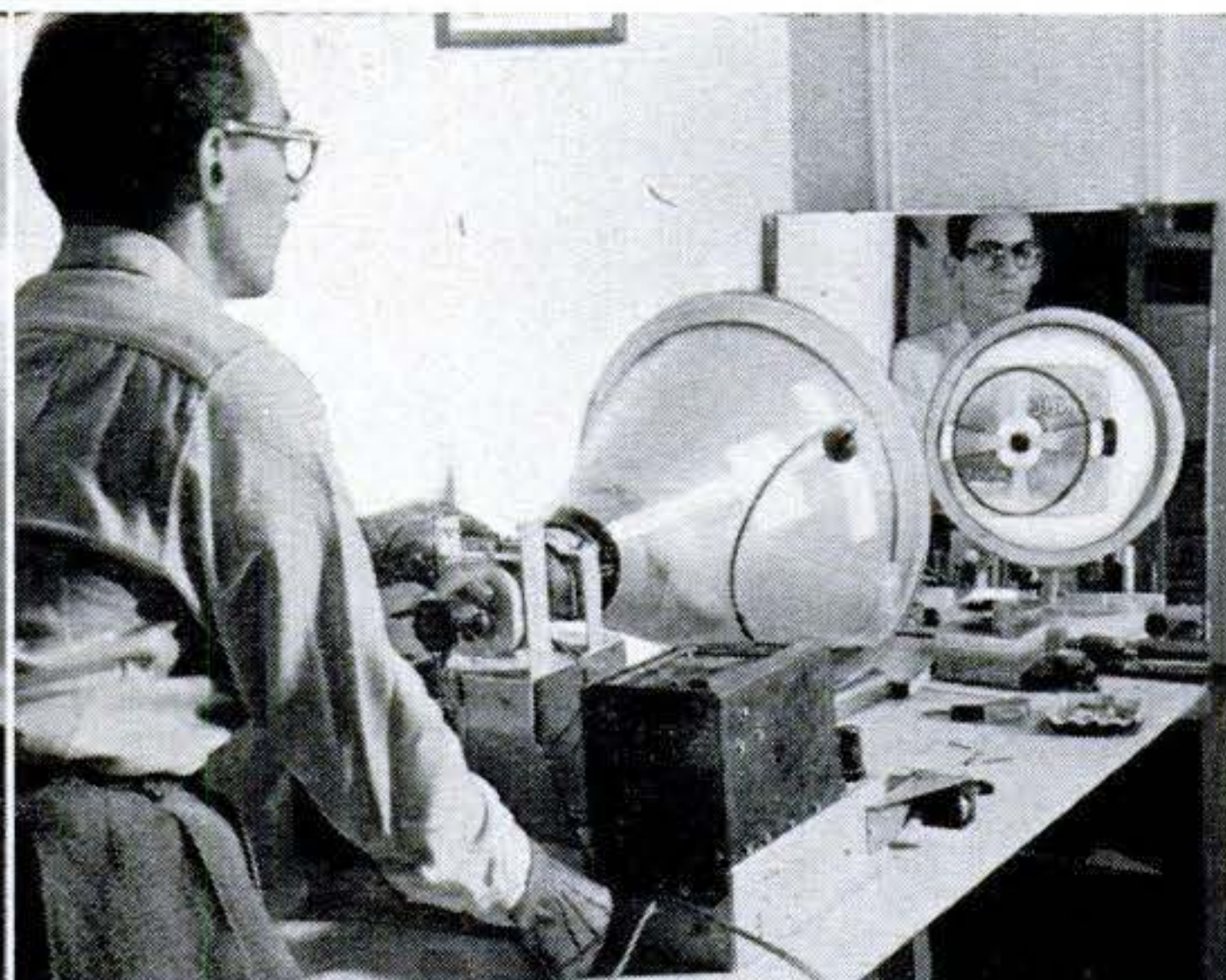

**17** Tuning the set consists of resetting the six rear controls as well as adjusting the ion trap, and focus and deflection coils. I wore gloves while I was working near tube neck.

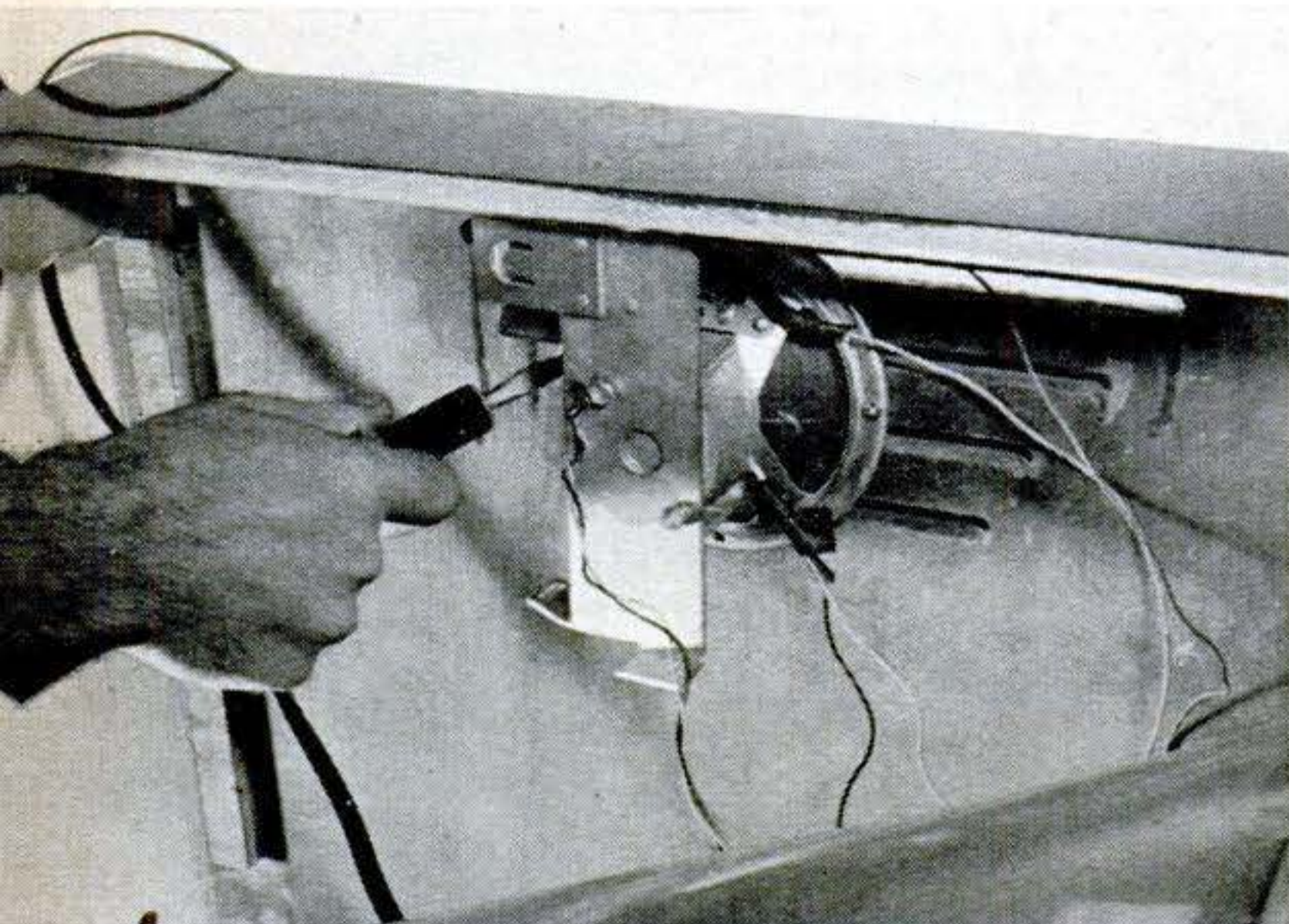

**18** After set was pushed into cabinet I re-mounted the speaker in its new location, frame and all. Leads have to be extended, and it's essential to ground speaker frame to chassis.

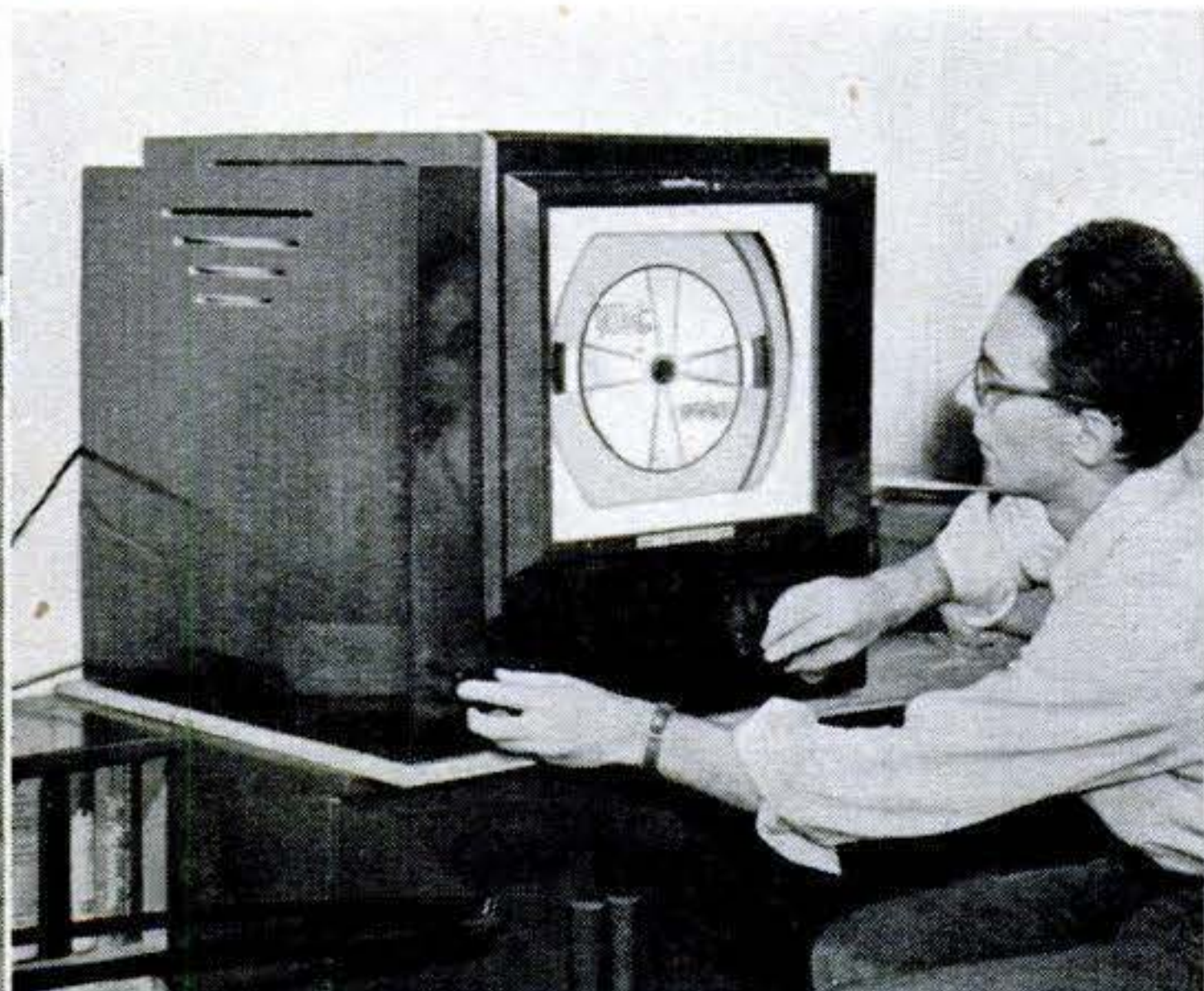

**19** Here's my new TV receiver, up-to-date again. When I got my 10 incher, big tubes were scarce, but they're not any more, and the current trend is in the direction of larger screens.



# Save Money by Making Your Own Television Cabinet

Cabinets add a chunk to TV prices. Here's how you can economize, whether you're buying or converting.



**I**F YOU put a larger tube in your TV receiver, as described in the preceding pages, you can make your own cabinet to the right dimensions for far less than a ready-built one would cost.

And if you're still shopping for a TV set, you can save money by buying a kit or wired chassis and putting it in a home-made cabinet. The dimensions given in the drawing below are for an RCA type 630 chassis, but by changing dimensions the same construction can be used for any set.

**Checking the Dimensions:** Place your set's chassis with mounted picture tube on a flat table. Measure the distance from the table to the highest point on the tube. This plus 2½" is the inside height of the cabinet. For the height of the front panel add 1" for overlapping the base and an extra ¼" for the top rabbet. To get the outside width of the front panel, measure the chassis at its widest point and add 4". Overall length of the chassis, plus 3" or 4" gives the depth.

**Marking the Panel:** On most chassis the picture tube is placed in the center, so the front panel has to be marked off symmetrically. Cut a sheet of cardboard to the height and width of the panel and draw a center line from top to bottom. Hold the cardboard against the front of the set with the line bisecting the tube face and press it against the control shafts to mark their position. Without moving the sheet, mark the points where the top and bottom of the tube face cross the center line. These two points represent the top and bottom of the rectangular picture-frame opening.

**Constructing the Cabinet:** When you have settled on the dimensions, cut out stock to suit. For the base, make a rectangular frame. Use ¾" by 1½" stock for front and sides. For the rear member use a piece ½" thick to allow some ventilation from below. Cover the frame with ¼" plywood.

Mount the ¾" by ¾" uprights on the base with long screws and glue. Do the same with the top crosspieces. Then cover it with gum plywood or other veneered stock, and give it a stained or rubbed-lacquer finish.—  
*Bernard Gladstone, Hempstead, N. Y.*

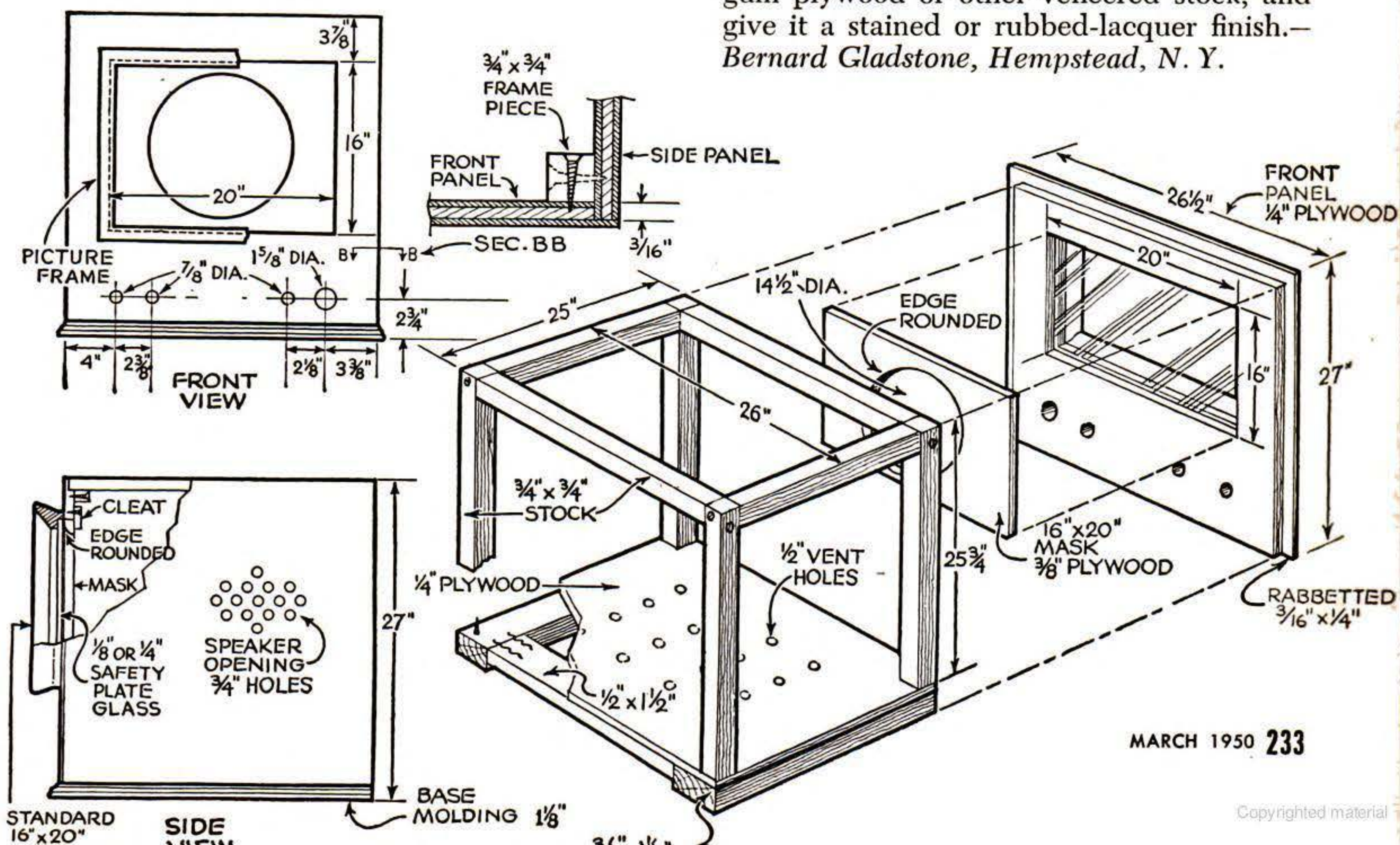



# I'd like to see them make...

Everybody has his own pet idea of some gadget he would like to see in general use. What is YOURS? Popular Science will pay \$5.00 for each one published. Use government postcards only. Contributions cannot be acknowledged or returned.



**Calibrations** etched on the stationary jaws of adjustable-end wrenches. These would enable you to set the wrench accurately for the size of nut or bolt you wanted to turn.—*Richard M. Colbert, Baltimore, Md.*



**A flexible attachment** for tank-type cleaners. This could be similar to the stem of a gooseneck lamp. You could use it to get into spots that are too small for other attachments.—*Esther L. Bigley, Athens, Ohio.*



**Nylon floor mops.** Big advantage of such mops would be their speedy drying after you used them. You wouldn't have to park a wet mop in a storage closet. They'd also wear longer.—*Mrs. John La Van, Bethlehem, Pa.*



**Removable plastic liners** for kitchen garbage pails. These would be easy to take out of the pail for cleaning, and they would prevent rust from forming in the bottom of the pail.—*James Wilson, Manhattan, N. Y.*

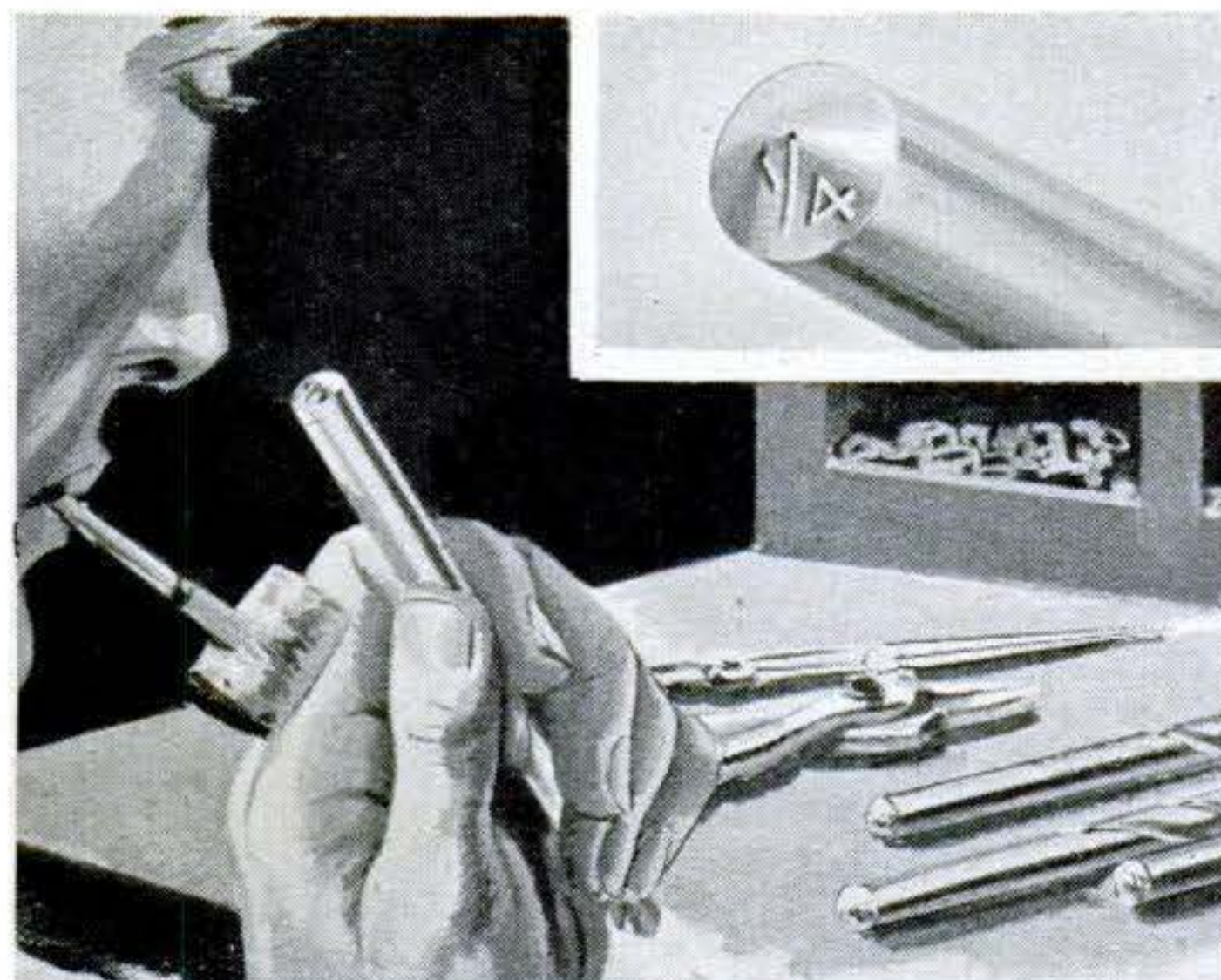

**Twist drills** with the sizes stamped on the ends instead of on the shanks. Lots of times a drill will slip in the chuck. After a few slips, the number is usually worn off.—*H. G. Radcliffe, Petersburg, Va.*





## Kodak Pony for Color

EQUIPPED with an f/4.5 lens and built-in flash synchronizer, the \$30 Kodak Pony 828 Camera® has been developed especially for amateur color photography. Shutter speeds range from 1/25 to 1/200 second, plus bulb; the lens focuses from 2½ feet to infinity. For simplicity, standard shutter-speed and opening settings for bright sunlight with Plus-X® film are marked in red.



## Plastic Pulls Are Luminous

SCRAP pieces of clear plastic, drilled and filled inside with a little luminous paint, make excellent pulls for overhead light cords. Almost any kind of scrap will do; flat stock can be hollowed out by internal carving, and bar stock can be turned, drilled, and polished at one chucking in the lathe or drill press. Design possibilities are endless, ranging from simple freehand turnings to elaborate miniature lamps. With flat stock, other possible designs include geometrical shapes, hearts, diamonds, small figures, and tiny models as in costume-jewelry miniatures.

## The Height of Ingenuity



• Junior was getting into places where he had no business—especially the drawers in my shop. I rigged up a gadget that not only startled him but also let me know when he opened a drawer. What was my alarm?

*I hooked up a mouse trap and an old alarm clock. I just wound the alarm spring; not the main spring. Then I tied a string from the alarm control to the trap. As long as the drawer was closed, the trap couldn't snap. When the drawer was pulled out, the trap cleared the top of the bench, snapped, and set off the alarm.—Richard Reichelt, Chicago.*

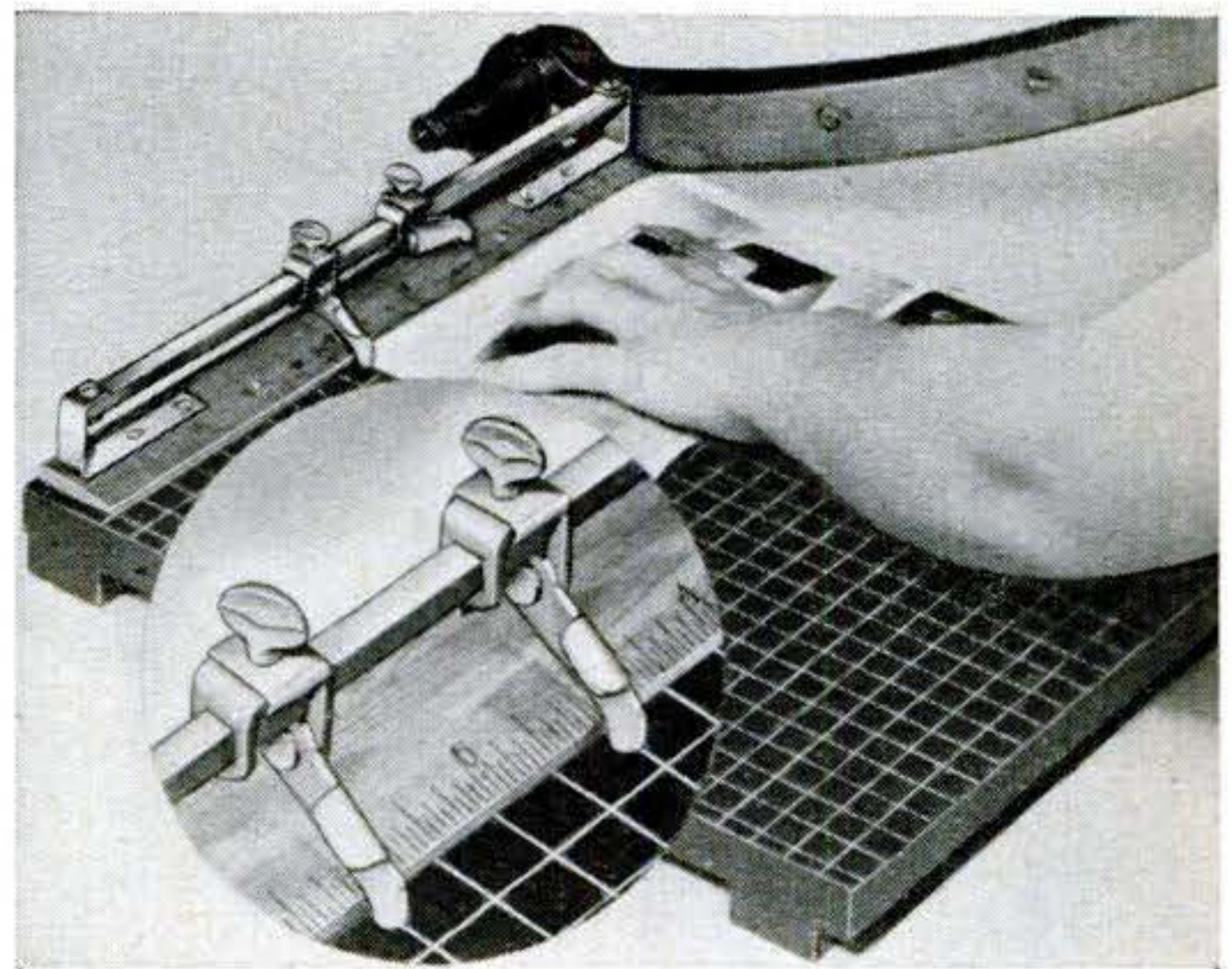

## Stop Aids Cutting in Dark

WHEN you trim a batch of photos or cut film to a smaller size, the new Trim-True® shown here will give you uniform sizes. Properly set, the two stops serve as your eyes while you are cutting film in total darkness. One gives the right width, the other the correct length to fit the holder. Trim-True is a product of the Webster Instrument Company, Los Angeles, Calif.



# Chemical Enlarger Stretches

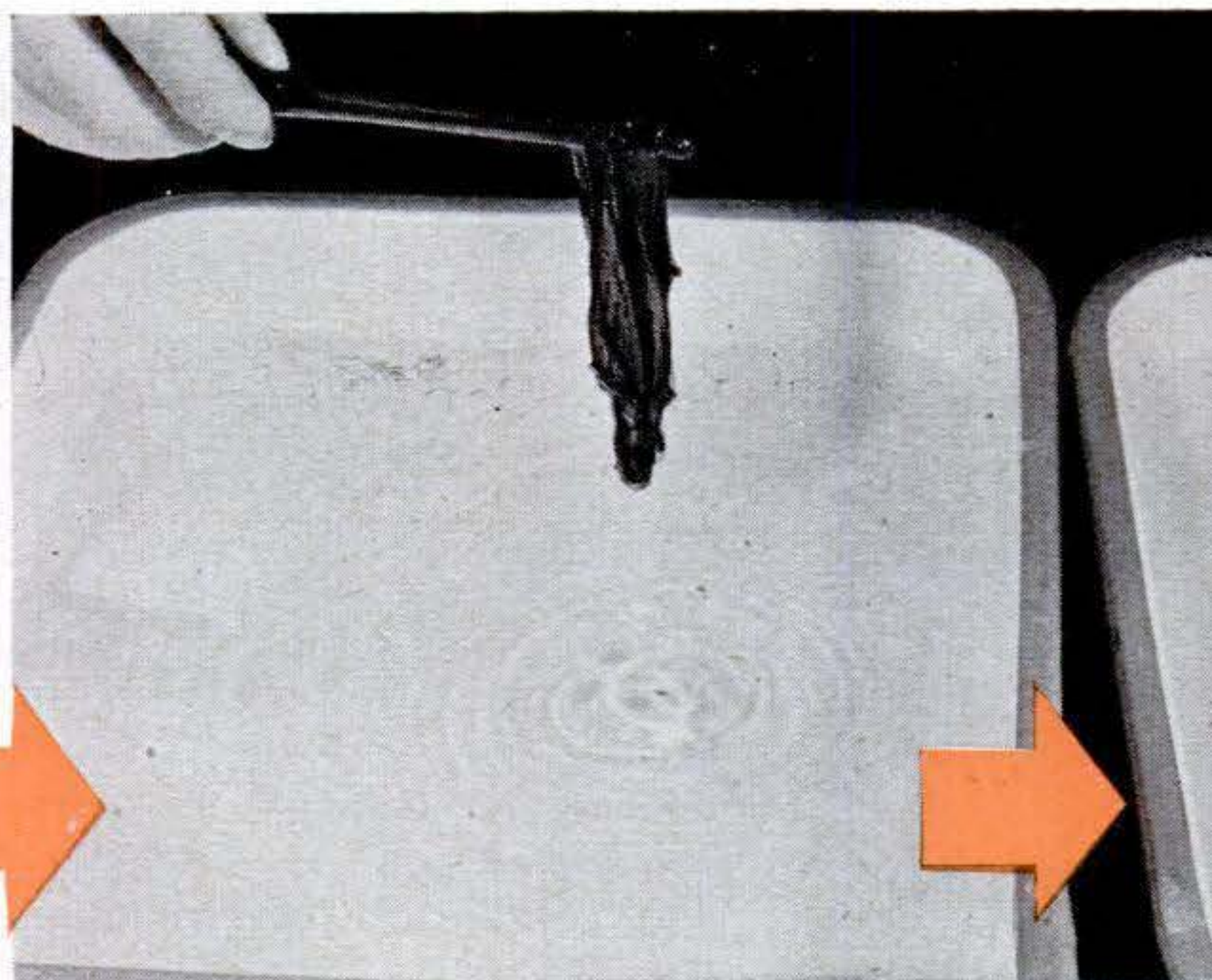
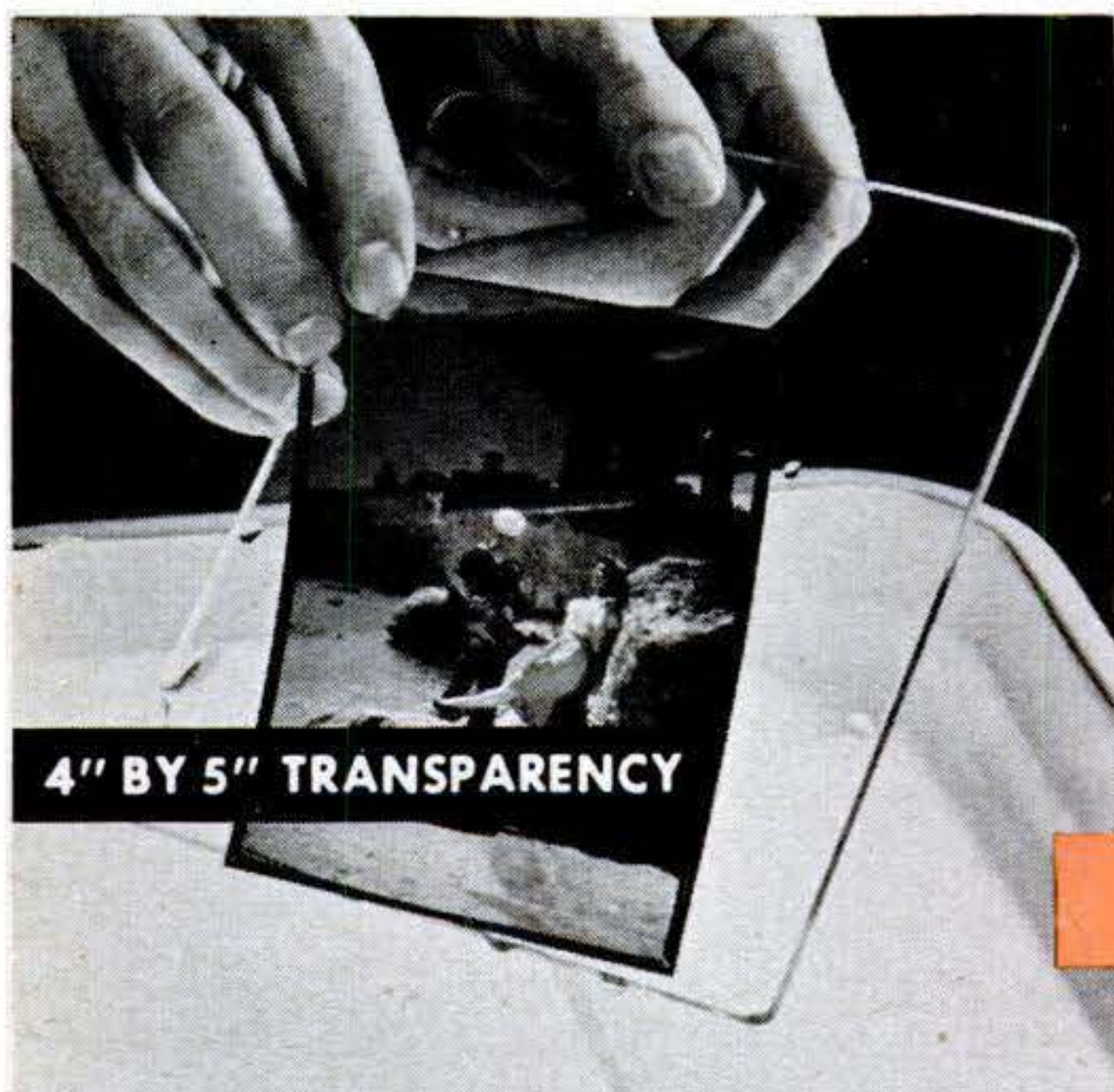

**New process enables you to turn a transparency into a big print in its natural colors—without an enlarger and in broad daylight.**

## **PS photos by Hubert Lockett**

ONE day this winter a professional photographer stopped before a counter in a New York store where a demonstrator was explaining a new process for making color photos. A moment later, he interrupted.

“But how can you stretch a transparency?” he asked. “I’ll have to see *that!*”

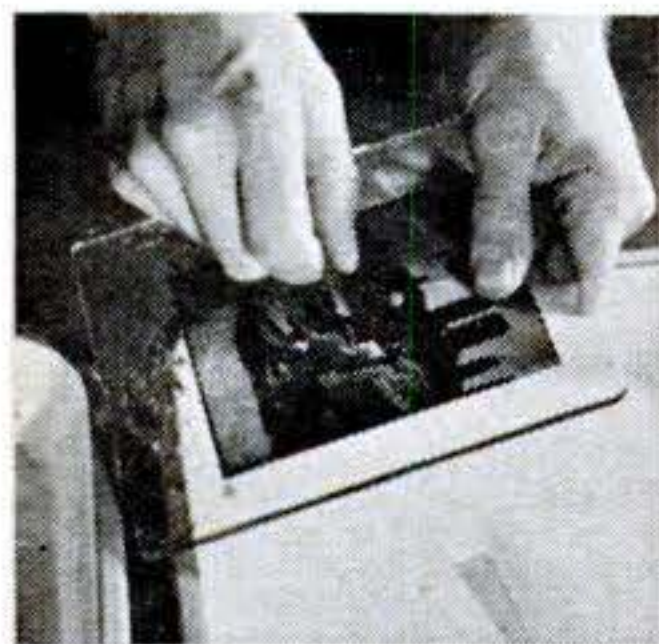

“It’s just the emulsion that stretches,” the demonstrator replied, “not the whole transparency. First you scrape off the gelatin backing as I’m doing and dissolve the film base. Then when you drop the emulsion into a chemical bath, it stretches—or, more correctly, it expands by itself.”

“And it looks just like a limp rag,” a spectator commented.

“But doesn’t expansion weaken the colors?” the photographer asked.

For answer, the demonstrator indicated a color print and a backlighted transparency.

“At the start,” he said, “these were identical transparencies.”

The photographer picked up the print—made by applying the expanded transparency emulsion to a white paper backing—and examined it closely. Then he compared it with the illuminated transparency.

“I wouldn’t have believed it!” he said.

DEVELOPED by the Larjachrome Corp., of New York, this new process produces prints with colors as natural as those of the transparency itself. The amount of expansion varies, but you usually get a print about twice the size of the original transparency. And the cost per print is far less than for other procedures.

Making a print takes about half an hour. In addition to a kit of materials supplied by Larjachrome, you need only ordinary photo equipment. Here are the steps:

**1** Soak transparency and a sheet of temporary support paper in water at 70° F. for five minutes. Use paper about 1" larger than transparency. It comes with kit.

**2** Place wet transparency on a sheet of glass with its emulsion side down.

**3** Scrape off the gelatin backing with a razor blade. Scrape well into the film base. For 35-mm. and 828 slides, omit this step. They have no gelatin backing.



# Kodachromes

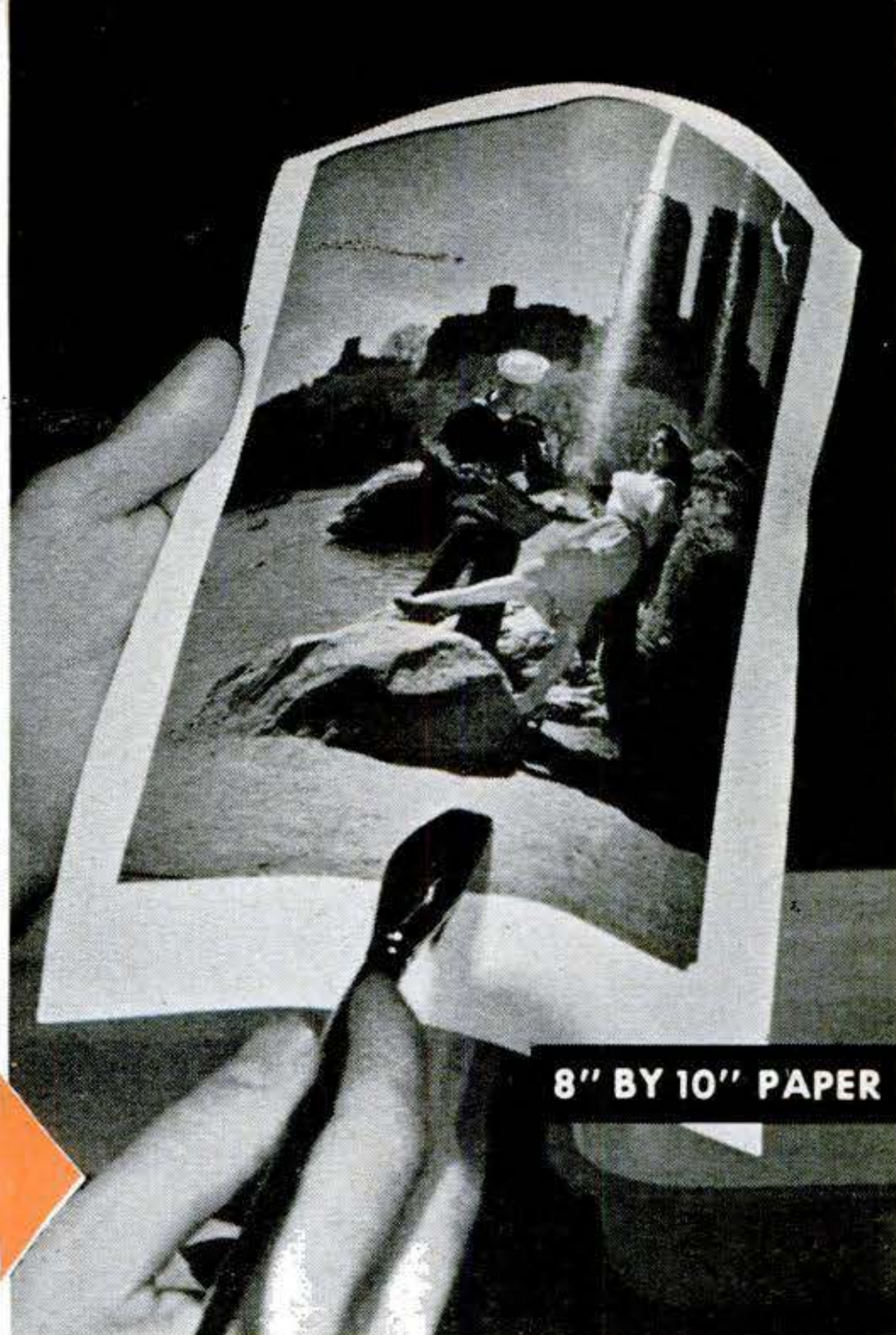
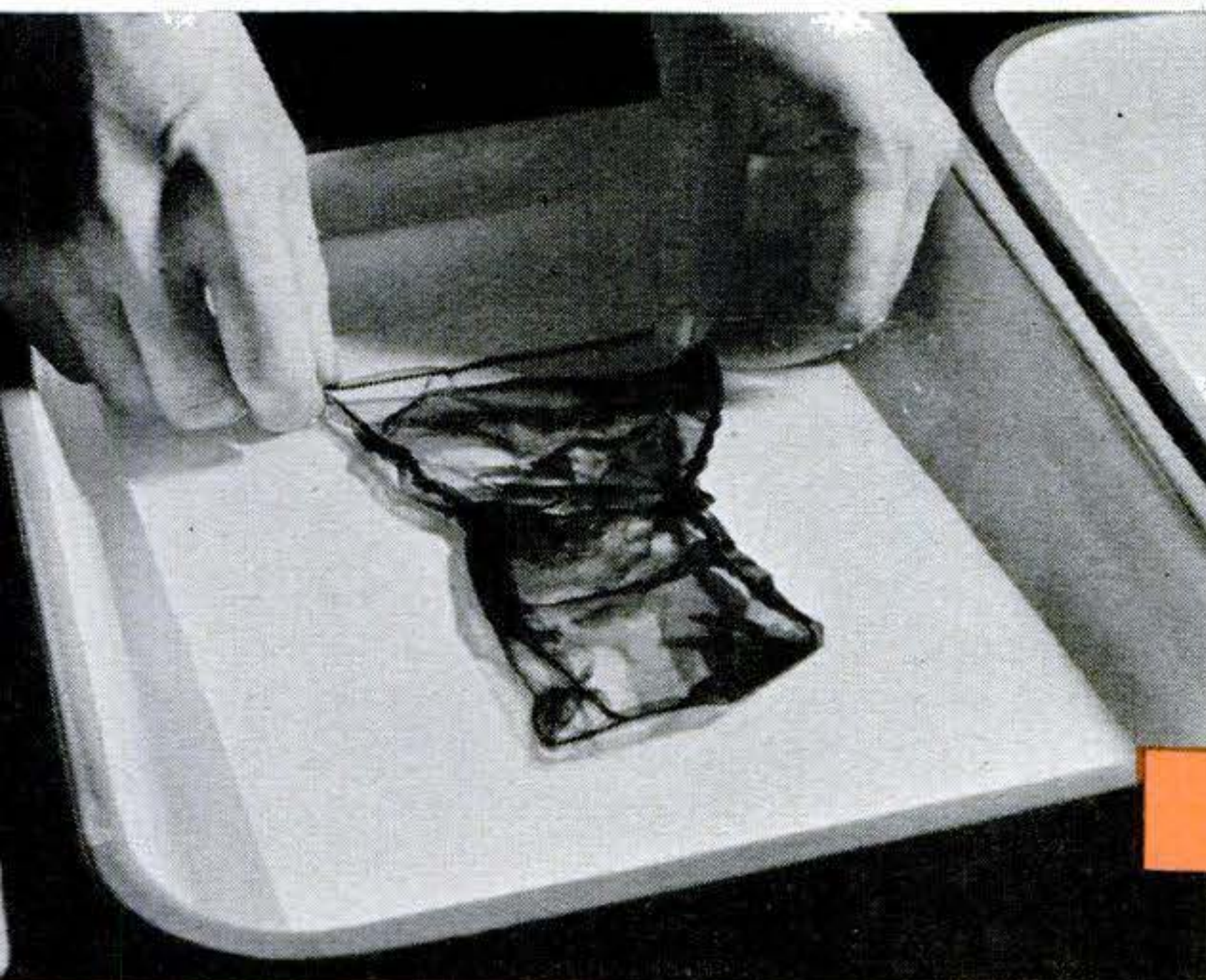

**4** Squeegee transparency and temporary support paper together face to face. Then squeegee the assembly on a ferrotype tin with paper on top. Let it dry.

**5** Roll up the paper and film, immerse it in beaker or jar containing film-base solvent that comes with kit. Cover tightly and let stand until the film base loosens.

**6** Base now peels off, leaving only the emulsion on support paper. Then soak some tissue with fresh solvent and clean the emulsion well. Trim border from film.

**7** Pour expansion solution at 150° F. into a tray containing the transparency. This solution is prepared from a powdered chemical that comes with Larjachrome kit.

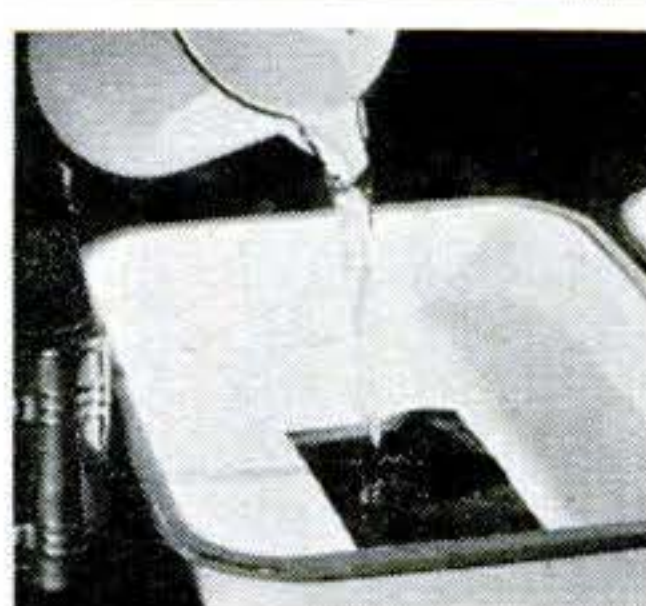
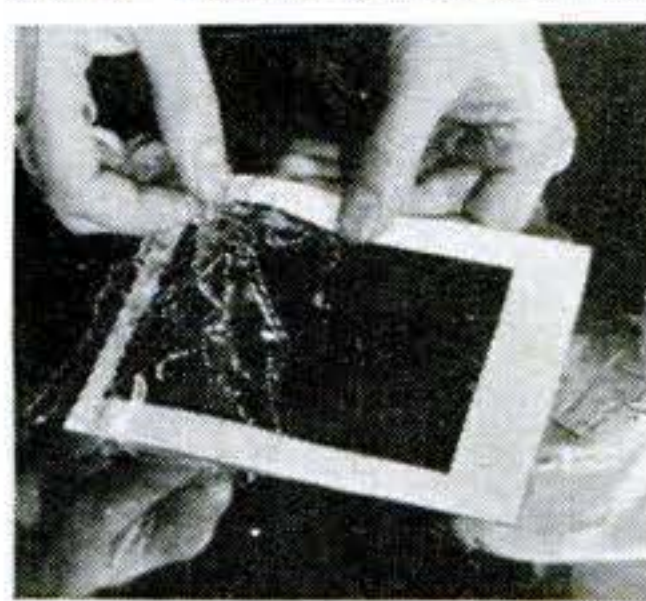
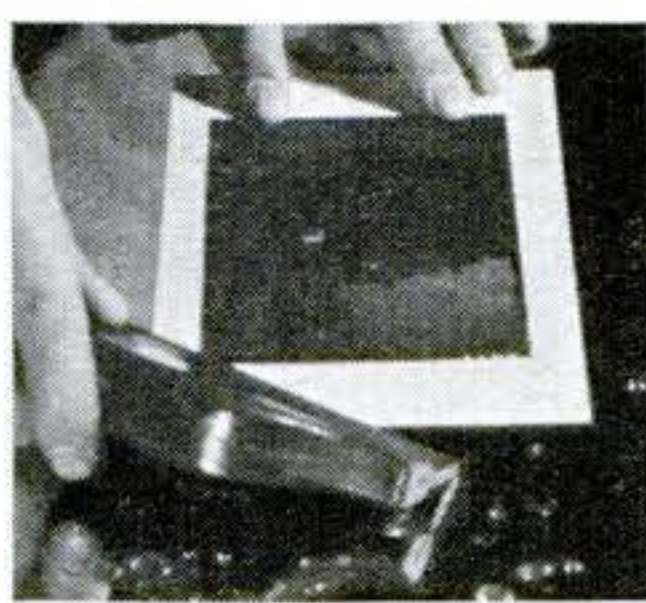

**8** After a minute or two the emulsion will loosen from the temporary support paper and begin to expand, assuming a wrinkled form. Let it expand fully.

**9** Lift it carefully out of the water and carry to a water-filled tray in which you have placed a large sheet of final support paper, previously soaked in Larjachrome paper conditioner for about five minutes.

**10** Float the emulsion on the water above the support paper and carefully unroll it, making sure the image is centered.

**11** Grasping the paper at opposite edges, lift it and the unrolled transparency from the water. Bending the paper backwards will make this step easier.

**12** Smooth out the image on the paper with a wet brush, dry it, and your print is finished. In making a print this way, you lose the transparency, but this can be overcome by making a color duplicate first. At the present time, the Larjachrome process is recommended for use only with Kodachrome transparencies.



END





**Remove black spots** by applying reducer sparingly with a brush. Take up any excess with a blotter before applying more. In portraits, you can lighten skin blemishes the same way.

## How to Doctor Your Photos

**F**ARMER'S reducer sounds like something for fat men, but experienced photographers know it is an essential darkroom aid. Named for Howard Farmer, who discovered its photographic value in 1884, the solution is most commonly used in saving over-exposed and fogged negatives. But you can also put it to work on prints. A few of the ways are shown here.

You can buy the reducer or make it yourself. Prepare it as two stock solutions—the first,  $\frac{1}{2}$  oz. potassium ferricyanide in 8 oz. water; and the second, 8 oz. ordinary hypo in 32 oz. water. To use, add one part of the first to four of the second. Dilute this mixture further with from 8 to 32 parts of water, depending on the use.—*Kenneth M. Swezey, Brooklyn, N. Y.*



**Pick a portrait** from a group picture by outlining the desired figure with reducer. Apply solution to broad areas of photo with a cotton swab. Use a fine-pointed brush near the



outlines. This will give you a white background, as seen at the right. After using reducer, always fix print again in regular hypo and wash it thoroughly to prevent stains. For



jobs like the one above, use the reducer strong. In all reducing, mix only enough of the two stock solutions to keep you going five minutes. The mixture decomposes rapidly.

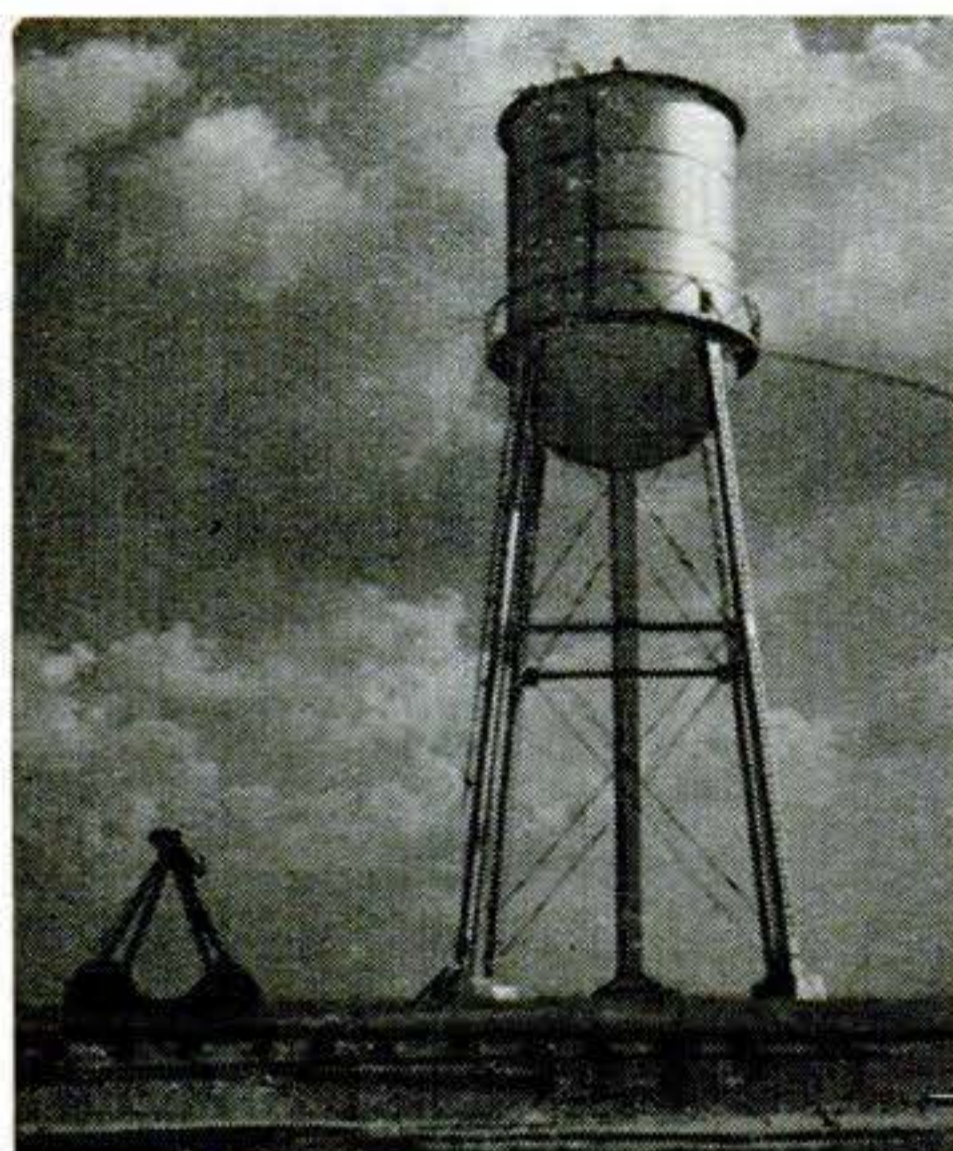

**Pep up clouds** in prints like one at left by swabbing on a weak reducing solution. This will lighten them, as at right. You can also use this trick to add highlights and lighten any dark areas. Always stop a little before you have reached desired reduction, for it may continue slightly after you have removed the solution. Prints that have been over-exposed in the enlarger can be saved by placing in tray of weak reducer. Agitate the tray until entire print reduces to satisfactory point.





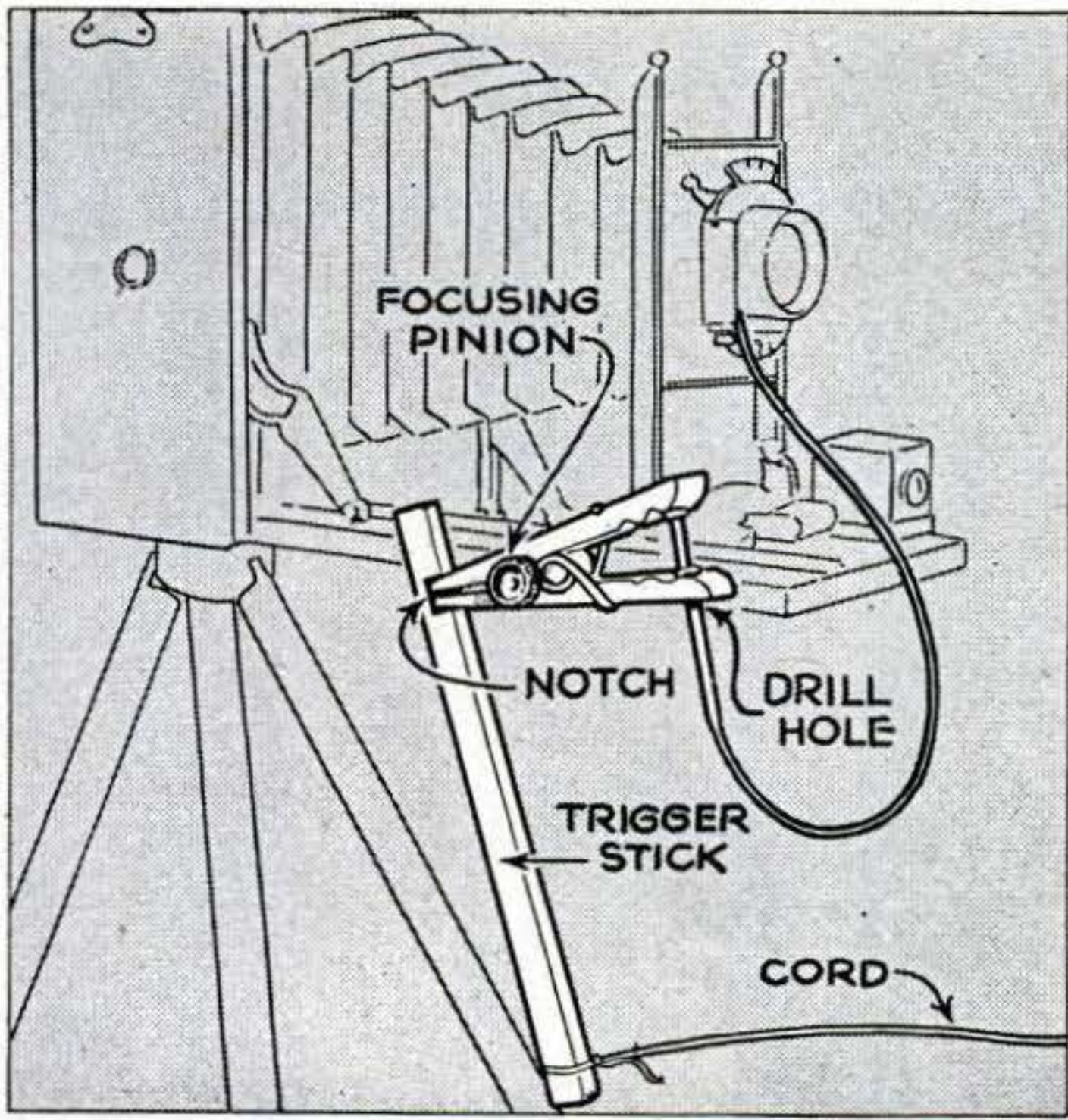

### Clothespin Snaps Your Photo

HERE'S an easy and inexpensive way to get into your own pictures by remote control. When you pull the cord, the trigger stick falls off the clothespin. The pin snaps together, pressing the cable release. The clothespin is slipped over the focusing pinion.—*Hallie H. Holt, Springfield, Ill.*

### Cement Stops Roof-Nail Leaks

EVEN though nails in roll roofing may appear firm, they sometimes permit water to seep through. The remedy is to withdraw the nail, force roof cement into the hole, and renail.—*Dexter Allis, Billerica, Mass.*

### Lazy Man's Chair Flops Over

AN ENERGETIC half hour and a 12-foot board 14 inches wide will yield this lazy man's chair. Set one way (right), it's fine for reading; turned over (below), it's splendid for taking a nap.—*Grover Brinkman, Okawville, Ill.*

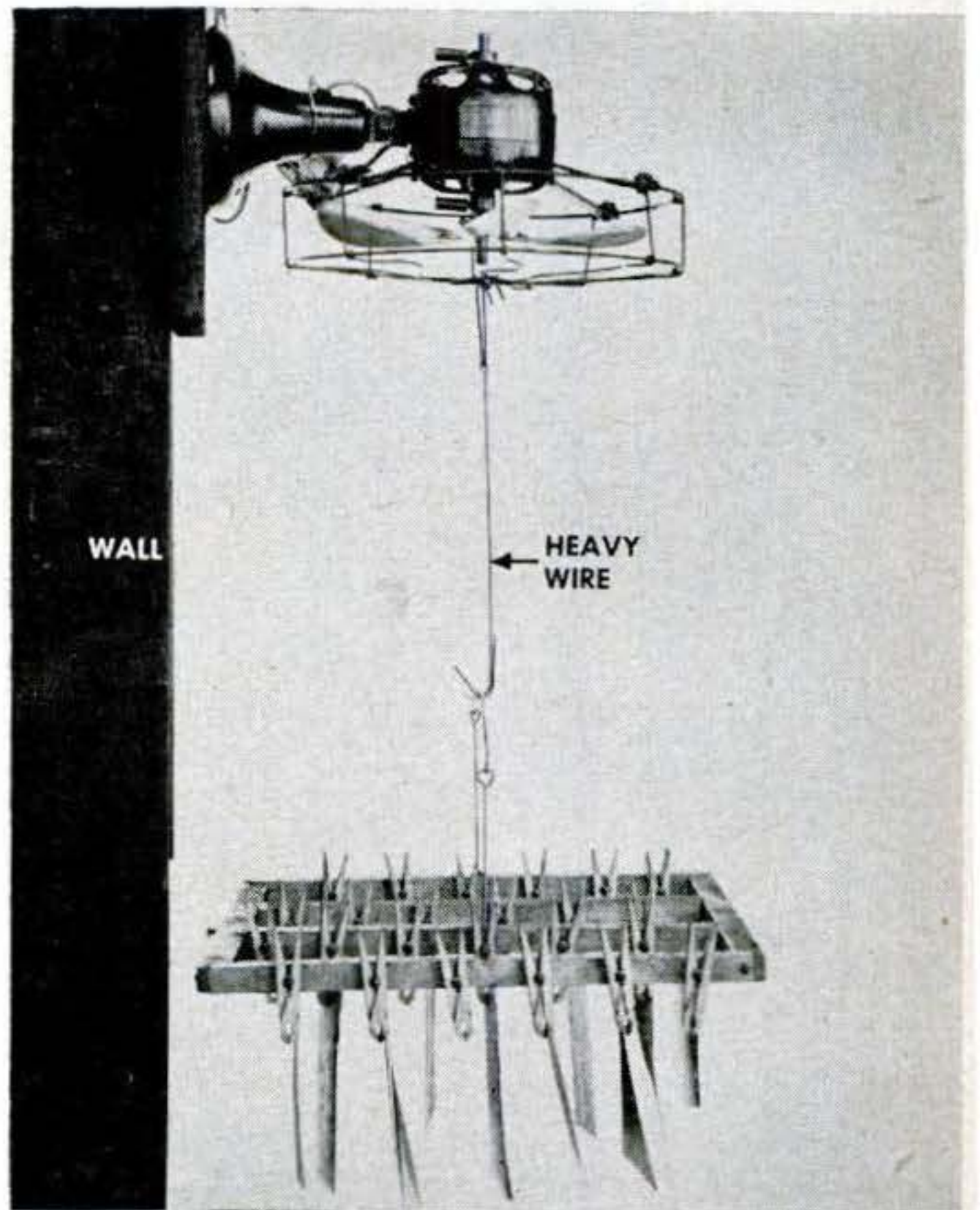

### Drying Fan Blows Downward

BESIDES conserving space in a compact darkroom, I find that this film-drying setup offers two other advantages. Even with a rather strong air stream, the negatives don't whip about and stick together. Less dust is carried to them than with the customary horizontal setup. The rack was made from thin strips of wood and spring-type clothespins. Four 15-inch strips provide space for 24 negatives.—*F. T. Sokolik, Chicago.*

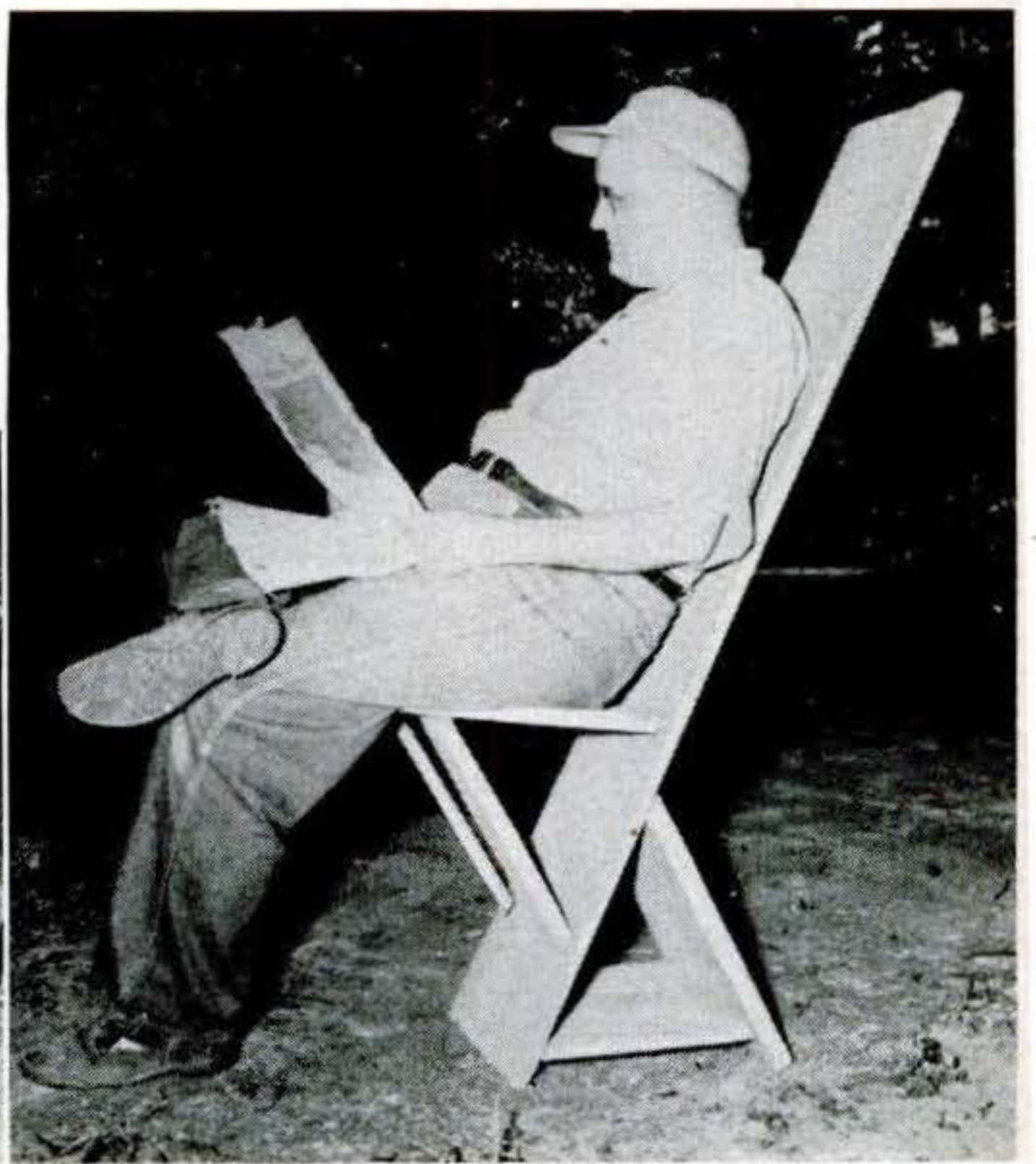



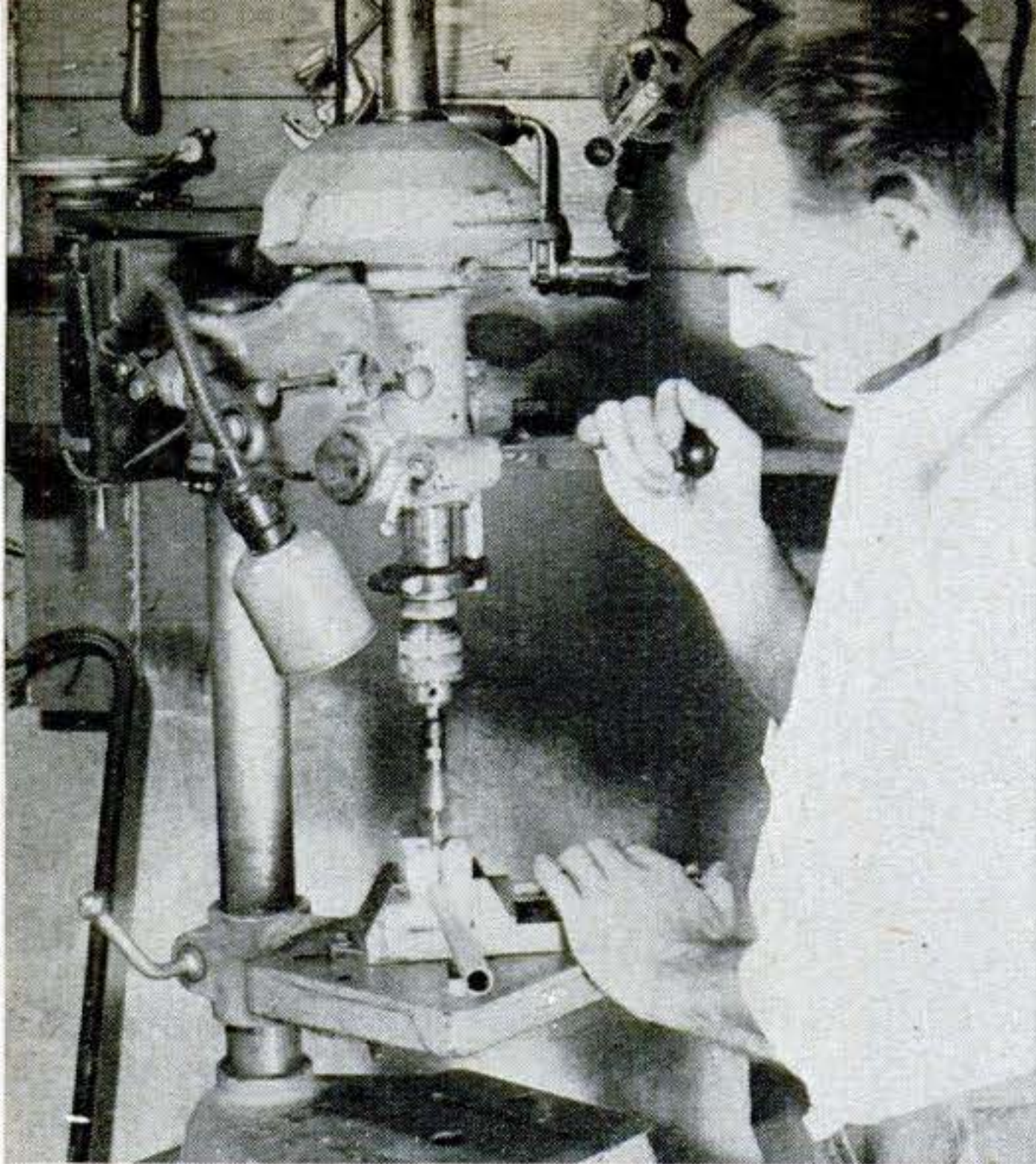

# You Can Do It With Conduit

Rigidly assembled, thin-wall tubing yields many useful items at little cost

**T**HIN-WALL conduit, a pipelike housing for electrical wires, can be put to many unexpected uses. By learning how to fit and fasten joints, you can turn it into handy items for the home, equipment for the shop, and sturdy toys for the children.

Made of galvanized steel, this conduit is light but strong. It resists rust—and can be painted or left unfinished. It can be bent quite easily. In  $\frac{1}{2}$ " size, it costs about 70 cents per 10-foot length; in  $\frac{3}{4}$ ", about a dollar for the same amount.

To fit the joints, chuck a hole saw in a drill press and clamp the conduit in a jig, made as shown from a  $2\frac{1}{2}$ " by  $2\frac{1}{2}$ " by  $2\frac{1}{2}$ " block. A leather hinge screwed to the bottom of the jig permits opening to insert the conduit. Clamp this jig in the drill-press vise.

Centerpunch the conduit to help start the pilot drill. Extend the drill  $\frac{7}{8}$ " to 1" below the saw so it will penetrate the opposite side of the conduit before the saw begins to cut. Run the saw at slow speed.

For assembling  $\frac{1}{2}$ " conduit, cut through butting pieces with a  $\frac{3}{4}$ " hole saw. This gives a clean semicircular cut that fits snugly at right angles to another piece of  $\frac{1}{2}$ "

A hole saw chucked in a drill press cuts the joints to an exact fit. To clamp the conduit, you can make a jig as shown in drawing below.

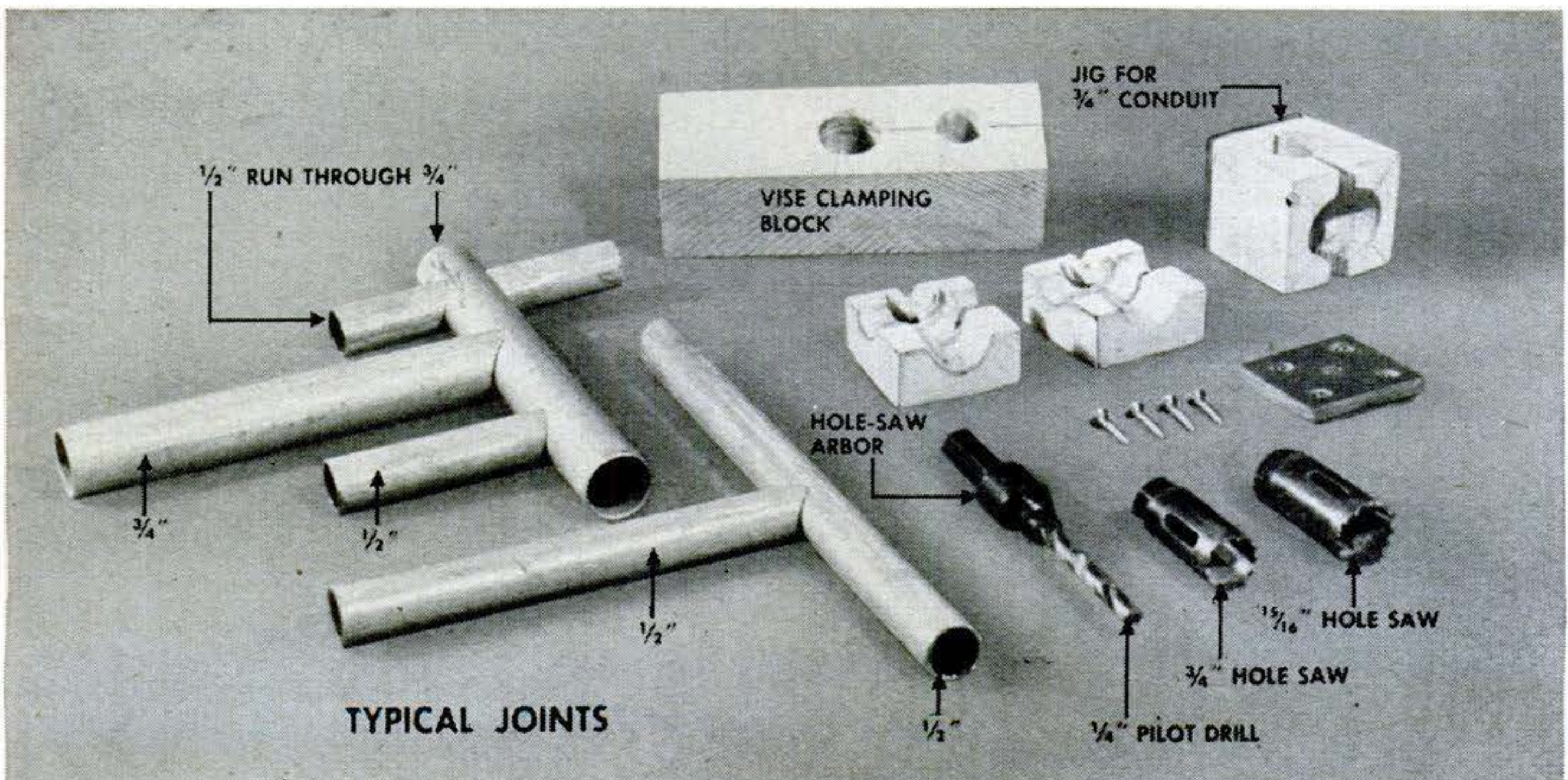
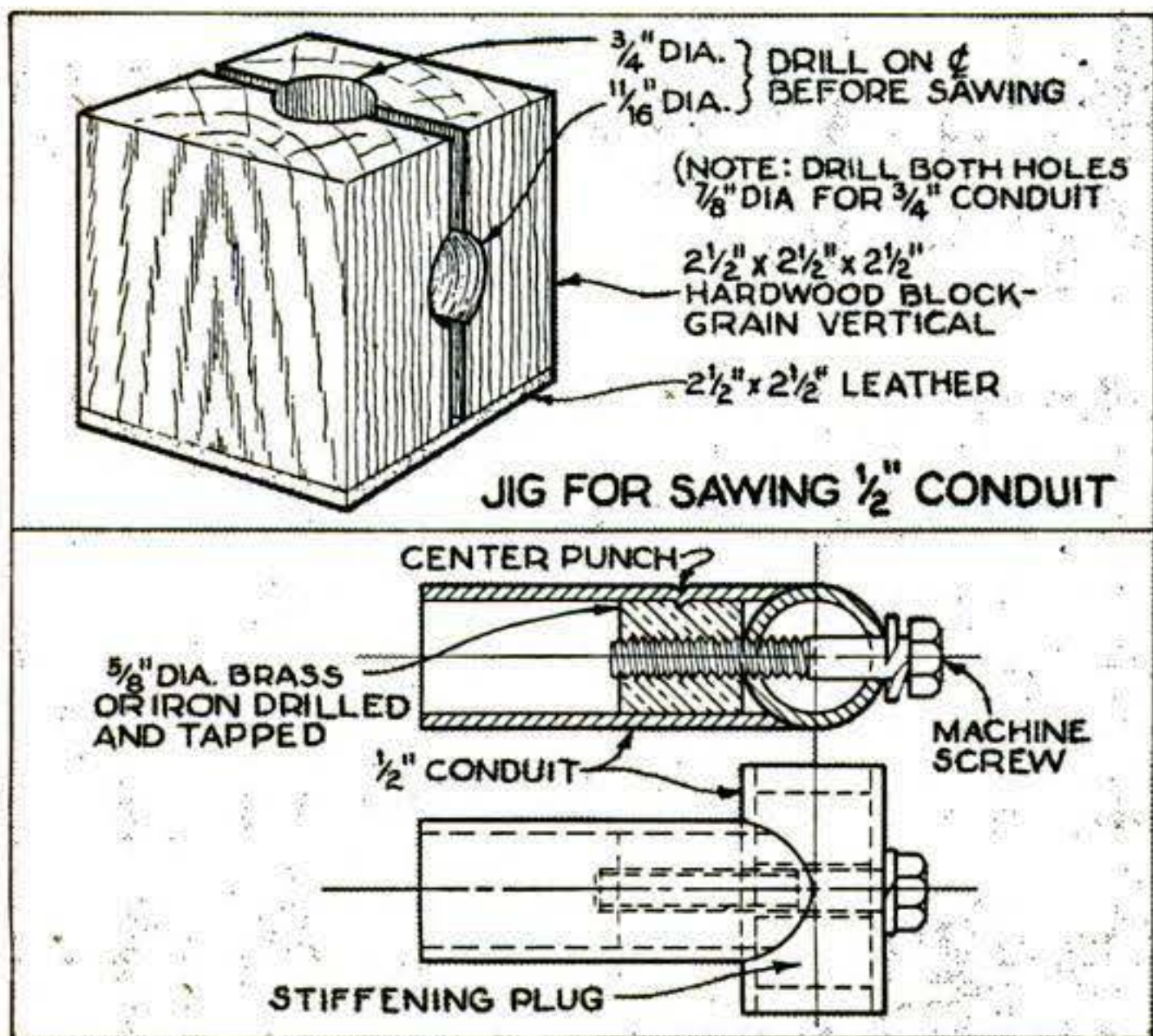

The clamping block in background is handy for hacksawing the conduit to desired length.



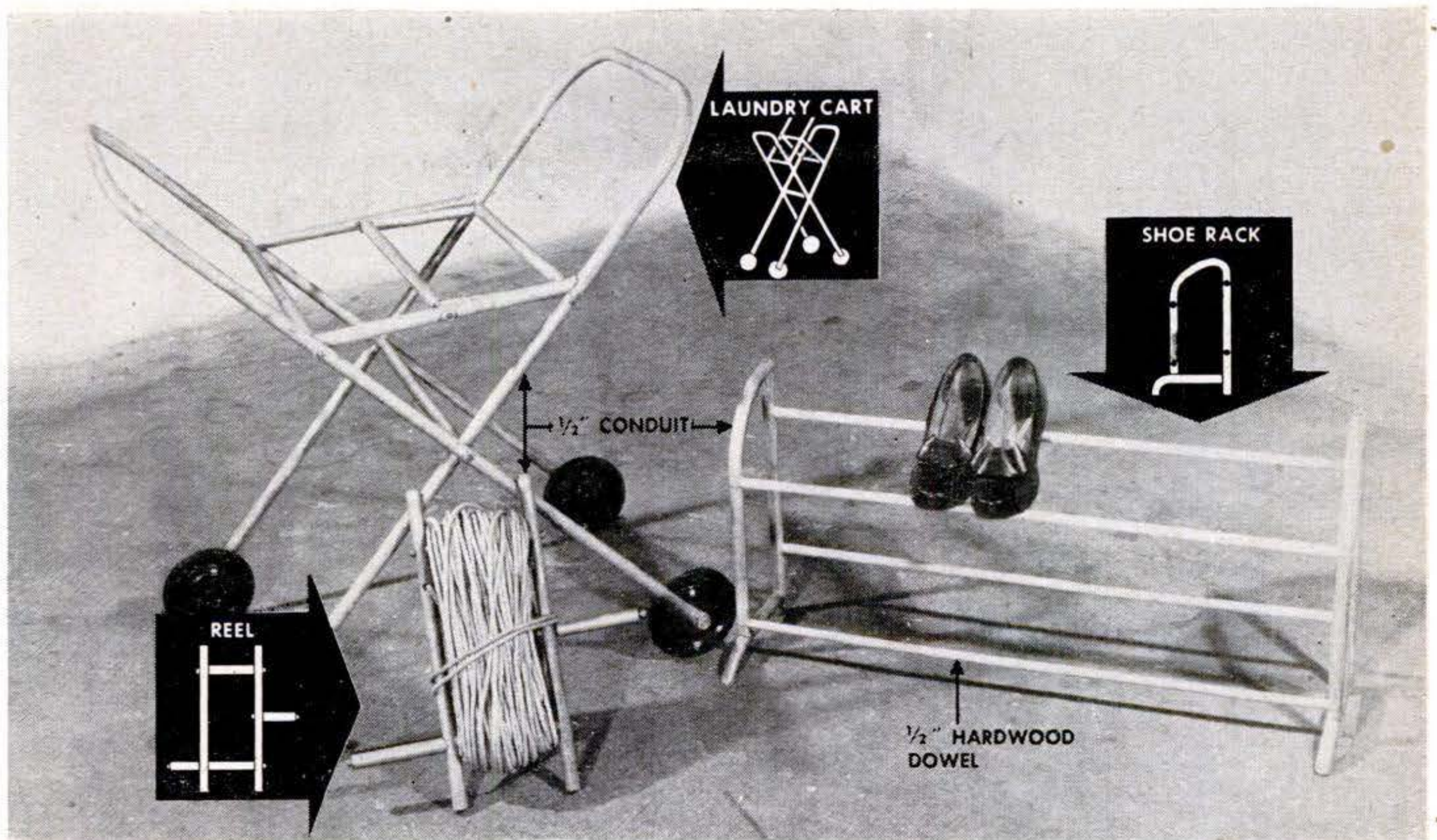

Here are some projects you can make. Conduit will bend without kinks if filled with sand.

conduit. For  $\frac{3}{4}$ " conduit, use a  $\frac{7}{8}$ " hole saw. To fit  $\frac{1}{2}$ " against  $\frac{3}{4}$ " conduit, cut the first with a  $\frac{15}{16}$ " hole saw. The  $\frac{3}{4}$ " conduit can also be drilled through and an uncut piece of  $\frac{1}{2}$ " run through it.

Brazing or welding gives good joints. But if you lack equipment for this, you can make the joint assembly as shown in the drawing on the facing page. A stiffening plug makes it possible to tighten the joint

without collapsing the wall. For some joints, you can simply drive in a hardwood dowel and use a wood screw. For bolted joints, turn tight-fitting metal plugs, pin them in place, and then drill and tap them.

For the shoe rack shown in the photo above, the  $\frac{1}{2}$ " dowel crosspieces were force-fitted after the conduit uprights had been drilled undersize ( $\frac{31}{64}$ " ) on one side only.—C. M. Burkholder, La Grange, Ill.

## RAFTERS

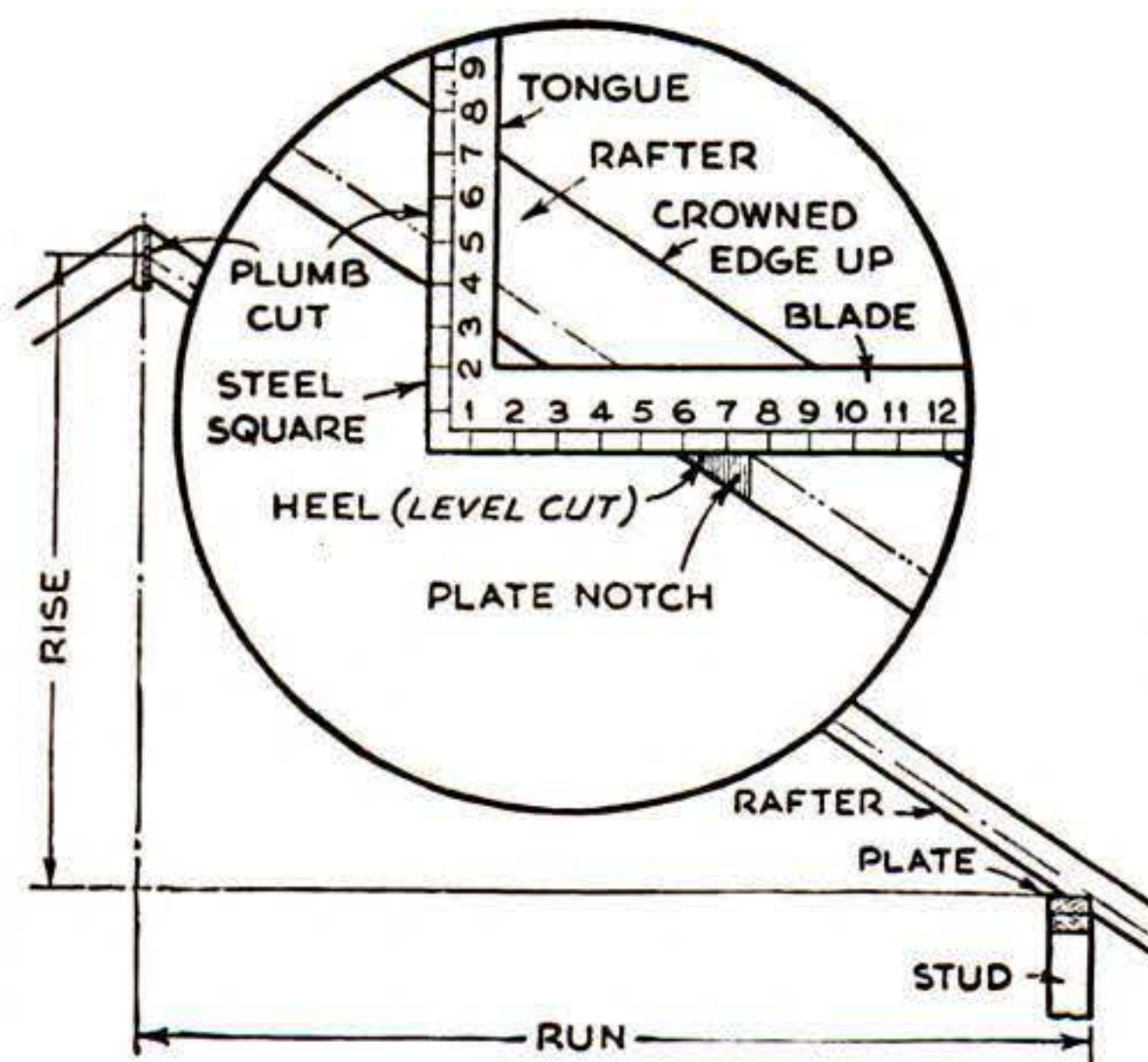

The plumb and level cuts of a common rafter are determined by the rise and run of the roof pitch. The rise is the vertical distance between the plate and a point on the plumb cut which is located by extending a line along the rafter, parallel to its edge, at the depth of the plate notch. The run is the distance from the center to the outside of the plate. This is usually expressed in terms of inches rise per 12" of run. The sketch illustrates 8" in 12".

Lay the square on the stock with the figures coinciding with the crowned edge. A line drawn along the tongue is the guide for the plumb cut, and a line drawn along the blade is a guide for the level or heel cut.

The plate notch is usually cut 1" deep on the plumb for 2" by 4" stock. On wider rafters, cut deep enough to provide a 2" or greater bearing of the heel on the plate.

The same principle applies to cutting butted braces.

FOR YOUR POPULAR SCIENCE INFORMATION FILE



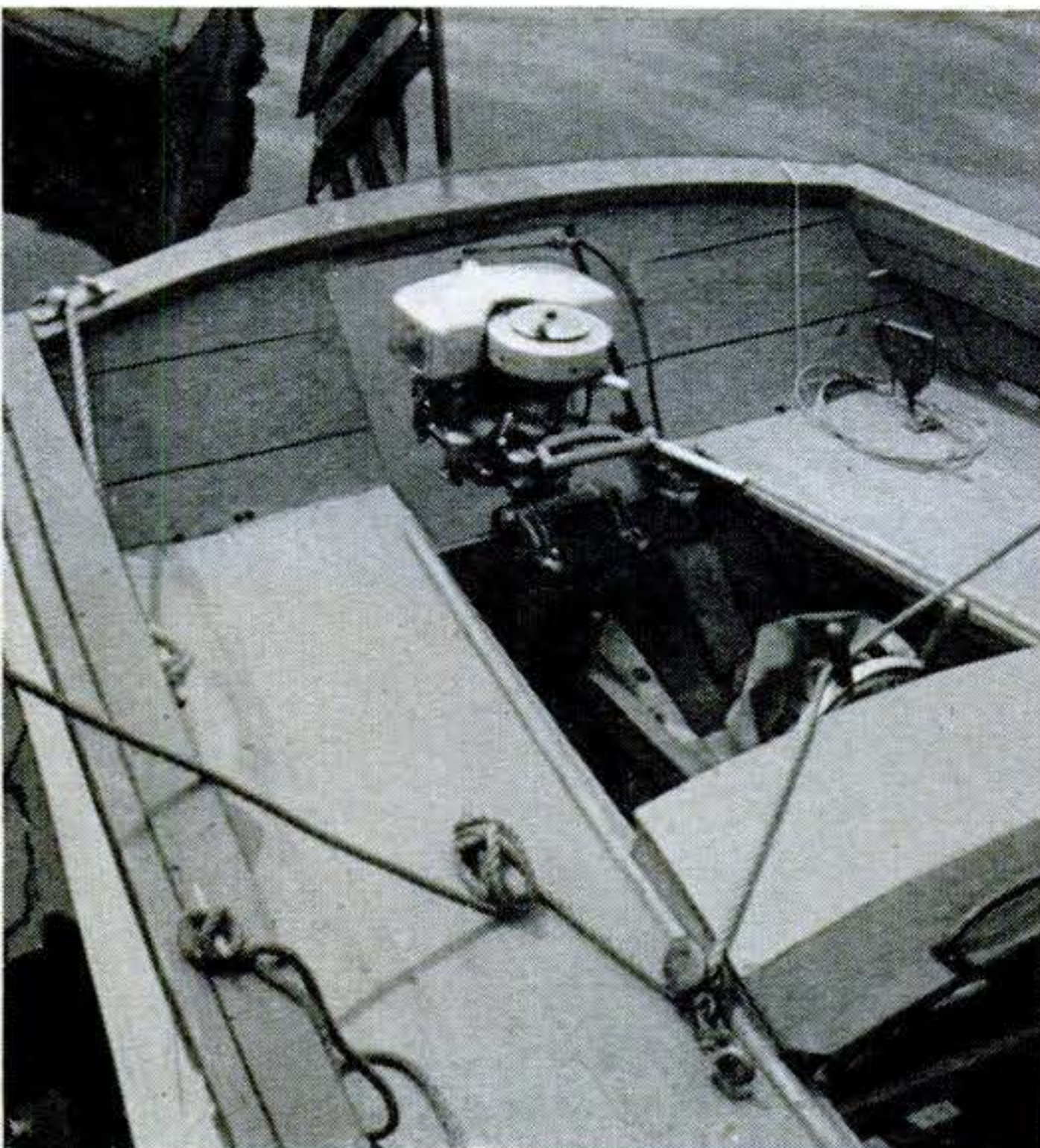
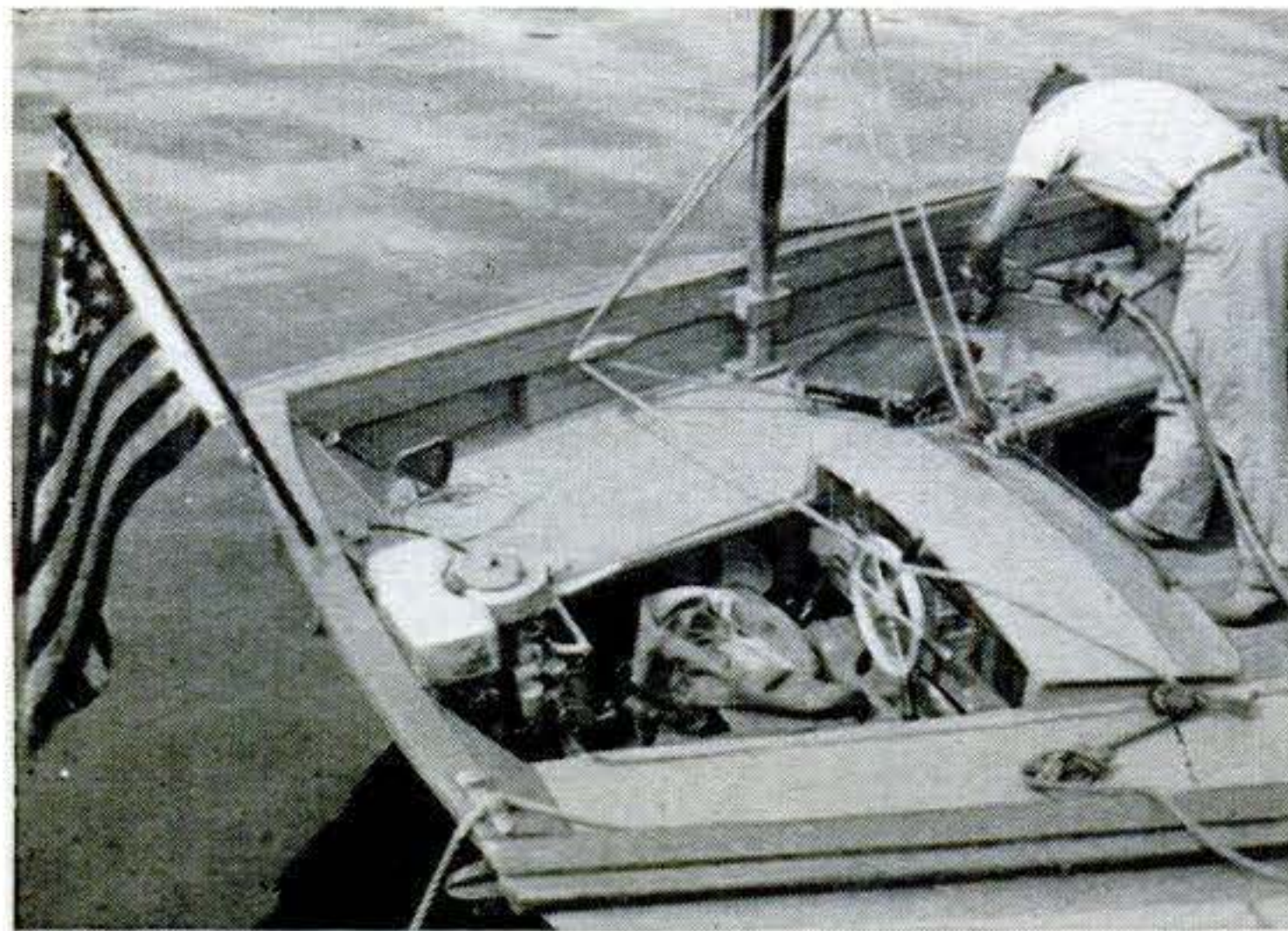

## Three Ways To Add Power To Your Sailboat

**W**ITH outboard motors becoming more versatile and dependable, more owners of sailing craft are turning to them for auxiliary power plants. For boats with a high freeboard, shaft extensions are avail-

The owner of this 28-foot sloop pulled out his 4-cylinder inboard engine and substituted a 9-hp. outboard. Says he enjoys more room and a cleaner boat. He also installed an auxiliary fuel tank, shown being filled at left above. Tank is war-surplus oxygen container mounted under a seat. Gas line connects it with outboard's tank. Bicycle pump creates air pressure to move gas from auxiliary tank to outboard's tank.

able to get the propeller down into the water. But in most cases, extensions aren't necessary. Three uses of outboards as auxiliaries, including a bracket mounting and a well installation, are shown here.

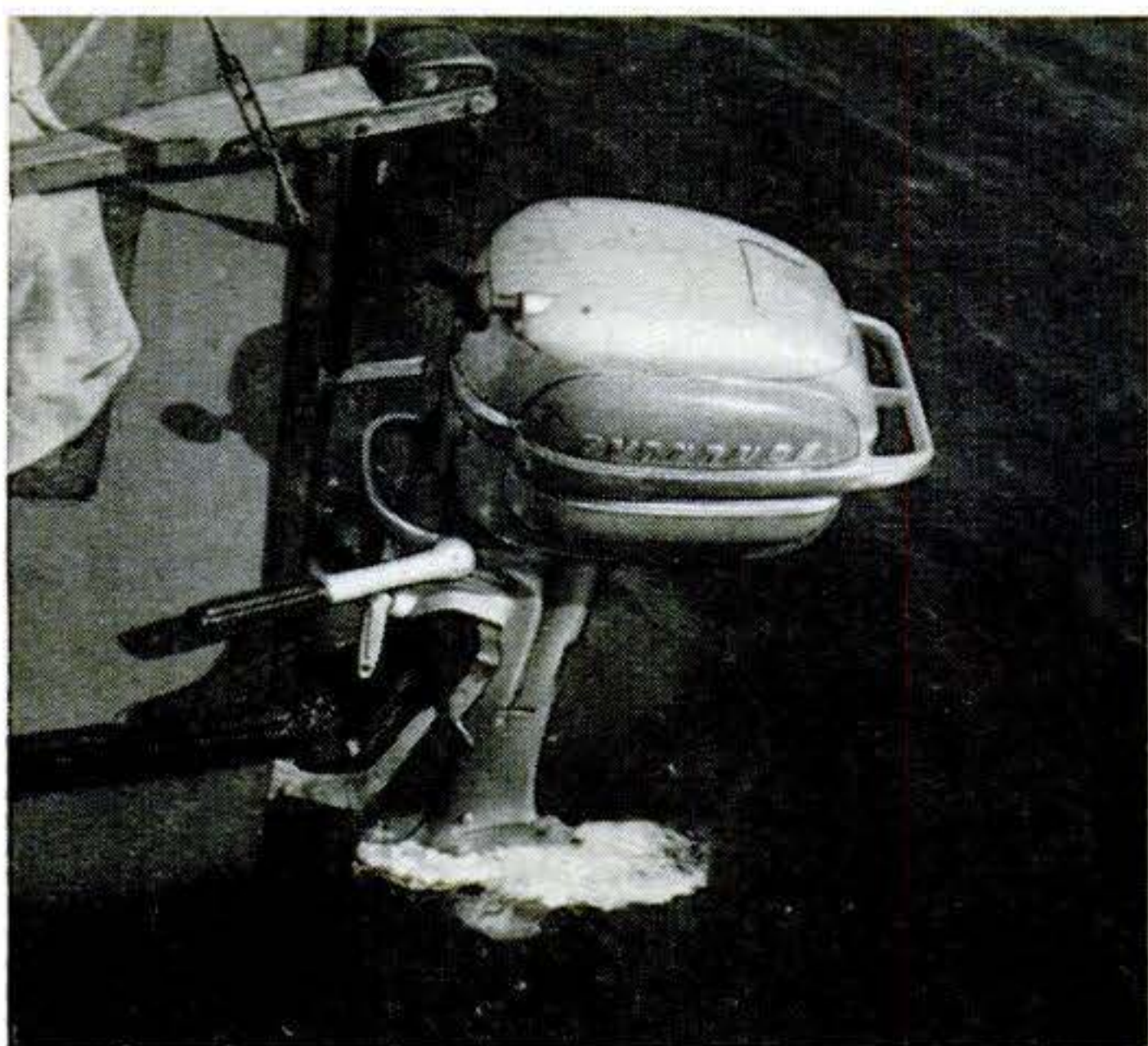

Here outboard is mounted on brackets bolted to transom. Some brackets are designed to handle motors weighing over 70 lb. A bracket can also be mounted on the side of a boat. This type keeps the propeller more constantly under water than the stern mounting, which may lift it spinning in the air as the stern rises out of the water on a pitch.

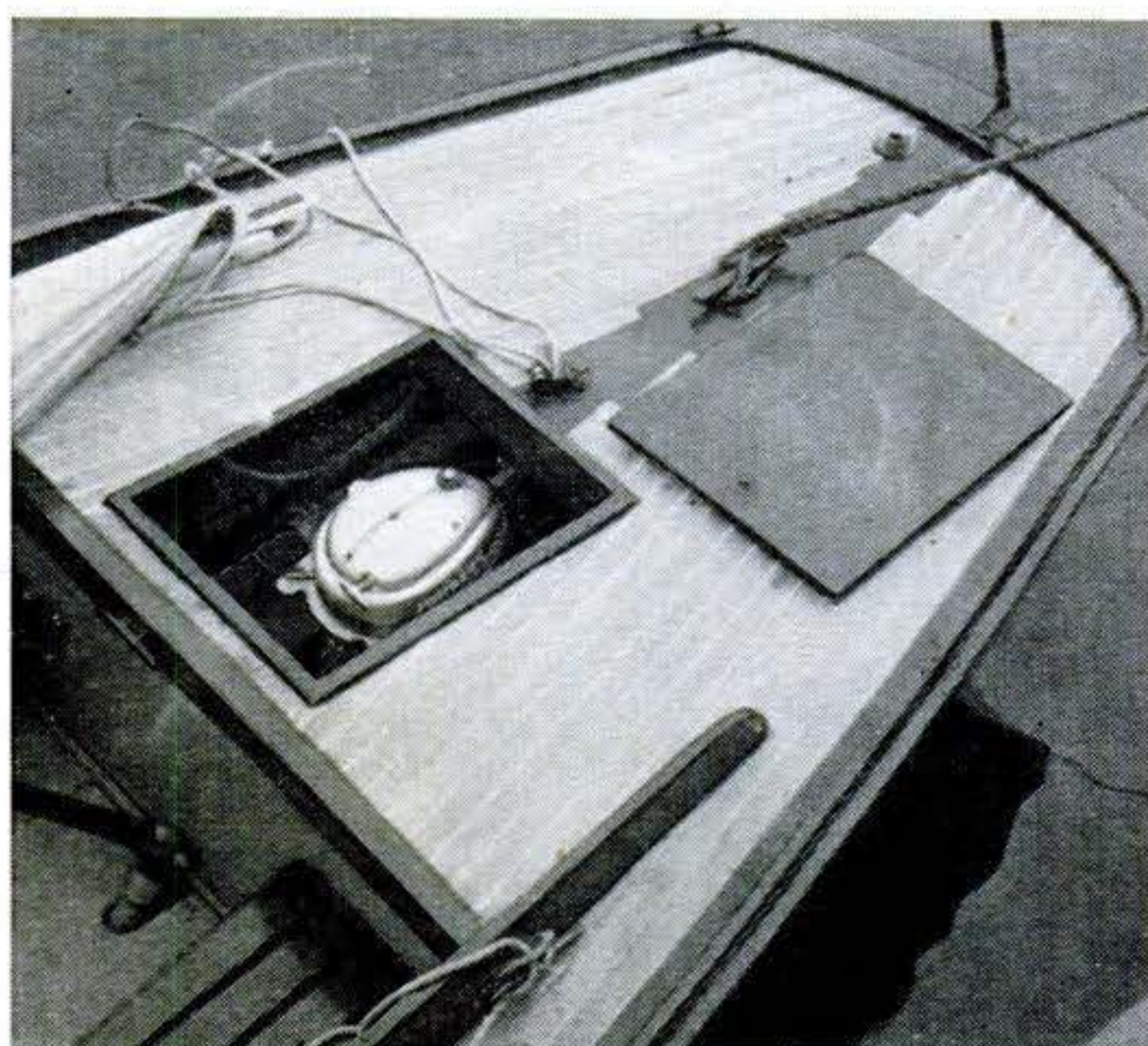

Well installation is shown here. Well consists of four-sided box built into stern section of boat. Box has open top and bottom. Motor hangs on bracket in forward side of box. Principle is same as that of a centerboard trunk. It must be tight and strong enough so that motor vibration won't cause leakage. Best installations of this type are put in when hull is built.



# TAILOR-MADE FOR YOU— in performance...in price

See these fine 2x2 slide projectors  
at your Kodak dealer's

## Images 7 feet wide—

What a "throw"—what a color show! For all-round brilliant performance, look at the Model 2A. Two fine *Lumenized* lenses available, the Kodak Projection Ektanon 5-inch *f*/3.5 and the Kodak Projection Ektanon 7½-inch *f*/4. Heat-absorbing glass protects slides. Turn of knob tilts projector. Price, \$47.50. Accessory Kodaslide Changer, \$17.50.



**KODASLIDE  
PROJECTOR,  
MODEL 2A**

**KODASLIDE  
PROJECTOR,  
MODEL 1A**



**Most for your money—**  
Kodak's "economy model," but with "big-time" performance. *Lumenized* optical system steps up screen brilliance 50%. Cooling by convection. *Lumenized* Kodak Projection Ektanon Lens 4-inch *f*/3.5, 150-watt lamp, slide carrier; and 12-foot cord included in price, \$27.50.

## Brightest of them all—

Projects your transparencies with new beauty, new brilliance and realism—at home or in an auditorium. 1000-watt lamp delivers more light to the screen than any other 2x2 projector. Turbine fan cools slides on both sides. Choice of 5 superb Kodak Ektar and Kodak Ektanon Lenses. Carrying case included. \$181 to \$295, depending on lens choice.

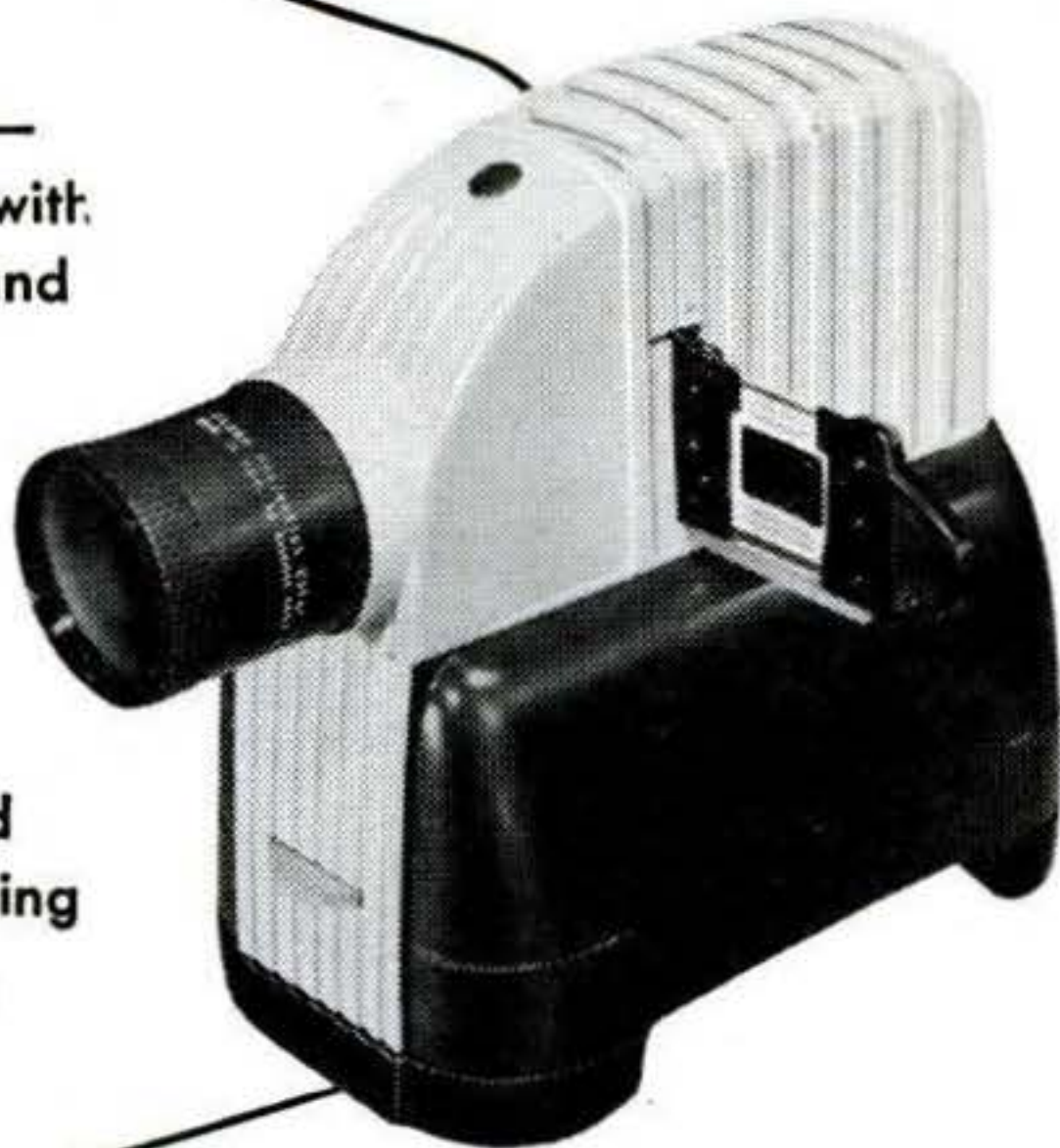

**KODASLIDE  
PROJECTOR,  
MASTER MODEL**

**EASTMAN KODAK COMPANY  
ROCHESTER 4, N. Y.**

**Kodak**  
TRADE-MARK



**A WORKSHOP WONDER**  
at a wonderful **LOW PRICE**



25  
piece set only  
**\$14.95**

**LIFE-TIME  
PLASTIC  
CHEST**

**Improved  
CASCO**

**ELECTR-O-TOOL KIT**

**DRILLS • SAWS • ETCHES • POLISHES**

Casco's ELECTR-O-TOOL kit is the most complete, practical power-workshop any craftsman or hobbyist can own. Has ALL the accessories you need to drill, cut, etch, carve, grind, buff, polish, sand, engrave, saw, clean and sharpen — metal, wood, glass, leather, plastic and fibre. 1001 year-round money-saving uses. Operates on AC and DC current. Fully GUARANTEED.

Now on sale at Department, Hardware, Appliance, Auto Accessory and Jewelry stores.

## Light your way to **SAFER CAR SMOKING**

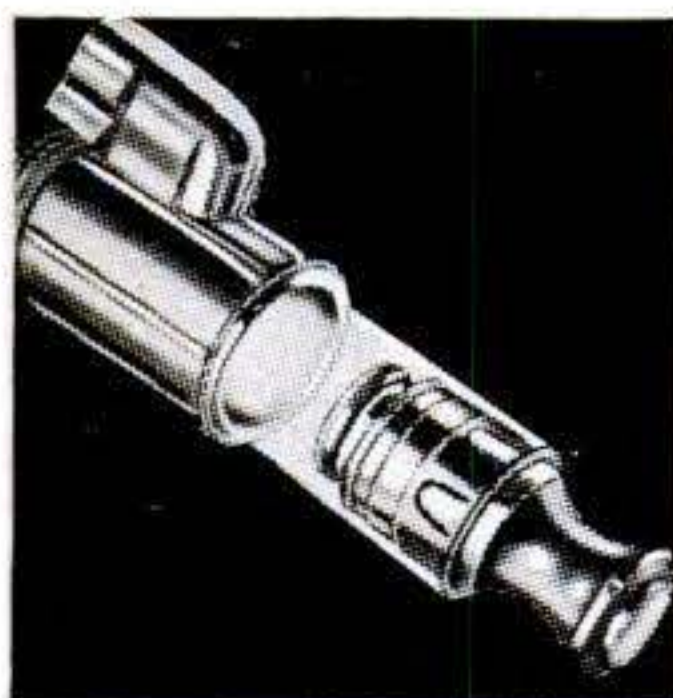

WITH A **CASCO**  
**ILLUMINATED "POP-OUT"**  
**CAR CIGARETTE LIGHTER**

Casco's VIS-O-LITE car lighter has an illuminated well that guides the lighter swiftly back. Eliminates fumbling in the dark... prevents scratched dashboard... keeps your eyes on the road. Now on sale at Dealers, Auto Supply Stores and Service Stations, only **\$2.75**

VIS-O-LITE illuminating well-assembly (minus pop-out unit)... **\$1.25**  
Replacement pop-out unit... **\$1.25** Replacement element... **\$1.00**

**CASCO** Products Corp.  
Bridgeport 2, Conn.

## **Navy Offers Films For Free Showings**

THE U. S. Armed Forces have many 16-mm. sound films available for nonprofit, non-theatrical, educational screenings. The following titles are among those that may be borrowed from your nearest Naval District headquarters. Subsequent issues of PS will list films from the Army and Air Forces.

"Sea Power for Peace." A panoramic view of the U. S. Navy today. Black and white. Running time 9 minutes 7 seconds.

"Naval Photography in Science." The first comprehensive compilation of the uses of photography in the various fields of scientific research and development. Techniques utilized in the film to make presentation effective include: time lapse, high speed, slow motion, stroboscopic, microscopic, macroscopic, and underwater photography. Color sequences never before shown on the screen are included: the moon in motion, the blood circulation of a living brain, and a picturization of the earth as seen from 101 miles altitude. Kodachrome. Running time 28 minutes.

"Naval Photography in Intelligence." This film presents the story of naval photographic reconnaissance during the war and continues with the documentation of naval photography in the postwar era. It also demonstrates the uses of photography for industrial surveys and long-range topographic mapping. Black and white. Running time 17 minutes.

"U.S. Naval Academy." A documentary film depicting life at the U.S. Naval Academy. Kodachrome. Running time 39 minutes.

"Antarctic Expedition." The greatest expedition ever organized to explore the unknown. Navy's Operation Highjump takes its officers and men into the heart of the least-explored section of the earth to discover new peaks and mountains, map vast areas, and test cold-weather equipment. Black and white. Running time 18 minutes.

"The Zipper Fleet." A review of some of the historical background and heroic wartime activities that Naval planes and ships engaged in prior to their decommissioning. Picture shows the technical servicing necessary to keep them shipshape for long-term storage and swift call to action. Black and white. Running time 10 minutes.

"They Came to an Island." A picturization of how Sea Bees land on battle-fogged beaches and make roads. Using bulldozers, the Sea Bees build bases and lay out landing fields in record-breaking time. Black and white. Running time 35 minutes.

"Silent Service." A documentary film of submarine service in World War II showing the destruction of Japanese shipping in authentic, on-the-scene photography. Kodachrome. Running time 38 minutes.

"Operation Crossroads." This film shows Able Day and Baker Day blasts of the atomic-bomb tests at Bikini, produced by joint Army-Navy Task Force One. Kodachrome. Running time 27 minutes.

"Atomic-Bomb Test—Bikini Island." A film about the atomic tests at Bikini, compiled by editors of Paramount News, including the best public-release picture of tests Able and Baker. Black and white. Running time 18 minutes.

"One-Man Task Force." This film demonstrates the im-



# NEW *Fastwin by Evinrude*



The  
Gearshift Motor  
with the  
"All-Day" Tank

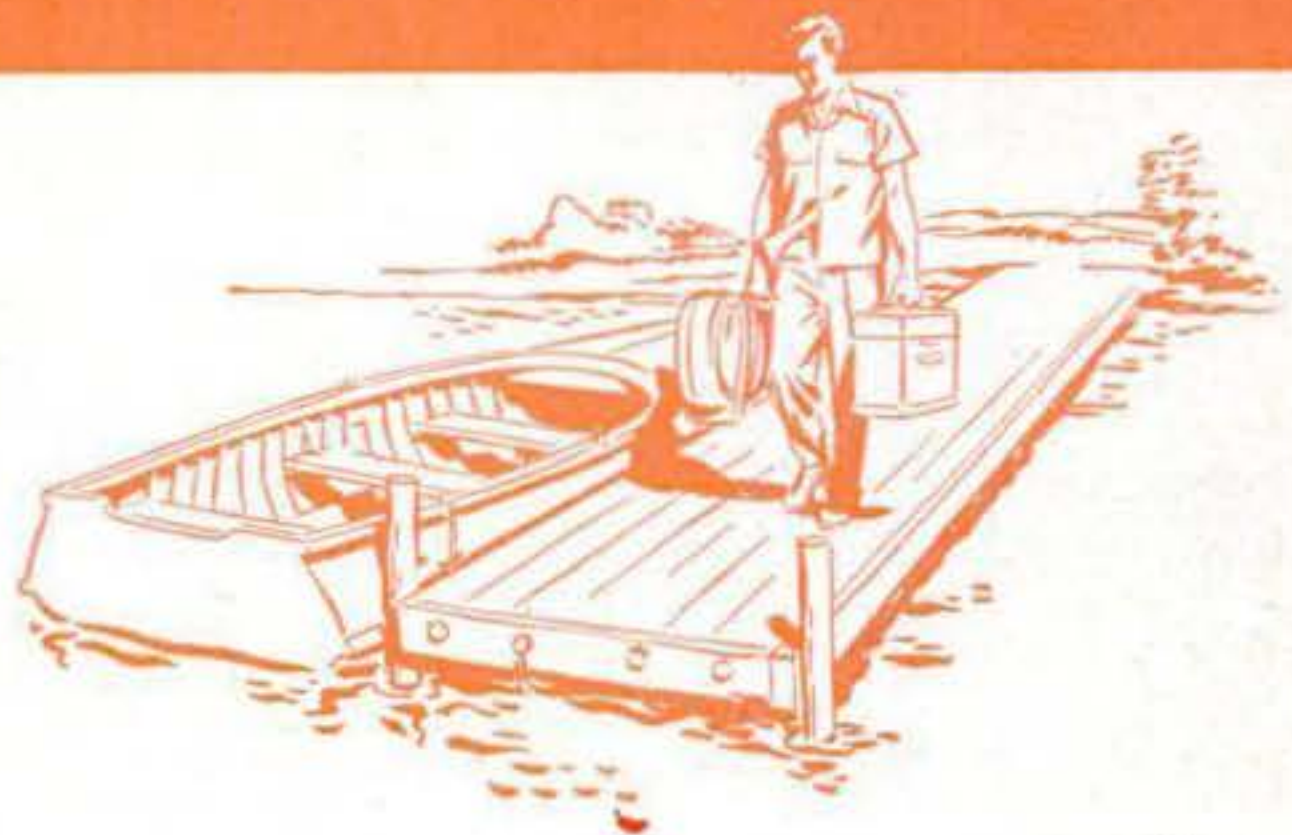

O.B.C.  
\*O.B.C. certified  
brake H.P.  
at 4000  
R.P.M.

● Here's the happy combination for boating fun!

A great new Evinrude packed with eager performance! 14 horsepower\* for thrilling speed! With *Gearshift Control*... you start in *Neutral*... back away from docks... maneuver with finger-tip ease. Separate *Cruis-a-Day Tank* provides fuel for an average day's running without re-fueling. Plug fuel hose into motor—stow tank anywhere! *Quik-Chek Fuel Gauge* tells you supply at a glance!

SEE YOUR EVINRUDE DEALER—and see the complete 1950 line of 6 advanced models... the right motor for every boat! New FLEETWIN with *Duo-Clutch*, 7.5 horsepower\*, gives you *Neutral* for starting and idling, *Safty-Grip Propeller Drive* for trouble-free operation in shoal water. Two famed light models with revolutionary FISHERMAN DRIVE. Look for your dealer's name under "Outboard Motors" in the yellow pages of your phone directory. CATALOG FREE—write for it today! EVINRUDE MOTORS, 4463 N. 27th Street, Milwaukee 9, Wis.

In Canada: Evinrude Motors, Peterboro, Ontario



NEW  
*Fleetwin*  
with  
DUO-CLUTCH

**EVINRUDE** FIRST IN OUTBOARDS  
... FORTY-FIRST YEAR



The saw most  
carpenters use

**DISSTON**<sup>®</sup>

HELPS YOU  
DO YOUR  
BEST WORK

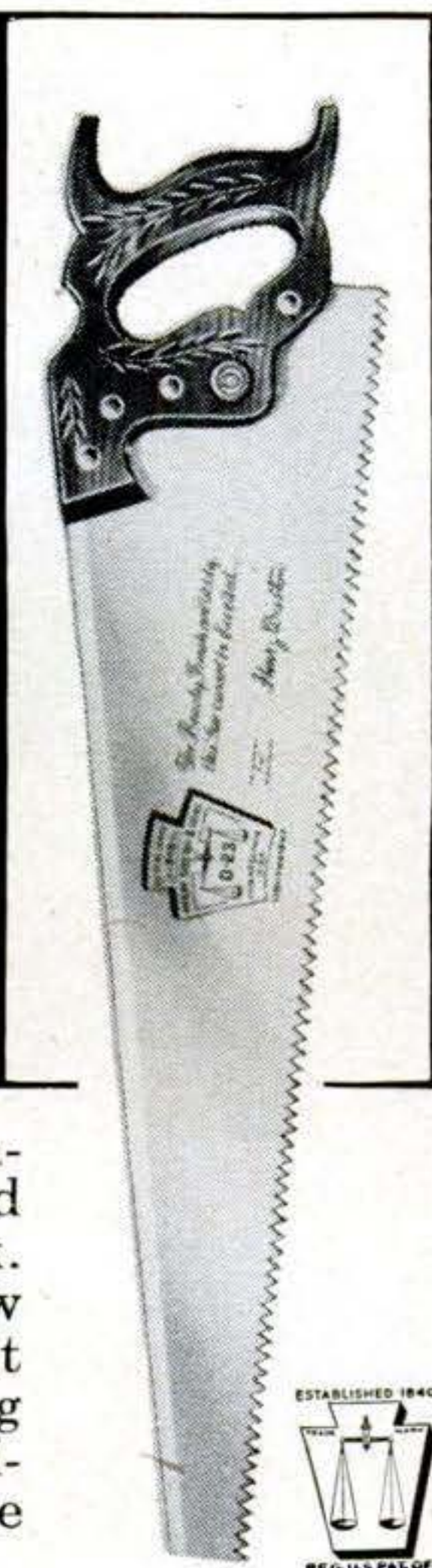

The Disston line is complete... correct sizes and types for all your work. You'll be sure of the saw made to standards that have won overwhelming preference from America's carpenters! Here are a few reasons:

**Disston Steel**, made under Disston control, means hardness and temper to make tooth edges last longer.

**Disston Skill** assures finest balance, plus true taper grind for easy clearance, plus uniform tooth edge—big aid to accuracy.

See your Hardware Dealer

**EXTRA LONG-LASTING EDGES—**  
in any Disston Saw for any work



Disston Back Saw



Disston Coping Saw



Disston Compass Saw



Disston Nest of Saws

**HENRY DISSTON & SONS, INC.**

310 Tacony, Philadelphia 35, Pa.

In Canada, write: 2-20 Fraser Ave., Toronto 3, Ont.

**FREE** Disston Saw, Tool and File Manual is a "gold mine" of information about choosing, using and caring for your tools. Send coupon now, for your copy free.

HENRY DISSTON & SONS, INC.,  
310 Tacony, Philadelphia 35, Pa.

Please send me a copy of the Disston Saw, Tool and File Manual entirely FREE.

Name \_\_\_\_\_

St. and No. \_\_\_\_\_

Town and State \_\_\_\_\_

portance and variety of use of long-range, shore-based air in the Navy. Black and white. Running time 38 minutes.

"History of Lighter-than-Air Rigid Airships." Title is self-explanatory. Black and white. Running time 40 minutes.

"The Fleet that Came to Stay." The invasion of Okinawa is told from the Navy's point of view. The film shows naval action at the time of the landing, the dramatic attack by the Kamikaze, and our counterattack. The picture explains why it was necessary for our fleet to remain at that base even under constant attack from land-based Japanese planes. Black and white. Running time 38 minutes.

"Prelude to Victory." The story of the Eighth Fleet and its advances from the shores of North Africa to final victory on the Italian beaches. The fury of the Luftwaffe in its last desperate attempt to annihilate the invasion forces provides many excellent combat scenes. Black and white. Running time 40 minutes.

"Sea Power in the Pacific." An interesting picturization of the importance of sea power and its great mobility. Combat shots are combined with animation sequences to show the part played by sea power in the advance across the Pacific. Black and white. Running time 30 minutes.

"Fury in the Pacific." This picture concerns the operations against and the capture of the Islands of Peleliu and Anguar, the airstrips that were needed to protect the subsequent Philippine invasion. The immensity and ferocity of aerial and off-shore bombardments are highlighted. In the photographing of these scenes 10 cameramen of a crew of 39 were casualties. Black and white. Running time 20 minutes.

"To the Shores of Iwo Jima." A color film showing the Marines' struggle against this heavily fortified island in the Pacific. Running time 20 minutes.

"Brought to Action." This film is about the part the Navy played in the second battle of the Philippines that began on October 19, 1944. Depicting some of the heaviest action in the Pacific war, the picture illustrates the Japanese plan of a pincer movement on Leyte as well as the Navy's counterattack plan. Black and white. Running time 21 minutes.

"Of Liberal Education." This is the story of the Naval Reserve Officers Training Corps. It shows various phases of NROTC, and an NROTC student's activities from the time he takes his aptitude tests until he graduates and receives his commission. Kodachrome. Running time 20 minutes.

"Naval Chapels in the Pacific." This film opens with a Naval unit preparing to leave for bases in the Pacific. The work of the Navy chaplain aboard ship and upon arrival at a Pacific island base is described. Beginning with church services held in the open, the film points to the need for places of worship and describes the construction of various kinds of chapels, in particular the "stick-and-canvas," thatched-roof, and quonset types. Kodachrome. Running time 12 minutes.

"Take Time for Tomorrow." This picture shows the educational opportunities available within the Armed Services to all military personnel. Academic and vocational courses are visually described, including many specific subjects in each course. The film shows how classes are conducted, materials prepared, correspondence lessons graded, and how to enroll for the study of a specific subject. Black and white. Running time 12 minutes.

"Army-Navy Football Game 1948." Kodachrome. Running time 35 minutes.



# It's FORD for '50

**ITS NEW  
SUPER-QUIET  
100 h.p. V-8  
WHISPERS QUALITY!**

New cast camshaft with special quieting ramp on cam lobes gives "hushed" valve operation.

New "super-fitted" pistons have steel struts in cam-ground skirts to control expansion, permit closer clearances. Result—longer life, extra quiet.

Perma-quiet valve assembly with straight-stem valve, one-piece valve guide and shot-peened valve spring requires no adjustment.



New 3-blade fan gives greater air flow with minimum noise.

New extra-narrow V-belts drive accessories quietly, efficiently.

New laminated composition timing gear meshes with metal gear on crankshaft for practically noiseless operation.

There's a *Ford* in your future  
...with a future built in!

# 50

# WAYS NEW



New rotary door latch, with nylon-plastic shock absorber in striker plate—doors close silently and securely.



Style Note—The rich, new Ford medallion on hood and rear deck marks America's "Fashion Car."

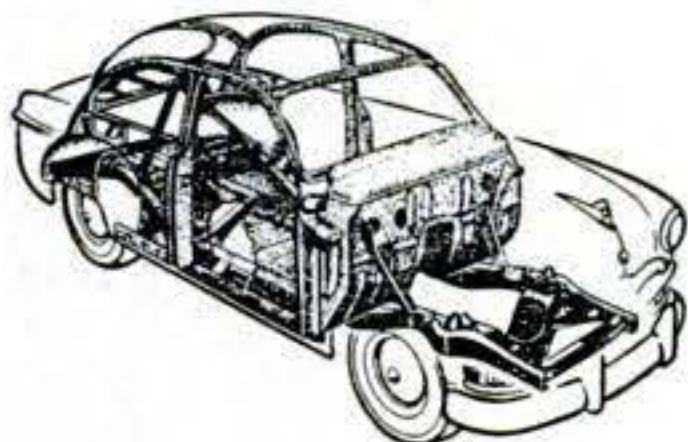

Ford's "Lifeguard" Body—now 13 ways stronger—additional heavier sealer in 41 areas for better sound and weather conditioning.

Dozens of other new advancements—AND 35% easier acting King-Size Brakes . . . "Hydra-Coil" and "Para-Flex" Springs... "Mid Ship" Ride . . . "Deep Deck" Luggage Locker.

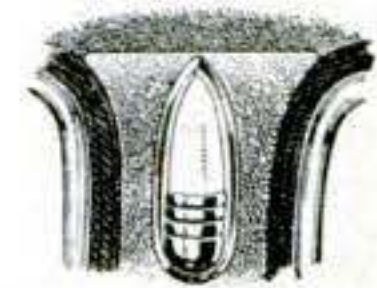

New automatic courtesy light goes on when either front door is opened—for comfort, convenience, safety.

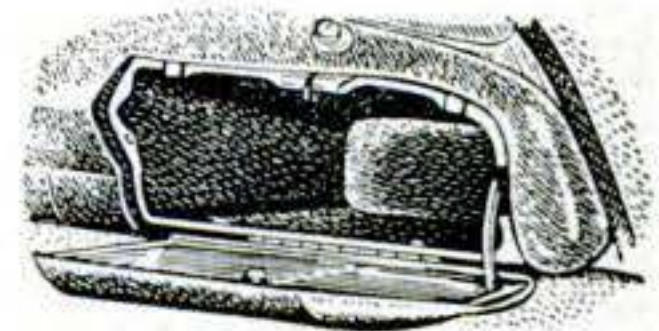

New double-walled glove compartment door has piano-type hinge. Looks and works better.



The one and only car with "Fashion Car" Styling—the one FINE car in the low-price field.

Take a **GOOD** look—Take a **GOOD** ride!  
AT YOUR FORD DEALER'S



**THE RIGHT FILE  
FOR COMBINATION  
CIRCULAR SAWS**

**6" CANTSAW  
FILE**

**I**F YOU have a bench saw in your workshop, you know what a difference a smooth-cutting, well-sharpened blade can make. And for filing most types of circulars, the Nicholson or Black Diamond Cantsaw File is just the thing. It bites clean and fast. Points a worn tooth or sets a bevel with one or two light strokes.

What's more, this Cantsaw file meets the Nicholson standards for uniformity—in shape, tooth cut, sharpness, hardening, balance. Your hardware dealer has it along with special files for Handsaws, Bandsaws, Auger Bits; wood, plastics and all kinds of metals. Write us for—

**"FILE PHILOSOPHY,"** the famous Nicholson 48-page book on kinds, care and use of files. It includes a section on filing circular saws. Post card request brings you your copy — **FREE**.

**NICHOLSON FILE COMPANY**



19 Acorn St.  
Providence 1, R. I.



(In Canada, Port Hope, Ont.)

**NICHOLSON  
FILES FOR EVERY PURPOSE**



**Bundle of wires** connects Bemac's mechanical section, at right, with electronic section.

## **Brain Tracks Missiles Without Firing Them**

**A** BATTERY of electronic and mechanical equipment can now foretell the behavior of a guided missile long before it is ever fired. It's done by a new kind of electronic brain, the Bemac—short for "Boeing Electro-Mechanical Analogue Computer". It is designed for use in a Boeing ground-to-air pilotless-missile project for the Air Force.

The 3,000-vacuum-tube missile tracker consists of a shelf-mounted electronic section and a table-mounted mechanical section. Together, they occupy an 11-by-24-foot room in a Seattle, Wash., company laboratory. Here, without actually firing a missile, the new Bemac predicts and records its every movement and attitude from the time it leaves the ground until the instant it touches the earth again—just as if it *had* been fired. Each waver, dip, and spiral is accurately determined, and the exact time and location of the landing is registered.

Instead of using an actual model of a missile, engineers preset the Bemac to a combination of voltages and mechanical shaft positions that represent the missile. The sum of these is the missile in a mathematical sense, and it will act just like a missile. Then the engineers feed into the machine such known data as the nature,



# A NEW STAR RISES



## PATENTED **CORALOX**

INSULATOR

**CORALOX** is rising swiftly in public preference, because it eliminates the principal causes of spark plug trouble.

Fouling at low engine speeds—misfiring under heavy loads—failure due to heat shock—accumulation of oxide coating—these are primarily *insulator* troubles.

**CORALOX** is AC's patented Insulator. It has 4 times greater heat conductivity—10 times greater electrical resistance at high temperatures—than the best ceramic insulator material in use before **CORALOX**. It is 3 times as strong. It is basic in chemical composition.

For better and more economical performance in your car, truck or tractor, use AC Spark Plugs with patented **CORALOX** Insulator. There's a size and type for *your* engine.



MORE NEW CARS AND TRUCKS ARE  
EQUIPPED WITH AC SPARK PLUGS  
THAN WITH ANY OTHER MAKE

AC SPARK PLUG DIVISION • GENERAL MOTORS CORPORATION

MARCH 1950 249



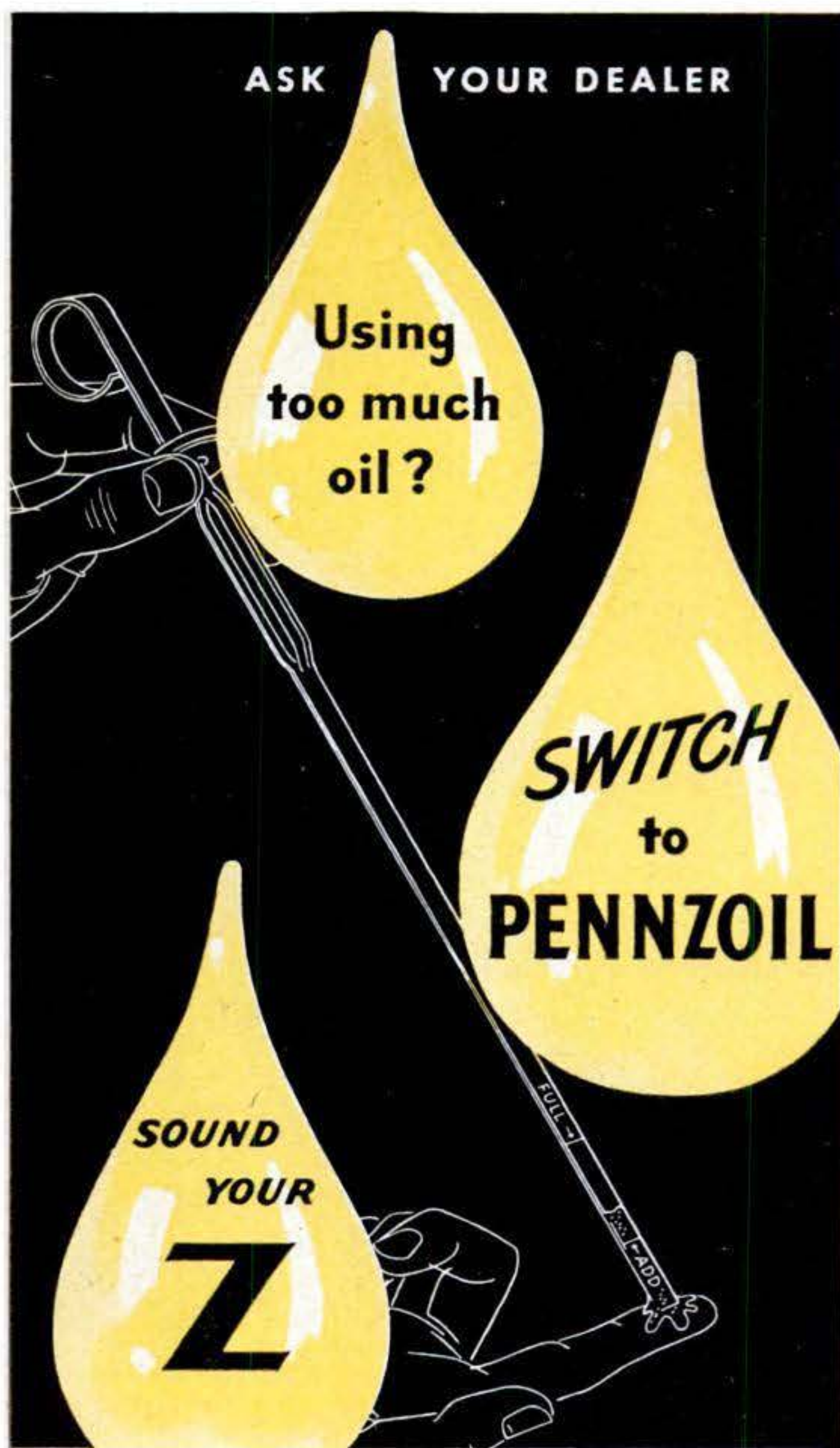

If you suspect you've been using too much oil, why not find out? Switch to Pennzoil, the 100% Pennsylvania oil with *staying power*.

Over 60,000 better dealers, coast to coast, recommend Pennzoil. It's worth looking for, easy to find at the yellow oval sign. Just sound your Z—get the genuine.



Member Penn. Grade Crude Oil Assn., Permit No. 2

**PENNZOIL® MOTOR OIL AND LUBRICANTS AT BETTER DEALERS... COAST TO COAST**

250 POPULAR SCIENCE

strength, and direction of the propulsive force and significant atmospheric conditions.

Once they set the Bemac in action, the imaginary projectile is under way, with all of its motions faithfully simulated by the battery of electronic units. Its trajectory appears as moving series of dots on the viewing screen of an oscilloscope, giving an instant-by-instant picture of its flight path. A rapid-fire camera trained on the 'scope makes a permanent photographic record of the "flight." Its all-revealing photos are guarded from the public view.

Unlike electrical brains that perform fabulous feats with long strings of digits, the Bemac does not work with numbers at all, but deals directly in motions. These include a missile's tendency to spiral or roll; its end-over-end motion, or pitch; its side-to-side swing, or yaw; its velocity; and its acceleration. All are constantly varying. Bemac will solve a problem involving as many as 20 of these variables at once. It could as easily foretell the path of a flying football, arrow, electron, old shoe, soup plate, or any other inanimate object not subject after launching to such unpredictable alterations as the flight of a bird, insect, or airplane.

At any point in its trajectory, the simulated projectile may be "stopped" in mid-air while the engineers reset the machine to represent a change in the setting of a guided missile's control surfaces. The Bemac then works out the corresponding new trajectory in a matter of minutes.

While the Bemac does not completely outmode the gathering of data by actual test firing, as is done at Alamogordo, N. M., its operators declare that the numerous problems it will solve will save thousands of dollars in time and material that would otherwise be expended in experimentation.

### Jar Brackets for Hardware

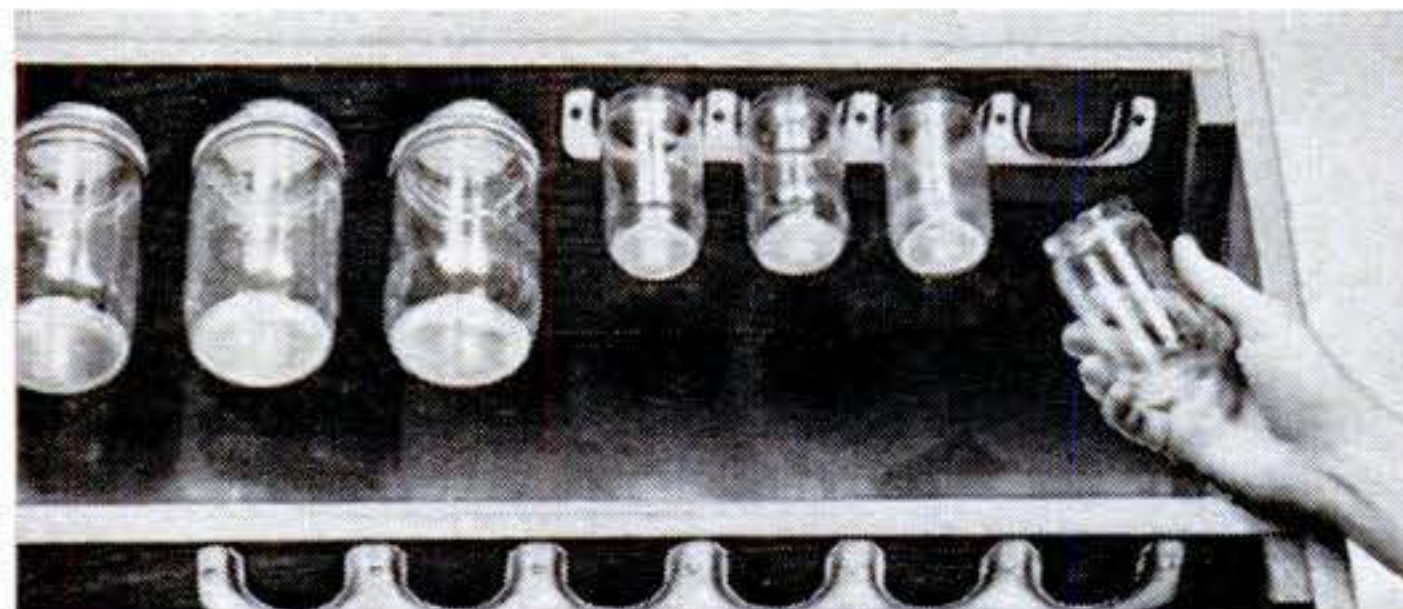

THE brackets pictured above hold empty baby-food jars, offering visible storage and quick dispensing of small parts. Ideas Inc., Stratford, Conn., markets the brackets in six- and four-jar sizes at about 30 cents each.



THIS IS  
A G-E  
"ALL-GLASS"  
HEADLAMP

THIS CUTAWAY  
SHOWS WHY  
A G-E  
HEADLAMP  
DOES NOT  
GROW DIM!

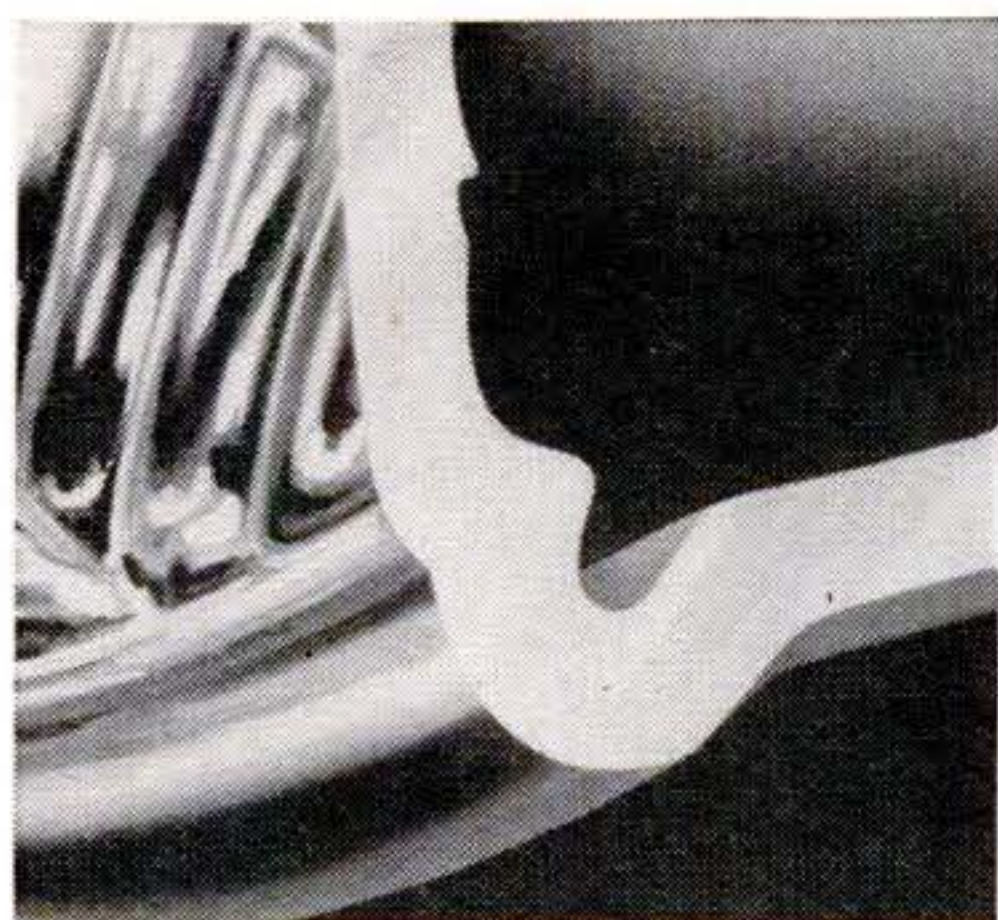

**1. RUGGED, ONE-PIECE** construction keeps dirt and moisture from getting in to steal the light. General Electric headlamps average 99% of original light output at end of life.

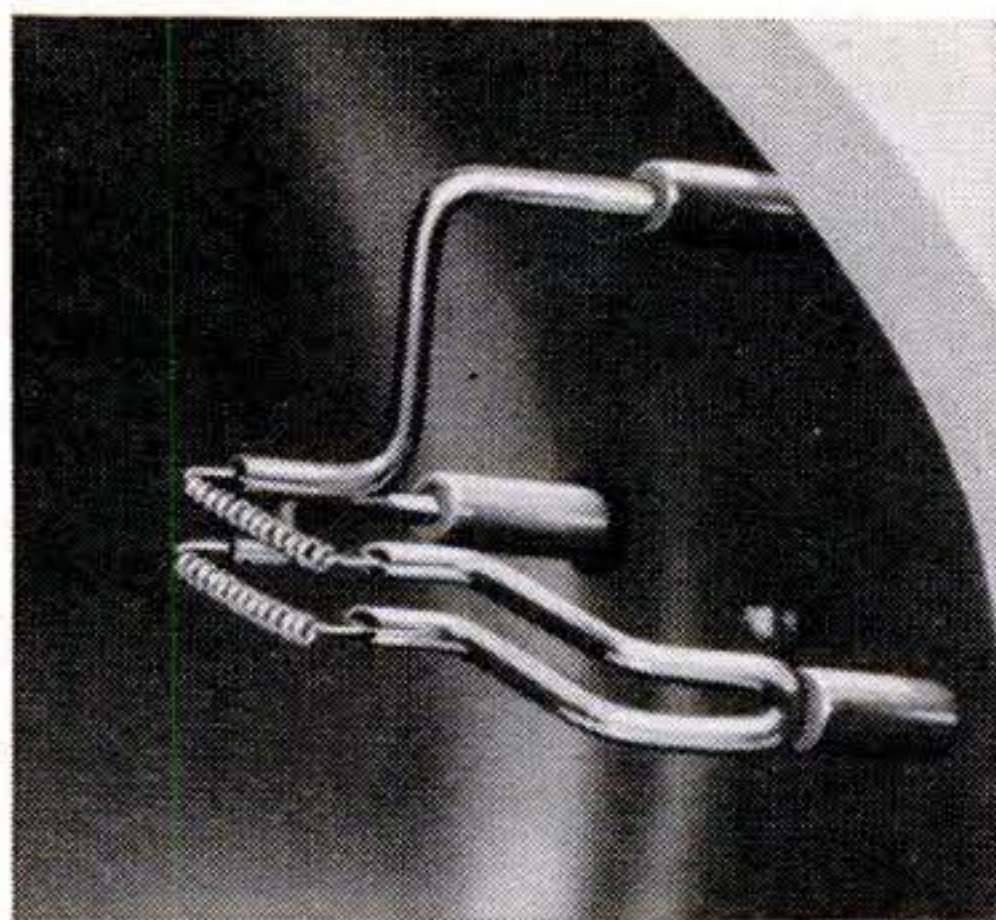

**2. IMPROVED FILAMENTS** give 12% more light on the road for driving—16% more light for passing. They're firmly anchored so they won't shake loose on bumpy roads.

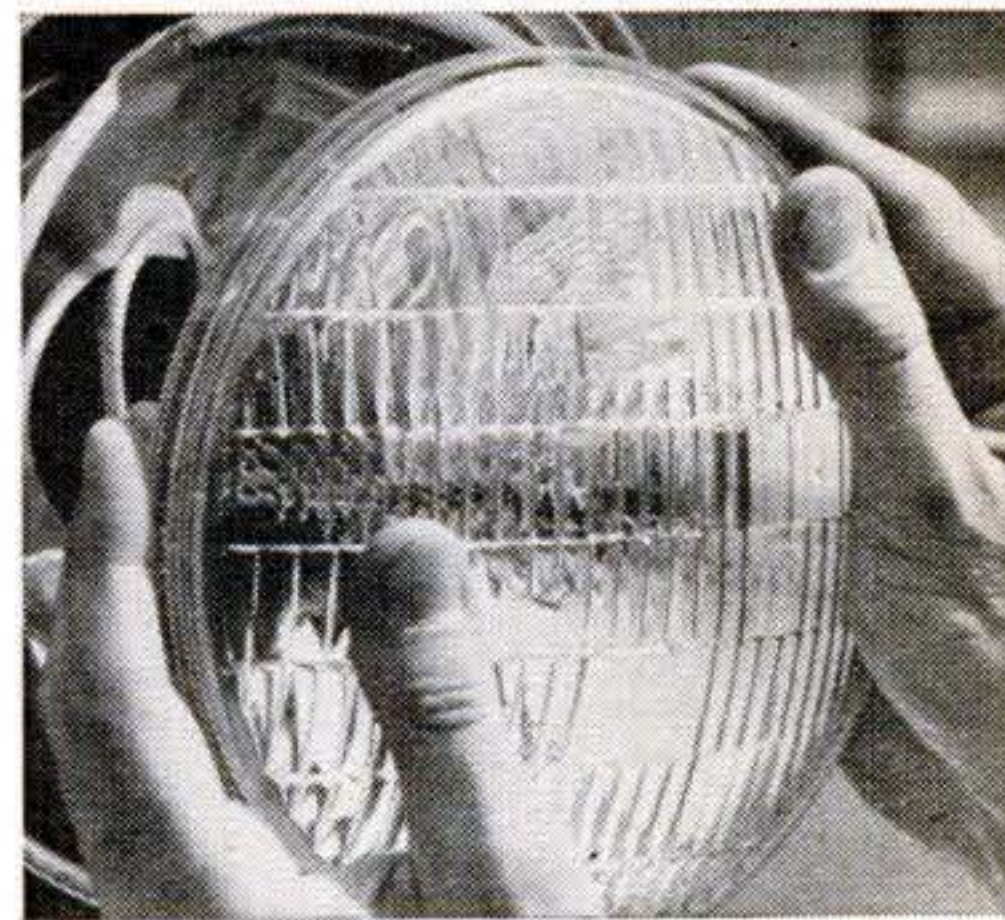

**3. HARD-GLASS LENS** resists shock—is precision-built to throw maximum light on the road. Have lights checked next time your car is serviced—and insist on G-E lamps for replacement.

*You can put your confidence in—*

**GENERAL**  **ELECTRIC**



**10 TIMES FASTER...  
FAR MORE ACCURATE...  
MUCH EASIER TO USE...**

*than a handsaw*

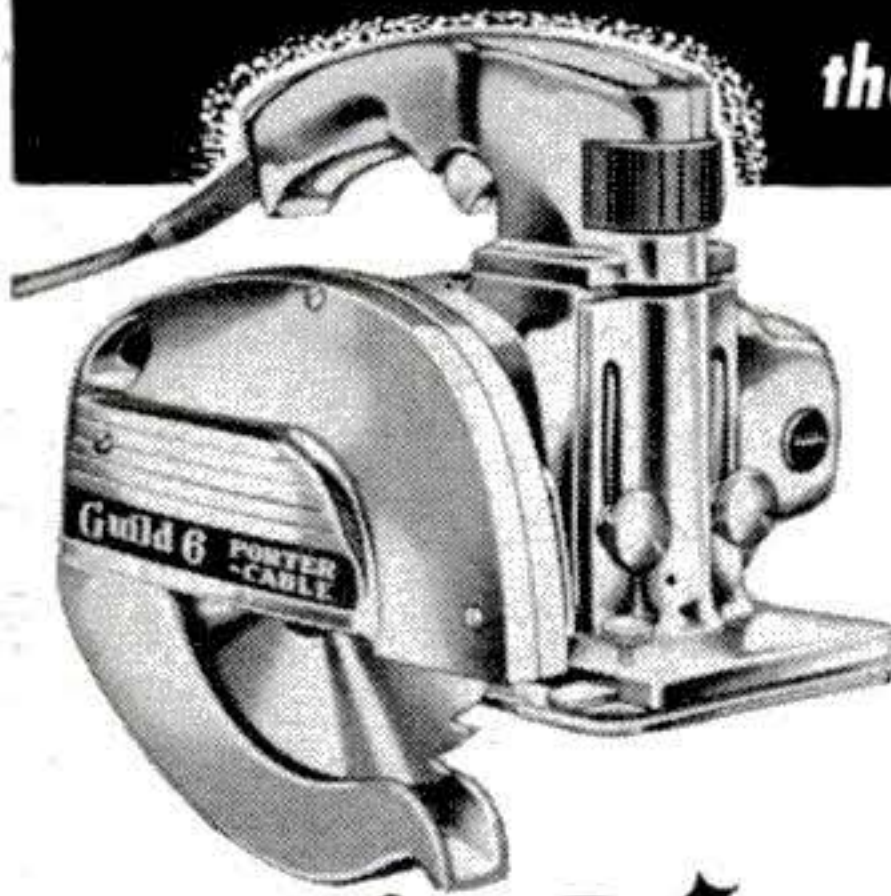

**A-6 SAW  
2 INCH  
CUT**

**Weights  
Only 12 lbs.**

**A Quality  
Carpenter's Saw**

**\$ 65.00**

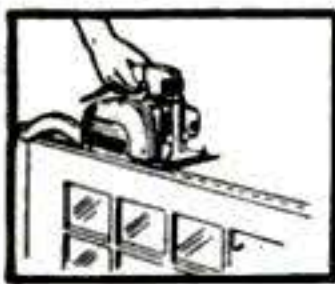

**Grooving for  
weatherstrip**



**Uncrating**

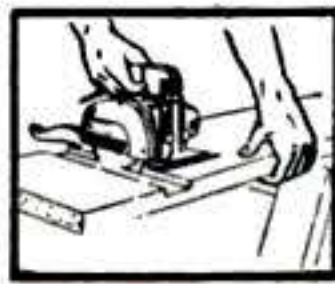

**Dadoing**

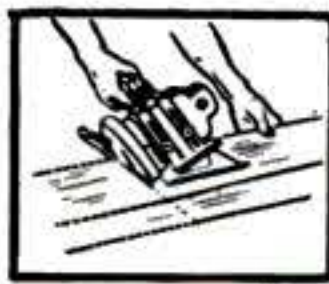

**Compound  
mitre cutting**

**STOP** that wearisome handsawing! Use the light, powerful Guild A-6 Saw. You'll speed up 10 times over the old way — and oh, so much easier! You can zip through a rip cut — and do cross-cutting straight and true. Using depth adjustment, dadoing is simple and accurate. With optional tilting attachment, (price \$7.00) angle cuts up to 45° are easy.

Use Guild Saws on various materials: lumber, plywood, compositions, plastics, asbestos board, tile, even thin metal sheets. Light, powerful, balanced, fully guarded — it handles in any position with one hand! Has the features of higher-priced saws: aluminum base and frame; efficient helical-gear drive; precision ball bearings; retractable safety guard. Outlasts cheaper saws. *Guild A-6 sells on value!*

Other sizes to fit your particular type of work:  
Guild A-4 — 1 1/4" cut; *Popular Price \$49.50.*  
Guild A-8 — 2 3/8" cut; *Unmatched at \$87.00.*

Get a demonstration at your Guild tool dealers. Or, fill out and mail coupon below — today.

**Other Guaranteed Guild Electric Tools**



**ROUTER**



**BELT  
SANDER**



**POWER PLANE**



**HEDGE SHEAR**

**PORTER-CABLE MACHINE CO.  
2303 N. Salina St., Syracuse, N. Y.**

Send me further information on the Guild Saw checked:  Type A-6,  Type A-4,  Type A-8.  
... Also name of nearest Guild Dealer.

Name.....

Address.....

City..... Zone..... State.....

**Contact Printer  
Copies Tape Records**

**A** NEW way to make "copies" of magnetic-tape recordings has put the recently developed magnetic system on an even footing with its older rivals—the disk-recorder and optical movie-film methods long in use. It can provide both cheap, professionally recorded tape for magnetic-tape phonographs and an easy new way to put the sound track on movie film.

The new copying method works something like the contact printing of movie film. The original recording, or "master," is run through a machine with the blank "copy" tape. Where the two tapes touch, a powerful magnet creates a rapidly varying magnetic field. This makes the magnetic particles in the copy tape line up the same way as the particles in the master, producing an exact duplicate of the original sound recording. Since the two tapes can be run through the duplicating machine at a fairly high speed, large quantities of copies can be produced quickly and cheaply.

Previously, the only way magnetic recordings could be duplicated was by re-recording from a master tape. Here signals from the master had to be picked up, amplified, and fed to a recording head that then copied them on a blank tape. Even with multiple recording (PS, April '49, p. 113), where several copy tapes were recorded simultaneously, the complex electronic equipment required and the time it took made the system too costly and slow to be commercially practical. Now the new system eliminates both obstacles, doing away with the expensive recording equipment and speeding up the recording rate.

Two research groups—both working at the same time, but without knowledge of each other's activities—figured out almost simultaneously how to remove this last stumbling block to the wider use of magnetic recording. Marvin Camras, Armour Research Foundation physicist who is responsible for much of the recent progress in this field, headed one team. The same day he reported his method, an almost identical system was announced by Minnesota Mining and Manufacturing Co., the firm that makes Scotch® tape and is also a leading producer of magnetic-recording tapes.







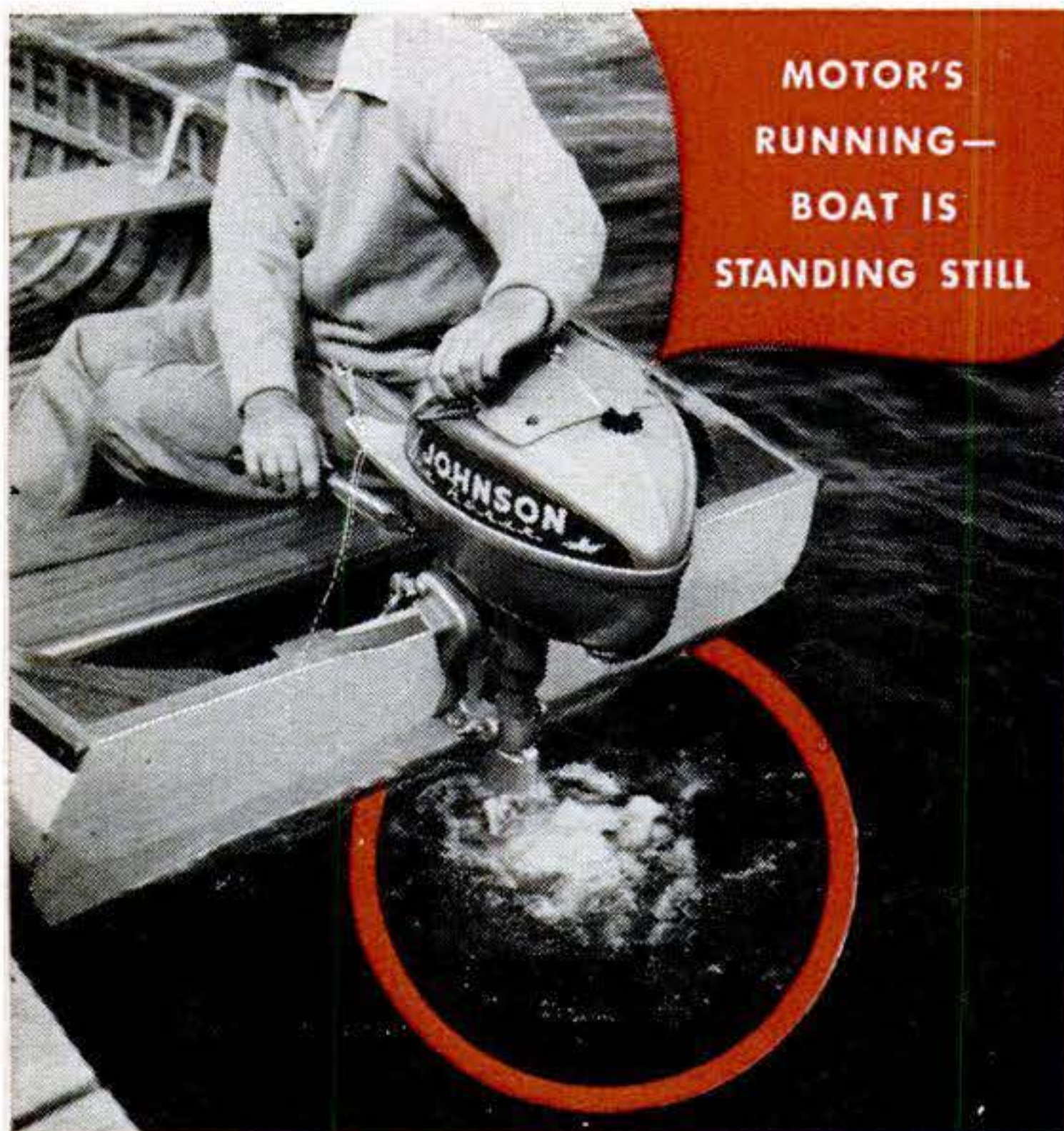

MOTOR'S  
RUNNING—  
BOAT IS  
STANDING STILL

## JOHNSON Neutral Clutch

Man, here's a fishin' friend—the new 5 h.p.\* Johnson outboard motor with Neutral Clutch and 31 other great features!

Start in neutral. Flip the lever, and GO! Idle, anywhere. Maneuver like an expert.

Go through shallows without a care—with sure-fire Shock Absorber Drive. Ride wide open or at a crawl—your motor runs *smooth* and *cool*. Relax—it's a Johnson, it's **DEPENDable!**

See your Johnson dealer. Look for his name under "Outboard Motors" in your classified telephone directory. 1950 Johnson prices are lower!

### **FREE!** HANDY CHART

Complete description of all five 1950 models including the sensational Model QD with Gear Shift Control and Mile-Master Fuel Tank. Sent free. Write!

JOHNSON MOTORS

500 Pershing Road, Waukegan, Illinois  
Johnson Motors of Canada, Peterboro, Canada

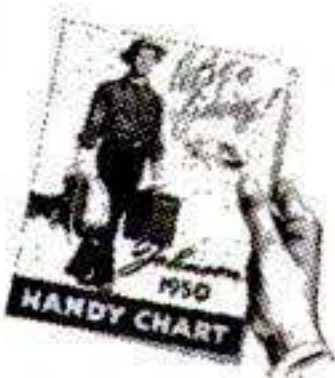

**JOHNSON**  
SEA-HORSES  
for *DEPENDability*

**NEW MODEL TN.** Johnson Neutral Clutch and Full Pivot Reverse. Alternate Firing. Dual Carburetion. Sure-fire Shock Absorber Drive. Vari-Volume Pump. Synchro-Control. Ready-Pull Starter. S-l-o-w Trolling—24 other features. *And no increase in weight or price!*



\*OBC Certified Brake H. P. at 4000 r. p. m.



### Grooved Logs Build Toys

LOGSTIX®, made by Charlen Products, Inc., West Orange, N. J., come in seven lengths. Each length has a different number of grooves that lock into grooves in other sticks. Permanent structures can be made by gluing the sticks. There are 201 pieces in a set.

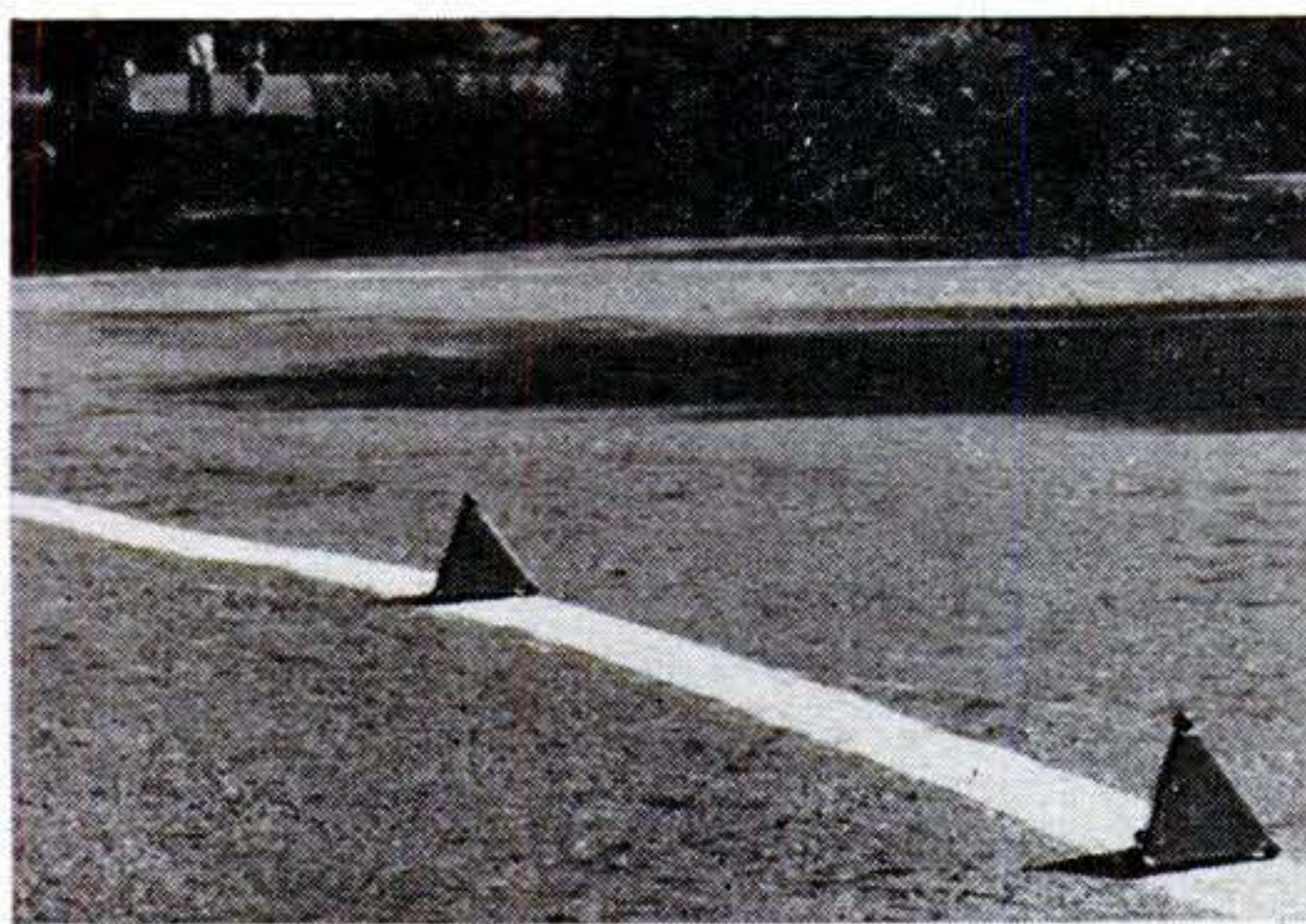

### Road Marker Is Plastic

A **PLASTIC**, crackproof marker now warns pedestrians and motorists of freshly painted highway lines and other road repairs. Made by Plastic Engineering, Inc., of Cleveland, the marker is unaffected by temperature changes, grease, or abrasives.



# DELTA MILWAUKEE

Delta-Milwaukee 14" Band Saws can be found in shops of all kinds — wherever accurate cutting must be done easily and economically.



Hobbyists who want the best in power tools equip with a Delta-Milwaukee 14" Band Saw.



**\$11585\***  
without motor or switch

**Double table-supports help you get greater accuracy—even on big, heavy work... with a DELTA-MILWAUKEE® 14" Wood-cutting Band Saw**

**Cuts wood, felt, corrugated board, paper, other materials**

Two trunnions — widely spaced — one on either side of the blade — support the table of the Delta-Milwaukee 14" Band Saw. This gives you a steadier surface to work on. The table stays rigid, at any angle. You're able to saw more accurately.

That's only one reason why this Delta-Milwaukee machine is first choice of those who know fine tools. There are many other quality construction features:

- Ball bearings are used, giving trouble-free performance — and they are lubricated for life.
- The table is big — 14" x 14". It has a 3/8" x 3/4" miter-gage groove. Tilts 45° right and 10° left.
- Blade guide controls can be adjusted safely at the front of the table.
- Aluminum wheels are carefully balanced, so that the blade is true-running.
- Upper and lower wheels are completely guarded, to protect you. Guard covers saw blade at rear; sliding guard covers all but working surface of blade in front.
- Rip gage is available for ripping.

Have your nearby Delta distributor tell you more about these features for safety, accuracy, economy, and convenience. Inspect the Delta-Milwaukee 14" Band Saw there now — and see his complete Delta-Milwaukee line.

Look for the name of your Delta distributor under "Tools" in the classified section of your telephone directory.

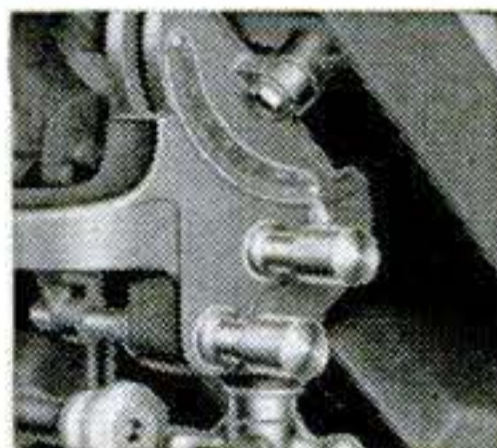

One of the 2 trunnions that are spaced 9 inches apart to support table.

Widely used wherever folks insist upon highest-quality tools:

- Cabinet Shops
- Carpenter Shops
- Display Shops
- Furniture Factories
- Home Workshops
- Hotels
- Pattern Shops
- Sign Shops
- Theatres
- Upholsterers
- and other places!



Upper wheel has blade-tension adjustment. Index shows correct tension for various widths of blades.

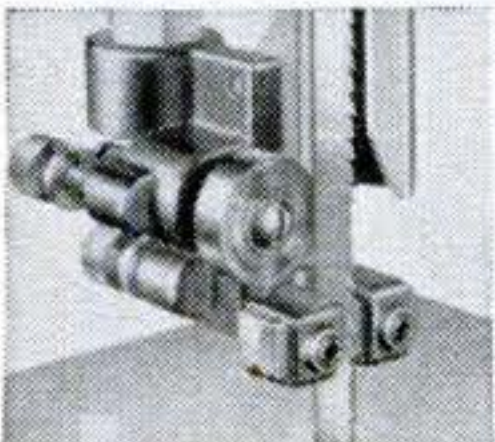

You can independently adjust blade guides and blade supports with micrometer accuracy.

**\$23575\***

without motor or switch rod

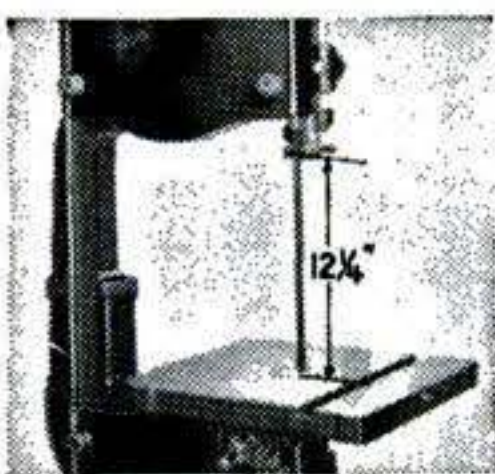

Simple attachment increases capacity from 6 1/4" under the guide to 12 1/4". Can be added any time.

**Two machines mounted together — to save space, time, and money DELTA-MILWAUKEE SAW-JOINTER COMBINATION**

Circular saw and jointer mounted on one steel stand and driven by same motor. Both may be operated singly or together. 10" circular saw cuts 3 1/4" stock. Rips to center of 50" panel. Jointer surfaces boards 6" wide; cuts rabbets 1/2" deep. Both tools have lubricated-for-life ball bearings. See this dual-purpose machine at your Delta distributor.

\*Prices subject to change without notice

Send for free catalog!



**TEAR OUT COUPON AND MAIL TODAY!**



**DELTA MANUFACTURING DIVISION**  
Rockwell Manufacturing Company  
804C E. Vienna Ave., Milwaukee 1, Wis.

Send me free copy of Delta-Milwaukee Catalog B-48.

Name.....

Title.....

Company.....

Address.....

City..... State.....

HM-65





**Reset loose drawer pulls—**

Replaces splintered wood . . . makes loose screws firm!



**Seal drafty cracks—**

Fills openings easily . . . dries tight and hard! Resists weather!

**Repair loose tiles—**

Holds tiles firm on walls and floors . . . Easy!



Also useful in filling cracks in floors, nail and screw holes, repairing broken toys. Handles like putty . . . hardens into wood!

**PLASTIC WOOD**

A CELLULOSE FIBRE FILLER

IN CANS OR TUBES



WEATHER RESISTANT

**Slotted Shelf Holds Trousers**

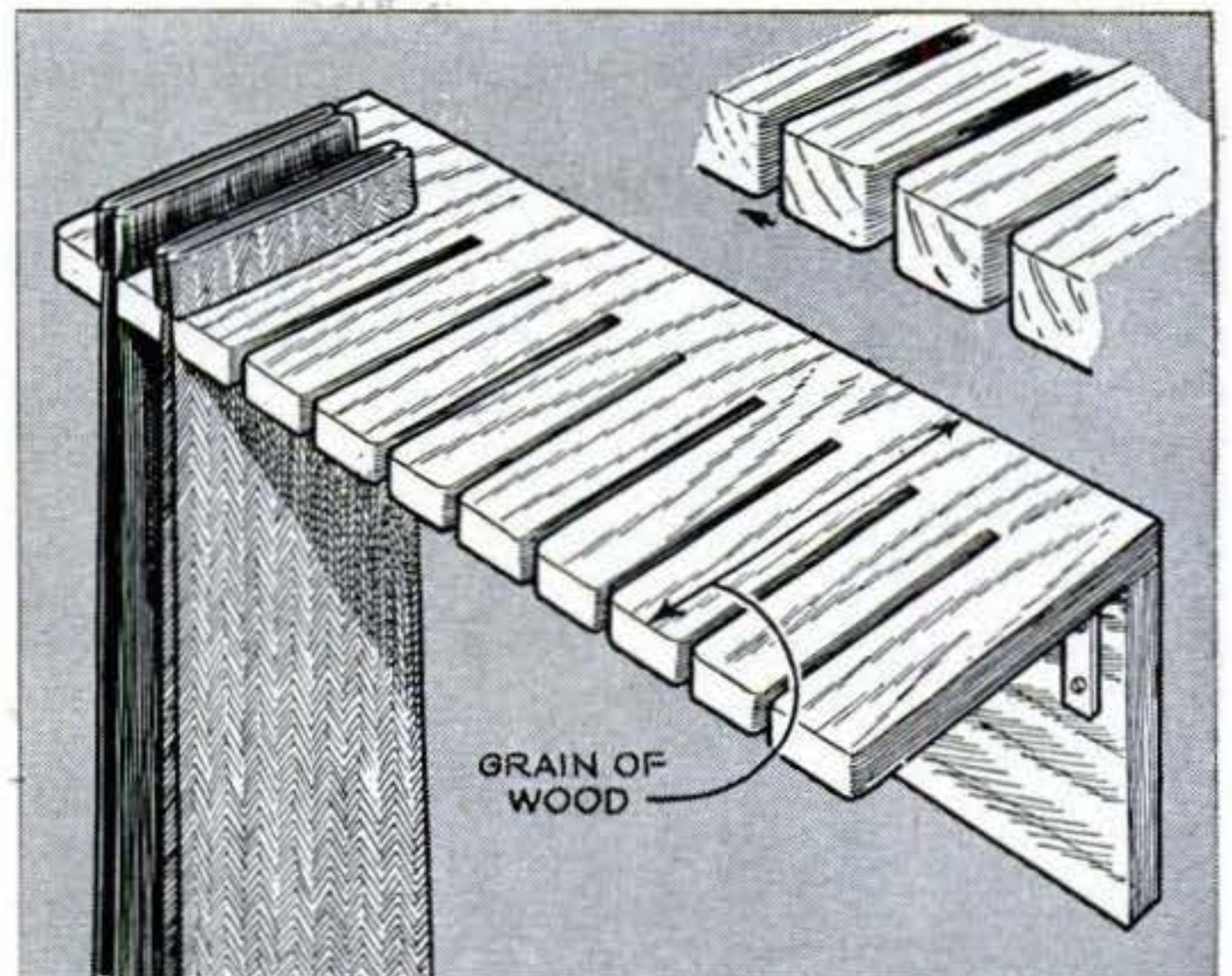

To MAKE this trousers shelf, cut the slots slightly less than  $\frac{1}{4}$ " wide. Widen the entrance of each slot by rounding off the corners. This will make it easier to insert the trousers. Cut the slots with the grain if you use solid stock instead of plywood.—T. H. Lavengood, South Bend, Ind.

**Circle Dipoles Added to Rods**

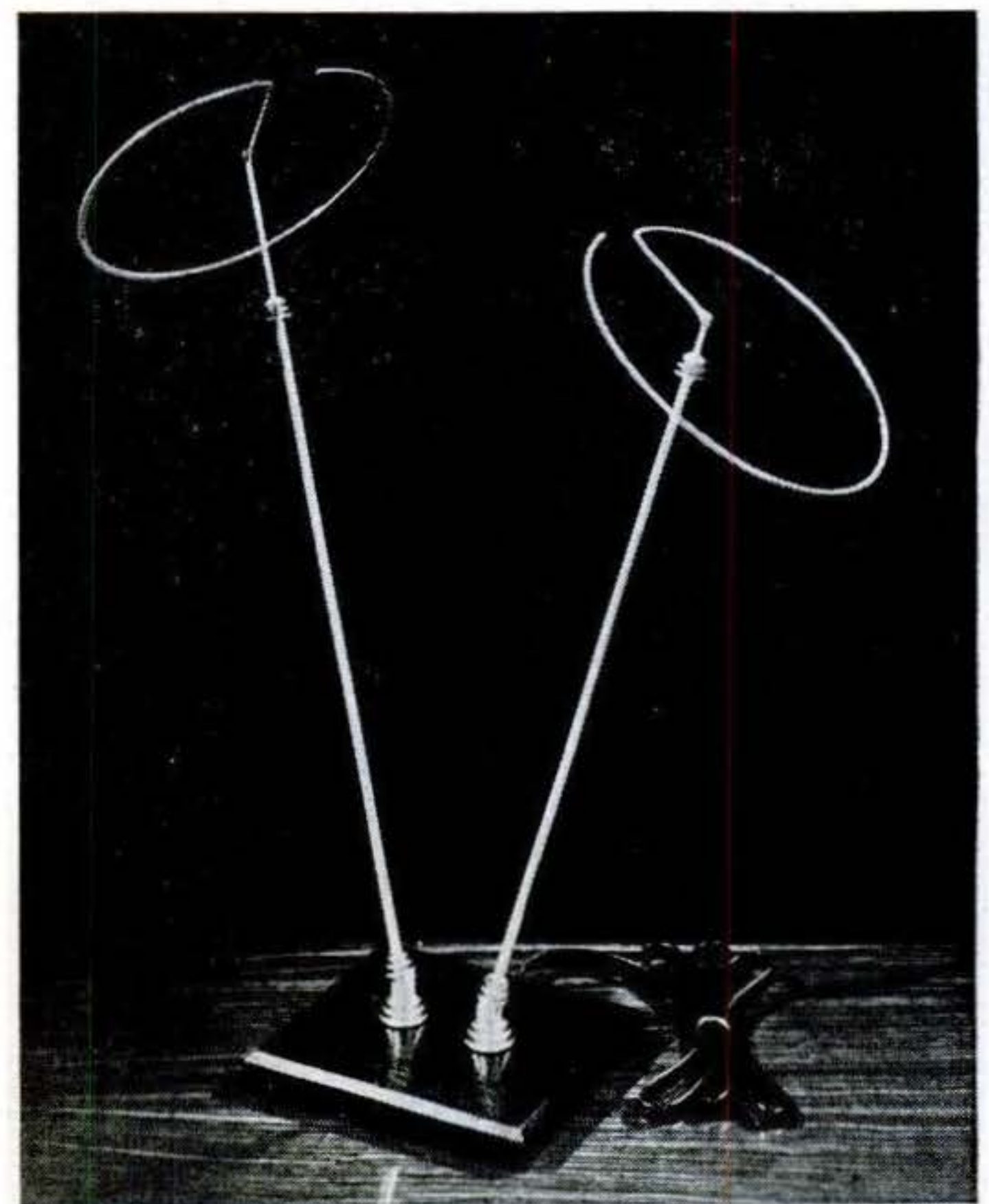

A NEW indoor television antenna combines both straight and circular dipoles in the arrangement shown. Straight arms are adjustable in length, angle, and rotation; the circles can be angled to any desired position. Gadgets, Inc., Dayton, Ohio makes the antenna. It retails for about \$7.



**TO EVERY SPARK PLUG USER!**

# **CAPT. EDDIE RICKENBACKER VOLUNTEERS THIS AMAZING STORY ABOUT CHAMPIONS!**

**President and General Manager of Eastern Air Lines  
Credits SAME SET OF DEPENDABLE CHAMPIONS with  
240,000 Miles of Air Travel!**



**"THIS SPARK PLUG** is one of the set of thirty-six (36) which operated in the #4 engine #75737 in Eastern Air Lines' new type Lockheed Constellation #115A for 811 consecutive hours of trouble-free operation. This amount of operating time, which is most unusual, based on an average cruising speed of 300 MPH, is equal to approximately 243,000 miles. During this period the spark plug fired approximately sixty million times. This type of service from a spark plug is remarkable even when compared to the type of operation as recent as a year ago. During its life it was one of the spark plugs (none of which were changed) that helped carry myself and party on our Latin American Tour during August of 1949."

*Eddie Rickenbacker*

**FOLLOW THE EXPERTS**

*Demand*

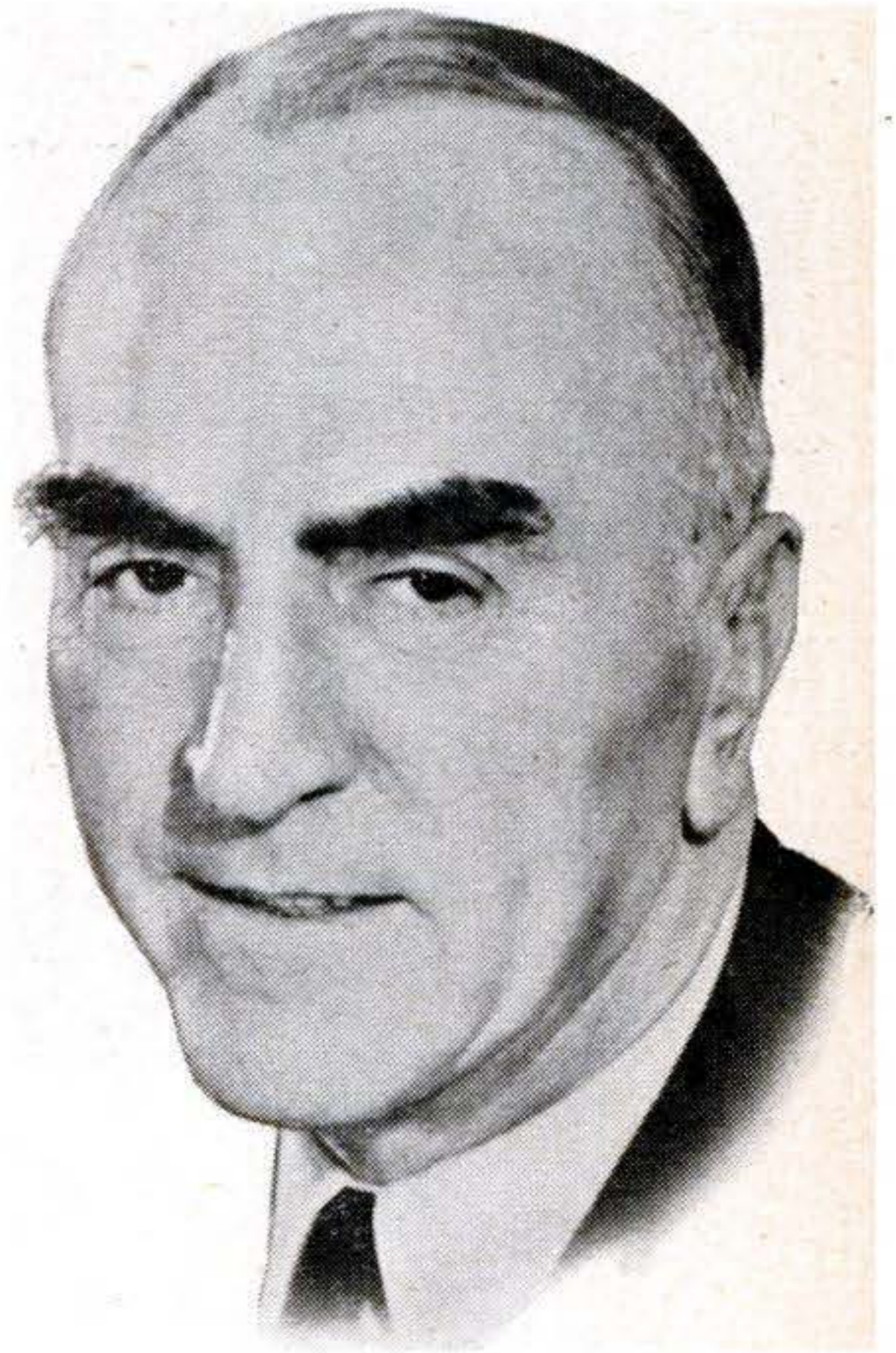

**All Champion Spark Plugs, regardless of type or purpose, are products of the same unequalled research engineering and manufacturing facilities. As a result, the same qualities of outstanding performance and dependability, so dramatically demonstrated above, are inherent in every Champion for every engine!**



CHAMPION SPARK PLUG COMPANY, TOLEDO 1, OHIO

Listen to the CHAMPION ROLL CALL . . . Harry Wismer's fast sportscast every Friday night, over the ABC network

MARCH 1950 257



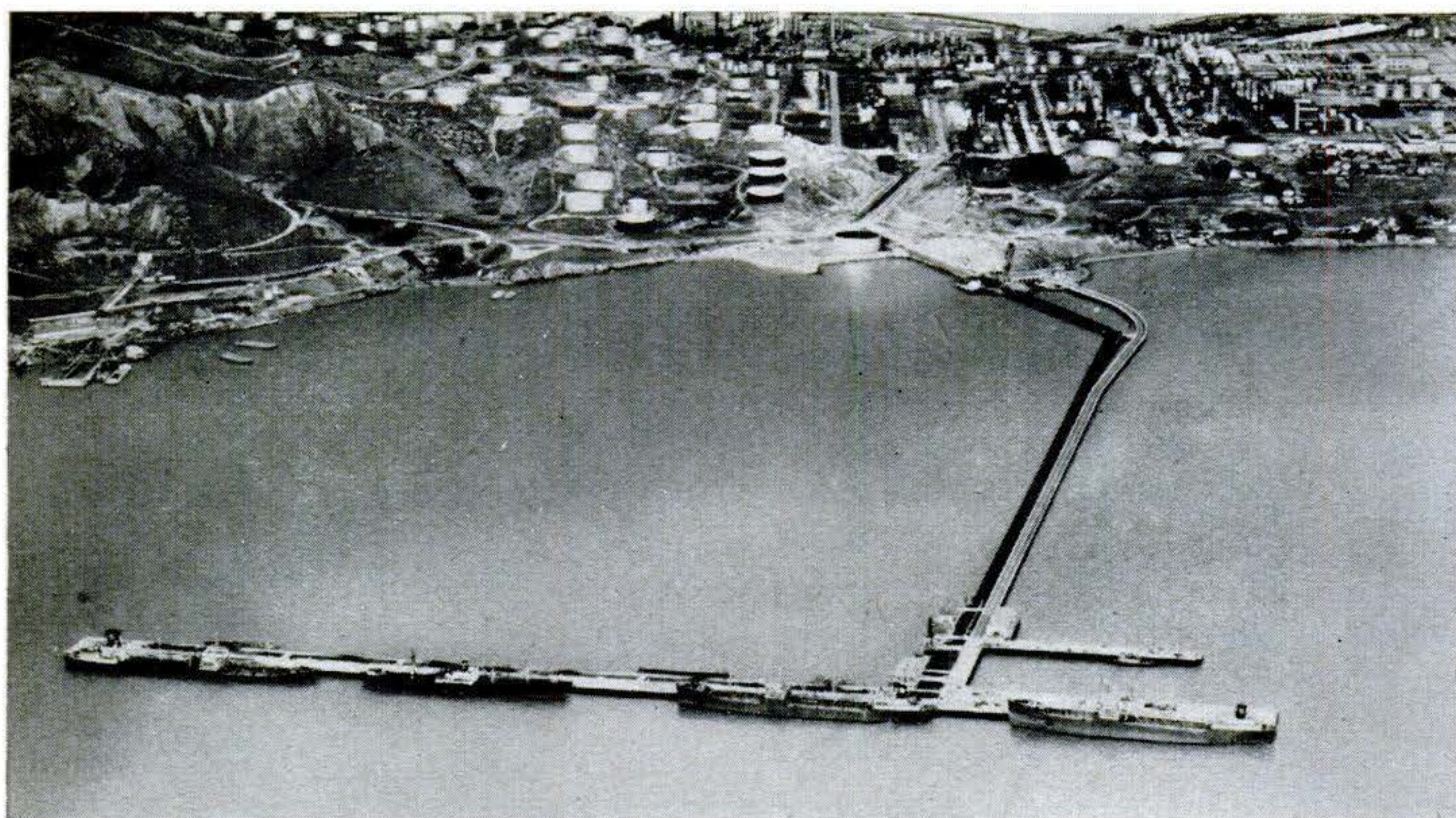

## Oil Loading Speeded Up by T-Shaped Wharf

FIVE tankers and seven barges can be loaded simultaneously at this wharf almost a mile out in San Francisco Bay, off Richmond. The loading berths are connected to the mainland by a four-lane causeway. Trucks carrying packaged petroleum products travel the roadway; bulk liquid flows through pipe lines alongside the causeway.

The installation, built by the Standard Oil Co. of California, cost more than \$5,000,-

000 and handles in excess of 5,000,000 barrels of crude and refined oils every month.



## Planter Runs 3 Times Faster

THIS new planter sows soybeans at 15 m.p.h., peanuts at 10 m.p.h.—three times the usual rate. Seeds are picked up in holes in a conveyer belt that runs through the hopper. Another belt runs against this to hold the seeds until a drop-out opening is reached. The planter was developed at the Georgia Agricultural Experiment Station.

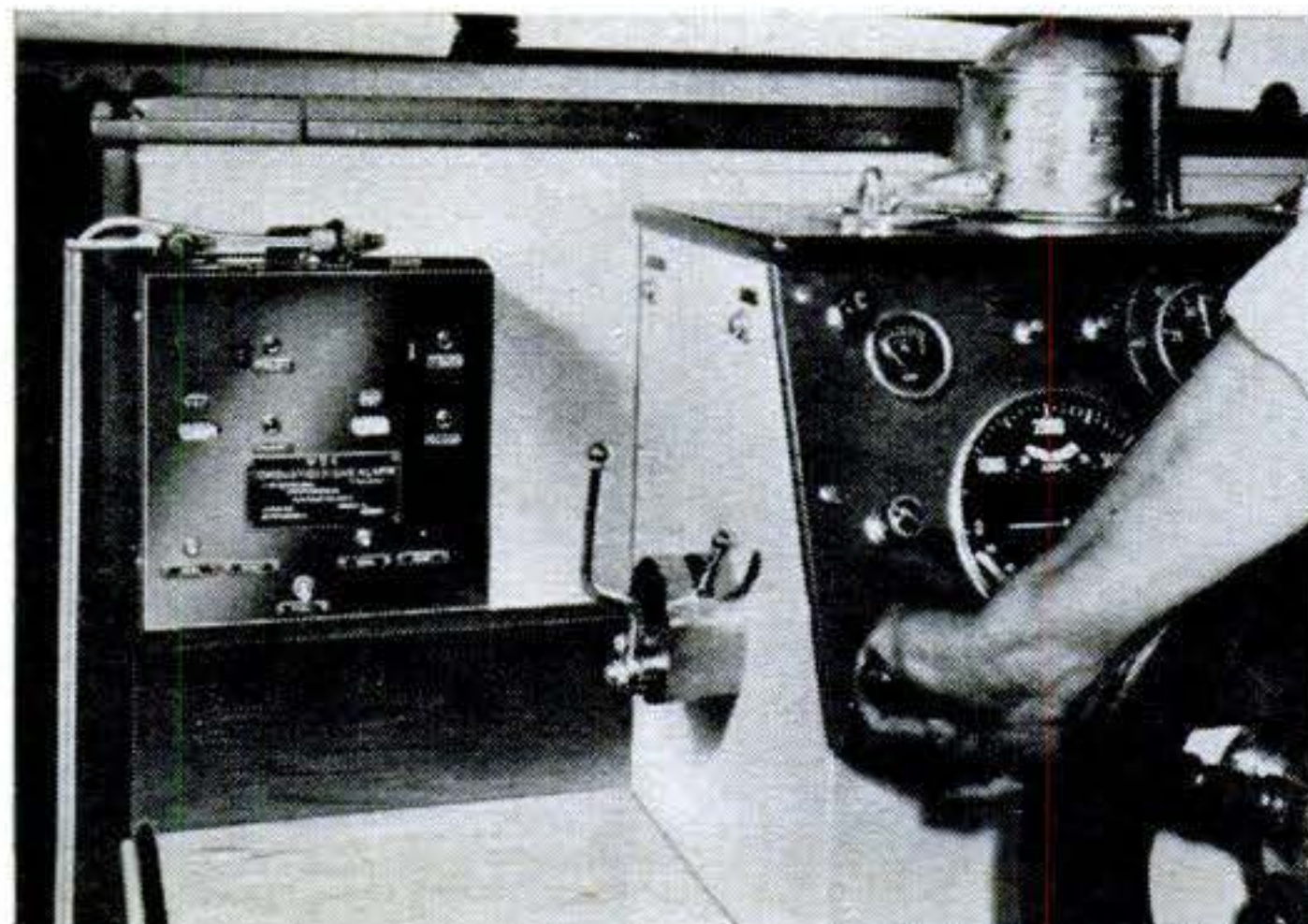

## Boat Blasts Banished

HERE'S a device to banish the deadly motorboat explosions that made headlines last summer. It's a combustible-gas alarm, contained in the box at left above, that warns of dangerous concentrations of explosive gases. Air from two below-deck locations is fed into it through pipes. Any combustible gases in the samples are burned by hot wires, raising the temperature. When this heat indicates the presence of more than 25 percent of the smallest amount of gas that will cause an explosion, an electrical circuit is closed. This lights a small warning bulb or sounds a buzzer near the helmsman. The alarm is made by the Mine Safety Appliances Co., of Pittsburgh.





Walter Chrysler's original tool chest—on display in the Chrysler Automobile Salon, New York

## The tools that money couldn't buy

Walter Chrysler made them himself. He was 17, working in a railroad roundhouse. His mechanic's fingers itched for a kit of tools of his own. So young Walter took steel and made his own.

As he shaped them, he shaped a dream as well. It was a special American kind of dream—free-ranging imagination anchored to solid things like common sense, working a little harder, making things a little better. And asking no odds.

It led Walter Chrysler to success in railroading when he was young. It led him to study the automobiles of the day. Why couldn't a man build *better* cars than any known—nimble, safer, more comfortable, handsomer?

So, 25 years ago, Walter Chrysler introduced the first Chrysler car. What he did changed the whole pattern of American motoring. He changed it with high-compression engines, 4-wheel hydraulic brakes, all-steel bodies, new ways of distributing weight for better riding . . . many originations the entire automobile industry eventually followed.

As Mr. Chrysler's birthday, April 2nd, approaches and as Chrysler Corporation this year observes its own 25th anniversary, it is fitting to pay this tribute to Walter Chrysler and his genius.

And the tools of his earlier mechanic's days? I remember when he found them in his mother's house. It was long after he had asked me to work with him. He brought the tools back from Kansas. A few of them needed fixing and he asked me to fix them. It was a compliment I have never forgotten.

The qualities Mr. Chrysler put into his own tools still mark the great organization he founded. He built not merely material things; he inspired men with a zeal to carry on his splendid ideals.

Chrysler Corporation is still young enough to feel his inspiration. He wished this company always to be a producer of fine automobiles of great value.

And those of us who were privileged to work with him believe that the new Plymouth, Dodge, De Soto and Chrysler automobiles live up to his tradition.

It is a tradition uniquely American—to live and work with the idea of finding better ways to make what people want.

*W. K. Kellogg* President

Fine Automobiles of Great Value  
PLYMOUTH DODGE DE SOTO CHRYSLER

**CHRYSLER CORPORATION**

Airtemp • Chrysler Marine & Industrial Engines • Dodge Job-Rated Trucks • Oilite • Mopar • Cycleweld

Copyrighted material



# Amazing New Fram Engine-Saver

## Really Stops Auto Sludge!

### Fram Positive Crankcase Ventilator

Here, at last is a new device that provides, for the first time, genuinely adequate crankcase ventilation. It circulates clean filtered air through the crankcase to remove corrosive blow-by gases as they form.

**For Stop - & - Go, Low - Speed, and Cold Engine Driving . . .** These types of engine operation cause excessive oil contamination and dilution . . . cause sludge, varnish, and asphaltene deposits because under such driving conditions blow-by gases are not properly removed. The Fram Positive Crankcase Ventilator corrects these conditions by providing a constant, uniform flow of clean air through the crankcase and out the road draft tube regardless of engine or vehicle speed. Operates whenever the ignition is on.

**Here's How It Works (See Diagram Right)** (1) Dust-laden air is filtered clean as it passes through Fram-Tex filtering media in Fram Crankcase Air Filter. (2) Fram-developed electrically-driven blower provides constant, uniform flow of clean air. (3) Flexible air duct carries air flow from blower to oil filler pipe. (4) Special oil filler cap with removable top replaces conventional cap. (5) Continuous, uniform flow of clean air circulates through crankcase. (6) Ventilation passes out the road draft tube, carrying with it corrosive blow-by fumes and vapors before they contaminate the oil and foul the engine. Cartridges to fit all operating conditions may be changed in 30 seconds.

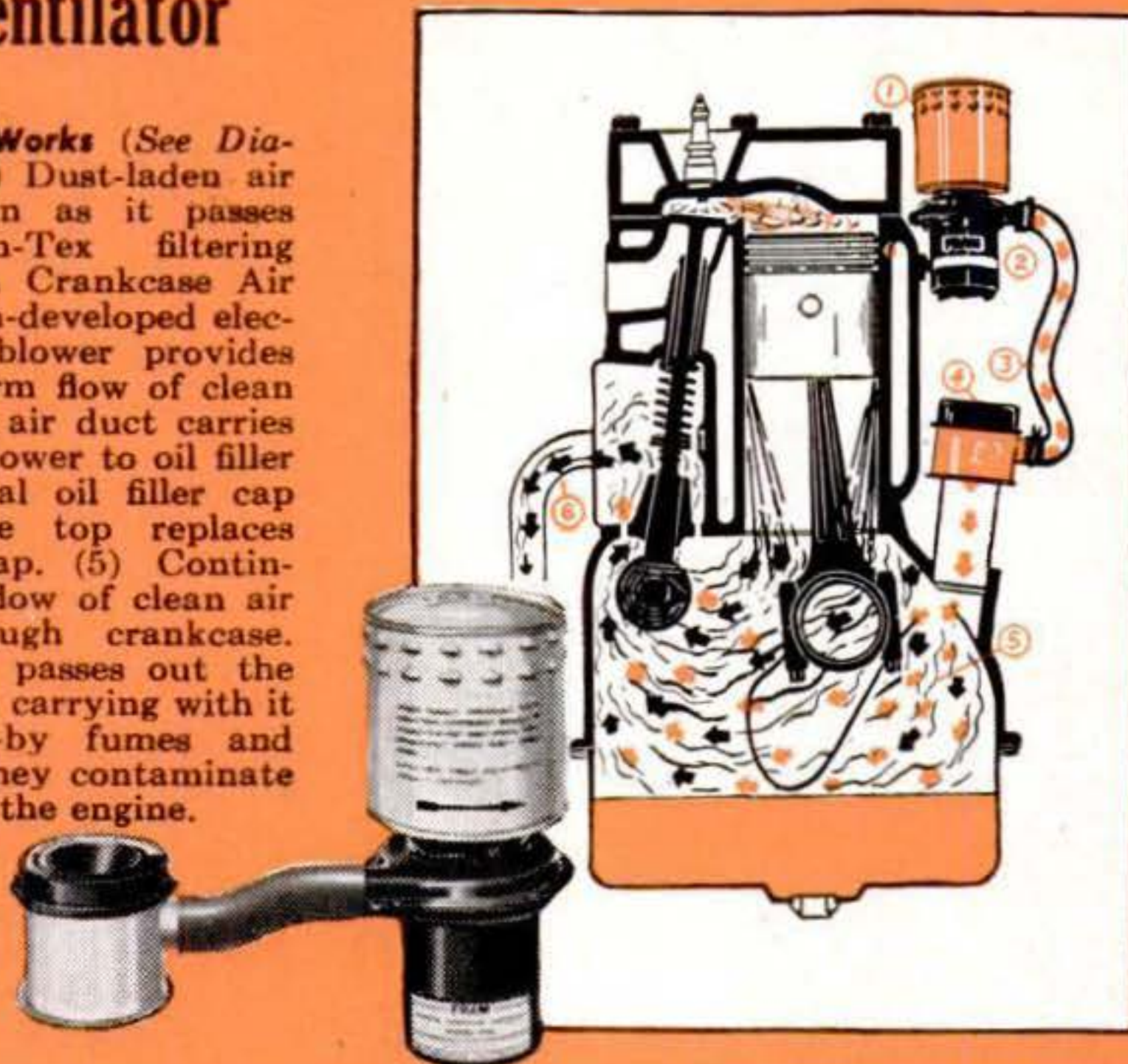

# Now FRAM Offers You Complete Engine Protection

Engineers have proved that internal combustion engines are the cause of their own destruction. With each explosion in every cylinder, combustion by-products in the form of blow-by gases are forced past the rings into the crankcase. Water vapor, carbon, and corrosive acids attack vital moving parts . . . combine with the oil to make sludge. Results in fouled rings, sticking valves, lost power.

Besides these internally manufactured contaminants, dirt, dust, grit and abrasives enter through the carburetor air intake and the crankcase breather to grind and score mirror-finished engine surfaces. Gas tank condensation and sediment, plus scale, jams carburetor needle valves.

To prevent all these engine killers from cutting miles off your car's life, Fram offers you Complete Engine Protection . . . four great Fram Filters that seal out damaging abrasives and remove internally-manufactured corrosives as fast as they form.

**1. Famous Fram Oil & Motor Cleaner . . .** "cleans the oil that cleans the engine." Reduces engine wear and lengthens engine life by removing harmful dirt, dust, grit, sludge and abrasives from your oil. Fram Filcron Replacement cartridges remove particles down to one micron (.000039"), offer highest

clean oil flow rate, lowest clean-oil cost per mile.

**2. Fram Carburetor Air Filter . . .** uses completely new, more efficient method to clean the air your engine breathes. Exclusive Fram-Tex dry filtering media removes over 98.5% of harmful dust from air before it enters engine. Easily installed. Low-cost replacement cartridge. Can be changed in minutes.

**3. Fram Gasoline Filter . . .** removes dirt, sediment, scale and water from gasoline. Protects finely adjusted modern carburetor mechanisms. Cartridge easily changed.

**4. Fram Positive Crankcase Ventilator . . .** as described above.

Put all four of these Fram engine-savers on your car for Complete Engine Protection. For the name of your nearest Fram Complete Engine Protection Dealer, call your local Western Union Office and ask for OPERATOR 25.

**FRAM CORPORATION, Providence 16, R. I.**  
In Canada: J. C. Adams Co., Ltd., Toronto, Ont.

Call WESTERN UNION  
by number and ask for  
**OPERATOR 25**  
for the name of your nearest  
FRAM DEALER



For Complete Engine Protection

# FRAM

OIL - AIR - FUEL

# FILTERS



## Flanges Make V-Belt Pulley

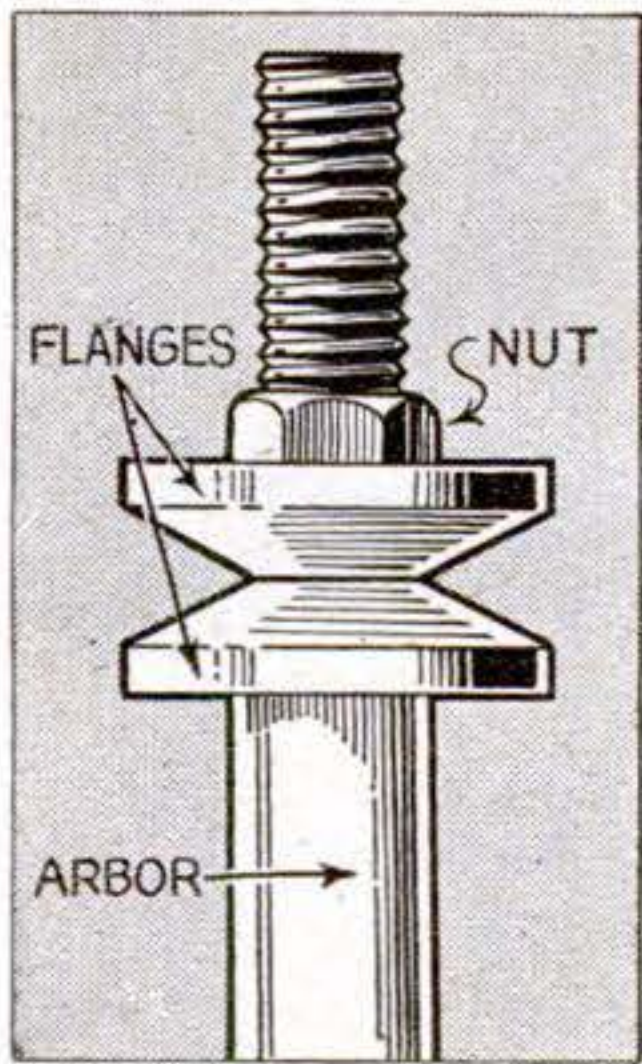

A PAIR of beveled grinding-wheel retaining flanges can be assembled as shown to serve as a pulley on a motor arbor or other threaded shaft. A small washer locked between the flanges will give greater space in between for the V belt. —M. Weisberg, *The Bronx, N. Y.*

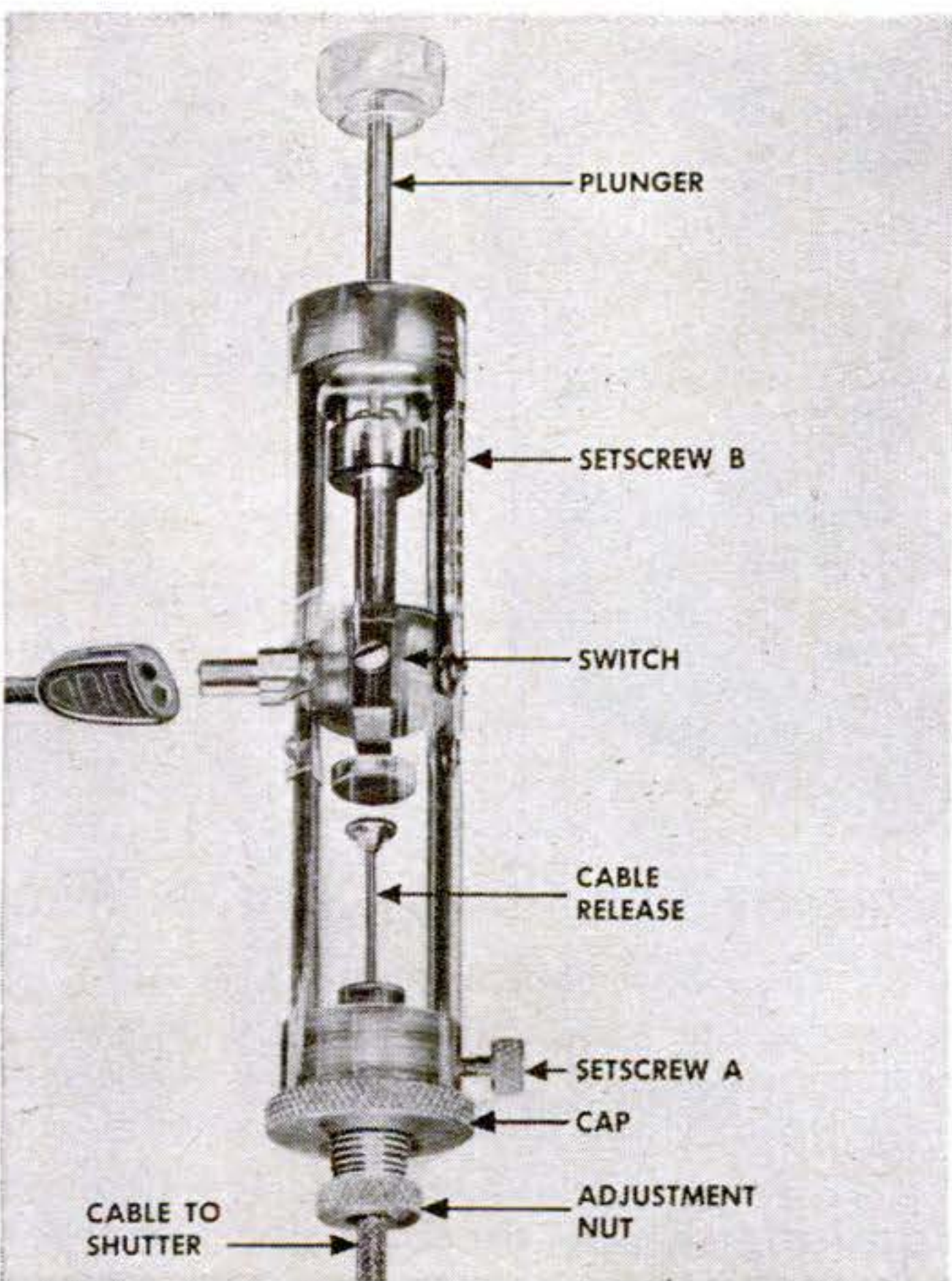

## You Can See Synchronizer Work

ALL working parts of a new photographic flash synchronizer are visible inside its clear plastic case. It can be fitted to most cameras that employ cable releases.

You put it in place by removing setscrew A, turning out the cap, inserting the cable release, and turning back the cap. Then you turn the adjustment nut until the camera shutter releases when the plunger is pressed. Finally, you loosen setscrew B and turn the plunger knob, either clockwise or counterclockwise, to synchronize the switch action with the shutter.

American Cinefoto Corp., New York, sells the synchronizer for about \$12.50.

# JUST FOR FUN-

reclaim idle space  
with Western Pines\*!

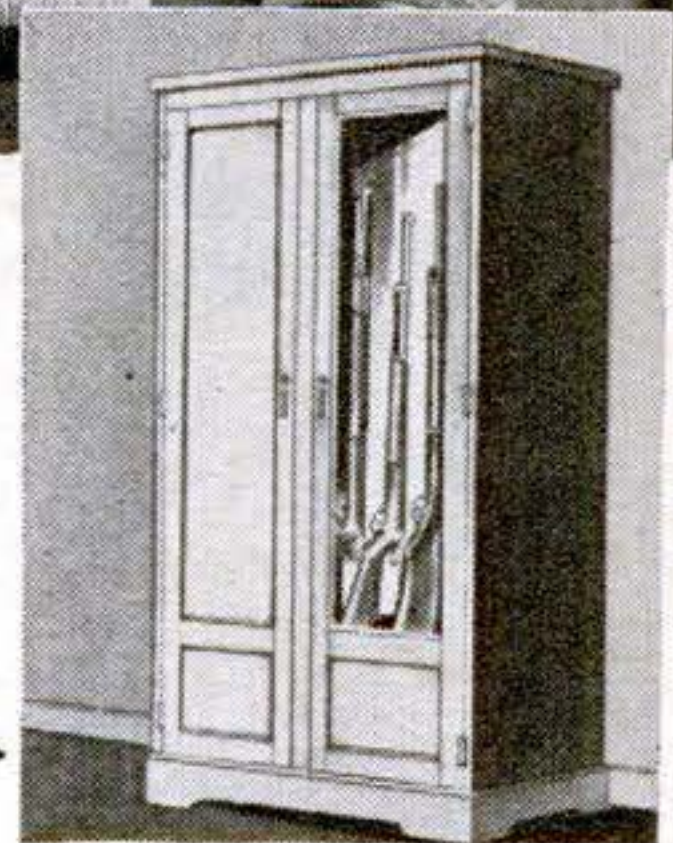

TURN that idle space in attic or basement into a fun room for the whole family! You'll be surprised how easily you can work this transformation when you use versatile Western Pines\*. These soft-textured, even-grained woods cut and shape so beautifully, are naturally lovely waxed and rubbed to a mellow glow, stained or painted. Ideal for paneled walls, trophy display shelves, bookcases, record cabinets, gun racks, and other built-ins that give individuality and personality to a family fun center.

You'll enjoy using these woods of the Western Pines\* in many workshop projects. This handsome gun-and-rod rack, for instance, for the safekeeping and display of weapons and fishing gear. Sturdy and good-looking when built of Knotty Pine throughout or in a combination of Knotty Pine and Clear Pine. Stain or paint to match room, or finish natural. You'll have satisfaction in making it and pride in its finished beauty!

### FREE! IDEA PACKET No. 305-L

Chock-full of remodeling ideas, illustrated how-to-do-it folders and booklets: New, colorful "Enchanting Homes of Western Pines," "How to Make a Rod and Gun Cabinet," "How to Treat Knotty Pine Paneled Walls." Write Western Pine Association, Dept. 305-L, Yeon Bldg., Portland 4, Oregon.

These are the Western Pines \* IDAHO WHITE PINE  
\* PONDEROSA PINE  
\* SUGAR PINE



# NEW POWER KING 8" Tilt/Arbor Ball Bearing Saw

A New Standard of Value for you  
Made by *Atlas*

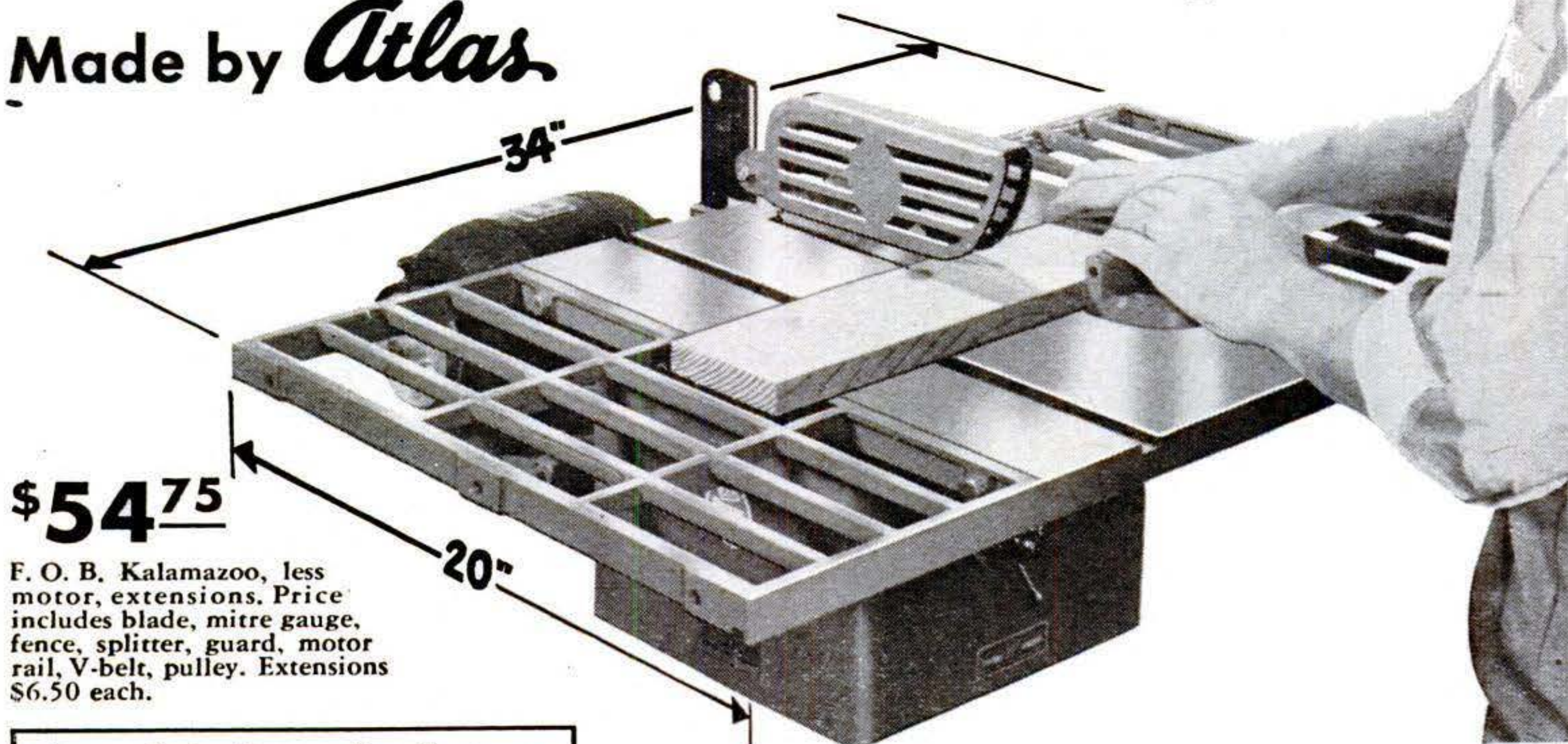

F. O. B. Kalamazoo, less motor, extensions. Price includes blade, mitre gauge, fence, splitter, guard, motor rail, V-belt, pulley. Extensions \$6.50 each.

### Some of the Outstanding Features

- ★ Tilt/Arbor, Ball Bearing Construction! Controls At Front!
- ★ 2 $\frac{5}{8}$ " Depth of Cut — Greatest in its class.
- ★ 11 $\frac{1}{2}$ " Table Surface Ahead of Blade on 1" Cut!
- ★ Big Precision-Ground 16" x 20" Grey Iron Table! 34" x 20" with two extensions.
- ★ Quick Positioning Rip Fence—Locks At Both Ends!

### The Big Capacity and Quality You've Wanted

Here — at low cost — is a saw that gives you the capacity you need for any type of construction for your home, the accuracy you need for fine model and furniture projects, and the quality manufacture that assures a lifetime of useful service.

You'll value the big grey-iron table of this new Power King — its solid support for long or wide boards and big panels. You'll value its *permanently* smooth, easy-sliding, *precision-ground* surface — the quick-adjusting, *full-length* rip fence, the convenient *front controls* for blade height and angles, and the tilting arbor, with sealed ball bearings. Only in saws costing much more do you find *all* the quality features that Atlas engineers have put into this new Power King No. 3102.

See it at your nearest Power King dealers at your first opportunity. And for a catalog with many useful woodworking hints, send a postcard today.

NEW! FREE CATALOG SHOWS  
ALL 8 POWER KING TOOLS

Send a Postcard



**ATLAS PRESS Company**

342 N. Pitcher St., Kalamazoo, Mich.



MATCHED PRECISION TOOLS FOR  
WOODWORKING AND METALWORKING



# Take the Thrill-road to Good times!

RIDE A NEW 1950

## HARLEY-DAVIDSON

### HYDRA-GLIDE



RIDE THE "CHAMP"!

You've got a *new* thrill coming! A touch of the throttle and you're off like a comet! Hills melt away like magic! Rough roads fly beneath you with hardly a quiver of the handlebars. Steering is feather light. Braking is smooth and sure. Day-long riding leaves you fresh and ready for more fun as you take in exciting races, hillclimbs, delightful gypsy tours and club events. Easy payment terms bring you this finest Harley-Davidson of all time. See your Harley-Davidson dealer today. Mail the coupon now!

HARLEY-DAVIDSON MOTOR CO., Dept. P5, Milwaukee 1, Wisconsin

Send for *free* copy of ENTHUSIAST Magazine filled with motorcycle action pictures and stories; also literature on new 1950 models.

Name.....

Address.....

City..... State.....

**DEALERS:** Valuable franchises available for the full line of famous Big Twins and 125 Model. Your opportunity to line up with the greatest name in motorcycles. Write or wire today.



# SHOPSMITH OUTPERFORMS SAWS, SANDERS, LATHES, DRILL PRESSES COSTING \$500<sup>00</sup>

It's a performance-proved fact! With SHOPSMITH you can do more jobs, actually do better work, than with any \$500 combination of single-purpose tools with motors. And here's why:

**SHOPSMITH IS VERSATILE!** It converts into five big, heavy-duty power tools. Takes all standard accessories. Can do 116 wood, plastic and metal working operations.

**SHOPSMITH IS EASY TO OPERATE!** Even without practice you can change it from tool to tool *in less than sixty seconds.*

**SHOPSMITH TAKES BIG WORK!** Its effective table width is so great you can saw to center of 8-foot plywood panels, sand and drill room-length pieces—*with no interference from other tools.* Lathe turns work bigger than a nail keg.

**SHOPSMITH IS PRECISION-BUILT!** It combines features found only in the finest tools. Grease-sealed ball-bearing action. Induction hardened spindle tip. Centerless ground steel ways. A score of precision features that assure hairline accuracy, lifetime service.

**SEE SHOPSMITH DEMONSTRATED!** At any Montgomery Ward, leading hardware or department store. And write for *free* 16-page, fact-packed illustrated booklet.



## \$169.50

complete except for motor. With special, 1/2-hp., capacitor type motor (shown). **\$199.50**

**CONVENIENT TERMS**

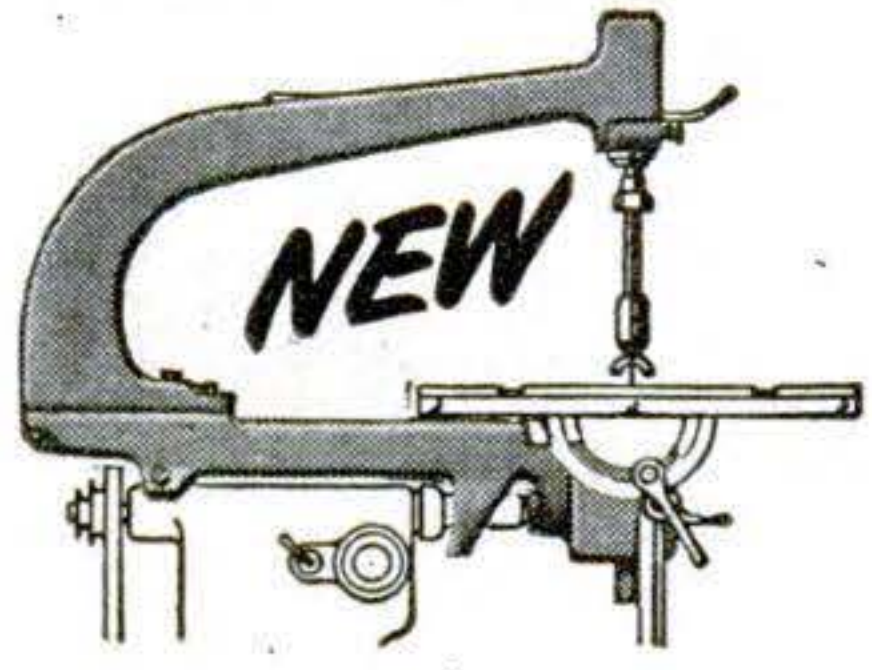

## JIGSAW FOR SHOPSMITH

*The finest precision jigsaw you could own*

Rugged construction. 18" throat. Large tilting table. Built-in blower. Attaches quickly with one bolt. Can be used also for saber sawing, machine filing. Complete attachment, **\$29.95**



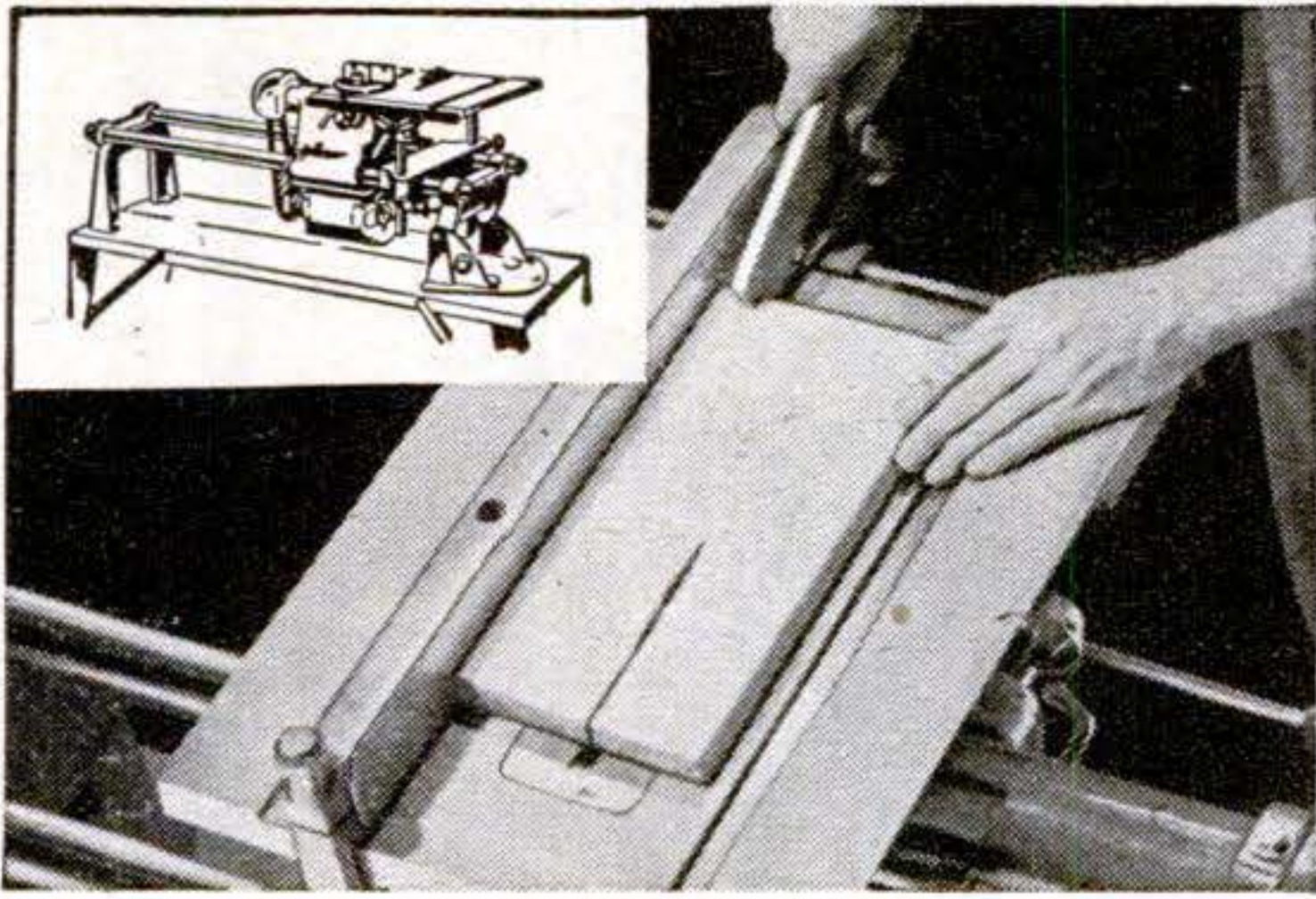

**1 8-inch Circular Saw.** You'd pay \$120 for a saw of equal quality, equal capacity. Effective table width, fence to blade, up to 48". Depth of cut 2 1/4". Sturdy tilting table with ball-crank raiser. Precision-tooled miter gauge with automatic stops. Self-aligning rip-fence.

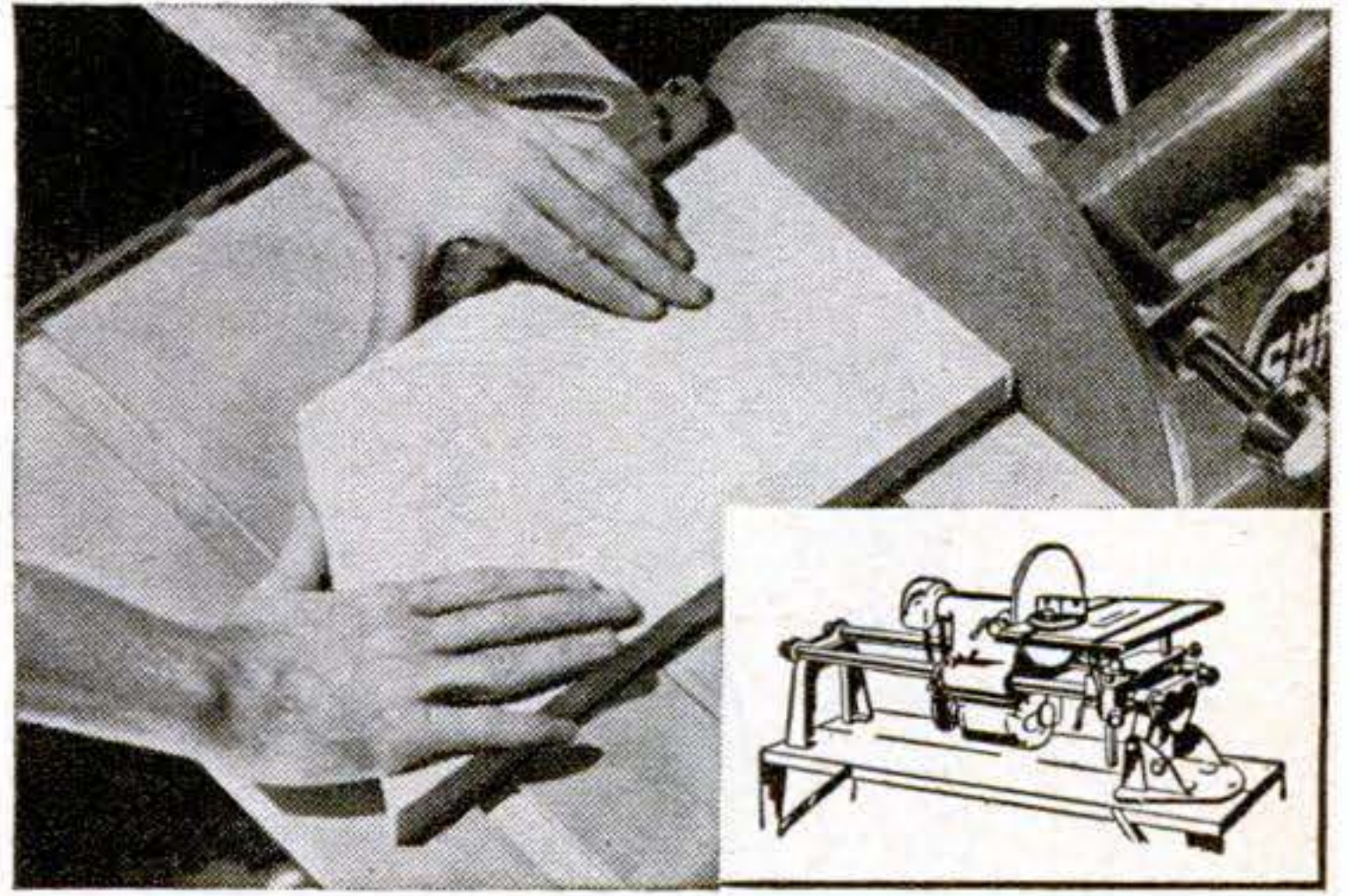

**2 12-inch Disc Sander.** No other disc sander can match it. None has 12" precision balanced disc, 14 1/2" x 17" tilting table, both miter gauge and fence. And with SHOPSMITH you can feed disc into workpiece with feed lever for greater accuracy, speed and safety.

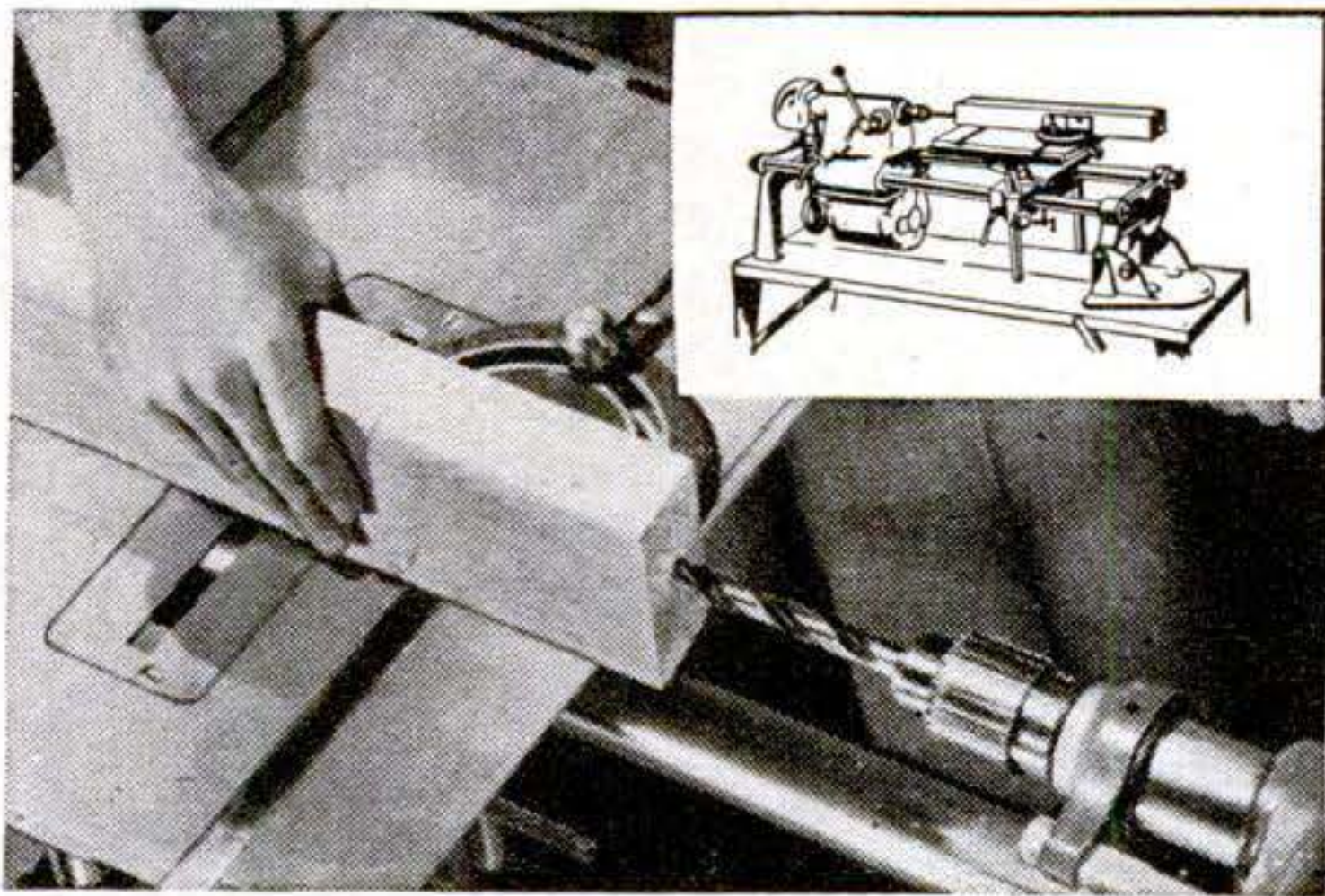

**3 Horizontal Drill Press.** Ever try to drill the end of a table leg? Dowel stock for table tops? Mortise doors for locks? You can do it quickly and easily with SHOPSMITH. Work lies flat on table, no special jigs needed. Speeds from 875 to 3500 rpm. 4" quill feed.

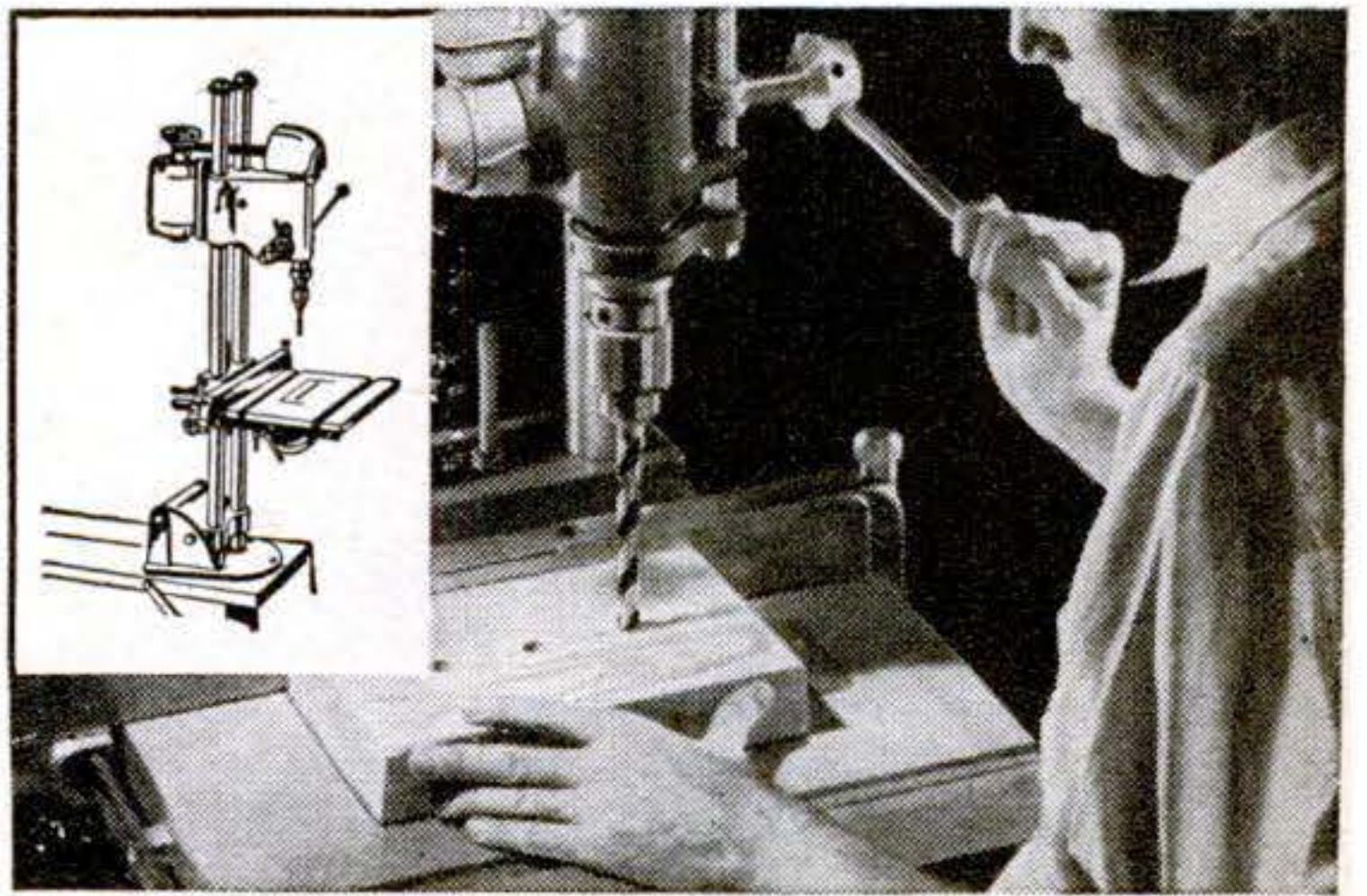

**4 Vertical Drill Press.** In vertical position, SHOPSMITH is both a bench and floor-type drill press. Drills to center of 15" circle. Has 4" spindle feed with right or left hand feed lever. Jacobs key chuck takes drills from 5/64" to 1/2" in diameter. Extra-large table.

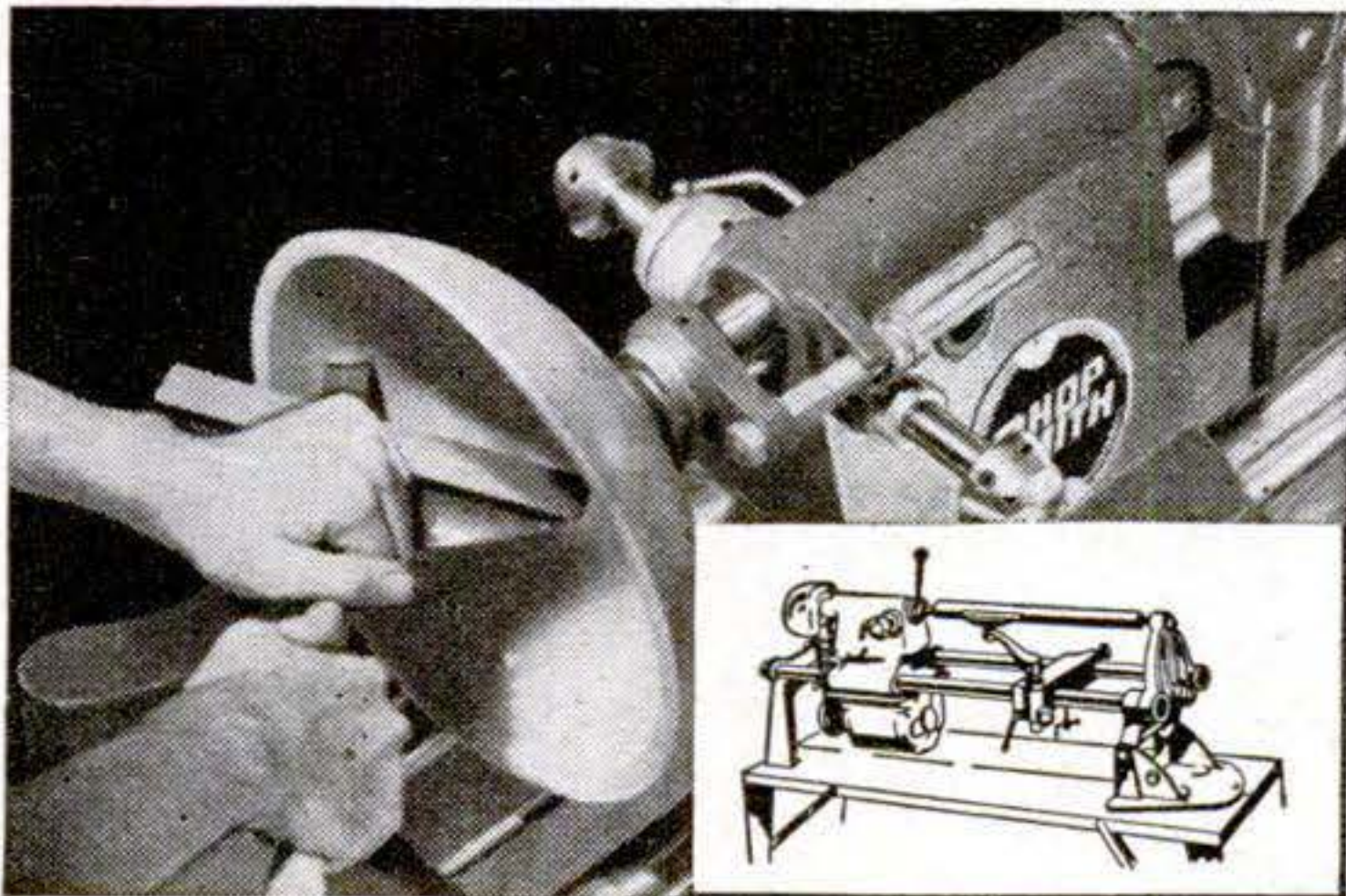

**5 33-inch Wood Lathe.** Turns stock up to 15" in diameter, 3" more than most heavy-duty lathes. Swivel-arm tool rest slides parallel to ways, lever-locks in position. Absolutely rigid lathe bed assures maximum accuracy—tubular steel ways each take over one-ton stress.



**FREE**

**GET ALL THE FACTS!** Compare before you buy! Fact-packed, 16-page booklet brings you detailed specifications, describes SHOPSMITH'S many operations. Send for it! It's FREE!

Address:

**SHOPSMITH**

Dept. 114-A, at factory nearest you:  
12819 Coit Rd., Cleveland 8, Ohio, OR  
417 Montgomery St., San Francisco, Calif.

Name \_\_\_\_\_

Address \_\_\_\_\_

City \_\_\_\_\_ Zone \_\_\_\_\_ State \_\_\_\_\_



PUT *Spring* IN YOUR HORSEPOWER

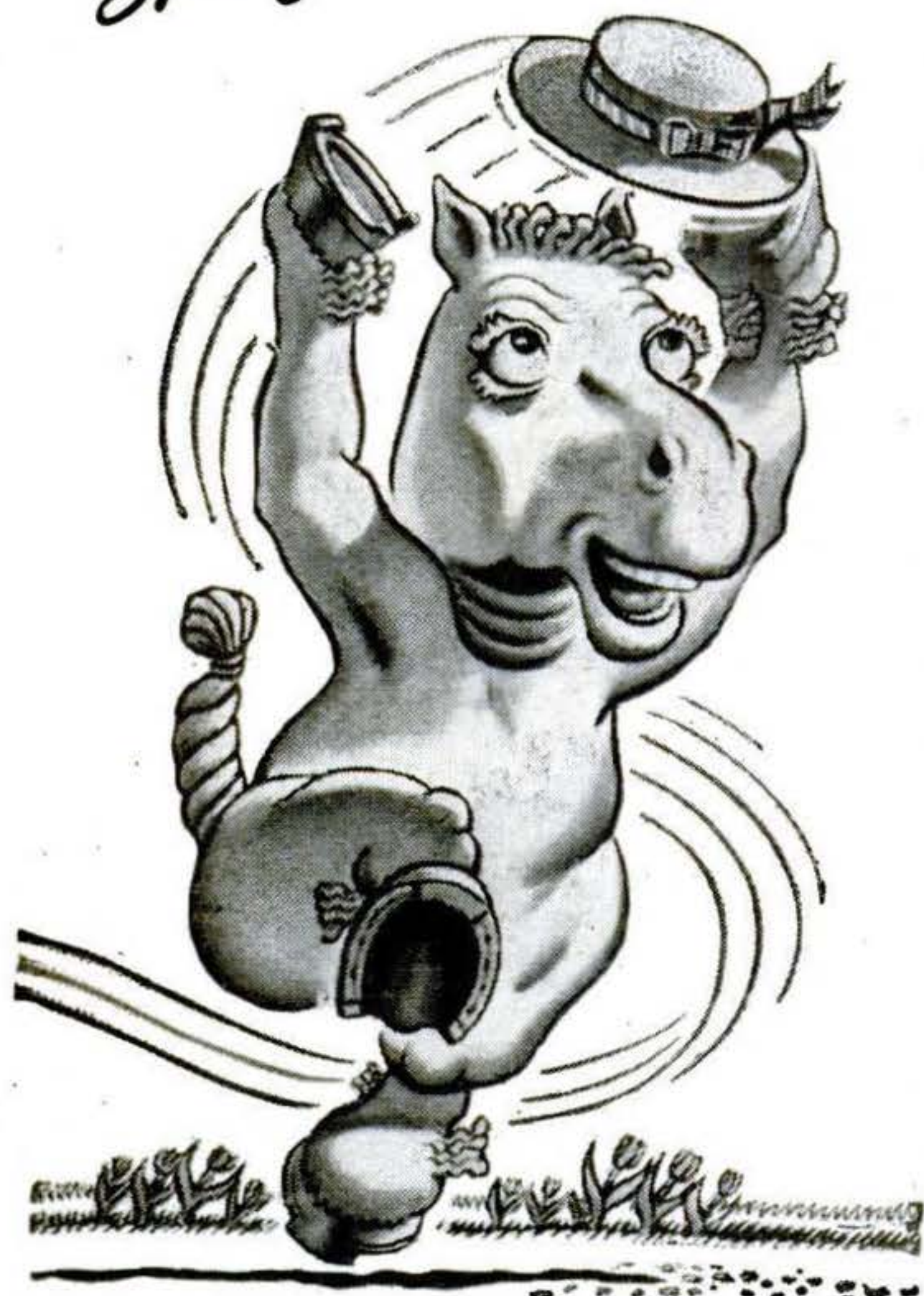

● Put new life in your motor—with a quick, simple Casite Treatment.

Casite through the carburetor air-intake frees sticky valves and rings, lets the power zoom through.

Casite in the crankcase keeps your engine clean and free-running—speeds lubrication—retards engine wear and cuts repair bills.

THE CASITE CORPORATION • HASTINGS, MICHIGAN

75¢  
A PINT



Better and  
Smoother Performance

or

Double-Your-  
Money-Back

The better tools  
you need  
for a better job!

# X-acto<sup>\*</sup>

## KNIVES and TOOLS



Exactly the blade and tool for a more expert job, quicker, easier.

**HOBBY DRILLS**  
**FILES, SAWS, PLIERS**  
**"C" CLAMPS, BLOCK PLANES**  
**HAMMERS, SCREW DRIVERS**  
and dozens of others

Knives from 50¢. Sets from \$1.  
At art, hobby, gift, hardware, dept. stores.  
Write for free illustrated catalog.

\*Reg. U. S. Pat. Off. X-acto Crescent Products Co., Inc.  
440 Fourth Ave., N. Y. 16



# ARC WELDING

FOR PROFIT OR PLEASURE

**60 LBS. OF READY MADE PARTS** Only \$24.95

**BUILD YOUR OWN HEAVY DUTY WELDER** SAVE BUY ONLY NECESSARY PARTS

All parts Ready-Made and easy to assemble. You can do all around welding on steel, cast iron and other metals after only a few hours practice. Illustrated instruction manual included. Sold on 30 Day Money-Back Guarantee!

**FREE:** Write today for fully illustrated Pamphlet S-3.

**ATOMIC ARC WELDER CO.** Gives 100% penetration. Welds are stronger than original metal. Operates on 110 or 220 AC.

1039 So. 19th St., OMAHA, NEBR.



METAL REPAIRS MADE EASY WITH

# Kester Solder

▶ SEND FOR NEW FREE Soldering Booklet

**KESTER SOLDER COMPANY**  
4254 Wrightwood Ave., Chicago 39, Ill.







*"But I always carry Weldwood Glue; it's wonderful for emergencies."*



Remember Weldwood Glue when you need dependable wood-to-wood bonds. Quick and easy to mix with cold water . . . tremendously strong . . . stain-free . . . rot-proof . . . and *permanent*. At paint, hardware, variety stores and lumber yards. 15¢, 35¢, 65¢, 95¢ and larger sizes.

## WELDWOOD PLASTIC RESIN GLUE

United States Plywood Corporation, New York 18, N. Y.

### ALSO HANDY FOR WOOD HOBBYISTS!



#### Firzite

— to give you smooth finishes on fir plywood and other soft woods.

A pre-finishing material that seals the wood pores . . . tames the wild grain . . . virtually eliminates checking and grain raising. An excellent base for stain, paint or enamel. White or clear. White Firzite provides an easy, low-cost way to achieve "blond," "bleached" or "wiped" finishes.



#### Satinlac

— to preserve the beauty of all woods.

An inexpensive coating for the proper finishing of Weldwood Hardwood Plywood and similar woods. Clear. No brush marks. Brings out all the natural beauty of wood. Does not yellow or darken with age.

FIRZITE and SATINLAC are available from paint, hardware and lumber dealers. Write for leaflet No. 3 on finishing plywood.



STANLEY  
No. 5  
JACK PLANE

## FEELS RIGHT...WORKS RIGHT!

The minute you grasp a Stanley Plane and ease the cutter into the wood, you feel the fitness of a fine tool . . . the skill of your hand and eye going right down to the face of the work. It's responsive! It's beautifully balanced! It's right in every detail, from the bevel of the cutter to the way the knob and handle fit into your hands. A lot more than good steel goes into a tool like that . . . the best ideas of generations of the best tool users. You can't get more than that in any tool: you always get a full measure of it in Stanley Tools.

Let this coupon bring you these two books

THE TOOL BOX OF THE WORLD

**STANLEY**

Reg. U.S. Pat. Off.

HARDWARE • TOOLS • ELECTRIC TOOLS • STEEL STRAPPING • STEEL

Stanley Tools, 230 Elm St., New Britain, Conn.

Please send by return mail:

FREE booklet: "The Joy of Accomplishment".  188-page book: "How to Work with Tools and Wood". \$1.00 enclosed.  
(In Canada: Send order to Stanley Tool Co. of Canada, Ltd., 114 Stanley St., Roxton Pond, Quebec.)

Name.....

Address.....

City..... State.....



# get the world's greatest RADIO & TELEVISION CATALOG! **FREE**

**ALLIED'S**  
196-PAGE GUIDE  
TO EVERYTHING  
IN RADIO & TV AT  
LOWEST PRICES



*Everything for Experimenters,  
Builders, Amateurs, Service-  
men, Engineers, Soundmen*

Save money on every radio need! Get the 196-page 1950 ALLIED Catalog featuring the world's largest stocks of top-quality equipment, at low, money-saving prices! Latest TV releases, home radios and radio-phonos, Amateur equipment, PA systems and High-Fidelity Sound, recorders, test instruments, builders' kits—plus thousands of parts, tubes, tools, books and diagrams. Get more for your money from the World's Largest Radio Supply House. Send today for your FREE copy of the 1950 ALLIED Radio Buying Guide!



TELEVISION AND HOME RADIOS



SERVICE SUPPLIES  
BUILDERS' SUPPLIES



AMATEUR GEAR



AMPLIFIERS, P.A.  
SYSTEMS, RECORDERS

## ALLIED RADIO ★

ALLIED RADIO CORP.  
833 W. Jackson Blvd., Dept. 7-C-0  
Chicago 7, Illinois

Rush FREE 196-Page Catalog

Name.....

Address.....

City.....Zone...State.....

**FREE  
CATALOG**

## Better, Easier, Quicker GROOVE CUTTING or CABINET-MAKING

with *Warren* DADO SAWING WASHERS

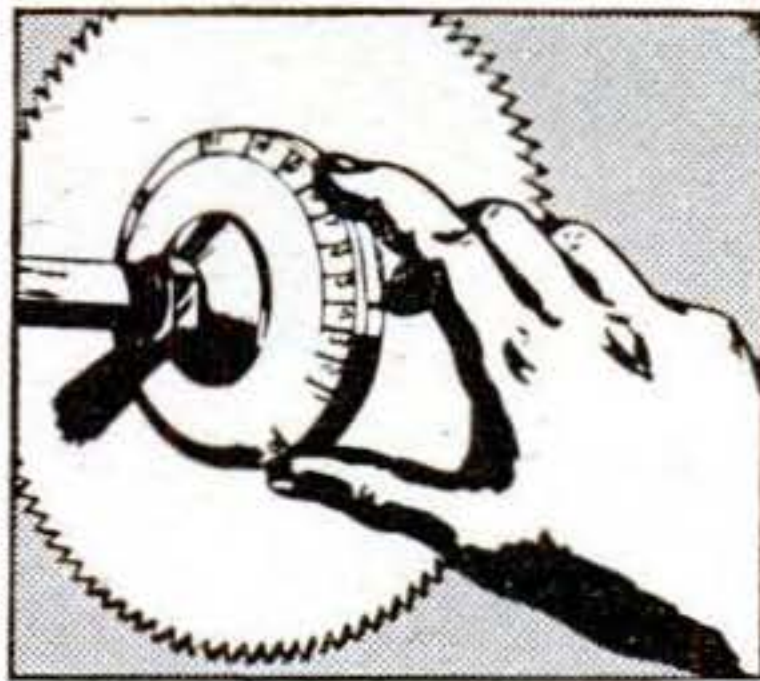

*Just dial*  
DESIRED CUT

Cut accurate, parallel grooves—any width, any angle. Just dial desired width with Micromatic adjustment. Cuts smooth and clean—no burning or chewing to mar fine wood. Just four simple washers. Available in 5 sizes— $\frac{1}{2}$ ",  $\frac{3}{4}$ ",  $\frac{5}{8}$ ", 1",  $1\frac{1}{8}$ ". Free booklet on request. See your dealer or write direct. Absolutely guaranteed! In Canada, send money order for \$4.95 (duty and sales tax extra).

**\$4.95**  
A SET

Dealers, Jobbers, Write for Information!

### WARREN DADO SAWING WASHERS CO.

70 Medbury, Dept. 43, Detroit 2, Michigan

### HYDRAULIC Power Transmission

WITH Infinitely VARIABLE SPEEDS, Clutch and INSTANT REVERSE  
OUTPUT TORQUE ADJUSTMENT UP TO 180 inch POUNDS

This positive displacement Hydraulic Torque Converter is the ideal fluid drive with thousands of uses. Output Speeds Infinite .0 to 550 R.P.M. in either direction. Change Speeds WHILE RUNNING. Control and Transmit your power this SMOOTH Oil-Way. Will handle  $\frac{1}{4}$  H.P. to  $1\frac{1}{2}$  H.P. Motor. Industrial or Home & Farm Use. Cost Government \$300. High Quality Precision Workmanship. Buy this unit to get the most for your money. Case measures  $7\frac{1}{2}$ " long 7" high  $6\frac{1}{2}$ " wide. Input & Output Shafts  $\frac{5}{8}$ " dia. Beautiful Red Crackle Finish Case.

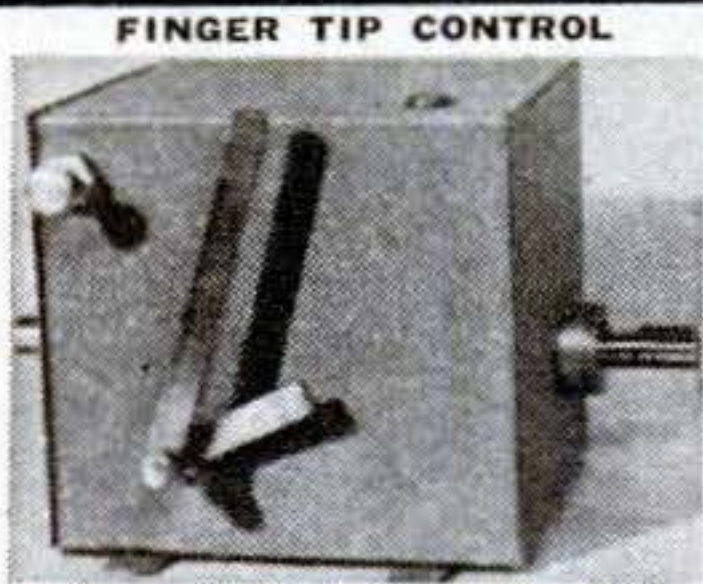

Shipping Wght.  
25 pounds

Only  
**\$54.50**

PREPAID

2 quarts oil included FREE

If C.O.D. is requested a 10% Deposit must accompany order and we ship F.O.B. Chicago.

$1\frac{1}{2}$ "-8 thread Lathe  
Chuck Adapter, \$3 extra

DIRZIUS MACHINE SHOP "Z" 1423-25 So. 52nd Ave., Cicero 50, Ill.

## A MUST for the Handy Man ALLEN HEAD HEX KEYS

You find Allen screws wherever you turn . . . in cars, appliances, instruments, radio, hobby, farm and workshop equipment. Don't be "stuck" without the right key. Get genuine Allen keys made by the originators of Allen Head screws. Seven popular sizes in a sturdy snap pouch, 75c. at your hardware store.

ALLEN MFG. CO.  
Hartford 2, Conn.

75c





ALL ITEMS  
BRAND  
NEW

# GROBAN'S WAR SURPLUS SPECIALS!

ALL FULLY  
GUARAN-  
TEED

115 Volt—60 Cycle A.C.



LIGHT  
PLANT

GENERATOR

(ITEM #67)

**Ideal For: Home Lighting, Hunting Lodges, Stand-by Electricity. Running All AC Electrical Appliances including: Fans, Motors, Electric Razors, Refrigerators, incubators, etc. 750 Watts at 1800 RPM using 1 1/2 HP gasoline engine. 0-150 Voltmeter with Regulator, 1" diameter shaft with keyway for direct or belt drive, carried in two bearings, one bronze and one ball-thrust bearing. Protection for emergencies to operate oil burner, stoker, freezer, water pump, and lights. These units, built to exacting Signal Corps specifications, are the answer to your lighting needs. Shipping wt. 60 lbs. AN OUTSTANDING VALUE. . . . . F.O.B. Chicago**

**59.50**

## PNEUMATIC AIR DRILLS

Made by Chicago  
Pneumatic Tool Co.



Light, powerful, compact, pistol grip, trigger control. Ideal for shop use where air pressure is available.

**ITEM #80**—Equipped with 1/4" Jacobs key chuck. Overall dimen.: 6 1/2" long, 5" high, 1 1/2" thick. Wt. 3 lbs. **F.O.B. Chicago. . . . . 14.95**

**ITEM #81**—Larger size, equipped with 1/4" Jacobs key chuck. Overall dimen.: 7 1/2" long, 5" high, 2" thick. Wt. 4 lbs. **F.O.B. Chicago. . . . . 19.95**

NOW . . . It's Easy to Weld with this handy

## ARC WELDER

250 AMP. MODEL 252

Designed for many years of trouble-free service.

Handles anything from light gauge sheet metal to 1/2" plate



ITEM #65

FOR ANY WELDING JOB, LIGHT OR HEAVY

This precision-engineered direct current ELECTRIC ARC WELDER is offered at but a fraction of its original value. It can be mounted permanently or easily transported for portable use. Does the job instantly, where and when you need it. The War Surplus generators for these Arc Welders were built by General Electric, Westinghouse, and Delco-Remy at a cost of over \$300.00. They are light in weight; have oversized lifetime grease-sealed ball bearings; air-cooled commutator; dial type rheostat for easy pinpoint control; high-low range switch; reactor coil for even arc; handles 1/16 to 1/4" rods. Run welder at 2500 R.P.M. from drive pulley or power take-off of tractor, a 7 1/2 H.P. electric motor or a 10 H.P. gas engine. Use two V-belts, or flat belt (on pulley). Continuous welding rating—200 amps.; intermittent rating—250 amps.; 0-30 volts. Now AT A FRACTION OF ITS VALUE. Price includes double V or flat belt pulley and instruction book. Ship. wt. 107 lbs. Only one or two jobs will pay for entire welder. **F.O.B. Chicago 99.50**

**ACCESSORY KIT** including welding helmet, electrode holder, two 10 ft. cables with clamp, and 5 lbs. of assorted welding rods. (ITEM #66) **F.O.B. Chicago 10.50**

Remember, Satisfaction is Guaranteed

**FREE: 1950, 44-Page CATALOG**  
Write For Yours Today—It's Waiting For You.

## PUROLATOR OIL FILTER

PERMANENT TYPE

The perfect oil filter to keep your motor oil or hydraulic fluid clean at all times. Protect your pump or engine with this unit. Just turn the handle and the element is clean. Standard 3/4" inlet and outlet ports to accommodate 12 gallons per minute. Shipping wt. 4 lbs. A \$13.00 value. (Item # 70 Now . . . . . Postpaid



**4.95**

## WATEROUS PUMP

Rated 500 gallons per minute at 120 P.S.I. This high efficiency pump is designed for front end mounting on General Motors, Dodge, Studebaker and Ford trucks and comes complete with gear box and power take-off for easy mounting and attachment to crank shaft. Net weight of pump 500 lbs. Shipping weight 1200 lbs. **F.O.B. Chicago. . . . . 149.50**

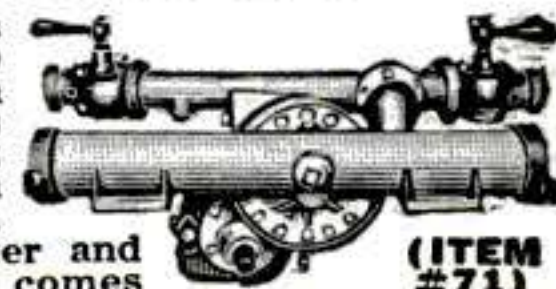

(ITEM #71)

GEAR TYPE—ALL MANGANESE BRONZE

## INSECTICIDE PUMP

For Spraying D.D.T., 2,4-D, Sulphur Compounds, etc. Pressures up to 200 lbs. and 14 gallons per minute—at 1200 R.P.M. Will not rust, pit, foul or freeze up. Use rubber hose inlet, 3/4" pipe outlet. Equipped with double mounting bracket. Weight 24 lbs. Dimen. 8"x7"x10". Standard 1" manganese bronze shaft with keyway. **U. S. Govt. Acquisition Cost \$62.00. NOW . . . . . 15.00**



(Item #50)

**FREE**—complete instructions and performance data with each pump.

NEW AIRCRAFT  
QUALITY

## HYDRAULIC EQUIPMENT

UNCONDITIONALLY  
GUARANTEED



### LOGAN HEAVY DUTY HYDRAULIC CONTROL VALVE

Has built-in adjustable relief valve, will operate one double-acting hydraulic cylinder or two cylinders as one or a reversible hydraulic motor. Valve handle latches in neutral position. Made of rugged cast aluminum alloy. Open center unloads the pump in neutral position. Throttling control allows operator to regulate the speed of movement of the hydraulic cylinder or motor. Has removable mounting brackets with 4 bolt holes, 3/8" pipe thread connections. Overall dimen.: 12 1/2" Hx8 1/2" Dx8" W. Ship. wt. 17 lbs. Gov't. Acquisition Cost over \$100.00. An Excellent Buy. **F.O.B. Chicago . . . . . 21.95**

Large supply of new labor-saving, economical hydraulic equipment in many types and sizes . . . including actuating cylinders, control valves, tanks, pumps, fittings, hose, and data on hydraulic applications.

Use these positive, highly efficient, smooth pressure hydraulics on presses, arbors, lifts, brakes, plastic dies, auto frame alignment, etc., etc.

### LOGAN HEAVY DUTY HYDRAULIC PUMP

For operating hydraulic cylinders and hydraulic motors on tractors, bulldozers, construction machinery, lift trucks, industrial applications, etc. Delivers 8 GPM at 1200 RPM at 1000 P.S.I. using 5 H.P. Has 1/2" pipe thread inlet, 3/8" pipe thread outlet. 3/4" shaft with flat and keyway for direct or pulley drive. Has flange with 4 bolt holes for convenient mounting. Ship. wt. 22 lbs. Overall dimen.: 7" L x5 1/2" Hx5 1/4" W. A \$105.00 value **F.O.B. Chicago. . . . . FOR ONLY 22.50**



(ITEM #29)

**ITEM #16**—Double acting cylinder, 1 1/2" bore, 27" stroke. (Will lift 1760 lbs. in 2 seconds with Logan Pump.) Wt. 8 lbs. A \$55.00 hydraulic cylinder value for only **12.95** postpaid

**ITEM #17**—Double acting cylinder, 2 3/8" bore, 8" stroke. (Will lift 4400 lbs. in one second with Logan Pump.) Will withstand 1500 P.S.I. against wall. Wt. 7 lbs. A \$65.00 value . . . . . **14.50** postpaid

**ITEM #15**—Double acting cylinder, 3" bore, 8 1/2" stroke. All steel hydraulic cylinder, (will lift up to 7000 lbs. in 3 seconds with Logan Pump). Wt. 12 lbs. A \$78.00 value . . . . . **19.50** postpaid

**ITEM #31**—Double acting cylinder, 3 1/2" bore, 11" stroke. (Will lift 9600 lbs. in 7 seconds using Logan Pump.) Wt. 15 lbs. A \$92.00 value. . . . . **22.50** postpaid

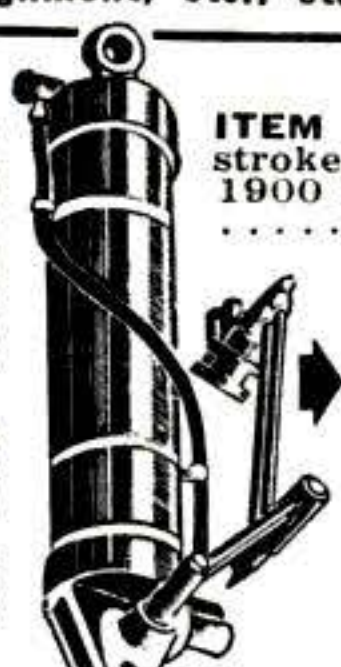

### VICKERS MF9 HYDRAULIC PUMP or MOTOR

complete with mounting kit ready to install **19.90** Post-paid

Pump is compact, powerful, rated 1,000 P.S.I., .507 cu. in. per revolution, 8 gal. per min. at 3750 RPM. Change rotation by reversing flow. Delivers up to 6 H.P. Requires 1/3 to 6 H.P. to drive directly or by pulley. Mounting kit has been especially designed to provide maximum utility and ease of mounting MF series Vickers Pumps. Brackets are constructed of heavy steel plate; shaft is made of 1/2" steel with one end splined to fit pump; other end of shaft has machined flat for mounting a standard pulley with 1/2" hole. Shaft runs in pilite bronze bearings.

**PUMP ONLY (ITEM # 18) . . . . . \$14.95 postpaid**  
**MOUNTING KIT ONLY (ITEM #38) . . . . . \$ 4.95 postpaid**  
**BOTH AS COMPLETE UNIT (ITEM #39) . . . . . \$19.90 postpaid**

### HYDRAULIC CONTROL VALVE

**ITEM #24**—Four-way control valve with built-in relief valve, for use with one double action hydraulic cylinder, may be used with 1500 P.S.I. hydraulic system to open and close hydraulic cylinders. Ship. wt. 8 lbs. A \$38.00 value . . . . . **7.95** Postpaid

**ITEM #26**—Four-way control valve for use with two hydraulic double-action cylinders. Each cylinder may be operated independently of the other or in conjunction with the other. Oil may be locked in any of the cylinders to hold the piston at any required position. Ship. wt. 6 lbs. A \$60 value. . . . . **10.95** postpaid

**ITEM #28**—A two cylinder double action valve with a unique arrangement, allowing the operator to raise both cylinders simultaneously, to lower them simultaneously or to raise one and lower the other at any predetermined rate and speed. Ship. wt. 8 lbs. A \$75.00 value . . . . . **14.95** postpaid



ORDER DIRECT FROM AD. SEND PAYMENT, CHECK OR PURCHASE ORDER, TODAY

**GROBAN SUPPLY CO. 1507 SOUTH MICHIGAN AVE. Chicago 5, Ill. Dept. PS-3**



# EXTRA BEDROOM IN YOUR ATTIC!

**F**INISH off an extra attic bedroom quickly and inexpensively with Gold Bond Insulation Board. This new material gives you 3 big benefits for one low price. It decorates, insulates and hushes noise. It comes in tiles and random width planks finished in ivory and harmonizing variegated blends. Also in big ivory-coated panels. No further decoration is needed. Ideal for game rooms, dens or for remodeling living or dining rooms. For further details write Div. X, Dept. PS-3.

Available at your local Gold Bond Lumber and Building Materials Dealer

**NATIONAL GYPSUM COMPANY  
BUFFALO 2, N. Y.**

# Ride Anywhere for LESS!

**75 MILES  
PER  
GALLON**



No wonder you see so many Cushmans everywhere! Thousands ride 'em because they're so Amazingly Economical! Think of getting 75 miles to the gallon! Cheaper than shoe leather! Far less than bus fare—and no long waits

Even more impressive is Cushman's advantage in traffic—its ease of handling, fast get-away, its ability to slip in and out of narrow places. You get there quicker and easier—then, you park anywhere! Wonderful for getting to work, school, market, doing errands, making deliveries. Dependable, safe, comfortable. Powered by famous long-life Cushman "Husky" engine. Powerful quick-acting brakes.

**FREE** See your Cushman dealer for demonstration of new 1950 models. Or, mail card to Dept. P3

**DEALER INQUIRIES INVITED**

**CUSHMAN MOTOR WORKS, Inc**  
LINCOLN, NEBRASKA USA

**STRIPE  
WITH  
PAINT  
EASY  
AS  
USING  
A  
PENCIL**

## PAINTERS' STRIPING TOOL

NOW you can do your own expert striping on furniture, bikes, model planes, bulletins, autos, toys, signs, linoleum, wall board . . . make plain walls look like tile! It's easy to paint straight, curved, circular, even parallel lines with any color. Handiest paint tool in your workshop! Type "M" Master Painters' Striping Tool complete with tip for 1/16" stripe, \$1.00. Other tools complete with following tips: 1/64", 1/32", 3/64", 5/64", 3/32", 1/8"; \$1.50 ea. Extra tips 75c ea. Entire kit with tool and 7 tips, \$5.00. **WENDELL MFG. CO., 4234-A Lincoln Ave., Chicago 18, Ill.**

**A TOOL . . .  
NOT A BRUSH**

Dealers  
Write  
Today!



### SPECIAL OFFER to Hobbyists

**ONLY  
4<sup>95</sup>**

#### Hard Angle Jobs Set-up in 5 Seconds

Save TIME! MONEY! Drill, mill, grind, etc., round, square, irregular pieces at any angle—Quickly—Easily—Accurately with **PALMGREN "HOBB-E" ANGLE VISE** Accurately machined and graduated. 1 1/4" Jaws, 1-Plain, 1-Grooved. Order NOW! Only \$4.95.

Write for "HOBB-E-HELPS" Circular. **CHICAGO TOOL & ENGINEERING CO.** 8396 South Chicago Ave., Chicago 17, Ill.



## Freeland METAL BOATS

Rugged, low up-keep boats that feature electronic seam weld; spray rails; styro-foam safety floats; removable flooring.

Models from \$65.00.  
Write Dept. 83  
for folder, prices.

**GALVANIZED  
STAINLESS  
STEEL**



**FREELAND SONS CO. Sturgis, Mich.**



**\$295  
EACH**

## NOW! FILE YOUR OWN SAWS

Do expert saw filing at home. Precision filing easy without experience. Two simple adjustments. Keeps any hand saw extra sharp and true-cutting. Complete with file. Money back guarantee. Cash with order, prepaid. (COD post-age extra.) Order today.

Another Speedcor Tool  
**THE SPEED CORP., PS-3**  
512 N.E. 73 Portland 16, Oregon

## Make-Ur-Own Rotary POWER MOWER

**ATLAS KEEN-MOWER**

**SHIPPED ASSEMBLED AS SHOWN**

Model 50M. Just add electric motor or gas engine. Concealed blade for safety. 3 cutting heights, 1 1/2", 2 1/2", 3 1/2". 18" blade. Cuts to within 1/2" of sidewalk. Ball-bearing rubber tired wheels. Wt. 43 lbs.

**Order Now**

**America's Greatest Power Mower Value**

FOB K. C. Send Check or M.O.

**ATLAS EQUIPMENT CO.**

229 S. W. Blvd.

Dept. PS-3

Kansas City, Mo.



**ONLY  
\$39<sup>95</sup>**



**GOLD BOND**  
BUY AT WHOLESALE



**Wholesale Exceptionally Good Used Tires Direct To You**  
with  
**Lifetime Tire Guarantee**  
(10% discount on 2 or more tires if you send this ad with order)  
**TUBE DELIVERED WITH TIRE AT NO EXTRA COST**  
For 15" or 16" Passenger Tires

Safe—Our tires used on school buses and ambulances  
**EXCEPTIONALLY GOOD TREAD—NO RECAPS**

600-16—6 ply Military—Mud and Snow Tires \$6.37	750-20(10) \$15.98
600-16 .....\$5.49	700-16 ..\$6.79
600-16 (6 ply) 6.49	525-18 \$ 6.69
650-16 ..... 5.49	825-20 ..... 16.98
700-15 .. 5.79	600-20 9.89
650-20 9.98	900-20 ..... 17.79
750-15 .. 5.79	1000-20 .... 18.29
550-17 .. 7.79	750-16 12.50

**ALL GOOD TIRES**

600-16 ....\$3.59	550-17 ....\$5.69	700-20(8) \$ 9.29	825-15(14) \$14.98
650-16 .... 3.89	750-16 .... 8.40	700-20(10) 12.48	825-20 .... 11.19
650-15 .... 3.89	600-20 .... 7.98	750-20(8) 11.79	900-20 .... 11.89
700-15 .... 3.98	650-20 .... 7.99	750-15(10) 11.97	1000-20 .. 12.89

**GOLD BOND SPECIAL—750-20 MILITARY TIRES**  
Will fit 650 x 20 700 x 20 (8 & 10 ply) 34 x 7 (8 & 10 ply)  
Special.....\$10.49  
Superior Quality.....\$12.98  
Gold Bond Finest.....\$14.98  
**900 x 16 SPECIAL \$9.03 900 x 16 EXTRA \$11.19**

Send check or money order with this ad  
**GOLD BOND TIRE CO., Dept. PS 24**  
512 NORTH 1ST ST., RICHMOND, VA.  
"A gold bond written guarantee with every tire"

**KINKADE GARDEN TRACTOR**  
and Power Lawnmower  
A Practical Power Plow and Cultivator  
for Suburbanites, Gardeners, Florists,  
Estates, Fruit, Nursery & Poultrymen.  
**Easy Terms - Write Today**  
**American Farm Machine Co.**  
1072 33rd Ave. S. E. Minneapolis, Minn.



Catalog Free

**NONE BETTER!** **SUPER DRILL GRINDER**



Sharpens round shank drills from 3/32" to 1/2" in diameter, up to 6" long. Grinds old drills like new in 4 different point angles, using hand or power grinding wheels. Money-back guarantee.

Price only \$2.95  
At Dealers or Postpaid  
**Crandall Mfg. Co.** 1512 W. Slauson, Dept. FB-47, Los Angeles 44, Calif.

**Removing Paint is no problem now!**



Yes, it's easy to remove any type of finish the professional WONDER-PASTE way. There's no arm-tiring work with a torch; no messy sanding needed afterward.  
Simply apply WONDER-PASTE directly over the old finish with a paint brush . . . Allow time for complete penetration—then remove with a putty knife. The butter-soft sludge peels off easily, quickly, cleanly! Won't injure wood, metal, fabrics, or your hands.  
At paint and hardware stores everywhere.

Write for Leaflet  
**WONDER-PASTE**  
Wilson-Imperial Company, 121 Chestnut Street, Newark 5, N. J.



**XPEL-IT!**  
Removes Harmful Gasoline Gums—  
Cleans Carburetor-Manifold  
**INSIDE—LIKE NEW**

The **XPEL-IT KIT**  
**SAVES MONEY—TIME**  
You don't remove carburetor—manifold



Gasoline gum steals power...  
**XPEL-IT!**  
CLEANS CARBURETOR INSIDE  
MORE POWER  
FASTER PICKUP  
SMOOTHER IDLING  
EASIER STARTING  
BETTER MILEAGE  
LESS STALLING  
Save \$\$\$ - Save time!  
**XPEL-IT**  
(Organized)  
**INJECTOR KIT**  
one pint treats  
MONEY-BACK GUARANTEE

**COMPLETE KIT only \$2.00**

**ALL GASOLINE CONTAINS HARMFUL GASOLINE GUMS**  
Especially gasoline made by today's methods. Harmful gasoline gums are accumulating in the carburetor and manifold of your car, new or old. RIGHT NOW! Robbing your engine of power—wasting gasoline—wasting your money. Up to now the ONLY way to remove these power-robbing gums was to lay up your car, remove carburetor and manifold — "boil out" harmful gasoline gums—at a cost of \$7.50 to \$15. Wonder-working XPEL-IT does away with all this—does it better.

**NEW EASY METHOD! SAVES TIME—MONEY!** XPEL-IT removes harmful gasoline gums chemically. XPEL-IT INJECTOR KIT gets XPEL-IT inside carburetor and manifold easily. Tested IN USE for thousands of miles on cars, all makes—old and new. CERTIFIED dynamometer tests prove XPEL-IT tremendously increases the USABLE power. Only a small part of the real engine power is usable under most favorable conditions. Even a 10% increase in USABLE horsepower means faster pickup and greatly increased gas mileage.

**YOUR CAR NEEDS XPEL-IT NOW.** If your carburetor and intake manifold haven't been cleaned INSIDE in 5,000 to 10,000 miles, XPEL-IT will increase your power and gas mileage much more than 10% CASH SAVINGS and greater pleasure every time you drive.

**FAST! EASY!** Only 20 minutes to treat your car—no matter what age or make—with XPEL-IT INJECTOR KIT. Everything you need in one complete package. No experience needed. You don't remove carburetor or manifold.

**ABSOLUTE MONEY-BACK GUARANTEE.** XPEL-IT Injector Kits are sold with a positive guarantee of satisfaction. If XPEL-IT doesn't perform as we say, when used as directed, return empty can and injector kit—purchase price will be refunded at once. Thousands of unsolicited testimonials. BUT! The important thing is what XPEL-IT does for your car. We guarantee you will see a great improvement after using XPEL-IT when you DRIVE JUST ONCE AROUND THE BLOCK.

**SEND NO MONEY—ORDER TODAY.** Don't continue to neglect the heart of your car. Order your XPEL-IT INJECTOR KIT NOW—TODAY! You need send no money!

Dealer Inquiries Invited

**MAIL COUPON - SEND NO MONEY**

**EXCELO SALES COMPANY**  
4163A West Third Street, Los Angeles 5, California

Gentlemen:  
 Rush me . . . . . XPEL-IT Kit(s). I will pay postman \$2.00 plus small postage and C.O.D. charge when my Kit(s) arrive(s). Save postage and C.O.D. charges. Enclose \$2.00 with order—Injector Kit(s) will be sent postpaid.  
Send my XPEL-IT Injector Kit(s) postpaid. Enclosed is \$ . . . . .

Name.....  
Address.....  
City..... Zone..... State.....



**ATTENTION SHOPMEN!**  
**Power-Flex**  
**GETS MORE WORK DONE**

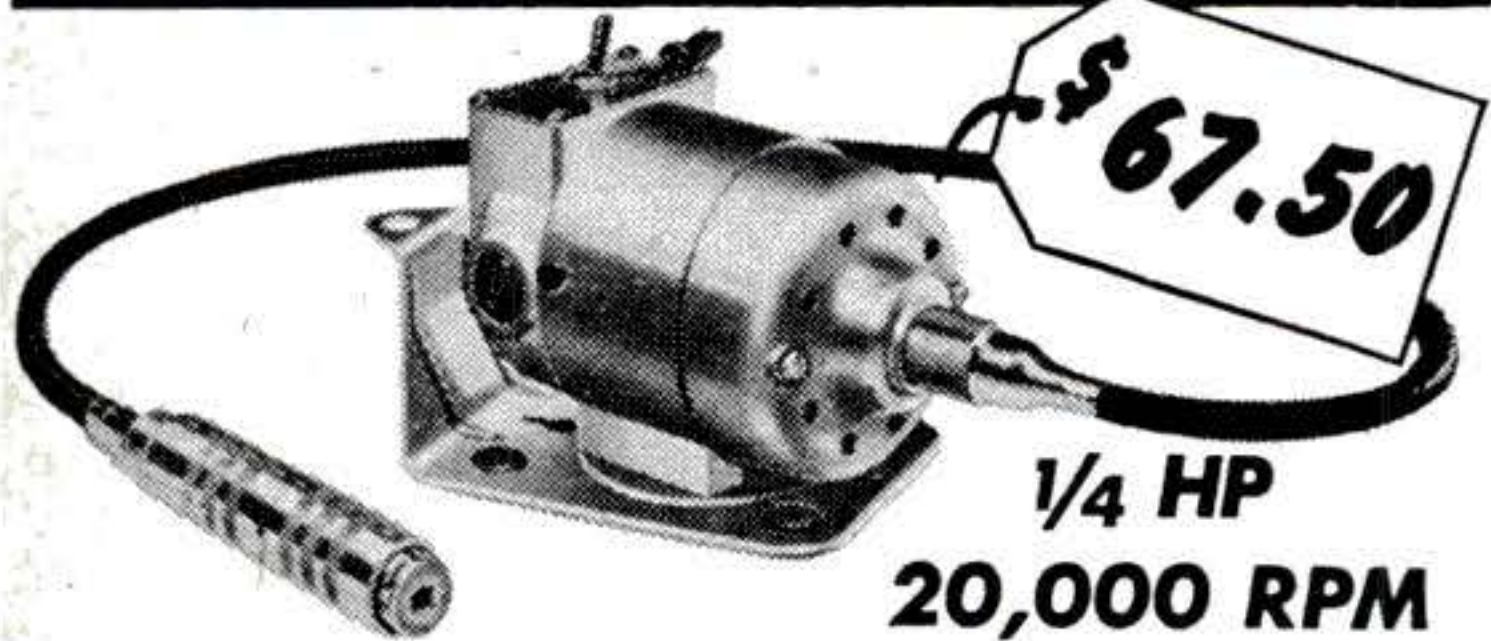

**1/4 HP**  
**20,000 RPM**

**GRIND—BURR—FILE—SAND—ETC.**

Watch your output increase when you put the power plant on the bench and hold the light-weight, smooth-running handpiece in your hand. With the Power-Flex you get a popularly-priced, "full-shift" production tool with all these advantages.

- Handles carbide cutters
- Gives finger tip control
- Handles all 1/4 and 3/8" mounted accessories
- Decreases work fatigue
- Gets in those tight places
- Leaves both hands free to work
- Ideal for women operators

Dumore Power-Flexes are job-tested . . . hundreds in use. See this flexible-shaft power house today at your Industrial Distributor or write



**THE DUMORE COMPANY**  
**DEPT. C73 RACINE, WIS.**

**IT'S EASY TO MAKE \$3 AN HOUR AND MORE SHARPENING LAWN MOWERS**

**IN YOUR SPARE TIME**

G. S. of Arkansas writes, "I have my Universal Grinder 2 months and made a net profit of \$227.00. C. R. of Ohio tried the Universal on a part-time basis and now gives it full time. He says "I have taken in, last season, more than \$3,500.00."

**ONLY, UNIVERSAL LAWN MOWER GRINDER** can the inside face and edge of the stationary blade, and all reel blades, be ground to proper clearance **ALL IN ONE SET-UP**

**WITHOUT REMOVING ANY BLADE FROM THE MOWER**  
 Write for details. Learn how to make real big money.  
**ROGERS MFG. CO., DEPT. P-30, LINDSEY, OHIO**

**SEND THIS COUPON NOW**

ROGERS MFG. CO., Dept. P-30, Lindsey, Ohio  
 Please send me full details about the profit possibilities of Lawn Mower Sharpening.

NAME \_\_\_\_\_  
 ADDRESS \_\_\_\_\_  
 CITY \_\_\_\_\_ STATE \_\_\_\_\_

**The New VISE-GRIP WRENCH**  
**Does Jobs No Other Tool Can Do!**

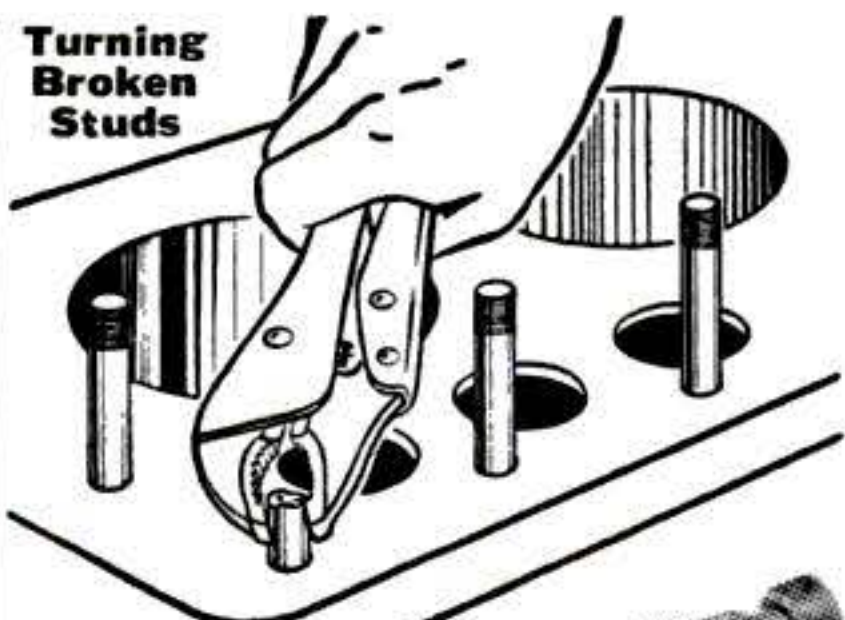

Does toughest jobs Easier and Faster! Jaws LOCK to work with more than Ton-Grip. leaves hands free. New Involute Jaw Curve holds all shapes—nuts, rounds, irregular shapes with ease. Knurled Jaw Tips grip to the very tip. Has Thin Nose and Super Wire-Cutter. WITH CUTTER—No. 7W. 7". \$2.25; No. 10W. 10". \$2.50. WITHOUT CUTTER—No. 7C. 7". \$1.85; No. 10C. 10". \$2.25. If not at your dealers, order direct.

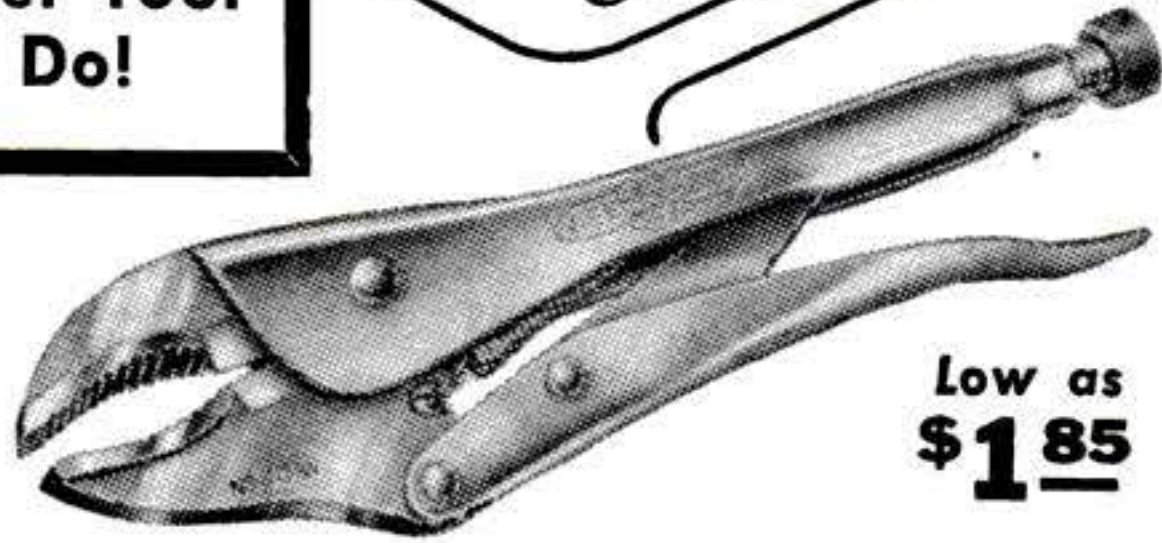

Low as **\$1.85**

**PETERSEN MFG. CO. Dept. M3 DeWitt, Nebr.**

**\$\$ EXTRA PROFITS! \$\$**  
**Flocks & Sandblasts**



**Dual Purpose Spray Gun! Uses only 25 lbs. Air Pressure!**  
 • Thousands of uses in Home, Shop, Industry: Makes Auto Interiors Clean & New, Lines drawers, Marproofs lamp bases, Refinishes any object. All in colorful Flock. Etch & Frost windows, glassware, etc. Removes Paint & Rust from Autos, Tools. Guaranteed! Send \$19.75 or write for free information. Complete Flocking Supplies!

**BLASTO SPRAY GUN MFG. Dept. PS-3, 7007 Haas Ave., Los Angeles 47, Calif.**

**SHARPEN CIRCULAR SAWS LIKE AN EXPERT**



No experience needed. Two simple adjustments. Gets hollow-ground, cross-cut or combination saw blades true and sharp. Fits 6" to 12" blades with 1/2" to 13/16" centers. Includes file and complete instructions. \$6.95 postpaid. (Check or money order) C.O.D.s postage extra. Guaranteed—Money back if not satisfied after 10 day trial. A money maker for fix-it shops. Soon pays for itself. Order today. Free folder.

**SURE SHARP MFG. CO., Dept. S-30 P. O. Box 24 Santa Ana, Calif.**

**USE YOUR BENCH SAW FOR JOINTING & CUTTING MOULDINGS**

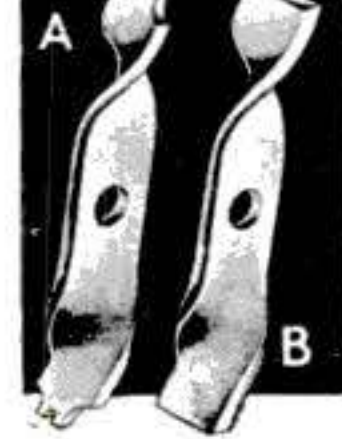

With our six inch tool steel cutters make mouldings, casings, drop-leaf tables, grooves beading and jointing. Moulding cutters, A 1 in. wide \$1.75. 1 1/2 in. \$2.25. Jointing cutters, B 1 in. \$1.75. 1 1/2 in. \$2.25. E 1 in. for drop-leaf tables, \$1.75. E 1 1/2 in. Makes 3/4 in. cove & Quarter. \$2.25. Postpaid. Guaranteed. State size hole. List & Folder free.



**JOHN A. SANDSTROM Rt. 2-P. Clearwater, Fla.**

**War Surplus BARGAINS**

Below are just a few of the many items we have in stock at sensationally low prices.

Pumps	Extension Cords	Gear Head Motors
Grinders	V Pulleys	Electric Hand Saws
Air Compressors	All Size Light Plants	Electric Chain Saws
Air Tanks	Generators	Saw Tables
Spray Outfits	Fire Pumps	Winches

**A Terrific Buy! GAS ENGINES**  
 Briggs & Stratton NEW in original crates. Model AP 13 1/4 to 21 HP. List Price \$102. Your Price \$49.50—Model ZZ, with pulley, 5 to 7 HP. List Price \$141. Your Price \$79.50.

**"MERCURY" CLUTCH**  
 For motor-scooters, motorbikes, lawn mowers, etc. Can be used with electric motor or any gas engine. "A" belt pulley. List Price \$28.00. Your price 5/8" bore \$7.95—3/4" bore \$8.95.

Write TODAY for our free catalog listing thousands of MONEY SAVING bargains.  
**C & H Electric Company, 438 W. Juneau St., Milwaukee 3, Wis.**





# Snap-on\* **ARMATURE RECONDITIONING TOOL**

**does both**

- turns down armature
- undercuts the mica

Here is a well-engineered, substantially built machine which turns out work comparable to that done on expensive lathes, yet is priced low enough to show a profit quickly. Standard tool handles armature work in the automotive garage. Special collet and bushings are available to adapt tool to fractional power motors used in vacuum cleaners, fans, sewing machines, etc.

\*Snap-on is the trademark of Snap-on Tools Corp.

**SNAP-ON TOOLS CORPORATION**

8060-C 28TH AVE.  
KENOSHA, WIS.



## MONEY SAVER

### BRIGHTEN YOUR BASEMENT

... at surprisingly low cost

Want an easy, inexpensive way to give your basement walls and ceiling a fresh, clean look? FREE BOOK TELLS HOW. Send for your copy of "Paint It Bright" —the 24-page book full of helpful painting hints. And remember, there is a difference in aluminum paints. Basement walls, for example, call for Aluminum Metal & Masonry Paint. It's available from the dealer who displays the Alcoa symbol of quality on the brand he sells.



MAIL THIS COUPON



Look for  this shield on aluminum paints made by many paint manufacturers using **ALCOA PIGMENTS**

Paint Service Bureau, ALUMINUM COMPANY OF AMERICA,  
1717C Gulf Building, Pittsburgh 19, Pa.

Please send me free copy of "Paint It Bright".

Name (please print) \_\_\_\_\_

Address or RFD No. \_\_\_\_\_

City \_\_\_\_\_ State \_\_\_\_\_

I want to paint the following: \_\_\_\_\_



Experts tell in "Paint It Bright" how to obtain best painting results with aluminum paints. For free copy, mail coupon.



OVER THE BACK FENCE Buy SAVAGE

MOWING IS A CINCH  
WITH MY NEW SAVAGE!  
QUICK-STARTING-NO GROUND SHOCK  
OR VIBRATION-AND IT'S  
SO EASY TO OPERATE!



**SAVAGE** 21-Inch YARD CHIEF  
SAVAGE ARMS CORPORATION, Lawn Mower Div., Chicopee Falls, Mass.

**PARTS FOR MILITARY TRUCKS**  
4 or 6 Wheel Drive at a SAVINGS

1/4 ton to 20 ton  
Parts List Available on Most Makes  
Military Trucks and Jeep Models.  
Write stating model of Truck



**Brand New—Weatherizing Kits  
JEEP TOPS and CURTAINS**

Fits all military jeeps, also adaptable to civilian jeeps. Complete top with back curtain and side curtains with doors, and 5 windows. Waterproof O.D. color. Shipping wght. 40 lbs. **\$49.50**  
Less Steel Bows. Our low price, for complete set, only  
Also available Tops only with back curtains attached....**\$29.50**  
Side curtains to match with doors and windows, only....**\$20.00**

**TRAILER AXLES**

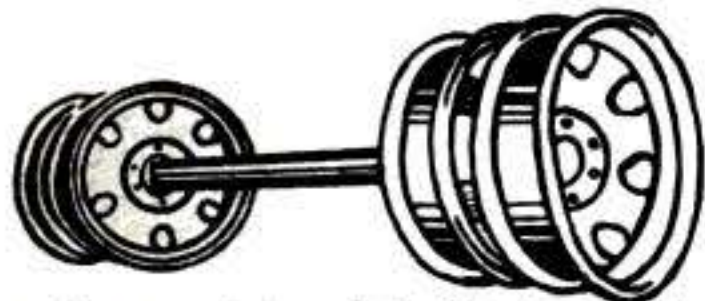

Heavy duty trailer axle suitable for many types of trailer construction. Also excellent for building of heavy farm trailers and wagons. It is a 12,000 lb. capacity square type straight trailer axle complete with Timken roller bearings, hubs, and 6 hole 750 x 20 Budd Wheels. Without brakes. Axle is 2 inches square and 69 inches between wheel mounting flanges. Std. width.  
With Single Wheels **\$59.50** With Dual Wheels **\$69.50**

**GAS TANK** Utility, 6 qts.—New Surplus Cylindrical 5 1/2"x15 1/2", complete.... **\$2.10**

**Brand New HYDRAULIC JACKS** Walker, 3 ton. Complete, limited supply, ea. **\$9.95**

**WINCH CABLE—1/2", 250 ft.**.....**\$30.00**

Hundreds of Other Truck & Jeep Parts and Supplies

All prices quoted good 30 days FOB. Kansas City, 25 % Deposit Required on All Orders.

**JEEP MOTORS UNITED AUTO PARTS CO. INC**  
1901 TROOST-GR.1800-KANSAS CITY, MO.

**Light!**



800 ft. spotlight — brilliant floodlight — from one electric lantern, Delta POWERlite! Convenient. Safe. Economical. Uses one 6-volt dry battery. Buy at hardware, sport, or electrical stores. Try one!

**\$4.65** less battery

DELTA ELECTRIC CO., MARION, IND.

**Delta POWERlite** 2-LITE ELECTRIC LANTERN

*Mustang*

**LIGHTWEIGHT**

Now Only **\$346.30**

(Fed. tax paid, at factory)

9.5 hp. 4-cycle. 3-speed. Foot-shift. Over 70 miles per gal. Over 60 m.p.h. Write for free circular.

**MUSTANG, Dept. GP-29**  
635 W. Colorado. Glendale 4, Calif.



**KEEPS BASEMENT PIPES DRY**

Just wrap "NO SWEAT" insulation around water pipes and seal with special Vapor Seal Elastic Tape. Pipes will stay dry even in hot, humid weather. Workshop and darkroom stay dry. Tools won't rust. Easy to apply. No fuss. No mess. No sticky tape. No tools required. Neat, clean, attractive installation. Send \$1.00 for enough to protect 20 feet of 1/2" pipe. Full instructions included. We mail postpaid. **MONEY BACK** if you are not completely satisfied.

ASSOCIATED SPECIALTIES, 10660 Gratiot, Detroit 13, Mich.

**GARDEN TRACTOR**

2-3-4 1/2  
5 1/2 H.P.  
and NEW  
4 1/2 H.P.  
Riding Model  
Guaranteed



• 30 ATTACHMENTS • NO BELTS  
• NO CHAINS • POWER TURNING  
• GEAR DRIVEN

Plows deep furrows. Change attachments in seconds. FREE Instruction Booklet.

Buy Direct • Special Discount  
Send Postcard for Big  
Free 32-page Catalog

**RED-E TRACTOR CO.**

61 Fond du Lac Road, Richfield, Wisconsin

**WELD** BRAZE, SOLDER, CUT quickly...easily

**THE FOUR-WAY PORTABLE ARC-WELDER**

COMPLETE ONLY **\$9.95** F.O.B.  
10 DAY TRIAL

MAKE OR REPAIR HOME & FARM APPLIANCES FENDERS BICYCLES METAL FURNITURE & 1001 ITEMS

YOU'LL BE AMAZED by the work you can do on your first job! Plugs into any convenient properly wired 110 volt A.C. or D.C. line. Follow simple directions. Work on iron, steel, bronze, brass, aluminum and other metals. Save money doing own repairs. Make money repairing for others. Thousands of users among maintenance and repair men, farmers, tinsmiths, engineers, home and auto owners, etc. Pays for itself over and over. Order on ten-day trial or send for details.

**FREE** **FOUR-WAY WELDER CO., Dept. F3-CA**  
2326 So. Michigan Avenue • Chicago 16, Illinois

**Full Details SEND TODAY**



# HOW TO SHARPEN YOURSELF CIRCULAR SAWS

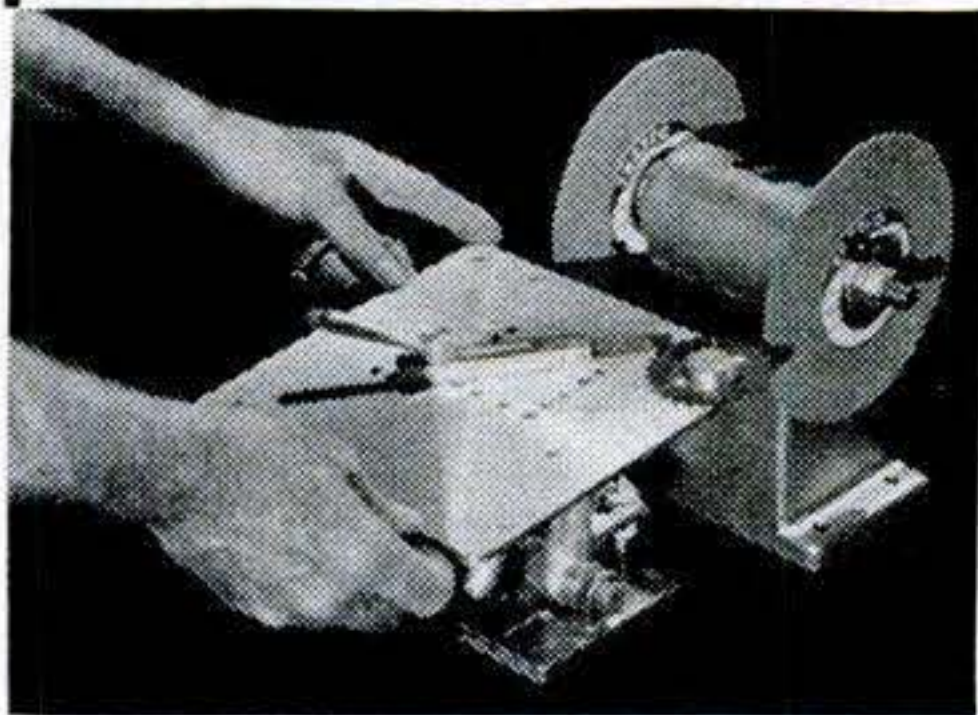

## Also Many Carbide Tip Tools And Cutters

This all-purpose, practical circular sharpening fixture is the ultimate in simplicity. Easiest, fastest sharpening method available. Precision built for precision sharpening.

Now, you can keep your saws and

tools always sharp for cleaner cuts. Sharpening is a business opportunity, too.

Send check or money order . . . money-back guarantee . . . nothing to lose . . . shipped prepaid with complete operating instructions.

**MODEL 135** (illustrated above) only **\$29.95** for 1 1/2" to 12" diameter saws and cutters.

**MODEL 160** only **\$49.50** for 1 1/2" to 16" diameter saws and cutters.

(Tables on above models tilt either side to sharpen angular faces.)

**MODEL 280 EX** only **\$8.95** for 7" to 8" diameter saws.

**MODEL 100 EX** only **\$10.95** for 7" to 10" diameter saws.

**MODEL 130 EX** only **\$17.50** for 2" to 12" diameter saws.

**MODEL 550** Swivel Vise graduated to 180" only **\$7.95**.

Grinder stand and grinding wheels not included in price of fixture.

**MODEL 300** Dust Proof Ball Bearing Grinding Wheel Stand with 30" "V" Belt **\$14.95** (illustrated above). Cast Aluminum Guards only **\$6.50** a pair.

2 Grinding Wheels **\$5.00** extra.

## TREYCO PRODUCTS

264 Hartford Ave. Dept. PS3 Buffalo 17, N. Y.

## MOTOR SPEED SELECTOR SURPLUS STOCK SALE

More than 120 speeds for your motor—22 R.P.M. to 3400. Quick changing, 10 interchangeable splined pulleys. Fits motors to 1 hp. Complete, assembled with belts, pulleys and ready to install on your motor. Built with sealed bearings to last. Completely adjustable. We mail prepaid if cash with order—or for C.O.D. send \$5.—pay postman \$9.95 plus postage. **MONEY BACK GUARANTEE.**

**SUNSET EQUIPMENT CO.**  
PS3, 800 No. Kenmore, Los Angeles 27, Calif.

Now only **\$14.95**

Reg. \$34.95  
Save \$20.



## Build your own JET ENGINE!

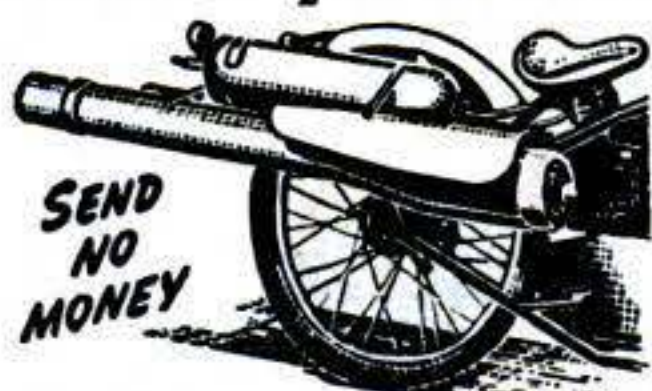

SEND NO MONEY

### Order these plans today

1. JET PROPELLED BICYCLE. Assemble your own. Photo and instructions \$1.00.
2. HOW TO MAKE EXPERIMENTAL JET ENGINES. Seven sheets drawings with information and instructions \$2.95.
3. BOTH OF ABOVE in one order \$3.75. SEND NO MONEY. Order both at once \$3.75 C.O.D. in USA plus c.o.d. postage. Send check or Money Order and we pay postage. Get other information too. Rush Order.

**J. HOUSTON MAUPIN, Dept. 66, Tipp City, Ohio**

## Print Your Own

Cards, stationery, circulars, tags, labels, photo and movie titles, advertising, etc. Save money. **Print for Others, Good Profit;** easy rules sent. Raised Printing like Engraving, too. Send dime for press samples, supply book, all details and advice on your needs. No obligation. **KELSEY INC., B-33, Meriden, Conn.**



Kent Moore  
**\$1.85**

## TORQUE WRENCHES

(At Real Bargain Prices)

New Torque Wrenches at a fraction of the usual price. All are guaranteed new and unused. Surplus stock . . . must be sold. Take Advantage Of These Low Prices.

**KENT MOORE:** 3/8 inch drive, 25 pound. Used largely by Chevrolet Service Departments. **\$1.85**  
Real Bargain

**STURTEVANT:** 3/8 inch drive. Floating handle, 25 pound. Recommended for Chrysler Service. **\$2.45**  
Value \$15.00

**STURTEVANT:** 1/2 inch drive, 100 pound. Floating Handle 19 1/2 inches overall. **\$6.50**

**DURO:** 1/2 inch drive, 100 pound. No. 80991. Yellow shock-proof plastic handle. Complete unit in green enameled metal box. Only **\$5.85**

**TERMS:** Cash with order or \$1.00 deposit balance C.O.D.  
**MAIN SUPPLY STORE, Dept. 1, 523 Main St., Kansas City, Mo.**

Speed every job from  
barn to bird house

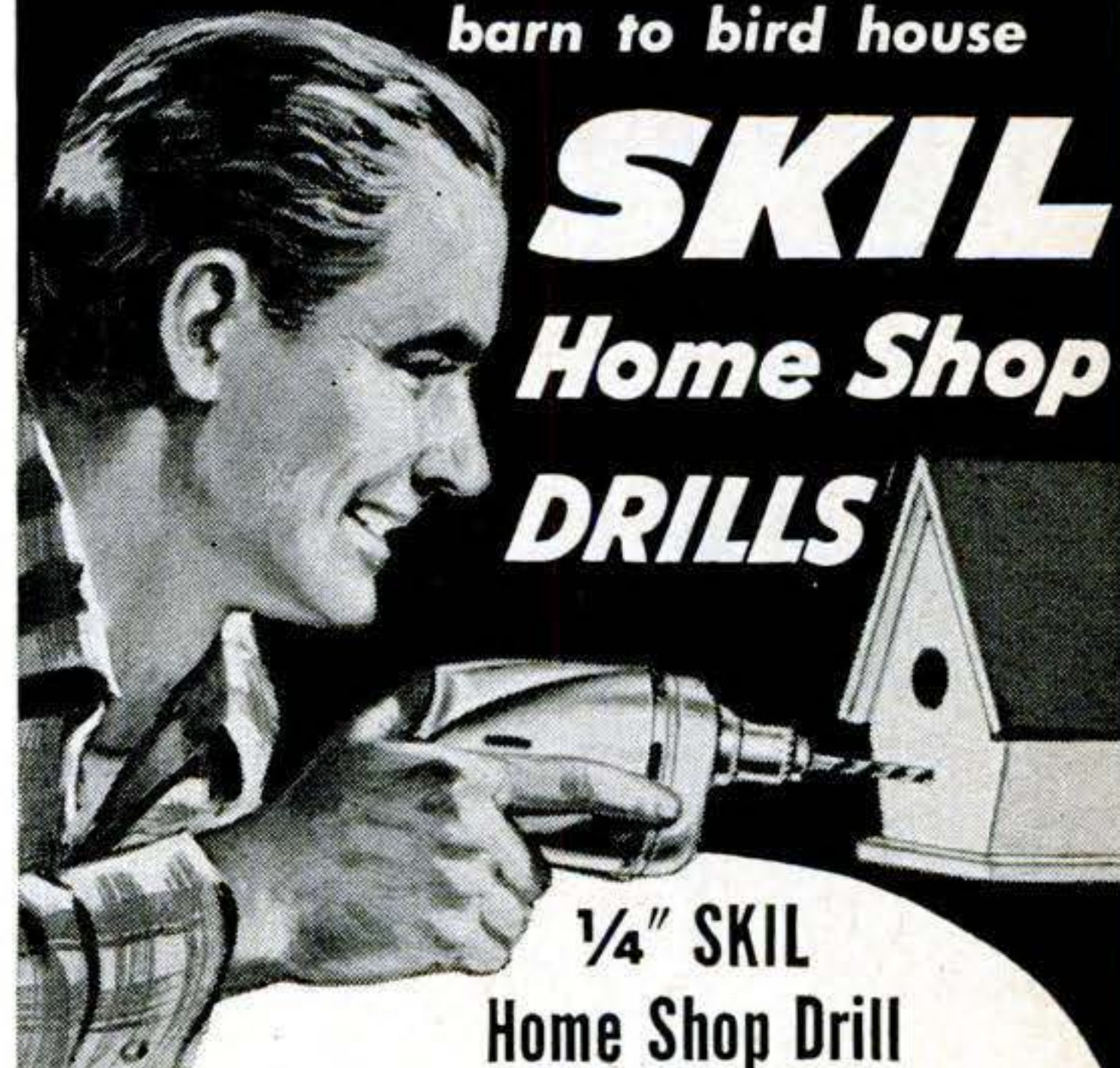

# SKIL Home Shop DRILLS

## 1/4" SKIL Home Shop Drill

If you do home repairs, remodeling or hobby work get 1/4 in. SKIL Home Shop Drill. Fast, easy-to-handle on all drilling up to 1/4 in. in steel . . . 1/2 in. in hard wood. With accessories it's a workshop in itself to help you grind, wire brush, polish . . . save time and work on a hundred jobs. See SKIL Home Shop Drill today!

## 1/2" SKIL Home Shop Drill

A sturdy, easy-handling drill for heavy jobs. Weighs only 7 1/2 lbs; only 12 1/2 inches long. Drills 1/2 in. in steel; 1 in. in hard wood. Ask to see 1/2 in. SKIL Home Shop Drill at your dealer's.



## SKIL Home Shop Drill and Kit

Do and enjoy 1,000 jobs with this well-planned kit. Includes 1/4 inch drill and everything needed for drilling, scouring, burnishing, grinding and sharpening, for buffing and surfacing on wood, metal, plastics. See it at your dealer's now.

### See these other SKIL Home Shop Tools!

- SKIL Home Shop Bench Stands
- SKIL Home Shop Saw
- SKIL Home Shop Saw Table
- SKIL Home Shop Belt Sander
- SKIL Home Shop Sander-Polisher
- SKIL Trimmer—the electric hedge clipper

SKIL Home Shop Tools made only by



**SKILSAW, INC.**  
5033 Elston Avenue  
Chicago 30, Illinois

**SKILSAW, INC.**  
Home Shop Division, Dept. D-3  
5033 Elston Ave. Chicago 30, Ill.

SEND COUPON TODAY FOR FULL INFORMATION

Please send me full information on SKIL Home Shop Tools and the name of my nearest dealer.

Name.....

Address.....

City.....Zone.....State.....





"SAVE IT AND  
FIX IT"

# REPAIRS

CHINA, TOYS, FURNITURE  
BOOKS AND LUGGAGE

It's transparent, waterproof,  
flexible and durable.  
Get a tube  
today.



## DUCO CEMENT

REG. U. S. PAT. OFF.

### HUNDREDS OF ITEMS AND IDEAS FOR THE WOODWORKER

A board or carload—Top grade kiln dried Mahogany—Walnut—Wh. Hd. Maple—Cherry—Poplar—Aromatic Red Cedar—Red, White and English Brown Oak—Sapeli—Andiroba—Balsa Wood. **NEW LOW PRICES.**

#### HARD TO FIND LUMBER

**BIG NEW NO. 17  
CATALOG FOR  
WOODWORKERS.  
144 PAGES  
OF HARD-TO-FIND  
SUPPLY ITEMS.**

The finest catalog  
we ever published.  
Full of unequaled  
bargains and useful  
information.

**Greatest Selection of Fine  
Domestic and Imported Woods**

Catalog shows in natural color 32 rare and fancy woods, 43 matched veneer designs, multi-colored bandings, inlays, overlays, 275 scroll patterns to choose from, labor-saving machinery and a section for beginner's instruction.

#### OVER 100 NEW ITEMS

My stocks are gigantic—bigger than ever before. Really **FAST SERVICE** on your orders. My new catalog includes a "gold mine" of hard-to-find hardware items. Whatever Wood Craftsmen need—I HAVE IT.

**MAIL COUPON TODAY for  
GIANT NEW CATALOG #17**

**Only 15c** Refunded on  
first order.

Harold F. Hunt, President  
CRAFTSMAN WOOD SERVICE CO.  
2729 S. Mary St., Dept. B-3, Chicago 8, Ill.

I enclose 15c, to be refunded on my first order. Please send me your big new Catalog No. 17.

NAME.....

ADDRESS.....

TOWN.....ZONE.....STATE.....

## AUTOMATIC RETOOTHING

**MAKES NEW  
PROFITS**

for **HAND  
SAWS**

Cuts new teeth in  
50 seconds—any  
size 4 to 16 points.  
Old teeth fall off  
as chips. Easy to  
operate. A perfect  
job.

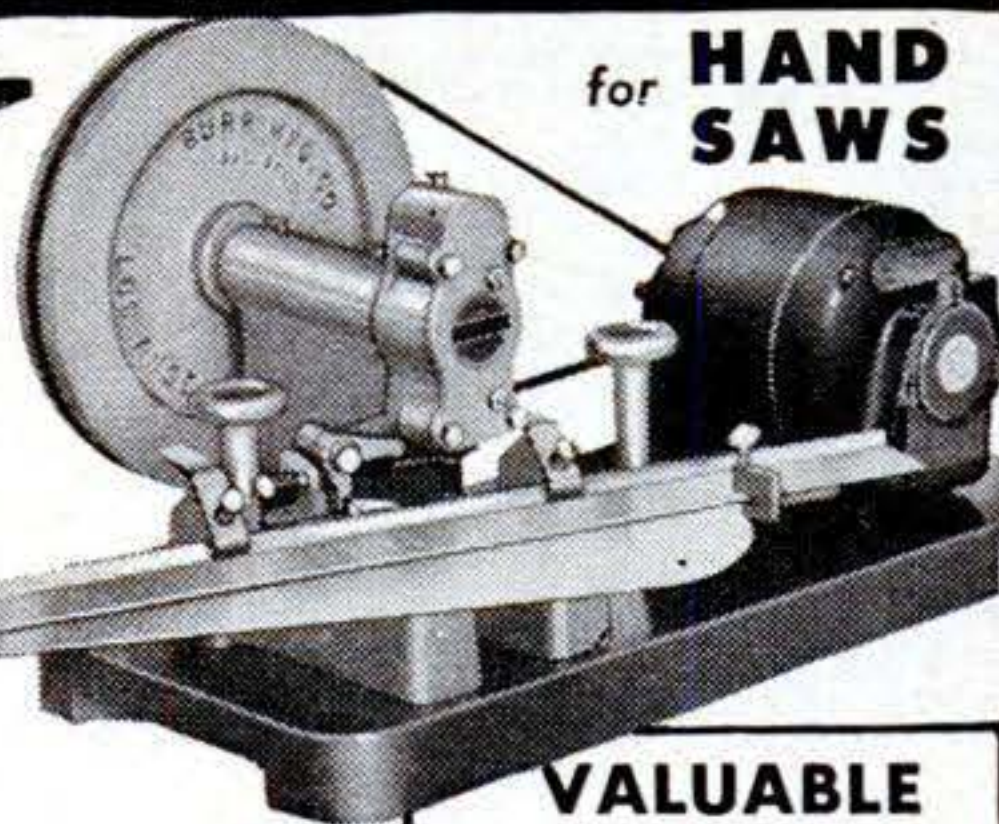

**IMMEDIATE  
DELIVERY**

**BURR MFG. CO.**  
8943 VENICE BLVD.  
LOS ANGELES 34, CALIFORNIA

**VALUABLE  
BOOK**

Order Burr's Blue  
Book of Coast to  
Coast prices for  
saw shop services. **25c**

### MACHINE SHOP EQUIPMENT

● The No. 49 edition of the famous Center Tool Co. Catalog is now ready! Every workshop owner should have a copy. 240 pages full of illustrations, descriptions, and prices of the latest tools made by best known manufacturers in U.S. You pay the cost of printing—50c. We refund your 50c with your first order of \$10.00 or more. Prompt delivery on most tools. Send check or money order today!

**CENTER TOOL CO.**

153 Centre Street, Dept. D, New York 13



### HANDY CALCULATOR FOR WOODWORKERS.. ONLY 10c

Just set dial, quickly solves countless problems. Converts linear to board feet, compares workability of various woods, shows bit sizes, nail specifications. Also tool sharpening tips, etc. 6" diameter heavily varnished cardboard. Send 10c to Greenlee Tool Co. 2123 Columbia Av., Rockford, Ill.



### ARMY SURPLUS BARGAINS FOR THE HOME — SHOP — HANDYMAN

Send for our **FREE** catalog of Surplus Bargains. All **NEW** top-quality merchandise. Buy from Army Surplus Sales of Fresno—and save! Also big stock of brand-new home utility power hand-tools, drills, saws, etc. All products of Black & Decker. Tremendous buying power and low overhead means lowest prices.

**ARMY SURPLUS SALES OF FRESNO—Dept. 13**  
1820 Tulare Street Fresno, California  
**THE FRESNO HARDWARE COMPANY**

## NEW! SPECIAL 18" LEVEL For Home Craftsmen!

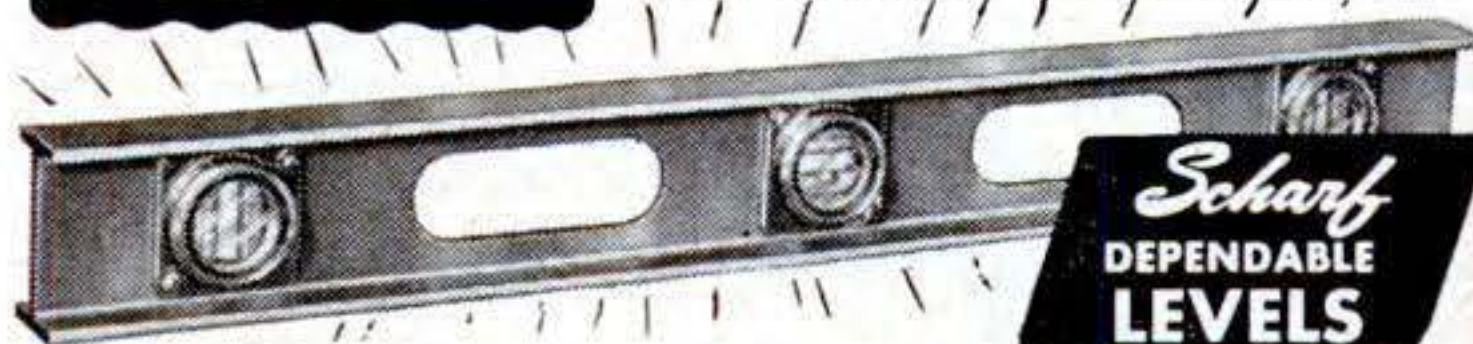

#### UNBREAKABLE FRAME OF EXTRUDED ALUMINUM ALLOY!

Not cast aluminum! Frame is extruded aluminum alloy. Will not break. This Scharf 18" Level made specially for Home Craftsmen. Straight, parallel, absolutely accurate, large hand-holds, extremely lightweight. Beautifully designed, gracefully streamlined. Has 6 vials. Greatest level ever built!

**Adjustable and Replaceable Vial Units**  
Finest, die cast, vial assembly. Vial units attached to level by screws. Easily adjusted or replaced entirely if damaged by accident.

#### BIG VALUE!

Get your Scharf 18" Home Craftsmen Level today. If your dealer can't supply you, order from us direct, but you must send dealer's name and address. Satisfaction guaranteed. If you send money order or draft, mailing charges will be prepaid. If C.O.D., mailing charges will be added. **"We Make All Sizes of Levels"**  
**J. H. SCHARF MFG. CO.**  
Dept. P.S.3, Omaha, Nebr.

**\$4.50**



## Manufacturing Opportunities in Concrete Products Industry

The great building industry is your profitable market for masonry products. Low investment... high returns... wide-open opportunity to establish a lifetime business.

The biggest building years in the nation's history are just beginning. New construction, involving billions of dollars, means huge demands for block, drain tile, and other masonry products which YOU can manufacture locally, from local materials with local labor for local consumption. Remember, MASONRY products mesh with today's demands.

Use our modern machines and equipment to insure the finest quality products at pared-to-the-bone manufacturing costs. Sold direct. Backed by 40 years of manufacturing. Write for catalog. Gives prices and full information.

**CONCRETE EQUIPMENT CO.**  
510 Ottawa Ave., Holland, Mich.



## ELECTRIC SHEAR SHARPENER

Over 65,000 Sold—It Must Be Good!



Genuine Carborundum Motor driven wheel ideal for shop or home use. Send remittance with order and shipment will be made at once, prepaid to your door, complete with electrical goods catalogue. **\$9.75** complete with vise

**WILLIAM MARVY COMPANY, Dept. 8**  
479 St. Peter Street St. Paul 2, Minn.

## NEW SLIP-PROOF, EFFORTLESS HYDRAULIC BUMPER JACK SIMPLIFIES TIRE CHANGING EVEN FOR WOMEN

Every car owner, garage, service station wants a Safe-T-Lifter, *specially women drivers*. Lifts 1½ tons 18 inches from adjustable heights. Easiest-to-use double action hydraulic lift. Huge profits. List at \$9.95—sample post paid \$7.50 on money back guarantee. Agents and dealers act now to secure profitable territory!

**BLACKHAWK MACHINE CO., Dept. P-3, 654 N. Albany, Chicago 12, Ill.**

<p>Make Money SELLING Eshelman Kulti-Mowers and DOING GARDEN WORK</p>	<p><b>ESHELMAN</b> \$125 PLUS TOOLS 1-2-3- H.P.</p>	<p>FOR BETTER LAWNS and GARDENS also POWER MOWERS and RIDING TRACTORS Women can operate it. Free Catalog Write <b>ESHELMAN,</b> Dept. 53 119 Light St., Balto. 2, Md.</p>
---	---	---

## MAKE THESE WOOD SHAPES

### With Your Drill Press and This LOW COST TOOL

Your drill press and this tool does all types of wood shaping—Routing, Tongue and Groove, Fluting, Notching, Inlay and any type of joint. Make window stiles, cabinets, doors, grooved sash, etc.

Complete with fence and platform to run professional work without slipping.

Write today for FREE facts about this unit, and special offer.



Complete with 3 blades



**T&H Mfg. Co. Inc., Dept. SSB-3, 811 E. 31st, Kan. City, Mo.**

Made  
**\$900**  
IN SPARE TIME

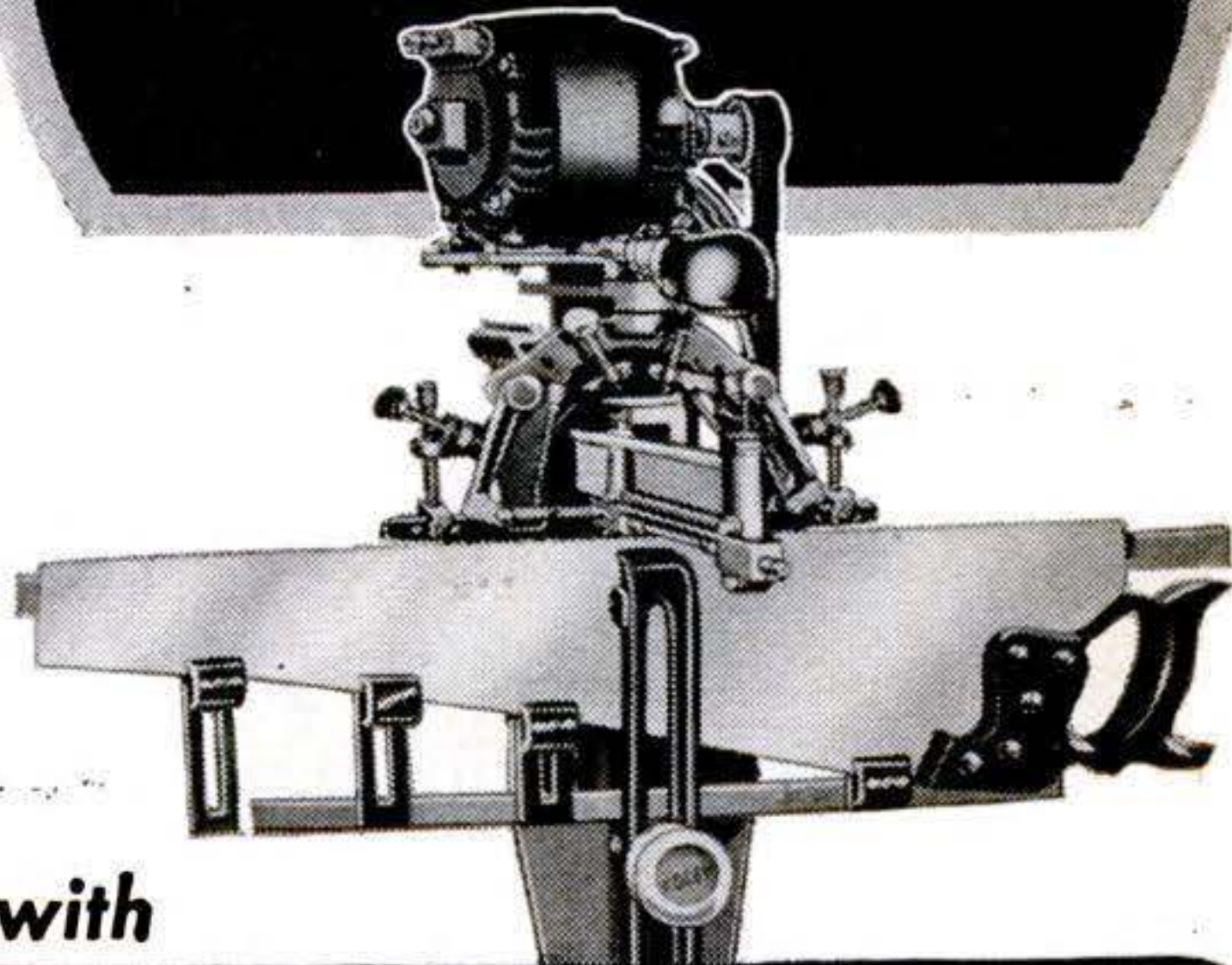

with

## FOLEY\* automatic SAW FILER

\*Trade Mark Reg. U. S. Pat. Off.

"I did very well last year with my Foley equipment, about 950 saws and 240 lawn mowers, in my spare time. About \$900 for me."—Leo H. Mix. "I have done 4 or 5 thousand saws in my spare time in the 4½ years since I got the outfit, and they are all coming back."—says Len Crego.

Make up to \$2 or \$3 an hour in Spare Time. With the high prices of food, clothing and everything else, just think what you could do with extra money every week! With a Foley Automatic Saw Filer you can file hand, band and circular saws better than the most expert hand filer. "The first saw I sharpened with my Foley Filer came out 100%"—writes Clarence E. Parsons. Every saw you sharpen with the machine accuracy of the Foley Saw Filer is an ad that brings you more customers. Cash business, no canvassing. No eyestrain, no experience needed.

### FREE BOOK

### "INDEPENDENCE AFTER 40!"

Shows just how you can start at home in spare time in your basement or garage. Just think—with a small investment, no overhead, no stock of goods to carry, you can get right into a cash business—and later on develop into a full-time repair shop. Send coupon today for this practical plan. No salesman will call.



### Send Coupon for FREE BOOK

FOLEY MFG. CO., 319-0 Foley Bldg., Minneapolis 18, Minn.

Send FREE BOOK—"Independence After 40".

Name.....

Address.....



**DELIVERED TO YOUR DOOR POSTAGE PREPAID!**

**MAIL ORDERS  
WE PAY POSTAGE ON ALL ARTICLES**



ARMY SURPLUS  
\$8.95 VALUE!

**BOOTS**

IDEAL ALL WEATHER BOOT FOR WORK—SPORTS

LEATHER UPPERS—RUBBER BOTTOM

- Flexible double chrome, tanned, tough wearing leather uppers!
- Leak-proof gusset tongue!
- Non-skid heavy duty rubber soles.

**\$3.45**  
WE PAY POSTAGE

SIZES  
9-10  
11-12-13

**LOWEST PRICES IN THE COUNTRY  
NEW CANVAS COVERS**

Made from 10 to 12 inch strips of 12-oz. olive drab Canvas. Waterproof! Double lap seams. Grommets on 4 sides! This multiple seam process gives added strength to small tarps!

ALL ARE FULLY RECONDITIONED

**100% WEATHERPROOF—All Purpose  
FOUL WEATHER SUITS**

For • Sportsmen • Hunters • Fishermen • Workmen  
Perfect for Deep Sea and Surf Fishing—Duck and Deer Hunting—Any Outdoor Work, Ranching.



Designed for U. S. Navy for use under toughest conditions. Two-piece parka hooded jacket: overall bib-style pants. O. D. Water repellent, wind-resistant fabric. Pants have zipper fly, button flap, pocket and adjustable shoulder straps. Draw strings on hood, breast, waist, ankles.  
SIZES: SMALL, MEDIUM, LARGE, EXTRA LARGE.

THIS IS ABOUT A \$6.95 VALUE  
**USED—GOOD CONDITION! COMPLETE SUIT.**  
**ONLY \$2.49**  
Delivered to You. We Pay Postage.

**NEW SMALLER SIZE  
MULTIPLE SEAM  
TARPS**

- 5 Ft. x 7 Ft. \$2.89 (\$3.95 Value)
- 6 Ft. x 7 Ft. \$3.49 (\$4.95 Value)
- 6 Ft. x 9 Ft. \$4.39 (\$6.95 Value)
- 7 Ft. x 9 Ft. \$5.10 (\$7.50 Value)
- 8 1/2 Ft. x 10 Ft. \$6.98 (\$8.95 Value)



**AIR CORPS—1 QT.  
FIRE EXTINGUISHERS**

All Brass—Hand Pump type, use Carbon Tetrachloride. All 100% Reconditioned. Cost about \$18 new. Delivered to you postpaid. **\$3.50**

SEND FOR FREE CATALOG — AMAZING VALUES!

**UNIVERSAL ENTERPRISES**

DEPT. 3 P.S., 946 S. MAIN ST. LOS ANGELES 15, CALIF.  
WE PAY POSTAGE, TAXES, INSURANCE ON ALL ARTICLES.

**3-Pc PAINT STRIPE SET** Only **\$1.00**



**3 SEPARATE TOOLS—**

**EACH MAKES DIFFERENT WIDTH**

Stripe perfect lines—straight, curved, with any paint, lacquer, enamel, easy as drawing lines with ruler! Beautify furniture, toys, autos; make signs and imitation tile. Simple instructions included.

SEND NO MONEY. Mail order. Pay postman only \$1.00 plus postage. If not delighted return in 5 days for money back. Order Now.

**STRADER MFG. CO., Dept. M-352**  
259 Strader Ave. Cincinnati 26, Ohio

**Wood Fasteners**



DON'T split wood—Use amazing new "CHEVRONS"—A new type hardened steel fastener for wood joining (miter joints). Scientifically designed to draw wood together eliminating doweling, mortising, nailing. Just drive in with ordinary hammer—"Presto"—A firm joint! No wobble, no distortion. Narrow surface outline of fastener lends artistic appearance. Can easily be countersunk and concealed with wood fillers. Permits planing of wood on all sides. Can be used in hard wood where others fail. Handy, easy-to-use for mill workers, artisans and HOME CRAFTSMEN for making and repairing screens, doors, sash, frames, cabinets, chests, furniture, moulding, etc. Hurry—Order now from your dealer or send Only 25c (no stamps) for box of 30. 3/8" depth, suitable for thickness of wood up to 1 1/4". or send \$1.00 for our GIANT-Size box NOW!

**E. B. PACKARD CO.**  
Dept. PS3, 139 Cedar St. New York 6, N. Y.  
DEALERS—Send for our folder "A."

**NOTICE!** You Can't Buy Better Quality at any price. We sell just GOOD TIRES — No fancy promises. ONE Quality — ONE Price—Why take less? Our Tires used on Buses & Trucks for every purpose—One Trial Will Convince You.



**WRITTEN GUARANTEE**

Sent with Every Tire You Buy  
**TUBE GIVEN WITH EACH TIRE**  
10% Discount May Be Taken on 1 or more tires if you SEND THIS AD

Be Wise — Read this Before You Buy!  
**OUR EXPERIENCE ASSURES YOU THE BEST BUY IN**

**GOOD ORIGINAL TREAD USED TIRES —**  
Needless to pay more — risky to pay less.  
**BUY IN CONFIDENCE POPULAR BRANDS**  
Positively Not Re-Caps or Re-Molds

5.50-17	5.02	6.70-15	6.75	7.50-16	7.62
6.00-16	5.02	6.70-16	6.75	7.60-15	7.62
6.50-15	5.02	7.00-15	5.30	7.60-16	7.62
6.50-16	5.02	7.00-16	6.30	8.20-15	8.62

**GOOD TREAD—NO RE-CAPS. THESE TIRES WILL CARRY YOU TWICE AS FAR!**

6.50-20(6)	\$9.22	8.25-20(10)	\$15.52	11.00-20(12)	\$16.42
7.00-20(8)	10.52	9.00-20(10)	15.52	11.00-22(12)	18.42
7.50-20(8)	10.52	10.00-20(12)	16.22	32x6 (8)	10.02

750-20 MILITARY 8 PLY REGULAR \$9.62—SUPER \$12.92  
900-16 MILITARY 8 PLY REGULAR \$8.72—SUPER \$10.72

Thousands of Tires Shipped to Satisfied Customers Throughout United States and Many Distant Points. Send This Ad with Check or Money Order. Dep't 5.

**STANDARD 834 N. Broad St., Philadelphia 30, Pa.**

**DO YOUR OWN WELDING!**

It's EASY with LeJay's NEW  
Powerful, SUPER Welder

ONLY **\$97.50**



This amazing machine delivers up to 300 amps. Has special dial-type control and easily mounts on tractor or elsewhere. Guaranteed 1 year with money back 10-day FREE trial offer. Even handles 1/4" rods. Over \$300 value. Order your welder from this ad. Free literature. Or, send 35c for PLAN "Build Your Own Arc Welder from Aircraft Generator". We'll include literature.

**LEJAY MFG., 823 LeJay Bldg., Minneapolis 8, Minn.**

**NEW WAR SURPLUS HOIST & WINCH**

Originally made to be used on B-29s for lifting bombs. Mounted on welded steel base, can be attached to truck body or any solid base. Ideal for lifting or moving loads onto trailers, trucks or tractors or for machine shops, garages or warehouses. Capacity 2,000 lbs. Equipped with ratchet for holding load and 18 ft. 3/16" steel cable. Shipping wght. 50 lbs. FOB. K. C. Mo. Quantity discounts 6 or more.

**\$29.95**

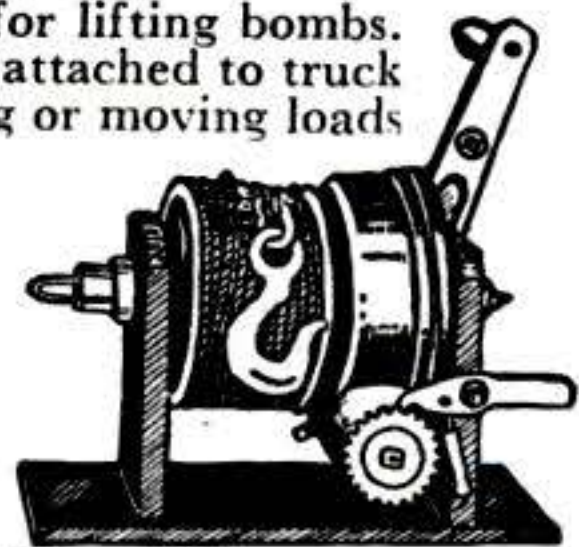

Send check or M.O. for immediate delivery. No COD's.

**UNITED AUTO PARTS, INC.**

1901 Troost Dept. PS10 Kansas City, Mo.

**SAFETY ON THE BOTTOM**

**NAVY SURPLUS DIVING HELMETS**

New, Surplus Shallow Water

**\$5.95** Diving Helmets, complete with Manifold.  
POST-PAID

**WODBECK SALES, Greenville, Michigan**

**WAR SURPLUS WINCH**

**Pulls Over 3,000 Lbs.**

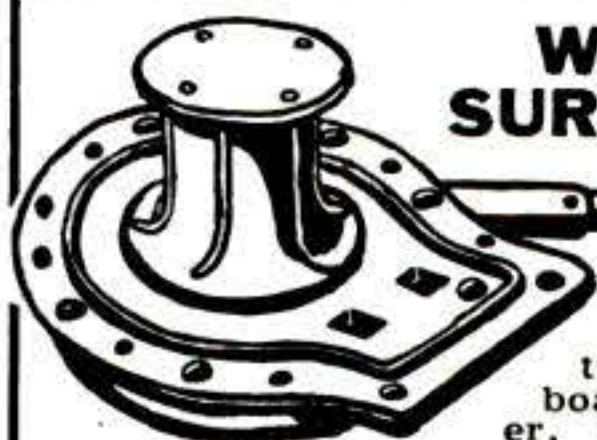

12"x14", 9" high. 80-to-1 ratio power. Used by leading truck lines for unloading. Ideal for farmers, contractors, etc. Excellent for any hoist, boat dock, wagon unloader, etc. Drive with small A-C motor, power take-off, fan pulley, etc. Mount on dock, tractor, truck or jeep. Finest steel and bronze gears. Guar. Cost Gov't. over \$100. Frt. **\$24.95**  
Paid Sale Price, only

Order from ad or write for Bargain Catalog!

**BURDEN SALES COMPANY**  
825 "O" St., Lincoln, Nebr.

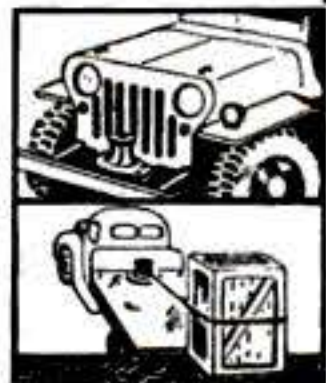



**Easy and Cheap to Operate**

**SAVE TIME, WORK, MONEY!**

# SHAW "DU-ALL"

and "PEPPY PAL" TRACTORS

**PLOW**

**CULTIVATE**

**MOW**

**RIDE**

**SHAW MFG. CO.**

These rugged walking or riding tractors ideal for farm, truck garden, orchard, poultry farm. They operate on a few cents an hour. A child can handle them.

**DO DOZENS OF JOBS**  
The Shaw Du-All or Peppy-Pal does many jobs quickly and easily. Plows, cultivates, harrows, disks, bulldozes, sprays, hauls, grinds, and saws wood.

**BUILT FOR RUGGED WORK**  
Sturdy, extra-strength construction means low upkeep, long life. Full year's guarantee.

**LOW FACTORY PRICES**  
Buy direct or through your dealer! Almost anyone who owns a garden can afford a Shaw Du-All or Peppy Pal. Mass production holds prices down—quality up.

**RIDING TRACTORS**  
4 models, from 5 to 12½ H. P., 58 in. wheel-base, 36 in. wide, 24 in. plant clearance. Hand or electric starter. Improved steering device, brakes enclosed in differential housing. Heavier frame and bearings. Standard hitch for trailers and wagons. Plow, harrow, cultivator, cutter bar, snow plow, bulldozer available.

**FREE:** Illustrated folders giving complete details and price lists—write today!

5703 Front St., Galesburg, Kan.  
668 PS North 4th St., Columbus, O.

**DELTA MILWAUKEE HOMECRAFT®**



**Only \$995**

Miter gage, motor and belt extra



**New! Low-cost Delta® Homecraft 8½" Disk Sander**

Helps you get a smooth finish easily and quickly. Sand any surface — on wood, plastics, ivory, and non-ferrous metals. Extra-value features include tilting table. Quality-made by Delta. Have your dealer demonstrate this new Delta Homecraft Disk Sander today!

**POWER TOOL DIVISION**  
**Rockwell Manufacturing Company**  
8045 E. Vienna Ave., Milwaukee 1, Wis.

**FREE BOOK!**  
"How to Start Your Home Workshop." Write for your copy today.

**A MAN'S BEST FRIEND IS HIS POCKET KNIFE**

And **CAMILLUS** means top quality. Many styles, at your dealer's. \$1.50 up.



**CAMILLUS**  
*has the edge!*

No. 5  
Fisherman's Luck.  
5 1/2" closed. About \$2.00

**CAMILLUS CUTLERY COMPANY, CAMILLUS, N. Y.**

**Start a NEW BUSINESS!**

or Add to your present Repair Business

**SHARPEN DULL PIPE WRENCHES**  
**PIPE TAPS & DIES**  
**"GUM" CIRCULAR SAWS**

Write for Information  
**J. C. MOORE INDUSTRIES**  
BOX S 276, Fredonia, Pa.

**GOVT. COST**  
~~\$81.25~~



**NOW \$19.75**

**CHRONOMETRIC TACHOMETER**

**U. S. NAVY SURPLUS—ACCURACY—PRECISION—GUARANTEED**

For PRECISION timing of all rotating mechanisms. Incomparable **GUARANTEED ACCURACY** of 1/10 of 1%. An RPM counter and surface speed indicator combined with chronometric operation which **AUTOMATICALLY** computes period of test in **EXACTLY 6 SECONDS**. No stop watch or personal equation necessary. **UNSURPASSED** for cameras, projectors, generators, motors, sanders, turbines, saws, shafts, looms, fans, lathes, etc. Packed in plush-lined, simulated leather case. **UNCONDITIONALLY GUARANTEED** subject to your inspection and approval. Manufactured by JAEGER and TOTCO, leaders in field of exacting measuring devices. Only \$19.75 Shipped postpaid in U.S.A. on cash orders.

**MOTOR BLOWER**



24 volt AC-DC squirrel cage blower assembly with motor. Is ideal for darkrooms, ventilators and many uses. Easily convertible to 110 volts. Converted by us, add \$3. Our price **\$2.95**

**WESTON VOLTMETER**



Model 433. 0 to 150 volts. Laboratory type precision built. Hair line pointer on mirror scale. 25 to 2400 cycles. Size: 3 1/2" x 5" x 6". Govt. cost \$65. **\$14.95**  
Our price .....

Order these surplus bargains today. We pay postage on cash orders. Add postage to other items. 20% dep. on C.O.D.'s

**Semlers' ASSOCIATED SURPLUS CO. 5720 WILSHIRE BLVD., LOS ANGELES 36, CALIF.**



# BUILD IT - FIX IT WITH AMBROID



## "IT STAYS STUCK"

Since 1910 Ambroid Cement has been the Standard product in its field. Ready-to-use, quick drying Ambroid is Waterproof, Transparent, Flexible, Extra Strong, Heat and Corrosion Resistant. Hobby enthusiasts and Industry alike use Ambroid. For assembling and repairing, keep Ambroid handy. At your supplier or send 25c for big 2 oz. tube postpaid. Money back guarantee

Also 50c 4 oz. tube. Pts., qts., gals., for industrial use.

2 oz. **25c** TUBE



306 Franklin St., Boston 10, Mass.

## MODERN LAWN MOWER SHARPENER

### PROFITS and SPEED

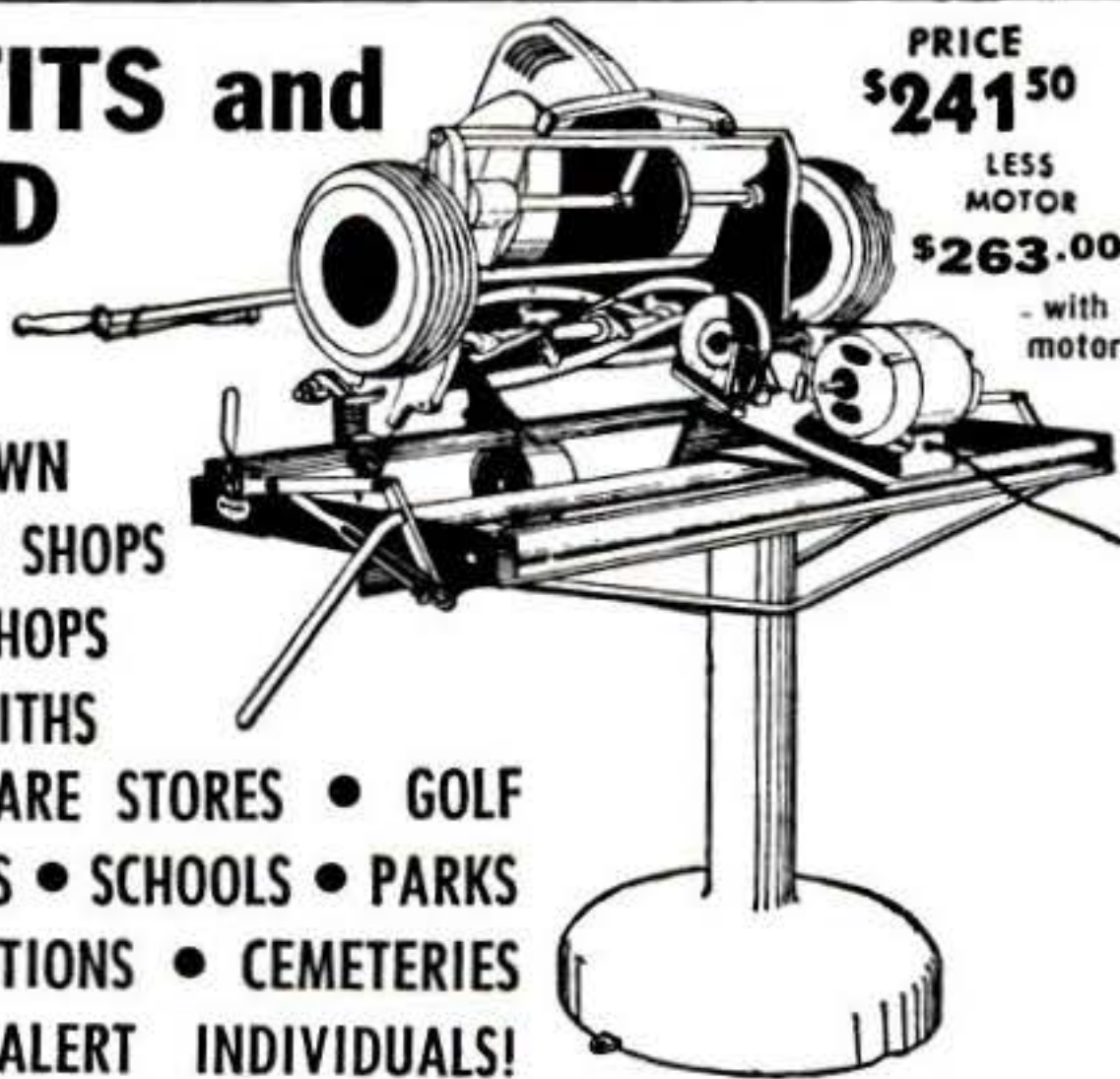

PRICE **\$241.50**  
LESS MOTOR **\$263.00**  
- with motor

- FOR LAWN MOWER SHOPS
- FIXIT SHOPS
- LOCKSMITHS
- HARDWARE STORES • GOLF COURSES • SCHOOLS • PARKS
- INSTITUTIONS • CEMETERIES
- AND ALERT INDIVIDUALS!

Sharpens All Reel Type Mowers • Hand, Power or Gang • 10 to 20 Minutes • No Dismantling No Extra Attachments Needed

All reel type mowers, from 5-inch edgers to 36-inch power mowers, are quickly sharpened to extreme ends of both left and right twist reel blades. Handle, wheels, roller and motor remain in place when sharpening is in process. Bed knife is sharpened in same brackets that hold mower in grinding position. No extra attachments required. One lever puts mower or bed knife in grinding position. 100% steel construction. Grinding head rides on five ball bearing races. Easy to operate. Sharpens wood chisels, joiner knives and planer blades without extra attachments.

**ORDER NOW**  
Immediate Delivery

Skate Sharpener Attachment Available  
Send for FREE ILLUSTRATED BULLETIN No. 11C

**MODERN MFG. CO.** 160 N. FAIR OAKS AVE PASADENA 1, CALIFORNIA

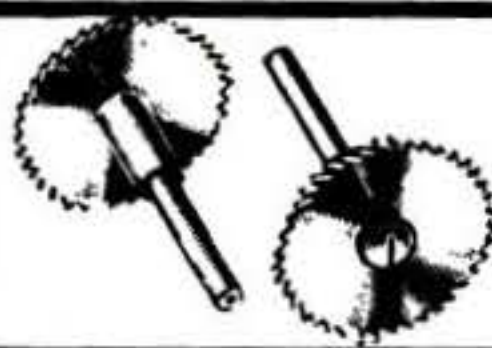

**2 CIRCULAR SAWS**  
ON 2 MANDRELS—ALL AT ONE AMAZING LOW PRICE **\$1.50**  
1" diameter saws on 1/8" mandrels. For cutting wood, plastics, or soft metals. Order at once! Send Check or Money Order for this big bargain. **Post Paid in U.S.A.**



**18 ROTARY CUTTERS**  
Value **\$13.50** **\$5.85**  
Post Paid in U.S.A.

Assorted shapes. Cutter on 1/4" or 3/32" shank. Will fit all hand grinders. Ideal for cutting wood, metal, or plastic. Brand new.

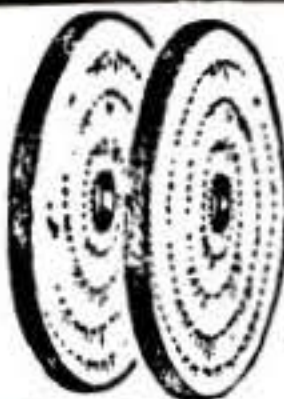

**6 BUFFING WHEELS** **\$1.00**  
Best quality muslin buffing and polishing wheels. 3" diameter, 1/2" thick, 1/2" arbor hole. For metal, plastic or wood. \$2.50 value, only \$1.00. **Post-paid in U.S.A.**

Order today. Send check or money order. **Illus. Bargain Catalog—10c.**

SCHUPACK SUPPLY CO., 7331 Cottage Grove, Dept. S-3, Chicago 19, Ill.

## SAFE JIG SAW READY!

At last—a revolutionary, new electric jig saw small children may use, yet powerful enough to be the basic tool in Dad's workshop. Make "Standing Photo Silhouettes" of favorite snap shots... fancy what-nots, toys, for fun and profit! Just plug in! No motor to buy—no oiling. Thousands sold. Use in livingroom, apartments, etc. Patented. Nothing else like it. Mail postal NOW for illustrated. Free Circular, low price! Dealers Write!



**SYNCR0**

**SYNCR0 CORPORATION** Dept. M-35 Rochester, Mich.

## STANDARD GARDEN AND SMALL FARM TRACTORS

**Plow Seed Cultivate Mow Hay and Lawns** Powerful Gas Tractors for Small Farms, Gardeners, Florists, Poultrymen, Fruit Growers, Suburbanites.

**1 & 2 Cylinders**

High Wheels. Rubber or Steel Tires. Walk or Ride.

Easy Terms—Free Catalog

**STANDARD ENGINE CO.**  
MINNEAPOLIS, MINN.  
4041 Como Avenue



NEW YORK, N. Y.  
681 West 26th Street

## PLASTIC ARTICLES IN GREAT DEMAND AT TOP PRICES

Make them at home on Emrick 5-in-1 Machine. Easy to Learn. Interesting work. Big profits. Less than \$20 gets you started in money-making business. Do wood and metal work on same machine. Send today for FREE literature.

**EMRICK, INC.** 1503 Clinton Kalamazoo, Mich.



**WAR SURPLUS BARGAINS**

**\$500,000.00 INVENTORY for QUICK LIQUIDATION**

Surplus items—hundreds of them for home, shop, factory, farm and outdoor use. New items, used items, reconditioned items—all at tremendous savings—all priced for quick sale.

**PAGE AFTER PAGE OF VALUES**  
This big catalog shows page after page of amazing money saving values. Write for your copy today. Send 10c to cover postage, mailing, etc. Write today!

**STARK'S**

509 So. State St. Dept. PS-3 CHICAGO 5, ILL.

**10c**



# Big 6 HORSEPOWER ROTARY TILLER

**\$299**

No Extras to Buy



The Mulsifier Rotary Soil Tiller! Unsurpassed for tilling and cultivating. Makes it easy to work 1 to 20 acres. Prepares the soil in one operation. Nothing to do but guide it. High-powered—adequate for all soils. Unbreakable tines. Gives you more horsepower per dollar than any other garden tractor. Attachments available. Money-back guarantee. Send postcard for circular.

**MULSIFIER IMPLEMENT CO.**  
7760 HAMILTON, DETROIT 2, MICH.

\* Trade Mark Reg. U. S. Pat. Off.

Free CIRCULAR

*Mulsifier*  
**ROTARY SOIL TILLER**

# 10 TIMES FASTER THAN HAND SAWING!

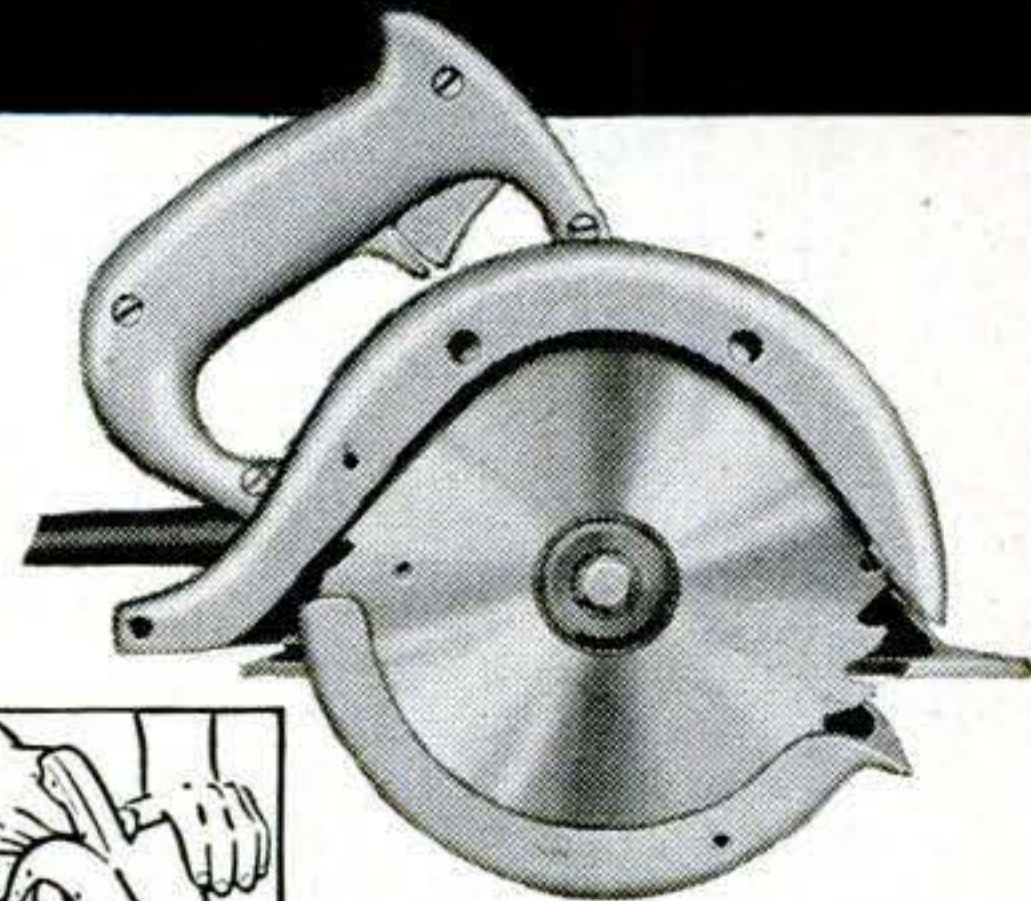

Crosscutting



Cutting Tile, Transite, Slate



Ripping



Angle Cutting

**HOME-UTILITY 6" Electric SAW**  
(Cuts to 2" Depth)

NOW Reduced to **\$54.50**

## HOME-UTILITY 6" Electric

Saws are a better buy than ever! At their new low price, they save days and dollars, beat hand sawing 10-to-1, in general carpentry, home construction and alterations, farm building and maintenance! Saw stair stringers; trim stock size mill-work to fit; cut out plywood and wallboard panels; saw lumber to construction length; do hundreds of other jobs!

Built by Black & Decker, world's largest maker of quality electric tools, this perfectly-balanced, close-coupled Saw has many features you wouldn't expect to find at such a low price. Powerful universal (AC-DC) motor operates on standard power line. Easy to handle, easy to follow, safe to use!

See it, try it, at your hardware, electrical or implement dealer.

## ELECTRIC HOME-UTILITY TOOLS



1/4" Drills



1/2" Drills



Sander-Polishers

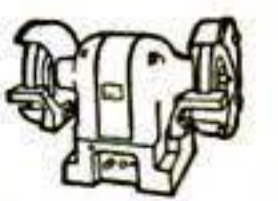

Bench Grinders

Products of The BLACK & DECKER Mfg. Co.  
Dept. H35 Towson 4, Maryland

## ELECTRIC DRILL COMBINATION SET \$24.40

Complete P.P. 60c



Cummins 1/4" Drill Continuous Duty With genuine Jacobs Worm-gear Chuck (Not Jacobs Allen or Keyless Chuck)



High Speed Rotary Files 6 Assorted Shapes For Wood & Metal



1/4" wheel Arbor



2" Stone



Regularly \$35.50

7 H.S. DRILLS From 1/16" to 1/4" By 32nds with Stand



4" Saw



3 pc. Buffing & Sanding Set Heavy Duty

**JOB LOT TRADING CO.** 53 Vesey St., N. Y. C.  
No. C.O.D.'s. Send check or money order.  
UNCONDITIONALLY GUARANTEED

## WASH YOUR CAR IN 10 MINUTES!

WITH FAST, EASY FOUNTAIN BRUSH. TURNS WORK INTO PLEASURE. WASHES AND RINSES IN ONE OPERATION, CARS, TRUCKS, WINDOWS, PORCHES, BOATS, ETC.

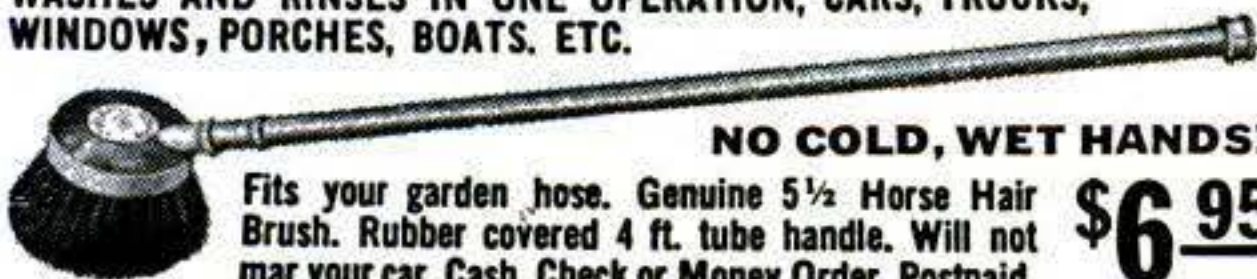

NO COLD, WET HANDS!

Fits your garden hose. Genuine 5 1/2 Horse Hair Brush. Rubber covered 4 ft. tube handle. Will not mar your car. Cash, Check or Money Order. Postpaid. **\$6.95**

PAYS FOR ITSELF—SATISFACTION GUARANTEED

**WINSLOW MFG. CO., P-3, 1428 Balfour, Detroit 30, Mich.**

THE BIGGEST VALUE ON THE MARKET DIRECT FACTORY TO YOU

# DYNAMIC ARC-WELDER

Super Charged

DOES WELDING, BRAZING, SOLDERING, CUTTING

This is one of the finest scientifically designed and precision-built genuine heavy duty transformer-welders on the market today! Made by an old established firm. High efficiency, heavy-duty output does work you'd expect from costlier machines. It's EASY TO OPERATE. Do expert work in a jiffy by following the simplified instructions furnished. Works on iron, steel, brass, bronze, aluminum or other metals. OPERATES from any convenient properly wired 110 VOLT A. C. line. SAVE TIME AND MONEY... build or repair your own auto, home, farm, or shop equipment and appliances, etc. Make big money doing work for others in spare or full time. OVER 50,000 SATISFIED USERS all over the country, hobbyists, maintenance and repair men, farmers, tinsmiths, engineers, home and auto owners. Order today on 10-day trial or send coupon for full details.

GIFT WORTH \$680 INCLUDED



For Prompt Action AT NO EXTRA COST

**DYNAMIC WELDER CO., Dept. D3-CA4, 15 E. 23rd St., Chicago 16, Ill.**

LOWEST PRICED TRANSFORMER TYPE INDUSTRIAL WELDER



SEND TODAY FOR FREE DETAILS

Please send complete descriptive Dynamic Welder literature and details on 10 day Money back trial and gift offer.

Name.....

Address.....

City..... State.....



# FIX IT...



## QUICK AS A WINK

Fills cracks and holes in wood, plaster, or almost any material. Savogran Crack Filler sets hard as stone. Savogran Wood Putty is easily tooled; contains real wood. Permanent, non-shrinking. Takes paint beautifully. Repairs furniture, floors, loose rungs, handles, knobs — 1001 uses. Big 1-lb. can only 35c where you buy paints.

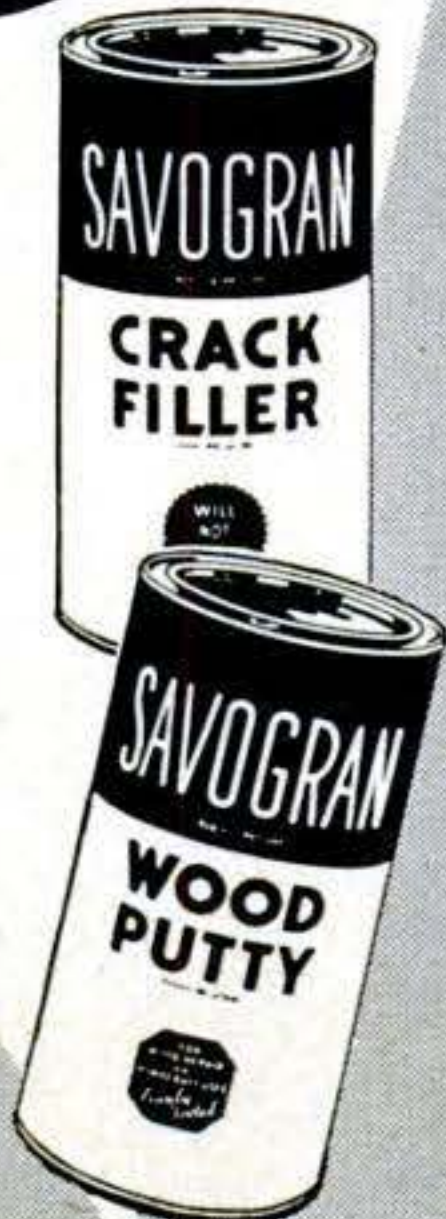

CRACK FILLER  
WOOD PUTTY

For FREE CIRCULAR Write

# SAVOGRAN

DEPT. 21, BOSTON 16, MASS.

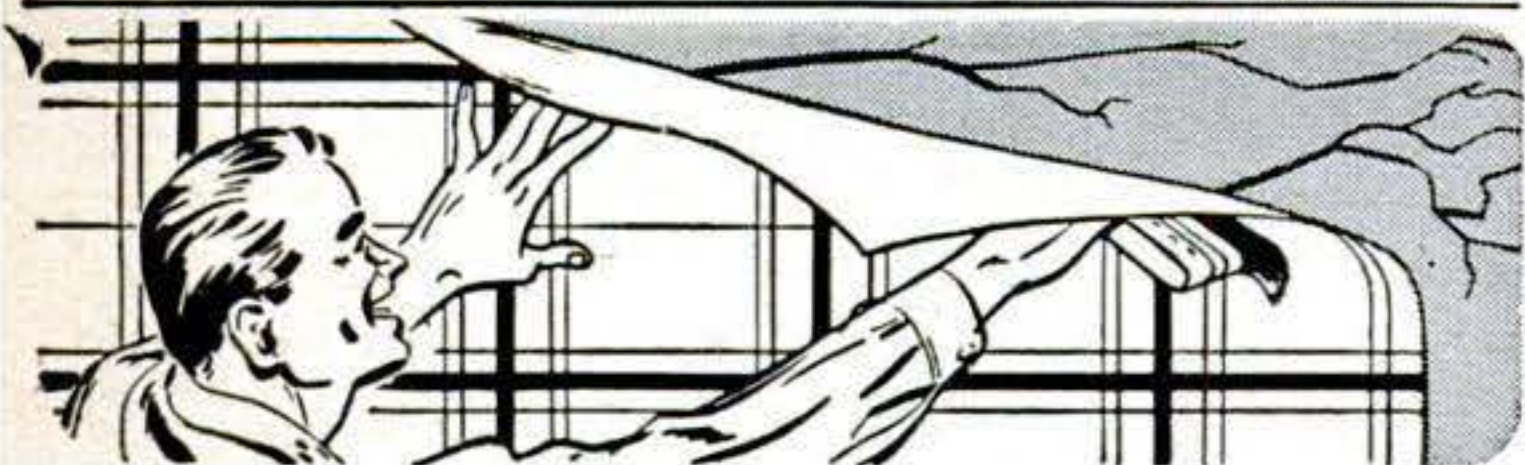

## DO IT YOURSELF

# with Sanitas<sup>®</sup>

### FABRIC WALL COVERING

It's easy to give your walls the beauty, wear, and plaster crack protection of Sanitas. Made of sturdy fabric, with 5 baked-on paint coats, Sanitas doesn't tear easily. If you make a mistake in matching, pull the strip off the wall and start over. If paste gets on the pattern side, just wash it off. No annoying paint odor; use the room the same day—and every day for years to come!

Sanitas is ideal for every room in the house because it's permanently washable, permanently decorative, permanently crack resistant. Over 100 beautiful patterns and plain tints to choose from, at better paint, wallpaper and department stores everywhere. Send today for "How to Hang Sanitas."

Standard Coated Products  
Division of Interchemical Corporation  
350 Fifth Ave., New York 1, N. Y.

Please send me, free, "How to Hang Sanitas."

NAME.....  
STREET.....  
CITY.....STATE.....

## WAR SURPLUS AND OTHER BARGAINS



### HYDRAULIC UNIT! VICKERS PF9 & 2 1/2 HP EMERSON PUMP & MOTOR

Wgt. pump: 6 Lbs.; complete unit 26 Lbs.

Small powerful pump rated 1500 P.S.I., 3750 R.P.M., Rotation changed by reversing flow. Pump capacity: .208 cu. in. per rev. Type D50EZ-218 Emerson Motor 24 V., D.C., 4000 R.P.M. Govt. Cost, complete unit, about \$285, pump \$85. Our price, while they last--Complete Unit, Motor and Pump, New . . . . \$29.75  
Hydraulic Pump only, New . . . . . \$13.95

### MICROMETERS

Chrome plated, precision engineered and carefully tooled to give long life. All new

0-1" cap. . . . .	each \$2.25
1-2" capacity . . . . .	each 3.50
2-3" capacity . . . . .	each 5.50
3-4" capacity . . . . .	each 6.50

### HIGH SPEED DRILLS

All New. Fractional & numbered. Orig. Val. \$15. Nationally known brand. Astd. sizes. Set 30, \$3.50



### ELECTRIC BELLS

Vibrating type, high pitch. 115 V., 60 Cycle. Ideal for use indoors or outdoors—on ranches, for schools, plant installations, as signal systems, burglar alarm systems, etc. Nationally known Mfr. ALL NEW in orig. Pkgs. Solid brass clapper & 8 1/2" gong. Wt. 8 lbs. Govt. cost about \$67.50. Close out at . . . \$7.95

Send check, money order or cash. 25% deposit required on C.O.D. orders. All prices F.O.B. Culver City, Calif. Send 25c for illustrated Catalog.

**AIRBORNE SALES CO., INC.** DEPT. PSM 3-0 CULVER CITY, CALIF.

### DRAINS CELLARS, WASH TRAYS CIRCULATES OIL



Pumps 1800 GPH 300 gal. 30' high, uses 1/8 to 1/3 HP motor. Will not clog. **\$6.50**

Postpaid if cash with order. (Add 50c for west of the Mississippi.)

Thousands in use since 1936

LABAWCO PUMPS, BELLE MEAD 3, N. J.

### HAUCK FLAME GUN KILLS WEEDS



KILL WEEDS, crab grass, Canada thistle—stalks, seeds and roots. Destroy brush, caterpillar nests, diseased trees, grasshoppers, chinch bugs, etc. Clear irrigation ditches, split rocks, burn tree stumps . . . Sterilize poultry houses, kennels, barns. Use as portable home forge. Melt ice, thaw pipes. Safe, inexpensive. Burns only 6% kerosene, 94% air! Thousands satisfied users. 7 models. Write for FREE CATALOG.

HAUCK MFG. CO., 81 Tenth St., Brooklyn 15, N. Y.

### HOLLYWOOD MUFFLER

THE TONE YOU LOVE TO HEAR

All Ford, Chevrolet, Plymouth . . . . \$6.00  
All other cars . . . . . \$8.00

DEALERS WRITE

Duals, Ford & Merc. \$24.50. Send check or M.O. We pay postage.

**TOM WILKINSON MUFFLER CO.** 811 WILT STREET FT. WAYNE, IND.



### AUTO WASHER

Your car sparkling clean—in a jiffy—magic "sponge" cleaning-cloth. Simply glide over car. PRESTO! Dust, grease, dirt, and grime disappear in a jiffy. Leaves finish clear, lustrous. Autos gleam like a mirror.

**SAMPLES for AGENTS**

Sample offer sent immediately to all who send name at once. Penny postal will do. Send no money—JUST YOUR NAME.

KRISTEE CO., 716 Bar St., Akron, Ohio

\$4.95

### REAL ENGINE VALUE



A miniature gas engine that really operates. Thousands of Buzz "B" gasoline engines have been sold at twice the price. Now is your chance to buy a real 1/8th H.P. gas engine for only \$4.95. Turns up over 8,000 rpm. For Boats, planes, midget cars, etc. Guaranteed and ready to run. Includes Champion spark plug and tank. Send only \$1.00, engine shipped collect for balance, same day. Write for free catalog or SEND 10c FOR NEW MAMMOTH ILLUSTRATED CATALOG OF THOUSANDS OF HOBBY ITEMS.

America's Hobby Center, Inc., Dept. S-30, 156 West 22 St., N. Y. 11



# BUILD YOUR OWN POWER MOWER!



**EASY TO ASSEMBLE!**

**SAVE MONEY!**

**MAKE GRASS AND WEED CUTTING EASY, QUICKER**

We supply everything needed: Parts, engines, wheels, etc. to build all types of power mowers.

Complete mower parts kit for either gasoline or electric power. You can easily assemble this highly efficient mower in a few hours. We furnish instructions. Cut your lawn or field quickly at small cost. Does the work of far more expensive mowers. Factory appearance. From the world's largest manufacturer of rotary power mowers.

**WRITE TODAY! FREE INFORMATION!**

**J. G. DOYLE ENGINEERING CO.**  
526 CHERRY ST. DEPT. B KANSAS CITY, MISSOURI

## BETTER PERFORMANCE FOR OUTBOARD MOTORS



Enjoy more speed, smoother performance, greater carrying capacity by equipping your motor with the Michigan propeller recommended for your particular motor and type of boat used. Write for FREE copy of 1950 catalog—“Outboarder's Bible” covers all motors old and new. Describes the “Aqua-Jet,” super speed wheel for racing runabouts. For finer inboard performance investigate our “Aqua-Master.” Write NOW! Michigan Wheel Co., Dept. J-1 Grand Rapids 3, Michigan.

## HIGH POWER TELESCOPE

60 POWER-ALUMINUM TUBES-OPENS TO 33"

Variable Power Eyepiece Adjustable to 15X, 30X and 60X.

4.50



Leather Case Included

5 Sections. 4 Ground & Polished Lenses. Also used as 50X Microscope. Ready to use, only \$4.50 POSTPAID.

**BROWNSCOPE CO.** Dept. 3P, 24 W. 45th St., NEW YORK 19, N. Y.



## Sensationally New HI SPEED COPE-SAW DRILL BIT

SAWS, CUTS, REAMS—Light metal, wood, plastic, etc. Amazing high speed combination bit and saw fits any electric drill or drill press; takes place of up to \$50 in tools. Drills own starting hole to cut, saw, and ream an opening in the center of material. Easy to operate. Ideal for mechanics, electricians, plumbers, hobby workers, many others. SEND CASH, CHECK OR M.O. ONLY

**\$3.95**

**INTERNATIONAL TWIST DRILL CORP.**  
624 WYANDOTTE DEPT. PS-1 KANSAS CITY, MO.



**Own Your Own Business on "Pay Out of Earnings Terms"**

With good, up to date, ample capacity welding equipment, you can get the big pay jobs that saves customers costly replacement parts and expensive delays.

The new Hobart Arc Welders make you independent of any electric company or power supply. Gasoline engine driven, electric self-starting and auxiliary power, if you wish, for making your own current for lights, tools, motors, etc.

You can quickly get into big paying welding service with practically no outlay on your part. There is a size and model suitable for all welding requirements in AC Transformer or DC Generator equipment—or you can save \$300 to \$500 by building your own arc welder, using the Hobart Generator Only and belting or coupling to a used gas engine. Free catalog and data. Write today.

**Easy "Pay out of Profits" terms**

Helps you get started now with minimum cash outlay

**REPAIRS . . .** automotive, farm tools, machines, anything metal.

**CONSTRUCT . . .** scaffolding, benches, etc.

**CONTRACT WORK . . .** Be busy year 'round on good paying jobs.

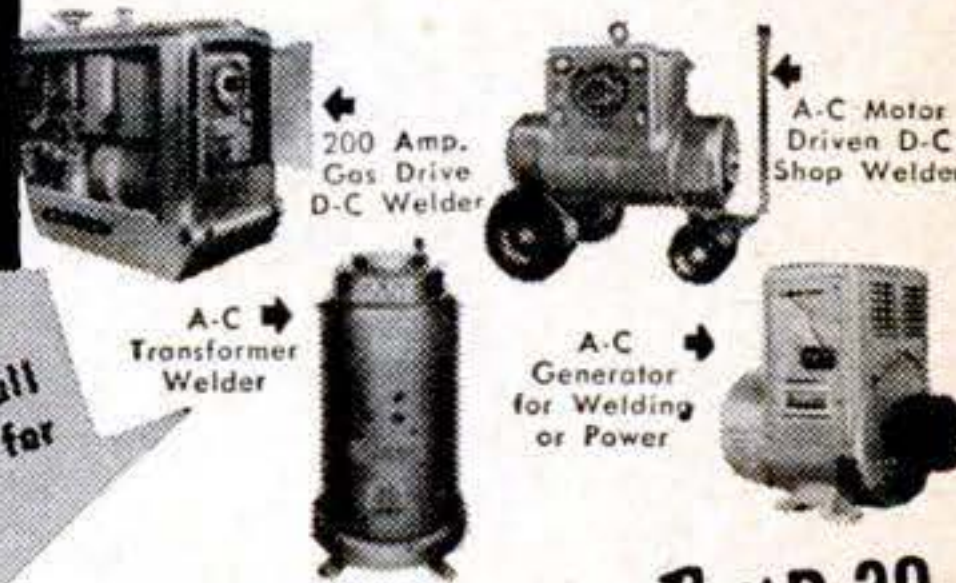

Free Booklet gives all details. Write for yours today!

**HOBART Brothers Co., Box P-30 Troy, Ohio—**

"One of the world's largest builders of arc welders"

In a tight spot?

**"YANKEE"**

**Offset Screw Driver Drives . . . draws screws in close quarters!**

Get 'em out or drive 'em easily in tight places with a "Yankee" Offset Ratchet Screw Driver! Lever action gives more power than a regular 8" screw driver. No. 3400 illustrated has 1/4" and 3/8" blades for slotted screws; other models for Phillips Recessed Head Screws. At your Stanley dealer's. Write for free "Yankee" Tool Book.

"YANKEE" TOOLS NOW PART OF **STANLEY** THE TOOL BOX OF THE WORLD

**NORTH BROS. MFG. CO., Philadelphia 33, Pa.**





## STOP LEAKS IN CELLAR WALLS

Do it with Smooth-On No. 7 Cement! Apply with trowel or stiff brush to leaky cracks, holes, porous spots, seams or other leaks in concrete, brick or stone walls and floors. The leaking will stop and Smooth-On will "stay put", for it expands slightly as it hardens. May be applied to wet or dry surfaces, indoors or outside. Use Smooth-On No. 7, too, to seal openings around pipes passing through walls. Buy Smooth-On No. 7 by name and number in 1-, 5-, 25- or 100-lb. size. If your hardware store hasn't it, write us.

### FREE Leaflet and Handbook

We'll send you leaflet showing No. 7 uses, also the famous 40-page Smooth-On Repair Handbook describing other Smooth-On Cements and showing many helpful home repairs. 170 illustrations. Write today.

SMOOTH-ON MFG. CO., Dept. 58-C  
570 Communipaw Ave., Jersey City 4, N. J.



Do it with  
**SMOOTH-ON**  
NO. 7 CEMENT



Take the "IRK  
OUT OF WORK"

there's  
always  
a job  
for

# CHOREMASTER

THE ONE WHEEL GARDEN TRACTOR

as low as \$132.00 Freight Extra

Now! New 1950 CHOREMASTER makes light work of lawn and garden chores. Quick starting, easy operation. Hitch your present hand mower to CHOREMASTER... shift from mowing to cultivating in a jiffy. This rugged unit provides auxiliary power for shop tools, pump, compressor... out on a job or away from electric power. Circular saw, power sprayer, cultivating tools, wagon, snow plow, riding sulky and other attachments available. 1, 2 and 3 H. P. models.

Write for literature and dealer name.

**CHOREMASTER DIVISION**  
THE LODGE & SHIPLEY CO.  
816-3 Evans St. Cincinnati 4, Ohio



"I Have Earned an Average of  
**\$1520 AN HOUR**"

with Science's New Midget Miracle,  
the PRESTO Fire Extinguisher



Says William F. Wydallis, Ohio.  
Many Others "Cleaning Up"—So Can YOU



Science's  
New Midget  
Miracle—  
"PRESTO"

AMAZING new kind of fire extinguisher. Tiny "Presto" (about size of a flashlight!) does job of bulky extinguishers that cost 4 times as much, are 8 times as heavy. Ends fires fast as 2 seconds. Fits in palm of hand. Never corrodes. Guaranteed for 20 years! Sells for only \$3.98!

Show it to owners of homes, cars, boats, farms, etc.—make good income. H. J. Kerr reports \$20 a day. C. Kama, \$1,000 a month. Write for FREE Sales Kit. No obligation.

MERLITE INDUSTRIES, Dept. 113, 201 East 16th St., New York 3, N. Y. (If you want demonstration sample too, send \$2.50. Money back if you wish.)

## FILE SAWS FOR PROFIT!

### NEW RAPID SAW FILER

Opens the door to extra income. Easy to operate. Fast efficient BeMaCo power filer for hand saws. Priced right! Does a beautiful job. Operator has complete control.



WRITE  
FOR  
DETAILS  
TODAY

### BEMACO AUTOMATIC SAW SET—

Uniformly sets 400 teeth per minute. Perfect hammer and anvil action. No tooth breakage.

## BEAVER MFG. CO.

801-A So. Isis St., Inglewood, Calif.

## NEW QUICK-CLAMP 30" BRAKE

Forms angles, flanges, seams. Bends 26 gage steel. Heavier copper and aluminum. Cam locking. Portable, can be clamped to edge of truck. All steel. Wt. 42 lbs. Ex-press collect..... \$24.50  
36" size ..... \$29.00

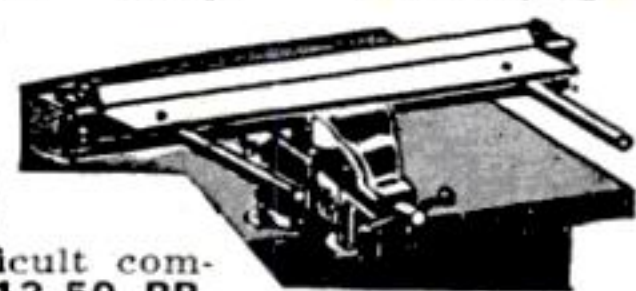

12" BRAKE. Fits in vise to form difficult compound bends, up to 20 gage steel. \$12.50 PP.  
CUTTER. Cuts 18 gage steel any length and width. \$12.50 PP.  
SHEET METAL PLIERS. 2 1/2" wide. \$2.00; 5", \$3.00.  
IRON BENDER. Forms hooks, braces, eyelets. Bends 1/4x2. \$10.00.  
Immediate delivery. Order cash or C.O.D., or send for folder.

WISE BRAKE MFG. CO., S1116 So. 27th St., Omaha 5, Nebr.



WAKE UP  
YOUR  
Scalp  
WITH THE NEW  
ELECTRIC-AUTOMATIC  
Vitabrush

**BE FAIR TO YOUR HAIR** Want better looking hair? Embarrassed by falling dandruff, itching scalp? Get the new VITABRUSH, the electric-automatic brush with built-in brush head motor... gives scalp and hair an invigorating "workout" in just 3 minutes. Cleans scalp, stimulates blood supply, distributes the natural oils. Fun to use—relaxing. Write for satisfaction-guaranteed offer—today. Hershey Mfg. Co., 3716 Field Bldg., Chicago 3



# How To Get MULTIPLE UTILITY When You Buy a SMALL GRINDER

## BUY THE FOREDOM MODEL 100 FLEXIBLE SHAFT MACHINE

the choice of tens of thousands because:—Pencil-size handpiece provides positive, sensitive, finger-tip control, works in hard-to-reach places. Your work always well in view. Precision construction and silencer-

equipped flexible shaft assures smooth-running performance. Motor not dwarfed to fit the hand, hence more power, longer motor life. Price only \$16.95. Foot rheostat \$4.85 extra.

Use It to Grind, Polish, Drill, Saw, Sand, Carve, Mill, Clean, Etch, Engrave, Etc. on all metals, wood, plastics, glass, leather, linoleum, etc.

35"  
FLEXIBLE  
SHAFT

\$16.95

COMPLETE  
WITH  
MOTOR



### BUT THAT'S NOT ALL—

For \$4.95 extra get Foredom's new **Drill Press Attachment**. Magically and quickly converts machine into a power drill press. **AND FOR ONLY \$3.50 EXTRA**, there's Foredom's new **B-R-S Attachment**. Makes machine serve 3 extra functions—

Bench Grinder with angular adjustment, Router with detachable guide for borders, and SHAPER.

Budget your purchase or buy **FOREDOM MULTI-PURPOSE THREESOME** comprising Model 100 Machine, Drill Press Attachment and B-R-S Attachment \$24.95

Model 100



PRESTO-FLEX  
\$5.95

### AND HERE'S ANOTHER AMAZING FOREDOM PRODUCT

Now turn your old motor, drill press or electric drill into a Flexible Shaft Tool with FOREDOM PRESTO-FLEX with PENCIL SIZE handpiece. Attached or removed in a jiffy! Gets into tight places. Handy 35" overall length. And—only \$5.95 complete! Precision made. For use on motor, specify motor shaft diameter and add 50c for coupling. (Available for 1/4, 5/16, 3/8, and 1/2" shafts.) No. 50 Accessory Set \$1.50 extra.



### NEW ACCESSO-RAK.

Mount on wall or back of bench and hang up machine. Comes with 40 highly useful accessories, all at your finger tips. Sensational value, only \$4.95.

**ORDER TODAY.** Send check or money order for items above or sent C.O.D. plus postage. Sold on 10 day money back TRIAL.

Write Today for FREE CATALOG No. 1027-E

**FOREDOM ELECTRIC CO., Dept. 1027-E, 27 Park Place, New York 7, N. Y.**

**FOREDOM — Used by INDUSTRY — Preferred by HOBBYISTS!**

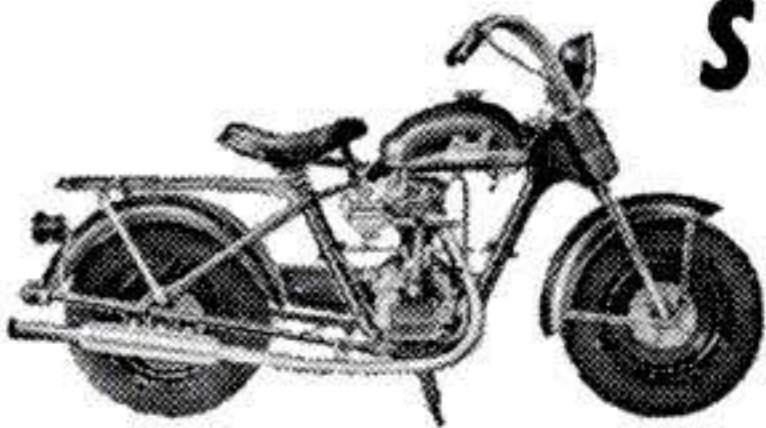

Dealer Inquiries Invited

## SET THE PACE WITH THE

- Cruises at 45 MPH—with faster pickup than car
- 39" high, 71" long overall, wt., 190 lbs.
- 8 HP motorcycle engine
- 50 miles to the gallon
- Automatic clutch
- Internal expanding brakes — handle-grip throttle controls

## POWELL MANUFACTURING COMPANY

DEPT. PS-350 • COMPTON, CALIF.

*Powell*  
**P-81!**

ONLY  
**\$247<sup>34</sup>**  
AT COMPTON, CALIF.  
EXCISE TAX  
INC.

Write for FREE folder and name of nearest dealer

## PRESSURE PRINCESS

Makes every job *EASIER*

**YOU** have never seen a single cylinder portable air compressor that packs so much power as this one. Built by the makers of the famous 4 cylinder Pressure Queen, the Princess will do any job, from inflating tires to painting buildings. Compact, simple and rugged, it will last your lifetime and pay for itself over and over again.



Powered by electric motor or gas engine.

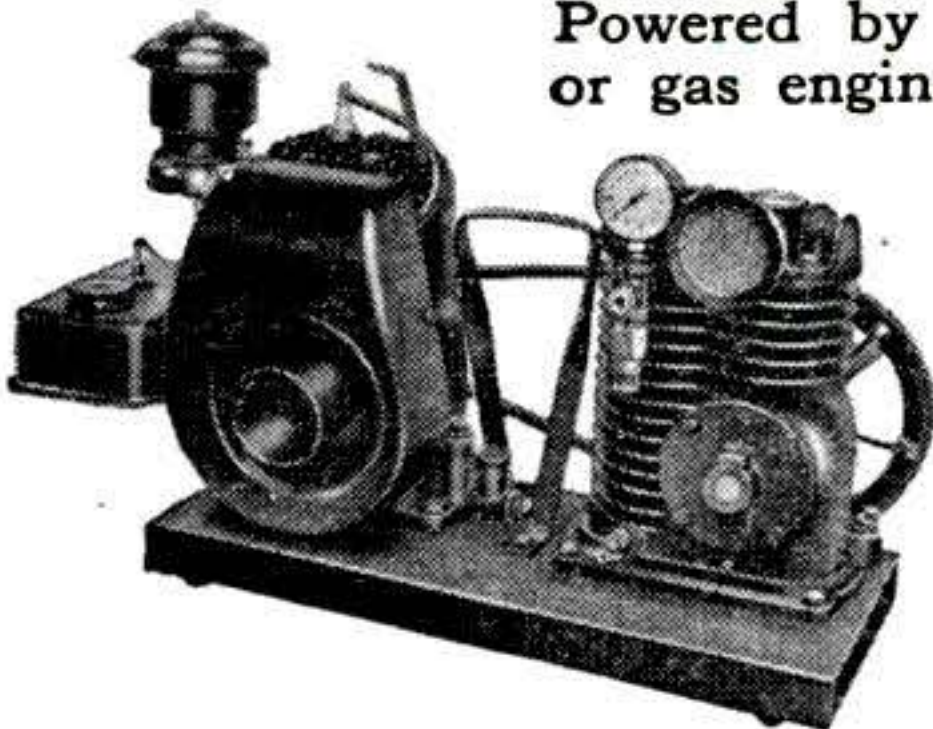

Write for  
Literature  
and Prices

### THE CAMPBELL-HAUSFELD CO.

151 Railroad Avenue

Harrison, Ohio

## PALMGREN

### No. 000 ANGLE VISE

For MILLING—DRILLING—GRINDING  
FITTING—FILING

Solve Difficult Angle Jobs



Quick, accurate set-ups at any angle. End make-shift methods — time loss — reflections. Ideal for tool rooms or home workshop. Accurately machined and graduated. Once set it stays locked. Jaws of steel—2 1/2" wide, plain or grooved. PRICE \$12.05 complete with Swivel Base—Vise only \$8.75. Write for other styles and sizes.



No. 6  
1 1/2"-GROOVED STEEL  
JAW. \$3.30

### No. 83 ROTARY TABLE with . . .

DUAL CROSS FEED and  
ROTARY FEED

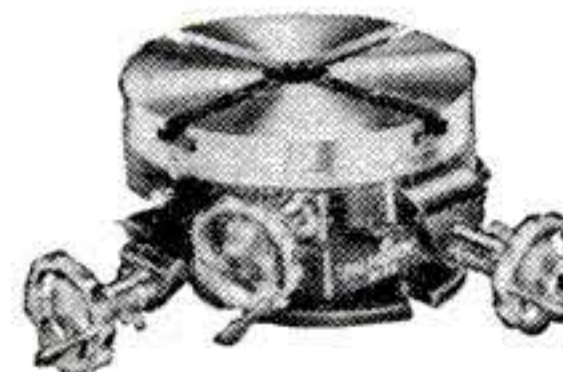

Has 8" Circular Table with full 360° movement and 4" crossfeed travel. Free moving adjusting wheels and dials graduated in degrees. Crossfeed adjusting screws have Acme threads with adjustable dials graduated in thousands. Four slots in base and key slots for bolting to table.  
No. 83 Rotary 8" Table . . . \$49.50  
No. 82 Dual crossfeed—with-out rotary . . . \$39.75

IMMEDIATE DELIVERY Write for Circular No. 12 — Order from dealer or direct postpaid if he can't supply.

### CHICAGO TOOL AND ENGINEERING CO.

8396 South Chicago Avenue

Chicago 17, Illinois

Telephone—Saginaw 1-9675



# BARRON Drill Press TOOLS



ROTARY WOOD  
PLANER \$7.50



1" and 2 1/2" DRUM  
SANDERS



ROTARY SURFACE  
SANDER \$5.95



\$9.85  
F.O.B. Detroit  
ALL-METAL  
DRILL PRESS TABLE

ALL-METAL  
SHAPER FENCE  
\$8.25  
F.O.B. Detroit



ROUTER &  
MORTISING  
BITS  
\$9.50  
per set of six

SHAPER  
CUTTERS  
\$9.00  
including  
3 sets Blades



## 15 ESSENTIAL WORKSHOP OPERATIONS...

You can convert any standard make drill press into your most versatile, useful, low cost workshop tool. Barron Precision Tools now enable you to perform 15 indispensable shop operations—surface-plane woods and plastics—rabbet—tenon—panel—bead—groove—bevel—mortise—route—cut dovetail—sand surfaces and contours—shape—cut moldings—grind and buff. Over 200,000 Barron Tool users. Every tool sold on full 10 day money back guarantee.

See Your Dealer... Or Write Direct

BARRON TOOL COMPANY, INC.  
870 Architects Bldg., Detroit 1, Mich.

FREE  
Workshop  
Guide &  
Catalog

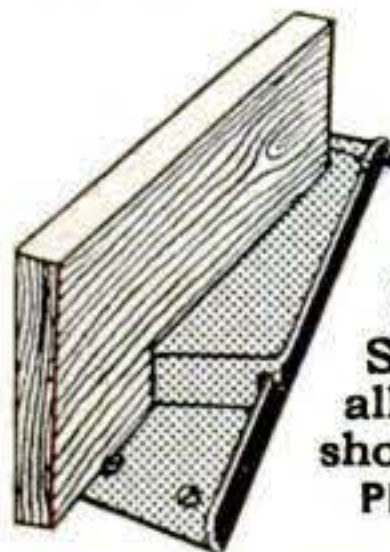

## SENSATIONAL BARRON SPEED-VISE!

### PERMANENT—PORTABLE

Slickest, handiest, most useful all-metal work bench vise. A workshop "must" for—  
PLANING • SAWING • DRILLING •  
SANDING • FILING • ETC.

Only  
\$175

Include 20c  
for shipping

Won't mar, mark or dent woods, plastics, metals. No piece too small or too large. 10 Day Money Back Guarantee.  
BARRON TOOL CO. Dept. SP DETROIT 1, MICH.

Money  
Back  
Guar.



## 7x50 PRISM BINOCULARS PRECISION OPTICS—BRAND NEW

\$36\*

6x50 Achromatic Field Glasses  
\$16\*

\*20% Federal Tax

Send for Free  
Catalog of Binoculars,  
Telescopes & Microscopes

BROWSCOPE CO.  
Dept. 3P, 24 W. 45th St.,  
New York 19, N. Y.

7x50  
\$36  
Illustrated

## NEW! MINIATURE DUST MASK

Wear when sanding, grinding, paint spraying, sweeping, dusting, furnace cleaning, etc. Handy as a pair of glasses. Just keep mouth closed and breathe through nose is all you do to operate. Protects against dusts, lint, coal, cement, grain dust. Has 9 sq. in. filter.  
Order today.



Order  
Today \$1.00  
POST  
PAID

JERRY BRYANT, Dept. PS, 919 N. Michigan Ave., Chicago 11, Ill.

## WHEELS—WHEELS

- 5" Disc Wheel 5/8" Tire 5/16" or 3/8" sleeve.....30c ea.
- 6" Disc Wheel 5/8" Tire 5/16" or 3/8" sleeve.....35c ea.
- 7" Disc Wheel 3/4" Tire 3/8" sleeve.....45c ea.
- 8" Disc Wheel 1 1/8" Tire 1/2" sleeve.....70c ea.
- 7" Disc Wheel 1" Tire 1/2" ball bearing.....80c ea.
- 8" Disc Wheel 1 1/8" Tire 1/2" ball bearing.....\$1.00 ea.
- 8" Disc Wheel 2" semi-pneum. T. 1/2" B.B.....\$1.35 ea.
- 10" Disc Wheel 1.75 semi-pneum. T. 1/2" B.B.....\$1.50 ea.

Above wheel prices include hub cap.  
10" Aluminum Wheel 2 3/4" semi-pneum. T. 1/2" B.B.....\$4.50 ea.  
Plus Postage, 20% — C.O.D.'s accepted.

UNITED WHEEL STAMPING CO., PS-3  
2756 W. 115th STREET CHICAGO 43, ILLINOIS



## YOUR CAR GLIDES with GLIDE-O-RIDE

### SAVE MONEY—WEAR AND TEAR

Yes, your car glides with the revolutionary, new GLIDE-O-RIDE—put Ball Bearing action between the leaves of any leaf-type auto spring. Long-wearing, steel balls held in patented steel keepers. Easily installed in 10 minutes by prying spring leaves apart with screw driver. Eliminates squeaks, rattles and extreme tire wear, helps keep front wheels in proper alignment. Prevents broken springs. Thousands in use—sold on a MONEY-BACK GUARANTEE. Set of 16 fits all late model cars with 2 rear leaf type springs—extra sets of 8 or 16 for older cars with 3 or 4 leaf type. Set of 16—\$4.95. Set of 8—\$2.50. Sent postpaid, cash or check with order—Plus small postage and C.O.D. charge.

LARSON AUTOMOTIVE SUPPLIES, Dept. 35

921 Francisquito, Puente, California

SIMPLE  
TO  
INSTALL

ONLY  
\$4.95  
SET OF  
16

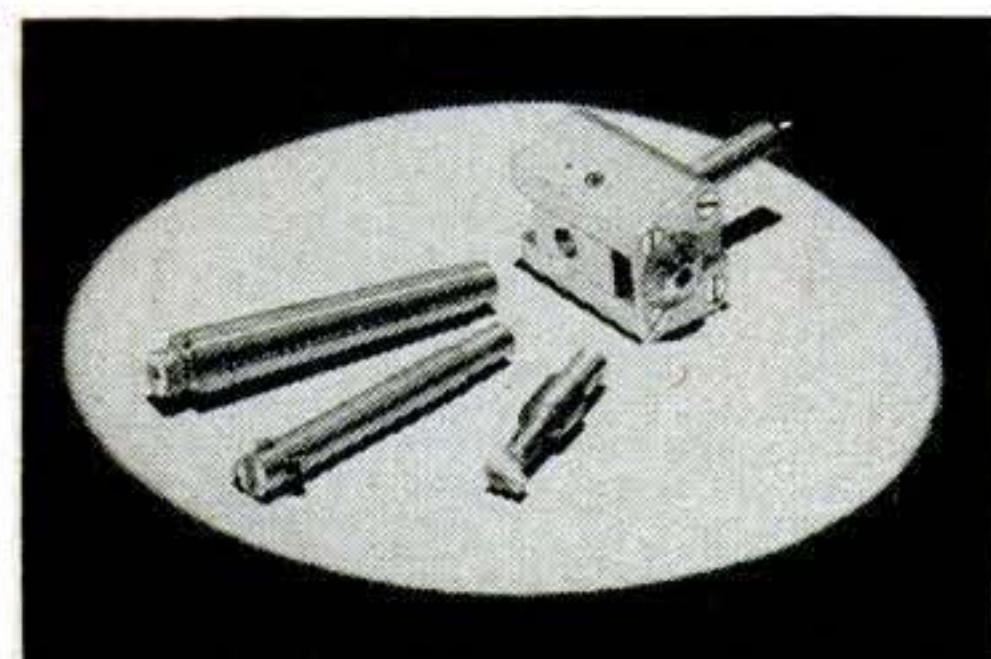
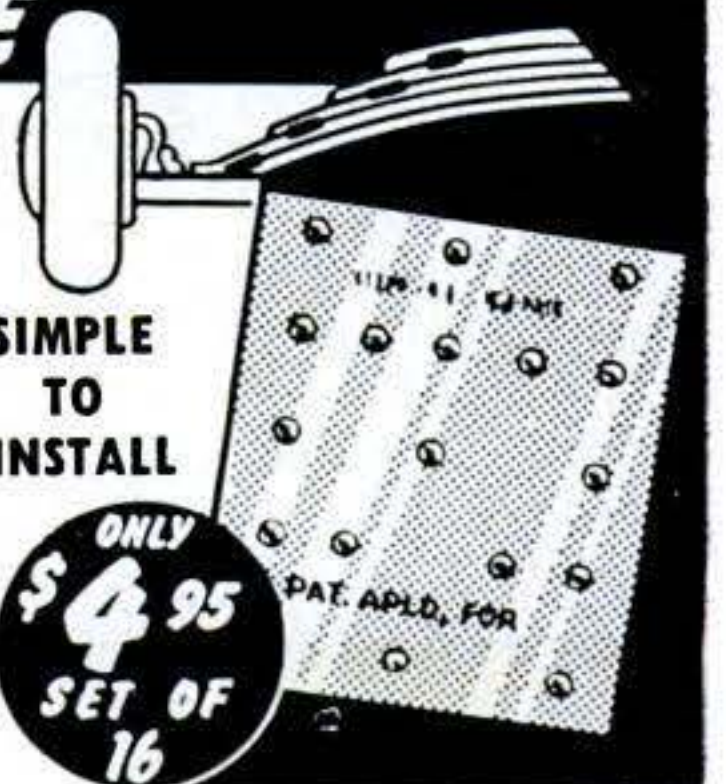

Copyrighted by H. B. Hazerodt 1949

## NEW! MARVIN MICROMETER BORING HEAD

A versatile precision tool of the highest quality, small in size, low in cost. Designed for use on Milling Machines, Drill Presses, Boring Machines and Lathes. **SPECIFICATIONS:** Cast iron body 2 1/8" x 1 3/4". Close fitting slide, adjusting screw to snug up slide or lock it. Slide has 3/8" travel. Dial graduates 1/1000". Hex socket for adjustment. (Accessories): 1-7/16" x 3" boring bar. 1—solid tool bit. 1—No. 2 Morse taper shank. 1—3/8" straight shank. 3—wrenches. Priced at ..... **\$18.00**

MARVIN MACHINE PRODUCTS, INC.

415 Ford Bldg.

Detroit 26, Mich.



**Motor Oil Changes**  
**ENTIRELY UNNECESSARY**  
 after attaching

**RECLAIMO** The World Famous HEATED Oil-Filter and Re-Refiner!!  
 (Cast Aluminum)

Makes short work of *solids and liquid* impurities—after 150 miles you won't believe it's the same oil! REMEMBER—"Oil does not wear out mechanically", states U. S. Bureau of Standards. Convince yourself—just read our "Oil Facts", 32 pages, FREE on request.

**RECLAIMO MFG. CO.**  
 5083 Elston Ave., Dept. 26, Chicago 30, Ill.  
 Dealers Wanted

Sand Casting—Forging—Heat Treating—Case Hardening  
**BRONZE FOUNDRY**

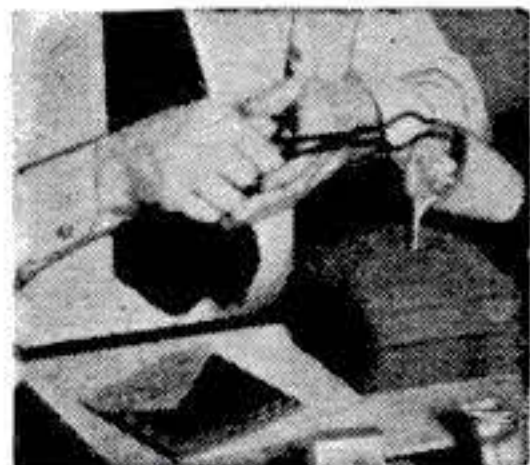

In your own workshop allows you to design and build your own GASOLINE ENGINES, STEAM ENGINES, STATUARY, ART OBJECTS, SPECIAL TOOLS, NEW INVENTIONS, ETC. You can also make forgings and case harden steel. Your shop is not complete without a FOUNDRYETTE. Three sizes are available capable of making bronze castings of 1½, 3 and 6 pounds weight, aluminum, copper, brass, etc., \$22.50, \$29.50, \$42.00 f.o.b. Kansas City. Domestic gas supply energy required for operation. Write for circular.

and 110 volt AC or DC  
**KANSAS CITY SPECIALTIES CO.**  
 Box 6022, Dept. S-2 Kansas City, Mo.

**POWER MOWERS & KITS** **FREE PLANS**



**LOW FACTORY PRICES DIRECT TO YOU** on America's finest Lawn Mowers and Easy-To-Assemble Kits and Parts. TRIANGLE Mowers are quality-built and powered high for easy cutting and long wear.

**SAVE MONEY 3 WAYS**

- Buy complete assembled mowers in 3 or 4 wheel models. 18" and 20" sizes.
- You assemble complete mower from our precision built Kits and Parts.
- Build your own from our FREE PLANS using Triangle Kits, Parts, Engines, Wheels, Etc.

WRITE TODAY for full facts, Free Plans, Parts List, and LOW Factory Prices.

**TRIANGLE MFG. CO.**  
 Dept. S-B, Box 185  
 Fort Scott, Kansas

**BIG FREE CATALOG**

of WAR SURPLUS

**OPTICAL BARGAINS**

Build Your Own RIFLESCOPE, BINOCULARS, TELESCOPES, ETC.

We Furnish Optics and Instructions

- LENSES, PRISMS & RETICLES
- EYEPIECES and OBJECTIVES

Send \$1.00 for Stock #2-N 10-Piece Lens Kit and Big Instruction Booklet.

We Have Numerous Types of Assembled Optical Instruments Including BINOCULARS and RIFLESCOPES. CHECK OUR BARGAINS . . . Request CATALOG N

**EDMUND SALVAGE COMPANY**  
 BARRINGTON, NEW JERSEY

**SURPLUS CUTTING TOOLS**

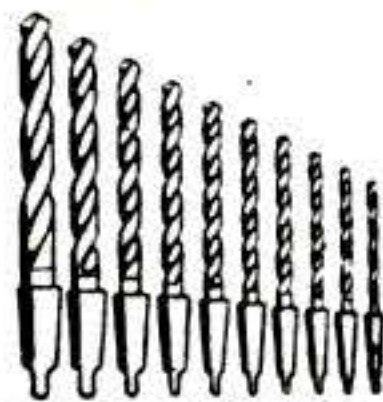

TAPER SHANK DRILLS



CHUCKING REAMERS



HAND REAMERS

- SET 8 different size High Speed Morse Taper Shank Drills up to 1½" with No. 1 and 2 Tapers. \$25 value. New and slightly used surplus. Sharpened. Priced at only..... **\$3.85**
- SET 10 different size High Speed Morse Taper Shank Drills from 1/8" to 1¼". \$50 value. New and slightly used surplus. Sharpened. Priced at only..... **\$7.85**
- SET 10 different size High Speed Hand Taps up to 5/8". Priced at only..... **\$2.00**
- SET 10 different size Straight Shank Drills from 3/8" to 1". Extra long drills. New and slightly used surplus. Priced at only..... **\$4.75**
- SET 10 different size Taper Shank High Speed Reamers up to 1". New and slightly used surplus. Priced at only..... **\$4.50**
- SET 6 different size Straight Shank High Speed Chucking Reamers. Up to 1½". Priced at only..... **\$3.50**
- SET 6 different size Straight Shank High Speed Chucking Reamers from 1/2" to 1". Priced at only..... **\$4.95**
- SET 6 different size Hand Reamers up to 1/2". Priced at only..... **\$3.10**
- SET 8 different size Hand Reamers 1/2" to 1¼". Priced at only..... **\$5.50**
- SET 10 different size High Speed Morse Taper Shank Drills 1" to 2". \$180.00 value for only..... **\$39.95**
- SET 10 different size Carbon Steel Morse Taper Shank Drills. 1" to 2". \$100.00 value for only..... **\$22.50**

**HYDRAULIC PUMPS**

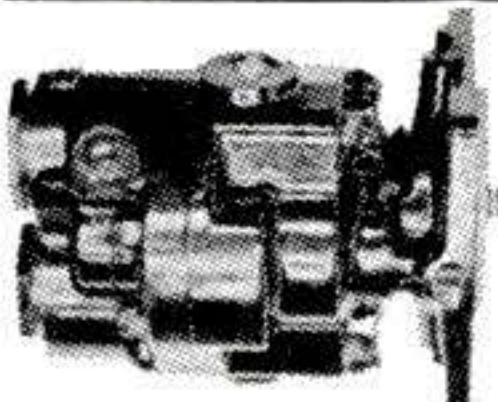

Pesco Model 1P730 Positive displacement gear type. Capacity 178 GPH @ 1500 RPM and 2000 PSI. Brand new. ¾" inlet and outlet pipe connections. 5/8" drive spline. **\$8.73** Priced at only.....

All merchandise is sold with money back guarantee and is shipped POSTPAID.

**T & T TOOL** 101 WEST ARCHER TULSA, OKLAHOMA

**EVERY ELECTRIC DRILL**

**A PORTABLE SAW**

**CAN BE USED WITH ONE HAND!**

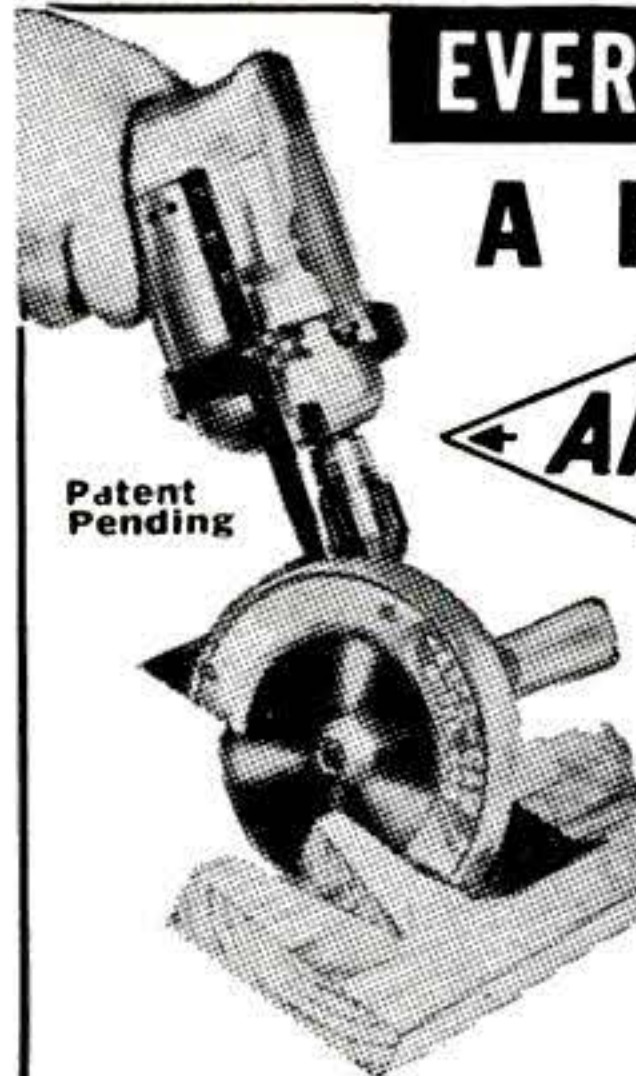

Just try it. You won't use a hand saw anymore.

**FITS ANY 1/4", 5/16", 3/8" ELECTRIC DRILL**

"ARCO-SAW" is a rugged precision woodcutting tool with right angle gear drive, backed by 90-day factory guarantee. (No clumsy direct drive with drill sideways.) Works like high priced Portable Saw. EXCLUSIVE SAFETY YOKE connects drill and saw. ABSOLUTELY SAFE.

Cuts 1½", 2 x 4 By Turning Over



**\$9.95**

**UNCONDITIONAL 10-DAY MONEY BACK GUARANTEE**

Compl. with 4" "HYCARBON" Blade  
 Extra Crosscut Blade, will Rip....\$1.60  
**ORDER TODAY** at your Dealer or send us check or M.O. (Postpaid). C.O.D.'s—postage extra.  
 Dealers: Write for name of nearest jobber.

**ARROW METAL PRODUCTS CO.**

Dept. PS3, 140 West Broadway New York 13, N. Y.



# Make up to \$4<sup>00</sup> an Hour THIS EASY WAY



with **FOLEY LAWN  
MOWER SHARPENER**

"At \$2.00 a mower the Foley makes me \$4.00 an hour and I am still under doctor's care. How many men punching time clocks can earn \$4.00 an hour?"—Frank S. Riley. "Will have my machine paid for and more than \$300 clear this season"—says A. W. Bishop.

Why don't you get into this steady CASH business? The Foley Lawn Mower Sharpener does a beautiful job on all hand and power mowers, without removing handles, which saves time and enables you to sharpen up to 3 or 4 hand mowers per hour at \$1.50 to \$3.00 each, and 1 or 2 power mowers at \$5.00 to \$8.00 each. Foley prices are only \$98.50 to \$139.50 and the Foley builds you a steady repeat business. Easy payments if desired.

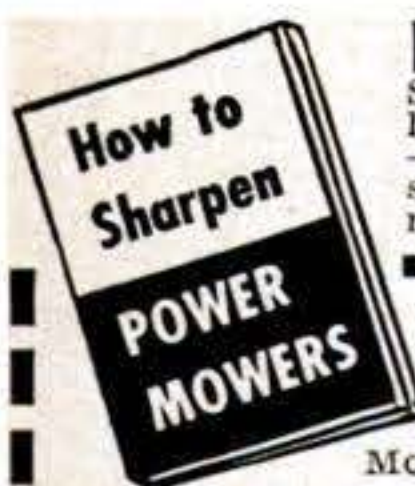

**FREE BOOK "HOW TO SHARPEN POWER MOWERS"**  
Shows just how to sharpen any make of power lawn mower with the Foley. Mail coupon today—we'll also send FREE PLAN telling how to start your own business without previous experience. No salesman will call.

**FOLEY MFG. CO.,**  
308-O Foley Bldg., Minneapolis 18, Minn.  
Send FREE BOOK "How to Sharpen Power Mowers," and FREE PLAN on lawn mower business.

NAME.....  
ADDRESS.....

"REDDY JACKET"  
says...

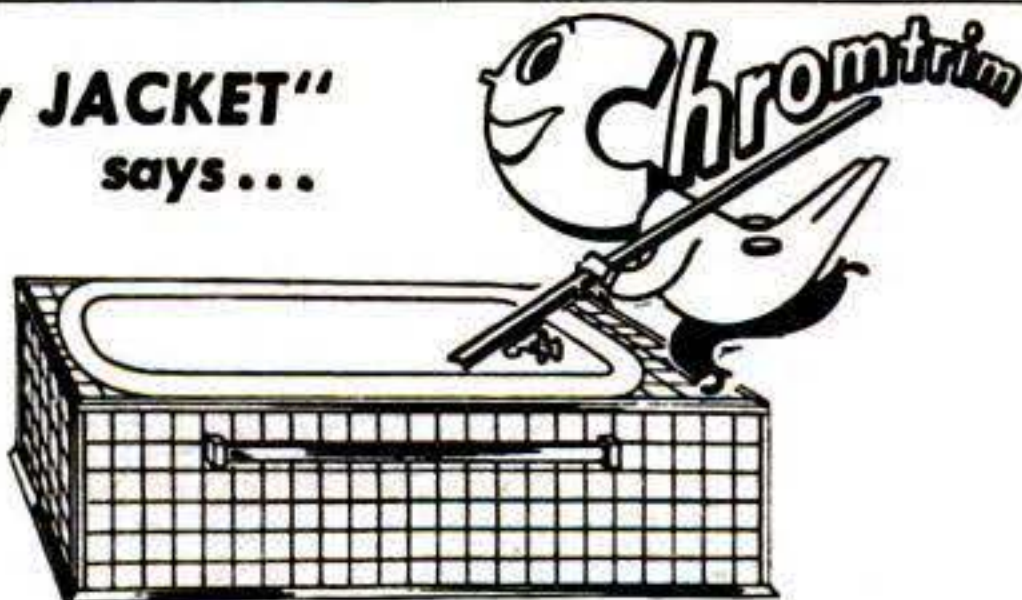

**MODERNIZE your old Bathtub**  
the easy, inexpensive

**Chromtrim way!** EASY TO BUY EASY TO APPLY

Follow the simple CHROMTRIM plan and use "thrifty priced" CHROMTRIM metal mouldings with the companion materials you choose.

Send 10¢ for 16 page full color "Trim Ideas" booklet—the Modern Bathtub plan and the name of your nearest CHROMTRIM dealer.

CHROMTRIM aluminum and stainless steel mouldings are easier to cut and available in shapes to fit all materials. Look for the CHROMTRIM REDDY JACKET to be sure it's genuine.

R. D. WERNER CO., INC., Dept. (PS)  
295 Fifth Avenue, New York 16, New York  
I enclose 10¢ for Modern Bathtub Plan and "Trim Ideas" booklet.

NAME.....  
STREET.....  
CITY..... STATE.....

# KING MIDGET HOME ASSEMBLED AUTO



**WORLD'S LOWEST PRICED AUTOMOBILE!**

80-90 MI. PER GAL.—45-50 MI. PER HR.

Drive for as low as 50c per week. Precision built parts direct from factory with beautiful all steel body. Get the facts on this amazing small auto—send 25c for detailed circular with large picture, 3 view drawings and price of all parts, or send \$1 (refunded first order) for this plus actual assembly book with 42 photos, drawings; blueprints of snow, ice conversions, information on mini-midget racing, etc.

MIDGET MOTORS MFG. CO., Athens 3, Ohio

King Midget is ideal for errands, sports use, to work, short business or pleasure trips, or second-car utility for the whole family. Also tops for mini-midget racing. Room for six footer.

## WAR SURPLUS

# Power Plants

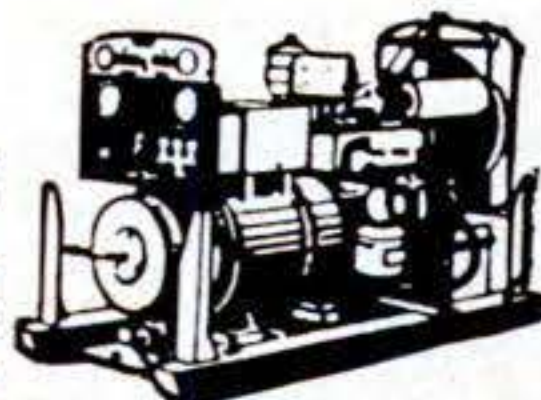

110-V, 60-C, 3,000-W. Remote switch electric self-starter. Easily made full automatic. Army's finest plants. Full instructions. Ideal for farmers, sportsmen, contractors. New condition. Fully guaranteed. Order from ad or rush card for gigantic mail-sale Bargain Catalog.

Cost Gov't. \$756

Sale \$345

**BURDEN SALES COMPANY**  
825 "O" St. Lincoln, Nebr.

Frnt. Prepaid

# POWER HACKSAW \$47.25

less motor  
F.O.B. Benton Harbor

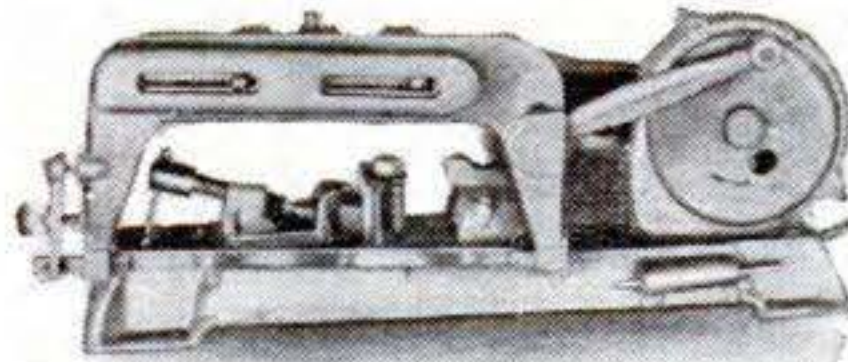

No other saw like it. Rugged cast iron construction. Bronze bearings. Quick action vise—jaws swivel to 45°. Draw cut. Automatic shutoff switch. Capacity 4" x 4". Send for full details and name of nearest dealer.

**EXCEL MACHINE TOOLS** Dept. PS-30  
Benton Harbor, Michigan

## AMAZING NEW WOOD-TURNING TOOLS

**SHARPEN ONCE IN 12-YEARS! (UNDER NORMAL USE)**  
These remarkable tools tipped with TUNGSTEN CARBIDE will astound you with their performance. They work FREE HAND equally well in wood, plastic or soft metals—and at the same time hold their razor-like edge almost indefinitely. Tests show that they will turn wood or plastic for days and days CONTINUOUSLY without showing any signs of dulling. They are the finest tools available at any price. Beautifully finished 5" blade—flush ground, polished tip—finest brass tube ferrule—9" hardwood handle—over all length 14"—25 tools to choose from: round and square nose from 1/8" to 1/2";—1/8" cut off; 1/2"x30° skew, spear, r. & l. skewers, turning and parting. Amazingly Low Prices! Write at once for free literature.  
**JOHNS MFG. CO., DUNELLEN 7, N. J.**

## STOP Dust and Pollen Irritation... New FLEX-a-FOAM Masks



Unbelievable relief with new feather-weight Flex-a-Foam Filter Masks! Stops particles as small as 1/25000 of an inch! A-1 protection for indoor and outdoor jobs. Comfortable snug fit—unequaled breathing freedom. Attractive, easy to clean... With three extra washable pure latex filters \$2.00 p. p. — Order Now!



GOOGLE PARTS CO. — Dept. PS — Cleveland 13, Ohio

## Who Ever Heard of Only \$8<sup>00</sup> Each? POWER TOOLS

EMRICK WORKSHOP includes Big, Heavy-Duty 30" Lathe, Drill Press, Saw Arbor, Grinder, Sander — in ONE machine, using ONE motor. Equals in performance single units up to \$200.00. Factory price only \$39.95 cash, or on Easy Payments. 10-Day Free Trial. MONEY-BACK Guarantee. Write for FREE literature on new 1950 features and New Low Priced Specials.



NEW LOW PRICES

5-in-1  
MACHINE

EMRICK, INC., 1947 Clinton, Kalamazoo, Mich.



# Reg. \$995 **OHIO GRINDER** \$395

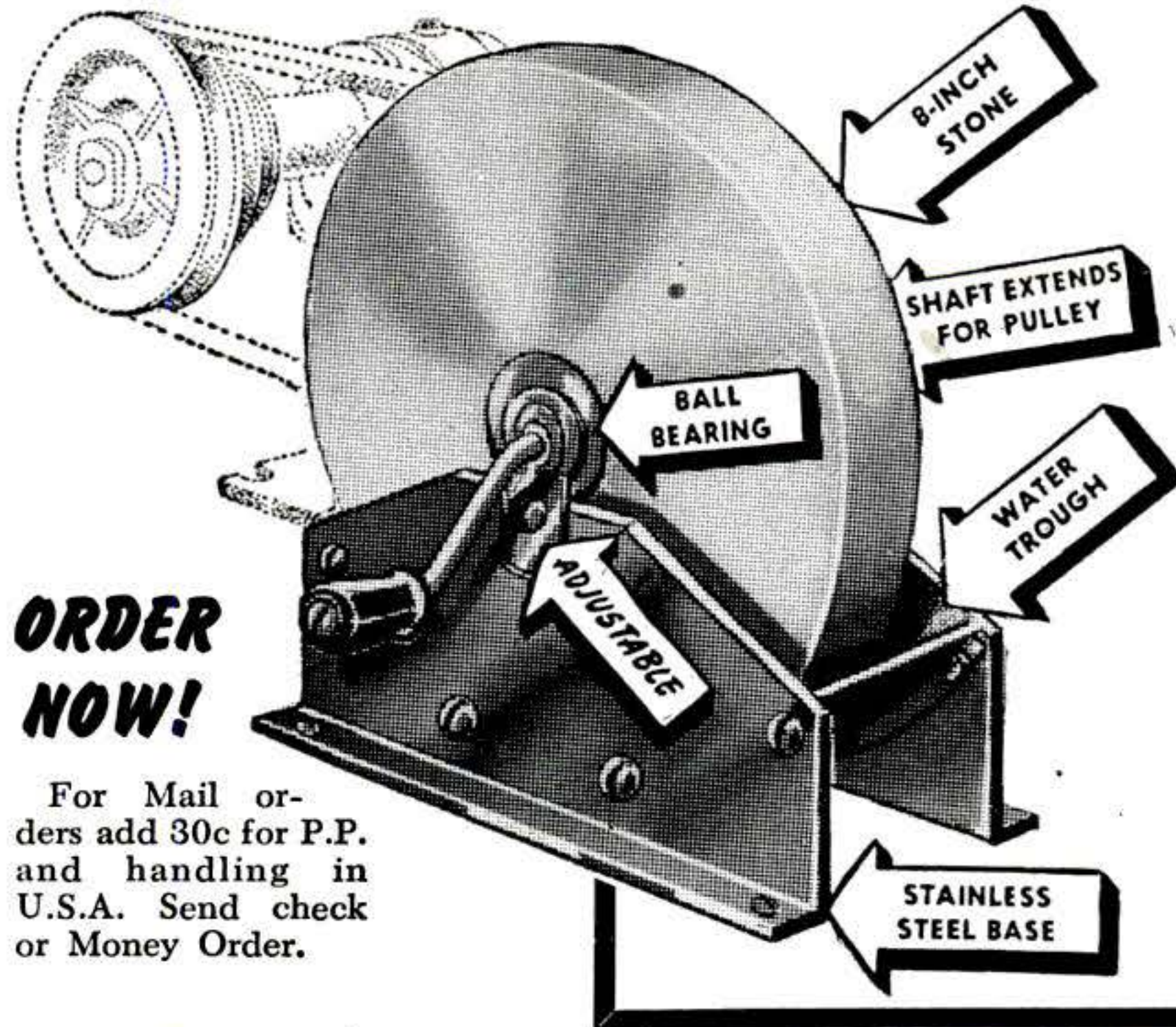

**BALL BEARING**  
8" x 1½" WET STONE

## THE BUY OF A LIFETIME!

- A practical hand operated sharpener for Homes, Farms and Work shops.
- Sturdy, Engineered and Adjustable.
- Brand new, first quality.
- No Temper removed.
- For precision sharpening.
- Weight 8 lbs., easy to assemble.
- **EASILY CONVERTED TO POWER DRIVE** (as shown in illustration)

**MARTIN**  
**ELECTRIC T & S COMPANY**

604 Arch Street Dept. A Phila. 6, Pa.

**ORDER NOW!**

For Mail orders add 30c for P.P. and handling in U.S.A. Send check or Money Order.

## Convert HAND MOWERS TO POWER MOWERS

**Takes less than 3 hours**  
The Handy-Dandy Lawn Mower Kit fits any hand mower from the 16 to the 20 inch size. Complete with all necessary parts. Kits can be purchased separately, complete with engines or complete with Pennsylvania mower.

Also manufacturers of a complete power mower and garden cultivator attachments.



**LE CLAIRE MFG. CO.**  
LE CLAIRE, IOWA, Dept. PS

## MAKE BIG PROFITS! OPERATE YOUR OWN SAW-FILING SHOP

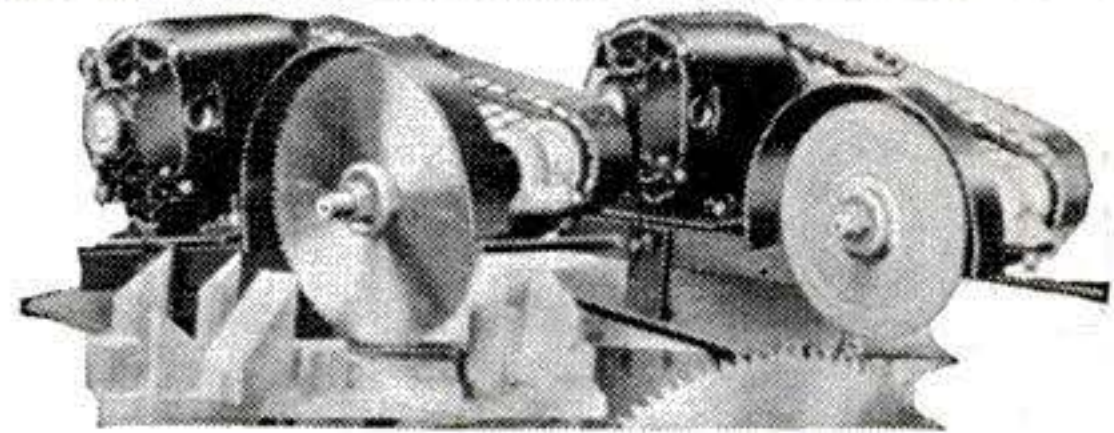

• Big earnings are yours with a saw-filing business. Prospects everywhere. Small investment starts you at once! Illus. shows how one Hand Gummer can be adapted to a saw sharpener and/or a cut-off saw. Machine will grind and gum out Rip & Cut-Off saws at any degree, bevel or hook. Also, rounds saws up. Easily adapted to grind skill saws. Up to 20" capacity. \$64 each. F.O.B., Portland. Act now!  
WRITE FOR FREE LITERATURE - DEALER INQUIRIES INVITED  
**P. T. HOBBS MACHINERY** 8375 N. Interstate, Dept. PS-119  
Portland 17, Oregon

## PRECISION INSTRUMENTS

### REMOTE CONTROL THERMOMETER



For automobiles, homes, refrigerators, milk coolers, brooders, orchards, workshops, etc. Temperature bulb at end of 5 or 15 ft. flexible tube (state which) Dial thermometer glows in dark—non electric—very sensitive—-40° to +50° C. and -40° to +125° F. on same dial. Aircraft quality—worth many times.....\$3.50

### ALTIMETER



Modernize your car. Fine desk ornament. Reads up to 20,000 feet. Fluorescent dial glows at night—no connections of any kind required—self contained—Suitable as a laboratory standard instrument—Same as used in airplanes. Brand new—cost gov't many times.....\$3.50

### PIANO HINGE

For doors, cabinet work, tool boxes. In full lengths only. Width measured open. Undrilled.

#### Stainless Steel

¾" x 4' 1½" x 6'  
1 1/16" x 4' 2 1/16" x 6'  
1¼" x 6'

#### Aluminum Alloy

¾" x 3' 1¼" x 6'  
1" x 6' 2" x 6'  
1¼" x 5'



Any size, per foot.....20c

### EMERGENCY PULL-OUT LIGHT



Use on car, boat, darkrooms, workshop, airplanes. White or red light. Small size 3"x3¼"x4¼" Also pulls out 6 ft. on self winding reel. Takes 6, 12, or 24 volt bulb. In durable plastic case. Only.....\$2.50

### MANIFOLD PRESSURE GAUGE



Indicates manifold pressure in your automobile, boat or stationary engine—allows you to operate your engine at maximum operating efficiency and gas economy Connects to windshield wiper hose or manifold. Complete with connections, hose and instructions. BRAND NEW!.....\$7.50

### PRESSURE GAUGES

For air, oil, hydraulic, gas, etc. Aircraft quality, with 2¼" dials. Any range 0-5, 0-15, 0-25, 0-30, 0-100, 0-120, 0-150, 0-200 0-400, 0-1000, 0-1400, or 0-2000 lbs. Also Suction Gauges 0-10 lbs. BRAND NEW.....\$2.50



### STORAGE BATTERY

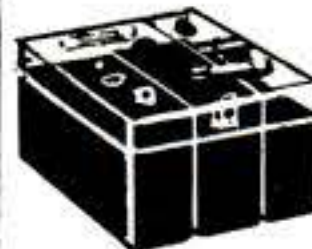

6 volt Willard, rechargeable, clear plastic spillproof case has self contained charge indicators for each 2 volt cell. For radios, experimenting, cars, models, 7x7x4½ inches. 12½ lbs. Brand New.....\$6.95

### ASTROGRAPH with case

New B-29 Navigation instrument which can easily be used to make a good contact printer, strip map holder, etc. The plywood case 14½"x11"x10" high is perfect as tool kit, camera projector case, or for building a portable phonograph, picnic kit, makeup case, etc. Has leather handle, reinforced cover, eight covered compartments in bottom. Cost Gov't \$125.00. Add postage for 22 lbs. ....\$3.95



Enclose sufficient postage—Excess will be refunded—No COD's

**AIRCRAFT COMPONENTS, Inc.**

800 Woodland Avenue Benton Harbor, Michigan

### RUSH ORDER BLANK

PLEASE SEND CIRCLED ITEMS:

Name .....

Address .....



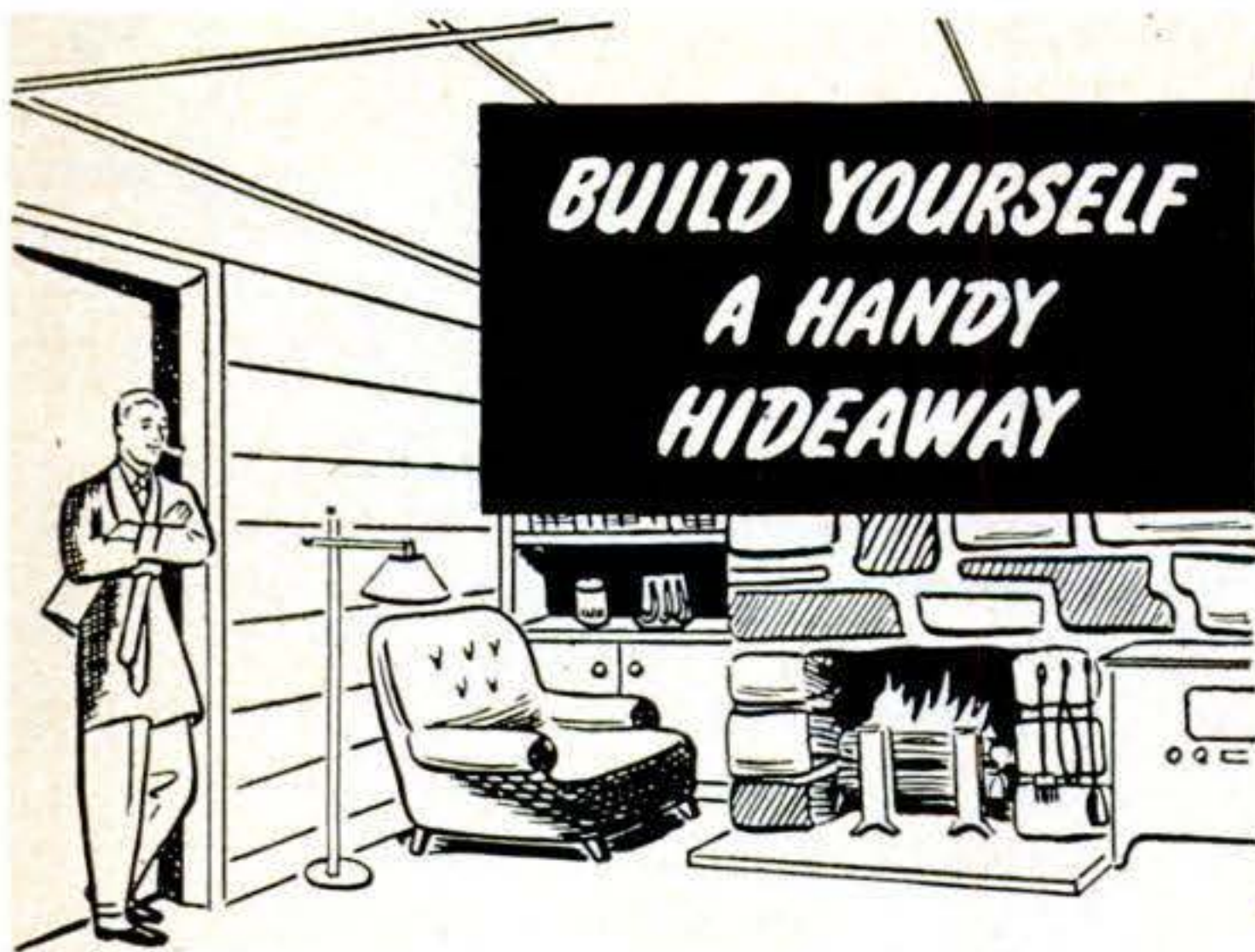

**I**T'S easy to turn unused attic space into your own private "office" with new Gold Bond Insulation Board. It comes in big ivory coated panels and in tiles and random width planks finished in ivory and harmonizing variegated blends. No further decoration is needed. Just nail the board in place and the job is done. You will not only have an attractive room, but one that's insulated ... warmer in winter, cooler in summer. For further details on new Gold Bond Insulation Board write Div. X, Dept. PS-3a.

*Available at your local Gold Bond Lumber and Building Materials Dealer!*

**NATIONAL GYPSUM COMPANY  
BUFFALO 2, N. Y.**

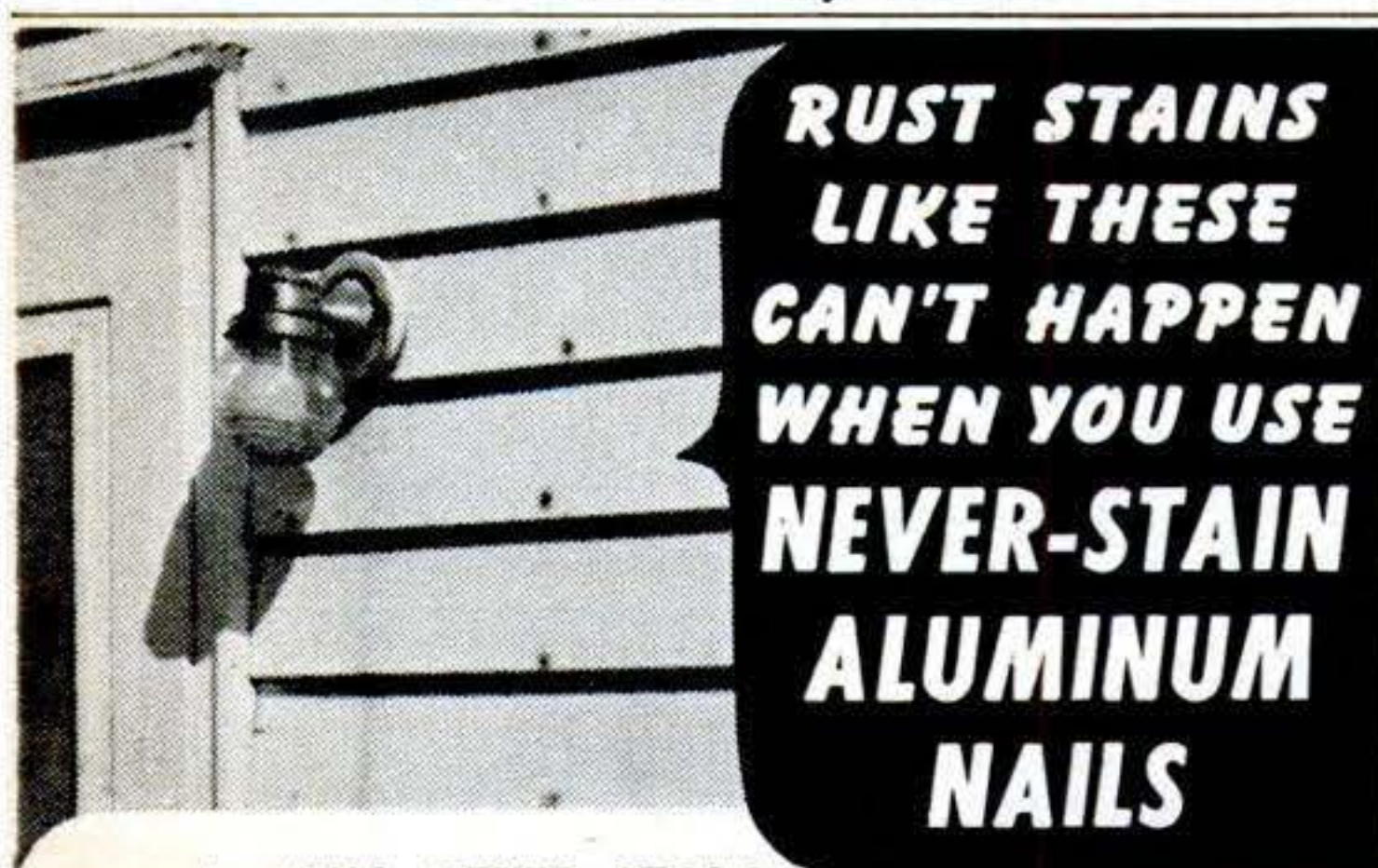

- ★ WILL NEVER STAIN OR STREAK PAINTED SIDING OR COLORFUL ROOFING
- ★ COST LESS TO APPLY—NO PUTTYING OR COUNTER-SINKING NECESSARY
- ★ ALMOST 3 TIMES AS MANY PER LB.

They pay for themselves in the savings they make—and they may save you a \$300 repaint job! Now packaged for the job in different colored boxes, each with quantity, size and type clearly indicated.

**ALUMINUM IS NOT A SUBSTITUTE!**

Write for FREE Samples.  
Address Dept. PS.



**NICHOLS WIRE & ALUMINUM CO.  
DAVENPORT, IOWA**

## Now... MEASURE CURVED LINES!



Simply hold instrument vertically and trace line or distance to be measured. The index hand on dial shows exact length of measured distance in centimeters or inches. (Multiply for feet, yards or miles).

**IDEAL FOR:** Motorists, architects, draftsmen, engineers, craftsmen, machinists, engravers, artists, photographers, teachers, students, decorators, hobbyists, designers, textile men, etc.

- Watch type. Has 2 faces 1 on front, 1 on back
- Precision made (Imported)
- Highest quality material
- Chrome finish
- Unbreakable lenses

**\$3.50** ea.

Comes in genuine leather sheath

**10 DAY MONEY BACK GUARANTEE**

Dealers Inquiries Welcome

1/2 actual size Send Check or Money Order to:

**ALVIN CO. Importers, Windsor, Conn.**  
"QUALITY AT THE RIGHT PRICE"



## WORLD'S LOWEST PRICED ADDING MACHINE

Vest Pocket Size **FREE TRIAL**

**IDEAL FOR BUSINESS AND PERSONAL USE—GUARANTEED ACCURATE.** Not a toy. Operates with only a finger flick. Adds, subtracts, multiplies, divides. Counts up to one billion. Pays for itself over and over. Ideal Gift—for Business, Income Tax and School use. **\$2.95 only**

**TOTAL COST SEND NO MONEY** MONEY BACK GUARANTEE. Send name and address. Pay postman only \$2.95 plus postage. (Send full cash if outside U.S.) Beautiful rich-looking Leatherette Case included at no extra cost. Money back in 10 days if not delighted. AGENTS WANTED.

**CALCULATOR MACHINE CO., (Mfrs.)**  
Dept. 522, P. O. Box 248 Glenview, Illinois

**RETAIL PRICE \$125.00  
FACTORY TO YOU \$59.95**

**SUPERSHOP** includes precision-built 8" tilting table saw, vertical and horizontal drill press, 30" lathe, sander, grinder. 100% BALL BEARING. Write for FREE catalog, full details, trial plan.

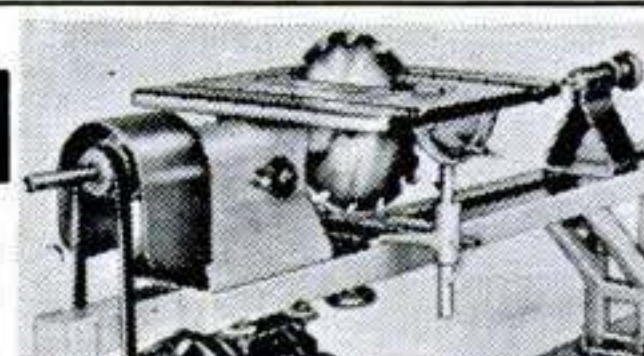

**POWER TOOLS, INC.**

209 Yates Avenue  
Beloit Wisconsin



## SAHARA WATERLESS HAND SOAP

Removes without water — Paint, Tar, Grease, Ink, etc. Quickly — Easily — Contains Lanolin. PREVENTS CHAPPING AND ROUGH, RED HANDS. SEND \$1.00 FOR TWO 60c TUBES — POSTPAID. Money-Back Guarantee — Agents Wanted.

Sahara Products Corp., Grand Rapids, Mich.

## OTTAWA Buzz Master

**7 MODELS — \$99.00 up**  
Greatest offer ever made by oldest and largest firm in the business. Made by men with the know-how. A model to fit your needs and your pocketbook. Endorsed by Conservation experts. Send for FREE details. Now in our 46th year.



**OTTAWA MFG. CO., 1-001 Brush Ave., Ottawa, Kan.**

## NU-WAY LAWN MOWER

Write for  
FREE Circular

Price **\$12.50**  
Why Pay More

*Build Your Own*  
Rotary Type Lawn  
Mower

We Supply Cutting Unit  
Complete.

**NO INCREASE  
IN PRICE**



**TRACTOR-LITE MFG. CO., SPIRIT LAKE, IOWA**



# "Wellworth" Sensational Offer! Reg. \$60.50 WESTINGHOUSE AIR COMPRESSOR

Model T-1 Brand New - 2 CYLINDER PISTON TYPE. Operates with 1/2 H.P. Motor or equivalent gas engine.

Compressor, pressure tank, air gauge, air chuck, 20-ft. hose, pop valve, copper tubing with 4 brass flared fittings for connecting compressor to tank, 4-way cross and 3 nipples. COMPLETE OUTFIT, wt. 52 lbs.

**\$32.50**

Equipment less Compressor, \$12.50. Compressor separately, \$21.50  
Compressor has 2" bore, 1 1/2" stroke, ball bearing, 3.27 CFM at 600 R.P.M. Capacity up to 6.54 CFM. Size 9"x11 7/8"x6 5/8". Wt. 26 lbs. Ideal for spraying paints, insecticides, etc., inflating tires, operating air tools, and other uses. All new equipment. U.S. government surplus. Replacement parts available. Amazing buy. Don't miss it.

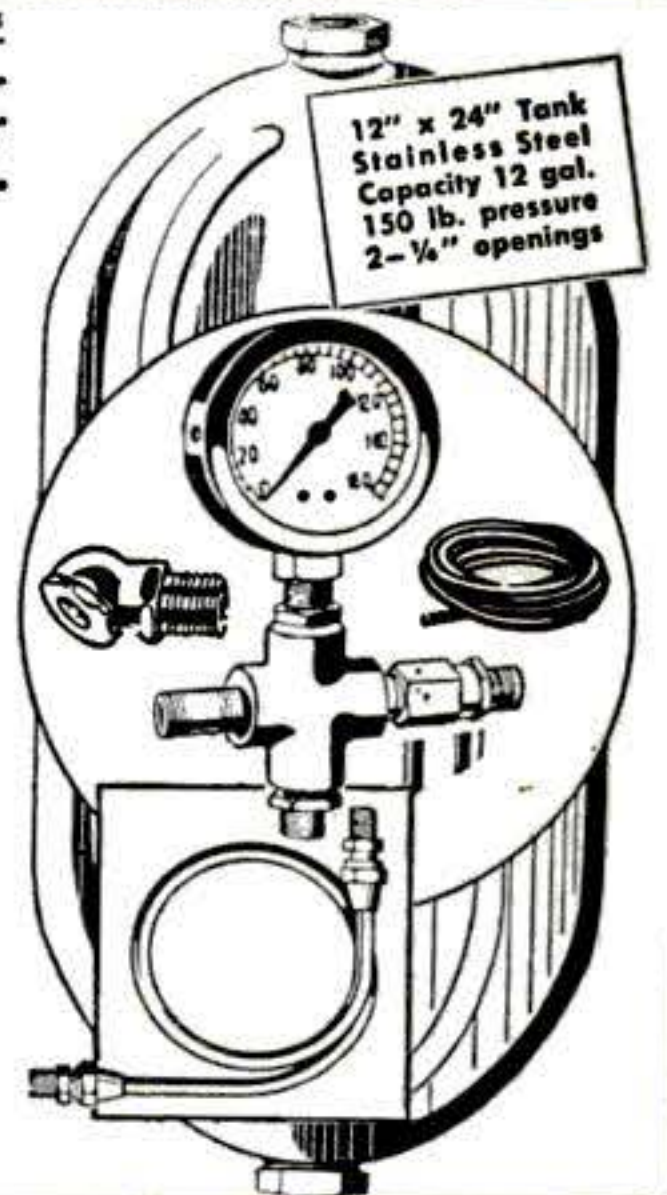
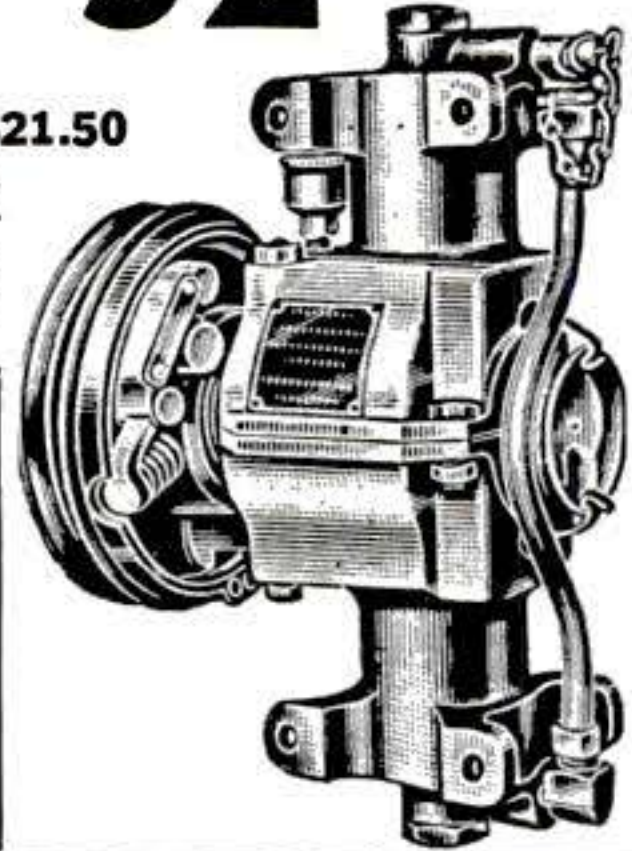

12" x 24" Tank  
Stainless Steel  
Capacity 12 gal.  
150 lb. pressure  
2-1/4" openings

## PORTABLE SPRAY OUTFIT

1/4 H. P. HEAVY DUTY MOTOR  
EXTERNAL  
ATOMIZING GUN

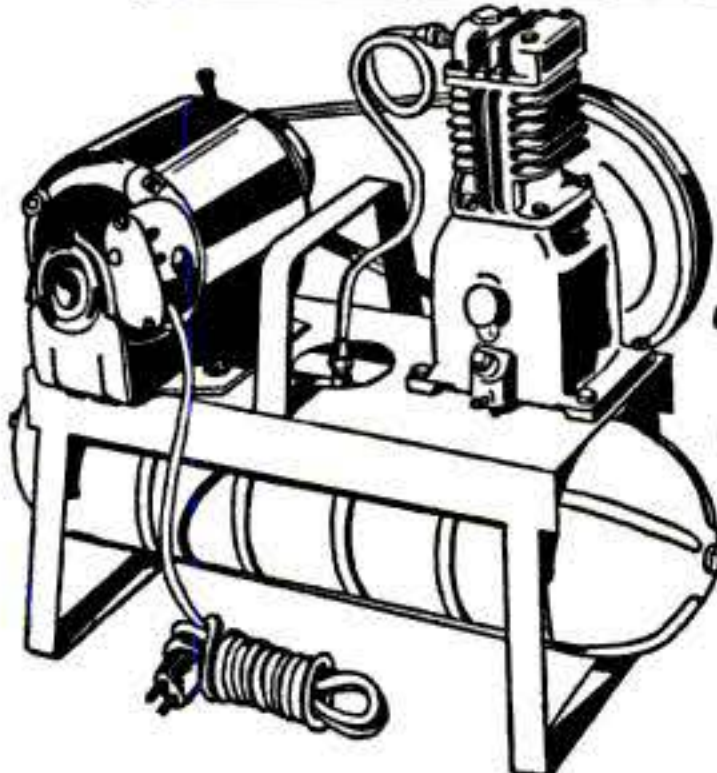

Paint Sprayer mounted on 6 x 24 inch tank, 1/4 H.P. 110 V. 60 cy. Heavy duty motor with overload relay, 10 ft. cord and plug, V belt drive. Piston type Compressor with 2 Compression rings, 1 oil ring, 2 inch Bore, 1 3/4 inch stroke, displacement 2.86 C.F.M. at 60 lbs. pressure. Safety Valve. Gun external atomizing. Flat and round spray, quart cup; maintains 35 to 40 lbs. working pressure. Oil and water extractor, 1 air gauge, 20 ft. heavy duty 2-braid air hose carrying handle.

**\$57.50**

COMPLETE OUTFIT

with leak proof fittings, complete with  
Net weight 54 lbs., ship. wt. 60 lbs.  
Outfit less motor. Wt. 30 lbs. \$47.50  
Compressor only. Wt. 14 lbs. 17.50  
Spray gun and 20 ft. hose. Wt. 7 lbs. 12.95

## Portable Automatic Paint Spray Unit

Spray paint your home, car, garage, etc.

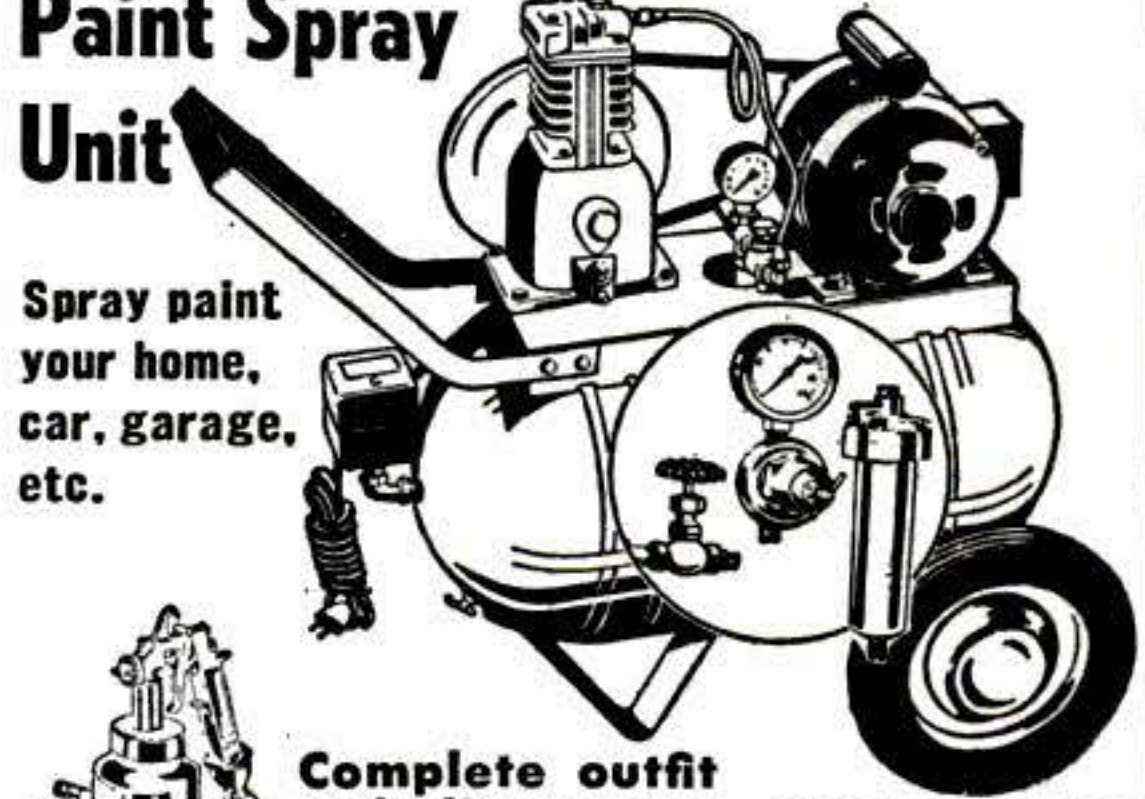

Complete outfit including Spray Gun. \$150.00 Value.

**\$89.50**

Same unit, stationary, \$79.50

Use also for spraying insecticides on plants and flowers. 1/3 H.P. heavy duty capacitor motor. AC 110/220 volt, 60 cycle, 2 x 1 3/4 inch piston type compressor, splash feed lubrication, 12 1/2 x 24 inch tank, automatic pressure switch. CFM 2.8 at 100 lbs. pressure, or 150 lbs. pressure for intermittent duty. Check valve, safety valve, air regulator with gauge and filter, spray gun with 20 ft. air hose and air chuck for inflating tires. V belt drive. Mounted on 2 wheels, ball bearing, with 2" x 10" pneumatic tires. Portable, with handle. Shipping wt. 90 lbs. Regular \$150.00 value. ONE YEAR GUARANTEE. Only \$89.50 complete.

### PARTS SOLD SEPARATELY

- Compressor.....17.50 wt. 16 lbs.
- Automatic pressure switch..... 7.50 wt. 3 lbs.
- Regulator, gauge and filter..... 8.50 wt. 5 lbs.
- Spray gun..... 9.95 wt. 4 lbs.
- Tank, wheels and base..... 17.50 wt. 32 lbs.
- 20 ft. hose..... 2.95 wt. 6 lbs.
- 1/3 H.P. Cap. motor..... 22.50 wt. 28 lbs.
- Air gauge...1.75 Adjustable pop valve...1.50
- 1/4" check valve..... 2.75 wt. 2 lbs.

## PNEUMATIC AIR TOOLS

USED, GUARANTEED LIKE NEW.



### CHICAGO PNEUMATIC RIVETER & CHIPPING HAMMER

CP4X Pistol grip handle. Takes up to 3/16" rivet. Weight 6 lbs. List price \$73.00.

Ideal for work on fenders and auto bodies

SPECIAL PRICE..... **\$10.95**

Same as above, brand new..... **\$22.50**

### Chicago Pneumatic Lever Type AIR DRILL



With 1/4" Jacob Chuck. Wt. 2 lbs. List price \$55.00. Only..... **\$14.95**



### Ingersoll Rand AIR DRILL

With 1/4" Jacob Chuck. Wt. 2 lbs. List price \$55.00. Only..... **\$14.95**

**68 PAGE BOOK!**  
Motor guide, air compressors, home and factory workshop tool catalog. Send 10c to cover postage and handling.

## AIR TANK and ACCESSORIES

Air receiver, stainless steel, 12 1/2"x24". 400 lb. test. Ideal for carrying on trucks, autos and wherever compressed air is needed. Equipped with 500 lb. air gauge, tire chuck, 3 ft. highest air hose, air inflation valve with core for retaining pressure in tank, and fittings.

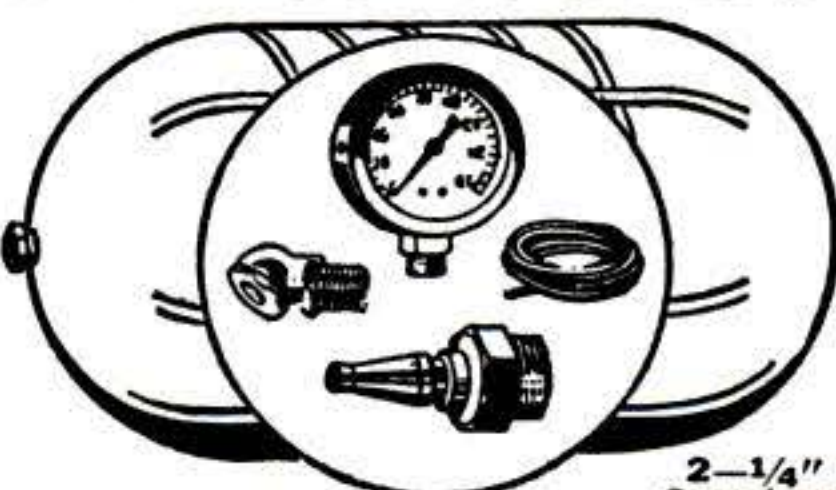

Complete outfit **\$6.95**  
Shipping wt. 20 lbs.  
Tank only.....**\$4.95**

2-1/4" Openings



### 6 FT. STOW FLEXIBLE SHAFT

Heavy Duty, 3/8" Core. Best piano wire. Ball bearing handle and arbor, rubber covered housing; for 1/2" motor shaft; for 1/2" bore wheels. Operates on 1/4 H.P. Motor at 1725 or 3450 R.P.M. \$29.00 Value, **\$14.50**. Wt. 8 lbs.

Reduced Price  
Only **\$14.50**

All items advertised on this page are guaranteed BRAND NEW

### 50 CFM Blower 2 1/2" discharge \$6.95

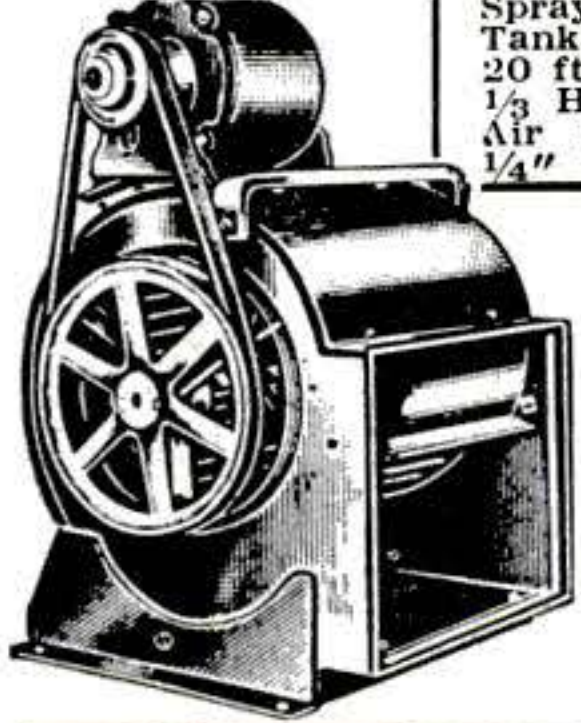

## "Wellworth" BLOWER at a Bargain Price

Quiet operating. Double wheel inlet, double width blower. For heating, ventilating, cooling, air washing, exhausting and forced draft. DIMENSIONS: 10" wheel; outlet 13 1/8"x 11 3/8"; inlet 8 3/4". Height 19". Width 18". Depth 16 1/2". C.F.M. 1/4" S.P. 1600; outlet vel. 1575; motor 1/4 H.P. with overload relay; cord & plug, 110 v. 60 cy. AC. Ship. Wt. 67 lbs. Special price..... **\$39.50**

### 140 CFM "WELLWORTH" BLOWER

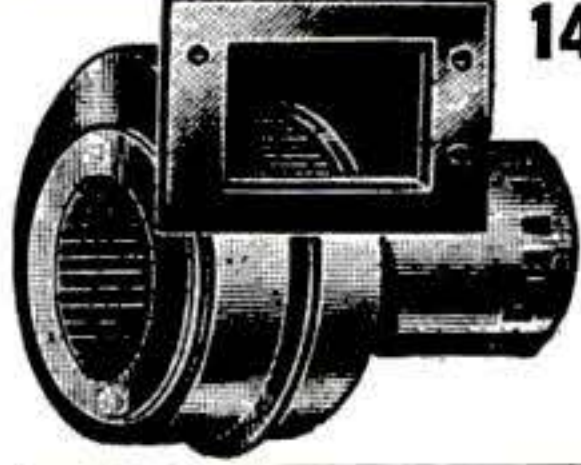

Single-inlet blower that gives top performance on heating, ventilating, exhausting, cooling, drying and similar applications. 5 1/8 x 4" mounting flange with 2 1/2" square discharge, 3 1/2" dia. blower wheel powered by direct-connected 1/15 H.P., 110 V., 60C., A.C. motor with conduit box and 20" leads. 7 1/2" wide less flange by 7 1/4" H. x 6 3/4" D. Suited for hundreds of new and replacement uses. Shpg. wt. 6 lbs..... **\$14.20**

## 300 GAL. COOLANT PUMP

A Heavy-Duty Pump at 40% Less

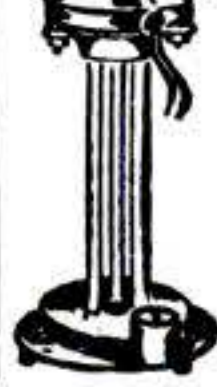

You pay less and get a larger, higher pressure, higher capacity, heavy duty coolant-type, recirculating pump. Also extensively used on evaporative coolers. Will deliver 60 gal. per hr. at 8 ft. head and 300 GPH at no head. Heavy duty 1/30 H.P. totally enclosed, 110V., 60C. motor with long life oiling. Noncorrosive shaft and pump. 10 1/2" high, 3/8" I.P.T. Ship. wt. 12 lbs..... **\$15.95**

SUMP PUMPS. ALL SIZES. BARGAINS. SEE CATALOG  
Prices f.o.b. Chicago. Immediate delivery. All items sold on money back guarantee. Send check or money order today.

**WELLWORTH TRADING CO.**  
1831 S. STATE ST. DEPT. B-3 CHICAGO 16, ILL.



# The JIFFY metal CABINET

**YOUR ANSWER TO SMALL ITEMS STORAGE** at home, office, and shop (IDEAL GIFT, TOO)

So handy to keep nuts, bolts, screws, nails, parts, washers, stamps, hobbyists' needs, etc., at your fingertips.



THIS 32 DRAWER UNIT ONLY \$5.95 POSTPAID

Stop searching, get a 32 or 64 drawer Jiffy to keep those small items that usually get mislaid. Spot welded steel, gray enamel finish, metal drawer guides. Dividers included with aluminum drawers make possible three compartments per drawer. Looks good anywhere. Send check or money order, please—no C. O. D.'s. Prices below. Your money refunded if not satisfied. Dealers write for quantity discount.

SPECIFICATIONS	WITH ALUMINUM DRAWERS	WITH CARDBOARD DRAWERS
<b>32 Drawer Unit</b> 6" Deep 12 3/4" Wide 15 1/4" High	<b>Dividers and Index Cards Included</b> One piece rustproof aluminum drawers for heavy service—good for work bench and industry use.	Suitable for most home uses. Heavy board kraft covered. Metal drawer pulls.
<b>64 Drawer Unit</b> 6" Deep 25 1/2" Wide 15 1/4" High	<b>32 drawer - \$8.95</b> <b>64 drawer - \$15.95</b>	<b>32 drawer \$5.95</b> <b>64 drawer \$9.95</b>
<b>Drawer Size</b> 1 1/4" Deep 2 3/4" Wide 6" Long	Ohio orders add 3% sales tax. Marproof Rubber Feet included with all cabinets <b>POSTAGE PAID</b>	<b>POSTAGE PAID</b>

KAYTEE PRODUCTS, Dept. S, Box 588, Canton, O.

WE FURNISH ALL MACHINED METAL PARTS, EVERY SCREW, NUT, BOLT, WASHER, AND COMPLETE PLANS FOR THIS...

## BIG 10" POWER SAW

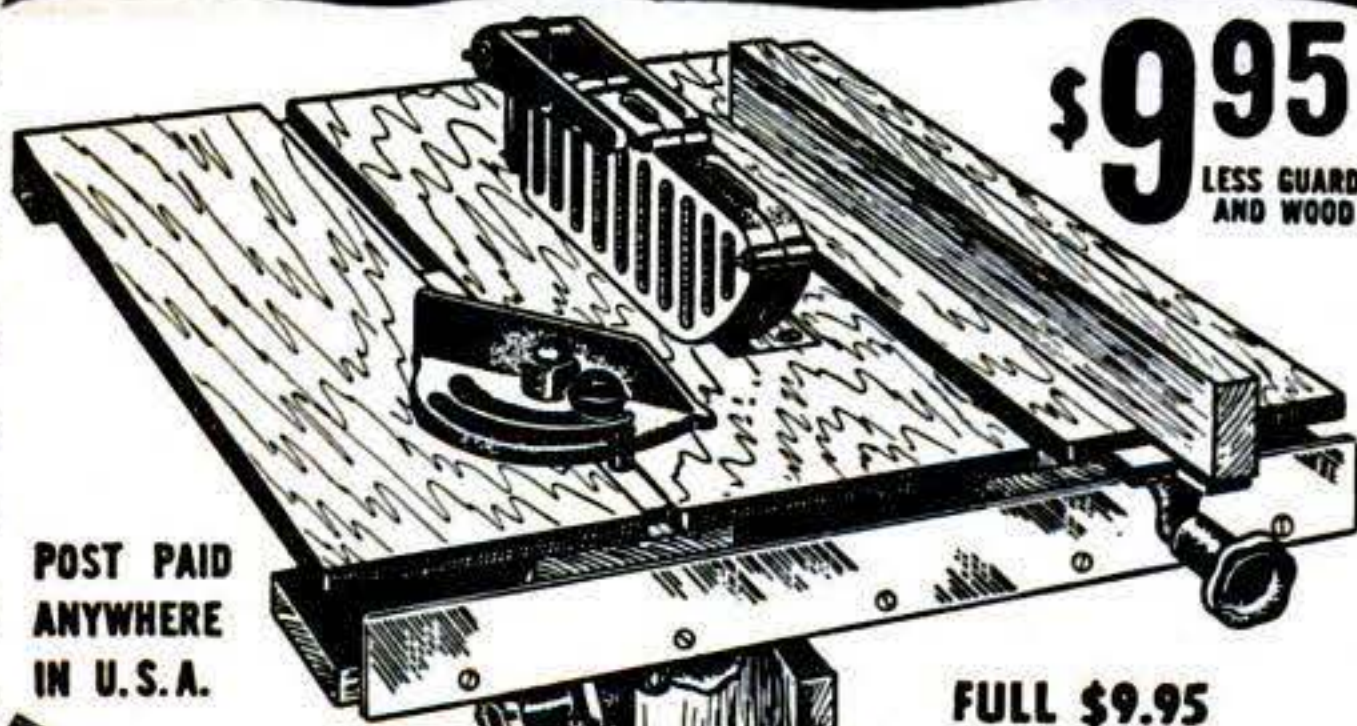

**\$9.95**  
LESS GUARD AND WOOD

POST PAID ANYWHERE IN U.S.A.

FULL \$9.95 REFUND IF NOT SATISFIED WITHIN 10 DAYS

ASSEMBLE IT YOURSELF WITH SIMPLE HOUSEHOLD TOOLS!

TABLE 24" x 20" • TILTS TO 45°  
CUTS 0" TO 3/4" DEEP • TAKES 10" BLADE

COMPLETE PLANS (WITHOUT PARTS) 10c

**MARCUS • POLLAK** DEPT. 18 ROYERSFORD, PA.

# We've gone NUTS!!



Just Purchased 180,000 lbs. of the FINEST PRECISION Made ELASTIC & FIBER LOCK NUTS!! All are NEW!!



Here's your chance to "STEAL" Aircraft Quality STOP NUTS at less than the cost of common commercial hex nuts. They're ALL NEW Cad plated Steel and a large quantity are even pre-tapped for easier wrenching. ELASTIC or FIBER LOCK SEAL gives a Positive . . . Shake-proof . . . Vibration & Rust Resistant fastener. No lock washer necessary . . . One operation does the job. Just run on the nut. Ideal for use in all types of metal fabrication, assembly, construction etc. . . .

AND LOOK AT THESE PRICES for ELASTIC or FIBER LOCK NUTS

	1,000	10,000	25,000	50,000	100,000	500,000
641	\$.25	\$.21	\$.19	\$.17	\$.15	\$.13
832	.31	.28	.25	.23	.21	.19
836						
1032						
1/4-28	.39	.36	.33	.30	.27	.25
5/16-24	.64	.61	.58	.56	.54	.49
3/8-24	.74	.71	.68	.66	.64	.59

Prices shown are per 100 in these quantities. Special discounts on larger quantities.



## BEARINGS

We also went CRAZY on these!!  
Needle, Roller, Recessed, Rod End, Shielded, Unshielded. Made by some of the WORLD'S FINEST MANUFACTURERS of BEARINGS!! These are the finest Precision Aircraft Bearings. YOURS at a FRACTION of commercial prices.



Description	O.D.	I.D.	Thickness	Price
SHIELDED				
K-3	.7774	.1895	.270	20¢
K-4	.9014	.2495	.335	25¢
K-5	1.250	.3120	.375	35¢
K-6	1.4375	.3745	.469	40¢
K6AR-48	1-3/32	23/64	5/16	30¢
NON-SHIELDED				
3L24BM	7-3/32	4-23/32	1 1/8	7.50
209V	3-11/32	1-3/4	17/32	1.95
NEEDLE				
B-1616P	1-1/4	1"	1"	45¢
B-3424	2 1/2"	1-7/8	11/32	1.25
ROD END (Thread 3/8 x 24)				
	I.D.	Length	Thick	
RE3M6A	3/16	2"	1/2"	35¢

NOTE: We have 168 other sizes of New Bearings in tremendous quantities!!

SAVE! SAVE!! SAVE!!! - We have TREMENDOUS quantities of AIRCRAFT Quality BOLTS - SCREWS & RIVETS. Our huge stocks include a great variety of sizes and lengths. PRICED LOWER THAN YOU PAY FOR ORDINARY COMMERCIAL QUALITY.

**Ellinwood "44"** Here's a Real BUY!! This engine is rated from 4.4 to 5 HP. Has optional power take-off of 1 to 1 from crankshaft or 2 to 1 reduction from camshaft. Makes an ideal auxiliary power plant or can be used to drive pumps, generators, compressors, small boats, etc. Lightweight rugged and contains such fine component parts as Bendix-Timken-Air Maze, etc. . . . . ONLY **69.50**



**RIFLESCOPE** Finest precision Acromatic optics 5 double element lenses, color corrected, spherical aberration. Dot reticle. Magnification 3 power. Length 9", tube dia. 7/8", objective lens 16", eye lens dia., 25mm. **\$8.95**

**6 in 1 HAMMER** It Hammers. It pins and has four graduated screw drivers 5/8" to 7/8" which telescope into handle - A real household aid. **NEW ONLY 89¢**

**NEW TARPS - HEAVY CANVAS**  
Mildew & Flame Resistant. Cheap Outside Storage. They are Really Moving at These Prices.  
5' x 7' **\$3.95**  
8 1/2' x 10' **\$8.50**  
Rubberized Linen 7' x 11' NEW **\$5.95**  
Only 3 lb. light weight yet waterproof Ideal for outside car storage.

**RUBBER Neoprene Sheet Stock**  
Thickness Approx. Width Price per run yd.  
#325 .020 1/64" 36" \$1.75  
#328 .032 1/32" 22" 1.38  
#330 .064 1/16" 36" 2.39  
#331 .093 3/32" 36" 3.39  
#329 .125 1/8" 46" 4.75  
Note: No. 329 is Laminated rubber sheet with cloth center. Flexible & very fine for heavy wear.  
No. 332 - Grey Neoprene Rubber Floor Mat. Has raised non-skid Diamond pattern with durable cloth backing. Stock size: 36" x 48" x 1/16" thick **\$1.95 EA.**

**Pressure Bottle**  
Steel - Tested to 3000 P.S.I. For spray painting, portable welding, etc. All have std. pipe port.  
H-3 9 1/2" x 3 1/4" dia. . . . \$1.75  
H-4 19" x 3 3/4" dia. . . . . \$2.75  
H-5 - 22 cu. ft. cap. internal vol. 295 cu. in. Shatterproof 20" long x 5" OD . . . . . \$3.75  
H-1 For Diving or Inflating tires with CO<sub>2</sub> - has dial gauge. 36" hose 2.29

**DOUBLE CASTER**  
2 Needle bearinged 6" Casters joined as a unit on a 7 1/2" x 8" rubber protected steel face plate. The unit is 9" high & will completely swivel. Ball bearings in swivel, entirely enclosed. Bolts furnished. If you have to move heavy machinery or Jigs these are just the thing. **UNIT 7.89**

Order from this Ad. All sales final. All Prices F.O.B. Los Angeles. Pay by M.O. or Check. P.O.'s Acptd. from D & B firms. 1/2 deposit with C.O.D.'s.

**PALLEY SUPPLY CO.** DEPT. P.S.3 6321 SAN FERNANDO RD GLENDALE 1, CALIF. **CATALOG 92 PAGES-ILLUSTR. SEND 25¢ TODAY!**



**SAVE UP TO 85%**

**IN WAR SURPLUS from "GADGETEERS" HEAVEN**

**92 PAGE CATALOG**  
War Surplus - Tools, Machinery, Raw Materials, Clothing, etc. Illustrated with valuable info., tables, charts & data. Send 25c to cover handling & postage.

**TV Antenna KIT** Mod. "B"

Set up your own antenna at tremendous savings! Kit contains all parts & instructions

Model "A" KIT - Features "V" Cone conical type head with 8 ft. x 1 1/2" Hard Aluminum mast. **775**

Model "B" DeLux Kit - Has phenolic head with Di-pole separator. Patented receiving elements. 8 ft. aluminum mast, reflector, 60 ft. lead-in wire, 25 ft. guy wire and full instructions. **1225**

**16mm MOVIE GUN CAMERA.** Has semi-telephoto 1 3/8" (35 mm) lens with yellow filter - 3 shutter speeds for normal (16 frames) semi-slow motion (32 frames) and slow motion (64 frames per second). Uses any standard Eastman film magazine or Type 'G' AAF magazine. Takes Black & White or Full color pictures. Operates on 24V (dry cell batteries) & require slight conversion for hand use. Diagram furnished. Cost Gov't \$235.00 - NOW **2450**

**CONVERTED GUN CAMERA** - Fully reconditioned with start switch on front. Choice of finishes - Gray, Black, Blue! **33.95**

**VIEW FINDER** - Calibrated for a 6mm lens **8.75**

**FILM** - Standard, type "G" magazine Fits gun camera and many other standard 16mm cameras - Loaded with 50ft. black and white film - Price includes processing. **225**

**16 POCKET VEST** Sturdy, Yet Light Wt. Satin Lined with Tie Straps, 14 Outside Pockets, Plus Knife, gun, or Tool, Leather Holder, 2 large 11" x 8" Pockets Inside, Wonderful Hunting, Fishing, or Mechanic. A Steal **\$2.49**

**HUNTING KNIFE** #307 6" chrome vanadium blade, handle, leather grip. In leather sheath **\$5.98** Value for ONLY **\$1.89**

(Like Above) 5 in. polished blade **\$1.69** With Parkerized black Finish **\$1.49**

**BOLO KNIFE** 10" x 2" Parkerized blade. 5" Grippled Handle. Weight 1 1/4 lbs. . . . Ideal for Hunting, Clearing Brush or Trails. With Case **\$1.19 ea.**

**Hand COMPASSES** #152 - MATCHBOX - both jewel & liquid floating dial **39c**

#153 - NEW!!! JEWEL Watch Pocket Compass **1.58**

#154 - WRIST STRAP Compass **69c**

**NYLON FISHLINE Special** Strong - Lightweight - 2 ply NYLON FISHING LINE. ROT-PROOF and WATERPROOF . . . Especially treated for strength and long life. ON SPOOLS.

a. 10 LB. TEST. **\$1.69**  
b. 45 LB. TEST. 150 FT. **\$3.19**  
GREEN  
c. 50 LB. TEST. 400 FT. **\$1.19**  
Green  
d. 75 LB. TEST. BRAIDED BLACK and GREY 300 ft. **\$3.49**  
e. 100 LB. TEST. 300 FT. WHITE **\$3.79**

**Loose Leaf BINDER** 3 metal post. Cylindrical locking heavy duty 3/16" fabricated hinged cover. End identification window Ideal for price books, salesmen catalogues, photo albums, students, publications, Reference books, etc. **59c ea.**

**NAVIGATORS WATCH** AM 5740 - NEW! Made for AAF by Hamilton. Has 24 hour and a 60 second dial - 21 Jewel movement. Black face & white numerals. Sweep sec. hand. Stainless steel case. Pocket size. No. NW-1 ONLY **\$39.95**

**MESS TRAY** 6 Compartment - Stainless Steel - Rustproof. Wonderful for Outdoor Serving, Barbecue etc. Saves dish-washing. Ideal for use in the home, hospital, 'roughing'. NEW **1.07**

311A - Used but in excellent, Servicable Condition. **79c**

**FOAM RUBBER** Molded & pre-shaped. Can be cut to fit your Chair seat, Boat, Auto, Truck or Trailer Seats. Ideal for all Sports Events.  
25" x 62" x 1 1/2" . . . . . **\$6.45**  
25" x 65" x 2" . . . . . **\$8.45**  
25" x 65" x 1 1/2" . . . . . **\$7.45**

**LEATHERETTE** To cover Chairs - Nooks - Auto Seats, etc. **129**

**SPECIAL!** 54" Ivory Leatherette **1.29** WIDTH - COLORS - PRICE (per. run yd.)  
36" Grey, Brown, Black . . . . . **\$1.19**  
36" Lt. Green, Dark Green, Blue **1.65**  
54" Red, Grey, Lt. Blue, Yellow **1.89**

**NAVIGATORS LAMP** A handy light for desk, work bench, chart table, engine room, etc. Can be used on 6-12-24-110 V by changing bulb. 3 ft. shaft has 4 joints to adjust position. . . . . ONLY **\$2.95**

**RADIO HEADSET** HS-16A - New! Low Impedence 200 Ohm headset. Ideal for amateur radio, crystal sets, or professional use. Adj. earphones, extra long 5' plug-in cord. **225 ea.**

HS-30U - Two Magnetic Type receivers in watertight brass case. Soft rubber inserts in each receiver to fit into wearers' ear. Pliable steel head band. Ideal for communications, divers, workers in noisy compartments, etc. NEW **1.59**

**CLAMP-ON ANYWHERE LAMP** With adjustable ball and socket swivel head, long rubber covered cord and wall plug. The All Purpose Lamp. Wonderful for Indoor Photography, Floodlights, Baby Spot or Large Spot, Personal Bed Reading, Workbench, Garage, etc. Lamp Alone **99c** Highly Polished 9" diameter Parabolic Reflector or 5" diameter Spot Reflector at Only **85c ea.**

**IMPORTED BINOCULARS**

One of the FINEST 6 POWER BINOCULARS MADE! Small & compact, yet has the same high magnification power as the larger 6 power glasses. Field of view is 370ft. at 1100yds.

1950 Eyepieces adjust individually. Ideal for Hunters, Sports Fans, etc. Weighs only 6 ozs. Size is 2" x 3 1/4". NAVY Type 7 x 50 BINOCULARS . . . Big, rugged 7 POWER BINOCULARS with full 50 mm objective lenses that insure maximum brightness, sharp definition & extra wide field of vision. Individual eye focusing. Complete with case. . . . . ONLY **49.95**

**7 jewel - sweep sec. hand metal face. Radium Dial & Numbers # SW-1 \$7.95**

**15 jewel - Waterproof. Radium dial & hands. sweep sec. hand. stainless steel screw back. A terrific buy at \$12.95**

**17 jewel - AUTOMATIC WINDING-SHOCKPROOF-WATERPROOF-SWISS WATCH.** Sweep sec. hand. stainless steel screw back. radium dial & hands. Body movements keep it properly wound. **#AW-1 \$23.95**

**Chronograph** 17 jewel - One of the finest made anywhere. Cased in Switzerland. Sweep sec. hand. stop & re-set buttons. Measures distance, airspeed, groundspeed, races. Ideal for the sportsman. **\$21.95** Special at #CH-1

**Navigator's WATCH** AM 5740 - NEW! Made for AAF by Hamilton. Has 24 hour and a 60 second dial - 21 Jewel movement. Black face & white numerals. Sweep sec. hand. Stainless steel case. Pocket size. No. NW-1 ONLY **\$39.95**

**MESS TRAY** 6 Compartment - Stainless Steel - Rustproof. Wonderful for Outdoor Serving, Barbecue etc. Saves dish-washing. Ideal for use in the home, hospital, 'roughing'. NEW **1.07**

311A - Used but in excellent, Servicable Condition. **79c**

**FOAM RUBBER** Molded & pre-shaped. Can be cut to fit your Chair seat, Boat, Auto, Truck or Trailer Seats. Ideal for all Sports Events.  
25" x 62" x 1 1/2" . . . . . **\$6.45**  
25" x 65" x 2" . . . . . **\$8.45**  
25" x 65" x 1 1/2" . . . . . **\$7.45**

**LEATHERETTE** To cover Chairs - Nooks - Auto Seats, etc. **129**

**SPECIAL!** 54" Ivory Leatherette **1.29** WIDTH - COLORS - PRICE (per. run yd.)  
36" Grey, Brown, Black . . . . . **\$1.19**  
36" Lt. Green, Dark Green, Blue **1.65**  
54" Red, Grey, Lt. Blue, Yellow **1.89**

**NAVIGATORS LAMP** A handy light for desk, work bench, chart table, engine room, etc. Can be used on 6-12-24-110 V by changing bulb. 3 ft. shaft has 4 joints to adjust position. . . . . ONLY **\$2.95**

**RADIO HEADSET** HS-16A - New! Low Impedence 200 Ohm headset. Ideal for amateur radio, crystal sets, or professional use. Adj. earphones, extra long 5' plug-in cord. **225 ea.**

HS-30U - Two Magnetic Type receivers in watertight brass case. Soft rubber inserts in each receiver to fit into wearers' ear. Pliable steel head band. Ideal for communications, divers, workers in noisy compartments, etc. NEW **1.59**

**CLAMP-ON ANYWHERE LAMP** With adjustable ball and socket swivel head, long rubber covered cord and wall plug. The All Purpose Lamp. Wonderful for Indoor Photography, Floodlights, Baby Spot or Large Spot, Personal Bed Reading, Workbench, Garage, etc. Lamp Alone **99c** Highly Polished 9" diameter Parabolic Reflector or 5" diameter Spot Reflector at Only **85c ea.**

**Genuine ARMY AIR FORCES SUNGLASSES** HERE'S THE REAL McCOY! ARMY AIR FORCE 6 base, Precision Polished & Ground, Glare-free lens with leather case to be attached to belt. Gold plated adjustable frame. ONLY Pearlized sweat bar & pads. **\$3.95**

**SG-2 AIR FORCE Type GLASSES** - 4 base, ground & polished, processed glass lenses. Gold Plated frame, Pearlized sweat bar and nose pads. Cable ear pieces, simulated leather case. . . . **1.95**

**NIGHT DRIVING GLASSES** With 57mm yellow amber, 6 base lenses. Optically Precision Ground and Polished! Your doctor will recommend these. Not a Cheap "Process" Lens. Reduces headlight glare & Sharpens 'object focus' during night driving. In Men's size or Ladies Harlequin style. ND-1 **\$16 VALUE \$4.59** SAME GLASSES but clip-on. **\$4.59** Fit-over style without temple bars

**Aviators (AN-6530) Windproof & Dustproof GENUINE GOGGLES** Rubber or chamois covered frame. Clear or Green GROUND LENSES are inter-changeable. Adjustable nose bar. Ideal for Flying, motorcycling, etc. **1.69**

**GO-1 GOGGLE KIT** NEW! U.S. Navy - One piece sponge rubber frame. With 4 polaroid lenses green, 1 clear, 1 red. A fine snow goggle **89c**

**\* START A PROFITABLE PLASTIC HOBBY** Kit #1 contains 2 lbs. plexiglass & Lucite sheet in various shapes, 1 oz. bottle of clearset cement, and 5 bottles of colors in Orchid, Red, Yellow, Peach, etc. Also a Plastic Handbook of uses & instructions. This set easily worth \$5.50. Our Price **\$2.19** Kit #2 contains 1 1/2 lbs. of plastic sheet, a 1 oz. bottle of clearset cement, and the Plastic Handbook. A \$2.50 Value for ONLY **99c**

**Plexiglass & Nascolite clear plastic shts.** NASCOLITE - Full sheets app. 1/8" x 37 1/2" x 49 1/2", app. 10 1/2 lbs. each **\$12.50**

**PLEXIGLASS - Full Sheet** 5/16" x 36" x 24" . . . Per Sheet. **\$13.00** 5/16" x 36" x 48" . . . Per Sheet. **\$25.00** Fabricators write in for our special quantity prices, all above are new & masked. Also inquire about other large stocks of Plastics.

**New Stewart-Warner Heater,** Compact Car-like Gasoline fired heater with motor, fan blower - Automatic Thermo Switch, Copper element, glow type spark plug - Manufactured by Stewart-Warner. 24 V D.C. - Can operate on 6 Volt Battery. Ideal for Auto, Boats, Light Aircraft, Etc. SW 2 A Steal at . . . . . ONLY **\$6.95**

**NAVY Sealed Beam LAMP** US Navy Portable Pistol Grip, Sealed Beam, Search, Spot or Emergency Lite. 12 volt. Light weight. Ideal for Auto, Boat, Trailer, Farm, etc. Cost Gov't \$35. OUR PRICE **\$2.95** Set of 3 extra filters, Red, Grn, Amber **99c**

Order from this Ad. All sales final. All Prices F.O.B. Los Angeles. Pay by M.O. or Check. P.O.'s Acptd. from D & B. firms. 1/2 deposit with C.O.D.'s.

**B-15 Style JACKET**

That "HOT" JACKET You'll be proud to Wear! Water repellent, wind resistant, Nile Green combed Gov't. Zeelan sanforized Poplin. Full sturdy zippered front with 100% wool pile lined sleeves & body. Two slash pockets & large Mouton Fur Collar. Ribbed cuffs and bottom. **\$10.95** Sizes: 36 to 46 **\$8.95** Boy's sizes: 6 to 18

**D-1 AIR CORPS JACKET** Genuine All Leather Flying Jacket. Fleece lined body & sleeves. Has full zipper and two slash pockets. Completely reconditioned & cleaned. A warm rugged jacket for Hunter, Farmer, etc. Sizes: Small, Med, large. A real Gov't. Surplus Value **8.95 ea.**

**FLIGHT COVERALLS** - Made especially for the NAVY of tan BYRD cloth. Strong, durable, yet light. Has 2 large breast pockets. One sleeve pencil pocket and 4 large zippered leg pockets. Full zippered front and tailored waist. Sizes: Small, Med., Large. A re-issue in Splendid condition. **4.95**

**Air Corp. NYLON COVERALLS.** Light wt. 8 pockets. Full zipper front. Sizes: Small, med., large. No. 480-A **6.95**

**FLYING SUIT or Blue Bunny SUIT** For hunting, winter sports, skiing or "bundling". As coveralls for cold outdoor, or farm work, 100% woven wool with extra flannel inner lining for double warmth & utility. Wiring so fine, flexible it does not interfere with movement. Can be used with or without heating or can be plugged into car, tractor, or truck battery. Sizes 36 thru 44. **\$3.49**

**FLYING HELMET** All New! Winter type with fleece or chamois lining. Has ear puffs & chin cup. Ideal for pilots, cycle-drivers, sportsmen, etc. **1.95**

NEW!! All leather, chamois lined with chin cup. For winter or summer. **1.59**

**AIR CORP CAP** All leather, sheepskin lined for cold weather. Turn down flap for ear protection. Leather bound long visor. Small, Med., & Large. **\$2.98**

**MITTENS** - Sheepskin lined, leather outer cover. For outdoor or winter work. Small, Medium, and Large. **\$2.69 PR**

**PLASTIC PARALLEL STRAIGHT EDGE** with knobs and rubber pads for non slippage on each section. A must for navigators, mechanics, draftsmen, and engineers. . . . You've never seen 'em at **97c ea.**

**NAVY Sealed Beam LAMP** US Navy Portable Pistol Grip, Sealed Beam, Search, Spot or Emergency Lite. 12 volt. Light weight. Ideal for Auto, Boat, Trailer, Farm, etc. Cost Gov't \$35. OUR PRICE **\$2.95** Set of 3 extra filters, Red, Grn, Amber **99c**

Order from this Ad. All sales final. All Prices F.O.B. Los Angeles. Pay by M.O. or Check. P.O.'s Acptd. from D & B. firms. 1/2 deposit with C.O.D.'s.

**PALLEY SUPPLY CO**  
6321 SAN FERNANDO RD.  
DEPT. P.S.3 GLENDALE 1, CALIF

**LARGEST FIRM OF ITS TYPE IN THE WORLD**



# Stop Engine KNOCKS



*Before they dent  
Your Pocketbook*

Add **BARDAHL**  
to *Your Crankcase Oil*

QUIET that motor by furnishing an extra-tough lubrication cushion! Simply add one quart of BARDAHL to regular oil.

When ordinary oil breaks down under heat and pressure, let BARDAHL come to the rescue. BARDAHL penetrates metal surfaces of engine, relieves critical friction, and holds lubrication in place.

Plenty of knocks and pings disappear with the BARDAHL treatment. You pay fewer repair bills, too.

Ask the *best* mechanic in town about BARDAHL. He's been using it for years!

**BARDAHL  
OIL**

*Reduces Friction  
to a Fraction*

BARDAHL OIL COMPANY  
Seattle • St. Louis



# New

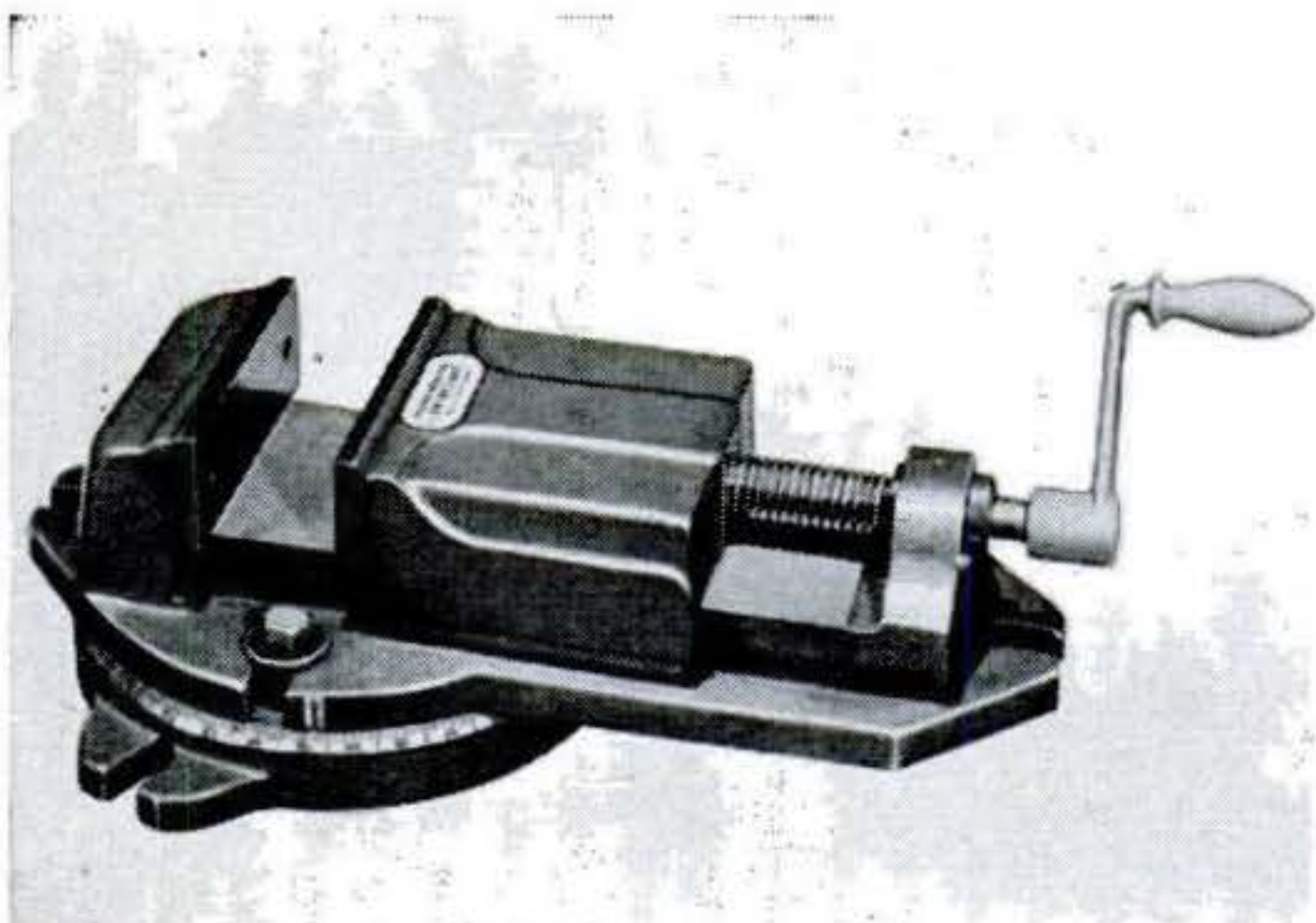

**New Machinist's Vise.** To keep the inside of the vise free of dirt and chips, this unit is built without T slots or bolt holes. The maker, Parma Manufacturing Co., of Parma, Mich., contends that this feature saves swiveling and clamping time because bolts need not be worked around in chip-filled slots. The vise is made in two models, one 4" and the other 5" high with base. The lockplate for the swivel permits locking anywhere in the 360° swing.



**Accessories Fit 1/4" Drill.** Included in this kit manufactured by Whirl-A-Way Inc., of Cleveland, is a right-angle attachment that cuts drill speed in half for heavy-duty work, three grades of sanding disks, a wool buffing bonnet, and a circular carpet pad for use with cutting and rubbing compounds. The attachments can be used directly as well as with the right-angle drive.

## POWER MOWERS

Only  
**\$74.63**  
Dealer's Price

**Powerful—Streamlined**

Complete with Maytag, Power Products or Briggs-Stratton Engine—18" rotary tool-steel, fully guarded blades—cast aluminum body. Cuts grass and weeds, wet or dry—does all trimming—chops grass into fine mulch, eliminating raking. Send check with order, or specify C.O.D. Write to Dept. S-3 for literature.

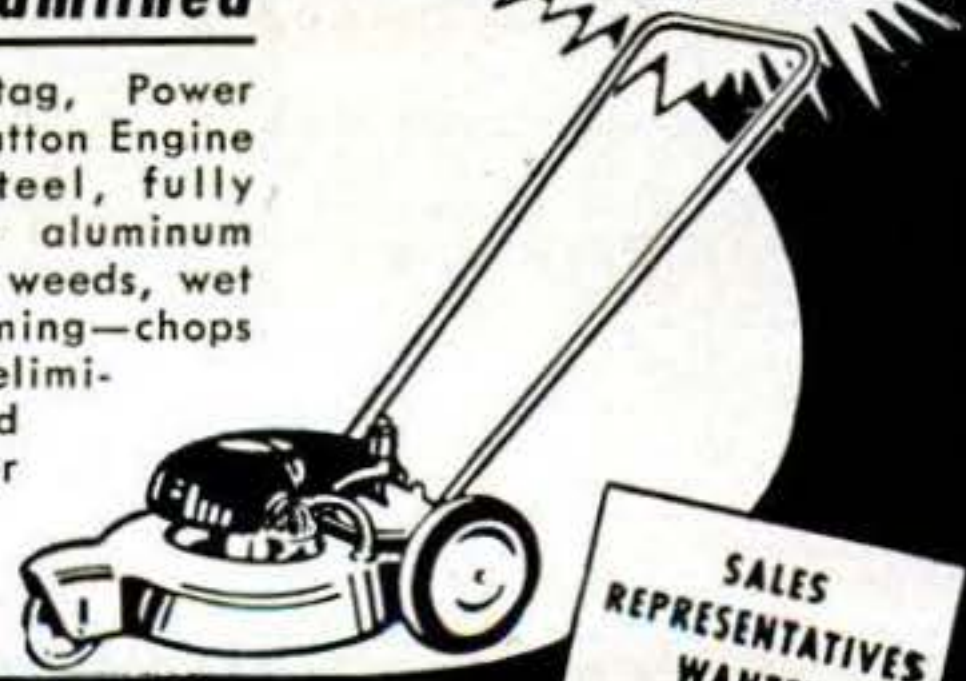

SALES  
REPRESENTATIVES  
WANTED

**HARTMAN Corp.**

1100 SOUTH KIRKWOOD ROAD • ST. LOUIS COUNTY 22, MO.



# Tools

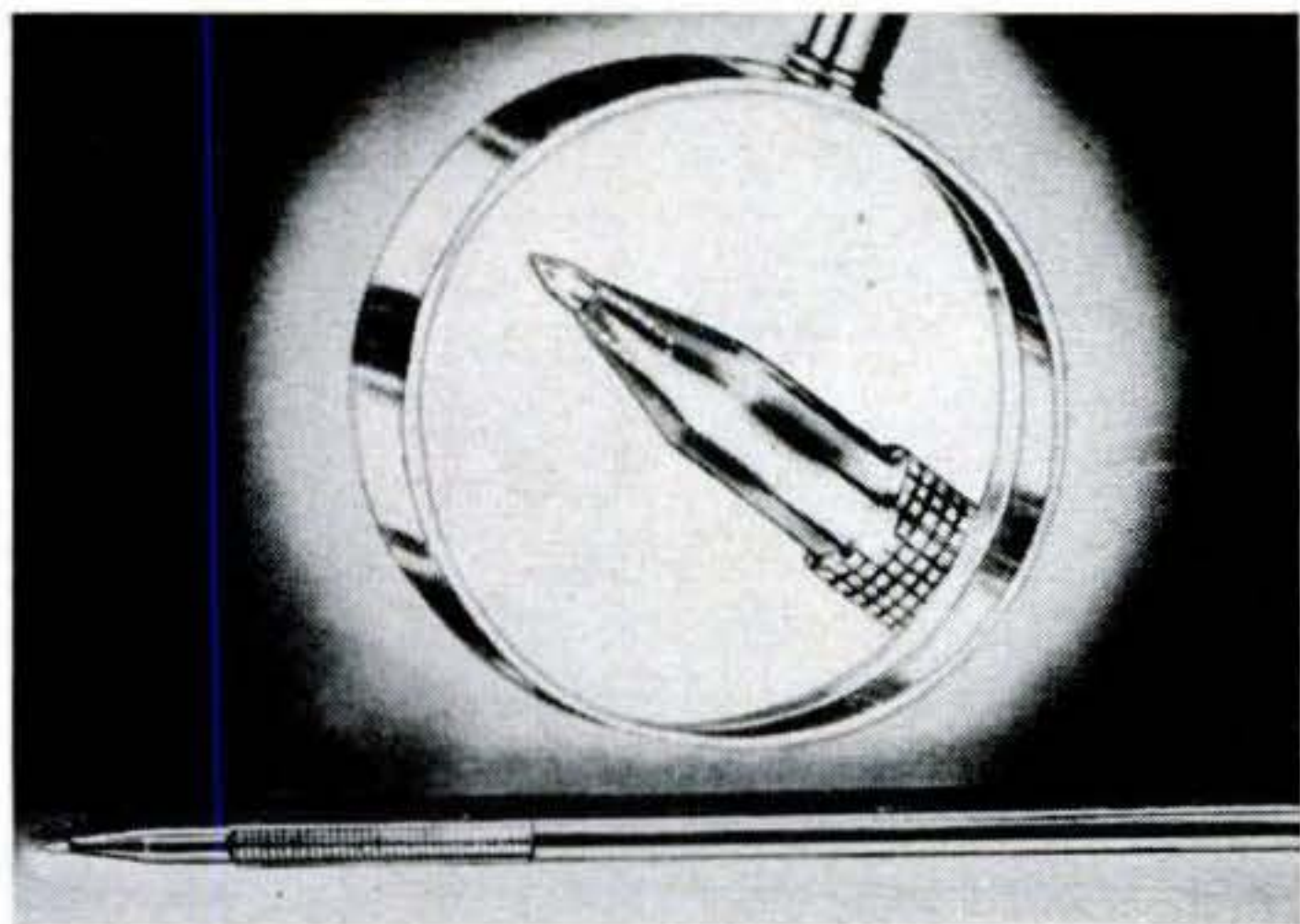

**New Scriber.** A tungsten carbide tip is brazed into the handle of this scriber, made by the Niagara Instrument Corp., Lockport, N. Y. According to the company, the tip can be sharpened many times without burning or softening. The scriber also can be used on rusty work, the point cleanly penetrating hard scale such as is sometimes found on boiler plate. The knurled shank is 5" long. Retail price is about \$1.



**Jigsaw Has Direct Drive.** A direct, beltless drive from a ¼-hp. motor gives this 56-lb. jigsaw exceptional cutting speed, according to the maker, Beebe Brothers, of Seattle, Wash. The saw will make inside and outside cuts in wood up to 2" thick and is built with either an 18" or 24" throat. Other features are the full-length tilting table, front-end table lock, and enclosed steel cabinet. The 18" model is priced at \$57.50 with motor; the other at \$69.50.

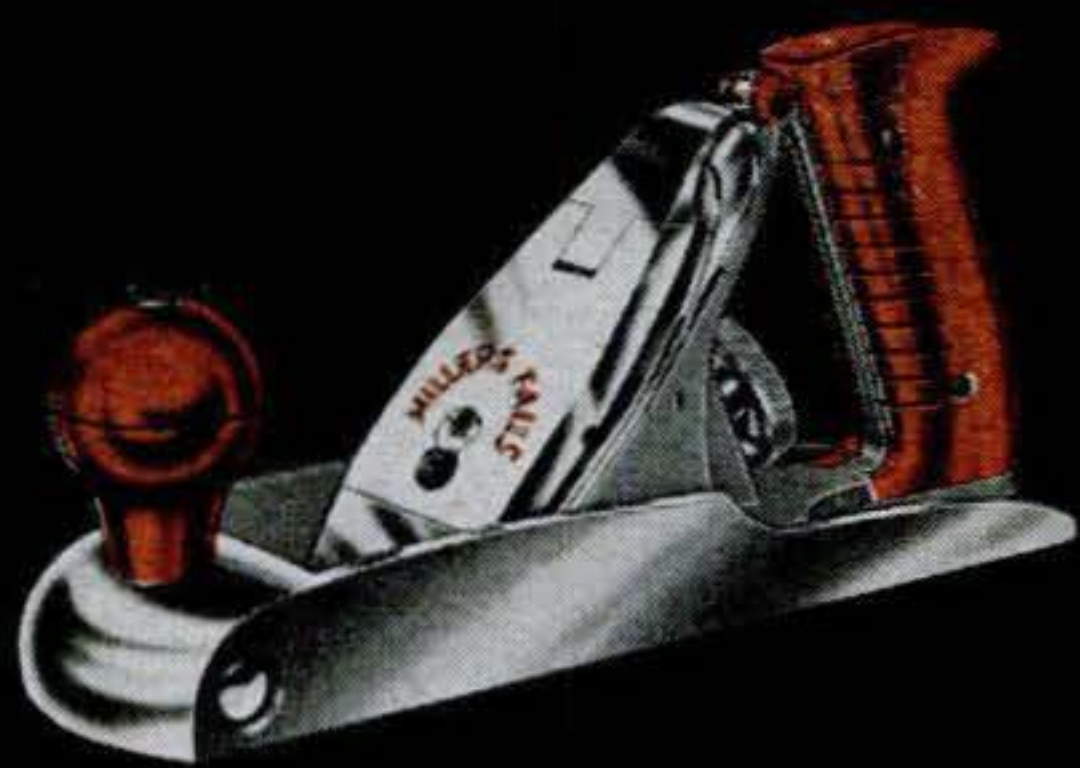

*The Finest Planes  
in the World*

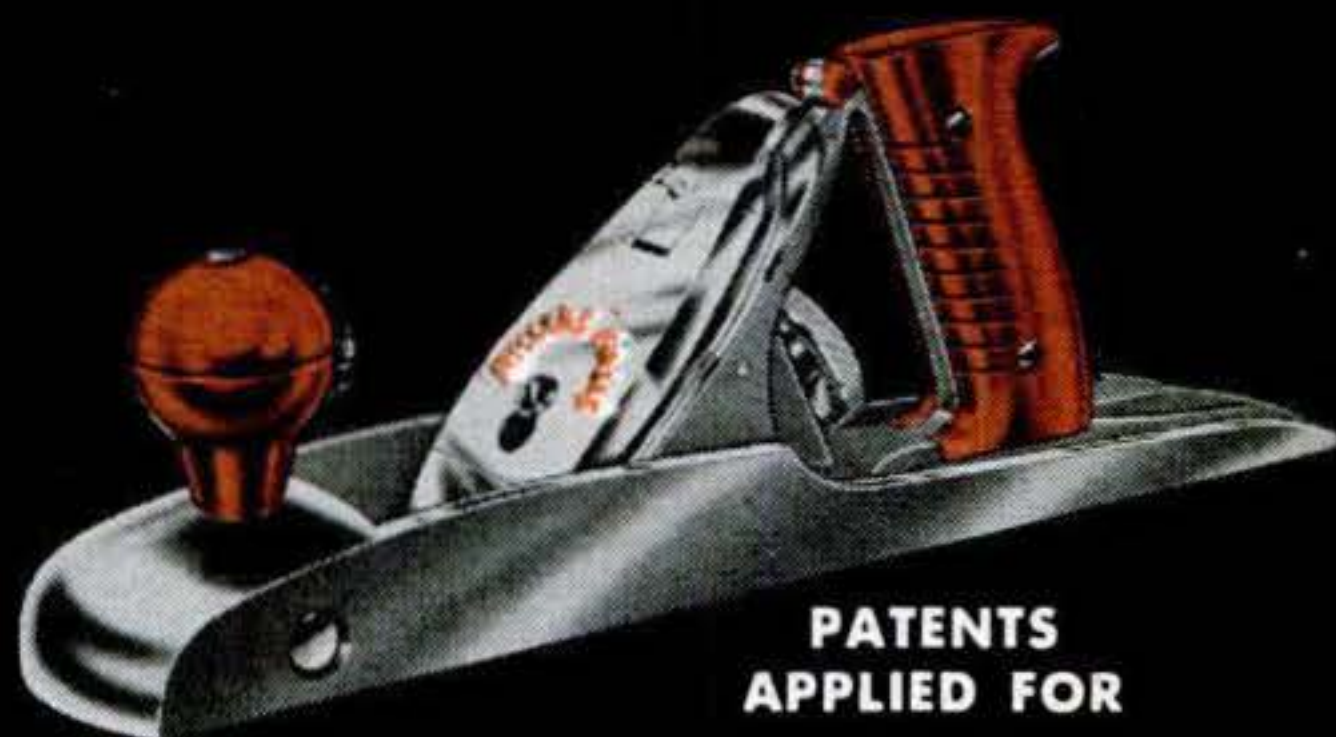

If you want the very last word in performance, you'll get it in these two new streamlined beauties. They are loaded with new features never before available in a bench plane — better balance . . . more positive clamping . . . easier adjustments . . . unbreakable handles . . . roomier, surer grip . . . finer performance in every way. See them, try them, buy them at your hardware dealer's today.

**MILLERS FALLS  
TOOLS**

SINCE  
1868

MILLERS FALLS  
COMPANY

GREENFIELD  
MASS.



# BUILD YOUR OWN TILTING ARBOR SAW!

## Exclusive GIL-BILT Build-It-Yourself Features

- No machining—build easily with hand tools only
- No blueprint reading—step-by-step pictorial plans, full scale patterns, actual photographs
- Sturdy wood, aluminum, and steel construction
- Capacity and performance of commercial saws selling for \$60 and up

SAVE  
**\$50**  
OR MORE

## GIL-BILT 10-INCH TILTING ARBOR SAW



- 27x28 in. table, 13 1/2 in. capacity in front of blade
- 10 in. blade cuts 3 1/4 in. deep, tilts full 45 degrees
- Floor model 34" high table always stays level
- New Departure ball bearing arbor, 3/4" precision shaft turned down for 5/8" bore blades, alum. housing, shipped ready to run
- Jackscrew and 4 1/2 in. dia. handwheel lowers and raises blade
- Cast aluminum miter gauge and self-aligning rip fence guide

GIL-BILT Metal Parts Kit includes Plans, ball bearing arbor, miter gauge and bar, rip fence guide, dado insert, lock knobs, jack screw mechanism and handwheel, and all other metal parts (less blade)..... **\$20.95**  
Same Kit with 10" Combination Blade. **\$24.90**  
Same Kit with 8" Combination Blade. **\$23.90**

## GIL-BILT 8-INCH TILTING TABLE SAW

- 21x27 in. table tilts full 45 degrees, 13 in. capacity in front of blade
- 8 in. blade cuts from 0 to 2 1/2 in.
- New Departure ball bearing arbor, 5/8" precision shaft turned down for 1/2" bore blades, alum. housing, ready to run
- Cast aluminum miter gauge and self-align, rip fence guide (same as above)



GIL-BILT Metal Parts Kit includes Plans, Ball Bearing Arbor, Miter Gauge and Bar, Rip Fence Guide, Machined Lock Knobs, Tilt Support Segments, and All Other Metal Parts (less blade)..... **\$15.95**  
Same Kit with 8" combination blade..... **\$18.90**

## GIL-BILT 12-INCH BAND SAW

- Cuts to center of 24 inch circle
  - Handles stock up to 6 inch thick
  - 18x18 inch table tilts 45 degrees
  - Lower wheel and drive pulley runs on sealed New Departure Ball Bearings; Upper wheel runs on two 5/8" bore Oilite Bronze bearings.
  - Upper wheel tension and tilt mechanism of cast aluminum, completely assembled.
  - Upper and lower blade guides. Each has ball thrust bearing, self-lub bronze jaws.
  - Rubber tired wheels. Choice of cast aluminum or make-your-own wood wheels on metal hubs.
  - Uses standard 78 inch blades up to 3/8 inch wide.
  - Fully enclosed mechanism for utmost safety.
- GIL-BILT Metal Parts Kit includes Plans, rubber tires, 1/4 inch blade, hubs for wood wheels, ball bearing spindle, tilt mechanism, guides, table tilt segments and all other metal parts..... **\$16.95**  
Same Kit with two machined ready-to-install 12" cast aluminum wheels..... **\$20.95**

**NO DEALERS—One Low Factory Price!** Return in 10 days for full refund if not satisfied. Prices include postage within 600 miles. Over 600 miles add 5%. Send cash, check, or money order for parts kit, or send \$1.00 for Step-by-Step Plans and order kit later less cost of Plans. Plans sent postpaid anywhere in the world.

**GILLIOM POWER TOOLS**  
P.O. Box 1-VC, Lambert Field, St. Louis 21, Missouri

COMPLETE  
PLANS  
only  
**\$1.00**  
EACH



## Handy Flexible SHAFT

Converts any motor, drill press, electric drill, electric fan (10 inch or larger) into a handy rotary tool

Attach ROTA-SHAFT in a jiffy. Use for grinding, polishing, sharpening, cleaning, engraving, making tools, carving on metal, plastic, wood, glass. Convenient handpiece for easy handling...with 1/8 inch Adjustable Chuck. 40-inch overall length. Complete with buff and sanding disc ready to use in a drill press chuck. Order today!

**SEND NO MONEY!** Mail your order. Pay postman only \$2.95 plus postage on delivery. Try 10 days—if not delighted, return for money-back. For use on motor, add 35c for Special Coupling and state size of shaft diameter.

**STRADER PRODUCTS CO.**

DEPT. P-102  
259 Strader Ave. Cincinnati 26, Ohio

ONLY  
**\$2.95**



## New Tools

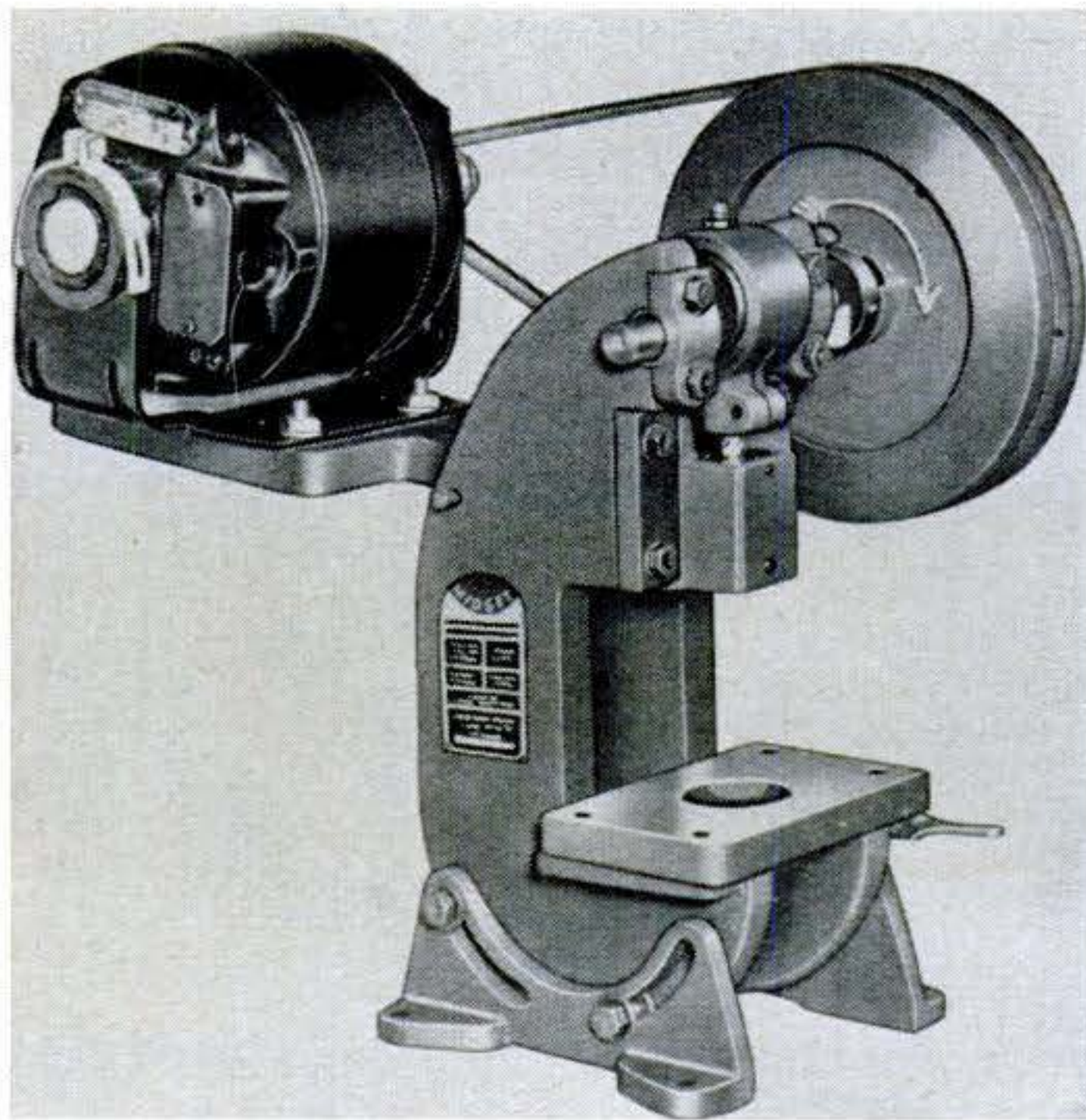

**Midget Punch Press.** This one-ton press, made by the Benchmaster Manufacturing Co., Los Angeles, handles all conventional jobs such as punching, shearing, staking, riveting, forming, and coining. The price is about \$80.

It has a maximum stroke of 3/4" and a 3/4" hole in the ram. Approximate speed is 290 strokes per minute with a 1/4-hp. motor. The alloy-steel crankshaft is 3/4" o.d., rotating in replaceable bronze bushings. The 20-lb. fly-wheel measures 9" in diameter. With the ram up, the die space to the bolster plate is 3 3/4". The throat depth is 2 1/8" and the weight, less motor, is 65 lb.

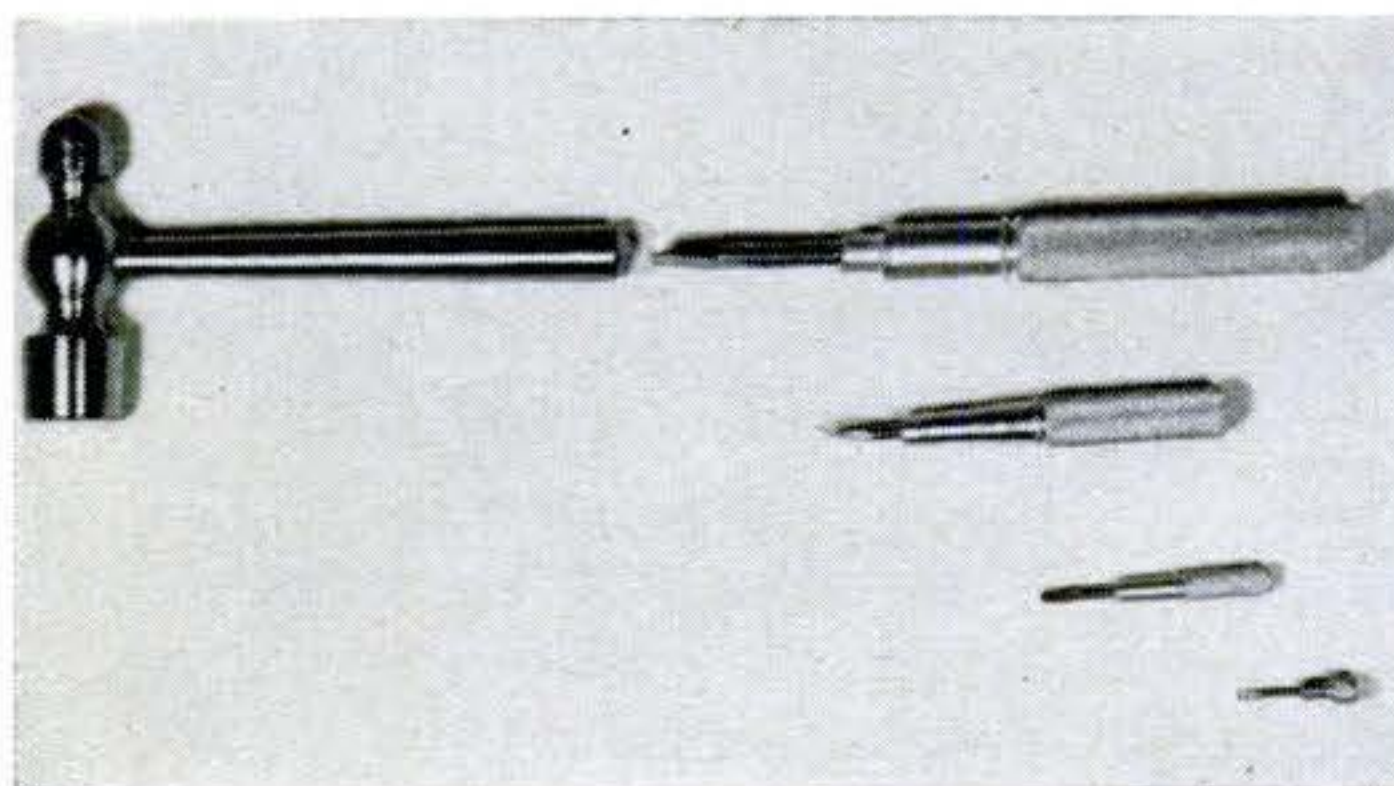

## Utility Tool for Home or Shop.

Four screwdrivers and a hammer are combined in this tool. The screwdrivers are stored inside the hammer handle. All handles are brass and the bits and hammer head are tool steel. The tool, priced at about 75 cents, is made by the G. M. Co. Manufacturing Inc., Long Island City, N. Y.





It's Fun! Assemble This Miniature Antique 1900 Packard for \$2.50!

BE "The man who owns one"

You'll be proud of your Packard, too. This authentic, 3/4" scale model, priced at \$2.50, is one of 8 famous antique autos that make up Hudson Miniatures' "OLD TIMER" line of auto construction sets. Colorful, accurate in detail, easy to assemble, economical to buy. Start your collection today.

See them at your local hobby store or write to us direct. In ordering, please add 25c for postage and packing.

1911 Maxwell .....	\$2.50	1910 Model "T" Ford.....	\$2.50
1903 Model "A" Ford.....	\$2.50	1903 Rambler .....	\$2.50
1904 Oldsmobile .....	\$1.95	1909 Model "T" Ford.....	\$2.95
1909 Stanley Steamer.....	\$2.95		

**Hudson Miniatures' "OLD TIMERS"**  
SCRANTON HOBBY CENTER, Dept. 28, Scranton 10, Pa.

# MEET THE NEW BULL SAW!

Convert your electric drill into a powerful, portable saw for only \$9.95

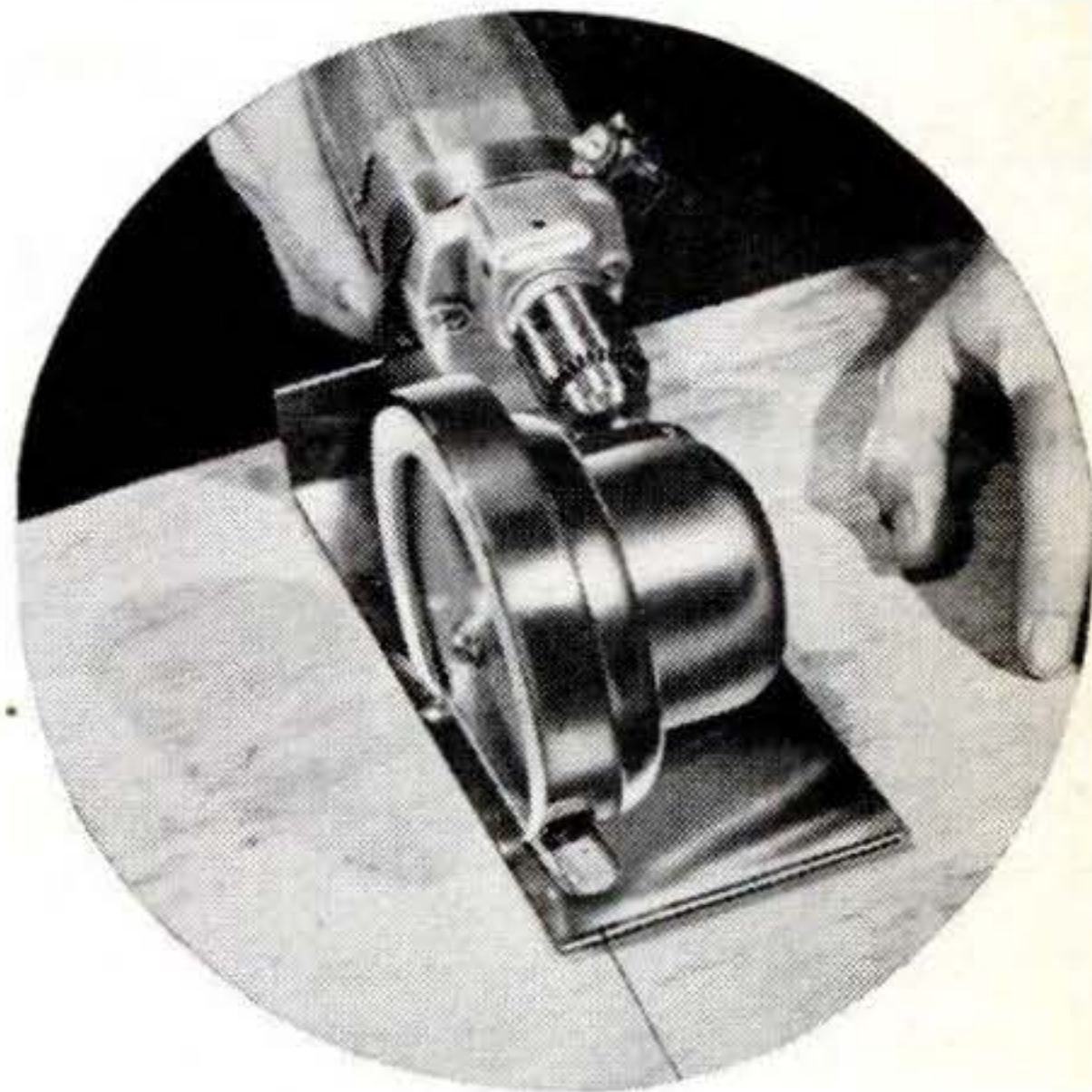

Your electric drill becomes a portable saw with power to spare when you attach the new Bull Saw! It's sturdy, rigid—yet light enough for one-hand operation. New visual guide lets you see where you're going; new extra wide shoe plate keeps saw blade on the straight-and-narrow. One-piece safety guard of polished aluminum . . . blade of high-carbon steel . . . double bearings for long life. Fits rigidly on any 1/4" electric drill. Depth of cut: 1 1/8". **OUR GUARANTEE:** *This tool is as outstanding in design and performance as the Bull Buffer.* Complete, ready to use as pictured. **\$9.95**

(When ordering, ask for Model BS-C)

## IF YOU ALREADY OWN A BULL BUFFER

you can make your own Bull Saw for only \$7.50! Here's how: Order the saw housing (photo 13) and attach it to the angle-head of your Bull Buffer following the simple directions we send you. That's all—it only takes 30 seconds to change your Bull Buffer into a powerful, portable saw! The housing you need comes complete, **\$7.50** only.

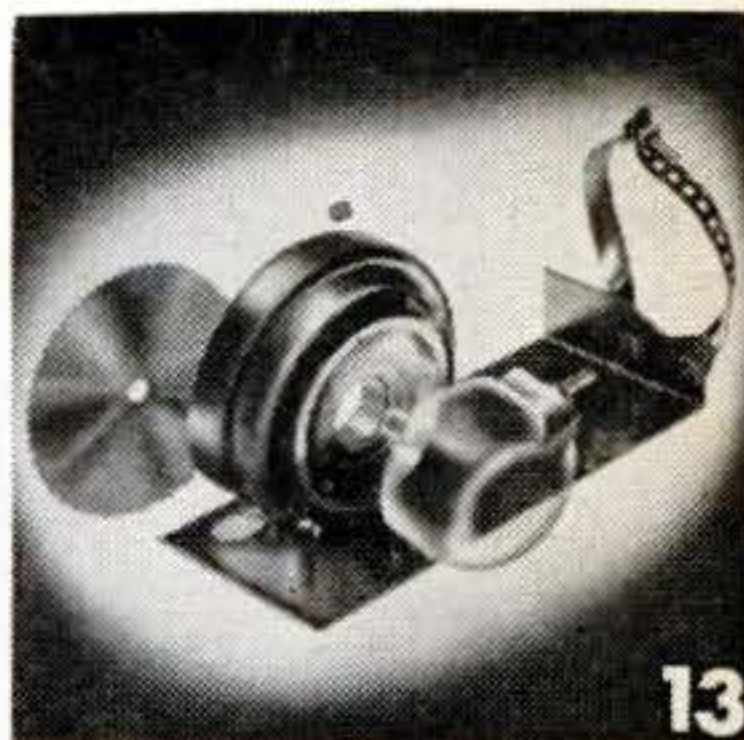

13

(When ordering, ask for Model BS-H)

## COMPLETE POLISH-SAND-'N-SAW KIT

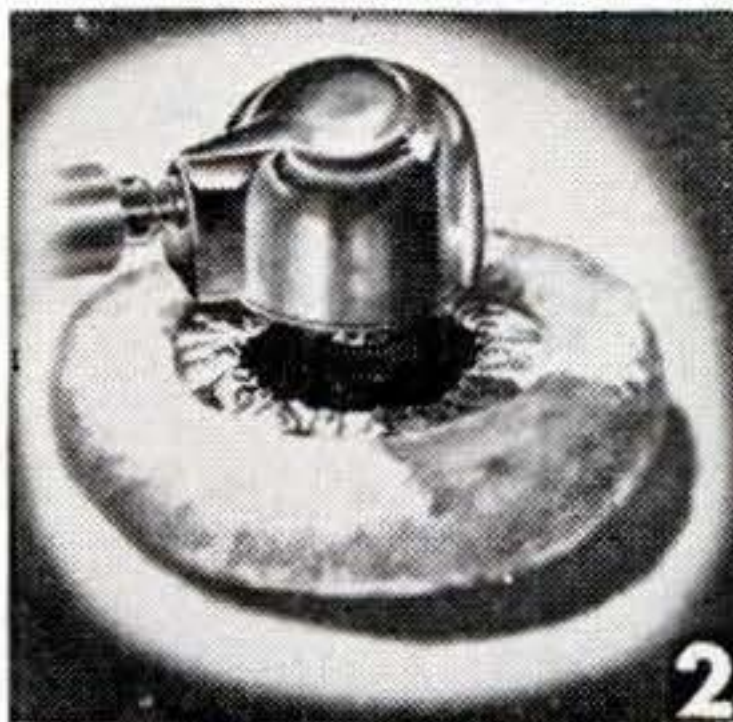

2

Includes (a) Bull Buffer\* (photo 2), the famous right-angle polisher-sander, complete with rubber pad, sheepskin bonnet, 2 sanding discs, and (b) Saw Housing (photo 13) that fits on Bull Buffer angle-head to give you a powerful Bull Saw. A \$19.90 value—but this kit is yours for **\$14.95** only.

(When ordering, ask for Model BS-K)

\***BULL BUFFER ONLY, without saw housing, \$9.95**  
At your dealer, or send cash, check or M.O. for prepaid shipment

**BERTRUM C. ENGINEERING CO.**

3121 Main Street

Kansas City, Mo.

MARCH 1950 297

World's Largest Stocks of Jeep Parts

Write for Your Special Requirements—We Can Fill Any Order!

The King of Jeeps



## GUARANTEED REBUILT JEEP MOTOR BLOCKS COMPLETE WITH PAN (Less Head)



This motor is completely rebuilt with all new parts. Guaranteed for 90 days or 4000 miles against defective parts or workmanship. You must prepay freight when shipping old block to us. Add \$2.50 for crating to above prices. **\$88.50** Exchange **\$107.50** Outright



### NEW RADIATOR ASSEMBLY

Complete with Shroud. Interchangeable with Civilian jeeps.

**\$24.95**



### BUMPER SNOW PLOW

**\$69.50**

Easy to install. Brand new. All steel. F.O.B. Buffalo, N. Y.

### MUFFLERS

**\$2.75**

A6118—Oval Type

**EXHAUST PIPES A10199**  
Complete from manifold to muffler. **\$3.50**

### CRANKSHAFT BEARINGS

A6798 Std. . . . . \$3.10  
A6746 .010 . . . . . 3.90  
A6747 .020 . . . . . 4.10  
A6728 .030 . . . . . 4.10

**CONNECTING ROD BEARINGS**  
All sizes. Each. . . . . 45c



**MASTER CYLINDER Complete A556-GPW2140 \$5.95**

**TERMS:** Net cash with order. Open account to rated firms only. C.O.D. shipments should have 25% deposit

## BIG, FREE CATALOG

Write For Your Copy Today

Thousands of other parts and accessories available. **SHOP BY MAIL**—Order direct from this ad today.

with order. All prices are F.O.B. our yards, Chicago, Illinois unless otherwise shown.

**BERG TRUCK & PARTS CO., INC.**

1603 So. Wabash Avenue, Dept. S-3, Chicago 16, Ill.  
Cable Address . . . JEEP KING



# P.S. Last minute news & notes...

SCOOP: "Some day soon, a brand-new chemical element seems likely to be added to the 96 now known," said last month's PS (p.143). The forecast speedily proved correct. While the February issue was on the press, word came from Berkeley, Calif., that Element No. 97 has been discovered. Dr. Glenn T. Seaborg announced it has been made in the University of California cyclotrons. He said it would probably be named "berkelium" in honor of the university city.

HOT BEDS for seedlings are easily heated electrically with Thermotape (t) made by Smith-Cates Corp., Plainville, Conn. The flexible, flat tape is looped under the soil layer and connected through a thermostat.

RADIO BILLIARDS. Microwaves are being "bounced" around a Pennsylvania mountain to provide radio communication between a power plant and sub-station. They are beamed at a 20-foot-square aluminum mirror on a 50-foot pole - which reflects them to a receiving station on the other side of the mountain.

ROLL ROOFING of a new type has a layer of aluminum laminated over half the width of the felt. Laid in asphalt

the usual way, it provides two layers of felt topped by metal, saving weight of gravel topping and reducing heat transfer. Reynolds Metals Co. makes it.

POLAROID LAND Cameras, which turn out finished pictures in a minute (PS, Feb.'49, p.232), report that 8 million pictures were snapped in their first year on the market. Amateurs are big users, but business use is increasing.

COLD-START BATTERY developed for Army use down to 40° below has been put on market by Reading Batteries, Inc., Reading, Pa. Makers say it has double the starting power of average battery at sub-zero temperature.

WATER-CONTROL cylinder in a new GE automatic washing machine is adjustable. It enables a housewife to reduce water consumption 40 percent when washing a small load of clothes.

TV RECEIVERS have about 1,100 component parts - 10 times as many as ordinary radio sets. Some experts predict the television industry at its peak may employ 10 times as many people as radio.

*The Editors*





New scintillation counter, using electron tube developed at RCA Laboratories, gives faster, more accurate measurements of atomic radiations.

## What can you hear through an **ear of grain**?

When agriculturists want to learn what nourishment a plant is getting, they inject radioactive materials into the soil and trace their absorption with sensitive instruments. Industry and medicine also use this ingenious technique.

Until recently, scientists *heard* what was happening, followed the passage of atomic materials with a clicking Geiger counter. Now a more sensitive instrument—a new scintillation counter made

possible by a development of RCA Laboratories—can do the job more efficiently.

Heart of this counter is a new **multiplier phototube** so sensitive that it can react to the light of a firefly 250 feet away! In the scintillation counter, tiny flashes, set off by the impact of atomic particles on a fluorescent crystal, are converted into pulses of electrical current and multiplied as much as a million times by this tube.

See the newest advances in radio, television, and electronic science at RCA Exhibition Hall, 36 West 49th Street, New York. Admission is free. Radio Corporation of America, Radio City, N. Y.



The principle of RCA's multiplier phototube is also used in the supersensitive RCA Image Orthicon television camera, to give you sharp, clear television pictures in dim light.



**RADIO CORPORATION of AMERICA**

*World Leader in Radio — First in Television*





**Hoot  
Mon!**

**Look what \$47.35\*  
puts in your shop!**

\*9" x 3' Model C Bench Lathe; 6-speed drive; 1/4 h.p., 115 v., motor and switch. Cash price— **\$187.35**

Payment terms: \$47.35 with order, \$12.36 for 12 months.  
Usual carrying charges included—All prices f.o.b. factory.

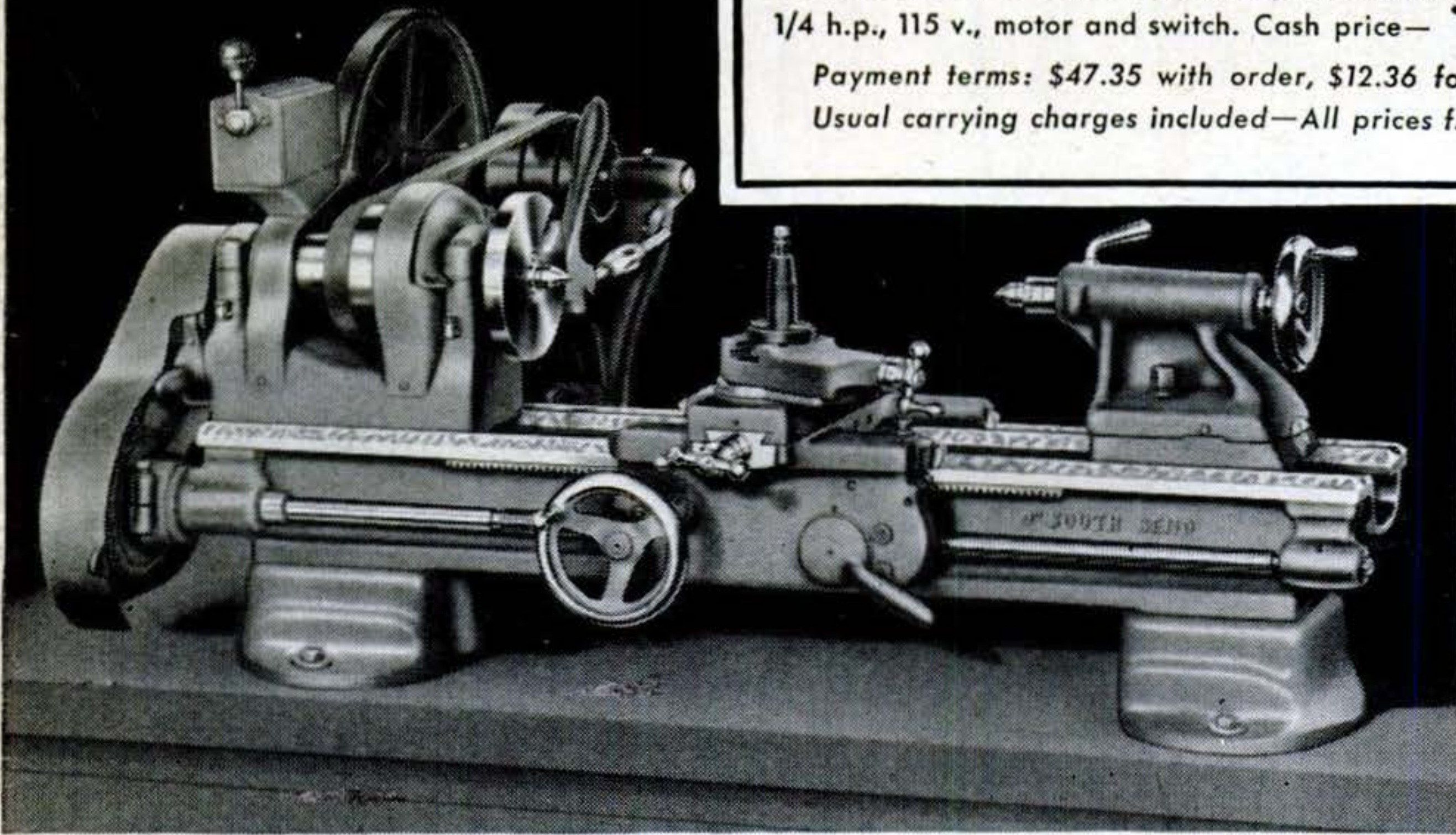

Install this fine lathe in your shop now and let it help pay for itself. Capable of a wide variety of operations, this lathe is ideal for general machine work in the small shop and for machining small parts in the large shop. A complete line of practical attachments and accessories simplify the tooling of this lathe for many special classes of work.

All sizes of South Bend Lathes, 14" Drill Presses, and 7" Bench Shapers are available on comparable time payment terms: 25% down, 12 monthly payments. Reasonable finance charges.

*Building Better Tools Since 1906*

**SOUTH BEND LATHE**  
SOUTH BEND, INDIANA

**Send for Information:**

- 9" BENCH LATHES
- LATHE TOOLS AND ATTACHMENTS
- TIME PAYMENT PLAN

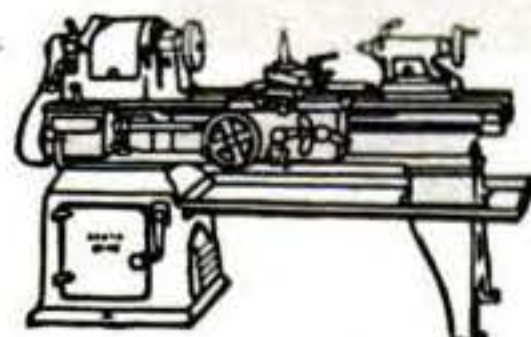

10" TO 16" FLOOR LATHES

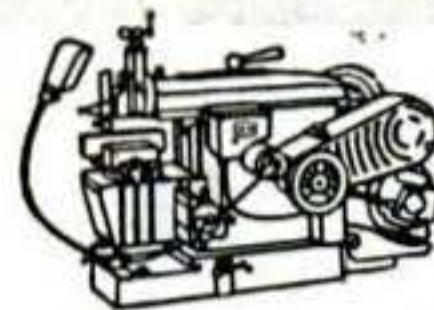

7" BENCH SHAPER



14" DRILL PRESSES

Name \_\_\_\_\_

Street \_\_\_\_\_

City \_\_\_\_\_ Zone \_\_\_\_\_ State \_\_\_\_\_

1/2" and 1" Collet TURRET LATHES





# BE A SUCCESS IN

# RADIO-TEL

## Learn by Practicing at Home

### Get a GOOD JOB -- Have a BRIGHT FUTURE in America's Fast Growing Industry

Do you want a good pay job in the fast growing RADIO-TELEVISION Industry? Or do you want to have your own money-making Radio-Television Shop? Here is your opportunity. I've trained hundreds of men to be successful Technicians . . . MEN WITH NO PREVIOUS EXPERIENCE. My tested and proved train-at-home method makes learning easy. You learn Radio-Television principles from my illustrated lessons. You get practical experience building, testing and experimenting with MANY KITS OF PARTS I send. All equipment yours to keep.

#### MAKE EXTRA MONEY IN SPARE TIME

The day you enroll, I start sending you SPECIAL BOOKLETS that show you how to make \$5, \$10 a week or more EXTRA MONEY fixing neighbors' Radios in spare time while learning. From here, it's a short step to your own shop or a good pay Radio-Television servicing job. Or let me train you for a Federal Communications Commission (FCC) License. Be a Radio-Television operator or Technician.



#### TELEVISION OFFERS NEW JOBS -- MORE JOBS FOR TRAINED MEN

In 1945, there were 943 Radio Stations. Today, about 2700 are on the air! RESULT--THOUSANDS OF QUALIFIED MEN STEPPED INTO GOOD JOBS. Another example--only 19 Television stations were on the air in 1947. Today, more than fifty. Within a few months, 150, say the experts -- and 1000 within 3 years. Then add developments in FM, Two Way Radio, Police, Marine, Aviation, Microwave Relay Radio. Think what this means! New jobs, more jobs for qualified men. The man who prepares NOW can reap rich rewards in this changing, developing, fast growing field!



#### SEE WHAT N.R.I. CAN DO FOR YOU

Act Now! Send for two BOOKS FREE. Actual Lesson on Receiver Servicing and 64-Page Book on winning success in Radio-Television. Cut out and mail postcard. J. E. SMITH, President, Dept. CCP3, National Radio Institute, Pioneer Home Study Radio School, Washington 9, D. C.



**I SEND YOU ANY KITS LIKE THESE FOR PRACTICAL EXPERIENCE**

### Make Extra Money While Learning

Many of my students earn money fixing Radios in their Spare Time while learning, often average \$5 to \$10 a week. I send you SPECIAL BOOKLETS that show how to do it . . . and I send parts to build a SET TESTER that helps you do it.



**FIND OUT ABOUT THIS TESTED WAY TO BETTER PAY MAIL NOW!**

**Mechanic For Air Line**  
qualify me Radio Me- nited Air- ny Radio- Class Li- Hauger, California.

**More Money With Own Shop**  
"Am doing Radio Serv- ing full time. Have my own shop and am making more money now than I ever did before. Owe this to N.R.I."—Curtis Staeth, Fort Madison, Iowa.

**Graduate Doubles Salary**  
"I am employed by Sta- tion WKBO, as trans- mitter operator. Have more than doubled my salary since starting in Radio full time."—A. A. Herr, New Cumberland, Pa.

**\$10 Week Extra In Spare Time**  
"I averaged \$10 a week fixing Radios in my spare time. After graduating, managed an electrical store's Radio Depart- ment."—M. Joseph, Sac- ramento, California.

**"Today I an expert Television Tech- 4 employe- me. Radio- ness has d- G. Miller, "**



NOTED THROAT SPECIALISTS REPORT ON 30-DAY TEST OF CAMEL SMOKERS...

# Not one single case of throat irritation due to smoking **CAMELS!**

YES, THESE WERE THE FINDINGS OF NOTED THROAT SPECIALISTS AFTER A TOTAL OF 2,470 WEEKLY EXAMINATIONS OF THE THROATS OF HUNDREDS OF MEN AND WOMEN WHO SMOKED CAMELS—AND ONLY CAMELS—FOR 30 CONSECUTIVE DAYS!



**COLLEGE STUDENT Anne Hogan:** "My doctor's report after my 30-day test proved what my own throat told me from the start—Camels are wonderfully *mild!*"



**MR. AND MRS. RICHARD COLE** of Fresh Meadows, N. Y., made the test under observation of a throat specialist. Both agree, "Camels are the mildest cigarette!"



**PERSONNEL DIRECTOR Robert R. Lamkie:** "Camel mildness agreed with my throat from the start. I like everything about Camels—my cigarette!"



*CONNIE SCHWOGLEGLER*

THE 30-DAY TEST SURE WON ME OVER TO CAMELS — THEY TASTE GREAT AND THEY AGREE WITH MY THROAT!

Twice winner of National Individual Match Game Championship and 1949 "Bowler of the Year"



R. J. Reynolds Tobacco Company, Winston-Salem, N. C.

## Start your own 30-Day Camel MILDNESS Test Today!

Smoke Camels — and only Camels — for 30 days. Compare them in your "T-Zone" (T for taste, T for throat). Let your own throat tell you about Camel's cool, cool mildness. Let your own taste tell you about Camel's wonderful flavor.