

POPULAR SCIENCE

June 1950

25¢

Monthly

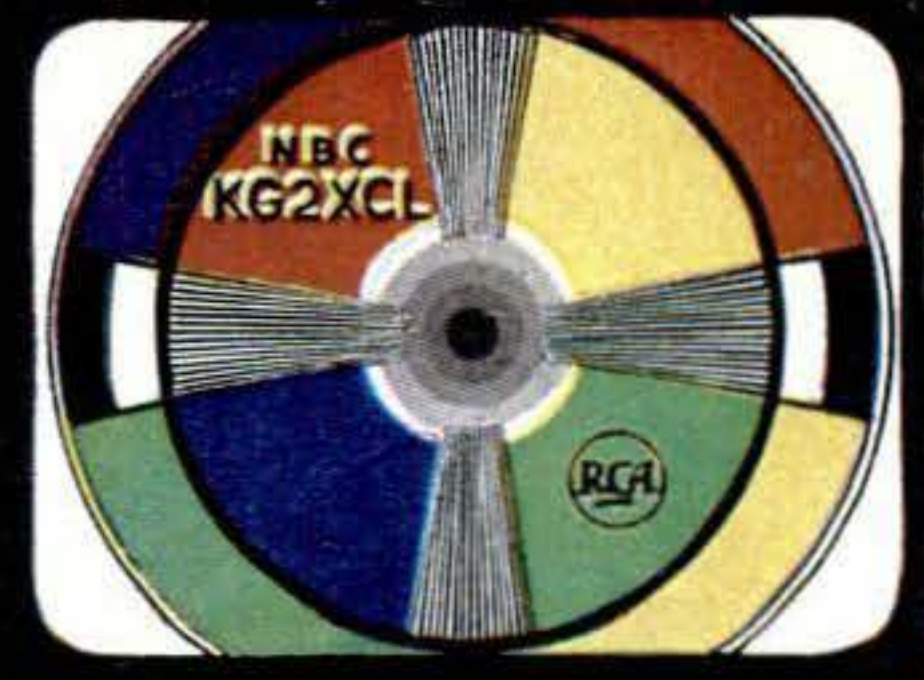

Newest TV
Color System

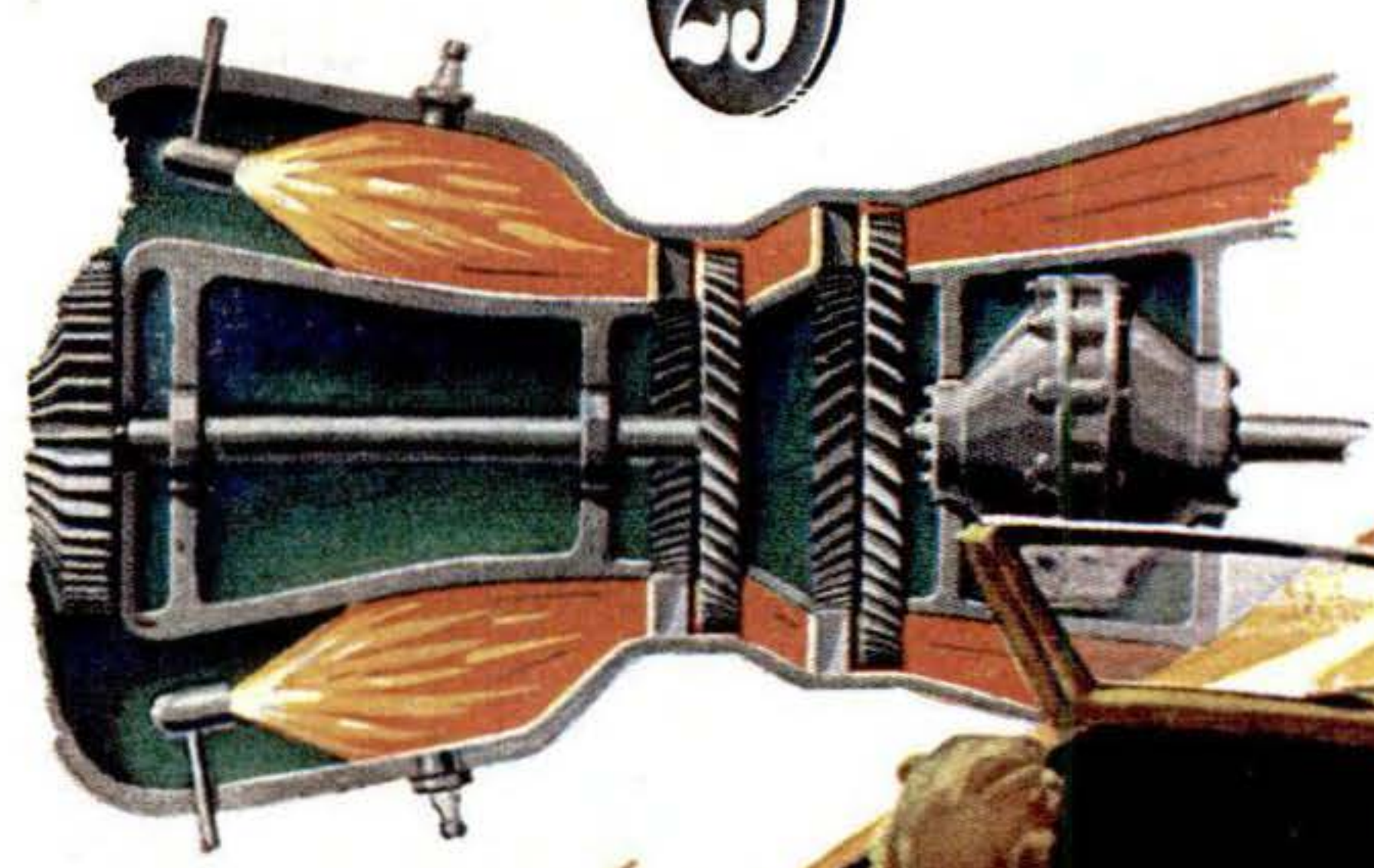

**Will We Drive
Turbo Cars?**

A new day is here in lowest price cars!

IT'S 4 TO SEE

INSTEAD OF 3

**The Studebaker Champion
is one of the 4 lowest price
largest selling cars
in America!**

\$ **1487⁵⁰**

Studebaker
Champion
Custom 6-pc
2-door sed
as shown

This is the South Bend
delivered price and incl.
Federal Tax

It does not include
transportation from
South Bend, or state and
local taxes, if any

Prices subject to change
without notice



© 1950, The Studebaker Corporation, South Bend 27, Indiana, U. S. A.

YOUR DREAM HOME—HOW TO BUILD IT FOR LESS THAN \$3500!

Build Any One of 8 Beautiful Homes Yourself with the aid of this Amazing Book!



7 DAYS ENJOYMENT FREE!



Looks Like a "Million Dollars"! Yet All Materials for Basic House Including Finished Dormers Cost Less Than \$3,500. Plans Show How to Finish Attic, Add Breezeway and Garage for Nominal Extra Cost Later!

Complete Plans and Instructions Show You How to SAVE 50c to 70c on EVERY DOLLAR Every Step Made Easy Even for the Novice!

THOUSANDS are doing it—so can you! With the aid of this easy-to-follow, step-by-step wonder book, you can build **YOURSELF** the home of your dreams—any one of 8 beautiful homes! Yes, you and your family can build and live in a home far more spacious, beautiful and comfortable than you ever dreamed of—a home that looks like a "Million Dollars"—a home you will always be proud of!

Own A \$10,000 Home for Material Costs Less Than \$2700!

Save up to \$7,000 on a \$10,000 house! And own a home that is stronger, sounder, handsomer than some profit-minded builders might give you! It's common knowledge that of every \$100 you spend for a commercially built house, only \$25 to \$35 goes for materials. Now this amazing volume shows you how to **SAVE** most of that big 75% difference! Complete building plans and simple easy-to-follow instructions offer you a choice of 8 grand spacious homes. Even a Vacation Hideaway for less than \$1500! 1,000 show-how pictures clearly explain **EVERY** step from selecting the site and starting foundation, to final landscaping. Complete material costs as low as \$1,500! Savings for you ranging from \$4,500 to \$15,000!

FULLY ILLUSTRATED—Complete lists of materials!

MAIL THIS FREE-TRIAL COUPON NOW!

Wm. H. Wise & Co., Inc., 50 West 47th St., New York 19, N. Y. Without obligation to me, rush me immediately, for Free Examination, a copy of the big new 512-page book "YOUR DREAM HOME—How to Build It for Less than \$3500"—bound in sturdy rich Novelex. After week's free trial, I will either return book promptly and owe you nothing, or I will keep it and remit only \$1 monthly until the amazingly low price of only \$3.95, plus a few cents postage, is paid.

SAVE CHARGES ON 3 LB. SHIPMENT!—Mail only \$4 with this coupon and we will stand shipping charges. Same return privilege and refund guaranteed.

MR. _____
MRS. _____
MISS _____ 188
(Print plainly in block letters)

ADDRESS _____ 806

CITY _____ ZONE _____
NO. _____ STATE _____

Check here to examine FREE beautiful De Luxe Edition, THUMB-NOTCHED, in Pinseal-Grained Binding, richly decorated with hand-tooled design. Only \$1 extra. Same terms, return privilege.

512 BIG PACKED PAGES! 1,000 CLEAR HOW-TO-DO-IT PICTURES! Picturized Step-by-Step Instructions From Start to Finish!

- How to Select Localities & Site
- Complete Material Lists for 8 Houses
- Masonry, Frame Construction
- Clearing Land
- How to Make a Foundation
- How to Build Frame
- How to Insulate
- Heating the Frame
- Building Roof
- How to Set in Windows, Doors
- How to Build Partitions
- How to Install Plumbing
- How to Install Electrical Systems
- How to Install Heating
- Interior Finishing
- How to Apply Siding
- Building Modern Kitchen and Bath
- Painting, Decorating
- How to Build the Garage
- How to Make Built-In Furniture
- Landscaping Your Grounds
- How to Finance Without 1c of Cash
- How to Live on Site While Building

Prepared by Top Building Experts and Edited by Famed "Handyman" Hubbard Cobb

For Week's FREE Enjoyment Mail Coupon Now!

If an ordinary small edition were made, this volume would still be a whale of a bargain at the necessary price of \$12.50. But our huge printing enables us to slash costs more than **TWO-THIRDS!** . . . bring you this wonder book for the amazingly low cost of only \$3.95! (YOU SAVE \$8.55!) Try it a full week **FREE**—return it without further obligation if not surprised and delighted, or keep it and pay only \$1 monthly. But act now—even our tremendous printing cannot last long with so many millions of families eagerly awaiting this opportunity! Mail **FREE-Trial Coupon** today.

Founded 1872. Vol. 156: No. 6

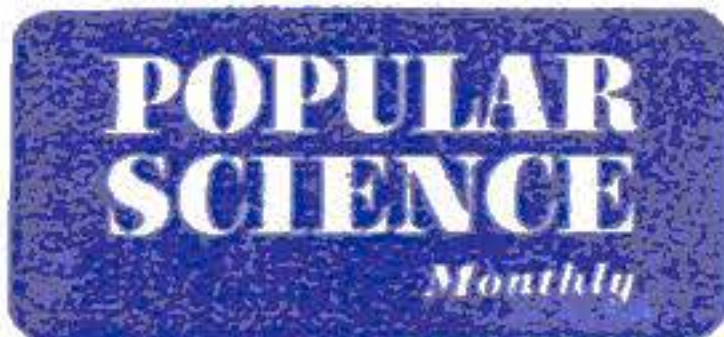

Mechanics and Handicraft

Perry Githens, EDITOR

Fred O. Newman, Volta Torrey, MANAGING EDITORS Howard C. Jensen, ART EDITOR

Harry Walton, MECHANICS & HANDICRAFT EDITOR

Hartley E. Howe, Frank Rowsome, Jr., ASSISTANT MANAGING EDITORS

ASSOCIATE EDITORS: Howard Allaway, Alden P. Armagnac, Devon Francis, Richard Giovine, Robert Gorman, Sheldon Gallager, Herbert Johansen, Martin Mann, Denis Sneigr, Robert P. Stevenson.

EDITORIAL ASSISTANTS: Julia Charnif, Carol Ennis, Georgette Sparks, Harriet Trowbridge, Ruth Westphal.

STAFF PHOTOGRAPHERS: W. W. Morris (Chief), Hubert Lockett, Orlando Guerra (Darkroom).

ART DIRECTOR: Harry Samuels. ART ASSOCIATES: Herbert Anthony, Eric Karminski, Jr., Richard Meyer, Edward Hallstrom, Frances Cooper (Production).

WESTERN EDITOR: Andrew R. Boone (Los Angeles).

WASHINGTON EDITOR: John F. Loosbrock.

Highlights FOR JUNE, 1950

Will We Drive Turbo Cars?..... 98

Airplane wonder engine gets a highway tryout in England and U. S., powering both auto and truck.

Color TV Comes Closer..... 108

Picture tube for receiver needs no spinning disks or trick mirrors to reproduce a full-color scene.

New Furniture Slides Together.... 113

Old-time butterfly joint stages a comeback for home-assembling this slick new prefab furniture.

Before Your Well Runs Dry..... 118

New drilling techniques and pumps are outmoding the old stone well for modern country dwellers.

Car Radio Finds Stations for You.. 130

This radio is target-seeking: it automatically marches along the dial, hunting for a station.

M.G. Gets Coil Springs..... 140

Latest version of perky British sports car has independent suspension and a higher top speed.

How They Make Cups & Saucers.. 148

The story behind your china tableware is one of a mechanized potter's wheel plus skilled workmen.

Gus Cools a Hot Engine..... 176

Gus proves he's not only a mechanical detective by spotting a "hot" car and trapping the thief.

Dash Gauge for Tire Pressure..... 188

Ingenious system shows pressure in all tires as you drive, gives advance warning of a slow leak.

Roll Power Tools to the Job..... 190

Build yourself a "sawcart" and you can wheel electric muscle out to the scene of operations.

How to Paint a House..... 196

Leery of tackling this big job? A master painter gives sound, practical tips on doing it correctly.

You Can Be Cooler This Summer.. 206

There's no need to let your house be a heat trap. Here is what you can do about it yourself.

Make Things Obey Your Voice..... 226

With a homemade sound-triggered switch, you can silence a radio commercial or open garage doors.

Folding House Moves by Truck..... 116

Giant Sphere Measures Light..... 117

Midget 'Scope Rivals Biggest..... 124

Homemade Car Wins Beauty Contest.... 126

Godfrey Hammond, PUBLISHER · Stephen P. Glennon, ADVERTISING DIRECTOR · Edward Roeder, Jr., ADVERTISING MGR.

EDITORIAL OFFICES: 353 Fourth Avenue, New York 10, N. Y. Manuscripts and illustrations submitted at regular rates should be so marked, addressed to "The Editors" and accompanied by stamped, self-addressed envelope. Popular Science Monthly exercises all possible care but assumes no responsibility for unsolicited material.

ADVERTISING OFFICES: NEW YORK - 353 Fourth Avenue; CHICAGO - 360 North Michigan Avenue; DETROIT - 820 Book Building; SAN FRANCISCO - 1003 TWA Building; PORTLAND (ORE.) - 907 Terminal Sales Building; CLEVELAND - 328 Citizens Building; LOS ANGELES - Granada Building.

Popular Science Monthly is published monthly at 353 Fourth Avenue, New York 10, N. Y., by Popular Science Publishing Co., Inc., Godfrey Hammond, President and Treasurer; R. C. Wilson, Raymond J. Brown, Stephen P. Glennon, Vice-Presidents; F. W. Briggs, Secretary. Entered as second-class matter Dec. 28, 1918, re-entered as second-class matter July 26, 1948, at the Post Office in New York, N. Y., under the act of March 3, 1879; additional entry as second-class matter at Dayton, Ohio. Entered as second-class matter at the Post Office Department, Canada. Printed in U.S.A. Copyright, 1950, by Popular Science Publishing Co., Inc. All rights reserved in the United States, Great Britain, and in all countries participating in the International Copyright Convention and Pan-American Copyright Convention. Yearly subscriptions to United States, its possessions and Canada, \$3.00 (2 years, \$5.50; 3 years, \$7.50); foreign countries \$1 per year extra. Subscribers must notify us of change of address four weeks before next publication date. Be sure to give both old and new addresses, including zone numbers. Vol. 156, No. 6.

LEARN RADIO



INSIDE OUT!

THAT'S the way to become an expert radio service man. Study the theory and principles first. These are vitally important. Then roll up your sleeves and actually work with radios—assembling, experimenting, trouble-shooting, repairing. That way you learn radio *from the inside out.*

Which explains why I.C.S., in its new Radio Course, concentrates on *equipment.* You get the best. Matched parts for an excellent 5-tube superheterodyne receiver. Your own professional-quality multimeter. A complete signal generator

kit. High-grade servicemen's tools. "Rider's Perpetual Trouble-Shooter's Manual." Plus lesson material and instruction service second to none. Also included is Principles of Television, which is a steppingstone to TV installation and service.

Learn by doing! That's the world-famous I.C.S. method. Thoroughly practical. Completely modern. *Success proved.* The coupon below brings you full details—on radio servicing or on any of the more than 400 I.C.S. Courses. Mark and mail it *today!*

INTERNATIONAL CORRESPONDENCE SCHOOLS

APPROVED
under the
G.I. BILL

BOX 7655-M, SCRANTON 9, PENNA.

Without cost or obligation, please send me full particulars about the course BEFORE which I have marked X:

- | | | | |
|--|--|--|---|
| <p>Air Conditioning and Plumbing Courses</p> <p><input type="checkbox"/> Air Conditioning</p> <p><input type="checkbox"/> Heating</p> <p><input type="checkbox"/> Refrigeration</p> <p><input type="checkbox"/> Plumbing</p> <p><input type="checkbox"/> Steam Fitting</p> <p>Chemical Courses</p> <p><input type="checkbox"/> Chemical Engineering</p> <p><input type="checkbox"/> Chemistry, Analytical</p> <p><input type="checkbox"/> Chemistry, Industrial</p> <p><input type="checkbox"/> Chemistry, Mfg. Iron & Steel</p> <p><input type="checkbox"/> Petroleum Refining</p> <p><input type="checkbox"/> Plastics</p> <p><input type="checkbox"/> Sulp and Paper Making</p> <p>Civil Engineering, Architectural and Mining Courses</p> <p><input type="checkbox"/> Architecture</p> <p><input type="checkbox"/> Architectural Drafting</p> <p><input type="checkbox"/> Bridge and Building Foreman</p> <p><input type="checkbox"/> Building Estimating</p> <p><input type="checkbox"/> Civil Engineering</p> <p><input type="checkbox"/> Coal Mining</p> <p><input type="checkbox"/> Contracting and Building</p> <p><input type="checkbox"/> Highway Engineering</p> <p><input type="checkbox"/> Lumber Dealer</p> <p><input type="checkbox"/> Reading Structural Blueprints</p> <p><input type="checkbox"/> Sanitary Engineering</p> <p><input type="checkbox"/> Structural Drafting</p> | <p><input type="checkbox"/> Structural Engineering</p> <p><input type="checkbox"/> Surveying and Mapping</p> <p>Communications Courses</p> <p><input type="checkbox"/> Electronics</p> <p><input type="checkbox"/> Practical Telephony</p> <p><input type="checkbox"/> Radio, General</p> <p><input type="checkbox"/> Radio Operating</p> <p><input type="checkbox"/> Radio Servicing</p> <p><input type="checkbox"/> Television</p> <p><input type="checkbox"/> Telegraph Engineering</p> <p>Electrical Courses</p> <p><input type="checkbox"/> Electrical Drafting</p> <p><input type="checkbox"/> Electrical Engineering</p> <p><input type="checkbox"/> Electric Light and Power</p> <p><input type="checkbox"/> Lighting Technician</p> <p><input type="checkbox"/> Practical Electrician</p> <p>Internal Combustion Engines Courses</p> <p><input type="checkbox"/> Auto Technician</p> <p><input type="checkbox"/> Aviation</p> <p><input type="checkbox"/> Diesel-Electric</p> <p><input type="checkbox"/> Diesel Engines</p> <p><input type="checkbox"/> Gas Engines</p> <p>Mechanical Courses</p> <p><input type="checkbox"/> Aeronautical Engineer's, Jr.</p> <p><input type="checkbox"/> Aircraft Drafting</p> <p><input type="checkbox"/> Flight Engineer</p> <p><input type="checkbox"/> Forging</p> <p><input type="checkbox"/> Foundry Work</p> <p><input type="checkbox"/> Heat Treatment of Metals</p> <p><input type="checkbox"/> Industrial Engineering</p> <p><input type="checkbox"/> Industrial Instrumentation</p> | <p><input type="checkbox"/> Industrial Metallurgy</p> <p><input type="checkbox"/> Machine Shop</p> <p><input type="checkbox"/> Mech. Drafting</p> <p><input type="checkbox"/> Mechanical Engineering</p> <p><input type="checkbox"/> Mold-Loft Work</p> <p><input type="checkbox"/> Patternmaking—Wood, Metal</p> <p><input type="checkbox"/> Reading Shop Blueprints</p> <p><input type="checkbox"/> Sheet-Metal Drafting</p> <p><input type="checkbox"/> Sheet-Metal Worker</p> <p><input type="checkbox"/> Ship Drafting</p> <p><input type="checkbox"/> Ship Fitting</p> <p><input type="checkbox"/> Tool Designing</p> <p><input type="checkbox"/> Toolmaking</p> <p><input type="checkbox"/> Welding Engineering</p> <p><input type="checkbox"/> Welding—Gas and Electric</p> <p>Railroad Courses</p> <p><input type="checkbox"/> Air Brake</p> <p><input type="checkbox"/> Car Inspector</p> <p><input type="checkbox"/> Diesel Locomotive</p> <p><input type="checkbox"/> Locomotive Engineer</p> <p><input type="checkbox"/> Locomotive Fireman</p> <p><input type="checkbox"/> Locomotive Machinist</p> <p><input type="checkbox"/> Railroad Section Foreman</p> <p><input type="checkbox"/> Steam-Diesel Loco. Eng.</p> <p>Stationary Eng'r's Courses</p> <p><input type="checkbox"/> Boilermaking</p> <p><input type="checkbox"/> Combustion Engineering</p> <p><input type="checkbox"/> Engine Running</p> <p><input type="checkbox"/> Marine Engineering</p> <p><input type="checkbox"/> Power Plant Eng'r's</p> <p><input type="checkbox"/> Steam Engr.</p> | <p>Textile Courses</p> <p><input type="checkbox"/> Cotton Manufacturing</p> <p><input type="checkbox"/> Loom Fixing</p> <p><input type="checkbox"/> Rayon Weaving</p> <p><input type="checkbox"/> Textile Designing</p> <p><input type="checkbox"/> Woolen Manufacturing</p> <p>Business and Academic Courses</p> <p><input type="checkbox"/> Accounting</p> <p><input type="checkbox"/> Advertising</p> <p><input type="checkbox"/> App. Psychology</p> <p><input type="checkbox"/> Bookkeeping</p> <p><input type="checkbox"/> Business Administration</p> <p><input type="checkbox"/> Business Law</p> <p><input type="checkbox"/> Bus. Correspondence</p> <p><input type="checkbox"/> Bus. Law</p> <p><input type="checkbox"/> Certified Public Accounting</p> <p><input type="checkbox"/> Commercial</p> <p><input type="checkbox"/> Commercial Art</p> <p><input type="checkbox"/> Cost Accounting</p> <p><input type="checkbox"/> Federal Tax</p> <p><input type="checkbox"/> First Year College</p> <p><input type="checkbox"/> Foremanship</p> <p><input type="checkbox"/> French</p> <p><input type="checkbox"/> Good English</p> <p><input type="checkbox"/> High School</p> <p><input type="checkbox"/> Higher Mathematics</p> <p><input type="checkbox"/> Illustration</p> <p><input type="checkbox"/> Industrial Supervision</p> <p><input type="checkbox"/> Motor Traffic</p> <p><input type="checkbox"/> Postal Civil Service</p> <p><input type="checkbox"/> Retailing</p> <p><input type="checkbox"/> Retail Bus. Management</p> <p><input type="checkbox"/> Salesmanship</p> <p><input type="checkbox"/> Secretarial</p> <p><input type="checkbox"/> Sign Lettering</p> <p><input type="checkbox"/> Spanish</p> <p><input type="checkbox"/> Stenography</p> <p><input type="checkbox"/> Traffic Management</p> |
|--|--|--|---|

Name _____ Age _____ Home Address _____

City _____ State _____ Working Hours _____ A.M. to _____ P.M.

Present Position _____ Employed by _____

Length of Service in World War II _____ Enrollment under G.I. Bill approved for World War II Veterans. Special tuition rates to members of the Armed Forces. Canadian residents send coupon to International Correspondence Schools Canadian, Ltd., Montreal, Canada.

NOW!

BRIGGS SMOKES 3 WAYS BETTER*



1. Stays lighted longer ... by 19%



2. Cleaner burning ... by 16.4%



3. Less tar ... by 21.6%

So today ...

Put this
in your
pipe

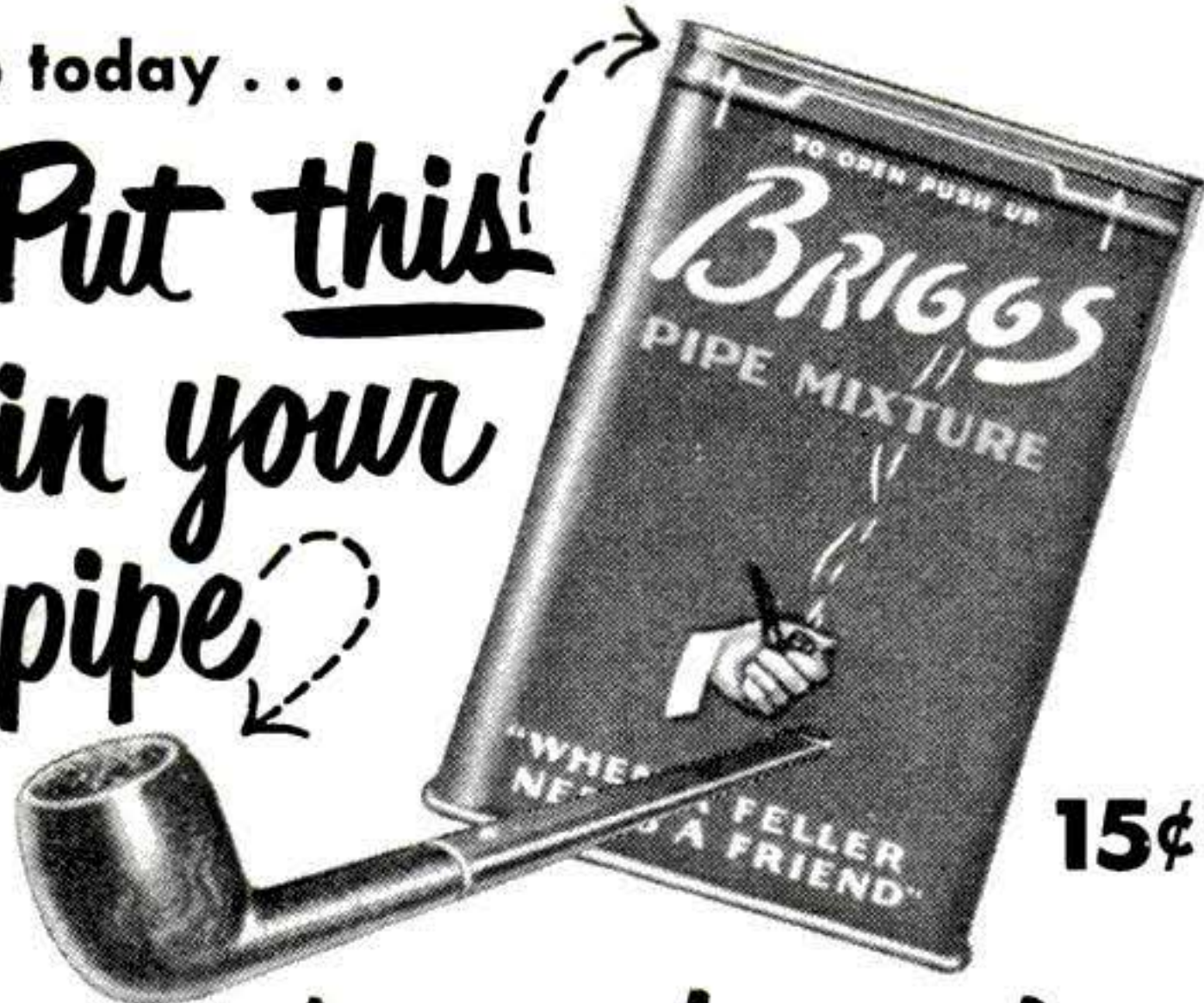

and smoke it!

*Yes, our new process makes Briggs better by actual test! Better even than the swell-smoking Briggs that proved so fine and friendly in your pipe before. And remember this: when tobacco burns steady, free and clean, that's when you enjoy *all* the goodness of Briggs' fine tobacco, aged and mellowed in oaken casks. Today—try 3-ways-better Briggs!

Also available in Canada

Midget Rolling Mill Trys Out Alloys.....	128
Periscope Looks Into Jet.....	129
Farmers Raise a Barn.....	132
Hot Breath Sampled for Safety.....	135
Just Try to Steal This Truck.....	136
Tank Razers Work from Boat.....	139
TV Towers Sprout from Sliding Form....	142
Inside the B-36.....	144
New Grease Is Compressible.....	147
Card Opens Electronic Lock.....	155
He Builds Thrills Into Home Movies.....	156
Detailed TV Color by Wire.....	160
Cinder Blocks Speed Home Building.....	162
How They Put Life in Old Umbrellas....	166
What's New on Car Tops.....	172

Mechanics & Handicraft

Homemade Visor Costs Only \$4.....	183
How Dashboard Instruments Work.....	185
Blower Sprays Orchards Fast.....	201
How to Use Tin Snips.....	202
Hand Tools Make Chinese Shelf.....	204
New Low-Cost Panels of Wood Waste..	205
Bookcase Lamp for End Table.....	211
What Plastic Is That?.....	214
Use a Doorstop.....	219
Making Dovetails with Power Tools....	220
What's Wrong?	232
Folding Bed Built in Open Boat.....	235
Build Your Own Fishing Chair.....	236
How to Pep Up a Drill Motor.....	238

Departments

Letters.....	10
New Ideas from the Inventors.....	105
Aids to Modern Living.....	170
Keeping the Home Shipshape.....	173
Hints from the Model Garage.....	181
New Shop Ideas.....	212
I'd Like to See Them Make.....	234
Craftsmen at Work.....	237
Mechanics of Farming.....	242
New Tools.....	276
P.S. Last Minute News and Notes.....	280

Camera Case Solved

HAVE you postponed buying a case for your camera because of the excise tax on leather goods? You can make a neat carrying case yourself out of leather from an old brief case or handbag. Walter E. Burton will tell you how to go about it in POPULAR SCIENCE next month.

Send for this Amazing New FRAM Lubri-Graf **FREE**



Gives instant check on oil and filter condition.

Helps save money, repairs, breakdowns.

Charts engine condition and efficiency.

Spots engine trouble before it strikes.

Mail Coupon Below!

NOW YOU CAN HAVE a continuous, instant check on your oil and oil filter condition. The amazing new Fram Lubri-Graf tells you at a glance when it's time to change oil and oil filter cartridge.

It's small, convenient, easy to use. Just tack up in your garage or carry in glove compartment. Then, periodically, depending on how much you drive, remove the dipstick and touch a drop of oil to one of the indicator spots on the Lubri-Graf. If you can't see the

colored dot through the oil, it's time to change oil and cartridge.

Tells you how fast your engine is contaminating oil. If it's excessive, you know it's time to spend a few dollars on corrective maintenance rather than wait and spend a fortune for a complete overhaul later on.

Test it! Send coupon now for your FREE Fram Lubri-Graf! No obligation . . . no charge!

Only FRAM offers you Complete Engine Protection

Add miles...save money...cut repairs! Fram offers you four great Filters to seal out the deadly contaminants that rob miles from the life of an engine—re-

move those formed internally—seal in engine power and performance. For the name of your nearest Fram Dealer, call Western Union by number and ask for Operator 25.

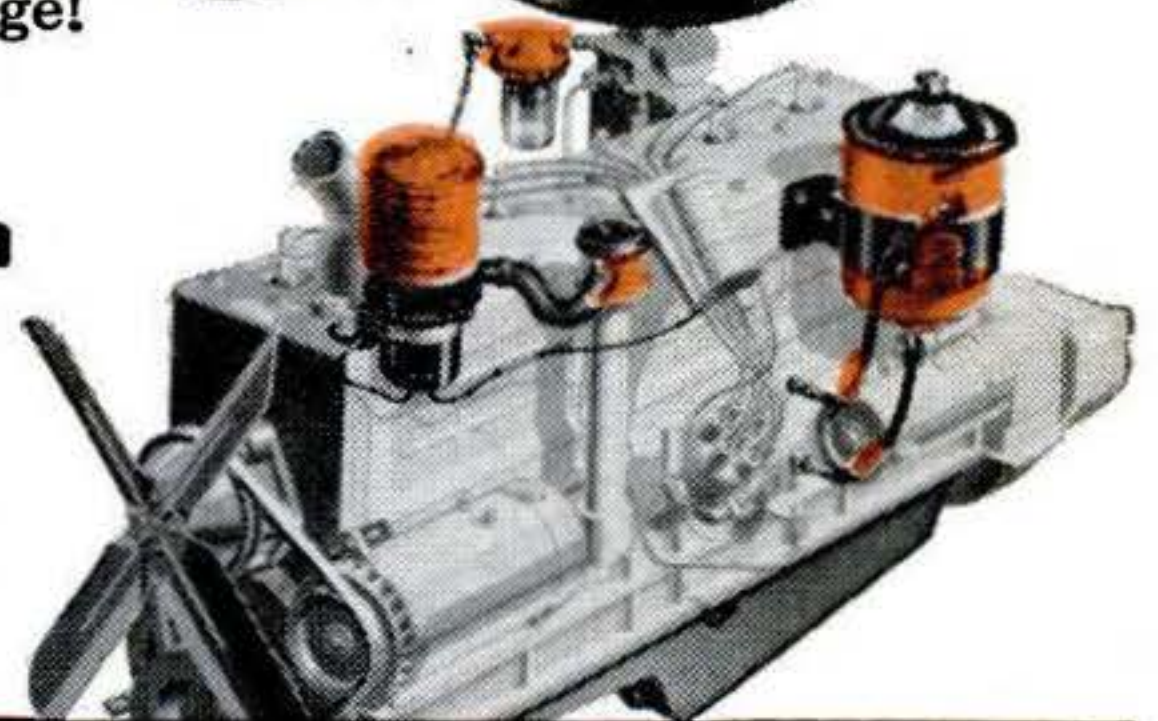

For Complete Engine Protection

FRAM



OIL - AIR - FUEL

FILTERS

Don't Delay!
No Obligation!
No Charge!

Absolutely
FREE!

MAIL COUPON NOW!

FRAM CORPORATION

Department PS-6, Providence 16, R. I.

Please send me FREE Fram Lubri-Graf.

Name.....

Address.....

City..... Zone State.....

JUNE 1950 5



This picture was taken in the Bridgeport office of The Southern New England Telephone Company, one of the 22 operating telephone companies which the Laboratories serve through the Bell System.

Cutting Board for Telephone Costs

Few of these tools have sharp edges. But they are powerful cost cutters. Whenever a telephone craftsman reaches for one, he finds the right tool ready to his hand. There's no time wasted trying to do a complicated job with makeshift equipment.

Most telephone tools are highly specialized. 90% of dial system tools were de-

signed by Bell Laboratories. Each saves time in maintenance work, installation or construction.

There are tools with lights and mirrors to work deep within relay bays; tools to brush, burnish and polish; tools that vacuum clean—even a tool to weld on new contact points without dismantling a relay. There are gauges to time

dial speeds, others to check spring tension. Some look like a dentist's instruments. Some you have never seen.

Keeping the telephone tool kit abreast of improvements is a continuing job for Bell Telephone Laboratories. It's another example of how the Laboratories help keep the value of your telephone service high, the cost low.

BELL TELEPHONE LABORATORIES

WORKING CONTINUALLY TO KEEP YOUR TELEPHONE SERVICE BIG IN VALUE AND LOW IN COST



Let me send You **FREE PROOF** that you can become an expert **ACCOUNTANT... BOOKKEEPER** **OR C.P.A.**

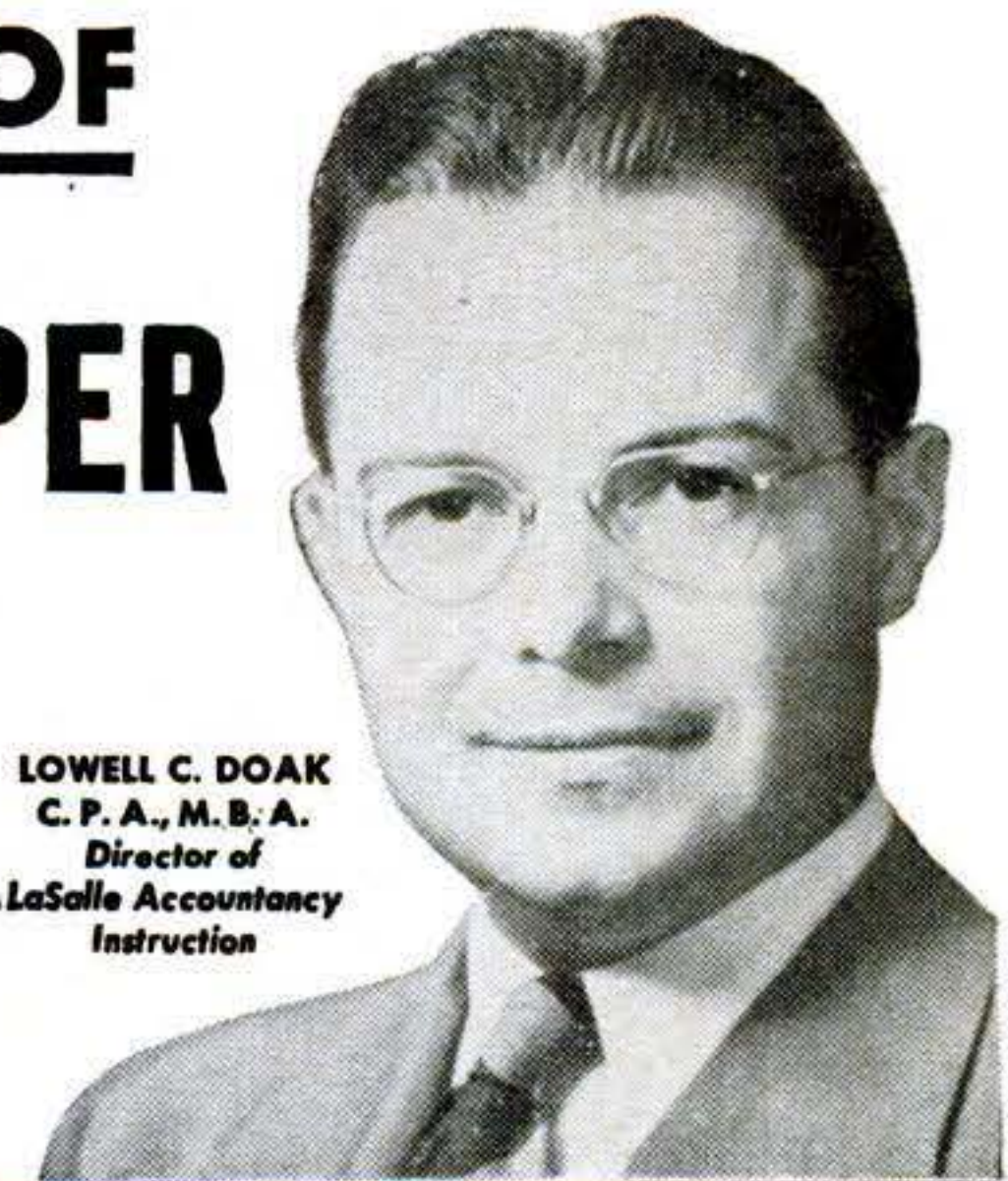

LOWELL C. DOAK
C. P. A., M. B. A.
Director of
LaSalle Accountancy
Instruction

FREE SAMPLE LESSON

I offer you this free sample lesson so that you can *prove to yourself* that you CAN master Accountancy—quickly, thoroughly—in spare time at home.

You will see exactly how LaSalle's famous "Problem Method" works . . . how you are led step-by-step through actual accounting work—*learning by doing* and not by study of theory alone. First you tackle easy problems, then more difficult ones—until soon you master them all. And at every step you have the close personal guidance of LaSalle's large staff of C.P.A. instructors.

HIGHER ACCOUNTANCY

By the LaSalle Problem Method..

• Practical Accounting

Assignment 1 THE BALANCE SHEET



QUOTING from the "Journal of Accountancy," the authoritative organ of the professional accountants of the United States:
"... the accounting profession is probably the best paid in the world. If there be a profession in which the average compensation is higher, it is not known to us."
"There is need for accountants. There is ample compensation for accountants. There is no prospect that the supply will overtake the demand within the lifetime of even the youngest of us"

LaSalle Extension University
A Correspondence Institution
CHICAGO

THIS SAME LESSON STARTED ME

toward a well-paid public accounting career—and my C.P.A. degree. I knew nothing of accounting before—yet my progress was rapid—my earning power climbed fast. This sample lesson will show you why.

If you have been envying the high incomes and good jobs enjoyed by thousands of men and women Accountants today . . . incomes ranging from \$4,000 to \$10,000 and more per year . . . why not launch such a career for yourself?

Do you doubt that you can?

Then let me send you—without cost or obligation—the same Lesson Number One with which LaSalle has started several hundred thousand

men and women toward successful accounting careers. I want you to see for yourself how this remarkable method, originated by LaSalle, makes Accountancy simple, interesting, practical, and certain . . . how it leads you step-by-step to a complete mastery of Accounting—and on up to the coveted degree of Certified Public Accountant if you so aspire.

It doesn't matter whether you've had previous bookkeeping experience, or whether you don't know a debit from a credit. Whether you wish to qualify as an expert bookkeeper, advanced accountant, cost accountant, auditor, government accountant, income tax specialist, or public accountant . . . you'll find in LaSalle's Problem Method the exact plan to prepare you rapidly and inexpensively—in spare hours at home—without losing a day from your present job.

So right now, today . . . if you are an adult, employed, and earnestly ambitious for rapid advancement in this highest-paying of all professions . . . send your name and address to me on the coupon below. I'll send the free sample lesson—plus our 48-page book outlining today's career opportunities and how you can qualify for them. A coupon like this has started many thousands toward greater success. It can do the same for you. Mail it today!

Clip Coupon . . . Mail TODAY!

LaSalle Extension University . . . A Correspondence Institution
Dept. 683H, 417 S. Dearborn Street, Chicago 5, Illinois

YES, MR. DOAK, I want to see how LaSalle's "Problem Method" works . . . how I can qualify for high-pay Accountancy positions. Also, send your 48-page book, "Accountancy, the Profession That Pays" . . . all without cost or obligation.

Name Age

Street Address

City, Zone & State

Present Position



**Nearly 10%
of all C.P.A.'s
in the U.S. have
been trained by the
LaSalle Problem
Method**

GOOD-PAY JOBS IN 5 BIG FIELDS

If you were an expert accountant right now, chances are you would find yourself among the highest-paid of all professional men and women. Surveys show that accountants earn more than those in other major professions.

There are five big fields of opportunity open to Accountancy-trained men and women . . . opportunities that are wide open and highly inviting, offering maximum income and job security in good times or bad. And under LaSalle's "Problem Method" you can start earning while still learning—either in spare-time or full-time employment . . . or in business for yourself with no capital required.

Get the latest information by sending for our 48-page book, "Accountancy, the Profession That Pays" . . . plus free sample lesson. The coupon at right will bring both to you without cost or obligation. LaSalle Extension, 417 S. Dearborn St., Chicago 5, Ill.

Serving You Well in America's Large *Citizen* Army

Meet Bruno Tomchesson of Bryan, Texas—expert cabinet-maker, family man, active in his community's affairs.

Typical of the thousands upon thousands enrolling in the Organized Reserve Corps, Bruno looks upon this good-citizenship opportunity in terms of *service*. He is active in Bryan's American Legion Post 159. He promotes his Legion's fine Youth's Baseball Organization.

And twice a month he trains as Motor Sergeant with Headquarters Battery, 352nd Armored Field Artillery Battalion.

A pleasant way to maintain old friendships! Rewarding, too—for under the *new* Reserve Program, Bruno draws full pay of his grade for each training assembly, builds retirement credits, equips himself for further advancement.

Bruno Tomchesson, civilian and soldier, indeed serves you well, as do Army Reservists everywhere, manning 9,000 units.

Learn more about the Organized Reserve Corps—a small part of your defense budget, a big part of your defense strength. Inquire at your nearby U. S. Army and U. S. Air Force Recruiting Station or for full particulars write directly to Executive for Reserve and ROTC Affairs, Dept. of the Army, Washington 25, D. C.



Why a "recessed floor" means Most Room! Best Ride! Safest!

Hudson's "step-down" design brings benefits in room, riding qualities and safety not obtainable in any other car at any price!



HUDSON: "Step-down" design, with its recessed floor, uses space between frame members that other cars waste. The result is America's lowest center of gravity (and full road clearance), with more head room and seating room than any other car.



OTHER CARS: All other cars have floor on top of frame, so they fail to utilize the space between frame members. Result is a higher center of gravity and either a high roof line or insufficient head room. Seats are narrower; passenger space less.

When you try Hudson's "New Step-Down Ride," we believe you will find it a delightfully new experience. For Hudson is the only motor car with a recessed floor ("step-down" design). This results in the lowest-built car of them all, with true streamlining and mag-

nificent beauty. It provides full road clearance and the most room in any automobile at any price! It creates America's lowest center of gravity, which brings you the best and safest ride ever known. Won't you accept your Hudson dealer's invitation—enjoy "The New Step-Down Ride" soon?

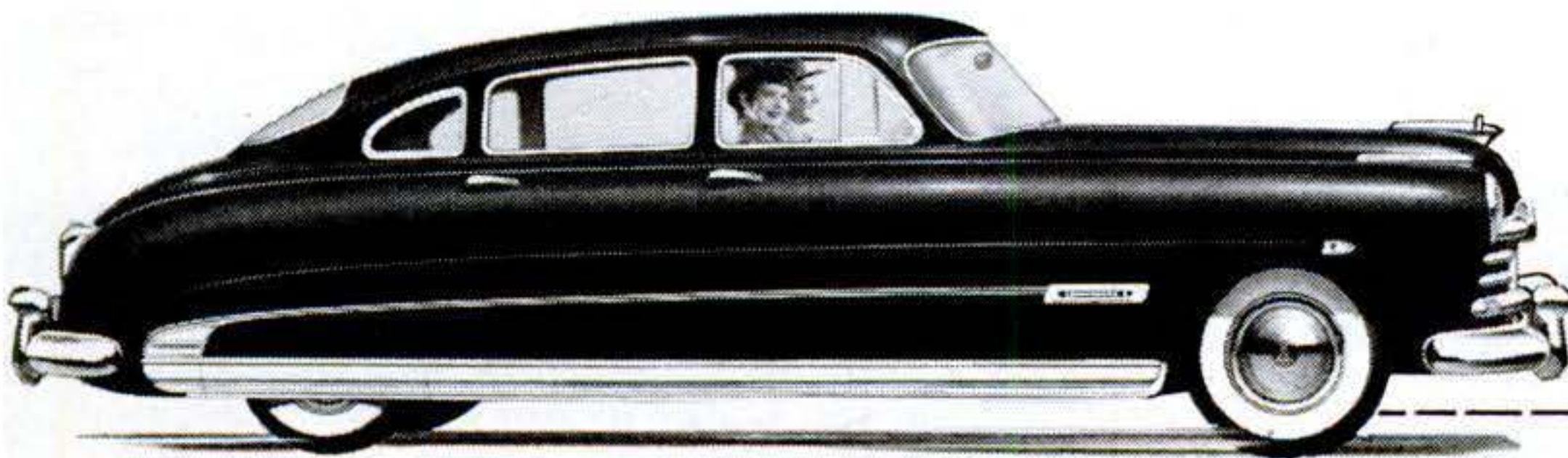

There's a thrilling story of engineering achievement behind the new Hudsons for 1950. Get it without obligation; just mail the coupon to Hudson Motor Car Company, Detroit 14.

Advertising Department
Hudson Motor Car Company
Room P.S.—1, Detroit 14, Mich.

Please send me, without obligation, additional information on Hudson's new way of building automobiles.

Name _____

Street _____

City _____ Zone _____ State _____

Hudson

NOW ... 3 GREAT SERIES

Lower-Priced Pacemaker • Famous Super • Custom Commodore

WHO ELSE WANTS BETTER SHAVES AT LESS COST?



**NOW! this Top Quality
FULL-WEIGHT Blade
in Handy
DISPENSER
10 FOR 25¢**

REGULAR PACK 3 for 10¢

*Make this
TOUGH SPOT TEST*



• Here's the smoothest-shaving razor blade that money can buy. Try it on hard-to-shave spots. If *any* other blade gives you better shaves than Blue Star, we'll give you double your money back! Get Blue Star blades in handy dispenser today.

Blue STAR

SINGLE EDGE

DOUBLE EDGE

PRECISION **A-S-R** PRODUCTS

AMERICAN SAFETY RAZOR CORP. • BROOKLYN 1, N. Y.

Letters



First Mechanical Dishwasher?

Sir:

The interesting article on Mr. La Raus's simplified dish-washing machine in your January issue [p. 116] prompts me to raise the question: Are mechanical dishwashers new?

In the early '90s while visiting an old farmhouse about half way between New Haven and Hartford, Conn., I had the doubtful pleasure of operating what, I am convinced, was one of the earliest—if not the first—mechanical dishwasher in the U.S.A. The owner of the farm, who was then about 80 years old, told me the dishwasher had been in use there as long as she could remember.

The washer was a square wooden tub, at the bottom of which was a paddle wheel connected through a train of gears to a hand crank. Soiled dishes were stacked on a rack inside, a solution of soft soap and three or four gallons of boiling water was poured over them, and the cover was tightly fastened.

As the operator turned the crank, about 60 times, the paddles splashed soapy water

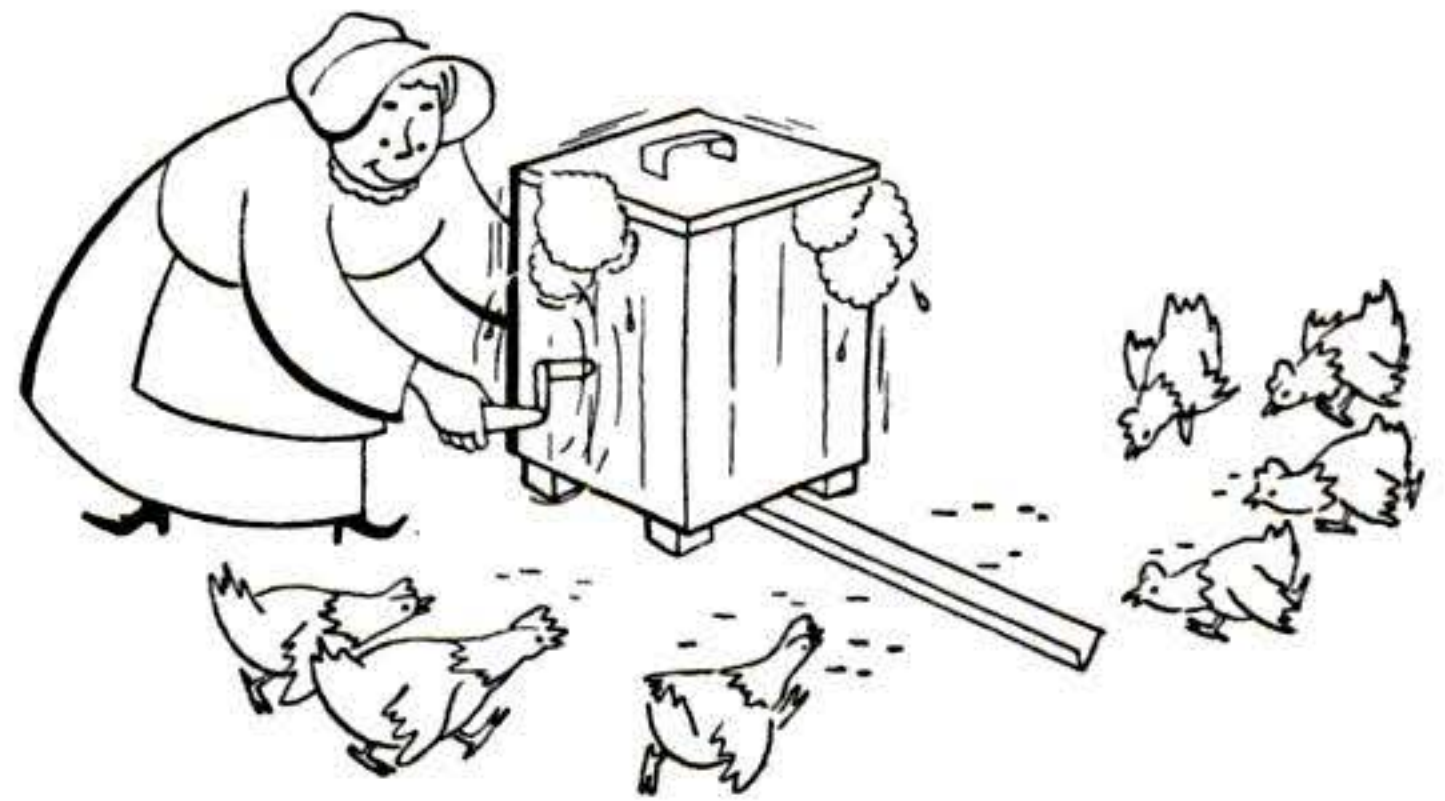

over the dishes. The plug was then pulled, allowing the water to run into a trough that drained into the farmyard—where chickens feasted on the food scraps from the dishes. A second filling of hot water, without soap, rinsed the dishes.

C. M. HUNTLEY

Seattle, Wash.

What's a Screwdriver For?

Sir:

I disagree with your advice to a reader in



I Will Train You at Home for Good Jobs in **RADIO- TELEVISION**

**I Send You Many
KITS OF PARTS
for practical experience**

You conduct many tests and experiments with equipment built from materials I furnish. Some of the equipment from my Servicing Course and some from my Communications Course is shown below. Everything I send is yours to keep.

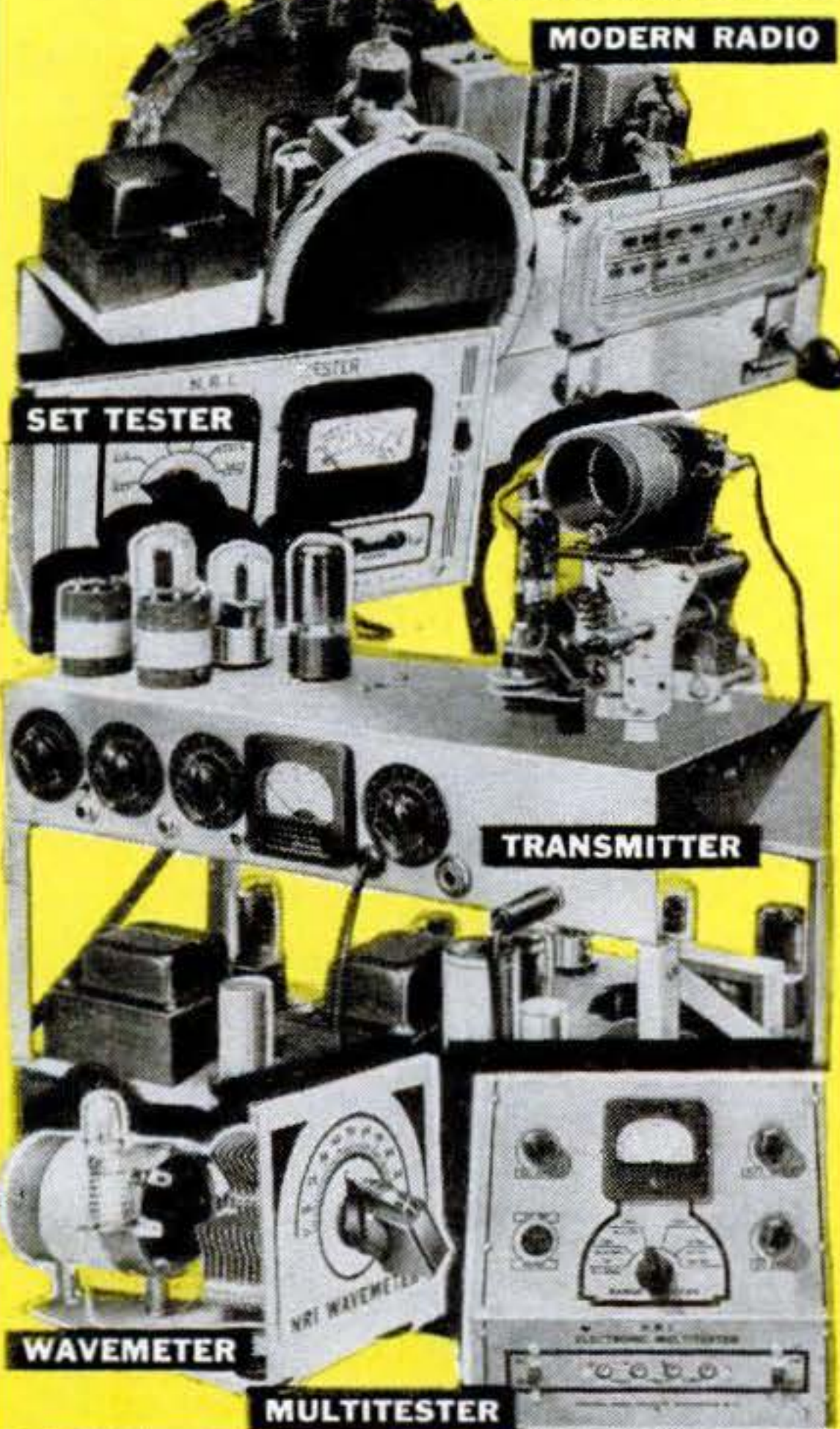

MODERN RADIO

SET TESTER

TRANSMITTER

WAVEMETER

MULTITESTER

America's Fastest Growing Industry Offers You **GOOD PAY--SUCCESS**

Want a good-pay job in the fast growing **RADIO-TELEVISION** Industry? Want a money-making Radio-Television shop of your own? Here's your opportunity. I've trained hundreds of men to be successful Technicians . . . **MEN WITH NO PREVIOUS EXPERIENCE.** My tested and proved train-at-home method makes learning easy. You learn Radio-Television principles from illustrated lessons. You get practical experience building, testing, experimenting with **MANY KITS OF PARTS** I send. All equipment yours to keep.

MAKE EXTRA MONEY IN SPARE TIME

The day you enroll, I start sending **SPECIAL BOOKLETS** that show you how to make \$5, \$10 a week or more **EXTRA MONEY** fixing neighbors' Radios in spare time while learning. From here, it's a short step to your own shop or a good-pay Radio-Television servicing job. Or be a licensed Radio-Television Operator or Technician.

TELEVISION OFFERS BRIGHT FUTURE

Today there are nearly 2700 Radio stations on the air—and within three years experts predict over 1000 Television Stations. Then add developments in FM, Two-Way Radio, Police, Marine, Aviation and Microwave Relay Radio! Think what this means. New jobs, more jobs, good pay for qualified men.

ACTUAL **FREE** LESSON

Act now! Send for my **FREE DOUBLE OFFER.** Coupon entitles you to actual lesson, "GETTING ACQUAINTED WITH RECEIVER SERVICING." It shows you that learning at home is easy, practical. You also get my 64-page book, "HOW TO BE A SUCCESS IN RADIO-TELEVISION." It tells what my graduates are doing and earning.

Send coupon in envelope or paste on penny postal. **J. E. SMITH, President, Dept. OFP3, National Radio Institute, Pioneer Home Study Radio School, Washington 9, D. C.**

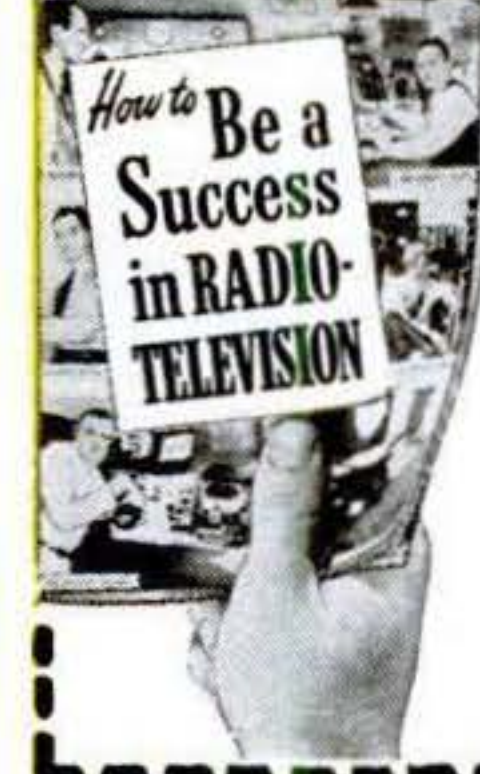

I TRAINED THESE MEN



"Before finishing course, I earned as much as \$10 a week fixing Radios at home in spare time. Recommend N. R. I."—**S. J. Petruff, Miami, Florida.**



"My first job was obtained for me by your Graduate Service Dept. Am now Chief Engineer, Police Radio Station WQOX."—**T. S. Norton, Hamilton, Ohio.**



"N. R. I. was my stepping stone from a few hundred to over \$4,000 a year as a Radio Engineer. Make extra money servicing Radios."—**A. B. Michaels, Trenton, Ga.**



"I am operating my own Radio Sales & Service business. With FM and Television in the offing, we have a very profitable future."—**A. Patrick, Tampa, Fla.**

Good for Both—**FREE**

**MR. J. E. SMITH, President, Dept. OFP3
National Radio Institute, Washington 9, D. C.**

Mail me Sample Lesson and 64-page book about How to Win Success in Radio-Television—both **FREE.** (No salesman will call. Please write plainly.)

Name.....Age.....

Address.....

City.....Zone.....State.....

Check if Veteran

Approved Under G. I. Bill

VETERANS GET THIS TRAINING UNDER G. I. BILL

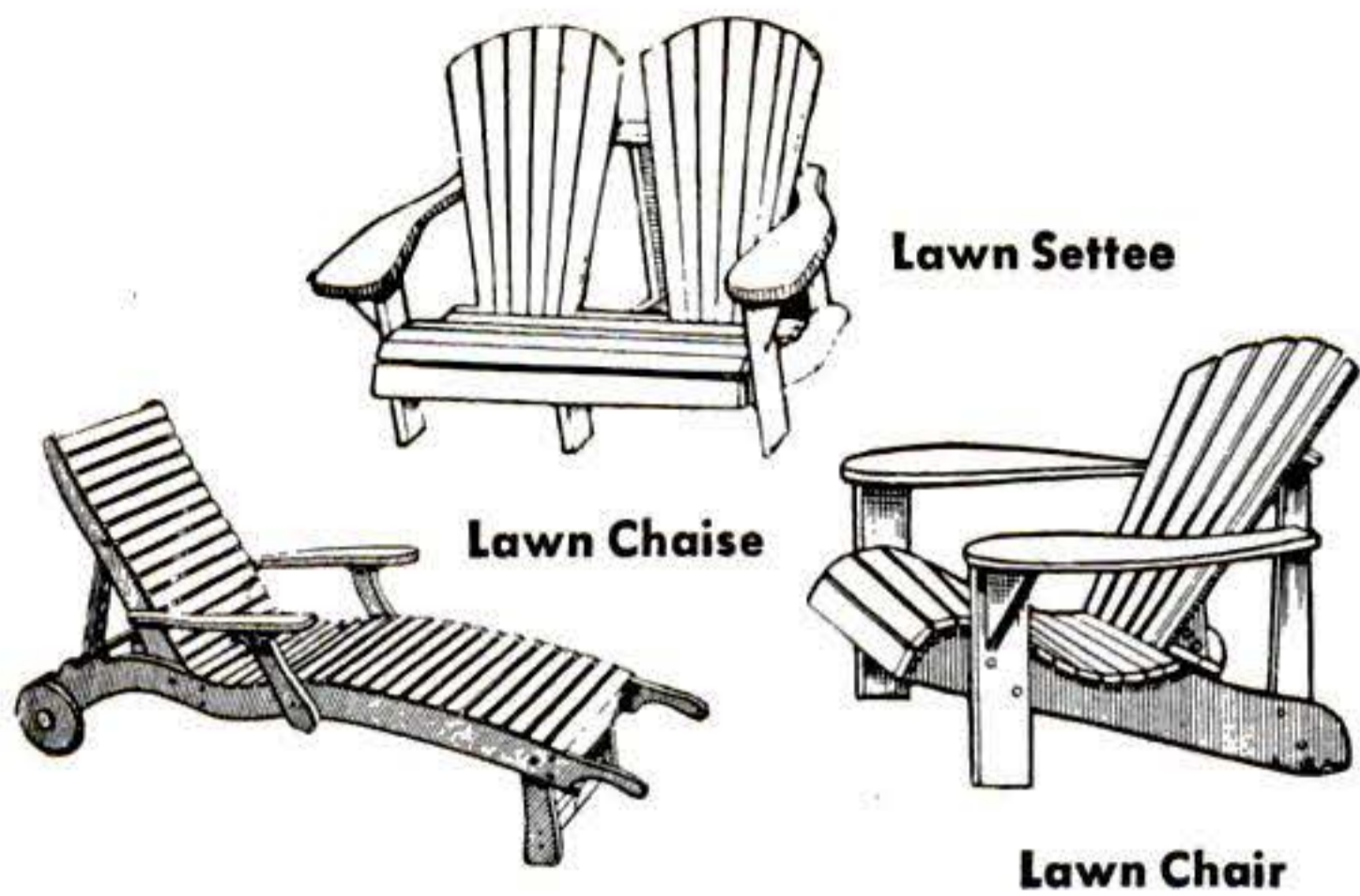

**SAVE MONEY, HAVE FUN,
BUILD LAWN FURNITURE..**
with EASI-BILD* Full-size Patterns

You can build this lawn furniture at less than 1/2 the store cost—without special tools or skill! Easi-Bild Full-size Patterns are easy to use. It's the dress pattern idea applied to flat lumber. Just trace, saw, and assemble. And for stronger joints throughout, use CASCOPHEN, Casco's new, waterproof glue.

Copr. 1949, Easi-Bild Pattern Co.

How to choose a glue!



- CASCOPHEN—waterproof glue for outdoor projects
- CASCO—for heavy-duty joints, rough surfaces
- CASCAMITE—for stain-free veneering, cabinets
- CASCOREZ—fast-set, ready-mix glue for home jobs

SEND COUPON FOR FURNITURE PATTERNS TO:

Casco Pattern Dept. PS-60
P. O. Box 215, Pleasantville, N. Y.
Enclosed is¢ for patterns checked below.

Lawn Chair, Pattern No. 32—25¢
 Lawn Settee, Pattern No. 39—35¢
 Lawn Chaise, Pattern No. 78—35¢
 Pattern book illustrating 94 pattern projects —20¢

Name _____
 Address _____
 City _____ Zone _____ State _____

THE BORDEN CO. • CHEMICAL DIVISION
Makers of Casco Glues

your March issue, page 20, where you say that prying open a drill chuck is not a legitimate job for a screwdriver.

A screwdriver is a universal tool and is used much more for prying, chiseling, wedging, etc., than for driving screws. When doing a job, your aim is not to save wear and tear on a cheap screwdriver—but to get the job done.

Screwdrivers are easily straightened and reground, and they come with shatterproof handles. So why not use them for any job that they will fit?

HARRY S. DAVIS

Nelsonville, O.

Shocking Suggestion?

Sir:

Some time back you showed how to make an unbreakable lamp pull with a wire banjo string and a shower-curtain ring [PS, Dec. '49, p. 155]. It seems to me that hooking a wire to an electric fixture is a sure way to get a shock.

MERLE HARTZ

Pleasantville, Ia.

A wire pull is no more dangerous than the standard beaded metal chain. In kitchen or bathroom, where the floor might be damp, insert an insulating link in either pull. It is also advisable to use a porcelain, rather than metal, socket and base.

The Great Conduit Mystery

Sir:

"The Height of Ingenuity" in your December issue, p. 214, set me wondering what kind of conduit they use in Chile. Writing from there, Mr. Federico Strasser tells how he located the end of a conduit inside a wall by feeding a small bar magnet into it, on the end of a copper wire, and then locating the magnet by moving a compass over the outside of the wall.

Have you ever tried to feed a bar magnet into a conduit? All the conduit I know of is either steel or iron; and any magnet stuck into it will immediately adhere to the wall of the conduit.

But supposing that, by sheer force, the magnet could be persuaded to reach the end of the conduit. Then would not the conduit itself prove a magnetic shield between the magnet and the compass needle?

In conclusion: Why use a magnet at all?

INVENTORS

Learn how to protect your invention. The U. S. Patent Laws provide that any new and useful art, machine, article of manufacture, or composition of matter, or any new and useful improvement thereof, may be patented if the act of invention is involved. Therefore, every inventor with a valuable invention should take advantage of the Patent Laws and proceed for patent protection in order to safeguard his rights.

A patent gives the inventor the exclusive right to prevent others from making, using, or selling the invention claimed in the patent for a period of seventeen years.

The Patent Laws were enacted for the benefit of the inventor to give him protection for the features of his invention which are patentable. These features must be properly and concisely set forth and claimed in a formal application for patent, in order to comply with the requirements of the Patent Laws. For that reason, unless the inventor is familiar with patent matters, he should engage a competent registered patent attorney or agent to represent him. We are registered to practice before the U. S. Patent Office and are prepared to serve you in the handling of your patent matters.

A specially prepared booklet entitled "Patent Guide for the Inventor", containing detailed information with respect to patent protection and procedure, together with a "Record of Invention" form will be promptly forwarded to you without obligation upon request.

CLARENCE A. O'BRIEN & HARVEY JACOBSON

Registered Patent Attorneys

O2-F DISTRICT NATIONAL BUILDING

WASHINGTON 5, D. C.

JUNE 1950 13

Your Success in Aviation begins at Embry-Riddle

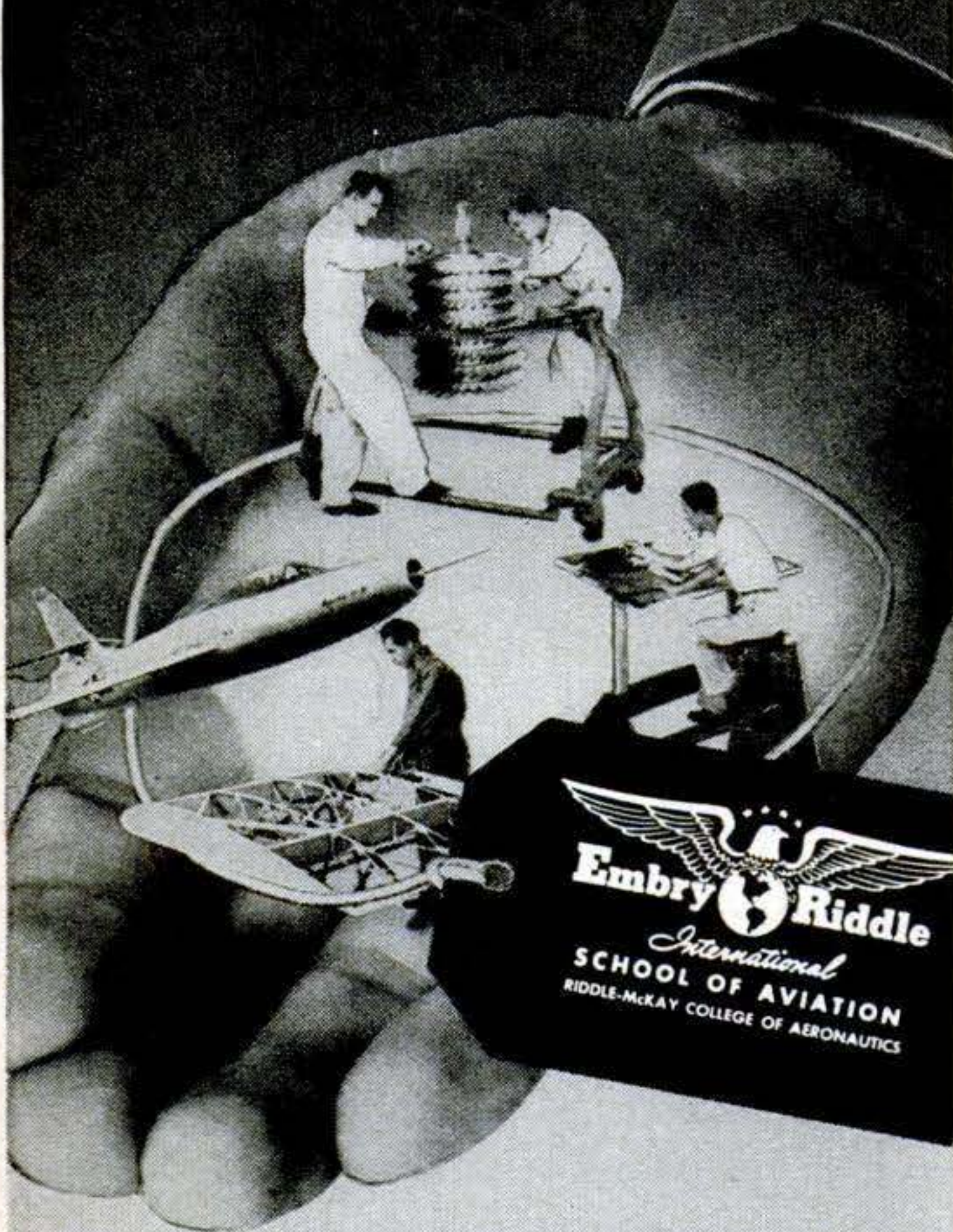

There's a bright future ahead for you in Aviation. In fact, no other career field today can possibly offer you so much opportunity. The aviation industry urgently needs men with skilled minds and hands to build, fly and maintain the giant aircraft of this great new Air Age.

The properly trained man climbs faster and higher in Aviation, just as in any other profession. That's why we say *your aviation success begins at Embry-Riddle*. For Embry-Riddle offers you the matchless advantage of knowledge and experience gained over a quarter-century of specialized aviation training.

In a few short months Embry-Riddle prepares you for engineering, master mechanic, flight or combined pilot and mechanic positions. All courses stress thorough, practical study including work on live aircraft in Embry-Riddle's airline-size hangars.

Enjoy Florida's unexcelled year-round climate, its wealth of aviation and recreational facilities. Live, work and play on Embry-Riddle's modern campus -- the most complete aviation school plant in America. Save time, earn good money faster...send coupon today for full information.

Dean of Enrollments - Dept. 93
Embry-Riddle School of Aviation
Miami 30, Florida

Please Print

NAME _____

ADDRESS _____

City _____

State _____ Age _____

I am interested in...

- A.&E. Mechanic
- Commercial Pilot
- Engineering
- A.&E. Combined Commercial Pilot
- Flying Mechanic
- Drafting & Design

Check One Veteran Non-Vet

TRAIN IN MIAMI--AIR CAPITAL OF THE WORLD

A compass needle, even though minute in power, is sensitive enough to point itself at any hidden conduit or even BX.

Is Mr. Strasser pulling your leg; or do they use very, very expensive non-magnetic conduit in Chile?

FRANK S. HALL

Terryville, Conn.

We'll let our Chilean correspondent, Mr. Strasser, answer for himself:

Mr. Hall's objections are perfectly legitimate--theoretically. But there are some "buts." Allow me, however, to tell you, first, what happened to my mother.

After her marriage, she wrote to her mother, telling her what a splendid provider her husband was: even for kitchen work, she reported, she wore silk dresses he had given her. To which my poor grandmother answered by lamenting that her son-in-law must be very poor if he was not able even to afford a cotton dress for his wife to wear while cooking.

The same thing happens in this country. We are very poor--in dollars and foreign currencies--and haven't got money to buy iron or steel for our conduit. But this country is one of the greatest producers of copper. Consequently, we try to employ that metal for all possible purposes. (During the last war we even made nails of copper.) And so in my house, recently built, all conduit is made from copper tubing. It gives me no trouble at all.

FEDERICO STRASSER

Santiago, Chile

Man Needs Rain Quick

Sir:

As a wheat farmer in this southwestern corner of Kansas, which is experiencing the driest weather on record, I read with extreme interest the article in your April issue entitled "Can We Make It Rain?"

With our once-promising wheat crop about dead, I am getting darn tired of gazing at heavily moisture-laden clouds that do not give us the needed rain. So I intend to try to make it rain in this locality.

I would, therefore, greatly appreciate your sending me sufficient information to enable me to construct a silver-iodide generator exactly like the one used by Project Cirrus in New Mexico.

HARRY B. TILLER

Satanta, Kansas

INVENTORS

If you believe that you have an invention, you should find out how to protect it. The first step is to have a search made of the prior pertinent U. S. patents. If a report on this search indicates that the invention appears patentable you can apply for a patent, and the specifications and claims should be prepared.

The firm of McMorrow, Berman & Davidson, with offices in Washington, D. C., is qualified to take the necessary steps for you. We can make a preliminary search on your invention, advise you whether we think it can be patented, and prepare your application for patent.

Unless you are fully familiar with the U. S. Patent Laws, we recommend that you engage the services of a Registered Patent Attorney to protect your interests. The patent laws are *your* laws. A patent gives you the right to prevent others from making, using or selling the invention claimed in your patent for a period of 17 years.

Use these patent laws for your protection. Investigate whether your invention can be patented. If you have what you believe to be an invention, we suggest that you have this firm make a search for you.

Send for a copy of our Patent Booklet entitled "How To Protect Your Invention," containing information about patent protection and patent procedure. Along with this we will also send you an "Invention Record" form, for your use in writing down and sketching details of your invention. We will mail them promptly. No obligation. They are yours for the asking.

McMORROW, BERMAN & DAVIDSON

Registered Patent Attorneys

PATENTS • COPYRIGHTS • PATENTS

142-C VICTOR BUILDING, WASHINGTON 1, D. C.

Which of these 2 one time WEAKLINGS PAID only a Few Cents to become an All-Around HE-MAN at Home?

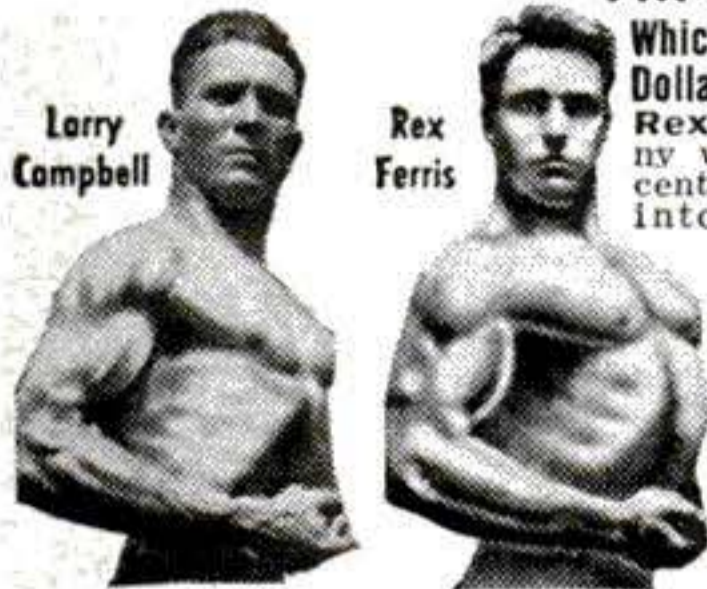

Which One Paid Hundreds Of Dollars To Train At My Side? Rex Ferris, was a skinny weakling, paid a few cents to start building into a Champion All Around He Man! Larry Campbell paid me hundreds of dollars to train at my side years ago. Start to become an All-Around He Man at home with these same secrets for only a few cents—like Rex Ferris did!

Amazing get-acquainted offer—YOURS for only **10c** INSTEAD OF \$1 FOR ALL 5 COURSES Plus FREE Photo Book!

Be a Winner at Anything YOU Tackle with Progressive Power—SPORTS! JOB! SCHOOL! FRIENDS!

Let's Go, Pal! I'll prove I can make YOU an

"ALL-AROUND" HE-MAN

FAST—OR NO COST! says George F. Jowett World's Greatest Body Builder

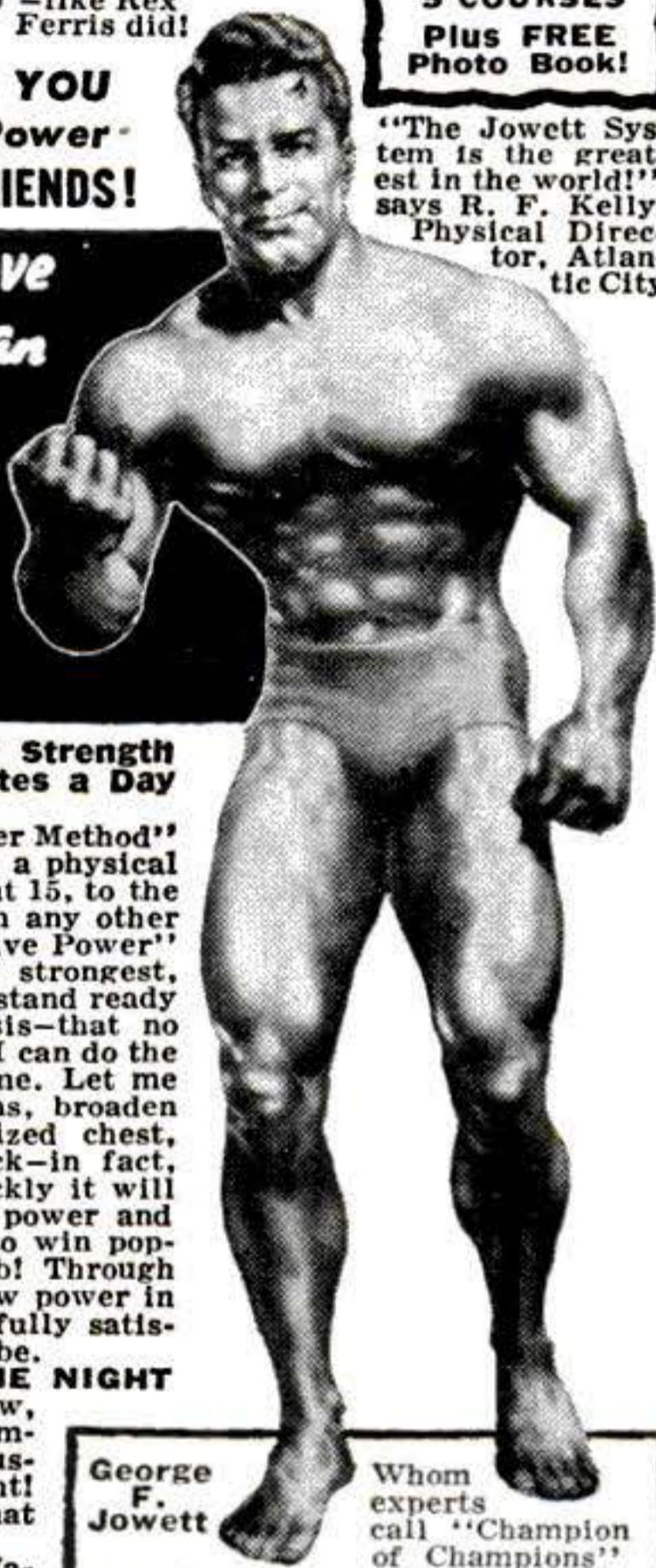

"The Jowett System is the greatest in the world!" says R. F. Kelly, Physical Director, Atlantic City

Enjoy My "Progressive Power" Strength Secrets! Give Me 10 Easy Minutes a Day—Without Strain!

I'll teach you the "Progressive Power Method" through which I rebuilt myself from a physical wreck the doctors condemned to die at 15, to the holder of more strength records than any other living athlete or teacher! "Progressive Power" has proven its ability to build the strongest, handsomest men in the world. And I stand ready to show you on a money back basis—that no matter how flabby or puny you are, I can do the same for you right in your own home. Let me prove I can add inches to your arms, broaden your shoulders, give you a man-sized chest, powerful legs and a Rock-like back—in fact, power pack your whole body so quickly it will amaze you! Yes, I'll jam you with power and confidence to master any situation—to win popularity—and to get ahead on the job! Through my proven secrets I bring to life new power in you inside and out, until YOU are fully satisfied you are the man you want to be.

PROVE IT TO YOURSELF IN ONE NIGHT

Send only 10c for my 5 easy-to-follow, picture-packed courses now in 1 complete volume "How to Become a Muscular He-Man." Try it for one night! Experience the thrilling strength that surges through your muscles. **10 DAY TRIAL!** Think of it—all 5 famous courses in one picture-packed muscle-building volume only 10c. You must actually FEEL results in ONE WEEK, or your money will be promptly re-funded!

George F. Jowett Whom experts call "Champion of Champions"

- World's wrestling and weight lifting champ at 17 and 19.
- World's Strongest Arms. • 4 times World's Perfect Body—plus other records.



FREE GIFT COUPON!



George F. Jowett Champion of Champions

Jowett Institute of Physical Culture Dept. PS-06
230 Fifth Avenue, New York 1, N. Y.
Dear George:—Please send by return mail, prepaid, FREE Jowett's Photo Book of Strong Men, plus all 5 Muscle Building Courses. 1. Molding a Mighty Chest. 2. Molding a Mighty Arm. 3. Molding a Mighty Grip. 4. Molding a Mighty Back. 5. Molding Mighty Legs—Now all in One Volume "How to Become a Muscular He-Man." Enclosed find 10c for postage and handling. No C.O.D.'s.

Name.....Age.....
Address.....
City..... Zone & State.....

Project Cirrus makes silver-iodide smoke with a specially designed blowtorch having a valve that squirts silver-iodide solution into the flame. There are other ways, too—charcoal, soaked in a solution of silver iodide in acetone and then burned, works quite well. However, amateur seeding operations don't often make rain, mainly because only an expert knows just when and how to do the job. Amateur seeding may also disrupt controlled scientific tests of this technique, since wind can carry the silver-iodide particles many hundreds of miles.

Utility vs. Eye Appeal

Sir:

It seems to me that the car designers have lost track of the prime function of an automobile—to provide a means of transportation. It's all right, I suppose, for the Paris dress salons to turn out merchandise with no other thought than eye appeal; but the cars now offered are loaded with supposed eye appeal at the expense of utility.

My first car, purchased in 1907, may have lacked some things now considered indispensable, but a mechanic could get at the works to fix them. If there had been any doors, they would have been designed solely as a means for getting into and out of the horseless carriage, instead of having to be a part of "flow lines".

It's time, I say, to call a halt to the senseless competition for spectacular lines and go back to planning cars for us common people who want to get places at a minimum of expense and a maximum of convenience.

W. P. SHEPHERD

Claremont, Calif.

Wanted: Old PSes

Sir:

I will deeply appreciate your publishing this request for back copies of POPULAR SCIENCE or any other magazine pertaining to hobbies. We here at Yokota Air Force Base feel we have the finest setup for hobbies of any field or camp in Japan. Besides shops for working in wood, leather, and plastics, and for building radios and repairing cameras, we have a model railroad layout worth several thousand dollars, and track for racing miniature cars.

S/Sgt. HENRY A. LUKE, 15234202
512th Recon. Sqd., A.P.O. 328,
Care of Postmaster, San Francisco

THESE MEN ARE GETTING PRACTICAL TRAINING

IN ELECTRICITY

On Real:



**A.C. and D.C. MOTORS
GENERATORS
SWITCHBOARDS
CONTROLLERS
WIRING JOBS
APPLIANCES
ELECTRONIC UNITS**

(Shown at left—Instructor demonstrating latest type of Test Unit for checking the efficiency of a Motor.)

AND RADIO-TELEVISION

On Real:

**TELEVISION SETS
RADIO RECEIVERS
F.M. (Frequency Modulation)
RECORD CHANGERS
AUTO RADIOS
AIRPLANE RADIOS
PUBLIC ADDRESS Systems**

(Right — Instructor explaining operation of 20-inch Cathode Ray tube used in Dumont Television Set.)



Just Like YOU Can Get in the Great SHOPS OF COYNE

Prepare NOW for a real future the quick, practical way. Come to the Great Shops of COYNE in Chicago. Largest and best equipped school of its kind—now celebrating our 51st Anniversary. GI approved. Finance plan for non-veterans. **Mail coupon.**

NOT "HOME-STUDY" COURSES! At Coyne you learn on real, full-size equipment. Trained instructors show you how, then you do typical jobs yourself. We don't teach by mail.

CLIP COUPON NOW for big new illustrated Coyne book on either ELECTRICITY or RADIO-TELEVISION or both. No obligation; no salesman will call. Get the facts now!

COYNE

**B. W. COOKE, Pres.
ELECTRICAL &
RADIO SCHOOL
500 S. Paulina St., Dept. A0-73H
Chicago 12, Ill.**



**Mail Coupon for
FREE BOOKS!**



B. W. COOKE, President
COYNE ELECTRICAL &
RADIO SCHOOL, Dept. A0-73H
500 S. Paulina St., Chicago 12, Ill.

Send FREE, the book checked below, and details of your training offer. This does not obligate me and no salesman will call.

ELECTRICITY RADIO-TELEVISION

NAME

ADDRESS

CITY.....STATE.....



NOW ANY AUTO REPAIR JOB CAN BE A "Push-Over" for You!

IN LESS TIME —
WITH LESS WORK —
AND MORE PROFITS!

Used by
U. S. Army
and Navy



**COVERS ANY CAR
BUILT SINCE 1935!**

Auburn	Kaiser
Austin	Lafayette
Bantam	La Salle
Buick	Lincoln
Cadillac	Mercury
Chevrolet	Nash
Chrysler	Oldsmobile
Cord	Packard
Crosley	Pierce
De Soto	Arrow
Dodge	Plymouth
Ford	Pontiac
Frazer	Reo
Graham	Studebaker
Hudson	Terraplane
Hupmobile	Willys

**Same FREE Offer On
MoToR's Truck and
Tractor Manual**

BRAND-NEW! Covers EVERY job on EVERY popular make gasoline truck, tractor made from 1936 thru 1949. FREE 7-Day Trial. Check proper box in coupon.



NOW, tackle anything from carburetor to rear end on ANY car built from 1935 thru 1950! Fix it quick, easy, right the FIRST time! Just look up make, model, and job in quick index of MoToR's brand-new 1950 Edition AUTO REPAIR MANUAL. Clear, illustrated instructions—you just can't go wrong! 7-DAY FREE TRIAL!

Earn More Money! Win Prestige!
Boiled down in one BIG handy 750-page book—the complete "dope" from 150 Official Factory Manuals. 200,000 service, repair, tune-up facts, 35,000 essential dimensions! Covers 741 car models. Includes all new automatic transmissions, GM Rochester carburetors. 2100 cut-away photos, diagrams, charts show what the clear text tells. Used by Army, Navy, Tech Schools, thousands of auto-repairmen. Makes every operation so easy, you'll tackle jobs you wouldn't think of doing before. You'll win added prestige, more money!

SEND NO MONEY

Mail coupon—without money! When book arrives—make it show you what it's got! Unless you agree it's the greatest time and work saver you've ever seen—return it in 7 days, pay nothing. Mail coupon NOW! MoToR Book Department, Desk 2G, 250 West 55th Street, New York 19, N. Y.

GOLD BOND

BUY AT WHOLESALE

WHOLESALE GUARANTEED
EXCEPTIONALLY GOOD
USED TIRES DIRECT TO YOU
10% discount on 2 or more tires if you send this ad with order
TUBE DELIVERED WITH TIRE AT NO EXTRA COST FOR 15" AND 16" PASSENGER TIRES

Safe—Our tires used on school buses and ambulances
EXCEPTIONALLY GOOD TREAD — NO RECAPS
GUARANTEED FOR 24 MONTHS

600-16	\$5.49	700-16	\$6.97	525-18	\$6.69	750-20(10)	\$15.98
600-16 (6 ply)	6.49	650-15	5.79	600-20	9.89	825-20	16.98
650-16	5.49	700-15	5.79	650-20	9.98	900-20	17.79
650-16 (6 ply)	6.97	550-17	7.79	750-16	12.50	1000-20	18.99
600-16—6 ply Military—Mud and Snow Tire.....							\$6.37

ALL GOOD TIRES
GUARANTEED FOR 12 MONTHS

600-16	\$3.50	550-17	\$5.69	700-20 (8)	\$11.79	825-15 (14)	\$16.98
650-16	3.89	750-16	8.40	700-20 (10)	13.98	825-20	11.19
650-15	3.89	600-20	7.98	750-20 (8)	11.79	900-20	11.89
700-15	3.98	650-20	7.99	750-15 (10)	12.79	1000-20	12.89

GOLD BOND SPECIAL—750-20—8 PLY MILITARY TIRES

Will fit 650 x 20 700 x 20 (8 & 10 ply) 34 x 7 (8 & 10 ply)

Special	\$10.49	Guaranteed 12 months	
Superior Quality	12.98	Guaranteed 18 months	
Gold Bond Finest	14.98	Guaranteed 24 months	
900 x 16 Special	9.03	900 x 16 extra	11.19

Send check or money order with this ad

GOLD BOND TIRE CO., Dept. PS 24
512 NORTH 1st ST., RICHMOND, VA.

"A gold bond written guarantee with every tire"

LEARN IN SPARE TIME— CARTOONING

by Easy PICTURE CHART METHOD!
Same Simplified Method that has helped train creators of "Steve Canyon," "Winnie Winkle," "Out Our Way," "Secret Agent X-9," "The Neighbors," "Reg'lar Fellers," "Strange As it Seems," and many others. Send 10c for Picture Chart (to test your ability), and full details. (State age.)
LONDON SCHOOL OF CARTOONING
5026 Cleve. Transit Bldg., Cleveland 14, Ohio



LEARN TO HYPNOTIZE



Yes, anyone. Modern speed hypnotism. Methods revealed. You are shown exactly what to say and do. Many interesting experiments. Self-hypnosis is fully explained. Amazing results. Detailed hypnotic tests given. Learn this exciting fascinating art. Hold your friends spellbound. Have fun.

Send for **"HYPNOTISM REVEALED"** \$1

12" Hypnotism Record Inducing Self-Hypnosis plus Individual & Group-Hypnotism \$5

MELVIN POWERS, Professional Hypnotist, 1324 Wilshire, Dept. 68, Hollywood 17, Calif.

LEARN TO SERVICE AND REPAIR ELECTRIC APPLIANCES

Get a Good Job—Run Your Own Business

Be the man who knows how to service and make quick repairs on washing machines, vacuum cleaners, heaters, toasters, stokers and household motors and gadgets of all kinds. Get into this pleasant, easy and good pay work. Get the sensational new book—Electric Appliance Repair and Servicing.

An investment of only \$3.00 will positively get you started in this vital field in a good-pay job or help you build up a profitable business of your own. Run it from your home. No starting capital needed. No experience in electricity required. The book explains how to diagnose and locate trouble and how to fix it. 302 pages. 188 how-to-do-it illustrations.



MONEY BACK IF NOT SATISFIED

Clip this ad and mail with only \$3.00, currency, check or M. O. or we will send C.O.D. Use the book for 5 days. See how easily you can make it pay for itself hundreds of times over. Then if you are not fully satisfied—send it back and we will refund your money quick. Rush order today. Get started at once.

DRAKE & CO., Dept. 5-A, 117 Green Bay Road, Wilmette, Ill.

MAIL COUPON NOW FOR 7-DAY FREE TRIAL

MoToR BOOK DEPT.

Desk 2G, 250 W. 55th St., New York 19, N. Y.

Rush to me at once (check box opposite book you want):

MoToR's New AUTO REPAIR MANUAL. If O.K., I will remit \$1 in 7 days (plus 35c delivery charges). \$2 monthly for 2 months and a final payment of 95c one month after that. Otherwise I will return the book postpaid in 7 days. (Foreign price, remit \$8 cash with order.)

MoToR's New TRUCK & TRACTOR REPAIR MANUAL. If O.K., I will remit \$2 in 7 days, and \$2 monthly for 3 months, plus 35c delivery charges with final payment. Otherwise I will return book postpaid in 7 days. (Foreign price, remit \$10 cash with order.)

Print Name.....Age

Address

CityState

Check box and save 35c delivery charge by enclosing WITH coupon entire payment of \$5.95 for Auto Repair Manual (or \$8 for Truck and Tractor Repair Manual.) Same 7-day return-refund privilege applies.



Get
Into

TELEVISION, RADIO ELECTRONICS

Master ALL Phases

Get Complete Training. You Receive and Keep All Tubes, Equipment, Parts and Lessons. No Extra Charges.

**GOOD PAY
and Unlimited Opportunities
in JOBS LIKE THESE:**

Business of Your Own
Radio Manufacturing, Sales, Service
Broadcasting Telecasting
Television Manufacturing,
Sales, Service
Laboratories: Installation, Maintenance of Electronic Equipment, Electrolysis, Call Systems
Garages: Auto Radio Sales, Service Sound Systems and Telephone Companies; Oil Well and Drilling Companies; Engineering Firms
Theatre Sound Systems Police Radio
And scores of other good jobs
in many related fields

**YOU CONDUCT MANY
EXPERIMENTS LIKE THESE!**

Checking action of condensers
Experiments with AF and RF Amplifiers
Experiments with resonance
Producing beat frequencies
Calibrating oscillators
Experiments with diode, grid-bias, grid-leak and infinite impedance detectors
Practical experience in receiver trouble shooting
Application of visual tester in checking parts and circuits
Experiments with audio oscillators
Advanced trouble-shooting
... and many, many others

Complete Training by Practical Resident Trade School, Est. 1905

The same highly trained faculty, instruction materials and methods used here in our large, modern resident school, are adapted to your training in your own home. Shop Method Home Training has been proved by hundreds of successful graduates.

**Both Resident and Home Study
Courses Offered**

YOU LEARN BY DOING

You receive special laboratory experiment lessons to show you how to build with your own hands various experimental units such as those shown at left, and how to conduct many tests.

You will find all lessons easy to understand because they are illustrated throughout with clear diagrams and step-by-step examples that you work out yourself. Every piece of the equipment and complete lesson material we send you is yours to keep and enjoy, including the multitester, experimental equipment, all parts of the Superheterodyne, tube manual, radio dictionary, and complete, modern Television texts. All parts are standard equipment.

Shop Method Home Training . . . Earn While You Learn

With our practical resident Shop Method Home Training, you study in your spare time. You receive Spare Time Work Lessons, which show you how to earn while you learn. Service neighbors' radios and TV receivers, appliances, etc., for extra money and experience. Many National students pay all or part of their training with spare time earnings!

DON'T DELAY! The Radio-Television Industry needs trained men NOW!

**APPROVED
FOR
VETERANS!**

Check coupon below!

For quick action,
mail coupon
today and we'll
rush you full information.

Free!

NEW, ILLUSTRATED
OPPORTUNITY
BOOK AND SAMPLE
LESSON SHOW YOU
HOW WE TRAIN
YOU . . . SEND FOR
THEM TODAY! NO
COST. NO
OBLIGATION.



**YOU RECEIVE THIS
PROFESSIONAL MULTITESTER
YOU BUILD ALL THESE AND
MANY OTHER UNITS WITH
PARTS WE SEND YOU!**

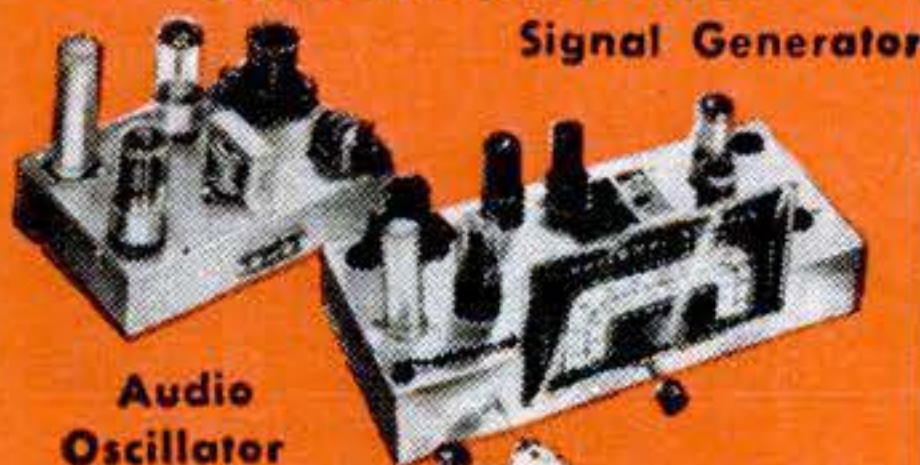

Signal Generator

Audio Oscillator

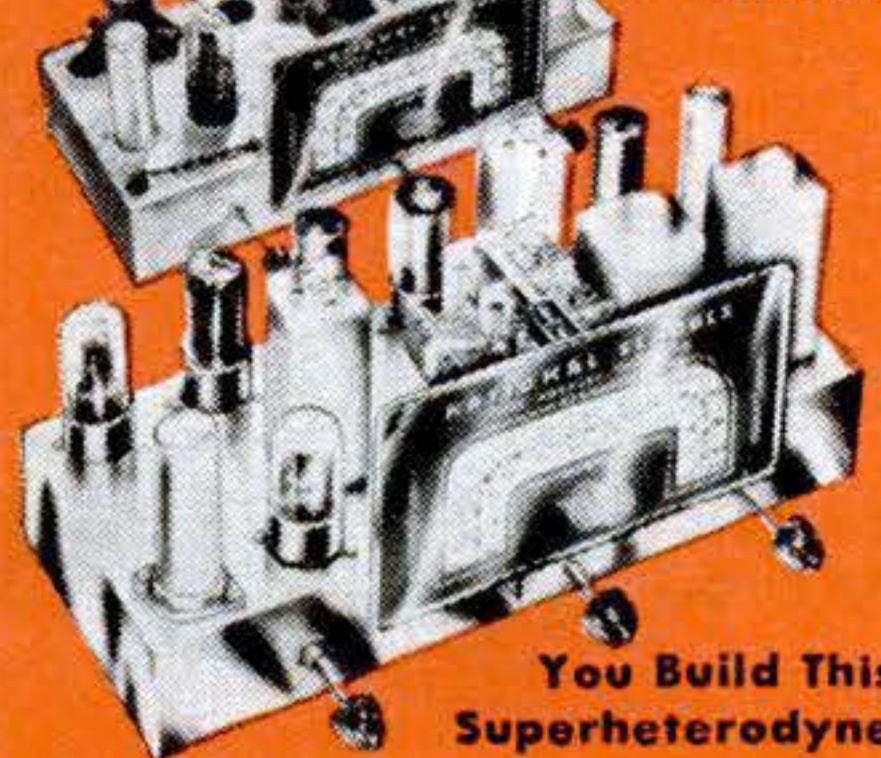

T.R.F. Receiver

You Build This
Superheterodyne

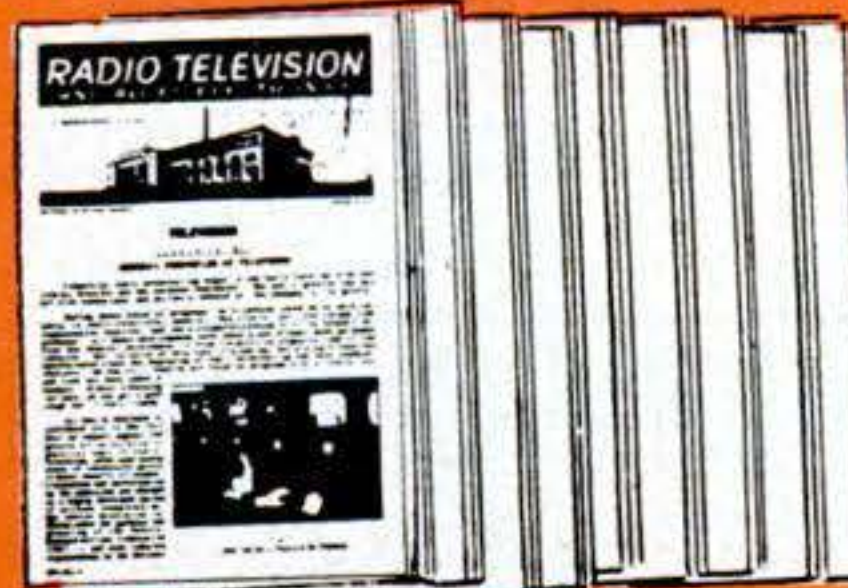

**You Receive a Special Series
of Modern Lessons in TELE-
VISION, all a part of your
course: you master all phases.**

NATIONAL SCHOOLS

LOS ANGELES 37, CALIF. • EST. 1905

FIND OUT NOW . . . MAIL COUPON TODAY

National Schools, Dept. PS-6
4000 South Figueroa Street
Los Angeles 37, California

Send me your FREE book "Your Future in Radio" and the sample lesson of your course. I understand no salesman will call on me.

NAME..... AGE.....

ADDRESS

CITY.....ZONE.....STATE.....

Check here if Veteran of World War II

Mail in envelope
or paste on
penny postal.



THOUGHTS HAVE WINGS

You Can Influence Others With Your Thinking

TRY IT SOME TIME. Concentrate intently upon another person seated in a room with you, without his noticing it. Observe him gradually become restless and finally turn and look in your direction. Simple—yet it is a *positive demonstration* that thought generates a mental energy which can be projected from your mind to the consciousness of another. Do you realize how much of your success and happiness in life depend upon your influencing others? Is it not important to you to have others understand your point of view—to be receptive to your proposals?

How many times have you wished there were some way you could impress another favorably—*get across to him or her your ideas?* That thoughts can be transmitted, received, and understood by others is *now scientifically demonstrable.*

This FREE Book Points the Way

The tales of miraculous accomplishments of mind by the ancients are now known to be fact—not fable. The method whereby these things can be **INTENTIONALLY**, not accidentally, accomplished has been a secret long cherished by the Rosicrucians—one of the schools of ancient wisdom existing throughout the world. Write for the free copy of the fascinating sealed book, "THE MASTERY OF LIFE," which explains how you may receive this unique wisdom and benefit by its application. Address: Scribe S.W.Z.

The ROSICRUCIANS
San Jose, (AMORC) California

USE THIS COUPON

Scribe S.W.Z.
The Rosicrucians
San Jose, California

I am sincerely interested in an intelligent method of attaining a mastership of life. Send me without obligation, your FREE Book which explains how I may receive and use your age-old method.

Name.....
Address.....
City.....

BIG BUYS IN WAR SURPLUS!

RUBBER BOATS

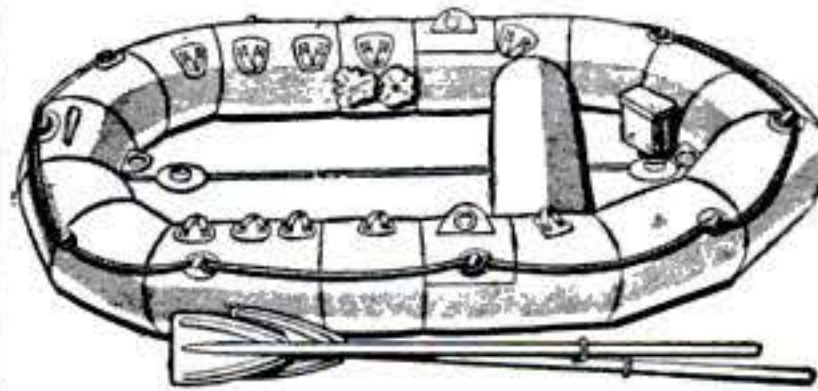

Brand new! Navy deluxe. Complete with pumps, oars & oar locks (except 1-man boats). Govt. cost—\$200. Will last for years. 1 MAN SIZE, 10 lbs. **\$14.95**

2 man size (25 lbs.)
5 man (35 lbs.) 7 man
(50 lbs.- only **\$39.95**
each F.O.B. Portland.
New 3-pc. sectional
aluminum oars. Will float.....Only **\$3.95** pair pp.

NAVY PHONES—VOICE POWERED

Brand new. No batteries needed. Simple hook up—splice 2 wires & talk. Mfg. by RCA. Over 1/2 mi. range. Each set has headset, adjus. transmitter, chest plate, switch (or mike) PLUS 24' of cable. No extras. Govt. cost —\$99 pr.—2 phones complete pp. **\$13.95**

SLEEPING BAGS



Brand new. 6 1/2' long. 3 pc.—sheet, wool zipper bag & water repellent cover. Govt. cost—\$15. Weight, 5 lbs. F.O.B. Portland **\$7.95**

NAVY MAE WEST LIFE JACKETS

Brand new. Pneumatic type. Inflate by mouth or sparklette bottle charge. Perfect for swimmers, fishermen, boat owners. Be safe this summer. Add 25c postage..... **\$2.49**

10 sparklette charges, 75c pp.

MACHETTE KNIVES. Brand new. Army. With sheath. 18" blade. Only **\$1.95** pp.

SEND CASH, CHECK, M.O. 25% DEP. ON C.O.D.'s

GRAND-HAWTHORNE SURPLUS

1439 SE Grand

Dept. S6

Portland, Oregon

Learn ACCOUNTING BOOKKEEPING

This nationally renowned school has demand for graduates in good salary positions thru Nationwide recognition and placement service. Write Department PSQ today for Big 32 page Success Book to be sent to you **FREE**

Hills BUSINESS UNIVERSITY AND
EXTENSION SCHOOL
619 W. MAIN ST. OKLAHOMA CITY 2, OKLAHOMA

REAL ESTATE BE A BROKER

PAYS BIG! SEND FOR FREE, BIG, ILLUSTRATED CATALOG NOW! No obligation. Graduates report making substantial incomes. Start and run **your own business quickly.** Men, women of all ages, learn easily. Course covers Sales, Property Management, Appraising, Loans, Mortgages, and related subjects. **STUDY AT HOME** or in our classrooms in big cities. Diploma awarded. G.I. approved. Nationally known.

WEAVER SCHOOL OF REAL ESTATE (Est. 1936)

15 E. Pershing Road, Dept. PS, Kansas City, Mo.

FREE
BOOK
TELLS
HOW

MICROSCOPE 20X - 40X - 60X

High Power

Pocket Type



This handy Pocket Microscope instantly adjusts from 20 to 60 Power. Highly ground and Polished lenses set into Fine Chromium Steel finished in black. Excellent for Hobbyists, Stamp Collectors, Textile Workers, Craftsmen wherever precision work is required. Wonderful Gift item. **MARDO SALES CO.**, 480 Lexington Ave., Dept. MPS, New York 17, N. Y.

Be an AUTO MACHINIST

Draw Top Pay—No Job Worries

Be a high-paid auto machinist! Specialize—make more money New FREE booklet tells how to prepare for good jobs as an auto machinist or auto mechanic. G. I. Approved School of Auto Mechanics.

FREE: Write for your FREE booklet today

AMERICAN TRADE SCHOOLS

2407B McGee Street, Kansas City, Mo.



TELEVISION

**RADIO and
ELECTRONICS
OFFER YOU**

**REAL MONEY and REAL
JOB OPPORTUNITIES!**

**OPTIONAL
FEATURE**



**BUILD AND KEEP FULL-VIEW 16-INCH
RECTANGULAR "BLACK" PICTURE TUBE
TELEVISION RECEIVER**

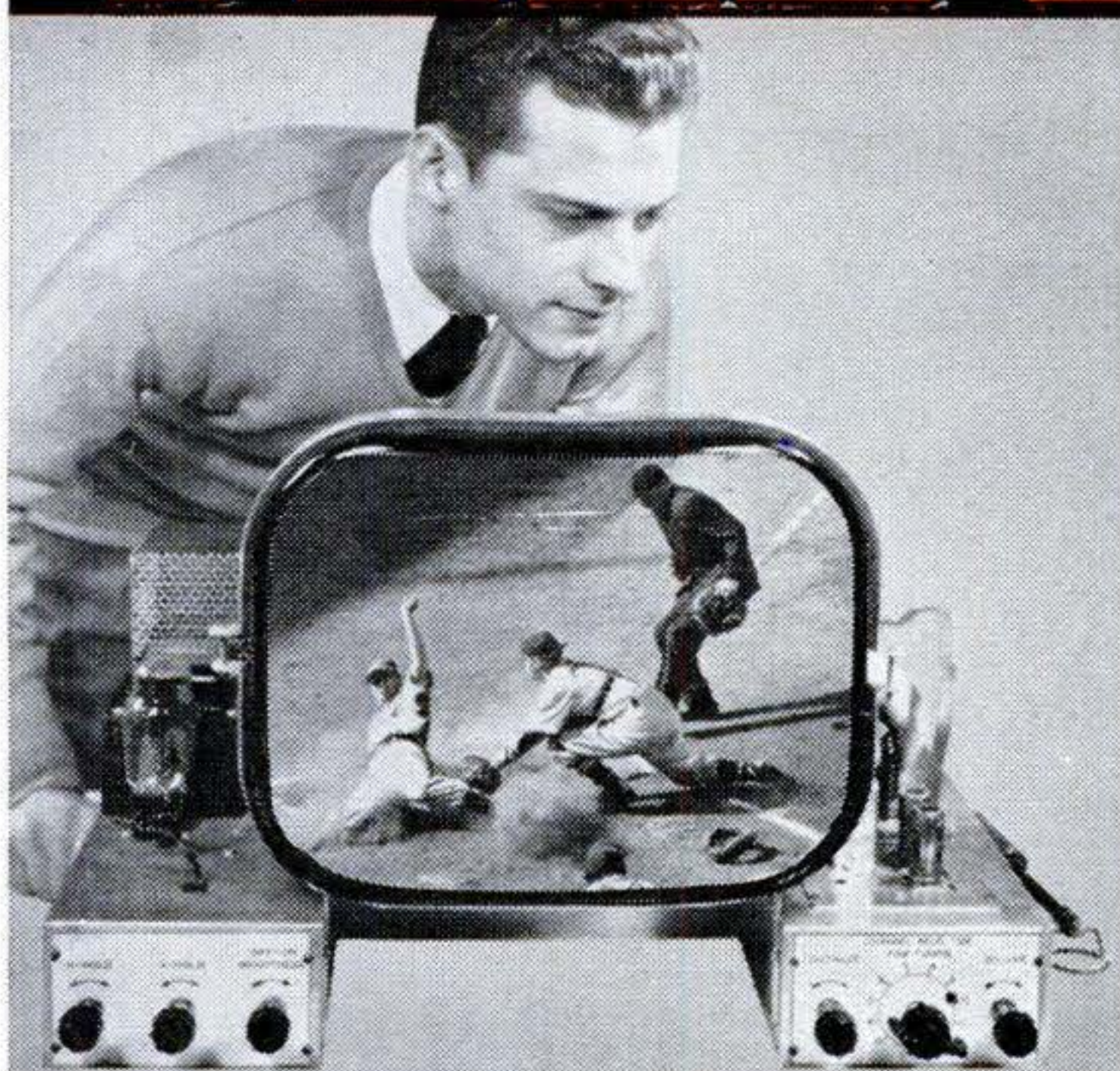

**PREPARE AT HOME . . . Become a
TELEVISION · RADIO · ELECTRONICS
TECHNICIAN! *No Previous Experience Necessary***

Here is everything you need to prepare you at home for FASCINATING WORK, GOOD MONEY and a THRILLING FUTURE in one of America's most promising fields. This includes the opportunity to build and keep the top-quality 16 inch rectangular picture tube television receiver shown above or a 10 or 12½ inch ROUND picture tube set . . . if you choose. No matter which tube you select, you will get bright, sharp, steady pictures. This is an optional feature—available at slight additional cost when you complete your training described below. Get the complete facts. See how D.T.I.'s wonderfully practical method meets industry's needs. No previous experience needed. Mail coupon today!

16 Big Shipments of Parts — Plus Lessons

Work over 300 electronic experiments and projects from 16 big shipments of parts. This includes building and keeping all test equipment and radio set shown at left side of page. Modern easy-to-read lessons with handy fold-out diagrams simplifies your entire training.

You Also Use Home Movies.

D.T.I., alone, includes the modern, visual training aid . . . MOVIES to help you learn faster, easier at home. See electrons on the march and other fascinating "hidden action" — a remarkable home training advantage that speeds your progress.

EMPLOYMENT SERVICE

When you complete your training, our effective Employment Service helps you get started toward a real future in Television-Radio-Electronics.

Modern Laboratories

If you prefer, you can get ALL your preparation in our new, Chicago training laboratories . . . one of the finest of its kind. Ample instructors . . . modern equipment. Write for details!

6 Tube
Radio
Receiver.

**LEARN-BY-
READING**



**LEARN-BY-
SEEING**

**LEARN-BY-
DOING**



DeForest's Training, Inc.

CHICAGO 14, ILLINOIS
A DeVry Institution

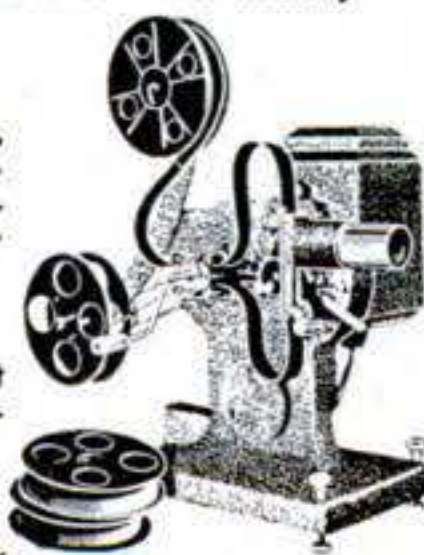

MAIL THIS COUPON TODAY!

DeFOREST'S TRAINING, INC. PS-G-6
2533 N. Ashland Ave.,
Chicago 14, Illinois

If under 16, check here
for special information.

Without obligation, give me complete facts showing how I
may make my start in Television-Radio-Electronics.

Name _____ Age _____

Street _____ Apt. _____

City _____ Zone _____ State _____

INVENTORS

If you consider your invention to be something of importance — if you have invented any new and useful art, machine, manufacture or composition of matter or improvement thereof — you are advised to protect your invention by applying for a U. S. patent.

This firm is registered to practice before the U. S. Patent Office and is available to assist in the preparation and prosecution of your patent application.

The "Evidence of Invention" form mentioned below is offered as a convenience to you in making your disclosure to us for search purposes.

You should date and sign your disclosure and have it witnessed by two or more persons who are capable of understanding your invention.

Your disclosure should be mailed to us together with a letter authorizing us to conduct a preliminary search among previously granted U. S. patents for similar types of invention.

We then make this search and prepare a report of the probable patentability of your invention. If such report is favorable, we recommend the further course for you to take.

The "Evidence of Invention" form and booklet are suggested as conveniences to you and us in starting action on your invention.

VICTOR J. EVANS & Co. *Merlin M. Evans*
REGISTERED PATENT ATTORNEY

540-G MERLIN BUILDING, WASHINGTON 6, D. C.

PATENTS

COPYRIGHTS

We shall be glad to send you promptly and without obligation, an instructive booklet, "Patent Protection for Inventors", which was prepared to give inventors detailed information and steps to take toward patent protection—also our convenient "Evidence of Invention" form. Use address Victor J. Evans & Co., 540-G Merlin Building, Washington 6, D. C.

PORTABLE
PLASTIC
INFLATABLE

**WADING
POOLS**



- a. Small Fry Size, 30"x30"x6".....\$3.95
- b. Junior Size, 38"x38"x6".....\$4.95
- c. Senior Size, 44"x44"x9".....\$7.95

The old swimming hole was never like this! With these inflatable pools you can be sure of fresh, clean water, right from your tap and have your own swimming pool on your front lawn. Safe, sanitary, no crowds, no danger, solves your hot-weather problems. Deflates to handbag size. Comes in 3 sizes (see above). Send no money! C.O.D. you pay postage. Remit with order, we pay postage.

NOVELTY MART, 59 E. 8th St., N.Y. 3, N.Y. Dept. M96

LEARN MOVIE PROJECTION THEATRE MANAGEMENT

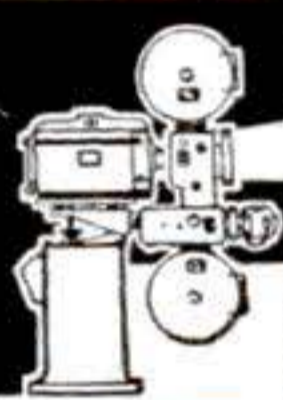

The Motion Picture Theatre Business offers big opportunities for trained men. Get into a fascinating field with a promising future. Train at home in spare time. Free Catalog. Established 22 years.

THEATRE INSTITUTE, 385 Washington St., Elmira, New York

SHORTHAND IN

Famous Speedwriting system. No signs; no symbols; no machines. Uses ABC's. Easy to learn, write, transcribe. Low cost. 100,000 taught by mail. Also typing. 27th Yr. Write for free booklet to:

Speedwriting
Dept. 2606-A
55 W. 42 St., N. Y. 18, N. Y.

6
WEEKS
AT HOME

LEARN

CABINETMAKING

Get into a well paying industry—or set up independent shop—after completing 18 months course. Competent instructors. Well-equipped shops. Job placements service. Win with wood-working! Write NOW for free booklet.

WOODWORKING, INC.

403 McClelland Ave.

Nashville 11, Tenn.

LEARN AT HOME TO MOUNT BIRDS



Animals, Heads, Fishes, Pets; to TAN. Be a Taxidermist. Profit and FUN.

Hunters, save your valuable TROPHIES. Mount ducks, squirrels, everything. Learn to TAN for leather and furs. Wonderful HOBBY Have a HOME MUSEUM.—BIG PROFITS mounting for others. INVESTIGATE NOW.

FREE BOOK With 100 fine game pictures. NOW absolutely FREE. Write TODAY.

Send Postal TODAY for FREE BOOK. State AGE. N. W. SCHOOL OF TAXIDERM, Dept. 2606, Omaha, Neb.



There isn't much difference . . .
 between a swing
 and a swat!



THREE inches higher and that powerful swing would have sent the ball out of the park.

And that's often about the same degree of difference between the fellow who *gets ahead* and the fellow who "gets along." It just takes a little extra — and that little extra is *training*.

I. C. S. takes average men and fits them for *above average* wages. It does so by careful, thorough, home instruc-

tion. You learn while you earn, develop confidence along with ability. I. C. S. receives more than 1500 letters a year from its students reporting salary increases and promotions.

This success-proved method of training can be yours. The first step is to mark and mail the coupon. It's a simple step, yet one that can change your entire future. Why not send for the facts *today*.

INTERNATIONAL CORRESPONDENCE SCHOOLS

APPROVED
 under the
 G.I. BILL

BOX 7656-M, SCRANTON 9, PENNA.

Without cost or obligation, please send me full particulars about the course BEFORE which I have marked X:

- | | | | |
|--|--|---|---|
| <p>Business and Academic Courses</p> <ul style="list-style-type: none"> <input type="checkbox"/> Accounting <input type="checkbox"/> App. Psychology <input type="checkbox"/> Business Administration <input type="checkbox"/> Bus. Correspondence <input type="checkbox"/> Certified Public Accounting <input type="checkbox"/> Commercial <input type="checkbox"/> Commercial Art <input type="checkbox"/> Cost Accounting <input type="checkbox"/> Federal Tax <input type="checkbox"/> First Year College <input type="checkbox"/> Foremanship <input type="checkbox"/> Good English <input type="checkbox"/> Higher Mathematics <input type="checkbox"/> Industrial Supervision <input type="checkbox"/> Motor Traffic <input type="checkbox"/> Retailing <input type="checkbox"/> Salesmanship <input type="checkbox"/> Sign Lettering <input type="checkbox"/> Spanish <input type="checkbox"/> Advertising <input type="checkbox"/> Bookkeeping <input type="checkbox"/> Bus. Law <input type="checkbox"/> Bus. Administration <input type="checkbox"/> French <input type="checkbox"/> High School <input type="checkbox"/> Illustration <input type="checkbox"/> Postal Civil Service <input type="checkbox"/> Retail Bus. Management <input type="checkbox"/> Secretarial <input type="checkbox"/> Stenography <input type="checkbox"/> Traffic Management <p>Air Conditioning and Plumbing Courses</p> <ul style="list-style-type: none"> <input type="checkbox"/> Air Conditioning <input type="checkbox"/> Heating <input type="checkbox"/> Refrigeration <input type="checkbox"/> Plumbing <input type="checkbox"/> Steam Fitting | <p>Chemical Courses</p> <ul style="list-style-type: none"> <input type="checkbox"/> Chemical Engineering <input type="checkbox"/> Chemistry, Analytical <input type="checkbox"/> Chemistry, Industrial <input type="checkbox"/> Chemistry, Mfg. Iron & Steel <input type="checkbox"/> Petroleum Refining <input type="checkbox"/> Pulp and Paper Making <input type="checkbox"/> Plastics <p>Civil Engineering, Architectural and Mining Courses</p> <ul style="list-style-type: none"> <input type="checkbox"/> Architecture <input type="checkbox"/> Architectural Drafting <input type="checkbox"/> Building Estimating <input type="checkbox"/> Civil Engineering <input type="checkbox"/> Coal Mining <input type="checkbox"/> Contracting and Building <input type="checkbox"/> Highway Engineering <input type="checkbox"/> Lumber Dealer <input type="checkbox"/> Reading Structural Blueprints <input type="checkbox"/> Sanitary Engineering <input type="checkbox"/> Structural Drafting <input type="checkbox"/> Structural Engineering <input type="checkbox"/> Surveying and Mapping <p>Communications Courses</p> <ul style="list-style-type: none"> <input type="checkbox"/> Electronics <input type="checkbox"/> Prac. FM and Television <input type="checkbox"/> Prac. Telephony <input type="checkbox"/> Radio, General <input type="checkbox"/> Telegraph Engineering <input type="checkbox"/> Radio Operating <input type="checkbox"/> Radio Servicing | <p>Electrical Courses</p> <ul style="list-style-type: none"> <input type="checkbox"/> Electrical Drafting <input type="checkbox"/> Electrical Engineering <input type="checkbox"/> Electric Light and Power <input type="checkbox"/> Lighting Technician <input type="checkbox"/> Practical Electrician <input type="checkbox"/> Power House Electric <input type="checkbox"/> Ship Electrician <p>Internal Combustion Engines Courses</p> <ul style="list-style-type: none"> <input type="checkbox"/> Auto Technician <input type="checkbox"/> Diesel-Electric <input type="checkbox"/> Diesel Engines <input type="checkbox"/> Aviation <input type="checkbox"/> Gas Engines <p>Mechanical Courses</p> <ul style="list-style-type: none"> <input type="checkbox"/> Aeronautical Engineer's, Jr. <input type="checkbox"/> Aircraft Drafting <input type="checkbox"/> Forging <input type="checkbox"/> Heat Treatment of Metals <input type="checkbox"/> Industrial Engineering <input type="checkbox"/> Industrial Instrumentation <input type="checkbox"/> Industrial Metallurgy <input type="checkbox"/> Machine Shop <input type="checkbox"/> Machine Shop Inspection <input type="checkbox"/> Mechanical Drafting <input type="checkbox"/> Mechanical Engineering <input type="checkbox"/> Flight Engineer <input type="checkbox"/> Foundry Work | <ul style="list-style-type: none"> <input type="checkbox"/> Mold-Loft Work <input type="checkbox"/> Patternmaking—Wood, Metal <input type="checkbox"/> Reading Shop Blueprints <input type="checkbox"/> Sheet-Metal Drafting <input type="checkbox"/> Sheet-Metal Worker <input type="checkbox"/> Ship Drafting <input type="checkbox"/> Ship Fitting <input type="checkbox"/> Tool Designing <input type="checkbox"/> Toolmaking <input type="checkbox"/> Welding Engineering <input type="checkbox"/> Welding—Gas and Electric <p>Railroad Courses</p> <ul style="list-style-type: none"> <input type="checkbox"/> Air Brake <input type="checkbox"/> Diesel Locomotive <input type="checkbox"/> Locomotive Engineer <input type="checkbox"/> Locomotive Fireman <input type="checkbox"/> Locomotive Machinist <input type="checkbox"/> Railroad Section Foreman <input type="checkbox"/> Steam and Diesel Loco. Eng. <input type="checkbox"/> Car Inspector <p>Stationary Engineering Courses</p> <ul style="list-style-type: none"> <input type="checkbox"/> Boilermaking <input type="checkbox"/> Combust. Engrg. <input type="checkbox"/> Marine Engineering <input type="checkbox"/> Power Plant Engr. <p>Textile Courses</p> <ul style="list-style-type: none"> <input type="checkbox"/> Cotton Manufacturing <input type="checkbox"/> Rayon Weaving <input type="checkbox"/> Woolen Manufacturing <input type="checkbox"/> Engine Running <input type="checkbox"/> Steam Engineer <input type="checkbox"/> Loom Fixing <input type="checkbox"/> Textile Designing |
|--|--|---|---|

Name _____ Age _____ Home Address _____

City _____ State _____ Working Hours _____ A.M. to _____ P.M.

Present Position _____ Employed by _____

Length of Service in World War II _____ Enrollment under G.I. Bill approved for World War II Veterans. Special tuition rates to members of the Armed Forces.

Canadian residents send coupon to International Correspondence Schools Canadian, Ltd., Montreal, Canada.

AUDELS Carpenters and Builders Guides 4 vols. \$6



Inside Trade Information for Carpenters, Builders, Joiners, Building Mechanics and all Woodworkers. These Guides give you the short-cut instructions that you want—including new methods, ideas, solutions, plans, systems and money saving suggestions. An easy progressive course for the apprentice and student. A practical daily helper and Quick Reference for the master worker. Carpenters everywhere are using these Guides as a Helping Hand to Easier Work, Better Work and Better Pay. To get this assistance for yourself, simply fill in and mail **FREE COUPON** below.

Inside Trade Information On:

How to use the steel square—How to file and set saws—How to build furniture—How to use a mitre box—How to use the chalk line—How to use rules and scales—How to make joints—Carpenters arithmetic—Solving mensuration problems—Estimating strength of timbers—How to set girders and sills—How to frame houses and roofs—How to estimate costs—How to build houses, barns, garages, bungalows, etc.—How to read and draw plans—Drawing up specifications—How to excavate—How to use settings 12, 13 and 17 on the steel square—How to build hoists and scaffolds—skylights—How to build stairs—How to put on interior trim—How to hang doors—How to lath—lay floors—How to paint.



Step up your own skill with the facts and figures of your trade. Audel's Mechanics Guides contain Practical Inside Trade Information in a handy form, Fully illustrated and Easy to Understand. Highly Endorsed. Check the book you want for **7 DAYS FREE EXAMINATION**. Send No Money, Nothing to pay Postman.

CUT HERE

MAIL ORDER



AUDEL, Publishers, 49 W. 23 St., NEW YORK 10, N. Y.

Please send me postpaid for **FREE EXAMINATION** books marked (X) below. If I decide to keep them I agree to mail \$1 in 7 Days on each book or set ordered and further mail \$1 monthly on each book or set until I have paid price, otherwise I will return them.

Check NOW!

You Can Look Over Any Guide In Your Own Home

Start the Easy Payments If Satisfied

MAIL THIS TODAY

- | | |
|---|-----|
| <input type="checkbox"/> CARPENTERS & Builders Guides (4 Book Set) | \$6 |
| <input type="checkbox"/> MASONS & Builders Guides (4 Book Set) | 6 |
| <input type="checkbox"/> PLUMBERS & Steamfitters Guides (4 Book Set) | 6 |
| <input type="checkbox"/> OIL BURNER GUIDE, 384 Pages | 1 |
| <input type="checkbox"/> HOUSE HEATING GUIDE, 1000 Pages | 4 |
| <input type="checkbox"/> PAINTERS & DECORATORS MANUAL, 450 Pgs. | 2 |
| <input type="checkbox"/> BLUE PRINT READING, 416 Pages | 2 |
| <input type="checkbox"/> REFRIGERATION & Air Conditioning, 1280 Pgs. | 4 |
| <input type="checkbox"/> SHEET METAL WORKERS Handy Book, 388 Pgs. | 1 |
| <input type="checkbox"/> SHEET METAL PATTERN LAYOUTS, 1100 Pgs. | 4 |
| <input type="checkbox"/> AIRCRAFT WORKER, 240 Pages | 1 |
| <input type="checkbox"/> GARDENERS & GROWERS Guides (4 Book Set) | 6 |
| <input type="checkbox"/> AUTO MECHANICS GUIDE | 4 |
| <input type="checkbox"/> DIESEL ENGINE MANUAL, 400 Pages | 2 |
| <input type="checkbox"/> WELDERS GUIDE, 400 Pages | 1 |
| <input type="checkbox"/> MACHINISTS Handy Book, 1600 Pages | 4 |
| <input type="checkbox"/> MECHANICAL DRAWING GUIDE, 160 Pages | 1 |
| <input type="checkbox"/> MECHANICAL DRAWING & DESIGN, 480 Pgs. | 2 |
| <input type="checkbox"/> MATHEMATICS & CALCULATIONS, 700 Pgs. | 2 |
| <input type="checkbox"/> MECHANICAL Dictionary, 968 Pages | 4 |
| <input type="checkbox"/> MILLWRIGHTS & Mechanics Guide, 1200 Pgs. | 4 |
| <input type="checkbox"/> POWER PLANT ENGINEERS Guide, 1500 Pages | 4 |
| <input type="checkbox"/> ENGINEERS & FIREMANS EXAMS, 528 Pages | 1 |
| <input type="checkbox"/> PUMPS, Hydraulics & Air Compressors, 1658 Pgs. | 4 |
| <input type="checkbox"/> MARINE ENGINEERS Handy Book, 1280 Pages | 4 |
| <input type="checkbox"/> ENGINEERS & Mechanics Guides (8 Book Set) | 12 |
| <input type="checkbox"/> Answers on Practical ENGINEERING, 254 Pages | 1 |
| <input type="checkbox"/> ELECTRIC WIRING DIAGRAMS, 210 Pages | 1 |
| <input type="checkbox"/> ELECTRICIANS EXAMINATIONS, 250 Pages | 1 |
| <input type="checkbox"/> ELECTRICAL DICTIONARY, 9000 Terms | 2 |
| <input type="checkbox"/> ELECTRIC MOTOR GUIDE, 1000 Pages | 4 |
| <input type="checkbox"/> HANDY BOOK OF ELECTRICITY, 1440 Pages | 4 |
| <input type="checkbox"/> ELECTRICAL POWER CALCULATIONS, 425 Pgs. | 2 |
| <input type="checkbox"/> RADIOMANS GUIDE, 975 Pages | 4 |
| <input type="checkbox"/> ELECTRONIC DEVICES, 216 Pages | 2 |
| <input type="checkbox"/> ELECTRIC LIBRARY, 7000 Pages (12 Book Set) | 18 |
- Vols. I, II, III, IV, V, VI, VII, VIII, IX, X, XI, XII \$1.50 Ea.

Name _____

Address _____

Occupation _____

Employed by _____

REMEMBER IT'S DANGEROUS to pay less if you want safe, balanced matched tires. You see our adv. every month. Positively not recaps. We serve ambulances, & school buses.

GOOD YEAR Firestone Goodrich U. S. ROYAL

& others. Fine nonskid tread. Slightly worn. Extra fine track. Our policy is to select your tires as carefully as if our very future depended on the service given by that particular tire.

FREE Tube with each tire 26 MONTHS GOLDEN RULE GUARANTEE BOND These are genuine "Many Purpose" "AAA" Tires Read that top line again! You'll save MORE than \$.

600-16 \$5.00	650-16 \$5.35	700-15 \$5.25	475-19 \$5.35
600-16(6) 5.85	700-17 9.00	650-15 5.15	525-18 5.35
700-16 6.15	750-16 7.15	550-17 6.15	550-16 5.00
670-15 6.00	710-15 6.00	760-15 7.00	820-15 7.00

America's great Lo-Price Value. 12 Months Guar. Limited Supply.

600-16 3.25	650-16 3.29	700-16 4.95	650-15 3.45
32x6(8) 7.79	750-20(10) 10.32	1100-20 11.88	900-20 10.04
32x6(10) 9.68	825-20 10.00	700-20 8.20	1000-20 11.40

WE ARE TRUCK-TIRE EXPERTS Matched Tires. Truck-owners the world over depend on us to keep their trucks rolling ON TIME. TRUCKERS—Paying these few cents more will mean thousands of extra miles to you. 6-8-10-12-14-16 ply. "Many Purpose" "AAAA" Grade

600-20 \$9.00	32x6(8) \$9.85	900-20 \$15.00	1000-22 \$14.00
650-20 9.00	32x6(10) 12.55	1000-20 16.00	1100-22 15.00
700-20 9.85	750-20(10) 12.55	1100-20 17.00	1100-24 16.00
750-20 9.85	825-20 15.95	750-15 10.25	700-17 11.00

Military "AAAA" Guar. 30 mos. (Supers 14 mos.)			
600-16 Super 5.75	900-16 Super 7.74	750-20 Super 7.95	RUGGED GUAR. 45,000 MILES
AAAA 6.75	AAAA 9.95	AAA 11.70	
Rugged 7.75	Rugged 11.25	Rugged 14.40	

ALSO TRACTOR TIRE PRICES SLASHED, STATE SIZE & TYPE
BLATT Girard & Lancaster Aves., Dept. PS
BLATT BUILDING PHILADELPHIA 31, PA.
Send ck. or money order and this ad for rush shipment. We won't ship a tire we wouldn't use ourselves. Instant shipment down South, Far West and the world over. The name to trust in rubber.

RADIO ENGINEERING

Television, FM, Broadcasting, Servicing, Electronics, Aviation, Marine & Police Radio taught thoroughly. 72 weeks' Engineering course equivalent to 3 years' college radio work. Approved Veteran Training. Catalog upon request.

VALPARAISO TECHNICAL INSTITUTE
Dept. 503 Valparaiso, Ind.

BIG-MONEY PROFESSION FOR YOU

EARN IN FULL OR SPARE TIME LEARN AT HOME
Large incomes in Scientific Swedish Massage, working for doctors, hospitals, sanitariums, clubs or in your own private practice. Hydrotherapy and Electrotherapy included in easy-to-learn course. Prepare for Diploma and Security in this interesting and profitable field. Write for facts and Success Book—FREE.
THE COLLEGE OF SWEDISH MASSAGE
Dept. 070G, 41 E. Pearson, Chicago 11

Build your own JET ENGINE!

Order these plans today
1. JET PROPELLED BICYCLE. Assemble your own. Photo and instructions \$1.00.
2. HOW TO MAKE EXPERIMENTAL JET ENGINES. Seven sheets drawings with information and instructions \$2.95.
3. BOTH OF ABOVE in one order \$3.75. SEND NO MONEY. Order both at once \$3.75 C.O.D. in USA plus c.o.d. postage. Send check or Money Order and we pay postage. Get other information too. Rush Order.
J. HOUSTON MAUPIN, Dept. 66, Tipp City, Ohio

OWN a Business

Clean and Mothproof rugs and upholstery "in the home." Patented equipment. No shop needed. Duraclean dealer's gross profits up to \$20 a day on EACH serviceman. These Nationally Advertised services create repeat customers. Easy to learn. Quickly established. Easy terms. Send today for Free Booklet—Full details.
Duraclean Co., 0-186 Duraclean Bldg., Deerfield, Ill.

**YOU BUILD THIS
23-TUBE
TELEVISION
RECEIVER**

NOW!

FOR THE FIRST TIME YOU CAN GET
Real Practical HOME TRAINING In

TELEVISION

RADIO AND ELECTRONICS

RTS LEADS THE WAY

WE GIVE YOU

11 BIG

TELEVISION

AND RADIO KITS

AT NO EXTRA COST

**YOU WORK AND LEARN
WITH REAL TELEVISION
AND RADIO EQUIPMENT**

RADIO-TELEVISION TRAINING SCHOOL'S master Technicians guide you. Located in the very heart of America's Television, Broadcasting, Radio and Sound Industries, RTS is right "on-the-spot" where new technical improvements are first introduced; is in the best possible position to bring students ACTUAL METHODS and practices developed by the RADIO-TELEVISION industry, leading to real money making opportunities. The 11 BIG KITS RTS GIVES YOU enable you to do many practical jobs, build the equipment illustrated; perform more than 100 other fascinating, valuable experiments. These jobs you do give you ACTUAL SHOP experience so vitally necessary to your future success. Thus RTS methods assure you BALANCED TRAINING—Theory PLUS Real Experience.

**OPPORTUNITIES NOW
WIDE OPEN FOR
Properly Trained Men**

Latest reports estimate 400 MILLION new television and radio sets will be built in the next 10 years... more than 72 million dollars is being spent RIGHT NOW just for radio repairs ALONE! When you are thoroughly trained by RTS Experts—who have their fingers on the pulse of the Radio-Television industry—a field of unlimited opportunities will open up for you in Your Own Radio-Television Sales & Service Business, F.M., Equipment Manufacturing, Communications and allied fields.

**EARN EXTRA MONEY
while learning at HOME**

Under the RTS amazingly easy, practical home-training plan there is no need for you to quit your present job. You study in SPARE TIME ONLY! RTS Experts show you how

to earn WELCOME EXTRA CASH, even BEFORE FINISHING YOUR TRAINING! In fact, when friends and neighbors know you are studying Radio-Television you may—like many RTS students—actually get MORE REPAIR WORK THAN YOU CAN HANDLE.

**27 YEAR
SUCCESS RECORD**

Backed by over a quarter-century of experience in home training, RTS (formerly Radio Training Association of America) offers practical "Learn-by-doing" methods, assuring you quick step-by-step progress. Begin preparing for your future in Radio-Television now while the time is ripe. If you are at all mechanically inclined—and have a grammar school education, RTS can teach you how to MAKE GOOD in Radio-Television.

GET THE FACTS

Send for FREE BOOK which tells you all about the RTS "time-tested" home-training plan, developed by technicians in the heart of the Radio-Television field. Fill out the coupon now—TODAY! and your FREE BOOK entitled "How To Make Good in Radio-Television" will go out to you AT ONCE. No Obligation. No salesman will call. Act now!

**YOU BUILD THIS
6-TUBE STANDARD
SUPER HETERODYNE
RADIO SET with
SHORT WAVE
CONVERTER**

★
**SEND
FOR THIS
30-PAGE
FREE
BOOK**
★

**YOU
KEEP ALL
EQUIPMENT
—it's Yours!**

RADIO-TELEVISION TRAINING SCHOOL
5100 SO. VERMONT AVE., LOS ANGELES 37, CALIF., U.S.A.
ESTABLISHED 1922 — 27 YEARS AGO

RADIO-TELEVISION TRAINING SCHOOL, DEPT. PS-6
5100 South Vermont Avenue, Los Angeles 37, Calif., U.S.A.
Send FREE Illustrated Book showing how I can make good in TELEVISION and Radio through training under the guidance of expert RTS Technicians. No obligation. (No Salesman will call).

NAME _____ AGE _____
St. & No. _____
CITY _____ ZONE _____
STATE _____

DRAW ME!

COPY THIS GIRL AND

Try for \$1,275 in Prizes

5 PRIZES! 5 Complete \$255 Art Courses, including Drawing Outfits!

Here's your big chance, if you want to become a commercial artist, designer, or illustrator! An easy-to-try way to win FREE art training!

Whether you win or not our instructors send you their comments on your work, if your drawing shows promise! Trained illustrators and artists now making big money. Find out now if YOU have profitable art talent. You've nothing to lose—everything to gain. Start your drawing now. Mail it today.



Art Instruction, Inc.

MINNEAPOLIS • NEW YORK
CHICAGO • LOS ANGELES

MEMBER NATIONAL HOME STUDY COUNCIL

ART INSTRUCTION, INC., Dept. 6140
500 S. 4th St., Minneapolis 15, Minn.

● Please enter my attached drawing in your August drawing contest. (Please Print)

Name _____ Age _____

Address _____ Phone _____

City _____ Zone _____ County _____

State _____ Occupation _____

Amateurs Only! Our students not eligible. Make copy of girl 5 ins. high. Pen or pencil only. Omit the lettering. All drawings must be received by Aug. 31, 1950. None returned. Winners notified.

Latest Winner List! Free course winners in previous contest—from list just released: Mrs. E. Eaton, Rt. 5, Coshocton, Ohio; Mrs. L. Webster, 259 Beechwood, Princess Anne, Md.; G. Ratzmer, 1468 Highland, Lakewood, Ohio; C. Faiello, Box 188, Magnolia, Ohio; U. Bahan, 5249A Devonshire, St. Louis, Mo.

SECURE YOUR FUTURE 3 TRADES in 1 CAREER



WATCHMAKING



JEWELRY—
STONE SETTING



ENGRAVING

Each Trade can be a full-time job; together they assure numerous high paying opportunities, or a business of your own. Profit by the **Nationally Recognized Training Methods** of the **Kansas City School of Watchmaking**. Enrollments now available.

CLIP AND MAIL THIS COUPON TODAY

KANSAS CITY SCHOOL OF WATCHMAKING

Admiral & Tracy, Kansas City 6, Missouri

Please send me, without obligation, complete information on training in the above courses.

Name.....

Street.....

City..... State.....

Check if Veteran.

G.I. Approved

How to IMPORT For Profit and Pleasure

New, big opportunities for men and women! Learn how you can import at low foreign prices for buyers in your locality at high U. S. prices.

BUY—SELL, WORLD-WIDE WITHOUT CAPITAL

Big profits possible without investing in goods, doing world-wide business from your own home by mail, no matter where you live. (See examples of recent prices in other countries, at left). Also big savings on clothes, tools, gems, antiques, watches, cameras, china, silk, toys, etc., for your own use. Imported products needed in every locality. It makes no difference where you live. You can carry on World Trade in or near small towns or large cities—anywhere. Travel opportunities. Practical, low-cost World Trade Course teaches you quickly at home in spare time.

EXCLUSIVE PRODUCTS FROM ABROAD

Full year's membership in International Traders Guild included with course. Helps you to get samples and prices and go after big profits now Importing and Exporting. No previous special experience or schooling required. World Trade Certificate awarded. There is no obligation when you send for our free illustrated book. (No salesman will call on you.) Write today. Airmail reaches us overnight. The Mellinger Co., Exporters-Importers, 1418 CP Westwood Blvd., Los Angeles 24, Calif.

GET INTO

DIESEL-AUTO

MECHANICS *Master All Phases*

JOBS LIKE THESE ARE AVAILABLE TO TRAINED MECHANICS. CHOOSE THE FIELD YOU LIKE BEST

Get Complete Training

Diesel Fuel Injection
 Automotive Motor Tune-up
 Diesel Engine Rebuilding
 General Garage Mechanic
 Agricultural Implements
 Auto Engine Rebuilding
 Auto Elec. Service
 Public Utilities
 Parts Dealers
 Bus & Truck Lines
 Industrial Maintenance
 Contracting & Excavating
 Business of Your Own
AND MANY other similar openings.

As a National Schools graduate, you are trained for ALL opportunities in the Diesel & Auto Industries.

EARN WHILE YOU LEARN

With our practical Master Shop-Method Home Training, you study at home in your spare time. You receive Spare Time Work Lessons, which show you how to earn while you Learn... for extra money and experience. You Learn by DOING.

TOOLS AND EQUIPMENT

To make your training complete, we give you selected mechanic's tools and equipment, illustrated below, including all-metal tool-box — as a regular part of your instruction.

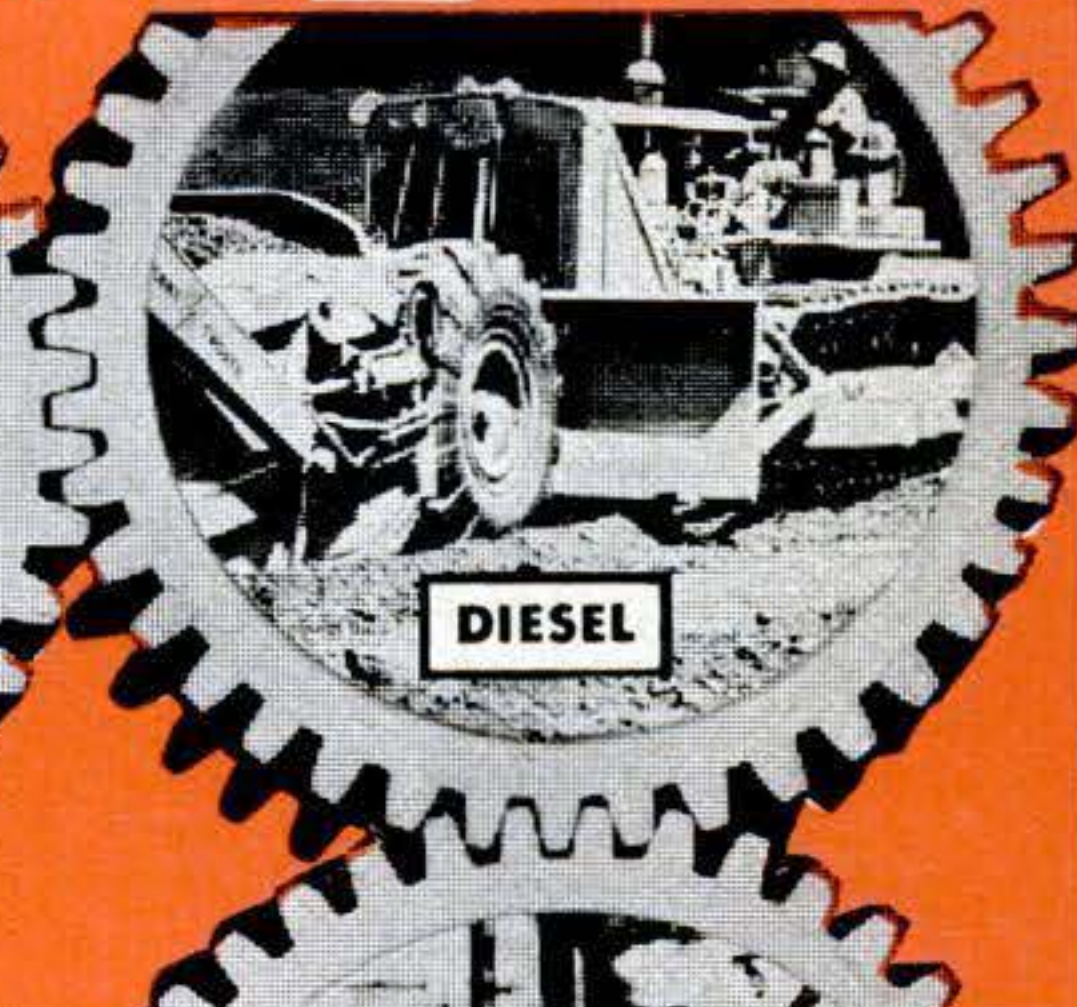
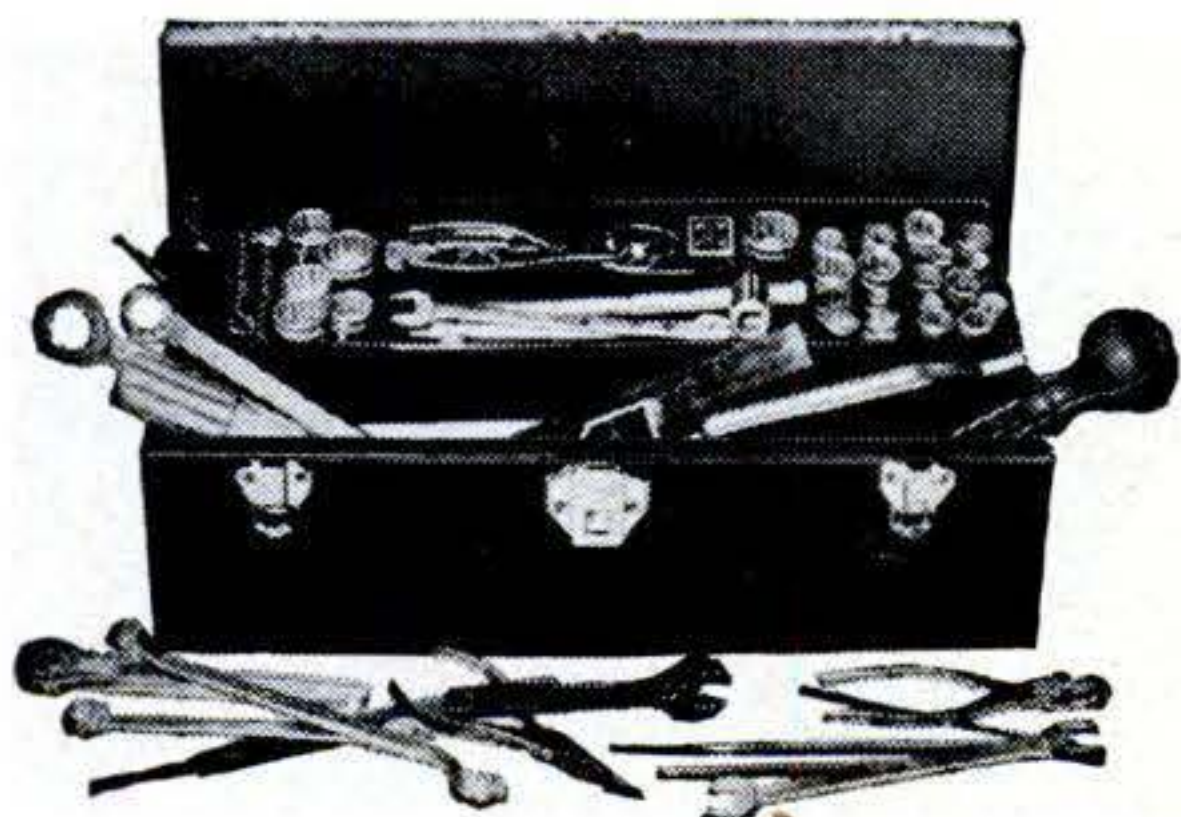

Shop-Method Home Training by an Established Resident School Prepares you for Many Good Jobs

Opportunity is everywhere for the trained Diesel - Auto Mechanic. Highways throng with cars, busses, trucks tractors. Garages and Service Stations are kept busy. Factories, ships, farms, railroads, general industry, are dependent upon engine power. Here's a dynamic, fast - growing field that needs trained men who know ALL phases: installation, operation, maintenance and repair. Now—National Schools offers you a practical, all-embracing Diesel-Auto Mechanic's Course, including all of these advantages:

Complete training, covering—Diesels, High Speed and Heavy Duty; Semi-Diesels, Gasoline and Special Fuel Engines AND Allied Mechanics.

Basic Lesson Texts
 Diesel Installation
 Operation—Maintenance
 Diesel Chart Manual
 Spare Time Lessons
 Engine Service Manuals
 Engine Repair
 Drive Systems
 Diesel Electric Power
 Thermodynamics

TOOLS AND EQUIPMENT INVESTIGATE

Secure Full Information

**NEW, ILLUSTRATED
 BOOK & SAMPLE
 LESSON SHOW
 HOW WE TRAIN
 YOU...SEND
 FOR THEM
 TODAY!**

**NO COST
 NO OBLIGATION**

**APPROVED
 FOR
 VETERANS**

Check coupon below

NATIONAL SCHOOLS

LOS ANGELES 37, CALIF. • EST. 1905



FIND OUT NOW...MAIL COUPON TODAY

NATIONAL SCHOOLS, Dept. PSD-6
 4000 South Figueroa Street
 Los Angeles 37, California

(Mail in envelope or paste on penny postcard)

Mail me FREE the book, YOUR FUTURE IN DIESEL-AUTO MECHANICS, together with the Sample Lesson. I understand I may keep and use the information with no obligation.

Name.....Age.....

Address.....

City.....Zone...State.....

Check here if Veteran of World War II

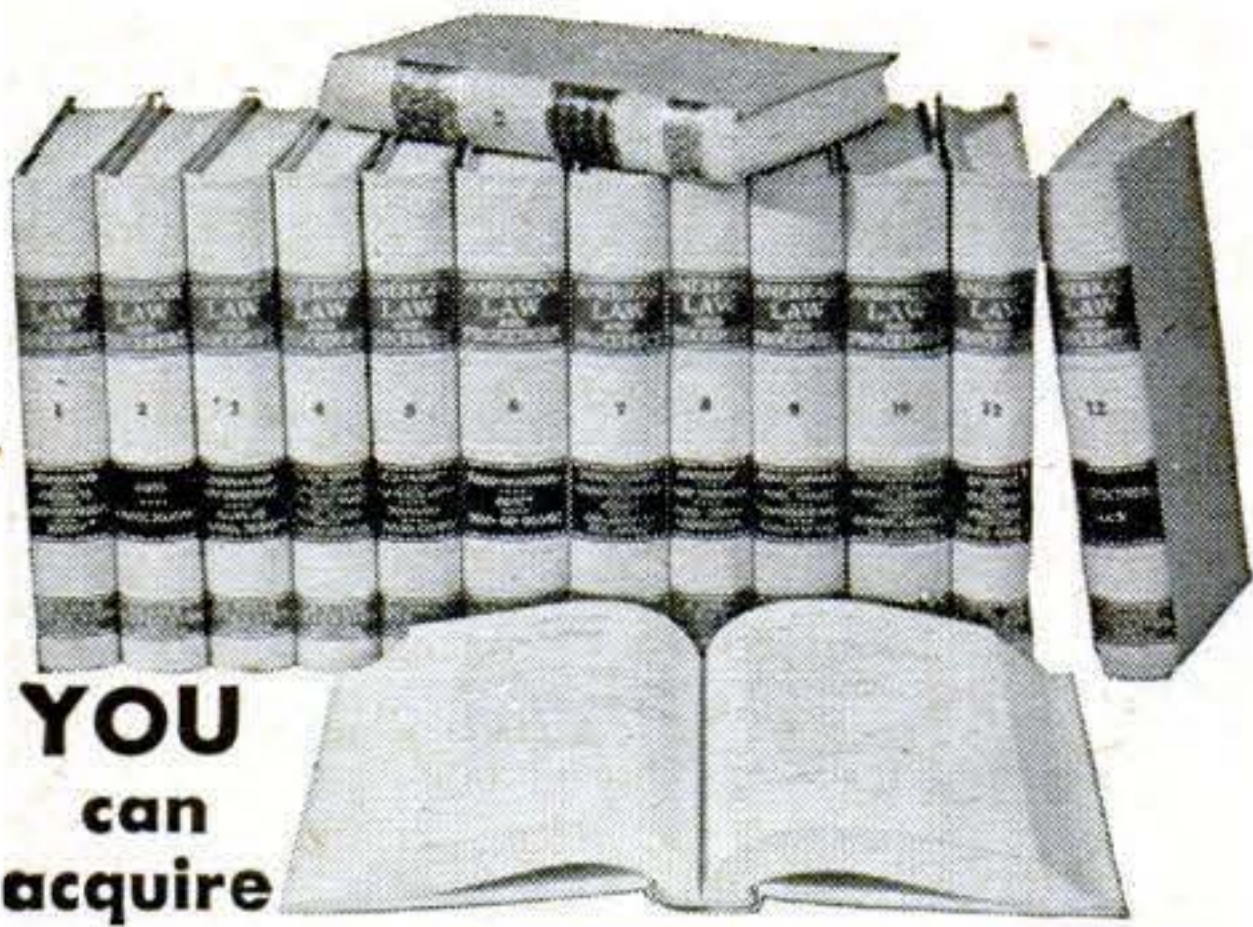

YOU
can
acquire

LAW NIGHTS AT HOME!
L. L. B. DEGREE

LaSalle's famous Law Library—used as reference in many Law libraries and Law offices—has enabled thousands to master Law surprisingly fast, in spare hours at home, for business and professional advancement.

These 14 remarkable volumes, compiled by leading professors and lawyers, cover the whole basic field of Law in condensed, orderly, simplified manner.

You advance rapidly with this great library, plus special lectures furnished. We guide you step-by-step with personalized Problem Method of instruction . . . you learn by doing—handling legal problems—not by memorizing rules.

Send for two FREE 48-page booklets, "Law Training for Leadership," and "Evidence," answering questions about Law and its value to you, and telling how LaSalle Law graduates are winning rapid advancement in business and public life. Mail coupon below. No obligation.

LA SALLE EXTENSION UNIVERSITY
A Correspondence Institution

417 S. Dearborn St. Dept. 683-L Chicago 5, ILL.

Send me your two FREE booklets described above; without obligation.

Name.....Age.....

Street.....

City, Zone & State.....

INVENTORS

Before you make any effort to market your invention, you should take the first steps toward proceeding for patent protection.

The usual first step is to have a search of the U. S. patent records conducted, so that I can report to you on the question of patentability.

I shall be pleased to furnish you with information relative to patent procedure upon request from you, and this will be without any obligation on your part.

PATRICK D. BEAVERS

(Formerly RANDOLPH & BEAVERS)
Registered Patent Attorney

937 Columbian Building, Washington 1, D. C.

INVENTORS

IF YOU WISH TO PROTECT YOUR INVENTION, You should take steps to protect it by a U. S. Patent. Write me for "RECORD OF INVENTION" form.

CARL MILLER
REGISTERED PATENT ATTORNEY

WOOLWORTH BLDG., 35th FLOOR, 60C,
NEW YORK CITY

HELP FOR INVENTORS

Hundreds of manufacturers have requested our assistance in locating marketable new products.

Complete information, free.

INSTITUTE of AMERICAN INVENTORS
Dept. 3, 631-E St., N.W., Washington 4, D. C.

PATENTS AND TRADE MARKS
C. A. SNOW & CO.
REGISTERED PATENT ATTORNEYS
WRITE FOR INFORMATION TO
246 SNOW BUILDING, WASHINGTON 1, D. C.

INVENTORS

Whether an invention is patentable can be substantially determined by a search of the U. S. Patent records. Without obligation, write for information explaining the steps you should take to secure a patent.

JOHN N. RANDOLPH

Registered Patent Attorney

205 Columbian Building Washington 1, D. C.

PATENTS PATENT LAWYER

Gustave Miller

REGISTERED PATENT ATTORNEY
60-PS WARNER BLDG.
WASHINGTON 4, D. C.

ASSOCIATE EXAMINER
U. S. PATENT OFFICE 1922-1929
PATENT ATTORNEY & ADVISOR
U. S. NAVY DEPT. 1930-1947

Send for **PATENT INFORMATION** Book and "INVENTOR'S RECORD" without obligation.

INVENTORS

Protect your invention by a U. S. Patent
Wire me for free record of invention form.

SHERMAN LEVY

620 Victor Building, 724-9th Street, Washington 1, D. C.



MASTER MIND!

Learn Short-Cut Mathematics

Juggle figures, do baffling number tricks. Make people gasp at your marvelous *lightning-quick* mind. Multiply 4 figures by 4 figures without using old-fashioned multiplication! Big cloth-bound volume; fully illustrated course. Includes worked-out problems, answers, etc. Sensational bargain, only \$1.49, postpaid — or COD plus postage. Satisfaction guaranteed or refund. Order this amazing "Short-Cut Mathematics" today!

NELSON-HALL CO., 1139 S. Wabash Ave. **\$1.49**
Dept. 3F-1 Chicago 5, Ill. Complete

YOU CAN'T LOSE!

HAVE A PROFIT MAKING BUSINESS OF YOUR OWN

NATIONALLY
ADVERTISED
PRODUCTS

NO
EXPERIENCE
NECESSARY

NO
MONEY
TO
INVEST

FREE
SAMPLE
OUTFITS

FULL
OR
PART
TIME

A LIFETIME FUTURE

Man or woman—young or old, YOU can earn a steady income in full or spare time as an independent Kendex dealer. Amazing and almost "impossible" earnings can become a reality for you. Herbert Armstrong of Tenn. earned \$202 in 9 days. C. O. Watkins of Oregon sent 92 orders in one day. You have the same opportunity to duplicate these exceptional earnings. Over one million dollars will be earned in 1950 by Kendex dealers—why not let us establish you in your own business and get a share of these wonderful earnings?

KENDEX NYLONS REPLACED FREE . . .

if they run or snag within guarantee period up to three months! Impossible? It's true! No matter what the cause—hard use or deliberate abuse—whether it is fault of the hose or the wearer—Kendex nylons are replaced FREE if they run, snag or become unfit for wear within the guarantee period. How could any woman resist a positive guarantee of satisfaction when she can obtain it without paying any more than other standard advertised brands? Kendex nylons are NOT sold in stores, so you have no competition. Complete line includes everything from heavy 70 denier service weight to gossamer luxurious ultra sheer 15 denier 60 gauge. Proportioned sizes and lengths. Latest colors plus white.

LINGERIE - ROBES - HOUSECOATS - MEN'S HOSE

In addition to the sensational Kendex nylons, you will have a complete line of glamorous lingerie, beautiful robes and housecoats plus a complete line of Kentcraft mens' hosiery guaranteed for one full year. Any pair or pairs of men's hose that does not give satisfactory wear within one year of purchase will be replaced FREE!

NATIONALLY ADVERTISED

Kendex will spend over \$350,000.00 in 1950 to tell millions of readers of the advantages in buying from you. Almost every issue of Good Housekeeping, Saturday Evening Post, McCall's, Women's Home Companion and Ladies' Home Journal carry our advertising in addition to many others. Kendex has advertised in Life, Look, Collier's, etc. Awarded Good Housekeeping Seal. Thousands of orders are shipped daily from coast to coast.

**FREE
NYLON
STOCKING**

EVERYTHING GIVEN FREE

Risk nothing! Mail coupon and we will send you, free and prepaid, complete money-making outfits including sample nylon stocking, samples of lingerie, robes, housecoats and men's hose fabrics and everything you need to immediately start making money. Complete outfits become your property even if you don't send any business. Simply write orders, we deliver and collect. Advance cash plus huge bonus. No money or experience needed. Mailing the coupon is all you need to start on the road to a 52-weeks-of-the-year high paying business of your own. You have everything to gain and nothing to lose.

KENDEX CORP., BABYLON 149, N. Y.



FOUR MONEY-MAKING LINES

- WOMEN'S NYLON HOSIERY
- GLAMOROUS LINGERIE
- HOUSECOATS — ROBES
- MEN'S HOSIERY

MAIL
TODAY

NOTHING
TO
PAY

NO
OBLIGATION

**KENDEX CORP.
BABYLON 149, N. Y.**

Date..... 1950

Send me, free and prepaid, everything I need to make money as a Kendex dealer, including sample stocking etc. There is nothing for me to pay now or later and I am under no obligation in accepting your money-making outfits.

Name.....

Address.....

City..... State.....

Yes, More Brilliant Than a Diamond!



Amazing New Discovery

Write today for the full story of the latest miracle of science, discovered in the laboratories of one of the world's largest corporations. The story of the beautiful Kenya Gem that so closely resembles a diamond that only an expert can tell the difference.

More Fire! More Brilliance!

Yes, this marvelous gem has more brilliance, more fire, and a more dazzling display of color than the finest diamond of equal size. And yet you can now own an unmounted Kenya Gem for only \$24 (1 carat) to \$96 (4 carats); also men's or ladies' beautiful gold rings for as little as \$45. If you wish, you can buy on EASY PAYMENT TERMS.

The Cinderella of Modern Science

Kenya Gems are the sensational discovery you read about in Sat. Eve. Post, Jewelers' magazine and N. Y. Times, "the only thing on earth more brilliant than a diamond." It is a true gem, crystallized by science instead of nature and perfectly cut by expert cutters.

Send Coupon or Write today for FREE illustrated literature.

KENYA GEM CORPORATION Dept. 306

Copyright 1950
Kenya Gem Corp.

Philadelphia 44, Pa.

Mail This FREE COUPON Today!

Kenya Gem Corporation (Dept. 306) Philadelphia 44, Pa.

Please send me, without obligation, the FREE illustrated descriptive literature telling all about Kenya Gems, the new discovery more brilliant than a diamond.

Name.....

Address.....

City..... State.....

**NATION'S
LARGEST
EXCLUSIVE
ELECTRICAL
SCHOOL**

**"LEARN-BY-DOING"
ELECTRICITY**

**PRACTICAL TRAINING
NOT "HOME STUDY"**

Get actual experience in great shops of M.T.I. Learn all phases Practical Electricity; Housewiring, Motors, Const., Maintenance, etc. Living arrangements, Part-time jobs, etc. Pay after graduate plan.

A post card brings the story.

**MICHIGAN TECHNICAL INSTITUTE, Dept. PS-6
2281 W. Fort St., Detroit 16, Michigan**

I Can Make You A New Man

Let Me Prove It In Only 15 Minutes a Day!

LET me PROVE that "Dynamic Tension" can give you a gloriously healthy body—powerful muscles, smashing strength, tireless energy! Many of those I have helped were run-down, nervous, flabby. They got rid of their "bay windows"—and now feel new vigor flowing through their systems. They feel that they added years to their lives.

Send postcard for my FREE 48-page book, "Everlasting Health and Strength." No obligation. Address:

CHARLES ATLAS, Dept. 16, 115 East 23rd St., New York 10, N. Y.



CHARLES ATLAS

DRIVING RELIEF!

New LEFT-FOOT ACCELERATOR

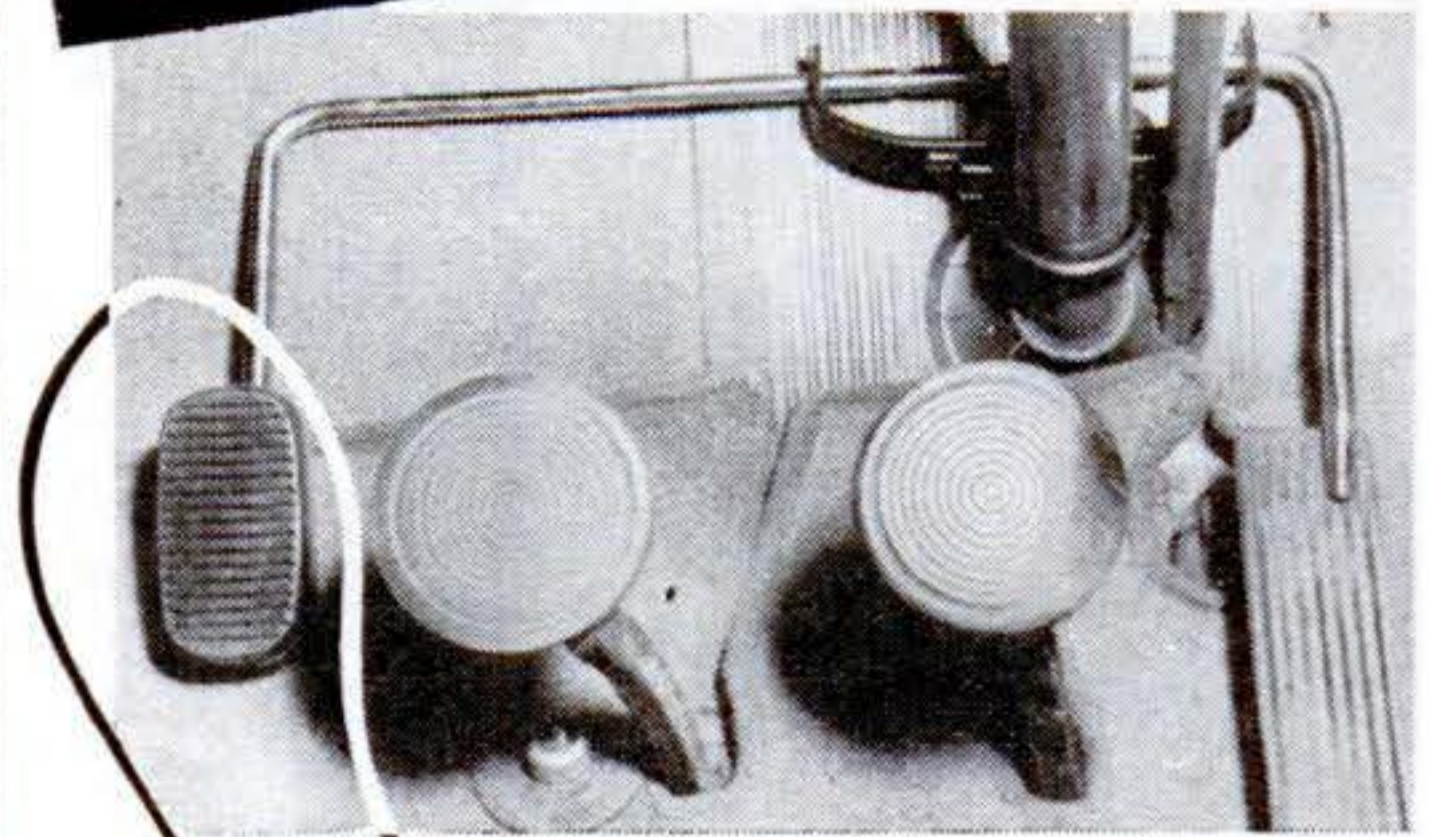

Dealer inquiries invited.

Long drives are short with "Lefty"! Eliminate leg, back, and foot fatigue and enjoy greater driving comfort... feed gas with left foot when desired with "Lefty," the new left-foot accelerator. One trip will convince you. Cars, \$4.85; trucks, \$6.75; plus 3% California sales tax. Specify year and make.

C & B Co., 235 Sumner Street, Yuba City, California

Learn PHOTOGRAPHY

There's big money in PHOTOGRAPHY—and an action-packed career for you. Our HOME STUDY COURSE is your spare-time SHORT CUT TO SUCCESS! Or, if you wish—PERSONAL ATTENDANCE TRAINING at our famous New York School is available with subsistence under the G. I. Bill. Our 40th year. Write immediately!

NEW YORK INSTITUTE OF PHOTOGRAPHY

Dept. "5," 10 West 33 Street, New York 1, N. Y.

DEPENDABLE CRAFT SUPPLIES

WRITE FOR CATALOG SINCE 1928

LEATHER CRAFT • PLASTICS • POTTERY CRAFT • BLOCK PRINTING • BELT CRAFT • TEXTILE COLORS • POWER TOOLS • WOOD BURNING • INSTRUCTION BOOKS • ETC.

DWINNELL CRAFT SHOP

Dept. PS 506—Wheeling, W. Va.



WHY DON'T YOU WRITE?

Writing short stories, articles on business, travel, shop crafts, sports, local and club activities, etc., will enable you to earn extra money. In your own home, on your own time, the New York Copy Desk Method teaches you how to write the way newspaper men learn—by writing. Our unique "Writing Aptitude Test" tells whether you possess the fundamental qualities essential to successful writing. You'll enjoy this test. Write for it, without cost or obligation. **Veterans: This course approved for Veterans' Training.**

NEWSPAPER INSTITUTE OF AMERICA

SUITE 5720-H, ONE PARK AVENUE, NEW YORK 16, N. Y.

JEWELERS' MAGNIFYING GLASS 4X



FREE YOUR HANDS! 1001 USES

For mechanics, school work, model and miniature building, art work, photography, sewing, study of diamonds and precious stones, watchmaking.

Reg. \$2.95 \$1 ppd.



STEVEN-KNIGHT Jewelers
Wholesalers • 315 West 5th Street
Los Angeles 13, Calif.

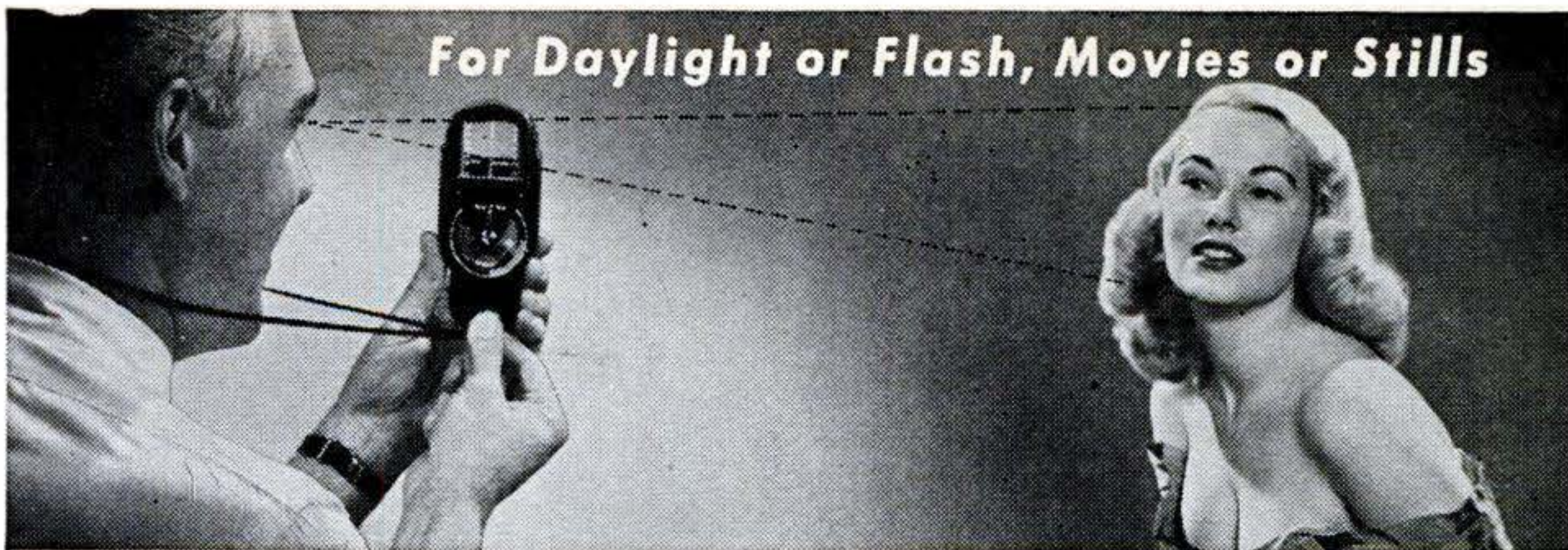

For Daylight or Flash, Movies or Stills

ANNOUNCING THE SENSATIONAL *Range O Matic*
THE 3-WAY PHOTO METER

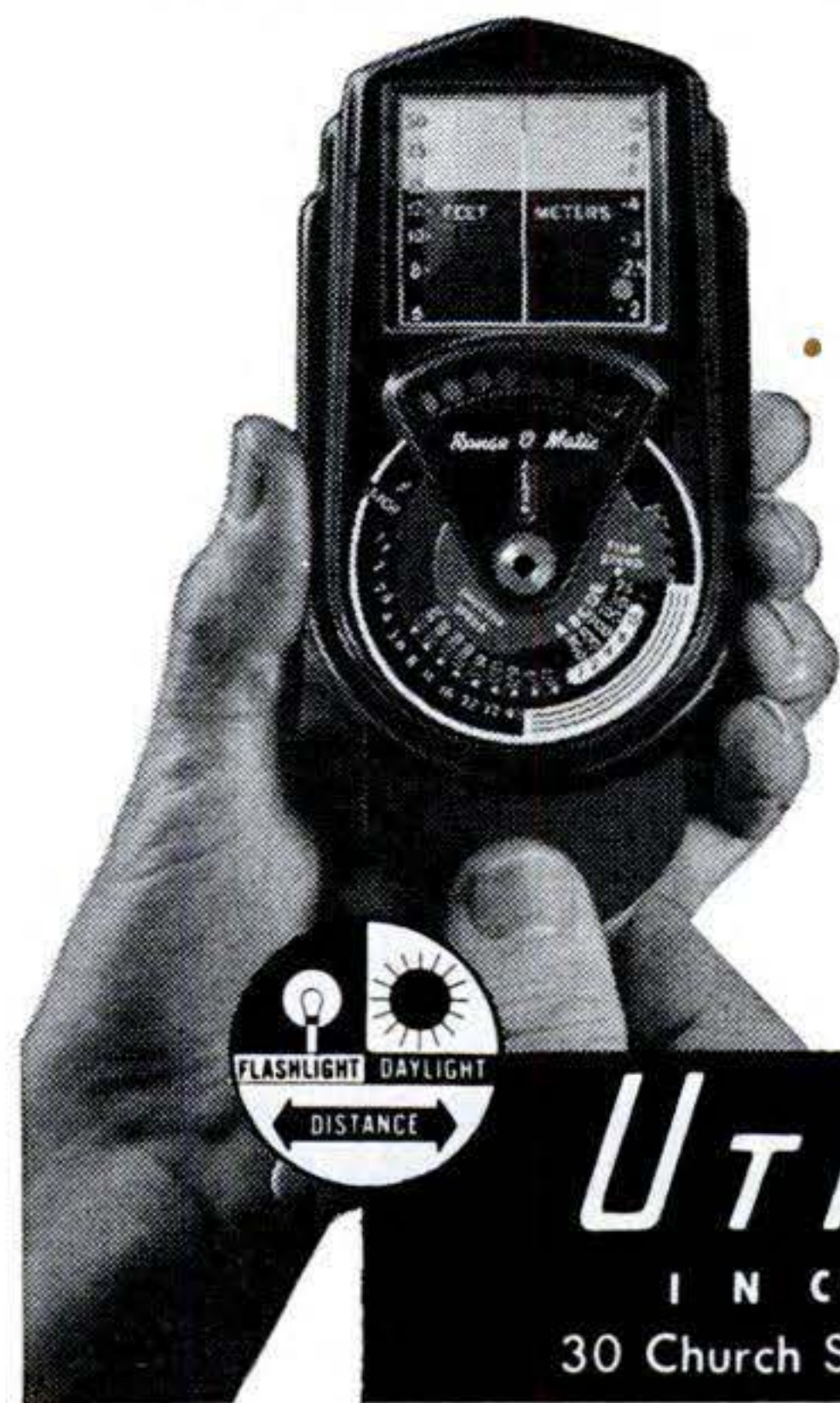

It's an Automatic

ONLY \$4.95
INCL. FED. TAX
SUEDE LINED CASE \$1.00

FLASH CALCULATOR
EXPOSURE METER
RANGE FINDER

Utilitron proudly announces the Range O Matic—a multi-purpose meter for flash, flood and daylight photography.

The Range O Matic takes the guesswork out of photography... gives you automatic readings for uniform flash picture results... gives you also a fast and efficient exposure meter and a dependable range finder.

Ask your camera dealer to show you the Range O Matic, and demonstrate how this amazing instrument works... how it actually gives you 3 instruments for the price of one. Or write to us.

The Only Range-Coupled Flash Calculator in the World



UTILITRON

INCORPORATED

30 Church Street,

New York, N. Y.



SANDEE

Mufflers—All Ford, Chev., Ply....\$4.45

All Buick, Pont., Olds., Chrys.,
Dodge, Hudson, K.F., Pack., etc.....\$5.45

V-8 and Merc. Duals
(32-50 incl.)
\$15.95



SPORTONE

DEALERS WANTED

Beautiful
SANDEE
Fender Skirts
\$9.95

DURABILITY

A SANDEE Sportone will outlast two ordinary mufflers and give More Power! More Speed! More Mileage!—plus a tone quality unsurpassed.

Please ship (item): _____ Price _____
Car and Year _____ Name _____
Address _____

SANDEE MUFFLER CO. 5643 Corryne Pl. Culver City, Calif.

ENGINEERING DEGREE IN 27 MONTHS

Big Demand for Graduates

AERONAUTICAL, CHEMICAL, CIVIL, ELECTRICAL, MECHANICAL and RADIO ENGINEERING (including Television).

Hundreds of young men are earning engineering degrees in this recognized institution each year—continuous operation. New terms start quarterly. Many students earn a major part of their college expenses in this large industrial center.

Low tuition. Competent instruction. Thorough intense practical program. Modern laboratory facilities including new physics lab. and modernized wind tunnel. Individualized instruction emphasized.

Approved for Veterans. Engineering preparatory courses. Students from 48 states and 21 foreign countries. Enter June, September, December, March. Send coupon for free catalog and full information. Enroll now.

SEND COUPON TODAY

INDIANA TECHNICAL COLLEGE

660 E. Washington Boulevard
Fort Wayne 2, Indiana

Please send me free information on B. S. Engineering degree in 27 months as checked.

- Aeronautical, Chemical, Civil,
 Electrical, Mechanical, Radio-Television.

Name.....

Address.....

BUY NO SUN GLASSES

until you have tried this amazing, no-risk, 10-day test



GENUINE POLAROID SUN GLASSES FOR ONLY \$1

Ordinary sun glasses allow a certain amount of annoying GLARE to reach your eyes, and DIM the details of things you want to see.

Polaroid sun glasses employ an optical principle which is entirely *different*. Glare is scientifically eliminated by polarization. The true details and colors you want to see are allowed to pass through the sun glasses *undiluted*, but the glare is blocked. No wonder the U. S. Navy, famous racing-car drivers, and others whose lives depend on clear vision use Polaroid sun glasses.

Car owners, sportsmen and fishermen find them invaluable. Polarization wipes off surface glare... greatly improving vision. Fishermen can see the fish and the lure. Adjustable ear pieces. Handsome carrying case. Men's and women's sizes.

10-day no-risk trial offer. Polaroid sun glasses in deluxe models have sold for as high as \$10 to \$15 a pair. Special purchases permit us to offer you genuine Polaroid sun glasses for the unbelievably low price of only \$1, or 6 pairs for \$5. Here is our no-risk trial offer: Wear the glasses for 10 days. If you are not delighted, your money will be refunded without question. Offer good for limited time only, so mail the coupon TODAY.

Sun Glass Sales Co.
Box 8—Dept. A, Brooklyn 1, N. Y.
Please send me _____ Men's _____ Women's Sun Glasses.
Send C. O. D. I will pay postman \$1 plus postage fees.
Enclosed find \$ _____ Mail Postpaid.
Name _____
Address _____
Town _____ State _____



STOP DRIP

caused from condensation on cold water pipes. Turn idle basement space into play or work rooms. Keep store rooms dry. Just wrap cork-filled No-Drip Tape around pipes and joints.



Do it yourself. Clean and easy to apply. Roll covers about 10 feet of 1/2" pipe, \$1.69. Higher west of Rockies and Canada. Get at Hardware, Department Stores, or sent post-paid. Write for free circular. J. W. Mortell Co., 534 Burch St., Kankakee, Illinois.



STUDY AT HOME

WITH AN EDUCATIONAL INSTITUTION

Courses in ENGINEERING: Electrical, Civil, Mechanical, Drafting, Architectural, Automotive, Steam, Diesel, Aeronautical, Radio, Structural, Mining, Industrial, Petroleum, Marine, Refrigeration, Air Conditioning, Chemical.
Courses in ARTS AND SCIENCES: Philosophy; Education; Letters; Public Health; Medical Jurisprudence; Psychology; Sociology; Physics; Chemistry; Geology; Pol. Science; Theology; Law; Business and Commerce; Accounting; Mathematics; Statistics; Agriculture.

McKinley-Roosevelt Incorporated, 4610-A3, Sheridan Rd., Chicago 40, Illinois

MEN A Blue Print For YOUR SUCCESS!

Here is your opportunity for Success An amazing new finishing system that will start you in your own profitable business. No experience necessary—up to \$10 an hour easy Spare or full time in your own home or garage Start small—grow big fast We will guide you every step of the way This is BIG—don't miss your chance Send name now for FREE SAMPLE of my complete, easy profit plan for your success

COAST INDUSTRIES
Dept. 16 1004 S. Los Angeles St., Los Angeles 15, Calif

FREE BOOKLET & SAMPLE

it's fun to earn RAISING HAMSTERS

Cash in on the growing demand for SYRIAN GOLDEN HAMSTERS recently introduced into the U. S. Ideal pets... big laboratory demand. Hardy, clean, odorless. Easily and profitably raised anywhere.



AKOPIAN HAMSTERY
the largest in the West
7358-BC VARNA AVE • NORTH HOLLYWOOD, CALIF.

write for FREE booklet

Be A MASTER PLUMBER

Earn \$15 To \$50 A Day

DON'T ENVY THE PLUMBER—BE ONE

Every skilled workman will tell you that Plumbers have the best of it. WINTER and SUMMER the Plumber is busy at top wages. No skilled Plumber is ever out of a job—compare his opportunities with any trade, plus the opportunities of having your own shop. We teach you Plumbing with TOOLS (not books) under Licensed Master PLUMBERS in one of the finest equipped schools in America. We make you a Plumber, every branch is taught thoroughly—Lead Work—Blueprint for plan reading—all other tricks.

LEARN IN 32 WEEKS WITHOUT PREVIOUS EXPERIENCE

If you like to work with tools you owe it to yourself to investigate. No need to ever work as an apprentice. Get free bulletin. Write now! G.I. APPROVED. Our 24th year.

UNIVERSAL PLUMBING SCHOOL
819 HOLMES STREET KANSAS CITY, MO.

WATCH REPAIRING

Learn *Earn while AT HOME you Learn*

This fascinating and profitable trade can be learned in YOUR SPARE TIME at HOME through our thorough and complete Home Study Course, especially designed and written for HOME STUDY

OR

AT OUR G.I. APPROVED RESIDENT SCHOOL

WRITE FOR FREE INFORMATION Individual instruction given by competent instructors in an atmosphere conducive to good learning.
JOHN VAN PUFFELEN DIRECTOR

American Institute of Specialized Watch Repair Department 1012-14 Franklin Street, S.E. P.S. 202 GRAND RAPIDS-7, MICH.

LEARN HOW TO MAKE REAL MONEY IN

TELEVISION

RADIO & ELECTRONICS

AT NO EXTRA COST!
YOU GET A ROUND TRIP TO
NEW YORK CITY
FROM ANYWHERE IN THE U. S. OR CANADA

After you have completed the home study section of your course, your transportation to *New York City*—both ways—from any point in the United States or Canada will be paid by RTTA. At our affiliated training shops in New York City you'll get 2 *solid weeks*—50 hours of intensive laboratory work—on the most modern and scientific equipment. You'll live in New York City, the heart of the television industry, where the headquarters of the National Broadcasting Company,

American Broadcasting Company, Columbia Broadcasting System, Mutual Broadcasting System and many large television and radio companies are located.

FREE EMPLOYMENT HELP

Upon completing your laboratory resident course, you will *personally be recommended* for a position by our placement director, who will help you get started toward a money-making future in television, radio and electronics.

RTTA FURNISHES EVERYTHING—TUBES, BATTERIES, and LARGE TV PICTURE TUBE

IN DOUBLE QUICK TIME
EARN BIG PAY,
OWN YOUR OWN BUSINESS

NOW—you can qualify for a money-making career, through RTTA's sensational plan. In addition to becoming a **CERTIFIED TELEVISION TECHNICIAN**, you build yourself a complete large screen television set of the finest commercial quality, for your own use. You get 15 **BIG KITS** to enable you to get practical experience, build the equipment illustrated, including a radiotelegraph and radiotelephone transmitter, and many other testing units.

No matter where you live, no matter what you do, RTTA's effective methods can help you toward a **FAT PAY CHECK** or **YOUR OWN BUSINESS**. *Previous experience is unnecessary.*

ALL EQUIPMENT FURNISHED

The kits you will receive contain all the necessary **TUBES** and **BATTERIES** . . . a complete set of tubes for your **TELEVISION RECEIVER** including the **PICTURE TUBE**. In addition, you'll receive everything needed to build a complete TV set, and many more testing units.

EARN WHILE YOU LEARN

You will learn how to *earn money* in your spare time, without interfering with the work you are now doing. From the very beginning,

the **RADIO TELEVISION TRAINING ASSOCIATION's** plan is a practical **MONEY-MAKING COURSE**. We will show you how to cash in on your new knowledge, even while you are learning. *Act now* by clipping the coupon to find out how you can become a **CERTIFIED TELEVISION TECHNICIAN** and *earn extra money*.

WE PREPARE YOU FOR YOUR FCC LICENSE

RTTA prepares you to qualify for your FCC license. *Pay is higher* for the FCC license holder because only a comparative few of the thousands of men in radio-television today hold FCC tickets.

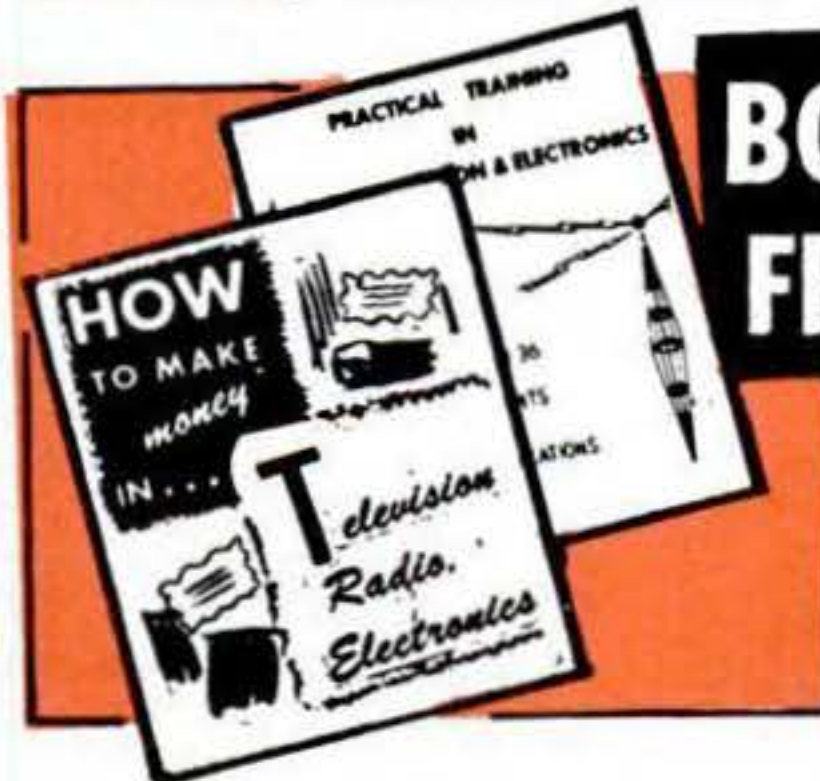

Yours absolutely **FREE**—an actual **SAMPLE LESSON!** Send for it today! You'll receive also our **FREE** catalog "How to Make Money in Television," telling how you can train for a money making job. *Mail Coupon Now!*

BOTH FREE!

RADIO TELEVISION TRAINING ASSOCIATION
972 BROAD STREET NEWARK 1, NEW JERSEY

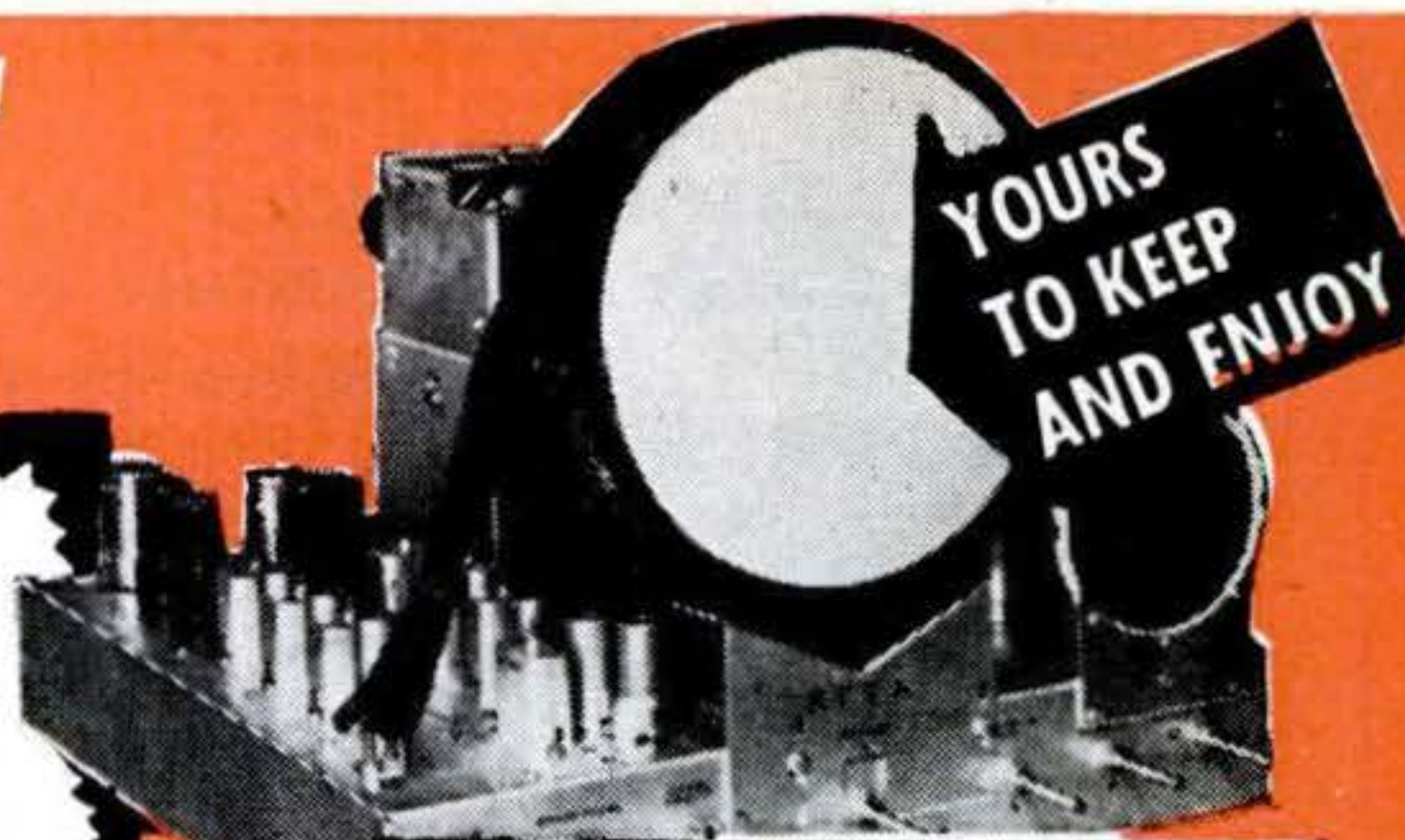

YOURS TO KEEP AND ENJOY

YOU BUILD THIS LARGE SCREEN TELEVISION RECEIVER

YOUR CHOICE OF 10, 12½ OR 16 INCH PICTURE TELEVISION TUBE

CAN BE CONVERTED FOR COLOR TELEVISION

STUDY AT HOME IN YOUR SPARE TIME

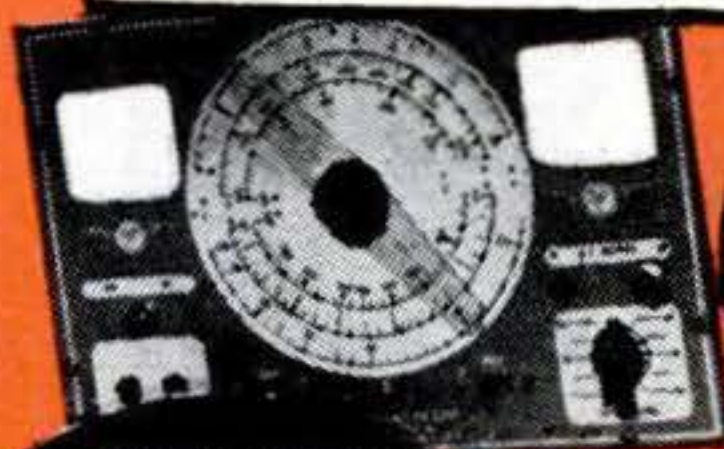

R. F. SIGNAL GENERATOR

15 YOU GET **BIG TELEVISION-RADIO KITS AT NO EXTRA COST.** YOU BUILD THESE **ILLUSTRATED UNITS**



MULTITESTER



AUDIO OSCILLATOR

YOU KEEP ALL EQUIPMENT

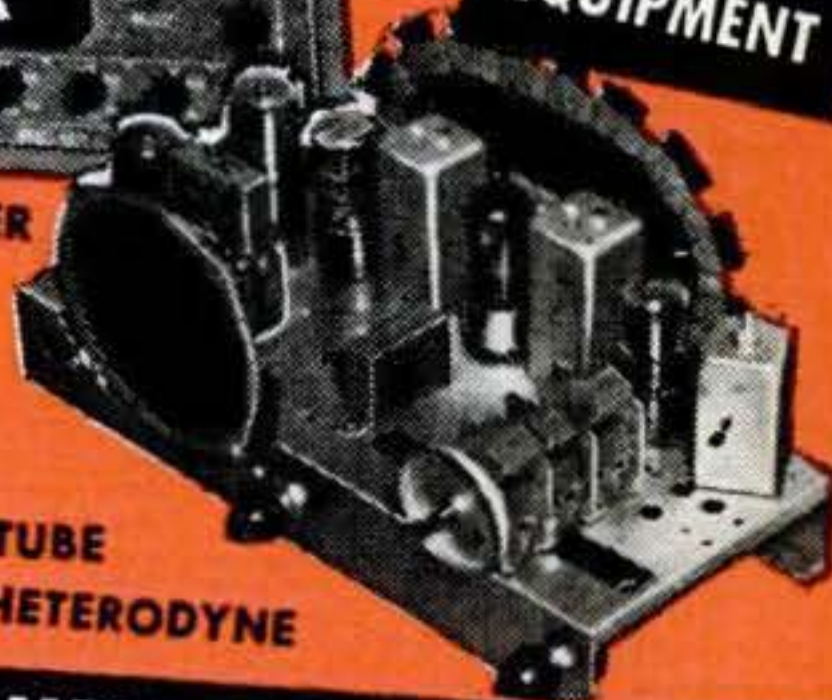

6 TUBE SUPER-HETERODYNE

FREE SAMPLE LESSON COUPON

RADIO-TELEVISION TRAINING ASSOCIATION, DEPT. 155
972 Broad Street, Newark 1, N. J.

Rush me the **FREE** Sample Lesson of your practical Home Television Course—together with your **FREE** Catalog "How to Make Money in Television" in **SPARE TIME** while learning. No obligations! I understand no salesman will call. **(PLEASE PRINT.)**

NAME _____ AGE _____
ADDRESS _____
CITY _____ ZONE _____ STATE _____

DELIVERED TO YOUR DOOR POSTAGE PREPAID!

MAIL ORDERS
WE PAY POSTAGE ON ALL ARTICLES

NEW! 3-WAY FOLDING SHOVELS

FOR GARDENING-CAMPING!

For use as a shovel, hoe, pick, hammer or axe. Handiest tool you ever saw! Has sturdy 20" hardwood handle. 6"x9" pointed tempered steel blade with 2 cutting edges.

This Fine ALL-PURPOSE TOOL is a \$1.95 VALUE!

79c

New, but slightly weather-soiled - no damage to shovel at all.

NEW! CARRYALL Waterproof Canvas Fishing - Camping Bag

Dandy for FISHERMEN • BEACH HUNTERS • CAMPERS • BOY SCOUTS

EASILY A \$1.95 VALUE!

Inside opens to 10" x 4" x 7". Has 2 outside pouches with snap fasteners. Cover fastens with buckle straps. Web carrying straps included.

69c

NEW-U. S. SURPLUS 1 1/2 QUART C.T.T. (carbon tetra-chloride)

FIRE EXTINGUISHERS

All Brass Handpump - throws powerful, continuous stream. For House, Garage, Car.

\$18 VALUE

\$3.39

WE PAY POSTAGE

NEW-DUAL TUBE PNEUMATIC SWIM FLOATS

FUN In the WATER with SAFETY! Use as a RAFT - PLAYBOAT - HEADREST - LIFESAVER. LEARN TO SWIM etc. Inflates by mouth. In original carton!

FOR KIDS ADULTS \$1.95 VAL.

89c

LOWEST PRICES IN THE COUNTRY NEW CANVAS COVERS

5 Ft. x 7 Ft., \$3.95 Value..\$2.79
 6 Ft. x 7 Ft., \$4.95 Value..\$3.39
 6 Ft. x 9 Ft., \$6.95 Value..\$4.29

SEND FOR FREE CATALOG - AMAZING VALUES!

UNIVERSAL ENTERPRISES

DEPT. 5-0 946 S. MAIN ST. LOS ANGELES 15, CALIF.
 WE PAY POSTAGE, TAXES, INSURANCE ON ALL ARTICLES.

HEED THIS NOTICE! Our Tires Are NOT Re-treads, Re-grooved or New Treads that have been re-capped. Our MATCHED tires give you **SAFETY and ECONOMY** - the BEST for LESS. You've seen our adv. month after month for years. We serve TRUCKS, BUSES and CARS. OUT-OF-TOWN folks buy now and take off 20% discount. Our EXPERIENCE assures you the BEST BUY in good ORIGINAL TREAD Tires. One Quality - One Price.



Don't Send a Cent

Until you see our tires. Remember you get what we advertise. We ship only good USED original tread tires. A trial of one tire is worth a thousand words and will make you a satisfied customer. We guarantee a special personal selection of tires for you.

BUT IF YOU SEND CHECK OR MONEY ORDER IN FULL WITH THIS AD "NOW" - you may take 20% discount on every tire. SAVE TIME - SAVE MONEY

TUBE GIVEN WITH EACH PASSENGER TIRE

WRITTEN GUARANTEE - Sent with Every Tire You Buy

These are **** Original Tread Tires - OUR BEST Can be used for "Every Purpose" - No Re-caps or Re-grooved
 READ THAT TOP NOTICE AGAIN AND SAVE \$ \$ \$

600-16	\$5.55	650-16	\$5.95	700-15	\$5.85	475-19	\$5.95
600-16(8)	6.50	700-17	9.99	650-15	5.75	525-18	5.95
700-16	6.85	750-16	7.95	550-17	6.75	550-16	5.55

SUPERCUSHION TIRES (24 lb. air) to fit your present wheels
 670-15(650-15) \$6.25 760-15(700-15) \$7.45 670-16(600-16) \$6.66
 710-15(650-15) 6.85 820-15(700-15) 6.25 760-16(650-16) 7.50



WE SPECIALIZE IN TRUCK TIRES ****
 Matched Tires Shipped all over USA and Foreign Countries. IMMEDIATE SHIPMENTS Same Day. Depend on STANDARD for SERVICE. Roll along those EXTRA MILES without Delays and SAVE \$ \$ \$

***** Five Star SPECIAL			
600-20	\$9.95	32x6(8)	\$10.95
650-20	9.95	32x6(10)	13.95
700-20	10.95	750-20(10)	13.95
750-20	10.95	825-20	17.77

900-20	\$16.66	1000-22	\$16.66
1000-20	17.77	1100-22	17.77
1100-20	18.88	1100-24	18.88
750-15	11.45	700-17	13.33

MILITARY *** GRADE TRUCK TIRES**
 9.00-16\$12.22 / 7.50-20\$13.00

Thousands of Tires Shipped to Satisfied Customers Throughout United States and Many Distant Points. Remember Send This Ad with Check or Money Order to Dep't 5.

STANDARD 834 N. Broad St., Philadelphia 30, Pa.

SPEED AND POWER Handbook



50 CHAPTER LIBRARY EDITION

Tens of thousands have been sold. Build Fast Stock Cars! California Roadsters! 160 MPH Rods! Covers Crosleys to Cadillacs—all makes. Breathtaking Methods.

Authentic—Direct from Californial

SAVE MANY DOLLARS

Build your own Dual Manifolds! Superchargers! Hot Cams! Water Injectors! Hi-Compression Heads! Mileage Devices! Get up to ten more miles per gallon! Get racing speed, lightning acceleration, dynamic power increases from any make passenger automobile! Get construction drawings! Tuning techniques! Speed tricks! Economy secrets! Ingenious formulas! Covers "Racing Frames"—"Reciprocating Masses"—"Jet Engines"—"Braking Characteristics"—"Dynamometers"—"Dual Pipes, Gears, Fuels, Manifolds, Porting, Relieving, Lowering! Balancing."

Includes "CALIFORNIA AUTOMOBILE CUSTOMIZING"—Drawings! Diagrams! 50 Photographs in Color. Newest Ideas! Conversions! Carson Tops! Re-Styling all makes! Streamlining! Chopping! Channeling! Including 1950 Racing Equipment Catalogue! Complete—\$1.98 Postpaid. Racing Equipment Catalogue without book—50c.

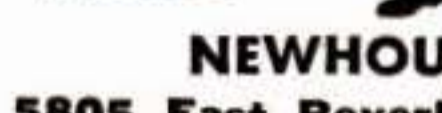

NEWHOUSE AUTOMOTIVE INDUSTRIES
 5805 East Beverly Blvd., Dept. A4, Los Angeles 22, Calif.

ELECTRIC MOTOR BARGAINS!



1 HP 3450 RPM \$34.50
 1/2 HP 1750 RPM \$15 3/4 HP 1750 RPM \$26
 1/2 HP 3450 RPM \$15 3/4 HP 3450 RPM \$26

Every Motor Fully Guaranteed

Heavy Duty, Repulsion Induction or Capacitor Types, 110-220 Volts, 60-cycle. Single-phase. Standard Makes (G. E., Wagner, Leland, Westinghouse, etc.). Rush your order TODAY—large stock of motors—1 & 3 phase. 32-v. direct current bargains. Prices f.o.b. ROBERTS ELECTRIC CO., 7232 Madison, Forest Park 16, Ill.



MECHANICAL DENTISTRY

To make Crowns, Plates, Bridgework, etc., for Dentists. Easy practical way to learn mechanical dentistry at home in spare time. FULL EQUIPMENT OF TOOLS AND MATERIALS INCLUDED WITH COURSE. Low tuition. Easy terms. Write for FREE BOOK about this money making profession that is not affected by the machine age.

McCARRIE SCHOOL of Mechanical Dentistry
 207 N. Broad St. Dept. 898 Philadelphia, Pa.



This can't happen WITH A Safety Ladder Holder

Avoid ladder accidents... use SAFETY LADDER HOLDER! Fastens in seconds to any roof gutter, end pitch or building side. Durable and weatherproof. Endorsed by casualty insurance companies. Send check or money order now!

only \$2.50 POST PAID Dealer inquiries invited

Dept. 5 LEWIS-SKINNER CO., New Boston, N. H.

Rupture Troubles Ended

Advanced method has healed thousands. No leg straps, no elastic, no plasters. No pressure on hips or spine. Flexo-pad. Entirely different. Endorsed by doctors, mechanics, clerks. Very light. **INEXPENSIVE. GUARANTEED.** Write for information and trial.

SMITH MANUFACTURING COMPANY
 EST'D 1893 Dept. PS, Preston, Ont. Can.

POWER MOWERS & KITS FREE PLANS



LOW FACTORY PRICES DIRECT TO YOU on

America's finest Lawn Mowers and Easy-To-Assemble Kits and Parts. TRIANGLE Mowers are quality-built and powered high for easy cutting and long wear.

SAVE MONEY 3 WAYS

- Buy complete assembled mowers in 3 or 4 wheel models. 18" and 20" sizes.
- You assemble complete mower from our precision built Kits and Parts.
- Build your own from our FREE PLANS using Triangle Kits, Parts, Engines, Wheels, Etc.

WRITE TODAY for full facts, Free Plans, Parts List, and LOW Factory Prices.

TRIANGLE MFG. CO.
 Dept. S-E, Box 185 Fort Scott, Kansas

PRINT YOUR OWN POST CARDS

COMPLETE OUTFIT
only
\$7.50

Amazing results in sales, inquiries and contacts... saves time and money... very easy to use GEM STENCIL DUPLICATOR is ideal for Advertising, Announcements, Notices, Labels, Forms, Price Lists—hundreds of uses for every type of business and organization. Comes complete with all supplies, instructions and 60-page Book of Ideas.

FREE TRIAL OFFER: Try it before you buy it! Write and a GEM OUTFIT will be sent you postpaid. After 10 days, send only \$7.50 or return the GEM, no questions asked. The GEM must sell itself; you be the judge.

BOND EQUIPMENT CO. • Dept. 151
6633 Enright • St. Louis 5, Mo.

SEND NO MONEY • FREE TRIAL OFFER

LEARN AERONAUTICAL ENGINEERING

Aircraft and Engine Mechanics (A & E)

Train at the Flying Wing school—New classes starting soon. Write for illustrated catalog.

Northrop Aeronautical Institute

APPROVED FOR VETERANS DIVISION OF NORTHROP AIRCRAFT, INC.
1525 E. Broadway, Hawthorne, Los Angeles County, California

MAKE MONEY IN LANDSCAPING

Thorough training by Internationally known Landscape Architect to start your own business, improve your home or advance in this well paid field. Many Opportunities. Approved for Veterans. Send for FREE BOOK.



NATIONAL LANDSCAPE INSTITUTE
310 So. Robertson Dept. PS-6 Los Angeles 48, Calif.

"PLASTICS"

FABRICATING MANUAL AND CATALOGUE

Work in a fascinating and profitable hobby. Just out—our latest fabricating manual. Tells you how to work with Plastics. Our new Catalogue provides all needed materials: Plexiglas—Lucite—Tenite—Catalin—Acetate—all in sheets, rods, and tubes. Complete line of cements, dyes, accessories and supplies. Send 20c today for latest Catalogue and Handbook.

HOUSE OF PLASTICS

8648 Linwood Avenue Dept. MO-6 Detroit 6, Michigan

OUT OF PAWN GENUINE DIAMONDS

SAVE UP TO 50% AND MORE
Money-Back Guarantee



Approx. 1/2 Ct. Incl. Tax
\$95
\$200 VALUE

SEND FOR FREE Diamond Catalog

BERMAN'S Illustrated Catalog

Diamonds from estates, banks, unredeemed pledges offered at substantial savings

VALUES FROM \$10 TO \$10,000

BERMAN'S DIAMOND LOAN BANK

DEPT. PS

BERMAN BLDG., BALTO. 1, MD.

Reference: Your Own Bank or Any Mercantile Agency

WHAT EVERY AUTO MECHANIC WANTS TO KNOW

1800 PAGES

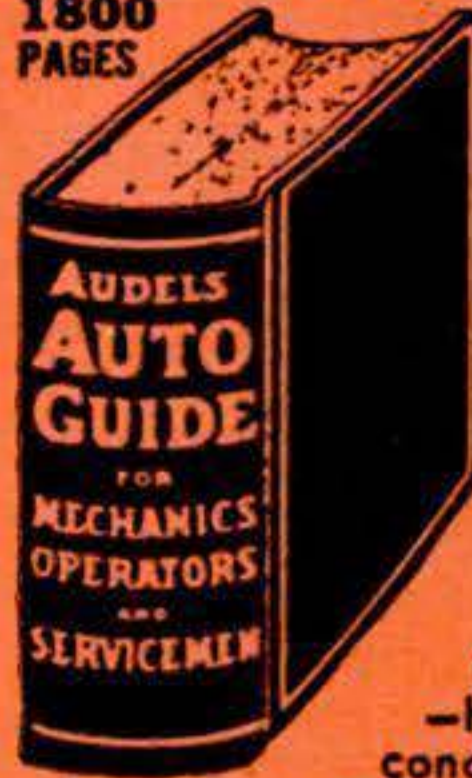

This Big Practical Book gives full information with working diagrams covering the principles, construction, ignition, service and repair of modern cars, trucks and buses.

Diesel Engines, Hydramatic and Fluid Drives Fully Explained.

A complete Guide of 1800 pages, with over 1500 illustrations showing inside views of the working parts, with instructions for service jobs.

IT PAYS TO KNOW

How to fit pistons—How to locate engine knocks—How to fit connecting rod bearings—How to service main bearings—How to recondition valves—How to time valves—How to adjust fan belts—How to adjust carburetors and chokes—How to rebuild a clutch—How to service automatic transmissions—How to service brakes—How to adjust steering gear—How to cope with ignition troubles—How to service distributors—How to time ignition—How to "tune up" an engine.

\$4 COMPLETE • PAY \$1 A MO. TO GET THIS ASSISTANCE FOR YOURSELF SIMPLY FILL IN AND MAIL COUPON TODAY.



Step up your own skill with the facts and figures of your trade. Audels Mechanics Guides contain Practical Inside Trade Information in a handy form, Fully illustrated and Easy to Understand. Highly Endorsed. Check the book you want for 7 DAYS FREE EXAMINATION. Send No Money, Nothing to pay Postman.

CUT HERE MAIL ORDER

AUDEL, Publishers, 49 W. 23 St., NEW YORK 10, N. Y.

Please send me postpaid for FREE EXAMINATION books marked (X) below. If I decide to keep them I agree to mail \$1 in 7 Days on each book or set ordered and further mail \$1 monthly on each book or set until I have paid price, otherwise I will return them.



Check NOW!

You Can Look Over Any Guide In Your Own Home

Start the Easy Payments If Satisfied

MAIL THIS TODAY



- AUTO MECHANICS GUIDE, 1800 pages . . . \$4
- DIESEL ENGINE MANUAL, 400 Pages . . . 2
- WELDERS GUIDE, 400 Pages . . . 1
- MACHINISTS Handy Book, 1600 Pages . . . 4
- POWER PLANT ENGINEERS Guide, 1500 Pages. . . 4
- ENGINEERS & FIREMANS EXAMS, 528 Pages. . . 1
- PUMPS, Hydraulics & Air Compressors, 1658 Pgs. . . 4
- MARINE ENGINEERS Handy Book, 1280 Pages . . . 4
- ENGINEERS & Mechanics Guides (8 Book Set). . . 12
- Answers on Practical ENGINEERING, 254 Pages . . . 1
- ELECTRIC WIRING DIAGRAMS, 210 Pages . . . 1
- ELECTRICIANS EXAMINATIONS, 250 Pages. . . 1
- ELECTRICAL DICTIONARY, 9000 Terms . . . 2
- ELECTRIC MOTOR GUIDE, 1000 Pages . . . 4
- HANDY BOOK OF ELECTRICITY, 1440 Pages . . . 4
- ELECTRICAL POWER CALCULATIONS, 425 Pgs. . . 2
- RADIOMANS GUIDE, 975 Pages . . . 4
- ELECTRONIC DEVICES, 216 Pages . . . 2
- ELECTRIC LIBRARY, 7000 Pages (12 Book Set). . . 18
- Vols. I, II, III, IV, V, VI, VII, VIII, IX, X, XI, XII \$1.50 Ea.
- OIL BURNER GUIDE, 384 Pages . . . 1
- HOUSE HEATING GUIDE, 1000 Pages . . . 4
- CARPENTERS & Builders Guides (4 Book Set). . . 6
- PLUMBERS & Steamfitters Guides (4 Book Set). . . 6
- MASONS & Builders Guides (4 Book Set). . . 6
- BLUE PRINT READING, 416 Pages . . . 2
- PAINTERS & DECORATORS MANUAL, 450 Pgs. . . 2
- GARDENERS & GROWERS Guides (4 Book Set). . . 6
- REFRIGERATION & Air Conditioning, 1280 Pgs. . . 4
- SHEET METAL WORKERS Handy Book, 388 Pgs. . . 1
- SHEET METAL PATTERN LAYOUTS, 1100 Pgs. . . 4
- AIRCRAFT WORKER, 240 Pages . . . 1
- MECHANICAL DRAWING GUIDE, 160 Pages. . . 1
- MECHANICAL DRAWING & DESIGN, 480 Pgs. . . 2
- MATHEMATICS & CALCULATIONS, 700 Pgs.. . . 2
- MECHANICAL Dictionary, 968 Pages . . . 4
- MILLWRIGHTS & Mechanics Guide, 1200 Pgs. . . 4

Name _____

Address _____

Occupation _____

Employed by _____

29

NEW AUTOMOTIVE DISCOVERY
FREE TRIAL
 IN YOUR CAR!

REPLACES
 IDLE ADJUSTMENT
 SCREW IN YOUR CARBURETOR
 HOLES FOR AIR FLOW

THE OBJECTIVE IS
 TO GIVE YOUR CAR
 MORE MILEAGE
 FASTER PICK-UP
 EASIER STARTING
 BETTER IDLING

INSTALL IT
 YOURSELF
 in a Few
 Minutes

Patent Pending

THE AMAZING NEW GANE "air-flow" NEEDLE

ABOUT 1/2 MILLION NOW IN USE!

Up to 25% MORE MILEAGE, EASIER STARTING, FASTER PICK-UP and SMOOTHER IDLING are reported by many users of this new SENSATIONAL Automotive Product. (Hundreds of such letters have already been received.) However, they do not show improvement in some cars—Therefore we want you to try them in your car AT OUR EXPENSE. TRY BEFORE YOU BUY. Just mail card or coupon below and TRY THEM FREE for 10 days. Then check your mileage and engine performance. If satisfied, send only \$1.50 per needle (8 cyl. cars take 2). If not entirely satisfied—just return them and YOU OWE US NOTHING—FAIR ENOUGH? TRY BEFORE YOU BUY

MAIL
 TODAY
 SEND NO MONEY
 PAY POSTMAN
 NOTHING



NATIONAL AUTOMOTIVE
 RESEARCH CORP.

Dept. H-6, Venice, California

RUSH Gane "Air-Flow" Needle for my FREE TRIAL. I SEND NO MONEY—I PAY POSTMAN NOTHING. I will try them for 10 days in my car. Then, if satisfied, I will send only \$1.50 per needle (8 cyl. cars take 2). If NOT SATISFIED, I will return them and I OWE YOU NOTHING.

Name _____

Address _____

City _____

State _____

Make of Car _____

Year _____

No. of Cylinders _____

Make of
 Carburetor _____

LAW FREE BOOK

Your FREE copy of "The Law-Trained Man" shows how to gain prestige and greater earnings through Blackstone home law study. All instruction material furnished including 18-volume Law Library written by 65 well-known law authorities. Lawyers, judges among our graduates. LL.B. degree. Low cost; easy terms. Write today. Dept. 120A, Chicago 1, Ill. 225 N. Michigan Ave. **BLACKSTONE COLLEGE OF LAW** A Correspondence Institution Founded in 1890

ALTIMETER

Modernize your car. Fine desk ornament. Reads up to 20,000 feet. Fluorescent dial glows at night—no connections of any kind required—self contained—Suitable as a laboratory standard instrument—Same as used in airplanes. Brand new—cost gov't many times.....\$3.50

REMOTE CONTROL THERMOMETER

For automobiles, homes, refrigerators, milk coolers, brooders, orchards, workshops, etc. Temperature bulb at end of 5 or 15 ft. flexible tube (state which). Dial thermometer glows in dark—non electric—very sensitive—-40° to +50° C. and -40° to +125° F. on same dial. Aircraft quality—worth many times.....\$3.50

MANIFOLD PRESSURE GAUGE

Indicates manifold pressure in your automobile, boat or stationary engine—allows you to operate your engine at maximum operating efficiency and gas economy. Connects to windshield wiper hose or manifold. Complete with connections, hose and instructions. BRAND NEW!.....\$7.50

Enclose sufficient postage—Excess will be refunded—No COD's

AIRCRAFT COMPONENTS, Inc.
 1300 Woodland Avenue Benton Harbor, Michigan

NEW! SENSATIONAL DEVICE
 ENABLES ANYONE TO TEST
OWN EYES
 RIGHT AT HOME



SAVE up to \$15.00 On Glasses

Big News to the Millions of Spectacle Wearers and Prospects. Means Freedom from Outrageous Prices. Perfect Satisfaction Guaranteed! No Risk!

MAKE BIG MONEY QUICK
 FREE SAMPLE KIT!

Send for Free Sample at once. Show it to friends and others. Let them use it Free and watch their amazement over this new system of Self Testing. Here is a great new opportunity in a tremendous new field of unlimited possibilities. Spare or full time. No experience or capital needed. Act quick!

Clark Optical Co., Dept. A-145, 1148 W. Chicago Ave., Chicago 22, Ill.

Trained Men Get the Better Jobs
PRACTICAL SHOP TRAINING
 in **AUTOMOTIVE MECHANICS**
BODY and FENDER REBUILDING

If interested write or wire

ATLANTA MOTIVE TRADES INSTITUTE
 Dept. C 254 IVY St., N.E. Atlanta, Georgia

Member of the Southern Association of Private Trade Schools
 Veterans ask about G I Training

Learn PHOTOGRAPHY at Home
 Splendid Hobby or Vocation

Prepare in spare time. Practical basic training. Long-established school. Send for free booklet, "Opportunities in Modern Photography" and particulars. Sent postage prepaid. No obligation.

AMERICAN SCHOOL OF PHOTOGRAPHY
 1315 S. Michigan Avenue, Dept. 136A Chicago 5, Illinois

NERVOUS STOMACH

ALLIMIN relieves distressing symptoms of "nervous stomach"—heaviness after meals, belching, bloating and colic due to gas. ALLIMIN has been scientifically tested by doctors and found highly effective. World famous—more than a 1/4 billion sold to date. Money-back guarantee. At all drug stores.

ALLIMIN Garlic Tablets

Be a DETECTIVE

A CHALLENGE FROM WASHINGTON, D. C. Help Stop Crime! Train at home. Earn big money. Amazing training course from the NATION'S CAPITOL (center of law enforcement) by former U. S. GOVT. AGENT and NAVAL INTELLIGENCE Officer exposes actual methods used by Criminals. Write for FREE BOOK. State age.

INTERNATIONAL DETECTIVE TRAINING SCHOOL
 1701 Monroe St., N.E. Dept. 216 Washington 18, D. C.

Inventors • Hobbyists • Home Owners
 Let us SOLVE your ELECTRICAL PROBLEMS
 with our "New Electrical Information Service"

HERE'S a new, unique service designed especially for the thousands of Inventors, Hobbyists, Home Owners with electrical problems on which they need help. Our staff of experts is prepared to give technical advice in layman's language in answer to your perplexing problems. This is how the service works. Send us an outline of your problem. We will return by air mail an estimate in writing of what the fee will be for our staff to solve this problem. All this is FREE. No obligation. Upon receipt of your authorization and check (or money order) we will begin work analyzing your problem. Every problem will be given confidential treatment. Minimum charge is \$1. Fee rises with complexity of problem. At present only a limited number of requests can be handled. Outline your problem and mail to us today for FREE ESTIMATE. Remember, no obligation to you.

**NO OBLIGATION!
 FREE ESTIMATES!**

Peninsula Electrical Products Co., Research Bureau
 Dept. S-5 719 Cedar St. Pacific Grove, California

AT LAST!

SCIENCE DISCOVERS the secret of man-made gems MORE BRILLIANT THAN



DIAMONDS

AT LESS THAN... **5%** THE COST OF DIAMONDS

Look prosperous—wear big beautiful TITANIA BRILLIANTS—more sparkling than diamonds. 64 perfectly cut and polished facets. Ideal for ENGAGEMENT RING, LADIES EARRINGS, MEN'S SOLITAIRE. New man-made gem of incomparable brilliance and fire; only gem on earth more brilliant than diamond. 1 Carat unmounted Titania Brilliant only \$16.95; 2 Carats \$33.95; 3 Carats \$49.95; MOUNTED IN 14K GOLD RING as low as \$32—all prices include Federal Tax. Ask about our LAY-A-WAY plan.

10 DAY RETURN PRIVILEGE If not thrilled and delighted, you may return within 10 days for refund. Enclose remittance and we send prepaid or pay on arrival, plus postage. Deal with 35 YEAR OLD COMPANY. SEND CHECK OR MONEY ORDER.

BRADLEY MARTIN CO. 495 WASHINGTON AVE. BROOKLYN 16, N.Y. DEPT. P

"How to Make Money with Simple Cartoons"

A book everyone who likes to draw should have. It is free; no obligation. Simply address **FREE BOOK**

CARTOONISTS' EXCHANGE
Dept. 196-D Pleasant Hill, Ohio

WATCHMAKING

Be a Watchmaker—Be Independent

Get practical training in Chicago's first accredited watchmaking school. Day and Evening Classes—Approved for Veterans.

Write today for free information

CHICAGO INSTITUTE OF WATCHMAKING

6 East Lake Street Dept. PS-6 Chicago, Illinois

PROFITS MAKE YOUR OWN RUBBER MOLDS

Write today for **NEW FREE CATALOG**

Learn to cast thousands of perfect figurines, plaques, book ends, ash trays, etc. Start NOW—NO EXPERIENCE, LITTLE CAPITAL needed. Earn GREAT PROFITS with X.L. RUBBER MOLDS. X.L. Rubber, Pts. \$2.00; Qts. \$3.50; Gallons \$8.95; Models and enough rubber for 3 molds . . . \$1.30 postpaid.

PLASTIC ARTS STUDIO 3403 S. MADISON ST. DEPT. 3, MUNCIE, INDIANA

NEW IMPROVED...AMERICANIZED JUDO

TWO BIG BOOKS FULLY ILLUSTRATED
1220 SHOW-HOW PHOTOS. 71 LESSONS
MANY NEW HOLDS

Protect yourself and others Size and strength mean nothing Knowledge and skill enable you to master any situation even against biggest bullies or armed thugs. Written and illustrated by one of the world's great Judo experts. Volume 1, basic and advanced holds. Volume 2, very advanced . . . each volume \$1 50.

Big Combination Offer!
SAVE...

BOTH BOOKS \$2.50 POSTPAID
OR C.O.D. PLUS POSTAGE
5-day Money Back Offer. ACT NOW!

DEPT. PS-6
IMPROVED JUDO, INC. P.O. Box 7355, Sta. 1, Los Angeles, Calif.

Become an Electrical Engineer
B. S. Degree in 36 Months

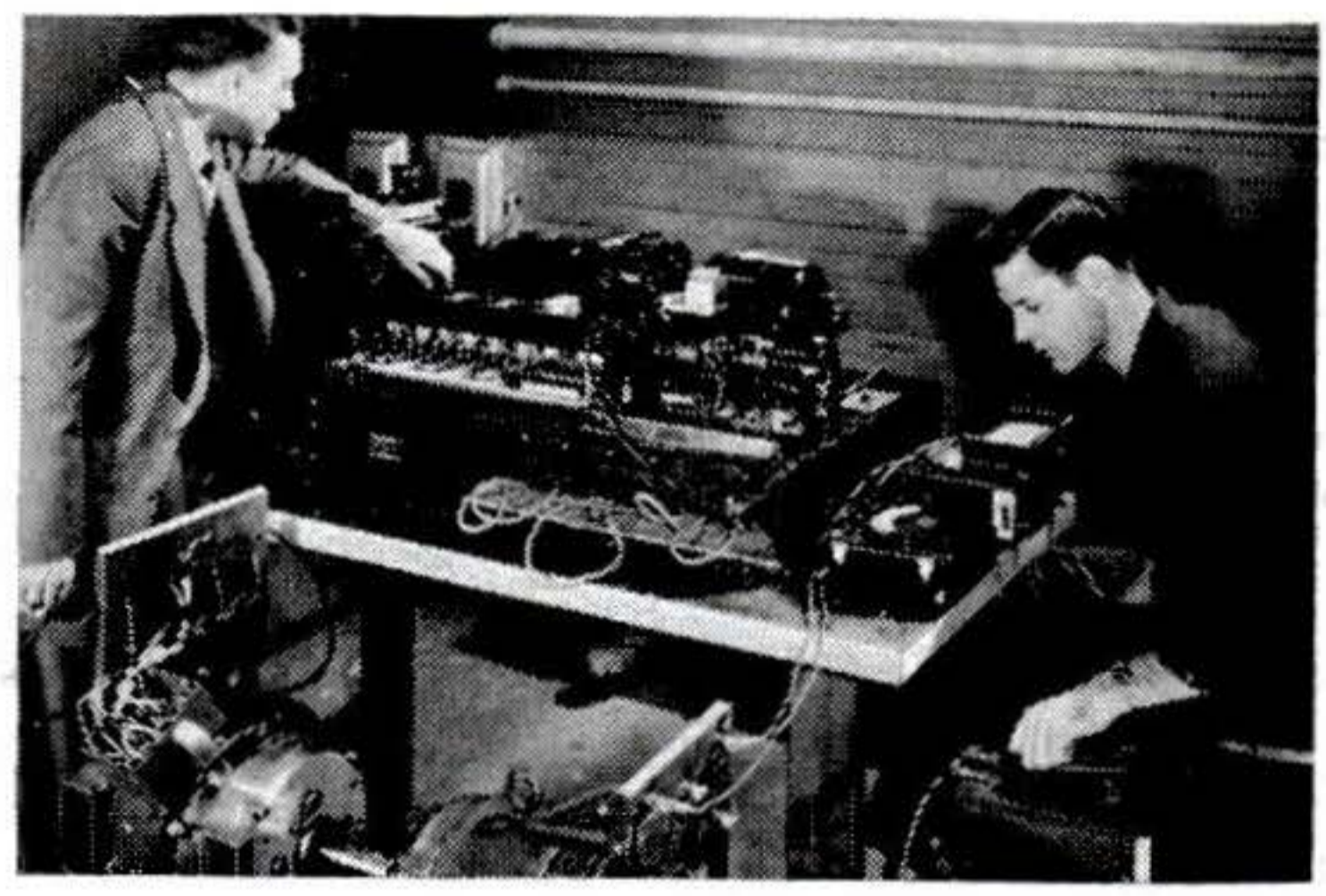

MAJOR IN POWER OR ELECTRONICS

Important advantages are yours at this nonprofit Technical Institute and College. A valuable year is saved by gaining your B. S. degree in 36 months of continuous study. You get both practical, specialized training in well-equipped laboratories—and a solid education in Electrical Engineering and related arts.

In 12 months, the world-famous concentric system equips you for specific occupations and brings the valued Electro Technician or Electronics Technician Certificate which is credited toward your B. S. degree.

Military, Academic or Practical Training is evaluated for advanced credit. Preparatory courses are also available.



Faculty of 85 specialists. 1555 currently enrolled from 48 states and 23 foreign countries. Over 35,000 alumni. Terms open July, Oct., Jan., April.

MILWAUKEE SCHOOL of ENGINEERING

Founded 1903 by Oscar Werwath

Write for free 110-page catalog and 48-page pictorial booklet, "Your Career".



MILWAUKEE SCHOOL OF ENGINEERING
Dept. PS-650
1020 N. Broadway, Milwaukee, Wis.

Without obligation, send me the 110-page catalog and 48-page "Your Career" booklet.

- (Check 6 to 36 month courses which interest you)
- Electrical Engineering Power Electronics
 - Radio-Television Heating Refrigeration
 - Air Conditioning Electricity Welding

Name.....Age.....

Address.....

City.....Zone.....State.....

Check if World War II Veteran



HIGH PAY • SECURITY When You LEARN A TRADE

Get ready for a well-paid, lifetime job or a business of your own in one of these FIVE ESSENTIAL TRADES. Complete training under expert instructors with practical experience prepares you to step into a good paying job with a future and security.

ELECTRICITY: Basic electricity, Residential and Industrial Wiring and Appliance Repair.

PLUMBING: Every phase — pipe cutting and threading to complete installations, blue print reading.

MASTER AUTOMOTIVE TECHNICIAN—INCLUDING BODY AND FENDER: Engine overhaul, Transmissions, Carburetion, Generator-Ignition Systems, Tune Up.

DRAFTING: College level training in general Machine and Architectural Drafting.

SHOE REPAIRING: Complete practical training includes reconditioning and rebuilding.

Approved For Veteran's Training

NATIONAL TRADE SCHOOL DEPT. C • 2610 Grand • Kansas City 8, Mo.

Without obligation to me please send full information on the course checked.

.....Master Automotive Technician including Body & Fender

.....DraftingPlumbingElectricityShoe Repairing

Name..... Age.....

Address.....

City..... State.....

Veteran?.....

Design! Build! WITH AMAZING, INEXPENSIVE, DEKTUFTS

Durable, leather-like beauty, 11 rich colors . . . and so easy to use that even a child can apply them . . . 4 inch square lumarith* DEKTUFTS† beautify any surface that takes an upholstery nail.

1,001 USES FOR NEW DEKTUFTS!



You'll construct headboards, home-bars, lamps, toy chests, valances, tables, jewel boxes, and many other projects of your own design.

At DEPARTMENT STORE drapery, notion, and houseware counters, all SEARS ROEBUCK STORES, Decorator's Supply Shops, lumber yards . . . or send 15c to Deks Inc., Dept. P-2, for sample and free literature.

† Pat. Pend.
* Celanese Plastic.

DEKS, inc. 482 Broome St., New York 13, N. Y.

HOLLYWOOD MUFFLER THE TONE YOU LOVE TO HEAR

MORE SPEED—POWER—MILEAGE

are yours with a Hollywood Muffler . . . plus a tone you'll love to hear! Not a gutted muffler. Easy to install.

Hollywood Muffler:
Trade-mark Reg.
U. S. Pat. Off.

Dealers
Write



IMPROVED
DESIGN
PRECISION MADE
ELECTRIC WELDED!

Outlasts ordinary mufflers 3 to 1

Ford, Chevrolet, Plymouth \$6.00

All other cars \$8.00

Duals, Ford & Merc. \$24.50. Also Fender Skirts, \$10.95. Order direct. Send check or M.O. and save postage.

TOM WILKINSON MUFFLER CO. 811 WILT STREET
FT. WAYNE, IND.

EASY TO LEARN CODE

Learn or increase speed with an Instructograph—the Radio-Telegraph Code Teacher that takes the place of an operator-instructor and enables anyone to master code without further assistance. Available tapes from beginners alphabet to typical messages on all subjects. Speed range 5 to 40 WPM. Always ready—no QRM. Thousands have "acquired the code" with the Instructograph System. Write today for convenient rental and purchase plans.

INSTRUCTOGRAPH COMPANY
4701-P Sheridan Road, Chicago 40, Illinois



Hobbyist Catalog



WE PAY POSTAGE!
SHIP MODELS . . . TRAINS . . . PLANES
Cars . . . Art Supplies . . . Tools . . .
Project . . . Games.
U.S.A. and Canada Orders Only.

10¢ write **Braun-Craft**
1232 ETOWAH, DEPT. PS-11A, ROYAL OAK, MICH.

MAKE!
FOLDING
TABLES
BENCHES
HORSES
IN A JIFFY

FOLD-A-WAY CHANNEL STEEL LEGS

Shipped complete, ready to fasten to your top in a minute. Rubber tipped. Used on the job, in homes, workshops, ping pong tables, trailers, camps, boats, churches, lodges, banquet halls. Send for free circular



\$4.98 Pr.
24" Legs
\$5.98 Pr.
30" Legs
Postpaid in
U.S.A.

THE DIAMOND MFG. COMPANY

Dept. PS. 1100 Altamont Ave. Schenectady 7, N.Y.

WANT \$10,000?

Earn the government Super Sensitive P.R.I. ment bonus. Locate Uranium with a **GEIGER COUNTER** Find gold, silver, and other valuable ores with a P.R.I. Treasure Locator. World's finest instruments. FREE catalog. Write today.

PRECISION RADIATION INSTRUMENTS, Inc.
5478 PS Wilshire Blvd., Los Angeles 36, Cal.

Dealer Inquiries
Invited



2 BIG SPECIALS FOR YOUR CAR

4.50

DEEP TONE MUFFLERS

More speed, power, economy, cooler engine. Mellow tone. Blowout-proof steel. No cutting, drilling. Complete. Ford, Chev. Plym. \$4.50. Others \$5. Add 80c for shipp. chgs. State year, model. Guaranteed! Send cash, check HOWARD AUTO SUPPLY 901 SE Grand, Dept. PS-6, M. O. or C.O.D. reference: D & B

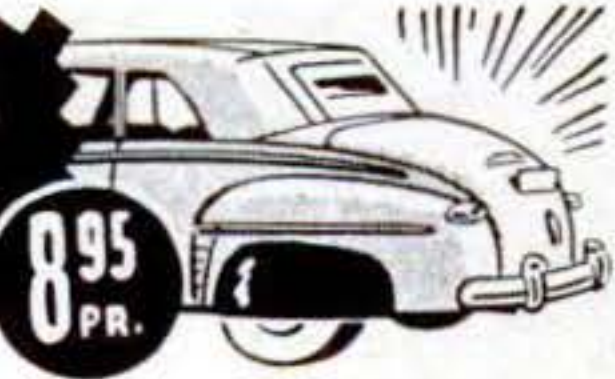

8.95 PR.

FENDER PANTS

Heavy, solid steel. Prime finished. Easily installed. Styles for all cars. Money back guarantee! State year model. Add 90c for shipp. chgs.

MONEY BACK
If Not Delighted
in 10 Days
WEAR AT OUR RISK

AMERICA'S BEST WATCH VALUES
PRACTICALLY WHOLESALE DIRECT TO USER

ORDER WITH CONFIDENCE
**5 YEAR WRITTEN
GUARANTEE**

17 JEWEL SELF WINDING
ORIGINALLY \$71.95

Factory Surplus NOW ONLY

One of World's finest. Needs no winding. Winds self as you move. Water and shock resistant. Anti-magnetic. Ace value at former \$71.95 price. Now only \$24.95, plus \$2.50 tax. Order now.

\$24.95



MEN'S OR WOMEN'S **BULOVA**

15 or 17 JEWEL
movement



Originally Sold up to ~~\$59~~

OUR PRICE ONLY **\$16.95**

Plus \$1.70 Tax

- Also
- BENRUS
 - GRUEN
 - WALTHAM
 - or ELGIN WATCHES

TRIAL OFFER!
Wear At Our Risk!

Genuine Bulova, Benrus, Gruen, Waltham, Elgin and other famous wrist watches in latest style Yellow Gold Cases. You get these unredeemed 5-year Guaranteed FAMOUS MAKE WATCHES now at truly enormous savings because we bought out SURPLUS STOCKS of leading New York and Maryland Jewelers. Order now while they last. State make preferred. Order men's or ladies'. Only \$16.95 plus \$1.70 tax. Order Now.

17 JEWEL 2 Push BUTTON CHRONOGRAPH
ORIGINALLY \$71.50

Thousands sold at \$71.50 Factory Surplus Now Only

2-push button combination wrist watch stopwatch, telemeter, tachometer. Incablock shock resistant feature. Sweep second hand. Anti-magnetic. Radium dial. Stainless steel back. Unbreakable crystal. Only \$21.95 plus \$2.20 tax. Order now.

\$21.95



2 PUSH BUTTON PLATED YELLOW GOLD CHRONOGRAPH
LOOKS LIKE A \$25 WATCH

Sweep second hand. Measures speed of cars, planes, horses, heart, etc. Combined time-piece, stop-watch, telemeter, tachometer. Perfect for Sportsmen, Boys, Young men. Shock-Resist case. Radium Dial. Leather Strap. Instructions enclosed. Only \$6.95, plus 70c tax.

NOW ONLY **\$6.95**



17 JEWEL SHOCK PROTECTED WATER RESIST

INCA-BLOCK—Shock Protected
ORIGINALLY \$59.00

OUR PRICE NOW ONLY

Handsome accurate. Has sweep second hand. Non-magnetic. Kept accurate time after 72-hour test under water. Amazing value at \$16.95 plus \$1.70 tax. Order now.

\$16.95



FREE!

Handsome expansion band included free with your order. Write for FREE Watch & Diamond Catalog. Practically wholesale prices to user direct.

ORDER DIRECT FROM THIS AD. FOR SELF AND FOR THRILLING GIFTS. Lowest prices ever, for these guaranteed watches! Order now on famous 5-year written guarantee. Send only \$1 down payment with order. Pay balance to postman on arrival plus postage. Or we pay postage if you enclose full payment plus tax with your order.

MARYLAND DISTRIBUTORS, Dept. 85 501 E. Baltimore St., Baltimore 2, Md.

Earn Dollars
in WATCH REPAIRING



Experienced watchmakers earn \$2500-\$5000 a year and up. Learn the "Sweazey Way" from 42-year-old school. Send today for FREE SAMPLE of Home Study watchmaking course.

GI approved resident courses also available. Write now. CHICAGO SCHOOL OF WATCHMAKING Dept. 460 1608 N. Milwaukee Avenue Chicago 47, Illinois

LEARN MEAT CUTTING AT NATIONAL
Pay After Graduation



The steady dependable trade of Meat Cutting taught easily in 8 short weeks. You LEARN BY DOING under actual meat market conditions in big modern school at Toledo.

For beginners or men with experience. Get a profitable store of your own. Remember, PEOPLE MUST EAT! Big pay jobs. Free employment help. Thousands of successful graduates.

Buying, cutting, percentage, pricing, advertising, selling, etc. A complete retail meat education. National School established over 25 years. Get National training NOW. Pay your tuition in easy weekly payments

after you graduate. G. I. approved. Send coupon for FREE 52 page school catalog—TODAY.

National School of Meat Cutting, Inc.
Dept. 51-F, Toledo 4, Ohio

Send me your FREE school catalog on National Training at Toledo in Meat Cutting, Meat Merchandising and Self Service Meats. No obligation. No salesmen will call.

Name.....

Address.....

City..... State.....

() Check here if Veteran of World War II

Be Your Own Boss



There's a great feeling to being in something for yourself, where all the profits go into your own pocket. American floor sanders make it possible for you to realize this ambition without special schooling or a big investment. Begin small and work up to as large an enterprise as you desire... It all depends on your ambition to get ahead. Ask for "tell-all" booklet entitled "Opportunities in Floor Surfacing". Use coupon and enclose 25 cents in coin or stamps to cover handling.

AMERICAN FLOOR SURFACING MACHINE CO.

532 So. St. Clair St. • Toledo 3, Ohio
Gentlemen:

Enclosed find 25c in stamps or coin for booklet "Opportunities in Floor Surfacing," telling me how I can start my own floor sanding business.

Name _____

Street _____

City _____ State _____



LABORATORY TECHNICIAN

BE A LABORATORY SPECIALIST; complete course. Big demand from hospitals, doctors, clinics. We teach all branches of medical laboratory work, including Medical and Dental X-Ray.

Approved by American College of Medical Technologists
Co-educational Free Placement Bureau
Free Catalog—Accredited for "veteran" training

CHICAGO COLLEGE OF LABORATORY TECHNIQUE
Dept. P.S. 431 S. Wabash Ave. Chicago 5, Illinois

ATOMIZED POWER FOR YOUR CAR!



Automatic GASOLINE INJECTOR



\$9.95

PATENT PENDING
More power, Greater acceleration, Top engine efficiency at all speeds. Stops Gas Waste—"cracks" fuel for fullest power! Dynamometer tests show up to 15% power increase resulting in decreased fuel consumption.

- MORE POWER
- QUICKER STARTING
- GREATER MILEAGE
- FASTER ACCELERATION
- LESS CARBON
- LONGER MOTOR LIFE

Quickly and Easily Installed

SOLD ON AN ABSOLUTE MONEY BACK GUARANTEE
Complete illustrated step-by-step instructions included

Send postal card for complete information. When ordering—state car make, year and model.

WESCO Box C—1665 Mission San Francisco 3, Calif.

YOUR "DREAMHOUSE"



ALREADY PLANNED FOR YOU

You will find it in the brand new HOME PLAN BOOK of the Home Building Plan Service.

This new book contains plans never before published. You will find the house of your dreams among the many plans, which include starter homes, small homes, and large homes, in a wide variety of contemporary and traditional designs for both frame construction and block masonry. \$1.00 for each book. No C.O.D.'s please.

Complete working blueprints are available for any home illustrated in the Home Building Service Plan books.

HOME BUILDING PLAN SERVICE
2454-P NE Sandy Portland 12, Oregon

Free Book

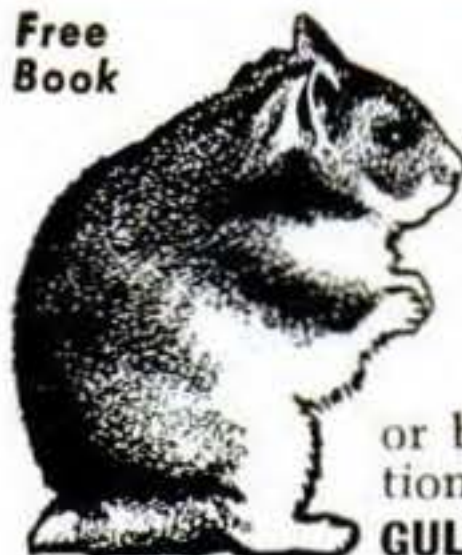

RAISE HAMSTERS

The new wonder animals from Syria. Often called Toy Bears. Delightful pets. Everyone wants them. Laboratories need thousands. Clean, odorless. Raise anywhere. A profitable and interesting hobby or business. We furnish breeders and instructions. Write today for free book.

GULF HAMSTERY, 1540 BASIL ST., MOBILE, ALA.



Treasure and Mineral LOCATORS GEIGER-COUNTERS

PURCHASE ON MONTHLY PAYMENTS

FREE LITERATURE

FISHER RESEARCH LABORATORY Inc.,
Palo Alto, Calif.

HAT AND CLEANING AND BLOCKING

Train for one of these Big Fields in the Largest and Best Equipped School of its kind. Learn by doing in modern training shops. Fine opportunities for good job or business of your own.

CHICAGO SCHOOL OF SHOE REBUILDING, Dept. PS-6
124 E. 26th Street Chicago 16, Illinois

Shoe Repairing

Complete Hat Cleaning and Blocking Training in only 12 weeks. Approved for Veterans under G.I. Bill. Low weekly or monthly payment plan for non-vets.

Write for free booklet.

BRAND NEW CAPSTAN WINCHES

NEW LOW PRICES. 6000 lb. capacity. Accurately machined gears provide for smooth efficient operation. Suitable 6 or more for both front or rear mounting. May be used on amphibious jeeps or trucks. All units are brand new and fully guaranteed.

BERG TRUCK & PARTS CO., INC.
1603 So. Wabash Avenue, Dept. S-6, Chicago 16, Ill.

Free Jeep Parts Catalog
1000's of Parts Listed
Wholesale Prices.
Write for Your Copy Today!

FENDER SKIRTS \$9.95 PER PAIR

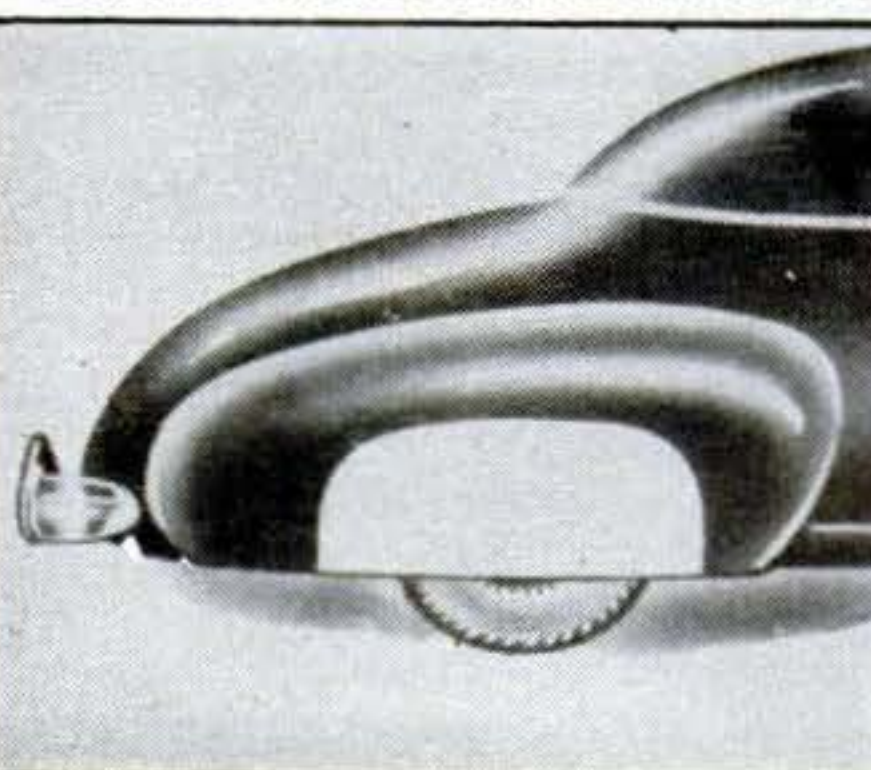

For 95% of all cars. Beautify your car... bring out the flowing lines designed in it. Sparkling beauty you'll like. Constructed of heavy gauge body steel, finished in prime. Perfect fit. Prompt delivery.

SANDEE MUFFLER CO.
5643 Corryne Place
Culver City, Calif.
Gentlemen: Please send me one set of Sandee Fender Skirts to fit my.....
.....(year and make of car).
 Check or M.O. for \$9.95 enclosed. No C.O.D.s at this low price, please.

WHICH OF THESE *Opportunities* INTERESTS *You* MOST?

● *Today*, choose the job you want—and prepare for it. Or if you are already engaged in the work you like best, start training *now* for quicker promotion. Acquire the knowledge that will help you to get ahead faster, make more money and have greater security.

American School, founded in 1897 as an educational institution *not for profit*, can help you to reach your goal just as it has helped others during the past fifty-three years. Check the coupon at right, add your name and address and mail it at once. The school will send you details on its training plan and outline of study prepared by specialists. There is no charge, no obligation, so send the coupon immediately.

CHECK, CLIP AND MAIL COUPON NOW

AMERICAN SCHOOL, Dept. GA-46, Drexel at 58th, Chicago 37, Ill.
Without obligation, Please send FREE and postpaid, bulletin and details of the Subjects checked:

- | | | |
|--|---|--|
| <input type="checkbox"/> PLASTICS ENG'R | <input type="checkbox"/> Accounting | <input type="checkbox"/> Drafting and Design for Men and Women |
| <input type="checkbox"/> Refrigeration | <input type="checkbox"/> Electrical Engr. | <input type="checkbox"/> Radio |
| <input type="checkbox"/> Architecture and Building | <input type="checkbox"/> Electricity-Pract. | <input type="checkbox"/> High School |
| <input type="checkbox"/> Contracting | <input type="checkbox"/> Electronics, Industrial | <input type="checkbox"/> Air Conditioning |
| <input type="checkbox"/> Practical Plumbing | <input type="checkbox"/> Bookkeeping | <input type="checkbox"/> Mechanical Eng. |
| <input type="checkbox"/> Automotive Engr. | <input type="checkbox"/> Private Secretary | <input type="checkbox"/> Shop Management |
| <input type="checkbox"/> Aviation Drafting | <input type="checkbox"/> Diesel Engineering | <input type="checkbox"/> Tool Making |
| <input type="checkbox"/> Aviation | <input type="checkbox"/> Sheet Metal Pattern Drafting | <input type="checkbox"/> Better Foremanship |
| <input type="checkbox"/> Business Management | <input type="checkbox"/> Railway Training | <input type="checkbox"/> Machine Shop Operations |

Name..... Occupation.....
Address..... Age.....
City..... State.....

AMERICAN SCHOOL

Dept. GA-46, Drexel at 58th Street, Chicago 37



Guiding untrained fingers to type

YOU TOO, CAN TOUCH TYPE QUICKLY!

NEW! SENSATIONAL! REVOLUTIONARY! POTTER TYPE-N-GUIDE

Guides your fingers in the right direction at all times! You can't miss touching the right keys. Even the blind learn with ease. These guides are now being used in private and public schools. Fits easily onto your typewriter.

40, 15-minute easy-to-follow lesson book with instructions on how to type correctly with each Type-N-Guide.

IMPORTANT: Send name, model and serial number state if portable or standard machine. Price \$3.95 plus postage, prepaid or C.O.D. Try it for 5 days. If you are not entirely pleased, return and your money will be cheerfully refunded.

Dealers Inquiries Invited

POTTER TYPE-N-GUIDE, INC.
501-A W. 145TH • NEW YORK 32, N. Y.



"GO TV, YOUNG MAN!"

Career Jobs Waiting for Trained Men
CREI TRAINS YOU IN MINIMUM TIME—

TELEVISION RADIO - ELECTRONICS ENGINEERING

Graduates of CREI residence school are preferred by industry because of their *training* and *ability*. This recognition is the reason that CREI men quickly find good jobs. With 23 years of practical teaching experience in these highly technical fields, CREI offers an outstanding faculty, modern and complete laboratories, shops and equipment. New students are accepted twice monthly and each may advance as rapidly as he is capable. The basic course with one specialized course requires an average of 20 months to complete. CREI is recognized as one of the country's leading technical institutes. Its work is of college level. It prepares the young man for a good job in industry in a minimum of time.

G. I. Approved



CAPITOL RADIO ENGINEERING INSTITUTE

An Accredited Technical Institute Founded in 1927

Mail coupon for Free Catalog

Capitol Radio Engineering Institute, Dept. 186B
16th & Park Road, N.W., Washington 10, D. C.

Please send me your residence school catalog and complete details.
(If interested in Home Study check below)

Name.....
Age..... If in school, what term?

Street.....
City..... Zone..... State.....

I am entitled to training under G.I. Bill Send information on Home Study Courses

You Can Learn To DRAW



ART

Offers You A
**PROFITABLE
CAREER!**

WSA Trains You At Home in Your Spare Time
TRAINED ARTISTS are capable of
earning **\$65, \$80 AND MORE A WEEK.**

Prepare now for a pleasant, profitable Art career.
**COMMERCIAL ART, DESIGNING, CAR-
TOONING**—all in one complete home study
course. Many fine art positions available in this
great field. You can become your own boss. Many
students earn extra money while learning by
making posters, simple commercial drawings,
lettering, etc. W.S.A. is now in its 36th year of
training successful men and women.

No previous art experience necessary, we
teach you step-by-step and prepare you for
good jobs. **TWO ART OUTFITS** and other
features included with training. Write for
FREE BOOK, "Art for Pleasure & Profit"
—tells about our course, instruction service,
what our graduates say, and commercial oppor-
tunities for you. Low cost—only \$5
monthly.

VETERANS: COURSE G.I. APPROVED

FREE BOOK gives details



WASHINGTON SCHOOL OF ART
Studio 136W, 1115 15th St., N.W.
Washington 5, D. C.

Please send me full information and your Free Book, "Art for
Pleasure and Profit." (Please print)

Name.....
Street..... Age.....
City..... Zone..... State.....

Learn **ELECTRIC APPLIANCE REPAIR AND SERVICE**

FREE! PLAN FOR YOUR SUCCESS

BIG PROFITS — BIG DEMAND for qualified men in field of
Home Freezers, Washing Machines, Dishwashers, House wir-
ing, Auto electricity, etc. Learn at home — start your own
business. **NO PREVIOUS EXPERIENCE NEEDED.** Special
tools & equipment furnished. Earn while learning. Write for
YOUR FREE SUCCESS PLAN — ACT NOW!

PACIFIC TRAINING SCHOOL Dept. S-506
7217 South Broadway • Los Angeles 3, California



TRI-STATE COLLEGE

FOUNDED 1884

Time tested, world famous accel-
erated B.S. Degree courses in
Civil, Elect., Mech., Chem., Aero.,
and Radio and Telev. Engineer-
ing; Bus. Adm. and Acct. May
be completed in 27 months. Also
36 weeks courses in Surveying,
Drafting. For ambitious, earnest
students. Preparatory Dept. for
those who lack required high
school work. G.I. approved. Visit
campus, see well equipped labs.
Low cost. Personalized instruc-
tion. World-wide student body.
Grads successful. Enrollment lim-
ited to 1600. Enter Sept., Jan.,
March, June. Write for Catalog.



**B. S.
DEGREE IN
27 MONTHS**
•
**World Wide
Enrollment**

560 College Avenue Angola, Indiana

World's Leading **AUTO BOOK**

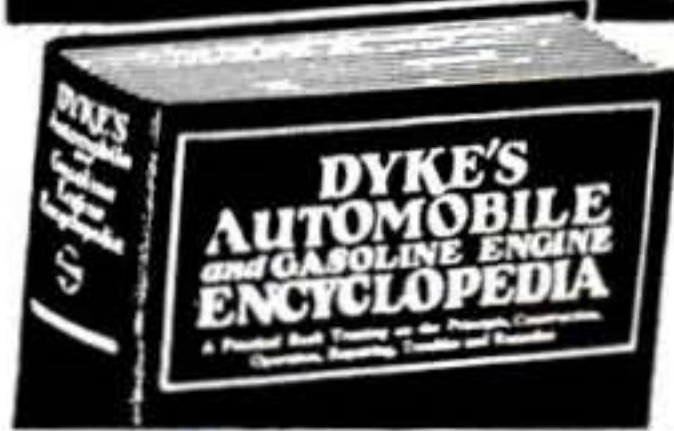

The Indispensable Book for
**Auto Repairmen-Beginners-
Car and Truck Owners.**

The new edition of Dyke's is a
complete course of instruction in
automotive mechanics with special
emphasis on trouble shooting, test-
ing, adjusting and repairing. Easy
to use. Easy to understand. New
edition with 100 new and revised
pages includes wiring diagrams and
test data on Ford Six, Ford V-8,
Chevrolet, Plymouth and 36 pages
of 1949 specifications. Covers new
vacuum spark control, ignition dis-
tributor spark control, Ford Venturi-Vacuum distributor, Buick Dyna-
flow, with maintenance, and operating manuals for electrical parts and
engine repair. World's biggest book value. Over 1500 Pages. 4600
Illustrations. Only \$7.50. Clip this ad and mail with \$7.50 check or
M.O. or we will send C.O.D. Money back if not satisfied.

NEW 22nd EDITION
1949 Specifications—Latest
on Ford, Chevrolet, Plymouth
NEW WIRING DIAGRAMS

GOODHEART-WILLCOX CO., Dept. 130, 1321 S. Michigan Ave., Chicago 5

STOP **GENERATOR REGULATOR BATTERY** TROUBLE



WITH THE AMAZING "W" WATTAGE REGULATOR
IT'S THE **MIRACLE** THE AUTO-DRIVING PUBLIC WAITED FOR
TO REPLACE THEIR OLD UNRELIABLE VOLTAGE REGULATORS
DRIVE WITH OR WITH-OUT YOUR BATTERY
GREATEST ADVANCEMENT IN AUTO-IGNITION SINCE THE SELF-STARTER
GUARANTEED 100,000 MILES OR ONE YEAR
STATE MAKE AND MODEL OF CAR FOR **FREE CATALOG**
WRITE TODAY
TO... **SCIENTIFIC ELECTRIC CO**

P.O. BOX 2162-C • STATION H • CLEVELAND 8, OHIO

WAR BARGAINS

Over 200 terrific
ALSO FACTORY SURPLUS VALUES!

SURPLUS

SEND FOR **FREE** catalog

**SIoux FALLS
SURPLUS STORE
SIoux FALLS, S.DAK.**

FREE—Amazing Book on **RHEUMATISM, ARTHRITIS**

If you suffer the aches, pains and discomforts of Rheumatism,
as manifested in **ARTHRITIS, NEURITIS, SCIATICA** or
LUMBAGO, send today for the **FREE** Book. It reveals im-
portant facts about why drugs and medicine give only tem-
porary relief without removing causes. Explains fully a proven,
specialized system of treatment that may save you years of
distress. No obligation. Write for this **FREE** Book today!

BALL CLINIC, Dept. 36, Excelsior Springs, Mo.

make your own *Gems* 29.50

F.O.B.

All necessary lapidary equipment is furnished,
including a super-charged diamond blade for sawing, and
all wheels for grinding, shaping and polishing; also com-
plete instructions. The complete equipment as shown,
less motor and belt, for only \$29.50.
f.o.b., Burlington, Wisconsin. Write
today for information and literature.

B&I MANUFACTURING CO.
Dept. M Burlington, Wis.

AMAZING INCREASED POWER

—FOR YOUR CAR—
**THE "TUR-B-LIZER" MAGIC ACTION
WILL DO THIS FOR YOU**



More Power... Greater Mileage... Smooth Pick-Up
... Perfect Idling... Quicker Starting... Complete
Gas Combustion... Reduce Crank Case Sludge... Less
Carbon "Ping"... Fewer Repair Bills. The "TUR-B-
LIZER" is quickly installed in auto, truck or tractor
carburetor. It's the same "TUR-B-LIZER" tested for
months in private, commercial & police cars, trucks &
taxi. If your dealer or service station does not stock
the "TUR-B-LIZER," order direct. Sent postpaid, \$3
for six cyl. car—\$4.50 for eight cyl. car. Installation
instructions included.

Money Back Guarantee if not satisfied
SALESMEN WANTED—A brand new "hot" item.
Sells on sight. Many dealers want it. Big
orders possible. Special distributor proposi-
tion. Other "live" auto items in line.

RALPH F. ROUSSEY & ASSOCIATES, Inc.
Dept. P3—179 N. Mich. Ave., Chicago 1, Ill.

THORESEN NATIONALWIDE SALE

BUY DIRECT AND SAVE



Thoresen's De-Luxe
17 JEWEL PRECISION **14.98**
tax paid

Masterpiece of superb styling and workmanship! Streamlined 14 Karat Rolled Gold Plate case, stainless steel back. Gilt numerals, curved dome crystal. Genuine Lever 17 JEWEL Precision movement of amazing accuracy. 5 YEAR free service guarantee! Recent list price \$59.50. REDUCED for quick sales! Tax paid price—14.98—no extras!

Fulcra-Matic Stop
CHRONOGRAPH **7.97**
tax paid

Genuine Fulcra-Matic Stop Chronograph & Wrist Watch combined, gives accurate, long satisfying service. Times Races, Autos, Planes, Sports, etc. 10 WONDER FEATURES: Tachometer, Telemeter & Stop Watch, Luminous Dial, Unbreakable Crystal, Sweep-second hand, Stainless steel expansion band. Best of all—Fulcra-Matic finger tip control! Instructions given. 3 year guarantee. Tax paid, only—7.97.



WATER & SHOCK **8.80**
Resist Case—G. I. Style! tax paid

Military Style! Drop it! Bang it! We guarantee it 3 years against any and all breakages—because of exclusive Swiss INSULATOR invention. 7 jewels. Luminous hands & numerals. Unbreakable crystal. Sweep-second. Heavy Chromed. Thin, smart! Marvelous accuracy. Long satisfying service. Tax paid, only... 8.80
15 JEWEL Model tax paid—no extras... 14.33
17 JEWEL Model (5 year guarantee!), tax paid... 17.65

Thoresen's 17 Jewel
FULL AUTOMATIC **29.88**
tax paid

De-Luxe model—fully automatic! Set it, then forget it! It winds itself as you wear it. Patented Incabloc. Anti-Magnetic. Sweep second. Luminous dial. WATER & SHOCK resistant. All stainless steel back case. 17 jewels. Near-miracle accuracy. Thin! Handsome! 5 YEAR GUARANTEE. Formerly \$75.00. Thoresen's direct-to-you-price, only—29.88—no extras for tax. Rush! Supply limited!



INITIAL **2.97**
Men's Ring
Extra Special! Genuine sterling silver with gold plate sides. Your initial in raised gold effect flanked by 2 sparkling pseudo ZIRCONS. Tax paid—2.97



"WEIRD" **1.98**
SKULL
Ruby color eyes flash "weirdly" in semi-darkness! Perfect miniature of skull & bones. Rich 14 Karat Gold Plated. It's the attention-getting ring. Our tax paid price—1.98



"BIG 5" **3.55**
Men's Ring
Wins distinction! Extra heavy simulation of a Solid Gold 5 Diamond Ring. Made to endure. Rich \$500.00 appearance. Imported stones of amazing brilliancy! Tax paid—3.55

FREE
10 DAY TRIAL

Price promptly refunded if not thrilled within 10 days after receiving. ALL prices tax paid—NO EXTRAS! Not a penny's charge for "handling," postage, parts or repairs on watches! THORESEN makes lifetime friends! References: Bank of Athens, New York, or any bank in America.

THREE SYNCHRO DIAL
Precision Made
Swiss Chronograph

Outstanding value sleek handsome 3 dial chronograph. Amazing accuracy. Ideal for hobbyists, mechanics, scientists, doctors, sportsmen, students, aviators, etc. 20 SUPER FEATURES—3 Synchro Dials, 30 minute register, 1/5 second calibration, rugged shock-resist case, sweep second, luminous dial. Built-in tachometer and telemeter measures speed and distance of planes, autos, horses, photos, etc. without stopping movement. 3 year guarantee. Formerly \$39.95. Now at slashed price of \$14.95. Tax paid. No extras.



14.95
Tax paid

THORESEN Direct Sales Dept. 7F-200 131 West 33rd St., NEW YORK 1, N. Y.

OWN YOUR OWN ELECTRIC APPLIANCE REPAIR BUSINESS!

New shop method home training system gives you electrical "know how". You learn at home building, testing, repairing. Earn right from the start. Electronic testing kit, heating element kit, illustrated lessons supplied on a "Pay as You Earn" plan.

FREE Illustrated book on Electrical Appliance Repairing. Send card today.

CHRISTY TRADES SCHOOL
4432 N. Kedzie Ave., Dept. D-9101
Chicago 25, Ill.

Waffle Irons, Grills, Ovens, Sewing Machines, Radios, Blenders, Toasters, Irons, Motors, Washers, Refrigerators, Vacuum Cleaners, etc.

MODERN LAWN MOWER SHARPENER

FOR LAWN MOWER SHOPS
FIX-IT SHOPS
GOLF COURSES • PARKS
101 OTHER JOBS

Sharpens All Reel Type Mowers • Hand, Power or Gang • 10 to 20 Minutes • No Dismantling • No Extra Attachments Needed.

All reel type mowers, from 5-inch edgers to 36-inch power mowers, are quickly sharpened to extreme ends of both left and right twist blades. Handle, wheels, roller and motor remain in place when sharpening is in process. Bed knife is sharpened in same brackets. Grinding head rides on five ball bearing races. Easy to operate. Also sharpens chisels, joiner knives, planer blades. Big profit maker. Own your own business. Send Today for **FREE** Illustrated Bulletin No. 11-C1

PRICE \$241.50
less motor

\$263.00
with motor

ORDER NOW
Immediate Delivery

MODERN MFG. CO. 160 N. FAIR OAKS AVE PASADENA 1, CALIFORNIA

TRAVEL FOR "UNCLE SAM"!

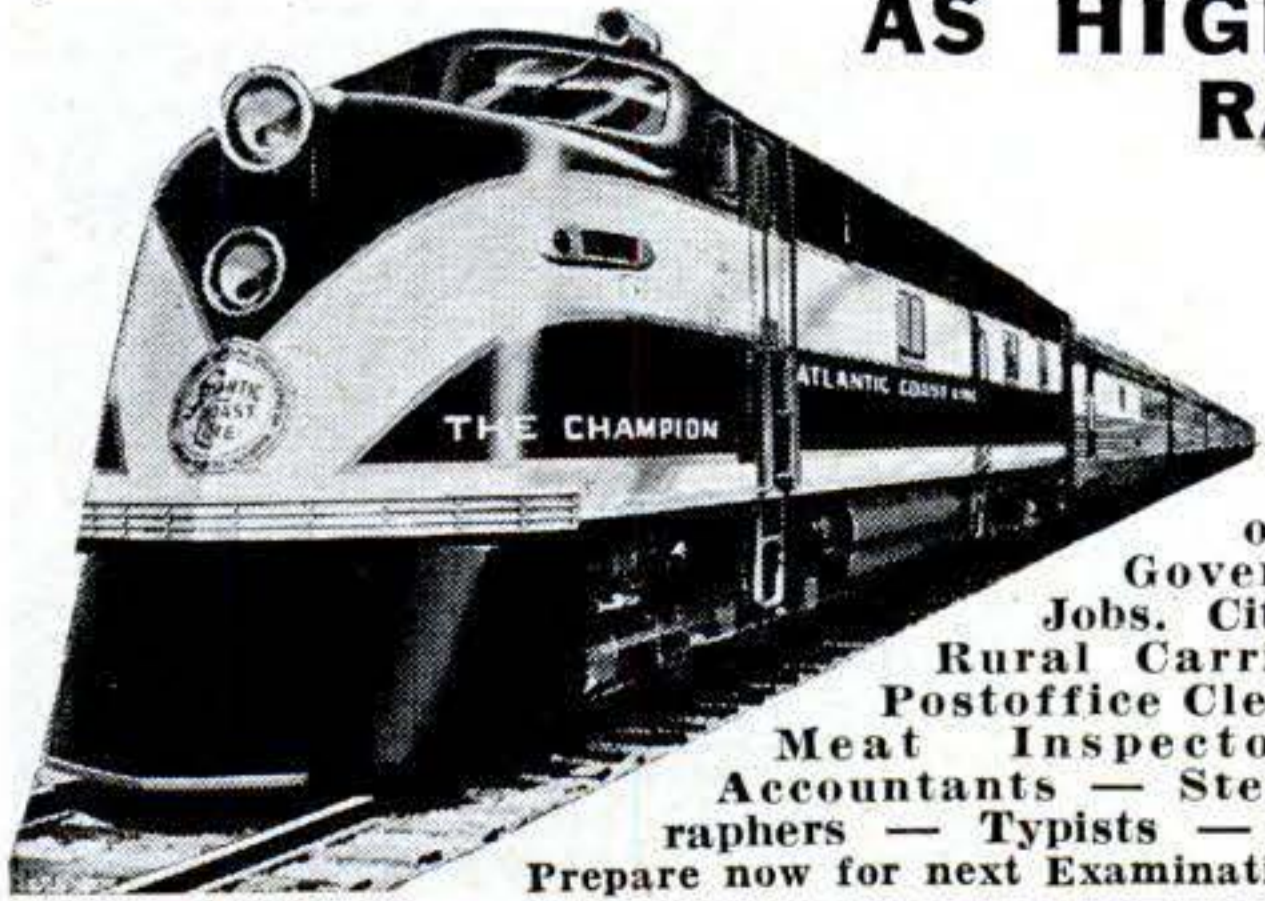

AS HIGH AS \$3,450 FIRST YEAR RAILWAY POSTAL CLERKS
Veterans Get Special Preference

Many other Government Jobs, City and Rural Carriers—Postoffice Clerks—Meat Inspectors—Accountants—Stenographers—Typists—etc.

Prepare now for next Examinations.

FRANKLIN INSTITUTE, Dept. E-81, Rochester 4, N. Y. (Not Government Controlled)

Sirs: Rush to me, without charge, copy of 40-page book, "How to Get a U. S. Government Job," list of positions, and full particulars telling how to qualify for them.

Name

Street

City Vet?

WIND SPEED?
WIND DIRECTION?
TEMPERATURE?

Know all the answers, INSTANTLY, with an **A-C-I WINDOMETER**

complete as illustrated **89.50**

FOR AIRPORTS, BOATS, HOMES, INDUSTRY, FARMS!

Know the important facts about outside weather instantly—and have them right at your fingertips, in one compact unit!

WIND VELOCITY—calibrated in leading University Lab. Wind Tunnel, for extreme accuracy.

WIND DIRECTION—built to aviation standards.

OUTSIDE TEMPERATURE—precision made, aircraft quality. All instruments and transmitters are highest quality precision aircraft type, with Gold-palladium and Silver contacts. Completely self-contained unit—use anywhere—easily installed.

NEVER BEFORE such quality and precision at this amazing price!

AIRCRAFT COMPONENTS, INC.

1200 Woodland Avenue Benton Harbor, Mich.

Please send me one WIND-OMETER complete as illustrated. My Check/Money Order for \$89.50 enclosed.

Name _____ Street _____ City _____ State _____

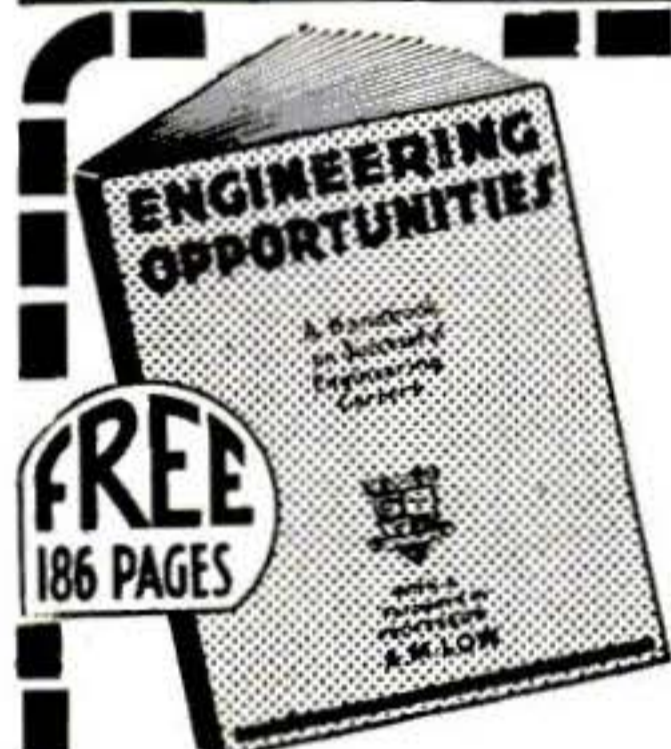

Your Guide to
SUCCESS

Increase your earning power. Our 150-page FREE handbook "Engineering Opportunities" explains how YOU can become thoroughly trained — earn more dollars. Opportunities exist in many fields of engineering — Aeronautics, Civil, Electrical, Mechanical, Plastics, Radio. "Engineering Opportunities" lists many home study courses in engineering and allied subjects written by world authorities. Write for this free handbook to the Canadian Institute of Science and Technology Ltd., 503 Century Building, 412, 5th Street, N.W., Washington, D.C.

Name.....Age.....

Address.....

CANADIAN ENQUIRIES: 263 Adelaide St. West, Toronto

Ball-Bearing SPEED WHEELS



JUVENILE WHEELS (No bearing, solid tires)

4"	40c	6"	65c
5"	45c	7"	75c

(Semi-pneumatic tire, ball bearing)

8 x 1.25.....	1.85	10 x 1.25.....	2.20
8 x 1.75.....	1.95	10 x 1.75.....	2.30
8 x 2	2.20	10 x 2.00.....	2.65
		12 x 1.75.....	3.45

INDUSTRIAL WHEELS

Lug Base, Semi-Pneumatic tire

5 x 1.75.....	3.65	10 x 2.00.....	6.10
6 x 2 SW	3.45	10 x 2.75.....	5.15
6 x 2.00.....	4.00	12 x 2.00.....	6.90
8 x 2.00.....	5.20	12 x 3.00.....	9.20
8 x 2.50.....	5.40	16 x 4.00.....	15.15

Smooth Base, Pneumatic tire and tube

8 x 3.00.....	11.00	12 x 4.00.....	12.10
10 x 2.75.....	6.80	4.00 x 8.....	13.10
10 x 3.50.....	10.55	14 x 4.50.....	13.40

Dealers, Jobbers, and Manufacturers! Our new prices will interest you.

No c.o.d. orders. Prices F.O.B. our plant.

JIM BROWN TOY COMPANY
1093 HOME AVE. AKRON 10, OHIO

Now Many Wear FALSE TEETH With More Comfort

FASTEETH, a pleasant alkaline (non-acid) powder, holds false teeth more firmly. To eat and talk in more comfort, just sprinkle a little **FASTEETH** on your plates. No gummy, gooey, pasty taste or feeling. Checks "plate odor" (denture breath). Get **FASTEETH** at any drug store.

Reduced from \$7.90
Imported Swiss Stop **CHRONOGRAPH** multi-purpose **WRIST WATCH** \$5.90
Plus 59c Fed. Tax
With instructions



GIVEN washable, ventilated plastic band "Wonder" Watch. Used to time autos, airplanes, horse races, athletic events.
• Tachometer • Telemeter • Hands & Nos. Glow in Dark • Unbreakable Crystal • Large Red Sweep Hand • Tells Time • Measures Speed and Distance • Stop Watch • Precision Made
Send money order for \$6.49. For C.O.D.'s enclose \$1.00 with order for Fed. Tax, postage, handling.
JEWELBOX, Dept. ST, 1674 Broadway, New York 19, N. Y.

2 PUSH BUTTONS
1 YR. WRITTEN GUARANTEE

"YOU ARE UNDER ARREST!"



Help Bring Crooks to Justice Through Scientific **CRIME DETECTION!**

We have taught thousands this exciting, profitable, pleasant profession. Let us teach you in your own home. Learn Finger Printing, Firearms Identification, Police Photography, Secret Service Methods thoroughly, quickly, at small cost. Over 800 of all American Bureaus of Identification employ I. A. S. students or graduates. We can prepare you for this fascinating work during spare time. Write today, stating age, for "Blue Book of Crime."

INSTITUTE OF APPLIED SCIENCE, 1920 Sunnyside Ave., Dept. 136-A, Chicago 40, Ill.

FOAM RUBBER

FOR HOBBYISTS, CRAFTSMEN, EXPERIMENTERS



Lowest Prices—SAVE 50%	AUTO SEAT TOPPER PADS
16 x 16 x 1 1/2" .. ea. \$1.25	Place on seat cushion and cover with your seat cover.
16 x 22 x 1 1/2" .. ea. 1.55	24" x 60" x 1 1/2" .. ea. \$5.00
18 x 24 x 2" .. ea. 2.00	24" x 60" x 2" .. ea. 7.50
24 x 24 x 2" .. ea. 2.75	

Use for furniture cushion fillers, mattresses, Mattress pads, cushions. Foam Rubber is available in any size or thickness. Send For Free Price List. Immediate delivery. No C.O.D.'s. Add 10% for Postage & Handling to Above Prices.

RIOR RUBBER COMPANY, Dept. S-7
50 East 22nd St. Chicago 16, Ill.



WOULDN'T TAKE \$1000 FOR COURSE

"The lessons are so simple that anyone can understand them. I have learned to play by note in a little more than a month. I wouldn't take a thousand dollars for my course." *S. E. A., Kansas City, Mo.



PLAYS ON RADIO

"I can't keep from telling you that I have a good position playing from KTHS, Hot Springs, Ark., every morning."

*J. S., Okla.



PLAYS AT DANCES

"The Piano course I'm taking is the 3rd course with your school. Previously I took Saxophone and Clarinet. Since then I've played a lot of dance jobs."

*E. A., Lake View, Iowa

THOUSANDS NOW PLAY who never thought they could!

You, too, can play any instrument by
this **EASY A-B-C METHOD**

YOU think it's difficult to learn music? That's what thousands of others have thought! Just like you, they longed to play some instrument. But they denied themselves the pleasure—because they thought it took months and years of tedious study to learn.

And then they made an amazing discovery! They learned about a wonderful way to learn music at home—without a private teacher—without tedious study—and in a surprisingly short time. They wrote to the U. S. School of Music about this remarkable short cut method. A free print and picture sample actually showed them how easy it was to learn.

The result? Over 850,000 people have studied music at home this simple, A-B-C way. They have found the key to good times, popularity and profit.

And that's what you can do right now. Simply mail the coupon. Get the proof that you, too, can learn to play your favorite instrument—quickly, easily, in spare time at home. Just read the fascinating illustrated booklet—examine the print and picture sample. Tear out

the coupon now, before you turn the page. Instruments supplied when needed, cash or credit. U. S. School of Music, 86 Brunswick Bldg., New York 10, N. Y. 52nd year. (Established 1898.)

*Actual names on request. Pictures by professional models.

FREE! Print and Picture Sample

U. S. School of Music, 86 Brunswick Bldg., New York 10, N. Y.

I am interested in music study, particularly in the instrument indicated below. Please send me your free booklet, "How to Learn Music at Home" and your Print and Picture Sample. (Do you have instrument?.....)

Piano Piano Accordion Reed Organ Clarinet
 Guitar Saxophone Tenor Banjo Trombone
 Violin Trumpet, Cornet Ukulele Other Instrument

Name..... (PLEASE PRINT)

Street.....

City..... State.....

Check here if under 16 years of age.

SAVE 2c—Stick coupon on penny postcard

A book every hobby crafter should have



May we
send it
to you?
Send 10¢
for
mailing
cost.

It's the new 28-page X-acto Catalog, handsomely illustrated, giving sizes, prices, contents of entire X-acto line.

KNIVES & TOOLS
KNIFE & TOOL SETS
LEATHERCRAFT TOOLS
PLEXON ARTCRAFT STRIP
METALCRAFT KITS
WOODCARVING KIT
TRIX and ELEKTRIX
Model Engineering System

Points the
way to a
lifetime of
fun with
hobbies.
Send for it
today.

x-acto
HOBBY KNIVES and TOOLS
X-acto Crescent Prod. Co., Inc. 440 4th Ave., N. Y.

*Reg. U. S. Pat. Off.

Learn A Trade NOW! PRACTICAL SHOP TRAINING!

In Our Chicago Shops

- AUTO MECHANICS
- DIESEL MECHANICS
- REFRIGERATION
- BODY-FENDER
- WELDING—ARC and GAS
- MACHINIST
- PIANO TUNING

Above Approved For G. I.'s and Civilians
One of America's Leading Practical Schools
7 Floors of Fully Equipped Shops
Over 48,000 Successful Graduates
Expert Individual Instruction
Learn by Doing—Low Living Expense
Established 1902—Day and Evening Classes

Also the following Home Study Courses

- PLASTIC
- REFRIGERATION
- DIESEL

CALL IN PERSON OR MAIL THIS AD TO
GREER SHOP TRAINING
(Desk 12) 460 South State St., Chicago 5, Ill.

Please send without obligation free information regarding trade checked above. (Specify whether you are a Veteran or Civilian)

Name..... Age.....

Address.....

City..... State.....

EASY WAY TO EARN BIG PAY

LEARN A TRADE

Train at Home or in C.T.I. Shops

Good jobs are waiting for trained men! You can qualify within months—either by training at home in spare time, or in our Chicago shops. The fields listed at right offer big opportunities for advancement. Or, you can prepare to open a shop of your own—and gain independence!

It costs nothing to get the facts. Mail coupon below for valuable FREE booklet!

C. T. I. OFFERS BETTER TRAINING IN:

- AUTO MECHANICS
- BODY-FENDER REPAIR
- DIESEL MECHANICS
- ELECTRICITY
- REFRIGERATION
- RADIO - TELEVISION
- MECHANICAL DRAFTING
- BUILDING CONSTRUCTION
- FACTORY MANAGEMENT

COMMERCIAL TRADES INSTITUTE

1400 Greenleaf Ave., Dept. E1-6
Chicago 26, Ill.

Veteran
 Non-Vet

Send valuable FREE information on opportunities in industry, and how I can train for them.

Name..... Age.....

Address.....

City..... State.....

Course interested in.....

JEWELER'S SCREW DRIVERS

8 Jeweler's Screw Drivers. A must for every hobbyist and model builder.

Ideal for precision work, camera and fine instrument repairs. In 8 sizes—from the smallest size 9 up to size 2. Finest tempered steel blades. Lowest price!

ONLY \$2.00 MONEY BACK GUARANTEE IF NOT SATISFIED

C.O.D. \$2 plus postage, or send \$2 and we pay postage.

SET OF 8

PINE WATCH CO. 29 ELDRIDGE STREET Room 40 N. Y. 2, N. Y.



Quickest Way to Wash Your Car!

Give your car a professional wash in minutes with a HANDEE CAR WASHER—a rubberized mitt with rubber sponge attached. Easy to use—just connect to garden hose and turn on water. Rinses as it washes. Youngsters will enjoy keeping the family car sparkling clean with a HANDEE! No splashing or cold, wet hands. Cannot scratch the car finish. Save time and money!

At Your Dealer's or Mailed Postpaid..... \$1.98

TRI-PRODUCTS CO.

314 S. Broad St., Holly, Mich.

Handee

CAR WASH MITT

SEND ONLY 10c for

BIG CATALOG of WAR SURPLUS OPTICAL BARGAINS

Build Your Own RIFLESCOPE, BINOCULARS, TELESCOPES, ETC.

We Furnish Optics and Instructions

- LENSES, PRISMS & RETICLES
- EYEPIECES and OBJECTIVES

Send \$1.00 for Stock #2-N 10-Piece Lens Kit and Big Instruction Booklet.

We Have Numerous Types of Assembled Optical Instruments Including BINOCULARS and RIFLESCOPES. CHECK OUR BARGAINS . . . MAIL 10c FOR CATALOG N

EDMUND SALVAGE COMPANY
BARRINGTON, NEW JERSEY



DUST-O-VAC FOR ALL MACHINES

For Home Workshops & Industry. DUST-O-VAC collects & bags wood & plastic chips, wood & metal dust, wood shavings. Free Bag. Attaches to circular saw, planer, band saw, grinder, belt or disc sander, shaper, drill press with shaper or sander attachment, spindle shaper, wood lathe, jig saw, 110 A.C., D.C. Send for mounting instr. for all machines.

\$19.95

Free Ship. east of Miss. West of Miss., add \$1. Check. M.O.

HEAVY CAST ALUMINUM BLOWER—ONLY \$9.75
110V, AC 50-60 cycles, cont. duty motor, deliver app. 100 C.F.M. For workshop, lab, kitchen, cellar, etc. Install yourself. Send for circular.
UNIVERSAL YONKERS CORP., 137 Alexander St., P-6, Yonkers 2, N. Y.

SHOE REPAIR OFFERS BIG INCOME

LEARN IN 12 WEEKS TIME

You can own your own shop or earn big income as skilled shoe repairman. Growing demand everywhere at top wages for men who know how. We teach you quickly by actually working on shoes and modern machines. School open to all from 18 to 60 years of age. Free Big 20 Page Book explains everything. Send for your copy today. Established 1927.

MODERN SHOE REBUILDING SCHOOL

Chicago and Los Angeles only Approved for Vets. Dept. PS-60
2937 Belmont Ave., Chicago, Ill. 361 12th St., Oakland, Calif.
806 So. Figueroa St., Los Angeles 14, Calif.

BURIED TREASURE. MINERALS AMAZING NEW GOLDAK LOCATORS

SENSATIONAL NEW MODEL!

ONLY 11 pounds weight! One hand operation! Money-Back Guarantee of Superiority. Write for full details.

THE GOLDAK CO.
1544 WEST GLENOAKS BLVD.
GLENDALE 1, CALIFORNIA

World's largest maker of fine locators.



WHEELS - WHEELS

- 5" Disc Wheel 5/8" Tire 5/16" or 3/8" sleeve..... 30c ea.
- 6" Disc Wheel 5/8" Tire 5/16" or 3/8" sleeve..... 35c ea.
- 7" Disc Wheel 3/4" Tire 3/8" sleeve..... 45c ea.
- 8" Disc Wheel 1 1/8" Tire 1/2" sleeve..... 70c ea.
- 7" Disc Wheel 1" Tire 1/2" ball bearing..... 80c ea.
- 8" Disc Wheel 1" Tire 1/2" ball bearing..... \$1.00 ea.
- 8" Disc Wheel 2" semi-pneum. T. 1/2" B.B..... \$1.35 ea.
- 10" Disc Wheel 1.75 semi-pneum. T. 1/2" B.B..... \$1.50 ea.
- 12" Disc Wheel 1.75 semi-pneum. T. 1/2" B.B..... \$1.85 ea.

Above wheel prices include hub cap. Plus Postage, 20% - C.O.D.'s accepted.

UNITED WHEEL STAMPING CO., PS-6
2756 W. 115th STREET CHICAGO 43, ILLINOIS



\$5

Wherever fine accessories are sold, or order direct giving us your dealer's name. Send for free literature on Dinsmore Compasses.

DINSMORE INSTRUMENT COMPANY
1808 REMELL ST.

EXTRA EYES FOR YOUR CAR

Take the best route FIRST every time. Eliminate guesswork, save time, reduce hazards with the Dinsmore Auto Compass. A reliable precision instrument with illuminated wide-angle visibility, attractive styling, exclusive fingertip compensator. Easy to install on any car. Thousands in use. Fully guaranteed by America's oldest auto compass maker.

DINSMORE INSTRUMENT COMPANY
FLINT, MICH.

IT'S HERE . . .
IT'S DIFFERENT . . .
IT'S DYNAMITE . . .

DYNATONE

Deep, Mellow Tone MUFFLER

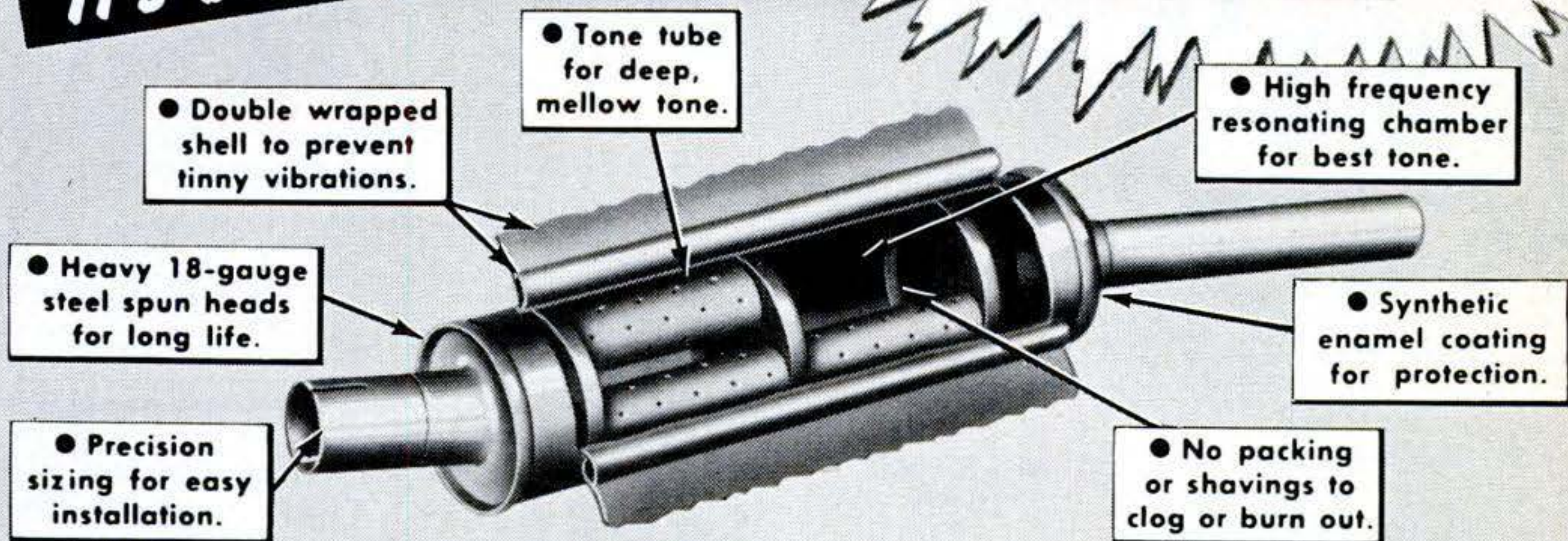

ENGINEERED—Not Packed

YET COSTS LESS THAN MOST HOLLYWOOD MUFFLERS!

The Dynatone has guts! It's the only special muffler engineered for your car. You'll go for its deep, mellow tone—and you'll go for these features, too —

- Lower back pressure
- More power
- More gas mileage
- Longer Life
- No tinny vibrations

Listen to a phonograph recording of the Dynatone at your automotive dealer. Or write us for the name of your nearest dealer.

GOERLICH'S 621 Smith Street • Toledo 1, Ohio

RUBBER HOSE SALE



TERRIFIC VALUES!

Brand new genuine Neoprene Hose—outlasts ordinary rubber 3 to 1. Reinforced with super tough cotton cord plies. Flexible, easy to handle. Easy Flo brass couplings with standard pipe threads for quick connections, included.

Pump water for irrigation, stock, tanks, home, barn, fire fighting, etc.

(Inside Diam.)	1 1/4 in.	1 1/2 in.	1 3/4 in.
Length	25 ft.	40 ft.	30 ft.
Price	\$8.75	13.75	13.75

If specified we will send special hose for gas or oil at same prices. All prices f.o.b. Chicago area. Satisfaction guaranteed. Send check or money order.

AIR HOSE, 1/4" I. Diam. heavy duty double braid suitable for gas stations, spray painting, air-tools, etc. 20 ft. with swivel couplings and tire chuck, Reg. \$6.50 val.—special only \$2.75 f.o.b.

MASTER MECHANIC CO., Dept. 25, BURLINGTON, WIS.

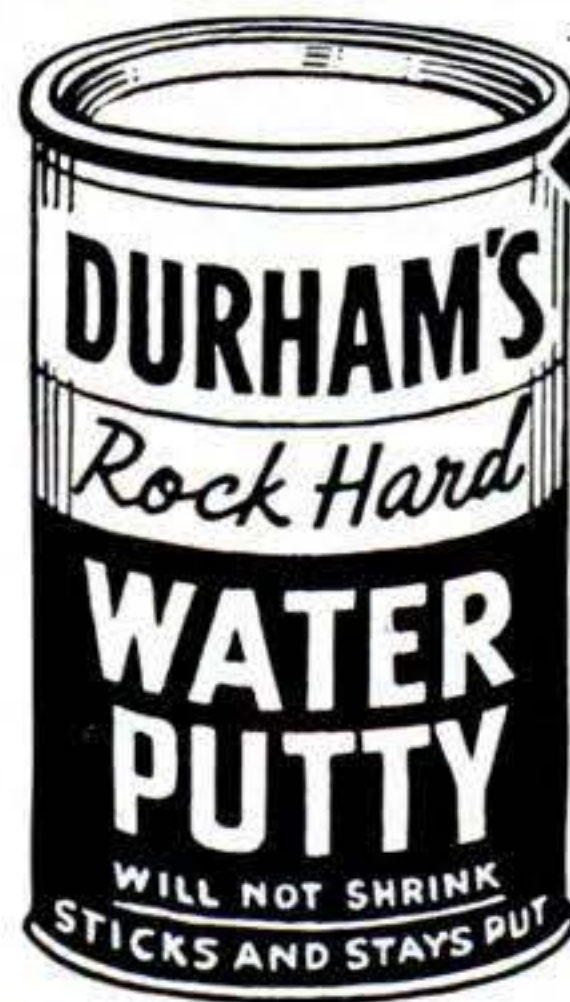

The Modern PLASTIC for lasting Home Repairs

PERMANENTLY mends cracks or holes in wood, tile, stone or plaster. Sticks and stays put—Does not chip, shrink or fall out. Easy to use. Economical. Mold it, chisel it, polish or paint it. If unobtainable from your lumber, paint or hardware dealer, the big 4-lb. can will be sent you post-paid (in U.S.) for only \$1. Full money-back guarantee, order now.

DONALD DURHAM CO.
 Box 804-R, Des Moines, Iowa

A BACKYARD RAILROAD! WEATHERPROOF — KIDPROOF

A 1 1/2" Scale, 7 1/2" Gauge Passenger Carrying System

CAR KITS: We offer complete kits, consisting of all necessary castings for building any Freight Car, for \$17.50 FOB. All you need is a drill-press, hammer and saw to complete one of these sturdy working models.

DIESELS: We offer Diesel Switchers or Streamliners, powered with a 1 HP gasoline engine, with full reverse. Safe for children. Kits or ready-to-run.

LIVE STEAMER: Kits for "live steam" 4-4-0 Locomotive.

RAILS: We stock 1"x1" duraluminum rails.

Send 6c in stamps for Bulletin "C" which describes these models and gives complete working drawings.

LANCASTER R. R. MODELS, Box 1413, Lancaster 1, Pa.



AMAZING NEW 1950

NOW 4 BEAUTIFUL COLORS

Powell P-81



10 HP AT 3400 RPMs! Thrill to 50 mph cruising—faster pickup than a car. **AUTOMATIC CLUTCH** with Powermatic Drive gives sensational performance.

No gears to shift! Safe, smooth Brakes—50 miles per gallon — Length 71" — Height 41" — Weight 196 lbs.

POWELL MANUFACTURING CO. Dept. PS-650, Compton, Calif.

DEALER INQUIRIES INVITED

ONLY \$289.44

AT COMPTON, CAL. INCLUDING EXCISE TAX

WRITE FOR FREE FOLDER AND NEAREST DEALER

Get into BUSINESS for Yourself!

METALIZING BABY SHOES AT HOME IN SPARE TIME



Get facts about amazing money-making Warner Success Plan that shows you every easy step in completely charted path to personal independence—with your home as your headquarters... This proved and tested Plan is working like magic. It's backed by an old, reliable company... And we send it to you on a No-Risk Trial Money Back Guarantee.

QUICK CASH WAITING

Demand for METALIZED Baby Shoes and other keepsakes is growing bigger daily. Our Tested Plan Shows How to Do the Work, How to Bring in the Business, How to Make as much as \$5 an Hour. Spare or full time, big steady profits are waiting for you. Send penny postcard or mail coupon for FREE Facts. Act! Time is precious.

FREE
offer of
**COMPLETE
MONEY
MAKING
PLAN**
•
**SEND NO
MONEY
Just Mail
COUPON**

Ray Brandell, Mgr., Warner Electric Co.,
1512 JARVIS AVE., DEPT. 2-H. CHICAGO 26, ILL.

Please rush complete details about your No-Risk Trial Money Back Plan for Metalizing Baby Shoes. Everything you send is FREE and costs me nothing—now or ever.

NAME _____

ADDRESS _____

CITY _____ ZONE _____ STATE _____

LEARN TO WRITE *a Good Hand!* FOR BUSINESS AND SOCIAL SUCCESS!

Improve your handwriting at home quickly with my new instruction books just off the press. Master all the secrets of better penmanship. Simple and easy, fully illustrated, highly endorsed. Begin today. Write for: New Free Book, "How to Become a Good Penman", or check books wanted. \$1.00 each. Business Writing Artistic Writing Card Writing Engrossing Alphabets Bird and Design Flourishing Complete Set \$4.50 Enclose 10c for your name beautifully written and shading penpoint. S. A. Ziller, President, TAMBLYN SCHOOL OF PENMANSHIP 439 Ridge Bldg. In Business Over 52 Years Kansas City, Mo., U.S.A.

HOUSE PLANS



275 BEST

DESIGNS — IDEAS — showing photographs of homes actually built; descriptions, floor plans, 1 & 2 story. All types architecture. Complete blueprint plans available. Circle your choice of books — 50c each:

- Selected Homes, 40 CALIFORNIA RANCH, Monterey.
- Dream Homes, 79 illustrations, Interiors and Exteriors.
- Charming Homes, 31 5-Rooms, Modern Exteriors.
- Attractive Homes, 40 Cape Cods and Colonials.
- Small Homes, 23 Attractive "Budget" Designs.
- Brick Homes, 62 2-3-4 Bedrooms.
- ALL 6 BOOKS FOR \$2.50 POSTPAID



38 BARBECUE FIREPLACES 60c

Book Shows Photos — Plans

- ALL 7 BOOKS FOR \$3.00 POSTPAID
No C.O.D.'s please. Money-back guarantee.
CLEVELAND PUBLICATIONS, INC.
Dept. 6F 369 W. Washington, Pasadena 3, Calif.

HY-SCORE ^{5 in 1} AIR PISTOL



World's finest air gun. Safe to use. Has quality finish, precision of fine revolver.

Kills Game, High Powered, Accurate

Barrel changes to accommodate 5 types of ammunition without loss of power. Shoots .22 or .177 cal. pellets, darts or BB's. Single shot, semi-automatic loading. Cock & load in 6 seconds. Rear shutter-type load. Single compression action. Fire 5 shots in 1 minute. More hits, better results. 7 1/2-in. rifled barrel insures maximum power & accuracy. Adjustable rear sight. Blued steel finish. Tenite moulded plastic grip, same as Army pistols. Fully guaranteed. Economical to use. 5x8-in. Wt. 2 lbs. ONLY... **\$17.95**

500 .177 pel. \$1.50; 500 .22 pel. \$2; BBs, 500—25c; Darts, 35c pkg.

JOHNSON SMITH & CO. Dept. 230 Detroit 7, Michigan

\$17.95

Most Powerful Air Pistol Made

POWER LAWN MOWERS

SAVE MONEY! TIME! WORK!

89 UP

Buy the Best for the Least

Our new direct blade drive VD-1 20-inch cut rotary mower with vertical shaft 4-cycle 1 1/2-2 h.p. Clinton engine is now available. Safety features. Easy adjustments. Order now. Draft or money order. Deposit of \$10 on C.O.D. orders. Other models available including larger self-propelled units. Write For Free Literature.



B-M MOWER CO., Box 66-PS, Blue Mound, Kansas

Complete FOB Factory Prompt Shipment Satisfaction Guaranteed

FALSE TEETH KLUTCH holds them tighter

KLUTCH forms a comfort cushion; holds dental plates so much firmer and snugger that one can eat and talk with greater comfort and security; in many cases almost as well as with natural teeth. Klutch lessens the constant fear of a dropping, rocking, chafing plate. 25c and 50c at druggists... If your druggist hasn't it, don't waste money on substitutes, but send us 10c and we will mail you a generous trial box.

© I. P. Inc.

KLUTCH CO., Box 5094-F, ELMIRA, N. Y.

Learn CARPENTRY BRICK LAYING

Get into the billion dollar building trades. Learn now while opportunities are greatest. Train in our completely equipped shops under expert instructors. G.I. Approved. Enroll now. Limited Classes. Write for FREE catalog.

MIDWEST SCHOOL OF BUILDING TRADES, Dept. PS-6
411 N. Center St. Bloomington, Ill.

BUILD A URANIUM LOCATOR! (GEIGER COUNTER)

GOVERNMENT NEEDS URANIUM!

Valuable undiscovered deposits may be at your finger tips! Find them with a Geiger Counter. Send \$1.00 for Big How-To-Build Plan... Describes easy, inexpensive construction and operation. No technical experience needed. This little locator may show you the way to wealth. Uranium and other needed metals are being discovered daily!

Send \$1.00 Today For Your Big Plan!

LEJAY MANUFACTURING CO.
223 LeJay Bldg., Minneapolis 8, Minnesota



GET THIS 1950 CAR ENGINE PROTECTION

the new **MARVEL** **INVERSE OILER**

FOR CONSTANT UPPER CYLINDER LUBRICATION

Here's the famous auxiliary lubricating oil system—in a sensational new, low cost, 1 Quart size—that meters MARVEL Mystery Oil to critical upper cylinder engine parts precisely in accordance with the demands of your engine under load. This new, compact OILER, with visible oil supply, functions on the same exclusive MARVEL principle—inversely to manifold vacuum—retarding feed when throttle is closed or at engine idle. You'll keep ring, piston and valve wear down and performance way UP with the MARVEL INVERSE OILER on your car.

MARVEL MYSTERY OIL

Learn about MARVEL Mystery Oil too—the nationally recognized leader among oil improving additives. Added to your regular motor oil, it shields vital parts from excessive frictional wear with its great film strength—produces a slow idle, faster engine pick-up and an even power pull.

**WRITE
FOR THE
FACTS—
NOW!**



EMEROL MANUFACTURING CO., INC.
242 WEST 69 ST. (DEPT. P.S.) NEW YORK 23, N. Y.

**SENSATIONAL NEW
MODEL Q, 1 QUART
VISIBLE RESERVOIR
UNIVERSAL
BRACKET**
Only \$11.20
SIMPLE TO INSTALL

AMAZING NEW INSTRUMENT



MEASURES DISTANCE AT SIGHT!

INSTANTLY FINDS EXACT FOCUS SETTING FOR SHARPEST, CLEAREST PICTURES FROM YOUR CAMERA. Just look at the subject through this professional **IDEAL PRECISION RANGEFINDER**. Turn the knob until the double images come together, and read the exact distance on the calibrated dial. **IT'S LIKE MAGIC, EVEN A CHILD CAN USE IT.** You get needle-sharp, perfectly-focused pictures from your camera, that can be enlarged without fuzziness or blurring. You will be proud of your professional-looking pictures, and proud, too, of this beautiful, efficient optical instrument in its maroon leatherette box. **FULL INSTRUCTIONS AND THREE YEAR GUARANTEE WITH EACH INSTRUMENT.**



**ONLY
\$2.95**

Get one today at your dealer's or send only \$3 for immediate prepaid shipment.
FEDERAL INSTRUMENT CORP. Dept. PS-6, 14-02 Broadway, L.I.C. 6, N.Y.

CHRONOMETRIC TACHOMETER

U. S. NAVY SURPLUS—ACCURACY—PRECISION—GUARANTEED

For **PRECISION** timing of all rotating mechanisms. Incomparable **GUARANTEED ACCURACY** of 1/10 of 1%. An RPM counter and surface speed indicator combined with chronometric operation which **AUTOMATICALLY** computes period of test in **EXACTLY 6 SECONDS**. No stop watch or personal equation necessary. **UNSURPASSED** for cameras, projectors, gen-

erators, motors, sanders, turbines, saws, shafts, looms, fans, lathes, etc. Packed in plush-lined, simulated leather case. **UNCONDITIONALLY GUARANTEED** subject to your inspection and approval. Manufactured by **JAEGER** and **TOTCO**, leaders in field of exacting measuring devices. Only \$19.75 Shipped postpaid in U.S.A. on cash orders.

GOVT. COST
~~\$81.25~~
~~\$61.25~~

**NOW
\$19.75**



ASTROGRAPHS

New in plywood cmpt. case. 14 1/2 x 11 x 10". Instrument adaptable for many useful gadgets. Govt. Cost \$300.00. Now **\$2.95**. 7 rolls Astrograph film add **\$1.50**

COMPASS

Mark IV Self-Compensating Floating Compass. U.S. Navy. 3 1/4 x 3 1/2 x 3 1/4". For car, plane, or boat. Govt. Cost \$72.00 Now **\$4.95**

A-10 Bubble SEXTANT

Never before at this price! Complete with hardwood case. Gov't cost \$300. Now..... **\$7.95**

Kohlsman ALTIMETER



Ideal for Auto or Airplane. Used but **GUARANTEED** accurate. Don't wait. Order NOW! Original gov't cost, \$168. Each **\$10.95**

Order these surplus bargains today. We pay postage on cash tachometer orders. Add postage to other items. 20% dep. on C.O.D.'s.

Semlers' ASSOCIATED SURPLUS Dept. PS-60 5720 WILSHIRE BLVD., LOS ANGELES 36, CALIF.

9 BIG BUILDING BOOKS

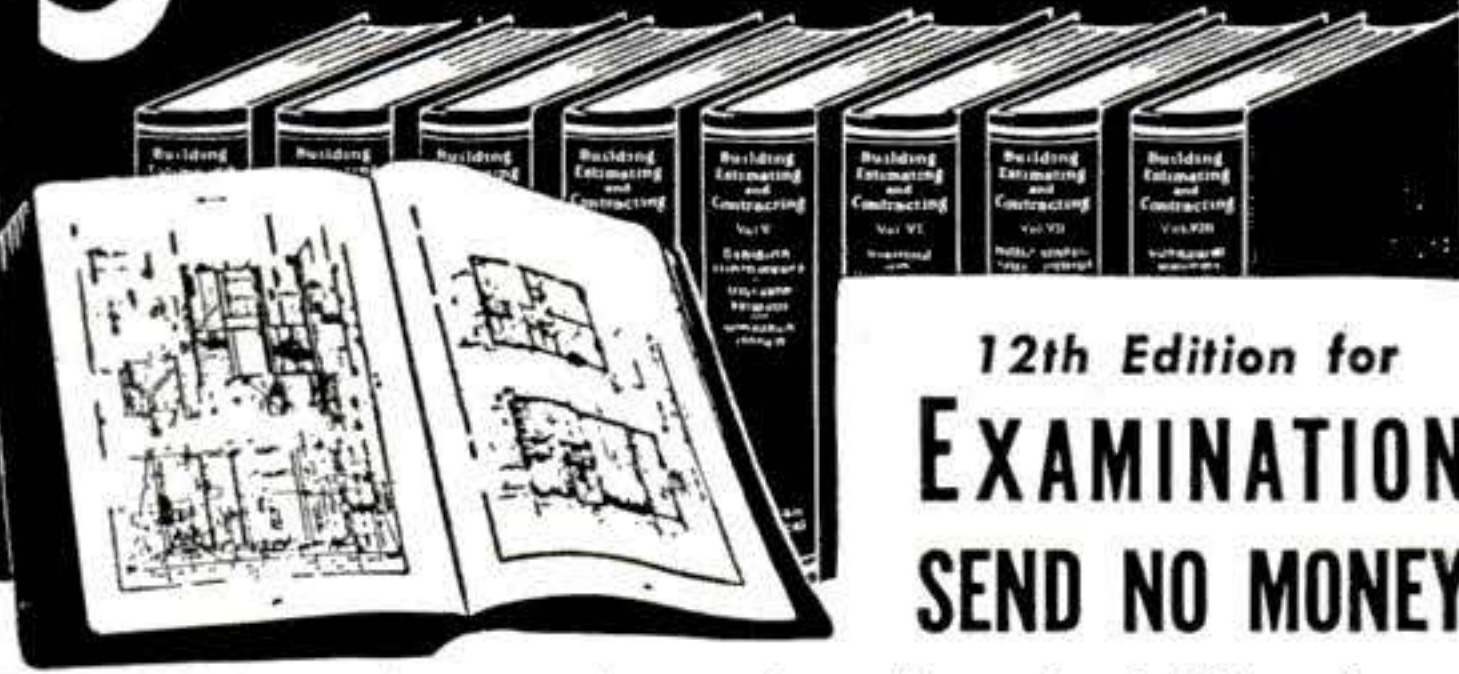

12th Edition for
EXAMINATION
SEND NO MONEY

Learn to draw plans, estimate, be a live-wire builder, do remodeling, contracting. These 9 practical, profusely illustrated books cover subjects that will help you to get more work and make more money. Masonry, concrete forms, carpentry, steel square, roof framing, construction, plumbing, heating, painting, decorating and many other subjects. More than 4000 pages—2750 illustrations.

BETTER JOBS—BETTER PAY UP-TO-DATE EDITION

A nationwide building boom is in full swing and trained men are needed. Big opportunities are always open for MEN WHO KNOW HOW. These books supply quick, easily understood training and handy, permanent reference information that helps solve building problems.

These books are the most up-to-date and complete we have ever published on these many subjects.

Coupon Brings Nine Big Books For Examination

AMERICAN TECHNICAL SOCIETY — Publishers since 1899
Dept. GA-20 Drexel at 58th Street Chicago 37, Ill.

You may ship me the Up-to-Date edition of your nine big books, "Building, Estimating and Contracting," without any obligation to buy. I will pay the delivery charges only, and if fully satisfied in ten days, I will send you \$2.00, and after that only \$3.00 a month, until the total price of only \$34.80 is paid. I am not obligated in any way unless I keep the books.

Name.....
Address.....
City.....State.....

Please attach a letter stating your age, occupation, employer's name and address, and name and address of at least one business man as a reference. Men in service, also please give home address.

Learn TELEVISION RADIO—ELECTRONICS

Prepare in spare hours for good pay in Television, Radio and Electronics. Train at home with Frank L. Sprayberry, America's outstanding Radio instructor. Big Kits of equipment furnished. Build testers, sets, etc. VETERANS: Approved for Training under GI Bill. Rush name and address for details and 2 BIG RADIO BOOKS—ALL FREE! No salesman will call. Write today!

2 Big Books FREE!

Sprayberry Academy of Radio, Dept. 55-K
111 N. Canal Chicago 6, Illinois

MEN WANTED as Local Manufacturers of New Masonry Wall Unit

CAVITEX is today's masonry—colorful, streamlined, scientific. Yet with price appeal to override competition. Size and proportion in direct line with modern architectural trends. Dimensions strictly according to modular standards. All the strength, safety and endurance of masonry at its peak point.

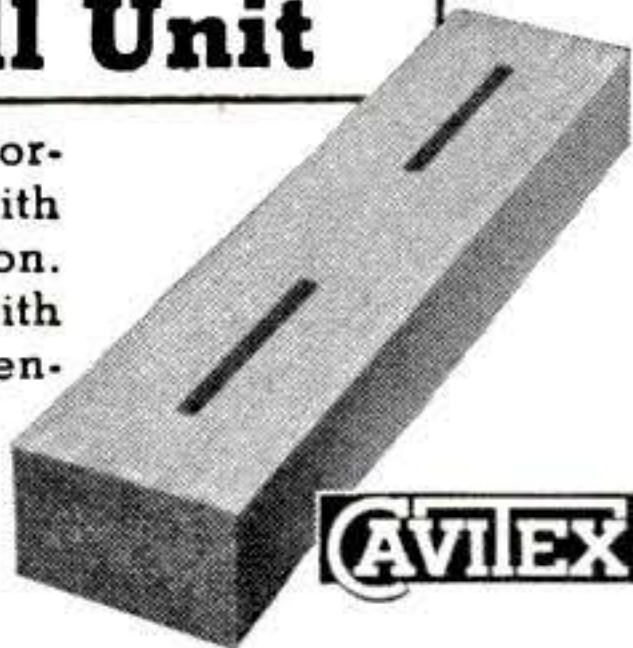

Outstanding Opportunities For Men of Vision—Cavitex can be made locally—of local materials, with local labor. Freight and distribution costs are saved. That's why Cavitex can be sold so low, yet still allow 100-150% mark-up on basic costs. Plants are compact, self-contained, require no skilled labor. We supply complete equipment—cash or time. Hundreds of territories open. Tie in with Cavitex and ride the tide of biggest building cycle in history. Write for full information at once.

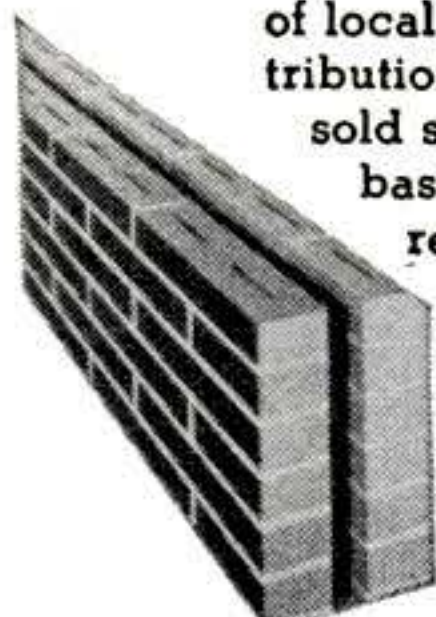

W. E. DUNN MFG. CO.
410 W. 24th ST. HOLLAND, MICH.

NEW! EXHAUST SUPER DISCHARGER



The object is to give your car
• GREATER ACCELERATION
• GREATER MILEAGE

A rotor is built into this Special Exhaust extension which automatically revolves with the forward motion of the car. The theory is to accelerate the exhaust gas flow from the engine, thus reducing engine back pressure and increasing thermal efficiency.

It's beautiful, gleaming finish complements your other accessories.

A brand new automotive invention, precision engineered to improve mileage and acceleration. Designed by a well known Exhaust Engineer and based on an old engineering principle. Experimental tests show a 14% increase in acceleration (measured by an electrical accelerometer) and mileage gains of 3.5%.

You may not get equal results in your car so TRY for 15 days and if not satisfied, return for full refund.

SIMPLE TO INSTALL. ABSOLUTE MONEY BACK GUARANTEE.
Special Price (while initial production run lasts)—\$4.50 complete with all fittings.

NATIONAL AUTOMOTIVE RESEARCH CORPORATION
New Products Division Venice, California

BUILD YOUR OWN FAN



One-piece cast aluminum propellers for cooling and ventilating.

Size Inches	Polished		Unpolished		Bore Inches
	2 Blade	3 Blade	2 Blade	3 Blade	
15	\$3.00	\$4.00	\$2.50	\$3.00	1/2, 5/8, 3/4
18	3.75	4.50	3.00	3.50	1/2, 5/8, 3/4
20	4.00	5.00	3.25	4.00	1/2, 5/8, 3/4
24	4.50	5.50	4.00	4.50	1/2, 5/8, 3/4

Let us give you our prices on your aluminum castings.

Write for pamphlet on larger fan blades, wire guards, fan bases, shutters, pillow blocks, exhaust fan frames, etc. Shipped prepaid if money accompanies order. Dealers write for discount.

KLOPPENBORG ALUMINUM FDY., Dept. PS60, Davenport, Iowa

BE A LOCKSMITH

Learn Locksmithing and Keymaking from Experts in Your Spare Time at Home!
Locksmiths in big demand! No layoffs, no slow seasons! Age or physical handicap no disadvantage. Year-round, steady income in this permanent, respected field. Full or part time. Practical, illustrated lessons show you how to make money even while learning! All materials and special tools supplied. Send for FREE BOOKLET.

LOCKSMITHING INSTITUTE, Dept. PS-6
55 Park Ave. Rutherford, N. J.

EARN A \$10,000 REWARD!

Famous Super Sniffer for URANIUM PROSPECTING
Compact 2 lb. Geiger counter. Uses only 2 flashlight batteries. Highly sensitive to both betas and gammas. Signals with flashing light and headphone clicks. Guaranteed, foolproof circuit. Complete with radium source, headphones, batteries, book \$54.50 post paid. (no c.o.d.)

DEALERS INVITED
NUCLEAR CORP., 253 W. Erie St., Chicago 10

NOW YOU CAN SHAVE IN YOUR CAR!

Car Shaver Motor—Use your electric shaver in your car! Dynamotor will supply 110-120 Volt DC approx. 15 Watts from 6 Volt DC auto battery and will operate most types of AC-DC Shavers. Also has many other uses, such as operating small 3 way portable radios in car, etc. Used by Gov't to supply voltage to radio equipment. **\$200**
Shipping Weight: 7 lbs. Order No. PS-6250
SEND FULL REMITTANCE WITH ORDER. POSTAGE C.O.D.

FAIR RADIO SALES
132 SOUTH MAIN ST. LIMA, OHIO

OVER 500 SURPLUS BARGAINS

JUST OFF THE PRESS!



NEW! CATALOG

TERRIFIC BARGAINS for Sportsmen — Farm & Home greatest stock of Gov't Surplus for everyday use in America!

SEND 10c FOR YOUR CATALOG TODAY!



CLINTON 1 1/2 - 2 H.P. ENGINE GUARANTEED

WAS 59.50
ONLY \$39.95

BRAND NEW!
In original factory cartons. 4 cycle, complete with gas and air filter, starter rope, etc. Parts manual and factory warranty included. Dependable power for mowers, saws, generators, etc. 37 lbs (Sent express collect)



AIR CORPS STYLE SUN GLASSES

Made by the manufacturer who made thousands of pairs for the Army Air Forces. These fine sun glasses are made of the same frames and lenses as others selling up to \$6.00. Each pair has lifetime guarantee!

\$1.98

GOGGLE CAPS, only 98c
U.S.A. Pith HELMETS 98c
\$5.00 TACKLE BOX, 16" 2-Tray \$3.95
Send 10c for BIG CATALOG!

SURPLUS BARGAIN



ONLY \$2.95 O.D.

Genuine U.S. Army Olive Drab "JEEP" CANS
Factory fresh! Heavy gauge steel, screw top. Not water cans or reconditioned gas cans, but BRAND NEW gas cans as received by the government from the factory. Sent Express Collect. "Jeep" Cans in red enamel \$3.25
New Flexible "Jeep" Nozzles ea. 59c

ALL PURPOSE STIRRUP PUMP

• INSECTICIDES • BAILING
• FIRE FIGHTING • CAR WASH
• WHITE WASH • BILGE PUMP
BRAND NEW!
Finest quality, easy working! Ruggedly built of all metal, wood grip! Complete with 10 ft flexible hose, spray nozzle. Approx. 27" high.

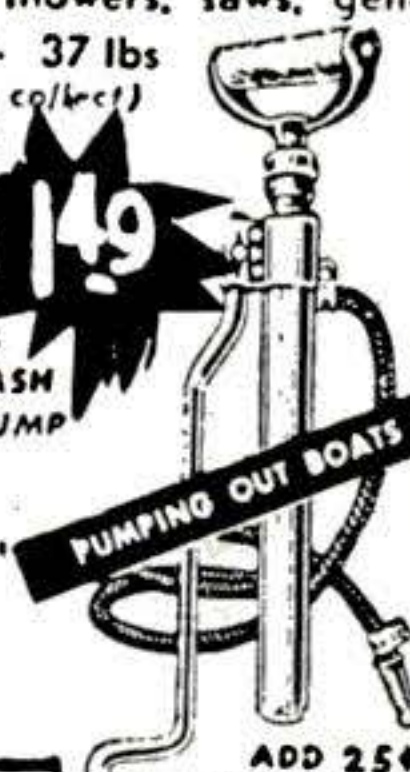

149

ADD 25¢ POSTAGE



STEEL-FRAME RUCKSACK

Extra tough Army Duck adjustable straps and bindings of heavy web and genuine leather. \$2.98



Nylon JUNGLE HAMMOCKS

Brand new hammocks. Insect-proof, rot-proof and bug free! Fine mesh, genuine Nylon net sides. Complete with ropes, hanging rings etc. Gov't cost \$14.00

only 4.98

• TENTS! Genuine U S ARMY 9x9 Ft New \$27.95 16x32 Ft New \$59.50
—Tents Shipped Freight Collect—
• LIFE PRESERVERS — KAPOK FILLED! U S COAST GUARD APPROVED NEW \$2.98
PONCHO'S — Nylon U.S.A. Perfect. \$2.98
—Mail Orders Add 10¢, Unless Otherwise Stated—



Genuine M-6 COMPASS

Precision compass by "Sherrill" Easy to compensate, equipped with nite lite, excellent for planes, boats, trucks, cars.

\$5.95

etc Easily mounted
Instruction manual and calculator included
\$25.00 value

NEW—DUAL TUBE PNEUMATIC SWIM FLOATS

FUN in the WATER with SAFETY!
Use as a RAFT — PLAYBOAT — HEADREST — LIFESAVER LEARN TO SWIM etc. Inflates by mouth. In original carton!
FOR KIDS
ADULTS \$1.95
VAL. 89c

Add 22¢ postage

2 IN ONE MAT RAFT
For Water or Beach
Easily inflated by mouth or cartridge
Separate air cells for safety
Folds when deflated 2 sizes—6 cell 55"x24" \$5.98
8 cell 55"x30" \$5.98
Extra Dual Tubes \$1.19 ea.
Inflating Cartridges, 10 for 79c

\$6.00 SMOOTHCASTER ROD & REEL Off set Alum Handle. Stainless Guides Guaranteed. Level Wind Reel 100 yd cap \$3.98
Add 50c p.p.



Genuine U.S. Army Folding Cots
OD canvas cover. Rigid hard wood frames
Steel braced legs. Approx 27"x78" open
Folds compactly for easy storage. \$4.98
Ship wt 25 lbs

\$9.95 GLASSMASTER ROD— 4 1/2 or 5 ft only \$6.95
Add 27¢ postage

FISLER SALES CO. 723 WALNUT KANSAS CITY 6, MO.

Now She Shops "Cash And Carry"

Without Painful Backache

As we get older, stress and strain, over-exertion, excessive smoking or exposure to cold sometimes slows down kidney function. This may lead many folks to complain of nagging backache, loss of pep and energy, headaches and dizziness. Getting up nights or frequent passages may result from minor bladder irritations due to cold, dampness or dietary indiscretions.

If your discomforts are due to these causes, don't wait, try Doan's Pills, a mild diuretic. Used successfully by millions for over 50 years. While these symptoms may often otherwise occur, it's amazing how many times Doan's give happy relief — help the 15 miles of kidney tubes and filters flush out waste. Get Doan's Pills today!

CHRONOGRAPH WRIST WATCH

\$7.90
Plus Tax



Lifetime Guarantee

(EXCLUSIVE OF PARTS)
3 DIALS—5 HANDS—2 BUTTONS
Multi-purpose watch that measures distance, speed, time, moving objects. Used as Stop Watch or Timepiece. Has Sweep-Second Hand for full 60 Second count. Second Dial records up to 45 minutes. Third Dial then records up to 6 hours. Seconds—Minutes—Hours, all recorded automatically.

INDEPENDENT MOVEMENTS

The movement of this fine Swiss Made watch continues to run when sweep hands are stopped. For sportsmen, professional men and women—time-keeper works when other hands and dials are stopped—separate movements permit dual use at same time.

RUGGED CONSTRUCTION

Precision workmanship and shock resistant features are added to enhance the value of this watch. Sold elsewhere for as high as \$17.00. Our low introductory price is only \$7.90 plus 10% tax. (Total \$8.69). Send check or money order and we prepay postage. Or sent C.O.D. plus charges. LIMITED STOCK!

MARDO SALES CO., 480 Lexington Ave., Dept. 1813, N. Y. 17, N. Y.

HIGHEST ROYALTIES and CASH

FOR YOUR INVENTIONS

(Patented and Patent Pending only)

Write for **FREE** booklet without obligation

UNIVERSAL MARKETING CO.

354 S. SPRING ST. (Suite C)

LOS ANGELES 13, CALIF.

Make 100% to 150% Profit!

MANUFACTURE BUILDING BLOCKS
In Your Own Back Yard

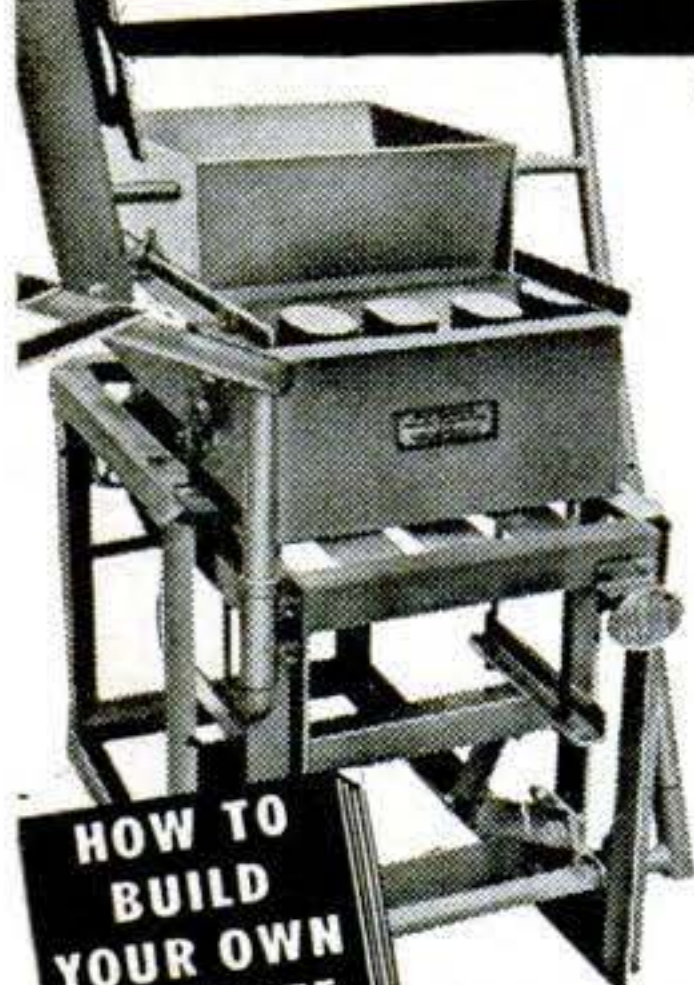

AMAZING GENERAL BLOCK MACHINE
CAPACITY 1000 BLOCKS PER DAY
Only \$199 LESS MOTOR
F.O.B. PLANT
SHIPPING WEIGHT 400 lbs.

Here is an outstanding opportunity for men of vision and small capital. Cinder and concrete blocks are in great demand. Millions used for homes, factories, public buildings. Sell all you produce at 100% to 150% mark-up.

PEAK BUILDING DEMAND!

The General Block Machine is amazingly practical, foolproof. Simple to operate indoors or outdoors. Rugged all steel construction. Vibrator mounted in sealed ball bearings. Produces up to 1,000 blocks per day. Superior 3 Core Type that meets all building code requirements. Can produce 4 x 8 x 16, 8 x 8 x 16, 12 x 8 x 16 blocks. All materials obtainable anywhere. All operating instructions and mixing formulas supplied. Full details FREE without obligation.

HOW TO BUILD YOUR OWN CONCRETE BLOCK HOME
Only \$1 Prepaid

Wonderful Book Written & Illustrated by Experts

GENERAL ENGINES CO.

DEPT. S-9 • 307 HUNTER ST. • GLOUCESTER, N. J.

Includes floor plans for 6 beautiful, easy to build concrete block bungalows. Shows ways to save money. How to lay blocks, lay out building lines, mix concrete, build steps, porches and concrete floors. Mail coupon at once with \$1.

Name.....
Address.....
City.....Zone.....State.....

GLASSES on 30 DAY TRIAL!

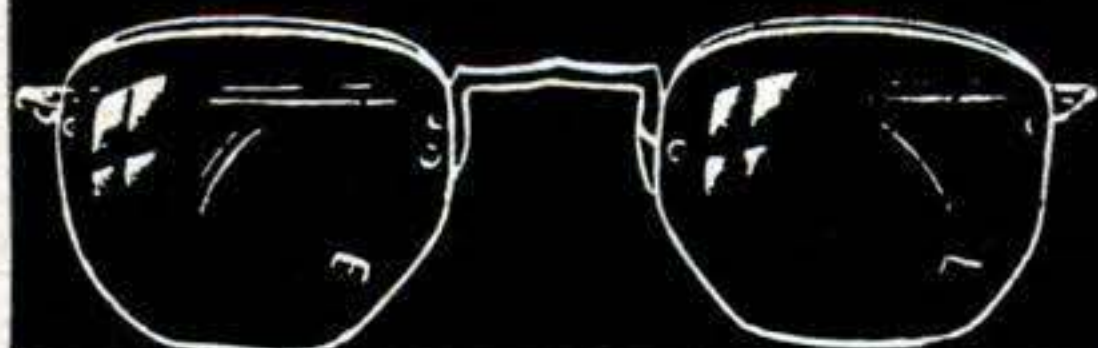

SAVE UP TO \$15.00

• Test your eyes at home with Home Eye Tester • See far & near. Perfect satisfaction guaranteed. Save money.

FREE: Send name, address, age, for 30 Day Trial Offer. Free Eye Tester. Latest Style Catalogue and full information. **Agents Wanted**

CLARK OPTICAL CO. 1148 West Chicago Ave. • Dept. C-1085 • Chicago 22, Illinois

FREE

A NEW HOME INDUSTRY



Let us show you how extremely easy and PROFITABLE it is to make beautiful and useful things out of LIQUID PLASTICS, LIQUID MARBLE, LIQUID IVORY, LIQUID GLASS, CERAMICS, ETC. . . . as easy as pouring water out of a glass! Make novelties, jewelry, gifts, art-ware, toys, tools, dies, gadgets, ceramics . . . a million useful things! We supply everything—MATERIALS, INSTRUCTIONS and BUYERS! Send only 25c for 1. Big catalog of 300 casting materials, molds and accessories, 2. A beautiful CASTING free (to show you what you can do), and 3. Actual INSTRUCTIONS on how to cast and start in the CASTING BUSINESS! VALUABLE MOLDS given FREE with orders! Send 25c today—this may be the lucky coin that will start the most fascinating and profitable phase of your life.

PLASTICAST COMPANY (DEPT. A)
170 N. Halsted St. (Write to nearest address) P. O. Box 987
Chicago 6, Ill. Palo Alto, Calif.
CANADIAN CUSTOMERS, please order directly from: CANADIAN INDUSTRIAL PLASTICS, LTD., 1056 1/2 Pender West, Vancouver, B.C.

YOU CAN BUILD A KIT-CRAFT BOAT

\$AVE over 50%

Complete for Easy Home Assembly



No experience necessary. All parts factory cut, easy to assemble with step-by-step directions. Full length 100% marine plywood panels. All hardwood frames. Rugged, guaranteed, safe construction. Designed by marine architect. **\$32.35**
6 models from.....

SEND \$.10 FOR FULLY ILLUSTRATED CATALOG. ADDRESS DEPT. P. 7.

Roberts INDUSTRIES INC. Durham, Conn.

EASY CARE for YOUR CAR



Paint your car in 1 hour with **SHON-IZE RUB-ON**

One quart gives your car a beautiful high-gloss lustre. All you do is rub it on . . . no streaks, no lap marks. Covers any color. Dries dust-free in 1 hour. Complete with applicator, no extras to buy! Blue, green, black, tan, grey, and maroon. **\$1.95 per qt.**



Don't throw your old battery away—

Give it **DUBLE-POWER BATTERY IMPROVER!**

Dissolves power-killing sulphation so your old battery will again take and hold a charge. Prolongs battery life, restores efficiency. **\$1.50**

SEND NO MONEY • ORDER TODAY
We'll ship C.O.D., plus postage. Remittance with order—we pay postage. Money-back guarantee. DISTRIBUTOR INQUIRIES INVITED

DUBLE-POWER CHEMICAL CO.
5511 S. E. 72nd Ave. Portland 6, Oregon

See The Wonders of the Heavens!

Amazing value! Wonderful 192-page cloth-bound book, *Everybody's Guide to Astronomy*, now yours for only \$1.00! Contains star charts, tables, telescope-making instructions, how-to-do-it ideas for astronomical equipment you can build, etc. *Supply limited!* Order today! Write:

POPULAR SCIENCE
Dept. 650, 353 4th Ave. New York 10, N. Y.

POWER MOWERS

Only **\$69.50**
DEALER PRICE

Powerful—Streamlined

Complete with Maytag, Power Products or Briggs-Stratton Engine—18" rotary tool-steel, fully guarded blades—cast aluminum body. Cuts grass and weeds, wet or dry—does all trimming—chops grass into fine mulch, eliminating raking. Send check with order, or specify C.O.D. Write for free information.

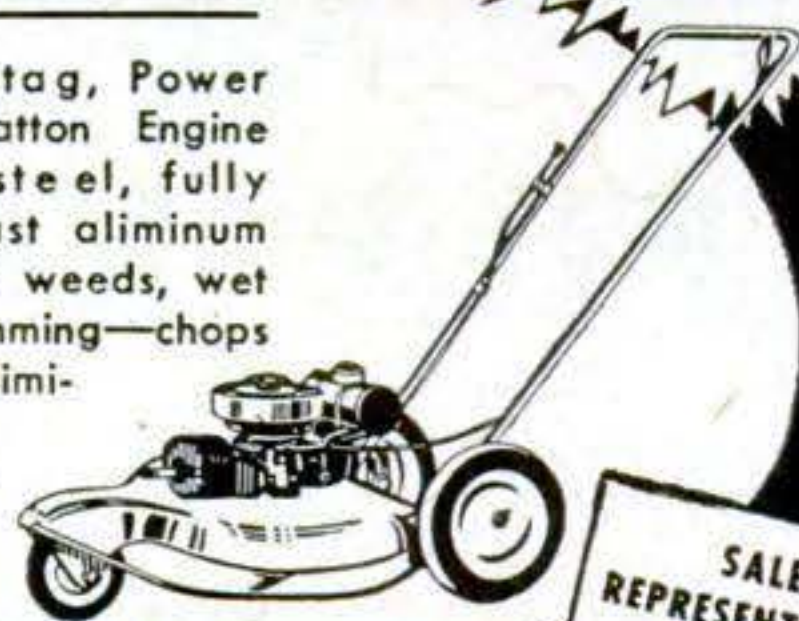

SALES REPRESENTATIVES WANTED

HARTMAN Corp.

1111 So. Kirkwood Rd., St. Louis 22, Mo.

BUY NOW and SAVE
BRAND NEW!
WAR SURPLUS

LIGHT PLANTS

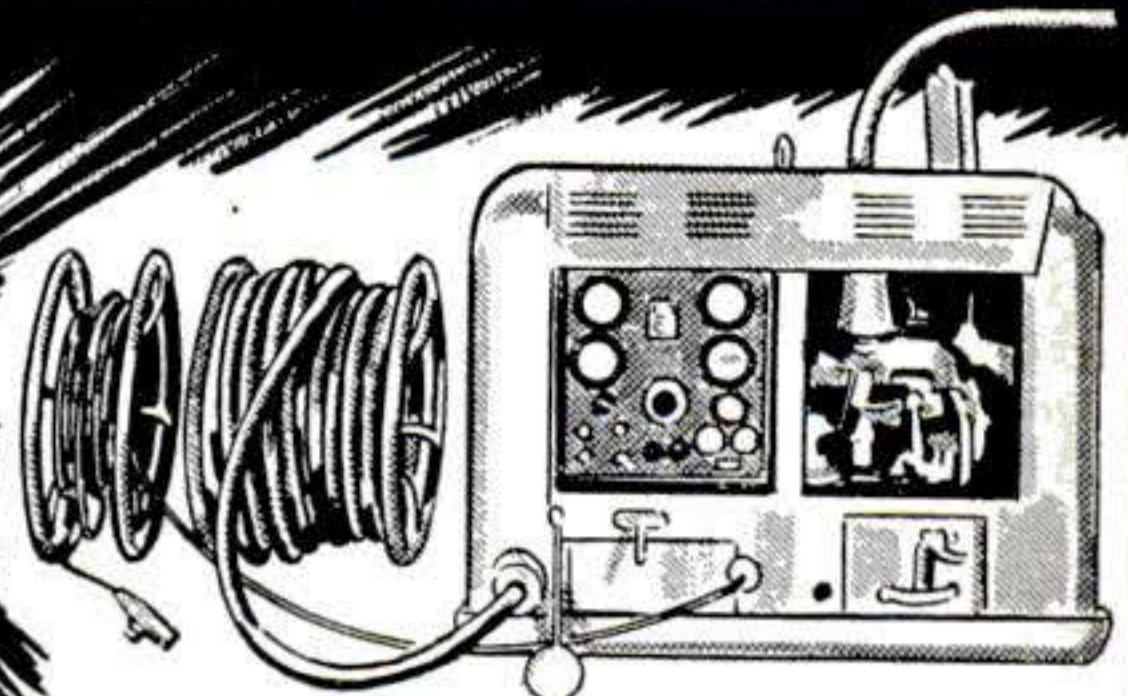

Don't miss these sensational buys.

50 to 75% savings

Use for: Farms, cottages, stores, garages, floodlighting, drilling rigs, refineries, house trailers, fire departments, sound trucks, yachts, tugs, construction, airports, police radios, etc.

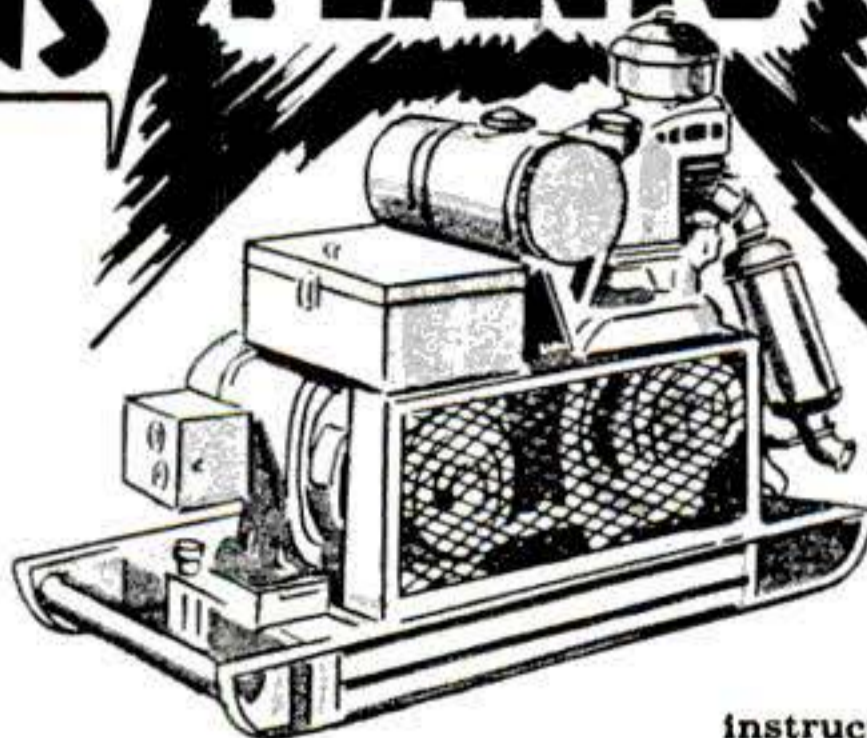

Below are TWO of the most SENSATIONAL light plant buys in the country.

2500 WATT, AC, 115 Volt, 60 Cycle, Single Phase. ENGINE: Briggs & Stratton, air cooled, 6 1/2 H.P. GENERATOR: Westinghouse or Leland, belt drive with guard and Duplex receptacle mounted. NET WEIGHT 310 lbs. Gross Shipping Weight 441 lbs. Shipping size 36" x 19" x 26". Complete with spare parts, tools, instructions and fully GUARANTEED. WAS FORMERLY PRICED AT APPR. \$700.00. **\$295.00** NOW PRICED FOR YOU AT ONLY NEW...

Reconditioned... \$225.00 Generator only, NEW... \$145.00

5 KW, 120 Volts, 60 Cycle, AC. ENGINE: Hercules 4 cycle, Gasoline. GENERATOR: Mfr'd by Hobart Bros. Unit includes remote control cable on reel, power cable on reel, exhaust pipe, power cable plug, remote control stop start switch, automatic volt regulator, continuous duty 6.3 KVA at 80% power factor, frequency meter, radio and television filtered. Unit is completely automatic and cannot be damaged by lack of care. Net weight 770 lbs. Shipping weight 1070 lbs. 44" long, 22 1/4" wide, 30" high, 220 volt output can be supplied on all units at a small additional cost. Guaranteed. FORMERLY PRICED AT \$1600.00 **\$475.00** -NOW PRICED FOR YOU AT ONLY.....

	VOLTS	WATTS	PRICE
ALL	110-220	300	\$ 89.50
	110-220 AC	750 to 1000. NEW	179.50
SINGLE	110	7500	575.00
	110-220	10000	995.00
PHASE	110	25000	2100.00
	110	35000	2750.00
	110	60000	5500.00

WAR SURPLUS Below are just a few of the many items we have in stock at sensationally low prices.

- Pumps
- Grinders
- Air Compressors
- Air Tanks
- Spray Outfits
- Extension Cords
- V Pulleys
- All size light plants
- Generators
- Fire pumps
- Gear head motors
- Electric hand saws
- Electric chain saws
- Saw tables
- Winches

A Terrific Buy!
GAS ENGINES

Briggs & Stratton NEW in original crates. Model AP 1 3/4 to 2 1/4 HP. 3/4" shaft. List Price \$102. Your Price... **\$59.50**



"MERCURY" CLUTCH

For motor-scooters, motorbikes, lawn mowers, etc. Can be used with electric motor or any gas engine. "A" belt pulley. List Price \$28.00. YOUR price 5/8" bore **\$7.95**, 3/4" bore **\$8.95**.

WRITE TODAY for our free catalog listing thousands of MONEY SAVING bargains.

C & H ELECTRIC CO., 434 W. Juneau Ave., Milwaukee 3, Wisconsin

LEADING THE FIELD EVEN MORE THAN BEFORE

Mustang **Lightweight Model "4"**

Only **\$346.30**

fed. tax paid, at factory.



... imitated but never equalled. Original American high performance lightweight. Exclusive 3-speed Burman GEAR BOX. High output flywheel generator-magneto. Big cross-country seat. Telescopic fork. 9.5 h.p., 4-cycle motor. 60 m.p.h. plus. 70 m.p.gal. plus. Write **MUSTANG, Dept. GP-41, 635 Colorado, Glendale 4, Calif.** for free circular.

BLISS Electrical Training

Intensive 32 weeks' residence course in fundamentals of industrial electrical engineering, including radio and electronics. Extensive laboratory, shop work, drafting. Prepares for electrical technician and engineering aides in communications, power, manufacturing, business machines, sales, service. G.I. approved. 57th year. Enter September 5. Catalog. 7610 TAKOMA AVENUE, WASHINGTON 12, D. C.

TRAVEL - for 'UNCLE SAM'

ARE YOU JOB-SATISFIED?
GET A U. S. GOVERNMENT JOB
Many Positions to Be Filled

Railway Mail Clerks—Postoffice Clerks—Mail Carriers—Stenographers—Typists. Statistical Clerks—Liquor Inspector, etc. 40 page Civil Service Book—FREE.

MEN - WOMEN

Veterans Get Preference

Mail Coupon immediately—today sure.

Although not government controlled this can be your first step toward a secure Civil Service career.

As high as **\$3,450.00**
FIRST YEAR



COUPON

FRANKLIN INST., Dept. E-80, Rochester 4, N. Y.

Gentlemen: Rush to me, without charge, 40 page book with list of U. S. Government big paid positions. Advise me also regarding salaries, hours, work, vacations, etc. Tell me how to qualify for a position.

Name.....

Address..... Vet?.....

INTRODUCING

The New POPULAR SCIENCE

TEACH-O-FILMSTRIP

LIBRARY

of More Than 150 Tested Titles

Now Available to Elementary, Junior and Senior High Schools, Churches, Clubs and Libraries, Farm and Service Groups

ALABAMA

Shop 21, 11 S. Court Street, Montgomery

ARKANSAS

All State Supply Co.
1401 W. Capitol Avenue, Little Rock
Democrat Prtg. & Litho. Co.
114 E. Second Street, Little Rock

CALIFORNIA

Long FilmSlide Service
944 Regal Road, Berkeley
Coast Visual Service
6058 Sunset Blvd., Hollywood
Audio Visual Supply Co.
247 Broadway, Laguna Beach
Teaching Aids Exchange
Sycamore Street, Modesta
Carroll W. Rice Co.
424—40th Street, Oakland

CANADA

Arrow Films Limited
1115 Bay Street, Toronto, Ont.
The Ryerson Press
299 Queen Street West, Toronto, Ont.

COLORADO

Centennial School Supply
3012 Huron Street, Denver

CONNECTICUT

Harrison Haries
110 High Street, Hartford
Rockwell Film & Projection Service
244 High Street, Hartford
H. B. Motion Picture Service
174 George Street, New Haven
Flieg & Newbury
45 Water Street, Torrington

DISTRICT OF COLUMBIA

John R. Minesinger
331 Carroll Street, Takoma Park
Paul L. Brand & Son
2153 "K" St., N.W., Washington
Queen Quality Motion Picture Service
2318 Shannon Place, S.E., Washington

FLORIDA

Florida School Book Depository
Union Term. Whse. Bldg., Jacksonville

GEORGIA

Audio-Visual Center
216—12 Street, Augusta
J. B. Coke & Co.
711 Cherry Street, Macon

IDAHO

Audio-Visual Equipment Co.
305 North 9th Street, Boise

ILLINOIS

Midwest Visual Equipment Co.
6961 N. Clark Street, Chicago
Shekleton School Supply Co.
528 California, Peoria
Lundgren's Camera Shop
419 7th Street, Rockford

INDIANA

Indiana Visual Aids Co.
726 North Illinois St., Indianapolis
Modern School Supply Division
Allied, Inc.
3810 East 16th Street, Indianapolis

IOWA

Midwest Visual Education Service
2819 Arbor Street, Ames
Ryan Visual Aids Service
409 Harrison Street, Davenport
Holley School Supply Co.
100 E. Grand Avenue, Des Moines

KANSAS

Mosser-Wolfe Co.
1107 Mass. Ave., Lawrence
Leffingwell's Audio Visual Service
232A S. Santa Fe, Salina
Frank Bangs Co.
315 N. Emporia Avenue, Wichita

KENTUCKY

Nat'l School Supply Co. of Ky.
422 W. Breckenridge, Louisville
Office Equipment Co.
(Kentucky School Equip. Co.)
117 South Fourth Avenue, Louisville

MAINE

D. K. Hammett, Inc.
620 Congress Street, Portland

MARYLAND

Folkemer Photo Service
927 Poplar Grove Street, Baltimore

MASSACHUSETTS

Stanley Winthrop Inc.
90 Washington Street, Quincy
Valley Cinema Inc.
255 Bay Street, Springfield
F. M. Carder
1411 Bacon Street, Waban

MICHIGAN

Engleman Visual Education Service
4754 Woodward Avenue, Detroit
Todd Visual Education Service
16019 Hamilton Avenue, Highland Park
Locke Film Library
120 West Lovell Street, Kalamazoo

MINNESOTA

Midwest Audio Visual Co.
1504 Hennepin Avenue, Minneapolis
St. Paul Book & Stationery Co.
55 East Sixth Street, St. Paul

MISSISSIPPI

Jasper Ewing & Sons
227 South State Street, Jackson

MISSOURI

Embassy Enterprises
34 N. Brentwood Blvd., Clayton
Hoover Bros. Inc.
1020 Oak Street, Kansas City
Pictosound Movie Service
4010 Lindell Blvd., St. Louis

MONTANA

Northern School Supply
1st Ave. North and
Great Northern Tracks, Great Falls

NEBRASKA

J. G. Kretschmer & Co.
315 S. 17th St., Omaha

NEW HAMPSHIRE

Rice Film Co.
123 Pleasant St., Manchester

NEW JERSEY

Visual Aids, Inc.
154 Valley Road, Montclair

NEW MEXICO

Allied Supply Co.
317 S. Second St., Albuquerque

Filmstrips of Outstanding Technical and Teaching Quality

SCIENCE • CONSERVATION • SAFETY

GUIDANCE • AGRICULTURE • TRAVEL • MAPS

And Many Other Vital Subjects

In 1945, POPULAR SCIENCE PUBLISHING COMPANY, recognizing the effectiveness of Audio-Visual instruction in training military personnel, extended its activities to cover the vital new Audio-Visual field.

Five years of research and planning have been poured into creating the POPULAR SCIENCE TEACH-O-FILMSTRIP library, under the Editorial Direction of Dr. David J. Goodman and the development of a nation-wide distributing organization of carefully selected dealers under the direction of James M. Goodsell.

Each filmstrip has been tested and proved useful and valuable by clubs and churches and by schools ranging from the elementary through Junior and Senior High School levels. Each strip consists of about 50 frames in black-and-white or full natural color. Accompanying each filmstrip is a fully-illustrated booklet that shows how it may be used to best advantage.

Educators, lecturers and group leaders all over the nation agree that filmstrips offer more educational value per dollar spent than any other form of audio-visual material!

NEW YORK

Educational Service & Equipment Co.
205 Alexander Ave., Scotia
American Seating Co.
935 W. Genesee St., Syracuse
Stanley Bowmar Co.
513 W. 166 St., New York City

NORTH CAROLINA

Christian Film Service
1302 E. 4th St., Charlotte
National School Supply Co.
14 Glenwood Avenue, Raleigh
Stone's Ed. Equipment & Supplies
108 S. Harrington St., Raleigh

NORTH DAKOTA

Colborn School Supply, Grand Forks
Northern School Supply Co., Fargo

OHIO

M. E. Lockard Co.
1125 N. Main St., Akron
Ralph Haile & Associates
215 Walnut St., Cincinnati

OKLAHOMA

Dowling's, Inc.
301 N. Broadway, Oklahoma City
Kirkpatrick, Inc.
1634 S. Boston, Tulsa

OREGON

Moore's Motion Picture Service
306 14 S.W. Ninth Ave., Portland
Northern School Supply Co.
1505 Northwest Lovejoy St., Portland

PENNSYLVANIA

American Seating Company
16th & Hamilton Streets, Philadelphia

RHODE ISLAND

Wescott, Slade & Balcom
95 Empire Street, Providence

SOUTH CAROLINA

R. L. Bryan Co.
1440 Main Street, Columbia

TENNESSEE

Tenn. Equipment & Supply Co.
116 Second Ave., N., Nashville
Modern School Supply
19 S. 2nd Street, Pulaski

TEXAS

Miller Visual Aids, Inc.
403 W. Magnolia, Ft. Worth
Sound Photo Equipment Co.
1012 Main Street, Lubbock
Southwest Radio & Sound Equip. Co.
635 S. Flores, San Antonio
Texas Educational Aids
225½ S. College, Tyler

UTAH

Deseret Book Company
44 East South Temple, Salt Lake City
Z.C.M.I. Visual Aids Service
51 South State Street, Salt Lake City

VERMONT

Visual Education Society of Vermont
164 Main Street, Montpelier

VIRGINIA

Tidewater Audio Visual Service
617 West 35th Street, Norfolk
J. M. Stackhouse Co.
5803 Patterson Ave., Richmond

WASHINGTON

Northern School Supply Co.
2603 First Ave., Seattle
Audio Visual Supply Co.
15-17 Washington Street, Spokane

WEST VIRGINIA

Pavis Inc.
427 W. Washington St., Charleston
Kyle and Co.
Court & Washington Sts., Clarksburg

WISCONSIN

Wisconsin Visual Equipment Company
Juneau
Filmstrip Distributors
2550 University Avenue, Madison

POPULAR SCIENCE TEACH-O-FILMSTRIPS, LITERATURE AND INFORMATION . . . AS WELL AS GUIDANCE IN USING THIS GREAT NEW EDUCATIONAL DEVELOPMENT . . . MAY BE OBTAINED FROM ANY OF THE SELECTED REPRESENTATIVES LISTED ON THESE PAGES. OR YOU MAY WRITE DIRECTLY TO THE AUDIO-VISUAL DIVISION OF POPULAR SCIENCE PUBLISHING COMPANY.

POPULAR SCIENCE PUBLISHING COMPANY

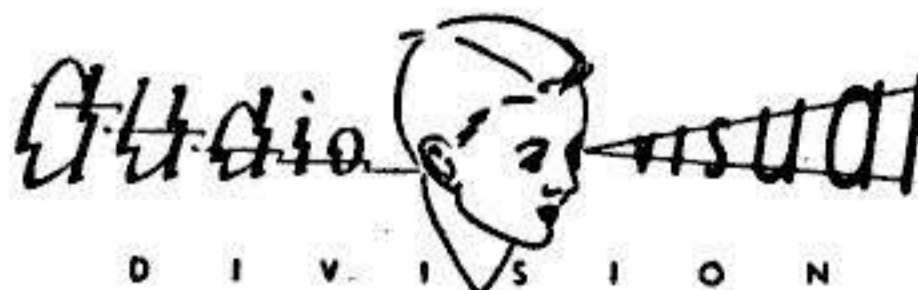

353 FOURTH AVENUE, NEW YORK 10, NEW YORK

WANT MORE MONEY? *Make Fast* **HUGE PROFITS** AT HOME - SPARE OR FULL TIME

Materials
COSTS YOU 5¢ —
YOU GET \$5.00



Now is the time to cash in on this big-paying easy-to-operate year 'round business for yourself and you need no experience! 4 MILLION new babies every year, with parents eagerly waiting for you to metallize baby shoes in real GOLD. SILVER. BRONZE. PEARL. and GLASS. Everything furnished so that YOU can start earning money at once — up to \$1,000 per month full time...\$50 to \$75 per week spare time — at \$5.00 per hour! They will last forever... huge new market every year waiting to buy! Start as small or as large as you wish, and watch it grow to a real BIG-MONEY operation. FREE DETAILS — send no money—a postcard with your name will bring all the facts. Don't pass up the golden opportunity to start your own business on a shoestring — so ACT NOW Write at once to:

**KIKTAVI COMPANY Dept. PS-6,
2111 West Manchester, Los Angeles 47, Calif.**

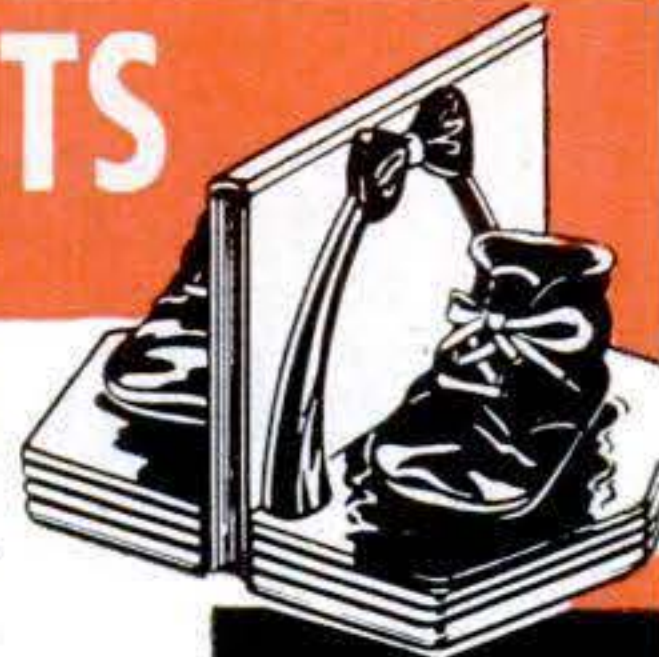

FREE! 3 way profit plan yours to inspect at my risk for 7 days. Includes two actual metallized baby shoes—or a pair of your own metallized at no extra cost.

- Big Income
- Huge Demand
- Future Security
- Your Own Boss
- Money Back Guarantee
- Most Successful Name in Metallizing



IDEAL LAWNMOWER SHARPENER

Saves work, saves time, helps you earn extra dollars! Sharpens hand, power mowers without disassembling. Complete shop in one machine—equipped with Bed Knife Grinder and "lapping-in" Reconditioner. Home owners, parks, clubs, cemeteries pay good money for efficient sharpening; get your share!

WRITE NOW FOR FREE CATALOG

THE FATE-ROOT-HEATH CO., Dept. I-4, Plymouth, Ohio



NEW! Trash Disposal Unit Burns Refuse Safely

• A new type outdoor dispose-all unit safely and quickly burns garbage and trash in any weather. All refuse, damp, green or dry is fully consumed. Scientific draft design completely eliminates fire hazard of flying ash, sparks, burning, blowing bits of paper. Intense combustion removes neighbor-annoying nuisance of flying scraps, smoke, smell.

Sturdily built to last for years. Nothing to get out of order. Needs no watching. Will not blow over. Will not destroy grass or shrubs. Ends refuse hauling and fire hazards to quickly pay for itself. Measures 23" square at base by 40" high. Weighs 23 lbs. Over 2 bu. capacity. Recommended by Bureaus of Fire Prevention. Full price \$9.95—nothing else to buy. Sent F.O.B. Cleveland. Money back guarantee. Send check, cash, or money order to:

ALSTO COMPANY, Engineers Bldg., Dept. PS-6, Cleveland, Ohio



Recirculating Pump. Large supply of water needed for recirculating. Motor: 1/30 H.P., 1550 RPM., 115V A.C. 12 3/4" high, 8 3/4 lbs. Fan cooled.

\$19.50

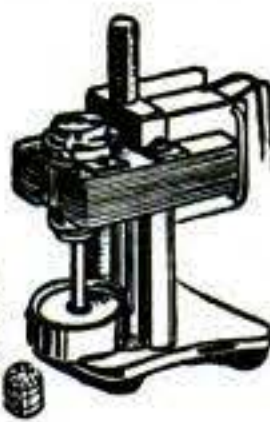

Make Your Own Fountain. Motor: 110V A.C. 4 11/16" high, 30 G.P.H. \$9.45 plus \$1.00 for Brass screen and spray nozzle.

For Miniature Water Falls and Rock Gardens. Motor: 110V A.C. 90 G.P.H. at no head to 40 G.P.H. at 3' head \$9.95.



Cellar Pump. Bronze and brass throughout. Motor: 1/2 H.P. G.E. 115V A.C. 38" high, 45 lbs., 3400 G.P.H.

\$49.50



Your Old Bird Bath Come to Life. Place unit in bird bath and it becomes an adjustable spray fountain. Motor: 110V A.C.

\$19.95

All Sizes Electric Motors In Stock. Mfr. of pumps and water display fountains.

CANAL ELECTRIC MOTOR, INC.
Dept. PS-6, 310 Canal St., N.Y. 13, N.Y.

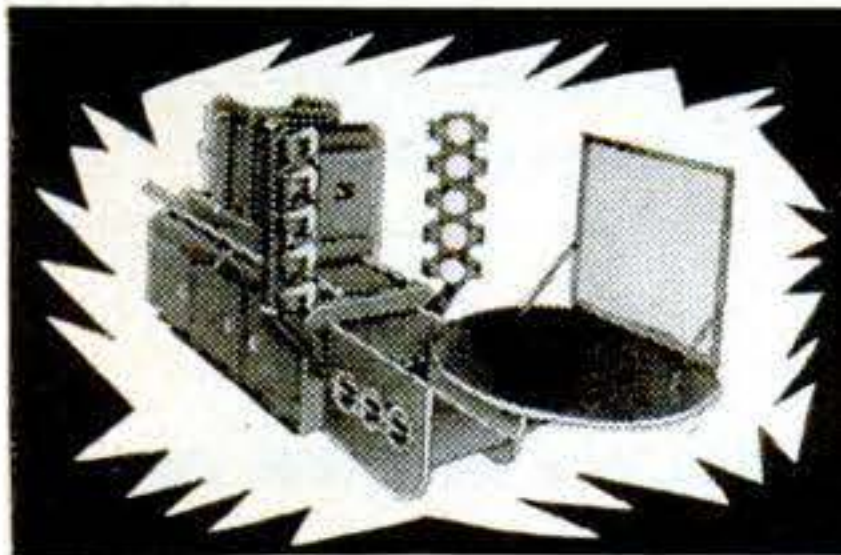

BE A PHOTO-ENGRAVER

We furnish complete equipment and supplies. Learn at home or in our modern, friendly APPROVED school in MISSOURI. Get into this big demand, high profit, high wage field. You can start your own profitable, full time or part time PHOTO-ENGRAVING business right in your own home.

Be independent, be your own boss or pave the way to a high pay job with experience gained in your own shop.

TASOPÉ TRAINING and TASOPÉ EQUIPMENT has enjoyed world wide recognition since 1931. Write for descriptive literature today. No obligation.

THE AURORA SCHOOL OF PHOTO-ENGRAVING, DEPT. PS-6 TASOPÉ BLDG., AURORA, MO.

FREE 152-PAGE RADIO-TELEVISION CATALOG OF SETS, KITS, PARTS! LATEST HAM, HI-FI AUDIO, RECORDING DATA! LOWEST PRICES!

WRITE FOR YOUR COPY!

GET THE WHOLE STORY IN THIS FREE CATALOG —
Radio Shack bargain mail-order catalog is best in the U.S.A. Profusely illustrated! An encyclopedia of radio-electronic equipment, tools, books, sound systems, plus war surplus and special buys! Rush request today.
— Ask for free catalog 50-PM.

DELCO (G-M) DUAL AC BLOWERS SALE! NOW ONLY \$14.85 POSTPAID



Brand new! FAR below regular price! Ideal for darkrooms, cooling xmtr tubes, draft boosting, humidifiers, dryers, ventilation, suction, shipboard, etc. Continuous duty, brushless, 115 V 60 cy. Operates at 2800 rpm, 200 cfm free vol. air delivery. 62 watts input. Over-all 10 1/2" by 5 1/2" by 6 1/2"

DEMAND INDICATOR ONLY \$2.49

Made by Stewart-Warner. No. 748A-RD. worth 5-10 times our POSTPAID sale price! 20 amp range, thermally operated, 2-wire, for 600 volts or less. Accurately checks transformer loading, load distribution, etc. Metal case 4 1/2 x 5 1/2 x 2 1/4"

CRYSTAL MIKE!

Record-Low-Price Lowest price EVER. Exclusive special purchase of a famous-maker's \$6.50-value crystal mike (crystal element alone is exact replacement for his \$10 units)! Excellent response 100-6000 cycles, ideal for public address, entertainers, hams, recording, etc. Streamlined metal case, 6 1/2 ft. cable. Sensitive!

POSTPAID! \$2.85

RADIO SHACK CORP. 167-B Washington Street, Boston 8, Mass.

Earn Up To **\$200⁰⁰** a Week!

Easy? Well, John C. West, Cleveland, made more than \$600.00 his first three weeks in spare time! Many other exceptional profit records.

And No Wonder! Just show housewives how to END FOREVER the nasty, messy job of defrosting refrigerators and profits come rolling in.



Amazing Patented Device!
Just plug in exclusive Patented D-Frost-O-Matic—SHOW what it does—and make up to \$6.50 easy.

FREE PROFIT PLAN

Just send card with name and address for GUARANTEED Starting offer and SURE PROFIT PLAN. Cash in on our National

Advertising to 29,000,000 prospects. RUSH—reserve your territory.

D-FROST-O-MATIC

6 North Michigan, Dept. PS-7, Chicago, Ill.



HANDI-GROMMET-KIT

Make Your Own Repairs To Your Canvas

This Kit is complete with Tools and 4 dozen Grommets for making quick, easy repairs to TENTS, AWNINGS, TARPAULINS, BOAT SAILS, SHOWER CURTAINS, etc. Grommets are available in either Natural Brass or Nickel Finish.

Size	I.D. Hole	Price	Send check
0	1/4	\$2.00	or M.O. to
1	5/16	2.25	DEPT. 1
2	3/8	2.35	
3	7/16	2.50	

LORD & HODGE, 40 Saybrook Rd., MIDDLETOWN, CONN.

ARMY SURPLUS BARGAINS

FOR THE HOME — SHOP — HANDYMAN

Send for our FREE catalog of Surplus Bargains. All NEW top-quality merchandise. Buy from Army Surplus Sales of Fresno—and save! Also big stock of brand-new home utility power hand-tools, drills, saws, etc. All products of Black & Decker. Tremendous buying power and low overhead means lowest prices.

ARMY SURPLUS SALES OF FRESNO—Dept. 16
1820 Tulare Street Fresno, California
THE FRESNO HARDWARE COMPANY

NEW! MINIATURE DUST MASK

Wear when sanding, grinding, paint spraying, sweeping, dusting, furnace cleaning, etc. Handy as a pair of glasses. Just keep mouth closed and breathe through nose is all you do to operate. Protects against dusts, lint, coal, cement, grain dust. Has 9 sq. in. filter.



Order Today \$1.00 POST PAID

JERRY BRYANT, Dept. PS, 919 N. Michigan Ave., Chicago 11, Ill.

LEARN MEAT CUTTING At Home — In Spare Time



Get into the vital meat industry. Concise, practical Home Training based on 25 years proven instruction methods used at National's famous resident school. Prepares you for bigger pay as Meat Cutter, supervision, market manager or more money in your own store. Go as rapidly as your spare time permits. Diploma. Start NOW to turn your spare hours into money. Send for FREE bulletin today. No obligation.

National School of Meat Cutting Inc., Div. O-91, Toledo 4, Ohio

WHAM-O SPORTSMAN

\$1.00 postpaid

At Dealers or Direct

HITS LIKE A .22 RIFLE — KILLS RABBITS, SQUIRRELS. For Hunting, Target, Routing Pests.



HUNTING SLINGSHOT

Powerful, silent, accurate. Complete with 40 pellets and extra rubber straps. Send \$1.00 today to—

Wham-O Mfg. Co., Box 8-N South Pasadena, Calif. PROFESSIONAL MODEL OF THE NAT'L SLINGSHOT ASSN.

WhiskER

THE ELECTRIC SHAVER THAT'S SOLD BY BARBERS



ONLY \$12.95 In Regular Package

NOW! SMOOTH, CLOSE SHAVES . . . EVEN IN SUMMER! WHETHER YOU SHAVE ONCE A DAY — OR, ONCE A WEEK

Barbers know a good shave when they see one. That's why they recommend and sell WhiskER. WhiskER whisks away any length beard, clean as a whistle, without pulling or stalling. It uses a time-tested hair clipping principle, with an extremely close-shaving blade. Operates quietly on 110v, 60 cycle AC; no radio interference. The next time you visit your barber or beautician ask to see the WhiskER. If he does not have WhiskER, he can order it for you on a 10 day trial.

NOW AVAILABLE IN DELUXE GIFT CASE



WhiskER in this attractive, sturdy case makes an ideal gift . . . a useful travel kit. WhiskER and case . . . \$14.95

ELECTRO TOOL CORPORATION Dept. 530-F, Racine, Wisconsin

High School at Home

Many Finish in 2 Years

No classes. No time wasted going to and from school. Progress as fast as your time and abilities permit. Standard H. S. texts supplied. Thousands enroll each year in this 52-year-old school. Send for FREE descriptive booklet.

AMERICAN SCHOOL, Dept. HA-46 Drexel at 58th St., Chicago 37, Ill.

Without obligation, please send FREE descriptive booklet.

Name.....

Address.....

WEST COAST UNIVERSITY

Extension Department

HOME TRAINING

Can Prepare You for a Great Future

UPHOLSTERING A Money-Making Vocation or a Business of Your Own. Practical. Easy to learn and do. You get materials to make and upholster a fine Ottoman. Professional tools available.

DIESEL Famous Hemphill system that has trained hundreds of successful Diesel operators and mechanics. Many Diesel opportunities the world over. Kit of tools included with lessons.

PLASTICS One of the world's fastest growing industries. Learn fabricating, laminating, molding. Practical type training includes 7 kits with materials and detailed instructions. Many successful graduates.

AIRCRAFT Famous Aero Tech course. Successful graduates since 1940—many holding important jobs in Aviation. Recent government contracts mean many new opportunities. Prepare now.

MAIL COUPON TODAY. Get detailed illustrated books describing field of your choice.

WEST COAST UNIVERSITY, EXTENSION DEPT. PS-60
1601 S. Western Ave., Los Angeles 6, Calif.

Please send me free information about your home training in course I have checked.

Upholstering Diesel Mechanics
Plastics Aircraft

Name _____
Street _____
City _____ State _____

OXYGEN BREATHING SET ORIGINALLY COST \$100—NOW ONLY \$7.95!

BRAND NEW SURPLUS. Ready to use. Portable with Automatic "Demand" type valve. The type set our Air Force depended on! A must for airman, mountaineers, firemen, paint shop workers and others who on occasion need extra oxygen. This popular "demand" type oxygen outfit requires no technical knowledge for use—just breathe into the mask provided and the regulator automatically delivers the oxygen you need as you breathe into the mask! Complete set includes D-2 type shatter-proof steel bottle 6x24 inches; demand type regulator AN-6022-1; 0-500 lb. oxygen gauge and type A-10 demand oxygen mask with hose. Net weight 7 lbs. Shipping weight 10 lbs. Outfit as described above but with empty tank shipped parcel post each \$7.95. With oxygen filled tank (available by express only) \$9.95. Refiller hose, orifice and valve for charging tank with oxygen \$2.00. 6 foot flexible extension hose with fittings \$2.00. PORTABLE AIR SUPPLY OUTFIT: Oxygen set minus mask only \$6.95. By adding hose and air chuck (not furnished) you have portable source air for auto tires, garden sprayers, etc. F.O.B. Houston.

SPECIAL DISCOUNT LOTS OF 6—20% LOTS OF 12—25%
LOTS OF 24—33 1/3%
Send check, money order.

AERO PARTS SUPPLY CO.
Dept. 101 8102 Lockheed, Houston, Texas

FACTORY-TO-YOU MIDWEST RADIO and TELEVISION at NEW LOW FACTORY PRICES

Available in Consoles and Complete Chassis

LONG EASY TERMS

30 DAYS TRIAL

Right In Your Own Home

Send for **FREE** 32-Page 4 Color CATALOG

MIDWEST RADIO & TELEVISION CORP.
Dept. X24B, 909 Broadway, Cincinnati 2, Ohio

NAME _____
ADDRESS _____
CITY _____ ZONE _____ STATE _____

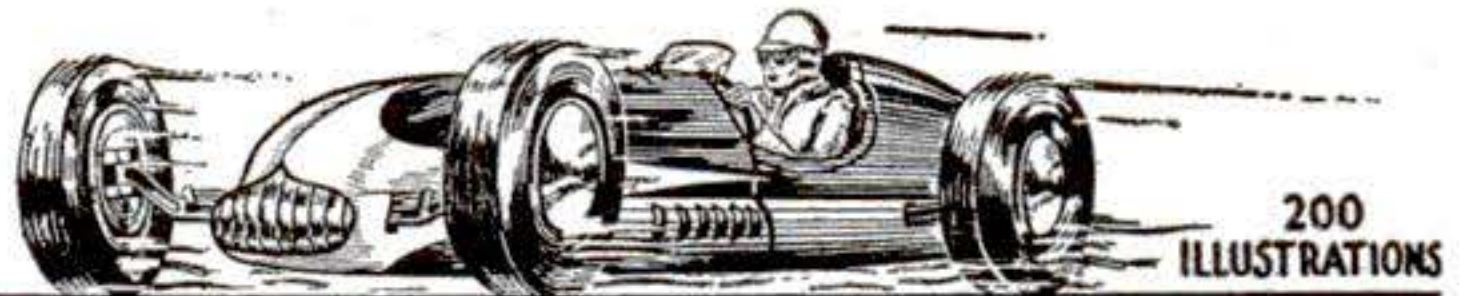

200 ILLUSTRATIONS

SPEED & MILEAGE MANUAL

Easily Get Super Speed, Acceleration, Mileage—Top Racing Performance From Any Automobile!

Famous New Book shows simplified Soup-up Methods—Speed Tuning—Economy Secrets—"Customizing Plans"—Latest Track Proven Methods for all cars! Tells how to build your own SPEED EQUIPMENT! FAST SPORT CARS! "CALIFORNIA HOT RODS"! 200 H.P. ROAD & TRACK CONVERSIONS! Complete Instructions on building inexpensive Superchargers! Dual Manifolds! "Water Injectors"! High Compression Heads! Twin Mufflers! Economizers! All about—Fast Engines, Gas Saving, Restyling, "Cam Secrets," Multiple Carburetion, Fuels, Porting, Ratios, Frames, "Offys"! BRAND NEW METHODS, Plans, Formulas, "Racing Tricks"—"STOCK CAR SPEED SECRETS"! Reveals 100 ways to save gas! Shows latest "HOLLYWOOD CUSTOM STYLING"! Streamlining! Sport Changes! Lowering! Speed Conversions! Including—California Roadster Plans! Racer Diagrams! Working Drawings! Performance Charts! Graphs! Beautiful Photographs! Etc.!

Large manual (plus) "California Equipment Catalog" and Hot Rod Handbook.

ALMQUIST AUTOMOTIVE ENGINEERING
Milford 622, Pa.



WASH YOUR CAR IN 10 MINUTES!

WITH FAST, EASY FOUNTAIN BRUSH. TURNS WORK INTO PLEASURE. WASHES AND RINSES IN ONE OPERATION, CARS, TRUCKS, WINDOWS, PORCHES, BOATS, ETC.

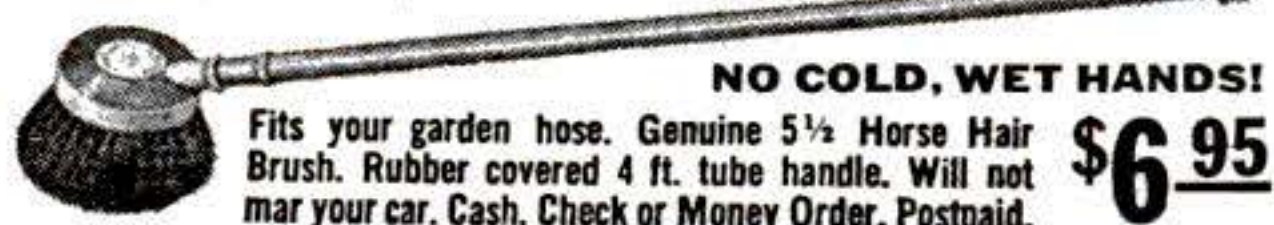

NO COLD, WET HANDS!

Fits your garden hose. Genuine 5 1/2 Horse Hair Brush. Rubber covered 4 ft. tube handle. Will not mar your car. Cash, Check or Money Order. Postpaid. **\$6.95**

PAYS FOR ITSELF—SATISFACTION GUARANTEED

WINSLOW MFG. CO., P-6, 1428 Balfour, Detroit 30, Mich.

NO SWEAT

KEEPS WATER PIPES DRY

No more dripping, sweating water pipes. Genuine Fiberglass insulation, covered with vapor seal tape. Easy to apply. Keeps basement dry—tools don't rust, even in hot, humid weather. Use on hot water pipes to cut heat loss. Neat installations. If dealer can't supply you, send his name and \$1.50 for enough to cover 20 ft. of 1/2" pipe. Postpaid. **Satisfaction or money back.**

NOTE: For root blocked sewers ask your dealer for DIG-NO-MORE. Folder on request. Dealers: Write.

ASSOCIATED SPECIALTIES, 10660 Gratiot, Detroit 13, Mich.

TRAIN

Your VOICE!

RESULTS GUARANTEED

STRENGTHEN your voice this tested, scientific way. Yes—you may now be able to develop the **POWER** of your speaking and singing voice in the privacy of your own room. Self-training lessons, mostly silent; no music required. Write **TODAY** for Eugene Feuchtinger's great booklet "How to Strengthen Your Voice." It's absolutely **FREE!** You must state your age. Booklet mailed in plain wrapper. No salesman will call. Send your name and age **RIGHT NOW!**
Perfect Voice Institute, 1141 S. Wabash Ave., Studio F-1, Chicago 5, Ill.

**Say You Saw
It In Popular Science**

RUPTURED? Get Relief This Proven Way

Why try to worry along with trusses that gouge your flesh—press heavily on hips and spine—enlarge opening—fail to hold rupture? You need the Cluthe. No leg-straps or cutting belts. Automatic adjustable pad holds at real opening—follows every body movement with instant increased support in case of strain. Cannot slip whether at work or play. Light. Waterproof. Can be worn in bath. Send for amazing **FREE** book, "Advice To Ruptured," and details of liberal truthful 60-day trial offer. Also endorsements from grateful users in your neighborhood. Write:

CLUTHE SONS, Dept. 14, Bloomfield, New Jersey

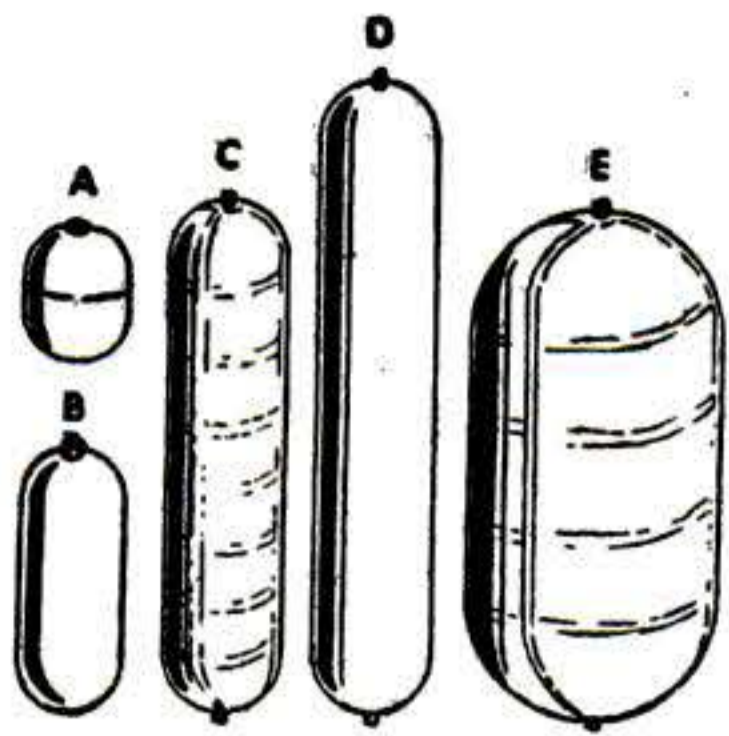

STEEL AIR TANKS

Steel pressure tanks suitable for compressors, pneumatic units, gases, hydraulics, and liquids. Rated at 500 lbs. per square inch pressure.

	Size	Wt. Lbs.	Internal Volume	Price
A	7 1/2" x 5 1/4"	1 1/2	104 cu. in.	\$1.25
B	14 1/2" x 5 1/2"	3 1/2	280 cu. in.	2.00
C	24" x 6"	5	500 cu. in.	2.50
D	45" x 6"	11	1000 cu. in.	4.50
E	24" x 12"	18	2100 cu. in.	5.50

Prices F.O.B. Chicago. Include approx. postage on orders paid for in advance. C.O.D. orders enclose 25%, balance sent C.O.D. WRITE FOR FREE ILLUSTRATED CIRCULAR.

U. A. S. Corp. Dept. PS-6 5637 W. 63rd Pl. Chicago, Illinois

"33" STOPS SASH DECAY

Miles Ahead of Putty

ARMSTRONG'S "33" Glazing Compound is permanently E-L-A-S-T-I-C (secret formula). Unlike putty, it won't crack or crumble. Never gets rock-hard. Use it on wood or metal windows for LASTING protection. Easy to apply. Costs little. Get "33" from your hardware or lumber dealer. Try it! ARMSTRONG CO., Chicago 9, Illinois.

Look

a 10 1/2 x 4, 6-ply Tire. Tube. Machined Wheel and Bearing at a "give away" price. Supplied in two types:—

- 1. With Highspeed TIMKEN BEARING (with Grease Retainer) \$8.95
- 2. With Slowspeed NEEDLE BEARING (with Grease Retainer) \$5.95

Freight Collect (8 1/2 lb.)

Ideal for Handcarts, Bgies, Trailers, Soap-box Racers, etc. A bargain from the world's largest stock of all types of Airplane Tires. Send your check or money order to:

Airplane Tire Co., 99 Hiway, Tulare S., California

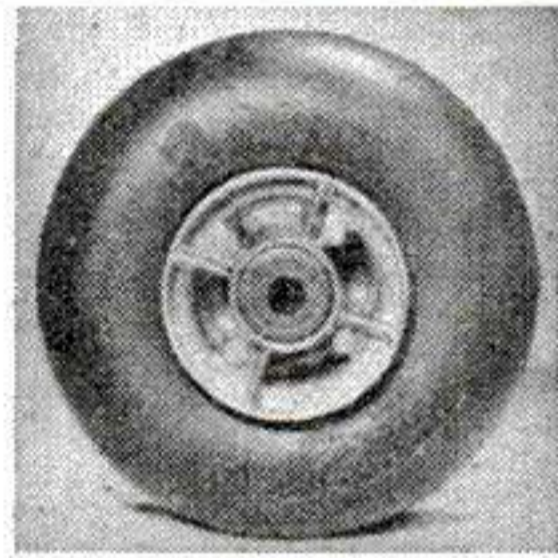

BOX-TYPE- STURDY STEEL PICNIC TABLE LEGS

Electrically-welded steel legs, ready-drilled. Simply apply your own lumber and it's complete. Send for Free literature!

\$7.95 Set

Complete for one table

East Moline Metal Prod. Co.
East Moline, Illinois

OIL FILTER REFILLS... 10c

Filters Oil the full length of the Pack

Here's News! Ordinary toilet paper makes an ideal oil filter. Laboratory tests prove it cleans oil faster and better than popular makes of filter elements. All you need is a simple set of Retlif Adapter Plates... and you can start using toilet paper rolls (costing about 10¢) in your present oil filter. For proof and descriptive literature, send name and address to:

10,000 Sq. In. of Filtering Surface

Plates Last Indefinitely

RETLIF CORPORATION, Dept. 32
1239 No. Highland Ave., Los Angeles 38, Calif.
DISTRIBUTOR INQUIRIES INVITED



Want to Write

A. E. Van Vogt Short Stories, Mysteries, Articles?

FREE Lesson Shows How You Learn at Home for Extra Income or Full-Time Career

HAVE you ever had an urge to write? Have you or friends had interesting experiences or ideas about people, places, hobbies, sports, business or social activities, that might make interesting stories or articles for general magazines, trade and technical journals, fraternal publications, etc.

Editors agree: the demand for new writers is greater than ever, and you don't have to be a genius to make money. Many Palmer beginners earn while learning, receiving small but welcome checks for material that may be turned out quickly once you acquire the technique. And now it's easier to learn than you may imagine, through Palmer's unique method of training—for not just one field of writing, but for all: Fiction, Article, Radio. Endorsed by famous authors—including Rupert Hughes, Gertrude Atherton, Katharine Newlin Burt, A. E. Van Vogt, and by hundreds of successful graduates.

Graduate Now Famous Author

A. E. Van Vogt, leading science fiction writer, says, "Your course is excellent. It was a milestone in my career."

You get practical writing assignments to do at home. Your work is **individually** handled by professional writers. Study fast or slow. Save time and effort. To find out how you too may make money writing, send for free illustrated book, "The Art of Writing Salable Stories," plus free sample lesson and typical writing assignment. Palmer Institute of Authorship (Est. 1917), Desk U-60, 1680 N. Sycamore, Hollywood 28, Calif. Send today.

APPROVED FOR VETERANS

FREE Palmer Institute of Authorship, Desk U-60
1680 N. Sycamore Hollywood 28, Calif.
Please send me free book, "The Art of Writing Salable Stories" explaining how your home-study training helps new writers get started. This is confidential. No salesman will call.

Mr. _____
Mrs. _____
Miss _____
Address _____
City _____ Zone _____ State _____

Please print clearly. Veterans: Check here.

NU-WAY LAWN MOWER

Build Your Own Rotary Type Lawn Mower

We Supply Cutting Unit Complete.

Write for FREE Circular

Price \$12.50
Why Pay More

NO INCREASE IN PRICE

TRACTOR-LITE MFG. CO., SPIRIT LAKE, IOWA

BECOME A JET ENGINE EXPERT

BE READY Start NOW

Aviation's NEWEST OPPORTUNITY — Study with LIVE JETS at CAL-AERO only — AERONAUTICAL ENGINEERING & MASTER AVIATION MECHANIC training since 1929 — Approved for VETERANS. WRITE TODAY for Special Information.

NAME _____ AGE _____
ADDRESS _____
CITY _____ ZONE _____ STATE _____

CAL-AERO TECHNICAL INSTITUTE
GRAND CENTRAL AIR TERMINAL • GLENDALE 1, CALIFORNIA

PS-6

NOW — The Most Fabulous
Sports Car In Auto History!

STUTZ BEARCAT

Colorful 3/4" Scale Model Hudson Miniatures'

"OLD TIMER"

Auto Set

\$3.95
Includes
step-by-step
instructions.
Fun to Build!
A Thrill to Own!

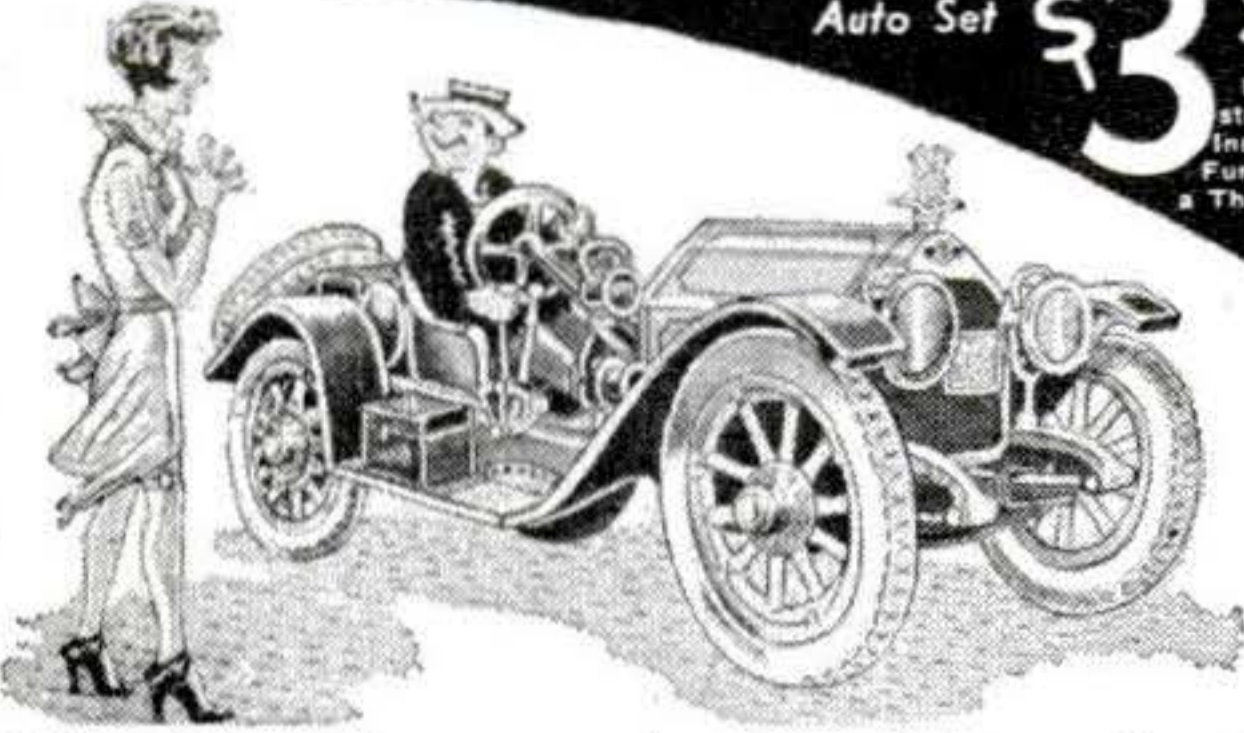

"The Car that made good in a day"

The Stutz Bearcat lives in stories as no other car has in all auto history! Once you assemble it, you'll be the proud owner of the most prized sports car known! Complete with plastic wheels, hub caps, head lamps, cowl lamps, radiator, horn and steering wheel. When completed, length 10 1/2". \$3.95. Ten other models:

1911 Maxwell\$2.50	1910 Model "T" Ford	\$2.50
1903 Model "A" Ford	1903 Rambler	\$2.50
1904 Olds	1909 Model "T" Ford	\$2.95
1909 Stanley Steamer	1900 Packard	\$2.50
1911 Buick	1903 Cadillac	\$2.50

SEE them at your hobby, toy, or department store, or write to us direct. Add 25c for postage and handling; no C.O.D.s, please.

Hudson Miniatures' "OLD TIMERS"
SCRANTON HOBBY CENTER, Dept. 28, Scranton 10, Pa.

MAKE BIG MONEY PLASTICS LEARN AT HOME

LEARN HOW TO MAKE fast selling PLASTIC NOVELTIES FURNITURE JEWELRY SIGNS TOYS LAMPS

There are RICH OPPORTUNITIES for MEN and WOMEN with "know-how" in Plastics. Interstate's amazing new Plastics course tells and shows how to make hundreds of fast selling items out of Plastics. Gives complete training in fabrication, casting, lamination, molding, etc., in simple, easy, step-by-step language and pictures.

START A PLASTICS BUSINESS OF YOUR OWN. No other industry holds such promise for the future. You can make big money manufacturing novelties, toys, signs, etc., in your own home in spare or full time. Don't wait! Learn NOW how Interstate's Plastics Training qualifies you for success in the plastics field.

Write for FREE Information Today!
INTERSTATE TRAINING SERVICE
School of Plastics
PORTLAND 13, OREGON (Dept. 2-F)

Command Bigger Money! STUDY LAW

STUDY AT HOME for BUSINESS SUCCESS and LARGER PERSONAL EARNINGS. 40 years expert instruction—over 114,000 students enrolled. LL.B Degree awarded. All text material furnished. Easy payment plan. Send now for FREE BOOK—"Law and Executive Guidance." It explains the course—how you may enroll and the many ways you may profit from Law Study. Write TODAY to:

AMERICAN EXTENSION SCHOOL OF LAW
Dept. 27-PS 646 N. Michigan Ave., Chicago 11, Ill.

BUILD YOUR OWN POWER MOWER

IT'S EASY!
MAKE that dandy new rotary power mower you want, and save the difference! Save yourself too—cut out the drudgery of old-fashioned lawn mowing! Royal's dandy new book gives easy-to-follow directions, insures a good job. 7-day return privilege if not satisfied. Send a quarter today to
ROYAL MFG. CO.
Dept. F25, 1205 Charlotte St.
Kansas City 6, Missouri

AMAZING NEW CHEMICAL MAKES OLD BUMPERS LIKE NEW!

NOT A PAINT! NOT A POLISH! Looks like expensive chrome plating! Wonderful new chemical puts chrome-like finish on car bumpers, door handles, trim, etc. No electricity—no plating tanks—no acids needed. Just smooth it on and watch it gleam! Takes a brilliant polish JUST LIKE CHROME—so simple a child can do it. **REFINISH BUMPER IN 10 MINUTES! WORKS LIKE MAGIC**—finish lasts for years. Increases resale value of your car and adds NEW beauty to other chrome plated or metal items. **TRY AT OUR RISK! SEND NO MONEY!** Just send name and address. Pay postman amazing low price of \$1.00 plus few cents postage for each kit ordered, or send cash and we pay postage. Try kit 10 days. If not delighted return for instant refund! **Bumper Re-Nu, Rm. 10, Box 147, Hamtramck, Mich.** **\$1.00**

NEW! DURABLE! 7 JEWELS!
3 YEAR SERVICE GUARANTEE
● SHOCK RESIST.
● ANTIMAGNETIC
● RADIUM DIAL
● SWEEP SECOND HAND
● CHROME CASE
● LEATHER BAND
\$6.95 Post-paid plus 70c tax
Refund if not satisfied. Special! Order
Now! Sorry, no C.O.D.'s.
LADIES Watch, as above, smaller Size \$7.95 plus 80c tax.
ELCO PRODUCTS CO., Dept. 10 166 W. Washington, Chicago 2, Ill.

Live joyously

triumphantly, through **YOGISM**, which adapts dynamic Yoga success secrets to modern living. Free Trial Lesson explains how to relax and re-charge flagging energies. Learn Yoga techniques which positively develop abundant confidence, strength, personality. Whatever your present circumstances, age or sex, Yogism spells a better life, new opportunities. Test it. Write now for FREE Lesson direct to **SCHOOL OF YOGA**, International HQ, 10B Insight House, New Malden, Surrey, England.

FREE YOGA LESSON

LEARN HOW TO HYPNOTIZE

COMPLETE—ONLY \$1.95, POSTPAID! Amazing self-study lessons... in simple, easy to understand language. How to select a subject—how to hypnotize by telephone—how to make money from hypnotism—mental telepathy—stage hypnotism—self-hypnosis; how modern hypnotism is used to conquer inferiority complex, fear, battle fatigue, timidity, etc. Clear, helpful pictures show operating positions, movements. Money-back guarantee. Only \$1.95, postpaid—or COD, plus postage. Write today!
Nelson-Hall Co., 1139 S. Wabash Ave., Dept. 2S-1, Chicago 5, Ill.

100 ALL STAR MODEL POSES

GORGEOUS PROFESSIONAL MODELS IN 100 POSES ON 16 MM FILM STRIP
Superb camera studies of 100 thrilling beauties. Ideal for discriminating sculptors, artists, art students, photography students. Add 10c for postage. Order Now!
\$1.00
FULL LIFE SIZE PROJECTOR UP TO 4' x 6' \$10 Value Now \$4.95 post-paid
Magnifying viewer for perfect detail \$1
BENEFIT CORP., Dept. A-26
3807 Benefit Street, Baltimore 24, Md.

BUILD YOUR OWN GEIGER COUNTER!
And SAVE 2/3 of Cost!
NO special knowledge necessary!
You need NO additional parts!

It's EASY to build your own Searchmaster Geiger Counter with this COMPLETE kit. Contains everything you need! Headset, tubes, geiger-counter tube, batteries, plus smart metal case 9 1/4" x 4" x 3 1/2". All parts laboratory tested! Sensitive to both beta and gamma radiation! Fully guaranteed! Illus. instructions show you how to assemble parts quickly.

SPECIAL FREE OFFER!
 Radioactive specimen sent FREE with each order. Plus FREE literature, showing you how to locate uranium with your Geiger Counter and win \$10,000! Write for details or order your Searchmaster Geiger Counter Kit now! Postage prepaid with check or money order. C.O.D. orders: send \$5, bal. on arrival.

only \$29.95

SCIENCE KITS LTD.
 5514-S Hollywood Blvd. • Hollywood 28, Calif.

Superior to many Counters selling for MORE than \$100!

COMPLETE KIT \$29.95

KIT COMES COMPLETE Nothing Else to Buy!

Easy-to-follow instructions Come with each Searchmaster Kit

Kit guaranteed to operate perfectly when assembled per instructions!

EARN MORE IN DRAFTING

MORE OPPORTUNITIES for EMPLOYMENT and PROMOTION

"Here I am at work making good money as a draftsman. I'm glad I sent the coupon to Chicago Tech for that Free Trial Lesson and found out how easy it is to learn Drafting in spare time at home. Today I feel secure in my job because the draftsman's work comes first on any new project. And, in addition, draftsmen can't be replaced with machines. What's more, I feel I'm slated for promotion and more pay, because I see so many draftsmen advancing to high-pay jobs."

LEARN IN SPARE TIME—AT HOME!

(or at the College in Chicago)

A few hours of pleasant home study every week—that's all. No interference with your present job. All the tools you need; drawing outfit included. With Chicago Tech's help, you train yourself step by step. This tested method—developed over 46 years of C.T.C. progress—prepares men quickly for good positions in industry.



FREE INFORMATION—SEND COUPON
 To prove to you how easy it is to learn Drafting at home by the Chicago Tech method, we will send you this FREE TRIAL LESSON. No charge for this lesson, now or later. Fill out and mail coupon, or send post card today.

Bar Bells

Buy Direct From Factory **\$8.95** up

Write for free booklet and price list

INDEPENDENT IRON WORKS
 2416 East 23rd Street, Dept. C
 Los Angeles 11, Calif.

New Amazing Oil
RUSTNIX #4 Protects Tools and Equipment from Rust

Rustproofs Tools and Equipment for home, Farm, Sport, Auto, Marine Transportation and Industrial uses. Protects metal in use, storage and transit. High resistance to salt spray, humidity, rain and snow. Protects bare, plated and some painted steel. Tends to arrest rust on poorly cleaned surfaces. Brush spray or dip—dries quickly to firm wax-like coating—easily removed. For the first time brings direct to the individual consumer the latest technical advances in rust prevention. 5 gallons \$19.95 prepaid. Handy 4 oz. trial package, \$1.00. Check or m.o. only. Satisfaction guaranteed.

Dept. 104 **ARLA CO.** Box 812, Cleveland 22, Ohio

DUAL TAIL PIPE EXTENSION

Fits all cars—chrome plated
DEEP TONE **\$2.95**
 produced by 2 1/2 inch outlets
 Postage free on prepaid orders
 TRADE INQUIRIES INVITED

LYONS PRODUCTS COMPANY
 Pat. Pend. 2426 So. LaBrea Ave., Dept. PS-6, Los Angeles 16, Calif.

DRAINS CELLARS, WASH TRAYS
CIRCULATES OIL

Pumps 1800 GPH 300 gal. 30' high, uses 1/8 to 1/2 HP motor. Will not clog. **\$6.50**

Postpaid if cash with order. (Add 50c for west of the Mississippi.)
 Thousands in use since 1936

LABAWCO PUMPS, BELLE MEAD 3, N. J.

SANDEE CHROME SILENTIP

\$2.95 EACH

FOR QUIETER PERFORMANCE

An exhaust tailpipe extension that is actually a small muffler. Chrome plated. Will make a sport muffler or dual set quieter and still give straight thru performance.

SANDEE MUFFLER CO., 5643 Corryne Pl., Culver City, Calif.

CHICAGO TECHNICAL COLLEGE

G-227 Tech Bldg., 2000 So. Michigan Ave.
 Chicago 16, Illinois

Mail me FREE Lesson with information about big opportunities in DRAFTING.

Name.....Age.....

Address.....

City.....Zone...State.....

BEAUTIFIES natural wood, pine paneling

POLISHES furniture, woodwork

IMPROVES paint jobs

PROTECTS wood and metal surfaces

49¢ 89¢ PINT QUART

101 HANDY HOME USES!

Every home, every workshop, needs Pol-mer-ik BOILED Linseed Oil. Free folder tells you how to use it. Write . . .

ARCHER-DANIELS-MIDLAND CO., Minneapolis 2, Minn.



AT WAREHOUSE-TO-YOU PRICES
Now... from one convenient and economical source you can get these high quality metals for your needs, pre-cut to your specifications.

ALUMINUM, BRASS, COPPER, STAINLESS STEEL in **RECTANGULAR SHEETS**
Easy to work, adaptable to hundreds of uses such as lamp shades, serving trays, wall brackets, etc. Ideal for modern silhouette cut-outs.

CIRCLES of ALUMINUM and COPPER
Perfect for shaping and forming into useful items, and for perforated design work.

Write for price lists and complete information

FREE BOOKLETS tell how YOU can use these metals—easily and quickly. Write for your free copies today.

METAL GOODS CORPORATION
Dept. PSM 642 Rosedale Ave. St. Louis 12, Mo.

What is your idea of a **GOOD** job?

Avoid dime-a-dozen trades—learn Watchmaking, today's top mechanical profession, at the world's largest and best equipped school of its kind. Work for established jewelers or build your own business. Veteran-training approved courses are offered in watch, clock, chronograph repair and engraving. Enroll any time, day or evening classes. Send now for free 116-page illustrated information packet. Certified by the Horological Institute of America, Washington, D. C.

WESTERN PENNSYLVANIA HOROLOGICAL INSTITUTE
DESK 39, FIRST FLOOR CHAMBER OF COMMERCE BLDG.
PITTSBURGH 19, PENNA.

World's Largest Watchmaking School



WAR SURPLUS BARGAINS

\$500,000.00 INVENTORY for QUICK LIQUIDATION

Surplus items—hundreds of them for home, shop, factory, farm and outdoor use. New items, used items, reconditioned items—all at tremendous savings—all priced for quick sale.

PAGE AFTER PAGE OF VALUES

This big catalog shows page after page of amazing money saving values. Write for your copy today. Send 10c to cover postage, mailing, etc. Write today!

SEND TODAY FOR YOUR COPY

STARK'S

509 So. State St. Dept. PS-6 CHICAGO 5, ILL.

10c

Save UP TO 25% ON QUALITY BALL-BEARING WHEELS



Bilt-Rite wheels roll smoothly and easily, are semi-pneumatic, ball-bearing, painted red; guaranteed top quality—and you save up to 25%! Compare Bilt-Rite's quality and price; then get your order in today! Dealer inquiries invited.

Ball-Bearing Wheels at Bargain Prices

(For 1/2" axles)			
6 x 1.00.....	\$1.30	10 x 1.25.....	\$1.95
8 x 1.25.....	1.65	10 x 1.75.....	2.15
8 x 1.75.....	1.80	10 x 2.00.....	2.45
8 x 1.50.....	\$1.50		
(For 5/8" axles)			
6 x 2.00.....	\$3.95	8 x 2.50.....	\$4.45
10 x 2.75.....	Only \$4.65!		

Bilt-Rite Guarantee
No better wheels are made regardless of price; 10 day return privilege.

If size you need isn't listed, write for Folio A. Order Today—Send cash, check, or M. O.—Pay postage on arrival.

BILT-RITE WHEEL COMPANY
520 East Missouri Ave. Dept. 76 Kansas City 6, Missouri

MONEY for MEN ALL DATA FREE

THE PLASTEX Industry needs manufacturers on small scale and for big production of Lamp and Clock Stands. Art Goods and Novelties in Plastex and Marble imitation. Experience unnecessary. 1/2c material makes regular 10c store sellers. Rubber moulds furnished for speed production. Small investment brings good returns. Big chain store orders now being placed. Ambitious men have chance for real prosperity. Our Free booklet will interest and benefit you.
PLASTEX INDUSTRIES, Dept. 2, 3400 Third Ave., New York 56, N. Y.

New Advertising Machine Prints Post Cards

FREE LEARN HOW thousands of business men, in every line, boost sales in spite of conditions—with ads printed on postcards by amazing new patented **CARDMASTER** advertising machine. Low price, sold direct. Guaranteed 5 years. **SEND NAME** for **FREE** illustrated book, new money-making ideas and complete, unique advertising plans.
Cardmaster Co., 1920 Sunnyside, Dept. 166, Chicago 40, Ill.



BARBELLS

\$7.98 **SATISFACTION GUARANTEED OR YOUR MONEY BACK!**

Proven \$15 bodybuilding course **FREE** with every purchase. **YOUR MONEY BACK** if not delighted with results after 6 weeks.

Send for **FREE CATALOG**
DAN LURIE BARBELL CO.
1729 S-6, Dept. 170-F Rockaway Parkway, Brooklyn 12, N. Y.



Find HIDDEN TREASURES

GEIGER COUNTERS for Uranium Detection (see at left). **TREASURE DETECTORS** for gold, silver, etc. Lightweight, ultra sensitive. None finer at ANY PRICE. **INFORMATION FREE.**

Detectron CO. Dept. 6-A
5631 Cahuenga, No. Hollywood, Calif.

CARBURETOR TOO RICH MAKES MOTORIST TOO POOR



Car owners who are wasting money and not getting proper gas mileage due to over-rich mixtures will be pleased to learn how to save gasoline by **VACU-MATING** over-rich mixtures. **VACU-MATIC** fits all cars, trucks and tractors. It is automatic and operates on the supercharge principle. Easily installed in a few minutes.

SALESMEN WANTED! Big Profits! Send name, address on penny postcard for free particulars and how to get yours for introducing.
VACU - MATIC CO., 7617 - 1614 W. State St., WAUWATOSA, WIS.

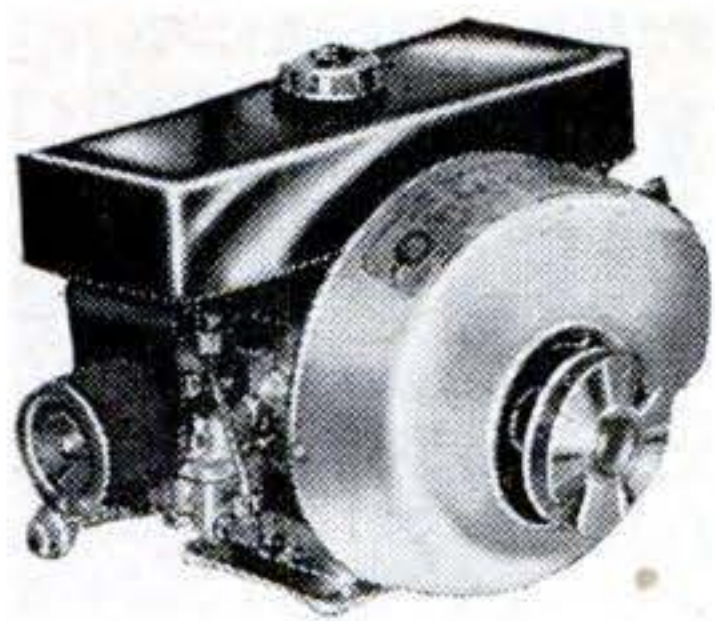

**SAVE
ABOUT 50%**
Limited Supply of the Popular POWER PRODUCTS Light-weight, Air-cooled Engines, 1 h.p., 2 cycle

Brand new, complete with air filter, magneto, gas tank, Tillotson float feed carburetor, accurate speed governor. Pulley shaft 5/8" diameter. Speed range 2700 to 3800 R.P.M. Suitable for use on pumps, air compressors, power tools, portable generators, light scooters.

Net weight 18 lbs. Shipping weight 21 lbs.

\$47.50 value for \$24.95

Shipped transportation charges collect. Send postal or express money order with order.

DEALERS PLEASE WRITE

OAKS MOTOR COMPANY, 432 North Street, Ludlow, Mass.

LAWN ORNAMENT-NOVELTY PATTERNS

28 Lawn Ornament Patterns, 25c. Other patterns: 15-20" high; Dutch Girl, Dutch Boy, Pirate, Bull Terrier, Mexican Girl, Mexican Boy, Dwarf, Penguin, Flower Girl, 10c each. 25 Novelty Patterns, 30c. All 62 Full Size Patterns, \$1.00 Postpaid.

FLYING DUCK

Wind revolves wings. Realistic appearance. Pattern, Instructions and wing Pinion Kit; brass bearing, steel shaft, wing lugs, bolts, nuts and washers. 50c. Pattern and Instructions without kit, 25c. Postpaid.

STROTHER PATTERN SERVICE
Dept. 7-BM Box 128 Belington, W. Va.

GENUINE WAR SURPLUS!

- PUP-TENTS—reissue open end type. \$2.95
- " " —like new open end type. \$3.95
- " " —reissue closed end type. \$3.95
- " " —like new closed end type. \$5.95
- SLEEPING BAGS, wool with cover, reissue. \$4.95
- BLANKETS, all wool army, new \$5.95—used. \$3.95
- JUNGLE hammocks—\$4.95—NAVY hammocks—\$3.95 NEW!

MONEY BACK GUARANTEE! ADD SUFFICIENT POSTAGE!

THE SURPLUS STORE, BOX 4065, GREENSBORO, N.C.

ATTENTION LEATHERCRAFTERS

LOOK WEST, to the home of Leather Carving and Stamping. More than 100 LEATHERCRAFT KITS in finest Tooling and Carving Leathers. Best assortment of tools and accessories in U.S.A. Other handcraft materials also. Send 10c for 96-page illustrated catalog.

GRIFFIN CRAFT SUPPLIES (since 1924)

5626-B Telegraph Avenue Oakland 9, California

**COMMERCIAL TRADES' GRADUATES GET
THE BETTER JOBS** because they are PROPERLY TRAINED!
Practical Shop Training In
Air Conditioning—Refrigeration
and/or
Electricity Major Appliances
Service, Maintenance & Installation
Write for Catalog PS4

COMMERCIAL TRADES INSTITUTE
200 South 20th St. Birmingham, Ala.
Member: Southern Association of Private Trade Schools
An approved school to TRAIN Veterans & Non-Veterans

Learn CRIME Detection!

Learn Scientific Criminology AT HOME. Opportunities in Investigation and Detective work—Identification—Finger Printing—Homicide Investigation—Infrared Photography—Photo-micrography for law enforcement. Send for FREE Book.

Institute of Scientific Criminology
310 So. Robertson Blvd., Los Angeles 48, Calif. Dept. PS-6
Name Age
Address

**Sensational Invisible
Belt Holds Pants Up
And Shirt Down!**

It does away with suspenders. Old style outside belt not needed. When you remove your coat your shirt tails won't be exposed.

**INVISIBELT IS GUARANTEED
to do everything we say it will, or your money back!**

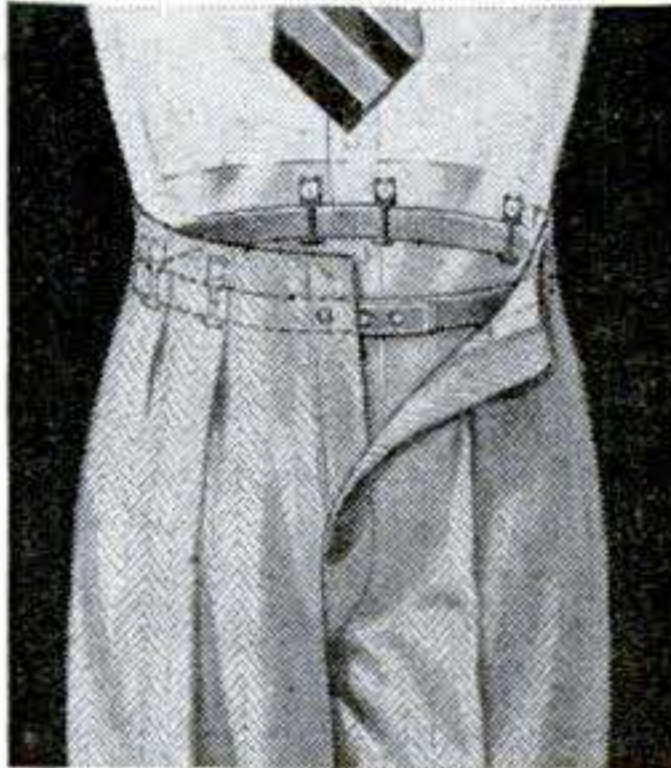

- ★ Worn inside pants over the shirt.
- ★ 6 Plastic Uprights snap onto the 6 suspender buttons.
- ★ Holds the shirt down.
- ★ Drapes your trousers perfectly.
- ★ Prevents waistline sag—your pants stay where you put them.
- ★ Relieves pressure on your stomach.
- ★ Gives luxurious waist-line comfort.

- ★ Economical -- will outwear any leather belt -- will outwear two pairs of suspenders.
- ★ Endorsed by Hollywood Screen Stars.

ORDER YOUR INVISIBELT TODAY

Small size for waistlines 28 to 32 in.
Medium, 32 to 36 in. Large, 36 to 40 in.
Extra Large, 40 to 44 in. Every Invisible belt adjustable to 4 waist lengths.

\$2 Post-paid

INVISIBELT

5028 Hollywood Blvd. Dept. G
Hollywood 27, California
Send Size Small, Med., Large, Ext. Large
Enclosed is \$2, Cash, Money Order
Name _____
Address _____
City.....State.....

**CARVE
LEATHER**

**Easy to Learn in Spare Time.
Fascinating, Profitable HOBBY.**

Have fun and make money too! Carve handsome bags, billfolds, belts, moccasins, key cases, etc. from our huge and varied stock of Leather Projects that come READY TO CARVE AND ASSEMBLE. To select what you need, write for complete, fully-illustrated catalog. Contains over 200 photographs of projects, leathers, tools and accessories. Learn this fascinating hobby—start small and experiment. Write for catalog today, include 25c to cover printing and mailing.



**BURTONS
LEATHERCRAFT**
Dept. PS-6,
1755 1/2 Glendale Blvd.
Los Angeles 26, Calif.

WRITE NOW FOR COMPLETE
LEATHER-CRAFT CATALOG!

L. H. of Chicago, Ill., turned leather-carving from a stimulating hobby into profitable business. In spare time he sells his completed leather projects for up to FIVE TIMES cost of materials.



SALESMEN!

WRITE
THREE
WORDS
COLLECT
\$7.65

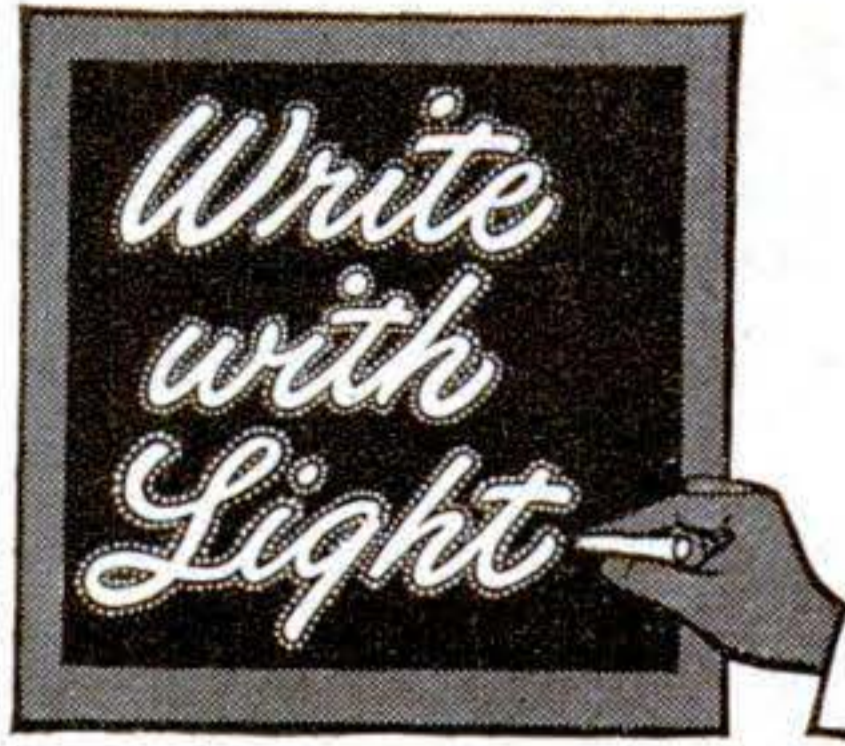

SENSATIONAL NEW ADVERTISING SIGN

YES, MAKE \$7.65 on 10-second demonstration to merchants. Write on glass with amazing magic crayon and presto—a 5-color advertising message takes fire and glows like a brilliant neon sign! Three sales a day and \$22.95 profit is for "lazy" men. Workers can double to triple that amount. FREE SALES KIT. Don't wait. Rush your name and address on a penny postcard for full details and complete sales kit—ALL FREE.

**MAXILUME CO., 125 W. Hubbard
DEPT. L-96 CHICAGO 10, ILLINOIS**

START YOUR OWN

MONEY-MAKING BUSINESS

Clean rugs on customers' floors with highly efficient electric machine which is making **BIG MONEY** for others and giving them independence. Special skill or experience not required. No shop necessary. Write today for complete **FREE** information. Address:

VON SCHRADER MFG. CO., 611 PL., RACINE, WIS.

Make Garden Masonry for Spare-Time Profits

Millions of homes can use these Ornamental products—urns, vases, flower boxes, bird baths, lawn seats, flagstones, etc. Easily made of sand and cement. Permanently glazed in a range of smart colors. Distinctive—attractive—quick selling.

Eye-Appeal Makes for Cash- and-Carry Sales



Selling prices allow 200% to 300% mark-up on basic costs. Only a small investment needed for supply of molds. Easily set up in shed or garage. Write immediately for catalogue OM and price list.
COLORCRETE INDUSTRIES, INC.
711 Ottawa Ave., Holland, Mich.



MEN! send for this MONEY- MAKING OUTFIT

MAKE \$15⁰⁰ IN A
UP TO DAY

Do you want to make more money in full or spare time... as much as \$15.00 in a day? Then write for this **BIG OUTFIT**, sent you **FREE**, containing more than 150 fine quality fabrics, sensational values in made-to-measure suits and overcoats. Take orders from friends, neighbors, fellow-workers. No experience needed. You'll say it's the greatest way to make money you ever saw.

SAMPLE SUITS TO WEAR Pay No Money! Send No Money!

Our plan makes it easy for you to get your own personal suits and overcoats without paying 1c. in addition to your big cash earnings. This offer is limited. Rush your name and address for big **FREE OUTFIT**—today!

**W. Z. GIBSON, INC., Dept. F-520
500 S. THROOP ST., CHICAGO 7, ILL.**

EYE- GLASSES BY MAIL

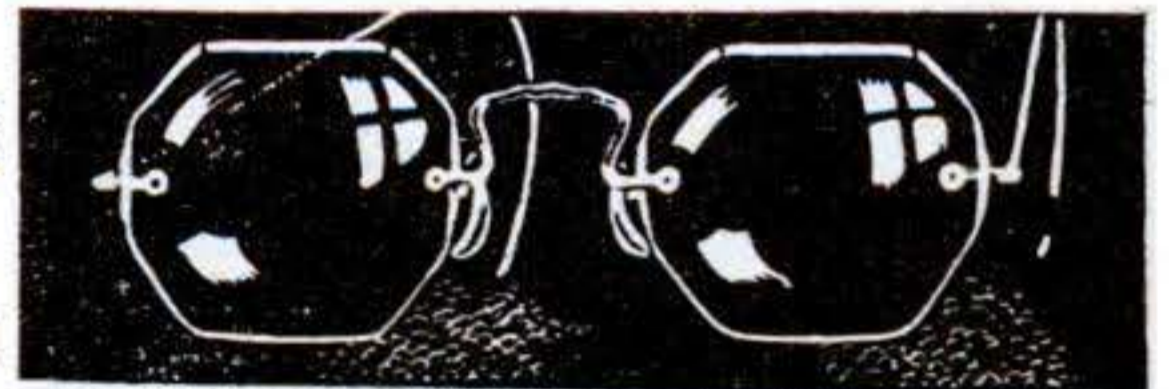

16 Days Trial

Write Today for Free Catalog. Send no Money

ADVANCE SPECTACLE COMPANY
537 South Dearborn Street, Dept. SP-6, Chicago, Illinois

Make Money
SELLING
Eshelman
Kulti-Mowers
and DOING
GARDEN
WORK

PLOWS
CULTIVATES
HARROWS
HAULS
SPRAYS
MOWS
CUTS
ROLLS
RAKES



FOR BETTER
LAWNS
and GARDENS
also POWER MOWERS
and RIDING TRACTORS
Women can operate it.
Free Catalog
Write **ESHELMAN,**
Dept. 73
119 Light St., Balto. 2, Md



FREE SAMPLES! GLOW IN THE DARK!

BIG PROFITS showing amazing Luminous Specialties—house numbers, pictures, plastic novelties, religious and nursery objects, ash trays, key-holders, etc. Large manufacturer. Enormous demand. Sell on sight. **WRITE AT ONCE** for **FREE** samples.
Madison Mills, 303 4th Ave., Dept. K-5, New York 10, N.Y.



U. S. Pat. D 153853

This **FREE** sample kit can make you a **HIGH-PAID MAN** in your community

LONG NEEDED INVENTION
Earn up to \$10,000 per year or more!
Be your own Boss! No investment!

You can get started on the road to success with this valuable sample case containing demonstration units and powerful sales literature. Handsome, leather-type finish. Tried and proved, it will make you money.

World-famous automatic fire ex-

tinguisher needed by every home, business, and farm... smotherers fires without human aid... priced to sell quickly.

ACT NOW! Be an independent business man! Someone in your community will be appointed soon.

WRITE FOR DETAILS TODAY!

RED COMET, INC. 638 RC Building
LITTLETON, COLO.

Piles May Lead to Chronic Ailments

FREE BOOK—Explains the Causes and Effects

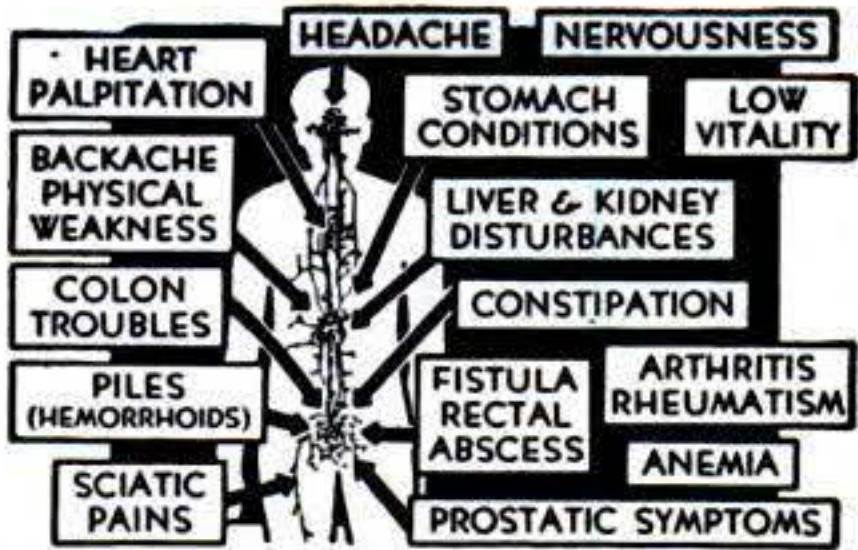

No obligation. Write to Thornton & Minor Clinic, Suite 649, 911 E. Linwood, Kansas City 3, Mo.

HOW TO MAKE MONEY!



RAISE HIGHLY PROFITABLE Angora Rabbits backyard easy way. Multiply fast. No experience required. Wool brings **TOP PRICE**. Plenty markets. Write **TODAY** for **FREE INFORMATION, PRICES & WHERE to SELL.**

WHITE'S RABBITRY
NEWARK 8, OHIO

SAVE 50% ON CUSTOM MADE VENETIAN BLINDS

by assembling them yourself

You do the simple assembly job and save *all* labor cost on these luxurious custom-made venetians. We custom-cut them to your windows. All-aluminum with enclosed metal head, self-leveling cords, matching or contrasting tapes, in all decorators colors. Write for complete details.

UNITED VENETIAN BLINDS
5835A N. E. Mallory • Portland 11, Oregon



\$ FREE COURSE! BIG PROFITS! \$ Flocks & Sandblasts



Only \$19.75 complete

Dual Purpose Spray Gun! Uses only 25 lbs. Air Pressure!

Thousands of uses in Home, Shop, Industry: Makes Auto Interiors Clean & New, Lines drawers, Marproofs lamp bases, Refinishes any object. All in colorful Flock, Etch & Frost windows, glassware, etc. Removes Paint & Rust from Autos, Tools. Guaranteed! Send \$19.75 or write for free information. **Complete Flocking Supplies!**

BLASTO SPRAY GUN MFG.
Dept. PS-6, 7007 Haas Ave., Los Angeles 47, Calif.

PROJECTION SCREEN

Improved screen gives wonderful reproductions. It takes rough treatment—can be cleaned with water. Extra strong steel hanger, roller and tripod. This big value possible through volume production. Roller screen (with fixtures to hang it anywhere) only \$4.79 each postpaid. Tripods: \$2.49 each postpaid. Order yours today... satisfaction assured.

HANG it ANYWHERE

SCREEN \$4.79
40" WIDE BY 30"

TRIPODS \$2.49 each

CHAS. W. RICE & CO., INC. UNION CITY, IND.

FANS! FANS! ALL TYPES — ALL SIZES

Kitchen Ventilators, Exhaust Fans, Attic Fans, Blowers, Heat Boosters, Desk Fans, Window Fans, Blades, Guards, Shutters, Motors, etc.

Send 25c for illustrated catalogue

EDWARDS BROS. ESTAB. 20 YEARS
WESTERN APPLIANCE CO., INC.
5650 Grand River Ave. Detroit 8, Mich



YOUR OWN RETAIL BUSINESS

You can make **\$150 to \$200** a week!

no experience necessary!



PICK YOUR CITY ... the brand-new "donut-bakery-on-display" is a sensational profit-maker anywhere. Makes all kinds of donuts, practically all automatic. Sets up as a department in a going retail store ... proven in hundreds of stores across the country. Big percentage of profit.

Training is included. Easy operation. Nationally advertised **DOWNY FLAKE** brand, is your franchise. New 1950 machinery installed. Starting investment \$2500. Send for details (no obligation).

FREE FOLDER — WRITE TODAY

Doughnut Corporation of America

393 Seventh Ave., New York, N. Y.

NOW YOU CAN DRILL YOUR OWN WELLS!

Sturdily Made—Hundreds of satisfied customers. Purchased and used by U. S. Dept. of Agriculture, U. S. Dept. of Forestry, U. S. Navy and many foreign countries. Fully Guaranteed.

NEW LOWER PRICE \$345.00.

Less Motor, F.O.B. Factory. Price includes drill, bailer and 100' cable. 200 ft. of additional length available at extra cost.

Drill your own wells for that needed water—as many as you need—outside—in the cellar—in the barn. The new improved **CONSOL Driller—1950 Model**—is equipped with a special replaceable Drill Head. It will drill through many feet of solid rock without resharpening. Simple to operate, easy to set up. Do the work yourself at small cost.



A **HEAVY DUTY MODEL** for 6" casings also available at \$1295., F.O.B. Factory, equipped with Gasoline Engine.

Write for free information and booklet, Dept. PS.

CONSOLIDATED INDUSTRIES
West Cheshire, Conn.

Classified Ads only 80c per word per insertion, payable in advance. Minimum ad 10 words. To be included in August issue, copy should be in our office by June 21st.

CLASSIFIED OPPORTUNITIES

POPULAR SCIENCE MONTHLY-351 FOURTH AVE.-NEW YORK CITY 10

1 AUTOMOBILES

WATER Vapor Injector—complete, ready to install \$1.00. Specify Car. Vapor-Air, Box 8129, Kansas City, Mo.

ENJOY New-Car pep and power in your old Buick. Same day service from world's largest stock of new (not rebuilt) Buick parts and engines. Ship anywhere. Dime brings catalog. Write today. Robertson Buick Co., 1002 S. Wabash Ave., Chicago 5, Illinois.

RACING Car Equipment for all cars. Engines, Racing Heads, Manifolds, Carburetors, Mufflers, etc. Speed instructions and literature \$1.00—refunded first order. Lee Motorcraft Co., 1412-B Great Northern Bldg., Chicago 4, Ill.

SILENCE Overhead-valves, attachments unnecessary. \$2.00. Derderian, Box 542, Sandston, Virginia.

"WATER Injection" Also—Speed—Power Economy—Methods! Free descriptive, illustrated, information, Neher Industries, La Verne 6, California.

DIRECT From California—Dual Manifolds for Willys Jeeps to Oldsmobile Rockets—Finned Heads—Three Carburetor Manifolds—over 150 different makes and models. Speed and Dress-up Equipment for passenger automobiles—Magneto Ignitions, Aluminum Flywheels, Racing Camshafts, Water Injectors, Crash Helmets, Exhaust Headers, New 1950 Illustrated Speed Catalogue—25c. (Dealers, request Wholesale Catalogue.) Newhouse Automotive Industries, 5805-A 7 East Beverly, Los Angeles 22.

"SPEED & Power" Handbook. Tens of thousands have been sold! 50 chapter Library Edition! Diagrams! Breathtaking methods—Authentic—Direct from California. Covers Crosleys to Cadillacs—All makes. Build your own Dual Manifolds, Superchargers, Hot Cams, Water Injectors, Hi-Compression Heads, Mileage Devices. Save many dollars! Get racing speed, lightning acceleration, dynamic power increases from any make passenger automobile! Build fast Stock Cars, California Roadsters, 160 M.P.H. Rods! Get construction drawings! Tuning Techniques! Speed Tricks! Economy secrets! Ingenious formulas! Covers "Racing Frames"—"Reciprocating Masses"—"Jet Engines"—"Braking Characteristics"—"Dynamometers". Also—Dual Pipes—Gears—Fuels—Porting—Relieving—Lowering—Balancing! Includes 1950 Speed Equipment, Catalogues! Also "California Automobile Customizing"—Colored Photographs, Drawings, (Newest ideas.) Conversions, Carson Tops, Re-styling all makes. Streamlining, Chopping, Channeling. Complete—\$1.98 postpaid, Newhouse Automotive Industries, 5805-A2 East Beverly, Los Angeles 22. (See page 34. Display Advertisement.)

S-P-E-E-D & Mileage Manual—"New Jumbo edition"! 200 Illustrations, Drawings, Charts, Photographs! "Guaranteed finest, most Authoritative book"! Easy, inexpensive ways to build Speed Equipment—California Hot Rods—Beautiful Custom Cars—200 H.P. Road, Track Conversions—Superchargers—Dual Manifolds—Racing Heads—Twin Mufflers—Water Injectors—Economizers! "Get super speed, mileage, acceleration—top racing performance from any car"! Complete instructions with working diagrams on Fast Engines, Speed Tuning, Restyling, "Customizing," Gas Saving, "Racing Tricks," Cams, Fuels, Balancing, Porting, Ratios, Frames, "Offys"—"Learn 100 ways to save gas"! Reveals "Stock Car Speed Secrets"! California Speed Shop Methods! "Custom Styling Information"! Streamlining! Lowering! Sport Changes! "Hollywood Roadster Plans"! 2 Speed Conversions! (Covers All Cars)—"Large Manual" plus Equipment Catalog plus "Hot Rod Handbook"—all three only \$1.98. Almquist Engineering, Milford 61Z, Pennsylvania.

INTERESTED in automobiles? Write for free sample copy. Franson's Weekly Motor News, Box 254, Eugene, Oregon.

BIG New Catalog—Over 500 racing, hot rod, speed equipment, auto parts and Hollywood Accessories! Pictures! Speed Tips! Customizing! Mileage Information! Lowest prices! Illustrated catalog 25c. Almquist Engineering, Milford 65Z, Penna.

"If You Want To Go Let Us Know" Complete Line of Sport's Car, Stock Car, Road Car Equipment. Illustrated Catalog 15c. Dealer's Wanted, Hi-Speed Power Equipment, 228-20 Merrick Road, Laurelton L. I., N. Y. La-5-9535.

"SPEED Equipment" bargains—California mufflers \$4.50, V-8 Duals \$15.90, Chrome carburetor stacks 98c, Duals Manifolds \$9.95, Chrome echo cans \$1.55, Racing camshafts \$29.95 exchange, Hi-compression heads \$19.75. All popular brands—Big illustrated catalog 25c (Dealers Wanted). Almquist Engineering & Mfg., Milford 63Z, Pennsylvania.

SAVE Gasoline, oil, tires, brakes—New Illustrated Economy Manual. Get more power, speed, better automobile performance. Introduces 17 new Economy products—Super sparkplugs, Water-oil injector, Rocket booster, Mileage motor, etc. Special 50c. National Automotive Research Corporation, Venice 16, California.

CHEVROLET Owners Handbook. Just out! Complete service data A to Z all Chevrolet models 1930 to 1950 inclusive. \$1.50 Postpaid, Clymer, Dept. 6B, 1268 S. Alvarado, Los Angeles 6, Calif.

CALIFORNIA Custom accessory headquarters. Buy direct from original designers and save. Chrome dash panels, solid hood sides, grille panels, speed equipment, dual pipes, push button door conversions, chrome motor accessories, fender skirts. 34 page illustrated catalog 25c. Eastern Auto, 3319D, South Grand, Los Angeles 7, Calif.

NEW Grand Canyon Economy Test Book. 31 American Cars Competed. Full technical details, rules, all information including gasoline saving article by winner. See how your favorite car performed in world's most important test. 145 photographs, charts, drawings, travelogue, historical Grand Canyon and Boulder Dam information. \$1.50. Outboard Motor Service Manual. All Makes. \$3.50—Ford Owner's Handbook All Ford data 1932 to 1950. \$1.50. Model "A" Ford Manual \$1.00—1950 British Car Catalog \$2.00—U. S. Car Catalog \$2.00 Postpaid, Clymer, Dept. 6B, 1268 S. Alvarado, Los Angeles 6, Calif.

JUST Published! Clymer's No. 6 Motor Scrapbook, Latest and best. Heretofore unlisted antique cars, motorcycles. \$2.00—History Motorized Vehicles, data on early gasoline, steam, electric cars, steam engines and motorcycles. \$2.00. Clymer, Dept. 6B, 1268 S. Alvarado, Los Angeles 6, Calif.

NEW Book! German Racing Cars and Drivers. Includes 300 Leica photographs, complete history all Pre and Post-War German Cars, Auto-Union, Mercedes-Benz, Veritas, BMW information all famous European Grand Prix Races, History Caracciola, Lang, Stuck, Rosemeyer, other great drivers and famous tracks. \$2.00 Postpaid. Clymer, Dept. 6B, 1268 S. Alvarado, Los Angeles 6, Calif.

"SEE our ad under Motorscooters for Midget Car Bargains, Midget Motors Directory, Athens, Ohio."

FREE Trial, 10 days, Latest Chevrolet "Speed-Power" Manual sent on approval! Ninety pages of accurate information tells how to increase speed, power and economy of 1937 thru 1950 Chevrolets. Learn how to install late engines in pre-1937 chassis. Full data on cams, high compression multiple carburetion, supercharging, ignition, etc. Proves that your Chevrolet can have superior power and speed. Send No Money, pay postman nothing. Try before you buy! If you don't agree this is the finest Chevrolet manual you've ever seen—just send it back within 10 days. If satisfied, send \$2.00 to California Bill, 4611 A-6 York, Los Angeles 41.

CHEVROLET Owners. Stop costly Oil leak from under tappet cover. Send for patented "Tappet Cover Retainer" 35c coin. Special Enterprise, 1065 Boston, Pontiac, Michigan.

AUTO HOOD HEATER for quicker cold-weather starting. 3-lamp Infrared unit, safe, efficient. BUILD IT YOURSELF. Save half the cost. Send \$1.00 for plans. Wagner-Green Company, 1935 Euclid Avenue, Cleveland, Ohio.

FREE Trial, . . . Latest Ford "Speed and Power" Manual! Sent on approval, this 128 page book of cutaway construction drawings, photos and understandable technical data. Includes information on installing V-8 motor in Model A chassis, hydraulic brakes for any Ford, roadster and fast car information. How to rework V-8. Mercury, Ford 6, Zephyr, Model A engines for speed. If you don't agree this is the finest hot rod manual you've ever seen—just send it back within 10 days. Send no money, pay postman nothing, try before you buy. If satisfied, send \$2.00 to California Bill, 4611 A-6 York, Los Angeles 41.

YOUR car burn oil? Poor compression? Slow starting? Excessive cylinder wear? Holt's Piston Seal restores compression! Cuts oil consumption! Checks piston slap! Lasts 10,000 miles! This amazing British Product now available forms self-expanding pliable lubricating seal around pistons. Compensates for wear! Cannot harm finest engine. Easily installed; full directions enclosed. \$3.98 tube for 6 or 8 cylinders up to 240 cubic inches. Details on request. Treglown Company, Department G, 200 West 7th Street, Plainfield, New Jersey.

2 AUTO SUPPLIES & EQUIPMENT

BRUSH Plating Outfits connect to a battery. No tanks or shop required. Free particulars. Gunmetal Co., Avenue K, Decatur, Illinois.

PARTS for cars and trucks 1920 up. Bill's Auto Parts, Valley Falls, R. I.

BIG Bargains! Fender Skirts for most cars \$9.95 pair. 6 volt Electric Siren with push button \$10.95. Send Deposit. Send 25c for new illustrated 15,000 item automotive catalog. J. C. Whitney & Co., 1919-DB Archer, Chicago 16.

"BURN Water in Your Car"! Free illustrated information. Write—Neher Industries, La Verne 6, Calif.

WELDING bodies, frames, fenders. Pays with Hobart Arc Welders. Easy terms. Free Catalog. Box 279-P-602, Troy, Ohio.

WHEEL Alignment Recorder. Drive over. Guaranteed. \$16.98 prepaid. Align-A-Matic, Box 94, W. Orange, N. J.

AIRCOOLED Oil Filter. Other Items. Free Folder. Stonewall Company, 2005-S Cedar, Alhambra, Calif.

CHEVROLET Parts. Scarce motor, body, sheet metal parts. Grossman Chevrolet, Minneapolis, Minnesota.

"HOLLYWOOD" Deptone Mufflers—"Straight-thru" design increases efficiency, speed, acceleration, mileage!—Singles, all cars \$4.98—Finest V-8 duals \$15.90. Satisfaction guaranteed. Speed equipment catalog 25c. Almquist Engineering, Milford (64Z), Pennsylvania.

SAVE Gasoline! Sensational Gane needles. Free Trial—See page 36.

COMBINATION Flashlight, Auto bulb, and fuse tester. Rubber cushioned! Complete with batteries. \$1.50. Weill Specialty Co., 1650 East 38th Street, Brooklyn, N. Y.

SAVE your Battery. Use Nulife Battery Preserver. Proven Product. Guaranteed Harmless. Inexpensive. Write for particulars. Nulife, 879 Bridge Drive, San Leandro, California.

SEAT covers. Fiber \$14.95. Plastic \$19.95. Excellent quality. State year. Make Model. Color. Autolux, 3834 Dolfield Avenue, Baltimore 15, Maryland.

PISTONS—1907 to 1950 any make. Merryman Co., Lawndale, California.

POPULAR SCIENCE OPPORTUNITIES

MAKE yourself super device, saves 45% gasoline guaranteed, purifies oil. Plans \$2.00. Mike Brodie, Vilna, Alberta.

"DON'T Change Flats. Air from spare gets you to nearby station. Get our tire inflator, only \$1.59 postpaid. Sorry no C.O.D. Central Auto & Home Supply Co., 1521 Central Ave., Far Rockaway, N. Y."

MOTORISTS save gasoline by Vacuumating overrich mixtures. Fits all cars. For Free particulars write Vacuumatic, Dept. 1615, Wauwatosa, Wis.

FROM Speedway to Roadway! Track-proved hi-speed heads, manifolds now available for any passenger car! No special tools needed! Increase horsepower 25%! Astounding getaway! Free illustrated catalog. Speedsport, 6215-F Diversey, Chicago 39.

NEW and used guaranteed parts for civilian and Army cars and trucks. Largest stock in America. Mail orders. Pioneer Auto Wrecking Company, 788 W. 13th Avenue, Denver, Colorado.

3 AUTO TRAILERS

BUILD Your own Trailer for boats, gen. Have every feature you want! Plans for house, sport, camp and utility trailers. Catalog describing 9 models 10c, 15c in Canada and overseas. Jim Dandy, Box 125-B, Wausau, Wisconsin.

BUILD Your own trailer! Save money! eral utility. New Axle and Wheel assemblies, with Timken Bearings. \$25.00 without tires or tubes. Write Standard Equipment Co., Dept. PS550, Cedar Rapids, Iowa.

UTILITY, camping trailer plans. 25c. Gray, 4517 East 12th Street, Oakland 1, California.

4 MOTORCYCLES BICYCLES, SUPPLIES

MOTORCYCLE Magazine — Worldwide Coverage. Yearly Subscription \$1.00. Sample 15c. Motorcycle News, 5424-H Sawyer, Chicago 25.

SAVE \$100 on new Harley Davidson Lightweight 3 speed, two brakes, 100 miles per gallon. Was \$360—now \$259.50 FOB. Carl Bush, 518 Broad Street, Newark 2, N. J.

MOTORCYCLE Road Racing. New book complete History all years British Isle of Man. World's greatest Road Race. \$2.00 Postpaid. Clymer, Dept. 6B, 1268 So. Alvarado, Los Angeles 6, Calif.

1949 MICROMIDGET racer \$85; home-made midget \$20. New Regal motorscooters. \$37.50, less engines; 3 to 5 H.P. gasoline engine \$5; Smith motorwheel \$8. Four Balloon tires \$3. Plenty new midget cars, motorscooters, homebuilders parts. 51 plans, transmissions, clutches, engines, sprockets, etc., at factory prices. Mail order only. Send 25c for new illustrated catalogue Number 35, just out, listing these and hundreds of other bargains, new and used. (35c by first class mail). Midget Motors Directory, Athens, Ohio.

"REBUILT and Tested 1½ to 3 H.P. Engines for Motorbikes, Motorscooters. Small Autos, Farms, Shops, etc. \$9.00 to \$30.00. Send \$1.00 for Forty Page Catalogue, Manual & Parts Book so you can order properly for immediate delivery. Cauffiel Motor Industries, Dept. 121, Temperance, Mich."

SPECIAL—1946 whizzer in Schwinn bicycle \$20. Also Cushman motorscooter (good tires and lights) \$15; Shaw bicycle motor \$15; midget car \$15. Rush 25c (35c for first class mail) for new Summer catalog #17 listing many other amazing post-war bargains in wheels, engines, motorscooters, midget cars, monocycles, motorettes, etc. Gail, 538 Erie, Toledo, Ohio.

KNEEACTION Moto-Scout \$10; motorbike (front and rear brakes) \$5; Whizzer motorbike with clutch and all attachments \$25; Indian motorcycle \$30; good midget car \$35; tire-wheel combination \$2.50. Rush 25c (35c for first class mail) for new catalog #945 listing sensational bargains in motors, motorscooters, motorcycles, Servicycles, midget cars, etc. Associated, Box 1764-CS, Toledo Ohio.

5 AVIATION

PROPELLERS, plans, supplies, for ice sleds, snow sleighs, air boats, literature 20c. Banks-Maxwell, Box 3301G, Ft. Worth.

6 AVIATION INSTRUCTION

CAA ratings the easy way. Free folder. Ross Aero Publishers, Tulsa, Oklahoma.

7 ELECTRICAL SUPPLIES & EQUIPMENT

ELECTRIC Pencil: Engraves all Metals \$1.25. Beyer Mfg., 10511-C Springfield, Chicago 43, Illinois.

LAMPS—Building, wiring made easy by charts and directions in 56 page illustrated lamp parts catalog. 25c. Gyro Lamps, 5+02B Clark, Chicago 40.

FANS—Parts, Kits, assemblies. Bargain list 10c. Engineering Sales, Box 458, Hopewell 3, New Jersey.

MOTORS, Fans, Blowers, Pumps, Power Tools and many electrical gadgets. 100 page catalogue 25c, refundable 1st order. Accurate, 2336 Milwaukee, Chicago 47, Ill.

APPLIANCE Parts catalog—repair handbook, \$1.00. See-Us Supply, 2512 Prevos., Ft. Worth 7, Texas.

32 VOLT appliances—World's largest line. Catalog Free. Haines Corporation, Dept. P, Minneapolis, Minn.

29 PIECE Electric tool kit in heavy steel chest, ¼ inch Jacobs Chuck; trigger switch, AC, DC, \$20.00 complete. One year's guarantee. Meyer Hurwitz Co., East St. Louis, Ill.

50 FT. heavy duty extension cord with bulbguard, \$2.98 postpaid. Tom Sheehan, 7156 Van Buren St., Chicago 7, Ill.

LAMPS—Build own Originals. Parts Wholesale, any amounts. Catalogue 10c. Brown Lamp Co., No. 501, Wellston, St. Louis 12, Mo.

ELECTROPLATING, Polishing, Buffing Materials, at prices we challenge anyone to meet. Free price list. Pasco, 15 Sandybank, Media, Penna.

8 WELDING, SOLDERING, PLATING

200 amp. GENERATORS, Brand new. Convert to welders, \$28.50 with plans. Free literature. Thorndyke Mfg. Co., Pipestone, Minnesota.

WELDING builds paying business with Hobart "Build-Your-Own" Portable. Free catalog. Box 279-P-604, Troy, Ohio.

RADIATOR Repairing Books, Supplies, Equipment, Gasoline Torch. Write for circular. Curfman Mfg. Co., Marvville, Mo.

110 V. PORTABLE Transformer Welders, \$29.50. Morris, 1850B State, Schenectady 4, N. Y.

ELECTROPLATING Units, \$2.00 and . J. Send 10c for instructions. Regency Sales, 5316 Justine, Dept. S, Chicago 9, Ill.

LOW heat tap and dial adjustment rheostat, on mounting panel for P-1, P-2, etc. Welding generators \$13.50 P.P. New 250 amp, air-cooled welding generators. Haddican Mfg. Co., Satanta, Kansas.

10 MACHINERY, TOOLS, SUPPLIES

ELECTROMATIC Paint Sprayer Ready for use, just plug in, \$8.90 p.p. Unconditionally Guaranteed. Flame, 2165 Tyson, Phila. 24, Penna.

POWER Tools, Big savings when you build your own with Lewis castings. 23 wood and metal working tools with blueprints. Most can be completed with lathe and drillpress. Commercial quality. Ideal for home shops, schools, small manufacturing. Catalog 10c. Lewis Machine Tool Co., 3217 Union Pacific Ave., Dept. S, Los Angeles.

GIGANTIC SURPLUS EQUIPMENT MAIL SALE. Amazing values. Everything must go. Meters, burglar-fire alarms, telephones, transmitters, cathode ray tubes, thermostats, motors, electric drills, A-C generators, air compressors, relays, 110-volt elements, etc. Everything less than manufacturer's cost. We pay parcel post charges. Rush card for sale catalog. Burden Sales Co., 854 "O" St., Lincoln, Nebr.

RUSTPROOFING Oil for tools, Metals, equipment. Rustnix #4. Four oz., \$1.00. Dept. 105 Aria, P. O. Box 812, Cleveland 22, Ohio.

"VERTICAL milling head precision gear driven for Atlas \$69.00. Adaptable many milling machines. WHH Design, Schwenksville, Penna."

BUY our conversion parts to change your auto engine into a high-grade marine engine. Marine manifolds, transmissions changed to high speed reverse. Marine bronze pumps, propellers, shafts, couplings, stuffing boxes, struts, rudders, etc. Heads for marine engines. Buy direct from the factory and keep the dealers profit for yourself. Money back Guarantee. Conversion Parts Co., 277 Adams St., Boston 22, Mass.

LAWNMOWER Sharpener. Precision built. \$95.00 less motor. Not a lapping machine. Write Lutts, Box 211-PS, Ontario, Calif.

11 MACHINERY FOR SALE

MAKE Seven dollars per hour. Investment \$90.00 Meat Block resurfacer. Manufacturer. Fay Marvin, Abilene, Texas.

12 FARM MACHINERY

BUILD Your Own "Tractor." Plans, instructions, Walking, riding, "Lawn Mower." Plans, Kits. Free information. Eltraco, D-5, Camptonville, California.

13 BATTERIES, GENERATORS, ETC.

EDISON Nickel Batteries, 37 to 600 amperes. Also Kits with Edison Plates; make your own. Interesting literature. Hawley Smith Co., Croton Falls 2, N. Y.

14 BOATS, OUTBOARD MOTORS, ETC.

MARINE and Industrial Engines, gasoline, diesel, guaranteed. J. Helwege Co., 1 Woodcleft, Freeport, N. Y.

MARINE conversions for Ford and Jeep engines. Catalog 10c. Lehman Manufacturing Company, Department A, Newark 2, N. J.

STEERING Wheels, windshield brackets, from \$6.95. Modern fittings "Water Skis." at lowest prices. Complete pre-cut plywood boats. Bargains galore. Folder 10c. Marine, Box 681, Mendota, Minnesota.

NEW, used, rebuilt marine motors. Marine conversions, fittings. Free Catalog. Stokes Marine Supply, Dept. 23, Coldwater, Mich.

FULL size, cut to shape boat patterns, blueprints, 7½-38 feet. Illustrated "Build a Boat" catalog, 25c (coin). "How to Build Boats" book, \$1.00. PolyWog Houseboat Plans \$10. Marine Catalog \$1.00. Cleveland Boat Blueprint Co., Dept. A-77, Cleveland 13, Ohio.

15" x 6' LATHE \$150.—20" Upright drill \$140.—Small Universal miller \$160.—larger one \$410.—14" shaper \$240.—24" x 12' lathe \$860.—Large Universal miller and motor in base \$840.—4 ft. Radial drill \$460.—Power hack saws \$80-\$125. Good machines, low prices, money back guarantee. Conversion Parts Co., 277 Adams St., Boston 22, Mass.

BUILD Your Own—Three point racing hydroplanes, others. Informative literature 25c. Champion Boats, P.O. Box 7132K, Long Beach, California.

SAVE 2/3 cost. Assemble your own boat. Complete plans and boat parts machined ready for assembly. No experience necessary. Rowboats to cruisers. Illustrated catalog 25c. Midwest Boat Company, Menomonee Falls, Wisconsin.

BUILD a better boat than you can buy for the money! Save 33-55%. Exclusive laminated ribbed construction, prefabricated for easy assembly. All popular types from simple car-top models to mahogany-decked runabouts, one-design knockabout sailboat, priced from \$39.50 to \$329.00. Send 25 cents for literature, to be returned on first purchase. Ozarka Boats, 760 Borden Lane, Woodstock, Illinois.

BUILD your own boat—but buy the best materials. Send 10c coin to Industrial Shipping Company Limited, Mahone Bay, Nova Scotia, Canada. For illustrations of Plycraft Kits Hulls that make the world's finest plycraft Racing and Pleasure Boats. Write now.

SAILS, canvas, wingdope, canoe motorboat, sailboat equipment, boat covers. Alan-Clarke, 96 Chambers, N.Y.C.

THOUSANDS have built better boats from our paper patterns or kits. Literature prices, 25c. Illustrated book, outboard boat construction \$1.50 postpaid. Germain Boat Company, Saginaw 1, Michigan.

POPULAR SCIENCE OPPORTUNITIES

15 ENGINES, MOTORS, ETC.

WINDING Data, listing 225 motors, single and three phase, \$1.00. Motor Data, Box 7631, Kansas City 3, Mo.

WELDER bargains, AC or DC, Engine or Electric Drive, Portable or Stationary. Write needs to Box 279-P-605, Troy, Ohio.

HOTTEST surplus list in the country. Electronics, Hydraulics, Aircraft, Gadgets. Dick Rose, Everett, Washington.

MOTOR Windows, free bulletins, winder and testing equipment, Motor Industries, Quincy, Illinois.

GENERATORS 750 watt 110 volt Alternating Current \$38.50, Welding Generator 150 ampere \$35.00. Other bargains. Butler, 1885 Milwaukee, Chicago 47.

16 AMERICAN POLICE JIU JITSU

DEADLY Judo—Fiercest fighting technique, Trick knockouts. (Over 200 illustrated pictures.) Expert instructions—Three volumes Complete \$2.25, Variety House, Box 46-A Wall Station, New York 5.

18 BODY-BUILDING COURSES

BARBELLS—finest quality \$7.98 up. Catalog Free. Lurie Barbell Co., 1729-S3 Rockaway Parkway, Brooklyn, New York.

PHYSICAL Perfection, 12 Courses \$2.00 (news and picture 10c), Sid's System, P.S.M., Southgate, Calif.

BARBELLS, Build Muscular Bodies, Illustrated, Catalogue, Jackson Barbells, Springfield 7, New Jersey.

BARBELLS, Dumbbells, Exercise equipment, Courses, Free booklet, Good Barbell Co., Reading, Penna.

19 SPORTING GOODS, GUNS, FISHING TACKLE, ARCHERY

5,000 BARGAINS, firearms, binoculars, war relics, catalog 40c, Smith Museum, Runnede, N. J.

SPECIAL 20 Assorted Spinners for trout, bass or pan fish, Postpaid \$1.00, Box 313, Lewiston, Idaho.

SEND 10c for list 100 used guns, Frayseths, Wilmar, Minn.

SEND now for this fascinating, new, free, Richardson 32-page booklet containing 357 fishing Tips, compiled by the expert fishermen who make Richardson Rods—the fishing rods that are tagged with the "Sign of the Fish!" For your copy, sent without cost or obligation, Print Your Name And Address On A Penny Post Card and mail to Richardson Rod & Reel Co., 3179 N. Sawyer Ave., Chicago 18, Ill.

SHOTGUNS, Rifles, Revolvers, Over 500 Modern, Obsolete, Also Cartridges, List .10 coin, Ed Howe, 26 Main Street, Coopers Mills, Maine.

FISHERMEN—Make your own bell type sinkers, Eyes cast in, No wires, Our aluminum mold casts nine sizes, $\frac{3}{4}$ oz. to 8 oz., Price \$3.45, Post paid, Send cash or money order, Gem Aluminum Products, P. O. Box 102, Robertson, Mo.

20 FIELD GLASSES, TELESCOPES, ETC.

TELESCOPES, Binoculars, Microscopes—big bargain catalog free, Brownscope Company, 24 West 45th Street, New York.

"FREE" Catalogue! Thousand war surplus optical bargains, Lenses, Prisms, Telescopes, Binoculars, etc. Send \$1.00 for 10 Lens Hobbyist Set and Project booklet, G. Jaegers, 93-08—95th Avenue, Ozone Park 16, N. Y.

BINOCULARS—Guaranteed repairs, Free estimates, Dealers invited, Tele-Optics, 5514 Lawrence, Chicago 30, Illinois.

ILLUSTRATED Catalog and Book, "How to Select Binoculars" Only 10c, Bushnell Importers, 43-P5 East Green, Pasadena 1, California.

GIANT, 100 power astronomical telescope with 6 ft. tripod (10,000 area magnification) Clear Vision, full power guaranteed, \$15.00 F. O. B. factory, Suffolk Science Service, Dept. TC, Riverhead, N. Y.

POWERFUL astronomical telescopes easily made, Perfect lenses and instructions; 100x \$3.00; 100x and 200x \$4.00; 100x, 200x and 400x \$6.00, Full power, clear vision guaranteed, Instructions alone 10c, Suffolk Science Service, Riverhead, N. Y.

PYNEX Mirror Kits 6"—\$18, 5"—\$12.50, 4"—\$9.00, 3"—\$5.20. Larger Mirrors, Free Booklet, Rake Inst. Co., 10c Booreau Ave., Jersey City, N. J.

ASTRONOMICAL telescopes, binoculars, microscopes; Bought, sold, repaired. Books, Lists 10c, Rasmussen-Reece, Amsterdam, New York.

REFLECTING Telescopes, completely assembled, 60X, \$25.00. Guaranteed Observatory clearness, Free information, Skyscope, 475 Fifth Avenue, New York 17.

WAR Surplus Bargains, Binoculars, Telescopes, Sextants, Millions of Lenses, Prisms, Reticles, Eyepieces, Objectives, etc. Mail 10c for Big "Catalog CN". Send \$1.00 for Stock CN—10-piece Lens Kit and Big Instruction Booklet, Edmund Salvage Co., Barrington, N. J.

24 DOGS, BIRDS, PETS, RABBITS

RAISE Highly Profitable Angora Rabbits, Plenty cash markets, Details free, White's Rabbitry, Newark, Ohio.

MAKE Money! Raise Chinchilla Rabbits, Experience unnecessary, Valuable Breeders, Extra profits from meat, furs, laboratories, Pleasant hobby, Write today! Rockhill Ranch, Sellersville 16, Pa.

RAISE Guinea pigs, Make extra cash, Booklet free, Taylor, Box 426B, Hapeville, Ga.

\$50 WEEKLY Raising Angoras, Free Illustrated Booklet tells How, Wilson's, Stanton 18, Calif.

ANGORAS, Giant Chinchillas, White Giants—World's most profitable rabbits, Finest pedigree, heavy-producing, prizewinners, Literature free, Grinstead's Edwardsville, Illinois.

MAGILL'S Hamsters, Wonderful Pets! Clean, easy to raise anywhere, Splendid profit opportunities, We furnish finest stock, supplies, everything needed, Write for Free illustrated literature, Magill's Hamstery, Drawer 430-C, Springfield, Mo.

SEE Golden Hamster ad on Page 40. Shows picture of Hamster.

RABBITS: New Zealand's, Ringland Rabbitry, 1726-30th, Des Moines 2, Iowa.

ST. BERNARD pups! Beauties! Details, also numerous delightful pictures free, Manitou Kennels, Watrous, Sask., Canada.

HAMSTERS and Supplies, \$50.00 weekly, Miami Hamstery, 216D East High, Oxford, O.

HAMSTERS: Finest pedigreed breeding stock, reasonably priced, Mount Clemens Hamstery, Mount Clemens, Mich.

HAMSTERS—\$1.50 up, Marketing booklet given with order, Literature free, Wisconsin Hamstery, Pewaukee 1, Wisc.

BOXERS Saint Bernards AKC registered, Schwarzwald Hof Kennels, 5136 Cascade Road, S.E. Grand Rapids 6, Mich.

25 FROG RAISING

"RAISE FROGS!" New book tells how! Illustrated Literature Free, Marlboro-B, Box 7002, New Orleans 19, Louisiana.

30 FARMS, OTHER REAL ESTATE

STROUT'S Golden Anniversary Farm Catalog Over 2800 outstanding Bargains! Coast-to-Coast; 32 states, Mailed Free! Strout Realty, 255-ZB-4th Ave., New York 10, N. Y.

FARMS, Ranches, lodges, resorts, Big selection, Milwaukee Road territory, Washington, Idaho, Montana, Dakotas, Minnesota, Iowa, Missouri, Michigan, Wisconsin, Illinois, Indiana, Free colorful descriptive folders, price lists, L. H. Robbins, 738K Union Station, Chicago 6, Ill.

OZARK Lands for All purposes, Actual river frontages, 5 acres \$90.00 and upwards, Free list and literature, Hubbard, 424-H, Minnesota Ave., Kansas City 4, Mo.

GOOD Farms—Ranches, Washington, Minnesota, Montana, Idaho, Oregon, North Dakota, Dependable Crops, favorable climate, Write for literature, lists describing typical farm opportunities, Specify which state, J. W. Haw.—Northern Pacific Ry., St. Paul 1, Minnesota.

BEST Ozark land, 80 Acres \$500, Terms, Armstrong, Shook, Missouri.

BIG Free Summer Catalog, farm bargains, Many equipped, illustrated, several states! United Farm Agency, 428-PS BMA Bldg., Kansas City 8, Mo.

FREE Fertile Lands obtainable in Latin-America! Descriptive booklet, 25c, Valles, 395-KT Broadway New York 13.

31 POULTRY AND SUPPLIES

MAKE up to \$2,000 raising Broilers and Fryers and the newest way in your backyard or unused farm buildings, Write for free booklet, National Broiler Institute, Dept. 5, Versailles, Missouri.

32 PROFITABLE OCCUPATIONS

BE independent, be secure, have your own profitable business—earn \$10 and more a day making beautiful, fast-selling lamps at home, No equipment needed, Illustrated course teaches you quickly, Course, parts catalog, wholesale price list—only \$2, Gearon Co., Dept. 200-E6, 27 S. Desplaines, Chicago 6, Ill.

\$5000 FROM half acre growing Ginseng, crop bought, Particulars 10c, Associated Growers, 1169 Corydon, Winnipeg, Canada.

\$40.00 WEEKLY, Made growing mushrooms, Fresh, Dried, Dominion Patent 331.583, free spawn, North American, 169Y Yonge, Toronto, Canada.

FREE Book "How to Make Money with Home Workshop" describes amazing methods used by hundreds of successful craftsmen, Tells what to make, how to sell workshop output spare time, Write at once for details, Remember it's free! Craftsman, 115B Worth St., New York City.

INFORMATION—Money making plans and Wholesale supply sources will increase your income! Write, Reynard Supply, Smithfield, Ohio.

RAISE Fishworms, Easy, Profitable, Send 25c in coin for complete instructions, Huffman's Worm Ranch, Rives Junction 5, Michigan.

BIG Money—Learn Watch-Clock repairing at home, Inquire Modern Technical Supply, 55PS West 42nd Street, New York 18.

LEARN photo offset printing at home, Build much of your own simple equipment, Details, John L. Moon, Box 1775, Spokane, Washington.

MAKE Money at Home—Casting Fast-Selling plastex novelties and metallizing baby shoes, Tremendous possibilities—full, spare time, No experience needed—full instructions given, Write: Leonard Moese, 161-B Madison Avenue, New York 16, N. Y.

HOME sewers wanted—Illustrated folders, 10c, Baby-Gay, Beaver Dam 3, Wis.

ANALYZE handwriting: earn real money! Complete outfit 25c, Dr. Flury, Box 7A, Darby, Penna.

LIFETIME income as Notary Public, Appointment assistance, Stationers, Helotes 50, Texas.

10,000 NYLONS, Rayons, 8c pair, up, Chenille Goods, Underwear, Uniforms, Wholesale, Free razor blades, Complete stock list 25c, Sibert Company, Chattanooga 4, Tennessee.

TRAVEL free throughout world in post-war Merchant Marine, Vacation or exciting career, Salaries High, Men, Women, 1950 guide tells how, Only \$3 American Seamen's guide, 545 5th Ave., New York City.

33 BOOKS, PERIODICALS, ETC.

BOOK Bargain Hunters! 20c buys our Unusual Book, Catalog and Abbott's 192 page Dictionary, E. M. Publishing Company, Pinellas Park, Fla.

BOOKHUNTERS! All Subjects, Send Wants! Jaher Book Service, 620-K East 178 Street, New York 57.

MAGAZINES (back dated)—foreign, domestic, arts, Books, booklets, subscriptions, pin-ups, etc. Catalog 10c. (refunded), Cicerone's, 86-22 Northern Blvd., Jackson Heights, N. Y.

ADULT Stories, 25c, Eight—\$1.00! Free catalogs! Hirsch, Spring Valley 3, N. Y.

HARD-To-Find Books supplied, Send wants, Pierce's, Winthrop, Iowa.

ADULT Books—Unusual—Revealing—illustrated, Five \$1.00, Catalogs 10c, Kogan, 1032-DP, Church Annex, New York 8.

BACK-date Magazines, Specific issues; years, Arkell's, Tarzana 2, Calif.

444 WAYS to entertain children, Lists games, tricks, things to make, party and money making ideas, \$1.00 postpaid, Play Associates, 3840 Randolph, Oakland 2, Calif.

POPULAR SCIENCE OPPORTUNITIES

RENT latest books by mail. Free catalog. Waterman Books, Bridgman, Michigan.

STRANGE, unique, unusual books, novelties, curios. Catalogue 35c. Box 216. Herkimer, N. Y.

35 MAGIC TRICKS, PUZZLES, ETC.

VENTRILOQUISM Taught. 3c stamp brings particulars. Smith, 801 Bigelow, Peoria 5, Illinois.

WE supply every noted magician. Large professional catalog 50c. Holden's, P220 West 42nd Street, New York.

MYSTIFYING Ace Disappears from between two Cards Instantly. Complete Trick Easy to do FREE if 25c is sent for Big Catalog 500 Amazing Magic Tricks. The Magician, 2463-S Kensington Ave., Philadelphia 25, Pa.

500 TRICKS, Douglas famous catalog 27 now only 10c. Unequaled service to magicians for 30 years. Send 10c today. Douglas Magicland, Dept. 2, Dallas, Texas.

200 ELECTRIC stunts. 110 volts. \$1.00. Cutting Sons, Los Altos 2, Calif.

MAGICIANS', Gamblers' secrets exposed. Cards, Dice, Punchboards, Slot Machine. Catalog 10c. Book Co., Box 671. St. Louis 1, Mo.

VANISHING Quarter trick and catalog 25c. Sterling Magic Co., Royal Oak, Mich.

FREE! Illustrated catalogue of world's greatest magic tricks, joker's novelties, etc. 2c and up! To cover cost send 25c (refunded first order). Fink Specialty Co. (B-1618), 9th and Market, Philadelphia 5.

500 TRICKS Catalog and Book "84 Card Tricks." both only 50c. Robbins Co., 131-P West 42nd St., New York.

500-PAGE Catalogue of 2500 Tricks, pocket, parlor, stage, World's Finest Magic. Send \$1.50 for catalogue (refunded first \$6.00 order). Kanters, S-1311 Walnut, Philadelphia 7.

VENTRILOQUIST Dummies. Catalogue 25c. Be a ventriloquist. Free Particulars. State age. Maher, Box 36-S60, Kensington Station, Detroit 24, Michigan.

BE a Magician. Large professional magic catalog of latest tricks. 35c. Ireland, F-109 North Dearborn, Chicago.

ENCYCLOPEDIA explaining several hundred tricks. 10c (Catalogue Free!) Aim Magic Company, 143 Verona Avenue, Newark 4, New Jersey.

GREATEST Magical Trick Ever Invented \$1.00. United Sales, Beverly, Mass.

36 GAMES, ENTERTAINMENT

SNIFFY. Something different. Lots of Fun. will make you popular. Faas Research Laboratory, 13A, Dogwood Road West Orange, N. J.

37 COIN COLLECTING

U.S. coins lowest prices. Send stamp for lists. Hutchinson, 3463 I Street, Philadelphia 34, Penna.

FREE! Foreign coin, banknote and Coin Collectors' Illustrated Catalog to approval service applicants. Send 3c postage. Tatham Coin Co., Springfield-D50, Mass.

GET Profit and Pleasure in collecting old coins. Send 10c for 56-page illustrated coin catalog. You'll be delighted with it. Send for it now. B. Max Mehl, 374 Mehl Building, Fort Worth, Texas. Largest rare coin establishment in U. S. Established 50 years.

OLD Money Wanted. Will pay \$100.00 for 1894 Dime, S. Mint. \$50.00 for 1913 Liberty Head Nickel (not Buffalo). Big premiums paid for all rare coins. Send 4c for Large Coin Folder. May mean much profit to you. Numismatic Co., Dept. 30, Fort Worth, Texas.

WE Pay \$2 to \$500 Each for hundreds of old or odd coins. Indianhead, Lincoln and foreign coins wanted. You may have valuable coins. Keep all until posted. Send 20c for new Ill. Coin Value Book. 4x6 Buying and selling prices. 44 years in business. Coin Exchange, Le Roy 1, N. Y.

COMMEMORATIVE \$1½ - Columbus, Washington, Cleveland, Stone Mountain, \$1.50 ea. Illustrated Catalogue 25c. Norman Schultz, Salt Lake 9, Utah.

100 PAGES of information, illustrations, prices. 25c. Huitt, 5450 Clark, Chicago 40.

WORLD'S greatest magazine for coin collectors and two wooden nickels 10c. Lawrence Bros., Anamosa, Iowa.

43 MIXED Indian pennies \$1.00. 33 Diff. Foreign \$1.00. Chelsea, 26 West 18, N.Y.C. 11.

40 STAMP COLLECTING

ZOWIE-E-E! A Barrel of Fun for only a Dime! 500 United States Stamps—Absolutely unpicked and unsorted. Just as received from church missions. Many varieties, including large commemoratives, airmails. High denominations up to \$5.00! Stampdom's biggest package of fun, and you might find something really valuable!! Price only 10c to serious approval service applicants. Money back if not delighted. Illustrated bargain lists with each order. Mystic Stamp Co., Dept. 55, Camden, N.Y.

FREE! Two Bicolored "Polar Bear" Triangles; Giant Five Colored Flag, Damascus, Will Rogers Airmail, First American Commemorative, Harem, etc. Free to approval buyers for 3c postage. Belmont Stampco, Washington 15, D. C.

102 "GOLD" Triangle, Diamond, others—5c. Piety, 215 Ocean, Laguna Beach, Calif.

NEWFOUNDLAND stamps Dollar packets. Price list. Cecil Patey, Kings Point, N.D.B. Newfoundland.

FREE United States Price List. Mark Hanna, 355 Fifth Avenue, Pittsburgh 22, Pa.

FINE Approvals, Fast, personal service. What countries do you prefer? I'll send their stamps. Milton Skinner, 438 Locust, Long Beach 12, Calif.

FREE. Scott's International Album, valuable colorful collection, hinges, other big premiums. Full particulars with approvals. Raymax, 123-X William St., N.Y.C. 7.

75 DIFFERENT U. S. Stamps 10c approval applicants only. Robert Anderson, R.F.D. No. 1, Madrid, Iowa.

200 DIFFERENT, including Roosevelt triangle, 5c to approval applicants. S. Avalon Stamp Co., Springfield, Mass.

WOW! \$10.00 Worth Of Fun 10c! What a treasure hunt! Big package 500 Foreign Stamps, including airmails, pictorials and others from the world over; stamps worth up to 25c each. This offer sent for 10c to Approval Applicants Only. Jamestown Stamp Co., Dept. 5, Jamestown, New York.

POSITIVELY Greatest Free Offer! Latest Scott's International \$6.00 stamp album—covering entire world, contains 36,000 illustrated descriptive spaces; Scott's 1950 Standard \$7.00 catalogues "Philately's Encyclopedia"—absolutely Free to applicants for foreign approvals becoming customers. Approval Service, P. O. Box 1700, San Francisco, California.

FREE! Powerful magnifying Glass—to approval applicants; also big bargain lists. Jamestown Stamp Co., Dept. 202, Jamestown, New York.

"HOW To Recognize Rare Stamps" Book Profusely Illustrated Only 10c. Kenmore, Arlington 74-H9, Mass.

FREE! 100 Worldwide different stamps to approval buyers. Big U.S. and illustrated bargain lists sent with approvals. Bookman, Maplewood 1, N.J.

UNITED States stamps nearly 100 years old. Roosevelt set, others, 40c value—only 6c to applicants United States approvals. Wakonda, 140F Nassau, New York 7.

FREE—Famous Americans Set, Flag Set, National Parks Set, and Presidential Set to \$5.00. A total of 90 Stamps Free to Customers for our unsurpassed U. S. and foreign selections. Send 3c for 15 of the above Stamps and full particulars. Triboro Stamp Co., 145 Nassau St., Dept. 202, N. Y.

WORLD'S Largest Stamp (7½ x 14 inches). A real curiosity! Retails for 50c, only 3c to approval applicants. Tatham Stamp Co., Springfield 50, Mass.

1050 DIFFERENT Stamps given to approval applicants becoming customers. Send 3c for particulars, lists and approvals. Bryson Stamp Company, Drawer F-30, Rossford, Ohio.

QUALITY Stamps on approval. Reference. White, P. O. 922, Pittsfield 6, Mass.

FREE \$25.00 Outfit Latest Large Scott album, valuable collection of 1050 all different beautiful stamps, airmails, triangles, diamonds, high values, etc. Plus watermark detector, tongs, "Stamp Finder" Magnifying glass, perforation gauge, hinges—actual value over \$25.00—but all absolutely free when you become a customer. Write for our foreign stamps on approval now. Americas' Stamp Service, Riverside, California.

FREE—Rare stamps from mysterious Nepal, plus octagonal (eight sided stamp), Giant triangle, gorgeous diamond, mammoth, midget stamps, value exceeds \$2.00. All free to approval buyers. Stamps, Box 58, Santa Ana, California.

DEALERS Wholesale catalog. Postage 3c. Franksco, 5031 Queensbury, Baltimore, Maryland.

PAY less. Buy more. Books of 1,000 at 1c & 2c each. Very good fillers. Attractive stamps. Adults only. Graveline, 14702 Troester, Detroit, Michigan.

TOPS! Our book "How to Collect Stamps". Send for your free copy today! Littleton Stampco, Littleton 29, N. H.

FREE—Cuba Roosevelt issue and illustrated catalog. Maynard, Littleton 11, N.H.

FREE—Illustrated Catalog! Kenmore Stamps, Arlington 74-C8, Mass.

25 DIFFERENT stamps 10c. F. Tunis, Wakeman Ave., Newark 4, N. J.

OLD, scarce U. S. seconds on approval. Slightly defective bargain prices. Hearnfeld, Clintonhill Station, Newark 8, N. J.

10,000 DIFFERENT 1c each! Gordon Davison, Box 1019, Manchester, N. H.

FIRST U. S. (1847)—Government Issues 5c, 10c, plus Giant Bargain U. S. Collection; only 5c to applicants U. S. approvals. Metropolitan, 140-K Nassau NYC 7.

POUND stamps containing thousands \$1.00. Longacre Shop, 100c West 42nd, New York City 18.

51 DIFFERENT Greece and Albania 10c. Junbo approvals. Chase, 1026 Walker Ave., Oakland 10, Calif.

1c EACH and Less! Thousands of Bargains! Cole, 43-G Rinewalt, Buffalo 21, N. Y.

WORLD WIDE Stamp List! Sample packet 25c. General Sales Service, 423 Brobst St., Shillington, Pennsylvania.

PENNY Approvals by Country. M. H. Hoerning, 102, Farmington, Arkansas.

SCARCE Bahawalpur Jubilee Set free to approval buyers. Plymouth F3, Bell, Calif.

WONDERFUL Offer 7 complete Mint Sets Manchukuo, Bohemia and Moravia and Germany, only 80c with approvals. Reich Stamp Co., 4647 Kenmore, Chicago 40, Illinois, Dept. S23.

ALBUM, 100 Stamps, Premiums—20c. Box 6618, Northeast, Kansas City, Mo.

1000 World Wide 67c; Pacific, P. O. Box 5704, Los Angeles, Cal.

ATOMIC Bomb Airmail and 100 all different War-issues. Airmails, etc. from War-torn China! 10c to approval applicants. Star Stamps, Jamestown, New York.

FREE! Beginner's Packet! With Lists! Stampmart, Box 2071, Hartford 1, Conn.

STAMP Magazine! Copy free! "Stamp Post." South Catalina, Pasadena 1, Calif.

2000 DIFFERENT Worldwide—\$2.50. Lists free. Beacon Sales, Northboro 3, Mass.

GENUINE "Goya Nude" set (Catalogs 55c) 15c. Approvals. Royal Stamp Company, Tamaqua 2, Penna.

SAN MARINO COLLECTION FREE—25 different, Old and New Issues, Airmails, Commemoratives, High Values—absolutely free with approvals. Viking, 130 Clinton St., Brooklyn, N. Y.

FREE "Stamp Finder." Tells instantly country to which any stamp belongs. 32 pages profusely illustrated. Garcelon, Calais 18, Maine.

"ROOSEVELT with six fingers: Unique Stamp free to approval applicants. Apex Stamps, Box 2188, Miami 13, Florida."

U. S. \$5.00 Used Block of 4 only 15c for U. S. Approval applicants. D. Kelly—235 86th St., Brooklyn 9, N. Y.

PENNY Approval Bargains!—Write Department PSM, 1267 Tutwiler, Memphis 7, Tennessee.

POPULAR SCIENCE OPPORTUNITIES

1893 BALKAN Packet Free! Approvals. Colonial. Box 376 B. Passaic, N. J.

1/2 LB. U. S. Old. New. 49c. 2 lb. \$1.50. Weatherby. Medina, Ohio.

FREE U. S. Illustrated catalogue. S. Stone, Box 52-S. Dorchester 24. Mass.

110 DIFFERENT Hitlers. Roosevelt, Liberia, Haiti, etc. 10c. Buckley, PS-208 Ludlow Bldg., Dayton 2. Ohio.

HITLER'S victims honored on colorful U. S. Flag Commemoratives. Five different (unused!), only 25c with quality U. S. approvals. Zaleyet, 55 West 42nd, New York 18.

15c CANADA Packet. 3c with approvals. Peterson, Box 31, St. Paul 2, Minn.

BOY Scout set complete. 1937. Netherlands. 10c with approvals. Vargo Stamps, 6044 South Fairfield, Chicago 29, Illinois.

AMAZING "Queer Countries" packet. Free with approvals! Saxon, Escondido, Calif.

GIANT midget, triangle, other odd stamps. Free with beginners' approvals. Niagara Stamps, Niagara-on-the-Lake 13, Canada.

250 STAMP Hinges Free with tiptop approvals (beginners' or advanced). Niagara Stamps, Niagara-on-the-Lake 21, Canada.

ALBUMS. New. Used. Illustrated lists free. Stamp bargains also. Aletalo, Maynard, Massachusetts.

FLAG Stamp free with your request for U. S. approvals. Wenigman's, 1933 Paterson, Chicago 13.

FREE Sample newsy, informative stamp weekly. Southern Philatelist, Miami 35, Fla.

DEALERS—"How to Make Money in Stamps" now in third printing! Amazing new methods! Information 3c. Wentz, San Marcos 2, Texas.

FREE—Canadian Sets Royal Visit. George VI. George V. Coronation Jubilee. others to approval applicants. Ensign, Box 118-P, So. Orange, N. J.

TOPS! Our book "How to Collect Stamps." Send for your free copy today! Littleton Stamp Co., Littleton 29, N. H.

307 ALL Different 15c. Beautiful collection of commemoratives, triangles, high values, bicolored stamps, etc., only 15c. Garcelon, Box 418, Calais, Maine.

42 HOBBIES, COLLECTIONS

WANTED Old cigarette cards. Write Charles Bray, East Bangor, Penn.

INVENTING can be an interesting and profitable hobby. Write for complete particulars. Institute of American Inventors, Dept. 30-E, 631-E St., N. W., Washington 6, D. C.

UNUSED matchbook covers—100 different \$1.00—Catalog 10c—Charles Edelman. 1311P East 84, Cleveland 3, Ohio.

YOUR name on our mailing list brings catalogs, literature. State your hobby. Hobby Clearinghouse, Box 541, Indianapolis, Ind.

44 ANTIQUES, RELICS, INDIAN GOODS

20 COMMON or 7 fine arrowheads \$1. Lynn Crandall, Idaho Falls, Idaho.

8 ANCIENT Indian arrowheads, \$1.00. Tomahawk \$1.00. List free. Lear's, Glenwood, Arkansas.

46 MINERALS & PRECIOUS STONES

URANIUM ore autunite (fluorescent) or carnotite guaranteed radioactive \$1.00 lb. postpaid. Miner, Box 17, Placerville, Colo.

METEORITE, guaranteed genuine. Interesting, illustrated, 57 page book, 60c postpaid. Robins, 5046 Glenwood, Chicago 40, Illinois.

GEMSTONES, Mineral specimens. Every variety. Lowest prices. Postcard brings free booklet. Plummer's, 2183D Bacon, San Diego 7, Calif.

ULTRA Violet mineral detector. Kit including tube, instructions \$1.75. Ultraco, 1474 Broadway, New York 19, N. Y.

AUSTRALIAN Opals. World's best Multi-colored Gems 8 x 10MM \$1.00, 4, 6, 8MM Collection \$3.00. Oldfield's, 11 Cherry Road, Balwyn Vic, Australia.

47 CAMERAS, PHOTO SUPPLIES

BASS Says: Bargaingram 257 ready and waiting for you. The book which tells all . . . the finest in new and used camera equipment, a veritable encyclopedia. Write, phone or call the sign of the old "Horse Trader", 39th year of satisfaction or your money back dealing. Bass buys, sells and trades. Bass Camera Company, Dept. AG, 179 W. Madison St., Chicago 2.

FREE Photographic Bargain Book packed with hundreds of sensational values in still and movie cameras, lenses and latest accessories. Super savings for you in new and used equipment. Liberal trade-in allowances, too, on your equipment. Write now for your free copy to Central Camera Company, Dept. 11-D, 230 S. Wabash Ave., Chicago 4 (Photographic Headquarters Since 1899).

SAMPLE Copy Science Magazine. Photo. Radio. Science, Box 1395, Memphis 1, Tenn.

BEAUTIFUL Pin-Up and artist model photos for your den 8-4 x 5 \$1.00. 32-4 x 5 \$3.50. Exclusive Releases, Centex, 930A W. Jefferson Dallas, Texas.

WOW! Adult art slide collectors! See "Sunnyside Up" in color. Send 50c for sample and list. Viewer \$1.00. Cliff Studios, Box 998, Sea Cliff 4, N. Y.

SNOOPERSCOPE Tube. Permits nighttime vision. Tube and complete instructions \$14.95. Snooperscope book shows Army-Navy models, 1550. Dime brings catalogue and free infrared filter. Precise, 942 Kings Highway, Brooklyn 23, New York.

KODACHROMES on approval. Name any Western National Park. We'll send selection. Douglas Whiteside, Yosemite, Calif.

48 PHOTO FINISHING

YOUR 8 exp. roll with 3 prints each good negative 45c. 2 each good negative 35c. One each good negative 25c. Reprints 3c. A few cents postage appreciated. L. A. Eastman, Bode, Iowa.

AMAZING Introduction offer. Film developed: 8 enlarged glossy prints 20c; 12 exposures—30c; 16—40c; 36—90c. Money back guarantee. Immediate delivery. Mail-A-Way Photo, Box 375, Fitchburg 42, Mass.

SNOOPERSCOPE Tube Permits nighttime vision. Tube and complete instructions \$14.95. Infrared filters 15c. Voltmeter, Oscillator Kit Special \$2.95. Precise, 942 Kings Highway, Brooklyn 23, New York.

2 BEAUTIFUL Hi-Gloss prints each good negative and enlarging coupon with each 6 or 8 exposure roll developed 28c. Owl-photo Co., Weatherford, Oklahoma.

THE Photo Mill. Immediate service! No delay! Eight exposure roll developed and printed for 30c plus valuable coupon for eight reprints, four jumbos or two 5x7 enlargements for a slight additional charge. Film developed and jumbo prints 35c. The Photo Mill, Dept. O, 1511 Hennepin, Minneapolis, Minnesota.

8 BEAUTIFUL Double Size pictures and roll developed 30c. 8 hour service. Free Mailers. Pacific Photo Service, Box 666, San Francisco, Calif.

SAME day service! Quality Finishing! Roll developed, and 8 brilliant Jumbo Enlargements in Plastic Ring-Bound Album, only 35c post paid. Calvert Studios, Box 1150, Binghamton, N. Y.

8 EXPOSURE films developed-printed. 25c. plus free enlargement. Hi Tone, Box 2446B, Cleveland 12, Ohio.

16 DECKLEDGE Velox prints from any 8 exposure roll film developed 30c. 10c package of 100 mounting corners free. T. Skrudland, Lake Geneva, Wisc.

FREE Two 5x7 Enlargements Roll Developed. Printed 50c. "Speed." G.P.O. 822 N. Y. 1, N. Y.

5 x 7 STAINLESS Steel Film Trays—Three for \$2.00 Postpaid—Cash or Money Order. Jophoto, 8442 Otis Street, South Gate, California.

50 PHOTOPRINTS, PHOTOCOPIES

PHOTOCOPY anything yourself. Papers, books. No darkroom, 8 1/2 x 11" complete, \$6.95. Fotoflek, 4801 Yarmouth Place, Cincinnati 29, Ohio.

51 MOTION PICTURES, SOUND EQUIPMENT

ART model films 16mm rentals exclusively, adults list. Enclose stamp. Revere Films, Box 1051, Detroit 31, Mich.

SUNSHINE and health Films available in 8mm and 16mm Tel-A-Film Co., 935 Cincinnati St., Dayton, Ohio.

FILM Duplicating Machines \$68.50 Up. Details (M-K) 451 Continental, Detroit 14, Michigan.

RENT 16mm sound films 50c reel. Large selection; free catalog. U. C. Film Service, 128 Chestnut St., Roselle Park, N. J.

GUARANTEED fresh anti-halo outdoor movie film! Weston 16! Daylight loading! Processing free! Three spools double 8mm. \$4.50! Six single 8mm for Univex, \$4.60! Postpaid! Catalog. Eso-S, 47th Holly, Kansas City 2, Missouri.

ALL New sparkling short subjects featuring glamorous beauties in unusual home movies. 50' 8mm \$2.75; 100' 16mm \$6.00; 100' 16mm Sound \$7.50. Rush dime for new catalog. Southern Films Supply, Box P-3786, Baltimore 17, Maryland.

8-16MM. Silent-sound films. Complete rental library. All latest subjects. Free catalogue. (sample film 10c). Garden Film, 317 West 50th, New York 19.

BASS Says: 39 years of leadership guarantees satisfaction. Finest Cine equipment, 8mm., 16mm., and 35mm., silent and sound. Write the old "Horse Trader". Satisfaction or your money back always! Bass Camera Company, Dept. A., 179 W. Madison St., Chicago 2.

SPECIAL movies for your private showings. 100 ft. 8mm \$5.50; 16mm \$6.00, sound available. Free list. Tasco Supply Co., P. O. Box 6, North Station, Providence, Rhode Island.

BETTER 8mm and 16mm Movie Camera Film. Free Equipment Catalog. Better Films, 742 New Lots, Brooklyn 7, N. Y.

2 NEW Autry Home Movies! "Indian Uprising." "Loaded Guns." \$1,000.000 cast! Send \$1 for sample reel and catalog. (State projector size) 200' Reel 8mm \$4.25. 100' Reel 16mm \$2.75. 400' Reel Sound \$17.50. Other sizes available. Your dealer or Hollywood Films, 6060-L Sunset Blvd., Hollywood 28, Calif.

ADULT entertainment, new. (Catalogue E). Trophy, #27 Valley Village Station, North Hollywood, California.

LEARN movie projection management. Free Catalog. Theatre School, Elmira, N. Y.

BIGGEST 16mm Sound Film Bargain. Twelve used 100' musical films, \$9.95 plus postage. Others \$13.95, \$15.95 per dozen Big list free. Blackhawk Films, Department PSC, Davenport, Iowa.

SAVE 50% on movies. Free circulars. Fromaders, Box 637-B, Davenport, Iowa.

WILD Game films, 8mm, 16mm. Natural color, black-white. Taken in natural habitats by famed Eberhart organization. Send for free list. Wild Life Films, Dept. 6-PS, 6063 Sunset Blvd., Hollywood, Calif.

HOLLYWOOD Film Club . . . Intriguing 8 and 16mm adventure and dance films by international beauties. Discounts to members. Send only \$1 for sample reel and illustrated catalog. Specify 8 or 16mm. International Films, Dept. PS-6, 1235 Vine Street, Hollywood, Calif.

NOW! New, exclusive Hollywood model movies. Available only from Camera Corner. "Home Girl." "Beauty Preferred." "Charming Eyefull." each, 8mm \$2.75. 16mm \$6.00. "Movie Preview No. 9" now ready. Send 50c for this projection-length sample short of other model movies, plus two-color brochure of exclusive subjects. (Former "Previews" 1 to 8 still available at 50c each). Specify 8mm or 16mm. Sample strip and brochure, 10c. Film strip viewer, \$1.00. Camera Corner, 391 Bridge Street, Room 130, Brooklyn 1, New York.

FREE, Movie Catalog; sample film, 10c. Big Bargains Now. Goodwill Company, Jackson, Tennessee.

16MM SOUND Film. Guaranteed Condition. Waverly, 5707 So. Christiana, Chicago 29.

POPULAR SCIENCE OPPORTUNITIES

52 MUSIC, MUSICAL INSTRUMENTS

NEW guitar by Ear Method. Never before offered. No music or diagrams to learn. 14 best loved ballads fully explained. \$1.00. Ralph T. Bolick—26th Ave. & 7th Street. Hickory, N. C.

PIANOS at wholesale prices. Save plenty on new, used, small. Hundreds of satisfied buyers. Write Piano Exchange. 627 Sumner St., Bakersfield, California.

MUSIC Printing. Leads, professional & sales copies. Lowest rates. Auto-Litho. Jensen 2, Fla.

RECORDS Guaranteed New, Hillbilly, Popular, Spirituals, 4 for \$1.00. Free Record with first order. Free Catalog. Mailorc. Dept. 88. 570 N. Gay Street, Baltimore 2, Md.

POPULARITY! Romance! Play Guitar. Free details guaranteed course. National Conservatory. 1184 Chapel, New Haven 11, Conn.

FINEST Swiss Music boxes. apply trustfully to Kobler, P. Postmaster, Berne, Switzerland. Neufeldstrasse.

SWISS Music Box. Plays continuously. Electrically operated, catalog 10c. Bell Music Box Company, Box 49, Planetarium Station, New York 24, New York.

SAPPHIRE Needle—Plays 5000 records—Tone will Amaze You—Only \$1.75—Melvin's, Harlingen, Texas.

53 SONG WRITERS

SONGWRITERS—Honest, Outstanding Music writing offer. Len-Tex Studios, Leonard, Texas.

SONG—Poems set to music. Send your poem for our proposition and useful Rhyming Dictionary. Richard Brothers, 46 Woods Building, Chicago.

POEMS wanted for musical setting. Send poems for free examination. Five Star Music Masters, Beacon Bldg., Boston, Massachusetts

"BEST Deal! Lyric & Songwriters; Free Lyrody! Topical Emprise Corporation 1527 Highland, Box 42 SP, Louisville 4, Ky."

POEMS Wanted. Percentage basis collaboration. Terry Tunemsmith, 709 1/2 N. Broadway, Oklahoma City 2.

POEMS Wanted to be set to music. Free examination. Send poems McNeil, Master of Music, 510-PS, S. Alexandria, Los Angeles, California.

PROFESSIONAL songwriting services. May we help you? Wyler, Box 95-H, New York City 18, N. Y.

SELL Your Song—252 pages, \$2.00. Lip-pa, 577-W Ontario, Montreal, Canada.

54 RADIOS, SUPPLIES & EQUIPMENT

MAKE Simple. Tubeless, Batteryless, Distance-Getting Crystal Radios, Crystal and illustrated instructions 25c postpaid. Allen, 427-s, Clinton, Mo.

FIX any radio. Amazing new instrument locates radio troubles double quick. Simple instructions show you how. Thousands now in use. Free—Write today for 32-page illustrated technical manual. "The Inside Story," Feiler Engineering Co., Dept. 6PS5, 1601 S. Federal St., Chicago 16, Ill.

FREE—Send for latest radio catalog and bargain bulletin. Has thousands of top values in television, radio electronic supplies. Concord Radio Corp., Dept. KF-50, 901 W. Jackson, Chicago 7, Illinois.

55 TELEVISION

SPECIAL offer—\$1.00 set of television schematics—only 50c. Melpro Company, P. O. Box 40, Brooklyn 20, N. Y.

WANT to be a television Director Actor Announcer? Send for free pamphlets. Hollywood Radio Publishers, 6411 Hollywood Blvd., Hollywood 28, California.

56 BUSINESS OPPORTUNITIES

SLOT Machines, Punchboards, Wholesale Catalog. Webb Distributing Co., 4966 West Chicago Ave., Chicago 51, Ill.

HOW To Set Up and Run A Mirror Shop! Resilver Mirrors, Make Chipped Glass Nameplates, Electroplating Salts and Rectifiers, John Sprinkle, V90, Marion, Indiana.

"HOW to start a successful mail order Business! The guide to sound, profitable mail merchandising. 25c. Manhattan House, P. O. 50 New York 28, New York.

LAMPS—earn money building and repairing in your home. Easy-to-understand wiring charts and detailed instructions in illustrated catalog showing all parts. Send 25c. Gyro Lamps, 5404 B Clark, Chicago, Ill.

CASH For your idea. 280 manufacturers need inventions, patented or unpatented. List free. Invention Bureau, 208-S Clinton, Oak Park, Illinois.

MAKE Money spare or full time, casting Metal Toys and Novelties. Big Wholesale and chain store demand for cast Metal Autos, Soldiers, Ashtrays, Banks, etc. Keeps manufacturers busy. Production moulds furnished for up to 100 and more casting per hour. No experience or special place necessary. Write for full information and illustrations of patterns needed. Metal Cast Products Co., Dept. E, 1696 Boston Road, New York 60, N. Y.

GOOD Paying Business Silvering mirrors, plating autoparts, reflectors, bicycles, bathroom fixtures, etc., by late methods. No tanks or shop required, outfit furnished. Free Booklet. Gunmetal Co., Ave. E, Decatur, Illinois.

MAKE money addressing envelopes. Our instructions reveal how. Glen Glenway, 5713 Euclid, Cleveland 3, Ohio.

EXTRA Money—No selling—operate vendors. Amazing profits, details Free. Silver King, Suite 282, 622 Diversey, Chicago 14.

OPERATE profitable mail order business. Write Walter Service, 4159-B East 112th, Cleveland 5, Ohio.

A FACTORY in your home garage! Mfg. and sales rights, mechanics' waterless hand cleaner, glass cleaner, and amazing "lazybones" auto cleaner-polish. \$500-\$800 monthly No special equipment necessary. All formulas free. Western Aircraft Mfg., Dept. G, Los Angeles 6, Calif.

ENVELOPES addressed accurately, reasonably. Fast Service. We have capable addressers in your city. Glenway System, 5713-X Euclid, Cleveland 3, Ohio.

POPCORN Equipment, Potato Chip Outfits, Long Eakins Company, 5063 High, Springfield 99, Ohio.

BIG money! Spare or full time in your home. No Selling! Spray New Miracle Finishes. Plush and Suede, on signs, radios, automobiles, figurines, lamps, toys, etc. Our business is booming. Help us fill huge demand. Cash in now on Big Christmas orders. New easy Flok-Kraft methods. Material costs few pennies. You get dollars. Free samples, complete powerful money making plan free. Write now, Coast, 1002-H S. Los Angeles St., Los Angeles 15.

\$25 WEEKLY working two hours daily. No canvassing. No Manufacturing, Lycke, Box 2471-B, Cleveland 12, Ohio.

EXPERIENCE Unnecessary. Earn \$300 month spare time sales and rental America's leading small tractor. Protected territory. Write Tiger Tractor, Fort Lee 2, N. J.

137 PLANS to make money local, mail order. Particulars free. Elite Co., 220-A Grand St., N. Y.

PEARL Finishing—New, Amazing—Huge Profits. Start Making Big Money first day. Free Facts show easy way to \$25 to \$50 per day at home. Absolutely no experience. Be first—scoop the market. Write Pearl-Kote, Dept. S, 2111 W. Manchester, Los Angeles 47, Calif.

RECAST old batteries into new. Latest achievements. Battery Laboratories, Minneapolis.

POPCORN poppers, peanut roasters, copper candy, caramelpcorn kettles. Northside Co., Indianola, Iowa.

BRONZECRAFT Baby Shoe Mountings, All Metal Bookends, Ash Trays, Picture Easels—Beautiful Designs—America's Lowest prices. Sample mounting \$1.00 prepaid. Baby Shoe Electroplating instructions Free. Bronzecraft, 630 Newark Ave., Jersey City, N. J.

LIQUID Marble—Colorful, glossy! Molded. Brushed, sprayed! Cast Novelties, Statuary, Colored Tiles, Flexible Molds, Composition Floors, Particulars Free. Marbelizing Service, Edwardsville, Ill.

TEL-A-RAMIC news flash! Save time and money on your business correspondence. Write for details. Tepco, New Providence, New Jersey.

USE Your Home as magazine subscription station. Represent all magazines. Liberal commissions. No experience—no capital needed. Catalog, full details free. Write McGregor Magazine Agency, Dept. 510B, Mount Morris, Ill.

UNPAINTED figurines—Wholesale-Retail. Illustrated list free! Oman, 642M Broadway, St. Paul 1, Minnesota.

LIQUID Rubber, make flexible molds. Free Sample. Chaney, 1130 E. 16th St., Jacksonville 6, Fla.

OPERATE Mail Business. Details free. Acheson, Box 23, Boston 17, Mass.

\$35. WEEKLY; Home, Spare Time Work; No investment; Guaranteed satisfaction 25c. John Walsh, 894 Main, Buffalo 2, N. Y.

MAKE money making new greaseless doughnuts at home on electric machine. Wholesale to grocers, drug stores, cafes, hamburger shops. Send for free recipes and plans. S. Ray Company, 3605 South 15 Ave., Minneapolis 7, Minnesota.

HAVE Profitable Home Business—Full-sparetime. Start small—grow big. Tremendous possibilities. Get interesting facts. Box 4066, San Francisco.

MAKE \$24.50 Using Formulas from "Schemer" Magazine, Box 775P, Alliance, Ohio. Year \$1.00. Three copies 25c.

START Mailorder Bookshop—Everything furnished. 25c brings booklet, samples, exciting ideas. General Publications, Ossining 1, New York.

MAKE flexible molds! Cast plaques, bookends, figurines! Free sample! H. Tooker, 630-A Chestnut, Hamilton, Ohio.

"YOU can actually see the metal flow on" with a TYCO Electro-plater! Electroplate Metals, Mirrors, Glass, Wood, Leather, Plastics! No tanks or expensive equipment. Start your own profitable Mirror and Plating business at home! Outfits furnished! Write for free booklet, TYCO Metals, Box 12008J, Houston 17, Texas.

BORROW Money or obtain Capital for any purpose. Details free. Rains and Associates, Box 907-A, St. Petersburg, Fla.

SENSATIONAL—New—Every Home needs them, "Evening Butler" Entrance Lights. Sample Postpaid \$2.95. Dealers Invited. Babco Products, 3735 W. 23, Denver, Colorado.

MAKE Rubber stamps, metalize baby shoes, repair dolls, silver mirrors, make plaster novelties. Catalogue of "30 Ideas" free! Universal, Box 1076-B, Peoria, Ill.

NATURAL Molding Latex, Extra thick. Free sample. W. Wooley, 115B Donald, Peoria, Ill.

SENSATIONAL nylons guaranteed against runs. Nationally advertised. Not sold in stores. No experience or money needed. Also lingerie, robes, men's hosiery. Outfit, samples, etc. free. Wonderful opportunity earn big money spare or full time. See our full page advertisement on page 29, Kendex Corporation, Babylon 149, N. Y.

YOUR own profitable home business. Preserve live flowers to last forever. Spare or full time. New discovery—simple—fascinating. No experience necessary. Send \$2.00 for working equipment, instructions and valuable sales plans. Satisfaction guaranteed or money refunded. Herman-sen, 210 Fifth Ave., Suite 1102, New York 10, N. Y.

MAGAZINES—Trade and Class. Help you get ahead. Latest copies. Nearly 1200 covering every business, trade, profession, sport, hobby or other interest available through our Easy-to-Get-Acquainted Service. Particulars and price-list FREE. Commercial Engraving Publishing Co., 34S North Ritter, Indianapolis 19, Indiana.

FREE Folio, 700 Money making deals. Plans, Formulas, Supply Sources, Kolamite Company, Box 572, Dayton 1, Ohio.

ELECTROPLATE on non-metallics. Instructions \$1.00. Four ampere plater \$19.95. Eight ampere \$29.95. 30 ampere \$85.00. Kissel Electric Products, 431 Sherman, Galion, Ohio.

"BETTER Jobs in Plating." Free details, Joseph Kushner Electroplating School, Stroudsburg 772, Pennsylvania.

POPULAR SCIENCE OPPORTUNITIES

MAILING postcards selling repeat merchandise is profitable. Everything supplied. Details free. Gordon Publishers, Box 23, Pawtucket, R. I.

AMAZING new book "The Real Truth About The Mail Order Business" exposes the crooks, the petty schemes, tells you how to start. Free information. Ralph A. Long, 208 W. Broad St., Tamaqua 8, Penna.

"HOW to build your own Mail Order business" Idea booklet for beginners. Mail Dealers tells how to use tested, workable, profitable plans. Send 25c and "Know How." Satisfaction guaranteed. Ludecke, 5809-A Franklin Ave., Hollywood, Calif.

COLORGLAZED Concrete Pottery made without molds. Patented method. Cemetery products, novelties, tiles. Basement leak-sealing. Money-making projects. Booklet, details free. Men only. National Potteries, Grand Rapids. "MINNESOTA"

LEARN Export-Import! Represent Manufacturers! Conduct barter-exchange without capital. Trade Bulletins, world trade directories supplied. Book Free! International Trade, 246-S, Fifth Ave., N. Y. 1.

REAL money making opportunity making Interlocking Concrete building blocks. Rex Products Co., Dept. 21, Piqua, Ohio.

EARN money cleaning automobile upholstery. Write Lambert, 5531 Plover, St. Louis 20, Missouri.

WHERE to buy 500,000 articles wholesale. Details free. Krueger, 3418B Wolcott, Chicago 13.

PLATING Equipment and Rectifiers. Unique opportunity to start own business or cultivate hobby. Surprisingly small investment. Plate or Replate baby shoes, jewelry, etc. Write for Free information. Plit, Box 125, N. Y. 51, N. Y.

BUY it wholesale. Manufacturers. Distributors. Over 850,000 items. Literature free. Olsen, 1231-B East Third St., Duluth 5, Minn.

\$124.50 WEEKLY Guaranteed! At home sparetime. \$1.00 (deposit). Science Syndicate. San Antonio, Texas.

WRITE for free booklet and catalog telling how to earn substantial profits in your spare time by forwarding new and renewal subscriptions to all magazines for your friends and neighbors. Oldest U. S. Agency, Established 1869. Moore-Cottrell, North Cohocton, New York.

400% PROFIT manufacturing hand cleaners at home. Formulas free. Lume Products, 252 State, Batavia, N. Y.

FREE! Complete Details. Operate profitable mail order business. Successful small "Beginner's" plan. Lynn, 5710-C, Bankfield, Culver City, California.

NEW "Magic" Hand Cleaner. Fast seller-repeater. Money-maker! Free Sample. "Acro-Sol-Ex." 2438-D Fifteenth, Denver 11, Colorado.

RUG Cleaning Instruction Course. Americlean Co., Inc., 211 N. 7th Street, St. Louis, Missouri.

BIG business concerns will help you profitably start a local business. Detailed booklet \$2.00. Room 707A, 1431 Broadway, New York 10, N. Y.

BE Appointed State Notary Public now! Details. Stationers, Helotes 50, Texas.

BOOKKEEPERS earn \$100.00 week operating your "Bookkeeping Service". Simplified plan. Information free. Bookkeeping Service, Box 664-P, Springfield, Mo.

QUICK Money! "Repairing Car Batteries"! At Home! Easy too! Batteryman, Grand Junction, Colorado.

GROW plants, flowers. Details free. Shiffer, Box 129, Millersburg, Penna.

BUY Nylons direct from mill. Write for jobbers prices. Joy Hosiery Mills, Delaware 14, New Jersey.

FREE illustrated course casting novelties. Genuine latex for molds. Major Chemical Co., 164 Portland St., Cambridge, Mass.

LEARN the profitable and fascinating art of Electroplating Baby Shoes at our expense! write for details to manufacturers of world's largest assortment all metal mounts, equipment and supplies. Dept. W2, Hollywood Bronze Supply, 1766-70 N. Vermont Ave., Hollywood 27, California.

EXCLUSIVE agencies and dealerships open. Most incredible lightweight motor-cycle in world. Sells in \$250.00 price range. Hydramatic-type drive. internal expanding brakes, rubber mounted 3-HP 4-cycle engine, up to 110 miles to gallon gas, many other exclusive features. Full protection on repeat orders. Small investment required. Write for literature. Foreign country inquiries welcomed. Pony Cycle Division, Box P6S, 1124 National Bank Building, Detroit 26, Michigan.

BRONZED Baby Shoe Mountings, equipment and supplies. Buy wholesale from world's oldest and largest manufacturers of all metal mountings. Sales Dept., Hollywood Bronze Supply, 1766-70 N. Vermont Ave., Hollywood 27, California.

"MOLDING Rubber, sample 1/2 Pt. \$1.00; \$2.95 Qt.; \$7.95 Gal. postpaid. Molds made to order. Plastercraft Supply Co., 3051 St. Clair Ave., Cleveland 14, Ohio."

SNOWBALLS and ices; make them yourself. Tremendous profits. Ice shaver with four flavors and instructions. Enough for 500 snowballs; \$2.00 plus 4 pounds postage. Free folder. Snowball Company, 9534F Lemturner, Jacksonville 8, Florida.

ELECTRICALLY inclined . . . Average \$50 weekly working few hours daily . . . No canvassing . . . Sensational (opportunity details) free . . . Manhattan, Box 6, New York 35, New York, Dept. S.

SAWDUST. Turn it into cash. Six methods. Instructions 25c. Charles Co., 12-BAV, Norwood, Ohio.

\$4,000.00 PROFIT in two months. No investment. Details 50c. Charles Co., 12-BAX, Norwood, Ohio.

MAKE Perfume—Men, women, write. Carey Laboratories, 1914 Chouteau PS6, St. Louis 3, Missouri.

MEN-Women! Make big money spare or full time at home. Flock and pearl finishing offers you opportunity of a lifetime. Write today for free sample and free catalog. Bing Products, 88-PS6 Broad, Boston 10, Massachusetts.

FREE Details! "The Magic Formula for Mailorder Success." Mailord Company, 204-A6 East 81, New York 28, N. Y.

QUALITY moldine latex \$2.25 Quart. Postage Extra. Free Model. Kendall, 108-L Central, Jersey City, N. J.

COLOR Concrete with chemicals. Marble-glaze cement benches, pottery, statues, 10c brings sample, pictures, Hollywood Cementcraft, 8527-B Wonderland, Hollywood 46, Calif.

\$46 FROM Square Foot Plywood; Jigsaw necessary. Write: Woodart, Bridgewater, Massachusetts.

EARN Money At Home with your typewriter! Spare time! Details free. Edwards, Publisher, 3915-PS, 12th, Des Moines 13, Ia.

MAKE Perfumes—Profitable mail order business—information free—"International", 6347 Parnell PS-6, Chicago, Ill.

Mail Selling opportunities galore! Free! Wehner, Box 142-E, Roxbury 19, Mass.

57 MONEY MAKING OPPORTUNITIES

GREAT Deal #10, 22 propositions, Quick Business, 35c coin, 25c article included. Skeptical? Postal, Teycer, Chemist, P. O. Box 1287, Chicago 90.

QUICK profits taking magazine subscriptions, handling greeting cards, Cassell Publishers Service, Westfield, N. J.

DETECTIVES Earn Big Money. Experience unnecessary. Particulars free. Waggoner, P-125, West 86th, N. Y., N. Y.

WANT Notary Public appointment? Official in usually 10 days. Stationers Exchange, Boerne 50, Texas.

RAISE Ginseng, Roots Bring Fortunes. Circular, Fezler Seed Company, Patchogue, New York.

SEWING Machine Home Setup. Our trained repair, sales and service men make big money first day. New Machines, motors, etc. furnished. Write Taylor Service Co., Hamilton, Ohio.

"EARN \$100/\$250 weekly, installing, maintaining fluorescent lighting. Proven business opportunity. Free facts. "Fluorescent." 712 State Tower Bldg., Syracuse, N. Y."

SELL your ideas for greeting cards. Big demand. Not a school. Write for details. Art Service, Box 483, New Orleans 1, La.

WOMEN. Make money at home. Amazing collection extra money making plans only \$1. Helps pay the bills. T. B. Gibson, 919 Broadway, Galveston 2, Texas.

WOULD You pay 3%—first \$350 made? Booklet "505 Odd, Successful Enterprises" free. Expect something odd! Pacific B, Oceanside, Calif.

SAVE Money. Make money. Reupholster own car, many others. Complete manual only \$1.00 refund. First Upholstery Service, 309B South Railroad Ave., Brookhaven, Miss.

\$250 WEEK reported! Free illustrated book "505 Odd, Successful Businesses." Work home! Expect something odd! Pacific, Oceanside, California.

RAISE your business value, standing, as State Notary Public. Information, Stationers, Helotes 50, Texas.

ADDRESS. Mail circulars for advertisers. Complete instructions—list of firms—25c. Imperial, PS-6, Wilmington, N. Car.

MEN! Build Lifetime Business in waterproofing and cement painting. \$20 daily not unusual! Easy-to-learn Course, teaches you all about it. Uncrowded field! Send for free folder. Edgar W. Thomas, Barnesville 1, Ohio.

EARN Money Evenings, copying and duplicating comic cartoons for advertisers. Adservice, Argyle 2, Wisconsin.

58 FORMULAS, PLANS, ETC.

FORMULAS—All kinds. Latest products. Literature free. Kemico, Park Ridge 15, Ill.

LABORATORY tested formulas. Lists free. Pont, Box 635-PS, Terre Haute, Ind.

10,000 FORMULAS and Trade Secrets. Free Literature. Stillmans, 555 Kingston Ave., Brooklyn 3, N. Y.

ANY formula \$1 or money back. G. S. McCollum, 383 Miller St., Vaux Hall, N. J.

59 PLASTICS

PLASTIC Sheets, Rods, Tubes, etc. Free List. Plastic Supply Co., 2901 N. Grand Blvd., St. Louis 7, Mo.

LUCITE, Plexiglas. Any size sheets, masked Square foot (12 x 12) cost 1/16". 96c; 1/8", \$1.25; 3/16", \$1.52; 1/4", \$1.80. Colors add 10%. Include 10% postage. Almac Plastics, 230 Fifth Avenue, New York 1, New York.

COMPLETE line internally carved gifts and jewelry. Free catalogue. Pilot Plastics Co., 67D Fulton St., N. Y. C. 7.

PLASTIC supplies, materials, instructions for hobby or business. Send for free catalog. Tells about internal carving. Hays Plastics, 1310 82nd Ave., Oakland Calif.

EMBED real flowers, butterflies, shells, photos, to make unusual coasters, plaques, tiles, jewelry, buttons, other objects with new liquid plastic. Crystal clear or colors. Saw, Carve, Turn, Drill. Use only home tools. Big, picture-packed manual shows how to make things very first day. Book also explains proved 6-point Success Plan for starting your own profitable plastics Business. Send 25c for "A Success Plan for you." Castolite, Dept. G-102, Woodstock, Illinois.

WHOLESALE Plastics supply catalog, 10c. Lucite, clear, colored, Metallic Acetate, 15 colors. Thick Lucite cutoffs, polished blanks for carving. Metal findings, tools, Ideas, bargains galore. Quantity prices on Casting Plastic, Gem-O'-Lite, Box 686Y, North Hollywood, Calif.

60 CHEMICALS AND APPARATUS

LUMINOUS Paints will glow in dark. Six colors. Fairmount Chemical Co., 136 Liberty St., New York City 6.

NEW Idea Chemical and Apparatus Outfits for Home Experimenting. Photo-Scales, Microscopes, Chemicals, Biological and Laboratory Supplies in Small Quantities. Catalog 15c. Established 1931. John H. Winn, 124-B West 23rd Street, New York 20, N. Y.

CHEMICALS and apparatus for industrial, analytical, and private laboratories. Catalog 15c. Dept. M-26, Biological Supply Co., 1176 Mt. Hope Ave., Rochester 7, N. Y.

POPULAR SCIENCE OPPORTUNITIES

EXPENSIVE Chemicals, organic, inorganic, 15c quantities. Catalog free. Vaughn Chemical, Box 756, Berkeley, California.

ILLUSTRATED Catalog: Chemistry, mineralogy, biology, 10c. Tracey Laboratories, Evanston, Illinois.

SNOOPERSCOPE TUBE. Permits nighttime vision. Tube and complete instructions \$14.95. Snooperscope book shows Army-Navy models, \$1.50. Dime brings catalogue and free infrared filter. Precise, 942 Kings Highway, Brooklyn 23, New York.

CATALOGUE of chemicals and apparatus for photographic, analytical, industrial, and private laboratories. Send 10c. Luther Laboratories, New Britain, Conn.

61 HELP WANTED

INTERESTED in Latin American & Foreign Employment????? \$1.00 brings 1950 Copyrighted "Foreign Service Directory" World Wide Listings in Constructions; Oil, Mining; Aviation; Steamships; Manufacturers; Transportation; Exporters, Importers, Hot List Firms Hiring, How-When-Where to apply. Application form free. Global Reports, P. O. Box 883-S, Hollywood 28, Calif.

ALASKA—Last Great American Frontier. \$1.00 brings 1950 Copyrighted Directory & Government Map Free. Big Construction Projects; Fishing; Mining; Aviation; Hunting-Fishing-Game rules; Fur-Farming; Lumber; Live Stock; Agriculture, Homestead Land & Highway information, Listing firms hiring. Application form. Alaska Opportunist, P. O. Box 883-S, Hollywood 28, Calif.

FOREIGN Employment. Construction men, building trades, mechanics, helpers, office men, Good workers interested in Foreign Development Projects. Pipe lines, Dams, Power Plants, Roadways, Shipping, Oil refineries, etc. Transportation and quarters furnished; High wages. Listings of firms actively working on projects in Arabia, Persian Gulf, Africa, Alaska, Canada, South America, Europe, etc. Send \$1.00 for Foreign Construction Compendium and Application forms. Foreign Service Bureau, Dept. PS4 (Employment) P. O. Box 295, Metuchen, N. J.

\$1,000,000 CONSTRUCTION job-Project Report. \$1.00 brings Monthly News Bulletin giving authentic projects starting "World Wide" USA; Alaska; Canada; Pacific; Arabia; Latin America; India; Mexico; Africa; Europe. Tells How-When-Where to apply. Global Reports, P. O. Box 883-PX, Hollywood 28, Calif.

X-MARINES for hire, write, M. Colaw, 1090 Mt. Pleasant, Dubuque, Iowa.

JOB Opportunities, Trade, professional vacancies in West, South, other Sections. Housing information. Free Particulars. Business Services, Baldwinsville, N. Y.

62 AGENTS WANTED

JEWELRY For Salesmen Distributors Direct Factory, Catalog Free. Pickcraft (c 19) Bank St., Attleboro, Mass.

SALESMEN—Make \$2500 next 7 weeks. New sensational deal every merchant wants. Beautiful sales kit free. States Trading, 330-C So. Wells, Chicago 6.

\$18.00 AN EVENING Spare Time! Ambitious, reliable men, women, wanted to END REFRIGERATOR DEFROSTING nuisance for every housewife. Exclusive patented device. West made \$600.00 first three weeks spare time. That's exceptional. Pleasant, dignified. Write for free details. D-Frost-O-Matic, Dept. PSC-6, 6 N. Michigan, Chicago 2.

AGENTS—300% profit selling genuine gold window letters; stores and offices. Free samples. Metallic Letter Co., 437 N. Clark, Chicago.

HOUSE Paint Outside white \$2.49 Gallon. F. O. B. Satisfaction Guaranteed. Johnson, 605 Wells, St. Paul 1, Minn.

ATTENTION, New Swimming Sensation. Write Finned Finger Manufacturing Co., 1716 E. Newton, Milwaukee 11, Wisconsin.

GOLD lacquered Window Sign Letters. Large Sizes Penny Each. New foils. Absolutely Beautiful. Free Samples, Atlas, 544 W. 79th, Chicago 20.

BIG PROFITS—Fast Selling Personalized Jewelry. Free literature, Delite Corp., 238-S Neptune Ave., Brooklyn, N. Y.

FAST profits—No investment. Send for big, free catalog. Plastic aprons, tablecloths, etc. 150 sure-fire items. We guarantee sales. Write The Halliday Company, Dept. P-4, 347 Broadway, Passaic, N. J.

PHOTO—Salesmen—Agents. Sell beautiful hand-colored plastic enlargements. Collect deposit, we deliver. Profitable sideline. Send card for free sample kit. Novel Portrait Co., 3343-A North Ave., Chicago, Ill.

SEWING Machine electrification kit. Nationally advertised. Has Good Housekeeping Guaranty Seal. Can be demonstrated and sold in 5 minutes. Make at least \$5 per sale. For complete details write today to Brownell Distributors, Inc., Dept. PS, 308 Canal St., New York 13, N. Y.

WHERE To Buy 800,000 articles direct from Manufacturers. Save by buying direct. Sent Free. "Your Profits Under the Spotlight." Glass Pub. Co., Ellwood City 3, Pennsylvania.

FREE Samples. Big profits showing amazing Glow-In-The-Dark Specialties. House numbers, pictures, plastic novelties, ashtrays, keyholders, religious and nursery objects, etc. Madison Plastics, 303 Fourth Ave., New York 10, N. Y.

EXCELLENT Sideline for printing and advertising salesmen. Decalcomania name plates in small quantities. Great demand. Also, make money with our line of Automobile Initials and Sign Letters. Free Samples. "Ralco", XL-Roxbury, Boston 19, Mass.

IF You Sell, you need Opportunity Magazine—the "Salesman's Bible," packed with down-to-earth ideas that boost your earnings; filled with hundreds of announcements of new, fast selling items and lines. Send your name and tell us what you're selling now for Free copy of latest issue. No obligation. Opportunity, 28 E. Jackson, Dept. 31, Chicago 4, Ill.

ADVERTISING book matches—Cash in on big demand—sell Union Label matches. Cuts for all businesses and political parties—Free powerhouse selling kit—low prices—protection guaranteed on repeat orders—Cash commissions. Superior Match Co., Dept. P-250, 7530 Greenwood, Chicago.

CASH in on tremendous demand for new low priced burglar alarm for cars, homes and farm building. Nothing like it. Everybody wants one. 286% profit. Unique sample offer. Northwest Electric Co., Dept. F-20, Pukwana, S. Dak.

START Your Own Business on Credit. Always your own boss. 1554 Dealers, sold \$5,000 to \$26,500 in 1948; their average \$6,742. We supply stocks, equipment on credit, 200 home necessities. Sales experience not needed to start. Wonderful opportunity to own pleasant, profitable business backed by world-wide industry. Write Rawleigh Co., Dept. F-U-PSC, Freeport, Ill.

DRESSES 18c; Coats \$1.00; Blouses 35c; Free Catalog; Crown, 164-PB, Monroe St., New York 2.

NEWEST Money-Making Sensation, personal initialed individualized belts, buckles, cap badges, tie holders, miniature authentic replicas, police, firemen's badges, pocket pieces, key chains; choice 2000 emblems. Write Hook-Fast, Box 1425PS, Providence, Rhode Island.

BE Renewal Headquarters for all magazines. Handle everything at home. Big profits. No experience—no capital needed. Free catalog tells how. Write McGregor Magazine Agency, Dept. 510A, Mount Morris, Illinois.

SELL Ultra-blue stock signs to stores, 1000 slogans, comedy, general, religious. "7 x 11" cost 6c, sells 35c. Make money, 15 samples \$1.00 postpaid. Lowy, 812 Broadway, Dept. 512, New York.

FOUND! Over 100 ways to make extra money and friends. Sell Metallic Christmas Cards, Wrappings, Children's Books, Gifts. Big profits. Bonus. Request Feature samples on approval, free samples Name Imprinted Christmas Cards, Stationery, Napkins, free Catalog and free Selling Guide. New England Art Publishers, North Abington 251, Massachusetts.

GOOD Paying Business Silvering mirrors, plating autospans, reflectors, bicycles, bathroom fixtures, etc., by late method. No tanks or shop required, outfit furnished. Free Booklet. Gunmetal Co., Ave. C, Decatur, Illinois.

INFORMATION—Wholesale supply sources. Money-making plans. Increase your income. Write Reynard Station, Smithfield 3, Ohio.

MAKE Money Fast! Sell Christmas and Everyday cards to friends, neighbors, clubs, others. Amazing profits. Over 100 sell on sight items including 5 leading 21 card \$1 assortments, Religious, 50 for \$1. Metallics, Comics, Stationery, Children's Books, Ladies' Rain Sandals, DeLuxe Personals, Bargain Offers, Extra Cash Bonus Plan. Write today for samples on approval. Hedenkamp, 361 Broadway, Dept. PS-6, New York.

SENSATIONAL nylons guaranteed against runs. Nationally advertised. Not sold in stores. No experience or money needed. Also lingerie, robes, men's hosiery, Outfit, sample, etc. free. Wonderful opportunity earn big money spare or full time. See our full page advertisement on page 29. Kenedex Corporation, Babylon 149, N. Y.

FREE Outfit! Write today! Sell Embroidered Advertising Uniforms and Work Clothes, Initial Buckles, Belts, Badges, 2000 Emblems. Hookfast Co., Box 480PS, Roanoke, Virginia.

NEW "Magic" Hand Cleaner. Fast seller-repeater. Money-maker! Free sample. "A-S-E." 2438-D Fifteenth, Denver 11, Colorado.

SELL \$2 Fire Extinguishers. Locally mailorder. Lorrac Products, Albany 1, N. Y.

SELL Big Money-Maker to men and Women. Easy handwork makes fast-selling useful articles. Sample free. Sunmade Company, Brockton 64, Mass.

SELL!! Balloons, Combs, Specialty Merchandise. Carleton House Distributors, Texas City, Texas.

LARGE commissions, steady repeat orders, lifetime income. Free outfit. Nichols Company, Dept. 150, Purvis, Miss.

PLASTONE—Amazing Auto Polish. New exclusive formula contains pure Carnauba plus genuine plastic. Nationally advertised. Sold by leading firms. Only 79c retail! Free samples for your customers. Exceptionally high repeat sales. Choice protected territories. 100% profits. Opportunity for large steady earnings. Plastone Company, 2014-PS6, Wabansia Avenue, Chicago 47, Illinois.

EVERY car owner a prospect. Earn big commissions selling INFRARED AUTO HOOD-HEATER for quicker winter starting. Complete information 10c. Wagner-Green Company, 1935 Euclid Avenue, Cleveland, Ohio.

"AUTOMOTIVE line for agents calling on car dealers, repair shops, etc. No investment. Good repeats. Exclusive territory. Write Rose, 70-20 60th Lane, Brooklyn 27, N. Y."

WRITE for free booklet and catalog telling how to earn substantial profits in your spare time by forwarding new and renewal subscriptions to all magazines for your friends and neighbors. Oldest U. S. Agency. Established 1869. Moore-Cottrell, North Cohocton, New York.

FIELD Agents, Power mowers—\$59.50. Gas-electric. Appoint dealers. Rotacut. R-2016. Excelsior Springs, Mo.

COIN Machines, Punchboards. Free catalog. Tyrcha Wholesale, 4532 N. Meade Avenue, Chicago 30, Ill.

POWER Mowers—\$59.50. Guaranteed sales. You risk nothing. Modern-BE, North Kansas City, Mo.

FREE Samples, and amazing plan, giving you Gorgeous Dress without penny cost. Rush name today with dress size. Harford, Dept. B-735, Cincinnati 25, Ohio.

BUY thousands of nationally advertised products direct from manufacturers and distributors. Write for "Buy Direct and Save." Service Publishing, 1420-B Investment Bldg., Pittsburgh 22, Pa.

\$250 WEEK reported! Free illustrated book "505 Odd, Successful Businesses." Work home! Expect something odd! Pacific, Oceanside, California.

DRAW side income under Notary Public appointment. Stationers, Helotes 50, Texas.

HOUSE Paint—Sell users and stores. Private label. Steady work. Big pay. Certified Products, Louisville, Ky.

POPULAR SCIENCE OPPORTUNITIES

BIG cash profits. Inspiring career. Importing. many high salaried positions. Hundreds overseas concerns seeking agents to represent them. Opportunity travel abroad. start immediately without investing. Agency list and particulars \$1. Free sales help. Imports. 1110 Caesar. Pasadena 10. California.

SELL custom made and stock decals. Up to 50% commissions. FREE sales kit. Radiant Co., 56 West Washington, Chicago 2. Ill.

MEXICAN feather pictures. Big profits; no investment! Free details; sample 10c stamps. Silvia-SC. Apartado 9036. Mexico City.

WHOLESALE Men's Hygienic Supplies! 48 Samples. \$3.00! List Free. Acme. Covington 3. Virginia.

AMAZING offer—\$40 is yours for selling only 50 boxes Christmas cards. And this can be done in a single day. Free samples. Other leading boxes on approval. Many surprise items. No experience needed. Free samples personalized Christmas cards, stationery, napkins. Write today. It costs nothing to try. Cheerful Card Co., 1416 White Plains. N. Y.

FREE Literature—Thousands Wholesale supply sources. Moneymaking Business ideas. Wilkin. Hillsboro 2. Ohio.

63 HIGHGRADE SALESMEN

SALESMEN—Absolutely make \$50.00 a day. New sensational utility item for every food, beverage outlet, etc. Big Profits. Johnson-Hill. 53-QQ West Jackson, Chicago 4. Illinois.

BIG Money Taking Orders: Shirts, Ties, Sox, Pants, Jackets, Sweaters, Shoes, Uniforms, etc. Sales equipment free. Experience unnecessary. Nimrod. 4922-AV Lincoln. Chicago.

LOOK Here! Wanted—Men and women to start in business on credit. Sell some 200 farm-home Products. Thousands our Dealers now make quick sales, big profits. For particulars write Rawleigh's. Dept. F-192-PSC. Freeport. Illinois.

SALESMEN—Put yourself in line for big money. real future. Keep stores supplied with 5c-10c to \$1 counter goods. Nationally advertised. Top profits for you and merchants. Liberal deals boost sales. Side-line or full time. World's Products. Dept. 83H. Spencer. Ind.

SENSATIONAL Nylons guaranteed against runs. Nationally advertised. Not sold in stores. No experience or money needed. Also lingerie, robes, men's hosiery. Outfit samples, etc. Free. Wonderful opportunity earn big money spare or full time. See our full page advertisement on page 29. Kendex Corporation. Babylon 149. N. Y.

LONG NEEDED INVENTION. Established company. Need full or part time men. Every home. store, factory a prospect. Low price, long profits. Free Sample Outfit. Write Red Comet, Inc., Dept. 643. Littleton. Colorado.

SALES Organizers—Just out! Greatest sport story of the year. "My 66 Years in Big Leagues" by Connie Mack. 50,000.000 prospects. Sensational seller. Red-hot deal. Write quick! Universal House. 1012-BL Arch. Philadelphia.

WRITE 3 Words—Collect \$7.65 on 10-Second Demonstration to merchants—write on glass with Amazing Magic Crayon—Presto!—5 color advertising message takes fire—glows like brilliant Neon. Three sales daily bring \$22.95 profit. Rush postcard for details.—Complete Sales Kit. Free! Maxilume Co., 125 W. Hubbard. Dept. CL-9. Chicago 10. Illinois.

\$15 TO \$20 daily can be made easily. Selling exclusive nationally advertised and endorsed sanitary plumbing accessory. Now being successfully sold to institutions, homes, service stations, garages, hotels, factories, restaurants, hospitals, dentists, doctors, etc. Awarded seal of merit by America's greatest architects. Live wire can't miss. Write for particulars. Approved Products Co., 205A East 42nd St., New York 17.

67 EDUCATIONAL AND INSTRUCTION

LEARN the Collection Agency business. Highly profitable. Easily mastered. Free folder. Cole Associates, Syracuse 2. N. Y.

BECOME a Doctor of Psychology or Metaphysics. Teach secret of contentment, happiness. Win degree of PsD, or MsD. Solve mental worries. Free book. College of Universal Truth, 5153-K N. Clark, Chicago.

USED Correspondence Courses and Books sold and rented. Money back guarantee. Catalog free. (Courses Bought). Lee Mountain. Pisgah. Alabama.

BE A real estate broker through home study or classroom instruction. Write for free book. Approved for veterans. Weaver School of Real Estate. 15 E. Pershing Rd., Box PC-11. Kansas City 8. Mo.

BOOKKEEPERS! Increase your earnings! Operate your own simplified "Dollar-A-Week" Bookkeeping and Tax Service. Full or spare time. Details Free. No obligation. Ellis. Box 203. Cedar Grove. North Carolina.

PIANO Tuning Pays. Learn this profitable profession at home. Our Tonometer and mechanical aids make learning easy. No knowledge music necessary. Diploma granted. Largest and oldest school—51st year. G. I. Approved. Write for booklet. Niles Bryant School. 77 Bryant Bldg., Washington 16. D. C.

LEARN Piano Tuning. Repairing—at home in 30 days. Unlimited income. Phonograph recordings, tools and instructions furnished. Write Capitol City Tuning Co., Department C-633. 129 East Michigan. Lansing 16. Michigan.

MAKE Up To \$35-\$45 Week as a Trained Practical Nurse! Learn quickly at home. Booklet free. Chicago School of Nursing. Dept. M-3. Chicago.

WELDING training pays. Operating under V.A. contract. Free Catalog. Box 279-P-603. Troy. Ohio.

JOB Success guaranteed. send for occupational self-analysis form \$1.00. National Consultants. 100 Barr Bldg., Washington 6. D. C.

AIRBRUSH Art. Learn this most modern of art techniques in your own home. New York School of Airbrush Art. 117-F E. 60 St., New York City. Approved as a Correspondence School under New York State Laws.

MEDICAL Laboratory Technicians in great demand. We train you in your own home. Catalogue free. Imperial Technical Institute. Box 973-B. Austin. Texas.

FREE—Bookkeeping lesson—Full Particulars. Buchalter. 110 West 42. New York 18. N. Y.

HOME Study Course. Chiro-Deo-Therapy. Drugless Healing Certificates. Diplomas. Degrees. Jacumba Hot Springs. Jacumba. California.

DENTAL Technician's Manual! Illustrated and written so you can understand. Grant Laboratory. 219 W. 7th. Los Angeles 14. Calif.

USED Correspondence Courses. Bought. Sold. Rented. Free Literature. Baker. 5509-A Winthrop. Chicago 40.

MEMORIZE Instantly. In One Evening. you can Astonish with Memory Feats. The Quickest System Known. \$1.00 or write Howard Deery. 35 Walworth Street. Worcester. Mass.

REVOLUTIONARY conception of Public Bookkeeping! \$5.00 hourly. Simple instructions. Full spare time. Systems shortcuts. obtaining clients. Auditax. 10775-C. Tabor. Los Angeles 34.

PHOTOGRAPHIC mind with Supermemory. write Thor Books. S-6. Box 1210. Chicago.

U. S. GOVERNMENT Jobs! Start high as \$66.34 week. Qualify Now for secure positions. Men-women. Many openings expected soon. Experience usually unnecessary. Free 40-page book shows jobs, salaries, sample tests. Write: Franklin Institute. Dept. F-22. Rochester. N. Y.

DRAFTING Design. Mathematics. Building Estimating. Surveying. Engineer's License Preparation. Veterans accepted. Mondell Institute. 230 West 41st. New York.

LEARN Clock Repairing. All types illustrated manual \$1.00. Burney and Co., Box 287. Dayton 1. Ohio.

HYPNOTISM Courses! 200 Different. Catalog 25c. Nelmar. 2820 No. Lawndale. Chicago.

READ With Speed! New Amazing Method. Save hundreds of hours yearly. Free home test. No obligation. Rush postcard. Brownson. 9109 Hoyne. Chicago 20.

PIANO Tuning quickly learned. Best means to supplemental income or as full-time profession. Rare opportunity for limited number to take accelerated course under actual working conditions of tuning, repair and regulation. Strictly individual minus theory and class work. Positively no correspondence courses. Write Mr. Cake. P. O. Box 582. Harrisburg. Pa. (Director Harmony School of Piano Tuning since 1945).

68 DANCE INSTRUCTION

ADAPT your talent to dancing scientifically. Free Talent Trial Lesson. Danceology. 35-W Warren. Youngstown 7. Ohio.

69 CONTESTS

WIN! Cars . . . Cash . . . Homes . . . Wonderful Prizes. "Winning Answers." Treasure Tips. Bulletins listing advisable contests and how to win in them. entry blanks. Introductory offer only \$1.00—Anniversary copy 25c. Personal Contest Club. Box 12-PS. Station P. Brooklyn 12. New York.

CASH Prizes Contest Bulletin. Current information. Treasure-Pleasure. Box 61. N. Y. 13. N. Y. Send 25c.

PRIZE Contests! How and Where to Win your Share! 25c coin (refundable) National Contest Bulletin. Box 2685-C. Miami 16. Florida.

70 LANGUAGE OUTFITS

LINGUAPHONE Makes Languages Easy At home learn to speak Spanish, Portuguese, Italian, French, German, Russian, by quick, easy Linguaphone conversational method. Save time, work, money. Linguaphone Institute. 54 Radio City. New York. 20. N. Y.

72 AUTHORS SERVICE

I WANT New Writers to cash checks of \$1 to \$100 offered daily. The easiest way to write for pay. No previous experience necessary. Free Details. Saunders M. Cummings. 468-15 Independence Bldg., Colorado Springs. Colo.

WRITE for pay easy. earn-as-you-learn way! Receive checks for \$3 to \$100—offered daily. for re-writing ideas in newspapers, magazines, books. C. C. Mich., writes: "Received check for \$27." Mrs. R. C. B., writes: "I made \$20." No experience necessary. Write for Free details and how to get Free Writer's Market Guide! Comfort Writer's Service. Dept. 4-J. 200 South 7th St., St. Louis. Mo.

73 BUSINESS SERVICE

WHERE to buy it information, almost anything. Write listing items. Kelly. 9544-C Whitcomb. Detroit 27. Michigan.

74 CARTOONING, SIGN PAINTING, DRAWING AIDS

MICALITE Sign Letters! Reflect Light! Sample 25c. Harwell. Bvrdstown. Tenn.

CARTOON Your Way To Success! Internationally known instructor. Raye Burns will personally teach you to create salable, original cartoons at home. Course of 26 lessons only \$2.85. Send remittance with order or write for Free Details and addresses of successful students. Raye Burns School. Box 3583-S. Cleveland 18. Ohio.

"HOW to make money with simple cartoons". A book everyone who likes to draw should have. It is free; no obligation. Simply address Cartoonists' Exchange. Dept. 196-C. Pleasant Hill. Ohio.

SIGN painting taught at home. Test lesson free. Ben Kerns. Box 812-PS. Greenville. S. C.

BECOME an Artist! Learn Cartooning. Commercial Art. Lettering. Showcard Writing. Photo Coloring, etc., quickly with our New. Easy Methods. Catalog Free. National Artists. Box 4248-C. Dallas 8. Texas.

75 CHALK TALK-STUNTS

CHALK Talks. Laugh Producing Program. \$1.00. Illustrated Catalog 10c. Cartoonist Balda, Oshkosh, Wisconsin.

76 TYPEWRITERS AND OFFICE MACHINES

PRINTOMATIC selffeeding Post Card printing Duplicator \$13.50. Envelope Addressing Machines \$24.50. Pittsburgh Typewriter Company, 336-G Fourth Avenue, Pittsburgh 22, Pa.

77 OFFICE SUPPLIES & EQUIPMENT

TYPEWRITERS \$17.50. Duplicators \$9.50; Adders \$12.50; Typewriters, 118N Spruce, Wichita, Kansas.

SPECIAL! 3 lines, two inches, knob handles, 90c. Agents wanted. S & O Rubber Stamps, 24½ S. Clinton, Iowa City, Iowa.

LOY'S Abacus, low-cost fast adding calculator for home or office, \$3.50, \$6.50. Free details. W. D. Loy, 1317 R. I. Ave., N. E. Washington 18, D. C.

79 PRINTING OUTFITS, SUPPLIES

"PRINTING presses, type, supplies. Send dime for complete illustrated printer's supply book, details and press samples. Kelsey, Inc., A-8, Meriden, Connecticut."

PRINTING Presses (table model) \$7.50. Keena, 1312 Jefferson, Grand Rapids 7, Michigan.

PRINTING Presses. Type Supplies. Lists 3c. Turnbaugh Service, Loysville, Penna.

MAKE Your Own rubber printing cuts. Self-molding process. Plexirubber, Argyle 2, Wisconsin.

80 PRINTING, MULTIGRAPHING, ETC.

ATTRACTIVELY Embossed Business Cards, 1000; \$3.50. Samples, Midwest Embossing, Box 999A, Wichita 1, Kansas.

500 ¾ x 2¼ PRINTED Stickers 50c. General printing. Willis Myers Company, Owosso, Michigan.

1000 BUSINESS Cards—Beautiful Raised Lettering, \$3.50 Delivered, One week. Samples Free, Gilbert Kuehl, Aledo, Illinois.

1000 8½ x 11 Photo Offset \$7.50. Printing, Mimeographing. Other prices equally reasonable. Send dime (refundable) for Pricelist, Mimic Reproductions, 383P No. Corona, Valley Stream 2, N. Y.

BUSINESS Stationery, Samples, Prices Free. Howprint, 717-23 Eunice, Webster Groves 19, Missouri.

82 PATENT ATTORNEYS

INVENTORS—Send today for booklet "Patent Protection for Inventors" giving detailed patent information and preliminary steps to take toward patent protection,—also "Evidence of Invention" form. Victor J. Evans & Co., 541D Merlin Building, Washington 6, D. C.

INVENTORS—If you believe that you have an invention, you should find out how to protect it. The firm of McMorrow, Berman & Davidson is qualified to take the necessary steps for you. Send for copy of our Patent Booklet "How to Protect Your Invention" and "Invention Record" form. No obligation. McMORROW, BERMAN & DAVIDSON, Registered Patent Attorneys, 143-Z Victor Building, Washington 1, D. C.

C. A. Snow & Co.—S-427, Snow Building, Washington 1, D. C. Registered Patent Attorneys. Write for information.

REGISTERED Patent Attorney offers services. Sanders, 6430 Evans, Chicago 37, Illinois.

INVENTORS. For "Record of Invention" form, contact Carl Miller, Registered Patent Attorney, Woolworth Building, New York.

INVENTORS: Without obligation, write for information explaining the steps you should take to secure a Patent. John N. Randolph, Registered Patent Attorney, 207 Columbian Bldg., Washington 1, D. C.

INVENTORS: When you are satisfied that you have invented something of value write me, without obligation, for information as to what steps you should take to secure a Patent. Write Patrick D. Beavers (Formerly Randolph & Beavers) Registered Patent Atty., 938 Columbian Bldg., Washington 1, D. C.

INVENTOR'S Guide free on request. Frank Ledermann, Registered Patent Attorney, 154 Nassau St., New York 7.

INVENTORS: Write for free brochure "Evidence of Invention." Labiner, World Building, New York 7.

INVENTORS: Learn how to protect your invention. Unless the inventor is familiar with patent matters, he should engage a competent registered patent attorney or agent to represent him. We are registered to practice before the U. S. Patent Office and prepared to serve you in handling your patent matters. "Patent Guide for the Inventor" containing detailed information concerning patent protection and procedure with "Record of Invention" form will be forwarded to you upon request—without obligation. Clarence A. O'Brien & Harvey Jacobson, Registered Patent Attorneys, 02B-D District National Building, Washington, D. C.

PATENT practice before U. S. Patent Office. Validity and infringement investigations and opinions. Booklet and form "Evidence of Conception" forwarded upon request. Lancaster, Allwine & Rommel, Registered Patent Attorneys, Suite 413, 815-15th St. N.W., Washington 5, D. C.

PATENTS—Trade marks. Irving L. McCathran, 316 McLachlen Bldg., Washington 1, D. C. Registered Patent Attorney.

83 FOR INVENTORS

INVENTORS—If you believe that you have an invention, you should find out how to protect it. The firm of McMorrow, Berman & Davidson is qualified to take the necessary steps for you. Send for copy of our Patent Booklet "How to Protect Your Invention" and "Invention Record" form. No obligation. McMORROW, BERMAN & DAVIDSON, Registered Patent Attorneys, 143-Y Victor Building, Washington 1, D. C.

PATENT Searches \$5.00. Includes patent copies. Same reliable search as conducted for patent attorneys. Free protection forms. 48 hour service. Patent Service Institute, 45-B Pennsylvania Avenue, Washington 4, D. C.

PATENT PROTECTION—This well-known organization will send you promptly upon request and without obligation, a booklet containing detailed information concerning steps to take to protect your invention by a United States Patent. VICTOR J. EVANS & CO., Merlin M. Evans, Registered Patent Attorney, 542-G Merlin Building, Washington 6, D. C.

SUCCESS Guaranteed. Inventors with patented and patent pending inventions for sale or lease, request our free book. No obligation. Dept. 2-F, Universal Marketing Co., 354 South Spring St., Los Angeles 13, Calif.

INVENTORS: Without obligation, write for information explaining the steps you should take to secure a Patent on your invention. John N. Randolph, Registered Patent Attorney, 206 Columbian Bldg., Washington 1, D. C.

CASH For your idea. 280 manufacturers need inventions, patented or unpatented. List free. Invention Bureau, 208-S Clinton, Oak Park, Illinois.

INVENTORS: The usual First Step is to have a search of the U.S. Patents conducted, so I can report on Patentability. Write, without obligation. Patrick D. Beavers (Formerly Randolph & Beavers) Registered Patent Atty., 939 Columbian Bldg., Washington (1), D. C.

INVENTORS: If you have an invention for sale, patented or unpatented, write Institute of American Inventors, Dept. 30A, 631-E St., N.W., Washington 6, D. C.

"INVENTOR'S Guide" free on request. Frank Ledermann, Registered Patent Attorney, 154 Nassau St., New York 7.

INVENTORS. For "Record of Invention" form, contact Carl Miller, Registered Patent Attorney, Woolworth Building, New York.

INVENTORS: Learn how to protect your invention. Unless the inventor is familiar with patent matters, he should engage a competent registered patent attorney or agent to represent him. We are registered to practice before the U. S. Patent Office and prepared to serve you in handling your patent matters. "Patent Guide for the Inventor" containing detailed information concerning patent protection and procedure with "Record of Invention" form will be forwarded to you upon request—without obligation. Clarence A. O'Brien & Harvey Jacobson, Registered Patent Attorneys, 02A-D District National Building, Washington, D. C.

INVENTIONS sold, leased, Patented, unpatented. Complete service. M. Joyce Humphries, 1424 Landtitle, Philadelphia 10, Penna.

INVENTORS: Obtain patents without assistance. Eliminate preliminary step of patent search. Complete Handbook \$2.00. International Patent Library, 1420 New York Avenue, Washington 5, D. C.

COMPLETE Services for inventors. Patent searches, including analysis, patent copies. Patent applications prepared. Inventions marketed. Protection forms free. Industrial Patent Reports, Box 1081, Massachusetts Avenue and North Capitol, Washington 13, D. C.

I. F. I. Creative Co-operation includes: Superscope patent searches; commercial prospects analysis; pre-patent priority protection; invention-improving; finding backers; invention-styling for sales-leadership, plus the Promoting, Marketing, and Selling of inventions for Maximum Cash and Royalties. Write today for free information. Inventors-for-Industry Inc., P.S. 6, Suite 501, 1947 Broadway, New York 23.

INVENTORS—Protect your invention by a U. S. Patent. Write me for free record of invention form, Sherman Levy, 620 Victor Building, 724 9th Street, Washington 1, D. C.

PATENT Searches with patent copies \$5.00 (48 hour service). Patent applications prepared (one sheet drawing) \$95.00. We serve the patent attorney, the general attorney and the inventor direct. Our patent specification writers are all graduate engineers who have served at least 15 years as Patent Office Examiners. Protection forms free. Write Patent Engineering Service, 500 Walker Building, Washington 5, D. C.

84 INVENTIONS WANTED

INVENTORS Marketing Assistance. Circular Free. Stanley Hull, 7829-P Euclid, Cleveland 3, Ohio.

SUCCESS Guaranteed. Inventors with patented and patent pending inventions for sale or lease, request our free book. No obligation. Dept. 2-P, Universal Marketing Co., 354 South Spring St., Los Angeles 13, Calif.

INVENTIONS Wanted, Patented or Pending only. Inventors Exchange-D. Hartford 1 Conn.

CASH For your idea. 280 manufacturers need inventions, patented or unpatented. List free. Invention Bureau, 208-S Clinton, Oak Park, Illinois.

INVENTIONS Promoted. Patented or Unpatented. Write Adam Fisher Company, 183-A Enright, St. Louis, Mo.

INVENTORS: Hundreds of manufacturers have requested our assistance in locating marketable new products. Complete information, free. Institute of American Inventors, Dept. 30C, 631-E Street, N.W., Washington 4, D. C.

INVENTORS—our clients are asking for new devices for manufacture and sale. Write Visioneering Inc., Security Bldg., West Bend, Wis.

INVENTORS—What have you, patented, patent pending to offer manufacturers? Booklet, information free. Market Contacting & Data Service, 11106-B3 Longwood, Chicago 43.

85 PATENTS

INVENTORS: Test the commercial value of your patented or unpatented inventions, quickly and inexpensively. Write for free information. Institute of American Inventors, Dept. 30-B, 631-E St., N. W., Washington 6, D. C.

THE U. S. Patent System does not compel inventors into rash "Patent (S)pending." The intent of the Patent Law is to give you the chance of making a Pre-patent test of the worth of your ideas. And high-character Priority Protection for this purpose can be obtained through: Inventors-For-Industry Inc., Dept. P.S. 6, Suite 501, 1947 Broadway, New York 23. Write today for free information.

86 PATENTS FOR SALE

MECHANICAL invention for automobiles, trucks, etc. Write Inventor, c/o M. Joyce Humphries, Patent Broker, 1424 Landtitle, Phila. 10, Penna.

89 MODELS, MODEL SUPPLIES

BUILD Historic Ship models, complete kits 39c to \$9.00. Catalog 10c. Ideal Models, 21 West 18th, New York 11, N. Y.

SHIP Model and yacht supplies, complete large 64 page catalogue, 30c. Wm. Wild, 510 E. 11th St., New York City.

SHIP Models—most complete line in New England. Kits, parts, plans, books. Steam and electric power plants. Illustrated catalog 25c. James Bliss & Co., Inc., 220 State St., Boston, Mass.

SHIP and Yacht model fittings; blueprints. Send 25c for illustrated catalog No. 25—Listing hundreds of items. A. J. Fisher, 1002-2 Etowah, Royal Oak, Mich.

READY! Our 1950 catalog of ship model kits and fittings; sail, steam, diesel. Send 25c for catalog. Model Shipways, Folio 41, 476 Main St., Fort Lee, N. J.

MINIATURE engines, castings and drawings. Catalog world's largest selection 25c. Miniature Engine Laboratories, 200-B Cement Ave., Sandusky, Ohio.

STEAM engines, boilers, castings. Catalog 25c. Anton Bohaboy, 2297 Price, Rahway, New Jersey.

91 HOME CRAFTSMEN

16 NEW lawn chairs, 22 picnic tables, benches, trellises, etc. All 38 plans, with necessary full size patterns, \$1.00. Mastercraft 63S, 7041 Olcott, Chicago 31, Illinois.

PANEL-Form Chests, Cherry, Cedar, Walnut, Easy Assembly. Free Catalog. Eby Reproductions, Paradise, Penna.

JIGSAW Owners attention! Start earning money at home cutting out wooden novelties and souvenirs. Write H. COOK, 4407 S. Normal Ave., Chicago 9, Ill.

HARDWOOD PLYWOOD—Small Sized Pieces for home craftsmen, Bargain Prices. Send for Free Monthly Price List. PLYWOOD SALES COMPANY, 2120 North Second Street, Minneapolis, Minnesota.

TURN your spare time into cash. Make quick-selling, highly profitable lamps—every home a prospect. No experience or special tools required. New 1950 56-page illustrated catalog shows shades, shade frames, figurines and bases, oil lamp converters, boring compounds, and dozens of similar items. Also all kinds of sockets, cords, pipes, harps, finials, bases, and hundreds of other parts—everything you need. Special 8-page section shows 6 beautiful lamps in kit form ready to assemble. You buy wholesale, sell at retail—make big profits. Hundreds doing it. You can, too. Send 25c today for catalog and wholesale price list. Refundable first order. Gearon Co., Dept. 500-E6, 27 S. Desplains, Chicago 6, Illinois.

90 ALL new, full size lawn ornament and novelty patterns, up to 20" high. Only \$1.00. Mastercraft 62S, 7041 Olcott, Chicago 31, Illinois.

PROFIT with Larson Leathercraft. Belts, purses, 100 other ideas. Largest supply in U. S. Catalog 10c. Larson, Dept. C, 826 S. Tripp, Chicago 24.

NEW 96 PAGE Leather and Craft catalog, 1000's of items. Send 10c. Russo Handcraft Supplies, Dept. 5H, 245 South Spring, Los Angeles, California.

INDEPENDENT income! Make tooled leather belts, billfolds, purses for gifts or sale. Big illustrated catalog of materials, tools, instructions. Send 10c. Genuine steerhide keyholder free with catalog. Tandy Leather, Box 397B, Tulsa, Okla.

8 BEAUTIFUL Full Size Whatnot patterns 25c. Joanness, P. O. Box 141-S, Omaha 7, Nebraska.

LEATHERCRAFT, Copper tooling, textile painting, Materials, tools, supplies. Free illustrated catalog. Kit Kraft, 7377 Melrose, Los Angeles 46, California.

KNOCKDOWN Cedar Chest, Lumber and Veneers. Free Price List. Giles Co., Brownsboro, Alabama.

BRASS and Copper Materials, 24 page catalog 10 cents. Groundmaster Company, Div. B, Boulder, Colorado.

SQUAREKNOTTERS! Make belts, hand bags, etc. Quality cord samples with catalog free. Special! Beginner's book, catalog and samples, 10c. P. C. Herwig Co., Dept. P40, 121 Sands St., Brooklyn 1, N. Y.

80 FULL sized patterns, toys, novelties, lawn ornaments, \$1.00. Modern Woodcraft, Saginaw, Mich.

LEATHERCRAFTERS: Complete supplies and leather. Free Catalog. Arts Leather, 411 Joseph Ave., Rochester 5, New York.

TOYS, novelties, furniture, garden figures, lawn chairs, etc. 68 popular plans, with full size patterns, \$1.00. Mastercraft 61S, 7041 Olcott, Chicago 31, Illinois.

UNUSUAL 8 & 16mm Films. Used by many Art Students. Send 25c for sample film strip. Write for FREE Catalogue. Friart 140 S—Liberty Street, New York 6.

SHELLCRAFT! Make seashell Jewelry Novelties. Supplies, Instructions. "Buy Direct." Pace's, Bradenton 1, Fla.

89 JIG SAW patterns of beautiful shelves, ornaments, novelties, toys. All full size. Plus "How and Where to Sell." Only \$1.00. Mastercraft 64S, 7041 Olcott, Chicago 31, Illinois.

93 BUILD IT YOURSELF

BUILD Your Own "LAWN MOWER". Plans, Kits, Completed. Write Eltraco, D-55, Camptonville, California.

50% COMMISSION, steady repeat orders, lifetime income, free outfit. Nichols Company, Purvis, Miss.

"CONCRETE Block Homes." 32 page booklet on how to build. \$1.00. Other Home Building booklets. \$1.00. H. C. Lightfoot, Civil Engineer, Richboro, Penna.

\$600. BUILDS Cozy 4 rooms and Bath. Concrete Block, stuccoed. Instructions & Blueprint \$1.00. Farrow, G-82, Box 645, Columbus 16, Ohio.

HARD water? Softener-Iron Pitter easily built. Big savings! Complete plans \$1.00. Details free. Wisconsin Water Systems, Pewaukee 1, Wisc.

94 WATCH REPAIRING

WATCHMAKERS' Journal contains helpful hints on watch repairing. Sample copy 20c. Dean Co., 116-B Nassau St., New York 7, N. Y.

WATCHMAKERS' Tools, Materials, Sold—Bought, Catalogue! Bengal Company, Culver City, California.

95 OLD GOLD, WATCHES, ETC.

HIGHEST Cash Paid For old, Broken Jewelry, Gold Teeth, Watches, Silverware, Diamonds, Spectacles, Platinum. Free information, Satisfaction Guaranteed. Government Licensed, Rose Smelting Company, 29-Y East Madison, Chicago.

HIGHEST Prices Paid for old gold, silver, platinum, diamonds, watches, gold teeth, spectacles. Cash immediately. Goods returned if offer unsatisfactory. Government Licensed, United Smelting Works, (The Old Reliable), 39-H South State, Chicago 3.

96 JEWELRY

JEWELRY Making. Illustrated catalog 20c. George Sassen, 35 Maiden Lane, N. Y. C. 7.

97 TOBACCO & PIPES

FREE Literature. Pipemaking, Profitable, economical. Carvapipe, 2829-S Dixie, Hamilton, Ohio.

100 MISCELLANEOUS

"INTERESTING Mails"—25c will keep your mail box full three months. Bentz, Jr., Desk A-98, Ghatawa, Mississippi.

FAMOUS letterwriter criticizes letters \$1. Author "The Master Letter Writer" 144, Westport, Conn.

BOOKFINDERS! (Scarce, out-of-print, unusual books) Quickly supplied. Send wants. Clifton, Box 1377-PSM, Beverly Hills, Calif.

OUTDOOR Toilets, Cesspools, Septic Tanks cleaned, deodorized with amazing new product. Just mix dry powder with water; pour into toilet. Safe, no poisons. Save digging and pumping costs. Postcard brings free details. Burson Laboratories, Dept. T-38, 955 Willard St., Chicago 22, Ill.

CLIPIT—Don't use rubber bands for storage, get Film clips for movie film reels. Clips edge of reel and holds film through perforations. Simple to attach and detach. Send 25c for six. Madison Products Co., Toledo 2, Ohio.

DRESSES 18c; Coats \$1.00; Blouses 35c. Free Catalog. Crown, 164 Monroe St., N.Y. 2.

HOME Envelope Addressers! Latest Issue: "How to contact 100 Mail Order Houses." \$1.00. Tralst, Box 2160, Seattle 11, Washington.

PANNING Gold Beginners booklet 36 pages. Catalogue—Supplies, Mining Books, Maps. "Where To Go" 25c. Old Prospector, B-315, Dutch Flat, Calif.

BIG Mails Three Month, 25c, year Name Listed Directory \$1.00. Harvey Teeple, Decatur, Indiana.

RARE interest photographs available. Lists—Olsen's 2331—Market—San Francisco 14, Calif.

FALSE Plate Wearers—New Plate for Old in 24 Hours! Low as only \$18.50! Enjoy comfortable, attractive false teeth. Made of lustrous Dupont Beauty-Pink Plastic. Amazing savings. Rush name for free details. West Dental Laboratory, Dept. J, 127 N. Dearborn, Chicago 2, Ill.

MONEY guaranteed. Proven, welcomed surprise. Paymaster, 2494 Fayette, McKeesport, Pennsylvania.

SIGNS & SHOWCARDS made to your copy. 7 x 11 50c, 11 x 14 75c, 14 x 22 \$1.00. Up to ten words. Paper, Cardboard, or cloth. 22 x 44 \$2.00 paper, \$2.50 cloth. Duplicates ½ price. Cash with order. Quick service. Postage paid. Satisfaction guaranteed. Quotations on larger sizes. Merchants Sign Service, 6349 N. Clark St., Chicago, Illinois.

REDHOT novelties for men. Unique novelty and catalog 25c. Novelart-D, Laurens, S. C.

REFRIGERATOR rubber door seals. Rues Trading 6013G—13th, Brooklyn 19, New York.

TREASURE—Mineral Locators—Geiger Counters can be purchased on monthly payment plan. Free literature. Fisher Research Lab., Inc., Palo Alto, Calif.

IF you are nervous, write The Herbmater, Forestville 8, Va.

BUY Nationally advertised appliances, furniture, photographic supplies at wholesale. 80 page catalog. \$1.00 applied toward initial order. Triangle, 6405 North Bell, Chicago, Illinois.

101 FOR SALE—MISCELLANEOUS

SENSATIONAL Automobile Record book and Mileage calculator. Save many Dollars on Gasoline and repairs. Send \$1.00 Cor-Pro, 630A Brooklyn Ave., Brooklyn 3, N. Y.

FREE catalog! Save money. Surplus clothing bargains. N. Y. Clothing Co., New York 29.

BRONZE Horses—10x11 ¼ \$4.95. Service Specialty, Box 2225, Portland 14, Oregon.

102 WANTED MISCELLANEOUS

SCRAP Mercury (Quicksilver) Tantalum—Bismuth—Tungsten. Metallurgical Products Co. Established 1909. 35th & Moore Sts., Philadelphia 45, Pa.

103 FOR THE HOME

OUTDOOR Toilets, Cesspools, Septic Tanks cleaned, deodorized with amazing new product. Just mix dry powder with water; pour into toilet. Safe, no poisons. Save digging and pumping costs. Postcard brings free details. Burson Laboratories, Dept. V-39, 955 Willard St., Chicago 22, Ill.

104 PERSONAL

STAMPED Air Mail letters reairmailed from anywhere in U. S., Alaska, Hawaii, Puerto Rico, Virgin Islands, Canton Island, Canal Zone, Guam: Three for \$1.00. D. N. Holt, Box 217, Sausalito, Calif.

PSORIASIS SUFFERERS: Has everything failed to bring even temporary relief from scales, lesions and itching? Then write today for FREE important information. You needn't invest one cent! PIXACOL Company, Box 3583-S, Cleveland, Ohio.

DETECTIVE'S Opportunities. Particulars free. Write, Wagoner, P-125 West 86th, New York 24.

"HOW Can I Find Out?" You Can! Information discreetly developed. Any matter, person, problem, anywhere. Worldwide. Officially licensed, bonded service. Established 1922. Reasonable. Confidential. William Herman, 170 Broadway, New York.

PILES! Do you suffer the miseries of itching, bleeding or protruding piles? Write today for free important information. Shaf-Mey Products, Box 836, Cleveland 22, Ohio.

INFORMATION for single people by Human Relations Consultant, Dr. B. Long, Box 375, Los Angeles 53, Calif.

DAV Contestants: Compare highest scientific score with yours. Box 3544-A, Cleveland 18, Ohio.

HYPNOTISM. Self-hypnosis courses. Free details. Craft Publications W2, 601 S. Vermont, Los Angeles 5, Calif.

RECEIVE Big Mails, four months listing, 25c. WRIGHT PUBLICATIONS, 2276-J Hubbard, Memphis 8, Tenn.

SAVE your hair. Dandruff, itch, hair loss. Your own easily prepared inexpensive remedy gets results. Formula \$1.00 bill. S. Viggiano, Pharmacist, 6556 Ladson, Pittsburgh 6, Penna.

ATHLETE'S Foot! Ringworm! Amazing new preparation (Dermo-Ring). Sure remedy with one application. Money back guarantee. Send \$1.00, includes postage. Candido Pharmacy, Box P-1256, Albany, N. Y.

BORROW by mail. Loans \$50 to \$300 to employed men and women. Easy, quick. Completely confidential. No endorsers. Repay in convenient monthly payments. Details free in plain envelope. Give occupation. State Finance Co., 210 State Finance Bldg., Dept. J-14, Des Moines 9, Iowa.

MEXICAN Law. General Practice Attorney. 1203 Arizona Street, El Paso, Texas.

ECZEMA victims! Does itching, burning or scaly skin torment you? Write for free important information. Shaf-Mey Products, Box 836, Cleveland 22, Ohio.

106 ADVERTISING

40 WEEKLY newspapers, 24 words, \$3.50. Pennebaker Advertising, San Marcos, Texas.

AVOID costly advertising mistakes. Get enlightening Ad-Guide and Ratebook leading newspapers, magazines, mailing lists, 10c. Chicago Advertising Agency (Established 1900), Chicago 4.

ADVERTISE: 24 words, 40 Newspapers, \$3.50. Lists free. Advertising Bureau, 10511-P Springfield, Chicago 43.

24 WORDS in 50 Weeklies, \$4.96. H. J. Darnell, 730 Hays, Jackson, Tennessee.

"NO RISK" Advertising! Sell by Radio: pay "per order"! 50c. Simon, 59-S Park Avenue, New York City 16.

115 DRAWING & ART SUPPLIES

FREE talent test information. Give age. Commercial, Box 8066, Dallas 8, Texas.

DRAFTING and artists' materials catalog—thousands of items—25c (deductible first \$2 order). Gordon's, 187 Madison, Chicago.

117 TATTOOING SUPPLIES

TATTOOING Outfits, Supplies. Illustrated List Free. Zeiss, 728 Lesley, Rockford, Illinois.

120 CANDY MAKING

MEN-Women—"Everybody likes Candy." Learn to make professionally at home. (Our 40th year.) Ragsdale Candies, East Orange, New Jersey.

LEARN Professional candy making profitable home business. Details 10c. Pate, Kissimmee 2, Florida.

122 GARDENING

REMOVE any tree stump for as low as \$1.00. New sensational compound—No Blasting, Chopping or Digging. 4 oz. \$1.00—(enough for stump up to 36" in diameter.) 8 oz. \$1.50; 1 lb. \$2.75; 5 lbs. \$12.50—Order Today—get rid of ugly stumps the easy way. Send No Money. Pay Postman or send cash with order and save C.O.D. charges. Money back if not satisfied. H. D. Campbell Co., Rochelle 8, Illinois.

131 TREASURE FINDERS

SENSATIONAL new line of Geiger Counters for Uranium detection. All types, all prices. No finer selection. Also Mineralights and new gold, silver and mineral Detectors. Complete information Free. Detectron Co., 5637 Cahuenga, Dept. A-5, North Hollywood, California.

TREASURE Hunters! New 11-pound featherweight Model 101 locator for gold, silver and minerals. Money-back guarantee best available. Also Geiger Counters for uranium prospectors. Complete information free. The Goldak Company, 1540 W. Glenoaks Blvd., Glendale 1, Calif.

METAL Detectors. The very latest circuit. Send 25c for literature. Hedden Metal Detectors, 3329 Liberty Ave., Pittsburgh 1, Pa.

SEEK Uranium, Gold, Buried Treasure! Recover lost Outboard Motors, Tackle, Guns. Latest low cost super-sensitive equipment. Free literature. Glen Scientific, Box 151-D, Glen Ellyn, Illinois.

TREASURE—Mineral Locators—Geiger Counters M-Scope Type. Lightweight. Unsurpassed in efficiency. Factory guarantee. Lowest prices. Can be purchased on monthly payment plan. Free literature. Fisher Research Lab., Inc., Palo Alto, Calif.

137 DETECTIVES

DETECTIVE Training. Phillips Secret Service System, 1917-C North Kenneth, Chicago 39.

DETECTIVES—Work home—Travel. Experience unnecessary. Write Wagoner P-125 West 86th, N. Y., N. Y.

DETECTIVE—Investigator courses. FREE literature. Allied Academy, 14 No. East, Indianapolis.

141 HEARING AIDS & REPAIRS

REVOLUTIONARY Hearing Device. No Battery. No Wires. Just a simple ear plug that carries sound to the ear drum. Beaudry, 4337—30th Avenue South, Dept. "Z", Minneapolis 6, Minn.

142 INFORMATION

AMATEURS—Radio and Electrical Research Engineering. H. Y. Twillmann, R. R. #1, Chesterfield, Mo.

145 SOUVENIRS

WORLD War II Thirty-five pieces Military Ribbon Bars, Naval Rates, patches, Marine, others send 50c—Pritt Co., 12 West 27 Street, New York City.

ARMY Emblems; 30 different 50c. Prices. Hobbyguild, Box 71, Station A, Brooklyn.

LOWEST Motorized PAINT PRICED SPRAYER

\$16⁹⁵

COMPLETE

Nothing Else To Buy



LIGHTWEIGHT—PORTABLE 1001 USES

Professional Results with ANY TYPE PAINT ENAMEL, Etc.

The ONLY Electric MOTOR POWERED Paint Sprayer At Such A LOW PRICE GUARANTEED FOR 1 FULL YEAR!

Just Pull The Trigger and SPRAY

This sensational, new, Portable Electric Sprayer will save you many hours and dollars on screens, furniture, auto touch-ups, and thousands of paint and spray jobs for the home, farm and office. Entire outfit is a compact, lightweight unit. Sprays with any type paint, lacquer, enamel, etc., either oil or water base. Applies a smooth, uniform finish. Sprayer stays clean, won't clog or drip because of special plating inside gun. Ten foot hose permits free, easy use of sprayer for any job. Compressor is piston-type, best there is. Delivers 20 lbs. pressure. AC-DC motor is fan-cooled. **SEND NO MONEY! JUST MAIL THIS AD** then pay postman on arrival only \$16.95 plus small delivery charge. Keep Sprayer for 10 days at our risk. If not delighted return for full purchase price refund.

STEVEN RICKY, Dep't C, 1227 Loyola Ave., Chicago 26, Illinois



STOP COSTLY Upper Cylinder WEAR

with the UNIVERSAL TOP OILER

★★ Atomizes top cylinder oil and distributes it evenly to upper cylinder area of car engines. Stops excessive piston, ring, and cylinder wear caused by insufficient upper cylinder lubrication. Frees sticky valves, prevents gum formation, reduces oil and gas consumption. Quickly pays for itself because of lower repair bills and better engine performance. Furnished complete—installed in 30 minutes with easy-to-follow instructions. Approved by leading top oil marketers. **MONEY BACK GUARANTEE.**

Only \$8.95 Postpaid

Best Top Oiler Buy AT ANY PRICE

NATIONAL APPLIANCES, INC.
300 N. Lexington Ave., Pittsburgh 8, Pa.

Send UNIVERSAL Top Oiler at once.
 Check or money order enclosed. Send C.O.D.
 Send descriptive literature.

Name _____
 Address _____
 City _____ State _____

EVER BETTER...

Buy Schult for Value!

Choose wisely, for value in relation to price, not over-glamorized gadgets. LIVING in a Schult, you'll appreciate the all-season comfort, day-by-day convenience, easy towing, and years-lasting ruggedness of your quality-built Schult... A great dollar-value!



Free...
"HOW TO BUY A TRAILER COACH"

Send today for new booklet. Tells what to look for... how to judge values... protect your investment... and make your dollars go farther.

SEE NEW MODELS... BEST VALUES EVER!

Now at dealers—new 1950 models with metal exteriors like fine autos. Or write for free catalogs showing choice of floor plans, Schult "Heat-Saver" and other unique features for livability.

SCHULT CORP., Dept. 3205, Elkhart, Ind.



WHAM-O SPORTSMAN*

HITS LIKE A .22 RIFLE—KILLS RABBITS, SQUIRRELS. Powerful, silent, accurate. For hunting, target, routing pests.

At dealers or send direct



HUNTING SLINGSHOT

Heavy ash hardwood stock. Forty steel balls, extra rubber straps. GUARANTEED. Send \$1.00 today to WHAM-O MFG. CO., Box 8-P, South Pasadena, Calif. * The professional model of the Nat'l Slingshot Assn

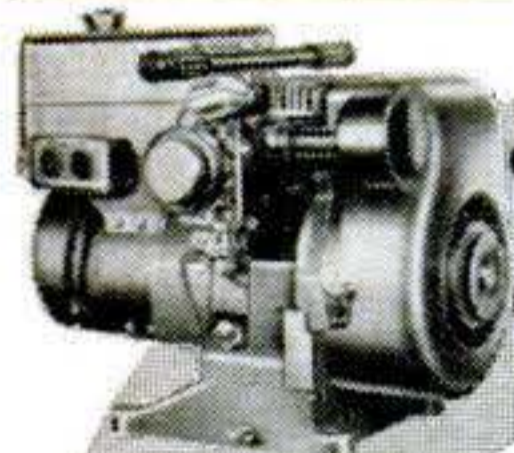

ONAN Portable ELECTRIC PLANTS

FOR CABINS, TRAILERS, CONTRACTORS, BOATS

Light weight, compact, air-cooled engine-driven. Furnish regular city-type A.C. electricity for lights, appliances, radios, etc. Can be carried by hand. Fit trunk of car. Plug-in receptacles on plant. Larger models for farms, homes, businesses beyond highlines. Catalog shows over hundred models. 350 to 75,000 watts.

Gasoline or Diesel Powered

Prices begin at \$169.50
WRITE FOR CATALOG

D. W. ONAN & SONS INC.
2808 Royalston Ave., Minneapolis 5, Minn.

Thompson
BEATS the World on BOATS



Better Built Lower Prices



Canoes



Rowboats



Outboards

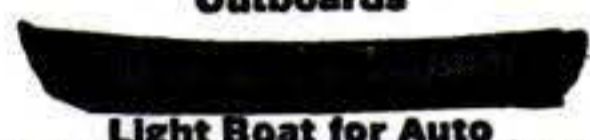

Light Boat for Auto

Safe Boats With Full Length Spray Rails
Keep passengers perfectly dry—even at high speeds. Catalog also shows two new models of "Take-Along" Boats. Two big factories—save you freight.

CATALOG FREE
Write for your copy. State kind of boat in which you are interested.

THOMPSON BROS. BOAT MFG. CO. (151)
219 Ann St. PESHTIGO, WIS. (Write to either place) 119 Elm St. CORTLAND, N.Y.

**TERRIFIC POWER, NO "PUMPING"!
WITH CROSMAN'S NEW CO₂ GUNS**



Amazing new "Power without Powder" principle adds new thrills to shooting the Crosman CO₂ Pistol and Rifle with safety indoors or out. See them at your Crosman dealers. Write for free literature. Crosman Arms Co., Inc., Rochester 7, N. Y.

TAKE 3-DIMENSIONAL PICTURES WITH YOUR OWN 35MM CAMERA

NOW ONLY (Outfit No. 101, was \$22.50 plus tax)

STEREO-TACH \$17.70
Plus \$2.09 Fed. Tax

and 3-D Slide Viewer complete. Make marvelous stereo color or b & w slides. Get Stereo-Tach from your dealer or direct. Money back guarantee.



Dept. PS6 ADVERTISING DISPLAYS, INC. Covington, Ky.

REAL ESTATE
BE A BROKER

PAYS BIG! SEND FOR FREE, BIG, ILLUSTRATED CATALOG NOW! No obligation. Graduates report making substantial incomes. Start and run your own business quickly. Men, women of all ages, learn easily. Course covers Sales, Property Management, Appraising, Loans, Mortgages, and related subjects. **STUDY AT HOME** or in our classrooms in big cities. Diploma awarded. G.I. approved. Nationally known.

WEAVER SCHOOL OF REAL ESTATE (Est. 1936)
15 E. Pershing Road Dept. P-1 Kansas City, Mo.

FREE BOOK TELLS HOW



TENTS & CAMPING EQUIPMENT

New Tents: 2-man mountain style nylon \$15.95; canvas \$11.95. 5 x 7 wall \$10.95 7 x 7 \$12.50. War Surplus, used, reconditioned: Pup tents, single flap \$2.95; double flap \$3.95 9 x 9 wall \$21.95; 16 x 16 \$32.95. Poles & Stakes included. Check or M.O. Money Back Guarantee. Free Tent & Camping Catalog

MOR-SAN-SALES 10-19D 50th AVENUE LONG ISLAND CITY 1, N. Y.

BRAND NEW



30 DAY FREE TRIAL
7x50 Prism BINOCULARS

Finest Precision Optics
Buy Direct From Importer
Money Back Guarantee

Many other models AS LOW AS \$6.00 * (* plus 20% fed. tax)

FREE Illustrated Catalog & Book, "How To Select Binoculars"
Dealers: Write for discounts.

7 x 50 \$36* with leather case

BUSHNELL Importers

43 E. Green St. Dept. P-8 Pasadena 1, California

Here's why millions of shooters prefer Remington "Hi-Speed" 22's



POWER—Ballistically balanced bullets, finest powder, uniform crimp . . . mean knockout *POWER*.

SPEED—Remington's progressive-burning smokeless powder provides increased acceleration for lightning muzzle velocity.

DEPENDABILITY—Nickel-plated cases are extra strong, extra safe. Feed and eject easily in any make of 22 rifle.

ACCURACY—Exclusive "Kleanbore" priming helps keep your gun accurate because it does not rust or corrode barrels.

For more shooting fun get Remington "Hi-Speed" 22's today!

Remington



"Hi-Speed" and "Kleanbore" are Reg. U.S. Pat. Off. By Remington Arms Company, Inc., Bridgeport 2, Conn.

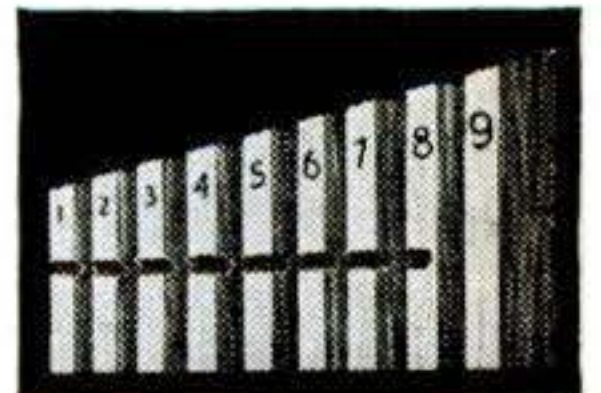

PENETRATION POWER. Remington "Hi-Speed" 22 drills through seven 7/8-in. boards at 10-yard range.



SHOCK POWER. This cake of soap was blasted by a Remington "Hi-Speed" 22 hollow-point bullet.

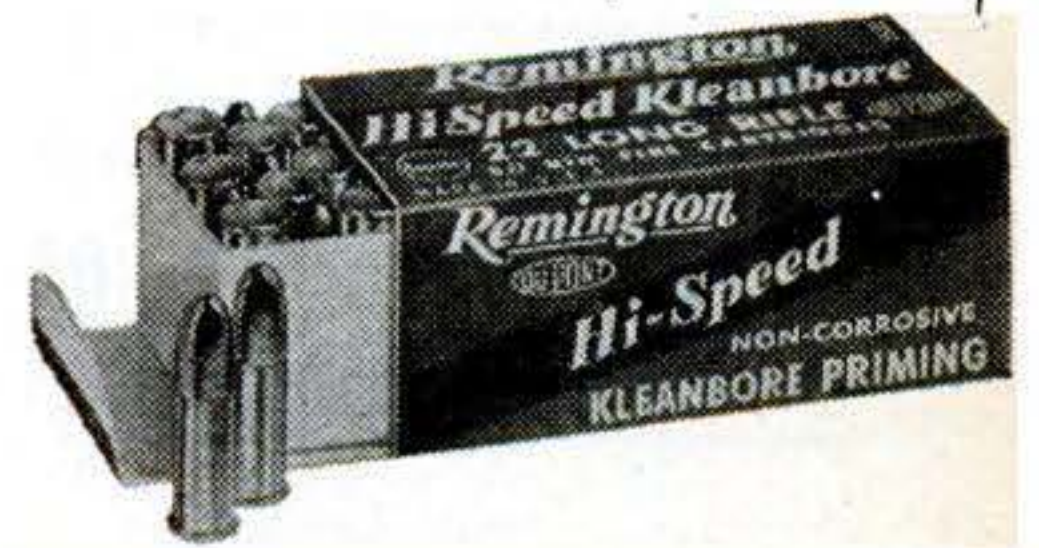

JITTERBUG TAKES CONTEST WINNER

Lou Hogue of Novelty, Ohio, who caught this 6-lb. 14-1/2 oz. beauty on a Jitterbug at Chipewa Lake to win the *Cleveland Press* Bass Contest, says "Day or night I always use a Jitterbug. Its erratic action gets Bass!"



NOISY SURFACE BAIT
3/8 oz.—Sinks slowly at rest
5/8 oz.—Floats

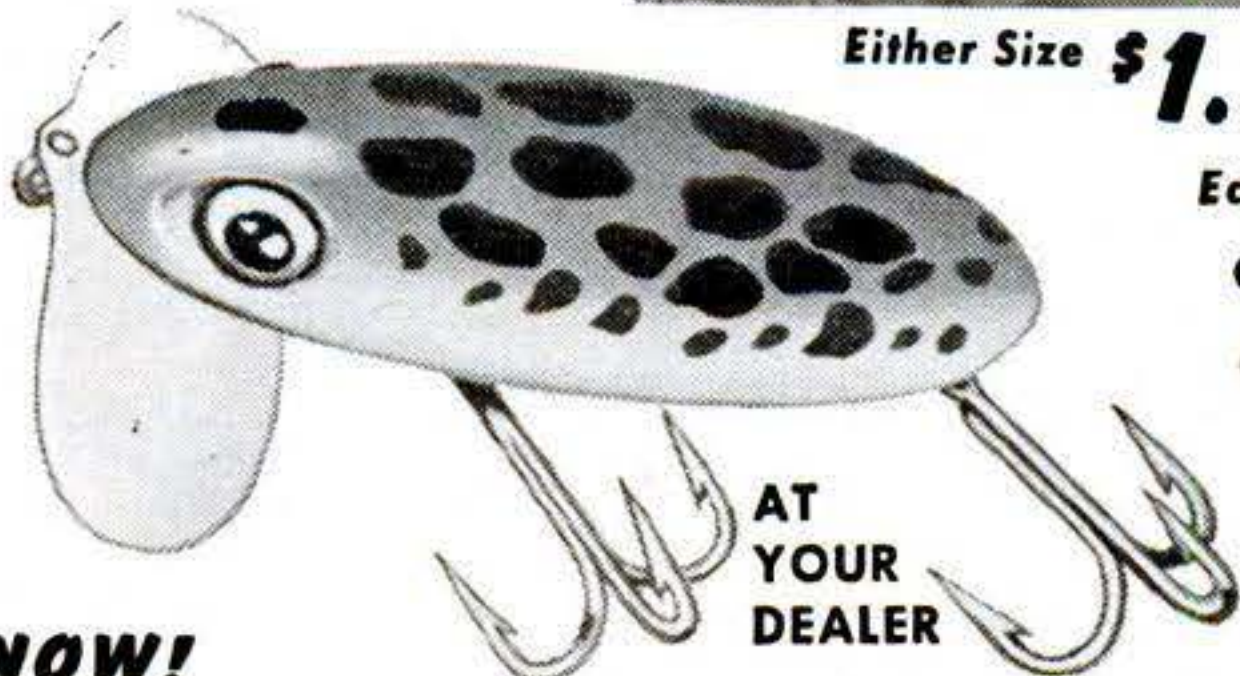

Either Size **\$1.21**

Each
Choice
10
Colors

AT
YOUR
DEALER

NOW!

Also in 3 FIREPLUG® FLUORESCENT FINISHES \$1.45 each.
▶ WRITE FOR FREE FULL-COLOR BAIT CATALOG ◀

FRED ARBOGAST & CO., INC.
1736 WEST NORTH STREET • AKRON 3, OHIO

NOW For The First Time YOU Can Get A HOFFMAN MOTORCYCLE

with Super Speed, Dynamic Power
Performance and Economical Operation



Full Year
Guarantee

From
\$199.95
Inc. Fed. Tax

Smooth, Safe Braking • Feather-light Steering

See the **HOFFMAN** at Your Dealer
or Contact the American Distributors

AMERICAN HOFFMAN CORPORATION
621 West 54th Street, Dept. C, New York 19, N. Y.

NEW CHRIS-CRAFT OUTBOARD MOTORS

FOR EVERY OUTBOARD MOTOR NEED

NOW, two great Chris-Craft Outboard Motors—popular 5½ h.p. and new, high-speed 10 h.p. models—to cover the complete range of outboard motor needs. Quick, easy starting; whisper-quiet operation at unbelievably low trolling speeds; almost vibrationless power flow at high top speeds; and smooth operation from idling to full throttle. Designed to give you years and years of outboard motor boating enjoyment. Built and backed by Chris-Craft, the world's largest and best-known manufacturer of marine products, your guarantee of a truly fine outboard motor. For world-famous quality, for proved dependability and superb performance, buy a Chris-Craft Outboard Motor. See your dealer today or send for free folder.



Chris-Craft
10 h.p.

Chris-Craft
5½ h.p.

FIRST CHOICE OF EXPERTS

Chris-Craft

OUTBOARD MOTORS

2000 BEVERLY, GRAND RAPIDS 9, MICHIGAN

Everybody's talking about a \$1,000 car - BUT ONLY CROSLY IS BUILDING IT!

Building cars in the \$1,000 price range is one thing. And we've built 70,000 of them. Announcing that you are considering building such a car is quite another thing. The Crosley is not a plan on paper or a showroom pilot model. It's a reality—the only \$1,000 car on the road today.

The Crosley car is not built to a demand that will reach a million cars a year in production. It's built for that one family out of a hundred, sophisticated, down-to-earth people who want 35 to 50 miles per gallon and other low upkeep features. It's built for intelligent buyers who want a new, shiny, practical car instead of someone's beat-up secondhand (or fourthhand) car.

The promises of a "big" car for less than \$1,000 create an unfair picture of the industry's ability to deliver more for the dollar than is humanly possible with current labor and material costs. You just can't build a big car and sell it at the price of a small car.



Drive the newest Crosley Station Wagon. All-steel, seats 4 or 2 with ¼ ton load.



CROSLY
A FINE CAR

"You see them everywhere!"

FREE! Latest 1950 CROSLY CATALOG. Write Crosley Motors, Inc., 2530-JS Spring Grove Ave., Cincinnati 14, Ohio.

1/3
USUAL
PRICE



7x50—\$30
Illustrated
Ht. 7 in.
Wt. 36 oz.

7x50 BINOCULARS

With COATED LENSES and PRISMS

Precision Optics \$30*
BRAND NEW

Highest optical performance. Over twice the light transmitting power of any 8x40, 10x50, 7x35 or 6x30, three times that of any 8x30, and eight times that of any 6x15 binocular. Fully corrected, needle sharp achromatic optics with wide angle of view. Lifetime aluminum alloy construction, leather covered.

OUTPERFORMS BINOCULARS COSTING OVER \$100

*20% Fed. Tax — Money Back Guarantee — We Pay Postage

BROWNSCOPE CO. Dept. 6P, 24 W. 45th St. NEW YORK 19, N. Y.

63% SAVINGS! . . . Army Type NEW ARCTIC SLEEPING BAGS!

- MONEY-BACK GUARANTEE
- Down & Feather filled!
 - Extra large! More foot & shoulder room!
 - Extra strong Talon Zipper closure!
 - Water repellent!

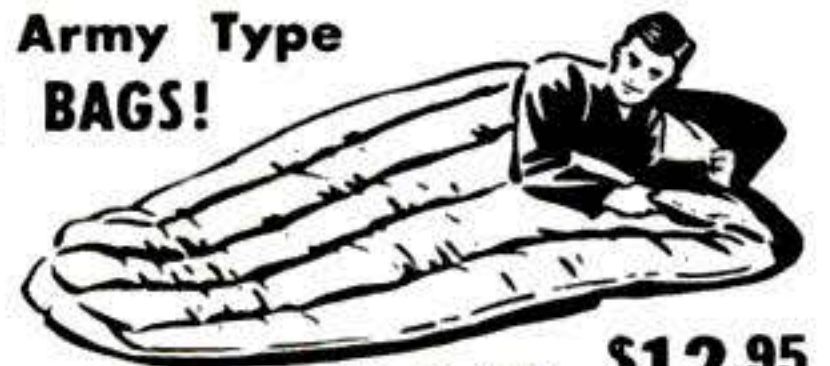

Worth \$35.... \$12.95

THE ELLIS GOLD COMPANY

Dept. B-4 86 North Market St. San Jose 22, Calif.
Kindly send check or Money Order . . .

FLATFISH! WORLD'S LARGEST SELLING PLUG!

Noted for its lifelike action. The only lure with offset hooking. That's why it catches 'em for keeps. World's largest selling plug. Made in 26 colors. Underwater, surface and trolling models, \$1.35 each. Musky, \$1.45. Flyrod size, \$1.10.

Send for FREE 48-page booklet, with plug-fishing secrets of famous anglers.



Free
CATALOG

HELIN TACKLE CO.
6342 Pulford Detroit 7, Mich.



GANGWAY! I'M DOING 50!

Large, easy-to-read dial gives speeds up to 50 mph on amazing new



New!
Colorful plastic with metal fittings!

Air-Flight
BICYCLE SPEEDOMETER

for bicycles, scooters, tricycles, motor scooters, etc. Uses same principle as aircraft air-speed indicators.

39¢

At dealers, or send 39c plus 6c for postage.

INSTRUMENT DIVISION
KNICKERBOCKER PLASTIC CO., INC.
4101 San Fernando Road • Glendale 4, California

PLYWOOD BOAT KITS

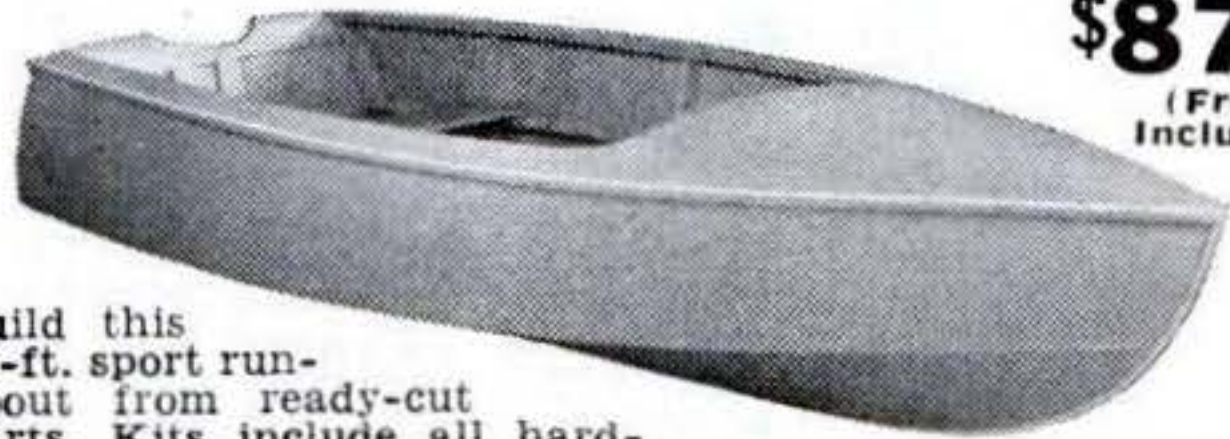

\$87.50
(Freight included)

Build this 12-ft. sport runabout from ready-cut parts. Kits include all hardware, paint, etc., to complete the boat shown. Send for free folders of all models as low as \$29.95 freight included.

TAFT MARINE WOODCRAFT
Dept. S, 636 39th Ave., N. E., Minneapolis 21, Minn.



FOR THE UTMOST IN MOTORING EASE
Drive By



HULL AUTOMOBILE COMPASS

Beaconlite Illuminated **\$5.95** Streamline Standard **\$3.95**

At your dealer's. Write for literature.
HULL MANUFACTURING CO., P. O. Box 246-E6, Warren, Ohio

Have Fun with your own Outdoor Fireplace



Build it Yourself — It's EASY

Everyone loves to cook and eat outdoors. For a fireplace that costs less and works right, just fit masonry to this Model OF-28. 21" high, 26" long, 13 1/2" wide. See your dealer or order direct. Send money order or check.

SEND FOR THIS BOOK OF DESIGNS 52 pages of helpful tips on fireplaces and outdoor cookery... Send 25c for your copy.



The Majestic Company
371 Erie Street, Huntington, Indiana

The Best and Safest For Your Boy

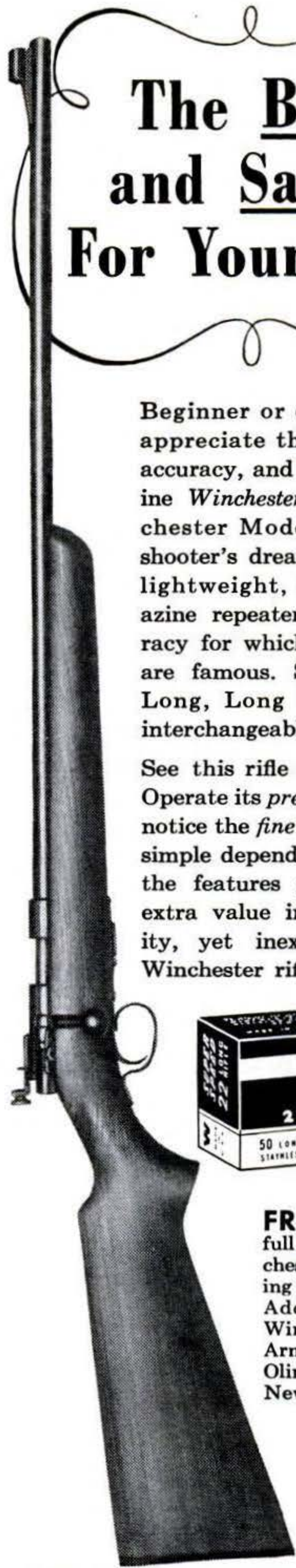

Beginner or expert, you will appreciate the extra quality, accuracy, and safety of a genuine Winchester rifle. The Winchester Model 69 is a young shooter's dream... a full size, lightweight, 5-shot box magazine repeater with the accuracy for which all Winchesters are famous. Shoots 22 Short, Long, Long Rifle cartridges interchangeably.

See this rifle at your dealer's. Operate its precision bolt action, notice the fine walnut stock, the simple dependable safety... all the features you recognize as extra value in this first quality, yet inexpensive, genuine Winchester rifle.



FREE! Folder giving full details of all Winchester 22 caliber sporting and target rifles. Address: Dept. 343-B, Winchester Repeating Arms Co., Division of Olin Industries, Inc., New Haven 4, Conn.



The World Famous Model 69
WINCHESTER
TRADE-MARK
SPORTING RIFLE

THOUSANDS BUILD AT 1/2 THE PRICE

20 MODELS U-MAK-IT BOAT KITS



**EASY
TO BUILD**

ROWBOATS

8 TO 14 FT.

Special Models
For Fishermen



PRAMS

OUTBOARDS

Fast Round or V Bottoms
12 TO 16 FT. Newest
Assembly Methods

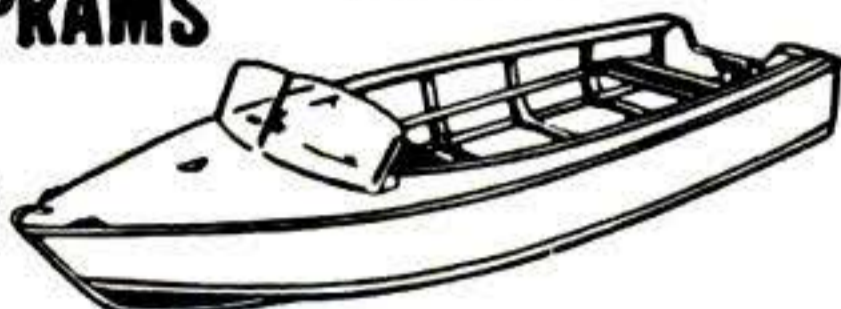

INBOARDS & CABIN CRUISERS

For Fishing, Racing or
Cruising 16 TO 23 FT.

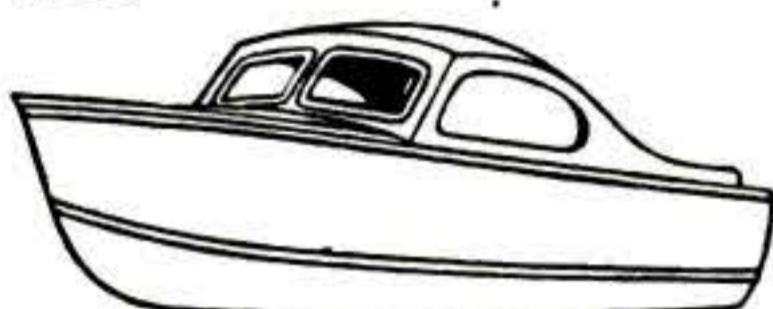

**SEND 25c (coin)
ORDER TODAY YOUR
NEW CATALOG**

U-MAK-IT PRODUCTS 703R-WHITTIER ST.
New York 59, N. Y.

Pioneers

Leaders

**AIR
RIFLES**

BENJAMIN

**AIR
PISTOLS**

SHOOT WITH SAFETY

BE SAFE—SHOOT WITH COMPRESSED AIR—ALWAYS READY
No Cartridges or Tanks to Replace or Recharge. If you want the most
PRACTICAL GUN to use anywhere—inside or outdoors—get a **SAFE—**
CLEAN—ECONOMICAL BENJAMIN with Adjustable Power and
Amazing Accuracy. Send for Free Folder of Latest Models Today.
BENJAMIN AIR RIFLE CO., 853 MARION ST., ST. LOUIS 4, MO.

BINOCULARS

BRAND NEW. Military type—Achromatic lenses! Have precision
ground optics, lightweight metal bodies. Moisture—Dust proofed.



7x35 Coated	\$49.50
7x40 Coated	52.50
7x50 Regular	42.50
7x50 Coated	49.50
10x50 Regular	52.00
10x50 Coated	62.00
12x50 Coated	65.00

6x25 Regular	\$26.00
6x30 Regular	31.50
6x30 Coated	34.50
8x30 Regular	33.00
8x30 Coated	39.50
8x40 Regular	46.50
8x40 Coated	49.50

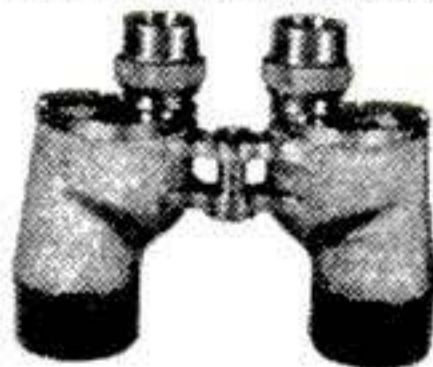

6 POWER PRISM BINOCULAR FITS PALM OF HAND



Coated! Dynamic in power. 370 ft. field at
1000 yds! Achromatic lenses. Individual
eye focussing. Weighs 4 ozs. All metal
construction. Adjusts all eye widths.
Quality binoculars that bear the **United**
seal on their frame. Because they are made
to rigid **UNITED** specifications. America's
leading binocular house—**\$19.50**
selling by mail since 1937.

All binoculars have individual eye focussing. Prices include genu-
ine leather case and straps.
TRY FOR 20 DAYS AT OUR RISK! If not fully satisfied return for
full refund! Cash orders rushed postpaid. On C.O.D.'s include \$2.00
deposit. Add Federal tax. **UNITED BINOCULAR CO., 7941 S. Hal-**
sted, Dept. ARF-2616, Chicago 20.

90 POPULAR SCIENCE

**THE MOST
POWERFUL
FLASHLIGHT MADE**

Yellow-Flash-8

2,500 foot beam
gives twice the
power of ordinary
camp lantern. Only
8" overall, yet takes
eight standard flashlight
batteries. 6-volt lantern bat-
tery may be used. Adjustable
head, folding handles. Rust-
proof metal, bright enamel.
See your dealer.

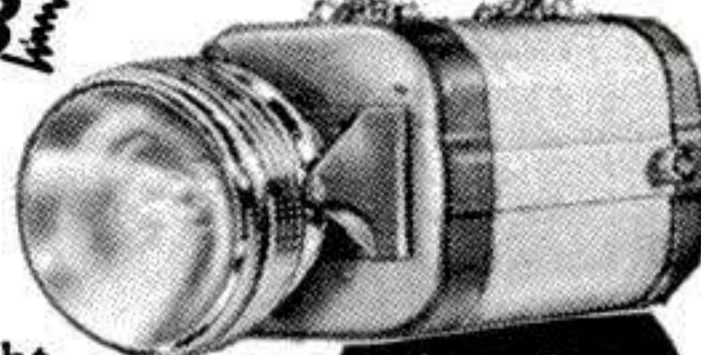

\$3.95

(less
batteries)

JUSTRITE MANUFACTURING COMPANY
2061 N. Southport Ave., Chicago 14, Ill.

REAL FLYING JET \$7.98

Ready-to-fly out of the box.
Nothing else to buy, nothing to
build. Includes finished jet-model plane, installed **REAL**
jet engine, fuel, etc. Fly your own jet-propelled plane.
3 to 5 minute flights at 500 ft. altitudes. Flashes thru the sky like
Air Force jet fighters—works on same principles. Order your
"Swisher" today. Write for free catalog or

SEND 10c FOR NEW MAMMOTH ILLUSTRATED CATALOG
OF THOUSANDS OF HOBBY ITEMS

AMERICA'S HOBBY CENTER, Inc., Dept. S-60, 156 West 22 St., N.Y. 11

BARBELLS

**95 lb.
SET**

\$10.80

Extra plates
10c lb.



Save Money—Buy the finest
barbell equipment direct from our
foundry—No other company can
match our low price or value!

Send to-day for our **FREE** Barbell Catalog

BUR BARBELL CO.
Lyndhurst 6, New Jersey

HERE IT IS

A MARVELOUS DREAM
COME TRUE

THE COMPLETE 2 TUBE RADIO
BUILT INTO A HAT!

the Man-from-Mars

RADIO HAT

COMPLETE WITH
BATTERY PACK

- Covers entire broadcast band within
20 mile radius
- Set weighs 5 ozs., hat, 7 ozs.
- Conceals in lining 1/4" thick
- Absolutely mobile, no extra aerial
needed
- Regulation waterproof sun helmet...
- adjustable size

- Volume & tone equal to many portables
- Breakproof tubes, rotatable Hi-Q
antenna, attached Tru-Fidelity earphone;
long-life battery pack

\$8.50 Postpaid
in U.S.A.
GUARANTEED

Send Cash. Check or M. O.

AMERICAN MERRI-LEI CORPORATION

BROOKLYN 33, NEW YORK

FORD - MERCURY OWNERS

Quicker Acceleration! Higher Top Speeds! More Gas Mileage!

Wohlfeil's new, special thin head gaskets increase compression
in your V-8 motor from 6.75 to 7.125 to 1 ratio. Easily in-
stalled by anyone. Money back guarantee.

Order Today. State year of car. **\$3.95** per
pair

Wohlfeil parts are standard equipment on
America's foremost racing cars. **postpaid**

WOHLFEIL DEE ENGINEERING
2274 S. TELEGRAPH RD. PONTIAC, MICHIGAN

NEW Time-Saving Wash-Mop for Home-Car Owners

"SPONG-IT"

Replaceable
DU PONT
Sponge

Brass handle
coupling fits
any garden
hose



NO-WIPE FLO-SPONGE

SCRUBS, WASHES & RINSES CAR IN 10 MINUTES

Clear water flows from supple
sponge, leaves surface spotless—no
streaking, no chamois needed. Can't
scratch cars, windows, boats, floors
etc. Fits into tight corners. Doubles
as superior wet mop. Special, long-
life, large DU PONT sponge replace-
able at cost under 1c per car wash.
Send payment with order to save

C.O.D. charges. **Satisfaction Guaranteed**

Dealer inquiries invited

SPONG-IT

Manufacturing Co.
HOLYOKE, COLORADO
DEPT. PS-2-W

\$3.95
POST
PAID

Cushman

MOTOR SCOOTER

Leads All Ways

Own-operate-maintain for less than 3/4c a mile! World's finest low-cost transportation! Easy to handle—starts fast, slips through crowded traffic. Parks anywhere. Wonderful for getting to work, school, market—doing errands, making deliveries. Many 15-year-old Cushmans still in use—new 1950 models greatly improved! Surprisingly powerful Cushman long-life engine. Comfortable. Safe.



- 75 Miles Per Gallon
- Up to 35 Miles Per Hour
- Powerful Cushman Engine
- Big Balloon Tires
- Heavy Brakes
- Many Models

FREE

See your Cushman dealer. Or rush card for Free Book.

RIDER AGENT PLAN AVAILABLE

CUSHMAN MOTOR WORKS, Dept. P6, Lincoln, Nebr.

HUSKY HITCH

WORLD'S FINEST TRAILER HITCH

Acts As Rugged Bumper Guard

FREE FOLDER!

Write, give car make, year.

HUSKY HITCH, Dept. PS-60, 118 E. Pomona Ave., Monrovia, Calif.

**NEW STREAMLINED TRAILER HITCH
CUSTOM MADE FOR YOUR NEW CAR!**



Handsome Husky Hitch is a heavy duty trailer hitch with boat keel design, railroad coupling construction. No extras to buy— everything furnished!

- Rust-proof hitch ball
- Smooth contours prevent snags
- Permanent gleaming chrome plate
- Hitch ball has removable cap cover

FREE Bargain Book



Packed with hundreds of sensational bargains—new and used—in still and movie photo equipment and accessories. Write for your free copy today to

Central Camera Co.
Dept. 10F, 230 S. Wabash, Chicago 4, Ill.

Photographic Headquarters Since 1899

SAVE 1/3 ON NEW POWERBIKE!

PRESTO—your bike's a speedy POWERBIKE when you install new POWERBIKE unit. Amazing new DIRECT FROM FACTORY PLAN now offers you speedy low cost transportation for only \$18.23 down. Send stamp for FREE PICTURE CATALOG.

SAGINAW PRODUCTS CORP.
113 River St. Saginaw, Mich.



Always mention Popular Science when writing

WANT DEVICES: LOOPS-KNOTS

string-threading, rotary printing presses, cylinder and platen presses; in greatly reduced sizes; also feeders, from rolls, sheets, or die-cutouts; eyelet fasteners, tag-patch re-inforcing; numbering presses, type-line duplicating, barb-threading. Paperboard straightener, from-rolls-to-sheets. May be old or new rigs, for private use. No patents, engineering or time and material work. Just old-fashioned gadget-making, for a price. Write Jul. Greenberg, 678 Bloomfield Ave., Montclair, N. J.



NEW 5 H.P.* JOHNSON MODEL TN



THREE WAYS BETTER!

- 1. NEW NEUTRAL CLUTCH**
Start in neutral. Idle. Flip the lever. Go! It's new—and wonderful!
- 2. NEW VARI-VOLUME PUMP**
Varies the flow of cooling water to the motor's needs—positive cooling at any speed. It's new—and wonderful!
- 3. NEW SURE-FIRE SHOCK ABSORBER DRIVE**
Absorbs the impacts of underwater obstructions. Forget about shearing pins in shallows. It's new—and wonderful!

Drive it and marvel! See your Johnson Dealer. Look under "Outboard Motors" in classified phone book. Time payments.

FREE HANDY CHART
Latest edition. Full details on the 5 great Johnsons for 1950 (2.5 to 22 H.P.*) including the sensational 10 H.P.* Model QD with Gear Shift Control and separate, plug-in Mile-Master Fuel Tank. Write. Sent free.

JOHNSON MOTORS
500 Pershing Road, Waukegan, Illinois
In Canada: Johnson Motors, Peterboro, Canada



JOHNSON

SEA-HORSES

for *DEPENDability*



* OBC Certified Brake H. P. at 4000 r. p. m.

TROUBLE

with your color shots?



Color can be cantankerous! But not when you expose with a WESTON. Your WESTON will give you correct camera settings . . . quickly and easily . . . for stills or movies. Ask your dealer for a demonstration.

WESTON

EXPOSURE METERS



The Meter Most Photographers Use

NEW PACKAGED BOATS

1950 KITS

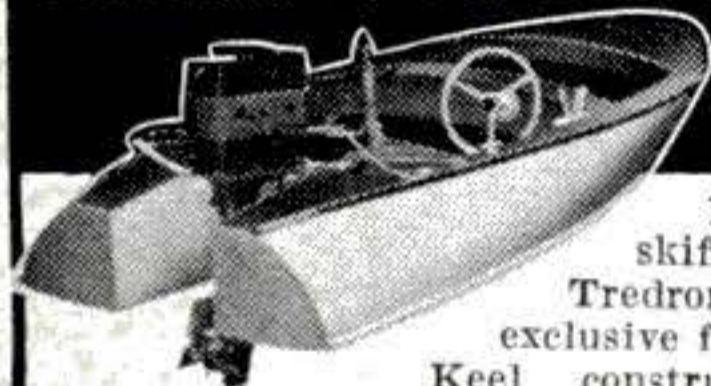

17 New models. Improved design, skiffs, outboards, inboards, sail boats. Tredronic racers, cruisers. 8 to 16 ft., exclusive features. Preassembled frames, Tri-Keel construction, Tredronic bottom, full length spray rails, widest beam, simplified construction, easy to build. World's best boat buy! Send 25c for new 1950 literature, or send \$1.00 for literature, plus booklet "Plywood Boats."

BOAT PATTERNS-BLUE PRINTS

1950 Catalog—over 100 modern designs by famous naval architects. Racing classes, cruisers, inboard, outboard, sail. 6 to 35 ft. Plywood—Steel—Plank. Construction plans, full-size patterns. Send 35c for catalog or \$1.00 for catalog and helpful booklet on "Boat Building."

MARINE MART-DEPT. 23-BUFFALO 7, N. Y.

SENSATIONAL

WORLD WAR II SOUVENIR

British Commando "Fairbairn"

FIGHTING KNIFE



\$2.95
Post paid

While they last ONLY . . .

Here is another import scoop by R. H. Vazquez & Co. The first time ever offered—the same knife used by British Commandos in hand-to-hand combat. Designed by Fairbairn, this knife is made of hi-quality steel, blade length 7", overall length 12". Metal handle, leather sheath with metal end.

We have purchased the entire available supply so that we could give you a rare and unusual bargain. Absolutely the most beautiful knife of World War II. Knives come blued or polished, state choice. Order today! Dealer inquiries invited.

Money Back Guarantee

R. H. VAZQUEZ CO.

Dept. PS-6, 972 E. Colorado Blvd., Pasadena 1, Calif.
SYcamore 3-0689



BULL DOG Hitches, Parking Jacks and Axles for all types of trailers!

Write for **FREE Catalog**
Hammer Blow Tool Company
Wausau 14, Wisconsin

Two New MARTIN BAIT CASTING REELS

with all the high quality that has made Martin Automatics famous for over 65 years. Fly-wate spool eliminates back-lash. Quick takedown without tools. Oilite self-lubricated bearings. Matched spiral bronze "Hunting Tooth Gears." Weighs only 4 1/2 oz. Write for free booklet.



MARTIN AUTOMATIC FISHING REEL CO., INC.
450 MARTIN STREET • MOHAWK, N. Y.

ASTONISHING New Pocket 6x15 PRISM

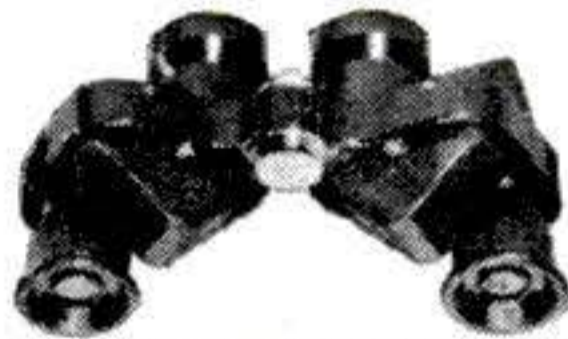

HOOVER, Importer, 1032

BINOCULARS—Powerful, handy. Precision made. Military type. Dust, Moisture Resistant. Ideal for Tourists, Hikers, Sportsmen (3 1/2" size, Flyweight, aids hunters). Athletic events. Ideal for Sportswomen. Individual Eye focus. This convenient powered Binocular—with soft leather zipper case. Fed. Tax included. Insured delivery, sold on money-back guarantee—ONLY . . . **\$19.95**

S.W. Jackson, PORTLAND 1, OREGON

STOPS DOG BODY ODOR FAST!

Fresh pine-needle bouquet makes dogs welcome even on humid days! Just rub soothing, refreshing, dry, Q-W PINE BAR on dog's back. Dogs like it. Not a soap. Lasts days. Adds sheen to coat. Stainless. 35c at Pet Depts., or send \$1.00 for 3 bars, postpaid, direct from



Q-W LABORATORIES
Plainfield 13, N. J.

Q-W PINE BAR

Take a "GYPSY VACATION" with a HARLEY-DAVIDSON *HYDRA-GLIDE*

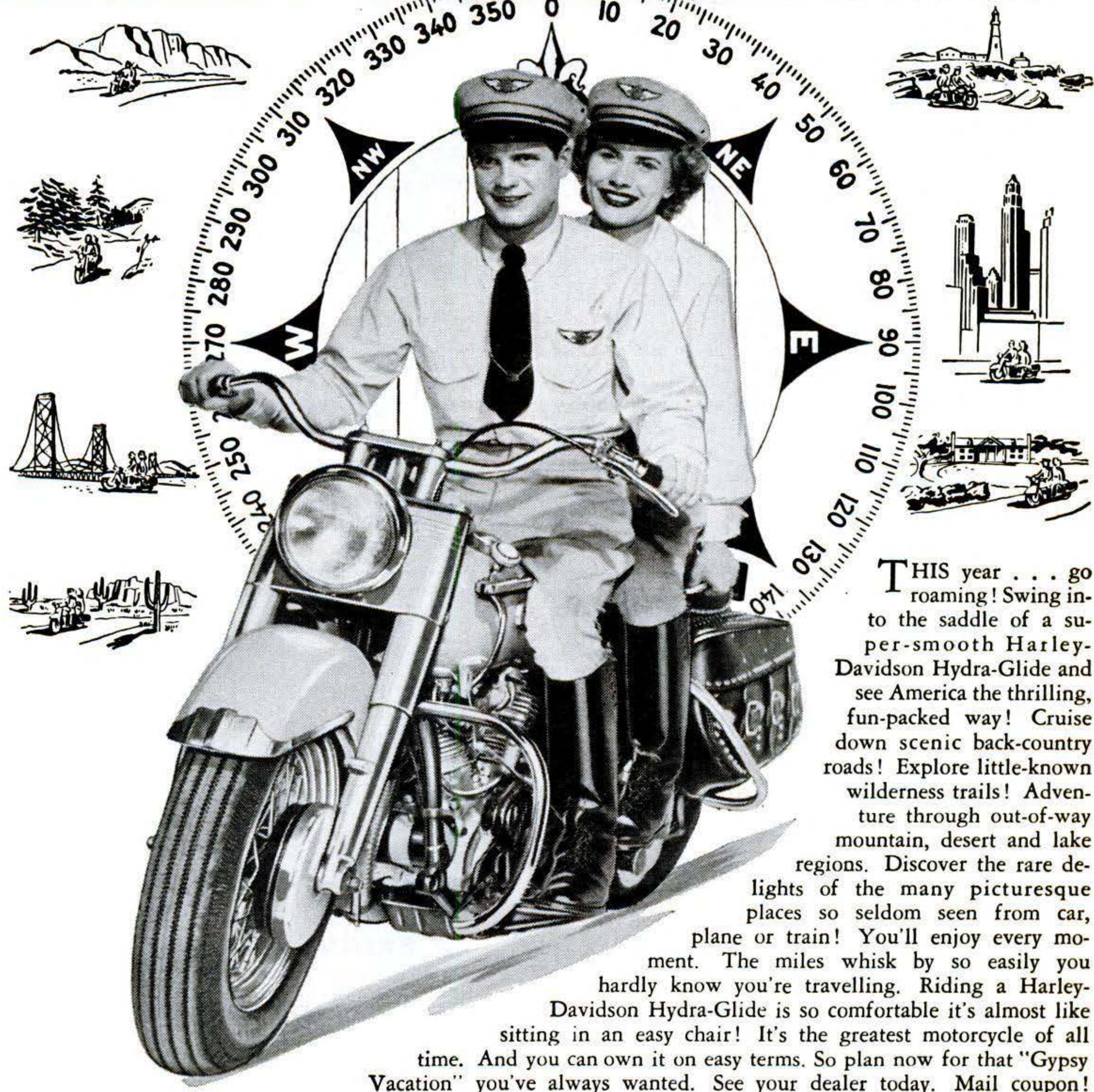

THIS year . . . go roaming! Swing into the saddle of a super-smooth Harley-Davidson Hydra-Glide and see America the thrilling, fun-packed way! Cruise down scenic back-country roads! Explore little-known wilderness trails! Adventure through out-of-way mountain, desert and lake regions. Discover the rare delights of the many picturesque places so seldom seen from car, plane or train! You'll enjoy every moment. The miles whisk by so easily you hardly know you're travelling. Riding a Harley-Davidson Hydra-Glide is so comfortable it's almost like sitting in an easy chair! It's the greatest motorcycle of all time. And you can own it on easy terms. So plan now for that "Gypsy Vacation" you've always wanted. See your dealer today. Mail coupon!

HARLEY-DAVIDSON MOTOR CO., Dept. PS, Milwaukee 1, Wisconsin
Send FREE copy of ENTHUSIAST Magazine filled with motorcycle action pictures and stories.



Name.....
Address.....
City.....State.....

DEALERS: Valuable franchises are now available for the full line of famous Big Twins and the 125 Models. This is your opportunity to line up with the greatest name in motorcycles. Write or wire for complete information today.

MOTORISTS! — TRUCKERS!

For easier, safer driving, check these Sparton accessories from the complete line of Sparton automotive equipment. At all good dealers'!



Sparton Tornado All-Electric Air Horns

Smartest on the road

EXTRA-POWERFUL, extra-clear *twin trumpet!* In gleaming, streamlined, chrome-plated design, for outside mounting. Connects with electrical system. No motor tapping. Costs less than many single-trumpet horns. Skippers' pride on boats, too . . . carries miles over water.



Polavision Rear-view Mirror

Sparton polarized mirror

SAVE YOUR EYES, perhaps your life. Sparton patented polarized rear-view mirror cuts blinding, reflected glare by 80%, lets you drive in ease. No finger flicking or adjusting. No other mirror like it. Available for trucks, buses: rubber-rim, rectangular Polavision mirrors.

CUTS REAR-VIEW MIRROR GLARE 80%!



Series 900 Class "A"



Series 500 Class "B"

Directional Signals

Approved in most states that require approval

Series 900, Class "A"

New type left and right flasher. Shell and rim bonderized. Rust-proof, dustproof, shakeproof. Visible 1500-1800 feet in daylight.

Series 500, Class "B"

New flasher type. Special signal lenses. Patented angular widespread visibility. 1000-foot daylight visibility. Over-all dia., 4".



Fog Lamps

Trim, shallow design for new lines. Chrome-plated, with brass doors and housing. Sharp, penetrating horizontal beams. Models adaptable for splash pan or body mounting. Sealed beam amber or white lens.

Our 50th Anniversary Year

Sparton

SPARTON AUTOMOTIVE
Division of
THE SPARKS-WITHINGTON COMPANY
JACKSON, MICHIGAN

One complete line . . . one reliable source. Makers of quality safety signals since 1900

BIG PROFITS FOR YOU

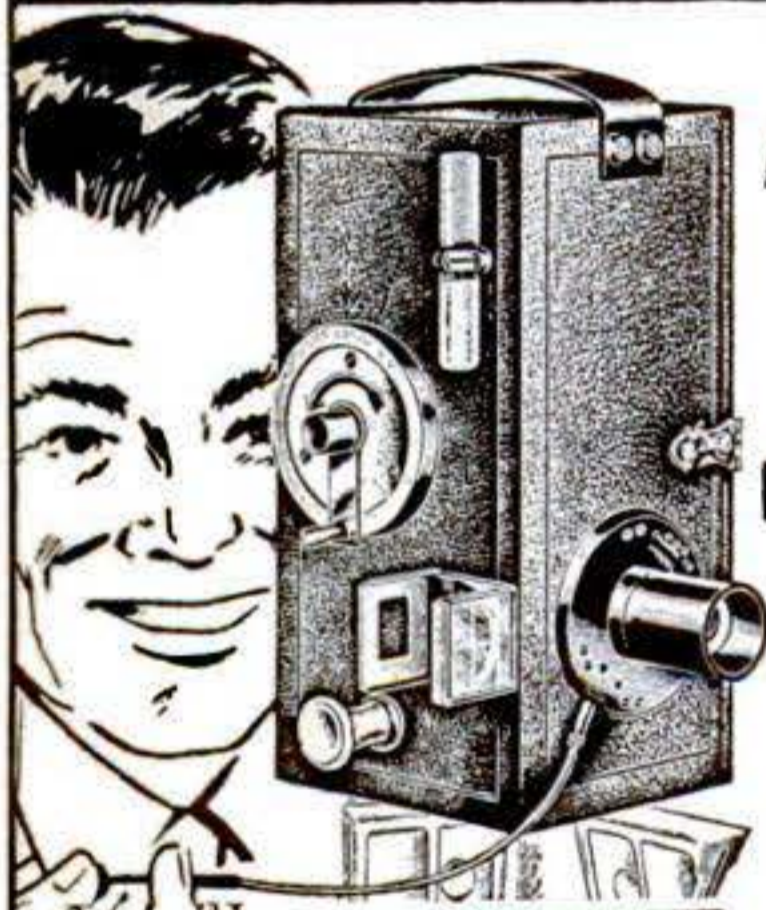

Making Finished Photos in 2 Minutes!
Wonderful Photo Invention
PDQ CHAMPION PHOTOMASTER

COMPLETE PORTABLE PHOTO STUDIO

Size 4 1/2" x 5" x 10"
Weighs only 6 lbs.

Takes and finishes 30 to 40 photos an hour

OVER 700% PROFIT!

Beautiful, everlasting photos — black and white or sepia, size 2 1/2 x 3 1/2 in. Guaranteed not to fade. No dark room needed. Photos are taken DIRECT on "SUPER SPEED" direct positive paper. Loads enough paper for 50 shots in half a minute — in broad daylight.

BE A P.D.Q. PHOTOGRAPHER

No experience required. Simple directions teach you quickly. Work at home or travel. Make expenses plus extra profits. Pictures cost you only 2c. Sell for 15c to 25c. Folks just grab for 'em. They are amazed to see their own photos come to life in broad daylight. Photomaster "shoots" any subject — individuals or groups — buildings and scenes. This new and fascinating business offers unheard-of money-making opportunities everywhere — every day throughout the year. **DETAILS FREE! WRITE**

PDQ CAMERA COMPANY
1161 N. Cleveland Ave., Dept. PS-6, Chicago 10, Ill.



ONLY 2 SHINES A YEAR AND SHE GLEAMS LIKE NEW!

\$1.00 BRINGS YOU BOTH CANS!

Yes sir—give your car the glow that rests your elbow! Use LACQUER CLEANER, the amazing pre-wax cleaner, and LACQUERWAX, the famous car finish protector. It's 5 times faster and easier to apply than ordinary paste waxes. One treatment lasts 4 to 6 months.

LACQUERWAX contains no lacquer, but this hard, liquid wax is CLIMATEPROOF! Its brilliant luster shines right thru hot sun and driving rain. You can't wash it off—it won't spot! It brings out and preserves the full beauty of your car's finish. Use the LACQUER CLEANER first to remove dead paste wax and dirt, then LACQUERWAX for the beauty treatment. BOTH 10 oz. cans for ONLY \$1. Mail coupon NOW!

LACQUERWAX CO. Dept. PS-6
HARTFORD 3, CONN.

Gentlemen: My dollar bill, check or money order is enclosed for the 2 ten oz. cans—LACQUERWAX & CLEANER.

Name

Address

City..... Zone.... State.....

LACQUERWAX

You say you want more for your money...



See these great .22 repeaters by

Marlin

Look at these big-value beauties! Each is a marvel of modern production methods. Each is traditionally sturdy, safe and dependable. Man-size, handsome firearms—pretested for performance at the factory—these Marlin Rifles give you years of sport and utility at nominal cost. See them today!

81-C packs a load for all-day hunting

18-25 shot tubular magazine repeater. Shoots .22 short or long rifle—regular and high speed. Crisp trigger action—self-cocking—side ejection—positive safety—Seasoned Walnut stock. Rocky Mt. rear sight—Bead front sight. Also available with hooded ramp front sight, peep sight, swivels; at slightly higher cost. A honey for hunting and all around sport! \$27.15*

88-C, America's sensational new 15-shot automatic

Smooth, rapid, automatic action; independent safety. Lightning-fast firing of .22 long rifle ammunition, regular and high speed. Positive safety—loads through end of buttstock. Foul-proof. Hooded ramp front sight, Rocky Mt. rear sight. Seasoned Walnut Stock. \$29.95*

80-C for rapid-fire shots on small game

8-shot clip magazine repeater. Shoots .22 short or long rifle—regular and high speed. Sharp, responsive action—side ejection—positive safety—Seasoned Walnut stock. Rocky Mt. rear sight—Bead front sight. Also available with hooded ramp front sight, peep sight, swivels; at slightly higher cost. Ideal for small game. \$22.30*

** Prices slightly higher west of the Rockies and in Canada*

The Marlin Firearms Company
New Haven, Conn.

YOURS on request, full specifications on all Marlin Guns, with photo-illustrations, in new 80th Anniversary Catalog.* Enclose 3¢ stamp for postage and handling. Mail coupon to Marlin, Dept. 69, New Haven, Conn.

** Sample pack of Marlin Blades included with our compliments.*

NAME.....

ADDRESS.....



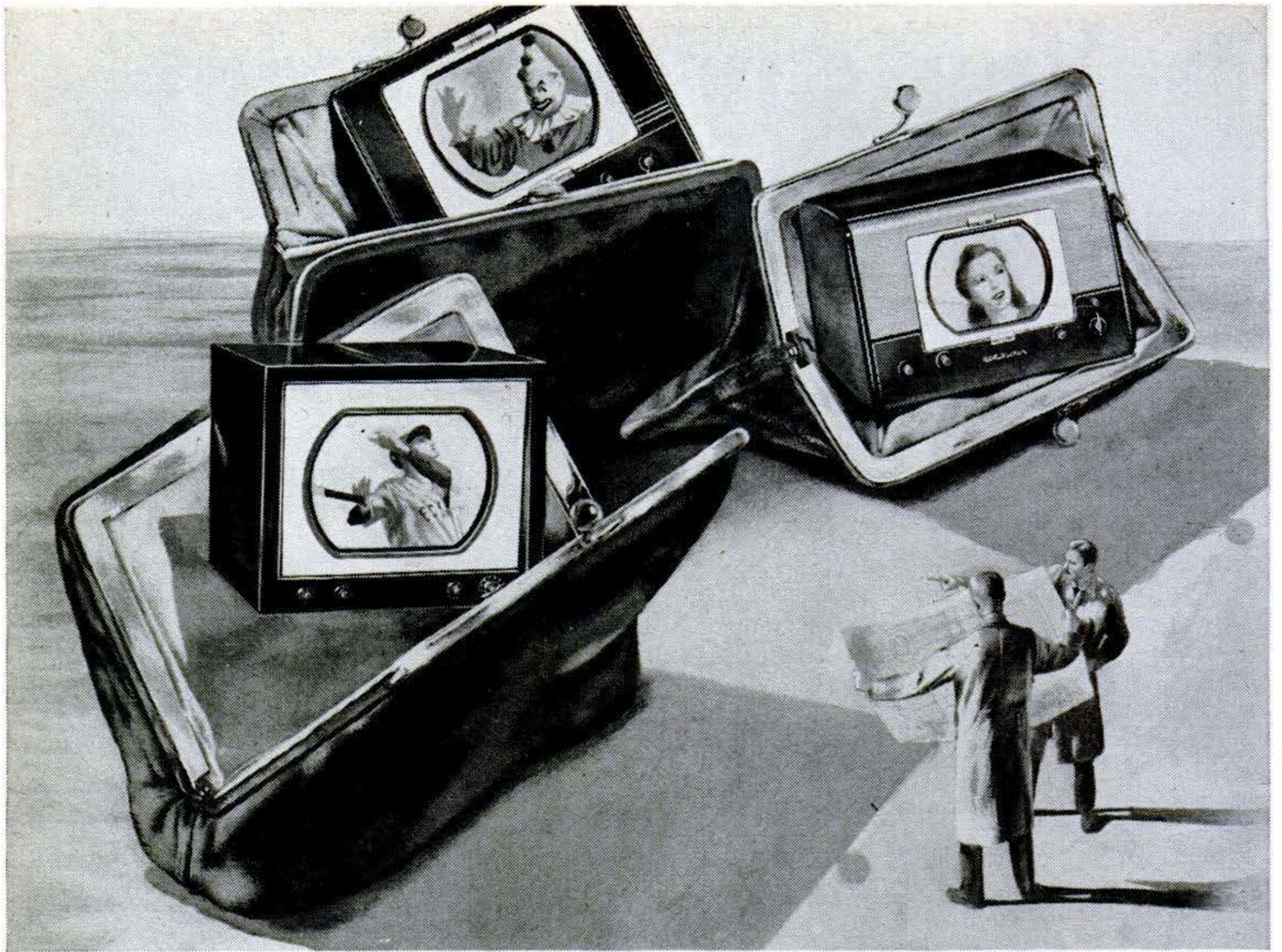

Developments by RCA scientists have made Television part of family life in homes of all incomes.

*How research fits television into **more purses***

Remember when television was "just around the corner," and guesses at receiver cost ranged to thousands of dollars? Came *reality*, and pessimists were wrong. Home television sets were reasonable, have grown more so year by year.

One factor has been research at RCA Laboratories. In 1949, RCA scientists perfected the glass-and-metal picture tube—so adaptable to mass production that savings of 30% in tube cost were made. Again, these scientists and development engineers learned

how to replace complex parts with less costly, and more efficient materials. A third contribution was the use of versatile *multiple-purpose* tubes—so that one could do the work of several!

Most important, the savings effected by RCA scientists have been quickly passed on to you, the consumer. RCA Laboratories is a great center of radio, television, and electronic research. It is indeed an institution which fits RCA products into more purses!

See the latest in radio, television, and electronics at RCA Exhibition Hall, 36 West 49th Street, N. Y. Admission is free. Radio Corporation of America, RCA Building, Radio City, N. Y.

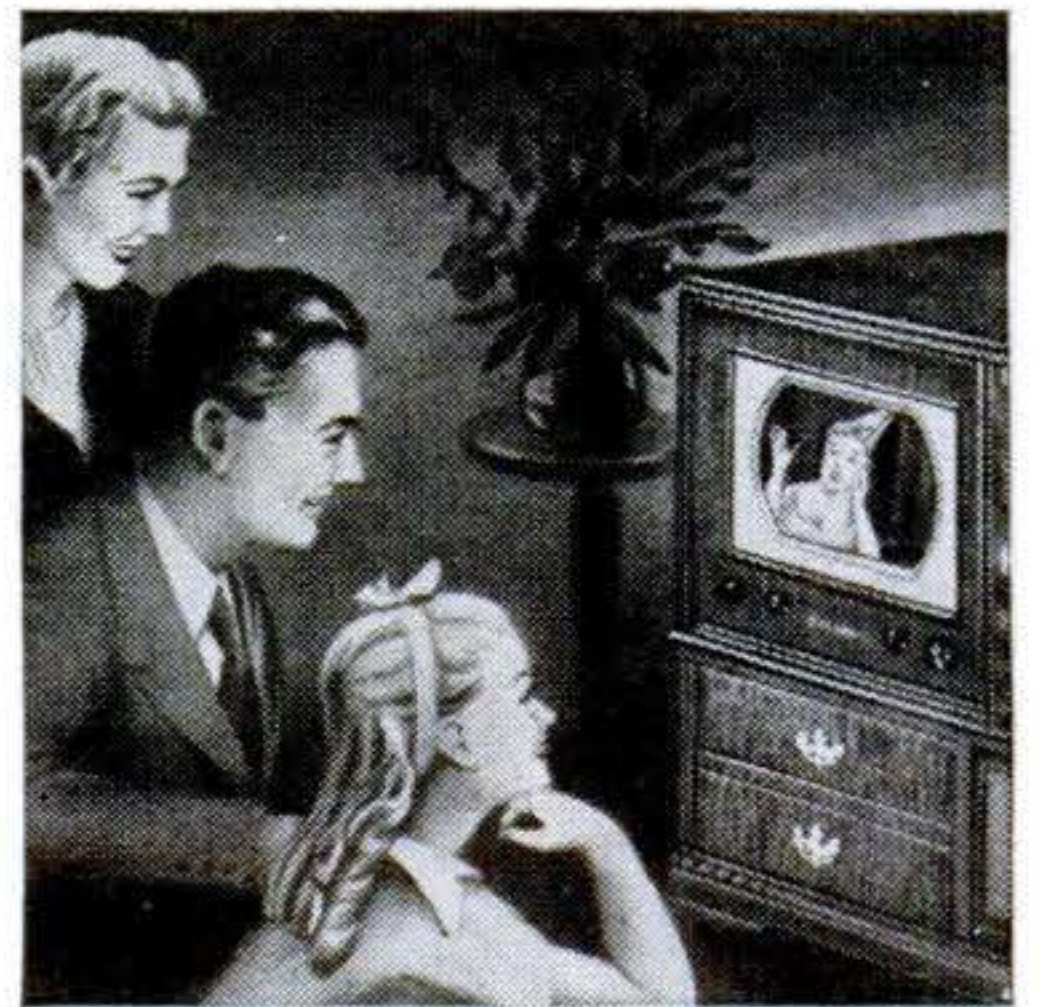

New RCA Victor 16-inch home television receiver, a leader in the 1950 line.



RADIO CORPORATION of AMERICA
World Leader in Radio — First in Television



Aiming Baseball Lights . . . At Cleveland's Municipal Stadium, where the Indians will play 24 night baseball games this season, a new lighting system virtually doubles former illumination. How Westinghouse engineers adjusted its 1,318 floodlights for maximum effectiveness is shown above. First they laid numbered disks on the field, at precalculated positions. Each disk served as a target for a 1,500-watt light, such as the engineer is seen aiming. Clustered in twos and threes, targets—these are on the right-field grass—are visible as small white dots.

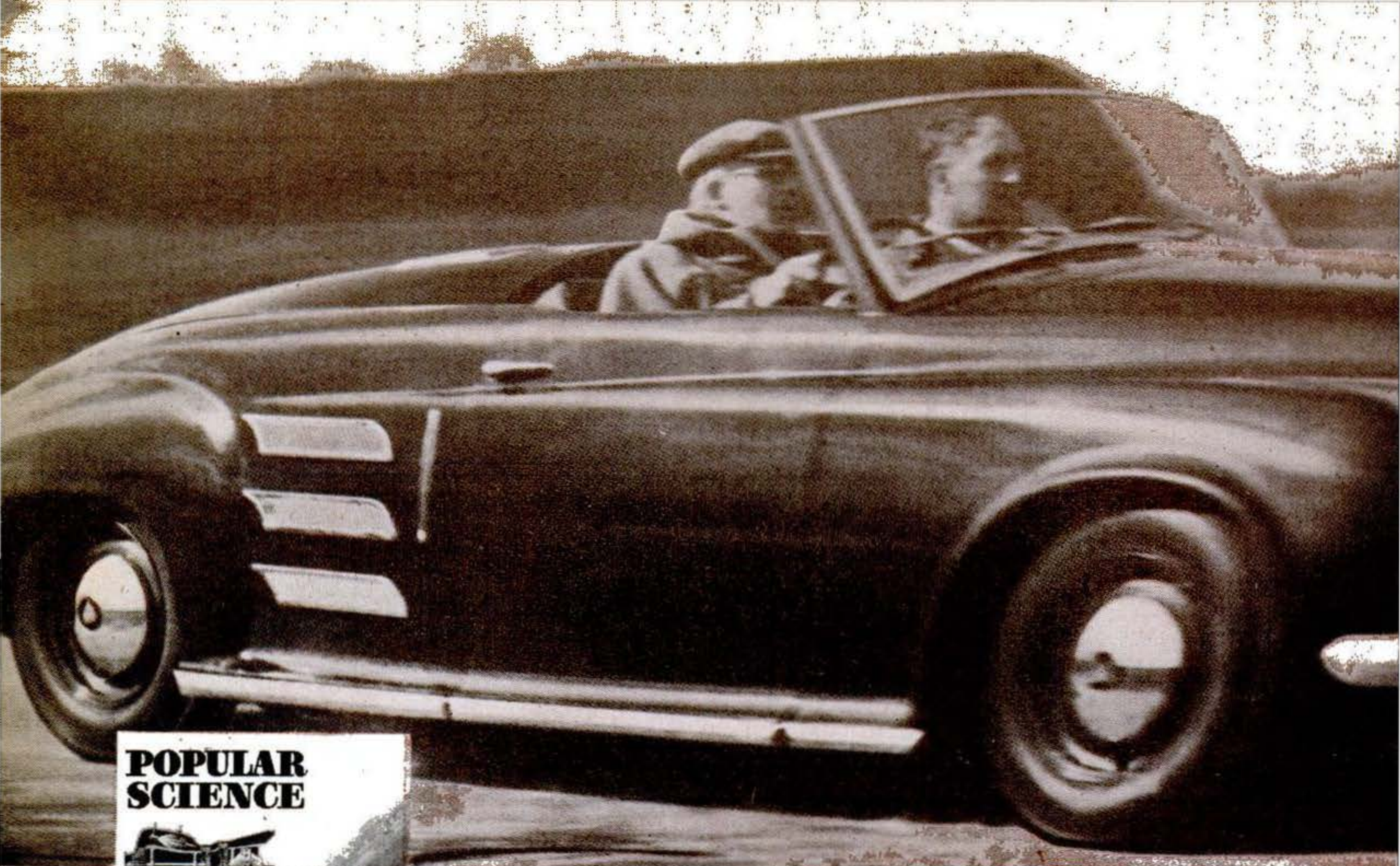

**POPULAR
SCIENCE**



Cover by Ray Ploch

World's first gas-turbine car achieved 90 m.p.h. on test track.

Will We Drive

Can the aircraft wonder engine earn a place on the highway? Both U. S. and British engineers think so.

Air intakes handle ten times amount of air required by piston engine of comparable power. Compressor rams this into combustion chambers at pressure of about 45 lb. per square inch.

LONDON, ENGLAND
NORTH of London, the other day, they tested out a brand new kind of automobile. It had no pistons and no cylinders. It had no carburetor. It had no crankshaft.

Exhaust issues at 100 m.p.h. It has no jet effect on propulsion. Windshield in top photo is replaced here with small windcreens. This photo and one at left are from *Mechanics*, London.

98 POPULAR SCIENCE

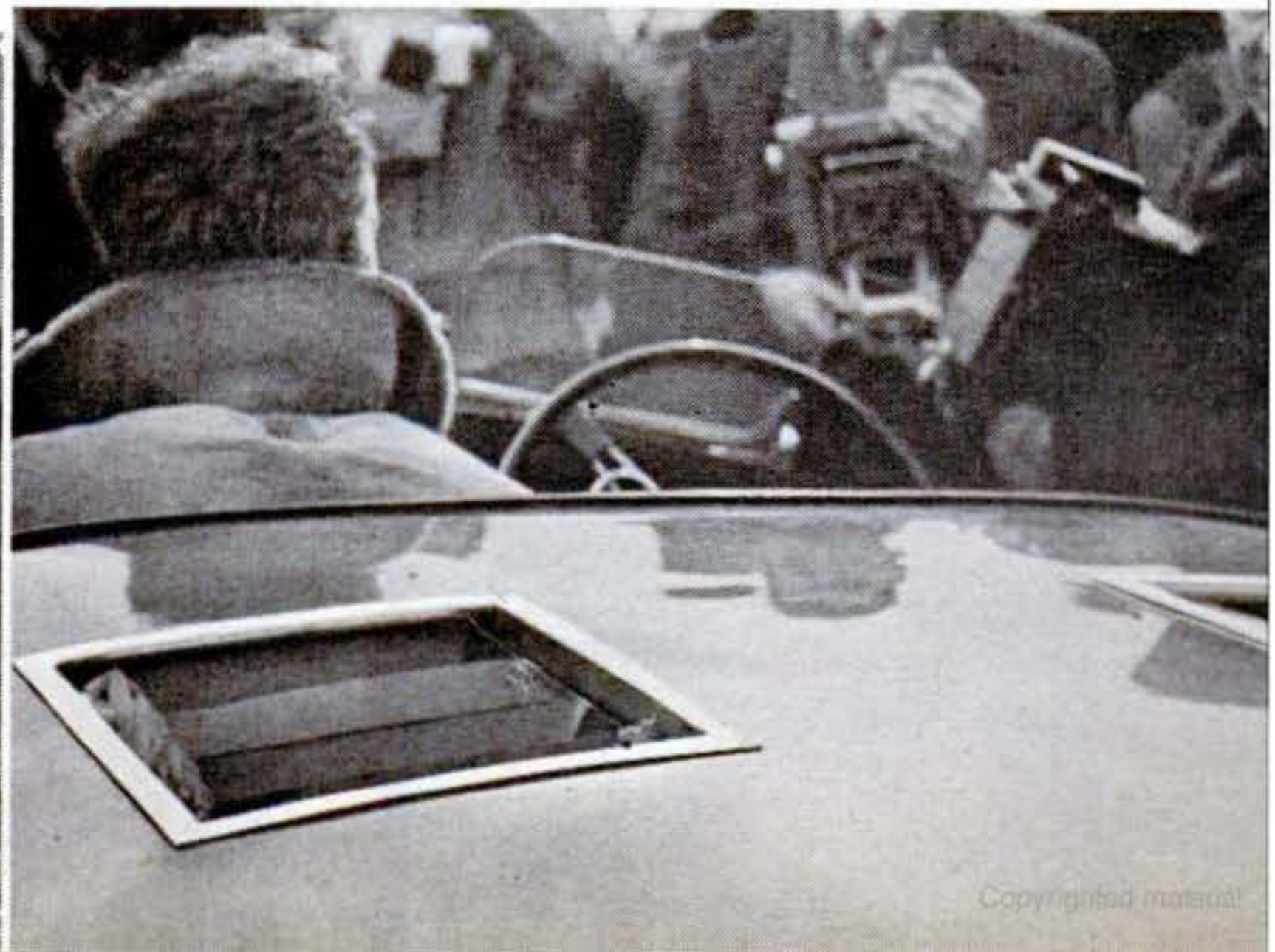
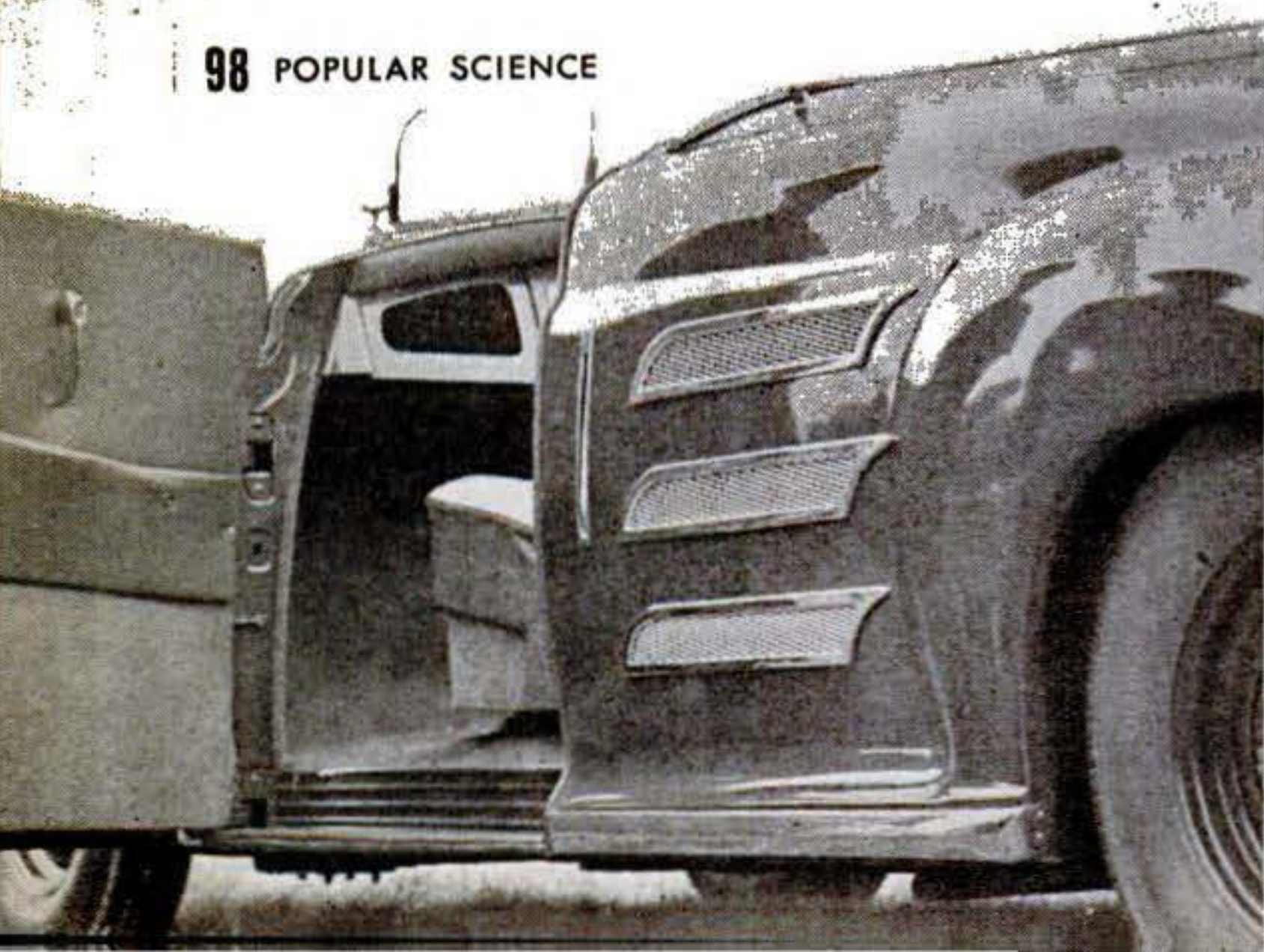

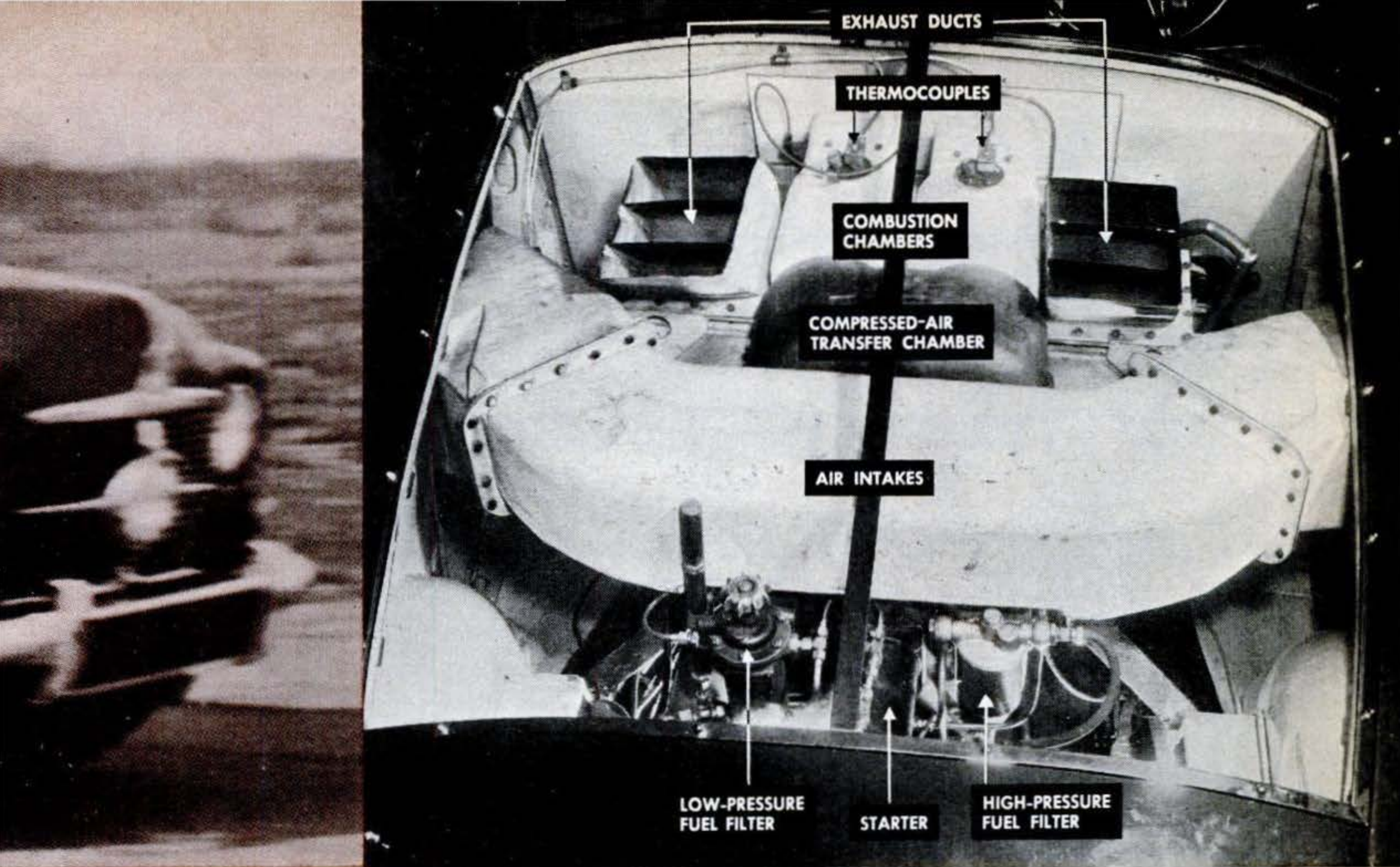

Rover engine is 3 feet long, 18 in. wide, and 20 in. high. Turbine wheels have 5-in. diameter.

Turbo Cars?

By Devon Francis

It had no clutch pedal, distributor, valves, radiator, or transmission. It had none of those conventional pulsing exhaust noises.

But it had performance.

It accelerated from a standing start to 60

Instruments on dash are largely for testing. Dials on production model would report compressor and oil pressures, compressor speed. Controls are accelerator, brake, reverse lever.

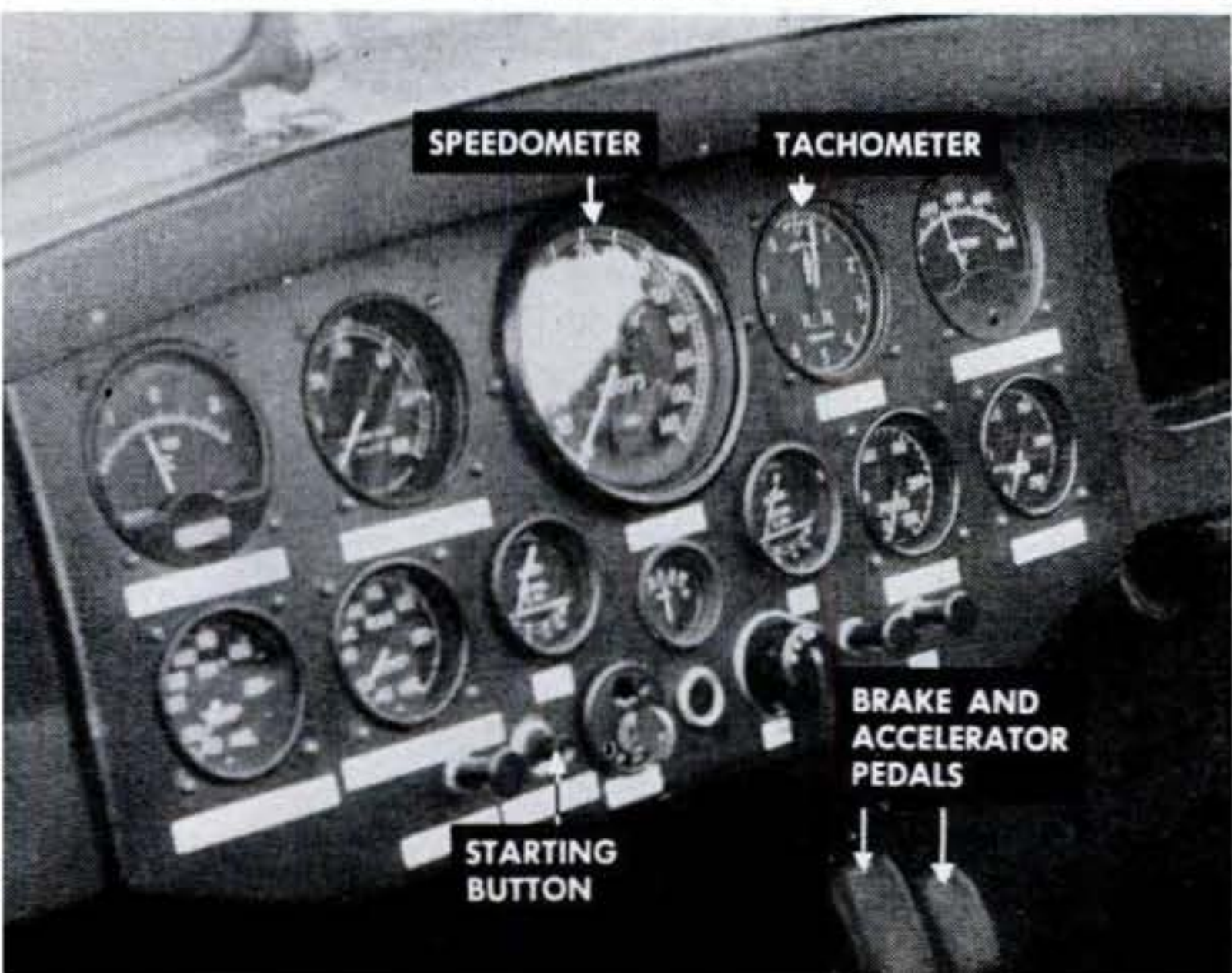

miles an hour in 14 seconds. It streaked up to 90 miles an hour with no apparent effort, and easily could have bettered 100. If it tended to "creep" at a standstill, a light pressure on the brake pedal would hold it stationary. The car had practically no vibration, moving or standing still.

Outwardly, it looked like a standard British-produced open car with the rear seat blocked off to accommodate an extra-long turtleback. It *did* smell of kerosene—that lowly product of crude oil—and that was the tip-off.

By coincidence, at the same hour, almost 6,000 miles away in Seattle, Wash., a 10-ton truck was cruising the highways under the thrust of a kind of engine that was brand new to truck wranglers. The weight of the engine was less than a twelfth of that of a Diesel of comparable power. It occupied less than a tenth of the space that would

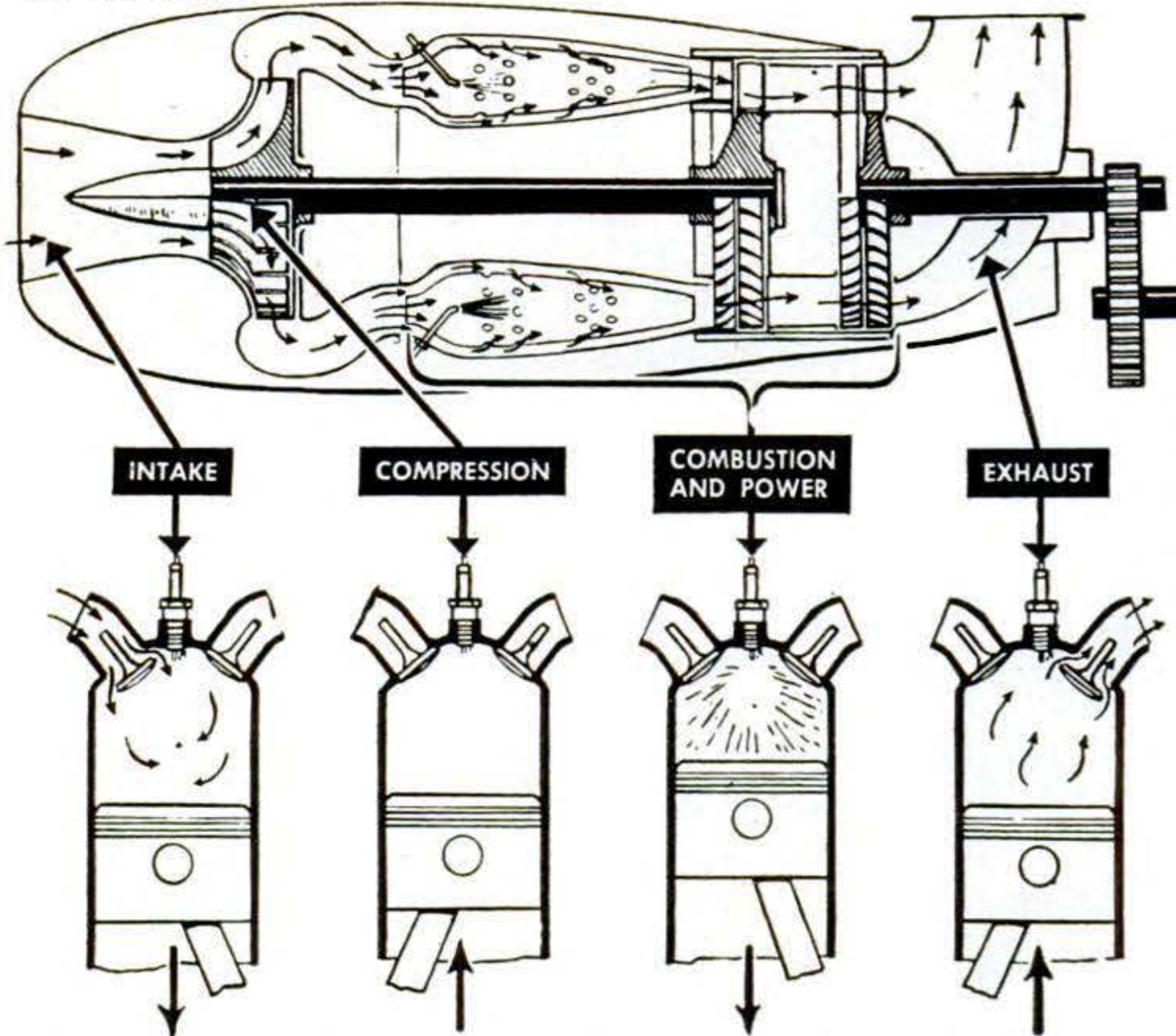

Gas turbine can be compared this way with piston engine.

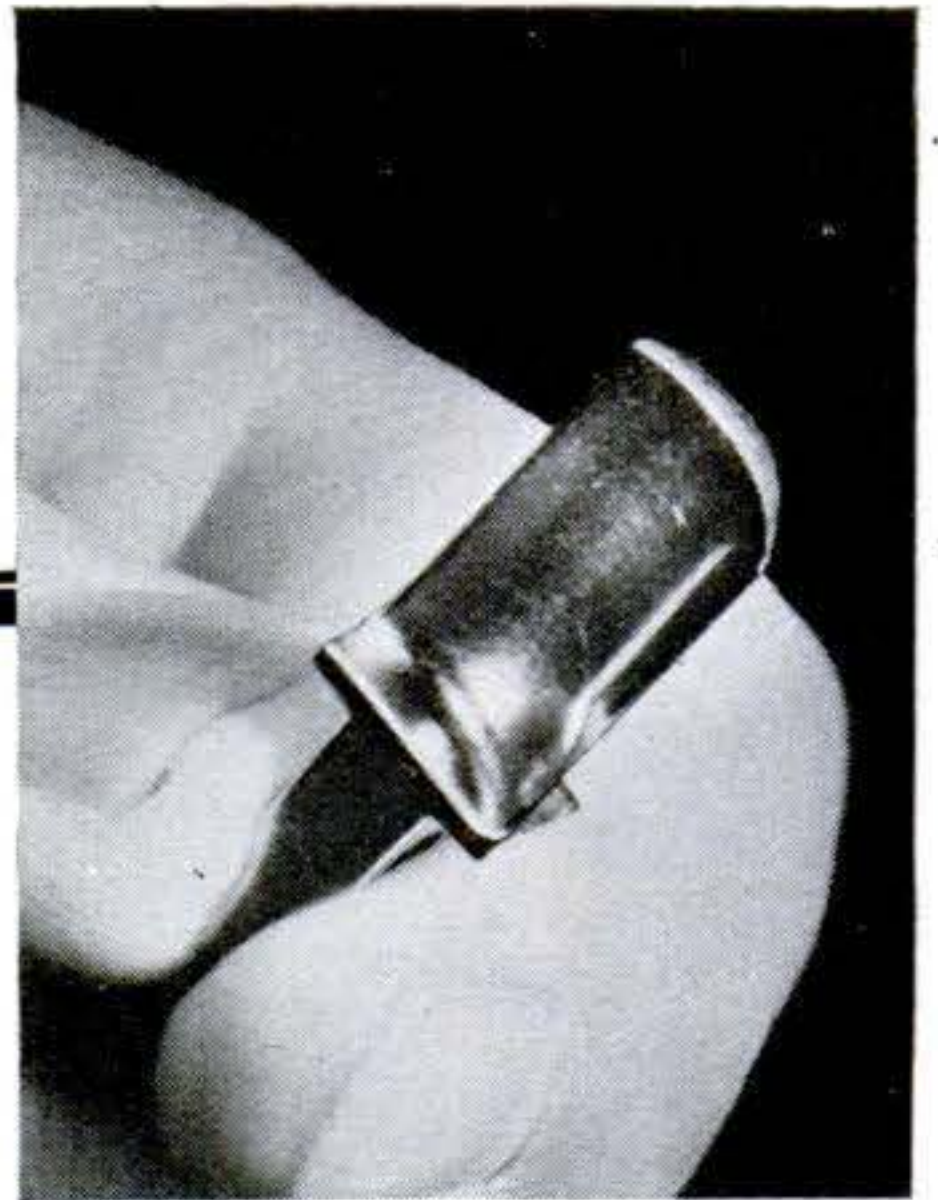

Sixty of these tiny blades are on perimeter of both compressor and power turbines of Rover engine. Made of "Ni-monic" nickel alloy steel, they must withstand constant gas blast of 1,500° F. Due to high speed, balance is big problem in turbines. Engine idles at 7,000 r.p.m., turns at 36,000 at car speed of 90 m.p.h.

have been taken up by a Diesel or gasoline engine and its accessories. It had only a tenth as many parts.

The truck, too, had a faint kerosene odor.

For the British automobile and the American truck had this in common: they were the world's first highway vehicles powered by gas turbines. They had engines that were close relatives of the engines that drive today's ultrafast fighter planes, some of the newest bombers, and that spectacular new British airliner, the Comet (PS, May '50, p. 98).

Boeing compressor, shown below with one of two turbines in engine, pumps air to combustion chambers at three times atmospheric pressure. Engine has diameter of 22 in. and is 42 in. long.

Contrary to newspaper accounts, this new automobile and new truck were *not* jet-propelled. They were not moved by a hot tailpipe blast. Instead, their turbines produced shaft power to drive the rear wheels.

Their turbines at full power whirred at an incredible speed for heat engines—from 36,000 to 40,000 revolutions a minute. In fact, that was three or four times as fast as current aircraft turbines.

The car and the truck represent the first basic change in automotive power plants since the invention of the internal combus-

Cutaway of Boeing engine shows compactness. It has an electric starter, 2 igniter glow plugs. Fuel system consists of pump, governor, spray nozzles. Top fuel pressure is 400 lbs. per sq. in.

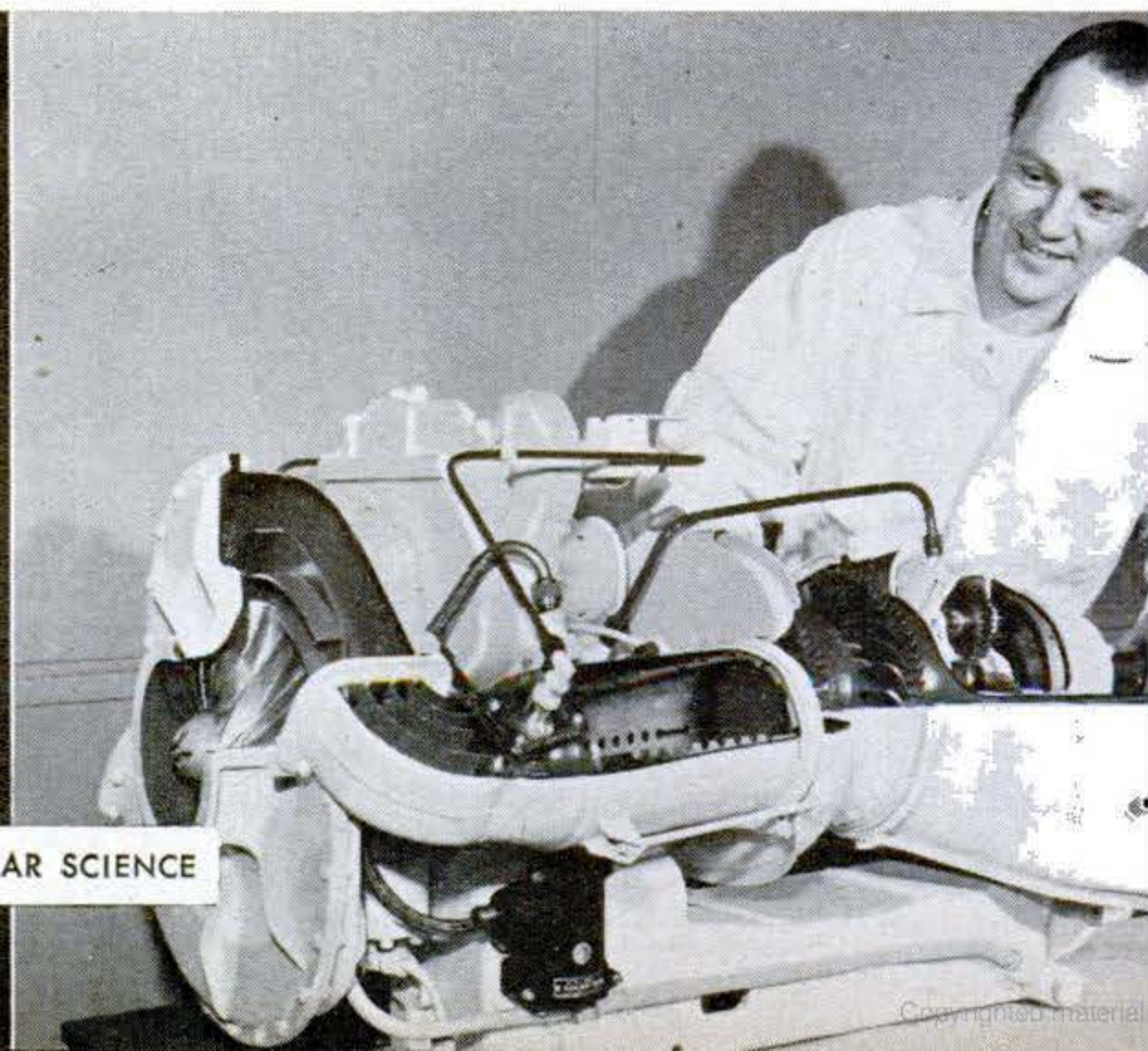

tion engine in the 19th Century. The car was designed and built by the Rover Company, Ltd., of Birmingham, England, as a "test bed" for road turbines (PS, Sept. '48, p. 138). The truck was powered by an engine designed and built experimentally by the Boeing Airplane Co., of Seattle, maker of the Stratojet, the world's fastest bomber.

The car and truck may bring a complete revolution in automotive power and design in the next five years—or less.

They may. No one knows just yet. There is a score of problems to be solved before the man on Main Street can walk into an

automobile showroom and order the turbine job with the chrome exhaust ports. Or the truck fleet owner can buy mechanical horses so compactly packaged that he can tote five to seven tons more cargo without increasing the length of his combo.

But those who have followed the progress of Rover and Boeing during the last couple of years are convinced that the day of turbine propulsion for passenger cars, trucks, and buses is almost a reality.

It wouldn't be surprising. The gas turbine as a replacement for the piston engine in aircraft is just coming into its own. The

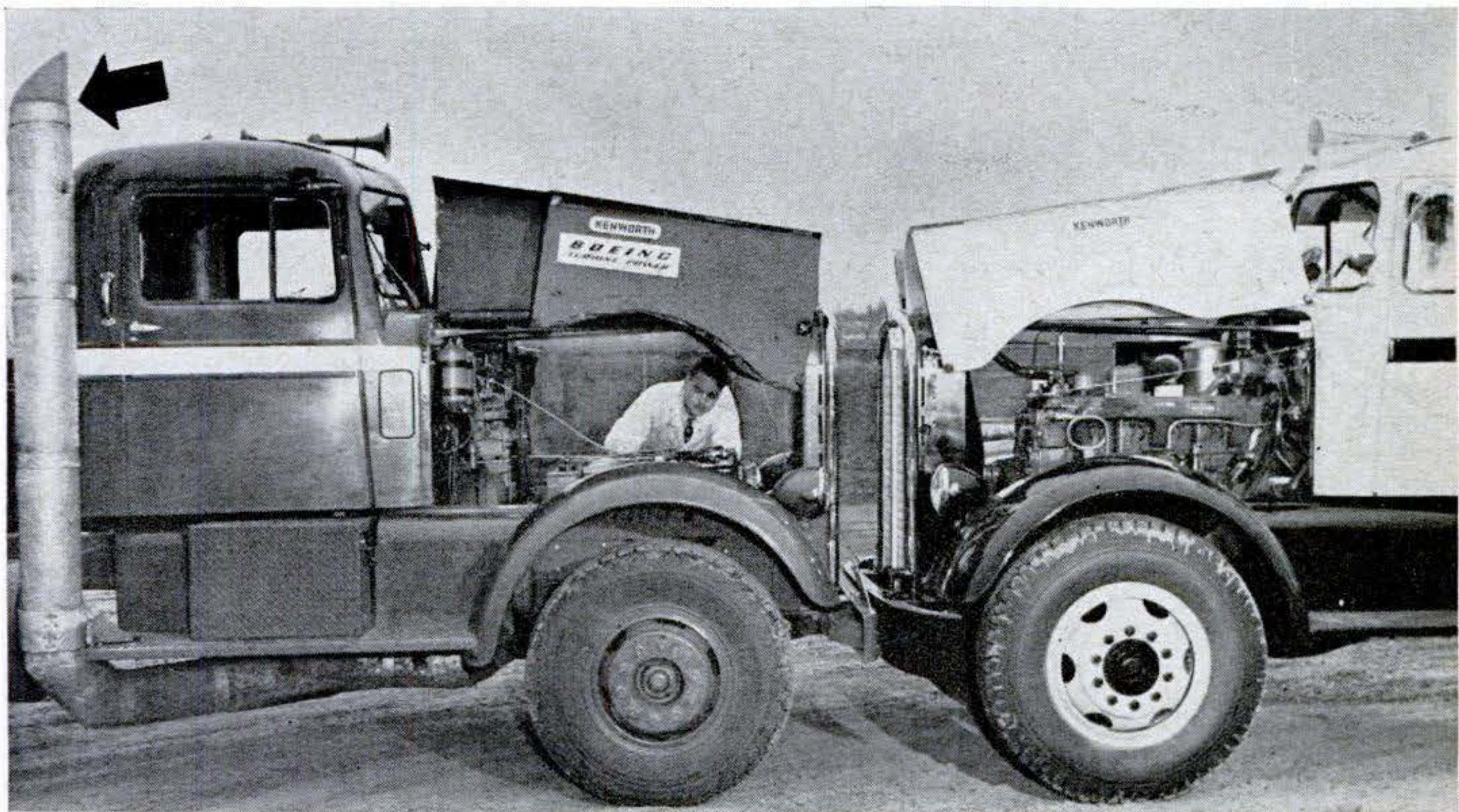

Turbine engine in truck is almost lost in chassis compared with Diesel at right. Vertical stack

at far left (arrow) is one of two for exhaust. Truck was made by Kenworth Motor Truck Corp.

Gas- and power-flow drawing of Boeing engine. It delivers shaft power via reduction gears.

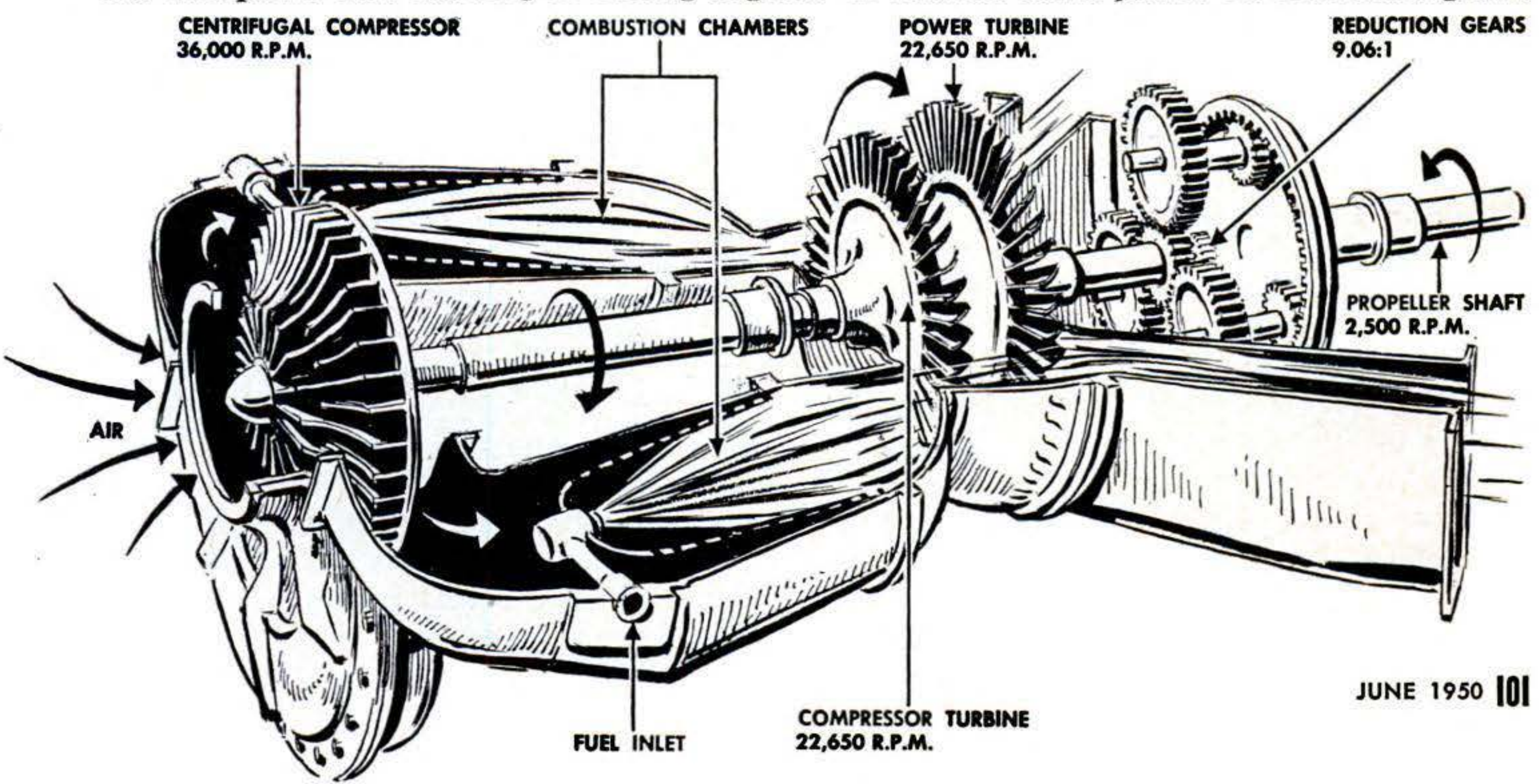

gas turbine as a shaft-power unit for propeller-driven aircraft will be flying the oceans as a "turboprop" in a couple of years. Both the steam turbine and the gas turbine have been adapted to railway locomotives. Turbines are an old story to ocean vessels. It's about time that rubber-tired vehicles got a crack at the turbine.

Like any gas turbines, the ones in the Rover and Boeing-powered truck are vastly

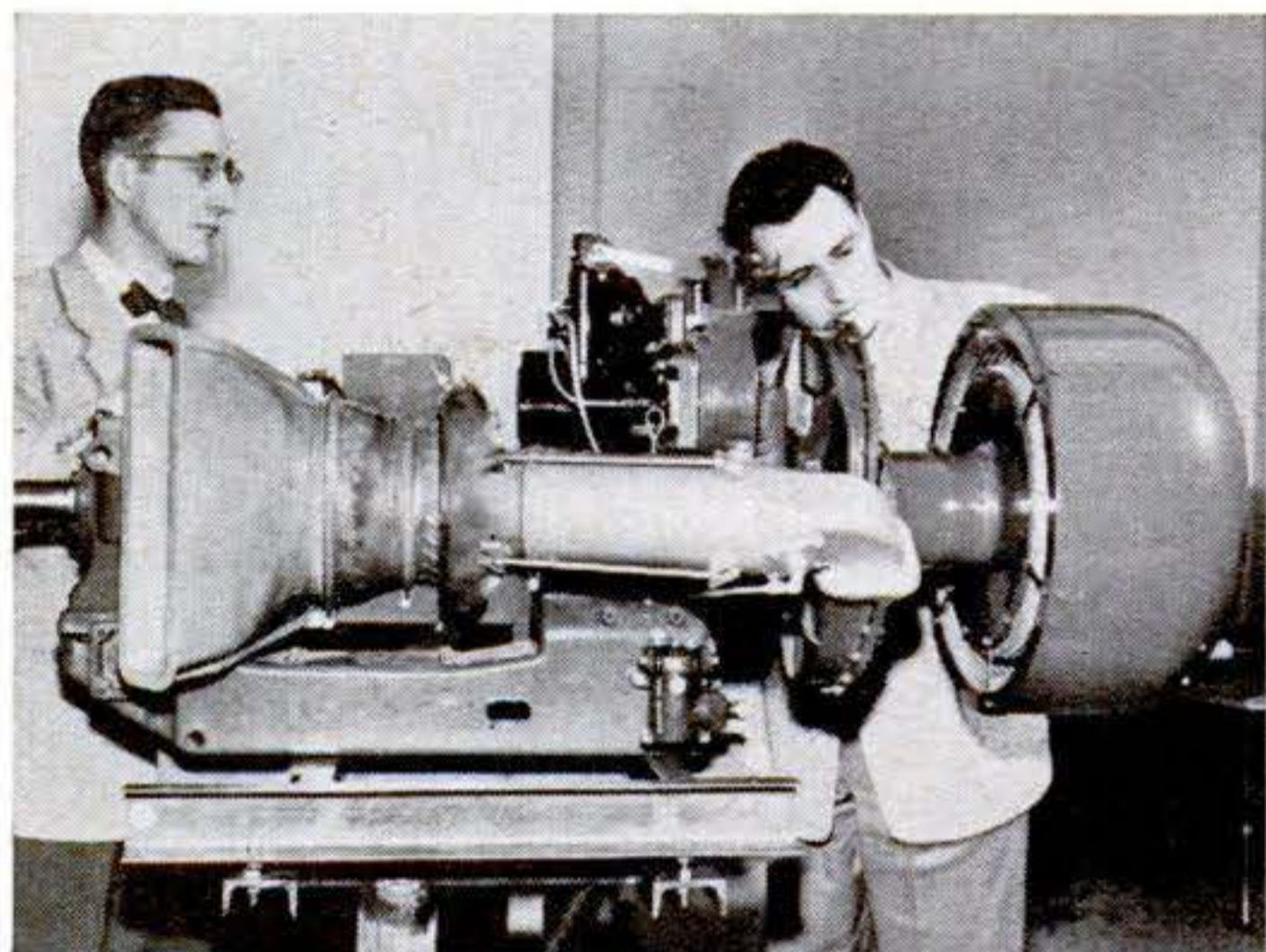

Boeing engineers have succeeded in silencing normal whine and roar of gas turbine through big muffler at far right. Turbine has been under development for U. S. Navy Bureau of Ships.

simpler than a piston engine. Substantially, they have only six parts—a compressor, two chambers to burn the fuel, a turbine to drive the compressor, another turbine to develop shaft-power, and two shafts. Three or four main bearings will take all the load of a turbine engine. There are no other bearings in the engine proper. There are no reciprocating parts. No pistons jump up and down. Moving parts rotate like an old-fashioned waterwheel.

The engine has only two "cylinders." In this instance the "cylinders" are a couple of containers where kerosene is burned as simply as in an oil heater. The compressor does the same job as the piston on the compression stroke of a reciprocating engine—it compresses air. Any engine must have a lot of air to burn its fuel, and gas turbines must have an extraordinary amount of air. They are pigs for air.

The *power* turbine is the gimmick, the key to the whole operation. The gases that have driven tornado-like through the compressor turbine attack the power turbine and spin it too. That produces shaft-power. Once you've got shaft-power, you can move something. Gear down the Rover and Boe-

ing power-shafts, and you've got torque for the rubber on the road.

It's no more complicated than that. The automotive turbine differs from an aircraft turbine in that it has *two* shafts. An aircraft turbine engine has only one. The reason for that is the same reason that a conventional automobile has a way of disengaging the engine from the rear wheels. If the automotive turbines were permanently geared to the rear wheels, it would stop every time the car stopped. So that second shaft, the power-shaft, is motionless when the car is at rest. Like the propeller shaft in a conventional car, it is in constant gear with the wheels. The shaft on which the compressor and the compressor's turbine turn isn't. It keeps going, whether the car is in motion or not. The *power* shaft delivers power as the driver needs it.

The power turbine revolves at a speed dictated by two conditions: the load on the engine and the amount of energy fed to it by the compressor. The speed of the compressor depends on the amount of fuel fed to the burning chambers. On a hill, the turbine, assailed by an inferno of gases, twists harder. In one sense, when the car hits smooth sailing on a straightaway the turbine becomes a "fluid" coupling between the



Within this quartz jacket, gas-turbine combustion is under study. Boeing engineer observes how and where burning occurs. Research is resulting in lower fuel consumption, higher power.

compressor and the wheels.

All that's on the plus side. So is quick starting, characteristic of the turbine engine. It will roll without a whimper at 65° below zero. It doesn't cough or die under load.

On the plus side too are the absence of a continuously operating ignition system, and the turbine's smaller size. Fitted with tur-

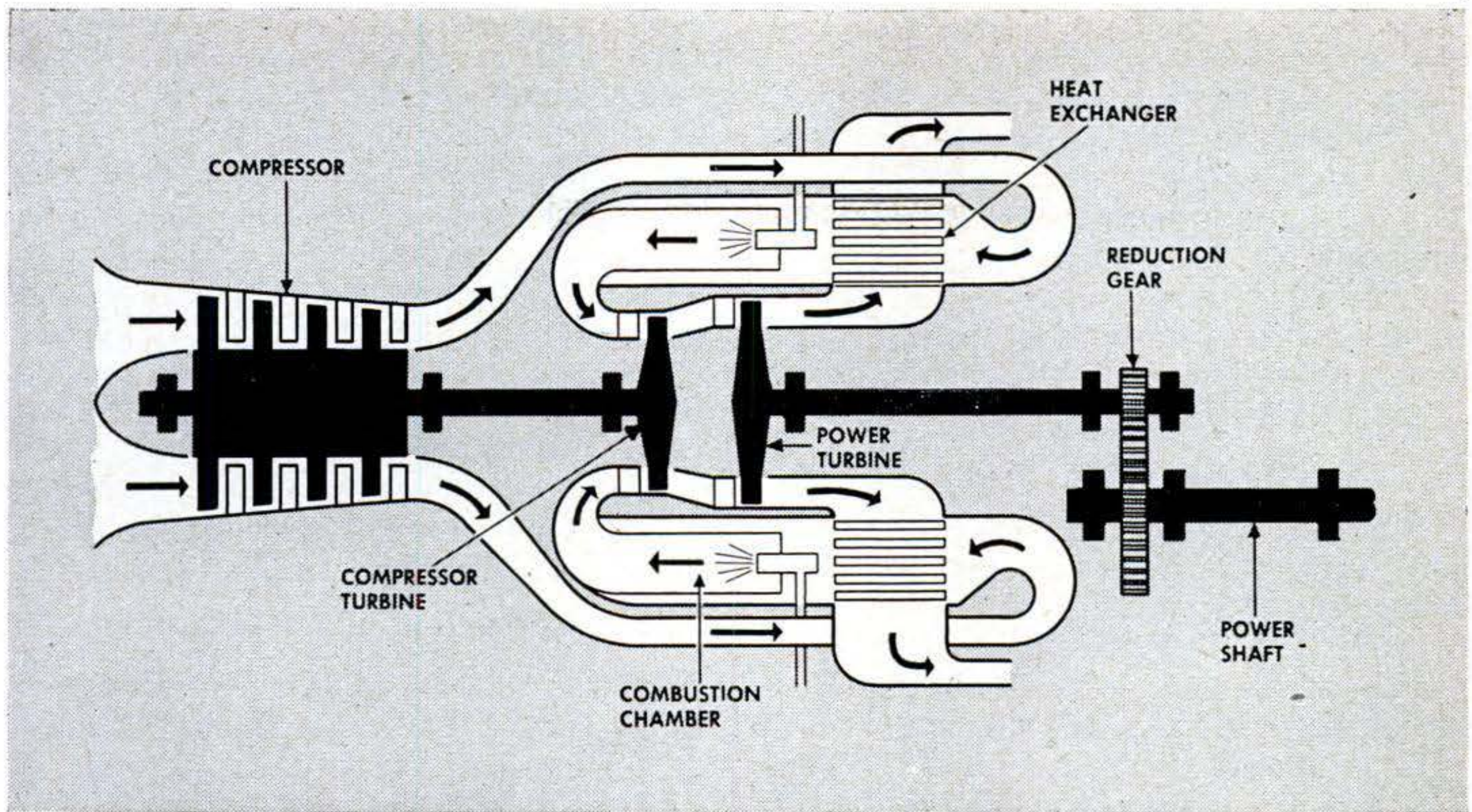

Diagram by R. H. H. Barr, British engineer, indicates how heat exchanger can be adapted to a gas-turbine engine. Power Jets, Ltd., of Lon-

don, pioneer in gas-turbine research for propulsion of road vehicles, holds copyright on drawing and concept of this type of engine.

bines, today's cars could be lowered several inches. Hoods could be shorter, increasing road visibility. Cars could be aerodynamically cleaner. There is no radiator to propel against the air.

The turbo car (as they are dubbing it here in England) can have a much lighter chassis without sacrifice of strength because the engine is light. That would boost fuel mileage. Moreover, it burns cheap fuel. A turbine will run on almost anything short of firewood. For railway use, they are even experimenting with powdered coal. Boeing proposes using natural gas.

Finally, sheer simplicity should make a turbo car's or turbo truck's maintenance costs considerably below those on a piston vehicle. Removing the Boeing turbine engine, dismantling it, inspecting it, reassembling it, and putting it back in the chassis is a job for one man—in just six hours. He doesn't even need a chain hoist.

Gas turbines supply extra dividends. The turbine-powered passenger car or truck doesn't need a special heater to keep its human cargo warm in frigid weather. Heat can be bled off the compressor at will.

All this sounds too good to be true. There has to be a catch somewhere. Actually, there are a good many of them. The biggest drawback to the gas turbine for road vehicles is that it does its best at near-maximum r.p.m. It falls down in its power

delivery at low speeds, or part-load, as the engineers say. And automobiles, trucks, and buses operate a lot more at part-load than they do at full load. The cure for this ailment may be a transmission, the same device that piston engines use to overcome their problem of low torque at low speeds.

Gas turbines are notorious for low fuel mileage. They develop a lot of heat but they waste too much of it. The Rover's engine, rated at 200 brake horsepower, gets around six miles to the gallon of kerosene. Using kerosene, the Boeing turbine, rated at 175 hp., is three and a half times more expensive to run than a Diesel.

There is a reason for that. It goes right back to that voracious appetite of a gas turbine for air. In a piston engine about 4,500° F. is developed in a cylinder head at the instant of fuel explosion, the start of the power stroke. The engine metals can stand this only because the explosions are intermittent. Water jackets, air, and oil keep carrying away the heat.

In a gas turbine there is *continuous* burning of fuel at about 3,500° F. There must be a great extra volume of air to *cool* the gas down to 1,500° before it is fed to the special-alloy turbines, so the metals can take it. That's where the loss occurs—most of the energy developed in burning the fuel to get gas volume and velocity to turn the power turbine is expended in turning the air com-

pressor. The engine produces shaft-power as a sort of afterthought.

The ultimate solution to better efficiency is better metals. The metallurgists are working on that one. Gas turbines will have to do a lot better in passenger cars before the crossroads of Great Britain and America grow forests of kerosene pumps. It may be another story on gas-turbine trucks, though. Fuel costs in trucking are the least of the operator's worries.

Preheaters May Help

Heat exchangers, transferring heat from burned gases to incoming air, will help fuel mileage. Preheating the air before it is burned may double the fuel mileage. That merely means better combustion, like getting a better draft in a fireplace.

There are other stoppers for the present. High engine speeds pose problems of exact balance or possible bearing overloads. Then, too, gas turbines don't do as well in summer heat as they do in the winter; the compressor can't bite thin, hot air as well.

For the first two or three seconds, acceleration from a dead stop is poor on the Rover. The engine is sluggish initially because it takes time to get the power turbine up to speed. But once it starts rolling, it goes. The jump from 10,000 r.p.m. to 15,000 takes just three seconds. Boeing

smartly put a gearbox in its job. The truck's acceleration leaves nothing to be desired.

Noise in the automotive gas turbine can be another problem. The Rover car hisses and whines. On sudden acceleration it roars. The noise comes from air intakes, compressor vanes, reduction gearing, and exhausts. Filters, insulation, and muffling may reduce the decibel level of turbo cars to that of piston-driven vehicles. Boeing has succeeded in reducing the noise level to less than that of piston-driven trucks.

Boeing, too, has whipped the problem of getting engine-assisted braking in going downhill. So far, Rover hasn't.

Says Turbos Are Coming

But no less an expert than England's leading lay authority on the gas turbine, G. Geoffrey Smith, editorial director of *Autocar*, and the first man ever to drive a gas-turbine car 90 m.p.h., says, "The Rover in performance already compares favorably with the modern piston-engine automobile—which has 50 years of experience behind it. I don't say the turbo car is here yet as a salable article. But it's coming. It's bound to."

So it may well be that presently you will roll up to a service-station pump and say, "Ten, please—of the lowest octane you've got." END

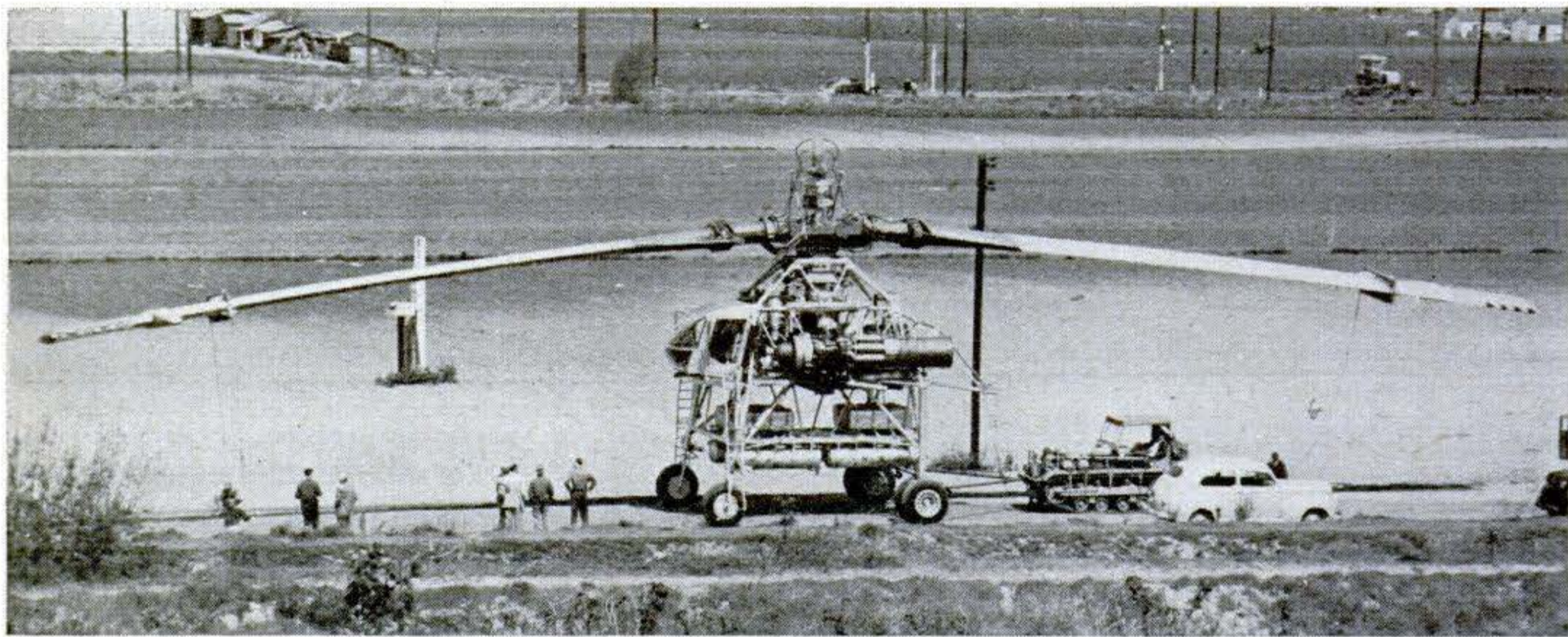

Giant 'Copter to Lift Tank

THIS is a nonflying early model of the "Flying Crane," one of the world's two largest helicopters. Being developed by the Hughes Aircraft Co., for joint use of the Army and Air Force, the XH-17 would be used to lift and ferry heavy equipment, such as tanks, trucks, and bridge sections, across

mountains and other inaccessible terrain. The huge craft is powered by a unique combination of turbojet and ramjet. Two J-35 turbojet engines, mounted on the fuselage, send blasts of compressed air to the tips of the 136-ft. rotor blade. At the tips, the air is mixed with fuel and burned in small ramjet engines, creating a thrust that rotates the blade like a pinwheel.

New Ideas from the Inventors

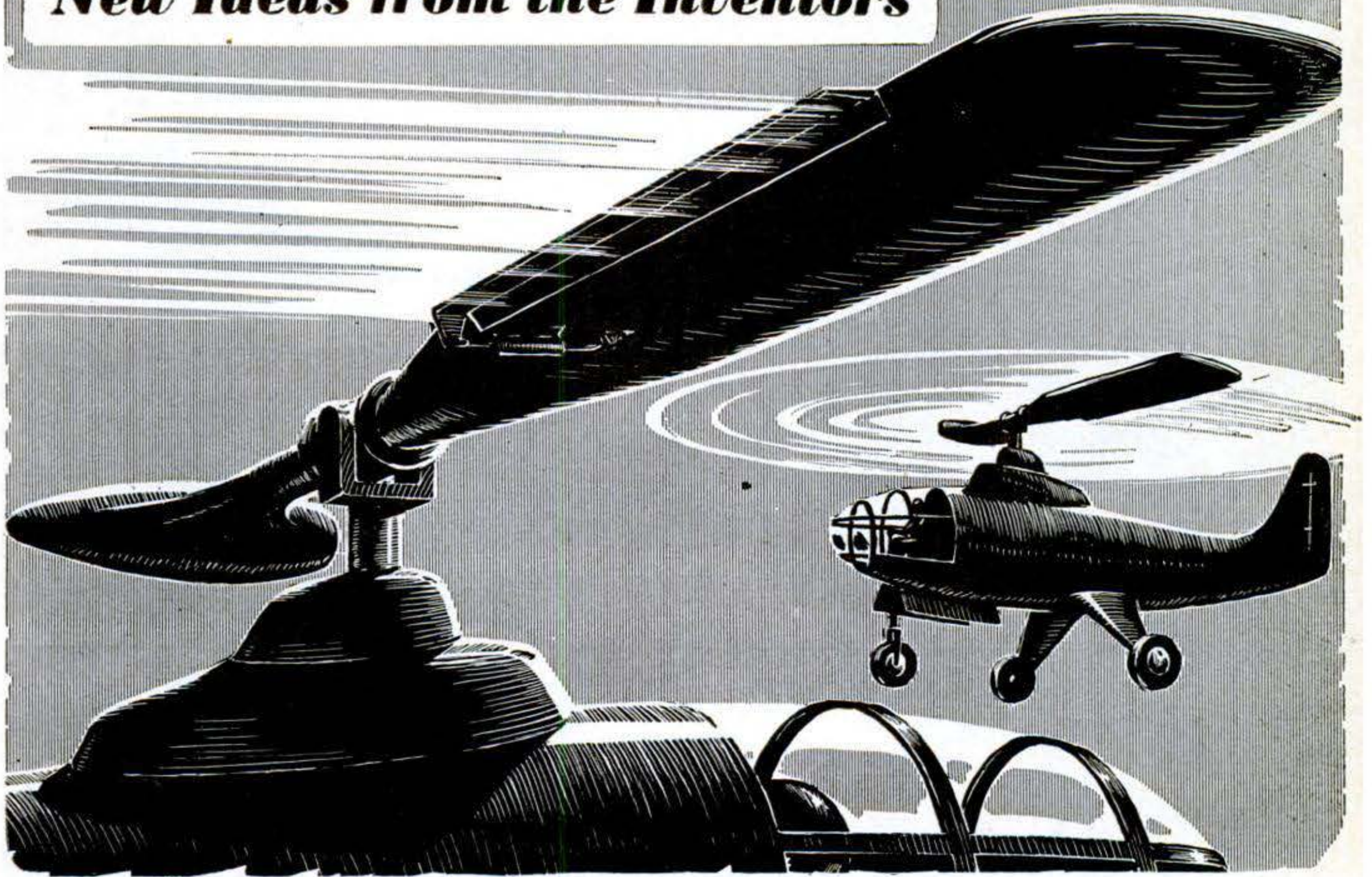

1 One Blade to Lift 'Copter. A jet-propelled blade, driven by compressed gas from a free-piston generator mounted in a housing that serves to counterbalance the blade, powers this helicopter.

Because the propulsion unit is confined entirely within the rotor, the problem of reactive torque is eliminated. The generator is similar to that designed for gas-turbine locomotives (PS, Nov. '48, p. 98).

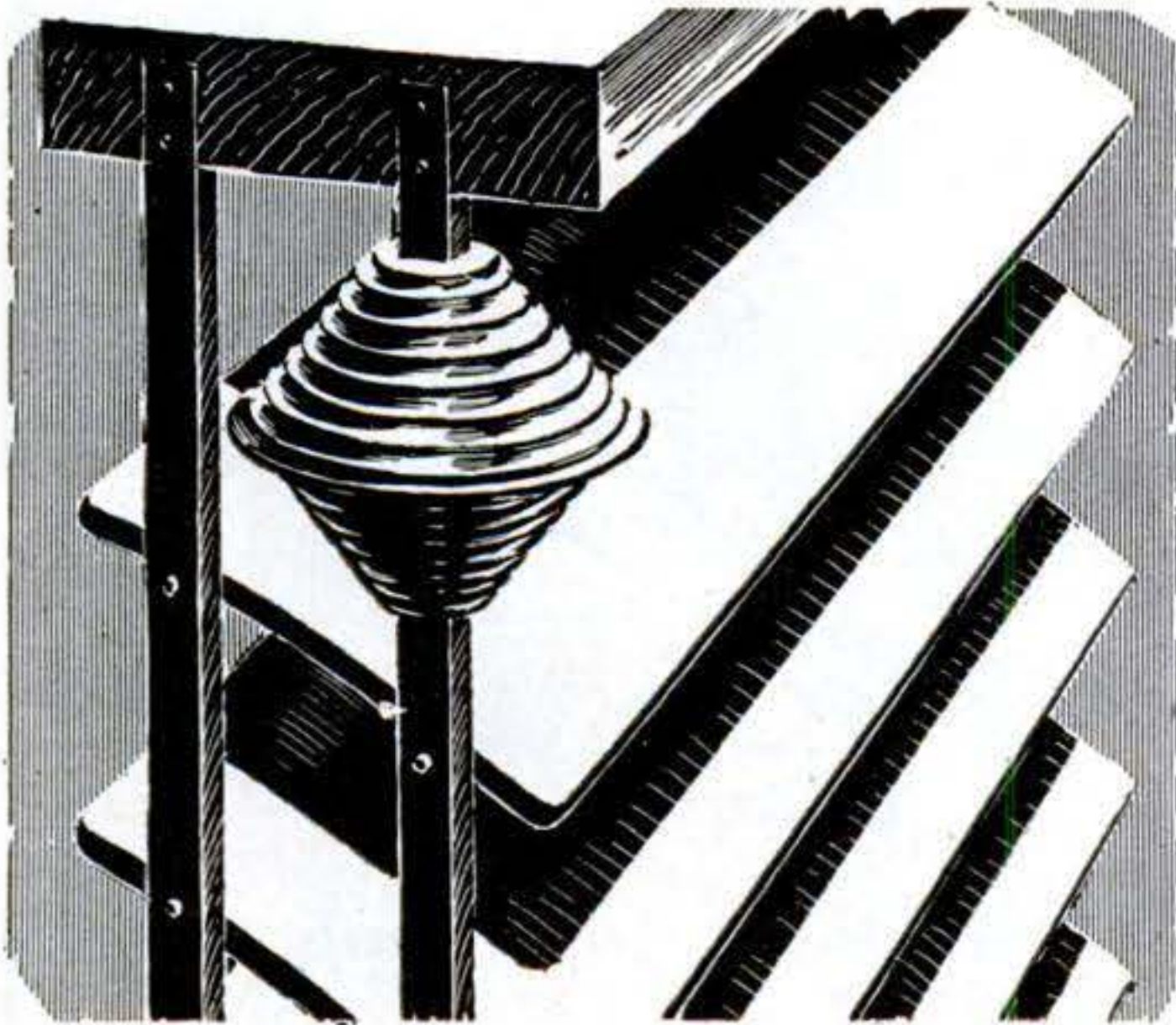

2 Sun to Operate Blinds. Venetian blinds fitted with this thermal control system would open and close automatically according to the heat from the sun's rays. When warmed above a predetermined temperature, the gas-filled control unit expands and closes the blind's pivoted slats. On cooling, it opens them.



3 Hat to Have P. A. System. Policemen handling traffic jams at ball games and similar gatherings would be able to save their voices with this helmet. It carries its own lightweight loudspeaker powered by a portable amplifier. The microphone can be either the hand-held type or the more compact throat variety.

Turn the page, please, for three more new ideas.

JUNE 1950 105

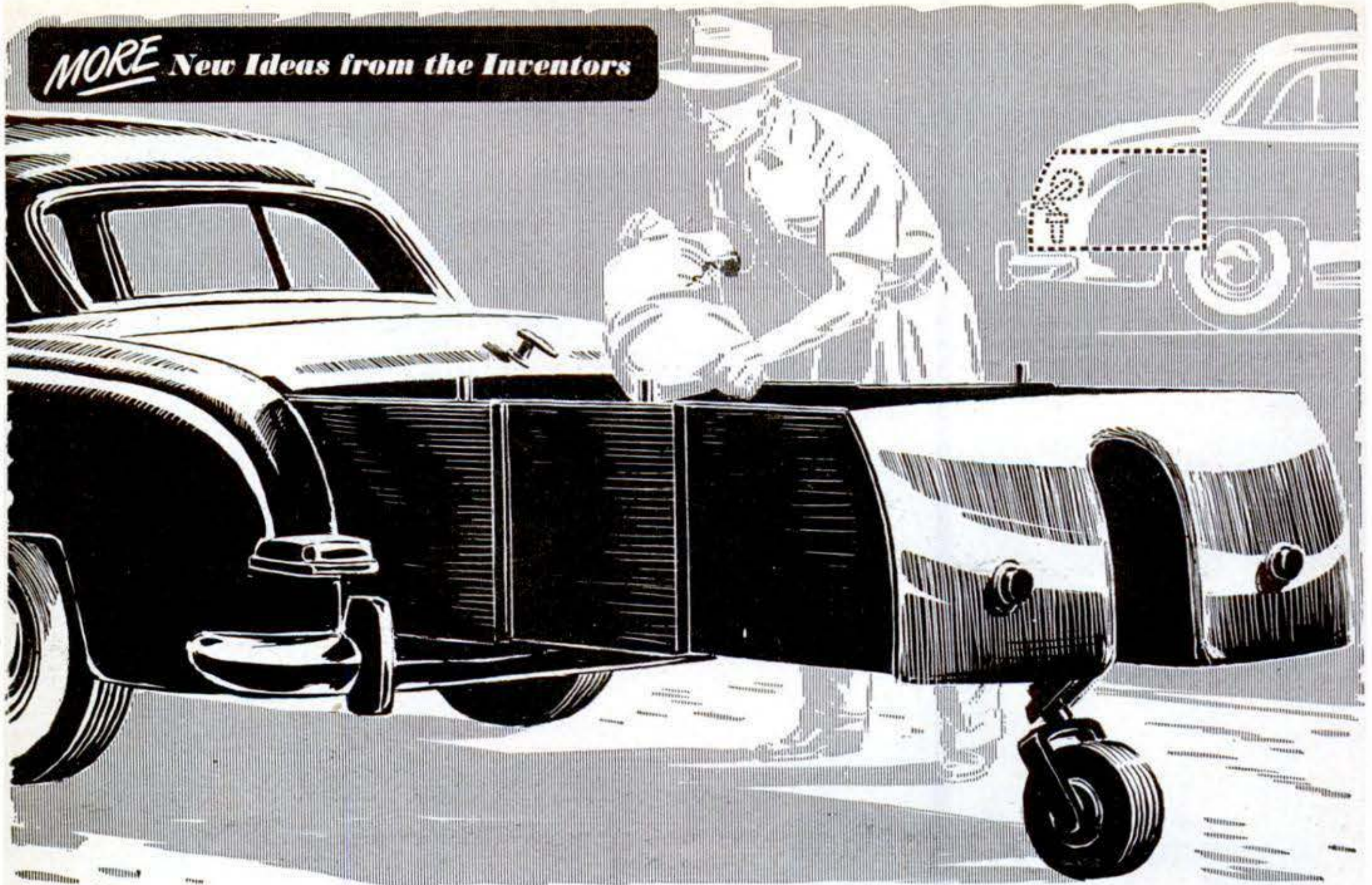

4 Trailer to Fit in Car. Designed to fit into the existing luggage space in a car, this trailer would simply be pulled out when needed. Also, since it is constructed to telescope, its capacity could be

adjusted, within limits, to fit the size of the load to be moved. The rubber-tired caster wheel, on which the rear of the trailer rides when it is extended, folds up out of the way when the trailer is not being used.

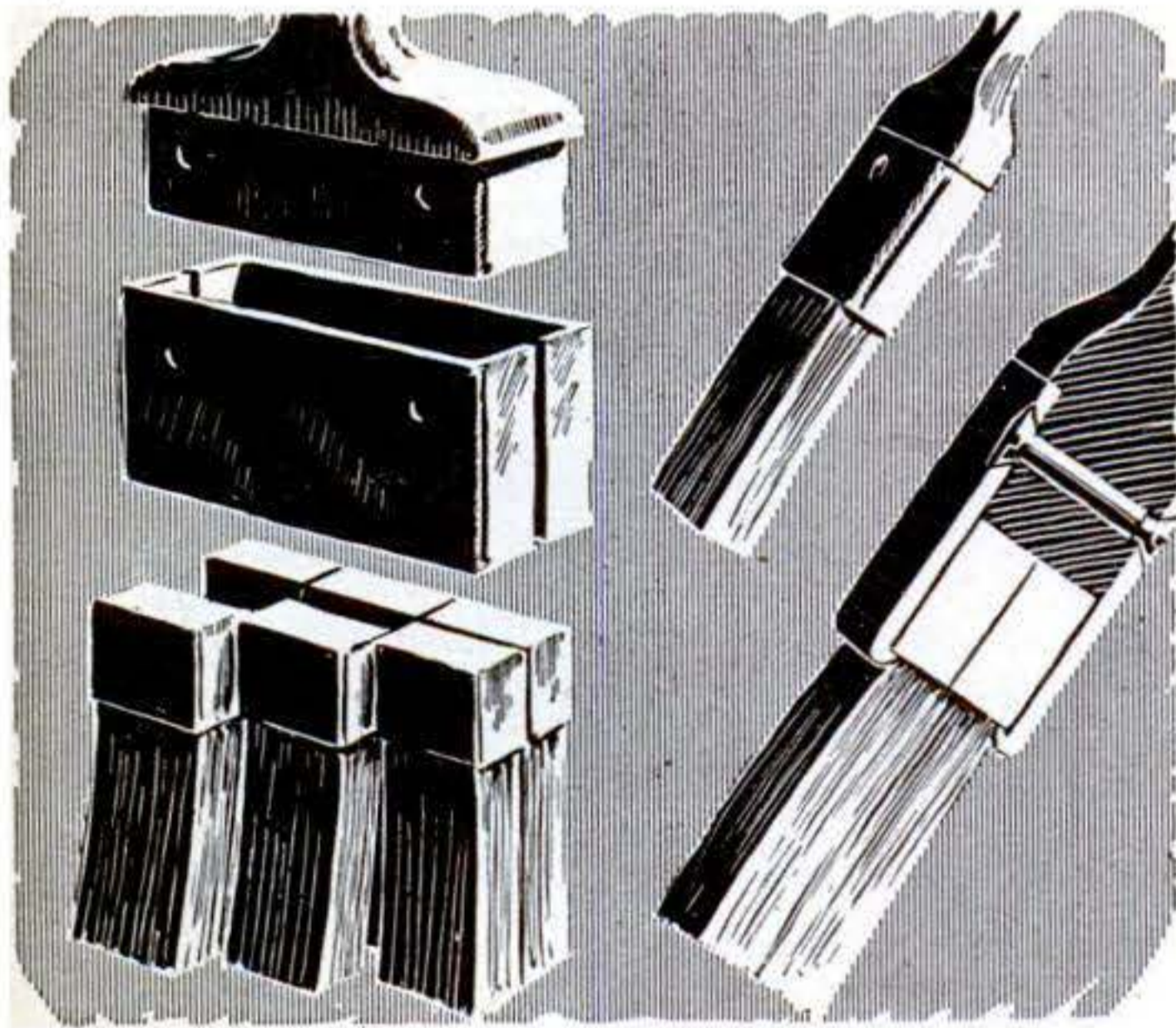

5 Brush to Be Sectional. A paintbrush could be made up to fit the job with these bristle units—one unit for a small brush, two for a medium-sized brush, or six for a large brush. Because the bristle units could be removed from the handle and be completely immersed in solvent, cleaning after use would be simplified.

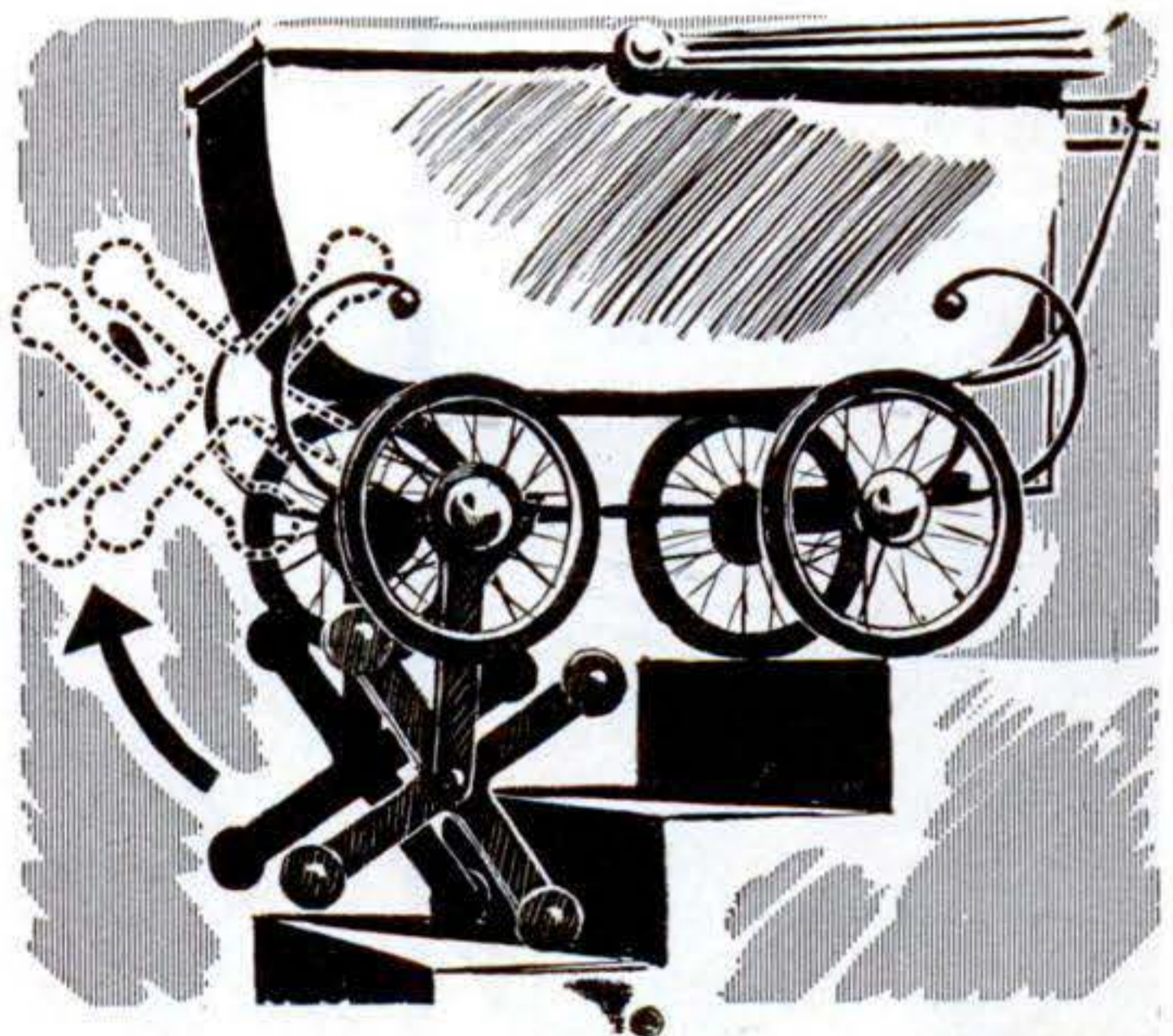

6 Carriage to Climb Stairs. Shown on a baby carriage, this device is designed to make it easy to move any similar wheeled cart or dolly up or down steps. When down in place, four rotating, roller-tipped spokes support the front end on the step below, "walking" up or down to the next step as the cart is moved.

Patents on these inventions have been granted to: 1. J. Lee, Farmington, Conn.; 2. J. Grebe, Midland, Mich.; 3. G. Eash, Toledo, Ohio; 4. D. Brand, Johannesburg, South Africa; 5. P. Ricchiuti, Chicago; 6. A. Pascoo, New York City.

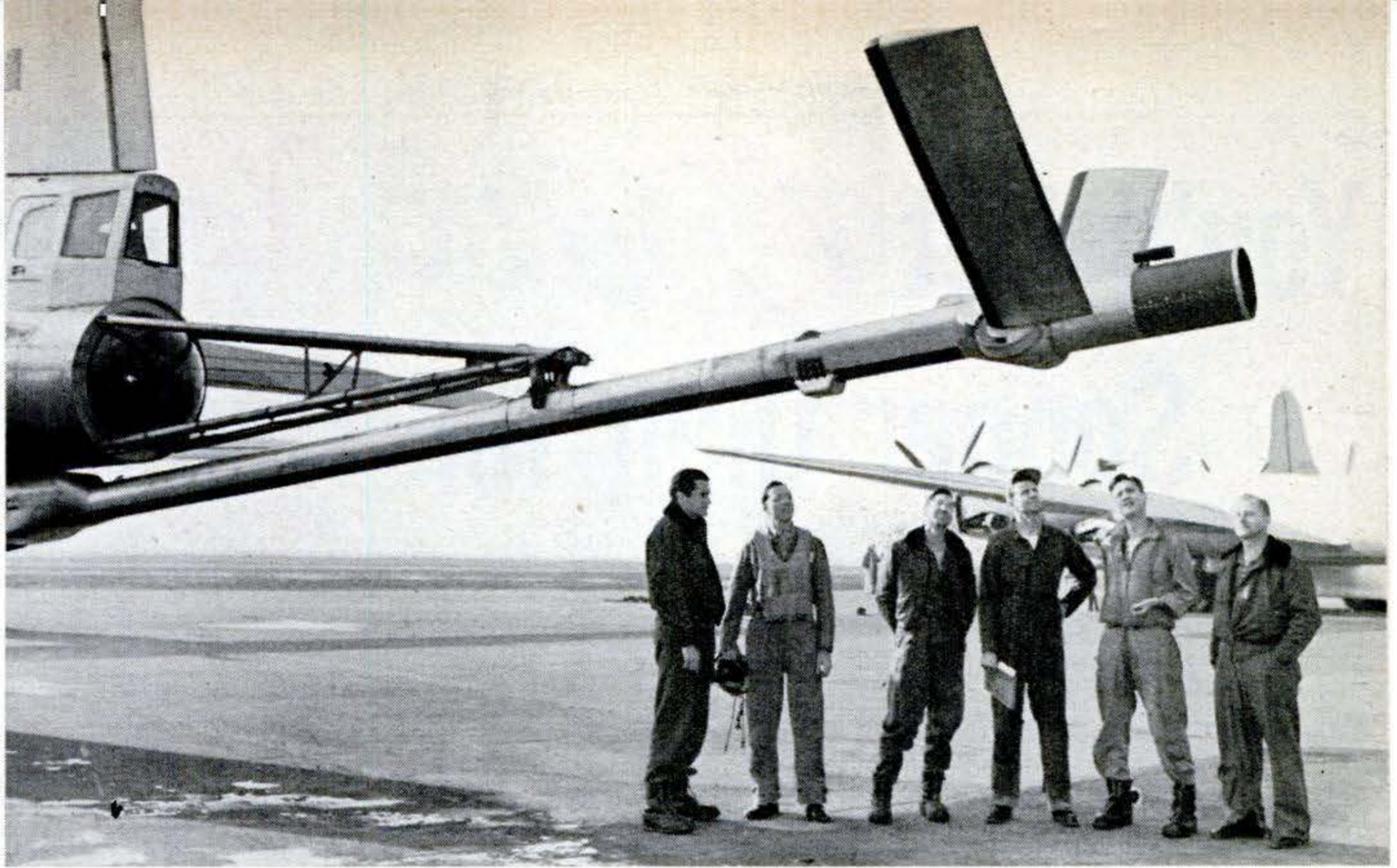

Fuel-transfer boom is a rigid, telescopic, hollow shaft. Support structure is hinged to tanker's

tail. Black strip visible on inner edge of the U-shaped ruddevator above is the electric de-icer.

De-Icers Protect Refueling Boom

CONTROL surfaces on the Flying Boom, designed for refueling in mid-air, are equipped with novel de-icers, made of rubber in which heated wires are imbedded. The rubber de-icing boots edge the V-shaped controls, called "ruddevators," used by an operator in a tanker plane to "fly" the boom to the plane to be refueled. The photos on this page show details of the boom recently released by Boeing, who developed it to increase the range of warplanes.

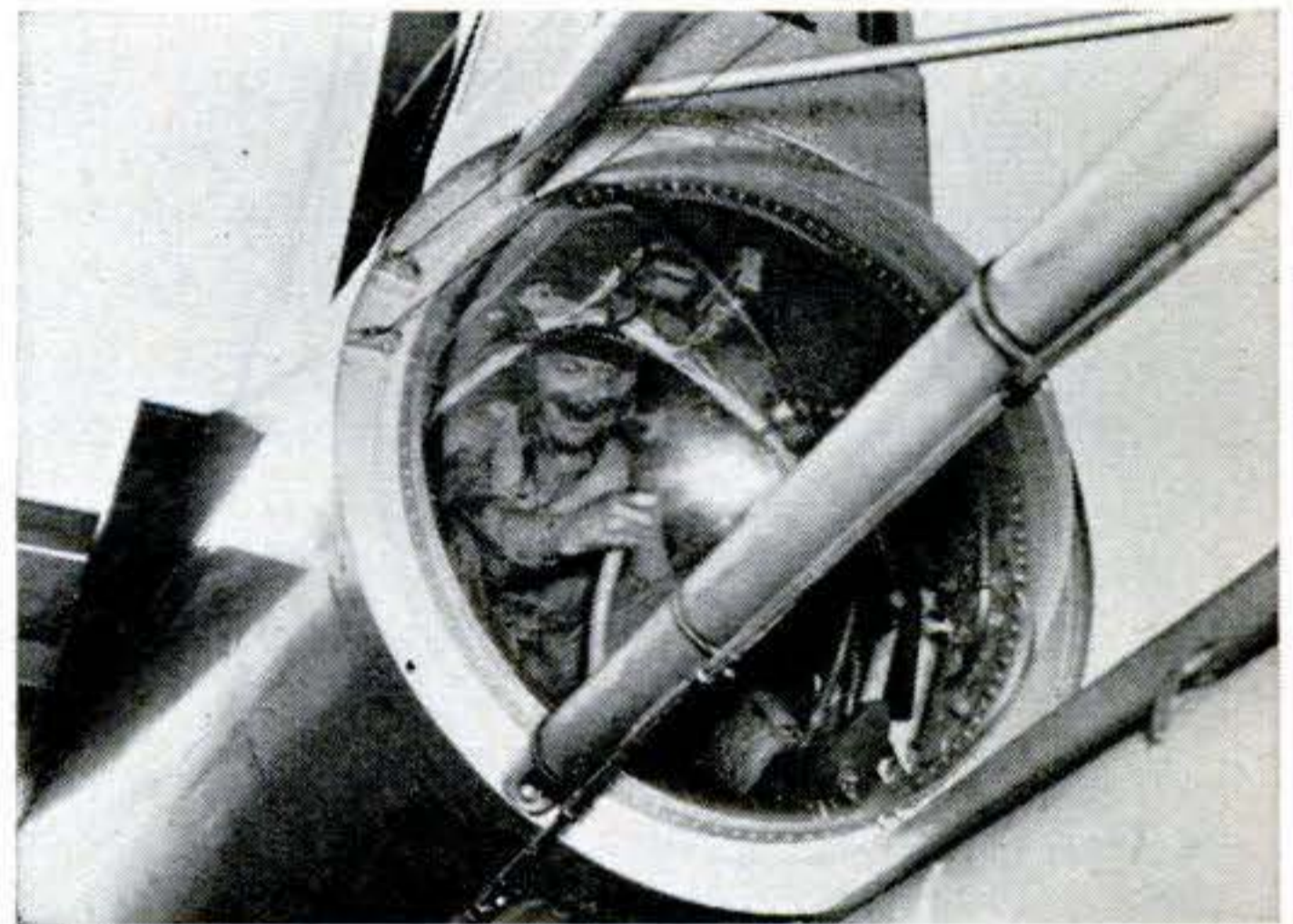

Here is a closeup of the boom operator, dubbed "Clancy" by Boeing Airplane Co. test pilots. By manipulating ruddevators, he "flies" boom into position for coupling the tanker and bomber.

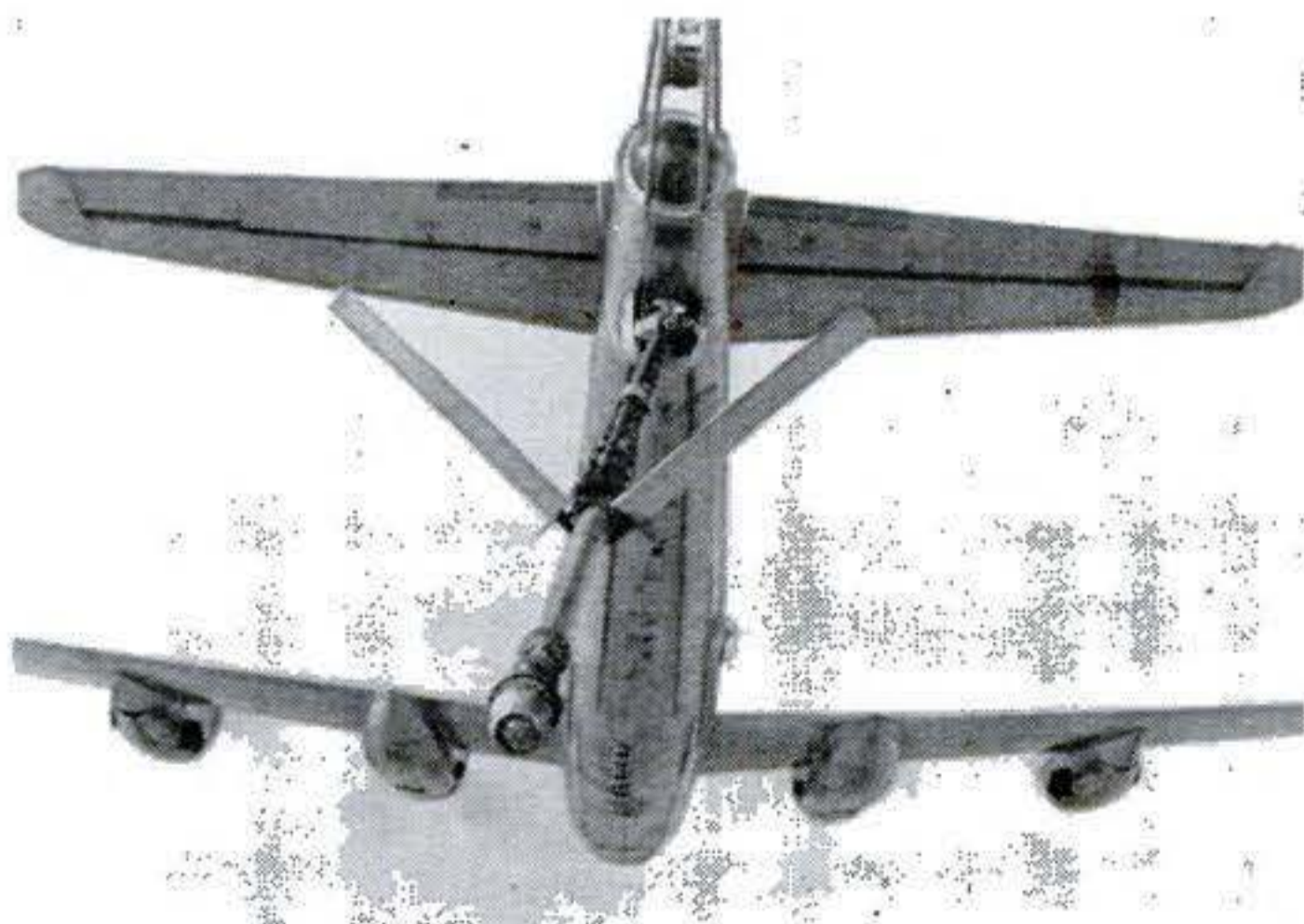

View from tanker shows boom being lowered into position for delivering fuel. Operator's station is in same space normally occupied by tail gunner and armament in B-29s used during war.

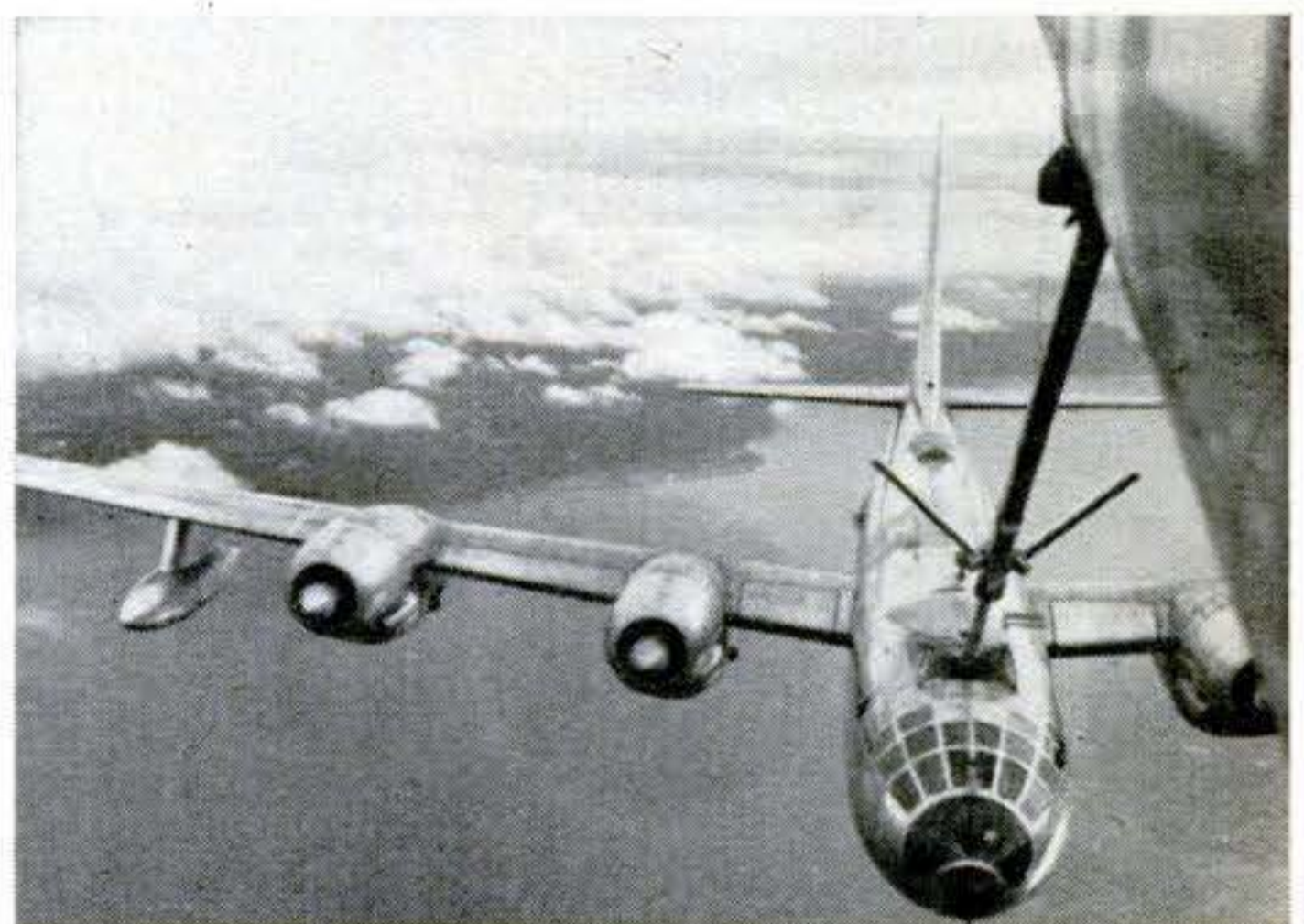

Contact has been made and fuel is being transferred. Boom connects to bomber's intake line through slip-away doors just back of nose. Tanker flies above and in front of other plane.

You'll Get *COLOR TV* Sooner than You Think

RCA's new tri-color tube mixes all three colors electronically—without lenses, disks, or mirrors.

By John F. Loosbrock

Drawings by Morris Cohen

THANKS to a new tri-color tube, color TV has moved much closer to your living room. Maybe you'll even find a set under your 1951 Christmas tree. And the pictures will compare in quality with the best you can get on your black and white set, with the dividend of glowing color.

The bottleneck breaker is a new viewing tube, developed by RCA, that puts the colors back together after the color camera has torn them apart. And it does this electronically, without mirrors, lenses, or disks.

At present, there are two versions of the new tube. One uses three electron guns to paint the colors on the screen. The other uses one. Both employ a viewing screen coated with rows of small, closely spaced phosphor dots. These are arranged in triangular groups of three. Each triangle contains a dot that glows red, when hit by an electron stream, a dot that glows blue, and a dot that glows green. The hand-made models used in recent tests before the Federal Communications Commission in Washington had 351,000 such dots, 117,000 of each color.

The tube that looked best during the tests uses three electron guns mounted in the tube neck—one for each of the three primary TV colors. Between the guns and the screen is a metal mask having 117,000 tiny holes, one for each group of dots.

The three guns are so mounted in relation to the mask that the electron stream from each gun strikes only the dot emitting the particular color that the gun is painting. Thus, the red gun can hit only the red dot, the blue gun the blue dot, and so on.

The second version uses essentially the

same principle. The mask and the dot groups are identical. But it works with a single electron gun. Its beam is rotated magnetically so that it occupies, in sequence, the positions of the three guns in the three-gun kinescope.

Thus when the beam is in a position corresponding to the red gun of the three-gun tube, it is modulated only by the red component of the video signal, and strikes only the red phosphor dots. A tiny fraction of a second later, it is rotated to a position where it excites only blue dots and is modulated

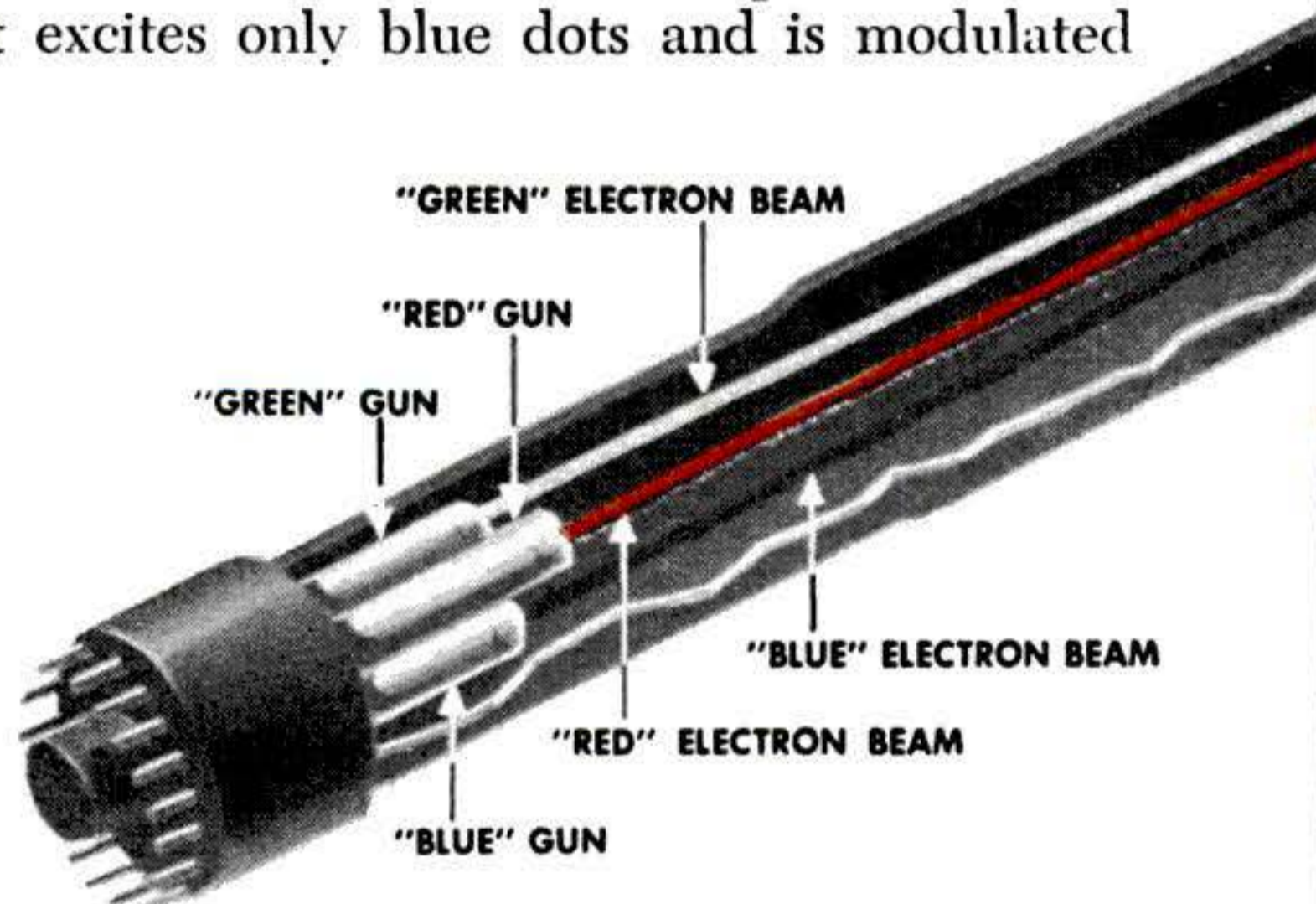

only by the blue component of the signal. The third position produces green. You see all three at once.

The pictures look good. I saw the new tube demonstrated in Washington. The colors were true and the pictures clear—at least as good as the best black and white picture, and you can't expect to do better with TV confined in its present bands.

Why is the tri-color single tube so important? It's because the most controversial part of the color TV problem to date has been that of putting the colors together for your eyes. As you've probably read, the color question is the nub of a hot controversy that the FCC must settle, one way or another, in the near future. Three warring systems have been beating the drums for their own particular product—RCA,

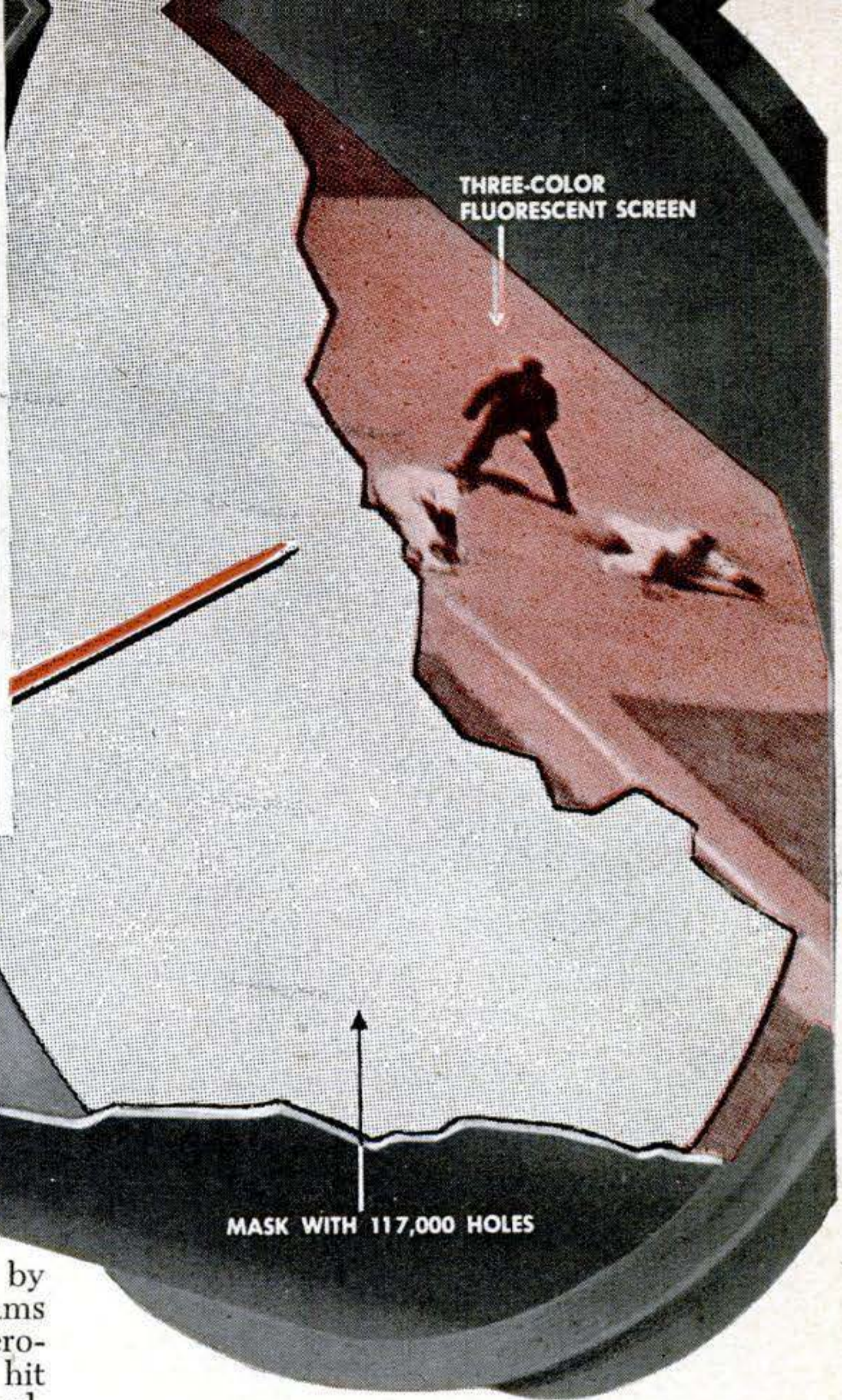
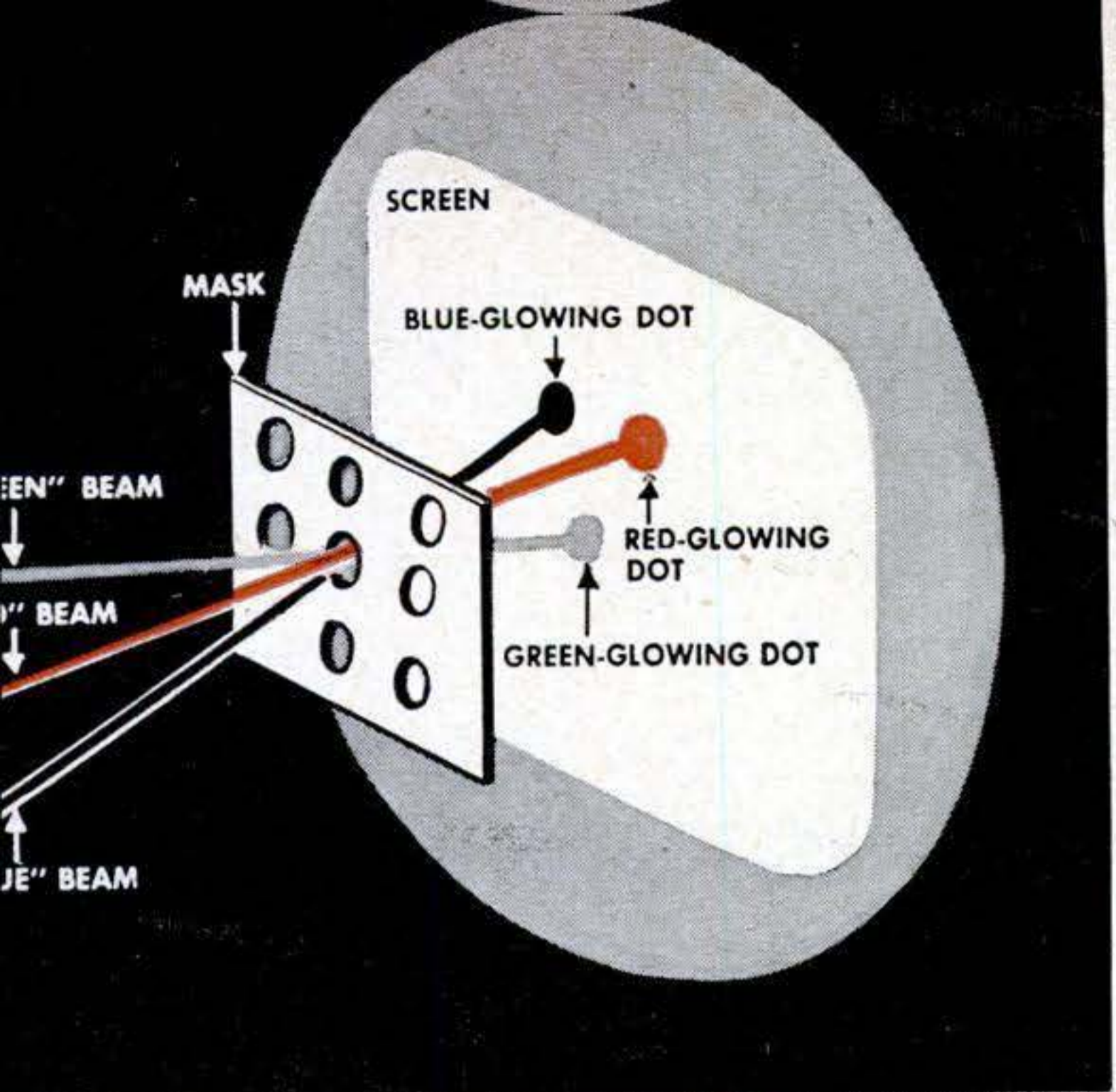

Each gun of three-gun tube is controlled by only one color signal. The three electron beams pass through a mask, which has 117,000 microscopic holes arranged so that "red" beam can hit screen only where there are dots that glow red, "green" beam can hit only green dots, and so on (see inset above). Individual colored dots, too tiny to be picked out by human eye, fuse together like dots in color engraving to give impression of smooth, continuous color picture.

In one-gun tube dots and mask holes are identical with three-gun job. But electron beam is rotated magnetically, changing "color" with position so one gun can do same work as three.

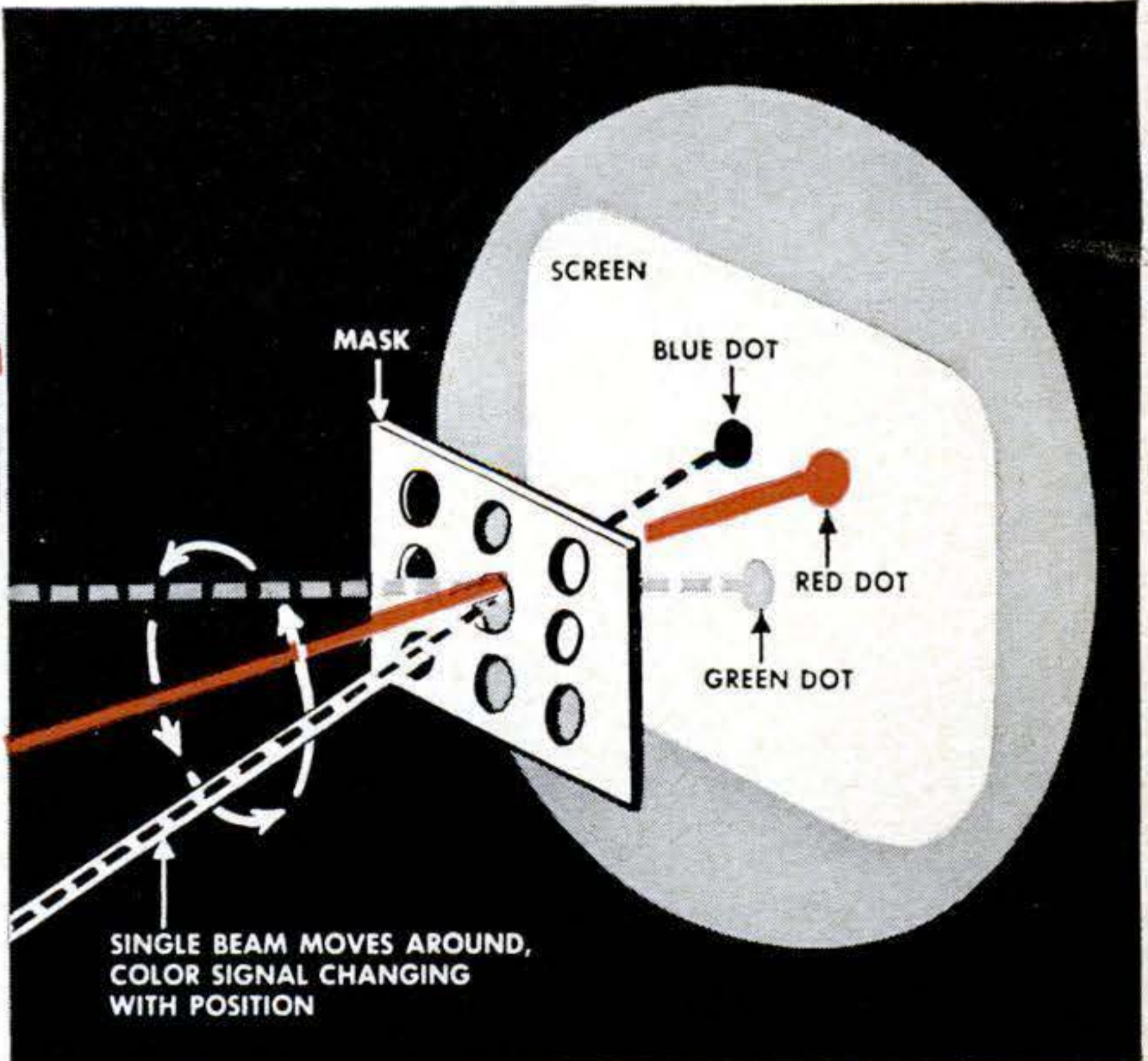
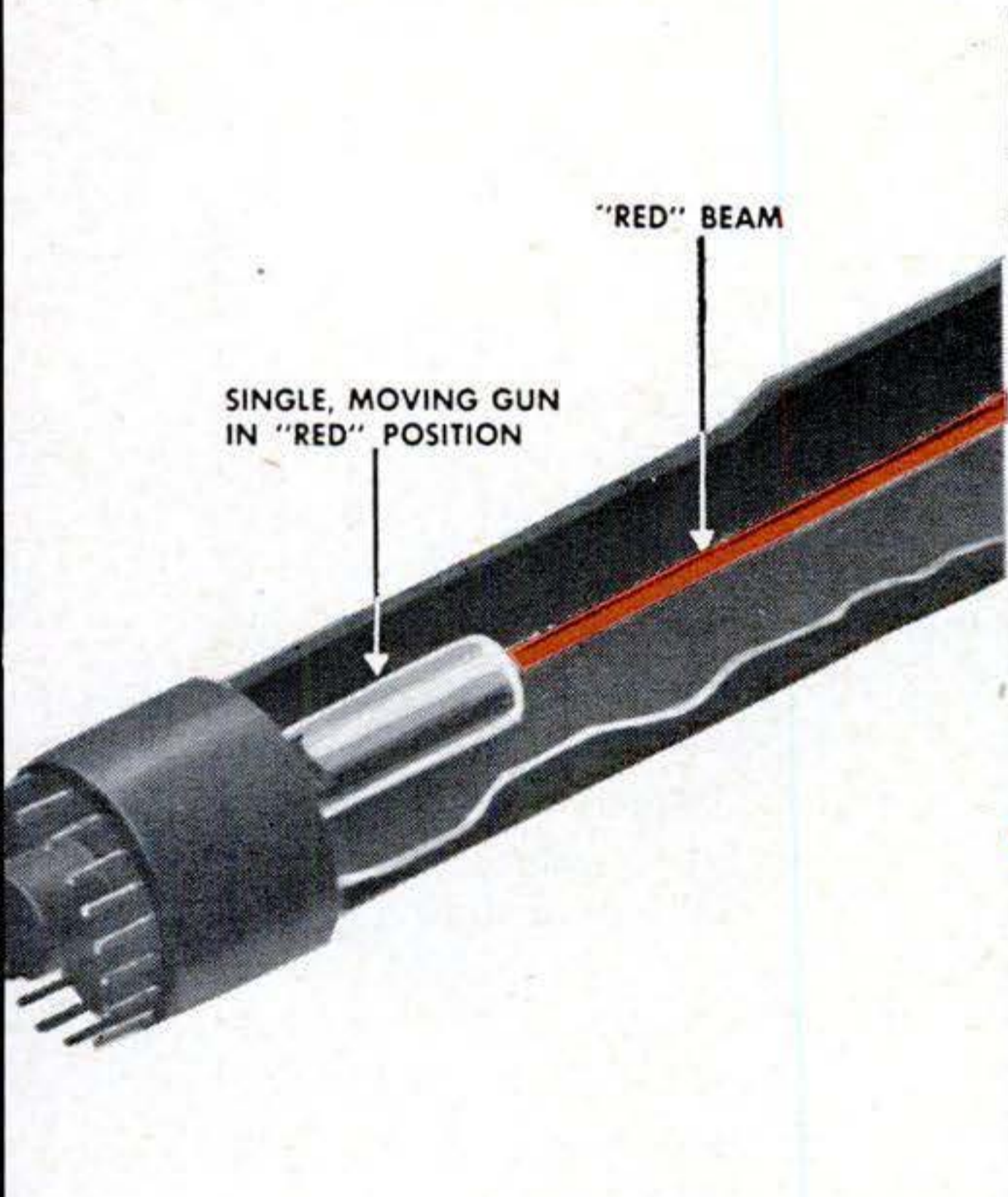



RCA's tri-color camera picks up telecast from station WNBW in Washington during demonstration of new RCA color tubes before the Federal Communications Commission.

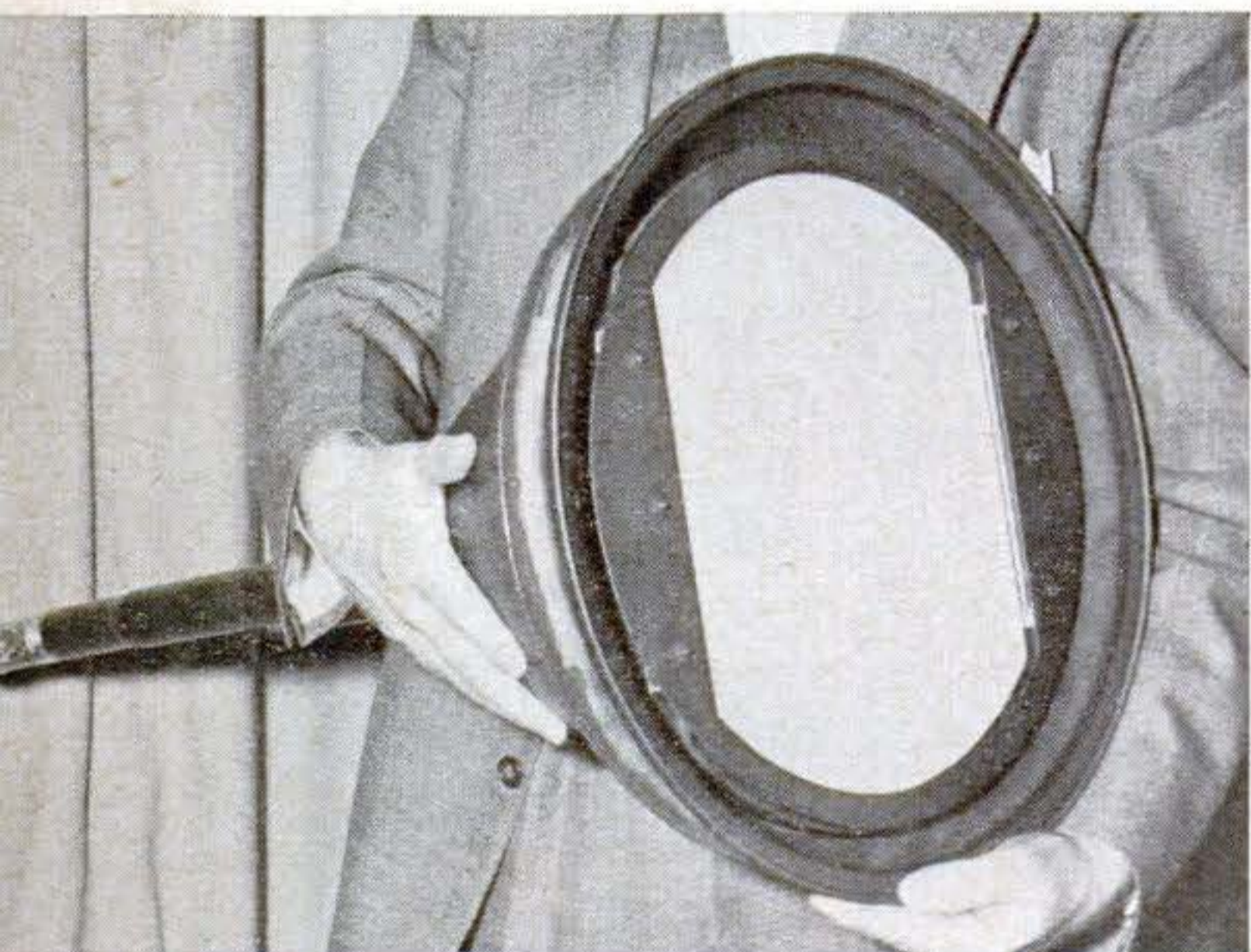

The one-gun, tri-color tube looks like this. RCA engineers are working on improved models, with more dots. Tube can be used in some standard receivers, but needs extra circuits.

Close-up shows neck of three-gun tube. It fits into standard RCA receiver, beefed up with 19 more tubes for color synchronization, sampling, and additional power supplies.

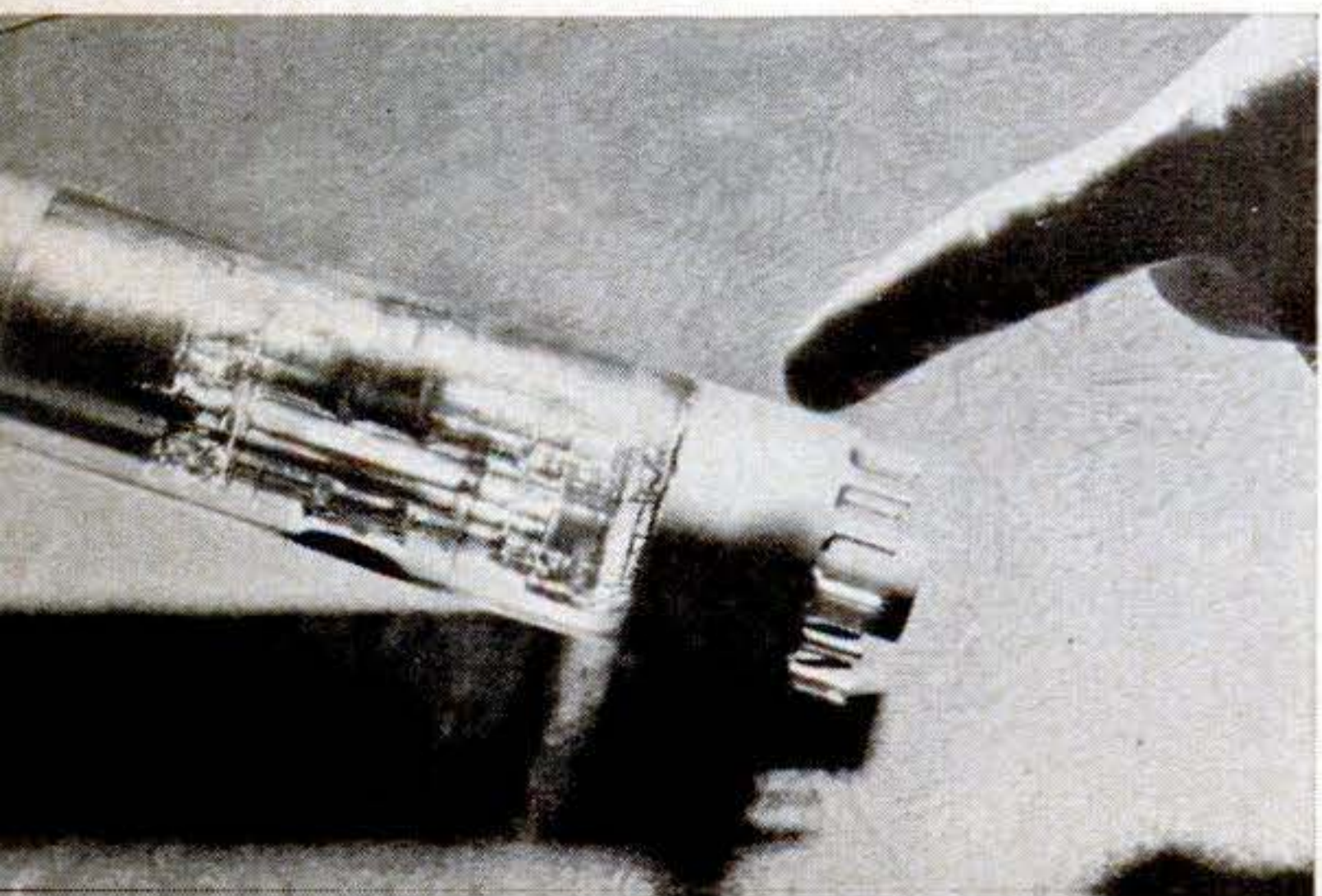

Columbia, and Color Television, Inc.

Here's how the three systems differ:

RCA. The camera directs red, blue, and green light from the subject into three different lenses. It does this with "dichroic" mirrors, each of which reflects only one color. Individual scanning tubes translate each image into signals for transmission.

In the receiver, RCA now uses the tri-color tube. In earlier tests it employed three tubes and a mirror system to put the colors back together on a screen.

CBS. The color camera uses a mechanical device—a whirling disk divided into primary-color segments. This rotates behind the camera lens and filters the light so that the colors pass through in succession.

At the receiver CBS puts the images together in black-and-white on a screen. In front of this another color disk, synchronized with the one in the camera, colors the images. Recently, however, CBS demonstrated an all-electronic receiver that eliminates the often-criticized mechanical wheel. It projects a big picture with a lens-and-tube system like CTI's (see below).

CTI. Like RCA it uses three lenses, with a dichroic-mirror setup to separate the colors. But these produce three small, separate images on the scanning tube face. Successive lines of red, blue, and green are then transmitted from the three images.

The CTI receiver uses a single tube, on which the three color images appear, greatly reduced and side by side. Another lens system magnifies and projects them.

One important virtue of the new RCA receiver tube is that it can be used with *any* of the three systems.

It eliminates the registry problem inherent in the projection systems used by RCA and CTI and now adopted by CBS. Or it could replace CBS's receiver disk, with its mechanical, size, and noise problems.

Each system has its own advantages and disadvantages, both in picture quality and in its effect on the some 5,000,000 persons who now own black and white sets. Let's take a critical look at all three, as I did.

CBS leads the parade in color quality, especially in the critical skin tones. Dr. Peter Goldmark of CBS, who started the color whirl back in 1940, says this is due to his "field sequential" system, which shows complete pictures in each color in rapid succession. But to get this, CBS must forego "compatibility." That means you can't watch a CBS color picture even in black

and white on your present set. To squeeze its signal into the six-megacycle band allotted to color TV, CBS had to cut down its picture lines from 525 (the black-and-white standard) to 405.

If you're willing to settle for black-and-white pictures of color programs, you could get a converter for an estimated \$15 to \$25. Conversion of your set to receive color would run around \$75. New color sets would cost somewhat more than present black-and-white prices. CBS claims that its system is the cheapest, and the only one that could begin color broadcasting now.

For RCA, the big advantage claimed is that it's compatible, since it uses a 525-line picture, so that you can see a color broadcast in black and white with your present set. But even with the new tube, the colors are colder and skin tones are darker than those obtained by CBS. Initial cost of converting your present set will probably cost more than CBS, although RCA experts have made no forecasts. David Sarnoff of RCA says new color sets will probably run around 20 to 25 percent more than comparable black-and-white jobs. This presumes quantity production, which RCA says will take one to two years. RCA breaks each line into "dot sequential" system.

CTI is all-electronic and compatible. But it uses a "line sequential" system. Each line in the picture is alternately red, blue, and green. Overlapping creates the full-color illusion. However, the Washington tests I witnessed weren't good. Colors weren't true, nor were they in register.

FCC Must Decide

Since the RCA single tube licks the receiving problems of all three systems, it's bound to bring color TV nearer. But until the FCC acts you can neither pay your money nor take your choice. The FCC can:

- 1) Approve one system;
- 2) Approve two, or all of them (which would toss the problem into the customer's lap, on a "let the best man win" basis); or
- 3) Approve none and tell the boys to go back to their labs. It did this once before.

But it must decide something. Because, until it does, no new TV stations can be built. And TV will have to stay within its present frequencies instead of moving up into the ultra-high bands. Besides, until industry engineers stop messing around with color, your black-and-white sets will get no better.

END

How Color TV Systems Differ

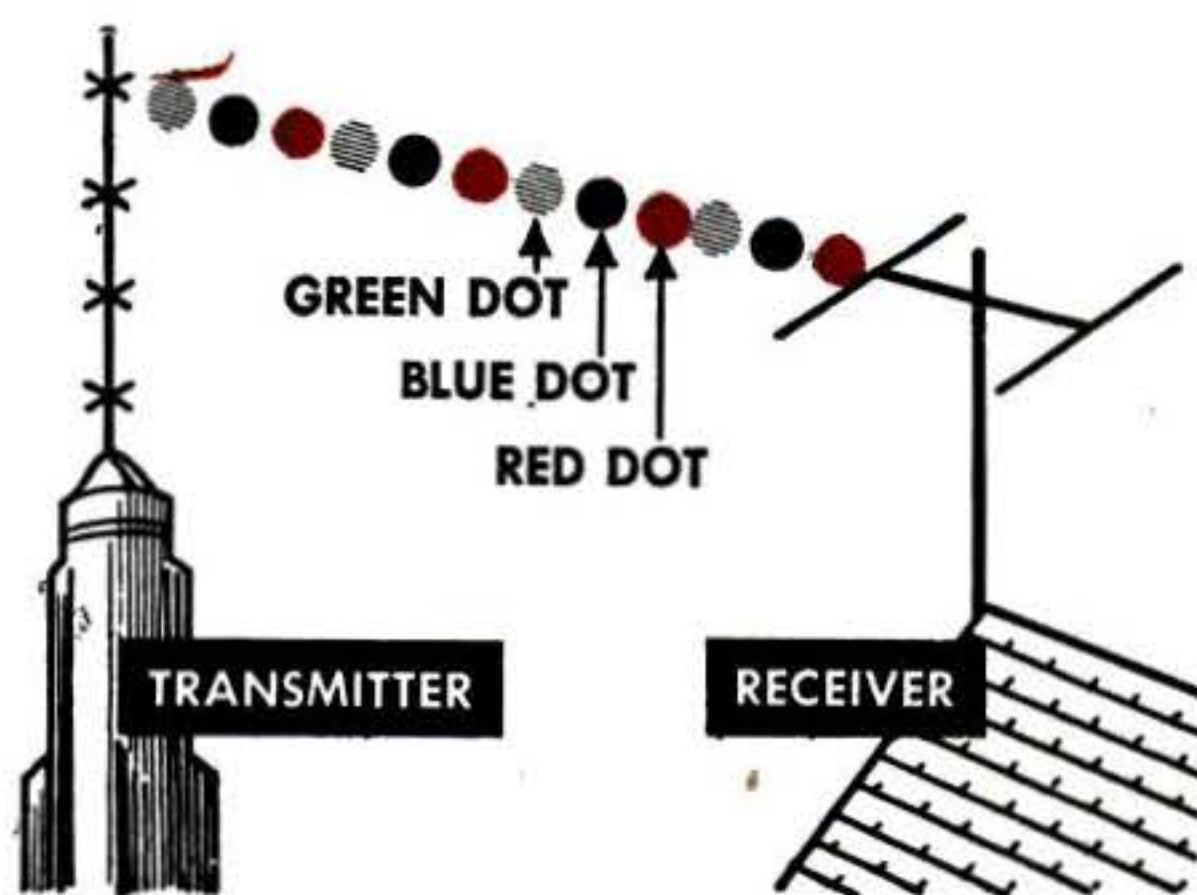

RCA's "dot sequential" system breaks up each line into individual microscopic specks of red, blue, and green. These are transmitted one after another.

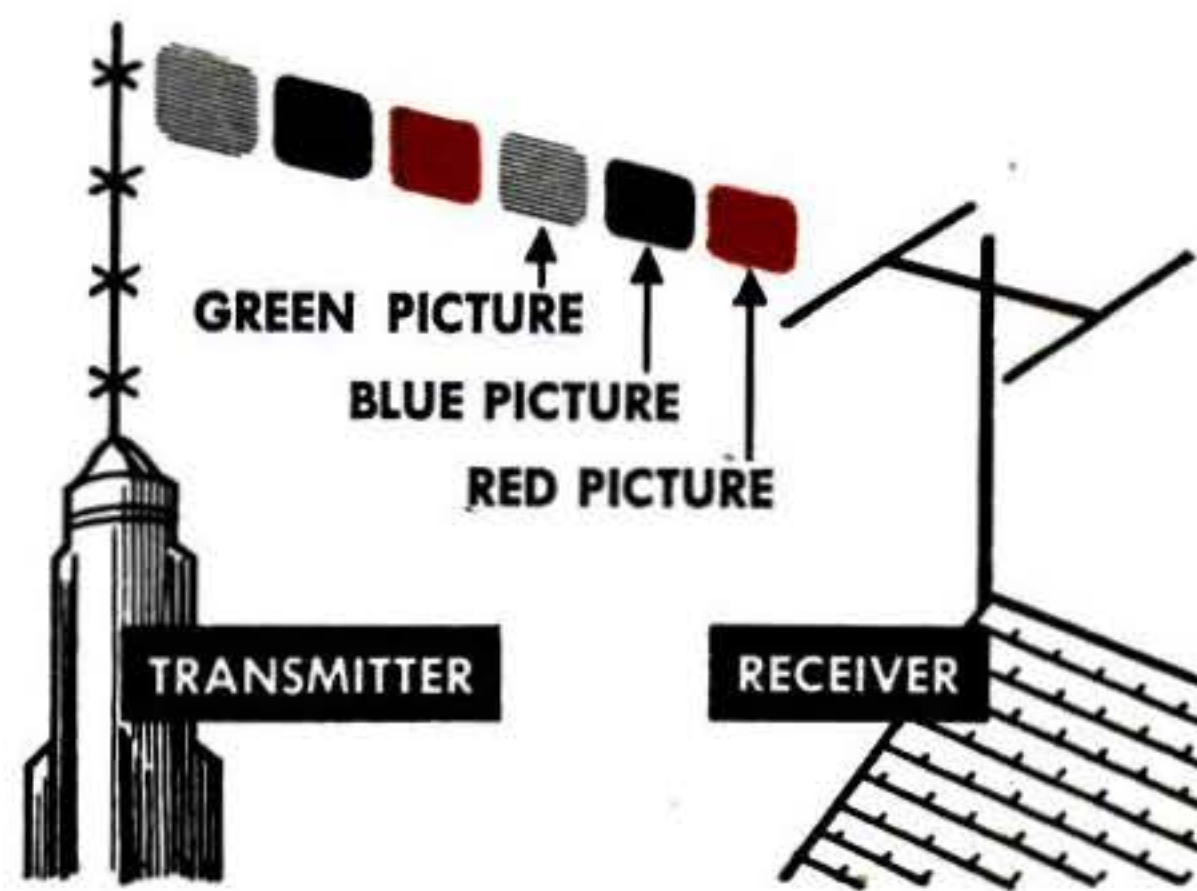

CBS's "field sequential" system sends complete picture in one color at a time. Successive pictures are red, blue, and green. New RCA tube can be used with it.

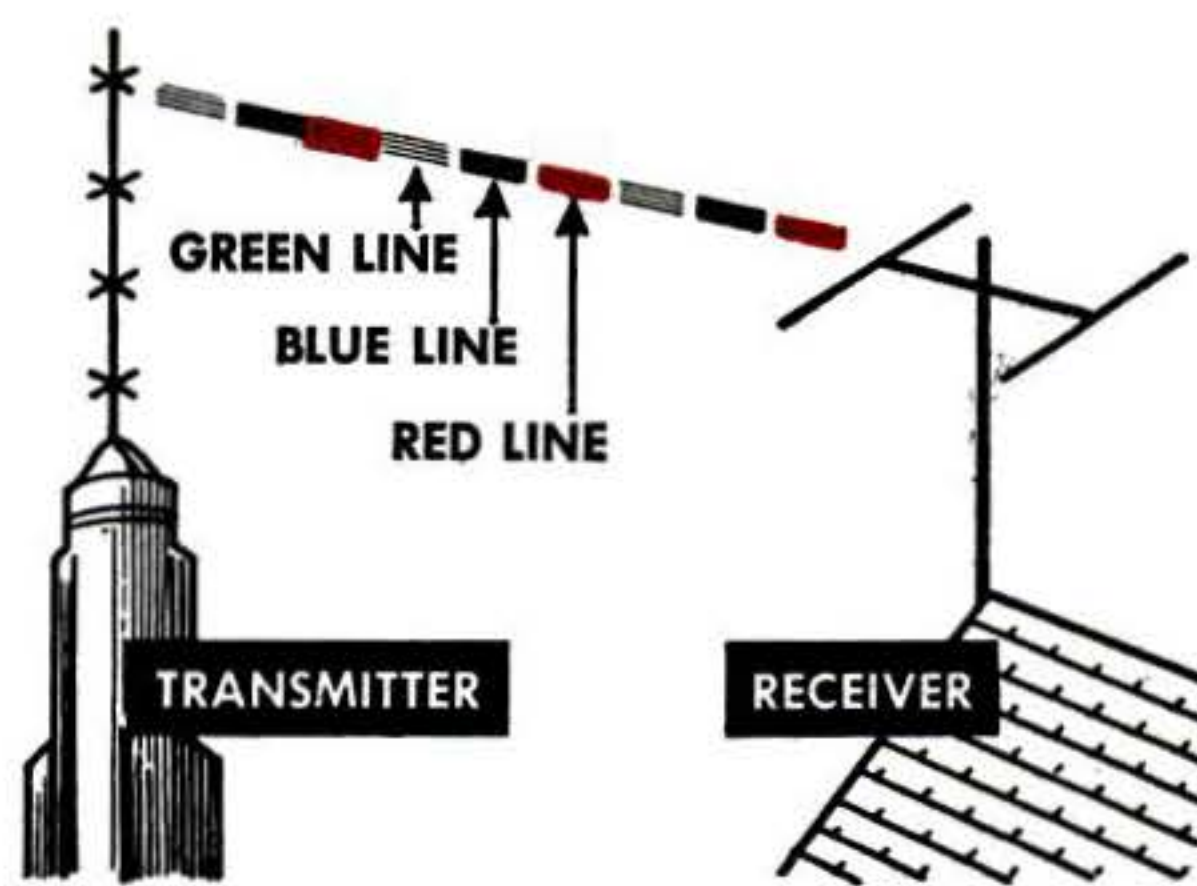

CTI's "line sequential" system transmits color in successive lines of red, blue, and green. These overlap in receiver in way that gives illusion of full color.



Fabric dome, 20 feet high and 30 feet across at base, is kept inflated by compressor. In center is large movie projector, ready to be moved in. Dome recently withstood 75-m.p.h. gale.



Inside dome, students follow movie target with dummy gun. Gun's sights, also projected onto dome, show instructor how close students are to yellow spot (invisible), correct point of aim.

Portable Domes Train Gunners

THE British are training antiaircraft gunners in portable fabric domes inflated like balloons to hold them up. Inside each dome, called a Portabel, a movie projector throws images of planes and other moving targets on the walls while student gunners follow them with a dummy gun. An image of the gun's sights is also projected onto the dome, showing how the gun is pointed. A yellow spot on the film indicates the correct point of aim but can be seen only by the instructor—the students wear yellow glasses. Gun sounds and other battle noises help give combat realism. Designed to save costly field training, the domes can be put up in two hours by unskilled crews. After training at one location, they can be packed into trucks and moved to new areas.

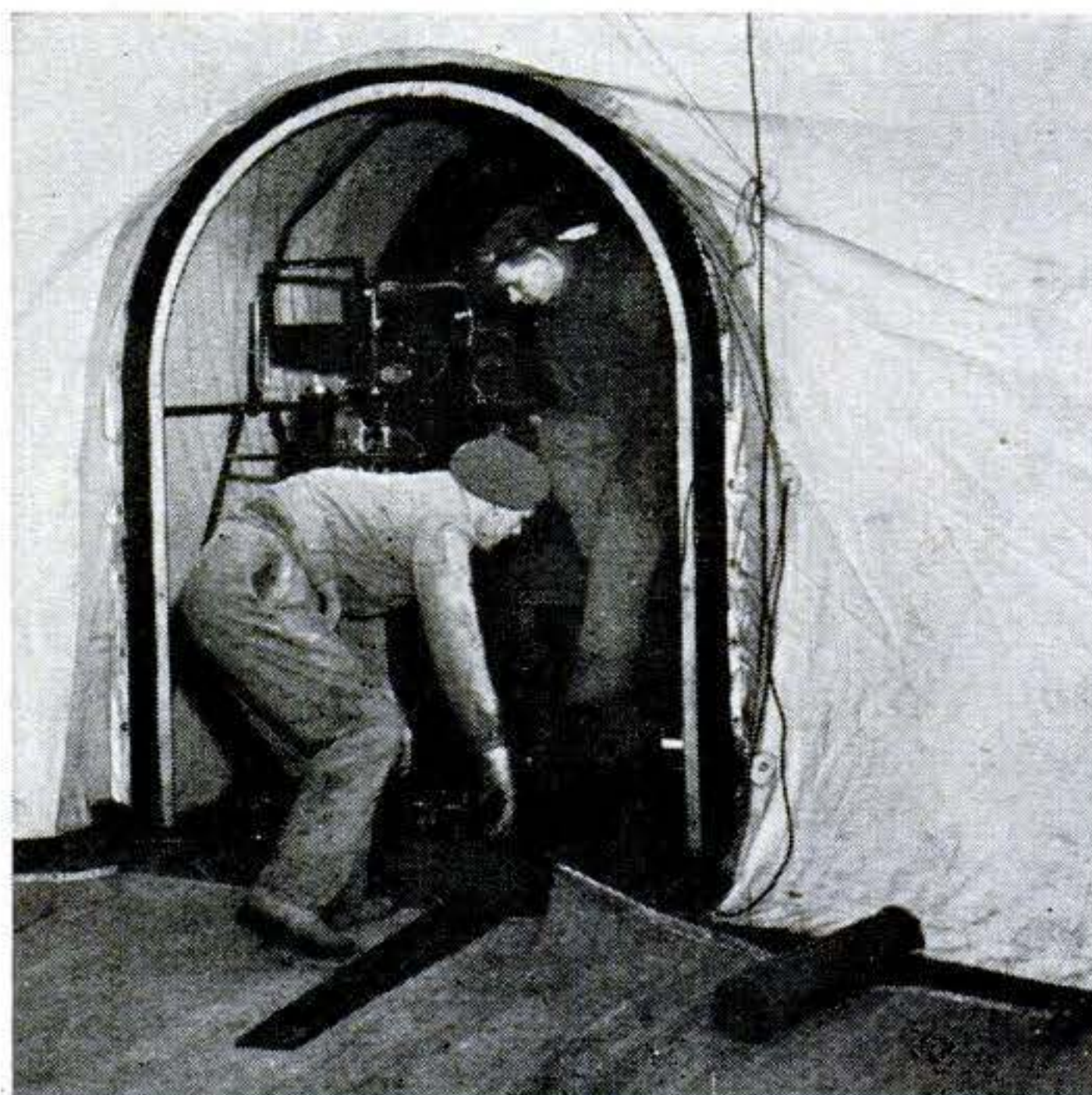

Double-door air lock lets men and equipment enter inflated dome without air escaping.

Hanger Hooks on Car Window

TRAVELING motorists can carry up to 10 garments on this new Hangaway Car Hanger. The top hooks over a window edge while the lower end is held to the glass by a suction cup. Made by the American Steel Products Co., Chicago, it sells for \$1.29.

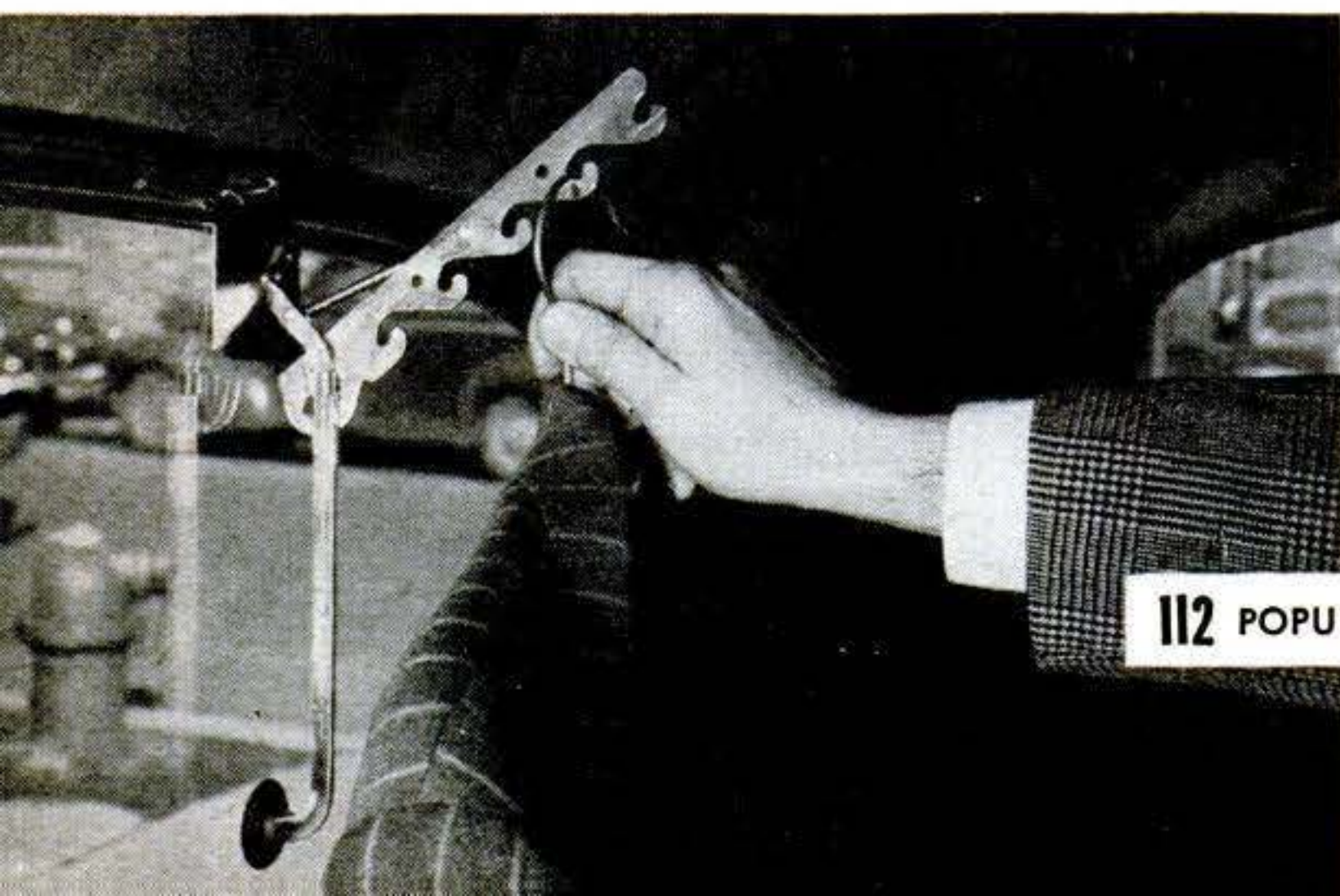

Lighter Has Built-In Rule

ENGINEERS, shopworkers, and sportsmen who like to carry a pocket rule as well as a cigarette lighter can do both with this new Ruliter. Made by the A. B. Hastings Corp., of New York City, the lighter has a 24-inch steel measuring tape built into its base.

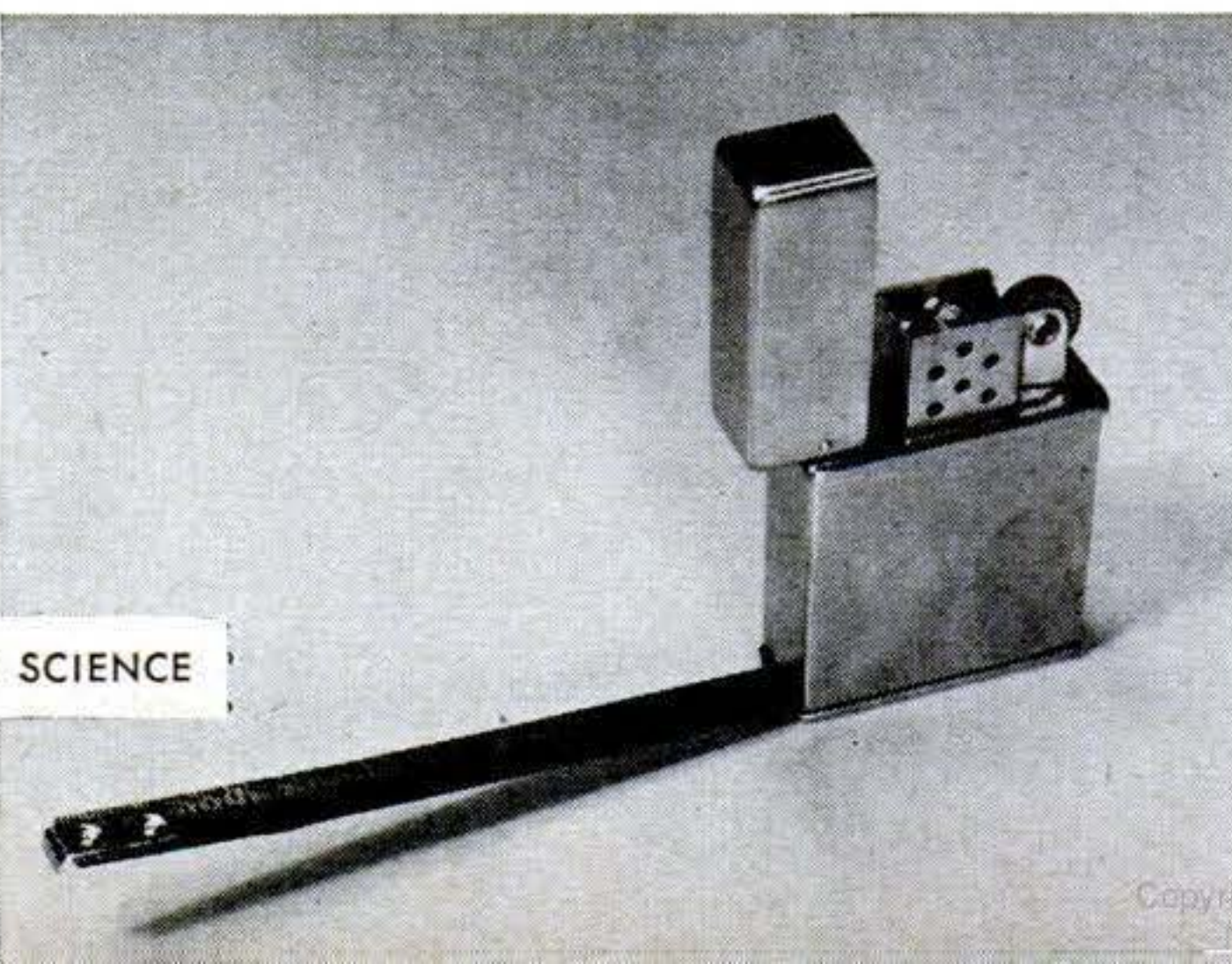



Prefab Furniture Slides Together

The butterfly dovetail, a favorite of early cabinetmakers, makes a comeback in new build-it-at-home furniture.

By Sheldon M. Gallager

PS Photos by W. W. Morris

YOUNG furniture designer Walter E. Blum started out to build some cabinets for his small New York City apartment and ended up with a brand-new kind of furniture. Now he's in business, busily turning out pre-cut pieces of his furniture for other small-space dwellers to put together.

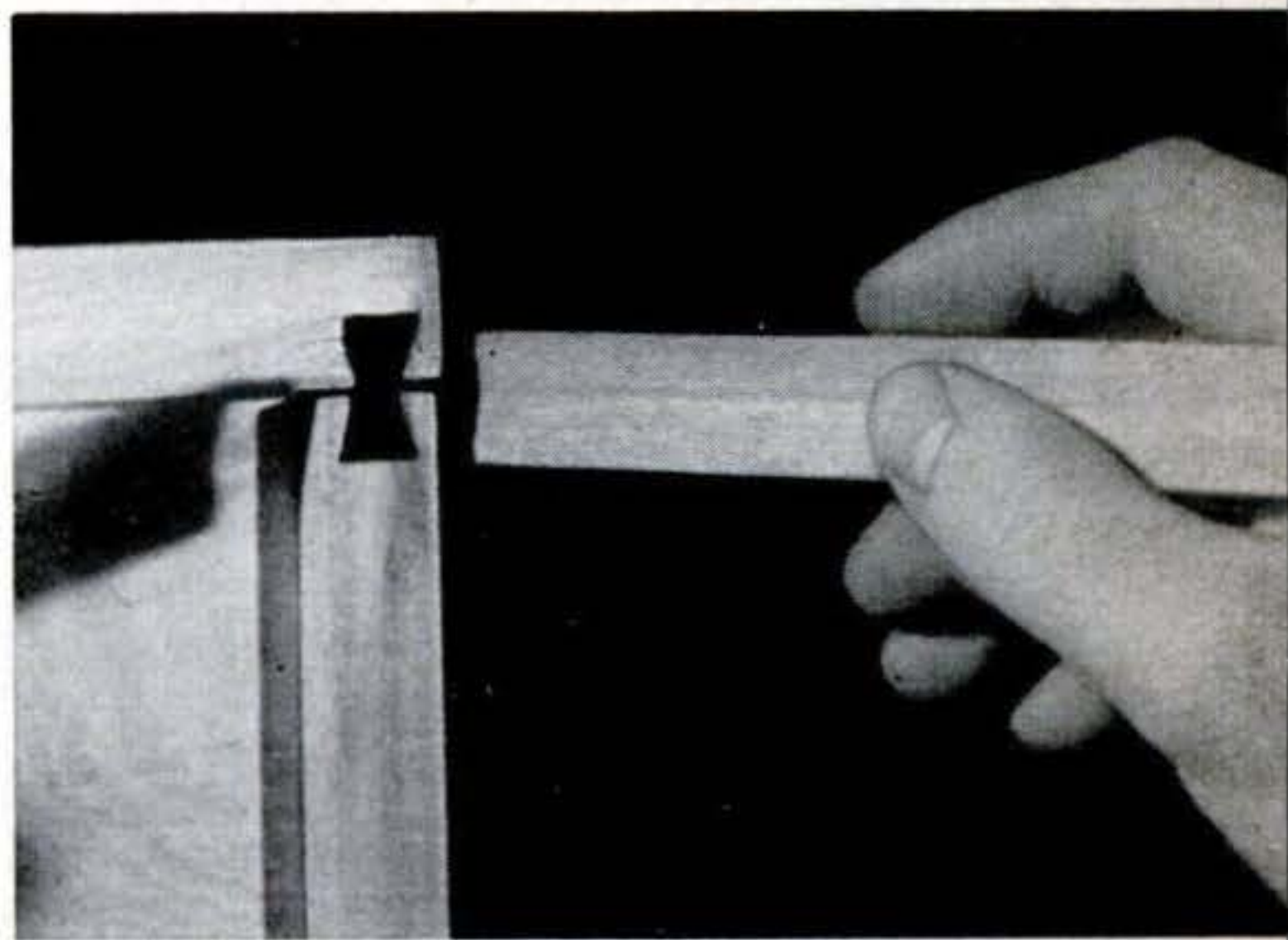

Slide-assembly principle is shown above. Matching dovetail grooves in joining pieces form a double dovetail socket. Spline, called butterfly, is then slid in, locking pieces together.

Blum calls his creation Slide Assembly Furniture—and it is literally just that. All of the pieces come cut to exact size and slide easily together, requiring only glue to hold them in place. To make this possible, Blum borrowed a trick, called a butterfly joint, from the oldtime makers of fine furniture. ➤

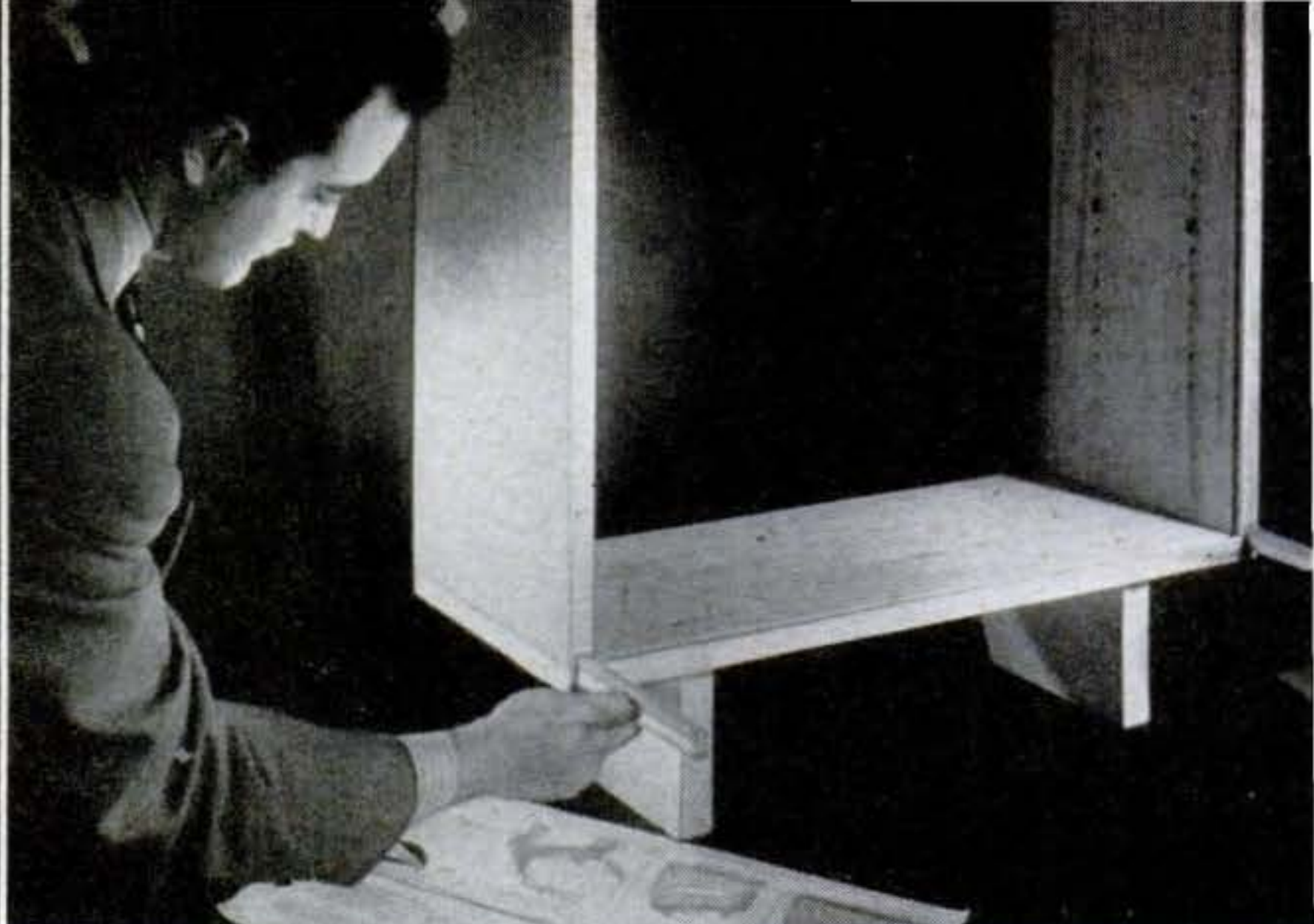
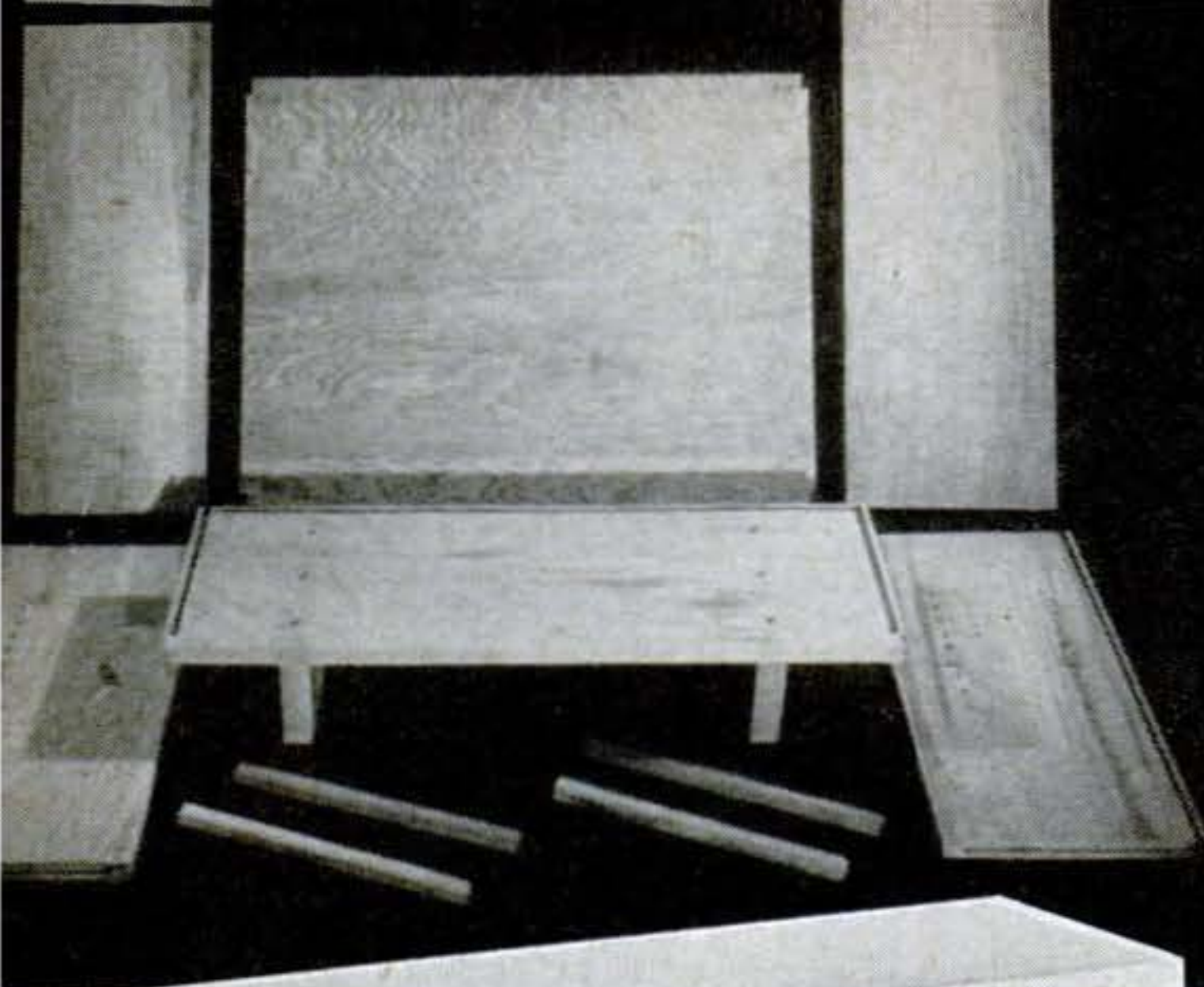

Bookcase kit (left above) includes everything needed for assembly, even glue, glue brush, and sandpaper (not shown). Construction begins by fitting sides to base, which comes with legs already attached. Matching grooves in sides and base are lined up and splines are slipped in,



Finished bookcase—assembly time about 10 minutes. Shelf rests on brackets that can be pushed into different holes to adjust its height.

All the purchaser has to do is line up two matching dovetail grooves, one in each part to be joined, and slide in an interlocking piece that holds the two parts firmly together. Some of the units, like the coffee table and dining table, can even be left un-

glued in part, permitting quick disassembly for storage or moving.

Except for the tables and a taller wardrobe, all of the modular, multipurpose units are scaled to the same height—28 inches—so they can be grouped in any combination and easily interchanged. For fuller use of limited space, two units can be stacked together by simply removing the legs from the upper one. And all stand high enough off the floor so they clear the baseboard and fit snugly against the wall, giving the sleek, modern appearance of built-ins.

By mass-producing the pre-cut, pre-grooved pieces, Blum figures he saves the purchaser money while at the same time providing him a type of construction usually found only in expensive furniture. His present designs, available from the Walter E. Blum Co., of New York City, are shown below. Prices range from \$16 for the bookcase to \$87 for the large wardrobe.

Tiny models of slide-assembly furniture show (left to right) sliding-door wardrobe, dining

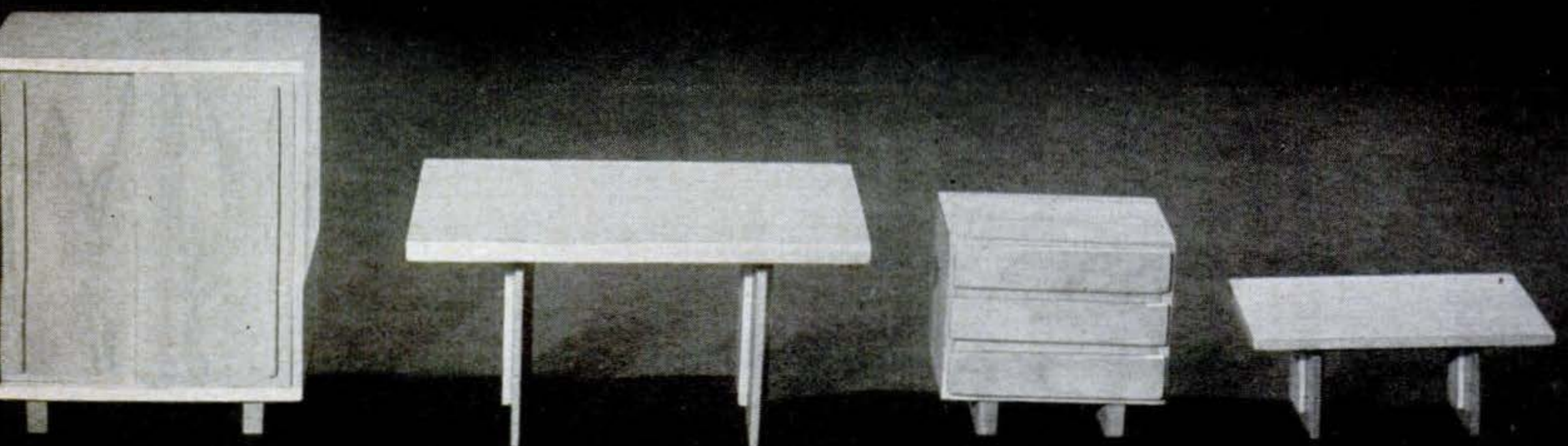

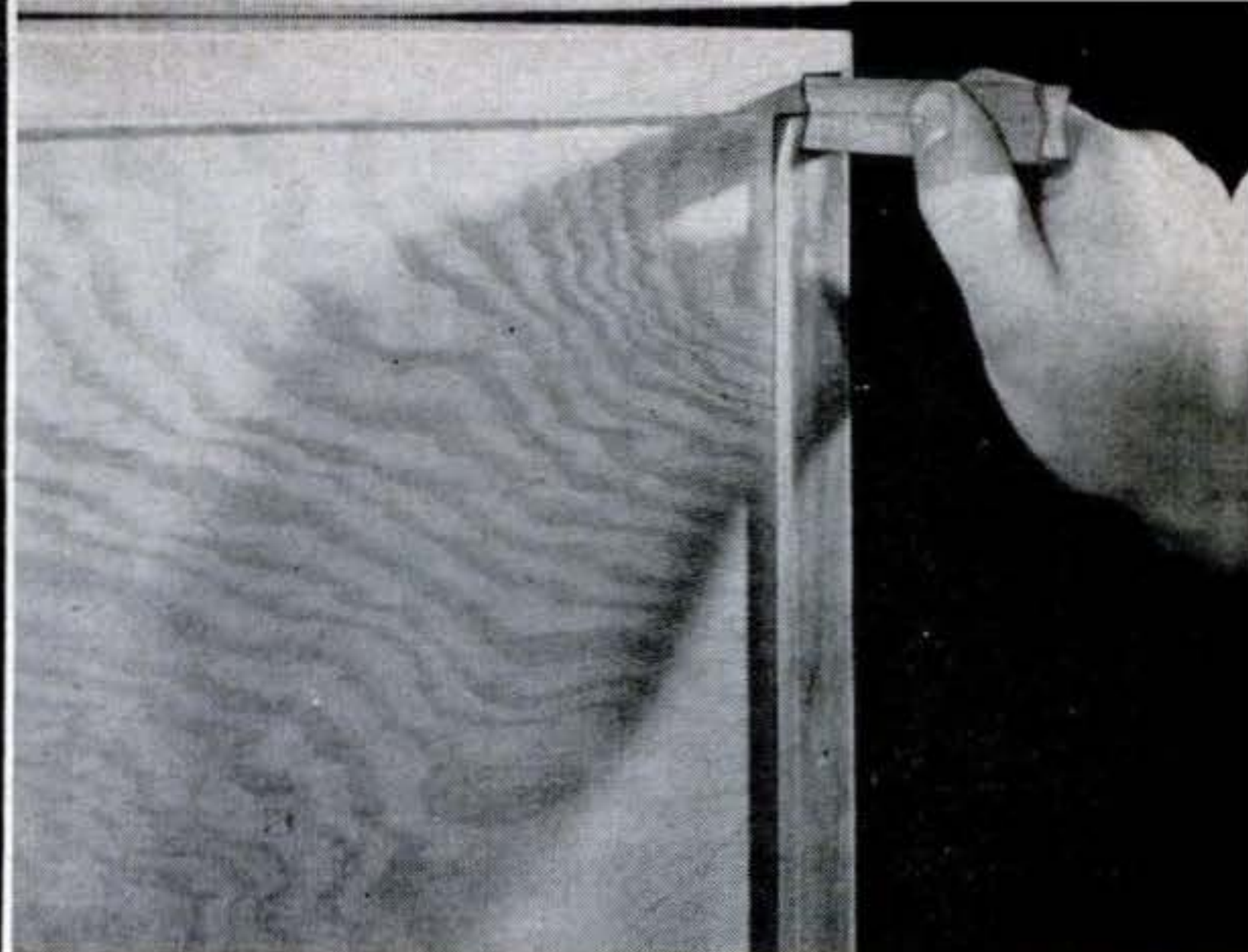
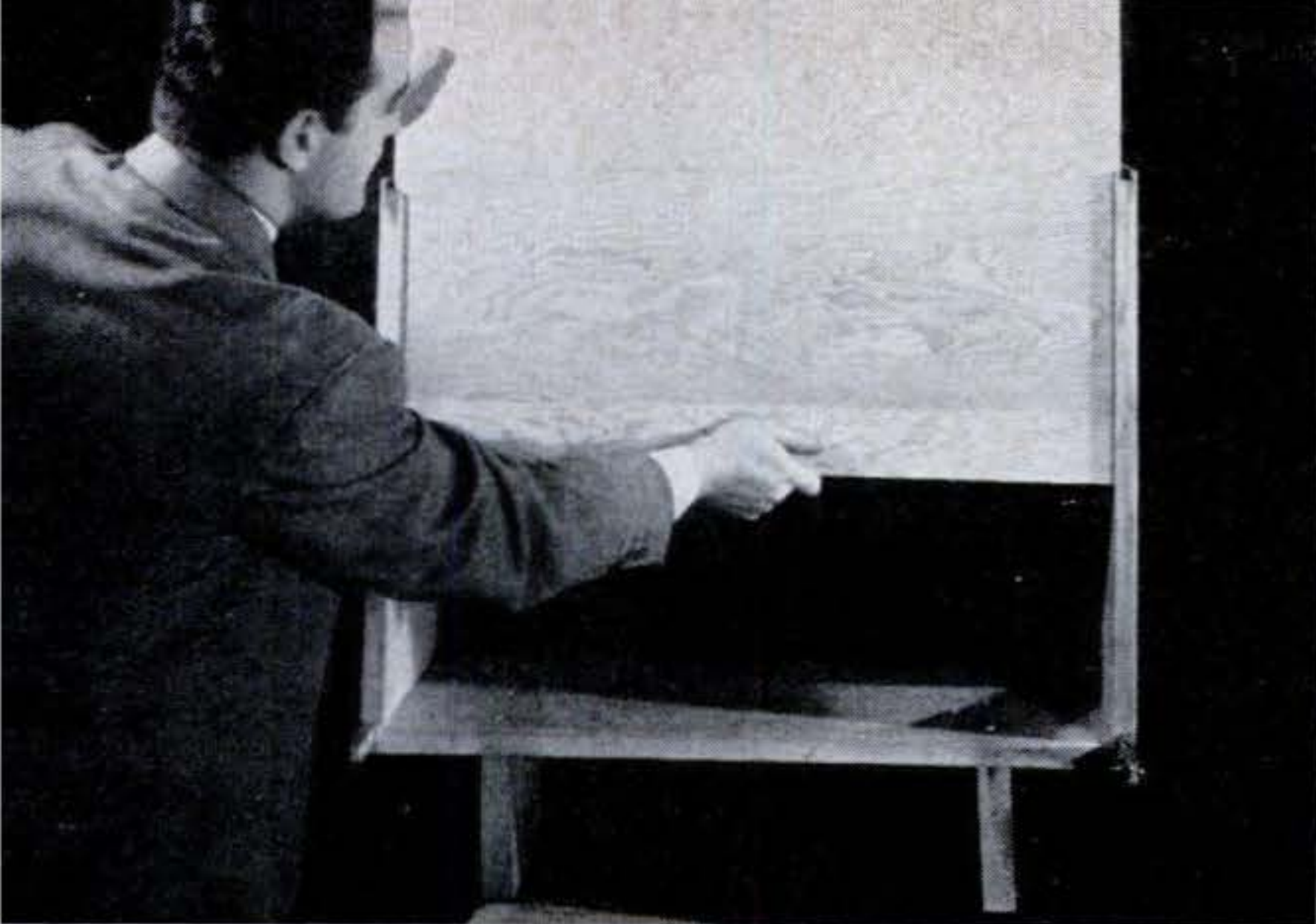

locking pieces together. Splines are inserted from rear and grooves are blind—run only part way through—so splines can't be seen from front. For permanent assembly, grooves are first given thin coat of glue. Next step is to slide the back down between upright sides. Grooves in

sides and base hold it in place. In final step (shown above) top is laid on and upper splines are inserted. Thorough sanding completes job. Wood comes with veneer of either birch, shown here, or maple, can be given natural, blond, tinted, stained, or painted finish.

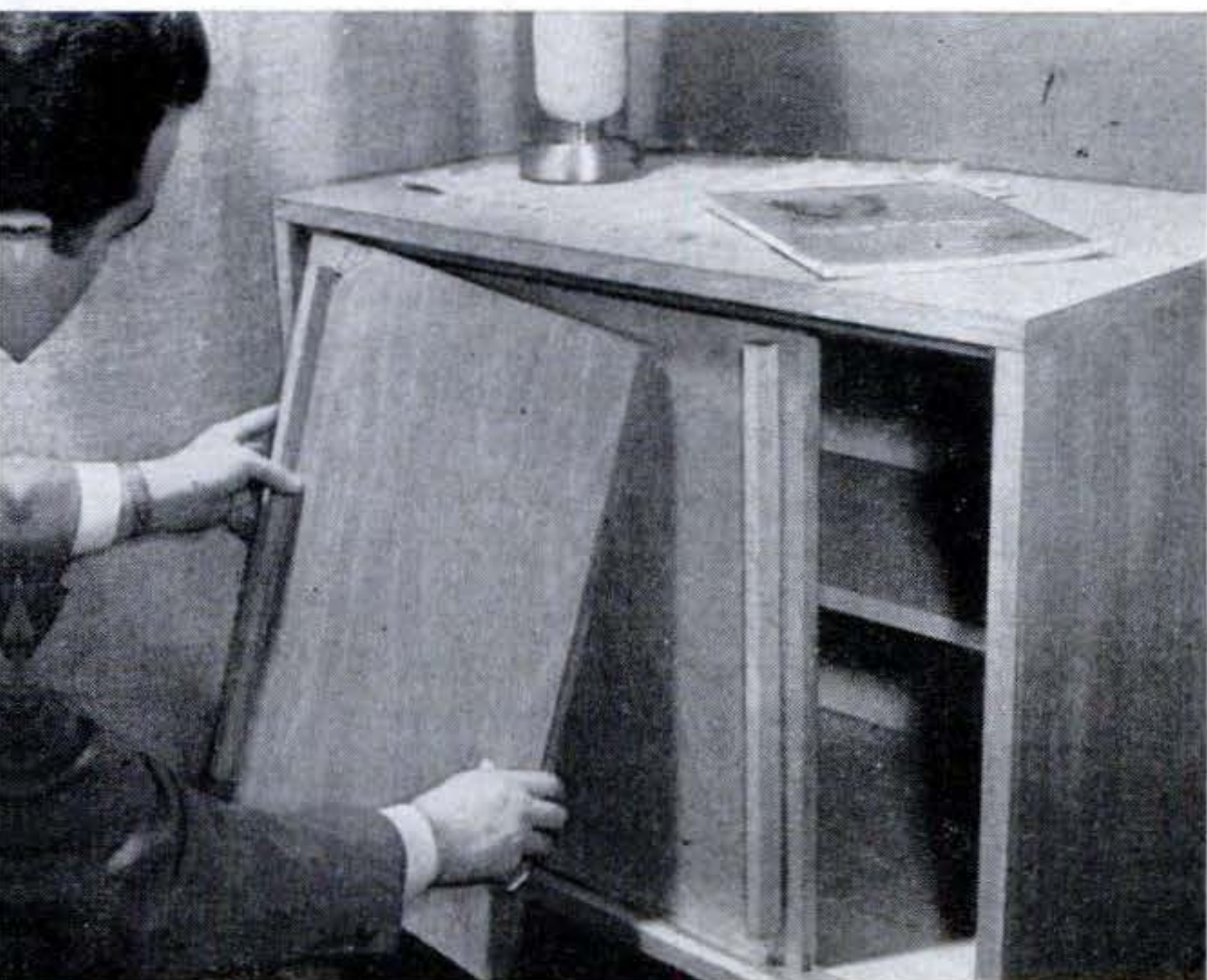

Slight clearance at top of sliding doors permits lifting doors out of track and removing them, making it easy to re-adjust shelf or install large units like radio or television set.

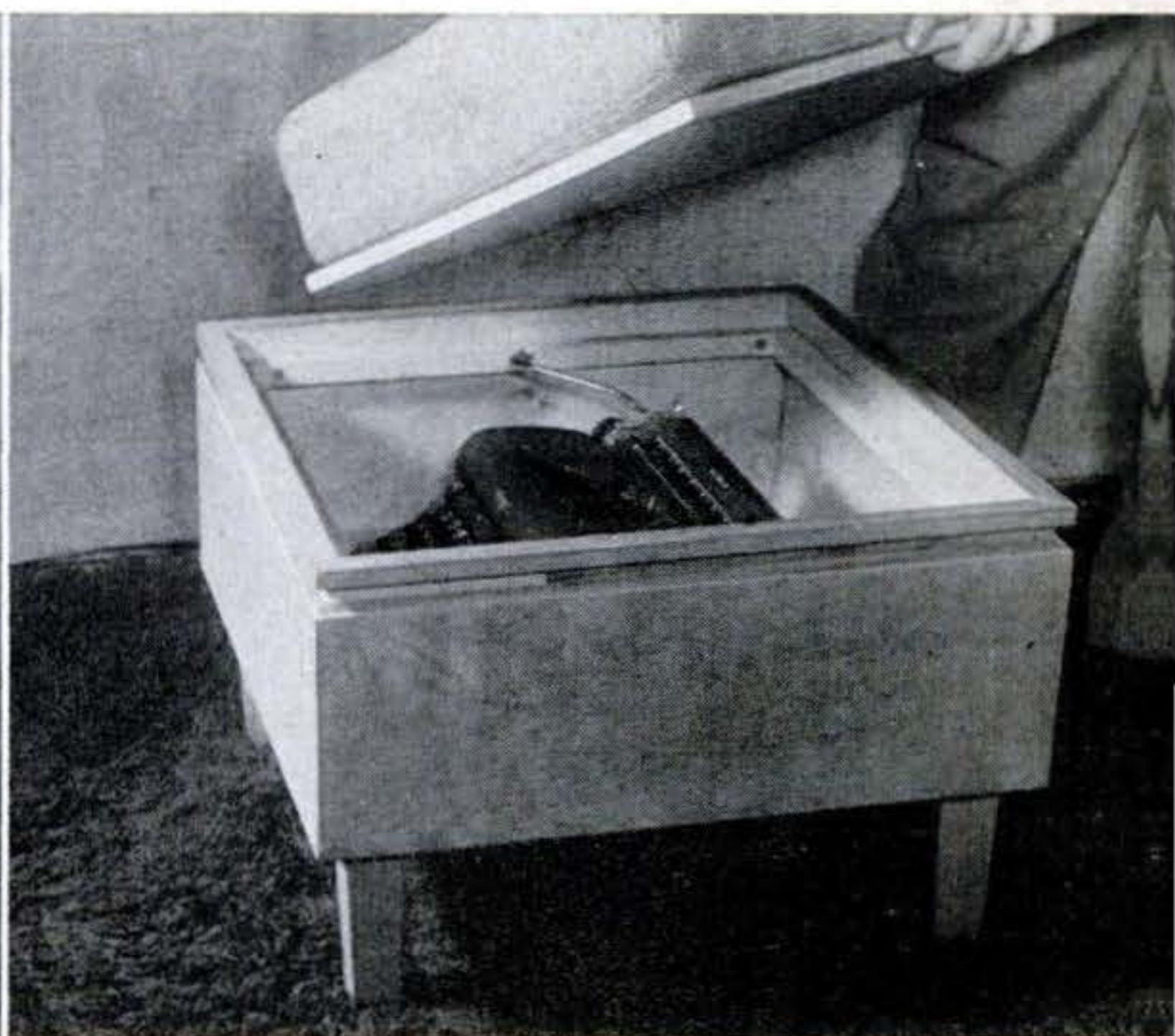

Small stool serves as desk chair or ottoman, has space inside for typewriter or record albums. When not in use, it fits out of way under desk. Several used together make sectional seat.

table, three-drawer chest, coffee table, desk and stool, sliding-door cabinet, and bookcase.

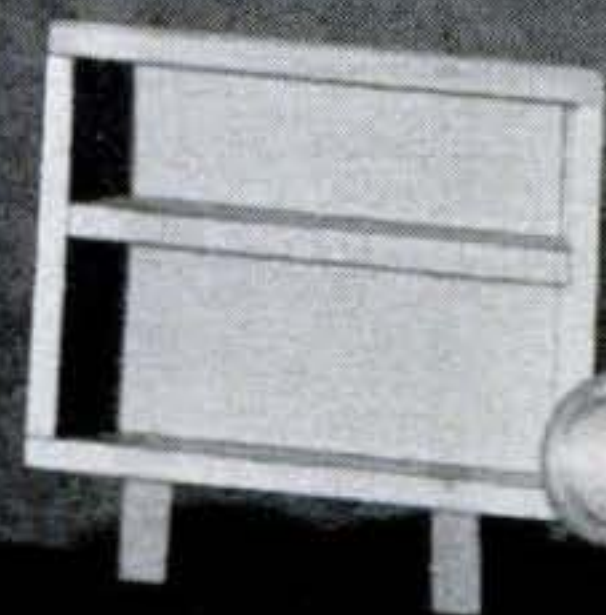
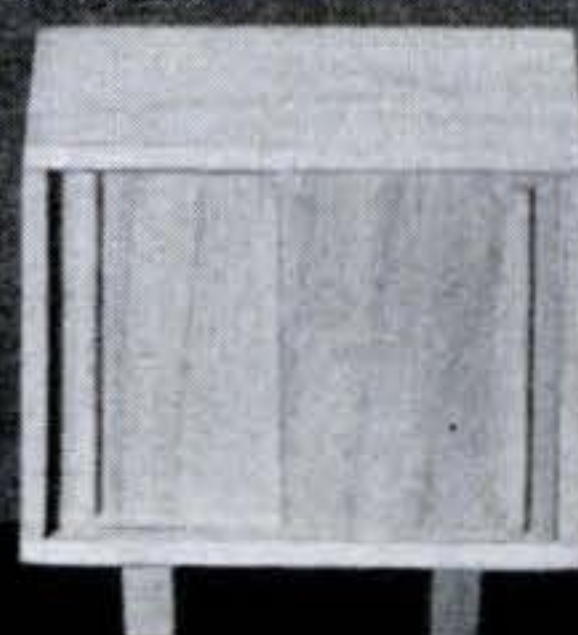

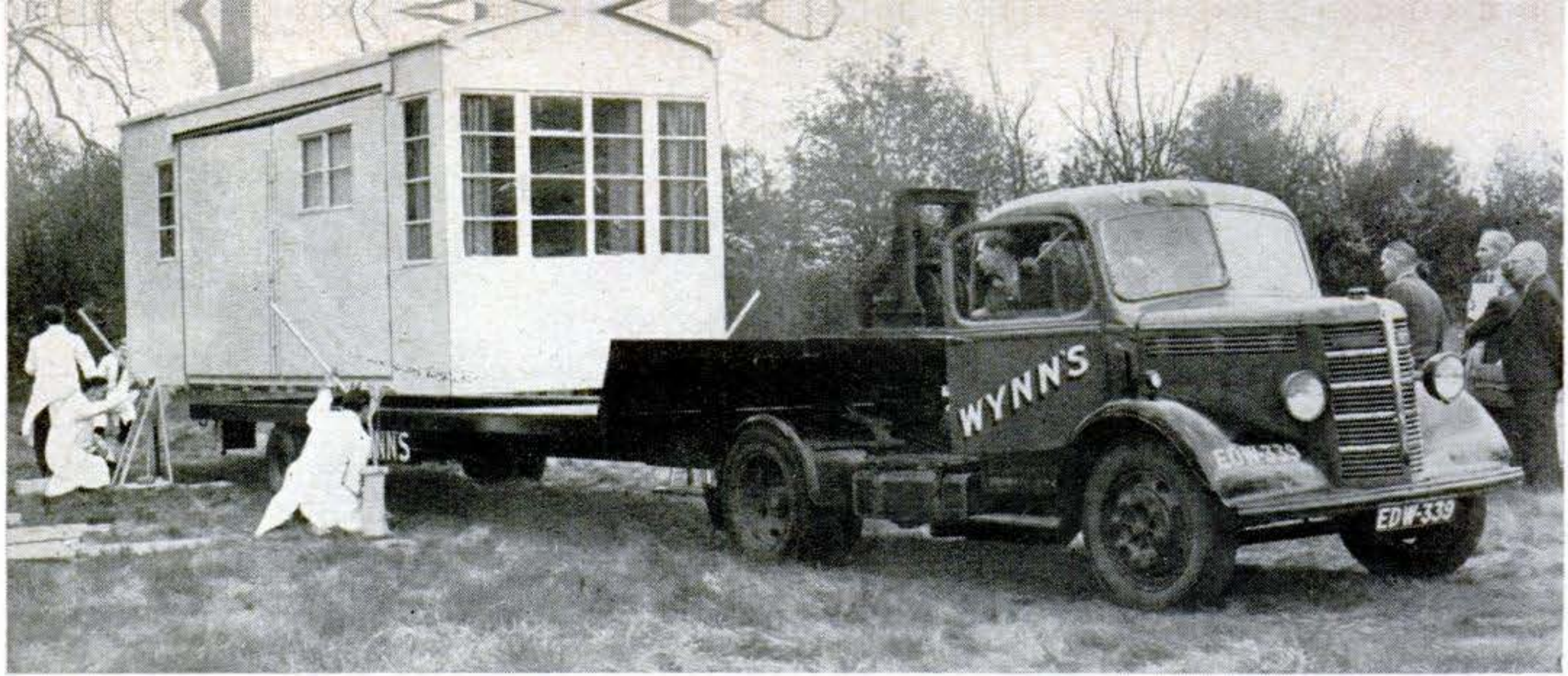

Hauled to a site by trailer truck, the folded center section is raised by four house jacks.

When the trailer has pulled out, the house is lowered to rest on its own built-in supports.

Folding House Moves by Truck

ON MOVING day, two bedroom wings fold into the center living-room section of this pre-assembled cottage, making a compact 22-ft. by 7½-ft. package for truck transport. The folding feature is made possible by placing all plumbing and wiring lines in the middle unit. The Terrapin house can be occupied six hours after delivery. It was developed by the British as temporary housing at construction sites and other areas without permanent housing.



The house is quickly expanded to full size by swinging out walls of the 7-ft. by 13-ft., 9-in. bedrooms. Outside walls and ceilings are covered by sheet aluminum, and are fully insulated.

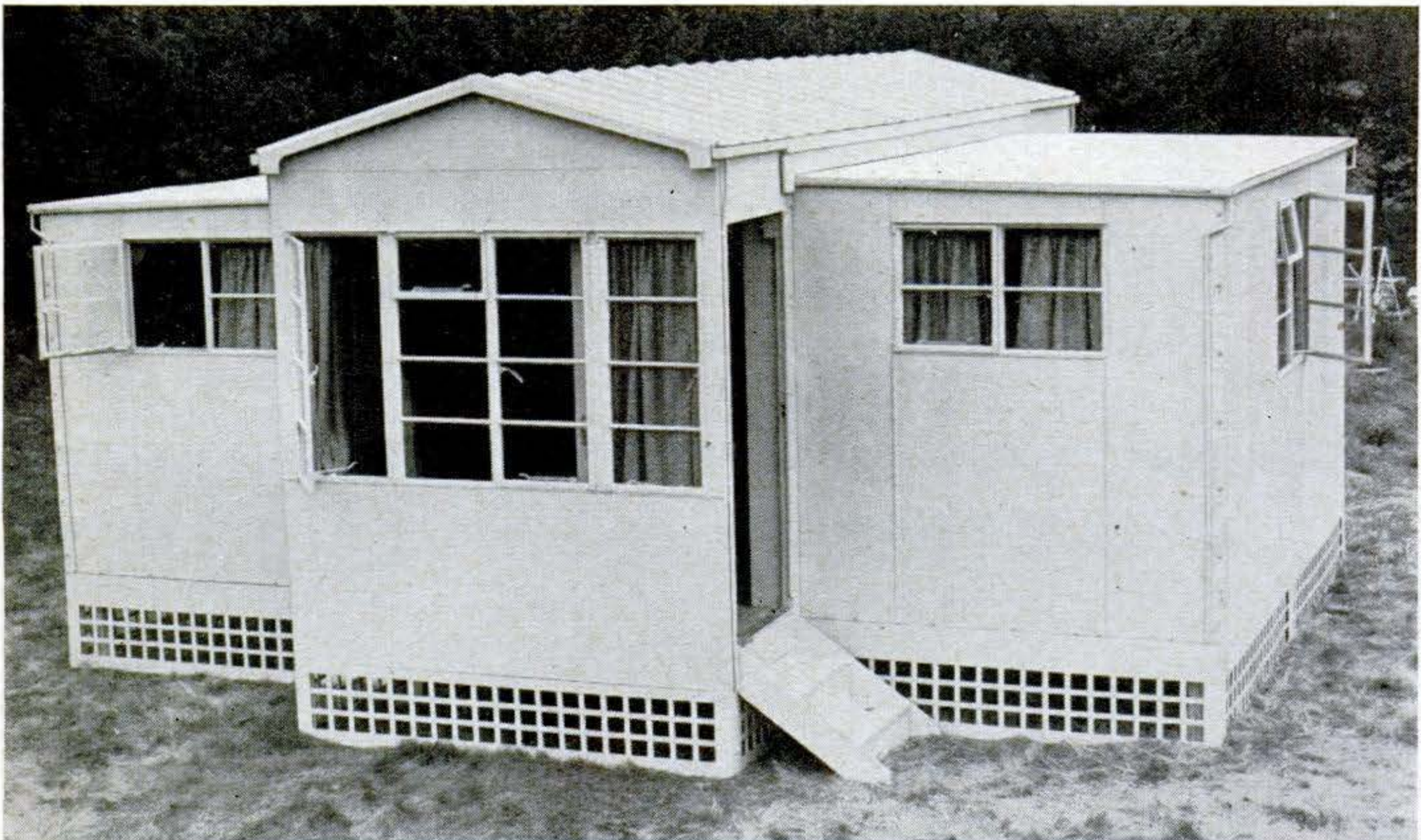

Six hours after delivery, the house is ready to be hooked up to water, power, and drainage

lines. The 333-sq.-ft. floor area includes a kitchen-bath unit in rear of the living room.

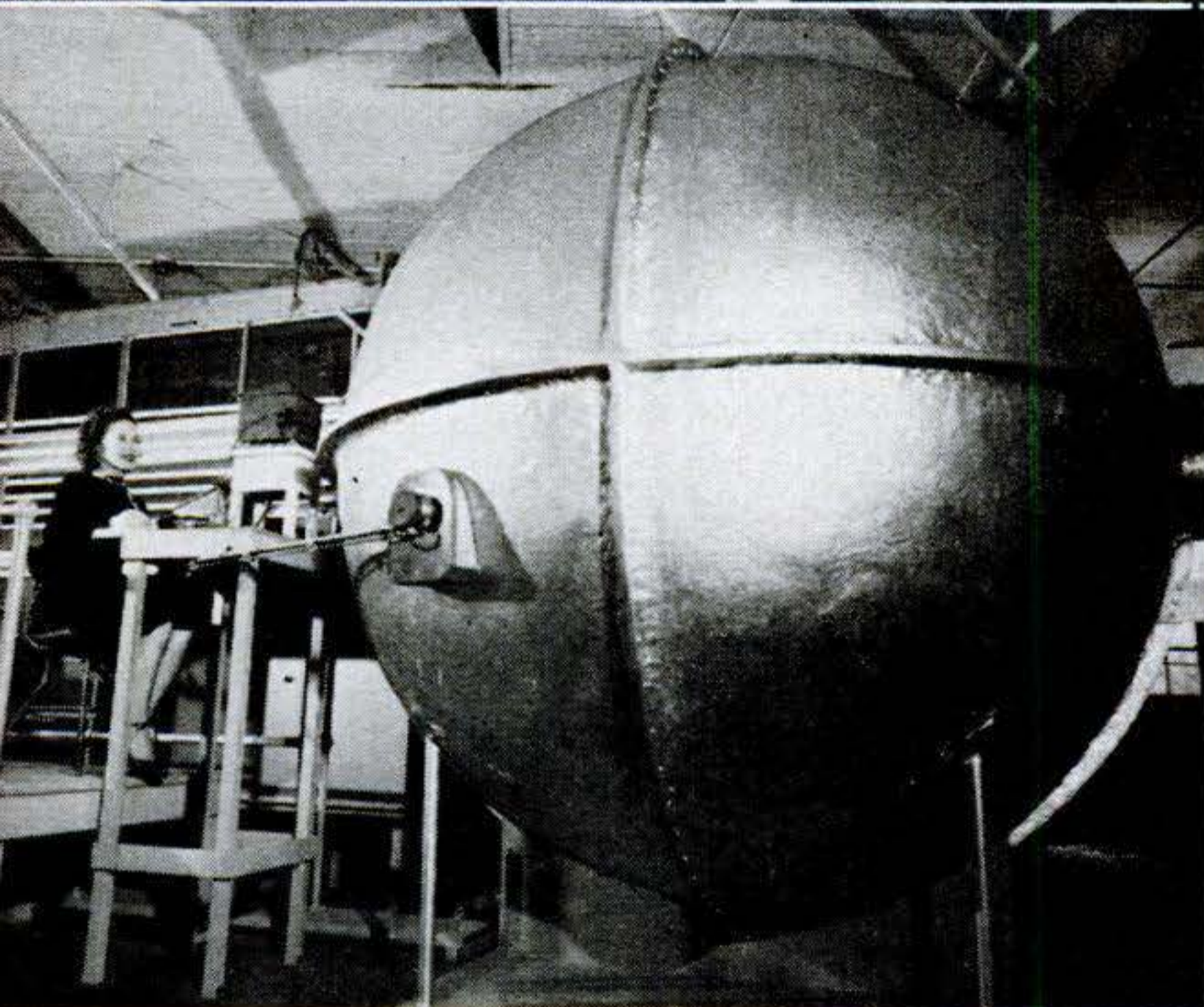
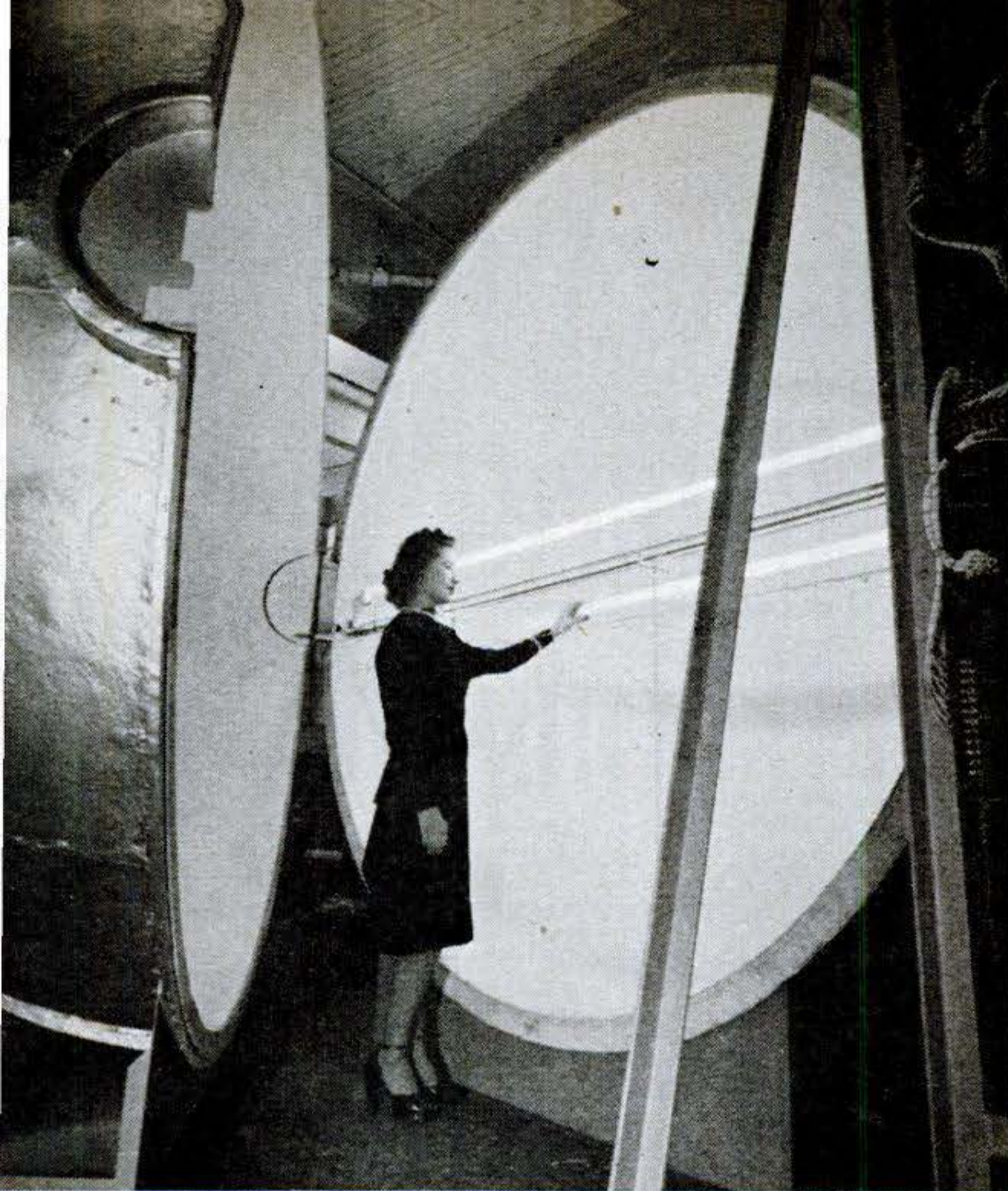

Giant Sphere Measures Light

TO MEASURE the light output of eight-foot-long fluorescent tubes that wouldn't fit inside the small spherical photometers used to test ordinary light bulbs, Westinghouse engineers designed this huge one. Top photo shows the 700-pound, 12-foot-high plastic sphere open for interior adjustment. When it is closed, prewarmed tubes are fed in mechanically through the side on a track. Their light, bouncing off all points of the sphere, is then reflected onto a sensitive photocell that records its intensity on meters outside.

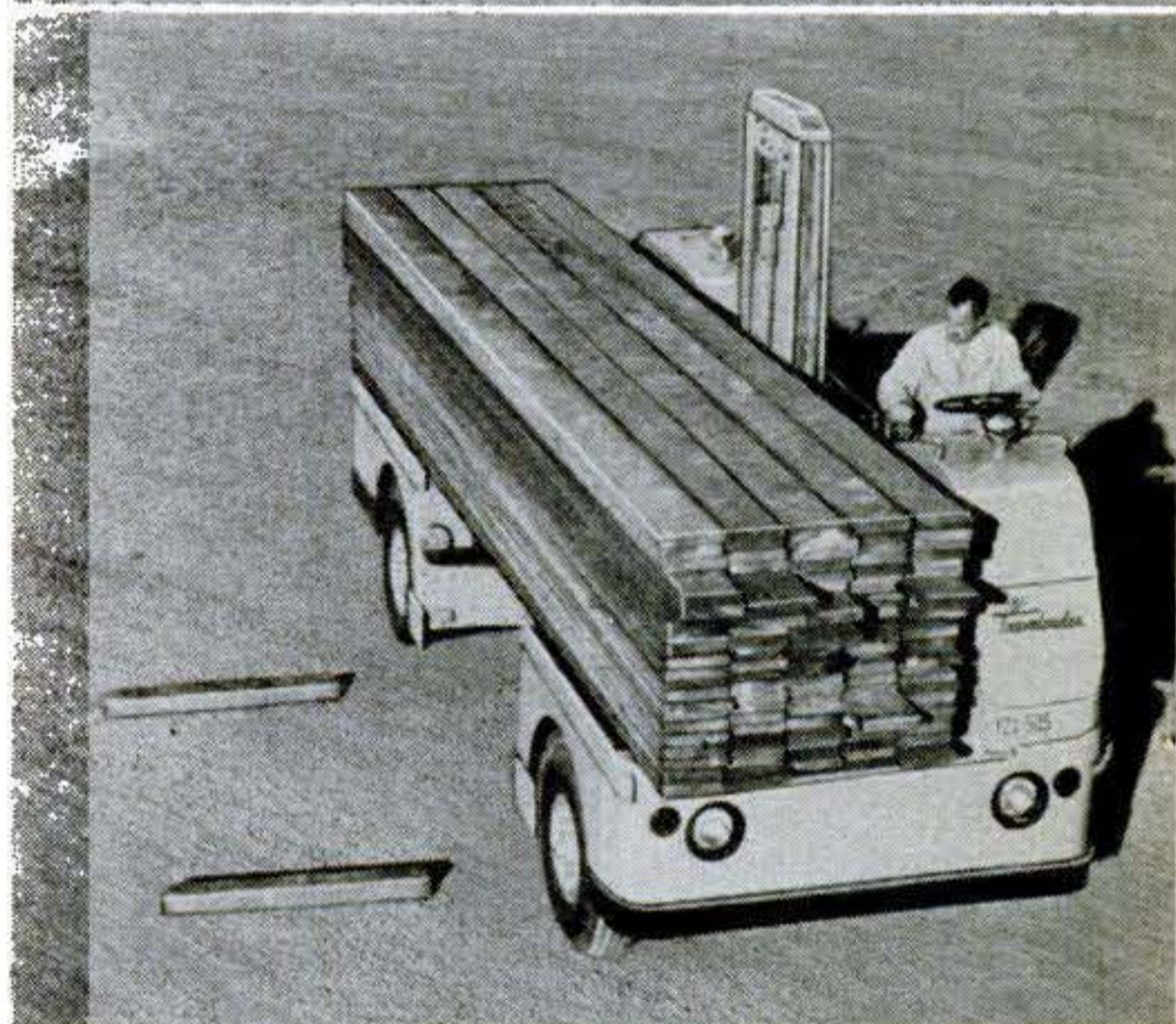
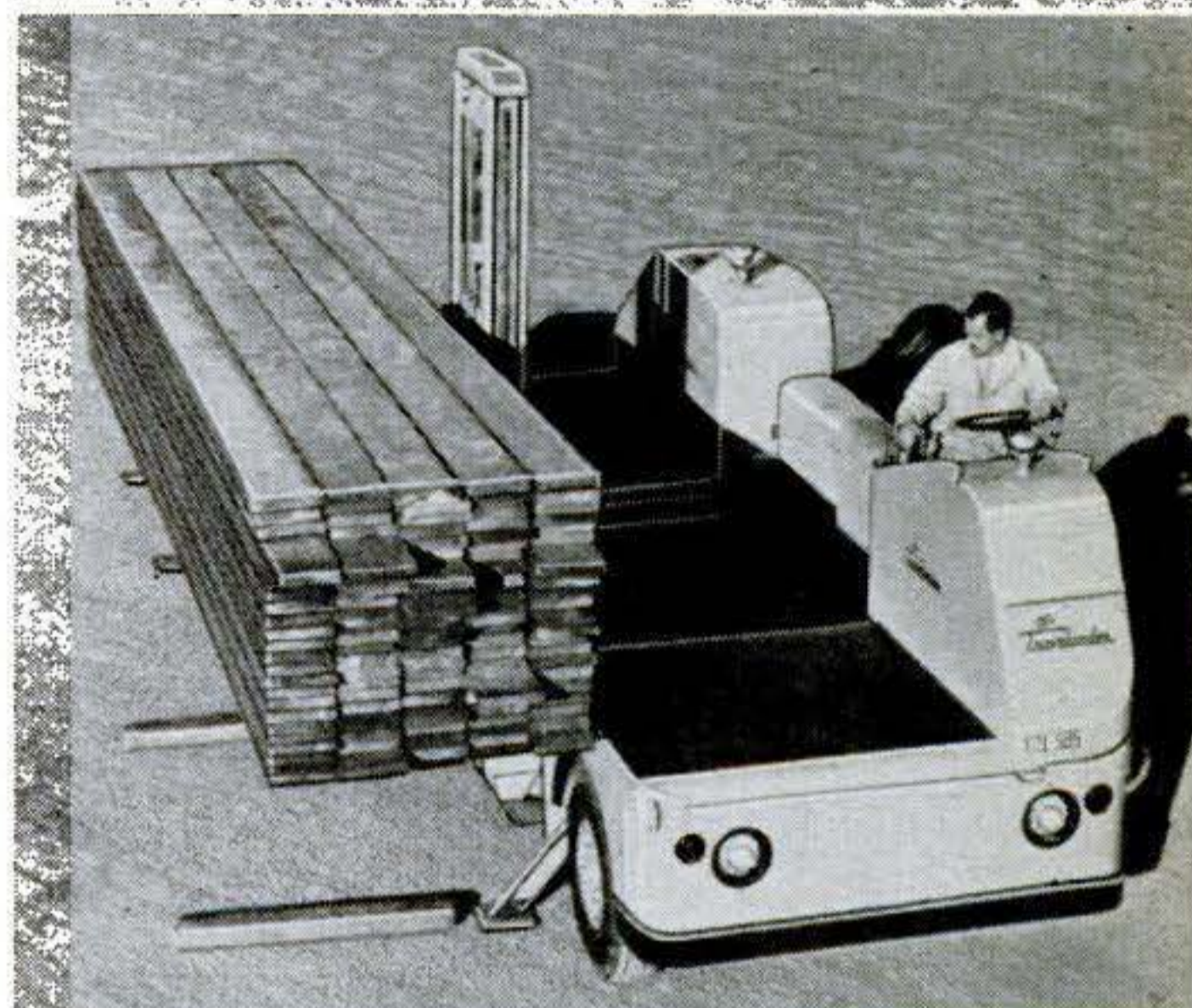
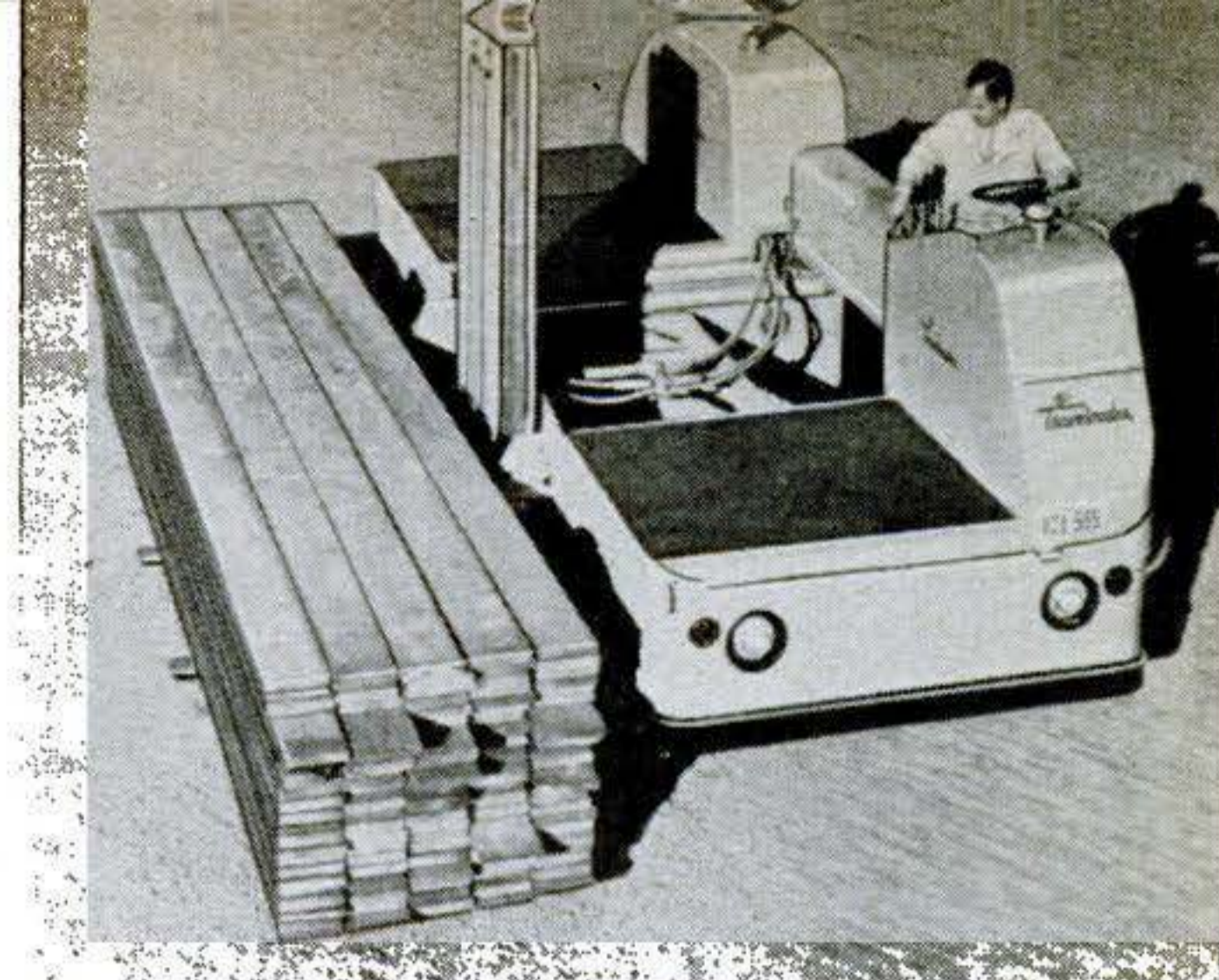

Side-Lifter Speeds Loading

THIS new side-loading hydraulic-lift truck can pick up a 30,000-lb. load and be off at 30 m.p.h. in 20 seconds. Carrying its load lengthwise instead of crosswise, it can easily maneuver in narrow aisles or on ordinary roads. To load, its fork extends out sideways after hydraulic jacks have braced the machine against the ground. For stacking, its fork lifts 12 feet; special arms can increase this to 17 feet. For carrying or unreeling cable spools, it can be fitted with a self-powered spindle. The Traveloader is made by the Lull Mfg. Co., Minneapolis.

What to Do Before Your Well Runs Dry

New drilling techniques and jet pumps help slake the countryman's growing needs for plenty of pure water.

By William Gilman

Photos and drawings by Eleanor Gilman

SO YOU'RE planning a new home beyond the city water mains, or remodeling an old one? It should be built on a firm foundation: pure water, plenty of it. That's something too many people who want city conveniences with country living are liable to forget. A little planning will save a lot of expense and grief later.

Recent publicity about New Yorkers going without baths and shaves only dramatizes the situation. From Maine to California, municipalities are doling out water, hunting new supplies, debating what's happened to Nature's water spigots.

Less publicized is the plight of the home owner whose automatic pump starts sucking air instead of water. Even if you can borrow some for drinking, you're in a first-class jam because of your dependence on water in modern living. The toilet won't flush, the hot-water heating system leaves you cold, and the electric washer just stands there looking pretty.

Even so, you can usually pull yourself out of your hole, while your city brother has to wait for vast new engineering projects to be planned, debated, and finished. Unless you live in a really arid region, you can have an expert shoot a deeper well, which usually solves the problem, or put down a new one. The price these days is around \$6-\$8 per foot plus cost of materials.

Improved drilling technique makes costly dry holes pretty rare. Strainers developed



Well-drilling rigs like this one are a familiar sight when homes are built beyond the city-water limits. Population growth and increasing needs make old-fashioned wells inadequate.

in the past 10 years allow wells to draw clear water even from quicksand. You may have to go through rock, and so get more dissolved minerals in the water—but modern softeners can overcome hardness.

Then there are the comparatively new ejector or jet pumps that make push-pull piston ones look almost as backward as the old oaken bucket. You can even get a submersible outfit with a pump and motor that swim hundreds of feet underground.

Pioneers found water first, then built their cabins next to it. Drillers swap stories about many moderns who go ahead building a layout complete with swimming pool and automatic sprinklers, phone for a water-finder afterward, then hover nervously as his expensive hole goes deeper. Plumbers complain of the householder who expects a boy-sized pump to do man's work, or a man-sized one to draw from a well that can't keep up.

Recent droughts have been, in a way, a blessing in disguise. Experts agree they have brought the real trouble to light—the inadequacy of hard-pressed water systems that can't stand our growing demands on them.

Living closer together increases our pollution problems, and living easier makes our water needs much greater. We've become a well-scrubbed nation, with even the family car being washed down at six gallons per minute. But water won't stretch. That's why it's best to take pad and pencil before deciding on the new well and the pump for it.

The average daily consumption per person in a modern home is figured at 40 to 50 gallons but varies widely and can easily run 100 gallons. Figure it out for your own home from the following table:

	<i>Gal.</i>
Shower bath	35
Bathtub	25
Toilet, each flushing	6
Lavatory basin, each filling	1½
Horse, daily	15
Cow, daily	25
Hog, daily	2
100 chickens, daily	4
Laundry tub	6-10
Kitchen sink	5-8
	<i>Gal. per minute</i>
¾-inch hose	6
Lawn sprinkler	3½

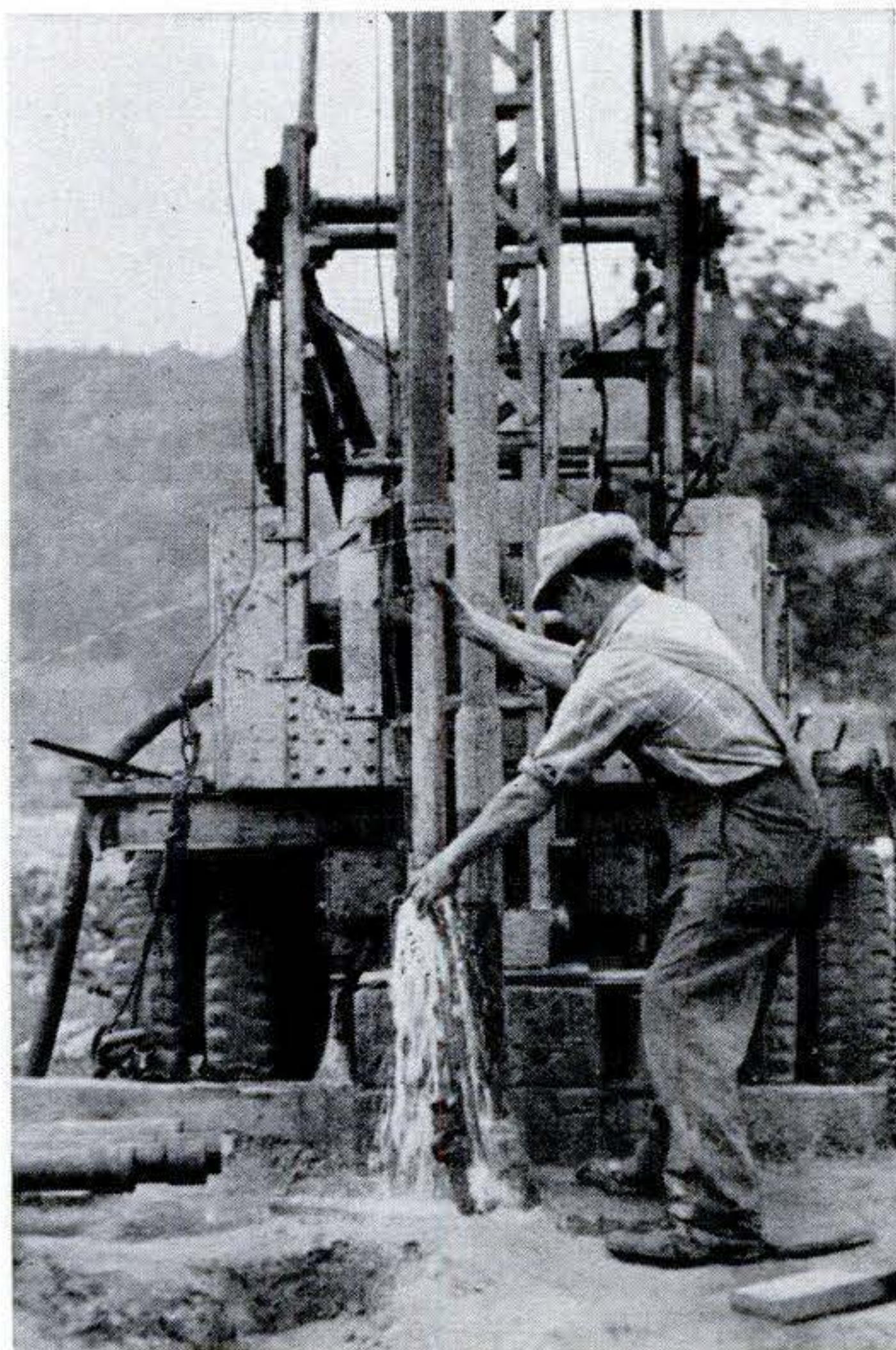

After a well is drilled, plunger-type pump is attached to rig to test water flow. On deep wells of over 100 feet, same type of pump, driven by electric motor, is often used permanently.



Small, streamlined jet pumps are becoming standard in many homes. This one lifts water about 20 feet, automatically starts when pressure tank gets low and shuts off when it builds up.

But after you've calculated daily gallons, remember there will be peak demands at times like Monday's washing or the morning hour when kids keep the bathroom humming. If you don't want pumping trouble, allow for peaks when clothes washer, dishwasher, shower bath, and lawn sprinkler may all be going at once.

One rule is to add up all outlets that will be in use at the same time, and figure each will need three gallons per minute. A small family might squeeze by with a well producing 2 gallons per minute and a large air-pressure tank for a reservoir. But a 5-gallon-per-minute one is safer, especially with a fast-working pump.

Generally, a pump with a capacity of

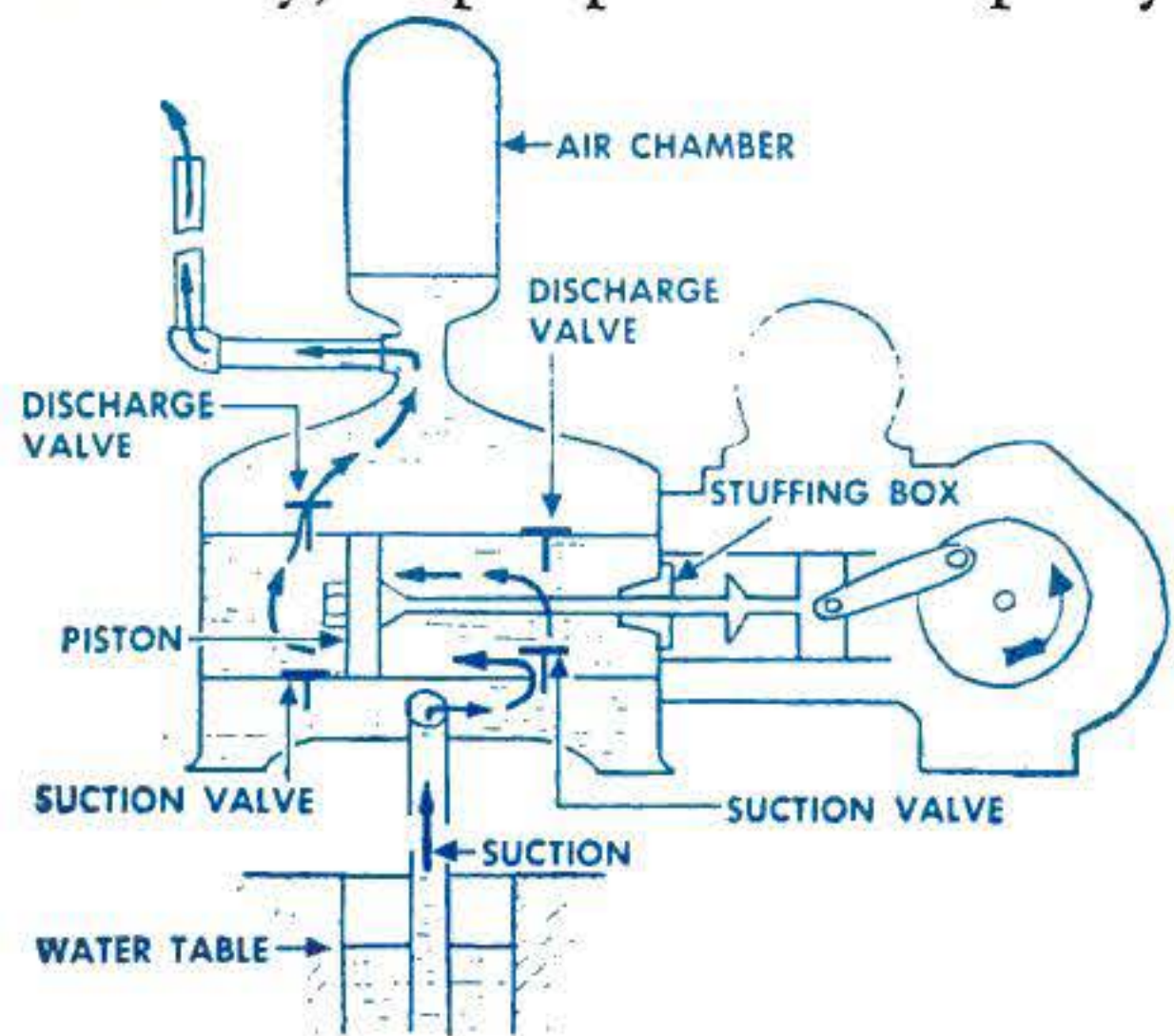

Old faithful among pumps is this double-acting, reciprocating type. Like jet, it lifts about 20 feet, but can operate on smaller water supply. For deeper wells, piston is in well pipe itself.

around 300 gallons per hour will handle the small home comfortably. One of around 600 g.p.h. is best if your daily needs run between 800 and 1,200 gallons.

If your needs require a deeper well or new one, get a reliable man for the job because he'll have know-how and proper equipment. Water engages in tricky underground activities. At a Connecticut estate, it rises and falls in a well with ocean tides 20 miles away. In sections of Michigan, a well may bring up salt brine. In Louisiana, it can be so near the surface that it floats the oil tank you're trying to bury. In Indiana, one home owner gets his cooking gas and water from the same 100-foot well.

Roughly speaking, there are two kinds of water—surface and ground. Surface water, piped from streams, ponds, and some springs, can be used for many purposes, al-

though in populated areas it's generally unsafe for drinking. Many rural dwellers with drought-hit wells use centrifugal pumps to supply surface water for gardens, livestock, irrigation, and fire protection.

Ground water is the old stand-by for home needs. It's rainfall percolating down into spongy gravel and sand, and collecting in pores and crevices of underlying rock. This ground water is in constant movement. Its upper surface is the water table, which sinks in dry seasons. Sometimes you can tap it from natural springs and fissures. But usually the trick is to get it up a pipe by suction.

The old-fashioned stoned-in well is often sufficient, but because of pollution dangers and lowering of the water table by drought and heavy use, most wells these days are going deeper. It's done by driving pipe through softer stuff, drilling in rock, and bailing out the muck. The result is a tubular well formed by the pipe casing.

Rock Man and Gravel Man

An experienced driller knows the terrain, where to shoot, and how deep he may have to go. He can read tell-tale signs in the mud he bails out. He's most valuable if he's both a "gravel man" and a "rock man" instead of a specialist in just one. Some of the best wells are brought in, at less expense, from spongy sands and gravels above rock.

One driller gave up after going down 640 feet, most of it through rock. He had cased right past water-soaked gravel that a new well tapped at only 70 feet.

It's a knack knowing how to gravel-pack a well properly—how to pump out sand and leave a screen of natural gravel to act as water filter. If it can be done, that's the best way.

Drillers say their biggest help in the past 10 years has come from the new, noncorrosive screens that make it possible to draw clear water from beds once shunned. Such a strainer, either within the casing or placed below it by jacking up the casing, may be 50 feet long and any mesh desired. One driller went down 150 feet and hit genuine quicksand that oozed 100 feet up the well. Instead of giving up, as he would have formerly, he installed the proper screen—and that well now draws 40 g.p.m. of crystal-clear water.

Figuring a well's capacity is more than calculating how much water is down there. It may stand 100 feet in the pipe. But when you start using it, how fast will new water

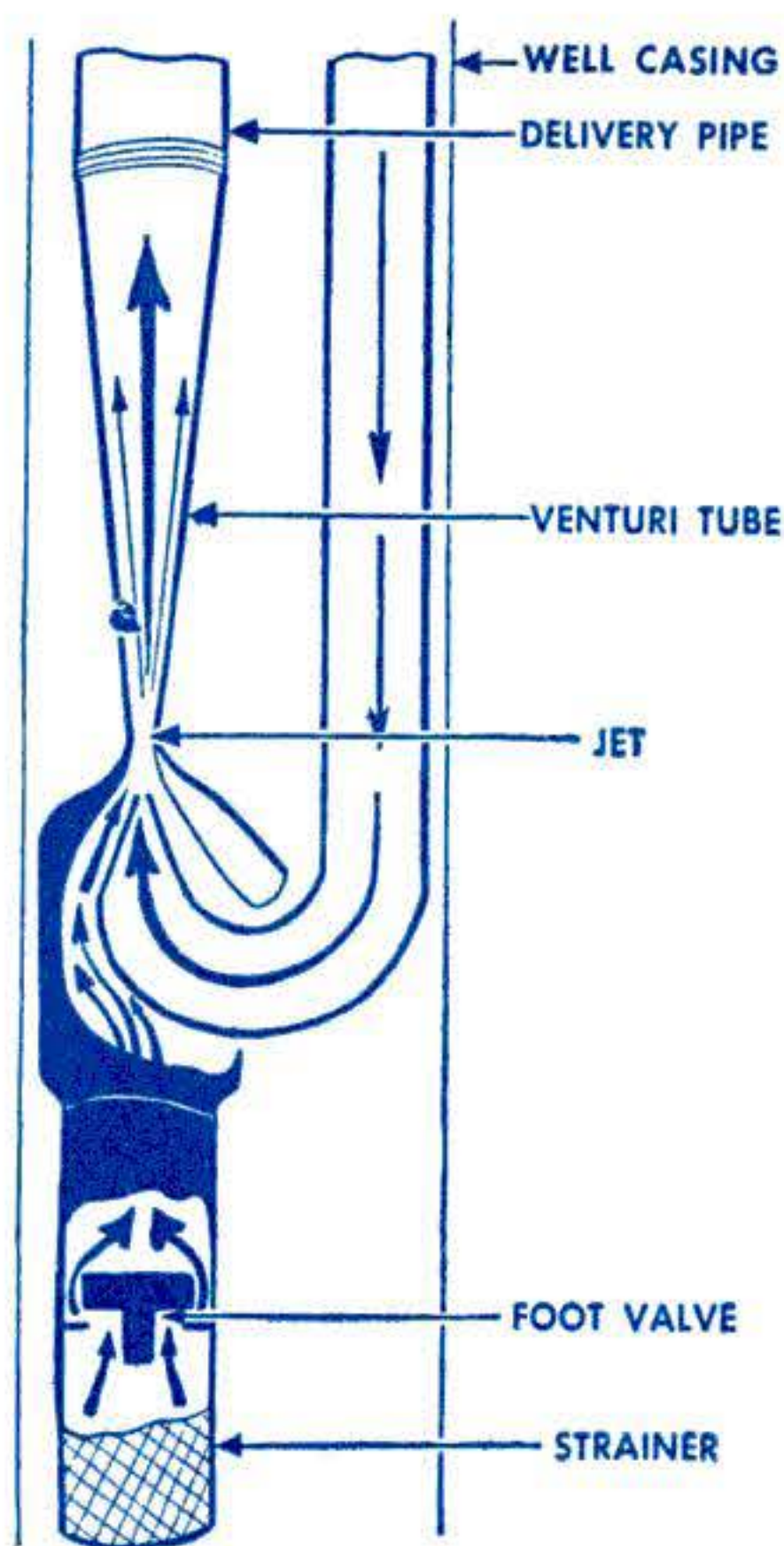

High-speed, twin-pipe jet pump can lift water 120 feet. Stream shooting down pipe at right through jet nozzle and into venturi tube creates vacuum that draws well water up pipe at left.

come in? That's why the driller uses a test pump to find the "draw-down point" where the well is giving as much as the pump is taking. This gives the gallonage you compare with your needs and use in determining the size of pump to install.

It's necessary to watch out for trickery down the well, which may be drawing from a temporary pocket in rock and do fine until that supply is emptied—and then the level drops like a plummet. Overnight the pocket may refill and repeat the trick. That's why a good driller will pump eight hours steady before he is satisfied with the test.

There are many types of motor-driven pumps—but for home use you're likely to pick a reciprocating or jet one. The former is the old reliable that's based on the hand-pump principle of a piston stroke pushing out water, leaving reduced atmospheric pressure behind to bring in more water for the next boost. Shallow-well types lift water about 20 feet (lift is from water table to pump—not delivery height) and are handy for basement installation. If you need more lift from a piston pump, there are deep-well models in which the plunger is worked up and down the well.

Piston types are fast being outmoded by jet pumps. Most manufacturers have begun putting out lightweight models that are non-corroding, self-priming, and quiet. Many come mounted right on a 15- or 30-gallon pressure tank, providing a neat package to fit any small corner. These high-speed pumps—a ½-hp. motor delivers 600 g.p.h. at 20 feet suction lift—work on a combination of venturi and centrifugal principles.

The only moving part is the spinning impeller. While whirling part of the water through a discharge pipe, it sends the rest back down through a line ending in a jet. As the high-pressure stream sprays out into a cone-shaped venturi tube, it creates a partial vacuum, pulling more water up the well to within reach of the impeller. The outfit is really two pumps working together.

The jet's only disadvantage is that it re-

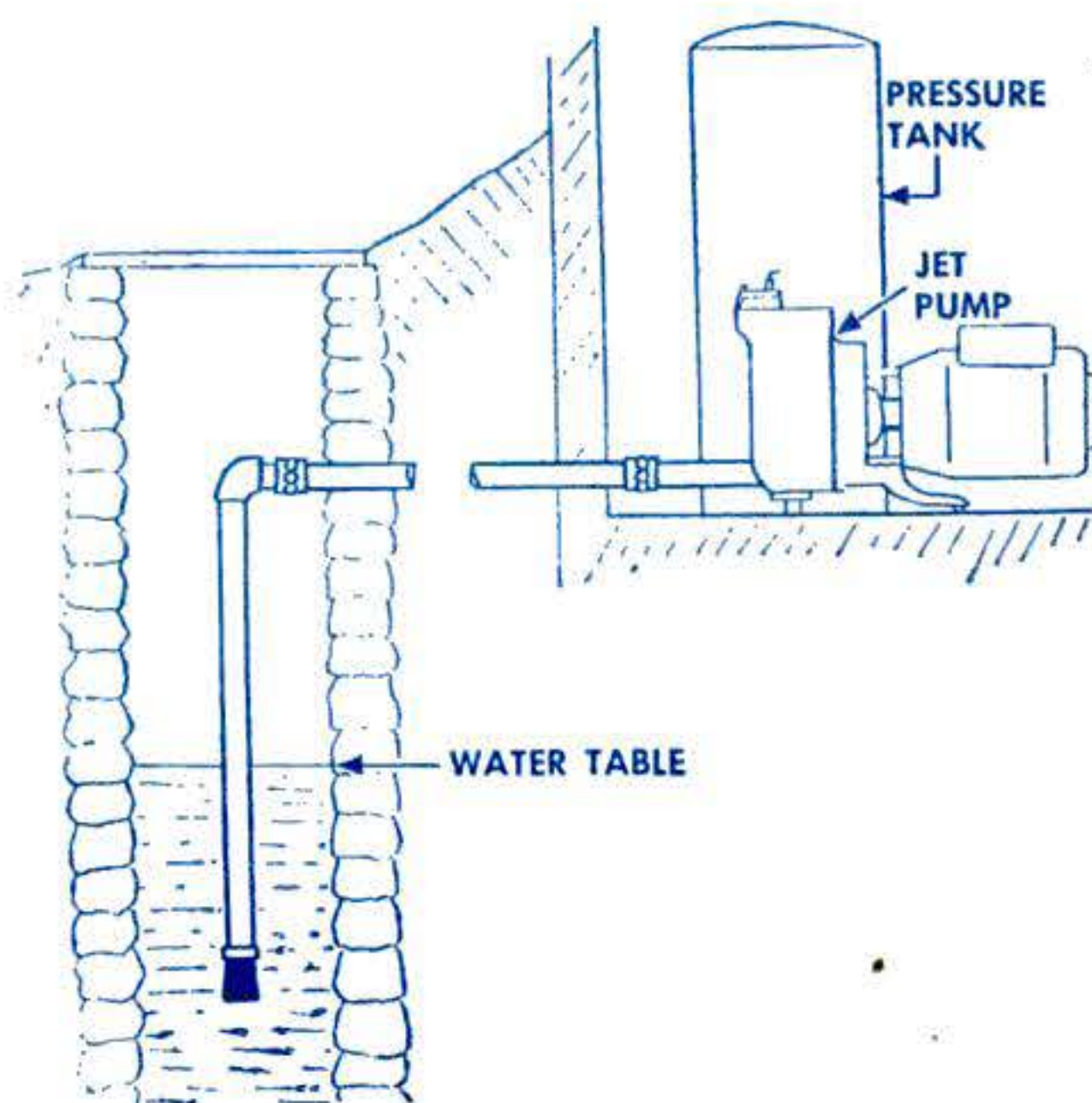

This type of jet pump is installed in house basement instead of in well casing, permitting well to be up to 600 feet from house. Here suction pipe is simply dropped down open well.

quires a good water supply behind it. Advantages are many. Unlike a piston type, its flow is steady and operation almost noiseless. It's a fast worker. As house pressure decreases, pump capacity increases—a ¼-hp. jet will deliver 500 g.p.h. at open discharge. It can go without oiling and greasing for years.

What's often important, it can be installed in the house 100 feet or more from the well. This allows a choice of where to shoot for water, and does away with need for a frost-proof pumphouse out over the well.

Theoretically, with perfect vacuum and

no friction, a shallow-well jet would lift water 33.9 feet at sea-level atmospheric pressure. Actually, its lift is usually around 20 feet. The deep-well jet is good for a 120-foot lift, and multistage versions will handle over 300 feet.

For shallow wells, the jet assembly is right in the pump. In deep-well types, it's down in the well casing. A pressure pipe goes down the well to the jet; another pipe brings water up to the pump. For smaller jobs, there is a single-pipe system in which space between casing and inner line is used in place of a second inner pipe.

If your supply turns out to be insufficient and the well needs deepening, a shallow-well jet can sometimes be converted into the deep-well type.

Motor Goes Down the Pipe

Even newer is a pump you don't see at all. With Submerga-Pump, the whole works—motor and pump—goes down the casing into the water. A heavily insulated power cable feeds it and the water itself cools it. Working on the multistage centrifugal principle, it was adapted from a design long used in oil wells. Requirements are casing at least 4 inches in diameter and water that's free of sand or other abrasives. The manufacturer claims pumping depths to 480 feet and capacities to 1,740 g.p.h. If the water table drops, all that's needed is to lower the outfit.

Whatever pump you use, it's standard to equip it with an air-pressure tank. The air trapped and compressed inside it provides energy to deliver small amounts of water, preventing the motor from starting every time you draw a cupful. It also serves as a cushion, absorbing the pulses of reciprocating pumps. The pressure switch is generally set to cut in the motor when pressure drops to 20 pounds and shut it off at 40 pounds.

Test for Pollution

Before hitching up a new system, be sure the water isn't polluted. This has always been a must, and is even more important now when homes crowd each other. Water may look clear as crystal and still be chock-full of germs. Polluted water can produce typhoid fever and a long list of other diseases. As you'd expect, a spring or shallow well is more likely to be contaminated than a deep well.

In suburban communities, wells may be fed by neighbors' drainage. Some surveys



Nature does her own pumping in true artesian well like this one at the Vermont State trout hatchery near Bennington. It delivers a steady 250 gallons a minute from depth of 110 feet.

indicate that probably half the water systems on old-fashioned farms are unsafe. The well platform or casing may not be tight enough, allowing foul drainage to come in. Or the well may be too near the barnyard.

Distance and elevation help, but what goes on underground can't be seen. Water drawn from porous ground or a seamy ledge can receive a long-distance taint. A well can even draw pollution from lower ground—when drought and heavy pumping drop the water table enough to make water “run uphill.”

Supposedly a septic tank converts and purifies everything coming into it. But there has been proof to the contrary; a septic tank may be overloaded or need replacing or cleaning. Badly functioning tanks have caused deaths from polluted drinking water.

In any case, analysis is the only sure answer. No water supply should become a permanent fixture until it has been okayed by a health officer or state laboratory. For safety, take samples during both wet and dry spells. If you must use untested water in the meantime, it should be boiled or chemically treated with lime or iodine. Check with your doctor on the best method.

While installing the water system, also remember what winter may do. If you depend on a well or spring away from the



Hydraulic ram, self-powered, is dependable for moving surface water if conditions are right. Falling water keeps closing valve, causing back-pressure kicks that ram water up to tank.

house, the pipeline may have to be buried as much as nine feet deep in some parts of the country for safety against freeze-up. In wet ground, it will need less protection. If you have a good spring, you can make a small brook out of its overflow and lay the pipeline in it. Water running over the pipe will prevent freezing.

Another way is to keep water always flowing through the pipeline. This can be done by having a by-pass through the basement and out through a drain. But don't try this with a motor-pump system; constant operation can burn out the motor.

Keep a Fire Hose Handy

An outdoor system should have a shut-off valve, allowing it to be cleaned or drained if you're going away for a few weeks or longer. Another tip—whatever your system, better have a handy outlet to which a fire hose can be permanently attached.

Besides a shallow or deep well, there are three other water sources for the home. If you own a spring, its water will probably be soft, cool, and sparkling. It's especially valuable if located above the house, so that Nature will do all the work by gravity. My own spring, at 70 feet elevation, provides an ideal 35 pounds pressure at the kitchen sink.

A small reservoir should be dug out at

the spring, or near it, to accommodate peak needs. A pair of standard concrete drains, two feet in diameter, will store around 100 gallons if you stand them on end. Hardware cloth covered by wooden lids will keep out leaves and animals.

A spring should not only be pure but faithful and adequate. Too many gush in April and can't deliver in August. If the spring is fickle it's cheaper in the long run to shoot a well.

True Artesian Has Pressure

A cross between natural spring and drilled well is an artesian supply. There's cause for celebration when the driller brings in one. Here Nature does the pumping after man provides the pipe outlet for underground water under pressure. So many drillers, as well as laymen, refer to an ordinary drilled well as an artesian that the word has almost lost its real meaning.

For a true artesian, underground water must be flowing downhill under a tilted rock formation. It wants to seek its own level but can't. Boring through to it provides an outlet and the water comes up the pipe. In some terrain, it shoots up geyser-fashion. One brought in at 3,100 feet yielded 750,000 gallons a day—shooting it 32 feet above ground.

Where conditions are suitable, a hydraulic ram can be used to give surface water from spring, brook, or pond a boost to the storage tank in the house from which faucets are fed. The ram makes water raise itself by its own bootstraps through a system of valves using the water-hammer principle. Much of its water is wasted in order to boost the rest, so the first requirement is a plentiful supply.

In the right place the motorless ram works like magic, raising water up to five times higher than its drop to the ram. I've seen some thudding away merrily after 50 years' service. The ram, the most economical pump in existence, requires only a valve replacement **every couple of years**. It can even be homemade (PS, Oct. '48, p. 231).

But since ideal conditions are rare, the ram is fast becoming a curiosity as power lines keep spreading through rural areas. They allow you to hitch up an automatic electric pump that's inexpensive and dependable. In harness with a proper well, such a pump will bring up the water that's still abundant underground even when drought is doing its worst up on top. **END**

Midget 'Scope Rivals Biggest

A TABLE-TOP electron microscope, to be introduced by RCA this September, approaches the world's mightiest instruments in power. It magnifies directly up to 6,000 diameters, and takes pictures that can be further enlarged to 50,000 diameters.

Permanent-magnet lenses of newly available material, replacing the electromagnetic coils used in big electron microscopes, permit the extremely compact and simple design. Auxiliaries are a power-supply cabinet, two vacuum pumps, and a control panel. The midget 'scope is expected to sell for less than \$6,000, enabling it to become a standard tool in hospitals, and in college and even high-school laboratories.

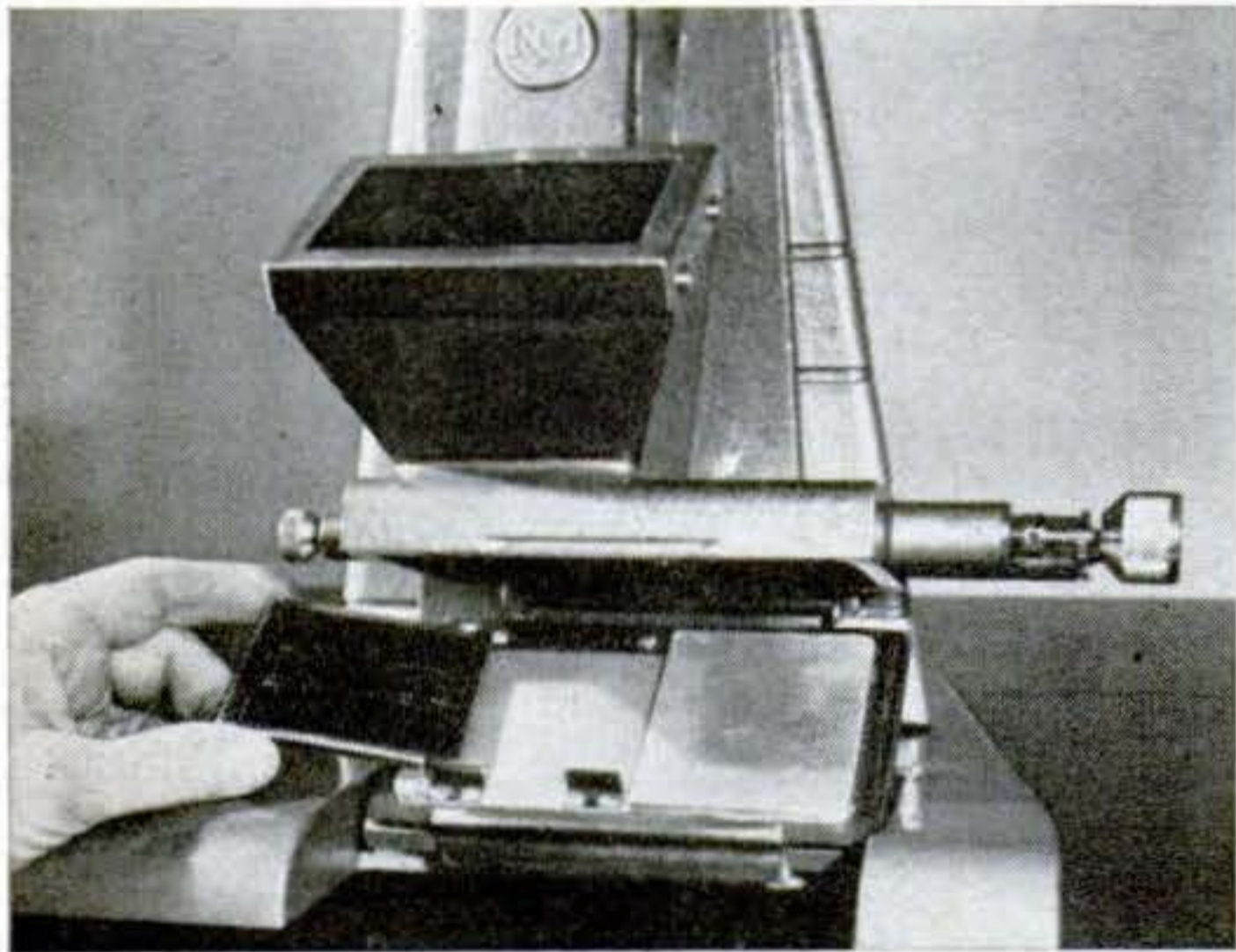

To get portrait of a virus, user inserts plate holder as above. Simply pulling out knob at right, and pushing it back, makes the exposure. Enlargement from plate reveals finest details.



Table-top 'scope made this picture showing tobacco mosaic virus magnified 40,000 diameters.

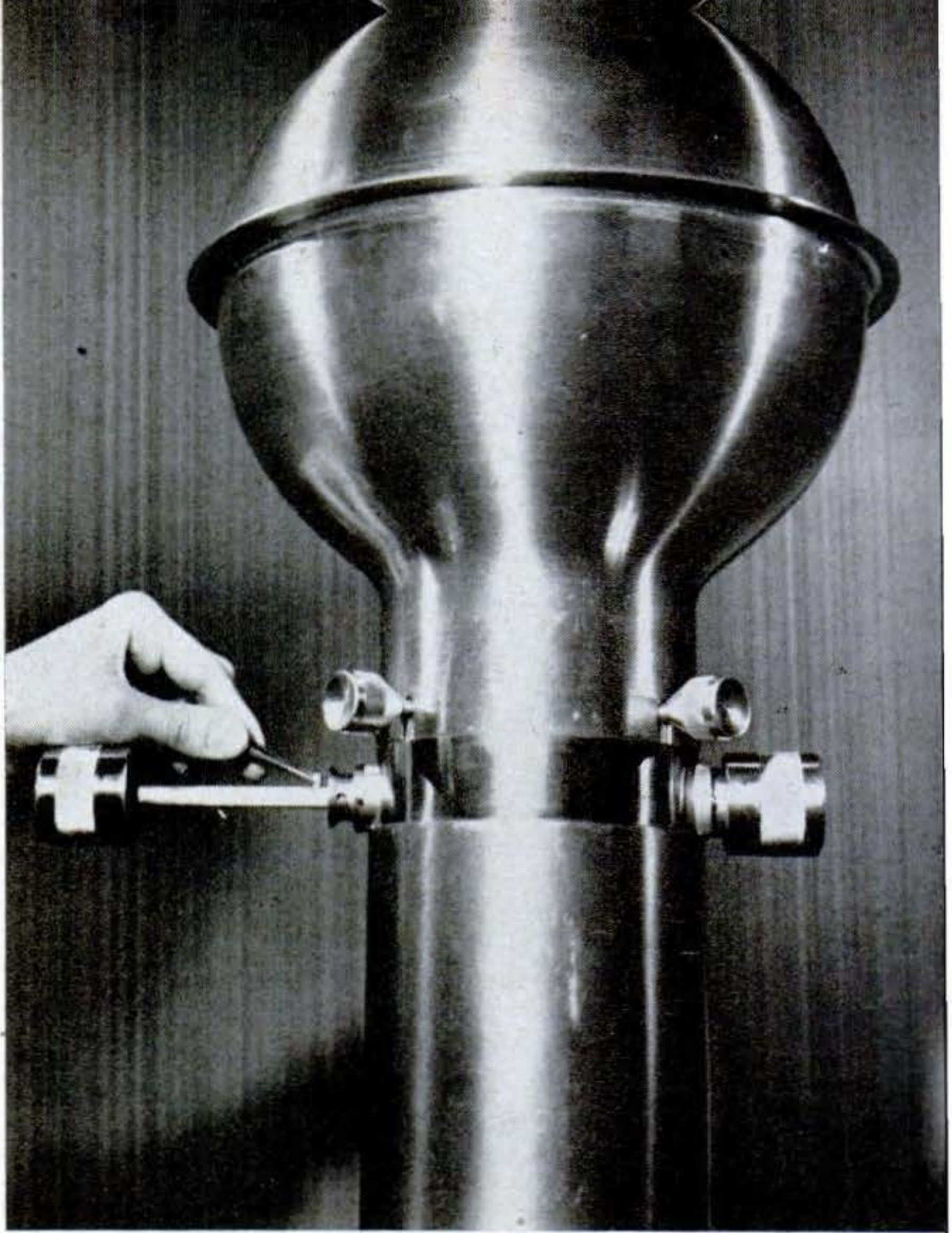

Tiny holder containing specimen, placed with forceps in slide of new microscope as shown, is pushed by knob into viewing position. Copper sphere encloses 50,000-volt electron gun.

As simple to operate as an ordinary microscope, new table-top electron microscope has magnifying power more than 20 times as great, approaching that of mightiest instruments in world.



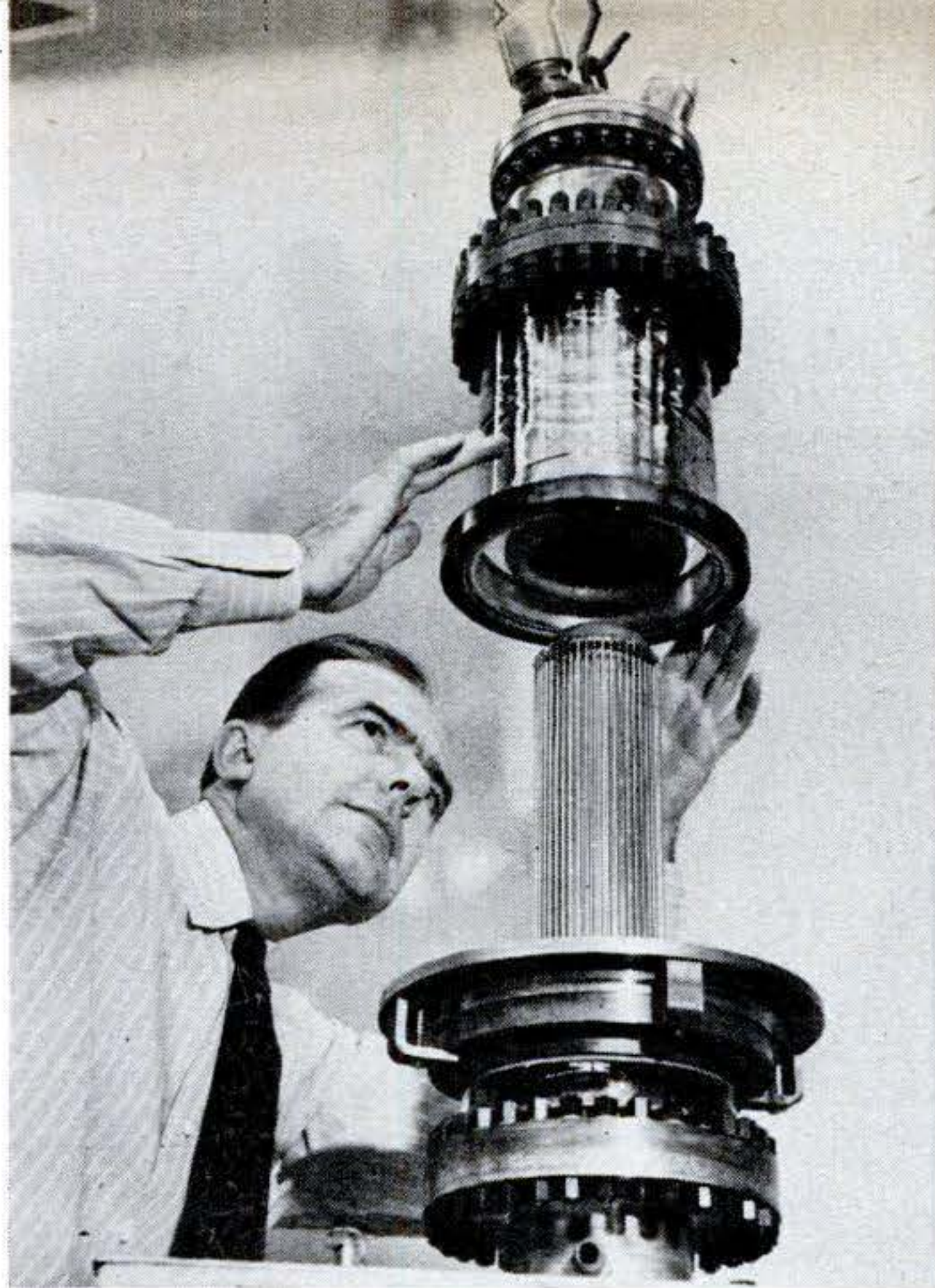

48 Radio Tubes Built in One

BY BUILDING 48 separate tube "units" inside one tube, RCA engineers have made what they believe to be the most powerful electron tube in the world. Intended primarily for radiotelegraph and international broadcasting stations, it can put out 500,000 watts continuously. In the photo above, the top has been lifted to show the cylindrical arrangement of the 48 separate triodes that make up this "Super-Power Beam Triode."

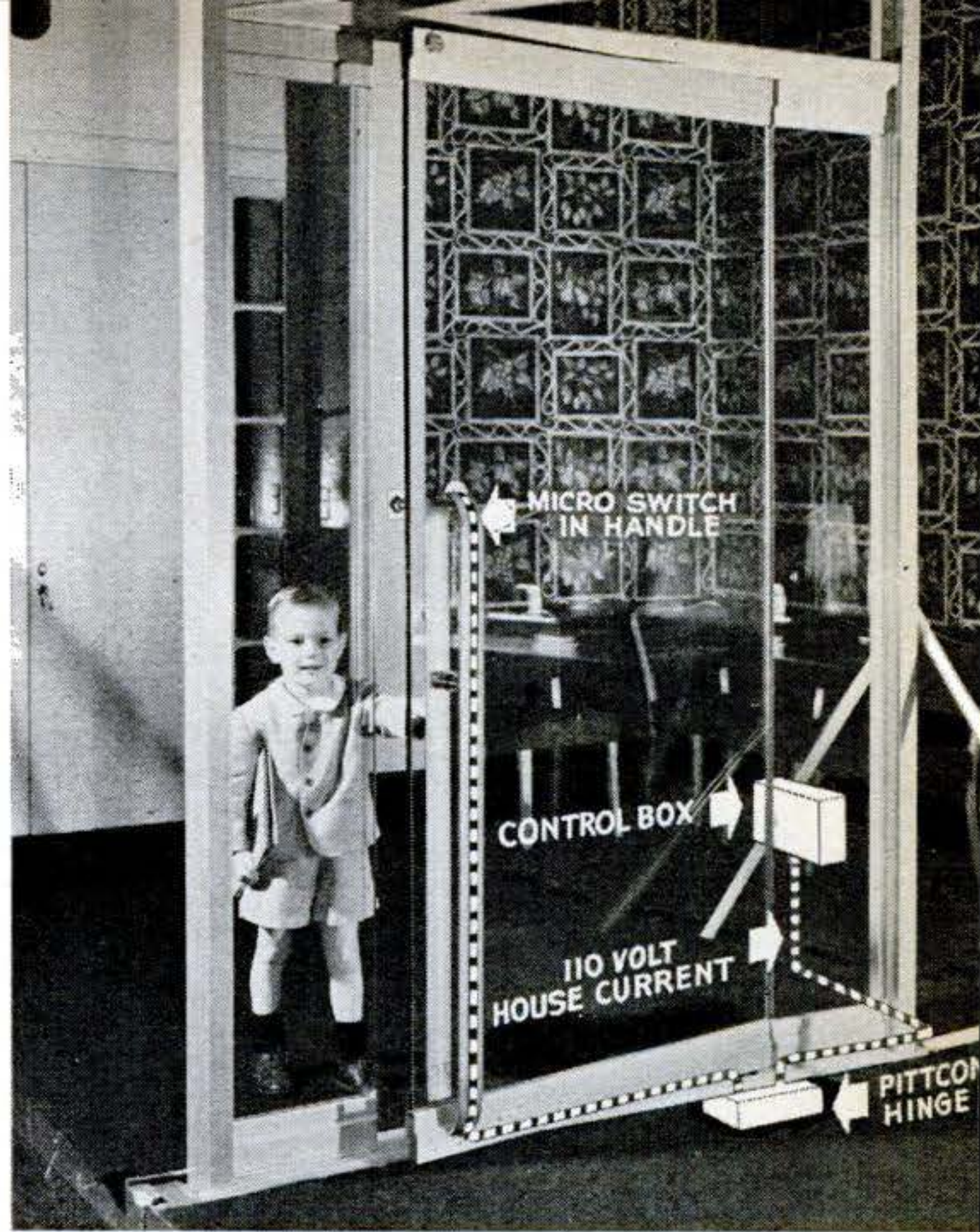

Power Door Opens at Touch

JUST a touch on the handle, even by small fry as above, and this door opens. The invisible doorman is an electric-hydraulic power hinge, hidden under floor or sidewalk and actuated by a microswitch in the handle. Unlike electric-eye devices, it needs no obstructing posts and opens doors both in and out. The power hinge, called Pittcomatic, was developed by the Pittsburgh Plate Glass Co. primarily for heavy glass doors.

Sensitive TV Mike Picks Up Sound Selectively

CLUTTERED television studios may be freed of bulky microphone booms and dollies by a new type of directional microphone. Its "aim" is so sharp it can pick up wanted sounds 12 feet away while ignoring those not desired. Two of these RCA micro-

phones are shown suspended above a stage set, below left, while a technician at a console switches from one unit to another to follow the actors. Each unit, shown at right below, uses two microphones, with eight feet of acoustical pipe for directivity.

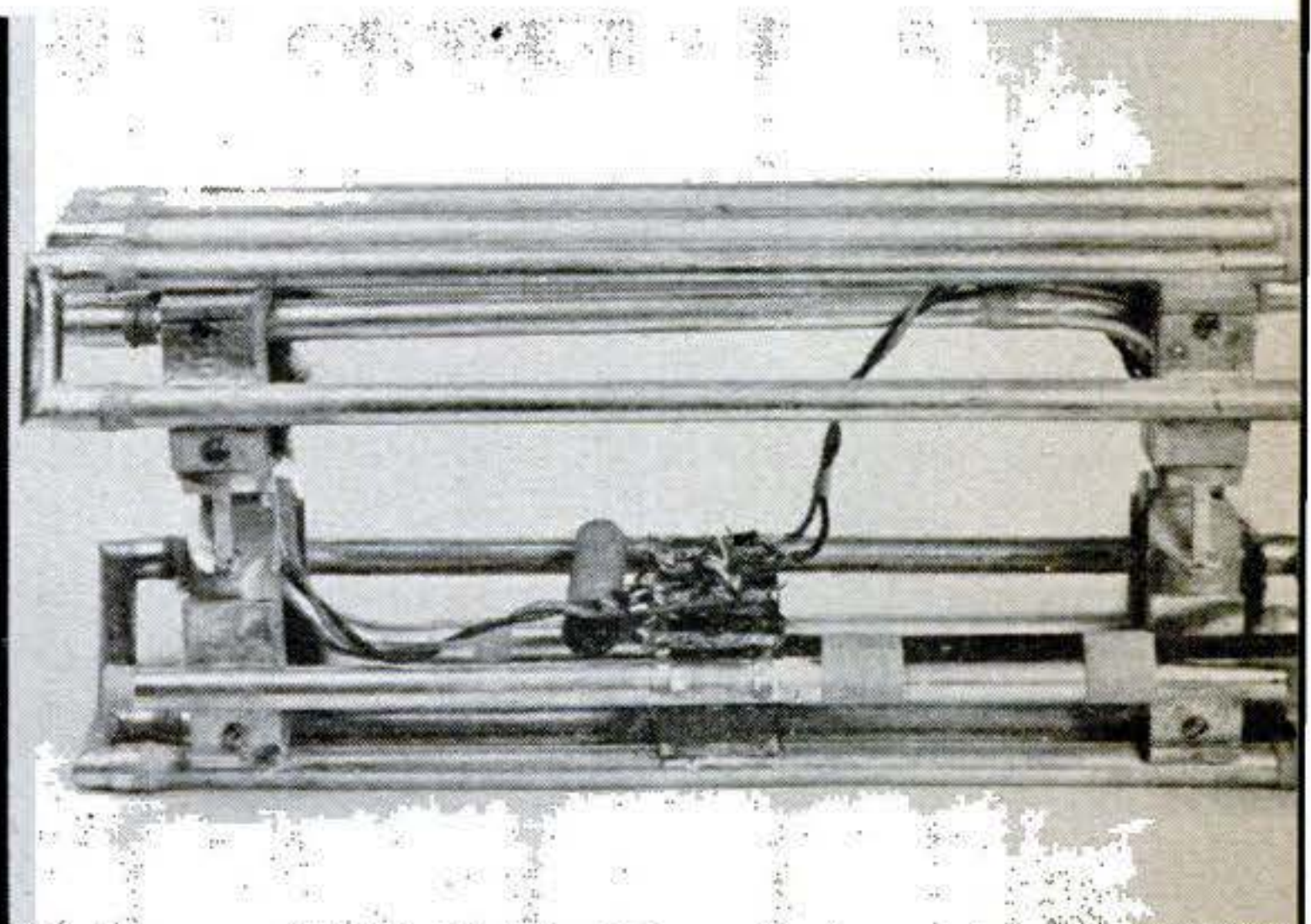

Homemade Roadster Wins Beauty Contest

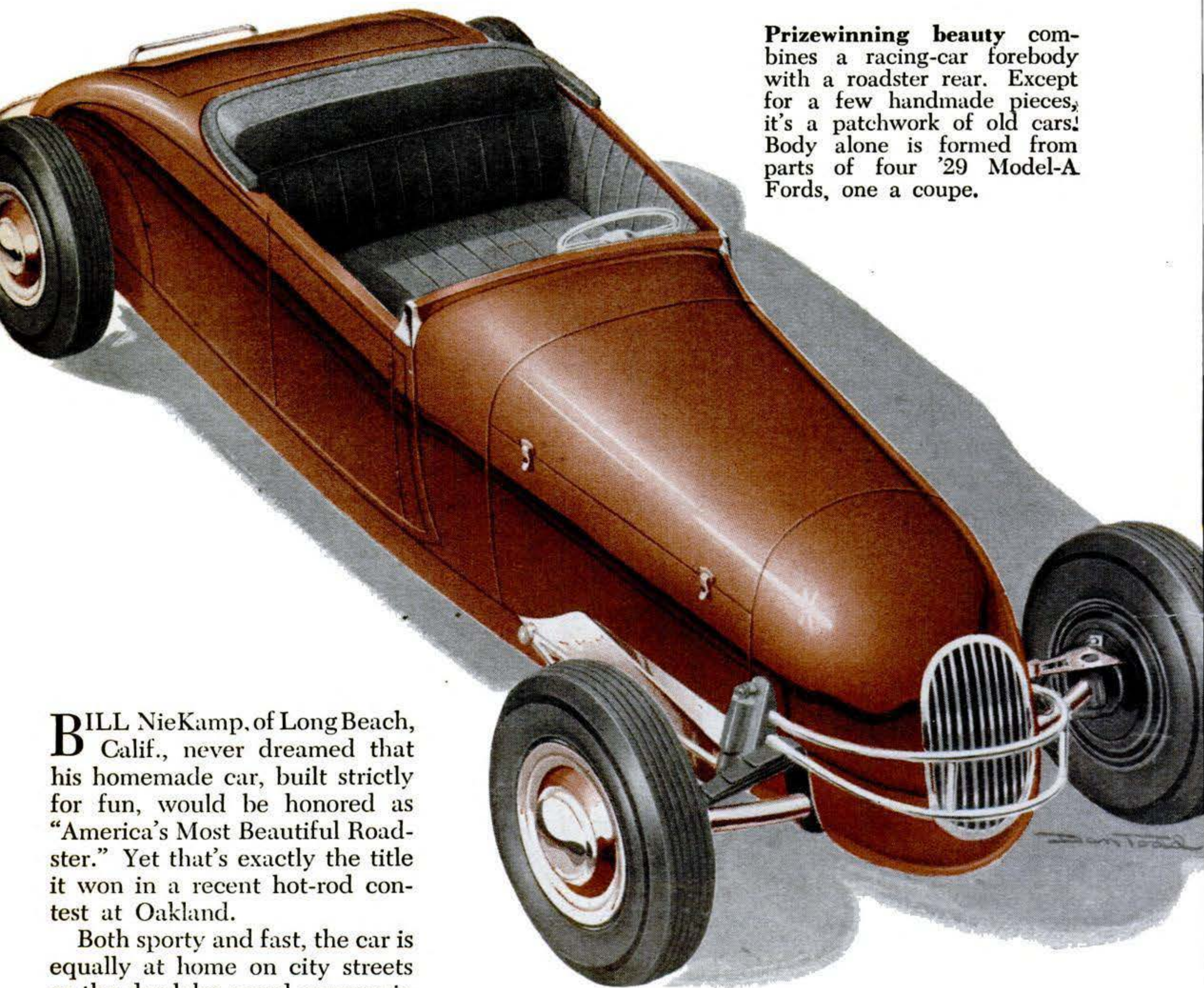

Prizewinning beauty combines a racing-car forebody with a roadster rear. Except for a few handmade pieces, it's a patchwork of old cars! Body alone is formed from parts of four '29 Model-A Fords, one a coupe.

BILL NieKamp, of Long Beach, Calif., never dreamed that his homemade car, built strictly for fun, would be honored as "America's Most Beautiful Roadster." Yet that's exactly the title it won in a recent hot-rod contest at Oakland.

Both sporty and fast, the car is equally at home on city streets or the dry-lake speed courses in Southern California where NieKamp frequently races it. Building it took him an estimated 300 working days, spare time from his regular job as an automobile painter. As you'd expect, the body finish is gleaming, set off by chromium plating on much of the running gear. The car's clean lines don't betray its patchwork origin.

Double sets of rear-end shock absorbers provide smooth riding as well as good con-

trol. For speed runs, the twin asbestos-wrapped mufflers can be quickly removed and replaced by racing stacks, which are installed through special snap-out plugs in the belly pan. Both the firewall and pan are designed to conduct ample cooling air past the engine during high-speed desert runs. For night driving, a pair of headlights can be quickly fitted.

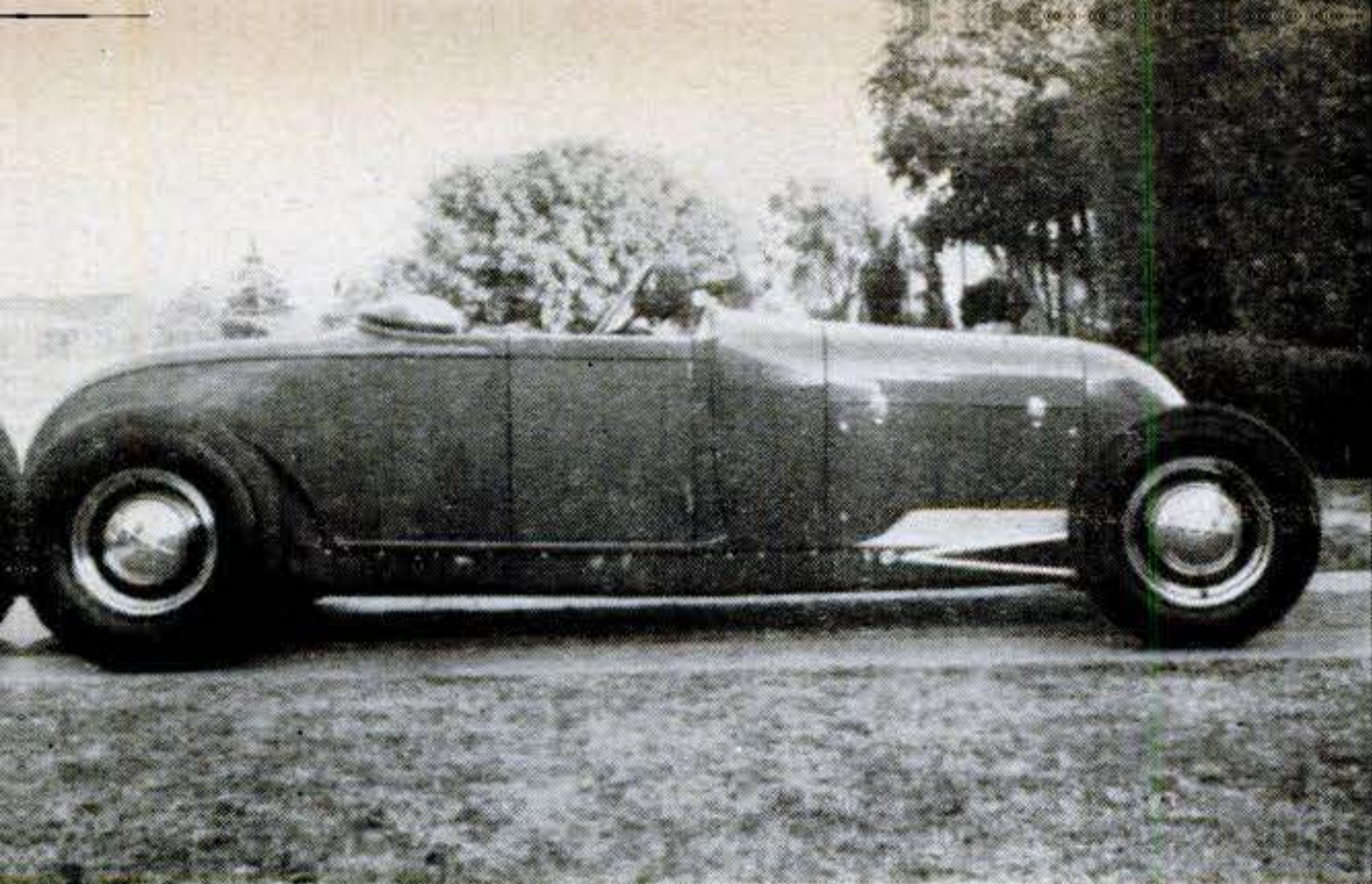

Roadster has '39 Ford rear end, with torque tube shortened 18½ in. Drive shaft is Model A. New wheelbase is 110 in. Frame rails are from '27 Essex, fitted with Model-A rear crossmember.

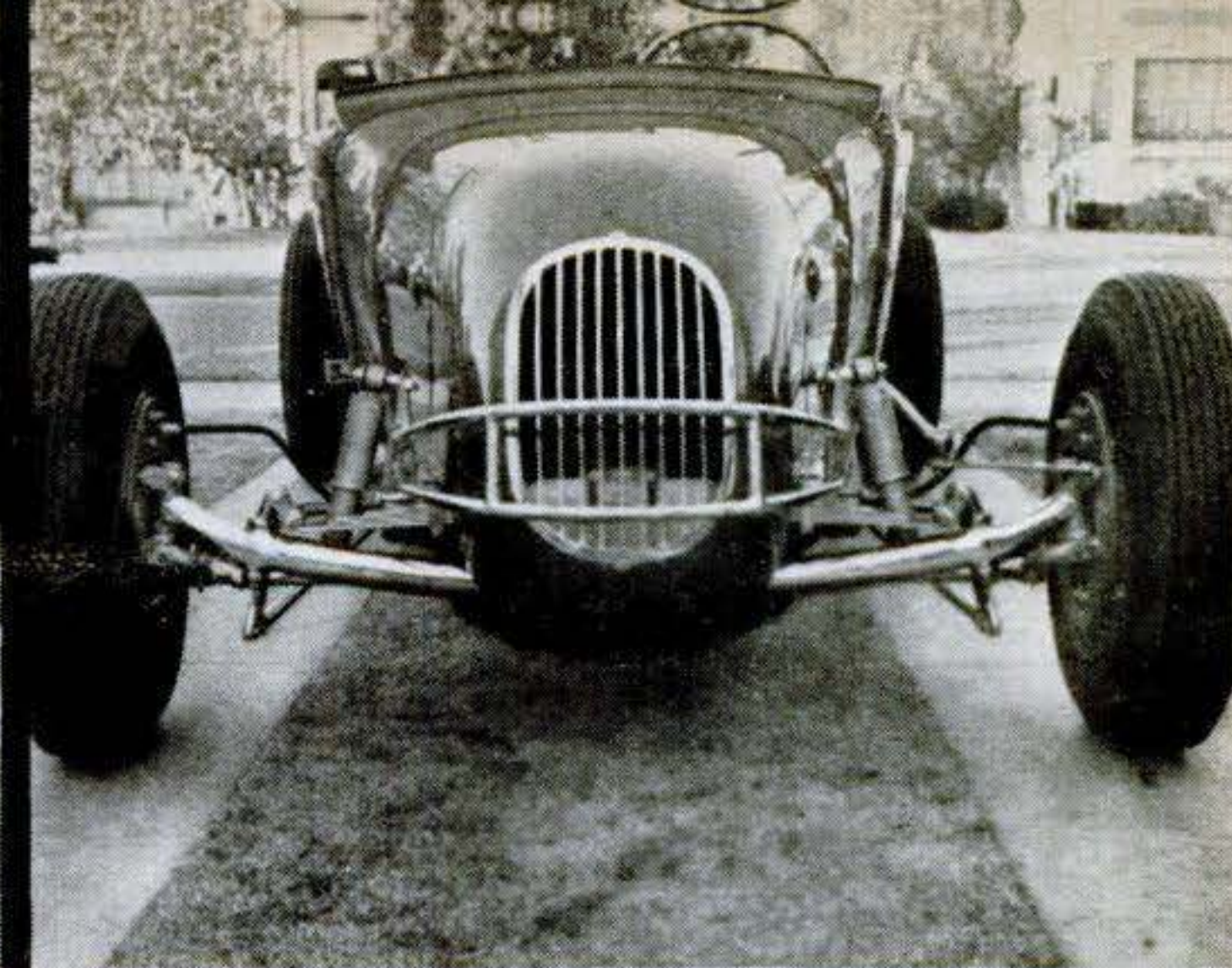

Aluminum cowl and hood, together with grille, were handmade. The front axle is from a '39 Ford, but has been fitted with earlier-model spring perches. Brakes are '41 Ford hydraulics.

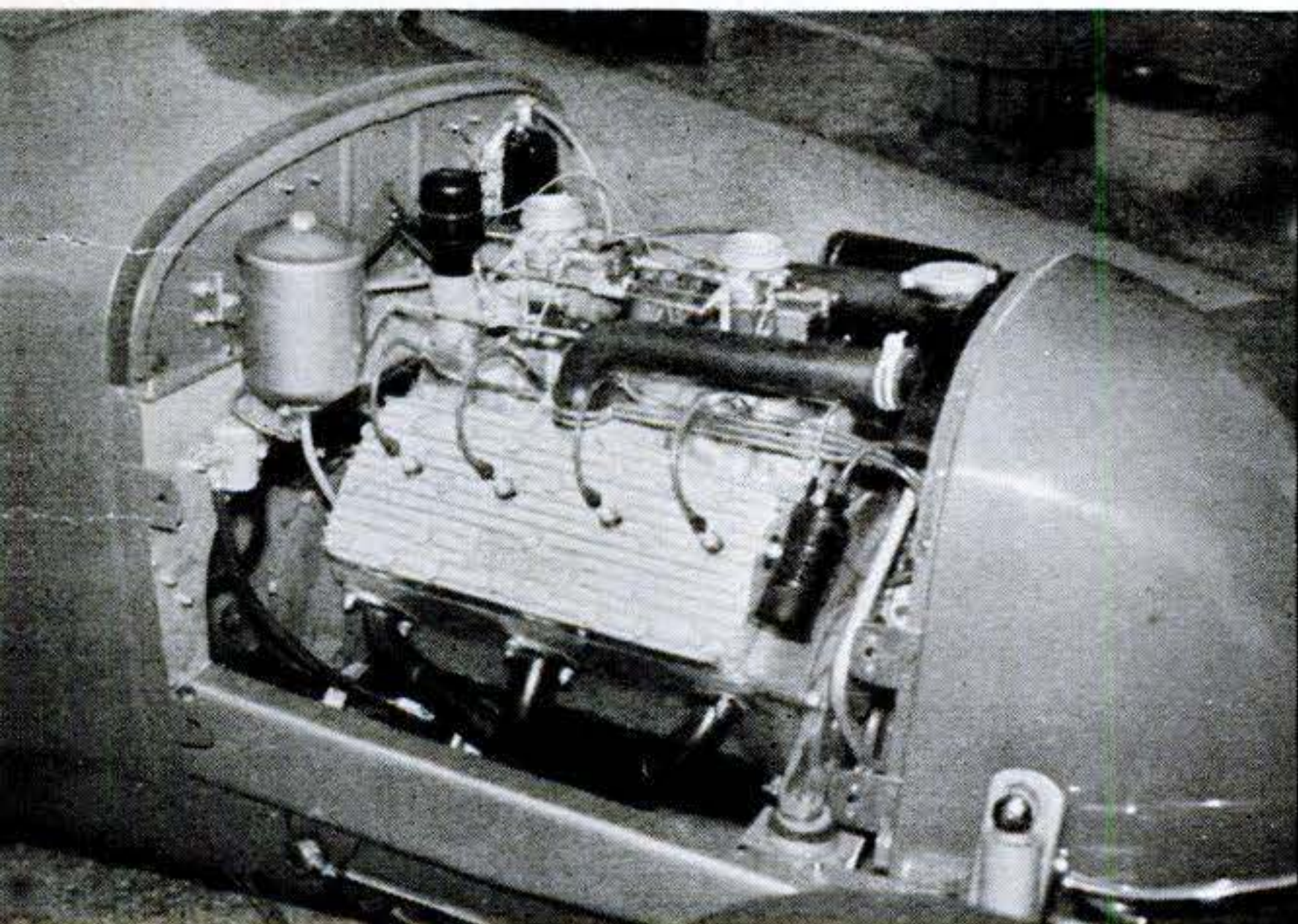

Speedy engine is '42 V-8 Mercury, of stock bore and stroke, with Evans heads, Weiand manifold, Kurten ignition, and Thompson 3-ring pistons. Rear support is Model-A crossmember.

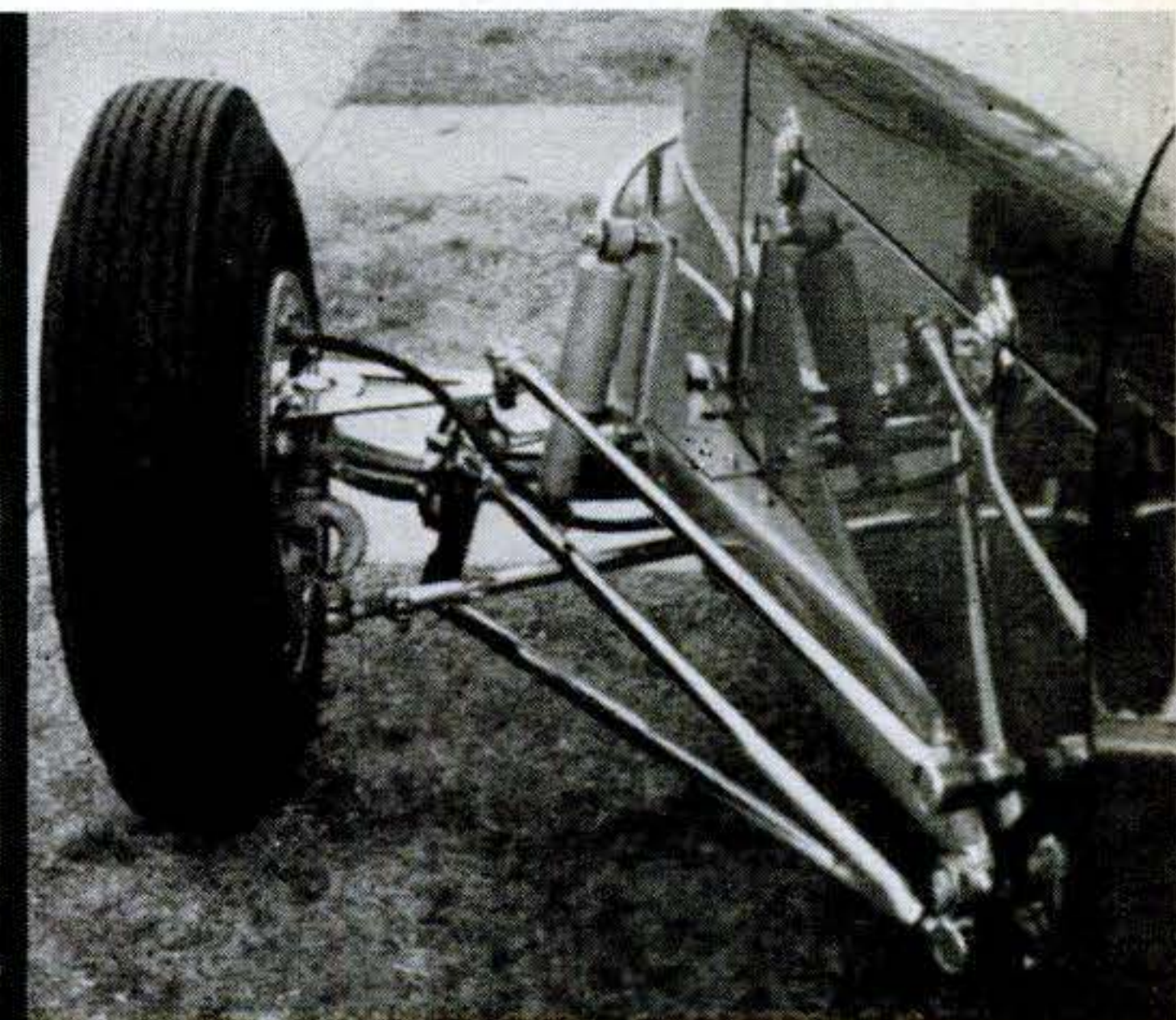

Unusual steering mechanism is '35 Ford cross-steering assembly turned on side, racer style, for ground clearance. Rear axle has teardrop fairings built around it to cut air resistance.

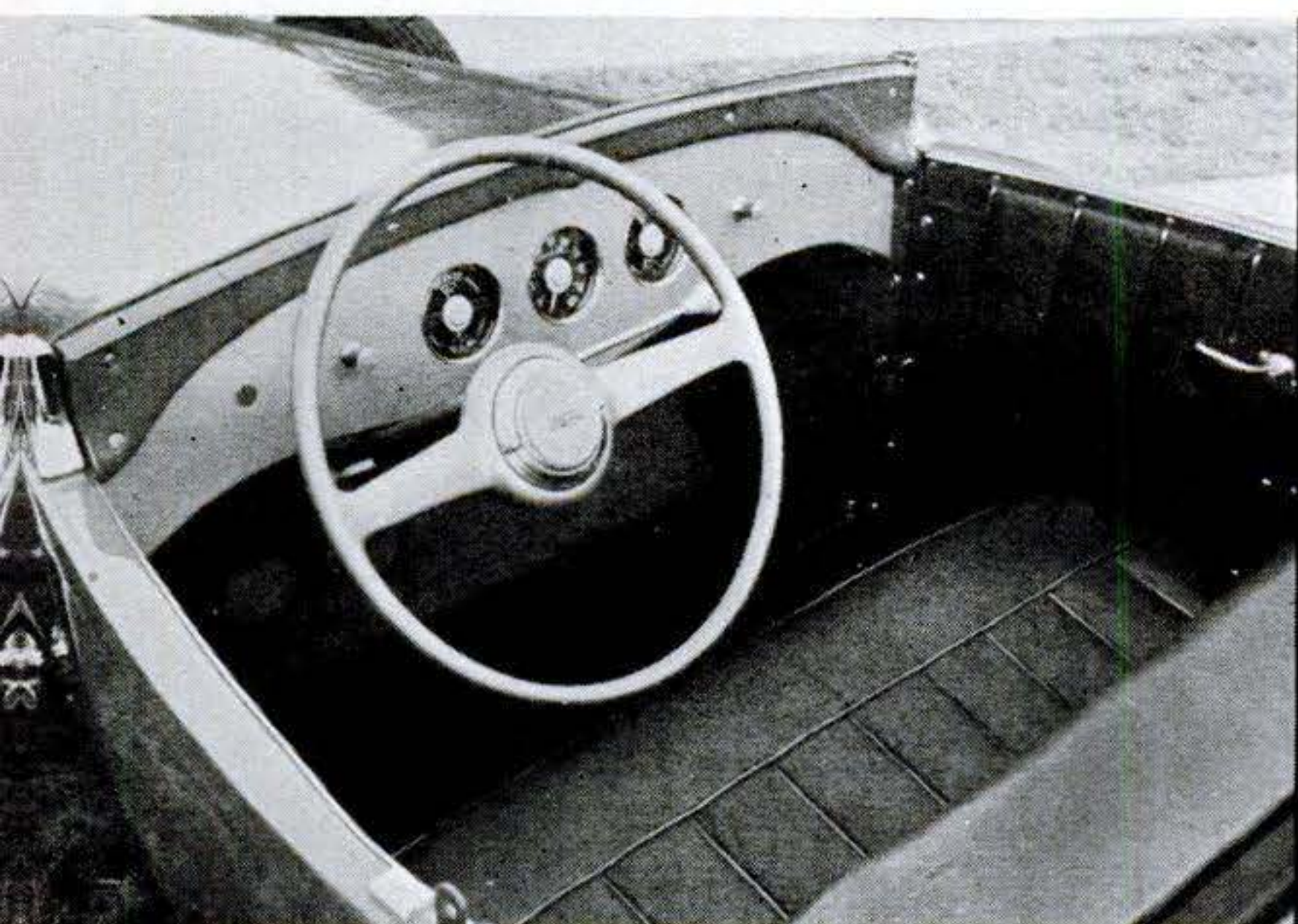

Dashboard is clean and simple, with '49 Plymouth instruments grouped in center. Steering-column gear shift and transmission are from '49 Ford. Headlights are added for night driving.



Rear end boasts two sets of shock absorbers, a pair of Houdaille needle-adjusted Fords and two tube-type Gabriels mounted at 45° angle to control body sway. Gas tank is '28 Chevy.



1 Molten metal is poured into a mold during the process used to make aluminum sheeting at the Kaiser Co.'s miniature mill, where alloys are tested before being run through big mill.



2 After a 23-lb. ingot is removed from its book-shaped mold, it is placed in an electric furnace with other ingots for a heat-soaking treatment to bring them to rolling temperature.



3 When an ingot has been properly heat-soaked, it's pushed in for its first pass through the baby rolling mill. A 50-hp. motor runs mill, which can make sheet only .01 in. thick.

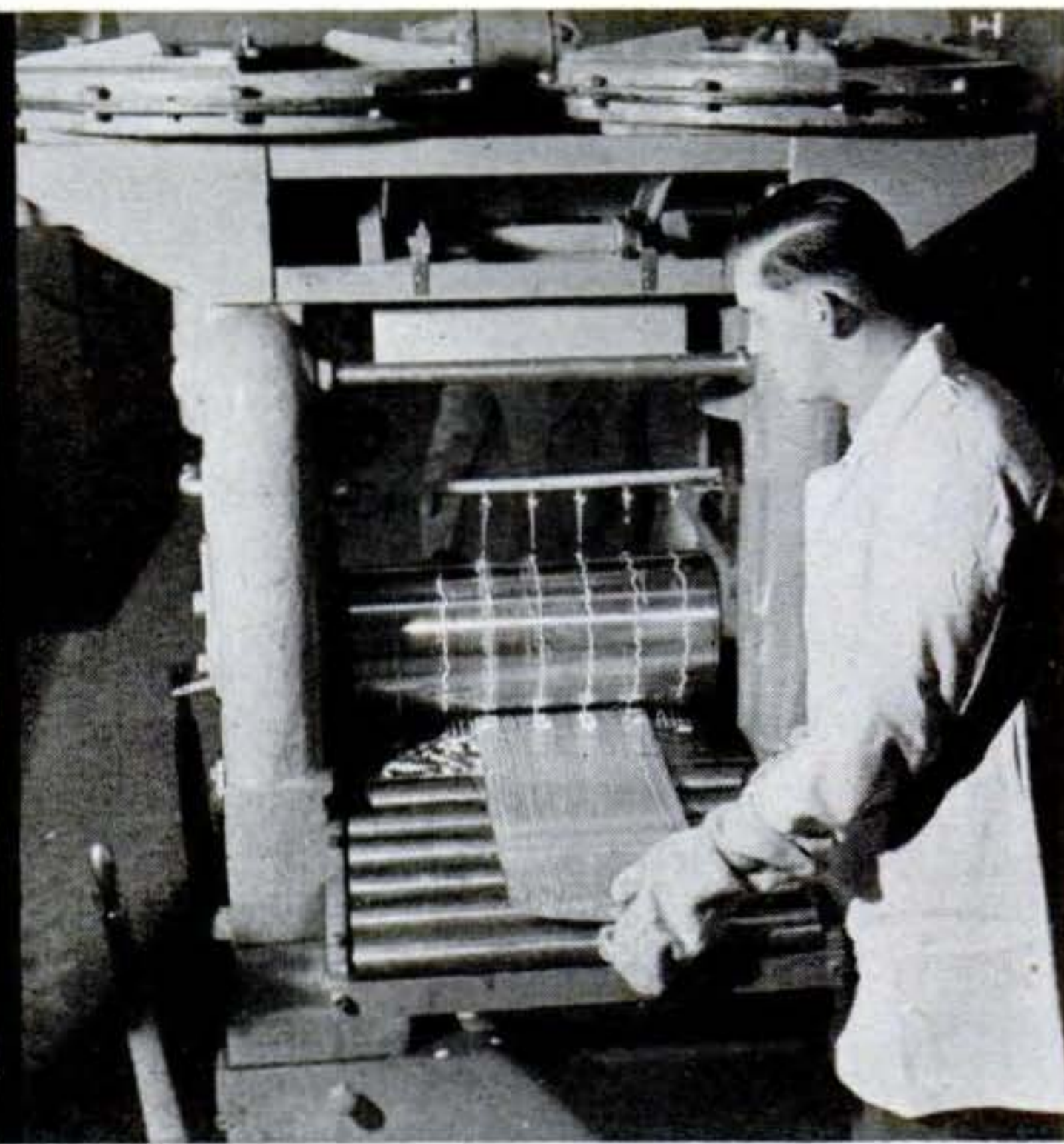

4 Operator above pulls aluminum sheet out of machine, whose rollers squeeze with a pressure of 700,000 lb. A full-size mill uses 2,000,000 lb. of pressure to flatten a 5,000-lb. ingot.

Midget Rolling Mill Trys Out Alloys

BEFORE a new alloy is okayed for use in the huge Kaiser aluminum rolling mill at Spokane, Wash., the metal is given a trial run through the pint-size version shown here. On a small scale, this pilot plant duplicates all the complex processes of its big brother that squeezes 5,000-pound ingots

into nearly 125,000 tons of sheet, strip, and plate aluminum annually. Miniature ingots weighing 10 to 23 pounds are fed into the six-foot-high rolling mill. After the alloy castings have been rolled into thin sheets, they are heat-treated and then carefully tested for strength and hardness.

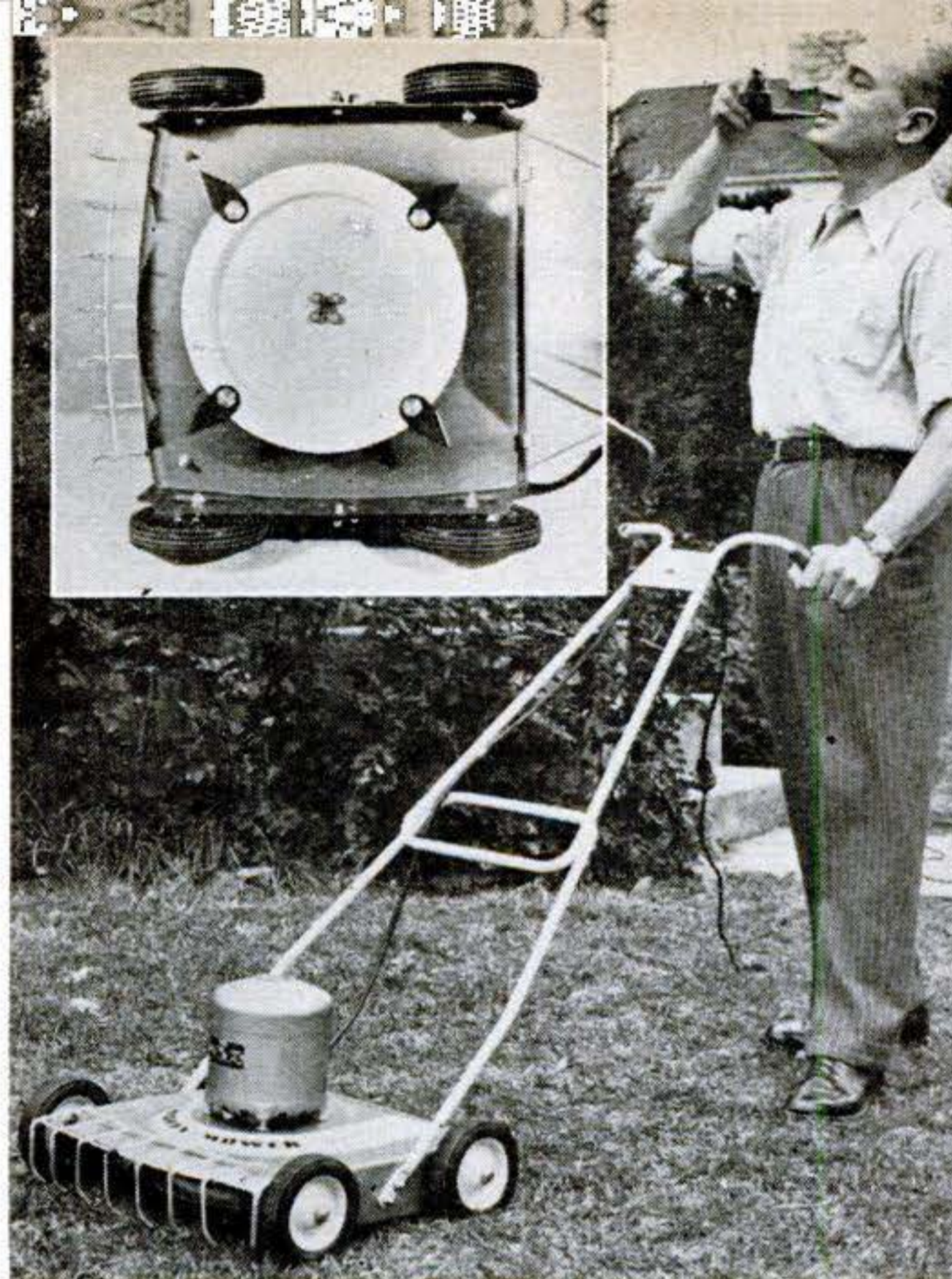

Mower Works Like Scythe

CENTRIFUGAL force holds in cutting position the four 2 $\frac{3}{4}$ -in., free-swinging blades of the lightweight $\frac{1}{2}$ -hp. electric mower pictured above. The blades are mounted on the rim of the horizontal disk seen in the underside view (inset), which revolves at high speed. Built by the Huffman Mfg. Co., Dayton, Ohio, the mower cuts a 16-in. swath. It will mow to within $\frac{1}{2}$ in. of any obstacle when a front wire guard is lifted.



Colors Warn of Ray Peril

A NEW civilian-defense Geiger counter, developed by the AEC, has a tricolor scale to gauge radioactivity after an A-bomb blast. Its needle swings to green in a safe area, yellow where it is unsafe to tarry long, and red as a warning to get out at once. Topmost reading, five roentgens an hour, is a new high for Geiger counters. Powered by flashlight cells, the device could be mass-produced for only \$10 to \$15.

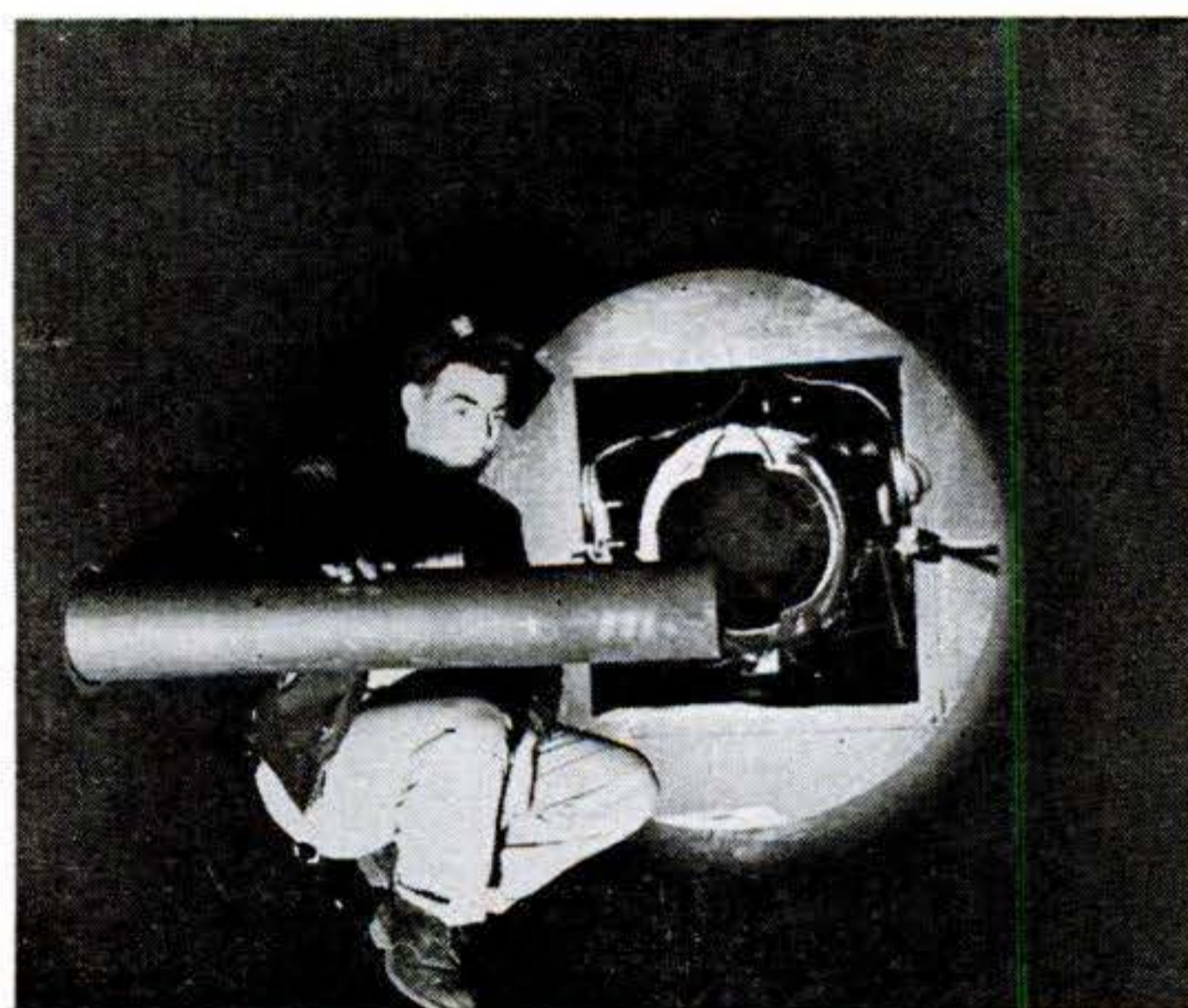

Periscope Looks Into Jet

MOUNTED squarely in the 2,500° exhaust blast of a jet engine on a test stand, the stainless-steel periscope above gives a close-up view of an inferno. Standing at the eyepiece on the opposite side of a wall from

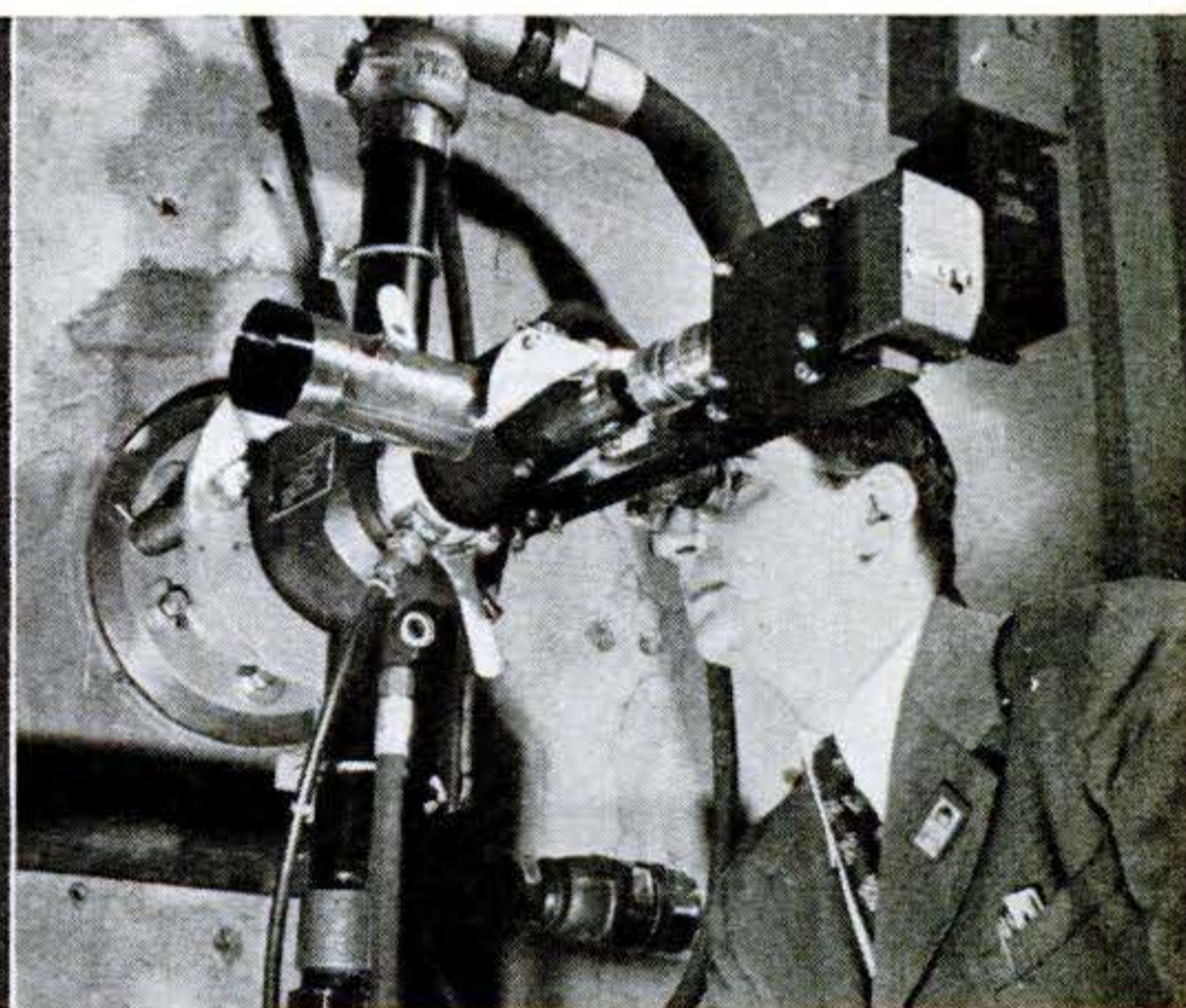

the exhaust, as seen in picture above, a GE engineer can study the pattern of burning gases. For a permanent record, color movies may be made through the 'scope. A cold-air blast protects its inner window of quartz, and a 45-gallon-a-minute water-cooling system also safeguards both window and tube.



New Car Radio Finds Stations for You

Dashboard controls appear conventional—except for bar, to let passenger select stations, and

sensitivity control. This adjusts tuner to stop on all stations, or to pass by the weaker ones.



Selector button is next to brake. Each time it's pressed it tunes radio automatically to next station within range regardless of where car is. No presetting to station frequencies is needed.

THERE'S a real "lazy-man's radio" in some of the new Buicks. All you have to do is press a button, whereupon the Selectronic receiver searches for a station and stops right on it. If you don't like that program, press the button again and it hunts the next one, and so on. Unlike ordinary preset push buttons, which are useless when you drive beyond the area they were adjusted to, this gadget works anywhere in the world. You don't have to know where stations are on the dial.

A simple clockwork gear train, a relay and solenoid, and one extra tube turn the trick. Pressing the button lifts the brake on the gears. Spring loaded, they tune through the broadcast band until a signal is picked up. The signal fires the trigger tube, which resets the brake. This stops the tuner right on the station—much more accurately than you could set it by hand. The trigger circuit discriminates between stations and power-line noise or static. When the tuner has crossed the dial, a solenoid automatically pulls it back and hunting starts again.

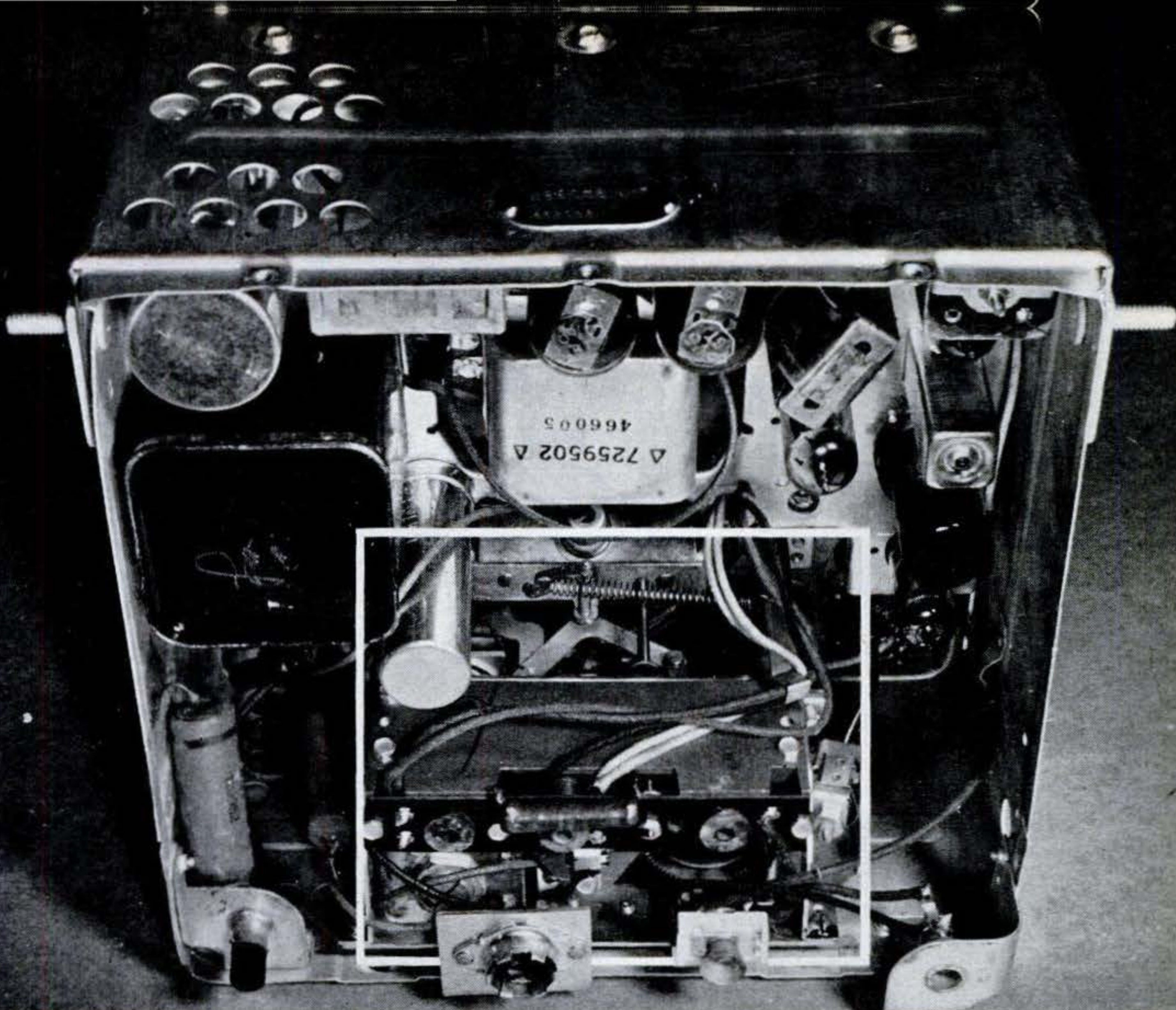

The chassis is a standard six-tube superheterodyne, to which the automatic tuner has been

added. The tuner, marked in photo above, is shown below as it looks when removed from set.

Gear train, shown in close-ups below, starts tuning across dial when stopping bar is lifted by relay. It tunes by raising slugs out of coils that make up permeability tuner. Stopping

bar brakes gears at station when trigger tube, fired by signal, trips relay. When slugs are all the way out, switch energizes solenoid to pull slugs back down and reset the springs.

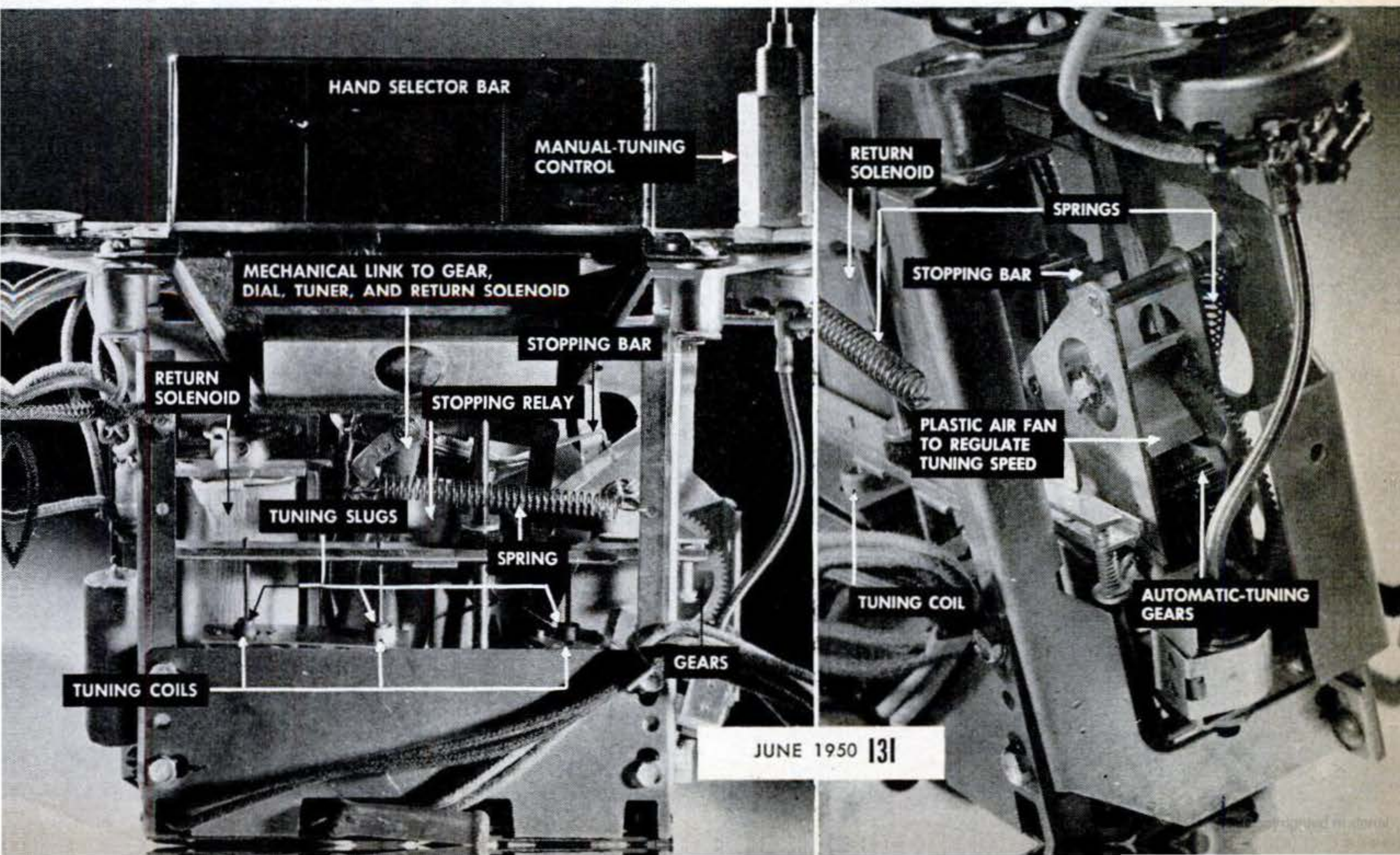



Barn raising is an old Pennsylvania Dutch

Farmers Raise A Barn

By Grant Heilman

PREFABS may be the hottest thing in the building trade, but they're old stuff to Pennsylvania Dutch farmers. They've been prefabricating and "raising" barns for generations.

Barn builders like John Gehr, who super-

← **Old-fashioned hand auger** is used to drill holes for pegs. Lower part of barn frame is made of oak, and siding of Pennsylvania white pine.

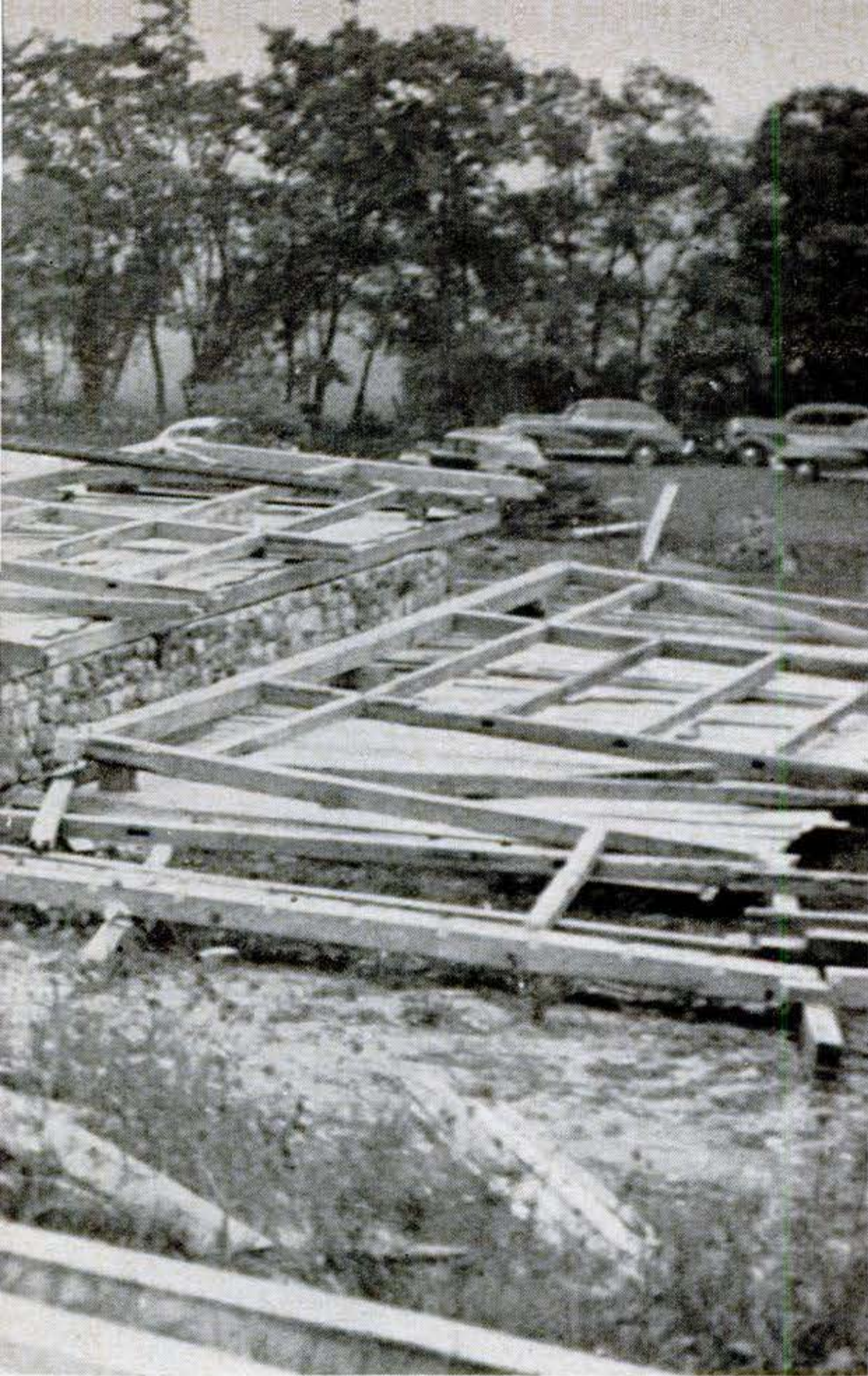

custom. Here neighbors arrive for big event.

vised construction of the one shown here, near Ephrata, Pa., don't even use blueprints or drawings. The only paperwork involved is in calculating the amounts and costs of materials—about \$12,000 for this barn.

Gehr and his skilled carpentry crew work for several weeks before the actual "raising." They cut more than 500 timbers to size, notch each one according to the position it will have in the finished frame, and drill each timber for the wooden pegs that will hold it in place. As each piece is finished, the carpenters place it on the ground beside the pieces to which it will be joined.

All this painstaking labor pays off when more than 100 volunteer helpers show up on the day of the raising. Under Gehr's direction, it takes them less than five hours to assemble the framework. Every piece fits exactly, and the only tools used are hammers, pike poles, and crowbars.

"It's just like a jigsaw puzzle," says Gehr. "There's nothing to it, especially after you've been building them for 40 years."

JUNE 1950 133



In the hands of an expert, the adze is a versatile tool, and can cut a chip the size of a man's fist, or slice a shaving as thin as paper. Cutting blade must be kept razor sharp.

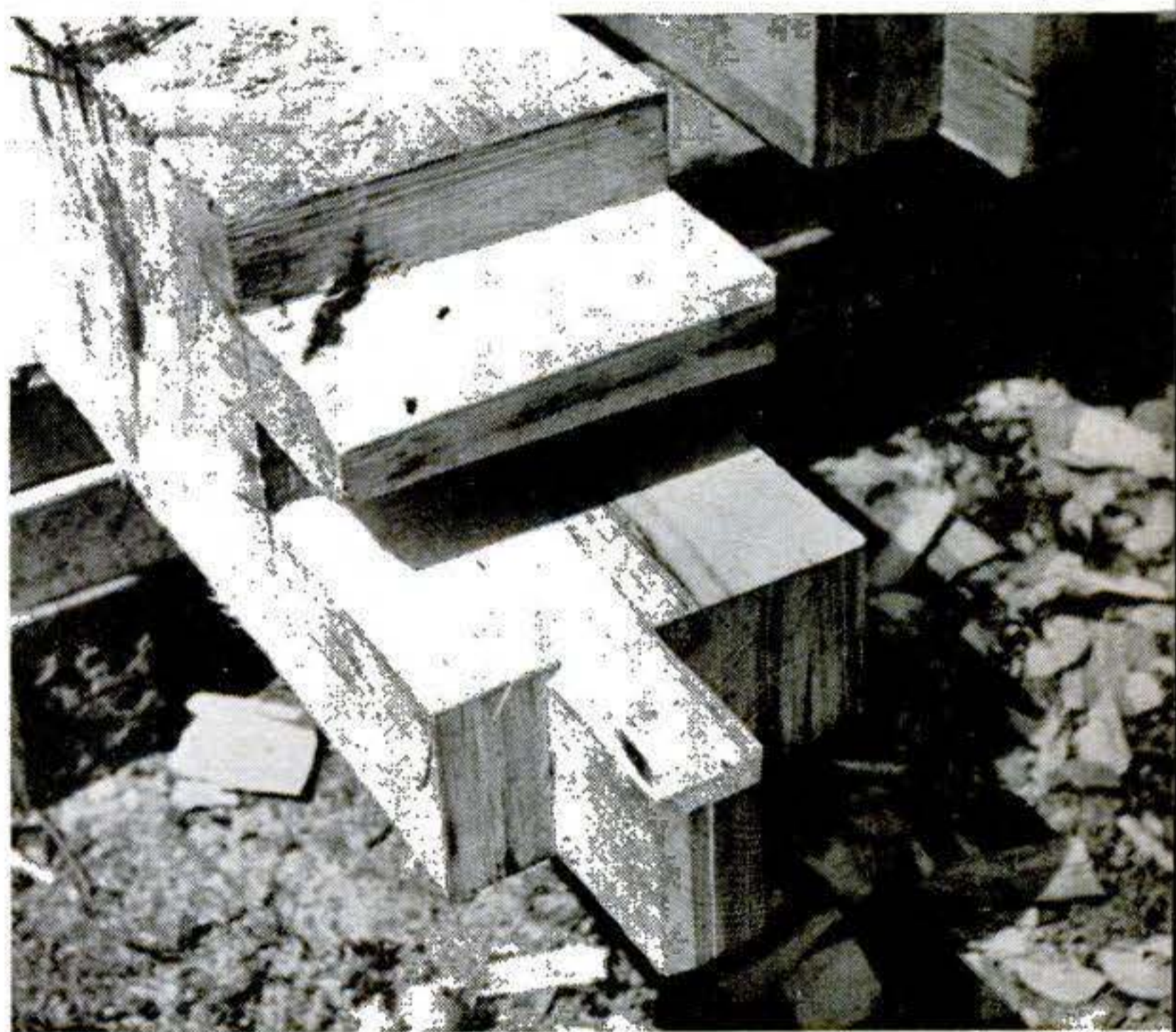

Strength of the completed barn depends on complicated joints, such as the *eesel fuus* (mule's foot) shown above. All joints are cut before any part of the barn is assembled. It takes experience to know where each should be used.

Not a single nail is used in the framework. Hundreds of sturdy oak pegs, like those below, are cut before raising. They are driven into holes drilled in the timbers, then cut off flush.

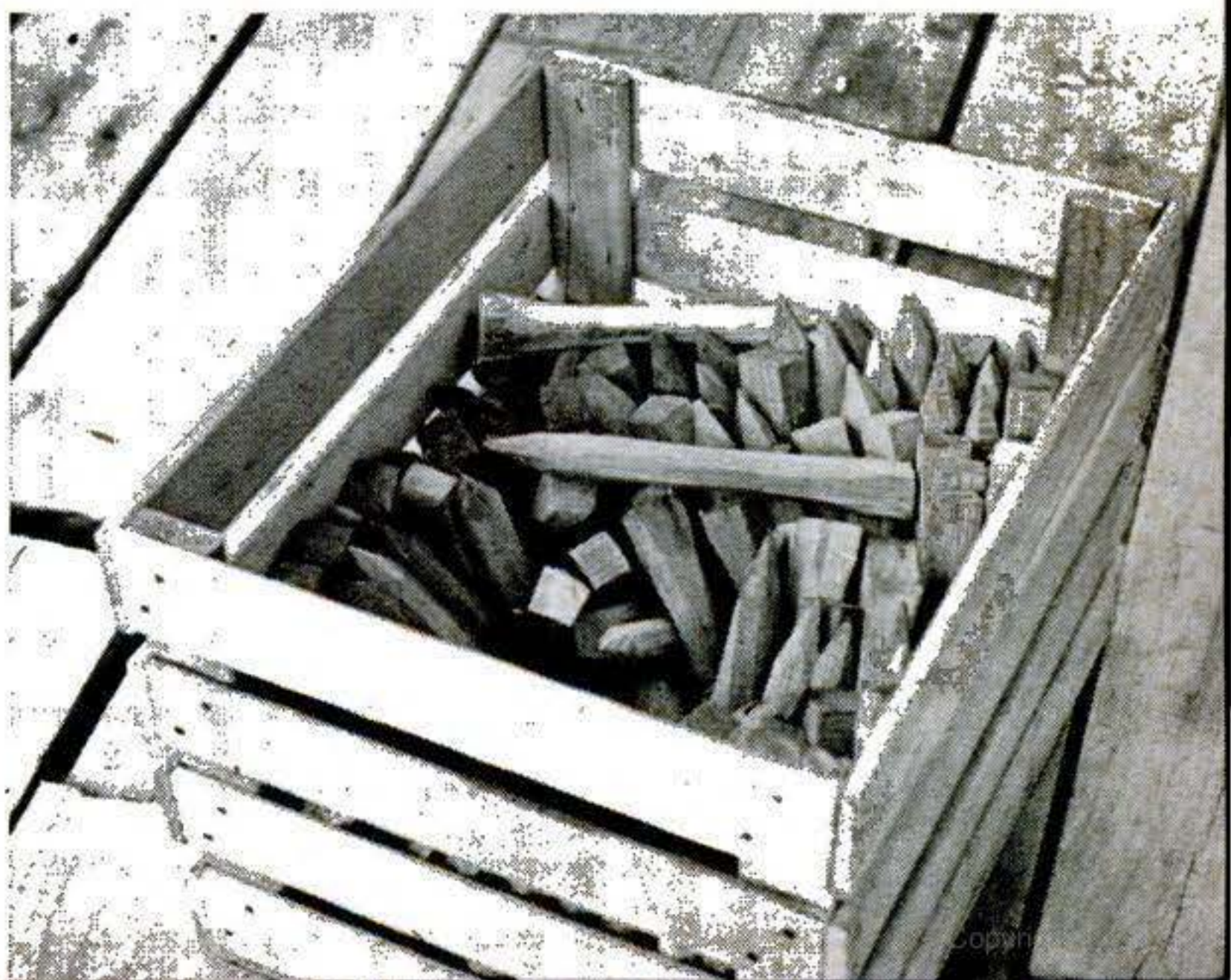



Old-fashioned muscle power puts giant beam where it's needed. Longest single timbers, 45 feet, span entire width of barn. Steel girders are used only in foundation against damp hillside.

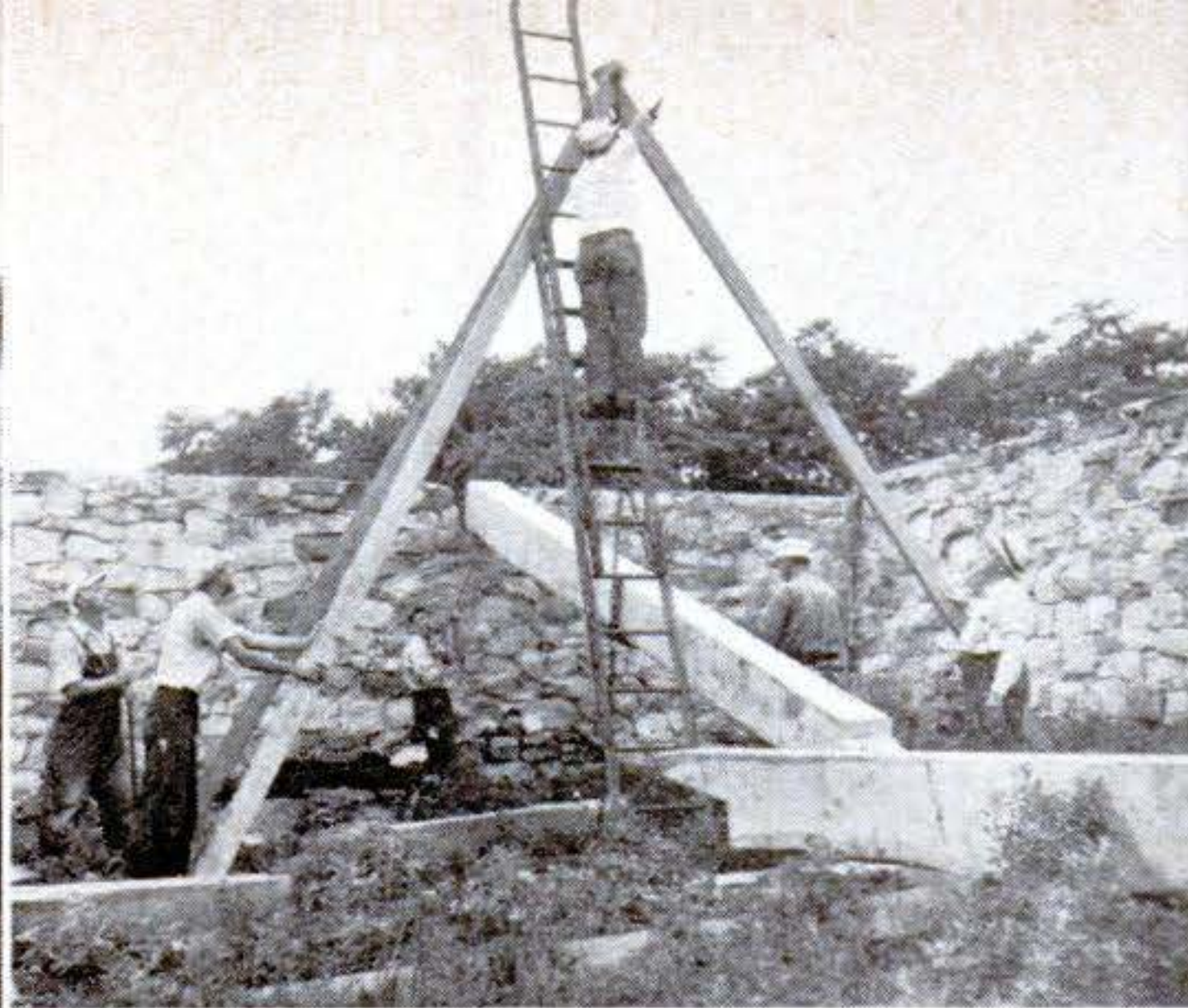

Carpenters use block and tackle to lift joists into place. These run the length of the barn, and are set into the stone foundation. Supporting posts are set in concrete on barn's floor.



Everybody gets into the act for a major raising job. The men are using long pike poles, or "stockades." The entire section, including diagonal braces, was preassembled on the ground.



Here first of the top rafters are swung into place. Roof is of gambrel type, with a flatter slope at the top. Haymow is reinforced so sides won't bulge when it is tightly packed.

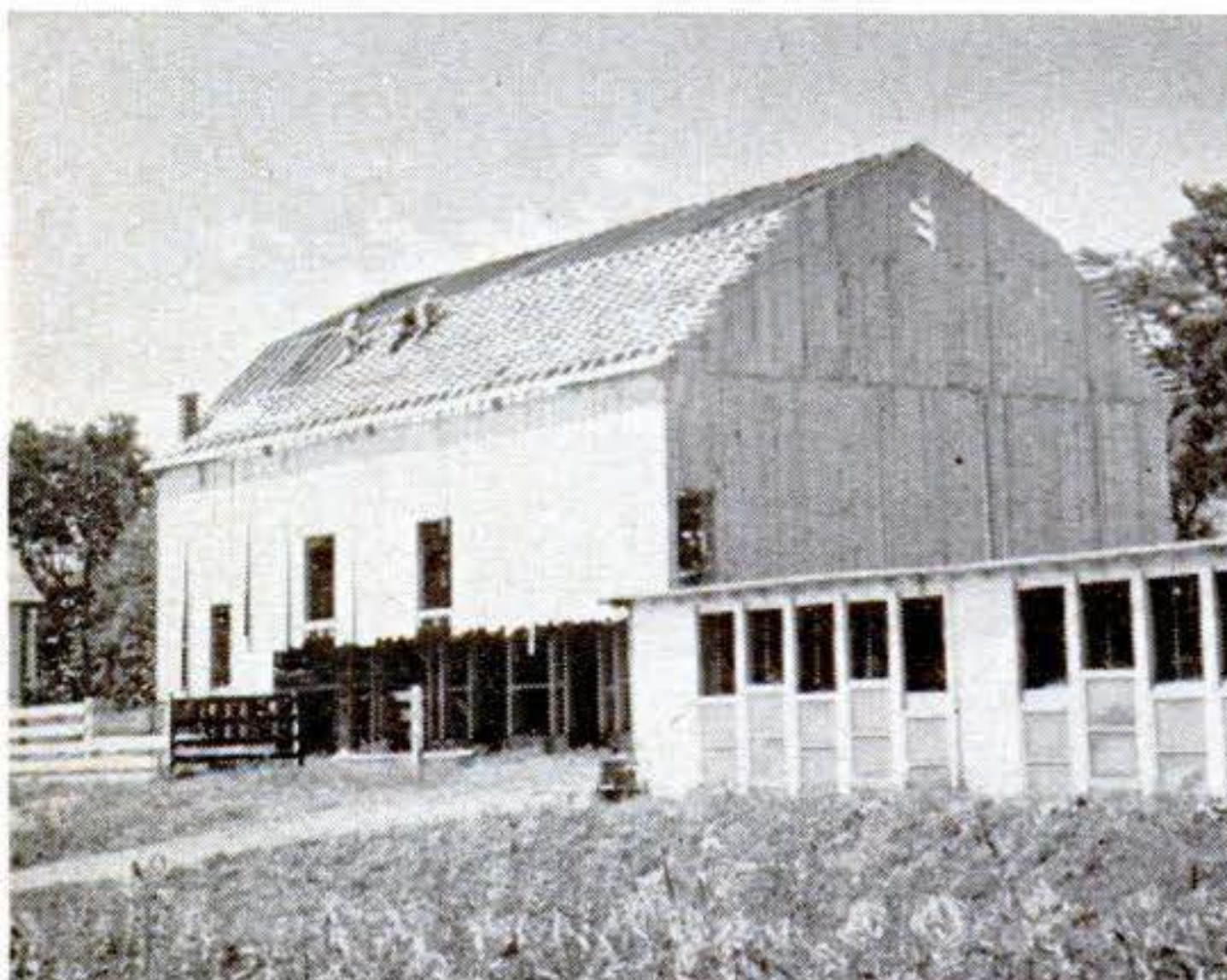

After framework has been raised, carpenters put on siding and finish the roof. According to Gehr, design for barn was brought from Switzerland by early "Pennsylvania Dutch" settlers.

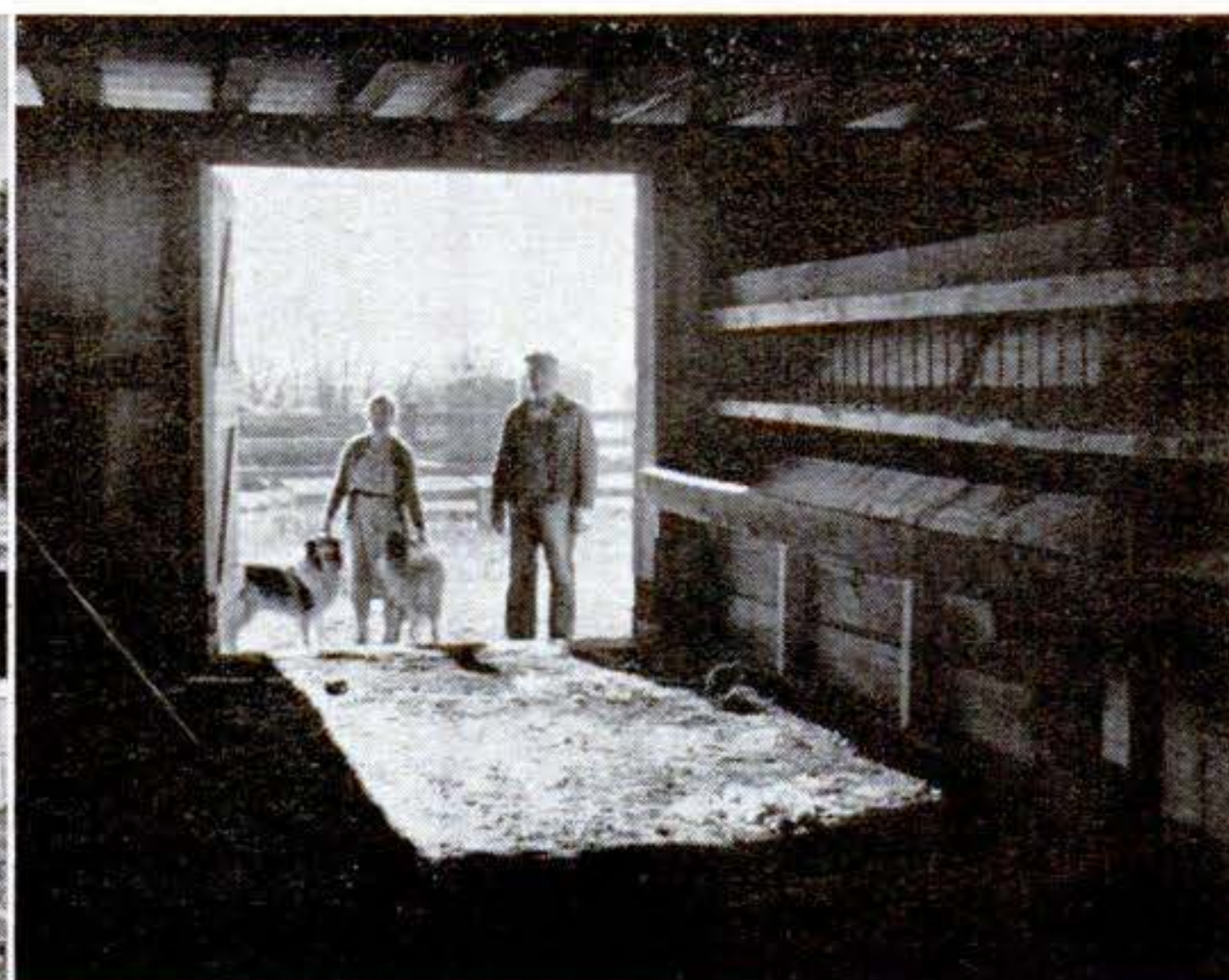

Mr. and Mrs. Levi Zartman inspect the stable of their new barn, raised by neighbors to replace one that burned. The completed structure is 45 feet high, 45 feet wide, 76 feet long.

Hot Breath Sampled For Safety

THIS, literally, is a breath-taking job. To protect workers who handle radioactive materials, the National Bureau of Standards in Washington takes breath samples sent in by private companies and government laboratories and analyzes them for harmful particles. The worker at right is shown breathing into a balloon. His breath is then collected in a vacuum flask, which is mailed in a metal container to the Bureau. There a series of complicated tests determine whether he is inhaling a dangerous number of radioactive particles. If the concentration is too high for safety, such precautionary measures as improved ventilation or rotation of workers are in order. Otherwise, the worker might get cumulative radiation sickness. **END**

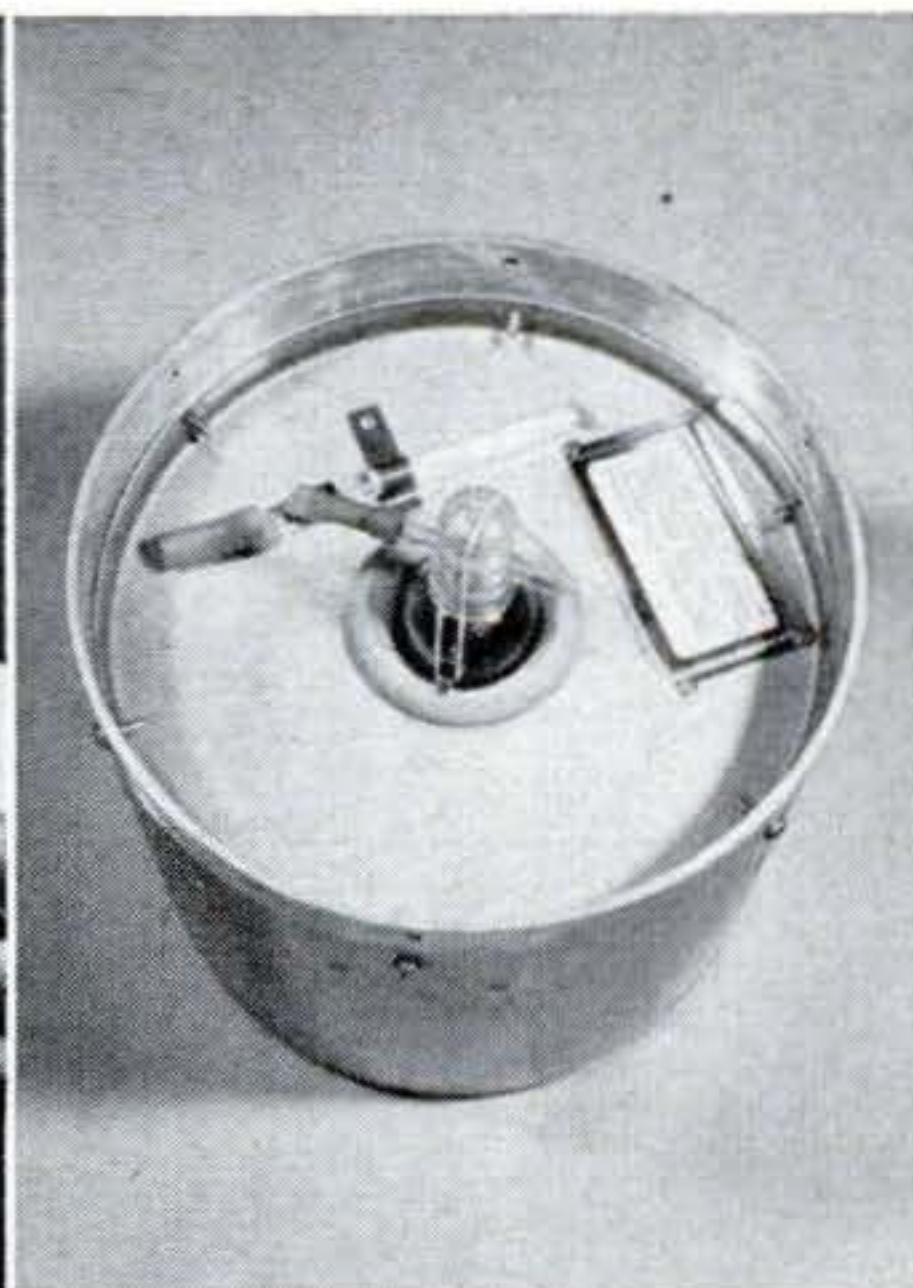
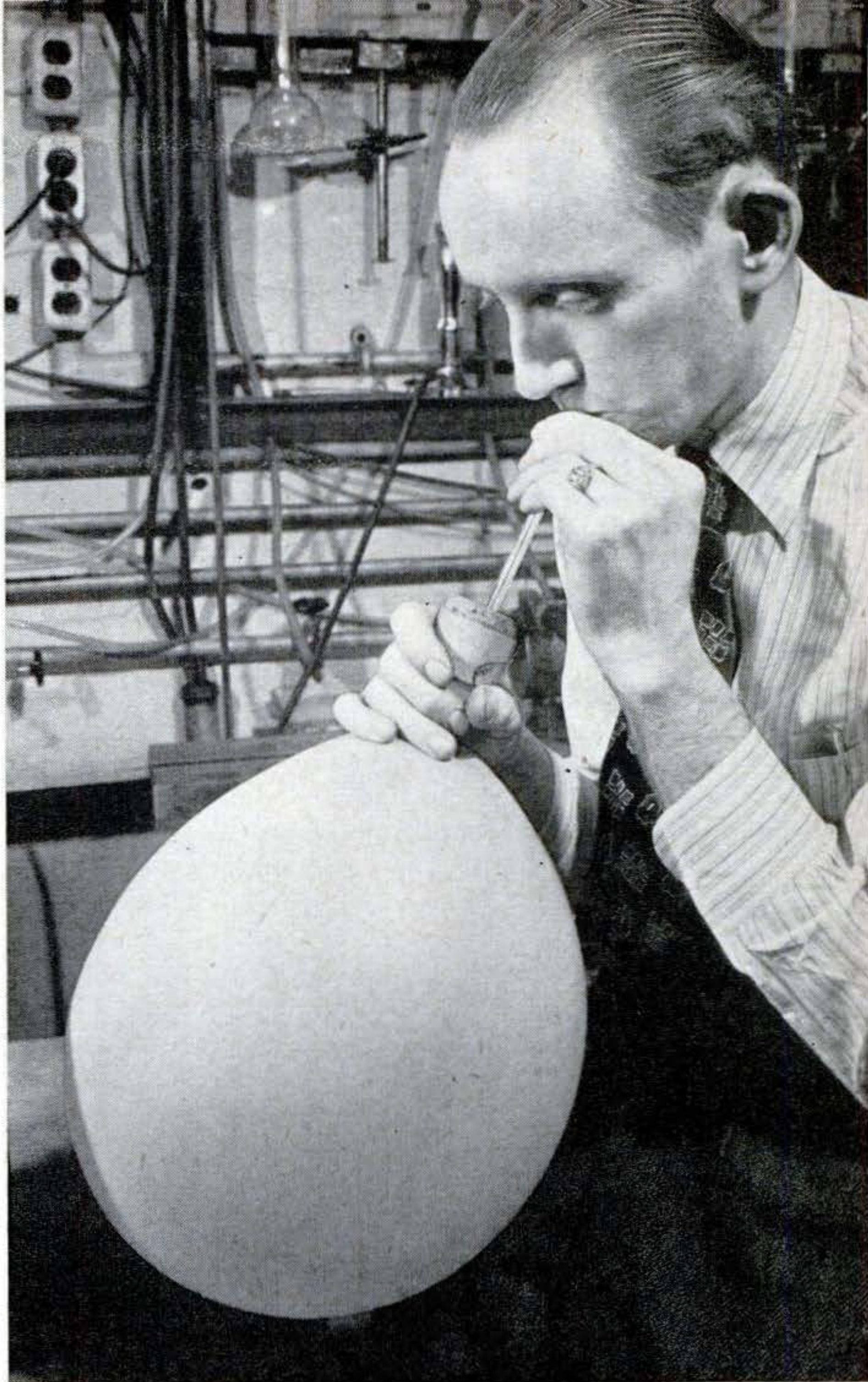

The gallon-sized flasks are tested with a 2,000-volt, high-frequency electrical discharge (left). If vacuum is complete, sealed flask gives off

bluish light. Metal mailing containers (center) are tagged with identifying number and date. Bureau's technicians (right) give the final word.

Just *TRY* to Steal

Thieves get a startling surprise when they tamper with a truck that screams out loud for help.

By C. C. Nash

PS photos by Hubert Luckett

JEWELRY salesman Jack Seide came out of a customer's store to find his car broken into and his sample kit gone.

"Second time in a month," he muttered. "This is getting to be tiresome—and expensive."

So, Seide, having a practical knowledge of electrical equipment and mechanics, made a contraption out of wires, a siren, a handful of triggers and other gimmicks, and a special coded lock. It was crude, but it worked, and the next thief that tampered with Seide's car set off an alarm that sent the burglar away from there at approximately the speed of light.

That was the first Babaco Alarm, devised by Seide in 1931 to protect his samples.

That siren reverberated over a lot of territory. The news soon spread to other salesmen of valuables, as well as to shippers and

truck owners. Before long, Seide was out of the jewelry business and in the business of manufacturing truck alarms.

In the 17 years since Seide shifted his occupation, his Babaco alarms have been guardians over some 250 billion dollars worth of truck cargo, without a single dollar lost by theft.

In the same 17 years, thieves have got away with an estimated \$200 million in furs, liquor, woolens, cigarettes, and other valuable loot—even kitchen sinks, eggs, construction steel, sewer pipe, and Frank Sinatra records. Not a single one of those losses involved a truck with a Babaco Alarm.

In New York City recently two trucks were stolen in one night from a terminal parking lot. They were the only trucks in the lot that were not Babaco equipped.

If you ever hear the Babaco Alarm shrieking from a truck, you can be sure that the thieving culprit is a novice. Usually he will need only one lesson. The alarm has a

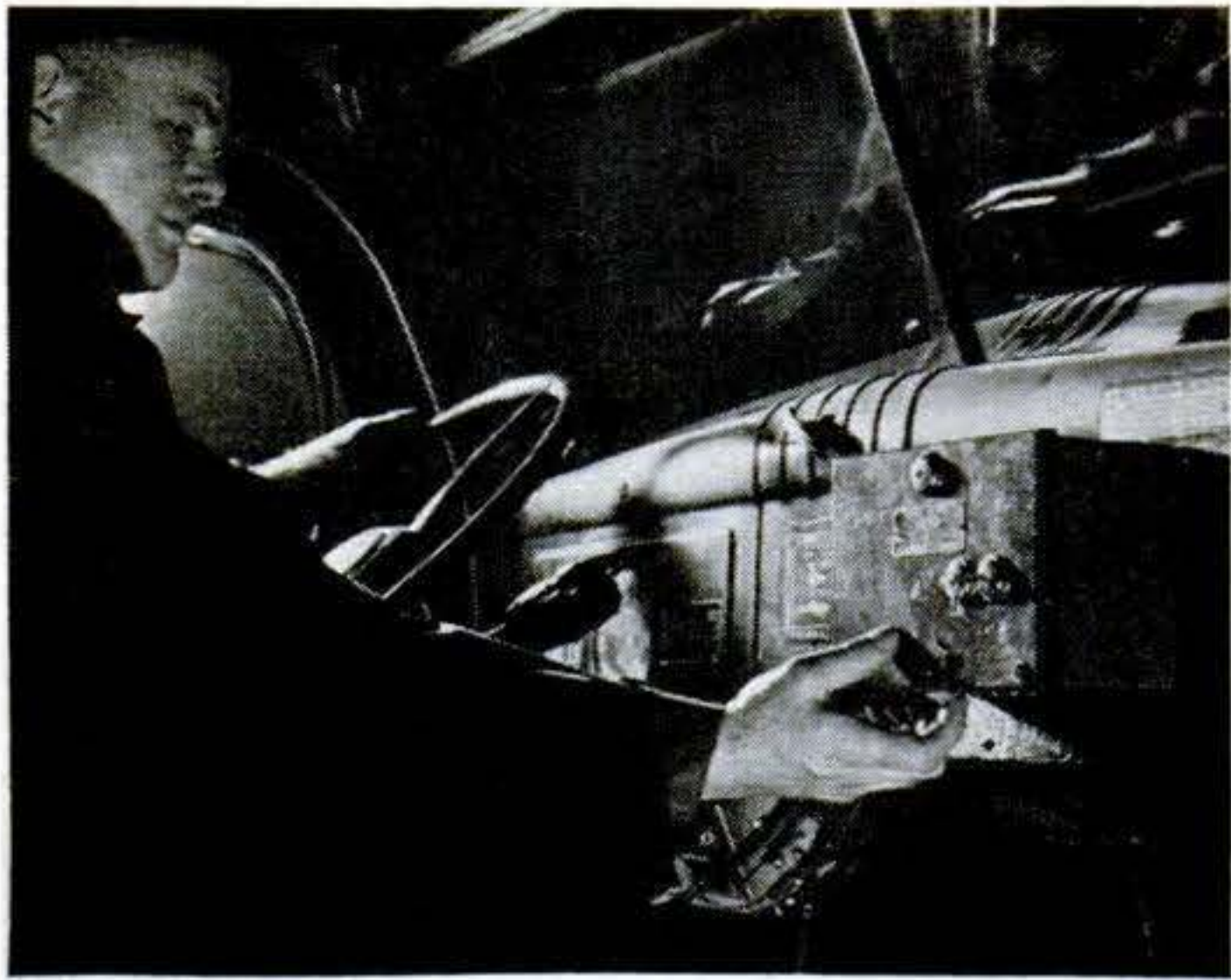

To leave truck, driver must first turn key to proper position in alarm's "brain," mounted on dash, then push right coded buttons underneath. Timer then gives him few seconds to get out.

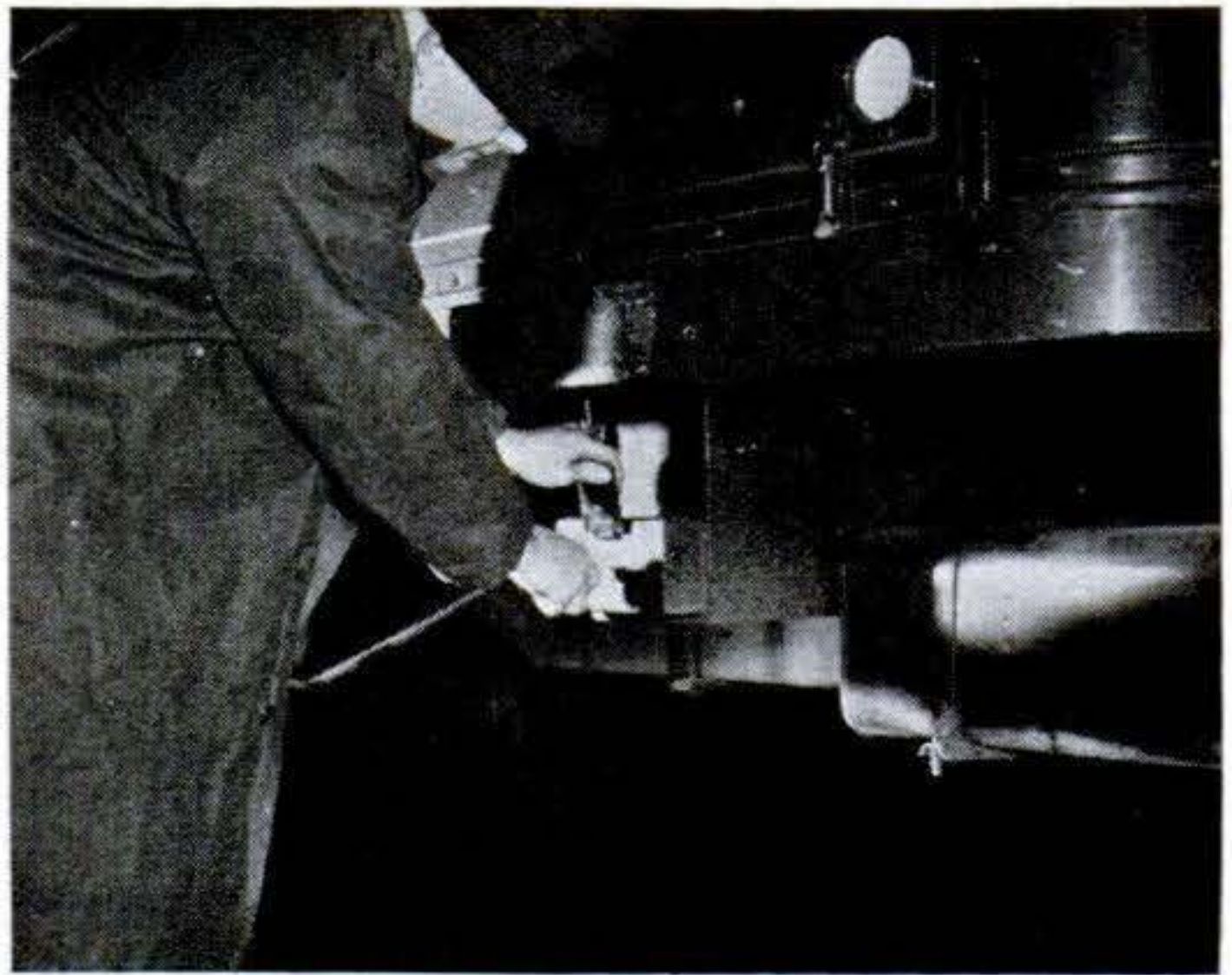

Siren and battery are mounted in box under body of truck. To open van doors, driver must turn key that temporarily disconnects alarm. If box is jimmied, vibration starts siren going.

This Truck



shriek audible for miles, screaming on for hours until stopped by the truck driver. Tampering with the cab door, a window, any loading door, or even the hood will set it off.

And if a thief thinks he might force a door in spite of the alarm, jump in, and drive off into some hidden side road to unload, he's due for a disappointment. The clutch freezes and the vehicle won't move—until the driver properly operates the coded push-button lock under the dashboard.

A thief may try to remove or break into the siren itself: the vibration automatically sets off the alarm. And cutting the wires won't do any good either. Closed-circuit

relays see to this. Breaking one circuit simply closes another, and the siren sounds off anyway.

With few trucks exactly alike in structure, the alarm system is tailored to fit each type. In a typical setup, a box made of tamper-proof metal is installed under the body. ▶

This box holds the battery, the siren, and the intricate apparatus that makes it all function. The front of the box opens with a special key (no two keys are alike). And even this has a trigger appliance so that anyone opening it other than the authorized operator will set off the siren.

Trigger connections also are wired into every door, window, or other opening in both cab and body. And under the dash is a series of coded push buttons. Only the driver knows the secret for a silent start.

To neutralize the alarm, the truck driver first unlocks the system with his key. This gives him a certain number of seconds to get into the cab and operate the code buttons. If he takes too long to push the buttons, the alarm goes off even for him. If his timing is right, however, he can drive off or open the truck.

A Year's Workout in a Quarter Hour

Before installation, every Babaco Alarm and every part of the unit goes through elaborate tests. One testing instrument simulates, in fifteen minutes, all the shocks, jars, and jolts that a truck would get in a year's operation. Another pushes in and out 50,000 times the plungers that govern window, door, clutch, and "parker" controls. A cold test puts every vital part through 30-degrees-below-zero operation; a heat test reproduces scorching desert temperatures.

The alarm systems are leased, not sold. By leasing, Babaco can make certain that its truck alarms will be checked every 30 days by experts in one of its 200 branches throughout the country.

The alarms are constantly being improved to meet new truck conditions and new twists in truck thievery. Long-haul trucks, carrying as much as \$100,000 cargo, often arrive at their destinations in the dead of night, too late to be unloaded. They have to stand by, locked of course, until morning. Recently a gang drove up to truck terminals at night with their own tractor units, and towed off parked, loaded trailers. Even the Babaco Alarm couldn't sound off under such conditions, for it was triggered only by tampering with points of entry.

Babaco engineers went to work, however, and almost before the truckers themselves were aware of the new thievery trend, a new gimmick was ready. It was a "parker" alarm, designed to go off not only when tampered with, but also if the vehicle was moved by anyone but its driver. **END**



To enter cab, driver must shut off system with key, or opening door would set off alarm by releasing push switch set in jamb. Even if thief gets in, clutch freezes and truck won't move.

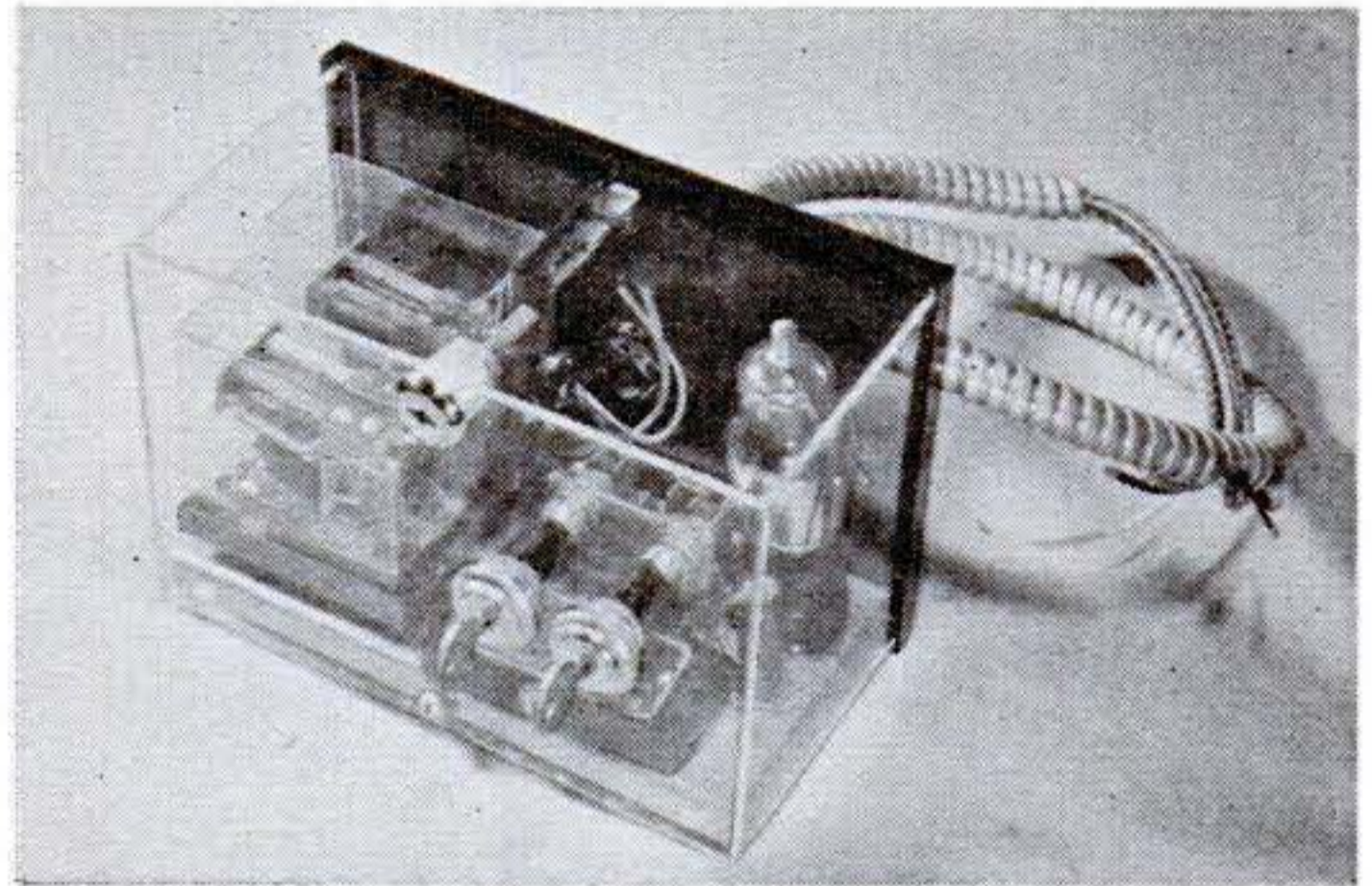

Alarm's "brain," shown here in plastic case, reveals intricate innards. Master key at left is kept by truck's owner, one at right by driver. Box's lock at top can be opened only by Babaco.

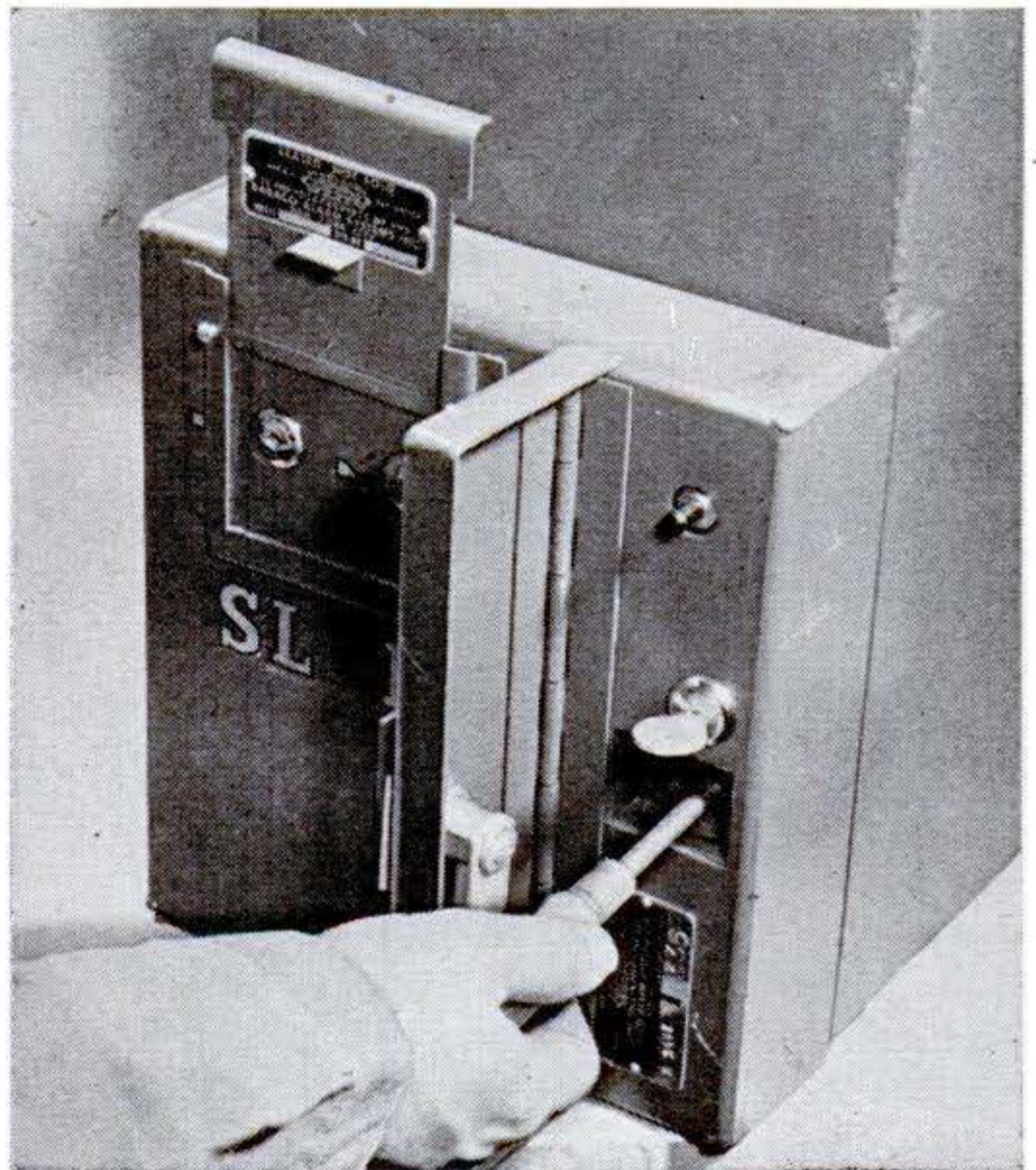

For repairs and inspection, serviceman first opens an outer door. An inner lock then opens a hole through which he inserts screwdriver, as above, to gain access to the siren mechanism.

Tank Razers Work from Rowboat

WHEN salvage workers in Erie, Pa., recently dismantled a steel water tank 125 feet high, they did the job from a rowboat floated inside, instead of the usual scaffolding and bo'suns' chairs rigged on an empty tank. Men and equipment could thus be lowered to a new working level, when necessary, simply by releasing the water inside.

The standpipe was cut away in 1,000-lb. sections by gas torches, and then lowered to the ground, as at right, by cables attached to a hoist that was mounted on a truck. An oil drum hooked to the side of the tank held the gas cylinders that fueled the torches. Ace Junk & Salvage Co. did the job.

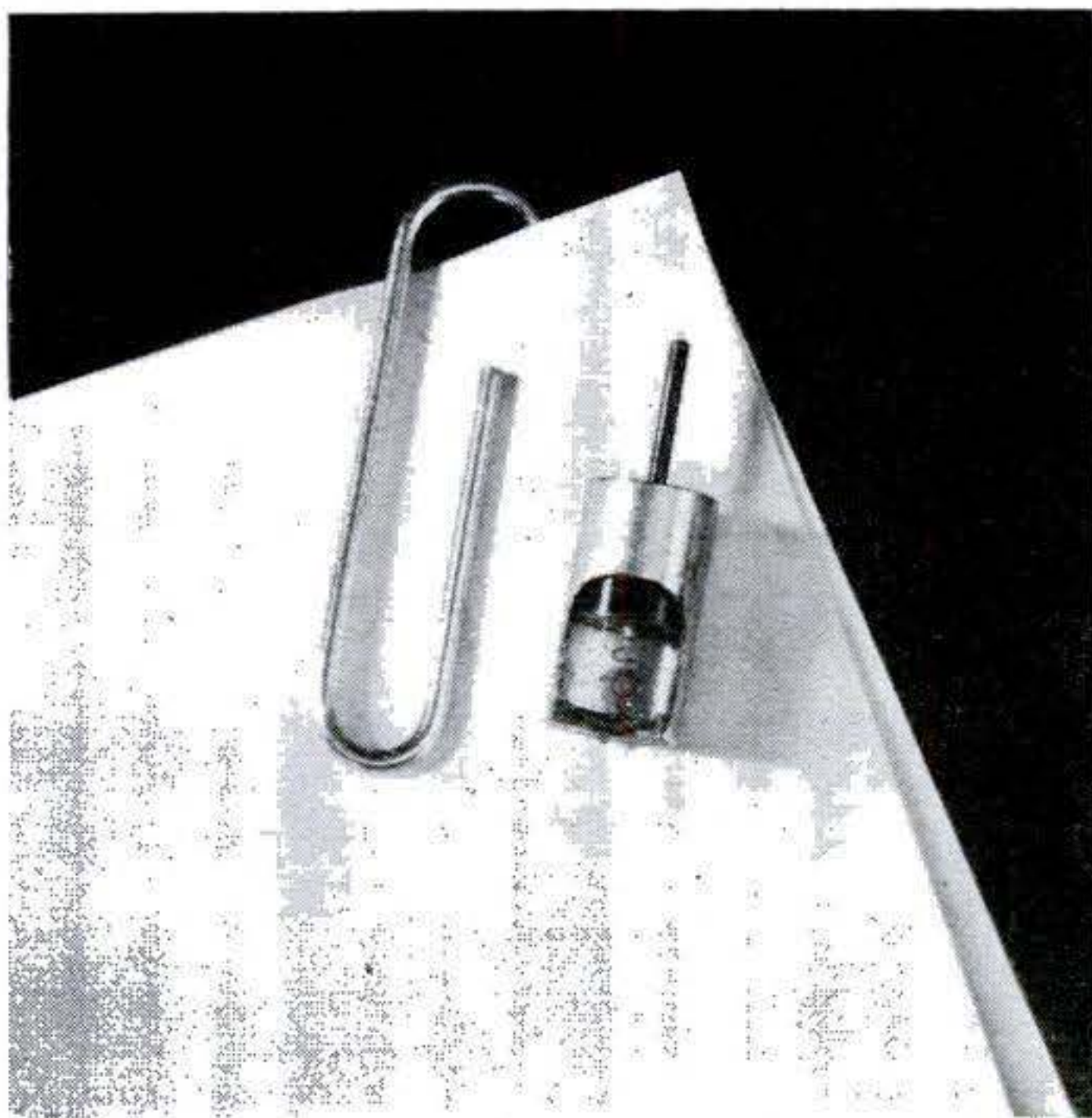

Electric Eye Gets Smaller

TINIER than a paper clip, the tube above, shown actual size, is a new type of electric eye. Called the Phototransistor, it is sturdier as well as smaller than present photoelectric cells. It stemmed from development of the transistor (PS, Sept. '48, p. 117), a device that performs most of the functions of the vacuum tube without requiring a vacuum or a filament supply. Bell Telephone Laboratories developed the eye.



Shovel's Cab Is Air-Cooled

THE operator of the electrically powered shovel above keeps comfortable in an air-conditioned cab even while it's handling steel-mill slag at 2,800°. Mounted on top of the cab, the cooling unit supplies 400 cubic feet of air per minute, filtered through fume-removing canisters. Using Freon-114 gas, it keeps temperature inside the cab down to 80°. Dravo Corp., of Pittsburgh, Pa., makes the cooler.

M. G. Gets Coil Springs, New Frame, More Speed

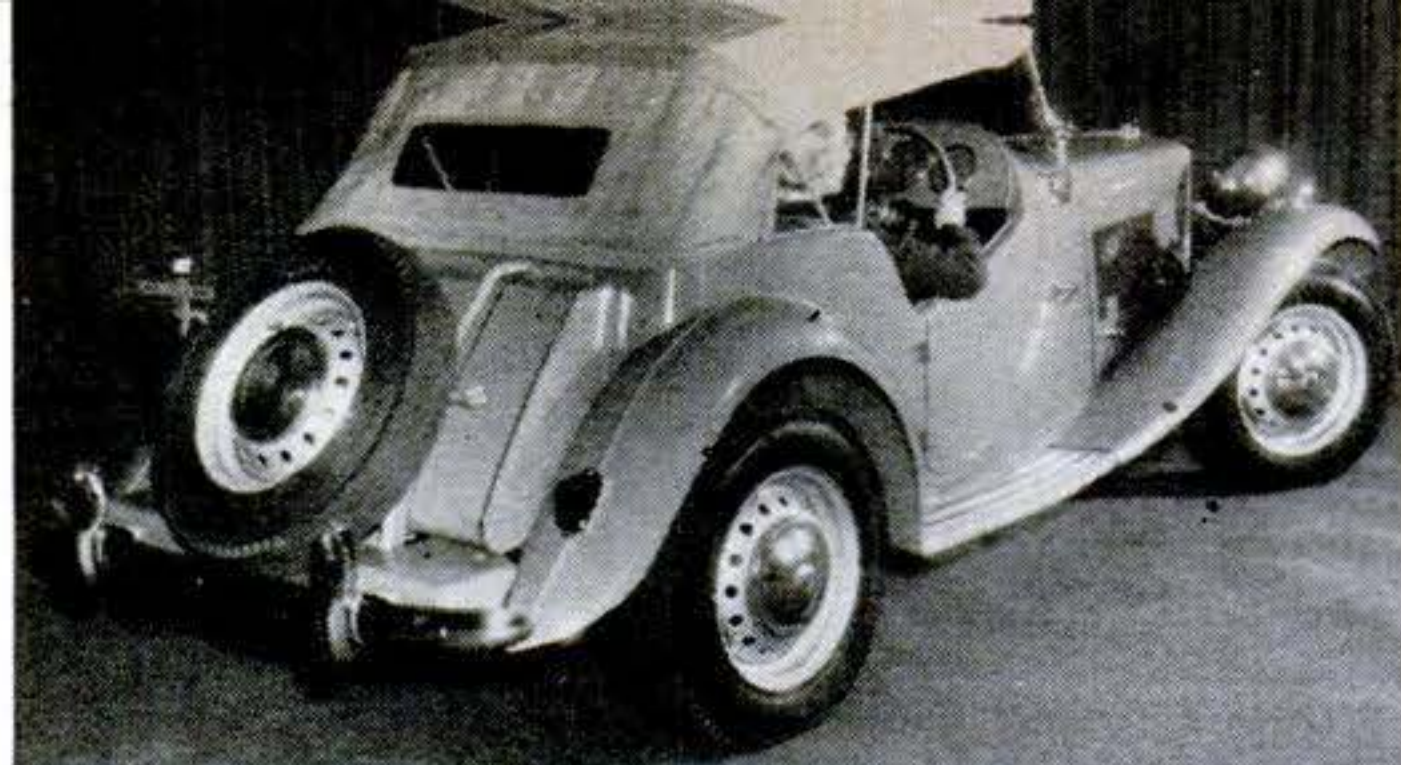

With top up, low-slung M.G. stands 4 ft. 5 in. high. Note deep-cut doors, exposed fuel tank.

Faster and sturdier than its fore-runners, this famed sports car now makes its first bid for comfort, too.

By Sheldon M. Gallager

PS photos by W. W. Morris

WHILE most American motorists have been taking a smooth ride for granted for years, the British-made M. G. Midget has been quietly exciting sports-car fans all over the world—without a knee-action to its name. Now, for the first time in its 21-year history, the snappy little two-seater will have independent front-wheel suspension with coil springs.

The M. G. isn't backward—just cautious. Its engineers took years to make sure they could come up with a design that would provide the smooth-riding comfort of coil springs without sacrificing the speed, ruggedness, and road-holding ability long expected of the M.G.

The result, except for appearance, is virtually a new car. The softer suspension required a more rigid chassis, so the old channel frame had to be discarded for a sturdy box-section frame. The heavier chassis, however, boosted the car's weight to 2,009 pounds, a 198-pound increase that threatened to steal vital speed. To offset this, wheels were made smaller, providing, in effect, a lower axle ratio. Now, despite the added weight, the same 54-hp. engine gives the new 1950 Midget, designated the TD, a top speed of 83 m.p.h., some 5 m.p.h. better than its predecessor, the TC.

In styling, the M.G.'s long-famous racy lines remain unchanged, except for a body four inches wider that gives greater roominess inside. Increased stability is also provided by a slightly wider track. At high speeds, the new TD will get 27 to 30 miles on a gallon; at low speeds, as much as 42 miles. Price? You can pick one up, delivered in this country, for about \$1,850.

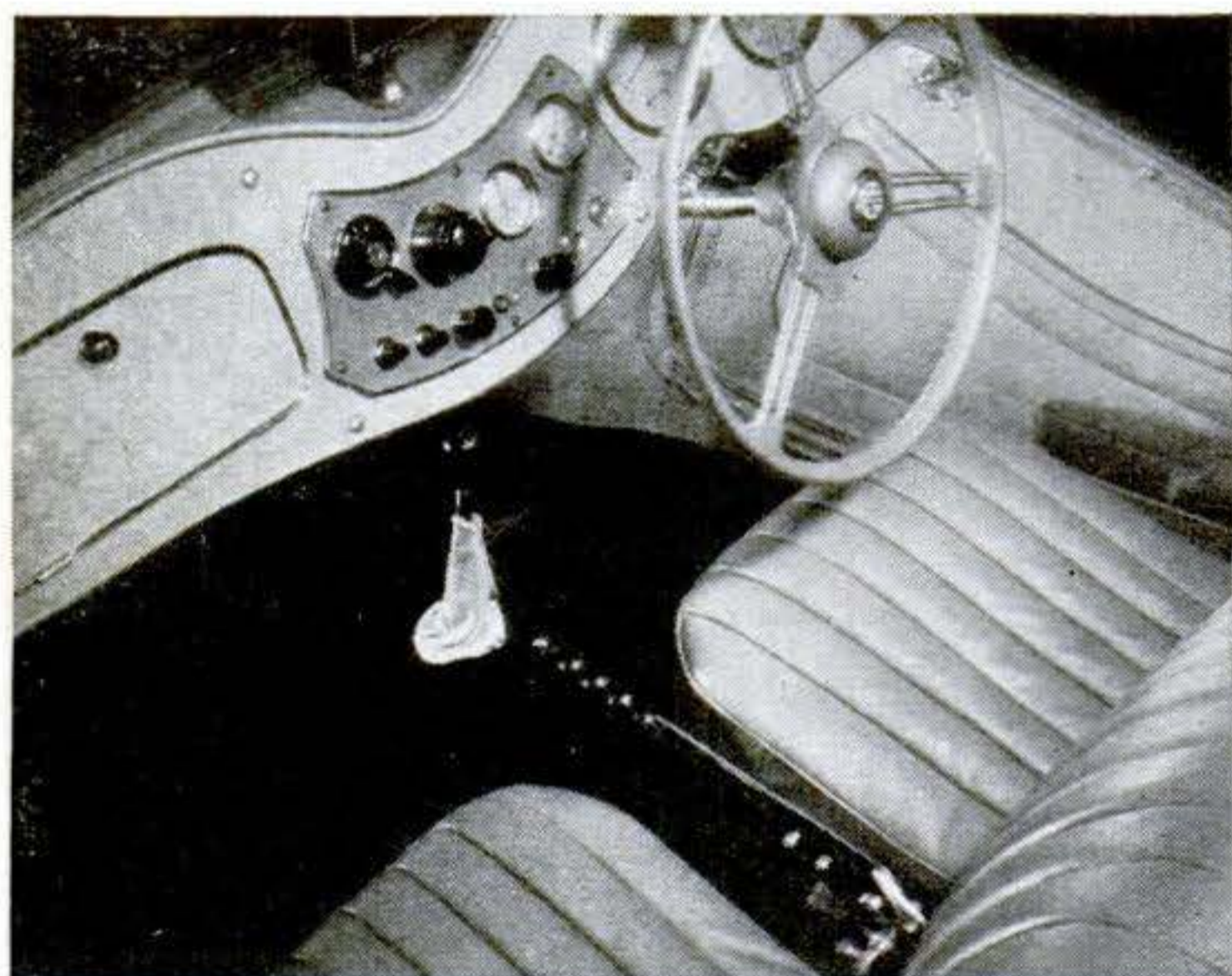

Double-hump dash is unchanged except for regrouping of instruments closer to driver. New one-piece seat back adjusts for tilt. Lever between seats is hand brake. Upholstery is leather.

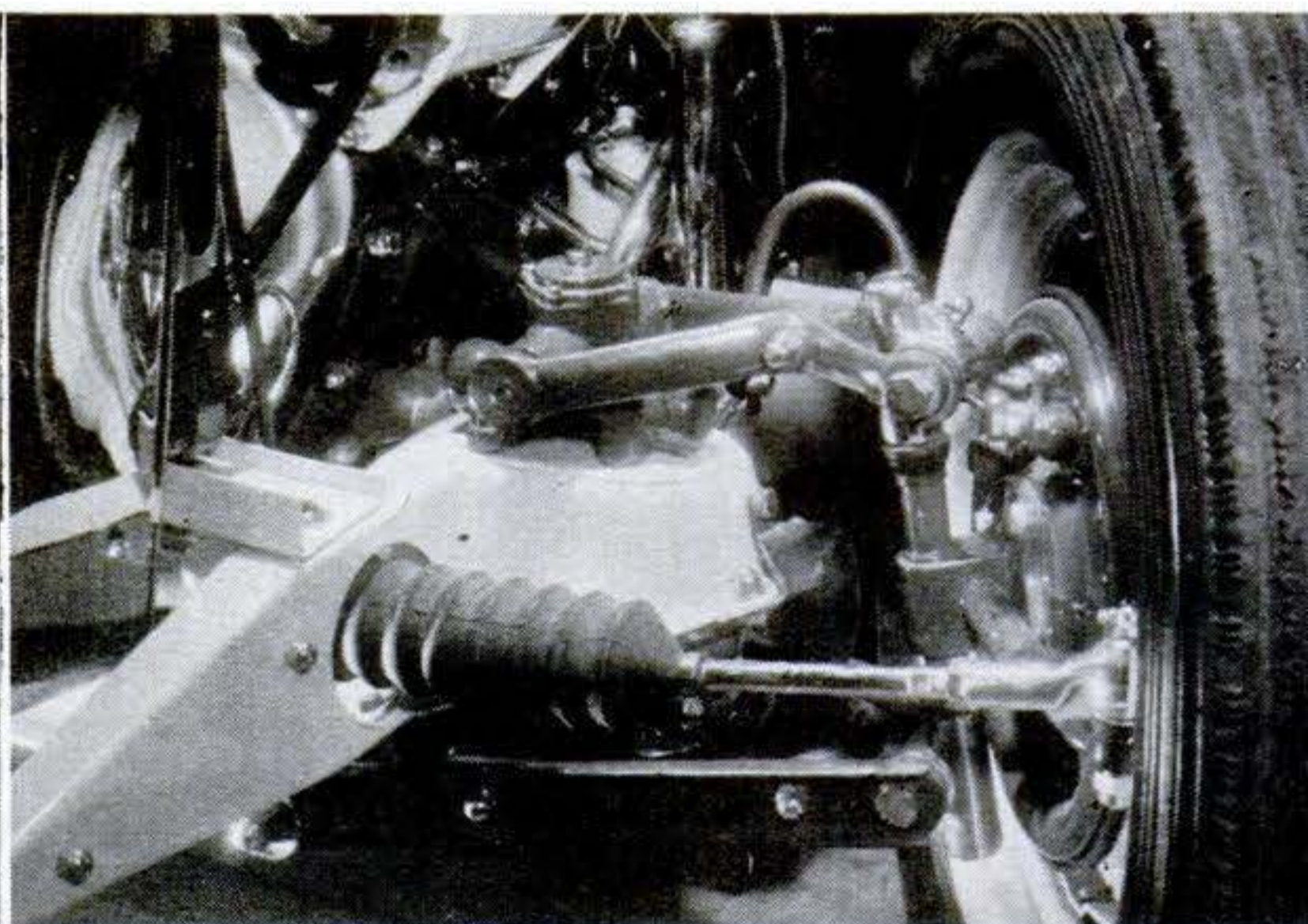

Independent coil suspension, a sight few M.G. followers expected to see, replaces old hard-riding leaf springs. Coil spring is supported by A-frame pan. Steering is rack and pinion.

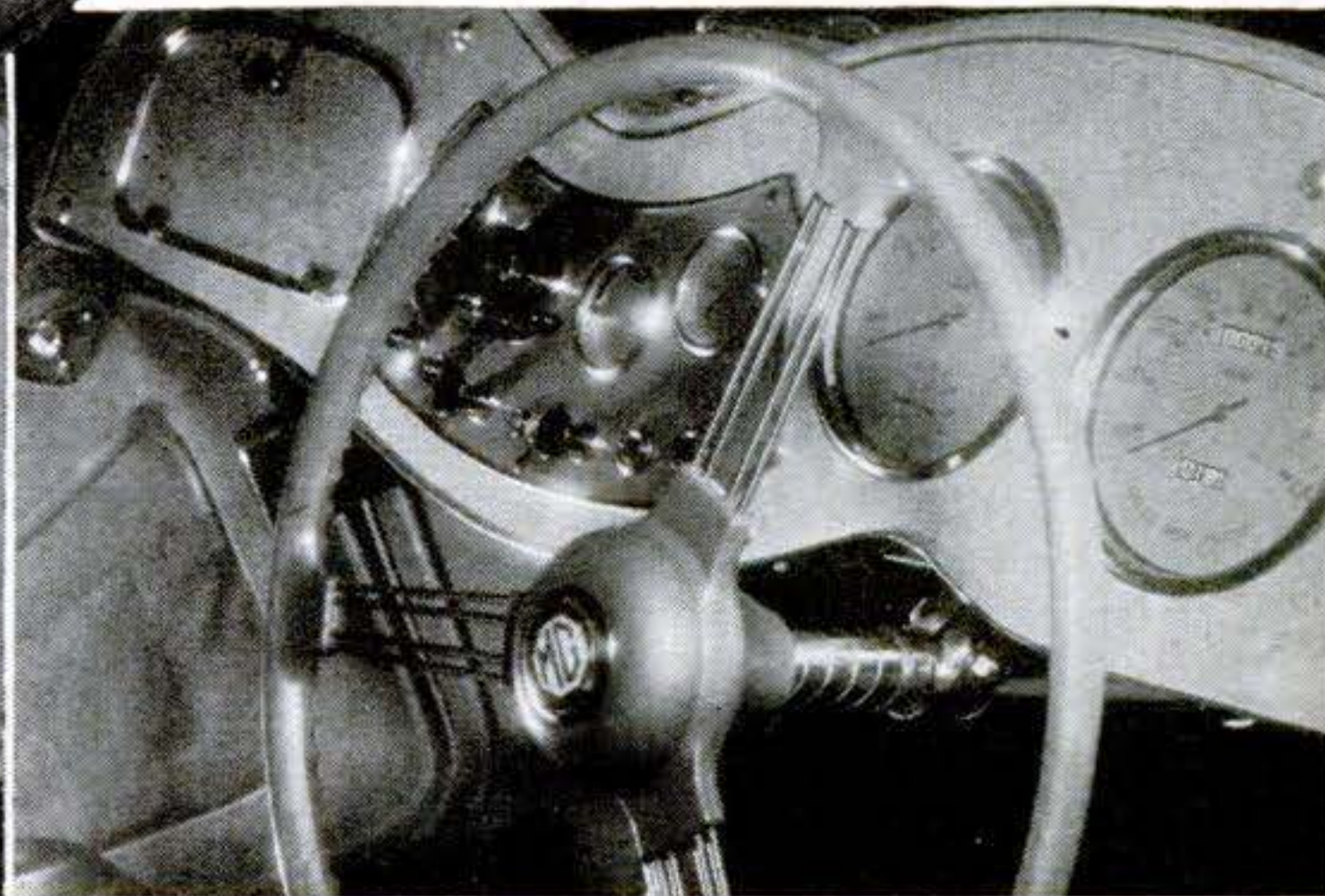
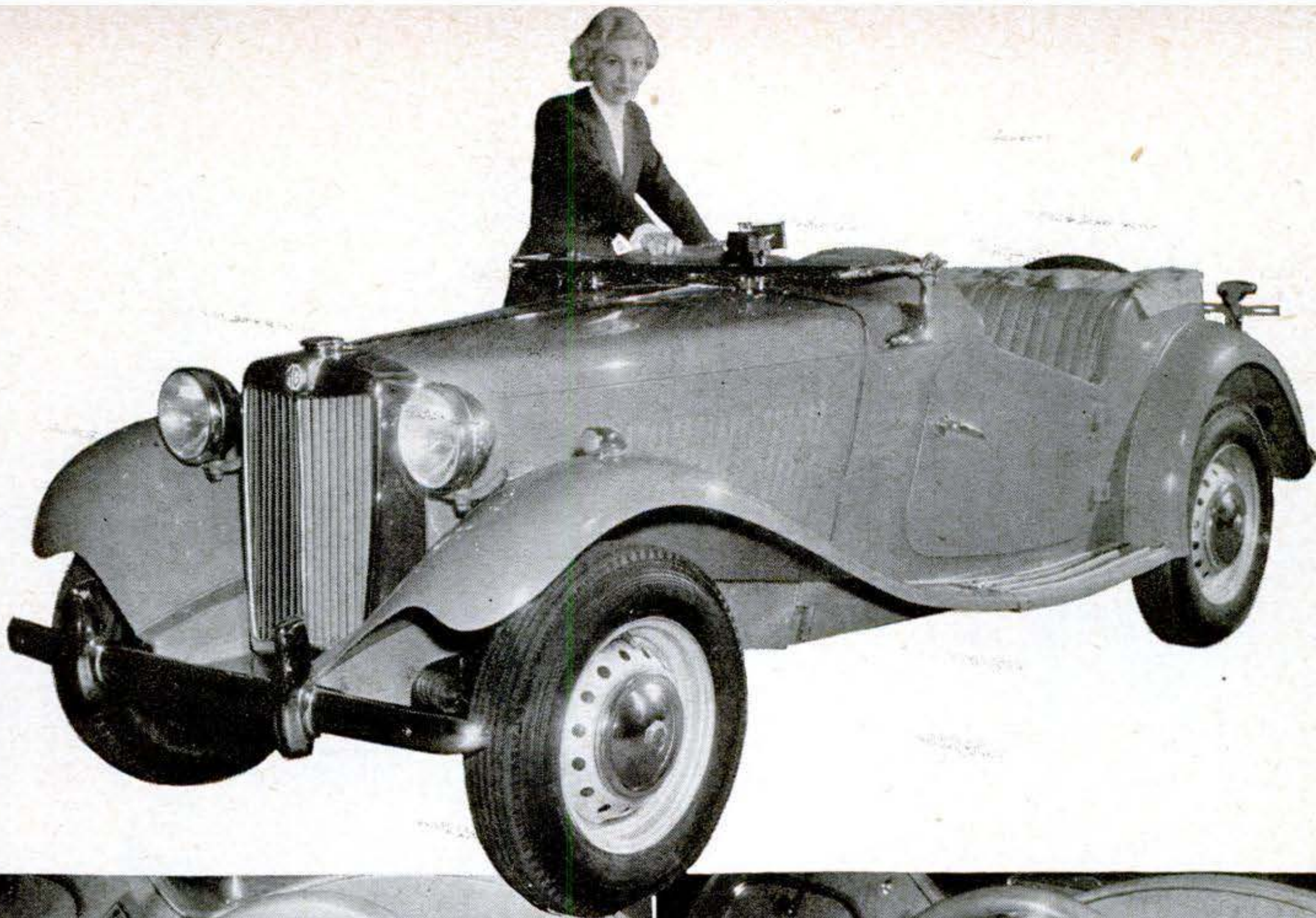

Telescoping steering wheel, shown retracted above and extended at right, permits tailoring car to driver. Car, shown here with right-hand drive, is now available with left-hand drive.

Twin 5-in. dials are speedometer and combined clock and rev counter. Grouped dash controls include horn button. Transmission has four speeds forward; rear axle uses 5.125 to 1 ratio.

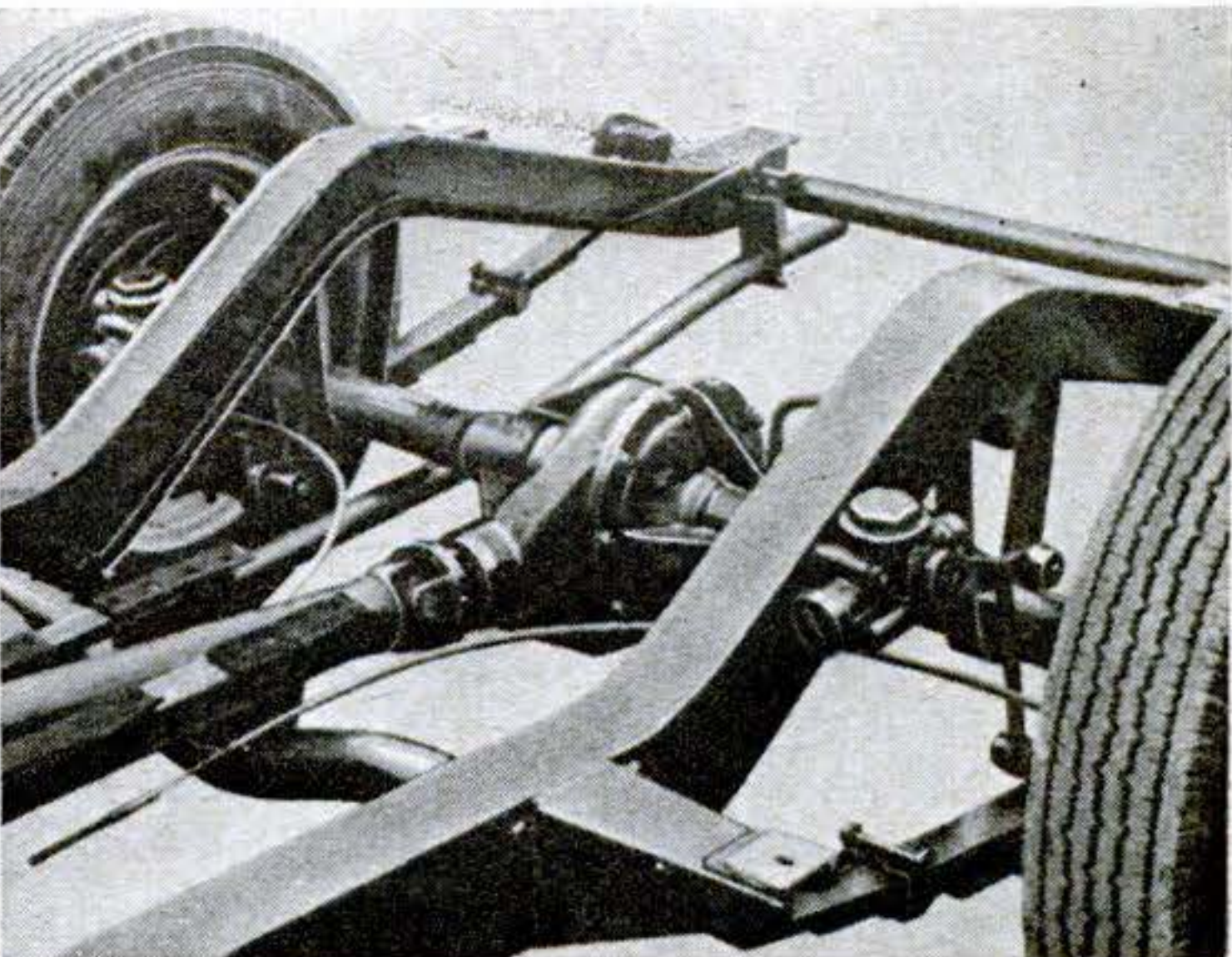
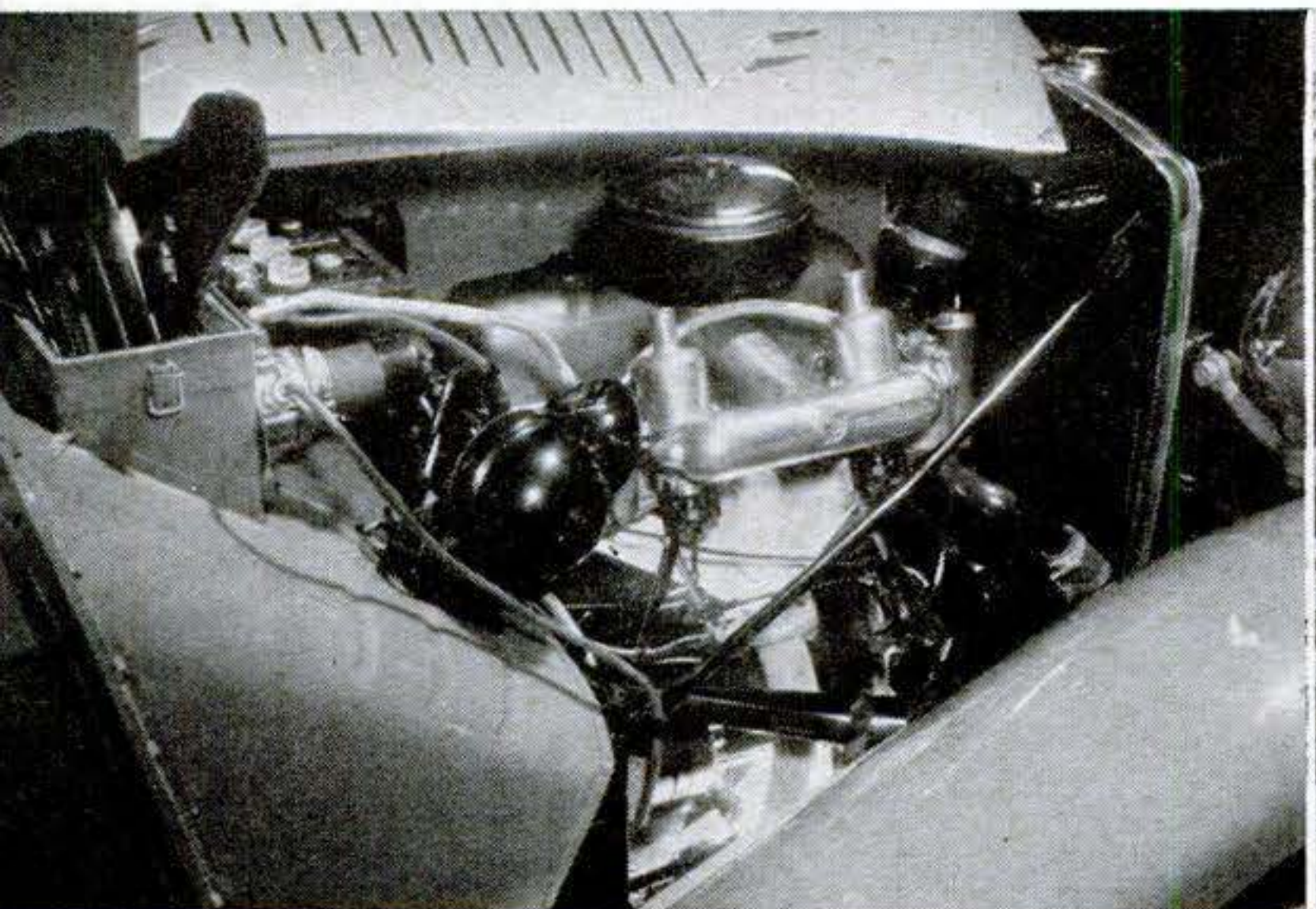

Engine is still 4-cylinder, 54-hp., unchanged except for T-shaped air intake connecting dual carburetors with single filter. Note built-in tool chest at left, large 12-volt battery in rear.

New box-section frame is upswept over rear axle to increase ground clearance. Rear springs are leaf, as before, but slightly softer. The wheelbase is 94 in.; over-all length, 145 in.

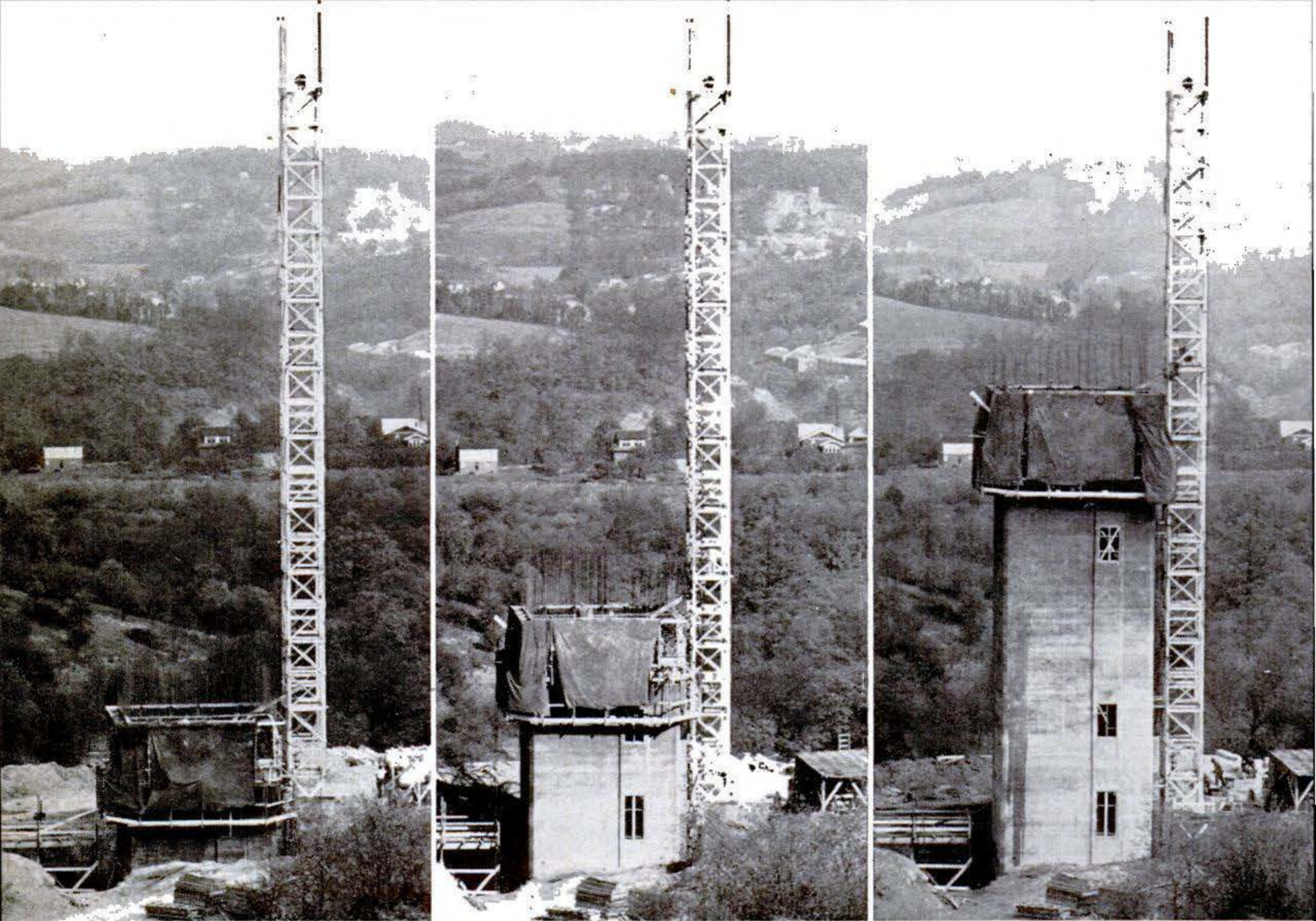

How a concrete building lifts itself by its own bootstraps is shown in the series of pictures above, made from the same location during the

construction of the radio relay station on Troy Hill, near Pittsburgh. The first photograph (far left) was made on a Wednesday, when the build-

TV Towers Sprout from Sliding Form

TOWERS that were raised by their own bootstraps will be relaying television shows cross-country this fall. Part of A.T.&T.'s New York-to-Chicago chain of radio relay stations, they were built with the help of an unusual wooden form that rises with the structure, sliding up as the concrete in it hardens.

Ordinarily, concrete buildings are poured one level at a time, the forms being knocked apart and reassembled for each higher level. Here, though, the sliding form stays together until the building is finished. It rides on 20 threaded steel rods that make up part of the vertical reinforcement of the structure. Screw jacks on these rods raise the form about six inches an hour. Since

the concrete must be poured continuously, work goes on day and night.

The sliding form consists of three wooden frames, two small ones fitting inside the third large one. Concrete poured into the space between the large frame and two small ones makes the outside wall. The space between the two small frames makes an inside wall enclosing the stairs.

The continuous-pouring method was employed by A.T.&T.'s Long Lines Department for much of the eastern leg of the 31-station New York-Chicago relay chain. While built primarily to relay television shows on its searchlight-like beams of micro-waves, it may also be used to carry great numbers of long-distance phone calls.

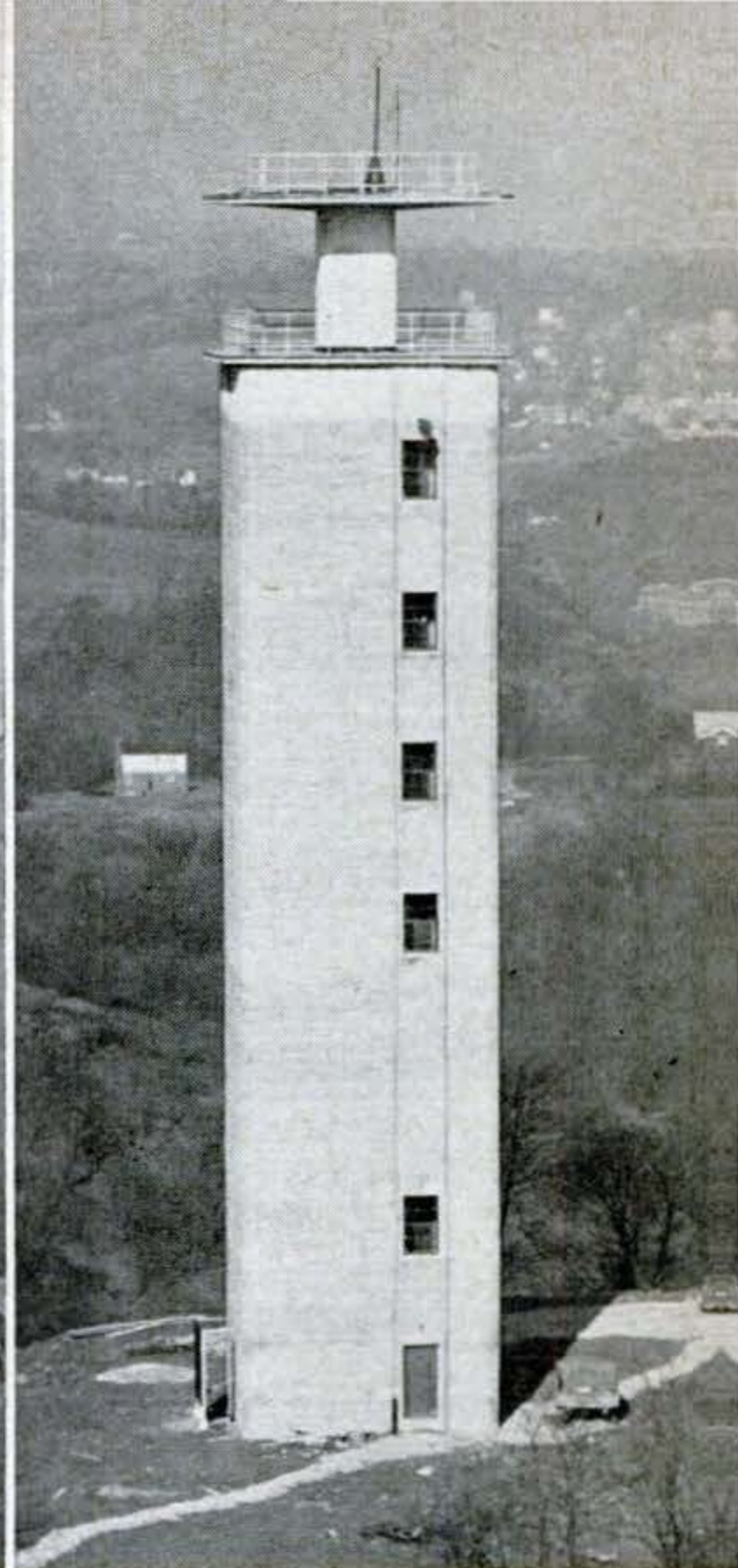
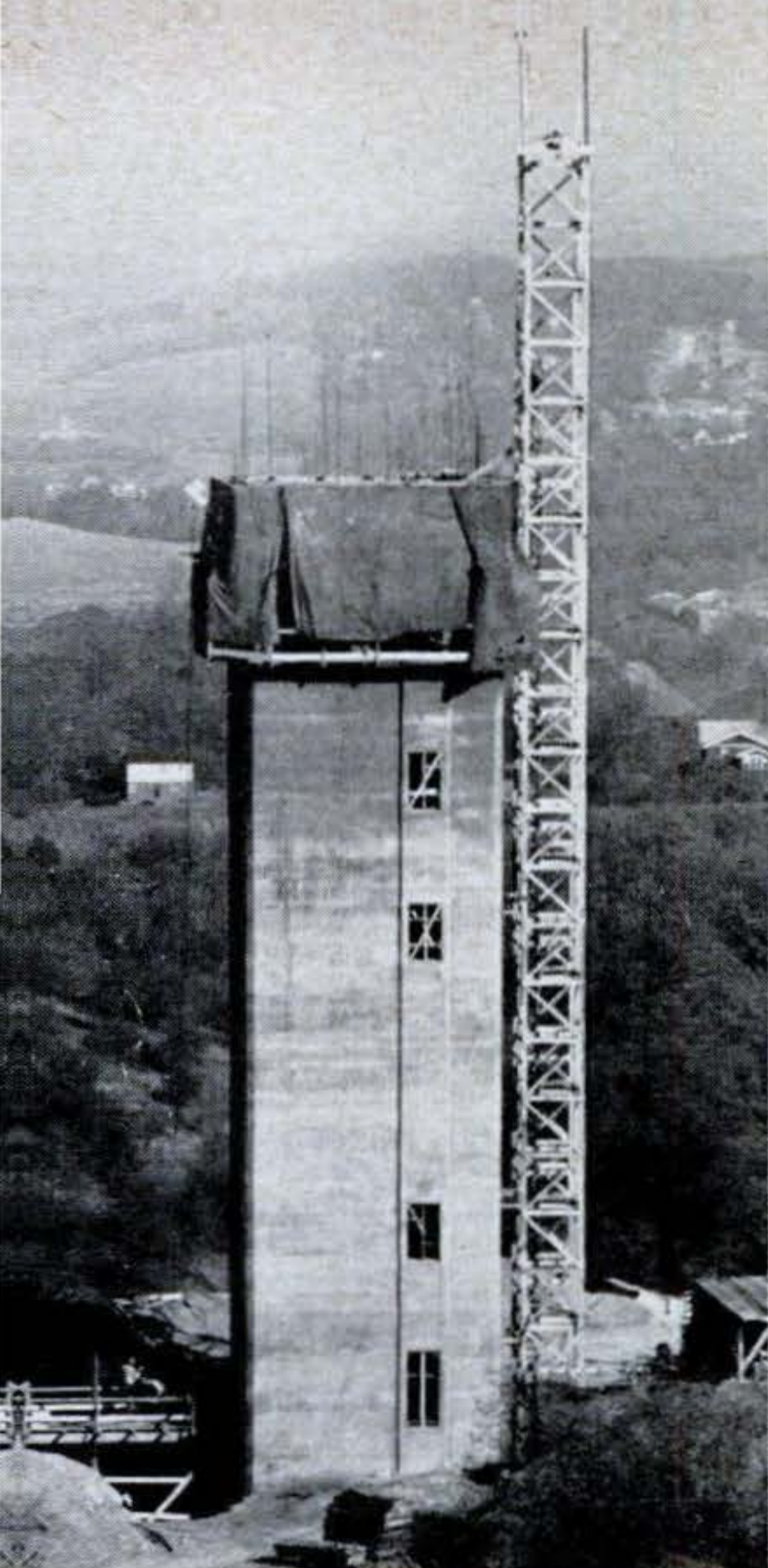

ing was only 16 feet high. By the next Monday (second from right) it had reached its full height of 103 feet. Photo at far right shows the

structure completed, but before installation of huge horns that serve as antennas. Tower is one link in New York-Chicago television relay.

Scaffolding hanging from the sliding form supports a "finisher," who smooths concrete as it is uncovered by the form. The workmen's platform atop the structure also rides on the form.

Form rises about an inch at a time as workmen operate jacks fitted to threaded steel bars. Note yardsticks placed behind threaded bars to aid in keeping platform level as it moves up.

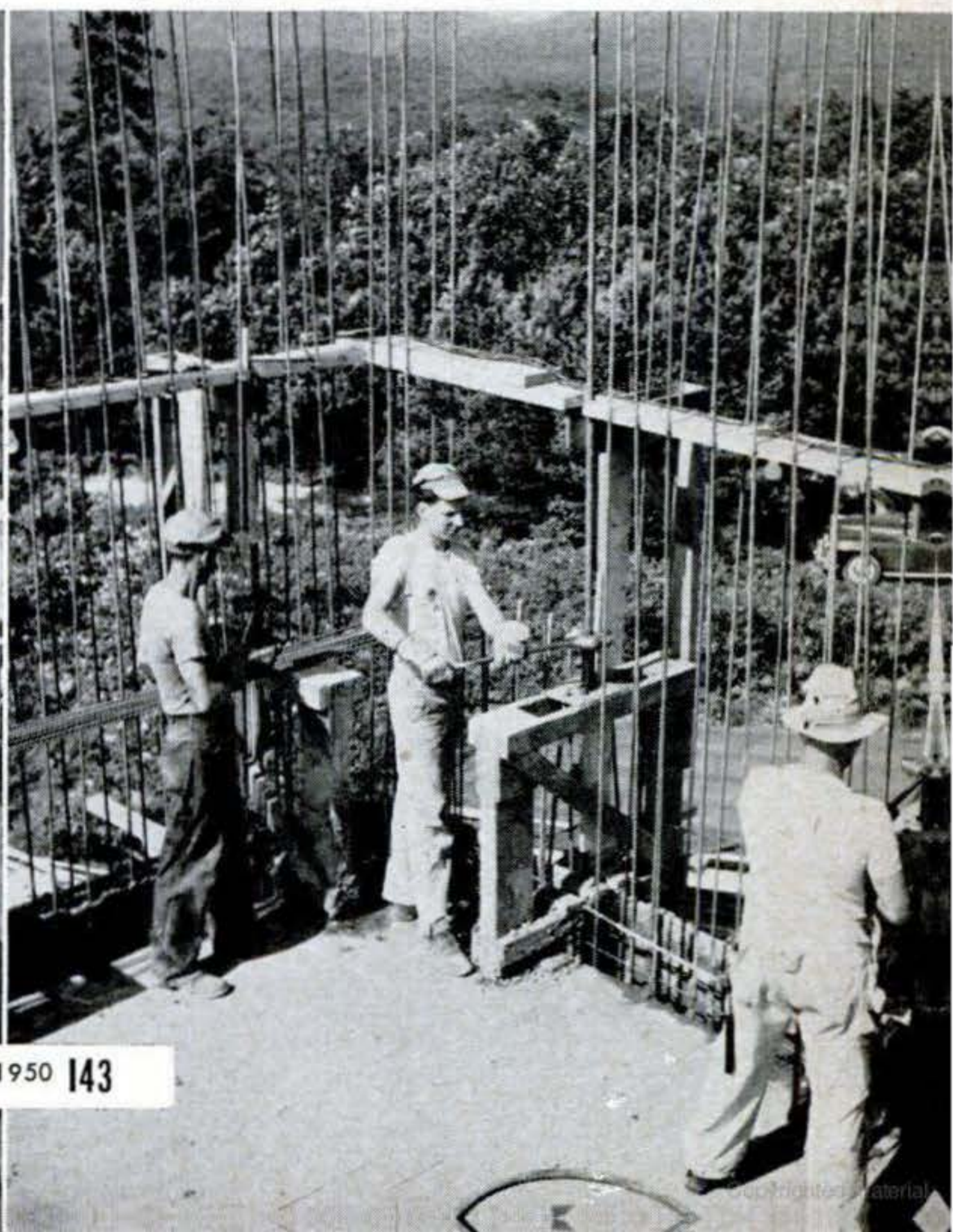
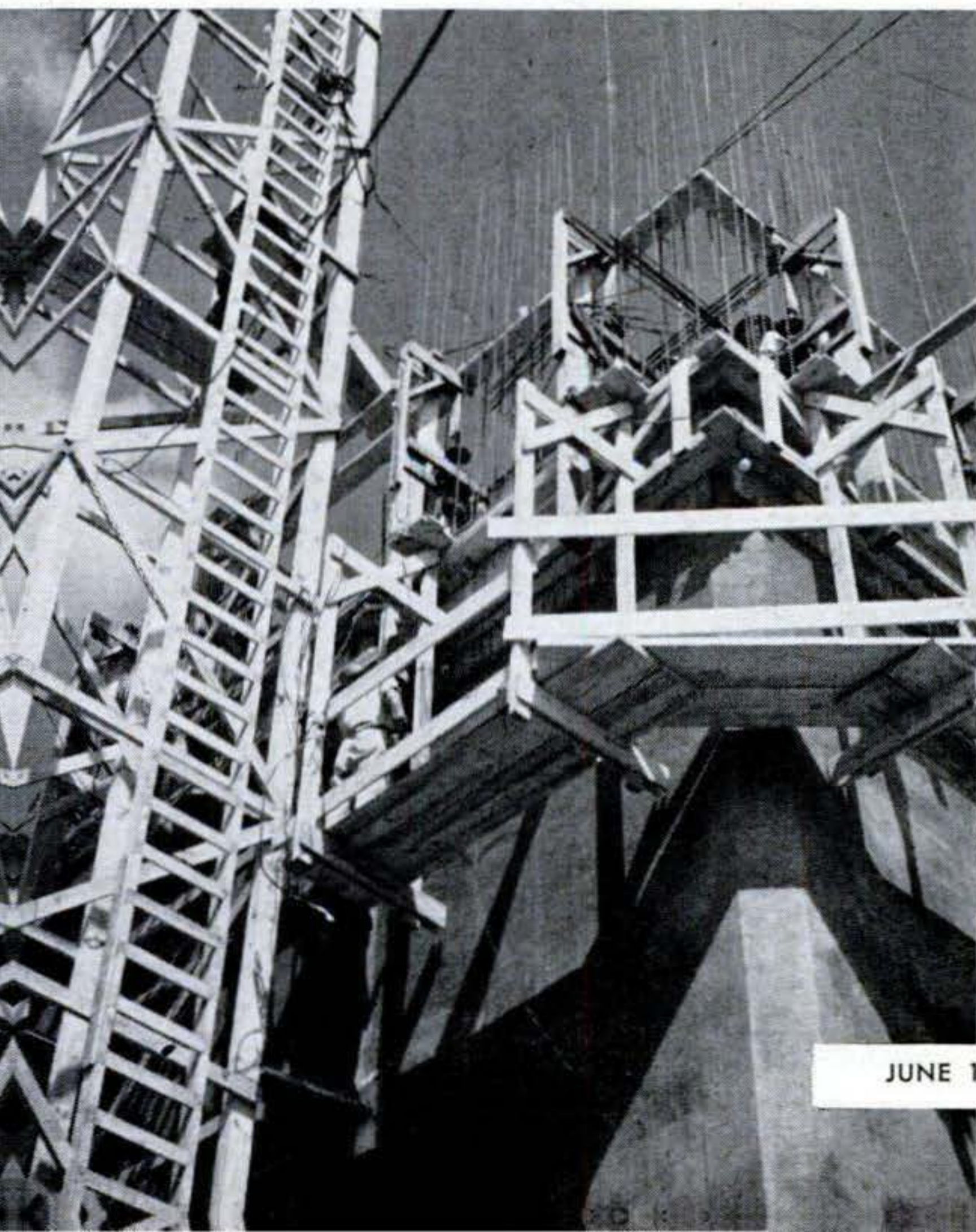

Inside the B-36

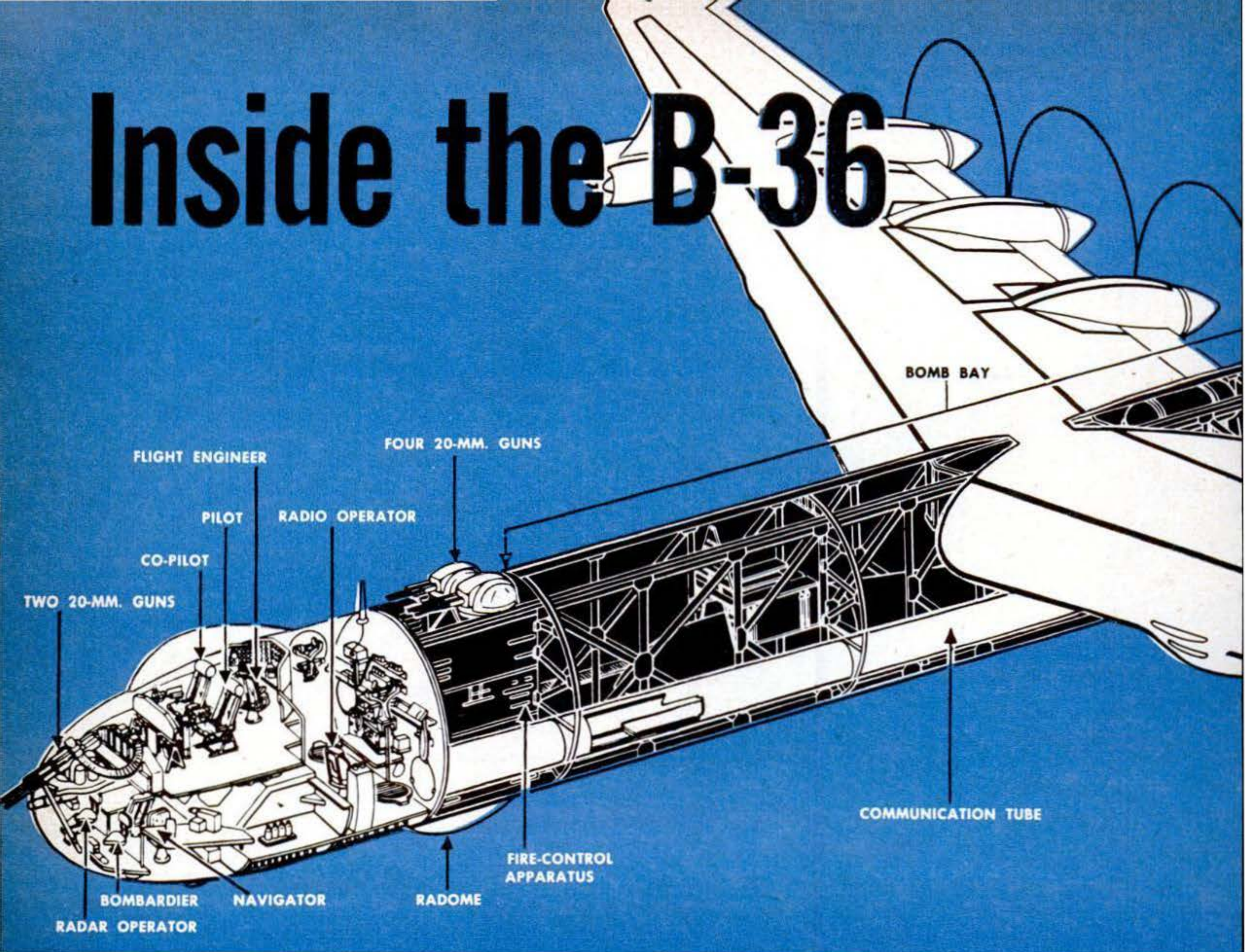

THIS CUTAWAY gives you your first over-all view of the interior of the Air Force's B-36 intercontinental

bomber. Pressurized areas of the 162-foot fuselage are shown in white. Designed to carry 10,000 pounds

By John F. Loosbrock

BACKBONE of the U.S. Air Force's Strategic Air Command, the Convair B-36 is the world's biggest bomber. Here, for the first time, a cutaway sketch and

photographs are combined to give you an inside look at this sky giant.

Its 13-man crew rides in pressurized comfort, even at altitudes up to 50,000 feet. The plane carries its own subway, an 87-foot airtight communication tube, 30 inches in di-

FLIGHT ENGINEER on the B-36 keeps an eye on the bewildering array of gauges and controls that harness the six 3,500 hp. engines. On late models, four 5,200-lb. thrust jet engines give added speed.

FORE AND AFT PRESSURIZED SECTIONS are connected by an 87-foot-long pressurized tunnel. Crewmen ride through it by lying on a four-wheeled cart, pulling themselves along a cable. Cart runs on rails.



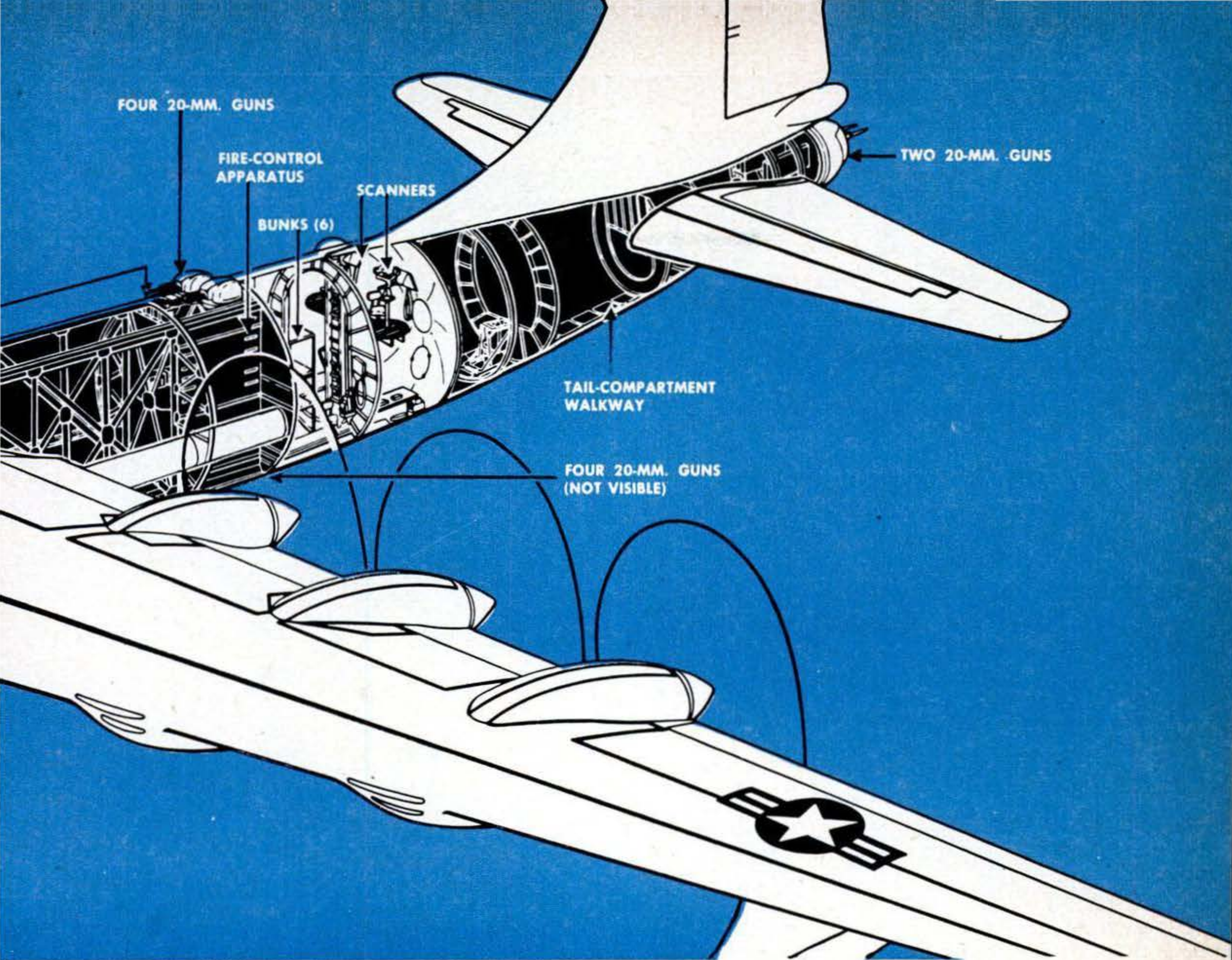

of bombs 10,000 miles, the huge plane can carry as much as 84,000 pounds for shorter distances. For

protection against enemy interceptor planes, the big Convair bomber mounts sixteen 20-mm. cannon.

an airlock, that connects the front and rear pressurized crew compartments. The rear one has six bunks, where crewmen sleep during long flights.

tract during flight and are elevated when the bomber reaches hostile territory.

In the air, the B-36's skin is sleek, unbroken by protruding gun turrets. These re-

The big bomber's sixteen 20-mm. cannon are mounted in eight turrets, fired remotely by a GE central fire-control system. And future experiments may replace these guns

PHOTO SHOWS two airmen working on part of the intricate equipment in one of the bomb bays. Bays have retractable doors that slide up inside fuselage, instead of dropping down, when opened.

DURING FLIGHT, crew members stand by at their stations in rear section. Scanners, with earphones, watch for trouble that pilot might not see. Off-duty crewmen can nap on the six bunks in compartment.

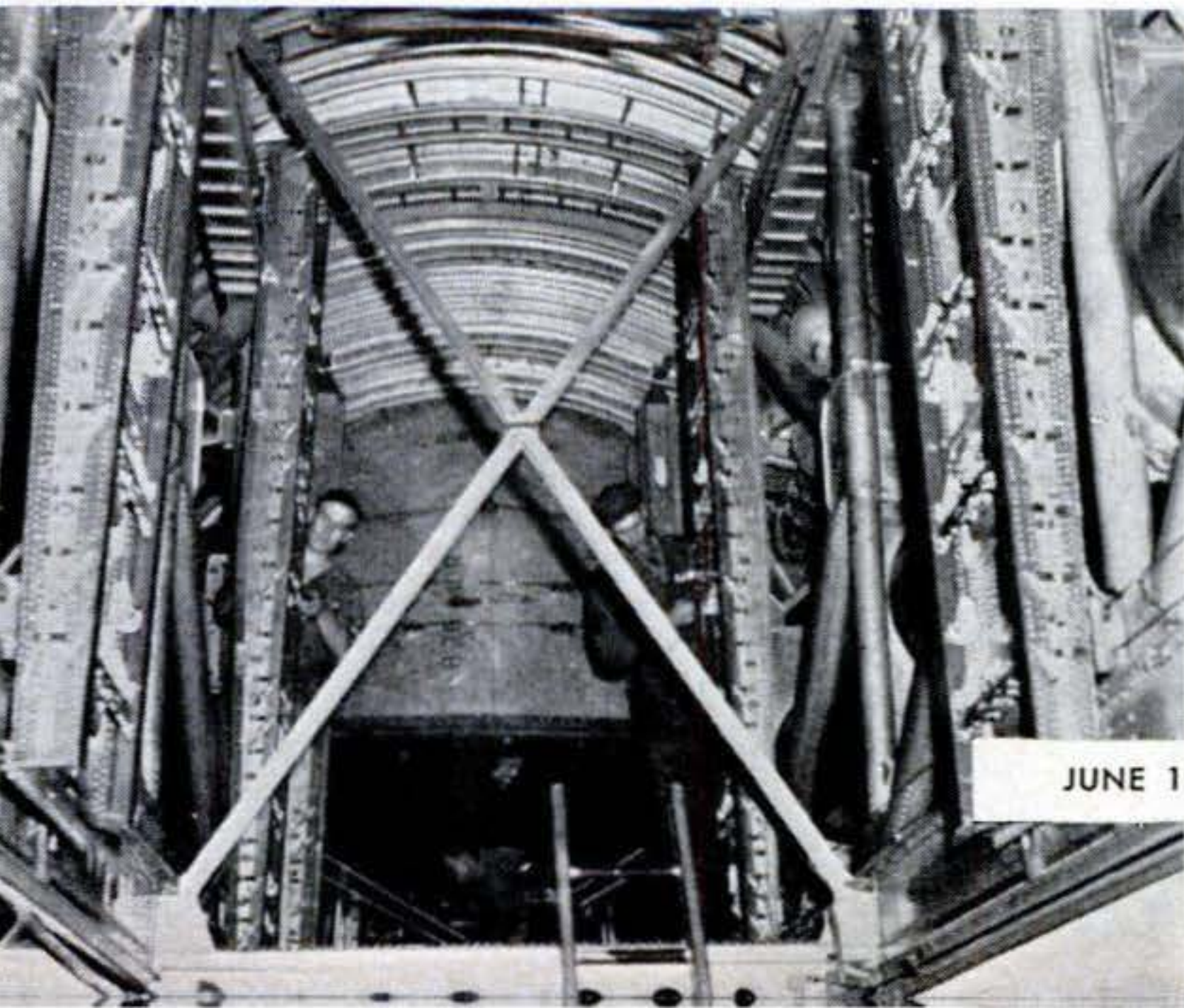



IN THE NOSE, directly beneath the pilot's compartment, sit the radar operator, navigator, and bombardier. Under new USAF training program, any of

these men can handle duties of other two in emergency. Above them, just in front of the pilot, two of the plane's sixteen 20-mm. cannons are mounted.

with rocket launchers, putting bomber-fighter tactics in a new light.

Also on the books, as part of the campaign to make the B-36 Superbomber faster and more deadly, are drastic design changes.

Wings would be swept back sharply and turboprop engines would replace the present reciprocating, pusher-type. This would enable it to exceed its present announced top speed of more than 435 miles per hour. **END**



THIS PHOTO SHOWS airman checking a portion of the maze of wiring that is interlaced throughout the bomber's fuselage. Unpressurized areas such as this are inaccessible during high-altitude flights.

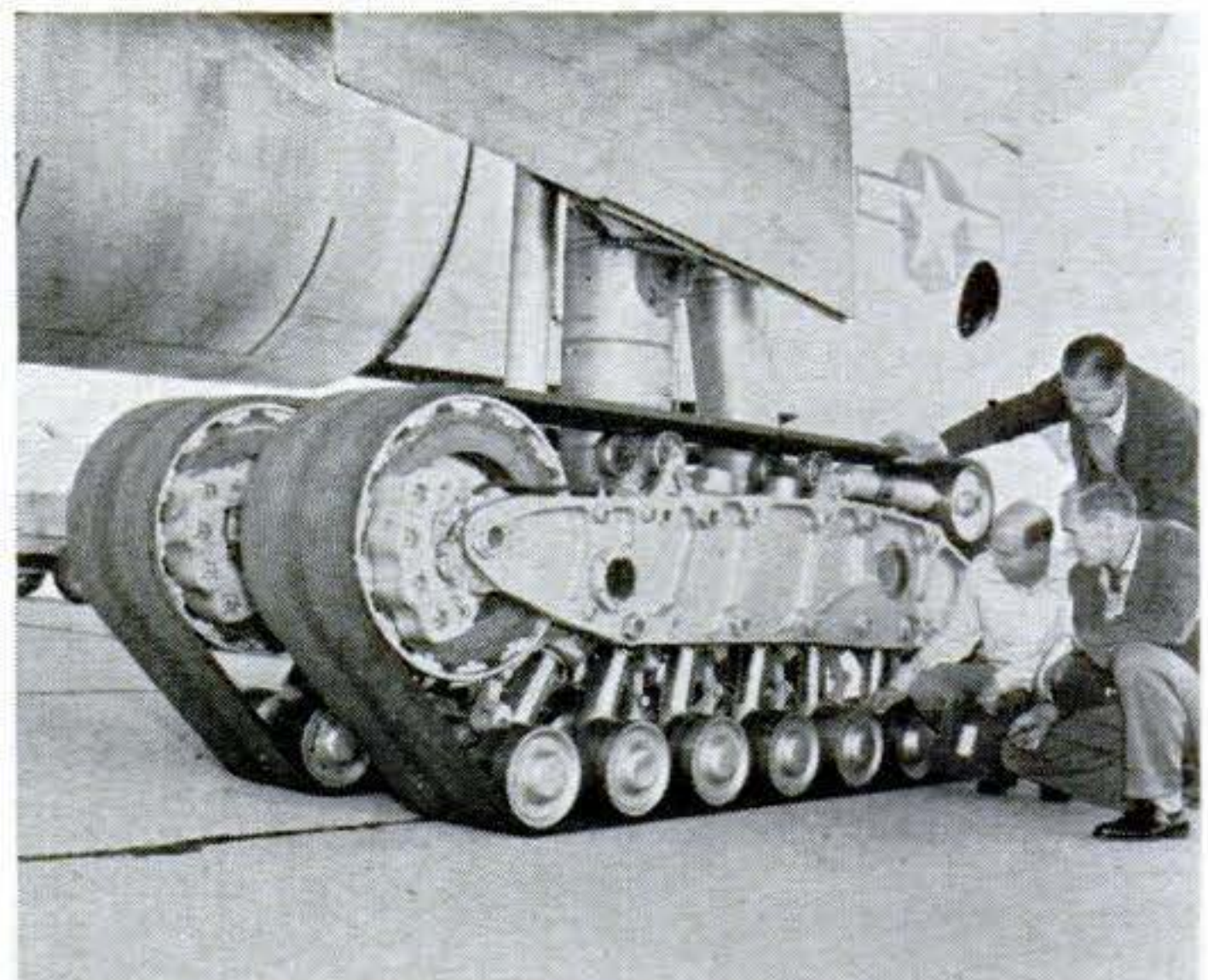

LATEST EXPERIMENTAL ADDITION is tracked landing gear. Weight rests on bogie wheels that roll on two endless belts. This spreads weight over greater area, so plane won't sink in soft runways.



New Grease Is Compressible

SEEMINGLY contradicting textbooks that say liquids are incompressible, lubricant in the sticks of grease above can be compressed under pressure. Graduated receptacles compare amount of new Rockwell Hypermatic lubricant (left) and of a standard lubricant that can be squeezed into valve at far right. Pressurized, the new type becomes self-feeding, and automatically lubricates

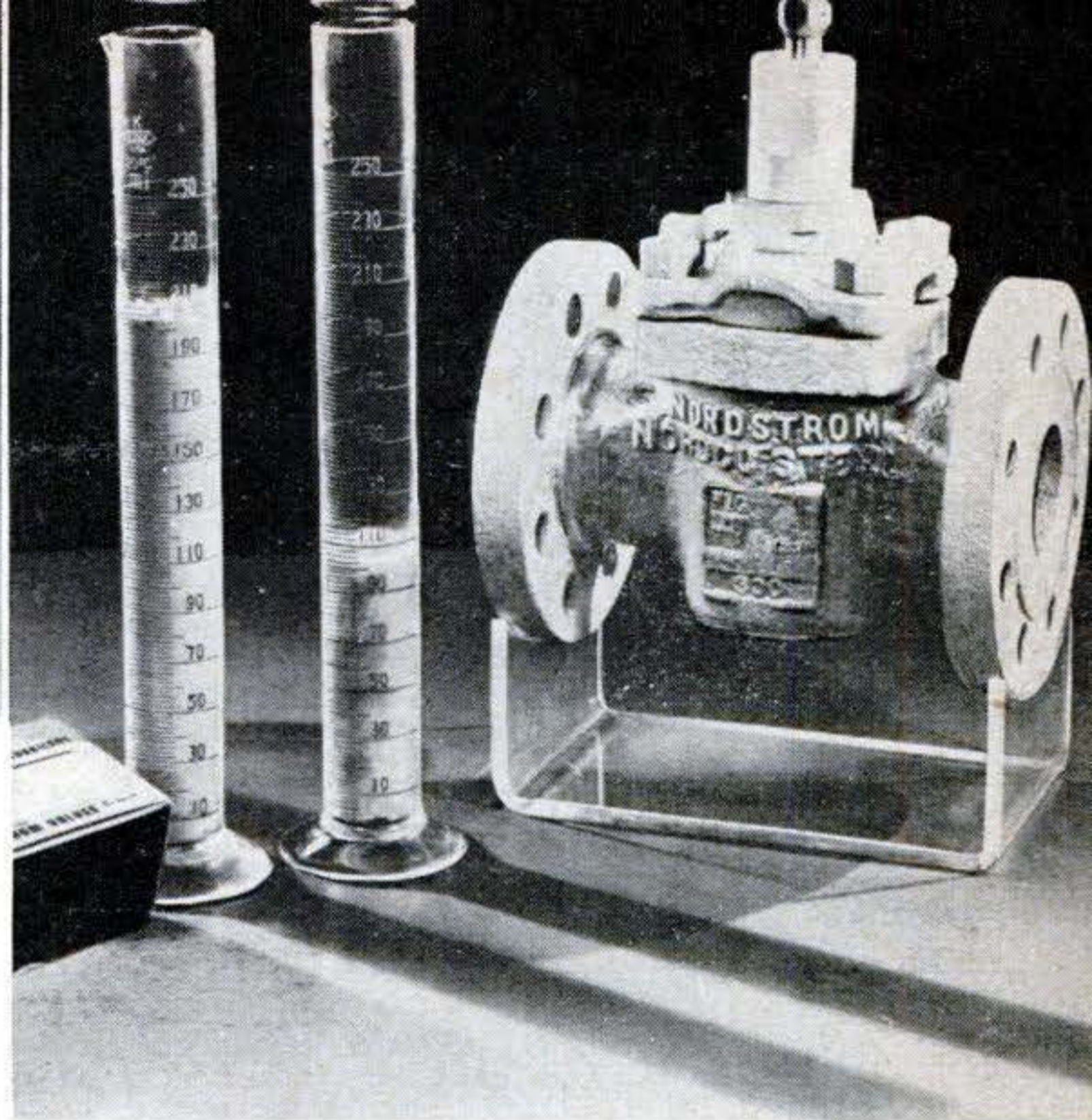

valves designed to use it. Entrained gas partly explains its compressibility, the maker says; the rest is his trade secret.

Glasses Dim Sun to Taste

ADJUSTABLE sun glasses, shown below, become darker or clearer to suit the light when you move a pair of metal control tabs beneath the unbreakable-plastic Polaroid lenses. Each lens consists of front and rear light-polarizing elements, the front one fixed and the rear one rotated through 90° by the tab. According to their relative position, any desired graduation between transparent and opaque is obtained.

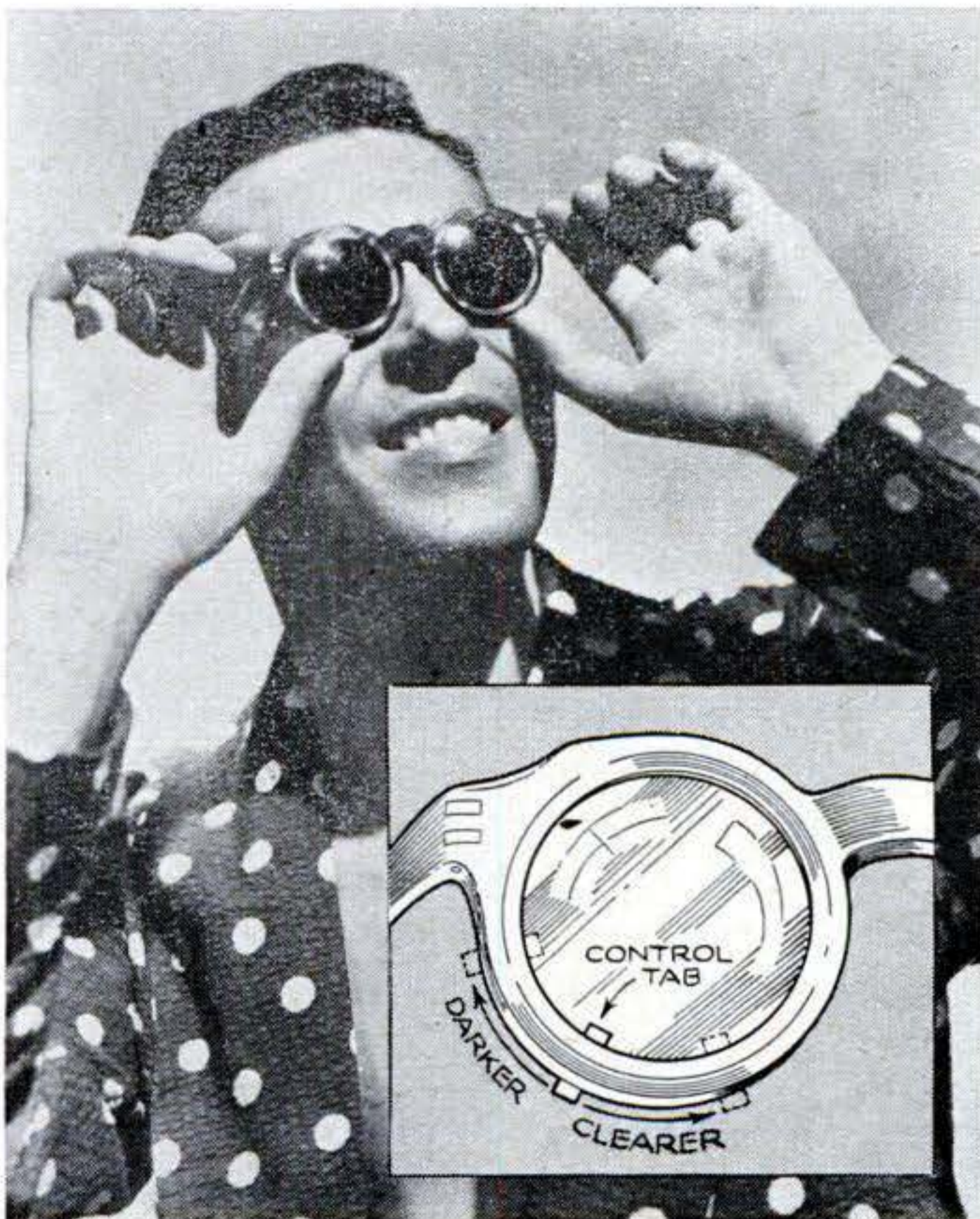

Hot Cargo Rides Wing Tips

SPECIAL compartments built into a plane's wing tips safely transport radioactive isotopes manufactured in Britain's atomic pile at Harwell, England. Except for carrying the isotopes to and from the plane, the heavy, lead-shielded containers, required when the "hot" materials share cabin space with passengers and cargo, are no longer needed. Below, a shipment is loaded with tongs for delivery to South Africa.



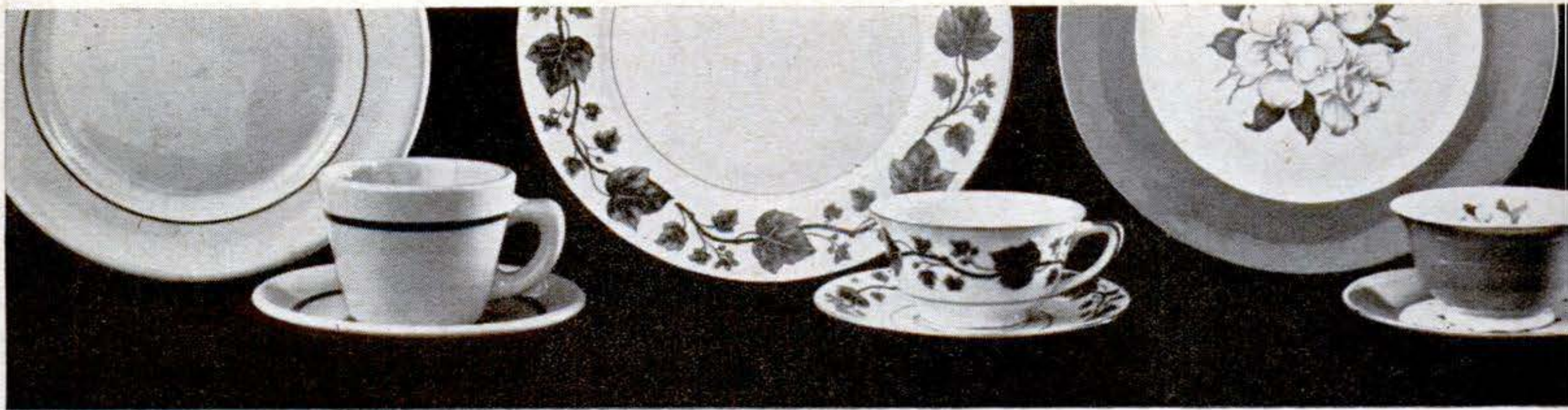

How They Make Your Cups and Saucers

The potter's wheel has been motorized, but mass production of modern American chinaware still takes skilled hands.

By George H. Waltz, Jr.

PS photos by W. W. Morris

IF YOU happened to overhear a group of men talking about such things as "biscuits," "mixers," "cakes," "saggers," and "jiggers," no one could blame you if you thought they were bakers. But you'd be wrong. If you asked them what sort of work they did, they'd tell you they were "pot makers." If that one stopped you, and you asked again, they probably would explain that "pot makers" was just a short name for pottery makers, and that they worked in a plant turning out china plates, cups, saucers, and other tableware.

PS photographer Bill Morris and I were introduced to the quaint jargon of the pot makers recently when we visited the Jackson Vitrified China Company's plant in Falls Creek, Pa. We learned that "biscuits" and "cakes" weren't edibles, that "saggers" didn't sag, and that "jiggers" weren't dancers or small glasses. We also learned that although modern American china may be formed on mechanized potter's wheels, be fired in a modern continuous gas-fired tunnel kiln, and get its outer coating of glaze on an automatic glazing machine, the process still requires the skilled hands of many workmen.

The china dishes that your wife sets out on your dining table three times a day

started out in life as a carefully blended mixture of clays, feldspar, flint, and water. Pot makers like to compare the mixtures to the human body (they even call it "body") with the various clays forming the flesh, feldspar the muscles, and flint the bones. Although each manufacturer has his own secret formula, the differences are largely a matter of proportions.

Oddly enough, in any one china plant the same cent-and-a-half-a-pound mixture that goes into making thin dinnerware for the home also is used in producing the heavier and less expensive ware for hotels and restaurants. The difference in cost lies in the increased difficulty in making the finer cups, plates, and other dishes *thin*, and in their decoration.

Basically, there are five main steps in the manufacture of china—preparation of the body mixture, shaping, drying, firing, and decorating and glazing. Cups, saucers, plates, and other simple forms are shaped by "jiggering" the plastic clay mixture into molds on a motorized potter's wheel. More complicated forms, such as gravy boats, are cast in multipart molds.

Careful firing is one of the secrets of good china. Firing in a modern tunnel kiln is a continuous 24-hour-a-day process. The china, still in its partially dried clay state, is placed in fire-resistant receptacles called "saggers," which in turn are stacked on kiln cars. The cars are loaded into the entrance of the kiln at proper time intervals and a hydraulic plunger pushes them along. As each car leaves the kiln's discharge end,

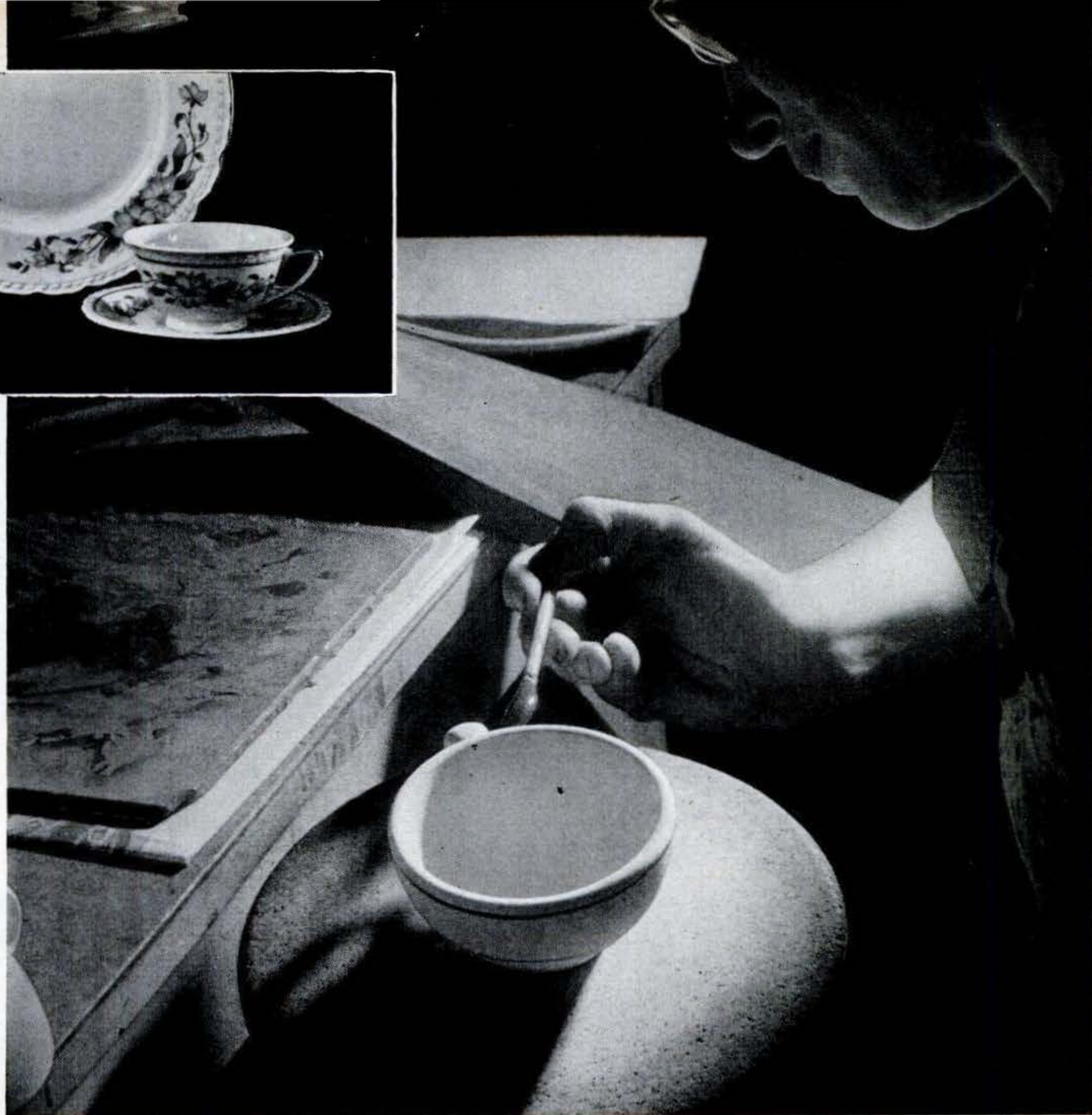

In hand painting stripes on a china cup, worker places it on a turntable, which she rotates.



1 Body mixture for American china consists of clays, feldspar, and flint. Each ingredient for a batch is carefully weighed out and shovelled into gigantic, motor-driven mixers.



2 Water is added to the mixture. After careful blending, the mixture is passed through fine screens to remove any coarse impurities. In this state, the mixture is called "slip." 



3 From storage tanks, the slip is pumped under pressure into filter presses, which press the excess water out of the slip and form the body mixture into large disklike "cakes."



4 The cakes then are worked and kneaded in a pugmill. The mixture is blended, compressed, and forced out through a nozzle to form sausagelike slugs. This is called "pugging."



6 Jiggering. The mold with its bat then is placed on a motor-driven potter's wheel, where a steel profiling tool mounted on a hinged lever shapes upper side of the bat.



7 Machine jiggering. Small-size plates also can be shaped on semiautomatic jiggers. Molds with bats, placed on machine's spindles, are shaped and trimmed automatically.

a new car is pushed into the loading end.

During its slow progress through the kiln, a number of physical and chemical changes take place in the body mixture. First of all, the remaining water is driven off. Then, as the temperature increases toward the maximum, the feldspar begins to fuse, and the clays start to decompose to form a new silicate. The latter crystallizes into tiny needle-like structures, and the flint begins to dissolve. In effect, a glassy matrix is formed

within the material. As a result, the clay-state cup, saucer, or whatever that entered the kiln fragile and porous, leaves it strong, dense, nonporous, and nonabsorbent.

Strangely enough, the decorating end of the china industry was one of the first to feel the repercussions of the A-bomb. Before the war, a material known as uranium oxide was used to produce yellows. Vanadium oxide is now substituting for its more famous brother.

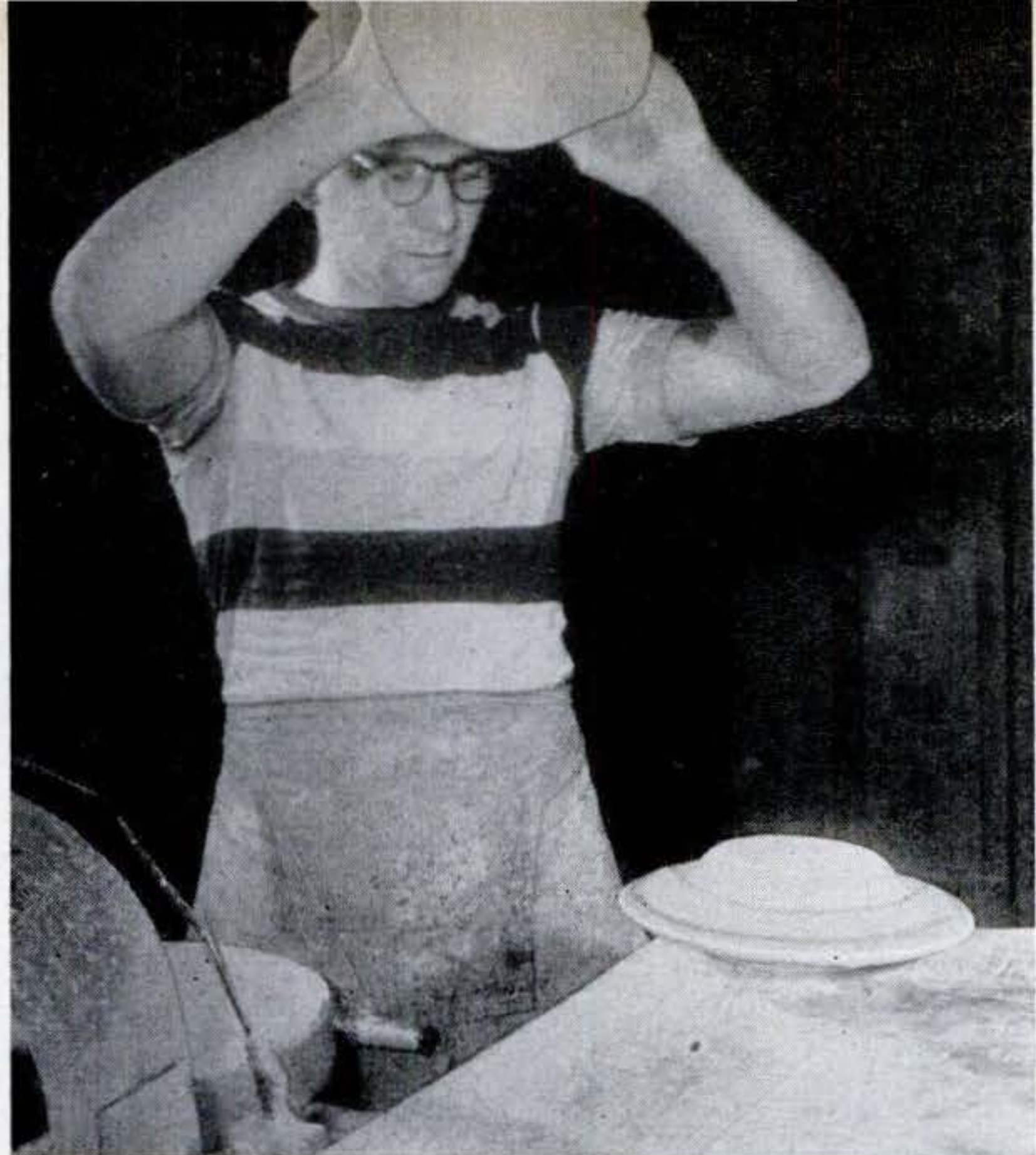

5 Batting out. This is first step in the actual making of a cup or a plate. A lump of body mixture is placed in the machine visible in lower left-hand corner of photo above, and pressed



into a flat pancake or bat. The worker then picks up the bat, raises it up high, and slaps it down hard on a plaster-of-Paris mold of the particular piece to be formed.

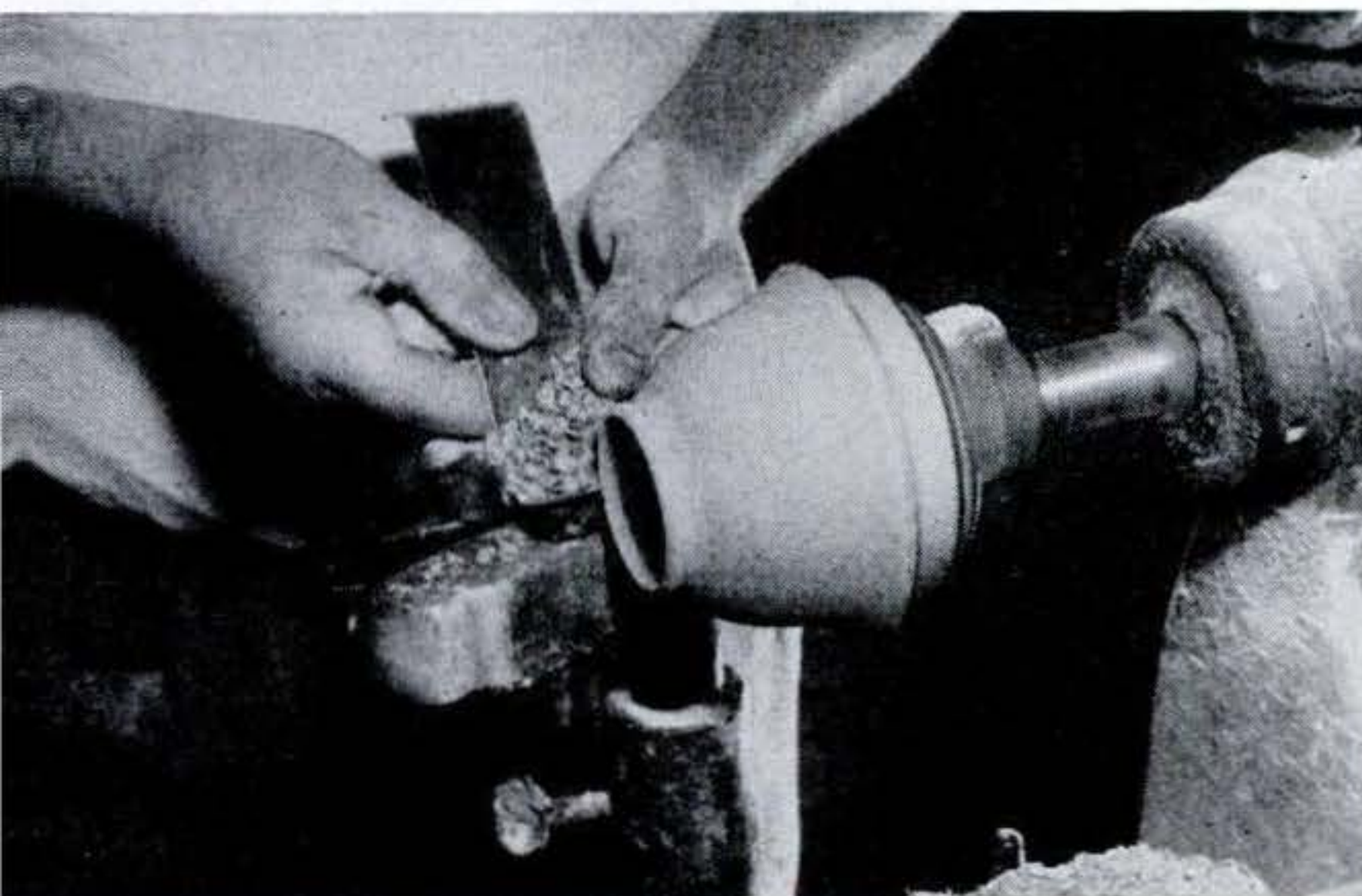

8 Cups are jiggered out in much the same way as plates. However, they must be finished on lathes. Because the body mixture contains flint, tools must be sharpened frequently.



9 Handles for cups are cast separately and, after being trimmed by hand with a knife to fit the double curves of the cup, are cemented in place with liquid body mixture.

10 Molds used in jiggering and casting have comparatively short lives. As a result, the casting of replacement molds in plaster-of-Paris master molds keeps the molders busy.

11 Intricate pieces, like gravy boats, cannot be jiggered, but must be cast in multipart molds. Body mix is made liquid for casting by using chemicals that add a little water. ➤



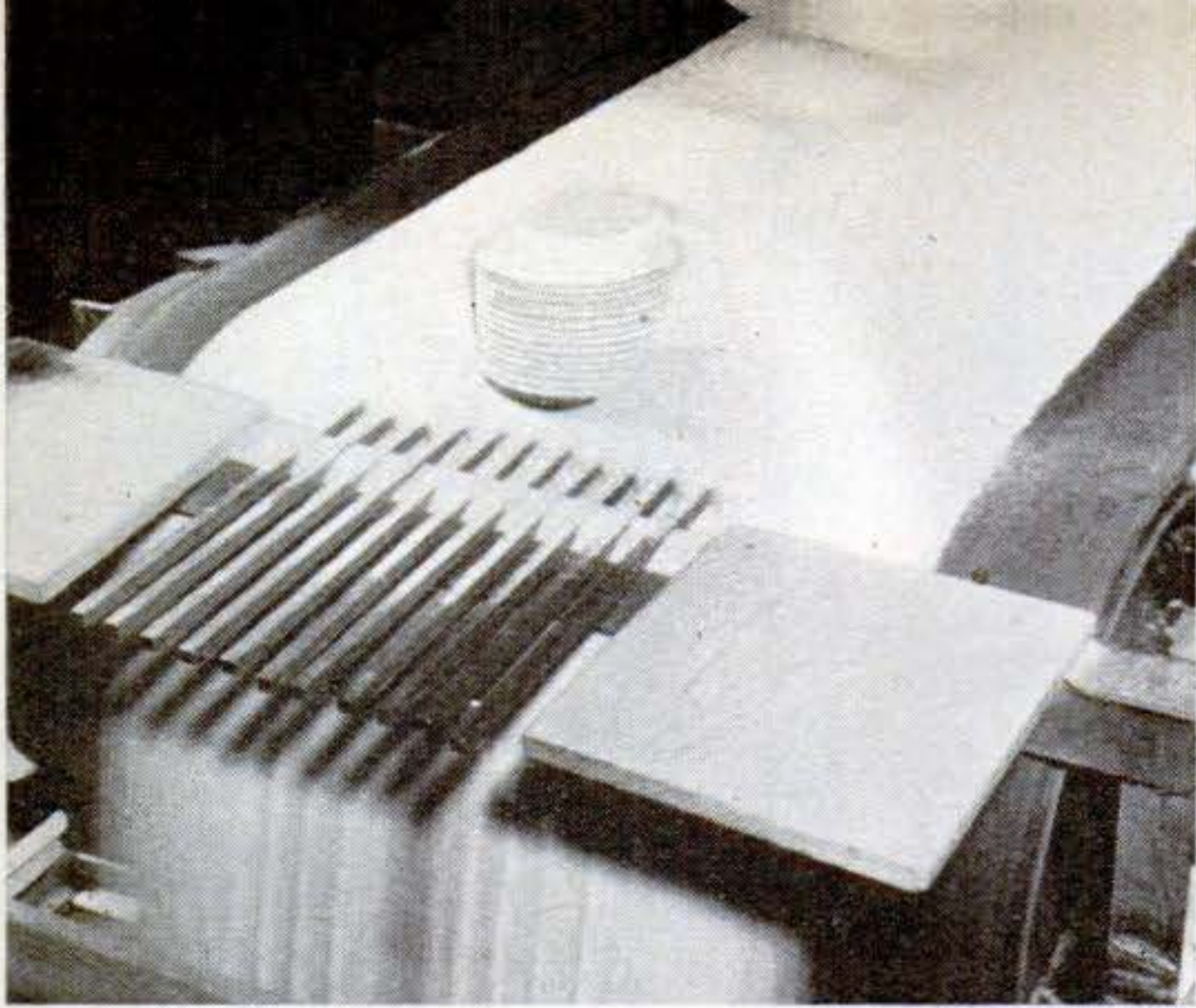

12 Plates, like all ware at this stage, are fragile. To keep them in shape during firing, sand, or similar material, is placed between rims. This is called "bedding."

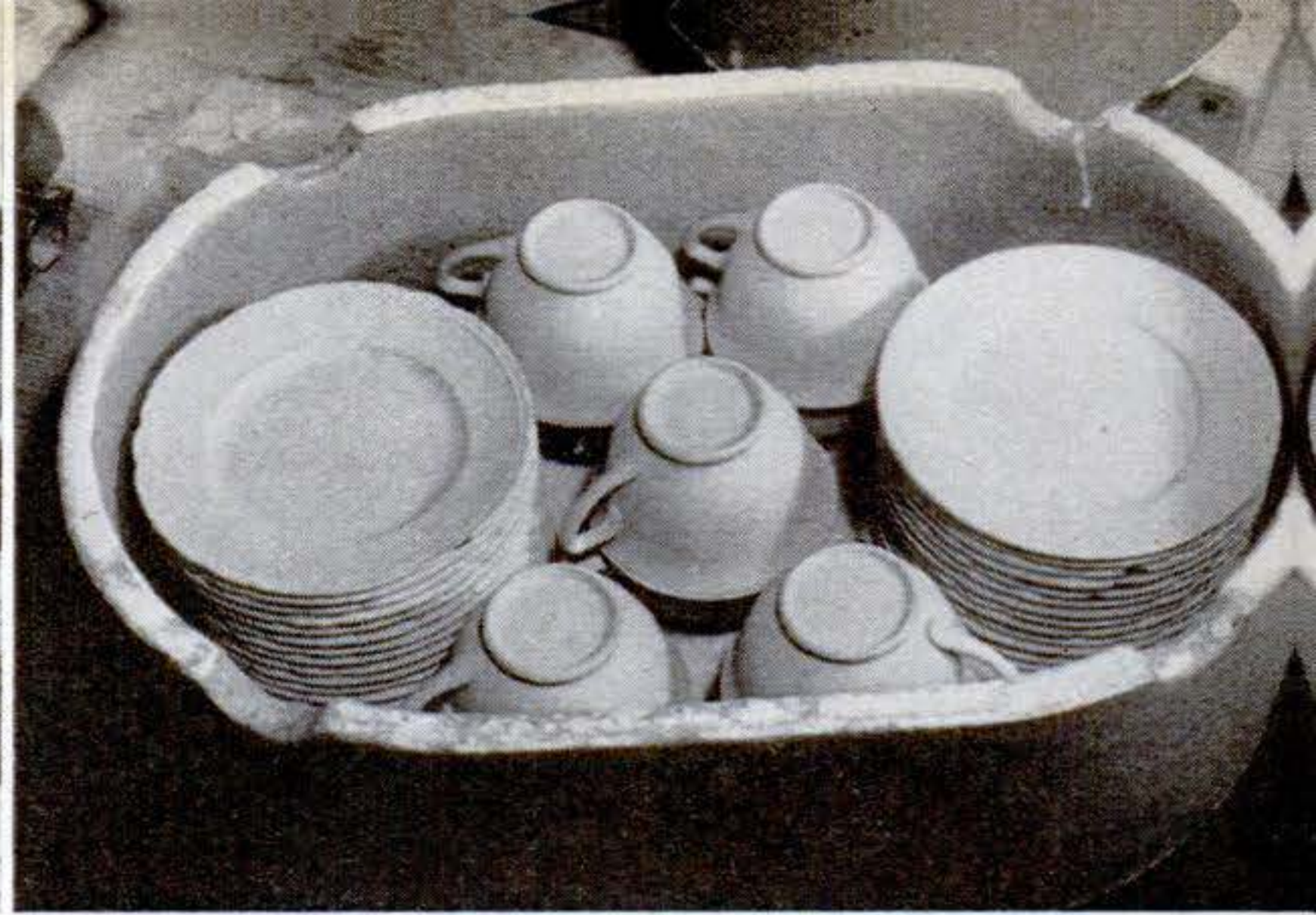

13 Before firing, the ware, still in its fragile clay state, is placed in fire-resistant containers called "saggers." The filled saggers then are carefully stacked on kiln cars.



16 Shrinkage. The cup at the top is still in the clay state before firing. The cup at the bottom has been fired. Shrinkage from molding through firing totals 12½ percent.



17 Biscuits, as fired pieces are called, are so tough that they can be smoothed down by tumbling them in long motor-driven drums partially filled with broken pieces of china.



20 Machine glazing. Some pieces can be machine glazed. Dishes are rotated automatically while battery of spray guns spreads on the liquid glaze. This glaze also is fired.



21 Finishing. Any slight imperfections in the glaze, such as marks caused by the pins used to support the plates in saggers during glaze firing, are removed by grinding.



14 Into the tunnel kiln for 65 hrs. of firing. As cars progress through kiln, ware is subjected to rising temperatures until about 2,200° F. is reached. Then it is cooled.

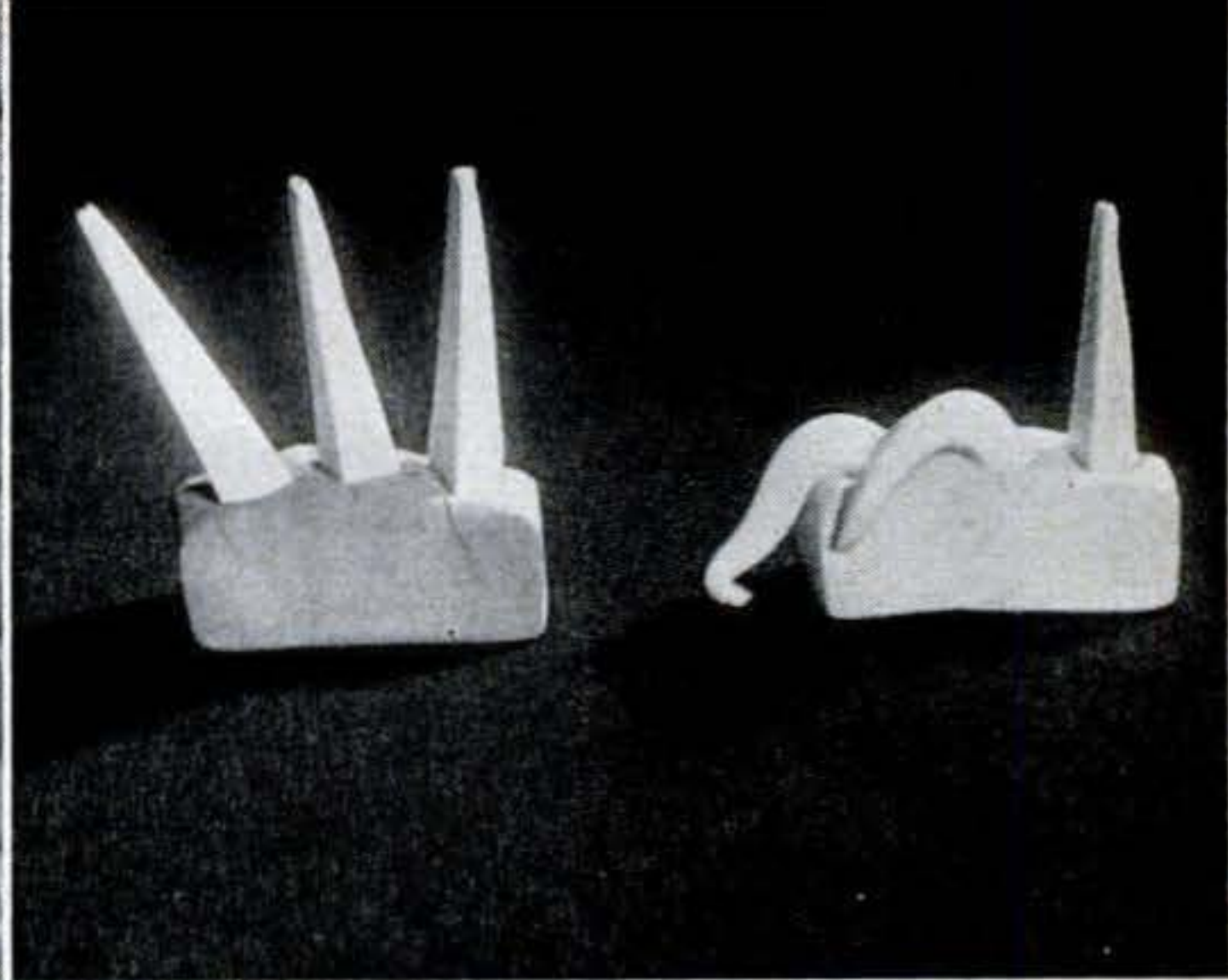

15 Pyrometric cones placed on kiln cars give a double check on recording pyrometers in control room. Melting of cones, as at the right, indicate maximum temperature reached.



18 Underglaze decoration. Decorations using metallic oxides that can stand high heat can be applied before piece is glazed. These are printed on with lithographic transfers.



19 Hand glazing is done by dipping the biscuit into a glaze solution, which is a form of glass. Pieces then are fired at 2,000° for 24 hours or more to melt the glaze.



22 Overglaze decoration. Decorations using metallic oxides that cannot stand high temperatures are applied over the glaze and fired separately. Decalcomanias do the trick.



23 Gold edging and stripes are applied by machine. After firing, the gold is burnished to a high luster by hand with a burnishing stick made up of tiny glass fibers.

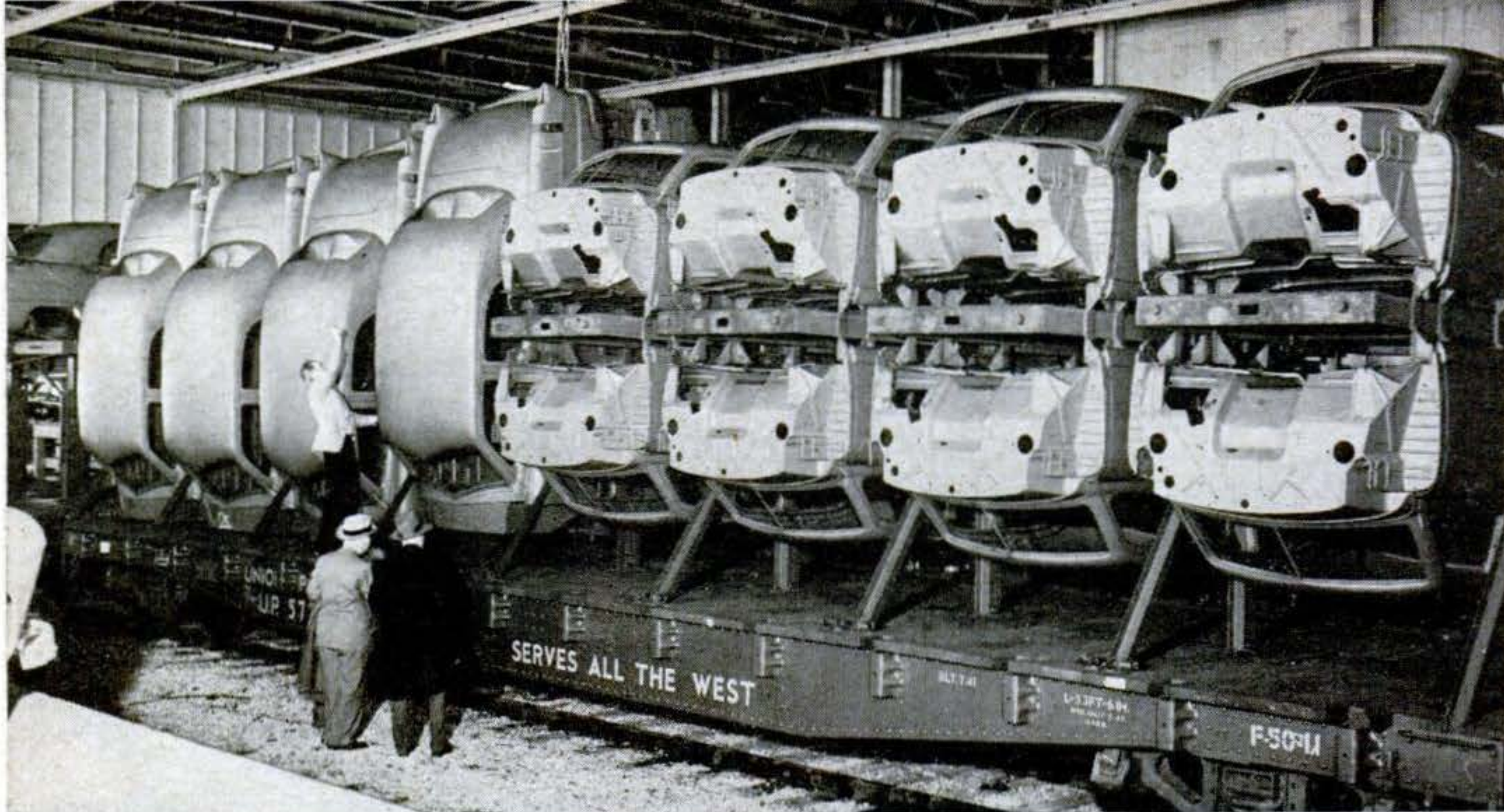

Flatcar Upends Auto Bodies

A SPECIAL mounting on the flatcar above allows auto bodies to be locked in pairs, belly-to-belly, like the eight shown at right. Then the mounting device "pinwheels"

them so that the bodies will ride vertically, tail end up, like those at left, with their noses protected. In this way twice as many cars can be carried as in a conventional auto boxcar. The system was devised by Union Pacific and Kaiser-Frazer engineers.

CO₂ Triggers Extinguisher



THIS new stainless-steel fire extinguisher doesn't have to be recharged from time to time as do the soda-acid ones. Only after use does it have to be refilled with water, as at left, and a new CO₂ cartridge inserted. To use the Pyrene extinguisher, it is turned upside down and banged on the floor. This releases the CO₂, forcing out a 40-ft. stream of water.



Sprayer Carries Own Power

THE compressor goes right along with this compact spraying outfit. Electrically operated, it has a nozzle pressure of at least 25 lb. per sq. in. Offenbach and Reimus, San Francisco, makes the Spraymaster.

Twist Puts on the Squeeze

THE turn of a cap on the bottom of Twist-tube, shown at right, squeezes a flexible plastic sack inside a hard container. And out of the top oozes just the right amount of toilet cream or paste. Among advantages of the new gadget, made by the General Cap and Container Corp., of New York, are that the outside cylinder always retains its original shape, and every bit of the contents can be squeezed out.



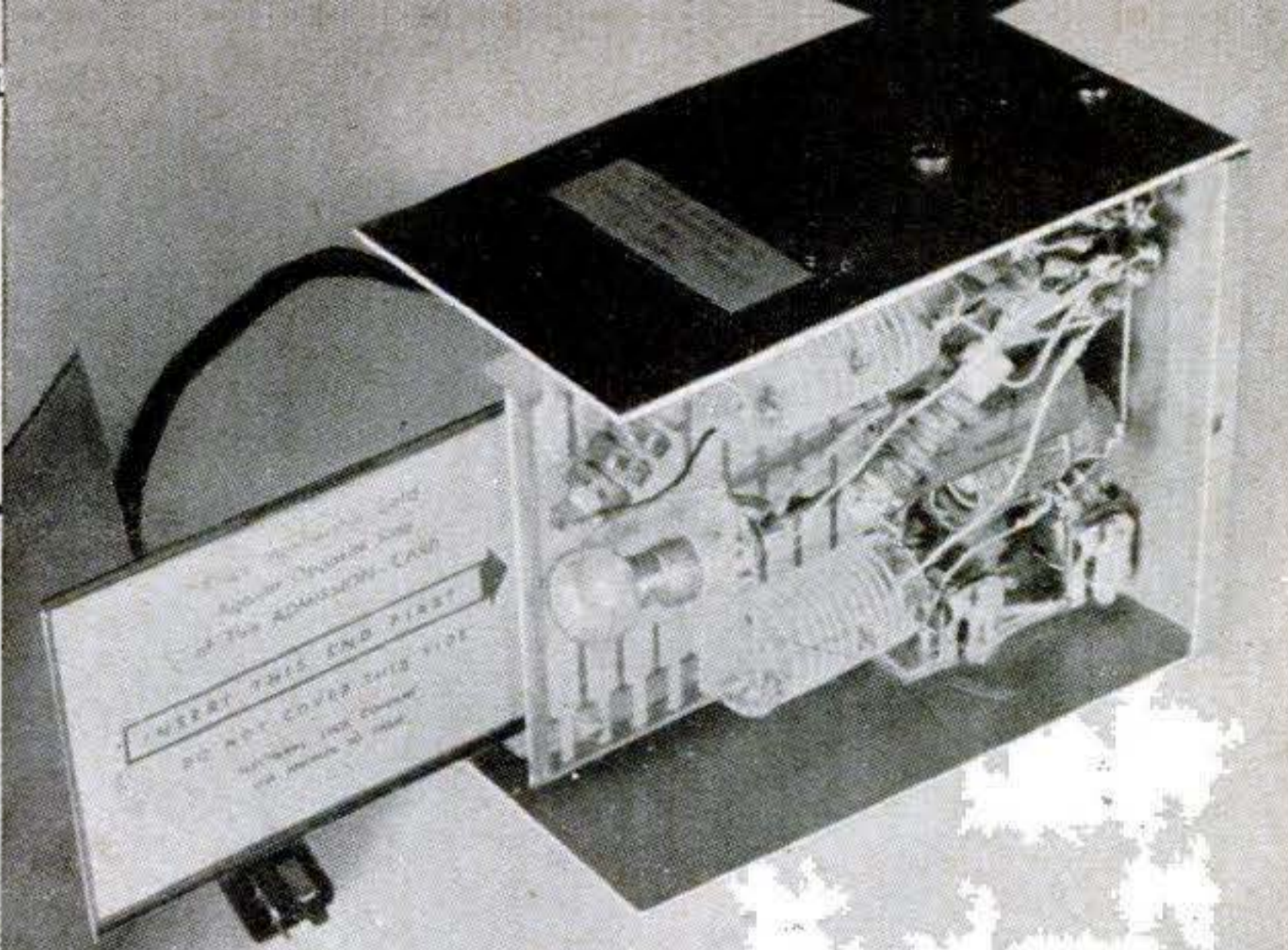
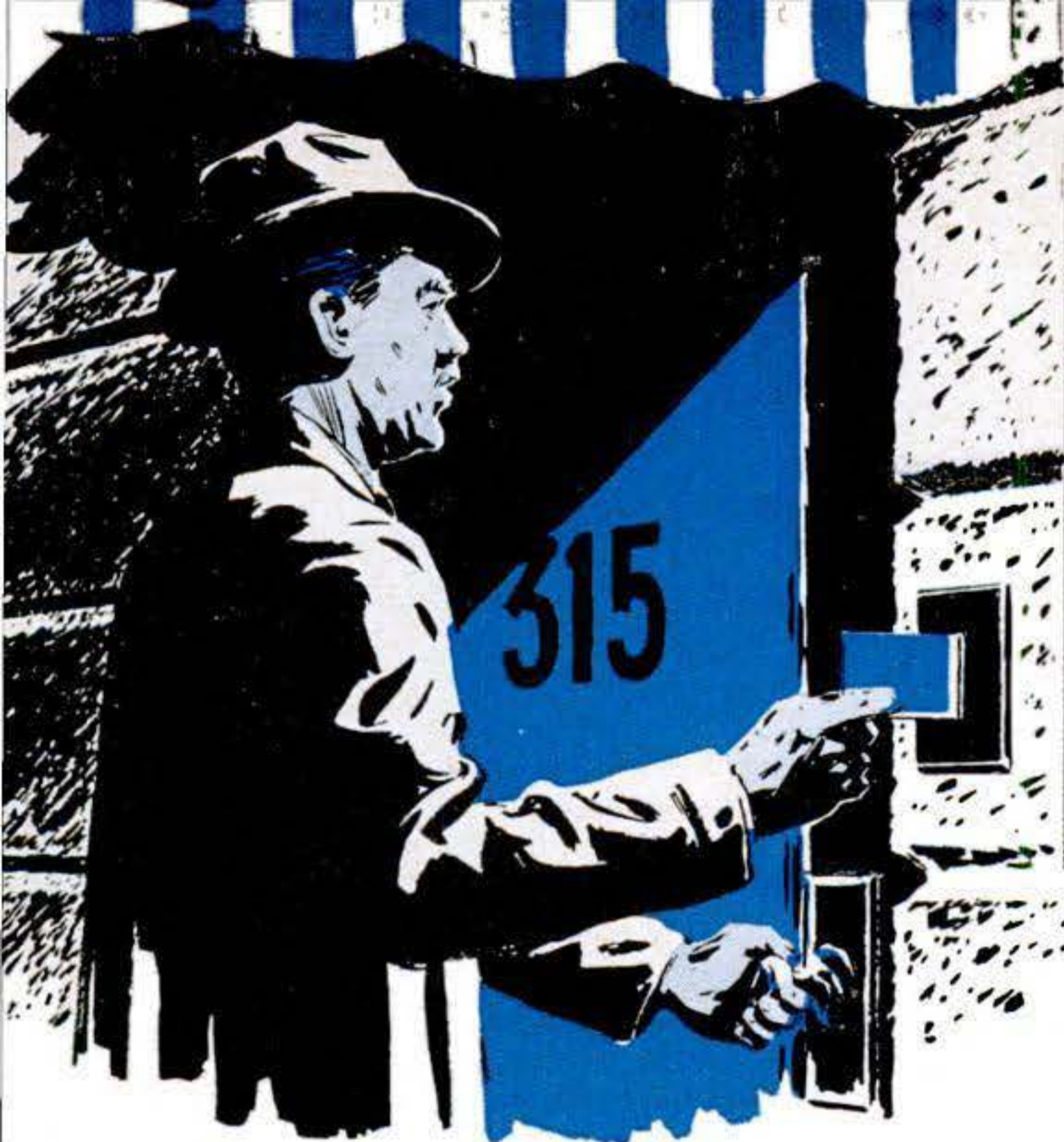

"Radar Lock" is mounted in steel box that fits inside house wall. It uses one twin-triode "peanut" vacuum tube, which is always kept warmed up. Snap-action switch turns on full power for tube when key card is inserted. Small bulb merely illuminates the key slot.

Card Opens Electronic Lock

IT LOOKS like an ordinary wallet-size identification card. You slide it into a slot near the door—and the door unlocks! The card is a key; the slot, an electronic lock.

One of the inner layers of cardboard that make up the key has several strips of graphite. If these strips are the same pattern as strips of silver inside the lock, the door opens. But if someone tries the wrong key—or a sheet of metal—the door stays locked.

The silver strips in the lock form one plate of an electrical condenser. The graphite strips in the key form the other plate. The capacity across the two plates loads a vacuum-tube "Go" oscillator, drawing current and tripping a relay that controls a standard electric door latch. If anything but the right key is used, a different "No-Go" oscillator is loaded, tripping a relay that breaks the connection to the latch. **END**

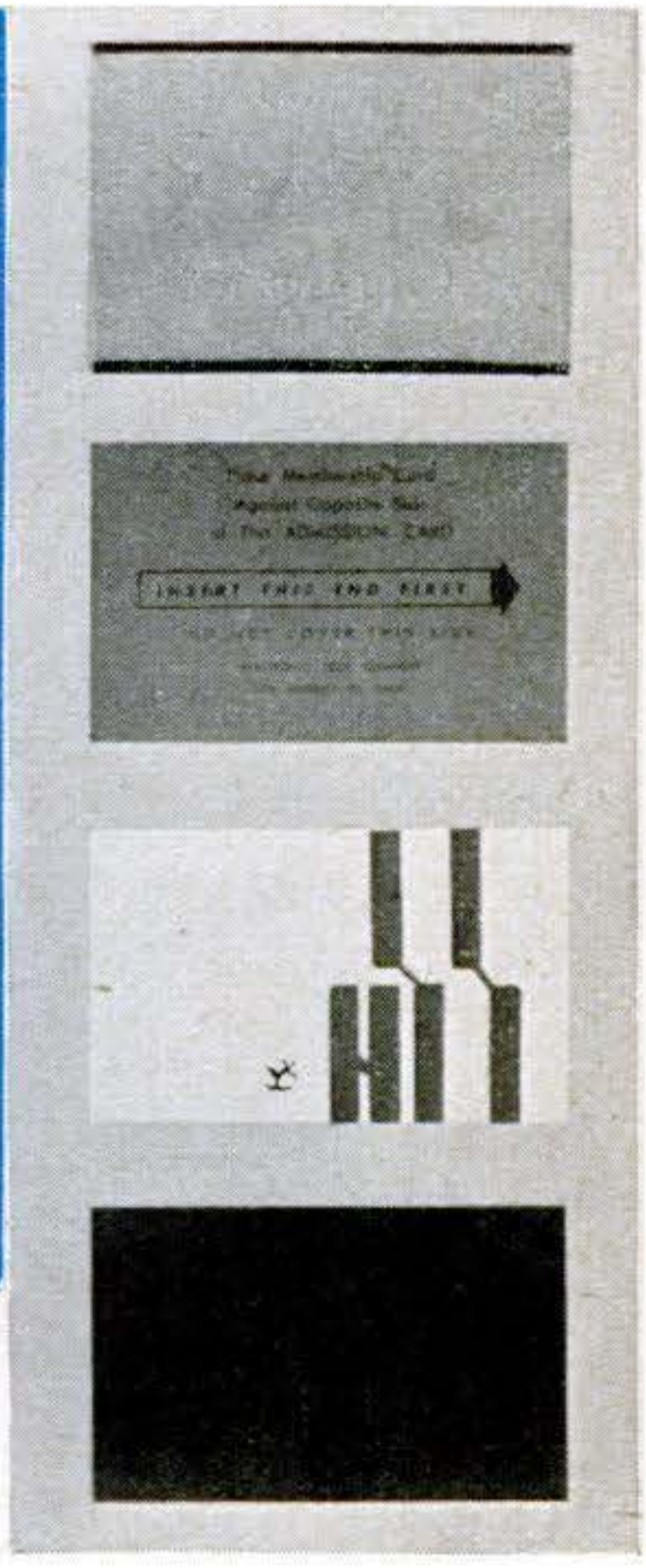
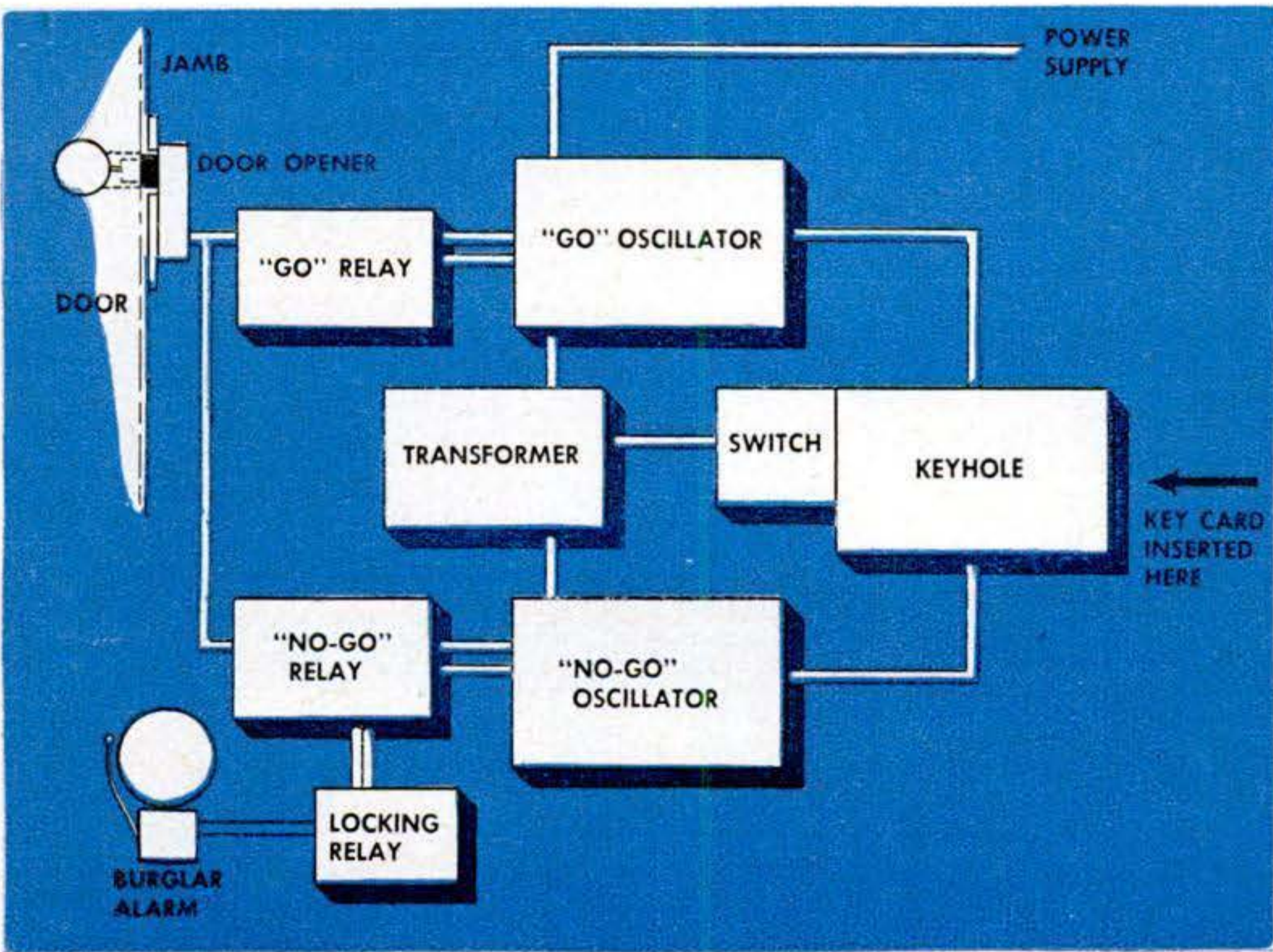

Block diagram shows components of lock made by Electronic Lock Co., Hollywood, Calif. At far right are key layers—from top down: outside sections, sheet with graphite strips, lightproof paper. Lock can be set so wrong key sets off a burglar alarm.

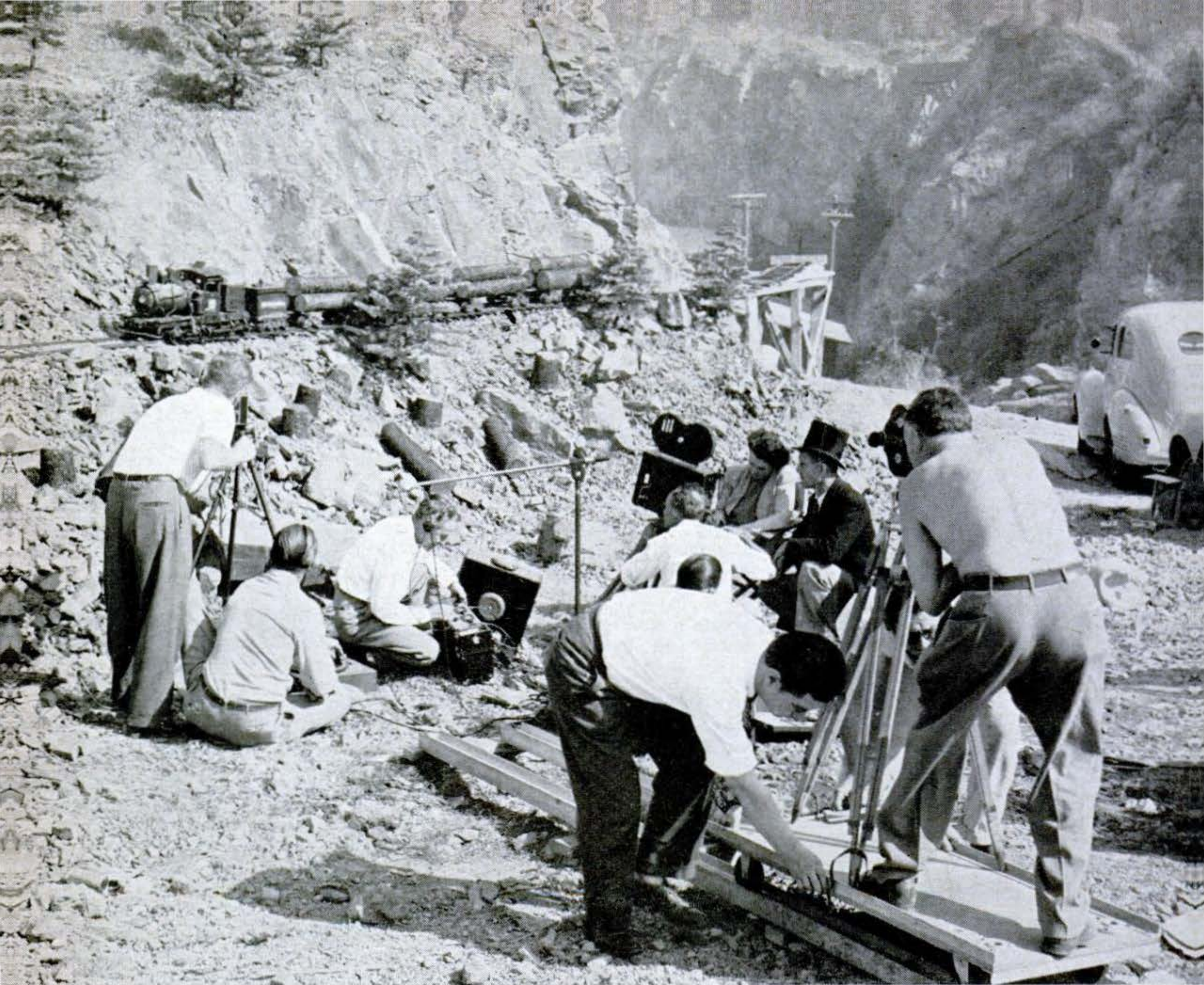

Unaware of impending disaster, miniature logging train races toward mined trestle, while

three cameras follow action. Tracked camera in foreground dollies in and out like pro rigs.

For movie, logging train rolls along 200 feet of 8-in. track, with wooden rails. Each flatcar rides on eight 3-in. plywood wheels. Here Maker is adjusting tiny chains holding logs in place.

Real logs would be too heavy a load for trestle, so hollow ones are made by tacking 1/16-in. chip board around circular end blocks, painting it brown, and then gluing on shavings for bark.



He Builds Thrills Into Home Movies

By Andrew R. Boone

HOLLYWOOD has nothing on home-movie hobbyist Ray Maker. When it comes to creating realistic scenes and unusual effects, he can give the dream-merchant professionals a run for their money.

For the past 15 years, Maker has been calmly turning out feature-length western thrillers from the pint-sized basement studio of his Oakland, Calif., bungalow. His total to date is an even dozen 50-minute sound films, most of them in color.

Gimmicks make his movies, and Maker makes the gimmicks. For one picture, a saga of the timber country, he built a miniature steam locomotive, seven log cars, and 200 feet of track and trestle—then promptly blew them all up to make one of the movie's exciting scenes. This was only the beginning. To change a barren, rock-quarry setting into real timber country, he had to transplant 30 small pine trees from a mountainside 100 miles away. Even the logs had to be specially made—real ones would have been too heavy for the frail trestle.

Model locomotive, patterned after Shay type used in logging, is 40 in. long, weighs 75 lb. Boiler develops 15 lb. of steam. Heavy black smoke is made by burning oil-soaked waste.

But Maker isn't content with outdoor scenes and long-distance shots. He likes to vary these with close-ups and interior scenes. For these he moves into his cramped basement. Here, squeezed within its narrow walls, are a small stage, cutting room, glassed-in projection booth, and assorted cameras, lights, scenery flats, sound-recording equipment, and special-effects gadgets. Six cameras give Maker a wide range of views and effects. To carry the current load of his lights, additional lines are brought in from two neighbors' homes.

A car-top maker by trade, accustomed to working with his hands, Maker has become expert at turning simple materials into eye-defying props. For the logging picture, he built a full-scale replica of the locomotive's cab out of wood and cardboard. Then he started his cameras, jumped into the seat, and spent several seconds peering intently down a track that wasn't there. A view of the swaying tender and log cars in the background, projected onto a screen behind him, completed this dramatic close-up.

In one movie, a courtroom scene re- ▶

Small auto-heater fan, powered by 6-volt battery, acts as blower to force draft in firebox. Egg-beater gears on side are dummy drivers, turned by belt from motor underneath engine.

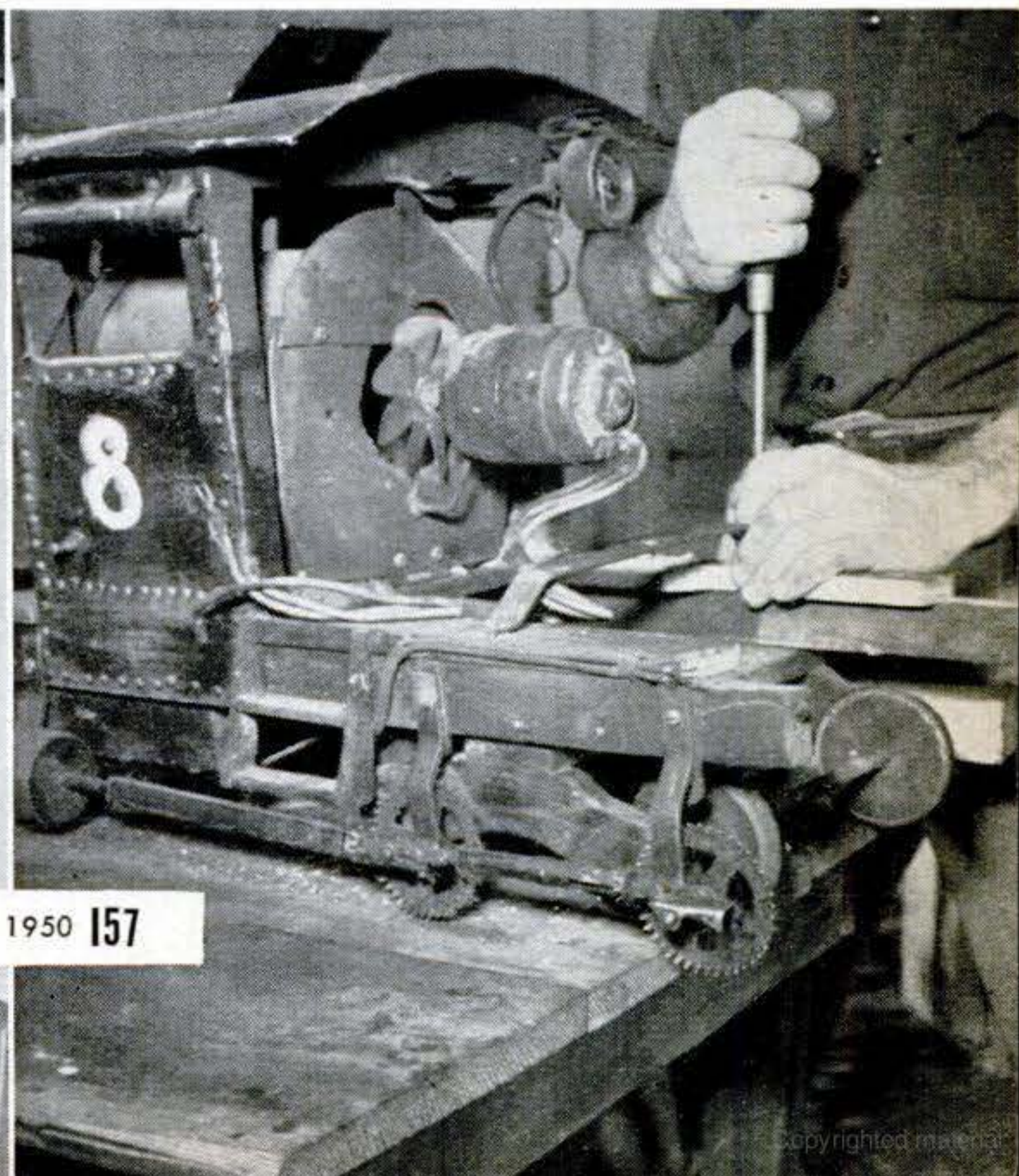
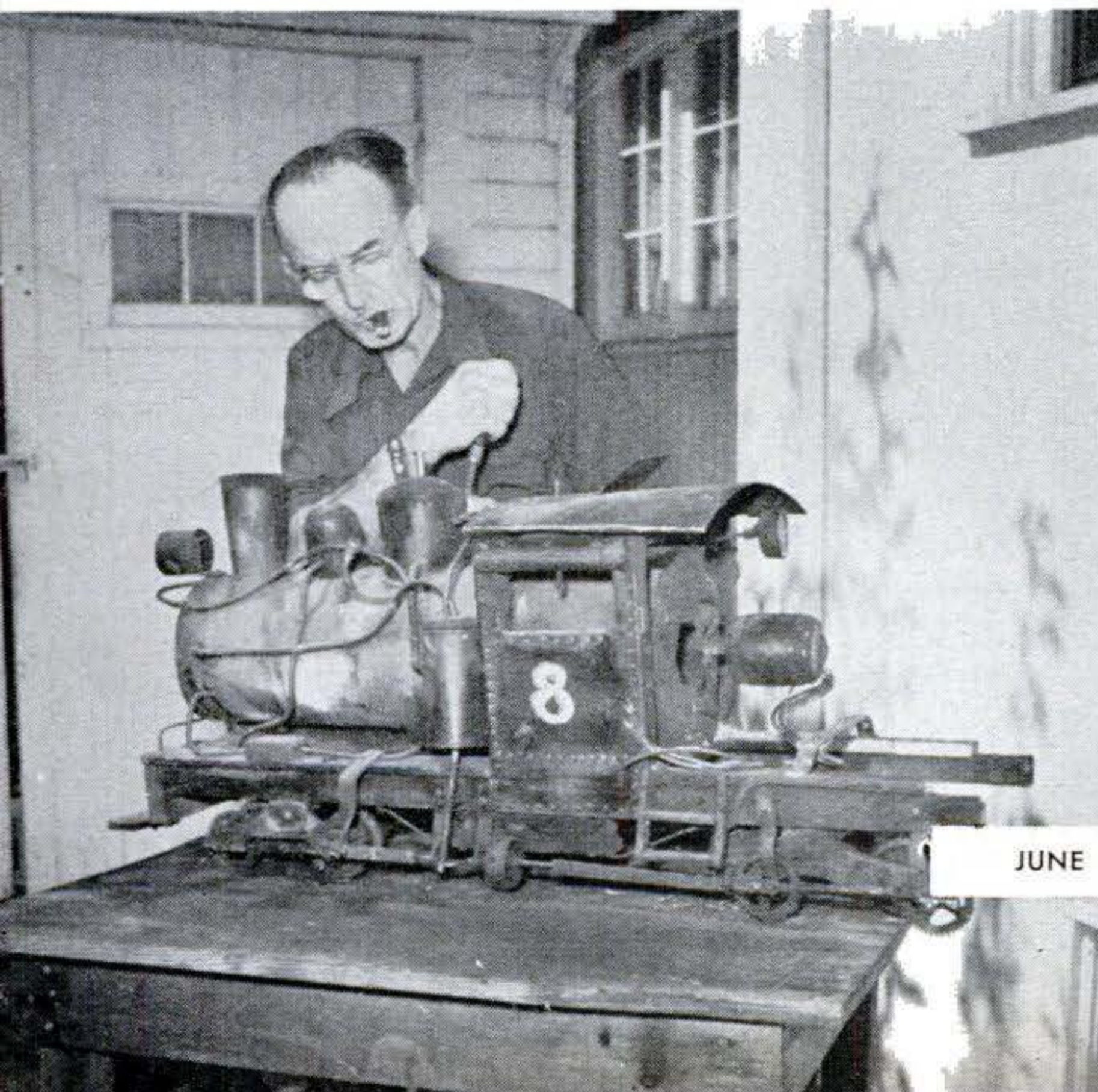



For close-ups showing villains planting powder to blow up train, Maker built nearly full-scale trestle 20 feet long. Actual explosion was light charge with chemicals to make smoke.



Imperiled engineer peers out from wood-and-cardboard replica of locomotive cab built in Maker's basement. Movie of lurching tender and cars is projected onto screen behind him.



For another movie, Maker rigged up interior of railroad car patterned after old Virginia and Truckee coach. Part of controls for sound-recording equipment can be seen in foreground.



Three seats and painted flats are only props used to create illusion of old-type coach, but they do the trick. Door in background is just knob, but sound camera will pick up its click.

quired that the judge be at one level, the prisoners at a lower level, and the spectators at a still lower level. Building a three-level stage under the low, 6½-foot ceiling would have been impossible. Maker solved this by having the judge sit high, the prisoners kneel, and the spectators sit on the floor.

In another picture, three seats and some painted flats made the authentic interior of an old-time railroad coach. The countryside flashing past the windows was a movie projected onto a screen in the background. Offstage, a burly assistant jumped up and

down on an inflated air cushion connected by tubes to air bladders under the coach seats. The passengers jounced realistically. Whistle toots and wheel clicks, recorded months earlier, were picked up from a nearby wire recorder.

Many of Maker's gimmicks come straight from Hollywood, and what he can't duplicate he improvises. By combining mechanical tricks with creative know-how, he can do most of the things the professionals can do—and sometimes better, say his enthusiastic audiences of friends and local clubs.



Cruiser at Home on Land or Sea

PICNIC base ashore or a fishing trip on the lake is all the same to this 16-ft. outboard cruiser. Built-in retractable wheels enable it to be towed behind the family car

as a house trailer, complete with bunks and galley. The bonded-plywood hull has a flat, double bottom for easy launching and beaching. The American Standardized Building Corp., Chicago, makes the Holiday to sell for around \$1,000.

Jig-Saw Plate Traps Auto Thief

SHOWN at a German inventors' fair in Munich, the license plate at right was invented by Ernst Descher to trap auto thieves. After parking, the owner would remove a thin section running diagonally across the number. Result: a "cancelled" plate that police could easily spot should a thief decide to take a spin around town.

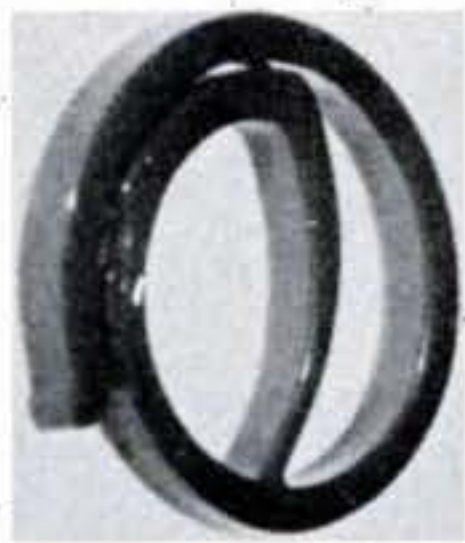
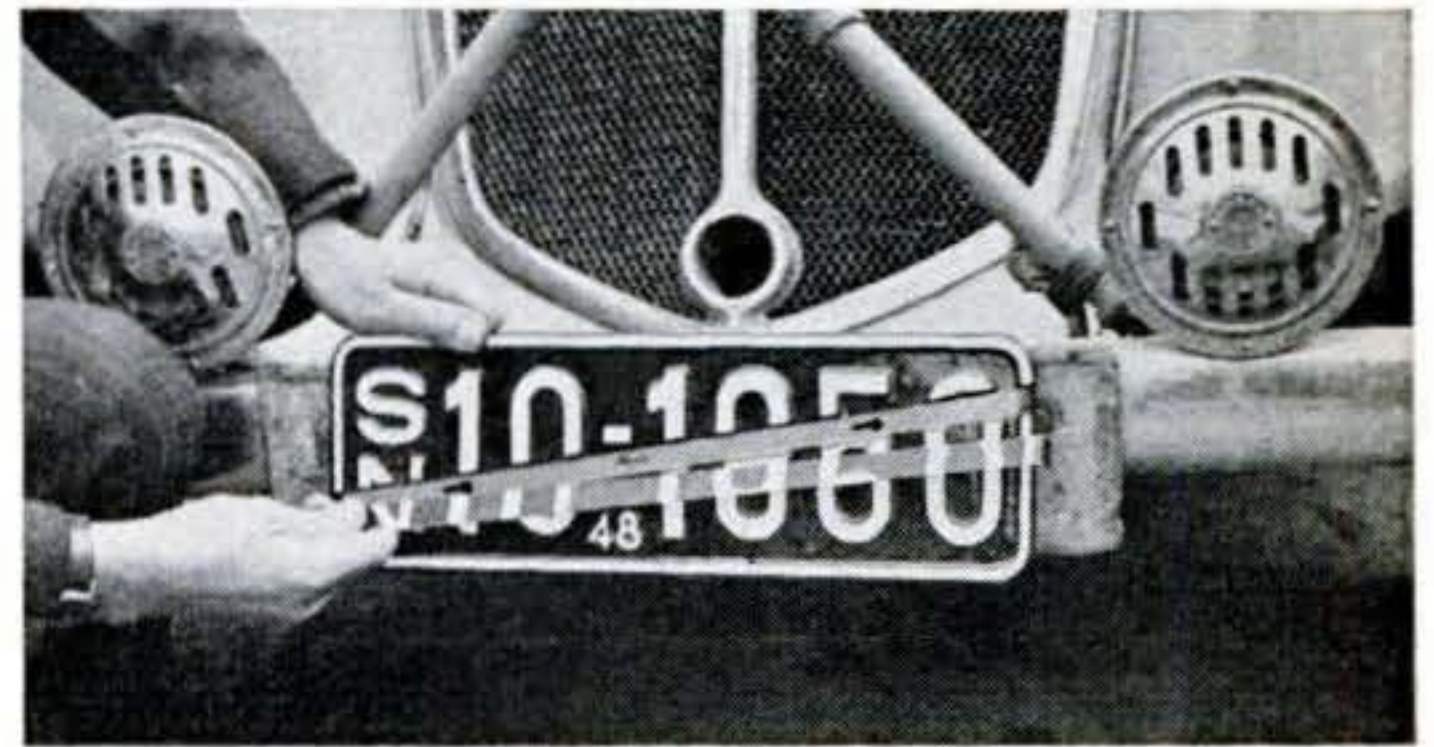

What's This For?

Guess before
you read
below



It's a new kind of clothespin, made of springy plastic. To clip laundry to a line, you pull open overlapping section of ring by squeezing the triggerlike crosspiece toward the opposite side of the rim with forefinger and thumb. Jiffy-Grip sells at 49c for two dozen.

Sprayed "Skin" Protects Paint

A RUBBERIZED plastic coating protects the newly painted surfaces of instrument panels at the East Pittsburgh plant of Westinghouse Electric. Applied with a spray gun on the production line, the transparent covering prevents dirt and scratches during shipment and installation. It's then peeled off like a banana skin, as seen below, leaving a "factory-fresh" appearance.



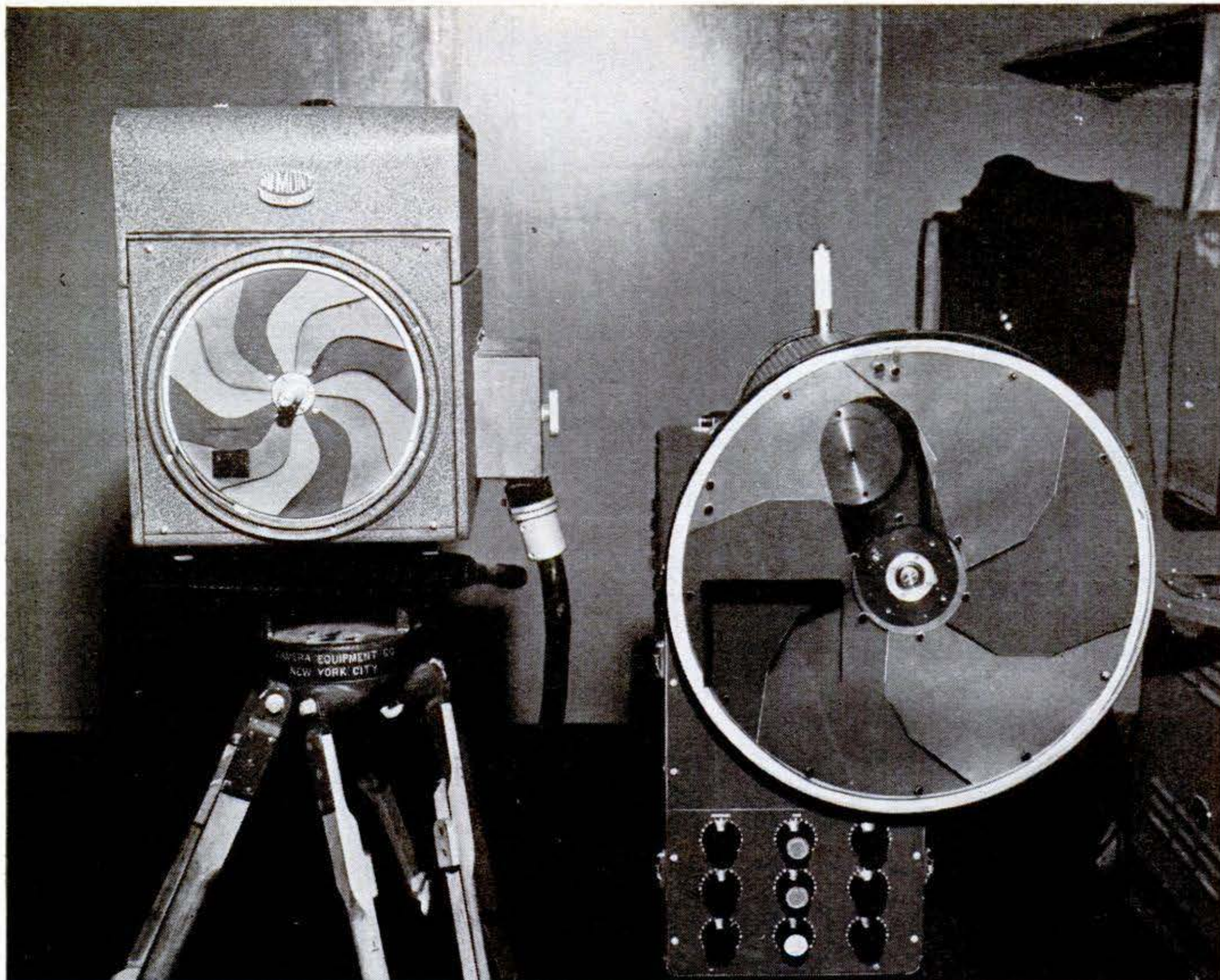

Camera (left) and viewing monitor (partly disassembled to show color disks) are main parts of

Du Mont wired color system. Additional, larger viewing screens can be connected to monitor.

Industry Gets Detailed TV Color by Wire

A COLOR television system that retains all the fine detail of present black-and-white TV has been developed for industrial use by Allen B. Du Mont Laboratories. It cannot be used for broadcasting, however.

The Du Mont system uses spinning disks in the camera and receiver to provide a rapid succession of red, green, and blue images that fuse into a full-color picture. This is similar to the proposed CBS system. But since the Du Mont pictures are carried only by wires, they need not be coarsened to keep the frequency band down to the FCC-set 6-mc. limit, as must broadcast color TV. The new system, which uses an 18 mc. band width, is expected to find wide use in showing operations—color helps distinguish details of a surgeon's work.



Bringing fashion shows to customers on many different floors of department store is one proposed use for new system. Monitor (far right) shows what customers would see on big screens.

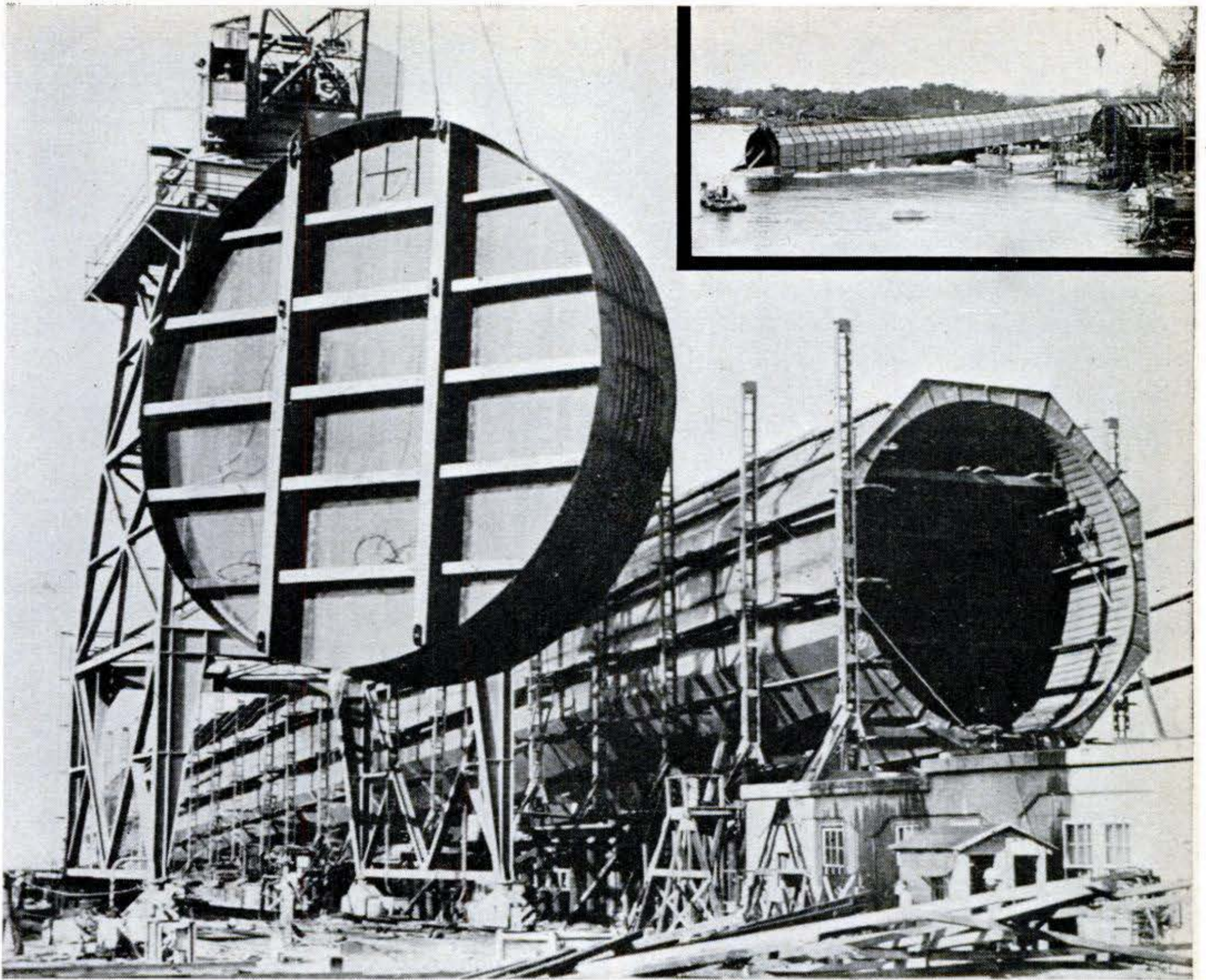

Tunnel Launched Like Ship

THAT'S not a new kind of ship on the ways —it's a tunnel. Four of these 375-foot steel tubes form the Washburn Tunnel under the

Houston (Tex.) Ship Channel. Above, a bulkhead swings into place to seal the end before the section is launched (inset) at Pascagoula, Miss., floated to the site, sunk in a trench, and embedded in concrete.



New Chemical Kills Fire Fast

A GASOLINE-SET fire of electric wiring was put out in less than a second by the new chemical being demonstrated above. Army Engineers say it is twice as effective as carbon tetrachloride and cheaper because so little is needed to put out a fire. Called bromo-difluoro-methane, it can be sprayed from a standard fire extinguisher.



Helmet Gives Rear View

RIVALRS trying to overtake Pete Rannie, British motorcycle racer, won't catch him unawares. To keep an eye on what's behind him, as well as what's ahead, he has devised a rear-view helmet. Now, without turning around, he can watch his trailing competition through a mirror conveniently mounted on brackets attached to his headgear.



Home of Russell R. Ferrer has cinder-block floor. Concrete was poured between blocks.

A nailable cinder block has furring strip molded as part of the block. Wallboard is nailed right to block instead of using wooden furring strips.

By Denis Sneigr

PS photos by W. W. Morris

RECENT developments in cinder blocks are stepping up home construction.

A new type of block has a furring strip molded as part of the block—eliminating wood furring strips to support wallboard. Another new angle is the use of cinder blocks as floors. Here they sometimes have a double purpose—the holes in the blocks serving as conduits for forced hot-air heating through the floor.

In the home of Russell R. Ferrer at East Patchogue, N. Y., described here, the blocks

Cinder Blocks

A new type of block, plus new

were used as an ordinary floor—laid on temporary forms at the first-floor level over a basement. The blocks were put down with a 4" space between each row of blocks. Two $\frac{3}{4}$ " steel reinforcing rods were set in each 4" channel and concrete poured in. Then a 2" mixture of cement and cinders was spread over the entire surface to form the floor of the house. This was kept flooded for a week to keep it from drying too fast. After the cement had set, the shoring beneath the floor was removed and later used as attic framing.

The basement walls are concrete blocks and the upper walls cinder blocks. Plastic



Cost of finished house—less accessories—was \$10,870. Only parts on exterior of house that

will ever need painting are the wooden gutters and leaders. Windows are aluminum.

Speed Home Building

uses for standard blocks, are helping lick housing shortage.

cement was coated on the outside of the basement walls and inside the cinder-block walls to waterproof them. The outside of the upper walls was coated with stucco.

To cover the cement-cinder floor, inlaid linoleum was used in the two bedrooms; asphalt tile and carpeting in the living room; ceramic tile in the bath; and rubber tile in the kitchen.

The spacious basement houses a four-car garage, a big storage closet, a utility room, and another room for a shop and darkroom. The house has four rooms and a dining alcove—a total of 1,360 sq. ft. of floor space, including the 7'4" by 13'8" porch.

Walls went up fast after floor was finished. Photo below—looking toward front porch of house—shows door frames set in place as cinder blocks are laid around them. ➡

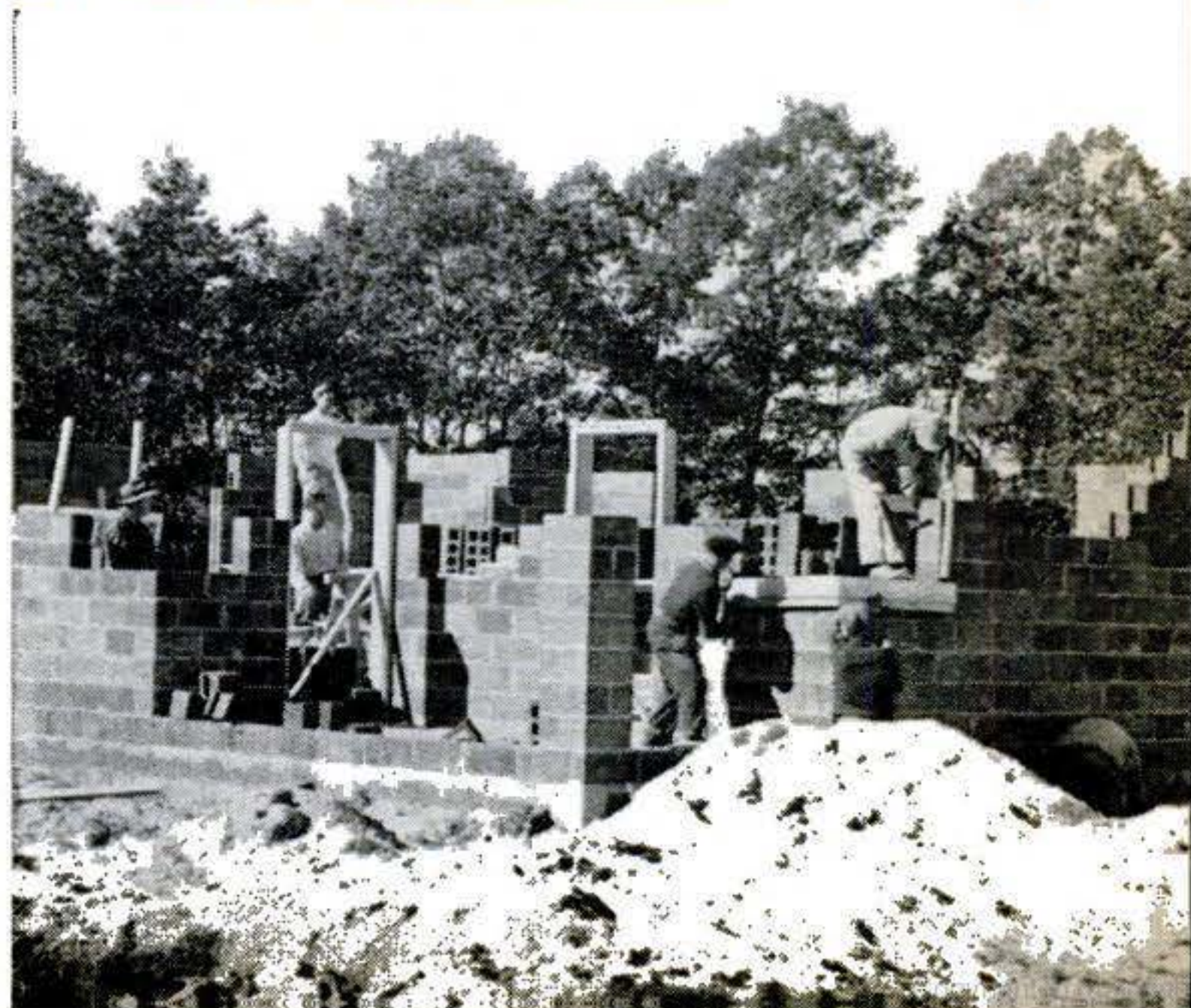

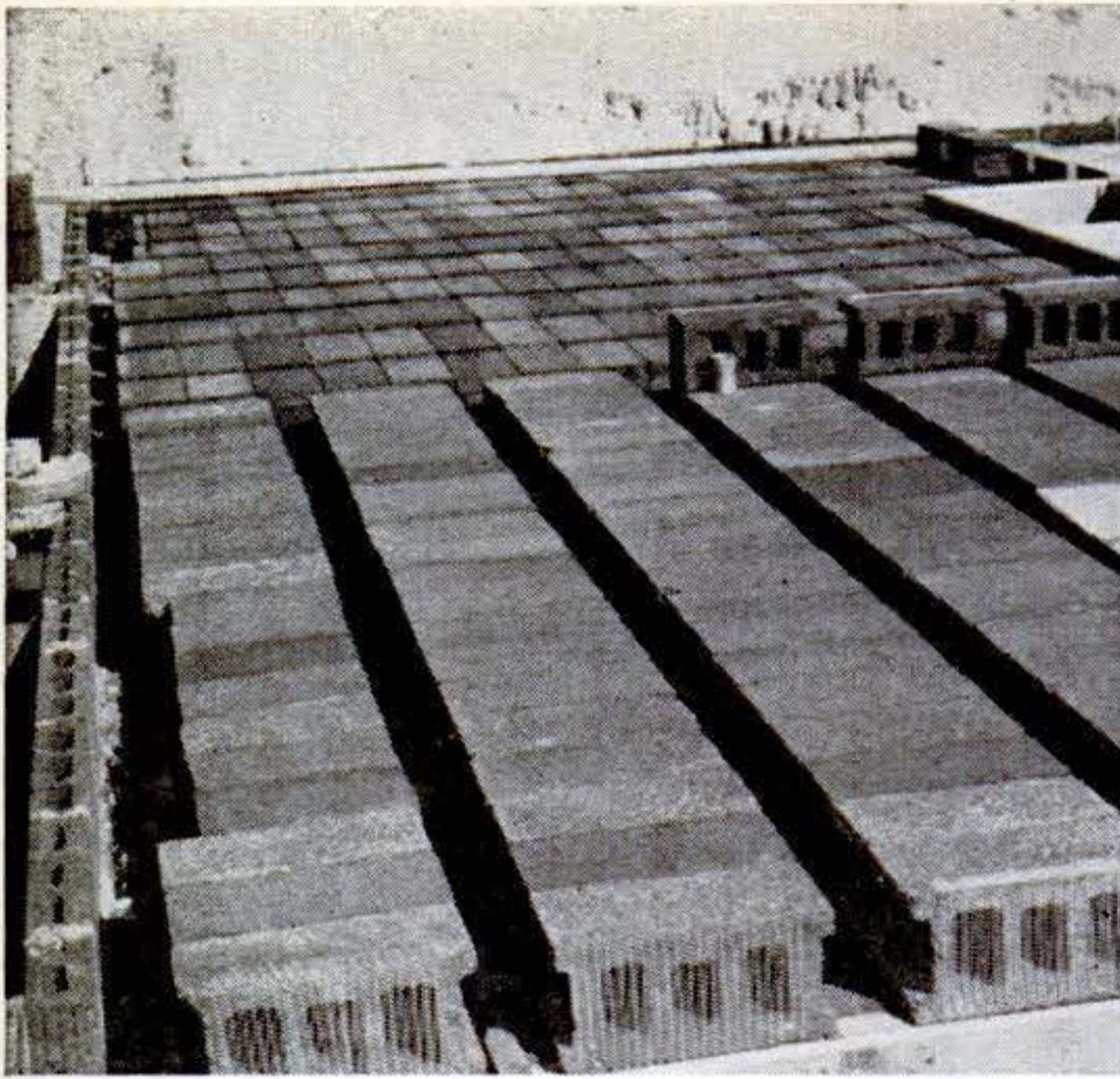

Close-up shows details of floor. Steel rods were laid in channels between blocks. Mesh on end blocks kept out cement-cinder mixture.



View from underside of floor after shoring was removed. Wood grain and knots in shoring left their imprint in cinder-cement mixture.

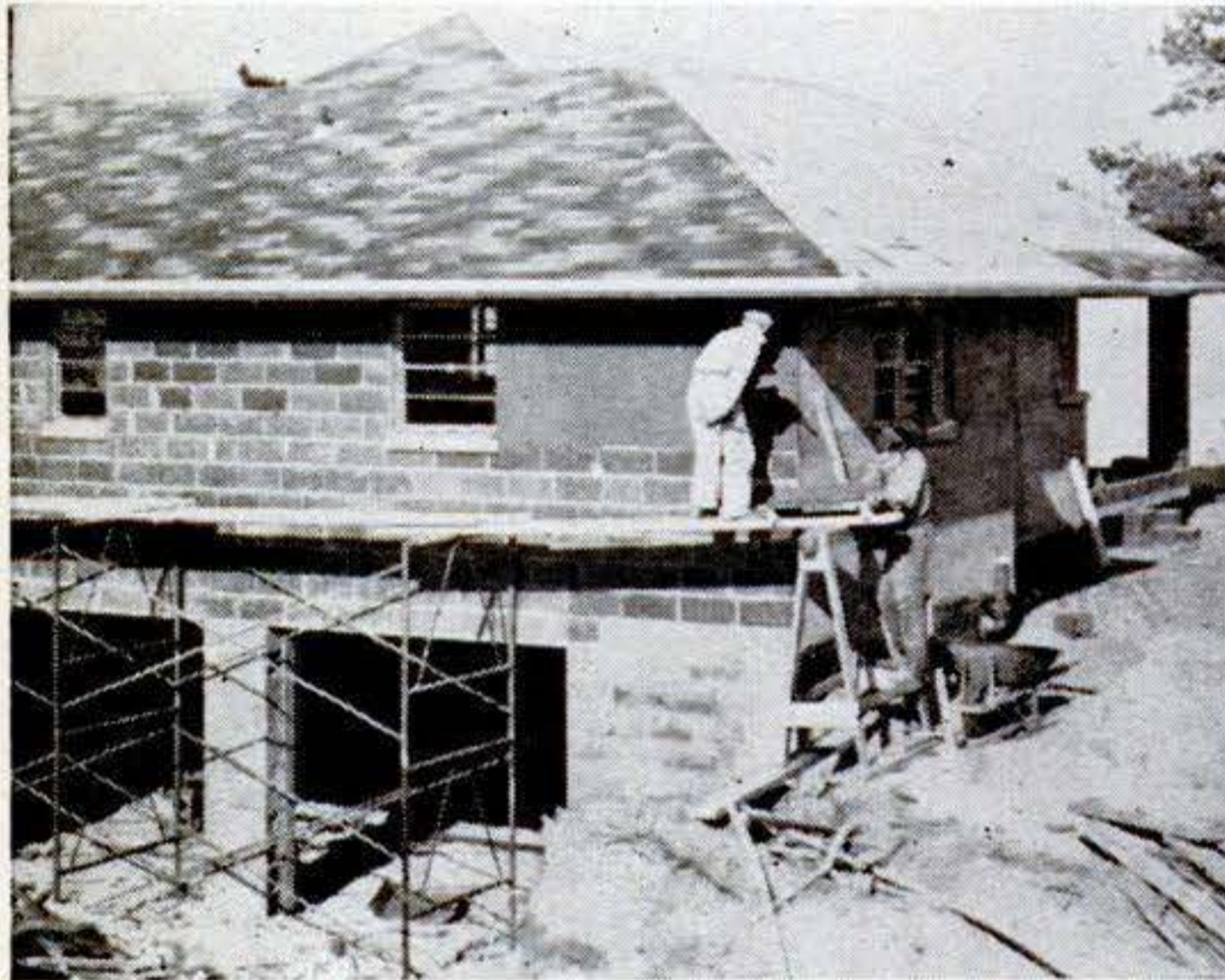

To waterproof walls, plastic cement was used inside and out. Then outside walls were finished with coating of red stucco cement.



Stainless-steel molding trims all interior doors. Base of two-part molding is screwed to wall. Outer part is then snapped on over base.



House is fireproof, rotproof, and bugproof. Window sash and frames are aluminum. Photo at left shows window when house was partially

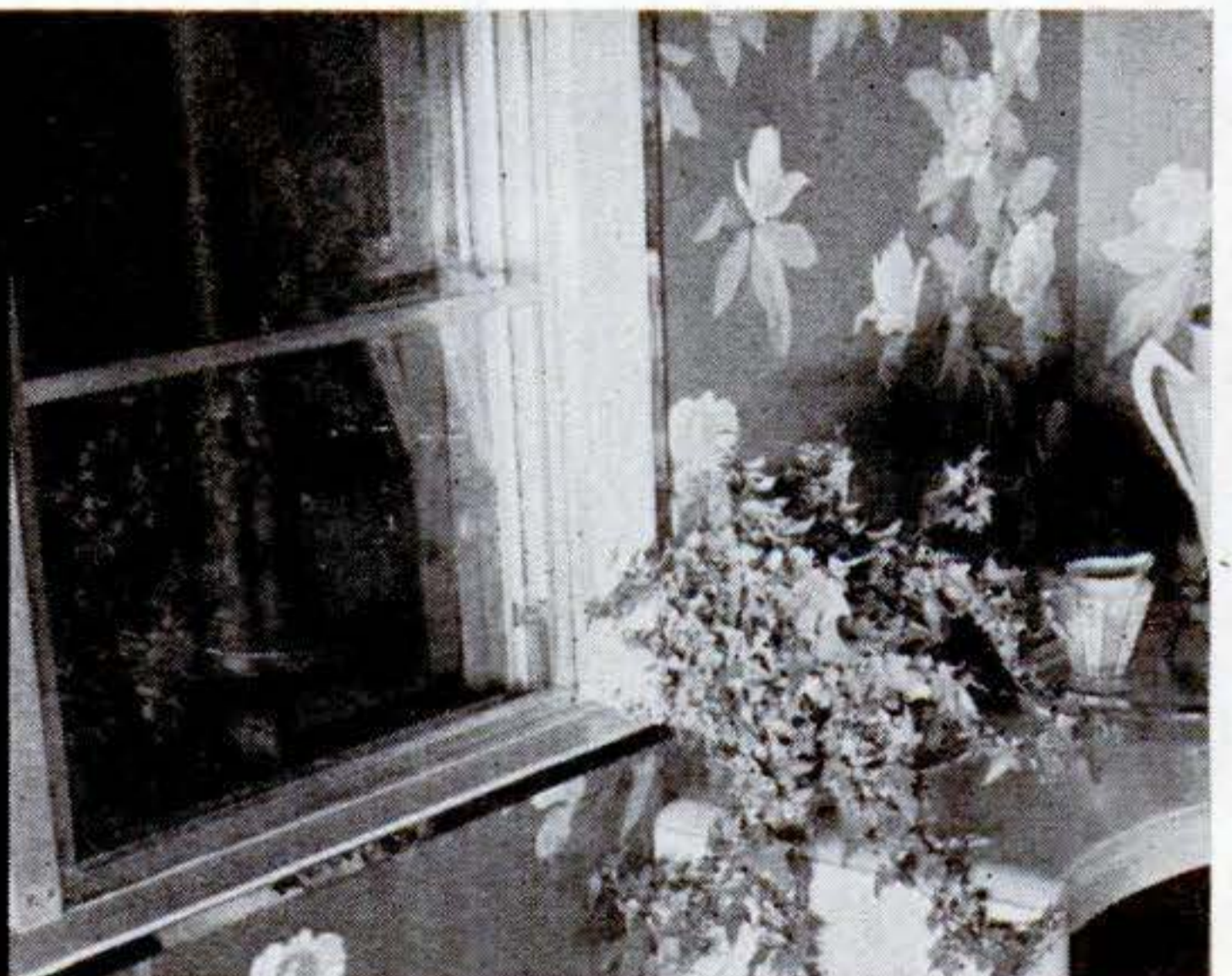

completed. At right is same window after house was completed. Interior walls are finished with wall board and covered with wallpaper.

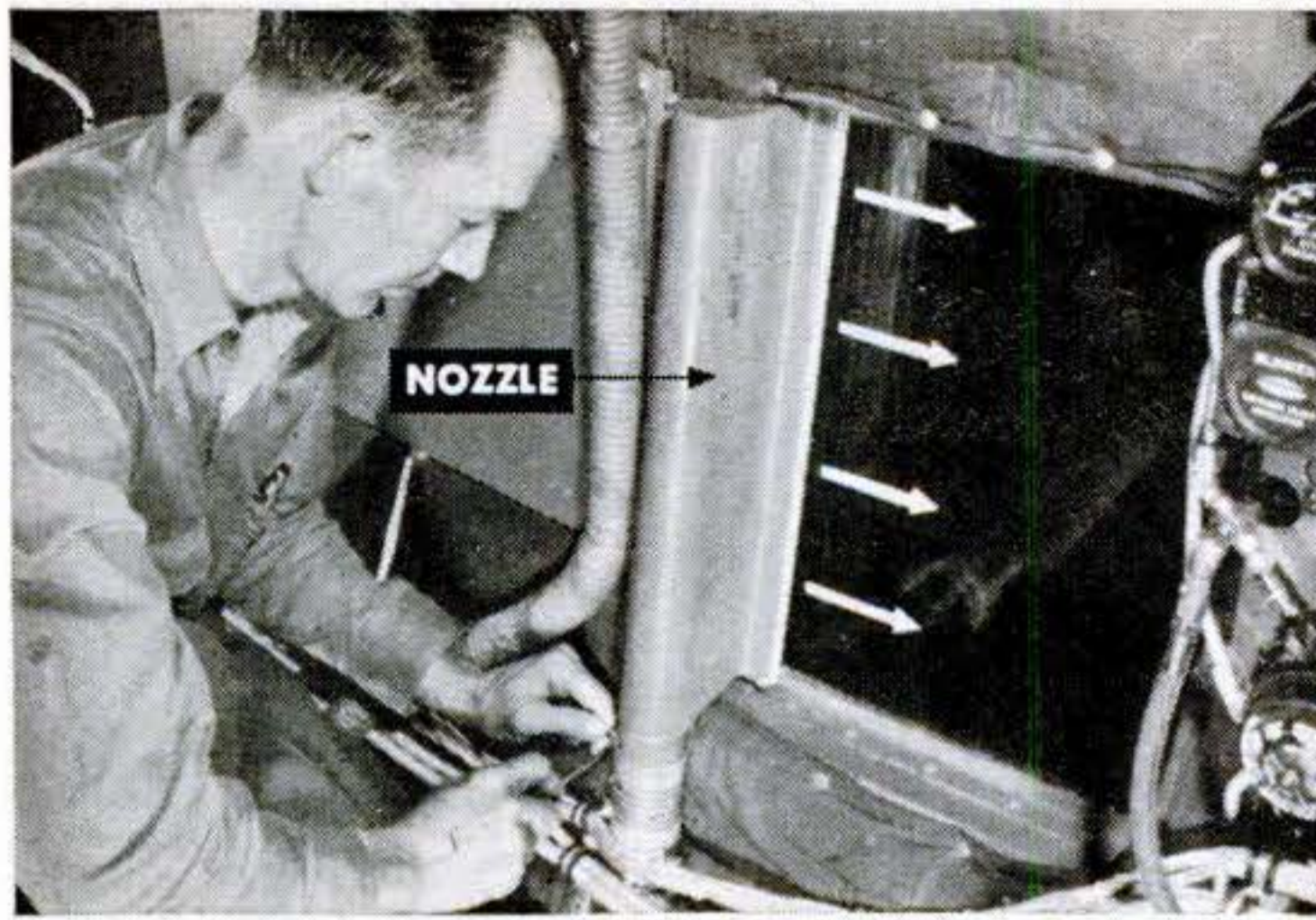

Aerial-Camera Ports Heated

Hot air keeps the seven optical-glass camera ports of Boeing's new B-50 photo plane free of moisture and ice. From a narrow slot in a nozzle by each window, preheated cabin air flows across the inside face of the pane (arrows). While a camera takes a picture, upper right, the flow stops automatically to avoid optical disturbance.

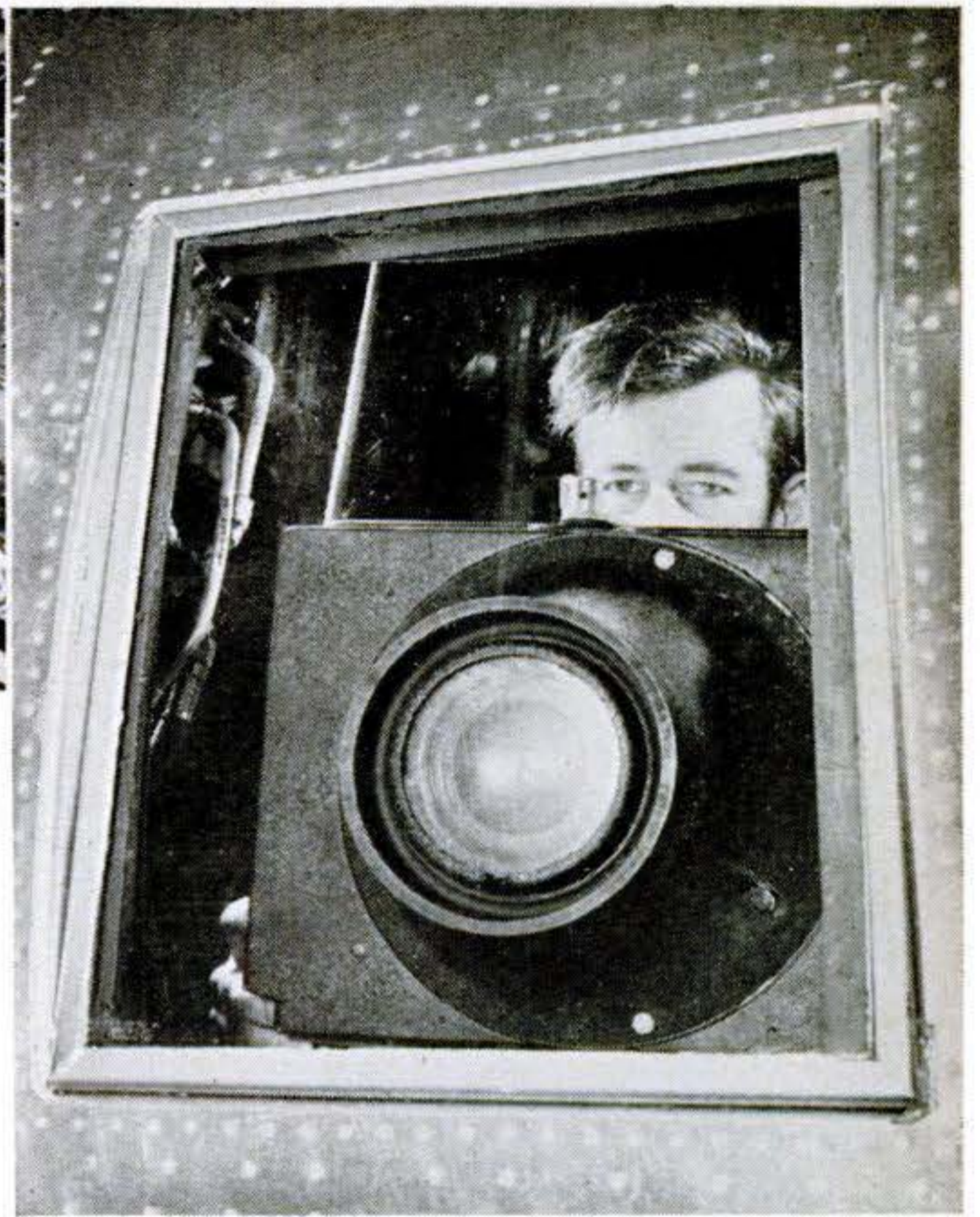

Keeps Your Pencil Sharp

ANY pencil becomes a mechanical one when the sharpener at right is kept on its end during use. A twist of the gadget instantly renews a worn-down point. The handy accessory also has a metal sleeve that encloses the lead, protecting it from breaking. It was invented by Frank J. Bambach, a metal-lathe operator, of Miami, Fla.

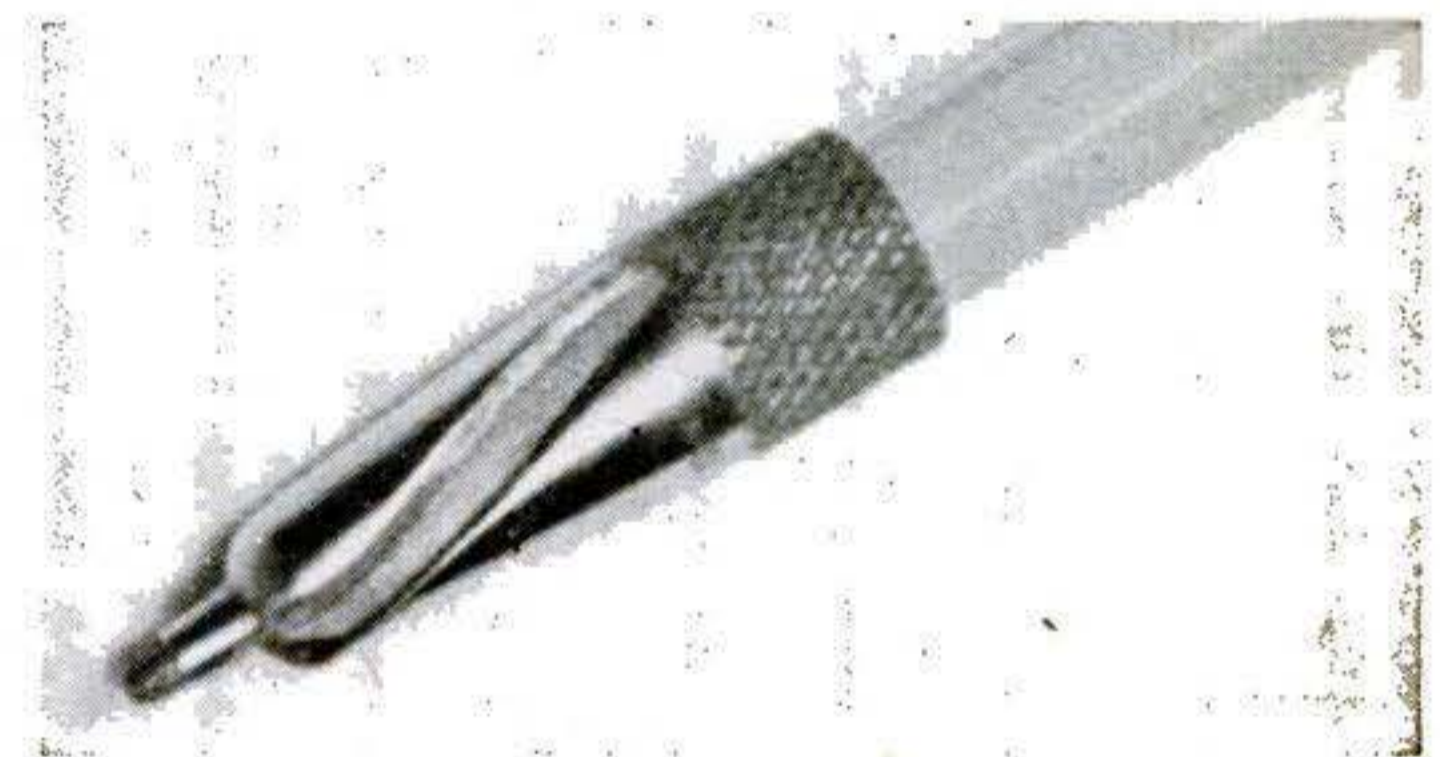

Machine Buries Fertilizer Without Disturbing Soil

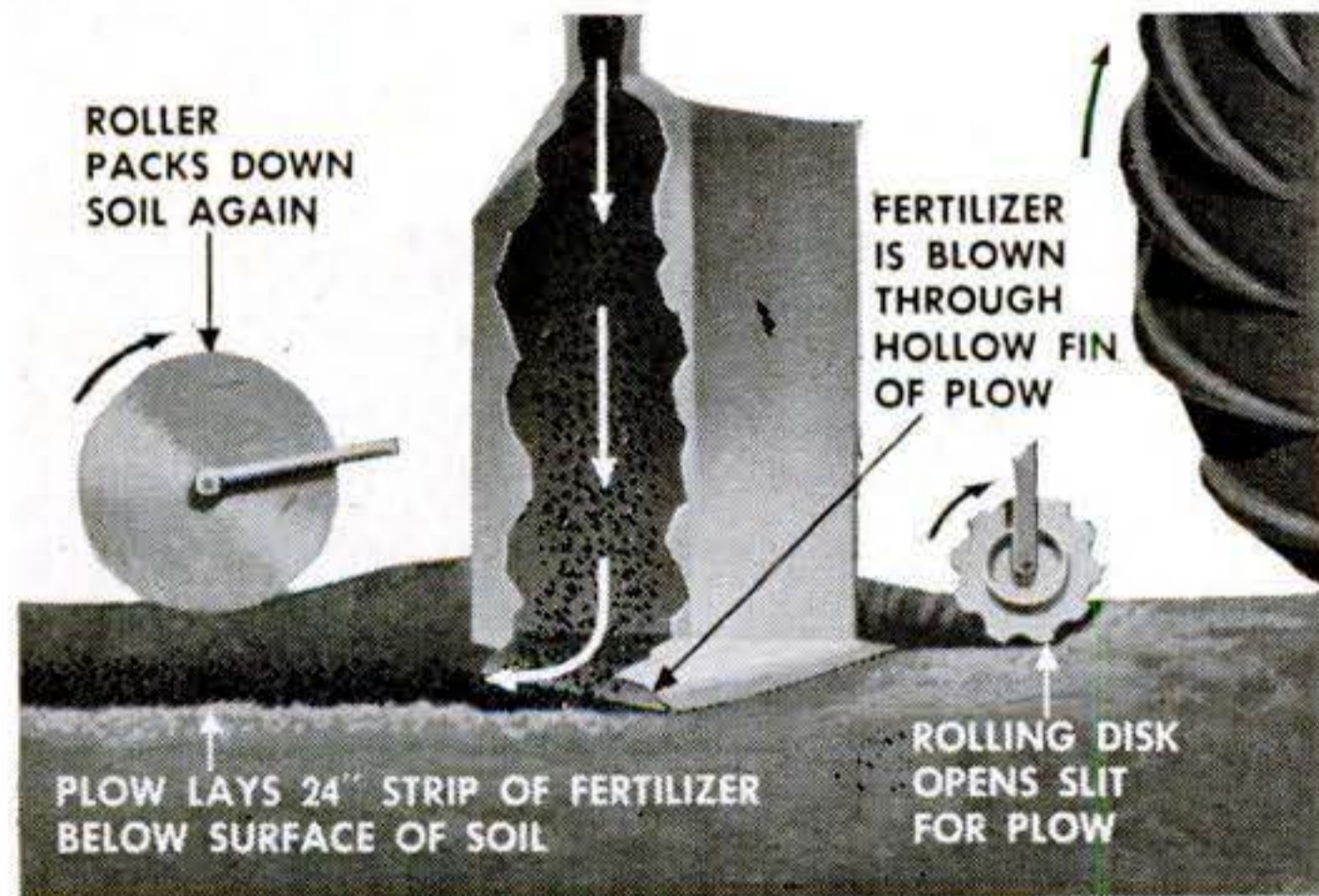

UP TO half a ton of fertilizer an acre is laid eight inches below ground by the new subsoil plow and fertilizer distributor shown here. Developed by Hutchens Implement Sales Co., Lamar, Mo., the machine enriches pasture and row-crop land without disturbing the top soil to expose it to erosion. A ½-hp. blower ejects the fertilizer through a hollow plow, a metal fin open at the rear, as shown in the simplified diagram.

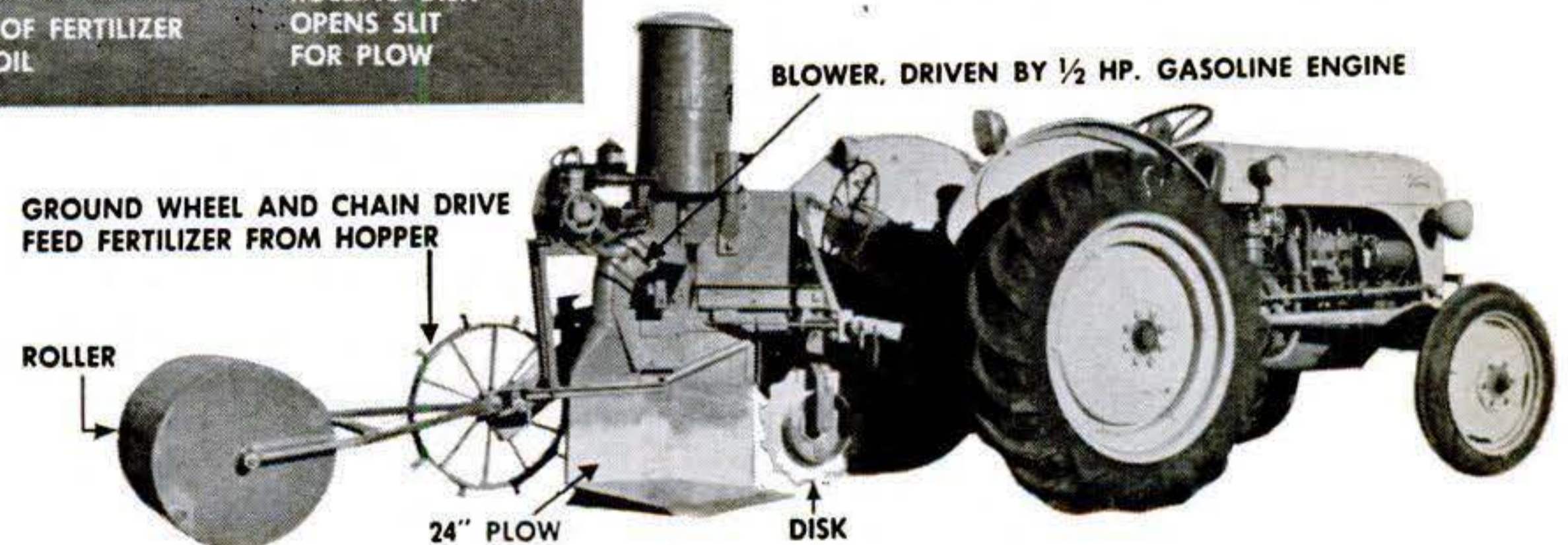

Copyrighted material



Result of the remodeling job shown in the pictures on the next two pages is the girl's Gay

Nineties umbrella above. The man's cane is actually a telescoping holder for his umbrella.

How Experts Put New Life in Old Umbrellas

An 84-year-old umbrella-repair shop shows how its workers can rebuild a beat-up bumbershoot into a new one.

By C. Ennis

PS photos by W. W. Morris

IF YOU have a storm-battered umbrella that's ready for the ash can, look it over first; it might be worth having fixed. Many broken umbrellas just need a few new parts or a cover replaced to be made serviceable again.

When an umbrella is badly damaged, it takes the hands of a skilled workman to refurbish it, as a PS reporter and photographer discovered on a recent visit to the Uncle Sam Umbrella Shop in New York. Expert in the craft of umbrella fixing, this shop has been making and repairing conventional bumbershoots since 1866. It also supplies magicians and other show people with trick umbrellas and canes. One of these is even an umbrella that makes its own rain when the user squeezes a concealed water bag.

The sequence of photos on the facing and following pages shows how a woman's tattered umbrella with an attractive 18th Century heirloom handle was remodeled. The handle was retained but the frame was replaced, a new cover added, and the design changed to one of the long-stick, Gay Nineties style, again popular today.



1 Brought to the Uncle Sam Umbrella Shop for remodeling and repair, this battered umbrella will be changed from a short-stick to a long-stick style, as shown on the opposite page.

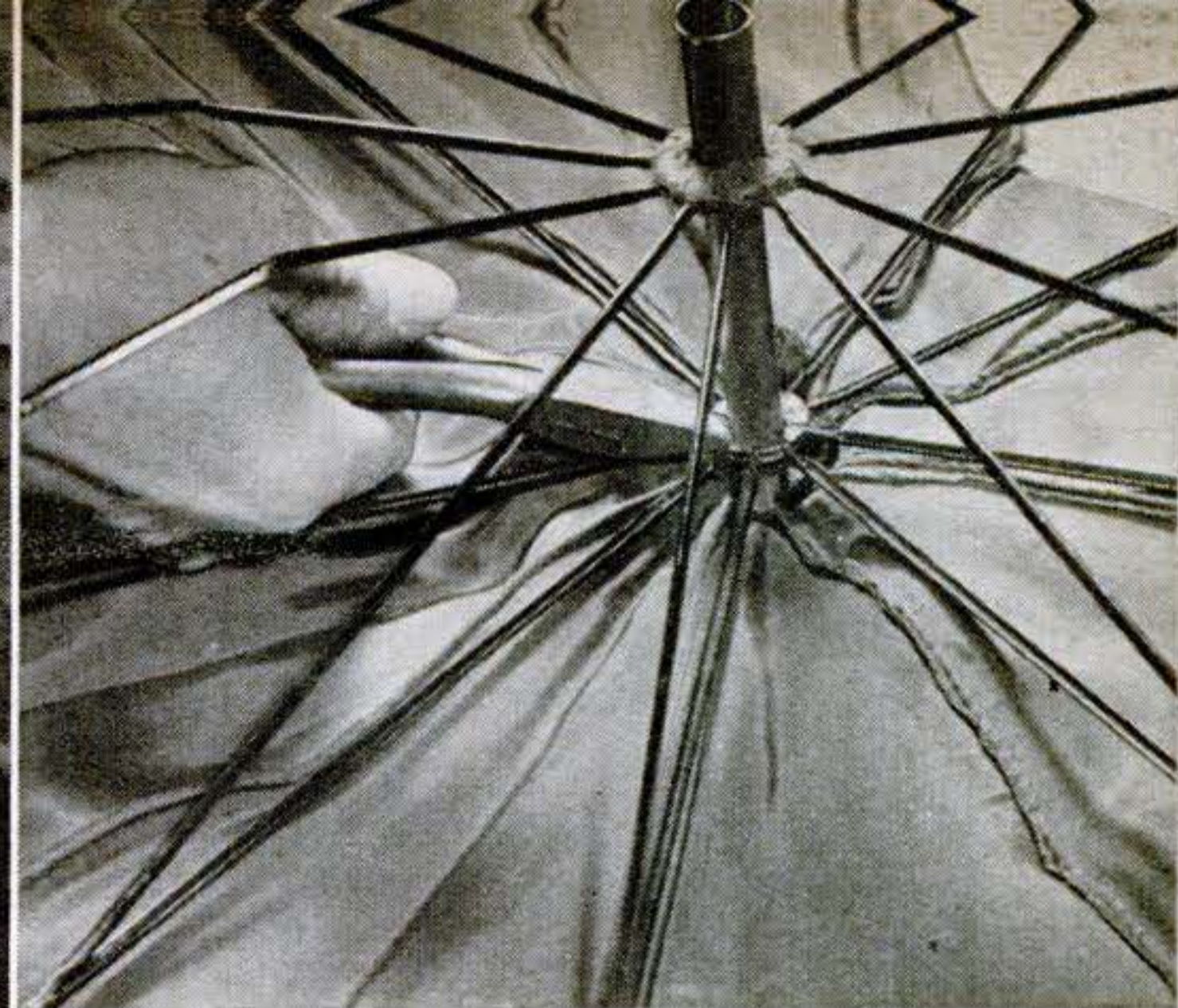

2 To free the twisted frame from the stick, which will be retained because it is still usable, the repairman cuts the wire that fastens the ribs to a metal ring, called the notch.

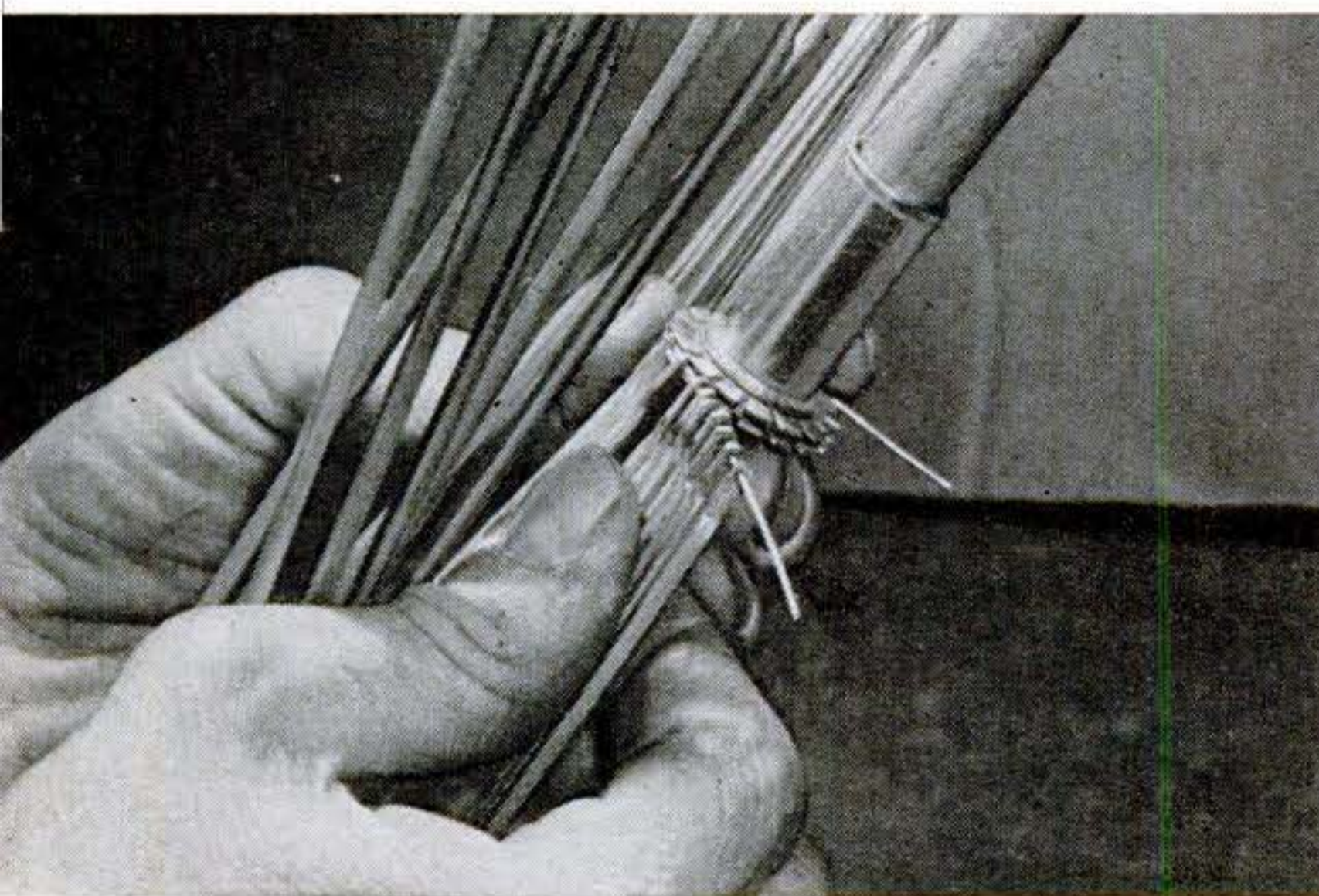

3 After replacing the old frame with a new one having 16 ribs, worker threads new wire through the rib eyes, and inserts ribs into separate slots in the runner, or sliding collar.

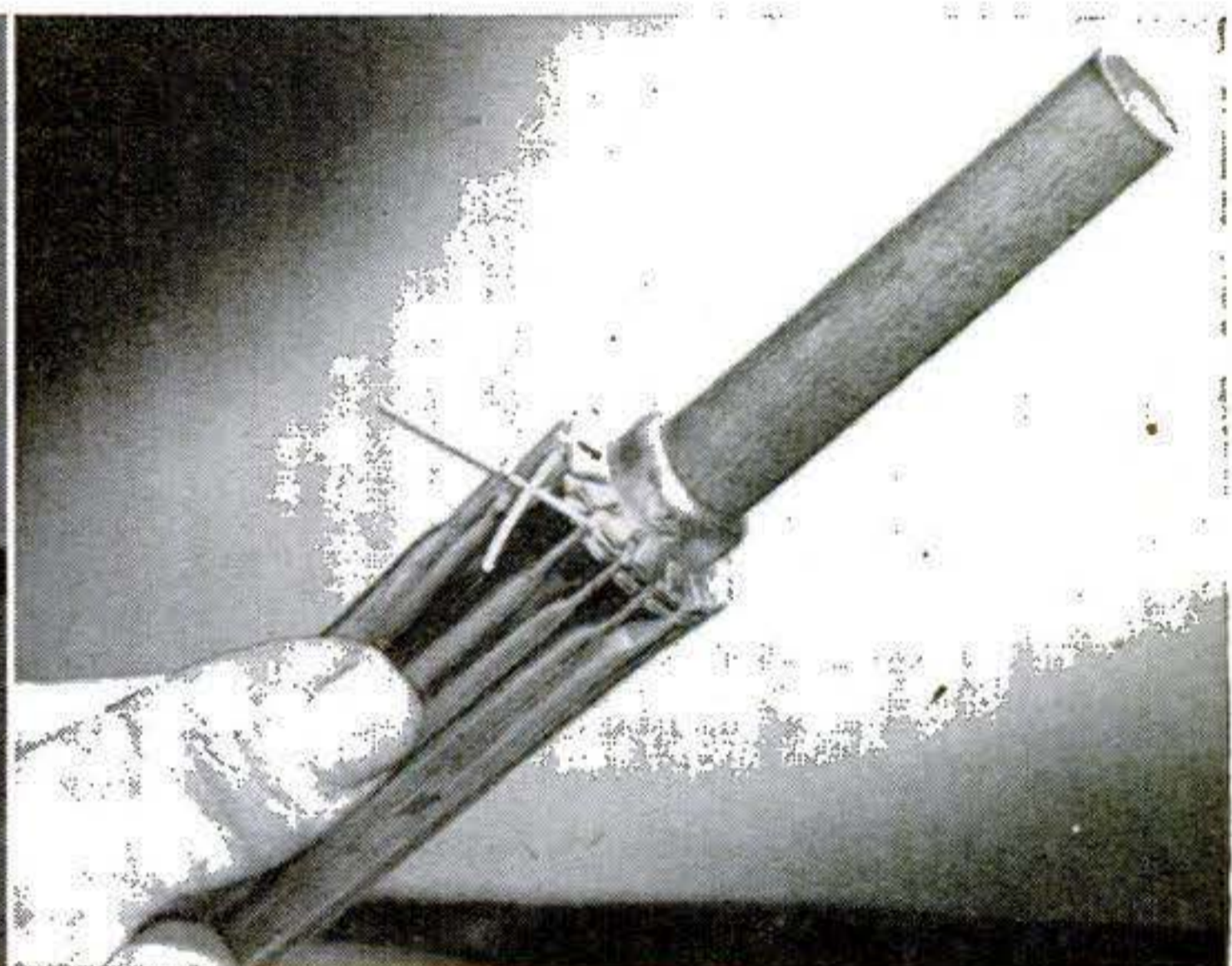

4 At foot of umbrella, ribs are also threaded with wire, and then placed in the notch. The sixteenth rib is about to be inserted above. Wire ends will then be twisted with pliers.



5 Pressing down on a wooden pattern, worker cuts into eight thicknesses of fabric to make panels for umbrella cover. Previously cut panels are shown in the background above.

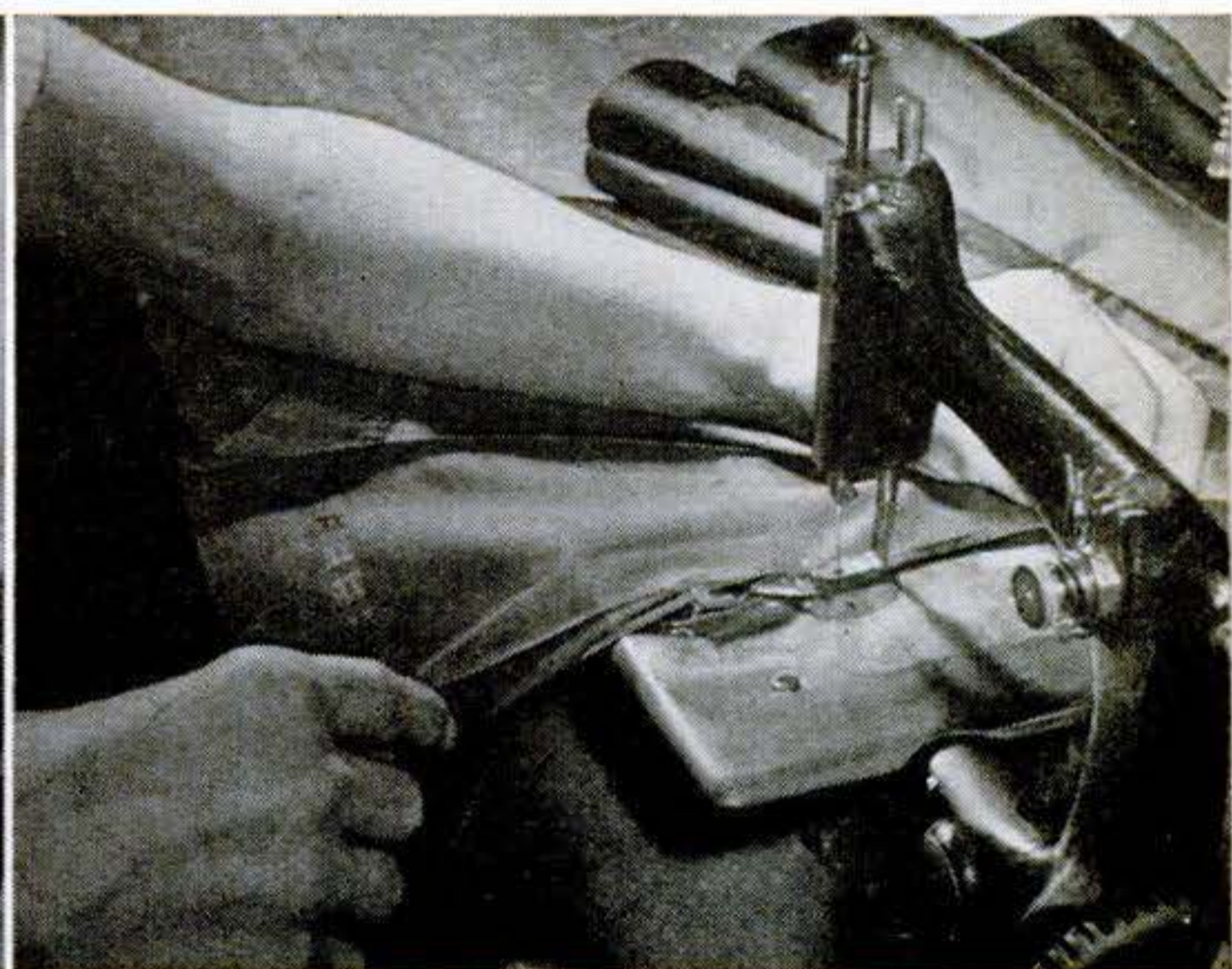

6 Worker sews panels together to make a complete cover. A metal guide, mounted in front of the machine's needle, folds fabric before it is stitched to avoid a raw edge. ▶

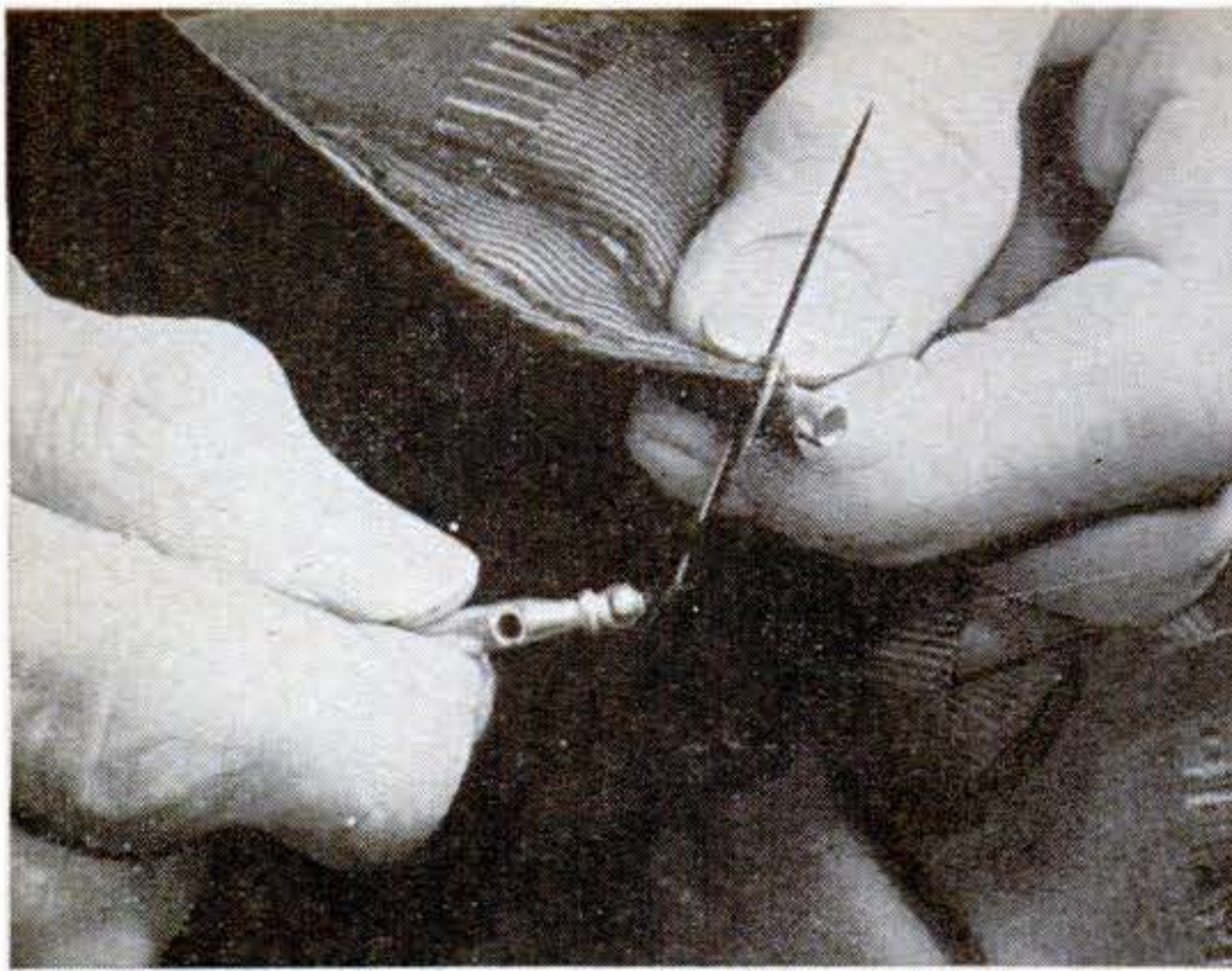

7 Metal tips that fit over the rib points are sewed to the umbrella cover by hand, above. Before sewing, seamstress pulls thread through a piece of wax to strengthen it.

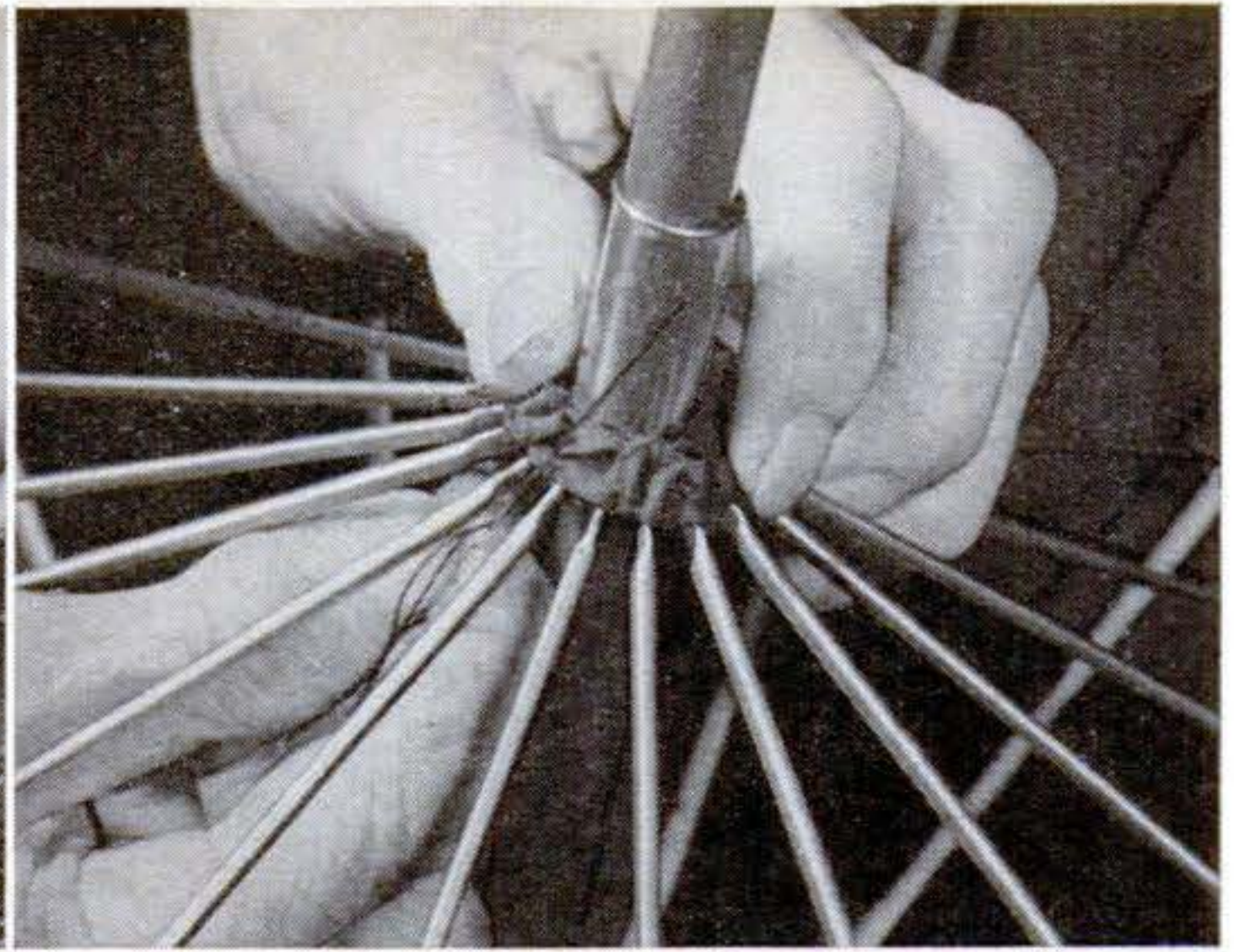

8 To protect user's fingers from being pinched by the rough edges on the runner when the umbrella is opened, a circular piece of fabric called a "puff" is sewed over the runner.

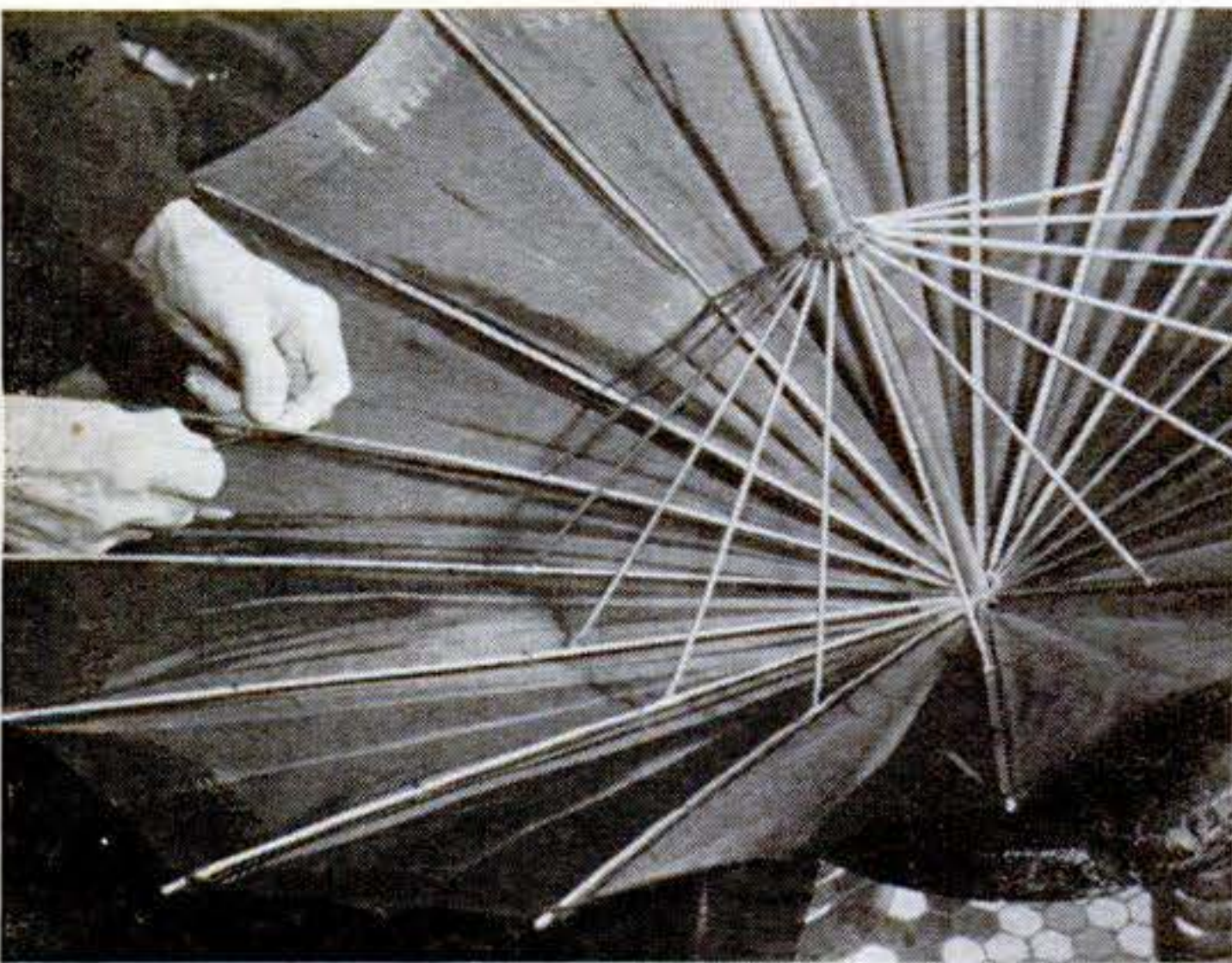

9 Each rib is tack-sewed securely to the cover in two places. For the final sewing operation, another fabric puff is stitched to the center of the umbrella on the outside.

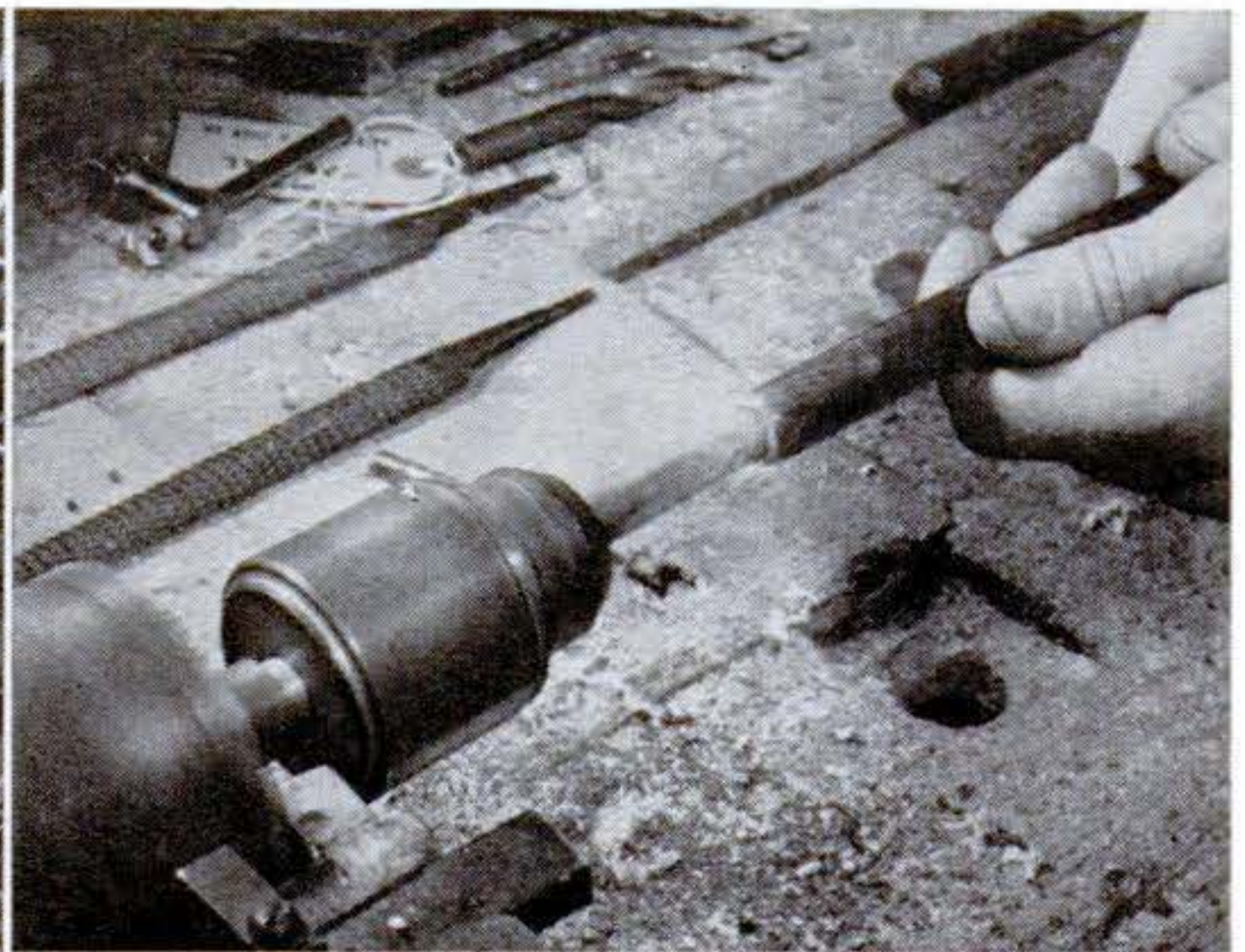

10 Whirling power drill bores hole in ebony rod, which will be fitted over umbrella stick to lengthen it. The extension rod is polished before it is attached to the stick.

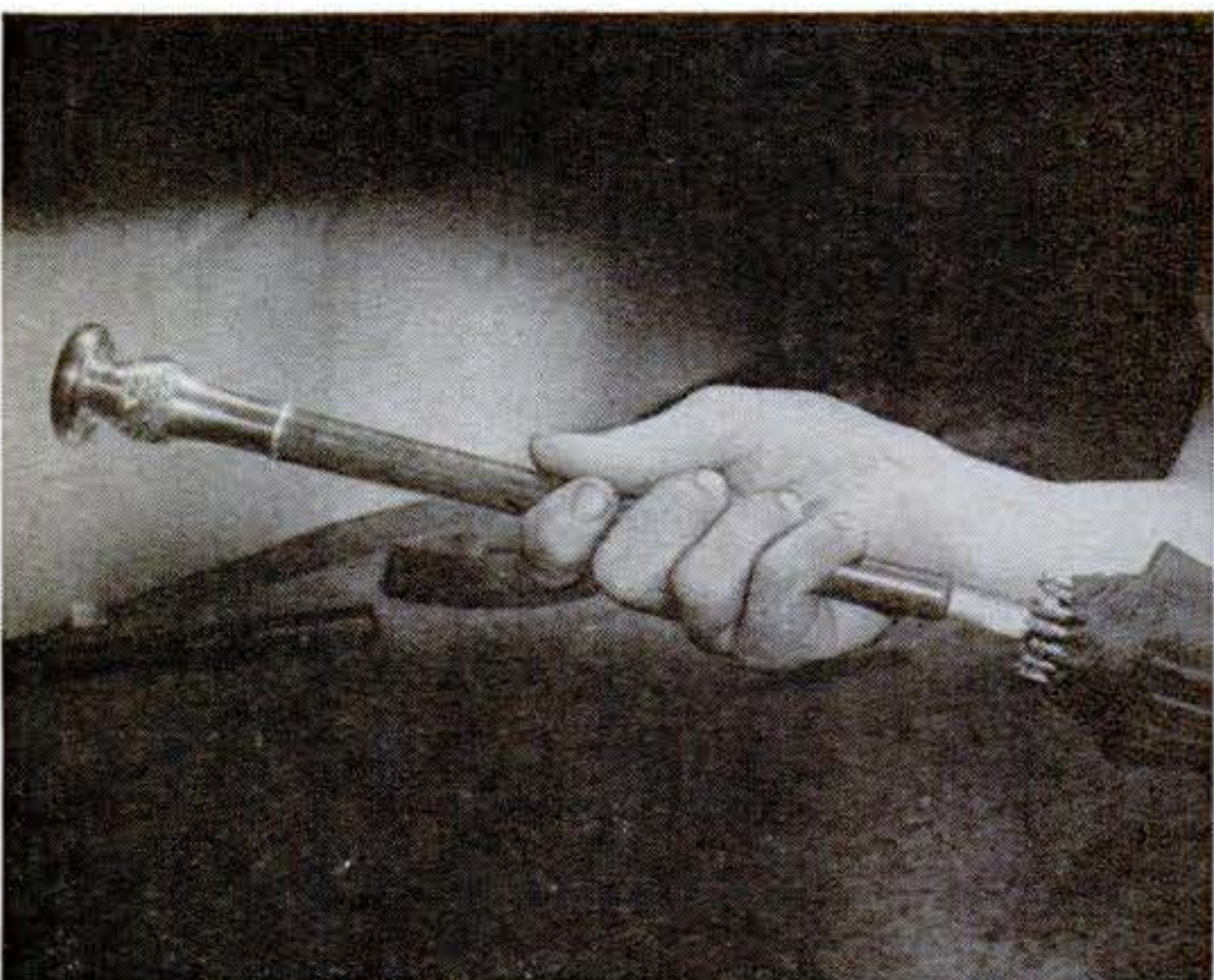

11 Before slipping the extension rod on the stick, it is smeared with glue to hold rod in place. As shown above, the umbrella's original heirloom-knob handle has been attached.

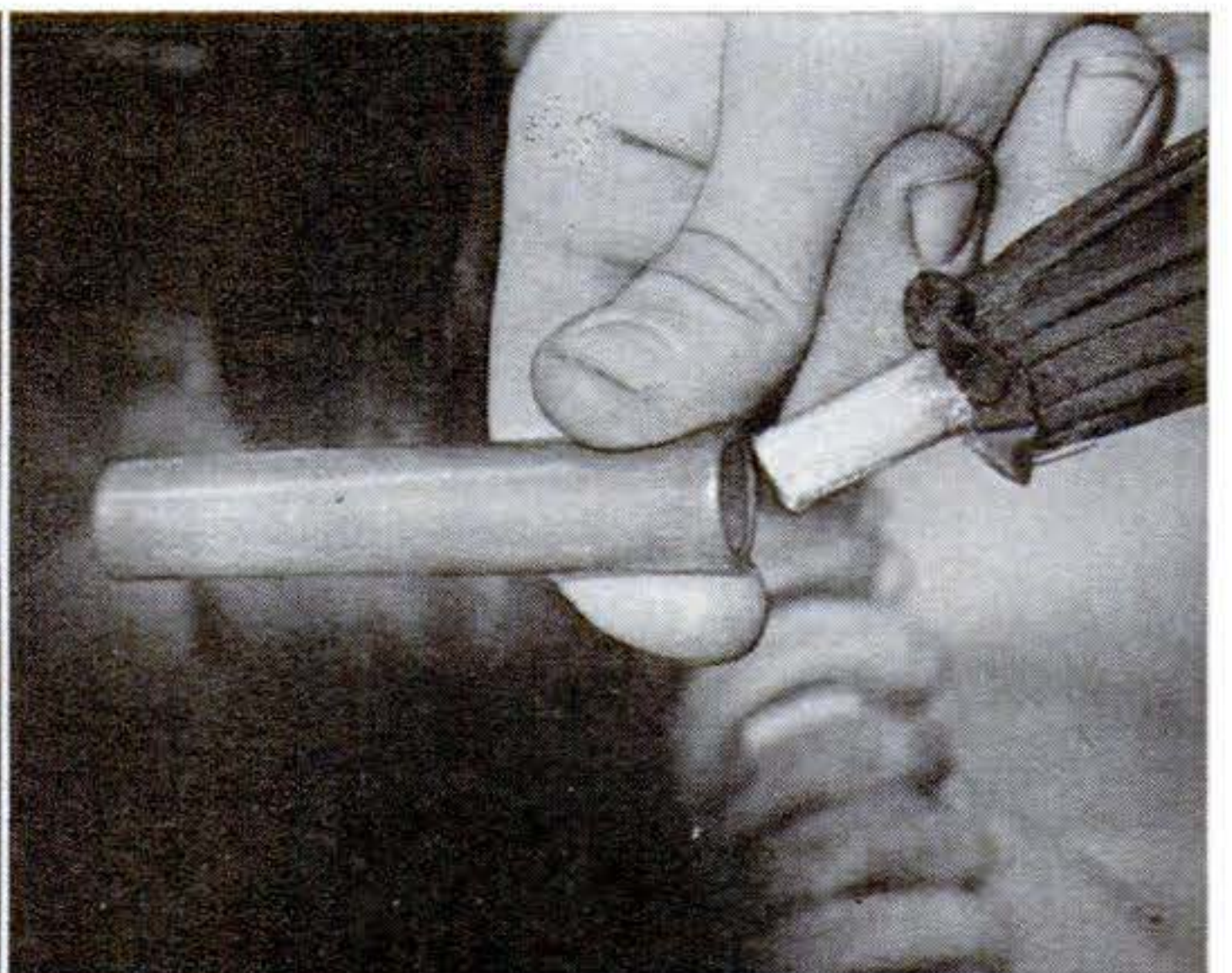

12 The final step in remodeling the umbrella is to slide an ebony ferrule over the foot end of the stick, so its length will be proportionate to the length of the handle.

Planes and Trucks Speed Uranium Hunt

THE hunt for "hot" atoms is getting hotter. Planes and trucks have joined in the search for vitally needed uranium. Now scientists of the U. S. Geological Survey can explore in minutes miles of prospective uranium-ore deposits that would take teams on foot days or months to cover. The upper photo at right shows one of the trucks with two 42-inch-long Geiger tubes mounted on the roof. They can detect deposits while traveling at speeds up to 30 m.p.h. At lower right is the interior of one of the planes, which trail magnetometers that detect changes in the earth's magnetic field produced by radioactive deposits. Also, air samples are tested for radon gas, given off by such deposits.

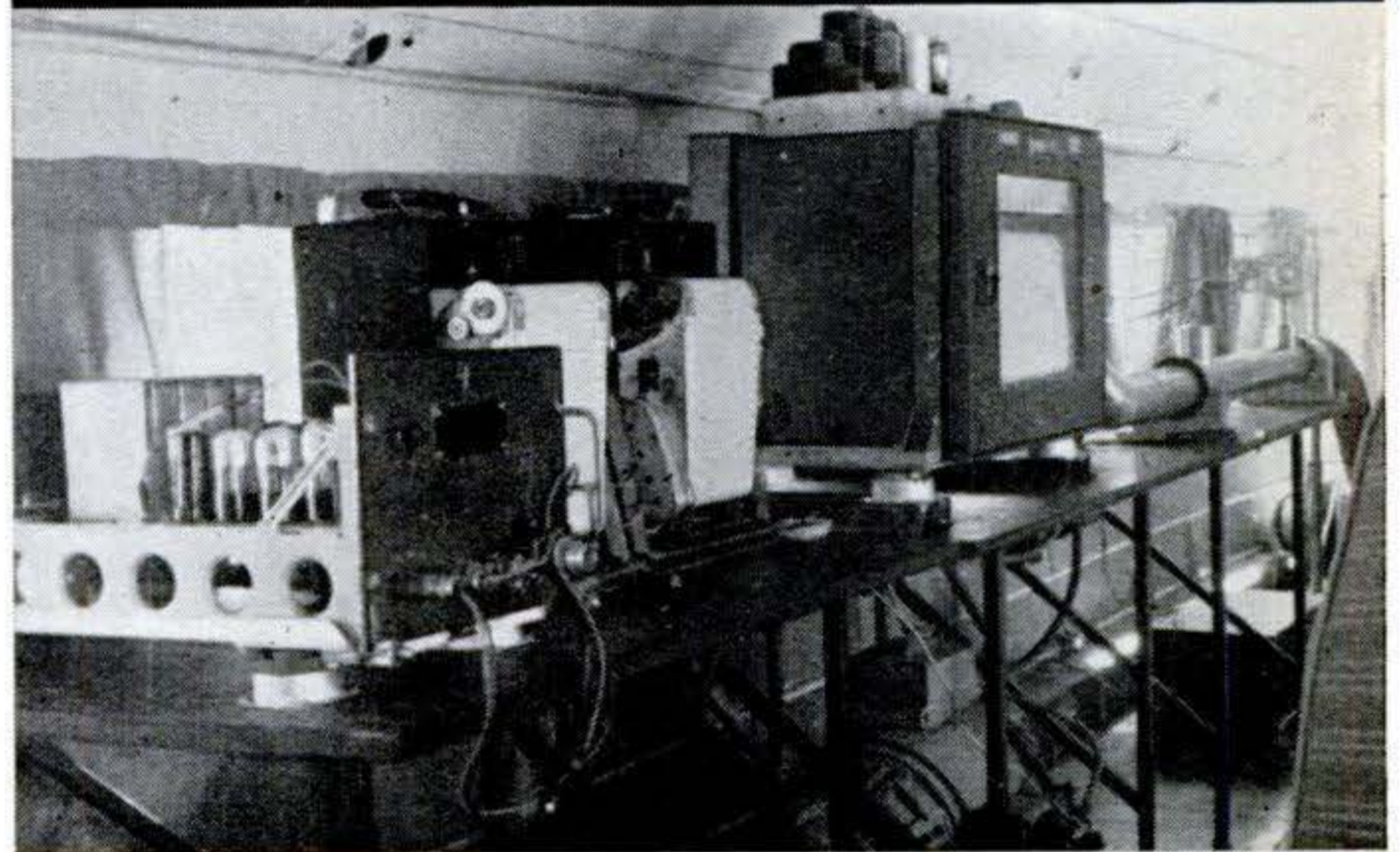

12-Foot Pipe Made of Wood

You could drive a two-ton truck through this giant wood pipe. It's 12 feet across inside. Recently completed, it carries water from the Umpqua River in Oregon to the Toketee hydroelectric plant 1,700 feet away. The pipe rests on concrete cradles and is formed of staves of 4- by 6-inch redwood, tongue-and-grooved and bound with 272,000 pounds of $\frac{3}{4}$ -inch-thick steel bands.

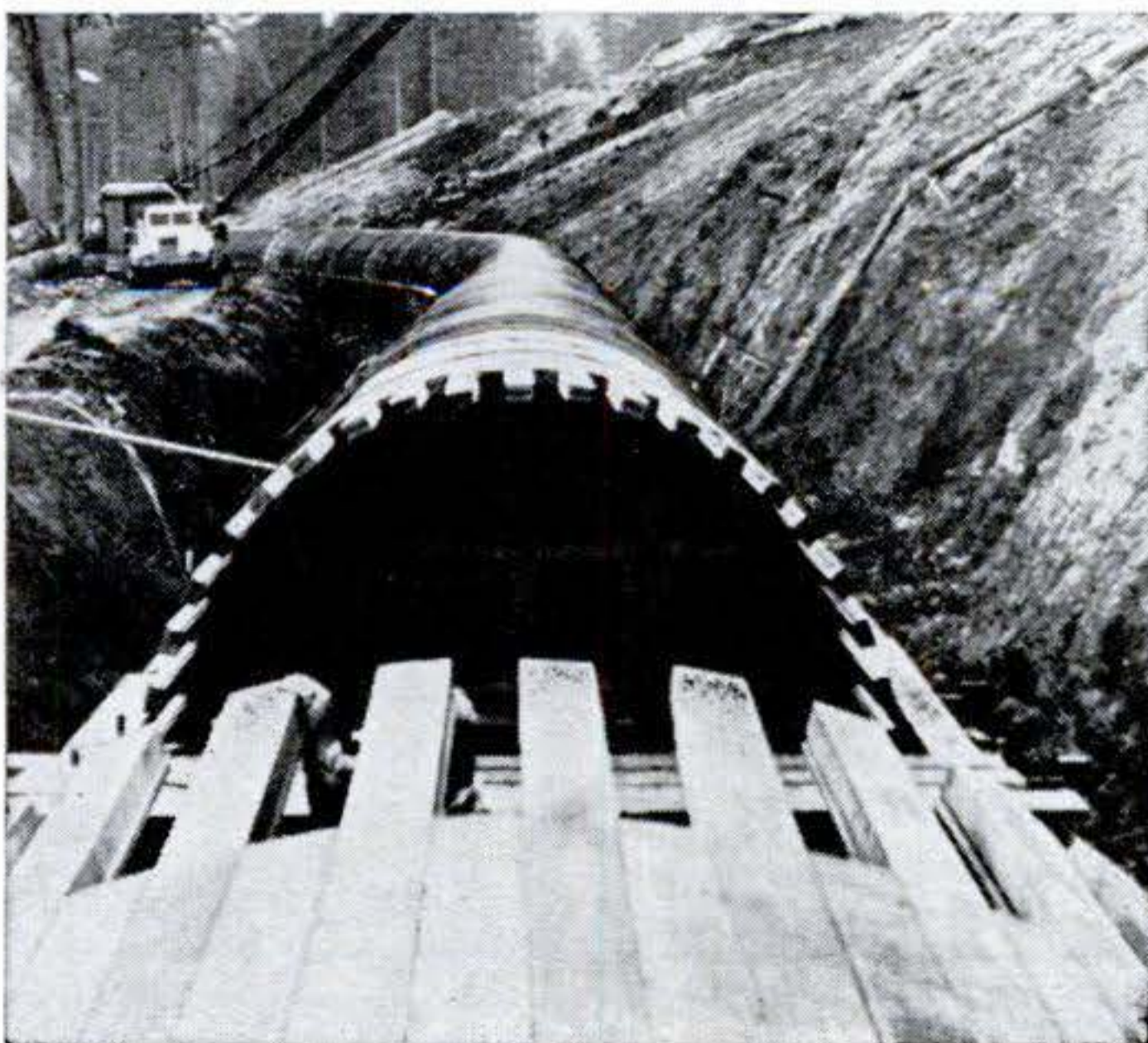

50,000 Feet Up in a Bell Jar

WHEN aircraft engineers want to find out what happens to a piece of electrical equipment at high altitudes, they simply place it in this bell jar and pump out the air. Here a switch begins to arc in the thin air of a simulated 50,000-foot altitude. Results of such tests, made at a new Boeing laboratory at Seattle, Wash., help engineers troubleshoot aircraft failures before they happen.

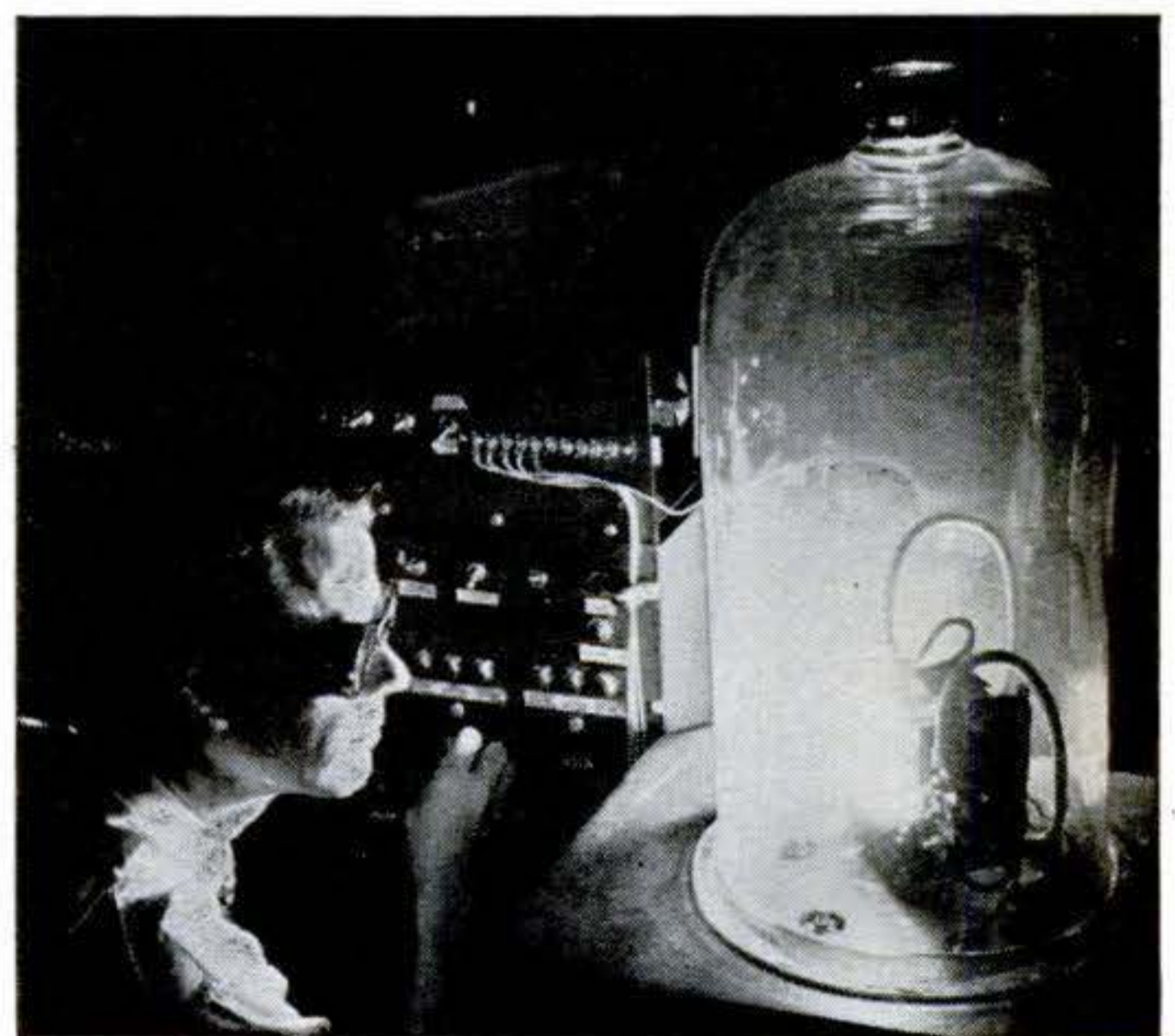



Aids to Modern Living



Hooks Stamped in Strip. Just bend out the hooks stamped in these metal strips and you have a place to hang cups and other small items used in the kitchen or bathroom. Each hook holds 20 lb. The strips, which come in several colors, are easily fastened to a shelf with screws. HoCup Mfg. Co., Boston, Mass., prices them at 25¢.



Iron at Right Height. This folding ironing board can be raised or lowered 10 inches so you can either sit or stand while you work. To lower the board, small legs underneath the ironing surface are folded down so they rest on the crossbar of the regular leg frame. Yeoman Corp., of Chicago, sells the board for about \$11.

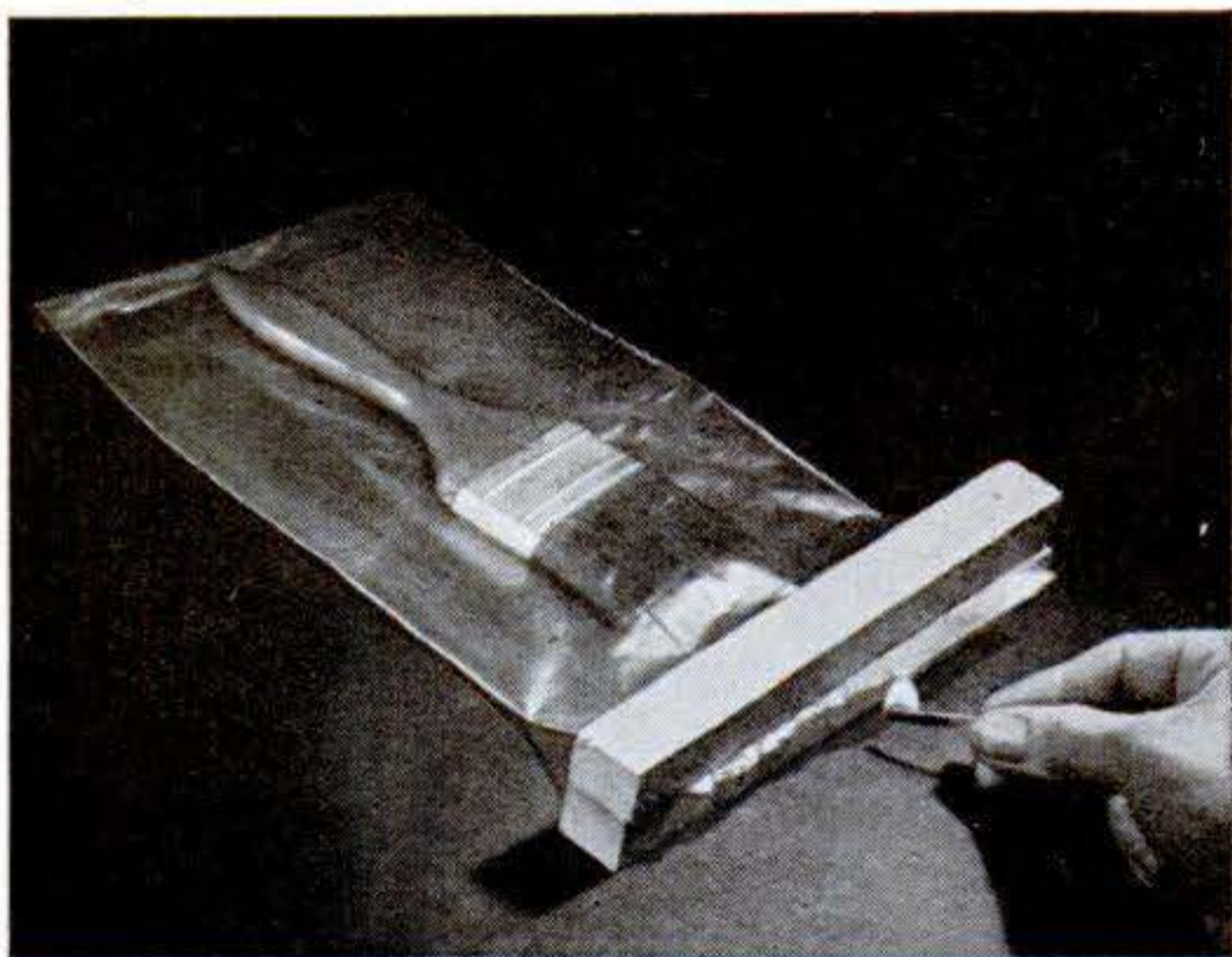

Paintbrush Kept Soft. You can seal this re-usable paintbrush bag with a match. Just place its open end between two pieces of wood, and fuse the edges, as above. Put away without cleaning, a brush can be kept soft by a teaspoonful of linseed oil or turpentine in the bag, Bauer-Lee and Co., Chicago, prices the Flash Seal bag at 25¢.

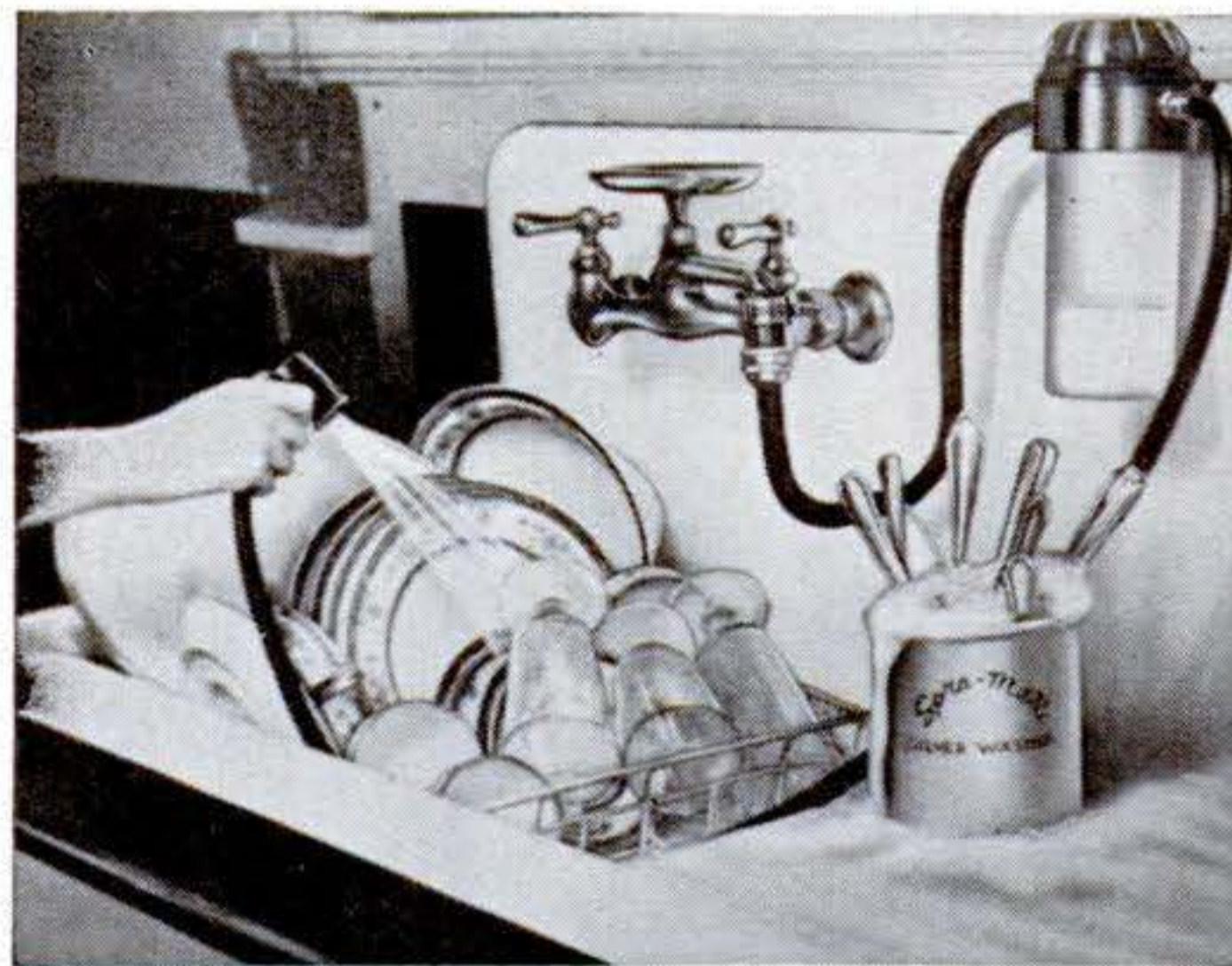

Faucet is Dishwasher. Twist a dial on the container at upper right and faucet water mixes with a detergent for spray-sudsing of dishes—all that's said to be needed for normal washing. Another turn, and water by-passes the detergent for a rinse. Spramatic is made by Atlantic Chemical and Equip., Co., Atlanta; sells for about \$16.

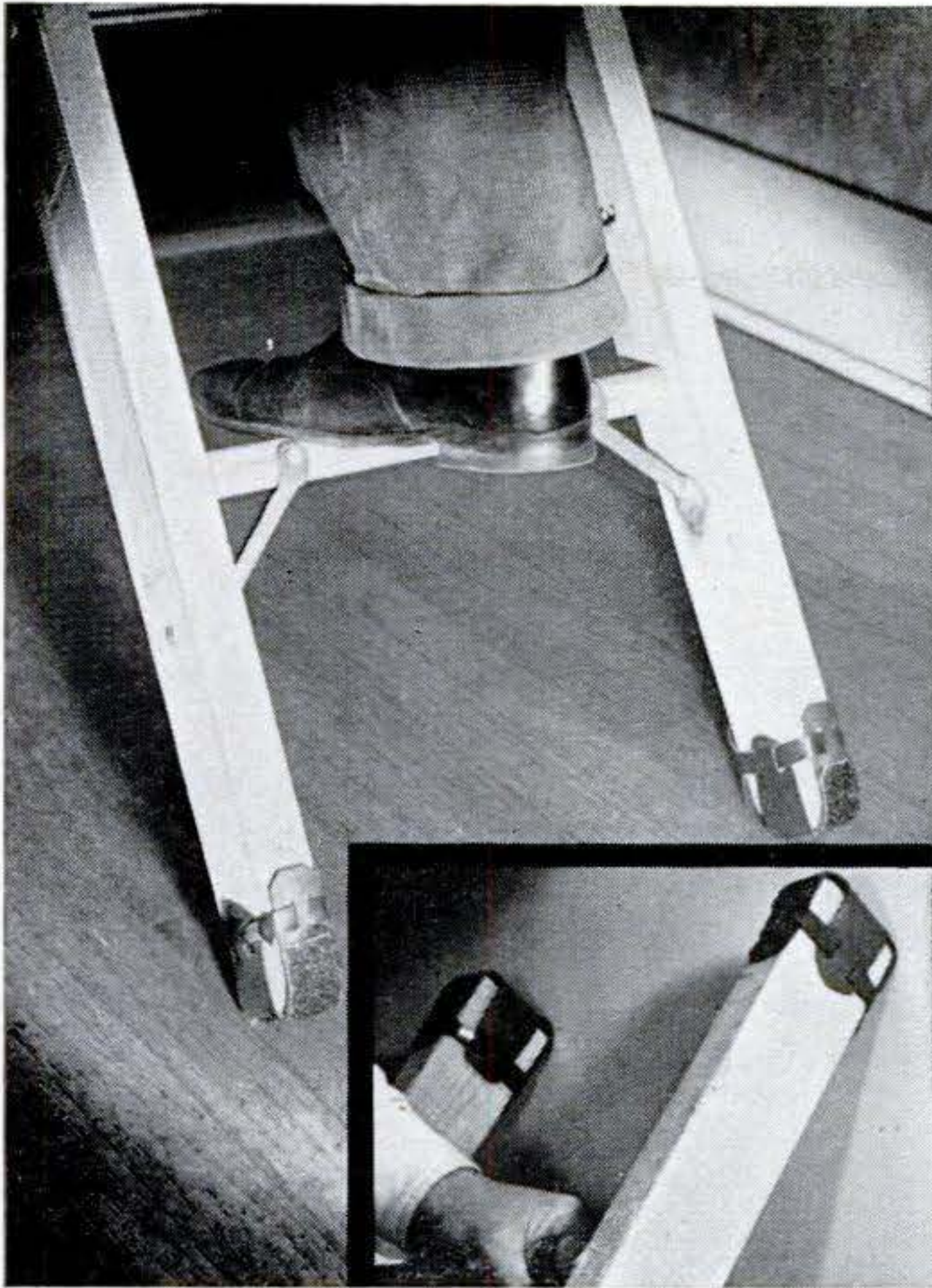

“Shoes” Prevent Ladder Slips.

A ladder shouldn't slip, either outward at the base or sideways against walls (inset), with these Sta-Put abrasive-coated rubber grips strapped to the leg ends. They are slip-proof on almost any material, says the maker, E. C. Forsythe & Co., of Schenectady, N. Y., and sell for \$1.25 a pair.

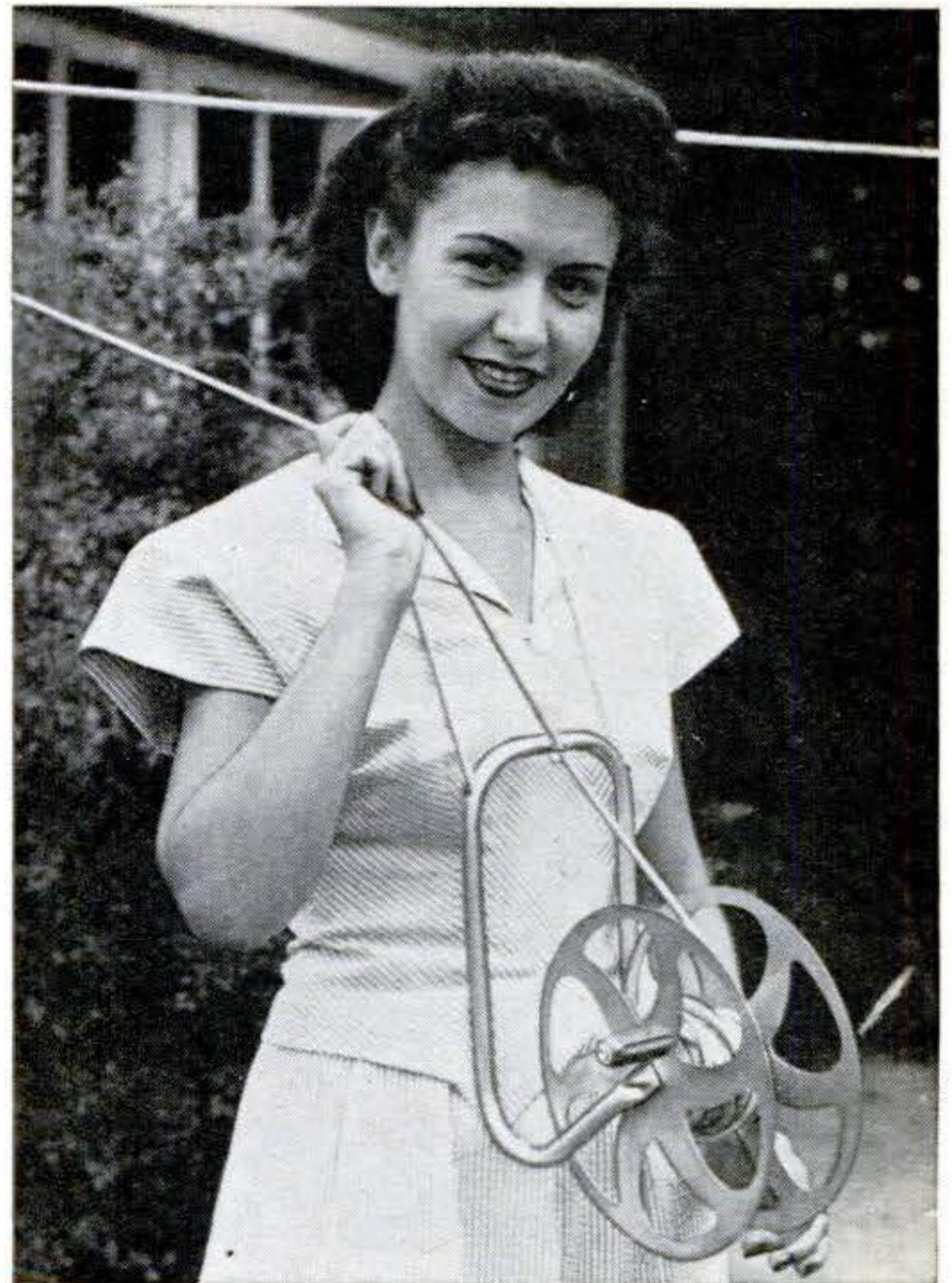

Reel Holds Clothesline. With a Reel-Eze winder hung from her shoulders, this housewife's hands are free for cleaning and pulling taut a laundry line as she puts it up. With a hand crank for winding in the line when being taken down, the reel, made by Bok Machine Products Co., of Ft. Wayne, Ind., sells for about \$3.

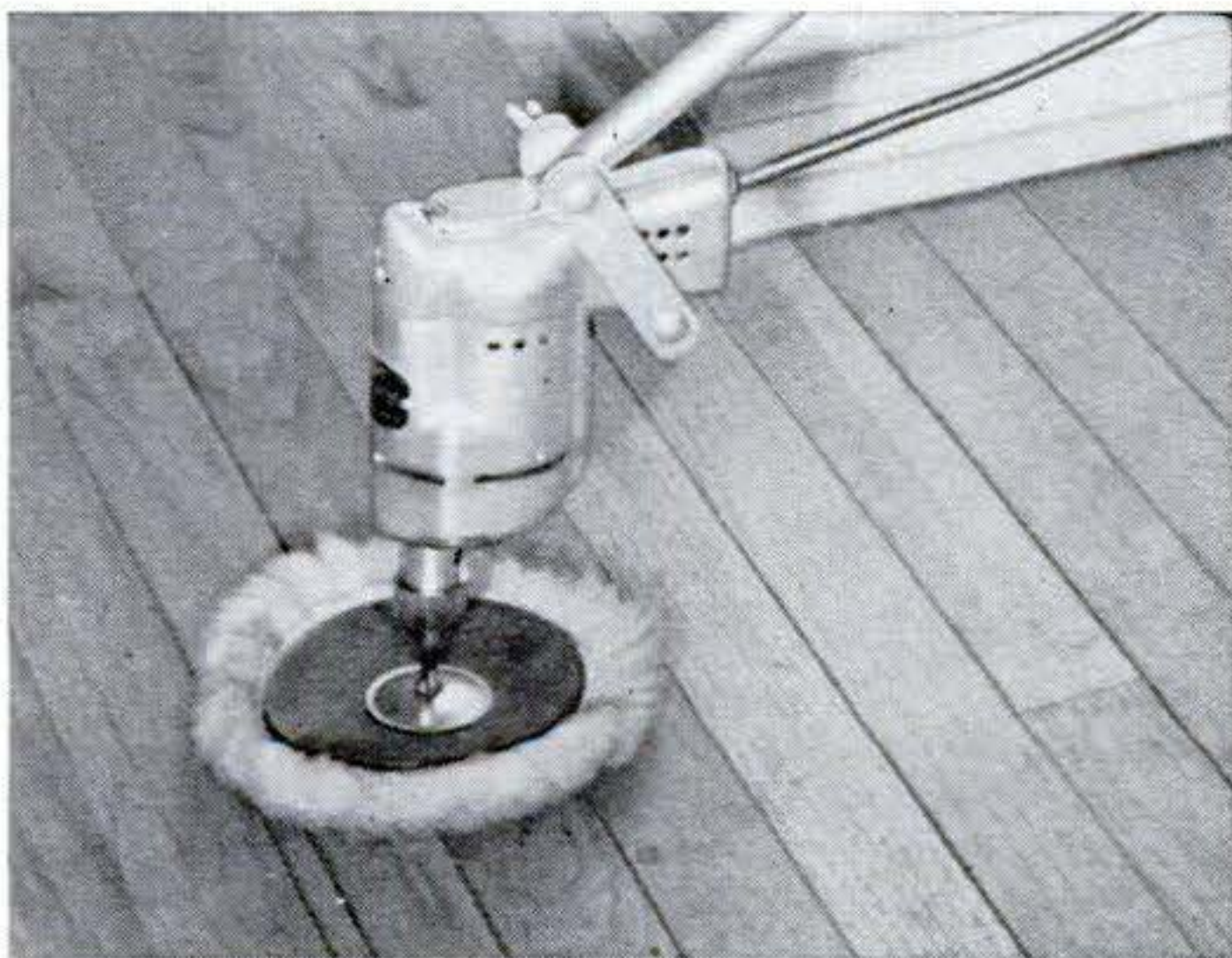

Electric Drill Becomes Floor Polisher. Fit a lamb's wool disk into the chuck of your electric drill, clamp on an aluminum lawnmower-like handle, as above, and you have an efficient floor polisher. These attachments, including a wax applicator, are priced at about \$6 by the maker, the Jonrich Co., of N. Y. and Miami.



Giving a Tube an Easy Squeeze. This handy gadget is a slotted plastic cylinder that fits over the base end of a collapsible toothpaste or ointment tube. A handle enables you to empty the tube completely by rolling it up to force out the contents. The Tube Roll-Up Co., of Toledo, Ohio, makes it in six colors to sell for 10¢.

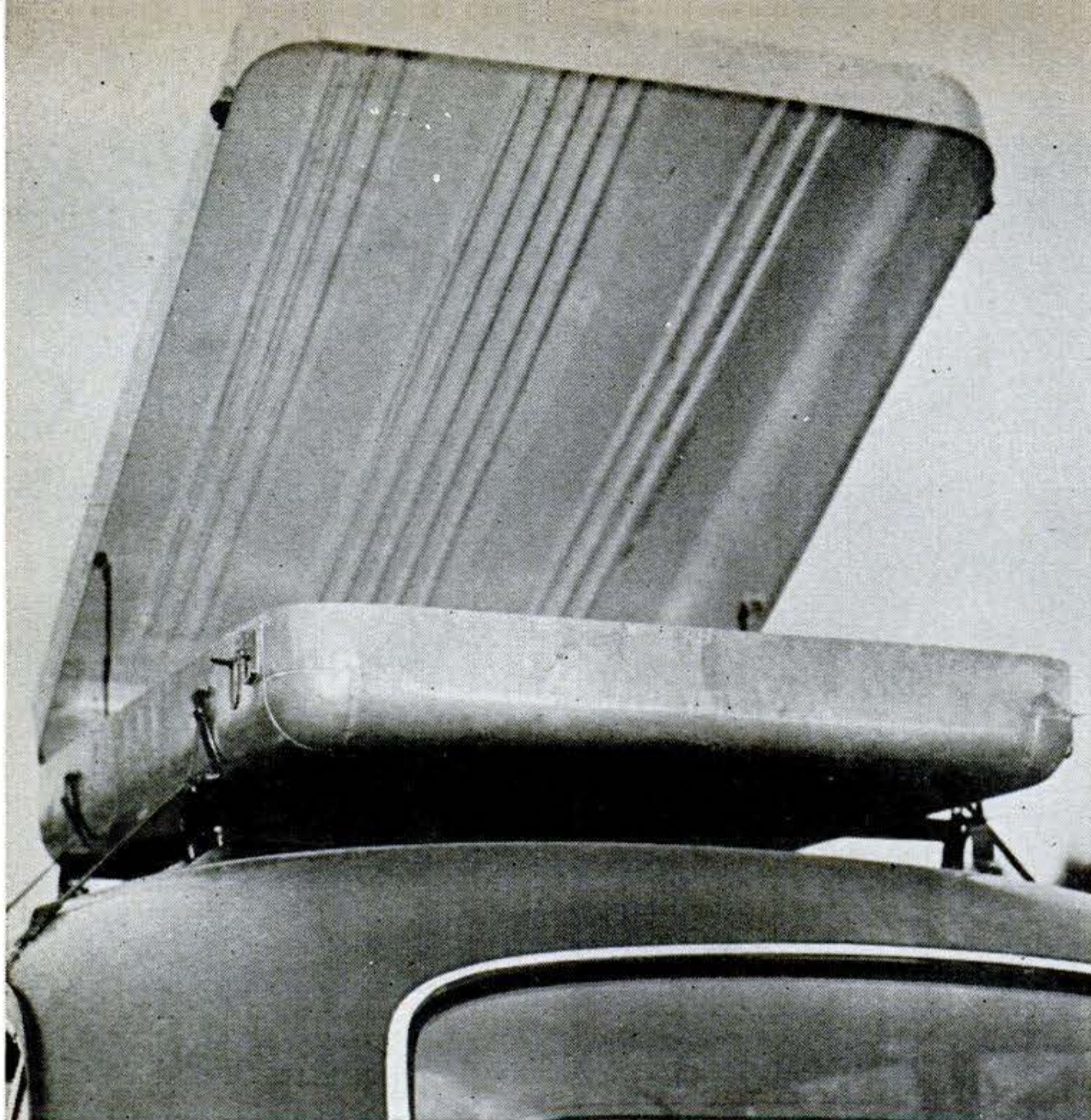

Luggage Carrier. The aluminum case at left gives you an extra 15 cu. ft. of storage space. It is waterproof, held fast by four rubber suction cups, and is sold by Carson Machine & Supply Co., of Oklahoma City, for \$49.95.

For Heavy Loads. Tubular steel bars form foundation of Kardek, below. Neoprene-faced saddles rest load on top's curved shoulders, and turnbuckle clamps anchor it to the eaves. The Miller Mfg. Co., of Detroit, is the maker.

What's New On Car Tops



Bed Carried on Roof. It takes only a minute to remove the portable sleeping unit shown below from its car-top carrier and assemble it into the combination bedroom-tent shown at right below. Sleeping two, the bed has a steel frame, innerspring mattress, a watertight canvas top, and insectproof screening. One Minute Bed-Tent Co., of Council Bluffs, Iowa, makes it.

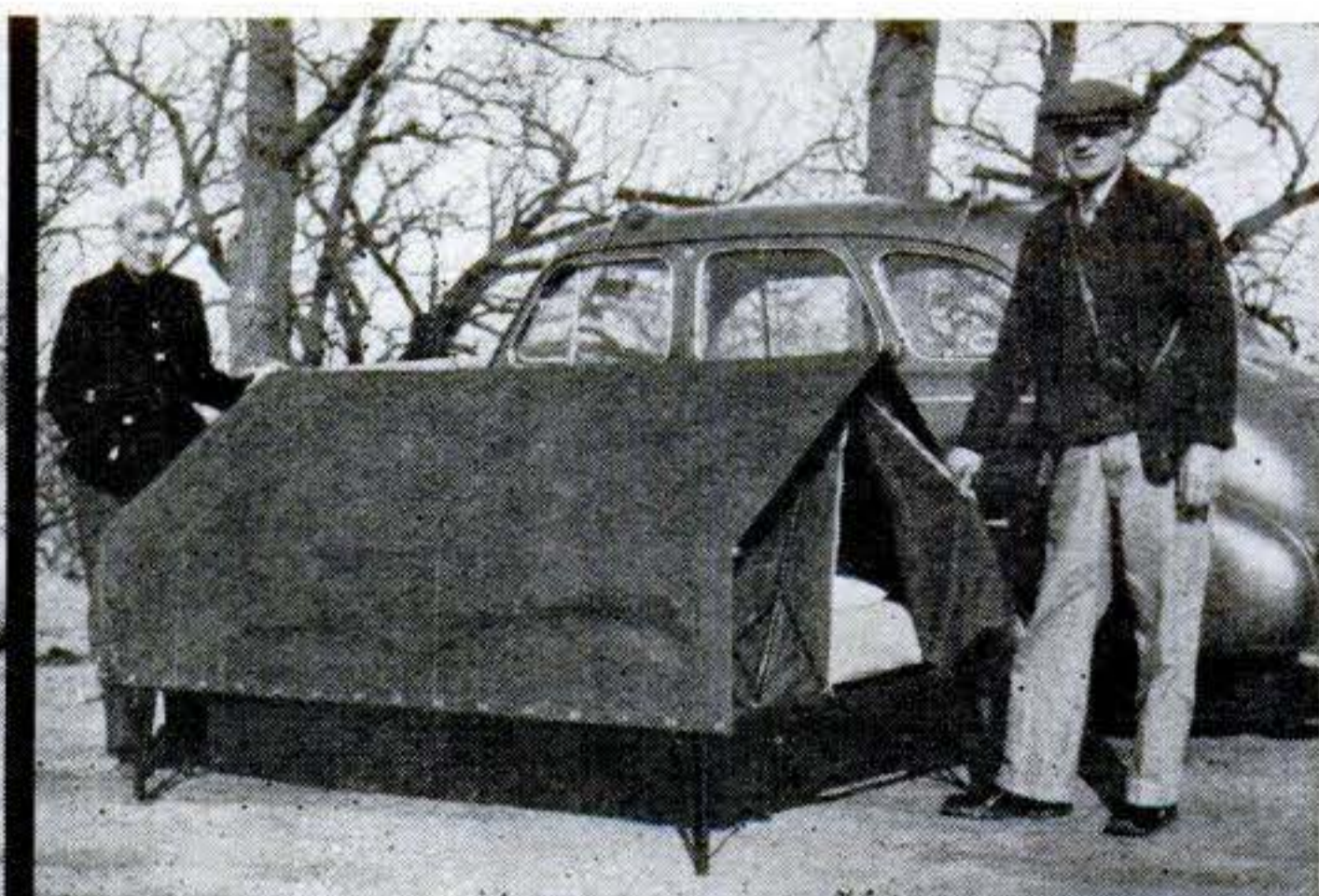
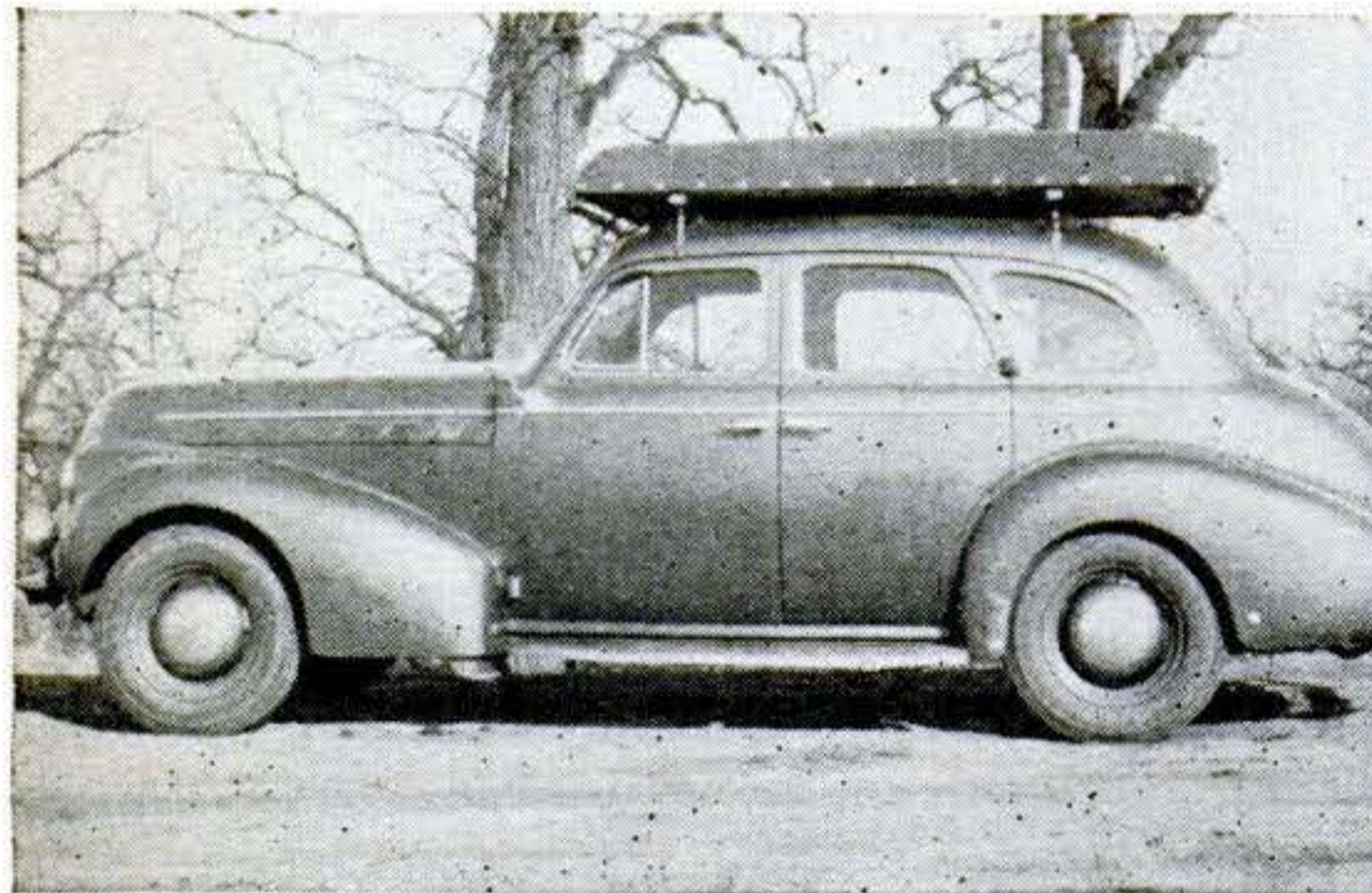

Keeping the Home Shipshape

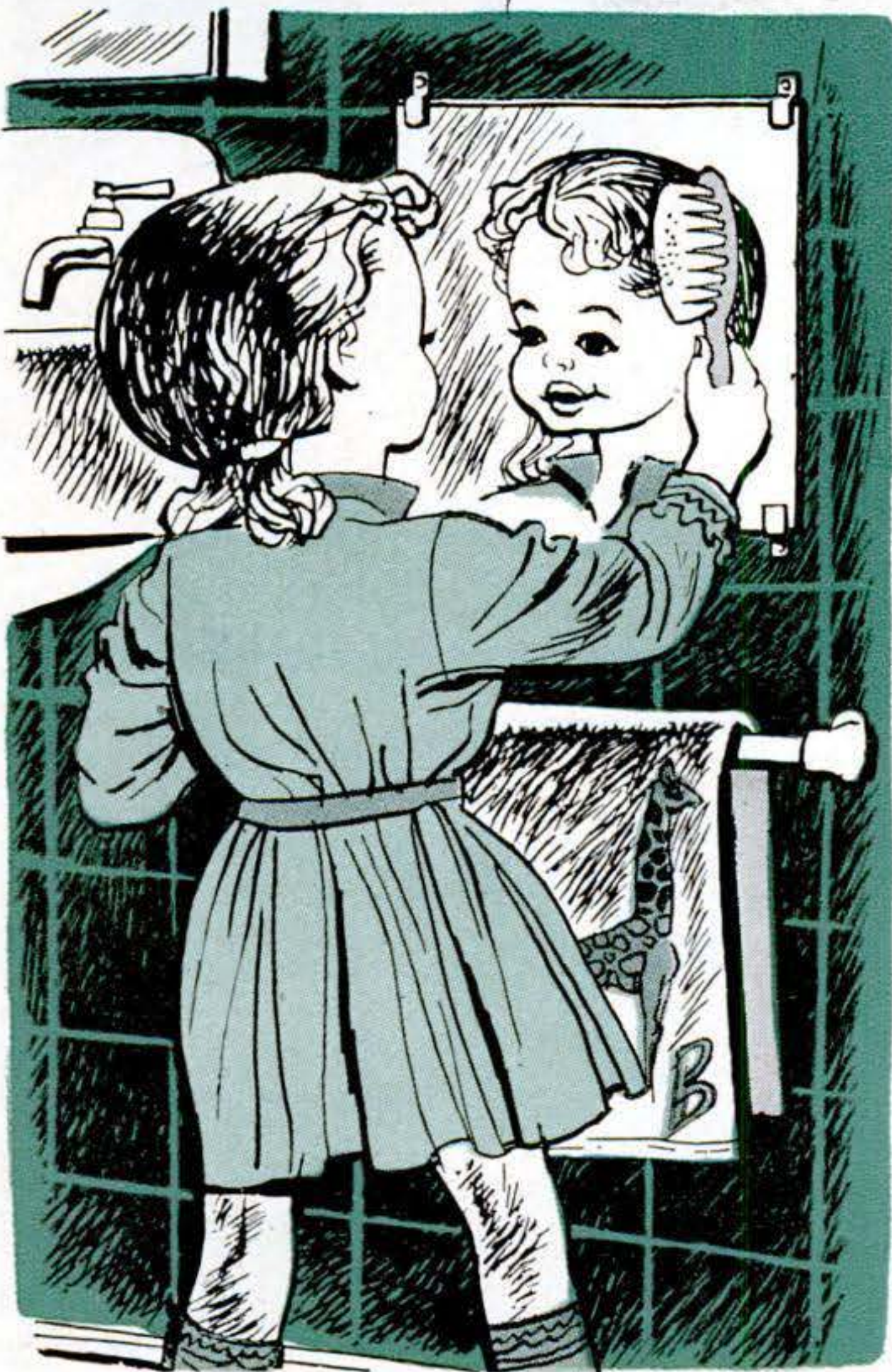

Give little folks big ideas by hanging a small mirror and towel rack in the bathroom low enough for them to use. If the mirror doesn't have holes, attach it with screw clips.

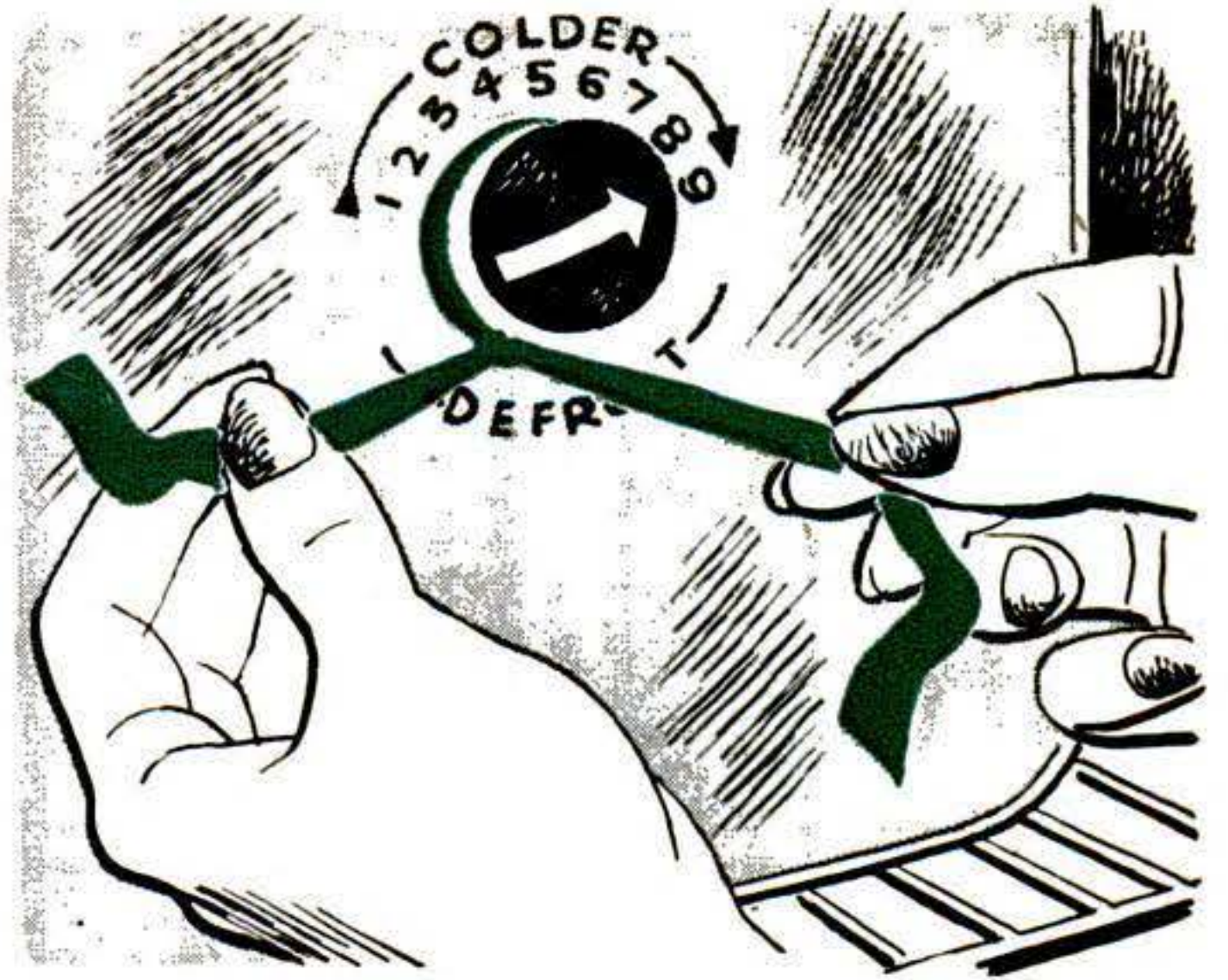

When you make a frozen dessert, tie a piece of bright ribbon to the refrigerator's control knob as a reminder to turn the control back to normal after you've removed the dessert.

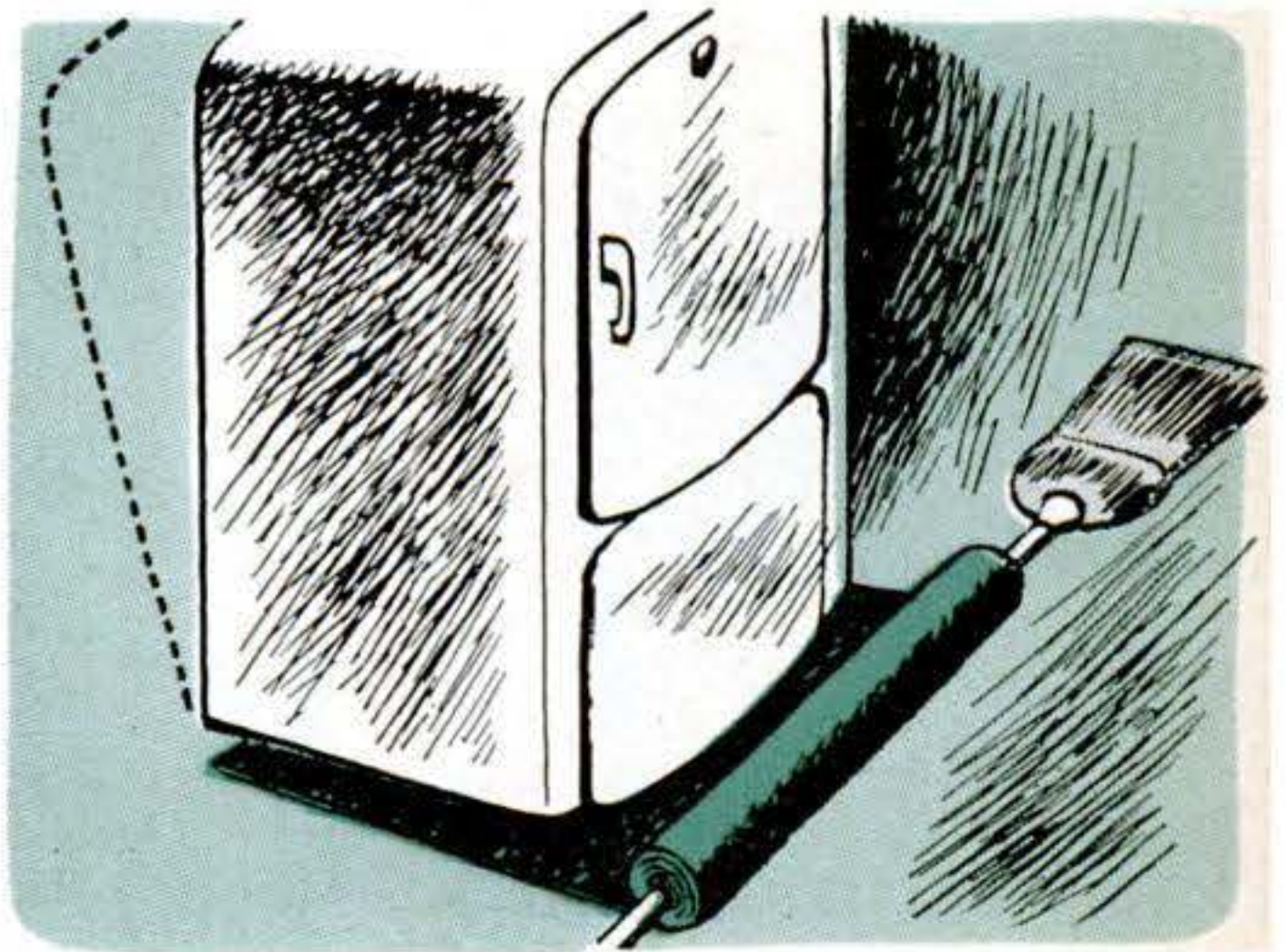

To avoid marring floors, when moving heavy objects, use a throw rug or piece of carpet. Tilt the object back to get the carpet under it. Roll the free end around a broom and pull.

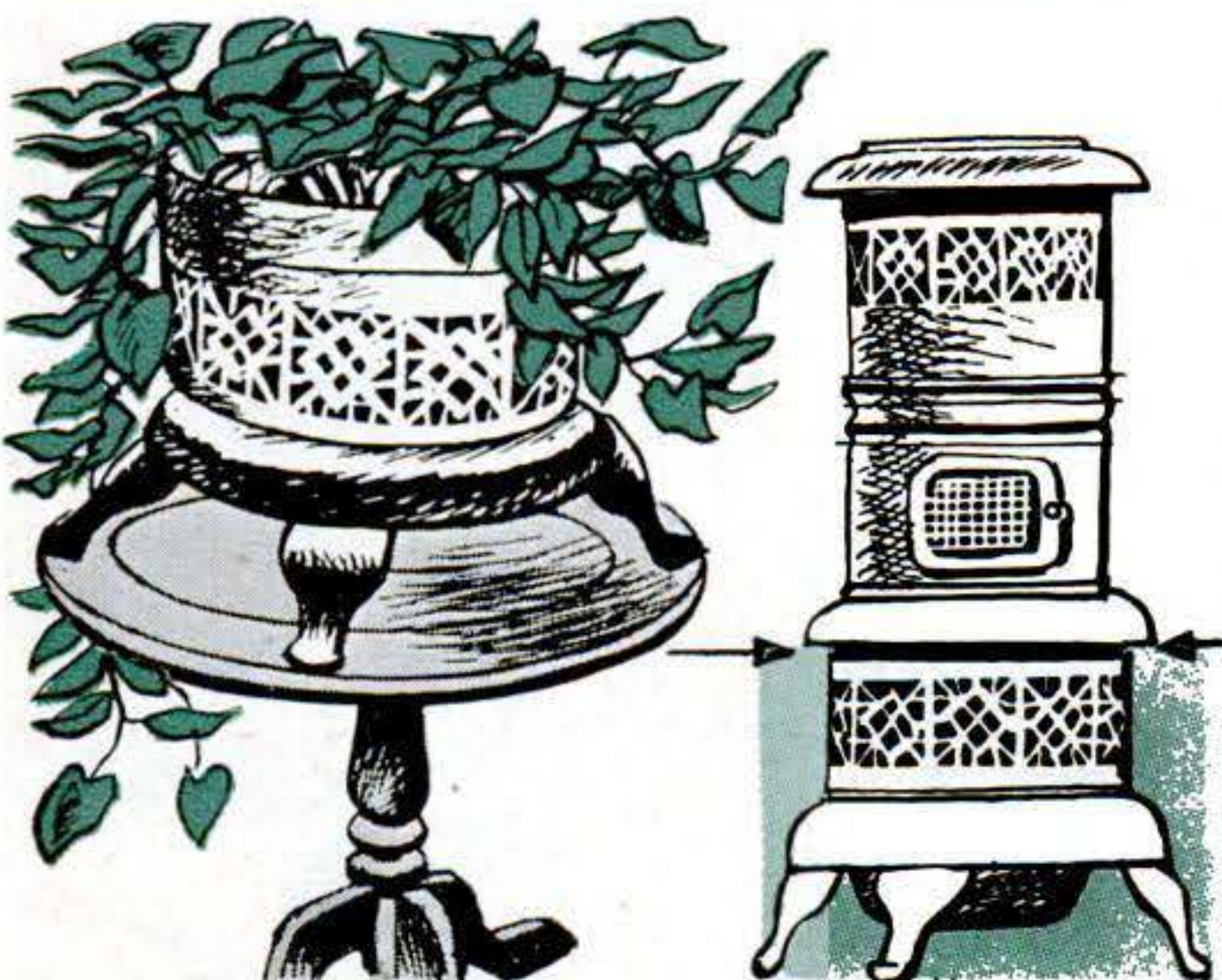

An old oil heater can be made into a flowerpot holder. Remove hinged top part as indicated by arrows in the drawing. Then paint the bottom to match porch furniture.



If you want to bake one potato but don't want to light up the oven these warm months, put a jar top in a coffee can. Put the potato in the jar top, cover, and heat over a burner.

Please turn the page for five more suggestions.

JUNE 1950 173

Keeping the Home Shipshape

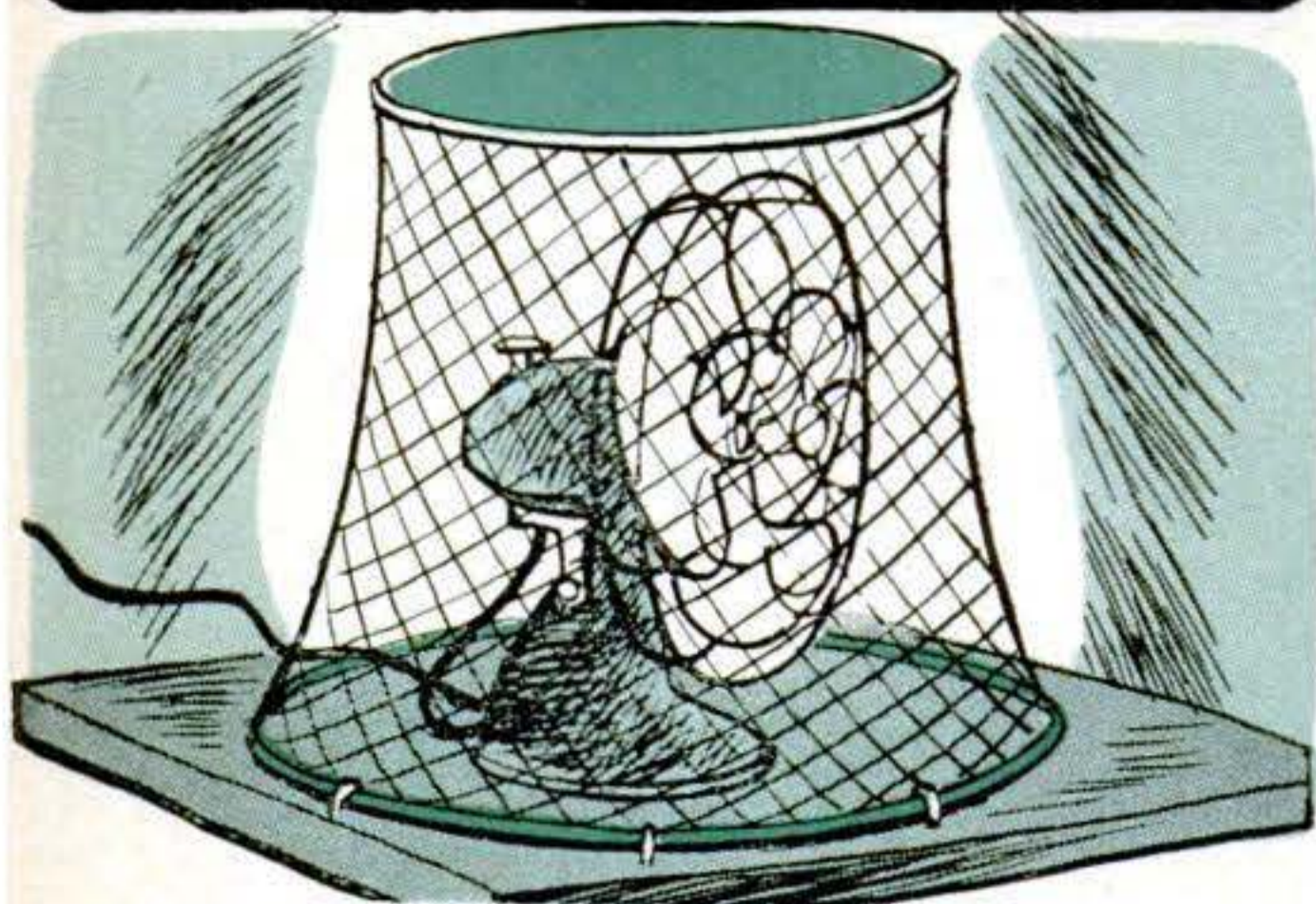

A simple fan guard to protect children can be made with a board—or any wooden surface—and a wire wastebasket. Invert the basket over the fan and staple the rim.

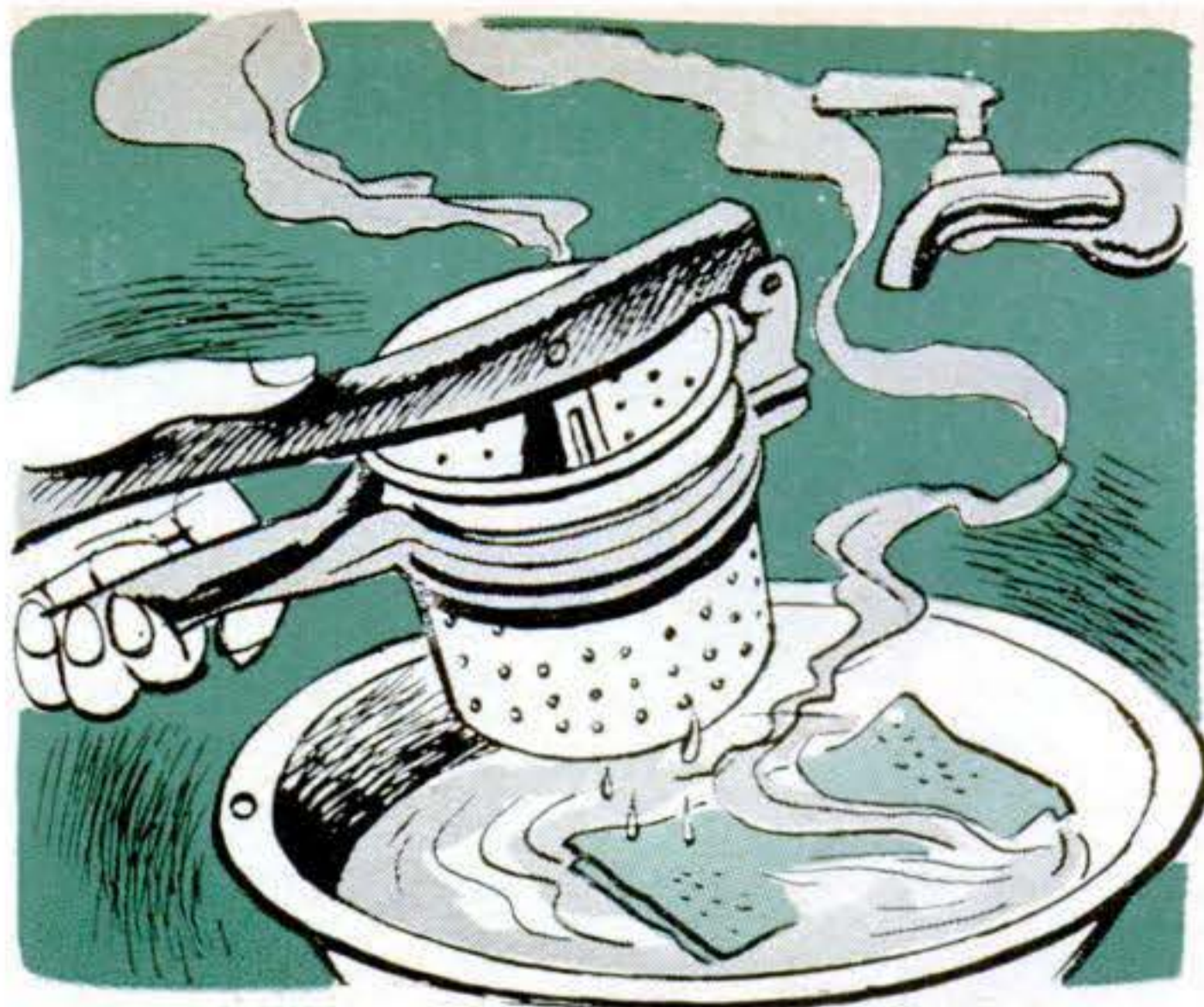

Here's an easy way to squeeze out hot compresses without burning your hands. Use a potato ricer. With the ricer, you can use water much hotter than your hands could stand.



Canned meat will slide cleanly out of the can if you place the can in hot water for a few minutes before opening it. The heat will melt the layer of gelatin or fat next to the tin.

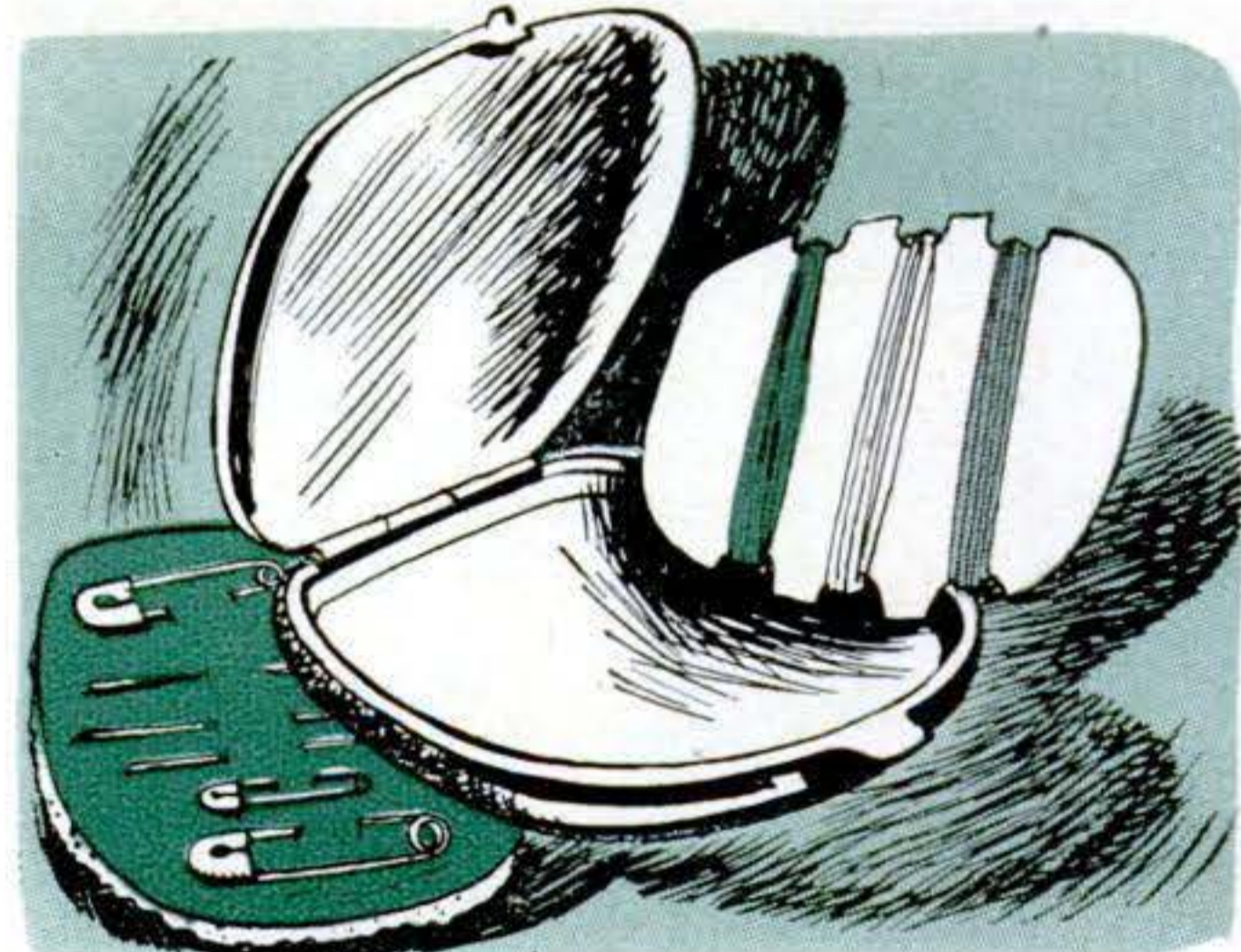

Sewing kit for a purse can be made from an old compact. Remove powder screen and cut cardboard to fit inside compact. Wind thread around cardboard, use puff for needles.



To make gelatin without ice, set bowl of gelatin in pie tin. Put another, filled with water,

over the bowl. Drape a cloth over top tin and into bottom one. Evaporation will do the rest.

Mechanics and Handicraft

REG. U. S. PAT. OFF.

How To:

Paint Your Own House

PAGE 196

Keep the Heat Outdoors

PAGE 206

Identify Plastic Material

PAGE 214

Give Your Voice Power

PAGE 226



Save time and manual labor by rolling your power tools to outdoor jobs

PAGE 190

JUNE 1950

175

Gus Cools



a Hot Engine

By Martin Bunn

A nasty customer gets slow service at Dan's Grille—but unexpectedly quick service and a pair of handcuffs at Gus's garage.

TUESDAYS, during June and most of July, are usually shorter than most days at the Model Garage. Gus Wilson generally goes bass fishing on Wednesdays, so on Tuesdays he likes to close shop fairly early so he can go home, get his gear ready, and pile into bed for an early start in the morning.

At about 6:30 on this particular Tuesday, Stan Hicks was finishing up his last job for the day, and Gus already had started to wash up. This, thought Stan, really would be an early evening.

That, as I say, was about 6:30. At 6:31 Stan wasn't quite so sure. For at that moment, a blue sedan with out-of-state license plates rolled through the open doors, came to a stop in front of the greasing rack,

When the hose popped loose, Gus reached for it and began probing one of the open ends with his fingers.

and a tall, heavy-set man unlimbered himself from behind the wheel.

"The boss here?" The tone of the man's voice made it sound more like a command than a question.

Before Stan could answer, Gus appeared from the rear of the shop. "Something we can do for you?" he inquired. "We were just about to close up for the night."

"Yeah, I've got troubles," the stranger grumbled, jerking his thumb in the general direction of the car. "Just a few miles outside town, the engine started to get hot and sputter. Seemed to lose its power. Just when I'm in a hurry, too. Got no time to waste. Think you can fix it for me right away?"

"We can try," Gus answered, patting his hands with a wad of waste as he looked over both the car and the driver. "Might take time, though, to locate your trouble."

"But I said I was in a hurry!" the stranger snapped. Then, as if a sudden evening breeze had cooled him down a bit, he added, "Okay, but step on it. I'll get some chow. Is there a diner or lunchroom close by?"

After Gus had pointed the way to Dan's Grille—that's one of Gus' favorite eating places—down on the Square, and the man had left, Stan said, "Unpleasant jerk. Why didn't you tell him to peddle his car, his troubles, and his ugly puss some place else 'cause you want to go fishin'?"

"A job's a job, Stan. Besides, those fish will wait for me; they always do. You finish up your job, while I'll see what I can do about tracking down the trouble here."

Gus slid into the driver's seat and started the engine. Stan could see him checking the gauges on the dash. Then he walked around to the front of the car and lifted the hood. The V-8 engine looked particularly clean. Next, he unscrewed the radiator cap. 

"Water seems to be circulating," Gus muttered to himself. "Might know it wouldn't be something simple to put your finger on." He touched one of the cylinder heads. It was considerably hotter than it should be.

Slowly and methodically, the veteran garageman proceeded to check the normal things that are apt to cause an engine to overheat and lose power—a slipping fan belt, wrong ignition timing or mixture, poor spark plugs, even low oil level. Everything seemed to be in fair shape. The timing was a little out, but not enough to cause much trouble.

When Stan finished with the car he'd been working on, he walked over to the blue sedan. Gus' head was deep inside the hood. He had a trouble light and was going over the engine carefully.

"What's the matter, boss, this car got you stumped?"

Gus straightened up and flicked off the light. "There's more than one thing about this car that's got me stumped," he answered.

What Else Is Wrong?

For a moment neither man spoke. They both just stood there thoughtfully looking down at the engine. Gus was leaning over, his right hand resting on the nearest of the two hoses that led from the tops of the cylinder heads to the top of the radiator.

Suddenly a big grin began to spread across his face. He squeezed the hose with his fingers.

"If it had been a snake it would have bitten me," Gus chuckled. "Stan, I think if you'll drain the radiator and take off that right-hand hose you'll find our trouble. While you're doing that," he added, after a look at his watch, "I've got to make a phone call. If you need me, just sing out."

Service with a Smile

That guy is just too good natured, Stan thought as Gus disappeared into the garage office and closed the door. Probably phoning Ed up at the lake to tell him he'll be late tomorrow, and all on account of some out-of-towner who barges in here at the last moment and wants on-the-spot service.

Stan took his time moving another car from the drain hole and setting to the job. By the time Gus came back, the last of the water was just dribbling out of the bottom of the radiator and Stan was attacking the hose clamps with a screw driver.

"I'll have it off in a jiffy," Stan reported.

When the hose popped loose, Gus reached for it and began probing one of the open ends with his fingers. In no time, he had succeeded in pulling out what looked like a cylinder of metal.

"Thermostat," Gus announced, holding it

Key Holder Times Parking

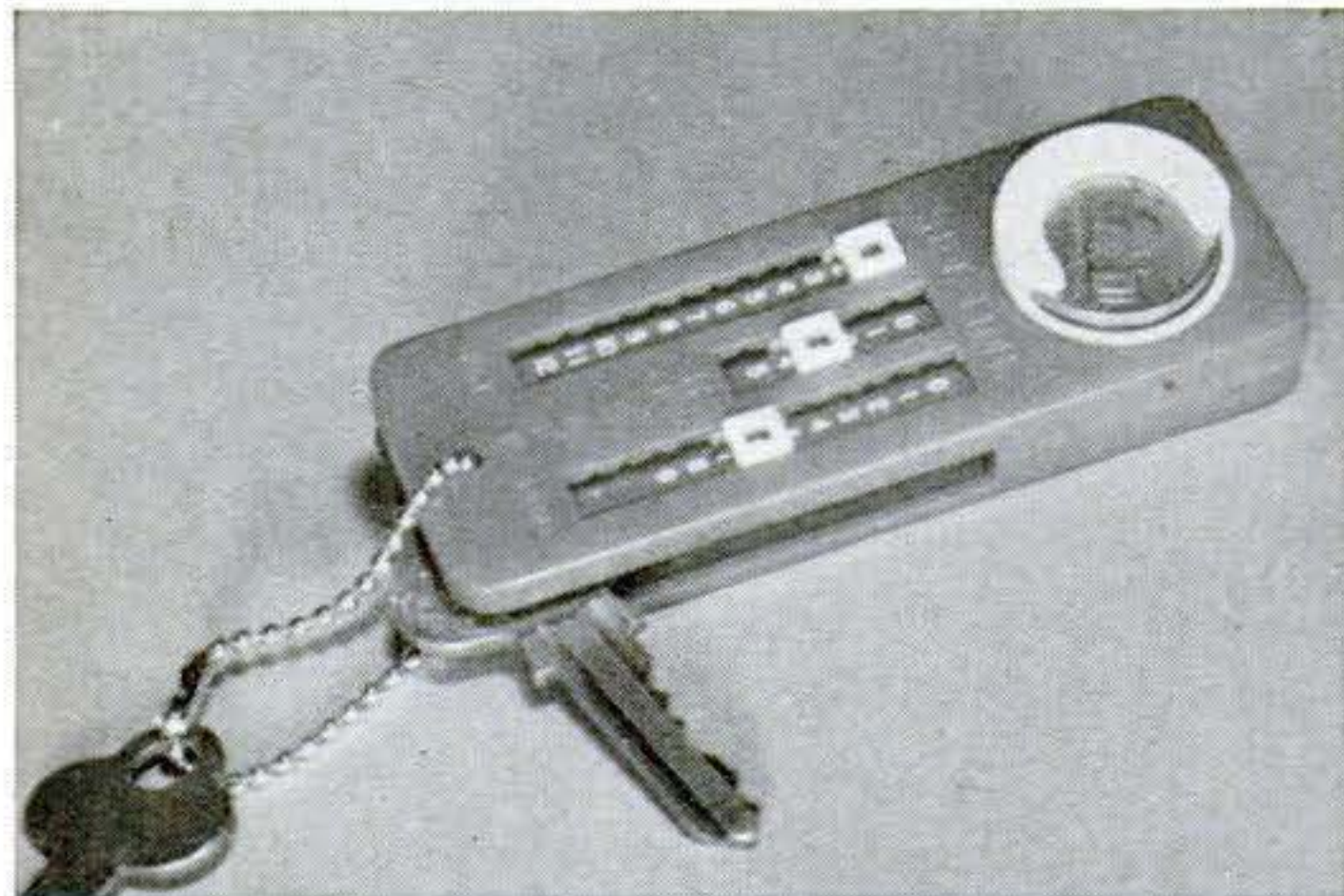

THIS novel plastic key container reminds you when your parking-meter time has expired. Simply adjust the sliding indicators along each of the three columns of figures to any predetermined time of the day. Top column represents hours; the middle one, units of 10 minutes; and the bottom one, minutes. The Park-Aid Key Kit, made by W. B. Youhon, of Wilkes-Barre, Pa., also has a handy small-change coin bank.

Hand Signals Visible at Night

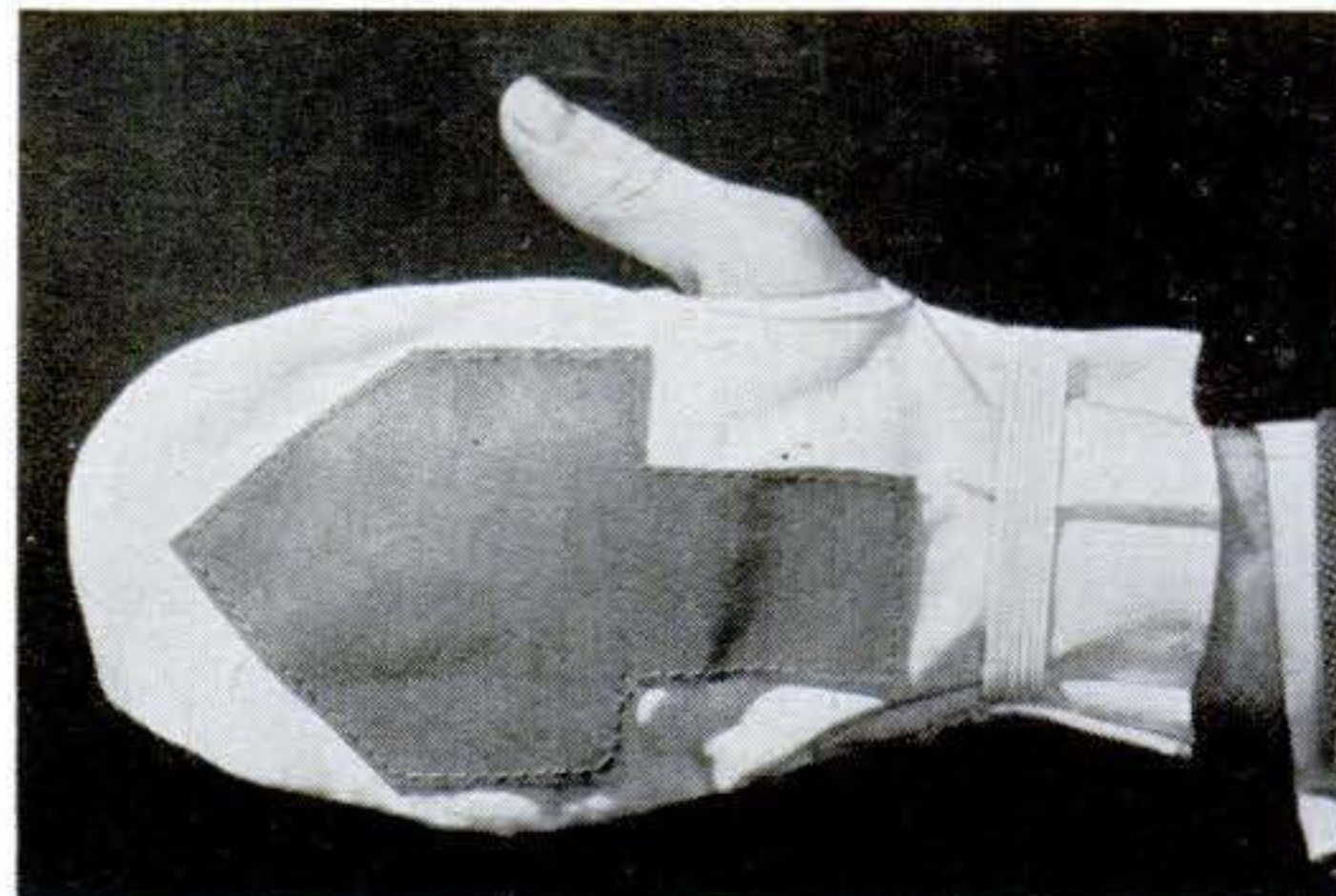

A DRIVER'S hand signals are spotted quickly at night with this soft, flexible thumbless mitt that fits loosely over the hand, but is held securely by an elastic band. A bright red arrow on the back and white arrow on the palm are made of special light-reflecting material, like that used on many road signs. Available in three sizes, the mitts are priced at \$1 each by the Nite-Signal Mit Co., Hollywood, Calif.

up for Stan to see. "Or at least part of one. There are two thermostats in these V-8s, one mounted in each of the two water outlet fittings that extend up from the cylinder heads. From the looks of things, this one got badly rusted and came loose. Water pressure forced it up into the radiator hose where it jammed and shut off most of the water circulation to that bank of cylinders.

"See if we've got a replacement in stock, Stan," Gus added. "I'll remove the water outlet fitting and cut a new length of hose."

Working together, it didn't take them more than about twenty minutes to install a new thermostat and the new length of hose. When they had finished, Gus looked at his watch.

All This and Timing Too

"Our man won't have reached dessert yet," Gus said. "Might as well do the job right and adjust the timing while we're at it."

Stan was just about to make some comment about doing so much for a peevish stranger they'd probably never see again when the office phone rang.

"I'll get it," Gus called as he hurried toward the office door. "Probably for me anyway."

Stan was fussing with the timing when Gus came back out of the office. What he saw next was hard to believe. Gus picked up a cloth and began wiping the car down.

"Pretty dirty," Gus offered in way of explanation. "Might just as well give it a good dusting while we're waiting. Nothing like a little extra service for a friend."

"Friend?" Stan grunted. "Why that guy wasn't even civil."

"Did seem that way," Gus answered with a grin, as he went right on with his cleaning job, even to spraying the windows and the windshield and wiping off the hub caps.

Best Is None Too Good

Stan couldn't figure out Gus's desire to give so much extra service to someone who obviously was just a one-time customer and a not-too-pleasant one at that. However, he'd worked for the gray-haired mechanic long enough to know that he usually had a good reason for just about everything he did.

Stan had just closed the car's hood and was rolling the engine analyzer back to the bench when the bulky stranger strode through the open doors.

"My car ready?" he barked as he came in.



"Just finished with it," Gus replied. "We had to put in one new thermostat and adjust the timing. That'll be \$8.75 for labor and parts."

"What?" the man bellowed belligerently. "\$8.75? I didn't expect to have to pay for an engine overhaul."

"Take it or leave it," Gus shot back.

"I'd sure like to leave it if I could," the man continued to grumble. Then, reluctantly, he dug down into his pocket, pulled out a wad of bills, and peeled off a crisp, new ten. "I haven't the time to argue. Give me my change and I'll get out of here."

"Did you just buy this car secondhand?" Gus asked as he slowly counted out \$1.25.

"What business is that of yours?" the fellow snapped.

"None, but it's plenty of mine," put in a new voice.

As the man spun around, he bumped smack into Sergeant Jerry Corcoran who had come quietly out of the office.

Quickly, the stranger made a dart for the door only to tangle with Gus's out-thrust foot and go sprawling on the floor. Jerry was on him almost before he hit.

"Nice work, Gus," Jerry said as he snapped a handcuff on the man's wrist. "Wouldn't be surprised if we find more than car snatching on this guy when we begin" ▶

checking up. In any case, he won't be around for awhile."

Stan just stood there bewildered as Jerry led the stranger out the back door to a white squad car where another trooper was waiting. Finally, he said, "Will you please tell me what the devil this is all about? If you knew the car was hot and the fellow

Robot Collects Parking Fees



THE hands at left are those of a driver making use of the Self-park system to park his car in an unattended parking lot. After placing a coin in the slot and pulling down on the knob, the driver takes the numbered ticket that comes out and at-

taches it to his steering wheel. One attendant can check many lots daily to make sure each car has that day's tag hung on it. Stanford Research Institute, Stanford, Calif., engineered the machine.

Change Wheel in 10 Seconds

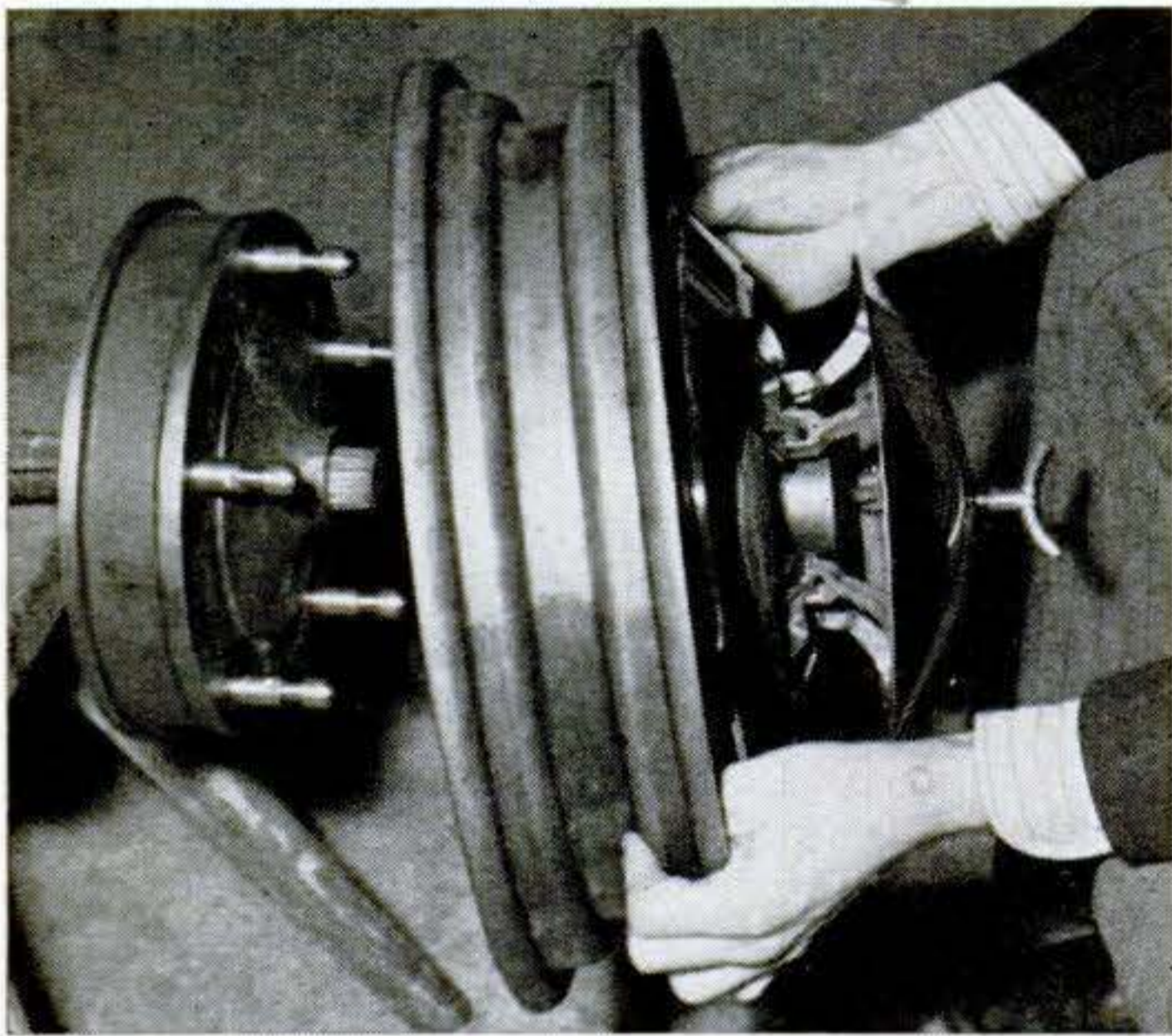

CHANGING auto wheels will become a simpler and speedier job if a new fastening device lives up to the claims of its inventor, Lothar Stanetzki, of Bonn, Germany. Five threadless bolts on the brake drum enter holes in the wheel, as shown above, and are grasped securely by five plierlike levers that are locked by pushing in on the hub cap. The gripping action is said to increase with the motion of the wheel.

was a crook, why did we do all that work?"

Gus laughed. "I just didn't want Jim Fleming to have to pay for those repairs," he grinned.

"I still don't get it. Who is Jim Fleming?" asked Stan.

"He's an old friend of mine, and the owner of this car," Gus explained. "When Jim lived here in town I used to see quite a lot of him. About a year ago, Jim and his family had to move over to Brighten and I hadn't seen either Jim or his car again until tonight.

Something Familiar Here

"It's funny, but the minute I started working on that engine," Gus continued, "I had a feeling I'd worked on it before. Then I happened to notice something—a welded brace on the generator support. I remembered I'd done a job just like that on Jim's car just before he'd left. So, I played a hunch. I made a note of the motor number and put in a long-distance call to Jim. I had no idea of his address, or whether he was still in Brighten, but the operator located him for me.

"He didn't know whether his car had been stolen or not. His wife had both the car and the license. He hadn't the slightest idea of what the motor number was; that was on the license. He said he'd try to locate his wife and call me back. When he did call back, everything checked, including the motor number. Seems his wife had parked the car in downtown Brighten and left the keys in the ignition. When she discovered the car was gone, she went right to the Brighten police without letting Jim know. They put a description of the car and the license number on the police teletype, but our pal had switched license plates.

"After I'd talked to Jim the second time, I called the State Police Barracks and tipped off Jerry Corcoran."

Waiting at the Plate

"But," put in Stan, "how did you know our friend wouldn't get back here ahead of time and mess up your little plan?"

"Elementary, Dr. Watson," Gus explained with a grin. "I just called Dan and told him to give our customer the slowest service that Dan's Grille ever served up."

"Okay, Boss," Stan grinned. "Tomorrow we'll have a new sign made: 'Model Garage—Sherlock Wilson, Prop.—Auto Repairs and Crimes Solved'." END



Hints from the Model Garage

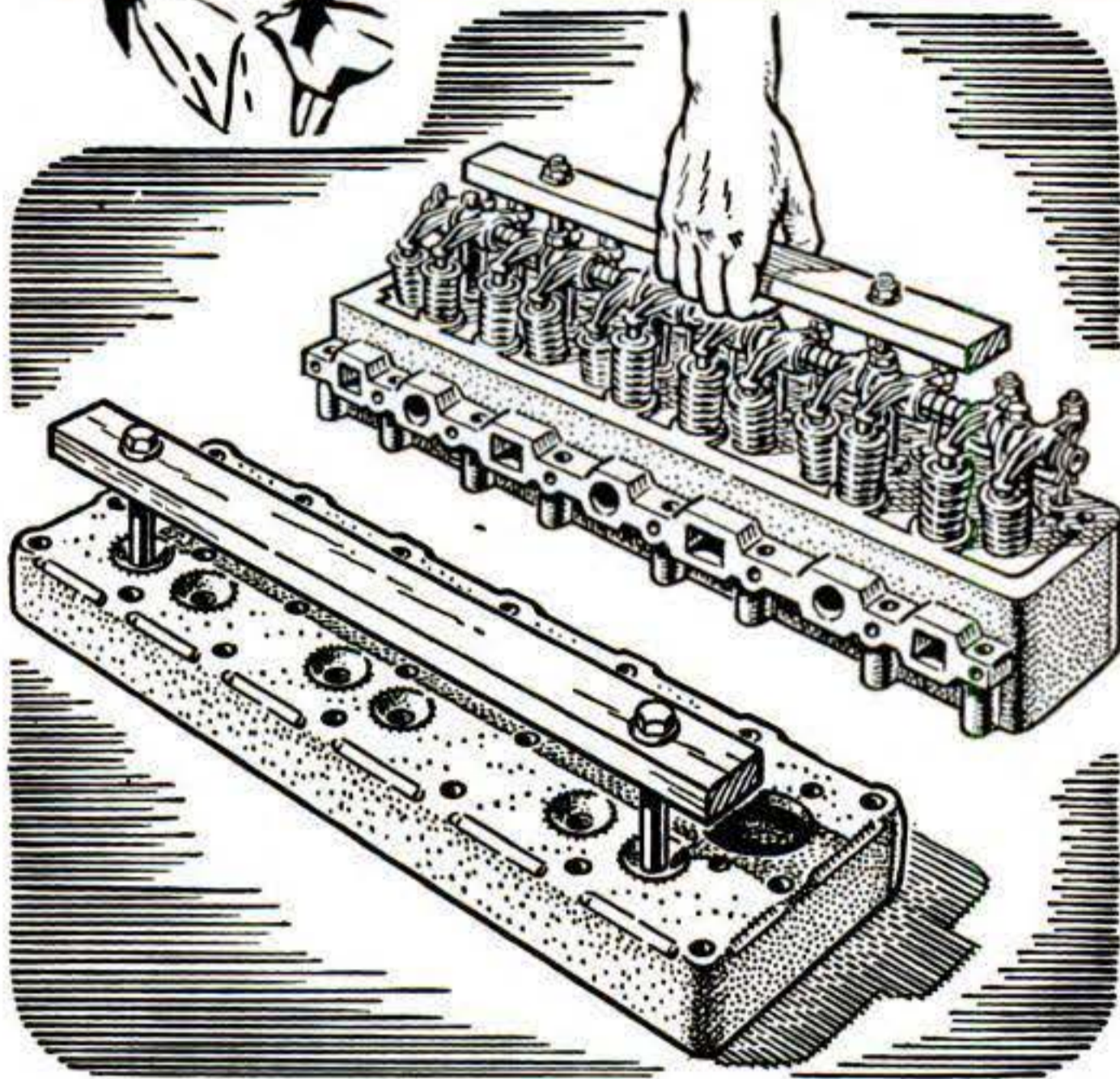

Lifting an Engine Head. A cylinder head is always a clumsy object to handle. A wood lifting bar makes the job easier. For an overhead-valve engine, drill holes in the bar to suit the studs that hold the rocker-arm cover. For a big L head, run bolts through properly spaced holes and thread into the end spark-plug holes.

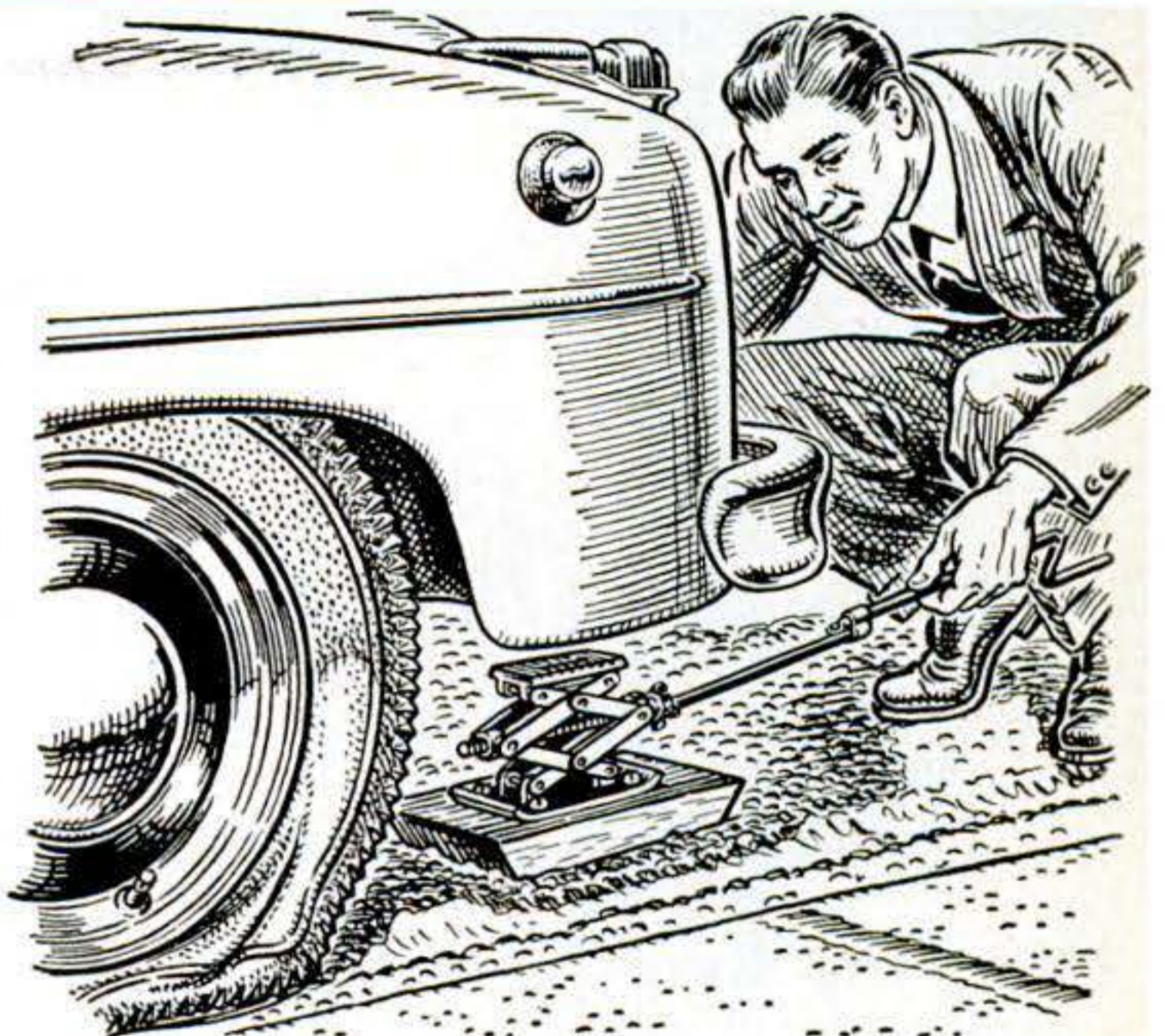

Block Keeps Jack Stable. Most jacks tend to tip over while being cranked up to the axle or jack pad. To prevent this, Clinton B. Casler, of North Westport, Mass., drilled four holes in the base and attached a block of wood to it with screws. Such an enlarged base also gives the jack a firmer footing on soft ground.

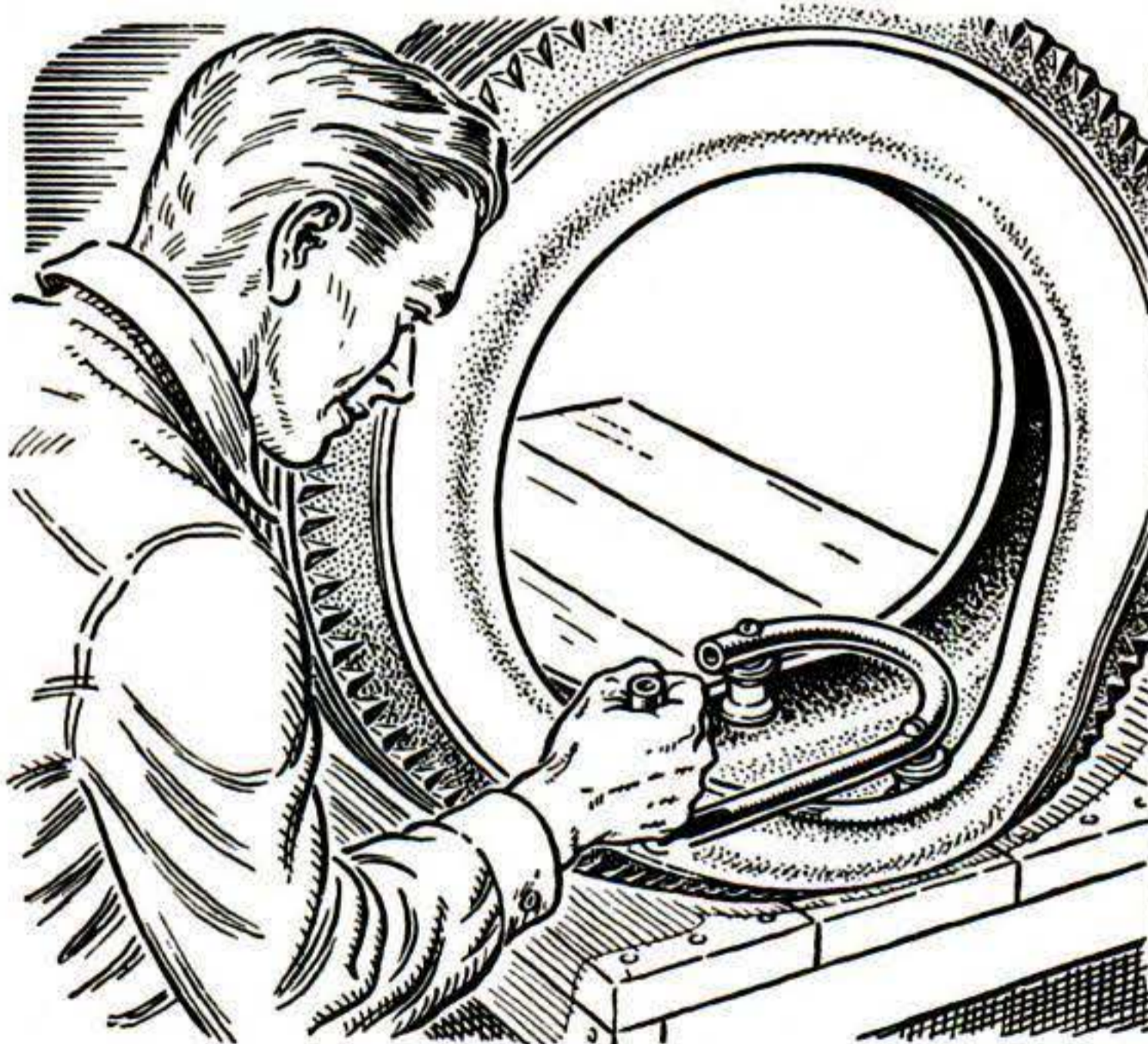

Tire Spreader from Scrap. If you run a repair shop, the convenience of this tire spreader will soon pay for the trouble of making it. Cut a piece of water pipe to 28" length. Bend one end to a 9" arc. The excess serves as a handle. Mount

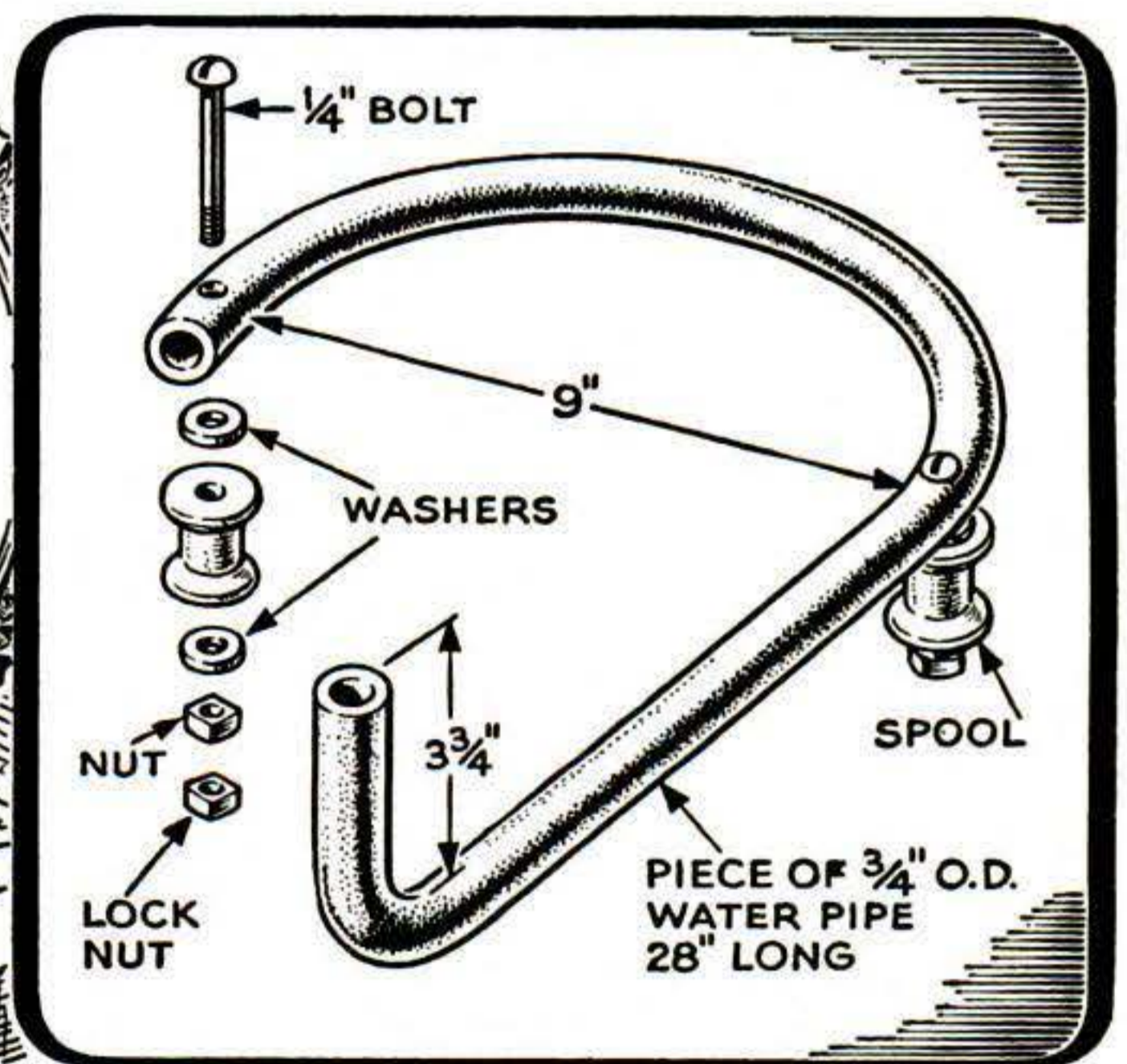

two thread spools in the locations shown, leaving them free to revolve.

To use the tool, insert the spools into the casing, allowing them to rest against the bead on opposite sides. To spread the casing, move the handle inward.

Turn the page, please, for three more auto hints

JUNE 1950 181

MORE Hints from the Model Garage

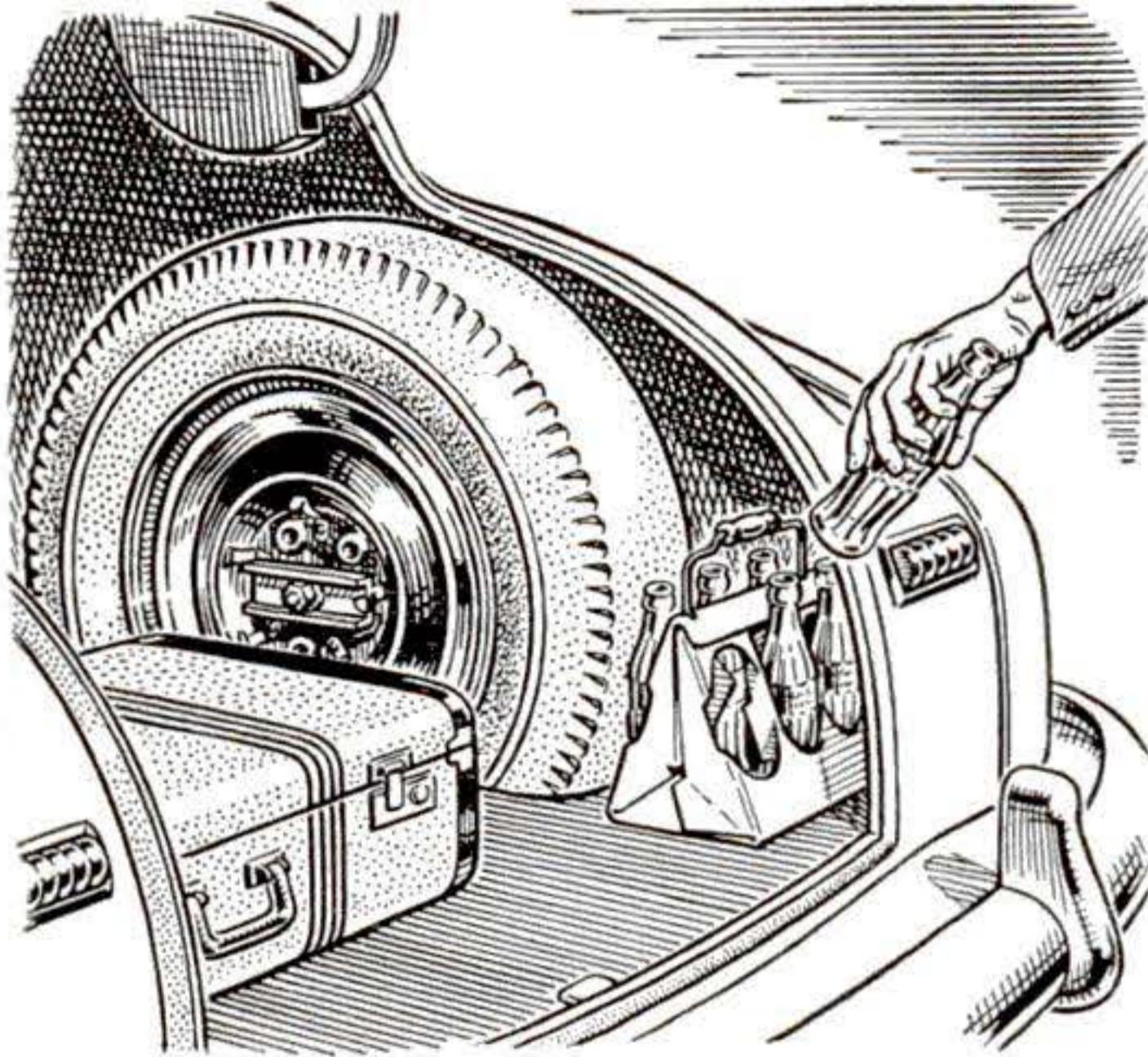

Carrying Empty Bottles. If you consume a lot of cold drinks while traveling during the summer, you're apt to collect quite a few deposit bottles. To store these, keep a 6-bottle carry carton in the trunk compartment and they won't rattle around.

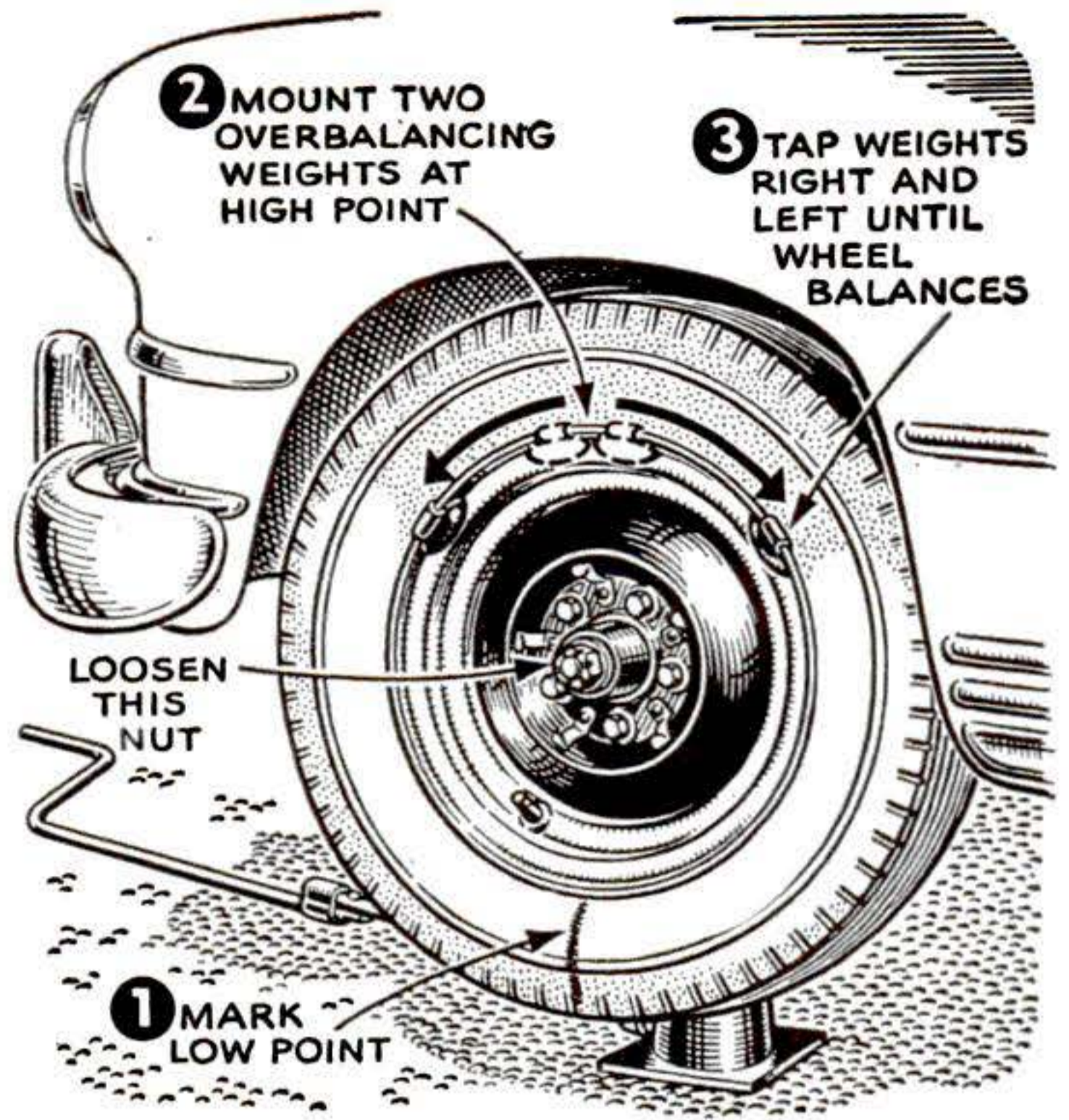

Balancing a Wheel. Paul L. Brat-ain, of Azusa, Calif., suggests you mount the wheel in front, loosen the bearing nut, and spin it to find the low (heavy) point. Then proceed as shown. At the high point, the weights must overbalance the low side.

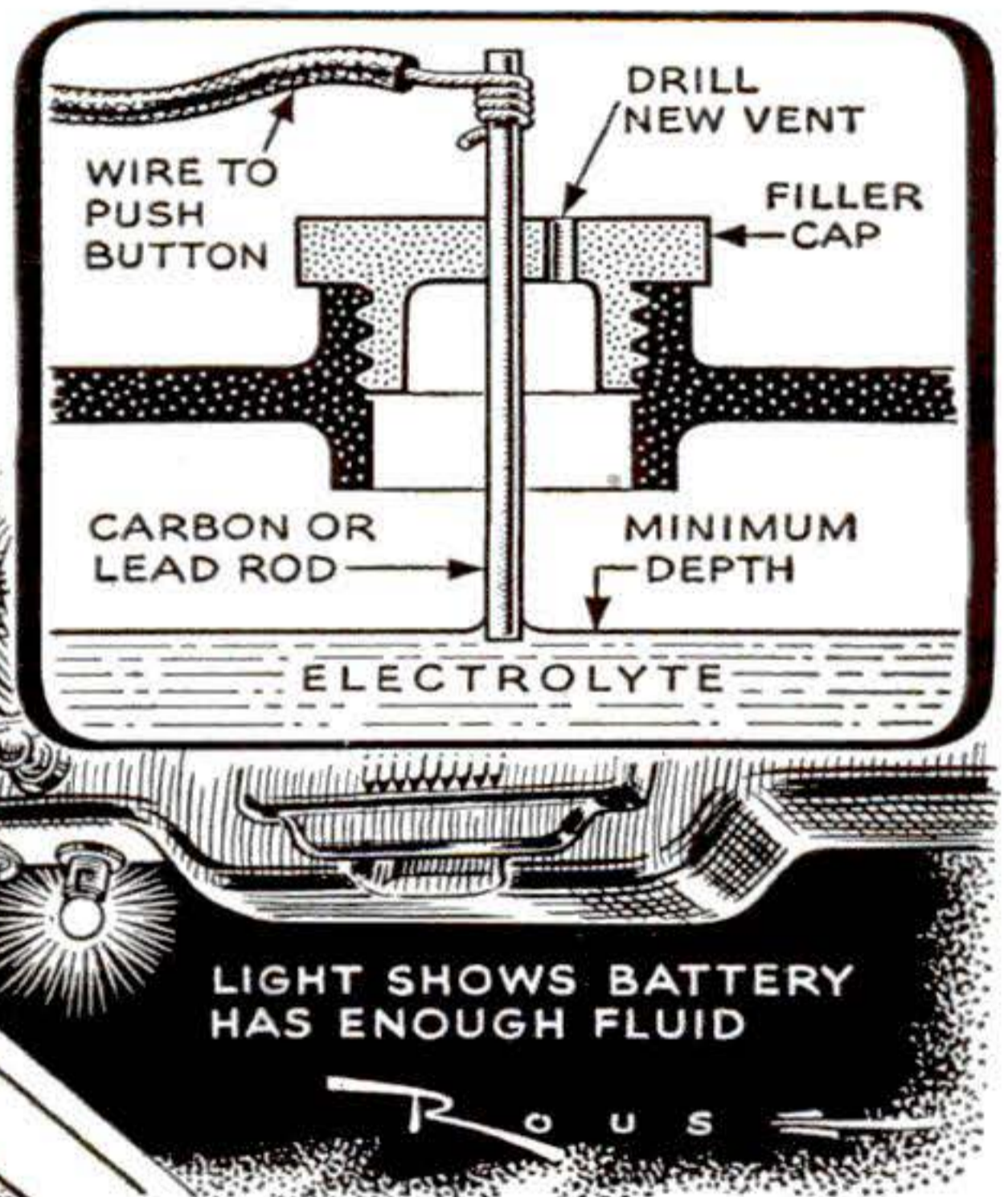
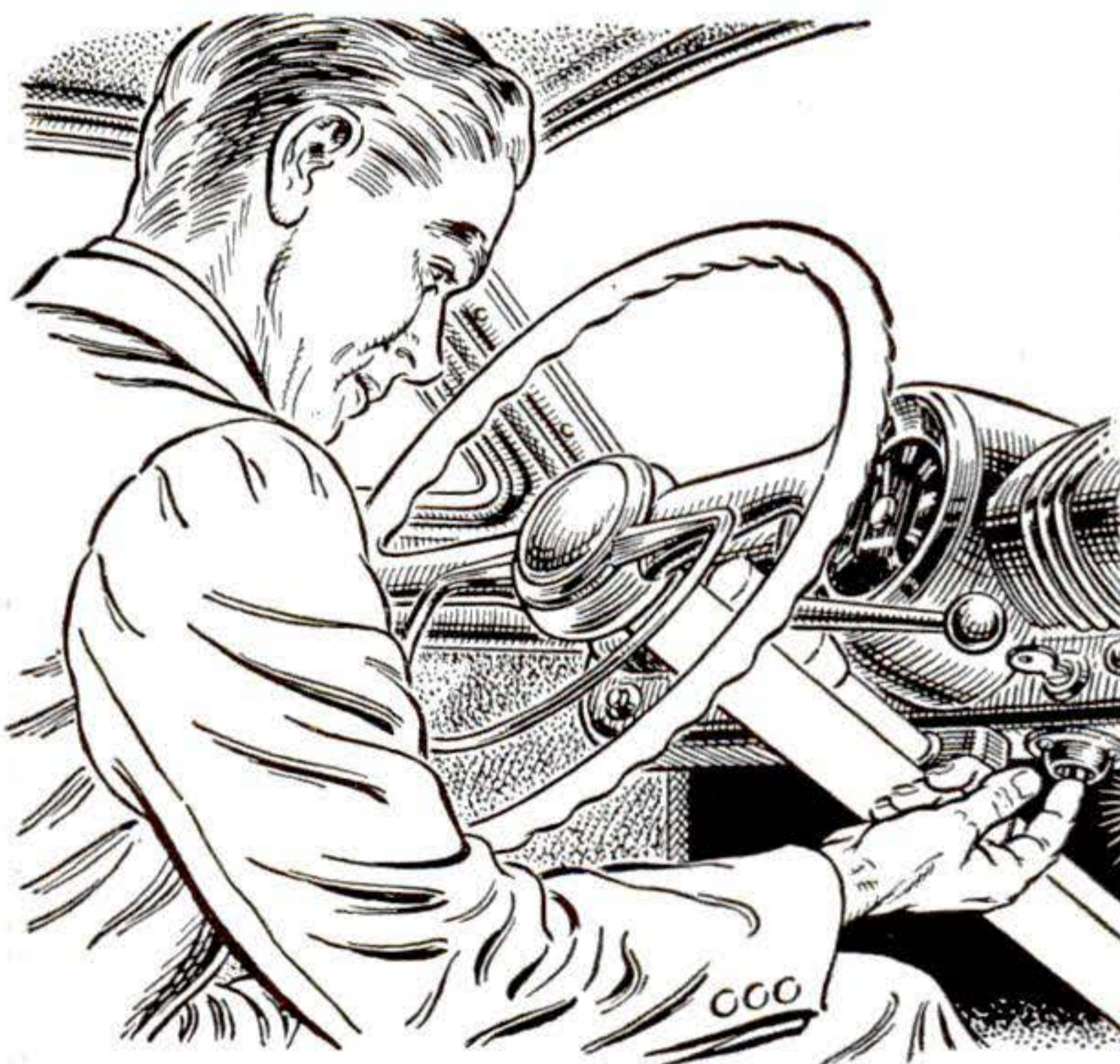

Light Checks Battery Level. To keep tabs on his battery electrolyte level during long, hot drives, Lawrence Avery, of Washington, D. C., installed a system like this. When you press the button, the bulb lights only if the fluid is still up.

You can rig such a system by mounting and grounding a 4-volt bulb on the dash.

Connect the other bulb terminal through a push-button switch to a carbon or lead rod set in the filler cap nearest the ungrounded side of the battery. When the electrolyte level falls below the rod tip, the light circuit is broken.

As a precaution, keep the electrolyte level a little higher in the other two cells.

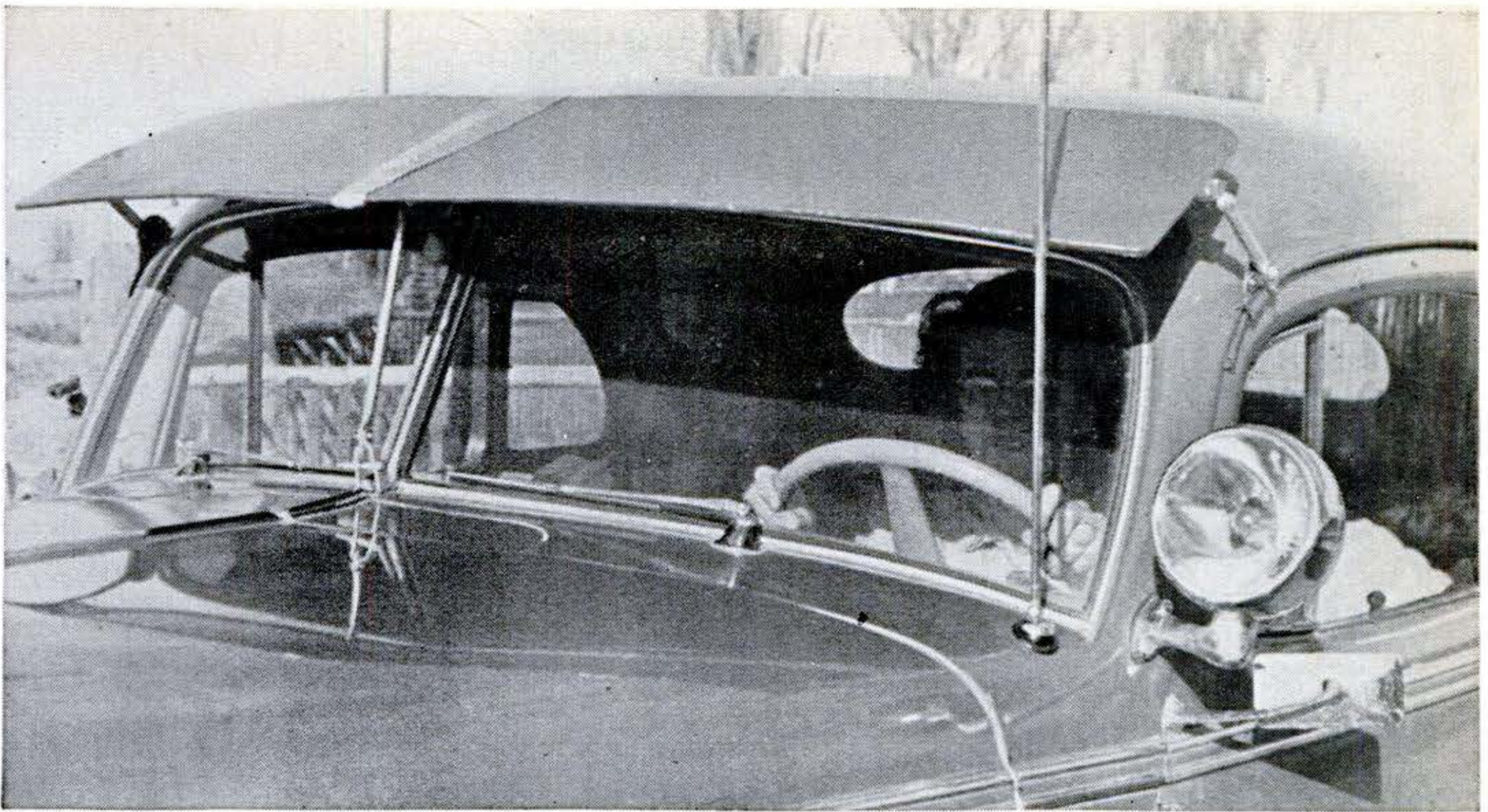

When mounted, aluminum visor compares favorably with a commercial job—and costs less.

Homemade Visor Costs Only \$4

By Roland Cueva

THE day I installed my aluminum visor, a friend wanted to bet it was too flimsy. I wish now I had taken the bet. Months later, the visor still is rigid. It has not shown the slightest sign of a wobble.

Even if you buy all materials, a visor like this usually can be built for less than \$4. Material at hand may reduce the total cost.

Frame. Measure the car width across the windshield posts and take the sweep- ➤

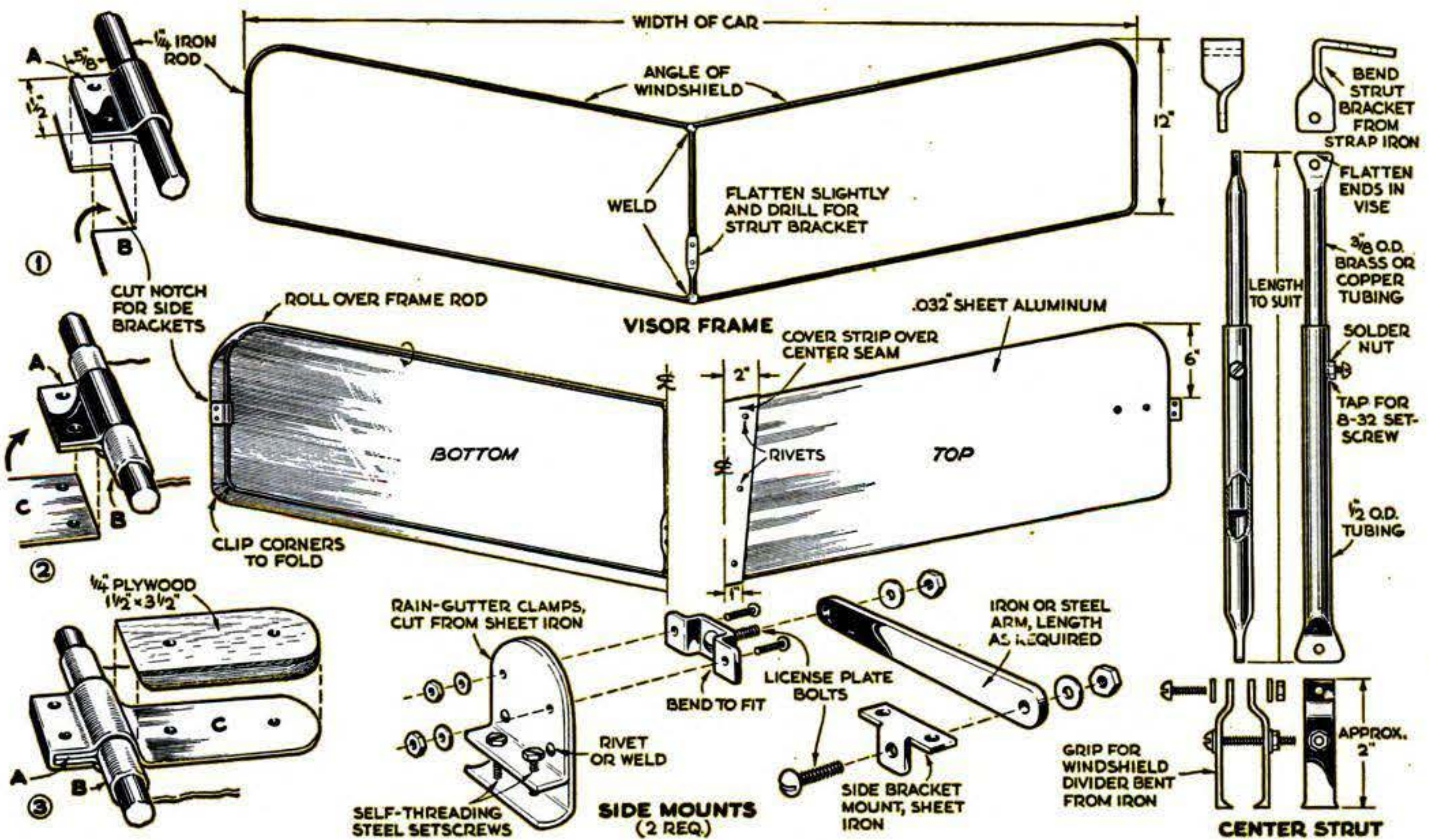

Side-bracket details are seen from below in Figs. 1 to 3. Roll the notched aluminum (B)

around the rod. Bend stiffener strip (C) up and over bracket (A). Rivet through plywood.

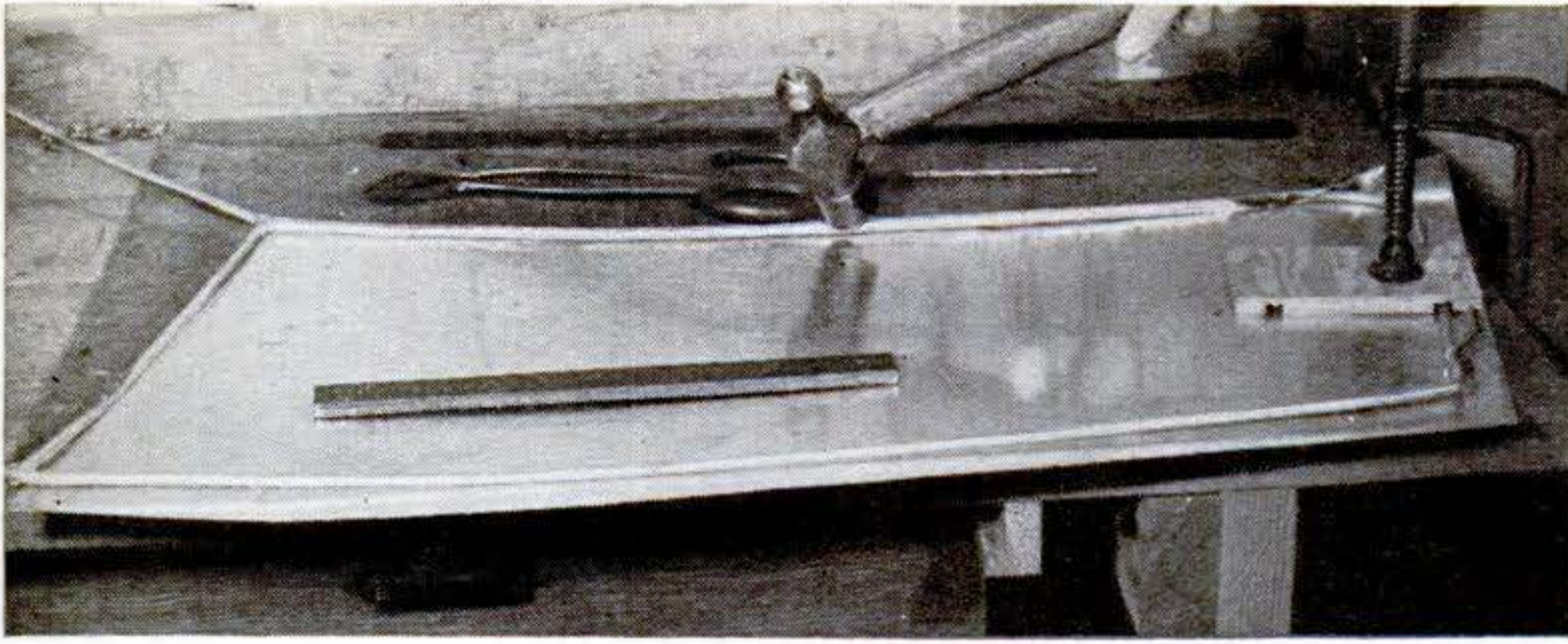

Aluminum rolls easily over the $\frac{1}{4}$ " rod frame. Pound it down as shown here and then smooth the rolled inner edge with an iron bar like the one in foreground. Notice side bracket on the rod at the right.

back angle. Then cut a cardboard pattern 12" wide for half the visor, transfer it to plywood, and saw it out.

Nail the wood pattern to your workbench or shop floor. Starting at the center back, form the $\frac{1}{4}$ " aluminum or iron rod around it. Clamp or nail the bent rod in place. When you reach the center front, pry up the pattern, flop it over, renail it, and continue bending the rod to the starting point. Cut off the excess rod and weld a piece 11 $\frac{1}{2}$ " long across the frame center. With a hammer, flatten a part of this member and drill two $\frac{1}{8}$ " holes for the strut bracket.

Covering. Use .032" aluminum for this. A sheet 18" wide and 5 $\frac{1}{2}$ ' long will do the job. Put down the pattern and mark around it $\frac{1}{4}$ " from the edge except at the center line, which you mark flush. Snip out this panel. Then turn the aluminum over. Use

the same center line to mark and cut the opposite panel.

Clamp the frame to the aluminum and roll the sheet over the rod. Clip the corners so they will pound down smoothly. When you install the side brackets, stiffen each, as shown, with an aluminum strip rolled over it and sandwiched between the cover sheet and a plywood block. Fasten by rivets through this sandwich. Make the center strut bracket and attach it with machine screws. An aluminum cover strip is riveted over the center seam and the ends rolled over the frame. Take the visor to the car. Bend it down gently over a sawhorse until it conforms to the roof curve.

Fittings. Details of these are illustrated but they must be made to fit your particular car. Shape the gutter clamps to match the gutter, and use nonrusting stock. **END**

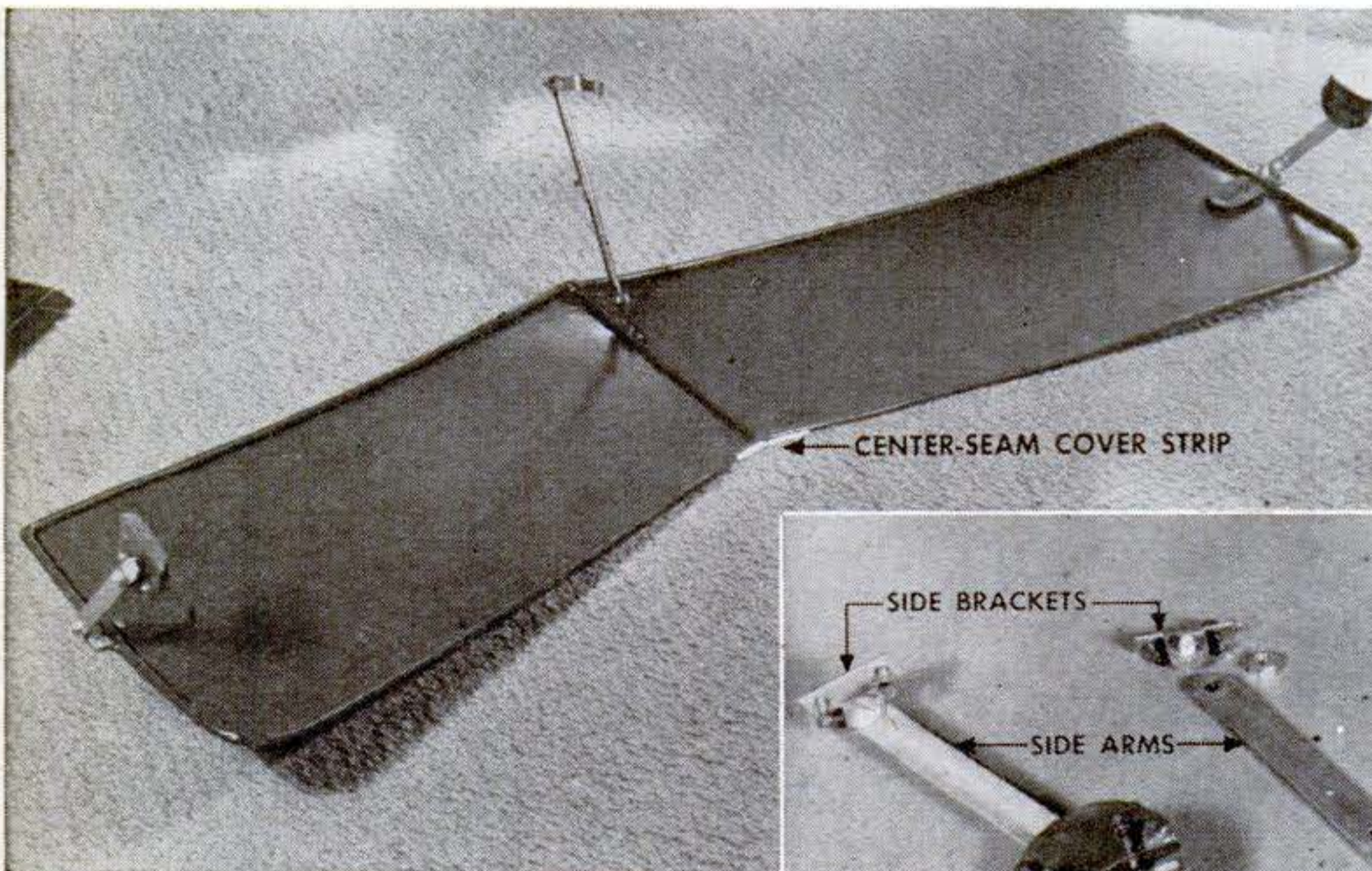

Finished visor, seen at left, can be lacquered to match car. In this case, the middle cover strip on the top surface was left bright. Note how side mounts and strut are attached.

Adjustable fittings used are pictured at right. Instead of making side arms as shown, you could use casement-window adjusters. The strut clamps to base of windshield divider.

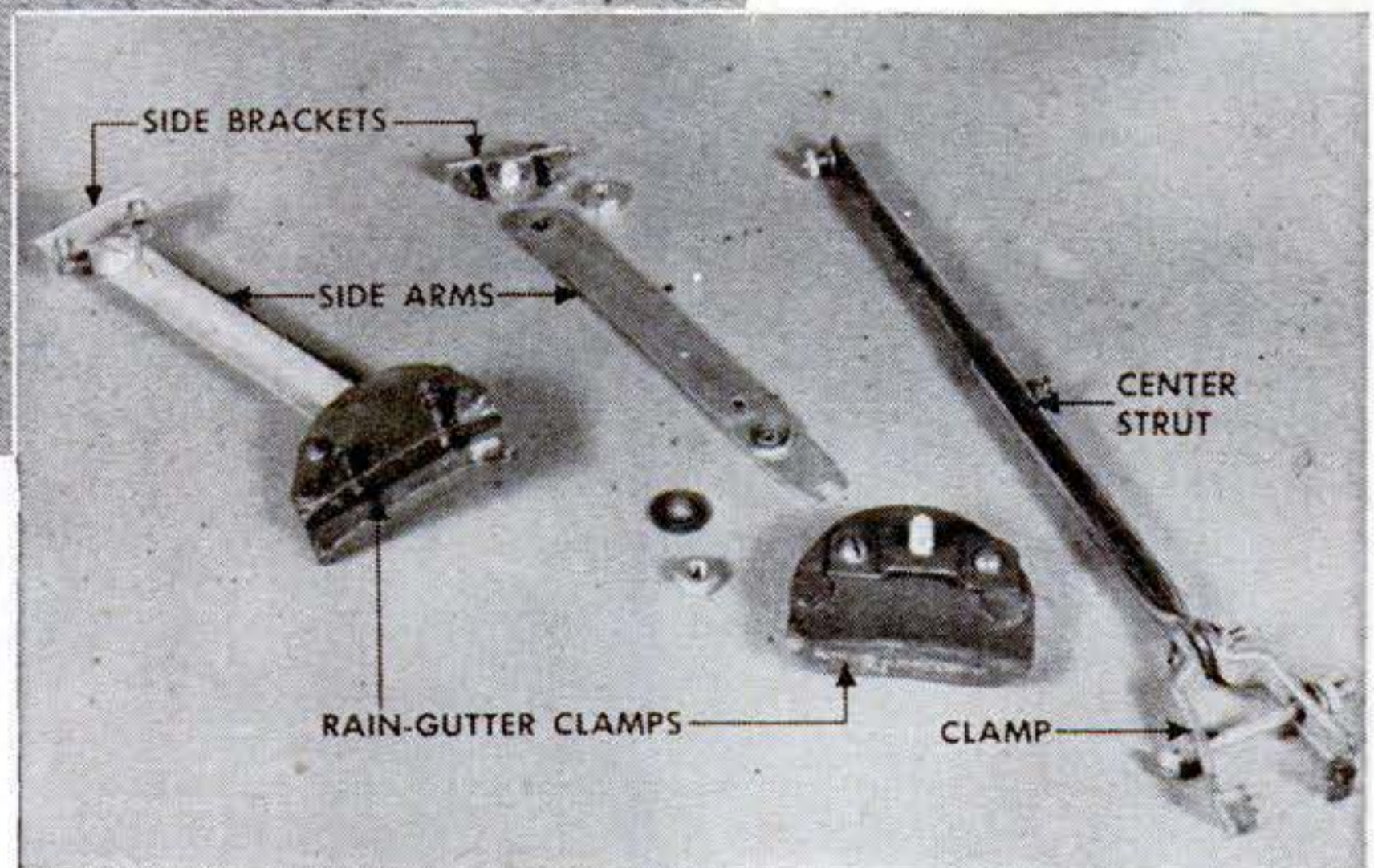

Performing these simple home experiments will disclose the secrets inside of the meters and gauges in your car.

How Dashboard Instruments Work

By Kenneth M. Swezey

The speedometer—connected to the propeller shaft by a flexible cable—tells you your car's speed by a little lightning arithmetic. It counts drive-shaft revolutions and relates them to the size of the wheels. In one type, the indicating pointer is coupled to the rotating shaft through a centrifugal governor. In the usual type, however, coupling is achieved entirely by a trick of magnetism. You can show how this is done with the simple setup pictured below.

Suspend the top of an aluminum flour shaker at its center from a short length of rubber band attached to a horizontal wire. Stick a bit of

NOT many years ago an auto driver tested his gas supply with a stick—or found it was gone when his car stopped. He figured that his cooling system wasn't working when the radiator steamed; that oil circulation must be bad when bearings burned out or pistons froze in cylinders. If a policeman chased him, he was going too fast.

Today—thanks to ingenious electrical and mechanical devices—all these important variables of car operation are clearly registered on dashboard dials.

How telltale pointers can gauge the depth of gasoline in a tank, the pressure of oil, the temperature of water, or the speed of a car mystifies many car owners. But a closer look reveals basic scientific principles that are easy to demonstrate and understand.

These stunts may help you do both.

gummed tape on one side as a marker and stand a pencil cap beneath the marker to note its position. Directly above the shaker top hang a strong horseshoe magnet on a rubber band.

Twist the magnet a dozen times and let go. As the magnet spins it *induces* currents in the aluminum, causes the cap to turn in the same direction. Speed of magnet rotation determines how far the shaker lid will swing. In a real speedometer a magnet connected to a flexible shaft rotates inside an aluminum cup to which the pointer is attached. A hairspring resists the torque of the rotating magnetic field. ▶

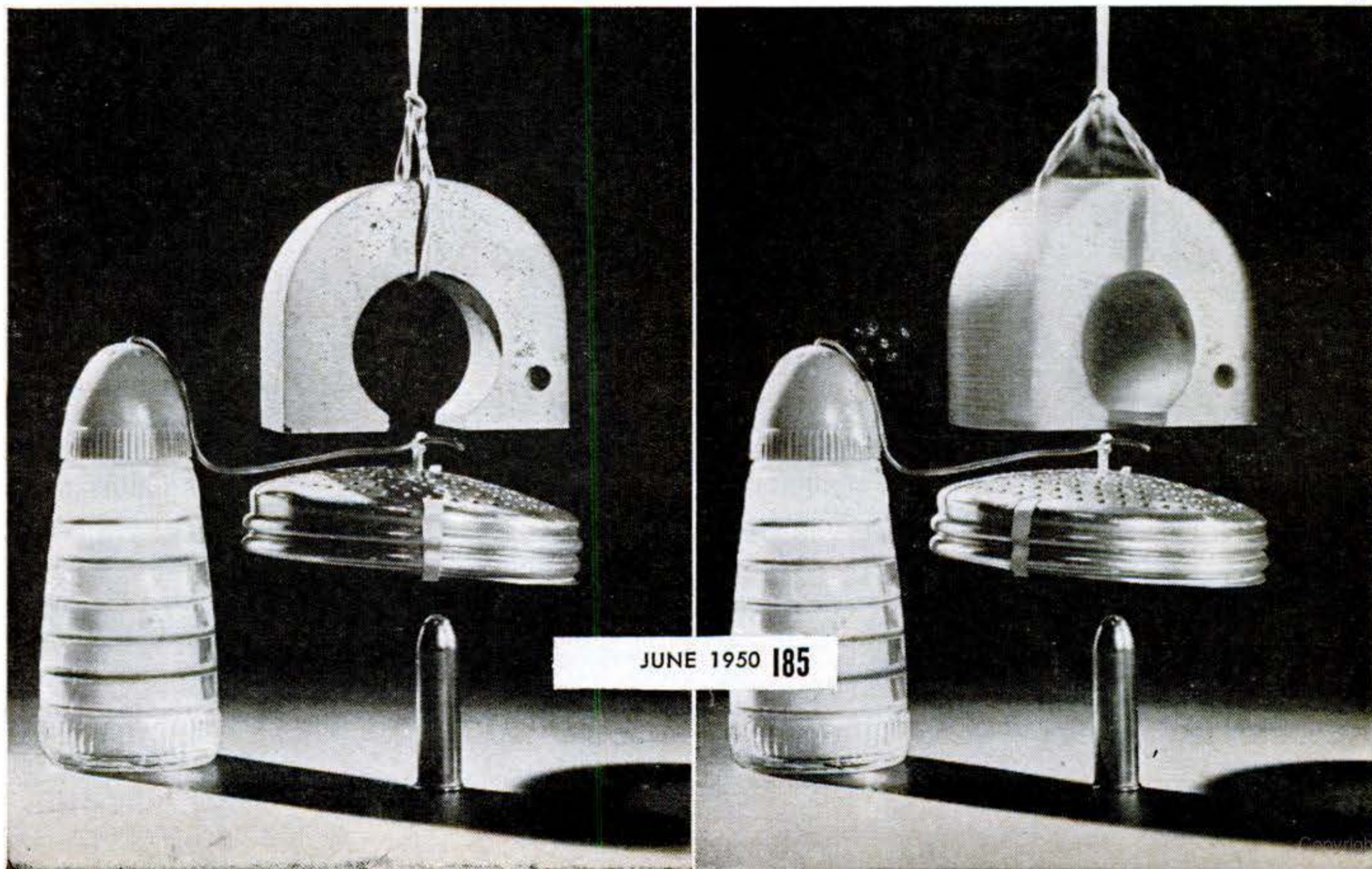

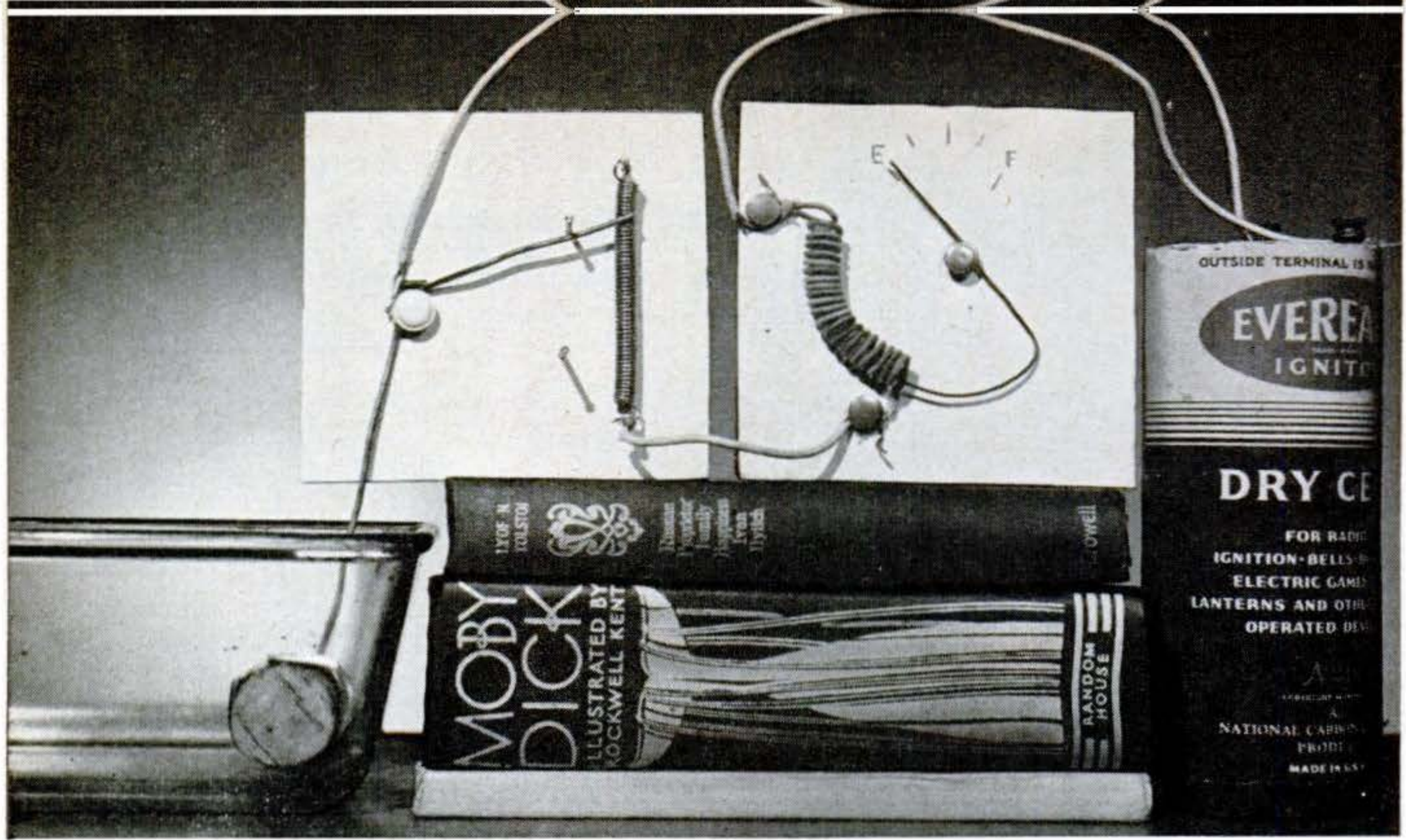

Gasoline gauges in most of today's cars work electrically. A tank unit—a rheostat controlled by a float—is in series with the battery and a current-reading meter on the dash. As the fuel level changes, the float rises or sinks, thus altering the resistance of the circuit and the reading of the meter.

You can make a simplified model of such a gauge as shown in the photo above. For the moving part of the tank unit, bend a stiff wire and form a small loop at the bend to serve as a bearing. Pivot the wire by driving an upholstery nail through the loop and into a board. Fasten a cork to the longer leg of the wire.

The resistance element is a light steel spring stretched slightly between two nails. The shorter leg of the bent wire slides along the spring. Two nails are used as stops for the slider.

The meter unit on the dashboard can be represented by the solenoid coil and pointer illustrated. Wind 20 turns of bell wire around a pencil and bend the coil in a quarter circle. Make the pointer and core from a single piece of iron wire, again forming a small loop for a bearing. When assembled as shown, the core will be drawn into the solenoid a distance proportional

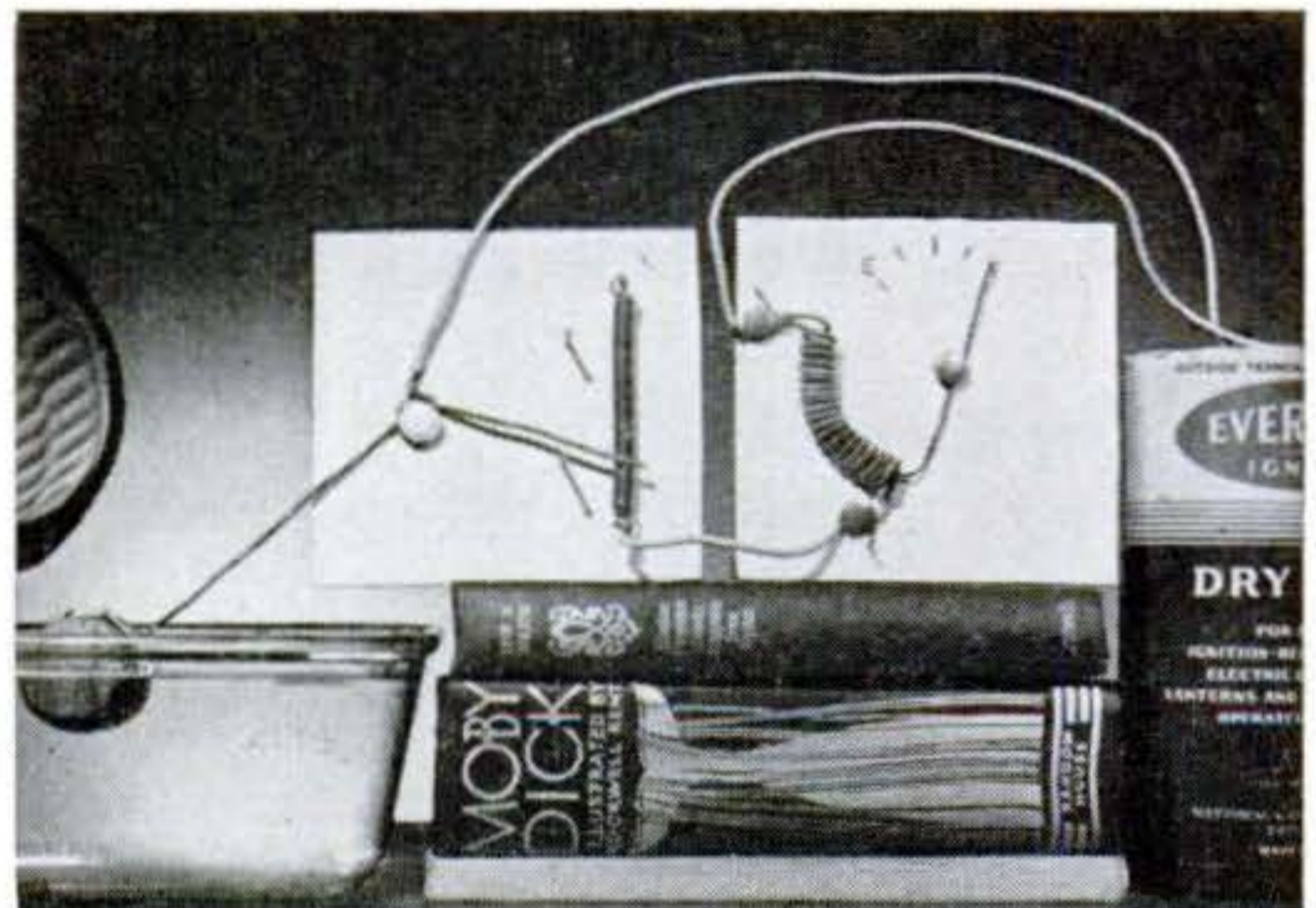

to the current that is passed through the coil.

Connect the two units and a dry cell in series. When the tank is empty (top) the cork rests on the bottom and the meter hand points to E. When the tank is filled (above) the cork rises, lowering the resistance of the circuit. This allows more current to flow, which draws the core further into the meter coil and moves the pointer up toward F.

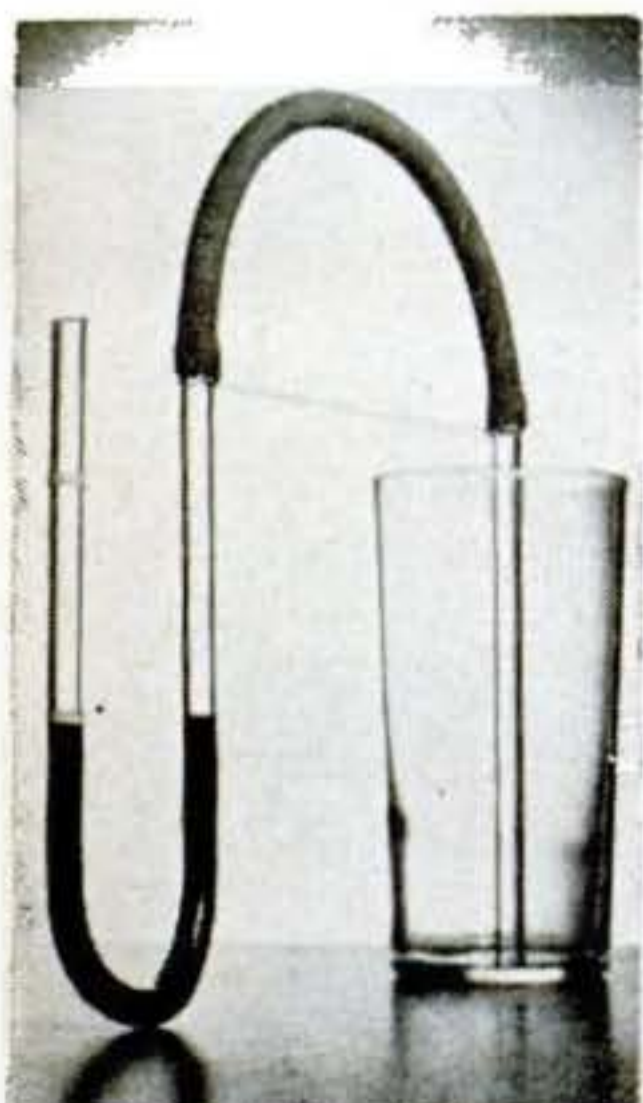

An earlier type of fuel gauge used hydrostatic pressure. In this system a vertical tube in the fuel tank is connected to one leg of a U-shaped tube containing colored liquid. The other leg forms part of the instrument panel. Gasoline rising in the tank tube compresses the air above it. Pressure transmitted to the dash unit raises the colored liquid in the open leg of the U.

To demonstrate the operation of this gauge, partly fill a glass U tube with ink-tinted water. (If you don't have a U tube, connect two straight ones with rubber tubing.) Join one leg with rubber tubing to a straight tube standing in an empty tumbler.

When the tumbler is empty the colored liquid stands at equal height in both legs of the U (left). But when you add water (right), the liquid in the open leg rises.

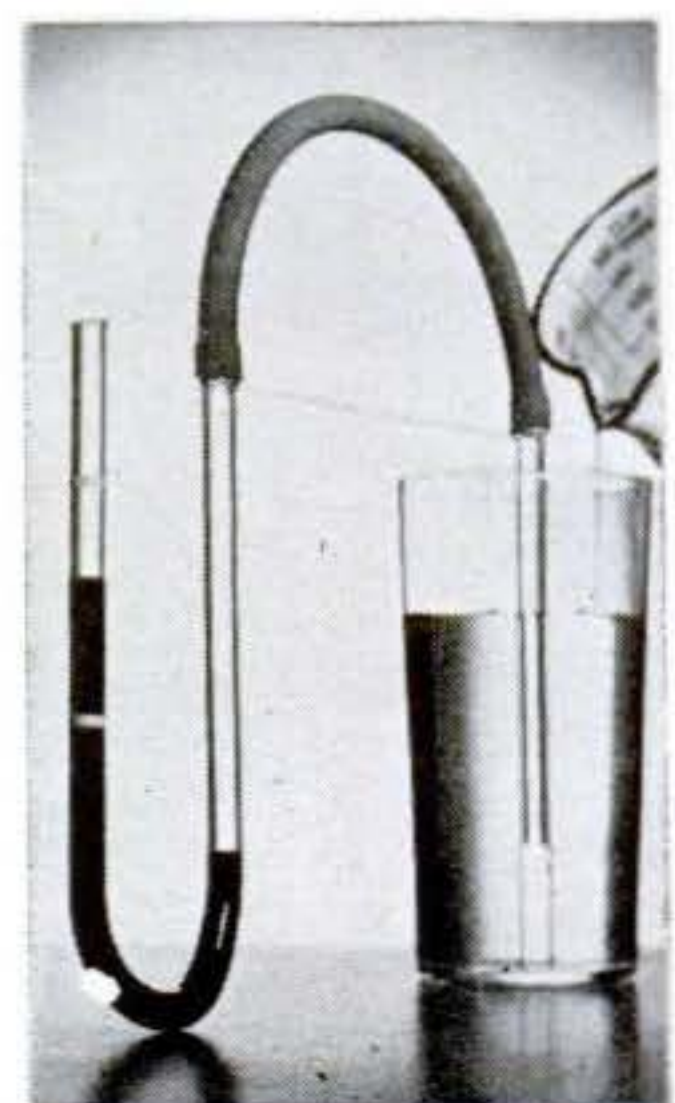

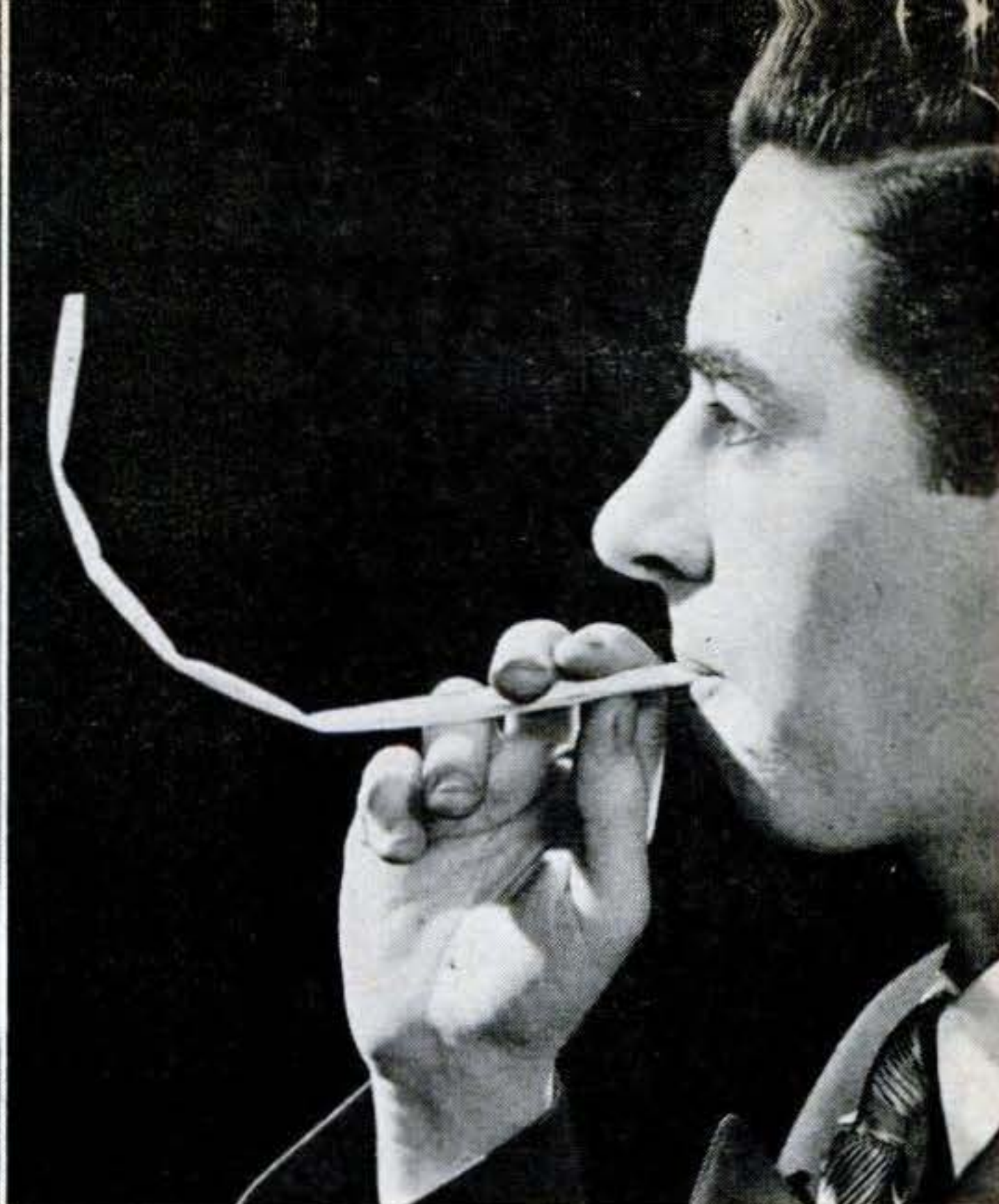
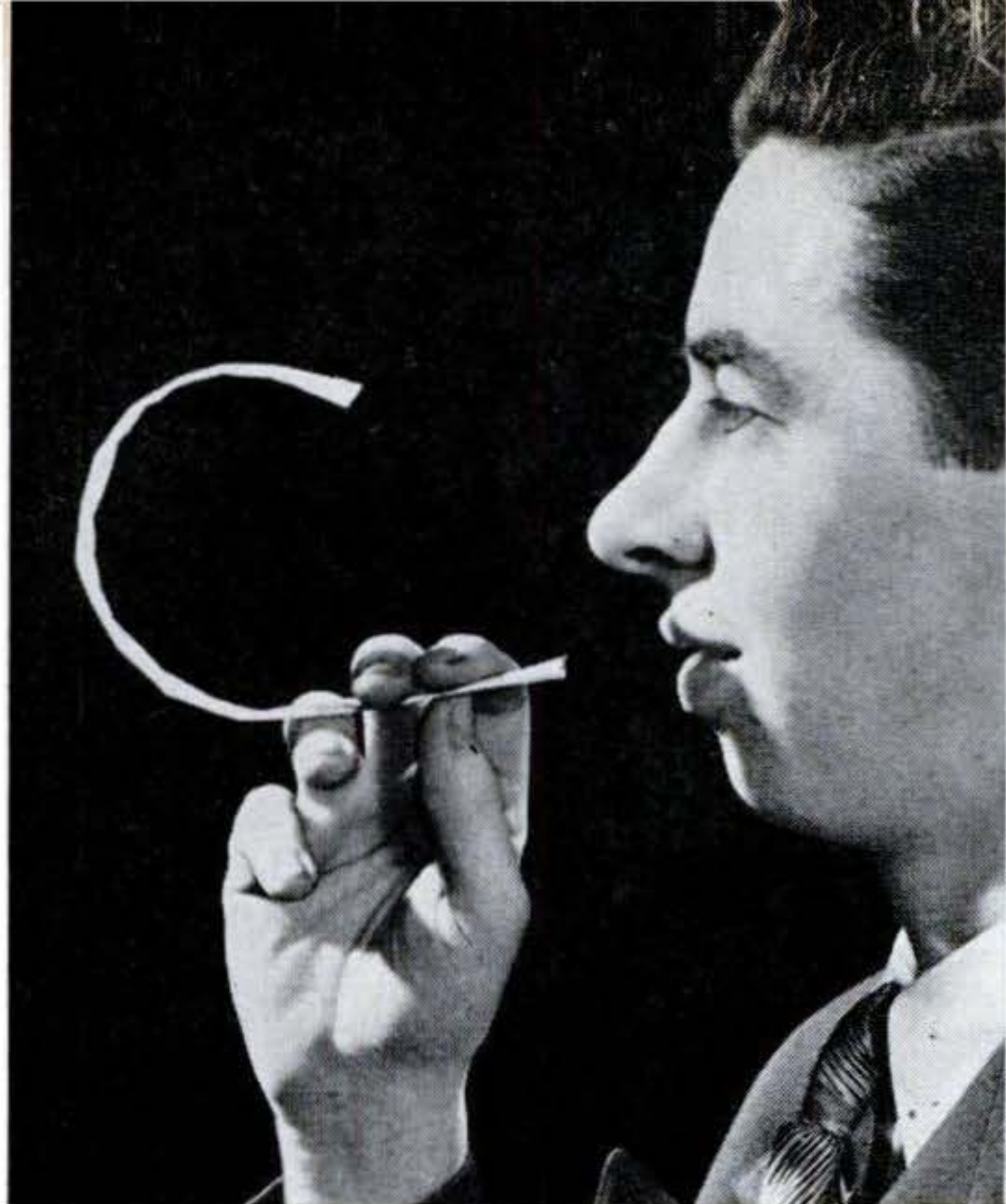

A Bourdon tube forms the heart of both oil-pressure and engine-temperature gauges in a lot of cars. This ingenious device consists of a thin metal tube of oval cross section, which is sealed at one end and bent to a nearly complete circle. When a liquid or gas is forced into the open end, the tube tends to straighten. The same principle is used in the toy "tickler" that unrolls a long paper tube when you blow in one end.

You can quickly make a working model of a Bourdon tube from a 1½" by 10" strip of paper, some cellulose tape, and a 10" length of springy wire. Fold the strip lengthwise and sandwich the wire in the fold (right). Seal the open edge and one end with the tape. Then bend the tube to the shape shown at the upper left. If you now blow in the open end, the tube will tend to straighten out in proportion to the pressure. This is because the flattened tube tries to become round, which straightens out the coil.

In a real oil gauge, a thin copper tube connects the open end of the Bourdon tube to the lubricating system. Oil entering the lower end of the connecting tube compresses the air above it. The closed end of the Bourdon tube is linked to the pointer of the oil gauge.

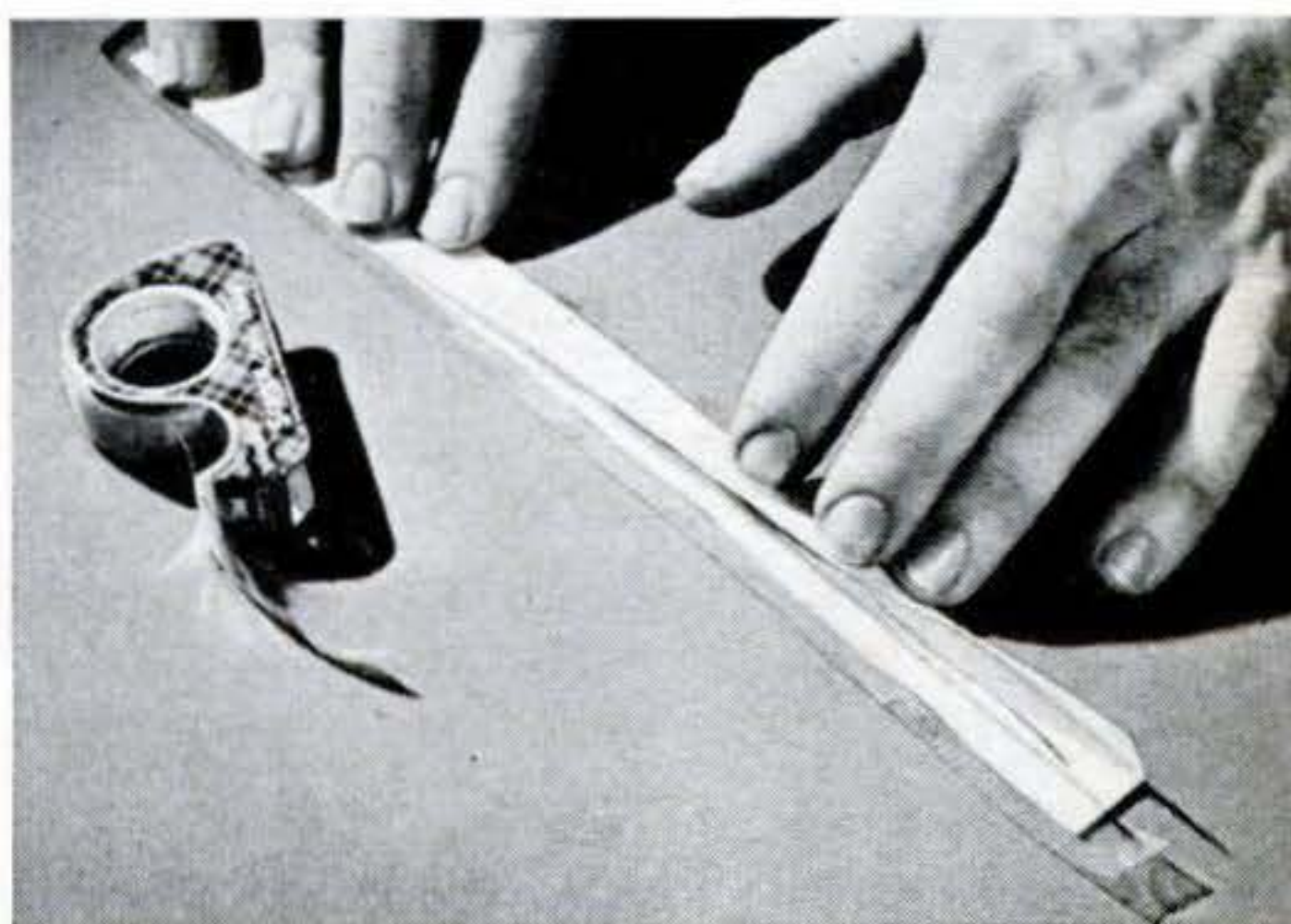

In the temperature gauge, pressure is supplied by the vapor of a low-boiling liquid such as ether. A bulb containing the liquid is screwed into the water jacket of the engine and connected to the dashboard gauge by a thin copper tube. As water in the jacket warms up, the vapor pressure of the ether increases, causing the Bourdon tube to straighten and move a pointer over a calibrated scale.



The power of vapor pressure at low temperatures such as is used in the temperature gauge can be demonstrated vividly with the equipment shown at the left. Pass a jet-ended glass tube (a medicine dropper connected by rubber tubing to a straight tube will do) through a one-hole stopper large enough to cork a milk bottle. Just below the stopper, attach a small open vial containing a little ether or acetone. Now fill the bottle three-quarters full of warm water (much warmer for acetone than for ether) and press the stopper in firmly.

When the liquid in the vial warms up, its increased vapor pressure will force water up the tube, forming the spectacular fountain you see at the right. *Caution: perform this experiment only in the open or in a well-ventilated room. Be sure there are no open flames nearby.*

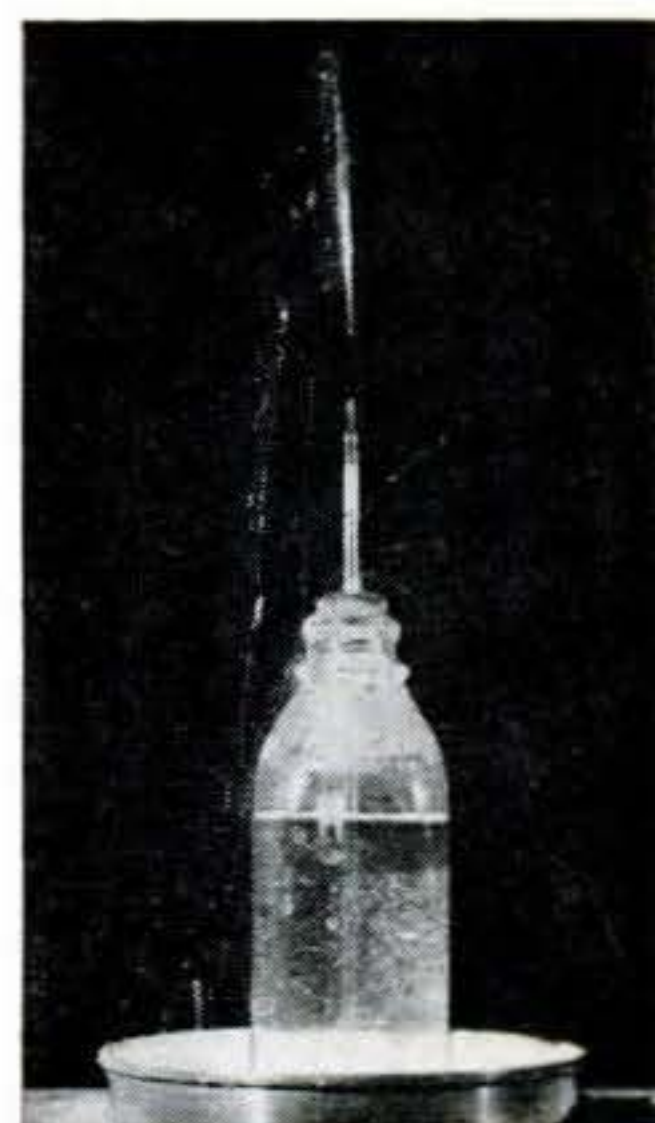

New Gauge Flashing Warning If Tire Pressure Drops

By R. P. Stevenson

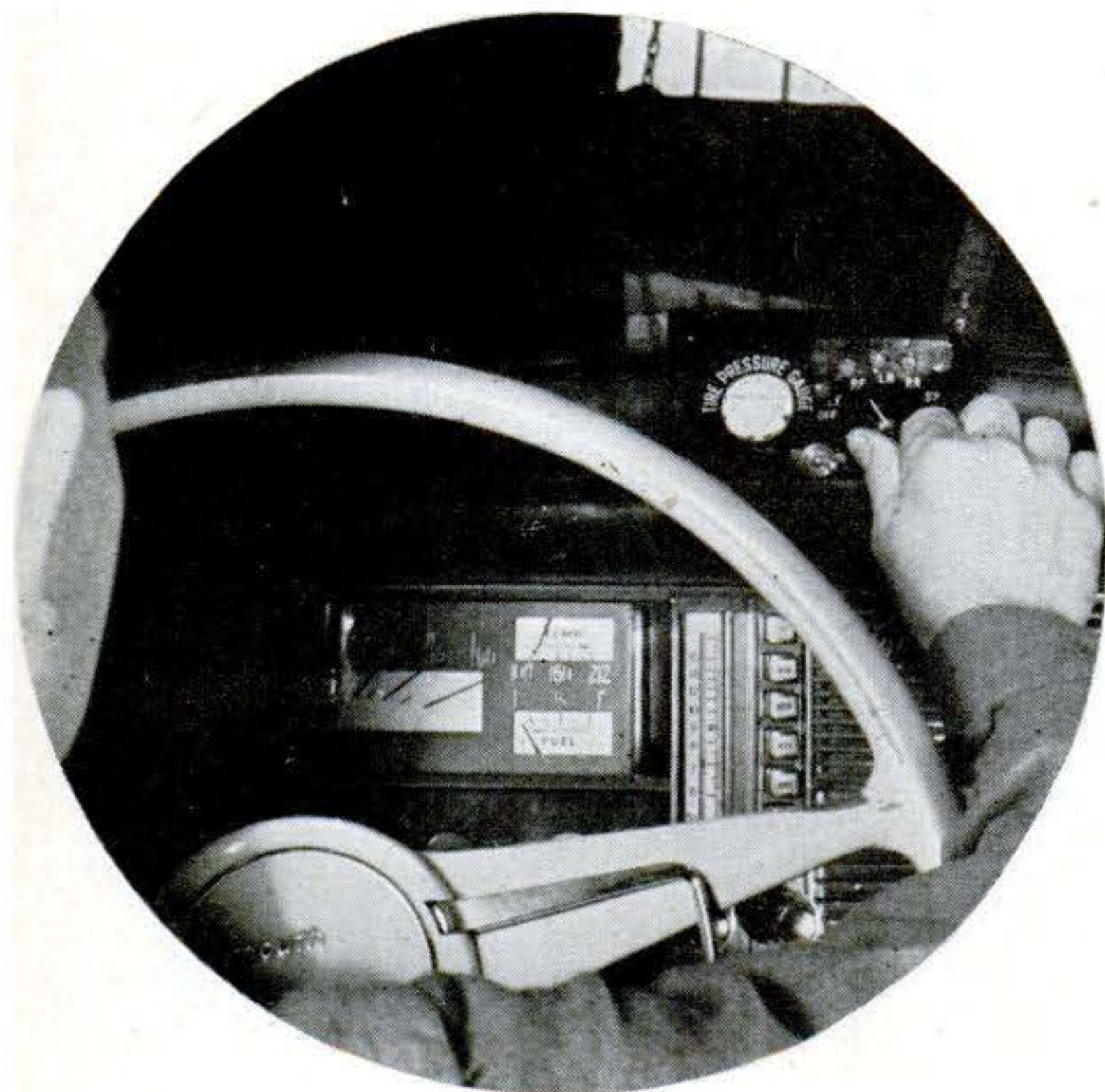

BACK in 1939, a couple of mechanics were doing some dreaming. Wouldn't it be fine if a motorist could check his tire pressures from the driver's seat?

Friends pooh-poohed the idea. But Roy Addy, of Flint, Mich., and his son, Henry, of Milwaukee, Wis., set to work. The result was the new Air-Rite Tire Gauge.

Here's what it will do:

- If tire pressure drops five pounds or so below normal, a dashboard light comes on. There are five lights—one for each tire, including the spare.
- If pressure builds up on a hot road to an unsafe maximum, the lights also flash a warning.
- When a light comes on, you

How it works. A resistance coil on each wheel controls the system. When tire pressure rises or falls, a spring-loaded diaphragm moves the coil

endwise. This varies the resistance and gives a relative reading on a dial. A second electrical circuit operates warning lights.

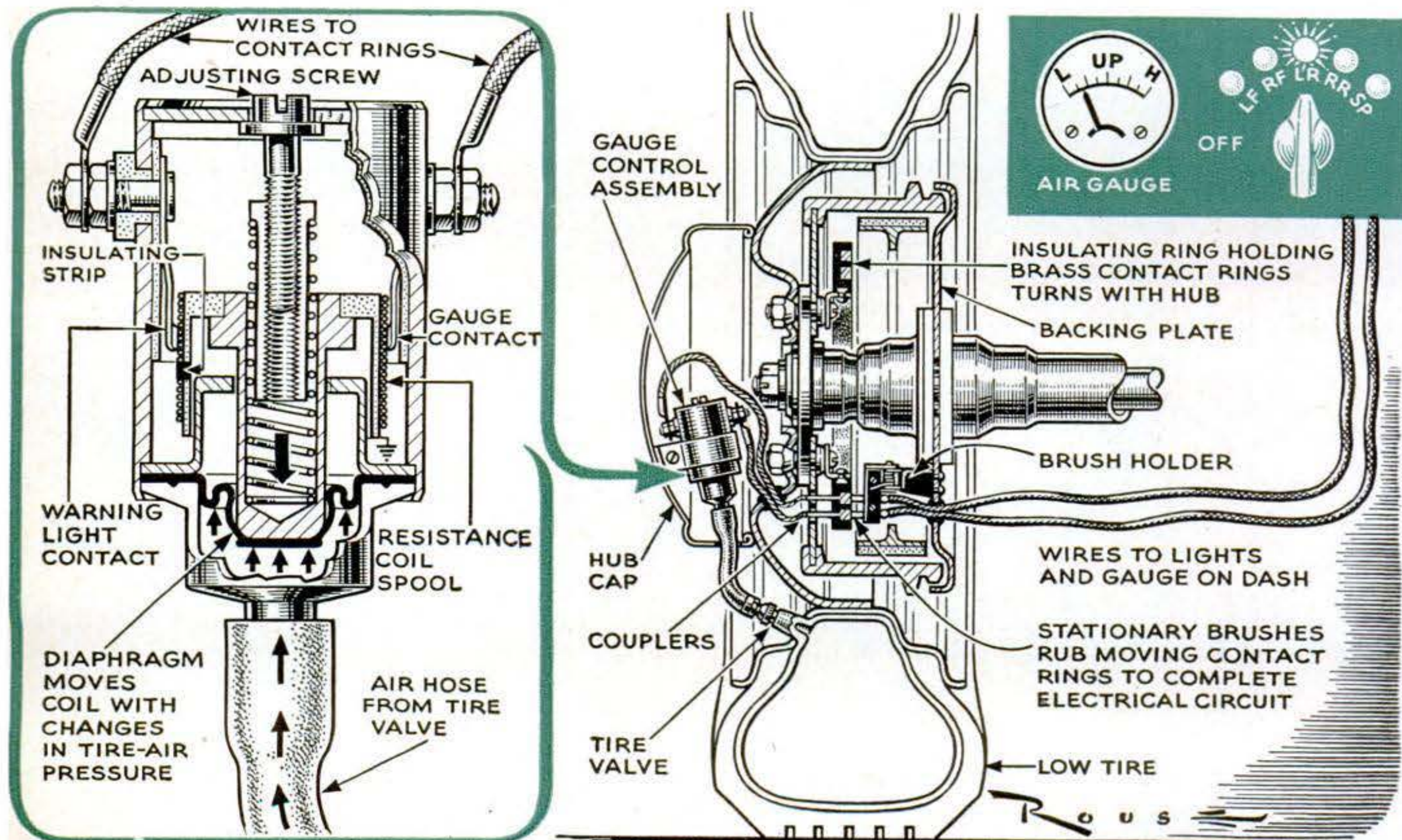

turn a selector switch, cutting into the electrical circuit that extends to the tire indicated by the light. A dial immediately shows whether the pressure is low or high, and about how much. If the pressure continues to fall, the needle will show it.

● At any time, with the ignition key on, you can check the pressure in each of the five tires simply by turning the selector switch to the five dial points. You can do this even while the car is in motion.

The key to the system is a control assembly under the hub cap of each wheel. Inside the control, tire pressure pushes against a spring-loaded diaphragm. This is fastened to the end of a resistance coil so that as pressure rises or falls, the coil moves in or out. Two brass contacts ride against the coil.

These contacts are wired to two brass rings inside the brake drum. Bearing against the revolving rings are stationary brushes mounted on the brake backing plate.

Each brush is connected to one of the two electrical circuits that operate to each wheel. One circuit actuates the warning lights, the other the gauge. The control coil is grounded and the electrical return of each circuit is made via the wheel bearings.

As long as tire pressure is at the recommended figure, the sliding contact of the warning-light circuit rests on an insulated spot on the coil. The electrical circuit, therefore, is incomplete. If pressure rises or falls, however, the coil moves, and the brass contact slides past the insulated section. Now the circuit is complete—and the warning light comes on. An adjustment screw sets the coil for any desired tire pressure.

Works Like Gas Gauge

The pressure gauge works like your gasoline gauge. As the coil moves endwise across the fixed contact, the resistance varies in the gauge circuit. This varying resistance is translated, through electromagnetic action in the dash unit, into a needle reading that shows tire pressure.

The George J. Mayer Co., of West Allis, Wis., is now making two versions of the Air-Rite gauge. The de luxe type shown is about \$85 installed. A simpler type, with only the warning-light feature, is expected to sell for about \$45 fitted to the car.

In the lower-priced gauge, an aluminum tube replaces the resistance coil in the wheel control. Like the coil, this tube has an insulated spot on which the contact rests as long as the tire pressure is normal. **END**

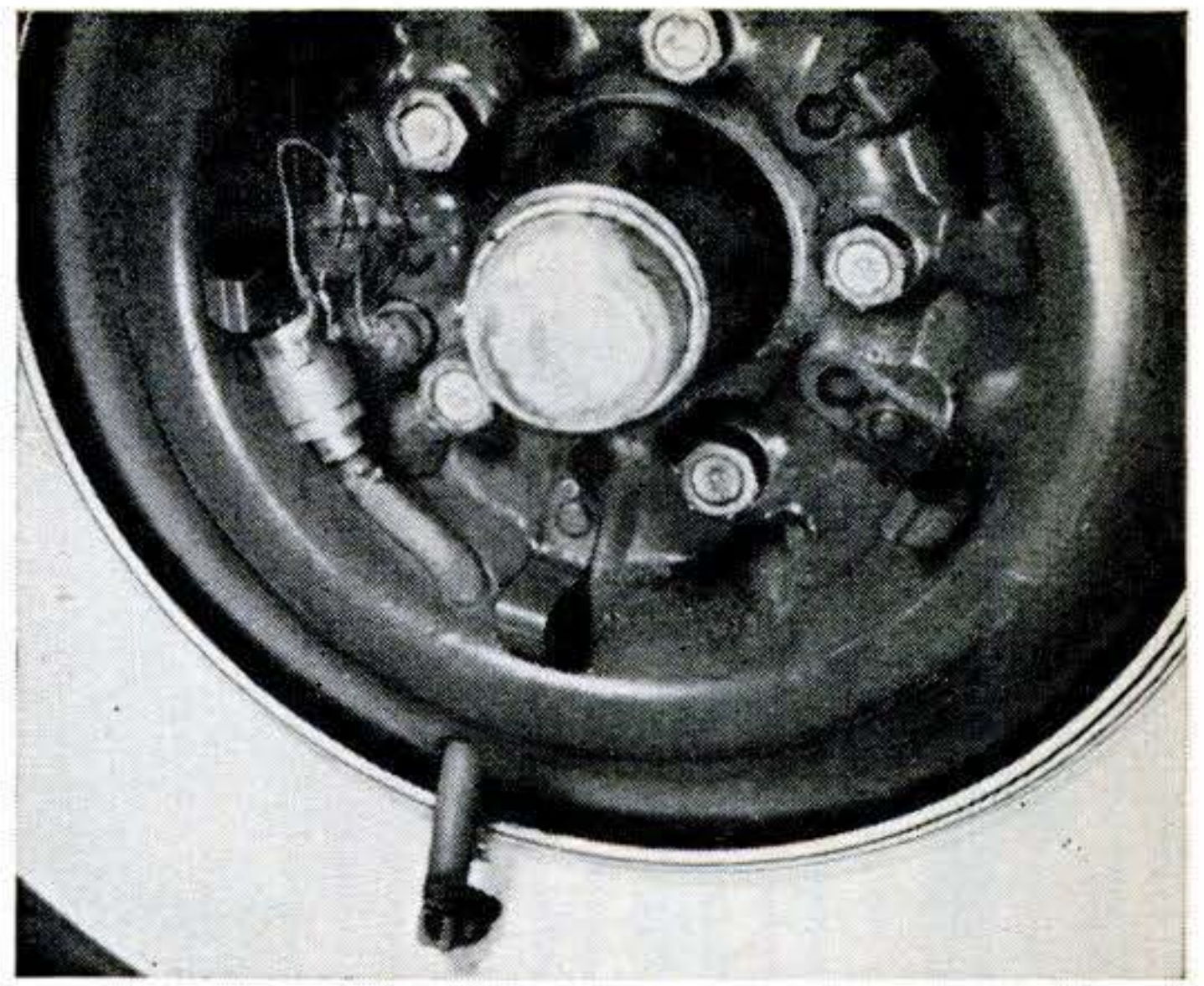

Control unit fits under hub cap. Hose connects it to tire valve. Wires run to two contact rings on the inner flat face of brake drum. Bayonet couplers disconnect wires for changing tires.

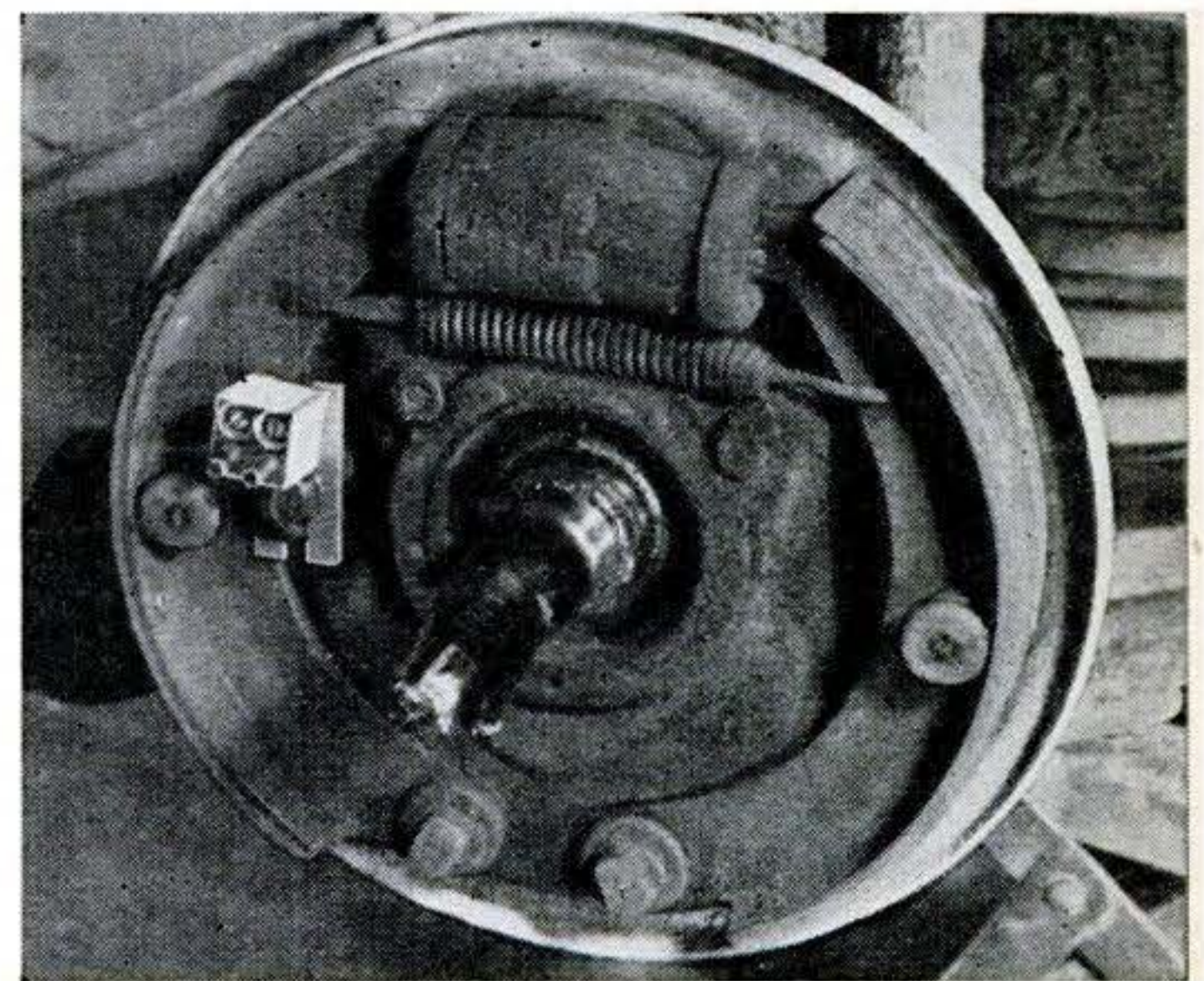

Two stationary brushes on the brake backing plate are seen at left above. Each rubs against one of revolving contact rings on drum. After unit is installed, the wheel must be rebalanced.

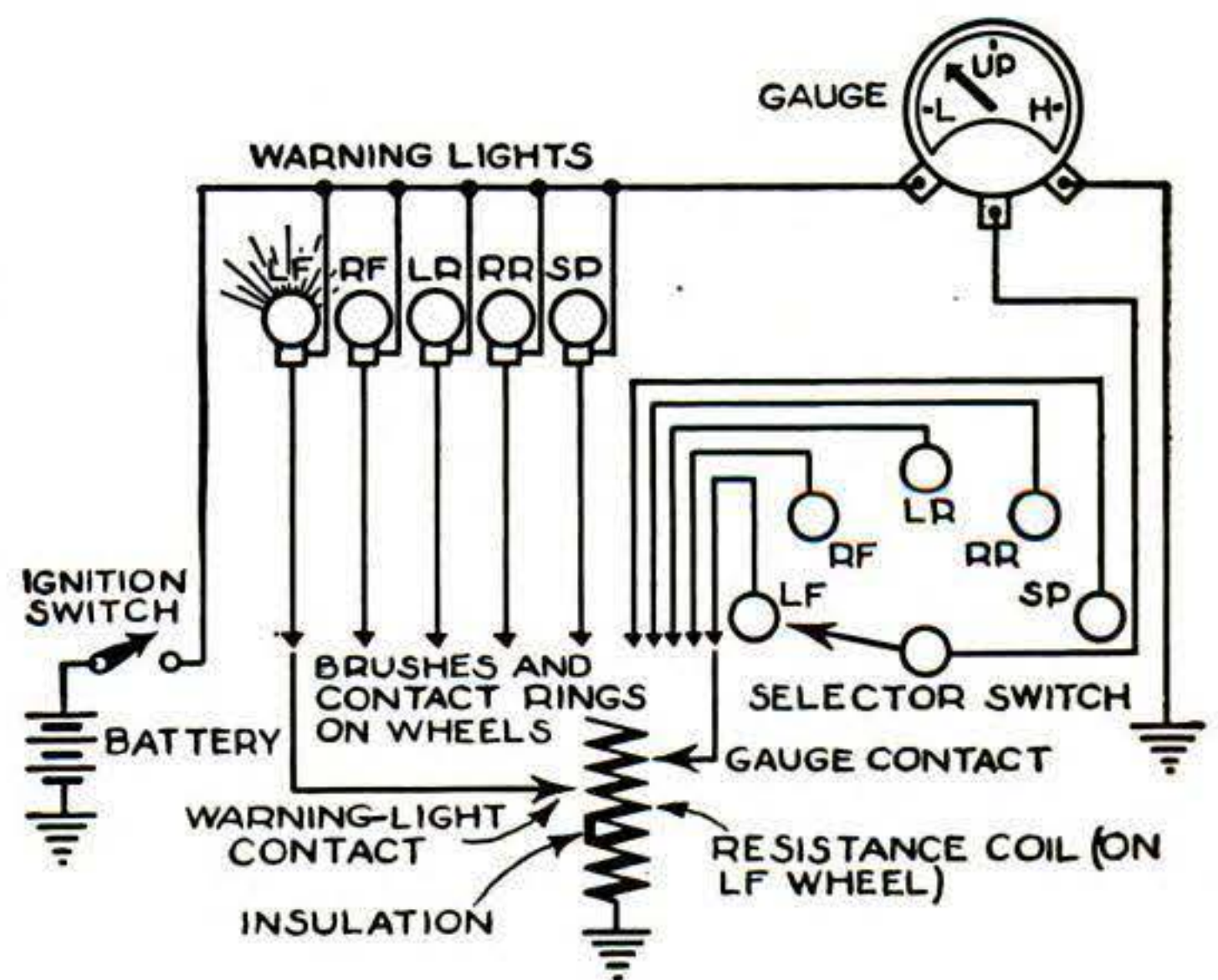

Warning-light contact rests on insulated spot if pressure is normal. When pressure changes, coil moves. This completes circuit, turning on the light. Sketch shows only one wheel coil.

Roll Your Power Tools To Outdoor Jobs

By Denis Sneigr

PS photos by W. W. Morris

WANT to build a garage, summer house, or maybe a dock at your summer cottage? Then take your power tools right along with you. Mount them on wheeled stands and you can use them anywhere within extension-cord reach of an electrical outlet.

Both the jointercart and the sawcart pictured here are so designed that all four legs clear the ground as soon as you raise the handles. They roll smoothly on the 10" semi-pneumatic wheels. Once you've pushed

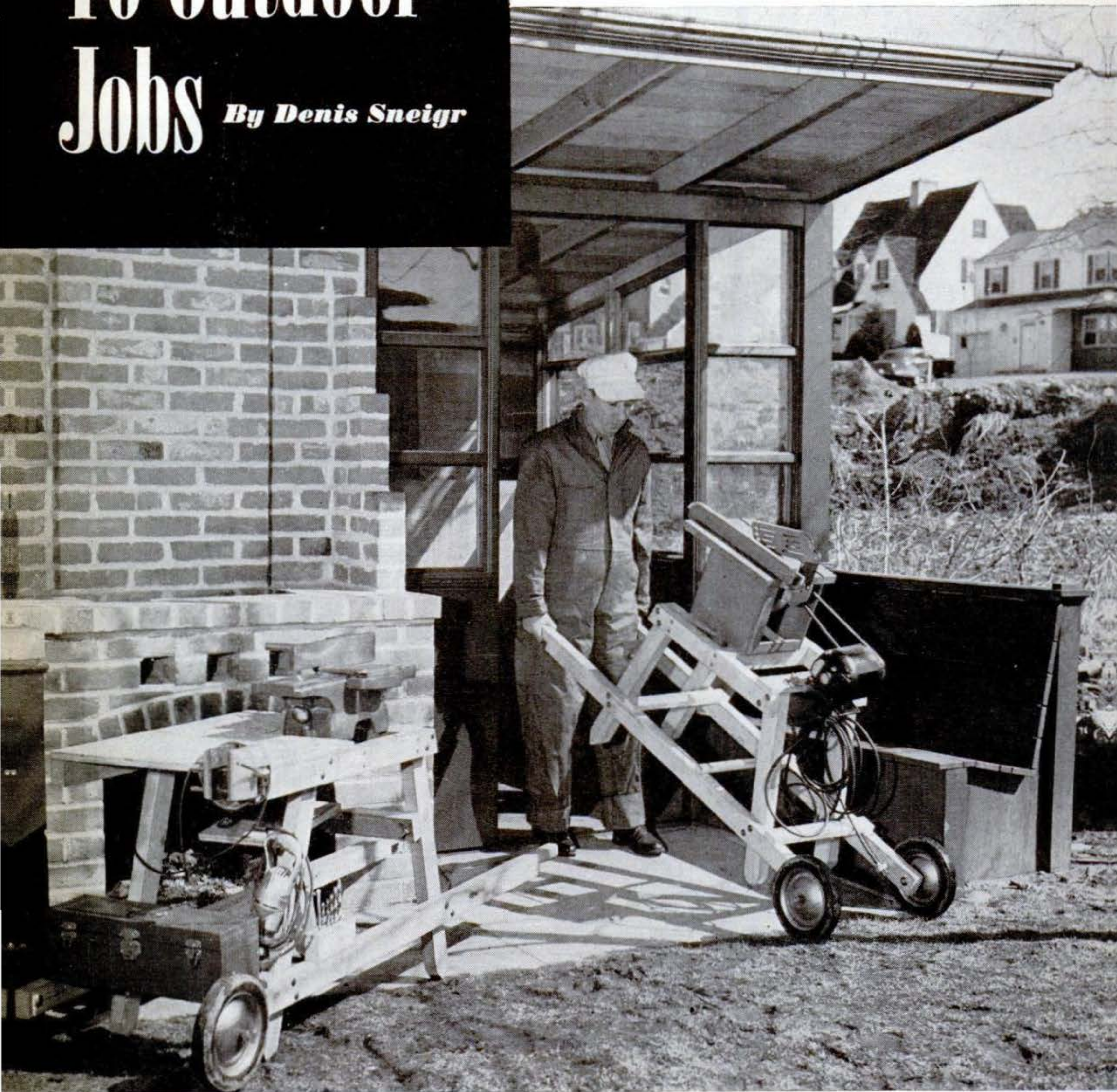

them to the job, the pointed legs set firmly in the ground to hold the tools steady as you work. And both the carts are heavy enough to be stable on a concrete floor or walk.

When you have finished a job outdoors, you can roll the carts back into your shop. Indoors you'll find your tools are more versatile on these carts than when mounted on permanent bases. That's especially true if the room that houses your shop is small. With the tools on wheels, you can move them around to handle longer work.

The dimensions of the frames depend on

your tools. The height you want the saw and jointer from the ground depends on your own preference. All the main frame members are 2" by 3", including the crosspieces to which the saw and jointer are bolted. The smaller crosspieces are ¾" stock. Four-inch ⅝"-16 carriage bolts hold the frames together. The legs sit at 15° to the frame and the points are cut at 35°. Before the 15° cuts were made, the sawcart's legs measured 25" and the jointercart's 29".

Positioning the wheels is important if the legs are to clear the ground properly when

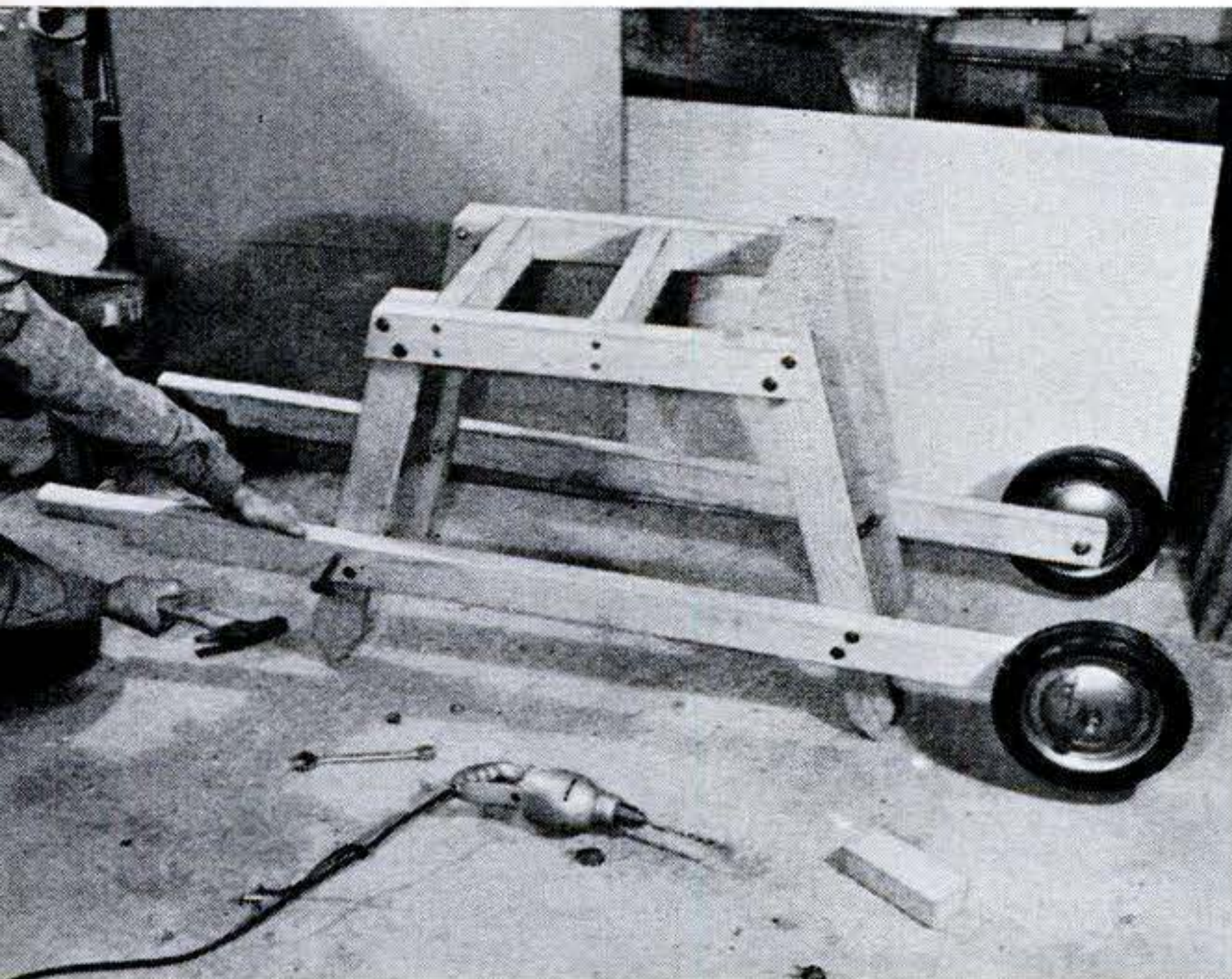

Details of sawcart construction are shown above. Crosspieces are held by wood screws 3½" long. Distance from grip to leg is 18".

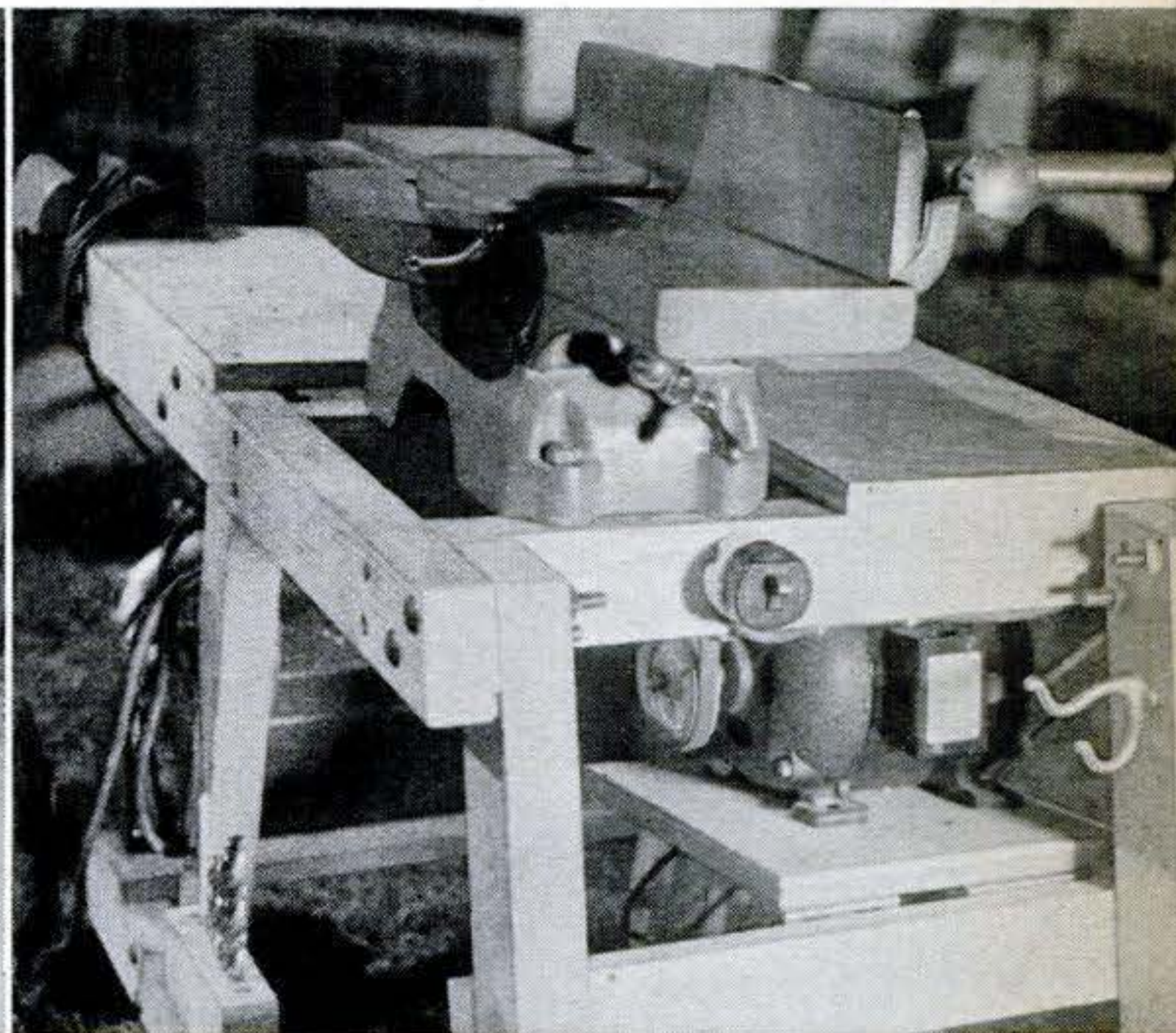

Motor of jointercart is bolted to ¾" plywood base that's hinged to crosspiece. Motor is offset for balance. Hook is for extension cord.

View from front of jointercart shows accessories. Drill chuck fits in metal loop and handle fits over hook so drill can't fall off.

Circular saw is centered on and bolted to pair of 2" by 3" crosspieces. When cart is moved, miter gauge hangs on nail in right front leg. ➡

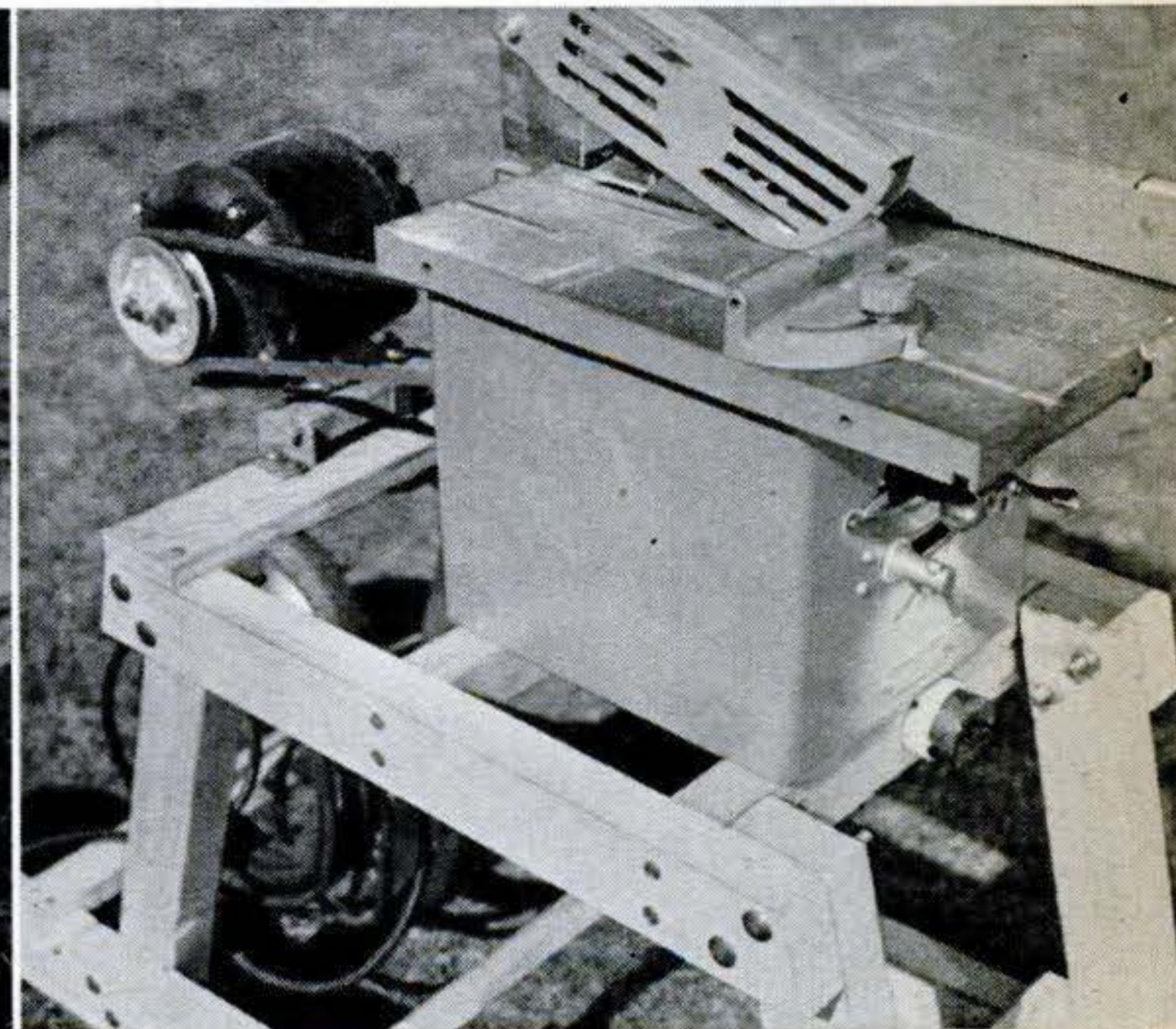
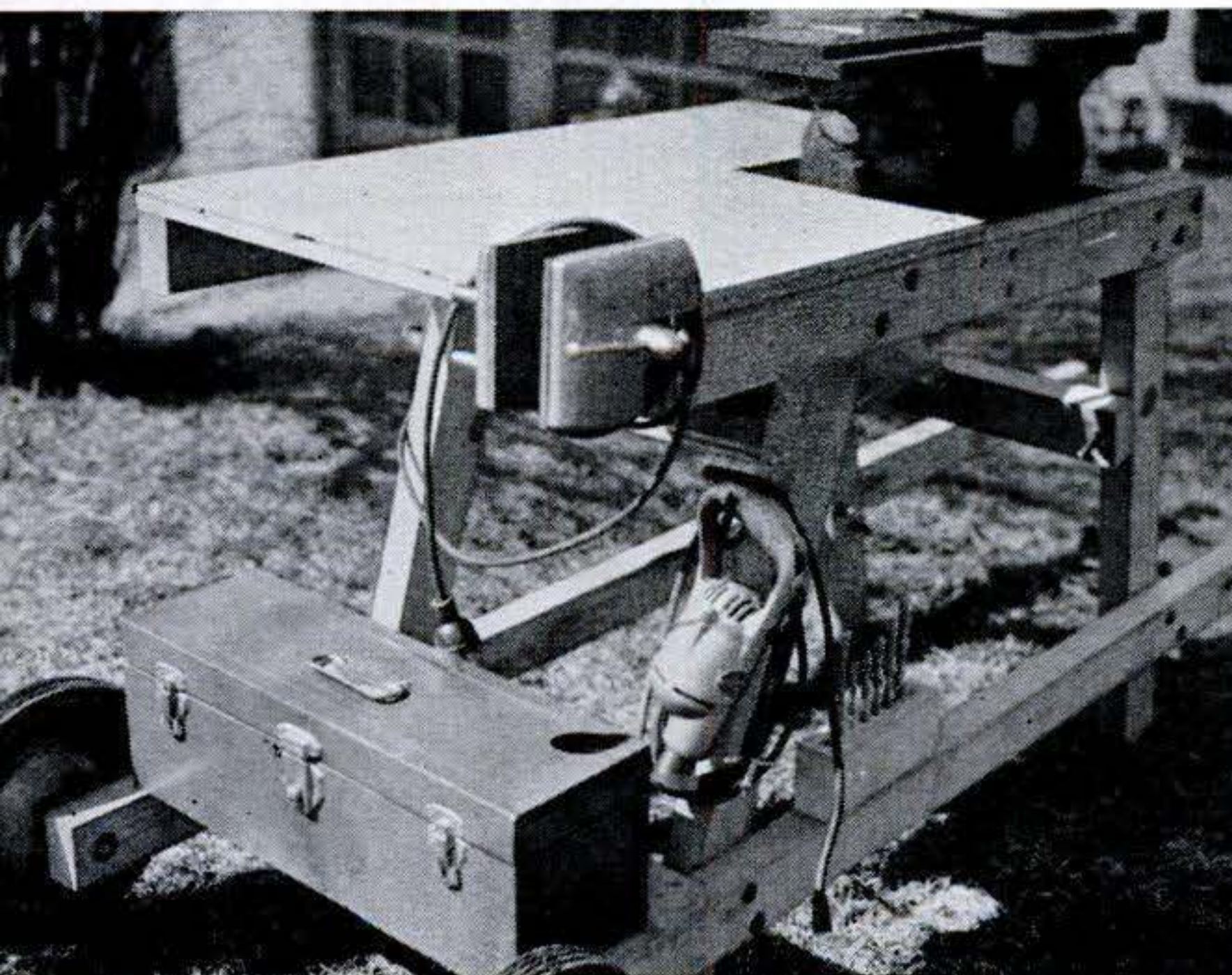

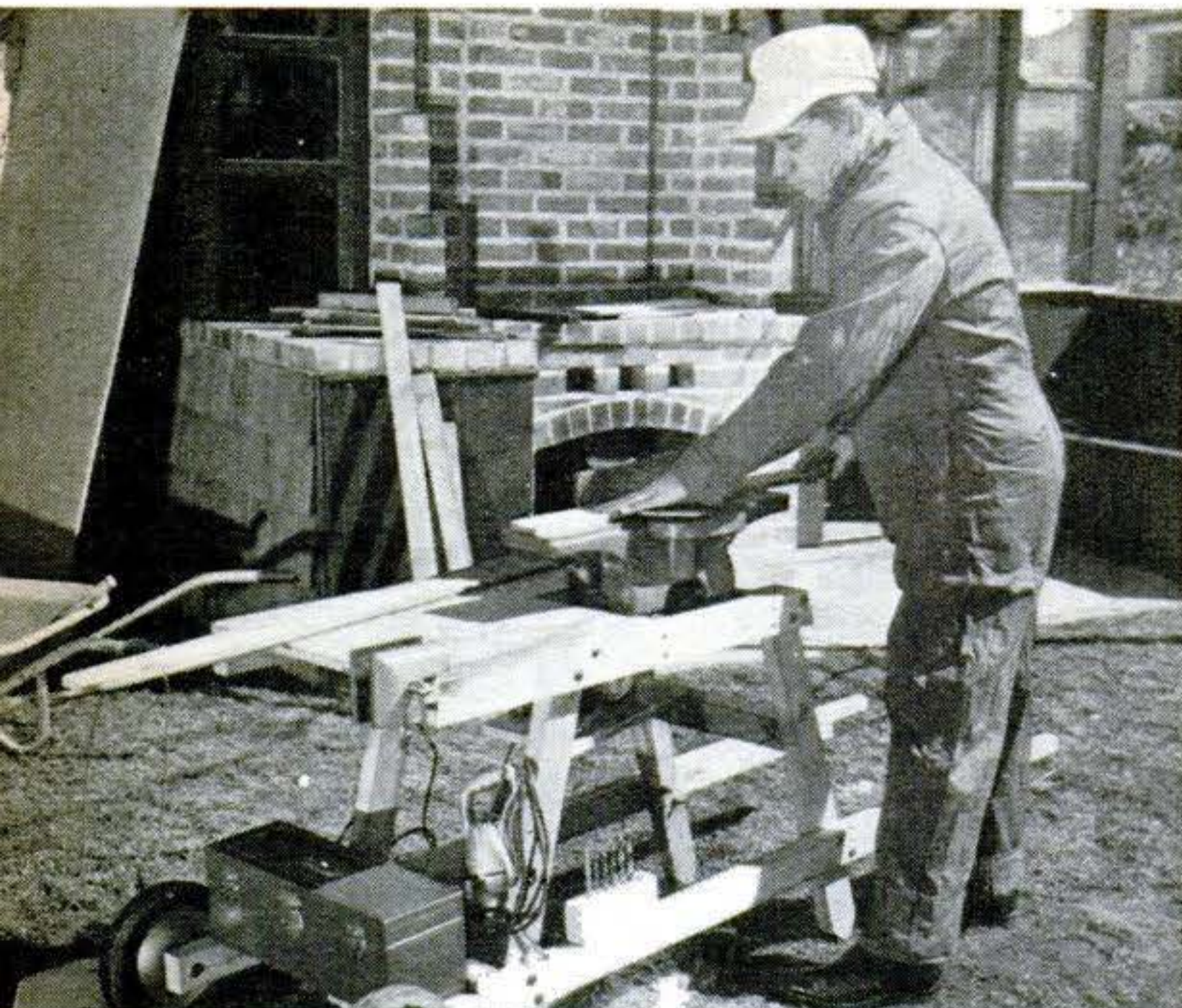

Jointer in use. Because infeed table extends beyond cart frame, handles are 26" from grip end to leg—8" longer than on sawcart.



Vise on corner of jointercart worktable is handy accessory. Since jointer isn't flush with side of frame, vise can handle long work.

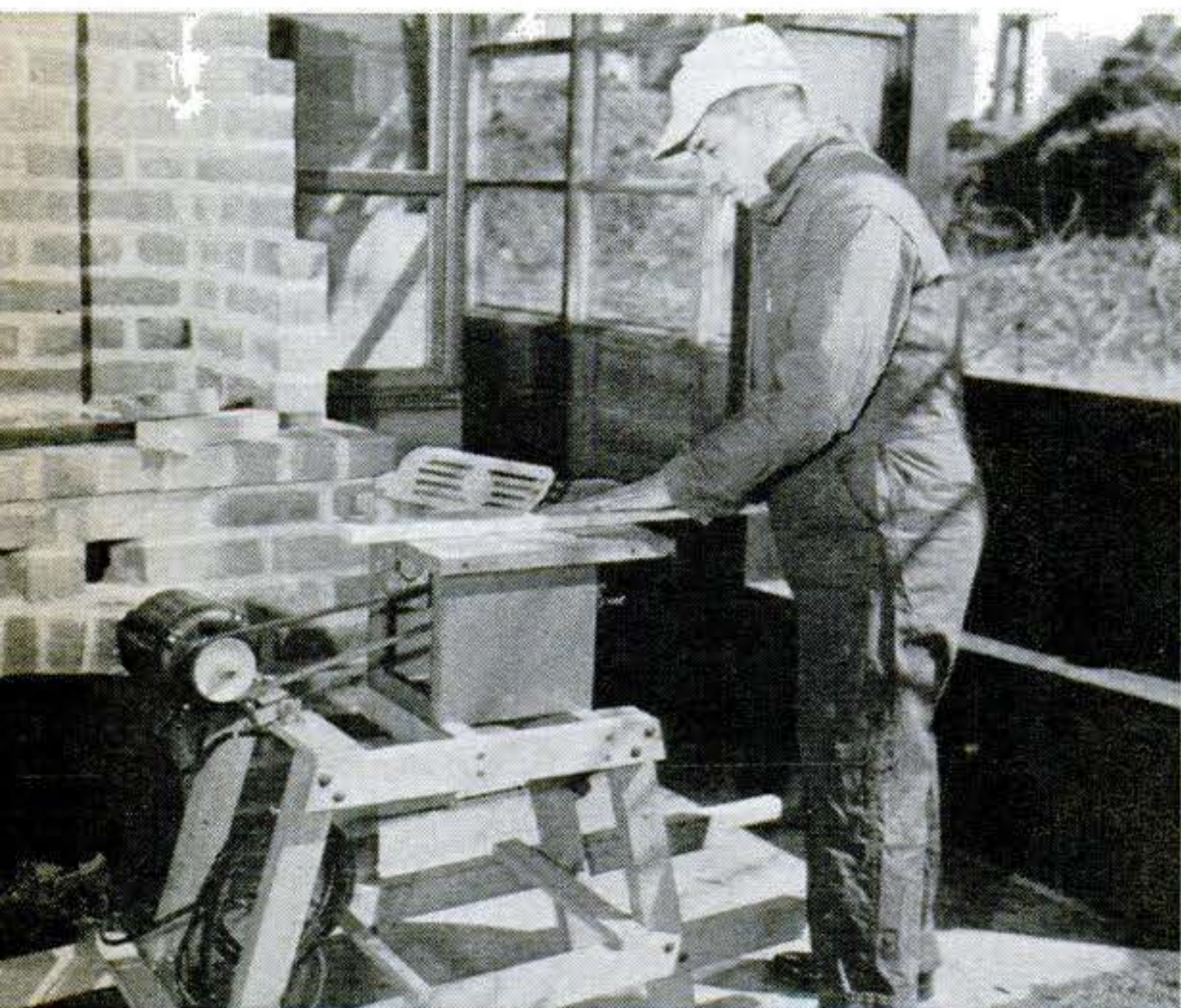

Saw in use. Even on hard surface like concrete walk, both units are heavy enough, and have legs spaced sufficiently, to be completely stable.



Triple outlet on leg of jointercart saves trouble of disconnecting and connecting main extension cord when drill is used.

the carts are moved. Holes for the axles— $\frac{1}{2}$ " by 5" carriage bolts—are centered $1\frac{1}{4}$ " from the ends of the handles. The wheels are attached with nuts, washers, and lock washers. From the wheel end of the handle to the front of the front leg is 13" measured along the top of the handle. Measured from the points along the center of the legs, the distance from the ground to the bottom of the handle is $5\frac{3}{4}$ " on the front leg and $7\frac{1}{2}$ " on the rear leg.

Besides the handy worktable of $\frac{3}{4}$ " plywood, the jointercart is fitted with a vise,

electric drill, rack for bits, and a toolbox. To avoid running more than one extension line to the job and still have all the tools plugged in for instant use, a triple outlet is screwed to one side of the jointercart. With this outlet plugged into the extension cord, the saw and other tools can be hooked into the triple outlet. The motor of the jointer is offset to balance the cart and to allow a free space below the jointer for the chips to drop through. To avoid poor motor performance from voltage drop, use the huskiest extension cord you can get. **END**

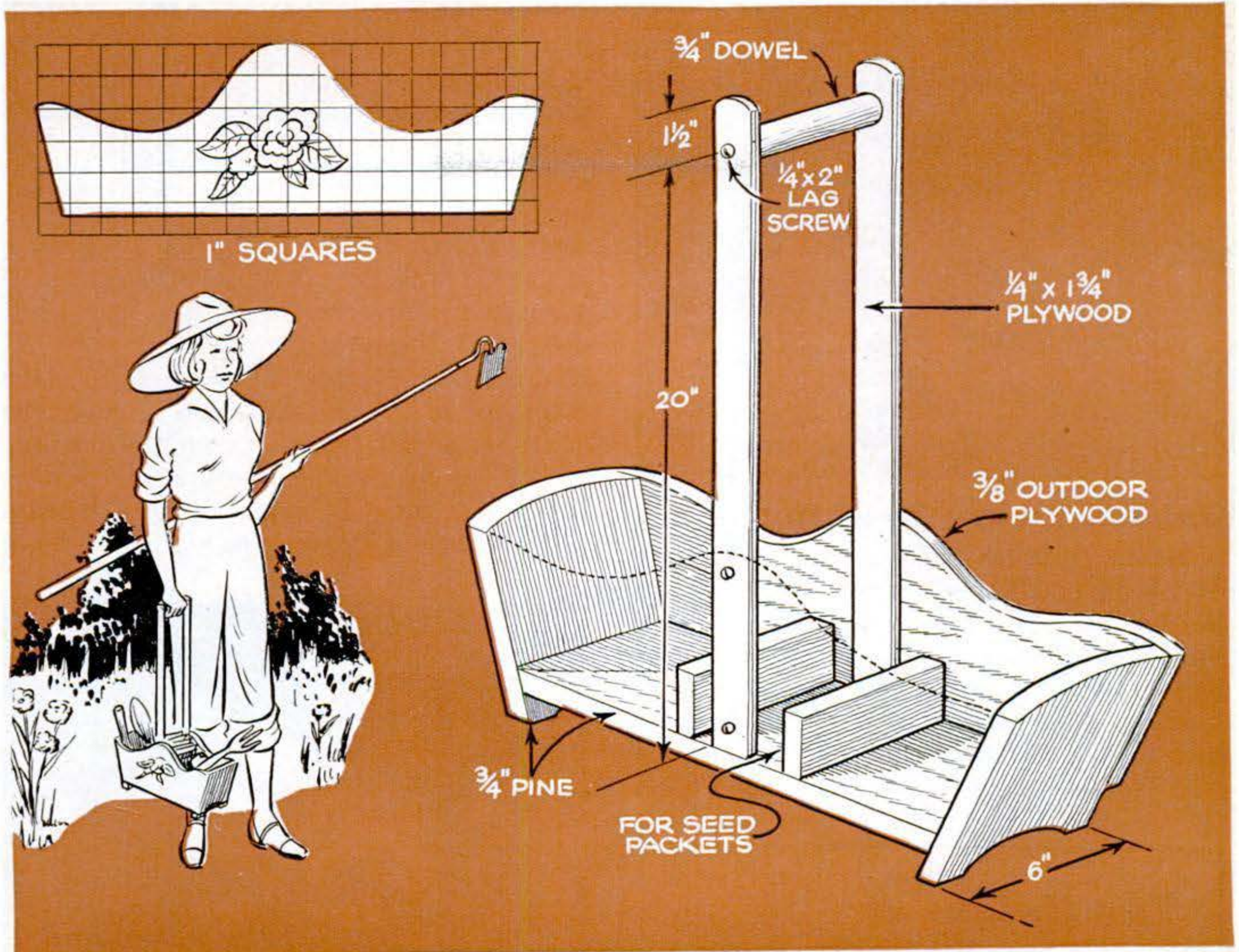

No-Stoop Kit Carries Garden Tools

CARRY small garden tools in a kit like this and you won't have to stoop over so often to pick up implements when you move from one spot to another. Besides space for several tools, the kit also has a compartment for

packets of garden seeds. The drawing gives you all the construction details. Put the parts together with wood screws and glue, paint the kit lemon yellow, and add decals for decorations.—*Hi Sibley, Nuevo, Calif.*

Make Cement Stepping Stones in Your Back Yard

HERE'S an adjustable form you can use to make stepping stones up to 22" square. You can make plain blocks or you can make them in different colors. The drawing below shows you how to build the frame. A C clamp at each corner lets you adjust the four sides to desired size.

Mix three parts of sand to one part cement. Add just enough water so the mixture will hold together when squeezed in your hand. In another box, mix a smaller batch in the same proportions. Into the second batch add dry mineral color. Mix the sand, cement, and color until it is the desired shade. Then add water.

Fill the frame to about 1/2" from the top with the gray cement. Finish filling it with the colored cement. Smooth it off with a wood float. If the cement is tamped hard and the mixture fairly stiff, the frame can be removed soon after the block is made.—*Dick Hutchinson, El Monte, Calif.*

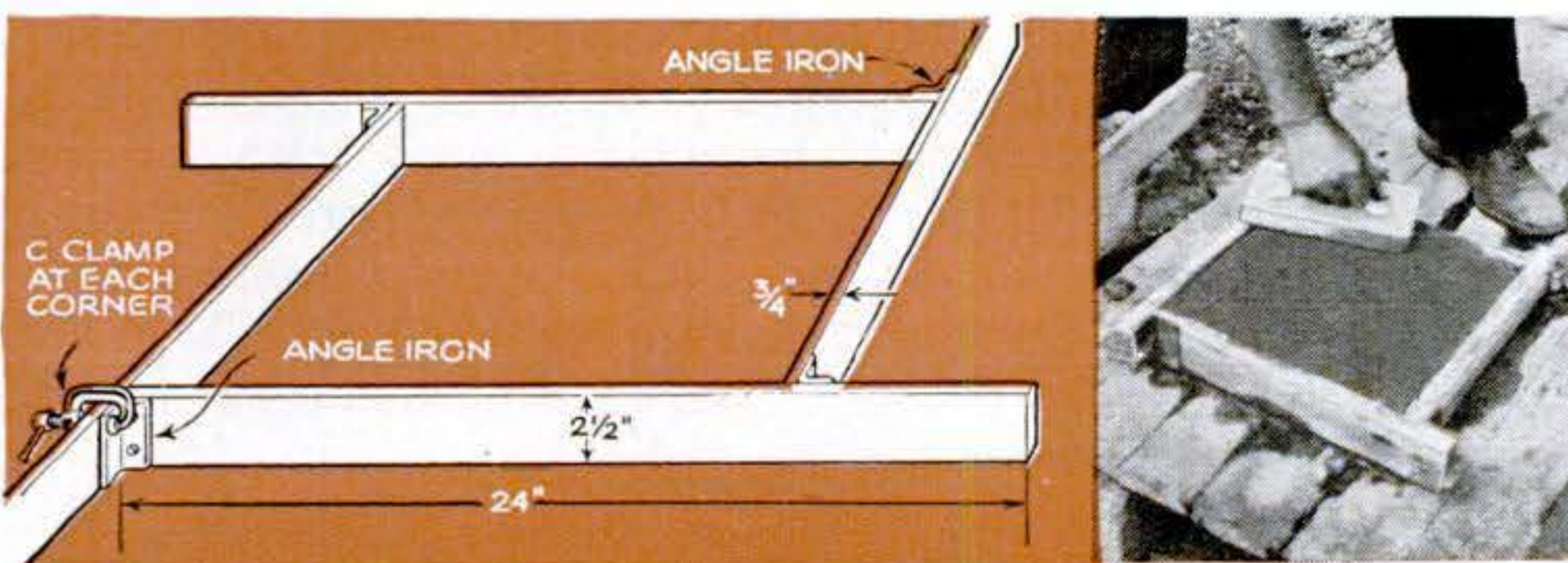

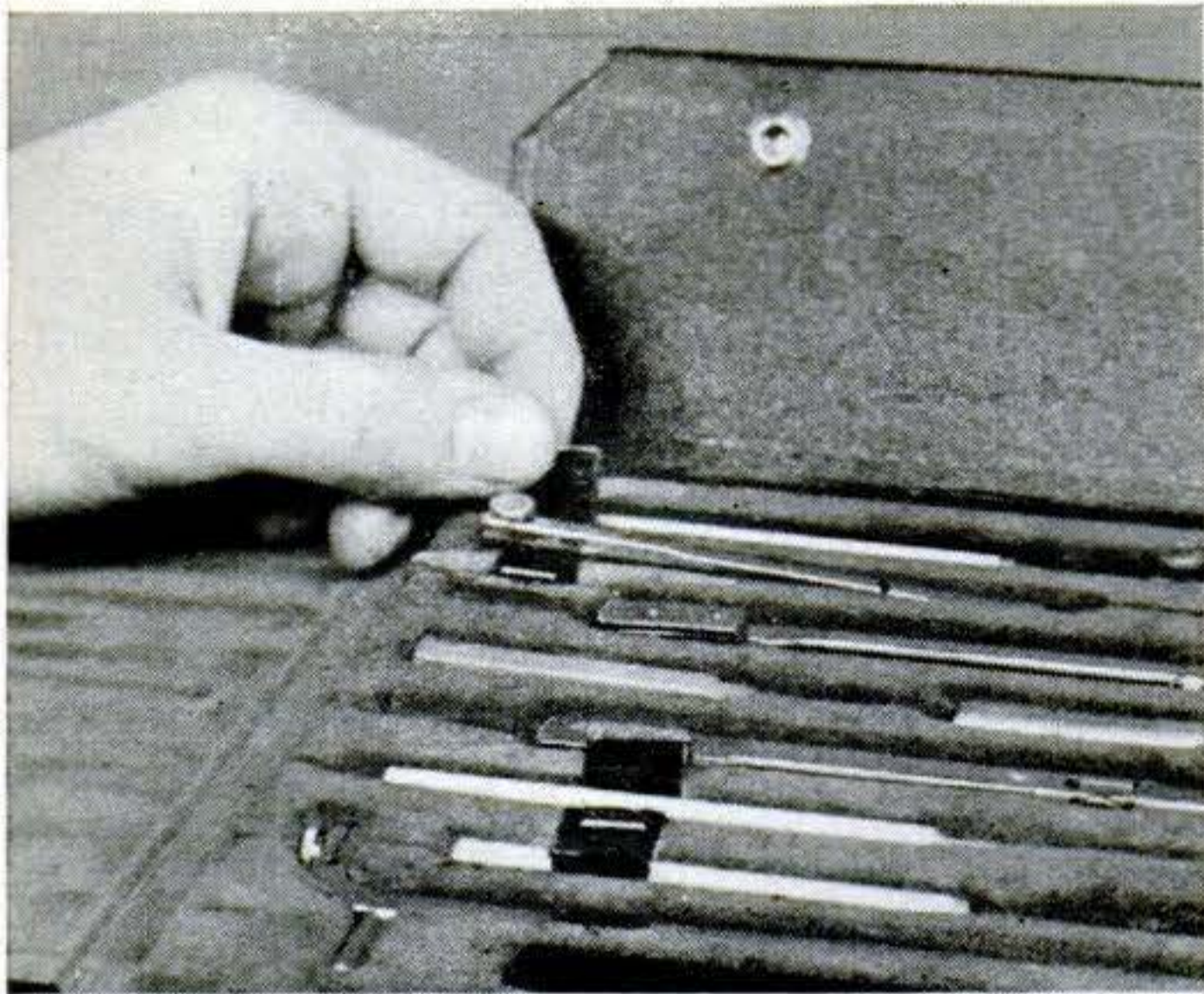

Tabs Improve Drafting Kit

SMALL cloth tabs stapled or glued in your drafting kit will speed removal of stubborn instruments. Fasten one end of the tab at the edge of the groove that holds the instrument. Lay the instrument over the tab so the free end of the tab sticks up on the other side. To remove the instrument, pull on the free end.—*Don Pittwood, Moscow, Idaho.*

The Height of Ingenuity

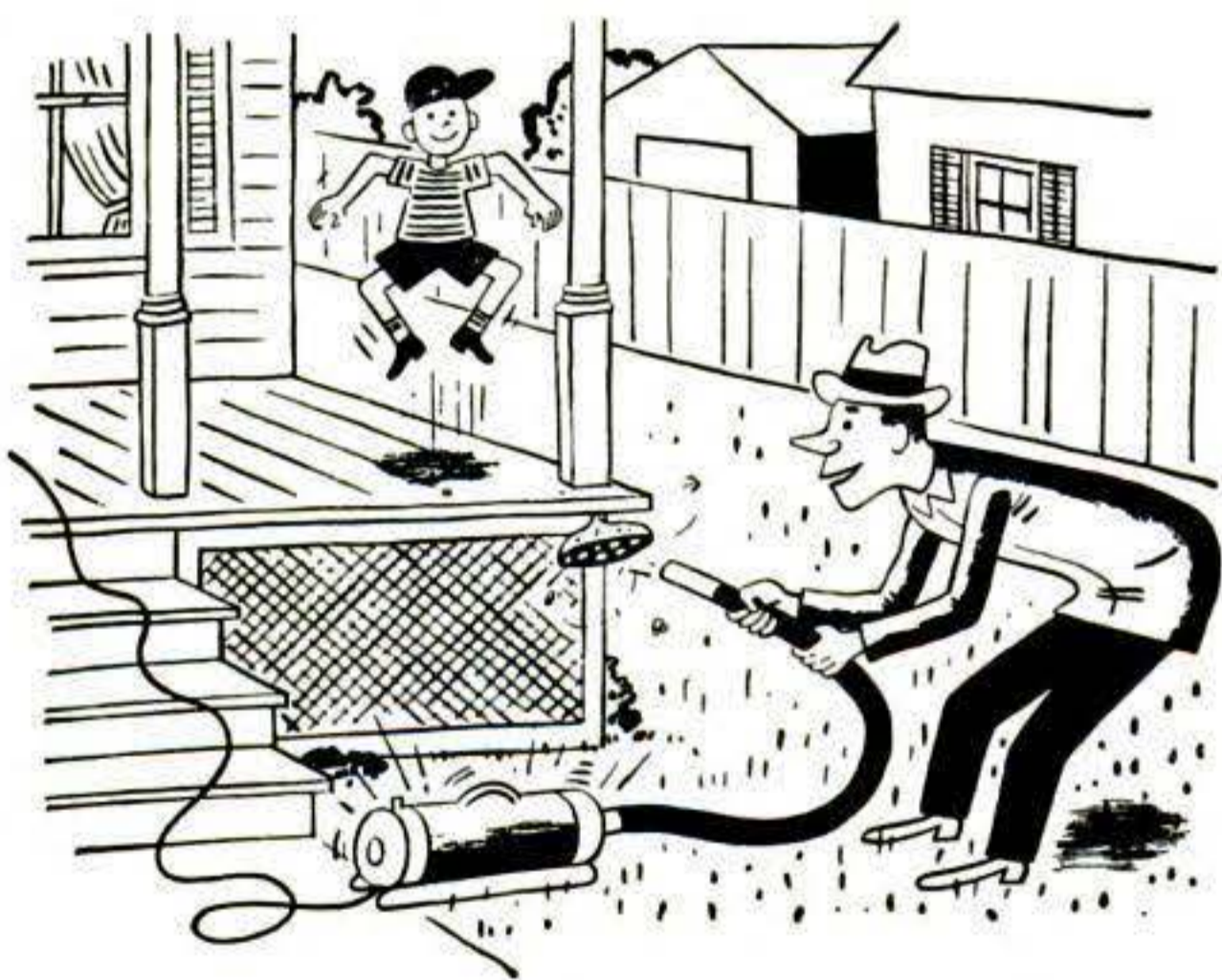

I got tired of yellow jackets zooming out of their nest under the porch and power diving on me. Here's the way I got rid of the whole gang.

While someone else jumped up and down on the porch to stir up the wasps, I stuck the nozzle of my tank-type vacuum cleaner near the nest. I neatly collected the whole swarm and then let the vacuum suck up some DDT powder.—*Jack Frederick, Bloomsbury, N. J.*

Installing Tubeless-Tire Valve

A DEFECTIVE valve in a bicycle or other tubeless tire is easily replaced by the method shown. Before forcing the bottom plate through the hole in the tire wall, put in a knotted cord as indicated. You can then hold the bottom plate in position against the inner side of the tire while you screw in the valve stem and tighten down the packing nut. Then cut the cord short and let it drop inside the tire. It won't do any harm.—*H. J. Bradshaw, Bradenton, Fla.*

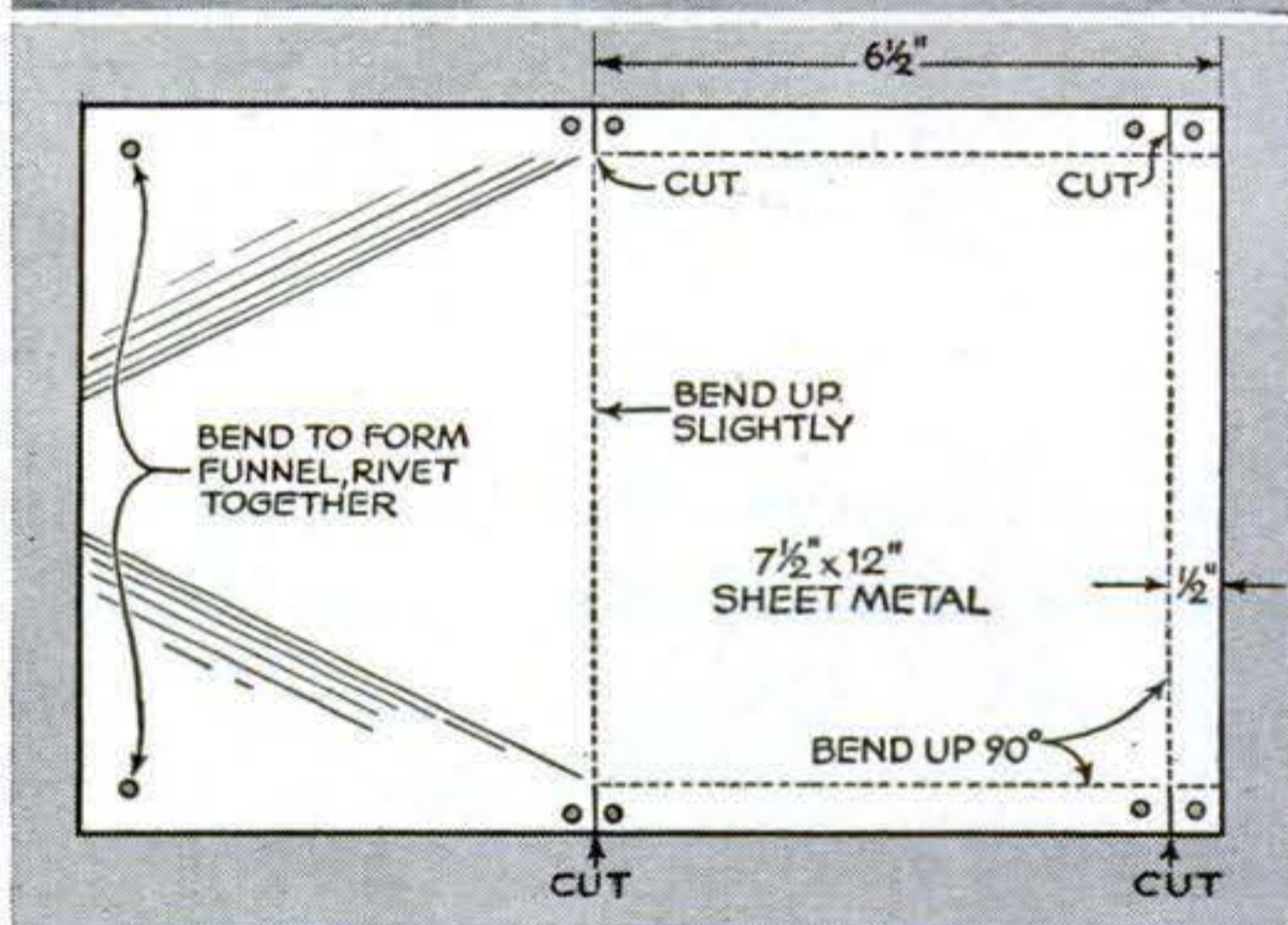
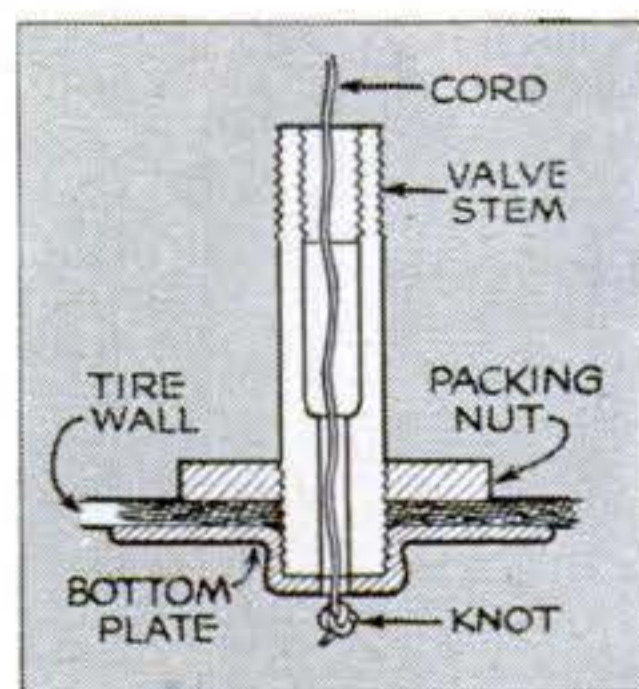

Funnel Is Sorting Tray

ONE piece of light sheet metal, galvanized iron or aluminum, is all you need to make this handy sorting tray and funnel. Snip the sheet to 7½" by 12" size. Mark the cuts and sharp bends with a scratch awl. After bending as indicated, fasten with small tinner's rivets. Rivet to the flat end a ¾" by 2½" tab of sheet metal, drilling a large hole in the outer end so the funnel tray can be hung on the wall. Smooth all edges with a file.—*Claude Sessions, Waynesville, Ill.*

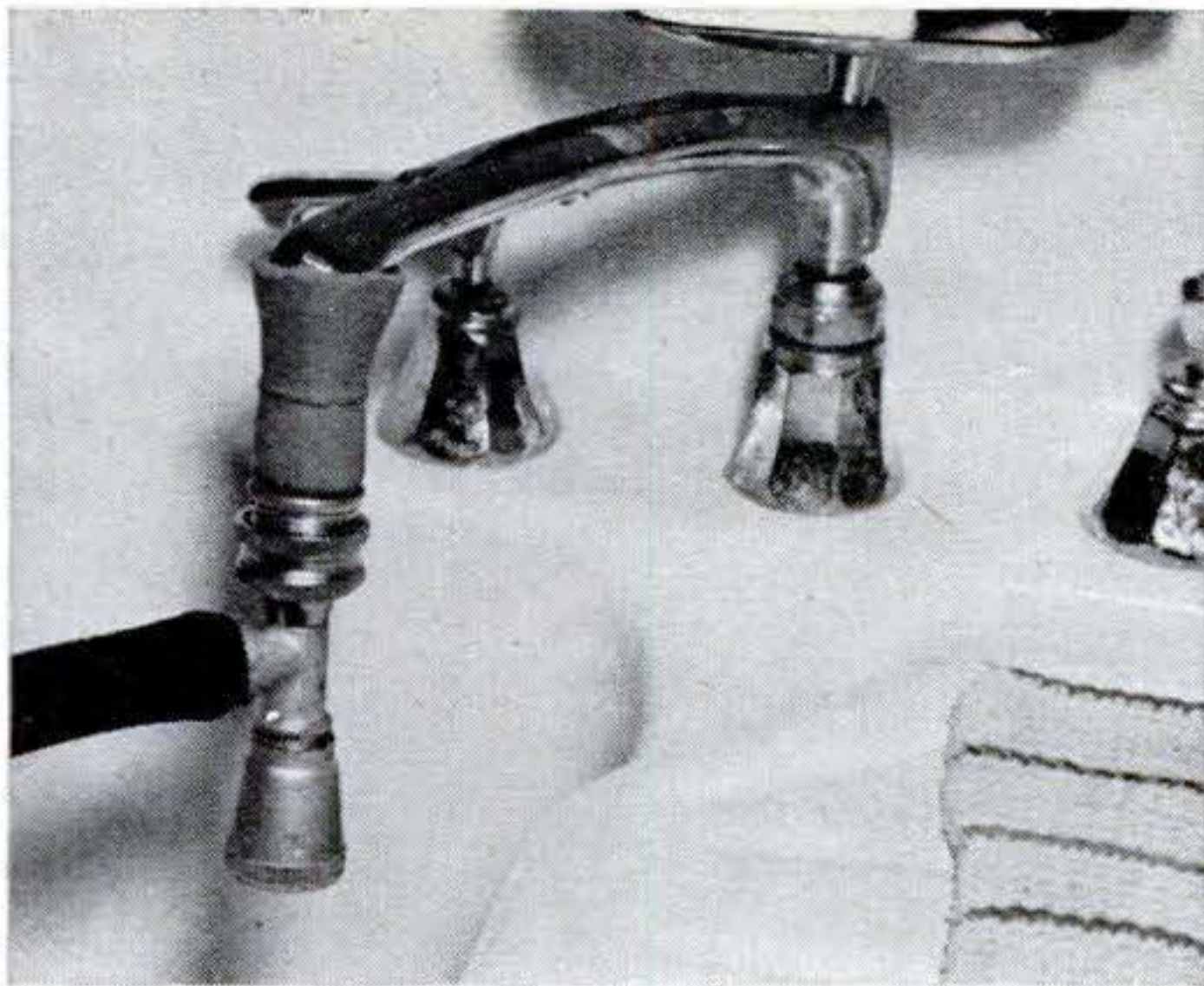

Siphon Hose Fills or Drains

WITH this device attached to a faucet, you can fill or drain heavy tubs or cans without lifting them. All you do is turn on the water and then twist the valve to the right to fill or to the left to empty. Water running from the faucet sets up siphoning pressure to empty containers. The device can be used to drain flooded cellars or small pools. It's priced at about \$4 by the Metalace Corp., New York City.

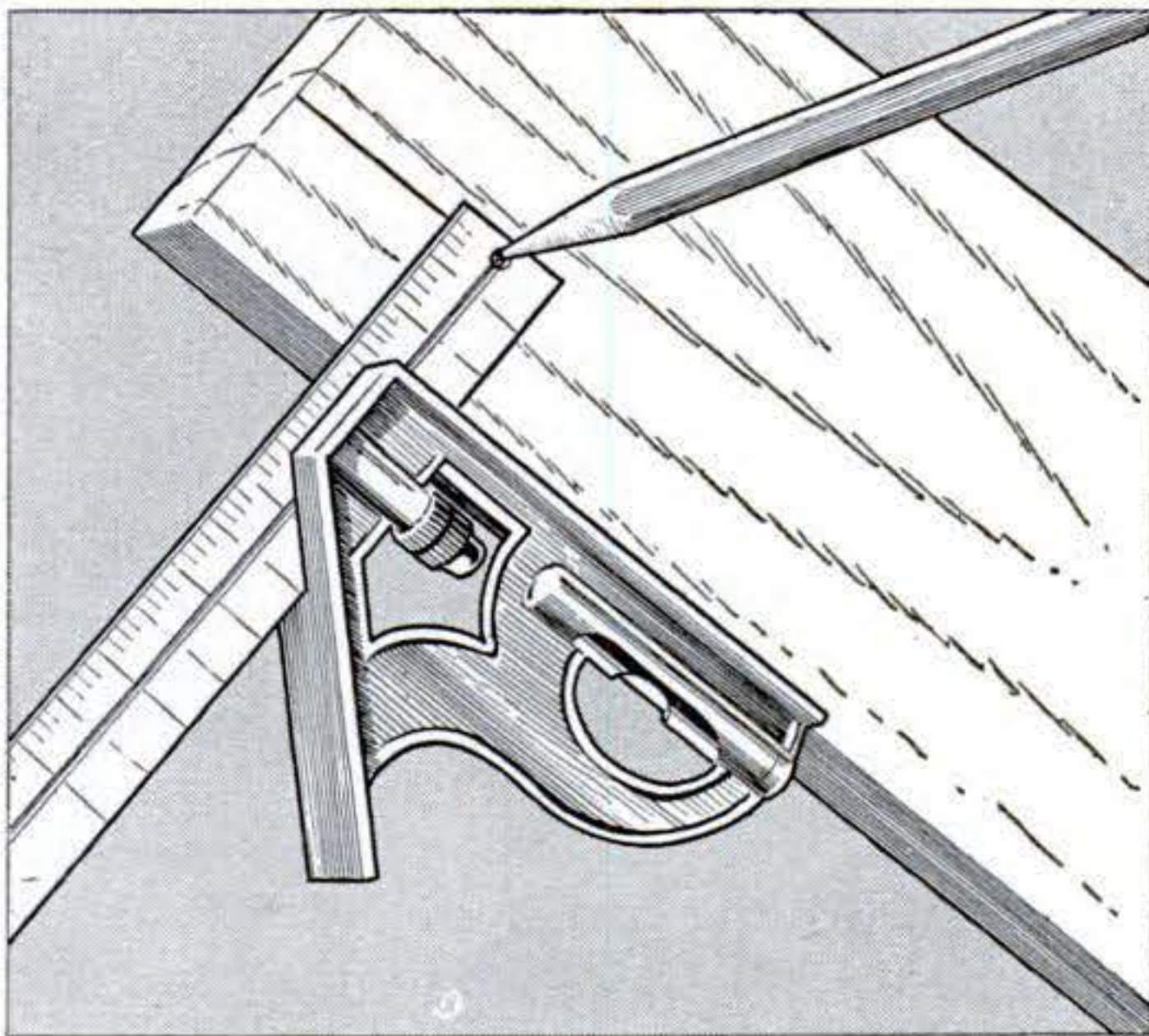

Square Doubles as Scribe

YOUR combination square can be used as an accurate scribing tool. Near one or both ends of the steel rule, drill a small hole to take the point of an awl, pencil, or nail. To use the scribe, press the straight side of the combination head against the edge of the work, set and lock the steel rule, and move the head along the edge. The point inserted in the hole will draw a line parallel to the edge as the head of the square is slid along.—N. C. Darling, Danbury, Conn.

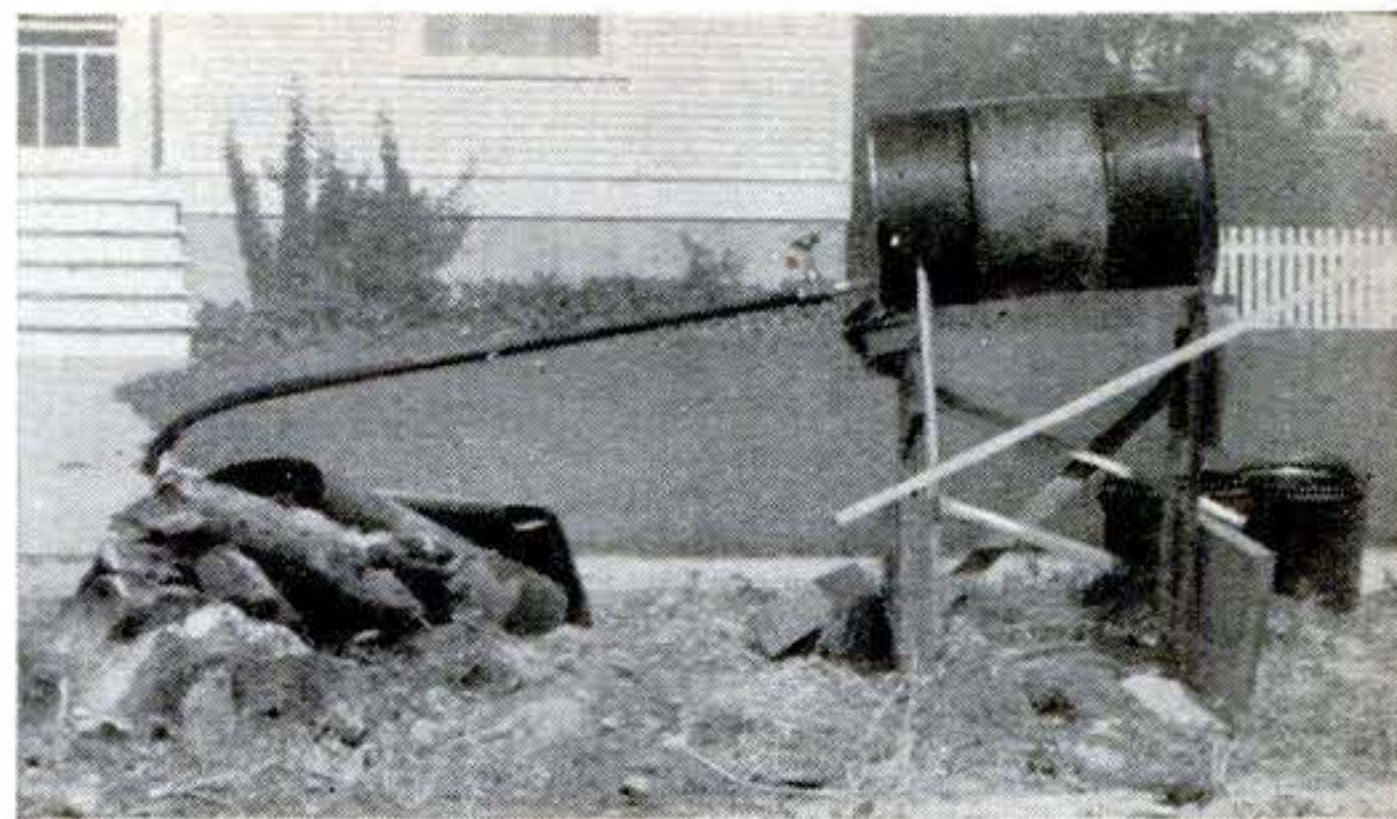

Stump Burner from Oil Drum

You can build an efficient stump burner with an old oil drum, pipe, and a valve. Build the stand so the drum tilts toward its opening. Curve the pipe as pictured. Adjust the valve so the oil—old crankcase drainings will do fine—drips slowly onto the stump. Once the fire is started right, it will burn for hours without attention.—E. V. Reyner, Townsend, Mont.

Give Your Star Drill a Rest

It's no longer necessary to drill holes in the bathroom wall to mount a towel rack or other fixture. Flat-based anchors now on the market can be stuck securely to tile, masonry, and other surfaces with a special adhesive.

Goodloe E. Moore Co., of Danville, Ill., makes its Gemco Anchor Bolts especially for home use. Devices, Inc., of New York, supplies Miracle Surface Anchors with bolts, nails, hooks, and other fastenings.

Shoptalk:

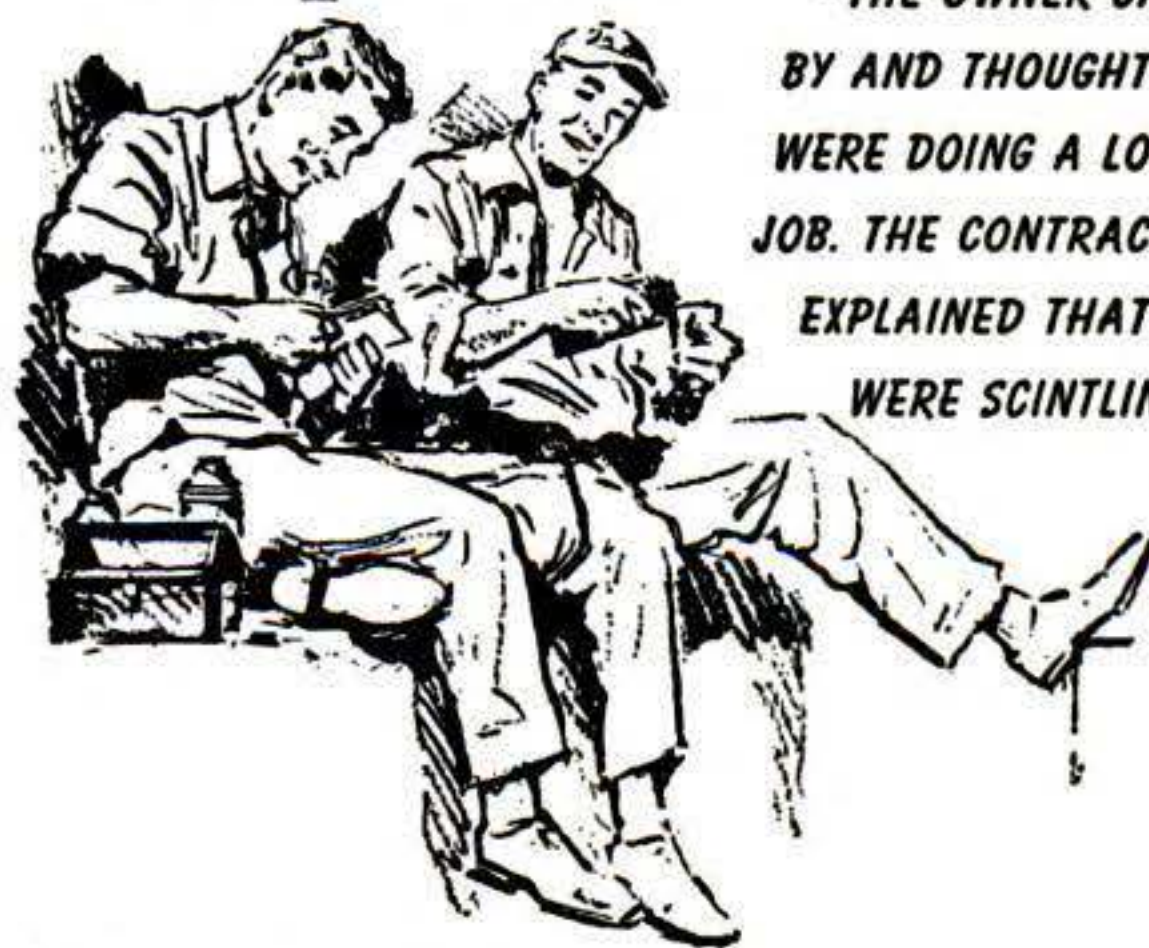

"THE OWNER CAME BY AND THOUGHT WE WERE DOING A LOUSY JOB. THE CONTRACTOR EXPLAINED THAT WE WERE SCINTLING."

What are they talking about?

Where do they work? Answer below.

They're masons. The owner of a house under construction thought they were doing a bad job of laying bricks. The contractor explained that they were scintling—laying bricks irregularly so the wall had a very rough texture for architectural contrast.

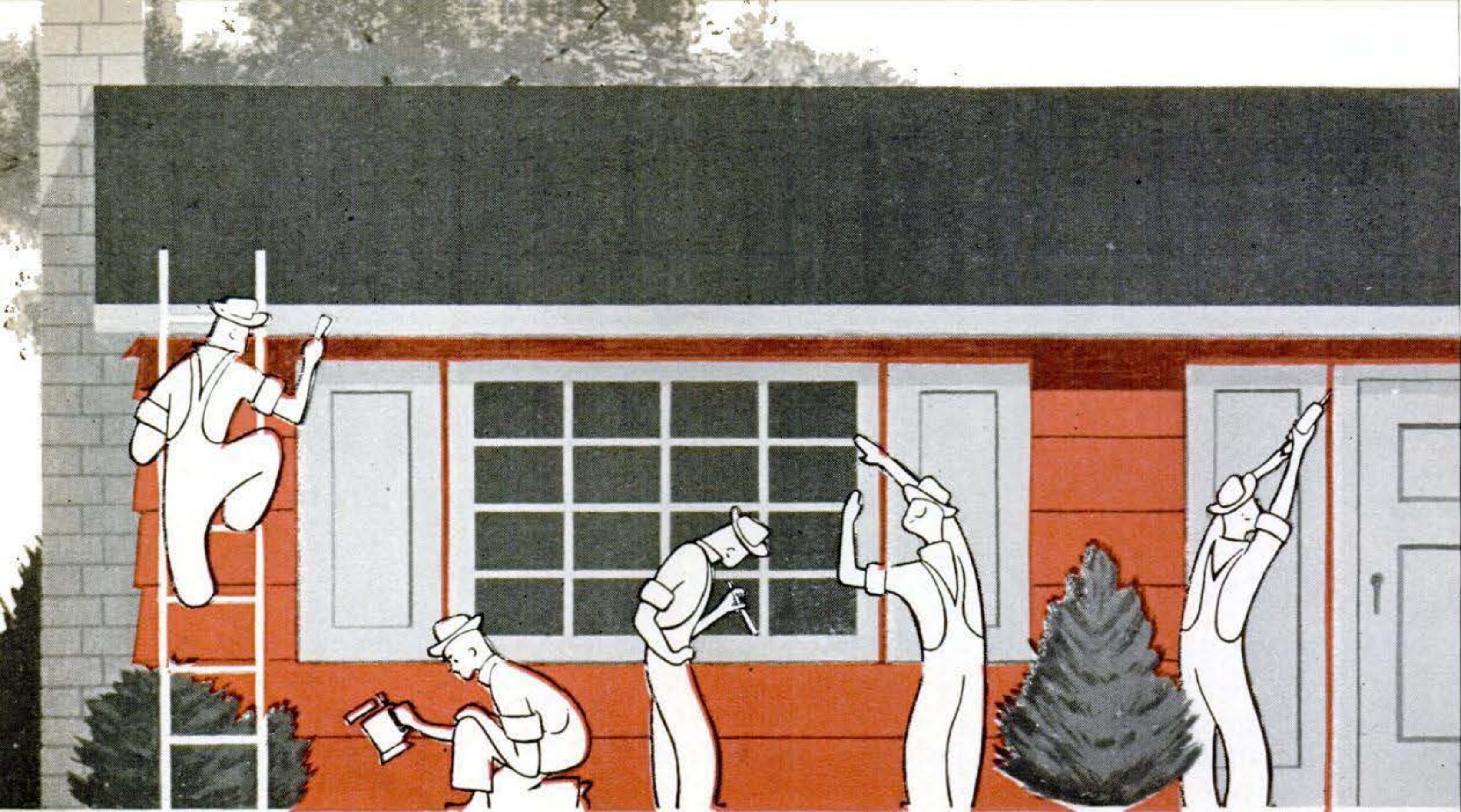

SCRAPE OFF LOOSE, BLISTERED, OR FLAKING PAINT.

USE BLOWTORCH TO REMOVE BADLY CHECKED AREAS.

CHECK ALL WINDOWS FOR LOOSE PUTTY. REPLACE IF NEEDED.

AFTER SCRAPING, DUST OUT ALL CORNERS AND CREVICES.

REPLACE CALKING AROUND DOOR AND WINDOW FRAMES.

How to Paint a House

Now's the time to dress up your home with a coat of fresh paint. Pick a dry, clear day and use good brushes and good paint.

By Bernard Gladstone

BESIDES keeping up the looks of your home, a new paint job at regular intervals is low-cost maintenance. Paint forms a durable, weatherproof film that protects wood and metal from rot and rust. And there's nothing complicated about doing your own painting. By following a few simple rules, you can turn out a really first-rate job.

If possible, do the painting during periods

of mild temperature and humidity. Never paint in damp weather or right after a rain. Be sure the surface to be painted is dry and clean. Otherwise, you'll find the new paint blistering and peeling in a very short time.

Preliminaries. Before you dip a brush in a pot of paint, take care of the preparation—removing old paint that is blistered, reputting, recalking, and removing shutters and screens. These steps are important. Painting over old paint that is blistered or peeling is a waste of time and money because the new paint will soon peel off.

Start by scraping off any loose, flaking, or peeling paint. Use a hand scraper or a stiff putty knife. Be particularly careful to remove all scaling paint and accumulated paint from window sills and other trim. Any area that is rough must be smoothed down with sandpaper or steel wool.

In some places, you may find the old film so thick and full of check marks that it is almost impossible to smooth it. In such cases, the usual method is to remove the old paint by burning it off with a blowtorch. Keep a pail of water or a fire extinguisher handy, and try to avoid charring the wood. Direct the flame horizontally and use a long-handled putty knife to keep your fingers away from the flame. Heat the old paint until it softens and blisters. Then



LET PRIMING COAT
DRY AT LEAST 36
HOURS.

START PAINTING
FROM HIGHEST POINT
AND WORK DOWN.

FINISH ALL SIDING
AND THEN PAINT
THE TRIM.

DUST METAL SUR-
FACES CLEAN AND
COAT WITH VARNISH.

THOROUGHLY CLEAN
BRUSHES IN TURPEN-
TINE AFTER USE.

scrape it off right down to the raw wood.

Puttying and calking. Examine all sash for putty that has loosened or fallen out. Scrape the rabbet clean, brush on a coat of primer, and—when dry—replace the putty. Examine siding and trim for nail holes and cracks. Brush these clean and give them a coat of primer. After the primer has dried, fill in the cracks and holes with white-lead putty.

Check around all the door and window frames for calking that is loose, cracked, or missing. Replace calking where necessary. For a good job, use a calking gun. It'll squeeze the calking material out with a smooth, even pressure—forcing it well into the joints.

Where you've scraped the old paint down to the wood, seal all knots and resinous spots with a coat of shellac followed by a coat of primer. Let the primer dry at least 36 hours before painting over it.

After you've smoothed and scraped the surface to be painted, use an old paint brush to whisk off all dust. The surfaces must be clean or you won't get a lasting job with the new paint.

Painting. When repainting over old work, the question of whether to put on one or two coats often comes up. Generally speaking, two coats are advisable. But if

Basic preparation step is removing old paint that is blistered, flaking, or peeling. Hook scraper is the tool for this job. Correct use of scraper is shown at right.

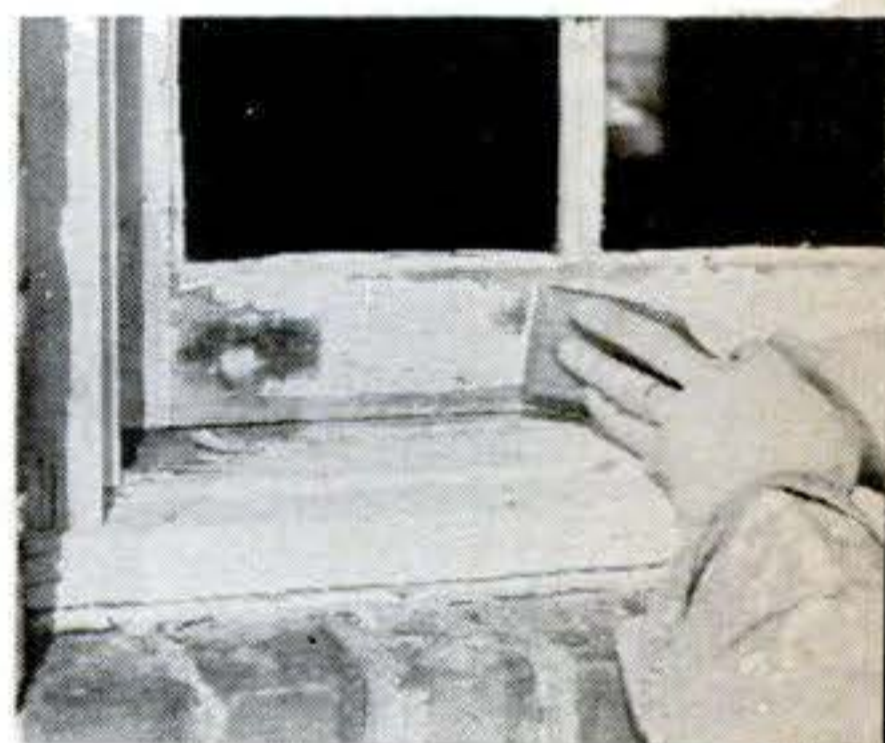

In close quarters, especially on sash, a stiff putty knife is sometimes better than a scraper. Flaking paint is being removed from sash in this photo.



Go over all sash carefully for cracked, loose, or missing putty. When you find putty that's in bad condition, remove it by scraping it away with a putty knife.

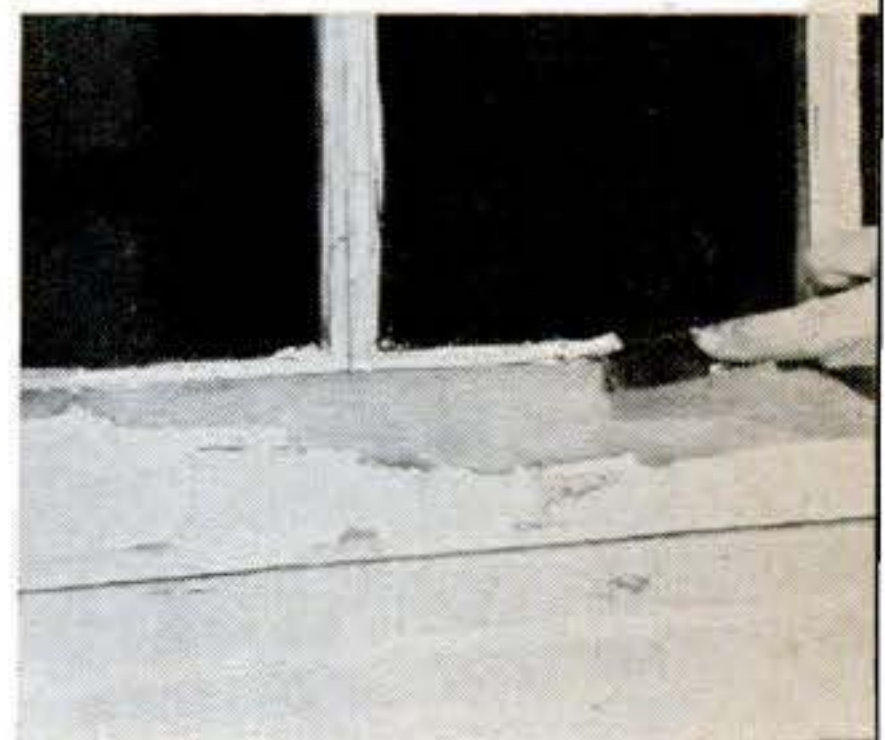

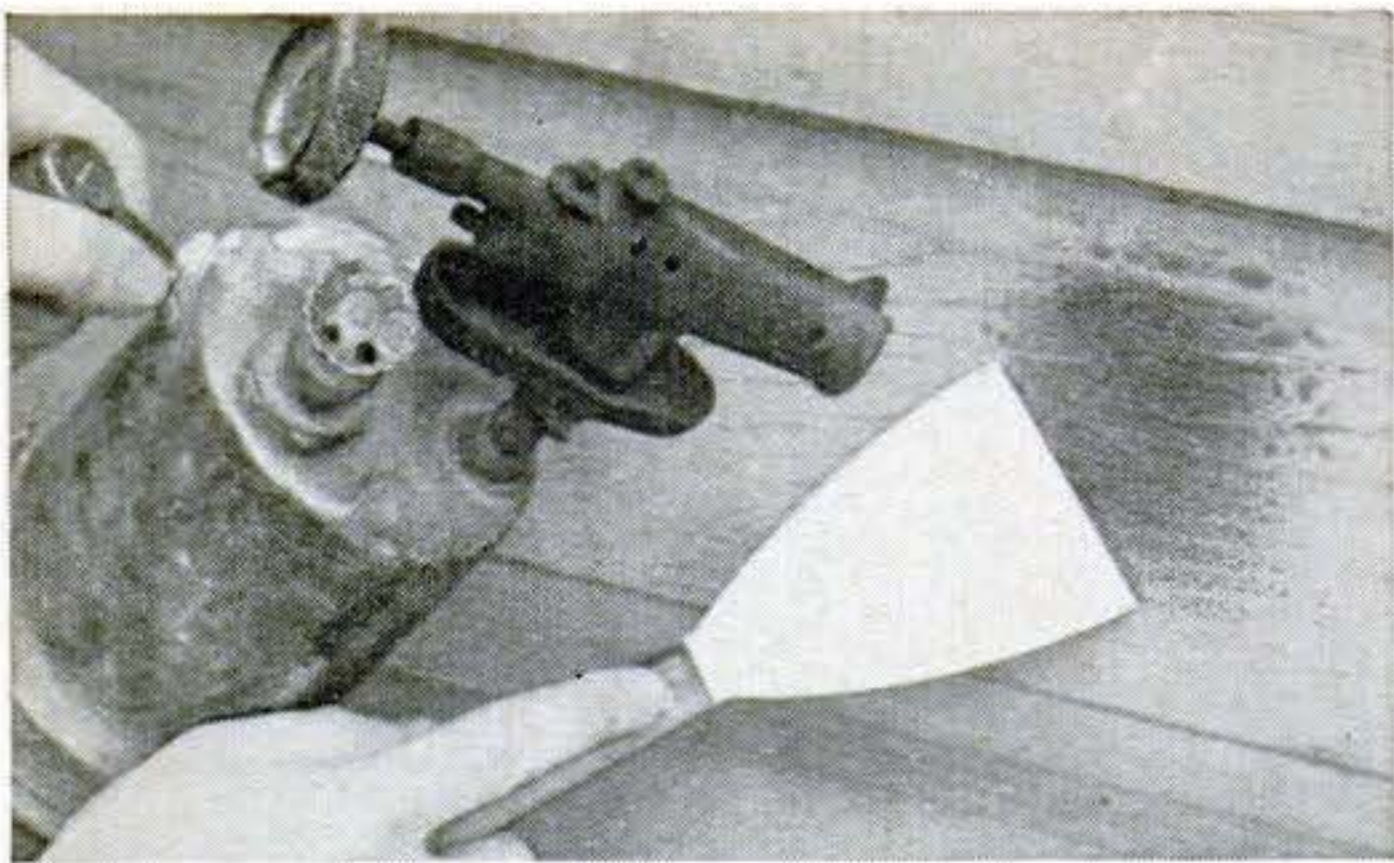

If old paint is thick and rough, use blowtorch to burn it off. Heat softens and blisters old paint so you can scrape it off.

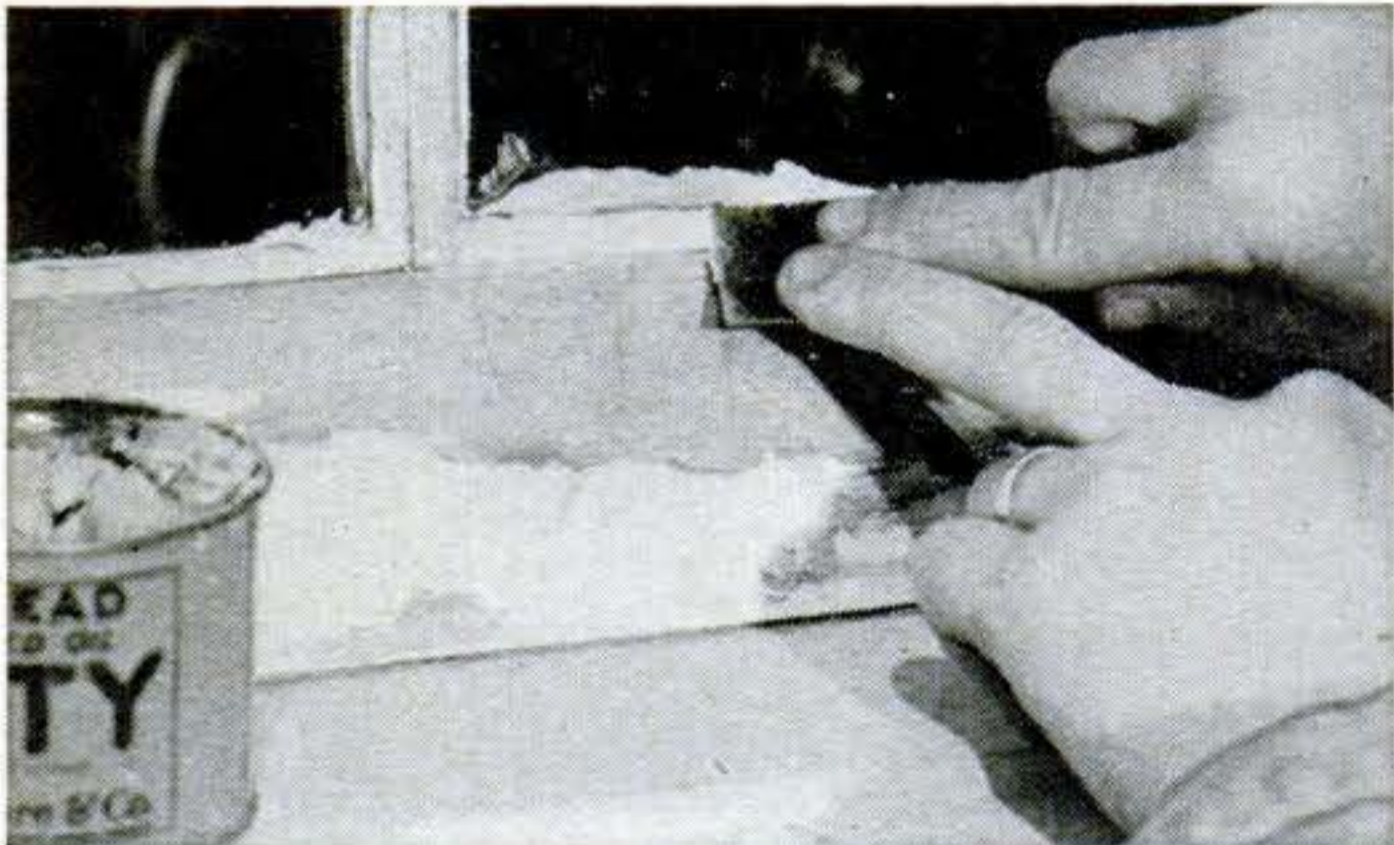

Before reputtying, brush dust out of rabbet and give it a coat of primer or raw linseed oil. Apply putty smoothly and scrape off excess.



Clean out all cracks, give them a coat of primer, and fill them with white-lead putty. Nail holes also should be filled with putty.

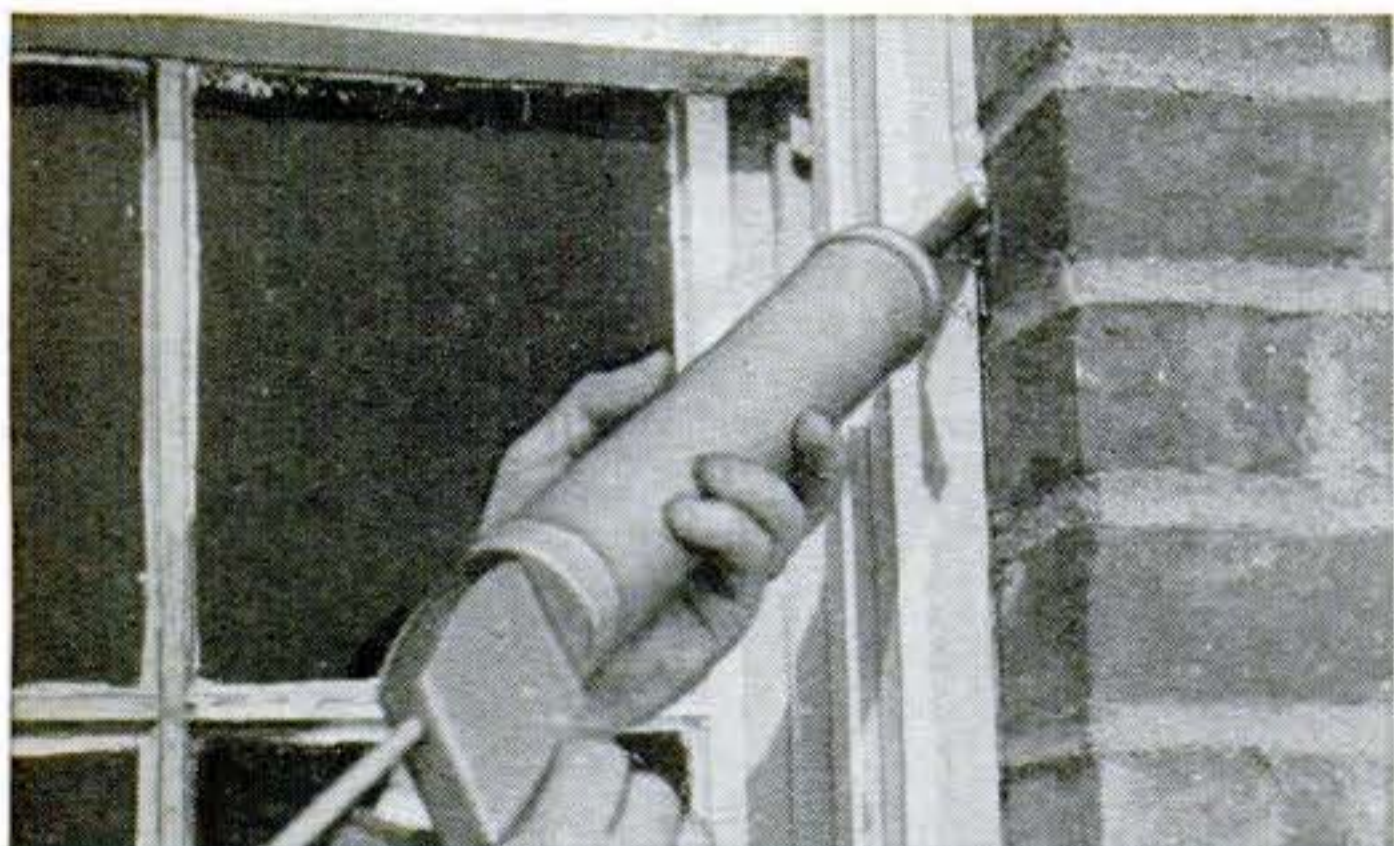

Use a caulking gun and a gun-grade caulking compound to seal all cracks around door and window frames. Do this before painting.

the surface is in pretty fair condition and has not been neglected too long, one coat will often do. At any rate, don't lay on one very heavy coat and expect it to do the work of two. This may cause the finish to wrinkle on drying. The surface of a thick coat dries before the paint underneath does, resulting in uneven shrinking. If two coats are used, let the first one dry four or five days.

Start the new paint job with the siding. Begin at the highest point and work across. Don't start at a high point and paint a strip down to the foundation. Work across, climbing down to move your ladder over for the next area. By working across, you'll avoid lap marks. Never move your ladder with the pot of paint hanging on it, unless you're after low-comedy effects. Instead, bring the paint down with you.

Always be careful that the ladder feet are anchored firmly in the ground. You can check this by jumping on the bottom rung before climbing up. When you have to rest the ladder on a concrete walk or driveway, nail a rubber heel to the bottom of each leg to prevent slipping. If you use a metal ladder, make sure it's fitted with rubber-covered safety shoes.

Finish painting all siding and double back to do the trim and sash. One exception to this would be a high peak where you have to paint both trim and siding. Two trips would mean a lot of extra climbing. In such a case, it's better to carry up two pots of paint—one for the siding and the other for the trim and do the job in one trip up the ladder.

If the siding of your home is clapboard, coat all the edges in any one stretch. Then paint the flat side or face, working horizontally across two or three boards at once. A 3½" or 4" brush will generally be found best for this work.

Painting trim. If your trim is to be painted a dark or bright color, it's wise to use one of the special trim paints rather than regular house paint. These trim colors are made to give a hard, glossy, nonfading surface. Ordinary house paints are designed to break down by a continuous, mild, chalking action. When washed down by rains, this action tends to leave a clean surface. Such paints are suitable for large wall areas. They're designed to eliminate the possibility of accumulating too heavy a layer of paint that'll eventually crack, or alligator, and have to be smoothed over for the next job. However, this chalking action can be ob-

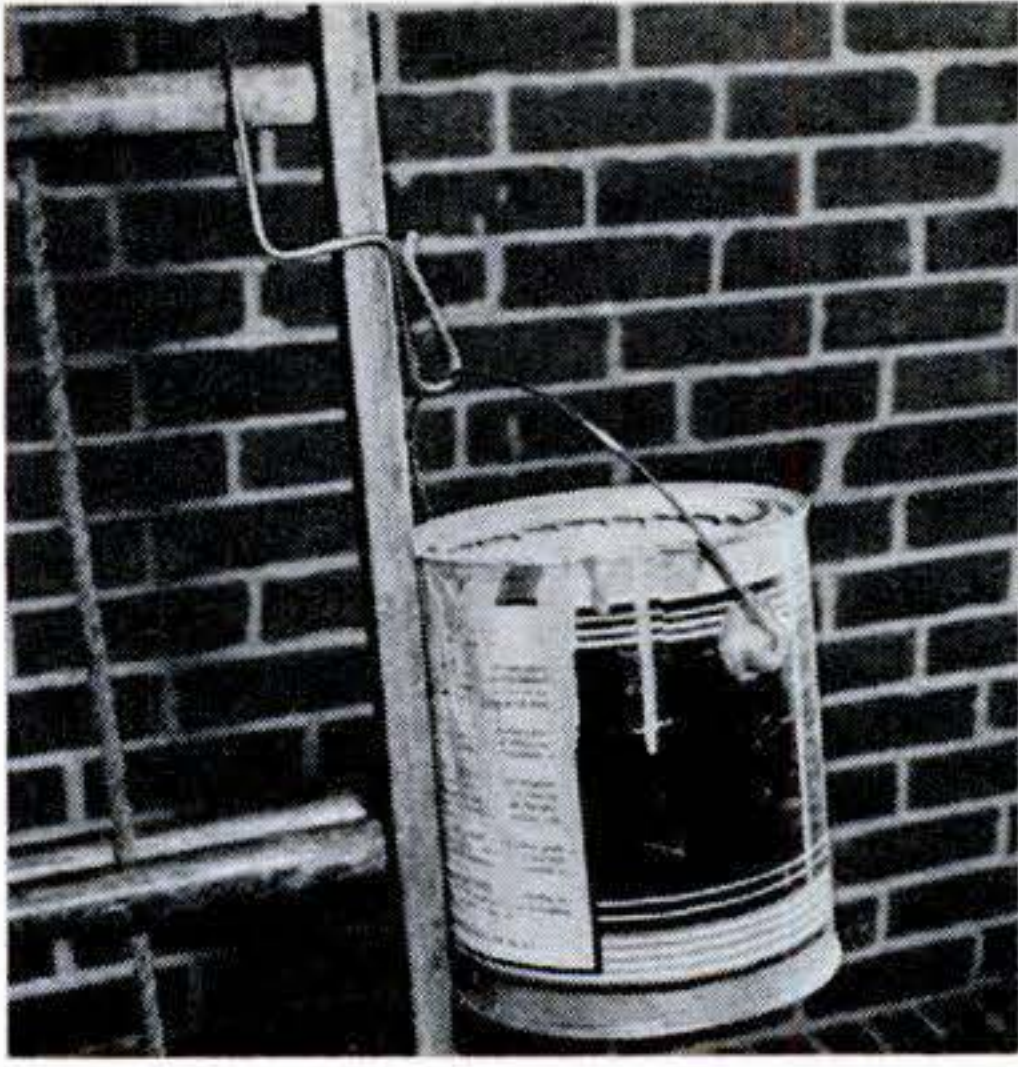

When working on an extension ladder, use a pot hook to hang your can of paint. Safest type hangs can outside of ladder as shown in photo at left.



Use sash brush on sash and trim. Press down to fan the bristles out to a sharp edge as shown at right. Control brush with your forearm; not just your wrist.

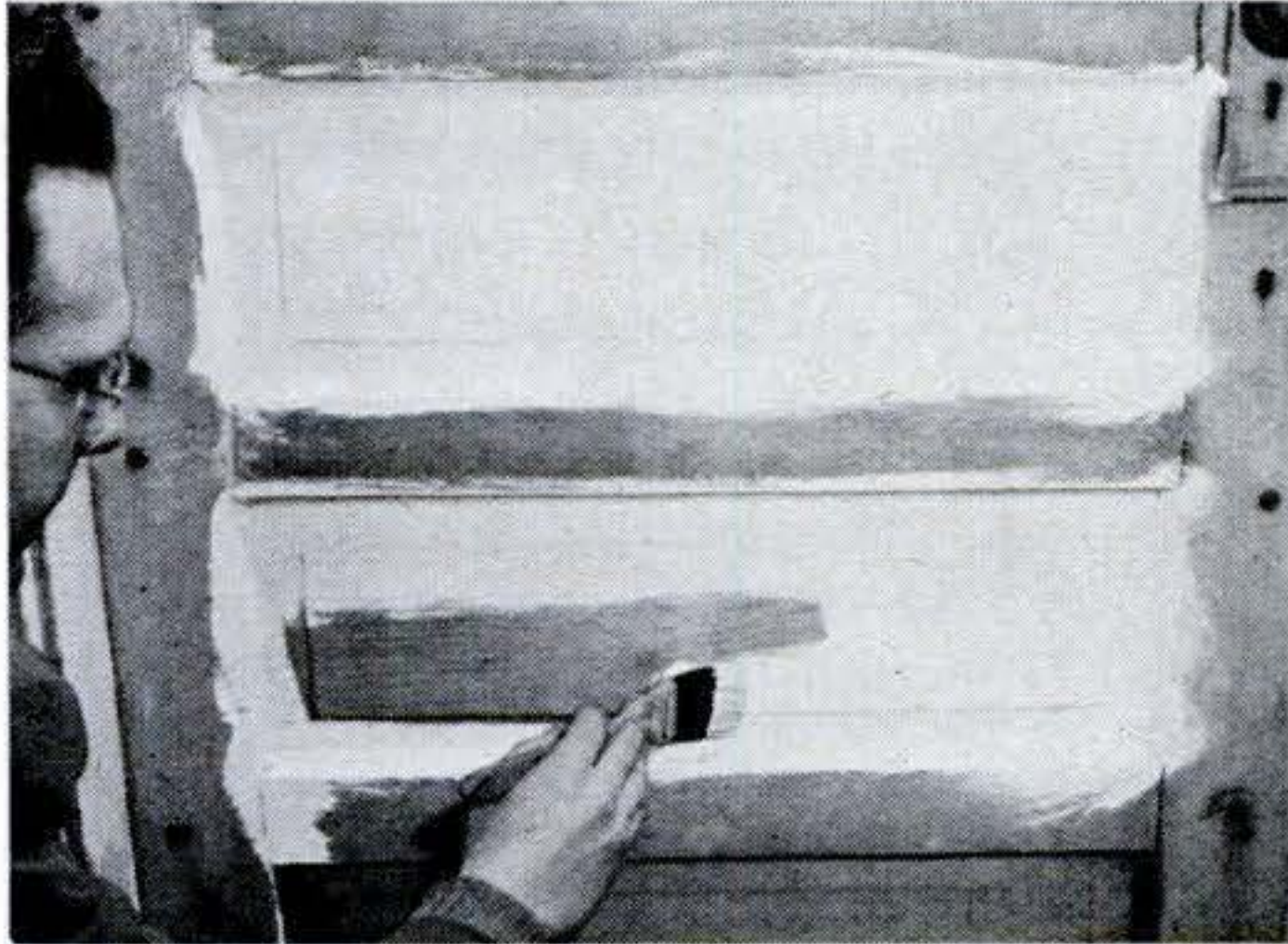

Paint doors like this. Do all panels. Then coat rails, stiles, and mullions. Rails run across; stiles and mullions, vertically.



To prevent copper gutters and other fittings from oxidizing and staining trim as shown here, coat them with spar varnish.

jectionable on surfaces that must be handled—such as doors and windows. Then, too, chalking usually results in a gradual fading of colors. Using trim paint on windows, doors, and trim gives you better protection.

Painting sash. Use a 1½" or 2" sash brush. These brushes are especially made to be used edgewise. Dip half the length of the bristles into the paint. Touch the brush to the sash a little way from the edge of the glass. Twist your hand slightly to fan the bristles out to a sharp edge. Then, keeping the bristles under tension, use your whole forearm to draw the brush smoothly and steadily along the sash.

When painting paneled doors, avoid runs by always painting in the panels first. Do the rails next and the stiles and mullions last.

Painting metal. Copper gutters, copper screens, and other unpainted metals that oxidize often stain the trim of a house after a few rains. You can prevent further oxidation and staining by brushing the metal clean and then coating it with spar varnish.

Metal surfaces—such as railings and grates—usually are painted along with the trim.

Use a wire brush to clean all rusted or peeling areas. Then spot-prime them with red lead or zinc chromate. In the case of new metalwork, brush on a coat of metal primer or zinc chromate and follow with one or two coats of trim paint.

Galvanized metals should first be washed down with a metal wash to etch the surface so the first coat of paint will stick. If possible, buy a ready-mixed wash. Otherwise, use a half-and-half solution of vinegar and water, rinse with plenty of water, and let the metal dry before painting.

When the job is done. Before you put the brushes away, wash them in three or four rinses of turpentine until thoroughly clean. Then comb the bristles straight and wrap the brushes carefully in heavy paper to preserve their shape.

Leftover paint should be poured back into the can from which it came. Then pour a little turpentine into the can, running it down the side so it floats on top the paint. Seal the can tightly. The turpentine floating on the top of the paint will keep it from skinning over for some time.

END

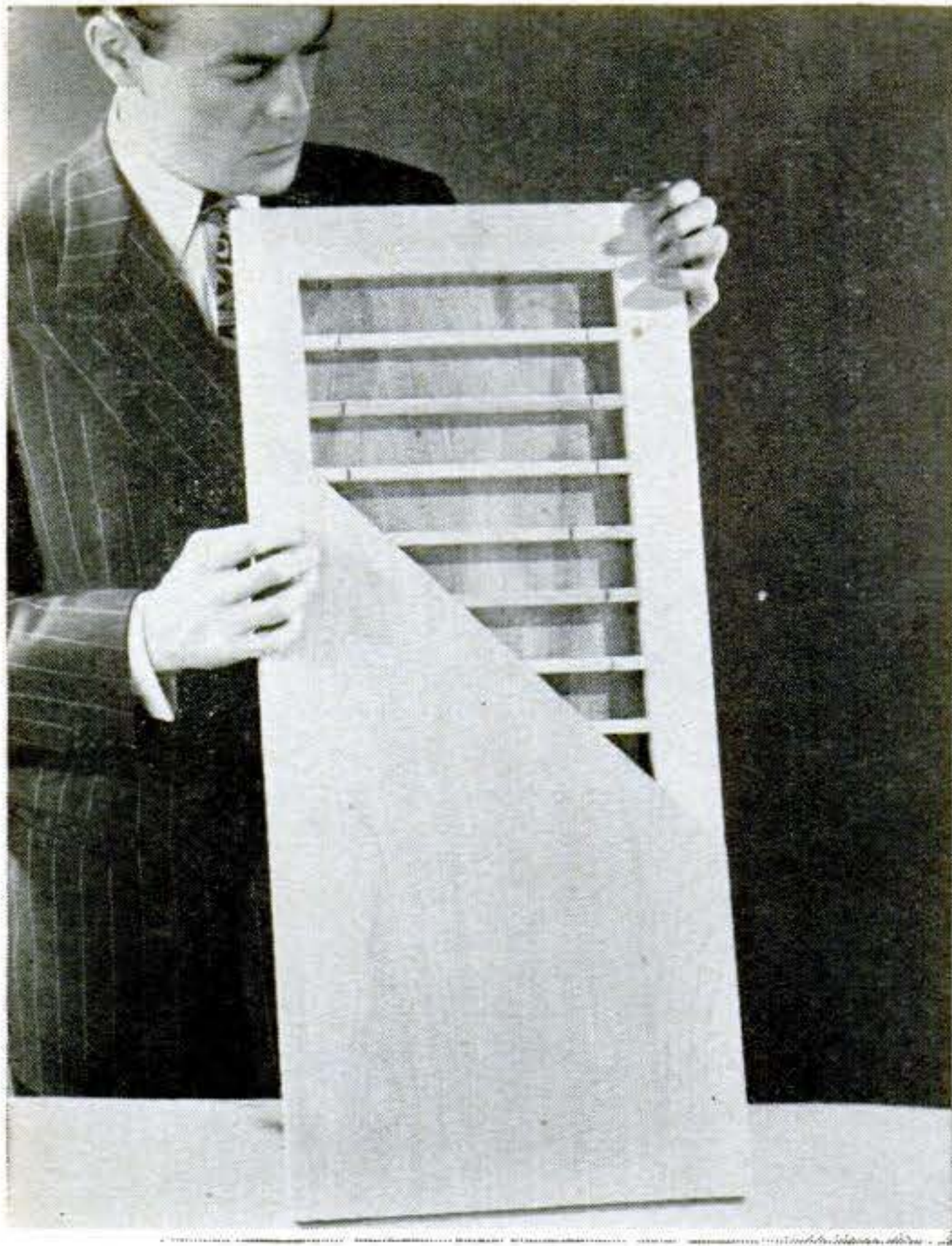

Cupboard Door Resists Warp

HARDWOOD plywood facings, bonded to a frame of low-density wood, make this door warp-resistant. The low-density wood is relatively inert and less subject to warp and twist. Ventilation keeps the interior of the door dry. The doors are made by the Wisconsin Laminating Co., of Chilton, Wis.

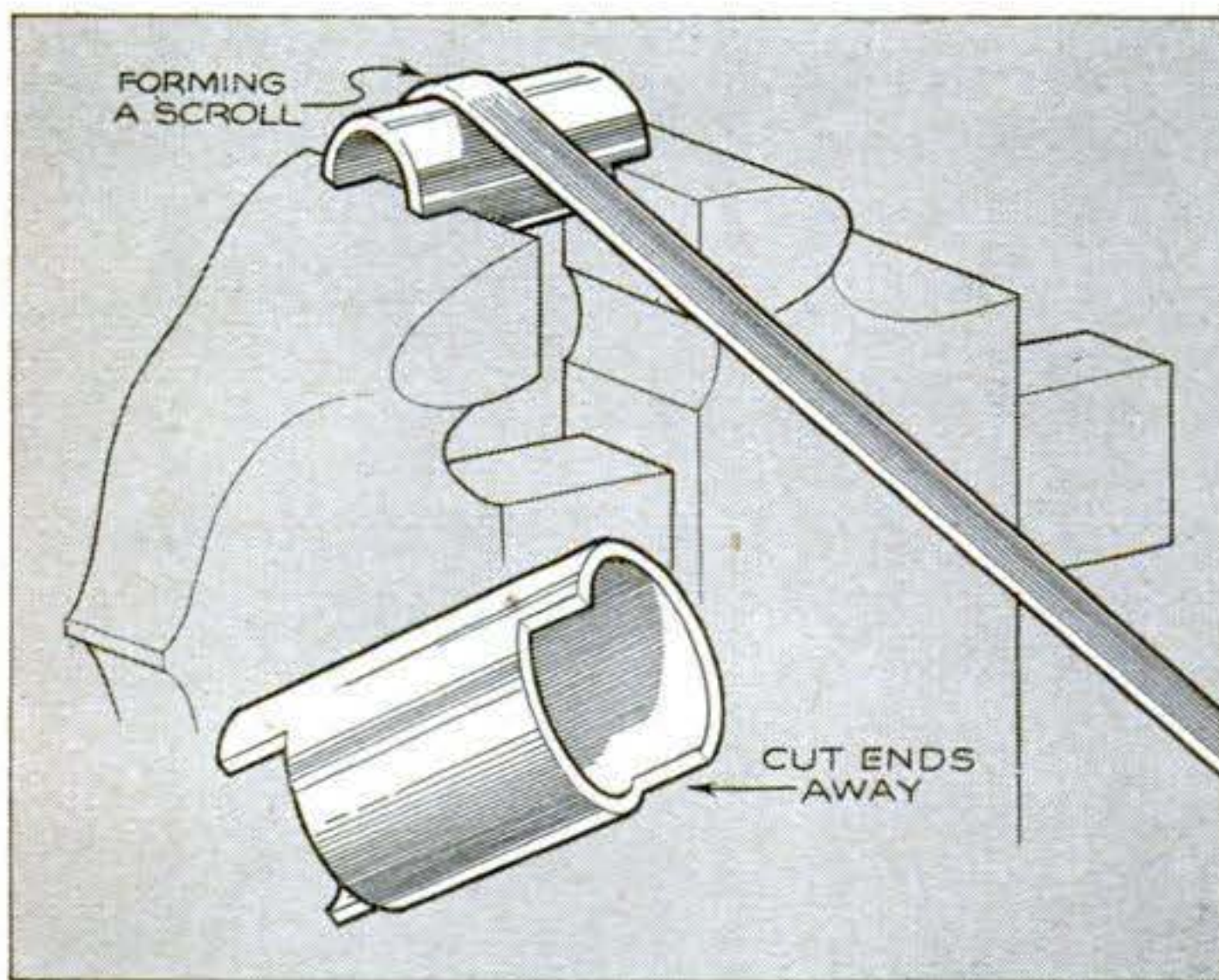

Stakes Made from Pipe

WITH a few pieces of pipe and a hacksaw, you can make your own metal-working stakes. For each size cut off half of each end of a 4" or 5" length of sturdy pipe. When you insert the shouldered ends in the jaws of your vise you have an inexpensive stake for shaping decorative strap iron.—*J. D. McCorkindale, Ames, Iowa.*

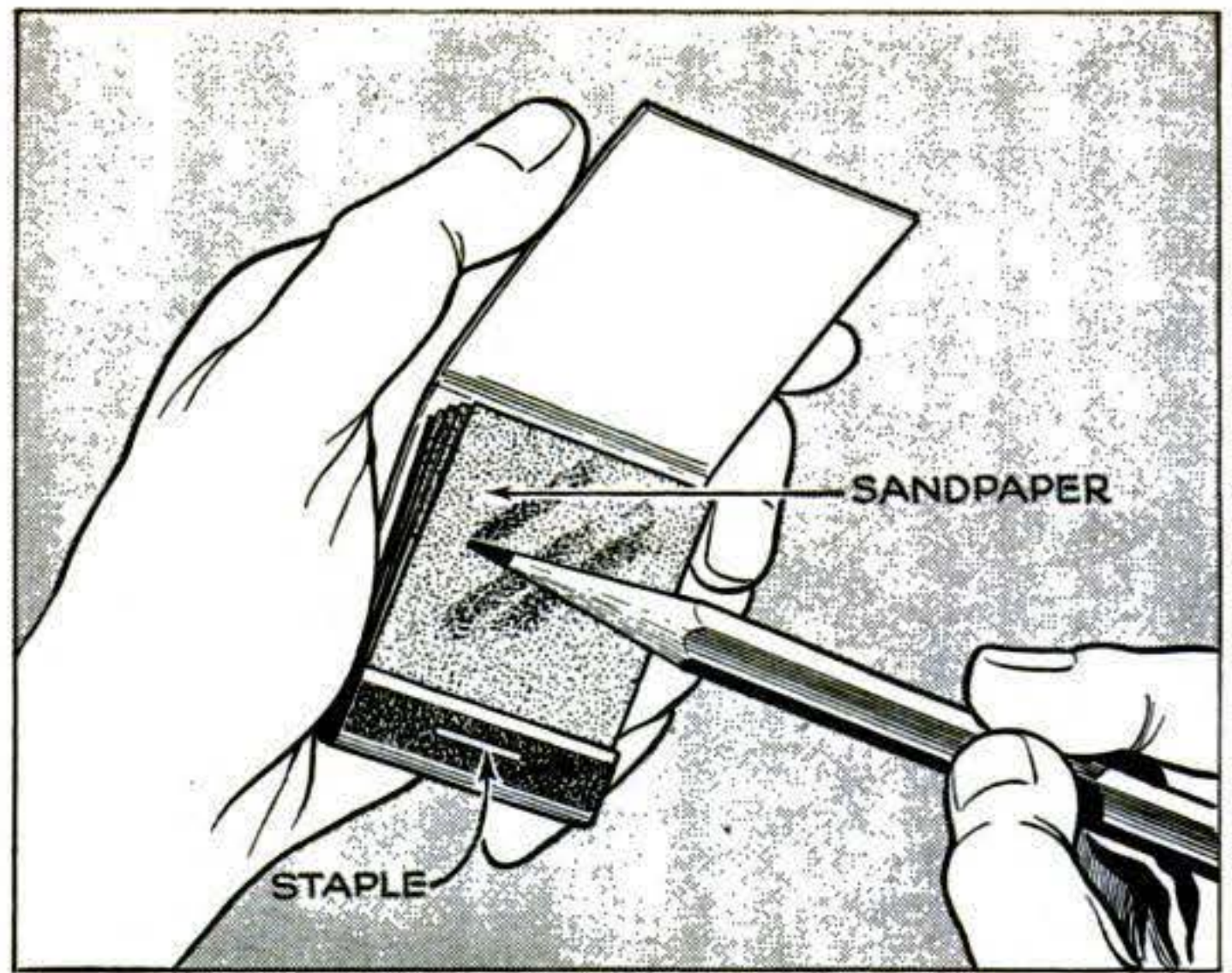

Matchbook Pencil Pointer

A CONVENIENT accessory for your drawing board or sketching pad is this little book of sandpaper. Cut six to 10 pieces of fine sandpaper to fit an empty matchbook. Run a narrow line of glue along one end of the pieces and stack them up to dry. Remove the staple, insert the glued edge and re-staple.—*H. E. Carter, Noblesville, Ind.*



New Paints Stick to China

LIQUID-PLASTIC glazes let you paint designs on china, glass, and metal, which then can be baked on in the kitchen oven. About an hour's baking at a temperature of 250° makes the designs permanent. Della Robbia, one of the new paints, is made by Sculpture House, of New York City. Dek-All, another such paint, is made by the American Crayon Co.

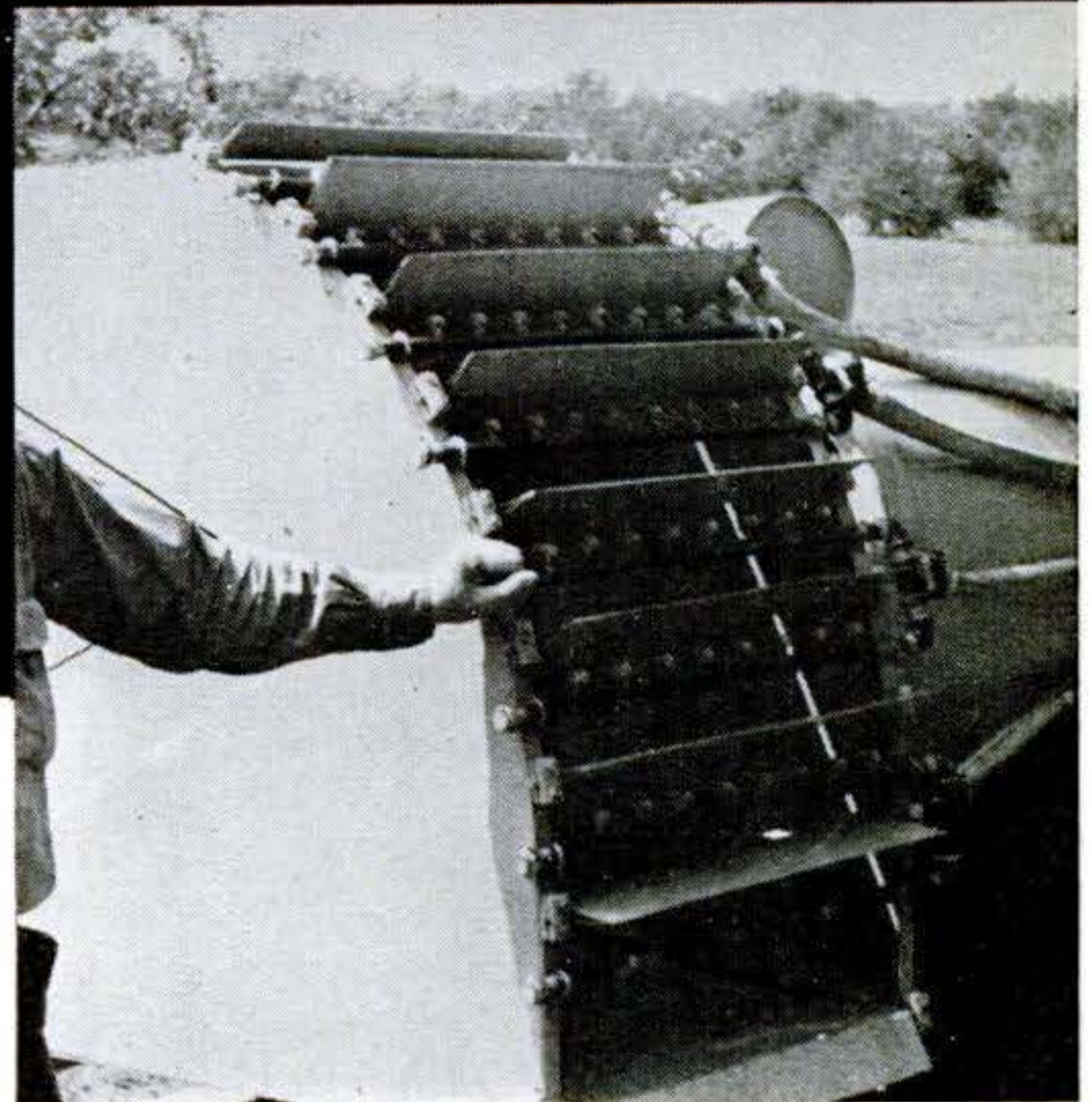
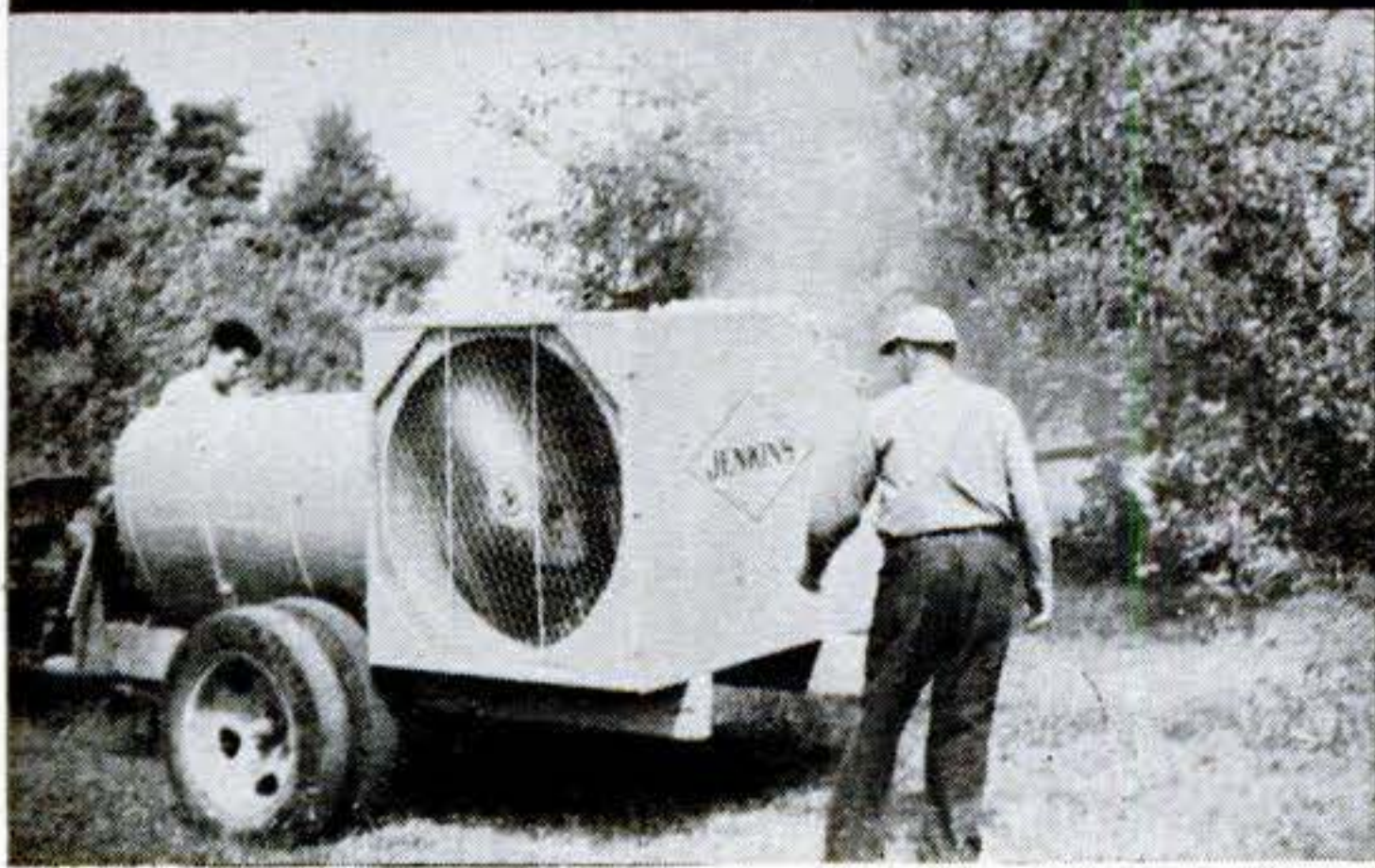
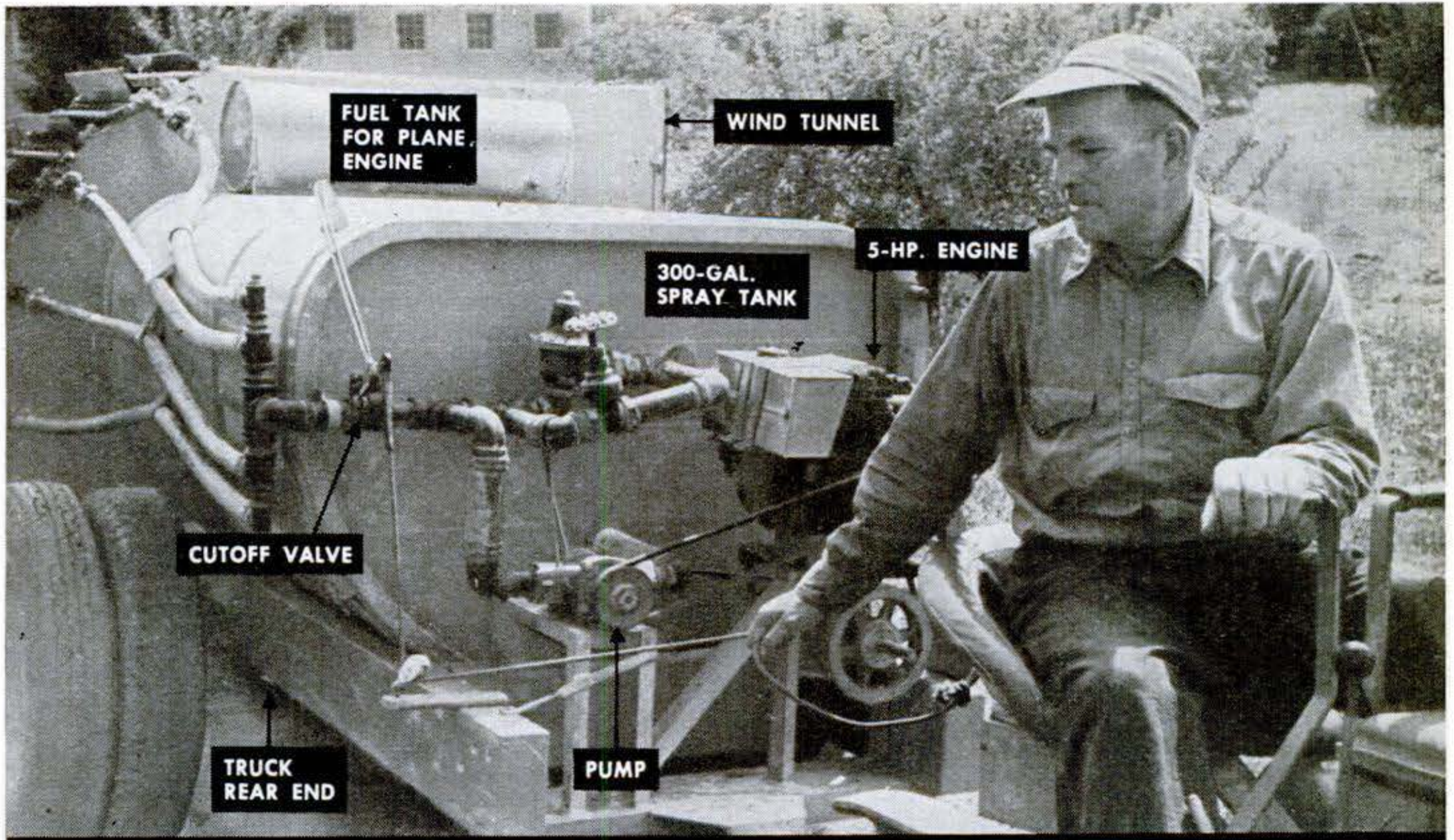

Airplane-Engine Blower Sprays Orchard Fast

WHEN Howard L. Jenkins sprays his orchards near Chester, N. H., with this home-made outfit, he must keep three engines going. One runs the tractor, a 5-hp., air-cooled job does the pumping, and a rebuilt 40-hp. Continental airplane engine, driving a sawed-off, four-blade propeller, blows spray into the trees.

A 300-gal. spray tank is mounted on a dual-tired truck rear end as above. Behind it is a sheet-metal wind tunnel containing the plane engine and prop in one end, and eight

tiers of atomizing nozzles in the other. Photo at right above shows how the pump feeds spray to the nozzles through four lengths of $\frac{3}{4}$ " hose. Metal vanes between the nozzles regulate the elevation of the spray. Riding the tractor, one man can operate the sprayer, which Jenkins claims does a job twice as fast as the usual commercial sprayer.

Workbench Drawer Slides on Angle-Iron Strips

ANGLE iron provides a husky method of mounting a drawer under a workbench. The

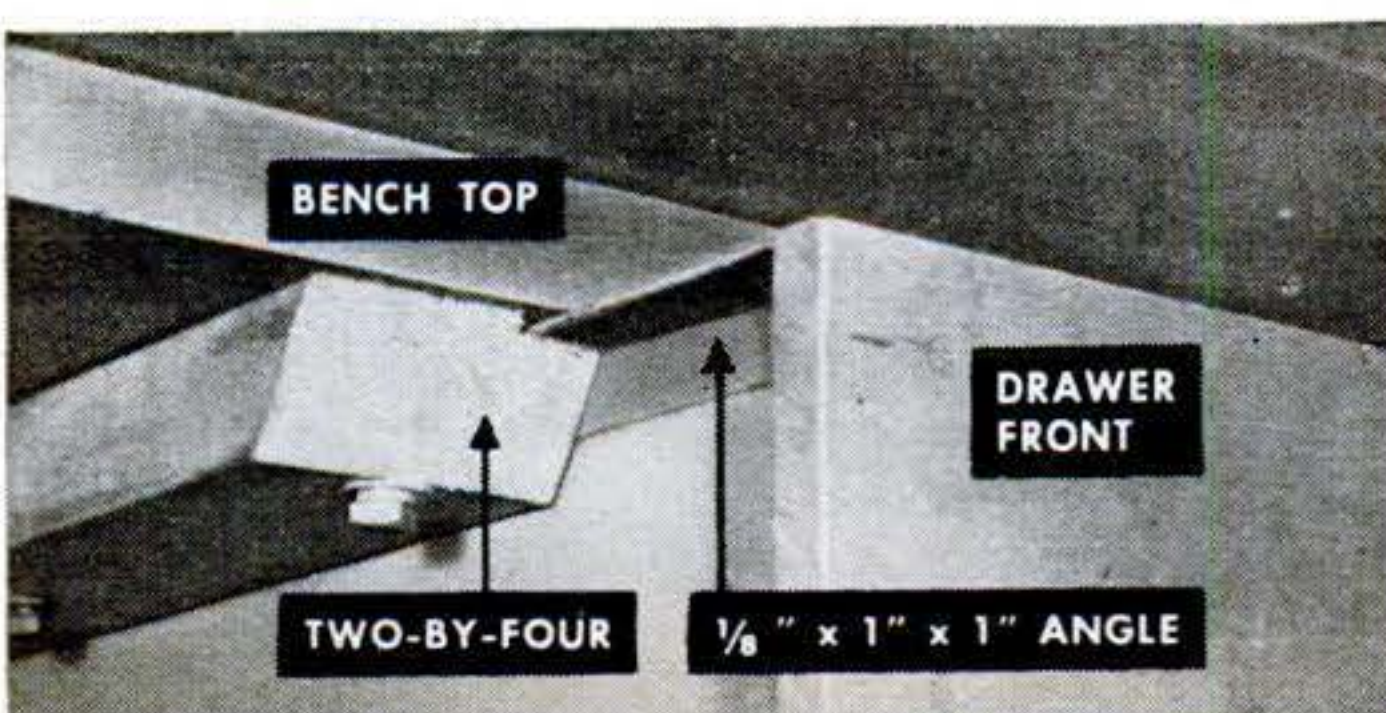
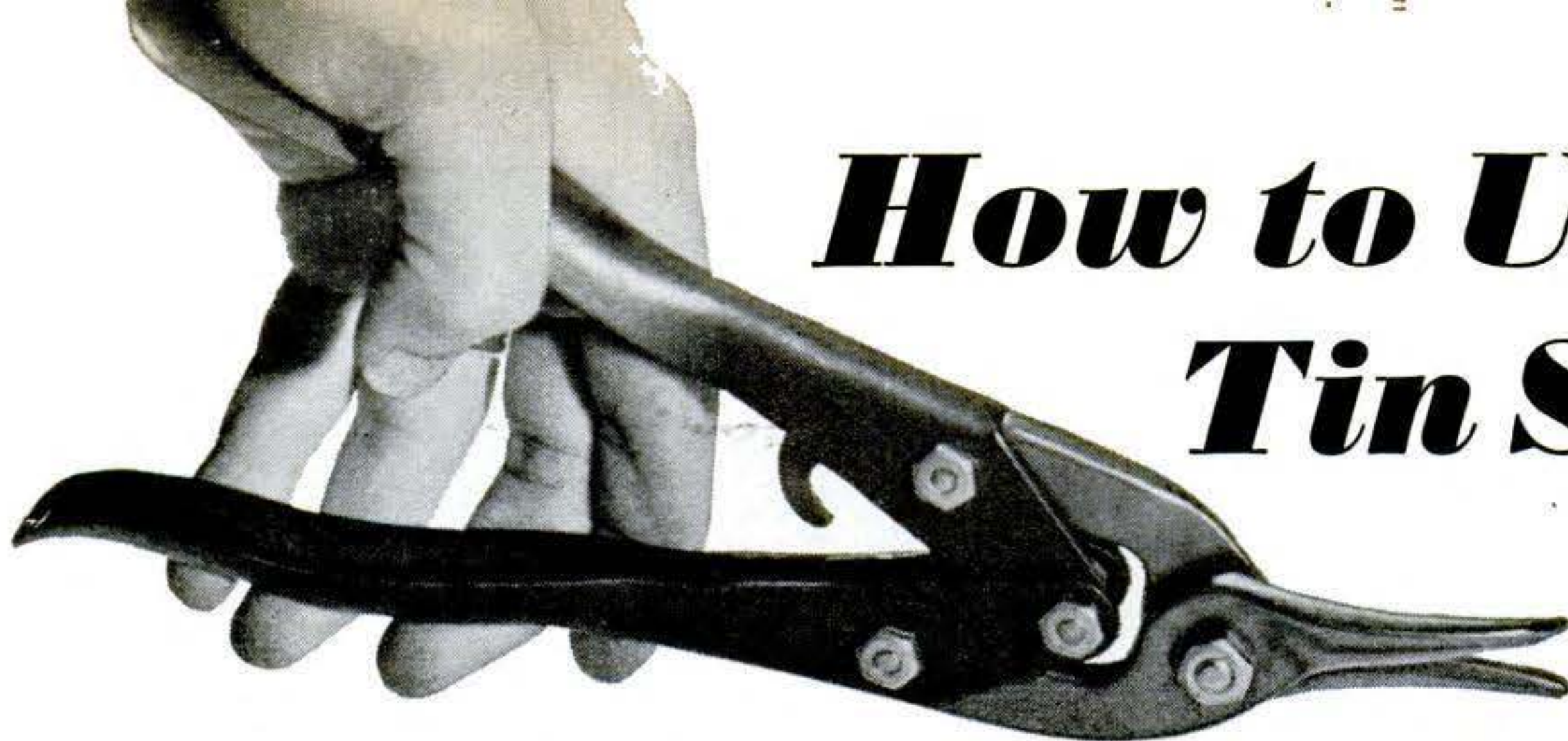
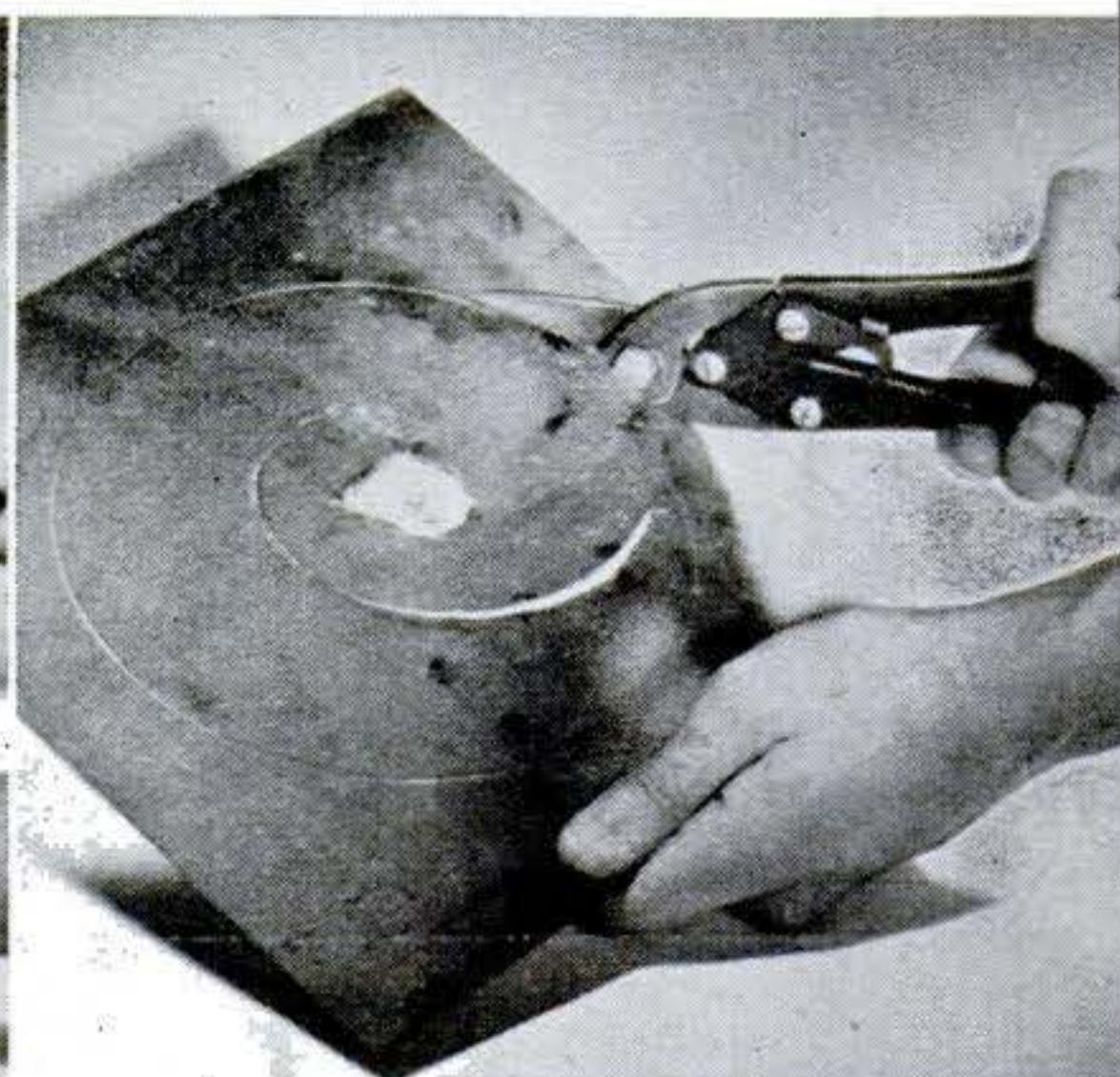
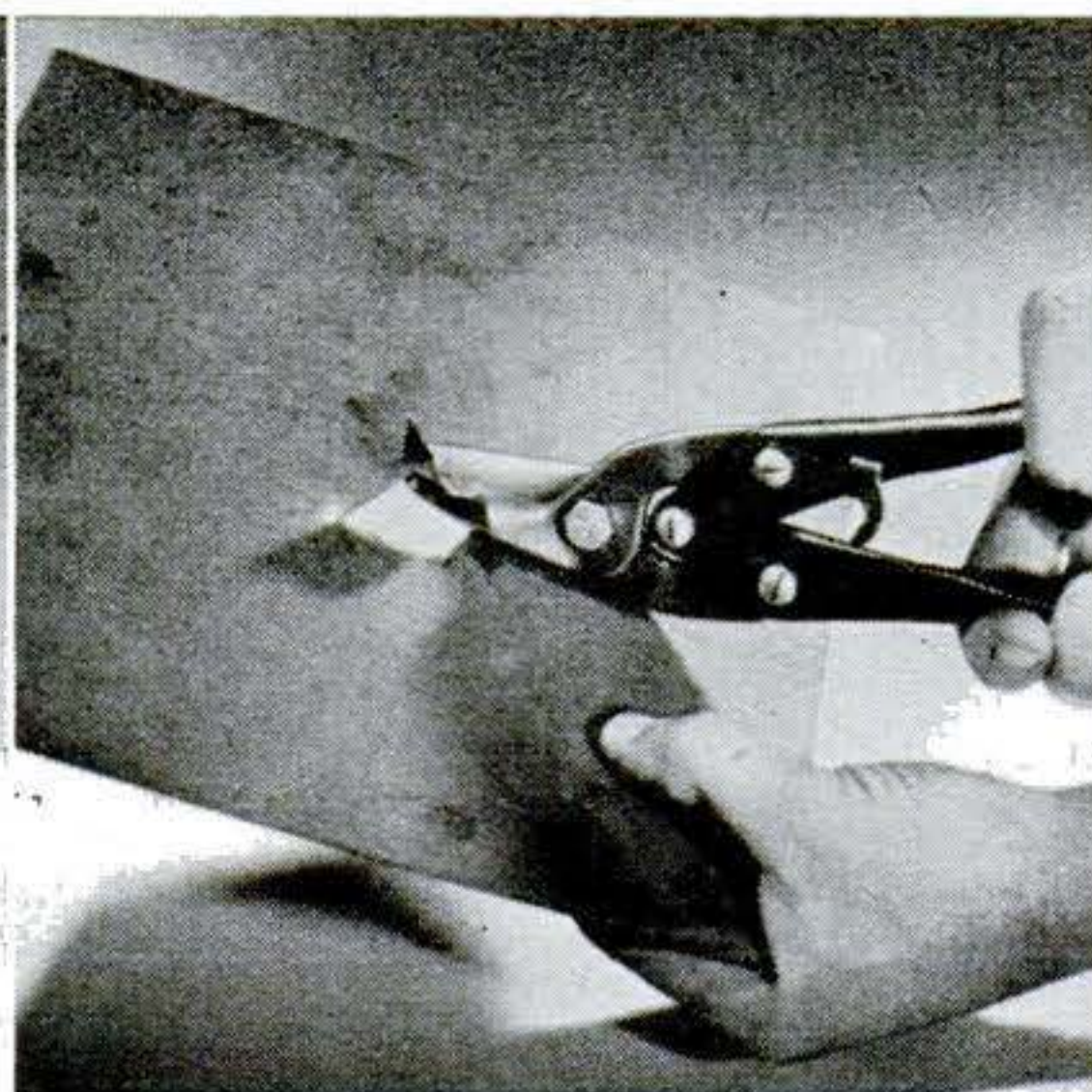
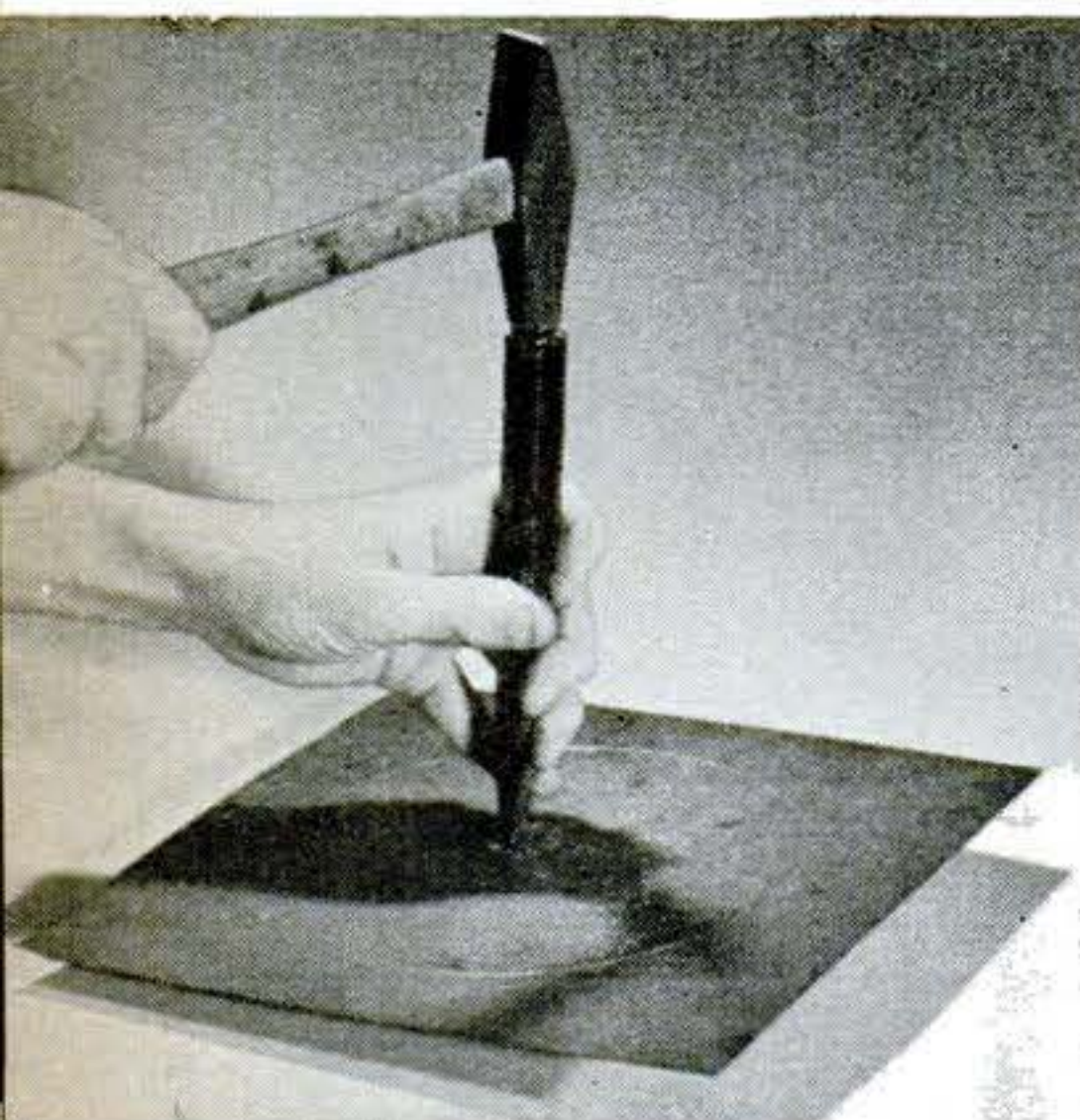

photo shows how to do it. Attached to each side of the drawer, the $\frac{1}{8}$ " by 1" by 1" angle iron slides in a $\frac{3}{16}$ " by 1" rabbet cut in two-by-four supports bolted under the bench. The drawer is ideal for heavy tools. —J. C. Magee, Schenectady, N. Y.



How to Use Tin Snips

Right- or left-hand? The gag about the left-hand wrench has whiskers, but the boss who asks for left-hand aircraft snips isn't kidding. Here is a left-hand pair, but you could use them in either hand. Do you know why?



Cutting an inside circle. After scribing the circle on the material, place the sheet on a wood block and make two crossing cuts with a cold chisel. Turn over the sheet, pry up the cut

material, and snip it out. Then turn the sheet right side up and cut from the hole to the guide line in a spiral path, above right. Follow the scribed line with very short cuts.

PROPERLY used and cared for, a good pair of snips should last for years in the home shop. Here are some pointers:

Always cut with the handles at right angles to the metal. Slanting makes cutting difficult and may spring the blades.

In beginning a cut, line up the upper blade with the scribed line and hold the grips a little above the plane of the work. To avoid scratching a polished surface, you can tape the blade "shoulder" that may touch the work.

Grip one handle in vise if you're using big snips to cut heavy stock. This gives better control and makes snips easier to handle.



Make it a rule to close the blades part way before making a cut. A Douglas Aircraft instruction booklet notes one possible exception, however. With duckbill snips, it's permissible to cut at the base of the blades to get full leverage on heavy stock.

While cutting, use even pressure and take short strokes, especially on curves. When very strong leverage is required, rest the snips on the bench and bear down on the upper handle. An alternative is the vise setup shown at left below. Never force the cut by hammering the handles.

Snips come in four major types: the regular pattern, for straight cutting only; the combination pattern, for straight and curved cuts; curved-blade snips, for cutting curves only; and aviation snips, for cutting curves, straight lines, and intricate designs.

Regular and combination snips are often similar in appearance, but the blades of the latter are ground in such a way that curves

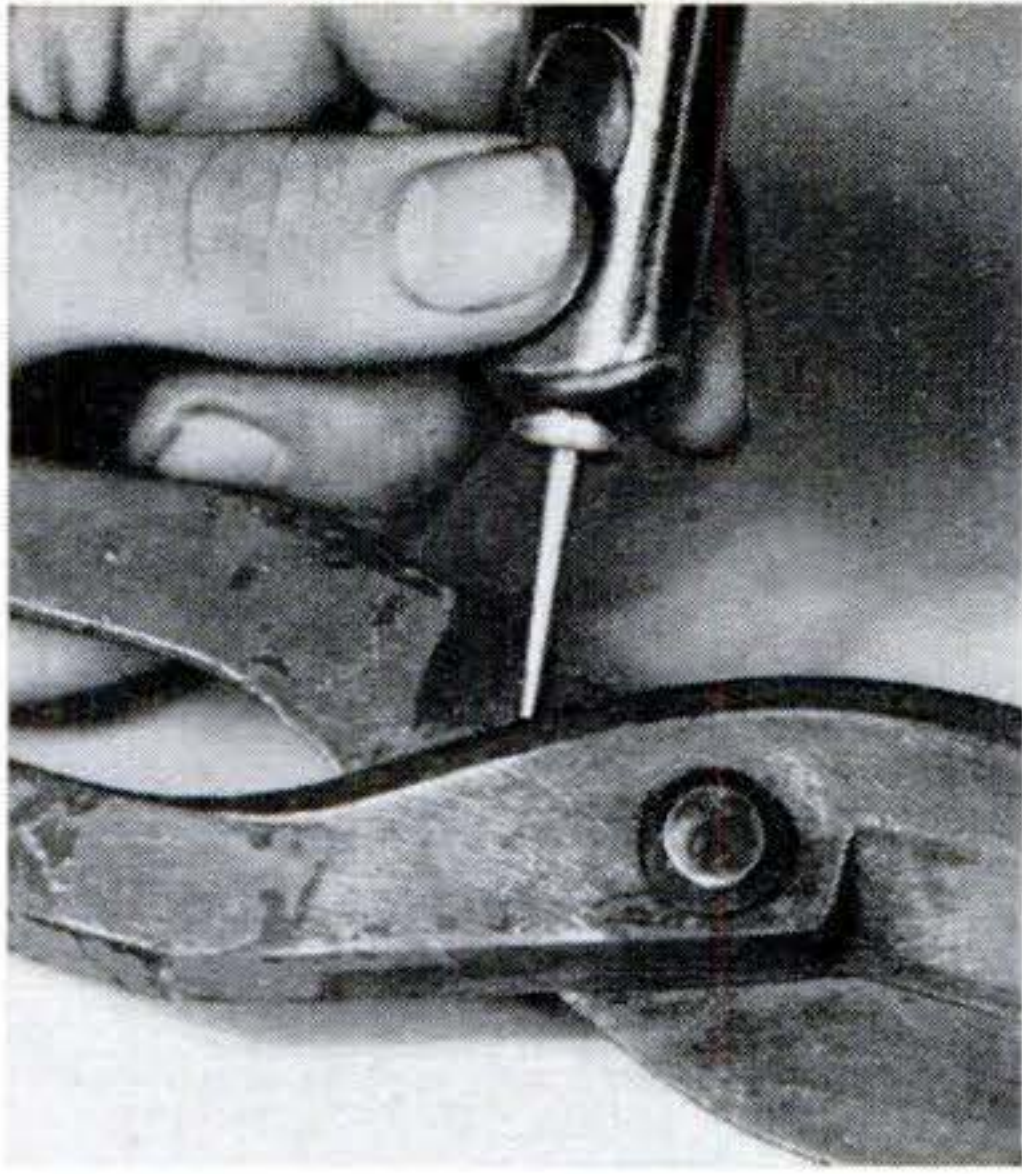

Oil and adjust snips at regular intervals. Use a machine-bearing lubricant. If blades are too tight, snips cut hard. If too loose, they chew metal. To adjust, pull the nut tight, then back it off slightly. Carefully used, snips will cut well for a long time without sharpening. If you try to sharpen them, be sure to keep original bevel angle on the blades.

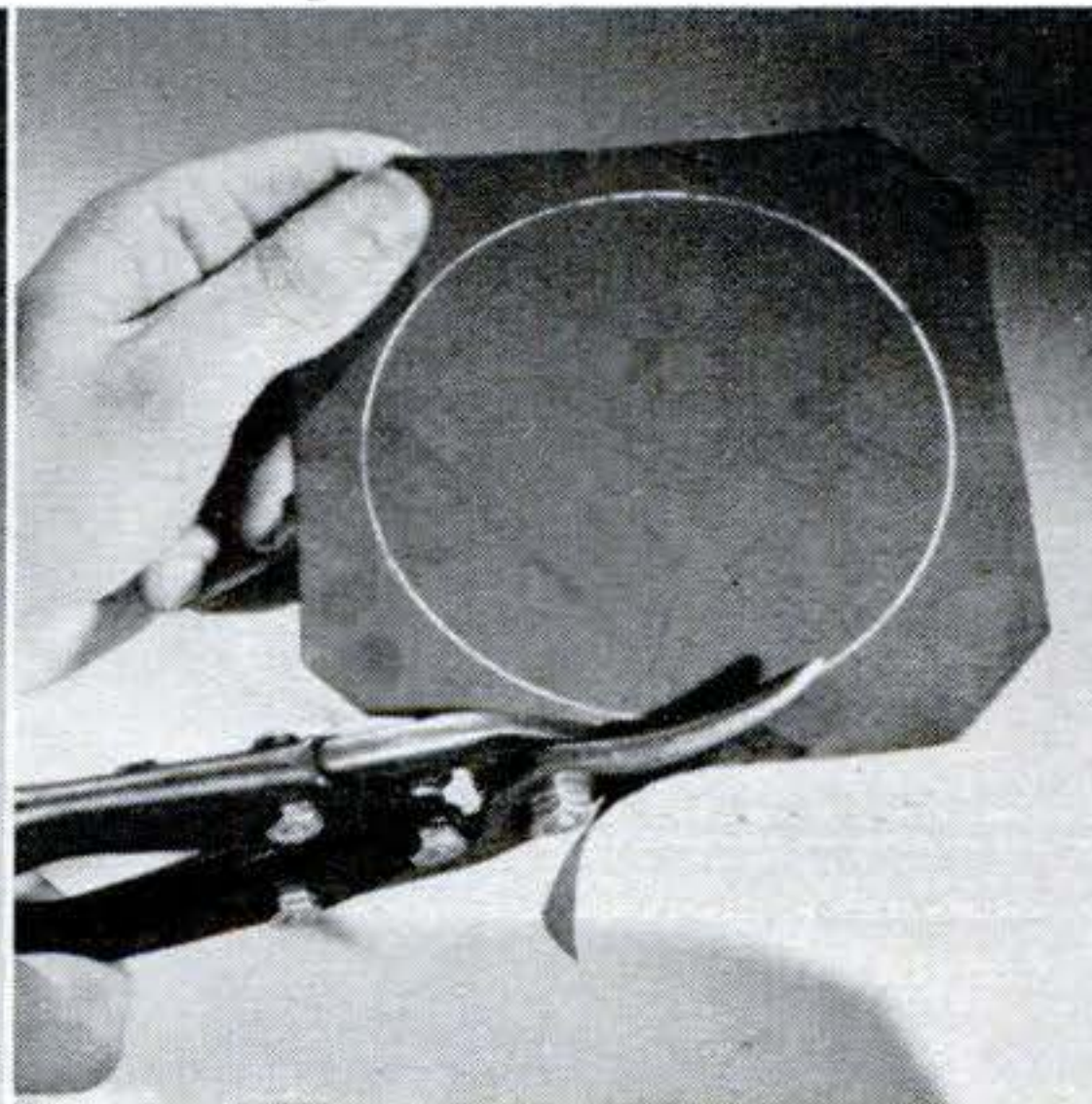
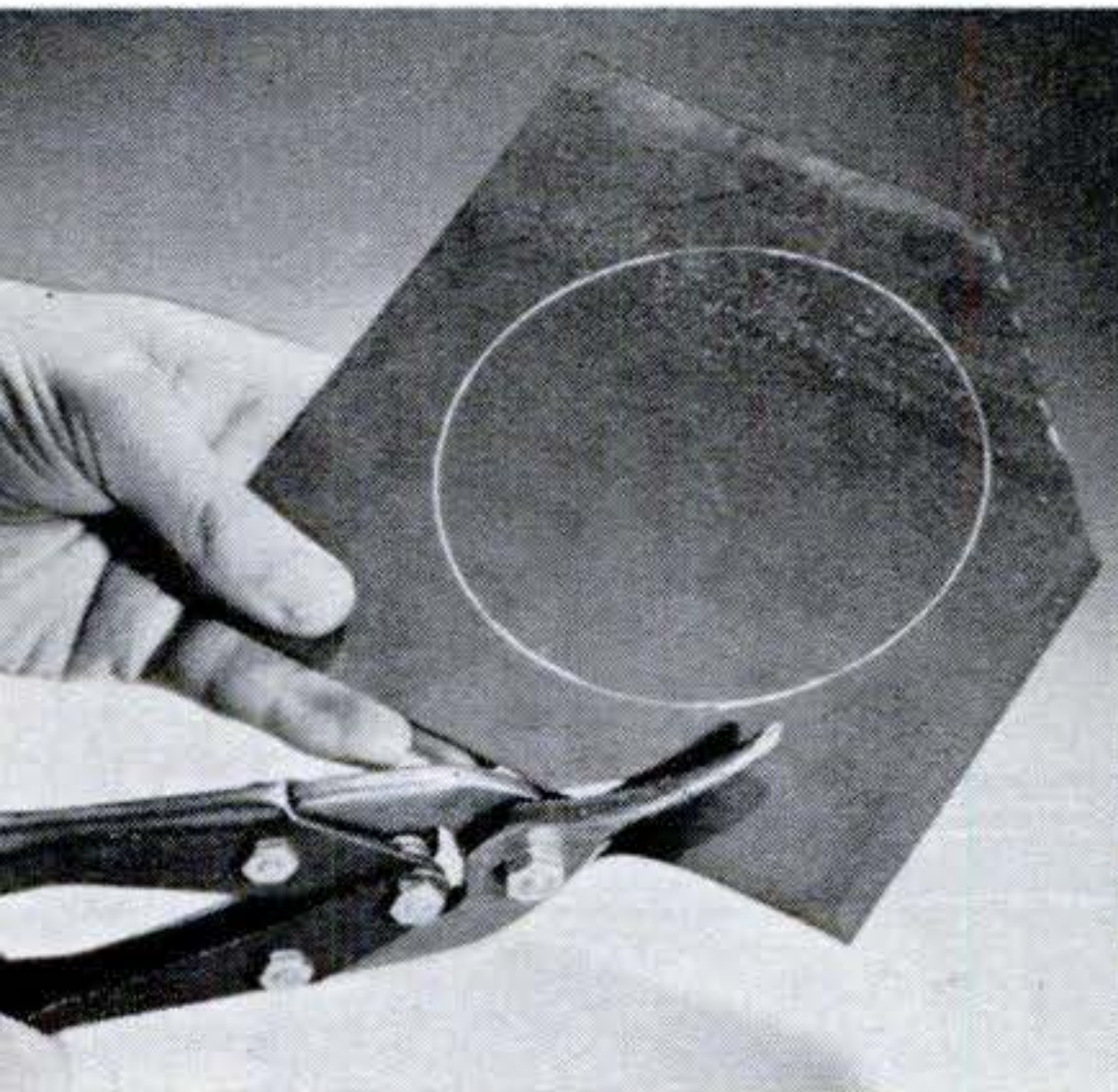
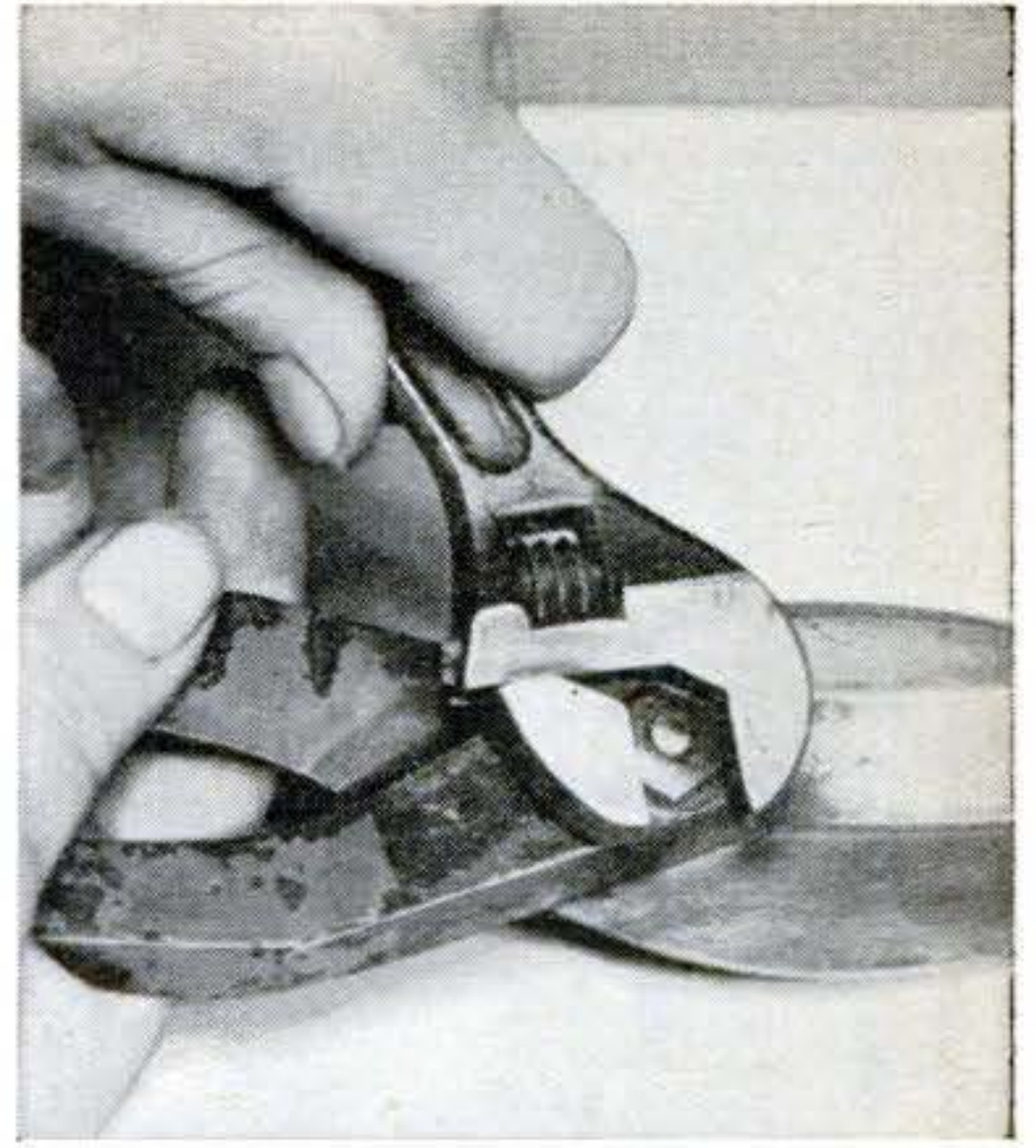

Cutting a disk. After scribing the circle, cut the corners from the material so the strip of waste will be narrow enough to roll out of the way. Then slant in to the guide line, as seen

in the center photo. If the waste strip gets in the way, snip it off, as at right, leaving a stub to guide the blades to their previous path as you begin cutting scribed line again.

can be cut. In curved-blade snips, the blades are curved to the side. To use them, you turn the blades so that they curve in the direction of the curved line that you have scribed.

Aircraft snips, pictured at the top of the facing page, give tremendous cutting power because of their compound leverage. Serrated jaws prevent slipping. A strong spring forces the jaws apart, a hook or loop being provided to keep them closed.

With some compound-lever snips, you can cut both right- and left-hand curves, depending on which way you turn them in your hand. Others, however, are designed for one-direction cuts and are called right- or left-hand snips. Right-hand snips cut curves to the right, that is, clockwise; left-hand snips in the other direction.

You can use each type in either hand. You are holding them properly when the blades curve up slightly, like a spoon. **END**

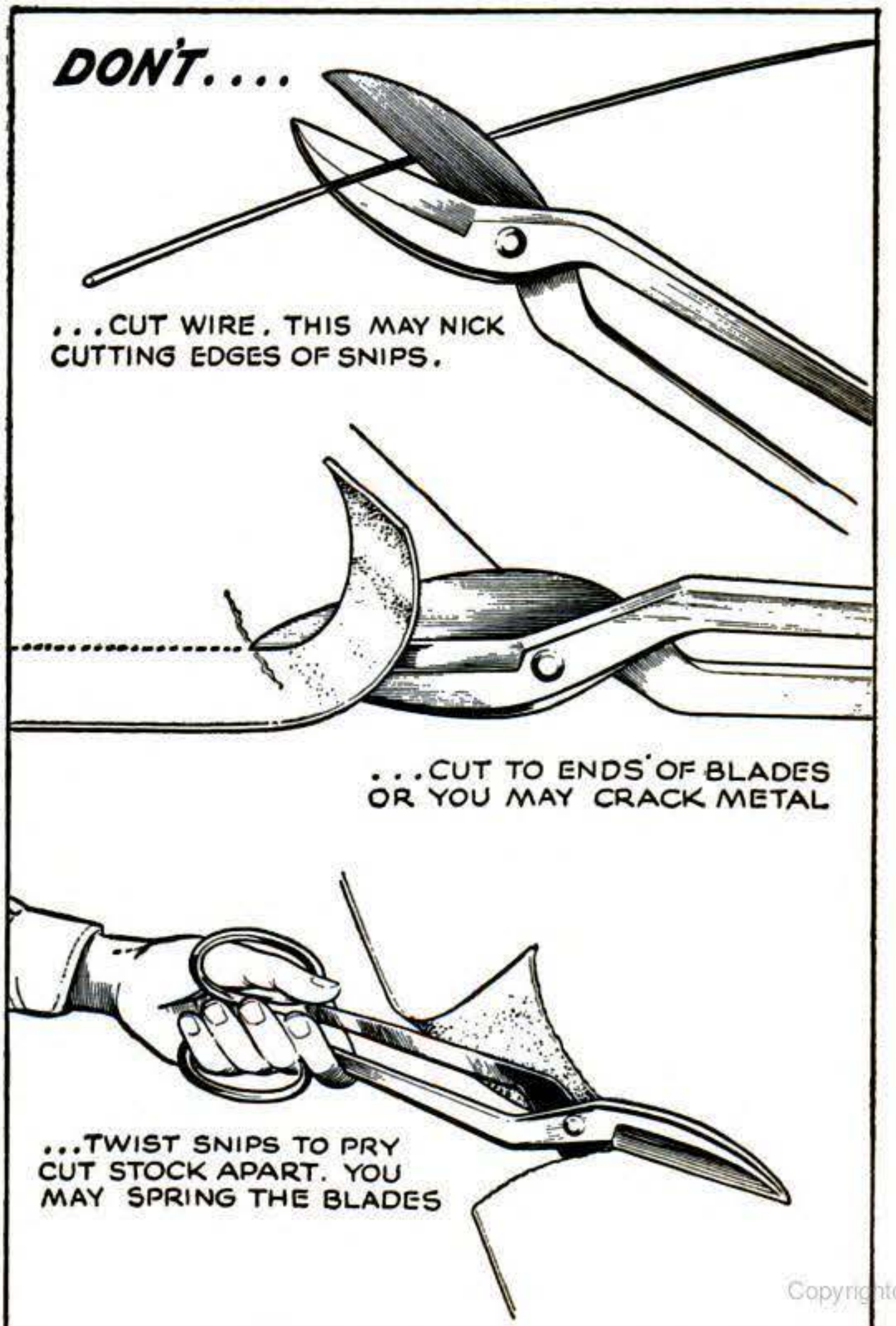



Hand Tools Make Chinese Shelf

THIS Chinese modern wall shelf for figurines or knickknacks looks like a much heavier and more complicated job than it is. Actually, it's a hand-tool job, made of $\frac{1}{4}$ " plywood. Only simple butt joints are used. The $\frac{1}{4}$ " by $\frac{3}{4}$ " facing around the sides and on the shelves and shelf supports gives the appearance of heavier pieces of wood.

After you cut the parts to size, assemble three of the sides—not the top—with brads and glue. Leaving the top off allows the inner assembly to be inserted and bradded more easily. Assemble the shelves and supports as one unit and fasten them in place with glue and brads. Then attach the top of the box.

Use a coping saw to cut out the top ornament and glue it and the facings in place. Glue triangular blocks behind the ornament to give it added strength. After the glue has set, sand all parts smooth.

On the cabinet shown here, the outer surfaces of the four sides and the framing pieces were finished with black enamel. The interior was given two coats of Chinese red.

If you use fir plywood, you can get an unusual finish by going over the outer surfaces of the four sides with a wire wheel. This will remove the soft parts of the wood, leaving a roughened texture. Give these surfaces a thin coat of white paint or enamel and wipe it off before it has set. Some of the white will remain, giving a weathered appearance much the same as driftwood.—*Whitney K. Towers, Los Angeles.*

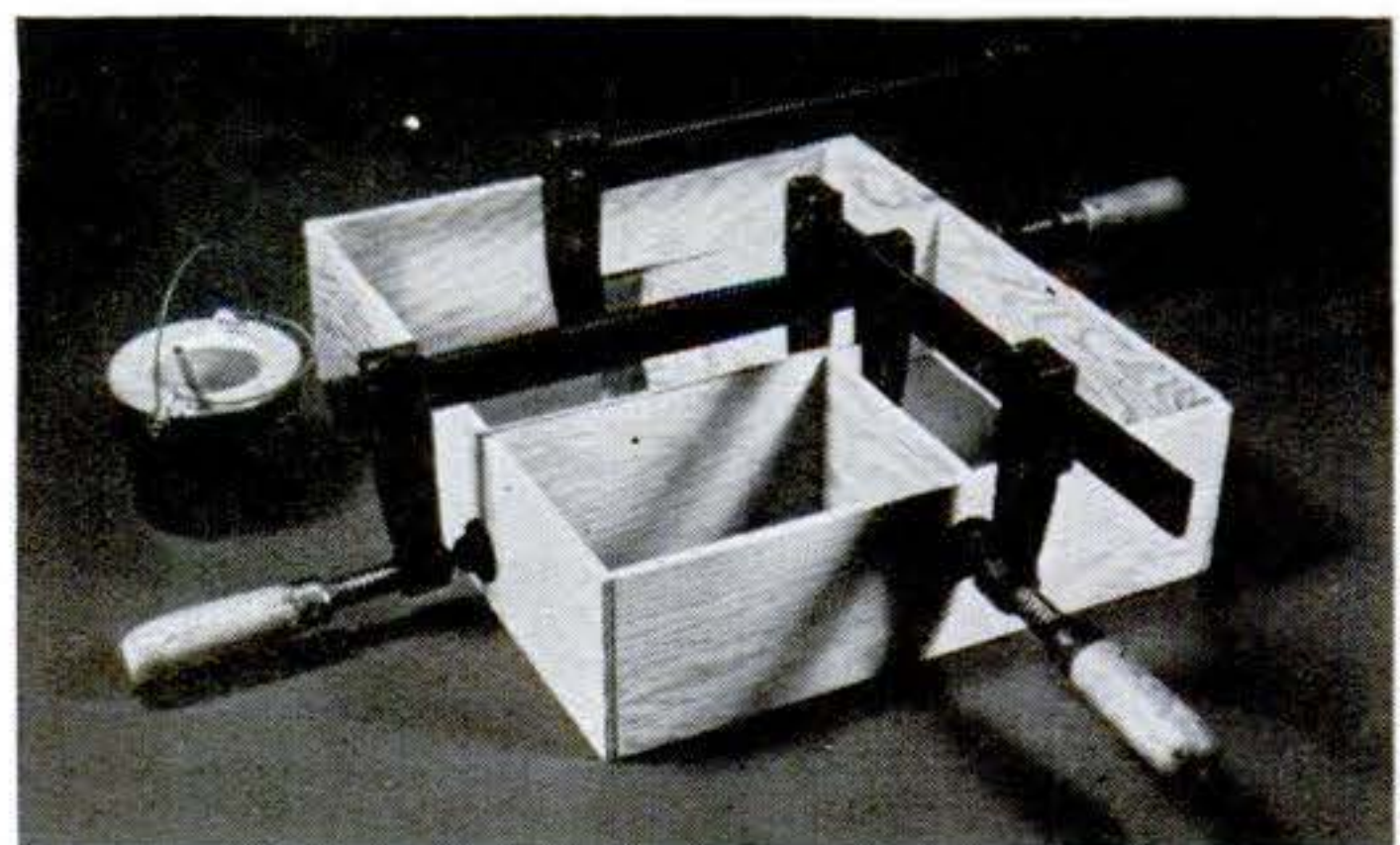
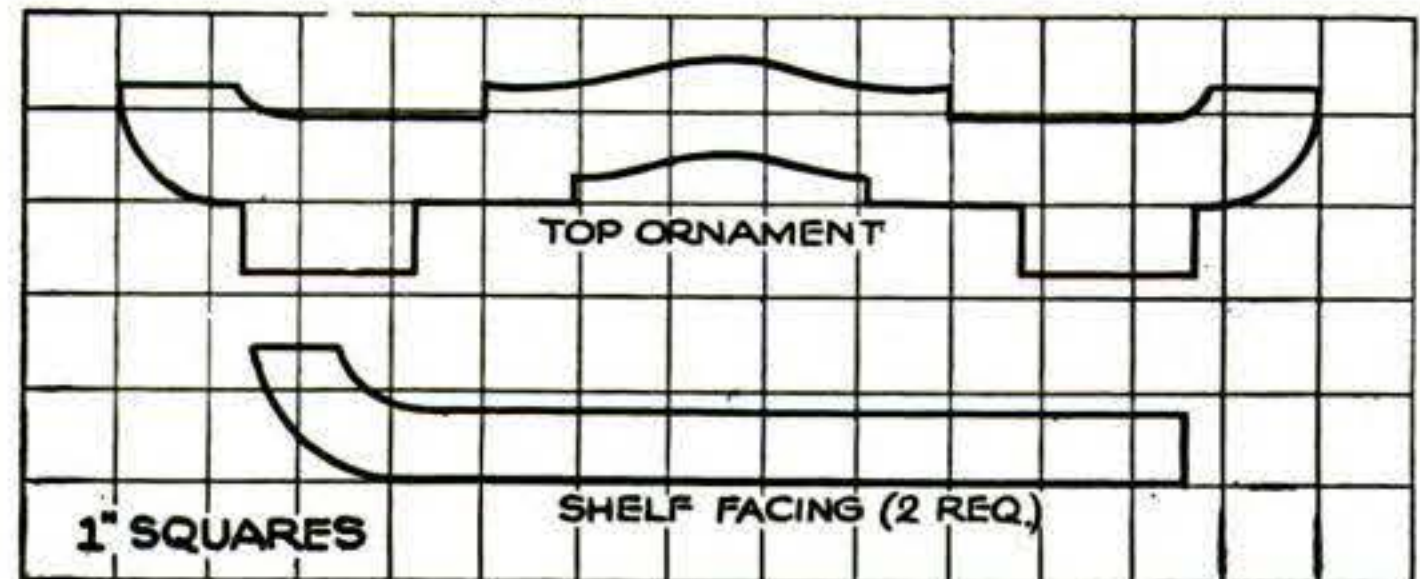
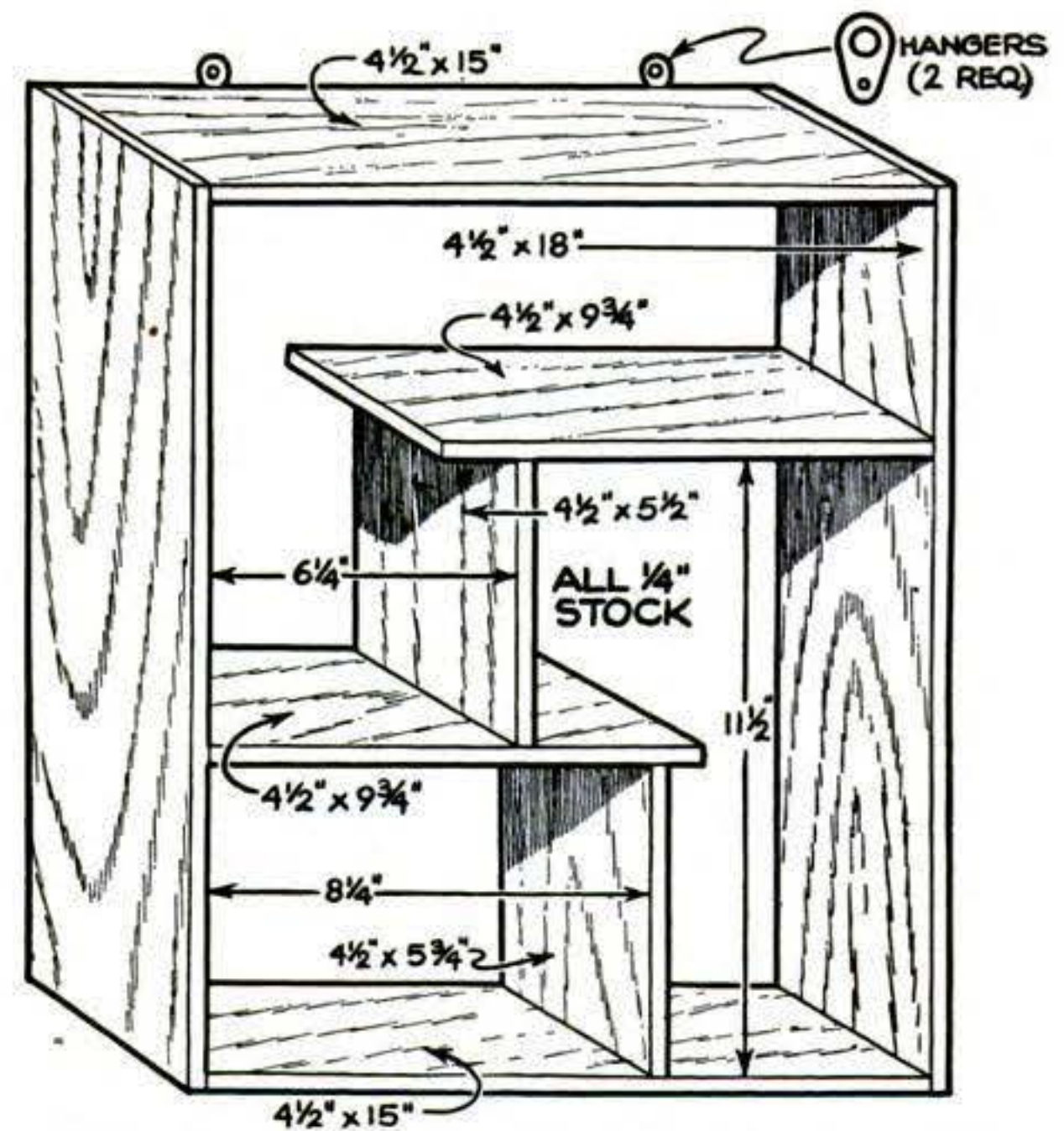

The two shelves and their supports are assembled as one unit and glued and bradded into the outer section. This shows clamp setup.

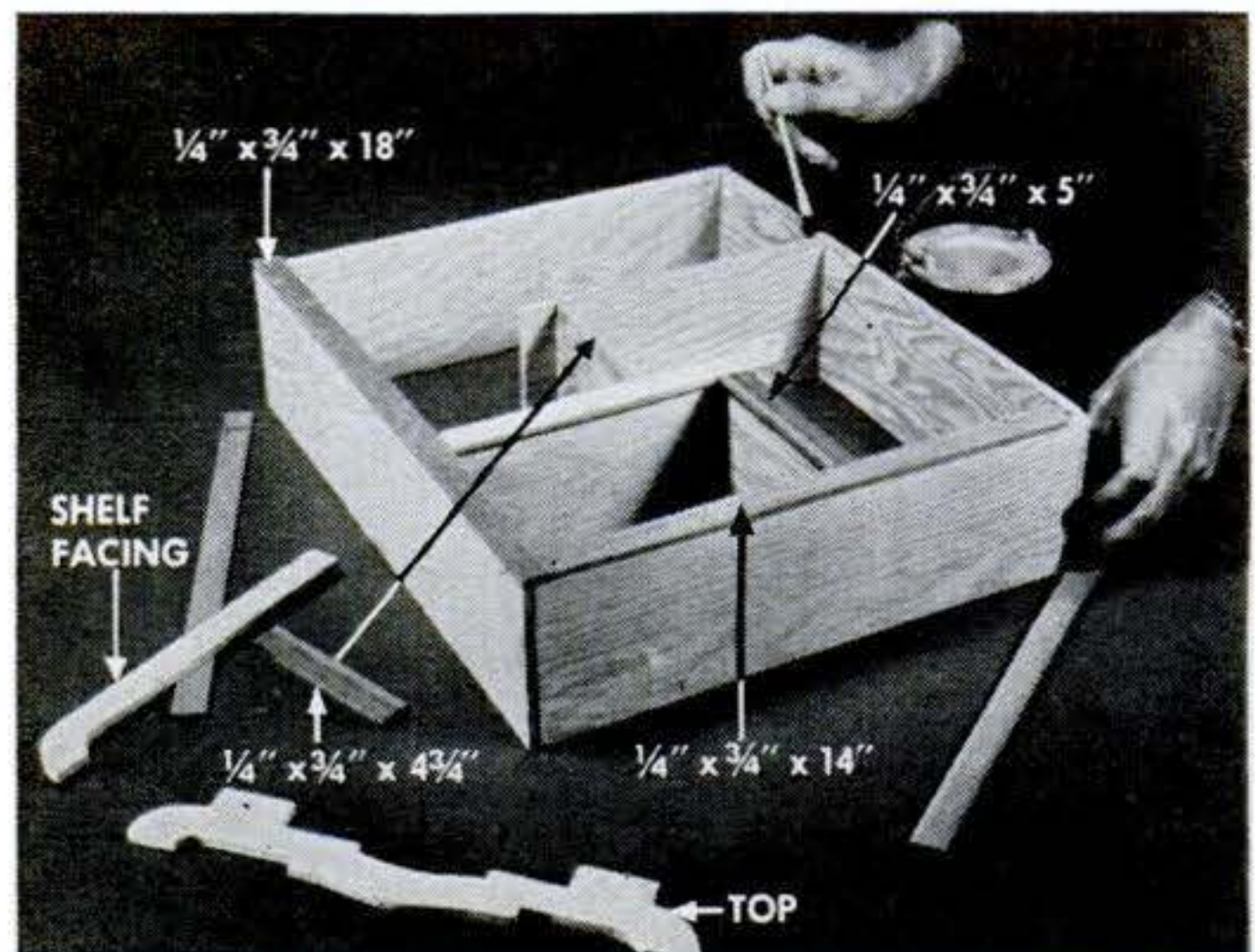

Glue is applied to the front edges of the shelves, the shelf supports, and the four sides. The framing pieces are then clamped in place.

You Will Soon See Panels Made out of Chips



Dimensional stability of new panel is good. These blinds are tied together at top and the sections pivot on pins in bottom and top.

A NEW wood panel made of wood chips and shavings and from one quarter to a third cheaper than the cheapest plywood is scheduled to be on the market by the end of this year. The new product, called Novoply, can be sawed, planed, drilled, nailed, and otherwise worked with ordinary woodworking tools. It can be painted, varnished, or given other finishes.

The core of the panel is wood chips. The two outer layers are wood shavings. Waste wood that makes up the panel is treated with a synthetic resin and then pressed at 200 p.s.i. under heat to form panels 4' by 8' and 6' by 12' up to 1¼" thick. Because it can be worked into curves, the product has been used in Europe in furniture manufacturing. It makes a solid, warp-resistant base for veneers.

Besides the low cost, the new panel—

called Novopan in Switzerland where it has been fabricated commercially since 1947—is good on two sides, has no grain rise, and will not burn readily.

The U. S. Plywood Corp. expects the first plant at Orangeburg, S. C., to produce between 40 and 50 million feet a year. At present the product is not for outdoor use although weatherproof panels have been fabricated experimentally.

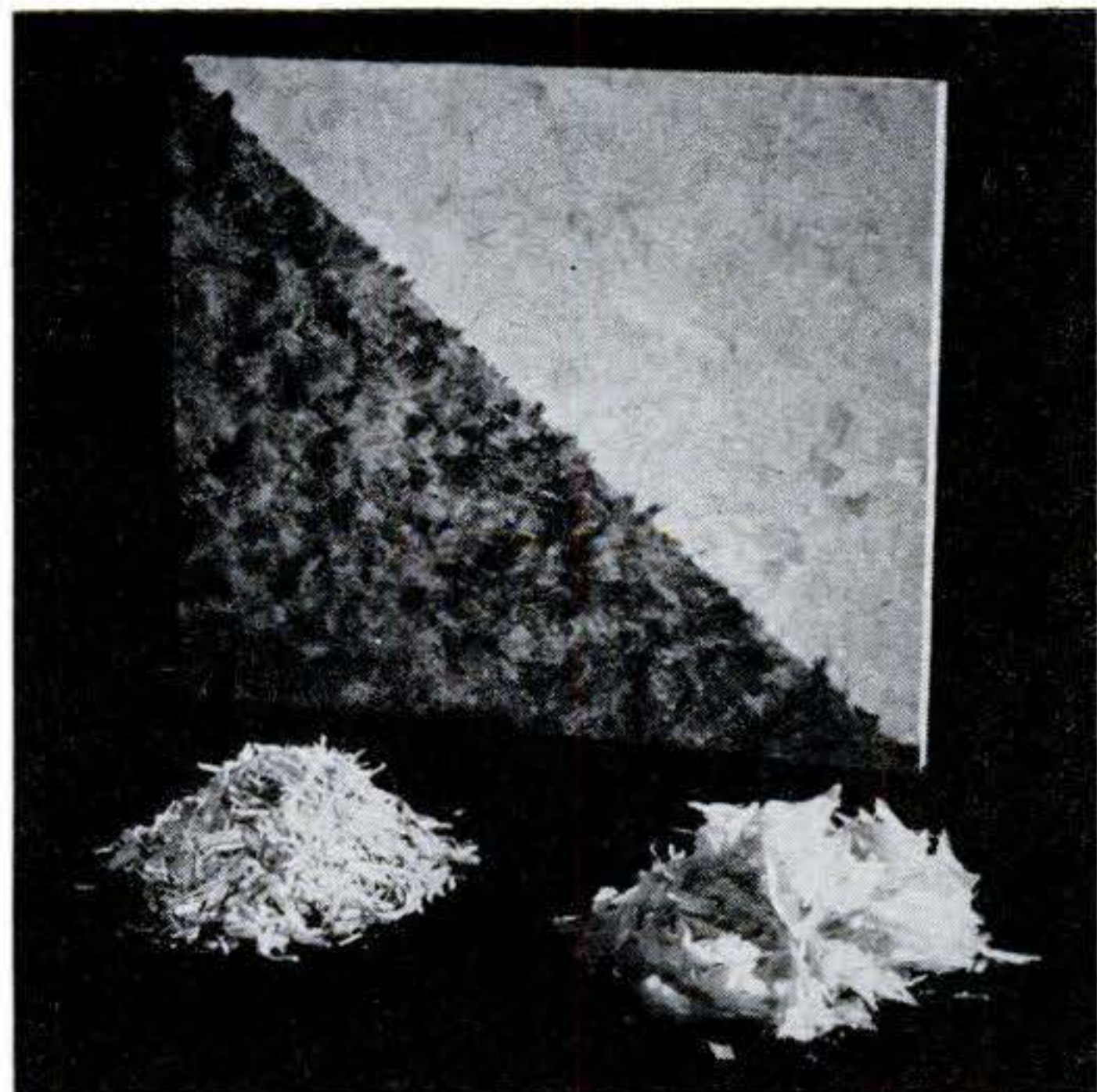

Wood chips, left, form core of Novoply. Shavings, right, make up surfaces. Oak stain was applied to the dark half of the panel.

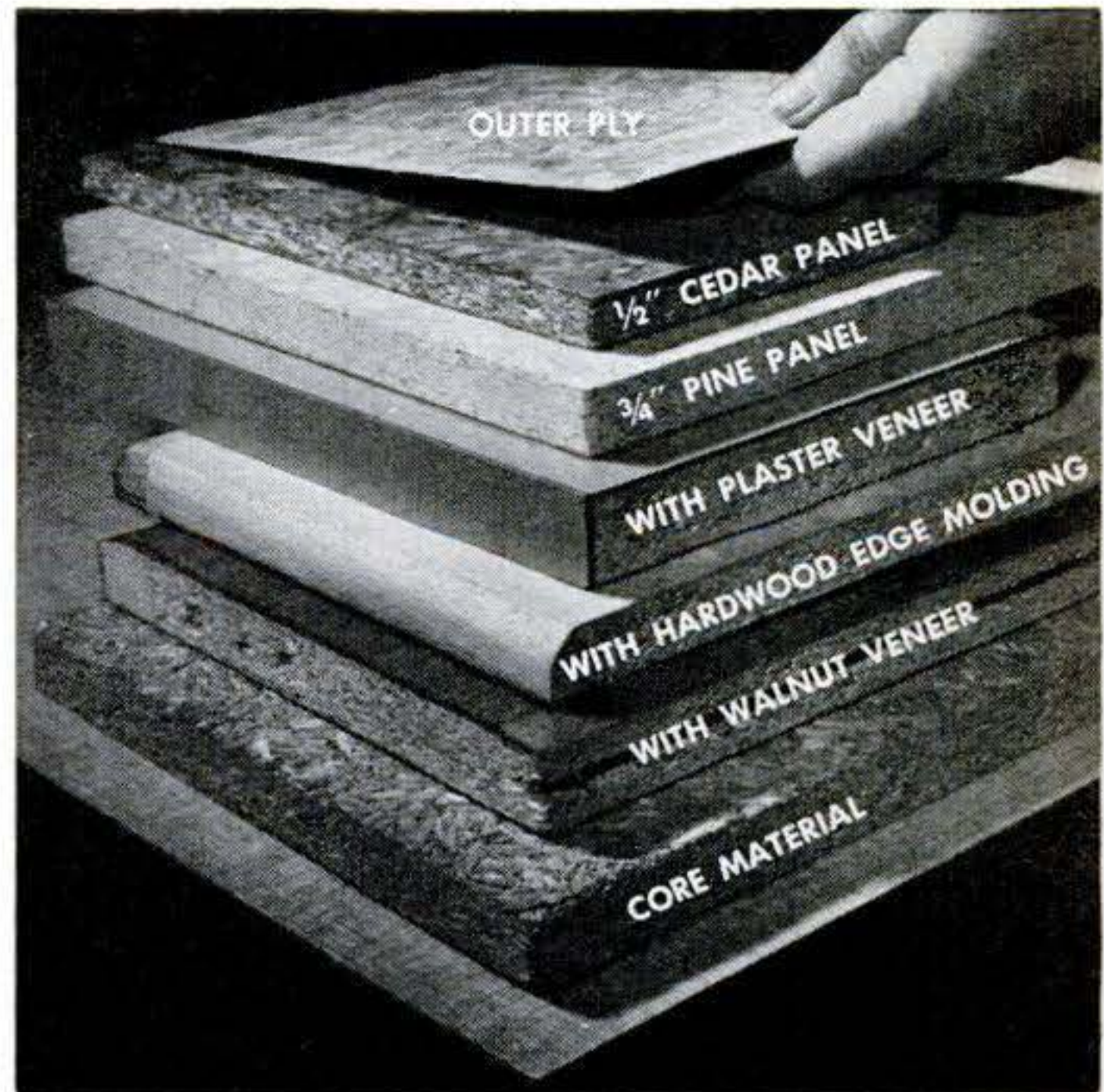

Some of the treatments Novoply can be given are shown here. Panels of different waste have different color but similar characteristics.

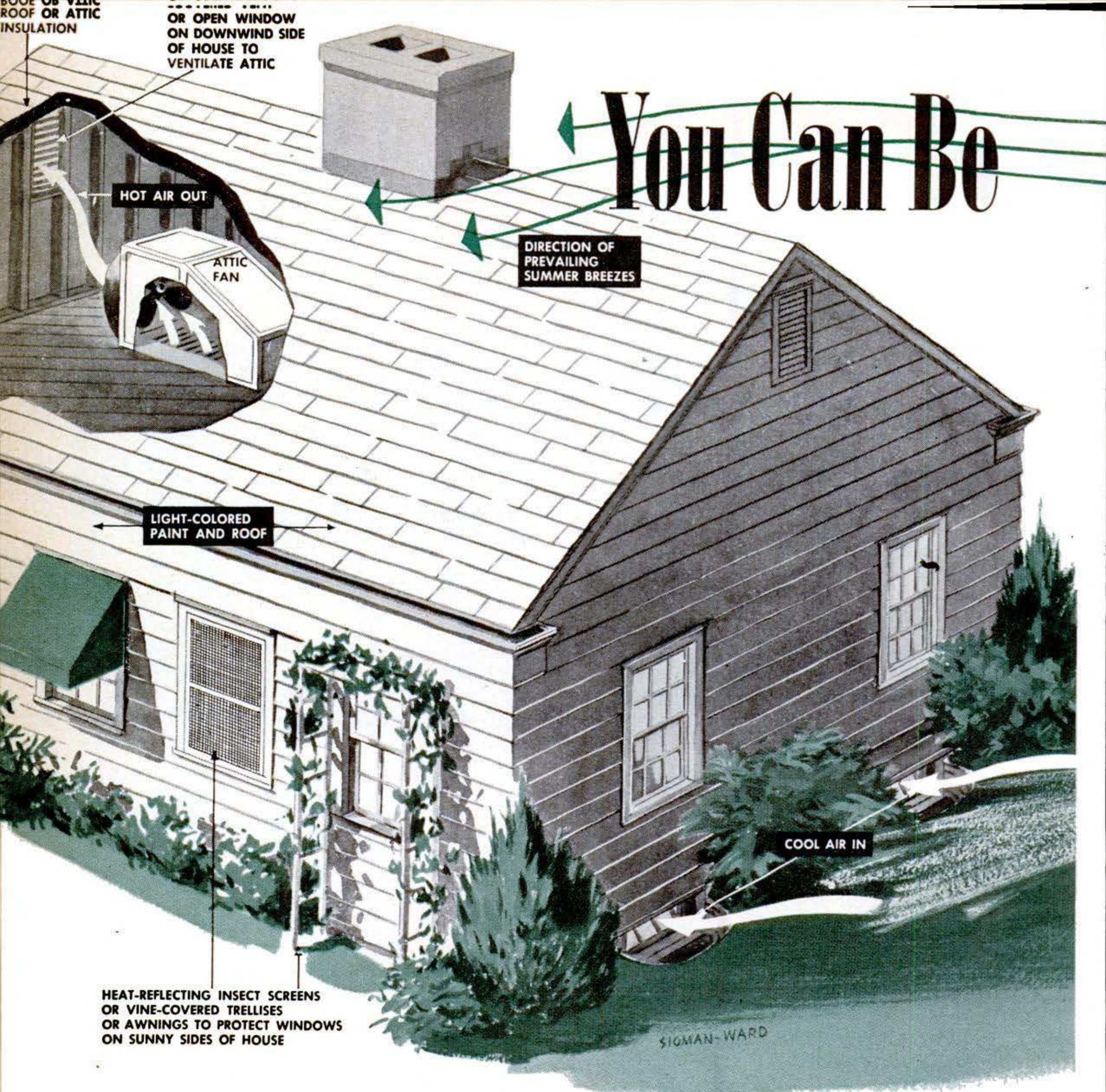

You Can Be

The difference between an insulated and an uninsulated roof can mean as much as 11° in attic temperatures. Dead-air space in an unventilated attic acts as an efficient heat trap.

Attic fans can be mounted in two ways—at the attic window or louvered vent, or over an exhaust vent in the attic floor. If roof has air leaks, the latter position is the better.

UNINSULATED ROOF

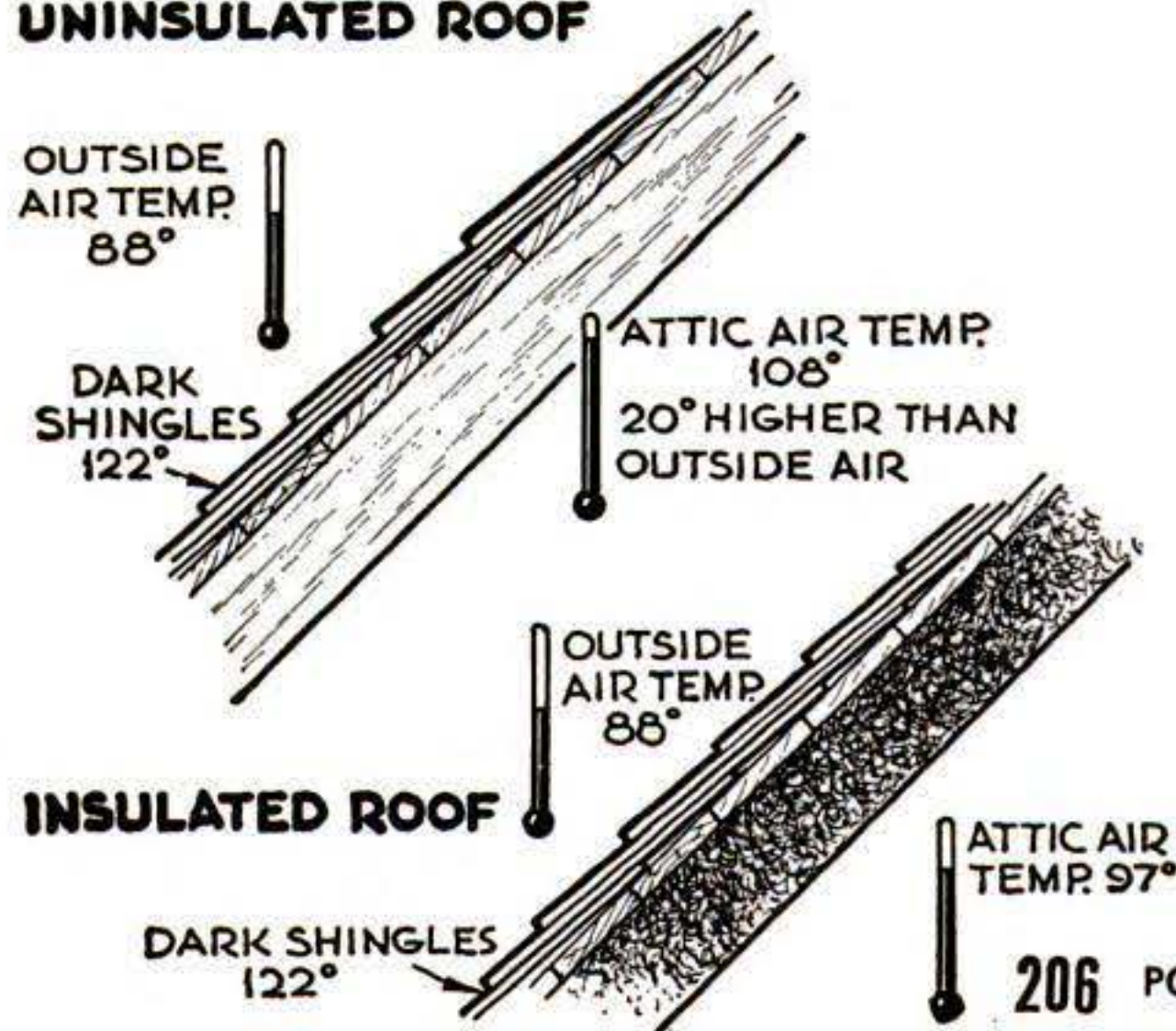

FAN MOUNTED DIRECTLY AT ATTIC VENT EFFICIENT ONLY IF ATTIC IS TIGHT AND HAS NO AIR LEAKS AROUND EAVES



IN MOST HOMES, FAN WILL WORK BEST IF IT IS MOUNTED IN HOUSING OVER CEILING VENT

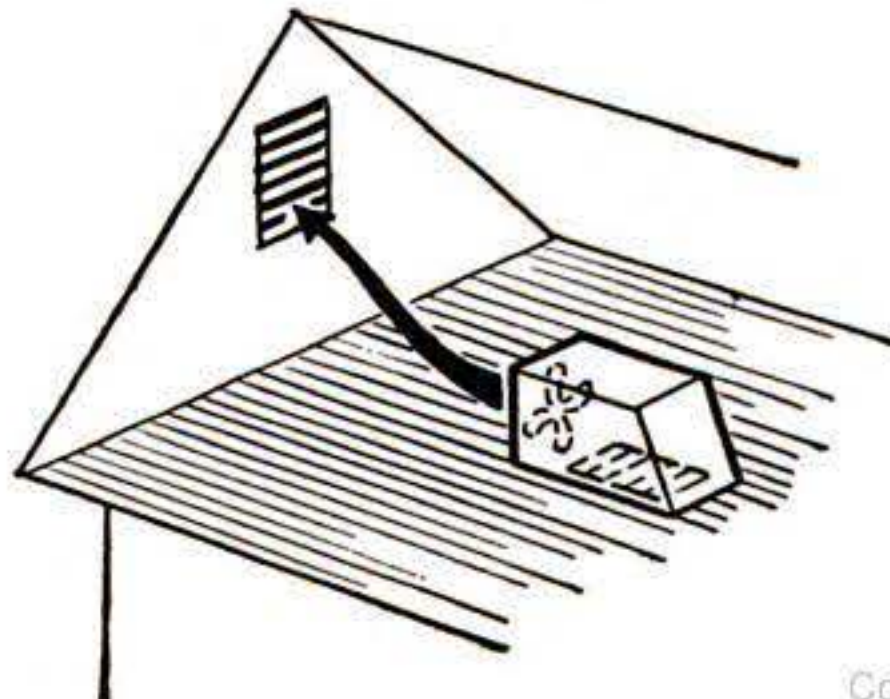

COOLER This Summer

There are plenty of simple tricks that you can use to keep your home more comfortable during hot weather.

By George H. Waltz, Jr.

Drawings by Sigman-Ward

THERE'S no reason why your house cannot be cooler this summer. And there's no reason why you should spend a stack of money for the added comfort. Careful planning plus ingenuity can reduce the cost to a few dollars and a little week-end work.

The way to keep a house cool is 1) to shut the blistering heat from the summer sun out of your rooms during the day, and 2) to take advantage of the usual nighttime drop in temperature. The things you can do to accomplish this range all the way from planting shrubs to building a room cooler.

The first thing to do is *study your house*. How is it situated with respect to the generally prevailing summer breezes? Which windows get the full brunt of the summer sun? Does it have a full cellar, with cellar windows? Is the roof insulated? Are the walls insulated? Is the attic closed or well ventilated?

Most American houses, unfortunately, are highly efficient heat traps. Once the ceilings, walls, and furnishings are thoroughly warmed in summer, they tend to hold the heat. By remaining warm, they prevent our bodies from losing heat—and we perspire and lose sleep—even though there may be cool air just outside the windows. The remedy is to get your house as cool as you can at night and then try to keep it that way as long as you can the next day.

Summer heat sneaks into a house mainly through the roof and the glass in windows. If you can barricade, even partially, 

LOW SHRUBS BORDERING CELLAR WINDOWS — CAN BE WETTED DOWN EACH EVENING

GOOD GREEN LAWN, WETTED DOWN EACH EVENING, IF NO WATER SHORTAGE

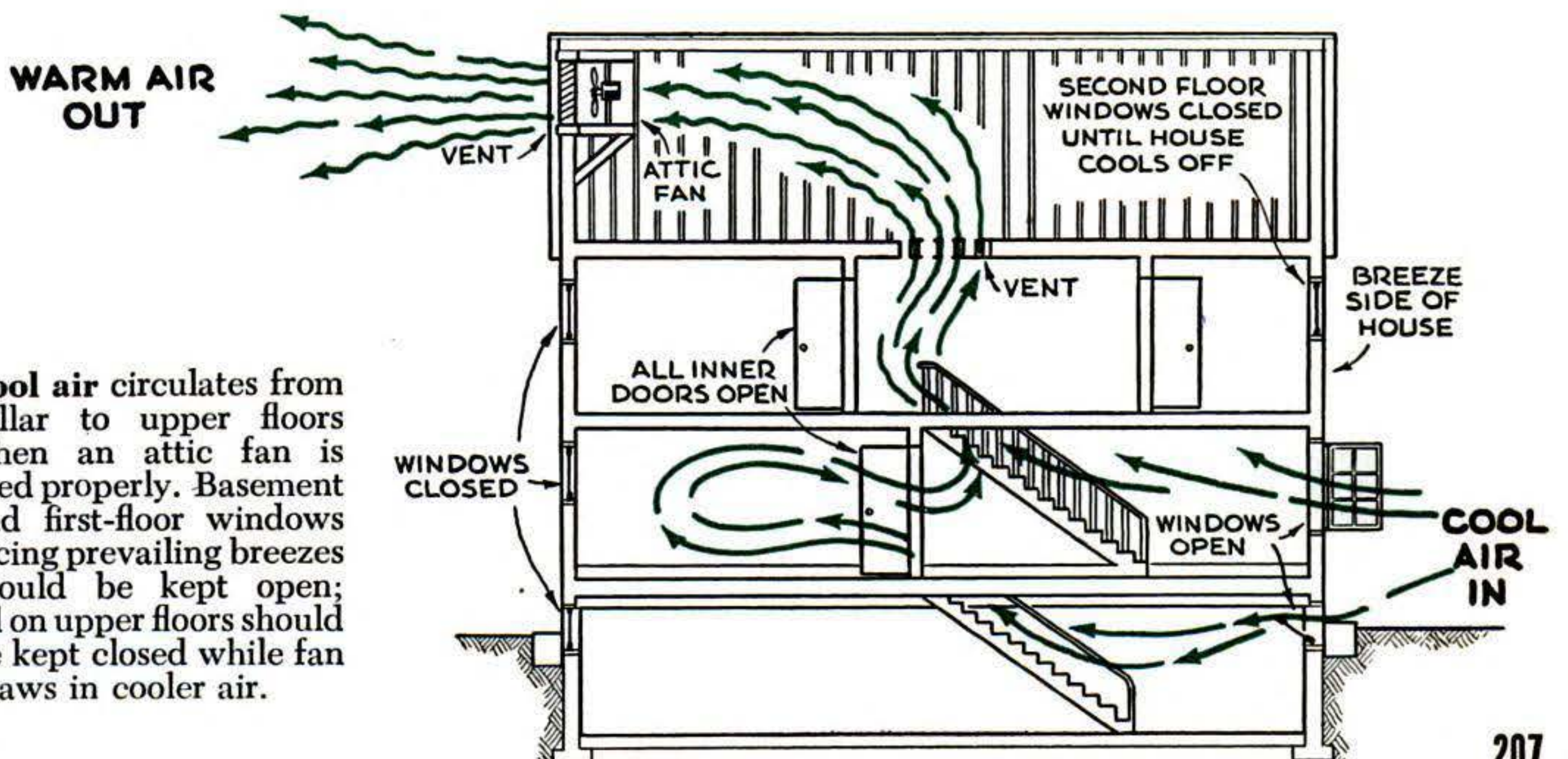

Cool air circulates from cellar to upper floors when an attic fan is used properly. Basement and first-floor windows facing prevailing breezes should be kept open; all on upper floors should be kept closed while fan draws in cooler air.

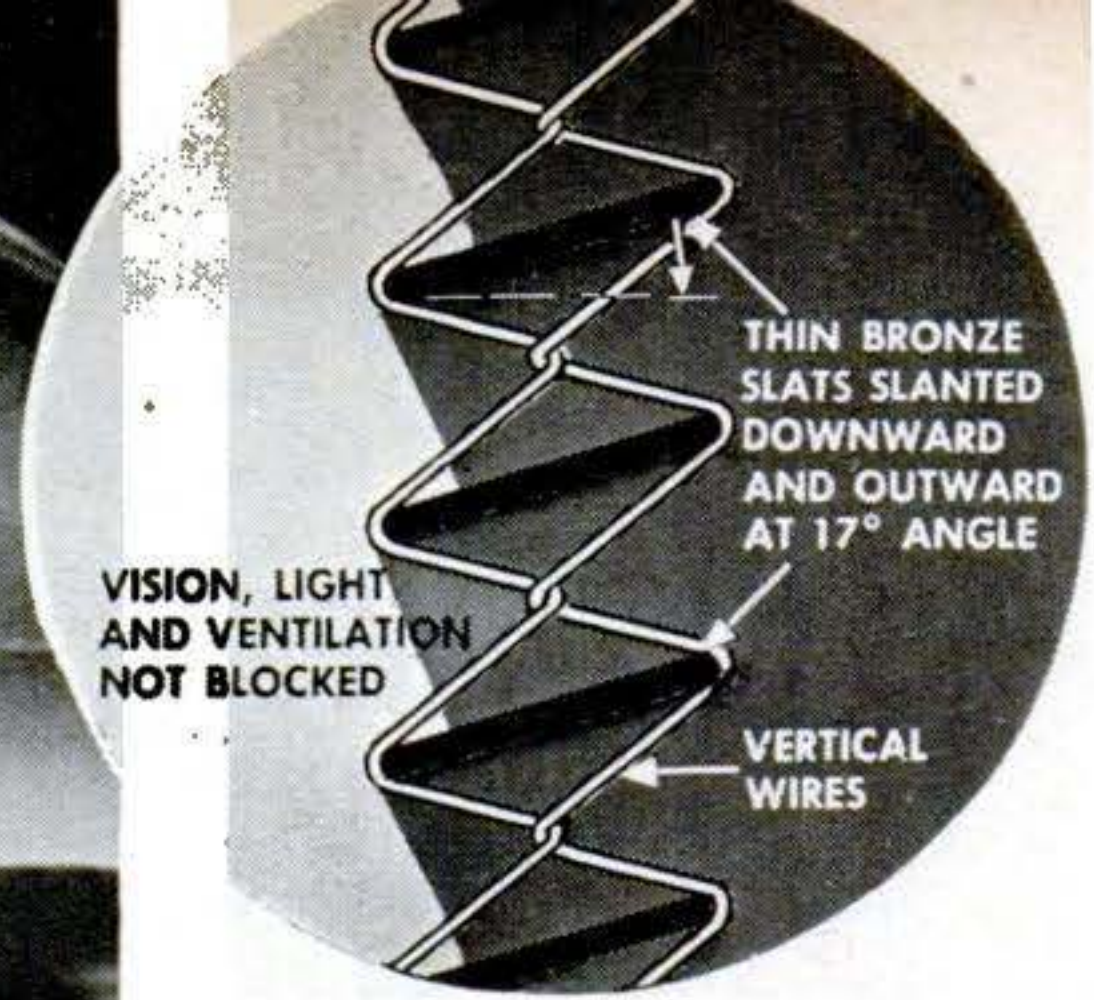

Special window screens will keep out direct rays, as well as insects, without interfering with view. Tiny horizontal slats placed at angle stop rays. Photo at left shows how sunlight passes unscreened window but is blocked by slats.

those two highways for heat, you can keep more than two-thirds of the added heat from the rays of a summer sun from getting in.

How to Keep Heat Out

Roof or attic-floor insulation, naturally, is one way to keep heat from coming in through the ceiling. Most of us think of insulation only as a means of saving fuel in the winter, but it also can help make us more comfortable in the summer. The insulating materials available range from metal foil to glass fiber. You can install some kinds your-

self; others require a professional's skill.

Quite a few things can be done about your windows. All of them, especially those on the sunny side of the house, should be kept closed during the day. Glass transmits about 85 percent of the heat that strikes it, though, so something more should be done. One old stand-by is to pull down the shades. This may slow down the heat-transfer process slightly, and help psychologically by keeping out the bright light. However, such experts as Dr. H. E. Landsberg of the U. S. Government Research and Development

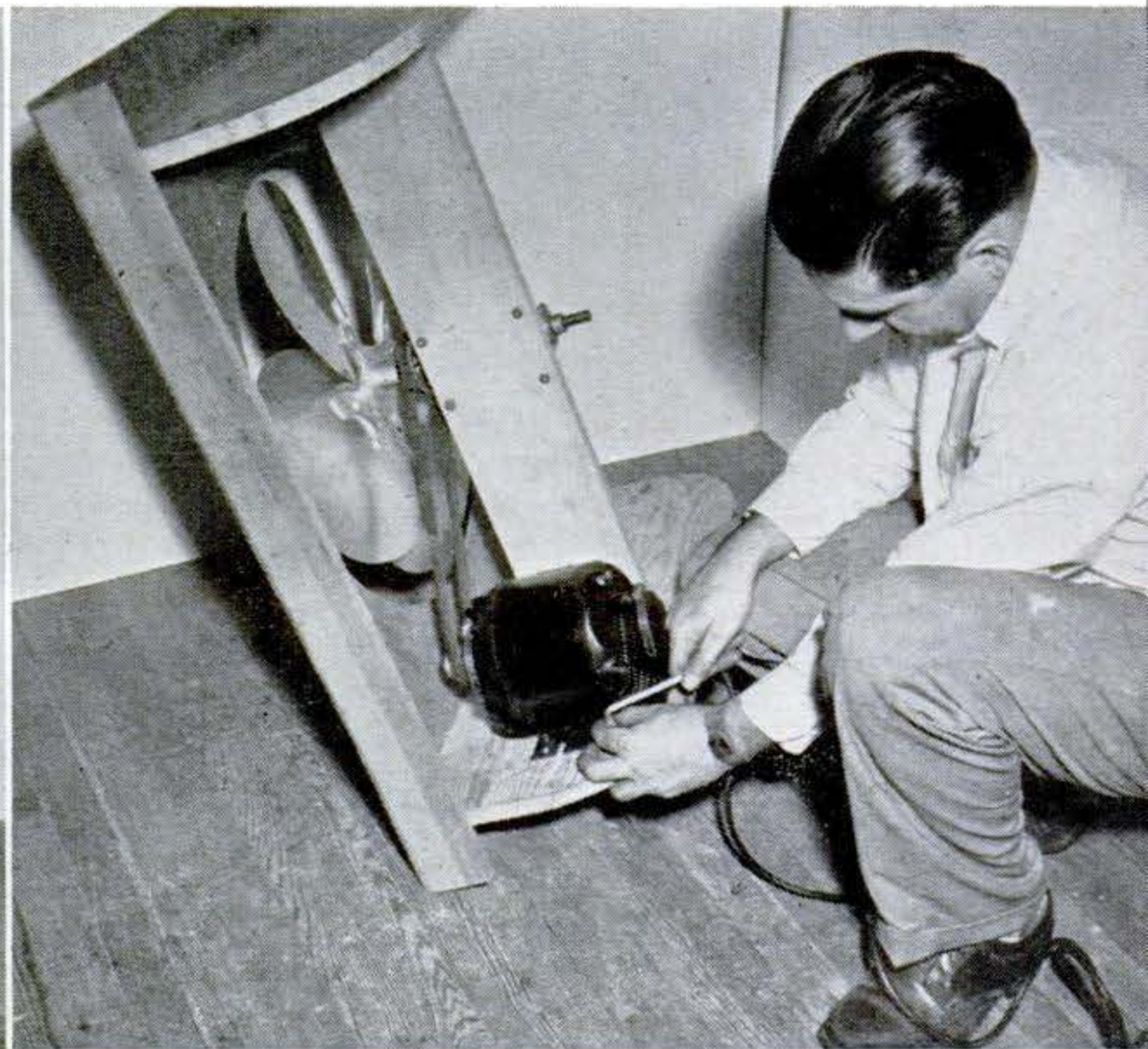
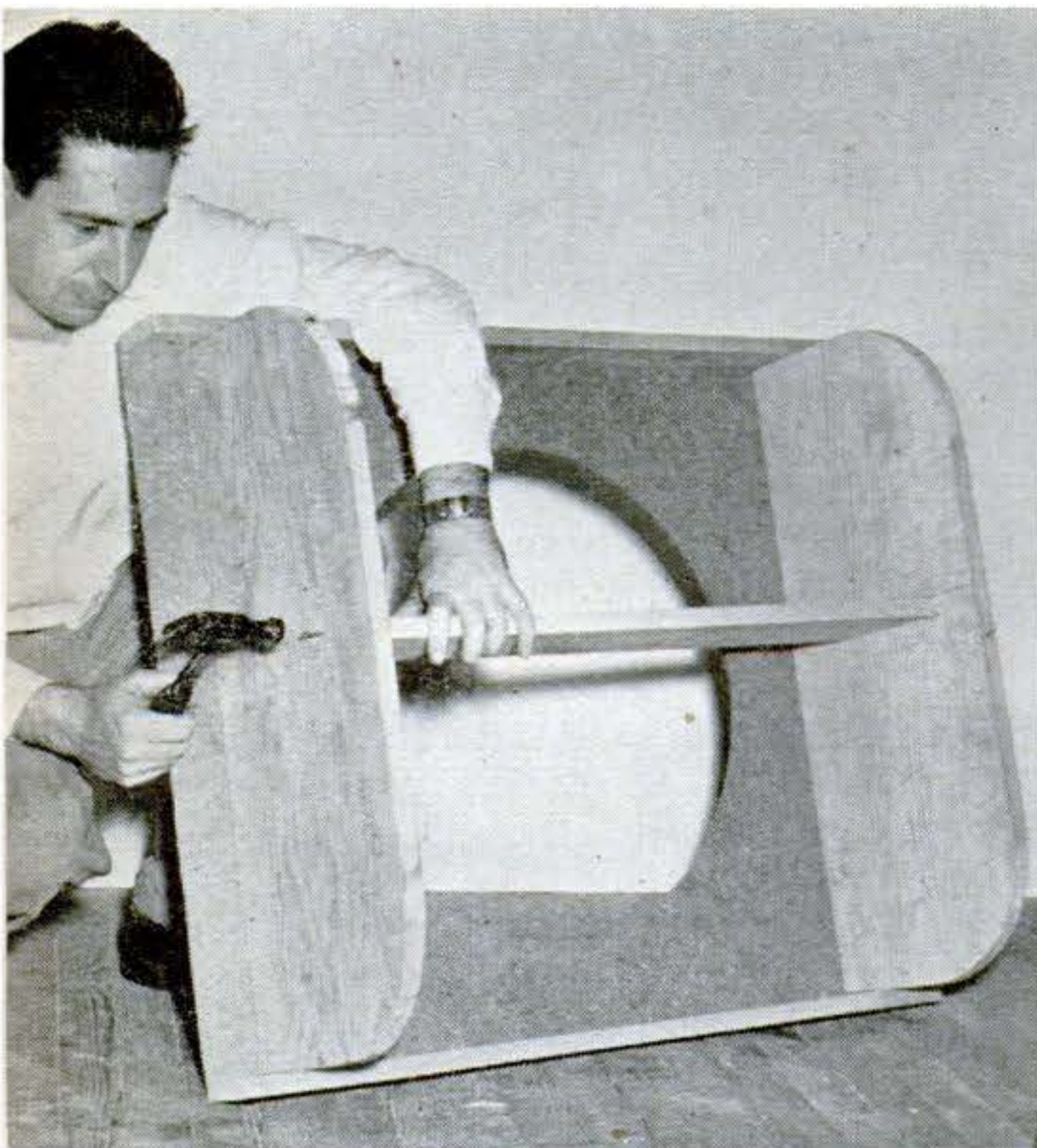

You can make a window ventilator from some lumber, a fan and arbor, a motor, and a few square feet of metal grille. Frame is made of 1" lumber; back, from composition board.

Fan and motor should be bolted in place. Rubber mountings are best. A 20" fan with 2½" pulley driven by 1/6 hp. motor with 1½" pulley will circulate air in small house.

Board say it is far less effective than preventing the sun's rays from reaching the outer surface of the glass in the first place. Dr. Landsberg recommends old-fashioned shutters (painted white on both inner and outer surfaces) as one of the best barriers.

Canvas awnings, particularly ones with open sides that allow air to circulate, also do a good job. The same goes for decorative architectural overhangs and window trellises covered with climbing vines.

Nowadays, you can also obtain heat-reflecting insect screens. They consist of thin strips of bronze or plastic that slant downward and outward. Thus they allow for light, ventilation, and a view, but prevent direct rays from the sun, as well as insects, from getting into the room.

How to Let Heat Escape

With roof and sunny windows well taken care of, your next step should be to provide an exit for heat that slips into your house despite your vigilance. This can be done by treating your house as though it were a chimney. Because hot air rises, the cellar normally will be the coolest spot in your house; the attic the hottest. It is not uncommon for the temperature in an unventilated attic under an uninsulated roof in midsummer to soar to 160° when it is only 90° outside. Such attic temperatures have

much the same effect as a network of radiant-heating coils in your ceiling.

Your whole house will be cooler if you open the cellar windows that face the cooler, shadier side of your house, and ventilate your attic either by opening a window or installing ventilation louvers on the downwind side. Every little breeze that blows will then pull hot air out of the attic. How big should the window or louvers be? The experts recommend at least 30 sq. in. of opening for every 100 sq. ft. of attic floor.

Once your attic has some sort of ventilator, you will have an open top to your "chimney." Then, by keeping open all inside doors, including the cellar and attic doors, you can create a natural upward draft that will draw the warm air off from the top of the house and suck cooler air up from the cellar. This natural cooling system is generally most effective after the sun has gone down and outdoor temperatures start down.

How to Shove Heat Out

You can increase the efficiency of your cellar-to-attic air-circulating system by inducing forced draft with an attic exhaust fan. Turned on a few hours every evening, it will pull cool air in through the cellar and ground-floor windows, circulate it through the house via the stair well, and expel through the attic ventilator. Soon

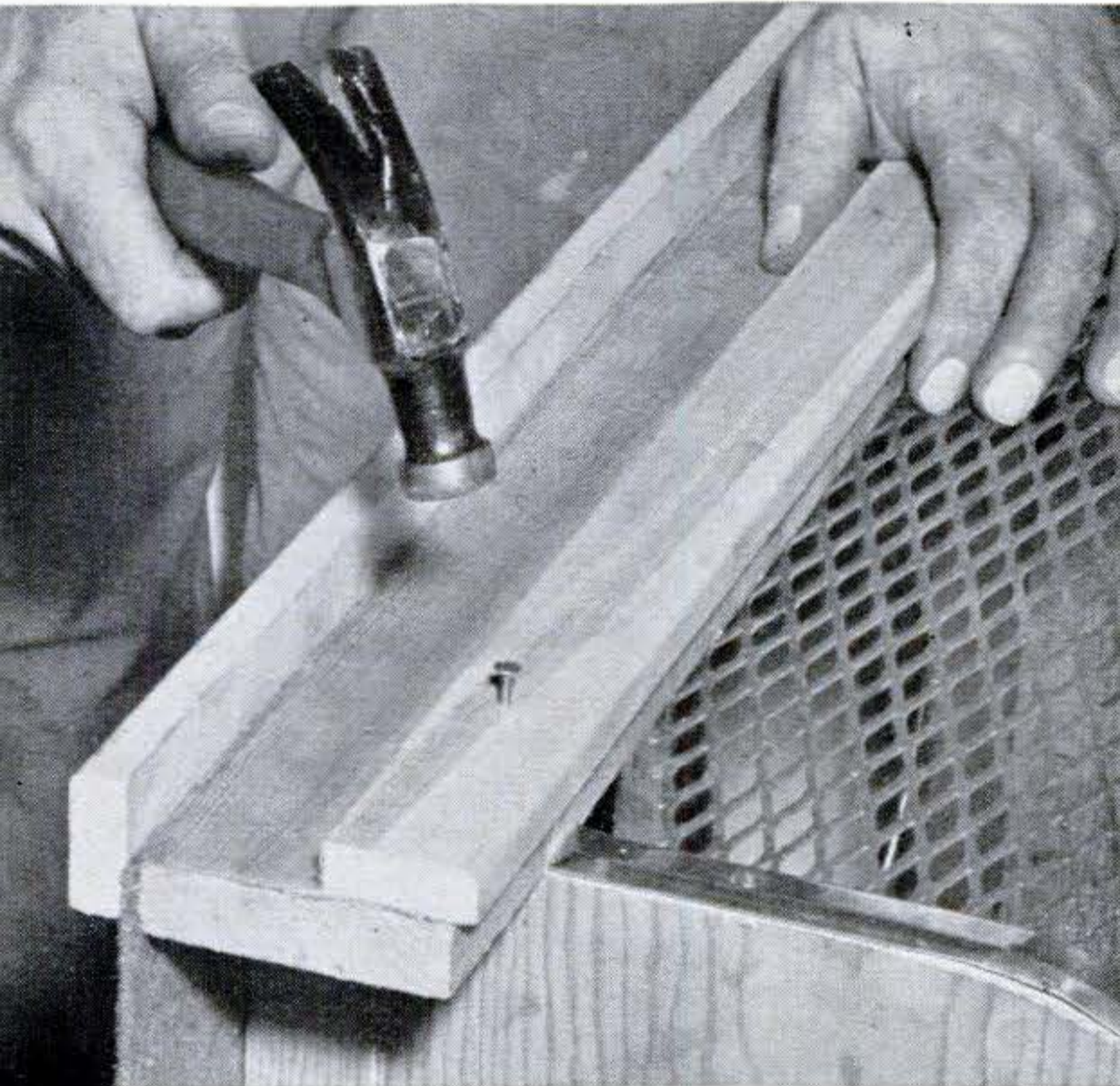

Metal grille, sometimes called "expanded metal," makes a good cover for the fan. Only the thinner gauges should be used, since the heavier gauges are difficult to work by hand.

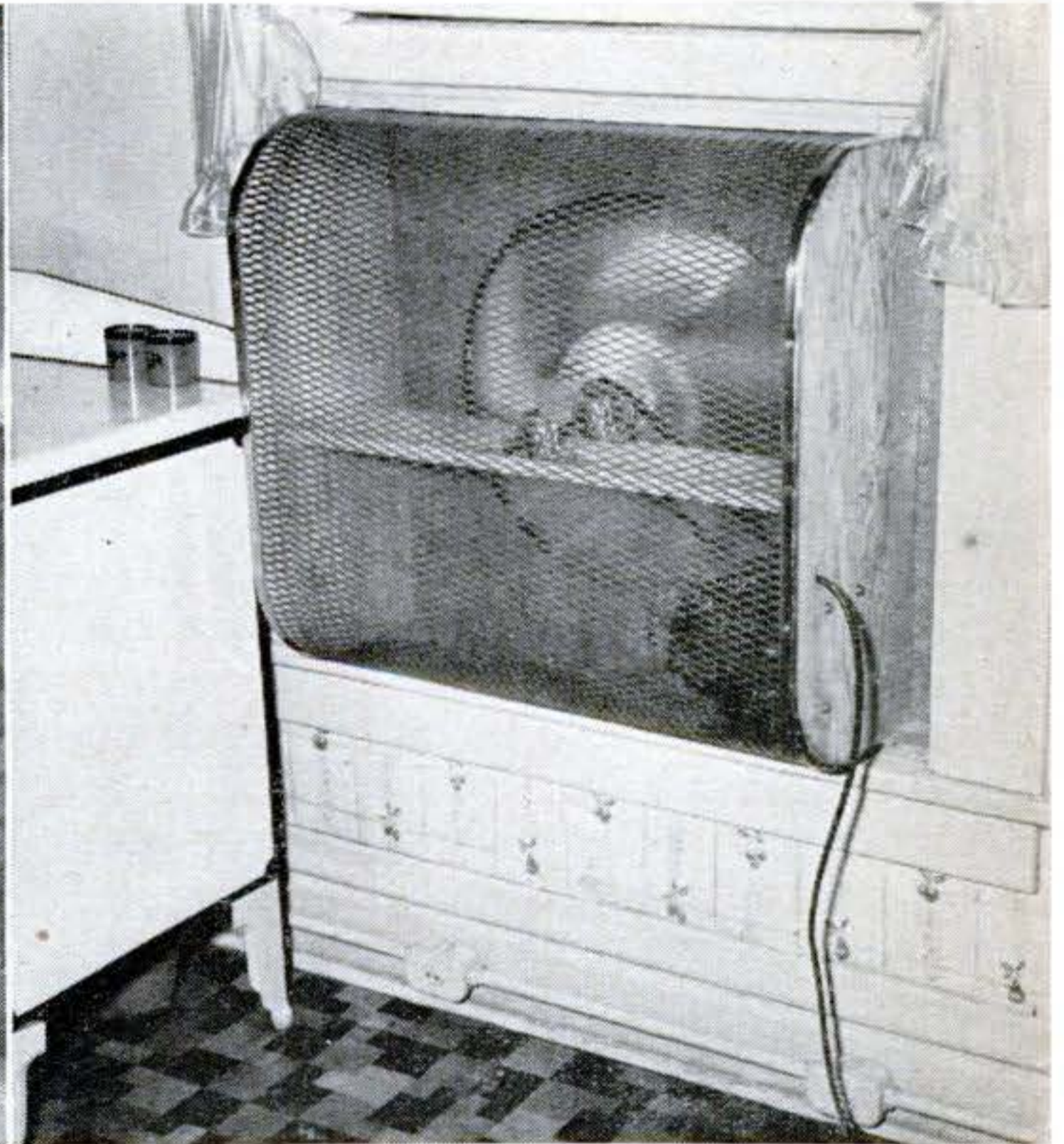

The completed fan is held in place by the window sash itself. The fan housing is simply slipped into the window, as shown, and the sash is pulled down to grip the upper edge.

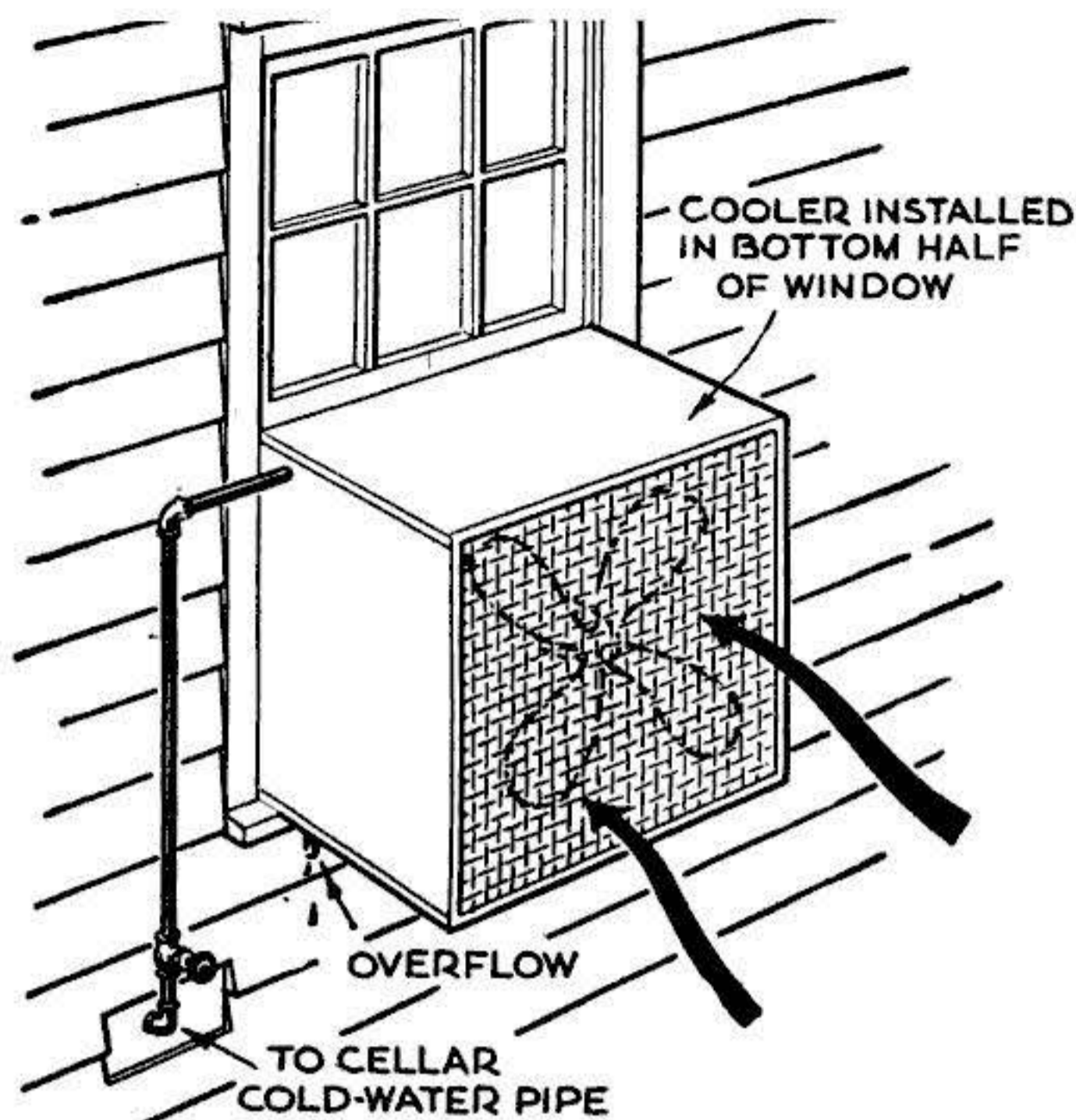

Evaporating water will help cool your bedroom if you build this window unit—a variation of a cooler improvised for many wartime barracks.

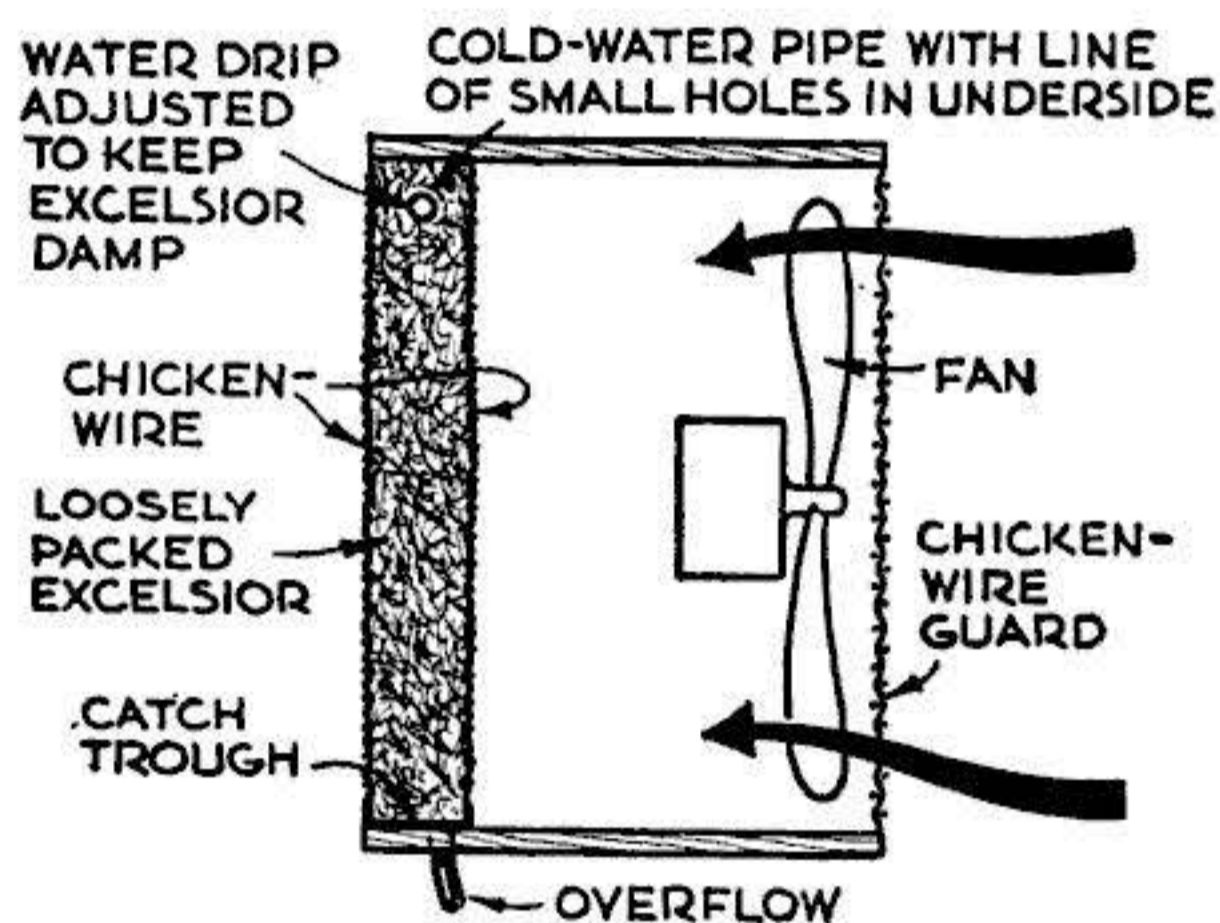

Fan blows air through filter of excelsior, which is continuously moistened by water dripping from pipe. Evaporation cools the incoming air.

the temperature of the walls, ceilings, and furnishings will be lowered. An attic fan can make a dent of as much as 15° in nighttime indoor temperatures, which can mean the difference between sleeping or not.

The fan can be mounted either right at the attic window or ventilator, or over an exhaust grille placed in the attic floor. If entrance to your attic is through a trap door, it can serve as the attic-floor exhaust vent. In either case, the fan should be mounted in a comparatively airtight housing.

The size of the fan you need depends on the size of your home and its geographic location. In the middle coastal states, about 30 air changes every hour are required to cool a house down to outdoor evening temperatures. In the broiling south, you may need as many as 50 or 60 air changes an

hour. In the north, ten may be ample. These figures assume that you'll run the fan two or three hours every evening.

Determine the over-all cubic-foot capacity of your house, multiply that figure by the required number of air changes per hour, and divide by 60 to get the minimum cubic-foot-per-minute capacity that your fan should have. If you live where 20 air changes an hour are recommended, for example, and your house has 9,000 cu. ft. of space, you simply multiply 9,000 by 20 and divide by 60 to get a required air movement of 3,000 cu. ft. per min.

Try the Fan Test

If you are dubious about the value of such a cellar-to-attic ventilating system, experiment first with any fair-sized electric fan. Some warm night—that is, warm indoors and cooler outdoors—open the door to your attic, place the fan so that it will blow toward an open attic window, and let it run for four or five hours—or for the entire night. Even the relatively small amount of air that a small fan can push (the average room fan doesn't move much more than 900 cu. ft. per min.) is likely to make a noticeable difference.

Just as important as figuring the size of your attic fan is gauging the size of the exhaust opening in the attic floor or trap door. Allow about 2 sq. ft. of exhaust opening for every 1,000 cu. ft. per min. of fan capacity.

Although, at first glance, it would seem reasonable to suppose that a practical room cooler could be made from a secondhand mechanical refrigerator, this is rarely the case. A good room cooler, to provide adequate cooling, should be able to deliver about ½ ton of refrigeration; a big refrigerator (10 cu. ft.) gives only about 1/6 ton. (A "ton" of refrigeration is the cooling effect of a ton of ice melting in 24 hours.)

However, if you live in a part of the country where the over-all humidity in the summer is relatively low and where tap water is plentiful, you can borrow a trick from the Army. More than one uninsulated, wooden barrack that fringed World War II airfields in Arizona, New Mexico, and eastern California—which Bob Hope called "runways built in ovens"—was cooled at night with an improvised air conditioner. It consisted of a large electric fan mounted in a window housing that blew air on excelsior kept damp by dripping water. If you buy secondhand parts, the whole business shouldn't cost you more than \$10 or \$20. END

Bookcase Lamp for End Table

THIS reading lamp packs its own ammunition. It holds reading matter as well as a light right up next to your easy chair. You can make this space-saver from four pieces of $\frac{3}{8}$ " or $\frac{1}{4}$ " lumber. Saw the stock to the dimensions shown and round off the upper corners of the upright members.

The next step is to drill a $\frac{1}{4}$ " hole lengthwise through the 9" upright. Some $\frac{1}{4}$ " drills are long enough to reach half way through from both ends. If yours isn't, use a long-shaft electrician's drill. Sight carefully along the drill as you work and keep the drill straight or you may find the point coming through the side. As an aid in sighting, you can clamp on a vertical strip of wood and keep the drill parallel to it.

Mark and drill a hole in the base to correspond with the hole in the upright and groove the bottom of the base. Glue and nail the ends and center to the base.

Enlarge the top of the upright hole, squeeze in a few drops of glue or cement, and thread in a short $\frac{1}{8}$ " pipe nipple, which



is actually about $\frac{3}{8}$ " o. d. Leave about $\frac{1}{2}$ " of the pipe exposed on top so that the base of the lamp socket can be screwed down over it.

Ease a length of lamp cord through the hole and wire the socket and plug. Cement cardboard or felt to the base to protect the table surface and to keep the lamp cord inside its groove.

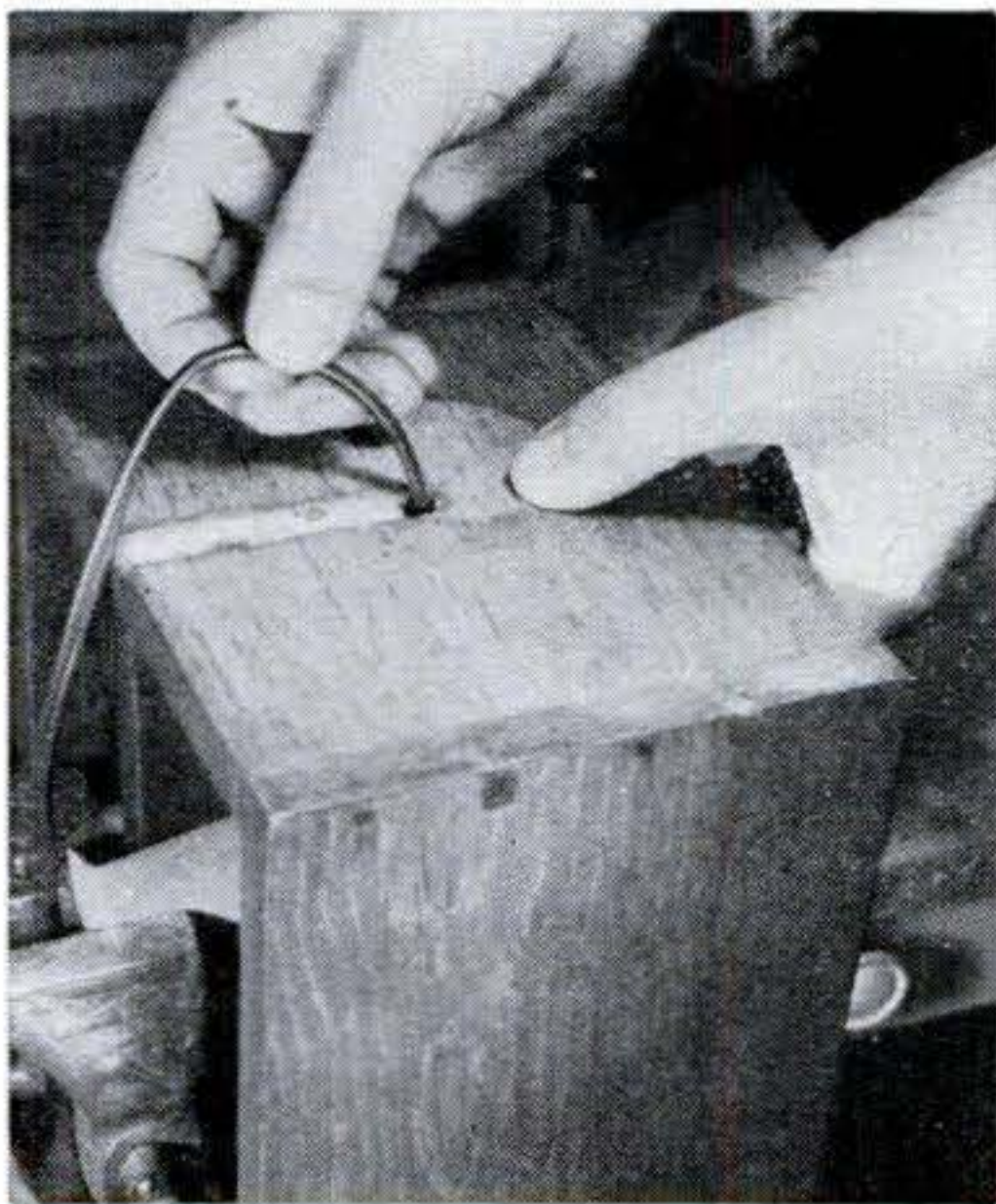

Lamp wire passes through a $\frac{1}{4}$ " hole that runs through the base and center upright. The base is grooved from the center to one edge to clear the wire.

The socket is attached by means of threaded pipe nipple. Part of it is turned down into the wood, part sticks up and is screwed into the socket.

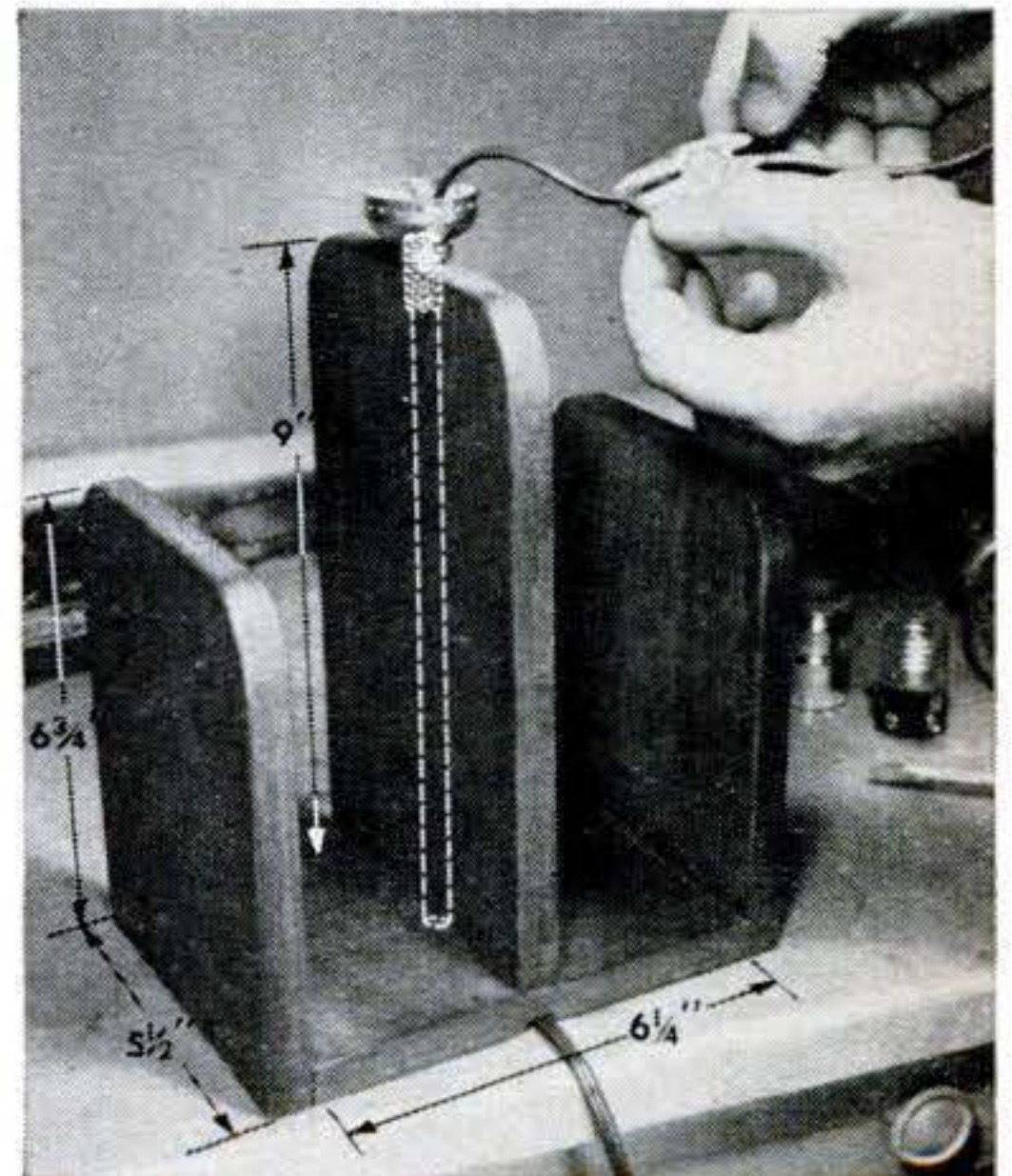

Restoring Scratched Linoleum

AREAS of your kitchen linoleum that have become scratched or marred can be improved in appearance by a little special treatment. First wash them. After they've dried, rub thoroughly with boiled linseed oil. Remove excess oil, allow to dry at least 48 hours, wash again, and apply a couple coats of wax. Hard wax, rubbed to a high polish, will give a satisfactory and durable finish.

Shade Conceals Cellar Shelves

AN UNSIGHTLY but necessary collection of soap boxes, polishes, and other household articles on shelves at the head of the cellar stairs spoils the appearance of a finished basement. A quick, simple, and inexpensive remedy is a 29-cent window shade, installed between the studs supporting the shelves. Pulled down, it conceals everything.—*Robert Hertzberg, Queens, N. Y.*



NEW SHOP IDEAS

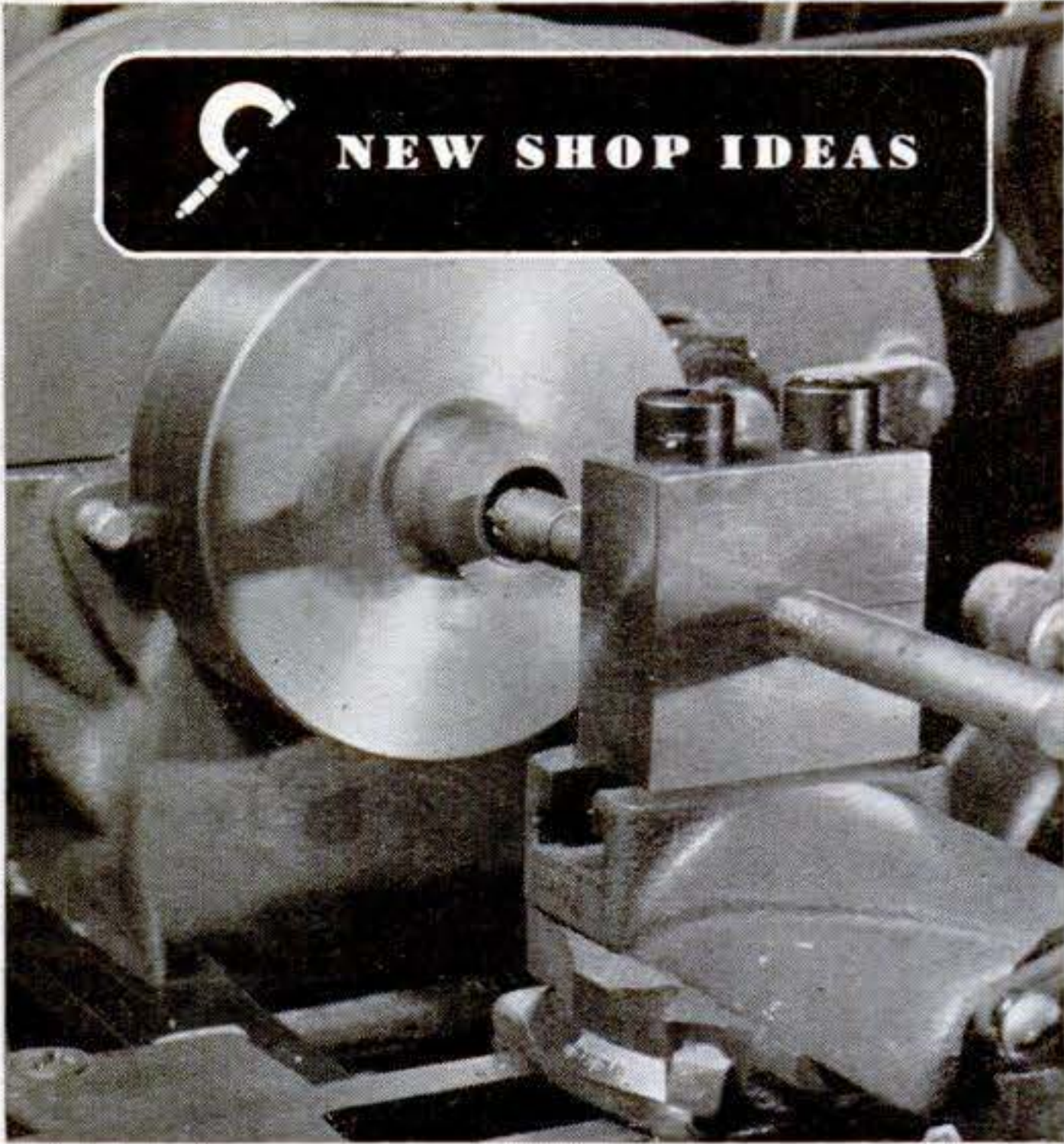

Rigid Boring-Bar Mount. The bar holder is often responsible for chattering when heavy boring cuts are taken on a small lathe. Here is a really substantial holder. It consists of two steel blocks, the lower one exactly as high as the distance from the top of the compound to lathe-center height. Clamp the blocks together to drill bolt holes through, and mark both for use in the same position as drilled.

Make a shoe to fit into the tool-post slot and tap for the clamping bolts. With the blocks tightly clamped and at 90° to the lathe bed, put a drill in the chuck and run the carriage up to make the hole for the boring bar. If bars aren't held tightly, dress off the meeting faces of the blocks on emery cloth.—*Joseph Tracy, Manhattan, N. Y.*



Pulls Screws. In the aircraft factory where I work we often have to get out Phillips screws having stripped slots, in which a Phillips screwdriver won't hold. We do it by drilling both ends of one slot at 45°, and using as big an ordinary screwdriver as will fit, sometimes tapping it in lightly. I've never seen this dodge fail.—*Kenneth W. Mallison, Pacoima, Calif.*

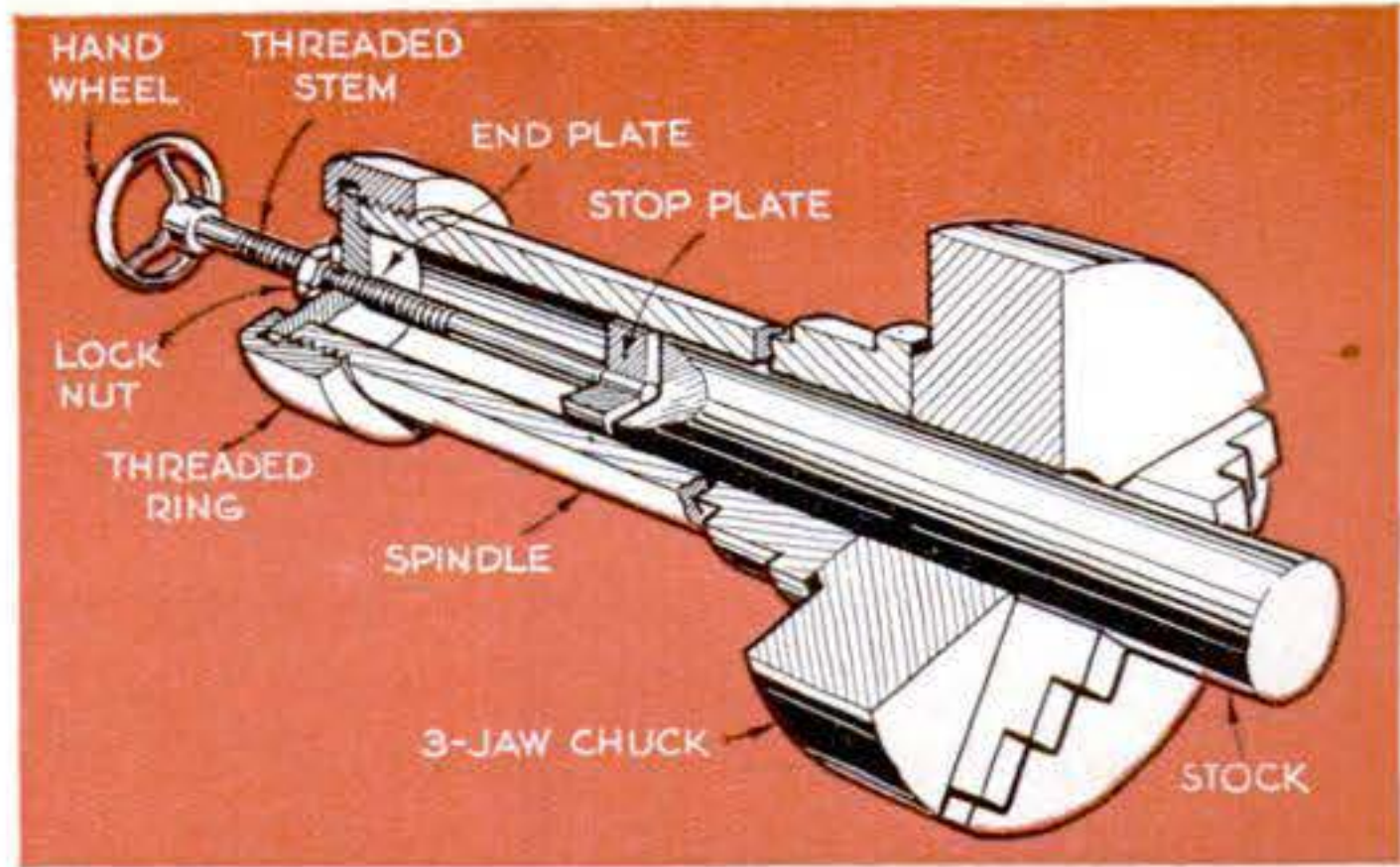

Spindle Stop Gauges Length. When work on limited production runs has to be held to close length limits, a carriage stop, plus the inside spindle stop shown, makes accuracy automatic. Reported by Herman Thoensen of E. Moline, Ill., in Warner & Swasey Company's *Blue Chips*, the device is being used on a saddle-type turret lathe. Work is pushed in against the stop, the chuck tightened, and the end faced or shoulders turned to set lengths with automatic precision by the turret tools.

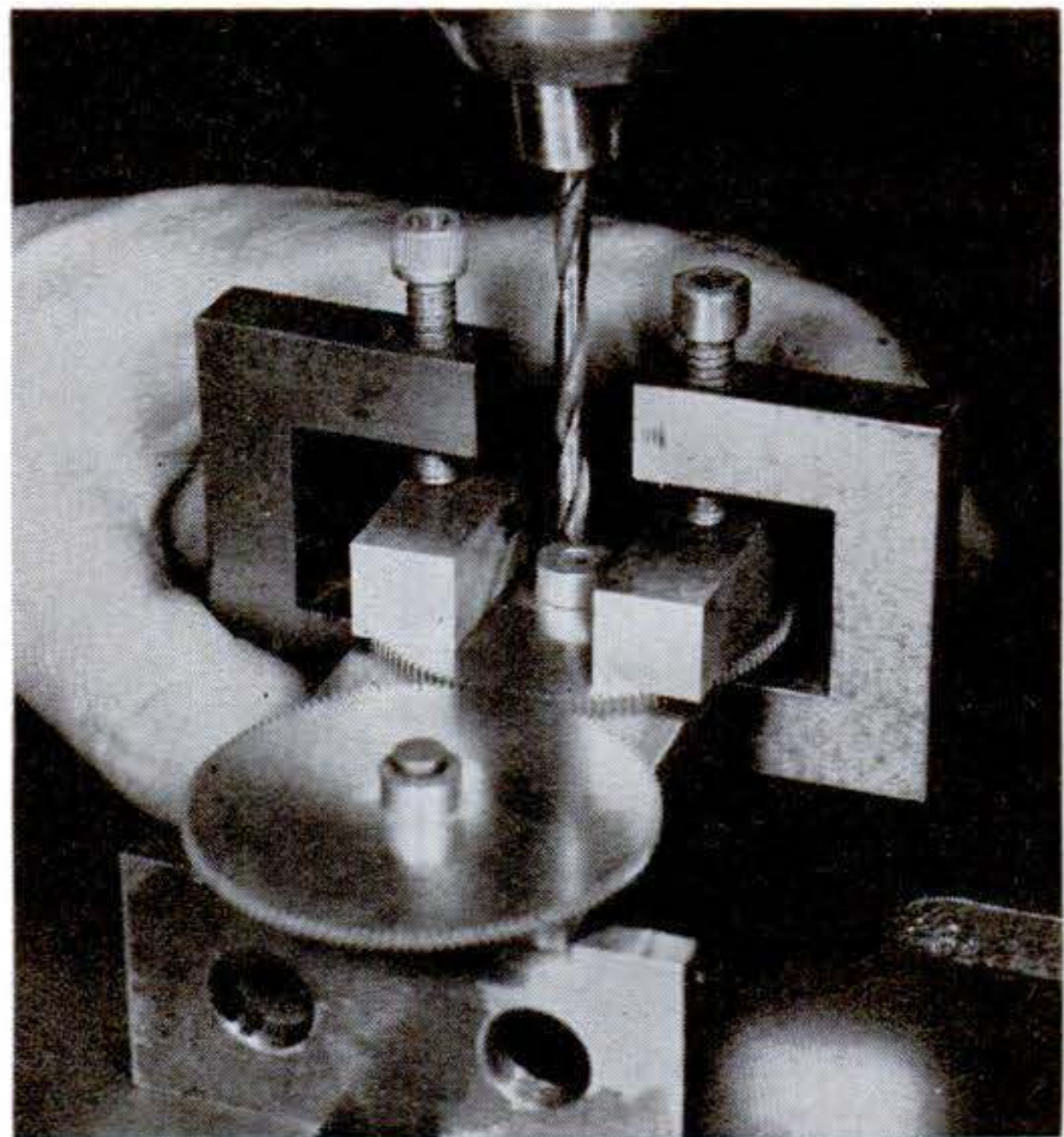

Gear Spots Its Own Center. When two or more gears are to be mounted, the critical job of locating them in proper mesh can be done with the gears. Mount the first on its shaft or pin. Then mesh the second with it and clamp this one. With a drill the same size as the hole in the gear, spot the mounting hole through it. If the gears are to go between two plates, clamp the plates together temporarily, with the gears outside for spotting.—*J. C. Magee, Schenectady, N. Y.*

Razor-Blade Gauges. By miking razor blades, you can collect an assortment of thicknesses for feeler gauges. Grind off the cutting edges, mark the thickness on each blade, and mount them on a bolt and nut.—*Federico Strasser, Santiago, Chile.*

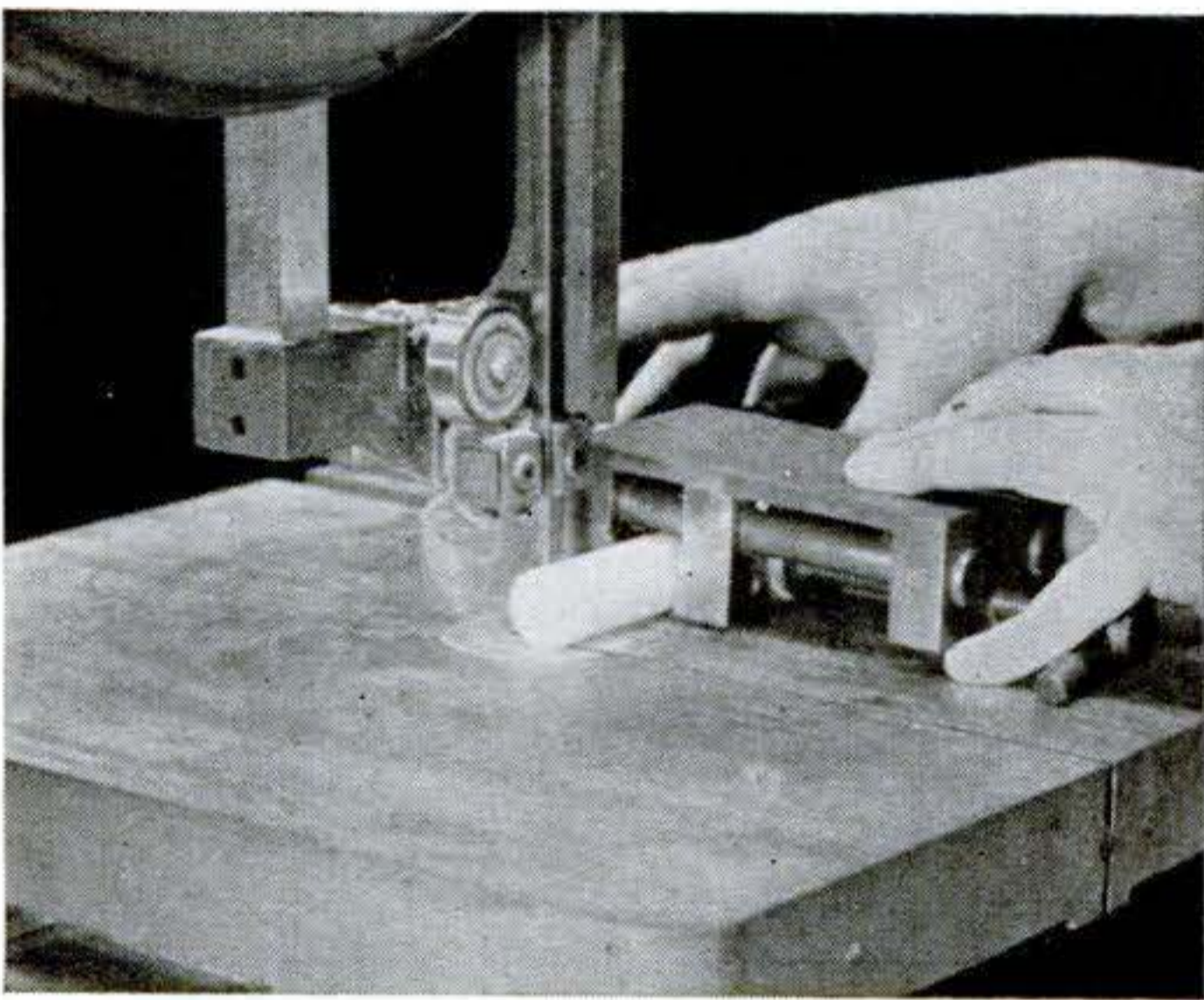

Holding Round Stock. If round work is allowed to roll on a bandsaw, it may strip off teeth, spoil the cut, or hurt the worker. To guard against this, clamp the work in a drill-press vise turned upside down, as shown. Short work can be held with a toolmaker's clamp held flat on the table.—*Arthur R. Morgan, Naugatuck, Conn.*

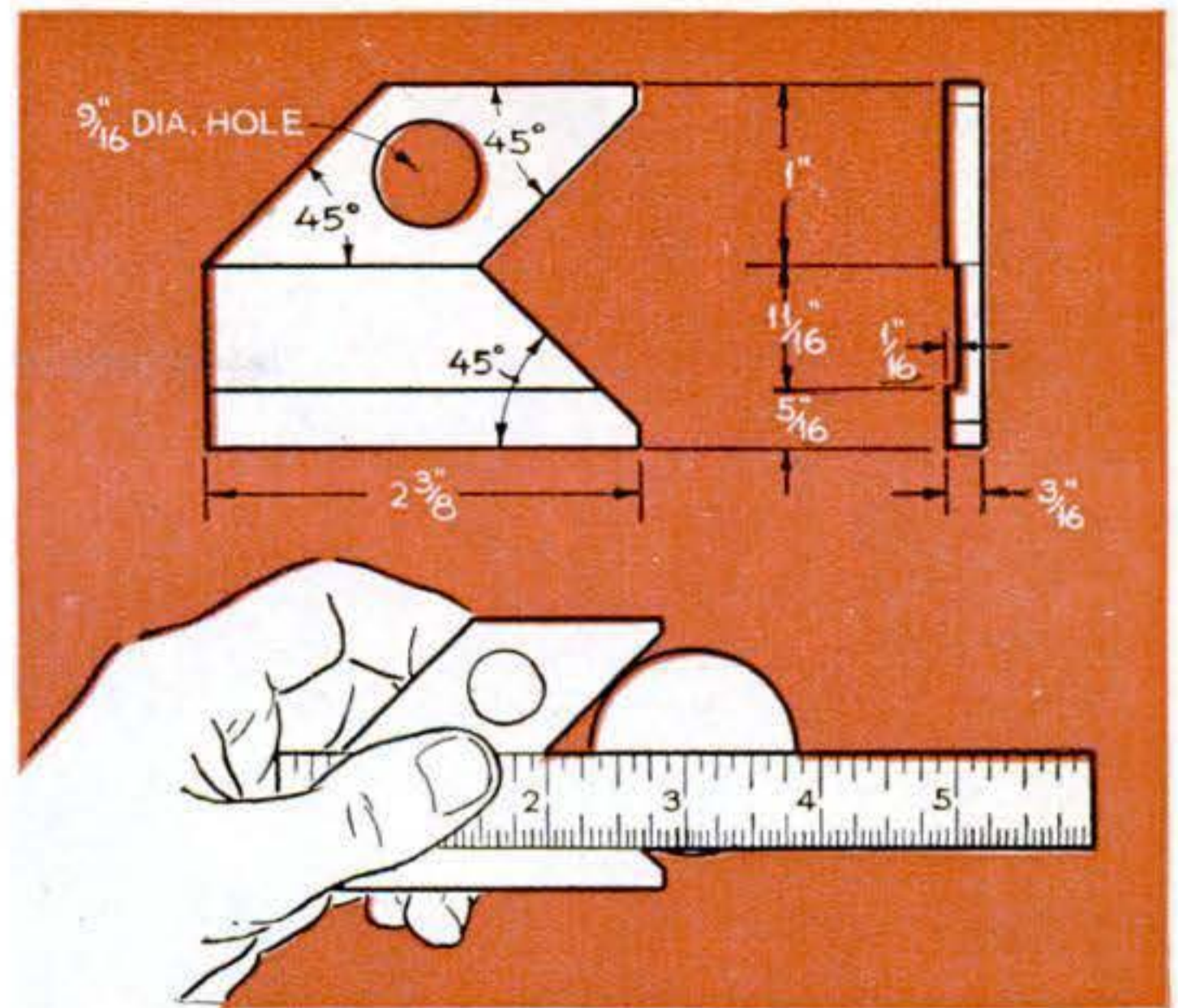

Tool Locates Centers. You'll find this gadget handy for spotting centers on round or square stock, as well as for squaring lines from an edge. A regular 6" steel rule fits into the groove. It's held by the thumb, while the tip of the forefinger in the hole supports the gauge.

Cut the groove first, in a piece of stock 3/16" by 2" by 2 3/8", on a shaper or by filing. Then lay out the sides of the notch at 45° to the edges. Hacksaw roughly to shape. File to the lines and drill a 9/16" hole as shown in the drawing above.—*H. L. Campbell, Oak Park, Ill.*

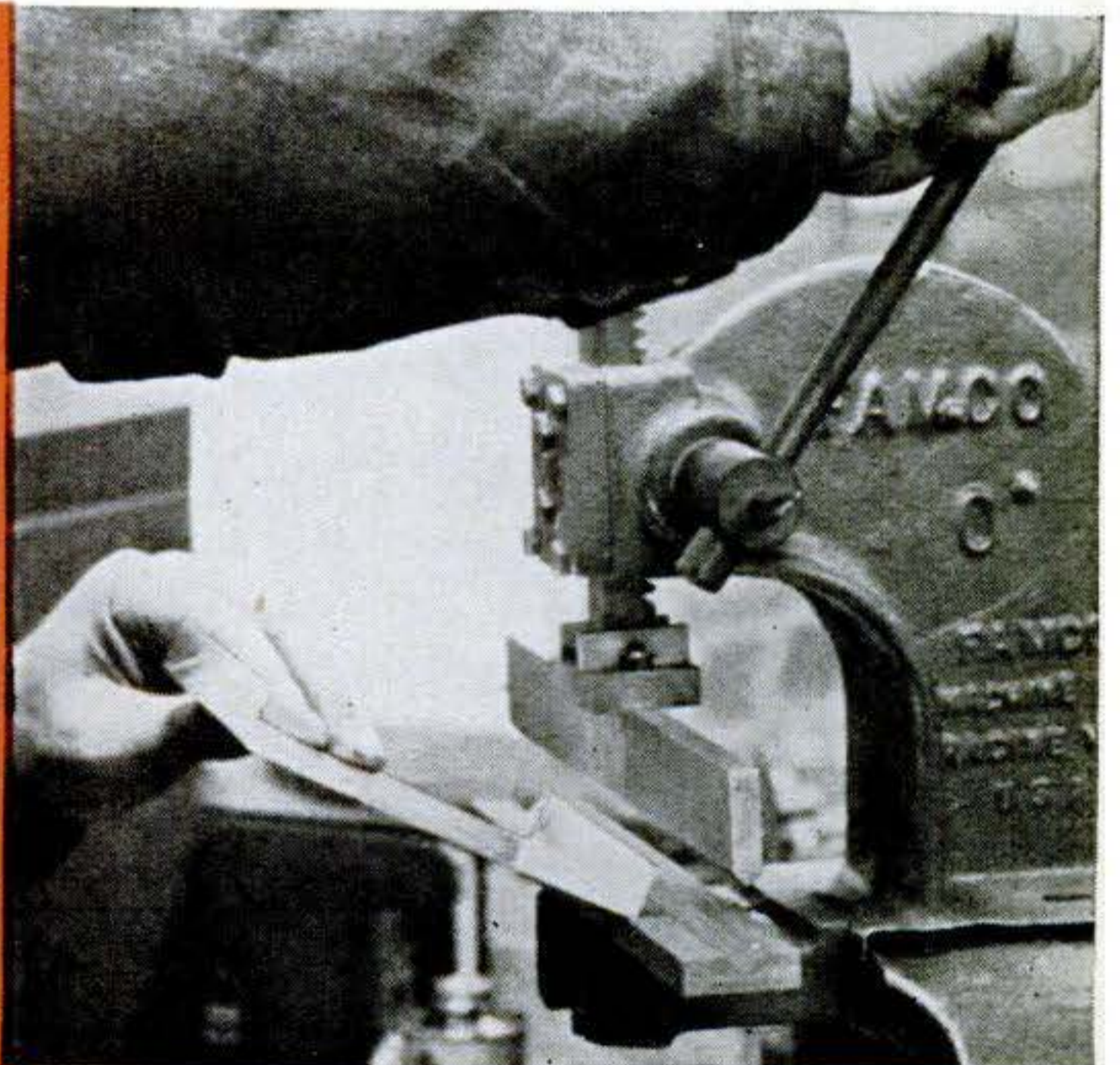
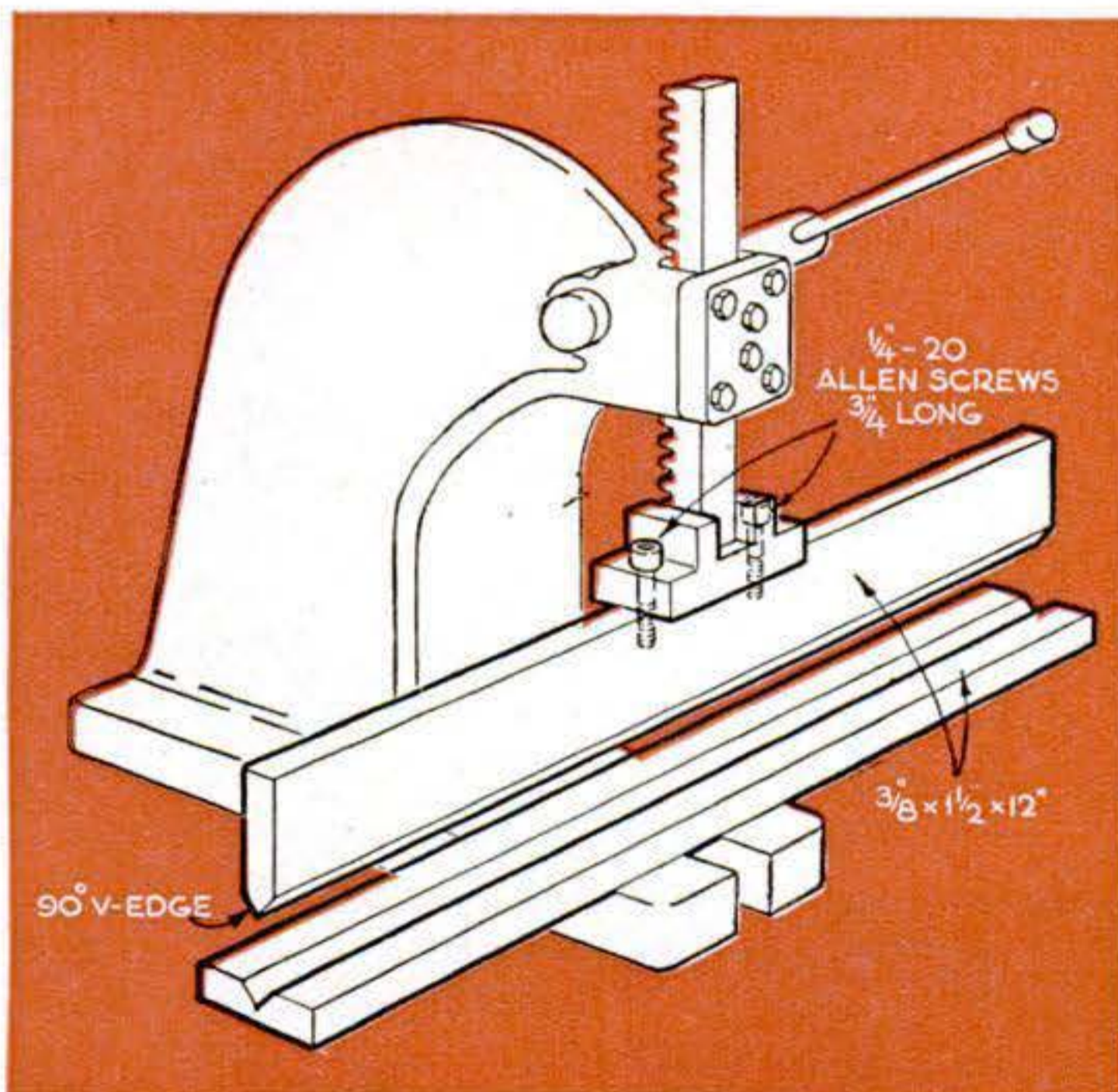

Press Bends Sheet Metal. With a V blade mounted on the arbor or spindle, and a V block on the table, any arbor or drill press becomes a small sheet-metal bending brake. An adapter machined as in the drawing secures the V blade on an arbor press. For a drill press, bore a tapered hole

in the adapter to fit the spindle, or butt the adapter against the end of the quill.

To form small boxes by turning all four sides up around a bottom, or for other bends in tight quarters, substitute shorter V blades that will fit within any bends already made.—*Samuel J. Kutner, New Rochelle, N.Y.*

What Plastic Is That?

Simple kitchen-table tests
identify wonder materials
of our Age of Plastics

By Howard Nechamkin

Assistant Professor of Chemistry,
School of Engineering, Pratt Institute

Photos by Kenneth M. Swezey



ACRYLATE, acetate, neoprene, styrene—maybe these are all Greek to you. But they belong to a new language, not an ancient one—the new language of the Age of Plastics.

Boil down a hundred and some trade names, and you'll find they designate about 18 kinds of plastics. You can identify these by home tests, and so determine whether an ornament can safely be washed in hot water, or a broken toy mended with a hot soldering iron, or lacquer thinner can be put in a container without dissolving it.

Originally considered substitutes, plastics are the dream stuff of modern industry. Want something that's transparent but unshatterable? A silk-sheer fiber with the tensile strength of iron wire? A "rubber" hose that will carry gasoline and stand heat? You can have them all—in plastics.

What's confusing is that the same plastic may be known by half a dozen trade names. The term Bakelite, on the other hand, can refer to any of four plastics. That's why it's best to know plastics by their chemical names.

All plastics belong to one of two main classes: thermoplastic and thermosetting. The chief difference is shown on the facing page.

Because heat will soften thermoplastics, some of them can be repaired by welding breaks together with heat. Thermoplastics can also be "cemented" with a suitable solvent that softens the joining surfaces and allows them to flow together. Solvents won't soften thermosetting plastics, but these can be patched together with certain cements.

Let's look at the plastics line-up, some of the trade names they go by, and a few of their uses.

Phenolics (thermosetting), most widely used of all plastics, are made by combining phenol (carbolic acid) with formaldehyde. They're hard, resistant to heat, water, and many chemicals, and are generally made in dark colors. Telephone instruments, electric plugs, and camera cases are made of phenolics. Trade names: Bakelite, Catalin, Durez, Gemstone, Indur, Marblette, Resinox, Uniplast.

Urea plastics (thermosetting) are made by reacting formaldehyde with urea, a compound of ammonia and carbon dioxide. Like phenolics, they're resistant to heat, water, and chemicals, but can be made in any color, including white. They are used for buttons, baking enamels, kitchenware, and certain

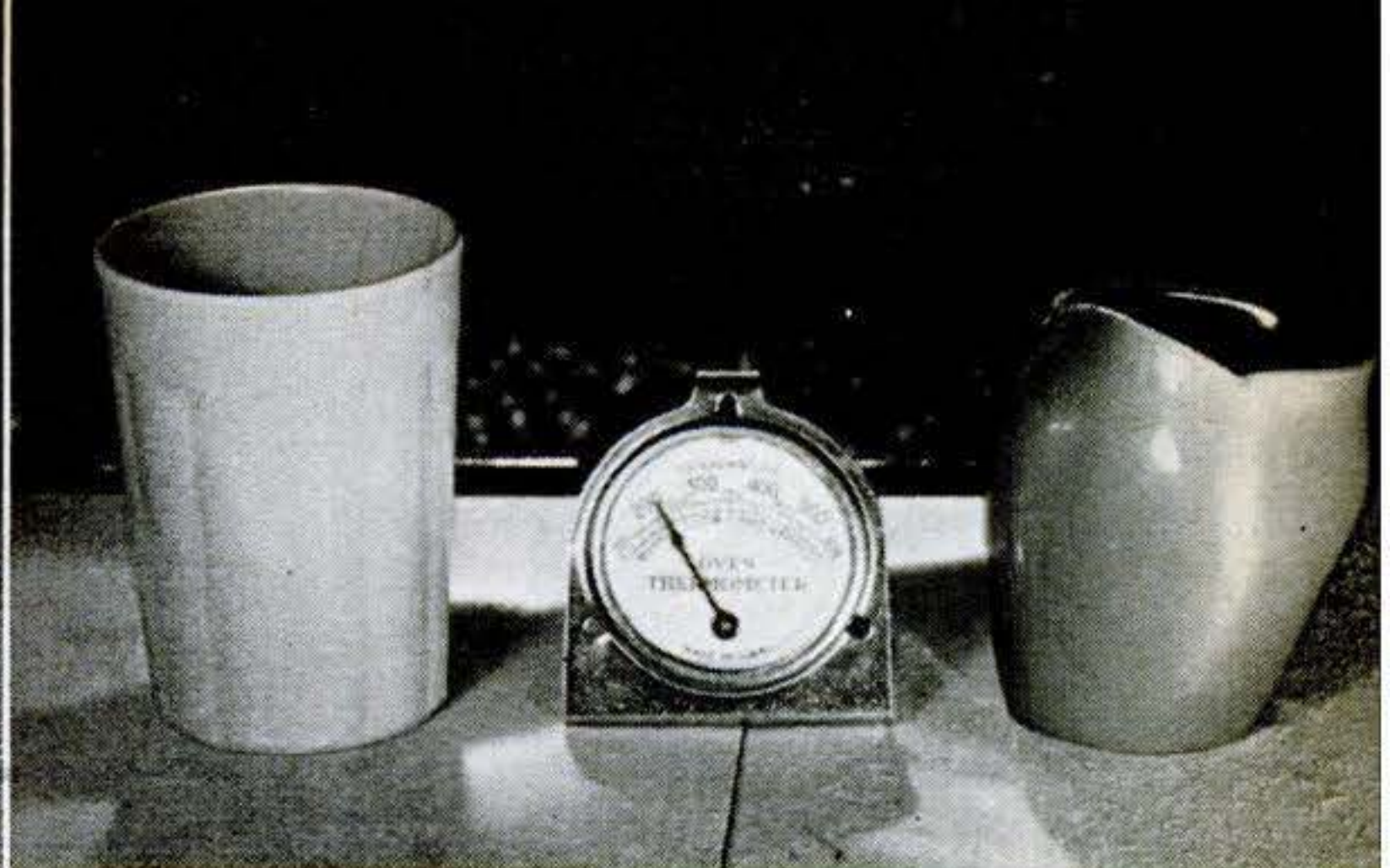

You can separate plastics into two main classes. *Thermoplastic* ones can be melted and recast again and again. *Thermosetting* plastics retain the shape they originally were molded in and cannot be melted and recast. Both have their advantages.

These pictures show the difference. The cup at the left in each photo is made of melamine, a thermosetting type. The one at the right is of polystyrene, a thermoplastic.

At about the temperature of boiling water (photo at right above) the polystyrene cup softens and begins to collapse. The other is unaffected. In photo at left below, at 375° the thermoplastic has become a blob. The melamine cup is beginning to blister and discolor.

At 550° (very hot baking oven) the polystyrene is a puddle. Though badly blistered, the thermosetting material retains its shape.

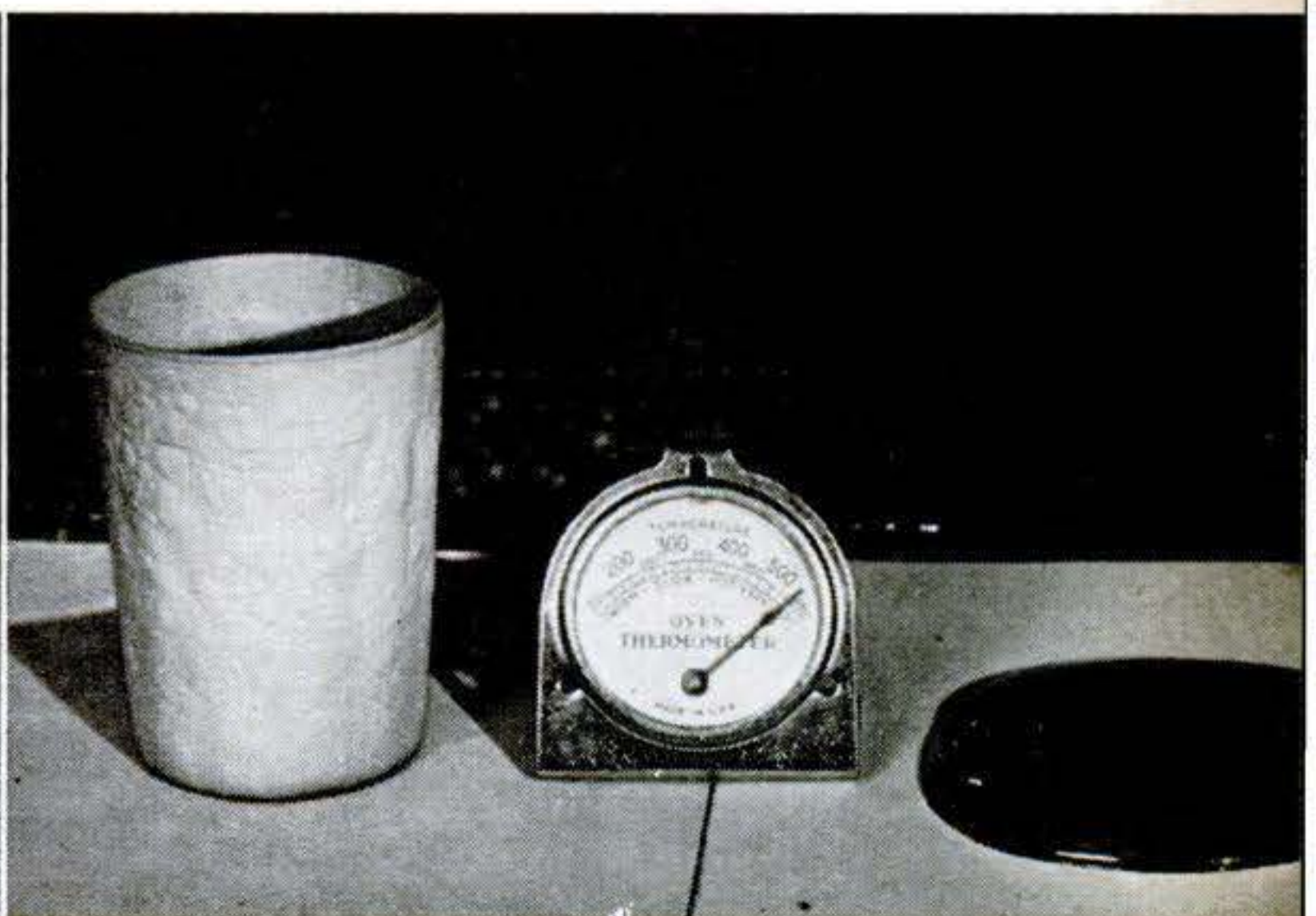
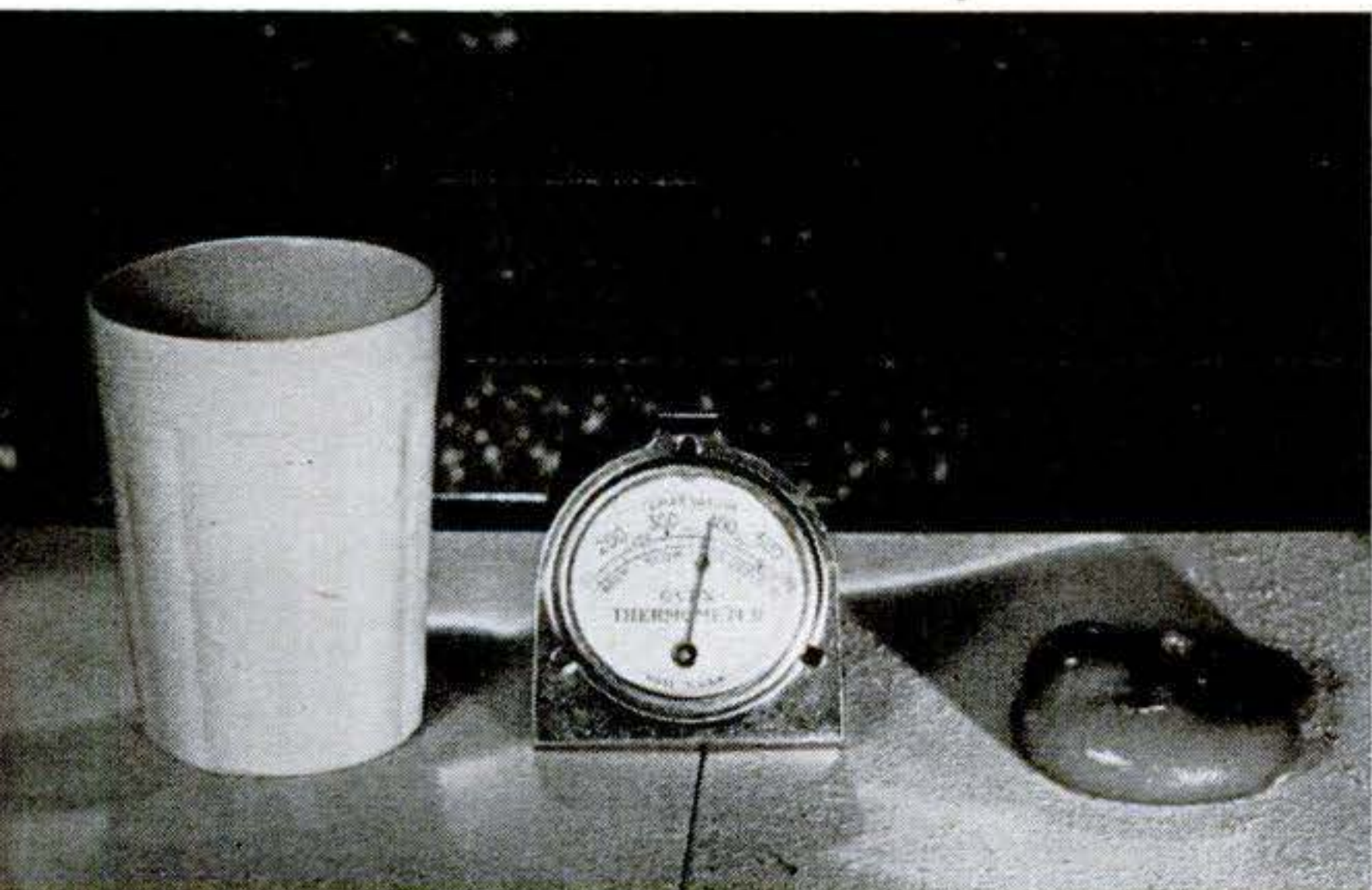

adhesives. Trade names: Bakelite, Beetle, Gemlite, Plaskon, Rhonite, and Sylplast.

Melamines (thermosetting) come from formaldehyde and melamine, a synthetic organic chemical. They too can be produced in beautiful light colors, and have very hard surfaces, excellent electrical properties, and great water resistance. Melamines are used for airplane and tractor ignition parts, circuit breakers, dishes, and buttons. Trade names: Catalin Melamine, Melmac, and Plaskon Melamine.

Acetate or cellulose acetate (thermoplastic) is made from wood. It does not burn readily, is resistant to shock and impact, and may be produced in transparent colors. You will find it in soap dishes, steering wheels, safety film, eyeglass frames, toys, and lacquers. Trade names: Acetate Rayon,

Bakelite, Berkalm, Celluplastic, Clearsite, Kodapak, Lumarith, Nixonite, Tenite I, and Vuepak.

Acetobutyrate (thermoplastic) is very much like acetate, but more resistant to water and shrinkage and more easily molded. It can be made transparent or any color, and finds use in toothbrush handles, instrument dials, and radio cases. Trade names: Rexenite, Rextrude, and Tenite II.

Nitrate (thermoplastic), also known as pyroxylin, is one of the oldest plastics. Made from wood or paper, it is extremely tough, water resistant, easily fabricated and colored. One great disadvantage is that it's highly combustible and tends to burst into flame if brought even near fire. For this reason, acetate has largely replaced nitrate. However, nitrate is used in tool handles, pens

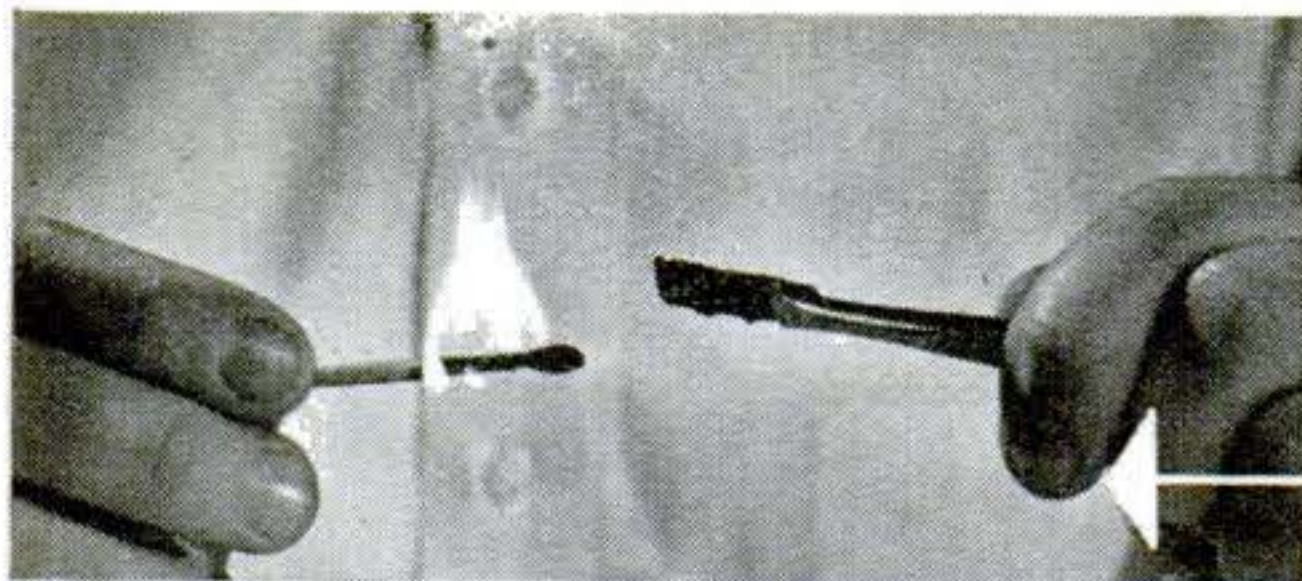

No flame at all. The sample retains its shape.

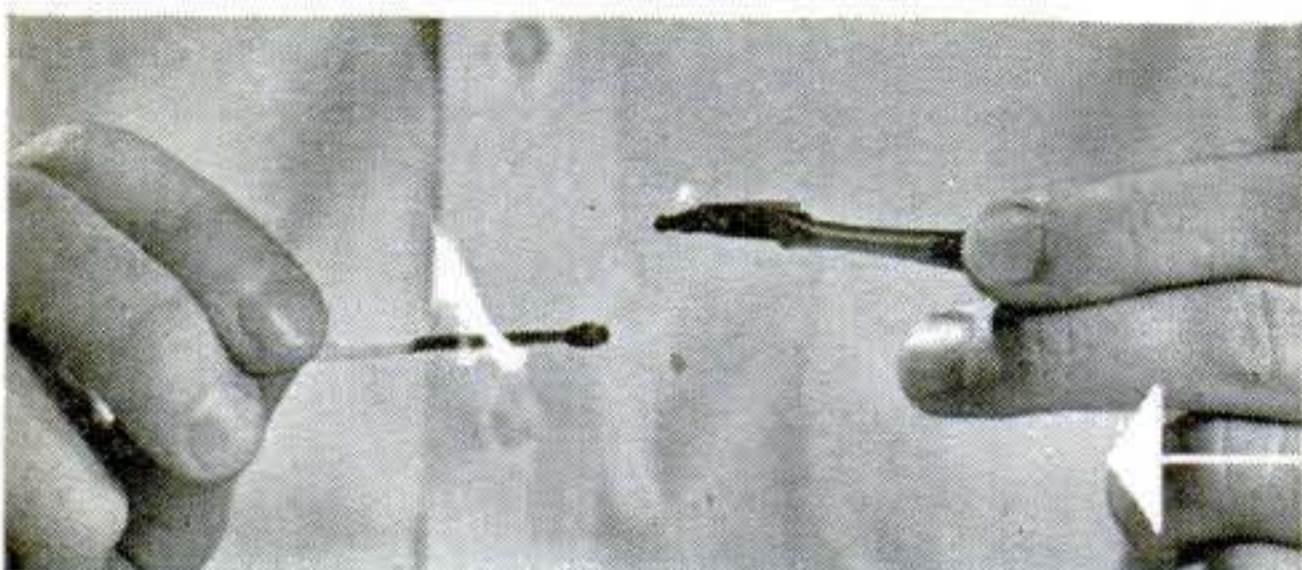

Sample burns but goes out when removed from flame. Return it just to edge of flame and note color characteristics it imparts.

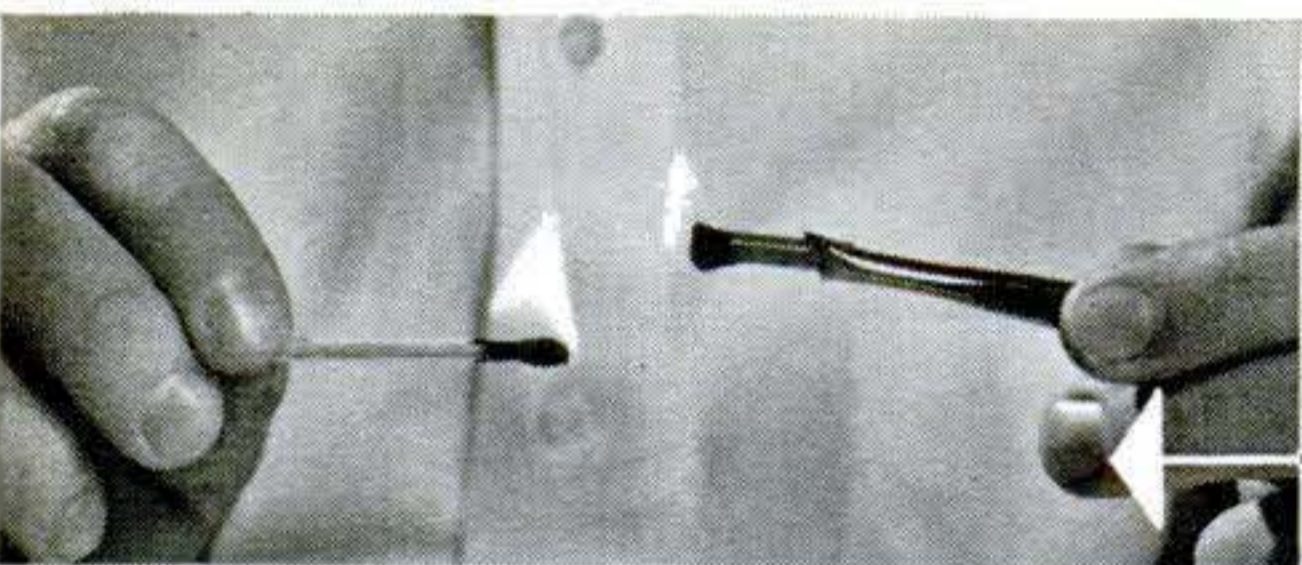

Sample keeps on burning after removal from flame. Try to judge flame color during the first second that it's burning.

How to Make Match Tests

CUT or shave off a small piece of the plastic. Holding it in tweezers, let it barely touch the match flame. If it doesn't take fire, hold it there for not more than 10 seconds. Note the color it imparts to the flame. If it does burn, note its own flame color. After ten seconds, blow the flame out, smell the fumes given off by the smoldering plastic, and locate flame color and odor on the chart at right.

Tests should be made where there is no draft to disperse the odor. Don't blow out the match along with the plastic, or the match smell will confuse you. A Bunsen burner is better because its flame is less luminous and it has no odor.

Five of the plastics appear twice in the table because their flame color changes after the first few moments of burning. Test some known samples if possible before tackling unknown ones.

COLOR AND NATURE OF FLAME	ODOR OF SMOLDERING PLASTIC	TYPE OF PLASTIC
	formaldehyde	UREA
	formaldehyde plus fishlike odor	MELAMINE
	formaldehyde plus carbolic acid	PHENOLIC
pronounced green area in flame	burnt rubber	PLIOFILM
small green area with much yellow	burnt rubber	NEOPRENE
green area	acid but <u>not</u> burnt rubber	VINYL
green area	sweet	VINYLDENE
green; sparks from burning plastic	vinegar	ACETATE
intense white; burns fiercely		NITRATE
mostly blue, white tip	floral, fruity odor	ACRYLATE
blue	burning leaves or fresh celery	NYLON
mostly blue	weak, slightly sweet	FORMAL
blue; with sparks	rancid butter	ACETO-BUTYRATE
blue; no sparks	rancid butter	BUTYRAL
yellowish, bright green mantle	burnt rubber	PLIOFILM
almost colorless, purple mantle	vinegar	ACETAL
yellow-white luminous	rancid butter	ACETO-BUTYRATE
yellow-white luminous; smoky	sweet floral	STYRENE
yellow-white luminous	weak, slightly sweet	FORMAL
yellow-white luminous	burnt paper	CELLULOSE
weak; small green mantle, much yellow	burnt rubber	NEOPRENE
yellow-green mantle	vinegar	ACETATE
yellow-green mantle; burns well, once started	slight, sweet	ETHYL CELLULOSE

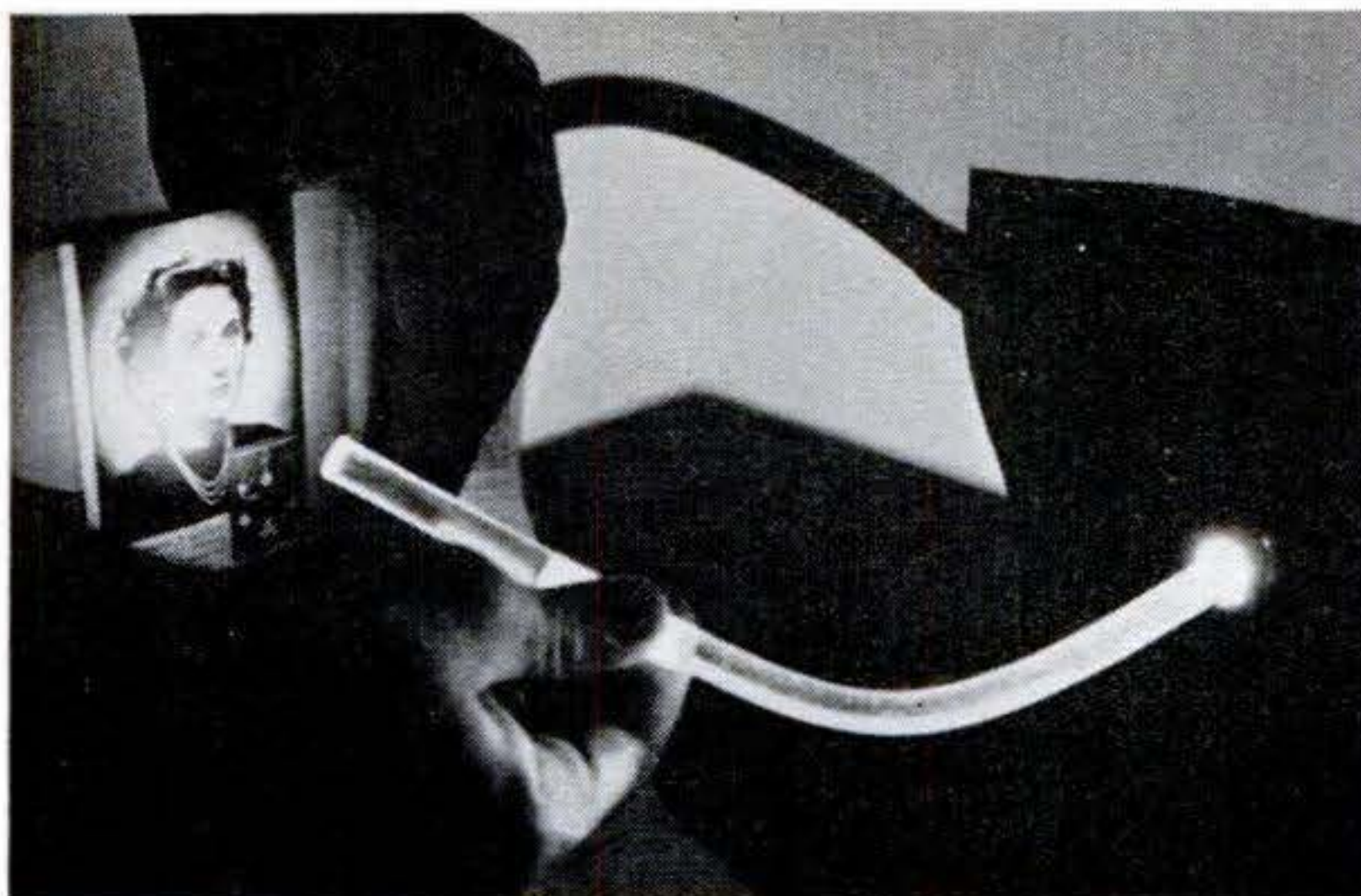

Piping light around corners is a curious property of acrylic. Throat illuminators, indirectly lit auto instruments, and striking window displays make use of the phenomenon.

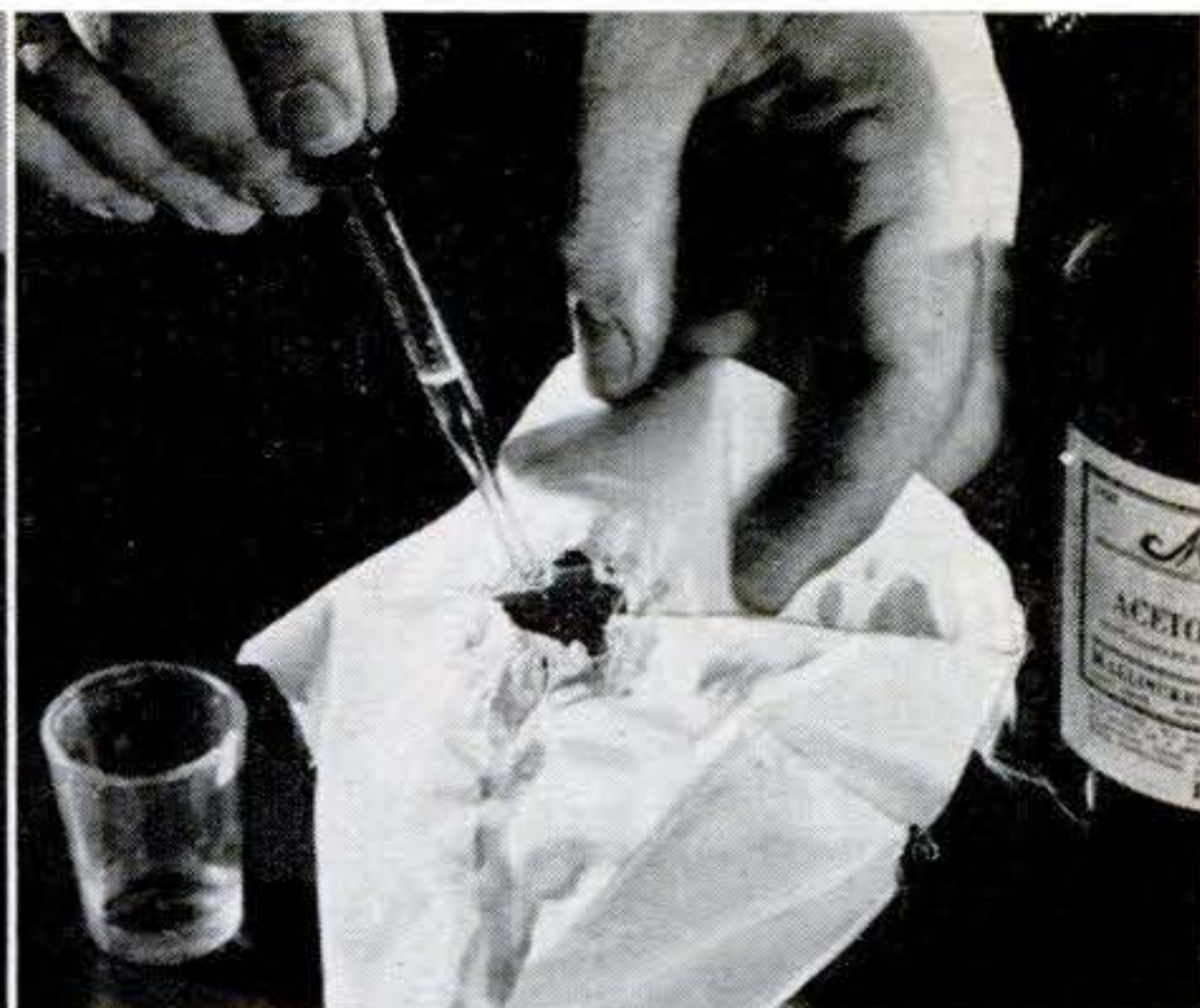

It melts away. Cellulose acetate dissolves readily in some solvents. Acetone, for one, puts a hole right through acetate rayon. Dissolve enough, and you have lacquer or nail polish.

and pencils, watch crystals, and shoe heels. Trade names: Amer-glo, Celastic, Celluloid, Herculoid, Kodaloid, Nitron, Pyralin, and Samson.

Ethyl Cellulose (thermoplastic) is made from wood and alcohol. Its best properties include low flammability, good electrical properties, acid resistance, toughness, and lightness. One of the newer plastics, it's used in airplane parts, electric appliances, wire coatings, ice trays, and hose nozzles. Trade names: Ethocel, Lumarith E.C., and Thermocast.

Cellulose (thermoplastic) is familiar under the trade name of Cellophane. Chemically it is nothing but transparent paper. What makes it so useful is its toughness in film form, plus its tastelessness and transparency. Trade names: Cellophane, Sylphrap, and, in fiber form, Rayon.

Pliofilm, a trade name, identifies a thermoplastic used as a more water-resistant packaging material. It's made from waste rubber and rubber products by treatment with hydrochloric acid gas.

Vinyl (thermoplastic) comes in the form of thin sheets and molding compounds, and may be flexible, elastic, or rigid. Vinyls are resistant to water and many chemicals, and do not burn. Things made of vinyl include suspenders and wrist-watch bands, shower curtains, raincoats, and phonograph records. Trade names: Flamenol, Koroseal, Plioflex, Vinylite, and, in fiber form, Vinyon.

Formal, Acetal, and Butyral (thermoplastic) find specific uses based upon their unique properties—toughness, moisture resistance, light and heat resistance, and ease of molding. They are used in safety glass,

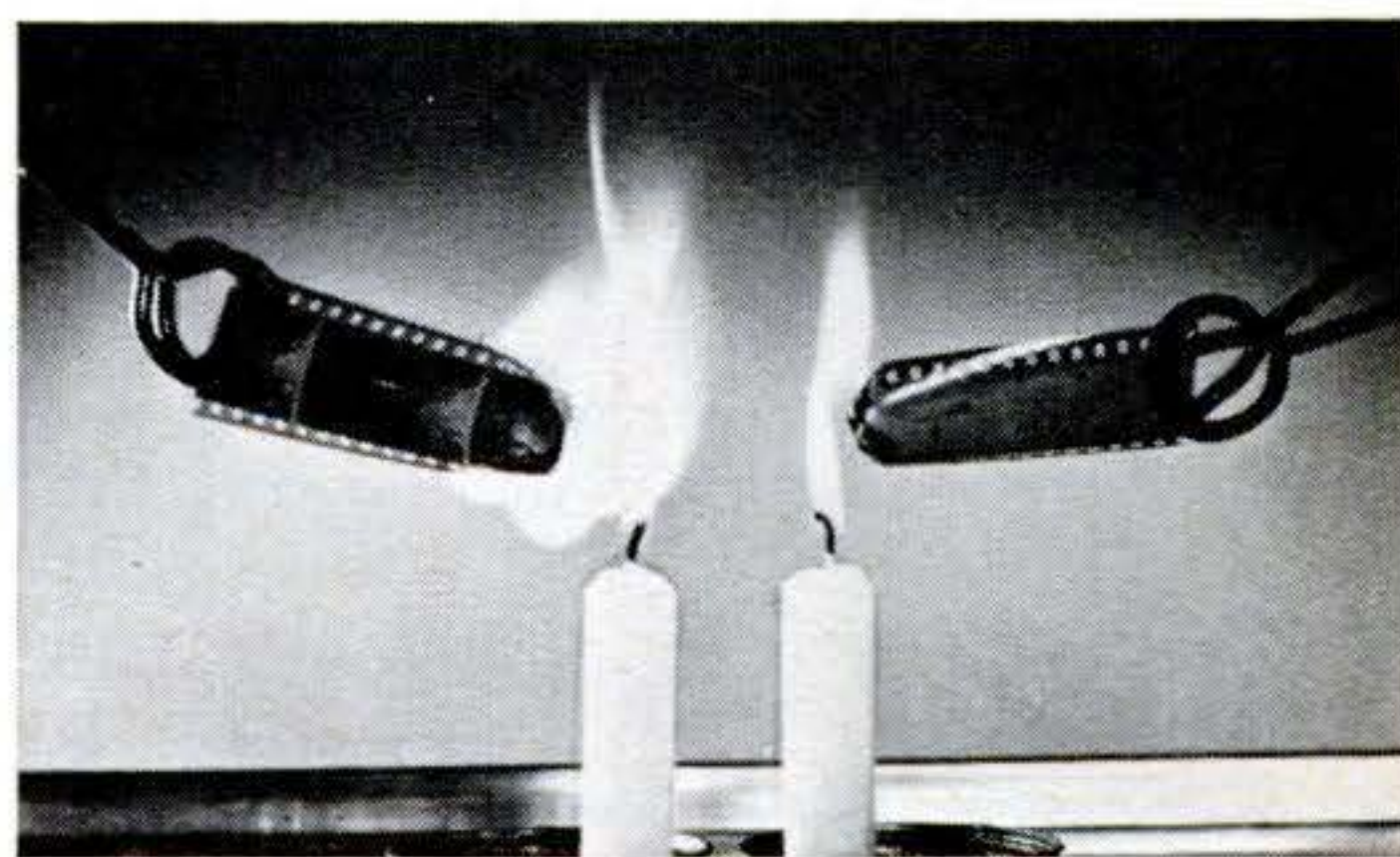

They look alike, but cellulose nitrate movie film (left) burns furiously. Cellulose acetate film at right (safety film) burns almost reluctantly. This type costs more.

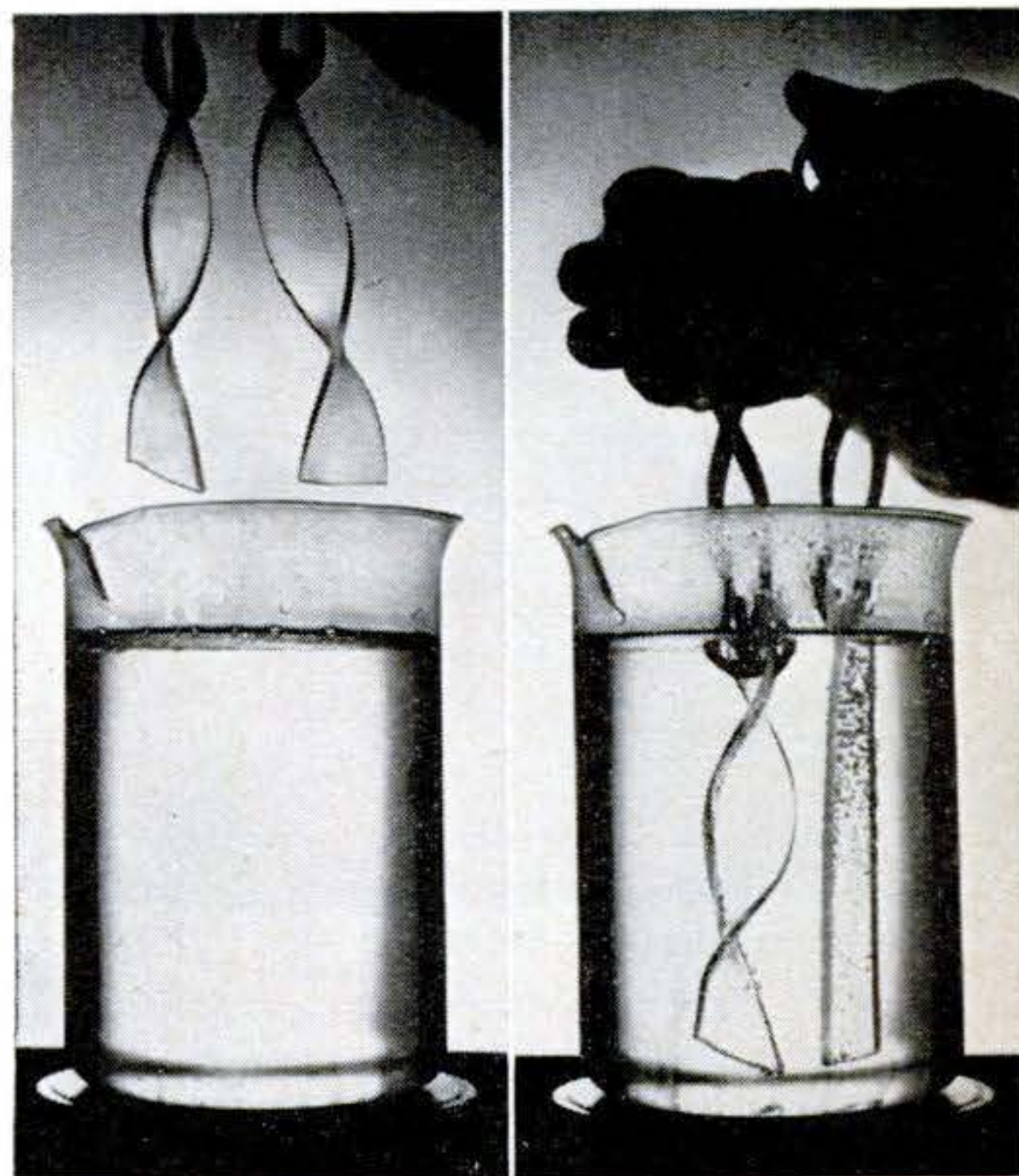

It "remembers." Heat a strip of polystyrene and another of acrylic, and twist both into spirals. Dropped into boiling water, the acrylic returns to strip form. Styrene stays twisted.

life rafts, army raincoats, and self-sealing gasoline tanks. Formal is called Formvar and Saflex-F; Acetal is called Alvar, and Butyral is called Butacite, Saflex, and Vinylite X.

Vinylidene plastics (thermoplastic), close relatives of the vinyls, are valuable for extreme resistance to water, solvents, concentrated acids and other chemicals, and for noncombustibility, toughness, colorability, and high tensile strength. Vinylidene has amazing wearing qualities, and therefore is used for seat covers, fishing leaders, netting, window screens, chemical pipes, clotheslines, and hoses. Trade names: Apla, Perflex, Saran, V.E.C., and Velon.

Styrene (thermoplastic) is made by a simple chemical process starting with benzene. The crystal-clear resin can be colored any shade desired. Its resistance to water, chemicals, and electricity is excellent. Styrene is used for dishes, radio insulators, lenses, and toys. Trade names: Bakelite, Loalin, Lustron, Polyflex, and Styron.

Acrylic plastics (thermoplastic) sometimes look very much like and are very frequently mistaken for styrene. But the acrylates range from soft sticky liquids to very

hard thermoplastics. They have excellent transparency and colorability, weather resistance, lightness, and the strange property of piping light around curves. Acrylic is so easily colored to match gums and teeth that dentures are made of it. Uses include aircraft windows, lenses, safety goggles, musical reeds, and displays. Trade names: Acryloid, Crystolex, Lucite, Plexiglas, and Vernonite.

Nylon (thermoplastic) is familiar for its use in women's hose. But that's a minor application. Nylon can have a tensile strength of 58,000 pounds per square inch. Parachutes, tennis-racket strings, toothbrush bristles, fishing line, paint brushes, surgical thread, gears, and electrical switch parts are made of Nylon. It has no other name.

Neoprene (thermoplastic) is a trade name for polychloroprene, one of the first substitutes for rubber. Made by a completely synthetic process from two gases—chlorine and another similar to acetylene—it closely resembles rubber but is far superior in resistance to sunlight, oxygen, heat, oils, and solvents. It's used for flexible gas and oil hoses, electrical insulation and sockets, shoe soles, and military balloons. END

The Height of Ingenuity



There's one house-cleaning job I never liked: Getting dirt out of corners. How do you think I do the job now?

I whittled the handle of a long, round brush until it fitted the chuck of my husband's electric drill. Now the dirt flies out of corners when I turn on the juice.—Mrs. Adeline Rhoades, Omaha, Neb.

New Changer Turns Disks Over



A THREE-SPEED, fully automatic record changer that turns records over to play the second side is now available for custom installations. The player handles all sizes of records in any sequence, the only manual operations being the selection of turntable speed and rotation of the cartridge to put the desired stylus in play. A full load of long-playing records will give up to 21 hours of continuous music. A load of 78- or 45-r.p.m. disks will play up to 3½ hours. The changer is made by Lincoln Engineering Company, St. Louis, and lists for \$250.

Use a Doorstop

THAT rubber-tipped finger that sticks out from the baseboard wasn't put there just to trip you up. Its job is to keep the door from banging into the wall. But

it can do a lot of other jobs, too, as you can see in these sketches. A doorstop is a ready-made handle or peg and has a built-in screw so it can be attached to any piece of wood in a jiffy. For any of the applications pictured here you can use either the older wooden type of stop or the newer metal one.



Need an awl? All you have to do is file down the screw threads of a doorstop. It's a perfect tool for piercing leather, making punch marks, or scribing.

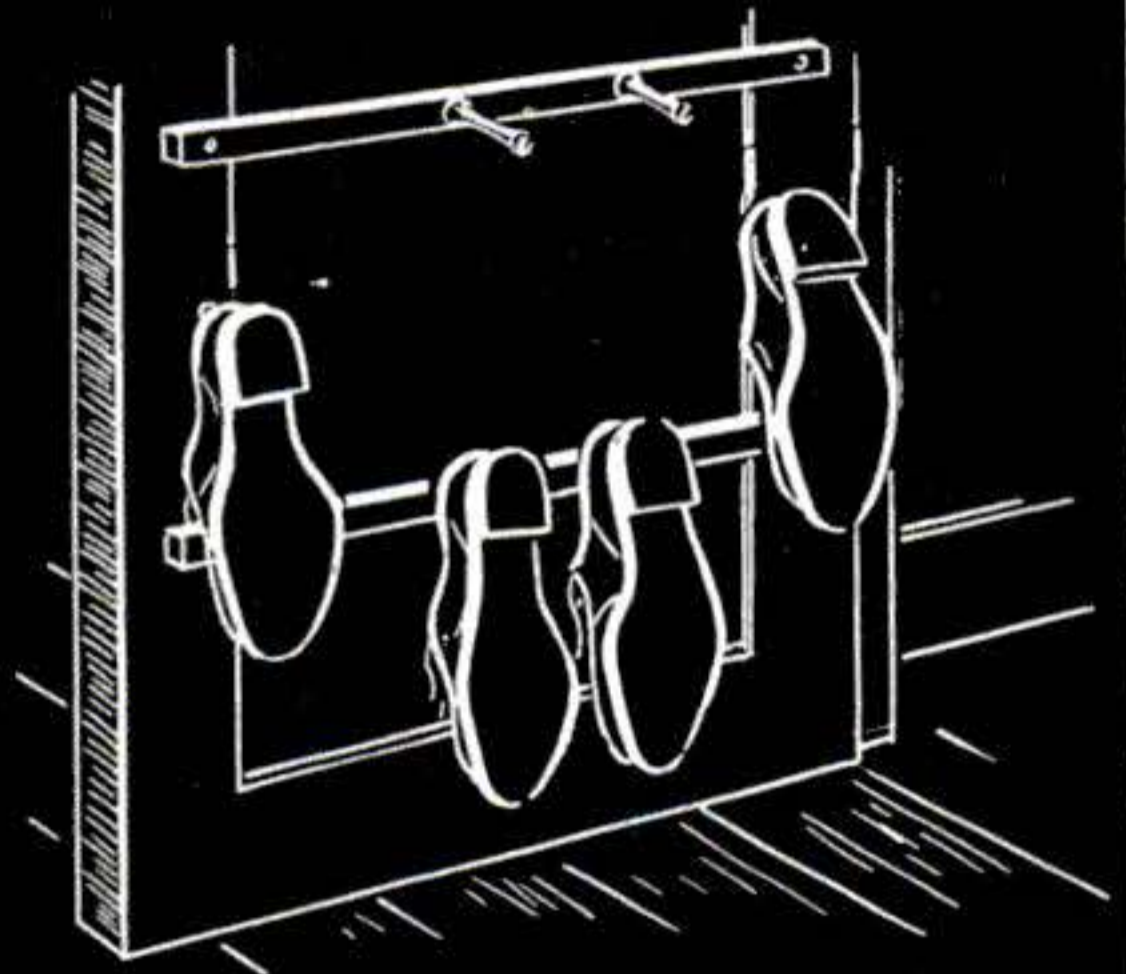

Do shoes clutter your closet floor? Here's a rack that will keep them in line. Just screw in a row of doorstops on the wall or door and hang the shoes in place.



A mortarboard is any old board with a doorstop screwed to the bottom. Use wood about $\frac{1}{2}$ " thick and shorten the screw so it won't stick through the working surface.



Handles are handy on sanding blocks. A doorstop attached to a block provides a better grip, makes it easier to use. For lengthwise work, screw stops into both ends of the block. Doorstop handles of this type can be adapted to scrubbing brushes, scrapers, and the like.

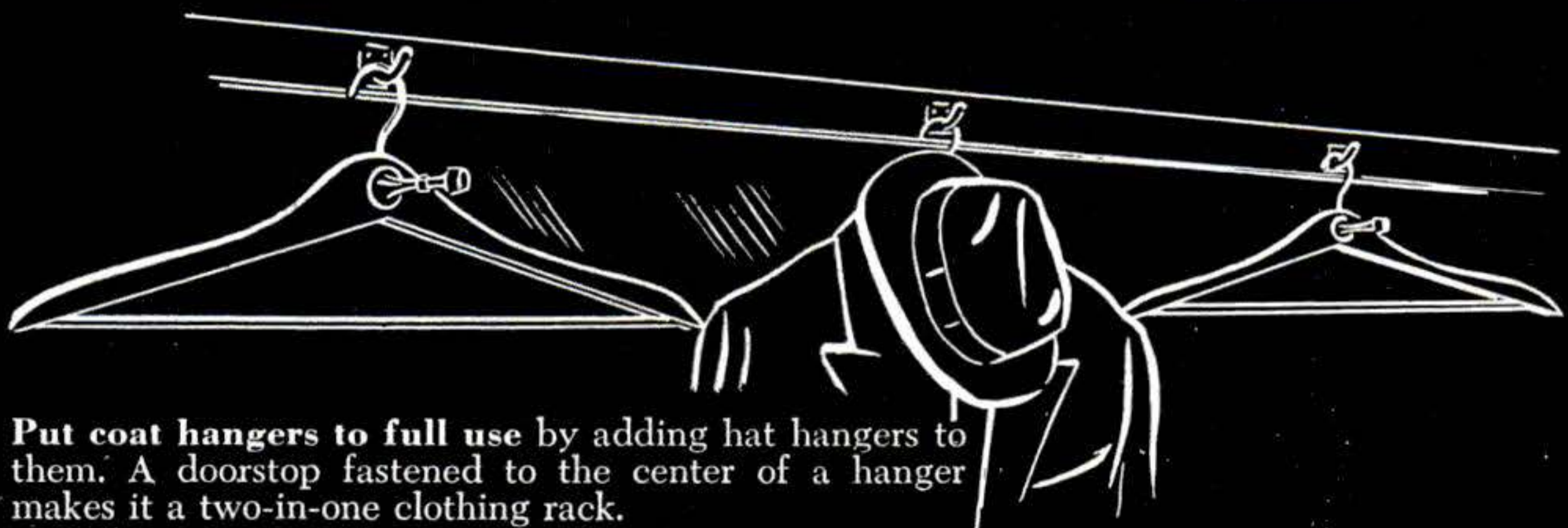

Put coat hangers to full use by adding hat hangers to them. A doorstop fastened to the center of a hanger makes it a two-in-one clothing rack.

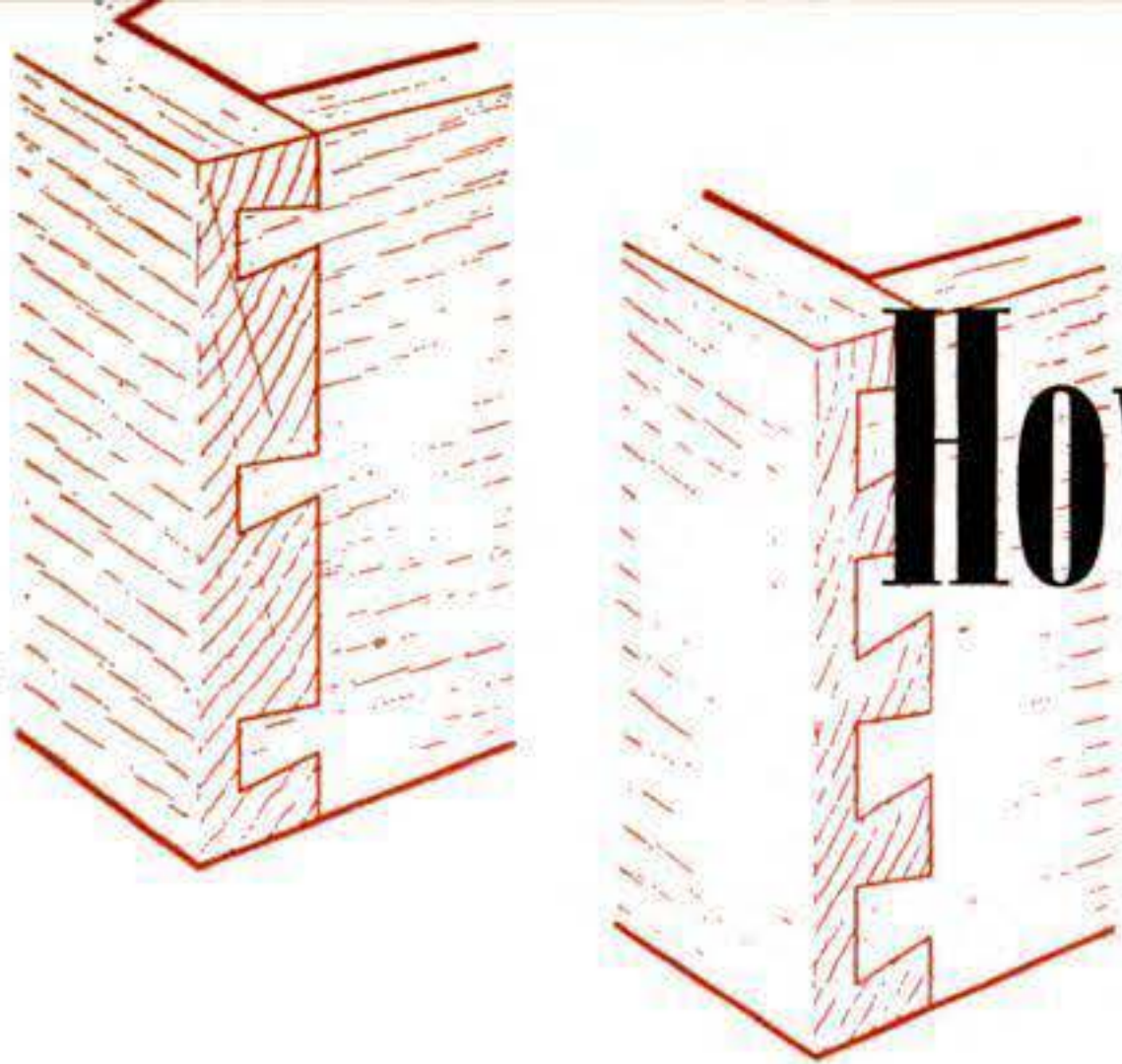

How to Make Dovetails with Power Tools

By Edwin M. Love

YOU can well be proud of a nicely fitted dovetail joint. Dovetailed drawers are a mark of fine cabinetmaking, but few craftsmen have time to fit a number of drawers by hand. Machine-made dovetails are the answer.

A drill press can be used to make perfect half-blind dovetails if you have the inexpensive jig shown. A drawer front and side are clamped in this jig, which is moved by hand against a rotating cutter. A metal comb guides it as it forms pins and sockets in both pieces simultaneously.

A circular saw, fitted with a dado head and a spacing jig, will cut plain dovetail joints requiring only a little hand trimming.

A bandsaw or jigsaw will cut various dovetails without extra equipment.

Mortises for half-lap work can be bored to depth on a drill press. This removes most of the waste, leaving less chisel work. End dovetailing is possible with a dovetail router in the drill press, or by dadoing on a circular saw.

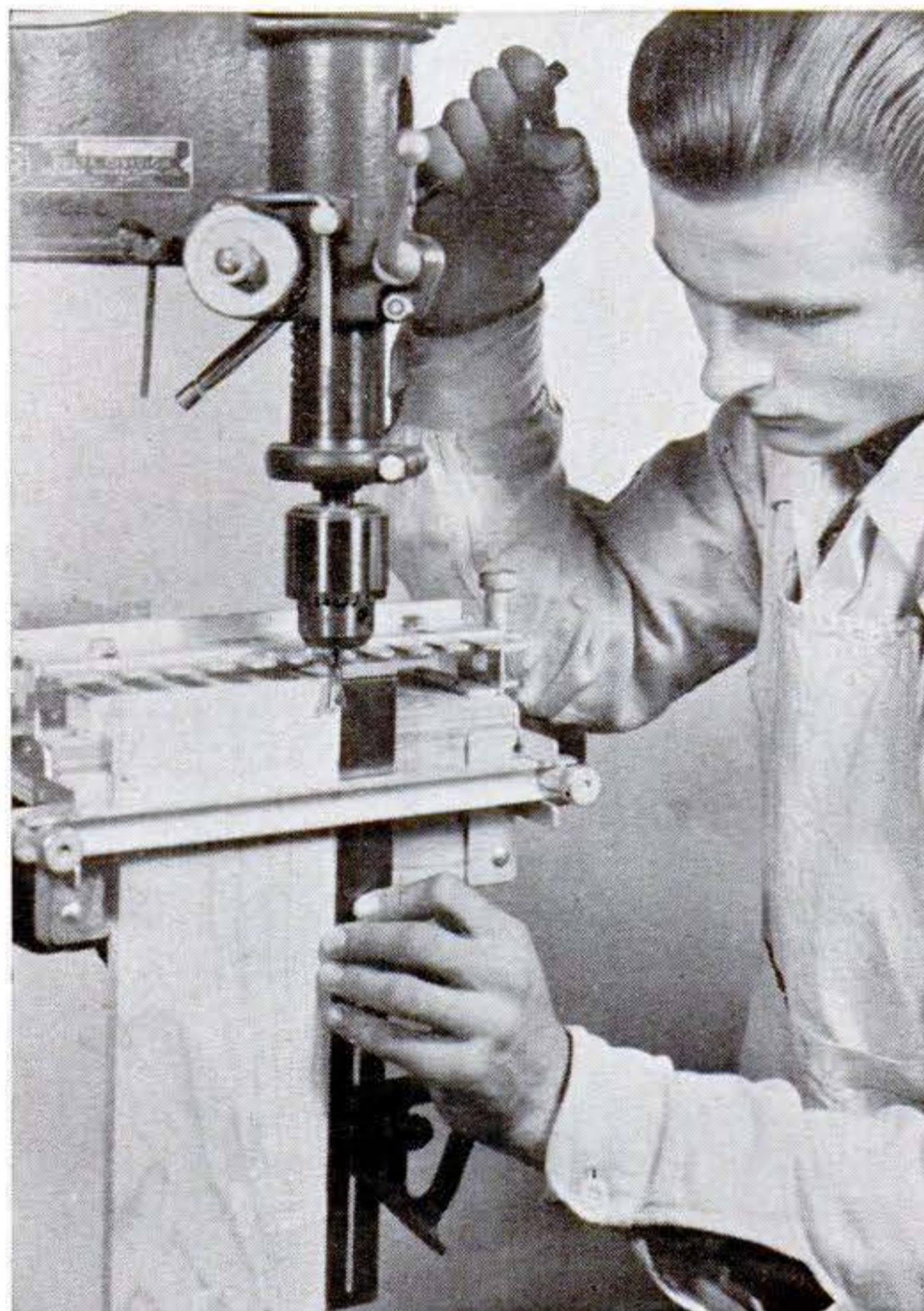

Dovetailing attachment. This accessory slides freely on the drill-press table, which is swung to center the quill about 1" outside the end of the jig, as in the photos. The dovetail router must have cutter and shank diameters as specified for the jig, or the joint will not fit. If your drill press has a tapered spindle, use a lock-on collet.

After the drawer parts are cut square and to length, clamp the drawer front under the upper hold-down bar, its end flush with the apron of the jig, and one edge against an edge stop. Clamp a drawer side against the vertical apron of the jig, aligning its upper edge with the uppermost face of the clamped front, and butt it against the side stop. The two pieces are offset by the stops

so that the spaces in both can be cut in line with each other—while on assembly, spaces will line up with pins, the edges being flush. The exposed faces will go inside the drawer.

Align the tips of the comb fingers with the exposed face of the drawer side. Then set the stop plate on top of the comb back from the tips a distance twice the thickness of the side, minus $\frac{1}{8}$ ", for the jig shown. This attachment cuts pins $\frac{3}{8}$ " long and $\frac{9}{16}$ " thick, regardless of the thickness of the stock. If the drawer side is thicker than $\frac{9}{16}$ ", the stop isn't used, and the comb is moved back the extra thickness to let the router shank go $\frac{7}{16}$ " back from the edge of the drawer front. The router will then cut back the pins, leaving them $\frac{9}{16}$ " thick.

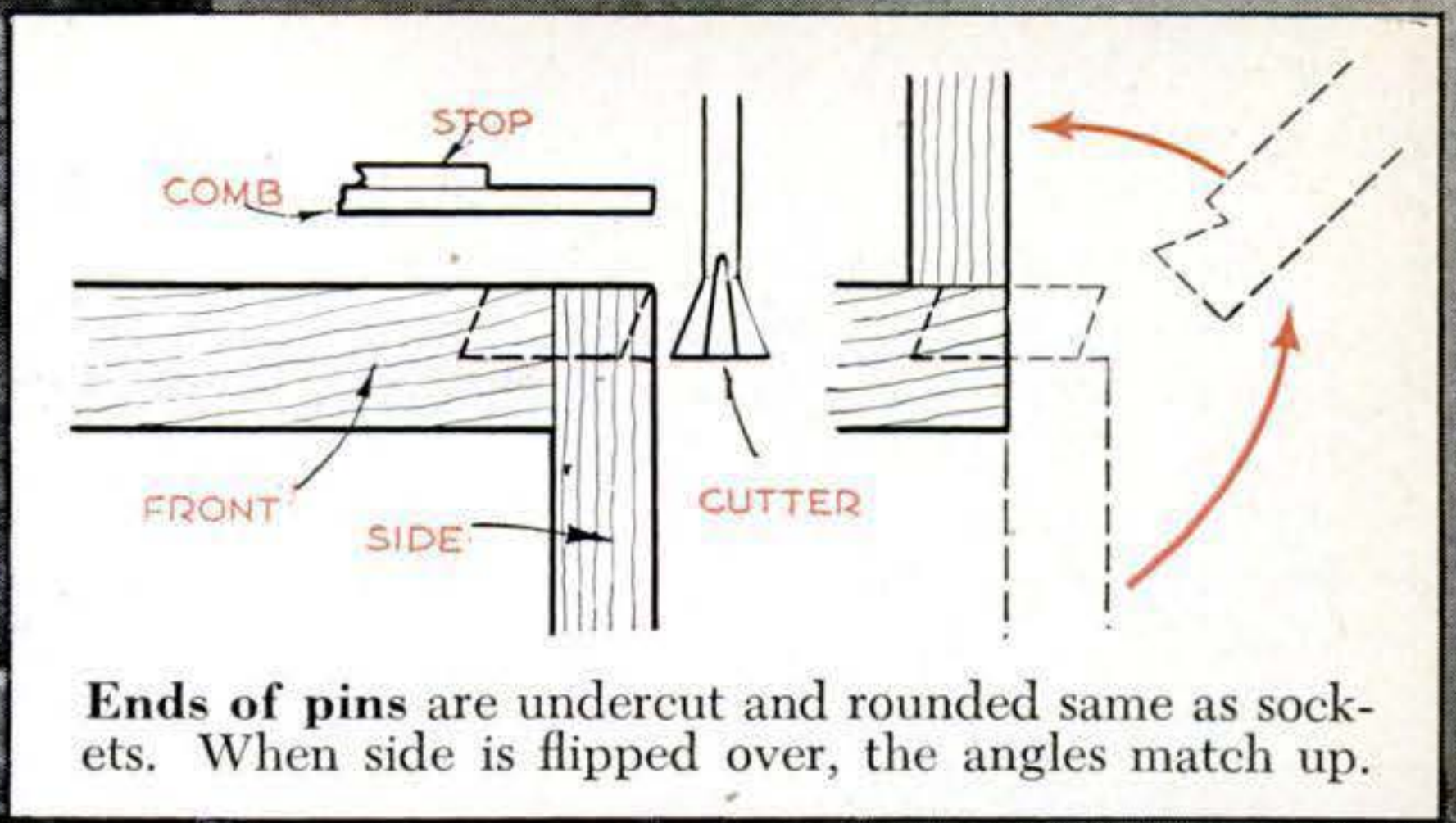

Ends of pins are undercut and rounded same as sockets. When side is flipped over, the angles match up.

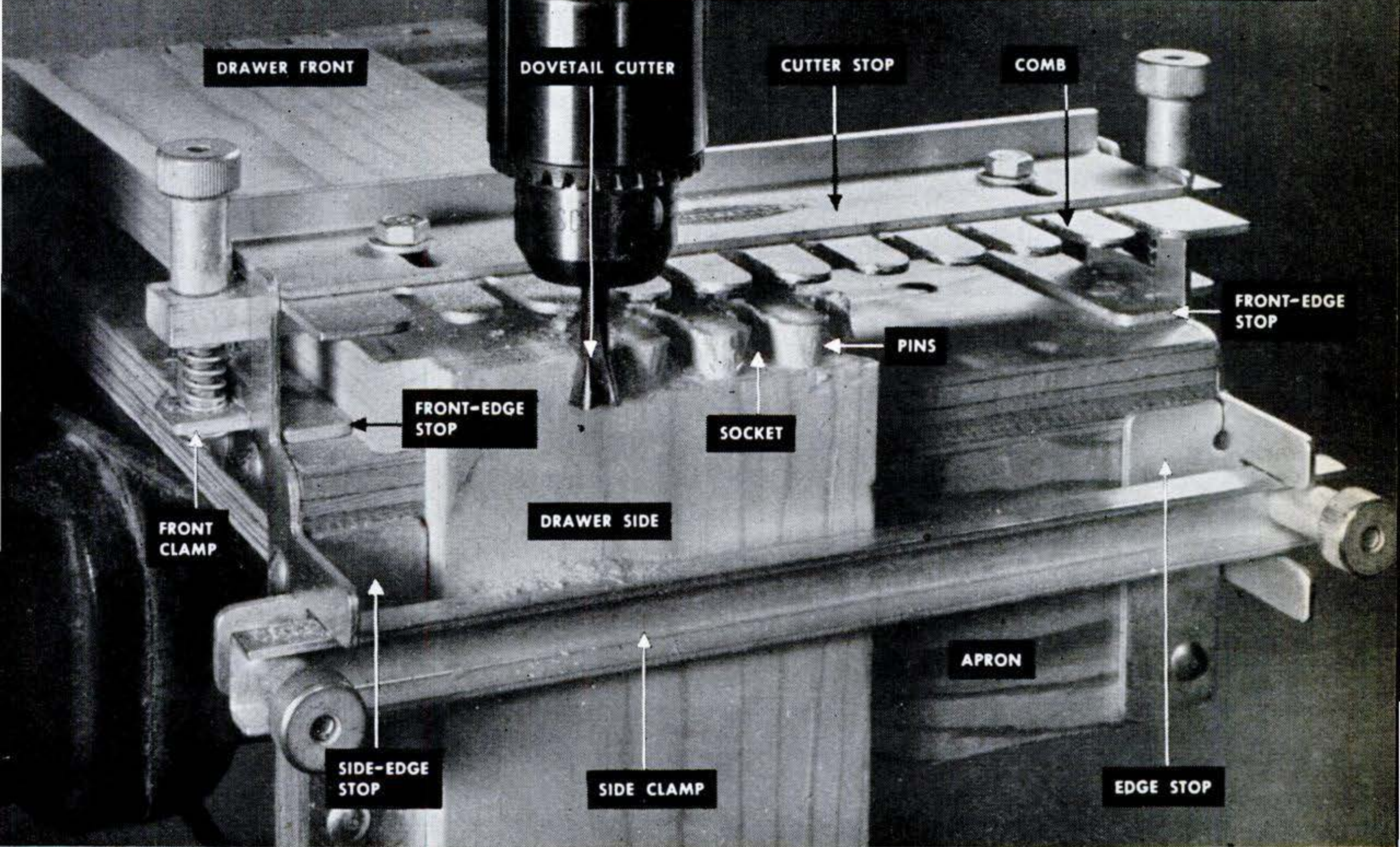

It's good practice to set the drawer sides in from the ends of the front, making a lip or rabbet on the latter. Then the front can be dressed to fit its opening with minimum clearance, while the sides will be set in enough to slide freely. To do this, set the router stop back twice the thickness of the side, plus the width of the rabbet, minus $\frac{1}{8}$ ". Cut the rabbet after the dovetails are made.

Lock the quill to make the router cut to a depth of $\frac{3}{8}$ ". Shift the belt for highest speed and pull the jig against the router. The outer faces of the pins will be rounded to fit the socket ends formed by the cutter.

In cutting the opposite end of the front and its mating side, clamp both pieces at the other end of the jig, using the second pair

of edge stops. Thus in a drawer with dovetail joints all around, diagonally opposite corners will be cut at the right side of the dovetailing jig, the other two at the left.

Since the dovetail spacing is fixed by the jig, the tails at the two ends will not be the same distance from the top and bottom edges unless the drawer width is scaled to suit. This can be overcome by inserting spacer strips between edges and edge stops.

Sawing through dovetails. On the circular saw, you can get a handmade effect by making the pins much wider than the sockets. Mount a dado head with spacers to cut the minimum width between the pins, and tilt the arbor or table 20° . Clamp a wood auxiliary head to the miter gauge, 

run it over the blade to cut a shallow notch, and glue in a small block to project 1". Now shift the piece to the right on the miter gauge a distance equal to the desired dovetail spacing and screw it fast. In use, the saw will cut a second notch in the head.

On one of a pair of sides mark the first cut to be made. Holding both sides vertically, ends down on the table against the auxiliary head, pass them over the saw. Lift the pieces and set the cut kerf over the projecting block, make the second pass, and so on. This cuts one side of all the pins. Now turn the pieces with the opposite face

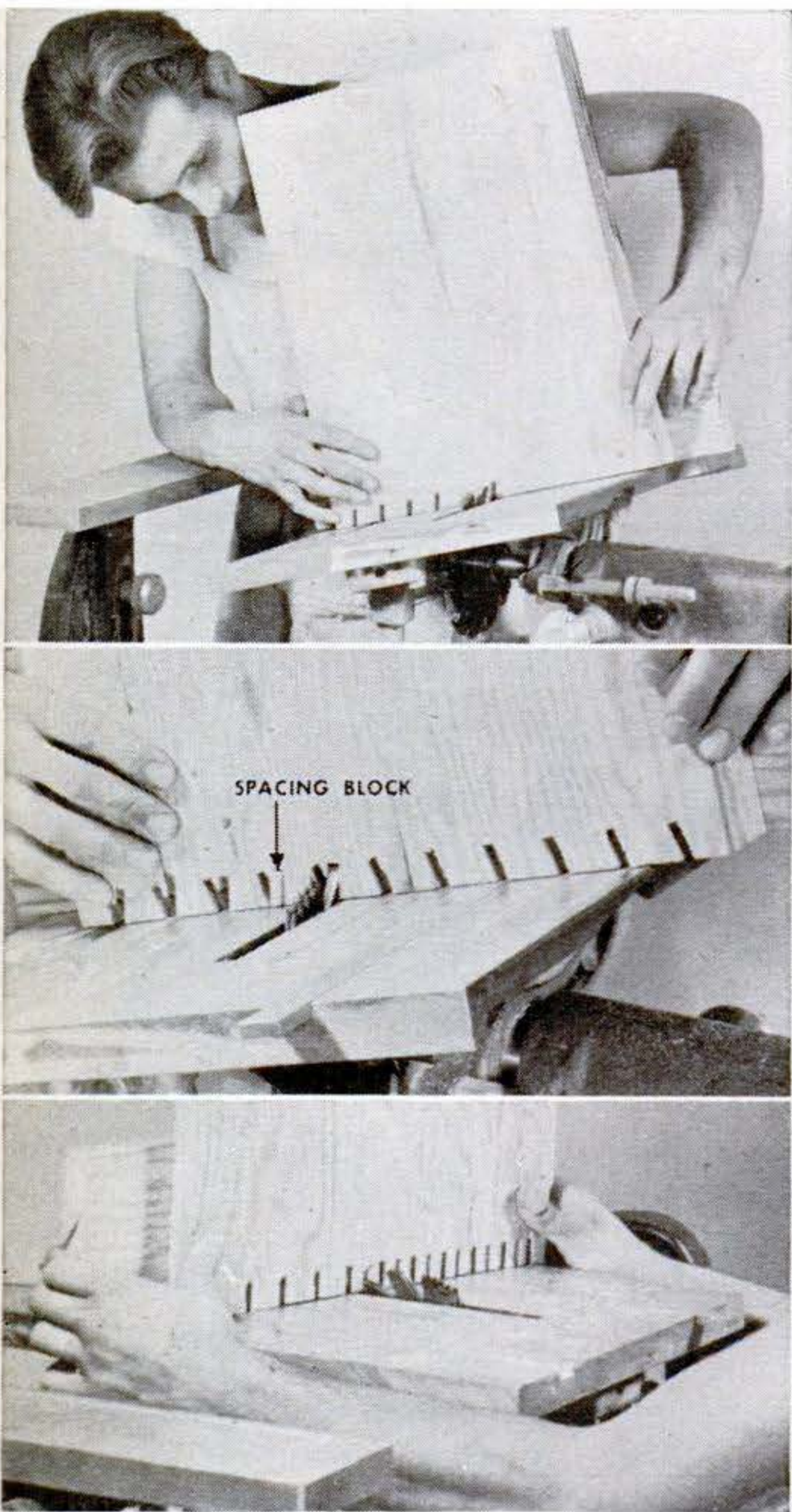

After cutting one side of all pins as in the top photo, turn work 180° to cut other sides (center photo), pressing sides of new kerfs against the spacing block. Sockets are cut with the table level but miter gauge at 20°. Use a second auxiliary head (lower drawing at right) or scribe sockets from pins in joining member. In this case, standing behind saw and pulling work toward you (lower photo) gives view of lines.

against the auxiliary head, and cut the other side. Chisel out the little triangular stubs.

For the sockets in the mating members, the cut is made with the table or arbor level, but with the miter gauge swung to 20°. Make a second auxiliary head, clamp it on, cut a notch, and glue in a block as shown below. Use one of the sides on which pins have been cut to mark the socket spacing on the head and the first socket location on the work. Drop each cut successively on the locating block. To saw the other side, swing the miter gauge 20° the other way. Turn the auxiliary head upside down and set a new block.

Half-blind sockets can't be sawed, but most of the waste can be bored out on the drill press. Set the spindle depth gauge to stop the bit at the bottom of the socket, and chisel out the corners afterward.

Bandsawing dovetails. The way a bandsaw can tackle thick stock makes it a natural for dovetailing several drawer sides at a time. Tack the pieces in a stack, laying out pins on the top one as for hand work. Cut the sides with a wide blade. Then bore out the waste between on the drill press. Nibble out the bottoms on the bandsaw.

Using a sidepiece as a template, scribe the sockets on the joining piece. Tilt the bandsaw table to the required slope, and cut the sockets in one piece at a time. If the table won't tilt sufficiently in both directions, clamp on an auxiliary table, propping up one side with a block. Trim the corners of the sockets by nibbling straight in parallel to each side cut. Don't turn the work on the table, or you'll slope the bottom.

The jigsaw is, of course, used in the same way except that its capacity limits it to cutting a pair of sides at a time. Both power

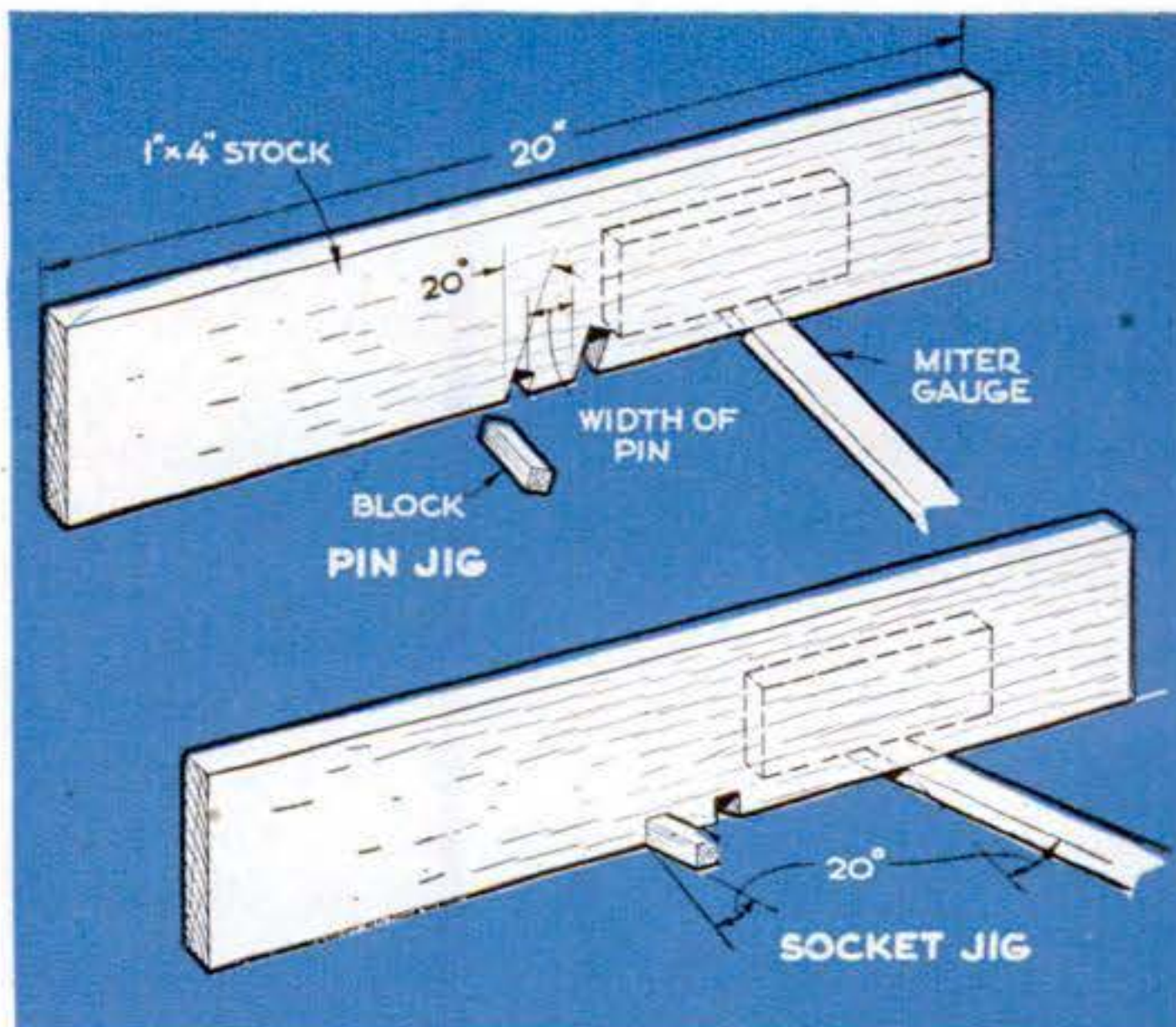

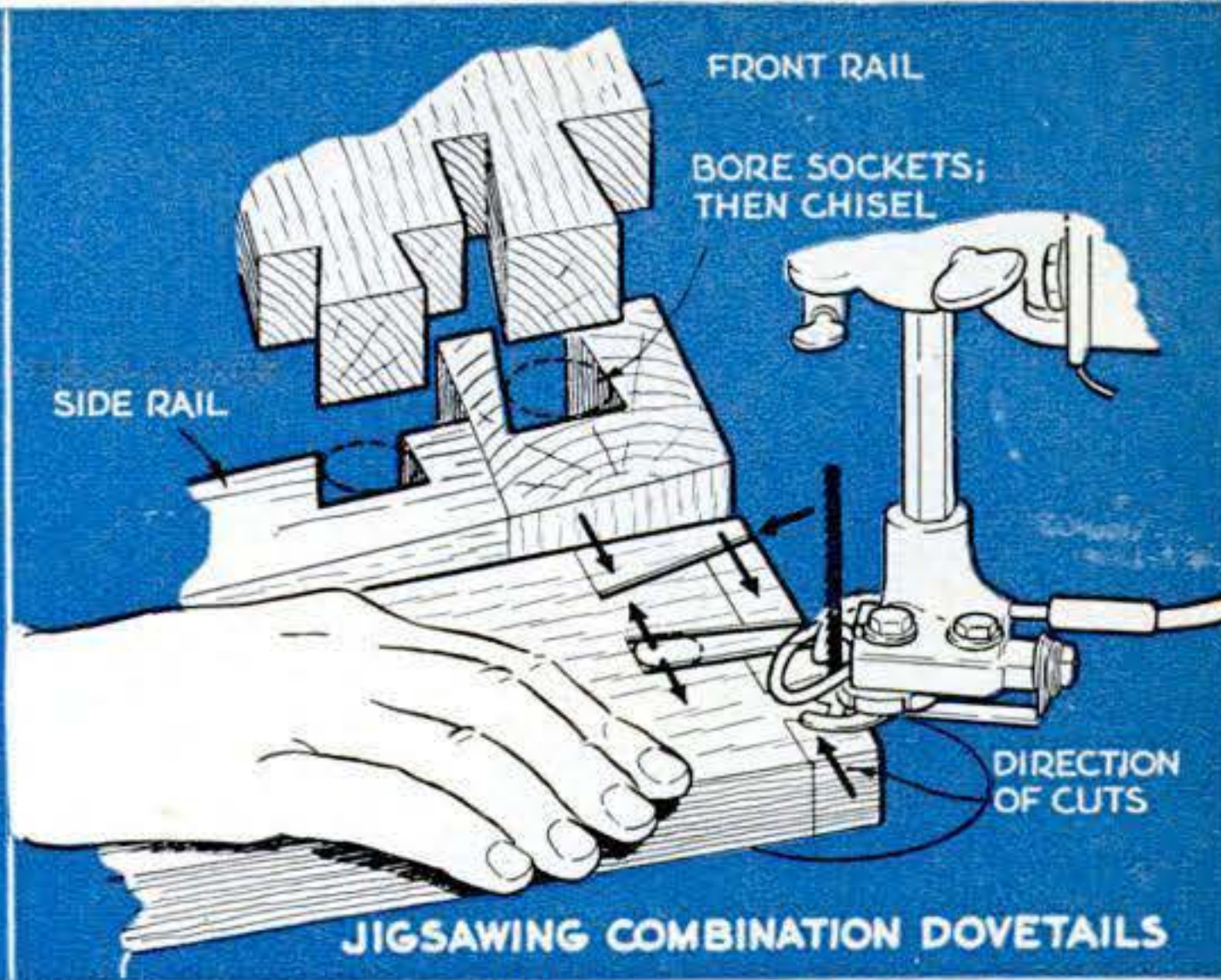
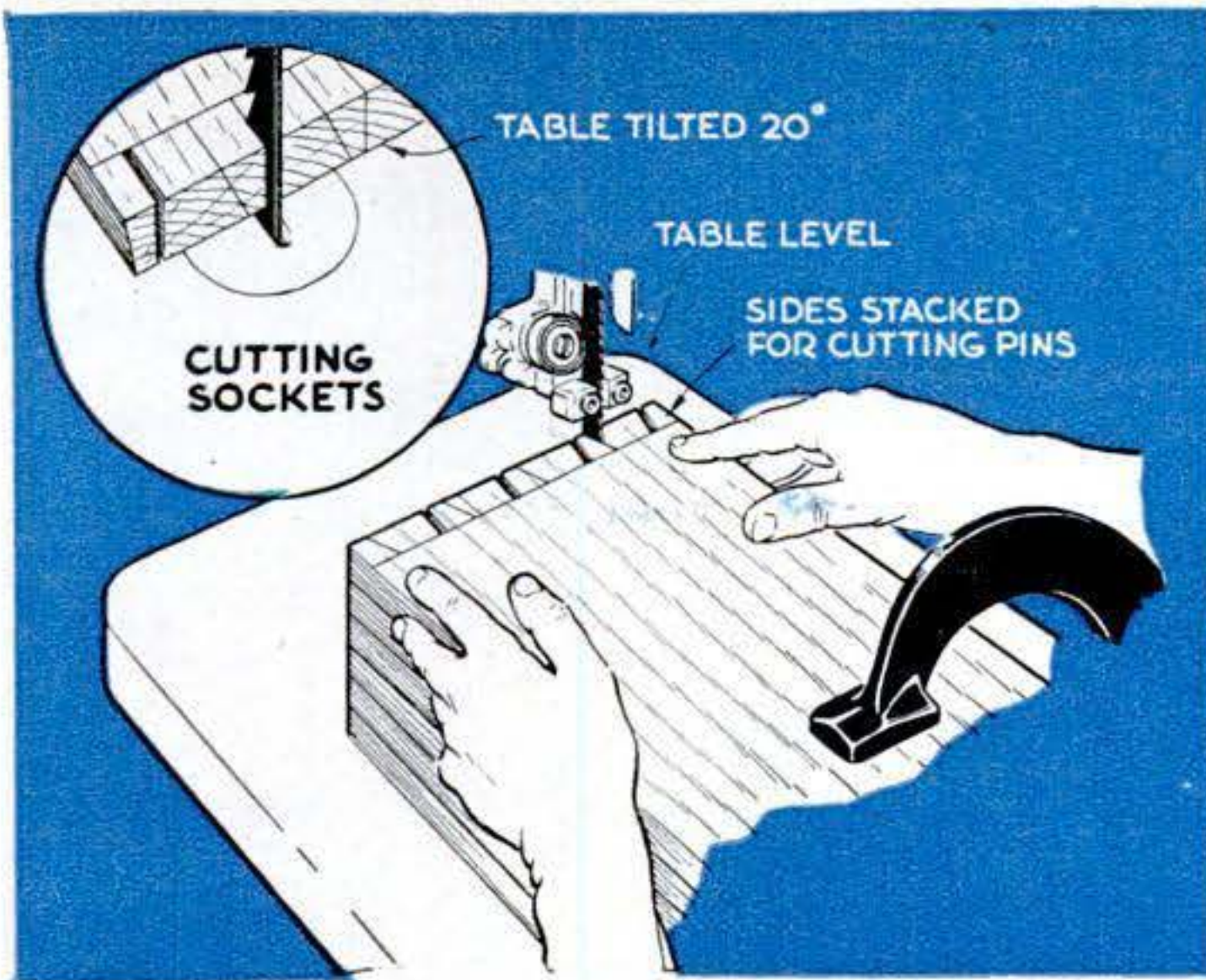

tools will make combination dovetails, as shown in the drawing, for joining posts and side panels or rails. Make cuts in the direction of the arrows in the drawing. Bore and chisel the blind sockets.

Half-lap dovetails can be made in several ways. The dovetailed end can be halved by ripping down the thickness and sawing the shoulder on a circular saw, bandsaw, or jigsaw, or by thinning it with a dado saw.

Ripping end-cleat dovetails. To form a dovetail groove in a cleat, mount a dado head, tilt the arbor or table, and run the work against the rip fence to cut one side of the groove. Turn the cleat end for end to rip the other side.

To dovetail the end of the board on which the cleat is to fit, leave the table tilted, set the fence to center the tenon correctly, and rip one cheek with a stiff blade, such as a single dado saw, as in the drawing below. Turn the opposite face of the work toward the fence to rip the other cheek. Then set the saw or table square, and with the board face down, cut the shoulders. END

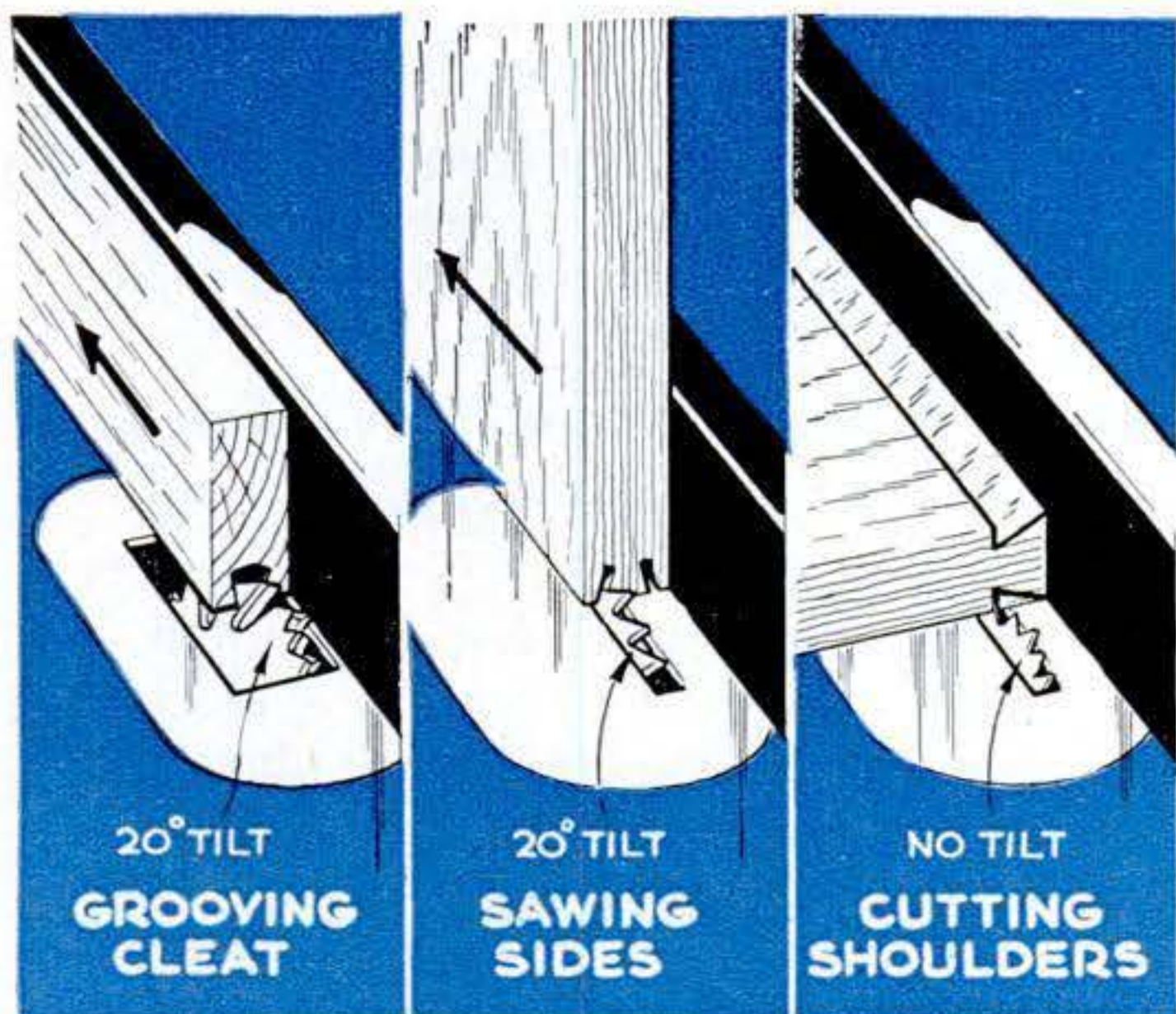
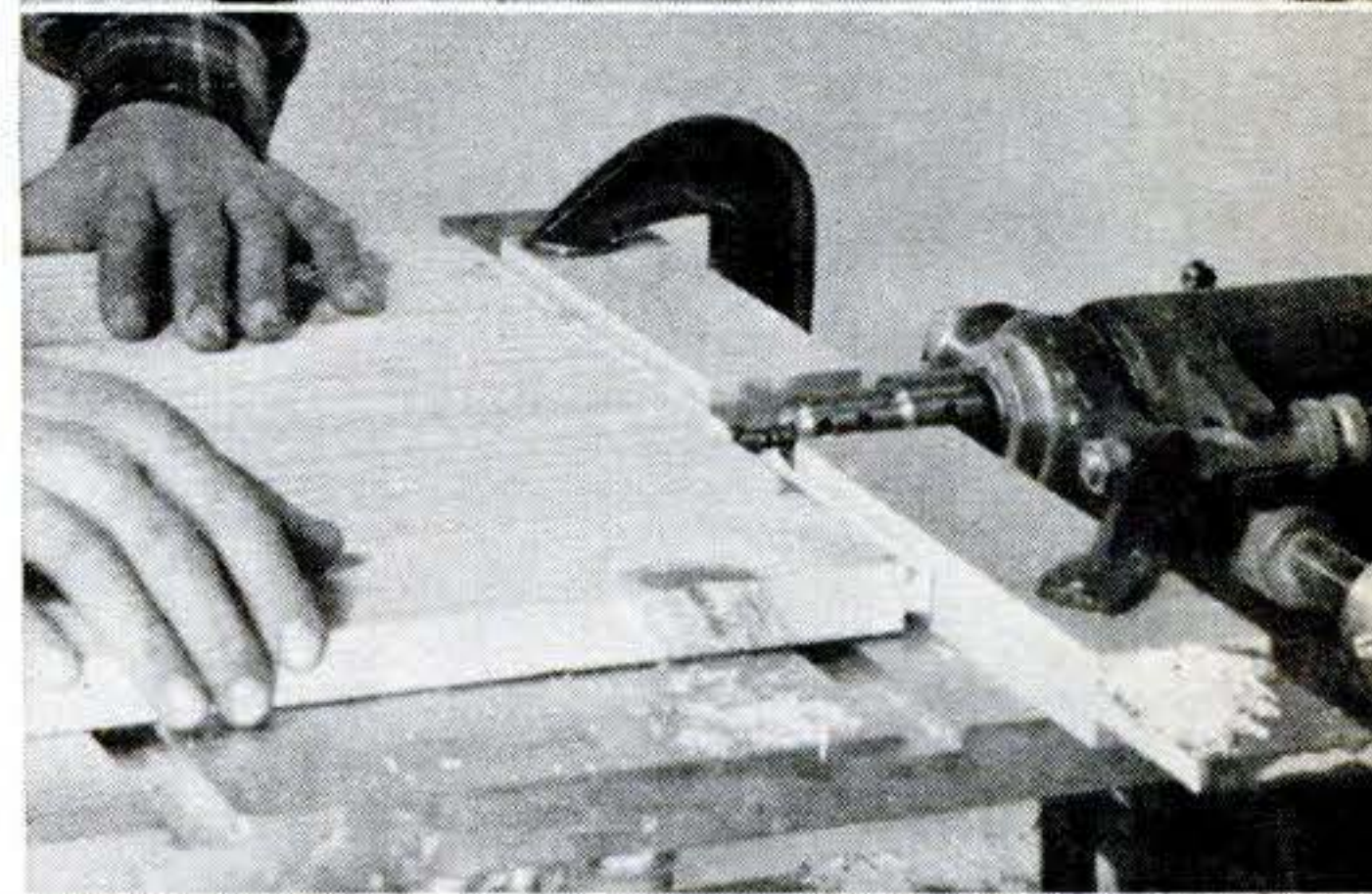
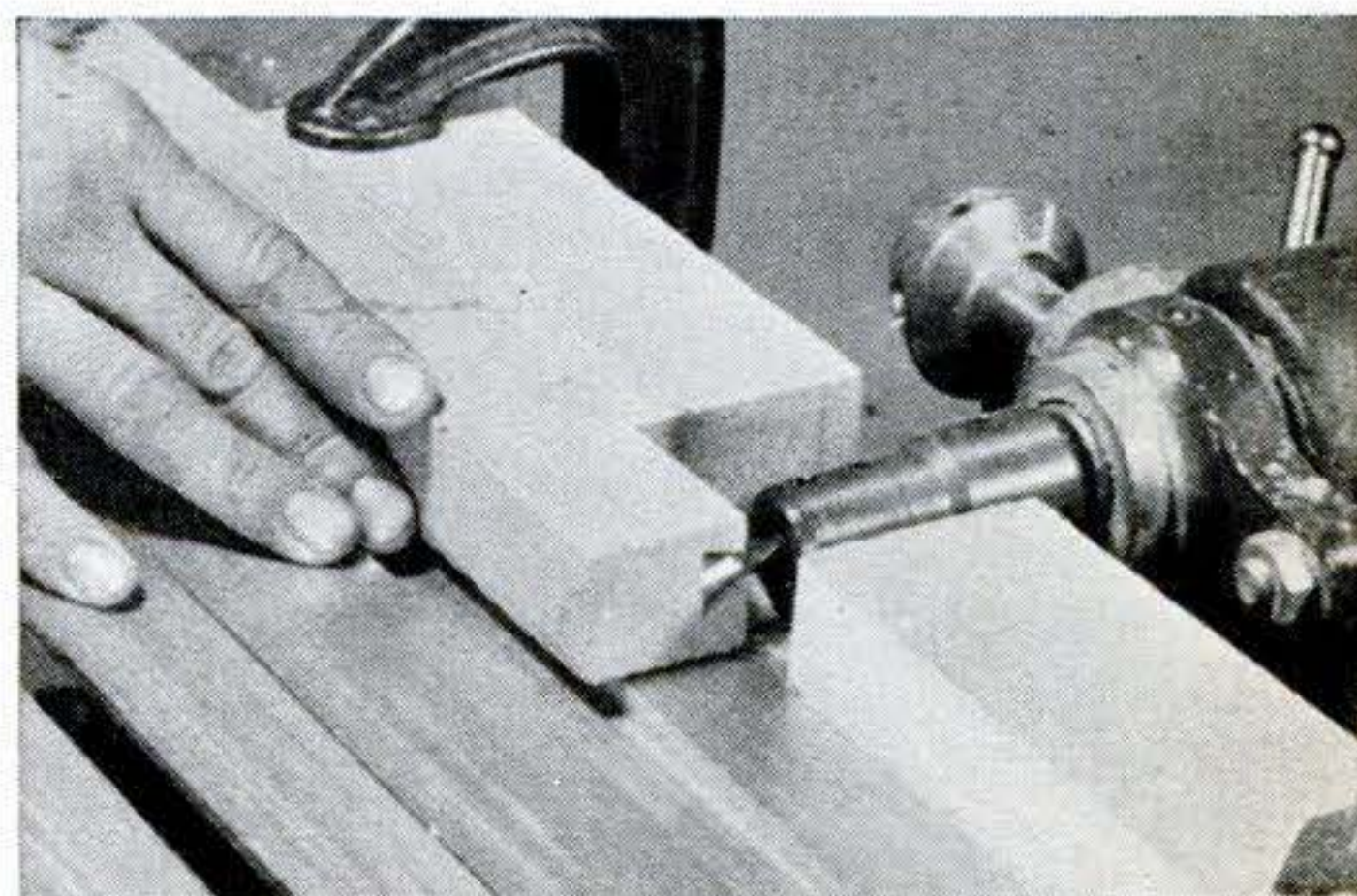

A dovetail router can form end-cleat joints on a combination power tool like that above, since the saw table can be set below and outside the spindle. Clamped-on wood strips form a fence. The groove is cut as in top photo. Then the tenon is made by running work under the cutter for each cheek (second photo). If the tenon is tight, make another pass with a sheet of paper under the board. Assemble joint without glue.

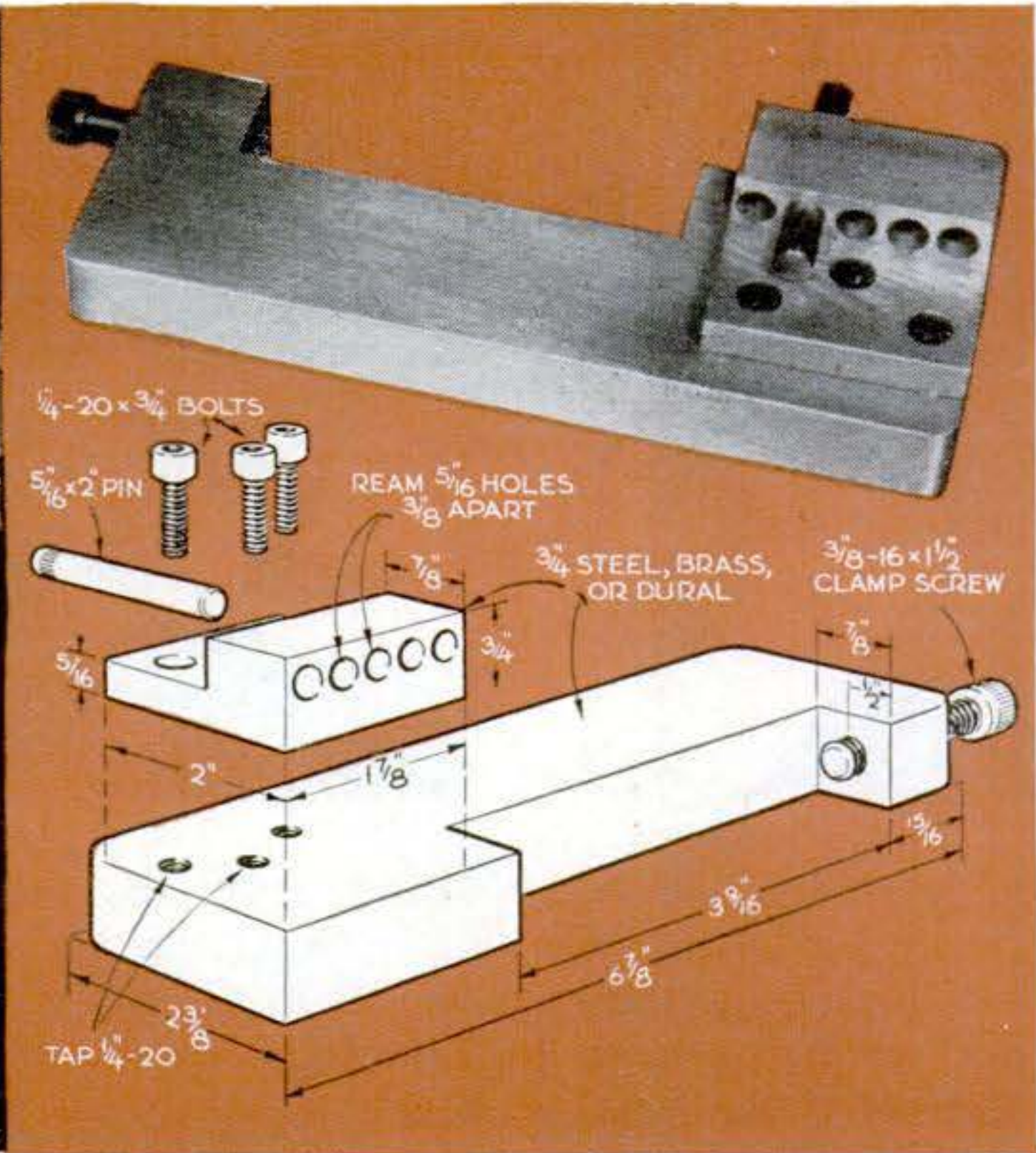
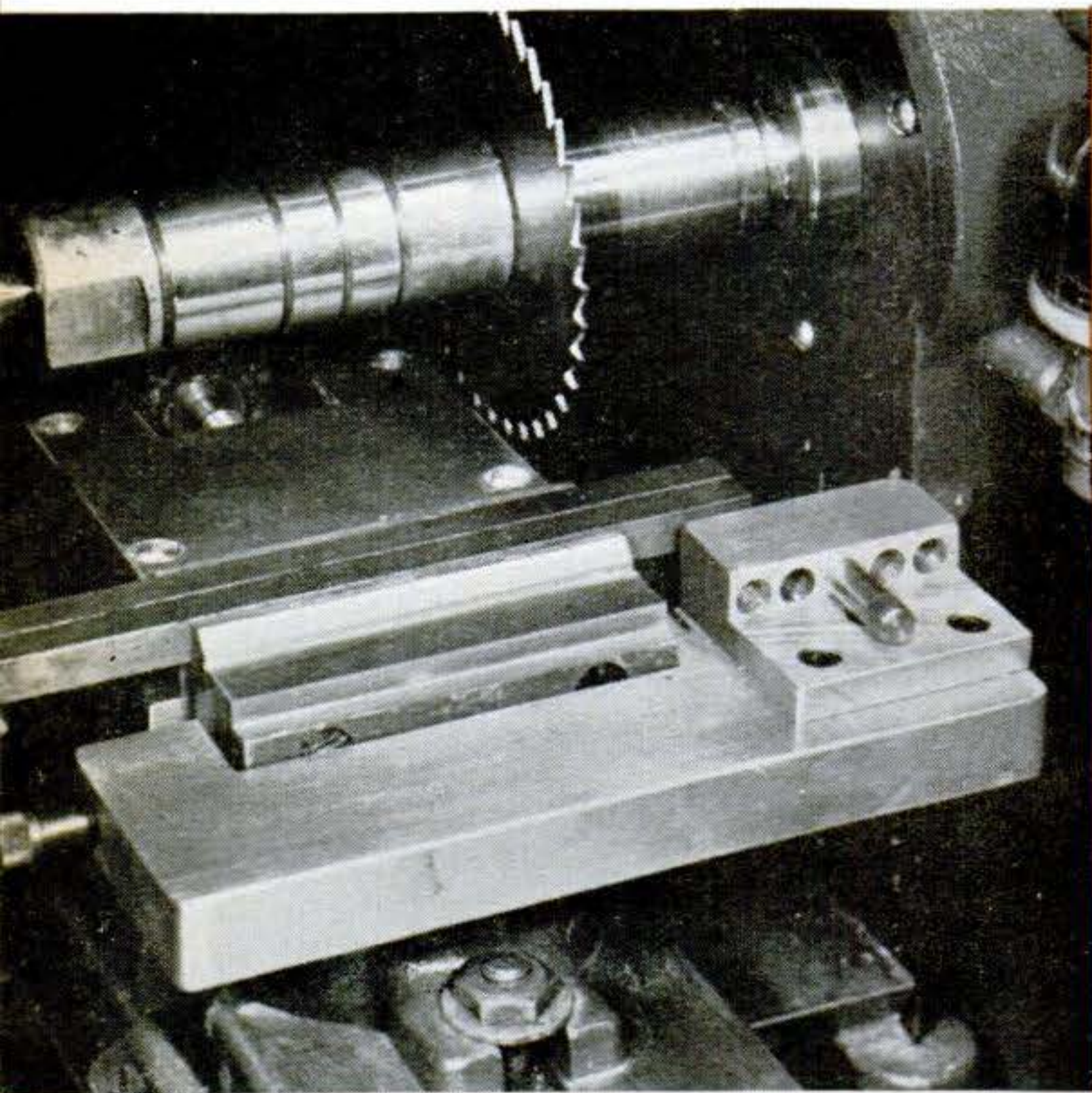

Pin Gauges Cutoffs in Milling-Machine Vise

EVEN if only a few pieces are to be cut off in the milling machine, this gauge is worth while for the speed and accuracy it affords. It also eliminates the dangerous practice of reaching behind the cutter with a scale to set each cut.

As each piece is cut, after the stock has been pushed against the pin and the vise tightened, the pin is pulled back. The piece then falls free when cut off; it cannot jam

between cutter and stop, as with fixed stops, and so break the cutter.

Dimensions given are for a 3 1/2" milling vise. For others, change the notch dimension to suit. Mount the locating block with three small bolts. Polish the locating pin to a snug sliding fit in the reamed holes.

Besides cutoffs, the gauge is useful for many jobs that take accurate positioning in the vise.—*J. C. Magee, Schenectady, N. Y.*

Simple Parts Add Depth Scale to Drill Press

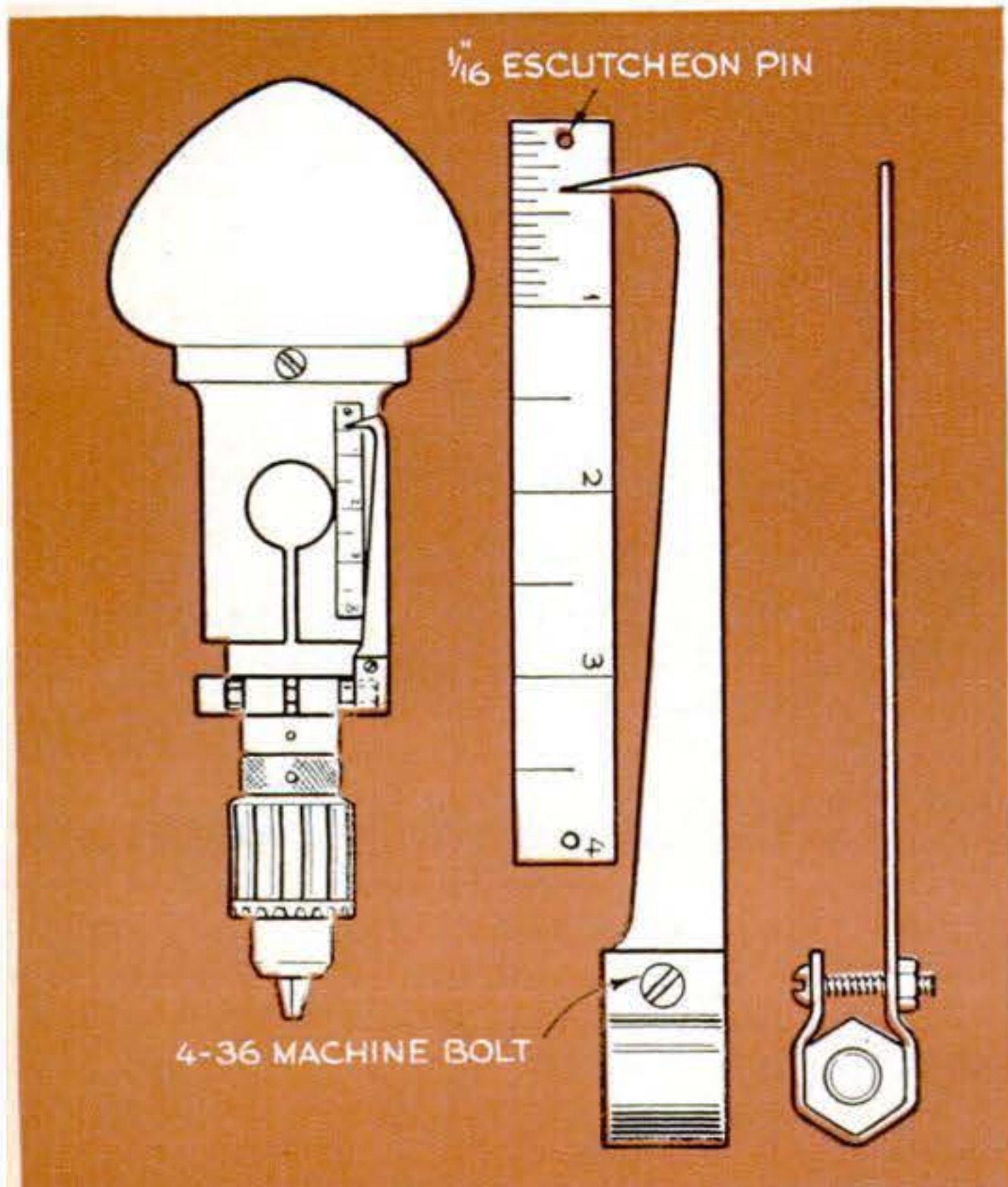

You needn't do without a depth-drilling scale just because your drill press didn't come with one. Mount a 4" length of carpenter's rule on the drill-press head with escutcheon pins driven into undersized holes. Bend a strip of sheet metal as shown to fit around the hex nut on the clamping ring. Or, instead, drill a hole in the ring and drive in a bent piece of heavy wire for a pointer.—*Fred Strickland, Portland, Ore.*

Double Setscrews Can't Loosen

THE rounded setscrews used in light machinery, especially in the home shop, often loosen because of vibration. A solution that has worked fine for me is to replace the usual long setscrew with two short ones, one on top of the other. The lower one is tightened hard on the shaft. The second, tightened above it, locks both of them for keeps.—*John C. Martin, Kings Point, N. Y.*

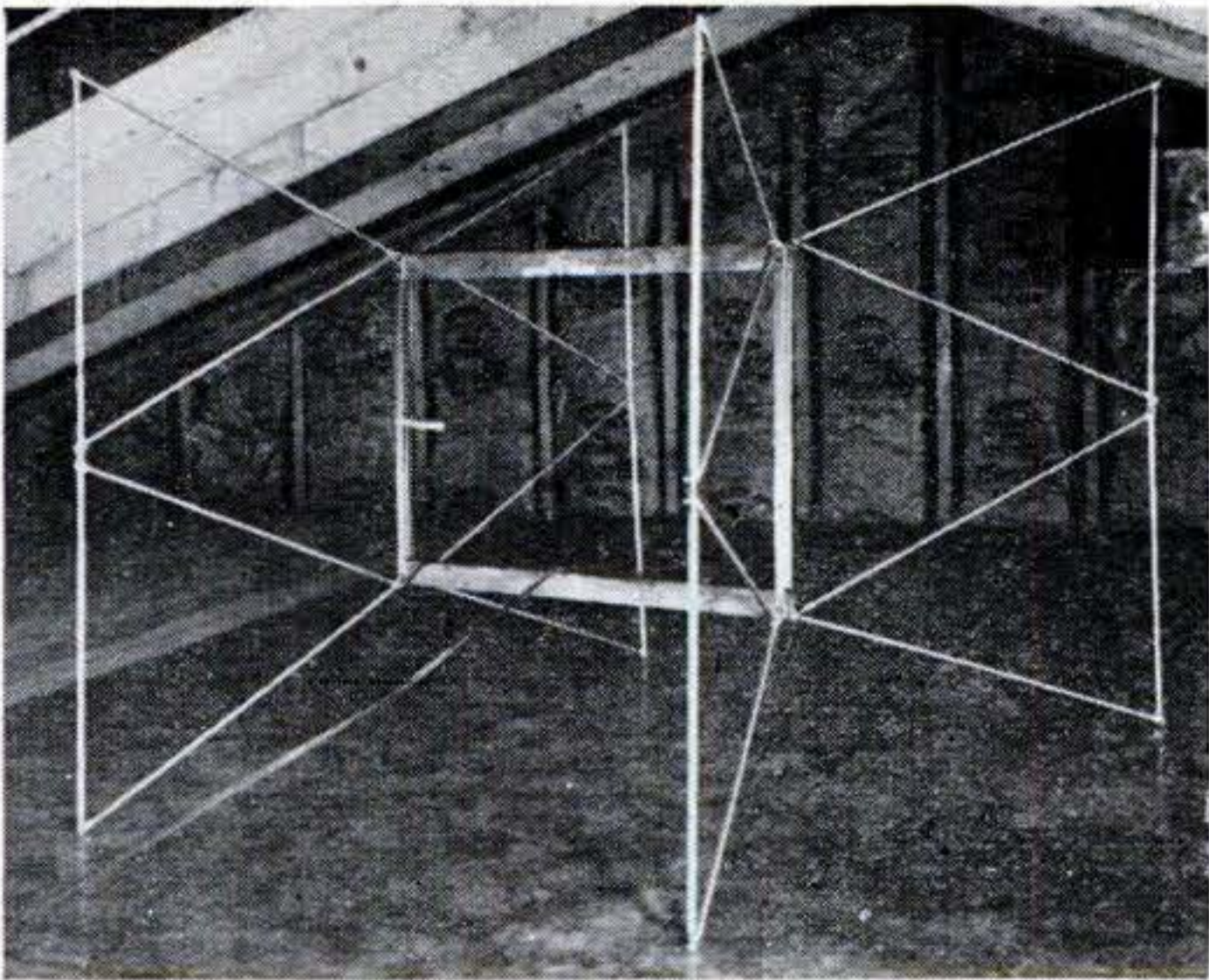

Attic Aerial Keeps Roof Clear

A TELEVISION antenna that you can hide in your attic may work as well as one on the roof. Smoke, soot, or chemical deposits won't reduce its efficiency, and it won't mar the appearance of your home. The Attic V Beam is described by its makers, Telrex, Inc., Asbury Park, N. J., as a full-scale, high-sensitivity antenna that can be placed on the attic floor or hung from the rafters. Its arms are hinged to make it easy to put it on the beam.

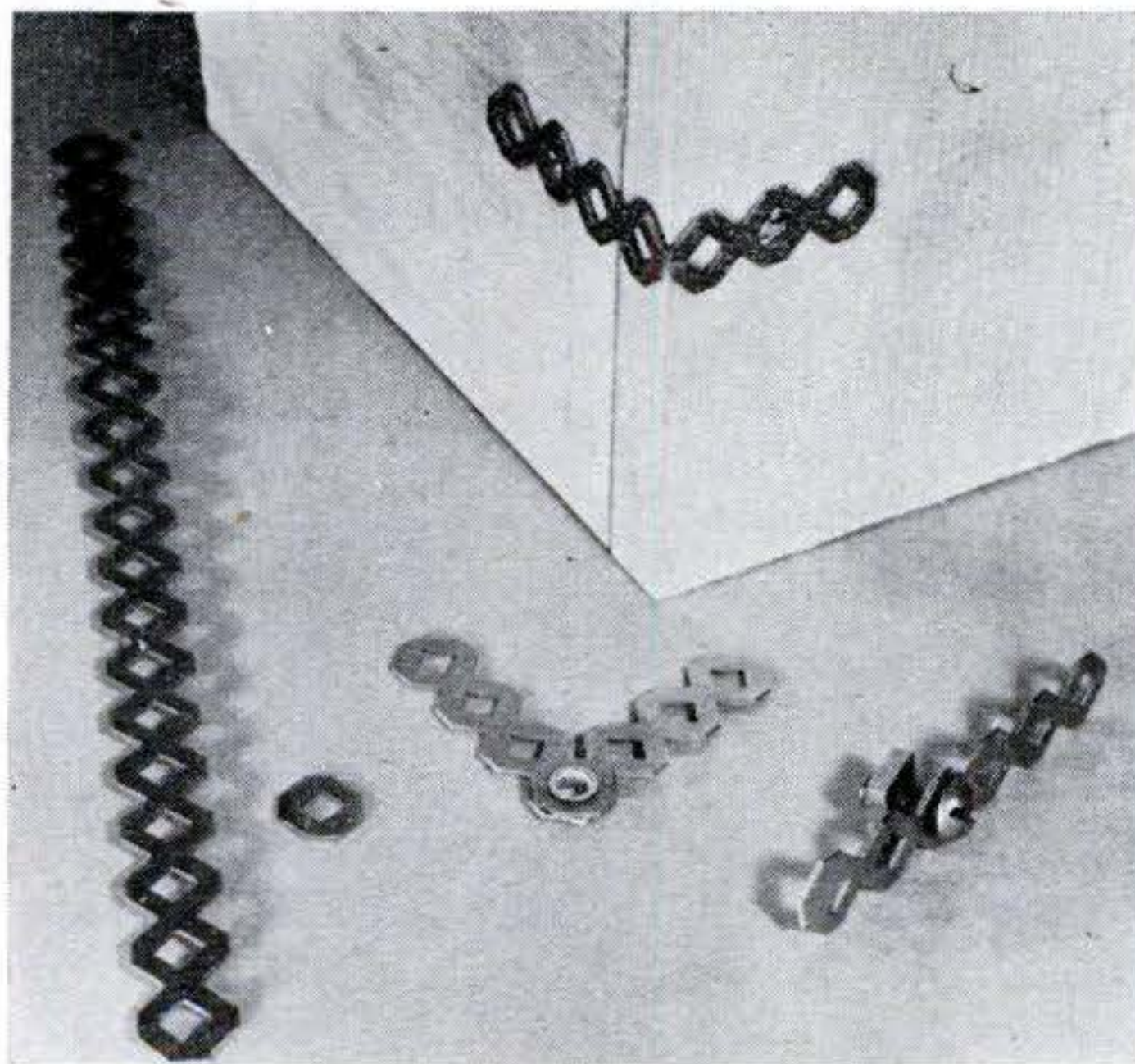

Mending Strips Speed Repairs

A VERSATILE mending strip that looks like a row of diamond-shaped holes can be used for many household repairs. Fix-O-Strips, marketed by Jayson Strips Co., Brooklyn, N. Y., can easily be broken off to any desired length or bent smoothly around corners or curves. The metal strips will join, reinforce, or support almost any type of material; the holes accommodate tacks, rivets, screws, or nails.



Recorder Works on Batteries

A COMPLETELY portable recording and playback machine weighing only 8 lb. operates on self-contained batteries. The new Walkie-Recordall, made by Miles Reproducer Co., Inc., New York, cuts sound tracks on an endless plastic film. It can record continuously for over three hours.

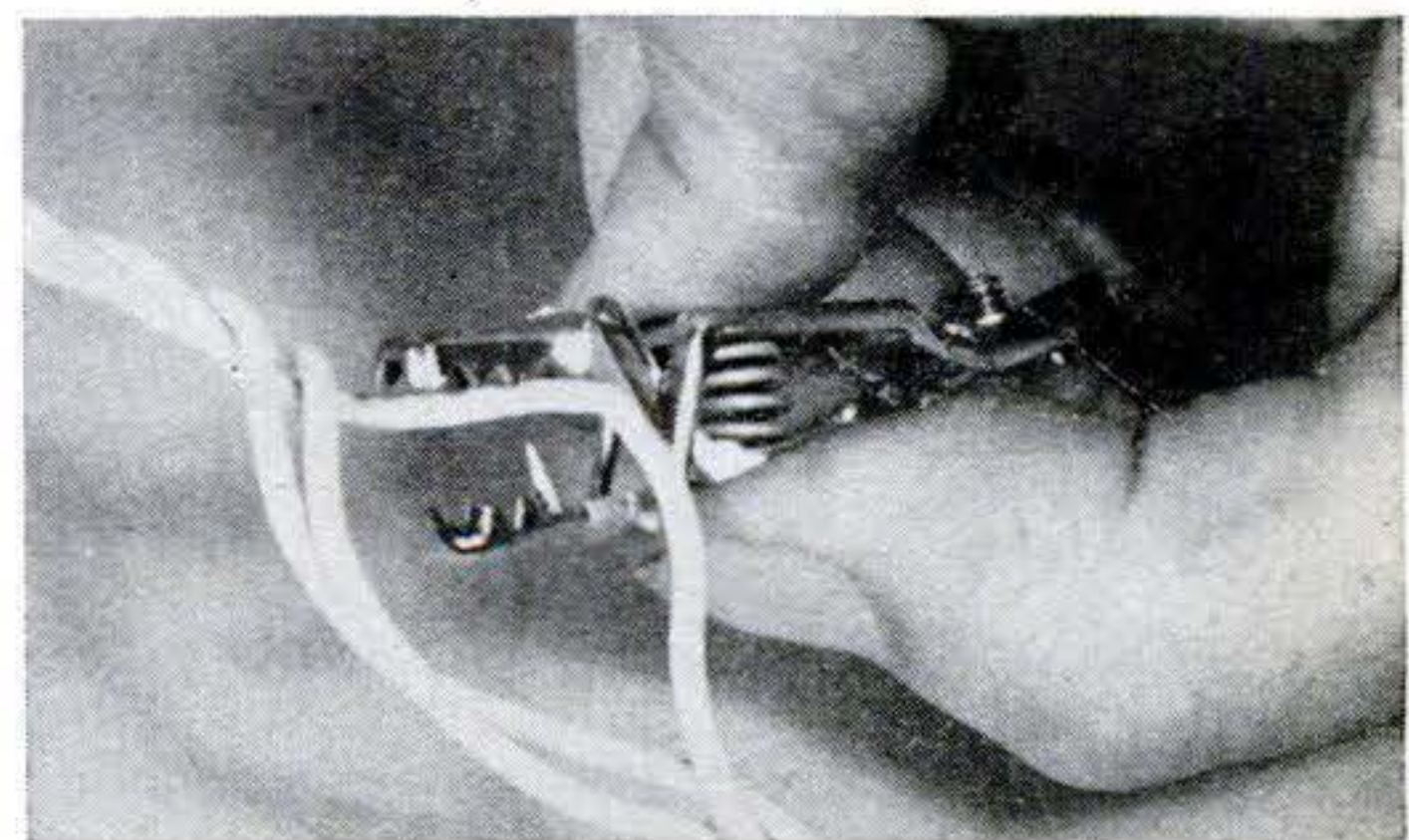

Clip Tooth Pierces Insulation

TEMPORARY electrical connections can be made more quickly and securely with this new Needle Clip. A sharp pin set rigidly in one jaw of the clip digs through insulation to make the electrical contact with the wire underneath. Mueller Electric Co., Cleveland, makes the device.

Make Things Obey

By building voice switches, you can cause all sorts of things to happen when you say the word.

By Karl Greif

THERE'S power in your voice. Like your hands and feet, it can be used to make many kinds of apparatus heed your wishes.

Three sound-operated switches that are easy to build and a pleasure to use are described in the three articles that follow. These devices turn words and syllables into electrical impulses that open and close relays. The result is the same as if you reached out and turned switches.

The sketch at the right shows you what happens. The microphone converts sound

This simple one-tube unit is all it takes to run a model train.

THIS one-tube voice switch will make standard remote-control locomotives of the type used in many model-train sets do what you tell them. These engines have sequence selectors that make the cars stop, start, or back up when a switch is pushed.

The switch momentarily breaks the flow

of current to the track. Each interruption moves the selector one notch. If the train is going forward, the first interruption brings it to a halt, the next sends it into reverse, then stop, forward, stop, and so on. Since the locomotive is built to do this, the control mechanism only has to meter your speech and change sounds into pulses. Each pulse closes a relay and interrupts the current flow.

Parts for this control unit were selected for economy and simplicity. The carbon microphone, for example, is a war-surplus item still available at a low price. The 117L7 is a good tube choice because it operates directly off the line and needs no filament transformer. It also contains its own rectifier diode.

You may have to experiment a bit to find the proper connections to the output transformer, T2. This can be done after the wiring is completed and the unit is in operation. If you have a voltmeter, clip the prods across the relay coil and whistle a steady note into the microphone. Note the voltage, reverse the leads to the transformer secondary, and repeat the test. Make the final connections to whichever taps give the highest output.

A child can learn to operate this voice controller. It is connected by four wires between the train transformer and the track.

Two penlight cells in series provide the mike voltage. If the relay tends to stick, adjust the spring or put a piece of paper over the pole.

If the relay picks up when you press the talk switch on the mike, remove the switch spring and lubricate the slide with petroleum jelly.

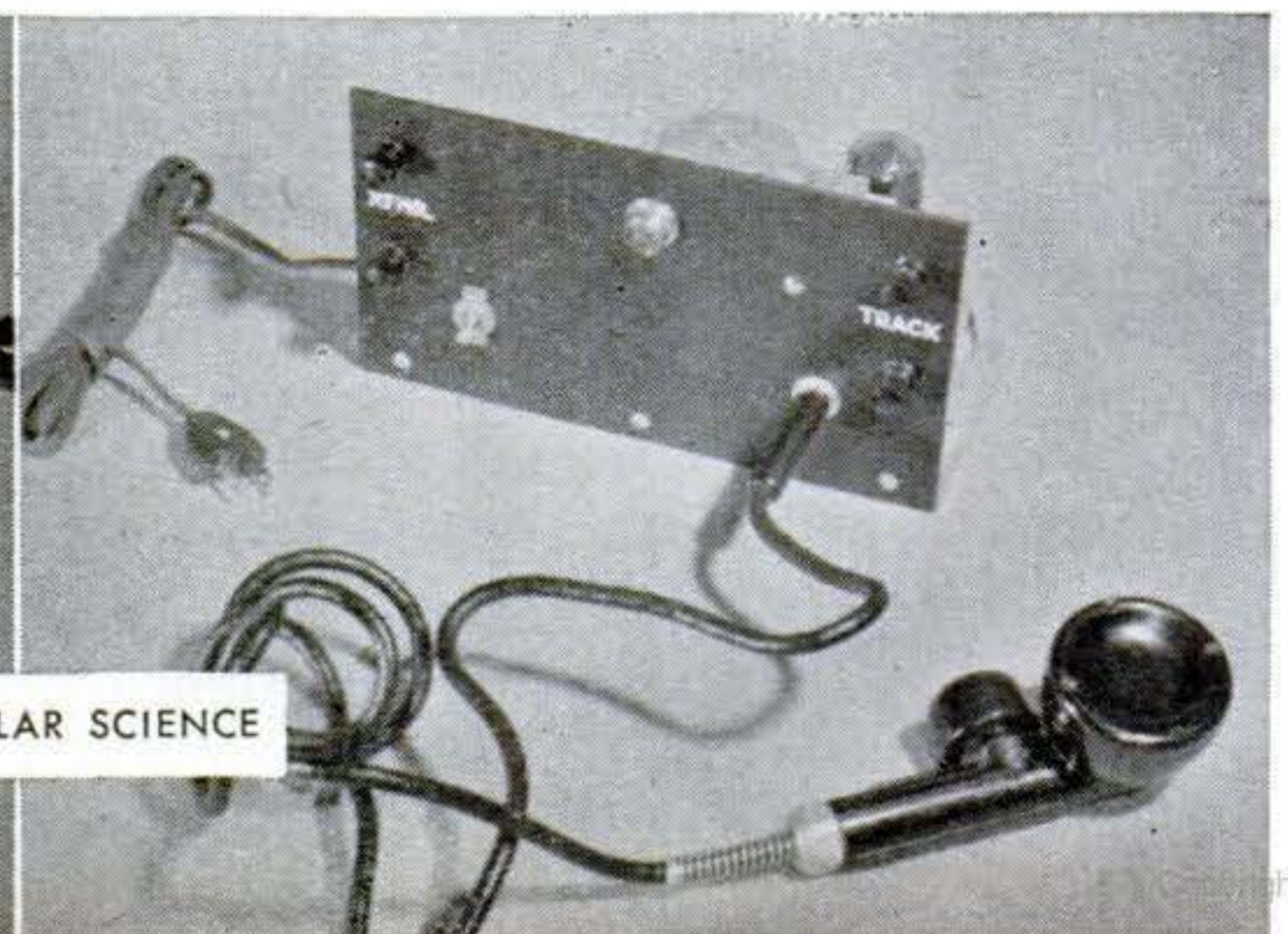
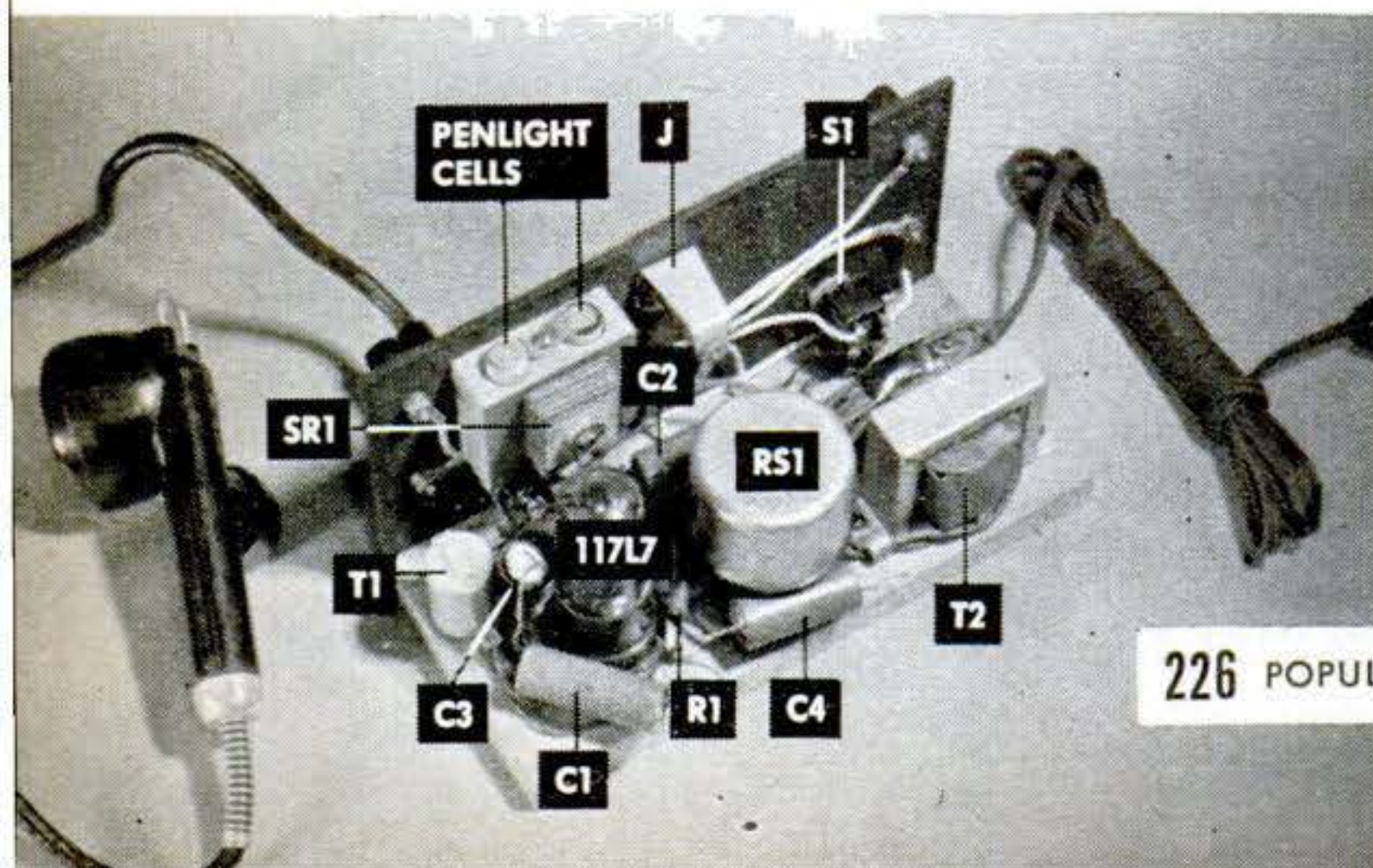
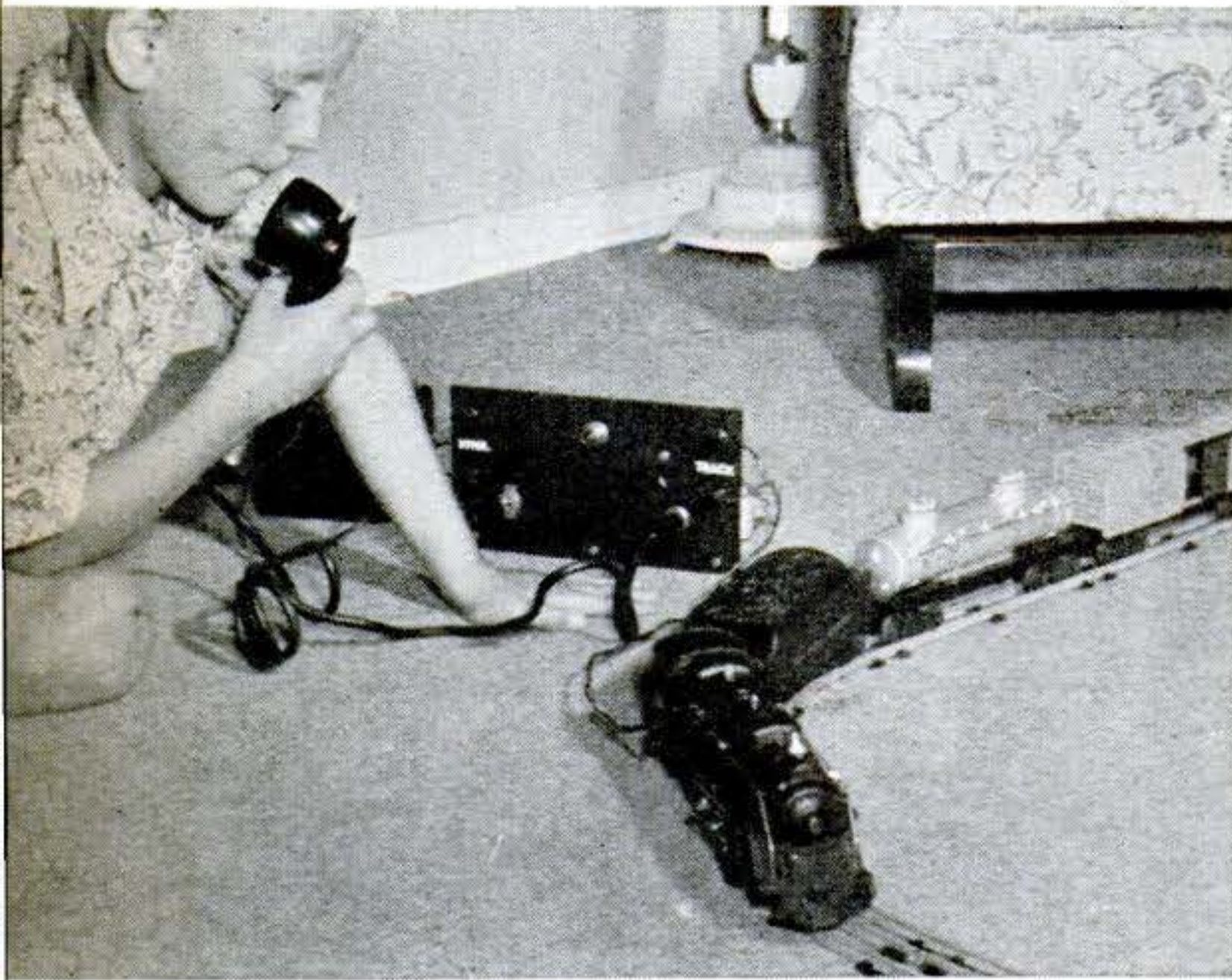

Your Voice

into alternating current. An amplifier puts muscle into this AC signal. It then is rectified and filtered into separate pulses of direct current that are fed to a relay.

What kind of sound do you need to make a pulse? That depends on the filtering. By choosing the right components you can mold the action of the relay to respond to long or short words or syllables.

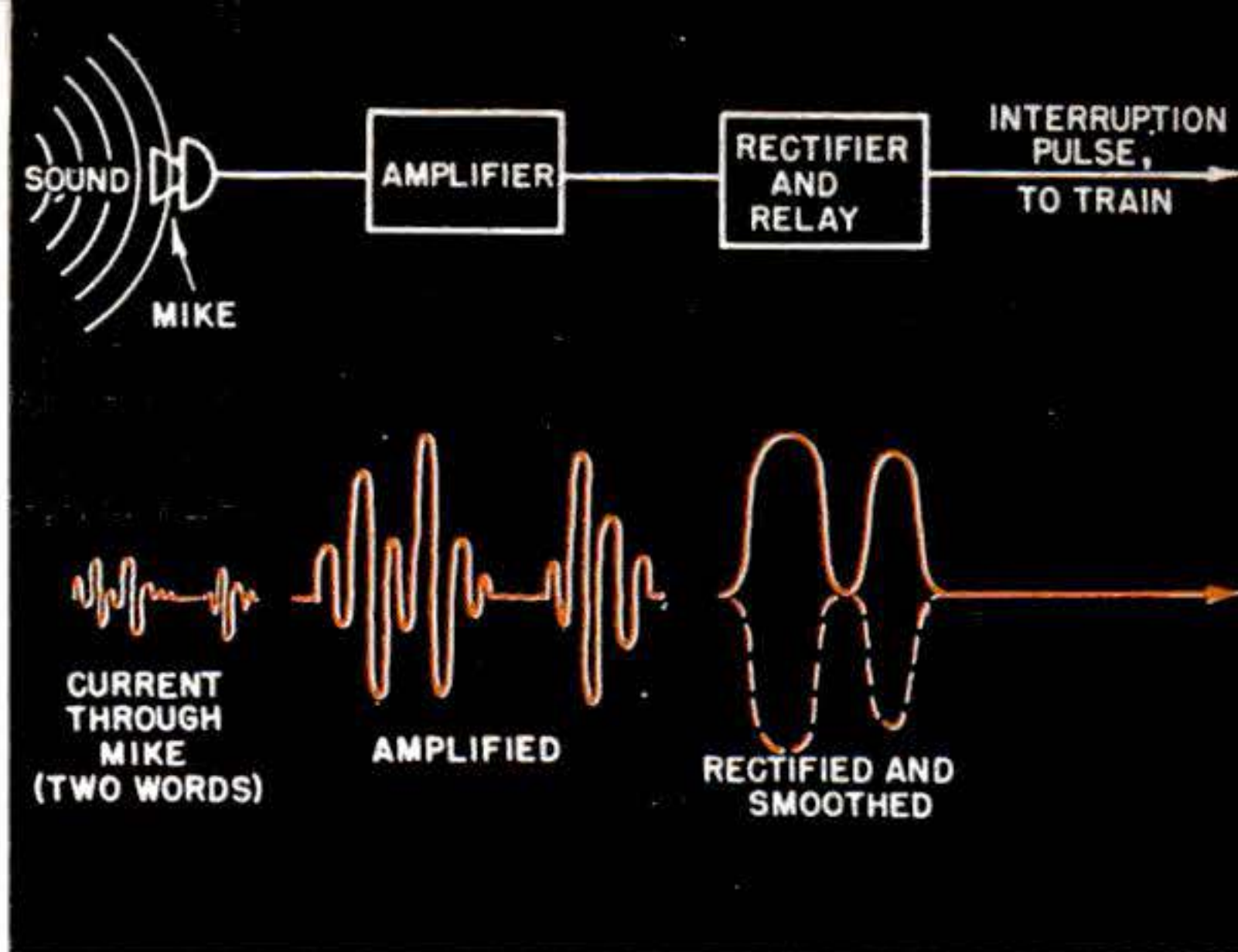

You don't have to make any changes in the train equipment. While the relay is in the up (normal) position, current flows from the train transformer to the track just as if the voice switch weren't there. But when a sound energizes the relay, the contact arm falls and interrupts the circuit.

Give yourself a practice workout with the

train controller before putting it on display. By spacing such words and phrases as "Stop," "Forward," "Now go back," and the like, you can advance the selector relay one, two, three, or more steps at a time. The trains will respond to *any* sound pulse. You have to pick the right number of words to make them do as you tell them.

LIST OF PARTS

R1: 150-ohm, 1-watt carbon.
 R2: 30-ohm, 1-watt carbon.
 R3: 5,000-ohm, 1-watt carbon.
 C1: 10-mfd., 25-volt electrolytic.
 C2: 40-mfd., 150-volt elect.
 C3: 20-mfd., 150-volt elect.
 C4: 4-mfd., 50-volt elect.

T1: Single-button microphone transformer, approx. 200-ohm pri. to 80,000-ohm sec.
 T2: Output trans., 10,000-ohm pri. to 2,500-ohm sec.
 RS1: 2,500-ohm SPDT plate-circuit relay.

SR1: 50-ma. dry-disk rectifier.
 S1: DPST toggle.
 J: Single-button microphone jack.
 Indicator lamp (same voltage as train set), breadboard chassis, panel, dial-light assembly, carbon mike (T-17 or other).

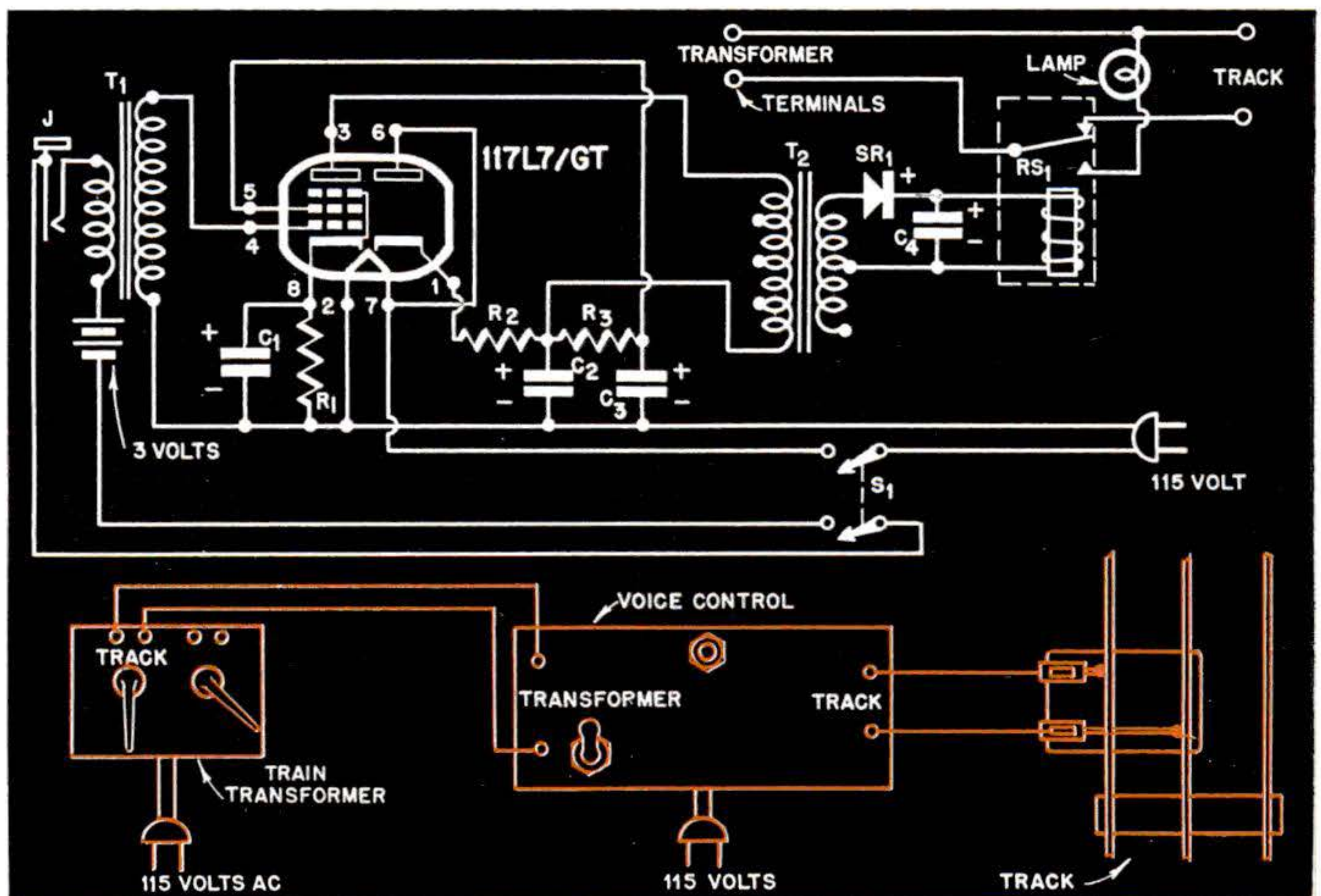

Here's a robot that will turn off radio commercials for you.

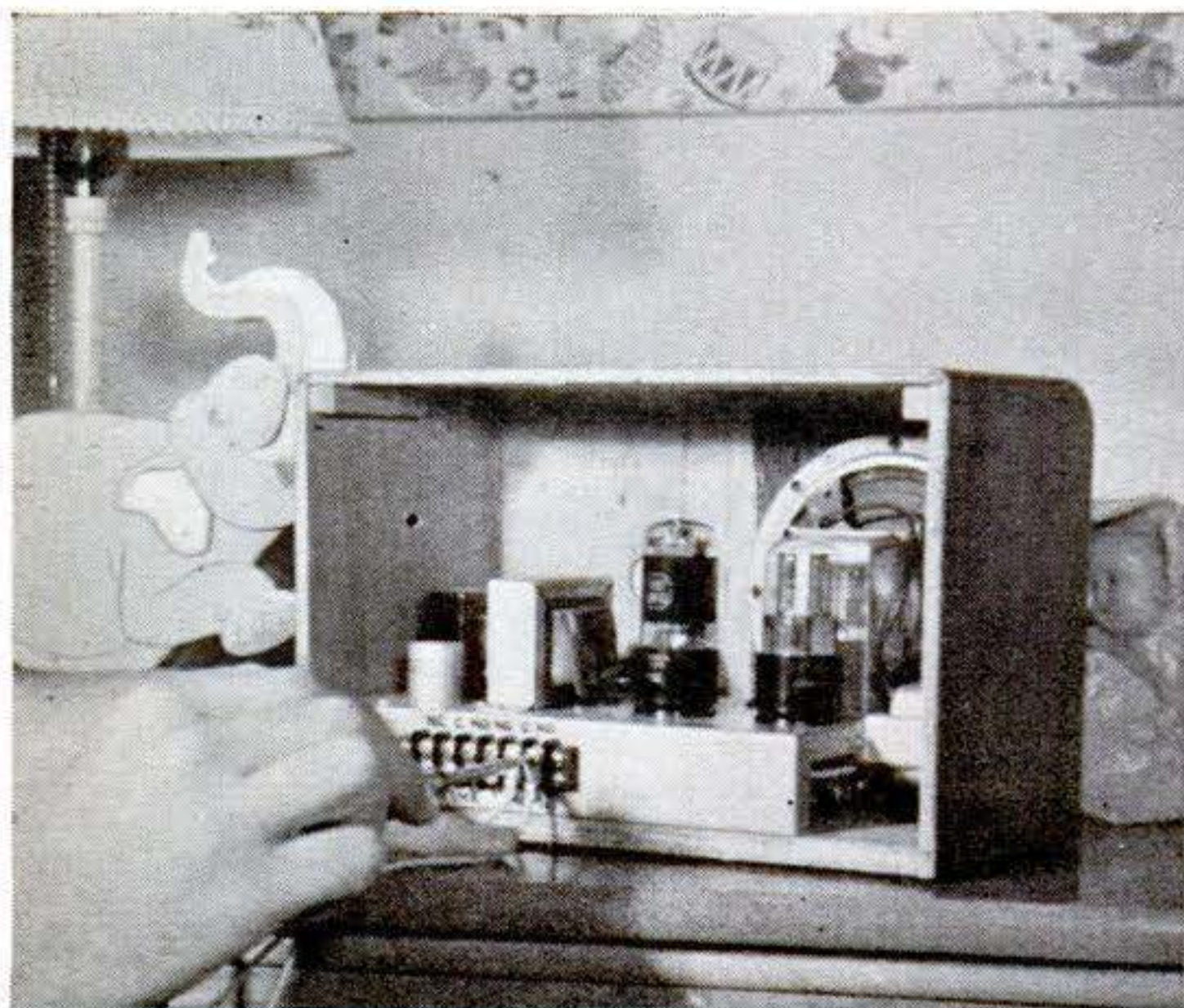

Connected to a bell and placed beside the baby's crib, this sound switch will set off a remote alarm whenever the baby cries.

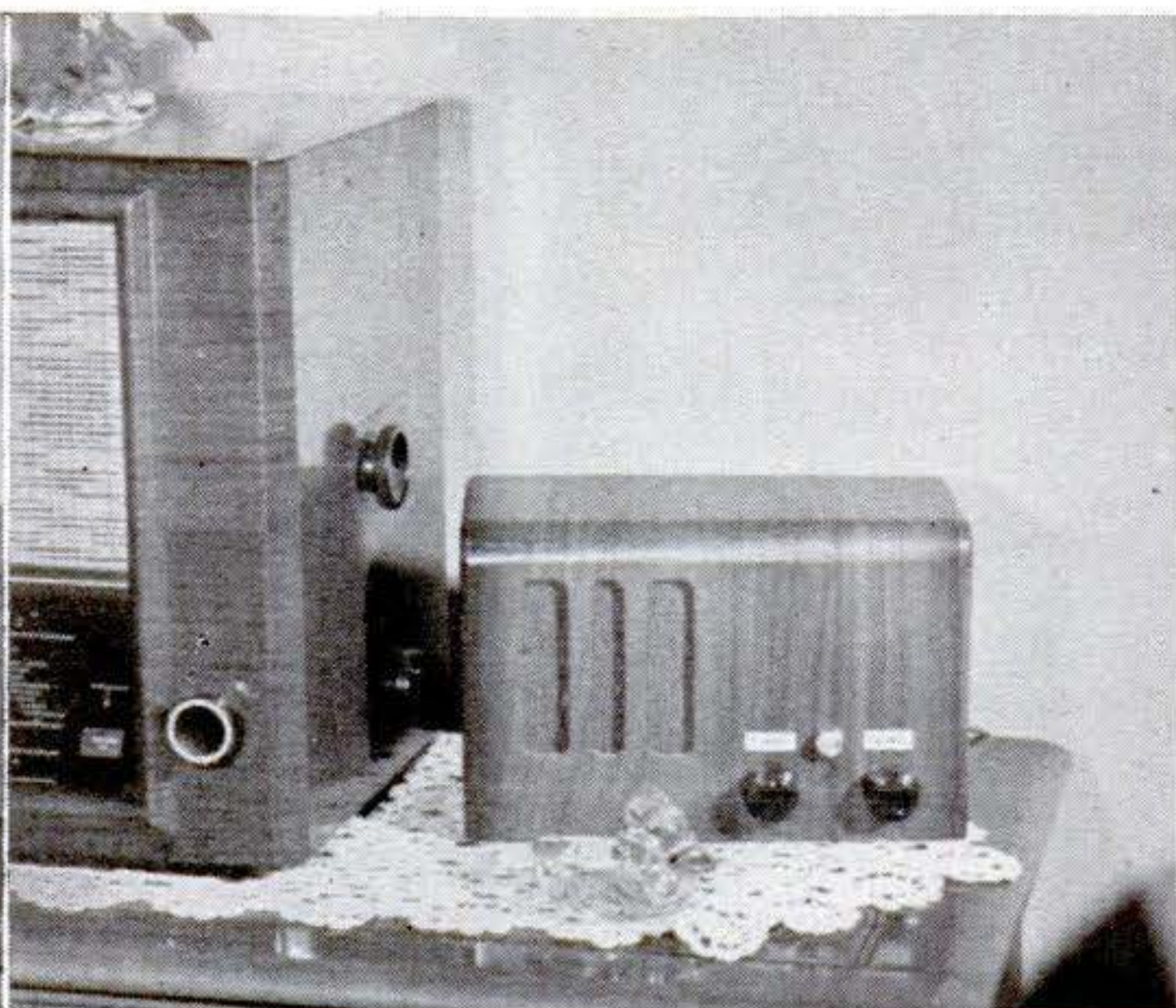

Connected to a radio, this box silences commercials on your spoken command. The radio will come on again after a period of quiet.

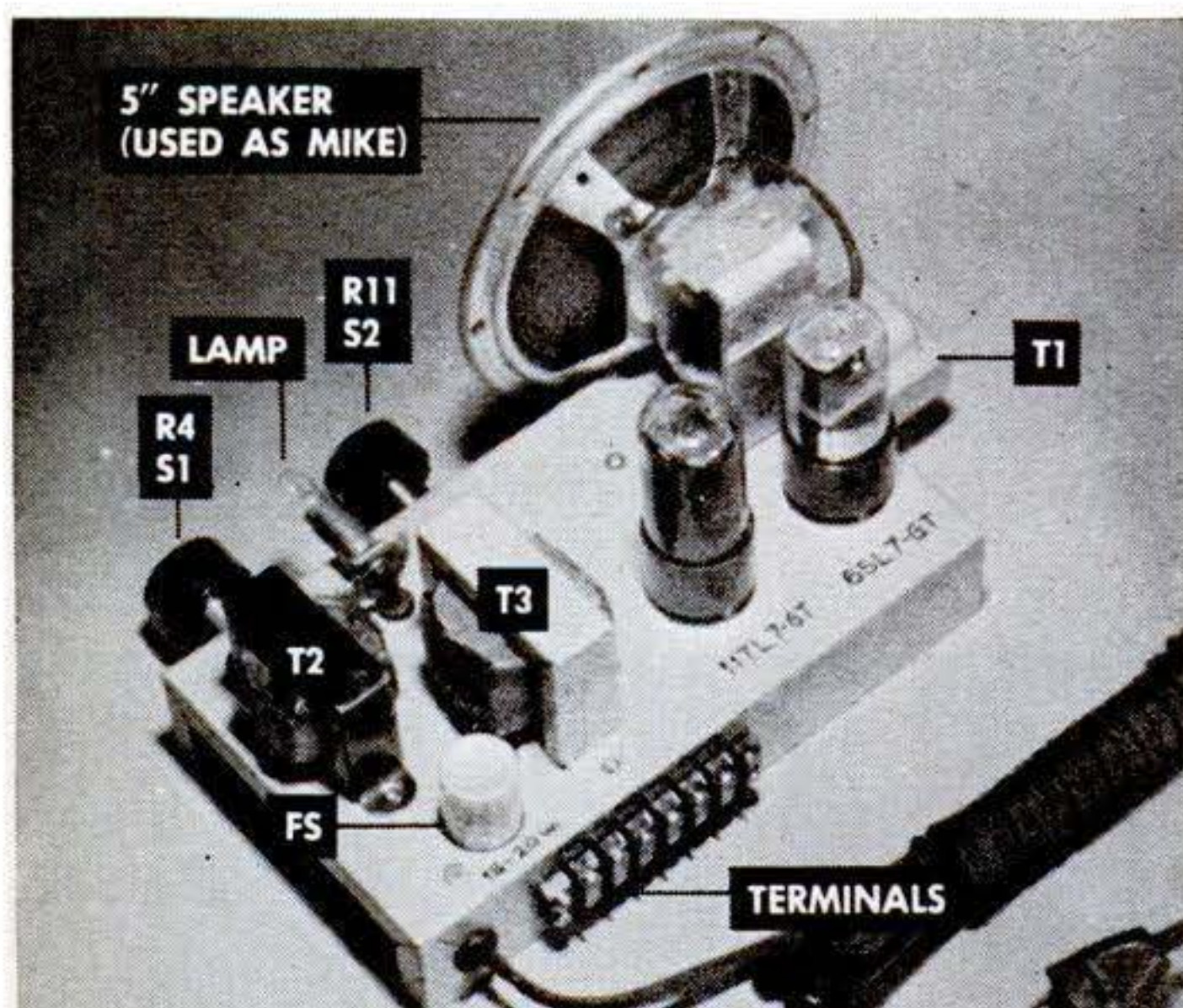

When using the timer circuit, turn on S2 before setting the sensitivity control. Otherwise the click of the switch might trip the relay.

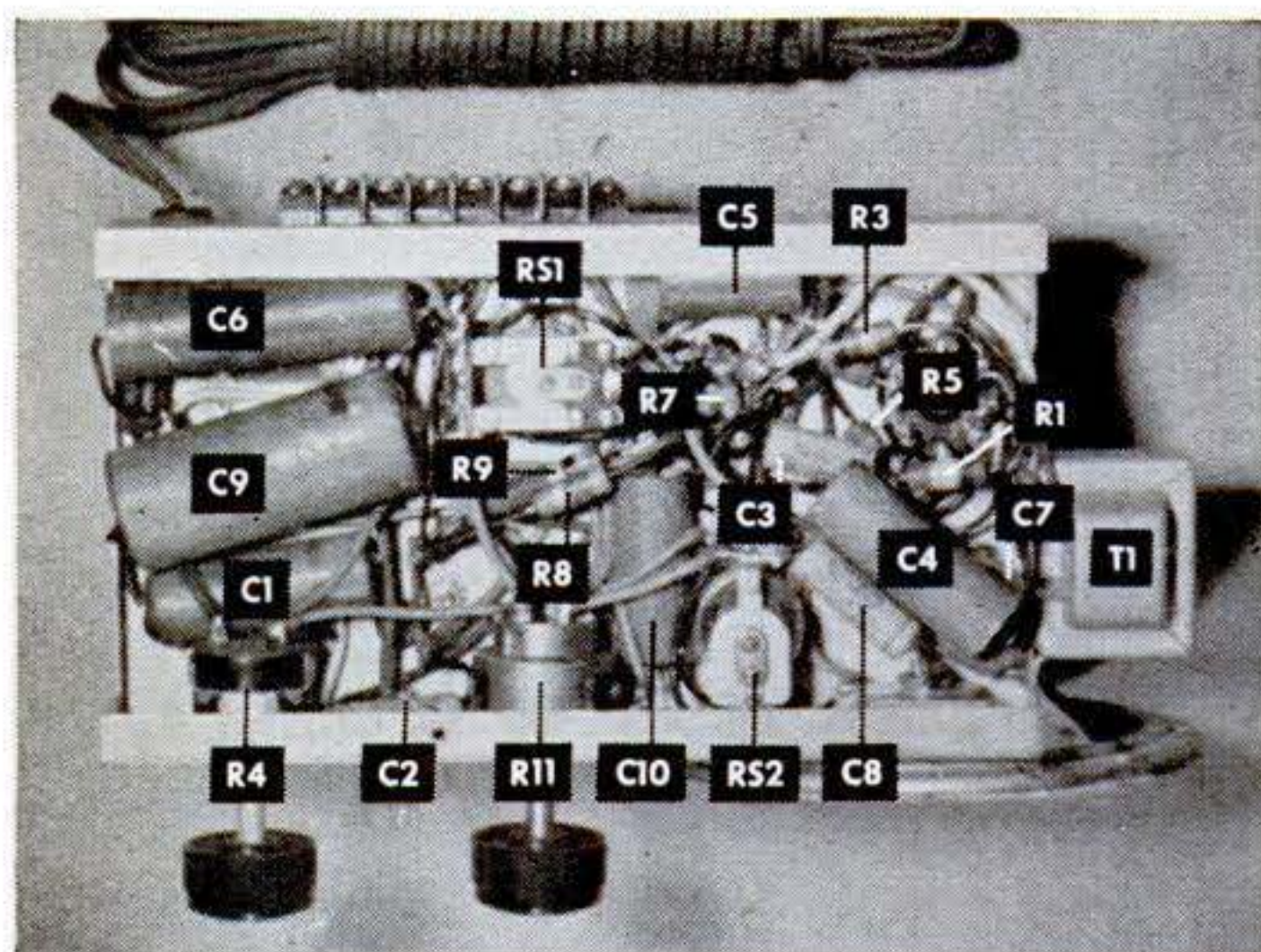

If you want the momentary contacts on RS1 to stay closed longer after the trigger sound stops, use a larger condenser in place of C10.

Adding two circuits to the basic voice switch described on the previous pages will make it more versatile. With the electronic package pictured above, you can turn off the radio during commercials without going near it. All you do is call "Quiet!" or even "Shaddup!" and the radio will be mute for about 45 seconds. A second use of the same device warns you in a distant part of the house whenever the baby cries.

One of the additional circuits is a timer that stretches out the switch action; the other is a preamplifier that increases sensitivity. The completed unit looks like a small radio, but in this case the speaker is used as a microphone.

The labeled photo at the left shows how the major parts are arranged. The high gain of the circuit makes their position rather critical. Note particularly that the shielded input transformer, T1, is placed at right angles to the output transformer, T3.

Two sets of terminals are attached to the rear edge of the chassis. One set provides momentary switching action, the other prolongs the action for a controlled period after the triggering sound impulse stops.

The time-delay circuit works like this: a sound picked up by the microphone-loudspeaker is turned into an electric pulse that energizes relay RS1. This relay remains picked up just long enough to close a second circuit and allow current to reach the coil of relay RS2, a 115-volt AC relay. This is wired in parallel with a fluorescent-lamp starter (FS) so any voltage that appears

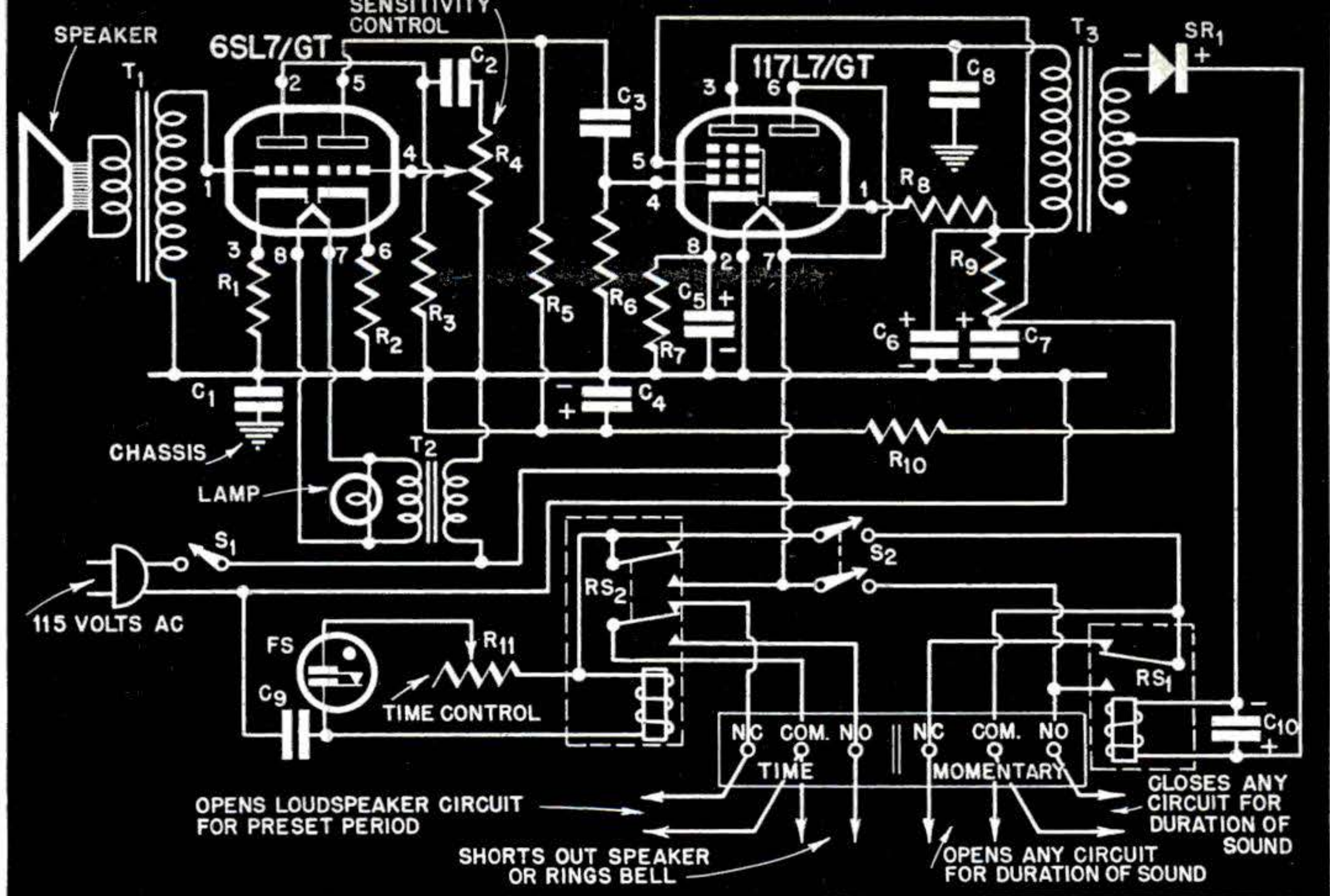

LIST OF PARTS

R1: 3,000-ohm, 1-watt carbon.
 R2: 2,500-ohm, 1-watt carbon.
 R3: 200,000-ohm, 1-watt carbon.
 R4: 500,000-ohm potentiometer.
 R5: 100,000-ohm, 1-watt carbon.
 R6: 500,000-ohm, 1/2-watt carbon.
 R7: 150-ohm, 1-watt carbon.
 R8: 15-ohm, 1-watt carbon.
 R9: 5,000-ohm, 1-watt carbon.
 R10: 3,000-ohm, 1-watt carbon.
 R11: 500-ohm wire-wound pot. or rheostat.
 C1: .1-mfd., 600-volt paper.

C2: .001-mfd., 400-volt paper.
 C3: .003-mfd., 400-volt paper.
 C4: 20-mfd., 150-volt electrolytic.
 C5: 10-mfd., 25-volt elect.
 C6: 40-mfd., 150-volt elect.
 C7: 20-mfd., 150-volt elect.
 C8: .002-mfd., 600-volt paper.
 C9: 1-mfd., 600-volt paper.
 C10: 4-mfd., 50-volt elect.
 T1: Intercom input transformer, secondary approx. 25,000 ohms; primary to match 3 to 6-ohm voice-coil.

T2: 6.3-volt filament trans.
 T3: Output trans. approx. 10,000-ohm pri. to 2,500-ohm sec.
 RS1: 2,500-ohm SPDT plate-circuit relay.
 RS2: 115-volt DPDT AC relay.
 SR1: 50-ma. dry-disk rectifier.
 S1: SPST switch on R4.
 S2: DPST switch on R11.
 FS: 15-20 watt neon-type fluorescent starter.
 6.3-volt pilot lamp, 5" PM speaker, 1 1/2" by 4 1/2" by 8" chassis.

across the relay coil also appears across the starter. When current flows through the starter, it heats the bimetal contacts and bends them till they finally touch. This lowers the voltage in the relay and ends the timing cycle. The time-control rheostat, R11, regulates the current through the starter and therefore the delay.

To use this unit as a radio silencer, connect either the normally-open (NO) time terminals across the voice coil of the radio's speaker or the normally-closed (NC) pair in series with one speaker lead. Turn on the time switch (S2) and set the time control to maximum. Then, while the radio is operating at normal volume, adjust the sensitivity control, R4. It should be below the point where the radio's sound can trigger the relay. A word or handclap will then silence the radio for about 45 seconds. It will come back on automatically.

The higher the sensitivity control is set,

the easier it will be to set off the device, but if the setting is too high it may respond to loud music, or an auto horn in the street, or even vigorous conversation. Sometimes the unit may have to be mounted on sponge rubber to keep it from reacting to vibrations other than a loud voice aimed directly at it.

To use this unit as a baby tender, connect the normally-open contacts either on "time" or "momentary" (depending on whether you want a long or short alarm) to a bell. Juice for the bell can be tapped off the 6-volt pilot-light terminals. Place the control box close to the crib, and place the alarm bell wherever you wish. Now when the baby cries, his voice will make the alarm bell ring.

This device also can be used as a night watchman, to make lights turn on, to trip a camera shutter, or to start or stop household appliances. For some of these purposes, however, relays capable of handling larger loads may be needed.

Continuous-duty switch uses little power, keeps its ear cocked.



Automatic garage doors can be honked open with this sound-operated switch. Mike is cushioned on rubber, enclosed in a watertight hood.

THERE are a lot of applications in which voice switches have to be left on for long periods of time. In such cases it's important that the power consumption be held to a minimum. Here's a circuit that will do it. It is built around a gas-discharge tube known as a thyratron.

The special advantage of a thyratron is that it needs no DC and draws plate current only when triggered. In other words, the only power used in stand-by operation is the small amount needed for the filament and for the carbon microphone supply.

When a signal hits the mike, it is stepped up through transformer T1 and impressed upon the grid of the tube. Voltage on the grid makes the tube "fire." You know it's firing when you see a blue-violet glow inside the bulb. What happens, actually, is that the tube becomes conductive and starts drawing pulses of current from the AC line. The pulses energize the relay. The higher the value of the pulse-smoothing condenser, C3, the longer the relay will remain picked up after the firing in the tube stops. Higher values of R6 will also increase the time lag.

LIST OF PARTS

R1: 1,000-ohm potentiometer.
R2: 50-ohm, 1-watt carbon.
R3: 5-meg., 1/2-watt carbon.
R4: 500-ohm, 1-watt carbon.
R5: 25,000-ohm, 1-watt carbon.
R6: 5,000-ohm, 1-watt carbon.
C1: 100-mfd., 15-volt electrolytic.

C2: .02-mfd., 600-volt paper.
C3: 40-mfd., 150-volt elect. (8- to 100-mfd. can be used to vary closed-time of relay).
T1: Single-button mike trans. approx. 200-ohm pri. to 80,000-ohm sec.

T2: 6.3-volt filament trans.
RS1: 2,500-ohm SPST plate-circuit relay.
SR1: 50-ma. dry-disk rectifier.
S1: DPST toggle.
S2: SPST toggle.
Carbon mike, chassis, tube.

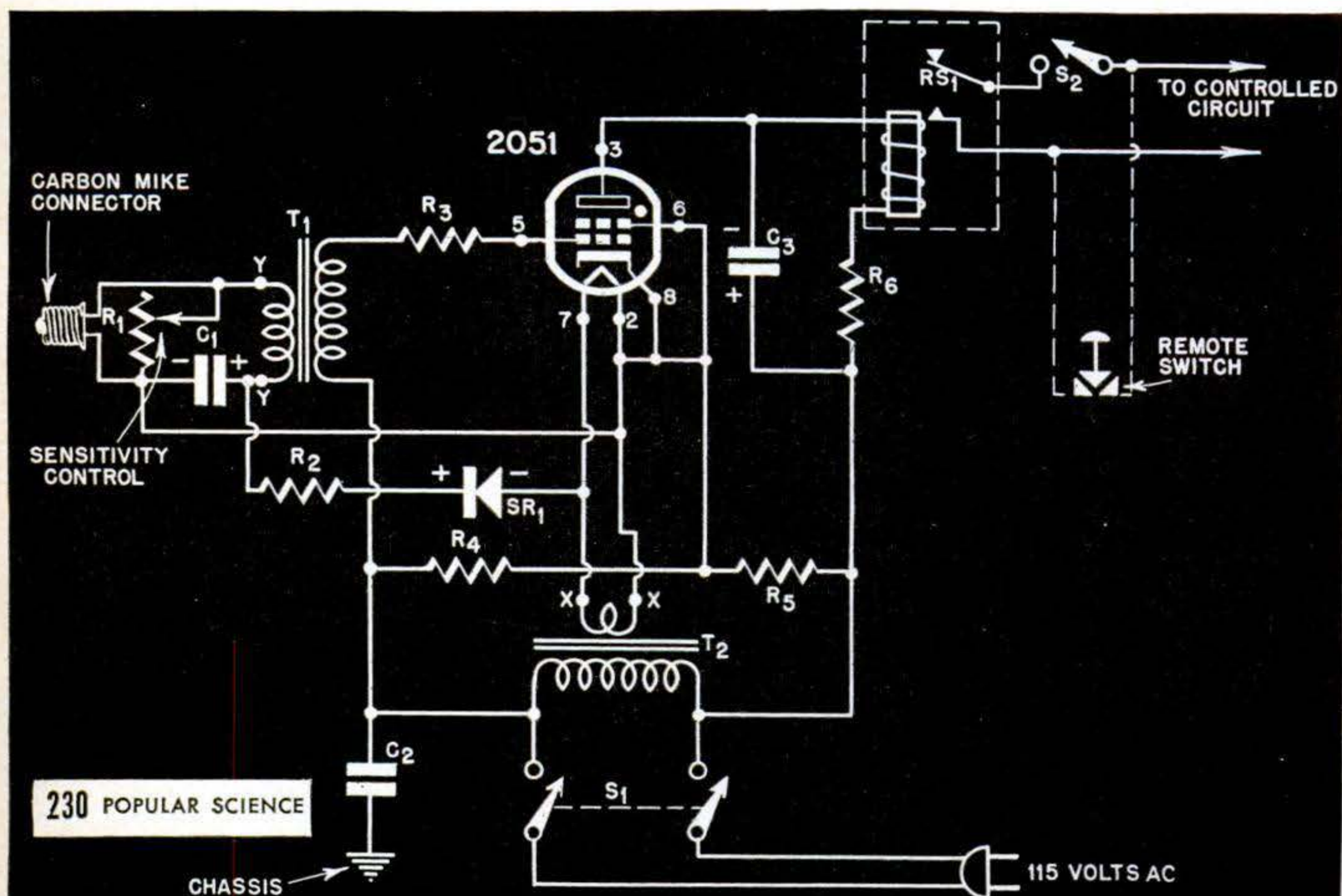

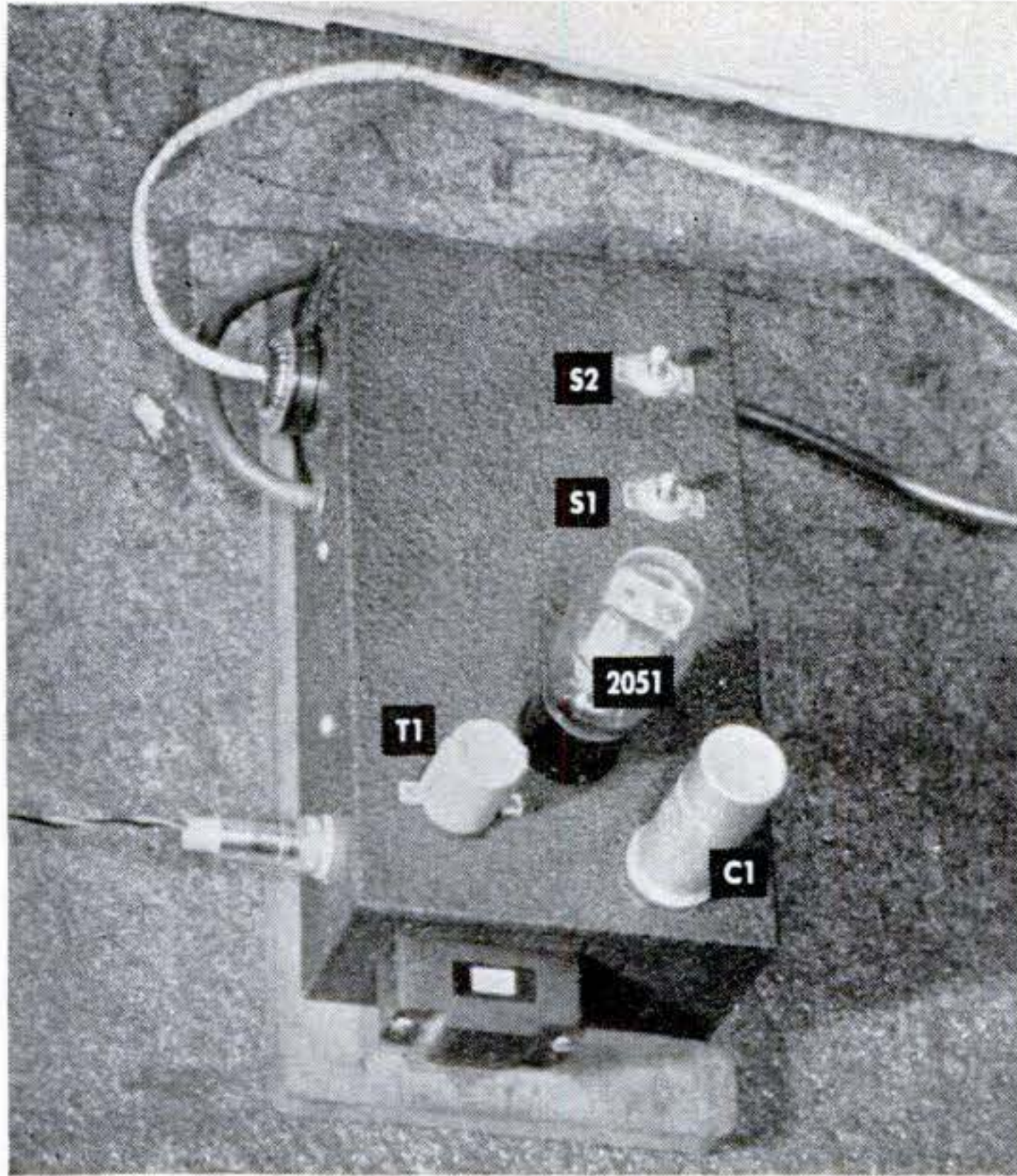

The wooden board on which the chassis rests can be screwed to a wall. The oversized chassis insures ample ventilation in tight quarters.

The entire unit is built on a 3" by 5" by 10" chassis. The only critical part of the wiring is that referred to by the letters "x-x" and "y-y" in the diagram. The position of these leads controls the phasing of hum voltage in the mike circuit. If the tube is uncontrollable or tends to pulse erratically, reverse the connections at x-x or y-y.

The single-button carbon mike shown in the photos was removed from a surplus telephone handset. For most applications it is important to mount the microphone on sponge rubber. A water-inlet hood from a washing machine was used as a protective housing for the mike.

Relay contacts are connected to the circuit to be controlled. In this case it happened to be an automatic garage-door opener. Dotted lines in the diagram show how

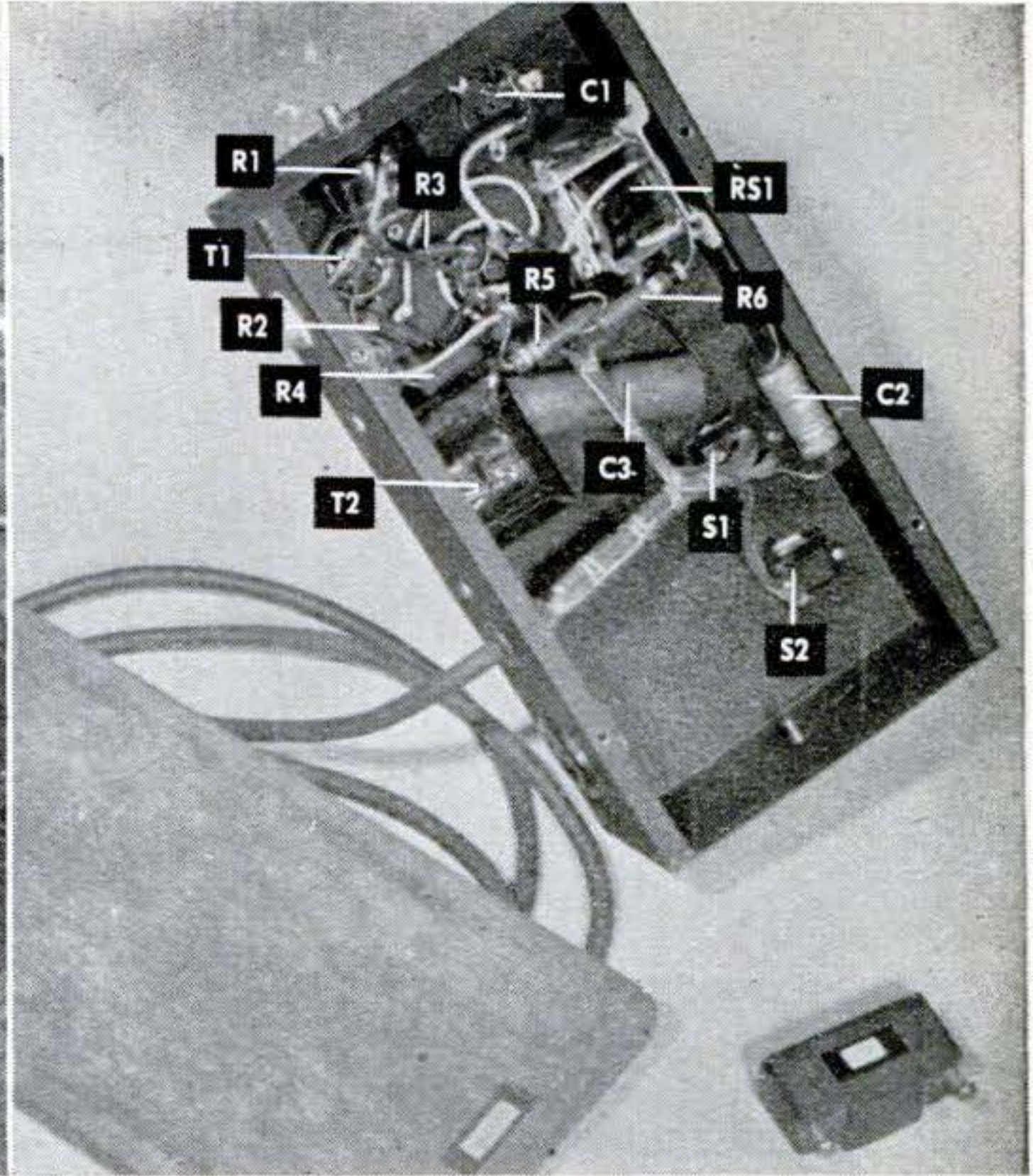

If the thyatron tends to fire too easily, increase the value of the bias resistor, R4; if it doesn't fire, try a smaller resistor.

the original control switch was connected into this circuit.

In use, the sensitivity control (R1) must be set at a fairly low point so that it will respond to an auto horn sounded four or five feet away but ignore other noises.

Another application for this control is to turn on runway and landing lights at a private or unattended airport. The mike could be mounted on a sounding-board panel and located near the runway. When a pilot "buzzed" the airport, the roar of the motor would trigger the thyatron and turn on the field lights through a heavy-duty latching relay. An automatic timing circuit would have to be added to turn the lights off after a suitable interval. Automatic turnoff is important since the circuit is necessarily subject to chance noises. END

Jumping Tests Your Shocks

THE function of automobile shock absorbers is to dampen, or slow down, the up and down movement permitted by the springs. You can test whether yours are doing their job by standing on the front bumper and bouncing the chassis up and down. If it continues to bounce excessively after you get off, the front shock absorbers need attention, perhaps replacement. Jump on the rear bumper for a similar test of the shock absorbers at that end.

Gluing Wood Controls Warping

WHY is the top of a workbench usually made of several strips of wood glued together, rather than a solid piece?

There's a sound reason. Under changing climatic conditions, any wood tends to warp and split. But if the wood is sawed into strips, rearranged, and then glued together, the tendency of one part to twist out of line is counteracted by the forces exerted by the others joined to it. This is a good point to remember in any woodworking job.

Answers

1. He's angling the exposure meter too high and holding it too far away from the child. Meter should be held closer to measure the light actually reflected from the subject.
2. The film is reversed. If it were being loaded correctly, the thumb of the right hand would cover the identifying notches. The rule: Hold film with notches at right-hand end of top edge. The light-sensitive coating then faces you. Shooting through film to the emulsion gives fuzzy results.
3. The negative isn't properly masked.

- Note the raw light spilling around the edges of the image. Stray light in the enlarger isn't fatal but does tend to gray highlights.
4. You can't flash a TV image. Video pictures are patterns traced in light; they will just be washed away by the over-all light of the flash bulb. Shooting this way is like beaming a light at a shadow to photograph it. Since he'll only get a blank screen it won't matter, but the angle is too high, also.
 5. Box cameras are generally fixed-focused from about 6' to infinity. This close to the camera, the subject will be out of focus.

EVEN professional photographers sometimes forget to remove the lens cap or dark slide, so it's not surprising that amateurs often draw blanks. Each of these pictures shows a different way you can go wrong.

1. As every shutter bug can tell you, correct exposure is vital. That's why the proud father here is checking his with an exposure meter.
2. Some tyros load their holders this way, may even get pretty fair pictures. Most photographers make their own enlargements when they want good ones. But this fellow isn't doing so well.
4. Johnny's sister made a guest appearance on a TV show. He was all ready to record the event. Did he get a good photo? Our nature lover felt fine when he finally coaxed a squirrel to sit still for a portrait. But even the squirrel was disappointed with the results.

WHAT'S WRONG ?

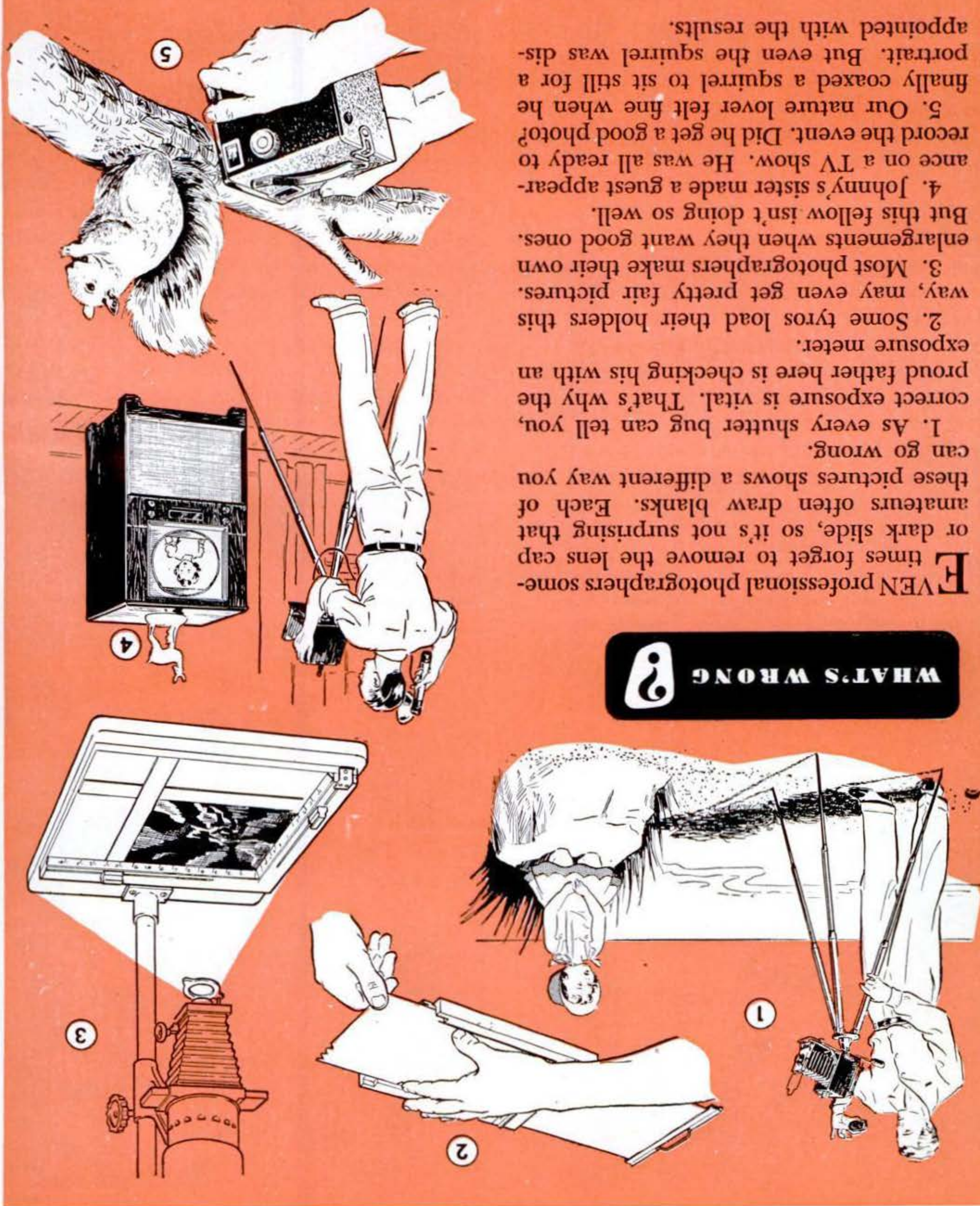



Camera Shows Depth of Field

WITH the new 35-mm. Kodak Pony 135 camera, you can tell the range in which all objects in your picture will be in focus. Used with the focusing scale, figures on the shutter plate show the depth of field at all distances and lens openings. Shutter speed, lens opening, and distance figures are visible as you look down at the camera. Film stop and exposure counter are automatic. Like the Pony 828, the 135 has an f/4.5 lens and speeds up to 1/200 sec. Priced at about \$35, it takes 20- or 36-shot magazines, and has built-in flash synchronization.



Sound for Home Movies

MOVIES and sound are automatically synchronized on 16-mm. sound film by the new Auricon Cine-Voice Camera above. Designed for the home movie maker, it records sound along one edge of the film. The camera takes 100-foot film spools. The \$700 outfit includes a microphone, amplifier, headphones, batteries, camera accessories, and fitted case. Lenses are extra. The outfit weighs about 34 pounds; camera alone, 12½.

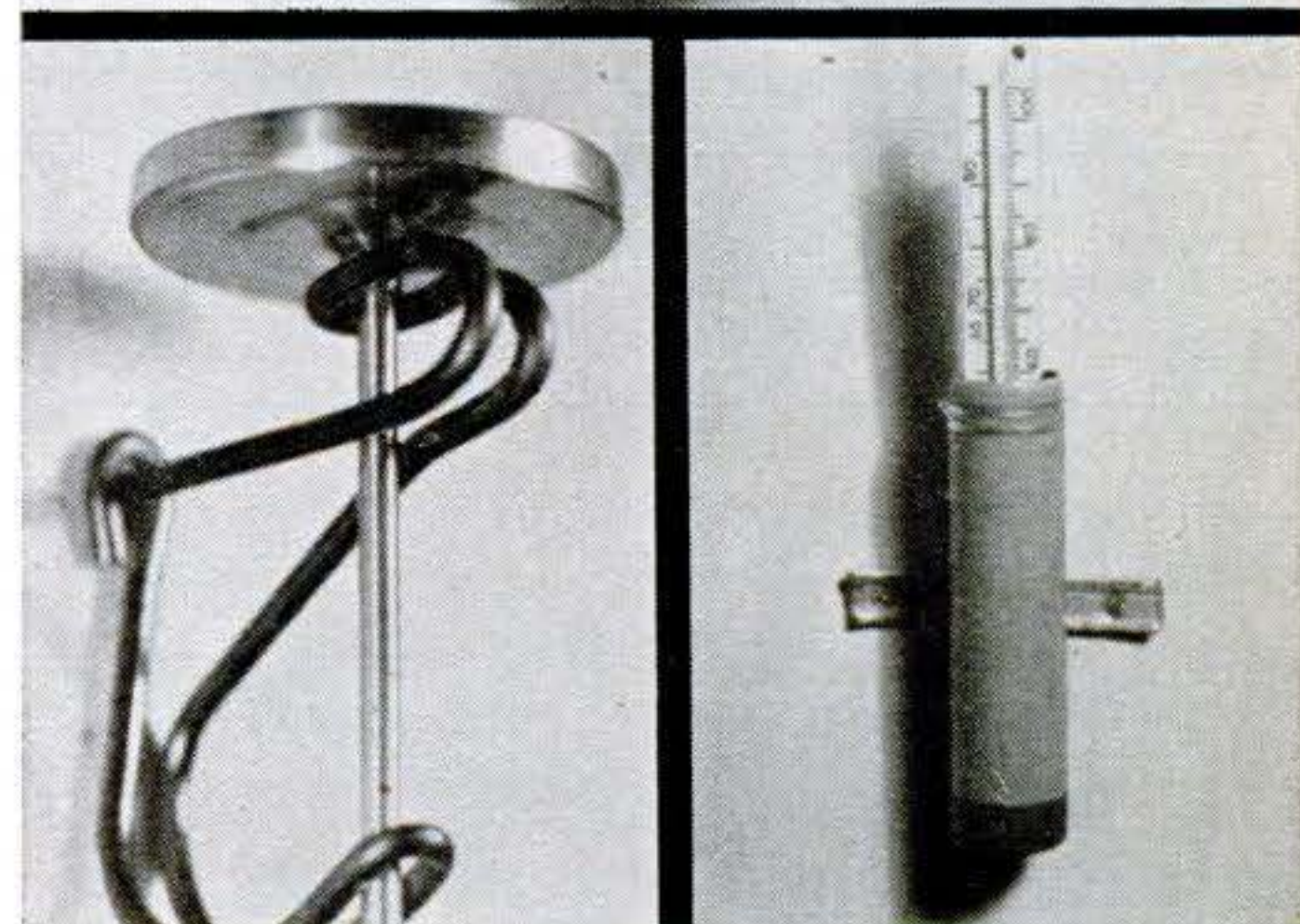
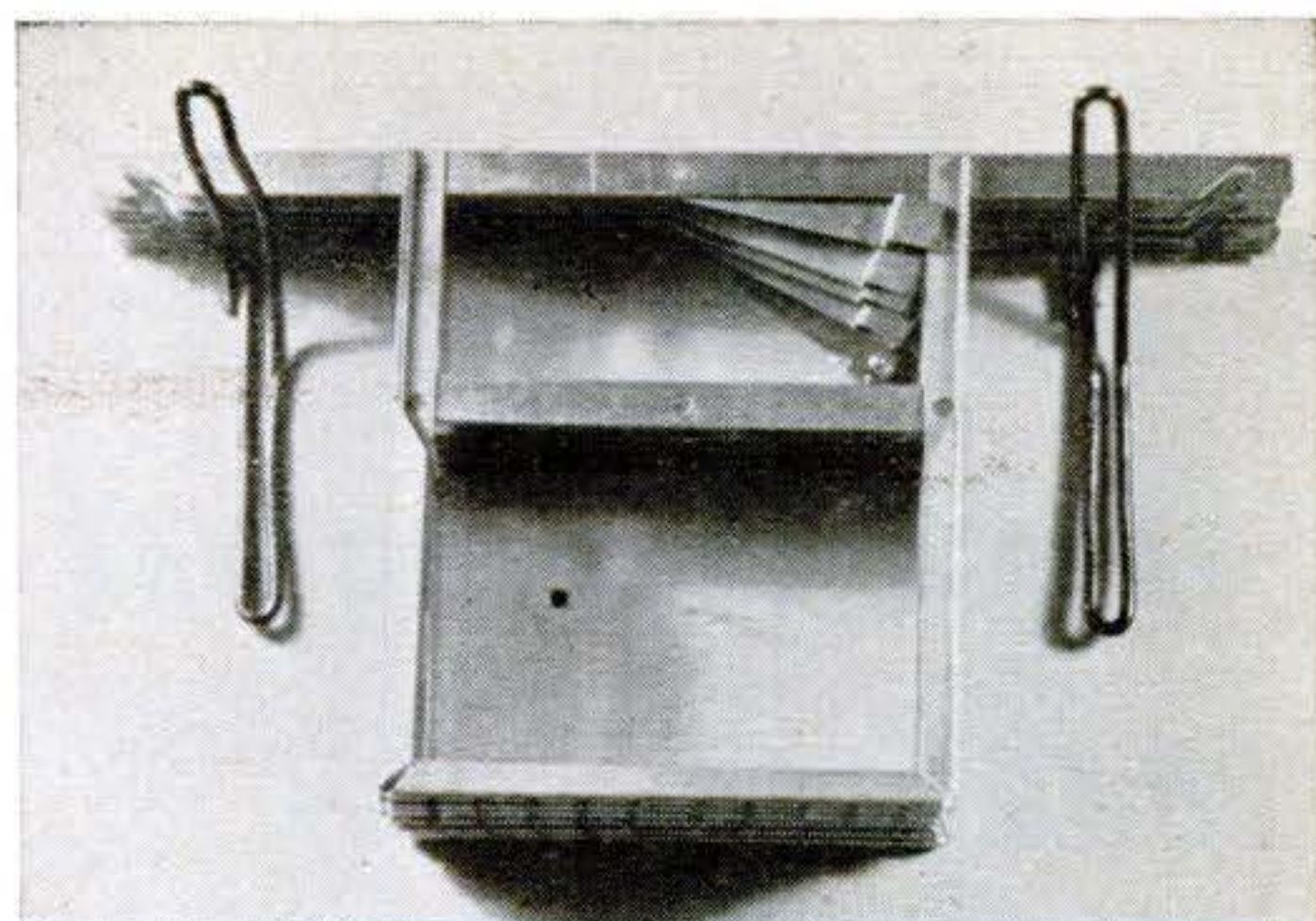

Store Accessories Out of Way

COAT hooks can be used in the photo darkroom for storing various accessories while not in use. Above are two examples. At top, film hangers are simply laid across two hooks screwed in the wall. At lower left, the top prong of the hook was bent up and back to provide a secure seat for a dial-type thermometer.

At lower right, the cap from an old fountain pen serves as a safe receptacle for another type of photo thermometer.

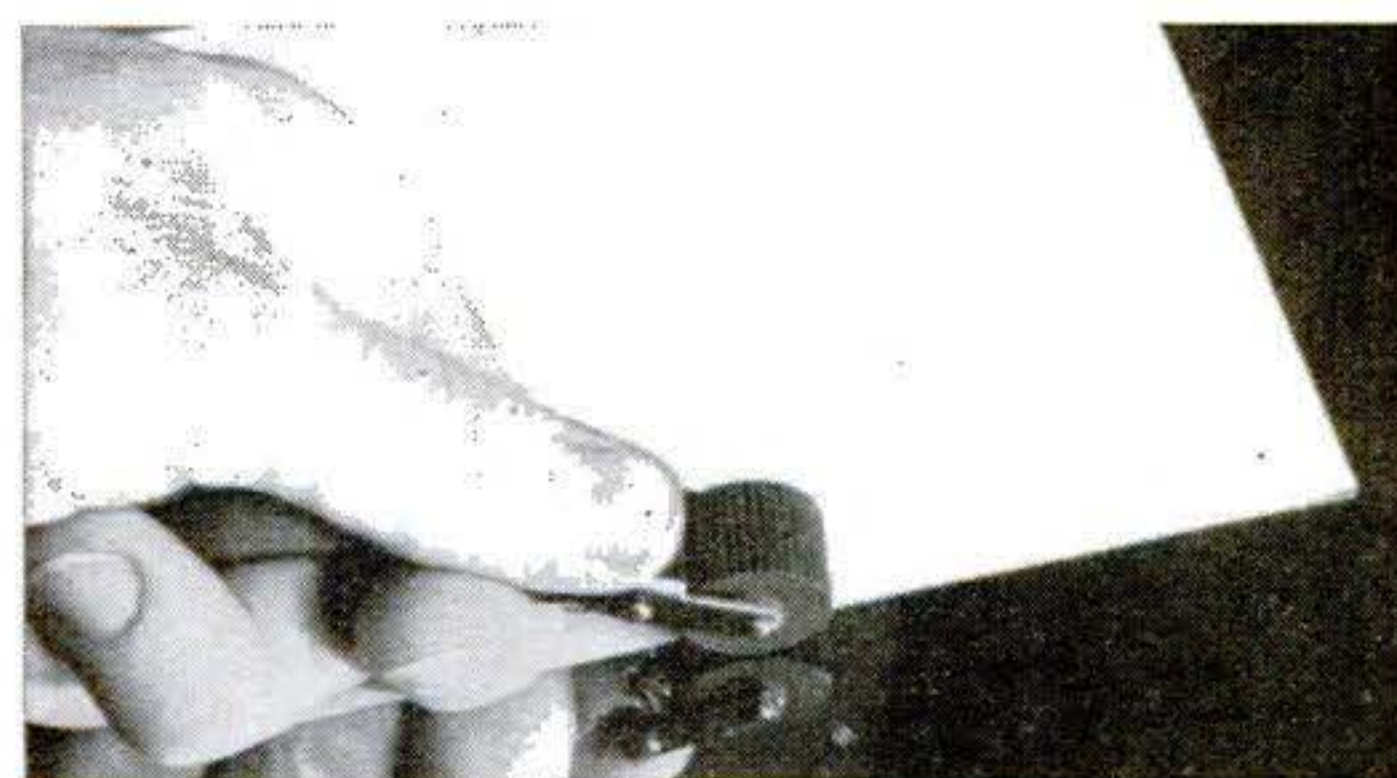

Caster Ferrotypes Print Edge

THE edges of a ferrotyped print sometimes fail to take a gloss because of poor contact with the plate. To avoid this, go around the edges with a small rubber-roller caster after the print has been squeegeed.—*John J. Rea, Urbana, Ill.*

I'd like to see them make...

Everyone has his own pet idea of some gadget he would like to see in general use. What is YOURS? Popular Science will pay \$5.00 for each one published. Use government postcards only. Contributions cannot be acknowledged or returned.



Left-hand threads on bottles of poison. Such threads, plus spikes on the cap, would warn you if you accidentally picked a poison bottle from a medicine chest in the dark, or when you're sleep-groggy.—*John Boniella, Perryopolis, Pa.*



Clean-out plugs for the sewer pipe that have a removable center section to take a garden hose. When the drain was stopped up, you could insert the hose for forced flushing.—*Mrs. Warren Bennett, Findlay, Ohio.*



Foot-treadle casters on electric refrigerators. By lowering the wheels, the refrigerator could be rolled away from the wall so the space behind and under it could be cleaned.—*John S. Saviello, Arlington, N. J.*

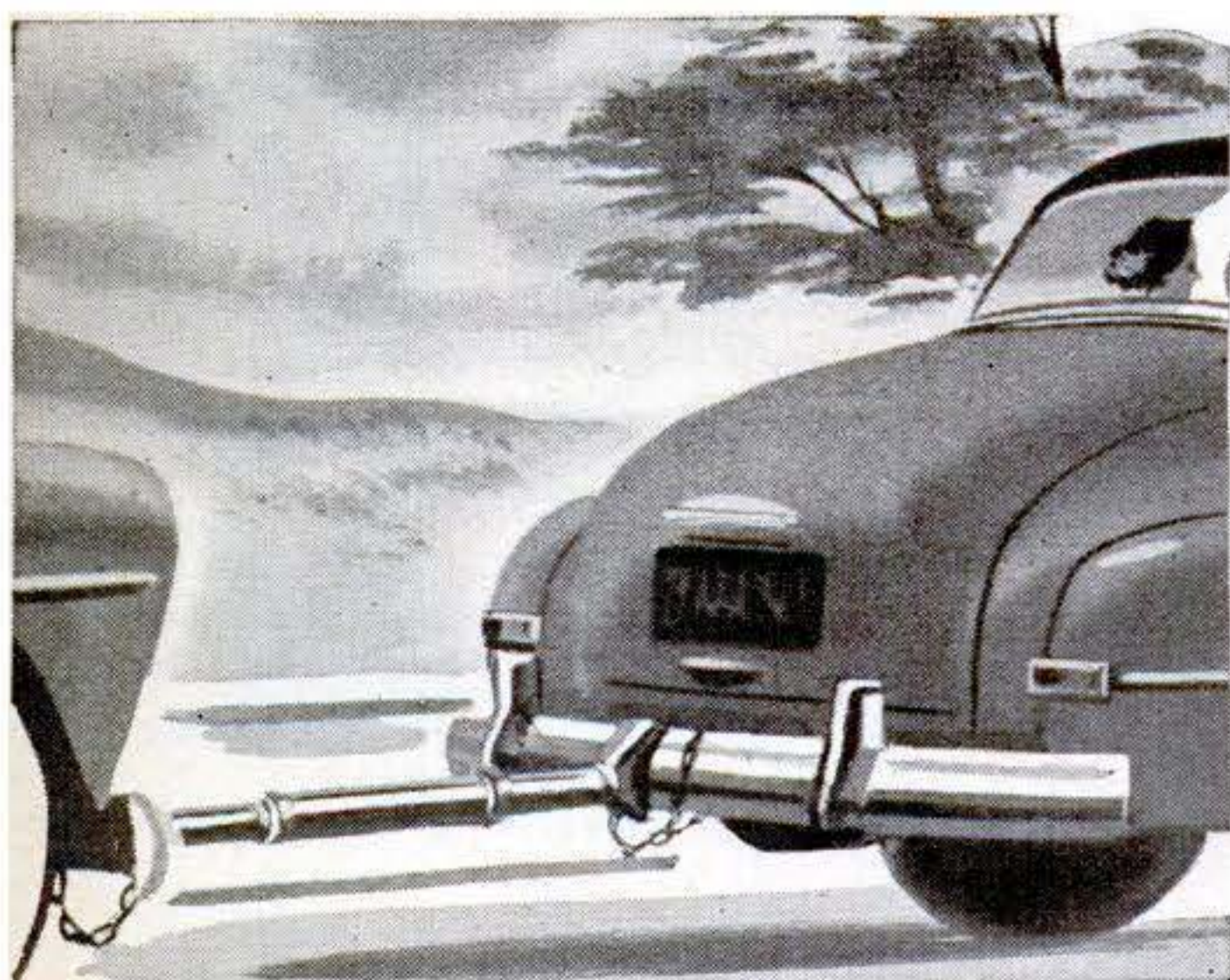

Hydraulic tow bars. These would be better than a towline since they'd take up the shock of starting when you towed another car. They should be small enough to fit the luggage compartment.—*Theodore Huddle, Deadwood, S. D.*

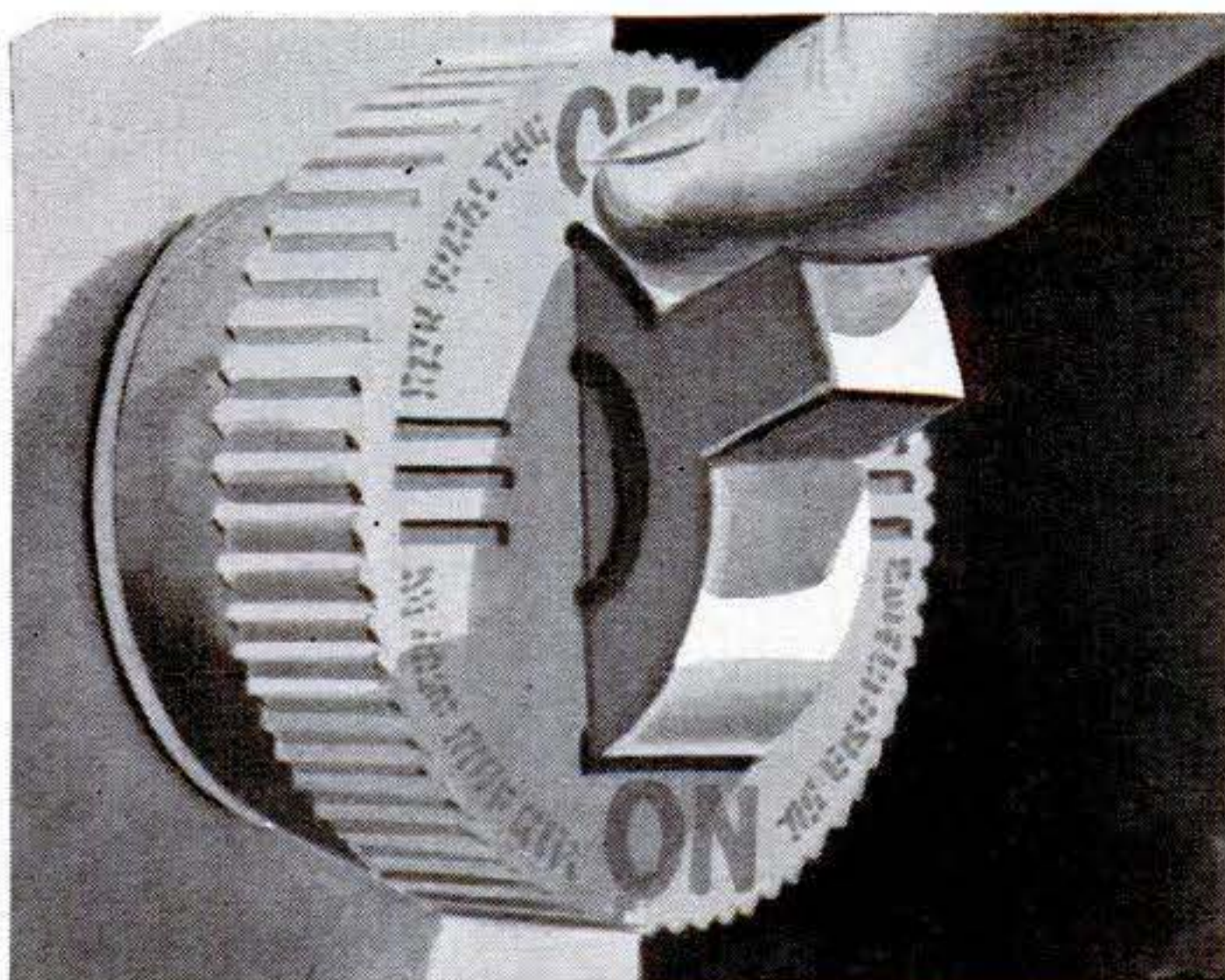

Circuit-breaker plugs. These plugs could be screwed into an ordinary home fuse box. Then when a short broke the circuit, you could just flip the lever to "on" instead of replacing a fuse.—*Bill Hall, Eugene, Ore.*

Folding Bed Built in Open Boat

YOU can make overnight trips in your outboard runabout when it's fitted with a folding bed like this one. Four pieces of $\frac{1}{4}$ " plywood make the bed for almost any 12' to 16' boat. All pieces are backed by $1\frac{1}{2}$ " hardwood framing for strength and to prevent the pieces from slipping off the seats. Headrest, attached to back of front seat with loose-pin hinges, also doubles as seat back. Pins can be pulled and headrest placed in position on the front of the seat. —Clinton R. Hull, Costa Mesa, Calif.



Sleeping pad, sheets, and blankets make comfortable bed. On this runabout the canvas shelter is folded forward for this photo.

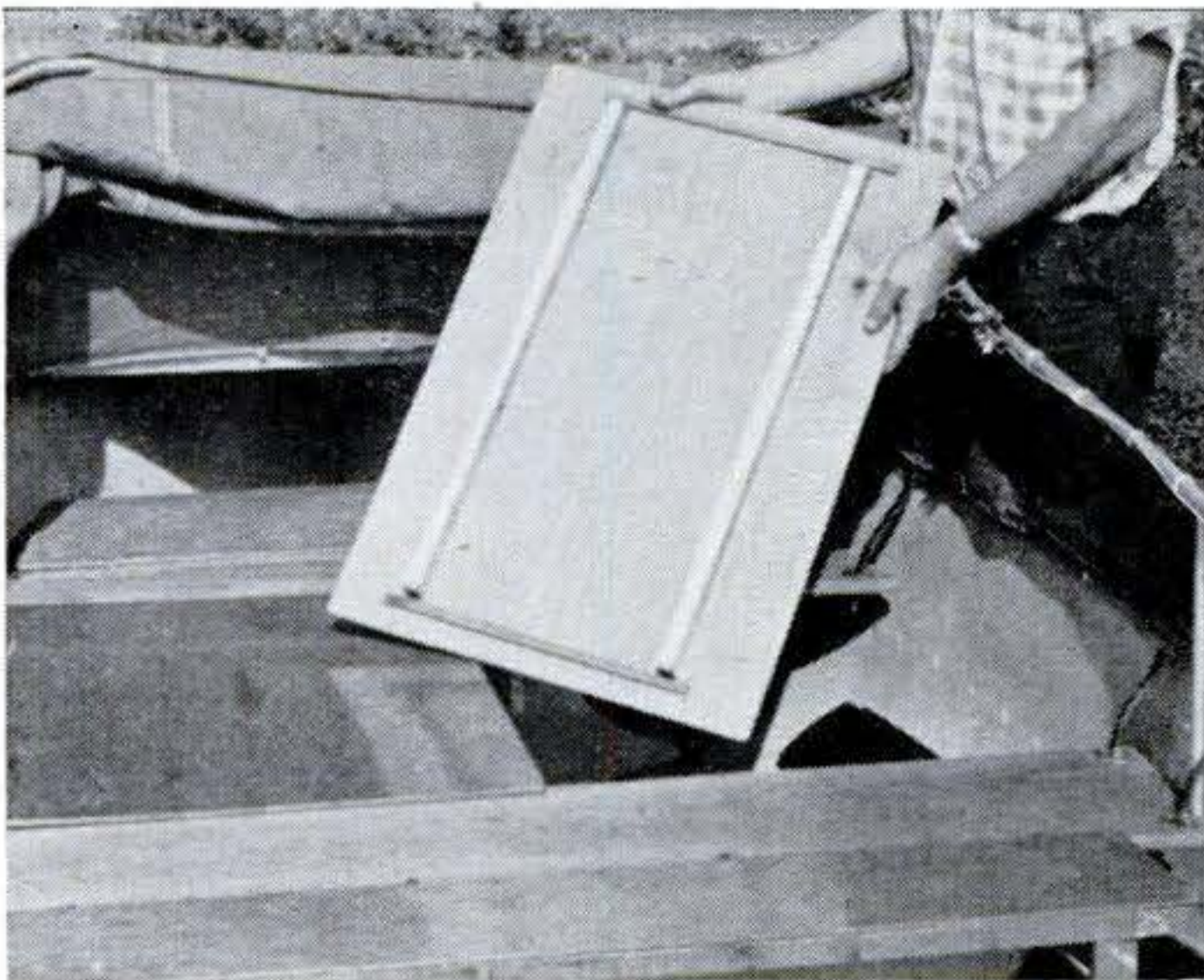

Hardwood ribs keep plywood sections from slipping off seats. Center sections, shown here, overlap front and rear seats by 1".



Legs hinged to top ribs of head and footrest convert them to tables for cooking and eating aboard. Bed roll is stowed forward.

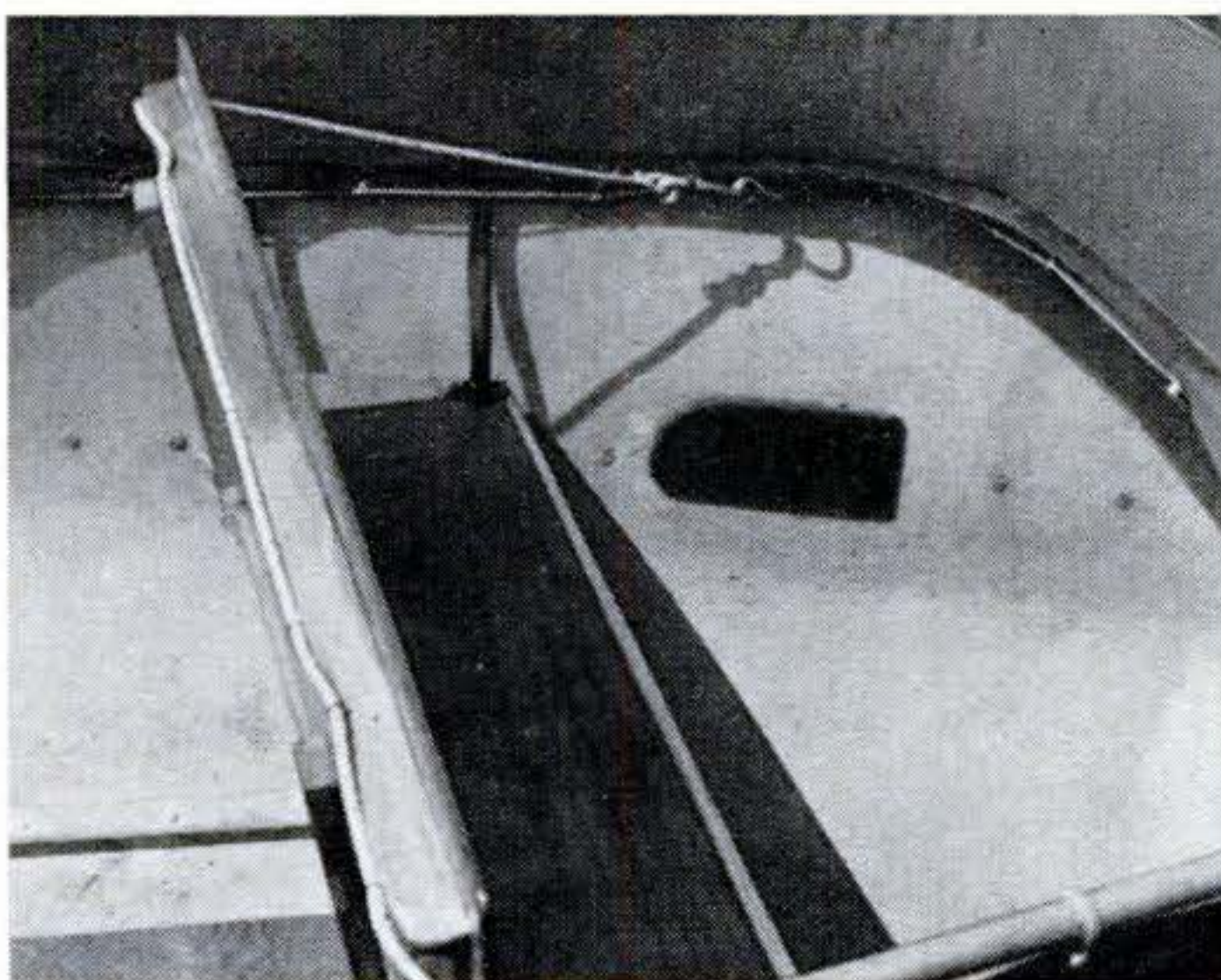

Headrest is also back of front seat. Rope holds seat back up. Block on side of boat is one of pair that support headrest when bed is made up.

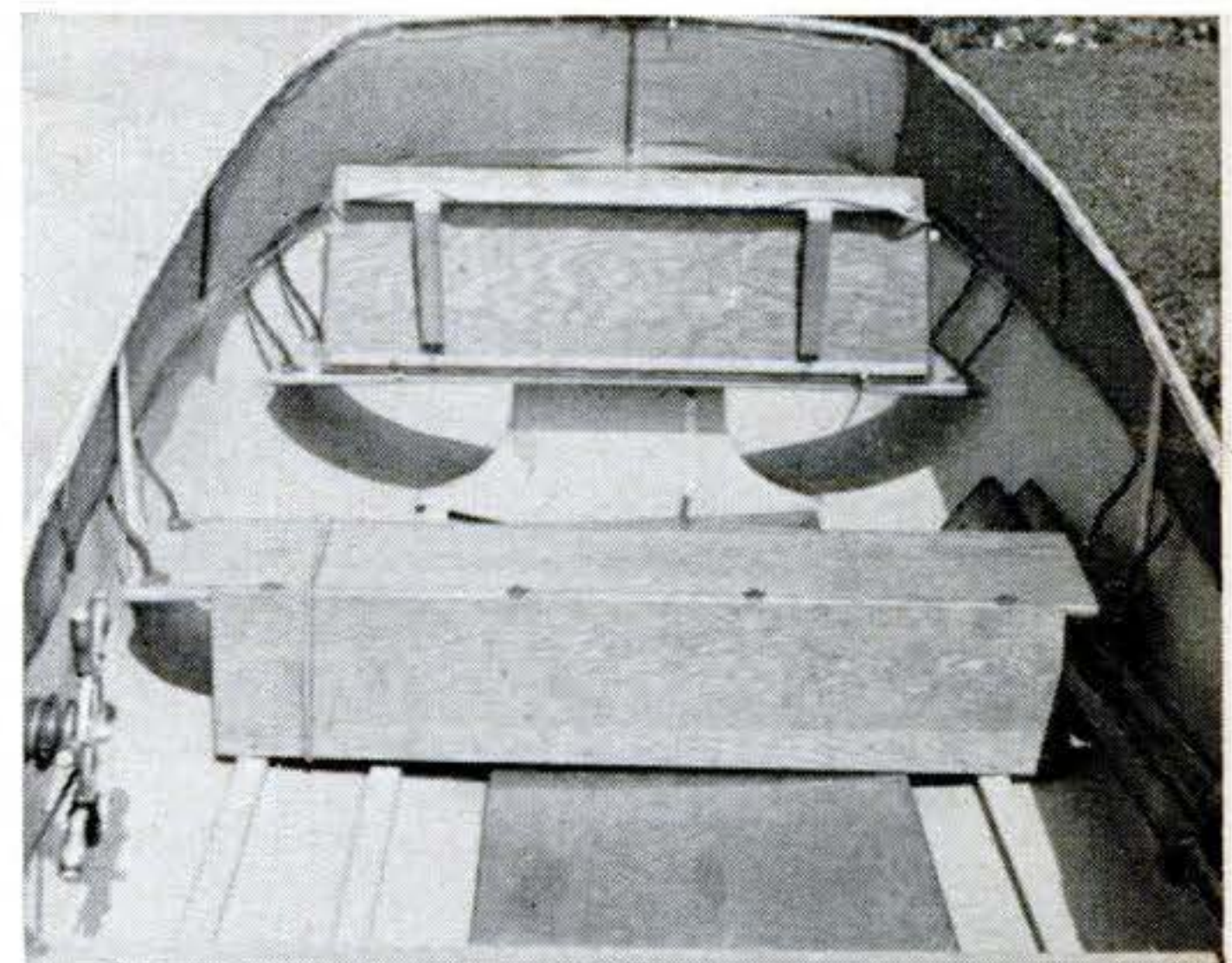

Looking forward. Headrest is in position as a seat back. Hinged legs of footrest have been folded, allowing footrest to drop out of way.

Details of chair are shown at right. Chair pivots on 2" pipe that is screwed into plate, 8" in diameter, bolted to the deck.

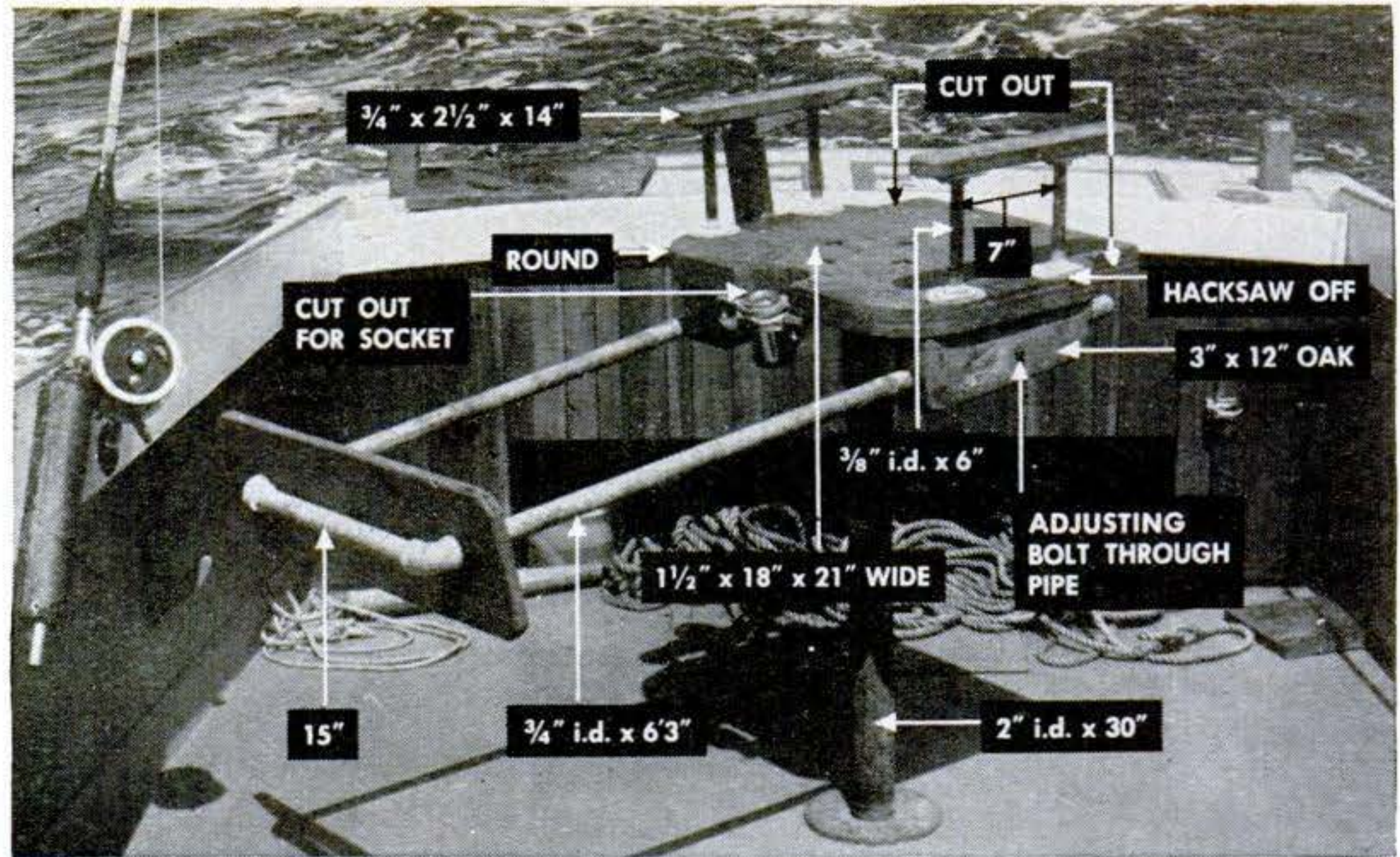

Fishing chair in use at left. Chair can be lifted off pedestal and pedestal unscrewed from deck plate for storage, leaving cockpit clear.

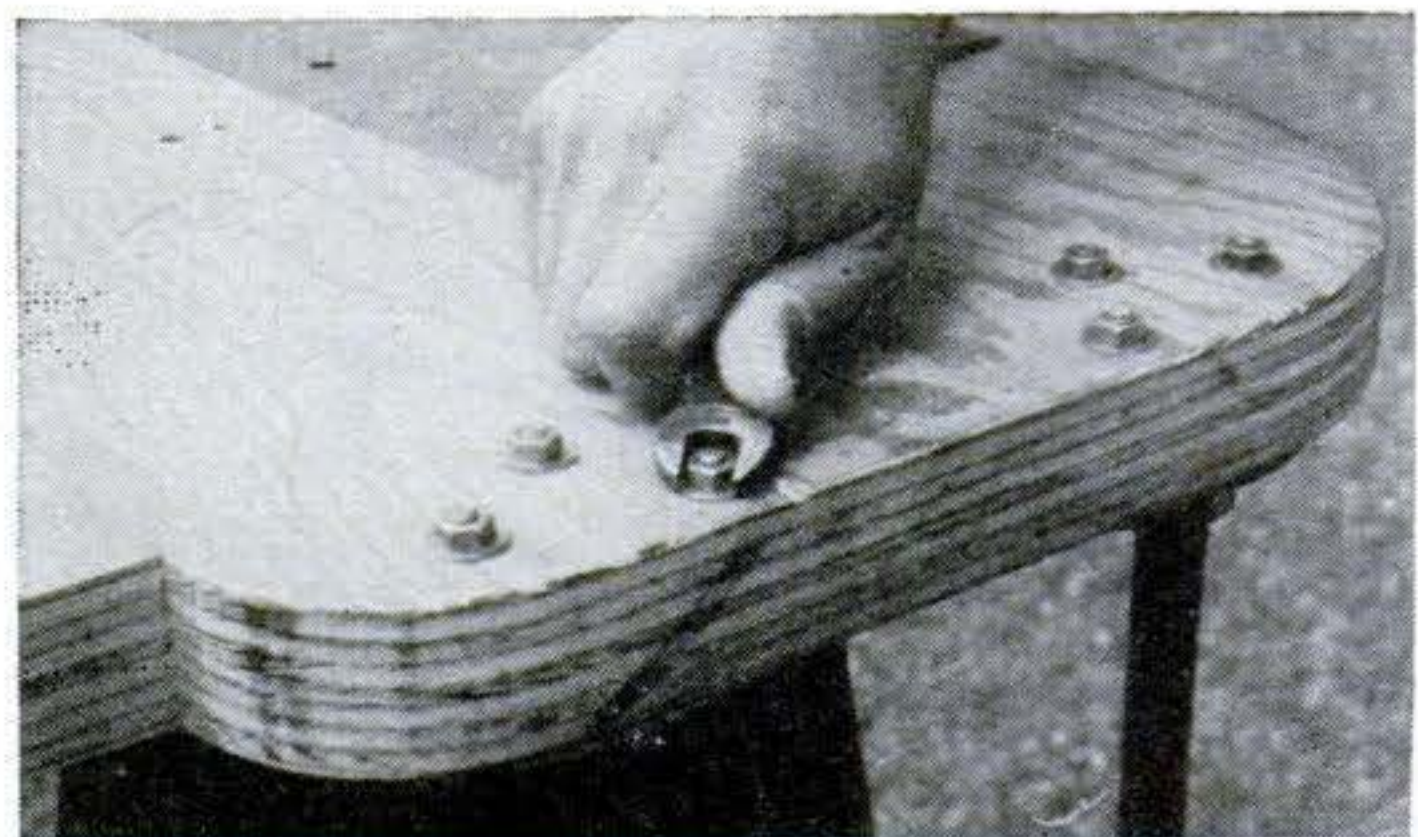

Bottom of seat is pictured above to show nuts that hold arm-support flanges, which are mounted overhanging seat edges.

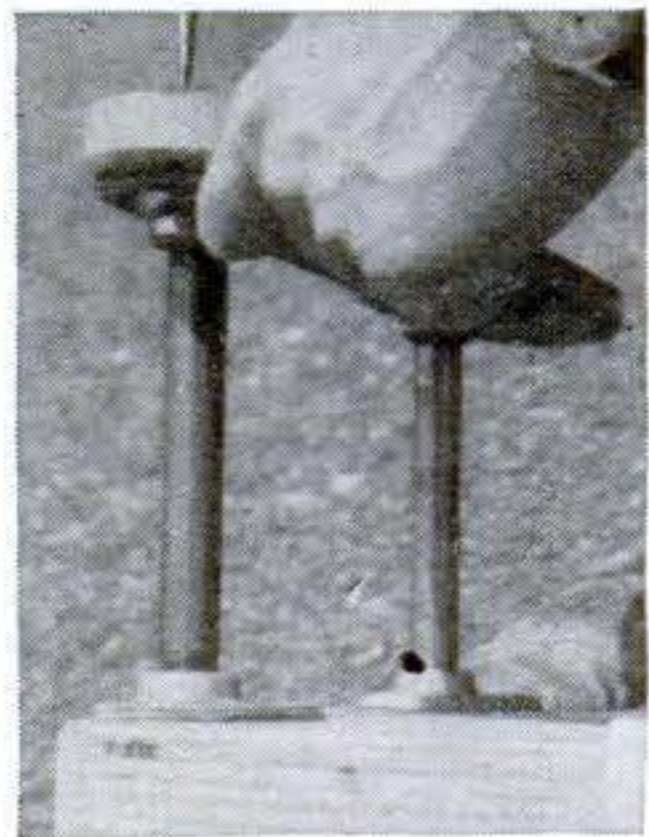

Arms being installed at right. Screwheaded $\frac{1}{4}$ " brass bolts are used through the arms and flanges. Nuts and flanges are underneath arms.

Build Your Own Fishing Chair

COST of a fighting chair for battling big-game fish can run into hundreds of dollars—if you buy it ready-made. Frank J. Mather, sports fisherman of Woods Hole, Mass., built the one pictured here for about \$25. Only part he didn't build is the rod-socket assembly. Two pieces of $\frac{3}{4}$ " waterproof plywood make up the seat. The footrest is adjustable by changing the adjusting bolts to various holes in the $\frac{3}{4}$ " galvanized pipe.—Elon Jessup, Woods Hole, Mass.

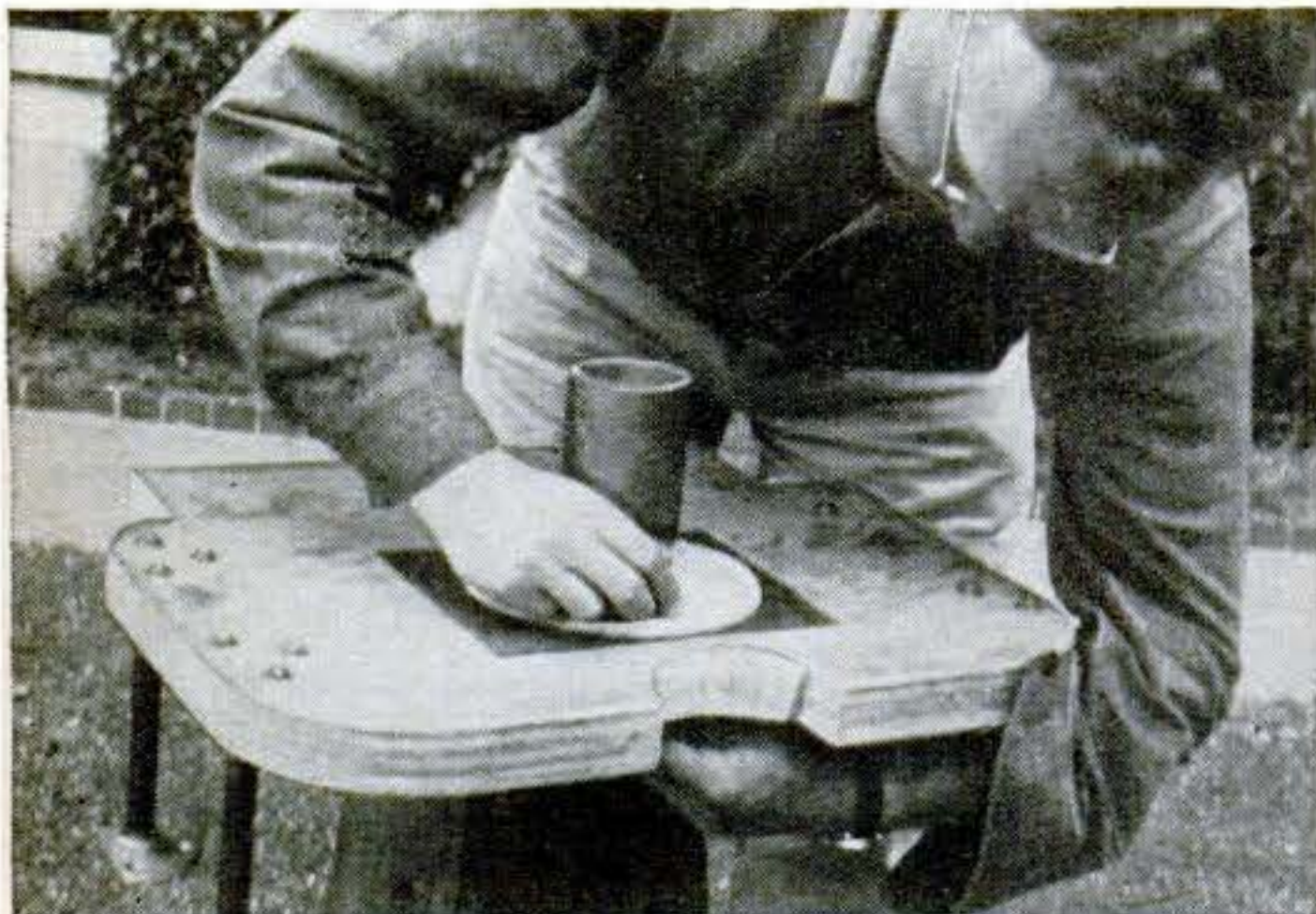

Details of under-seat assembly, left. Brass backing plate $7\frac{1}{2}$ " by 9" is screwed down. Flange is bolted down and 6" length of pipe

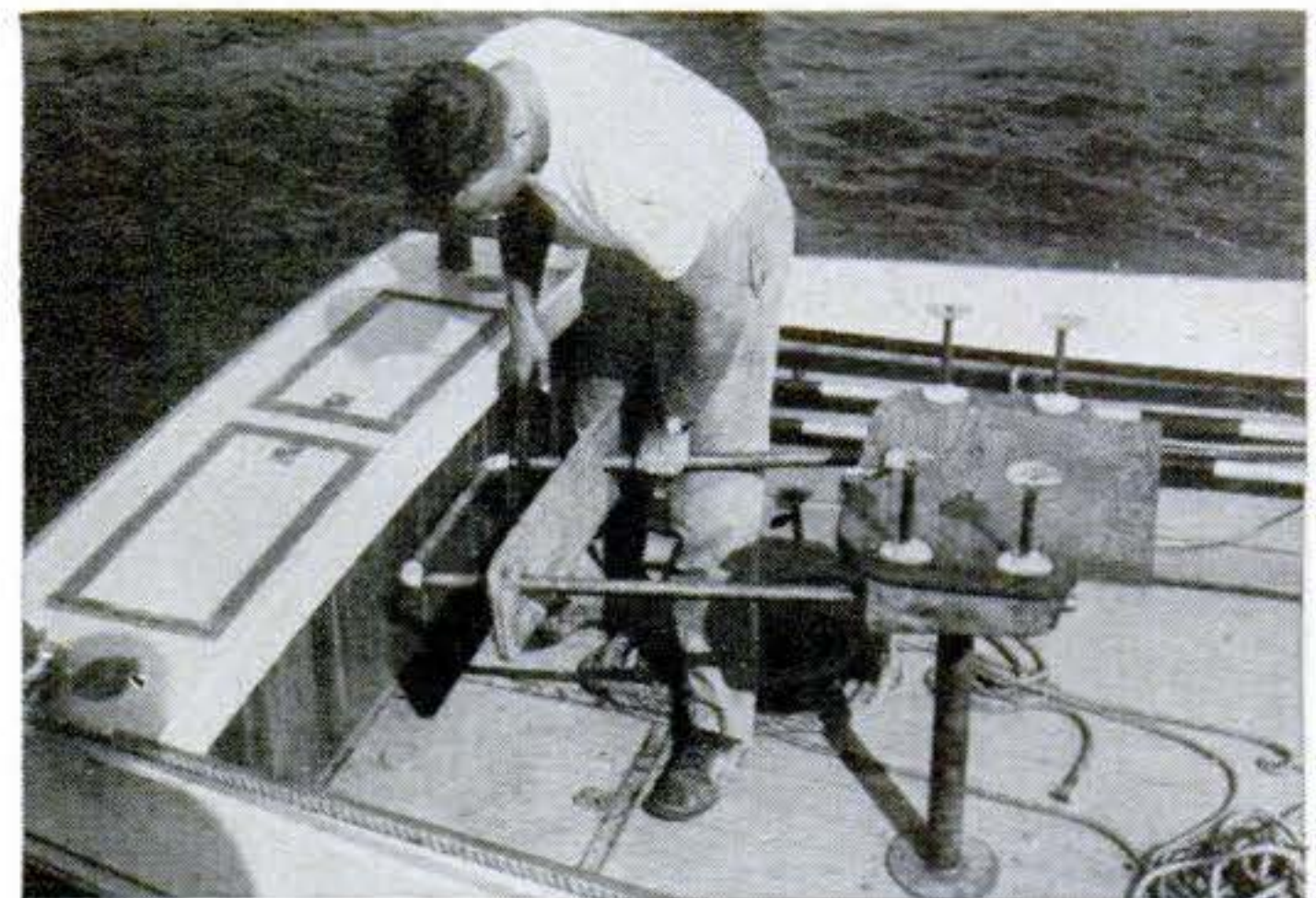

brazed to it. Top of 30" pedestal nests snugly in the 6" pipe so seat will pivot. Photo at right shows foot-brace installation of galvanized pipe.

CRAFTSMEN AT WORK



Siamese Twin Outboard. Two Akron, Ohio, men—Norman Lucky and Marvin Haas—converted a pair of droppable airplane fuel tanks to build this novel outboard runabout. After the tanks were cut

open and seats and upholstery installed, they were joined by a narrow deck that supports a 7½-hp. motor at the stern. Top speed is about 20 m.p.h. Cost of building the boat, exclusive of motor, was less than \$75.

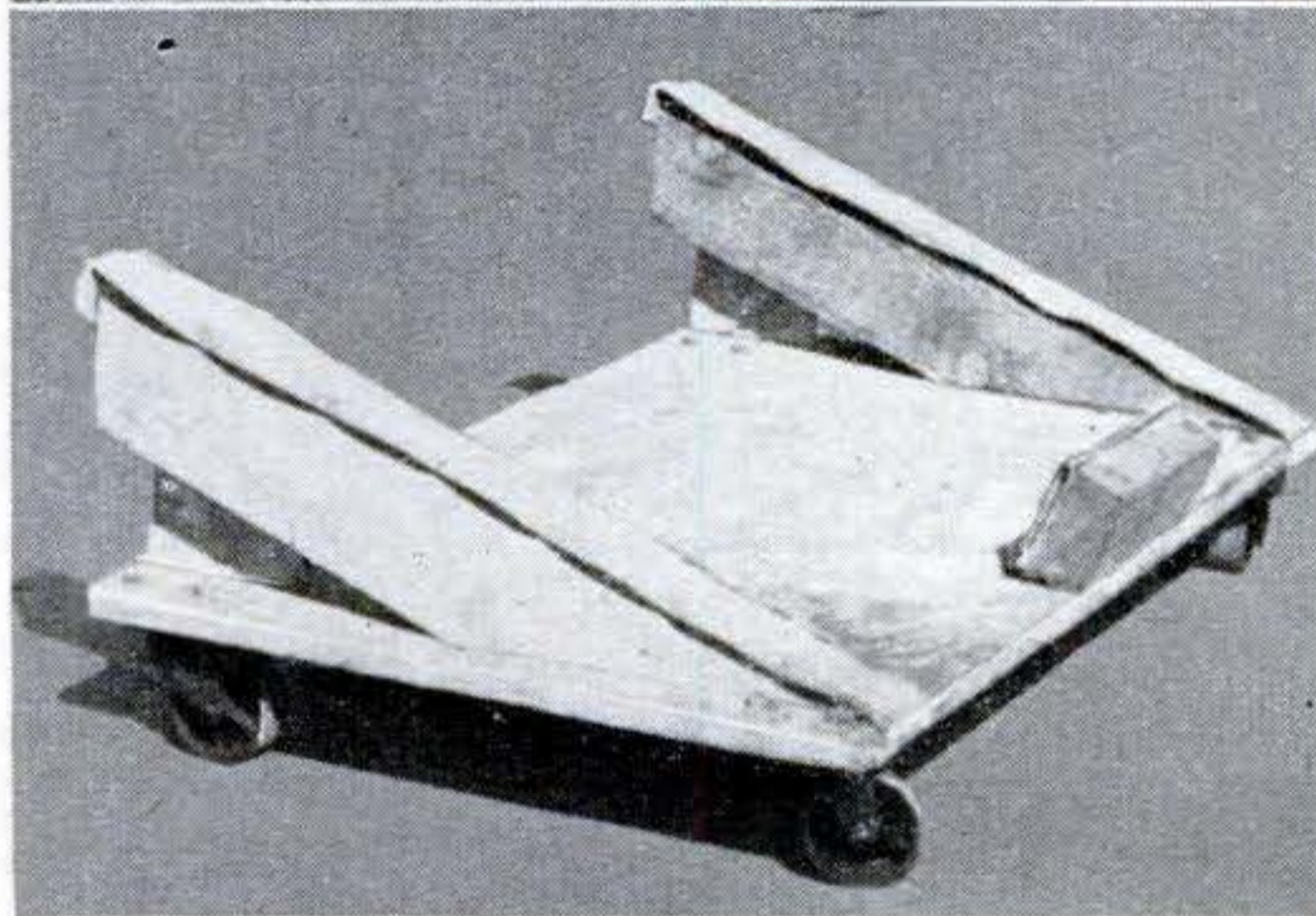
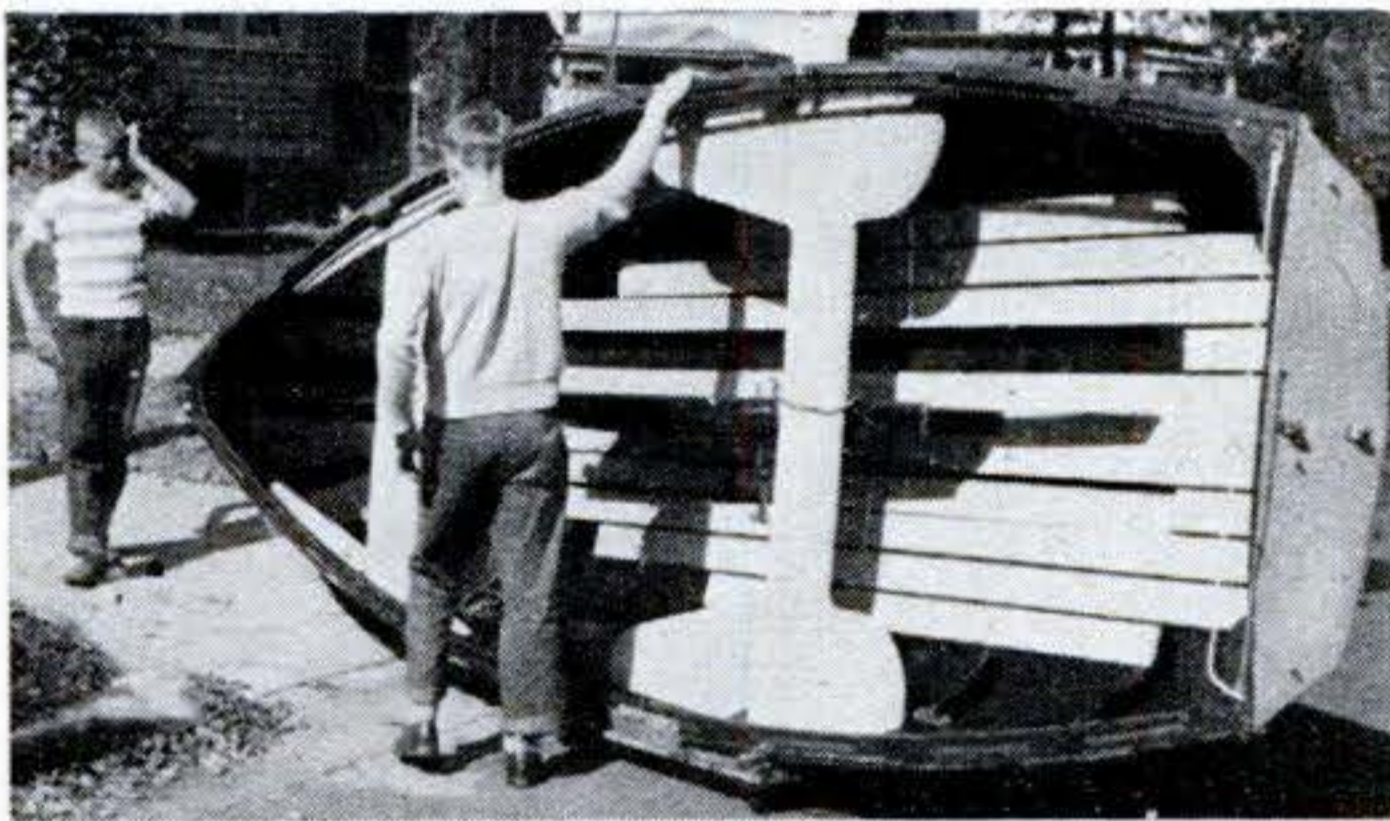

Dolly Stores Boat on Side. To save storage space and facilitate handling of his boat in his workshop-garage, Tom Severs, of Moline, Ill., built this side-mount boat dolly. He used scrap lumber, four large casters, and discarded fire hose for padding. In building this type of dolly, care must be taken so the boat's center of gravity rests on the dolly's center. Otherwise, the boat would tend to topple off the dolly.

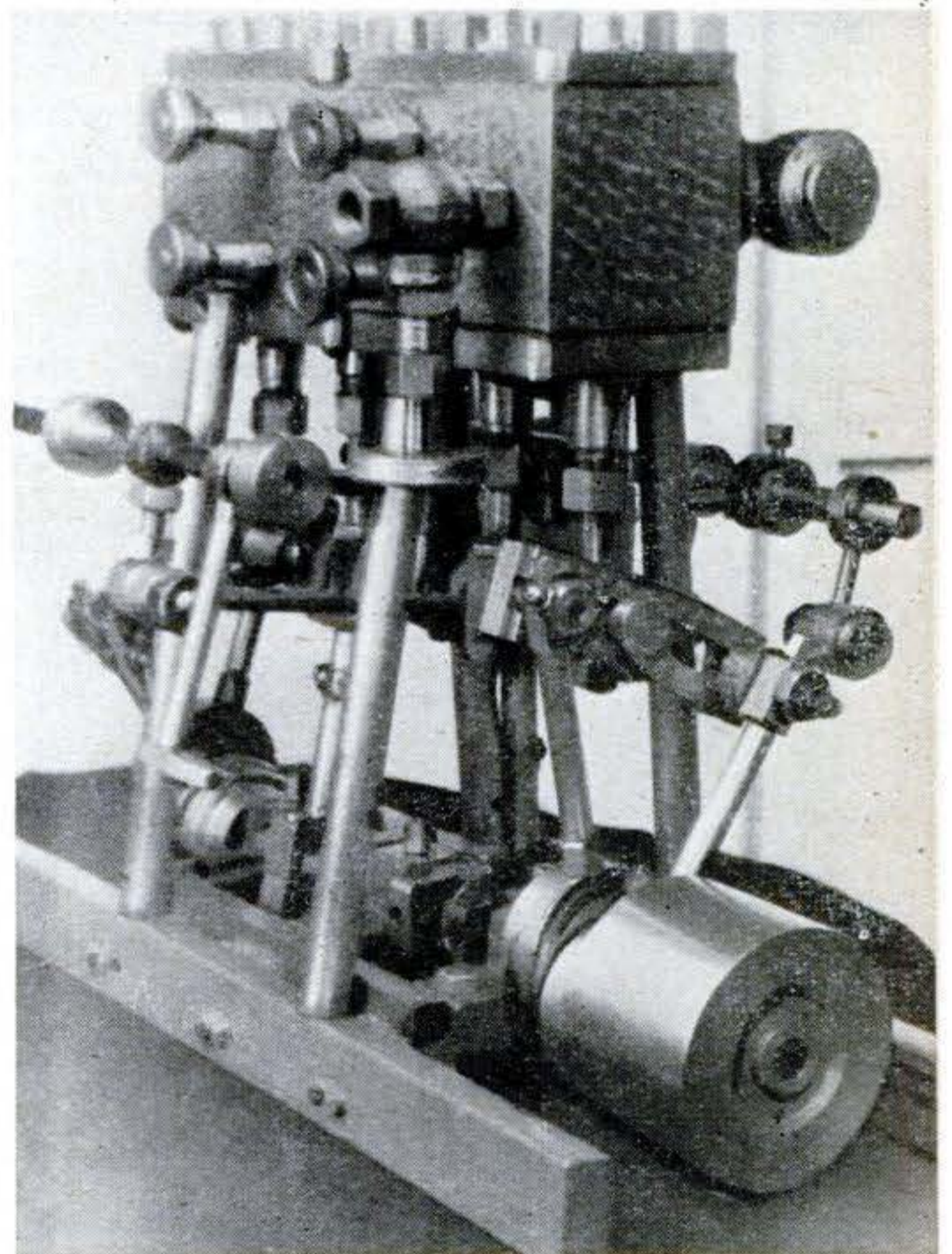

Engine Built with No Castings. This reversing, compound, marine steam engine, built by T. De Rosa, of South Vineland, N. J., measures 11" high and 12" long. No castings were used in its construction. It was built up of flat stock and rod stock and decorated with spot finishing. The engine has blow-off valves.

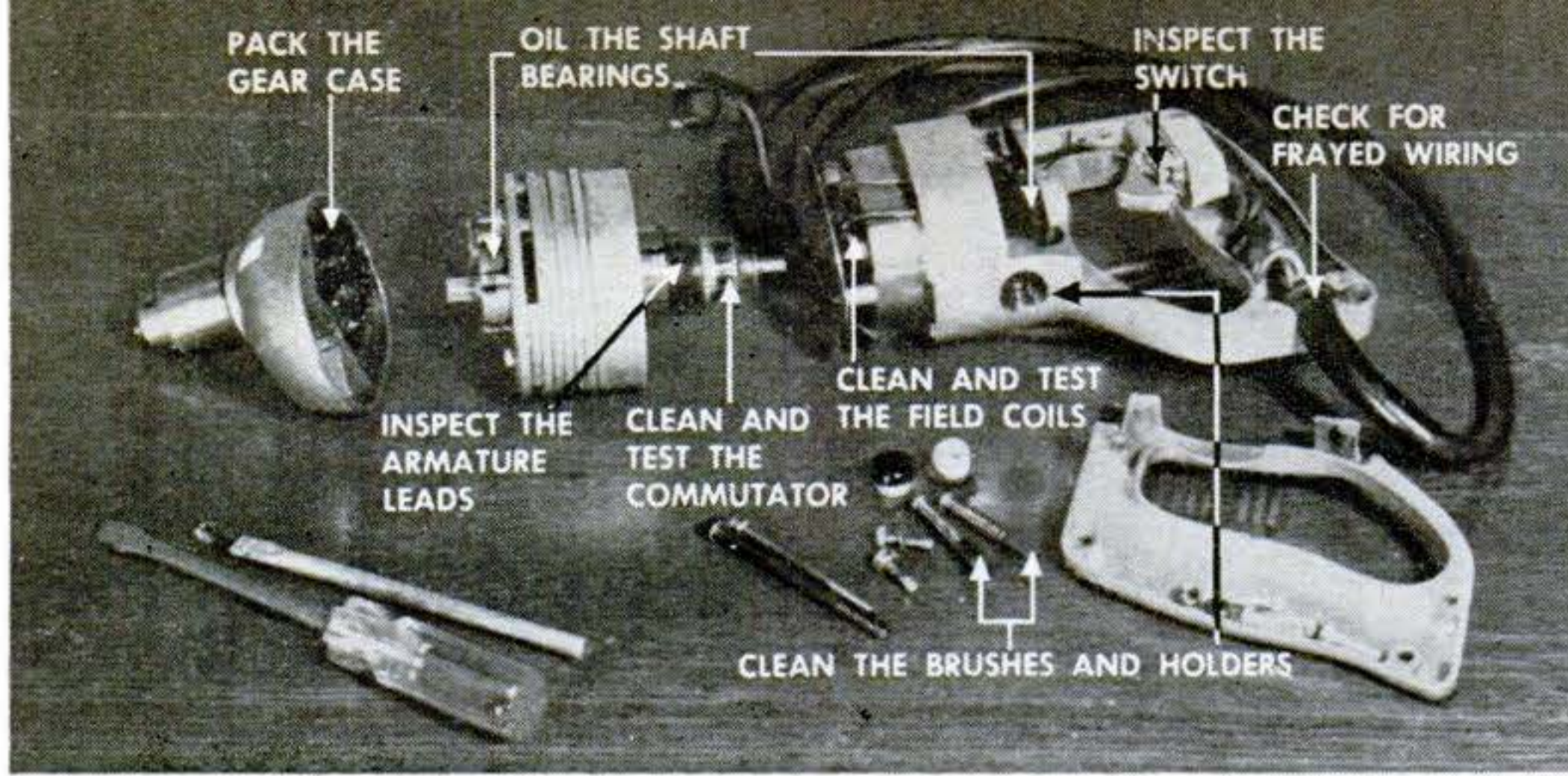

Most drills look like this when you get them apart, though the job of taking them apart will vary from one model to the next. Universal motors of this type are also generally used in vacuum cleaners, so new brushes and other replacement parts can often be found in vacuum-cleaner shops.

How to Pep Up a Drill Motor

By **J. W. Rocke**

ELECTRIC drills usually give a lot more service than they get. If your drill has lost its pep, it may be that the motor is pulling its weight in dirt or running on dry bearings. If so, you can put it back in top condition with a brush and an oilcan.

Or the trouble may run deeper. Defective armature and field coils can make a drill sluggish and unsafe to use. Coil rewinding is a tricky job, best left to specialists, but knowing when the job has to be done may minimize the damage and keep other parts from burning out.

What's wrong with *your* drill? These photos show what to check and how. The parts illustrated are standard for most drills.

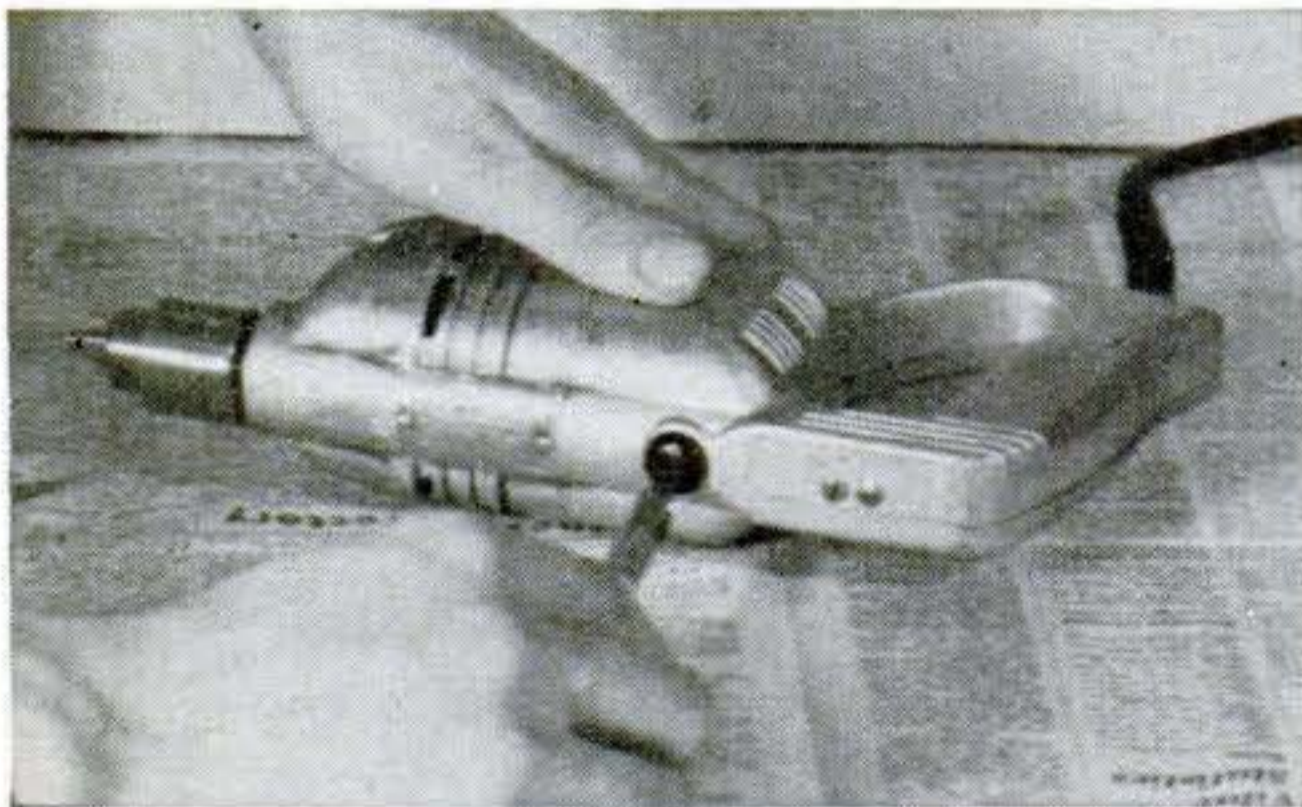

1

Remove motor brushes first. Unscrew the caps and lift the springs and brushes from their holders. Often you need go no farther to find trouble. Carbon brushes that are dirty, chipped, or excessively worn will cause arcing and loss of speed. They should be replaced.

To seat a new brush properly, wrap a strip of fine sandpaper (not emery cloth) around the commutator, grit side out. Fit the brush into its holder and rotate the armature by hand till the brush tip is shaped to match the curve of the commutator.

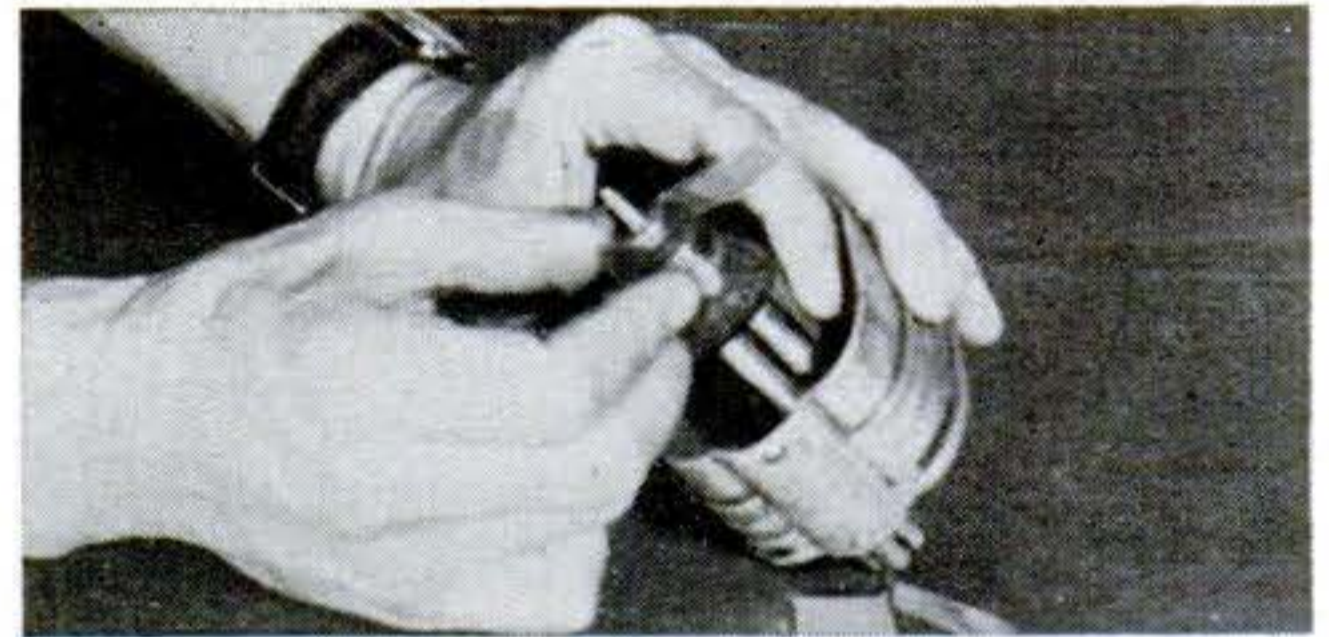

2

Clean the commutator and examine it for signs of roughness. Scored segments may cut down running speed. If the commutator looks okay, polish it with fine sandpaper. If it is out of round or badly pitted it will have to be trued up in a lathe. Mica separators will then have to be undercut—trimmed back so they lie below the copper bars.

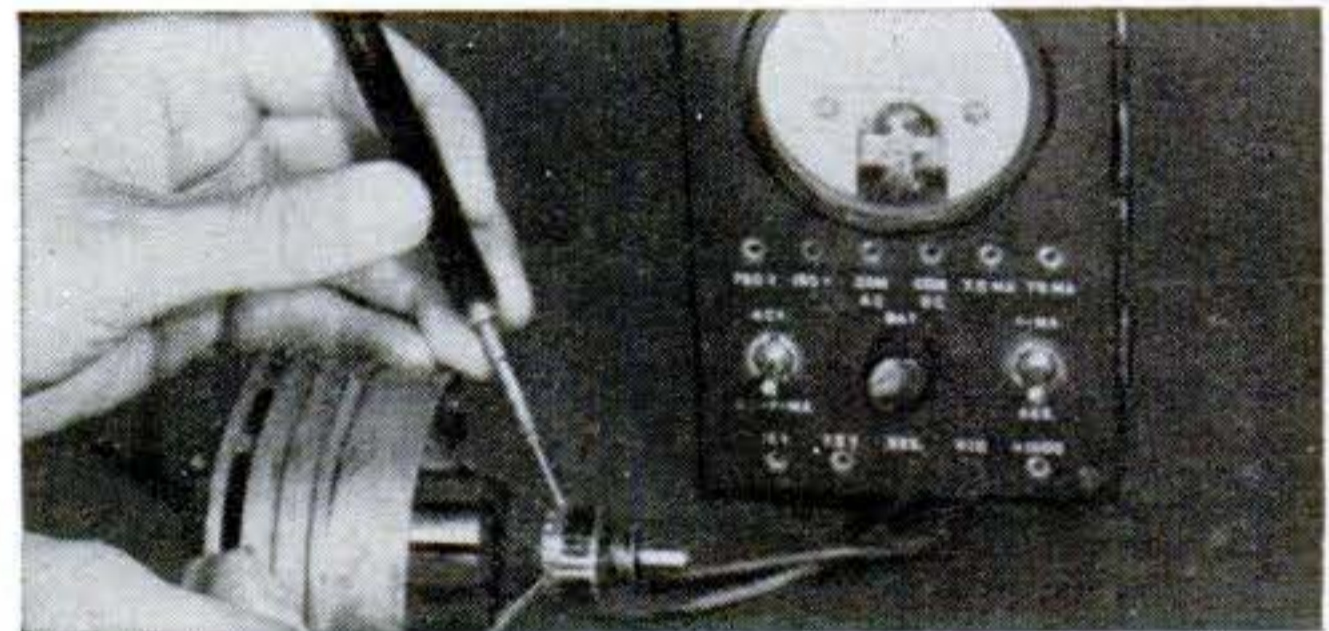

3

An ohmmeter will tell you whether the armature needs rewinding. Use it as shown above to measure resistance between any commutator segment and the one next to it. Then measure from the second segment to the third, from third to fourth, and so on around the circle. The meter reading should be uniform from pair to pair. If a reading is too low, a coil may be shorted; if too high, the winding may be open. Either defect can rob the motor of power.

If the winding is grounded to the armature shaft, your drill is a shock hazard. To check this, touch one test prod to the shaft and the other to each commutator segment. If you get any reading, have the armature rewound. If you don't have an ohmmeter, make this test with a continuity checker. You can improvise one by wiring a bulb and a pair of test prods in series with the 115-volt line.

4

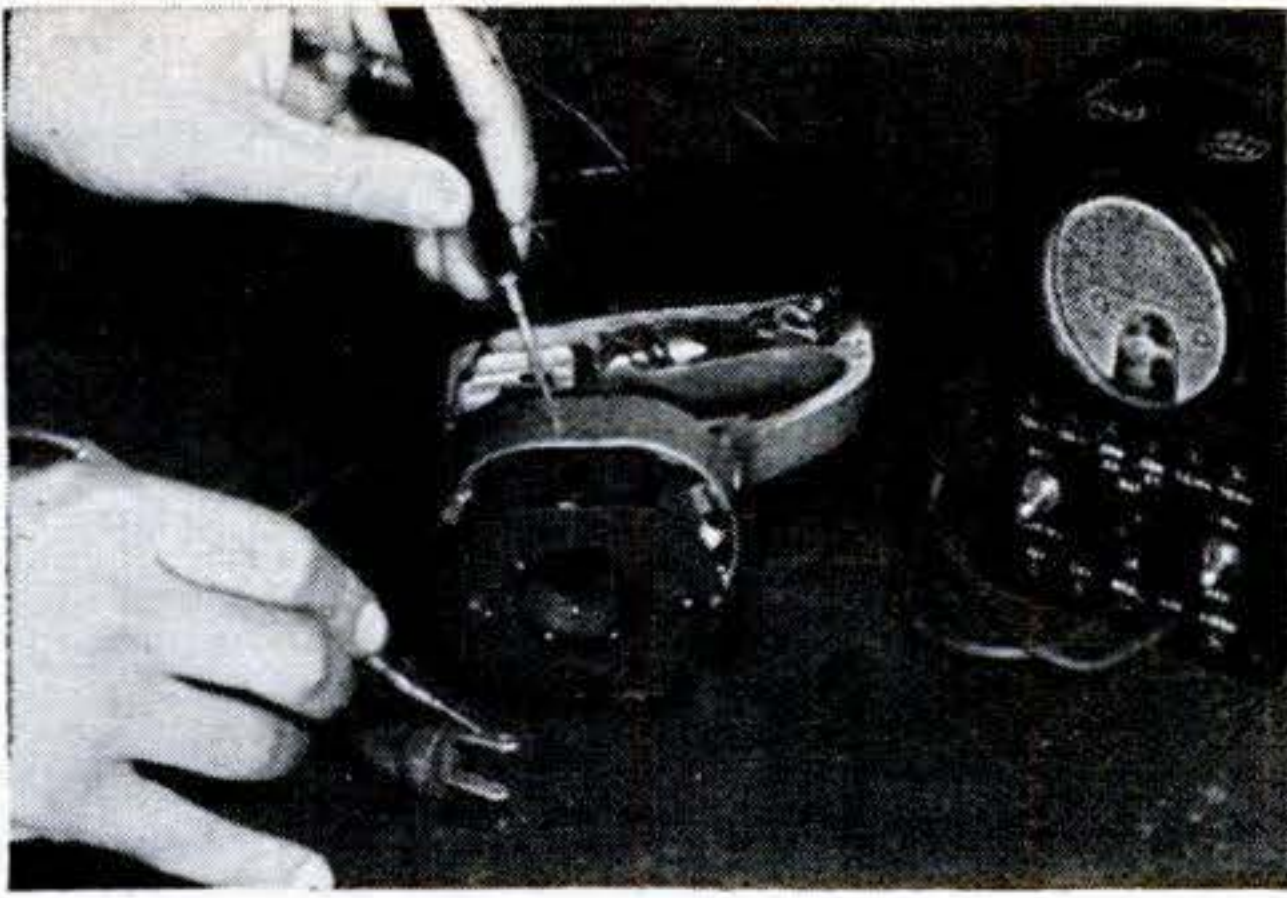

For safety, also test continuity between each side of the power cord and the case. There should be absolutely none. A "hot" drill handle conceivably could kill you. Examine the wires particularly at the point where they enter the handle. If they look frayed, cut away the damaged part or replace the whole cord.

Trace the wires that leave the field coils; one usually goes to a brush holder, the other to the power cord. Test between these points and the frame to make sure there are no grounds.

5

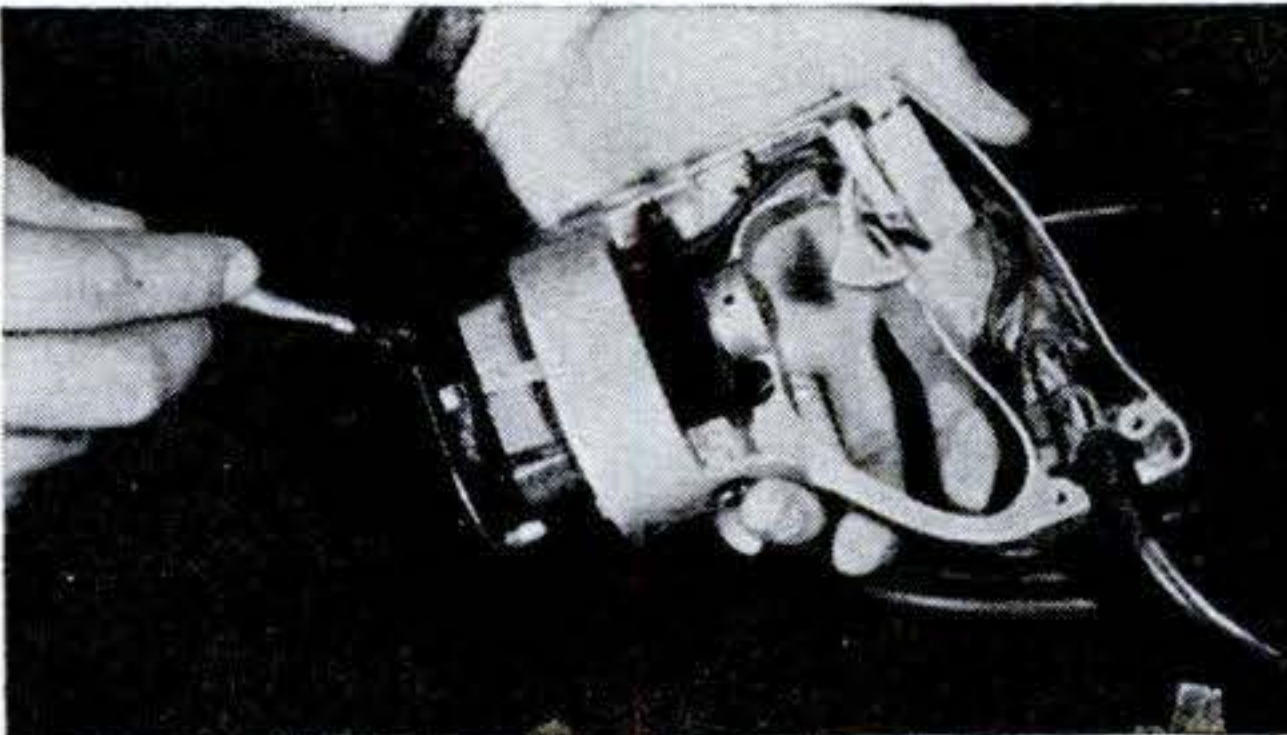

Visual checks can also give a lot of information, but to see properly you must first get rid of dust and grime. Brush and blow off as much dirt as possible, and clean the bearings, shafts, commutator, brushes, and coils with carbon tetrachloride. Examine all parts carefully for signs of scoring, pitting, excessive wear, burnt insulation, and the like.

6

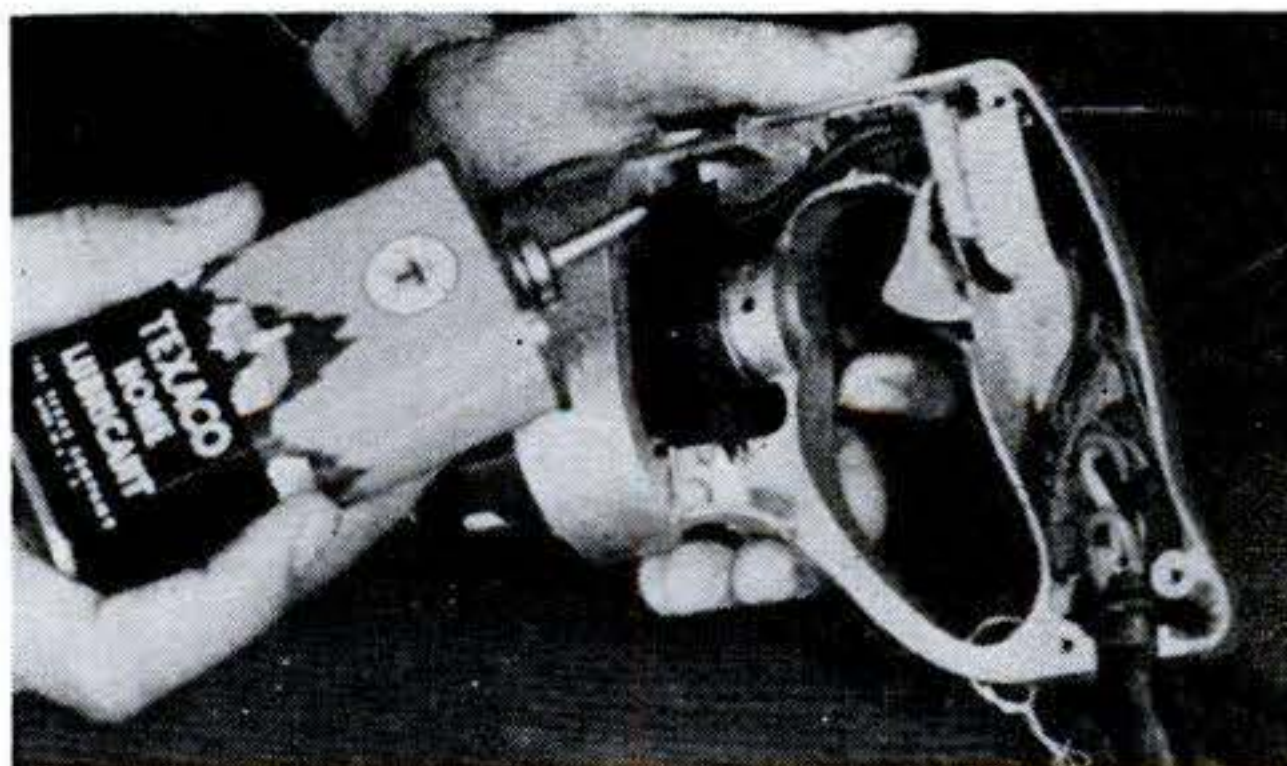

Lubricate the bearings. A drop or two of light machine oil will help keep your drill running smoothly. Oil holes are often placed inside the castings so proper lubrication is only possible while the drill is disassembled. Don't use too much oil, for the excess may work onto the commutator and foul the brushes. If there are no oil holes the drill probably has sealed bearings that need no lubrication.

7

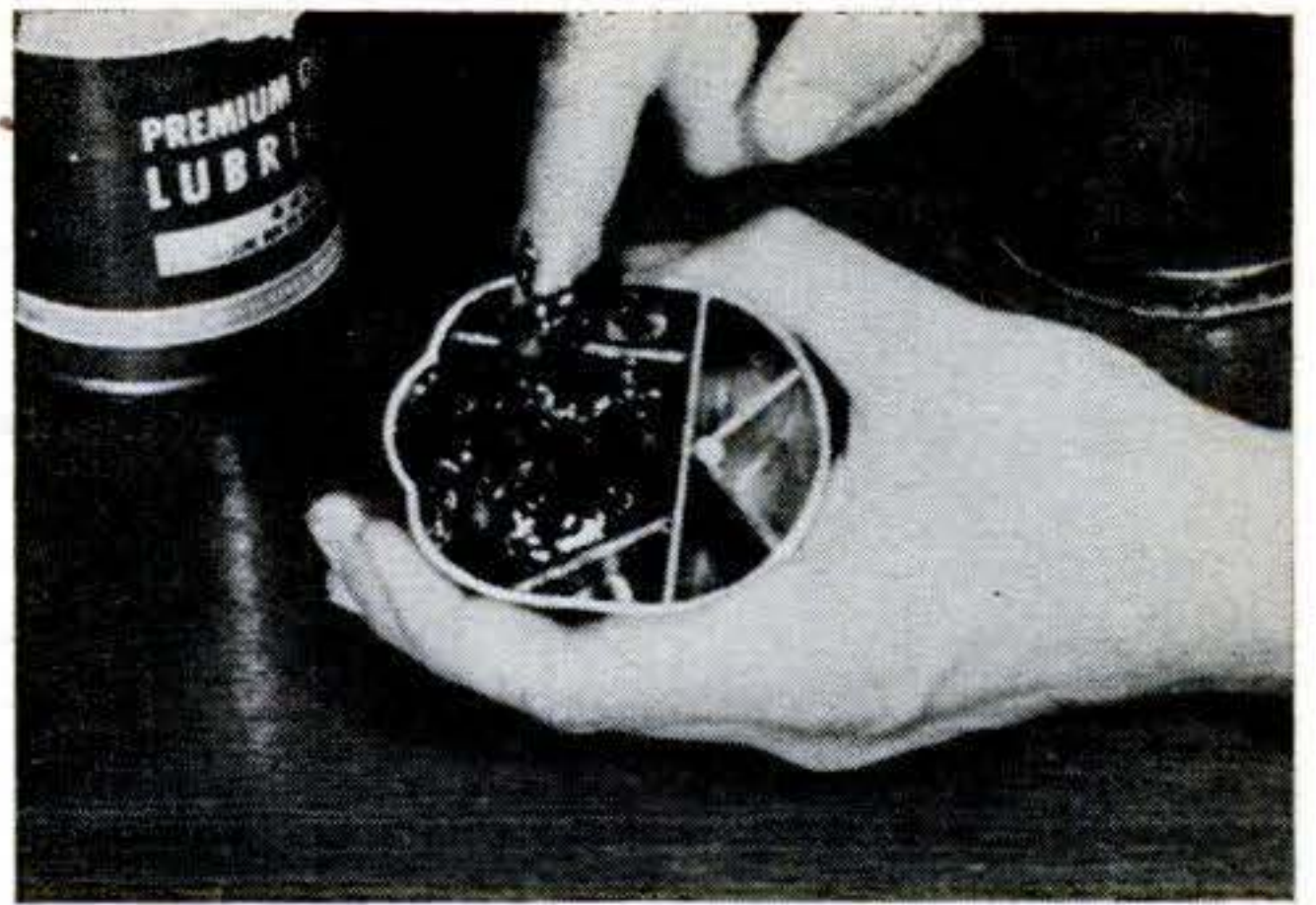

The gearbox can be lubricated with a mixture of graphite and light grease. Never pack the box solidly, for too much lubricant can create a power-robbing motor drag. Excess grease will also tend to leak out. Take careful note of the gear positions before removing them to pack the gearbox.

8

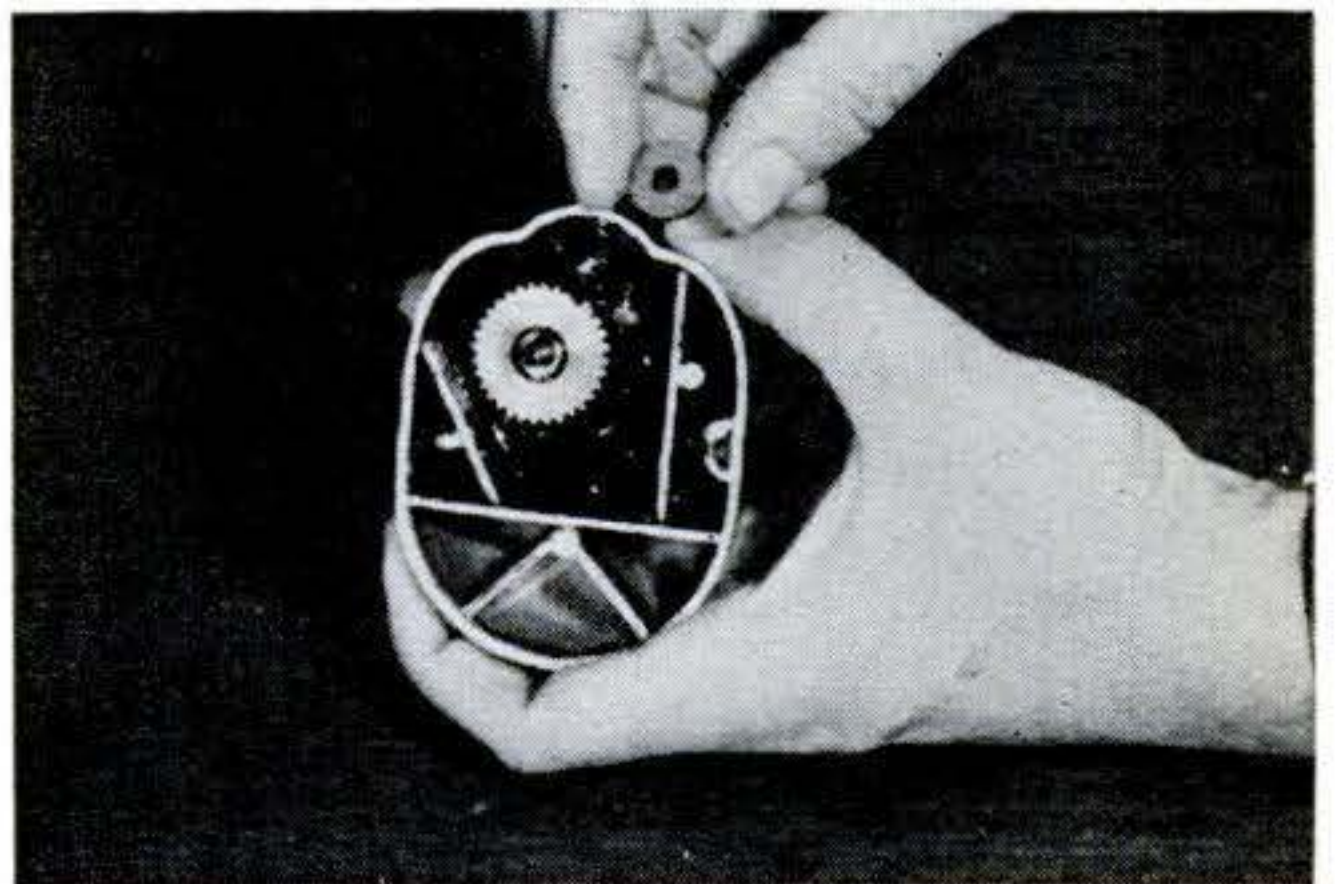

Thrust washers are used in most gear housings to prevent end-play between the gears. Worn washers will make the gears noisy. Chipped or broken gear teeth may cause premature wear of the gear train. Faulty parts should be replaced.

9



Reassemble the drill carefully. It should never be necessary to force any part into place. Tighten all screws evenly. Those shown join the two halves of the motor housing; if they are drawn up unequally, they may cause misalignment that will tend to bind the armature and gear shafts.

As a final precaution, repeat the continuity test by putting one prod across both prongs of the power plug and touching the other prod to the case. If you get any reading, the drill is unsafe.

END

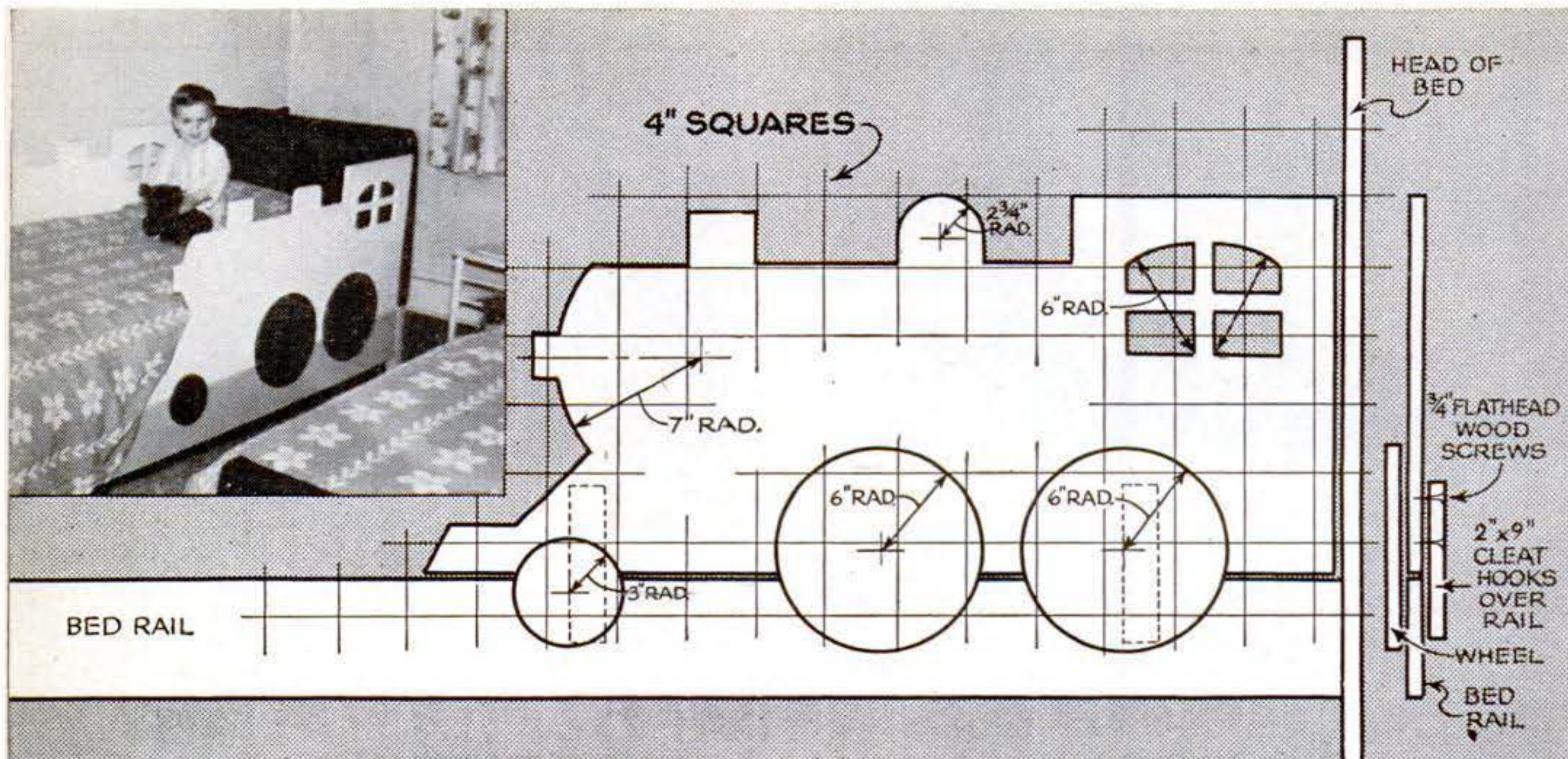

All Aboard for Slumberland!

WITH a sheet of $\frac{1}{2}$ " plywood and a jigsaw, you can make it fun for Junior to go to bed—as well as keep him from rolling out during the night.

Cut out the locomotive silhouette and butt the bottom edge on top of the bed rail.

After sawing out and painting the wheels, tack them in place so they overlap the rail. A clamping cleat also goes on the back. This makes it easy to remove the locomotive when Junior outgrows it.

With this side on his bed, a child can graduate directly from a crib to a full-size bed—Robert V. Stewart, Cleveland, Ohio.

Hard-Soldering Broken Saw

REPAIRING a broken bandsaw blade will save you money. I do the job with a special clamp, made by cutting a notch $\frac{1}{2}$ " deep and 1" wide in a closed butt hinge.

File the broken ends of the blade as shown. Clamp them close together in the hinge and grip one of the two clamping bolts in a vise. Put a little flux and a dab of silver solder on the joint and turn your torch on it.—W. V. Carter, Washington, D.C.

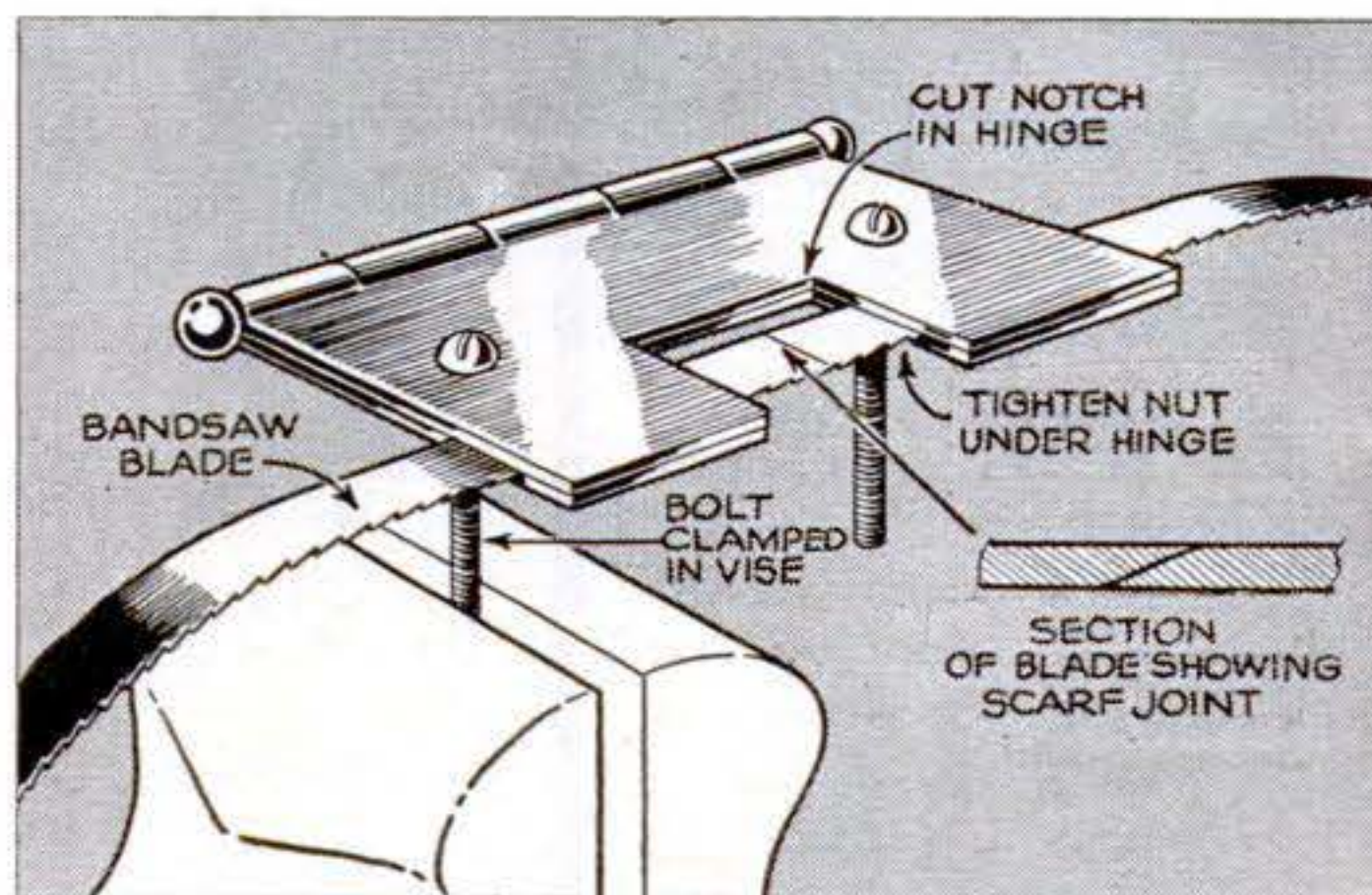

Pipe Extends Reach of Clamp

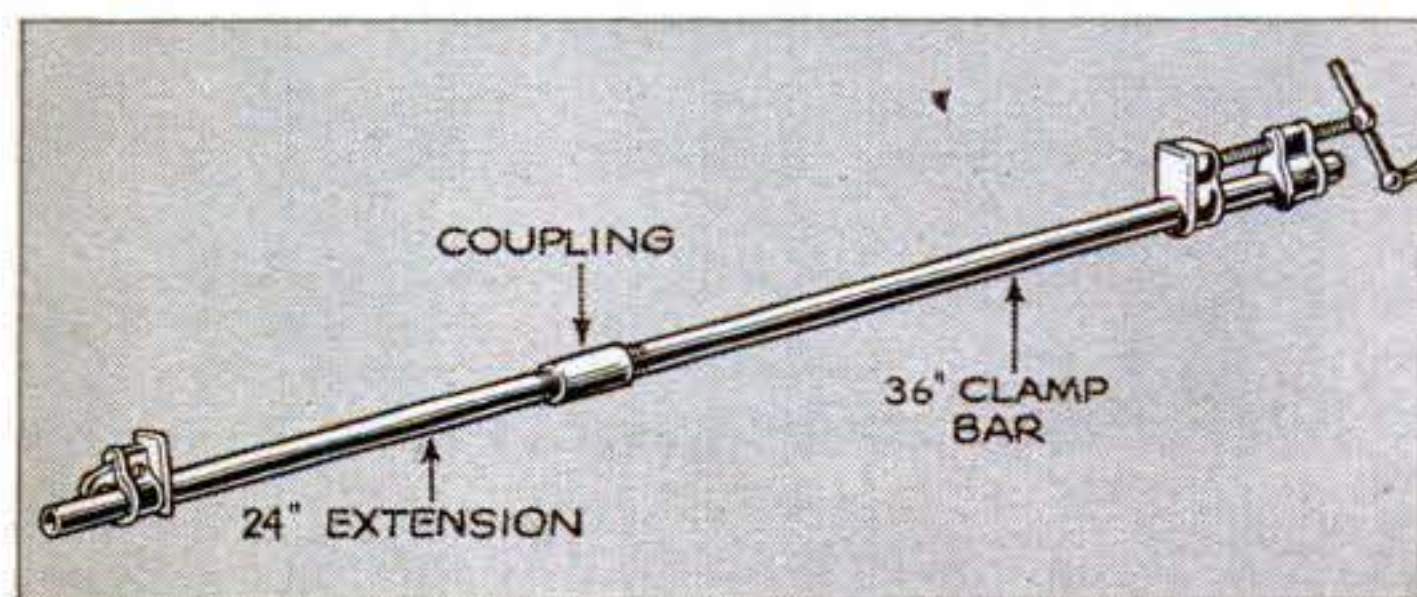

WHEN I set out to glue up a panel 55" wide, I found that the only available cabinet clamp had a maximum reach of 33". To extend it, I coupled a 24" piece of $\frac{1}{2}$ " pipe to the 36" length on which the clamp jaws were originally mounted. That did it. The removable extension makes the clamp easy to store.—Wally Farnsworth, Los Angeles.

Car Louvers Ventilate Wall

LOUVERED hoods from old-model cars in a junk yard can be used to make wall ventilators. The louvers below came from an old Nash.

With a solvent, clean the grease and dirt from the metal. Cut a piece of the louvered part of the hood to the size desired for the ventilator. Mount it with small screws to the back of a mitered frame of 1" by 3" baseboard stock. Paint the frame and ventilator to match the wall and nail in place over the wall opening.

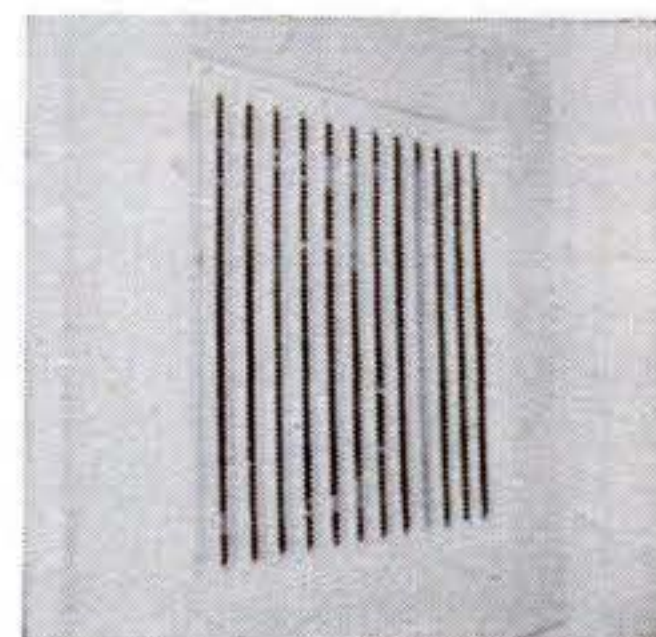



A. Kodak Auto-Release—Lets you get in the picture; snaps it for you about 10 seconds after setting. Fits any camera that has cable release socket. Double spring insures shutter tripping. Grips cable release firmly. \$4.25.

B. Kodak Metal Cable Releases—Take shot after shot without jarring camera. Excellent for time and bulb exposures. Non-stretching braided metal won't kink. 7- and 12-inch, \$.99 and \$1.17, respectively.

C. Kodak Eye-Level Tripod—"Steady does it" for still or movie camera. Quarter turn locks legs at any height from 2 to 5 feet. \$23.33. And *Kodak Turn-Tilt Tripod Head* allows effortless panning with multiple-disk, felt-friction clutches. \$15.46.

D. Kodak Service Range Finder—Good-by to guesswork in focusing. Just look through eyepiece, adjust knob until split image becomes single unit. Read scale for focusing distance. Split-field-type finder permits close adjustment even in poor light. With case, \$14.58.

E. Kodak Carrying Cases—Here's smart appearance and protection—the *Kodak Snapsack*, for Kodak "Tourist" models and many similar folding cameras. \$3.95.

F. Kodak Field Cases—You "wear" your camera 'round your neck for instant use without removal from the case. Illustration shows field case on Kodak Flash Bantam f/4.5 Camera. Prices of field cases start at \$2.50.

See all these—and many other helpful Kodak picture-taking accessories—at your Kodak dealer's

Prices include Federal Tax where applicable

Kodak
TRADE-MARK

EASTMAN KODAK COMPANY, ROCHESTER 4, N. Y.

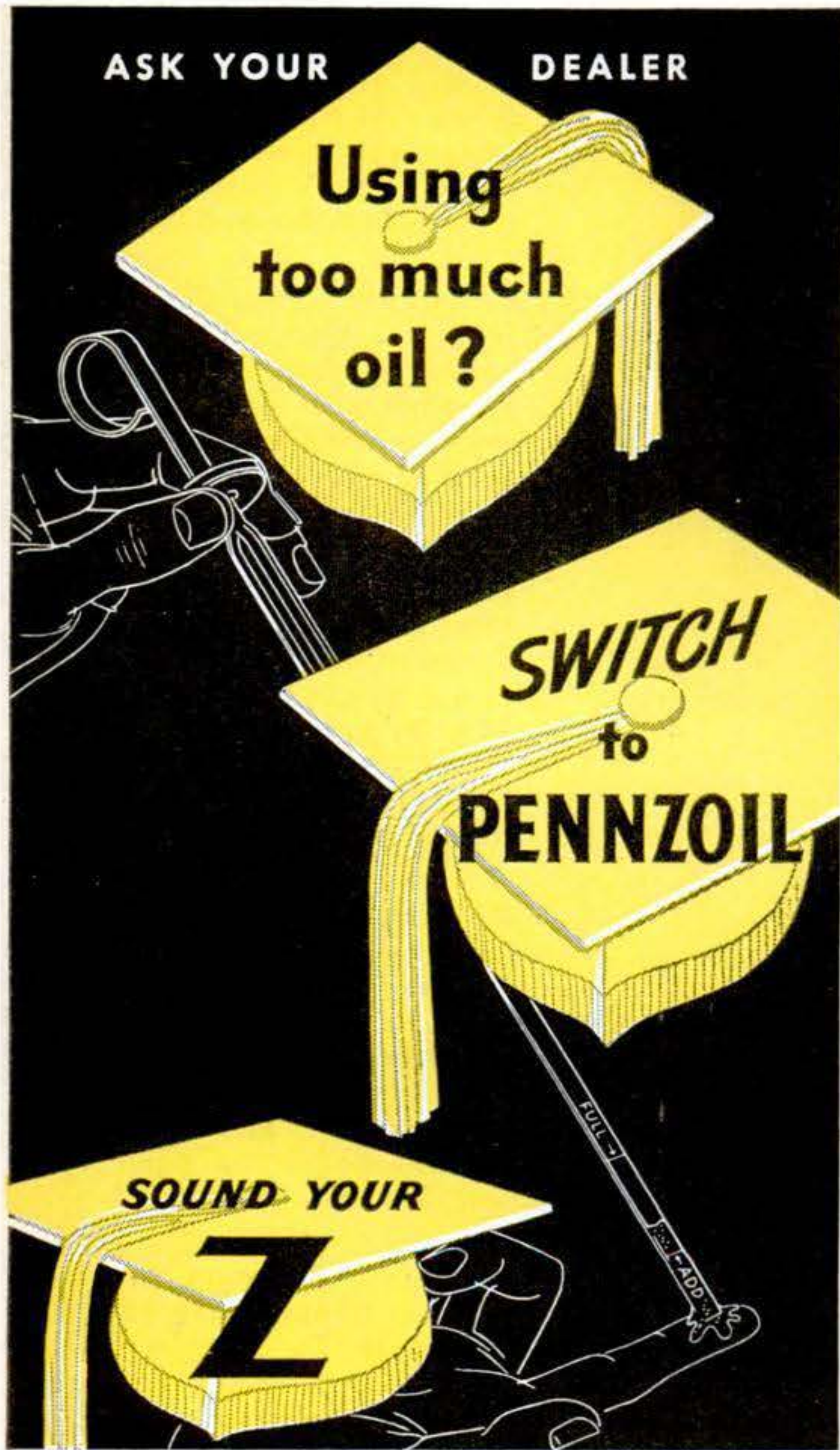

If you suspect you've been using too much oil, find out with your next oil change. Switch to Pennzoil, the 100% Pennsylvania motor oil that lasts longer, grade for grade.

Over 60,000 better dealers recommend Pennzoil at the yellow oval sign. Drive in now and sound your "Z" for the genuine.



Member Penn. Grade Crude Oil Assn., Permit No. 2

**TOUGH-FILM PENNZOIL® MOTOR OIL & LUBRICANTS
AT BETTER DEALERS... COAST TO COAST**

Mechanics of Farming



By Ladd Haystead

■ Tractors powered with butane are sweeping the southern part of the nation. Neither the oil companies nor the farm-equipment people are promoting the change, but farmers are making their own conversions for economy. As one Mississippi planter put it to this reporter, 'I save the labor cost per day of the driver by switching to butane.' Besides cutting fuel bills, operators say, the tractors require less maintenance, partly because there is no dilution of lubricating oil by liquid fuel. (On butane-fueled trucks, cylinder walls show no wear even after 300,000 miles of operation.) However, the change is limited to areas close to the source of supply, because the cost of shipping butane cylinders long distances eats up the saving in operating costs.

■ Airplanes seeded as much as 50,000 acres of pasture land apiece in a Government-sponsored project last year in the West. The planes drop pellets that contain, besides the seed, fertilizer, rodent repellants, and a growth starter. This year extensive areas of reforestation as well as range land will get the airplane treatment.

■ The Atomic Energy Commission announces that 'farmers cannot expect increased yields from money invested in radioactive materials.' But at the same time, the AEC emphasizes that radioisotopes have made a great contribution to the understanding of how fertilizers react on plants. Sixteen agricultural experiment stations have obtained valuable results in the last year in radioactive phosphorous 'tracer' research.

■ On the mineral-rich lands of the West, bumper crops could be produced if only there was water. In the past, this meant heavy Government expenditure for enormous dams. But recently, fresh interest has been generated in underground rivers and lakes, such as one now being devel-

IT'S

EVINRUDE for the features that make FISHING more fun!

● If fishing's your sport, mister... get a *real fishing motor!* Get the great fishing features that mean more fun every run... for years to come! Features such as Evinrude Gearshift... Evinrude Duo-Clutch... Evinrude Fisherman Drive... and scores of other advancements that have made Evinrudes favorites with fishermen for more than forty years!

See your Evinrude dealer. Choose from a complete series of models in the most popular fishing sizes... and for standout performance on fast fishing boats, try the thrilling new Fastwin with Gearshift and Cruis-a-Day Tank... the new Fleetwin with Duo-Clutch and Safti-Grip Propeller Drive. See the two deluxe models for smaller fishing craft—the Sportsman and Sportwin with the famed Fisherman Drive that lets you power through weeds, over rocks and shoals... "wherever there's water to float your boat."

NEW LOW PRICES start at less than \$80.00. Time payments available. If you now have a motor this is the year to trade it in! Ask your dealer for an appraisal. Look for your dealer's name under "Outboard Motors" in your classified phone directory.



New FASTWIN 14 H.P.*

New FLEETWIN 7.5 H.P.*

Free CATALOG

Write today for free full-color catalog of Evinrude's 1950 lines of fishing motors and Hi-Power models for largest outboard boats. Address EVINRUDE MOTORS, 4498 N. 27th Street, Milwaukee 16, Wis.

In Canada: Evinrude Motors, Peterboro, Ontario



*O.B.C. certified brake H.P. at 4000 R.P.M.

GEARSHIFT

New HANDLING EASE

DUO-CLUTCH

NEUTRAL STARTING

New SMOOTHNESS

S-L-O-W TROLLING

CRUIS-A-DAY TANK

FISHERMAN DRIVE

FIRST IN OUTBOARDS

EVINRUDE

41st YEAR

JUNE 1950 243

Mechanics of Farming

oped in the Estancia Valley of New Mexico. Here, there is no visible running water, but a young sheepman named Walter Mayer gambled there was a lake under the valley. He prospected for water--not oil--and hit. Now wells 60 to 300 feet deep provide 2,000 gallons per minute each--sufficient to irrigate 150 acres. The land, once worth only a few dollars an acre for grazing, is producing fabulous crops of as much as 4 tons of alfalfa per acre (usual average is $\frac{3}{4}$ ton), and the land is being quoted at \$200 per acre. It is possible that lands in the more humid climates may also be sitting on lakes. If so, the droughts that have cut farm income may be offset by drilled wells to provide stand-by watering in dry years.

■ Ties and poles discarded by the railroads each year amount to 3,000,000 tons of raw wood pulp, according to Dr. William M. Murray, Jr., director of Southern Research Institute, Birmingham, Ala. This equals one-seventh of the total annual needs of the country's paper industry. Paper bags and wrapping paper made from the discarded material are somewhat weaker than those made from new wood, but further research may raise the strength to the level of new-wood paper. Dr. Murray also suggests that sericea lespe-deza, the widely popular forage plant of the South, may provide a source of pulp from the woody stalks left after the livestock feed is harvested. Experimental runs have already proved them useful in paper manufacture.

■ Paper towels for cows is the newest wrinkle in bovine sanitation, says Cornell University. Instead of washing and cleaning a cow's udder with a cloth towel, which might carry infection from one cow to another, paper towels are used and then thrown away. The claim that this method will materially reduce the \$600,000,000 yearly loss from mastitis is greeted with some reserve by veterinarians, who point out that mastitis seems to be caused by traumatic injury, cold stalls, etc., as well as by transference of infection.



*How long's that muck
been in my car?*

Too long, Mister, it's engine-wrecking stuff...and if you want to duck some unpleasant repair bills...you need a new Purolator Refill for your oil filter...quick!

If you've been neglecting to have your oil filter checked, chances are there's horrible muck like this in your car. So when you change your oil this summer, start fresh with a *new filter refill*.

Be sure you get a Purolator Refill. Filters more *completely*, hence saves more substantially on repair bills. Costs only \$1.38 to \$3.00, depending on make of car. Inserted in a few minutes.

P. S. If your car has no oil filter, a *complete Purolator, both housing and refill*, costs only \$6.50 or a bit more, depending on make of car. Purolator Products, Inc., Rahway, N. J. and Toronto, Ontario, Canada.



PurOlator

MICRONIC OIL FILTER



*Reg. U. S. Pat. Off.



**"I Joined the
Air Force**

**to build
a Career"**



**The new Airman Career Program
develops skills for lifetime careers.**



**Airmen enjoy ample free time for
sports and recreation, 30 days
annual vacation with pay.**



**An Airman is a career man, with
opportunities for advancement,
security and success.**

**Where else can you find such
opportunities as you're offered in
the new Airman Career Program!**

As an Airman you're on your way to a real career. Scientific aptitude tests reveal your strongest abilities. Then you are expertly trained, either on the job or in the world's finest technical schools, for one of the 400 job specialties in the many Airmen career fields—with full pay from the start. You have many opportunities for education, advancement, security, and the good things of life. Inquire about the Airman Career Program at your nearest Recruiting Station.



U. S. AIR FORCE

Visit Your U. S. Army and U. S. Air Force Recruiting Station

WHY WASTE TIME

with "temporary polishes?"

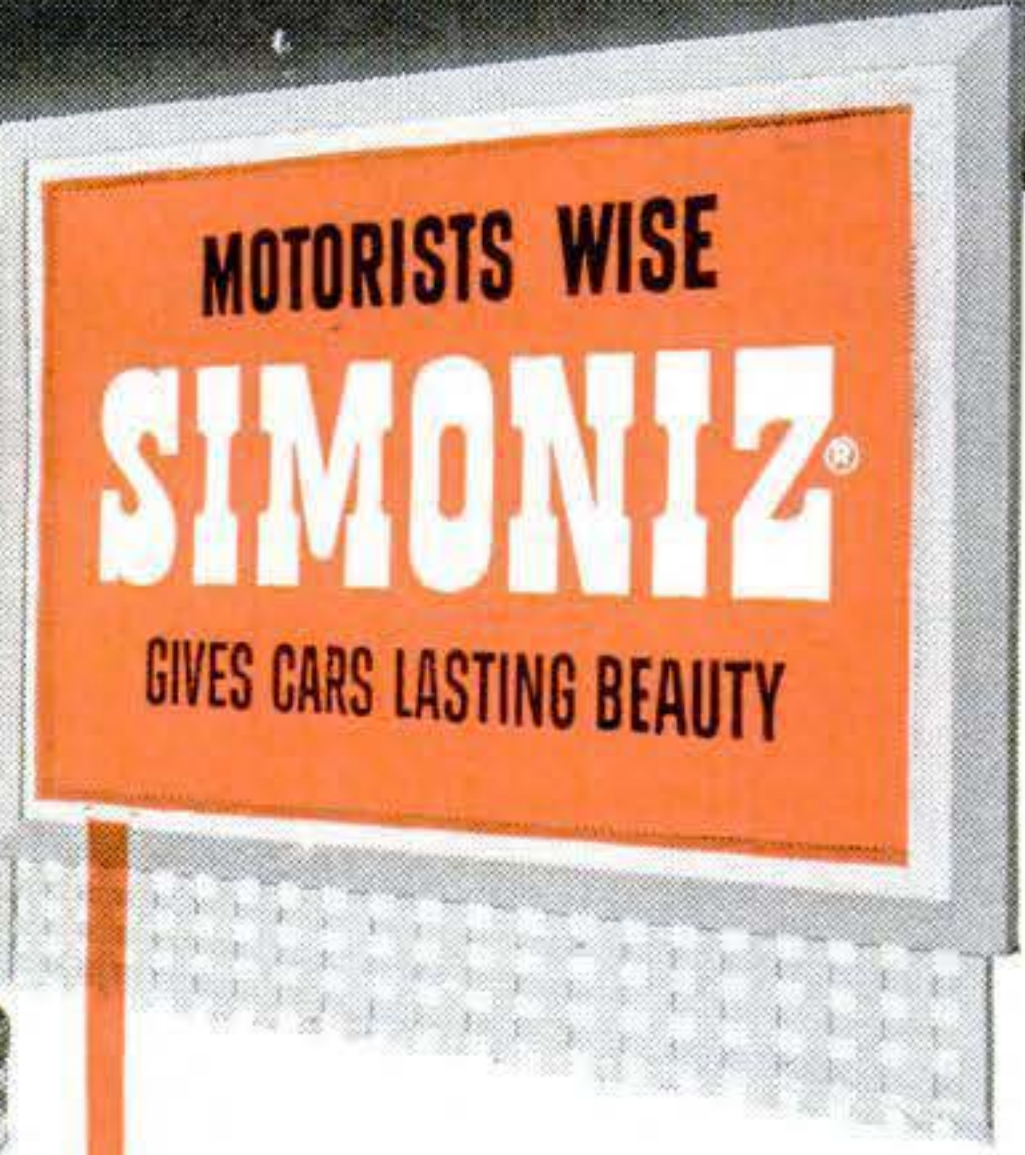

Newer cars need only Simoniz to clean and beautify the finish... a single, simple operation. On older cars, first use Simoniz Kleener (Liquid or Paste) to clean the finish. Then Simoniz for lasting beauty.

SIMONIZ GIVES TWICE THE SHINE AND IT LASTS!

Long lasting Simoniz saves time and effort...really protects and preserves the finish...keeps colors from fading! Your car will stay brighter than new with Simonizing—the Deluxe Beauty Treatment.

THE SIMONIZ COMPANY, CHICAGO 16, ILL.

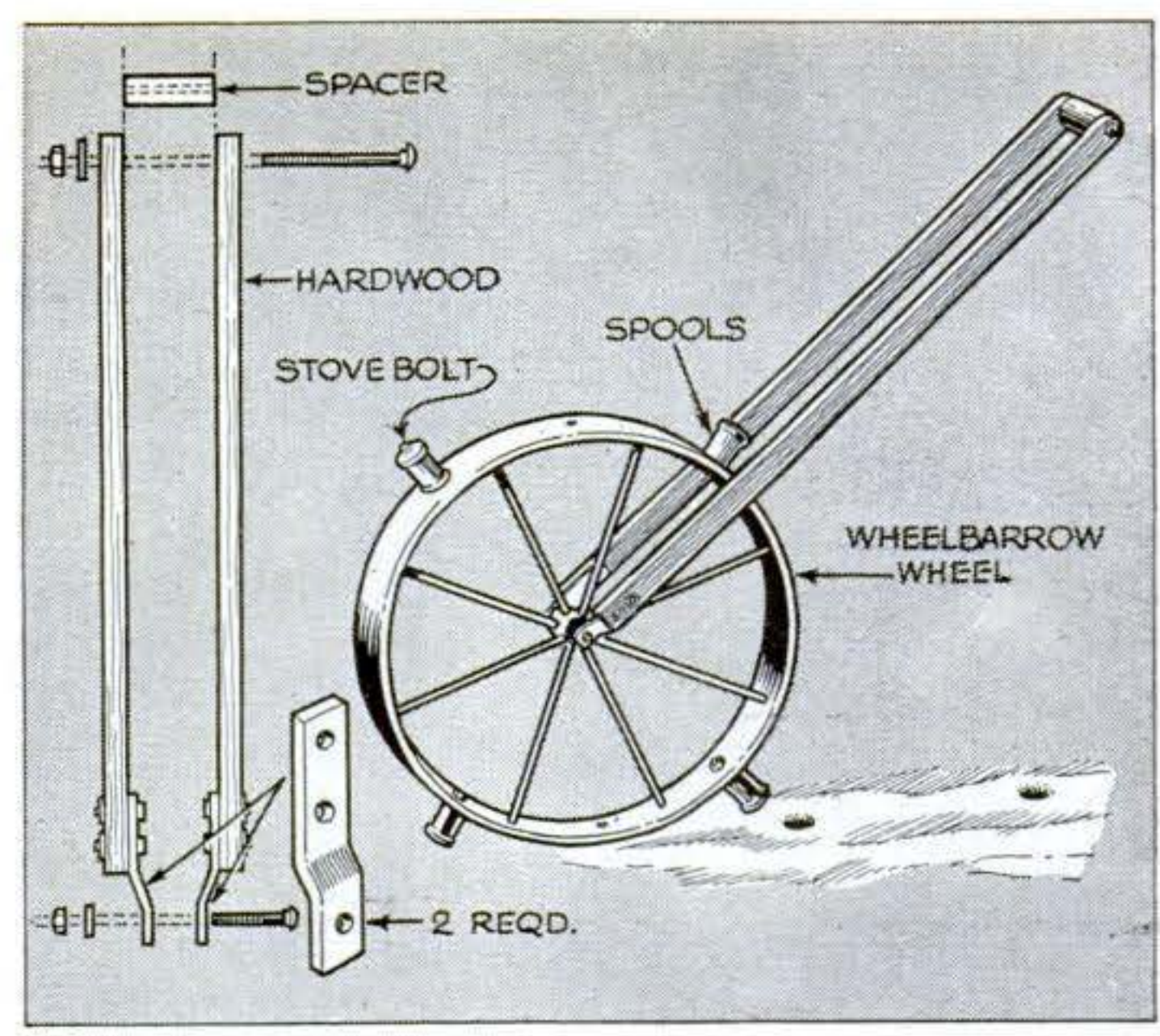

Old Wheel Spaces Plants

THE wheel from an old wheelbarrow and odds and ends of scrap will make a plant spacer for your garden. Drill holes in the wheel at about 6" intervals. Then you can adjust the spools for various intervals between plants.—V. H. Lamoy, Upper Jay, N.Y.

Scoop Cut from Gallon Can

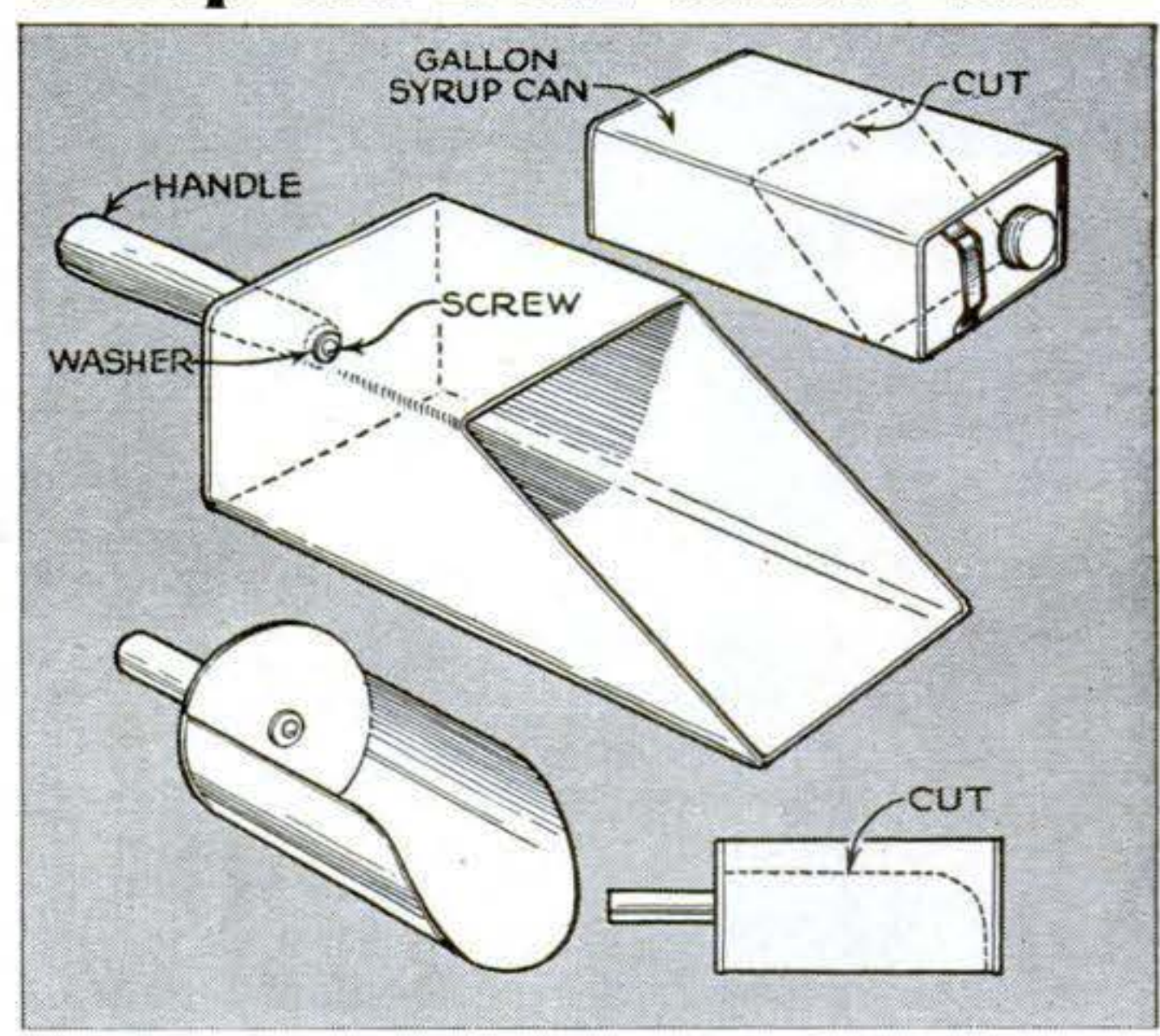

FARMERS and storekeepers will find this scoop handy for grain, flour, and feed. Cut a gallon syrup can as shown and put a wood handle on it. A washer keeps the screw head from pulling through the metal. A round can may also be used.

Aluminum Keeps a Cool Head

IF YOU have to be out for a long time in the hot sun, you can protect your head from some of the effects of the rays by lining your hat with aluminum foil. Slip the edges of the foil under the sweatband to prevent actual contact with hair or skin.—P. A. Dalal, Bombay, India.

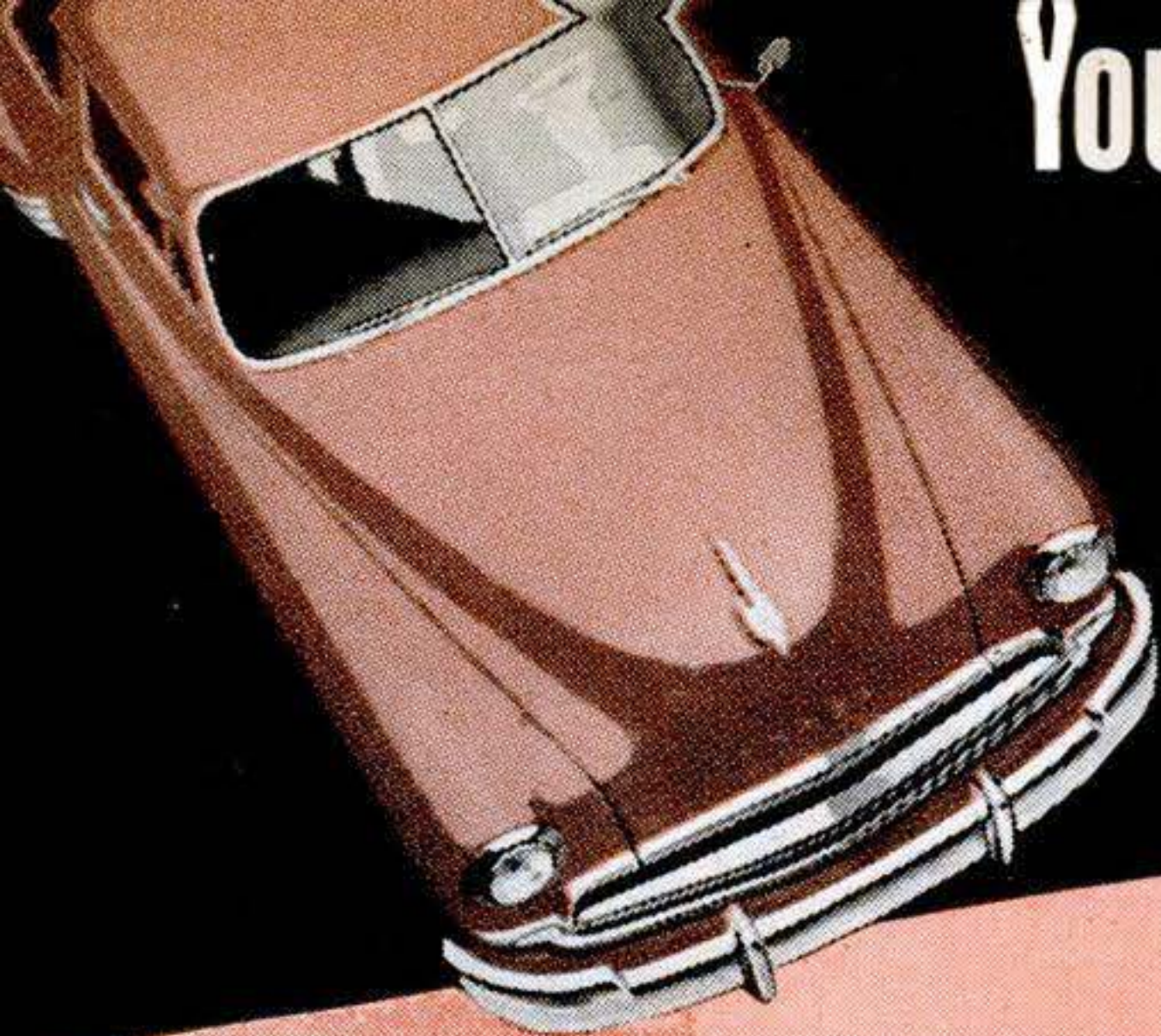

You're driving into the Danger Zone

WARNING ZONE

Engine loses pep ...

DANGER ZONE 1

Engine begins to smoke ...

DANGER ZONE 2

Engine pumps oil badly ...

DANGER ZONE 3

Destructive wear sets in ...



Needs a tune-up

Clean, adjust and re-time ignition. Clean fuel supply and carburetor screens. Adjust carburetor. Adjust tappets and fan belt. Check compression and vacuum readings for symptoms of ring wear.

Needs new piston rings and minor engine repairs

Replace piston rings. Align rods. Adjust rods or replace rod bearings. Reseat and reface valves.

Tune engine.

These repairs are comparatively inexpensive and put the engine back in peak condition for thousands of economical miles. Delay puts the engine in Danger Zone 2.

Needs new piston rings and major engine repairs

Replace piston rings. Replace piston pins. Adjust—probably replace—main bearings. Align rods. Adjust rods or replace rod bearings. Reseat and reface valves. Tune engine.

These repairs naturally cost more than those needed in Danger Zone 1, but they put the engine back in condition for thousands of additional miles of satisfactory service. Delay leads to costly Danger Zone 3.

Needs new piston rings and complete overhaul

Repairs cost three or four times as much as in Danger Zone 1.

Remove engine. Rebore cylinders. Replace pistons, pins, rings. Replace main bearings. Align rods, refit or replace rods, or replace rod bearings. Overhaul valve lifters, rocker arms. Replace timing chains or gears. Reseat, reface valves. Replace guides and springs. Replace camshaft bearings. Clean oil lines. Overhaul oil pump.

Clean, re-install and tune engine.

The more you delay - the more you pay!

Piston rings should be replaced ... *at the first sign of wear!*

You'll be money ahead if you replace your piston rings when your car first gets into the Danger Zone. But if you delay until the second or third Danger Zone, repairs cost two to four times as much.

In any Danger Zone, ask your motor service man

for Hastings Piston Rings. They *stop* oil-pumping, *check* cylinder wear and *restore* performance.

It's the best money you can spend on your car.

HASTINGS MANUFACTURING COMPANY • HASTINGS, MICH.
Hastings Ltd., Toronto

TOUGH BUT OH SO GENTLE



HASTINGS

STEEL-VENT PISTON RINGS



TOUGH on Oil-Pumping • GENTLE on Cylinder Walls

Vacuum-Grip Bulb Changer



CHANGING ceiling electric-light bulbs is a simple task with this device that clasps the bulb in a vacuum-operated rubber holder. A single stroke of the pull-out rod at the handle end, as shown at left, works a built-in vacuum pump. Since no pressure is exerted against the bulb as in mechanical grippers, it is claimed that breakage is eliminated. Made by the Lumidor Mfg. Co., of Los Angeles, the gadget will handle all bulbs from 15 to 1,500 watts.



Small Fry Thirst Quencher

NO NEED to boost Junior Miss or her kid brother to reach this "small fry" drinking fountain made by Westinghouse. Mounted halfway down the side of a standard water cooler, the child's bubbler may be finger operated at the same time mother is having her fill at the upstairs fountain.

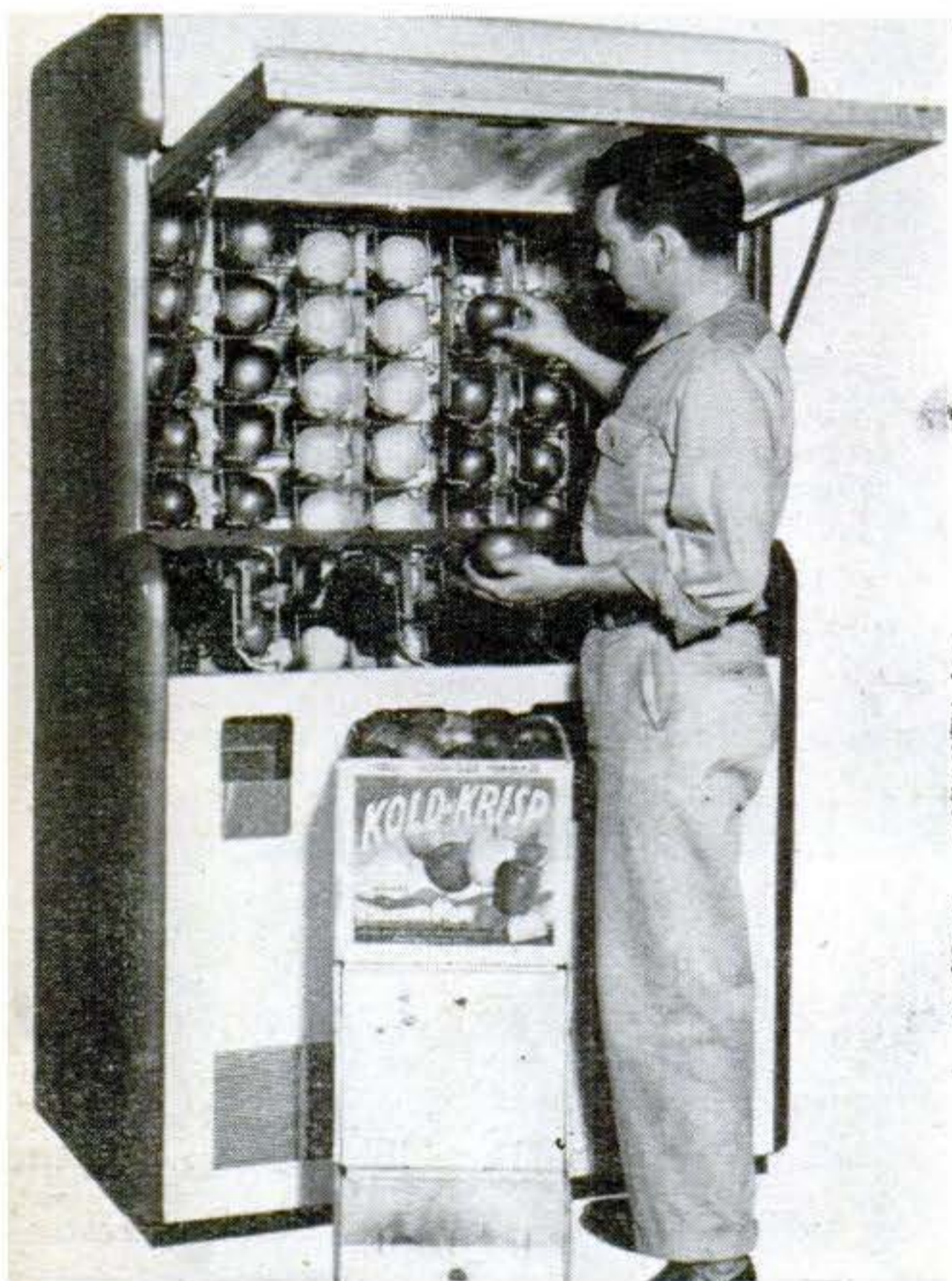

Machine Vends Fresh Fruit

A COIN dropped into the slot of the Fruit-O-Matic, shown being loaded above, brings you a choice of four kinds of fruit chilled to perfect eating temperature. The refrigerated vendor has a capacity of 208 pieces of fruit held in small steel wire baskets that rotate on endless metal bands. The machine is made by the Fruit-O-Matic Manufacturing Co., of Los Angeles, Calif.



Sandbox Is Also Wading Pool

MADE from a single sheet of heavy gauge steel, this sandbox is strong enough to support several children. The playbox measures 40 by 45 inches, and can be assembled in a few minutes without tools. Filled with water, it doubles as a wading pool. Sturdy one-inch plank seats fit along two sides. Made by the American Metal Specialties Corp., of Hatboro, Pa., the Sand-E-Wade comes with a colored vinyl-fabric canopy.

HOW'YA TRADE
COUSIN?

NOT FOR A
DOZEN!

MONTA MOWER

Mows and Trims

LAWNS

IN ONE EASY OPERATION

"I wouldn't trade my MontaMower for a dozen ordinary lawn mowers!"

The above statement is a direct quotation from one of thousands of unsolicited testimonial letters received from MontaMower owners every year.

And little wonder MontaMower owners are so enthusiastic! MontaMower represents the first basic advancement in lawn mowing devices during the past half century. It is a new and different kind of lawn mower that mows and trims in one easy operation.

Actually, the MontaMower is a live, 8 $\frac{1}{4}$ lb. precision machine that smoothly and quietly cuts a full 16" swath through grass, dandelions, spike grass and tall lawn weeds (including the ones that ordinarily pop back-up to cause you extra work).

AND WHAT'S MORE — MontaMower does what no conventional mower can do! It cuts right up to walls, fences, trees and posts — practically eliminates hand trimming. It cuts under foliage, around flower gardens and close-quarter borders which cannot be mowed successfully with conventional hand or power mowers.

The MontaMower is so light, so sturdy and responsive, that even women and children can operate it easily and efficiently. Owners tell us that with their new MontaMowers they cut their lawns in half the time — with less than half the effort.

Learn these facts about the MontaMower from actual experience...it's sold under a liberal "Written Guarantee" which permits you to try it on your own lawn...makes you the sole judge of its merits. Get the complete facts about the moderately priced MontaMower, AT ONCE! Just fill out the coupon below and mail it today.

ONLY MONTA MOWER
TRIMS AS IT CUTS

SAVE TIME AND LABOR WITH A MONTA MOWER

Trims close to
buildings, trees
and shrubs.

Cuts clean...
grass, tall lawn
weeds and all.

Mowing
on terraces
requires
little effort

Weight
only 8 $\frac{1}{4}$ lbs.

SOLD DIRECT — ON APPROVAL

MONTA MOWER DISTRIBUTING CO.

Sales and General Offices

P5-06 KEELER BUILDING • GRAND RAPIDS 2, MICHIGAN

Gentlemen: Without obligation, kindly send me complete descriptive literature, price, guarantee information, and full details of Approval Offer.

NAME _____

ADDRESS _____

CITY _____ STATE _____

FACTORIES, TRAVERSE CITY, MICHIGAN

Here's HOW IT WORKS

The new, improved MontaMower has eight pairs of sharp-edged, precision made and fitted, tool-steel cutting disks, slightly overlapping and self-sharpening, working as a unit. Each pair revolving toward each other gathers the grass and cuts it cleanly at the intersection of the disks. The new improved model is easily and quickly adjustable to cutting height! It's as modern and efficient as an electric razor!

The MontaMower is sold only by direct mail to users
(no agents or dealers... no foreign sales at present.)

TRY IT ON YOUR OWN LAWN!

MAIL THIS COUPON TODAY!



**NOW... LIGHT
WHEN YOU NEED IT!**

Ray-O-Vac leak-proof batteries
stay fresh for years!

(because they're sealed in steel!)



© 1950 BY RAY-O-VAC COMPANY, MADISON, WIS., RAY-O-VAC, CANADA LTD., WINNIPEG, MAN.



See how much more you get

in these truly modern batteries. Each Ray-O-Vac Leak Proof starts with a powerful, well made battery. Then . . .

1. Steel bottom is added.
2. And a steel top.
3. Next—multi-ply insulation. Many layers of protection against corrosion.
4. Last—a steel jacket. This completes an air-tight seal, to stop corrosion and keep the battery fresh and powerful. Only Ray-O-Vac builds batteries with all four of these safeguards.

GUARANTEE on every Ray-O-Vac Leak Proof: "If your flashlight is damaged by corrosion, leakage or swelling of this battery, send it to us with the batteries and we will give you FREE a new, comparable flashlight with batteries."

Ask for Ray-O-Vac Leak Proofs

Buy Spares... they stay fresh

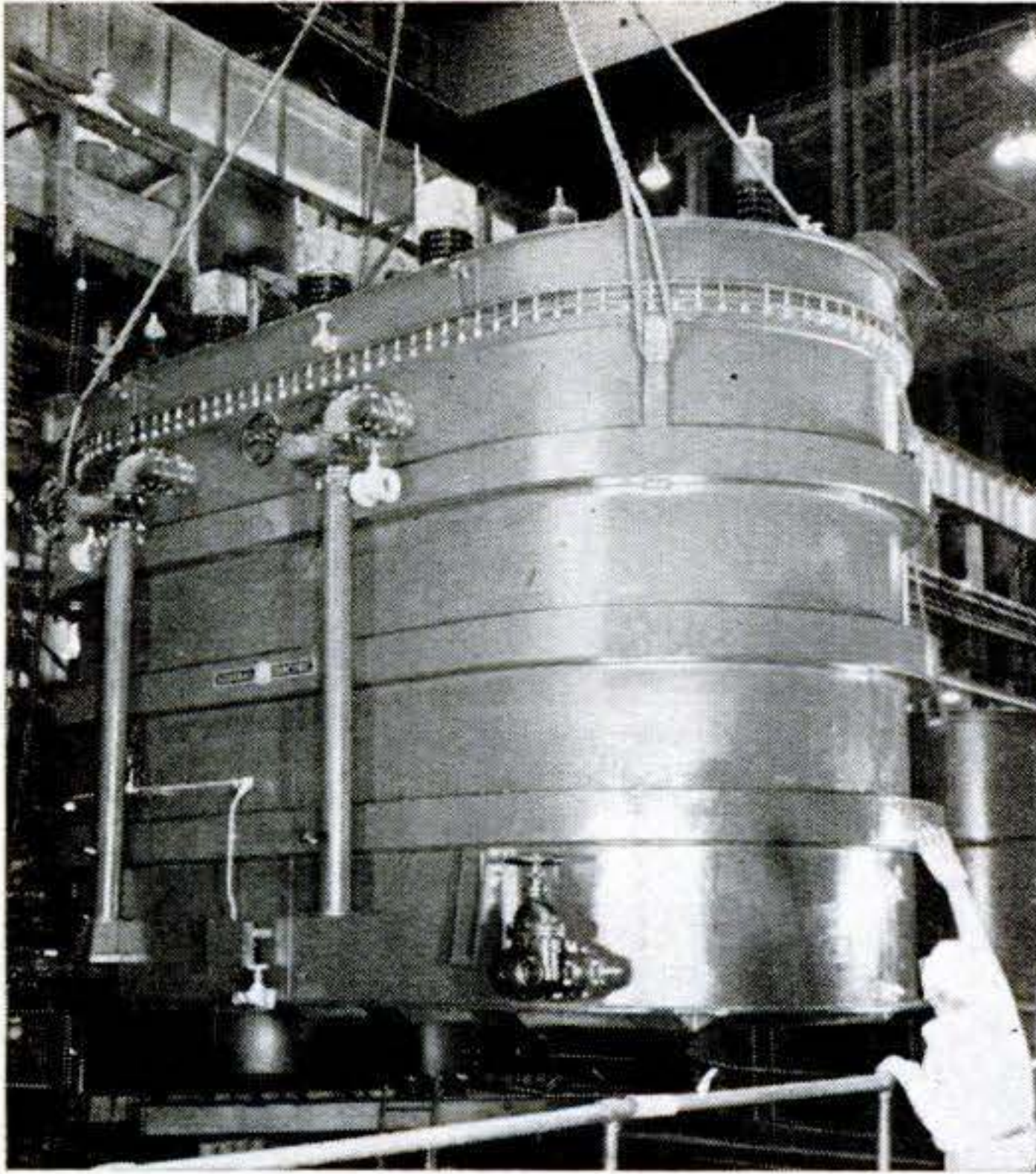

Transformer Takes Big Load

THE 150-ton transformer shown above being lifted out of a General Electric test pit will handle enough electric power to supply a city of 150,000 people. Rated at 145 million watts, it raises 15,000 volts to the 135,000 volts needed to power Detroit Edison transmission lines. Big as it is, the huge transformer is 25 percent less bulky than previous models with this rating.

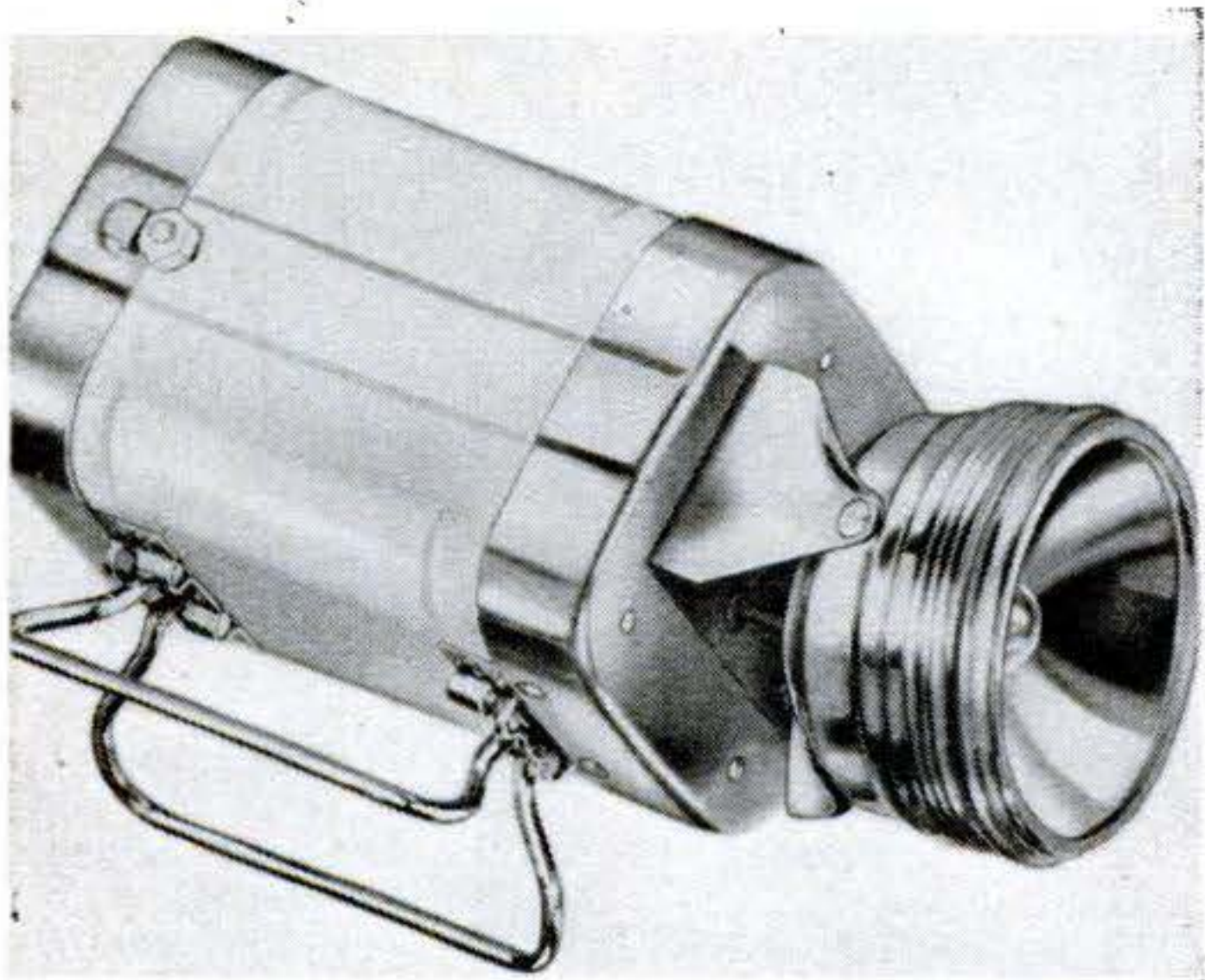

Flashlight Has Double Power

WITH eight standard flashlight batteries in its compact case, the Yellow-Flash light shown above claims twice the power of an ordinary camp or fishing lantern. Less than 8 inches long and only 3¼ inches square, the light fits easily in a glove compartment or tackle box. The Justrite Mfg. Co., of Chicago, makes it to sell for about \$4.

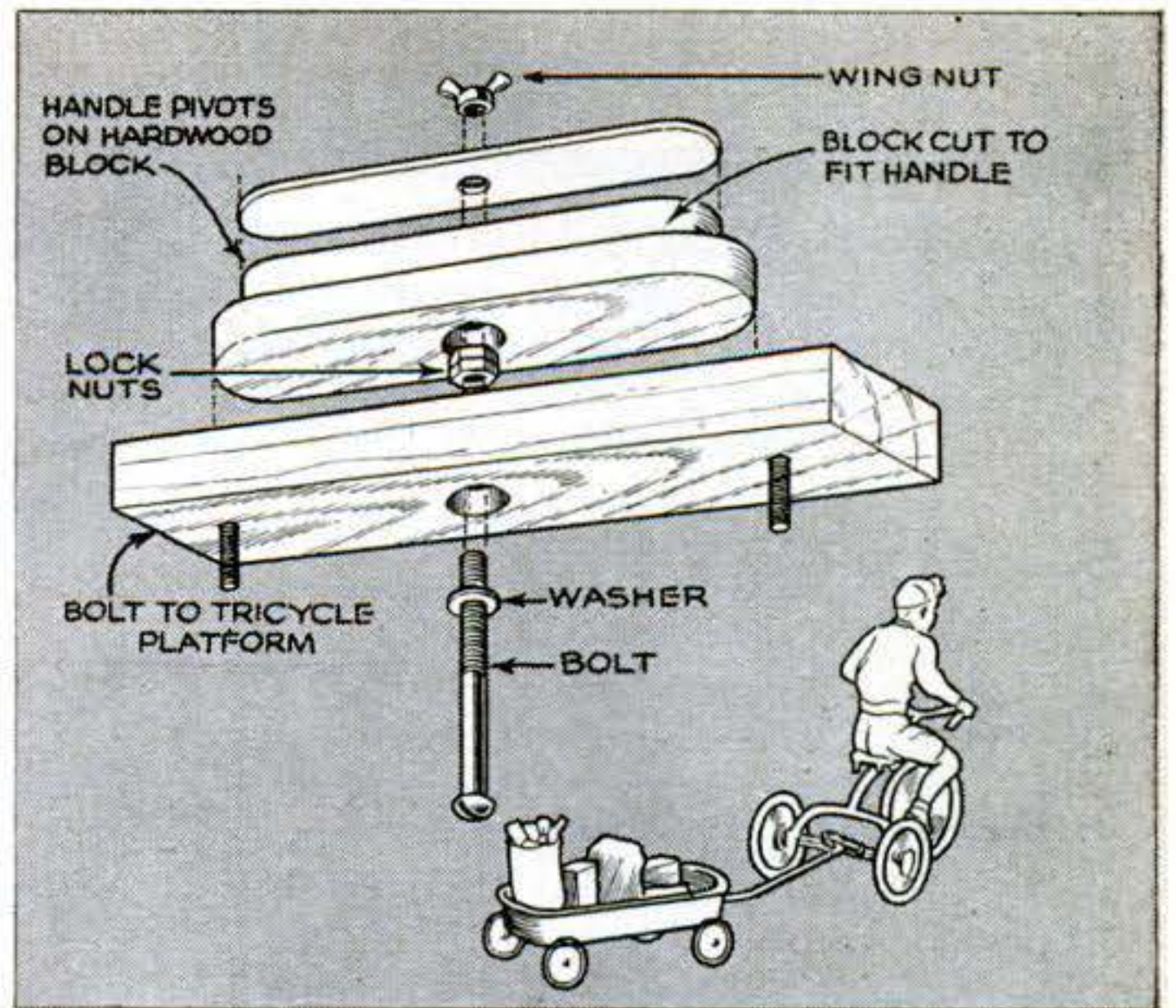

Hitch a Wagon to a Tricycle

YOUR youngster will get a kick out of this simple trailer hitch with which he can tow a wagon behind his tricycle. For neat appearance and accurate control, it's miles ahead of a messy, tangled towrope.

Carve a hardwood block to fit the wagon handle and leave a supporting flange on the bottom. If it's easier, make the two steps separately and fasten the pieces together. The turning block is pivoted to a base as shown. If the platform of the tricycle is smooth and flat, the base can be omitted. The clamp plate, cut from ⅛" strap iron, swivels at right angles to the block to hold on the wagon handle. The wing nut clamps it fast.—*Charles H. Hardy, Los Angeles.*

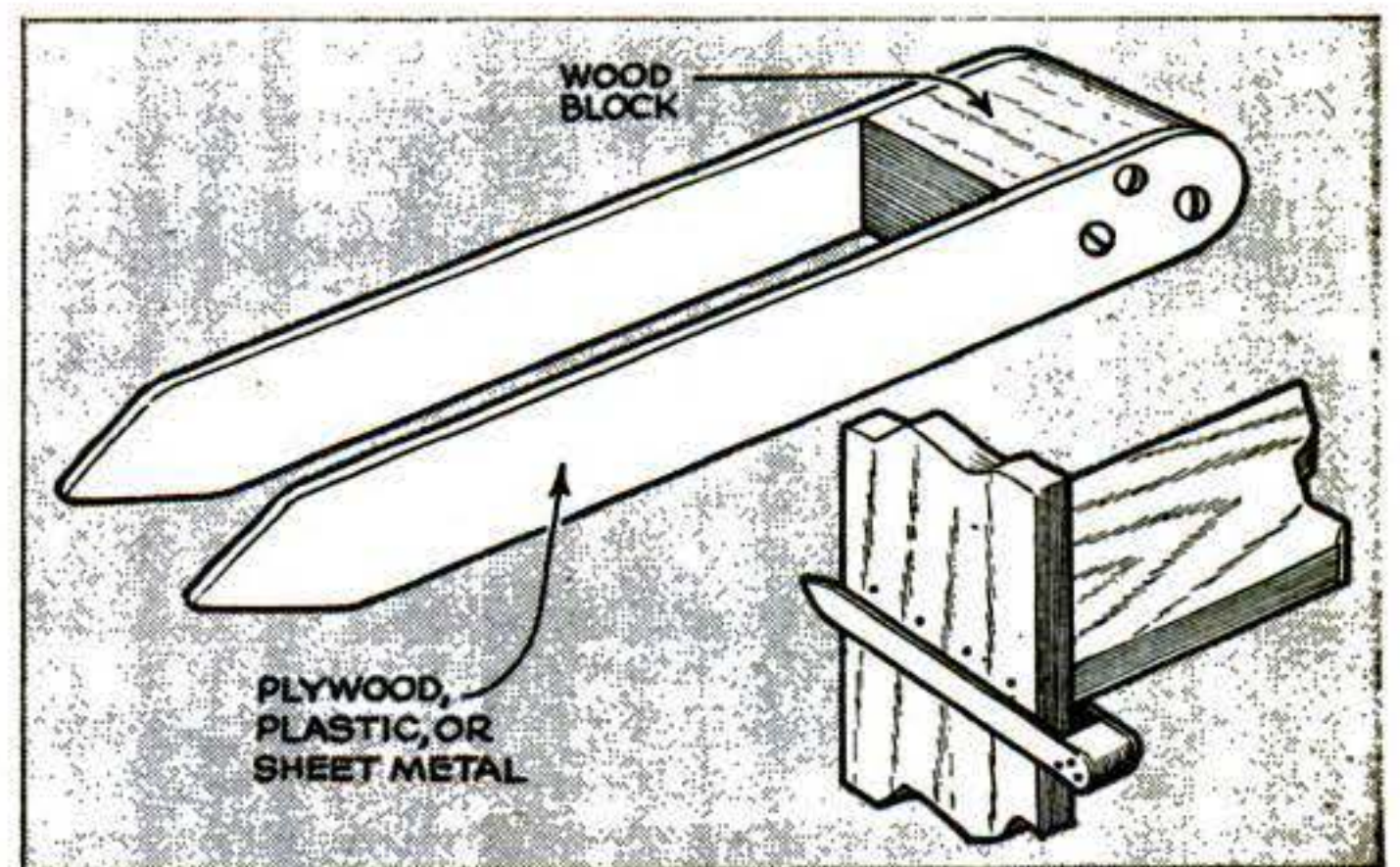

Parallel Tool Guides Assembly

HERE'S a homemade tool that helps a lot in such assembly operations as locating screws or nails for bookshelves. Make the blades of any material that won't warp or bend out of shape. In attaching the blades to the wood divider, be careful to get them parallel and their edges even so you can transfer measurements around a board.—*Stinson Scram, Brantford, Ont.*

DO ALL THIS

... and more with the
Super-Value **CASCO**

Electr-o-matic POWER TOOL-KIT

Super-speed, precision-engineered — the most practical power workshop you can own! Pays for itself a hundred times over when put to work on dollar-saving repair jobs throughout the home. Makes decorative objects, too! No home repair or hobby job too difficult. Complete with 50 accessories, lifetime plastic chest and 36-page project book. At Department, Hardware, Jewelry and Appliance Stores.



55 PIECES
ONLY
\$19⁹⁵



IT SAWS



IT POLISHES



IT CARVES



IT SHARPENS



IT DRILLS



IT ETCHES



New! Glamorous!

ILLUMINATED FENDER GUIDE

LUCITE! Smartly styled to beautify your car . . . to make driving and parking safer day and night! Rod glows faintly all the way to top. Soft light shines from tip for ease of seeing in the dark. Chrome mounting bracket allows adjustment on any fender and is easily attached.

\$2⁶⁵

Chrome mounting bracket allows adjustment on any fender and is easily attached.

IF YOUR CAR-LIGHTER'S
LOST OR BROKEN, REPLACE
IT WITH THE ORIGINAL

CASCO POP-OUT CIGARETTE LIGHTER

Replace your lost or broken car lighter with a new Chrome-plated "Pop-Out", best because it's original equipment in 9 out of 10 cars. Automatically pops out in 10 seconds with an even glow. Get Casco Accessories at Car Dealers, Auto Supply Stores, Service Stations.



\$1⁵⁰
ONLY

CASCO

CASCO PRODUCTS CORP.
BRIDGEPORT 2, CONN.

NOW!



FILL CRACKS IN A JIFFY

EASY WAY to fill cracks and holes in wood, plaster and other materials. SAVOGRAN CRACK FILLER dries hard as stone. SAVOGRAN WOOD PUTTY contains real wood — is easily tooled. Both are quick-hardening, non-shrinking — take paint beautifully. Repair furniture, floors, woodwork, tile, knobs — 1001 uses! Big 1-lb. can ONLY 35¢ where you buy paints.

Write for Helpful Free Folder

SAVOGRAN

DEPT. 29, BOSTON 16, MASS.

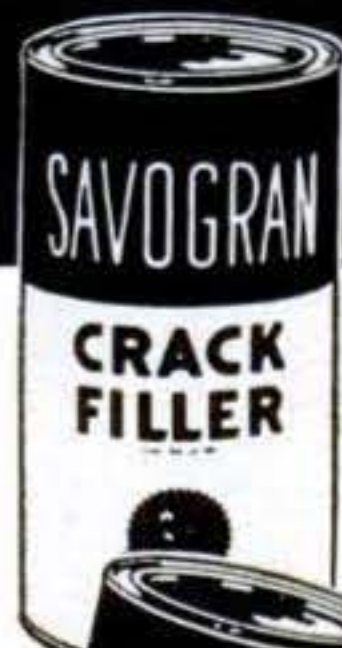

CRACK
FILLER
WOOD
PUTTY



Snap-on*
UNIVERSAL
RETHREADING
TOOL
reclaims damaged
threads

Rethreads bolts 1/2" to 5" dia., and pipe 1/4" to 4" dia. Seven chasers to recut threads from 6 to 24 pitch are included.

\$14.90 plus local sales tax

*Snap-on is the trademark of Snap-on Tools Corp.

**SNAP-ON
TOOLS**
CORPORATION
8060-F
28th Ave.
Kenosha,
Wisconsin

I enclose check money order or
 Company Purchase Order for the TR-20
Rethreading Tool.

Name.....

Address.....

City.....State.....

Drive anywhere this summer

AND NEVER HAVE A FLAT TIRE!



Fishing haunts back in the woods . . . picnic spots off the main road . . . unexpected puncture-full detours . . . and never worry for a second about having a flat tire!



Run right over razor-sharp glass! The punctures will be sealed as you ride, with Seiberling SEALED-AIR Tubes (completely different from any other tubes in the world!)

NO ONE CAN IMITATE THE WAY THIS TUBE SEALS PUNCTURES!

Exclusive design principle . . . perfected, proved, and patented by Seiberling . . . makes SEALED-AIR Tubes different from all others in the world . . . gives you *more protection* against troublesome flats and dangerous blowouts.

Outlasts set after set of tires. Think of the savings! And you won't have to spend a nickel on tire repairs, either. If you drive a car or truck, mail the coupon below for complete details on this amazing tube . . . and what it can do for you.

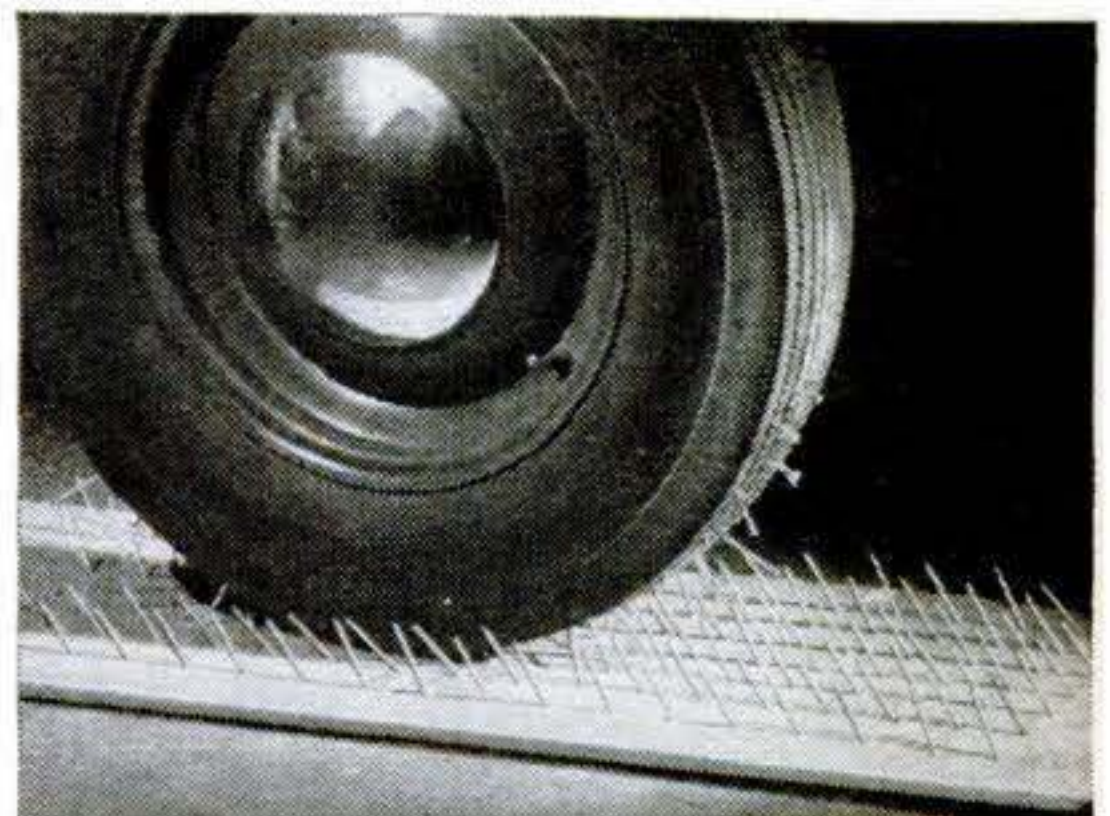

Pick up nails . . . not just one nail, but a dozen or a hundred . . . and what happens? NOTHING, when Seiberling patented SEALED-AIR Tubes are inside your tires.

Mail the Coupon NOW!

SEIBERLING

Sealed-Air TUBES

WITH PATENTED BULKHEADS

FREE

True Story: "10,189 PUNCTURES, AND NOT ONE FLAT." Learn how the only tube built around patented Bulkheading principle can save you money . . . AND TROUBLE. No obligation. Simply mail this coupon now (before YOU have a flat!) to Seiberling Rubber Co., Dept. PS-3, Akron 9, Ohio.

Name _____

Address _____

City _____ State _____

JUNE 1950 253

FATHER'S DAY
JUNE 18

KING for a DAY!



For the King!



SYNCRO
Electric
HONE
\$1250

with **STONES THAT MOVE**
240 STROKES PER SECOND!

Make Dad glad with this! SYNCRO is the only all-purpose electric hone with 240 strokes a SECOND. Hones sharp home and shop tools, knives—most anything else. Easy. Speedy. Safe. Beautiful chrome finish.

With BUILT-IN MOTOR, 4 stones—\$12.50.



SYNCRO Sander-Polisher-Massager



\$1450

Dad will like this work-saving tool with exclusive Double Arc Motion. For light sanding, polishing, relaxing massaging! Just guide it. Comparison proves it best. Silvery chrome body and black bakelite top. With BUILT-IN MOTOR, 10 sandpapers, lamb's wool, fabric polish pads, \$14.50.

SAFE SYNCRO JIG SAW

For the Royal Family!

Ideal for Dad's workshop—safe for children! THOUSANDS used in schools, hospitals, homes. Saws any length 1/2" wood, thin metal, plastic. Portable. 14,400 safety strokes a minute.

With BUILT-IN MOTOR—\$17.50.



\$1750

Shows arm adjusted
← Arm normal position

THAT'S the Name to Ask For!

SYNCRO

ELECTRIC TOOLS

Operate on 60 cycle, 110-120 volt, AC only. At best hardware stores. If none near you send article price, we'll ship POSTPAID promptly.

SYNCRO CORPORATION
Dept. G-60, Oxford, Michigan, U. S. A.



Keep Brushes like New

BEFORE

AFTER

• 10c
• 25c

DICA-DOO
PAINT
BRUSH
BATH

Clean and Restore
PAINT BRUSHES

KEEPS BRUSHES SPRINGY AND CLEAN
NET WEIGHT

Perfect for **NYLON BRUSHES**, too!

At Paint, Hardware, Dept., and 5 & 10c Stores
Patent Cereals Co. Geneva, N. Y.

PROBLEM: Pipe union against wall. No space for pipe-wrench. How to turn it?

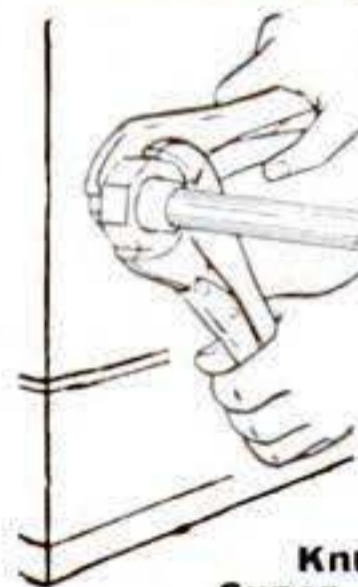

ANSWER: New Genuine Thin-Nose

WISE-GRIP

WRENCH



VISE-GRIP gets into close quarters... **LOCKS with Ton-Grip**—makes "impossible" jobs easy! Has 100s of uses about the home, shop, factory. Only the genuine VISE-GRIP has **Involute Jaw Curve** that holds all shapes. **Knurled Jaw Tips** that hold to the very tip, **Thin Nose, Super Wire-Cutter**. With cutter—No. 7W, 7", \$2.25, No. 10W, 10", \$2.50; Without cutter—No. 7C, 7", \$1.85, No. 10C, 10", \$2.25. If not at your dealers, order direct.

PETERSEN MFG. CO., Dept. M-6, DeWitt, Nebr.

SHAW CAN MAKE IMMEDIATE DELIVERY



Easy and Cheap to Operate

SAVE TIME, WORK, MONEY!

SHAW

"DU-ALL"

and "PEPPY PAL" TRACTORS

PLOW



CULTIVATE

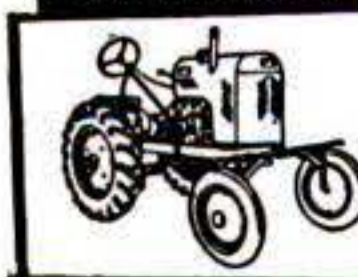

SHAW

MFG. CO.

These rugged walking or riding tractors are ideal for farm, truck garden, orchard, poultry farm. Operate on a few cents an hour. A child can handle them.

DO DOZENS OF JOBS Both riding and walking tractors quickly and easily plow, cultivate, harrow, disk, bulldoze, spray, haul, grind, saw wood, etc. **LOW FACTORY PRICES** Buy direct or through your dealer. Year's guarantee!

RIDING TRACTORS 4 models from 5 to 12 1/2 H.P., 58 in. wheelbase, 36 to 52 in. wide, 24 in. plant clearance. Hand or electric starter. Walking Tractors 1 1/2 to 5 H.P.

FREE Illustrated folders giving complete details and price lists—write today!

5706 FRONT ST., GALESBURG, KANS.
668 PS NORTH 4TH ST., COLUMBUS, O.

A MILLION DOLLAR SECRET !



There's a million-dollar secret behind the spectacular performance of the new AC Spark Plugs: It's *CORALOX*, AC's patented Insulator.

But there's no secret at all about the easier starting, surer firing and longer life of these new AC's with *CORALOX* Insulator.

Engineers know those facts—hence more new cars and trucks are equipped with AC's than with any other make.

More and more owners, too, are learning about these better AC's—and are buying them for improved service in their cars, trucks and tractors.

AC spent years of scientific research and development work in perfecting *CORALOX*, yet you can have its extra benefits at the price of ordinary spark plugs. Your AC Service Dealer has the new AC's now—to save you time, fuel and money.



AC SPARK PLUGS



AC OIL FILTERS



AC FUEL PUMPS

preferred on millions of vehicles

P A T E N T E D

CORALOX
INSULATOR

AC SPARK PLUG DIVISION • GENERAL MOTORS CORPORATION

JUNE 1950 255

Screen chores are **LIGHT**

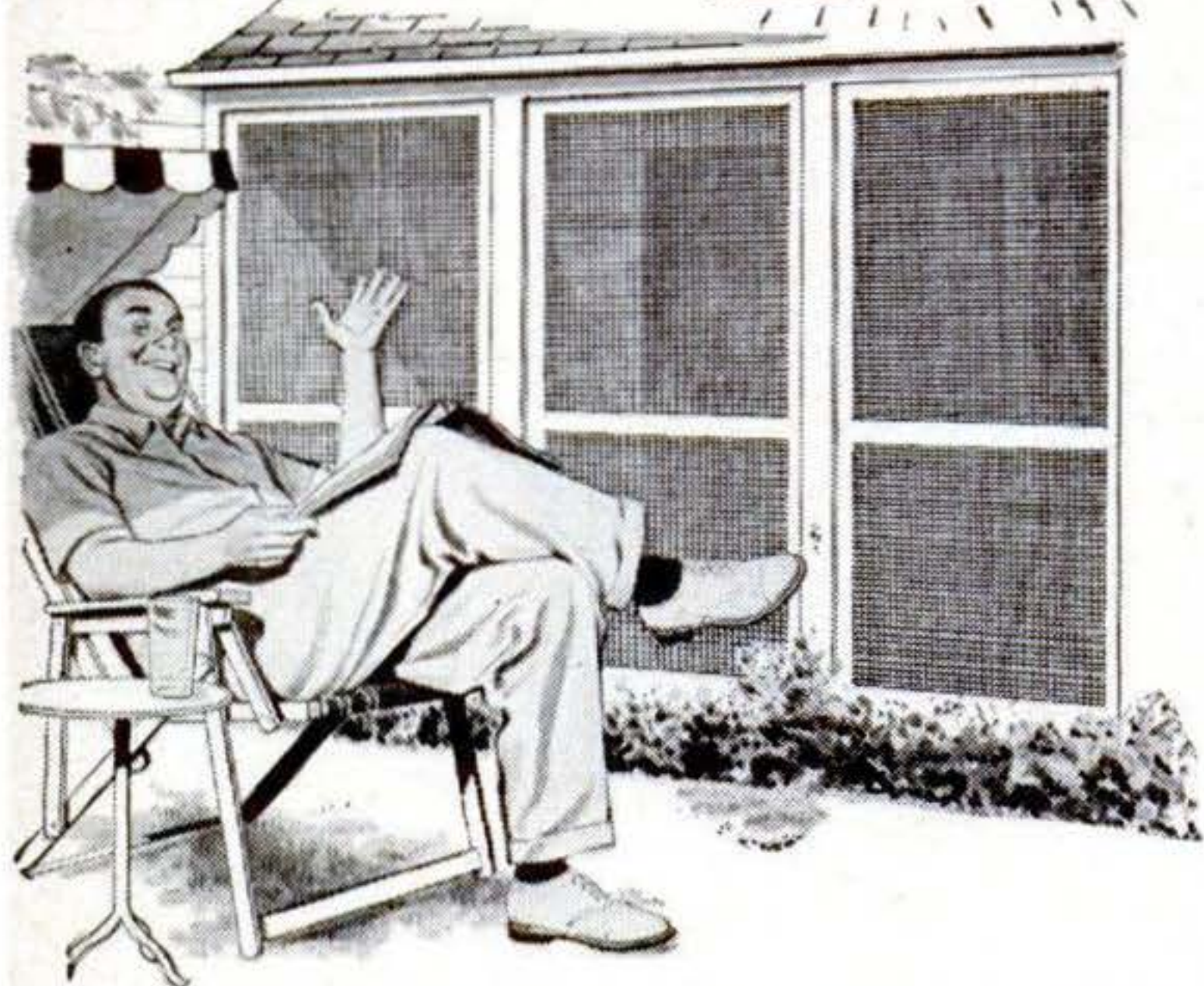

with **LUMITE**
saran screening!

because it's . . .

*** RUSTPROOF** Guaranteed never to rust, rot or mildew . . . unaffected by salt air or smoke, rain, snow or industrial fumes! It's the ideal screening for every exterior use.

*** STAINPROOF** Lumite is guaranteed stainproof because it's rustproof. It never needs protective painting. It cleans easily.

*** LASTS AND LASTS** Lumite offers long range economy . . . costs only 11½ to 12¢ a square foot . . . when adequately framed gives years of trouble-free screen protection! Sold by hardware, lumber, and building supply dealers.

LUMITE

SARAN SCREENING

*Registered Trade-mark

SEND FOR FREE SAMPLE TODAY

LUMITE DIVISION,

Chicopee Manufacturing Corp. of Ga.
40 Worth Street, New York 13, N. Y.

Please send me information and FREE sample of Lumite Screening.

Name.....

Address.....

City.....Zone.....State.....

PS-6

NEW DUMORE GRINDER
Low Cost - Dual Purpose
Combines Lathe & Bench Grinding



\$67.50

Slightly higher west of Rockies

FULL ¼ HP

.0002" Accuracy . . . Full Shift Stamina

The versatile, new Dumore Utility Grinder converts your 9" - 13" lathe to a precision external grinding machine. Bench or vise mounted, it serves as bench grinder, polisher, wire brusher, or buffer. It's a natural for small machine shops and general shops as well as metal working hobbyists. It gets those occasional special grinding jobs as well as production jobs finished fast and at LOW COST!

Grind It In Your Own Shop—FASTER—CHEAPER

With Utility Grinder garages, repair-shops, fleet operators and maintenance shops can now do fast and low-cost valve grinding, resizing after metalizing, welding clean-up and similar operations requiring precision grinding as well as the every day production jobs. Write for literature to:

The DUMORE COMPANY, Dept. F-73
RACINE, WISCONSIN

Now ALL SHOPS CAN AFFORD PRECISION GRINDING!

ENJOYABLE WOODWORKING PROJECTS!

15 years of THE DELTAGRAM® reprinted in hard-bound volumes

Clear plans, otherwise out of print. Buckhorn cloth bindings. Write for full description.

POWER TOOL DIVISION
ROCKWELL MFG. CO.
804G E. Vienna Ave., Milwaukee 1, Wis.

All 3 books
\$10
postpaid



HM-85

BUILD YOUR OWN POWER LAWN MOWER

WHY BREAK YOUR BACK MOWING FIELD OR LAWN?

WRITE FOR **FREE BUILDING INSTRUCTIONS**

The Rite-Way Mower Attachment Ball Bearing

SAVE MONEY SAVE TIME

Now anyone can save time and effort mowing field or lawn by building their own whirl type power mower. Build according to your own ideas and needs at small cost. Cut close to fences, walks, buildings, etc. Build in short time with parts and instructions we furnish. Save hours of time and back breaking labor. Write today for FREE information.

T & H MFG. CO., Dept. SMB-6
811 E. 31, Kan. City 3, Mo.



IT'S FUN TO BUILD

ELECTRIC WELDER

AC or DC 110 Volts

"The Little Marvel" All-Metal welder. 5-year written guarantee. Welds ¼" thick metal or money back. Repairs tanks, tools, fenders, machine parts, etc. Comes complete with everything — rods, unit, eye shield, and directions. We also make a welder for 16 to 22 gauge metal . . . \$3.95 complete. On C.O.D., postage extra.



ESSAY MFG. CO., Inc., Dept. 47, Quincy 69, Mass.

\$645
Complete

When you use pliers . . .

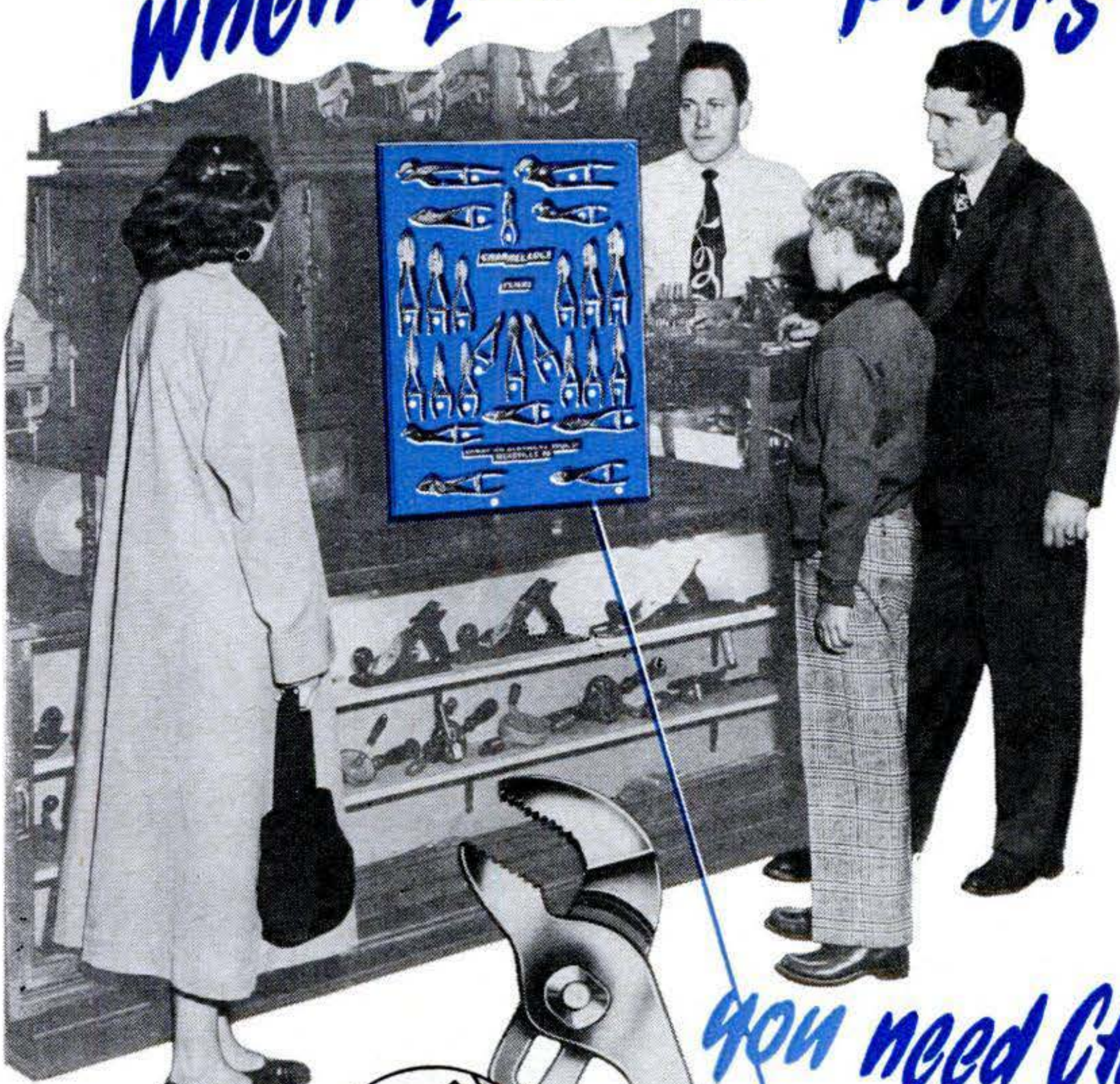

you need CHANNELLOCK

Channellock's patented tongue and groove joint gives you these "plus" features: Greater Strength, Longer Wearing, Self-Cleaning, Closely-spaced Adjustments, Visible Adjustment, No Wear on Joint Bolt.

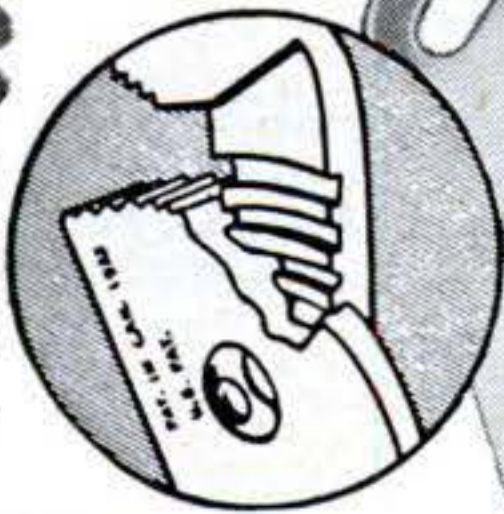

There are lots of "fussy fix-it" jobs around the house that Dad, Mom or the kids can easily do when Channellock pliers are handy. No matter what—electrical, automotive, plumbing, battery, or anything mechanical—you need Channellock pliers. Look for the Blue Channellock Display Board the next time you're shopping for tools.

Step up and select the plier you need from the complete Channellock line. If you use pliers . . . you need Channellock.

CHAMPION DEARMENT TOOL CO.
MEADVILLE, PA.

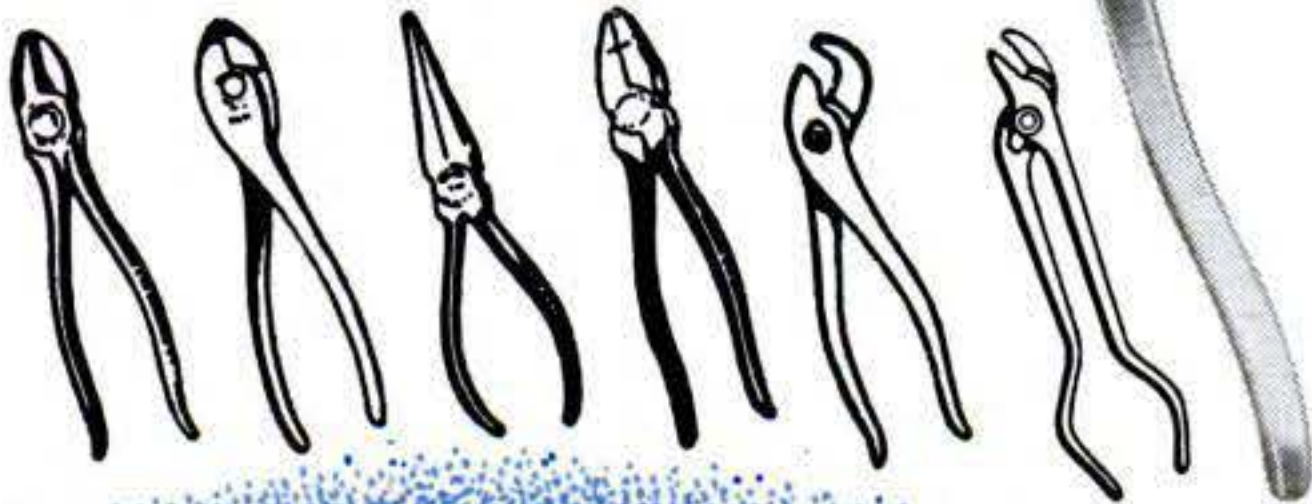

Send for Catalog C-15 today.

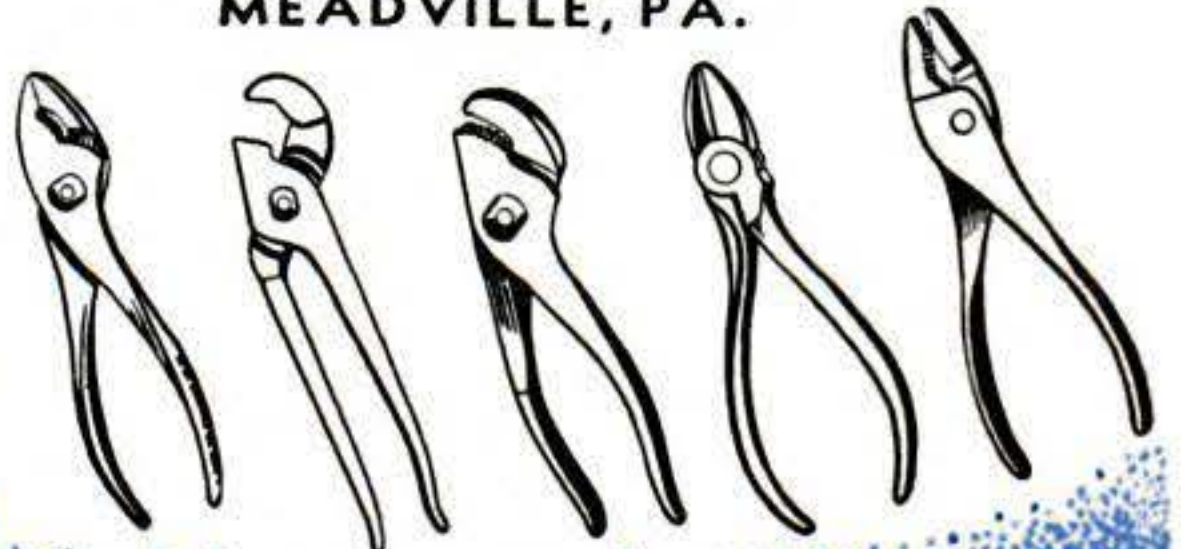

Only CHAMPION DEARMENT MAKES . . .

CHAN NEL LOCK

TRADE MARK REG.

U. S. PATENT OFFICE

get the world's greatest RADIO & TELEVISION CATALOG! **FREE**

ALLIED'S

196-PAGE GUIDE
TO EVERYTHING
IN RADIO & TV AT
LOWEST PRICES



TELEVISION AND
HOME RADIOS



SERVICE SUPPLIES
BUILDERS' SUPPLIES



AMATEUR GEAR



AMPLIFIERS, P.A.
SYSTEMS, RECORDERS

Everything for Experimenters,
Builders, Amateurs, Service-
men, Engineers, Soundmen

Save money on every radio need! Get the 196-page 1950 ALLIED Catalog featuring the world's largest stocks of top-quality equipment, at low, money-saving prices! Latest TV releases, home radios and radio-phonos, Amateur equipment, PA systems and High-Fidelity Sound, recorders, test instruments, builders' kits—plus thousands of parts, tubes, tools, books and diagrams. Get more for your money from the World's Largest Radio Supply House. Send today for your FREE copy of the 1950 ALLIED Radio Buying Guide!

ALLIED RADIO ★

ALLIED RADIO CORP.
833 W. Jackson Blvd., Dept. 7-F-0
Chicago 7, Illinois

Rush FREE 196-Page Catalog

Name.....

Address.....

City.....Zone...State.....

FREE
CATALOG

New **POWER KING** 8" TILT/ARBOR BALL BEARING SAW

A New Standard of Value from *Atlas*

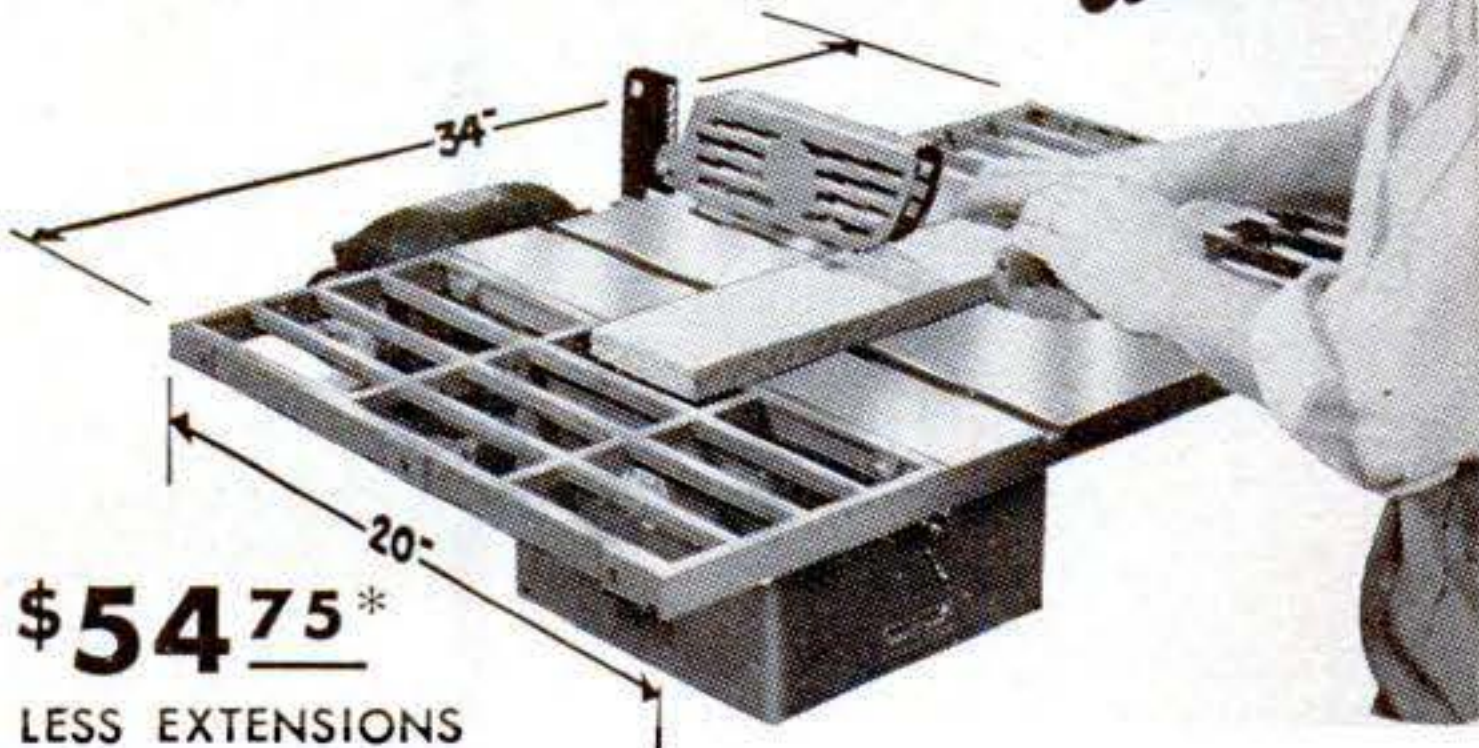

\$54.75*

LESS EXTENSIONS

Has the capacity you need for any type of construction for your home. Cuts 25/8" deep. Precision-ground grey-iron table, full-length rip fence, tilting/arbors, sealed ball bearings. *Price, F.O.B. Kalamazoo, less motor, extensions, only \$54.75—\$67.75 with two extensions as shown. Send a postcard for new catalog.

ATLAS PRESS COMPANY

642 N. Pitcher St., Kalamazoo, Mich.



IT'S EASY TO CONVERT YOUR MOWER TO A POWER MOWER

MAKES LAWN MOWING FUN

Equip your hand mower with a LeJay MidgeTractor. It snaps on in a jiffy. It's ready to go! Backs up and maneuvers amazingly easy. Costs far less than regular power mowers. Unheard of low price—Only \$54.95 complete. Or, \$29.70 less engine... use your own engine (any make 3/4-1 1/2 HP or 1/3 HP electric motor). Free literature. Guaranteed with money back 5-day trial offer. Order your LEJAY MidgeTractor from this ad, do it today. (Sold by mail order only.)

ONLY
\$29.70



If you are a handyman, send 35c for PLAN "Build Your Own MidgeTractor", literature included.

LEJAY MANUFACTURING CO
2923 S. Emerson, Minneapolis 8, Minn.

CHAMPION V-GLOW PLUGS

for model engines only

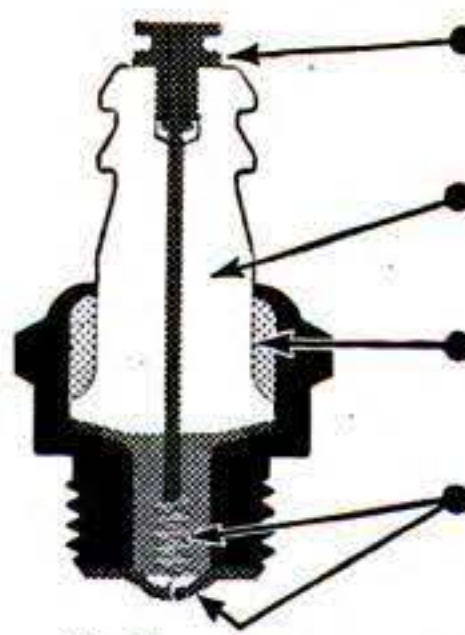

- **CHAMPION TERMINAL**—assures better center electrode seal and provides sturdier electrical connection.
- **CHAMPION-CERAMIC INSULATORS**—proved dependable in millions of Champion Spark Plugs.
- **CHAMPION SILLMENT SEAL**—prevents excessive compression leakage between insulator and shell.
- **CHAMPION "THERM-O-FLEX" CONSTRUCTION**—longer element life, more dependable performance.

Follow recommendations of plug types and fuels approved by engine manufacturer.

CHAMPION SPARK PLUG COMPANY, TOLEDO 1, O.

BE A CHAMPION DRIVER

LEARN THE "SIGN LANGUAGE" OF THE HIGHWAY!

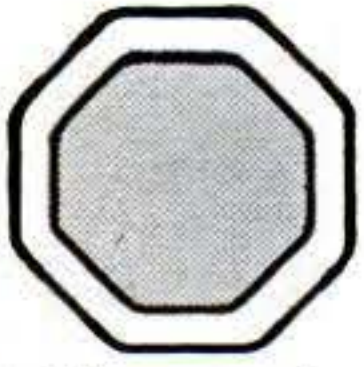

1. The meaning of a highway sign is generally indicated by its shape. The octagonal sign means STOP.

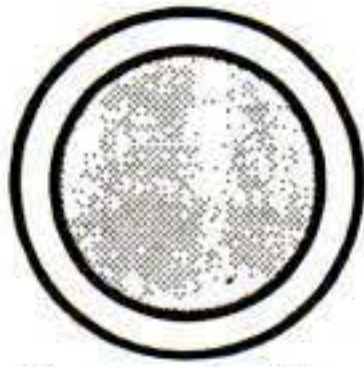

2. A round sign indicates a RAILROAD CROSSING and warns you to approach it with caution.



3. A diamond shaped sign tells you to SLOW DOWN—indicating a dangerous curve, hill, or similar hazard.



4. A square sign normally indicates SCHOOL ZONE or other areas involving hazards to pedestrians.

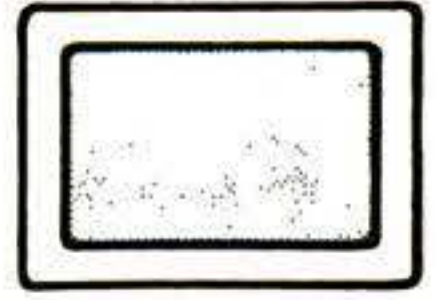

5. A rectangular sign gives TRAFFIC DIRECTIONS—Keep To Right, No Left Turn, No Parking, etc.

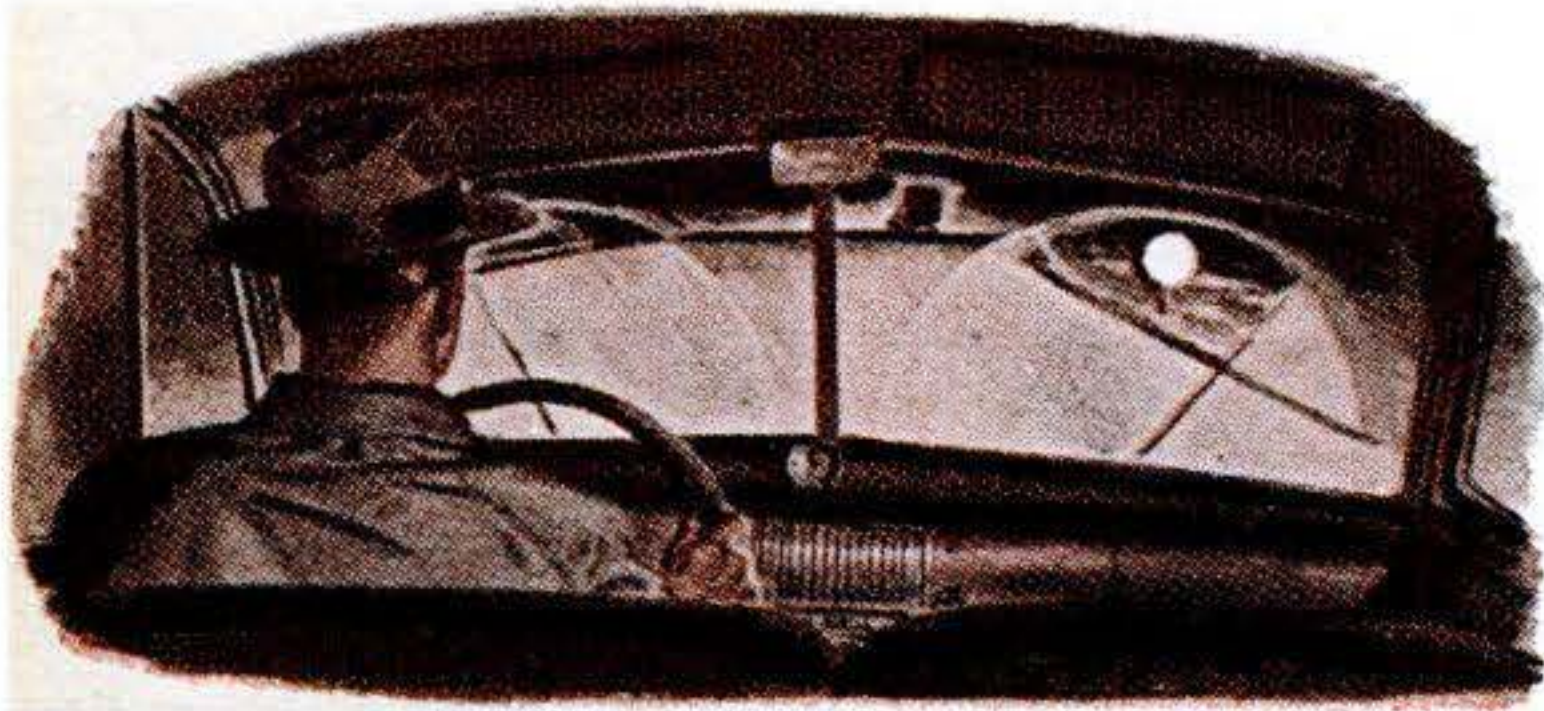

On a dark, rainy night like this, the shape of the sign ahead tells this driver that a railroad crossing lies ahead. It alerts him in time and warns him to **approach it with caution.**



Because children are inclined to be heedless, drivers should be particularly watchful for signs indicating school zones. Caution and courtesy distinguish **the Champion driver.**

A Champion driver is attentive to little things that pay big dividends in the pleasure, security, economy and dependability that you derive from your car. Spark plugs contribute largely to these dividends. Check them at regular intervals and replace them every 10,000 miles. They quickly pay for themselves. The great majority of champion drivers prefer and use Champions—the spark plugs champions use.

... BE A CHAMPION DRIVER—IT PAYS!

FOLLOW THE EXPERTS—

Demand



"I used the same identical set of Champion Spark Plugs in winning four major speedboat events last year, including the international Harmsworth race."

—R. Stanley Dollar

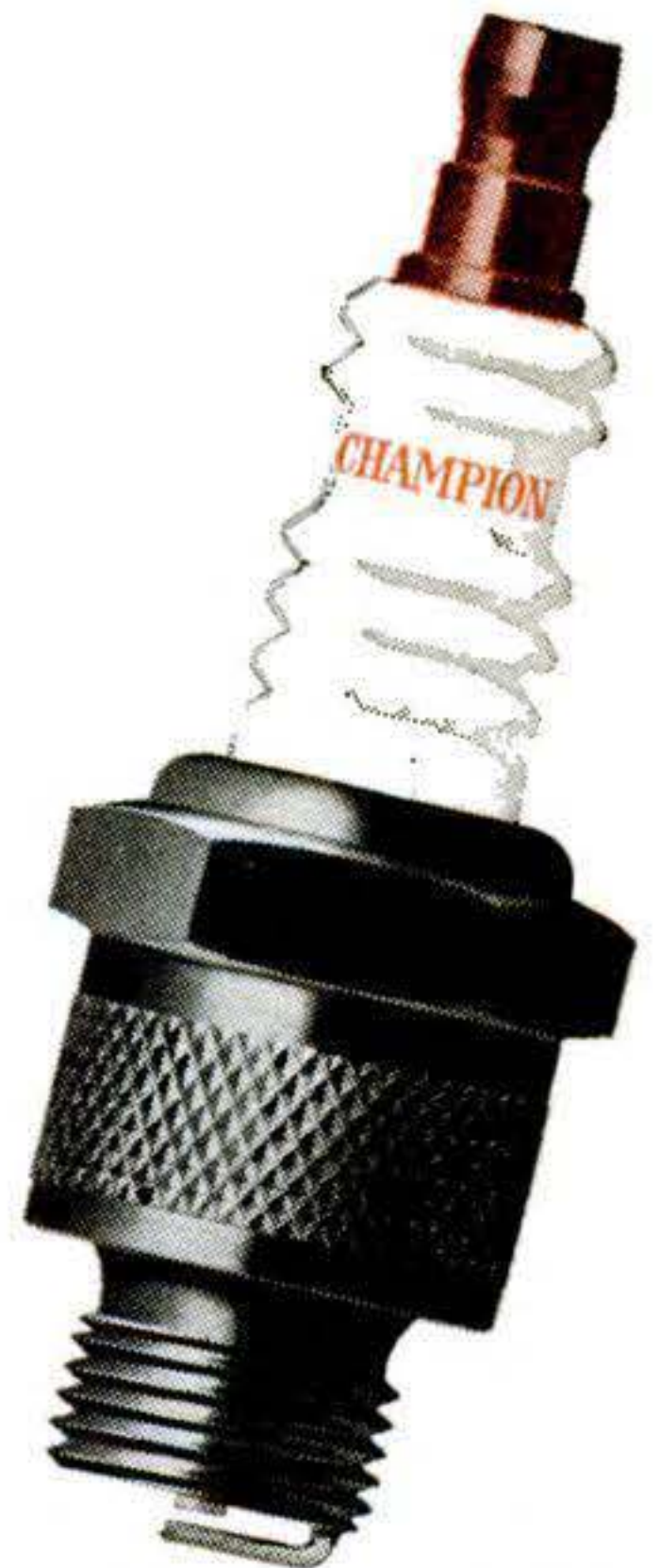

CHAMPION SPARK PLUG COMPANY, TOLEDO 1, OHIO

Listen to the CHAMPION ROLL CALL... Harry Wismer's fast sportscast every Friday night, over the ABC network

BUILD YOUR OWN COOLING FANS

EXCLUSIVE GIL-BILT BUILD-IT-YOURSELF FEATURES

- Engineered for home construction by world's leading manufacturer of build-it-yourself power tools.
- No machine work. Build easily with hand tools only.
- No guess work. No blueprint reading. Step-by-step pictorial plans, full size patterns, actual photographs.
- Sturdy wood & plywood construction, engineered for reduced noise and vibration.

SAVE UP TO
\$50
OR MORE

GIL-BILT 36 INCH ATTIC FAN

- Molded rubber cushions minimize vibration.
- Soundproofed ball bearings, sealed against dust and dirt.
- Efficient 36 in. Torrington Steel Blade.

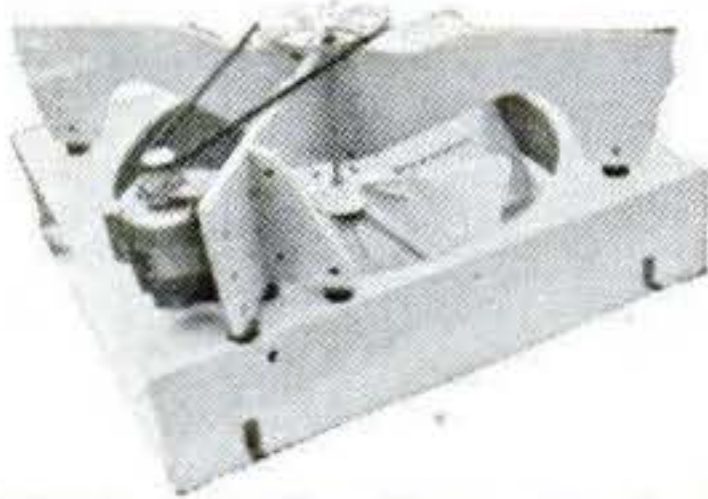

- Horizontal mounting makes installation easier.
- Rubber cushioned mounting brackets reduce noise.
- 9000 C.F.M. with 1/3 h.p. motor. Cools entire house.

GIL-BILT KIT #510-A Includes Plans, bearing blocks, 3/4 inch steel shaft, Torrington blade, two V-pulleys, V-belt, rubber cushions, mounting brackets, plus all necessary screws & bolts (less motor & wood for wood parts) . . . **\$25.95**
GIL-BILT Plans #510, Full Size Patterns, Installation Instructions 1.00

GIL-BILT 24 INCH WINDOW FAN

- Two heavy OILITE oilless bronze bearings
- 24 inch TORRINGTON 40 degree pitch aluminum blade
- Pedestal mount for blade and pulley simplifies construction. Shipped ready to run.
- Mounts out of way on outside of window.
- Belt driven with any 1/6 or 1/4 h.p. motor.
- Rubber cushioned mounting brackets reduce noise, simplify installation.
- 5000 C.F.M. at 620 r.p.m. cools 4 or 5 room house.



GIL-BILT KIT #520-A Includes Plans, TORRINGTON rustproof blade and V-pulley mounted ready to run on cast aluminum pedestal. V-belt, motor pulley, mounting brackets, plus all necessary screws and bolts. (less motor and wood for wood parts) . . . **\$19.95**
GIL-BILT Plans #520, Full Size Patterns50

GIL-BILT 20 INCH ROOM COOLER FAN

- Complete fan shipped ready-to-run. Cut out plywood panel and bolt to fan guard with four bolts.
- Direct drive nationally known REDMOND motor complete with cord and two-speed switch.
- Precision balanced TORRINGTON blade.
- Sturdy wire guard, rubber mounted to minimize vibration.
- 3000 Cu. Ft. of air per Min.
- Build to fit any window 24 inches wide or over



GIL-BILT KIT #530-A. Includes Plans, all screws and bolts. Motor, blade, guard, switch, and cord shipped completely assembled ready to run (less wood panel) **\$28.95**
GIL-BILT Plans #530, Full Size Patterns25
NO DEALERS—One Low Factory Price! Prices include postage within 600 miles. Over 600 miles add 5¢. Send cash, check or money order for fan kit, or send for Plans now and order Kit later less cost of Plans. Write for free descriptive folder.

GILLIOM POWER TOOLS

P. O. BOX 1-FV Lambert Field St. Louis 21, Mo.



Now **10 FEET long!**
Yes, here it is—that extra length you've always wanted. . . 120 inches of accurate, more useful measuring ease. Jet black markings on a wear-resistant, acid-resistant snow white blade.
Carlson quality throughout with famous 10-second blade change economy and the new convenient swing-tip. . . a real value at YOUR HARDWARE DEALER.
Just be sure it's the White Chief by Carlson.
P.S. And don't forget to get an extra blade to keep on hand as a "spare."

Blade produced under Pat. No. 2089269

CARLSON STEEL TAPE RULES

CARLSON & SULLIVAN, INC.

MONROVIA, CALIFORNIA



MEET THE NEW BULL SAW!

Convert your electric drill into a powerful, portable saw for only **\$9.95**

Your electric drill becomes a portable saw with power to spare when you attach the new Bull Saw! It's sturdy, rigid—yet light enough for one-hand operation. New visual guide lets you see where you're going; new extra wide shoe plate keeps saw blade on the straight-and-narrow. One-piece safety guard of polished aluminum . . . blade of high-carbon steel . . . double bearings for long life. Fits rigidly on any 1/4" electric drill. Depth of cut: 1 1/8". Complete, ready to use in drill (When ordering, ask for Model BS-C)



\$9.95

IF YOU ALREADY OWN A BULL BUFFER

you can make your own Bull Saw for only **\$7.50!** Here's how: order the saw housing (photo 13) and attach it to the anglehead of your Bull Buffer, following the simple directions we send you. That's all—it only takes 30 seconds to change your Bull Buffer into a powerful, portable saw! The housing you need comes complete, only . . . (When ordering, ask for Model BS-H)

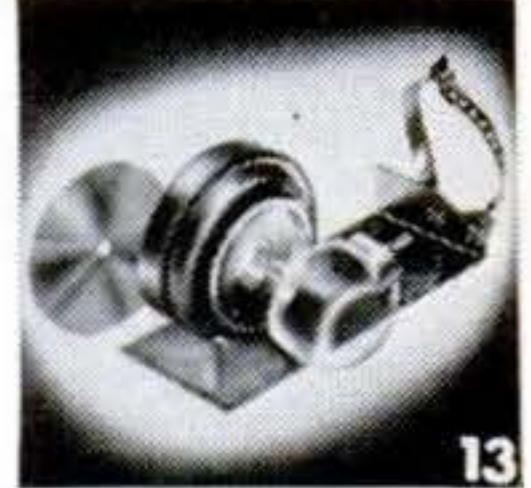

\$7.50



COMPLETE POLISH-SAND-'N-SAW KIT

Includes (photo 2) Bull Buffer*, famous right-angle polisher-sander complete with rubber pad, sheepskin bonnet, 2 sanding discs and (photo 13) Saw Housing that fits on Bull Buffer angle head to give you a powerful Bull Saw. A \$19.90 value, yours for only **\$14.95**
(When ordering, ask for Model BS-K)

*Bull Buffer only, with sheepskin bonnet and 2 sanding discs, \$9.95.
At your dealer, or send cash, check or M.O. for prepaid shipment

BERTRUM G. ENGINEERING CO.
3121 MAIN STREET KANSAS CITY, MO.

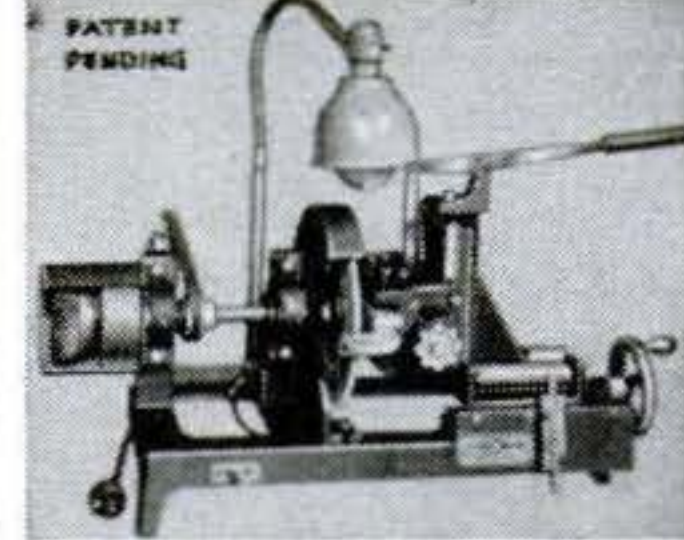

Start a NEW BUSINESS!

or Add to your present Repair Business
SHARPEN DULL PIPE WRENCHES
PIPE TAPS & DIES
"GUM" CIRCULAR SAWS
Write for Information
J. C. MOORE INDUSTRIES
BOX S 276, Fredonia, Pa.

Your Finest Buy for HOME, FARM, WORKSHOP!

ELECTRIC HOME-UTILITY TOOLS

DRILLS • SAWS • SANDER-POLISHERS
Products of The BLACK & DECKER Mfg. Co.

ARC WELDING

FOR PROFIT OR PLEASURE

60 LBS. OF READY MADE PARTS Only **\$24.95**

BUILD YOUR OWN HEAVY DUTY WELDER

SAVE BUY ONLY NECESSARY PARTS

All parts Ready-Made and easy to assemble. You can do all around welding on steel, cast iron and other metals after only a few hours practice. Illustrated instruction manual included. Sold on 30 Day Money-Back Guarantee!

FREE: Write today for fully illustrated Pamphlet S-6.

ATOMIC ARC WELDER CO.
1039 So. 19th St., OMAHA, NEBR.

Gives 100% penetration. Welds are stronger than original metal. Operates on 110 or 220 AC.

SAVE ON THESE BRAND NEW

WAR SURPLUS BARGAINS

UNCONDITIONALLY GUARANTEED

AUXILIARY ELECTRIC GENERATING PLANT

For General Utility and Emergency Use

2500 WATTS—115 VOLTS—60 CYCLES A.C.

Plenty of current to operate your: Oil Burner, Sump Pump, Refrigerator, Home Freezer, Power Saw, Lights, Radio and Television, Home Water System Pumps.

Complete integrated heavy duty electric power plant, Signal Corps Model PE-75, driven by Briggs & Stratton, one cylinder 6 1/2 H.P. Model ZZ, 4-cycle engine with killer button, oil bath air cleaner, governor, muffler, starting rope, and radio interference filter. The self-excited Leland or Westinghouse generator is rated 2500 Watts, 115 Volts, 60 Cycle A.C. single phase, belt driven, with guard and duplex receptacle. When generator is not in use, you can use the engine separately to power other equipment. Mounted on adjustable steel skids, notched for carrying poles, Net wt. 310 lbs. Shpg. wt. 440 lbs. Dimen. 36" x 19 1/2" x 24". 12 month guarantee. \$726.00 value. NOW **F.O.B. Chicago 295.00**

Brand New

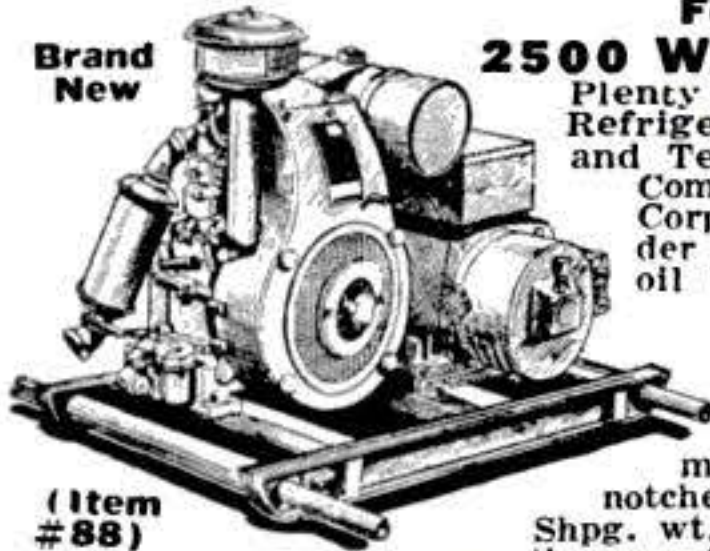

(Item #88)

VANE TYPE—MANGANESE BRONZE

INSECTICIDE PUMP

For spraying DDT, 2-4D, sulphur compounds, arsenic, oil solubles, etc. Pressures up to 200 PSI delivering 5 gallons per minute at 1200 RPM, 8 Gals. per min. at 1800 RPM. Will not rust, pit, foul or freeze up. Standard 1" pipe thread ports. Rotation—either direction 9"x6"x7". Shpg. wt 10 lbs. Gov't. acquisition cost \$42.00... NOW **15.00** Free: Complete instructions and performance data with each pump. F.O.B. Chicago



(ITEM #50)

A.C. GENERATOR

750 Watts 115 Volts 60 Cycles

Manufactured by Elcor, rated 750 watts at 1800 R.P.M. Complete with voltmeter regulator; 1" shaft, with keyway for direct or belt drive, carried in one bronze and one ball-thrust bearing. These units,



(Item #67)

built to exacting Signal Corps specifications, are the answer to your lighting needs. Shipping wt. 60 lbs..... **F.O.B. Chicago 59.50**

AIRCRAFT QUALITY HYDRAULIC CYLINDERS

Large supply of new labor-saving, economical hydraulic equipment in many types and sizes... including actuating and double action cylinders, control valves, tanks, pumps, fittings, hose, and data on hydraulic applications. Use these positive, highly efficient, smooth pressure hydraulics on presses, arbors, lifts, brakes, plastic dies, auto frame alignment, etc., etc.

- ITEM #4**—All steel double action hydraulic cylinder, 1 1/2" bore, 27/8" stroke. Clevis mounting. Will lift 1000 lbs. with 1000 P.S.I. line pressure. Perfect for positioning and feeding movements. Shpg. wt. 4 lbs. **F.O.B. Chicago 4.95**
- ITEM #33C**—Double action hydraulic cylinder. 1 1/2" bore, 4 1/2" stroke. Clevis mountings at both ends. Uses 1/4" pipe fittings. **Postpaid 8.95**
- ITEM #32**—Double action, 1 1/2" bore, 9" stroke, will lift 1760 lbs. with 1000 P.S.I. line pressure. Wt. 4 lbs. A \$45.00 value. **Postpaid 10.95**
- ITEM #41**—Double action hydraulic cylinder, 2" bore, 6" stroke. clevis mounting at base and end of shaft. Overall length closed 12 1/2". Has 3/4" stainless steel shaft, uses 1/4" tubing fittings. Will lift up to 3100 lbs. with 1000 P.S.I. line pressure. Weight 7 lbs. **Postpaid 12.50**
- ITEM #16**—Double acting cylinder. 1 1/2" bore, 27" stroke. (Will lift 1760 lbs. with 1000 P.S.I. line pressure. Wt. 8 lbs. A \$55.00 hydraulic cylinder value for only **Postpaid 12.95**
- ITEM #15**—Double acting cylinder, 3" bore, 8 1/2" stroke. All steel hydraulic cylinder, will lift up to 7000 lbs. with 1000 P.S.I. line pressure. Wt. 12 lbs. A \$78.00 value, **Postpaid 19.50**
- ITEM #31**—Double acting cylinder, 3 1/2" bore, 11" stroke. Will lift 9600 lbs. with 1000 P.S.I. line pressure. Wt. 15 lbs. A \$92.00 value..... **Postpaid 22.50**
- ITEM #6**—Double action, 3" bore, 23" stroke, hydraulic cylinder will lift 7070 lbs. with 1000 P.S.I. line pressure. Especially suited for farm and construction machinery. Clevis mounting for easy use. Wt. 22 lbs. A \$154.00 value. **F.O.B. Chicago 27.50**
- ITEM #42**—Double action hydraulic cylinder, 4" bore, 18" stroke. Rated lift capacity with 1000 P.S.I. line pressure is 12,560 lbs. Ship. wt. 30 lbs. AN EXCELLENT VALUE for **F.O.B. Chicago 32.50**

HI-PRESSURE FITTINGS for cylinders and valves available at 35c ea. for 3/8" pipe and 50c ea. for 1/2" pipe.

LOGAN HEAVY DUTY HYDRAULIC PUMP

For operating hydraulic cylinders and hydraulic motors on tractors, bulldozers, construction machinery, lift trucks, industrial applications, etc. Delivers 8 GPM at 1200 RPM at 1000 P.S.I. using 5 HP. Has 1/2" pipe thread ports. Rotate in either direction. Also use as hydraulic motor. 3/4" shaft with flat and keyway for direct or pulley drive. Has flange with 4 bolt holes for convenient mounting. Ship. wt. 22 lbs. Overall dimen.: 7" L x 5 1/2" H x 5 1/2" W. A \$105.00 value. **FOR ONLY 22.50** F.O.B. Chicago



(Item #29)

HAND HYDRAULIC PUMPS

- Item #11—Postpaid..... **8.95**
- Item #83—Hand hydraulic pump with built-in transfer valve. **Postpaid 12.95**

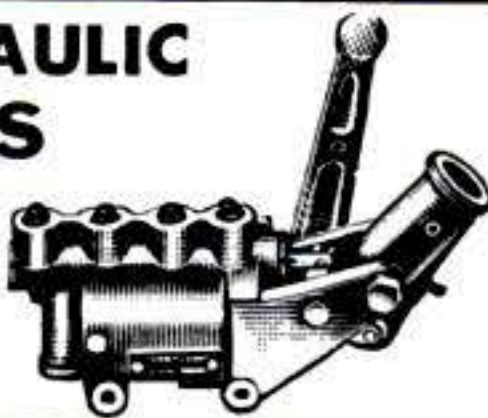

PNEUMATIC AIR DRILLS

Used—Like New Light, powerful, compact, pistol grip, trigger control. Ideal for shop use where air pressure is available.

- ITEM #80**—Ingersoll-Rand. Equipped with 1/4" Jacobs key chuck. Overall dimen.: 6 1/2" long, 5" high, 1 1/2" thick. Wt. 3 lbs. **F.O.B. Chicago 14.95**
- ITEM #81**—Chicago Pneumatic, Larger Size, Model A, equipped with 1/4" Jacobs key chuck. Overall dimen.: 7 1/2" long, 5" high, 2" thick. Wt. 4 lbs. **F.O.B. Chicago 19.95**



LOGAN HEAVY DUTY HYDRAULIC CONTROL VALVE

Has built-in adjustable relief valve, will operate one double-acting hydraulic cylinder or two cylinders as one or a reversible hydraulic motor. Valve handle latches in neutral position. Made of rugged cast aluminum alloy. Open center unloads the pump in neutral position. Throttling control allows operator to regulate the speed of movement of the hydraulic cylinder or motor. Has removable mounting brackets with 4 bolt holes. 3/8" pipe thread connections. Overall dimen.: 12 1/2" H x 8 1/2" D x 8" W. Ship. wt. 17 lbs. Govt. Acquisition Cost over \$100.00. An Excellent Buy. **F.O.B. Chicago 21.95**



(ITEM #37)

VICKERS HYDRAULIC TRANSMISSION MODEL AA16801A

Ideal for lathe drive, miniature cars, power machinery, gearing, etc. Rated 2 HP maximum input at 3750 RPM. Output speed continuously variable from 0 to 1/3 of input speed in either direction. Self contained reservoir. All controls external. Even power at all speeds. Complete with two 1/2" shafts with flat for pulley attachment. Shpg. wt. 20 lbs. Gov't. acquisition cost \$325.00. A tremendous value at **(ITEM #85) F.O.B. Chicago 25.00**

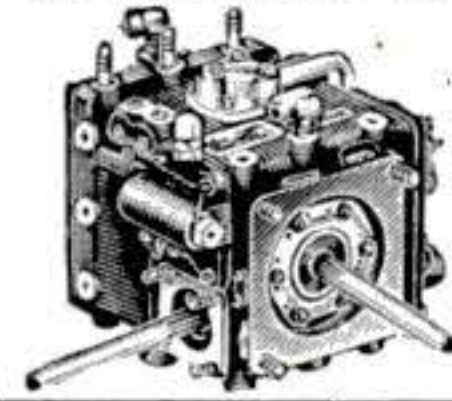

NEW Stationary or Portable D.C. ARC WELDER

250 AMP. MODEL 252

STOP COSTLY REPAIR BILLS WELD IT YOURSELF ... AND SAVE!



ITEM #65

FOR ANY WELDING JOB, LIGHT OR HEAVY
Designed for many years of trouble-free service. Handles anything from light gauge sheet metal to 1/8" plate. This precision-engineered Direct Current ELECTRIC ARC WELDER is offered at but a fraction of its original value. It can be mounted permanently or easily transported for portable use. Does the job instantly, where and when you need it. The War Surplus generators for these Arc Welders were built by General Electric, Westinghouse, and Delco-Remy at a cost of over \$300.00. They are light in weight; have oversized lifetime grease-sealed ball bearings; air-cooled commutator; dial type rheostat for easy pinpoint control; high-low range switch; reactor coil for even arc; handles 1/16" to 1/4" rods. Run welder at 2500 R.P.M. from drive pulley or power take-off of tractor, a 7 1/2 H.P. electric motor or a 10 H.P. gas engine. Use two V-belts, or flat belt (on pulley). Continuous welding rating—200 amps.; intermittent rating—250 amps.; 0-30 volts. Now... AT A FRACTION OF ITS VALUE. Price includes double V or flat belt pulley and instruction book. Ship. wt. 107 lbs. Only one or two jobs will pay for entire welder. **F.O.B. Chicago 99.50**

ACCESSORY KIT including welding helmet, electrode holder, two 10 ft. cables with clamp, and 5 lbs. of assorted welding rods. **(ITEM #66) F.O.B. Chicago 10.50**

Remember, Satisfaction is Guaranteed

PUROLATOR OIL FILTER

PERMANENT TYPE

The perfect oil filter to keep your motor oil or hydraulic fluid clean at all times. Protect your pump or engine with this unit. Just turn the handle and the element is clean. Standard 3/8" inlet and outlet ports to accommodate 12 gallons per minute. Shipping wt. 4 lbs. A \$13.00 value. **(Item #70) Now 4.95**..... **Postpaid**



SELF-PRIMING ELECTRIC PUMP

APPLICATIONS: Oil burners, aquariums, fluid metering, fuel pump, tool post grinder, coolant pump, pressure lubricating pump, general industrial, etc.
Motor Mfd. by Black & Decker: Double ball bearing series wound, continuous duty 1/30 H.P. electric motor, rated 12,000 R.P.M. Transformer included for use on 110 V AC current. Also applicable for 24-32 V DC.
Pump Mfd. by Weldon Tool Co. with standard 1/4" tubing ports; rated 2 G.P.H.; remove pump and use motor as high speed grinder.
Overall Dimensions: 7 3/4" long x 3 1/4" wide x 3 1/4" high. Approx. wt. 5 lbs. \$51.00 value. **(Item #1) postpaid. 12.95**



FREE: NEW 44-PAGE CATALOG

Chuck-full of sensational War Surplus "buys" and informative data on hydraulic applications.

ORDER DIRECT FROM AD—SEND PAYMENT OR PURCHASE ORDER TODAY—SATISFACTION GUARANTEED

GROBAN SUPPLY CO. 1507 SOUTH MICHIGAN AVE. Chicago 5, Ill. Dept. PS-6



TIME-SAVING TOOLS for SHOP and HOME

The Most Versatile Tool
a Man Can Own

MOTO-TOOL

Approx.
25,000 RPM

Grinds, Routs, Drills, Polishes, etc.

Moto-Tools, Kits and Accessories should not be confused with "bargain offers". Compare Dremel Products feature for feature, with other similar equipment. If ours are not superior in quality, design and performance, we don't want you to buy.

Look at those MOTO-TOOL Features
Dynamically balanced armature eliminates vibration. Oilless (oil-sealed) bearings • Patented automatic chuck lock pin • Snap-type sliding switch • Cord protector • Shockproof bakelite housing • Dust-filtered air-cooling system • Weighs 13 oz. • Plugs into any 110-120 V. AC outlet • Backed by over 13 years use in plants of General Electric • Ford • Remington Arms • Nash-Kelvinator • Westinghouse • Douglas Aircraft, etc. . . . plus a money-back Guarantee if not delighted after 5 days' trial.



PRE-WAR
PRICES STILL
PREVAIL

MOTO-TOOL KIT No. 2, with 23 accessories including high-speed steel cutters and Model 2 Moto-Tool in natural finish hardwood case

\$23.50

MOTO-TOOL No. 2 with one emergency wheel point

\$16.50

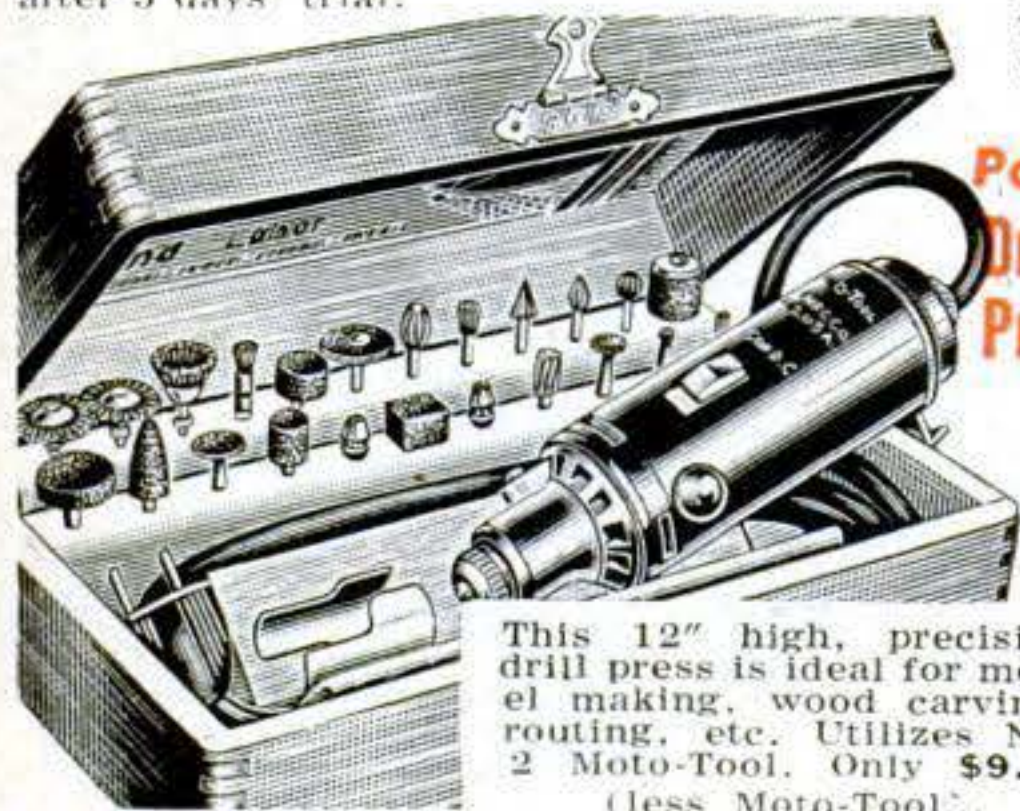

Portable
Drill
Press



This 12" high, precision drill press is ideal for model making, wood carving, routing, etc. Utilizes No. 2 Moto-Tool. Only \$9.95 (less Moto-Tool)

WHERE TO BUY—If your dealer can't supply, send full remittance and we ship postpaid. Or send \$2 and pay postman balance plus postage. Money back if not delighted after 5 days' trial.

DREMEL MFG. CO., DEPT. 120-F, RACINE, WIS.

FUN FOR BOYS FROM 8 TO 80

DREMEL Electric COPING SAW

CUTS SCROLLS LIKE MAGIC—SANDS AS IT SAWS



BLADE
FACES
4 WAYS

SAFE!
AS A
HANDSAW

JUST
GUIDE IT!

Only
\$5.85
with 3 saw
blades

For men who harbor a hobby or do their own repair work . . . for boys who like to make things . . . no other tool will give so much pleasure and satisfaction in the home or workshop for the small amount of money invested as a Dremel Electric Coping Saw. It works in any direction . . . delivers 7,200 strokes per minute . . . so easily, there is no effort . . . so smoothly, work needs no sanding. Saws through 3/4" medium-hard wood at a foot-a-minute speed. Touch-of-the-trigger, foolproof action. Only two moving parts, never needs oiling. Operates on 110-120 V. AC. Thousands of satisfied users.

WHERE TO BUY—If your dealer can't supply, send full remittance and we ship postpaid. Or send \$2 and pay postman balance plus postage. Money back if not delighted after 5 days' trial.

DREMEL MFG. CO., DEPT. 120-F, RACINE, WIS.

FREE
PROJECT
PLANS

Plans for making six useful, decorative projects packed with each Dremel Copping saw.

The JIFFY metal CABINET

**YOUR ANSWER TO
SMALL ITEMS STORAGE**
at home, office, and shop
(IDEAL GIFT, TOO)

So handy to keep nuts,
bolts, screws, nails,
parts, washers, stamps,
hobbyists' needs, etc.,
at your fingertips.



THIS 32 DRAWER UNIT ONLY \$5.95 POSTPAID

Stop searching, get a 32 or 64 drawer Jiffy to keep those small items that usually get mislaid. Spot welded steel, gray enamel finish, metal drawer guides. Dividers included with aluminum drawers make possible three compartments per drawer. Looks good anywhere. Send check or money order, please—no C. O. D.'s. Prices below. Your money refunded if not satisfied. Dealers write for quantity discount.

SPECIFICATIONS

32 Drawer Unit

6" Deep
12 3/4" Wide
15 1/4" High

64 Drawer Unit

6" Deep
25 1/2" Wide
15 1/4" High

Drawer Size

1 1/4" Deep
2 3/4" Wide
6" Long

WITH ALUMINUM DRAWERS

Dividers and Index
Cards Included

One piece rustproof aluminum drawers for heavy service—good for work bench and industry use.

32 drawer - \$8.95

64 drawer - \$15.95

WITH CARDBOARD DRAWERS

Suitable for most home uses. Heavy board kraft covered. Metal drawer pulls.

32 drawer \$5.95

64 drawer \$9.95

Ohio orders add 3% sales tax. Marproof Rubber Feet included with all cabinets
POSTAGE PAID | POSTAGE PAID

KAYTEE PRODUCTS, Dept. S, Box 588, Canton, O.



BARGAIN! BRAND NEW! SPINNER!

only \$42.50 Save \$40! REG. \$82.50
7-in. disc

Direct From Manufacturer—

Uses 7-in. or 9-in. disc—Sands, grinds, wire brushes, etc. Makes tough jobs easy. 3/4 h.p., Heavy Duty Motor. 10-day, money-back guarantee. No C.O.D. Send check or M.O. TODAY—while they last! Californians add 3% State Sales Tax

HOLT MFG. CO. 651 20th Street Oakland 12, Calif. | 272 Badger Avenue Newark 8, New Jersey

D.C. ARC WELDER

OVER \$300 VALUE AT LESS THAN 1/3

200 Amperes Continuous Duty. Up to 250 amps. intermittent duty. Easily mounted on your tractor. Welding range from 0-up by dial type control. 1-yr. guarantee with money back 10-day trial period. Write for FREE literature. OR send 35c for PLAN "Build Your Welder from Aircraft Generator" literature included.

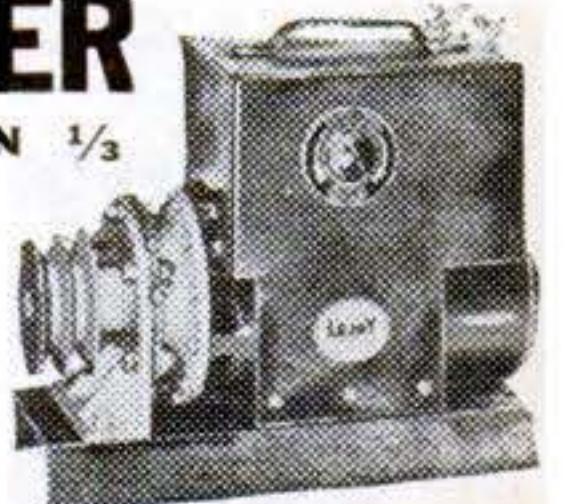

LEJAY MFG., 3323 LEJAY Bldg., Minneapolis 8, Minn.

Who Ever Heard of Only \$8.00 Each? POWER TOOLS

EMRICK WORKSHOP includes Big, Heavy-Duty 30" Lathe, Drill Press, Saw Arbor, Grinder, Sander—in ONE machine, using ONE motor. Equals in performance single units up to \$200.00. Factory price only \$39.95 cash, or on Easy Payments. 10-Day Free Trial. MONEY-BACK Guarantee. Write for FREE literature on new 1950 features and New Low Priced Specials.

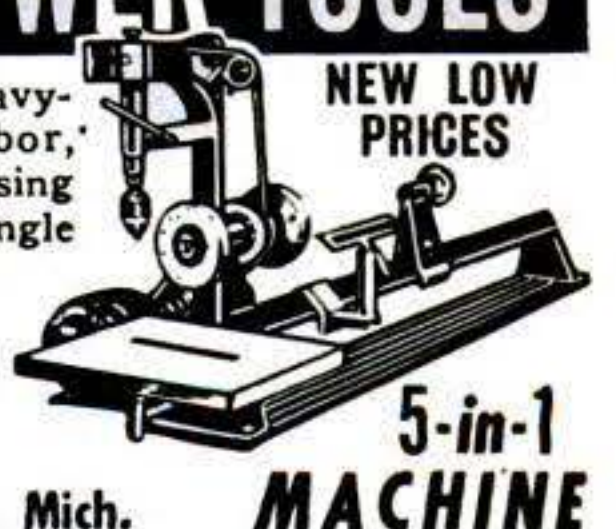

NEW LOW
PRICES
5-in-1
MACHINE

EMRICK, INC., 1502 Clinton, Kalamazoo, Mich.



When Screws Won't Stay Tight, Use SMOOTH-ON

Apply Smooth-On No. 1 Iron Cement to screw threads and into the screw hole. Insert and tighten up the screw. It will take hold and, when set, will stay tight, for Smooth-On expands slightly as it hardens, wedging the screw in place. This is only one small use for this general-purpose iron cement. With it you can stop leaks and seal cracks in cast metal parts, tighten loose knobs, casters, tool and utensil handles, make many auto repairs. Buy it in 1 3/4-oz., 7-oz., 1-lb. or larger size at your hardware store. If they haven't Smooth-On, write us.

FREE 40-page Repair Handbook

Many original uses for Smooth-On around the house, on the car, etc. Simple directions. 170 illustrations. Send postcard for YOUR free copy.

SMOOTH-ON MFG. CO., Dept. 58-F
570 Communipaw Ave., Jersey City 4, N. J.

Do it with

SMOOTH-ON

THE IRON CEMENT OF 1000 USES



REYNOLDS *Lifetime* ALUMINUM GUTTERS

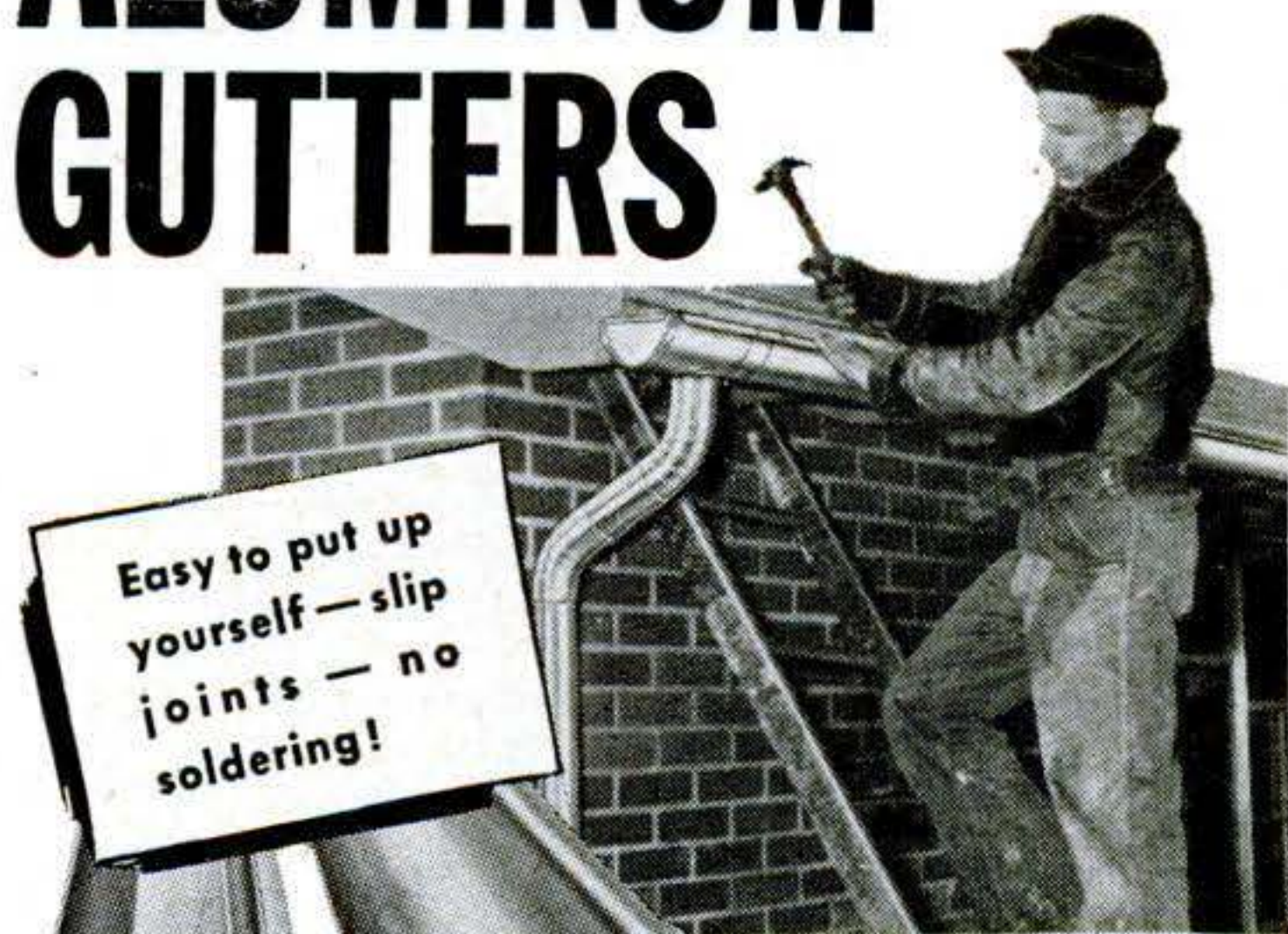

Rustfree permanence at 1/2 the price of other rustproof material.

Here's modern beauty and protection for your home with these lowest-cost rustproof gutters. They go up like a charm—save on application that used to cost more than gutters themselves. They're lightweight—easy to carry. They won't rust—won't stain walls—never need paint. Non-toxic; won't affect the purity of collected water. No special skill needed to apply. All pieces assemble with slip joints. Half-round and Ogee styles—stippled or smooth finish—downspouts, fittings to match. World's best buy in rust-proof gutters.

For all-purpose Aluminum Sheet, roll or flat, check "Flashing" in coupon.

Reynolds Aluminum Reflective Insulation



Like magic it reflects up to 95% of radiant heat. Aluminum foil bonded to kraft paper. Just tack or staple up. Rolls—250 sq. ft., 25", 33" and 36" wide.



WORLD'S LOWEST PRICED ADDING MACHINE

VEST POCKET SIZE FREE TRIAL \$2.95
IDEAL FOR BUSINESS AND PERSONAL USE—GUARANTEED ACCURATE. Not a toy. Operates with only a finger flick. Adds, subtracts, multiplies, divides. Counts up to one billion. Pays for itself over and over. Ideal Gift—for Business, Income Tax and School use. MONEY BACK GUARANTEE. Send name and address. Pay postman only \$2.95 plus postage. (Send full cash if outside U.S.) Beautiful rich-looking Leatherette Case included at no extra cost. Money back in 10 days if not delighted. AGENTS WANTED. CALCULATOR MACHINE CO., (Mfrs.) Dept. 522, P. O. Box S-1, Glenview, Illinois

EVERY ELECTRIC DRILL A PORTABLE SAW



9.95

compl. with 4" "HYCARBON" Blade

CONVERTS ANY 1/4" OR 3/8" DRILL into a Powerful Saw in ONE MINUTE! CAN BE USED WITH ONE HAND "ARCO-SAW" is THE ORIGINAL low priced saw attachment, sold from coast to coast. More "ARCO-SAWS" bought daily than all other makes combined. HERE'S WHY: "ARCO-SAW" is a rugged, precision-made tool with right angle gear drive. (No clumsy, dangerous direct drive with drill sideways.) Built for years of reliable service—works like a high priced Portable Saw. SAFETY YOKE connects drill and saw, makes it ABSOLUTELY SAFE TO USE! 90-Day Factory Guarantee. Cuts 1-3/16", or 2x4 by turning over Extra Crosscut Blade, will Rip...\$1.60

ORDER TODAY at your dealer or send us check or M.O. (Postpaid). C.O.D.'s—postage extra.

UNCONDITIONAL 10-DAY MONEY BACK GUARANTEE

DEALERS—Write for nearest jobber.

ARROW METAL PRODUCTS CO.

DEPT. PS-6, 140 WEST BROADWAY, NEW YORK 13, N. Y.



See your building supply dealer

MAIL THIS COUPON NOW!

Reynolds Metals Company
Building Products Division
2032 So. Ninth St., Louisville 1, Ky.

Send full information about Gutters and Downspouts. Details and FREE SAMPLES of Reflective Insulation; Information on Nails; Flashing.

Name _____
Address _____
City _____ State _____

Snap-on* MAGNETIC PICK-UP TOOLS

- Powerful Lift • Small Size
- Hinged Handles

Perfect for retrieving iron and steel objects, such as bolts, nuts, washers, cotter pins, etc., that fall into small places.



9" Size \$1.00
Lifts 8 oz.

16" Size
Extends to 27" \$1.95
Lifts 24 oz.

DIRECT THRUST HACKSAW

One-piece steel tube back is fitted into a precision-machined cast-aluminum handle. With 10" blade

\$3.95



* T. M. REG. U. S. PAT. OFF.

SNAP-ON TOOLS CORPORATION
8060-F
28th Ave.
Kenosha,
Wisconsin

I enclose Check Money Order for the following tools:

Pick-up Tool 9", 16"

Hacksaw Frame, blade

Add Local Sales Tax

Name.....

Address.....

City.....State.....

SAVE ON REMODELING

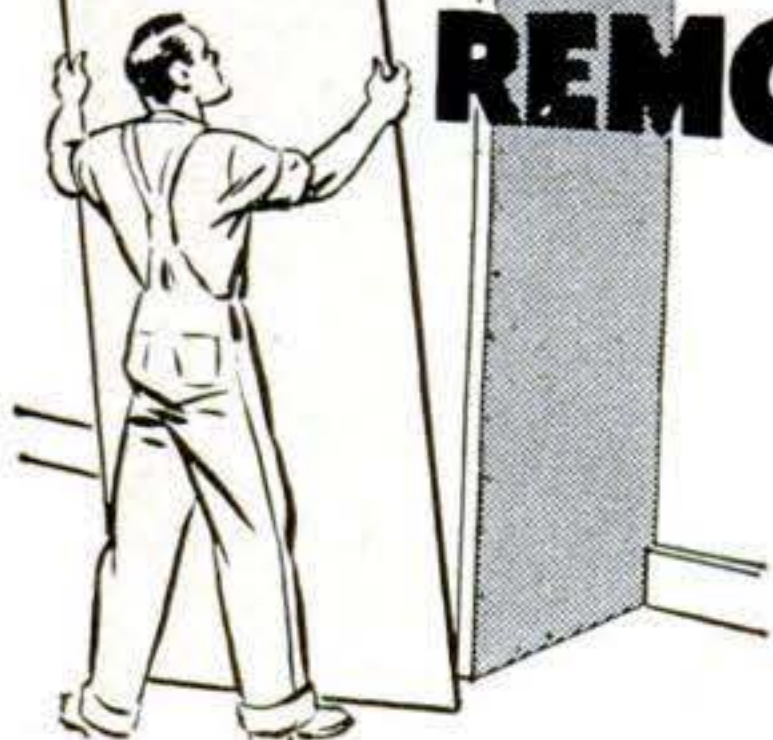

IT'S easy and inexpensive to build an extra bedroom, bathroom, game room, photography darkroom or what-have-you with Gold Bond Gypsum Wallboard. Just nail the

sturdy, fireproof panels right to lumber framework or over an old wall or ceiling. Joints can be completely concealed with Gold Bond Perforated Tape Joint System. Decorate with Gold Bond Sunflex—the one hour wall paint. Or, if you prefer papered walls, Gold Bond Gypsum Wallboard takes wallpaper beautifully. It's moisture resistant, won't warp, swell or contract. For further details, write Div. W., Dept. PS-6.

Available at your local Gold Bond lumber and building materials dealer!

NATIONAL GYPSUM COMPANY
BUFFALO 2, NEW YORK



Fell a tree like this in less than a minute with a McCULLOCH



New One-man POWER SAW



Finest gasoline-powered chain saw for all tree work, wood cutting, land clearing, etc. Use it to fell, buck, or rip. For trees up to 3-foot diameter. Weighs only 25 lb., develops full 3 hp. Starts instantly. Cuts in any position—take it anywhere. Send for free data.

\$295.00
f. o. b. Los Angeles

Endorsed by professional loggers everywhere

NATION-WIDE SALES and SERVICE



McCULLOCH MOTORS CORP.

6101-A West Century Boulevard
Los Angeles 45, California

SEND FOR FREE LITERATURE

SHEET METAL BRAKES

Forms angles, flanges, and Pittsburgh locks. Bends 26 gauge steel. Heavier copper and aluminum. Cam locking. Portable, can be clamped to edge of truck. All steel, reinforced. Wt. 42 lbs. Express collect. \$26.50

36" Size. Wt. 52 lbs. \$31.00

12" BRAKE. Fits in vise to form difficult compound bends, up to 20 gage steel \$12.50 PP. 18" CURVE FORMER, Capacity—16 gage steel \$10.00

SHEET METAL PLIERS. 2 1/2" wide. \$2.00; 5", \$3.00.

IRON BENDER. Forms hooks, braces, eyelets. Bends 1/4 x 2. \$10.00

Immediate delivery. Order direct, cash or C.O.D., or send for folder.

WISE BRAKE MFG. CO., S-1116 So. 27th St., Omaha 5, Nebr.



Clark EXPANSIVE BIT



CUTS BETTER • COSTS LESS! Accurate, fast; cuts smooth holes in hard or soft wood. Chrome vanadium steel blades, all chrome body. No. 250, 1/2"-1 1/2", \$1.69; No. 251, 7/8"-3", \$1.89. **GUARANTEED.** At your dealer or write

ROBERT H. CLARK COMPANY • Beverly Hills, California

Easy way to strip paint . . .

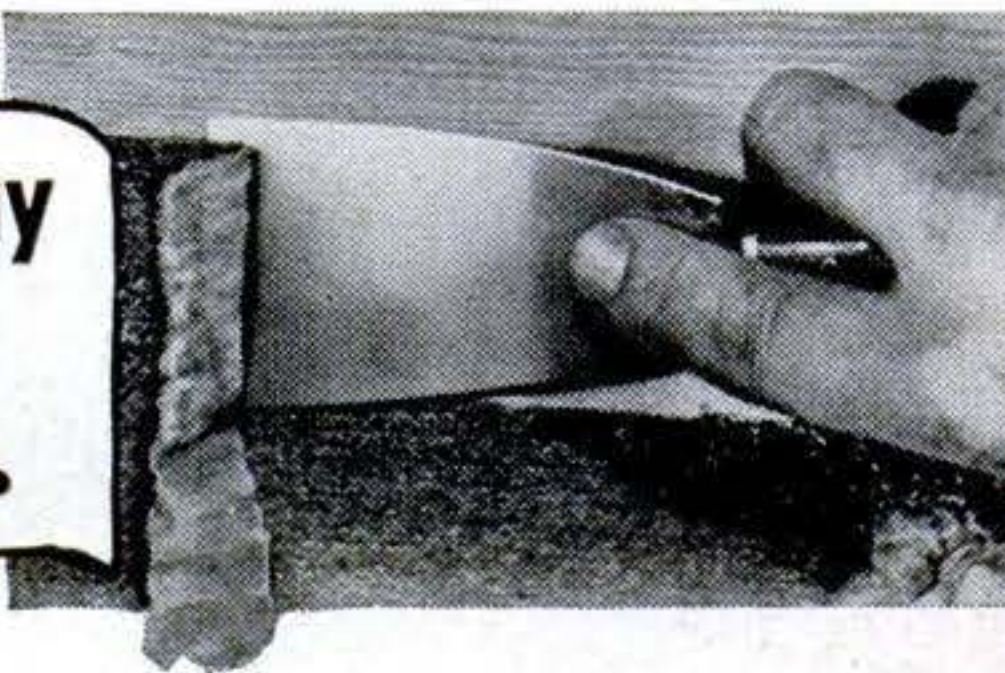

WONDER-PASTE, applied with a paint brush, softens up the toughest paint, varnish, enamel or shellac right down to the surface. Comes off clean at every stroke of your putty knife. Try it. At paint and hardware stores. . . . Write for leaflet on Wonder-Paste and advice on your particular removing problem.

Wilson-Imperial Company, 121 Chestnut Street, Newark 5, N. J.

SURPLUS



COMPRESSION TESTERS

BRAND NEW complete with stem. Manufactured by U.S. Gauge, Auto-Lite, etc. Relief valve built into handle. Retains pressure reading until released. 15° bend in handle gives access to all cylinders—3 1/2" dial calibrated to 200# pressure. Ideal for checking variation in compression between cylinders, amount of piston ring leakage, and amount of valve leakage. Rubber cone is replaceable. Priced at only... **\$4.25.**

Two for **\$8.00.** Further discounts on larger quantities.

VICKERS HYDRAULIC PUMP OR MOTOR. Mod. PF2.

This brand new, compact, powerful pump is rated at 1000 PSI. .507 Cu. In. per Rev., 8 G.P.M. at 3750 R.P.M. Delivers up to 6 H.P. Requires 1/3rd to 6 H.P. to drive directly. Change rotation by reversing flow. 5/8" drive spline and 1/2" pipe ports. Wt. 4 lbs. Priced at only **\$8.95**



Discount on quantity.

SOLDERING FLUX (Paste)

In 1/2 lb. cans manufactured by Kester. For general soldering. Priced at 2 cans for **\$1.10**

CARBURETOR AIR FILTER

5 1/2" x 5" x 2" metal case with brass filter element. Easily cleaned with gasoline. Weight only 1 lb. Ideal for engine filter, darkroom breather, etc. Brand new. Price each... **\$1.50**
4 for **\$5.00** 8 for **\$8.00**

3-WAY LOW PRESSURE SELECTOR VALVE



With 3/4" pipe thread. One port for inlet and three separate outlet ports with selector. Weight 2 3/4 lbs. Brand new. Priced at only **\$3.95**

DRAWER AND CABINET HANDLES

Brand new with solid brass, bright chrome finish body. Black plastic handle. This durable handle will dress up any piece of furniture. Available in two sizes: 2 1/4 x 1" and 1-11/16 x 5/8" body base. These handles are screw mounted, but screws are not included. Minimum order of either size is: **\$1.75** six handles
\$3.00 twelve handles
Further discounts on larger quantities.

BRAND NEW REX HIGH SPEED TOOL STEEL BITS

5/16 x 5/16 x 2 1/2" **\$1.79** 1/2 x 1/2 x 4" **\$1.95** 7/8 x 7/8 x 5 7/8" **\$1.95**
8 Pieces
3/8 x 3/8 x 3" **\$1.95** 3/4 x 3/4 x 4 7/8" **\$2.49** Additional discounts on larger quantities.

FITTED SOCKETS FOR MORSE TAPER SHANK DRILLS

Male, MT	Female, MT	Price
2	3	\$1.29
3	3	\$1.49
3	4	\$1.95
4	4	\$1.95
5	3	\$4.95
5	5	\$4.95



BRANDNEW STRAIGHT FLUTE HAND EXPANSION REAMERS

1-3/16 x 1-11/32.....**\$2.50**
1-11/32 x 1-17/32.....**\$2.95**



BRAND NEW CARBON EXPANSION REAMERS

1-3/16**\$1.95**
1-13/32**\$2.50**

Maximum expansion for these reamers is .010 above size stated.

BRAND NEW PARKER CONTROL RELIEF VALVE

With check valve type seat. Ports at 90°. 7/8"-18 thread. Can be adjusted between 1200 and 1250 P.S.I. Priced at only **\$2.00**

Valve same as above with 1/2" pipe connection. Adjustable between 200 and 500 lbs. Brand new priced at only **\$2.00**

SURPLUS CUTTING TOOLS



TAPER SHANK DRILLS

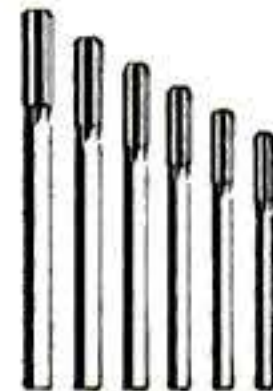

CHUCKING REAMERS



HAND REAMERS

SET 12 Different Size High Speed Morse Taper Shank 1b Drills up to 9/16" with No. 1 and 2 taper. \$40.00 value. Priced at only... **\$4.95**

SET 10 Different Size High Speed Morse Taper Shank 2b Drills from 1/2" to 1 1/4". \$90.00 value. Priced at only **\$8.95**

SET 15 Different Size Hand Reamers up to 1/2" including 3b one small Taper Pin Reamer. ALL BRAND NEW. Priced at only... **\$6.25**

SET 6 Different Size Large Hand Reamers from 1" to 4b 1 9/16". Wt. 23 lbs. approx. Brand new. Priced at only... **\$19.50**

SET 10 Different Size Morse Taper Shank Reamers up 5b to 1". Priced at only... **\$4.50**

SET 10 Different Size High Speed Straight Shank Chuck- 6b ing Reamers up to 1/2". Priced at only... **\$3.95**

HIGH SPEED MILLING CUTTERS



SIDE MILLING CUTTERS

Dia.	Width	Arbor Hole	Price Ea.
2	1/8	5/8	\$1.20
2	3/16	5/8	1.25

PLAIN MILLING CUTTERS

(without side chip clearance)

2 1/2	2	1	\$3.95
-------	---	---	--------

All merchandise sold with money back guarantee of satisfaction and is shipped PREPAID.

T & T Tool 111 West Archer Tulsa, Okla.

ELECTRIC SHEAR SHARPENER

Over 65,000 Sold—It Must Be Good!



Genuine Carborundum Motor driven wheel ideal for shop or home use. Send remittance with order and shipment will be made at once, prepaid to your door. complete with electrical goods catalogue. **\$9.75** complete with vise

WILLIAM MARVY COMPANY, Dept. 8
479 St. Peter Street St. Paul 2, Minn.

Make Your Own POWER LAWN MOWER

with this DRIVE CUTTER ASSEMBLY.

Constructed for those who desire to build their own mower or to replace your old cutter assembly. Complete with 18" blade and double ball bearing drive. Add 50c to cover handling & shipping. No COD's. **\$11.95** only



ATLAS EQUIPMENT CO., Dept. P.S.6
229 S W BLVD. KANSAS CITY, MO.

SAFETY ON THE BOTTOM

NAVY SURPLUS DIVING HELMETS

New, Surplus Shallow Water

\$5.95 Diving Helmets, complete with Manifold. **POST-PAID**



WOODBEEK SALES, Greenville, Michigan



5 big-capacity power tools
in
1 precision-built unit



Write for free, 16-page, profusely illustrated book. **SHOPSMITH, Dept. 127-A, 12819 Coit Rd., Cleveland 8, O.**

Earn \$300⁰⁰ to \$500⁰⁰ per month—ARC WELDING!

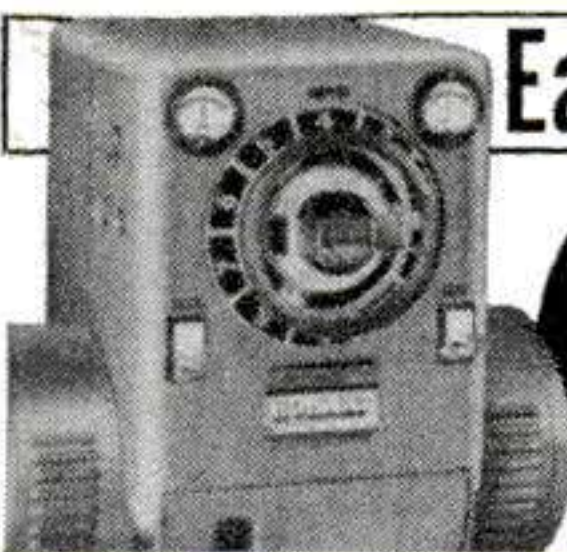

"Pays for itself" **TERMS as low as \$16.50** monthly

DC welding generator can be powered with any gasoline engine or belt driven from other power source. Same unit as used in Hobart's complete welder with exclusive features and controls for easier, faster, better welding. Helps you start profitable welding business on right basis, with small monthly payments.

It's easy!



... to build your own portable welder With Hobart Generator on used auto engine and chassis, go where welding is needed, make money. Write for info on "Build Your Own" Welders.

HOBART Brothers Co., Box P-601, Troy, Ohio "One of the world's largest builders of arc welders"

TERRIFIC SURPLUS BARGAINS



BRAND NEW STRATOPOWER CONSTANT DISPLACEMENT HEAVY DUTY PUMP for operating hydraulic cylinders, motors, tractors, Bulldozers, Construction machinery, Lift trucks. For fuel or oil transfer, Industrial applications, etc. Delivers 375 G.P.H. at 3750 R.P.M. Rated 1250 to 1400 P.S.I. 3750 to 4500 R.P.M. HAS BUILT IN RELIEF AT HEAD. Rotation either direction without adjustment. Can be used as hydraulic motor. \$85.00 value. Stock #37. **\$12.50** Wt. 8 lbs. Only.....

NEW HYDRAULIC CYLINDER SPECIAL. Gives 12560 lbs. with 1000 P.S.I. input. Gives 17584 lbs. thrust (push-pull) with 1400 P.S.I. pressure with our STRATOPOWER PUMP. Or 34168 lbs. with 3000 line pressure. Can also be operated on low pressure air system. 4" bore, 8 3/4" Stroke, 1 5/16" shaft. Clevis mounting. \$300.00 Gov't cost. Stock #12..... **\$19.50** Only

NEW HYDRAULIC CYLINDER No. 11. Here is a double action 1 1/2" Bore, 6" Stroke, 5/8" Dia. Shaft, Clevis mounting base & shaft end Gives 1160 lbs. with 1000 P.S.I. input or 1625 lbs. with our STRATOPOWER PUMP. \$50.00 value. (Engineering data incl.) **\$9.50** post paid

HYDRAULIC CHECK & RELIEF VALVE. \$2.50
VICKERS ACCUMULATOR. Brand new. Use it for constant pressure both in line and reserve storage or pressure booster. Ball type 5 1/2" dia. Stock No. A-650. Wt. approx. 4 lbs. Now **\$5.50** Only

ADEL SELF PRIMING PUMP. New. Compact for pumping light oils, aquarium, fluid metering, fuel pump, tool post grinder, coolant pump. Pressure lubricating pump and general industrial use. With built in double ball bearing series wound motor, continuous duty. Can be operated on 24V. D. C. or A. C. Rated 30 G. P. H. A **\$7.95** post paid \$50.00 value.....

PESCO VACUUM AIR-GENERAL PURPOSE PUMP. Here is your pump for air, fluid, or vacuum. Standard 1/2" pipe thread. Delivers 300 G.P.H. at 2000 R.P.M. Self aligning shaft. Spline terminal for direct drive, readily replaced with a pulley. Use this pump for OIL BURNERS, MILKING MACHINES, COMPRESSORS, VACUUM PUMP, Weed Killer Solutions, Etc. UNUSED. Original. Price per pair \$45.00. Now Only **\$8.50** post paid

VALUABLE GEARS BARGAINS SPEED REDUCER 10-1 or 5-1 ratio, 90 degree angle. Shaft Driven 1/2" spline Shaft with 3 mounting holes 5/16". Gears held in forged and machined aluminum housing with two needle bearings, one bronze bearing, and three high speed shielded bearings. Sealed self lubricating chamber. Price (Plus 35c Postage) **\$3.95**

D. C. GENERATOR. Brand new. For farm—Home—Ranch. Delivers 430 Volts D.C. at 3450 R.P.M. Ball bearing supported. Fan cooled armature. Self lubricating bearing. Drive it off farm tractor gas engine, etc. #211220-A, Wt. 21 lbs. Now only **\$5.50**

SENSATIONAL FASCINATING MYSTERIOUS SELSYN. Two or more connected together can be adapted for 110 V. A.C. For weather vanes, rotating directional antennas or controlling distance operations. Diagram and instructions incl. Price per pair **\$4.50** post paid

CUNO OIL FILTER. BRAND NEW Aircraft type. Filters oil without cartridge replacements. Just turn handle and cartridge is clean. Standard 3/8" inlet and outlet ports. STOP CHANGING OIL. Instructions incl. **\$4.95** post paid

All items guaranteed as represented. Send check or money order. Prices f.o.b. K.C. except when marked postpaid.

GENERAL SALVAGE COMPANY

Dept. 6-27, 2922 E. 27th St. Kansas City, Mo.



HANDY CALCULATOR FOR WOODWORKERS.. ONLY 10c

Just set dial, quickly solves countless problems. Converts linear to board feet, compares workability of various woods, shows bit sizes, nail specifications. Also tool sharpening tips, etc. 6" diameter heavily varnished cardboard. Send 10c to Greenlee Tool Co. 2126 Columbia Av., Rockford, Ill.



HOLD-E-ZEE

The Original AUTOMATIC GRIP SCREWDRIVERS

See these popular, high-quality drivers with the exclusive Gripper that holds, starts and sets up screws in unhandy places!

New Models FOR RECESSED HEAD SCREWS

At Leading Dealers Everywhere

UPSON BROS., INC., ROCHESTER 4, N. Y.

5 BIG POWER TOOLS

in ONE

8" TILTING TABLE SAW

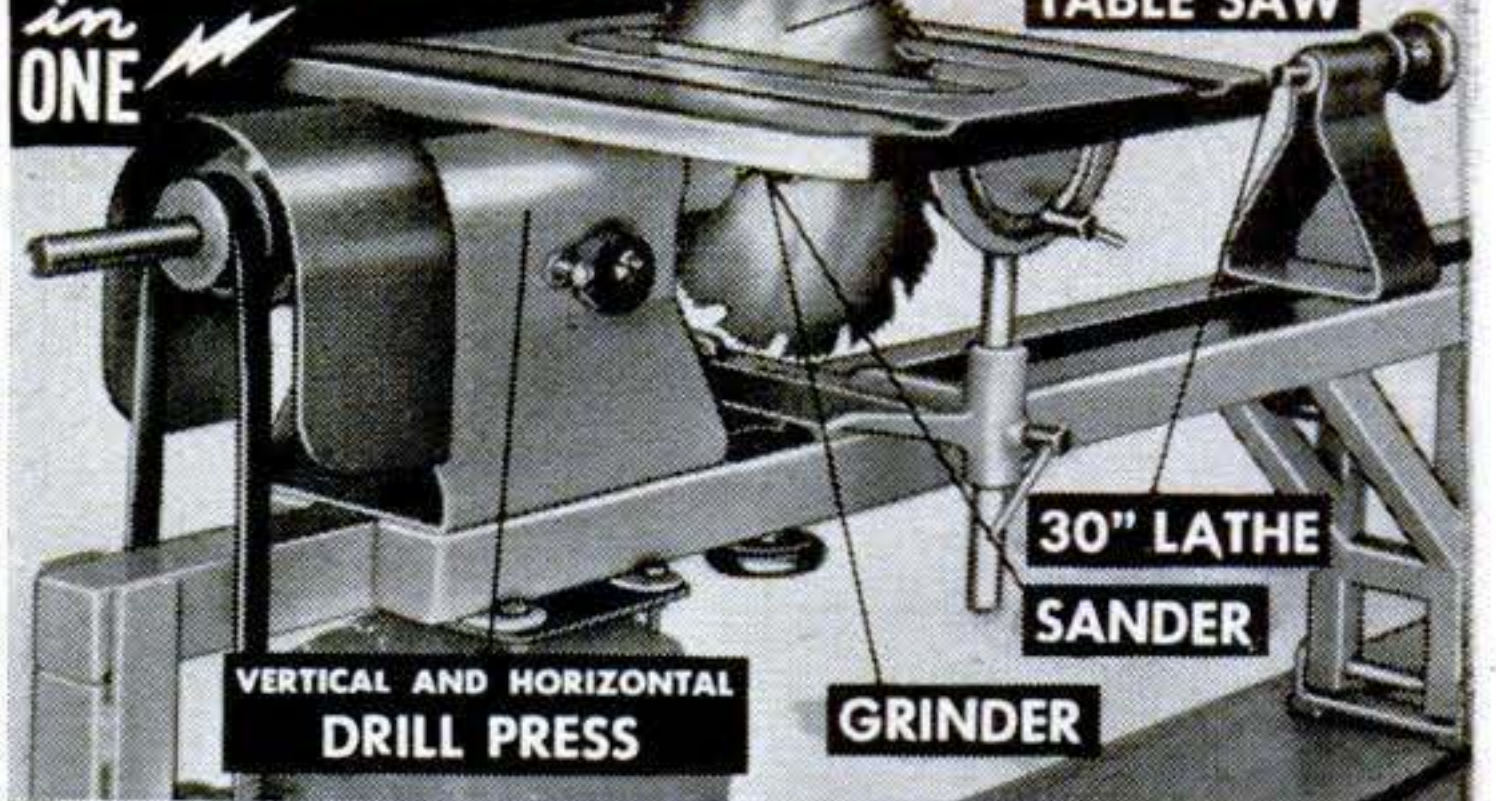

RETAIL PRICE \$125.00

FACTORY TO YOU \$59.95

SUPERSHOP the PRECISION BUILT WORKSHOP. Lifetime lubricated BALL BEARINGS. All running parts precision GROUND. Compare finest production tools. BIG capacity. Amazing VALUE. Write for FREE catalog, full details, trial plan.

POWER TOOLS, INC.

212 Yates Avenue
Beloit, Wisconsin

COMPLETE 8" TILT ARBOR SAW MOVEMENT

TABLE STAYS LEVEL



FULL BALL BEARING

COMPLETE MOVEMENT & PLANS*

\$22.75

F. O. B. ROYERSFORD, PA. LESS GUARD

PLANS ONLY 25c

\$22.75 REFUND IF NOT SATISFIED IN 10 DAYS

Write DEPT. C, MARCUS-POLLAK
ROYERSFORD, PA.

SAVE \$50

BLADE TILTS TO 50°

MAKE ANY SIZE . FLOOR OR BENCH MODEL

BRONZE FOUNDRY

Schools and Home Workshops

Make your own castings of aluminum, copper, bronze, silver. Foundry sets are available in three sizes including 2400 Deg. F. blast Furnaces, \$22.50; \$29.50; and \$42.00. f.o.b. Kansas City. Free Circular.

KANSAS CITY SPECIALTIES CO. P. O. BOX 6022, DEPT. S-5 KANSAS CITY, MO.

SHARPEN CIRCULAR SAWS LIKE AN EXPERT



\$6.95

No experience needed. Two simple adjustments. Gets hollow-ground, cross-cut or combination saw blades true and sharp. Fits 6" to 12" blades with 1/2" to 13/16" centers. Includes file and complete instructions. \$6.95 postpaid. (Check or money order) C.O.D.s postage extra. Guaranteed—Money back if not satisfied after 10 day trial. A money maker for fix-it shops. Soon pays for itself. Order today. Free folder. SURE SHARP MFG. CO., Dept. S-60 P. O. Box 24 Santa Ana, Calif.

WELD BRAZE, SOLDER, CUT quickly... easily

The FOUR-WAY PORTABLE ARC-WELDER

COMPLETE ONLY \$9.95 F.O.B. 10 DAY TRIAL



YOU'LL BE AMAZED by the work you can do on your first job! Plugs into any convenient properly wired 110 volt A.C. or D.C. line. Follow simple directions. Work on iron, steel, bronze, brass, aluminum and other metals. Save money doing own repairs. Make money repairing for others. Thousands of users among maintenance and repair men, farmers, tinsmiths, engineers, home and auto owners, etc. Pays for itself over and over. Order on ten-day trial or send for details.

MAKE OR REPAIR HOME & FARM APPLIANCES FENDERS BICYCLES METAL FURNITURE & 1001 ITEMS

FREE FOUR-WAY WELDER CO., Dept. F3-FA 2326 So. Michigan Avenue • Chicago 16, Illinois Full Details SEND TODAY

PALMGREN

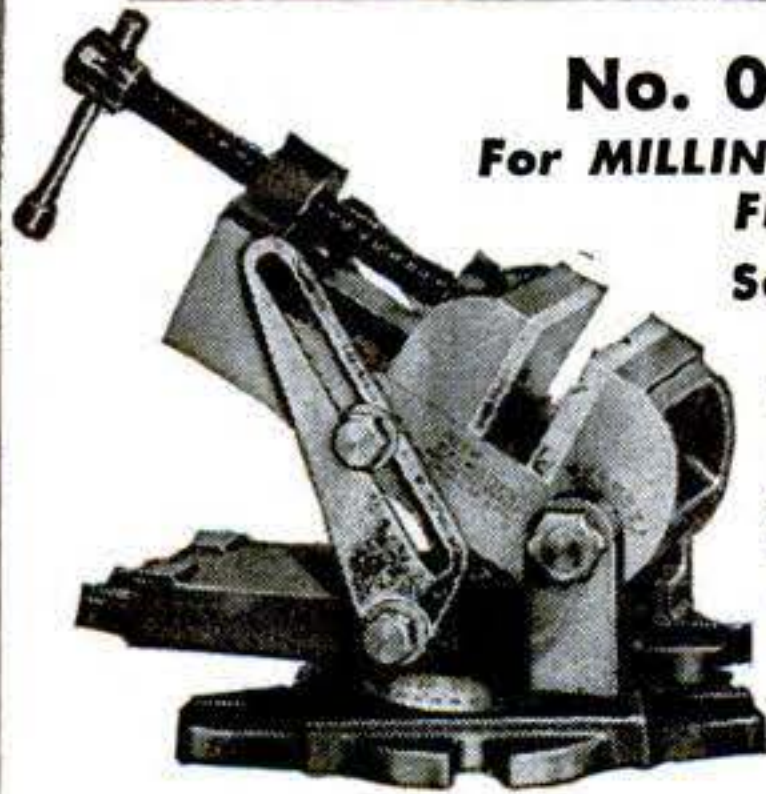

No. 000 ANGLE VISE
For MILLING—DRILLING—GRINDING
FITTING—FILING

Solve Difficult Angle Jobs

Quick, accurate set-ups at any angle. End make-shift methods—time loss—reflections. Ideal for tool rooms or home workshop. Accurately machined and graduated. Once set it stays locked. Jaws of steel—2 1/2" wide, plain or grooved. PRICE \$12.05 complete with Swivel Base—Vise only \$8.75. Write for other styles and sizes.

DRILL PRESS VISES

For tool room, machine shop, school shop, home shop or repair shop. Accurately machined. Best semi-steel castings. Adjusting screw of hardened steel with fine pitch thread and long bearing. Jaws of steel, grooved or plain. Sizes 1 1/2" — 2 1/2" — 4" Jaws.

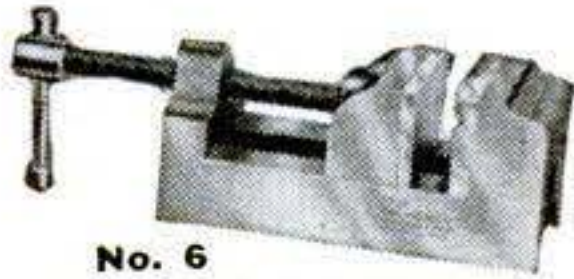

No. 6
1 1/2"-GROOVED STEEL
JAW. \$3.30

No. 83 ROTARY TABLE with . . . DUAL CROSS FEED and ROTARY FEED



Has 8" Circular Table with full 360° movement and 4" crossfeed travel. Free moving adjusting wheels and dials graduated in degrees. Crossfeed adjusting screws have Acme threads with adjustable dials graduated in thousands. Four slots in base and key slots for bolting to table.
No. 83 Rotary 8" Table . . . \$49.50
No. 82 Dual crossfeed—with-out rotary . . . \$39.75

IMMEDIATE DELIVERY Write for Circular No. 12 — Order from dealer or direct postpaid if he can't supply.

CHICAGO TOOL AND ENGINEERING CO.

8396 South Chicago Avenue Chicago 17, Illinois
Telephone—Saginaw 1-9675

HYDRAULIC Power Transmission

WITH Infinitely VARIABLE SPEEDS, Clutch and INSTANT REVERSE
OUTPUT TORQUE ADJUSTMENT UP TO 180 inch POUNDS

This positive displacement Hydraulic Torque Converter is the ideal fluid drive with thousands of uses. Output Speeds Infinite .0 to 550 R.P.M. . . in either direction. Change Speeds WHILE RUNNING. Control and Transmit your power this SMOOTH Oil-Way. Will handle 1/4 H.P. to 1 1/2 H.P. Motor. Industrial or Home & Farm Use. Cost Government \$300. High Quality Precision Workmanship. Buy this unit to get the most for your money. Case measures 7 1/2" long 7" high 6 1/2" wide. Input & Output Shafts 5/8" dia. Beautiful Red Crackle Finish Case.



FINGER TIP CONTROL
Shipping Wght. Only
25 pounds **\$54.50**
Prepaid in U.S.A.
2 quarts oil included FREE

If C.O.D. is requested a 10% Deposit must accompany order and we ship F.O.B. Chicago.

1 1/2"-8 thread Lathe
Chuck Adapter, \$3 extra

DIRZIUS MACHINE SHOP "O" 1423-25 So. 52nd Ave., Cicero 50, Ill.

HUNDREDS OF ITEMS AND IDEAS FOR THE WOODWORKER

HARD TO FIND LUMBER

A board or carload—Top grade kiln dried Mahogany—Walnut—Wh. Hd. Maple—Cherry—Poplar—Aromatic Red Cedar—Red, White and English Brown Oak—Sapeli—Andiroba—Balsa Wood.

**BIG NEW No. 17
CATALOG FOR
WOODWORKERS.**

144 PAGES
OF HARD-TO-FIND
SUPPLY ITEMS.
Full of unequalled bargains and useful information.

The finest craftsman catalog Harold Hunt ever published—32 rare and fancy woods in natural colors—also in color, 43 matched veneer designs, multi-colored bandings, inlays, overlays, scroll patterns, etc. Price 15c. rebated on first order.

CRAFTSMAN WOOD SERVICE CO.

2729 S. Mary St. Dept. B-6 Chicago 8, Ill.

NEW!

NYLON

paint brushes



- Smoothest painting**
- Easy to clean**
- Ideal for nearly all finishes**
- Durable bristles... won't break off**

When you ask for a paint brush, ask for a NYLON . . .

Nylon paint brushes are made by leading paint brush manufacturers. Sold in paint, hardware and wallpaper stores everywhere, in all popular sizes. Buy a nylon paint brush today!

NYLON
PAINT BRUSHES
*for smooth painting
...easy cleanup*



Better Things for Better Living
... through Chemistry

Just off the Press
-and **FREE!**

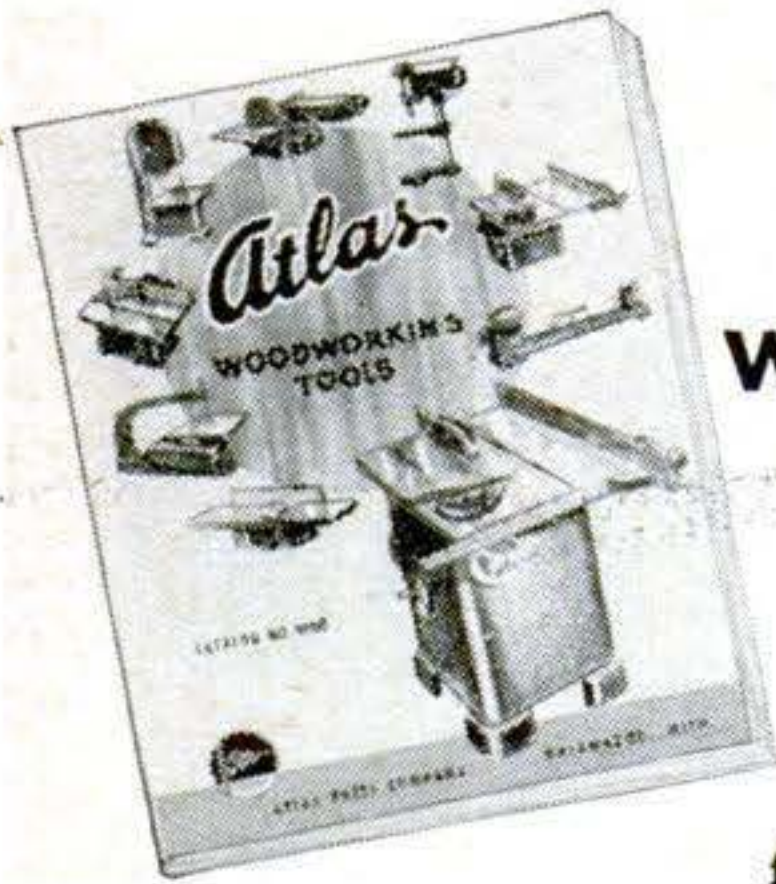

Atlas
WOODWORKING CATALOG

Gives you complete information and operating views of these "industrial quality" tools for home shops. Atlas tools can help you this summer on your home building, improving.

SEND A POSTCARD FOR YOUR COPY

ATLAS PRESS COMPANY
655 N. Pitcher St., Kalamazoo, Mich.



MATCHED PRECISION TOOLS FOR WOODWORKING AND METALWORKING

3 Speed Whirl-A-Way BUFFER AND SANDER KIT \$7.95

Own this fine outfit. Adds many uses to your 1/4" electric drill, both right angle and direct. Precision built. Polished speed-up and reducing gears in hand-grip housing, grease packed. Amazing Value. 3 SPEEDS . . . a right speed for every use. Includes: Sheepskin Bonnet, "Carpet Buffer", 3 types sanding discs, flexible rubber head . . . all equipment and supplies ready to use.

SEND NO MONEY SAND GRIND POLISH FINISH
Try "on the job" for 3 days at OUR RISK. Nothing finer for BOATS, CARS, HOME or WORKSHOP. Order today COD (or remit and we pay postage) GUARANTEED to please or full price refunded.
WALTER WILLIAMS & CO. Dept. PSM
2410 N. Lakeview Chicago 14



WAR SURPLUS AND OTHER BARGAINS



ELECTRIC BELLS—Vibrating type, high pitch. 115 V., 60 Cycle. Ideal for use indoors or outdoors—on ranches, for schools, plant installations, as signal systems, burglar alarm systems, etc. Nationally known Mfr. ALL NEW in orig. Pkgs. Solid brass clapper & 8 1/2" gong. Wt. 8 lbs. Govt. cost about \$67.50. **Close out at . . . \$7.95**

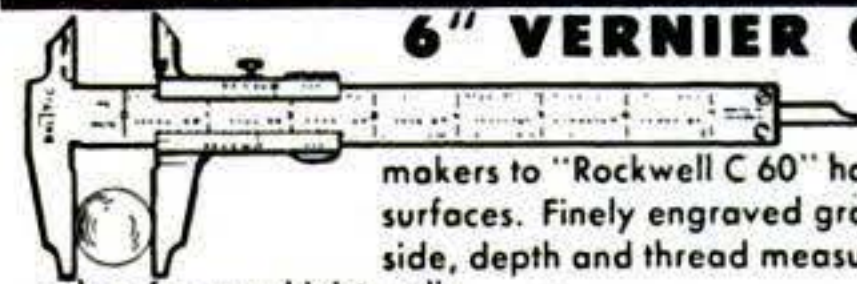

6" VERNIER CALIPERS

Imported from Sweden of finest steel. Made by master tool makers to "Rockwell C 60" hardness. Precision lapped measuring surfaces. Finely engraved graduations in 1/1000" for outside, inside, depth and thread measurements up to six inches. Wonderful value for machinists, die makers, etc. Accuracy unconditionally guaranteed
6" VERNIER CALIPER, postpaid . . . \$14.95
Imported grained leather case, postp'd 1.25

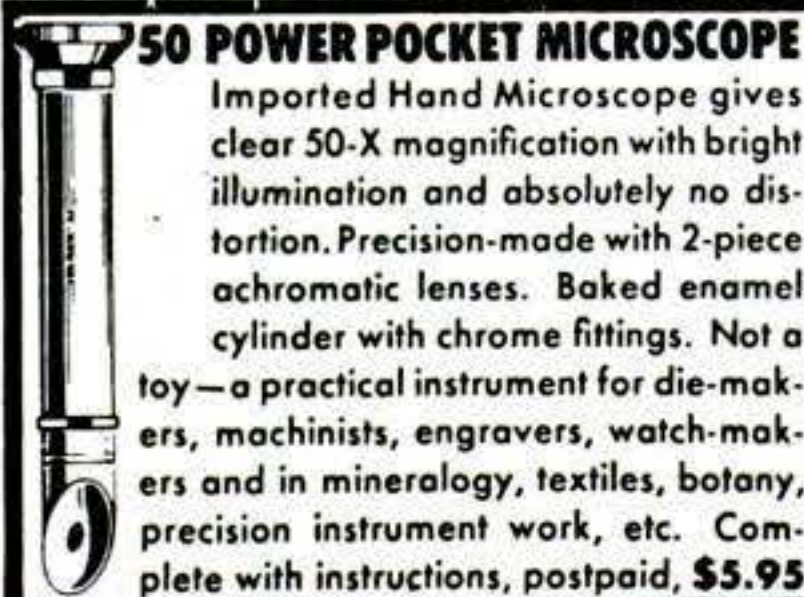

50 POWER POCKET MICROSCOPE

Imported Hand Microscope gives clear 50-X magnification with bright illumination and absolutely no distortion. Precision-made with 2-piece achromatic lenses. Baked enamel cylinder with chrome fittings. Not a toy—a practical instrument for die-makers, machinists, engravers, watch-makers and in mineralogy, textiles, botany, precision instrument work, etc. Complete with instructions, postpaid, **\$5.95**

HIGH SPEED DRILLS

All New. Fractional & numbered. Orig. Val. \$15. Nationally known brand. Astd. sizes. Set 30, **\$3.50**

EXTENSION DRILLS

High Speed Steel, like new. Astd sizes from No. 1/4 to 40. Lengths from 6" to 12". Approximately \$20 value. Set of 12 . . . **\$3.75**



MICROMETERS

Chrome plated, precision engineered and carefully tooled to give long life. All new. 0-1" capacity . . . ea. **\$2.25**. 1-2" cap. **\$3.50**. 2-3" cap. **\$5.50**. 3-4" cap. **\$6.50**.

Send check, money order or cash. 25% deposit required on C.O.D. orders. All prices F.O.B. Culver City, Calif. **Send 25c for Illustrated Catalog.**

AIRBORNE SALES CO., INC. DEPT. PSM 6-0
CULVER CITY, CALIF.

\$ RETOOTHING SAWS PAYS BIG \$

EARN \$15.00 HOURLY . . . as automatic rethooter cuts new 4 pt. to 16 pt. rip or cross-cut teeth on hand saws in 50 seconds. Requires less space, less time and less effort . . . while doing a perfect job. Gives a lifetime of service and has a 1 year guarantee. Free folder on request.

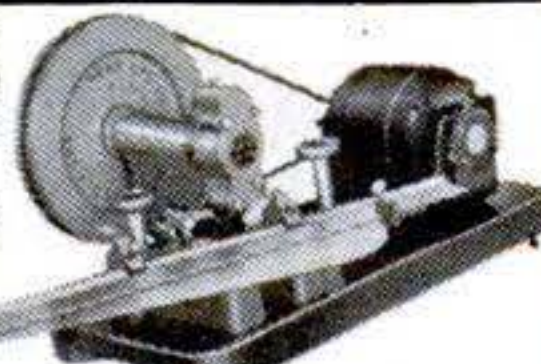

SAW SHOP CHARGES COAST TO COAST

WRITE FOR VALUABLE BOOK Automatic Retooter
Send 25c in coin for Burr's Blue Book of saw shop charges and other valuable information.

BURR MFG. CO., Dept. PS-6, 8943 Venice Blvd., Los Angeles 34, Calif.



Ask Your Hardware Store for FULLER'S Unbreakable Amber Handle SCREW DRIVERS

America's most popular line of moderately-priced screw drivers! Wide range of sizes. **FULLER TOOL CO., Inc., 911 Faile St., New York 59**
World's largest maker of Amber-Handle Tools

HERE'S A GREAT LITTLE TOOL—I don't know how I'd get along without it

It's the handiest thing in my home workshop. Just the thing to fix broken tools, and gadgets for the house. Even charges batteries if you get the optional rectifier . . . Plug it

into a 110 volt socket and you're welding. That's simple enough isn't it? Price with accessories shown . . . only \$48.00 in U.S.A. Order your "Lincwelder 60" now.



ORDER NOW
Fill out and mail to
The Lincoln Electric Co.
Dept. 203
Cleveland 1, Ohio

- Ship me the "Lincwelder 60" with accessories \$48.00 Enclosed is check money order
- Send me free bulletin on the new "Lincwelder 60"

Name _____
Address _____
City _____ State _____ 203

Last Year's Profit \$3,000!

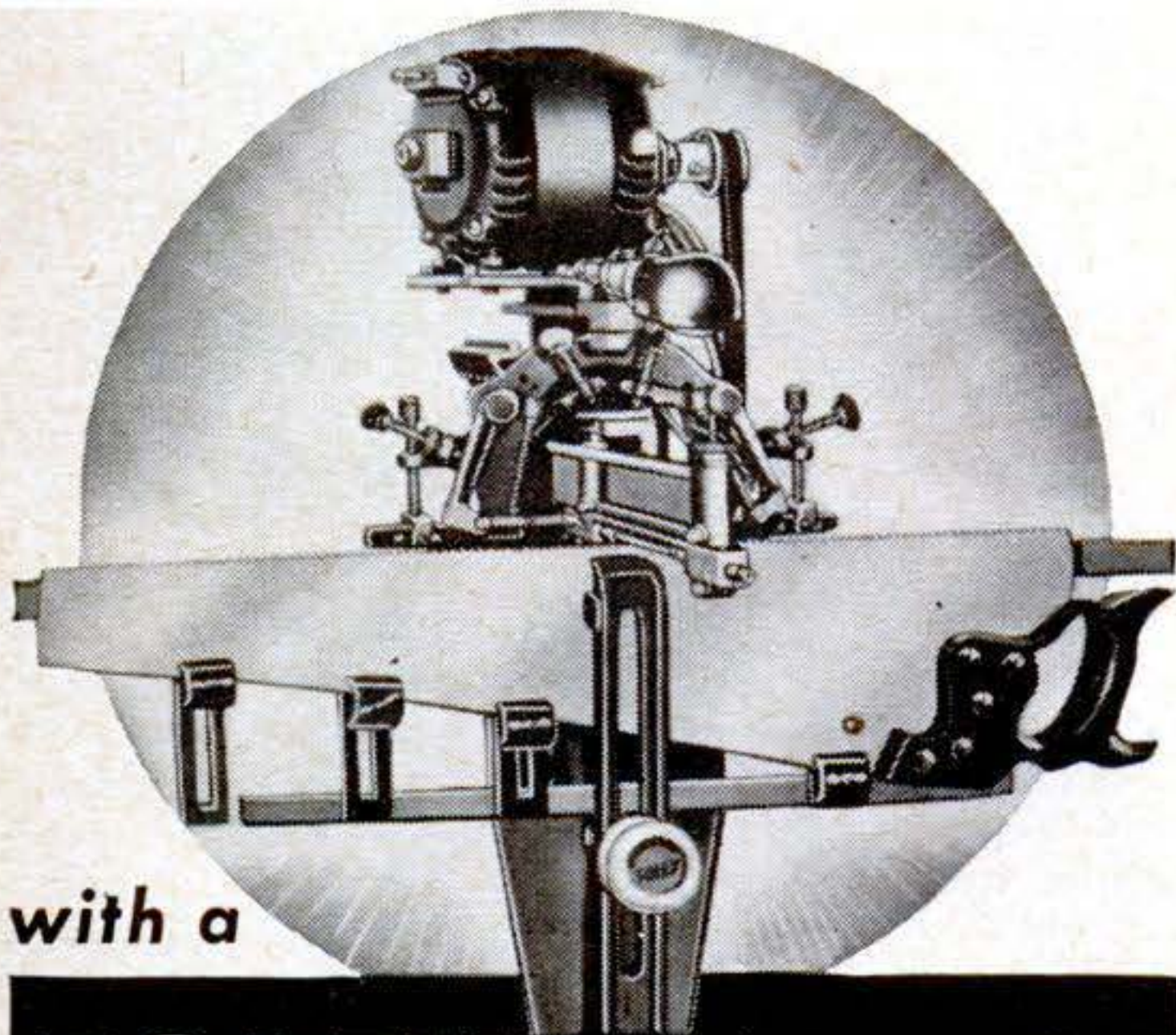

with a

FOLEY automatic SAW FILER

"Last year's profit amounted to \$3,000. Not so bad for a one-man outfit"—from Chas. C. Hough. James B. Williams wrote us—"I made \$765 last year filing saws, and it sure comes in handy. I do this work in my spare time". Men in communities of all sizes make up to \$2 or \$3 an hour with the Foley Saw Filer working full time or part time. That extra money comes in mighty handy in these days of high prices.

It's no trick to take care of the saw filing for your neighborhood hardware or lumber dealer—plus looking after the saws for farmers, townspeople, manual training departments and factories. The Foley files all hand saws, also band and cross-cut circular saws. It's a cash business, no canvassing, no eyestrain and no experience needed.

FREE BOOK SHOWS HOW TO START

"INDEPENDENCE AFTER 40" shows just how you can start at home in your spare time working in your basement or garage. It's an immediate cash business that can develop into a full-time repair shop. Send coupon today—no salesman will call.



Send For **FREE BOOK**

FOLEY MFG. CO., 619-0 Foley Bldg.
Minneapolis 18, Minn.

Send me free book "INDEPENDENCE AFTER 40!"

Name

Address

QUALITY POWER MOWERS FOR LESS

Make-Ur-Own Rotary POWER MOWER

SHIPPED ASSEMBLED AS SHOWN
Model 50M Just add your elec. motor or gas → engine. Concealed 18" blade for safety. 3 cutting heights. Ball bearing wheels.

← Model 50GM with 2½ H.P. McCullough gas engine...\$119.50

Model 50GVC with Clinton Vertical 1.8 H.P., 4 cycle.....\$104.50

Model 50E with ½ H.P. electric motor, 75 ft. cord.....\$69.50

America's Greatest Power Mower Values
Fully Guaranteed

Order Model Desired NOW!
F.O.B., K. C. Send check or M.O.

ATLAS EQUIPMENT CO.

229 S.W. Blvd.

Dept. SP6

Kansas City, Mo.



ONLY
\$39⁹⁵

SOUTH BEND

LATHES
DRILL PRESS
SHAPER



9" to 16-24" Lathes



14" Drill Presses



7" Bench Shaper

Write for literature—indicate machine.

SOUTH BEND LATHE, SOUTH BEND, IND.

Only
\$498



OTTAWA Mule Team Tractor

Finest low-cost tractor. Costs too little to do without. Engines burn gasoline or kerosene. Starter and lights available. Other larger Models to choose from. Over 4,000 in world-wide use. Time-proved and tested. At low cost they easily mow, plow, disc, harrow, plant, cultivate, etc. Sold only direct to user. Write for FREE details.

OTTAWA MFG. CO., 2-001 Garden St., Ottawa, Kansas

USE YOUR BENCH SAW

FOR JOINTING & CUTTING MOULDINGS



With our six inch tool steel cutters make mouldings, casings, drop-leaf tables, grooves beading and jointing. Moulding cutters. A 1 in. wide \$1.75, 1½ in. \$2.25. Jointing cutters. B 1 in. \$1.75, 1½ in. \$2.25. E 1 in. for drop-leaf tables, \$1.75. E 1½ in. Makes ¾ in. cove & Quarter. \$2.25. Postpaid. Guaranteed. State size hole. List & Folder free.

JOHN A. SANDSTROM
Rt. 2-P. Clearwater, Fla.



KING MIDGET HOME ASSEMBLED AUTO



WORLD'S LOWEST PRICED AUTOMOBILE!

80-90 MI. PER GAL.—45-50 MI. PER HR.

Drive for as low as 50c per week. Precision built parts direct from factory with beautiful all steel body. Get the facts on this amazing small auto—send 25c for detailed circular with large picture, 3 view drawings and price of all parts, or send \$1 (refunded first order) for this plus actual assembly book with 42 photos, drawings: blueprints of snow, ice conversions, information on mini-midget racing, etc.

MIDGET MOTORS MFG. CO., Athens 3, Ohio

King Midget is ideal for errands, sports use, to work, short business or pleasure trips, or second-car utility for the whole family. Also tops for mini-midget racing. Room for six footer.

DREMEL'S STRAIGHT-LINE ACTION GUARANTEES SCRATCH-FREE SURFACES

Here's fast cutting, finish sanding at its best. Dremel introduces a new electric sander, sturdily built to withstand hours of continuous use. It is light in weight . . . will not tire operator. Its **straight-line (non-rotary) action** leaves no scratches, no rotary marks—just satin-smooth surfaces ready for any type finish. Here, for the first time, is an electric sander built for years of faithful service—all at the remarkably low price of **only \$24.50**.

Model 2000 MEETS EXACTING NEEDS OF CRAFTSMEN, HOME and INDUSTRIAL USERS

Craftsmen find this new Dremel model has the extra stroke and power needed for heavier woodworking projects such as cabinet-making, boat building, garden furniture, etc. Home-owners say it's exactly right for refinishing varnished floors, plaster walls, woodwork, furniture, siding and other exterior surfaces. For polishing too, the Model 2000 does a professional job—eliminating all the back-breaking labor on any waxed surface, including cars, furniture, floors, stairways, etc. Industrial users likewise find this new Dremel Sander a faithful performer in furniture, cabinet, building and body shop operations.

RUGGED DESIGN and PERFORMANCE FEATURES

- Only two moving parts—requires no oiling.
- Reciprocal (straight-line—non-rotary) action leaves no marks . . . cannot burn surface.
- 21 square in. sanding surface speeds production . . . 14,400 cutting strokes per min.
- Cam-type holder permits changing paper in seconds.
- Die-cast aluminum housing with moulded Bakelite cover . . . Light weight, only 5 pounds . . . Over-all size 3 1/8" wide x 4 1/2" high x 7" long.
- 8 ft. Underwriter's Approved cord . . . operates on 110-120 v. A.C.

ONLY
\$24.50

WITH STEEL
CARRYING CASE
AND COMPLETE
ACCESSORIES

14,400
Sanding
Strokes
Per
Minute



PRICE INCLUDES STURDY CARRYING CASE

Perfect portability of Sander, cord, abrasives, and polishing pads is provided in this sturdy, 3-shelf metal storage case. Price also includes 25 assorted sheets Garnet Paper and a high-grade sheepskin polishing pad.

WHERE TO BUY—Dremel Tools are sold everywhere. If your dealer cannot supply you, order direct from factory. Send remittance in full and we will ship **postpaid**. Or send only \$2 now and pay postman balance plus postage and fee. Money back if you are not delighted after 5 days' trial.

DREMEL MFG. CO., Dept. 120-F, Racine, Wis.

DREMEL Model "A" SANDER-POLISHER OVER 200,000 NOW IN USE!

A lighter-capacity model that takes all the work out of home or hobby projects. Meets requirements of most users. Same design and construction features as larger model. Furnished in attractive cardboard box. If your dealer can't supply, order direct from factory.

\$14.85



It Pays *to do* your own **ARC WELDING.**

"Pays for itself"
Easy TERMS
as low as
\$11
monthly

It's Simplified

Start doing expert work right away. No guesswork or "experience" needed. Just set controls and make high quality welds. Economical to operate. Save and earn money in hundreds of ways with today's biggest value in transformer A-C Welders.

earn \$ \$ \$ welding for others

Shop owners earn \$300 to \$500 or more monthly. Many began in spare time and now have their own business. Possibilities are unlimited if you get started now. Send for booklet "Hundreds of ways it pays" . . . FREE! Real help in earning more with welding. Write today. Hobart Brothers Company, Box P-60, Troy, Ohio, U. S. A.

Made by **HOBART** "One of the world's largest builders of arc welders"

SPECIAL! Gigantic Mail Sale! Army POWER PLANTS

2500-WATT, 110-VOLT, 60-CYCLE

Here's probably your last chance to own one of the Army's finest power plants—at tremendous saving! Genuine PE-75, brand new, in original crate! Cost Gov't. over \$600—yours, while they last, only \$269!

Ideal for contractors, filling stations, cabin camps, carpenters, utilities, businesses in small towns, farmers, ranchers, etc. Use full-time or as emergency plant when regular power lines fail—to operate lights, refrigerator, oil furnace motor, etc. Will stand substantial overload. Voltage output remains constant from zero to full load. Filter prevents radio noise. Comes complete, no extra equipment to buy. SPECIFICATIONS: 2500-watt, 110-volt, 60-cycle single-phase generator. Genuine 6.5 h.p. model ZZ Briggs engine. Uses very little fuel. Use for other purposes when not operating plant. This may be last call! **ORDER NOW!**

BRAND NEW with original spare parts and tools

Kit contains—gaskets, ignition parts, spark plugs, valves, rings, wrenches, wheel puller, pliers, etc.

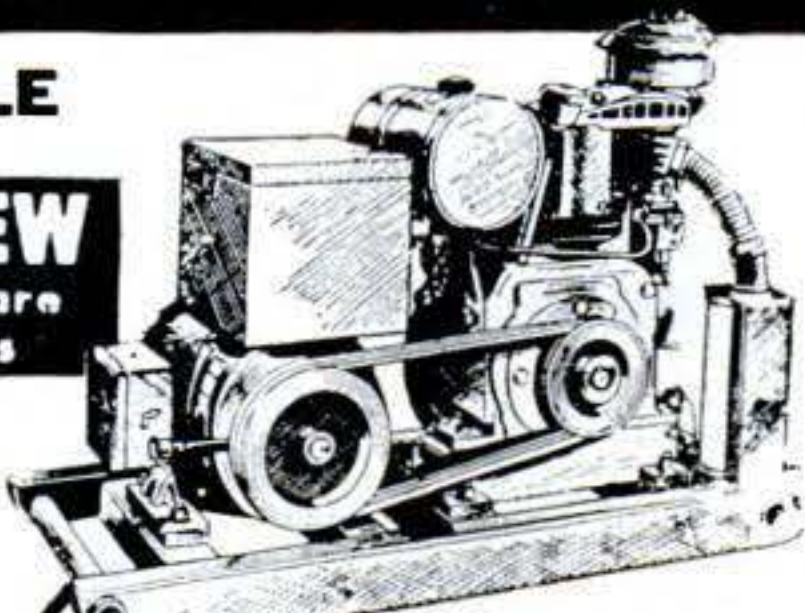

Cost Gov't
over \$600

\$269
FOB Lincoln
Nebr.

Or we'll ship Frt.
Ppd. in U.S.A.
\$279

Limited number
used plants excel-
lent condition guar.
\$225

FOB Lincoln, Nebr.

\$235

Ppd.
U.S.A.

FREE
CAT
ALOG

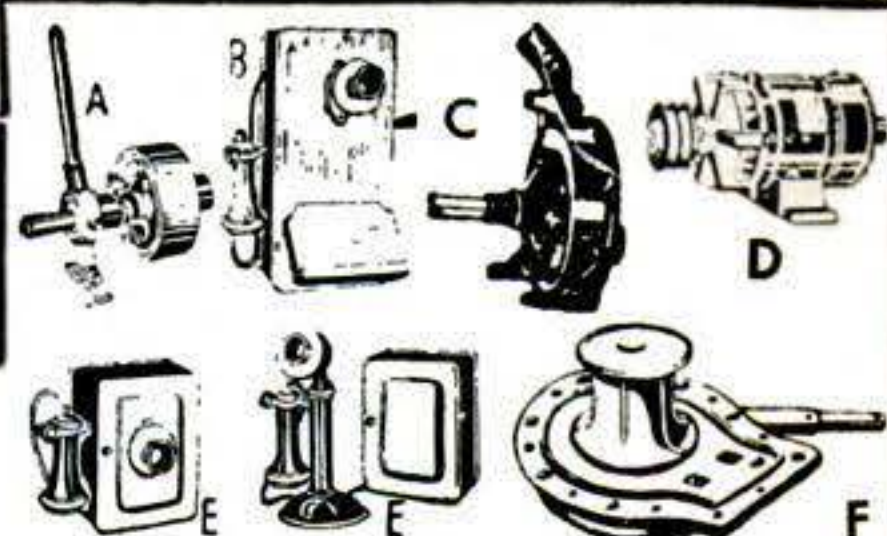

OTHER ITEMS ON SALE!

- A. Utility Clutch, up to 6.5 h.p. **\$13.95**
 - B. Magneto Rural Telephone.. **12.40**
 - C. Centrifugal 3 1/2" Pump. . . . **6.50**
 - D. G. E. 300-Amp. Welder
Generator **89.90**
 - E. City Wall or Desk Phone.. **4.99**
 - F. Winch, 5000-lb. Cost \$150 **21.95**
- All shipped prepaid

- Other power plant bargains including 750-watt, 3000-watt and 6300-watt sizes. Also generators, alone.
- Dozens electronic, mechanical, power tool bargains.
- Order from ad. Satisfaction guaranteed. Or send card for surplus listings.

BURDEN SALES COMPANY
828 "O" St. Lincoln, Nebr.

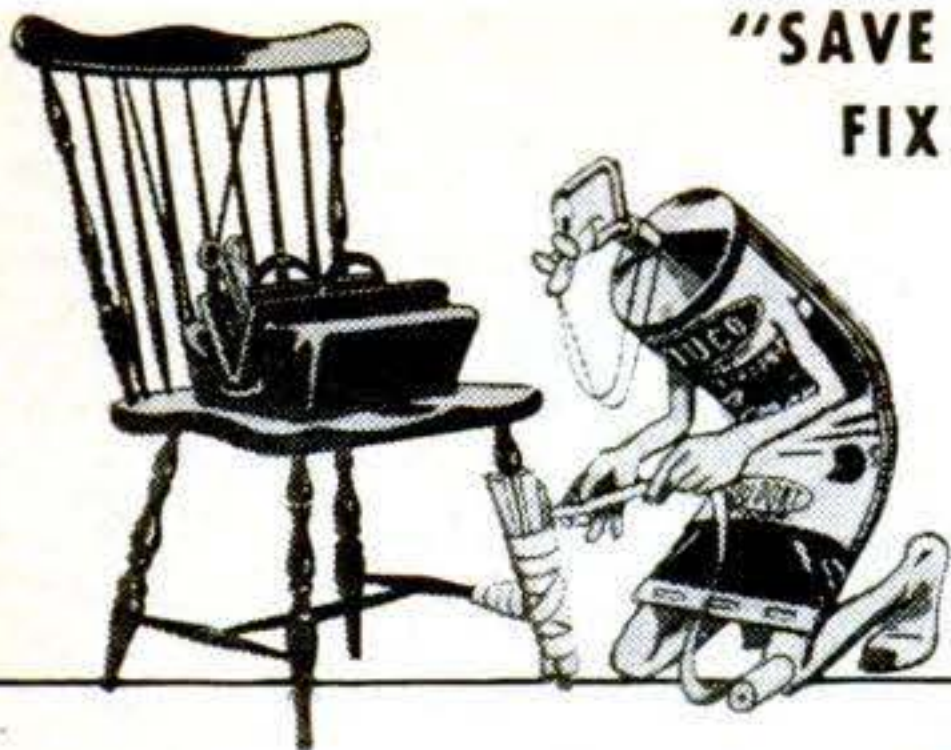

"SAVE IT AND
FIX IT"

FIXES

FURNITURE, DISHES, TOYS
BOOKS AND GLASSWARE

It's transparent, waterproof,
flexible and durable.
Get a tube
today.

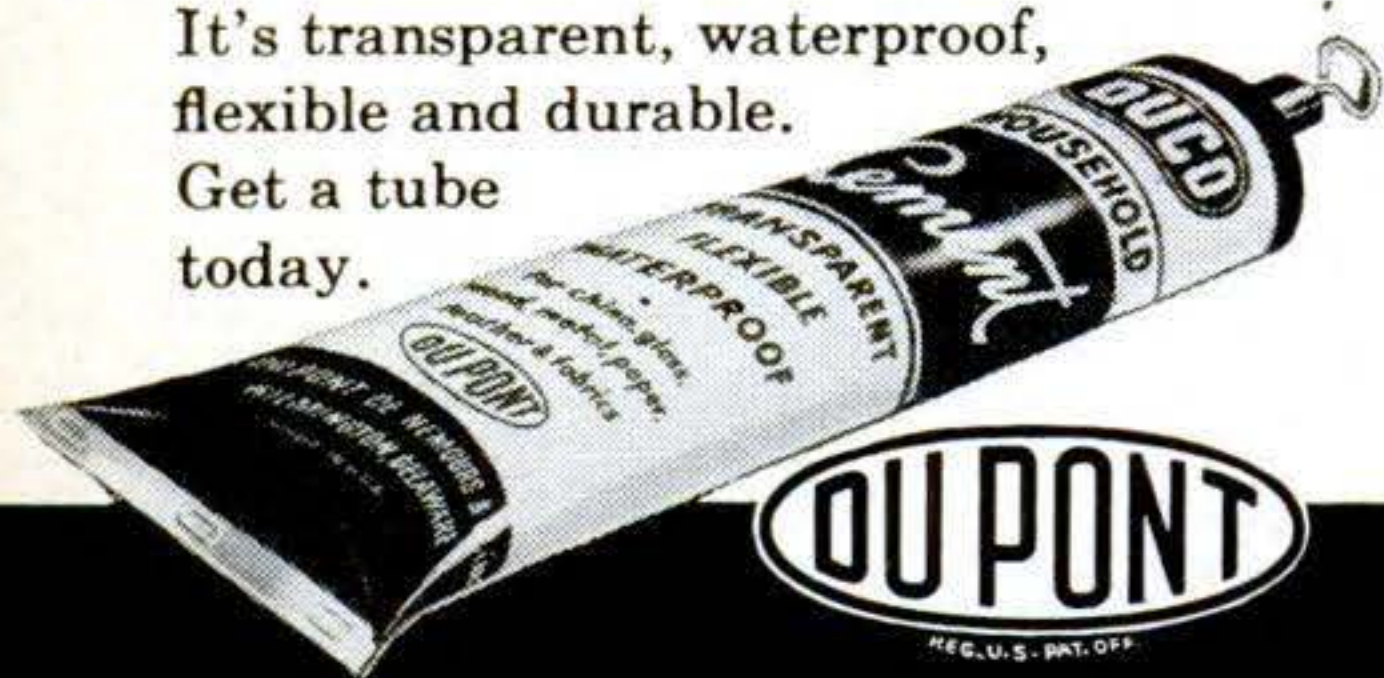

DUCO CEMENT

REG. U. S. PAT. OFF.

MILLER ROTARY

Hi-SPEED [OPEN-SAW] DRILL-BIT
IT SAWS & CUTS & REAMS

SAWS, CUTS, REAMS . . . sheet metal, angle iron, pipe, wood, plastic, Transite, etc. Amazing high speed combination bit and saw fits any 1" or 3/4" electric drill or slow drill press; takes place of up to \$50 in tools. Drills own starting hole to quickly cut, saw or ream opening. Easy to operate. Ideal for carpenters, auto mechanics, electricians, plumbers, hobby workers, many others. Abrasive resistant high speed steel. Will withstand severe continuous use. 1" diameter, overall length 3 1/2", cutting section 2" long with flutes ground from solid.

DRILL PRESS SAW-CUTTING

ELECTRICIAN'S HANDY CUTTER

SEND CASH, CHECK OR M.O.

PRICE \$3.95
POSTPAID

Order Now

International Twist Drill Corp. Room 694
7th & Wyandotte PS-4 Kansas City 6, Mo.

FIX IT WITH EASY TO USE KESTER METAL MENDER GENUINE TIN-LEAD SOLDER



Write for
NEW FREE
16 page booklet
on **SOLDERING**

KESTER SOLDER COMPANY
4254 Wrightwood Ave.
Chicago 39, Illinois

STILL ONLY
25c
IN MOST AREAS

PAINTERS' STRIPING TOOL

**STRIPES
WITH
PAINT
EASY
AS
USING
A
PENCIL**

NOW you can do your own expert striping on furniture, bikes, model planes, bulletins, autos, toys, signs, linoleum, wall board . . . make plain walls look like tile! It's easy to paint straight, curved, circular, even parallel lines with any color. Handiest paint tool in your workshop! Type "M" Master Painters' Striping Tool complete with tip for 1/16" stripe, \$1.00. Other tools complete with following tips: 1/64", 1/32", 3/64", 5/64", 3/32", 1/8"; \$1.50 ea. Extra tips 75c ea. Entire kit with tool and 7 tips, \$5.00.
WENDELL MFG. CO., 4234-A Lincoln Ave., Chicago 18, Ill.

**A TOOL . . .
NOT A BRUSH**



Dealers
Write
Today!

\$1.00
POST
PAID

Amazing FOREDOM PRESTO-FLEX

ONLY \$5.95

Turns motors, or electric drills into flexible shaft tools! Pencil-size handpiece, 35" overall length. Attached or removed in a jiffy. For use on motor add 50c for coupling, available for 1/4, 5/16, 3/8, 1/2" motor shafts. Write for catalog 1030-E.

FOREDOM ELECTRIC CO., Dept. 1030-E
27 Park Place New York 7, N. Y.

WOOD FASTENERS

Don't split wood—Use "CHEVRONS"—New steel fastener for wood joining (miter joints). Draws wood together eliminating doweling, mortising, nailing. Hammer in—"Presto"—firm joint. No wobble, distortion. Fastener lends artistic appearance. Can be countersunk, concealed, in hard wood where others fail. For mill workers, artisans, HOME CRAFTSMEN for repairing screens, doors, sash, frames, cabinets, furniture, moulding. Hurry—Send **ONLY 75c** for box 100, 3/8" depth, suitable for thickness of wood up to 1 1/4 inch, or \$1.00 for GIANT-Size box NOW! Money back if not delighted.

E. B. PACKARD CO., Inc., Dept. PS-6, 139 Cedar St., N. Y. 6, N. Y.

SEND FOR BOOKLET and LEARN WHY MOTOR OIL SHOULD NOT BE CHANGED!

Mention year and make of your car, truck or tractor.
RECLAIMO MFG. CO., Inc., 5083 N. Elston Ave., Dept. 33, Chicago 30, Ill.

Build your own SMITH Compressor

Operates spray guns, rock drills, tampers, paving breakers, sandblasting . . . Uses only 1 gallon of gas an hour!

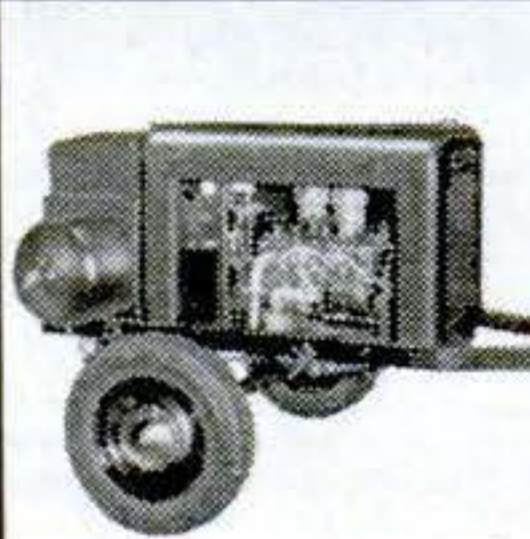

Save Money—build your own Smith Air Compressor! Famous the world over! Capacity 60 cu. ft.; pressure up to 100 lbs. per sq. inch. Just order the Smith Compressor Head and Accessories with complete instructions for assembling. All you need is a Ford Motor and shop facilities. Head equipped with high speed compressor valves; automatic unloading and idling.

Write for complete information!
GORDON SMITH & COMPANY, Inc.
405 College Street • Bowling Green, Ky.

"Wellworth" Sensational Offer! Reg. \$60.50 WESTINGHOUSE AIR COMPRESSOR

Compressor, pressure tank, air gauge, air chuck, 20-ft. hose, pop valve, copper tubing with 4 brass flared fittings for connecting compressor to tank, 4-way cross and 3 nipples. COMPLETE OUTFIT, wt. 52 lbs.

Equipment less Compressor, \$12.50. Compressor separately, \$21.50
Compressor has 2" bore, 1 1/2" stroke, ball bearing, 3.27 CFM at 600 R.P.M. Capacity up to 6.54 CFM. Size 9"x11 7/8"x6 5/8". Wt. 26 lbs. Ideal for spraying paints, insecticides, etc., inflating tires, operating air tools, and other uses. All new equipment. U.S. government surplus. Replacement parts available. Amazing buy. Don't miss it.

Model T-1 Brand New — 2 CYLINDER PISTON TYPE. Operates with 1/2 H.P. Motor or equivalent gas engine.

\$32.50

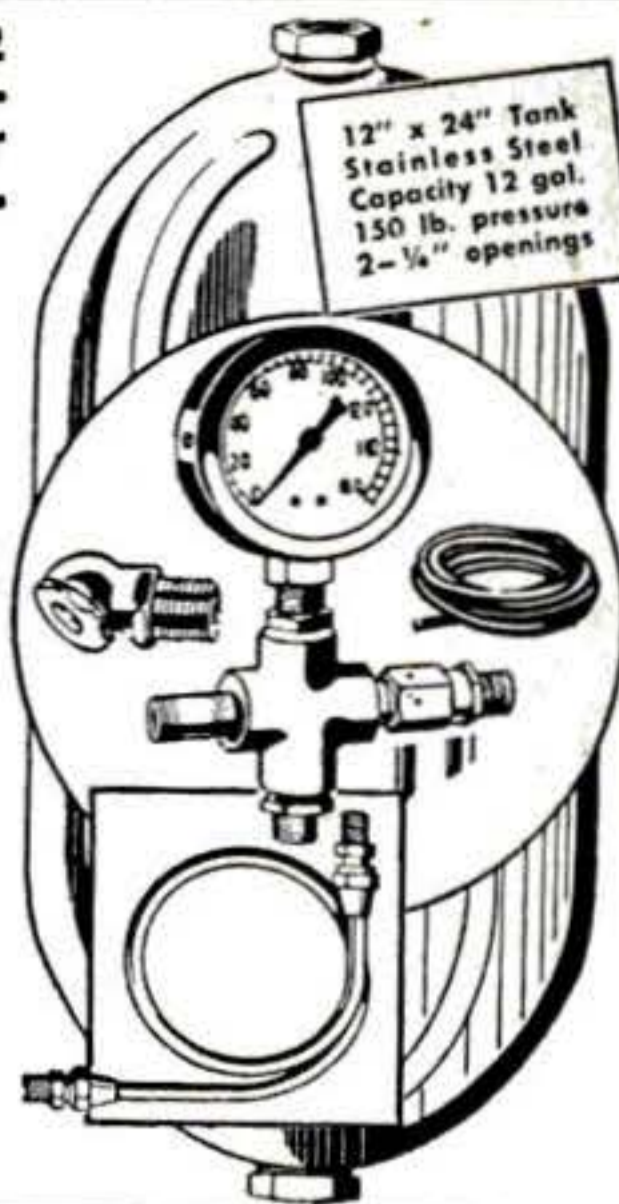
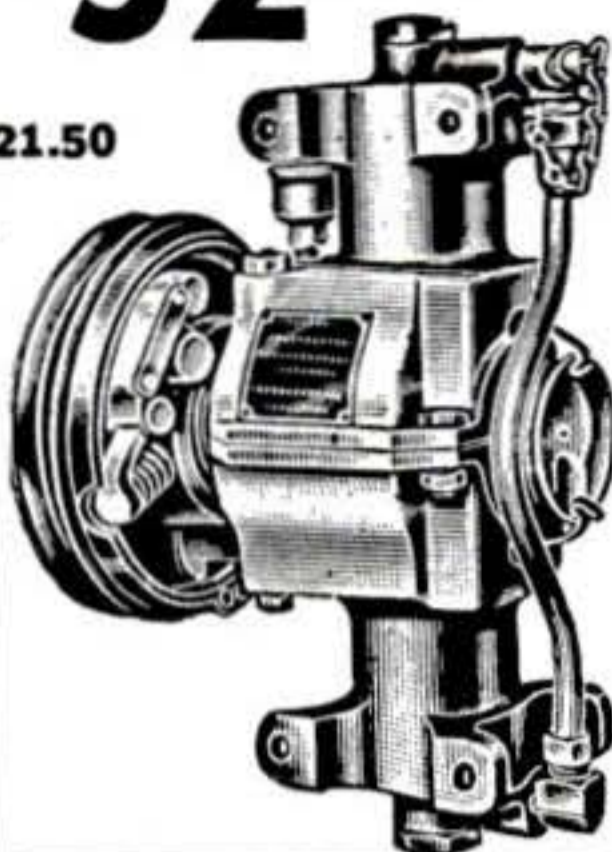

ELECTRIC LIGHT and POWER PLANT

Same as high power line
GASOLINE DRIVEN

Advantageous purchase from U. S. government enables us to offer this great bargain. Ideal for farms, homes, garages, shops, etc. Will operate oil burner, deep freeze units, compressors, saw, pumps, radio and sound systems and general lighting.

SPECIFICATIONS: 115 Volts, single phase 2500 watt, A.C., 60 cycle with 25% reserve power. **ENGINE:** Briggs & Stratton, Air Cooled, 6 1/2 H. P. **LELAND GENERATOR.** "V" Belt drive with guard, and Duplex Receptacle plug-in. NET WT. 310 lbs. Shipping Wt. 440 lbs. Brand New! Complete with spare parts, tools, instructions. **Fully Guaranteed.**

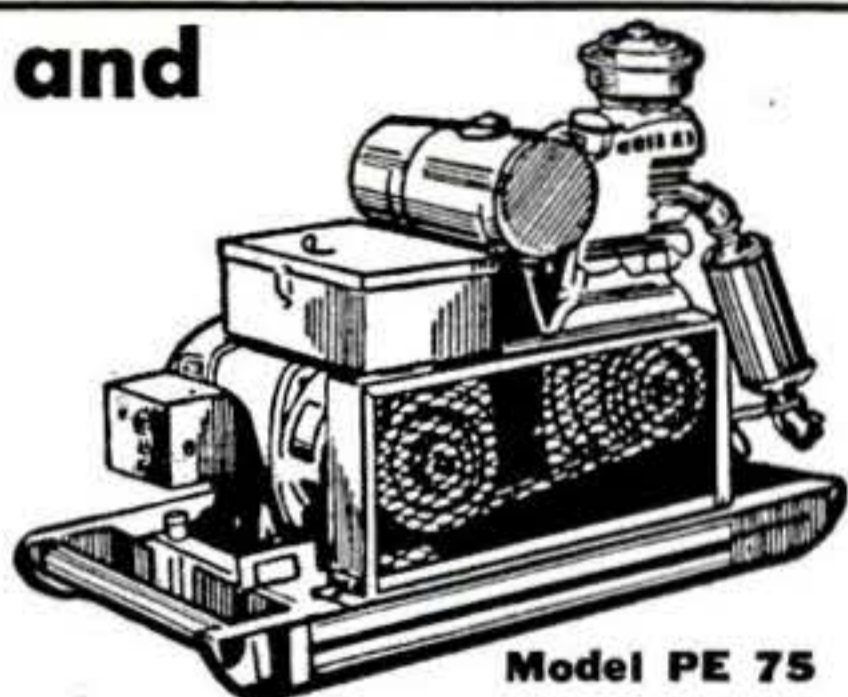

Model PE 75

Mfrs. List Price **\$700.00**
Our special bargain price **ONLY \$295.00**
f.o.b. Chicago

SEND FOR OUR 68 PAGE BOOK

A handy buyer's guide for home and factory workshop. Unusual bargains in motors, air compressors, electric tools, and many more items. Send 10c for postage and handling.

AIR TOOLS

Used—Like New!

CHICAGO PNEUMATIC RIVETER & CHIPPING HAMMER
CP4X Pistol grip handle. Takes up to 3/16" rivet. Weight 6 lbs. List price \$73.00. Ideal for work on fenders and auto bodies
SPECIAL PRICE \$8.95
Same as above, brand new **\$22.50**

Ingersoll Rand AIR DRILL
Used Like New
Lever or Pistol type with 1/4" Jacob Chuck. Wt. 2 lbs. List price \$55.00. Only **\$14.95**

"Wellworth" BLOWER



Quiet operating. Double wheel inlet, double width blower. For heating, ventilating, cooling, air washing, exhausting and forced draft.
DIMENSIONS: 10" wheel; outlet 13 1/4" x 11 3/8"; inlet 8 3/4", Height 19", Width 18", Depth 10 1/2", C.M. 1/4" S.P. 1600; outlet vel. 1575; motor 1/4 H.P. with overload relay; cord & plug, 110 v. 60 cy. AC. Ship. Wt. 67 lbs. Bargain price. **\$39.50**
Same as above

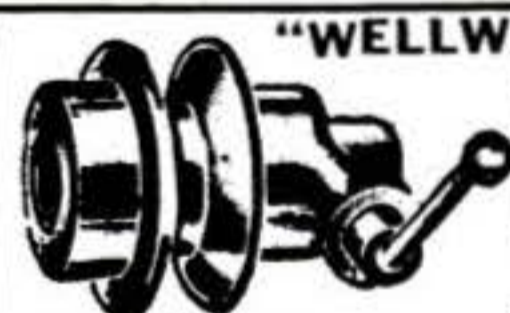

"WELLWORTH" V-BELT CLUTCH

Takes starting load off engines or motors. When speed is reached, a flip of handle shifts clutch from idling driving position. Handles "A" belts, 2.35" pitch diameter, 5/8" bore. Ideal for use with lawn mowers, garden tractors, home workshop motors, etc. 3 1/4" long. Safe, easy to mount, sealed bronze bearings, positive action. Shpg. wt. 3 lbs. **\$7.50**

AIR TANK and ACCESSORIES

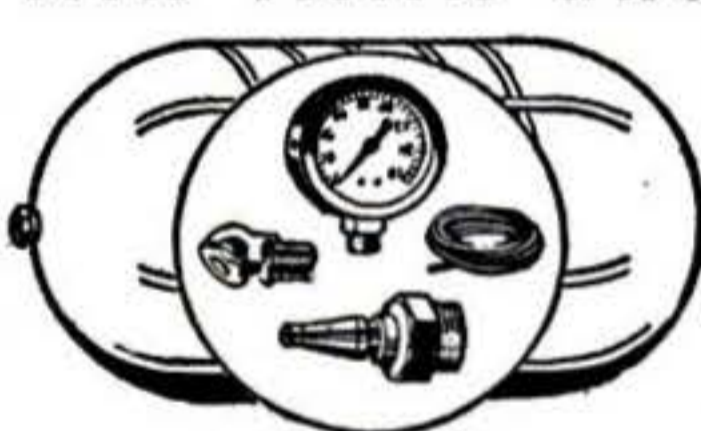

Air receiver, stainless steel, 12 1/2"x24", 400 lb. test. Ideal for carrying on trucks, autos and wherever compressed air is needed. Equipped with 500 lb. air gauge, tire chuck, 3 ft. highest air hose, air inflation valve with core for retaining pressure in tank, and fittings. Two 1/4 openings. Complete outfit Shipping wt. 20 lbs. **\$7.95**
Same unit but with 6" x 24" tank **\$6.95**



AUTOMATIC PRESSURE SWITCH
For Air or Water
20 to 40 lbs. **\$5.50**
75 to 100 lbs. **7.50**
125 to 150 lbs. with unloader **10.25**
1/4" check valve **2.75**
1/4" regulator and gauge **5.75**

Prices f.o.b. Chicago. Immediate delivery. All items sold on money back guarantee. Send check or money order today.

WELLWORTH TRADING CO.

1831 S. STATE ST. DEPT. B-6 CHICAGO 16, ILL.

New BELT SANDER ONLY \$10.95



Stationary and Portable

Ideal all-purpose sander for home or shop! Stop-Fence Unit adjusts to 4 positions — tilts to 45°. Sturdy aluminum construction. May be powered by electric motor, drill, lathe, etc.

Send for free circular NOW!

JOHNSON Mfg. Co., Dept. 2D, Lincoln Park 7, R. I.

HIGH POWER TELESCOPE

60 POWER-ALUMINUM TUBES-OPENS TO 33"

Variable Power Eyepiece Adjustable to 15X, 30X and 60X.

\$4.50 Leather Case Included

5 Sections. 4 Ground & Polished Lenses. Also used as 50X Microscope. Ready to use, only \$4.50 POSTPAID.

BROWNSCOPE CO. Dept. 6P, 24 W. 45th St. NEW YORK 19, N. Y.

THE CHOICE OF THOSE WHO WELD FOR PLEASURE AND PROFIT!

DYNAMIC Super Charged ARC-WELDER

DOES WELDING, BRAZING, SOLDERING, CUTTING

It's the finest, precision built heavy duty transformer-welder available for home, farm, or shop use. Does work you'd expect from costlier machines. EASY TO OPERATE. Do expert work; follow simple instructions. Works on iron, steel, brass, bronze, aluminum and other metals. Operates from any properly wired 110 volt 50/60 cycle AC line. Save time, Make money — Build or repair auto, home, farm or shop equipment, etc. for yourself and others in spare or full time. Comes complete Ready-To-Operate. Order today for 10 day trial on money back guarantee or write for Free Particulars. **DYNAMIC WELDER CO., Dept. D3-FA4, 15 E. 23rd St., Chicago 16, Ill.**

OVER 50,000 SATISFIED USERS

GIFT WORTH \$6.80 INCLUDED



FOR PROMPT ACTION SEND TODAY



\$40.30 VALUE Only \$28.50 F.O.B. COMPLETE

ORDER BY MAIL FROM WORLD FAMOUS GADGETEERS HEAVEN

NEW 1950 TOOL CATALOG
72 pages of Machine Tools (taps, drills, dies, reamers, etc.) Hydraulic cylinders Air tools. Send 25¢ for your copy today.

NEW BEARINGS

These are the Finest, Precision, AIRCRAFT BEARINGS!! We have more than 168 types and sizes in TREMENDOUS QUANTITIES!! Needle, Roller, Recessed, Rod End, Shielded, Unshielded, Self-aligning, etc. Made by some of the WORLD'S LEADING MANUFACTURERS OF BEARINGS. Yours at a FRACTION of COMMERCIAL PRICES. . . . Write for complete list.



FIRE EXTINGUISHER

Kiddie Lux CO₂ Type. Built to Gov't spec. Shatter-proof, heavy case. Fully charged. with horn

No. 602A - 7½ lb. \$35 Value. **19.25**
 No. 603 - 10 lb. A \$65 Value. . . . **25.75**
 No. 605-A - 15 lb. New. Break disc. Type, A \$75 Value. . . . **29.75**
 No. 605-B - 15 lb. Wheel Control Type. **32.95**
 No. 605-C - 15 lb. New. Squeeze Grip Type, \$85 Value. . . . **39.95**

Note: Weights listed are capacity extinguisher charge.



PRESSURE FEED PAINT TANK

BINKS MODEL Q - TYPE D-5307 . . . For conveyance of large quantities of paint or finishing materials to the spray gun. Keeps the material under constant pressure & agitation at all times. Consists of 10 gallon tank with air motor, agitator, safety valve air regulator & a 150 PSI gauge.

125.00

SPEEDY SPRAY TANK - For full pressure painting or spraying systems. Holds 3 gallons of material. All steel construction with brass hose fittings and relief valve. Easy to clean and fill. Has carrying handle and 10 ft. of air and paint hose. Complete Only **18.95**



AIR COMPRESSOR

High Pressure
General Electric, 2 stage AC - DC. Rated pressure 1000 lbs. per sq. in. with 1/3 H.P. 27 volt, 7 AMP series wound motor with fan for cooling. Thousands now in use for spraying, inflating, laboratory use, etc. Can be adapted to 110 volt A.C. with transformers

A tremendous value at approx. 5% of original cost **22.50**

We also have transformers for above.



TINY MITE WINCH HOIST

This mighty little gem lifts up to 1000 lbs. with its 30 to 1 Bronze Gear drive. Cable drum is 4" x 1¼". Ratchet handle - Safety and release pin. Ideal for Boats, Farm, Factory, Home or Garage. Save your back for . . . **10.49**



6 in 1 HAMMER

A very handy household or shop tool for man or woman. Ideal for hundreds of Fix-it jobs. Has 4 graduated screw-drivers in the handle, from 1/8" to 5/16" Steel hammer head & knurled brass handle. A Bargain at **89c**



5 TON POWER DRIVE HOIST

Here's a real, rugged power unit! Combines a cable drum winch with a separate power pulley drive & 2 individual, 1½" square power take-off shafts. A "throw-in" clutch operates the winch & both take-off shafts. Ideal for use on trucks or boats or as a stationary hoist. **79.89**

A \$300 VALUE for **ONLY**



1/4" HEAVY DUTY MALLORY Electric Drills

A \$350 VALUE 17.95

Again we are able to offer a limited supply of these Genuine Gov't Surplus Drills. Made to take the most rugged abuse. Used but in excellent condition. 110V A.C. - 60 cycle - 1 phase, Ball Bearing Motors turning 2500 R.P.M. Finest 1/4" Jacobs Chuck **DON'T MISS THIS BUY!!!**



We've gone NUTS!!

Just Purchased 180,000 lbs. of the FINEST PRECISION Made ELASTIC & FIBER LOCK NUTS!! All are NEW!!

Here's your chance to "STEAL" Aircraft Quality STOP NUTS at less than the cost of common commercial hex nuts. They're ALL NEW Cad plated Steel and a large quantity are even pre-tapped for easier wrenching. ELASTIC or FIBER LOCK SEAL gives a Positive . . . Shake-proof - - Vibration & Rust Resistant fastener. No lock washer necessary . . . One operation does the job. Just run on the nut. Ideal for use in all types of metal fabrication, assembly, construction etc. . . .

AND LOOK AT THESE PRICES for ELASTIC or FIBER LOCK NUTS





Prices per 100 in these quantities - Special Discount for larger quantities -

	100	1000	10,000	25,000	50,000	100,000	500,000
640	\$.49	\$.25	\$.21	\$.19	\$.17	\$.15	\$.13
836	.59	.31	.28	.25	.23	.21	.19
1032	.59	.31	.28	.25	.23	.21	.19
1/4-28 FL	.63	.39	.36	.33	.30	.27	.25
1/4-28 PT	.63	.39	.36	.33	.30	.27	.25
5/16-24PT	.84	.64	.61	.58	.56	.54	.49
3/8-24PT	.94	.74	.71	.68	.66	.64	.59

Note: FL means Fiber Lock (not pre-tapped.) PT means Pre-tapped, ESSNA Brand.

2 TON WINCH

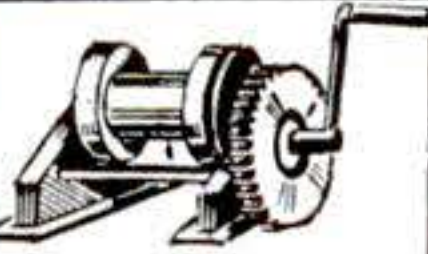
Can be Hand or power operated. Has large capacity steel drum for cable. Powerful gear - reduction drive and manual brake. **36.50**



WHEELS

For Wagons, Dollies, Handtrucks, Wheelbarrows, etc. 10" dia., with 1/2" center hole. (can be drilled out to take 5/8" axle) Wheel is 1/8" steel with 10 x 1.75 heavy duty, semi-pneumatic cushioned rubber tire. **\$1.75**



SAVE! SAVE! SAVE! - We have TREMENDOUS quantities of AIRCRAFT Quality BOLTS - SCREWS - RIVETS & BEARINGS. Our huge stocks include a great variety of sizes and lengths. PRICED LOWER THAN YOU PAY FOR ORDINARY COMMERCIAL QUALITY.

NAVY PULLEY BLOCK

Big, rugged blocks. Contain 2 pulleys in heavy duty, reinforced steel frames. Designed by Navy for heaviest lifting operations. Will take rope or cable tackle upto ¾" dia. Drop forged steel hook. 4" pulley dia. . . . 2.75
6" pulley dia. . . . 3.95



BEADING TOOL

Made for the U.S. NAVY. For turning an edge bead on all kinds of metal up to 18 gauge thickness. Has high grade steel faces, hardened & polished. Easily removable from shafts. Back gearing drive is enclosed in case. Top shaft adjustable for thickness & pressure. 5 faces furnished include Nos. 0 - 01, 1, 2 & 3. Has 1-1/4" hexagon shaft for bench mandrel. **17.95**



METAL SNIPS

Hard steel blades. Compound action. Expansion spring & lock'g device. Right and Left hand types . . . **\$2.59**



NEW CLAMP

Carpenters, Cabinet makers, Wood workers - you need this one! Opens to 8" with 2 3/4" thumb screw. All Steel sturdy and dependable. Handy for gluing, etc. **ONLY \$1.59**



UTILITY HAMMER

For use as masonry chisel, stake driver, sledge, etc. Head is special forged steel, with sharp cutting edge. Handle is select hardwood. 1½ lb. with 14" handle . . . **79¢**
2 lb. with 21" handle. . . . **99¢**



INSTRUMENT MIX

6 DIFFERENT TYPES 6

Contains 1 each of the following items. Flight Check-off • Position Indicator Selsyn Fuel Gauge • Air Speed Indicator Fuel/Air Ratio • Oxygen Regulator These instruments contain sensitive meter movements, jewels, bearings, gears & valves. **COST THE GOV'T MORE THAN \$500.00 SPECIAL!! ALL 6 FOR ONLY 5.95**



CLECO PLIERS

For inserting and removing Cleco type skin fasteners. Heavy black enamel finish. NEW **69c**



TUBE BENDER

Made by Parker Appliance Co. For bending thin wall seamless tubing of soft Copper, Brass, Aluminum Alloy or fully annealed steel. Ideal for Plumbers, Auto & Aircraft Mechanics, Steam Fitters, etc. Makes bend from 0 to 180 deg. No. 5 - 5/16" Capacity . . . **5.45**
No. 6 - 3/8" Capacity . . . **7.65**



MICARTA TUBE

Ideal for Insulating or Bushing Stock. 36" x 1/2" wall x 1" O.D. Original use was for trailing antenna - F 10. Use for towel rack, bearings, etc. **59¢ ea.**



RUBBER Neoprene Sheet Stock

Thickness	Approx. Width	Price per run yd.
#325 .020	1/64" 36"	\$1.75
#328 .032	1/32" 22"	1.38
#330 .064	1/16" 36"	2.39
#331 .093	3/32" 36"	3.39
#329 .125	1/8" 46"	4.75

Note: No. 329 is Laminated rubber sheet with cloth center. Flexible & very fine for heavy wear.



TANK

Made of Dural. Has welded seams, 2" filler with cap, and two standard pipe ports for hook-up. Visible liquid level gauge on one side. An ideal tank for Gas, Oil, Water or as a 'spare' on your auto, tractor, truck, boat or plane. Sturdy-Lightweight. **4.95**



RAWHIDE Mallet

Weights 2½ lbs. Has metal collar with rolled leather insert head. Used for working soft metal, plastic driving pins, etc. Leather is replaceable. **ONLY 1.09**



No. 332 - Grey Neoprene Rubber Floor Mat

Has raised non-skid Diamond pattern with durable cloth backing. Stock size: 36" x 48" x 1/16" thick **\$1.95 ea.**



GROUND ROD

Made by a leading manufacturer of electrical conductors. This rod is all new and in excellent condition. Most commonly used as ground conductor on high power lines, telephone poles, etc. Has solid iron core covered with non-rusting Copperweld. **1.00**



New SUN VISOR

Made of clear grn plastic. Adjustable arm & swivel head. Holds firmly. Can be swung in any direction. Made for the Air Corp. Very useful on your Car, Tractor, Truck or Boat. **SPECIAL 1.29**



U.S. NAVY PHONE SETS

Used by the Navy for Flight Deck & Gunnery Control. Each set is complete with 2 phones, mounted on chestplate, 2 headsets, battery cases, push-button switches & 35 ft. of cable. Can be used successfully up to 1/2 mile distance. Set is sound-powered needs no battery. Ideal for home-to-garage, house-to-barn, office-to-shop, etc. You'll find many uses that make these worth much more than our price. Set of two **7.95**

Same as above but uses 2 flashlight batteries for power. Set of two **7.25**



COMFO RESPIRATOR

Approved by the U.S. Bureau of Mines for DUST and MIST! Very high filtering efficiency is obtained thru unusually large filter area. New cushion face-piece fits comfortably and permits the wearing of goggles & helmets. Easy vision - adjustable head strap. Single filter for all dust. Respirator plus 10 extra filters. Complete **ONLY 1.59**

NEW DUST RESPIRATOR

M-1 Valve Type. Rubber on inside, felt filter outside. Rubber valves. Adj. headband. Light-Comfortable. **29¢**



We stock other respirators. Write for list.
Order from this Ad. All sales final. All Prices F. O. B. Glendale. Pay by M.O. or Check. P.O.'s Acptd. from D & B. firms. ½ deposit with C.O.D.'s.

92 PAGE CATALOG
 War Surplus - Tools, Machinery, Raw Materials, Clothing, etc. Illustrated with valuable info., tables, charts & data. Send 25¢ to cover handling & postage.

SAVE UP TO 85% IN WAR SURPLUS



PALLEY FAMOUS MIXES!! Prepared especially for the HOME CRAFTSMAN, HOBBYIST, INVENTOR, GADGETEER or SHOP MECHANIC.

GADGET MIX - Rivets, Spacers, Bolts, Screws, Gears, Wheel bearings, Springs and C Lamps.
 No. 106, 5 lbs. **1.19**

BEARING MIX, No. 170A. Approx. 20 needle, Ball & Roller Bearings, New & Used. Sizes: 1/2" to 4". Some of these cost Gov't \$10 a piece. Never such a value!
 5 lbs. **ONLY 1.59**

HINGE MIX, No. 170H. 12 pairs of Strap and butt hinges, Hasps, 1" x 1" to 7/8" x 10" in length and 8" strap. 2 lbs.
1.09

ABRASIVE AND GRINDING WHEEL MIX - 50 pieces including honing stone, pencil rolls, wheels, etc. A sharp value. No. 170AG **99c**

SPRING MIX, No. 206 - Torsion, Compression & Tension Springs. Ass'd. sizes. A treasure trove for emergencies.
 5 lbs. for **ONLY 1.69**

RIVET MIX - 3 POUNDS - Consisting of sizes from 1/4" long to 3" long in many diameters & alloys. **1.19**

FILE MIX - Ten assorted Files, 4" to 12", includes 3 Vixens, half rounds bastards, mills, etc., in seconds and use but in good condition. 1 Vixen alone worth our price for entire mix. F-1 **99c**

PULLEY MIX, No. PM-1 - You'll want this one around. 10 micarta & metal pulleys ranging from 1" to 5" with ball and one piece bearings. These are aircraft pulleys, the best made with 100's of uses. A WONDERFUL BUY!!! **2.95**

COUNTERSINK MIX, No. 168. Wide assortment. Excellent condition. High speed steel. Assortment of ten 100° and 110° with pilot sizes ranging from 3/32" to 3/16" No. CM-1 **2.69**

SCREW MIX - 5 lbs. incl. 2 1/2 lbs. wood screws & 2 1/2 lbs. machine screws. All sizes. Save dollars and always have plenty of screws on hand. **1.39**

NUT MIX NM-1 - 3 lbs. approx. 500 nut. Anchor, Lock, Castle, Hex, Elastic Stop Nuts, etc. You'll always have plenty of Nuts in the shop. NM-1 **1.39**

SUPER COMBO MIX - No. SC2. Here's a real bargain. All eleven above mixes for **ONLY 14.95**

REAMER MIX - No. 168. Reamer assortment: Special Taper line finish Reamers. High Speed Steel. Slightly used but in excellent condition. Ten assorted sizes ranging from .168x.165 & .244x.215 to .425x.385 & .432x.403. One alone worth our selling price of ten.
 For set of ten Reamers . . . **4.49**

PLASTIC Mallet CLEAR PLASTIC with 2" dia. x 4" head & 12" handle. For soft metal or plastic work where non-mark or light tapping is desired. **79c ea.**

15" MONKEY WRENCH
 Adjustable Jaw - Opens to 4"
 Drop Forged. . . Auto Type.
 Cadmium Plated **89c** Black **79c**

PIANO HINGE
 Overall Width Length Price Ea.
 1 1/4" (5/8" side) 72" alum. \$1.00
 2" (1" side) 9" alum. . . . \$1.75
 3 1/2" (1-3/4") 54" st. steel \$1.69
BRASS HINGE - 1 1/4" (5/8" side). 040
 Any length at 29¢ per ft.

PALLEY SUPPLY COMPANY
 6321 SAN FERNANDO RD.
 DEPT. PS-6 GLENDALE 1, CALIF.

JUNCTION BOX
 Formerly used in aircraft electrical circuits. Have many uses around home & shop. All brand new!!
 13 1/4" x 11 1/2" x 4" --- .064 Alum. \$2.75 ea.
 12 1/2" x 10 1/4" x 6" --- .064 Alum. \$2.69 ea.
 7 1/2" x 5" x 4" --- .040 Alum. 99¢ ea.

HANDY REPAIR KIT
 Here's one for every purpose. 6 useful tools... a steel trimming knife - pair of genuine WISS Heavy Duty scissors, - a sealing roller for cementing fabrics, 2-1/2" half round files & a burnishing brush. Ideal for wallpaper, linoleum, etc. Comes in compact cloth roll. A 9.50 Value For. **3.29**

TACHOMETER - Type C-9A. Operates on direct drive with flexible shaft. Range is 0 to 4500 RPM. Ideal for use on single engine planes or boats, autos, etc. Drives direct from crankshaft or at 2-1 reduction from crankshaft. **4.75**

Sperry Aircraft Directional GYRO COMPASS
 Dial is 360° swing calibrated 1/10° (6 min). Panel Mount 4 1/2" square with 3" luminous dial. Can be used in autos, planes, or boats by attaching one tube to intake manifold for required vacuum. Complete with reset caging knob. Gov't. overhauled - **ONLY \$449**

NEW ELECTRIC MOTORS
 No. 500 - New 1/2 HP - 27 Volt DC-AC. This motor can be readily adapted to deliver up to 1/2 HP on 110 Volts AC by the simple method of rearranging armature brush-leads. Free diagram with each order. A sensational Value **\$5.95**
 No. 500-A - Converted to 110 Volts-AC Equipped with plug and 3/2 ft. Heavy Duty Cord **\$8.49**
 No. 502 - 2 HP-24V. DC Motor Used **8.95**

U.S. NAVY BATTLE LANTERN - A powerful lamp complete with 2 1 1/2 volt dry cell batteries. Size: -" x 7" x 4" **3.29**

NEW PRESSURE TANKS
 Stainless Steel, Shatterproof & Rustless. Ideal for painting, cooking, spraying, ocean buoys, underwater fishing, or diving.
 G-1 - 12 1/2 x 24 inches. 2100 Cu. In. capacity **NEW 4.75**
 F-1 - 10 x 18 inches. 1000 Cu. In. capacity **USED 4.19**
 F-2 - 6 x 45 inches. 1000 Cu. In. capacity **NEW 3.95**
 D-2 - 6 1/2 x 24 inches. 500 Cu. In. capacity. Stainless Steel Construction **USED 3.49**
 D-2A - Corrosion resistant steel. Same as D-2 **NEW 2.49**
 A-6 - 5 1/2 x 15 inches. 280 Cu. In. capacity **USED 2.25**
 A-4 - 5 x 8 inches. 104 Cu. In. capacity **NEW 1.35**
 NOTE: All tanks listed as used are guaranteed serviceable and free from leaks or dents.

HIGH PRESSURE BOTTLE
 Steel - Tested to 3000 P.S.I. For spray painting, portable welding, etc. All have std. pipe port.
 H-3 9 1/2" x 3 1/4" dia. **\$1.75**
 H-4 19" x 3 3/4" dia. **\$2.75**
 H-5 - 22 cu. ft. cap. internal vol. 295 cu. in. Shatterproof 20" long x 5" OD **\$3.75**
 A-2 - 3-3/4" x 16" - 96 cu. in. volume. With valve. **\$3.95**

PNEUMATIC AND AIR TOOLS
 10,000 in various popular makes, sizes, types, Cleco, Aro, Ingersol Rand, Chicago, Pneumatic, Buckeye, etc.
 #180 **RIVET GUNS**, Pistol & Gooseneck Type #181 **PISTOL**
 Gooseneck **\$55** **\$8.95**
SPECIAL ARO PISTOL
 Air Drill or Air Motor with 1/4" Jacobs chuck. **\$17.95**

NEW HYDRAULIC CYLINDER SPECIAL
 Gives 20,000 lb. thrust (push pull) using 1500 PSI line pressure as obtained from our hyd. pumps. Or will produce 40,000 lb. thrust with 3,000 lb. line pressure. CAN ALSO BE OPERATED ON LOW PRESSURE AIR SYSTEMS. 4" Bore, 1 1/2" dia. piston shaft, 18" stroke, length 30 1/2". Equipped with ball bearing loaded clevis type mounting and swivel type high pressure steel pipe bracket for easy use. Ideal for road, farm & shop machinery, presses, etc. Cost Gov't \$390.00 **2250**

No. 9-E HYDRAULIC CYLINDER
 Double action cylinder. Has a bore of 1-3/8" and shaft of 1". Stroke is 9". Overall length 15 1/2". Built for 1500 lbs. continuous duty, 3000 lbs. intermittent duty. Will lift or push up to 2300 lbs. Can be adapted to hundreds of jobs. **NOW 895**

No. 3 HYDRAULIC CYLINDER - Double action. Bore is 1". Shaft 3/4". Has a stroke of 2 1/2" to 4". Stroke can be adjusted with internal sleeve stops. Overall length is 8 1/2". Will take 1500 lbs. continuous duty. 3000 lbs. intermittent. Will lift or push up to 1100 lbs. **375**

4-WAY VALVE
 Poppet Type. Valve shuts off at neutral position. Has 3/8" AC Tube Ports - 9/16 - 20 thread. Will stand 1,500 P.S.I. **475**

BENDIX HYDRAULIC HAND PUMP
 Provides an instantaneous source of tremendous power for almost any heavy work. Double action stroke. Delivers .30 cu. in. per cycle at 3000 PSI. Max. press. 5000 PSI. Built-in Reservoir cap. 2 1/4 qts. 3/8" pipe outlets. Has Pressure Release Valve. 7 1/2" dia. by 23 3/16" overall ht. Weight 15.2 lbs. A **\$15.95**
 \$40.00 Value for... **NEW 11.95**
 Used - In Good Condition...

D. C. GENERATORS
 Suitable for adaption to home welding units, portable and rural lighting. power plant on boats, etc.

TYPE	AMPS	VOLTS	
P1	200	27 1/2	17.95
R1	300	30	27.95
ESA	50	12	14.95

 Above used, but in guaranteed condition. 03 NEW 100 24 **1895**

D. C. METERS
AMMETERS **VOLTMETERS**

- 30 - 0 - 30	+ 0 - 120	0-30	\$3.95
- 60 - 0 - 60	+ 0 - 240		
- 120 - 0 - 120	+ 0 - 300		

 Your choice 3.95 ea.
COMBINATION VOLTMETER - AMMETER
 30V - 30 AMP **\$4.95**
 30V - 60 AMP **\$4.95**
 All meters 2" face except 0-300 which is 3" face.
SHUNTS - Required for use with D.C. Ammeters 30-60-120-240-300 **\$1 00**
SOLD ONLY WITH METERS.

AIRCRAFT CABLE
 Rust resistant alloyed steel, extra flexible, preformed - 7 x 19 strand-on reels.
 1/16" 3¢ ft. 1/4" 8¢ ft.
 3/32" 4¢ ft. 9/32" 9¢ ft.
 1/8" 4 1/2¢ ft. 3/8" 12¢ ft.
 5/32" 5¢ ft. 1/2" 15¢ ft.
 3/16" 6¢ ft. 1/4" Bronze 14¢ ft.
 1/8" Stainless Steel. 12¢ per ft.
 1/4" Stainless Steel. 21¢ per ft.
 Aircraft control cable 18 ft. long, 3/16 in. diam. with turnbuckle ends. **99c**

TWO HEAT SOLDERING IRON
 World's Hottest Iron Value!
 Two soldering irons in one with button heat control. Push the button - Select 150 or 300 Watt heat for light or heavy work. Complete with tip, bench holder, 5' asbestos cord. 110V AC. \$15.00 Value For. . . **\$3.95**

ARMY AIR FORCE Type SUN GLASSES

These are the very popular "price" favorite. Made similar in every detail to the genuine AAF Glasses but have a 4 base, processed glass lens. Frames are Gold Plated and have Pearlized sweat bar and nose pads. Cable ear pieces are adjustable. Complete with simulated Leather Case . . . **1.79**

U.S. NAVY SUN GLASSES - With finest precision ground and polished lenses. Light weight plastic frame and leather carrying case. . . Special. . . **69¢**

4 BASE SHOOTING TYPE GLASS - Has hardened, UNBREAKABLE LENSES. Ideal eye protection for the hunter and outdoorsman. **2.79**

Aviators (AN-6530) Windproof & Dustproof GENUINE GOGGLES
 Rubber or chamois covered frame. Clear or Green GROUND LENSES are interchangeable. Adjustable nose bar. Ideal for Flying, motorcycling, etc. . . **1.69**

G-1 GOGGLE KIT
 NEW! U.S. Navy - Has soft sponge rubber frame. 4 Polaroid lenses 2 green, 1 red, 1 clear. Perfect for racing, cycling, etc. **89¢**

MOSQUITO HEADNET
 Protect your head and face from all kinds of stinging insects. This Jungle Headnet is made from mosquito netting & has a draw string at neck to close it tightly. Ideal for campers, Hunters, Fishermen. **69¢**

New Navy Boat Fender
 Here's a Real Buy! Ball type fender made of special woven Coir rope in India. Rotproof & mildew resistant. Size of ball 15". Ideal for Yachts, fish boats & tugs. **2.95**

Boat Fender 21" long, 5" dia. Give your boat the protection it deserves!! These rugged hemp & manila fenders are cheap insurance. **795**
 A \$6.50 Value. Only **795**

VALUABLE GEAR BARGAINS!
 8 to 1 ratio, spindle drive #110 **\$2.98**
 6 to 1 with screw shaft #111 **\$4.98**
 85 to 1 (can be used for radio, antennae, etc.) . . #112 . . **\$3.95**
 #G-11 - 10-1 gear ratio **\$3.95**

GEAR BOXES VTG-1 - 90°
 bevel gear 1 1/2 to 1 reduction, size 7" x 6". A Lifetime Value. **\$3.95**
 VTG-2 - Inline spur gear 16 to 1 reduction, thru 4 gears. Final take-off 4 1/2" dia, 26 tooth. 1/4" Alum. spur gear. . **\$6.49**
 Both above gear boxes have lever control for engaging & disengaging positive clutch. Dust proof housing. Pre-lubricated bearings. Both can be adapted to Vickers Transmission.

ELECTRONIC TRANSMISSION GEAR TRAIN
 GT-1 Containing approx. 50 Bronze Spur & Pinion Gears - ranging from 3/8" to 4" dia, 5 sets of 7 cluster gears, 2 complete worm & worm gear drive sets, 40 N.D. ball bearings from 1/2" to 1 1/2" dia. watch springs, bushings, posts, face plates, housings - Micro Switches, 2 miniature, controlled clutches, etc. 19lbs Of Pleasure and profit. A Tremendous Gadget Mine. **ONLY \$8.49**
 Gears in above train are all in multiple size & sequence with identical teeth ratio giving 100's of ideal gear reduction comb.

THE LARGEST FIRM OF ITS TYPE IN THE WORLD

NOW... DRILL HARDEST STEEL

SOLID FIRTHITE Sintered Carbide DRILLS

You can drill holes in Heat-Treated steels (up to RWC-66) with an ordinary drill press.

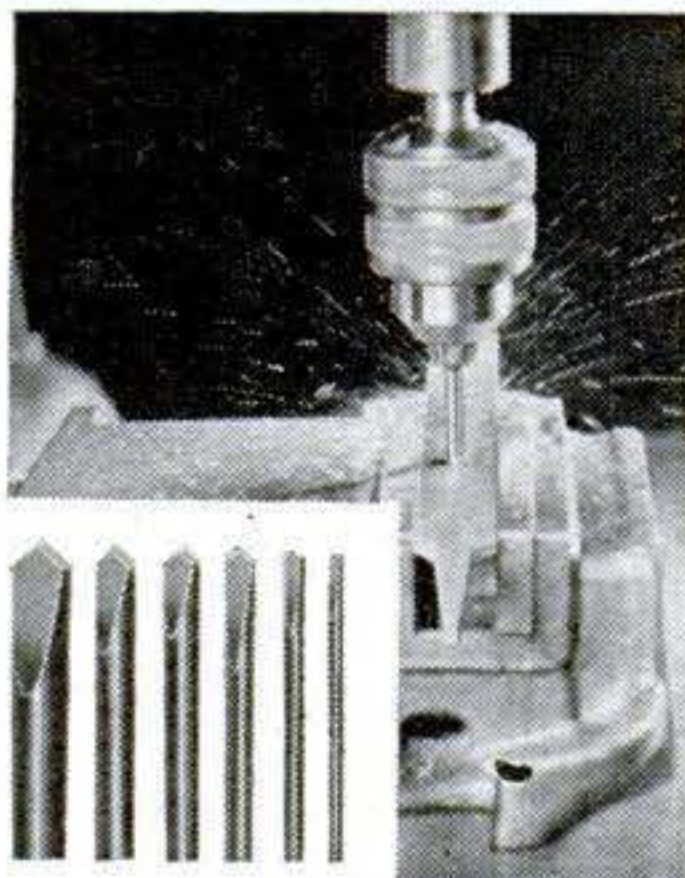

Firth Sterling

STEEL AND CARBIDE CORPORATION
McKEESPORT, PENNA.

\$36

FOR KIT OF
SIX DRILLS

Please send Firthite Drill Kit.

Single Drills

- 1/8", \$4.00; 3/16", \$4.50; 1/4", \$5.25;
 5/16", \$6.60; 3/8", \$9.00; 1/2", \$10.50.

Enclose check, money order or purchase order.

Send more information on Firthite Drill

Name _____

Address _____

City _____

Next to a Diamond in Hardness

BUILD YOUR OWN TILTING ARBOR SAW!

Exclusive GIL-BILT Build-It-Yourself Features

- No machining—build easily with hand tools only
- No blueprint reading—step-by-step pictorial plans, full scale patterns, actual photographs
- Sturdy wood, aluminum, and steel construction
- Capacity and performance of commercial saws selling for \$60 and up

**SAVE
\$50
OR MORE**

GIL-BILT 10-INCH TILTING ARBOR SAW

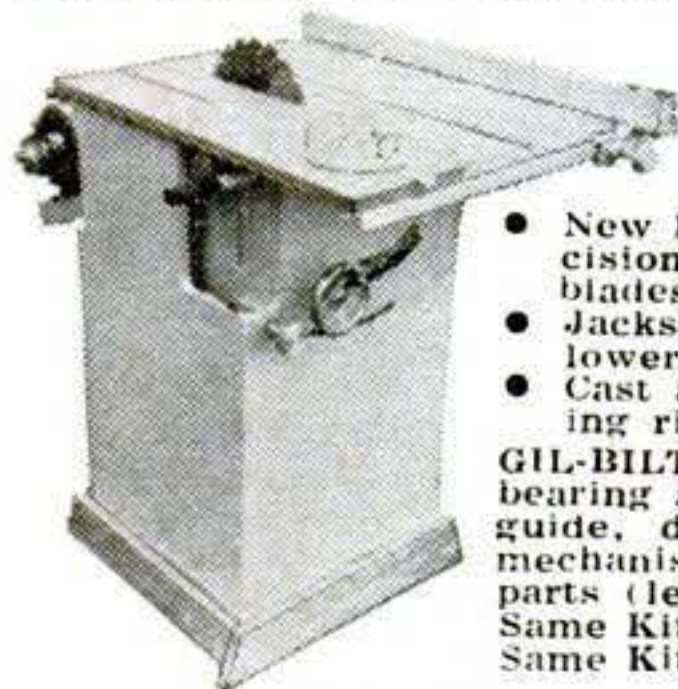

- 27x28 in. table, 13 1/2 in. capacity in front of blade
- 10 in. blade cuts 3 1/4 in. deep, tilts full 45 degrees
- Floor model 34" high table always stays level
- New Departure ball bearing arbor, 3/4" precision shaft turned down for 5/8" bore blades, alum. housing, shipped ready to run
- Jackscrew and 4 1/2 in. dia. handwheel lowers and raises blade
- Cast aluminum miter gauge and self-aligning rip fence guide

GIL-BILT Metal Parts Kit includes Plans, ball bearing arbor, miter gauge and bar, rip fence guide, dado insert, lock knobs, jack screw mechanism and handwheel, and all other metal parts (less blade).....**\$20.95**
Same Kit with 10" Combination Blade.....**\$24.90**
Same Kit with 8" Combination Blade.....**\$23.90**

GIL-BILT 12-INCH BAND SAW



- Cuts to center of 24 inch circle
- Handles stock up to 6 inch thick
- 18x18 inch table tilts 45 degrees
- Lower wheel and drive pulley runs on sealed New Departure Ball Bearings; Upper wheel runs on two 5/8" bore Oilite Bronze bearings.
- Upper wheel tension and tilt mechanism of cast aluminum, completely assembled.
- Upper and lower blade guides. Each has ball thrust bearing, self-lub bronze jaws.
- Rubber tired wheels. Choice of cast aluminum or make-your-own wood wheels on metal hubs.
- Uses standard 78 inch blades up to 3/8 inch wide.
- Fully enclosed mechanism for utmost safety.

GIL-BILT Metal Parts Kit includes Plans, rubber tires, 1/4 inch blade, hubs for wood wheels, ball bearing spindle, tilt mechanism, guides, table tilt segments and all other metal parts.....**\$16.95**
Same Kit with two machined ready-to-install 12" cast aluminum wheels.....**\$20.95**

Return Kits in 10 days for refund if not satisfied.
(Prices include postage within 600 miles. Over 600 add 5%)

Also available—Plans and Parts Kit for 8" Tilt/Table saw. Order Plans at \$1.00 each—sent postpaid anywhere in the world or write for FREE descriptive catalog.

GILLIOM POWER TOOLS P. O. Box 1-VF, Lambert Field
St. Louis 21, Missouri



New

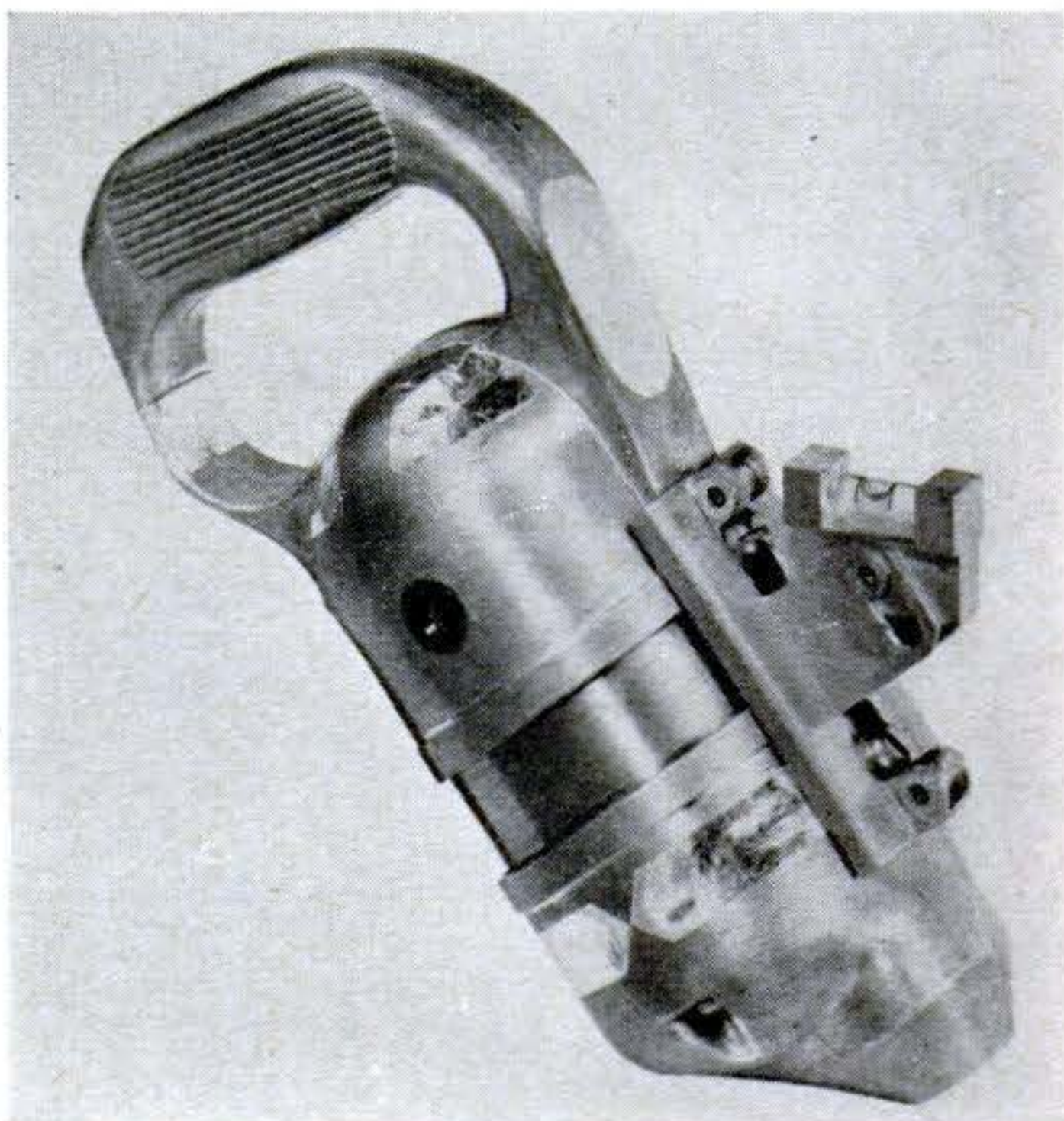

Level Fits on Drill. A level on an electric drill was suggested by John L. McClung, of Port Huron, Mich., in "I'd Like to See Them Make," PS, Dec., '49. Now you can buy such a level from the Singer Kennedy Corp., Chicago, for about \$5. This level is attached by two small machine screws. It can be adjusted to any angle from 0° to 90°. After setting the level to the desired angle, the operator watches the bubble—not the drill—keeping it centered in the glass to drill a hole at the correct angle.

Drives Screws Automatically.

Screwsticks, a development of the American Screw Co., Providence, R. I., are used in this rotary pneumatic tool made by the Independent Pneumatic Tool Co., Aurora, Ill.

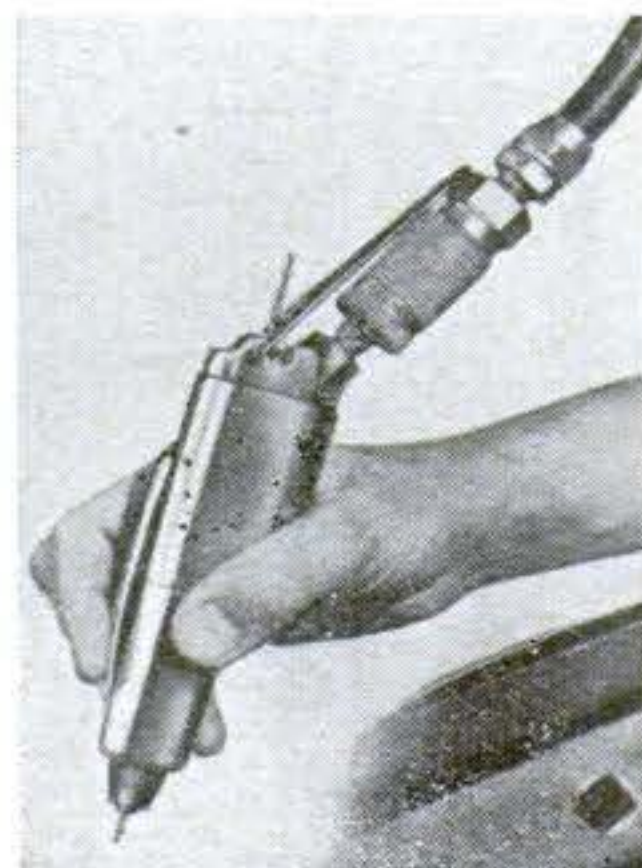

Screwsticks are a series of hex-head screws joined head end to thread end. The tool feeds and drives screws as fast as the operator can move from hole to hole in the work. When the tool drives a screw home, it is automatically twisted off.

Tools

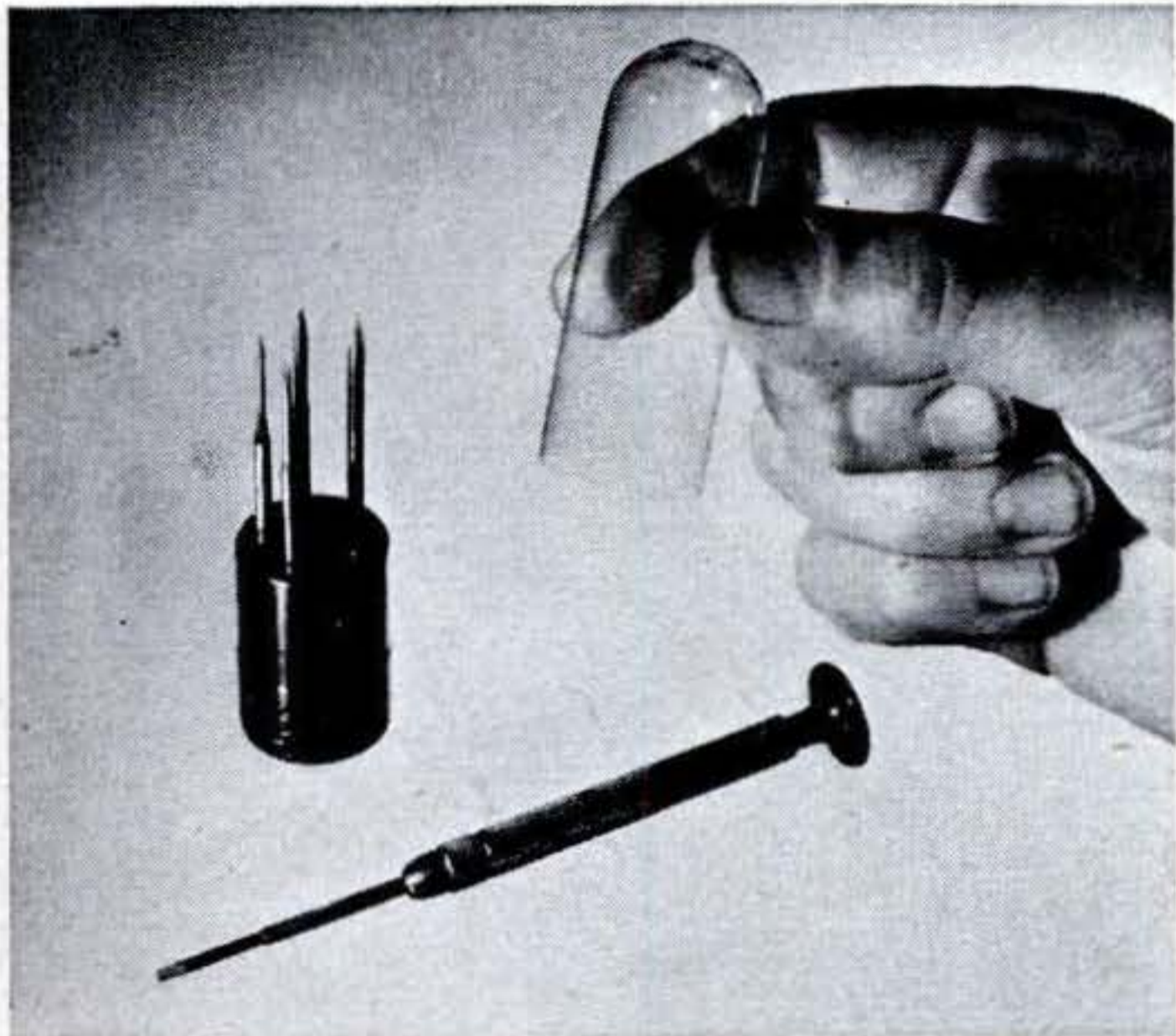

Precision Screwdriver Set. Five interchangeable blades ranging in width from .100" to .040" and a nickel-plated, knurled handle are included in this set of jeweler's screwdrivers. The top of the handle swivels for convenience in running fine screws. A chuck holds the blades in the handle. Blades and handle are stored in an aluminum base. The Shadow Box, Brooklyn, N. Y., prices the set at \$1.50.

Heat Gun Burns Off Paint. This flameless heat gun, made by Kinetic Laboratories, Philadelphia, quickly reduces old paint to a flaky ash that can easily be scraped off. It leaves the surface clean, without gummy deposits. It also can be used to heat

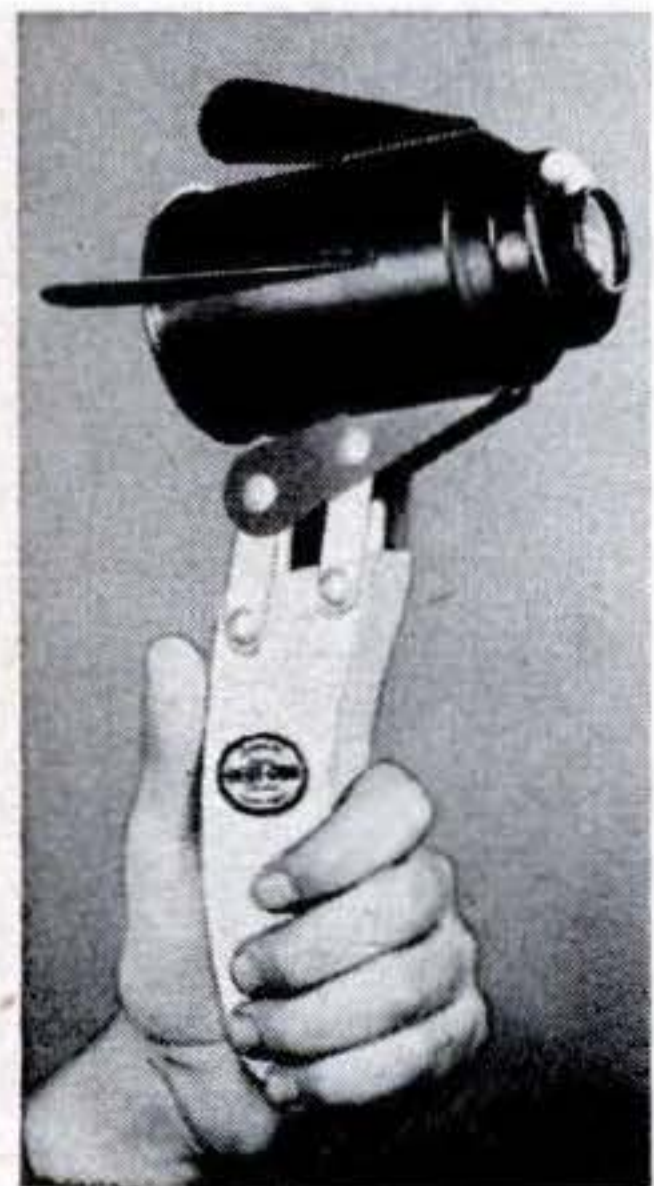

plastics for bending. The unit, drawing 400 watts at 115 volts AC, consists of an electric resistance embedded in ceramic. A steel container encases the unit. Including the wooden handle, the gun weighs about 2 lb. The gun projects about 1,200° of heat and may be used for the same purposes as a gasoline blowtorch, except for brazing.

AMAZING NEW 3 SPEED

- BUFFER
- SANDER
- POLISHER

Fits Any 1/4" Drill



Now you can buff, sand, grind and polish at exactly the right speed. Most flexible kit ever offered. New, exclusive, 2 speed right-angle drive unit gives just the right speed for every operation—double drill speed for fast, fine sanding, 1/2 drill speed for added power and high lustre polishing and buffing, direct drill speed for run-of-mine work. Light and easy to use. Swivel action between drill chuck and angle-drive unit permits use at any angle on any surface. Even an inexperienced operator can get professional results. Buffs, grinds, polishes, sands car bodies, furniture, woodwork, floors, metals. For home and shop use, garages, farms, service stations, machine and cabinet shops, building maintenance and many other uses. Heavy duty steel cut Zerol gears of right angle drive operate in grease-packed, sealed chamber. Will give long, hard, smooth service. Complete kit includes:

- Right angle drive 2 speed unit
- Flexible molded rubber head
- Direct drive adaptor, cup washer, screw
- Polishing bonnet, highest grade lambs wool
- Heavy-pile carpet compound rubbing pad
- Three sanding discs—coarse, medium, fine grits
- Full directions



ONLY
\$7.95
POST PAID

Full money back guarantee. Sent postpaid anywhere in U. S.



ONLY
\$1.49
Postpaid

DIRECT DRIVE Polishing and Sanding Kit

Designed for use with any electric drill. Kit contains: Rubber head with cup washer, screw and adaptor; highest grade genuine lambs wool polishing bonnet; medium grit sanding disc. Ideal for use with chuck and drill bench mountings and for 1/4" electric drills. Operates at drill speed. Full money back guarantee. Sent postpaid anywhere in U. S.

PALM GRIP RATCHET SCREW DRIVER SET

Handiest thing yet for loosening those hard-to-get wood and metal screws. Heavy duty palm ratchet fits 3/8" standard socket in driver heads. Also fits all 3/8" standard wrench sockets. Heavy duty screw drivers have tool steel blades and tough, non-burning "Tenite" handles. 3 sizes fit every need. Practical, time saving. Designed for auto mechanics, machinists, electricians, carpenters, farmers, home craftsmen, building maintenance men, cabinet and furniture workers. Palm ratchet operates right and left with center lock. Full money back guarantee. Sent postpaid anywhere in U. S.

ONLY
\$6.50
POST PAID

SEND CASH, MONEY ORDER OR CHECK with coupon today

LAKE SALES, INC.

6536 Carnegie Avenue, Cleveland 3, Ohio

Enclosed find () cash; () check; () money order for which please send me the kit checked below.

- () Complete, 3 Speed Kit **\$7.95**
- () Direct Drive Kit **1.49**
- () Ratchet Screw Driver Kit **6.50**

Name:

Address:

City & State:

DEALERS—SEND FOR FULL INFORMATION



For Dad on Father's Day

with these
3 tools
you can

grip join
turn squeeze
hold straighten
twist fasten
push tighten
pull loosen
bend cut

anything in and
around the house

MagneKit includes

6" Long Chain Nose Pliers
6" Adjustable Wrench
7" Angle Nose Pliers,
PLUS Magnetic Tool Holder,
all for price \$5.85
of tools, alone

UTICA MagneKit
with Magnetic Tool Holder

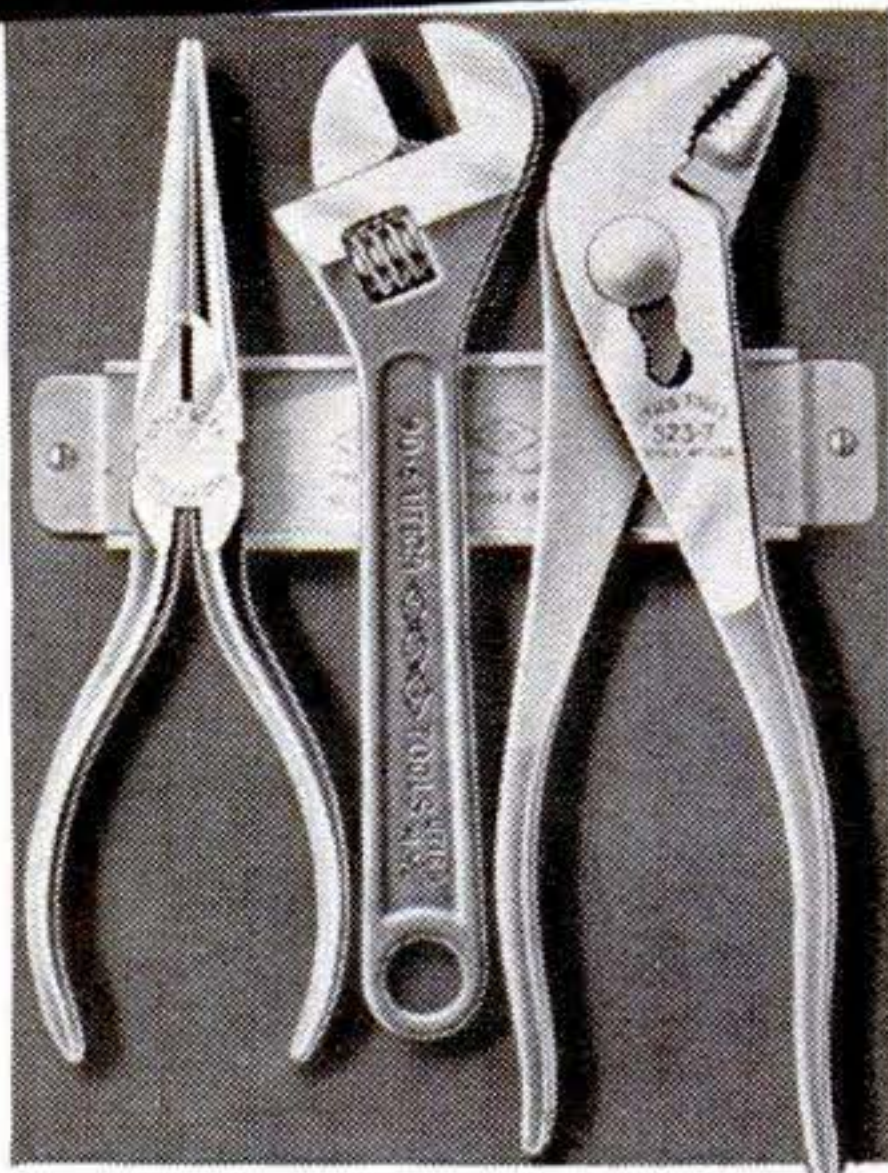

Here's a gift Dad will prize! The 3 basic tools the hobbyist or handyman uses constantly in construction and repair work—PLUS a powerful, permanent Magnetic Holder. "Professional" tools, these, that enable anyone, novice or expert, to do the job easier, quicker, better. Your hardware store has the handy, new MagneKit or can get it for you.

Utica Drop Forge & Tool Corporation • Utica 4, N. Y.

It pays
to buy



quality
tools



PEEL PAINT TO BARE WOOD WITH ONE EASY STROKE

NEW ELECTRICAL TOOL removes 1 to 10 or more coats of paint from any wood surface as easy as cutting butter with a hot knife. No scraping, cutting, burning, sanding, or chemicals. The new Lectro Paint Peeler instantly softens paint electrically and peels it off the surface clean to the bare wood with one easy stroke. It's faster than a blow torch—there's no danger of fire—will not scorch or burn delicate wood surfaces. Makes no mess—no smell—it's even fun to use. Removes any paint, enamel quickly and easily. Sturdily constructed to last for years. Sent complete with extra long, quality electrical cord. Simply plug into any A.C. or D.C. outlet—let heat for several minutes and remove paint to the bare wood on exterior or interior painted surfaces, floors, woodwork, cupboards, furniture, antiques, boats, window-sills, screens, doors—a hundred other uses. Price \$4.95 postpaid—nothing else to buy. Full money back guarantee. For immediate shipment—send check, cash or money order to:

LECTRO WELD, INC.
3495 West 140th St. Dept. PS-6 Cleveland 11, Ohio

New Tools

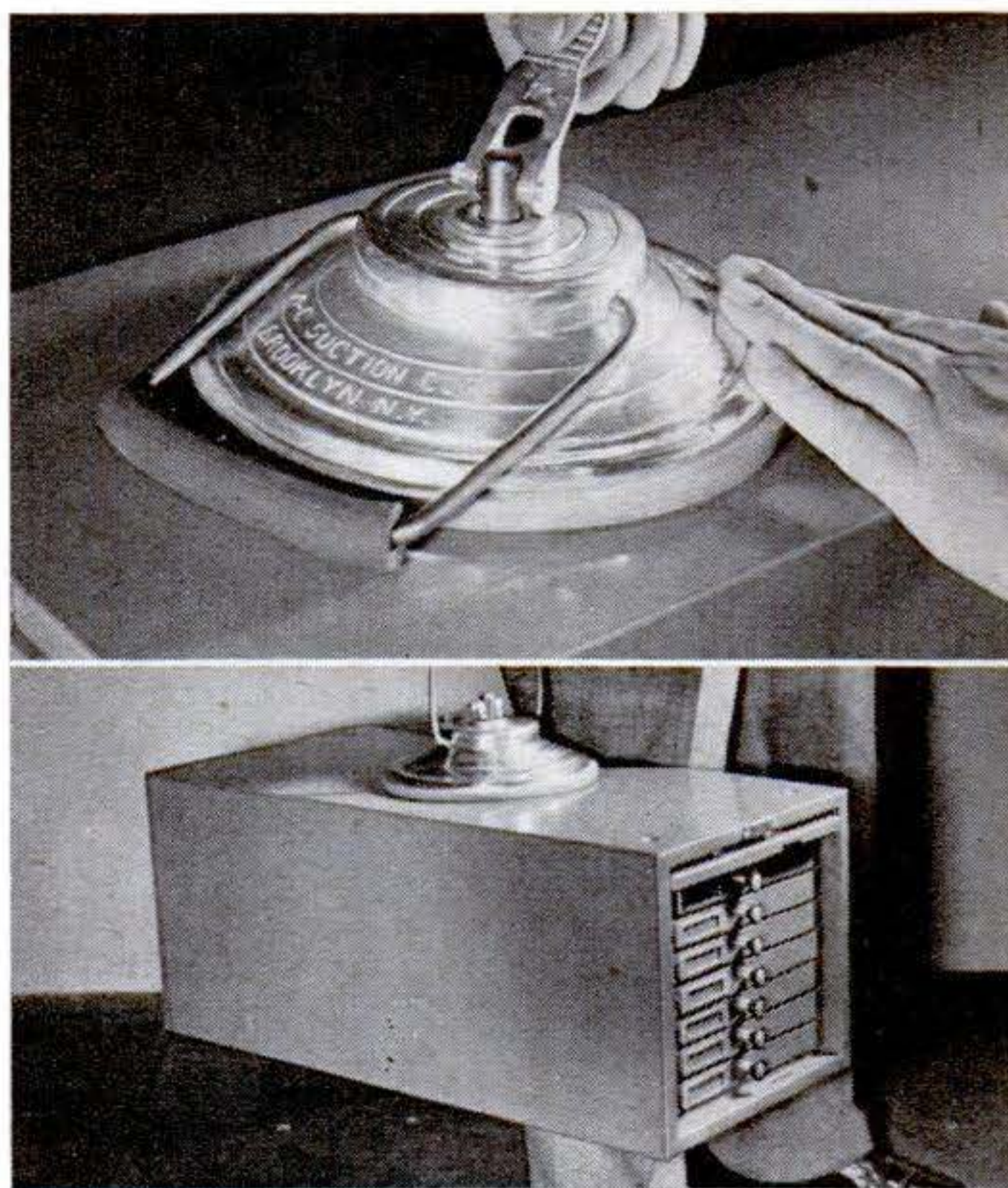

Giant Suction Cup. Heavy, bulky objects—if they have a smooth, flat surface—can be moved easily with this jumbo suction cup. Its manufacturer, the A-C Suction Cup, Brooklyn, N. Y., makes no specific claims as to the amount of weight the cup will handle, since surfaces vary greatly. However, it has proved successful in moving furniture and large sheets of plate glass.

To attach the cup, the control lever is pushed down. This brings up a metal disk in the center of the rubber disk, creating a strong suction that is sealed by the rubber around the edges.



Calking Gun Has Plier Grip.

This gun is said by the maker—Western Reserve Manufacturing Co., Cleveland—to cut calking time as much as 30 percent. The gun is operated by a squeezing action of your hand—the same as you'd use with a pair of pliers. Either cartridge or bulk compounds can be used in the gun. Change-over from bulk to cartridges requires only the removal of two leather washers. Interchangeable nozzles for various jobs are available. The gun comes in three sizes: 15-, 30-, and 45-cu. in. capacity.

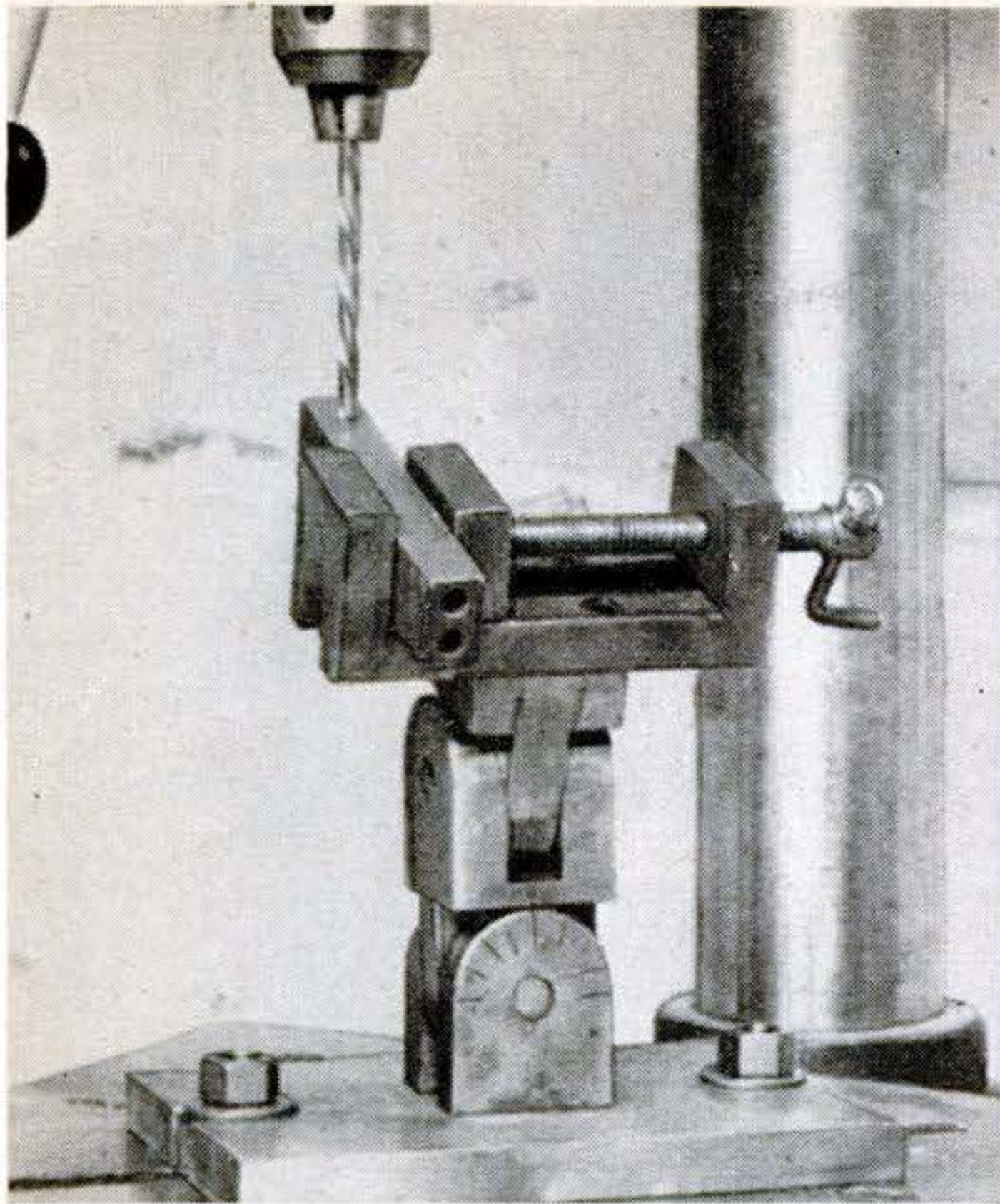

Compound Angle Vise. This vise, made by En Fab, Inc., of Kalamazoo, Mich., holds work at compound angles for grinding, milling, or drilling. The price is about \$25. By removing four recessed-head screws, the swivel vise can be converted to a straight drill vise. The vise will hold work up to 1½" by 2½". Size of the slotted base is 4" by 6". Over-all height is 6". The unit swings 180° in either direction. Original setups may be made by the index marks, but for greater accuracy, a surface gauge is suggested.

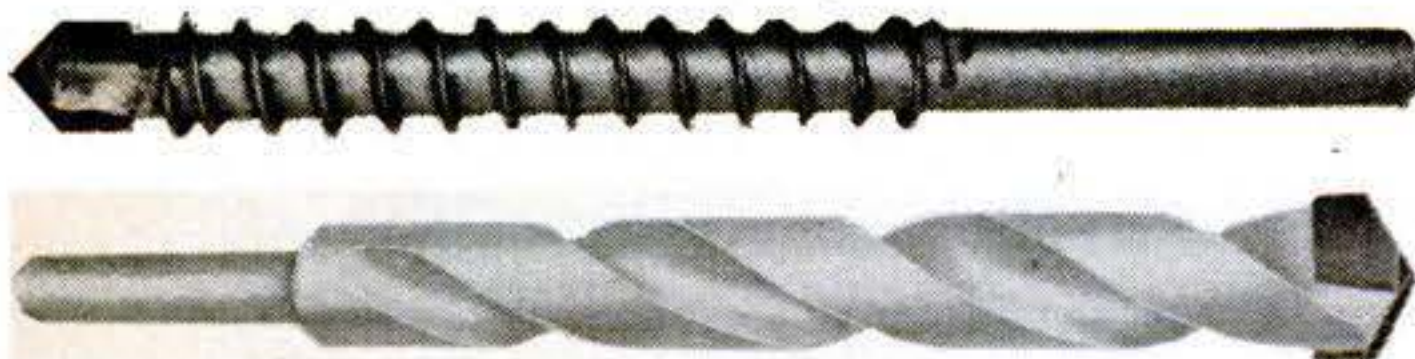

Two New Masonry Drills. Both of these drills—made in standard sizes—speed up masonry drilling by carrying the dust out of the hole as they drill.

The drill in the upper photo is made by Carboloy Co., Inc., Detroit. High-tensile strength wire, swaged to the shank at upper and lower ends, is wound around the shank. Dust cut loose by the tip is lifted up and out of the hole by the wire spiral.

The other photo shows a drill made by Kennametal Inc., Latrobe, Pa. It has an angled cutting point of cemented carbide that the maker claims gives the drill greater biting power. The spiral cleans the dust out of the hole.



Dependable under trying conditions, the Eskimo dog performs the hardest kind of work. Sturdily built, light in weight, he does the job that would otherwise fatigue his master.

Dependable PERFORMANCE

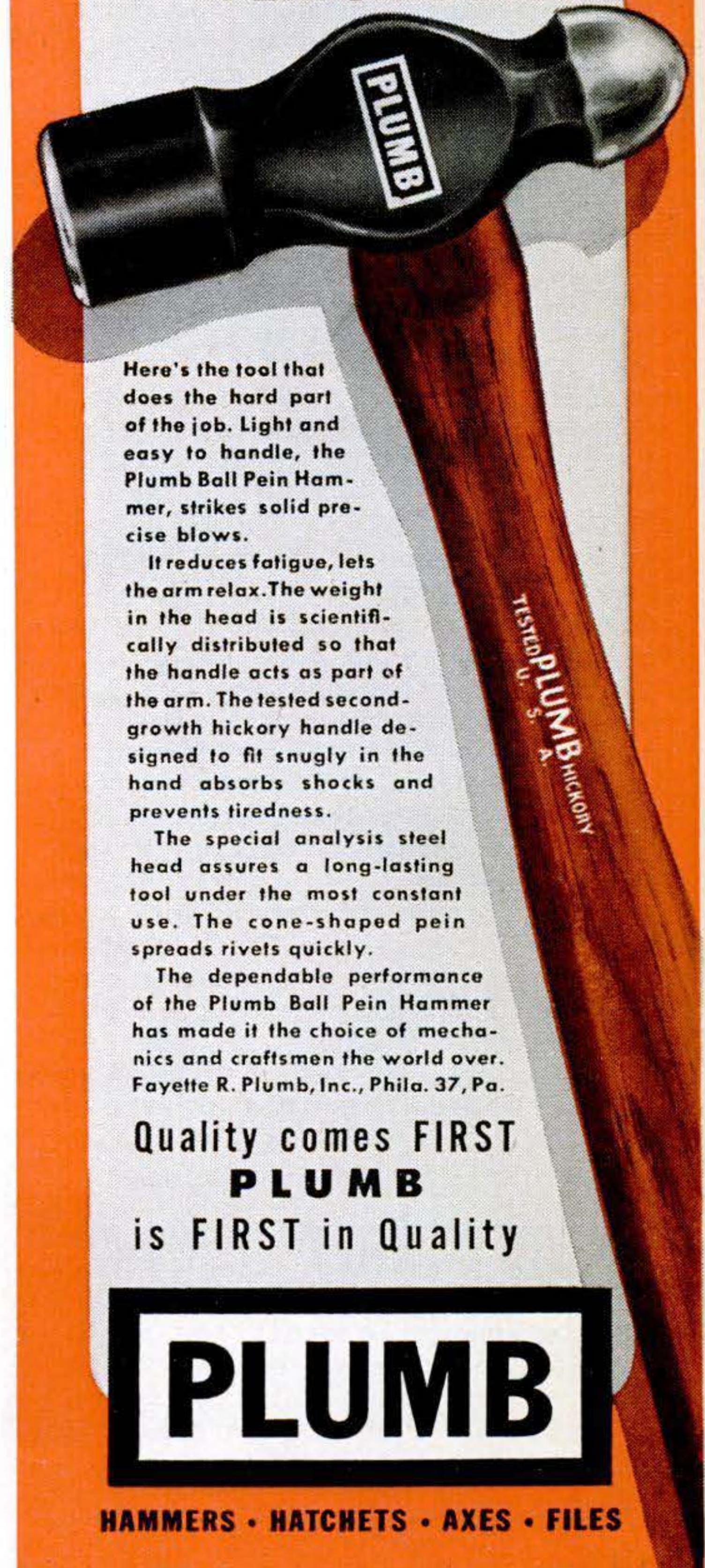

Here's the tool that does the hard part of the job. Light and easy to handle, the Plumb Ball Pein Hammer, strikes solid precise blows.

It reduces fatigue, lets the arm relax. The weight in the head is scientifically distributed so that the handle acts as part of the arm. The tested second-growth hickory handle designed to fit snugly in the hand absorbs shocks and prevents tiredness.

The special analysis steel head assures a long-lasting tool under the most constant use. The cone-shaped pein spreads rivets quickly.

The dependable performance of the Plumb Ball Pein Hammer has made it the choice of mechanics and craftsmen the world over. Fayette R. Plumb, Inc., Phila. 37, Pa.

Quality comes **FIRST**
PLUMB
is **FIRST** in Quality

PLUMB

HAMMERS • HATCHETS • AXES • FILES

P.S.

Last minute news & notes...

AUTO FIGURES: The U. S. now has 35,000,000 cars. Los Angeles County alone has more than the whole of Asia. Two out of every five cars now on the road are 10 or more years old. Since 1925, the average life-time of a car has nearly doubled. Life expectancy of those now being made is 12 years. There've been 1,850 American makes of autos, but only 20 are still being produced. Last year 5,000,000 passenger cars were made in the U. S.--enough to fill 16 traffic lanes from Boston to Los Angeles.

CANCER DETECTION will be easier through a new technique devised by four scientists of the University of California at Los Angeles. More work must be done, however, before it is available for general use.

COLORADO SHEEPHERDERS' children never use the hundreds of rubber wading pools now being sold to Western ranchers. Instead of the heavy galvanized iron tanks once used for dipping and watering sheep, the new neoprene, portable, collapsible wading pools fill the bill exactly.

ENGINE PROGRESS: Combinations of metals and ceramics (called Metamics) are being tried to withstand the high temperatures in jet engines . . . Magnetic-fluid clutches in which cylinders are used in place of disks are being tested in General Electric's labs . . . Better self-starters for gas-turbine planes have been made possible by the development of a new auxiliary power system.

WHEN THINKING MACHINES of the future make a mistake, they'll know it and automatically correct it. A Bell Telephone Laboratories mathematician has figured out a way to build a conscience into computers that will give them this superhuman ability.

SAFETY SCHEMES: A traffic light that talks is being tried out in Syra-

cuse, N. Y. It reminds pedestrians, 'Look right, look left; it may save your life.' . . . Coal mining is being made safer by bolting layers of rock together like plywood. This makes the mine roofing self-supporting . . . Shooting galleries can be made safer now, too--by using newly developed cartridges that pulverize rather than spatter.

ATOMIC NEWS: Construction of a nuclear reactor to yield power for peacetime purposes at West Milton, N. Y., has been postponed. Instead, GE scientists who've been planning that project have been directed by the AEC to concentrate on developing an atomic engine for ships--the second one now in the works . . . Another gigantic atom-smasher is scheduled to be built near San Francisco for secret work.

A RAPID-REVERSING MOTOR developed by the National Bureau of Standards can change direction of rotation 20 times while you're winking an eye. It has been easy to stop a motor quickly with a brake; the hitch was to rev it up to full speed quickly the other way. In NBS's invention, kinetic energy of the rotor, instead of being dissipated as heat in a brake, is used to twist a spring-steel rod that then flips the rotor rapidly in the opposite direction. The new motor is expected to be useful in electronic computers, instruments, and industrial machinery.

PLASTIC PADS are being produced now to go between railroad ties and the steel tie plates. Tests have shown that they prolong the life of the wooden ties . . . **VACUUM TUBES** put in the 'bulges' (amplifiers) of a telephone cable that is being laid between Florida and Cuba are expected to last 25 years . . . **MOUSE TRAPS** that work like flypaper (the feet of the mouse stick to 'em) are being sold now by Electronic Rat Traps, Inc., Rochester, N. Y.

The Editors

Dave Saves the Day

Puts
"NEW LIFE"
 in his trusty Ford!

LIFE SAVER

1 ON SUNDAY THE GANG IS GOING UP TO SWAN LAKE. WHY DON'T WE GO ANY PLACE ANY MORE?

CAN'T HELP IT, DEAR. WHEN A FORD HAS AS MANY MILES AND YEARS ON IT AS OURS HAS, IT NEEDS REPOWERING

2 AN **AUTHORIZED** RECONDITIONED FORD ENGINE COSTS JUST A LITTLE MORE THAN A MAJOR OVERHAUL. AND BROTHER, WHAT PEP IT ADDS TO YOUR FORD!

YOU SAY ONE DAY TO PUT IT IN? GOOD DEAL! I'LL SURPRISE NANCY—I'M GOING OVER TO SEE THE FORD DEALER THIS NOON!

I FIGURE THERE'S NO SENSE IN NOT GETTING THE BEST—THAT'S WHY I CAME HERE TO GET AN **AUTHORIZED** RECONDITIONED ENGINE FOR MY FORD

YOU'RE RIGHT! IT'S RISKY NOT GETTING THE GENUINE ARTICLE. IT'S LOW-PRICED AND WE CAN WORK OUT AN EASY PAYMENT PLAN FOR YOU

DAVE, IT RUNS LIKE A NEW CAR! WE'LL BE UP AT SWAN LAKE BY THE TIME THE REST OF THE GANG GETS THERE!

YOU SAID IT, HONEY! AND NOW OUR CAR WILL LAST US FOR MANY MORE THOUSANDS OF MILES!

Your guarantee of the real thing

- All wearing parts and surfaces reconditioned or replaced with new Genuine Ford Parts •
- Guaranteed by Authorized Reconditioner against defects for 4,000 miles or 90 days •
- See your nearest Ford Dealer or Independent Garage.



WHEN YOUR PATCHING
TURNS OUT LIKE THIS...
IT'S TIME FOR A NEW TUBE...

and IF YOUR CAR FEELS LIKE THIS
...IT'S TIME FOR MARFAK
CHASSIS LUBRICATION

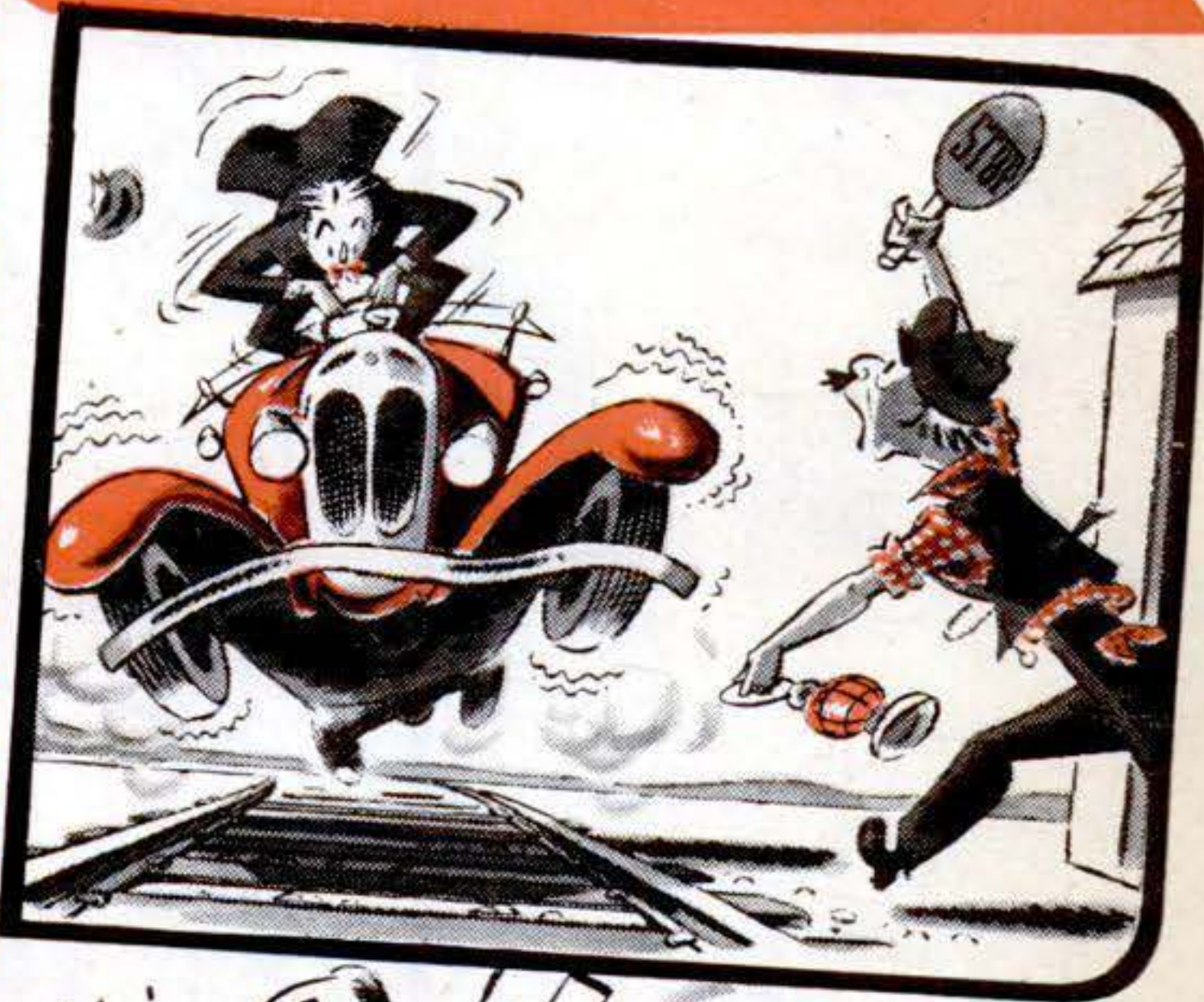

THAT CUSHIONY FEELING LASTS LONGER WITH MARFAK!

Marfak is extra tough and stretchy—specially compounded to cling to bearings and vital wear points. That's why *Marfak* protects the chassis—not for a few hundred miles but for 1,000 miles and *more!* Enjoy that swell “cushiony” driving ease that *lasts*. Applied by chart, never by chance. Get *Marfak* lubrication today at your Texaco Dealer, *the best friend your car ever had.*



THE TEXAS COMPANY

TEXACO DEALERS IN ALL 48 STATES

Texaco Products are also distributed in Canada

TUNE IN . . . TEXACO STAR THEATER starring MILTON BERLE on television every Tuesday night. See newspaper for time and station.

\$15 ²⁰ an ho

FOLKS ARE
AMAZED
WHEN YOU
TELL THEM
THIS NEW
KIND OF
PROTECTION
COSTS ONLY

\$3.98



- Only Presto Has ALL These Features**
- ▶ Ends Fire as Fast as 3 Seconds
 - ▶ Chemical Contents 1.5 to 6 Times More Effective than Others on Equal Weight Basis
 - ▶ Weighs Less Than 1 lb.
 - ▶ Easily Held in One Hand—Even by a Child
 - ▶ Needs No Inspection or Re-Charging—Does Not Corrode or Deteriorate
 - ▶ Costs Only \$3.98—Yet Out-Performs Bulky Extinguishers Costing Several Times As Much
 - ▶ Automatic Pressure—No Pumping
 - ▶ Guaranteed for 20 Years—Certificate Packed with Every Presto

This is the average earning reported by Pre WILLIAM F. WYDALLIS. "The sky's the limit profits because of America's serious need for extinguishing discovery.

WOULD'N'T YOU like to be making the kind of money William F. Wydallis is making? His story (printed at right) is just one example of the brilliant success that Presto salesmen are meeting everywhere!

A Florida salesman earned \$600 in one month. An Ohio man earned \$2100 in two months. A New York salesman earned \$1500 in one month. A New Hampshire salesman added the Presto as a *sideline* and picked up an extra \$1800 in 20 months.



Help Save Your Town's Homes from pan bursts into flame . . . a seconds minutes the entire house is the flames like these fast as 2 seconds representatives are welcome

WHAT IS THE SECRET?

PRESTO contains an amazing new chemical — "Chlorobromomethane" or "C.B." The Germans developed "C.B." as a secret defense against fire during the war. After the war, a famous American firm, The Dow Chemical Company, acquired the formula from the U. S. Government and began manufacturing it here. Then we (Merlite Industries) designed a *handy—yet amazingly effective—fire extinguisher* to contain and release this new wonder-chemical.

Dow's Findings on "C.B."

In comparing the effectiveness of "C.B." in fighting various kinds of fires The Dow Chemical Company's report states: "It has been proved that 'C.B.' is *about 1.5 to 6 times as effective as other common extinguishing agents on an equal weight basis.*"

This extra effectiveness of "C.B." means that Presto can be made light and handy enough for even a woman or child to use. No pumping—no heavy tank or tangled tubes to struggle with. Just a twist of the knob . . . and flames disappear! "Sells on sight" to owners of homes, cars, stores, farms, service stations, boats, motorcycles, factories, offices.

Why Large Presto Profits Are So Easy

Everyone is terrified at the very thought of FIRE! Every year fire kills more than 11,000 people—and destroys over SEVEN HUNDRED MILLION

dollars worth of property in The annual fire toll is more than BLE what it was 10 years ago! of people have been waiting for simple, inexpensive fire safe most people who see Presto immediately want to buy one **ESPECIALLY WHEN THE ONLY \$3.98 EACH!**

You can demonstrate Presto minutes, and every sale will n or more. We give you free your Demonstrator . . . free matically powerful) printed s rial to "talk from" . . . free e testifying that Presto is GUAR FOR 20 YEARS!

YOU DON'T NEED TO IN PENNY. Just collect and ke more every time you write an e collect the balance and delive tinguisher. (Or if you *wish*, yo from us at extra-low wholes and then make up to \$2.18 unit supplying both dealers a customers—we'll send you free

Get Started Now—Mail C

Get started in this rich new Don't "put it off"! Every day tate may cost you \$10, \$15, or you could otherwise be making coupon NOW for everything yo get started right away! **MERLITE TRIES, Inc., Dept. 116, 201 Street, New York 3, N. Y.**

NOTED THROAT SPECIALISTS REPORT ON 30-DAY TEST OF CAMEL SMOKERS . . .

Not one single case of throat irritation due to smoking **CAMELS!**

Yes, these were the findings of noted throat specialists after a total of 2,470 weekly examinations of the throats of hundreds of men and women who smoked Camels — and only Camels — for 30 consecutive days.



"As a singer, naturally I smoke the cigarette that agrees with my throat...CAMEL!"

LANNY ROSS

The golden tenor voice that has entertained millions explains: "The 30-day test showed me how much fun smoking can be! Camels suit my throat, and they're a great-tasting smoke."

R. J. Reynolds Tobacco Company, Winston-Salem, N. C.

"ON MY JOB, MY THROAT GETS A WORKOUT. THAT'S WHY I MADE MY OWN 30-DAY TEST AND CHANGED TO CAMELS FOR KEEPS!"



TELEPHONE OPERATOR MRS. ETHEL JAMES

"THROAT IRRITATION DOESN'T GO IN MY JOB—I SMOKE ONLY CAMELS. THEY'RE RIGHT FOR MY THROAT— THEY'RE COOL AND MILD!"



COSMETIC DEMONSTRATOR MADELINE OSTROWE

"I TALK TO THOUSANDS OF SHOPPERS. WHEN I SMOKE, I HAVE TO THINK OF MY THROAT. THAT'S WHY CAMEL IS MY CIGARETTE. CAMELS ARE SO MILD!"

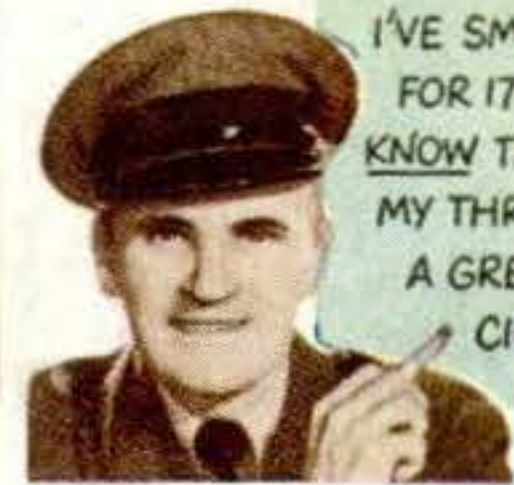

MUSEUM GUIDE WALTER McGRATH

"30-DAY MILDNESS TEST? I'VE SMOKED CAMELS FOR 17 YEARS AND I KNOW THEY AGREE WITH MY THROAT! THEY'RE A GREAT-TASTING CIGARETTE, TOO!"



RADIO ANNOUNCER GEORGE ANSBRO

● You have the word of Camel smokers . . . of noted throat specialists . . . but test Camels for yourself in your "T-Zone" (T for Taste and T for Throat). See if you don't agree that Camels are the mildest, best-tasting cigarette you ever smoked!

Start your own 30-Day Camel MILDNESS Test Today!