

# POPULAR SCIENCE

MONTHLY

MECHANICS AND HANDICRAFT



Can "Death Sand" Win Battles?

PAGE 144

25¢ February, 1951

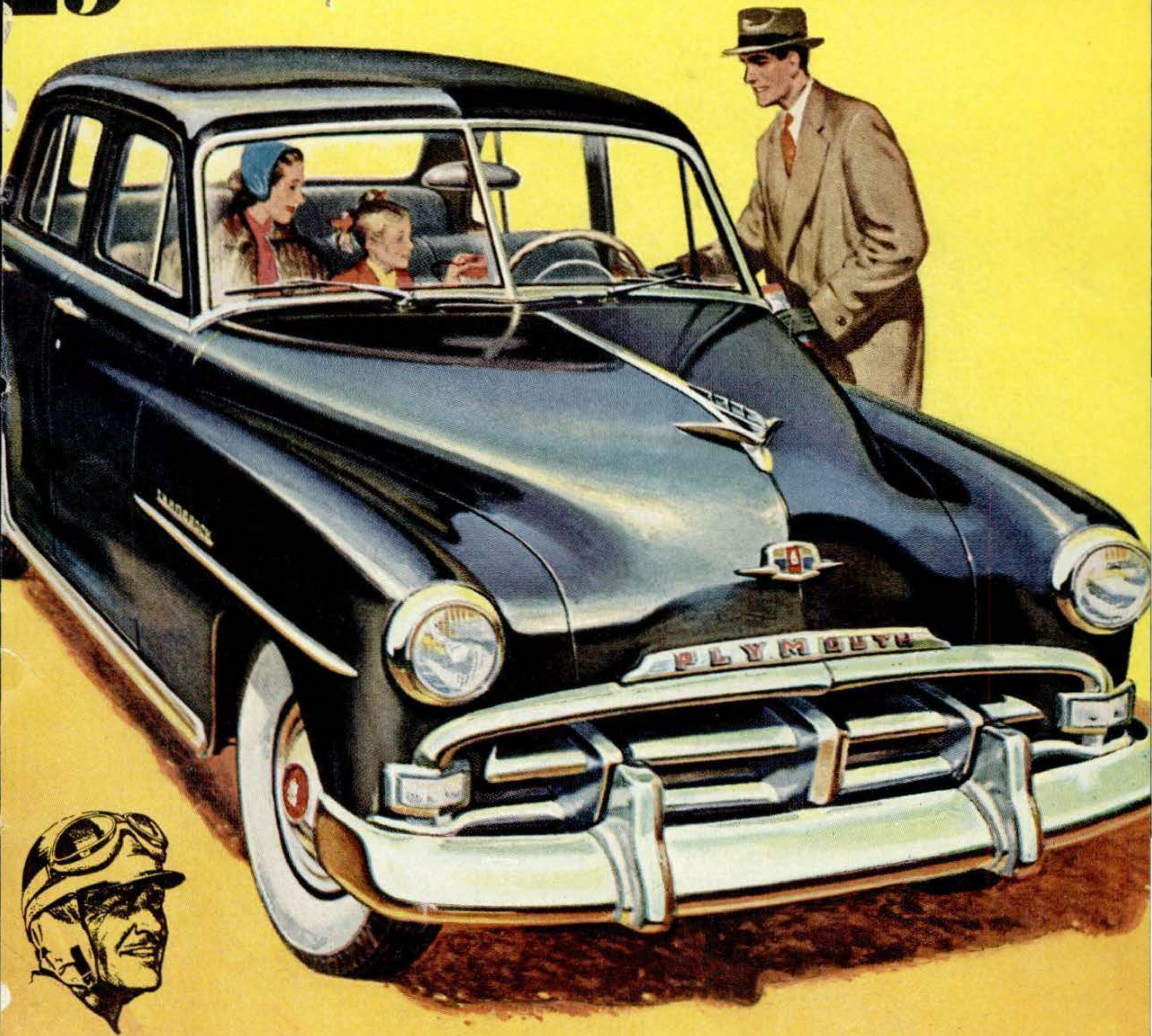

## Wilbur Shaw Drives 1951 Plymouth

*Raymond Brown*

# "Your Dream HOME"

**8 Beautiful Plans**

**4 With Material Costs Under \$3500**

also **4 More Spacious Homes**  
**4 Requiring More Material**

\*Based on Estimates Secured Last Year in the Midwest and on the East and West Coasts.

Looks Like a "Million Dollars"! Yet Materials for Basic House Including Finishing Dormers Cost Less than \$3500. Famous "That-Grows" Plans Show How to Finish Attic, Add Breezeway and Garage for Nominal Cost Later.



Free Trial  
 this De Luxe  
**LUMBER-NOTCHED**  
 Edition, check De Luxe  
 Paragraph in coupon.



## AMATEURS Saving Thousands of Dollars

**SAVED \$5500!** Young D. A. D. built his own home near Washington, D. C., with help of "YOUR DREAM HOME"—and saved \$5500! Four of D's co-workers also built homes worth up to ONE-HALF more than they spent.—*Pathfinder*, Sept. 5, 1950.

**NET COST \$4500!** R. H. S., New Bern, N. C., who built from "YOUR DREAM HOME," writes, "My home is complete and I live in it today. Net cost \$4500."

**SAVED \$4000!** v "DREAM HOME" D. M. L., Lexington, Md. "Though inexperienced, we easily saved \$4000. Anyone considering building a home should have your excellent book."

**SAVING \$5000!** E. New York City, ordered two copies of "YOUR DREAM HOME" and writes, "Will put to good use. In building our own home, we should save at least \$4000-\$5000."

**Amateur Building Sweeps the Land!** *Coronet* describes "\$15,000 Home for Only \$6000!" *Ladies' Home Journal* reports \$18,000 home for only \$9089, built with Bild Patterns! *American Home* tells of \$5000 street to "\$15,000 Worth of House"! *Better Homes & Gardens* survey shows less than half of the homes being built by contractors. Yes, by the thousands, amateurs are **SAVING** countless thousands of dollars!

## 576 Big Double-Column Pages—650 "How-to-Do-It" Pictures!

HERE'S A MERE HINT OF THE HUNDREDS OF PRACTICAL "SHOW-HOW" FEATURES!

**Selecting the Locality and Site**  
 Choosing Proper Elevation; Drainage Sun Light; Solar Heating, etc.

**Complete Material Lists**  
 Each of the 8 House Plans Includes Complete Material Lists of Lumber, Masonry, Hardware, Plumbing, Insulation, Wiring, Heating Equipment, etc., so your supply dealer can quote exact total cost

**Masonry and Frame Construction**  
**Clearing the Land**  
 Positioning House to Make Most of Lot  
 Clearing Trees, Rocks

**How to Make the Foundations**  
 How to Mix Concrete  
 Pouring Cement Foundation  
 Cement-Block Foundation  
 Waterproofing

**How to Build Frame**  
 Setting the House Girder or Lintel  
**Foundation Sills**



Any amateur can do a beautiful wall tiling job with new plastic and metal tiles!

Nailing Wall Studs to Floor Joists  
 Framing the Walls  
**How to Sheathe the Frame**  
 Two Days Work—Sheathing House with these Easy Tips  
**How to Insulate**  
 How to Apply Blanket, Batt, Fill and Board-Type Insulations  
**How to Build Storage Walls**  
**Building the Roof**  
 Types of Roof  
 How to Erect the Batters

Laying Roof Boards  
 Metal Flashing  
 Erecting Chimney  
 Shingling the Roof  
 Roof Cornice, etc.

**How to Build the Inside Partitions**  
 Making Livable Rooms

### LUMBER PRICES GOING DOWN!

The *Wall Street Journal* reports wholesale prices of West Coast fir 2 x 4's (used for framing houses) down \$10 to \$20, and 1" x 6" No. 2 pine boards down \$5 to \$6 a thousand feet. Dealers see further 33 1/3% drop in early 1951.

Plywood, Composition Wallboard, Plaster  
 Novel Effects Possible With Glass Blocks  
 Constructing Stairs

**How to Set in Windows and Doors**  
 Doors and Windows from Which to Choose  
 How to Hang Doors

**How to Install Plumbing System**  
 How and When Every Pipe and Fitting Goes in—You Can't Go Wrong  
 Locating Tub, Sink, Water Closet, Etc.

How to Lay Sewer Pipes  
 Installing Gas Pipes  
 —And Much More!

**How to Install Electrical System**  
 How to Wire Each Room  
 Outside Lighting



Stapling roll-insulation between wall studs is fast and easy!

How to Join Wires, Connect Fixtures and Outlets, etc.

**How to Install Heating System**  
 Installing Warm-Air Heating  
 Insulation Precautions  
 Other Types of Heating—Solar, Radiant, Steam, Hot Water

**How to Apply Interior Finish**  
 Quick, Easy and Satisfactory Wall and Ceiling Finish  
 Making Plaster Arch  
 Laying Finished Floor  
 Interior Trim, etc.

**How to Apply Exterior Siding**  
 Comparison of Brick, Stone, Shingle, Stucco, Clapboard, Aluminum and Other Siding

**Building a Modern Kitchen and Bath**  
 How to Build Your Own Modern Cabinets  
 How to Apply Lino-leum or Asphalt Tile  
 Bathroom Walls  
 How to Install Every



Save thousands on kitchens, baths, closets—even a new apartment

Kitchen and Bath-ture, etc.  
**Building a Fireplace**  
**Painting, Decorating Outside and Inside**  
 Painting Complete Wall-papering Instructions

**How to Make Built-in Furniture**  
 Alcoves, Dine! Kitchen Cabinets, ity Tables, Ward and-Chest Storage, etc.

**How to Build Garage & Breezeway**

Mail Coupon on Opposite Page

# How to Build it for LESS THAN \$3500!\*

Enlarge and Modernize Your Present Home at Thousands of Dollars Savings!

**MODERN HOMES TO DELIGHT EVERY FAMILY!**  
**Complete Plans and Instructions Show How to SAVE up to \$8,000!**



**RANCH HOUSE** This easy-to-build, spacious ranch house was designed for gracious living by C. R. Stork.



**Modern Suburban** Separate dining room, 4 bedrooms! By Victor Civkin.



**Colonial Home** Build this home at possible savings of \$5000. By T. Johnson.



**Vacation Hideaway** Average material estimate only \$1930.79. C. Sigman.



**Tudor Cottage** Average material cost estimate only \$3149.30.

Fully illustrated, all materials listed! Prepared by outstanding building experts, headed by Hubbard Cobb, "Handyman" of national radio and newspaper fame! For each of 8 houses, you get complete material lists of EVERYTHING down to the last nail—clear, easy-to-follow instructions on EVERYTHING—How to Arrange Financing—Select Site—Clear Land—Lay Foundations—right along to Roof, Doors and Windows, Insulation, finishing and decorating Cellar to Attic.

**Let Your Building Supply or Lumber Dealer Help You SAVE MORE!**

Consult your local lumber and materials dealer. He's a good man to know. Take complete materials list on your Dream Home to him. He will give you exact up-to-date costs, show you additional savings possible by using local materials, aid you in financing and help you all along the way. And remember Government Regulation X—while slowing contractor-building, especially on homes over \$20,000—actually works in your favor. Already it has brought lumber and other material prices down. On a \$5,000 house it permits a loan of \$4,500; on a \$9,000 house a loan up to \$7,100. Such loans would cover your material costs more than twice over. So plan your Dream Home now and SAVE MORE!



**Cape Cod Cottage** Material estimate only \$2716.75. By C. Sigman.

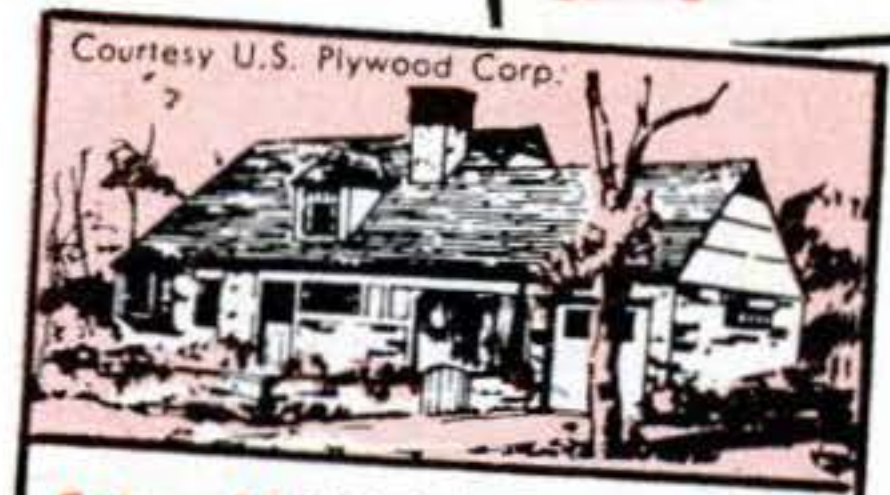

**Cotswold Cottage** Delightful cottage for some proud housewife.

THOUSANDS are doing it—so can you! With the aid of this easy-to-follow, step-by-step wonder book, you can build YOURSELF the home of your dreams—any one of 8 beautiful homes! Yes, you and your family can build and own a home far more spacious, beautiful and comfortable than you ever dreamed of—a home you will always be proud of and your neighbors will envy!

Save up to \$8,000! It's common knowledge that, of every \$100 you spend for a commercially-built house, only about \$30 goes for materials. Now this amazing volume shows you how to SAVE most of that big \$70 difference—by building your dream home yourself!

Complete building plans and simple, easy-to-follow instructions offer you a choice of 8 grand, spacious homes—sure to delight your taste and purse! Over 650 how-how pictures clearly explain EVERY step, from selecting the site and starting foundation to final landscaping. Complete material costs as low as \$1,500! Savings on you up to \$8,000 on a lovely house worth \$16,000.

**Own a \$10,000 Home for Material Costs as Low as \$2,717!**

Think of it! No longer need price tags of \$9,000 to \$25,000 and more stand between your family and the home of your dreams. YOU can build a showplace home and save 50c on every dollar! SAVE up to \$8,000!

Or perhaps you want that family Vacation Home in the mountains, lake or seashore. Actual East Coast material costs estimate on this comfortable home came out only \$1,495!

**SAVE UP TO \$8,000 —For Week's FREE Enjoyment Mail Coupon Now!**

IF AN ordinary small edition of this great volume were made, it would still be a whale of a bargain at the necessary price of \$12.50. But our huge printing enables us to slash costs... bring you this wonder-book for the amazingly low cost of only \$3.95! (YOU SAVE \$8.55!) Try it a full week FREE—return it without further obligation if not delighted, or keep it and pay

only \$1 monthly. But ACT NOW! Over 750,000 copies were sold in just a few months. Soon as new edition is gone, offer must be withdrawn! Mail FREE-Trial coupon today!

**Mail This FREE-Trial Coupon NOW!**

Wm. H. Wise & Co., Inc., 50 West 47th St., New York 19, N. Y. Rush me, for Free Examination, a copy of the big 576-page book "YOUR DREAM HOME—How to Build It for Less Than \$3500"—bound in sturdy rich Novelex and illustrated with more than 650 pictures. After a full week's free trial, I will return the book and owe you nothing, or I will keep it and remit only \$1 monthly until the low price of \$3.95, plus postage, is paid. Save Charges on 3 lb. Shipment! Mail only \$4 with coupon and we will pay shipping charges. Same return privilege, refund guaranteed.

Name..... 188  
 (Print plainly in block letters.)  
 Address..... 802  
 City..... Zone..... State.....  
 Check here to examine FREE beautiful De Luxe Edition, THUMB-NOTCHED, Pinseal-Grained Binding, hand-tooled design. Only \$1 extra. Same terms, return privilege.

Founded 1872, Vol. 158: No. 2

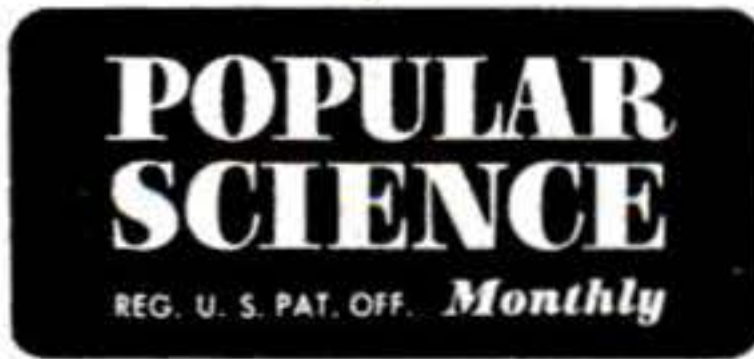

Mechanics and Handicraft

PERRY GITHENS, EDITOR

Fred O. Newman, Volta Torrey, MANAGING EDITORS    Howard C. Jensen, ART EDITOR

Harry Walton, MECHANICS & HANDICRAFT EDITOR

Hartley E. Howe, Frank Rowsome, Jr., ASSISTANT MANAGING EDITORS

ASSOCIATE EDITORS: Howard Allaway, Alden P. Armagnac, Devon Francis, Richard Giovine, Robert Gorman, Sheldon Gallagher, Herbert Johansen, Martin Mann, Denis Sneigr, Robert P. Stevenson.

ART DIRECTOR: Harry Samuels. ART ASSOCIATES: Herbert Anthony, Eric Karminski, Jr., Richard Meyer, Edward Hallstrom, Frances Cooper (Production).

EDITORIAL ASSISTANTS: Julia Charnif, Carol Ennis, Rita K. Gilbert, Georgette Sparks, Harriet Trowbridge, Ruth Westphal.

STAFF PHOTOGRAPHERS: W. W. Morris (Chief), Hubert Lockett, Orlando Guerra (Darkroom).

WESTERN EDITOR: Andrew R. Boone (Los Angeles).

WASHINGTON EDITOR: John F. Loosbrock.

# Features FOR FEBRUARY, 1951

## The Cover:

Reynold Brown made the sketches for his painting of the new Plymouth on the spot at Detroit.

## Shaw Drives the 1951 Plymouth .. 98

The Master of the Indianapolis Speedway reports on this dressed-up model of the family car.

## Mines Are Dirty Tricks .....107

The men who lay them and sweep them point to Korea as a warning of what might come our way.

## "Iron Heart" Subs for Real One..114

This mechanical miracle takes over the work of both heart and lungs when human organs fail.

## Navy Brain Answers with Pictures 124

Meet Typhoon, a machine that shows what a guided missile will do before it is built.

## Atom-Furnace Secrets Revealed....133

Ever wonder what an atomic pile really looks like? Here are first photographs ever released.

## What You Should Know About "RW" .....144

Radiological warfare may bring "death sand" and "radioactive clouds" as new atomic weapons.

## Water Can Be Dynamite.....156

You may have a blockbuster right down in your cellar—if you don't take these precautions.

## Story of an Expansion Attic.....177

How a young couple converted an empty attic into three bedrooms in their spare time.

## How Auto Horns Work.....197

It's a long way from klaxon to musical trumpet, but home experiments show you both are ingenious.

## Taking Sag out of Garage Doors 200

If there's a struggle every time you open yours then follow these how-to-mend-them tips.

## How to Photograph Fights on TV 214

There's more to it than just aiming your camera at the television screen. Here's how to do it.

## How to Build a Flying Saucer.....226

This flying saucer is no myth—it's a class M out-board racing hull you can build in your shop.

## Cigar-Smoking Camera Acts in TV.....106

## Cuts Cost of Make-believe Worlds.....118

## New Jaguar Offers Luxury, Speed.....120

Godfrey Hammond, PUBLISHER · Stephen P. Glennon, ADVERTISING DIRECTOR

EDITORIAL OFFICES: 353 Fourth Avenue, New York 10, N. Y. Manuscripts and illustrations submitted at regular rates should be so marked, addressed to "The Editors" and accompanied by stamped, self-addressed envelope. Popular Science Monthly exercises all possible care but assumes no responsibility for unsolicited material.

ADVERTISING OFFICES: NEW YORK — 353 Fourth Avenue; CHICAGO—360 North Michigan Avenue; DETROIT —820 Book Building; SAN FRANCISCO—Howard Building, 209 Post Street; PORTLAND (ORE.)—907 Terminal Sales Building; CLEVELAND—328 Citizens Building; LOS ANGELES—Granada Building.

Popular Science Monthly is published monthly at 353 Fourth Avenue, New York 10, N. Y., by Popular Science Publishing Co., Inc., Godfrey Hammond, President and Treasurer; R. C. Wilson, Stephen P. Glennon, Vice-Presidents; F. W. Briggs, Secretary. Entered as second-class matter Dec. 28, 1918, re-entered as second-class matter July 26, 1948, at the Post Office in New York, N. Y., under the act of March 3, 1879; additional entry as second-class matter at Dayton, Ohio. Entered as second-class matter at the Post Office Department, Canada. Printed in U.S.A. Copyright, 1951, by Popular Science Publishing Co., Inc. All rights reserved in the United States, Great Britain, and in all countries participating in the International Copyright Convention and Pan-American Copyright Convention. Yearly subscriptions to United States, its possessions and Canada, \$3.00 (2 years, \$5.50; 3 years, \$7.50); foreign countries \$1 per year extra. Subscribers must notify us of change of address four weeks before next publication. Be sure to give both old and new addresses, including zone numbers. Vol. 158, No. 2.

# Put yourself in the I.C.S. HALL OF FAME\*

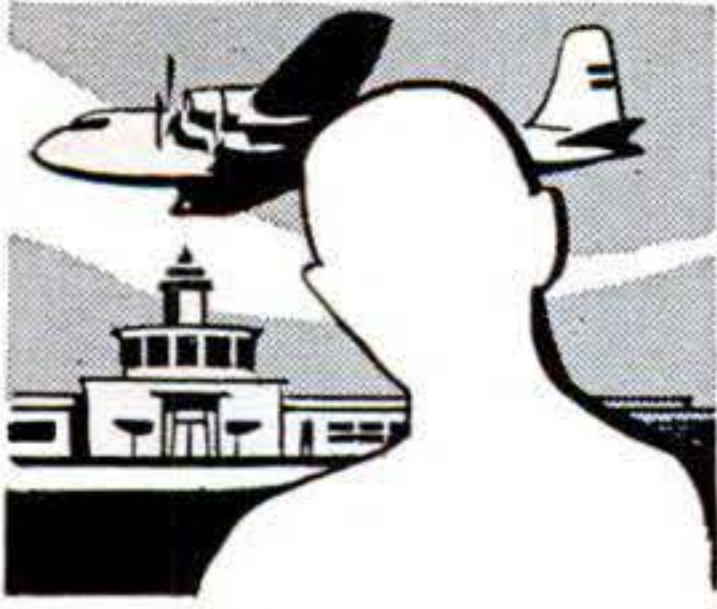

**PRESIDENT** of a leading airline.



**CHAIRMAN** of an important national defense board.



**INVENTOR** of a well-known U. S. Army rifle.

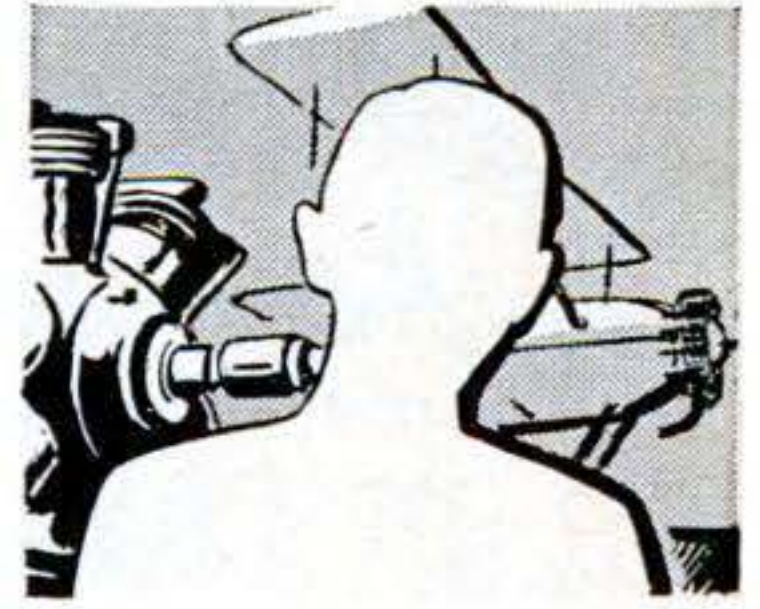

**DESIGNER** of a famous aircraft engine.

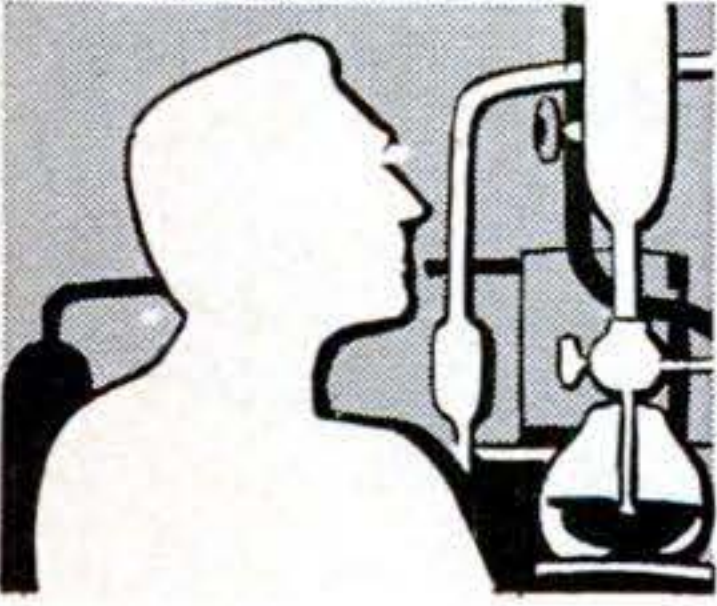

**CHEMICAL** director of nationally known research laboratory.

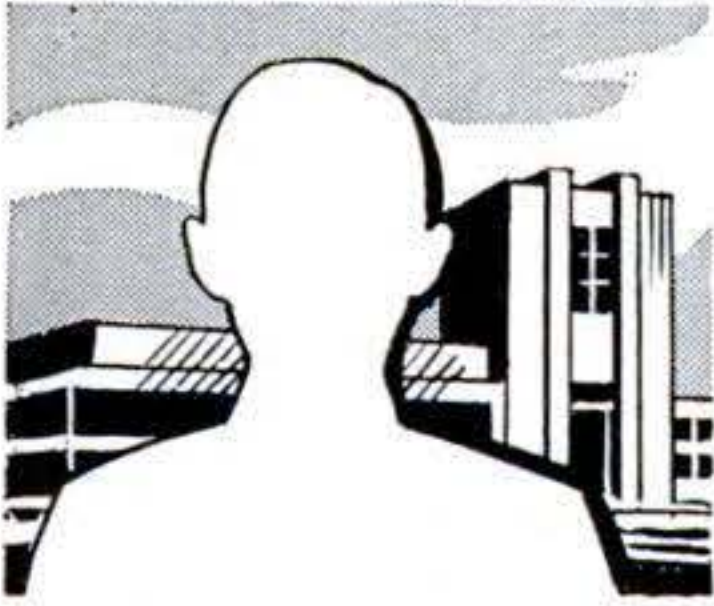

**ENGINEER** in charge of a famous company's engineering laboratory.

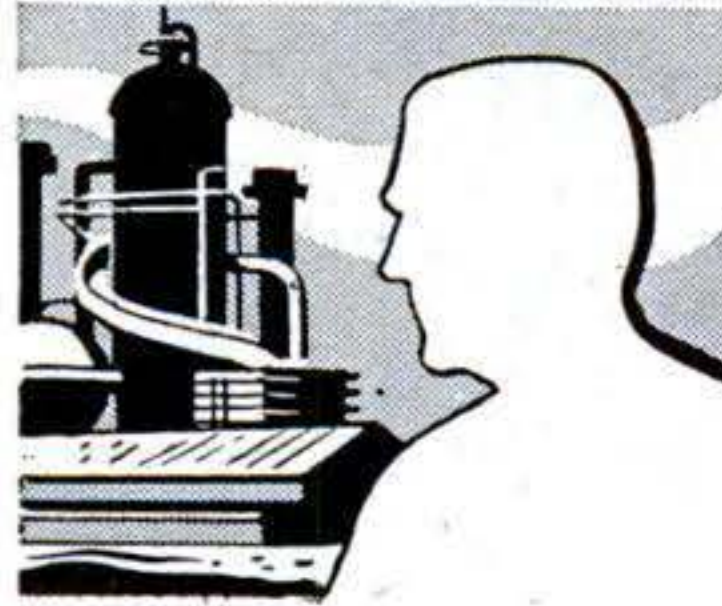

**GENERAL MANAGER** of one of America's largest chemical companies.

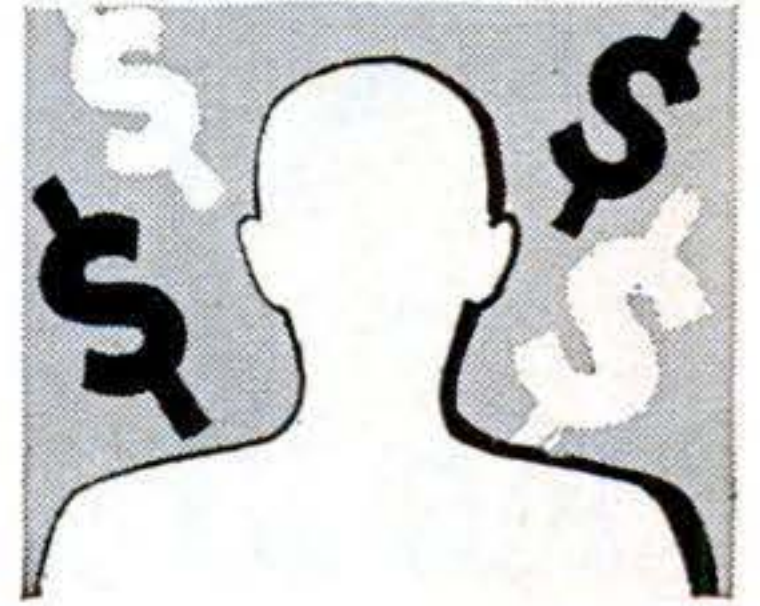

# YOU

**JOIN** these men who have made their mark! Men who by dint of ambition, intelligence and sound, practical I. C. S. training now enjoy positions of leadership in business and industry.

The sooner you start, the better your chances of making the grade. Right now, with the criti-

cal shortage of skilled labor, trained men are becoming leaders overnight. Hundreds of I. C. S. students are reporting promotions and pay increases, earning greater security for themselves and their families. How about marking and mailing the coupon today?

\*Names and positions sent on request.

## INTERNATIONAL CORRESPONDENCE SCHOOLS

**APPROVED**  
under the  
**G.I. BILL**

BOX 7671-M, SCRANTON 9, PENNA.

Without cost or obligation, please send me full particulars about the course BEFORE which I have marked X:

- |   |  |   |  |
|---|--|---|--|
| <p><b>Business and Academic Courses</b></p> <ul style="list-style-type: none"> <li><input type="checkbox"/> Accounting</li> <li><input type="checkbox"/> Bookkeeping</li> <li><input type="checkbox"/> Business Administration</li> <li><input type="checkbox"/> Bus. Correspondence</li> <li><input type="checkbox"/> Certified Public Accounting</li> <li><input type="checkbox"/> Commercial</li> <li><input type="checkbox"/> Cost Accounting</li> <li><input type="checkbox"/> Federal Tax</li> <li><input type="checkbox"/> First Year College</li> <li><input type="checkbox"/> Foremanship</li> <li><input type="checkbox"/> Good English</li> <li><input type="checkbox"/> Higher Mathematics</li> <li><input type="checkbox"/> Industrial Supervision</li> <li><input type="checkbox"/> Motor Traffic</li> <li><input type="checkbox"/> Retailing</li> <li><input type="checkbox"/> Salesmanship</li> <li><input type="checkbox"/> Sign Lettering</li> <li><input type="checkbox"/> Spanish</li> <li><input type="checkbox"/> Typing</li> </ul> <p><b>Air Conditioning and Plumbing Courses</b></p> <ul style="list-style-type: none"> <li><input type="checkbox"/> Air Conditioning</li> <li><input type="checkbox"/> Heating</li> <li><input type="checkbox"/> Refrigeration</li> </ul> | <p><b>Chemical Courses</b></p> <ul style="list-style-type: none"> <li><input type="checkbox"/> Chemical Engineering</li> <li><input type="checkbox"/> Chemistry, Analytical</li> <li><input type="checkbox"/> Chemistry, Industrial</li> <li><input type="checkbox"/> Chemistry, Mfg. Iron &amp; Steel</li> <li><input type="checkbox"/> Petroleum Refining</li> <li><input type="checkbox"/> Pulp and Paper Making</li> </ul> <p><b>Civil Engineering, Architectural and Mining Courses</b></p> <ul style="list-style-type: none"> <li><input type="checkbox"/> Architecture</li> <li><input type="checkbox"/> Building Estimating</li> <li><input type="checkbox"/> Civil Engineering</li> <li><input type="checkbox"/> Contracting and Building</li> <li><input type="checkbox"/> Highway Engineering</li> <li><input type="checkbox"/> Lumber Dealer</li> <li><input type="checkbox"/> Reading Structural Blueprints</li> <li><input type="checkbox"/> Sanitary Engineering</li> <li><input type="checkbox"/> Structural Drafting</li> <li><input type="checkbox"/> Structural Engineering</li> <li><input type="checkbox"/> Surveying and Mapping</li> </ul> <p><b>Communications Courses</b></p> <ul style="list-style-type: none"> <li><input type="checkbox"/> Electronics</li> <li><input type="checkbox"/> Prac. FM and Television</li> <li><input type="checkbox"/> Prac. Telephony</li> <li><input type="checkbox"/> Radio, General</li> <li><input type="checkbox"/> Telegraph Engineering</li> </ul> | <p><b>Electrical Courses</b></p> <ul style="list-style-type: none"> <li><input type="checkbox"/> Electrical Drafting</li> <li><input type="checkbox"/> Electrical Engineering</li> <li><input type="checkbox"/> Electric Light and Power</li> <li><input type="checkbox"/> Lighting Technician</li> <li><input type="checkbox"/> Practical Electrician</li> <li><input type="checkbox"/> Power House Electric</li> <li><input type="checkbox"/> Ship Electrician</li> </ul> <p><b>Internal Combustion Engines Courses</b></p> <ul style="list-style-type: none"> <li><input type="checkbox"/> Auto Technician</li> <li><input type="checkbox"/> Diesel-Electric</li> <li><input type="checkbox"/> Diesel Engines</li> </ul> <p><b>Mechanical Courses</b></p> <ul style="list-style-type: none"> <li><input type="checkbox"/> Aeronautical Engineer's, Jr.</li> <li><input type="checkbox"/> Aircraft Drafting</li> <li><input type="checkbox"/> Forging</li> <li><input type="checkbox"/> Heat Treatment of Metals</li> <li><input type="checkbox"/> Industrial Engineering</li> <li><input type="checkbox"/> Industrial Instrumentation</li> <li><input type="checkbox"/> Industrial Metallurgy</li> <li><input type="checkbox"/> Machine Shop</li> <li><input type="checkbox"/> Machine Shop Inspection</li> <li><input type="checkbox"/> Mechanical Drafting</li> <li><input type="checkbox"/> Mechanical Engineering</li> </ul> | <p><input type="checkbox"/> Mold-Loft Work</p> <p><b>Railroad Courses</b></p> <ul style="list-style-type: none"> <li><input type="checkbox"/> Air Brake</li> <li><input type="checkbox"/> Diesel Locomotive</li> <li><input type="checkbox"/> Locomotive Engineer</li> <li><input type="checkbox"/> Locomotive Fireman</li> <li><input type="checkbox"/> Locomotive Machinist</li> <li><input type="checkbox"/> Railroad Section Foreman</li> <li><input type="checkbox"/> Steam and Diesel Loco. Eng.</li> </ul> <p><b>Stationary Engineering Courses</b></p> <ul style="list-style-type: none"> <li><input type="checkbox"/> Boilermaking</li> <li><input type="checkbox"/> Combust. Engrg.</li> <li><input type="checkbox"/> Marine Engineering</li> <li><input type="checkbox"/> Power Plant Engr.</li> </ul> <p><b>Textile Courses</b></p> <ul style="list-style-type: none"> <li><input type="checkbox"/> Cotton Manufacturing</li> <li><input type="checkbox"/> Rayon Weaving</li> <li><input type="checkbox"/> Woolen Manufacturing</li> </ul> |
|---|--|---|--|

Name \_\_\_\_\_ Age \_\_\_\_\_ Home Address \_\_\_\_\_

City \_\_\_\_\_ State \_\_\_\_\_ Working Hours \_\_\_\_\_ A.M. to \_\_\_\_\_ P.M.

Present Position \_\_\_\_\_ Employed by \_\_\_\_\_

Length of Service in World War II \_\_\_\_\_

Enrollment under G.I. Bill approved for World War II Veterans. Special tuition rates to members of the Armed Forces. Canadian residents send coupon to International Correspondence Schools Canadian, Ltd., Montreal, Canada.

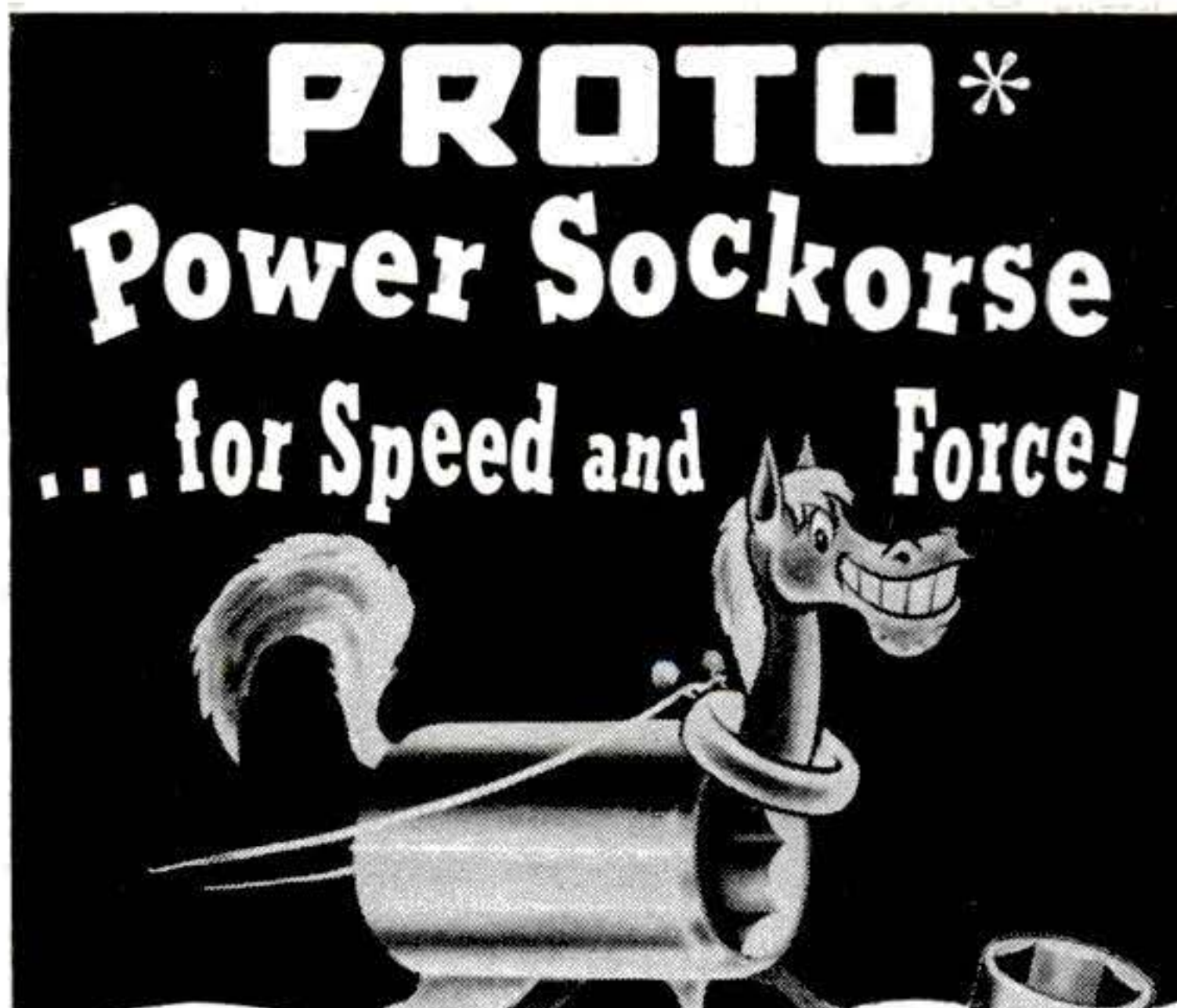

**BIG NEWS!!**

**PROTO\* Power Sockets Tripled**

Fast as a Derby winner and strong as a plow horse, PROTO\* power socket wrenches are equally useful with power nut runners and manual attachments. The greatly expanded PROTO\* line has many types and designs—to provide the right power horse for your work. Race to your PROTO\* dealer and buy the ones you need. Write for catalog to

**PLUMB TOOL COMPANY**  
2257X Santa Fe Ave.,  
Los Angeles 54, Calif.



6-Point (Hex) Socket



Double-Square Socket



6-Point Deep Socket



Universal Socket

**\* PROTO** means **PRO**fessional **TO**ols. It's the new name for the tools that have been preferred for 43 years.

5086



Liner Has Biggest Lifeboats.....123  
 G.M. Builds 300-Hp. Preview Car.....130  
 German Jeep Styled for Sports.....136  
 Dodge, De Soto, Cadillac.....137  
 Engine Surgery Boosts Airliner Range...138  
 Scooter Speeds at 83 M.P.H. ....141  
 The Dreams That Make the Fords.....142  
 Why Marching Is Hard Work.....150  
 Tractor Has Motor in Each Wheel.....152  
 Cow Conveyor Milks, Feeds, 100 an Hour 154  
 How Your Glassware Is Made.....161  
 One Pedal Stops, Starts Car.....167  
 Wrapping Paper Makes Sturdy Canoe...172  
 Plastic Helps Prevent Runs.....176

**Mechanics & Handicraft**

How Dry Wells Should Be Built.....183  
 Know About Paint Removers.....186  
 Lazy Suzan Rolls on Pulleys.....189  
 Gus Parlays a Pair of Hunches.....190  
 Homemade Tools from Old Auto Valves..193  
 Winter Evening Craft Projects.....204  
 An Extra Chair You Can Build.....206  
 Flooring Makes a Fine Table.....208  
 Would a Booster Help Your TV Set?.....210  
 Magnetic Lock Foils Snoopers.....219  
 This 4"x4" Amplifier Sounds Big.....221  
 Two-Faced Bench Saves Space.....225  
 Sunless Garden Hastens Spring.....235

**Departments**

Letters ..... 14  
 New Ideas from the Inventors.....103  
 I'd Like to See Them Make.....166  
 Keeping the Home Shipshape.....169  
 Aids to Modern Living.....174  
 Hints from the Model Garage.....195  
 New Shop Ideas.....238  
 Mechanics of Farming.....250  
 New Tools.....274  
 P. S. Last Minute News and Notes.....278

**How to Buy a Good Used Station Wagon**

WILLIAM J. CANELL is one of the leading reconditioners of station-wagon bodies in the New York City area. Next month he will tell POPULAR SCIENCE readers what he has learned about caring for such bodies—and how to spot a good one on the used-car market.

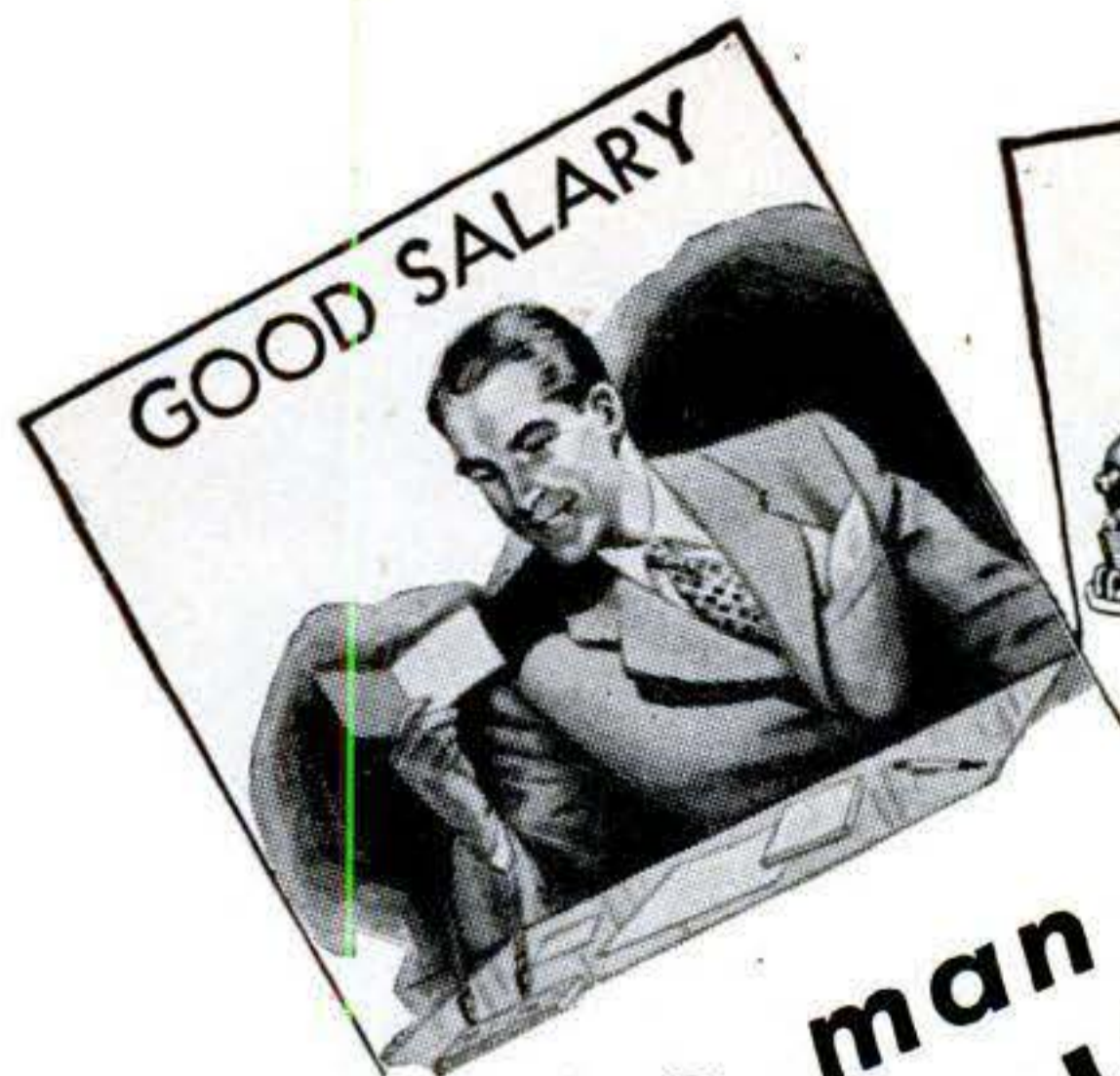

To the man who wants to enjoy  
**an ACCOUNTANT'S CAREER**

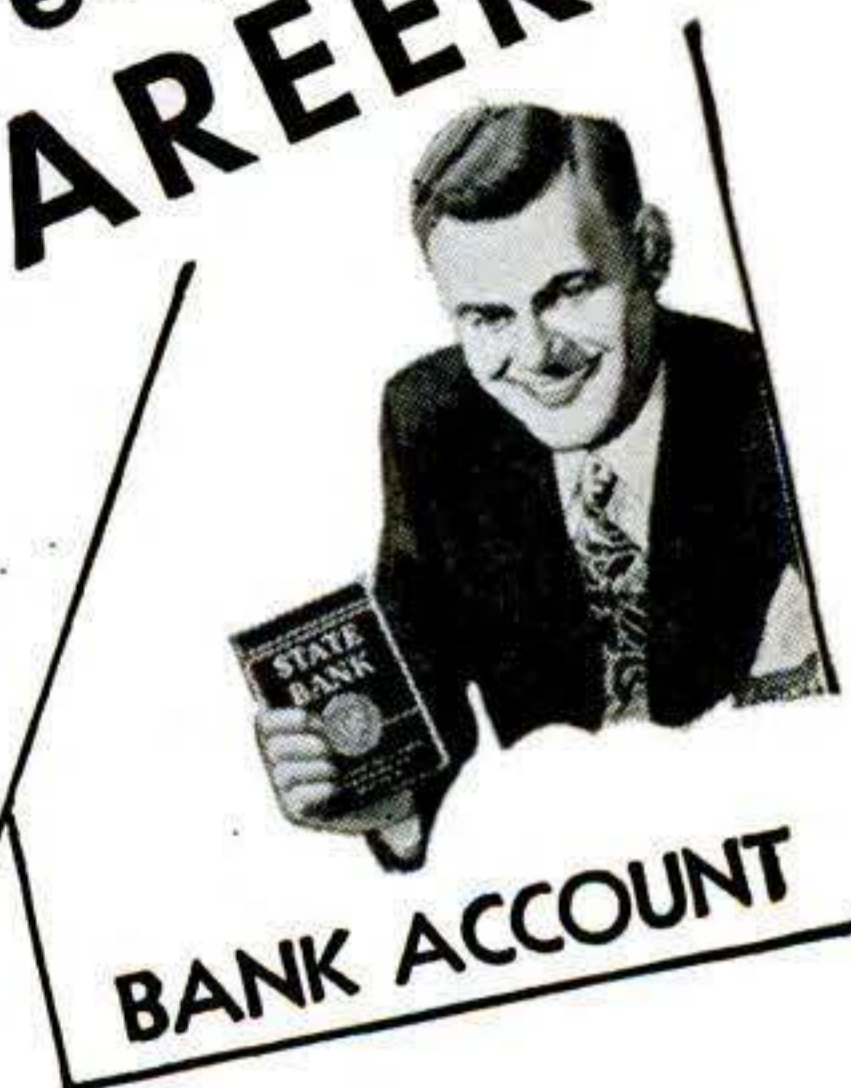

**IF** you're that man, here's something that will interest you.

Not a magic formula—not a get-rich-quick scheme—but something more substantial, more practical.

Of course, you need something more than just the desire to be an accountant. You've got to pay the price—be willing to study earnestly, thoroughly.

Still, wouldn't it be worth your while to sacrifice some of your leisure in favor of interesting home study—over a comparatively brief period? Always provided that the rewards were good—a salary of \$4,000 to \$10,000?

An accountant's duties are interesting, varied and of real worth to his employers. He has *standing!*

Do you feel that such things aren't for you? Well, don't be too sure. Very possibly they *can* be!

Why not, like so many before you, investigate LaSalle's modern Problem Method of training for an accountancy position?

Just suppose you were permitted to work in a large accounting house under the personal supervision of an expert accountant. Suppose, with his aid, you studied accounting principles and solved problems day by day—easy ones at first—then more difficult ones. If you could do this—and could turn to him for advice as the problems became complex—soon you'd master them all.

That's the training you follow in principle under the LaSalle Problem Method.

Over 3200 Certified  
 Public Accountants among  
 LaSalle alumni

You cover accountancy from the basic Principles right up through Accountancy Systems and Income Tax Procedure. Then you add C. P. A. Training and prepare for the C. P. A. examinations.

As you go along, you absorb the principles of Auditing, Cost Accounting, Business Law, Statistical Control, Organization, Management and Finance.

Your progress is as speedy as you care to make it—depending on your own eagerness to learn and the time you spend in study.

Will recognition come? The only answer, as you know, is that success *does* come to the man who is really *trained*. It's possible your employers will notice your improvement in a very few weeks or months. Indeed, many LaSalle graduates have paid for their training—with increased earnings—before they have completed it! For accountants, who are trained in organization and management, are the executives of the future.

**Write For This Free Book**

For your own good, don't put off investigation of *all* the facts. Write for our free 48-page book, "Accountancy, The Profession That Pays." It'll prove that accountancy offers brilliant futures to those who aren't afraid of serious home study. We'll also include "Ten Years' Promotion in One"—a book which has helped many men. Send us the coupon *now*.

**LASALLE EXTENSION  
 CHICAGO 5, ILL.**

- Other LaSalle Opportunities**
- Higher Accountancy
  - C.P.A. Coaching
  - Bookkeeping
  - Law: LL.B. Degree
  - Business Management
  - Salesmanship
  - Traffic Management
  - Foremanship
  - Industr'l Management
  - Stenotypy (Machine Shorthand)

**LASALLE EXTENSION UNIVERSITY**  
 A CORRESPONDENCE INSTITUTION

417 S. Dearborn St. Dept. 283-HR Chicago 5, Ill.

I want to be an accountant. Send me without obligation, "Accountancy, the Profession that Pays"—also "Ten Years' Promotion in One."

Name.....Age.....  
 Address.....  
 City, Zone & State.....

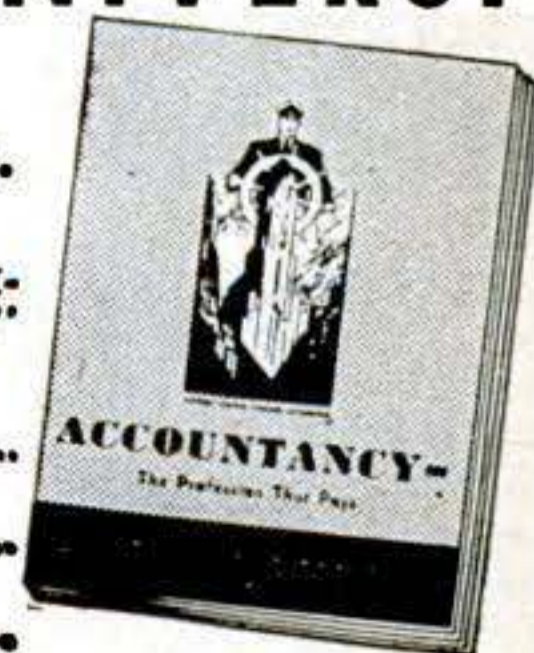

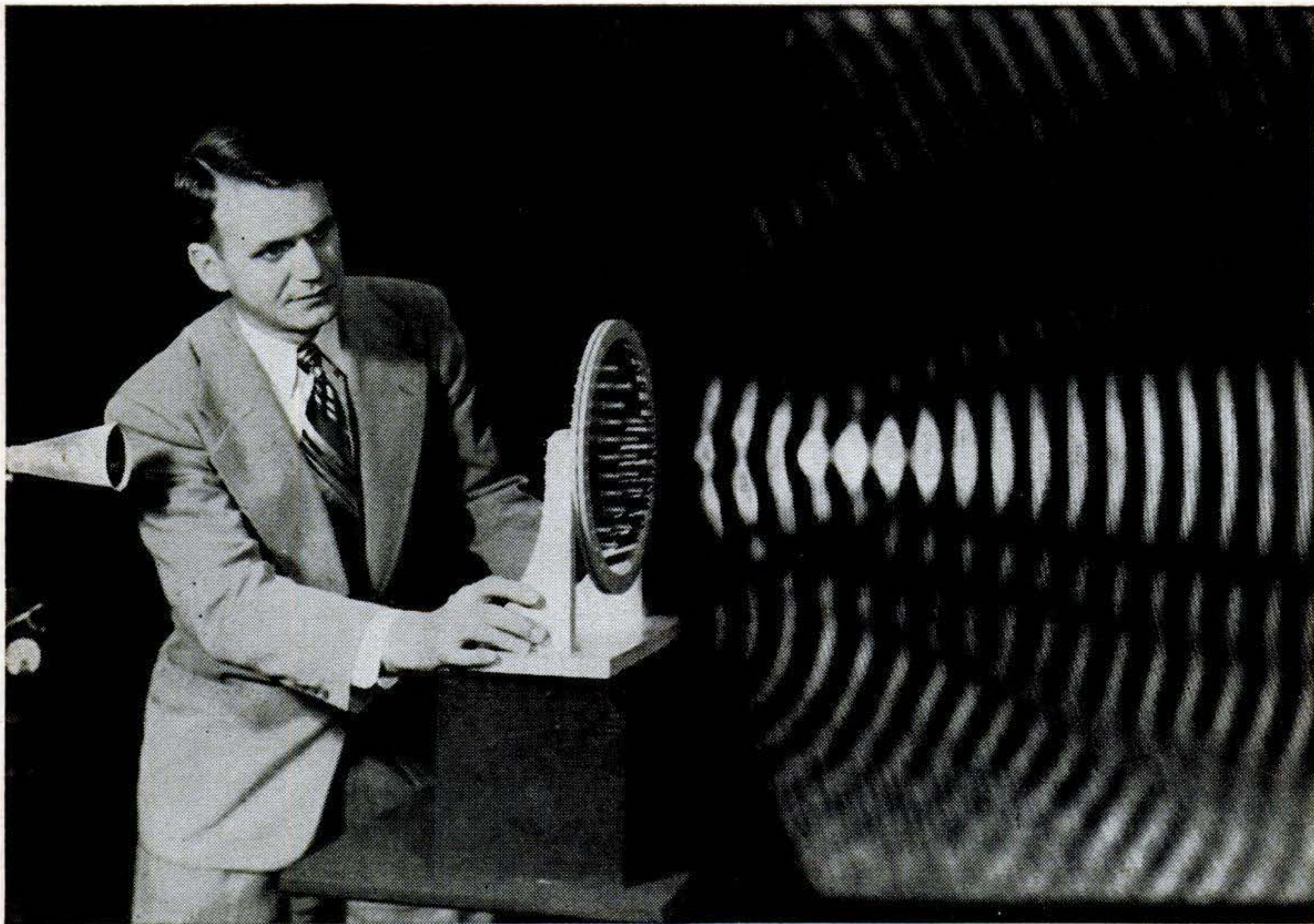

## WAVE MAKING

*—for better  
telephone service*

At Bell Telephone Laboratories, radio scientists devised their latest microwave lens by copying the molecular action of optical lenses in focusing light. The result was a radically new type of lens—the array of metal strips shown in the illustration. Giant metal strip lenses are used in the new microwave link for telephone and television between New York and Chicago.

The scientists went on to discover that the

*Waves from the sound source at left are focused by the lens at center. In front of the lens, a moving arm (not shown) scans the wave field with a tiny microphone and neon lamp. The microphone picks up sound energy and sends it through amplifiers to the lamp. The lamp glows brightly where sound level is high, dims where it is low. This new technique pictures accurately the focusing effect of the lens. Similar lenses efficiently focus microwaves in radio relay transmission.*

very same type of lens could also focus sound . . . thus help, too, in the study of sound radiation . . . another field of great importance to your telephone system.

The study of the basic laws of waves and vibrations is just another example of research which turns into practical telephone equipment at Bell Telephone Laboratories . . . helping to bring you high value for your telephone dollar.

## BELL TELEPHONE LABORATORIES

Working continually to keep your telephone service one of today's greatest values





SPECTACULAR **NEW**  
"SAFETY-FLOW RIDE"

ON DISPLAY  
**NOW**

# new Plymouth



## A new driving experience

New "Safety-Flow Ride" provides extra shock-resistance when you run upon a sudden bump or hole—keeps you gliding with a steady motion. You enjoy new freedom from tension and fatigue—new comfort and steering ease. New steadiness too—an important safety feature. Learn more about this great new kind of ride at your Plymouth dealer's.

## Introducing

**THE CONCORD** Two-door Sedan • Three-passenger Coupe

**THE CAMBRIDGE** Four-door Sedan • Club Coupe

**THE CRANBROOK** Four-door Sedan • Club Coupe  
Convertible Club Coupe

Plus that famous all-purpose car, the "Suburban," and its still more luxurious version, the "Savoy."

## Exciting new styling

A new grille of graceful yet massive form. Heavy bumpers of sleek, wrap-around design. New-style rub rails, moulding and scuff guards. Completely new interiors with a new variety of rich fabrics. New colors. New trim. New dash. Other style improvements you'll want to see!

## Other new features

Greater all-around vision with narrower front corner posts and wider rear window. Constant-speed electric windshield wipers. More headroom. New easy-action hand brake. Waterproof ignition system. New by-pass thermostat for faster warm-up, now standard on all models. Many other mechanical advances.

See it at your Plymouth dealer's

PLYMOUTH Division of CHRYSLER CORPORATION, Detroit 31, Michigan

NEW  
INSIDE

OUTSIDE

PLYMOUTH  
BUILDS GREAT CARS



**Ready  
for take-off...**

**... to a top spot in the U. S. Air Force!**

The flight engineer of a U. S. Air Force B-29 . . . waiting the pilot's signal to return props to high pitch for take-off after engine run-up . . . is a man with power at his command. This Master Sergeant is a vital member of a flying team . . . a man who has proved his power to get on top and stay on top in a topflight job with a great Air Force.

Technical courses for flight engineers . . . available to qualified Air Force enlisted personnel . . . are typical of training in 42 Air Force career fields. *You* can have this kind of training . . . furthering your service career and paralleling civilian jobs . . . as an Airman in the U. S. Air Force.

To be ready for take-off, with power to climb . . . take to the Air Force.



**U. S.  
AIR FORCE**

**GET DETAILS AT YOUR NEAREST  
U. S. ARMY AND U. S. AIR FORCE  
RECRUITING STATION TODAY**

**Get on Top . . . Stay on Top . . . in the U. S. Air Force!**

# WHAT Every MECHANIC Wants to Know

## AUDELS CARPENTERS & BUILDERS GUIDES—(4 Book Set).....\$6

A practical illustrated trade assistant on modern construction for carpenters, joiners, builders, mechanics and all woodworkers. 4 vols., 1600 pages, 3700 illustrations. Fully indexed, flexible covers. Each volume sold separately \$1.50 a vol.

## AUDELS PLUMBERS & STEAMFITTERS GUIDES—(4 Book Set).....\$6

A Practical Trade Assistant & Ready Reference. Explains in plain language & by clear illustrations, diagrams, charts, graphs, pictures principles of modern plumbing practice including Marine Pipe Fitting and Air Conditioning. 4 Vols.—1670 Pages—3642 Diagrams & Illustrations. Each Vol. Sold Separately \$1.50 a Vol.

## AUDELS OIL BURNER GUIDE.....\$1

384 Pages Covering Installation, Servicing & Repairs All Types Domestic & Industrial Burners. Illustrated. Highly Endorsed.

## AUDELS HOUSE HEATING GUIDE.....\$4

1000 Pages Covering Working Principles, Installation, Service of All Modern House Heating, Ventilating & Air Conditioning Systems. Explains New Radiant Heating. Fully Illustrated & Indexed.

## AUDELS REFRIGERATION & AIR CONDITIONING GUIDE.....\$4

New from Cover to Cover—1280 Pages, Fully Illus. Covering basic principles, servicing, operation & repair of household, commercial & industrial refrigeration & air conditioning. A gold mine of essential important facts for engineers, servicemen, users.

## AUDELS SHEETMETAL WORKERS HANDY BOOK.....\$1

Practical inside information. Fundamentals of Sheet Metal Work. 388 pages. Illustrated. 11 sections. Clearly written. Essential & important facts, figures, pointers in everyday language. Ref. Index.

## AUDELS SHEETMETAL PATTERN LAYOUTS.....\$4

Developed by Experts for Sheet Metal Workers, Layout Men & Mechanics. A Practical Encyclopedia in 10 Sections, size 7 x 10 x 2—1125 Pages—350 Layouts—1600 Illustrations. 1001 Key Facts. Fully indexed for ready reference in answering your layout problems. Covers all phases of sheet metal work including Pattern Cutting, Pattern Development & Shop Procedure.

## AUDELS BLUE PRINT READING.....\$2

For Mechanics & Builders. Covers all types of blue print reading including ship & airplane. 416 pages, fully illustrated.

## AUDELS MATHEMATICS & CALCULATIONS FOR MECHANICS \$2

Mathematics for home study or reference. 700 pages, 550 illus. Practical mathematics from beginning. How to figure correctly. Easy, correct methods covering complete review. Illus. & Indexed.

## AUDELS AUTOMOBILE GUIDE.....\$4

A practical quick ready reference book for auto mechanics, service men, operators & owners. Explains theory, construction & servicing of modern motor cars, trucks, buses & auto type Diesel engines. 1700 pages, fully illustrated. 55 chapters. Indexed. A standard book for mechanics. New Hydraulic drive covered.

## AUDELS DIESEL ENGINE MANUAL....\$2

A practical, concise treatise with questions and answers on the theory, operation and maintenance of modern diesel engines. Over 400 pages, fully illus. All details plainly brought out, this book is of extreme value to engineers, operators & students.

## AUDELS WELDERS GUIDE.....\$1

A concise, practical text on operation & maintenance of all welding machines for all mechanics. Over 400 pages, illustrated. Covers all methods of electric and acetylene welding including airplane work.

## AUDELS MACHINIST & TOOLMAKERS HANDY BOOK.....\$4

Covers modern machine shop practice in all its branches. Tells how to set up & operate lathes, screw and milling machines, shapers, drill presses & all other machine & hand tools. 1600 pages, fully illustrated. Indexed. 5 sections. 1—Modern Machine Shop Practice. 2—Blue Print Reading & How to Draw. 3—Calculations & Mathematics for Machinists. 4—Shop Physics. 5—How to Use the Slide Rule. 60 chapters. Easy to read and understand. A shop companion that answers your questions.

## AUDELS ELECTRIC MOTOR GUIDE \$4

Practical Information Covering Construction, Control, Maintenance & Wiring Hookups of All Types Electric Motors also Armature Winding. 1000 Pages Fully Illustrated & Indexed.

## AUDELS ELEC. WIRING DIAGRAMS \$1

210 Pages. Illustrated. Gives practical facts on wiring of electrical apparatus. It shows clearly how to wire apparatus for practically all fields of electricity. Each diagram is complete & self-explanatory. Highly Endorsed Pocket Companion.

## AUDELS PRACTICAL ELECTRICITY \$4

A key to a practical understanding of Electricity. For maintenance engineers, electricians & all electrical workers. 1440 Pages, 2600 Illus. Covers important electrical information in handy form—including wiring for Light & Power. Indexed.

## AUDELS RADIOMANS GUIDE.....\$4

A key to the practical understanding of radio including Frequency Modulation, Television, etc., Aircraft & Marine Radio. For radio engineers, servicemen, amateurs, 914 Pages, 633 Illustrations & Diagrams. Photos. Review Questions & Answers. Reference Index.

**AUDEL, Publishers, 49 W. 23 St., N.Y. 10**

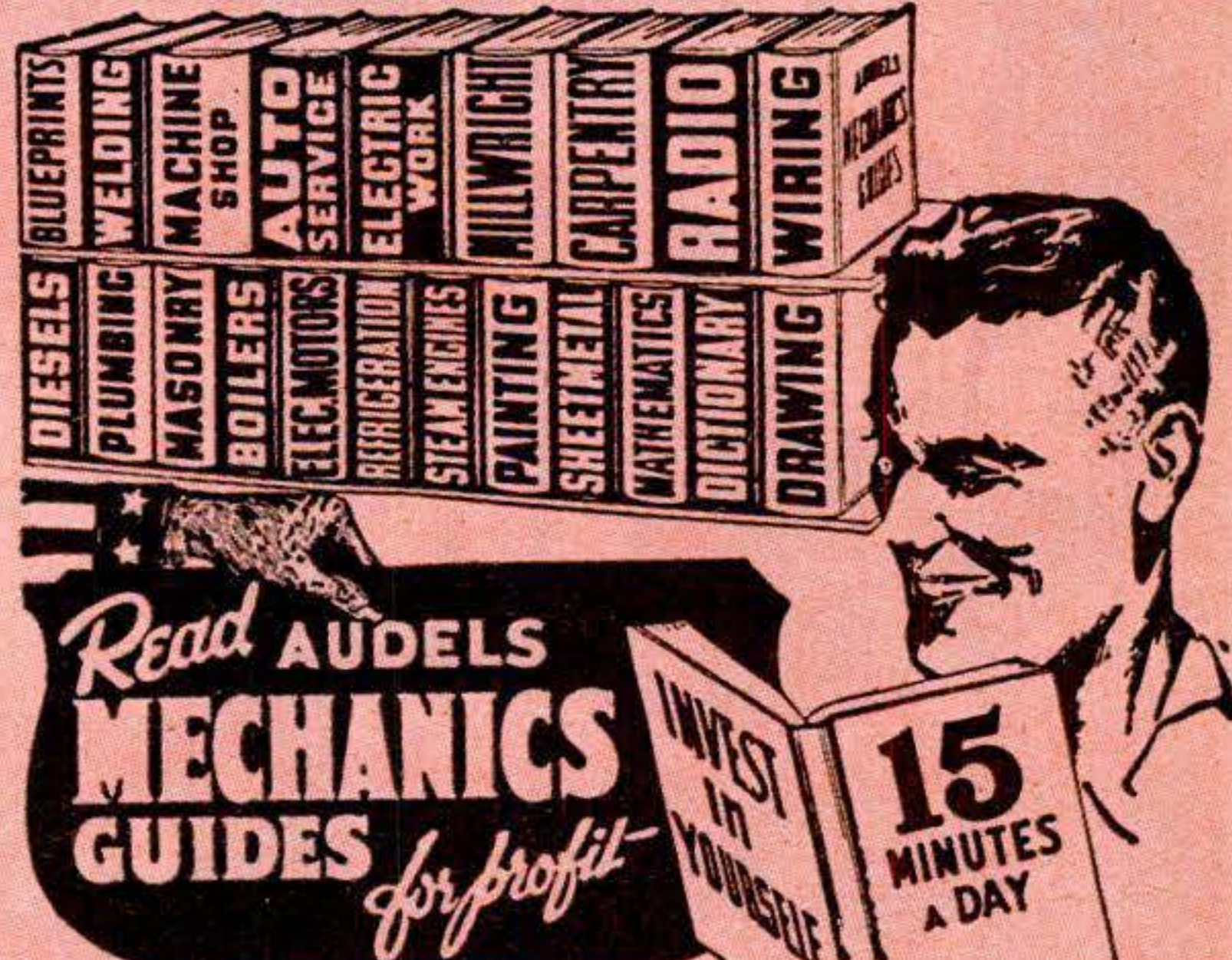

**AN AUDEL GUIDE IS A GOOD FRIEND!**  
Step Up Your Own Skill with the Practical Facts and Figures of Your Trade. Save time and money with right methods, short cuts, labor saving ideas. CHECK NOW! You can look over any Audel Guide in your home. Start the Easy Payments if satisfied.

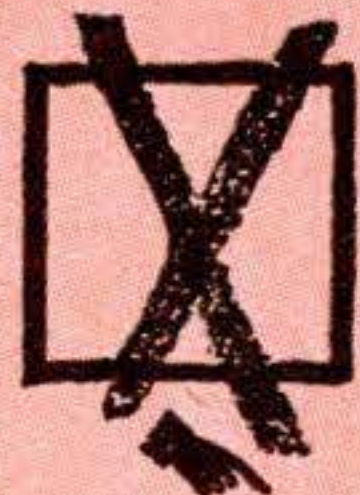

**Check NOW!**

*Audels List Of Time Tested Practical Handy Books For Mechanics That Will Answer Your Questions — Highly Endorsed*

**MAIL THIS TODAY**

## CUT HERE MAIL ORDER

AUDEL, Publishers, 49 W. 23 St., NEW YORK 10, N. Y.

Please send me postpaid for FREE EXAMINATION books marked (x) below. If I decide to keep them I agree to mail \$1 in 7 Days on each book or set ordered and further mail \$1 monthly on each book or set until I have paid price, otherwise I will return them.

- MACHINISTS HANDY BOOK . . 1650 Pgs. . . \$ 4
- WELDERS GUIDE, 400 Pages . . . . . 1
- BLUE PRINT READING, 416 Pages . . . . . 2
- MATHEMATICS & CALCULATIONS, 700 Pages. . . . . 2
- SHEET METAL PATTERN LAYOUTS, 1100 Pages . . . . . 4
- SHEET METAL WORKERS HANDY BOOK, 388 Pgs. . . . . 1
- MECHANICAL DRAWING GUIDE, 160 Pages . . . . . 1
- MECHANICAL DRAWING & DESIGN, 480 Pages . . . . . 2
- AUTOMOBILE MECHANICS GUIDE, 1800 Pages . . . . . 4
- DIESEL ENGINE MANUAL, 575 Pages . . . . . 2
- AIRCRAFT WORKER, 240 Pages . . . . . 1
- RADIOMANS GUIDE, 914 Pages . . . . . 4
- ELECTRONIC DEVICES, 216 Pages . . . . . 2
- ELECTRIC MOTOR GUIDE, 1000 Pages . . . . . 4
- ELECTRIC WIRING DIAGRAMS, 272 Pages . . . . . 1
- ELECTRICIANS EXAMINATIONS, 250 Pages. . . . . 1
- ELECTRIC POWER CALCULATIONS, 425 Pages. . . . . 2
- HANDY BOOK OF ELECTRICITY, 1440 Pages. . . . . 4
- ELECTRIC DICTIONARY, 9000 Terms . . . . . 2
- ELECTRIC LIBRARY, 7000 Pages (12 Book Set) . . . . . 18
- MARINE ENGINEERS HANDY BOOK, 1258 Pgs. . . . . 4
- SHIPFITTERS HANDY BOOK, 250 Pages . . . . . 1
- REFRIGERATION & Air Conditioning, 1280 Pgs. . . . . 4
- MILLWRIGHTS & MECHANICS GUIDE, 1200 Pgs. . . . . 4
- POWER PLANT ENGINEERS GUIDE, 1500 Pages . . . . . 4
- ENGINEERS & FIREMANS EXAMS, 525 Pages . . . . . 1
- PUMPS, Hydraulics & Air Compressors, 1658 Pgs. . . . . 4
- ENGINEERS LIBRARY (3 Book Set) . . . . . 9
- MECHANICAL DICTIONARY, 950 Pages . . . . . 4
- GARDENERS & GROWERS GUIDES (4 Book Set) . . . . . 6
- CARPENTERS & BUILDERS GUIDES (4 Book Set) . . . . . 6
- PLUMBERS & Steamfitters Guides (4 Book Set) . . . . . 6
- MASONS AND BUILDERS GUIDES (4 Book Set) . . . . . 6
- PAINTERS & DECORATORS MANUAL, 450 Pgs. . . . . 2
- HOUSE HEATING GUIDE, 1000 Pages . . . . . 4
- OIL BURNER GUIDE, 384 Pages . . . . . 1

Name \_\_\_\_\_  
Address \_\_\_\_\_  
Occupation \_\_\_\_\_  
Employed by \_\_\_\_\_

23A



Makes \$10

"Be cor w

Shop Specializes in Television



\$5 to \$8 Week In Spare Time



Calls N.R.I. His "Stepping Stone"

ized service-manufacturing for y an envia-in Televi-iller, Mau-mee, O.

"When halfway through the course, made \$5 to \$8 a week fixing sets. Now sell and install Television sets."—E. J. Streitenberger, New Boston, O.

"N.R.I. has been my stepping stone to over \$4,000 a year as a Radio Engineer. Make extra money servicing Radios."—Alton B. Michaels, Trenton, Ga.

# BE A SUCCESS IN RADIO- Learn by Practicing

## Build Equipment Like This With Kits I Send You

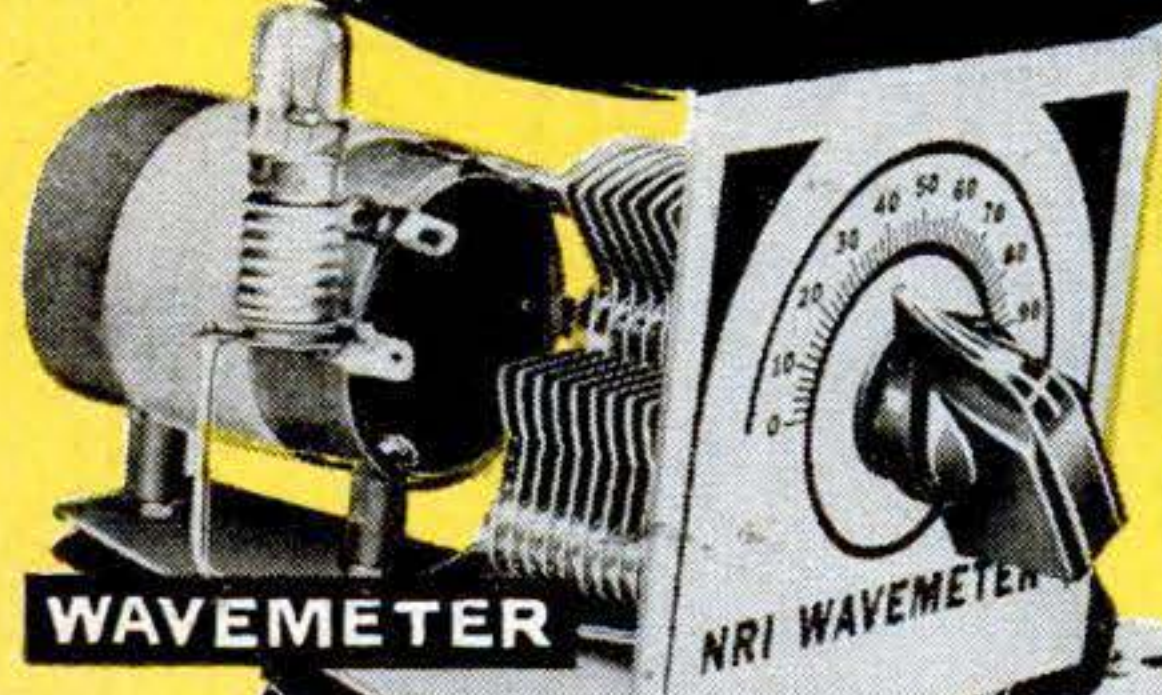

WAVEMETER



MODERN RADIO

I give you PRACTICAL EXPERIENCE with many valuable Kits I send that "bring to life" my illustrated texts. In my Servicing Course, you build a modern Radio, Multitester, AM Signal Generator, etc. In my Communications Course, you assemble a low-power Broadcasting Transmitter, Wavemeter, Electronic Multitester, etc. Some equipment from both these courses is shown on this page. All of the equipment that you build is yours to keep.



**NOW! Advanced Television Practice!**

New, special TV kits furnished to build high-definition SCOPE . . . RF OSCILLATOR with flyback power supply . . . complete TV SET . . . many other units. You see pulse, trapezoidal, saw-tooth wave forms. Get valuable PRACTICAL EXPERIENCE locating and correcting TV troubles. Mail coupon for facts and pictures!

## MAKE EXTRA MONEY WHILE LEARNING

I show you how to earn \$5, \$10 a week or more, fixing Radios in spare time while training. I send you parts to build the multitester (shown at right) that helps you do it. You get practical experience. I send you Special Booklets that tell you how to get and do these profitable spare time jobs.



TRANSMITTER

MULTITESTER



**NRI-  
Graduate  
Doubles  
Salary**

"I am employed by Station WKBO as transmitter operator. Have more than doubled salary since starting in Radio full time."—A. Herr, New Cumberland, Pa.



**Manager  
Radio and  
Television  
Dept.**

"From Radio and Television Technician . . . was promoted to Manager of Television Service and Installation. Thanks to N.R.I."—L. Hauger, San Bruno, Calif.



**Gets  
First Job  
Through  
N.R.I.**

"My first job was operator with KDLR, obtained by your Graduate Service Dept. Now Chief Engineer Police Radio Station WQOX."—T. S. Norton, Hamilton, Ohio.



# TELEVISION

## at Home in Spare Time

**Get a Good Job--Have a Bright Future  
in America's Fast Growing Industry**

Do you want good pay, a job with a bright future and security? Would you like a profitable shop of your own? The fast growing, prosperous RADIO-TELEVISION industry is making these opportunities for you. Radio alone is bigger than ever. 90 million home and auto Radios, 3100 Broadcasting Stations, expanding use of Aviation and Police Radio, Micro-Wave Relay, Two-Way Radio for buses, taxis, etc., are making opportunities for Servicing and Communications Technicians and FCC-Licensed Operators.

**Television is TODAY'S  
Good Job Maker**

In 1946 only 6,000 TV sets sold. In 1950 over 5,000,000. By 1954, 25,000,000 TV sets will be in use, according to estimates. Over 100 TV Stations are operating in 35 states. Authorities predict there will be 1,000 TV Stations. This means new jobs, more jobs, good pay for qualified men.



**HAVE A BUSINESS  
OF YOUR OWN**

Let me show you how to have a good, steady income from your own Radio-Television shop. Many N.R.I.-trained men each year start without capital, like Robert Dohmen, New Prague, Minn., above. He writes, "Am now tied in with two television outfits."

# Veterans

**Get this training  
under G. I. Bill**

**Mail Coupon Now**

**Many Soon Make \$10 A  
Week Extra in Spare Time**

Keep your job while training at home. Hundreds I've trained are successful RADIO-TELEVISION TECHNICIANS. Most had no previous experience; many no more than grammar school education. Learn Radio-Television principles from illustrated lessons. Get PRACTICAL EXPERIENCE—build valuable multimeter for conducting tests; also practice servicing Radios or operating transmitters—experiment with circuits common to Radio and Television. You keep all equipment. Many students make \$5, \$10 a week extra fixing neighbors' Radios in spare time. SPECIAL BOOKLETS start teaching you the day you enroll.

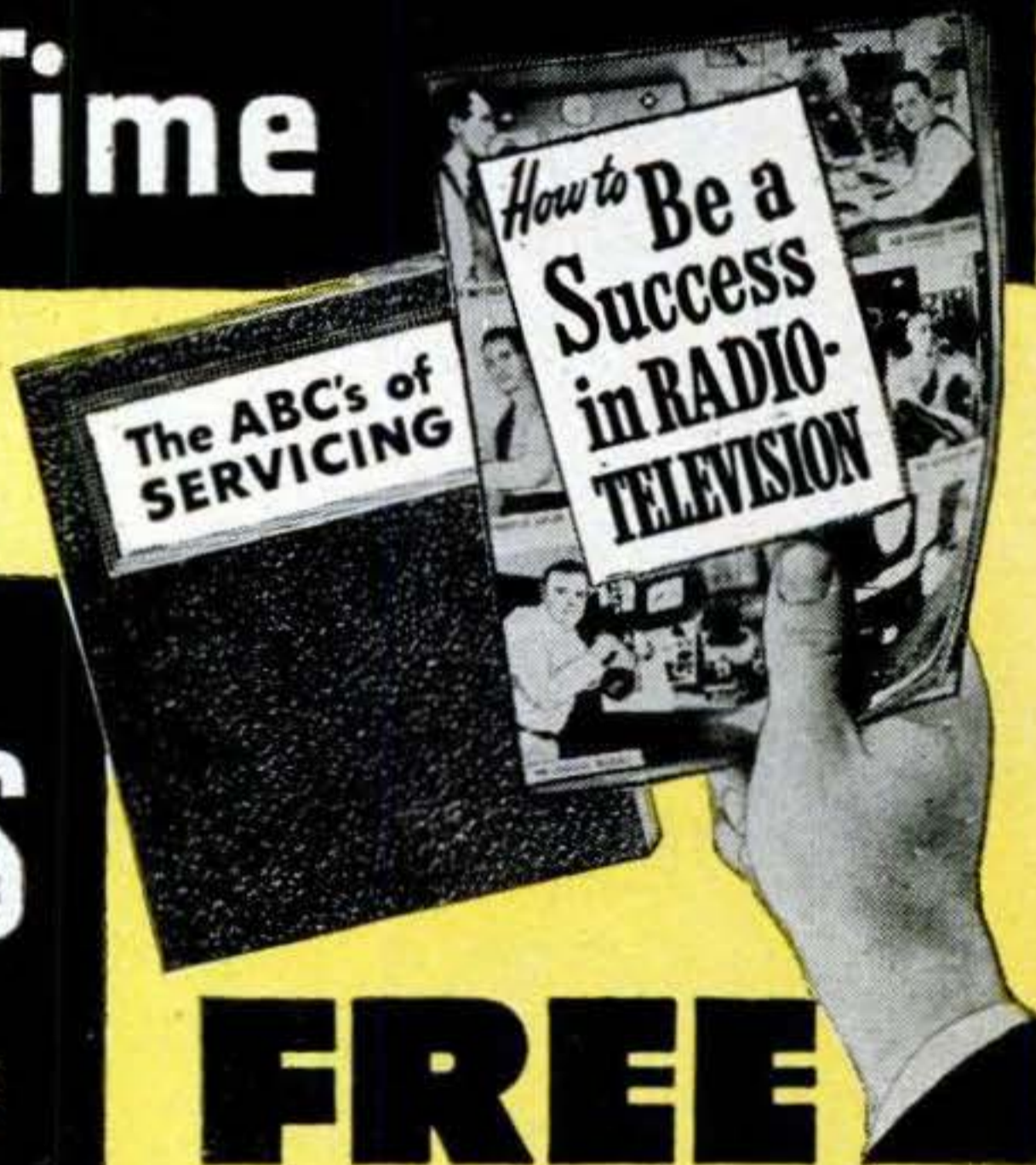

**FREE  
ACTUAL LESSON  
AND 64 PAGE BOOK**

Act Now! Send for my FREE DOUBLE OFFER. Coupon entitles you to actual lesson on Servicing; shows how you learn Radio-Television at home. You'll also receive my 64-page book, "How to Be a Success in Radio-Television." You'll read what my graduates are doing, earning; see photos of equipment you practice with at home. Send coupon in envelope or paste on postal. J. E. SMITH, President, Dept. 1BB, National Radio Institute, Washington 9, D. C. OUR 38th YEAR.

**MAIL  
THIS  
NOW**

**Good For 2 Books FREE**

MR. J. E. SMITH, President, Dept. 1BB  
National Radio Institute, Washington 9, D. C.

Mail me Sample Lesson and 64-page Book "How to Be a Success in RADIO-TELEVISION." Both FREE. (No salesman will call. Please write plainly.)

NAME.....AGE.....

ADDRESS.....

CITY.....ZONE.....STATE.....

Check if Veteran. Approved Under G. I. Bill.

# In your Mind's Eye

## The Secret of MENTAL CREATING

IF you just like to dream, read no further. There comes a time when your fancies *must be* brought into light—and stand the test of every-day, hard realities. Are you one of the thousands—perhaps millions—whose thoughts never get beyond the stage of *wistful wishing*? Do you often come to from a daydream with the sigh, "If only I could bring it about—*make it real*?"

All things begin with thought—it is what follows that may take your life out of the class of those who hope and dream. Thought energy, like anything else, can be dissipated—or it can be made to produce actual effects. *If you know how to place your thoughts* you can stimulate the creative processes within your mind—through them you can assemble things and conditions of your world into a happy life of accomplishment. *Mental creating* does not depend upon a magical process. It consists of *knowing how* to marshal your thoughts into a power that draws, compels and organizes your experiences into a worth-while design of living.

### ACCEPT THIS *Free* BOOK

Let the Rosicrucians tell you how you may accomplish these things. The Rosicrucians (not a religious organization), a world-wide philosophical fraternity, have preserved for centuries the ancients' masterful knowledge of the functioning of the inner mind of man. They have taught men and women how to use this knowledge to *recreate their lives*. They offer you a free copy of the fascinating book, "The Mastery of Life." It tells how you may receive this information for study and use. Use coupon opposite.

*The* ROSICRUCIANS  
(AMORC)

SAN JOSE

CALIFORNIA

SCRIBE: X.S.Z.  
The Rosicrucians (AMORC),  
San Jose, California.

Please send free copy of "The Mastery of Life,"  
and I shall read it as directed.

Name.....

Address.....

City.....

Prepare in our  
Big Training  
Shops for these

# GREAT OPPORTUNITY FIELDS!



This big fire-proof building is occupied entirely by Coyne.

## FIVE BIG FLOORS PACKED WITH MASSIVE EQUIPMENT

Thousands of men and young men have come to our big training shops where we have floor upon floor packed with massive equipment. Here they prepare for good jobs and real futures in the opportunity fields of Television-Radio and Electricity. For many years, these fields have offered great opportunities to trained men. With new developments, including Electronics and Television, they will continue to grow and offer even greater opportunities. Why be satisfied with a "no future" job? Many "one operation" jobs that exist today will not last. Prepare for a good job with a real future for steady pay and advancement by training NOW in the great training shops of COYNE in Chicago.

### NOT "HOME-STUDY" COURSES

Our famous Television-Radio Practical-Technical method gives you practical experience on a massive outlay of equipment. Not by correspondence, but actual shop work plus necessary technical training. You are trained right here in the great Coyne shops that have been training men and young men for over 50 years.

### TELEVISION-RADIO      ELECTRICITY

A great field now, even greater growth ahead. Here at COYNE you're trained for Construction, Testing, Trouble-Shooting on Radio, Public Address, Sound Units. Training includes FM, Television Installations, Servicing, etc. Many Coyne trained men in good jobs or own well paying Television-Radio businesses of their own.

### INCLUDING INDUSTRIAL ELECTRONICS

Big future in Power Plant Work, Motors, Armature Winding, Home and Factory Wiring, Appliances, Refrigeration, Maintenance, Illumination, etc. Electricians are in demand everywhere —lifetime job service to Coyne graduates. Send for BIG FREE BOOK.

## LARGEST, OLDEST, BEST EQUIPPED SCHOOL OF ITS KIND IN THE U.S.

### Mail Coupon for Big FREE Book!



Whether you prefer Television-Radio or Electricity, train on actual equipment at Coyne. We will send you a Big, fully Illustrated Book, if you will indicate below, which course interests you. No salesman will call. Mail coupon TODAY.



### START NOW—PAY LATER

Don't let lack of money hold you back. You can finance most of your tuition and pay for it later, in easy monthly payments. We'll help you get part time work, if you need it, to help pay living costs while at Coyne.

G. I. APPROVED

B. W. COOKE, President

### ELECTRICAL AND TELEVISION-RADIO SCHOOL

An Institution not for Profit

# COYNE

500 So. Paulina St., Dept. 21-73H, Chicago 12, ILL.

B. W. Cooke, President  
COYNE ELECTRICAL AND TELEVISION-  
RADIO SCHOOL 500 S. Paulina St.,  
Dept. 21-73H, Chicago 12, Ill.

Send me your Big Free book, and details of your training offer. I am interested in the course checked below. This does not obligate me.

TELEVISION-RADIO       ELECTRICITY

NAME.....

ADDRESS.....

CITY..... STATE.....

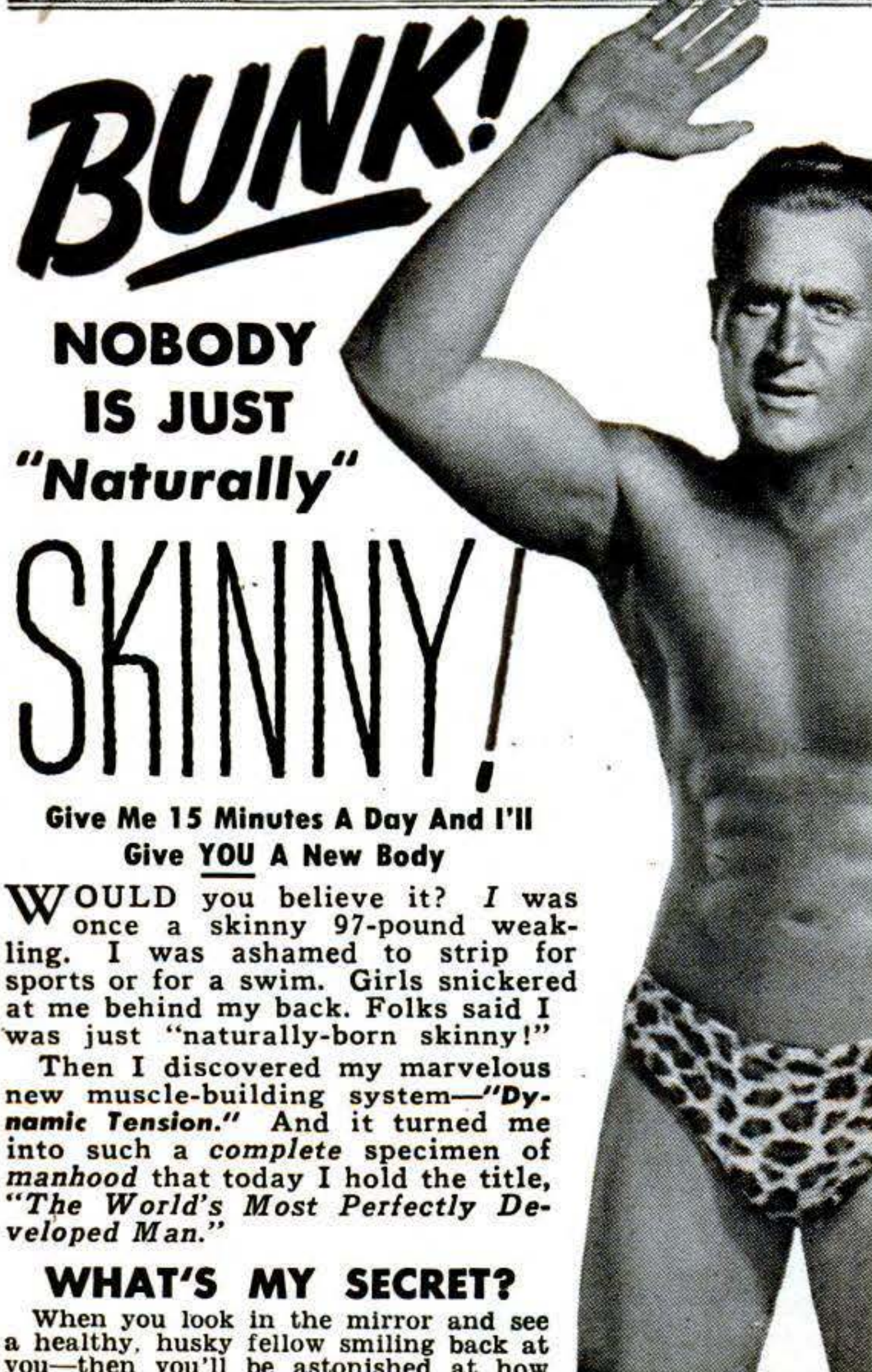
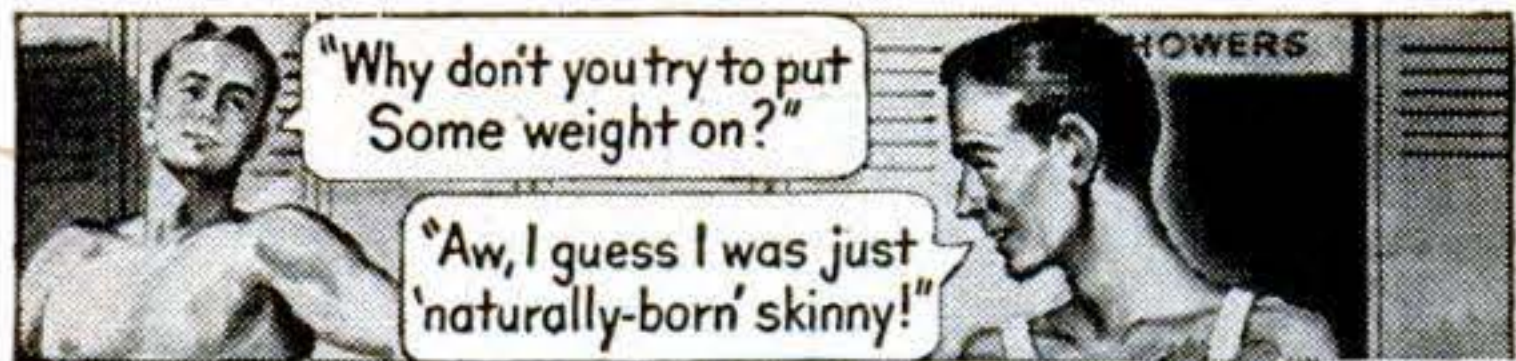

**BUNK!**  
**NOBODY IS JUST "Naturally" SKINNY!**

Give Me 15 Minutes A Day And I'll Give YOU A New Body

WOULD you believe it? I was once a skinny 97-pound weakling. I was ashamed to strip for sports or for a swim. Girls snickered at me behind my back. Folks said I was just "naturally-born skinny!"

Then I discovered my marvelous new muscle-building system—"Dynamic Tension." And it turned me into such a complete specimen of manhood that today I hold the title, "The World's Most Perfectly Developed Man."

**WHAT'S MY SECRET?**

When you look in the mirror and see a healthy, husky fellow smiling back at you—then you'll be astonished at how fast "Dynamic Tension" gets results! And you'll be using the method which many great athletes use for keeping in condition—prize fighters, wrestlers, baseball and football players, etc.

"Dynamic Tension" is the easy, natural method that you can practice in the privacy of your own room—just 15 minutes each day—while your scrawny chest and shoulder muscles begin to swell . . . those spindly arms and legs bulge . . . and your whole body starts to feel full of zip, self-confidence, new energy!

**My Illustrated Book is Yours —Not for \$1.00 or 10c—But FREE**

Send NOW for my famous book, "Everlasting Health and Strength." 48 pages, packed from cover to cover with actual photographs, valuable advice, answers to many vital questions. Page by page it shows what I can do for YOU. This

book is a real prize for any fellow who wants a better build. Yet I'll send you a copy absolutely FREE. Just glancing through it may mean the turning point in your whole life! Rush the coupon to me personally: **Charles Atlas, Dept. 1B, 115 East 23rd St., New York 10, N. Y.**



*Charles Atlas*  
 Awarded the title of "The World's Most Perfectly Developed Man."

**CHARLES ATLAS, Dept. 1B, 115 East 23rd St., New York 10, N. Y.**

Send me—absolutely FREE—a copy of your famous book, "Everlasting Health and Strength"—48 pages, crammed with actual photographs, answers to vital health questions, and valuable advice to every man who wants a better build. I understand this book is mine to keep, and sending for it does not obligate me in any way.

Name.....Age.....  
 (Please print or write plainly)  
 Address.....  
 City.....State.....

**Letters**



**Flagged Down**

Sir:

As a rural mail carrier, I have a boner to pick with your mostly excellent magazine. That's your suggestion under "Keeping the Home Shipshape" in November, page 170, for making a mailbox flag automatic.

Your scheme is against Post Office Dept. regulations, under which the signal flag is supposed to be in lowered position except when the patron has placed mail in the box for the carrier to collect. The carrier puts it down when he picks up the mail—whether or not he delivers any.

Your doctored-up flag, working backwards, would cause us carriers a lot of trouble, since it would indicate there was mail in the box to be collected when actu-

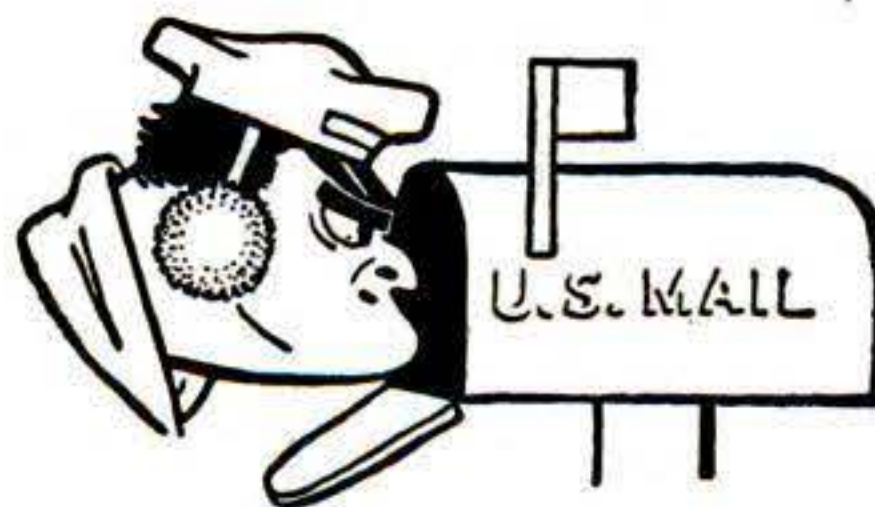

ally the patron had only failed to pick up the mail we'd left the day before. Now if you could figure out a flag that would go down automatically after the patron had set it up, then you would really earn the thanks of all rural carriers!

Seriously, I wish patrons on rural mail routes, instead of forever trying to fancy up their mail boxes, would spend half the energy lobbying for better country roads and in fixing up turnouts so that we letter carriers could serve their boxes without getting stuck in the mud or hit by passing traffic.

NIC. KLEIN

New Hampton, Ia.

Officially, you're right in objecting to our mailbox suggestion. Says Joseph J. Lawler, Assistant Postmaster General, in a letter to PS:

"The Postal Regulations provide that rural carriers shall open and examine mailboxes of patrons only when signals are displayed to indicate that the boxes contain mail for dispatch. When the mail is collected from the box, the carrier shall lower



# INVENTORS

Learn how to protect your invention. The U. S. Patent Laws provide that any new and useful art, machine, article of manufacture, or composition of matter, or any new and useful improvement thereof, may be patented if the act of invention is involved. Therefore, every inventor with a valuable invention should take advantage of the Patent Laws and proceed for patent protection in order to safeguard his rights.

A patent gives the inventor the exclusive right to prevent others from making, using, or selling the invention claimed in the patent for a period of seventeen years.

The Patent Laws were enacted for the benefit of the inventor to give him protection for the features of his invention which are patentable. These features must be properly and concisely set forth and claimed in a formal application for patent, in order to comply with the requirements of the Patent Laws. For that reason, unless the inventor is familiar with patent matters, he should engage a competent registered patent attorney or agent to represent him. We are registered to practice before the U. S. Patent Office and are prepared to serve you in the handling of your patent matters.

A specially prepared booklet entitled "Patent Guide for the Inventor", containing detailed information with respect to patent protection and procedure, together with a "Record of Invention" form will be promptly forwarded to you without obligation upon request.

---

**CLARENCE A. O'BRIEN & HARVEY JACOBSON**

*Registered Patent Attorneys*

**12-B DISTRICT NATIONAL BUILDING**

**WASHINGTON 5, D. C.**

FEBRUARY 1951 15

# Only Bolens Power-Ho DeLuxe Garden Tractor gives you:

1. **Quicker Hitching** — Patented front Snap-Hitch and back drop-pin for 10-second attachment of 19 different implements!
2. **Smoother Running** — Precision needle bearings, powerful 2½ HP Briggs and Stratton engine. Variable speed transmission.
3. **Simpler Operation** — Fingertip controls, perfect balance — a child can use it!
4. **Easier, Shorter Turns** — The most maneuverable tractor on the market today by actual test!
5. **Longer Use** — High arch construction for late season cultivation to increase crop yield.

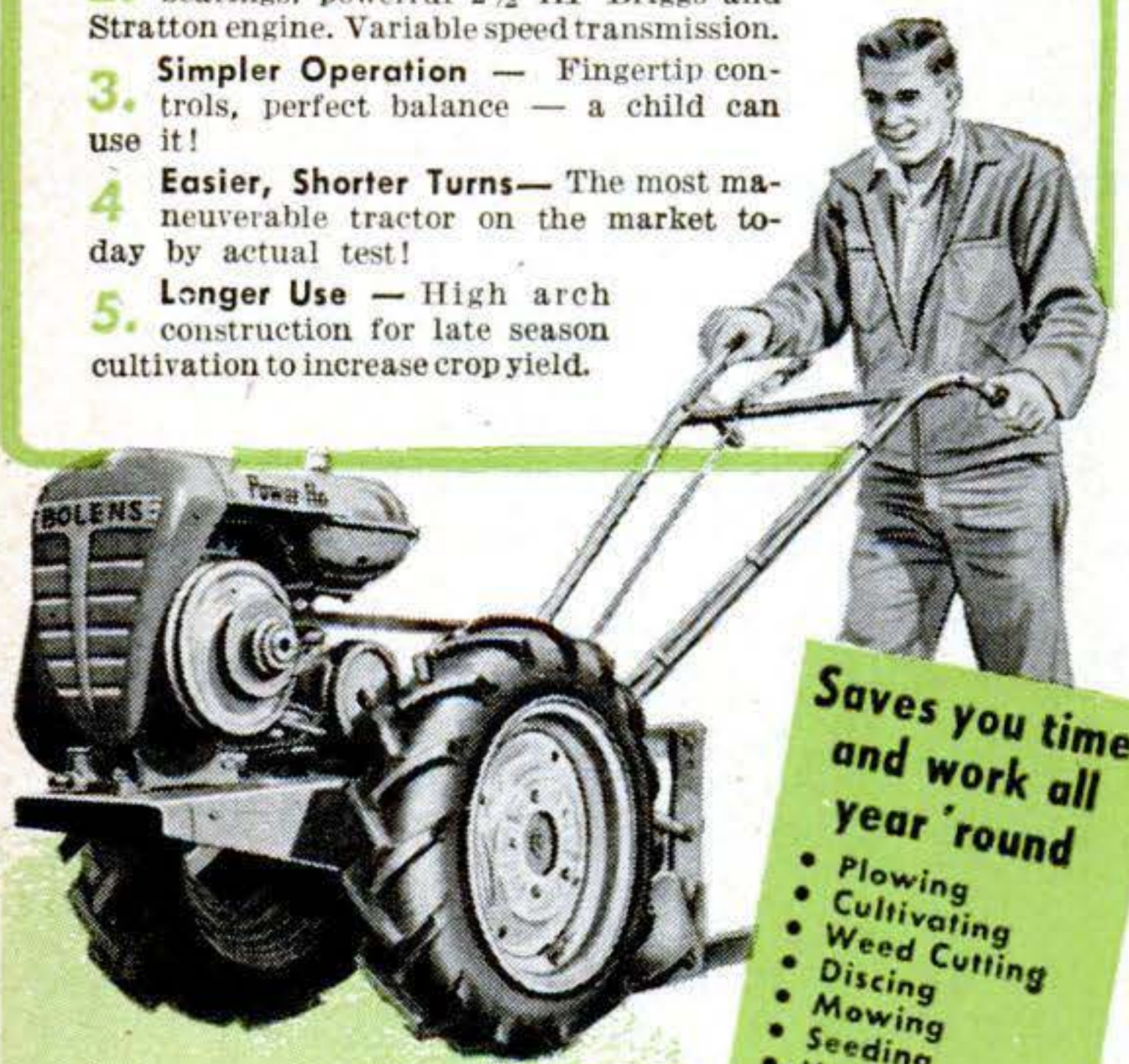

**Saves you time and work all year 'round**

- Plowing
- Cultivating
- Weed Cutting
- Discing
- Mowing
- Seeding
- Hauling
- Grading
- Snow-plowing
- etc., etc.

19 different attachments to use!

**5 extra value features**

**Do more yard and garden jobs faster and easier!**



Prove it to yourself! These 5 features make the Bolens Power-Ho DeLuxe superior to any other garden tractor. It delivers easier, faster operation and more all-round usefulness—to your complete satisfaction. Only Bolens, the garden tractor pioneer, can offer these exclusive features. See Your Bolens dealer today.

*Compare dollar-for-dollar and you'll buy Bolens!*

**Complete selection of sizes**

Send for FREE LITERATURE and the name of nearest dealer. Tear out this coupon and mail today.

**Bolens Products Division** B-1C  
**Food Machinery and Chemical Corp.**  
 267-2 S. Park St., Port Washington, Wis.  
 Please send free literature and nearest dealers' name.

Name.....  
 Address.....  
 City..... (.....) State.....

the signal, regardless of whether he has deposited mail in the box. The carrier shall not raise the signal on a box at any time."

Practice, however, varies with communities. Several rural-route patrons have told us that both they and their carrier customarily use the mailbox flag to signal each other to pick up mail.

**Safety Suggestions**

Sir:

I have two suggestions that might avert railroad disasters like that which occurred in the collision of two commuter trains in New York on Nov. 22:

1. Have two red lights on the rear coach that blink alternately when the train is moving less than 20 m.p.h. and at all times when it is stopped on a main track.
2. Install in the cab of each locomotive a radio or radar device that would flicker a light and sound a warning as soon as the engine came within one mile of a train ahead.

HERBERT W. TERWILLIGER

Oil City, Pa.

**Shock Treatment**

Sir:

Here's the simplest way I've found to avoid those shocks from static electricity generated by friction of clothing on plastic seat covers when sliding into a car [PS, Dec., p. 12]:

Avoid touching any metallic part of the car until seated. Then ground yourself without shock by touching a key or a coin—or a ring, if you're wearing one—to the ignition switch, door handle, or other metallic part of the car.

EDWIN WIEGAND

San Bernardino, Calif.

**Tooling vs. Carving**

Sir:

That article about leather working in your October magazine, page 226, confuses the arts of "leather tooling" and "leather carving."

Leather is tooled when the design is first traced on the leather, then retraced with a tooling instrument to set the design into the leather.

Leather is carved when the design is first traced on the leather, then cut into the

# INVENTORS

If you believe that you have an invention, you should find out how to protect it. The first step is to have a search made of the prior pertinent U. S. patents. If a report on this search indicates that the invention appears patentable you can apply for a patent, and the specifications and claims should be prepared.

The firm of McMorrow, Berman & Davidson, with offices in Washington, D. C., is qualified to take the necessary steps for you. We can make a preliminary search on your invention, advise you whether we think it can be patented, and prepare your application for patent.

Unless you are fully familiar with the U. S. Patent Laws, we recommend that you engage the services of a Registered Patent Attorney to protect your interests. The patent laws are *your* laws. A patent gives you the right to prevent others from making, using or selling the invention claimed in your patent for a period of 17 years.

Use these patent laws for your protection. Investigate whether your invention can be patented. If you have what you believe to be an invention, we suggest that you have this firm make a search for you.

*Send for a copy of our Patent Booklet entitled "How To Protect Your Invention," containing information about patent protection and patent procedure. Along with this we will also send you an "Invention Record" form, for your use in writing down and sketching details of your invention. We will mail them promptly. No obligation. They are yours for the asking.*

**McMORROW, BERMAN & DAVIDSON**

*Registered Patent Attorneys*

**PATENTS • COPYRIGHTS • PATENTS**

**142-M VICTOR BUILDING, WASHINGTON 1, D. C.**

Which of these 2 one time WEAKLINGS PAID only a Few Cents to become an "All-Around" HE-MAN at Home?

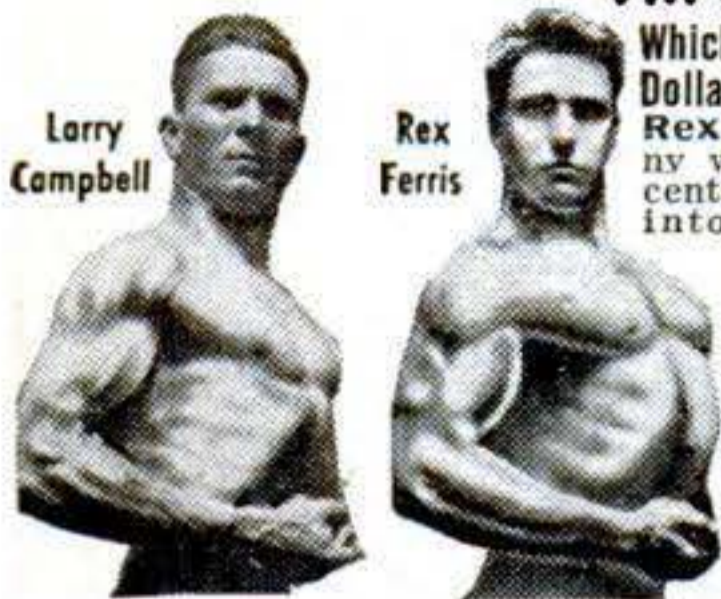

Which One Paid Hundreds Of Dollars To Train At My Side? Rex Ferris, was a skinny weakling, paid a few cents to start building into a Champion All Around He Man! Larry Campbell paid me hundreds of dollars to train at my side years ago. Start to become an All-Around He Man at home with these same secrets for only a few cents—like Rex Ferris did!

Amazing get-acquainted offer—YOURS for only **10c** INSTEAD OF \$1 FOR ALL 5 COURSES Plus FREE Photo Book!

Be a Winner at Anything YOU Tackle with Progressive Power SPORTS! JOB! SCHOOL! FRIENDS!

Let's Go, Pal! I'll prove I can make YOU an "ALL-AROUND" HE-MAN FAST—OR NO COST! says George F. Jowett World's Greatest Body Builder



"The Jowett System is the greatest in the world!" says R. F. Kelly, Physical Director, Atlantic City

Enjoy My "Progressive Power" Strength Secrets! Give Me 10 Easy Minutes a Day—Without Strain!

I'll teach you the "Progressive Power Method" through which I rebuilt myself from a physical wreck the doctors condemned to die at 15, to the holder of more strength records than any other living athlete or teacher! "Progressive Power" has proven its ability to build the strongest, handsomest men in the world. And I stand ready to show you on a money back basis—that no matter how flabby or puny you are, I can do the same for you right in your own home. Let me prove I can add inches to your arms, broaden your shoulders, give you a man-sized chest, powerful legs and a rock-like back—in fact, power pack your whole body so quickly it will amaze you! Yes, I'll jam you with power and confidence to master any situation—to win popularity—and to get ahead on the job! Through my proven secrets I bring to life new power in you inside and out, until YOU are fully satisfied you are the man you want to be.

PROVE IT TO YOURSELF IN ONE NIGHT

Send only 10c for my 5 easy-to-follow, picture-packed courses now in 1 complete volume "How to Become a Muscular He-Man." Try it for one night! Experience the thrilling strength that surges through your muscles. 10 DAY TRIAL! Think of it—all 5 famous courses in one picture-packed muscle-building volume only 10c. You must actually FEEL results in ONE WEEK, or your money will be promptly refunded!

George F. Jowett

Whom experts call "Champion of Champions"

- World's wrestling and weight lifting champ at 17 and 19.
- World's Strongest Arms. • 4 times World's Perfect Body—plus other records.

**FREE!**

Photo Book of Famous Strong Men!

I want thousands of new friends—regardless of cost! Get all 5 (Valued at \$5.00 each), Muscle Building Courses, for only 10c. Packed with How-To-Do-It Pictures! Start to build a body you will be proud of.

How to MOLD A MIGHTY CHEST

How to MOLD A MIGHTY ARM

How to MOLD A MIGHTY BACK

How to MOLD A MIGHTY LEGS

How to MOLD A MIGHTY GRIP

**How to BECOME A MUSCULAR HE-MAN**

With these 5 Complete Courses on Molding:

1. A Mighty Arm
2. A Mighty Grip
3. A Mighty Chest
4. A Mighty Back
5. A Mighty Leg

**FREE GIFT COUPON!**



George F. Jowett  
Champion of Champions

Jowett Institute of Physical Training Dept. 230 Fifth Avenue, New York 1, N. Y. PSA-12

Dear George:—Please send by return mail, prepaid, FREE Jowett's Photo Book of Strong Men, plus all 5 Muscle Building Courses. 1. Molding a Mighty Chest. 2. Molding a Mighty Arm. 3. Molding a Mighty Grip. 4. Molding a Mighty Back. 5. Molding Mighty Legs—Now all in One Volume "How to Become a Muscular He-Man." Enclosed find 10c for postage and handling. No C.O.D.'s.

Name..... Age.....  
Address.....  
City..... Zone & State.....

leather with a swivel knife, and the leather then decorated by means of stamping tools and a mallet.

The illustrations with your article are of carving and not, as you said, of tooling.

HAROLD L. POTTER

Burlingame, Calif.

Your point, though a fine one, is well taken.

**Mobile Power Saw**

We "mobilize" our power saw in a much simpler way than shown in your story, "Power Tools Can Ride on Retractable Casters" [Oct., p. 209]. The machine is fixed in stationary position under normal conditions,

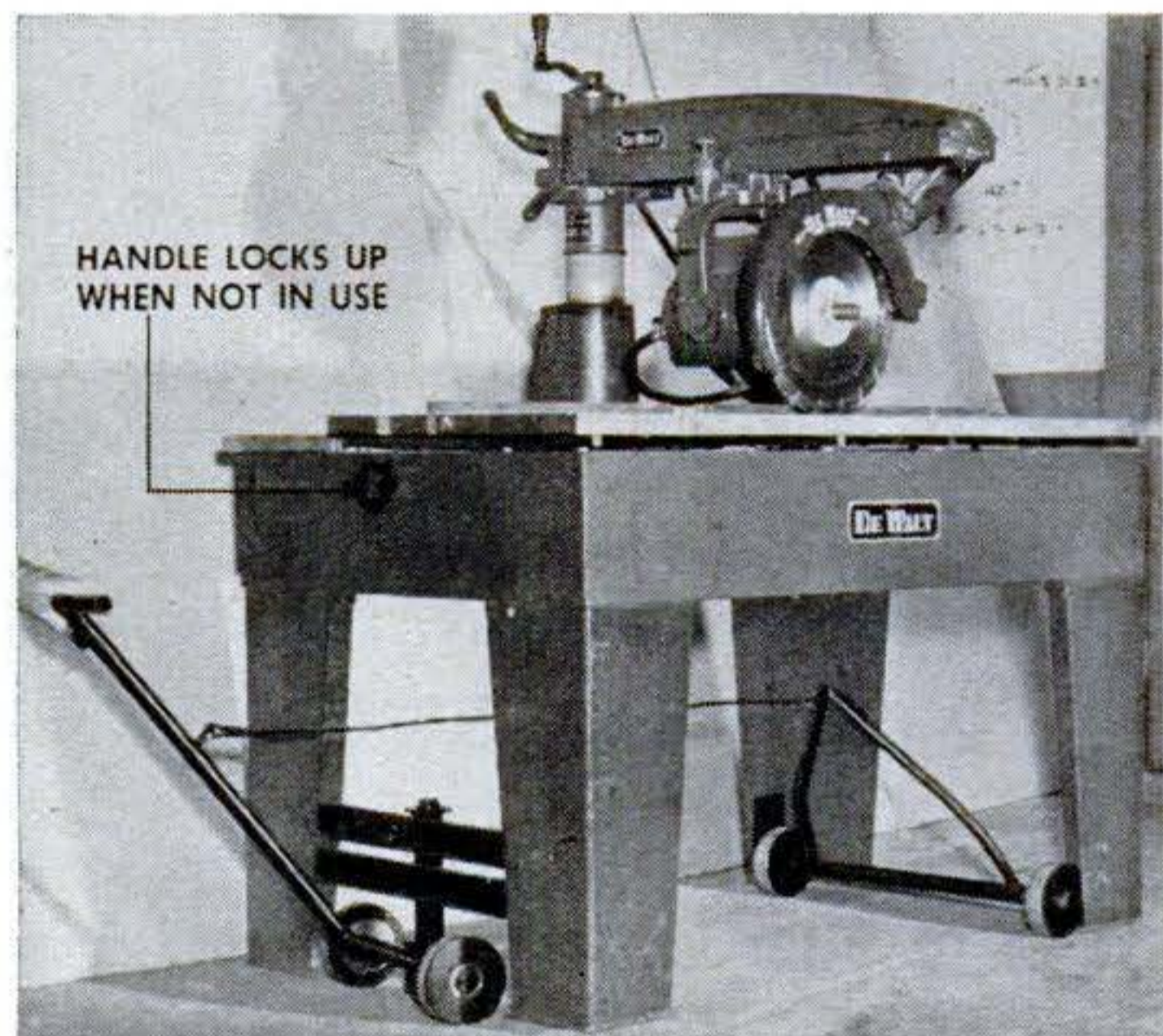

HANDLE LOCKS UP WHEN NOT IN USE

for safety. Only when moved—as shown in the enclosed photo—does it rest on casters. This condition is assured by the fact that the handle, attached to the axle on which the wheels are mounted eccentrically, serves as a lever to lift the machine when pulled. As soon as the saw is in its new location, the handle is released and returned to its original position by the weight of the machine. When the handle then is locked up, the machine cannot be moved.

E. GEORGE STERN

Professor, Virginia Polytechnic Institute Blacksburg, Va.

**Data-Card Dilemma**

Sir: I like those file-card-size tables of shop data and materials specifications that you print from time to time "for your Popular Science information file." But I hate to cut



# Learn RADIO

## TELEVISION, ELECTRONICS

by

## SHOP METHOD HOME TRAINING

Let NATIONAL SCHOOLS, of Los Angeles, a practical Technical Resident Trade School for almost 50 years, train you for today's unlimited opportunities.

You receive all parts, including tubes, for building this fine, modern Superheterodyne Receiver. This and other valuable standard equipment becomes your property.

these two **FREE** books will tell you how



WE BRING NATIONAL SCHOOLS TO YOU!

### GOOD JOBS AWAIT THE TRAINED RADIO TECHNICIAN

You are needed in the great modern Radio, Television and Electronics industry! Trained technicians are in constant and growing demand at excellent pay—in Broadcasting, Communications, Television, Radar, Research Laboratories, Home Radio Service, etc. National Schools Master Shop Method Home Study Course, with newly added lessons and equipment, can train you in your spare time, *right in your own home*, for these exciting opportunities. Our method has been proved by the remarkable success of National Schools-trained men all over the world.

#### You Learn by Building Equipment with Standard Radio Parts We Send You

Your National Schools Course includes not only basic theory, but *practical* training as well—you learn by doing. We send you complete standard equipment of professional quality for building various experimental and test units. You advance step by step until you are able to build the modern superheterodyne receiver shown above, which is yours to keep and enjoy. You perform more than 100 experiments—build many types of circuits, signal generator, low power radio transmitter, audio oscillator, and other units. The Free Books shown above tell you more about it—send for them today!

you perform more than 100 experiments—build many types of circuits, signal generator, low power radio transmitter, audio oscillator, and other units. The Free Books shown above tell you more about it—send for them today!



#### NOW! NEW PROFESSIONAL MULTITESTER INCLUDED



This versatile testing instrument is portable and complete with test leads. Simple to operate, accurate and dependable. You will be able to quickly locate trouble and adjust the most delicate circuits. You can use the Multitester at home or on service calls. It is designed to measure AC and DC volts, current resistance and decibels. You will be proud to own and use this valuable professional instrument.

GET THE DETAILS — SEND THE COUPON →

#### Lessons and Instruction Material Are Up-to-date, Practical, Interesting

National Schools Master Shop Method Home Training gives you basic and advanced instruction in all phases of Radio, Television and Electronics. Each lesson is made easy to understand by numerous illustrations and diagrams. All instruction material has been developed and tested in our own shops and laboratories, under the supervision of our own engineers and instructors. A free sample lesson is yours upon request—use the coupon below.

#### TELEVISION TRAINING

A complete series of up-to-the-minute Television lessons is an integral part of your course, covering all phases of Television repairing, servicing and construction.

Here are just a few of the interesting facts you learn with the **FREE SAMPLE LESSON**

1. How radio receivers operate.
2. How the antenna circuit is constructed.
3. Converting signal currents into sound.
4. How the R-F transformer handles the signal.
5. How the tuning circuit functions.
6. The Radio "bands."

**APPROVED FOR VETERANS**  
Check coupon below.

### NATIONAL SCHOOLS

LOS ANGELES 37, CALIFORNIA EST. 1905



#### MAIL OPPORTUNITY COUPON FOR QUICK ACTION

National Schools, Dept. 2-PS  
4000 South Figueroa Street  
Los Angeles 37, California

(Mail in envelope or paste on penny postcard.)

Mail me FREE the book "Your Future in Radio-Television" and the sample lesson of your course. I understand no salesman will call on me.

NAME \_\_\_\_\_ AGE \_\_\_\_\_

ADDRESS \_\_\_\_\_

CITY \_\_\_\_\_ ZONE \_\_\_\_\_ STATE \_\_\_\_\_

Check here if veteran of World War II

# I'LL TRAIN YOU for RADIO



**MEET  
A FEW OF MY  
GRADUATES**



**Appreciates Sprayberry  
Personal Interest**  
"Before completing  
your course I had  
a good paying job.  
I appreciate the  
personal interest you  
gave me."—Leonard  
Petrus, Arkansas



**Best Investment  
He Ever Made**  
"Began fixing ra-  
dio sets after first  
few lessons. Your  
course is one of the  
best investments  
I've ever made."  
—A. R. Foronda,  
Hawaii

**I Send You  
18 BIG  
KITS  
OF RADIO-  
TELEVISION  
EQUIPMENT**

## EXTRA MONEY

**Earn While You Learn  
In Your Spare Hours!**  
You do all your training  
with me AT HOME in  
spare hours. Keep right on  
with your present job and  
income while learning—and  
earn extra cash besides! The  
day you enroll I begin send-  
ing you plans and ideas for  
doing profitable spare time  
Radio-TV work. Many of  
my Sprayberry students  
pay for their entire Radio-  
TV training this way!



## YOU KEEP THIS VALUABLE EQUIPMENT

The many big kits of Radio-Television parts and equipment are sent to my students "for keeps." Nothing need be returned—it is YOURS! There is absolutely nothing else to buy!

# AT HOME IN SPARE TIME TELEVISION



**Training Leads To Good Radio Job**  
"Got a job in local radio shop soon after enrolling. Very satisfied with training" — Stanley Clemmons, Kansas



**Lucky To Be Sprayberry Trained**  
"I consider myself lucky I chose your training in preference to others I considered. Here's thanking you again." — Paul White, Ohio



**Radio Profits Pay Cost of Training**  
"I have more than taken in the cost of your training doing spare time radio repair work. See bright future ahead" — Thomas Shearer, N. Y.



**Earns Easy Spare Time Cash**  
"While training I made about \$180.00 in spare time. Thank you for wonderful Radio-TV training" — Herbert Burroughs, W. Va.

## My Proved Training System—Backed by a Quarter Century of Experience—Prepares You FAST for a Good Job or Your Own Profitable Radio-Television Business!

Radio-Television is now America's greatest opportunity field. Correctly trained men are needed NOW—more than ever—to fill good jobs and handle the profitable Radio-Television Service work. I have trained hundreds of successful men for Radio-Television—and I stand ready to train YOU too—even if you have no experience or knowledge of this field. My training is modern—right up to the second—with all the newest developments included! This is 100% practical training that eliminates the frills that only waste your time and progress. Sprayberry Training provides the all-important practical knowledge and skill you need to start making money in Radio-Television in the shortest possible time. You can start at once and be earning welcome spare time cash in a few short weeks. Upon completion of my Training you will be ready to handle any practical Radio-Television job.

You receive all the equipment I have illustrated on the opposite page—and MUCH MORE besides! In addition to your fascinating Sprayberry home study lessons, I send you a total of 18 kits of quality parts and equipment with which you do over 300 practical demonstrations, experiments and construction projects. You build a complete television set that you can use in your shop or at home—you build a powerful TWO-BAND superheterodyne radio set—a multi-range test meter—signal generator and other valuable test equipment—a cathode ray oscilloscope—everything needed to set up your own Radio-Television Service Shop! All equipment I send you is yours to keep. In addition I send you many valuable service manuals, books and reference material to help you in your day-to-day Radio-Television work. I firmly believe I offer the ambitious man the most outstanding training value of its kind in America today!



## Be Ready for Top Paying Radio-Television Jobs!

Radio-Television is growing with amazing speed. More than 2000 broadcasting stations PLUS an additional 102 Television stations are now on the air. Radio sets and TV receivers are being made and sold in record breaking numbers. If you enjoy working with your hands . . . if you like interesting and varied work . . . YOU BELONG IN RADIO-TELEVISION. But you MUST have good Training to "cash in" . . . the training that starts with basic fundamentals and carries through every circuit and problem of Radio-TV.

## No Previous Experience Needed to Succeed

My Training in Radio-Television is so complete, so down-to-earth that previous experience is not necessary. I start you with basic fundamentals and carry you in easy, practical steps through one Radio-Television subject after another. You will be amazed at your rapid progress and your knowledge of Radio-Television. Best of all, you put this knowledge to work making spare time cash soon after you enroll! You may train as fast or as slowly as suits your convenience. Each of my students receives individual training!

## VETERANS

My Radio Training is approved for Veterans under the G.I. Bill.

## If you are Experienced . . .

in radio . . . I'll qualify you for Television in 4 to 8 weeks. Check coupon for special details.



## FREE 3 Big Radio and Television Books

I want you to have ALL the facts about my complete system of Radio-Television Training! Act now! Rush the coupon for my three big Radio-Television books: "How To Make Money in Radio-Television," PLUS my new illustrated Television bulletin PLUS an actual sample Sprayberry Lesson—all FREE with my compliments. No obligation and no salesman will call on you. Send the coupon in an envelope or paste on back of post card. I will rush all three books at once!

**Mail Coupon Today!**

**NO OBLIGATION  
No Salesman  
Will Call**

SPRAYBERRY ACADEMY OF RADIO, Dept. 55-T

111 North Canal St., Chicago 6, Ill.

Please rush to me all information on your Radio-Television Training plan. I understand this does not obligate me and that no salesman will call upon me.

Name..... Age.....

Address.....

City..... State.....

Please Check Below About Your Experience

Are You Experienced?

No Experience

**Sprayberry Academy  
of Radio, Dept. 55-T**  
111 North Canal St., Chicago 6, Ill.



Fill cracks in chairs—

Makes loose joints firm, sands to a smooth finish!



Reset loose hinges—

Replaces rotted wood, tightens loose screws . . . easy to apply!



Repairs broken toys—

Mend cracks, nicks! Smooth finish!



Also useful in filling cracks in floors, nail and screw holes, repairing loose tiles. Handles like putty . . . hardens into wood!

**PLASTIC WOOD**

A CELLULOSE FIBRE FILLER

IN CANS OR TUBES



DOZENS OF OTHER USES

them out for filing, for almost always there's something printed on the other side that I also want to keep for future reference. Why not print them on a page with a picture or advertising on the back?

ARTHUR BUZY

Lackawanna, N. Y.

Many such letters as Mr. Buzy's have had the editors knuckling their heads for months. The trouble is that what one man would put on the back another man would consider useful information. Even leaving the back blank would be no solution, since it would reduce the total content of the magazine. One obvious answer, for those so inclined, is to acquire an extra copy.

**Defense-Contract Information**

Sir:

I would like to get my shop started as soon as possible on defense work along the lines suggested in the article "Can You Help America Arm?" in your December issue, page 186.

I have a 200-amp. AC welding machine, an acetylene burning and welding outfit, a metal lathe, a bench grinder, two electric drills, a spray outfit with air compressor, a large assortment of hand tools—and several years experience in welding, lathe work, ordnance repair, and all kinds of machine work.

I'd appreciate any information you can give me on what defense contracts are being let, to whom, and what small parts I might produce on subcontract.

HOWARD J. BALDWIN

Detroit, Oregon

The National Production Authority issues a weekly "Consolidated Synopsis of Contract Awards," listing prime contracts awarded by the Government, names and addresses of the contractors, and materials contracted for. This list is not available to individuals by mail but may be seen by a personal visit to field offices of the Department of Commerce and such public places as banks, libraries, Chambers of Commerce.

A small workshop operator, on examining this list, has to use his own imagination in figuring out what part of a contractor's work he might be able to produce. He must then get in touch with the contractor directly to make any proposal for a subcontract; the Government does not enter into this negotiation.



**NOW... GET EVERYTHING YOU  
NEED TO LEARN AND MASTER**

# TELEVISION

**RADIO-ELECTRONICS  
...AT HOME!**

**Use REAL commercial-type equip-  
ment to get practical experience**

Your future deserves and needs every advantage you can give it! That's why you owe it to yourself to find out about one of the most COMPLETE, practical and effective ways now available to prepare AT HOME for America's billion-dollar opportunity field of TELEVISION-RADIO-ELECTRONICS. See how you may get and keep the same type of basic training equipment used in one of the nation's finest training laboratories... how you may get real STARTING HELP toward a good job or your own business in Television-Radio-Electronics. Mail the coupon today for complete facts — including 89 ways to earn money in this thrilling, newer field.

ABOVE: Build and keep a real 16 INCH commercial TV receiver. Optional after completing regular training at slight additional cost.

**D.T.I., ALONE, INCLUDES BOTH MOVIES and HOME LABORATORY**  
In addition to easy-to-read lessons, you get the use of HOME MOVIES — an outstanding training advantage — plus 16 big shipments of Electronic parts. Perform over 300 fascinating experiments for practical experience. Build and keep real commercial-type test equipment shown at left.

**MODERN LABORATORIES**

If you prefer, get all your preparation in our new Chicago Training Laboratories—one of the finest of its kind. Ample instructors, modern equipment. Write for details!

**MILITARY SERVICE!**

If you're subject to military service, the information we have for you should prove doubly interesting. Mail coupon today.

**Get BOTH of these  
information packed  
publications FREE!**



**ACT NOW! MAIL COUPON TODAY!**

DeFOREST'S TRAINING, INC., Dept. PS-2-H  
2533 N. Ashland Ave., Chicago 14, Ill.

Without obligation, I would like your late News-Bulletin showing 89 ways to earn money in Television-Radio-Electronics... and how I may prepare to get started in this thrilling field.

Name..... Age.....  
Street..... Apt.....  
City..... Zone..... State.....

**Here's the  
REAL THING!**

**SET UP YOUR OWN  
HOME LABORATORY**



Oscilloscope  
R-F Signal Generator

6-Tube Radio

Multimeter

**HOME  
MOVIES**

**De FOREST'S TRAINING, INC.**  
CHICAGO 14, ILLINOIS  
A De VRY INSTITUTION

**NOW!**  
 a completely  
 waterproof  
**GLUE**  
 for home use!



At last, CASCOPHEN...the *completely waterproof* and *boilproof* glue for hobby and home repair use. Complies with rigid Army-Navy specification JAN-A-397.

Ideal for boat-building, outdoor furniture, sports equipment, toys...*all* critical wood gluing... makes a joint stronger than the wood itself that withstands a shear test of over 2800 lbs. per square inch. Bonds oily woods like lemonwood, osage orange, yew and hard-to-glue woods like oak.

Cures quickly at 70° F. Stores indefinitely. Requires only moderate clamping pressure. At better hardware, paint and marine stores. For free folder, write to Borden's Chem. Div., 350 Madison Ave., New York 17, N. Y.

**Make it with EASI-BILD patterns!**

This 6 ft. bench is easy, quick, economical to build with EASI-BILD FULL-SIZE Patterns. No special tools or skills... trace pattern on wood, saw, assemble with CASCOPHEN. Mail coupon!



*Borden's* CASCOPHEN

CASCO Pattern Dept. PS-21  
 P. O. Box 215, Pleasantville, N.Y.

Enclosed is \$..... for:

- Handy Workbench, Pattern No. 15-25¢.
- 32-page Pattern Book illustrating 94 pattern projects-20¢.
- Free descriptive folder on CASCOPHEN.

NAME \_\_\_\_\_  
 ADDRESS \_\_\_\_\_  
 CITY \_\_\_\_\_ ZONE \_\_\_\_\_ STATE \_\_\_\_\_

**WHOLESALE BY MAIL**  
**GOOD USED TIRES**  
 with a GOLD BOND GUARANTEE



Goodyear - Firestone - Goodrich - And Others  
**FREE Tube With 15" & 16" Passenger Tire**

12 Month GOLD BOND GUARANTEE							
600-16	\$4.16	700-15	\$4.56	650-20	\$7.96	32x6 (8)	\$8.66
650-16	4.66	670-15	4.76	700-20	8.56	32x6 (10)	9.96
700-16	5.06	710-15	4.96	750-20	8.66	900-20	13.96
650-15	4.46	550-17	4.66	825-20	13.96	1000-20	13.96

24 Month GOLD BOND GUARANTEE							
600-16	\$5.56	650-15	\$5.96	600-20	\$9.96	900-20	\$16.56
650-16	5.96	670-15	6.26	650-20	9.96	1000-20	17.56
700-16	5.96	700-15	6.56	700-20	10.96	1100-20	17.56
750-16	6.96	710-15	6.36	32x6 (8)	10.56	1200-20	18.56
550-17	5.96	760-15	6.56	32x6 (10)	11.96	1000-20	15.56
525-18	5.56	820-15	7.06	750-20	12.56	1100-22	17.56
650-18	6.96	475-19	5.96	825-20	16.56	750-15	9.96

**MILITARY MUD AND SNOW TIRES**

12 Month GOLD BOND GUARANTEE			
600-16	900-16	750-16	750-20
Special \$6.46	Special \$9.66	Special \$9.96	Special \$10.46

When ordering give make and year of vehicle. 10% discount on 2 or more tires if you send this ad with this order.  
 Send check or money order to

**GOLD BOND TIRE COMPANY, Dept. PS 24**  
 1501 North 2nd Street RICHMOND, VIRGINIA P. O. Box 2175

**A "GOOD HAND" HELPS YOU SUCCEED!**  
**LEARN TO WRITE WELL**

*Your Name* beautifully written, plus special pen-point for shaded writing. **Only 10¢**

Handwriting quickly improves with our easy-to-understand picture lessons! Put your spare time to good use; send today for  FREE BOOK, "How to Become a Good Penman", or check volumes wanted below at \$1 each:  Business Writing  Artistic Writing  Card Writing  Bird & Design Flourishing  Engrossing Alphabets. **COMPLETE SET \$4.50**

**TAMBLYN SCHOOL of PENMANSHIP**  
 S. A. Ziller, Pres. 438 Ridge Bldg., Kansas City, Mo., USA

**HYPNOTIZE**

YES, ANYONE. Mystify Friends. Authentic fascinating hypnotic feminine photographs show you precise spellbinding genuine techniques. Instructions reveal to you how easily hypnotism is accomplished. Amazing results. Selfhypnosis fully explained.

Send for the exciting illustrated book "HYPNOTISM REVEALED" → **\$1**  
 12" Phonograph Record Inducing Mass-Hypnotism & Self-Hypnosis → **\$5**

MELVIN POWERS, Professional Hypnotist, 1324 Wilshire, Dept. 76 Hollywood 17, Calif.

**FUN!**

**MAKE THIS Squirrel Lamp**

Yes sir, out of a real squirrel! Also make ash-trays, book-ends, etc., using rabbits, frogs, etc. **LEARN AT HOME TO MOUNT BIRDS, ANIMALS & FISH;** tan skins and make rugs. Decorate your room. **It's FUN! BIG profits in spare time!**

Free book tells how. **FREE BOOK!** Write TODAY for beautiful free book telling how to learn this fine hobby. Book is free. Contains many fine pictures. **STATE YOUR AGE.**

**N. W. SCHOOL OF TAXIDERMY, Dept. 2602 Omaha, Nebr.**

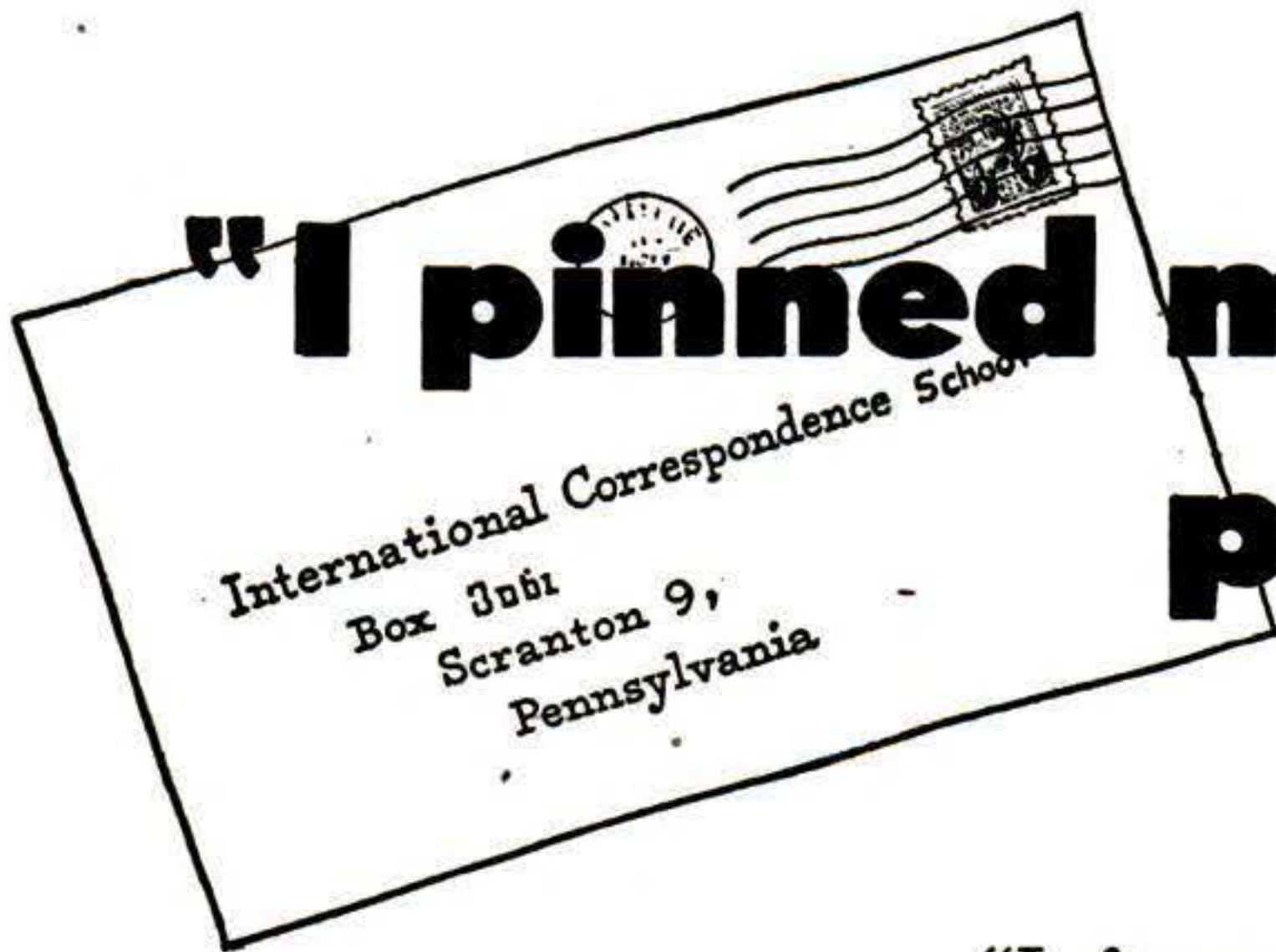

# "I pinned my hopes to a penny postal"

**JESSE K. KIMBALL**  
Chief Building Inspector, Washington, D. C.



"I often wonder what sort of job I'd have now if it were not for a penny postal and the International Correspondence Schools.

"Today I'm Chief Building Inspector for the District of Columbia. It's a good job and pays a good salary. Just recently, I got another \$600-a-year raise. I. C. S. instruction made it all possible."

THE coupon you mail today might very well start a chain reaction that could change your entire future. For it brings you information about successful careers and how to prepare for them. It puts you in touch with the world's largest educational institution. It starts you off the way hundreds of today's leaders in business and industry started. Why not mail it today?

## INTERNATIONAL CORRESPONDENCE SCHOOLS

**APPROVED**  
under the  
**G.I. BILL**

BOX 7672-M, SCRANTON 9, PENNA.

Without cost or obligation, please send me full particulars about the course BEFORE which I have marked X:

- |   |   |   |   |
|---|---|---|---|
| <p><b>Air Conditioning and Plumbing Courses</b></p> <ul style="list-style-type: none"> <li><input type="checkbox"/> Air Conditioning</li> <li><input type="checkbox"/> Heating</li> <li><input type="checkbox"/> Refrigeration</li> </ul> <p><b>Chemical Courses</b></p> <ul style="list-style-type: none"> <li><input type="checkbox"/> Chemical Engineering</li> <li><input type="checkbox"/> Chemistry, Analytical</li> <li><input type="checkbox"/> Chemistry, Industrial</li> <li><input type="checkbox"/> Chemistry, Mfg. Iron &amp; Steel</li> <li><input type="checkbox"/> Petroleum Refining</li> <li><input type="checkbox"/> Pulp and Paper Making</li> </ul> <p><b>Civil Engineering, Architectural and Mining Courses</b></p> <ul style="list-style-type: none"> <li><input type="checkbox"/> Architecture</li> <li><input type="checkbox"/> Architectural Drafting</li> <li><input type="checkbox"/> Bridge and Building Foreman</li> <li><input type="checkbox"/> Building Estimating</li> <li><input type="checkbox"/> Civil Engineering</li> <li><input type="checkbox"/> Coal Mining</li> <li><input type="checkbox"/> Contracting and Building</li> <li><input type="checkbox"/> Highway Engineering</li> <li><input type="checkbox"/> Lumber Dealer</li> <li><input type="checkbox"/> Reading Structural Blueprints</li> <li><input type="checkbox"/> Sanitary Engineering</li> <li><input type="checkbox"/> Structural Drafting</li> </ul> | <ul style="list-style-type: none"> <li><input type="checkbox"/> Plumbing</li> <li><input type="checkbox"/> Steam Fitting</li> </ul> <p><b>Structural Engineering</b></p> <ul style="list-style-type: none"> <li><input type="checkbox"/> Structural Engineering</li> <li><input type="checkbox"/> Surveying and Mapping</li> </ul> <p><b>Communications Courses</b></p> <ul style="list-style-type: none"> <li><input type="checkbox"/> Electronics</li> <li><input type="checkbox"/> Practical Telephony</li> <li><input type="checkbox"/> Radio, General</li> <li><input type="checkbox"/> Radio Servicing</li> <li><input type="checkbox"/> Telegraph Engineering</li> </ul> <p><b>Electrical Courses</b></p> <ul style="list-style-type: none"> <li><input type="checkbox"/> Electrical Drafting</li> <li><input type="checkbox"/> Electrical Engineering</li> <li><input type="checkbox"/> Electric Light and Power</li> <li><input type="checkbox"/> Lighting Technician</li> <li><input type="checkbox"/> Practical Electrician</li> </ul> <p><b>Internal Combustion Engines Courses</b></p> <ul style="list-style-type: none"> <li><input type="checkbox"/> Auto Technician</li> <li><input type="checkbox"/> Diesel-Electric</li> <li><input type="checkbox"/> Diesel Engines</li> </ul> <p><b>Mechanical Courses</b></p> <ul style="list-style-type: none"> <li><input type="checkbox"/> Aeronautical Engineer's, Jr.</li> <li><input type="checkbox"/> Aircraft Drafting</li> <li><input type="checkbox"/> Forging</li> <li><input type="checkbox"/> Heat Treatment of Metals</li> <li><input type="checkbox"/> Industrial Engineering</li> <li><input type="checkbox"/> Industrial Instrumentation</li> </ul> | <ul style="list-style-type: none"> <li><input type="checkbox"/> Radio Operating</li> <li><input type="checkbox"/> Television</li> </ul> <p><b>Industrial Metallurgy</b></p> <ul style="list-style-type: none"> <li><input type="checkbox"/> Machine Shop</li> <li><input type="checkbox"/> Mechanical Engineering</li> <li><input type="checkbox"/> Mold-Loft Work</li> <li><input type="checkbox"/> Patternmaking—Wood, Metal</li> <li><input type="checkbox"/> Reading Shop Blueprints</li> <li><input type="checkbox"/> Sheet-Metal Drafting</li> <li><input type="checkbox"/> Sheet-Metal Worker</li> <li><input type="checkbox"/> Ship Drafting</li> <li><input type="checkbox"/> Tool Designing</li> <li><input type="checkbox"/> Toolmaking</li> <li><input type="checkbox"/> Welding—Gas and Electric</li> </ul> <p><b>Railroad Courses</b></p> <ul style="list-style-type: none"> <li><input type="checkbox"/> Air Brake</li> <li><input type="checkbox"/> Diesel Locomotive</li> <li><input type="checkbox"/> Locomotive Engineer</li> <li><input type="checkbox"/> Locomotive Fireman</li> <li><input type="checkbox"/> Locomotive Machinist</li> <li><input type="checkbox"/> Railroad Section Foreman</li> <li><input type="checkbox"/> Steam-Diesel Loco. Eng.</li> </ul> <p><b>Stationary Eng'r's Courses</b></p> <ul style="list-style-type: none"> <li><input type="checkbox"/> Boilermaking</li> <li><input type="checkbox"/> Combustion Engineering</li> <li><input type="checkbox"/> Engine Running</li> <li><input type="checkbox"/> Marine Engineering</li> <li><input type="checkbox"/> Power Plant Eng'r's</li> </ul> | <ul style="list-style-type: none"> <li><input type="checkbox"/> Mech. Drafting</li> <li><input type="checkbox"/> Ship Fitting</li> <li><input type="checkbox"/> Car Inspector</li> <li><input type="checkbox"/> Steam Engr.</li> </ul> <p><b>Textile Courses</b></p> <ul style="list-style-type: none"> <li><input type="checkbox"/> Cotton Manufacturing</li> <li><input type="checkbox"/> Loom Fixing</li> <li><input type="checkbox"/> Textile Designing</li> <li><input type="checkbox"/> Rayon Weaving</li> <li><input type="checkbox"/> Woolen Manufacturing</li> </ul> <p><b>Business and Academic Courses</b></p> <ul style="list-style-type: none"> <li><input type="checkbox"/> Accounting</li> <li><input type="checkbox"/> Advertising</li> <li><input type="checkbox"/> Bookkeeping</li> <li><input type="checkbox"/> Business Administration</li> <li><input type="checkbox"/> Bus. Correspondence</li> <li><input type="checkbox"/> Certified Public Accounting</li> <li><input type="checkbox"/> Commercial</li> <li><input type="checkbox"/> Commercial Art</li> <li><input type="checkbox"/> Cost Accounting</li> <li><input type="checkbox"/> Federal Tax</li> <li><input type="checkbox"/> Foremanship</li> <li><input type="checkbox"/> Good English</li> <li><input type="checkbox"/> Higher Mathematics</li> <li><input type="checkbox"/> Industrial Supervision</li> <li><input type="checkbox"/> Motor Traffic</li> <li><input type="checkbox"/> Retailing</li> <li><input type="checkbox"/> Salesmanship</li> <li><input type="checkbox"/> Sign Lettering</li> <li><input type="checkbox"/> Spanish</li> <li><input type="checkbox"/> Traffic Management</li> </ul> |
|---|---|---|---|

Name \_\_\_\_\_ Age \_\_\_\_\_ Home Address \_\_\_\_\_

City \_\_\_\_\_ State \_\_\_\_\_ Working Hours \_\_\_\_\_ A.M. to \_\_\_\_\_ P.M.

Present Position \_\_\_\_\_ Employed by \_\_\_\_\_

Length of Service in World War II \_\_\_\_\_

Enrollment under G.I. Bill approved for World War II Veterans. Special tuition rates to members of the Armed Forces. Canadian residents send coupon to International Correspondence Schools Canadian, Ltd., Montreal, Canada.

# INVENTORS

If you consider your invention to be something of importance — if you have invented any new and useful art, machine, manufacture or composition of matter or improvement thereof — you are advised to protect your invention by applying for a U. S. patent.

This firm is registered to practice before the U. S. Patent Office and is available to assist in the preparation and prosecution of your patent application.

The "Evidence of Invention" form mentioned below is offered as a convenience to you in making your disclosure to us for search purposes.

You should date and sign your disclosure and have it witnessed by two or more persons who are capable of understanding your invention.

Your disclosure should be mailed to us together with a letter authorizing us to conduct a preliminary search among previously granted U. S. patents for similar types of invention.

We then make this search and prepare a report of the probable patentability of your invention. If such report is favorable, we recommend the further course for you to take.

The "Evidence of Invention" form and booklet are suggested as conveniences to you and us in starting action on your invention.

VICTOR J. **EVANS & Co.** *Merlin M. Evans*  
REGISTERED PATENT ATTORNEY

640-B MERLIN BUILDING, WASHINGTON 6, D. C.

PATENTS

COPYRIGHTS

We shall be glad to send you promptly and without obligation, an instructive booklet, "Patent Protection for Inventors", which was prepared to give inventors detailed information and steps to take toward patent protection—also our convenient "Evidence of Invention" form. Use address Victor J. Evans & Co., 640-B Merlin Building, Washington 6, D. C.

## No Experience Needed To PRINT YOUR OWN POST CARDS

The GEM STENCIL DUPLICATOR saves money... gets results quickly! Hundreds of uses for every type of business and organization. We ship the GEM complete with all supplies, Guide Board for accurate printing and 60-page Book of Ideas at the special low price of only \$8.50 (a-\$15 value).

**FREE TRIAL OFFER**

Use the GEM FREE at our expense! SEND NO MONEY. Write and complete GEM outfit will be sent you postpaid. After ten days, send us only \$8.50 or return the GEM. You must be satisfied!

**BOND EQUIPMENT CO.**

Dept. 49

6633 Enright • St. Louis 5, Mo.



Our  
21st Year

## Learn PHOTOGRAPHY

There's big money in PHOTOGRAPHY—and an action-packed career for you. Our HOME STUDY COURSE is your spare-time SHORT CUT TO SUCCESS! Or, if you wish—PERSONAL ATTENDANCE TRAINING at our famous New York School is available with subsistence under the G. I. Bill. Our 41st year. Write immediately!

NEW YORK INSTITUTE OF PHOTOGRAPHY

Dept. "5," 10 West 33 Street, New York 1, N. Y.

## Learn CARPENTRY BRICK LAYING

Get into the billion dollar building trades. Learn now while opportunities are greatest. Train in our completely equipped shops under expert instructors. G.I. Approved. Enroll now. Limited Classes. Write for FREE catalog.

MIDWEST SCHOOL OF BUILDING TRADES, Dept. PS-2

411 N. Center St.

Bloomington, Ill.

## 'How to' MAKE MONEY with Simple CARTOONS



A book everyone who likes to draw should have. It is free; no obligation. Simply address **FREE BOOK**

**CARTOONISTS' EXCHANGE**

Dept. 192-A

Pleasant Hill, Ohio

## Get into Good Paying AUTO BODY and FENDER WORK



Write for  
facts

Auto-Crafts Division, **UTILITIES ENGINEERING INSTITUTE**  
2523 SHEFFIELD AVE., DEPT. XM-7, CHICAGO 4, ILL.

Big demand in Auto Body and Fender work. Start training now spare time at home for good pay work. Practical shop experience included. U.E.I. Training covers metal work, welding, painting, etc. Placement service—or we will show you how to start your own shop. Behind U. E. I. TRAINING is a large national organization founded 1927. Write today for FREE facts—no obligation.



**7 DAY FREE TRIAL**  
Return and Pay Nothing if Not Completely Satisfied



**NOW! You can easily**  
**Fix ANY Car**  
in less time -- and do a better job too!

Used by U. S. Army and Navy



"MoToR's Manual paid for itself on the first 2 jobs, and saved me valuable time by eliminating guesswork." — **W. SCHROP, Ohio**



"Instructions so clear have no trouble learning anything about any car. Now working as mechanic in big plant." — **SAM ORDONEZ, Cal.**



"I have become foreman of my garage — thanks to help of your Manual." — **ELMER HENSLER, Wisc.**

**Here's the Quick, Easy Way to Repair ANY CAR BUILT SINCE 1935. Step-by-Step Instructions by Factory Experts, Over 2100 "How-to-do-it" Pictures, Over 200 "Quick Check" Tables Make it "Easy as Pie" For Even a Beginner To Do A First-Rate Job.**

**N**O auto repair job is tough when you've got MoToR's brand-new **AUTO REPAIR MANUAL**. Shows how to save work on those "ornery" jobs. Helps you make **MORE MONEY** by doing more jobs in less time. Try this amazing book **FREE** for 7 days.

Want to fix anything from carburetor to rear end, Jeep to Cadillac, shaky '35 to shiny '50? Here's the quick, easy, *right* way — the way factory experts advise. Just look up make, model, and job in quick index — and go to it. Clear, **ILLUSTRATED** instructions lead you step by step through whole job.

**NO OTHER MANUAL LIKE IT!**

The engineer-editors of MoToR Magazine collected and "broke down" over

150 official factory shop manuals for you — spotted all the vital repair information you need — dove-tailed it all together into **ONE** handy, easy-to-understand book.

**EVERYTHING YOU'LL NEED TO KNOW**

MoToR's Manual takes nothing for granted. Starts at the very beginning; tells how to identify all 741 car models. More than 2100 easy-to-follow Photos, Drawings, Diagrams guide you step-by-step right thru each operation. Almost 750 big pages crammed with Factory Specifications and Adjustment Tables, Tune-up Charts, Tables of Measurement and Clearances, Overhauling and Replacement facts, Automatic Transmissions, New GM Rochester Carburetor, and much **MORE!**

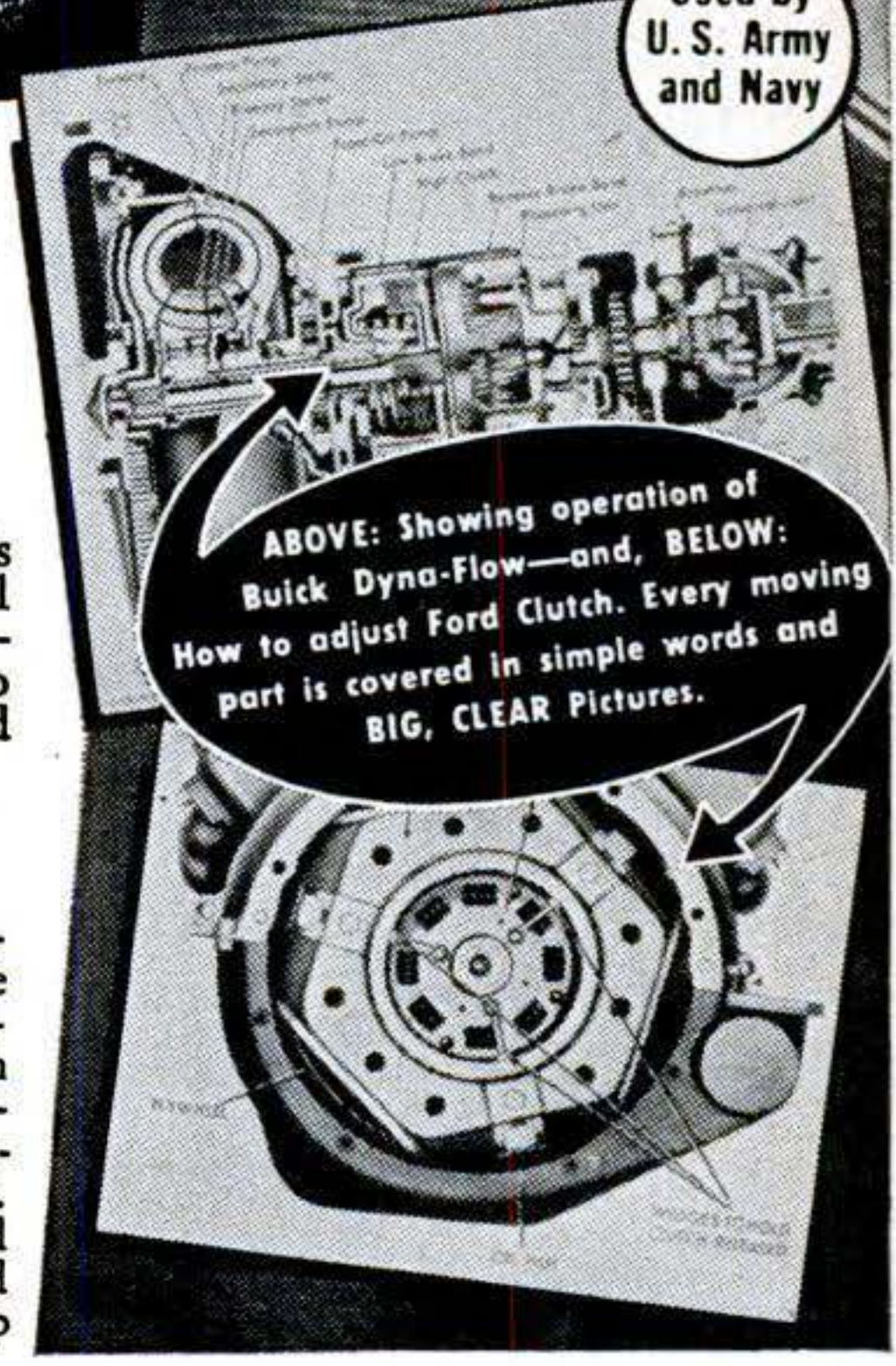

**ABOVE: Showing operation of Buick Dyna-Flow—and, BELOW: How to adjust Ford Clutch. Every moving part is covered in simple words and BIG, CLEAR Pictures.**

**COVERS ANY CAR BUILT SINCE 1935!**

- |           |           |              |
|-----------|-----------|--------------|
| Auburn    | Ford      | Mercury      |
| Austin    | Frazer    | Nash         |
| Bantam    | Graham    | Oldsmobile   |
| Buick     | Hudson    | Packard      |
| Cadillac  | Hupmobile | Pierce Arrow |
| Chevrolet | Kaiser    | Plymouth     |
| Chrysler  | Lafayette | Pontiac      |
| Cord      | La Salle  | Reo          |
| Crosley   | Lincoln   | Studebaker   |
| De Soto   | Lincoln   | Terraplane   |
| Dodge     | Zephyr    | Willys       |

**Same FREE Offer on NEW MoToR's TRUCK & TRACTOR REPAIR MANUAL**

New Edition covers EVERY job on EVERY popular make gasoline truck and farm tractor made from 1936 thru 1949! Over 1400 pictures, 961 pages, 300,000 facts. All types Gasoline Engines, Fuel Systems, Governors, Lubrication, Ignition, Starters, Generators, Clutches, Axles, Brakes and more!

For FREE 7-DAY TRIAL, check box in coupon.

**Try Book FREE 7 Days**

**SEND NO MONEY!** Just mail coupon! When the postman brings book, pay him nothing. First, make it show you what it's got! Unless you agree this is the greatest time-saver and work-saver you've ever seen—return book in 7 days and pay nothing. Mail coupon today!

Address: *MoToR Book Dept., Desk 22, 250 West 55th St., New York 19, N. Y.*

Published by MoToR, The Leading Automotive Business Magazine.

**MAIL COUPON NOW FOR 7-DAY FREE TRIAL**

**MoToR BOOK DEPARTMENT**  
Desk 22, 250 West 55th Street, New York 19, N. Y.

Rush to me at once: (Check box opposite book you want)

MoToR's New **AUTO REPAIR MANUAL**. If O.K. I will remit \$1 in 7 days, (plus 35c delivery charge), then \$2 monthly for 2 months, and a final payment of 95c a month later. Otherwise I will return book postpaid in 7 days. (Foreign price, remit \$8 cash with order.)

MoToR's New **TRUCK AND TRACTOR REPAIR MANUAL**. (Described at left.) If O.K. I will remit \$2 in 7 days, and \$2 monthly for 3 months, plus 35c delivery charge with final payment. Otherwise I will return book promptly. (Foreign price, remit \$10 cash with order.)

Print Name.....Age.....

Address.....

City & Zone No.....State.....

**SAVE 35c delivery charge** by enclosing **WITH COUPON** check or money order for full payment of \$5.95 for Auto Manual (or \$8.00 for Truck Manual). Same return-refund privilege applies.

# Oil alone won't lubricate your engine

Oil does not cling to metal. It starts to drain into the crankcase the instant you stop your engine and, after long stops, engine parts are dry. When you start, the oil pump carries oil back to moving parts. But it may take up to five minutes before oil reaches all vital parts. Meantime, your engine runs without lubrication. This DRY STARTING causes "Metal Ulcers" . . . accounts for most engine wear.

Save wear and repair—use Miracle Power regularly in your gas and oil. It protects engine surfaces with a clinging film of colloidal synthetic graphite . . . lubricates until oil takes over. Save gas and oil too—because lubricated parts move with less effort. Next time you get gas, get Miracle Power.

Miracle Power Division

THE AP PARTS CORPORATION • TOLEDO, OHIO

Manufacturers of: AP Mileage Getting Mufflers  
and Other AP Quality Products

# Miracle Power

in gas and oil every  
1000 miles—75c per can

If your dealer is out of Miracle Power,  
send \$1.50 for 2 trial containers.  
Prove its value in your car.



THE AP PARTS CORPORATION  
271 AP Building, Toledo 1, Ohio

I want to prove the benefits of Miracle Power myself. Enclosed is  check  money order for \$1.50. Please send me 2 trial containers of Miracle Power.

NAME \_\_\_\_\_

ADDRESS \_\_\_\_\_

CITY \_\_\_\_\_ ZONE \_\_\_\_\_ STATE \_\_\_\_\_

MY DEALER'S NAME \_\_\_\_\_

MY DEALER'S ADDRESS \_\_\_\_\_

# MAKE YOUR OWN!

WITH

## Griffin READYCUT LEATHER PROJECTS

Over 100 KITS in every kind of Tooling and Carving Leather, accurately cut, all parts included. Only Top Grade Leathers used. You do the choosing. You do the tooling, carving, stamping, the punching and assembling.



SEND 25c FOR  
COMPLETE CATALOG  
116 pages, shows  
all hand craft supplies.  
25c refund with first order.

OUT OF THE WEST, THE HOME OF LEATHER CARVING

## Griffin CRAFT SUPPLIES

Since 1924 • 5626-B TELEGRAPH AVE.  
OAKLAND 9, CALIFORNIA

## EVERYTHING FOR THE LEATHER WORKER

Largest, most complete stock of  
Leathercraft Tools and Accessor-  
ies in U.S.A.



HIDES AND  
SKINS of Craft  
Leathers of every  
kind if you prefer  
to cut your own.



## Learn Watch Repairing

This highly skilled, well paid trade offers unusual opportunities today. Watch repair men are in great demand for repairing watches and for working with the many new, delicate instruments of industry and re-armament. Study at G.I. approved resident school or by low-cost, home study course in your own home. Thorough training. Catalog free. Write Dept. C-21 today.

AMERICAN INSTITUTE OF SPECIALIZED WATCH REPAIR  
1012 Franklin Southeast Grand Rapids 7, Mich.



## MECHANICAL DENTISTRY

To make Crowns, Plates, Bridgework, etc., for Dentists. Easy practical way to learn mechanical dentistry at home in spare time. FULL EQUIPMENT OF TOOLS AND MATERIALS INCLUDED WITH COURSE. Low tuition. Easy

terms. Write for FREE BOOK about this money making profession that is not affected by the machine age.

McCARRIE SCHOOL of Mechanical Dentistry  
207 N. Broad Street Dept. 908 Philadelphia, Pa.



## ILLUSTRATED COMIC BOOKLETS

THE KIND MEN LIKE!  
(VEST POCKET SIZE)

They are loaded with rare cartoons. Full of Fun and Humor. 20 DIFFERENT booklets sent prepaid for \$1 in plain sealed wrapper. No C.O.D.'s.

GRAYKO, Dept. 2129, Box 520, G.P.O., N.Y.C. 1



IS YOUR FUTURE WORTH 1¢?  
that's all it costs to find out about  
correspondent courses in

## FREIGHT TRAFFIC MANAGEMENT

\$60 a week is the average starting salary . . . others earn up to \$20,000 a year in this uncrowded field.

Courses: General, Advanced, Air Freight, Export and Import, Motor Carrier. Practical training given as well as theory — by men daily engaged in Traffic Management. Get the facts today.

Send a penny card for FREE BOOKLET  
Co-educational Veterans Inquiries Invited

RESIDENT CLASSES: Hartford, Bridgeport, Trenton, Rochester, New Haven, Buffalo, Erie, Baltimore.

## TRAFFIC MANAGERS INSTITUTE

154 Nassau Street, New York  
Branches: 294 Washington St., Boston, Mass.; 10 South 18th St., Phila., Pa.

GET INTO

# DIESEL-AUTO MECHANICS

Master *All Phases*

**JOBS LIKE THESE ARE AVAILABLE TO TRAINED MECHANICS. CHOOSE THE FIELD YOU LIKE BEST**

### Get Complete Training

- Diesel Fuel Injection
- Automotive Motor Tune-up
- Diesel Engine Rebuilding
- General Garage Mechanic
- Agricultural Implements
- Auto Engine Rebuilding
- Auto Elec. Service
- Public Utilities
- Parts Dealers
- Bus & Truck Lines
- Industrial Maintenance
- Contracting & Excavating
- Business of Your Own
- AND MANY other similar openings.

As a National Schools graduate, you are trained for ALL opportunities in the Diesel & Auto Industries.

### EARN WHILE YOU LEARN

With our practical Master Shop-Method Home Training, you study at home in your spare time. You receive Spare Time Work Lessons, which show you how to earn while you Learn... for extra money and experience. You Learn by DOING.

### TOOLS AND EQUIPMENT

To make your training complete, we give you selected mechanic's tools and equipment, illustrated below, including all-metal tool-box—as a regular part of your instruction.



### Shop-Method Home Training by an Established Resident School Prepares you for Many Good Jobs

Opportunity is everywhere for the trained Diesel - Auto Mechanic. Highways throng with cars, busses, trucks tractors. Garages and Service Stations are kept busy. Factories, ships, farms, railroads, general industry, are dependent upon engine power. Here's a dynamic, fast - growing field that needs trained men who know ALL phases: installation, operation, maintenance and repair. Now—National Schools offers you a practical, all-embracing Diesel-Auto Mechanic's Course, including all of these advantages:

**Complete training, covering—Diesels, High Speed and Heavy Duty; Semi-Diesels, Gasoline and Special Fuel Engines AND Allied Mechanics.**

- Basic Lesson Texts
- Diesel Installation
- Operation—Maintenance
- Diesel Chart Manual
- Spare Time Lessons
- Engine Service Manuals
- Engine Repair
- Drive Systems
- Diesel Electric Power
- Thermodynamics

### TOOLS AND EQUIPMENT INVESTIGATE

Secure Full Information

**NEW, ILLUSTRATED BOOK & SAMPLE LESSON SHOW HOW WE TRAIN YOU... SEND FOR THEM TODAY!**

**NO COST NO OBLIGATION**

**APPROVED FOR VETERANS**

Check coupon below

**WE GIVE YOU TOOLS OF YOUR TRADE**

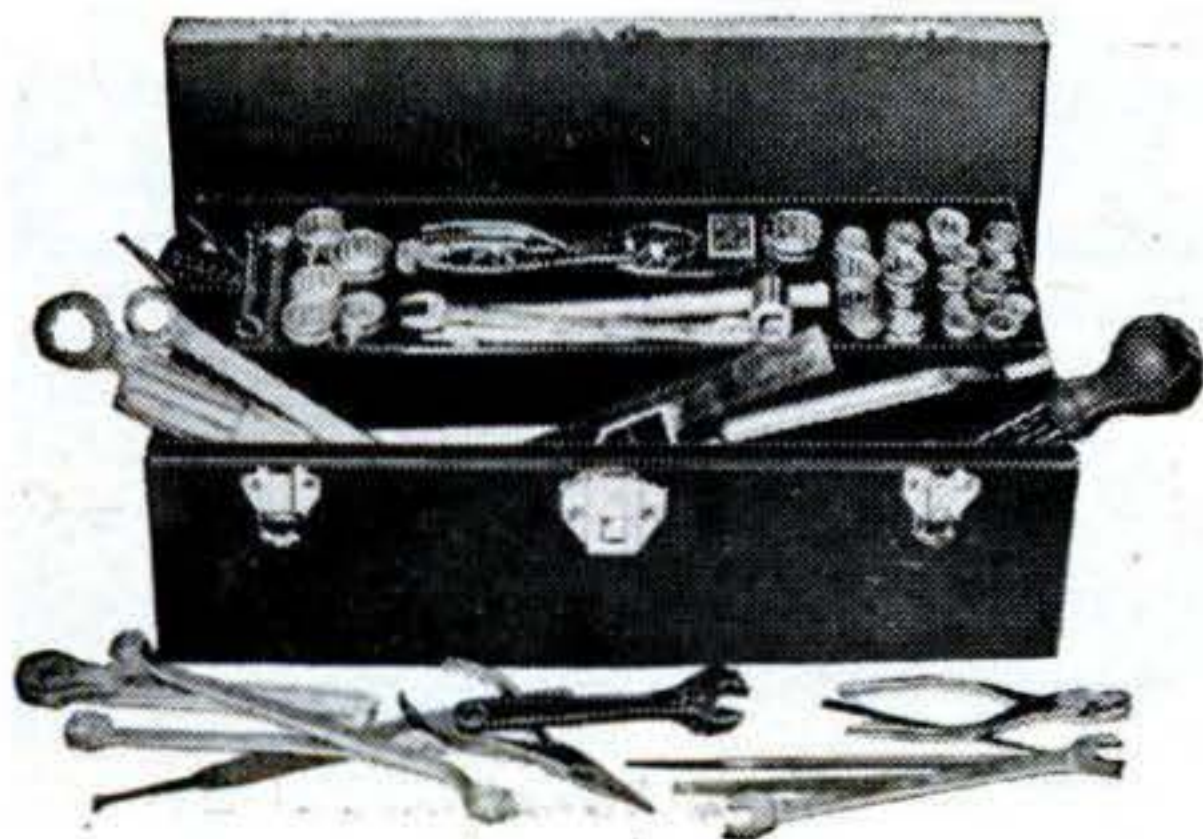

## NATIONAL SCHOOLS

LOS ANGELES 37, CALIF. • EST. 1905



### FIND OUT NOW... MAIL COUPON TODAY

NATIONAL SCHOOLS, Dept. 2-PSD

4000 South Figueroa Street  
Los Angeles 37, California

(Mail in envelope or paste on penny postcard)

Mail me FREE the book, YOUR FUTURE IN DIESEL-AUTO MECHANICS, together with the Sample Lesson. I understand I may keep and use the information with no obligation.

Name..... Age.....

Address.....

City..... Zone... State.....

Check here if Veteran of World War II

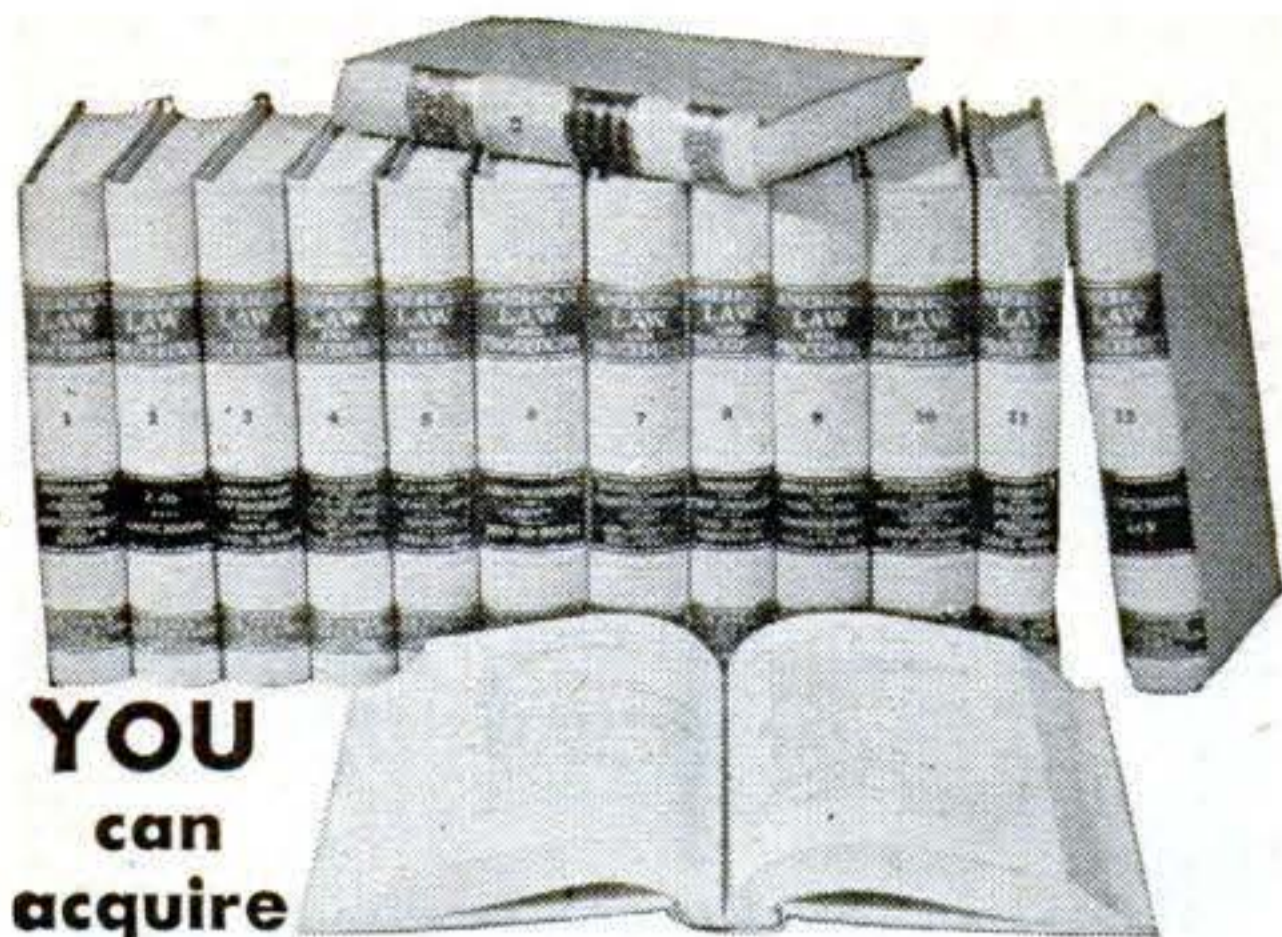

**YOU  
can  
acquire**

**LAW NIGHTS AT HOME!  
L. L. B. DEGREE**

LaSalle's famous Law Library—used as reference in many Law libraries and Law offices—has enabled thousands to master Law surprisingly fast, in spare hours at home, for business and professional advancement.

These 14 remarkable volumes, compiled by leading professors and lawyers, cover the whole basic field of Law in condensed, orderly, simplified manner.

You advance rapidly with this great library, plus special lectures furnished. We guide you step-by-step with personalized Problem Method of instruction . . . you learn by doing—handling legal problems—not by memorizing rules.

Send for two FREE 48-page booklets, "Law Training for Leadership," and "Evidence," answering questions about Law and its value to you, and telling how LaSalle Law graduates are winning rapid advancement in business and public life. Mail coupon below. No obligation.

**LA SALLE EXTENSION UNIVERSITY**  
*A Correspondence Institution*

417 S. Dearborn St. Dept. 283-L Chicago 5, ILL.

Send me your two FREE booklets described above, without obligation.

Name.....Age.....  
Street.....  
City, Zone & State.....

**INVENTORS**

Before you make any effort to market your invention, you should take the first steps toward proceeding for patent protection.

The usual first step is to have a search of the U. S. patent records conducted, so that I can report to you on the question of patentability.

I shall be pleased to furnish you with information relative to patent procedure upon request from you, and this will be without any obligation on your part.

**PATRICK D. BEAVERS**  
(Formerly RANDOLPH & BEAVERS)  
*Registered Patent Attorney*

937 Columbian Building, Washington 1, D. C.

**CAN A MAN MY AGE  
BECOME A HOTEL EXECUTIVE?**

**YES!**

"Answered Lewis ad, now hotel manager."—  
*L. M. Mueller*



**YES!**

"Now assistant club manager, thanks to Lewis."—*C. B. Corley*



The success of Lewis Graduates proves you can qualify for fascinating hotel, club and travel field. Opportunities everywhere for both young and mature. Previous experience proved unnecessary. Train in spare time at home. Nation-wide Placement Service FREE of extra charge. Write for free book, "Your Big Opportunity."

**Lewis Hotel Training School**  
Desk TB-2703, Washington 7, D. C.

**Write Today for FREE BOOK**

**PATENTS PATENT  
LAWYER**

**GUSTAVE MILLER**

REGISTERED PATENT ATTORNEY

PS-21 WARNER BLDG.  
WASHINGTON 4, D. C.

ASSOCIATE EXAMINER  
U. S. PATENT OFFICE 1922-1929  
PATENT ATTORNEY & ADVISOR  
U. S. NAVY DEPT. 1930-1947

Send for PATENT INFORMATION  
Book and "INVENTOR'S RECORD"  
without obligation.

**PATENTS**  
**C. A. SNOW & CO.**  
REGISTERED PATENT ATTORNEYS  
WRITE FOR INFORMATION TO  
426 SNOW BUILDING, WASHINGTON 1, D. C.

**INVENTORS**

Whether an invention is patentable can be substantially determined by a search of the U. S. Patent records. Without obligation, write for information explaining the steps you should take to secure a patent.

**JOHN N. RANDOLPH**

*Registered Patent Attorney*

205 Columbian Building Washington 1, D. C.

**HELP FOR INVENTORS**

Hundreds of manufacturers have requested our assistance in locating marketable new products.

Complete Information, free.

**INSTITUTE of AMERICAN INVENTORS**

Dept. 3, 631-E St., N.W., Washington 4, D. C.

**INVENTORS**

IF YOU WISH TO PROTECT YOUR INVENTION, You should take steps to protect it by a U. S. Patent. Write me for "RECORD OF INVENTION" form.

**CARL MILLER**  
REGISTERED PATENT ATTORNEY

WOOLWORTH BLDG., 35th FLOOR, 21-C  
NEW YORK CITY





**TO HELP YOU PREPARE FOR  
ONE OF THE BETTER JOBS  
IN BUSINESS or INDUSTRY**

**You can take subjects which have *Real Job Value*  
and still earn graduation!**

• This is your opportunity to make completion of high school *work* for you. Your AMERICAN SCHOOL home study course can include high school subjects closely related to your present job or the kind of work you want to do later. Not only can you qualify for your high school course diploma but you can benefit from course subjects that will aid greatly in winning promotions.

**50 Job Help Subjects  
from Which to Choose**

Our FREE, 44-page book of detailed information lists 100 high school subjects, of which 29 are technical and 21 are commercial. Whether you work in a shop, factory, garage or office you will find subjects of practical benefit in your climb toward better jobs at better pay. Some of these are Blueprint Reading, Mechanical and Machine Drawing, Tool Making, Foundry Work, four Automotive subjects, Electricity, Carpentry—and Bookkeeping, Accounting, Secretarial Practice, Office Machines, Salesmanship.

**Turn Spare Time Into Money**

During more than 50 years American School has helped thousands to reach higher job goals by profitable use of spare time at home—and it can help *you*. Others have prepared for college entrance. If you have not completed high school, check that subject on the coupon below, add your name and address and mail it *right now*. Or if you are a high school graduate and are ambitious to succeed in the vocation of your choice, check that subject. Your coupon will bring you the book of information, without obligation of any kind. Mail it *now*.

**HOME - STUDY TRAINING SINCE 1897**

**Take This First Easy Step**

**CHECK, CLIP AND MAIL COUPON NOW**

**AMERICAN SCHOOL, Dept. G246, Drexel at 58th, Chicago 37, Ill.**  
*Without obligation, please send me FREE information on training course checked below.*

<input type="checkbox"/> HIGH SCHOOL COURSES	<input type="checkbox"/> Bookkeeping	<input type="checkbox"/> Plastics Engineering
<input type="checkbox"/> Accounting	<input type="checkbox"/> Business Management	<input type="checkbox"/> Plumbing—Practical
<input type="checkbox"/> Air Conditioning	<input type="checkbox"/> Contracting	<input type="checkbox"/> Private Secretary
<input type="checkbox"/> Architecture & Building	<input type="checkbox"/> Diesel Engineering	<input type="checkbox"/> Radio Operating & Servicing
<input type="checkbox"/> Automotive Engr.	<input type="checkbox"/> Drafting & Design	<input type="checkbox"/> Railway Training
<input type="checkbox"/> Aviation—Practical	<input type="checkbox"/> Electrical Engineering	<input type="checkbox"/> Refrigeration
<input type="checkbox"/> Aviation Drafting & Design	<input type="checkbox"/> Electricity—Practical	<input type="checkbox"/> Sheet Metal Pattern Drafting
<input type="checkbox"/> Better Foremanship	<input type="checkbox"/> Electronics, Industrial	<input type="checkbox"/> Shop Management
	<input type="checkbox"/> Machine Shop Operations	<input type="checkbox"/> Tool Making
	<input type="checkbox"/> Mechanical Engineering	

**AMERICAN SCHOOL**  
Dept. G246, Drexel at 58th Street, Chicago 37

Name \_\_\_\_\_ Occupation \_\_\_\_\_  
Address \_\_\_\_\_ Age \_\_\_\_\_  
City & Zone \_\_\_\_\_ State \_\_\_\_\_

# EARN MORE IN DRAFTING



**MORE OPPORTUNITIES for EMPLOYMENT and PROMOTION**

"Here I am at work making good money as a draftsman. I'm glad I sent the coupon to Chicago Tech for that Free Trial Lesson and found out how easy it is to learn Drafting in spare time at home. Today I feel secure in my job because the draftsman's work comes first on any new project. And, in addition, draftsmen can't be replaced with machines. What's more, I feel I'm slated for promotion and more pay, because I see so many draftsmen advancing to high-pay jobs."

## LEARN IN SPARE TIME—AT HOME!

(or at the College in Chicago)

A few hours of pleasant home study every week—that's all. No interference with your present job. All the tools you need; drawing outfit included. With Chicago Tech's help, you train yourself step by step. This tested method—developed over 46 years of C.T.C. progress—prepares men quickly for good positions in industry.



### FREE INFORMATION — SEND COUPON

To prove to you how easy it is to learn Drafting at home by the Chicago Tech method, we will send you this FREE TRIAL LESSON. No charge for this lesson, now or later. Fill out and mail coupon, or send post card today.

## CHICAGO TECHNICAL COLLEGE

B-228 Tech Bldg., 2000 So. Michigan Ave., Chicago 16, Illinois

Mail me FREE Lesson with information about big opportunities in DRAFTING.

Name..... Age.....

Address.....

City..... Zone... State.....

# SHORTHAND IN 6 WEEKS AT HOME

Write 120 Words Per Minute

AGE NO OBSTACLE

Famous Speedwriting System. No signs; no symbols; no machines. Uses ABC's. Easy to learn and use. Fast preparation for a position and a sound future.

Nationally used in leading offices and Civil Service; also by executives, speakers, writers, lawyers, students at college, scientists. Over 100,000 taught by mail. The very low cost will surprise you. Also class-room instruction and typing. 28th Year.



Speedwriting was as easy to learn as their ad claimed, and I did so in 40 hours of study. I was able to go out and secure a new job with more money and better opportunities." — Miss Ruth E. Rubinow, Norwalk, Conn.

Write for Free Booklet to

**Speedwriting**  
Dept. 2602-1, 55 W. 42d St. N.Y. 18



WRITTEN GUARANTEE SENT WITH EVERY TIRE YOU BUY

PLEASE NOTE: Our Tires are NOT Re-Treaded or Re-Capped We serve TRUCKS — BUSES — PASSENGER CARS

GOOD USED TIRES

WE PERSONALLY SELECT YOUR TIRES A TRIAL OF ONE TIRE WILL CONVINCE YOU.

ONE QUALITY ONE PRICE OUR BEST!

*Why Pay More!*

SEND CHECK OR MONEY ORDER IN FULL WITH THIS AD NOW — AND YOU MAY TAKE **20%** DISCOUNT ON EVERY TIRE SAVE TIME & MONEY ALSO TUBE GIVEN WITH EACH PASSENGER & TRUCK TIRE AT NO EXTRA COST — SEND THIS AD!

550-15	\$6.40	670-15	\$7.00	710-15	\$7.75	760-16	\$8.45
600-16	6.40	700-15	7.75	750-16	8.40	820-15	8.50
650-15	6.50	700-16	6.95	750-17	10.95	825-18	6.50
650-16	6.60	700-17	10.00	760-15	7.75	550-17	6.50



600-20	\$10.90	32x6(8)	\$12.50	1000-20	\$20.40
650-20	11.50	32x6(10)	14.65	1100-20	20.40
700-20(8)	12.50	825-20	19.40	1000-22	20.40
750-20	15.00	900-20	19.40	1100-22	20.40

Thousands of tires shipped all over U.S.A. All tires shipped F.O.B. Phila. Send Check or M.O. with this ad. Dept. 5. If your size is not listed write for prices. 17 YEARS AT THIS ADDRESS.

STANDARD 834 N. Broad St., Philadelphia 30, Pa.

# STUDY AT HOME

WITH AN EDUCATIONAL INSTITUTION

**Courses in ENGINEERING:** Electrical, Civil, Mechanical, Drafting, Architectural, Automotive, Steam, Diesel, Aeronautical, Radio, Structural, Mining, Industrial, Petroleum, Marine, Refrigeration, Air Conditioning, Chemical.

**Courses in ARTS AND SCIENCES:** Philosophy; Education; Letters; Public Health; Medical Jurisprudence; Psychology; Sociology; Physics; Chemistry; Geology; Pol. Science; Theology; Law; Business and Commerce; Accounting; Mathematics; Statistics; Agriculture. Send for free catalog.

McKinley-Roosevelt Incorporated, 4610-A3, Sheridan Rd., Chicago 40, Illinois

## Learn BAKING at home

Baking is one of America's high industries in wages. Not seasonal, but year 'round good field for trained and experienced men. Thorough basic spare time home study course lays solid foundation. If you have the aptitude for this type of work, send for FREE Booklet, "Opportunities in Commercial Baking."

NATIONAL BAKING SCHOOL

835 Diversey Parkway, Dept. 1362, Chicago 14, Ill.



# LEARN AT HOME LOCKSMITHING

YOU CAN EARN BIG MONEY ALL YEAR ROUND IN FULL OR SPARE TIME!

Locksmiths are always in big demand! Age or physical handicap is no disadvantage in this respected, permanent field. Learn how to make keys, fix locks, make duplicates, etc. Practical, illustrated lessons by experts show you how! All materials and special tools supplied. Send for FREE booklet.

LOCKSMITHING INSTITUTE, Dept. PS-14  
55 Park Ave., Rutherford, N. J.  
Licensed & Approved by State of New Jersey

# Free for Asthma

If you suffer with attacks of Asthma and choke and gasp for breath, if restful sleep is difficult because of the struggle to breathe, don't fail to send at once to the Frontier Asthma Company for a FREE trial of the FRONTIER ASTHMA MEDICINE, a preparation for temporary symptomatic relief of paroxysms of Bronchial Asthma. No matter where you live or whether you have faith in any medicine under the sun, send today for this free trial. It will cost you nothing.

FRONTIER ASTHMA CO.  
462 NIAGARA ST.

24-H FRONTIER BLDG.  
BUFFALO 1, N. Y.

# Earn Big Money

## WRITING ORDERS

# AMAZING NYLONS

*Guaranteed Against*  
**RUNS AND SNAGS**

*Regardless of Cause!*

The world's **ONLY** complete, nationally advertised nylon hosiery line actually guaranteed against runs, snags or excessive wear, **REGARDLESS OF CAUSE!** It's amazing, but true! No matter what the cause—hard use or deliberate abuse—Kendex nylons are replaced **FREE** if they run, snag or become unfit for wear within entire guarantee period! Every weight from sheerest 15 denier to heavy 70 denier—all gauges up to luxury 60 gauge—all sizes, lengths, popular shades, fancy heels, black seams—full fashioned and seamless. Nothing is missing to make sure every woman is pleased. In spite of the amazing guarantee, retail postage prepaid prices are no higher than comparable quality national brands. Should free replacement be necessary, actual cost is cut in half! How could any woman possibly resist saving money and solving her hosiery problems? **NOT SOLD IN STORES.** Men and women wanted **NOW**, spare or full time, to write orders and earn big money. You can get orders even if you never sold a thing in your life!

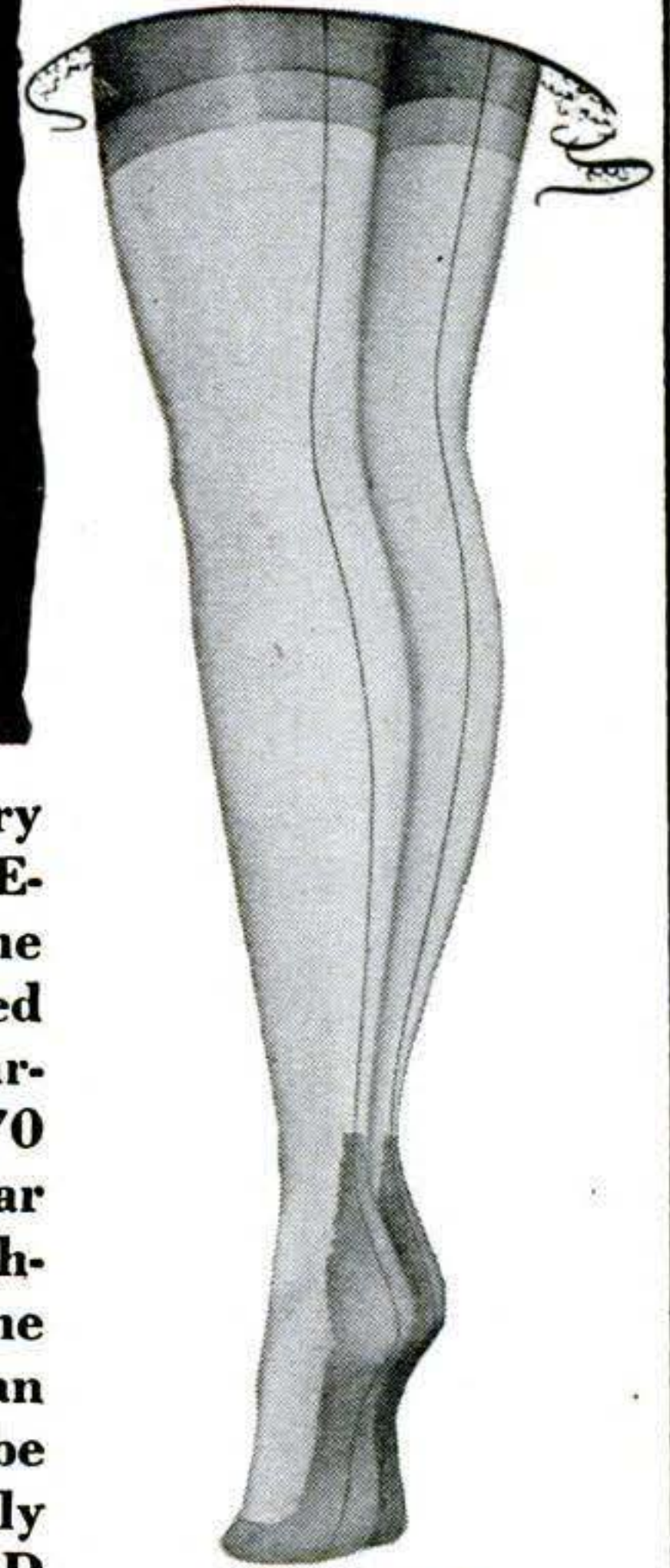

# FREE SAMPLE STOCKING

Man or woman—young or old, **YOU** can easily earn steady income, spare or full time. No money or experience needed. We supply **EVERYTHING** free and set you up in business at **OUR** expense. Nothing to buy or deliver. Write orders. We deliver and collect. Big advance pay plus huge cash bonus that increases your earnings up to **40%**! Your name and address on postcard will bring you sample stocking; self-selling sales books with **FULL COLOR** illustrations; 32-page sales manual showing you easy steps to success; color cards, free “door openers” worth \$1 each but which you give away free; special plan to have others sell for you, etc., etc. You can start making money the minute you receive the complete **FREE** outfits!

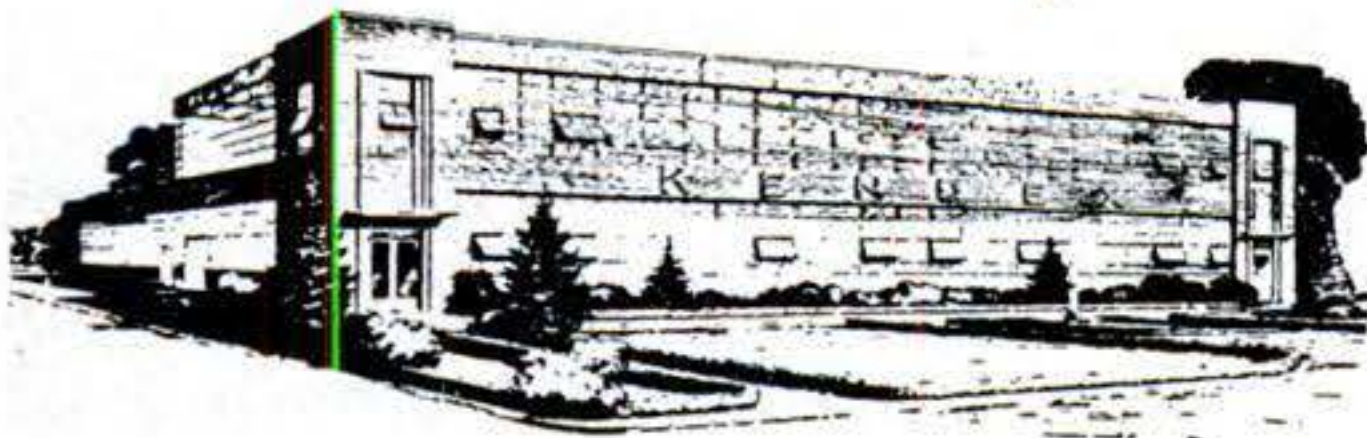

**YOUR COST ONE CENT!**

**SEND NO MONEY.** Pay nothing now or later. No obligation. Not even a promise to return outfits. Simply write your name and address on a penny postcard and mail to us. We'll immediately rush you everything you need **FREE** and postage prepaid. **WRITE TODAY!**

**KENDEX CORPORATION • BABYLON 949 N. Y.**

# Yes, More Brilliant Than a Diamond!



## Amazing New Discovery

Write today for the **FREE** illustrated booklet that tells the full story of the latest miracle of science—the story of a glorious jewel discovered in the laboratories of one of the world's largest corporations. Read all about the Kenya Gem that so closely resembles a diamond that only an expert can tell the difference.

## More Fire! More Brilliance!

Yes, this marvelous gem has more brilliance, more fire and a more dazzling display of color than the finest diamond of equal size. You can own an unmounted Kenya gem for only \$27 (1 carat) to \$120 (4 carats); also men's distinctive rings and ladies' fashionable rings and earrings in 14K gold set with expertly cut Kenya gems. **EASY PAYMENT TERMS.**

## The Cinderella of Science

Kenya gems are the sensational discovery you read about in Reader's Digest, Popular Science and Sat. Eve. Post, "the only thing on earth more brilliant than a diamond." It is a true gem, crystallized by science instead of nature.



Copyright 1950  
Kenya Gem Corp.

Write Today or Send Coupon  
for **FREE** Illustrated Booklet

**KENYA GEM CORPORATION, Dept. 302**  
Philadelphia 44, Pa.

— Mail This **FREE** Coupon Today —

Kenya Gem Corporation, Dept. 302 Philadelphia 44, Pa.  
Please send me, without obligation, the **FREE** illustrated booklet telling all about Kenya Gems.

Name .....

Address .....

City .....

State .....

# LAW FREE BOOK



Your **FREE** copy of "The Law-Trained Man" shows how to gain prestige and greater earnings through Blackstone home law study. All instruction material furnished including 18-volume Law Library written by 65 well-known law authorities. Lawyers, judges among our graduates. LL.B. degree. Low cost; easy terms. Write today.

**BLACKSTONE COLLEGE OF LAW** Dept. 122 Chicago 1, Ill.  
225 N. Michigan Ave.  
A Correspondence Institution Founded in 1890

## LEARN NEON TUBE BENDING AND NEON SIGN FABRICATION



Prosperous neon sign and fluorescent lighting industries urgently need well-trained men to fill top-paying jobs. Learn luminous tube bending and installation at the school whose skilled graduates are sought by leading neon shops throughout the nation. Thorough 15-month GI-approved courses, best professional equipment. Write for illustrated Catalog "PS" today.

## GENERAL INDUSTRIAL TRAINING INSTITUTE

130 SOUTH SEVENTH ST.

STUEBENVILLE, OHIO

34 POPULAR SCIENCE



## Gasoline Engine Generators: HOMELITE

Gasoline Engine Generator—30 Volt DC (Direct Current) 50 ampere (1500 Watts) generator driven by single cylinder, two cycle air-cooled gas engine approx. 3 HP. Rope or electric starting. From unused Govt. vehicles, reconditioned. Shipping Wt. **\$59.50**  
150 lbs. Order No. 112.....

**HOMELITE GAS ENGINE GENERATOR**—Same as above except produces 2000 Watts. **\$79.50**  
Order No. 212.....

## GILBERT DRILL SET

**BIG VALUE Gilbert Drill Set**—Complete with 1/4" electric drill and 20 attachments. One compact set ideal for drilling, grinding, mixing, sanding, polishing, waxing, shaping, burring, etc. Drill has Universal 110 volt AC-DC motor, 1400 RPM no load speed, steel hobbled gears; 1/4" chuck; 16 to 1 gear reduction and toggle switch. A few of the 20 attachments include wood and metal drills, mounted grinding wheel, burr, buffer, screw-driver, etc. Set comes complete in metal chest size 13 1/8" x 7 1/8" x 3 1/4". Shpg. **\$16.95**  
Wt. 8 lbs. Order No. 312.....

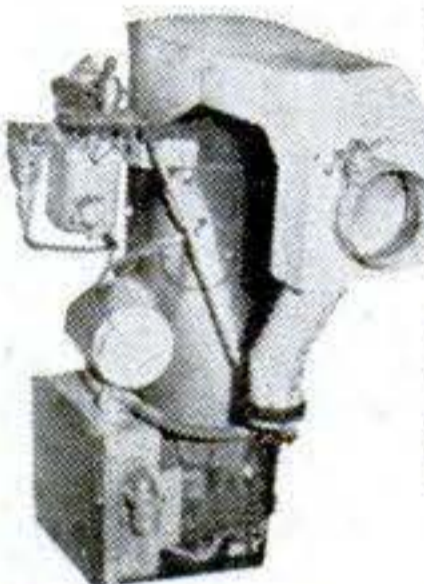

**HEATER UNIT**—Gasoline or oil forced air heater used to pre-heat tank engines. Easily adapted to other uses. Operates from 24 Volt DC (Direct Current only) source. Has electric igniter, thermostat control, forced air blower, autopulse electric fuel pump. Approx. 35,000 BTU. Size: 26" H x 12" W x 10" D. Removed from unused Govt. vehicles. Shpg. Wt. **\$29.95**  
approx. 65 lbs. Order No. 412

Prices F.O.B. Lima • 25% Deposit  
With Order—Balance C.O.D.

**FAIR SALES** 132 SOUTH MAIN ST.  
LIMA, OHIO

## \$100 "MIRACLE" CAMERA

can be Yours for **\$3.95**  
Only



Make your own High-Speed Camera—  
Enlarger—Slide Projector—Movie Film  
Viewer—Shadowgraph—Burglar Alarm  
Lights—Engraving Spot—Telescope—Signal  
Light—Magnifier—Code Blinker Light.

ALL OF THESE and many more useful things can be made with this fine precision made piece of optical equipment.

Contains color corrected anastigmat lens 2 1/4 inches in diameter, 5 1/2 inch focal length. Cast Aluminum Case, Water-Tight Cover Glass, Front Surface Reflecting Mirror, Reticle, Lamp Socket, 28-Volt Lamp Bulb, Bull's-Eye, etc. Booklet of instructions showing how to make many of the above items included. This offer may never be repeated. Shipped Postpaid. Rush check or money order today to

**ELECTRONIC PRODUCTS CO., Dept. PS-1, St. Charles, Ill.**

## Rupture Troubles Ended

Advanced method has healed thousands. No leg straps, no elastic, no plasters. No pressure on hips or spine. Flexo-pad. Entirely different. Endorsed by doctors, mechanics, clerks. Very light. **INEXPENSIVE. GUARANTEED.** Write for information and trial.

**SMITH MANUFACTURING COMPANY**  
EST'D 1893 Dept. PS, Preston, Ont. Can.

## MODEL BUILDERS!

### NEW 1951 CATALOG

MODEL AIRPLANE ENGINES • GLOW  
PLUGS • MARINE ENGINES • FUELS  
MODEL RACERS • ACCESSORIES



CUT OUT AND MAIL TODAY

**OHLSSON & RICE, INC.**  
3340 Emery St.,  
Los Angeles 23, California

Please RUSH \_\_\_\_\_ copies of the NEW 1951 O&R Catalog at 15c each for which I am enclosing \_\_\_\_\_ in stamps or coins to cover handling and mailing.

Name \_\_\_\_\_  
Address \_\_\_\_\_  
City \_\_\_\_\_ Zone \_\_\_\_\_ State \_\_\_\_\_



# BE AN ARTIST

Here's the Amazing Way You Learn to Draw  
— Step by Step — at Home in Spare Time

**DRAW FOR MONEY**

### TWO BIG ART OUTFITS GIVEN

Upon enrolling, we send you the first of TWO complete Artists' Outfits, including all the material you need to start this fascinating training. Later in the course you receive the second, advanced outfit. All at no extra cost!

### Read What These Graduates Say:

**TRAINING PAYS OFF**—Fred B. Chott of Cicero, Illinois, says, "I have turned your teaching into profit very quickly." (1-49)

**STAFF ARTIST AND CARTOONIST**—G. W. Thomas, Los Angeles newspaper artist, says, "WSA is Number One School in U. S. A." (1-48)

### FREE BOOK GIVES DETAILS

"Art for Pleasure & Profit" tells about our course of instruction and commercial opportunities for you—also about WSA students, reproductions of their artwork, and results enjoyed by our graduates.

**G. I. APPROVED FOR VETERANS** Est. 1914



Enjoy a pleasant, profitable Art career. **COMMERCIAL ART, DESIGNING, CARTOONING**—all in one complete, modern home study course. Trained Artists are capable of earning \$65, \$80, \$100 and more a week. Good Art positions await you in this great field. Become your own boss—work at home on your own time. Many students earn extra money while learning by designing posters, doing simple artwork, lettering, etc. WSA is now in its 37th year of training successful men and women. No previous Art experience necessary. We teach you from the beginning. Qualify for professional Art jobs in advertising, television, newspaper and magazine publishing, department stores, printing, art studios, etc. Get the exciting facts now in free, illustrated book. Low cost, easy terms.

### MAIL COUPON FOR FREE BOOK



**WASHINGTON SCHOOL OF ART**  
Studio 132-A Washington 5, D. C.

Send me without obligation your Free Book, "Art for Pleasure & Profit", with full information. No salesmen will call. (Please print).

Name..... Age.....

Address.....

City..... Zone..... State.....

I am entitled to training under G. I. Bill.

**WASHINGTON SCHOOL OF ART**

# WANTED! DRAFTSMEN!

LEARN THIS BIG PAY PROFESSION  
AT HOME IN YOUR SPARE TIME

The need for more skilled draftsmen continues to grow. Essential jobs await trained draftsmen in every major industry. The war emergency has increased an existing shortage. Machines will never replace the draftsman. Before production can start plans must be drawn. Draftsmen are the first to be hired. Drafting is light, pleasant work, in pleasant surroundings and leads to top managerial position.

### CTS OFFERS NEW TRAINING PROGRAM

A program that teaches you the hows and whys of production planning while studying at home. You learn by making actual drawings. CTS sends you a set of professional drafting instruments, portable drafting table, drafting supplies, etc., everything you need at no extra cost.

EVERYTHING  
IN THE  
FIELD  
OF

• ARCHITECTURE •  
ELECTRONICS • MACHINERY

### MAIL COUPON FOR FREE BOOK !

**CHRISTY TRADES SCHOOL, Dept. D-9901**  
4432 N. Kedzie Ave., Chicago 25, Ill.

Mail me at once your big FREE book on Drafting and Blue Printing. How your Home Training and Professional Drafting Instruments, Equipment, etc. can be had on PAY AS YOU LEARN PLAN.

NAME..... Age.....

ADDRESS..... CITY..... STATE.....

# WORK FOR THE

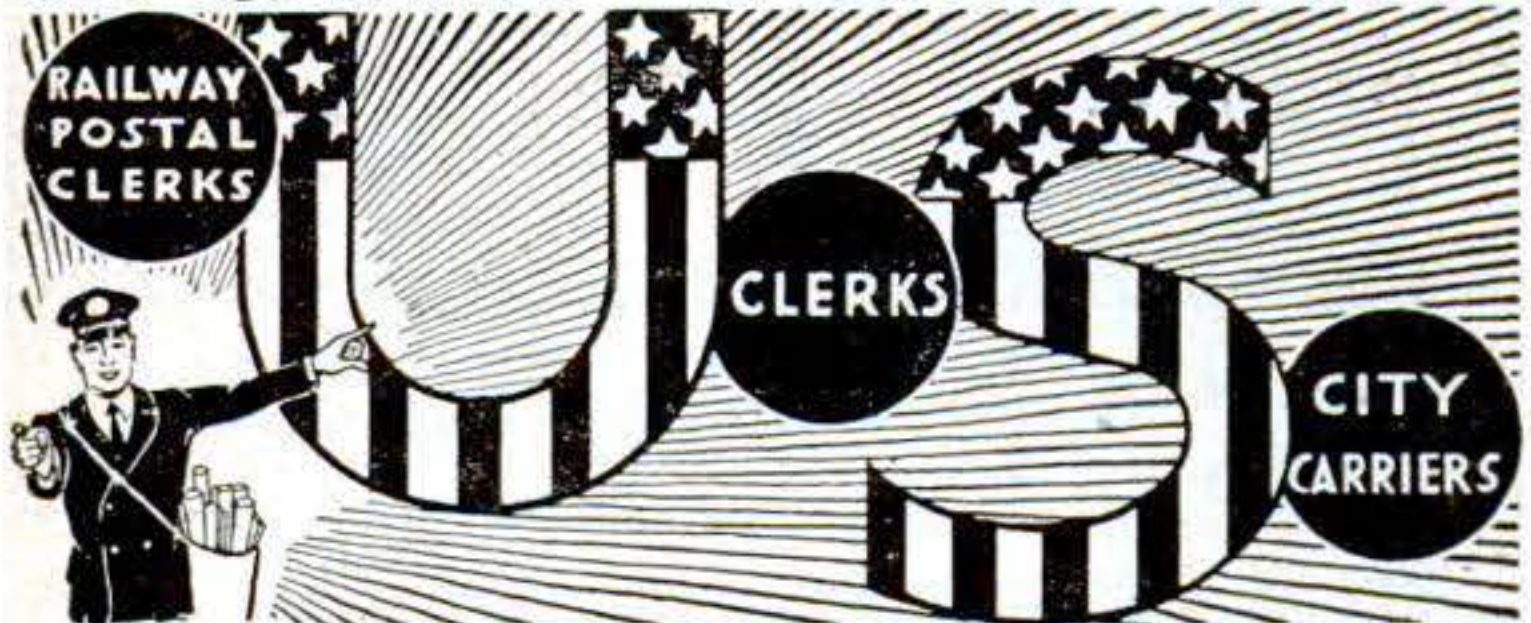

## GOVERNMENT START AS HIGH AS \$3,450.00 YEAR

### Veterans Get Special Preference

#### MEN—WOMEN

Railway Mail Clerks  
Postoffice Clerks, Carriers  
Storekeeper-Gaugers  
Stenographers-Typists  
Meat Inspectors  
Many Other Jobs

PREPARE  
IMMEDIATELY  
FOR NEXT EXAMS  
Common Educa-  
tion Often  
Sufficient

Mail  
Coupon  
TODAY  
★

Franklin Institute  
Dept. N-80,  
Rochester 4, N. Y.  
(Not Government Controlled)

Gentlemen: Rush to me,  
FREE of charge, list of U. S.  
Government big pay jobs.  
Send FREE 40-page book de-  
scribing salaries, vacations,  
hours, work. Tell me how to  
qualify for one of these jobs.

COUPON

Name.....  
Street.....  
City..... Vet?.....

Listen  
to this  
Record!



## SPEAK FRENCH-SPANISH

RUSSIAN-GERMAN  
ITALIAN-BRAZILIAN-JAPANESE

"Learn by Listening" to CORTINA RECORDS, at home,  
the NATURAL way—quickly, easily, cheaply.

### Only 15 Minutes a Day!

THOUSANDS have found it the most fascinating, most  
effective way to learn languages for Pleasure, Business,  
Travel, Culture. INVESTIGATE!

### Send For FREE BOOK!

Illustrated 32-page book, "The Cortinaphone Short-Cut"  
sent FREE. Tells just what you want to know. Interesting.  
Get it!

### Write Today--NOW

**CORTINA ACADEMY (Est. 1882)**  
Suite 122, 105 W. 40 St., N.Y. 18, N. Y.  
Please send me—without obligation—your free book.  
I am interested in (check)

French  Spanish  German  Italian  Brazilian  
 Russian  Japanese

Name.....  
Address.....  
City..... State.....  
 Check here if you are a VETERAN

**VETS!** FRENCH OR SPANISH COURSE  
AVAILABLE UNDER G. I. BILL



## Save Fingers with Industrial Finger Guards

Lower Your Hand Protection Cost

Hundreds of factories save time and injuries by protecting workers with Industrial Finger Guards. Used for handling rough or sharp articles, for buffing, grinding, sanding, polishing and punch press work and hundreds of other jobs. Protect fingers or thumbs, front or back, from cuts, abrasions or blisters. Various designs made in several leathers and other materials, with elastic web back for snug, cool, comfortable fit. Sizes for men or women. Send 10c each for samples. *Catalog of Safety Apparel Free. Write.*

**INDUSTRIAL GLOVES CO.**  
1436 Garfield, Danville, Illinois  
(In Canada: Safety Supply Co., Toronto)

## STOP THE COLD! DUCK-IT <sup>post paid</sup>



Real comfort in cold climates for sportsmen, farmers, outdoor workers. Keeps face, neck and ears warm during long exposure. Worn over face or under chin. Heavy, durable yet soft and flexible. Fits all head sizes. 100% wool. Brown only. Send \$2.00 to The Woolwear Co., Box 86 South Pasadena, California

## MONEY for MEN ALL DATA FREE

THE PLASTEX Industry needs manufacturers on small scale and for big production of Lamp and Clock Stands. Art Goods and Novelties in Plastex and Marble Imitation. Experience unnecessary. 1/2c material makes regular 10c store sellers. Rubber moulds furnished for speed production. Small investment brings good returns. We are now placing big chain store orders with manufacturers. Ambitious men have chance for real prosperity. Our Free booklet will interest and benefit you.

PLASTEX INDUSTRIES, Dept. 2, 3400 Third Ave., New York 56, N. Y.

## Learn ACCOUNTING BOOKKEEPING

This nationally renowned school has demand for graduates in good salary positions thru Nationwide recognition and placement service. Write Department PSY today for Big 32 page Success Book to be sent to you **FREE**

**Hills BUSINESS UNIVERSITY AND EXTENSION SCHOOL**  
619 W. MAIN ST. OKLAHOMA CITY 2, OKLAHOMA

## Ball-Bearing SPEED WHEELS



JUVENILE WHEELS (No bearing, solid tires)	
4" .....	40c
5" .....	45c
(Semi-pneumatic tire, ball bearing)	
8 x 1.25.....	1.85
8 x 1.75.....	1.95
8 x 2 .....	2.20
12 x 1.75.....	3.45
INDUSTRIAL WHEELS	
Lug Base, Semi-Pneumatic tire	
5 x 1.75.....	3.65
6 x 2 SW .....	3.45
6 x 2.00.....	4.00
8 x 2.00.....	5.20
8 x 2.50.....	5.40
Smooth Base, Pneumatic tire and tube	
8 x 3.00.....	11.00
10 x 2.75.....	6.80
10 x 3.50.....	10.55
6" .....	65c
7" .....	75c
10 x 1.25.....	2.20
10 x 1.75.....	2.30
10 x 2.00.....	2.65
10 x 2.00.....	6.10
10 x 2.75.....	5.15
12 x 2.00.....	6.90
12 x 3.00.....	9.20
16 x 4.00.....	15.15
12 x 4.00.....	12.10
4.00 x 8.....	13.10
14 x 4.50.....	13.40

Dealers, Jobbers, and Manufacturers! Our new prices will interest you.

No c.o.d. orders. Prices F.O.B. our plant.  
**JIM BROWN TOY COMPANY**  
1093 HOME AVENUE AKRON 10, OHIO

**LIFETIME WRITTEN GUARANTEE**  
**17-JEWEL WRIST WATCH** **14.95**  
PLUS \$1.50 TAX

ORIGINAL PRICE \$59

INCABLOC Shock Protected  
 WATER-DUST PROOF

**YOU SAVE \$44**

Worn by Army, Navy & Marines During War

Luminous dial... Sweep second hand... Super Accurate... Imported Swiss precision movement and case. You get these men's New Lifetime Guaranteed Watches now for a small fraction of the original price. You save \$44, because we bought-out surplus stock! Don't delay!



Order now... while they last  
**TRIAL OFFER! Wear at our risk!**

Money back in 5 days if not delighted. SEND ONLY \$1 down payment with order. Pay balance to postman on arrival plus postage. Or we pay postage if you include full payment, plus tax with your order. Return this ad with your order.

FREE Handsome Expansion Band included. ORDER NOW!  
**MARYLAND DISTRIBUTORS, Dept. 216**  
 501 East Baltimore Street Baltimore 2, Maryland  
 Free Watch & Diamond Ring Catalog  
 Practically Wholesale Prices to User Direct



**LEARN MEAT CUTTING**  
**At Home - In Spare Time**

Get into the vital meat industry. Concise, practical Home Training based on 25 years proven instruction methods used at National's famous resident school. Prepares you for bigger pay as Meat Cutter, supervisor, market manager or more money in your own store. Go as rapidly as your spare time permits. Diploma. Start NOW to turn your spare hours into money. Send for FREE bulletin today. No obligation.

National School of Meat Cutting, Inc., Div. 0-99, Toledo 4, Ohio

**Do You Make These Mistakes in English?**

MANY persons say "between you and I" —use "who" for "whom"—don't know whether to use one or two "e's" or "m's" or "r's." Every time you speak or write you show what you are. A command of effective English brings you added advantages, better opportunities.

You can improve your English through Sherwin Cody's 100% self-correcting invention. If you are ever embarrassed by mistakes in grammar, spelling, punctuation, or pronunciation, write for FREE book "How You Can Master Good English in 15 Minutes a Day." No obligation. **SHERWIN CODY COURSE IN ENGLISH, 182, B & O Bldg., Rochester 14, N. Y.**



**YOU CAN DO FINE LEATHERCRAFT**  
 COPPER TOOLING • TEXTILE PAINTING

Real enjoyment and pleasure of creating valuable things for your own use or to sell. It's so easy, too! Send for your free Kit Kraft Catalog today.

**KIT KRAFT** DEPT. PS • 7377 MELROSE AVE., HOLLYWOOD 46, CALIF.

**Auto Spark Intensifier Gets ROCKET Performance**

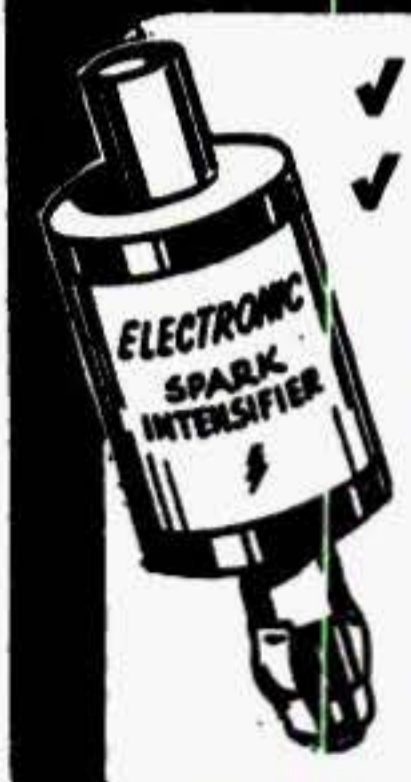

- ✓ More Power
- ✓ More Speed
- ✓ Better Mileage
- ✓ Quicker Starting

The ELECTRONIC-SPARK INTENSIFIER is an efficient, scientifically developed automotive device which can be easily installed in the center hole of the distributor cap of all autos, trucks and tractors in sixty seconds. By boosting the high voltage current passing through the distributor, it gives a "hotter spark" permitting a wider spark gap... thus reducing "misfiring," ring and cylinder wear and allowing all-around better performance. FREE TRIAL, send \$2.00 cash, check or money order... if not fully satisfied after 10 day trial, return for immediate refund.

ELECTRONIC DEVELOPMENT CO., Dept. PS-2, Los Angeles 34, Calif.

**Build a career in**  
**AIR CONDITIONING**  
**HEATING**  
**REFRIGERATION**  
 on *This Plan*

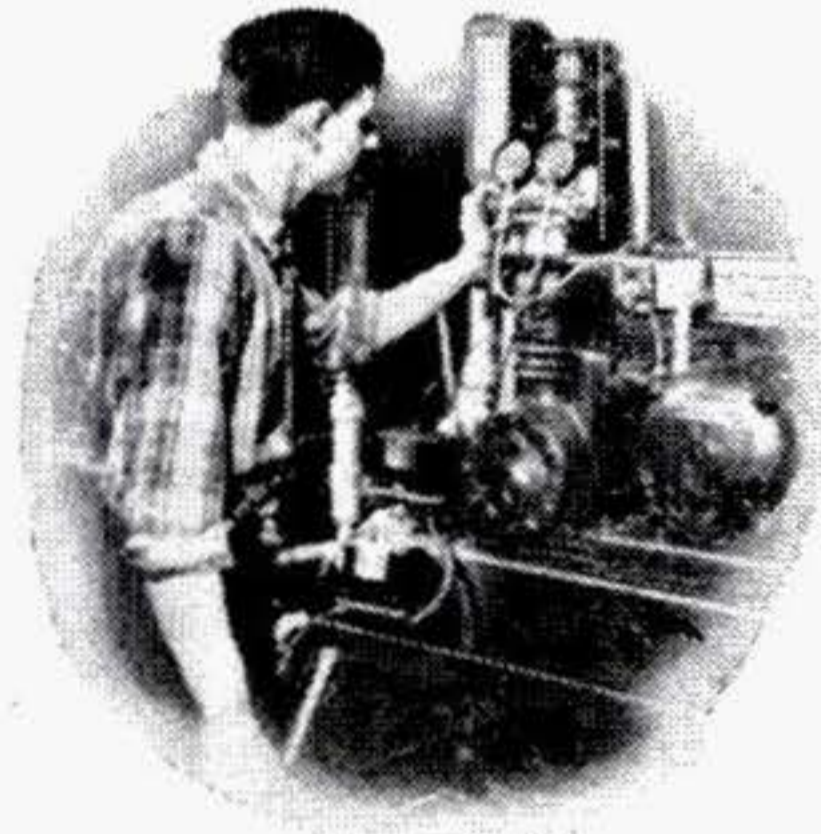

Train NOW for opportunities in these highly essential, expanding fields.

**REFRIGERATION OR HEATING SERVICE IN ONLY 6 MONTHS**

These service courses prepare you for domestic and commercial service, installation and maintenance of refrigeration or heating equipment. A forecast of continued high-level building activity promises great opportunities for trained men.

**BECOME AN AIR CONDITIONING TECHNICIAN IN 12 ADDITIONAL MONTHS**

Either of the above courses will apply as full credit towards your *Technician's Certificate*. Prepare for specific jobs in contracting, manufacturing, sales, as operating engineer, service manager, system lay-out man. The technician curriculum is fully accredited.

**MILWAUKEE SCHOOL of ENGINEERING**

Technical Institute • College of Electrical Engineering

Military, practical or prior academic training evaluated for advanced credit. Over 35,000 alumni. Faculty of 85 specialists. Terms open APRIL, JULY, OCTOBER, JANUARY.

FREE — Write for "Occupational Guidance Manuals" and 1951 Catalog.



**MILWAUKEE SCHOOL OF ENGINEERING**  
 Dept. PS-251, 1020 N. Broadway, Milwaukee, Wis.

Without obligation, mail Occupational Guidance Manual on:

- REFRIGERATION, HEATING, AIR CONDITIONING
- Radio-Television     Electrical Power
- Welding    Also 1951 Catalog for Electrical Engineering, B.S. degree
- Power     Electronics
- Check if World War II Veteran

Name..... Age.....  
 Address.....  
 City..... Zone... State.....

# Learn this Profitable Profession



**IN 90 DAYS AT HOME**

## Money-Making Career Open to Men and Women, 18 to 60

Hundreds of men and women between 18 and 60 make \$10 to \$20 in a single day giving scientific Swedish Massage and Hydro-Therapy treatments. There is big demand from doctors, hospitals, sanatoriums and clubs. Graduates earn large full time incomes from these or in private practice in their own offices. Others make good money from home treatments given in spare time. Learn this interesting, money-making profession in your own home, through our home study course. Same instructors as in our nationally known resident school. You can win independence and prepare for future security by qualifying for your Diploma. Course can be completed in 3 to 4 months. Many earn while they learn. Begin your training at once.

### Anatomy Charts & Booklet FREE

Enroll now and we will include, at no extra cost, many needed supplies. Fit yourself to help meet growing demand for Scientific Swedish Massage. Send the coupon at once for complete details, Anatomy Charts and 32-Page Illustrated Booklet, FREE, postpaid.



**THE COLLEGE OF SWEDISH MASSAGE**  
Dept. 170B, 41 E. Pearson, Chicago 11, Illinois

Please send me FREE and postpaid, Anatomy Charts, 32-page Booklet and complete details on Home Training.

Name.....Age.....  
Address.....  
City.....State.....

## Thousands Enjoy New LEFT-FOOT ACCELERATOR

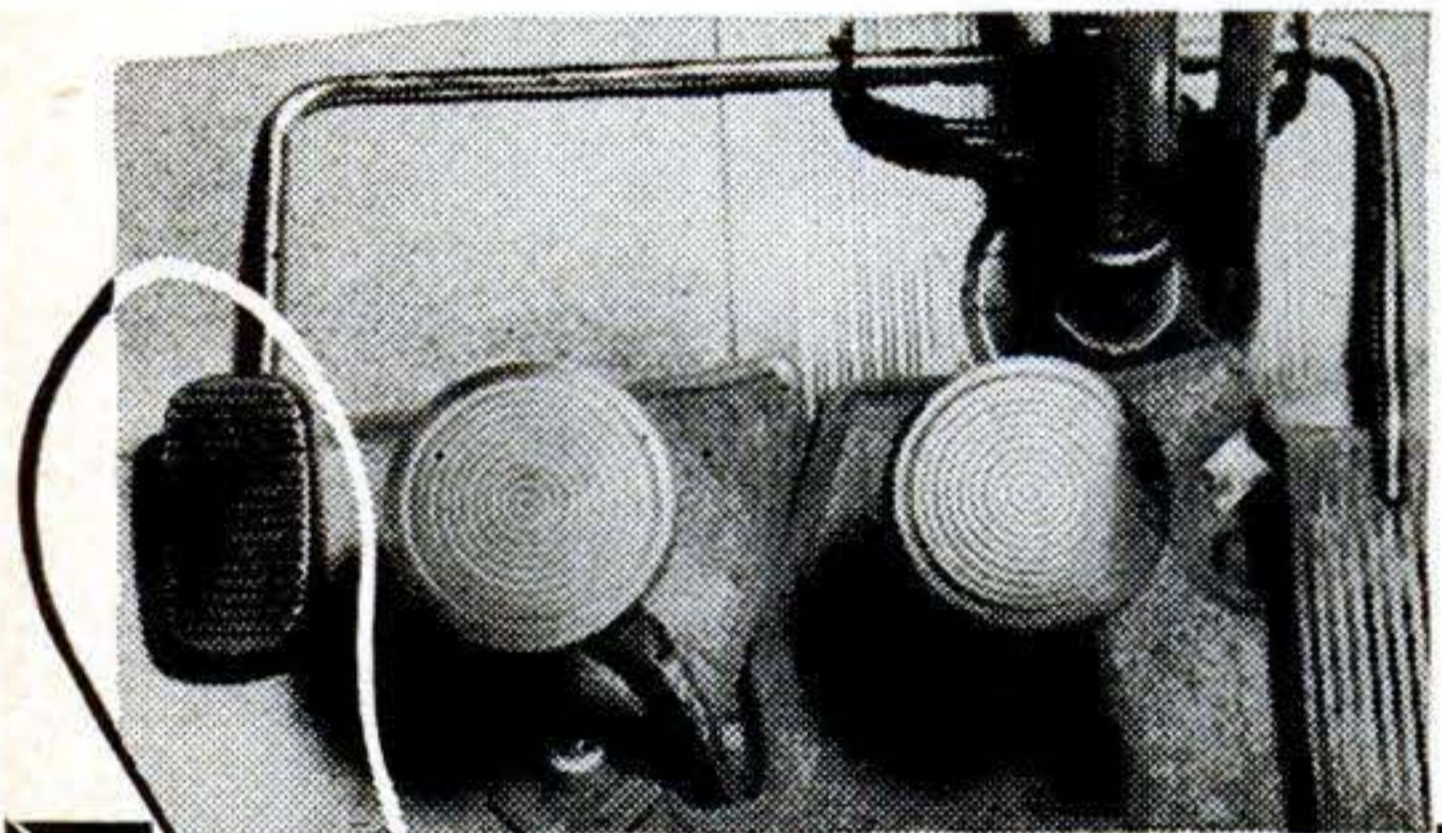

**FITS NEW CLUTCHLESS MODELS**

Dealer inquiries invited.

CUT driving fatigue in half with Lefty! Install this new left foot accelerator yourself in 60 seconds with just a wrench—no alterations to your car are necessary. Enjoy relaxed comfort on long drives. Lefty lets you feed the gas with your left foot when you desire, relieves tension and fatigue in leg, back, and foot. Safe, positive and convenient. Swings out of way when not in use. Does not interfere with light switch. Brings your car up to date. Ppd. **\$5.**

SPECIFY YEAR AND MAKE. No COD's please.  
**INVENTORS MARKETING LAB**  
1209 DeYoung Bldg., 690 Market St., San Francisco, Calif.

## SPEED AND POWER 1951 HANDBOOK

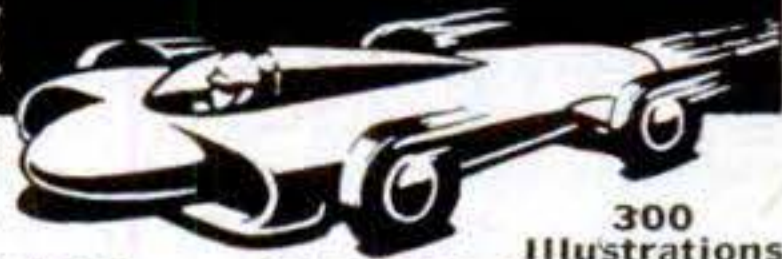

Direct from the Dry Lakes of California, comes authentic information to thrill the most sedate motor enthusiast.

**BIG LIBRARY EDITION . . . 128 PAGES**

Tens of thousands of copies have been sold—Shows by photos and drawings how to build fast stock cars! California Roadsters! 225 M.P.H. Rods! Covers ALL MAKES. Build your own Dual Manifolds! Superchargers! Hot Cams! Water Injectors! Hi-Compression Heads! Mileage Devices! Get up to ten more miles per gallon! Get racing speed, lightning acceleration, dynamic power increases from any make passenger automobile! Get construction drawings! Tuning techniques! Speed tricks! Economy secrets! Ingenious formulas! Covers "Racing Frames"—Reciprocating Masses—"Jet Engines"—"Wheel Geometry"—"Dynamometers"—"Re-Styling"—"Customizing"—Dual Pipes, Gears, Fuels, Porting, Relieving, Lowering! Balancing. 50 breathtaking chapters!



**SPEED SHOP METHODS**

**BIG CATALOGUE (Without Books) 25c**

**GREATEST VALUE EVER OFFERED**  
Also get 40 page "DRIVING ECONOMY BOOK," plus big "1951 SPEED EQUIPMENT CATALOGUE," plus "WATER INJECTION," plus "MILEAGE INFORMATION," with purchase of 128 page "SPEED & POWER"—5 items \$1.98 ppd.

**NEWHOUSE AUTOMOTIVE INDUSTRIES**  
5805 EAST BEVERLY BLVD.  
LOS ANGELES 22, CALIF.



**FREE BOOKS**

DEPT. A-24

## WANT TO Write Stories

**FREE LESSON** shows how you learn at home

Articles Mysteries?



The demand for writers is creating great new opportunities and it's not as hard to succeed as you may imagine. At home, you may learn fiction writing, best basis for all fields: short stories, radio & TV, articles, business items. Palmer training is endorsed by famous authors, scores of successful graduates. Complete instruction, professional coaching. FREE book and lesson show how you may enjoy an ideal part-time or full-time career. Write TODAY (no salesman will call). Approved for veterans: advise if eligible.

**PALMER INSTITUTE OF AUTHORSHIP, Since 1917**  
1680 N. Sycamore, Hollywood 28, Calif., Desk U-21

## Play GUITAR in 10 DAYS

**OR GET YOUR MONEY BACK!**  
Let Ed Sale teach you to play with his famous diagram photo system. Book contains 53 photos, 43 diagrams showing exactly how to place your fingers. Gives you 110 popular songs, words and music—along with complete, easy to learn instructions. Imagine your joy when you find after only two weeks you are playing beautiful music! Amaze your friends! Be the life of the party! SEND NO MONEY. Pay Postman \$1.95 Plus Postage. Dept. PS-2 **POINT PLEASANT, NEW JERSEY**

## TALK—SING—PLAY OVER YOUR RADIO

with the real Radio Mike! Attaches in a jiffy—full instructions given! Swell for "parties"—"cut in" on or "kid" regular network programs or put on your own broadcasts! Amaze your friends—real fun. Beautiful Metallic Plastic 6 in. high! **12 RADIO BROADCAST LESSONS GIVEN with each mike**  
**SEND NO MONEY** Just pay postman \$2.99 COD plus postage or send \$2.99 and we pay postage! Radio Mike is available only from us by mail—guaranteed.  
**Midway Co., Dept. MPS-2, Kearney, Nebr.**

## BE A MASTER PLUMBER

**Earn \$15 to \$50 a Day**

**DON'T ENVY THE PLUMBER—BE ONE**

Every skilled workman will tell you that Plumbers have the best of it. WINTER and SUMMER the Plumber is busy at top wages. No skilled Plumber is ever out of a job—compare his opportunities with any trade, plus the opportunities of having your own shop. We teach you Plumbing with TOOLS (not books) under Licensed Master PLUMBERS in one of the finest equipped schools in America. We make you a Plumber, every branch is taught thoroughly—Lead Work—Blueprint for plan reading—all other tricks.

**LEARN IN 32 WEEKS WITHOUT PREVIOUS EXPERIENCE**

If you like to work with tools you owe it to yourself to investigate. No need to ever work as an apprentice. Get free bulletin. Write now! G.I. APPROVED. Our 24th year.

**UNIVERSAL PLUMBING SCHOOL**  
800 HOLMES STREET KANSAS CITY, MO.





EARN \$25 AND MORE A DAY!  
NO SCHOOLING!

STEADY ALL-YEAR WORK!  
THOUSANDS ARE SUCCESSFUL!

# MAKE BIG MONEY BE YOUR OWN BOSS!

WANTED—men with ambition and desire to get ahead and *make money* in something for themselves. *Act now*—do as thousands of successful men have done—start on your own in floor surfacing with American Machines!

Take advantage of this opportunity if you want steady year 'round work—earnings of \$25 and more a day—pleasant indoor working conditions—and a lifetime of comfortable living for yourself and your family. No schooling—no experience needed. Sanders are easy to operate. Hundreds of prospects—new and old homes. Send coupon for "money-making" booklet entitled "Opportunities in Floor Surfacing"—enclose 25c in coin or stamps to cover handling.

**AMERICAN**  
FLOOR MACHINES



The American Floor Surfacing Machine Co.  
532 So. St. Clair St., Toledo 3, Ohio

Enclosed find 25c in stamps or coin for booklet "Opportunities in Floor Surfacing", telling me how I can start my own floor sanding business.

Name \_\_\_\_\_  
Street \_\_\_\_\_  
City \_\_\_\_\_ State \_\_\_\_\_

## USE YOUR CHOREMASTER

*every day!*

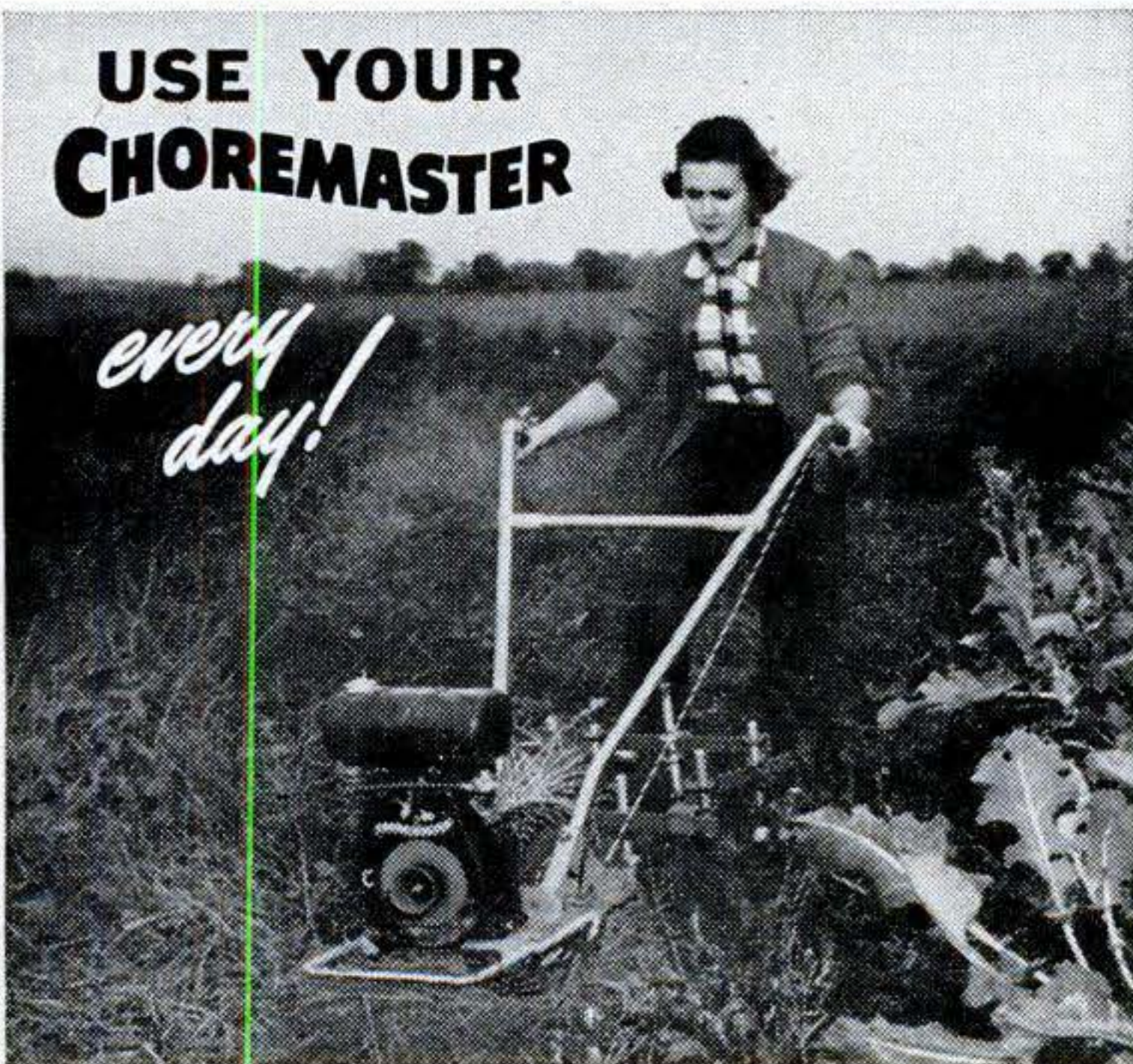

- Cultivation
- Discing
- Plowing
- Mowing
- Snow Plowing
- Paint Spraying
- Hauling
- Animal Spraying
- Seeding
- Weeding
- Dusting
- Weed Spraying
- Grading—Leveling
- Leaf Sweeping
- Wood Cutting

Write for CHOREMASTER literature showing uses year-round; and name of dealer.

as low as  
**\$148.00**

1½ to 3 H. P.  
Freight extra.

**CHOREMASTER** DIVISION

The Lodge & Shipley Co. 816-2 Evans St., Cincinnati 4, Ohio

# AVIATION TRAINING



The aviation industry urgently needs properly trained young men for essential civilian aviation positions. Embry-Riddle offers maximum training in minimum time. Fully accredited 8-mo. to 26-mo. courses in all aeronautical phases. Thorough, practical instruction backed by 25 yrs. experience training today's aviation leaders. Complete school campus.



Send coupon today!

**Embry Riddle**  
Address Registrar  
SCHOOL OF AVIATION  
DEPT 91 MIAMI 30, FLORIDA

Please Print

NAME \_\_\_\_\_

ADDRESS \_\_\_\_\_

City \_\_\_\_\_

State \_\_\_\_\_ Age \_\_\_\_\_

I am interested in...

- A.&E. Mechanic
- Commercial Pilot
- Engineering
- A.&E. Combined Commercial Pilot
- Flying Mechanic
- Drafting & Design

Check One  Veteran  Non-Vet

TRAIN IN MIAMI -- AIR CAPITAL OF THE WORLD

# MORE PAY through HOME STUDY TRAINING in SPARE TIME

Do you want a better position—a larger salary? They are within your reach—now. LaSalle experts will guide you step by step in gaining business training which leads to greater earnings.

The time-saving, interesting LaSalle Problem Method helps you prepare at home, without interference with your present duties.

Simply mark on the coupon the field in which you desire success, and we will mail you a valuable book describing the opportunities in that field—plus "Ten Years' Promotion in One"—a book which has helped many men. Let us tell you how we have started thousands of average men and women on the high road to success and more money. Check and mail the coupon now.

## LASALLE EXTENSION UNIVERSITY

A Correspondence Institution

417 S. Dearborn St., Dept. 283-R, Chicago 5, Ill.

Send me full information regarding the course I have marked—without obligation—plus "Ten Years' Promotion in One."

- |  |   |
|--|---|
| <input type="checkbox"/> Higher Accountancy  | <input type="checkbox"/> Salesmanship                     |
| <input type="checkbox"/> C.P.A. Coaching     | <input type="checkbox"/> Traffic Management               |
| <input type="checkbox"/> Bookkeeping         | <input type="checkbox"/> Foremanship                      |
| <input type="checkbox"/> Law: LL.B. Degree   | <input type="checkbox"/> Industr'l Management             |
| <input type="checkbox"/> Business Management | <input type="checkbox"/> Stenotypy<br>(Machine Shorthand) |

Name.....Age.....

Address.....

City.....Zone.....State.....

**Prepare Now!**

# ENGINEERING

## B.S. DEGREE IN 27 MONTHS

WORLD FAMED SCHOOL - ESTABLISHED 1884

Mechanical, Civil, Electrical, Chemical, Aeronautical, Radio (Television) Engineering, Business Administration and Accounting. Also 36-weeks diploma courses in Surveying and Drafting.

Personalized instruction. Accelerated courses. For ambitious earnest students. Preparatory department. Approved for veterans.

Graduates in Demand. Hold positions of responsibility the world over. Placement service. Future shortage of engineers indicated. Prepare now, for the civil and military opportunities ahead.

Extensive campus. Well equipped, modern buildings and labs. Low cost. New terms start quarterly. Enter March, June, September, January.

Mail Coupon Today

### TRI-STATE COLLEGE

521 College Avenue, Angola, Indiana

Please send me free catalog and special information. I am particularly interested in courses as checked.

Mechanical  Civil  Electrical  Chemical  Aeronautical  
 Radio (Television)  Business Administration  Accounting  
 Short Diploma Courses

NAME.....  
 ADDRESS.....

# FISTULA

FREE BOOK—Explains Dangers of Associated Ailments

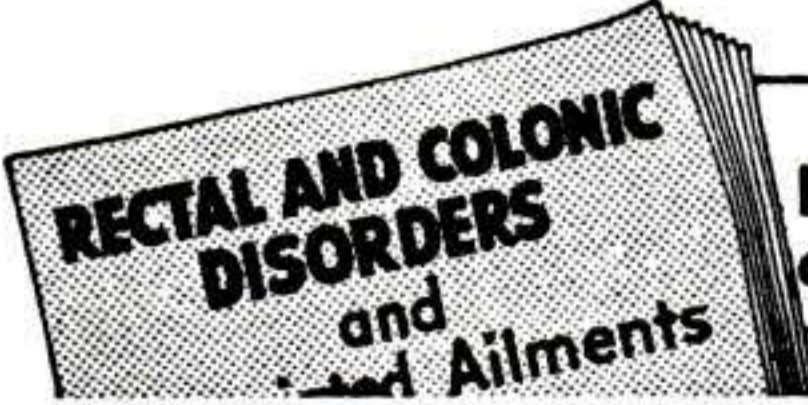

Avoid Dangers of Delay

Piles, Fissures and Rectal Abscess are common ailments that may also be associated with neglected Fistula. Our new 164-page illustrated book sent FREE. Write today—McCleary Clinic & Hospital, 271 Elms Blvd., Excelsior Springs, Mo.

## "RED-E" GARDEN TRACTORS

Gear Driven! No Belts! No Chains!—New 1951 Models Now Available!

More Jobs Easier Quicker

You'll like the smooth, powerful, gear-driven, easy operating action of the 4-cycle gasoline engine-equipped Walking Model with power turning clutch for each wheel or the Riding Model with automotive type differential. Dozens of attachments for plowing, sowing, cultivating, harrowing, mowing, raking, wood-sawing, snow-plowing. EASY TERMS—with Pays-For-Itself-Plan. SPECIAL Discount to User Agents.

Buy Direct from Manufacturer and SAVE

WALKING MODEL 2-3-4 1/2-6 HP  
 RIDING MODEL 6 HP Fully Guaranteed

Write for FREE Catalog!

**RED-E TRACTOR CO.** Richfield 49, Wis.

## PROFITS MAKE YOUR OWN RUBBER MOLDS

WRITE TODAY FOR NEW FREE CATALOG

Learn to cast thousands of perfect figurines, plaques, book ends, ash trays, etc. Start TODAY!

NO EXPERIENCE GREAT PROFITS

Little capital needed. Full instructions. X.L. Rubber. Pts. \$2.00. Quarts \$3.50. Models and enough rubber for 3 molds —\$1.30 postpaid.

PLASTIC ARTS STUDIO 3403 S. MADISON ST. DEPT. 3, MUNCIE, INDIANA

## make your own Gems 29.50 F.O.B.

All necessary lapidary equipment is furnished, including a super-charged diamond blade for sawing, and all wheels for grinding, shaping and polishing; also complete instructions. The complete equipment as shown, less motor and belt, for only \$29.50, f.o.b., Burlington, Wisconsin. Write today for information and literature.

**B&I MANUFACTURING CO.** Dept. M Burlington, Wis.

# FOAM RUBBER

FOR HOBBYISTS, CRAFTSMEN, EXPERIMENTERS

<b>Lowest Prices—SAVE 50%</b>	<b>AUTO SEAT TOPPER PADS</b>
16 x 16 x 1 1/2" ... ea. \$1.35	Place under seat cover
16 x 22 x 1 1/2" ... ea. 1.75	24" x 60" x 1 1/2" ... ea. \$6.45
18 x 24 x 1 1/2" ... ea. 2.00	24" x 60" x 2" ... ea. 7.95
24 x 24 x 1 1/2" ... ea. 2.95	12" x 14" x 1 1/2" ... ea. 1.25

Use for furniture cushion fillers, mattresses, Mattress pads, cushions, Foam Rubber is available in any size or thickness. Send For Free Price List. Immediate delivery. No C.O.D.'s. Add 10% for Postage & Handling to Above Prices. Please print.

**RIOR RUBBER COMPANY, Dept. S-16**  
 50 East 22nd St. Chicago 16, Ill.

# IMAGINE THEIR JOY when they found they could play this easy-as-ABC way!

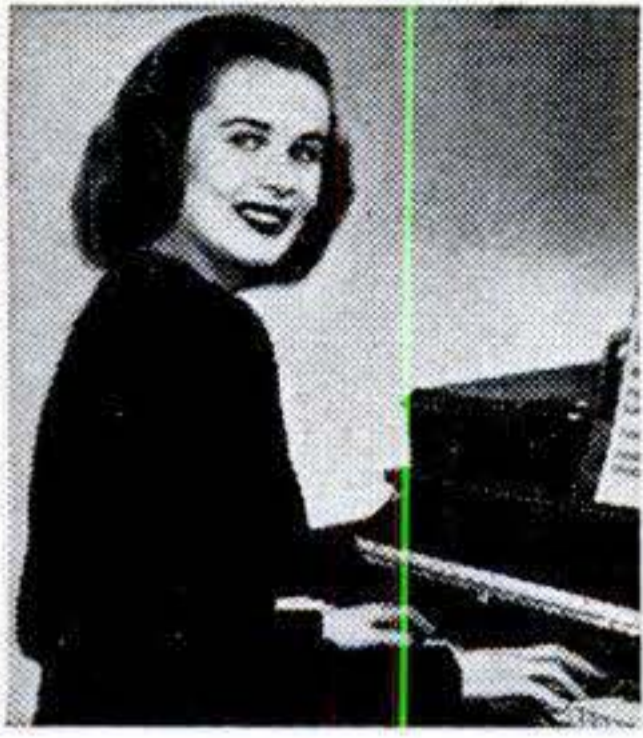

**LEARNED QUICKLY AT HOME**  
 "I didn't dream I could actually learn to play without a teacher. Now, when I play for people they hardly believe that I learned to play so well in so short a time."  
 \*H.C.S., Calif.



**PLAYS AT DANCES**  
 "Your lessons have been most satisfactory. I can play all of the popular songs. I have earned money playing at dances."  
 \*E.N.J., New York.



**PLAYS ON RADIO**  
 "I can't keep from telling you that I have a good position playing from KTHS, Hot Springs, Ark., every morning."  
 \*J.S., Okla.

## What Instrument Would You Like to Play?

**JUST** name your instrument and we'll show you how you can learn to play it—quickly, easily, in spare time at home. Never mind if you don't know one note of music from another—don't worry about "special talent." And forget all you've ever heard about music being hard to learn.

The truth of the matter is that *thousands now play who never thought they could!* Yes, men and women everywhere have discovered this amazingly easy way to learn music at home. Now they are enjoying the thrilling satisfaction of playing the piano, violin, guitar, saxophone or other favorite instruments. Some of them are playing in orchestras and over the radio; others are teaching music, making money in spare or full time. And thousands are having the time of their lives playing for their own enjoyment and the entertainment of their friends.

No tedious study and practice, no tiresome exercises. You learn to play by *playing*—start right in with the mel-

### EASY AS A-B-C



ody of a simple tune! It takes only a few minutes a day; the cost is trifling. Does it sound too good to be true? Mail the coupon and get the **FREE PROOF!**

### SEND FOR FREE PROOF

Fascinating illustrated booklet answers all your questions; free Print and Picture Sample shows how method works. If interested, just mail coupon. U. S. School of Music, 82 Brunswick Bldg., New York 10, N. Y. 53rd Successful Year.  
 \*Actual Pupils' names on request. Pictures by professional models.

### FREE! Print and Picture Sample

U. S. School of Music, 82 Brunswick Bldg., New York 10, N. Y.  
 Please send me Free Booklet and Print and Picture Sample. I would like to play instrument checked below.

<input type="checkbox"/> Piano	<input type="checkbox"/> Saxophone	<input type="checkbox"/> Modern Elementary
<input type="checkbox"/> Guitar	<input type="checkbox"/> Trumpet, Cornet	<input type="checkbox"/> Harmony
<input type="checkbox"/> Hawaiian Guitar	<input type="checkbox"/> Reed Organ	<input type="checkbox"/> Mandolin
<input type="checkbox"/> Violin	<input type="checkbox"/> Tenor Banjo	<input type="checkbox"/> Practical Finger
<input type="checkbox"/> Piano Accordion	<input type="checkbox"/> Clarinet	<input type="checkbox"/> Control

Name..... Have You Instrument?.....  
 Address.....  
 City..... State.....

Save 2c—Stick Coupon on Penny Postcard

"My selling time actually shows me a profit of  
**\$20 TO \$25 AN HOUR**  
 with Science's New Midget Miracle, the  
**PRESTO Fire Extinguisher**

says M. R. Stanley of Montana. Many others "cleaning up"—so can YOU!

**THIS** is an amazing new kind of fire extinguisher. Tiny "Presto" (about the size of a flashlight) does job of bulky extinguishers that cost 4 times as much, and are 8 times as heavy. Ends fires fast as 2 seconds. Fits in palm of hand. Never corrodes. **Guaranteed for 20 years!** Sells for only \$3.98!



Science's New Midget Miracle—**"PRESTO"**

Show it to owners of homes, cars, boats, farms, etc., and to stores for re-sale. Make good income. C. S. Melious made \$175 in just first 5 days. C. Kama, \$1,000 a month. Write for **FREE** sales Kit. No obligation.

**MERLITE INDUSTRIES, Inc., Dept. 112, 201 East 16th St., New York 3, N. Y. IN CANADA: Mopa Co., Ltd., 371 Dowd St., Montreal 1, P. Q.**

(If you want a regular Presto to use as a demonstrator, send \$2.50. Money back if you wish.)



M. R. STANLEY

Which of these 2 one time **WEAKLINGS** PAID only a Few Cents to become an **All-Around HE-MAN** at Home?

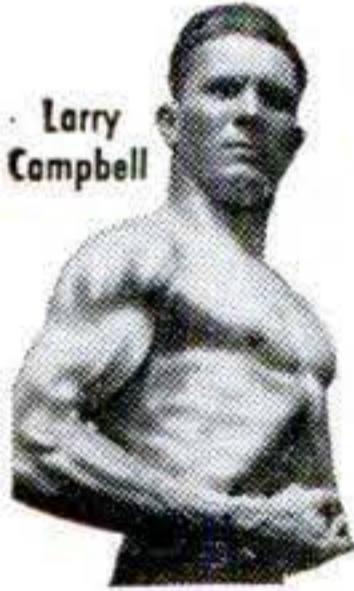

Larry Campbell



Rex Ferris

Which One Paid Hundreds Of Dollars To Train At My Side? Rex Ferris, was a skinny weakling, paid a few cents to start building into a Champion All Around He Man! Larry Campbell paid me hundreds of dollars to train at my side years ago. Start to become an All-Around He Man at home with these same secrets for only a few cents—like Rex Ferris did!

**5 GREAT BODY BUILDING PICTURE COURSES ALL YOURS for only 10c instead of \$1.00**

Be a Winner at Anything YOU Tackle with Progressive Power SPORTS! JOB! SCHOOL! FRIENDS!

Let's Go, Pal! I'll prove I can make YOU an

**"ALL-AROUND" HE-MAN**

FAST—OR NO COST! says George F. Jowett World's Greatest Body Builder

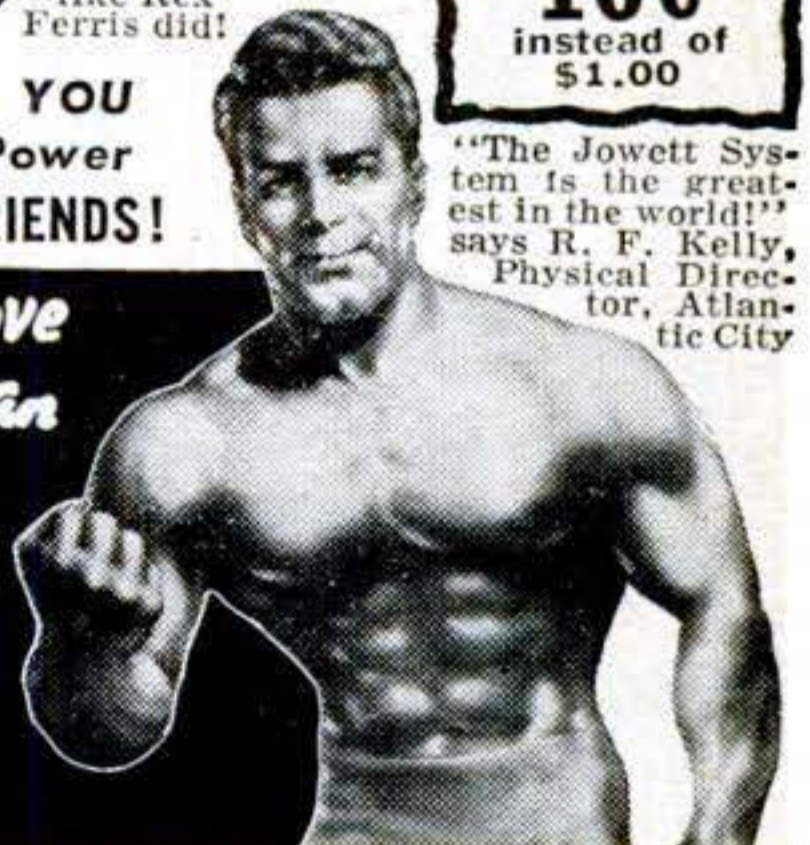

"The Jowett System is the greatest in the world!" says R. F. Kelly, Physical Director, Atlantic City

**JOWETT INSTITUTE, 230 Fifth Ave., N. Y. 1, N. Y. PS-12**

**FREE** Photo Book of Strong Men Dear George:—Please send by return mail, pre-paid, **FREE** Jowett's Photo Book of Strong Men, plus all 5 Muscle Building Courses. 1. Molding a Mighty Chest. 2. Molding a Mighty Arm. 3. Molding a Mighty Grip. 4. Molding a Mighty Back. 5. Molding Mighty Legs—Now all in One Volume "How to Become a Muscular He-Man." Enclosed find 10c for postage and handling. No C.O.D.'s.

Name..... Age.....  
 Address.....  
 City..... Zone & State.....

**Defense Plans Mean Bigger Pay  
for Good Machine Shop Men!**

**Now You Can Be a  
MASTER MACHINIST!**

GET bigger pay in this ESSENTIAL field! Learn shop work quickly—with big home study and reference course, the thoroughly revised American Machinists' Library. 6 Volumes, 2987 Pages, 2900 Pictures

How to operate lathes, drills, other machine tools; turning, boring, grinding, gear cutting, jigs and fixtures, drilling and surfacing, punches and dies, and MUCH MORE! Timely information on airplane assembly fixtures. Illustrations show every operation clearly. The facts are up to date. Brings you the extra "know-how" that means difference between "just another machinist" and



**FREE 10-Days' Examination**

a Master Machinist. Invaluable help for anyone—from apprentice to shop executives. Packed with short-cuts. Will help to put you in big-pay class and to rate as an ESSENTIAL worker. Send no money. Mail coupon for 10-DAY FREE TRIAL. Note special price, easy terms.

**McGraw-Hill Book Co., Dept. PS-2  
327 West 41st St., New York 18, N.Y.**

Send for 10 days' FREE trial, the American Machinists' Library. If not satisfied I will return books. Otherwise I will send \$3.50, plus postage, then: and \$4 a month for 6 months. (Reg. price \$30.50; you save \$3.)

Name.....

Home Address.....

City & State..... PS-2

WE'LL PAY POSTAGE if you enclose \$3.50 first payment WITH coupon. Same return privilege for full refund.

**CAMPBELL-HAUSFELD  
Spray Painting Outfits**



**SAVE** time, materials and money

**PAINT** buildings, tractors, trucks. Refinish furniture and fenders. Inflate tires; lubricate motors and implements.

Destroy weeds. Rid live stock and pens of pests and parasites.

First job pays for the outfit. Then it is yours for a lifetime of trouble-free service. 4 models at 4 money-saving prices. If your dealer does not have them, write for literature and prices, giving his name.

**pressure queen**

The only 4 cylinder portable. Outperforms them all for spray painting without pulsation.

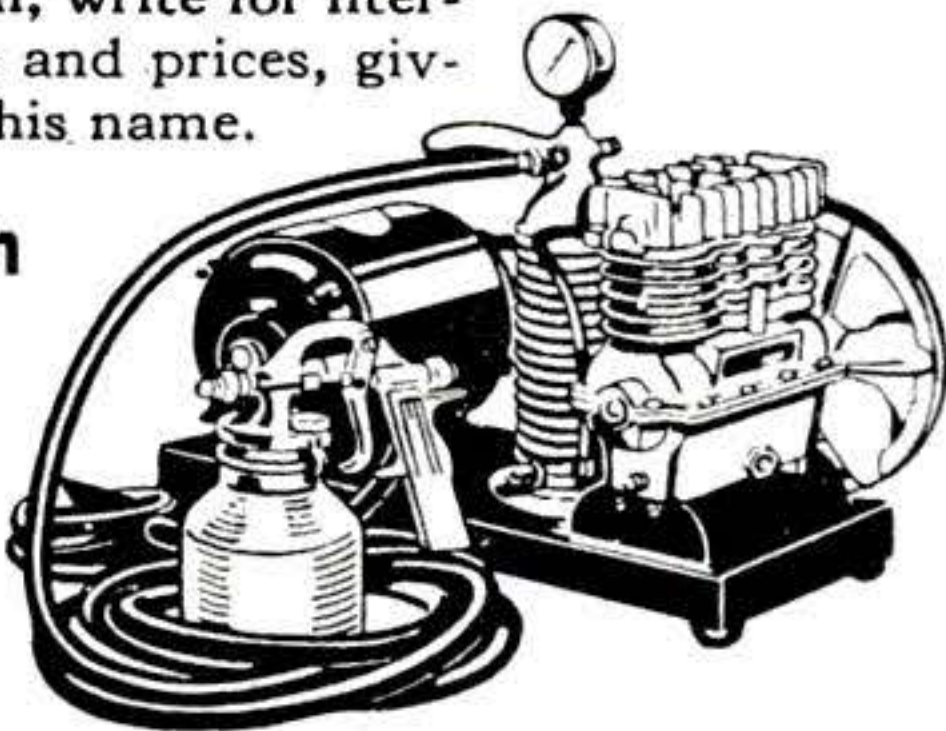

**THE CAMPBELL-HAUSFELD CO.  
151 RAILROAD AVE. HARRISON, OHIO**

**EVERYTHING IN  
LEATHERCRAFT**  
*For Beginners - For Professionals  
For Advanced Hobbyists*

**America's Most Complete Stock of Kits, Leathers, Tools, Supplies**

It will pay you to get acquainted now with LARSON Leathercraft. Easy-to-Assemble kits for beginners require no tools or experience to make belts, billfolds, purses, gloves, woolskin animals, etc. Complete stock of moderate-priced tooling leathers, top-quality calfskins, tools, supplies for advanced hobbyists and leatherworkers. Send 10c TODAY for new 24-page catalog.

**J. C. LARSON CO., 820 So. Tripp Ave.  
Dept. 517 CHICAGO 24, ILLINOIS**

**CLEANS WINDOWS  
WITHOUT WATER**

**NEW CHEMICAL MITT**

Sensational! DRY Window Cleaner! Uses no water, no messy liquids. Chemically Treated. Simply glide over windows; leaves glass sparkling clear. No heating water, no heavy buckets to carry. No rags, powders, sponges, chemicals. No mess or muss. No red chapped hands. Dust, dirt, grime, fog disappear like magic. *Wonderful for auto windows, windshields!*

**SAMPLES TO INTRODUCE** Sample offer sent immediately to all who send name at once. A penny postal will do. SEND NO MONEY—just your name. KRISTEE CO., Dept. 704, AKRON 8, OHIO.

**20 DAYS TRIAL**

**8-MILE RANGE!**

**\$4.95**

American made. Sturdily constructed, yet weighs only 11 ounces! Scientifically-ground, powerful lens that gives field of vision of 110 yards at 1000 yards distance. Adjustable all distances, eye widths. **20 Day MONEY BACK GUARANTEE.** Case and straps included. SEND NO MONEY. Pay postman \$4.95 plus postal charges on delivery. Cash orders prepaid. Add Federal Tax.

**UNITED PRODUCTS CO.  
9043 S. Western Dept. KG-401 Chicago 20**

Money Back Guarantee

**RUPTURE!**

An amazing Air-Cushion Invention allows body freedom at work or play. Light, neat, cool, sanitary.



Durable, cheap. Day and night protection helps Nature support weakened muscles gently but surely. No risk. **Send on Trial!** Write NOW for free Booklet and **Proof of Results.** All correspondence confidential.

**Brooks Company, 163-H State St., Marshall, Mich.**

**MEN! WOMEN!**

**TAKE ORDERS FOR NATIONALLY ADVERTISED WATERLESS COOKWARE**

**Big Money Full or Spare Time Starting a Carlton Cookware Club**

Big earnings daily taking fast orders for amazing new kind of Stainless Steel Waterless Cookware under Sensational Plan that makes it easy for every housewife to buy. Club privileges permit your customers to get Matched Sets of CARLTON WARE without missing the money—on sensational new Easy Payment "ADD-A-PIECE" Plan—PLUS up to \$8.00 worth of gift bonuses. No experience needed. We show you everything—supply everything FREE. Earnings start at once. Rush name and address. Be First!



**FREE! 20-Use Set of Stainless Steel Cookware Given As a Bonus**

**CARLTON OF CARROLLTON, Dept. 27-B, Carrollton, Ohio**

**MAIL THIS OPPORTUNITY COUPON TODAY!!**

**GET FASCINATING NEW FREE PROFIT PLAN**



**NELS IRWIN** says — "Benefit by my experience. My plan has helped thousands."

Tired of monotonous, low-pay jobs... tired of working for the other fellow? Cash in on rich profits in this huge NEW field. Have your own successful lifetime business... earn REAL money and say goodbye forever to time clocks and bosses! Become a part of this tremendous new expanding industry — yet work right from your own home!

Learn how to get **BIG PROFITS** on new **MIRACLE** finish that makes old objects beautiful, salable — new things worth much more.

**COVERS: WOOD, AUTO DASHBOARD, JEWELRY BOXES, RADIOS, SHOES**

**FABRICS, METALS, PLASTER, ANY SURFACE, LAMPS, AUTOTRUNK INTERIORS, TOYS BUSINESS.**

**PHONOGRAPH TURNTABLES**

**FREE BOOKLET & SAMPLE**

**AMAZING NEW Miracle Finish MEANS \$\$\$ TO YOU**

**COAST INDUSTRIES**

**INVESTIGATE TODAY!**

**USE COUPON FOR FREE SAMPLE**

**FLOK KRAFT**

**COAST INDUSTRIES Dept. 11**  
1004 S. Los Angeles St., Los Angeles 15, Calif.  
Gentlemen: Please rush me all the details—FREE.

NAME \_\_\_\_\_  
STREET \_\_\_\_\_  
CITY \_\_\_\_\_ STATE \_\_\_\_\_

**NOW!**  
**LEARN IN A FEW DAYS THROUGH PROVED, TESTED METHODS** to start earning more money than you've dreamed of with this amazing **MIRACLE** finish, which gives a velvety, luxurious surface to radios, lamps, signs, store displays, figurines auto dashboards and hundreds of other items. **FREE PROFIT PLAN** offers everything you need to start at once!

**ENORMOUS DEMAND FOR NEW MIRACLE FINISH**  
We show you every step on the road to success, filling huge year-round demands plus tremendous XMAS holiday business... easy to understand instructions tell you how to earn up to \$5 an hour full or spare time. A few cents worth of materials brings you dollars!

"Pleased with your course and I'm being swamped with work to do." W.F., Pa.

"Got \$52.50 for those 7 trunk interiors for about 4 hours work. \$7.50 per trunk." J.O., Missouri

**READ WHAT OTHERS SAY ABOUT OUR PLAN**

**COAST INDUSTRIES Dept. 12**  
1004 S. Los Angeles St.  
Los Angeles 15, Calif.

**a complete shop in one precision machine!**

**The IDEAL LAWNMOWER SHARPENER**

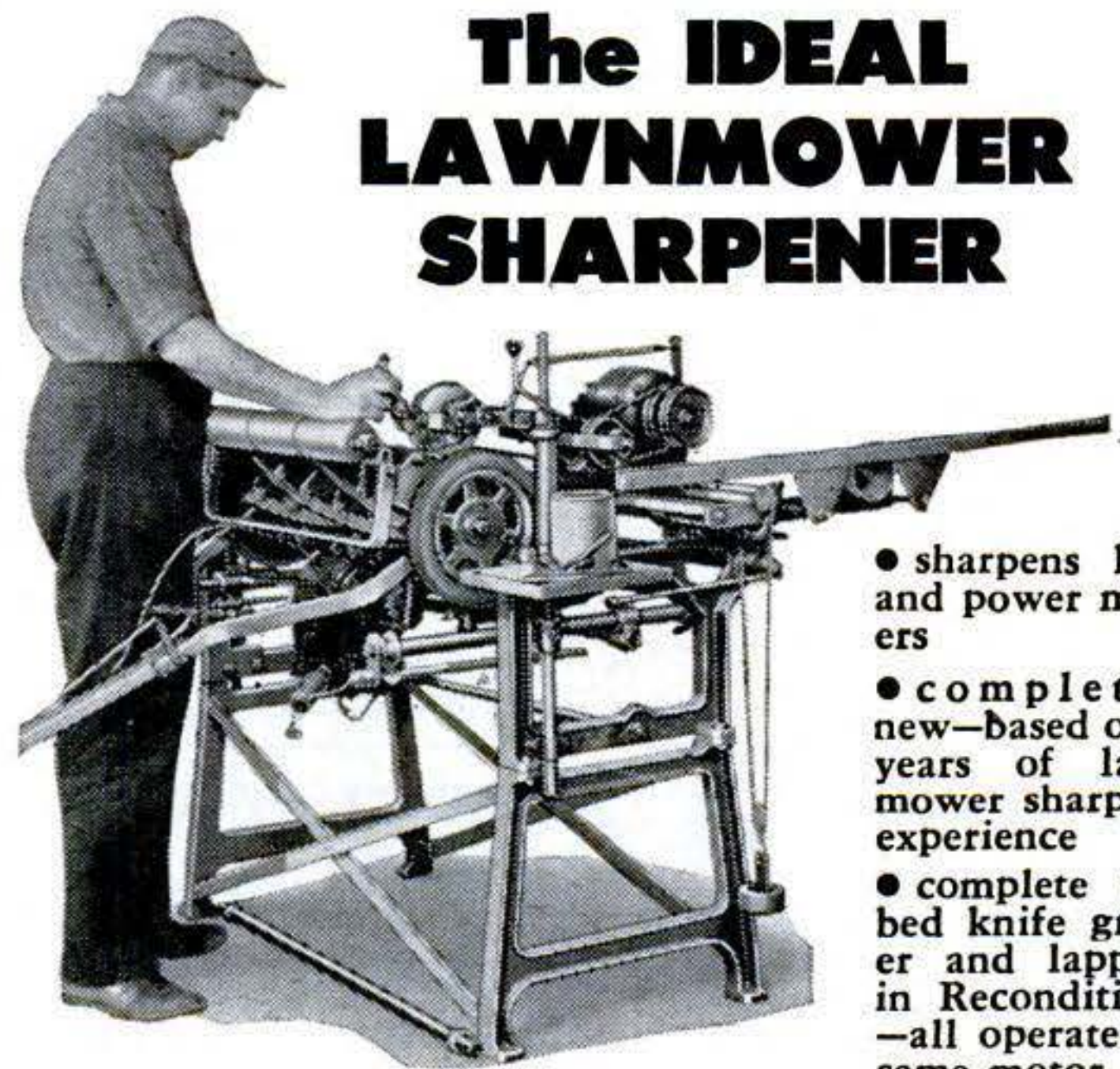

- sharpens hand and power mowers
- completely new—based on 48 years of lawn-mower sharpener experience
- complete with bed knife grinder and lapping-in Reconditioner—all operated by same motor

You can do *precision* lawnmower sharpening faster and easier than ever before on the Model 300 Ideal Sharpener. No disassembling needed, place the entire mower in the machine. You can make more money and do better work with an Ideal. Get all the facts, compare, no other sharpener offers as much as the Model 300 Ideal.

Write Today For Free Catalog

**THE FATE-ROOT-HEATH COMPANY**  
DEPT. H-4, PLYMOUTH, OHIO

**GET**

**A Government JOB!**

**START AS HIGH AS \$3,450.00 YEAR**

Many early Examinations Expected. Prepare NOW! Veterans Get Special Preference! 40-Page Civil Service Book **FREE**

Franklin Institute  
Dept. N-81  
Rochester 4, N. Y.  
(Not Gov't Controlled)

Gentlemen: Rush to me **FREE** of charge, list of U. S. government big pay jobs. Send **FREE** 40-page book describing salaries, vacations, hours, work, etc. Tell me how to qualify for one of these jobs.

Mail Coupon Today **SURE**

Name \_\_\_\_\_  
Street \_\_\_\_\_  
City \_\_\_\_\_ Vet? \_\_\_\_\_

Copyrighted material

# FREE INFORMATION

## CAREER OPPORTUNITIES

### Now in AVIATION

SEND TODAY FOR THIS IMPORTANT FREE LITERATURE

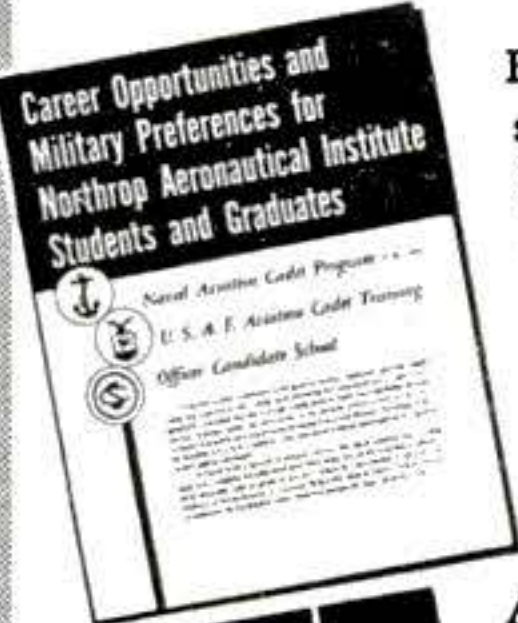

Regardless of your present draft status you should investigate immediately the advantages of Northrop training. Northrop Aeronautical Institute is accredited by the U. S. Air Force and the Navy. Graduates in Aeronautical Engineering meet the educational requirements for Air Force Cadets and Officer Candidate School as well as the Naval Aviation Cadets.

A 34-page illustrated catalog describes Aeronautical Engineering and Aircraft & Engine Mechanics courses. Tells you how this training can affect your whole future. Includes information on curricula, equipment in use — jet engines, large and small aircraft, and experimental and laboratory equipment. This detailed up-to-the-minute information is available to you immediately without obligation.

SEND TODAY FOR THIS VALUABLE INFORMATION

# Northrop

Division of Northrop Aircraft, Inc.

APPROVED FOR VETERANS

## Aeronautical Institute

1525 E. Broadway, Hawthorne, Los Angeles County, California

# The NEW Model 50 UTILITY TESTER FOR REPAIRING ALL ELECTRICAL APPLIANCES-MOTORS

an all-around electrical trouble shooter

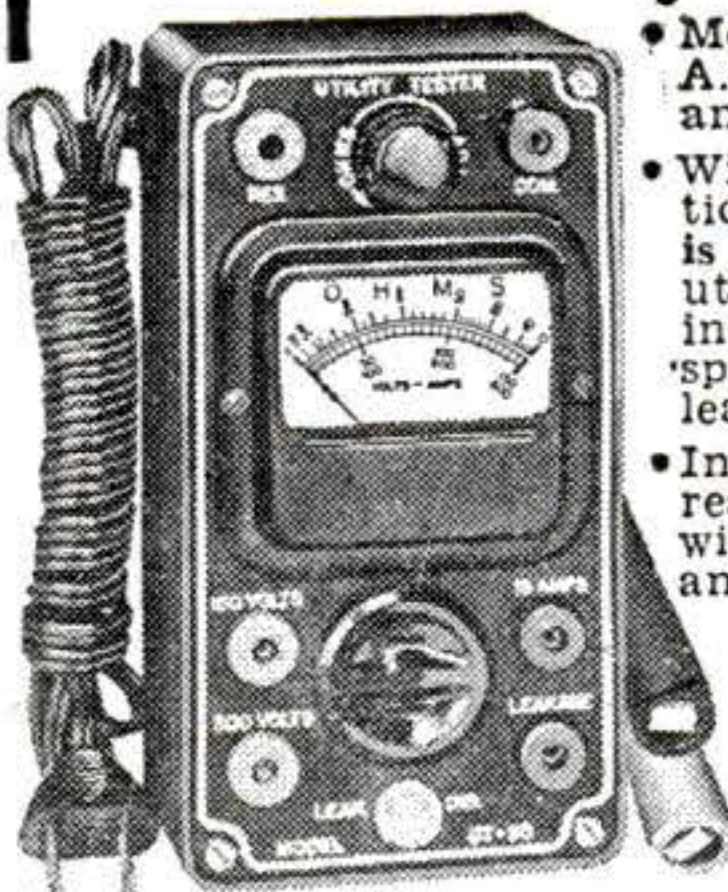

- Measures A.C. and D.C. Voltages, A.C. and D.C. Current. Resistances, etc.
- Will measure the current consumption while the appliance under test is in operation. The appliance or utility may be plugged directly into the front panel receptacle. A special pair of insulated clip-end leads is included for motors, etc.
- Incorporates a sensitive direct-reading resistance range which will accurately measure all resistances commonly used in electrical appliances, motors, etc. This range will enable continuity checks and tests for shorts and opens.
- Will test thermostats, radio tube filaments, bulbs, fuses, fluorescents, condensers, switches, field coils, circuit breakers, lighting systems, etc.

Handsome round cornered molded bakelite case 3 1/8" x 5 7/8" x 2 1/4". Complete with all test leads and instructions.

# \$13.90

**SHIPPED ON APPROVAL**  
**No Money With Order — No C.O.D.**

Try it 10 days before you buy. If completely satisfied send check or M.O. for \$13.90, if not, return to us—no explanation necessary.

SUPERIOR ELECTRONIC CO., INC.

Dept. A-9 • 227 FULTON STREET • NEW YORK 7, N. Y.

# Watch Repairing Pays Big Money Learn at home

Free Literature Tells How

Watchmakers in big demand. You train step-by-step under experts. You learn to take a watch apart—repair and put in perfect working order. 10 easy lessons. We furnish all tools, and a 15 jeweled watch. Practicemovement with first lesson.



Turn spare time into cash—perhaps a business of your own. A licensed school. Students 18 to 65 have profited by our training. Low cost.

Write Today for All the Facts—No Obligation

WATCH REPAIRING Dept. PS-21, 2870 Elston Ave., Chicago 18, Ill.

BRAND NEW



## 30 DAY FREE TRIAL

### High Power BINOCULARS

Finest Precision Optics  
Featherlight

Money Back Guarantee  
Easy Pay Plan  
Leather Case Incl'd.

Free! Catalog & Book  
"How to Select Binoculars"  
Dealer Inquiries Invited

BUSHNELL Binoculars

Bushnell Bldg., Dept. P22  
Pasadena 1, Calif.

# BIG MONEY FOR YOU

Selling Mechanical Trades

\$9.00 Prepaid

It saws all Metals, Bolts, Asbestos, Rivets, Wood, Fibre, Pipe and Tubing. Invest only \$9 in demonstrating sample. You can make over \$50 daily. Write for details.



E. H. STACKHOUSE  
219 N. 63rd St.  
Dept. PS-1250  
PHILA., PA.

**AIM YOUR APTITUDES** They'll pay bigger dividends in earning power, job satisfaction. Remember, it's never too late to be right about yourself—never too early, either. Our new aptitude analysis, based on methods applied to over 7 million veterans, helps you plan your career. Write for our free questionnaire.

U. S. VOCATIONAL GUIDANCE BUREAU Dept. A.—P. O. BOX 2521 HARTFORD, CONN.

# FLASH Your Turns



ELIMINATE HAND SIGNALLING  
S & L DIRECTIONAL SWITCH

The lowest priced Directional Switch that meets all S.A.E. requirements.

Here is a safe, comfortable way of signalling your intention to make a left or right turn. Flashes from 60 to 80 times per minute. No need to roll down window to signal turns in cold winter weather.

Kits furnished with all necessary material for perfect installation. No outside mounting of any kind. Uses your present parking and tail lights. Either of our two models fits most cars from 1942 to 1950.

Specify year and make of car. Money-back guarantee.

A Perfect Gift for Motorists

S & L AUTO SALES  
Box 6414, Dept. C, Chicago 7, Ill.



# \$5.95

postpaid in U.S.A.

Send check or Money Order. Postage extra on C.O.D.'s

# A FASCINATING...MONEY-MAKING art career can be yours

America's **12** Most Famous Artists Show You How!



Norman Rockwell  
Al Parker  
Jon Whitcomb  
Ben Stahl  
Stevan Dohanos  
Robert Fawcett  
Peter Helck  
Austin Briggs  
Harold Von Schmidt  
John Atherton  
Fred Ludekens  
Albert Dorne

Now, for the first time, you can study art under the personal supervision of America's 12 most famous artists. And you learn at home, in your spare time! Write today for our handsome illustrated booklet that tells you all about it. **It's FREE—Write today!**

## FAMOUS ARTISTS COURSE

**FREE**

Dept. 11-N, Westport, Conn.  
Please send book about  
your home study art course.

Mr. Mrs.  
Miss ..... Age .....

Street .....

City, Zone, State .....

**MILLIONS OF  
APPLIANCES  
NEED REPAIR!**

# EARN BIG MONEY.. WORK PART OR FULL TIME IN ELECTRIC APPLIANCE REPAIRING!

ELECTRIC REFRIGERATORS

WASHING MACHINES

VACUUM CLEANERS

ELECTRIC RANGES

MOTORS

SEWING MACHINES

TOASTERS

WAFFLE IRONS

MANGLES

HEATING PADS

FREEZERS

ELECTRIC FANS

ELECTRIC IRONS

LAMPS

ETC., ETC.



### ELECTRONIC KIT TROUBLE DETECTOR

(Checks shorts, wattage,  
continuity, etc.)  
is sent to all students

**MAIL COUPON FOR  
FREE BOOK**

Learn this fascinating big money paying profession at home in your spare time. Learn by doing, by working with your hands building, testing, repairing electrical appliances of all kinds. Electrical appliance repairmen are needed everywhere—wherever electricity is used. You need no special previous training or experience. Age is no handicap. CHRISTY has trained over 33,000 men in all parts of the world. Men who today command big wages or own profitable businesses of their own.

### PAY LATER FROM EARNINGS WHILE LEARNING

CHRISTY shows you how to make money while still learning, what to charge, how to set up your own shop, how to build power tools from spare parts, etc. It will pay you to write today.

CHRISTY TRADES SCHOOL, Dept. DB-604  
4432 N. Kedzie Ave., Chicago 25, Ill.

Send me your FREE book on Electrical Appliance Repairing and special form for "paying later from earnings made while learning."

NAME.....AGE.....

ADDRESS.....

CITY.....STATE.....

# TRADES THAT PAY OFF In Defense & In Industry



**Jewelry-  
Stone Setting**



**WATCHMAKING  
& Chronographs**



**Engraving**

## "3 High-Paying Trades in 1 Career"

### Serve in Emergency—Profit in Industry

Increasing needs in industry—defense—the trades—for thoroughly trained men.

Write for catalog and full information—also inquire about correspondence courses.

**MAIL THIS COUPON TODAY**

**KANSAS CITY SCHOOL OF WATCHMAKING**  
1218 Admiral Blvd.  
Kansas City 6, Missouri

Please send me, without obligation, complete information on training in the above courses.

Name \_\_\_\_\_  
Street \_\_\_\_\_  
City \_\_\_\_\_ State \_\_\_\_\_  
 Check if Veteran G. I. Approved

**Grow with diesel**  
and **SCIENTIFIC MOTOR TUNE-UP**  
—One of America's  
**Fast-Growing Big-Pay Industries!**

● Lay the foundation now for something bigger and better—get into the fabulous Diesel industry. The U.E.I. Plan for learning Diesel and Scientific Motor Tune-Up is simple, practical and is based upon the principle of learning-to-do-by-doing. Essential fundamentals are gained through spare-time home-study, followed by actual shop practice. Competent instructors guide you step by step—you learn the HOW and WHY of Diesel operation, service and maintenance. Get all the facts—mail the coupon and we'll send you a free copy of "Earning Power in Diesel." Mail coupon today!



**UTILITIES ENGINEERING INSTITUTE**  
Chicago 14, Illinois Founded 1927

UTILITIES ENGINEERING INSTITUTE, Dept. DM-10  
2525 Sheffield Ave., Chicago 14, Illinois

Please send me, without obligation, your book "Earning Power in Diesel."

NAME (print).....AGE.....  
ADDRESS .....

CITY..... Zone..... State.....  
 Check here for information if you are under 17

## MODERN LAWN MOWER SHARPENER

**FOR LAWN MOWER SHOPS  
FIX-IT SHOPS  
GOLF COURSES • PARKS  
101 OTHER JOBS**

Sharpens All Reel Type Mowers •  
Hand, Power or Gang • 10 to 20  
Minutes • No Dismantling • No  
Extra Attachments Needed.

All reel type mowers, from 5-inch  
edgers to 36-inch power mowers,  
are quickly sharpened to extreme  
ends of both left and right twist  
blades. Handle, wheels, roller and motor re-

main in place when sharpening  
is in process. Bed knife is  
sharpened in same brackets.  
Grinding head rides on five ball  
bearing races. Easy to operate.  
Also sharpens chisels, joiner  
knives, planer blades. Big profit maker. Own your own  
business. Send Today for **FREE Illustrated Bulletin  
No. 11-C1**. Prices Subject to Change Without Notice.

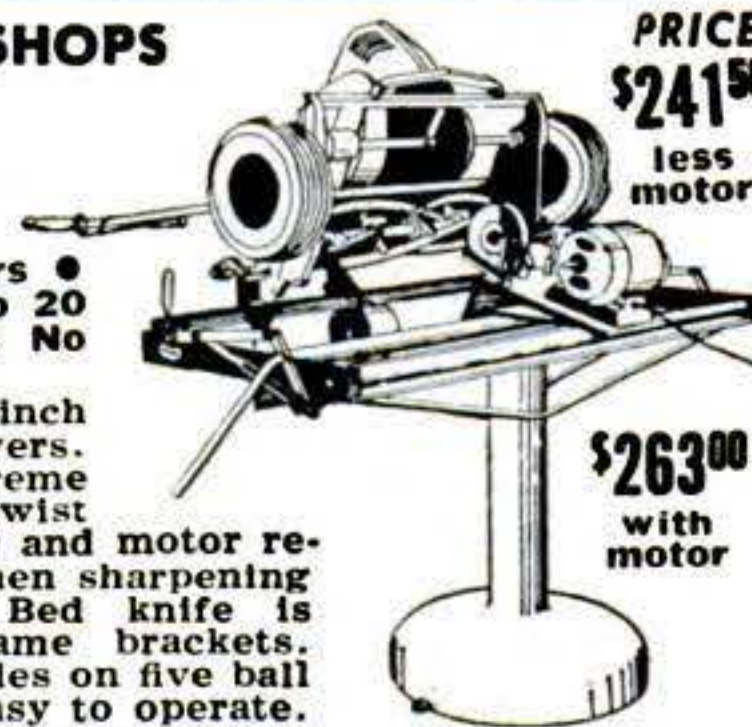

PRICE  
**\$241<sup>50</sup>**  
less  
motor

**\$263<sup>00</sup>**  
with  
motor

**ORDER  
NOW**  
Immediate  
Delivery

**MODERN MFG. CO.** 160 N. FAIR OAKS AVE  
PASADENA 1, CALIFORNIA

## IMPROVE YOUR T-V RECEPTION

**\$4<sup>95</sup>** Avoid Flicker and Fuzz . . .  
ea. Get Sharp, Clear Pictures



### Fletcher T-V Antenna Rotator

Simple to install, rugged in construction, nothing  
to go wrong. Rotates outside antenna full 360°  
for best picture reception on each channel.  
Shipped Prepaid...Send your check or money  
order today. Stocks are limited.

**Satisfaction guaranteed or money  
cheerfully refunded.**

**ELECTRONICS SUPPLY CO.**

150 West Green Street, Pasadena 1, California

## SUCCESS! CAN BE YOURS!

Would YOU like to have ALL THE LAWS  
OF SUCCESS in ONE COMPLETE COURSE—  
So you won't have to read hundreds of books to  
get it? Then write for FREE Booklet "The Mas-  
ter Mind" by Napoleon Hill. No Obligation. One  
student writes, "My salary went up from \$50 a  
week to \$8000 a year." Write today.  
RALSTON PUB. CO. 148 Engineers Bldg. Cleveland, 14, Ohio

## SILVER SOLDER TORCH & KIT \$6



**Joins All Metals Permanently  
EQUAL TO WELDING FOR MOST PURPOSES**

Do your own repairing. Kit includes one tube  
silver solder flux and 10 5-in. lengths silver solder alloy.  
Hottest ALCOHOL TORCH known, 2700° F. flame. Operates  
in any position, indoors or out. Torch alone \$5. Kit alone  
\$1.50. Complete instructions included with torch and kit.

Add 25c on each order to apply towards shipping charges

AMERICAN PRODUCTS CORP., 422 S. Dearborn St., Dept. 28, Chicago 5, Ill.

## If Ruptured



**Do What Others Now Do—  
Wear a Form Fitting  
MILLER Truss**

which provides natural freedom  
and comfort in working, play-  
ing, walking, dancing, horse  
back riding, swimming, when  
sleeping, etc. You just cannot  
afford to be without this pro-  
tection and convenience.

Wear the MILLER Truss and  
consult your physician before  
deciding to keep it.

Write me today for **FREE**  
descriptive circular. Sent in a plain, sealed envelope.

**FRED B. MILLER Manufacturer**  
Dept. P.S., Hagerstown, Maryland.



# NEW *Coprion* SEAMLESS BELL



First and only seamless bell, of superior new metal, made by electro-mechanical process. Impossible to overblow or crack a note! Gives amazingly greater flexibility, richer tone quality, easier response. Exclusive on Conn trumpets, cornets and trombones. Most important development in years. Preferred by the leading artist. See your Conn dealer or write us. Please mention instrument. Conn Band Instrument Div., C. G. Conn Ltd., 232 Conn Bldg., Elkhart, Ind.

MAKES YOUR  
PLAYING

*Easier!  
Better!*

*Write  
FOR FREE  
FOLDER*



**CONN**  
BAND INSTRUMENTS

## TRAIN

- IN — AIR CONDITIONING — REFRIGERATION
- AND/OR ELECTRICITY, MAJOR APPLIANCES,
- SERVICE, MAINTENANCE & INSTALLATION

*Write for Catalog PS4*

• **COMMERCIAL TRADES INSTITUTE**  
200 South 20th St., Birmingham, Ala.

• Member: Southern Association of Private Trade Schools  
An approved school to TRAIN Veterans & Non-Veterans

## Be a DETECTIVE

**A CHALLENGE FROM WASHINGTON, D. C.**  
Help Stop Crime! Train at home. Earn big money. Amazing training course from the NATION'S CAPITOL (center of law enforcement) by former U. S. GOVT. AGENT and NAVAL INTELLIGENCE Officer exposes actual methods used by Criminals. Write for FREE BOOK. State age.



**INTERNATIONAL DETECTIVE TRAINING SCHOOL**  
1701 Monroe St., N.E. Dept. 212 Washington 18, D. C.

**learn to HYPNOTIZE!**



Command others with hypnotic power! Amaze everyone with your new spell-binding technique. New, easy to master course teaches you this mystic art quickly, professionally. Send for this Valuable Book now! "25 Lessons in Hypnotism" Just Pin \$1 to this ad. Satisfaction guaranteed or money back.

**Books Publishing Co. 56 W. 24th St. New York 10, N. Y.**

## GET MY SECRETS of BUSINESS SUCCESS!



**MAKE BIG MONEY SHOWING THE BOSS HOW TO SAVE MONEY! STUDY AT HOME**

Do you want to double or triple your pay? Do you want to give instead of take orders? Then send for my Short-Cuts to Success without cost or obligation. Tells how men like yourself win big money and industry's top jobs in the no-competition Management Profession after a few short months! Previous experience not important. Earn extra money while learning. Knowledge of this profession is VITAL to men about to enter the Armed Forces. DON'T DELAY—write for FREE booklet and information today!

**GODFREY H. KURTZ, President, Industrial Engineering College, 3309 W. Washington Blvd., Chicago 24, Ill.**

LET US PUT THIS  
Magnificent NEW 1951

# MIDWEST

## TELEVISION- RADIO-PHONO

Console In Your Home

for 30  
DAYS  
MONEY BACK  
TRIAL



FACTORY  
TO YOU

EASY  
TERMS

MAMMOTH 19 1/2-Inch PICTURE  
TUBE  
AM-FM Radio and 3-Speed Phonograph

Be your own judge! See and hear Midwest Television in your own home. Then decide whether to keep it or have your money refunded. Low Factory Prices.



Also Available on 30 DAYS TRIAL!  
The Sensational New 5-Band  
World-ranging 1951 Model  
**MIDWEST RADIOS**

Send This  
COUPON  
on 1c Post  
Card for  
NEW 1951  
FREE  
4 Color  
MIDWEST  
CATALOG

**MIDWEST RADIO & TELEVISION CORP.**  
Dept. 24H, 909 Broadway, Cincinnati 2, Ohio

NAME \_\_\_\_\_

ADDRESS \_\_\_\_\_

CITY \_\_\_\_\_ ZONE \_\_\_\_\_ STATE \_\_\_\_\_

# MACHINE SHOP MEN

*Needed Now!*

TODAY shop men are in big demand. Don't miss the chance to get into the big money class and to qualify for promotions to high pay positions. Opportunities are open to men who add to their "know how" day by day. Equip yourself without delay.

## 8 BIG BOOKS ON APPROVAL

Modern Shop Practice, 14th edition, is the 8-volume set for the use of ambitious men. It contains 4,000 pages of vital information—3848 illustrations—167 tables. Written simply and clearly by 41 experts in tool making, pattern making, foundry work, forging, mechanical drawing, blueprint reading and many other skills. With the set we include a special binder of 860 profusely illustrated pages covering machine shop operations step by step, and 293 actual job tickets. 9 books in all! See also our gift offer at the left.

### DICTIONARY OF MACHINE SHOP TERMS

Pocket Size

Included as gift if you act NOW, whether you keep or return the set.

Send the coupon NOW. Examine these books and note their great help to you. If you want to keep the set, pay on the very easy terms. If not, return the 9 books and owe us nothing. Remember—we now give a year's consulting privileges with our engineers without charge.

PUBLISHERS SINCE 1898

AMERICAN TECHNICAL SOCIETY, Dept. S220  
Drexel at 58th St., Chicago 37, Illinois

Send me the 8 big books and special binder on approval. I will pay delivery charges only. If I decide to keep the books I will send \$3.00 in ten days and \$4.00 per month until the total price of \$34.80 is paid. If I return them in 10 days I can keep the dictionary and owe you nothing. You also agree to send me a certificate entitling me to consulting privileges without extra charge.

Name \_\_\_\_\_

Address \_\_\_\_\_

Please attach a letter stating age, occupation, employer's name and address and name and address of at least one business man as reference. Men in service, also please give home address.

## AVIATION CAREERS



Prepare for success in aviation — World's fastest growing industry. Train at Spartan—Internationally-famous school. Complete, thorough courses in all phases of aviation. Gov't approved. Write Department PS-21

SPARTAN SCHOOL OF AERONAUTICS  
MUNICIPAL AIRPORT • TULSA, OKLAHOMA

## Big 6 HORSEPOWER ROTARY TILLER

**\$349**

No Extras to Buy



The Mulsifier Rotary Soil Tiller! Unsurpassed for tilling and cultivating. Makes it easy to work 1 to 20 acres. Prepares the soil in one operation. Nothing to do but guide it. High-powered—adequate for all soils. Unbreakable tines. Gives you more horsepower per dollar than any other garden tractor. Attachments available. Money-back guarantee. Send postcard for circular.

**MULSIFIER IMPLEMENT CO.**

7760 HAMILTON, DETROIT 2, MICH.

\*Trade Mark Reg. U. S. Pat. Off.

Free CIRCULAR

*Mulsifier*

**ROTARY SOIL TILLER**



## BRUSHES

Suitable for  
• PAINT, ENAMEL  
• LACQUER  
• GLUE, PASTE  
• OIL & CHEMICALS

Ideal for

Workshop use Household, Factory and Hobbyists

100 Assorted Brushes.....\$4.00  
50 Assorted Brushes..... 3.00  
25 Assorted Brushes..... 2.00

MINIMUM ORDER \$2.00

Postpaid. No C.O.D.

PS. ELGENE MFG. CO. 9015 Fifth Ave. Brooklyn 9, N. Y.

## PICTURE DEVELOPING OUTFIT \$4.99!



Complete Home Photo Developing, Printing Lab Outfit at Half the Price Offered in Stores! Includes printer and light box—3 developing trays, 3 packs developer, 3 packs fixer, 25 sheets of 4 x 6 photo paper, stirring rod, safelight, 4 oz. graduate, thermometer, 100 art corners, Beginning Photography Course and How You Can

EARN \$25.00 to \$50.00 A WEEK

making pictures, photo cards and developing films for others. Approved by Professionals. Many boys and girls from 8 years up learn in a Few Hours! Ideal Start in Photography For Anyone!

SEND ONLY \$1.00 (bill, ck, mo) and pay postman \$3.99 plus C.O.D. postage or send \$4.99 plus 40c postage for p.p. delivery. ORDER YOUR LAB NOW AND START LEARNING AND EARNING GOOD MONEY IN PHOTOGRAPHY THE FIRST WEEK! MIDWAY CO. Dept. FPS-2 KEARNEY, NEBRASKA

## How to win an Executive's JOB and PAY

Only one thing stands between you and a top executive's pay—the right kind of ability. You may be skilled in your work, yet if not trained in management you are not likely to be promoted to important executive jobs. Thousands win promotions thru LaSalle's Executive Training—and YOU too can gain tremendous advantage over others by knowing management principles. Write today for FREE 48-page book, "14 Steps to Executive Leadership."

LASALLE Extension University, 417 So. Dearborn St. A Correspondence Institution Dept. 283-BM, Chicago 5, Ill.



SEND FOR THIS FREE!

Make money. Know how to break and train horses. Write today for this book FREE, together with special offer of a course in Animal Breeding. If you are interested in Galting and Riding the saddle horse, check here ( ) Do it today—now.

BEERY SCHOOL OF HORSEMANSHIP  
Dept. 582 Pleasant Hill, Ohio

## AMAZING POCKET ALARM

You've always wanted one of these sturdy, accurate, 7-jewel alarm watches . . . so here it is —at tremendous savings. Check these value extras.

- Loud Alarm
- Fits Watch Pocket
- Stands on table
- Unbreakable crystal
- White, pink or black luminous dial
- All Chromium case

ONLY \$8.95 Post Paid

Check or money order plus 10% Federal Tax. 10 day return privilege—1 year guarantee.

FRANKLIN SALES CO.

Dept. PS-2  
17 John Street, New York, New York

*It Rings*



# \$200 GROSS IN MY FIRST WEEK!



**Some Make More, Some Less . . . Start This Business for YOUR OWN**

Would YOU like to own a permanent, year-round business in which it is possible to take in as much as \$200 gross the first week, as did L. A. Eagles? R. E. Traynor says, "I made \$62 gross in one day." R. R. Newlin reports, "I have averaged \$173 gross per week." Others report gross from \$100 per week to \$12,000 per year.

Surely YOU will want to investigate a golden opportunity like that. You need not have any special skill or experience, but if you are ambitious, honest and courteous, we will help you to start and succeed in YOUR OWN money-making business where net profits are high.

### No Shop Necessary

Our Electric Rug Washer cleans rugs and carpets like new right on the customer's floor. This quick, thorough and highly efficient method removes dirt and grime, thus restoring the natural, fresh beauty of floor coverings. Anyone can run it. Rugs and carpets are not harmed.

There are hundreds of possible customers in YOUR vicinity. Most of them have several rugs needing regular cleaning. To get a quick start,

## FREE BOOK! MAIL COUPON

**VON SCHRADER MFG. CO.**  
211 PL., Racine, Wis.

Send at once (no obligation) your FREE booklet containing information about your Electric Rug Washer and how I can own my own permanent, profitable business.

Name \_\_\_\_\_

Address \_\_\_\_\_

City \_\_\_\_\_ (Zone) \_\_\_\_\_ State \_\_\_\_\_

shampoo a few rugs or carpets. These customers tell their friends and soon you should have an independent, prosperous business, and you should be able to keep it growing. Send the coupon RIGHT NOW for booklet that explains everything.

### Every Machine Guaranteed and Easy to Own

You take no risk. These wonderful, fully guaranteed machines have been used and endorsed by largest hotels, railroads—also used by U. S. Government. Many individuals have built up successful businesses that made big profits. Mail the coupon TODAY and we will send complete information, including how to start and succeed in YOUR business without a large investment. Don't delay your BIG opportunity. Send the coupon AT ONCE.



**MAIL COUPON TO VON SCHRADER MFG. CO., 211 PL., RACINE, WIS.**

**now!** Foredom offers a **POWER-PACKED** 14000 RPM 1/15 H.P. **FLEXIBLE SHAFT MACHINE** YOU can afford

**ONLY \$29.<sup>60</sup>**  
including 6-STEP FOOT RHEOSTAT

**3-WAY USEABILITY**  
● Hang it up ● Set it on Bench ● Mount under Bench

Foredom's Model 9050 gives you industrial quality at a popular price. Here is what you get: ● 14000 rpm 1/15 H.P., air-cooled universal motor ● precision-made pencil-size, quick-detachable handpiece ● flexible shaft of extra good flexing qualities running in a metal sheath covered with tough, long-lasting Neoprene. Here's a small power grinder with the kind of power, speed, stamina and all-around versatility you have been waiting for. TOPS THEM ALL. For commercial users and home users who insist on industrial quality in their tools.

**Use it to grind, polish, drill, saw, sand, carve, mill, clean, rout, etch, engrave, etc. on all metals, wood, plastics, glass and linoleum.**

Includes your choice of 3/32" or 1/8" capacity collet. Add 85c if you want both.

Backed by Foredom's 28-year-old reputation for quality and workmanship. Other motor-driven models for as little as \$17.75, all precision-made.

Catalog 1038-E on request.

**FOREDOM ELECTRIC CO.**  
27 PARK PLACE Dept. 1038-E NEW YORK 7, N. Y.

## KNOW your car engine MOTOR TUNE-UP MANUAL

Gives you ALL the information you need in order to understand THOROUGHLY the modern automobile engine and how to keep it in top running order.

ALL principles as well as detailed practical instruction

Explains all electrical and engine principles; the function of EVERY part in batteries, ignition system, distributor, spark plugs, fuel and accelerator pumps, carburetor, choke system, valves, power jet, bearings, manifold, cooling system, starter motor, generator, voltage regulator, etc. Shows step by step how to test each part, make sure meter readings are accurate, locate all types of trouble, make all adjustments. Full information on fuels included.

**ONLY \$5.50**  
Handy lists of trouble symptoms and all possible causes.  
Complete summaries of each step in all tune-up jobs.  
190 diag., il.

**SEE IT ON APPROVAL**

The Macmillan Co., 60 Fifth Ave., New York 11

Please send me Motor Tune-Up Manual on approval. I will either remit \$5.50 or return the book in 10 days.

Signed.....

Address.....

EARN **\$20** A DAY

Learn in your spare time at home

ACRI INSTITUTE One of America's finest schools

Approved Md. State Board of Education. Member of Better Business Bureau

## AIR CONDITIONING REFRIGERATION

Air Conditioning and Refrigeration is one of America's greatest opportunity fields. Qualified men are needed now—needed by industry, by the Army and other services. Learn a trade with a future in your spare time with two weeks practical training in the great, modern shops of ACRI. Free room and board. Round trip transportation free (up to 1,000 miles).

Investigate ACRI Institute, one of America's finest schools.

ACRI Institute, 110-114 North Poca Street, Baltimore 1, Maryland., Dept. PS-1

Please send me without obligation, free information regarding Home Study Course and the big opportunities in Air Conditioning and Refrigeration.

Name .....  
Address .....  
City .....  
Zone ..... State.....

MAIL COUPON TODAY!

## BE A LANDSCAPE CONTRACTOR

or a Landscape Architect. Make \$15 to \$50 a day. Compare the competition in this field to others & you'll see why we have hundreds of employed graduates from coast to coast. Course includes practical instruction here in addition to approved home study work. Write for free information



NATIONAL LANDSCAPE INSTITUTE  
310 So. Robertson Dept. PS-2 Los Angeles 48, Calif.

New Advertising Machine



Prints & Illustrates 1¢ Post Cards

**FREE** Learn how thousands of business men, in every line, are boosting sales in spite of conditions—with 1¢ messages—printed and illustrated in a few minutes on gov't post cards—with amazing new patented **CARDMASTER**. Your "today's" ideas, read by your prospects next morning. Not a toy, but a sturdy advertising machine, built to last for years. Low price, sold direct. Guaranteed for five years. Send name today.

**SEND NAME** We'll send **FREE** illustrated book of money-making IDEAS for your business and complete, unique advertising plans. RUSH YOUR NAME TODAY.

**CARDMASTER COMPANY**  
1920 SUNNYSIDE, Dept. 162, CHICAGO 40, ILL.

50 POPULAR SCIENCE

## TRY HOME STUDY WATCHMAKING

### FREE Sample Lesson

Famous Sweazey System shows how to master watchmaking . . . expertly, quickly, successfully . . . right in your own home. No previous experience needed to learn one of the highest paid trades. Try it without obligation.

### G. I. APPROVED RESIDENT COURSES

. . . in Watchmaking, Engraving, Jewelry Repair, Diamond and Stone Setting at our modern, fully-accredited resident school. Founded 1908. Write for **FREE CIRCULAR**.

**CHICAGO SCHOOL OF WATCHMAKING**  
1608 N. Milwaukee Avenue, Dept. 421, Chicago 47, Ill.

## FALSE TEETH KLUTCH holds them tighter

KLUTCH forms a comfort cushion; holds dental plates so much firmer and snugger that one can eat and talk with greater comfort and security; in many cases almost as well as with natural teeth. Klutch lessens the constant fear of a dropping, rocking, chafing plate. 25c and 50c at druggists. . . . If your druggist hasn't it, don't waste money on substitutes, but send us 10c and we will mail you a generous trial box.

**KLUTCH CO., Box 5194-B, ELMIRA, N. Y.**

## BRAND NEW! 7 JEWELS

3 YEAR SERVICE GUARANTEE

★ SHOCK RESIST.  
★ RADIUM DIAL  
★ SWEEP SECOND HAND  
★ CHROMED CASE  
★ LEATHER BAND

**\$6.95**  
Post-paid  
Plus 70c tax

Refund if not satisfied. Special! Order Now!  
Sorry, no C.O.D.'s.

LADIES WATCH, **\$7.95** plus 80c tax  
as above, smaller Size



166 W. Washington  
Chicago 2, Ill.

**ELCO PRODUCTS, Dept. PS-2**

## 1/2" ELECTRIC DRILL \$2.95

ADAPTER takes all drill sizes to 1/2"

Fits any small 1/4" Electric Drill—  
in just a second! Well-made

and a Mighty Handy Tool!

**DANIELS PRODUCTS CO. P2-822 W. 22nd St., Kearney, Nebr.**



Postpaid in U.S.A.

Order Now

MAIL ORDERS—Postage Prepaid—Money Back Guarantee



## U. S. Air Force Surplus—All Brass BRAND NEW! 1 1/2 QUART

Just like the HAND PUMP FIRE EXTINGUISHER you see in Public Bldgs., Warehouses, etc. Made by best known Fire Extinguisher Manufacturers. Every CAR, TRUCK, GARAGE, HOME should have one. Just fill with carbon tetra-chloride. Complete with wall bracket.

Cost **\$18.50**  
New

**\$4.49**

**Universal Enterprises, 946-B. S. Main, Los Angeles, Cal.**  
We Pay Taxes, Insurance, Postage. Calif. residents add 3% Sales tax

# MARVEL MYSTERY OIL and INVERSE OILER

**THIS GREAT COMBINATION KEEPS PERFORMANCE UP**

**RING, PISTON AND VALVE WEAR DOWN**

MARVEL INVERSE OILER—Feeds Marvel Mystery Oil to critical upper cylinder area in proportion to acceleration. Visible supply in 1 qt. glass container functions on the exclusive Marvel principle.

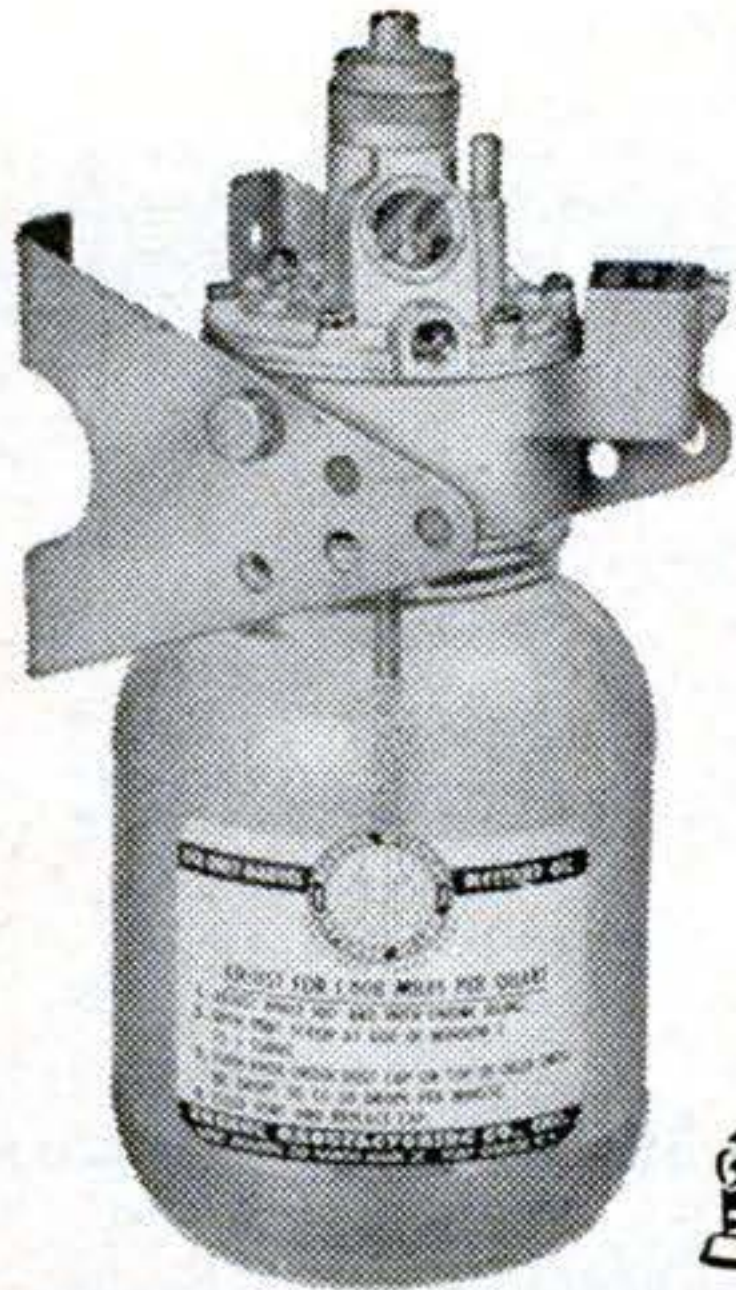

**UNEQUALED FOR NEW CAR BREAK-IN!**

MARVEL MYSTERY OIL—Protects rings, valves and pistons and produces highly-polished, wear-resistant finish on cylinder wall and parts. Can be used in Marvel oiler, crank case or gas tank.

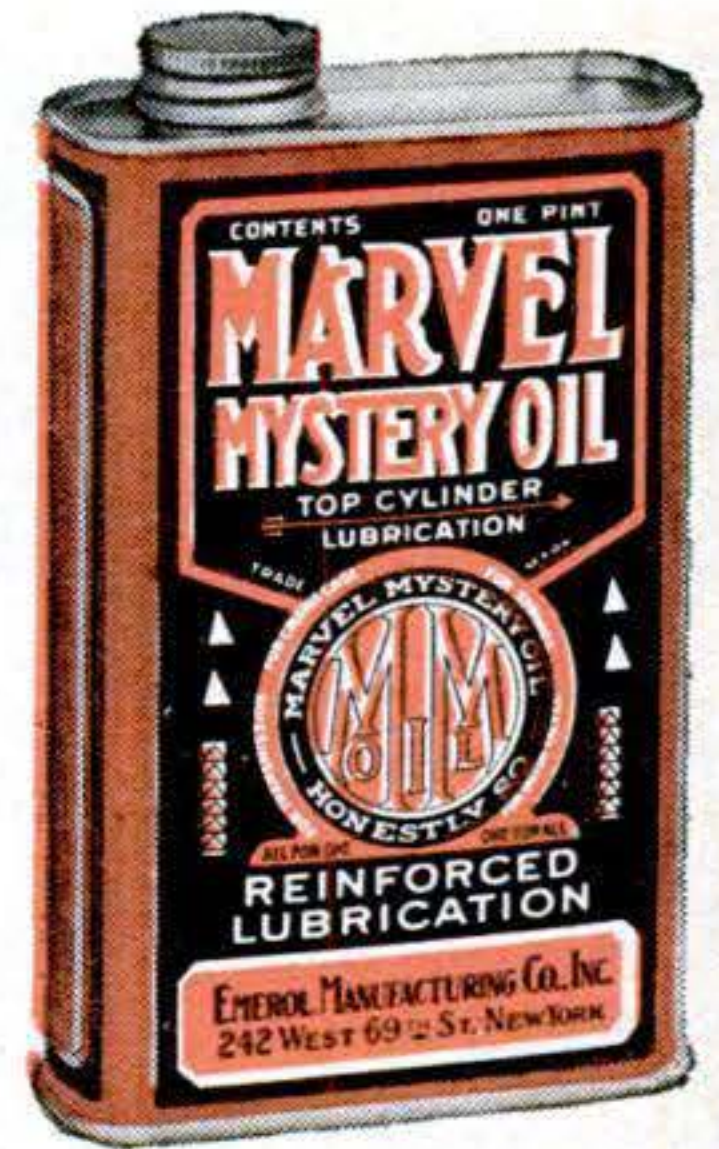

Have your car Marvelized at your dealer today, or write for free information. Dept. 102

**EMEROL MANUFACTURING CO., INC.**  
242 West 69th Street, New York 23, N. Y.

## BE A PHOTO-ENGRAVER

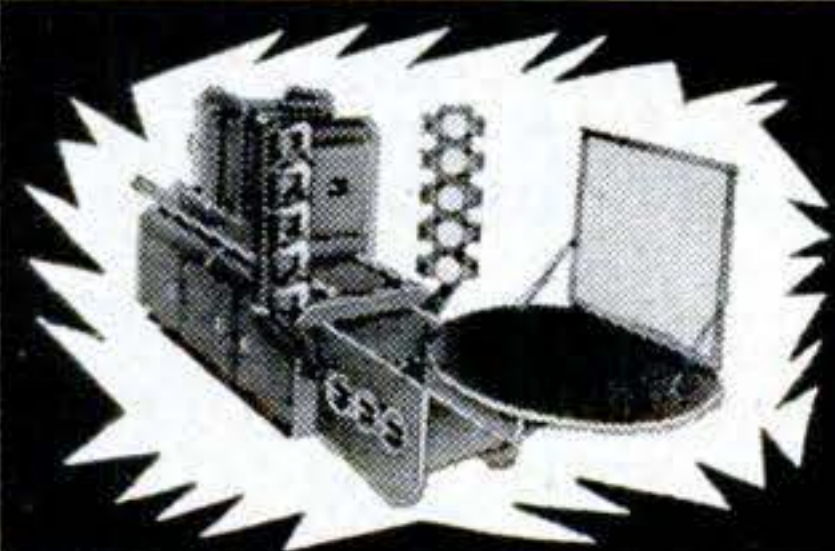

We furnish complete equipment and supplies. Learn at home or in our modern, friendly APPROVED school in MISSOURI. Get into this big demand, high profit, high wage field. You can start your own profitable, full time or part time PHOTO-ENGRAVING business right in your own home.

Be independent, be your own boss or pave the way to a high pay job with experience gained in your own shop.

TASOPÉ TRAINING and TASOPÉ EQUIPMENT has enjoyed world wide recognition since 1931. Write for descriptive literature today. No obligation.

THE AURORA SCHOOL OF PHOTO-ENGRAVING, DEPT. PS-2 TASOPÉ BLDG., AURORA, MO.

## MAGIC-SCREEN INCOME PLAN OFFERS BIG MONEY, AT HOME, SPARE OR FULL TIME

Reproduce any painting, design, trade-mark, picture, printing, in full color, on any surface! Proven new method enables you to cash in on established business where Profits up to \$5.00 or more an hour are being made, right now! Examine complete Plan and equipment without risk! Write today for free sample — complete free details! Act NOW!

CALIFORNIA ACADEMY OF SCREEN PROCESS — Dept. 122  
5100 S. VERMONT AVE., LOS ANGELES 37, CALIF.



## weather station

**WIND SPEED, DIRECTION, TEMPERATURE**

The ACI WINDOMETER in use by airlines, govt., yachtsmen, flyers, industry — complete precision units — send for free literature. **\$89.50**



AIRCRAFT COMPONENTS, INC.  
1571 Woodland Ave., Benton Harbor, Mich.

## GADGETS, TRICKS, JOKERS, HOBBIES, FUN-MAKERS, ETC.

## Catalog of Nearly 8,000 Novelties---Nearly 600 Pages

Collier's, Coronet, New Yorker, Tide Magazine Write About This Amazing "World's Most Unusual" Catalog

More interesting than carnival, circus, world's fair & science exhibit rolled into one. Odd hard-to-get novelties, gadgets, funmakers from all over world. More fun than reading best selling book. Costs us nearly \$1.00 a copy. You send only 10c for this big 600 page catalog—nothing more to pay or buy. Partial contents:

Accordions	Axes	Bugles	Cowboy Items	Flowers, Seeds	Home Exper.	Live Animals	Plating Equip.	Skirts, Hula	Thermometers
Addresses	Badges	Buyers' Guide	Crosses	Flying	Home Repair	Locks	Poker Items	Skull Novelties	Throwing Knives
Airplane Models	Balloons	Calculators	Crucifixes	Football	Horse Racing	Looms	Printing Items	Skunk, Live	Tie Novelties
Air Rifles, Pistols	Banks	Calcs, Animat	Crystal Gazing	Forecasters	Houses, Model	Lovers' Items	Projectors	Slide Rules	Time Savers
Albums	Bar Novelties	Cameras	Crystal Radios	Formulas	Hunting	Lucky Novelties	Purses	Smokers' Items	Tools
Alligators	Barometers	Camper's Items	Cuckoo Clocks	Fortune Tellers	Hypnotism	Luminous Items	Racers, Auto	Snake Novelties	Trapping
Altars	Baseball Items	Caps, Guns	Dancing	Fun Makers	Imported Goods	Magie	Rackets	Sneezing Items	Treasure Finders
Animals, Live	Basketball Items	Card Tricks	Dice Items	Gadgets	Indian Novelties	Magnetic Items	Radio Items	Soap Novelties	Tricks
Archery	Bead Looms	Cartoonist Items	Disguises	Gambling Items	Indoor Games	Magazines	Razors, Etc.	Spiritualism	Trophies
Artist Supplies	Beards	Cash Boxes	Dog Novelties	Games, Supplies	Ink Novelties	Magnifiers	Religious Goods	Sporting Goods	Turtles
Ash Trays	Beer Novelties	Chameleon, Live	Drawing Items	Garden Items	Insect Killers	Make Up Goods	Stamp Col. Items	Stag Novelties	Typewriters
Astronomy	Belts	Charms	Electric Eye	Geiger Counter	Itching Powder	Maps	Stationery Sup.	Sure-Winners	Vaults & Banks
Astronomy	Betting	Chemistry Items	Electrical Goods	Girls, Pretty	Jewelry	Masks	Surprise Package	Sweater Emblem	Ventriloquism
Atomic Science	Bibles	Chess	Electro-Platers	Glasses	Joke Novelties	Massagers	Swim Items	Watches	Water Novelties
Auto Items	Bicycle Supplies	Chimes	Emblems	Golf Items	Ju Jitsu	Medals	Tattooing	Whip Novelties	Whip Novelties
Awards	Billfolds	Cigar & Cigaret	Engines	Guitars	Key Chains	Microphones	Taxidermy	Whip Novelties	Whip Novelties
Awls	Binoculars	Novelties	Engraving Tools	Guns, Supplies	Kits, Hobby	Microscopes	Team Supplies	Whip Novelties	Whip Novelties
	Blankets	Novelties	Enlargers	Gymnastic Items	Keys, Master	Mineralogy	Telegraph Sets	Whip Novelties	Whip Novelties
	Boats	Novelties	Enlargers	Handicraft Items	Knives	Mirrors	Telephones	Whip Novelties	Whip Novelties
	Bodies, Shrunken	Novelties	Explosive Items	Hardware	Labels	Model Supplies	Telescopes	Whip Novelties	Whip Novelties
	1000 Books	Novelties	Fencing Items	Harmonicas	Lamps	Money Savers	Television Items	Whip Novelties	Whip Novelties
	Boxing	Novelties	Field Glasses	Head, Shrunken	Lenses	Money Makers		Whip Novelties	Whip Novelties
	Bracelets	Novelties	Fireworks	Height Builders	Letters, Sweater	Monkeys, Live		Whip Novelties	Whip Novelties
	Bug Killers	Novelties	Fishing Items	Hobbies	Lighters	Motors		Whip Novelties	Whip Novelties

SEND 10c TODAY WITH YOUR NAME AND COMPLETE ADDRESS—NO LETTER NECESSARY

Big 600 page catalog of over 7000 novelties, 3500 pictures, 6-color cover, 1-inch thick. Send 10c at once—no obligation. (Postage stamps accepted).  
Rush 10c with name & address today to: JOHNSON SMITH & COMPANY, DEPT. 351, DETROIT 7, MICHIGAN

# Build Your Own DREAMHOUSE at 1/3 Cost

Or Start A Business of Your Own



**GENERAL HOMEMAKER**  
Concrete Vibrator  
**BLOCK MACHINE**  
and Mixer  
only \$435 F.O.B. PLANT  
COMPLETE WITH 2 ELEC. MOTORS

You can build your own home at one-third cost. Or, you can start a profitable business of your own with this unique machine. Sell all the block you can produce at 100 to 150% profit.

### 1000 BLOCKS PER DAY

The General Homemaker comes complete with mixer, 2 electric motors, belts and switches, 25 pressed steel pallets. Heavy steel construction with attachments for quick changeovers. Mixer is reversible and detachable for pouring foundations, cellars, sidewalks, steps. Sealed ball bearing vibrator assembly. Anyone can operate. Complete instructions and mixing formulas supplied. Write for FREE details.

**HOW TO BUILD YOUR OWN CONCRETE BLOCK HOME**  
Only 1/3 Prepaid

Wonderful Book Written & Illustrated by Experts

## GENERAL ENGINES CO.

DEPT. S-17 • 307 HUNTER ST. • GLOUCESTER, N. J.

Includes floor plans for 6 beautiful, easy to build concrete block bungalows. Shows ways to save money. How to lay blocks, lay out building lines, mix concrete, build steps, porches and concrete floors. Mail coupon at once with \$1.

Name.....  
Address.....  
City.....Zone...State.....

## OWN a Business

Clean and Mothproof rugs and upholstery "in the home." Patented equipment. No shop needed. Duraclean dealer's gross profits up to \$20 a day on EACH serviceman. These Nationally Advertised services create repeat customers. Easy to learn. Quickly established. Easy terms. Send today for Free Booklet—Full details.

Duraclean Co., 1-182 Duraclean Bldg., Deerfield, Ill.

## ENGINEERING DEGREE IN 27 MONTHS

### Big Demand for Graduates

**AERONAUTICAL, CHEMICAL, CIVIL, ELECTRICAL, MECHANICAL and RADIO ENGINEERING** (including Television). Hundreds of young men are earning engineering degrees in this recognized institution each year—continuous operation. New terms start quarterly. Many students earn a major part of their college expenses in this large industrial center.

Low tuition. Competent instruction. Thorough, intense, practical program. Modern laboratory facilities including new physics lab. and modernized wind tunnel. Individualized instruction emphasized.

Approved for Veterans. Engineering preparatory courses. Students from 48 states and 21 foreign countries. Enter March, June, September, December. Send coupon for free catalog and full information. Enroll now.

SEND COUPON TODAY

## INDIANA TECHNICAL COLLEGE

621 E. Washington Boulevard  
Fort Wayne 2, Indiana

Please send me free information on B. S. Engineering degree in 27 months as checked.

- Aeronautical,  Chemical,  Civil,  
 Electrical,  Mechanical,  Radio-Television.

Name.....  
Address.....

## BURN WATER OR ALCOHOL OR BOTH IN YOUR CAR!

FOR ALL CARS, TRUCKS & TRACTORS  
The gasoline mileage of new high compression automobile engines can be increased up to 30% with alcohol-water-gasoline fuels. (Say U.S. Agricultural Department scientists.)

WRITE FOR FREE LITERATURE  
Illustrated — Interesting — Descriptive  
YOU'LL BE GLAD YOU DID

NATIONAL AUTOMOTIVE RESEARCH CORPORATION, Dept. OG-2  
Venice, California

## LAWN ORNAMENT-NOVELTY PATTERNS

28 Lawn Ornament Patterns, 25c. Other patterns: 15-20" high; Dutch Girl, Dutch Boy, Pirate, Bull Terrier, Mexican Girl, Mexican Boy, Dwarf, Penguin, Flower Girl, 10c each. 25 Novelty Patterns, 30c. All 62 Full Size Patterns, \$1.00 Postpaid.

## FLYING DUCK

Wind revolves wings. Realistic appearance. Pattern, Instructions and wing Pinion Kit; brass bearing, steel shaft, wing lugs, bolts, nuts and washers, 50c. Pattern and Instructions without kit, 25c. Postpaid.

STROTHER PATTERN SERVICE  
Dept. 7-BW Box 128 Belington, W. Va.

## For Hard-to-Heat Rooms

INSTALL this 7" NESTER Booster Fan in a few minutes with cutting tool furnished by us at price below. Fan throws extra heat to cold room as desired. Furnished assembled to curved mounting brim 6" x 10" for simple fastening with 2 metal screws. Quiet motor is 110 V. 60 cycle, has 4 ft. cord & plug. Fan delivers 300 cu. ft. min. Complete instructions and cutting tool furnished. See your dealer or send check or money-order today \$8.95 ea. postpaid U.S.A. or COD plus charges.

Money-Back Guarantee.  
NESTER METAL PDCTS., ALBION, MICH.

Only \$895 each Postpaid

## EASY TO LEARN CODE

Learn or increase speed with an Instructograph—the Radio-Telegraph Code Teacher that takes the place of an operator-instructor and enables anyone to master code without further assistance. Available tapes from beginners alphabet to typical messages on all subjects. Speed range 5 to 40 WPM. Always ready—no QRM. Thousands have "acquired the code" with the Instructograph System. Write today for convenient rental and purchase plans.

INSTRUCTOGRAPH COMPANY  
4701-P Sheridan Road, Chicago 40, Illinois

## MAKE MONEY with Bostonian SHIRTS

TAKE orders for old, reliable line finest quality dress and sport shirts. All styles...fabrics...colors...sizes. Sensational LOW PRICES. No experience needed. FREE Samples of actual fabrics and big Style Kit waiting for you! Send no money, but rush name NOW! BOSTONIAN MFG. CO., 89 Bickford St., Dept. B-41, Boston 30, Mass.

## TUBELESS Personal RADIO

POCKET SIZE! GUARANTEED to play on local stations

- No Tubes
- No Batteries
- No Electricity

Costs nothing to run, lasts indefinitely. Range up to 25 miles (some users report up to 50 miles on 50,000 Watt stations). New Germanium Diode rectifier—same as used in Army, Navy Radar sets. Extra sensitive stethophone. Designed, mfgd. by a widely known electronic engineer. Beautiful red plastic case, with bright green trim. Single-control tuning, has rich, mellow tone. Just hook it up on simple instructions—it plays instantly, never turns off. Nothing to wear out; should last for years. Sent with everything complete, \$5.

Send \$1 Pay postman \$4 balance plus small C.O.D. cost & postage.  
Dept. PS-2, 2450 E. 52nd St., Indianapolis, Indiana



I MADE  
**\$14 PER DAY**  
While still learning!

T. E. H. - WEST VIRGINIA



I MADE  
**\$800 IN 3 MONTHS**  
While taking your course!

F. V. - NEW YORK

Get into the

## ELECTRIC APPLIANCE REPAIR & SERVICE BUSINESS

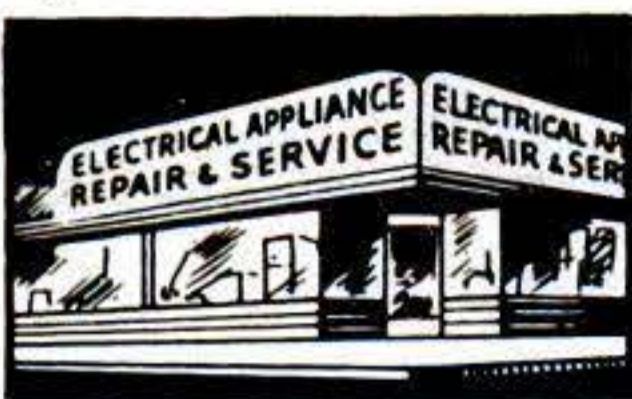

### OPEN YOUR OWN SHOP

As soon as you enroll, I send you my New Book "How to Open Your Own

Business" at no extra cost. PTS training is more than a home study course in electric appliance repair and service. It gives you the "know how" on the operation of your shop from a business standpoint: What to charge, how to get customers. Everything possible is done to start you on the road to success.

### WE TEACH YOU:

Electric motors, house wiring, refrigerator, auto ignition, automatic washers, garbage disposals, fluorescent lights, irons, cleaners, etc., at home.

FULL OR SPARE TIME

### SPARE OR FULL TIME

You can actually increase your income while still learning—spare or full time

### ACT NOW

Want a good-paying business—a job in a fast-growing industry? Send now for your BIG FREE BOOK—"My Plan for your Success." Get started NOW

### EASY TO LEARN

Men of all ages, yes, even the man of 69 can get into this expanding field. A REAL OPPORTUNITY for the practical man who wants the BETTER THINGS IN LIFE. The easy PTS Home Study Plan prepares you for greater earnings NOW!

I SEND YOU A

**BIG KIT of TOOLS at No Extra Cost**



H. T. ARMSTRONG

### MAIL THIS COUPON TODAY

PACIFIC TRAINING SCHOOL H. T. ARMSTRONG  
7219 So. Broadway, Dept. S-512 Los Angeles 3, Calif.  
Please send me, without obligation, your free booklet and details.

Name \_\_\_\_\_

Address \_\_\_\_\_

City \_\_\_\_\_ Zone \_\_\_\_\_ State \_\_\_\_\_

SEND FOR THIS FREE BOOK

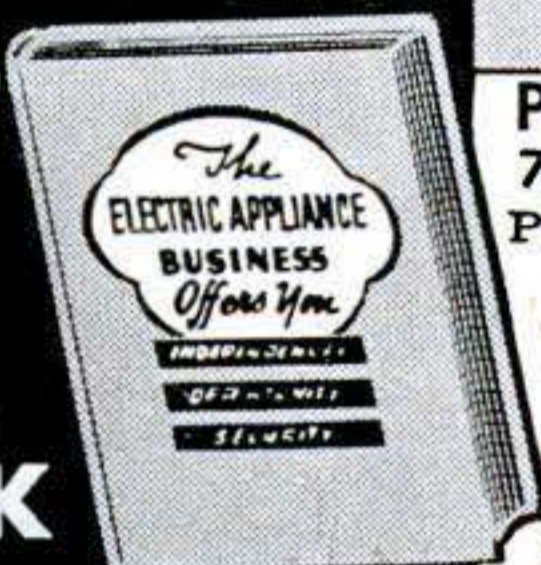

## CUT-TO-FIT HOMES CUT BUILDING COSTS

CHOICE OF 57 DESIGNS

ORDER NOW

SAVE UP TO 1/3



Build your own home and save the builders' profit—plus savings in lumber and labor with Sterling Ready-Cut-Homes. Anyone can assemble with simple, easy to follow plans furnished. Every house complete with all lumber, roofing, nails, glass, hardware, paint, doors and windows marked ready to erect. Freight paid. Complete building plans ready for filing at low cost. Sold separately if desired. Write today!

PRICED FROM \$2132 UP  
Five Easy Payment Plans

Send 25c for NEW COLOR CATALOG

INTERNATIONAL MILL AND TIMBER CO.  
DEPT. P.S. 251 BAY CITY, MICHIGAN

## Recipro Register CHRONOGRAPH

WORLD FAMOUS SPLIT-SECOND TIMER

### 10 DAY FREE EXAMINATION

A handsome wristwatch of incredible accuracy! Precision made in the highest traditions of Swiss craftsmanship. Thoresen's new RECIPRO-REGISTER CHRONOGRAPH automatically computes speeds and distances down to 1/5th second tolerances! RECIPRO-REGISTER system HOLDS the result indefinitely. It remembers for you while movement continues to keep time. Compare with other stop-chronographs and you will never be satisfied with anything less than this truly precision timepiece.

### OVER 25 HIGH QUALITY FEATURES!

- Times Planes
  - Times Races
  - Times Sports
  - Times Photography
  - Times Lab experiments
  - Times Shop Work
  - Shock-Resist
  - It "remembers"
  - 17 Ruby Jewels
- Three multi-function dials automatically coupled and synchronized for hours, minutes, seconds & 1/5th seconds. Contact clutch to start computation and brake clutch to freeze Recipro-Register result. Erases back to zero. Hairline sweep-second. Radium-active dial. Unbreakable crystal. Sturdy, yet thin case with stainless steel back. Its 17 Jewel Ruby movement is electronically time tested for accuracy. A smart, thin timepiece of functional beauty. The pride of every owner.

SAVE \$50.00—ORDER YOURS DIRECT! Recent list price 79.95. Now reduced for quick sales to 29.95, tax paid . . . while supply lasts. Featured in Esquire and leading magazines. Instructions and gift case included. Price subject to change without notice because of international crisis. Remit 29.95, or order C. O. D. plus postage.

THORESEN DIRECT SALES, Dept. 7B-233

131 West 33rd Street. (Phone LA 4-5996 & 7) New York 1, N. Y.

UNLIMITED Service Guarantee

Exclusive of Parts  
FREE repair service ANYTIME if needed by skilled watchmakers. NO COST EVER for labor, "handling" or adjustment, provided watch is returned with all parts. FREE: Annual oiling, cleaning & time-making service. Thoresen makes lifetime friends!

Buy Direct

# FIXES

Toys, Dishes,  
Books, Furniture



It's transparent, waterproof,  
flexible and durable.  
Get a tube  
today.



**DUCO CEMENT**

REG. U. S. PAT. OFF.



## Bar Bells

Buy Direct From Factory **\$8.95** up

Write for free booklet  
and price list

INDEPENDENT IRON WORKS  
2416 East 23rd Street, Dept. C  
Los Angeles 58, Calif.

## Ugly BLACKHEADS OUT IN SECONDS



Keep your complexion free of  
Blackheads this  
new way — look  
attractive  
instantly!



### Try VACUTEX Blackhead-Remover

The amazingly effective  
Vacutex extracts Blackheads  
automatically — **WITHOUT**  
squeezing the skin or injuring  
tissues. Easy to use with  
three fingers. It reaches  
Blackheads anywhere. Try it  
10 days and if not delighted,  
return VACUTEX and your  
money will be refunded.

\$7.00

### 10 DAY TRIAL COUPON

BALLCO PRODUCTS CO., Dept. A1102  
19 West 44th St., New York 18, N. Y.  
 Enclosed find \$1. Send postpaid.  
 Send C.O.D. I will pay postman \$1 plus postage;  
\$1 refund if not delighted.  
**SORRY. NO C. O. D.'s OUTSIDE U. S. A.**

## Piles May Lead to Chronic Ailments

**FREE BOOK**—Explains the  
Causes and Effects

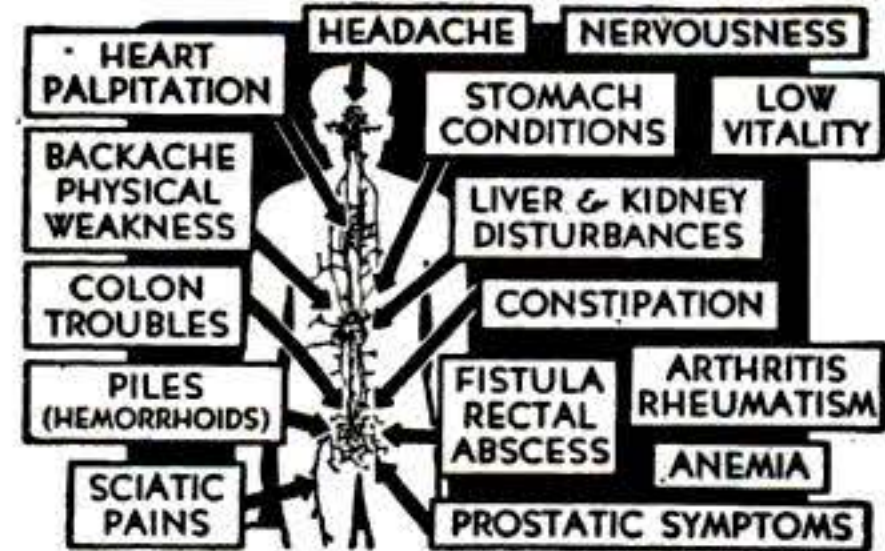

No obligation. Write to Thornton & Minor Clinic,  
Suite 249, 911 E. Linwood, Kansas City 3, Mo.

## ALNICO MAGNETS LIFT 125-lb.

**AMAZING PERMANENT MAGNETS—WILL NOT WEAKEN! NON-ELECTRIC.** Retrieve guns, tackle, tools and other steel items from lake, river, plating tanks, drains or other hard-to-reach spots. Recover drills, taps, etc. from floor sweepings. Clear alley of harmful tacks, nails. Many other uses listed. Pays for itself quickly. **GUARANTEED:** Try any magnet one week. Money refunded if you are not well-pleased. Cat. No. 125 (has a pull of 125 lbs. on a flat steel block) ... \$7.50 Cat. No. 40 (40 lb. pull) \$2.79. Cat. No. 7 (10-lb. pull) \$1.35 Cat. No. 20—Hobbyists assortment of seven medium magnets \$1.25

MIAMI MAGNET CO.  
3240 N.W. 27th Ave., Aviation Bldg. No. 43, Miami, Florida

## BECOME AN EXPERT IN TRAFFIC

Traffic men earn \$4,000 to \$10,000 and up. Thousands of firms need experts on rates, tariffs, regulations. We train you thoroly in spare time at home for executive traffic jobs. Personal training under traffic authorities. Placement counsel and help. Write for free 48-page book "Traffic Management—the Fast Growing Profession."

LASALLE Extension University, 417 So. Dearborn St.  
A Correspondence Institution Dept. 283T Chicago 5, Ill.

## MASTER COURSE IN HYPNOTISM

### SECRETS REVEALED!

Actual methods, techniques of master hypnotists . . . how to hypnotize suitable subjects at a glance—a command—by phone! How to control subjects after they awaken—help break tobacco, other habits. Self-hypnosis. Group hypnosis. Entertain with amazing hypnotic stunts for fun or profit. Get this easy-to-understand, how-to-do-it course now! **Money-back guarantee.** Fully photo-illustrated . . . \$2 (complete). **EXTRA!** Unique "ALARM-CLOCK MIND" instruction folio and Hypnotic Catalog No. 2 included. Order "Hypnotism Course" today!

Complete \$2



POWER PUBLISHERS, Dept. PS2, 790 Broad St., Newark, N. J.

### NEW! POLARVISION "SAFETY" LIGHT



A revolutionary new light discovery recently released for civilian use.

## STOP HEADLIGHT GLARE

Fits All Cars & Trucks

FOR SAFETY AND COMFORTABLE DRIVING  
The Amazing "Ergon Glass Lens" is an integral part of the Polarvision Light. It produces a Black Light (barely visible to the eye) which counteracts oncoming headlights, street lights, etc. without interfering with your visibility. Easy to install above windshield—beautiful accessory. Light encased in high grade chrome holder. Works off car's central lighting circuit. Limited \$6.95 Supply. Complete (including all parts) . . . \$6.95

Send cash, check, or money order.  
Electronic Development Company, Los Angeles 34, California



WHERE DID IT COME FROM? HOW DID IT GET HERE?

WHAT IS IT?

THE THING

from Another World!

HOWARD HAWKS' *Amazing* MOVIE!



**\$600 BUILDS 4 ROOMS & BATH!  
WHY PAY RENT?**

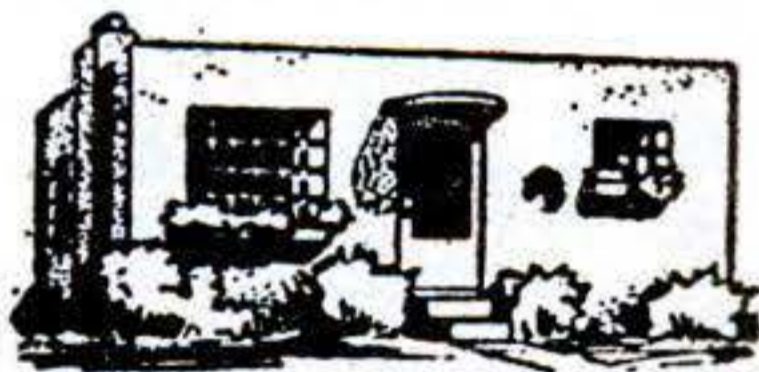

For Six Hundred dollars and 30 days of your spare time you can build yourself this Beautiful Home. Living room 10x15. Front bedroom 9x10. Back bedroom 10x11. Kitchen 8x10. Bath 5x7. Hall 3x4. Wind out steel Casement windows. Concrete block, stuccoed. \$1.00 brings you Step-by-Step Instructions. Blueprint & Material List.  
L. H. Farrow, Dept. D  
Box 645 Columbus 16, Ohio

**CASH IN YOUR SPARE TIME**

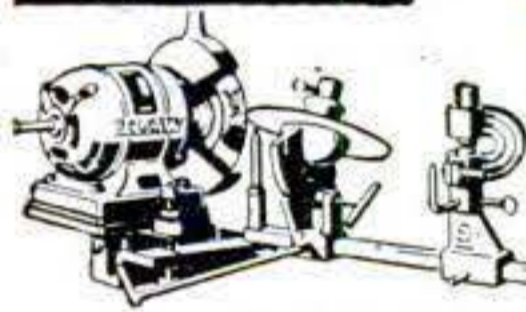

**BIG MONEY IN OWN BUSINESS**  
YOU CAN MAKE UP TO \$40 A DAY sharpening and setting circular saws for factories, builders, lumber yards -- with NEW BELSAW COMPLETE CIRCULAR SAW SHOP. LOW COST, Sharpens 4 to 5 saws per hour, no experience needed, complete instructions. Send today for FREE Catalog.

**BELSAW MACHINERY CO**  
4403 Field Bldg. Kansas City 2, Mo.

**LEARN MEAT CUTTING AT NATIONAL**  
Pay After Graduation



The steady dependable trade of Meat Cutting taught easily in 8 short weeks. You LEARN BY DOING under actual meat market conditions in big modern school at Toledo.

For beginners or men with experience. Get a profitable store of your own. Remember, PEOPLE MUST EAT! Big pay jobs. Free employment help. Thousands of successful graduates.

Buying, cutting, percentage, pricing, advertising, selling, etc. A complete retail meat education. National School established over 25 years. Get National training NOW. Pay your tuition in easy weekly payments

after you graduate. G. I. approved. Send coupon for FREE 52 page school catalog—TODAY.

**National School of Meat Cutting, Inc.**  
Dept. 51-P, Toledo 4, Ohio

Send me your FREE school catalog on National Training at Toledo in Meat Cutting, Meat Merchandising and Self Service Meats. No obligation. No salesmen will call.

Name.....

Address.....

City..... State.....

( ) Check here if Veteran of World War II

**"I'M EARNING \$300 A MONTH!"**



... says Leonidas Burgoyne of Chicago, Illinois, "Expert individual instruction in the fully equipped shops of Greer Shop Training gave me the right start to get my good paying job."

**GREER SHOP TRAINING** . . . . established 1902, is one of America's largest trade schools. Over 48,000 successful graduates. You learn by tearing down, repairing and rebuilding. Day and evening classes. Mail this coupon today!

**LEARN A TRADE NOW!**

**GREER SHOP TRAINING, Desk 311,460 S. State St., Chicago, Ill.**

Gentlemen: Please send me information about trade I have checked below. (Specify if you are VET  or NON-VET .

**IN OUR CHICAGO SHOPS**

<input type="checkbox"/> AUTO MECHANICS	<input type="checkbox"/> BODY, FENDER REPAIR
<input type="checkbox"/> DIESEL	<input type="checkbox"/> WELDING—ARC, GAS
<input type="checkbox"/> REFRIGERATION	<input type="checkbox"/> MACHINIST
	<input type="checkbox"/> PIANO TUNING

Above courses approved for Vets and Civilians.

**ALSO THE FOLLOWING HOME STUDY COURSES**

<input type="checkbox"/> REFRIGERATION	<input type="checkbox"/> DIESEL	<input type="checkbox"/> PLASTICS
--	---------------------------------	-----------------------------------

Name \_\_\_\_\_ Age \_\_\_\_\_

Address \_\_\_\_\_

City \_\_\_\_\_ State \_\_\_\_\_

**GREER SHOP TRAINING**

**EARN MONEY IN UPHOLSTERING**

<b>BUSINESS OF YOUR OWN OR A GOOD JOB</b>	Learn at home from experts. Simplified, fully illustrated training program. Full plans for establishing your business—profits big. Fine earning opportunities also in good jobs. Upholster your own furniture at fraction of cost. Valuable booklet free. Write now.	<b>PROFESSIONAL HOME TRAINING—TOOLS, SUPPLIES, EQUIPMENT INCLUDED</b>
---	--	---

**GENERAL TRADES SCHOOLS, 3810 Broadway, Dept. PS-2, Chicago 13, Ill.**

**Manufacturing Opportunities in Concrete Products Industry**

The great building industry is your profitable market for masonry products. Low investment... high returns... wide-open opportunity to establish a lifetime business.

The biggest building years in the nation's history are just beginning. New construction, involving billions of dollars, means huge demands for block, drain tile, and other masonry products which YOU can manufacture locally, from local materials with local labor for local consumption. Remember, MASONRY products mesh with today's demands.

Use our modern machines and equipment to insure the finest quality products at pared-to-the-bone manufacturing costs. Sold direct. Backed by 40 years of manufacturing. Write for catalog. Gives prices and full information.

**CONCRETE EQUIPMENT CO.**  
510 Ottawa Ave., Holland, Mich.



**Model Railroading is more fun than you imagine, and less expensive than you think!**



● 250,000 people can't be wrong. They are having real fun with the world's fastest growing hobby. Get this picture-packed book that tells how simple it is to start . . . and how surprisingly little money is needed.

Fully illustrated, this book tells how constructive this hobby is. Enjoyed by anyone from 7 to 70. Send 10c today for your copy of "Model Railroading for You," written by a well-known authority.

**MODEL RAILROADER MAGAZINE**  
Dept. 1650—Milwaukee 3, Wis.

**Thousands In Use**



**SMALL! POWERFUL!**

America's finest low cost tractor. Ruggedly built. Easy to operate. No belts, no chains. Borg-Warner clutch, trans. and diff. 140 to 1 reduction. 40% more drawbar pull than ordinary tractors. 8-1/4 H.P. engine—gasoline or kerosene. 20 quick change implements. Write for complete details.

**ENGINEERING PRODUCTS CO.**  
915-A-2 Niagara Ct., Waukesha, Wis.



**FREE SAMPLES!**  
**GLOW IN THE DARK!**

**BIG PROFITS** showing amazing Luminous Specialties—house numbers, pictures, plastic novelties, religious and nursery objects, ash trays, key-holders, etc. Large manufacturer. Enormous demand. Sell on sight. **WRITE AT ONCE** for FREE samples. **Madison Mills, 303 4th Ave., Dept. U-5, New York 10, N.Y.**

**KEN ADJUSTABLE LEVEL**



**For Portable Electric Drills**

The NEW adjustable KEN LEVEL that attaches to top of any drill housing. For drilling horizontal, vertical, or angular \$5 Post-holes with utmost accuracy. Only... paid Bubble Glass is firmly mounted in adjustable holder. May be locked in any position from zero to 90 degrees. Simple to attach. Check, money order, or C.O.D.

**SINGER KENNEDY CORP., PS 21 E. Van Buren St., Chicago 5, Ill.**

**FREE—Amazing Book on RHEUMATISM, ARTHRITIS**

If you suffer the aches, pains and discomforts of Rheumatism, as manifested in ARTHRITIS, NEURITIS, SCIATICA or LUMBAGO, send today for the FREE Book. It reveals important facts about why drugs and medicine give only temporary relief without removing causes. Explains fully a proven, specialized system of treatment that may save you years of distress. No obligation. Write for this FREE Book today!

**BALL CLINIC, Dept. 36, Excelsior Springs, Mo.**

**New MIRACLE WALL CLEANER**



**Saves Costly Redecorating!**

**AMAZING INVENTION.** Banishes old-style housecleaning mess and muss. No rags—no sticky "dough"—no red, swollen hands. No more dangerous stepladders. Literally erases dirt like magic from walls, ceilings, window shades, upholstered furniture, etc. *Endsdrudgery!* **SAVES REDECORATING!**

**SAMPLES TO INTRODUCE** Sample offer sent immediately to all who send name at once. A penny postal will do. **SEND NO MONEY—just your name.** KRISTEE CO., Dept. 703, AKRON 8, OHIO

**NOW!** SCIENCE DISCOVERS THE SECRET OF MAN-MADE GEMS  
**MORE BRILLIANT** Than  
**DIAMONDS**



AT LESS THAN **5%** THE COST OF DIAMONDS

LOOK PROSPEROUS—IMPRESS YOUR FRIENDS—wear big beautiful TITANIA BRILLIANTS—more sparkling than diamonds. 57 perfectly cut and polished facets. Ideal for ENGAGEMENT RING, LADIES EARRINGS, MEN'S SOLITAIRE, REPLACEMENTS FOR YOUR DULL STONES. New man-made gem of incomparable brilliance and fire; only gem on earth MORE BRILLIANT than DIAMOND. 1 CARAT unmounted Titania Brilliant ONLY \$19.20; 2 CARATS \$38.40; 3 CARATS \$57.60; MOUNTED IN 14K GOLD RING as low as \$52—all prices include Federal Tax. Ask about our LAY-A-WAY plan.

**10 DAY RETURN PRIVILEGE** If not thrilled and delighted, you may return within 10 days for refund if in same condition as when received. Enclose remittance and we send prepaid or send 25% deposit and pay balance on arrival, plus postage. Deal with 35 YEAR OLD COMPANY. SEND CHECK OR MONEY ORDER. ASK FOR FREE BOOKLET P.

**BRADLEY MARTIN CO.** 495 WASHINGTON AVE. BROOKLYN 16, N. Y. DEPT. P-2

**NEW! CHEAP!** **OIL BURNER** SWEEPING THE COUNTRY!

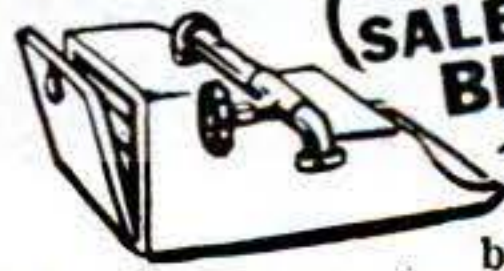

SALESMEN BIG MONEY

SLIPS INTO ANY COAL RANGE, STOVE OR FURNACE. Amazing quick, intense heat. By finger-tip control. Cheaper than coal. No more shoveling coal or ashes. SENT ON TRIAL. Prove it pays for itself quickly by what it saves. \$1 bonus for testing. We'll let you try one in your own home for one month. Write for details today.

**NORTHWEST MFG. CO., Dept. 204, Mitchell, S. Dak.**

**Find HIDDEN TREASURES**



**GEIGER COUNTERS** for Uranium Detection (see at left). **TREASURE DETECTORS** for gold, silver, etc. Lightweight, ultra sensitive. None finer at ANY PRICE. INFORMATION FREE.

**Detectron CO.** Dept. 2-A  
 5631 Cahuenga, No. Hollywood, Calif.

**CUTS SHAVING TIME IN HALF!**



Amazing new plastic and rubber Lather-Cup gives quick, hot lather in 1/2 the time. Cuts shaving time 50%! Cuts shaving costs by using just the amount of cream necessary for best shaves. Better shaves, in less time, at lower cost. Fits any size tube. Send \$1. postpaid. Money back guarantee. **DEALERS-AGENTS!** Rush \$6.25 for dozen in display carton. Sells fast on sight. **Conway Products, Box 385, Lemon Grove, Calif.**



**High School at Home**

**Many Finish in 2 Years**

No classes. No time wasted going to and from school. Progress as fast as your time and abilities permit. Standard H. S. texts supplied. Thousands enroll each year in this 52-year-old school. Send for FREE descriptive booklet.

**AMERICAN SCHOOL, Dept. H-246**  
 Drexel at 58th St., Chicago 37, Ill.  
 Without obligation, please send FREE descriptive booklet.

Name.....  
 Address.....

**new 1951 ALLIED RADIO and TV CATALOG**

**free**



SEND FOR THIS 212-PAGE Value-Packed CATALOG COMPLETE UP-TO-DATE

**SAVE ON EVERYTHING IN RADIO & TELEVISION**

**Get Radio's Leading Buying Guide**

Save money on every purchase you make from the world's largest radio supply house! Send for ALLIED'S 212-page 1951 Catalog, the value-packed guide to everything in Radio and Television. Biggest selections of home radios, TV equipment, radio-phonos, Amateur equipment, P.A. systems, Hi-Fidelity Sound, recorders, test instruments, builders' kits—plus thousands of parts, tubes, tools, books and diagrams. Get more for your money—send today for your FREE 1951 ALLIED Radio and TV Catalog!

EVERYTHING FOR:  
 Servicemen  
 Engineers  
 Experimenters  
 Builders  
 Amateurs



**FREE CATALOG**

**ALLIED RADIO**

ALLIED RADIO CORP., Dept. 7-B-1  
 833 W. Jackson Blvd., Chicago 7, Ill.

Rush FREE 212-Page Catalog No. 126.

Name \_\_\_\_\_

Address \_\_\_\_\_

City \_\_\_\_\_ Zone \_\_\_\_\_ State \_\_\_\_\_

## HERE'S THE RIGHT SLANT:

If the high cost of living is eating into your pay-check, you ought to acquire technical skill! *Trained men are earning good money.* If you're eligible for the draft, skill will help you get a better rate, or even a commission.

Over 12,000 men have learned trades through C.T.I. home study or in the resident school. One of six starts a business. It costs nothing to get the facts.

AUTO MECHANICS  
 BODY-FENDER REPAIR  
 DIESEL MECHANICS  
 ELECTRICITY  
 RADIO & TELEVISION  
 REFRIGERATION  
 MECHANICAL DRAFTING  
 BUILDING CONSTRUCTION  
 HIGH SCHOOL FOREMANSHIP  
 FACTORY MANAGEMENT

**ACT TODAY**

Fill out and mail coupon today. We'll send valuable free booklet. No cost or obligation.

**Commercial Trades Inst.**  
 1400 Greenleaf  
 Chicago 26, Dept. E1-2

Name \_\_\_\_\_

Address \_\_\_\_\_

City \_\_\_\_\_ State \_\_\_\_\_

Course \_\_\_\_\_ Veteran? \_\_\_\_\_

## FALSE TEETH FIT TIGHT

FOR LIFE OF PLATE  
 With One Application  
 or YOUR MONEY BACK  
 Professionally Developed AMAZING



### LINO-DENT

**REAL COMFORT INSTANTLY FOR ALL PLATE WEARERS** . . . No fuss or bother—looseness and slipping vanish—gum soreness heals and disappears—forever.

**Not Messy — Not Sticky**

Not a paste or powder but an amazing development in field of plastics. The same material modern dentures are made of. That's why we can guarantee perfect plate comfort permanently with one application.

Absolutely Safe. Pure, non-toxic, non-irritating, harmless, odorless, tasteless, pleasant. Needs no heat. Easy to use! . . . **Money back guarantee**

**SEND NO MONEY**—Full size package only \$1.25 plus postage. Specify upper or lower. Both \$2.25 plus postage C.O.D. Enclose payment and save postage.

(Dept. A-7) 507-5 Ave.,  
**LINO-DENT, Inc.** New York 17, N. Y.

## WALKIE TALKIES \$3.99 SET OF 2

POCKET SIZE —ELECTRONIC VOICE POWERED



No tubes, batteries, adjustments, license or permit needed! Guaranteed to work anywhere up to 1/4 mile with extra wire. Swell for room to room—garage to house, etc! Your own private, talk-listen phone. Not war surplus. Brand new. Guaranteed. Two complete units with wire —READY TO USE!

**SEND \$1.00** deposit and pay postman \$2.99 plus postage charges or send \$4.25 for postpaid delivery. Limited Supply available.

**THE MIDWAY COMPANY, Dept. WPS-2, Kearney, Nebraska**

## NEW HYPNOTISM REVEALED



New sensational hypnotic chart makes hypnotism easy and simple to master in a few short hours. Be a masterful entertainer—amaze your friends. People will admire and envy your power to control and command. Absolute 10-day money-back guarantee. Instructions and chart shipped in plain wrapper—\$1.98 postpaid.

Send to  
**HYPTO-EYES, Dept. 21**  
 254 NE 103rd St., Portland 16, Oregon

## GOLD - SILVER - COINS



Easily located with new Lightweight M-Scope Detector. Superior performance, lowest price, monthly payment plan.

FREE LITERATURE

**FISHER RESEARCH LAB., INC.**  
 PALO ALTO CALIF.

## Making Patent Drawings

X  
 HARRY RADZINSKY

▶ for **DRAFTSMEN**  
 a large, steady income

▶ for **INVENTORS**  
 money- and time-saving information

**AT THE TOTAL COST TO YOU OF ONLY \$3**

There is constant work and high pay for skilled patent draftsmen. If you know basic drafting, you can easily learn this highly profitable specialty from this book. And if you are an inventor it can save you many costly mistakes or delays. In it a patent attorney of 35 years' experience—a man who has himself made thousands of patent drawings—tells you step by step just how to make the drawings required for all types of patents and trade-marks. You learn here every detail: how best to meet the regulations and preferences of the U. S. Patent Office in all such matters as reference numbers, shading, number and arrangement of views, and surface indications; how to avoid mistakes or imperfections that may cause rejection by the Patent Office; the special methods used by experienced professionals to save time or work and to insure perfection. And here too you will find invaluable advice on what and what not to show in the drawings. Making Patent Drawings will give you a thousand-fold return on its cost—only \$3.00. But you don't have to take our word for it.

**USE THIS COUPON TO GET A FREE TRIAL COPY**

**The Macmillan Co., 60 Fifth Ave., New York 11**

Please send me a copy of MAKING PATENT DRAWINGS for 10 days' free examination. If I decide to keep it I will pay \$3.00. Otherwise I will return it.

Signed .....

Address .....

(Please give postal zone number if you have one)

## WAR SURPLUS OPTICAL BARGAINS

**SLIDE PROJECTOR SETS.** Consists of all unmounted lenses you need to make the following size projectors:

Stock #4029-N—35 mm. . . . .	\$2.85 Postpaid
Stock #4038-N—2 1/4"x2 1/4" . . . . .	\$3.35 Postpaid
Stock #4039-N—2 1/8"x3 1/2" . . . . .	\$3.35 Postpaid

**MAKE A MICROSCOPE**—Get wonderful results. Own an instrument worth many times the cost to you. Simply convert a U. S. Govt. Rifle-scope (Govt. cost over \$65.00). It's easy! We show you how. No machining required. Get up to 40 Power. Scope we furnish is used but good condition . . . sent complete with extra lenses and direction sheet.

Stock #959-N . . . . .	\$7.90 Postpaid
------------------------	-----------------

**10 POWER SPOTTING SCOPE**—A WONDERFUL BUY! Pocket-Size! Complete with tripod and swivel head. Only 5 1/2" long—8 1/2" high on tripod. Adapted from Army telescope and worth many times our price. Has prism erecting system, achromatic objective, Ramsden Eye-Piece. Lenses low reflection coated.

Stock #955-N . . . . .	\$14.95 Postpaid
------------------------	------------------

**SIMPLE LENS KITS**—Include plainly written, illustrated booklet showing how you can build lots of optical items. Use these lenses in photography and for dozens of other uses in experimental optics, building TELESCOPES, low power Microscopes, etc.

Stock #2-N—10 lenses . . . . .	\$ 1.00 Postpaid
Stock #5-N—45 lenses . . . . .	5.00 Postpaid
Stock #10-N—80 lenses . . . . .	10.00 Postpaid

We Have Literally Millions of War Surplus Lenses and Prisms for Sale at Bargain Prices. Numerous Types of Instruments. Too! Write for FREE CATALOG-N.

**EDMUND SALVAGE CO., BARRINGTON, NEW JERSEY**

# TREMENDOUS WATCH VALUES WITH A LIFETIME GUARANTEE!



## MARDO QUALITY!

We offer —  
**TOP-QUALITY PRECISION MADE TIMEPIECES**

- Money Back Guarantee
- Lifetime Guarantee
- Accuracy Guarantee

You can buy with complete faith and confidence. We sell direct, eliminating the storekeeper and his profit and pass along these savings to you.

## SHOCK-WATER PROOF

Full 17 Jewel. Protected by water tight screw back and balance gasket. Give it hard treatment, **IT CAN TAKE IT.**

Luminous Dial, Sweep Second Hands, Unbreakable Crystal. Stainless Steel Case. Incl. Tax. .....\$19.75

## FLYBACK REGISTER CHRONOGRAPH!

**VALUE!** Amazingly accurate 1/5 seconds. 3 dials keep record of elapsed time as timepiece operates. Computes, Speed, Distance, Time. Great for Sports, Races, Doctors, Photographers, Workroom experiments, tests, etc. **DIALS** record, hours, minutes, seconds — automatically coupled for split second accuracy.

\***FLYBACK** (Sweep Hand and Automatic Recorder Reset to Zero).

17 JEWELS Inc. Tax .....\$26.35  
 \*GOLD FILLED MODEL \$36.85

## SHOCK PROOF

Hardy Chromed Case that can take knocks. 7 Jewel Movement — Luminous dial, Sweep Second Hand and also second computations. Handsome in appearance — a real watch for active people.

Inc. tax .....\$8.75

## 3 DIAL CHRONO

Swiss Made. Second, minute and hour dials that are automatically coupled to give dependable, accurate readings. Sportsmen, Doctors, Technicians, Army and Navy men need this dependable time-keeper and recorder. Measures Speed, moving objects, distance and elapsed time. Unbreakable Crystal, Sweep Second Luminous numerals & hands. **WHAT A VALUE!**

Tax Inc) .....\$9.95

\*Same as above in Gold Plate .....\$14.95

\*Charge for Broken parts only.

# 10-DAY MONEY BACK GUARANTEE

You have nothing to lose with our three way, triple **GUARANTEE**. Order Now. Enclose Check or Money Order for the watches of your choosing (Tax is included) and we prepay postage. C.O.D. orders are accepted. You Pay Postman plus charges.

MARDO SALES CORP., 480 Lexington Avenue, Dept. CW-1, New York 17, N. Y.

## IT'S NEW!



\$49.95 11" x 7" x 7"

SW-54

## It's Terrific!

**TUNES ALL MAJOR BROADCAST AND SHORTWAVE BANDS!**

Hear foreign stations, ships, radio amateurs and police, plus standard broadcast programs on this amazing table radio built by the world's leading maker of communication radio equipment. Covers 540kc. to 30mc. AC/DC operation. In smart unbreakable metal cabinet. For details and name of nearest supplier, write Dept. A

**National COMPANY, INC.**



61 Sherman St., Malden, Mass.

## Streamline Your Bathroom!

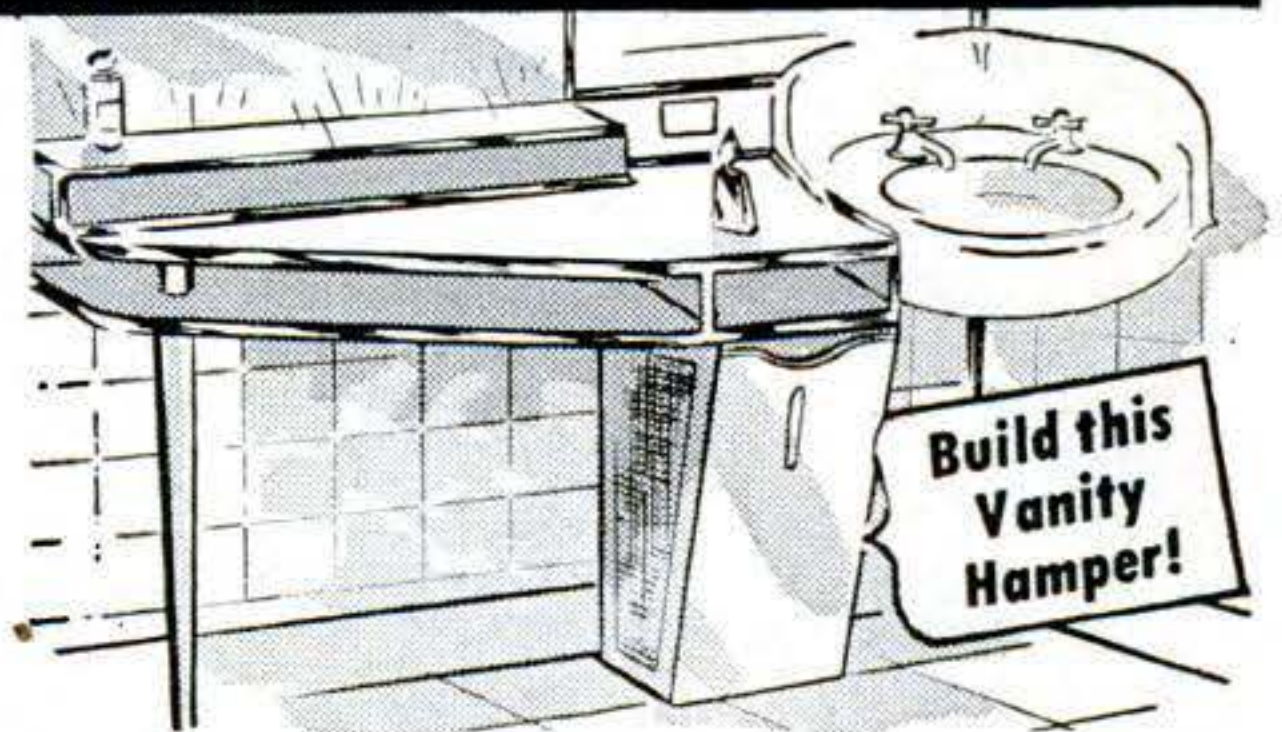

It's simple to dress up your basin with this vanity hamper ledge. "Trim-It-Yourself" with **CHROMTRIM** aluminum and stainless mouldings.

Send 10¢ for Bathroom Plan and 16 page full-color, project-packed, home-modernizing booklet, "Trim Ideas."

**CHROMTRIM** is easy to apply, easy to buy... in shapes to fit any material. Insist on *genuine* **CHROMTRIM**, in the **RED**-striped jackets.



R. D. WERNER CO., Inc., Dept. PS  
 295 Fifth Avenue, New York 16, N. Y.

I enclose 10¢ for Bathroom Plan and "Trim Ideas" booklet.

NAME \_\_\_\_\_

STREET \_\_\_\_\_

CITY \_\_\_\_\_ STATE \_\_\_\_\_

## The Steady Pay Profession Good Times or Bad!

### SCIENTIFIC CRIME DETECTION

FOLLOW  
THIS MAN

Operator  
No. 38



#### It Is Easy to Learn!

I will teach you this fascinating science during your spare time at home. It pays to be an expert in Finger Printing, Firearms Identification, Police Photography and Criminal Investigation. I have trained hundreds of men and women now successfully serving in identification bureaus throughout America. You, too, may quickly prepare yourself to become a well-paid valued officer of the law, often sharing in the generous rewards offered for wanted criminals.

## FREE! OVER 800

### "BLUE BOOK OF CRIME"

This book is full of exciting information on scientific crime detection. It will show how You can get started in a grand career. Now, at amazingly low cost. Clip coupon Now... Mail it today.

of all Identification Bureaus in the U. S. employ students and graduates of I. A. S. A majority of these men are heads of Bureaus. Many of them knew nothing about crime detection before training with me. Now they have steady jobs, good salaries and a fine future. Write today for full particulars and free book. Give age. No salesman will call.

### INSTITUTE OF APPLIED SCIENCE

(A Correspondence School since 1916)

1920 Sunnyside Ave., Dept. 1362, Chicago 40, Ill.

### INSTITUTE OF APPLIED SCIENCE

1920 Sunnyside Ave., Dept. 1362, Chicago 40

Gentlemen: Without any obligation on my part, send me the "Blue Book of Crime," and complete list of Identification Bureaus employing your students or graduates, together with your low prices and Easy Terms Offer. (Literature will be sent ONLY to persons stating their age.)

Name..... Age.....

Address..... R. F. D.....

City..... State.....

### WHAM-O SPORTSMAN\*

\$1.00 POSTPAID

45-LB. PULL

HITS LIKE A .22 RIFLE—  
KILLS RABBITS, SQUIRRELS.  
Powerful, silent, accurate.

For hunting, target,  
routing pests.

Sportsman's choice  
sold world  
over!

### HUNTING SLINGSHOT

Heavy duty 7" ash stock.

40 steel balls, extra rubber straps.

GUARANTEED—at dealers, or send \$1. to

Wham-O Mfg. Co., Box 2P, South Pasadena, Calif.

\* Professional model of Nat'l Slingshot Assn  
Extra steel balls 300 for \$1. Rubbers 15c a pair.

## MEN! WOMEN!

New Car given  
as Bonus!



TAKE ORDERS for  
Nationally Advertised

## NYLONS

GUARANTEED NINE MONTHS

Sensational Guarantee creating a tremendous demand for Wilknit Nylons! If they run, wear out or even snag from any cause whatever... within NINE MONTHS... depending on quantity... they are replaced FREE OF CHARGE. No wonder it's easy to quickly build up fine, steady, year-round income. Earnings start immediately. Look at these exceptional figures—Ralph Shearer made \$67.11, first week—Mrs. Paul Estes, \$42.92—Mrs. Ivey Gentry, \$43.37. Doris Jensen in addition to making as much as \$17.00 in a single day, earned two cars as EXTRA BONUSES. Learn how you can make money in your full or spare time without a bit of previous experience.

SEND NO MONEY... Just Hose Size

When you send for Selling Outfit, I also send your choice of Nylons or Socks for your personal use. Don't lose a minute. Rush name on penny postcard for full money-making facts on Sensational Sales Kit. Send hose size, too. Lowell Wilkin, WILKNITHOSIERY CO., 322 Midway, Greenfield, Ohio

### EARNED TWO NEW CARS

... and as much as \$120.00 in one week

That's the exceptionally fine record of Chas. Mills with the famous Wilknit hosiery line. Offer of New Chevrolet as a bonus open to EVERYONE. Send name for facts FREE.

## Convert HAND MOWERS TO POWER MOWERS

Takes less than 3 hours  
The Handy-Dandy Lawn Mower Kit fits any hand mower from the 16 to the 20 inch size. Complete with all necessary parts. Kits can be purchased separately, complete with engines or complete with Pennsylvania mower.



Also manufacturers of complete power mowers and garden cultivators.

LE CLAIRE MFG. CO.  
LE CLAIRE, IOWA, Dept. PS

BUILD FAST STOCKS!  
RACERS! HOT RODS!



## SPEED & MILEAGE

"Get This Famous POWER MANUAL..."

COVERS ALL MAKES—Double power and mileage of your car! Racing Tricks! Souping! Speed Tuning! Customizing! 100 Gas Saving Secrets! SAVE MONEY—Build Superchargers, Dual Manifolds, High Compression Heads, Racing Cams, Dual Mufflers, Water Injectors! Covers Racers, Sports Cars, Stock Car Racer, California Roadster Construction—Engine Rebuilding, Frames, Bodies, Fuel Formulas, Ratios, Offys, Speed Shop Methods! Photo Section on HOLLYWOOD CUSTOM RESTYLING! 320 Illus! Satisfaction Guaranteed.



YOU GET: "California HOT ROD HANDBOOK & BUILDERS KIT" free with BIG MANUAL—All For (p.p.d. or C.O.D.) \$1.98 (Racing Catalog without above books 25c) ALMQUIST Engineering, Milford 222 Penna.

## Build your own JET ENGINE!



Order these plans today

1. JET PROPELLED BICYCLE. Assemble your own. Photo and instructions \$1.00.
2. HOW TO MAKE EXPERIMENTAL JET ENGINES. Seven sheets drawings with information and instructions \$2.95.
3. BOTH OF ABOVE in one order \$3.75. SEND NO MONEY. Order both at once \$3.75 C.O.D. in USA plus c.o.d. postage. Send check or Money Order and we pay postage. Get other information too. Rush Order.

J. HOUSTON MAUPIN, Dept. 66, Tipp City, Ohio

## NEON SIGN SCHOOL

Learn Neon in 12½ weeks. Many jobs open. Start at \$1.50, \$2.00 hour. We train you in Glass Blowing. Neon

Tube Bending, Color Gassing. Glass Blowers often deferred. ACME TRAINING G. I. APPROVED. Course also open to Non-Vets. FREE FOLDER explains. Write ACME NEON INSTITUTE, Dept. B-2, 330 South Paulina St., Chicago 12, Ill.



## WAR SURPLUS BARGAINS

\$500,000.00 INVENTORY for QUICK LIQUIDATION

Surplus items—hundreds of them for home, shop, factory, farm and outdoor use. New items, used items, reconditioned items—all at tremendous savings—all priced for quick sale.

PAGE AFTER PAGE OF VALUES

This big catalog shows page after page of amazing money saving values. Write for your copy today. Send 10c to cover postage, mailing, etc. Write today!

SEND TODAY FOR YOUR COPY  
STARK'S

509 So. State St.  
Dept. PS-2  
CHICAGO 5, ILL.

10c

**NEW! NOW YOU CAN  
EARN \$5 PER HOUR  
PRINTING  
WITHOUT A PRINTING PRESS  
OR ANY SPECIAL EQUIPMENT**

**START IN YOUR SPARE TIME  
IN YOUR HOME**

**One of America's FASTEST GROWING BUSINESSES** - Thousands already are making BIG MONEY using the MIRACLE new SCREEN-PRINT method. Yes, they're printing signs, posters, banners, drapes, wall paper, show cards, flags, fabrics, etc. WITHOUT A PRINTING PRESS OR ANY SPECIAL EQUIPMENT. Now! - the secret can be yours to read, learn, and decide your future... just mail coupon now.

**GET INTO BUSINESS FOR YOURSELF** - Be your own boss - make your home your office in this profitable business. Make EXTRA money in your SPARE TIME or start your own FULL TIME business. IT'S EASY. Get orders from stores, markets, gas stations, theaters - from every kind of business - A HUGE ready-made DEMAND.

Print paper of all kinds (even greeting cards)

FREE OFFER

PRINT BANNERS



PRINT FABRICS



PRINT INSTRUMENTS



PRINT POSTERS

FOR SALE

PRINT SIGNS



PRINT TIES

**YOU CAN PRINT ANYTHING AND EVERYTHING WITH THE NEW SCREEN-PRINT METHOD**

1010 SO. LOS ANGELES ST., LOS ANGELES 15, CALIF.

**CLIP AND MAIL FOR FREE SAMPLE—Send No Money**

SCREEN-PRINT PRODUCTS CO., DEPT. 22  
1010 SOUTH LOS ANGELES ST., LOS ANGELES 15, CALIFORNIA  
Mr. Tom Reese: Please rush FREE sample and all information necessary.

Name \_\_\_\_\_  
Address \_\_\_\_\_  
City \_\_\_\_\_ State \_\_\_\_\_

**AT LAST! MY AMAZING NEW  
BIG MONEY SCREEN-PRINT PLAN  
is yours for the asking.  
ABSOLUTELY FREE—OFFER LIMITED  
MAIL COUPON TODAY**



TOM REESE  
General Manager

**Easy to learn—no experience necessary.** ANYONE - (young or old) can profit handsomely with the sensational Screen-Print method.

**EARN \$50 EXTRA PER WEEK—TO START.** It's easier than you think—materials cost you only 10%—YOU EARN 90%. Few businesses make this big profit.

**GET WAR CONTRACTS!** - Instrument faces, insignias, etc.—hundreds of war products are produced by SCREEN-PRINTING and materials are NEVER SCARCE. (Here's a way to make EXTRA MONEY if your wages are frozen).



Written in EASY-TO-UNDERSTAND SHOP TALK... complete with MANY ILLUSTRATIONS. Yes, that is my AMAZING OFFER... Read it all WITHOUT RISKING A PENNY. This OFFER IS LIMITED - mail coupon TODAY!

**ABSOLUTELY FREE**

SEND NO MONEY!  
PAY POSTMAN NOTHING!

**JUST MAIL COUPON** - Examine ACTUAL SAMPLE and facts about this AMAZING BOOK that tells you **HOW**

- to do Screen Printing
- to set up Screen-Print Shop of your own
- to get customers COMING TO YOU
- to start spare time and GROW
- to have TWO INCOMES instead of one
- TO CHARGE (on some jobs you make \$10 or more per hour)
- to EMPLOY OTHERS to help you

...EVERYTHING YOU NEED TO START!



**Good Luck—Fishing Fly—Personal Initial Key Tags**

These unusual and very useful key chain tags were made by embedding a four leaf clover, a fishing fly and gold-plated personal initials in Castolite Liquid Casting Plastic. You can also embed real flowers, butterflies, coins, photos, shells, etc., to make distinctive necklaces, pins, brooches, buttons, coasters, tiles, trays, book ends, other objects. Have a happy hobby or make big money in spare-time. Use home tools. Follow simple instructions. Information FREE. Just write for new illustrated folder "Liquid Magic."

**THE CASTOLITE CO., DEPT. B-2, WOODSTOCK, ILL.**

**INVENTORS**

**If you have a PATENTED or PATENT PENDING  
Invention TO SELL or LEASE  
Request our FREE book  
(No Obligation)**

**U.S. PATENT EXCHANGE**

406 SOUTH SPRING STREET (Suite M)

LOS ANGELES 13, CALIF.

# I need 500 Men to wear SAMPLE SUITS



## Pay No Money— Send No Money

My values in made-to-measure suits are so sensational, thousands of men order when they see the actual garments. I make it easy for you to get your own suit to wear and show—**MAKE MONEY IN FULL OR SPARE TIME THIS EASY WAY!**

## My Plan is AMAZING!

Just take a few orders at my low money-saving prices—that's all! Get your own personal suit to wear and show—make money fast taking orders. No experience needed. Spare time pays big. You pay no money, now or any time.

### MAIL COUPON!

Rush this coupon today for full facts and **BIG SAMPLE KIT** containing more than 100 fine woolsens in all popular weights and shades. Be one of the 500 top-notchers I need to wear, show, and take orders for my suits. Act now!

**PIONEER TAILORING CO.**  
Dept. P-1120 • Congress and  
Throop Sts., Chicago 7, Illinois

**FREE**

Costly Sample  
Kit containing  
over 100 actual  
fabric samples.

**PIONEER TAILORING CO., Dept. P-1120  
Congress & Throop Sts., Chicago 7, Ill.**

Dear Sir: I WANT A SAMPLE SUIT TO WEAR AND SHOW, without paying 1c for it. Rush Valuable Suit Coupon and Sample Kit of actual fabrics, **ABSOLUTELY FREE.**

Name.....

Address.....

City..... State.....

# AERONAUTICAL ENGINEERING

PS-2

Design Aircraft & Components—Study with Jets & Rockets—Great Future—Advanced Aeronautical Subjects—World-Wide Enrollment—Fully Accredited—Established 1929—Approved for Vets—CAL-AERO grads in heavy demand.

WRITE TODAY for Special Information.

NAME.....AGE.....

ADDRESS.....

CITY.....ZONE.....STATE.....

**CAL-AERO TECHNICAL INSTITUTE**  
GRAND CENTRAL AIR TERMINAL • GLENDALE 1, CALIFORNIA

# Tired of Working for 'PEANUTS?'

If you've ever sold anything, you can cash in your selling know-how by becoming a Superior distributor who hires, trains and supervises his own force of direct salesmen. Your salesmen make big money for you and for themselves.

Product is complete newly-designed line of carbon-tetrachloride fire equipment, easily sold in every home and business building. Superior Automatic Fire Extinguisher (see illustration) gives automatic fire protection which operates without human aid. Present distributors of this long-profit line are earning big money.

To qualify for a Superior distributorship, you must have a car, must be a capable salesman. We furnish everything you need to start. Write today, stating complete qualifications in first letter.

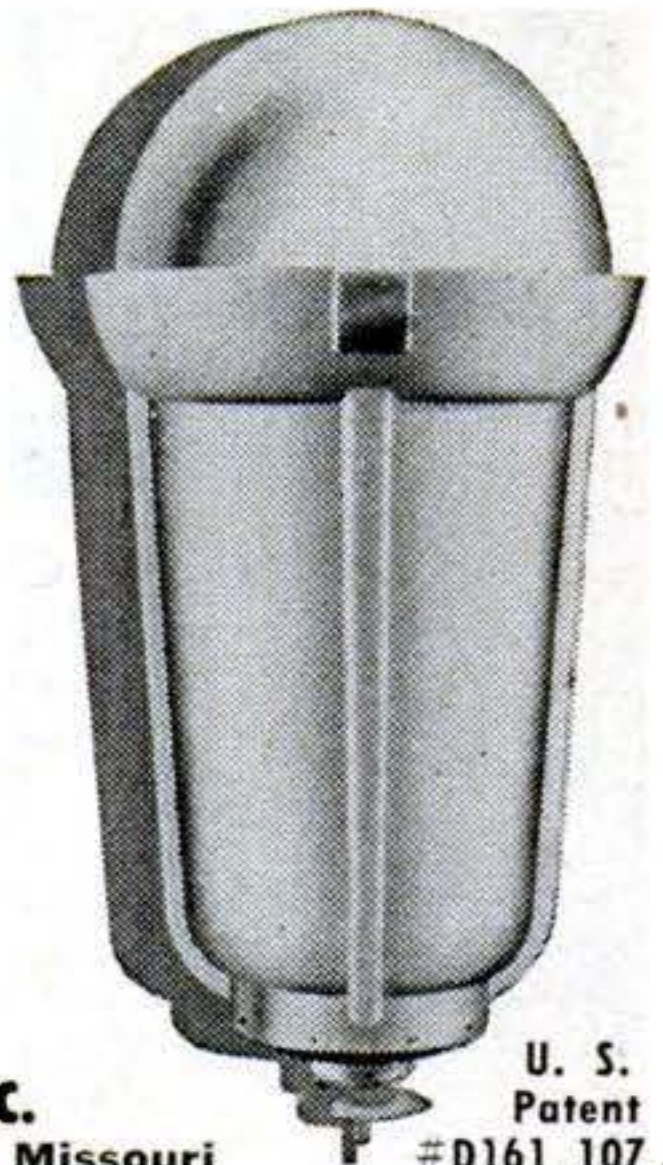

**SUPERIOR PRODUCTS, INC.**  
3414 Main St. Kansas City, Missouri

U. S. Patent #D161 107



## Sell ARTISTIC All-Occasion Cards

Make money this easy, congenial way! All your friends need Greeting Cards for Birthdays, other occasions. They buy fast when you show our big value Assortments. **Proven Line for Fast Earnings!** "Premium" 21-Card All-Occasion Box sells for only \$1. Your profit up to 100%! Many other new-idea Assortments, Imprinted Scented Scripts, Personal Stationery. No experience needed. Assortments on approval and **FREE Imprint Samples.**

**ARTISTIC CARD CO., Inc.**  
542 Way St., Elmira, N.Y.

**SAMPLES  
On Approval**

# REAL ESTATE BE A BROKER

**PAYS BIG! SEND FOR FREE, BIG, ILLUSTRATED CATALOG NOW!** No obligation. Graduates report making substantial incomes. Start and run **your own business quickly.** Men, women of all ages, learn easily. Course covers Sales, Property Management, Appraising, Loans, Mortgages, and related subjects. **STUDY AT HOME** or in our classrooms in big cities. Diploma awarded. G.I. approved. Nationally known.

**WEAVER SCHOOL OF REAL ESTATE (Est. 1936)**  
15 E. Pershing Road, Dept. PS, Kansas City, Mo.

**FREE  
BOOK  
TELLS  
HOW**

## "How to Make Money with Simple Cartoons"



A book everyone who likes to draw should have. It is free; no obligation. Simply address

**FREE  
BOOK**

**CARTOONISTS' EXCHANGE**  
Dept. 192D Pleasant Hill, Ohio

## GARDEN TRACTORS

### NEW CATALOG IN COLOR



It's New! The finest broadside on garden tractors ever issued gives you full details on the famous Speedex 2½ H.P. walking Model C, and on the heavy-duty 8 H.P. riding Model

23. Illustrates many labor-saving uses, shows wide range of implements for plowing, discing, cultivating, mowing, snow removal, lawn mowing, etc. Gives you complete descriptions . . . full information.

Supply limited—write today!

**SEND A POSTCARD FOR YOUR FREE COPY  
SPEEDEX GARDEN TRACTOR CO.**

Box 216-D12B, RAVENNA, OHIO

P-1150-42



# BRAND NEW SURPLUS UP TO 85% DISCOUNT



**Portable LIGHT PLANT**  
PUSH BUTTON START  
500-700 watts 110-120 v. — 60 cyc. A.C. Powered by a sturdy dependable, easy starting, air cooled 1 3/4 hp. gas engine. No wiring necessary, just plug in and operate. Plenty of current for oil burner, emergency lights, freezer, radio, incubator, etc. Complete protection against current failure. Ideal for hunting or camping. Complete with Voltmeter and built-in winding to charge 6 v. auto batteries. Wt. 85 lbs. Fully guaranteed. Be prepared if electric power fails. Reg. \$275.00 value..... **\$138.50**

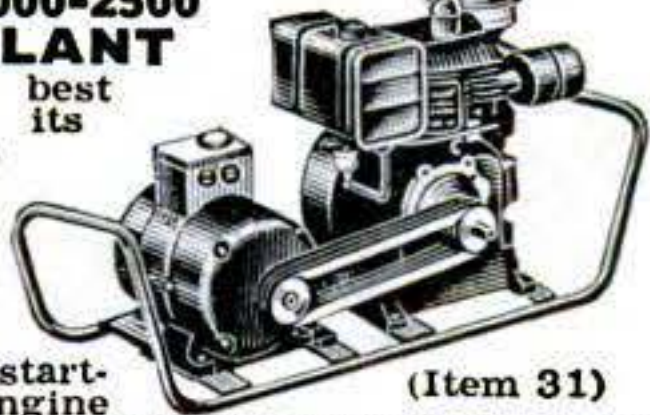

**GIANT 2000-2500 WATT PLANT**  
Absolutely the best made because its heavy windings develop up to 5000 watt overload for motor starting. Skid-mounted—portable. Powered by 5 h. p. easy starting Briggs engine—complete with all accessories; engine easily disconnected for other uses. Big outlet box, voltmeter, no wiring necessary. Ample current for all purposes. Factory warranty and instructions included. Wt. 220 lbs. Reg. \$585.00. Spec. at \$299.50. 110-120 V.—A.C. **GENERATOR ONLY** and control box. Drive it with your engine or tractor. **\$169.50.**



**HOT WATER HEATER**  
(Item 26) Immersion type, heavy duty. 115v. A.C. 300w. Does not require watching. Thermostat shuts off at 165°. Keeps water hot for shaving, washing, dishes, etc. Also good for keeping water from freezing in big troughs or tanks. Made by Cities Service. Wt. 4 lbs. Worth \$9.50. Our Spec. **\$4.50.**



**GAUGE TESTER**  
(Item 27) Precision made of solid bronze by Star Brass Co. Calibrated weights acting against hydraulic piston, provides quick, accurate testing of all pressure gauges up to 3000 lbs. per sq. in. Brand new in hardwood cases. Wt. 100 lbs. Reg. \$435.00. Our spec. **\$125.00.**



**EXTENSION CORD**  
(Item 16) 40 ft. heavy duty, made of specially insulated No. 14 2-conductor wire. So tough that you can drive over it and yet amazingly flexible and easy to handle. Resists oil, grease or water. Extends electricity up to 400 ft. without voltage drop. Use indoors or out. Complete with heavy rubber plug and outlet. Wt. 2 1/2 lbs. Usually \$4.50—Special 40 ft. **\$1.99** Comb: 2-40 ft. and 1-20 ft. (total 100 ft.) **\$4.95**



**PRESSURE SWITCH**  
(Item 30) Penn Electric Model 110 BPO2, best made. For pumps and air compressors. Heavy duty. Will handle up to 250 lbs. press. and up to 5 h.p. Autom. unloader valve, for easy starting. 110-220 v. A.C. or D.C. 2 pole. Wt. 5 lbs. Reg. list \$17.50. Our Spec. **\$8.95.**



**HYDRAULIC HOSE**  
High pressure, heavy duty, complete with swivel fittings. Pipe thread connections. Ideal for farm equip., bulldozers, grease guns, airbrakes, etc. Any length. Minimum \$1 per lgh. **INSIDE DIAMETER, 1/4" 40c per ft. 3/8" 50c, 1/2" 70c, 5/8" 90c.**



**PARTS WASHER**  
(Item 20) Store gas or carbon tet. in 5 gal. safety can. Valve releases just the right amount into washing compartment. Parts are washed and drained on a "dunking" screen—no fishing for parts. Eliminates fire-danger, waste, spillage, evaporation. Wt. 14 lbs. Reg. \$19.50—Special **\$5.95**



**RUBBER HOSE**  
New genuine Neoprene Hose—outlasts ordinary rubber 3 to 1. Reinforced with super tough cotton cord plies. Flexible. Easy Flo brass couplings with standard pipe threads for quick connections, included. Pump water for irrigation, stock, tanks, home, barn, fire fighting, etc. Pump Gas or Fuel Oil. Save more than 60%.  
(Inside Diam.) 1 1/4" 1 1/4" 1 1/2"  
Length 25 ft. 40 ft. 30 ft.  
Price 9.25 14.75 14.75  
If specified we will send special hose for gas or oil at same prices.



**HEATING & VENTILATING FAN**  
(Item 10) Easily installed in furnace pipes. Forces even heat to all rooms. Over range, removes kitchen smoke and odors. Powerful continuous duty motor, 110-120 V. A.C. Quiet, super efficient fan moves huge volume of air (400 to 600 c.f.m.) 8" Fan, wt. 5 lb. **\$6.35**; 9" Fan, wt. 6 lbs. **\$7.45**; 10" Fan, wt. 7 lb. **\$8.45.**



**ANGLE DRILL**  
(Item 23) Fits into chuck of any electric or pneumatic drill or flex. shaft. Operates at any angle in a full 360° arc. Makes possible drilling, grinding, carving, routing, etc. in close cramped quarters. Makes impossible jobs easy. Made by Kett Tool Co. Complete with built-in chuck and adjusting key. Hardened alloy gears. Precision built for heavy duty. Lists at \$39.95—while they last **\$9.95.**



**CARRY-AIR**  
Stainless steel tank—capacity 500 cu. in. at 400 lbs. press. complete with inlet and shut-off valves, press. gauge, detachable air hose, tire chuck. Fill at any service station. Carry air for tire inflation, blowing out lines, spray painting, insecticides, etc. One emergency pays back cost. Wt. 7 lbs. Worth \$20.00. Our price—**\$8.95.** (Item 32)



**FRAM OIL FILTER**  
(Item 12), Model F21. Big 73 cu. in. size. Ample capacity for all cars, trucks, tractors. Universal bracket, standard openings. Fram filters are tops. Easy to install. Wt. 8 lbs. Usually \$7.95—now **\$3.75.**



**CLIP BOARD**  
(Item 17) Heavy Masonite, with self-adjusting spring hinge to hold up to 100 sheets of 8 1/2 x 11 paper. Push back cover for instant release. Flip cover shut and notes or drawings are protected. Perfect for pilots, engineers, students, artists, truck drivers. Wt. 2 1/2 lbs. Usually \$2.95. Spec. **\$1.10, 2 for \$2.00.**

All items brand new. Prices f.o.b. Chicago area. Money back guarantee. Send check or M. O. **MASTER MECHANIC CO., Dept. 35, Burlington, Wis.**

## CARBURETOR TOO RICH MAKES MOTORIST TOO POOR



Car owners who are wasting money and not getting proper gas mileage due to over-rich mixtures will be pleased to learn how to save gasoline by VACU-MATING over-rich mixtures. VACU-MATIC fits all cars, trucks and tractors. It is automatic and operates on the supercharge principle. Easily installed in a few minutes.

**SALESMEN WANTED! Big Profits!** Send name, address on penny postcard for free particulars and how to get yours for introducing.

VACU - MATIC CO., 7617 - 1709 W. State St., WAUWATOSA, WIS.

**5 YEAR WRITTEN GUARANTEE**  
**BENRUS 15 & 17 JEWEL**  
MOVEMENT  
ORIGINALY SOLD UP TO **\$59.50**  
OFFICIAL SHOCKPROOF WATCH OF FAMOUS AIRLINES  
Choice of MEN'S OR LADIES'  
In latest style Yellow Gold Cases. You get these unredeemed 5-year guaranteed lifetime quality FAMOUS BENRUS WATCHES now at only \$14.95 because we bought out SURPLUS STOCKS of leading N. Y. and Md. jewelers. Order now. Order men's or ladies'.  
**TRIAL OFFER! WEAR AT OUR RISK!** Money back in 5 days if not delighted. SEND ONLY \$1 with order. Pay balance COD. plus postage. Or we pay postage if you enclose \$14.95. plus \$1.50 tax.  
**FREE!** Handsome Expansion band included with Prepaid Orders. Order now.  
**MARYLAND DISTRIBUTORS**  
501 E. Baltimore St., Dept. 227, Baltimore 2, Md.  
Free Watch & Diamond Ring Catalog.  
Practically Wholesale Prices to User Direct.  
War or No War, There's No Increase in Our Prices



**YOUR CHOICE ONLY \$14.95**  
Lifetime Guaranteed  
**17 JEWEL**  
Military Style  
**WRIST WATCH**  
Originally \$59 while they last  
**\$14.95** Plus \$1.50 tax  
New Incablock Shock-Protected WATER-DUST PROOF

## CHEMISTRY

**LEARN AT HOME...** You need chemical knowledge to qualify for thousands of today's good jobs in industry, business, science, the professions. This Course enables you to master practical chemistry. You learn by performing actual experiments at home, using chemicals and apparatus furnished with course. Illustrated lesson books guide you. Course approved. Equivalent to recognized college courses in general chemistry. Send today for free catalog.

**INSTITUTE OF PRACTICAL CHEMISTRY**  
2 PROSPECT AVENUE, HAGERSTOWN, MD.

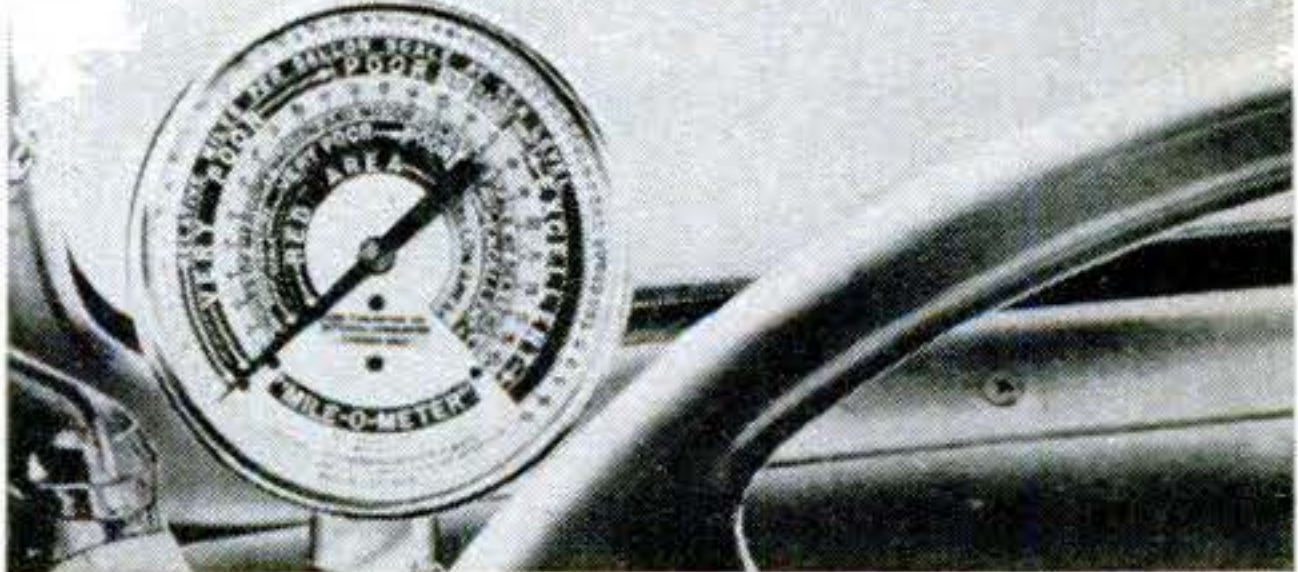

**SAVE GAS WITH A MILE-O-METER**  
The Mile-O-Meter gauge is a scientific instrument of known merit for showing any driver the condition of his engine and miles-per-gallon rate. Operates on intake manifold vacuum. Easily installed on any car or truck. Simple-to-read, 4-color dial is set in steel case with non-shatter crystal. Accurate internal movement. Over 1,000,000 already in use. Gift packaged—beautiful leather case. De Luxe Model \$14.95 Ppd; Standard Model \$9.75 Ppd. Gale Hall Engineering, Inc., Dept. 1245 Boston 18, Mass.  
**WORLD'S LARGEST PRODUCERS OF TUNE-UP GAUGES**

# WAR SURPLUS AND OTHER BARGAINS



## PNEUMATIC RIVETER & CHIPPING HAMMER

Mfd by Ingersoll-Rand, Chicago Pneumatic and Thor

Pistol grip. Ideal for fender, brake lining, concrete breaking work. Weight 5 lbs. Like new. Price each..  
2X — \$6.95    3X — \$7.50    4X — \$8.50

## INSIDE MICROMETER 2" to 8"

Precision made of tool steel. Hardened tips on all six measuring rods. One 1/2" spacer. Chrome finish. Complete with case. **\$6.95**

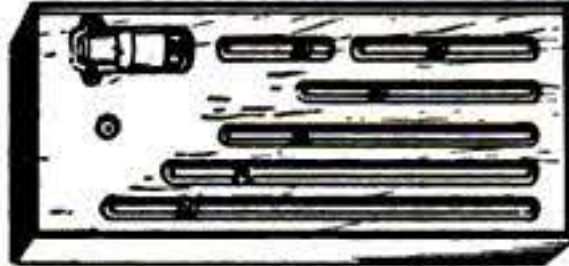

## MICROMETERS



Chrome plated, precision engineered and carefully tooled to give long life. All new 0-1" capacity ea. **\$2.25.**  
1-2" cap. **\$3.50.** 2-3" cap. **\$5.50.** 3-4" cap. **\$6.50.**

## DRILL GRINDER

.. Sharpens round, square or tapered drills up to 6" long. Even an amateur mechanic can get a new, factory finish on a drill in 25 seconds. New protractor feature gives every drill sharpening angle, with 5 convenient angles already marked off. Usable with hand or power stone. A brand new development, manufactured by Ten Eyck. Shipped postpaid

All New **\$2.80** each.



## HIGH SPEED DRILLS



All New Fractional & numbered. Orig. Val. \$15 Nationally known brand. Ast'd sizes. Set 30, **\$3.50**

## EXTENSION DRILLS

High Speed Steel, like new Asst'd sizes from No. 1/4 to 40. Lengths from 6" to 12". Approximately \$20 value. Set of 12 ..... **\$3.75**



**ELECTRIC BELLS**—Vibrating type, high pitch. 115 V., 60 Cycle. Ideal for use indoors or outdoors—on ranches, for schools, plant installations, as signal systems, burglar alarm systems, etc. Nationally known Mfr ALL NEW in orig. Pkgs. Solid brass clapper & 8 1/2" gong. Wt. 8 lbs. Govt. cost about \$67.50 **Close out at ... \$7.95**

Send check, money order or cash. 25% deposit required on C.O.D. orders. All prices F.O.B. Culver City, California, unless otherwise stated. **Send 25c for Illustrated Catalog.**

**AIRBORNE SALES CO., INC.** DEPT. PSM 2-51 CULVER CITY, CALIF.

## COATED! FEATHERWEIGHT!

12x50—\$65.00

16x50—\$69.50

**CENTER FOCUS!**

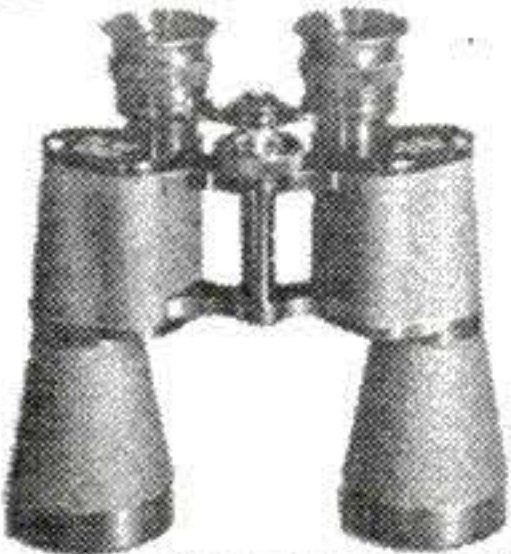

The ultimate in fine binoculars. Tremendous power (12 or 16 Power). Featherweight (weighs only 31 ounces!) Precision made in every detail. COATED providing sharper, brighter images. Center focus gives instant finger tip adjustment. Individually focussing right eye piece. Objective lens is 50 MM (2 inches) across! UNCONDITIONALLY GUARANTEED. Complete

satisfaction or your money refunded. Prices include genuine leather carrying case and straps. Add tax. \$2.00 deposit required on C.O.D.'s. Cash orders prepaid.

**UNITED BINOCULAR CO.**

9043 S. Western

Dept. ARF-3616

Chicago 20.

## new, easy way to.. STRIPE with PAINT

### Do Perfect Paint Striping at Home with New Kind of PAINT STRIPING TOOL

This amazing new **Paint Striping Tool** makes it easy to do expert striping on furniture, bikes, model planes, autos, signs, toys, linoleum, wall board, etc. Makes plain, painted walls look like tile. Paint straight lines... curved... circular or evenly spaced parallel lines the same way a professional painter does. Simply fill Tubular Glass Paint Fountain with any color paint and wheel tip feeds paint evenly without spreading, or smearing—smudging. Tips interchangeable—jaws split apart for easy cleaning. Tool complete with tip for 1-16 in. stripe only \$1.00 postpaid. Other complete tools with 1-64, 1-32, 3-64, 1-16, 5-64, 3-32, 1-8 inch tips, \$1.50. Separate tips—75c each. **COMPLETE KIT** with tool and 7 tips, \$5.00. Here's the handiest tool in your whole painter's kit. C.O.D.'s postage collect.



**\$1 ONLY**  
**POSTPAID ATTENTION**  
**Home Craftsmen and Hobbyists**

**DEALERS**  
**Paint Striping Tool**  
packed in attractive display cartons of 1 doz. Fast, profitable seller. Write for illus. circular, discounts.

Just the tool you've been waiting for! New **PAINT STRIPING** tool gives "professional" results every time, yet simple and easy to use as a fountain pen. Adjustable guide keeps lines straight as an arrow. Just as easy to make curves or free hand designs. Adds new beauty and finished look to everything you paint. Send dollar today.

**WENDELL MFG. Co., 4234 N. Lincoln Ave., Dept. 22, Chicago 18, Ill.**

# Happy Is The Day When Backache Goes Away . . . .

As we get older, stress and strain, over-exertion, excessive smoking or exposure to cold sometimes slows down kidney function. This may lead many folks to complain of nagging backache, loss of pep and energy, headaches and dizziness. Getting up nights or frequent passages may result from minor bladder irritations due to cold, dampness or dietary indiscretions.

If your discomforts are due to these causes, don't wait, try Doan's Pills, a mild diuretic. Used successfully by millions for over 50 years. While these symptoms may often otherwise occur, it's amazing how many times Doan's give happy relief—help the 15 miles of kidney tubes and filters flush out waste. Get Doan's Pills today!



100% PROTECTION

## TEAR GAS

### A REAL SURE-FIRE SELLER! THUGS AND THIEVES BEWARE!

Here is a tear gas pencil gun which discharges smothering clouds of tear gas to instantly stop, stun and incapacitate the most vicious man or beast. A safe and effective substitute for dangerous firearms. No permanent injury. Needed in Stores, Banks, Autos and Homes, everywhere to protect Life and Property. No skill required. Handle our tear gas as a side line and you'll soon give it full time. For a quick start send \$3.60 for complete demonstrator outfit consisting of an Automatic Pencil Gun with 10 demonstrators and 3 powerful Tear Gas cartridges fully guaranteed. Many thousands now in use. Order your outfit today. Not sold to minors.

Hagen Supply Corp.

Dept. D-502

St. Paul 4, Minn.

## TRY WATER-INJECTION 30 DAYS AT OUR RISK!

Add zip to your car with "Vapo-Jet." Automatically combines water, oil vapors, with fuel, to help give smoother performance, more power, faster get-away, better pick-up, fuel economy. Complete. Nothing else to buy.



**Limited Supply**

Rush order today! Give car make, model, no. of cyl. Remittance with order saves postage!

**BANTEL MFG. CO., 757-K Venice Blvd., Los Angeles 15, Calif.**

**ONLY \$9.95 Post Paid**

## ★ ★ GET A FINE SUIT AND START IN BUSINESS

Get your made-to-measure suit without cost taking orders from friends at direct-from-factory prices. Pocket big commission on all orders. Get splendid demonstration outfit and tested plans FREE. Work from home or office, full or spare time. Top men make up to \$12,000 in a year. Famous 38-year-old firm. Write **BUSINESS MANAGER, Dept. 84, Box 23, Cincinnati 6, Ohio**



**PAY US NOTHING**

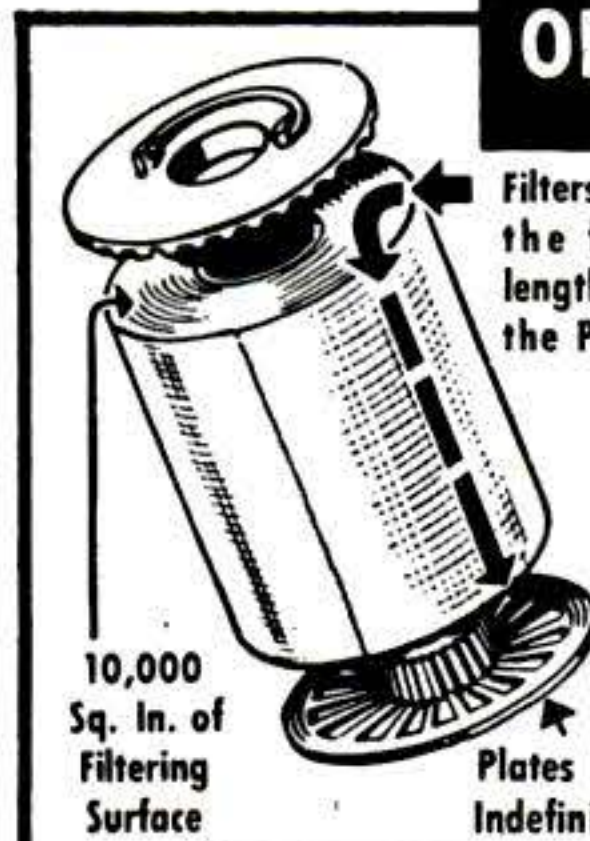

## OIL FILTER REFILLS... 10c

Filters Oil the full length of the Pack

10,000 Sq. In. of Filtering Surface

Plates Last Indefinitely

Here's News! Ordinary toilet paper makes an ideal oil filter. Laboratory tests prove it cleans oil faster and better than popular makes of filter elements. All you need is a simple set of **RETLIF ADAPTER PLATES**... and you can start using ordinary toilet paper rolls in your present oil filter. For proof and descriptive literature, send name and address to:

**RETLIF CORPORATION, Dept. 66**  
1239 No. Highland Ave., Los Angeles 38, Calif.

## 65 KW. 225 Volt D. C. Diesel Electric GENERATING UNIT

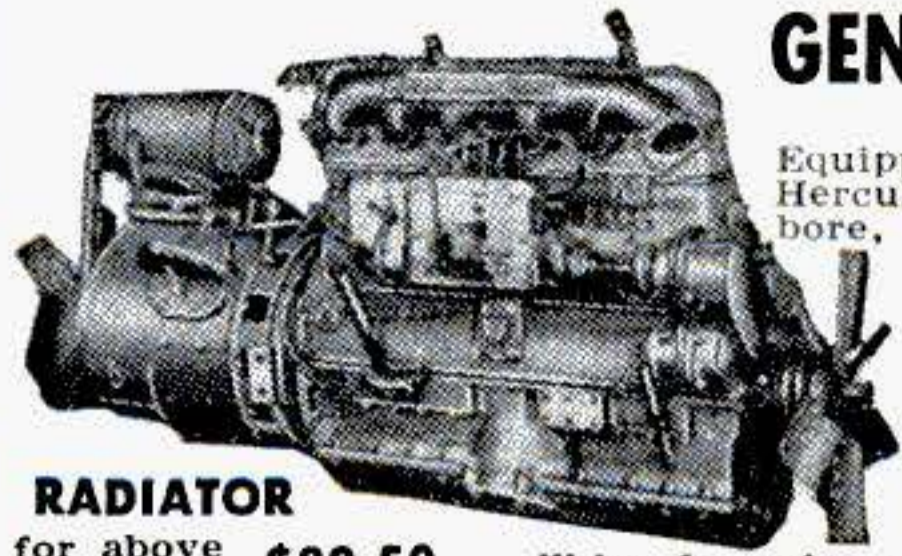

**RECONDITIONED**  
Equipped with 6 cyl. DRXC Hercules DIESEL engine, 4 5/8" bore, 5 1/4" stroke, 133 H.P. at 2000 R.P.M. Complete with injector, pump, nozzles and electrical equipment. Generator attached to engine. Complete as shown.

**RADIATOR**  
for above unit . . . . . \$89.50

Ea. \$1375.00  
Lots of 2, ea. \$1295.00  
Write for price on DIESEL ENGINE only.

**60 HP. Jeep Engine** Reconditioned, tested & Guaranteed in perfect order, ready to run. **\$192.50**

SEND 25% CASH WITH ORDER, BALANCE C.O.D.

1951 Edition! It's New! It's Different! Get World's largest Auto Accessory & Parts Catalog and save money. Over 50,000 items, including Hollywood Accessories, Hi-Speed Equipment, Rebuilt Engines, all parts & accessories for all cars & trucks. We have that Hard-To-Get part! Jam packed with bargains. Completely illustrated. Send 25c (refundable).

**J. C. WHITNEY & CO.**

1917SC Archer Ave.

Chicago 16, Ill.

## NEW! Electric Motors

New General Electric 1/2 H.P. Induction Type 3450 RPM 110 V, 60 cy. 1 ph. A.C. **\$21.75**  
Motor #GEH-5  
New General Electric 1/2 H.P. Cap/Ind. Ball Brg. 1750 RPM, double 1/2" shaft. 110 V, 60 cy. 1 Ph. A.C. Motor . . . . . **\$26.50**  
#GE-17  
New General Electric 3/4 H.P. Cap/Ind. Ball Brg. 1750 RPM double 1/2" shaft. 110-V, 60 Cy. 1 Ph. A.C. Motor . . . . . **\$34.50**  
#GE-75  
New Eicor 1 H.P. Capacitor Induction 1750 RPM, 110/220 V, 60 Cy. 1 Ph. A.C. **\$45.00**  
Motor #EG-17  
New Emerson 1 H.P. Heavy Duty, Repulsion Induction. 3450 RPM, 110/220 V, 60 Cy. 1 Ph. A.C. Motor . . . . . **\$42.50**  
Same as above, 1 1/2 H.P. 220-V only, #EH-15 \$57.50  
Same as above, 2 H.P. 220-V only, #EH-20 \$67.50



These prices are F.O.B. Chicago. Order by number. We have large stock of special & standard motors. ALL SIZES. Write for prices on the motor you need.

C. MARSHALL SALES, 3546 W. Fullerton Av., Dept. PS-2 Chicago 47

## Wheels Wheels



## Wheels Wheels

5" Disc Wheel 5/8" Tire 5/16" or 3/8" sleeve . . . . . 30c ea.  
6" Disc Wheel 5/8" Tire 5/16" or 3/8" sleeve . . . . . 35c ea.  
7" Disc Wheel 3/4" Tire 3/8" sleeve . . . . . 45c ea.  
8" Disc Wheel 1 1/8" Tire 1/2" sleeve . . . . . 70c ea.  
7" Disc Wheel 1" Tire 1/2" ball bearing . . . . . 80c ea.  
8" Disc Wheel 1 1/8" Tire 1/2" ball bearing . . . . . \$1.00 ea.  
8" Disc Wheel 2" semi-pneum. T. 1/2" B.B. . . . . \$1.35 ea.  
10" Disc Wheel 1.75 semi-pneum. T. 1/2" B.B. . . . . \$1.50 ea.  
12" Disc Wheel 1.75 semi-pneum. T. 1/2" B.B. . . . . \$1.85 ea.  
Above wheel prices includes hub cap.  
Plus Postage, 20% . C.O.D.'s accepted.

**UNITED WHEEL STAMPING CO.**

2756 W. 115th STREET PS-2 CHICAGO 43, ILLINOIS

**GREATEST SAVING EVER OFFERED!**  
U. S. GOV'T SURPLUS



## "BARGAIN BOOK"

**JUST OFF THE PRESS!**

Greatest Bargain Book ever offered low, low prices, terrific savings on scarce war surplus. Mail 10c TODAY - NOW - begin saving on hundreds of items for farm, home, shop, sports. Get your Bargain Book by return mail.

500 BARGAINS  
• FARMS • SPORTS  
• HOME • SHOP

MAIL TODAY Only **10c**

**FISLER SALES CO.**

723 WALNUT ST., DESKA-5, KANSAS CITY, MO.

# PLASTICAST

THE GREATEST THING IN PLASTICS!



## A NEW HOME INDUSTRY AND HOBBY!

We have started THOUSANDS of people in a wonderful new kind of business! Here are 4 reasons why: (1) The work is pleasant and very easy . . . actually as easy as pouring water out of a glass! (2) VERY LITTLE investment is required; imagine, less than \$5.00 is required in order to start you off in your own manufacturing business! (3) Can be started ANY WHERE . . . at home, garage, basement, etc. and most important (4) The things you can make in QUANTITY PRODUCTION are not only exceptionally attractive and useful but are always in big demand every season of the year! VAST QUANTITIES OF PLASTIC COMPONENTS NOW NEEDED BY ARMED SERVICES.

## YOU CAN MAKE ANYTHING!

What is this new business? It is CASTING . . . Casting with liquid plastics. CASTING is a method of production manufacturing WITHOUT MACHINERY OR TOOLS! CASTING is the exceedingly simple process of pouring liquids into molds . . . It is as simple as that! Like making Jello, only these liquid plastics SOLIDIFY in a few minutes after mixing into extremely HARD, DURABLE and ATTRACTIVE articles such as Jewelry, Novelties, Giftware, Figurines, Statuary, Knick-knacks, Baby Shoes, Souvenirs, Ceramics, Imitation Marble, Bookends, Lamps, Pen sets, Cigarette Lighters, Toys, Dolls, Banks, Fishing Lures, Tools . . . A THOUSAND USEFUL THINGS! The field is really unlimited. We supply EVERYTHING . . . Casting Materials, Molds, Accessories and Instructions.

## 1000 GOLDEN OPPORTUNITIES!

Regardless what you are doing now you can get into the CASTING BUSINESS in your spare time or evenings. We assure you, once you do, you will be eagerly devoting all of your time to this very easy, fascinating and HIGHLY PROFITABLE OCCUPATION until it leads into a dependable business all your own! BUT LET US PROVE IT. Send only 25c for our big 40 page Catalog of Casting Materials, hundreds of Molds, etc. We will also send you FREE an attractive CASTING to show you what can be done with liquid plastics in a few minutes! We will also send you FREE a valuable book giving you details on the ART AND BUSINESS OF CASTING which shows you how to cast and get started! All this for only 25c, but write for it today. This may be the lucky coin that will start the most fascinating and profitable phase of your life!

## COMPLETE OUTFIT—Only \$3.50

If you want to get started at once send for our big SENIOR PLASTICAST OUTFIT consisting of TEN VALUABLE METAL MOLDS for making extremely beautiful and useful TRANSPARENT crystal-clear or colorful plastic articles of real value! Make unusual Penholders, Cigarette Lighters, Ashtrays, Pendant Hearts, Souvenirs, Imbed Flowers and Photos, Brooches, Key-Chain Fobs, Paperweights and countless attractive items! Pipette, Measure, Imbedding and Polishing Materials, 2 dyes, Instructions and quart of PLASTICAST and hardener for about \$100 worth of castings! COMPLETE AS DESCRIBED, SENIOR PLASTICAST OUTFIT NO. 464...ppd. \$7.50 MASTER OUTFIT, 4 molds, pt. PLASTICAST, and smaller quantity of accessories ppd. \$3.50

# FREE



**PLASTICAST CO. (Dept. A)**

170 N. Halsted St. (Write to Chicago 6, Ill. nearest address)  
P. O. Box 987 Palo Alto, Calif.  
CANADIAN CUSTOMERS, please order directly from: CANADIAN INDUSTRIAL PLASTICS, LTD., 1056 1/2 Pender West, Vancouver, B.C.

## POWER MOWERS & KITS

**FREE PLANS**

LOW FACTORY PRICES DIRECT TO YOU

3 & 4 Wheel Model



4 Wheel Direct Drive

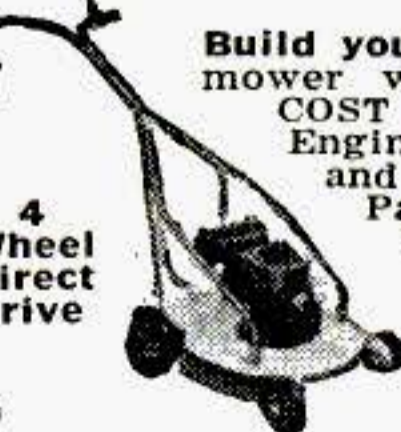

Build your own quality mower with our LOW COST KITS, Parts, Engines. Free Plans guide you, 3 and 4 Wheel Kits, complete. Parts precision finished, ready to use. Write TODAY for Free Plans, Low Prices, Parts List and Guarantee.

**3-WHEEL KIT NO. T-800**

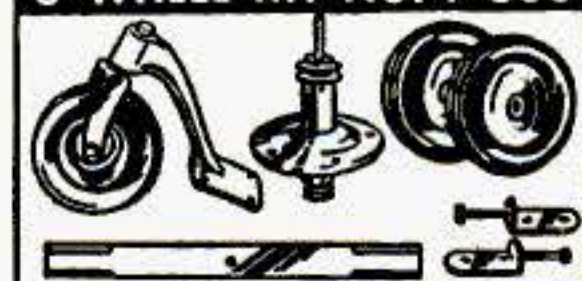

America's Finest Power Mowers completely assembled in 3 and 4 wheel models. Belt or direct drive. 18" and 20" sizes. Nationally known make engine optional. Latest improved features, sturdy construction and money back guarantee fully described in color folder. Write Today.

TRIANGLE MANUFACTURING CO., Box S-3, Fort Scott, Kansas

# MANUFACTURE THIS BEAUTIFUL CONCRETE OUTDOOR FIREPLACE

Right In Your Own Backyard

\$4.00 Worth of Sand & Cement produces this Attractive Fireplace.

Sells on Sight from \$60. to \$80. Easy to start your own Profitable Business.

The General Fireplace Molds and Process are the most amazing and foolproof ever invented. Simple to operate, two men can produce five fireplaces a day.

## BIG DEMAND!!

Sell all you produce to Department Stores, Homeowners, Parks, Nurseries and Picnic Groves. Fireplaces sell on sight. No experience necessary, we supply full operating instructions and equipment plus the know how that spells BIG PROFITS. This is an outstanding opportunity for men of vision and small capital to get into a busy rich paying field. Don't delay, be the only exclusive manufacturer in your own home town. Mail coupon at once for full details as to how you can reserve your territory.

Molds sold only on exclusive franchise.

**GENERAL ENGINES CO., Inc., Dept. S 17 F**

307 HUNTER ST.

GLOUCESTER CITY, N. J.

Mr. Tor of Phila. writes: Sold 250 in first 4 months. Selling to Sears Roebuck, John Wanamaker & Gimbel Bros. in Phila. area.

Name.....  
Address.....  
City.....Zone.....State.....

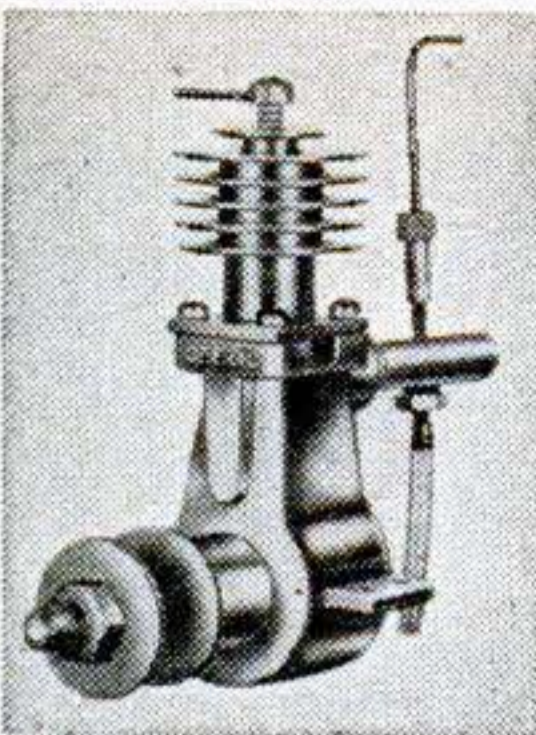
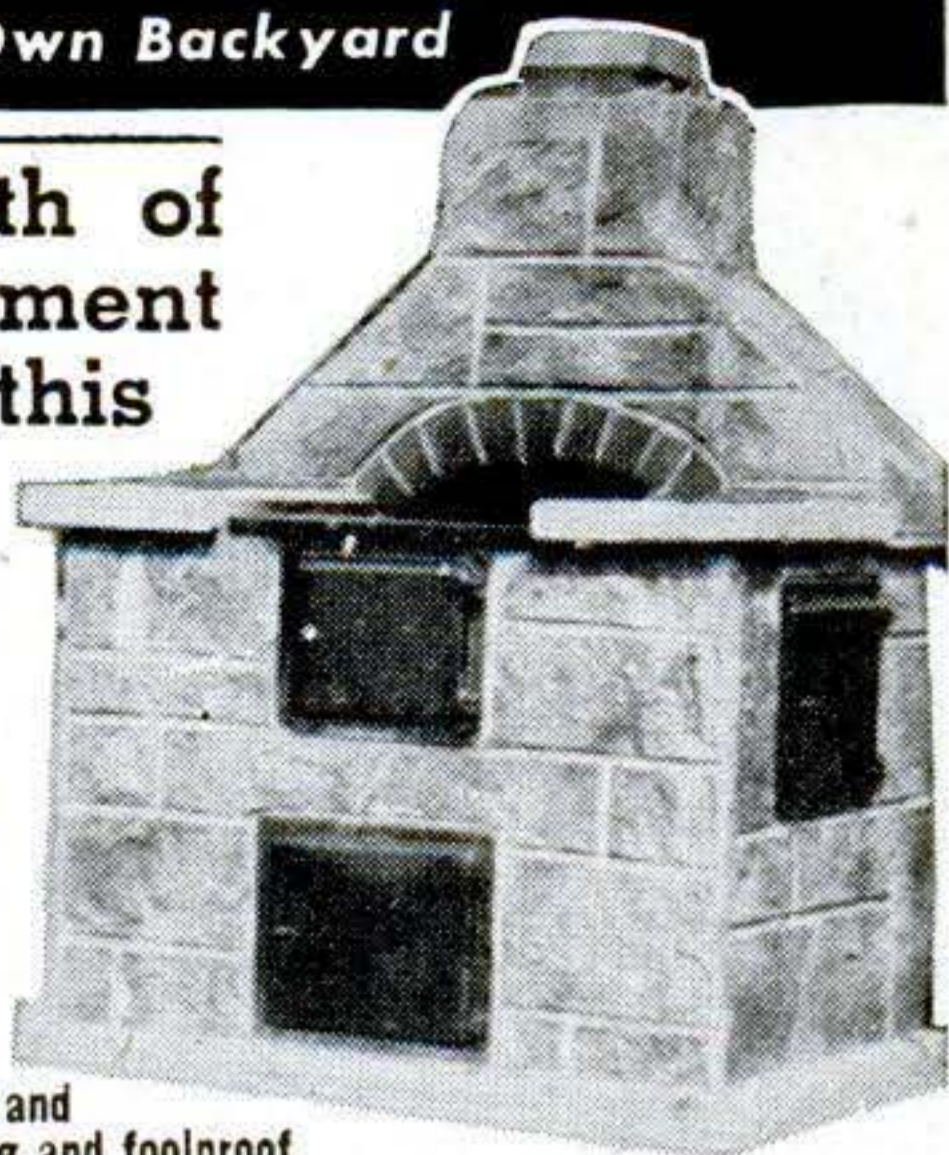

★ ★ ★ ★ ★ ★ ★ ★ ★ ★ ★ ★ ★ ★ ★ ★ ★ ★

Our 360th Advertisement

## REAL DIESEL ENGINE!

**\$295**

You can't beat this price!

- Ideal for planes, boats, midget cars
- Actually runs at 7500 RPM, produces 1/7 HP
- Height a full 3 1/2 inches; weight 5 ounces.
- Comes to you completely assembled, ready for operation.

MAYBE WE'RE CRAZY, giving away a precision diesel engine, complete with cylinder and piston, carburetor, crankshaft, connecting rod, etc. for ONLY \$2.95. But we're selling thousands of DEEZILS all over the world, and that keeps our production costs down. DEEZIL is streamlined, compact, rugged. Starts quickly, easy to install, runs for years! Fast delivery if you ORDER DEEZIL TODAY!

Send \$2.95 plus 25c postage

GOTHAM HOBBY CORP., Dept. S, 107 E. 126th St., New York 35, N. Y.

★ ★ ★ ★ ★ ★ ★ ★ ★ ★ ★ ★ ★ ★ ★ ★ ★ ★



## PIPE TRAY \$1.50

Ends pipe mess!

\$2.50 VALUE

Empties your pipe with one easy rotation of bowl on rod. Ashes drop in tray. No dirty hands, no ashes on floor, no broken stems. Every pipe smoker and hostess should have one. Beautiful bronze, satin finish. Sturdy and heavy. Send \$1.50 today to WHOLESALE DIE CO. Box 92A, South Pasadena, Calif.

**NEW ECONOMY MODEL AS LOW AS \$9750**

**ROCKLIN BUZZMOBILE**

- Clears Brush
- Falls Trees
- Cuts Logs
- Makes Fence Posts
- Mows Weeds, Grass
- Cuts Hedge
- Trims Limbs
- Cuts Fence Rows

World's Lowest Priced!

Write for Bonus Weed Mower Offer: Easier to Operate

**ROCKLIN MANUFACTURING CO.**  
DEPT. PS Sioux City, Iowa

## Tighten Loose Handles

**TO STAY**



Use the "repairman's standby" — Smooth-On No. 1 Iron Cement — to anchor loose tool and cutlery handles, knobs, pulls, casters, clothes-hooks, bolts, screws, etc. You apply it like putty — no heat required. It hardens like metal. And because Smooth-On expands slightly as it sets, your repairs stay tight. Buy Smooth-On No. 1 in 1 3/4-oz., 7-oz. or 1-lb. size at your hardware store. If they haven't it, write us.

## FREE Repair Ideas

40 pages of time-saving, money-saving ways to stop leaks, seal cracks, tighten loose parts. 170 illustrations. Clear, simple directions. Send now.

SMOOTH-ON MFG. CO., Dept. 58B  
570 Communipaw Ave., Jersey City 4, N. J.

Do it with

**SMOOTH-ON**  
THE IRON CEMENT OF 1000 USES



## TREASURE -- \$10,000

New locator detects metals, valuable minerals and buried treasure. Money-back guarantee of superiority.



Also geiger counters. Govt. reward of \$10,000 for uranium discovery. Write for FREE information.

**THE GOLDAK COMPANY**  
1544 W. GLENOAKS BLVD., GLENDALE 1, CALIF.

## Make Personalized HOUSE, LAWN MARKERS For Fun Or Profit



17 new silhouette cutouts (3 shown plus 14 other novel designs) complete alphabet and numbers, ready to trace onto wood. Sawing is easy. Marker with name or address is distinctive personalized

gift or addition to your own home. Make markers for fun and to sell. Set of 17 full-size, ready-to-use patterns, alphabet numbers, only \$1.00, postpaid. Money Back Guarantee.

Clip This Ad and Mail With **CRAFTPLANS** Dept. S-185, Chicago 5, Ill  
Dollar Bill or Check TODAY 1321 S. Michigan Ave.



## DRIVE 3 TO 6 DAYS A MONTH



**Gas Free!**

Amazing discovery, tested in Engineering Dept. of leading U. S. University, reduces gasoline consumption as much as 20% — gives you up to 6 days a month gas free driving — may actually pay for itself in cash savings. Also better performance, more power, quicker starts, faster acceleration, on all cars, light trucks, tractors — any age, make or model. It can help keep you rolling if emergency gas restrictions come.

## TEST IT 30 DAYS ON YOUR OWN CAR BEFORE DECIDING

No one can appreciate the astounding benefits of this new miracle development without actual day-by-day experience on the road — so we want you to try it for 30 days on your own car at our risk. Write or wire today for complete FREE details, technical explanation and 30-Day Examination Request Blank.

**SEND NO MONEY**

**G. B. SCHUYLER, Dept. 32**  
1665 Mission St. San Francisco 3, Calif.



# MEN! send for this MONEY-MAKING OUTFIT FREE!

MAKE \$15<sup>00</sup> IN A UP TO 15 DAY

Do you want to make more money in full or spare time... as much as \$15.00 in a day? Then write for this BIG OUTFIT, sent you FREE, containing more than 150 fine quality fabrics, sensational values in made-to-measure suits and overcoats. Take orders from friends, neighbors, fellow-workers. No experience needed. You'll say it's the greatest way to make money you ever saw.

## SAMPLE SUITS TO WEAR Pay No Money! Send No Money!

Our plan makes it easy for you to get your own personal suits and overcoats without paying 1c, in addition to your big cash earnings. This offer is limited. Rush your name and address for big FREE OUTFIT—today!

**J. C. FIELD & SON., Dept. P-1720**  
Harrison & Throop Streets, Chicago 7, Illinois



# FREE TO HOME PLANNERS

Our color folder showing 5 popular home designs sent FREE to demonstrate our MONEY SAVINGS home planning service. Over 1,250 Tested Designs of homes already built shown in beautiful illustrated books. Floor Plan shown with each design. Blue Prints, material lists, specifications available at LOW COST. Mail request today or order new 1951 Plan Books below.

### 1 TO 4 BEDROOMS—ALL TYPES CONSTRUCTION

America's Best Home Plans... 125 Designs, many in color.....	50c	} All BOOKS POSTPAID Order 2 or more and get "Little Red Book" of 29 designs at nothing extra.
Ranch and Suburban.....	50c	
158 Designs, many moderate cost. All American Homes.....	50c	
120 Designs, varied types, sizes. Our Future Home.....	50c	
149 Designs, all sizes, styles....	\$1.00	

**L. F. GARLINGHOUSE CO., INC., Box PS-8 TOPEKA, KANSAS**

# ITALIAN ACCORDIONS



All types, all models, Very best. Hand Made. Fully guaranteed. Buy direct from Factory representative at lowest wholesale prices, and Save Money. Also Button Accordions, Chromatic Accordions and Concertinas. We take any instruments in trade. Send name and Address for FREE catalog.

**ITALIAN ACCORDION MFG. CO.**

7600 Cottage Grove Ave., Dept. PS-2, Chicago 19, Ill.

**When Writing to Advertisers, Mention Popular Science**

## 2 HIGH-SPEED STEEL SAWS-\$2.25

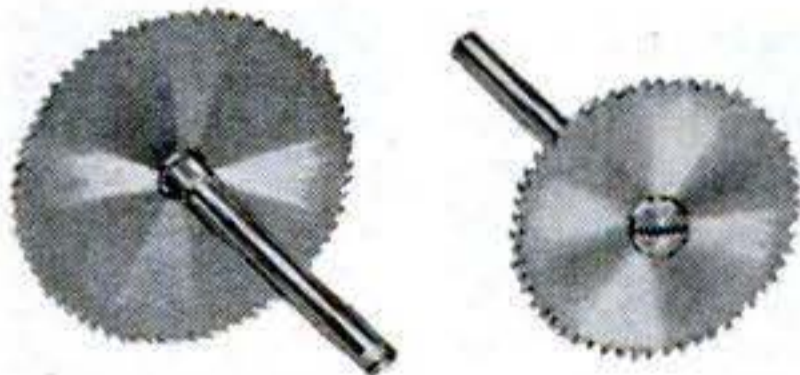

2 - High speed steel circular saws 1" and 1 1/4" diam. by .025" thick, with 1/8" mandrels, for cutting wood, plastic and most metals. Both postpaid in U.S.A. \$2.25  
2 - Tungsten steel saws 3/4" diam. by .025" thick, with 1/8" mandrels. Both, postpaid in U.S.A. \$1.50  
12 - Abrasive stones, assorted shapes and sizes up to 1" diam. by 1/4" thick used with mandrel for cutting stone, glass, metal, etc. Postpaid in U.S.A. \$1.00

**48 ROTARY CUTTERS only \$2.50 postpaid**

Assorted shapes and sizes (approx. 1/32" to 3/32"). Shafts 3/32" Enlarged illustrations of cutter heads shown below. Ideal for work shops. Also brass and nickel-silver for model makers—Gold, silver, amateur jewelers supplies—Small tools and accessories for hand grinders, polishers, etc. Write for 68 page illustrated catalog PS51.

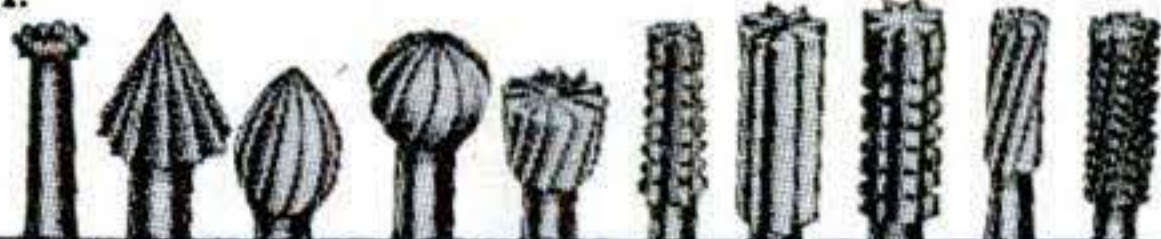

**SCHRADER INSTRUMENT CO., INDEPENDENCE, IOWA**

# WE TRAIN YOU AT HOME FOR RADIO TELEVISION JOBS

Prepare now for high-pay jobs with SECURITY. Big demand for trained men! Get to the top faster through practical shop-training methods! You earn big money at home while learning; start your own business! Fastest growing industry in the country!

**RTTA FURNISHES**

**EVERYTHING—**

**TUBES,**

**BATTERIES,**

**LARGE TV**

**PICTURE TUBE**

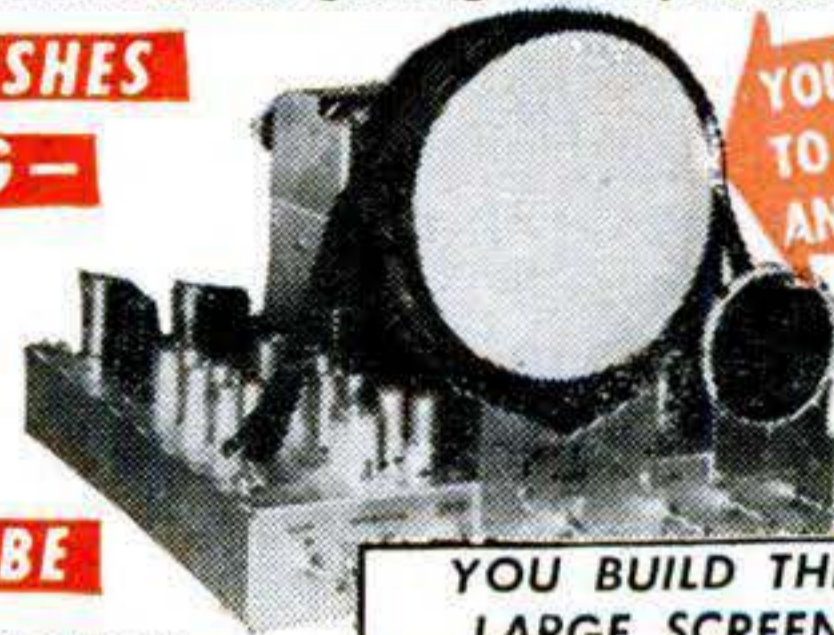

**YOURS TO KEEP AND ENJOY**

**YOU KEEP ALL EQUIPMENT!**

**YOU BUILD THIS LARGE SCREEN TELEVISION RECEIVER**

**YOUR CHOICE OF 10, 12 1/2 OR 16 INCH PICTURE TELEVISION TUBE**

**CAN BE CONVERTED FOR COLOR TELEVISION**

**FREE...At No Extra Cost... YOU GET A ROUND TRIP TO NEW YORK CITY**

After completing home study training, your transportation both ways from any point in U.S. or Canada will be paid by RTTA. At our affiliated training shops in New York City you get 2 solid weeks of laboratory work on newest equipment.

**NO PREVIOUS EXPERIENCE NECESSARY FREE EMPLOYMENT HELP**

RTTA helps you earn while you learn. Open to men of all ages! RTTA prepares you for BIG PAY and to open your own shop.

**DRAFT AGE MEN**

Special "SPEED-UP" Radio Communications program helps you get BETTER SERVICE RATING—BETTER PAY! You can find out by return mail! Send Coupon TODAY!

**YOU GET 15 BIG TELEVISION-RADIO KITS AT NO EXTRA COST. YOU BUILD THESE & THREE OTHER UNITS**

**STUDY AT HOME IN YOUR SPARE TIME**

**RF SIGNAL GENERATOR**



**AUDIO OSCILLATOR**

## FREE "SPEED-UP OFFER" COUPON

### RADIO TELEVISION TRAINING ASSOCIATION

972 Broad Street, Dept. 152, Newark 1, N. J.

Rush me FREE Sample Lesson & Catalog "How to Make Money in Television," in spare time. AT HOME, while learning; also ( ) Special Home Plan for Men over Draft Age. ( ) "Speed-Up" Service Rating Plan for Draft Age Men. No obligations! I understand no salesman will call.

Name.....Age.....

Address.....



## LEARN TO DANCE \$1<sup>00</sup>

Why be a lonely, unpopular wall-flower? Learn all the smart dances from the most modern to the old favorites—at home, in private without teacher, music or partner. So simple even a child can learn quickly. Tap dancing, Waltz, Collegiate, Samba, Rhumba, Jitterbug and many others, including illustrations. Complete course only \$1.00. Also, delightful old square dances with illustrations for \$1.00. Get each Separate or both for \$1.98. If you order both take your choice of FREE-DREAM BOOK or LOVE LETTERS. C.O.D. orders 25c extra and Postage.

Superior professional taps, both toes and heels \$2.98 prepaid or C.O.D. plus shipping charges. State size, large or small.

**ROLLDEX, P. O. Box 445, Dept. D-85, Huntington Sta., N. Y.**

## BUY FROM THE OLDEST ESTABLISHED FIRM IN THE UNITED STATES SELLING EYE GLASSES BY MAIL

As Low As \$1.95

Send No Money



**Write Today For Free Catalog**

In the convenience of your home it is now possible to buy eye glasses by using our 14 lens testers with their many combinations. We have thousands of delighted customers who have purchased eye glasses by this new method.

**ADVANCE SPECTACLE CO.**  
537 S. Dearborn—Chicago 5, Ill. Dept. 114

# WANT TO SAVE GAS?

BE PREPARED IF RATIONING RETURNS

1/4 MILLION NOW IN USE

TRY IT **FREE** IN YOUR CAR

TEST FOR  
 ✓ MORE MILEAGE ✓ FASTER PICK-UP  
 ✓ EASIER STARTING ✓ BETTER IDLING

You can install it easily in a few minutes

MANY GANE NEEDLE USERS REPORT up to 25% more mileage, faster pick-up, easier starting and smoother idling. TRY A GANE NEEDLE IN YOUR CAR for ten days at our expense, then compare your mileage and performance. If fully satisfied, send only \$1.50 per needle (8 cylinder cars take 2). If not satisfied, just return it—FAIR ENOUGH? Since authorities differ on its merits and some users report no improvement. TRY BEFORE YOU BUY!

Write today. Enclose no money. Pay postman nothing. Send us your name, address, make and year of car—and the make of carburetor if convenient.

## THE AMAZING GANE

AIR FLOW NEEDLE

Gane replaces the idling adjustment screw in gasoline carburetors.

Holes for Air Flow



**BOOK SENT FREE!** This auto economy manual is sent absolutely free, to all who try Gane Needles. It tells how to save gas, tires, brakes and tells how you can gain more power, speed and better performance from your car. This combination manual-catalog also introduces many new and ingenious economy products.

NATIONAL AUTOMOTIVE RESEARCH CORP., Dept. H-2  
 350 West Washington Blvd. Venice, Calif.

# MILLER ROTARY HI-SPEED ROPE-SAW DRILL-BIT

IT SAWS & CUTS & REAMS

Presents The Big 3

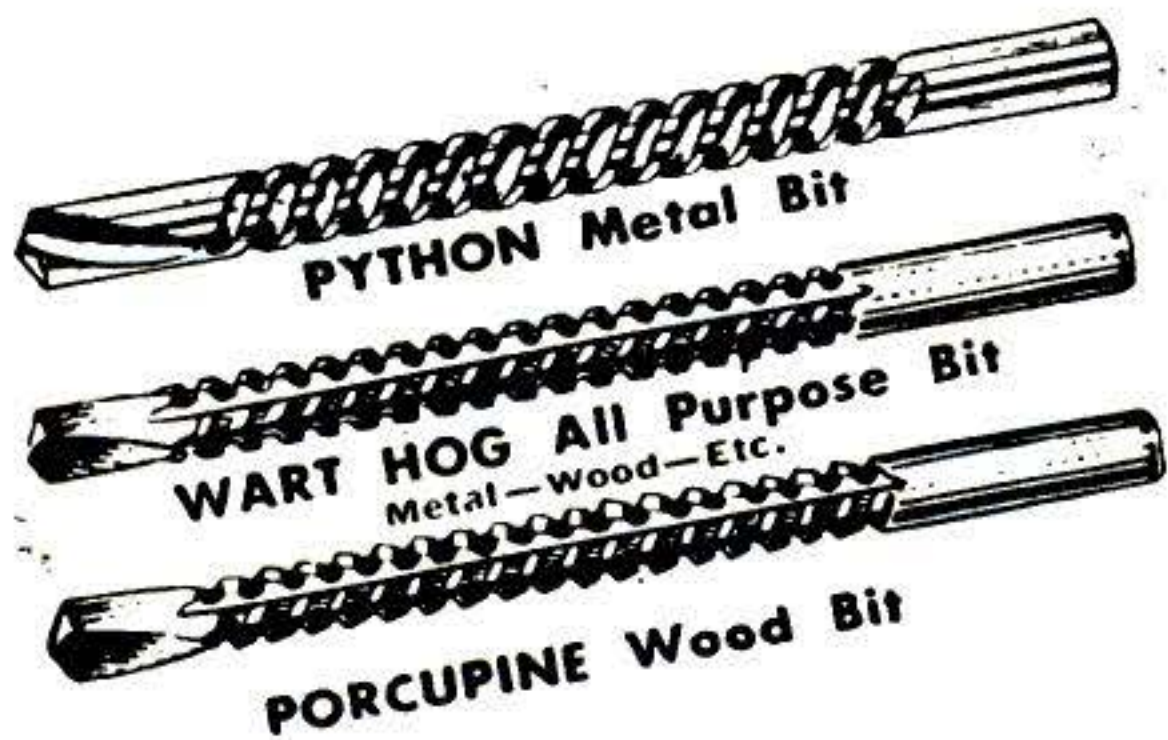

Each Bit Performs its own Function Specify Which

SAWS, CUTS, REAMS Sheet metal, angle iron, pipe, wood, plastic, Transite, etc. Amazing high-speed combination bit and saw fits any 1/4" or 1/2" electric drill or slow drill press. Drills own starting hole to quickly cut, saw or ream opening. Easy to operate. Ideal for carpenters, auto mechanics, electricians, plumbers, hobby workers, many others. Abrasive resistant high speed steel. No breaking Will withstand severe continuous use. Resharpener at no charge 1/4" diameter, over-all length 3 1/2", cutting section 2" long with flutes ground from solid. Shipped same day—money back guarantee Discounts on quantity orders from dealers. Takes place of up to \$50 in tools. SEND CASH, CHECK OR M.O.

Each \$3.95 Post-paid 3 for only \$11.50 Post-paid

Manufactured and distributed by

INTERNATIONAL TWIST DRILL CORP.

624 Wyandotte Rm. 253 Kansas City 6, Mo.

"Pioneers in break resistant short drills"

MAKE EXTRA MONEY

# PLASTICS

LEARN AT HOME

LEARN HOW TO MAKE fast selling PLASTIC NOVELTIES FURNITURE JEWELRY SIGNS TOYS LAMPS



There are RICH OPPORTUNITIES for MEN and WOMEN with "know-how" in Plastics. Interstate's amazing new Plastics course tells and shows how to make hundreds of fast selling items out of Plastics. Gives complete training in fabrication, casting, lamination, molding, etc., in simple, easy, step-by-step language and pictures.

START A PLASTICS BUSINESS OF YOUR OWN. No other industry holds such promise for the future. You can make big money manufacturing novelties, toys, signs, etc., in your own home in spare or full time. Don't wait! Learn NOW how Interstate's Plastics Training qualifies you for success in the plastics field.

Write for FREE Information Today!

INTERSTATE TRAINING SERVICE

School of Plastics  
 PORTLAND 13, OREGON

(Dept. 2B)



## MAKE YOUR OWN SCABBARD

Live Oak Texas Steerhide 60c to \$1.10 per sq. ft. Learn the easy and simple way to make all kinds of leather goods. We sell for less. Since 1919. Write for Free Catalog

TANDY LEATHER CO

P. O. BOX 791-T, FORT WORTH, TEXAS

## THROWING DAGGER \$2 postpaid

This MALAYAN FIGHTING KNIFE is used for self-defense, killing game, target skill. Powerful, silent, accurate weapon. Splits 1" board at 30 ft.

Balanced to stick!

Fun, Thrills, Excitement!

Indoors - outdoors. Learn this Sport! Easy to throw accurately with our clear instructions. Beautiful, heavy-duty 10" knife. Tempered steel. Tough, rawhide-bound handle. Rare souvenir, unusual bargain. Limited quantity. Sold direct only. Send \$2 to Wholesale Import Co., Dept. 4, 604 S. Marengo, Alhambra, Calif.



Say You Saw It In Popular Science



PLOW



CULTIVATE

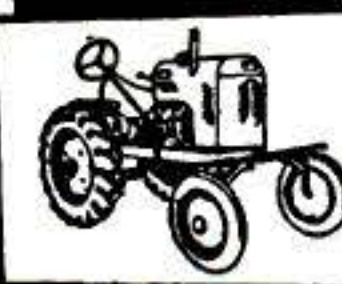

SHAW MFG. CO.

SAVE TIME, WORK, MONEY!

# SHAW DU-ALL

and "PEPPY PAL" TRACTORS

These rugged walking or riding tractors are ideal for farm, truck garden, orchard, poultry farm. Operate on a few cents an hour. A child can handle them.

DO DOZENS OF JOBS Both riding and walking tractors quickly and easily plow, cultivate, harrow, disk, bulldoze, spray, haul, grind, saw wood, etc. LOW FACTORY PRICES Buy direct or through your dealer. Year's guarantee!

RIDING TRACTORS 4 models from 5 to 12 1/2 H.P., 58 in. wheelbase, 36 to 52 in. wide, 24 in. plant clearance. Hand or electric starter. Walking Tractors 1 1/2 to 5 H.P.

FREE Illustrated folders giving complete details and price lists—write today!

5702 FRONT ST., GALESBURG, KANS.  
 668 PSNORTH 4TH ST., COLUMBUS, O.

# PARTS FOR MILITARY TRUCKS

At A Savings. New FREE Catalog  
For Jeep, Dodge, Chevrolet, G.M.C., Studebaker  
4 x 4—6 x 6. Drive

Brand New—Not War Surplus—Complete  
**JEEP TOPS and SIDE CURTAINS**

Fits all Military Jeeps. Also adaptable to some Civilian Jeeps. Waterproof O.D. **\$59.50**

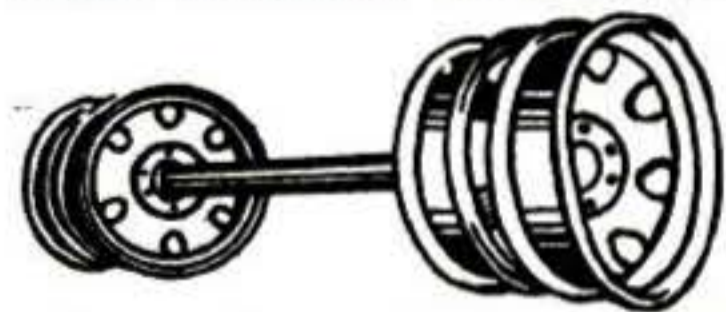

## TRAILER AXLES

Heavy duty trailer axle suitable for many types of trailer construction. Also excellent for building of heavy farm trailers and wagons. It is a 12,000 lb. capacity square type straight trailer

axle complete with Timken roller bearings, hubs and 6 hole 750 x 20 Budd Wheels. Without brakes. Axle is 2 inches square and 69 inches between wheel mounting flanges. Std. width.

With Single Wheels **\$59.50** With Dual Wheels **\$69.50**

Hundreds of Other Truck & Jeep Parts and Supplies

All prices quoted good 30 days FOB, Kansas City  
25% deposit required on all orders.



**UNITED AUTO PARTS CO. INC**  
1901 TROOST-GR.1800-KANSAS CITY, MO.

# FREE JEWELRY CATALOG

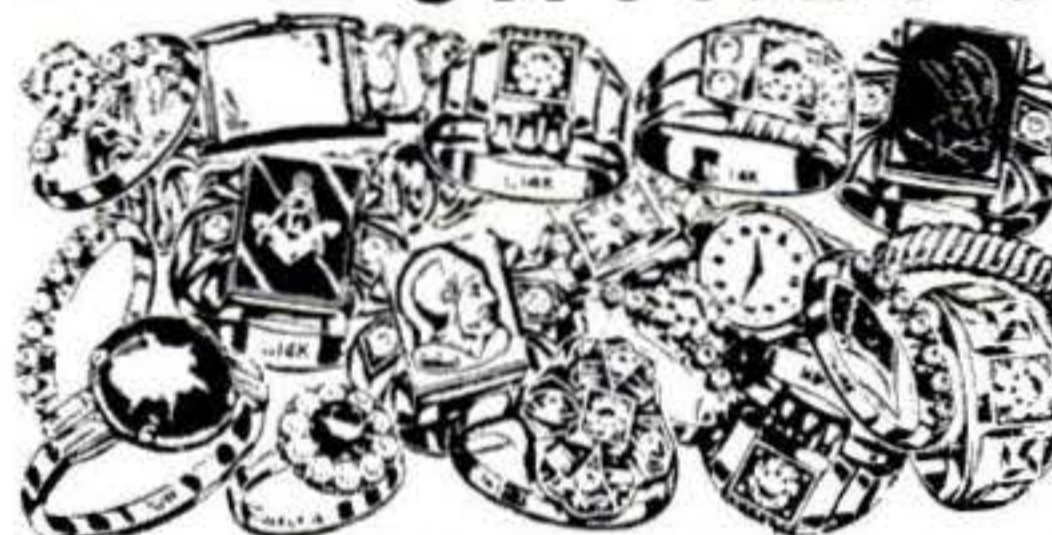

**BUY DIRECT AND SAVE**

Quality merchandise from an old reliable firm. Satisfaction guaranteed.

**GRAND JEWELRY Co., Dept. P, Des Moines 11, Iowa**

## BRAND NEW NAVY PHONES

Voice powered, no batteries or electricity needed. Mfd. by RCA. 1 mile range. Govt. cost \$99 pair. Simple hook-up, splice 2 wires and talk. Complete, no extras to buy. Each phone has headset, adjustable transmitter, chest plate, switch (on mike)—PLUS 24 ft. rubber covered cable. All new. For farms, mills, mines, warehouses, contractors & home use. Extra cable available. Money-back guarantee. Send cash, check, M.O. C.O.D.'s pay postage.

**\$13.95** ppd. for 2 complete phones



**GRAND-HAWTHORNE SURPLUS**

1439 S.E. Grand Dept. PS-21 Portland, Oregon

## BUY U.S. SAVINGS BONDS

# \* Shoot Your Own Natural-Color 16mm TALKING PICTURES \*

with the New "Cine-Voice" 16mm Sound-On-Film Camera

**\$695<sup>00</sup>**



Please write for free illustrated folder. No obligation.

**BERNDT-BACH, Inc.** 7335 Beverly Blvd., Los Angeles 36, Calif.

16mm SOUND-ON-FILM SINCE 1931

# WHICH DO YOU WANT?

Better Digestion  
Restful Sleep

Normal Elimination  
Strong Healthy Teeth

Continued Good Eyesight

**STOP WASTING VITAMINS, MINERALS IN FOOD**

# VITA-MIX

**Makes It Easier to Get Essential Vitamins, Minerals From Fruits and Vegetables**

**VITAMINS and MINERALS ARE ESSENTIAL TO GOOD HEALTH**

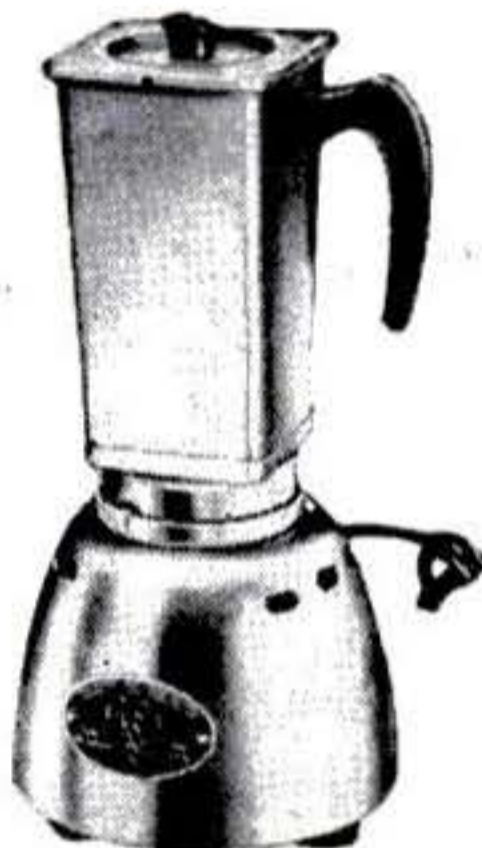

The Only Machine With Stainless Steel Bowl and Bakelite Handle

In preparing food the ordinary way, you usually peel off and throw away those vitamin and mineral filled parts which are so essential to good health. With the Vita-Mix you keep the natural health-giving food value. That's why you may drink your way to health with the Vita-Mix. Liquefies, whips, chops, emulsifies all fruits and vegetables into tangy, appetizing drinks. No cooking, juicing or peeling of rinds necessary. Easy to sterilize.

**SELF CLEANING—ADD SOAP, WATER, TURN ON**

## Look What VITA-MIX Does

Makes health drinks in 1 to 4 minutes, makes soup without boiling in 3 minutes, chops whole grain into flour in 1 to 4 minutes, chops vegetable salad in 5 seconds. Many other uses. Fully guaranteed for one year. No dealers, low direct-to-you price.

**\$34.95**

**Two Valuable Gifts Given With Order**

**VITA MIRACLE Recipe Book**



533 recipes for relishes, desserts, spreads, icings, sherbets, fruit drinks, soups, salads, bisques, others. Recipes will produce compliments for cook.

**WHEEL-O-LIFE**



Know part food plays in building eyes, teeth, nerves, digestion. Analyze most common foods for vitamin, mineral, calory content with Wheel-O-Life. Prepare meals scientifically.

Order Now While Stainless Steel is Still Available

**MAIL THIS COUPON RIGHT NOW**

**NATURAL FOODS INSTITUTE**  
Dept. PS-2, Olmsted Falls, Ohio

Enclosed is \$34.95. Rush me, postpaid, one Vita-Mix plus gift Wheel-O-Life and Vita Miracle Recipe Book.

Name .....

Address .....

City.....Zone...State.....



## MONEY IN HAMSTERS

The new wonder animals from Syria. Often called Toy Bears. Delightful pets. Everyone wants them. Laboratories use thousands. Clean, odorless. Raise anywhere. NOW, spotted and golden breeds. We furnish breeders, equipment and manual of instructions. Write today for free illustrated literature.

**GULF HAMSTERY, 1540 Basil St., Mobile 17, Ala.**

# Now! YOU CAN MAKE MONEY...

## TURNING WORTHLESS OBJECTS INTO GOLDEN TREASURES—

### ... BY METALIZING!

HERE ARE JUST A FEW OF THE HUNDREDS OF ARTICLES THAT CAN BE RESTORED BY REPLATING—INCREASED IN VALUE—OR “ETERNALIZED” AS KEEPSAKES WITH A COATING OF EVERLASTING BRONZE, STERLING SILVER, OR 14 KARAT GOLD.

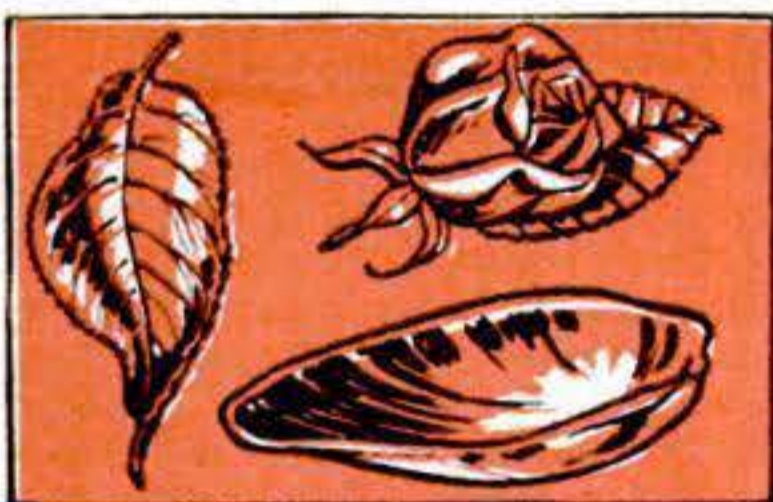

Costume Jewelry from flowers, insects, shells, and leaves.



Ash trays, paper weights, from leaves, fruit, vegetables.



Metalize busts, figure, from plaster cast or wood carvings.



Metal plate object of glass, cloth, leather, plastic or rubber.



Eternalize Baby Shoes, Toys, and other sentimental mementoes.



Metalize baskets, plates, ceramics and other non-metallic objects.



Preserve sports and war trophies in solid Bronze, Silver or Gold.

**YES—ANY MAN OR WOMAN CAN DO WORK LIKE THIS IN ONE CORNER OF THE KITCHEN OR IN ANY SPARE ROOM!**

## Make \$5<sup>00</sup> An Hour For Your Spare Time!

### Amazing book tells you how

**HOW** to do the work—how to get customers coming to you—how to set up the simple equipment—how and where to buy the materials—what to charge—how to start in spare time—how to expand into a full time business whenever you wish. Shows you in pictures and words how to put a coating of pure metal on such things as flowers, leaves, insects, shells, wood carvings, plaster castings, busts, statues, religious figures, buttons, baskets, feathers, base balls, golf balls, mementoes of all kinds, such as, baby shoes, party and wedding favors and decorations. Operating a home metalizing business is one of the greatest insurance policies a man could ask for his future. Read about it without risking a penny.

### OWN YOUR OWN HOME-OPERATED BUSINESS

Think of turning 56 cents worth of materials into a profit of \$5.00 and over for just a few minutes of easily learned handiwork. Sounds fantastic? . . . Yet it is absolutely true . . . **AS YOU CAN QUICKLY PROVE TO YOURSELF.**

#### AN EXCITING NEW OPPORTUNITY

Just at a time when hundreds of men and women would like to make an extra \$35.00 to \$50.00 a week in spare time home work, the old—established—and highly profitable Metalizing Business has been turned into a home-work money-maker. Where in the past a few big companies have been making fortunes, now hundreds of smaller home operators can become independent. I have ready to send you a complete set of simple instructions by which anyone—regardless of age or education—can learn the fascinating art of metalizing.

ing. By this process you can replate worn objects in silver, copper, or real gold—you can change silver to gold by overplating—you can even deposit a heavy coating of solid metal on non-metallic objects such as baby shoes, golf balls, toys and other precious keepsakes—or you can take inexpensive articles and make them worth 10 to 20 times their cost by jewel plating with precious metals.

#### ALL THIS INFORMATION IS FREE

The information is free. A stamp brings you the details of the exact plan by which hundreds are NOW MAKING EXTRA MONEY EVERY WEEK. Study it over. Analyze the possibilities. Then if you don't think it's made to order for you—your only loss is your 3c stamp. You can read every fact, every secret, every step of the instructions—all at my risk.

**NO "CATCH" TO THIS OFFER DON'T SEND ME A PENNY ... Just Your Name!**



Learn about this wonderful "Ace in the hole". See how you can start without risking job or pay check—how you can turn spare hours into \$5.00 bills—how you can actually have fun making money in a business that all the family can help with. No charge now or at any time for the

R. E. Brandell, Warner Electric Co., 1512 Jarvis, Dept. 22, Chicago 26, Ill.

complete facts about this permanent lifetime business that has now opened its door to home operation. Scores of men and women have already started . . . Plenty of opportunity for hundreds more. **BUT DON'T PUT IT OFF.** Send your name and address **TODAY . . .** It may open new horizons in your life.

**R. E. Brandell, Warner Electric Co.**  
1512 Jarvis, Dept. 22, Chicago 26, Ill.

Rush complete facts showing how the old and profitable Metalizing Business has now been converted into a homework money-maker for full or spare time. No charge or obligation for the information you send.

Name .....

Address .....

City.....Zone.....State.....



Classified Ads only 80c per word per insertion, payable in advance. Minimum ad 10 words. To be included in April issue, copy should be in our office by February 22nd.

# CLASSIFIED OPPORTUNITIES

POPULAR SCIENCE MONTHLY-351 FOURTH AVE.-NEW YORK CITY 10

## 1 AUTOMOBILES

**BIGGEST "Racing & Hot Rod Catalog"** in world—just out! Lowest Prices—Hollywood Mufflers \$4.50, Duals \$15.90. Chrome Megaphones \$1.55, Dual Manifolds \$9.95, Racing Cams \$29, Heads \$23.50, Water Injectors \$12.95, Superchargers, Bargains! (Free "Power Calculator" included.) 25c coin or stamps. Almquist Engineering, Milford 23Z, Pennsylvania. (Dealers Wanted).

**SILENCE** Overhead-valves. Attachments unnecessary. \$2.00. Derderian, Box 542, Sandston, Virginia.

**AUTOMOBILE History Scrapbook #1** just published! Over 250 ads and illustrations of antique and vintage automobiles dating back to 1901. Money-back guarantee. \$1.50. Wiglesworth-Chasteen, 7134-PS2 Alhambra, Mission, Kansas.

**WORLD'S 1st** economical gas turbine Jet engine for automotive use. Wow, for Hot Rods. Custom Built. Dealers Wanted. Literature 25c. Plans \$10.00. Jet Engine Co., St. Augustine, Fla.

**CALIFORNIA** custom accessory headquarters. Buy direct from original designers and save. Chrome dash panels, push button door-trunk conversions, chrome motor accessories, lowering kits, speed-dress-up equipment. 1951 Catalog. 40 pages, hundreds of photos—25c. Eastern Auto, 3319D South Grand, Los Angeles 7, California.

**FREE Books** . . . Don't miss the world's greatest automotive book offer by Newhouse. See page 38.

**"WATER Injection."** Also—Economy—Power—Methods. Free illustrated information. Neher Industries, La Verne 6, Calif.

**PHOTOGRAPHS**, World's Finest Automobiles. List, Sample 25c. Box 1028, Minneapolis, Minnesota.

**MODERN Motor Car Magazine—Facts, Figures, Photographs and Features** on all cars. Sample Copy 25c; \$3.00 yearly. Crestline Publications, Box 581-B, Holliston, Mass.

**MEXICAN Road Race Book Just Out!** Complete history 2135 mile race across Mexico. 132 stock cars. Articles by famous authorities, drivers, personalities. Rules, leg by leg description. Travelogue over Mexico's famous new Highway. 152 pages. 300 photographs. Postpaid, \$2.00. Deluxe Edition \$3.50—B. Clymer, 1268 S. Alvarado, Los Angeles 6, Calif.

**NON-PROFIT** organization for automobile collectors, mechanics and hobbyists now distributes old car literature, new car information, engineering papers, shop manuals, data books, free magazines. Fraternize with world's foremost automobile nuts. Write today; get on free mailing list. Auto Mainiacs, Stockbridge, Mich.

**THOUSANDS** of Speed Equipment items now ready for all makes of cars. See big Catalogue Offer on page 38.

**SPARK Intensifier** gives more power, quicker starting, better mileage all cars, trucks, tractors. Only \$2.00. See ad page 37.

**AMAZING Discovery** reduces battery heat and sulphation, increases the life of all Automobile and Truck Storage batteries. Full treatment only \$2.00 postpaid, last the life of the battery. Give battery size. Standard Motor Supply Co., Billings, Montana.

**FORD owners!** Safe-T-Scope driving light turns with steering. Fits 1949, 1950 grill. \$29.50 value. \$12.95 postpaid. Darbee, 35-A Pare, Clawson, Michigan.

**MOTORISTS—Stop Wasting Gas!** New automatic vaporizer injects water vapors into combustion chambers. Fits all cars. List make, year and no. cylinders. Only \$5.95 postpaid—Send cash or money order. Literature Sent Free. Vaporizer Company, Box 7033, Station G, Los Angeles, Calif.

**NEWHOUSE** now offers the world's greatest Automotive Book deal. See page 38 for details.

**"SPEED & Mileage"**—World's #1 Power Manual! Championship methods, all cars . . . shows Speed Tuning, "Souping", Racing Tricks, "Customizing", 100 gas saving secrets! "Double your power, gas mileage, acceleration!" Covers Racers, Stock Cars, California Roadsters, Sports Car Construction—Engine Rebuilding, Frames, Bodies, Fuels, Formulas, Ratios. "Speed Shop Methods"! How to build Superchargers, Dual Manifolds, High Compression, Racing Cams, Dual Mufflers, Water Injectors, Economizers! Photo-section on "California Custom Cars", Body Restyling, Streamlining, Sports Conversions! Working Plans! Catalogs! 320 Illustrations! Includes (Free) California Hot Rod Handbook and "Custom Builders Kit"! Books plus Kit \$1.98 (postpaid or C.O.D.) Almquist Engineering, Milford 21Z, Pennsylvania. (See page 60.)

**DON'T** spend big money overhauling your car! Use Holt's "Piston Seal" instead! Exactly what's your trouble? Burning oil? Lacking power? Piston slap? Worn cylinders? "Piston Seal" effectively eliminates these ailments! By forming self-expanding pliable lubricating seal around pistons, this amazing British product compensates for wear! Restores compression! Cuts oil loss! Checks piston slap! Lasts 10,000 miles! Cannot harm engine; easily installed. British call it "Godsend!" You will, too. Details free; write today! Treglown Company, 200 West 7th, Plainfield 37, New Jersey.

## 2 AUTO SUPPLIES & EQUIPMENT

**STOP Thieves**. Secret. Simple. Rayda starts automobile for owner only. Equipment, instructions, Dollar. George Patorno, Box 1351, N.Y.C. 8.

**FOR** free descriptive literature on alcohol-water injection for cars—trucks—tractors write Shade, Webster, New York.

**NEW** and used guaranteed parts for civilian and Army cars and trucks. Largest stock in America. Mail orders. Pioneer Auto Wrecking Company, 788 W. 13th Avenue, Denver, Colorado.

**FROM** Speedway to Roadway! Track-proved hi-speed heads, manifolds now available for any passenger car! No special tools needed! Increase horsepower 25%! Astounding getaway! Free illustrated catalog. Speedsport, 6215-F Diversey, Chicago 39.

**BRUSH** Plating Outfits connect to a battery. No tanks or shop required. Free particulars. Gunmetal Co., Avenue K, Decatur, Illinois.

**CHEVROLET** Parts. Scarce motor, body, sheet metal parts. Grossman Chevrolet, Minneapolis, Minnesota.

**CONVERTIBLE** Top covers. Plastic fabric. Tailored. \$24.00. Vassar, Cleveland 5, Ohio.

**NEW "Economy—Power"**—Methods. Free information. Neher Industries, La Verne 6, California.

**NEWHOUSE**—One of the world's largest speed equipment distributors, now makes amazing offer. See page 38.

**TAKE** advantage of the complete new range in driving with the Overdrive Selector. Automatic Hillholder, full engine compression, optional free wheeling. Six selective forward speeds. Eliminates use of clutch. Now available for Ford, Mercury, Lincoln, Nash, Kaiser, Fraser, Hudson, Studebaker, Jeepster. Easily installed. When ordering specify year and make. Sent postpaid with check or Money Order for \$9.95. Send 25c for over 70 page illustrated catalog of Auto Accessories and Speed Equipment—Auto Accessories Co., 127W Washington, Los Angeles 15, Calif.

**MOTORIST** save gasoline by Vacuumating overrich mixtures. Fits all cars. For Free particulars write Vacuumatic, Dept. 1712, Wauwatosa, Wis.

**WELD Sticks!** Cracked battery repair! Sample for letterhead! Northlakco, Peoria 4, Illinois.

**AUTOMOBILE Side-Window Wiper** \$1.00 Postpaid. Park Sales, P. O. Box 73, Forest Park, Illinois.

**OPERATE Your Car On Propane—\$1.00.** Save up to 1/2 on motor fuel costs. Our manual "Operate Your Car On Propane" completely explains carburetion, shows how simple and easy it is to install on any car, truck, or tractor. Manual includes catalog of equipment and special prices. Manual price refunded on equipment order. LPG Products Co., 822 W. 22 St., Kearney, Nebraska.

**DOUBLESEAL** Insulates Under Sectional Overhead Doors. Edwards Industries, Dept. 353, 4268 Shenandoah, St. Louis 10, Mo.

## 3 AUTO TRAILERS

**BUILD** your own trailer! Plans for all kinds. Illustrated catalog 10c. Jim Dandy, 125-S, Wausau, Wisconsin.

## 4 MOTORCYCLES BICYCLES, SUPPLIES

**PARTS** Harley Indian Standard and Racing List 10c. State Model Cycle Co., 813 Ohio, Wichita Falls, Texas.

**RECONDITIONED** motorcycles and motors. Chromium accessories. Complete stock Indian parts. Expert rebuilding. Fast service. Indian Motorcycle Sales, Kansas City 1, Mo.

**MIDGET** racer, less motor \$10; 1946 Whizzer \$15; 1938 Cushman \$35; James motorcycle \$45; Indian \$30; Smith motor-wheel \$8; Motorbike conversions \$5; 2 h.p. engine \$5. Four balloon tires \$3 (Mailorder only). Send 25c for catalogue Number Thirty-Nine just out listing these and hundreds of other bargains, in new and used machines, parts, plans, War Surplus, etc. (35c by First Class Mail). Midget Motors Directory, Athens, Ohio.

**WHIZZER** in Schwinn bike \$20; good motorscooter (twist grips) \$22.50; midget racer \$40; Shaw bicycle motor \$15. Send 25c (35c first class mail) for catalog #17 jammed with other sensational bargains in wheels, motors, clutches, motorscooters, midget cars, motorettes, motorbikes, etc. Gail, 538 Erie, Toledo, Ohio.

**WHIZZER** (all attachments) \$25; Cushman motorscooter, extra tires, \$20; Indian motorcycle \$30 complete; Midget car \$35. Rush 25c (35c first class mail) for catalog #947 listing these and scores of other amazing bargains in motors, midget cars, motorscooters, motorbikes, motorcycles, etc. Associated, Box 1764-CS, Toledo, Ohio.

**REBUILT** Gasoline Engines \$9.00 to \$30.00. Cauffiel Motor Industries, Temperance, Michigan.

**MOTORCYCLE Magazine**—Worldwide Coverage. Yearly Subscription \$2.00. Sample 20c. Motorcycle News, 5424-B Sawyer, Chicago 25.

## 5 AVIATION

**PROPELLERS**, plans, supplies, for ice sleds, snow sleighs, air boats, Catalog 20c. Banks-Maxwell, Box 3301G, Ft. Worth, Texas.

## 7 ELECTRICAL SUPPLIES & EQUIPMENT

**NEW** Electrical Tester—Makes Testing Easy. \$20.00 Tester for \$6.95. Free Information. Spicers Products (D-5), 1834 Milburn, Indianapolis 2, Indiana.

**2% TO 20% Discount** on Radios, Cameras, Electric Appliance-Toaster Catalog \$1.00 (Refundable). Points Mail Order House, Box 331, Middletown, Penna.

**FREE** New Catalog. Bargains in Welders, Motors, Generators, Surplus Equipment. Or, Build Your Own Kits—Save. LeJay Company, Minneapolis, Minnesota.

**LAMP** Parts—Sockets, wire, harps, cords, bases, pipes—all parts to build and repair. 64 page catalog with charts and instructions 25c. Gyro Lamps, 5402B Clark, Chicago 40.

# POPULAR SCIENCE OPPORTUNITIES

WE make low cost forced circulation electric industrial ovens, 1001 uses; 10 cubic feet, 110 volts. Fully guaranteed. Write Dept. PS, Grieve-Hendry Co., 1101 Paulina, Chicago.

**LAMPS**—Build own Originals. Parts Wholesale, any amounts, Catalogue 10c. Brown Lamp Co., No. 501, Wellston, St. Louis 12, Mo.

**REFRIGERATION** Parts New and Used, we sell to anyone. Write us your needs. Refrigeration Salvage Co., 1220 South Division Ave., Grand Rapids, Mich.

## 8 WELDING, SOLDERING, PLATING

200 AMP welding generators. Brand new. \$25.00. Free literature. Thorndyke Mfg. Co., Pipestone, Minn.

**RADIATOR** Repairing. Books, Supplies, Equipment, Gasoline Torch. Write for circular. Curfman Mfg. Co., Marvill, Mo.

"BUILD Your Own" portable arc welder. Hobart Generator plus your auto engine. Saves hundreds, gets big paying jobs. Catalog Free. Hobart Welders, Box P-212, Troy, Ohio.

**GOVERNORS** for any gasoline driven engines. Candee-Smith, Box 612, Riverside, California.

## 10 MACHINERY, TOOLS, SUPPLIES

10" TILTING Table Bandsaw. Special!! Latest design—Smartest features. Introductory price only \$34.00!! Investigate! Free literature—Write today! American Hardware, 323 Russell North, Minneapolis 5, Minnesota.

**POWER** Tools. Build your own with Lewis Casting. Save up to 80%. Complete castings, material and blueprints supplied for 23 woodworking and metalworking tools. 32 page Catalog 10c. Write today. Lewis Machine Tool Co., 3217 Union Pacific Avenue, Dept. S, Los Angeles, Calif.

**INDEX** Heads for the lathe, drill-press, milling machine, etc. Very reasonable. Write for free folder. Long's Index Heads, Box 534, Torrington, Wyo.

**MACHINES** for your shop. 14" lathe \$150—Universal milling machine \$540—Drill press \$180—Shaper \$280—23" x 10' lathe \$640—24" x 28' \$1640. Good condition. money back guarantee. Conversion Parts Company, 277 Adams Street, Boston 22, Massachusetts.

**WATERLESS** hand cleaner satisfaction guaranteed or money refunded. 13 oz. can \$1.00 postpaid. A. J. Doxsee, Pt. Lookout, New York.

## 13 BATTERIES, GENERATORS, ETC.

**EDISON** Nickel Batteries. Foolproof. Odorless. Low Prices. Sizes 37 to 600 Ampere Hour. Interesting Literature. Hawley Smith Co., Croton Falls 2, New York.

## 14 BOATS, OUTBOARD MOTORS, ETC.

**FASTEST** Boats In The World—Build Now. Complete plans available for sleek Three Point Racing Hydroplanes, Runabout and others. Send 25c now for new illustrated catalogue. Champion Boats, Box 7006, Dept. 23-B, Long Beach, Calif.

**STEERING** Wheels, windshield brackets, from \$6.95. Modern fittings "Water Skis," at lowest prices. Complete pre-cut plywood boats. Bargains galore. Folder 10c. Marine, Box 681, Mendota, Minnesota.

**FULL** size, cut to shape boat patterns, blueprints, 7½-38 feet. Illustrated "Build a Boat" catalog, 25c (coin). "How to Build Boats" book, \$1.00. PolyWog Houseboat Plans \$10. Marine Catalog \$1.00. Cleveland Boat Blueprint Co., Dept. A-77, Cleveland 13, Ohio.

**SAVE** 2/3 cost. Assemble your own boat. We furnish parts. No experience necessary. Rowboats, Cruisers. Illustrated Catalog 25c. Midwest Boat Company, Menomonee Falls 1, Wisconsin.

**NEW**, used, rebuilt marine motors. Marine conversions, fittings. Free Catalog. Stokes Marine Supply, Dept. 23, Coldwater, Mich.

**EXPRESS** Cruiser or Open Utility, 20' Prefabricated, Mahogany, oak, bronze. 15 to 40 mph. Easy terms! Complete illustrated information 25c, refundable. Bay City Boats, Inc., Bay City 102, Michigan.

**MARINE** conversions for Ford and Jeep engines. Catalog 10c. Lehman Manufacturing Company, Department A, Newark 2, N. J.

**TWIN** Tank Boat Plans \$1.00. P-38 Tanks \$9.95. Free Picture. Twin Tank, Box 89 Merced, Calif.

**BOAT** Kits, marine hardware, fittings, accessories, etc. Catalog 10c. Minnesota Marine, 3207 Fremont South, Minneapolis 8, Minnesota.

## 15 ENGINES, MOTORS, ETC.

**WINDING** Data, listing 225 motors, single and three phase, \$1.00. Motor Data, Box 7631, Kansas City 3, Mo.

**HOTTEST** surplus list in the country. Electronics, Hydraulics, Aircraft, Gadgets. Dick Rose, Everett, Washington.

**REBUILT** Gasoline Engines \$9.00 to \$30.00. Cauffiel Motor Industries, Temperance, Michigan.

**MOTOR** Winders, free bulletins. Winding and testing equipment. Motor Industries, Quincy, Illinois.

**MOTORS** ½ horse \$15, ¾ \$22, 1 \$35. Compressors \$17.50. Other bargains. State your needs. Butler, 1885 Milwaukee, Chicago 47.

## 16 AMERICAN POLICE JIU JITSU

**DEADLY** Judo—Fiercest fighting technique. Trick knockouts. (Over 200 illustrated pictures.) Expert instructions—Three volumes Complete \$2.25. Variety House, Box 46-A Wall Station, New York 5.

## 18 BODY-BUILDING COURSES

**TALLER**. Be one to three inches taller. A new scientific method for permanent height increase has now been developed. Free Information, Natural Methods, Box 453-S Briggs, Los Angeles.

**BARBELLS**. Dumbbells. Exercise equipment. Courses. Free booklet. Good Barbell Co., Reading, Penna.

## 19 SPORTING GOODS, GUNS, FISHING TACKLE, ARCHERY

**SEND** 10c for list, either rifles, shotguns, handguns, ammunition or send 25c for all lists. Frayseth's, Willmar, Minn.

**NEW** Book—Antique Gun Prices. Lists 2000 American Revolvers \$1. Pioneer Press, Harriman, Tenn.

**HANDICAST** for spincasting handlines. \$2.25. Free details. Handicast, 5254, Cleveland 1, Ohio.

**190** PROFUSELY illustrated pages antique and modern pistols, swords, daggers, armor, etc. 50c. Robert Abels, PS860 Lexington Ave., New York 21.

**ANTIQU**e, modern guns. Bargain list 10c. Martin Rywell, Harriman, Tenn.

**5,000** BARGAINS, firearms, binoculars, war relics, catalog 40c. Smith Museum, Runnemede, N. J.

**NEW!** Free Catalog. Complete, easy-to-build Glass Rod Kits, other fine fishing tackle values. Valuable free offer. Write today. Trimline Tackle Co., Dept. S, 508 Tinton Avenue, New York City 55.

**CAST** Iron Molds—for making your own sinkers. Write for free illustrated booklet. Reading Instrument Co., Box 78, Reading, Pennsylvania.

**OVER** 500 guns, modern, obsolete. List 10c coin. Ed Howe, 26 Main, Coopers Mills, Maine.

**ANTIQU**e handguns popularly priced. Beginners or general collectors list 10c. Hi-Fulton Gun Corner, 413 South High, Columbus 15, Ohio.

**MOLDS** "For fishermen, sinker, squids, jigs, and lures" handled and hinged, quality fishing tackle, free catalogue, Sweets Molds, Tonawanda, New York, Box 163.

**SEND** 10c for list, either rifles, shotguns, handguns or send 25c for all lists. Frayseth's, Willmar, Minnesota.

**LEARN** Gunsmithing! Details, copy Guns and Gunsmithing, plus 50 page Gun Catalog, 25c. We buy, sell, trade. Gunsmith, Palatine, Illinois.

## 20 FIELD GLASSES, TELESCOPES, ETC.

**TELESCOPES**, Binoculars, Microscopes—big bargain catalog free. Brownscope Company, 24 West 45th Street, New York.

"FREE" Catalogue! Thousand war surplus optical bargains. Lenses, Prisms, Telescopes, Binoculars, etc. Send \$1.00 for 10 Lens Hobbyist Set and Project booklet. G. Jaegers, 93-08—95th Avenue, Ozone Park 16, N. Y.

**WAR** Surplus Bargains. Binoculars, Telescopes, Sextants, Millions of Lenses, Prisms, Reticles, Eyepieces, Objectives, etc. Mail 10c for Big "Catalog CN." Send \$1.00 for Stock CN—10-piece Lens Kit and big instruction Booklet. Edmund Salvage Co., Barrington, N. J.

**BINOCULARS** repaired, all makes. Authorized dealer. Hensoldt and Zeiss binoculars, scopes, Tele-Optics, 5514 Lawrence, Chicago 30, Illinois.

**SAVE** 50% On New Binoculars! Free Catalog. Free book, "How to Select Binoculars." Write today! Bushnell's, 43-P22 Green, Pasadena 1, California.

**REFLECTOR** Telescope Kits, Refractors. Free Illustrated Bulletin, Rake Instrument Laboratory, 612 Adams, Hoboken, N. J.

**REFLECTING** Telescopes, completely assembled, 60X, \$25.00. Guaranteed Observatory clearness. Free information. Skyscope, 475 Fifth Avenue, New York 17.

**GIANT**, 100 power astronomical telescope with 6 ft. tripod (10,000 area magnification) Clear Vision, full power guaranteed, \$15.00 F. O. B. factory. Suffolk Science Service, Dept. TC, Riverhead, N. Y.

**POWERFUL** astronomical telescopes easily made. Perfect lenses and instructions; 100x \$3.00; 100x and 200x \$4.00; 100x, 200x and 400x \$6.00. Full power, clear vision guaranteed. Instructions alone 10c. Suffolk Science Service, Riverhead, N. Y.

**ASTRONOMICAL** Telescopes, binoculars, microscopes; bought, sold, repaired. Books, lists 10c. Rasmussen-Reece, Amsterdam, N. Y.

## 22 BABY CHICKS

**BABY** Chicks, Champion Mated, 52 varieties, 7 crosses, licensed inspected, blood-tested. Rush postal, large colored book Free, low prices. Berry's Farm, Route 11, Clarinda, Iowa.

## 24 DOGS, BIRDS, PETS, RABBITS

**NATURALIST'S** Catalog 10c. Reptile Bulletin 5c. Chameleon 45c. Turtle 45c. Mealworms 50c hundred. Quivira Specialties, Topeka 10, Kansas.

**SEE** Gulf Hamstery ad on Page 69. Shows picture of Hamster.

**HAMSTERS**—Send \$3.00 for Pair Virgin breeders and illustrated instructions. Pair and cage \$5.00. Free Prices, Dixie Hamstery, 502-D Trinity Lane, Nashville 7, Tenn.

**MAKE** Big Money! Raise Chinchilla Rabbits. Cash markets supplied for your production. Write today! Rockhill Ranch, Sellersville 16, Penna.

**EARN** up to \$400 monthly—Raise Angora Rabbits! Experience unnecessary. Wool brings \$5 Pound. Plenty markets. Folder Free, White's Rabbitry, Newark 35, Ohio.

**BRED** Mink Booklet Pen Plans 20c. Wettlaufer Mink Ranch, Gravel Road, Webster, New York.

**RAISE** Mink: Free booklet, pen plans, inside "secrets", feed, care. Mink are money makers. Investigate today. Lawrence Molgard, Brigham City 13, Utah.

**RAISE** Guinea Pigs. Market guaranteed. Booklet free. Taylors, B426B, Hapeville, Georgia.

**HAMSTER** and Animal Cages. Write for Illustrated Literature. Fuller's, 16745 Sierra Hiway, Saugus, Calif.

**BEAUTIFUL** Golden Great Danes—Loving Companion, Guard, 36 W, 1st. N. St., Salt Lake City, Utah.

## 25 FROG RAISING

"RAISE FROGS!" New book tells how! Illustrated Literature Free. Marlboro-B, Box 7002, New Orleans 19, Louisiana.

## 30 FARMS, OTHER REAL ESTATE

**OZARK** Lands for all purposes. Actual river frontages, 5 acres \$90.00 and upwards. Free list and literature. Hubbard, 424-H, Minnesota Ave., Kansas City 1, Kan.

# POPULAR SCIENCE OPPORTUNITIES

**NEW Free Spring Catalog** just off press! Farm and country real estate bargains, good pictures, many states, easy terms, many equipped, crops included, For Special Service, state requirements, desired location. United Farm Agency, 2825-PS Main St., Kansas City 8, Mo.

**FLORIDA.** Beautiful homesites in new Lake County development, \$245 at \$10 monthly. Near Ocala National Forest, many pretty lakes, streams, pavement. World's best bass fishing, wonderful hunting. Safe from bombs. Folder free. Winfree Vernor, DeLand, Florida.

**GOOD Farms—Ranches.** Washington, Minnesota, Montana, Idaho, Oregon, North Dakota. Dependable Crops, favorable climate. Write for literature, lists describing typical farm opportunities. Specify which state. J. W. Haw, 120 Northern Pacific Ry., St. Paul 1, Minnesota.

**STROUT'S Catalog—Farms, Homes, Country Businesses, World's Largest!** 3029 outstanding Bargains, 31 states. Mailed Free. Buy now and Save thru Strout, 255-ZB 4th Ave., New York 10, N. Y.

**FLORIDA 5 Acre high dry tracts** only \$10.00 down, \$10.00 month. Write Potterfield, Charleston, W. Va.

**40 ACRES retirement farming** \$195, \$5 Monthly. Armstrong, Shook, Mo.

## 31 POULTRY AND SUPPLIES

**BABY Chicks \$10.00 per 100 C.O.D.** New Hampshires, Barred Rocks, White Rocks and Heavy Assorted. Prices at Hatchery. A. F. Hockman, R. 5, Bellefonte, Pa.

**RAISE Turkeys the new way.** Write for free information explaining how to make up to \$3,000 in your own backyard. Address National Turkey Institute, Dept. 57, Columbus, Kansas.

**POULTRY Farmers—Broiler Growers—Turkey Raisers** read the new American Poultry Journal for latest ideas and greater profits. 12 months, 50c. Special offer, 4 years \$1.00. American Poultry Journal, 559 South Clark, Chicago.

## 32 PROFITABLE OCCUPATIONS

**RAISE fishworms.** Profitable. Free literature, complete instructions 10c. Huffmans Ranch, Rives Junction 5, Mich.

**RAISE pheasants on the \$100 week plan.** Little capital and space can make you independent. Free details. Great Central Game Management System, Columbus 6, Kansas.

**WANT a Diesel Job?** Our approved, up-to-the-minute Diesel Training Program can help you qualify for steady, big pay jobs or specialized military training. Covers Diesel, Tractor, Heavy Equipment. Easy to master. No loss of present income. Job Placement Advisory Service. Investigate! Write for information today. Interstate Training Service, Dept. 2B, Portland 13, Oregon.

**\$5 HOUR Easy!** Sell name plates for houses. Free Sample, order blanks. Write: National, 214 Summer, Boston, Mass.

**BE independent, be secure, have your own profitable business—earn \$20.00 and more a day** making beautiful, fast-selling lamps at home. No equipment needed. Illustrated course teaches you quickly. Course, parts catalog, wholesale price list—only \$2. Gearon Co., Dept. 200-A2, 27 S. Desplaines, Chicago 6, Ill.

**LIFETIME income as Notary Public.** Appointment assistance. Stationers, Helotes 50, Texas.

**FREE book "How to Make Money With Home Workshop"** describes amazing methods used by hundreds of successful craftsmen. Tells what to make. How to sell workshop output spare time. Write at once for details. Remember it's free! Craftsman, 115-B2 Worth St., New York City.

**HAVE Fun! Make Money!** "Working with Leather"—64-page booklet tells how. Send 25c for copy. Free catalog and valuable information included. Wilder-Craft, 1040 Crosby, Chicago 10.

**DETECTIVES Earn Big Money.** Excellent opportunity. Detective Particulars free. Write, Wagoner, P-125 West 86th, New York 24.

**\$5000 FROM half acre growing Ginseng.** crop bought. Particulars 10c. Associated Growers, Sperling, Manitoba.

**\$40.00 WEEKLY.** Made growing mushrooms. Fresh, Dried, Dominion Patent 331,583, free spawn, North American, 169Y Yonge, Toronto, Canada.

**EARN Money in Spare Time in Radio and Television.** Send for full information. Receive Free copy of Radio Trouble-Shooting Guide. Progressive Electronics Co., 497 Union Ave., Dept. PS 101, Brooklyn 11, New York.

**OPERATE a Letter Shop By Mail.** Unlimited Possibilities. Information Free. P. Dougherty, Box 12, Phillipsburg, N. J.

**100,000. NYLONS, Rayons, Cottons, \$2.00 Doz., up.** Sample Razor Blades. Complete Stock List, 25c. Sibert Co., Chattanooga 4, Tenn.

**MUSHROOMS Grown, Boxes, Barrels.** Instructions 50c. Spawn \$1.00. Manureless process, \$2.00. Gordens, 553 William, Winnipeg, Manitoba.

**PRINT Without A Printing Press.** Big Profits. See Page 61.

## 33 BOOKS, PERIODICALS, ETC.

**STRANGE Stories!** Sample and illustrated literature, 25c. Stone, Lunenburg 22, Mass.

**WHAT Every Mason wants.** We have Masonic books for Blue Lodge, Chapter, Commandery Scottish Rite and Shrine. Our rituals are used the world over. Send for our free catalog of books and rituals for Masons, Odd Fellows, Knights of Columbus, etc. Ezra A. Cook, Publisher, Inc., P. O. Box 796-PS-F, Chicago 90, Ill.

**MAGAZINES (back dated)—foreign, domestic, arts, Books, booklets, subscriptions, pin-ups, etc.** Catalog 10c. (refunded). Cicerone's, 86-22 Northern Blvd., Jackson Heights, N. Y.

**UNUSUAL, strange out of print books.** Send 25c for catalog and private collectors list. Hollywood Book Store, Dept. N, Box #2221, Hollywood 28, Calif.

**BOOKHUNTERS! All Subjects.** Send Wants! Jaher Book Service, 620-K East 178 Street, New York 57.

**SAVE through subscriptions.** Free list. Rural Magazine Agency, Grenada 2, Miss.

**"OUR Saviour's Message."** \$1.75 with order. Postpaid, Box 363, Farmland, Ind.

**BACK-date Magazines.** Specific issues; years. Arkell's, Tarzana 2, Calif.

**HARD-To-Find Books supplied.** Send wants. Pierce's, Winthrop, Iowa.

**MENTAL Freedom—Your superexcellent successful living guidance Book \$4.95.** Address: Vincenzo Cattano, Box 6296, Metropolitan Station, Los Angeles, California.

**HOW To Find Your Supply!** Scriptural "key" to prosperity. 25c. Ward, Box 283-PS, Richmond, Indiana.

**RENT Fiction, non-fiction.** Catalog 10c. Santens, 2700a Ann, St. Louis 4, Missouri.

**BOOKS-Booklets, Arts, Novels 4 \$1.00.** Catalogues 10c. Kogan, 1032-PS, Church Annex, New York 8.

**ADULT Book Bargains.** Send Stamp. Joseph P. Vallon, 63 Perry, New York 14.

**FREE Book Catalog.** "The Mysteries." Occultism, Prophecy, Astrology, Masonry, Comparative Religion, Philosophy, Theosophy, Yoga, Spiritualism, Occult Fiction. Self-Improvement Book Club, 1130 Keller Avenue, Louisville 13, Kentucky.

**READ With Speed!** New Amazing Method. Save hundreds of hours yearly. Free test. Speed-Reading, 9111-U, Hoynes, Chicago 20.

**SENSATIONAL \$1.00 Value.** Unusual Adult reading. Entertainment fun for your pleasure and enjoyment. Something new to show your friends. Prepaid, no C.O.D.'s. Price list plus samples 50c. Paris Sales Company, Dept. M-1, P. O. Box 1649, Grand Central Station, New York 17, N. Y.

## 35 MAGIC TRICKS, PUZZLES, ETC.

**584 PAGE Catalog.** 7500 Novelties, Jewelry, funmakers, gadgets, hobbies, sports, tricks, jokes, timesavers, radios, animals, music, guns, etc. 10c. Johnson Smith Company, Dept. 313, Detroit 7, Michigan.

**MAGICIANS' Gamblers' secrets exposed.** Cards, Dice, Punchboards, Slot Machine. Catalog 10c. Book Co., Box 671, St. Louis 1, Mo.

**WE supply every noted magician.** Large professional catalog 50c. Holden's, P220 West 42nd Street, New York.

**200 ELECTRIC stunts.** 110 volts. \$1.00. Cutting Sons, Los Altos 2, Calif.

**500 TRICKS new 1950 edition now ready!** Send only 10c for your copy, containing latest in good magic for pocket, parlor, stage. Unequaled service to magicians for 30 years. Douglas Magician, Dept. 2, Dallas, Texas.

**VENTRILOQUISM Taught.** 3c stamp brings particulars. Smith, 801 Bigelow, Peoria 5, Illinois.

**"VENTRILLO."** Professional Voice Thrower and Catalog 25c! Box 971-PS, Philadelphia.

**VANISHING Quarter trick and catalog** 25c. Sterling Magic Co., Royal Oak, Mich.

**FREE Trick And Catalog 25c.** Lerro's Magic, 509 80th Street, Brooklyn, N. Y.

**GAMBLING Expose books.** Magic tricks, cards, dice. Catalog Free. Magic, Box 202-B, Bonham, Texas.

**FEBRUARY Special! 10% Discount.** Magic Tricks, Etc. Free Illustrated List. Pineland Magic Center, Metedeconk, N. J.

**LUSCIOUS Red Plastic Lips.** Funniest gag yet. Open and close—talk while wearing. Also new Buck Teeth—fit like dental plate. Great fun maker. Sent postpaid 50c (coin) each. Both for \$1. Lange Art-craft, 533 Union, Eau Claire, Wis.

**VENTRILOQUIST Dummies.** Catalogue 25c. Be a ventriloquist. Free Particulars. State age. Maher, Box 36-S251, Kensington Station, Detroit 24, Michigan.

**512-PAGE catalogue of 2500 tricks,** pocket, parlor, stage. World's Finest Magic. Send \$1.50 for catalogue (refunded first \$6.00 order). Kanter's, S-1311 Walnut, Philadelphia 7.

**BE a Magician.** Large professional magic catalog of latest tricks. 35c. Ireland, F-109 North Dearborn, Chicago.

## 36 GAMES, ENTERTAINMENT

**HOME Slot Machines, Punchboards, Novelties.** Webb Amusements, 4966 West Chicago Ave., Chicago 51, Ill.

## 37 COIN COLLECTING

**OLD Money Wanted.** Do you know that Coin Collectors pay up to \$100.00 for certain U. S. Cents? And high premiums for all rare coins? We buy all kinds. Send 4c for Large Coin Folder. May mean much profit to you. Numismatic Co., Dept. 30, Fort Worth, Texas.

**SCARCE Lincoln Cents 1913S, 1914S, 1915S, 1915D, 1921S, 1923S, 1924S, 1926S, 1913D, 1932D, 1933D.** 10c each, 11 for \$1.00. Reynolds Coins, Flint 3, Mich.

**GOLD, Silver, Copper, Paper Money.** If You Are Not Satisfied With Offers From Others Let Me Pay You More. C. J. Dochkus, 3522 E. Thompson Street, Philadelphia 34, Penna.

**GET Profit and Pleasure in collecting old coins.** Send 10c for 56-page illustrated coin catalog. You'll be delighted with it. Send for it now. B. Max Mehl, 374 Mehl Building, Fort Worth, Texas. Largest rare coin establishment in U. S. Established 51 years.

**COIN collectors new magazine,** just out, and two wooden nickels 10c. Lawrence Brothers, Anamosa, Iowa.

**FREE! Foreign coin, banknote and Coin Collectors' Illustrated Catalog** to approval service applicants. Send 3c postage. Tatham Coin Co., Springfield-D50, Mass.

**U. S. coins lowest prices.** Send stamp for lists. Hutchinson, 3463 I Street, Philadelphia 34, Penna.

**COLLECT Coins.** Profitable. Illustrated literature 5c. Numismatic, 5450 Clark, Chicago 40.

**COMMEMORATIVE \$1½ — Columbus, Washington, Cleveland, Stone Mountain.** \$1.50 ea. Illustrated Catalogue 25c. Norman Schultz, Salt Lake 9, Utah.

**WANTED—1894-S Dime.** Pay \$500.00. Certain 1913 Nickel \$1,000.00, 1901-S Quarter \$10.00-\$150.00. Hundreds of others. complete catalogue 25c. Worthycoin Corporation (D-312), Boston 8, Mass.

# POPULAR SCIENCE OPPORTUNITIES

## 38 OLD STAMPS WANTED

I WILL Pay \$100.00 each for 1924 1c green Franklin stamps rotary perforated eleven (up to \$1000.00 each unused). Send 10c for Large illustrated folders showing Amazing prices paid for old stamps, coins & collections. Vernon Baker, PS-12, Elyria, Ohio.

## 40 STAMP COLLECTING

**PREMIUMS**, prices, and service that satisfy. U. S. approvals at rock bottom prices. Foreign, from 1/10 to 1/2 catalogue, mounted in books and sheets. No matter how large or small your collection is, we can help. References appreciated. Roseland Stamp Co., Dept. 9B, Spring Lake, Mich.

**ROOSEVELT Triangle**, 53 others, approvals, 5c, Marylandco, Arlington, Baltimore, Maryland.

**ZANZIBAR**, Pitcairn Islands, Turks, Caicos, Gilbert, Ellice, Solomon, Borneo, Gambia, Tanganyika and others. Complete collection free. Send 5c for postage. Gray Stamp Company, Dept. PR, Toronto 5, Can.

**LOOKING for Bargains?** Try our 1 & 2c approvals mounted in books of 1,000. We believe in both quantity and quality. First try will satisfy. Clark, Box 544, Muskegon, Michigan.

**FREE—Canadian Sets Royal Visit**, George VI, George V, Coronation Jubilee, others to approval applicants. Ensign, Box 118-P, So. Orange, N. J.

**POUND stamps** containing thousands \$1.00. Longacre Shop, 100c West 42nd, New York City 18.

**FREE! Big United States Catalog!** Invaluable guide and check list. Hundreds of illustrations. Harrisco, Boston 17-B, Mass.

**FREE: Jungleland Packet**, Contains 10 different Congo, Fiji map stamp, Liberia triangle, Mozambique giraffe, North Borneo monkey stamps, with approvals. D. Moublow, 740 Hegney, Bronx 56, N. Y.

**25 DIFF. Japan Free With Approvals**, Karl Scheerer, Box 301, Pottsville, Pa.

**STAMP Tongs Free With Approvals**, Dolin, 31 Park Row, New York 7, N. Y.

**TRY "Gold Nugget" approvals: U. S., Americas, British Colonies, World**, Nothing like them! 312 mixed U. S. only 10c to approval applicants, Kessels, Folsom, Calif.

**FREE! 100 Worldwide different stamps** to approval buyers. Big U.S. and illustrated bargain lists sent with approvals. Bookman, Maplewood 1, N. J.

**FREE—Cuba Roosevelt issue and illustrated catalog**, Littleton Stamp, Littleton 11, N. H.

**AMAZING Offer!** 500 United States stamps—including commemoratives, airmails, high values to \$5.00—Only 10c to Approval Applicants!! Illustrated Bargain Lists free. Mystic Stamp Co., Dept. 55, Camden, New York.

**300 DIFFERENT** given free with approvals. Postage 3c. Windsor Stamps, 1435 E. 67th Place, Chicago 37.

**750 FRANCE and colonies stamps 10c**, Littleton Stamp Co., Littleton 26, N. H.

**500 STAMPS For Only 10c!** This mammoth value includes Airmails, Pictorials; stamps from strange countries cataloguing up to 25c each!! Also approvals. Mystic Stamp Company, Camden 55, New York.

**200 DIFFERENT**, including Roosevelt triangle, 5c to approval applicants. S. Avalon Stamp Co., Springfield, Mass.

**FREE—Rare stamps from mysterious Nepal**, plus octagonal (eight sided stamp), Giant triangle, gorgeous diamond, mammoth, midget stamps, value exceeds \$2.00. All free to approval buyers. Stamps, Box 58, Santa Ana, California.

**COLUMBIANS**, Trans-Mississippi, Pan-Americans, Pan-Pacific, ten other different commemoratives. All 10c with your request for US approvals. Moda Stamps, Box 251-V, C.S.A., New York 8.

**FREE! Powerful Magnifying Glass**, Jamestown Stamp, Jamestown 207, N. Y.

**UNITED States stamps nearly 100 years old**, Roosevelt set, others, 40c value—only 6c to applicants United States approvals. Wakonda, Box 272-H, Jackson Heights, N. Y.

**TOPS! Our book "How to Collect Stamps"** Send for your free copy today! Littleton Stampco, Littleton 29, N. H.

**FIRST U. S. (1847) Government Re-issues 5c, 10c, plus Giant Bargain U. S. Collection—only 5c to applicants U. S. approvals**, Metropolitan, Box 312K, Jackson Heights, N. Y.

**FREE**, Scott's International Album, Other big premiums, Full particulars with approvals, Raymax, 123X William St., N. Y. C. 7.

**FREE—Famous Americans Set, Flag Set, National Parks Set, and Presidential Set to \$5.00**, A total of 90 Stamps Free to Customers for our unsurpassed U. S. and foreign selections. Send 3c for 15 of the above Stamps and full particulars. Triboro Stamp Co., 145 Nassau St., Dept. 202, New York 8.

**25 U. S. Commemoratives—All Different from 1893 Columbian to present day issues**, This U. S. commemorative collection only 5c to approval applicants. S. L. Engel & Co., 38 Park Row, New York 7, N. Y.

**50,000 STAMP Grabags 25c each**, Anderson, 630a Bingaman, Reading, Pa.

**PENNY Approval Bargains!**—Write Dept. PSM, 1267 Tutwiler, Memphis 7, Tenn.

**FINE Approvals**, Fast, personal service. What countries do you prefer? I'll send their stamps. Milton Skinner, 438 Locust, Long Beach 12, Calif.

**500 EXOTIC Japan Stamps—10c!** Kenmore, Richford J-58, Vermont.

**100 OLD U. S. between 1861 and 1935 50c**, Roush Stamps, 51 Chestnut, Mansfield, Ohio.

**UNUSUAL—Unheard of cancelled sets of Roosevelts and Washington bicentennials complete**, All yours for fifteen cents. Bargain approvals accompanying. Park Stampco, Box 191, New York 21, N. Y.

**WORLD'S Largest Stamp (7½ x 14 inches)**, A real curiosity! Retail for 50c, only 3c to approval applicants. Tatham Stamp Co., Springfield 50, Mass.

**"HOW To Recognize Rare Stamps," Free Book Illustrated!** Kenmore, Richford H-58, Vermont.

**FINE U. S. Exclusively**, Glades Stamp Co., Box 2842, Miami 18, Florida.

**OLD, scarce U. S. seconds on approval**, Slightly defective bargain prices. Hearnfeld, Clintonhill Station, Newark 8, N. J.

**10,000 DIFFERENT 1c each!** Gordon Davison, Box 1019, Manchester, N. H.

**SEND for free folder "How to sell stamps profitably by mail"**, Sure-fire ideas, plans. Write Science Syndicate, Box 802 A, Milwaukee, Wisc.

**FREE—Illustrated Catalog!** Kenmore, Richford C-58, Vermont.

**WOW! 203 All Different Germany 10c!** Zeppelins, Semipostals, Airmails, High Values, etc. to new customers. Jamestown Stamp, Jamestown 509, New York.

**50 DIFFERENT stamps 10c with approvals**, F. Tunis, 54 Wakeman, Newark 4, N. J.

**SCARCE Bahawalpur Jubilee Set free to approval buyers**, Plymouth F3, Bell, Calif.

**PENNY Approvals by country**, M. H. Hoerning, 102, Farmington, Ark.

**MAGNIFICENT! Nineteenth Century U. S. Plus Civil And Spanish War Revenues**, 20 Different, 10c To Approval Applicants. AAA Stamp Company, Arcade Building, St. Louis 1, Missouri.

**TRAINS! Trains! Trains!** 12 train stamps and packet of 100 different stamps for 10c with approvals. Reich Stamp Company, 4647 Kenmore, Dept. S20, Chicago 40, Ill.

**"MONACO Nudes" 10c**, Approvals accompany. Royal Stamp Company, Tamaqua 2, Penna.

**BEAUTIFULLY illustrated U. S. catalog 10c refundable**, 524 Chester-ninth Building, Cleveland, Ohio.

**ZOUNDS! Amazing "Queer Countries" Packet—Free with approvals!** Saxon, Vista, California.

**UNUSED U. S. Bargain! 33 different unused U. S. commemoratives; \$1.00**, Unused U. S. approvals accompany. Patrick Agencies, 3650L Central, Indianapolis 5, Ind.

**50 DIFFERENT U. S. 10c**, No Approvals, Seidenberg, 944, Appleton, Wis.

**1050 DIFFERENT Stamps including UPU's, Roosevelts, Silver Wedding, AMG's, Triangles, 4 rare imperf. errors; Plus 100 Different Bohemia—Total Catalog over \$24.00 for only \$1.00 with bargain approvals**, Stampex, 116-F Nassau St., N. Y. C. 38.

**WE Give Away—Your Choice Latest Scotts Albums; Catalogue and available philatelic accessories**, Realize—You Get These Worthwhile Rewards When You Buy From Our Better Foreign Approvals. Write Today For Full Particulars Sent With Trial Approval Selection. Americas' Stamp Service, Riverside, Calif.

**WORLDWIDE Stamps**, All Different, 200—25c 500—50c; 1000—\$1.00; 2000—\$2.50; 5000—\$12.50. Beacon Sales, Maynard 3, Massachusetts.

**FREE! Two Bicolored "Polar Bear" Triangles; Giant Five Colored Flag, Damascus, Will Rogers Airmail, First American Commemorative, Harem, etc.** Free to approval buyers for 3c postage. Belmont Stampco, Washington 15, D. C.

**CANADA Scarce error set 10c**, attractive approvals, Rheume, 6591 11th Ave., Montreal, Canada.

**BARGAIN Bulletin coins and stamps** Free, Gage, Box 991, Pasadena, California.

**100 DIFFERENT U. S. commemoratives one Dollar**, Request approvals. Harold Holub, 18 East 198th Street, New York 58, New York.

**FREE "Stamp Finder"**, Tells instantly country to which any stamp belongs, 32 pages profusely illustrated, Garcelon, Calais 18, Maine.

**APPROVALS Selective Foreign Stamps Sets Singles With U. S. Price List**, Pitzer, 241 South Winchester, Campbell, Calif.

**FREE—Five Foreign Sets, Approvals**, Stoll, 2634 Burnett, Louisville 10, Ky.

**U.S. 797 SPA Sheet only 5c to applicants for U. S. approvals**, M. Haycock, 235 86th St., Brooklyn, N. Y.

**100 DIFFERENT Worldwide, 5c Approvals**, Stearns, Box 602-C, Inkster, Michigan.

**FLAG Stamp—Free with hygrade U. S. approvals**, Weniggman's, 1933 Patterson, Chicago 13.

**½c-1c APPROVALS! 12,000 bargains!** Cole, 43-G Rinewalt, Buffalo 21, N. Y.

**MONACO Nudes Set—10c**, Approvals accompany. Atlas, 3210-P Republic, Racine, Wisconsin.

**SAN Marino Collection Free—25 different, Old and New Issues, Airmails, Commemoratives, High Values—absolutely Free with approvals**, Viking, 130-PP Clinton St., Brooklyn 2, N. Y.

**POSITIVELY Free! Scott's Latest \$6.00 International Album, 1951 Catalogues To Approval Customers**, Claire's, 7402 Bayparkway, Brooklyn 4, N. Y.

**VALUABLE U. S. illustrated catalog free**, S. Stone, X-52 Dorchester 24, Mass.

**SOUVENIR Sheet Free if you request approvals**, Knight, Box 3770, Portland 88, Oregon.

**ALBUM, Hinges, Gauge Detector Stamps, Sets, All 10c**, Approvals, Cornette, 228 West 25th, New York 1.

**110 DIFFERENT Hitlers, Roosevelt, Liberia, Haiti, etc. 10c**, Buckey, PS-208 Ludlow Bldg., Dayton 2, Ohio.

**FREE! Scarce Atomic Bomb Airmail! Approvals**, Star Stamps, Jamestown, N. Y.

**SUPERB Approvals, net prices**, Stamps ⅓ to ⅛ catalog, P. G. Beals, 170A Tremont St., Boston, Mass.

**FREE! Big worldwide collection! Commemoratives, high values, etc.** Approvals, Concord, Box 23-C, Beeville, Texas.

**BOY Scout set complete**, Netherlands 1937, 10c with approvals, Vargo Stamps, 6044 South Fairfield, Chicago 29, Illinois.

**307 ALL Different—Only 15c!** Beautiful collection: Commemoratives, Triangles, High Values, Bicolored Stamps, etc. Garcelon, Calais 418, Maine.

**FREE—World's only Giant "Cardboard" Triangle**, Approvals, Beaman, Leeds 10, Ala.

**205 AUSTRIA—All different only 10c!** Beautiful Commemoratives, Pictorials, Airmails, High Values, Catalog price nearly \$6.00! Approvals included. Garcelon, Calais 112, Maine.

# POPULAR SCIENCE OPPORTUNITIES

## 42 HOBBIES, COLLECTIONS

**WANTED** Old cigarette cards. Write Charles Bray, East Bangor, Penna.

**INVENTING** can be an interesting and profitable hobby. Write for complete particulars. Institute of American Inventors, Dept. 30-E, 631-E St., N. W., Washington 6, D.C.

**START** a profitable and Fascinating Hobby. Learn Radio and Television at home at a minimum cost. Send for full particulars. Receive free copy of Radio Troubleshooting guide. Progressive Electronics Co., 497 Union Ave., Dept. PS 201, Brooklyn 11, N. Y.

**EXCHANGE** Viewcards with members world over. 10c brings magazine with list members. World Viewcards, King, N. Car.

**UNUSED** matchbook covers—100 different \$1.00—Catalog 25c—Charles Edelman 1311P East 84, Cleveland 3, Ohio.

## 44 ANTIQUES, RELICS, INDIAN GOODS

**TEN** good or seven fine arrowheads \$1. Lynn Crandall, Idaho Falls, Idaho.

**SELLING** 500 Historical Firearms. 20,000 Indian Relics. Coins. Collectors Cartridges. Confederate Money. Revolutionary, Civilwar Flintlocks, Muskets, Swords, Bayonets, Percussion Caps, Ramrods, Bulletmolds, Powderhorns, Blunderbusses—Arrowheads, Tomahawks, Wampum, Spearheads, Bannerstones—Blo-horns, Steerhorns, Mounted Pheasants, Owls, Elk Antlers, Squirrels—Agates, Minerals, Fossils, Marine Shells, Gold Dollars, Stagecoach Winchesters. Illustrated Catalog #17, 1951, 35c, Heike, Wenona 42, Illinois.

**SPECIAL:** 10 Indianheads 68c—Bayonet \$1.98—Civilwar Saber \$7.88—10 Arrowheads \$1.85—Tomahawks \$3.85—Agate 38c—Fossil 38c—Geode 38c, Heike, Wenona 42, Illinois.

## 46 MINERALS & PRECIOUS STONES

**"GENUINE"** deep red Arizona Rubies (Garnets). Send quarter for packet, Bitner's, Box 724, Scottsdale, Arizona.

**LOW** priced prospecting Geiger Counter. Smallest, lightest, manufactured. Guaranteed operation. Free literature. Batson Electronics, 1030 S. 27th St., Omaha, Nebr.

**MINERALS.** Gems, Gem Materials, Carvings, Gifts of Beautiful Onyx. Send For Free Price List. Warren's Minerals And Gems, 1969-B Abbott St., San Diego 7, Calif.

**GEMSTONES.** Mineral specimens. Every variety. Lowest prices. Postcard brings free booklet. Plummer's, 2183D Bacon, San Diego 7, Calif.

**AGATES.** Gems, Free List, North West Gem Shop, Box 305, Tacoma 1, Wash.

## 47 CAMERAS, PHOTO SUPPLIES

**FREE** Photographic Bargain Book packed with hundreds of sensational values in still and movie cameras, lenses and latest accessories. Super savings for you in new and used equipment. Liberal trade-in allowances, too, on your equipment. Write now for your free copy to Central Camera Company, Dept. 2-M, 230 S. Wabash Ave., Chicago 4 (Photographic Headquarters Since 1899).

**SEND** for free catalog 700 2x2 kodachromes, Cape Cod, Maine Coast, White Mountains, Gaspé, Quebec, Santa's Workshop, Niagara, Fall foliage, many others. Pilgrim Productions, 81 Bosworth St., Boston 8, Massachusetts.

**SPECIAL** selections Glacier Banff, Jasper on approval, Douglas Whiteside, Yosemite, California.

**BASS** Says: Trading cameras a national habit since 1910. Write to Bass the old "Horse Trader." A postcard will do. Simply say: "Bass, I have and I want... How much will you allow me?" Satisfaction guaranteed. Bass Camera Company, Dept. AG, 179 W. Madison St., Chicago 2.

**PHOTOMURALS.** Your negatives or ours. Catalogue 25c. Photomammoth, 12048 Vanowen St., North Hollywood, Calif.

**UNBEATABLE!!** Up to 40% discount on brand new photographic equipment, appliances, typewriters, silverware. Write Straus Supply Center, 113 West 42nd St., New York 18.

## 48 PHOTO FINISHING

**OIL** coloring photographs can be a fascinating hobby or profitable sideline for those with artistic talent. Learn at home. Easy simplified method. Send for free booklet. National Photo Coloring School, 835 Diversey Parkway, Dept. 1721, Chicago 14, Illinois.

**16 PRINTS** or 8 Jumbos from Roll. 25c with this ad. Y Skrudland, River Grove, Ill.

**GUARANTEED** first quality oversize prints. 8 exposure roll 80c. 12—45c. 20—95c. Free mailers. Western Photo, Dept. SJ, Box 298, San Francisco 1, Calif.

## 50 PHOTOPRINTS, PHOTOCOPIES

**24 GLOSSY** Photos. Beautiful Models \$1.00. Illustrated catalog 25c, none free. Nutrix Co., Dept. D-37, 212 East 14 St., New York 3, N. Y.

**PHOTOCOPY** Anything—Papers, books. No darkroom. 8 1/2"x11" complete \$6.95. Fotoflek, 8555 Plainfield Lane, Cincinnati 36, Ohio.

**PHOTOCOPY** kit, instructions, \$1.00 (C.O.D. \$1.32). Wentworth Co., 1112 N.W. 18th Pl., Miami, Fla.

## 51 MOTION PICTURES, SOUND EQUIPMENT

**NEW** 1-reel 16mm, sound films low as \$3.98, formerly \$17.50; new 1-reel 16mm, silents, \$1.98 up, formerly \$8.75—all first quality prints in original cartons. Used Panoram 100' 16mm, musicals, \$9.95 per dozen. Equally attractive bargains in good used feature pictures, cartoons, sports, comedies, musicals, travels. Big selection of used 16mm, sound projectors. Save on new and used reels and cans, projection lamps, and other supplies. We have the biggest stock of 16mm, films in the world—over 100,000 prints on hand! Write today for your copy of Blackhawk's big catalog 6-F, "Sixteen's Super Market." Blackhawk Films, Inc., Davenport, Iowa.

**KODACHROME** Movies—lists 10c, sample—\$1.00. S.O.F. rentals; Color slides—lists and three samples—\$1.00. Galloway Films, P. O. Box 6953, Washington 20, D. C.

**ADD** "Spice" to home projection shows with colorful old-time Nickelodeon slides. 2x2. Write for Free list, Nickelodeon Co., New Fleidner Bldg., Portland 5, Oregon.

**BETTER** 8mm and 16mm Movie Camera Film. Free Equipment Catalog. Better Films, 742 New Lots, Brooklyn 7, N. Y.

**LATEST** Beauty Glamour Films. Sample, 8mm 50 ft. only \$3.75. 25c brings exclusive catalog of movie titles. Empire, Dept. PS-2, Box 23, White Plains, N. Y.

**8-16MM.** Silent-sound films. Complete rental library. All latest subjects. Free catalogue. (sample film 10c). Garden Film, 317 West 50th, New York 19.

**RENT** 16mm, sound films 50c reel. Large selection; free catalog. U. C. Film Service, 128 Chestnut St., Roselle Park, N. J.

**THE** World's Greatest Story. "Entire Life of Christ" 8mm, 16mm, Sound & Silent. Rent or Purchase. Hemenway Film, 33-W Melrose Street, Boston 16, Mass.

**GUARANTEED** Fresh 8mm roll, magazine; 16mm roll, magazine movie film. Color, b&w. Free catalog. ESO-S, 47th Holly, Kansas City 2, Missouri.

**"CINE-Voice"** Sound-On-Film Camera shoots your own 16mm Color Talking-Pictures, \$695.00. Write for free illustrated folder. Berndt-Bach, Inc., 7347 Beverly Blvd., Hollywood 36, California.

**1000'** Silent-Sound projection film, \$7.50. International, 2120 Strauss, Brooklyn, 12, New York.

**WE** trade, sell, buy movie films. Gallard, 29C Coe Ave., Hillside, N. J.

**1951 ROSE** Parade Movies, Kodachrome, Colorful floats! Beautiful girls! 16mm 200' \$29.95, 8mm 100' \$14.95. C.O.D.'s accepted. California add tax. Avalon Dagget, 441 North Orange Drive, Los Angeles 36, Calif.

**FILM** with Free processing 100 foot 16MM \$2.95. 25 foot 88MM \$1.29. Fromaders, Box 637B, Davenport, Iowa.

## 52 MUSIC, MUSICAL INSTRUMENTS

**WHOLESALE**—Popular Used Jukebox Records. (100—\$15.00) F.O.B. No Catalogs. Milner, 204 Griffin, Atlanta, Ga.

**POWERFUL.** Strong, Magnetic Voice developed with Diaphragm Exerciser (New Invention). Write, Inventor Oz, Box 665-(60V) St. Louis, Mo.

**HÖHNER** Harmonicas, Singles, Doubles, Chromatics, Ukuleles, Guitars, Accordions, Everything Musical. Hawes Music Store, Portland, Maine.

**PHONOGRAPH** Records Cheap. Catalogue. Paramount, FT-313 East Market, Wilkes-Barre, Penna.

## 53 SONG WRITERS

**WANTED!** Poems for musical settings. Write Songwriters' Service, Clifton, N. J.

**POEMS** Wanted to be set to music. Free examination. Send poems, McNeil, Master of Music, 510-PS, S. Alexandria, Los Angeles, California.

**POEMS** Wanted for musical setting. Send poems for free examination. Five Star Music Masters, 646 Beacon Bldg., Boston, Mass.

**POEMS** Wanted. Broadcast consideration. Sooner Song Co., 22 Northwest 8th, Oklahoma City 2.

**POEMS** Set To Music. Guaranteed Satisfaction. Send Poems. Songmaker, 802 Main, Clinton, N. C.

## 54 RADIOS, SUPPLIES & EQUIPMENT

**FREE**—Send for new 1951 Buyer's Guide. Has thousands of top values in television, radio, electronic supplies. Concord Radio Corp., Dept. KB-51, 901 W. Jackson, Chicago 7, Illinois.

**BUILD** Modern improved "Diode Detector Radio." Diode with complete illustrated instructions, \$1.00. "Five Best Tested Circuits," 25c, Electronics, Dept. B21, Box 7101, Chicago 80, Illinois.

**EARN** while building radios. Learn television. Experience unnecessary. Parts, tools, instructions supplied. Free details. Federal, 176-71 Union Turnpike, Flushing 1, New York.

**FIX** any radio. Amazing new instrument locates radio troubles double quick. Simple instructions show you how. Thousands now in use. Free—Write today for 32-page illustrated technical manual. "The Inside Story." Feiler Engineering Co., Dept. 2PS-1, 1601 S. Federal St., Chicago 16, Ill.

**MAKE** simple, tubeless, batteryless, distance-getting crystal radios. Crystal and illustrated instructions 25c postpaid. Allen, 427-S. Clinton, Mo.

**PORTABLE** Crystal Radio. No Aerial. No Ground. Send 50 cents for Crystal detector, drawings, and instructions. Bill Cotter, Washington 18, D. C.

**BUILD** 15 radios at home, only \$1.30 each. Experience unnecessary. Home Radio Course includes Trouble-Shooting and Servicing, Lessons, Quizzes, and all parts and instructions. Nothing else to Buy. Earn money doing Radio and Television repairs while learning. Prepare for Profitable Future. Free Trouble-Shooting Tester with each course. Send for full particulars and receive absolutely Free a copy of the Progressive Trouble-Shooting Guide. Progressive Electronics Co., 497 Union Ave., Dept. PS 11, Brooklyn 11, N. Y.

**FREE!** 212 page Radio and Television Catalog! World's largest stocks, lowest prices. Complete supplies for builders, experimenters, amateurs, servicemen. Latest radios, phonos, television, recorders, sound equipment. Thousands of parts, tubes, test instruments, books, diagrams. Top quality money saving values. Get it now! Allied Radio Corp., 833 W. Jackson Blvd., Dept. 31-B-1, Chicago 7, Illinois.

## 55 TELEVISION

**LEARN** Television, adjustments, repair. Manual, special lifeguard circuit, dollar. George Patorno, Box 1351, N. Y. C. 8.

## 56 BUSINESS OPPORTUNITIES

**CASH** For your idea, 280 manufacturers need inventions, patented or unpatented. List free. Invention Bureau, 208-S Clinton, Oak Park, Illinois.

**ELECTROPLATE** Brass, Nickel, Chrome, Baby Shoes. Free Literature. Electroplate, Box 293, Red Lion, Pa.

**HUNDREDS** of Products from 1c and up. Free Catalog. Z.&Z.—1143 Manhattan Ave., Brooklyn 22, N. Y.

# POPULAR SCIENCE OPPORTUNITIES

**GET** into big profit leather jacket business. Horsehide, Suede, Capeskin, all fine quality leathers, low factory prices. Write S112, Chippewa Falls, Wisconsin.

**AMAZING** patented screw-holding screw drivers! Removes, inserts screws hard-to-get-at places! Urgent mechanics tool. Also non-skid rug underlay that prevents accidents in home. Tremendous profits, exclusive territories; Toolco, 90C Summit Ave., Brookline, Mass.

**LEARN** Sewing Machine Repair. Electrify. Rent. Trade. Sell. Big profit home setup. I show you how. Motor kits, new machines, etc. supplied wholesale. Free particulars. Taylor Service Co., Hamilton PS-2, Ohio.

**SELL** by mail; free booklet, instructions; Manhattan House, P. O. Box 50-L, New York 28, N. Y.

**\$5 HOUR** Easy! Sell name plates for houses. Free Sample, order blanks. Write: National, 214 Summer, Boston, Mass.

**EXTRA** Money — No selling — operate vendors. Amazing profits, details Free. Silver King, Suite 282, 622 Diversey, Chicago 14.

**GOOD** Paying Business Silvering mirrors, plating autoparts, reflectors, bicycles, bathroom fixtures, etc., by late methods. No tanks or shop required, outfit furnished. Free Booklet. Gunmetal Co., Ave. E. Decatur, Illinois.

**ENVELOPES** addressed accurately, reasonably. Fast Service. We have capable addressers in your city. Glenway System, 5713-X Euclid, Cleveland 3, Ohio.

**OPERATE** profitable mail order business. Write Walter Service, 4159-B East 112th, Cleveland 5, Ohio.

**\$25 WEEKLY** working two hours daily. No canvassing. No Manufacturing. Lycke, Box 2471-B, Cleveland 12, Ohio.

**137 PLANS** to make money local, mail order. Particulars free. Elite Co., 220-A Grand St., N. Y.

**BE** Appointed State Notary Public now! Details. Stationers, Helotes 50, Texas.

**MAKE** money addressing envelopes. Our instructions reveal how. Glen Glenway, 5713 Euclid, Cleveland 3, Ohio.

**VENDING** Machines earn big money! An investment as low as \$10.50 will start you in this fascinating, profitable business that can lead you to the road of success and independence. Routes can be established and operated in either full or spare time with no experience needed. Write for full details and our Free catalog illustrating our nut, candy, gum and stamp vendors; also pin ball machines, music boxes, etc. Write immediately to: Parkway Machine Corporation, Dept. 9, 715 Ensor Street, Baltimore 2, Maryland.

**RECAST** old batteries into new. Latest achievements. Battery Laboratories, Minneapolis.

**START** Mailorder Bookshop—Everything furnished. 25c brings booklet, samples, exciting ideas. General Publications, Ossining 1, New York.

**MAKE** Money spare or full time, casting Metal Toys and Novelties. Big wholesale and chain store demand for cast Metal Autos, Soldiers, Ashtrays, Banks, etc. keeps manufacturers busy. Production moulds furnished for up to 100 and more castings per hour. No experience or special place necessary. Write for information, and illustrations of patterns needed. Metal Cast Products Co., Dept. E, 1696 Boston Road, New York 60, N. Y.

**EARN** while building radios. Learn television. Experience unnecessary. Parts, tools, instructions supplied. Free details. Federal, 176-71 Union Turnpike, Flushing 2, New York.

**BIG** money! Spare or full time in your home. No Selling! Spray New Miracle Finishes, Plush and Suede, on signs, radios, automobiles, figurines, lamps, toys, etc. Our business is booming. Help us fill huge demand. New easy Flok-Kraft methods. Material costs few pennies. You get dollars. Free samples, complete powerful money making plan free. Write now. Coast, 1002-B, Los Angeles St., Los Angeles 15.

**HOW** To Set Up and Run A Mirror Shop! Resilvering Mirrors. Making Chipped Glass Nameplates. Electroplating. Salts and Rectifiers. John Sprinkle V90, Marion, Indiana.

**MAKE** Money At Home as renewal headquarters for all magazines. Liberal commissions. No experience, no capital needed. Supplies furnished. Write for Free Catalog. McGregor Magazine Agency, Dept. 510B, Mount Morris, Ill.

**IMPORT-Export!** Men—Women. Learn from established World Trader. Your own profitable world-wide business by mail order from home without capital; or travel abroad. Experience unnecessary. Free details. Mellinger, A-3, Los Angeles 24.

**MAKE** Perfume—Big Profits—Mailorder—Expect Secrets—Write "Imasco", 6347 Parnell-PS-2, Chicago 21, Illinois.

**FABULOUS** Earnings—Fascinating pastime. Growing Genuine, living miniature (Ming) Trees. New sensational Business or Hobby. Astounding information free. Dwarf Gardens, Box 355H, Briggs Station, Los Angeles 48, Calif.

**OPERATE** Profitable Mail Order Business. Write Universal, 24-D Main, Tangier, Virginia.

**SLOT** Machines. Punchboards. Wholesale Catalog. Webb Distributing Co., 4966 West Chicago Ave., Chicago 51, Ill.

**YOUR** own profitable home business. Preserve live flowers to last forever. Spare or full time. New discovery—simple—fascinating. No experience necessary. Send \$2.00 for working equipment, instructions and valuable sales plans. Satisfaction guaranteed or money refunded. Hermansen, 210 Fifth Ave., Suite 1102, New York 10, N. Y.

**MAKE** money making new greaseless doughnuts at home on electric machine. Wholesale to grocers, drug stores, cafes, hamburger shops. Send for free recipes and plans. S. Ray Company, 3605 South 15 Ave., Minneapolis 7, Minnesota.

**EARN** Money At Home With Your Typewriter! Spare time! Details free. Edwards, Publisher, 3915-PS, 12th, Des Moines 13, Iowa.

**24 ASSORTED** small unpainted figurines, \$1.59 postpaid. Illustrated figurine list free. Oman, 642L Broadway, St. Paul 1, Minnesota.

**MADE** Big Money. So Can You. Wamsteker, Box 34-E, Wynberg, Cape, South Africa.

**MAKE** flexible molds! Cast plaques, bookends, figurines! Free sample! H. Tooker, 630-A Chestnut, Hamilton, Ohio.

**NATURAL** Molding Latex. Extra thick. Free sample. W. Wooley, 115B Donald, Peoria, Illinois.

**TRADE** Magazines help you to success. Get latest copies through our easy-to-get-acquainted service. More than 1200 business, professional, farming, investment, educational, sport, hobby, music, radio, etc. List free. Commercial Engraving Publishing Co., 34S North Ritter, Indianapolis 19, Indiana.

**FUN** plus extra money—for particulars. Ed's Hobby Press, 2508 Mass. Ave., Cambridge 40, Mass.

**HOW** and where to obtain Capital? Free details. Star Service, Wapakoneta, Ohio.

**WOULD** You pay 3%—first \$350 made? Book "505 Odd Successful Businesses" free! Work Home. Expect something odd! Pacific-PS, Oceanside, Calif.

**MOLD** Makers—Attention! Genuine Natural Latex for reproducing Statuary, figurines, plaques, etc. Instructions free. B. M. Barron, 77 Francis St., Everett, Mass.

**BUY** Wholesale. Big-Name Items Average 40% Below Retail. Folks Eagerly Patronize You For Big Savings. Details Free. Young's, Kent 1, Ohio.

**HAVE** Your Own Business. Big Earnings Local And Mail Order Get The Facts. Crittenden, Lombard 11, Ill.

**OPERATE** Profitable Mailorder Business. Particulars Free. George Lenhoff, Lincoln 1, Nebraska.

**ADDRESS** and Mail circulars for advertisers. Profitable home business. Instructions free. Mailserv, Box 1232, Denver, Colo.

**START** Home Manufacturing Business. Formula Catalog Free, June, 101-S Beech, Holyoke, Massachusetts.

**\$124.50 WEEKLY** Guaranteed! At Home. Spare time. \$1.00 (deposit). Science Syndicate, Box 791-A, San Antonio 6, Texas.

**MAKE** Rubber stamps, metallize baby shoes. Repair dolls, silver mirrors, make plaster novelties. Catalog of "30 ideas" free! Universal, Box 1076-B, Peoria, Ill.

**WANTED!** Home Producers by manufacturers in our Clearing House Service. Become a sub-contractor, casting plastic products for these companies. Thousands of easy to make items required. Cash in at home without previous experience. For details write Plastic Service Guild, Dept. P.S., 233 Condor St., East Boston 28, Mass.

**EXCEPTIONALLY** Profitable making finest perfume. Sample fragrance, full particulars free. Genmerco, Box 142-J, Dorchester 24, Massachusetts.

**\$35 WEEKLY!** Home! Two hours daily! Invisible Textile Reweaving Course \$2. Twenty seven other methods! Free details! Walsh, 894 Main, Buffalo 2, N. Y.

**WIN** Outstanding Success with New-Different home-operated business opportunities. National, Box 88-K, Dorchester 22, Massachusetts.

**A Business In Your Own Home!** Our chemicals, plus free water and cheap "grocery store" materials can bring you over \$500 monthly earnings. Plans and formulas free. Western Aircraft, Dept. G, Los Angeles 19.

**BEAT** Inflation. Wartime Plans! Free Book "372 Unusual Worldwide Businesses." Work home. Start sparetime! Publishers-PS, Carlsbad, Calif.

**MAKE** money by mail. Easy, big profits. Everything furnished. Write—Thomas' Service Enterprise, P.O. Box 56, Brooklyn 28, New York.

**BOOKKEEPERS** earn \$100.00 weekly operating simplified "Bookkeeping & Tax Service." Details Free. Universal Bookkeeping, Box 664-P, Springfield, Missouri.

**LOCKSMITHING** & Keymaking Home training outfit includes key machine, supplies and tools necessary to get started in business. Cut keys by code, master locks, change combinations. Booklet of Information Free. Write today. United Supply & Service, 3327 Madison St., Dept. PS-2, Chicago, Illinois.

**HOMEWORK**—Addressing—Envelopes—Details—25c. Siegel—P.O.B.—183—Knick.—New York 2.

**MAKE** Perfumes at home, write. "Carey Laboratories," 1914 Chouteau, PS-2, St. Louis 3, Missouri.

**UNIQUE** business. Profits unlimited. Experience unnecessary. Complete details \$1.00. B. Andrews, 49 Riley St., Buffalo 9, New York.

**MAILING** postcards selling repeat merchandise is profitable. Everything supplied. Details free. Gordon Publishers, Box 23, Pawtucket, R. I.

**TIN** Cans. Turn them into cash. Nine methods. Instructions 50c. Charles Co., 12-BPK, Norwood, Ohio.

**\$4,000.00 PROFIT** in two months. No investment. Details 50c. Charles Co., 12-BPM, Norwood, Ohio.

**POPCORN** Equipment. Potato Chip Outfits. Long Eakins Company, 5163 High, Springfield 99, Ohio.

**BE** income happy. New local and mail selling opportunities. Free literature. L. Mallory, 266E South Court, Neillsville 5, Wisconsin.

**"ELECTROPLATING - Know - How"** includes baby shoe metallizing, brush plating, chrome plating; other lucrative fields. Learn easily. Free particulars. Joseph B. Kushner Electroplating School, Stroudsburg 50, Pennsylvania.

**\$46 FROM** Square Foot Plywood; Jigsaw necessary. Write: Woodart, Bridgewater, Massachusetts.

**BUY** it wholesale. Manufacturers, Distributors. Over 850,000 items. Literature free. Olsen, 1231-B East Third St., Duluth 5, Minnesota.

**COLORGLAZED** Concrete Pottery made without molds. Patented method. Cemetery products, novelties, tiles. Basement leak-sealing. Money-making projects. Booklet, details free. Men only. National Potteries, Grand Rapids, "Minnesota"

**FREE** Illustrated course casting novelties. Genuine latex for molds. Major Chemical Co., 164 Portland St., Cambridge, Mass.

# POPULAR SCIENCE OPPORTUNITIES

**LIQUID Rubber**, make flexible molds. Free Sample. Chaney, 1130 E. 16th St., Jacksonville 6, Fla.

**START Own Mailorder Business**, Details Free. Laird's, 1309B, North Princeton, Albuquerque, New Mexico.

**METALLIZING (Plating) Equipment**, Supplies, Hard-to-Get Chemicals and Anodes. Complete assemblies for plating baby shoes, jewelry, novelties and industrial products; copper, bronze, gold, silver, nickel, chrome, etc. Home workshop to production shops priced from \$79.50 complete. World's largest line of metals, onyx and marble mounts for bronzed baby shoes. Instructions furnished. Buy Direct from Manufacturer. Write for Free catalog and address of local branch, Hollywood Bronze Supply, 1624 East First Street, Los Angeles 23, California.

**"SEWING Machine Business Guide"** covers sales, services, rentals, conversions, wholesale supply sources. New, complete guaranteed, \$3.00 postpaid. Literature free. Century, 1321 Melbourne, Corpus Christi, Texas.

**UNPAINTED Figurines, Lamp Bases**, Finest Selection. Write For List, Wells' Decorative Arts, 3632 W. Flagler, Miami, Florida.

**\$124.50 WEEKLY guaranteed!** At home. Sparetime, Easy, Pleasant, \$1.00 [deposit]. Science Syndicate, Box 1140-A1, Wilson, North Carolina.

## 57 MONEY MAKING OPPORTUNITIES

**INDEPENDENT income!** Make leather belts, billfolds, purses. Big catalog and genuine steerhide keyholder, 10c. Tandy Leather, Box 397G, Tulsa, Okla.

**BE Independent Operate Vending Machines Full Or Part Time**, Small Investment, Long Profits, Details Free. T. O. Thomas Co., 1572 Jefferson, Paducah, Ky.

**MONEY Made Tanning Furs—Leather**, Copyrighted Instructions, Roy Herrington, Rt. 2, Ontario, Oregon.

**\$5 HOUR Easy!** Sell name plates for houses. Free Sample, order blanks. Write: National, 214 Summer, Boston, Mass.

**DETECTIVES Earn Big Money**, Experience unnecessary. Detective Particulars free. Wagoner, P-125 West 86th, N. Y. 24.

**SCHOOL Seniors—Earn sensational profits** selling classmates America's Most Beautiful Graduation Name Cards. Largest selection, outsells all others. Free sample kit. Printcraft Dept. P, 1425 E. Elm Street, Scranton 5, Pa.

**QUICK profits** taking magazine subscriptions, handling greeting cards. Casell Publishers Service, Westfield, N. J.

**PROFITABLE Home Business**, Make fast-selling Easter, Mother's Day flowers, monkey trees, dolls. Literature free. Velva, Dept. X, Bohemia, N. Y.

**BOOKKEEPERS: Earn up to \$520 month** part or full time serving small firms. Simplified System; Free Details, Tax Saver System, Dept. A, Fort Worth 2, Texas.

**RAISE your business value**, standing, as State Notary Public. Information, Stationers, Helotes 50, Texas.

**UNPAINTED Novelties**, Good Profits. List Free. Novelty Products, 146 Railroad St., Tiffin, Ohio.

**\$250 WEEK Reported!** Free book "505 Odd Successful Businesses." Work home! Expect something odd! Pacific-E, Ocean-side, California.

**\$35 WEEK extra!** Operating proven business and moneymaking plans. Nacci, 7731 Heyden, Detroit, Michigan.

**MIMEOGRAPHED newspaper** clears \$50 weekly. Copy 25c. Advertiser, Ajax, Ont.

**PROFITABLE mailorder magazine** 25c. Filey, 3519 St. Charles, Cincinnati 8, Ohio.

**EARN Money Evenings**, copying and duplicating comic cartoons for advertisers. Adservice, Argyle 2, Wisconsin.

**MONEY from Water, Salt and Air**. Send \$1.00 for copyrighted information. Box 1372, Des Moines 5, Iowa.

**INEXPENSIVE Fire Extinguishers** From Light bulbs, now Possible. Complete Instructions Only \$1.00 Postpaid. Fred A. Lewis, Box 104, Kensington Sta., Brooklyn, N. Y.

**LEARN Auctioneering** by mail or working with successful auctioneer. \$100.00 daily often earned! Revolutionary new method gives you actual experience at home. Advance Auction School, 5944-J North Newark, Chicago 31, Ill.

**NEW Patented, Hobby-horse**, It walks. It rocks. Exclusive territory. Manufacturing rights. Free details. Carl Markowski, Lewiston, Idaho.

**SHELLCRAFT! Make Beautiful Seashell Jewelry And Novelties**, Income or Hobby. Supplies, Instructions. (Buy Direct) Pace's, Cortez, Fla.

**HOBBYIST Earn Extra Money**, Free Literature, Laird's, 1309B, North Princeton, Albuquerque, New Mexico.

**PRINT Without a Printing Press**, Big Profits. See Page 61.

## 58 FORMULAS, PLANS, ETC.

**FORMULAS**, trade secrets, for nearly everything. Catalog free. Creative Publishers, Winnetka 7, Illinois.

**FORMULAS—All kinds**, Latest products. Literature free. Kemico, Park Ridge 15, Ill.

**MAKE artificial gold**, Instructions \$1.00. Western Laboratories, 1124 East Apache St., Phoenix, Arizona.

**FREE Formula Catalog** anything analyzed \$20.00. Western Chemical, Salem, Ore.

**10,000 FORMULAS and Trade Secrets**, Free Literature, Stillmans, 555 Kingston Ave., Brooklyn 3, N. Y.

**ELECTRONIC Construction Plans** Drawn, Models Built, Portable Geiger Counter, Sepcial, \$45.00. Island Engineering, Box 263, Great Neck, L. I., N. Y.

**WRITE For Miller's Monthly Messenger** Listing Newest 1951 Money-Making Formulas. Fifty Years Supplying The Best. Miller, Manufacturing Consultant, Tampa, Florida.

**LABORATORY tested formulas**, Lists free. Pont, Box 635-PS, Terre Haute, Ind.

## 59 PLASTICS

**LEARN Plastics at home**, Small cost—spare time. Complete experimental outfit and full instructions furnished. Details free. Plastic Projects, Box 5151-D, Detroit 35, Michigan.

**PLASTIC supplies**, materials, instructions for hobby or business. Send for free catalog. Tells about internal carving. Hays Plastics, 1310 82nd Ave., Oakland, Calif.

**NEW liquid plastic**, Clear, colors. Cast without heat. Embed flowers, insects, coins. Saw, drill, carve. Free Folder, "Liquid Magic," shows fine things you can make and sell. Write today. Castolite, Dept. B-102, Woodstock, Illinois.

**LUCITE, Plexiglas**, Any size sheets, masked Square foot (12 x 12) cost 1/16", \$1.20; 1/8", \$1.40; 3/16", \$1.75; 1/4", \$2.08. Colors add 10%. Include 10% postage. Almac Plastics, 230 Fifth Avenue, New York 1, New York.

**PLASTIC Sheets, Rods, Tubes, etc.** Free List. Plastic Supply Co., 2901 N. Grand Blvd., St. Louis 7, Mo.

**LUCITE, plexiglas, Acetate**, 85 different colors, thicknesses. Immediate shipment from stock. Rod, Tube, Casting plastic. Wholesale, retail. Catalog, instructions, bargain lists, 10c. Gem-O-Lite, Box 686Y, North Hollywood, Calif.

**PLASTIC letters for Signs, House Numbers, etc.** Samples 25c. Plastic Exchange, Box 302, Bradenton 5, Fla.

## 60 CHEMICALS AND APPARATUS

**NEW Idea Chemical and Apparatus** Outfits for Home Experimenting. Photo-Scales, Microscopes, Chemicals, Biological and Laboratory Supplies in Small Quantities. Catalog 15c. Established 1931. John H. Winn, 124-B West 23rd Street, New York 11, N. Y.

**LABORATORY Apparatus, Chemicals**, Microscopes, Complete Chemistry Sets, Minerals, Uranium Ore, 10c brings catalog. Porter Chemical Company, Hagerstown 2, Maryland.

**ILLUSTRATED Catalog: Chemistry, mineralogy, biology**, 10c. Tracey Laboratories, Evanston, Illinois.

**LUMINOUS Paints** will glow in dark. Six colors. Fairmount Chemical Co., 136 Liberty St., New York City 6.

**CHEMICALS and apparatus** for industrial, analytical, and private laboratories. Catalog 15c. Dept. M-26, Biological Supply Co., 1176 Mt. Hope Ave., Rochester 20, N. Y.

**SAVE on chemicals, supplies**, Catalog 10c. Laboratory Sales, Box 161, Brighton, Massachusetts.

**URANIUM ore sample, weighing scale**, catalog of chemicals, apparatus, kits, \$1.00. Catalog only, 10c. Rex Laboratories, 2849-B Birchwood, Chicago 45, Illinois.

**LABORATORY chemicals and apparatus**, New catalogue 10c. Luther Laboratories, New Britain, Connecticut.

**OH Boy! New Book Of Science**, Experiments, Formulas, Secret Processes, together with Catalogue of Laboratory Supplies, Only 25c. National Scientific Company, Dept. 15, 2204 W. North Avenue, Chicago 47, Illinois.

## 61 HELP WANTED

**CONSTRUCTION Workers!** Where is your next job going to be? Learn where the big jobs are. Bigger pay checks! Longer jobs! Big job list, Latest information, Accurate, Don't delay. Send today, \$1.00. Dempster's Construction Scout News, Dept. 268-DB, Bridgeport, Ill.

**HONOLULU, Hawaii Employment?** Latest male and female help wanted columns airmailed for \$1.00. Certified Services, #3 Campbell Block, Honolulu, Hawaii.

**ALASKA—America's Frontier**, \$1.00 brings 1951 Business Directory, Large Government Map giving Up-To-Date Construction Projects, Current employment information, Homestead & Highway facts, Hunting-Fishing-Game Rules, Firms hiring & application forms, Alaska Opportunist, P.O. Box 883-S, Hollywood 28, Calif.

**FOREIGN & Latin American Employment**, 1951 "Foreign Service Directory" gives Up-To-Minute Facts on Military & Civilian Construction, Government Jobs, Major Oil Listings, Aviation, Transportation, Steamship Lines, Mining, Importers, Exporters, How-When-Where to apply, application forms, Hot List Firms Hiring, \$1.00 post-paid, Global Reports, P.O. Box 883-S, Hollywood 28, Calif.

**FOREIGN & Domestic Construction Projects**, \$1.00 brings Report published each month on World Wide Jobs in Canada, South America, Arabia, India, Africa, Alaska. How to apply & application forms. Jobs, P.O. Box 883-PX, Hollywood 28, Calif.

**\$5 HOUR Easy!** Sell name plates for houses. Free Sample, order blanks. Write: National, 214 Summer, Boston, Mass.

**HELP Wanted**, Reliable person to address and mail post cards in spare time, from your home town. Good pay. Sample card with printed instructions 10c. None free. W. E. Martin, 1148C Lawson St., Martinsville, Va.

**FOREIGN Employment Construction Men, Building Trades, Mechanics, Helpers, Office Men**, Good workers interested in Foreign Development projects, Pipe Lines, Dams, power plants, Roadways, Shipping, oil Refineries, etc. Transportation and quarters furnished; High Wages. Listings of firms actively working on projects in Arabia, Persian Gulf, Africa, Alaska, Canada, South America, Europe, etc. Send \$1.00 for Foreign Construction Compendium and Application forms. Foreign Service Bureau, Dept. PS-2 (Employment), P. O. Box 295, Metuchen, N. J.

**DOLLAR brings Project Directory**; 150 Projects and branches; application form. Foreign Service, Box 3980, Miami, Fla.

**MAN to earn \$85 week and up**, Long needed invention, Advertised in Saturday Evening Post, Full or part time. Exclusive Territory. No investment. Free sample outfit. Write Red Comet, Inc., Dept. 867, Littleton, Colorado.

## 62 AGENTS WANTED

**EXTRA money!** Free gift offers! Sell friends extraordinary 21 for \$1.00. Metallic, Humorous greeting cards, Gift wrappings, novelties, Big profits, Bonus, Experience unnecessary. Request Feature All-Occasion assortments on approval, free samples Name Imprinted Stationery, Napkins, Towels, and free Catalog. New England Art Publishers, North Abington 418A, Massachusetts.

# POPULAR SCIENCE OPPORTUNITIES

**STRANGE "Dry" Window Cleaner.** Sells like wild. Replaces messy rags, liquids. Simply glide over glass. Samples sent on trial. Kristee 124, Akron, Ohio.

**FREE Samples, and amazing plan,** giving you gorgeous Dress without penny cost. Rush name today, with dress size. Harford, Dept. 335, Cincinnati 25, Ohio.

**SELL Ultra-blue stock signs to stores.** 1000 slogans, comedy, general, religious. 7" x 11" cost 6c, sells 35c. Make money. 15 samples \$1.00 postpaid. Lowy, 812 Broadway, Dept. 608, New York.

**\$3.00 AN hour selling cushioned shoes direct.** Advance commissions. Bonus. No investment. Experience unnecessary. Free outfit. Samples. Paragon Shoes, 738 Columbus, Boston, Mass.

**SELL new clothing. Lowest Prices.** Operate from home, auto, store. Enormous Profits. Big Catalog Free. S&N, 565-AB Roosevelt, Chicago 7.

**NYLON'S First Quality. Low Mill Prices.** Miracle Manufacturers, Conshohocken, Pa.

**TO \$35.00 Weekly. Spare Time. Home Operated Mail Order Business.** Successful Small "Beginner's" Plan. Everything Supplied. Lynn, 5710-C Bankfield, Culver City, California.

**\$5 HOUR Easy! Sell name plates for houses.** Free Sample, order blanks. Write: National, 214 Summer, Boston, Mass.

**WHERE To Buy 800,000 articles direct from Manufacturers.** Save by buying direct. Sent Free. "Your Profits Under the Spotlight." Glass Pub. Co., Ellwood City 3, Pennsylvania.

**COMMERCIAL Deep Frying Course.** Mock Chicken Legs, Potatoes. New and proven methods. Learn about this money-making field. \$2.50. PP. Concession. Toledo 13, Ohio.

**NEW Jobs open in selling! Send name, address for five free issues of Opportunity Magazine's money-making guide.** listing hundreds of companies who'll pay you well, full or part-time. No experience needed. Opportunity, 28 E. Jackson, Dept. 18, Chicago 4, Illinois.

**DRESSES 18c; Coats \$1.00; Blouses 35c;** Free Catalog; Crown, 164-PB, Monroe St., New York 2.

**SCHOOL Seniors! A postal will bring you our wonder, Kwick-Sell Cardalog of popular Graduation Name Cards.** Biggest profits! Only firm giving free Golden Memory Book and Souvenir Chest. Don't miss out. Hurry that postal! Craftcards, Box 235 (m), Pittsburgh 30, Pa.

**AGENTS—300% profit selling genuine gold window letters; stores and offices.** Free samples. Metallic Letter Co., 437 N. Clark, Chicago.

**AGENTS—Big Line Including Food Products.** Fast selling premium and bargain deals. Low prices. Send card for big outfit offer with gift. Ho-Ro-Co., 2771 Dodier, St. Louis 7, Mo.

**NYLON, Poplin, Rayon Uniforms, white and colors.** Immediate Delivery. Immediate Profits. Sell to Doctors, Dentists, Nurses, Waitresses, Beauticians, Housewives. Free Sales Kit. Superior Fabrics, Dept. A-2, 3936 Market St., Phila. 4, Pa.

**START Your Own Business on credit.** Always your own boss. 1559 Dealers sold \$5,000 to \$28,000 in 1949; their average \$6,834. We supply stocks, equipment on credit. 200 home necessities. Selling experience unnecessary to start. Wonderful opportunity to own pleasant profitable business backed by world-wide industry. Write Rawleigh's, Dept. B-U-PSC, Freeport, Ill.

**GOLD lacquered Window Sign Letters.** Large Sizes Penny Each. New foils. Absolutely Beautiful. Free Samples. Atlas, 544 W. 79th, Chicago 20.

**FAST profits—No investment.** Send for big, free catalog. Plastic aprons, tablecloths, etc. 150 sure-fire items. We guarantee sales. Write The Halliday Co., Dept. P, 15-19 Pennington Ave., Passaic, N. J.

**IS \$210, a week worth a penny postcard to you? Then rush card with name and address for special Free Trial Plan that sells amazing new Automatic Refrigerator Defroster "like hot cakes!"** Write to Mr. Lewis, D-Frost-O-Matic Corp., Dept. PSC-2, 6 N. Michigan, Chicago 2, Ill.

**OUR Agents Make Big Money selling all-occasion greeting cards.** Terrific box of 21 only \$1.00. Over 75 other boxes. Profits to 100% plus bonus. Free samples. Kit on approval. Regal Greetings, Hazel Park 56, Michigan.

**BE A Money Maker . . . Use your home as magazine headquarters.** Liberal commissions. No experience—No capital needed. Everything furnished. Write for Free Catalog. McGregor Magazine Agency, Dept. 510A, Mount Morris, Ill.

**NO experience needed to make money fast for yourself or organization.** Sell gorgeous new All-Occasion assortments. 21 cards \$1.00. Valentines, Easter Cards, Religious, Novelties, unusual gifts. Scented Stationery, Notes, Wrappings. Over 100 items. "Get Started" plan. Write for samples on approval. Hedenkamp, 361 Broadway, Dept. PS-11, New York.

**PHOTO-Salesmen-Agents.** Sell beautiful hand colored plastic enlargements and sensational new photo compacts, rings, bracelets, lockets, etc. Collect deposit, we deliver. Profitable sideline. Send card for Free sample kit. Novel Portrait Co., 3343-A North Ave., Chicago, Ill.

**FREE sample nylon stocking of world's only nationally advertised hosiery line actually guaranteed against runs, snags or excessive wear, regardless of cause!** It's amazing but true. Every weight from sheerest 15 denier to heavy 70 denier—all gauges to luxury 60 gauge. Amazingly low prices, starting at \$1.08 prepaid for sheerest 15 denier 51 gauge. Not sold in stores. Good Housekeeping Guarantee Seal. Also complete line men's hosiery guaranteed one full year or replaced free. Full variety lingerie in crepe, satin and nylon, featuring all nylon slip at \$2.95, satin slip at \$1.58, etc. Housecoats and robes. Kendex sales people will earn one million dollars this year. Get your share. No money or experience needed. Pay nothing now or later. Just show free outfits. Write orders. We deliver and collect. Advance cash plus huge bonus. Earn money spare or full time. Become manager—appoint others to sell for you—earn steady income on their sales. Man or woman—young or old, you can earn more money than you ever thought possible. Everything you need is furnished free and prepaid, including nylon stocking, samples of materials, sales books, 36-page salesmanual, color cards, etc. Simply write your name and address on postcard and mail to Kendex Corporation, Babylon 24, N. Y.

**JEWELRY For Salesmen Distributors Direct Factory.** Catalog Free. Pickcraft (c 19) Bank St., Attleboro, Mass.

**MAKE Perfume—Big Profits—Mailorder—Expect Secrets—Write "Imso".** 6347 Farnell-PA-2, Chicago 21, Illinois.

**FREE SAMPLES.** Big profits showing amazing Glow-in-the-Dark specialties. House numbers, pictures, plastic novelties, ashtrays, keyholders, religious and nursery objects, etc. Madison Plastics, 303 Fourth Ave., New York 10, N. Y.

**ABSOLUTELY Free! Big package actual sample fabrics and style presentation of dresses, lingerie, hosiery, etc.** Take orders. Commissions big. Send no money. Melville Co., Dept. 7007, Cincinnati 25, Ohio.

**NEW "Sponge" Wall Cleaner.** Erases dirt like magic. Wallpaper, painted walls, ceilings. Saves redecorating. Lightning seller. Samples sent on trial. Kristee 123, Akron, Ohio.

**BRAND New! Amazingly different and smart Everyday Cards, 21 for \$1.** Magic Window Designs. Take Easy orders. Make up to 100% Cash Profit. Big line \$1 Assortments, Personal Stationery, Imprinted Matches. Free Imprint Samples. Assortments on approval. North Star, 31 Glenwood, Dept. R-19, Minneapolis, Minn.

**GREETING card salespeople, \$50 without risk.** Sell America's leading 21 card. Everyday Boxes—samples on approval. Amazing newest gift items. Free samples. 150 for \$1.00 Personalized Stationery. Write today. Lorain Art Studios, Dept. F-45, Vermillion, Ohio.

**SELL Du Pont Nylon Uniforms.** Complete line famous exclusive Hoover Styled nylon uniforms for beauty shops, nurses, doctors, waitresses, others. Best quality, splendid values. Exceptional income. Real future. Equipment free. Write fully. Hoover, Dept. L-101, New York 11, N. Y.

**JUST Out! New Thrilling sensation in Everyday Cards.** Rich foils, satins, velours sell on sight, 21 for \$1. Make up to 100% profit. 50 Assortments, Imprint Stationery and Book Matches, Gift Items. Two \$1 Assortments on approval, Imprints Free! Joy Greetings, 507 N. Cardinal, Dept. G-61, St. Louis, Mo.

**AT Last! Something New and Sensational in Everyday Cards, 21 for \$1.** Make Extra Money Fast! Show Satin, Velour, Metallic Cards. Get orders easy. Big line \$1 Assortments, Scented Stationery, Personal Matches, Kiddie Books, Imprints Free. Two \$1 boxes On Approval. Puro Co., 2801 Locust, Dept. 141-B, St. Louis 3, Mo.

**MAKE Money Calling On Friends! Show nationally advertised Greeting Card Assortments—new All-Occasion Assortment and laugh-packed Barrel-of-Fun Assortment.** Sells for \$1.00—up to 50c profit for you! Also Personal Notes, Gift Wrappings, Stationery, Gift Items, others! Get Two assortments on approval. Write Wallace Brown, 225 Fifth Ave., Dept. S-4, New York 10.

**AMAZING New Way to Earn Money Quickly and Easily with Gifts, Stationery, Cards.** No Experience Necessary. Send Now for Free Home Demonstrator and All Else Needed. 2 Best Sellers on Approval. Terry Studios, 501 Westfield, Mass.

**EXTRA cash—easy! Sell friends newest design 21 for \$1.00, Dark Card, Novelty All-Occasion greeting card assortments.** Gift Wraps, Animated Books. Profits to 50c per \$1.00 box. Special offers. Bonus. Prompt Service. Experience unnecessary. Write today for free samples Name Imprinted Scented Stationery, Napkins, Book Matches, feature assortments on approval, free catalog, selling plans. Elmira Greeting Card Co., 2210 Elmira, New York.

**AMAZING discovery.** Master Glaze, puts brilliant glass-like surface on cars. Free Sample, information. Big commissions. Master Glaze, Dept. 709, 7720 Harwood, Milwaukee, Wisc.

**DO you need money? \$40.00 is yours for selling only 50 boxes of our 200 Greeting Card line.** And this can be done in a single day. Free samples. Other leading boxes on approval. Many surprise items. Experience unnecessary. Free samples Personalized Stationery, Napkins. Write today. It costs nothing to try. Cheerful Card Co., 118 White Plains, N. Y.

**ADVERTISING book matches—Cash in on big demand—sell Union Label matches.** Cuts for all businesses and political parties—Free powerhouse selling kit—low prices—protection guaranteed on repeat orders—Cash commissions. Superior Match Co., Dept. P-251, 7530 Greenwood, Chicago.

**FREE! Let me send you food and household products to test in your home.** Tell your friends, make money. Rush name. Zanol, Dept. 9091-B Richmond St., Cincinnati 3, Ohio.

**WOULD You pay 3%—first \$350 made? Book "505 Odd Successful Businesses" free!** Expect something odd! Pacific-PS, Oceanside, Calif.

**NYLONS Direct from Factory to Wearer.** Only way you get fresh nylon, that's why can guarantee against runs. Sample Free. Pay High Comm. Advance Cash plus 40% Bonus. Sell Women necessities needed all year: Nylon Slips, Panties, Gowns, Robes. Also Ergim Gold Chains and Religious Medals. Become Manager, have your own Salesmen. We pay 40% Comm. on Salesmen's earnings. Ergim Co., 992 Columbus Ave., New York.

**SELL Big Money-Maker to Men and Women.** Easy handwork makes fast-selling useful articles. Sample free. Sunmade Company, Brockton 64, Mass.

**EASIEST money you ever made! Big commissions selling work shoes guaranteed six months, exclusive cushioned shoes.** Free outfit. Concordian Shoes, 16-A West Concord, Massachusetts.

**BUY thousands of nationally advertised products direct from manufacturers and distributors.** Write for "Buy Direct and Save." Service Publishing, 1420-B Investment Bldg., Pittsburgh 22, Pa.

**MEXICAN feather pictures.** Sell on sight; 200% profit! Free details; sample 10c stamps. Sylvia-S1, Apartado 9036, Mexico City.



# POPULAR SCIENCE OPPORTUNITIES

LEOPARD Blankets. Simulated Diamonds. Tyrcha Wholesale, 4532 N. Meade Ave., Chicago 30, Ill.

SELL!! Balloons, Combs, Specialty Merchandise, Carleton House Distributors, Texas City, Texas.

SELL \$2. Fire Extinguishers. Locally, mailorder, Lorrac Products, Albany 1, N.Y.

NEED Extra Cash? Take orders for personal initialed belts and buckles, cap badges, tie holders, etc. Choice of 3000 emblems. Free sales kit. Hook-Fast, Box 1425PS, Providence, R. I.

POWER Mowers—\$59.95. Liberal deal. Delivered. Sales kit—Free. Rotacut, R-2002. Excelsior Springs, Mo.

POSITIVELY New. Over 100% Profit. Two Sided Reversible Neckties. Free Details. Farrell Company, Dept. C-19, 1377 Van Zandt, Cincinnati 31, Ohio.

PAINTS—All kinds. 65c gallon up. Private label. Big profits. Certified Products, Louisville, Ky.

FREE uniforms as bonus! Biggest commissions! Sell famous direct-from-factory Nylon uniforms to housewives, waitresses, nurses, others, full or part time. Exclusive styles. No experience or investment needed. Write today for free Style Book, Sales Guide, Upland Uniforms, 255 West 28th Street, Dept. H-4, New York.

UP to \$50.00 in a week spare time, and tailored suit for yourself without paying one cent. Write for plan, and Free Sample Case, Stonefield Corp., 532 S. Throop, Dept. P-821, Chicago 7, Ill.

## 63 HIGHGRADE SALESMEN

EXTRA money easy, taking orders for world-famous Stark-Brand Apple, Pear, Peach, other Fruit Trees, Grapes and Berries. Gorgeous Flowering Shrubs, Roses, etc. Sensational patented, hardy, quick-growing varieties. Enormous demand for yards, small plots, farms. No experience needed. Rush name for Free Plate Book and Sales Kit, Stark Bro's., Dept. 961, Louisiana, Mo.

FREE Sample & information. Sensational new fishermen's article. Nelson Company, Dept. G, St. Paul 2, Minnesota.

\$5 HOUR Easy! Sell name plates for houses. Free Sample, order blanks. Write, National, 214 Summer, Boston, Mass.

BIG Money Taking Orders: shirts, ties, Sox, pants, jackets, sweaters, shoes, uniforms, etc. Sales equipment free. Experience unnecessary. Nimrod, 4922-AV Lincoln, Chicago.

MAKE Money with famous, easy-selling Bostonian shirts—spare time, full time, sideline. Fabrics, outfit Free, Bostonian, 89 Bickford, Dept. B-11, Boston 30, Mass.

EARN Big Money Fast! Sell finest-quality advertising work uniforms to garages, factories, filling stations, etc. Free selling kit. Topps, Dept. 542, Rochester, Indiana.

RICH Opportunity for Men in Their 50's. Healthful, pleasant occupation. No investment needed. 150 of our men made \$500 to \$3,000 in one month; many just beginners. Heckman made \$104 first 2 hours; Crowley made \$224 first day; exceptional earnings. Openings available. Write President, Dept. PS-2, Fort Worth 1, Texas. (If you live in Canada write: President, 25 Industrial St., Dept. PS-2, Leaside, (Toronto, Ontario.)

MEN 30 or older. Top earnings. C. H. Libbey made over \$7,081.25 last year, even more this year. Call on building owners, schools, etc. with famous maintenance product 30% commission. Write in detail. Vice President, Dept. MC, Box 789, Fort Worth 1, Texas.

WANT to make real money? You can positively make \$50.00 a day and up selling a brand new item going to every type of food and beverage store, factories, Laboratories, Hospitals, etc. First time advertised. Write for Free Details today. Johnson-Hartman, 53 West Jackson Blvd., Dept. PS-2, Chicago 4, Illinois.

AD Matches! Sell Amazing Designs—20, 30, 40 and 240-light book matches. Big spot cash commissions; every business a prospect. Low prices for high quality. Repeats. Start without experience; men, women; full, part time. Buy Nothing! Sales kit furnished. Match Corp., Dept. PS-14, Chicago 32, Illinois.

EARN spare time extra money. Show amazing cushion comfort shoes. To \$3.25 commission per pair, plus big Cash Bonus. Experience unnecessary. Write for Free Catalog, full information. Tanners Shoes, 779, Boston, Mass.

## 67 EDUCATIONAL AND INSTRUCTION

LOGARITHMS Simplified. The dollar book that tells how logarithms save time and obtain accuracy in mathematical work. Written for students, shop men and others. Page Publications, McFarland, Wisconsin.

USED Correspondence Courses and Books sold and rented. Money back guarantee. Catalog free. (Courses Bought), Lee Mountain, Pisgah, Alabama.

LEARN Piano Tuning, Repairing—at home in 30 days. Unlimited income. Phonograph recordings, tools and instructions furnished. Write Capitol City Tuning School, Department C-233, 129 East Michigan, Lansing 16, Michigan.

BOOKKEEPERS! Increase your earnings! Operate your own simplified "Dollar-A-Week" Bookkeeping and Tax Service. Full or spare time. Details Free. No obligation. Ellis, Box 203, Cedar Grove, North Carolina.

MEDICAL Laboratory Technicians in great demand. We train you in your own home. Catalogue free. Imperial Technical Institute, Box 973-B, Austin, Texas.

BECOME a Doctor of Psychology or Metaphysics. Teach secret of contentment, happiness. Win degree of PsD, or MsD. Solve mental worries. Free book. College of Universal Truth, 1553-K N. Clark, Chicago.

MAKE Up To \$35-\$45 Week as a Trained Practical Nurse! Learn quickly at home. Booklet free. Chicago School of Nursing, Dept. M-2, Chicago.

PIANO Tuning Pays. Learn this profitable profession at home. Our Tonometer and mechanical aids make learning easy. No knowledge music necessary. Diploma granted. Largest and oldest school—51st year. G. I. Approved. Write for booklet. Niles Bryant School, 77 Bryant Bldg., Washington 16, D. C.

AMAZING new scientific way to remember. Free Details. H. Kaye, P.O. Box 261, S. I. #1, New York.

ACHIEVE business and financial success in your own collection-Credit Agency business. Home or office. Quickly learned. Free folder. Write Cole & Associates, Syracuse 2, N. Y.

YOU for President of your own credit-collection agency. Many who answered our ads now have their names on office doors. Franklin Credit, Roanoke 7, Va.

SELF-HYPNOSIS. Infallible method! \$1.00. Hampton, 3121 Hamilton Way, Los Angeles 26, California.

CORRESPONDENCE courses bought, sold, rented. Write Baker, 5509-A Winthrop, Chicago 40.

WELDING training pays at Hobart Welding School, Box P-213, Troy, Ohio. VA Contract. Best equipment. Catalog Free.

EARN While You Learn. Day or Night Classes. Thorough courses in: Automobile Mechanics, Diesel Mechanics, Motor Tune-Up, Auto Body and Fender, Welding, Refrigeration, Radio, Etc. Living accommodations. Veterans may earn \$210 to \$290 per month while in school including subsistence. Fully Accredited to Train Veterans. Thirty-two Years' Experience Training Men, Nashville Technical College, Dept. #251, Y.M.C.A. Bldg., Nashville 3, Tenn.

USED Correspondence Courses and Educational Books Bought, Sold, Rented, Catalog Free. Educational Exchange, Summerville, Georgia.

READ 100% Faster! New Amazing Method. Save time. Learn more. Earn more! Free home test. Speed-Reading, 9111-T Hoyne, Chicago 20.

MULTIPLY Your Income! Finance, Business, Stock Market, Investment, Economics Course \$1.00. Refundable. Titan Company, 45 Clinton St., Newark 2, N. J.

EARN \$10,000 annually! Learners \$2,700. Unlimited opportunities in Merchant Marine. Instruction-Employment Manual \$1.00. Refundable-Titan Company, 45 Clinton St., Newark 2, N. J.

SHORT writing in week. Lesson ten cents. Elliott, 4426 Carrollton, New Orleans, La.

## 69 CONTESTS

WIN Cash, Cars in Prize Contests! Write for copy filled with current contests, winning hints and tips. Send only 25c. Wright Contest Digest, Dept. 20-B, P. O. Box 2266, St. Louis 9, Missouri.

## 70 LANGUAGE OUTFITS

IT'S Fun Learning A Language by Linguaphone. At home, in leisure time, quickly, easily, correctly master Spanish, French, German, Russian, Oriental—any one of 29 languages through Linguaphone Conversational Method. Add to service, job, travel opportunities. Send for free book, Linguaphone Institute, 5402 Rockefeller Plaza, New York City.

## 72 AUTHORS SERVICE

I WANT New Writers to cash checks of \$1 to \$100 offered daily. The easiest way to write for pay. No previous experience necessary. Free Details. Saunders M. Cummings, 468-15 Independence Bldg., Colorado Springs, Colo.

SUCCESSFUL writer reveals "Tips for Beginning Authors". Booklet 10c. Send to: Career Aids, Dept. PS 2, 204 East 81, New York 28, N. Y.

## 74 CARTOONING, SIGN PAINTING, DRAWING AIDS

"HOW To Make Money With Simple Cartoons"—A book everyone who likes to draw should have. It is free; no obligation. Simply address Cartoonists' Exchange, Dept. 192-C, Pleasant Hill, Ohio.

LEARN Sign painting, 152 Lesson Course. Results Guaranteed. Stewart Sign Co., Box 287M, Pasadena, California.

UP To \$4.50 an hour, spare time, if you can do small, simple lettering. Details Free. National Artists, Dept. C, 801 North Marsalis, Dallas 8, Texas.

ARTISTIC Back dated Art Magazines. Eight \$1; 36 \$3.50 postpaid. Art bargains. Catalogue 10c. Art Book Shop, Arnold 5B, Missouri.

CARTOONISTS, artists, earn \$100-\$200 monthly, sparetime. Proven Plans \$2.00. Jay Borosky, 1571 Fulton, San Francisco, California.

SIGN painting taught at home. Test lesson free. Ben Kerns, Box 812-PS, Greenville, S. C.

## 75 CHALK TALK-STUNTS

CHALK Talks. Laugh Producing Program. \$1.00. Illustrated Catalog 10c. Cartoonist Balda, Oshkosh, Wisconsin.

## 76 TYPEWRITERS AND OFFICE MACHINES

PRINTOMATIC selffeeding Post Card printing Duplicator \$13.50. Envelope Addressing Machines \$24.50. Pittsburgh Typewriter Company, 336-G Fourth Avenue, Pittsburgh 22, Pa.

RECONDITIONED typewriter office machines. Bargains. Write Dixie Service, King, N. Carolina.

TYPEWRITER Sale. Up to 50% Discount from Original Price. Catalogue Free. Apple, 933a Westchester Ave., N. Y. 59, N. Y.

## 77 OFFICE SUPPLIES & EQUIPMENT

TYPEWRITERS \$27.50; Adders \$12.50. Duplicators \$12.50. Addressers \$9.95. Meier's, 118N Spruce, Wichita, Kansas.

## 79 PRINTING OUTFITS, SUPPLIES

PRINT your own cards, stationery, circulars, advertising. Save money. Simple rules. Print for others, nice profit. Raised printing like engraving too. Have home shop. Details free. Kelsey Presses, L-8, Meriden, Connecticut.

PRINTING Presses. Type Supplies. Lists 3c. Turnbaugh Service, Loysville, Penna.

PRESSES, Supplies, Paper. Catalog 10c. Printers Supply, 211-S, Springfield, Mo.

MAKE Your Own printing cuts. Self-molding process. Plexirubber, Argyle 2, Wis.

# POPULAR SCIENCE OPPORTUNITIES

80

## PRINTING, MULTIGRAPHING, ETC.

\$1.00: 50 8½x11 LETTERHEADS With Envelopes. Benneville, Box 1931, Pittsburgh 30, Pa.

BEAUTIFUL Genuine Raised Letter Business Cards \$4.95—1000 Postpaid. Taylor Printing Company, 1823 Franklin Avenue, St. Louis 6, Missouri. Established 20 Years.

PHOTO-Offset Special; 5000—8½x11 \$14. Samples Free. Reiffe, 160-S Monroe St., New York 2.

1000 BUSINESS Cards \$2.50 Prepaid samples Free. Reliable Print Shop, 905 East Jefferson, Louisville 6 Ky.

1000 ATTRACTIVE embossed business cards; \$3.50. Balto. House, Box 951, Baltimore, Maryland.

BUSINESS Printing. Reasonable. Prices Free. Howprint, 723-S Eunice, Webster Groves 19, Missouri.

100 LETTERHEADS (8½x11 Hammermill) \$1.00 Postpaid. Envelopes same. Race Printing, Hudson, New York.

GUMMED Labels, Cards, Stationery. List free, Box PS-135, Spiro, Okla.

OFFSET Printing. Mimeo Prices! Samples. Athens, 2816-E Vaughn, Fort Worth 5, Texas.

BUSINESS Stationery. Low cost. Samples. Mero Products, 99 Morrison, Punxsutawney, Penna.

BUSINESS Cards with glamour. Free Samples. Roscoe Heavener, Colmar, Pa.

## 82 PATENT ATTORNEYS

INVENTORS—Send today for booklet "Patent Protection for Inventors" giving detailed patent information and preliminary steps to take toward patent protection.—also "Evidence of Invention" form. Victor J. Evans & Co., 641-B Merlin Building, Washington 6, D. C.

INVENTORS: Learn how to protect your invention. Unless the inventor is familiar with patent matters, he should engage a competent registered patent attorney or agent to represent him. We are registered to practice before the U. S. Patent Office and prepared to serve you in handling your patent matters. "Patent Guide for the Inventor" containing detailed information concerning patent protection and procedure with "Record of Invention" form will be forwarded to you upon request—without obligation. Clarence A. O'Brien & Harvey Jacobson, Registered Patent Attorneys, 12B-A District National Building, Washington, D. C.

PATENT practice before U. S. Patent Office. Validity and infringement investigations and opinions. Booklet and form "Evidence of Conception" forwarded upon request. Lancaster, Allwine & Rommel, Registered Patent Attorneys, Suite 413, 815—15th St. N.W., Washington 5, D. C.

C. A. Snow & Co.—S-427, Snow Building, Washington 1, D. C. Registered Patent Attorneys. Write for information.

INVENTORS: When you are satisfied that you have invented something of value write me, without obligation, for information as to what steps you should take to secure a Patent. Write Patrick D. Beavers (Formerly Randolph & Beavers) Registered Patent Atty., 938 Columbian Bldg., Washington 1, D. C.

INVENTORS. For "Record of Invention" form, contact Carl Miller, Registered Patent Attorney, Woolworth Building, New York.

INVENTORS: Without obligation, write for information explaining the steps you should take to secure a Patent. John N. Randolph, Registered Patent Attorney, 207 Columbian Bldg., Washington-1, D. C.

REGISTERED Patent Attorney offers services. Sanders, 6430 Evans, Chicago 37, Illinois.

INVENTORS: Write for free brochure "Evidence of Invention." Labiner, World Building, New York 7.

PATENTS—Irving L. McCathran, 316 McLachlen Bldg., Washington 1, D. C. Registered Patent Attorney.

INVENTOR'S Guide free on request. Frank Ledermann, Registered Patent Attorney, 154 Nassau St., New York 7.

INVENTORS—If you believe you have an invention, you should find out how to protect it. The firm of McMorrow, Berman & Davidson with offices in Washington, D. C., is qualified to take the necessary steps for you. Send for copy of our Patent Booklet "How to Protect Your Invention." We will also send you an "Invention Record" form. No obligation. They are yours for the asking. McMorrow, Berman & Davidson, Registered Patent Attorneys, 143-G Victor Building, Washington 1, D. C.

## 83 FOR INVENTORS

PATENT Searches \$5.00, including patent copies. Same reliable search as conducted for patent attorneys. Free protection forms, 48 hour service. Patent Service Institute, 945-B Pennsylvania Avenue, Washington 4, D. C.

CASH For your idea, 280 manufacturers need inventions, patented or unpatented. List free, Invention Bureau, 208-S Clinton, Oak Park, Illinois.

PATENT Protection—Unless you are thoroughly familiar with such matters, you are advised to employ a competent, registered Patent Attorney because the value of a patent depends largely upon the skillful preparation of the specification and claims. Send for booklet, "Patent Protection for Inventors", outlining preliminary steps to take to obtain patent protection. Victor J. Evans & Co., 642-B Merlin Building, Washington 6, D. C.

INVENTORS: Without obligation, write for information explaining the steps you should take to secure a Patent on your invention. John N. Randolph, Registered Patent Attorney, 206 Columbian Bldg., Washington 1, D. C.

INVENTORS. For "Record of Invention" form, contact Carl Miller, Registered Patent Attorney, Woolworth Building, New York.

SEARCHES—Put your patent searches in the hands of a Registered Patent Attorney or Agent, as he qualifies to give a worthwhile patentability report. Record of Invention form upon request and information on patent protection. Patrick D. Beavers, Registered Patent Attorney, 939 Columbian Bldg., Washington 1, D. C.

INVENTORS: Learn how to protect your invention. Unless the inventor is familiar with patent matters, he should engage a competent registered patent attorney or agent to represent him. We are registered to practice before the U. S. Patent Office and prepared to serve you in handling your patent matters. "Patent Guide for the Inventor" containing detailed information concerning patent protection and procedure with "Record of Invention" form will be forwarded to you upon request—without obligation. Clarence A. O'Brien & Harvey Jacobson, Registered Patent Attorneys, 12A-A District National Building, Washington, D. C.

INVENTORS—If you believe you have an invention, you should find out how to protect it. The firm of McMorrow, Berman & Davidson with offices in Washington, D. C., is qualified to take the necessary steps for you. Send for copy of our Patent Booklet "How to Protect Your Invention." We will also send you an "Invention Record" form. No obligation. They are yours for the asking. McMorrow, Berman & Davidson, Registered Patent Attorneys, 143-F Victor Building, Washington 1, D. C.

ACTION—Action—Action. Inventors with patented and patent pending inventions for sale or lease request Free book. No obligation. Dept. 2-F, U. S. Patent Exchange, 239 Hellman Bldg., Los Angeles 13, Calif.

INVENTORS: If you have an invention for sale, patented or unpatented, write Institute of American Inventors, Dept. 30A, 631-E St., N.W., Washington 6, D. C.

INVENTORS sell your patents quickly with minimum expense. "Short Cuts to Patent Sales" tells how. Prepared from years of experience. \$1.00 postpaid. Return privilege if not pleased. Jennings Bros., 118 Naples St., San Francisco 12.

INVENTION Sold, Leased, Patented, Unpatented; M. Joyce Humphries, 1424 Landtitle, Phila. 10.

INVENTORS! For complete services write: Industrial Patent Reports, Box 1081, Massachusetts and North Capitol, Washington 13, D. C.

PATENT Searches by former Patent Office Examiners \$5.00, 48-hour service. Protection forms free. Write Patent Engineering Service, 1404 New York Avenue, Washington 5, D. C.

## 84 INVENTIONS WANTED

PRACTICAL Inventions Wanted. Inventors Patent Exchange, Dept-D, Hartford 1, Connecticut.

CASH Or Royalty: Our unusual service sells inventions, patented, unpatented, because alert manufacturers constantly ask us for ideas. Also, we make special calls on live manufacturers, promoters, agent-houses, mail order houses, etc., in rich Chicago industrial area. List of needed ideas free. Inventors Sales Bureau, 208-T Clinton, Oak Park, Illinois.

INVENTIONS Promoted, Patented or Unpatented. Write Adam Fisher Company, 183-A Enright, St. Louis, Mo.

ACTION—Action—Action. Free book to inventors with patents and patent pending inventions for sale or lease. No obligation. Dept. 2-W, U. S. Patent Exchange, 239 Hellman Building, Los Angeles 13, Calif.

INVENTORS: Hundreds of manufacturers have requested our assistance in locating marketable new products. Complete information, free. Institute of American Inventors, Dept. 30C, 631—E Street, N.W., Washington 4, D. C.

INVENTORS—What have you, patented, unpatented to offer manufacturers? Request free booklet without obligation. Market Contacting & Data Service, 11106-B2 Longwood, Chicago 43.

## 85 PATENTS

INVENTORS: Test the commercial value of your patented or unpatented inventions, quickly and inexpensively. Write for free information. Institute of American Inventors, Dept. 30-B, 631-E St., N. W., Washington 6, D. C.

## 88 MANUFACTURING

POTATO Chip Machines sent on demonstration. Small deposit. Potato King Co., 2023 W. 22nd Place, Chicago 8, Ill.

## 89 MODELS, MODEL SUPPLIES

SHIP and Yacht model fittings; blueprints. Send 25c for illustrated catalog No. 26—Listing hundreds of items. A. J. Fisher, 1002-2 Etowah, Royal Oak, Mich.

BUILD Historic ship models, complete kits, 39c to \$9. Catalog 15c. Ideal Models, 21 West 18th, New York 11, N. Y.

SHIP Model and yacht supplies, complete large 64 page catalogue, 30c. Wm. Wild, 510 E. 11th St., New York City.

SHIP Models—most complete line in New England. Kits, parts, plans, books, tools. Engines and motors. Illustrated catalog, 25c. James Bliss & Co., Inc., 220 State St., Boston, Mass.

RAILROADERS, 50c Gets new Catalog—Reference Manual. State O or HO gauge. Walthers, 269 Erie, Milwaukee 2, Wis.

POWER Models. Unusual steam, gasoline and traction engines. Metals, tools, accessories. Catalog 50c. Charles Cole, Ventura, Calif.

BRASS gears and model supplies for the inventors. Send 10c for catalog. Pierce Model Works, Tinley Park, Ill.

SPEEDY 1" motor, runs atop flashlight battery. Parts, instructions, 50c. Fonskov, 27 Sunnycrest, Little Silver, N. J.

TWO Free Catalogues, Models—Magic, 10c Postage—Handling, Fun, Box VEE-ps, Avalon, Calif.

## 91 HOME CRAFTSMEN

SAVE On Leather Items. Make Easy-to-Assemble belts, purses, gloves, woolskin toys, etc., as gifts or to sell. Send 10c for big catalog. 100 Money-making ideas. Largest Leathercraft stock in U. S. J. C. Larson Co., 820 S. Tripp, Dept. 776, Chicago 24, Illinois.

MAKE leather belts, billfolds, purses. Big catalog and genuine steerhide keyholder, 10c. Tandy Leather, Box 397D, Tulsa, Oklahoma.

LEATHER, tools, lacing, supplies. Free Catalog. National Handicraft, 199 William St., New York 7.

# POPULAR SCIENCE OPPORTUNITIES

16 NEW lawn chairs, 22 picnic tables, benches, trellises etc. All 38 plans with necessary full size patterns, \$1.00. Mastercraft 23S, 7041 Olcott, Chicago 31, Illinois.

**REPLATE Your Own Silver and silver-plate copper, brass, bronze articles, worn chromium-plated brass, Wonder Silver-Plate rubs on with a cloth and silver-plates costume jewelry, ash trays, electrical and boating equipment, musical instruments, etc. 8 oz. bottle \$2.49, 3 for \$6.00 (check or M.O. postpaid), Orange Manufacturing, 545-5th Ave., New York City 17.**

**TURN your spare time into cash. Make quick-selling, highly profitable lamps—every home a prospect. No experience or special tools required. New 1951 56-page illustrated catalog shows shades, shade frames, figurines and bases, oil lamp converters, boring compounds, and dozens of similar items. Also all kinds of sockets, cords, pipes, harps, finials, bases, and hundreds of other parts—everything you need. Special 8-page section shows 6 beautiful lamps in kit form ready to assemble. You buy wholesale, sell at retail—make big profits. Hundreds doing it. You can, too. Send 25c today for catalog and wholesale price list. Refundable first order. Gearon Co., Dept. 500-A-2, 27 S. Desplaines, Chicago 6, Illinois.**

**LEATHERCRAFT Supplies, Leather & Tools. Low prices. Send 10c for catalog. Jonas Handicraft Co., (Dept. 2-B), 30 Frankfort St., New York 7.**

**TURN Workshop Into Cash. Send dime for new 32-page catalog describing hundreds things to make for fun, profit. Craft-plans, 1321-B South Michigan, Chicago 5.**

**8 BEAUTIFUL full-size whatnot patterns 35c. Joanness, P. O. Box 141-S, Omaha 7, Nebraska.**

**LEATHERCRAFT. Copper tooling. Textile painting. Make spare time profitable time! Free illustrated catalog shows everything you need. Kit Kraft, 7377 Melrose, Hollywood 46, California.**

**89 FULL size Jig Saw patterns of beautiful shelves, ornaments, toys, novelties. Plus "How, Where to Sell." Only \$1.00. Mastercraft 24S, 7041 Olcott, Chicago 31, Illinois.**

**KNOCKDOWN Cedar Chest. Lumber and Veneers. Free Price List. Gilles Co., Brownsboro, Alabama.**

**NEW leathercraft catalogue Pleasure & Profit, new styles, Belts, Purses, Shoes, largest leathercraft school in U.S.A. G.I. approved. Send 10c for catalogue. Dept. PS-2, Apache Leather Co., 2804 E. Washington St., Phoenix, Arizona.**

**NEW 96 PAGE Leather and Craft catalog, 1000's of items. Send 10c. Russo Handicraft Supplies, Dept. O-1, 245 South Spring, Los Angeles, California.**

**KNOCKDOWN 16 drawer chest solid wood, no veneer. Ask for illustrated price list. Henry E. Piltz, Box 148, East Orange 6, New Jersey.**

**70 LAWN-ornament and novelty patterns only \$1. Write at once for new, free, price-list. Mosbro Patterns, 44-R Victor, Mimico, Ontario**

**BRASS and Copper Materials, 24 page catalog 10 cents. Groundmaster Company, Div. B, Boulder, Colorado.**

**80 FULL sized patterns, toys, novelties, lawn ornaments, \$1.00. Modern Woodcraft, Saginaw, Michigan.**

**90 ALL new, full size lawn ornament and novelty patterns, up to 20" high. Only \$1.00. Mastercraft 22S, 7041 Olcott, Chicago 31, Illinois.**

## 93 BUILD IT YOURSELF

**BUILD Your Own "Tractor." Plans, Walking, riding. Free information. Ellsworth Tractor Co., D-5, Camptonville, Calif.**

**MODERNIZE your kitchen. Illustrated manual shows every step. Save 70% the Thombert way. Wholesale on knockdown parts. All for \$1.00. Thombert Company, Newton 21, Iowa.**

**BUILD with Concrete or Fieldstone. You Make Movable Form System. Free Literature. Smith PS, 2646 SE 122, Portland 66, Oregon.**

**FREE Literature describing needed Farm and Home Machinery, easily built by you from salvage materials. Kenneth Reeves, Box 3357-B, El Paso, Texas.**

**BUILD inexpensive Concrete Block-maker, also mixer. Motor-hand. Write Clyde Lee, Mountain View 1, Oklahoma.**

**GRANDFATHER clock building made easy. Shoptested photopack plans dollar. Kuempel Clocks, Minneapolis 16.**

## 94 WATCH REPAIRING

**WATCHES Completely Repaired; \$3.50. Guaranteed; Berkowitz, 1265 Olmstead Ave., Bronx 61, N. Y.**

**WATCHMAKERS' Journal contains helpful hints on watch repairing. Sample copy 20c. Dean Co., 116-B Nassau St., New York 7, New York.**

**WATCHES Rebuilt. Made to Run Like New. Friesen Jewelers, Buhler, Kansas.**

**LEARN Watch-Clock Repairing at home. While learning we fix all watches for you. Inquire Modern Technical Supply Co., 55-PS West 42 Street, New York 18, N. Y.**

**WATCHMAKERS Tools, Materials, Supplies. Repairs Catalog. Gales, Box 1000, Chicago 90, Ill.**

**WATCHMAKERS', Jewelers', Hobbyists', tools-supplies. Catalogue! Bengal Company, Culver City, California.**

## 95 OLD GOLD, WATCHES, ETC.

**HIGHEST Cash Paid For old, Broken Jewelry, Gold Teeth, Watches, Silverware, Diamonds, Spectacles, Platinum. Free information, Satisfaction Guaranteed. Government Licensed, Rose Smelting Company, 29-Y East Madison, Chicago.**

**WATCHES Wanted. Any condition. Also broken jewelry, spectacles, dental gold, diamonds, etc. Cash sent promptly. Mail articles today or write for free shipping container. Lowe's, Dept. PS, Holland Bldg., St. Louis 1, Mo.**

## 96 JEWELRY

**HIGHEST Cash Prices paid promptly for old and broken watches, jewelry, spectacles, dental gold, diamonds, etc. Mail articles today or write for Free shipping container. Lowe's, Dept. PS, Holland Bldg., St. Louis 1, Mo.**

**RHINESTONES, jewelry settings, cameos, sequins, beads. Catalog Free. J & M Novelties, Dept. CB-4, Griffith, Ind.**

## 97 TOBACCO & PIPES

**FREE Valuable "pipemaking" instructions! Exciting new hobby. Carvapipe, 2829-M Dixie, Hamilton, Ohio.**

## 98 RAZOR BLADES, SHAVERS

**100 GUARANTEED Finest Chrome double edge Blades \$1.00 Postpaid, Kaple Sales, 14 Oak, Shelby, Ohio.**

**FREE Pocket Knife With 100 Double Edge Razor Blades Guaranteed. Mail \$1.00 Bill. Payne, 5426 5th Ave., Los Angeles 43, Calif.**

**100 SUPERB Chrome Steel Razor Blades. Single or Double Edge, \$1.00—Pincus, 1755 St. Johns Pl., Brooklyn, N. Y.**

## 100 MISCELLANEOUS

**DRESSES 18c; Coats \$1.00; Blouses 35c. Free Catalog. Crown, 164-PC Monroe St., N. Y. 2.**

**YOUR Leather Jacket renovated expertly. Free circular, Berlew Mfg. Co., Dept. 7, Freeport, N. Y.**

**OUTDOOR Toilets, Cesspools, Septic Tanks cleaned, deodorized with amazing new product. Just mix dry powder with water; pour into toilet. Safe, no poisons. Save digging, pumping costs. Postcard brings free details. Burson Laboratories, Dept. D-13, Chicago 22, Illinois.**

**"INTERESTING Mails"—25c keeps your mail box full three months. Bentz, Jr., Desk C/70, Chatawa, Mississippi.**

**SUCCESS Simplified! Become a financial wizard; a mental giant; an athletic Superman; a romantic magnet; an expert in any field! Free literature. Success Society of America, Box 5852, Cleveland 1, Ohio.**

**PANNING Gold lesson—Catalogue Beginners supplies. Mining Books, Maps, "Where To Go". Free. Old Prospector, Box 729D2, Lodi, Calif.**

**BUYERS, or sellers located; Oddities antiques, property, anything of value. Registration, listing, \$1.00. (Refundable). Wright Publications, 2276-F Hubbard, Memphis 8, Tenn.**

**10 BALL Point Pens \$1. Postpaid. Cheaper than refills. Pojeskey, 37 H Poplar, Mt. Carmel, Pa.**

**BIG Mails Three Month, 25c, year Name Listed Directory \$1.00. Harvey Teeple, Decatur, Indiana.**

**MINERAL—Treasure Locators—Geiger Counters. Superior performance, lowest prices. Payment plan available. Free literature. Fisher Research Lab., Inc., Palo Alto, California.**

## 101 FOR SALE—MISCELLANEOUS

**BARGAINS Galore! 150 D.E. Blades \$1.00. Money Makers List 10c. Shively's, 2494 Fayette, McKeesport, Penna.**

**DRESSES 18c; Coats \$1.00; Blouses 35c. Free Catalogue. Crown, 164-PS Monroe Street, New York 2.**

## 102 WANTED MISCELLANEOUS

**SCRAP Mercury (Quicksilver) Tantalum—Bismuth—Tungsten. Metallurgical Products Co. Established 1909. 35th & Moore Sts., Philadelphia 45, Pa.**

## 103 FOR THE HOME

**"CUT own Hair" device \$2.00, notch-proof. Guaranteed. Mitchell's, Aurora, Ill.**

**GLO-Candles—Beautiful imitation candles—glow mysteriously from lite, lasts for years. Mail \$2 for pair to P. O. Box 28, Bronson, Mich.**

## 104 PERSONAL

**PSORIASIS Sufferers: Has everything failed to bring even temporary relief from scales, lesions and itching? Then write today for Free important information. You needn't invest one cent! Pixacol Company, Box 7097-S, Cleveland, Ohio.**

**PRAYERS For sale. Nine for one dollar. Many types. Send now. Florence Graham, 25½ Franklin Street, Danville, Illinois.**

**FREE Aptitude Testing booklet. Find right career. Write Vocational Center, Director, 2227 DeLancey, Philadelphia 3, Pennsylvania.**

**HONOLULU, Hawaii Postmark—Letters remailed \$1.00. Certified Remailers, #3 Campbell Block, Honolulu, Hawaii.**

**DETECTIVE'S Opportunities. Particulars free. Write, Wagoner, P-125 West 86th, New York 24.**

**INFORMATION for single people by Human Relations Consultant. Dr. B. Long, Box 375, Los Angeles 53, Calif.**

**BORROW by mail. Loans \$50 to \$300 to employed men and women. Easy, quick. Completely confidential. No endorsers. Repay in convenient monthly payments. Details free in plain envelope. Give occupation. State Finance Co., 210 State Finance Bldg., Dept. T-14, Des Moines 8, Iowa.**

**VALUABLE Big Mails, four months Listing, 25c. Wright Publications, 2276-J Hubbard, Memphis 8, Tenn.**

**INCREDIBLE! Unprecedented! Become a mental superman overnight! Floor everybody! No studying! 'memoprop' does all your thinking! It's uncanny! Revolutionary! Write: Bijou, Box 1727-V8, Hollywood 28, California.**

**PILES! Tormented with itching, bleeding, or protruding piles? Write for free important information. Shaf-Mey Products, Box 836-P, Cleveland 22, Ohio.**

**LOSING Your Hair? Have Dandruff? Itchy Scalp? Then send \$1.00 bill for effective scalp treatment formula. S. Viggiano, Pharmacist, 6556 Ladson, Pittsburgh 6, Penna.**

**HAIRSAVER booklet. Avoid Baldness. Send 25c coin to Woods, 966-76th St., Brooklyn, N. Y.**

**MEXICAN Law. General Practice Attorney. 1203 Arizona Street, El Paso, Texas.**

**SHOCKING Bubble Dancer 50c. Tupler Bros., 216 W. Jackson, Chicago.**

**PALM Beach Postmark. Letters Retailed 25c. Rogers, Box 887, Palm Beach, Florida.**

## 105 ADVICE

**"YOUR Problem is my Problem." Professional—Experienced consultants on any matter. Send \$1.00. Michael Pacilio, 218 Grand Street, N.Y.C. 13.**

24 WORDS in 50 Weeklies. \$4.96. H. J. Darnell. 730 Hays. Jackson. Tennessee.

ADVERTISE: 24 words. 40 Newspapers. \$3.50. Lists Free. Advertising Bureau. 10511-P Springfield. Chicago 43

BEFORE Advertising—get instructive Ad-Guide. ratebook 10c. Ideas developed. Advertisements prepared free. Chicago Advertising Agency (Established 1900). Chicago 4.

**115 DRAWING & ART SUPPLIES**

FREE Art Test. Give Age. Commercial. Box 8066. Dallas 5. Texas.

DRAFTING and artists' materials catalog—thousands of items—25c (deductible first \$2 order). Gordon's. 219 Madison. Chicago.

**117 TATTOOING SUPPLIES**

TATTOOING Outfits. Supplies. Illustrated List Free. Zeiss. 728 Lesley. Rockford. Illinois

**120 CANDY MAKING**

MEN-Women—"Everybody likes Candy." Learn to make professionally at home. (Our 40th year.) Ragsdale Candies. East Orange. New Jersey.

**121 FRUITS AND FOODS**

FOR a delicious, nutritious treat try Hiltner's Crystal Clear Honey. Finest Clover Honey. Gallon postpaid 4th zone \$3.00. Hiltner's Apiaries. North Creek. Ohio.

**124 TREES, SHRUBS, ROOTS, HERBS**

MULTIFLORA Rose. the living self repairing fence. For ornament, erosion control, windbreak, snow fence, other uses. A rapid grower. Raise from seed. Free planting guide. Woodlot Seed Co., Norway. Zone 2. Michigan.

**131 TREASURE FINDERS**

FORTUNE may be yours. Detect uranium, gold, silver, precious metals, minerals. America's finest Geiger Counters, metal and mineral detectors and mineralights. None finer at any price. Factory guaranteed. Write manufacturer for free information. Detectron Co., 5631 Cahuenga, North Hollywood, California.

SEEK Gold, Uranium, Buried Treasure! Latest low cost super-sensitive equipment. Free literature. Glen Scientific. Box 151-D. Glen Ellyn, Illinois.

TREASURE—M-Scope Geiger Counters—Mineral Locators. Why buy something inferior when you can buy the best at a lower price? Backed by years of experience. Fully guaranteed by factory. Detects minerals, metals, gold, silver, coins. Payment plan available. Proven superior performance. Free 16 page illustrated booklet. Fisher Research Lab., Inc., Palo Alto, Calif.

URANIUM prospecting information Free. Prospector. Box 142 C North Battleford. Saskatchewan. Canada.

TREASURE Hunters! New 11-pound featherweight Model 101 locator for gold, silver and minerals. Money-back guarantee best available. Also Geiger Counters for uranium prospectors. Complete information free. The Goldak Company. 1540 W. Glenoaks Blvd., Glendale 1, Calif.

GEIGER Counter, Skeleton. \$16 post-paid. Mineralights. Metal detectors. Western Radiation Lab., 1107 W. 24th Street. Los Angeles 7. Calif.

**137 DETECTIVES**

DETECTIVES—Work home—Travel. Experience unnecessary. Detective Particulars free. Write. Wagoner, P-125 West 86th. New York 24.

DETECTIVE Training. Phillips Secret Service System, 1917-C North Kenneth. Chicago 39. Illinois.

SECRET Service. fingerprint training at home. in spare time. Write. Associated Special Investigators, Box 474. Saint John. N.B., Canada.

**140 HAIR PREPARATIONS**

HAIR. For falling hair, Itching Scalp, Baldness, Dandruff Scales, Hair that doesn't get longer, Faded, lifeless, Brittle, Ends breaking off. Why not give our home Applications a try—32 to 45 to a \$25.00 Box. Means not a dollar a treatment. We have people everywhere praising God for results obtained in my office. The home treatment box is the Same Thing, pronounced to be the best; by two write-ups in Cleveland's papers, and a free broadcast by a famous Commentator. Full directions in every box. Sent C.O.D. or by Certified Check, Loreene Scalp Salon, 9200 Hough Ave., Cleveland 6 Ohio.

**142 INFORMATION**

COFFEE Substitute; Four Different Formulas. \$1.00. R. Plumb. Herkimer 1. N. Y.

**143 NAME LISTS**

MAILING Lists. All Kinds 1000 \$5.00. Dixie Service. King. N. Carolina.

**Handsome Leopard\* and Zebra\* SEAT COVERS**



\*Simulated

**ZEBRA HIDE**

Call of the wild! Gay stripes mean a gay fellow . . . the ladies love 'em! Look and feel like real Zebra hide. Never scuff, fade or soil. Custom tailored just \$32.95 complete!

Send \$1.00 deposit. Balance paid COD. We can fit all make and year cars.

**SHORR'S**

Dept. PS-2  
10600 Grand River  
Detroit 4, Michigan

**LEOPARD SKIN**

Let's go native! Smart looking, easy sliding seat covers . . . guaranteed fadeproof, soil-proof, custom tailored. Complete set \$32.95.



MAKE.....  
YEAR..... MODEL.....  
Leopard..... Zebra.....

**TODAY'S BIGGEST PREFAB BOAT BUY**

Build a better boat than you can buy. Save up to 55%. See OZARKA'S deluxe line of trim, top-quality 12- and 14-footers, with exclusive laminated rib construction, all-oak frame and other features, for motors up to 25 H.P. Send 25c for complete Boat & Accessory Catalog, to be refunded on first purchase. OZARKA, INC., 721 BORDEN LANE, WOODSTOCK, ILL.



**Fix It Yourself**

Save yourself a lot of expense by doing your own odd repair jobs. Get this new addition of a famous book, showing with diagrams and directions, how to fix and repair furniture, electric outlets, windows, doors, leaky pipes, floor boards, chimneys, boilers, weather proofing, painting, and hundreds of other construction and repair jobs. Picture diagrams show how each job is done. Full cloth bound de luxe edition only \$1.49.

POPULAR SCIENCE MONTHLY, DEPT. 251  
353 FOURTH AVE. NEW YORK 10, N. Y.

**Amazing Attachment MAKES OLD REFRIGERATORS INTO MODERN Automatic Defrosters!**

Thirty Million Prospects. Sell without "selling pressure" on sensational Free Trial Plan. Just plug it in and leave it. Frees women from drudgery and mess of defrosting. Saves electricity. Keeps food longer, better. Gives longer life to refrigerator. Secret "follow-up" Plan often brings five additional sales by making every user your agent. Big season now on! **SENT FREE... JUST SEND NAME!**

Don't send a cent—just your name on penny postcard. We'll send you the biggest money-maker you ever got your hands on and guarantee your sales at profits as high as \$5.00 on each sale. Rush your name!

MAXILUME COMPANY, 125 West Hubbard Street, Dept. D-92, Chicago 10, Illinois

**Women buying by the thousands!**  
Salesmen Cleaning up on "Free Trial" Sales Plan  
Sent Free with Instructions.  
Make as high as \$5 on Every Sale!

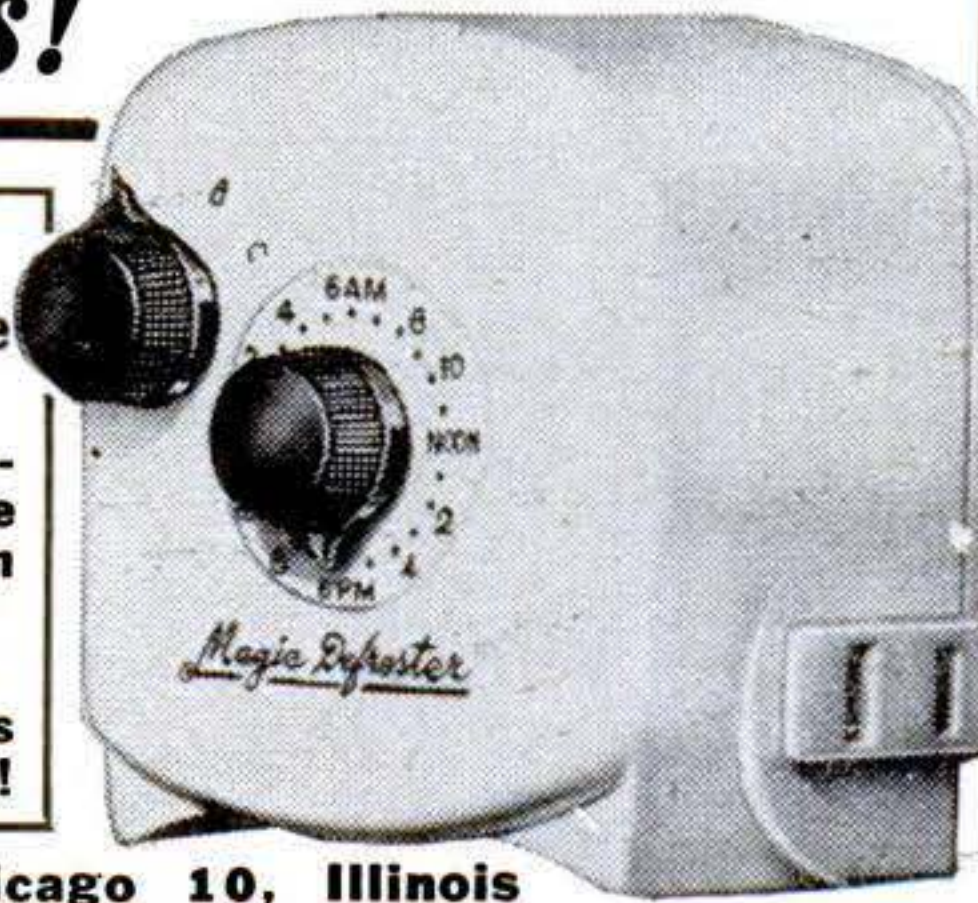

Look AHEAD...be AHEAD...

MAN A *Martin* "75"



WITH

SYNCROW-TWIST CONTROL

FACE FORWARD  
WHILE YOU  
CONTROL SPEED  
AND DIRECTION!



"Go '75'!"

... with one of the 8 great MARTIN MOTORS for '51! Precision-built, "Performance-Tested" by expert craftsmen, MARTIN offers incomparable power, speed and maneuverability! EXCLUSIVE features put control of speed and direction RIGHT IN THE PALM OF YOUR HAND!

**ONLY MARTIN GIVES YOU:** ✓ "SYNCROW TWIST" ✓ "TWIST-SHIFT" ✓ "AQUAMATIC CONTROLS" ✓ Mechanically-controlled intake poppet valves ✓ Vertical stern adjustment ✓ Full 360-degree steering ✓ Improved carburetion and cooling systems, and many others!

**FREE!** Complete, illustrated booklet with descriptions of The 8 Great Martin Motors for 1951. Sent on request. Write: Martin Motors: Dept. 5112, Eau Claire, Wisconsin

**8 GREAT MARTIN MOTORS:**

- MARTIN "200" with full "Twist-Shift" 17 H.P.
- MARTIN "200" Hi-speed "P-T" 17 H.P.
- MARTIN "100" with neutral "Twist-Shift" 10 H.P.
- MARTIN "100" with "Aquamatic Control" 10 H.P.
- MARTIN "75" with neutral "Twist-Shift" 7.5 H.P.
- MARTIN "75" with "Synco-Twist" 7.5 H.P.
- MARTIN "45" with "Synco-Twist" 4.5 H.P.
- MARTIN "20" 2 1/3 H.P.

MARTIN MOTORS are priced from \$114.75 F.O.B. Factory



MARTIN "75" with "Synco Twist" 7.5 H.P. Twin 44 lbs.



*"Best Outboards Ever Built!"*

MARTIN MOTORS

Division: National Pressure Cooker Co., Eau Claire, Wis.

Canadian Sales by: MARTIN MOTORS

Division: National Pressure Cooker Co. (Canada) Ltd., Wallaceburg, Ontario



**MAKE BIG MONEY**

*Sharpening*  
**LAWN MOWERS**  
WITH THE  
*Universal*  
**LAWN MOWER GRINDER**



Enjoy a profitable lawn mower sharpening business of your own. No previous experience needed. Place a hand or power mower on the Universal Grinder. With only **one set-up** you quickly grind the stationary blade and all of the reel blades to proper clearance **without removing a single blade from mower.** A Real Money Maker.

J. L. Peterman of Pa. writes: "Thank you for getting me started in this wonderful business . . . I averaged \$100.00 a week in May, and made \$1000.00 spare time this season."

G. Spurlock of Arkansas writes: "I have had my Universal Lawn Mower Grinder only 2 months. Live 1 1/2 miles from town. Yet have already made net profit of \$227.00."

**PROOF**

TRULY A BIG MONEY MAKING BUSINESS

**ROGERS MFG. CO., Dept. P-21** **Lindsey, Ohio**

**SEND THIS COUPON NOW!**

ROGERS MFG. CO., Dept. P-21, Lindsey, Ohio  
Please send me full facts about the Universal Lawn Mower Grinder and its big money making opportunities.

NAME \_\_\_\_\_  
ADDRESS \_\_\_\_\_  
CITY \_\_\_\_\_ STATE \_\_\_\_\_

*things*  
*stay*  
*stuck*

WITH

Many major industries depend on Pliobond\* for joining all kinds of materials where the joint must be permanent. Pliobond literally "Bonds Anything to Anything." Joins metals, china, tile, wood, plastics and plastic films, glass, concrete, paper, leather, rubber, wallboard to themselves and to each other—permanently! Sets quickly; never gets brittle; stays flexible; easy to use; one adhesive for all purposes. Brush-top bottles 25c & 50c at dime stores, hobby and hardware stores. Or write.



**W. J. RUSCOE CO.**  
**AKRON 13, OHIO**

\*TM Goodyear T&R Co

# WEATHER-PROOF YOUR CAR...

LIKE THE NEW

NASH • FORD • HUDSON • CHRYSLER



Go Thru Rain, Snow, Puddles Protected by the ORIGINAL Ignition Weather-Proofing Line! **SEALTIGHT IGNITION INSULATORS**

Seal Out All Weather from Your Ignition System **SHORT - PROOFS YOUR CAR**

The most needed protection on your car. At last—manufacturers, too, are recognizing the need for Sealtight ignition insulators, which WEATHER-PROOF and SHORT-PROOF the spark plugs, distributor, magneto and coil. Now Sealtights—the first Weather-Proofing Insulators—are original equipment on many new cars. You can weather proof your own car like the new Ford, Nash, Hudson, Chrysler, etc.—in minutes. Why call a tow car or be stalled in rain, snow, sleet, when Sealtights can keep you going thru any weather?

ASK YOUR DEALER or Write Us for Information, Giving Make and Model of Car.

Full Directions for Installation with Each Set

**SEALTIGHT CORP.**

Dept. PS251

Cedar Rapids, Iowa

## Guide to Better Living

beyond city water mains

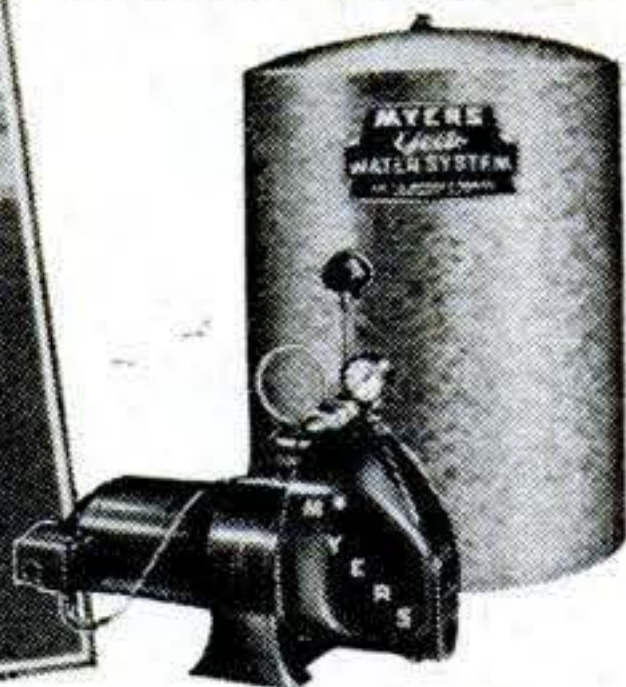
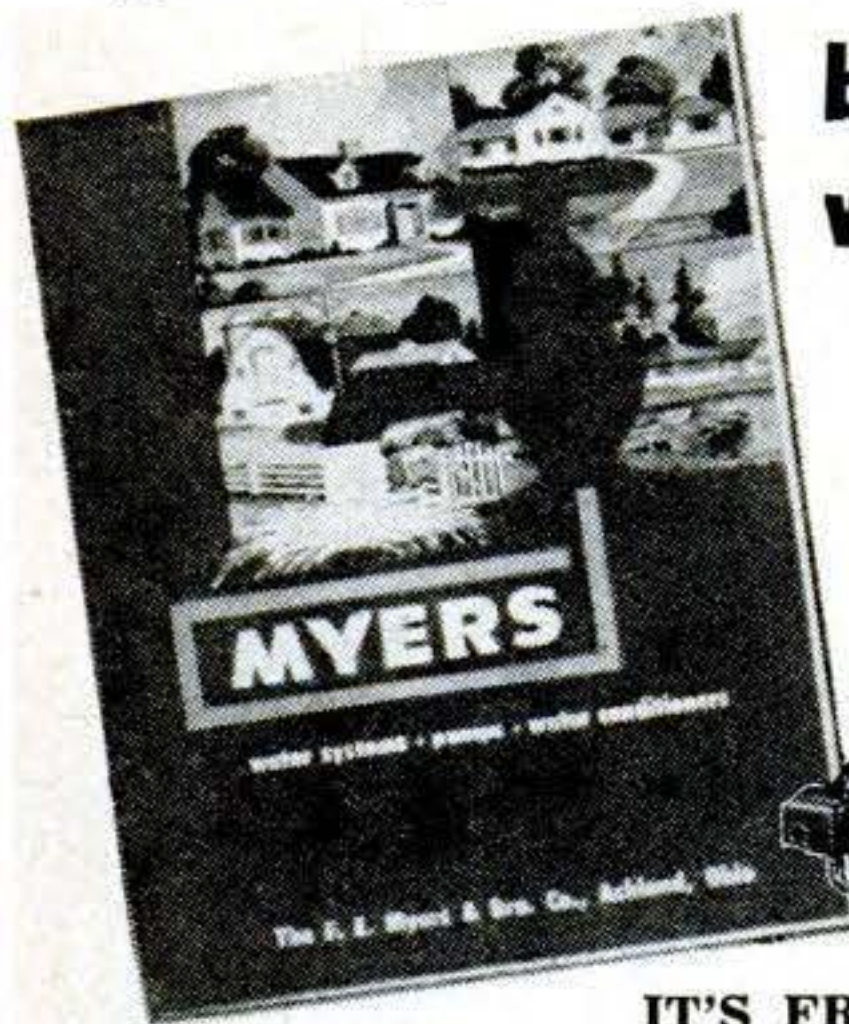

IT'S FREE — and it's filled with valuable data on famous Myers Pumps and Water Systems. Gives you complete facts and figures on construction, engineering features, capacities, etc. Covers full Myers line of water supply equipment—including brand-new Myers Water Conditioners to solve every water problem. Makes it easy to plan the ideal water service for any size home or farm. Mail coupon today for your personal copy.



THE F. E. MYERS & BRO. CO.  
Dept. T-94, Ashland, Ohio

Send my free guide to better water service:

My Name \_\_\_\_\_

Address \_\_\_\_\_

Town \_\_\_\_\_ State \_\_\_\_\_

## TOOLS AT WHOLESALE

### DIRECT FROM FACTORY

Full line of top quality, fully guaranteed, chrome, factory-new mechanics hand tools. You save **HALF REGULAR PRICE** for tools of this quality. Our Permanent Price Protection Plan guarantees you wholesale prices.

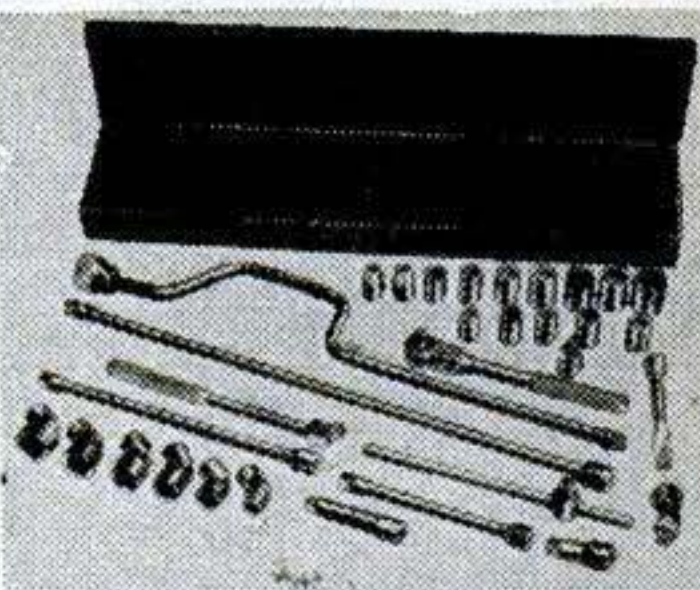

WRITE TODAY FOR FREE CATALOG

## MECHANICS CO-OP

Dept. B OAKLAND 8, CALIFORNIA

## BUILD HEAVY DUTY MACHINES



SAVE UP to 90% You can build, using our practical, easy-to-read plans, all kinds of machines, for home, farm or shop—scooters, portable sawmills, metal working machines, concrete machinery of all kinds, printing equipment, woodworking machines, midget autos, dish washers, farm equipment, freezers, tractors.

**FREE CATALOG HANDBOOK**  
183 SETS OF PLANS  
VALUABLE INFORMATION

**NICHOLS EQUIPMENT COMPANY**  
Dept. D-10 PURVIS, MISS.

## ELECTRIC MOTOR BARGAINS!



1/4 HP	1750 RPM 110-v. 60 Cy. Split Phase Type.....	\$ 7.50
1/2 HP	3450 RPM 110-v. 60 Cy. Capacitor Type.....	15.00
3/4 HP	3450 RPM 110-220 v. 60 Cy. Rep. Ind.....	29.75
1 HP	3450 RPM 110-220 v. 60 Cy. Rep. Ind.....	37.50

Every motor fully guaranteed. Prices F.O.B.

32-v. direct current bargains

ROBERTS ELECTRIC CO., 7232 Madison, Forest Park 11, Ill.



## GROW WITHOUT SOIL!

YOU can grow vegetables, flowers or rare plants without soil (HYDROPONICS) every day of the year. Start this fast, clean EASY way to grow any plant for fun or PROFIT now. Big returns from small space. Send postcard today for FREE picture book showing how others from every state are succeeding in this new wide open field.

C. GILBERT & CO., 3535d Enterprise, San Diego 10, Calif.



FOR FAST ECONOMICAL WINTER TRAVEL BUY A

## SnowCar

Four passenger 125 h.p. model as low as \$1985.00. Two passenger models—\$1550.00.

CALLAIR AFTON, WYOMING

"It Measures As It Rolls"

## ROLLER RULE

HANDY MECHANICAL PENCIL

Measures Curves and Straight Lines. Any Shape, Any Distance. Any Surface.

\$1.00 POST PAID

Roll head over surface. Inches and fractions record accurately on "Inch-O-Meter". Excellent pencil too! Order Now! 10 Day Money Back Guarantee! C.O.D. (postage extra). In Calif. add 3% Sales Tax.

PENCIL SALES CO., Dept. PS-2  
Room 6, 1213 E. Ocean Blvd., Long Beach, California



# WHAT LASTS FOREVER?



**THIS DEAD BLADE** still looks new but it blurs rain, smears muck, streaks glass. DEAD blades make dead drivers!

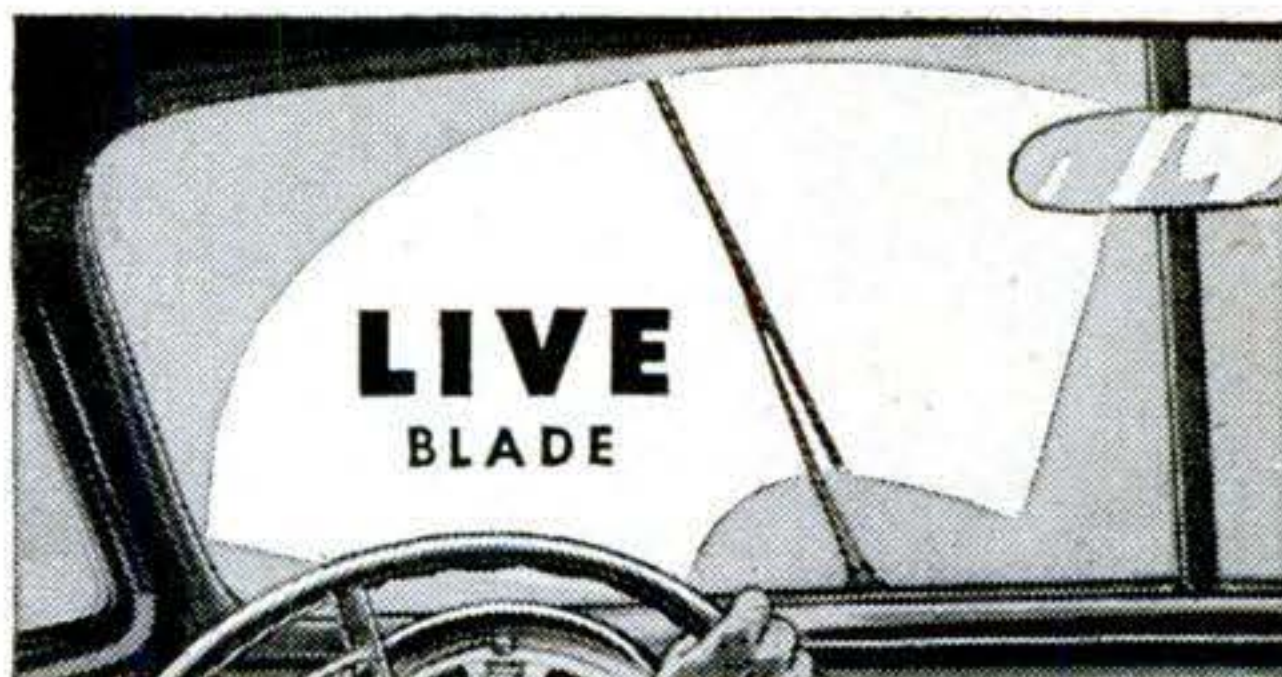

**THIS LIVE ANCO BLADE** wipes clean, clears rain, clears road muck . . . lets you *SEE*. Protects your loved ones.

**WHAT LASTS FOREVER?** Nothing does. This is especially true with Windshield Wiper Blades—even though made of finest natural rubber. Corrosive windshield film, wind burn and hot sun **BAKE** the life out of wiper blades, often in six months or less. **DEAD** blades cause dangerous windshield smear. **DEAD** blades make dead drivers. Make sure your car has live, new windshield wipers.

**Change Your Wiper Blades**  
Next time you buy gas, change to **LIVE**,

**NEW ANCO BLADES . . . RAIN-MASTER** for Flat windshields . . . **CLEAR-FLEX** for Flat or Curved windshields. They fit all cars—wipe quicker and cleaner than any other blades.

**Mr. Dealer:** ANCO Wiper Motors give lots more power, lots less stall. Controlled wiping arc prevents blade slap. Only six models give **COMPLETE** replacements for **ALL** Cable Linkage, Bar Linkage, and Direct Drive original equipment vacuum wiper motors.

**THE ANDERSON COMPANY**  
**GARY, INDIANA**

the  
new  
**CUSHMAN**  
**EAGLE**  
truly a  
**TRIUMPH**  
in  
low-cost  
transportation!



Ride it  
for **ONLY**  
**3/4¢**  
per mi.

**WRITE FOR  
RIDER-AGENT PLAN**

**gives you ALL THESE FEATURES:**

- Automatic disc-type clutch; selective gear transmission!
- Silent action shock-absorbing springs!
- Doubly-dependable heavy duty brakes—**BOTH** front and rear wheels!
- 75 miles **PLUS** per gallon!
- Special heavy duty tires for added safety and comfort!
- Powered by the famous 4-cycle **CUSHMAN "Husky"** engine, acclaimed by thousands of users.
- Rapid pick-up, quick acceleration!
- Cruises up to 50 m. p. h.

All these plus **CUSHMAN** quality, dependability and design, make the new **CUSHMAN "Eagle"** the **ONE** to buy in '51!

Write for free folder and prices to Dept. 45

**Cushman MOTOR WORKS, INC.**  
**LINCOLN, NEBRASKA**

**FOR EASY HOME ASSEMBLY**  
**20 MODELS**  
**U-MAK-IT BOAT KITS**

**PRAMS \$39<sup>60</sup>**  
8 TO 11 FT

**ROWBOATS**  
10 TO 14 FT.

**OUTBOARDS**  
12 TO 16 FT

**INBOARDS & CABIN CRUISERS**  
16 TO 23 FT.

**BUILD THE BEST U-MAK-IT KITS**

**SEND 25c (coin) TODAY**  
**NEW CATALOG**  
SHOWING ALL 1951 MODELS,  
MOTORS AND ACCESSORIES

**U-MAK-IT PRODUCTS** 703R-WHITTIER ST.  
New York 59, N. Y.

## AMAZING SHIFT OUTBOARDS HAVE NEUTRAL, FORWARD, REVERSE

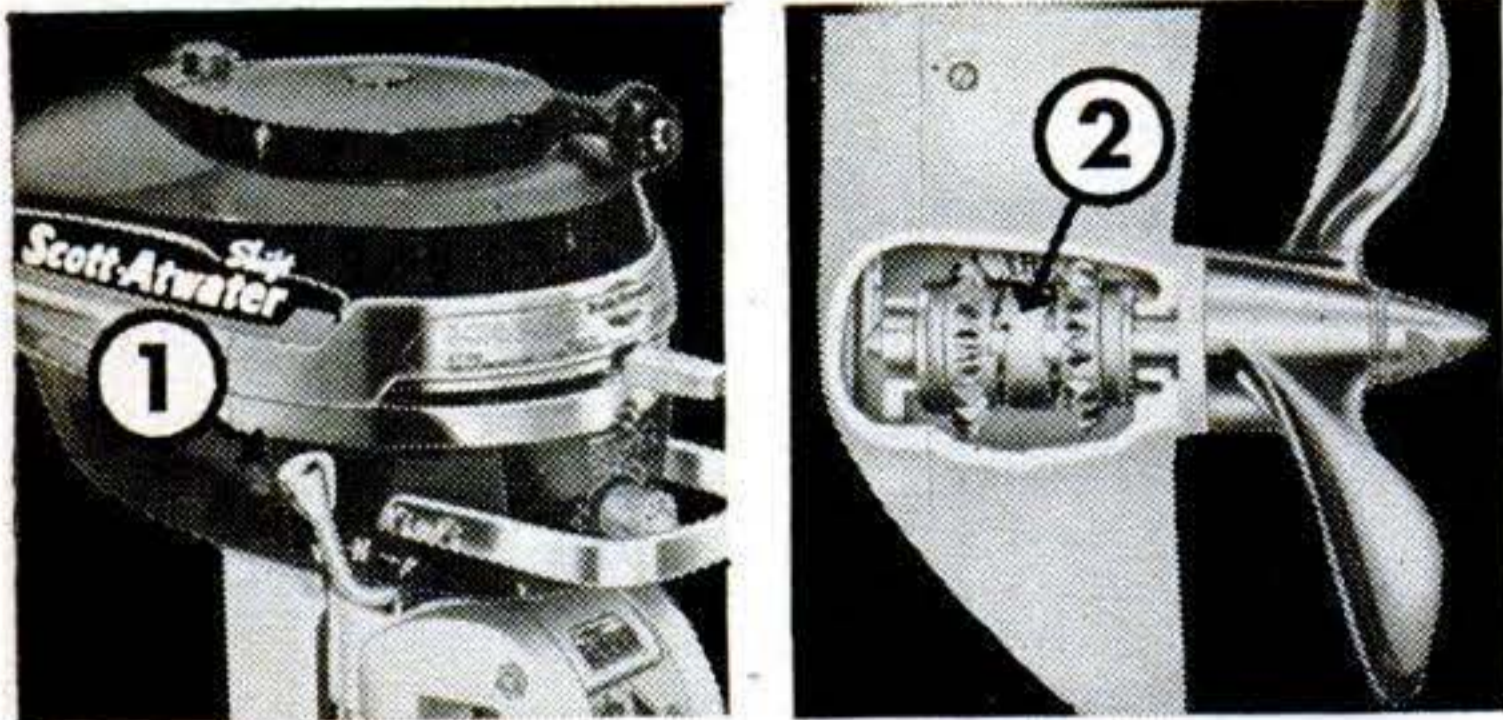

**HOW SCOTT-ATWATER SHIFT WORKS.** Shift lever (1) moves gear selector (2) to the left to engage forward gear, right for reverse. When selector is in between, motor is in neutral.

**FREE OUTBOARD BOOKLET** shows Shift, latest Scott-Atwater improvements, automatic controls. Helps you pick the right shift motor for your boat. Explains easy plan for buying your outboard. Packed with pictures, detailed motor facts.



### MAIL COUPON NOW!

Dept. 48, Scott-Atwater Mfg. Co., Inc.,  
Minneapolis 13, Minn.  
Please send FREE OUTBOARD BOOKLET.

Name \_\_\_\_\_  
Address \_\_\_\_\_  
City \_\_\_\_\_ State \_\_\_\_\_  
Export Dept. - American Steel Export Co., 347 Madison Ave., N. Y. 17, N. Y.

## Thompson BEATS the World on BOATS



**Better Built  
Lower Prices**

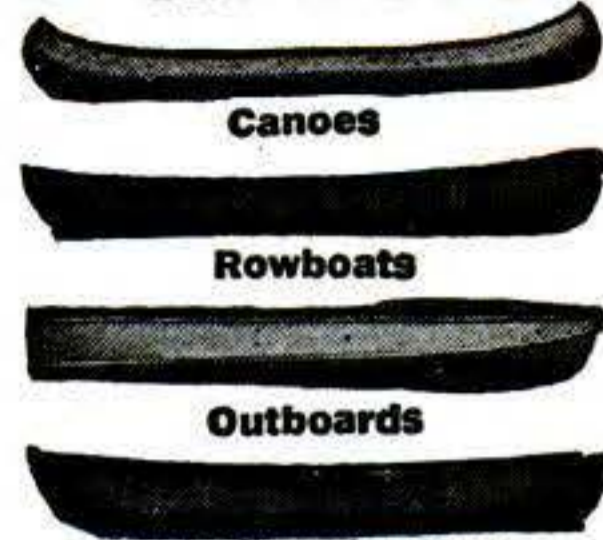

### Safe Boats With Full Length Spray Rails

Keep passengers perfectly dry—even at high speeds. Catalog also shows two new models of "Take-Along" Boats. Two big factories—save you freight.

**CATALOG FREE**  
Write for your copy. State kind of boat in which you are interested.

**THOMPSON BROS. BOAT MFG. CO.** (151)  
219 Ann St. (Write to either place)  
PESHTIGO, WIS. 119 Elm St. CORTLAND, N.Y.

Light Boat for Auto

## HAUCK FLAME GUN KILLS WEEDS



**KILL WEEDS**, crab grass, Canada thistle—stalks, seeds and roots. Destroy brush, caterpillar nests, diseased trees, grasshoppers, chinch bugs, etc. Clear irrigation ditches, split rocks, burn tree stumps. Sterilize poultry houses, kennels, barns. Use as portable home forge. Melt ice, thaw pipes. Safe, inexpensive. Burns only 6% kerosene, 94% air! Thousands satisfied users. 7 models. Write for FREE CATALOG.

**HAUCK MFG. CO.**, 81 Tenth St., Brooklyn 15, N. Y.

Only  
\$498



## OTTAWA Mule Team Tractor

Finest low-cost tractor. Costs too little to do without. Engines burn gasoline. Seven models. Starter and lights available. Other larger Models

to choose from. Over 4,000 in world-wide use. Time-proved and tested. At low cost they easily mow, plow, disc, harrow, plant, cultivate, etc. Sold only direct to user. Write for FREE details.

**OTTAWA MFG. CO.**, 2-101 Garden St., Ottawa, Kansas

**Look** —a 10½x4, 6-ply Tire. Tube. Machined Wheel and Bearing at a "give away" price. Supplied in two types:—  
1. With Highspeed **TIMKEN BEARING** (with Grease Retainer) **\$8.95**  
2. With Slowspeed **NEEDLE BEARING** (with Grease Retainer) **\$5.95**  
Freight Collect (8½ lb.)

Ideal for Handcarts, Boggles, Trailers, Soap-box Racers, etc. A bargain from the world's largest stock of all types of Airplane Tires. Send your check or money order to:

**Airplane Tire Co.**, 99 Hiway, Tulare S., California

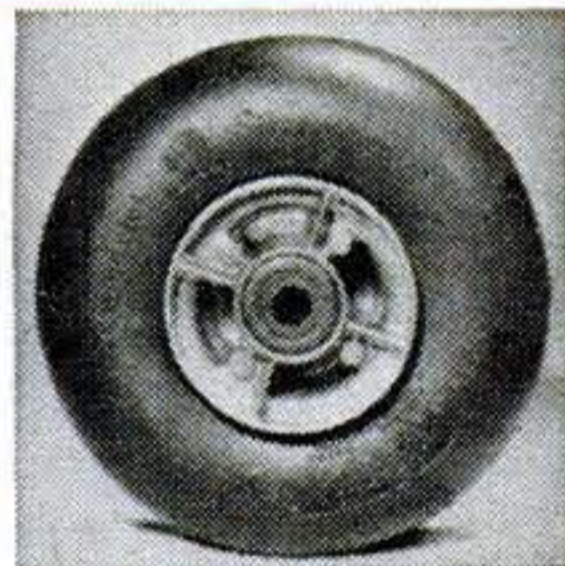

## MAKE YOUR OWN FOLDING TABLES · BENCHES · HORSES



WITH **FOLD-A-WAY...**  
CHANNEL STEEL LEGS!

Shipped complete, ready to fasten to your top in a minute **FOLDS** flat for easy carrying or storage. Rubber tipped. Used on the job, in homes, workshops, ping pong tables, camps, boats, trailers, banquet halls, lodges, churches, etc.

SEND FOR  
FREE  
CIRCULAR

**THE DIAMOND MFG. CO.** Dept. 10 1100 ALTAMONT AVE. · SCHENECTADY 7, N.Y.

## IS \$21000 A WEEK Worth a Penny Post Card?

Then RUSH postcard with name and address. Get FREE details of amazing full-and-spate-time PROFITS made by ambitious men handling new Automatic Defroster for refrigerators on FREE TRIAL basis. Learn how housewives hand you big profits when you just plug in the D-Frost-O-Matic to end defrosting mess forever. Send card for Special Offer TODAY.

**D-FROST-O-MATIC** Dept. PS-2  
6 N. Mich. Ave. Chicago, Ill.

## USE YOUR ATTIC

Install the  
**PRECISION**  
folding stairway  
**YOURSELF**

Fits all ceilings. Just saw the hole in your ceiling—frame the hole with 2x6's, nail the stairway in place and cut off the stairway at the calibrated ceiling height. The Precision Stairway is simple and easy to operate. No springs, actuated by counterweights, it's perfectly balanced, raising or lowering easily with one hand. Composition safety treads on steps. Insulated door panel. Requires no attic space. Made of No. 1 kiln dried poplar with cast brass hinges, heavy cast aluminum rocker arms and brackets. Approved by F.H.A. everywhere

See your local lumber dealer or write direct today.

Manufactured by

**PRECISION PARTS CORP.**  
Nashville 7, Tennessee



# PRESTO! ANYONE CAN MASTER GLAZE



LEAVES HARD GLASS-LIKE FINISH  
EASY TO APPLY  
PROTECTS THE SURFACE  
NO SMEAR OR STREAKS AS WITH WAX  
LASTS SIX MONTHS TO A YEAR

SEALS THE PORES OF THE SURFACE  
WILL NOT FINGER-MARK  
NO OILY FILM AS WITH POLISH  
SAVES YOU MONEY

Car Owners! Meet Master Glaze—the sensationally different luster for new and used cars! Not a wax—not an oil polish—not a paint!—nothing that “smears” over the surface.

**MASTER GLAZE** is a unique discovery—a creamy liquid—quick and easy to apply! Gives a hard, glass-like surface. Even gasoline cannot dull it! Lasts six months to a year! Amazing luster—beautiful, sparkling clean and brilliant! Doesn't finger-mark—doesn't smear! A match box full glazes an entire car. Seals the pores—protects! **NOTHING LIKE IT!**

**AGENTS**

An unusual opportunity! Quick, flashy demonstrator. Big profits. Good territory. Write today!

**FREE SAMPLE**

Just send your name and address to

MASTER GLAZE CO., 7720-706 W. Harwood Ave., Milwaukee, Wis.



**LIGHTWEIGHT**

Now Only \$346.30

9.5 hp. 4-cycle. 3-speed. Foot-shift. Over 70 miles per gal. Over 60 m.p.h. Write for free circular.

**MUSTANG, Dept. GP-73**

635 W. Colorado. Glendale 4. Calif.



(Fed. tax paid, at factory)

**ELECTRIC SHEAR SHARPENER**

Over 70,000 Sold—It Must Be Good!



Genuine Carborundum wheel ideal for shop or home use. Motor driven. Send remittance with order and shipment will be made at once, prepaid to your door, complete with electrical goods catalogue.

**\$9.75** complete with vise

**WILLIAM MARVY COMPANY, Dept. 10**  
479 St. Peter Street St. Paul 2, Minn.



Build and drive the fastest boats in the world. 3 point Hydroplanes, Runabouts, Inboard and Outboard. With our easy to use plans you save 3/4 of cost usually required. Be first. Send 25c to **Champion Boats** for illustrated catalog. P. O. Box 7006-18-B, Long Beach, California.



**The Modern PLASTIC for lasting Home Repairs**

PERMANENTLY mends cracks or holes in wood, tile, stone or plaster. Sticks and stays put—Does not chip, shrink or fall out. Easy to use. Economical. Mold it, chisel it, polish or paint it. If unobtainable from your lumber, paint or hardware dealer, the big 4-lb. can will be sent you post-paid (in U.S.) for only \$1.15. Full money-back guarantee. order now.

**DONALD DURHAM CO.**  
Box 804-N, Des Moines, Iowa

**More Hours of FUN with this NEW Outdoor Light**



Model 200



Used and Endorsed by **LEADING OUTDOORSMEN** Everywhere!

**New Coleman**

**FLOODLIGHT LANTERN**

You can fish and hunt longer, have plenty of light on the trail or in camp at night with this great new all-purpose Coleman Floodlight Lantern. Superior in structure, appearance and service; more compact in design; sturdier built for hard use. Improved burner. Larger fuel fount (1 1/2 pints) gives 8 to 10 hours lighting service. New attractive red porcelain ventilator top. Instant lighting. Floodlights 100 ft. area. Stormproof. Safe. See it lighted—ask your dealer.



**Big Outdoor Spotlight**

Easily attached Coleman Reflector makes a powerful spotlight of your lantern. Concentrates a flood of brilliant light wherever wanted. Made of high luster steel; adjustable handle.

**Easy Meals Quick... More Fun**

**Coleman FOLDING CAMP STOVE**



Cooks like a city gas range. Lights instantly; easily regulated. Folds up and carries like a suitcase. Durably built for long service. See your dealer.

The Coleman Company, Inc., Wichita 1, Kansas

**MAIL COUPON TO** The Coleman Co., Inc., Dept. 102-PS  
Wichita 1, Kans.

Please send me free literature about Coleman Lanterns, Camp Stoves and other Coleman Appliances.

NAME \_\_\_\_\_  
ADDRESS \_\_\_\_\_  
CITY \_\_\_\_\_ STATE \_\_\_\_\_

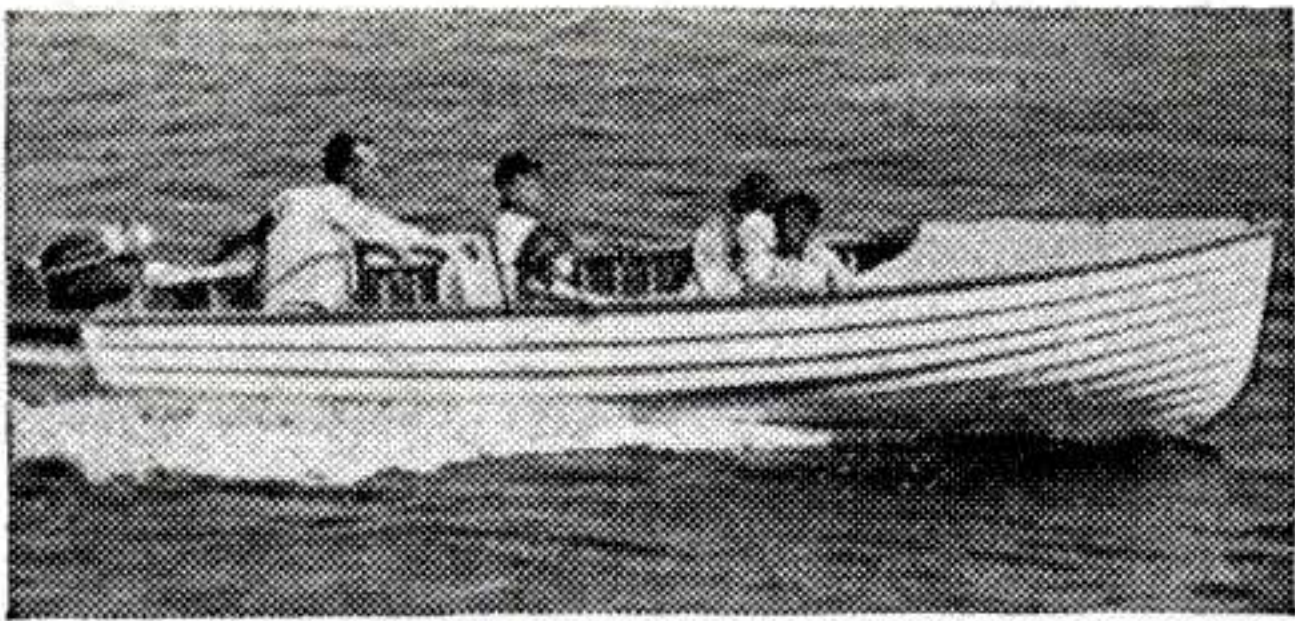

## FAST—Old Town Lapstrake Boat

SMOOTH lines of this lapstrake out-board boat help you start in a hurry—and get there fast! She's roomy, too, with wide cross seats (folding backs) and long seats on both sides at the stern. Handles easily, with deep bow to fight stormy waves! Built of handsome woods for strength and service. Upkeep is easy.

FREE CATALOG shows just the model you need. Write for one today! Also rowboats, sailing dinghies, sailboats, canoes.

## OLD TOWN BOATS

Old Town Canoe Co., 742 Wood St., Old Town, Maine  
PLEASE SEND ME FREE CATALOG

Name \_\_\_\_\_  
Address \_\_\_\_\_  
City \_\_\_\_\_ State \_\_\_\_\_

Now! The Most Fabulous Road Racer In Auto History!

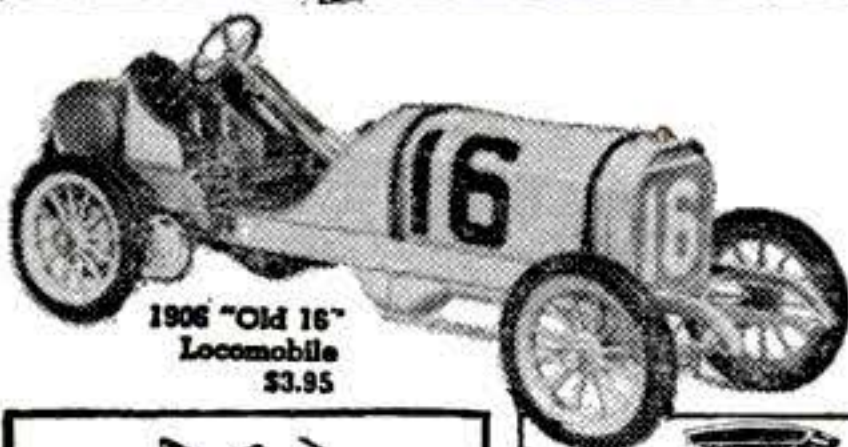

Our scale model from the original "Old 16" now owned by Peter Helck, the well-known artist. Build this Vanderbilt Cup Winner! Length 10" when completed — newest "Old Timer" Antique Auto Set! Below we show 12 other famous "Old Timers":



Check "OLD TIMERS" You Want:

- |  |  |
|--|--|
| <input type="checkbox"/> 1911 Maxwell \$2.50             | <input type="checkbox"/> 1911 Buick \$2.50               |
| <input type="checkbox"/> 1904 Olds. \$1.95               | <input type="checkbox"/> 1903 A Ford \$2.50              |
| <input type="checkbox"/> 1910 T Ford \$2.50              | <input type="checkbox"/> 1910 Internat. Harvester \$2.95 |
| <input type="checkbox"/> 1909 Stanley Steamer \$2.95     | <input type="checkbox"/> 1903 Cadillac \$2.50            |
| <input type="checkbox"/> 1909 T Ford \$2.95              | <input type="checkbox"/> 1900 Packard \$2.50             |
| <input type="checkbox"/> 1903 Rambler \$2.50             | <input type="checkbox"/> 1914 Stutz \$3.95               |
| <input type="checkbox"/> 1911 Mercer \$3.95              | <input type="checkbox"/> Bearcat \$3.95                  |
| <input type="checkbox"/> 1906 "Old 16" Locomobile \$3.95 |  |

Mail order to us for your favorites. Add 25c for postage and handling. No C. O. D.'s please

SEE them at your hobby, toy, or department store, or write to us  
Add 25c for postage and handling; no C.O.D.'s, please

Hudson Miniatures' "OLD TIMERS"  
SCRANTON HOBBY CENTER, Dept. 28, Scranton 10, Pa.

HOBBYISTS and Collectors want these nostalgic Antique Autos—each one easy to assemble with pre-fabricated parts! Actual 3/4" scale models, they're decorative and authentic. 6 1/2" to 10 1/2" in length. See them at hobby, toy or department stores. They're the cutest things on wheels! Or write to us. Prompt delivery. Guaranteed satisfaction.



If it is accuracy you want  
ROAD-MISER has it!!

Any vacuum operated gas mileage indicator or tune-up tester can be made to fit your car to an accuracy within 1 mile per gallon at maximum level road economy with a ROAD-MISER Dial. We supply a set of ROAD-MISER sectional dials to cover all probable variations in cars of the same specifications. You easily attach the correct dial strip to your indicator after making a short mileage check by simple instructions. ROAD-MISER leaves all present dial numbers exposed on most indicators. The best index to your car's condition is a constant reading of its maximum mileage. Test it anytime with a ROAD-MISER equipped indicator. Money refunded if not satisfied. (Please give make, year, and model of car. Also, indicator name and dial size.) \$1.50 in check or money order pays for set of ROAD-MISER Dials and airmail postage.

ROAD-MISER DIALS 4198 Sunnyside Drive  
Riverside, California



INLAND MFG. CORP., PS-2 • 164 Ellicott St., Buffalo 3, N. Y.



DEPT. P DOUGLAS MAGICLAND  
DALLAS, TEXAS



BULL DOG Hitches, Parking Jacks and Axles for all types of trailers!

Write for FREE Catalog

Hammer Blow Tool Company  
Wausau 14, Wisconsin

WONDERFUL WAY  
to remove paint



Here's a really EASY way to remove any paint, enamel, varnish, shellac or lacquer from any kind of surface. Just apply

WONDER-PASTE

with a paint brush, and the thickest, most time-hardened finish quickly turns to a soft sludge. Then watch how easily it peels off with a putty knife! The surface is left so clean, no tedious scraping or sanding is needed. Safe for wood, metal, fabric or your hands. Try WONDER-PASTE—it works wonders on the toughest finish.

Write to us for Wonder-Paste leaflet  
At paint and hardware dealers everywhere

Wilson-Imperial Company, 121 Chestnut Street, Newark 5, N. J.

## STOPS LEAKS PERMANENTLY

Cut your fixture replacement, water and fuel bills with Economy Renewable Seats. Make economical, permanent repairs quickly and easily with the Junior Kit (illus.). Repair bathroom, kitchen and laundry fixtures. Everything you need included in steel box. This is a natural for the "Fixit" shops—get extra income from making permanent repairs on your customers' faucets.

Senior Master Kit also available—repairs faucets and valves up to 1" pipe. Write for illustrated circular and prices.

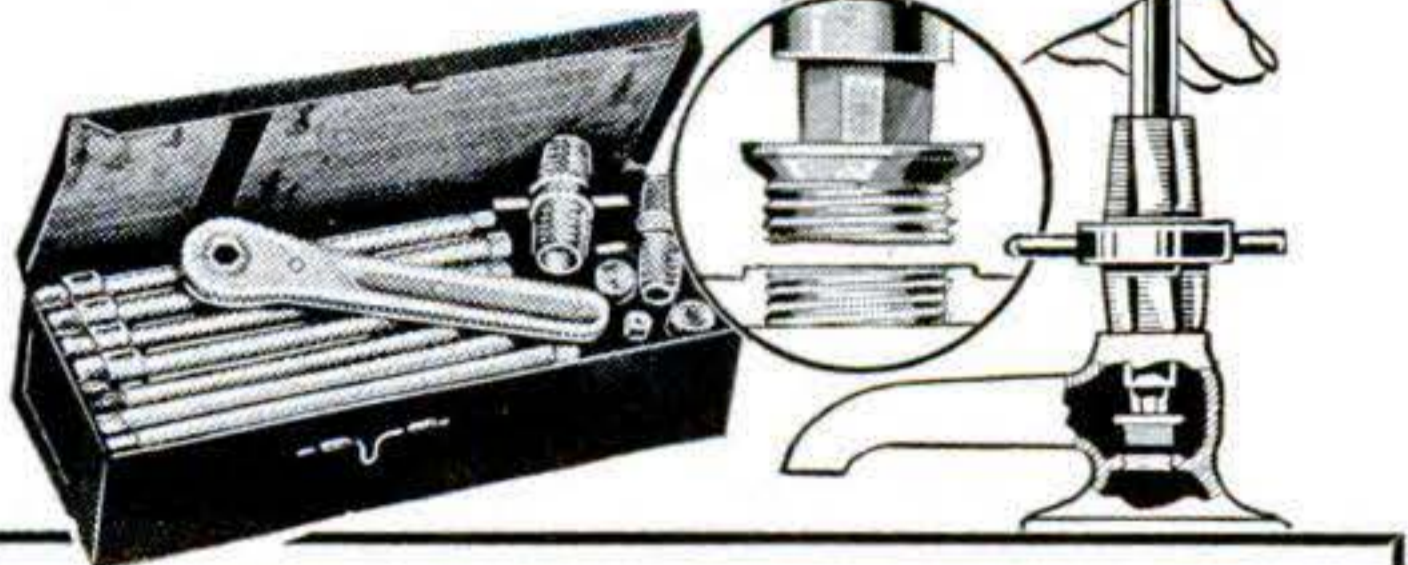

### ECONOMY VALVE SEAT CO.

1426 N. Keating Ave., Chicago, Ill.

## GENUINE Mahogany BOAT KITS

First Time Ever! Expensive "Yacht" Look!



All parts pre-cut, ready to assemble. Easy to follow plans. Choice of 11' or 12' models. Also 6 other marine plywood models. 12' utility rowboat \$69.50.

For FREE catalog and name of dealer WRITE

**BAY STATE BOAT CO.**  
20 MAIN ST., CAMBRIDGE, MASS.

## BATTERIES START A FACTORY AT HOME

—and re-cast junk batteries into new, with and without new materials; the latest achievement. We supply complete instructions and everything needed. Big profits daily!

**BATTERY LABORATORY SCHOOL**  
DEPT. PSM, MINNEAPOLIS 4, MINNESOTA

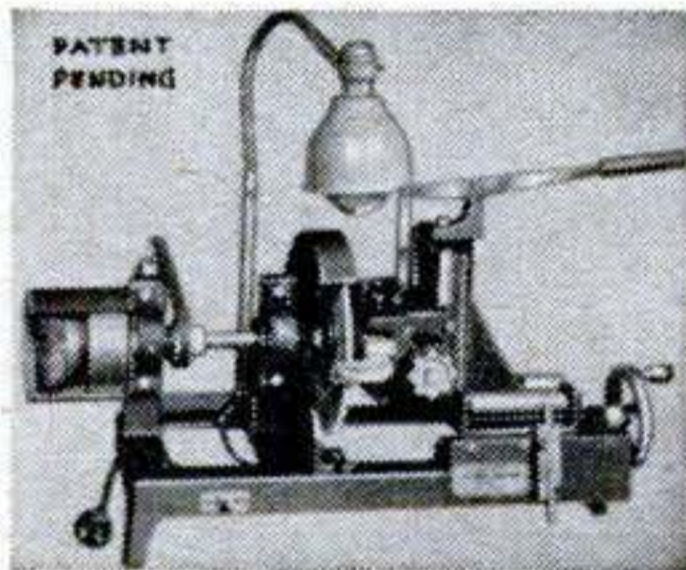

## Start a NEW BUSINESS!

or Add to your present Repair Business

**SHARPEN DULL PIPE WRENCHES**  
PIPE TAPS & DIES  
"GUM" CIRCULAR SAWS

Write for Information  
**J. C. MOORE INDUSTRIES**  
BOX S 276, Fredonia, Pa.

## ELECTRICITY Anywhere

FOR PORTABLE, EMERGENCY OR HOME USE

**ONAN** Electric Plants furnish modern city-type electric service for homes, farms, cabins and resorts beyond the high-line. Lightweight, portable A.C. and D.C. plants serve contractors, estates, fire departments, etc. Automatic standby plants protect hospitals, radio stations, hatcheries. Over a hundred models—400 to 55,000 watts. Gasoline or Diesel powered

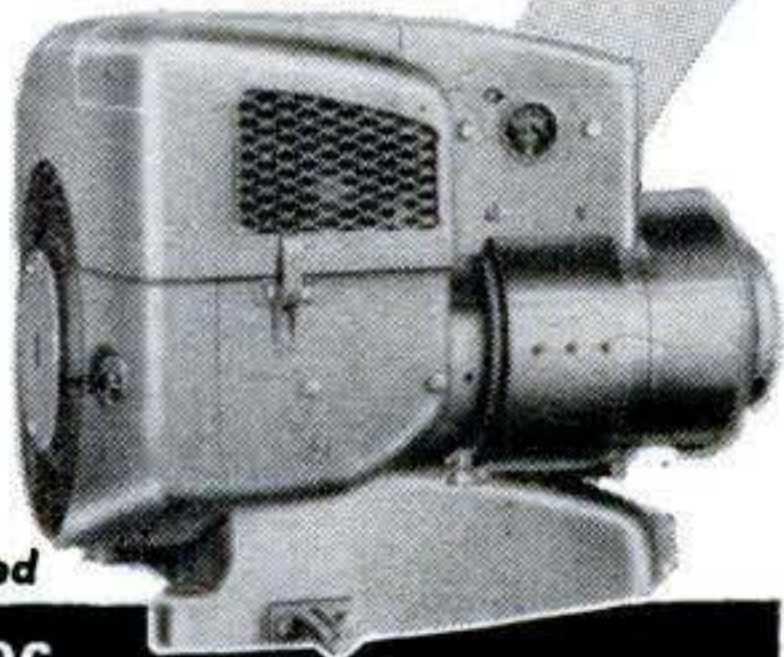

WRITE FOR CATALOG

**D. W. ONAN & SONS INC.**

6724 ROYALSTON AVE. • MINNEAPOLIS 5, MINN.

LOW-COST, 3-SHOT REPEATING

## Shotguns with Quick-Changeable Chokes

Change chokes quickly, in the field. No special tools required.

# "3 GUNS IN ONE"

Model 185D—with Full, Modified and Imp. Cyl. Bore choke tubes.

Only \$25<sup>95</sup>

(\$26.95 west of Rockies)



# "2 GUNS IN ONE"

Model 183D—with Full and Modified choke tubes.

Only \$22<sup>95</sup>

(\$23.95 west of Rockies)



## HUNTER'S FRIENDS

The game laws help preserve for you the sport you love. Cooperate with your friend the game warden. And be considerate of your "host", the property owner.

Ask for MOSSBERG SHOTGUNS at your dealer's.

FREE catalog—Send for it!

No sales at factory.

**O.F. Mossberg**  
® & SONS, INC.

16502 St. John St., New Haven 5, Conn.

BEAUTIFIES natural wood, pine paneling

POLISHES furniture, woodwork

IMPROVES paint jobs

PROTECTS wood and metal surfaces

49¢ 89¢  
PINT QUART

**101 HANDY HOME USES!**  
Every home, every workshop, needs Pol-mer-ik BOILED Linseed Oil. Available at all stores. Free folder tells you how to use it. Write Dept. 604 . . .  
ARCHER-DANIELS-MIDLAND CO., Minneapolis 2, Minn.

# NEW! HULA DIVER



"BEST BAIT BY A DAM SITE"—say Toby Shopper (left) and Hank Werner, who took these beauties at Fontana Dam, N. C., on the new Hula Diver. You control amazing new wiggling action by speed of retrieve. Sinks slowly at rest. You control running depth by length of cast and sinking time allowed Red-hot open-water bait for Bass, Walleyes, and other game fish. Ideal for trolling.

DEEP RUNNER

PERFECT CONTROL



EACH \$1.25

AT YOUR DEALER

5/8 oz.

Choice 7 body colors

**FREE** WRITE TODAY FOR BIG FREE 1951 ARBOGAST COLOR CATALOG—FULL OF PICTURES OF CATCHES

**FRED ARBOGAST & CO., INC.**  
2362 WEST NORTH STREET • AKRON 3, OHIO

## NEW Saginaw BALL-BEARING BUMPER JACK

- SAFEST, STURDIEST BUMPER JACK EVER BUILT!
  - PRESSED-STEEL TUBULAR SHAFT—RIGIDLY ATTACHED BASE.
  - SAME PRINCIPLE OPERATES AIRPLANE WING FLAPS.
  - HANDLE CAN'T SPIN WHILE CAR IS IN AIR—FOLDS OUT OF WAY FOR STORING.
  - FITS EVERY BUMPER.
- ROLLING BALLS REDUCE FRICTION—A CHILD CAN OPERATE IT.

AVAILABLE NOW THROUGH YOUR UNITED MOTORS DEALER OR USE THIS COUPON



United Motors Service, Dept. S-31  
General Motors Bldg., Detroit 2, Mich.  
Send me information about the new Saginaw jack, and where I can buy it.



MONTH AFTER MONTH, YEAR AFTER YEAR, YOU SEE OUR AD. REMEMBER IT'S DANGEROUS to pay less if you want the finest matched USED tires.

**GOOD YEAR Firestone**  
GOODRICH, UNITED STATES, GENERAL, & OTHERS, NOT RECAPS

Our policy is to select your tires so carefully, as if our very future depended on the service given by that particular tire.

**FREE TUBE WITH "ALL" BLATT'S GOOD GRADE TIRES**

GOOD GRADE, 16 MONTHS GOLDEN RULE GUARANTEE BOND.			
600-16	\$4.17	700-15	\$4.57
650-16	4.67	670-15	4.77
700-16	5.07	710-15	4.97
650-15	4.47	550-17	4.67

26 MONTHS GOLDEN RULE GUARANTEE BOND.			
650-20	\$7.97	32x6 (8)	\$8.67
700-20	8.57	32x6 (10)	9.97
750-20	8.67	900-20	13.97
825-20	13.97	1000-20	13.97

**FINEST GRADE, 26 MONTHS GOLDEN RULE GUARANTEE BOND THIS GRADE MADE THE BLATT NAME "WORLD FAMOUS."**

MATCHED BALANCED TIRES		MATCHED BALANCED TRUCK TIRES	
600-16	\$5.37	650-15	\$5.97
650-16	5.97	670-15	6.27
700-16	6.57	700-15	6.57
750-16	7.77	710-15	6.37
550-17	5.97	760-15	6.57
525-18	5.57	820-15	7.07
650-18	6.97	475-19	5.97

600-20	\$9.97	900-20	\$17.57
650-20	9.97	1000-20	18.57
700-20	10.97	1100-20	18.57
32x6 (8)	10.57	1000-22	17.57
32x6 (10)	11.97	1100-22	18.57
750-20	14.57	750-16 (8)	8.97
825-20	17.57	1100-24	21.57

**Military Xtra-Traction Guar. 45,000 Miles (Reg. 16 mos.)**

750-16	\$11	900-16	\$11	750-20	\$10.47
Xtra Traction	\$14	Xtra Traction	\$14	Xtra Traction	\$16.67

1000-22 REG. \$22 XTRA-TRACTION \$38 | 1100-20 REG. \$22 XTRA-TRACTION \$39

**BLATT** BLATT BLDG., GIRARD & LANCASTER AVES., DEPT. PS, PHILADELPHIA 31, PA. Send check or money order and this ad for rush shipment. We won't ship a tire we wouldn't use. The name to trust in rubber. Shipments RUSHED Down South, Up North and Far West

### POWERFUL

NO PUMPING

**HY-SCORE**

5 in 1

**AIR PISTOL**

ONLY

**\$19.95**

Interchangeable rifled barrels for 5 types of ammunition. .22 or .177 Cal. Hy-Score Pellets & Darts, & BB's. Small game HUNTING, indoor and outdoor TARGET shooting. The perfect gift. At your dealer now or write Dept. S-2



HY-SCORE ARMS CORP., 25 Lafayette St Brooklyn 1, N. Y.

\$ FREE COURSE! BIG PROFITS! \$

### Flocks & Sandblasts



Only \$19.75 complete

Dual Purpose Spray Gun! Uses only 25 lbs. Air Pressure!

• Thousands of uses in Home, Shop, Industry: Makes Auto Interiors Clean & New, Lines drawers, Marproofs lamp bases, Refinishes any object. All in colorful Flock. Etch & Frost windows, glassware, etc. Removes Paint & Rust from Autos. Tools. Guaranteed! Send \$19.75 or write for free information. Complete Flocking Supplies!

**BLASTO SPRAY GUN MFG.**  
Dept. PS-2, 7007 Haas Ave., Los Angeles 47, Calif.



### SPORTONE MUFFLERS

Ford & Chevrolet	\$ 4.45
All other popular cars	5.45
V-8 Dual Sets	15.95
Chromed Silentips	2.95

(Please state make & year of car on all orders.)

**SANDEE MUFFLER CO.**  
5643 Corryne Place • Culver City, California

EASY TO BUILD

## Roberts Kit-Craft BOATS

8 NEW MODELS! FROM \$42.50

Prams - Cartops - Skiffs - Rowboats - Sailing Prams - Speed Hulls - Runabouts . . . 8 to 14 ft.

Every model thoroughly guaranteed . . . Finest marine materials.

Easiest home construction known! No "throwaway" jig required. All brass screw fastenings.

Available at your favorite marine store - or order direct.



Send 10¢ for Illustrated Booklet

**Roberts INDUSTRIES, Inc.**

357 MAIN STREET, DURHAM, CONNECTICUT, U.S.A.



You'll always have lots of fun  
with a

# HARLEY-DAVIDSON

**HYDRA-GLIDE®**

Thrills and adventure are all around you, when you ride the exciting, super-smooth Harley-Davidson Hydra-Glide! It's your all-season ticket to endless good times, on delightful gypsy tours, sightseeing trips, at races, runs, and other motorcycling pleasure-events. Easy to buy on convenient terms, so why not join in the fun? See your dealer today. Mail coupon now.



**HARLEY-DAVIDSON MOTOR CO.**  
Dept. PS, Milwaukee 1, Wisconsin  
Send me free copy of ENTHUSIAST Magazine filled with motorcycle action pictures and stories; also literature on new models.

Name.....

Address.....

City..... State.....

**OPPORTUNITY:** Valuable franchises available for full line of Big Twins and 125 Model. Write today.

**FREE CATALOG**

**23 MODELS-SAVE 50%**



16' Sport Cruiser \$330

★ **EASY TO ASSEMBLE**

**PACKAGED BOAT KITS**

WORLD'S BEST BOAT BUY!

**CUSTOM-CRAFT**

★ SEMI-FINISHED BOATS (READY TO PAINT)  
★ CUSTOM-FINISHED BOATS (READY FOR THE WATER)  
FACTORY TO YOU

Racers 12'-14'



\$135. up

Dinghies 8'-10' \$37. up

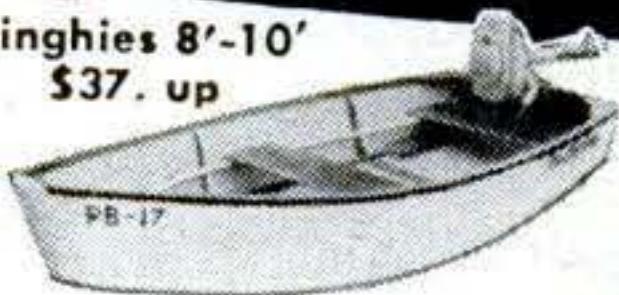

Skiffs 10'-14' \$55. up

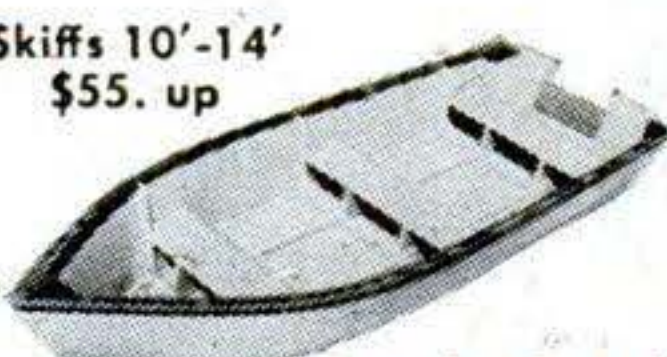

Runabouts 12'-16'

\$137. up



Outboards 12'-16' \$125. up



Exclusive features. Top-grade materials. Precision cut and pre-assembled parts. Advanced design. Top performance.

Kit prices approx. - F.O.B. Buffalo

**BOAT PLANS - PATTERNS**

Over 50 modern plans and full size patterns. Racing classes, cruisers, inboards, outboards, sail — by famous designers. 6'-30'. CATALOG 35¢. Catalog and boat building handbook, \$1.00

**BOAT HARDWARE**

Send 10¢ for literature on small boat hardware, paints and finishing materials. Literature and book "How to paint your boat" 35¢.

**MARINE MART**  
Dept. 51  
BUFFALO 7, N. Y.

**GET THE FACTS ABOUT FISHING RODS FREE!**

• What kind should you buy? Solid steel, tubular steel or glass? What are the advantages of each? Which gives best action—most sport—best value? A new "True Temper Fact Folder" explains the merits of each. It describes world's finest, most complete line of rods—including the new True Temper Dynalite laminated glass fiber rod. No obligation—write today for free copy.

USE THIS COUPON PLEASE

**TRUE TEMPER Corporation**  
MAKERS—THE ROD OF CHAMPIONS

Sporting Goods Division, Dept. 10  
Geneva, Ohio

Please send your new True Temper Fact Folder to—

Name \_\_\_\_\_

Street \_\_\_\_\_

City \_\_\_\_\_

State \_\_\_\_\_

**FINE TOOLS NEED FINE OIL!**



• Lubricates



• Prevents Rust

• Cleans • Polishes

SOLD EVERYWHERE

**3-IN-ONE Oil**

Are You Interested In **SHOOTING?**

Send 6¢ in stamps for sample copy 96-page 35¢ monthly magazine. The **AMERICAN RIFLEMAN**, exclusively about guns and shooting. Or send \$4.00 for subscription next 12 issues, and receive 2 back numbers, free.

**NATIONAL RIFLE ASSOCIATION**  
1605-C Rhode Island Ave., N. W., Washington 6, D.C.

**WORLD'S SMALLEST RADIO \$4.99!**



made today. Cigarette Pack Size—A Real Radio—Not a Toy! No tubes, batteries or electric "plug-ins" needed! Red plastic cabinet. Guaranteed to work on local stations if used as directed or money back! Use most anywhere you go! Should last for years! SEND ONLY \$1.00 (bill, ck., mo.) and pay postman \$3.99 C.O.D. plus postage or send \$4.99 for p.p. delivery. Complete with personal phone and Extra Long Distance Aerial Kit. Wonderful Gifts. Limited Supply on Hand—Order Now!

MIDWAY CO., Dept. BPS-2, KEARNEY, NEBR.



26" OPERATING SCALE MODEL SUBMARINE

Heavy duty spring motor drives twin propellers thru sealed gears, running in oil. Water ballast chamber with air valve control for diving or operating submerged.

**CONSTRUCTION KITS AND ASSEMBLED MODELS**

Price Range \$3.95 to \$16.50. Send 3c stamp for detail literature.  
**WESTLAKE MODEL CO. Dept. PS 115 ERIE, PA.**

**NOW! Build Your Own RADIO-TELEVISION SETS**



It's easy as A-B-C to built your own 30-Tube TV set... tiny pocket radio... luxury portable... home intercom system... 3-speed record player... and no less than 73 other sets! Detailed plans with step-by-step pictures tell you correctly **HOW TO BUILD 78 RADIO AND TELEVISION SETS!** This big bargain book is handsomely printed in SIX colors... 256 pages... cloth-bound... over 900 charts and pictures! Only \$1.98 if you order while this edition lasts!

**TRY IT FREE FOR 7 DAYS!**

Drop us a postcard today and we'll rush this amazing, easy-to-follow book now for a FULL WEEK'S FREE TRIAL! On delivery, pay postman only \$1.98 plus postage fees—or send \$1.98 now and we'll pay postage—then try it yourself for 7 days WITHOUT OBLIGATION! If not delighted, return book for full refund. Order from:

**POPULAR SCIENCE, Dept. 251, 353 Fourth Ave., New York 10, N. Y.**

# IT'S Sensational!

**25 HORSEPOWER!**

**...YET IT TROLLS!**

**ONLY 85 POUNDS!**

**AND ONLY \$390\***



THE NEW

# JOHNSON

## SEA-HORSE 25



WITH GEAR SHIFT . . . SYNCHRO TWIST-GRIP SPEED CONTROL . . . SEPARATE MILE-MASTER FUEL TANK. A *super-powered* motor that handles *easily*. A smooth-running motor with an unbelievable range of performance. A Gear Shift motor with Neutral-Forward-Reverse. A long-cruising motor with separate Mile-Master Fuel Tank. Ideal for speed (over 30 m.p.h.) —“big” waters—outboard cruisers—water sports—and *fishin'*! See it! Drive it! Look for your Johnson dealer's name under “Outboard Motors” in your classified phone book.

**FREE! NEW HANDY CHART.** Full details on the 4 versatile Sea-Horses for 1951... a motor for every outboard need. Write today! It's free!  
 JOHNSON MOTORS, 500 Pershing Road, Waukegan, Illinois  
 In Canada: Johnson Motors, Peterborough

### FOUR VERSATILE MOTORS FOR 1951

- |           |           |  |
|-----------|-----------|--|
| SEA-HORSE | <b>25</b> | 25 H.P. . . . . . 85 lbs. . . . . \$390.00*  |
|           |           | With Gear Shift, Synchro Twist-Grip Speed Control, six gallon Mile-Master Fuel Tank. |
| SEA-HORSE | <b>10</b> | 10 H.P. . . . . . 58 lbs. . . . . \$295.00*  |
|           |           | With Gear Shift, separate Mile-Master Fuel Tank (6 gal.)                             |
| SEA-HORSE | <b>5</b>  | 5 H.P. . . . . . 44 lbs. . . . . \$187.50*   |
|           |           | World's fishing favorite. Neutral Clutch. No Shear Pin.                              |
| SEA-HORSE | <b>2½</b> | 2.5 H.P. . . . . . 31 lbs. . . . . \$137.50*   |
|           |           | World's lightest Alternate Firing Twin.  |

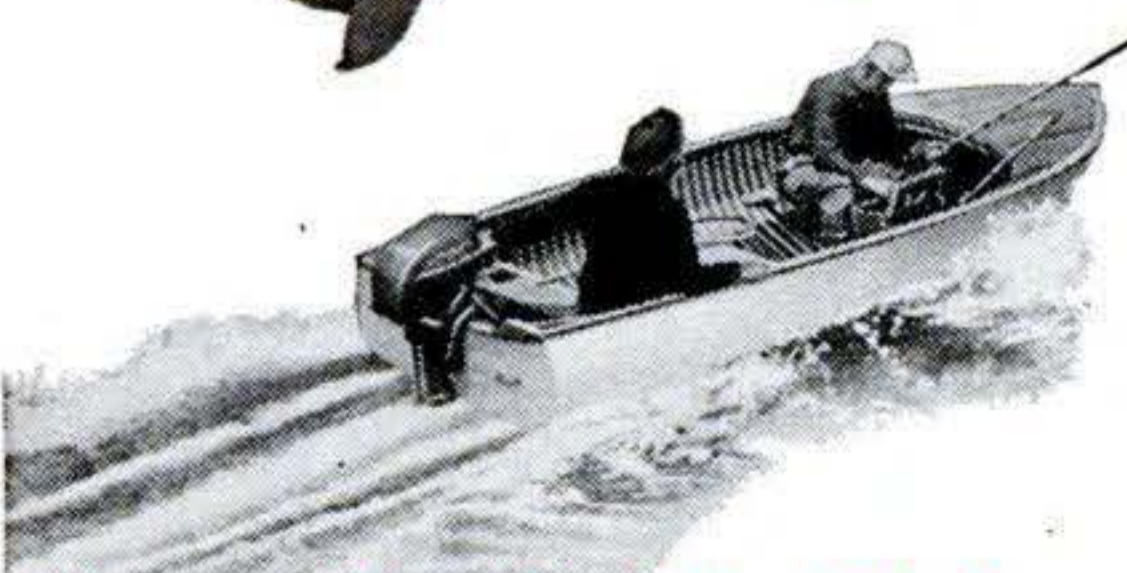

**Johnson—America's No. 1 Choice for DEPENDability**



\*All prices f.o.b. factory. All prices subject to change without notice. All h.p. ratings are OBC Certified brake h.p. at 4000 r.p.m.



**Make Money  
with Spare-Time  
Plowing &  
Mowing!**

**5-HP**

**GRAVELLY Tractor**

**OFFERS 20 MONEY-MAKING TOOLS!**

Make good money this spring plowing gardens with the powerful Gravelly Tractor! Perfect seedbed in one operation. It's easy to earn \$30 to \$40 a week—extra!

The tractor does the work—you collect the fee. After plowing season, use Sickle or Lawn Mower attachments for cutting brush, weeds, lawns. Remember, with 20 tools, Gravelly does every lawn, garden and field job! All-gear drive, power reverse; moderate investment. . . . An easy way to get a Gravelly of your own—and make a profit besides! "Power vs. Drudgery" tells you how to put Power to work making money for you! Spring's almost here—write today!



GRAVELLY MOTOR PLOW & CULTIVATOR CO.  
BOX 284 DUNBAR, W. VA.

Pioneers

Leaders

**AIR RIFLES**

**BENJAMIN**

**AIR PISTOLS**

**SHOOT WITH SAFETY**

**BE SAFE—SHOOT WITH COMPRESSED AIR—ALWAYS READY**  
No Cartridges or Tanks to Replace or Recharge. If you want the most PRACTICAL GUN to use anywhere—inside or outdoors—get a SAFE—CLEAN—ECONOMICAL BENJAMIN with Adjustable Power and Amazing Accuracy. Send for Free Folder of Latest Models Today. BENJAMIN AIR RIFLE CO., 853 MARION ST., ST. LOUIS 4, MO.

**HARDENING • FORGING • MELTING**

For general heat-treating applications



**UTILITY OIL BURNER**  
**\$89.50 fob**

Specifications: 26" x 10" x 9"; 22 lbs; 50,000-200,000 Btu/hr; 2800°F max. temp.; 110v. 60 cycles; fuel gravity feed; manual operation; controllable atmosphere. Converts kerosene, #1 or #2 fuel oil into a clean, hot, gas flame for firing into ovens, furnaces, forges or into open. Tell us your needs. We furnish plans, or build furnaces to suit your requirements. Average unit costs \$20. to construct. Write for literature and specific data. Immediate delivery. Complete satisfaction guaranteed.  
STODDARD PRODUCTS CO., Inc., 66 Amity Road, New Haven 15, Conn.

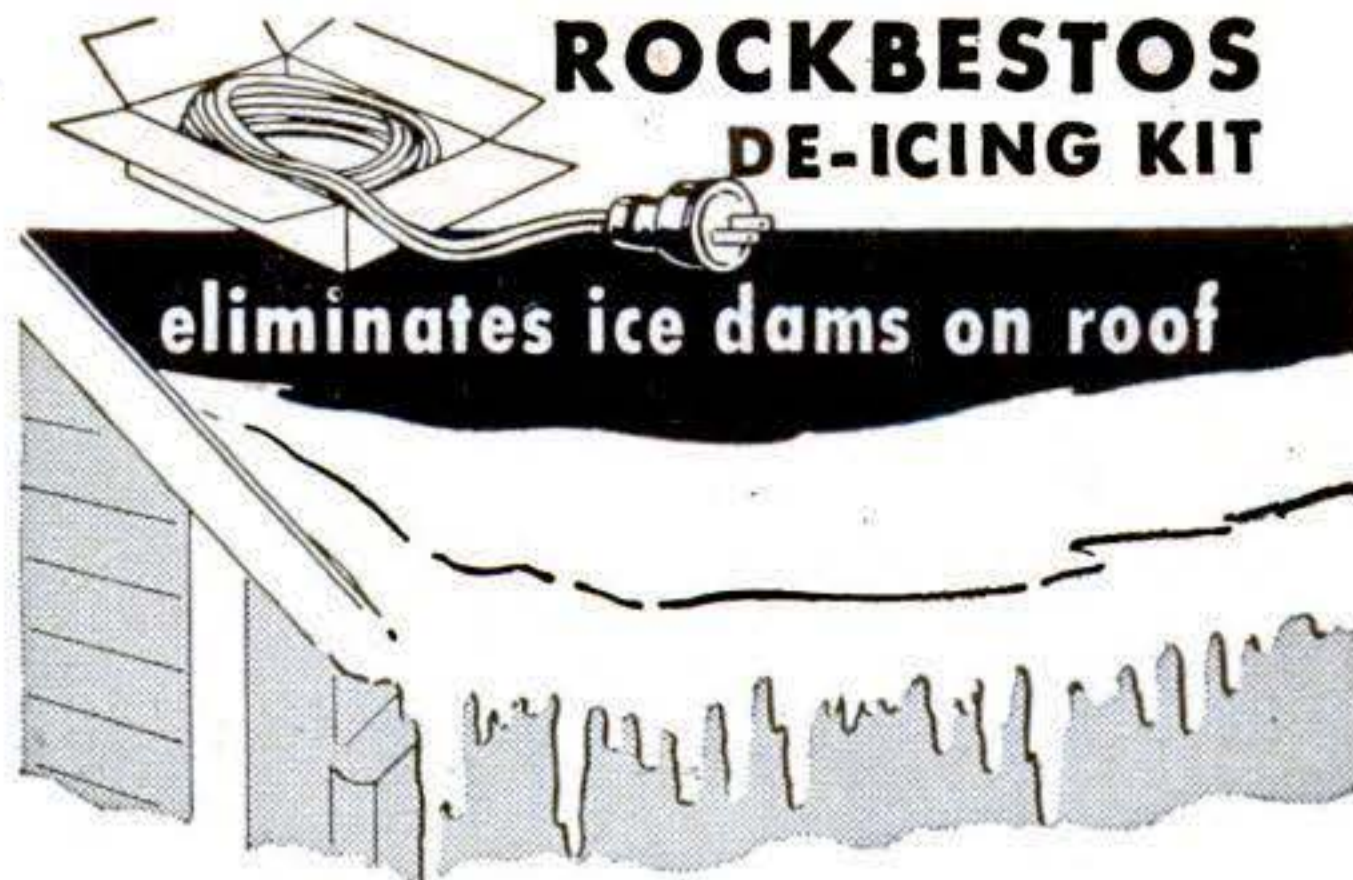

**ROCKBESTOS DE-ICING KIT**

eliminates ice dams on roof

**...saves costly repair  
of walls and ceilings**

This complete heating kit—ready to use—protects 18' of roof by melting ice on roof edge and gutter. Eliminates winter water damage... costly replastering and repapering. Easy to install... will not damage roof. Kit contains 60' durable, lead-covered heating cable with plug, roof clamps, instructions. 120 Volt AC-DC.

**ROCKBESTOS PRODUCTS CORP.**  
New Haven, Connecticut

See your  
**ELECTRICAL  
DEALER**  
or  
**WRITE to**

**DRIVE BEHIND A FRIEND WHO  
KNOWS EVERY TURN**



**Beaconlite**  
Illuminated \$6.95  
**STREAMLINE**  
Standard (Not illus.) \$4.95

Ever been out of town and had a friend lead you through confusing turns and intersections until you were on the right road home? Sure is welcome help—the kind you get EVERY DAY with a Hull Automobile Compass. At your dealer's. Write for literature.

See HULL Quality Before You Buy  
**Hull Mfg. Co.** P.O. Box 246-E2,  
Warren, Ohio



**Build Your Own Authentic Miniature Ships**  
Anyone can build an IDEAL ship model . . . just a few hours of simple, satisfying work and you have a completed historic miniature you'll proudly display! No workshop, no tools necessary—kit contains simple plans, many finished parts. ORDER TODAY!  
**GOLDEN HIND**  
Sir Francis Drake's Flagship only \$1.50 plus 15c postage for complete kit. Send 15c for catalog of various models.  
**IDEAL MODELS**  
28 W. 19th St., New York 11, N. Y.



**MAKE EXTRA MONEY!**



**SELL QUICK-BEARING NEW FRUIT TREES**

Gorgeous Flowering Shrubs, Ornamentals, Roses Get FREE SALES KIT—make money fast demonstrating world-famous Stark Patented Apple, Pear, Peach and other fruit trees, Grapes and Berries. Gorgeous flowering shrubs, roses, ornamentals sell fast to home owners. Sensational hardy, Quick Bearing new varieties. Enormous demand for small farms, home yards, etc. No experience needed. Rush name for giant kit and Color Plate Book—FREE.  
**STARK BRO'S, Dept. 1292, Louisiana, Missouri**

**PLYWOOD BOAT KITS**

**\$97<sup>00</sup>**  
(Freight Included)



Build this 12-ft. sport run-about from ready-cut parts. Kits include all hardware, paint, etc., to complete the boat shown. Send for free folders of all models as low as \$32.00 freight included.

**TAFT MARINE WOODCRAFT**  
Dept. S, 636 39th Ave., N. E., Minneapolis 21, Minn.



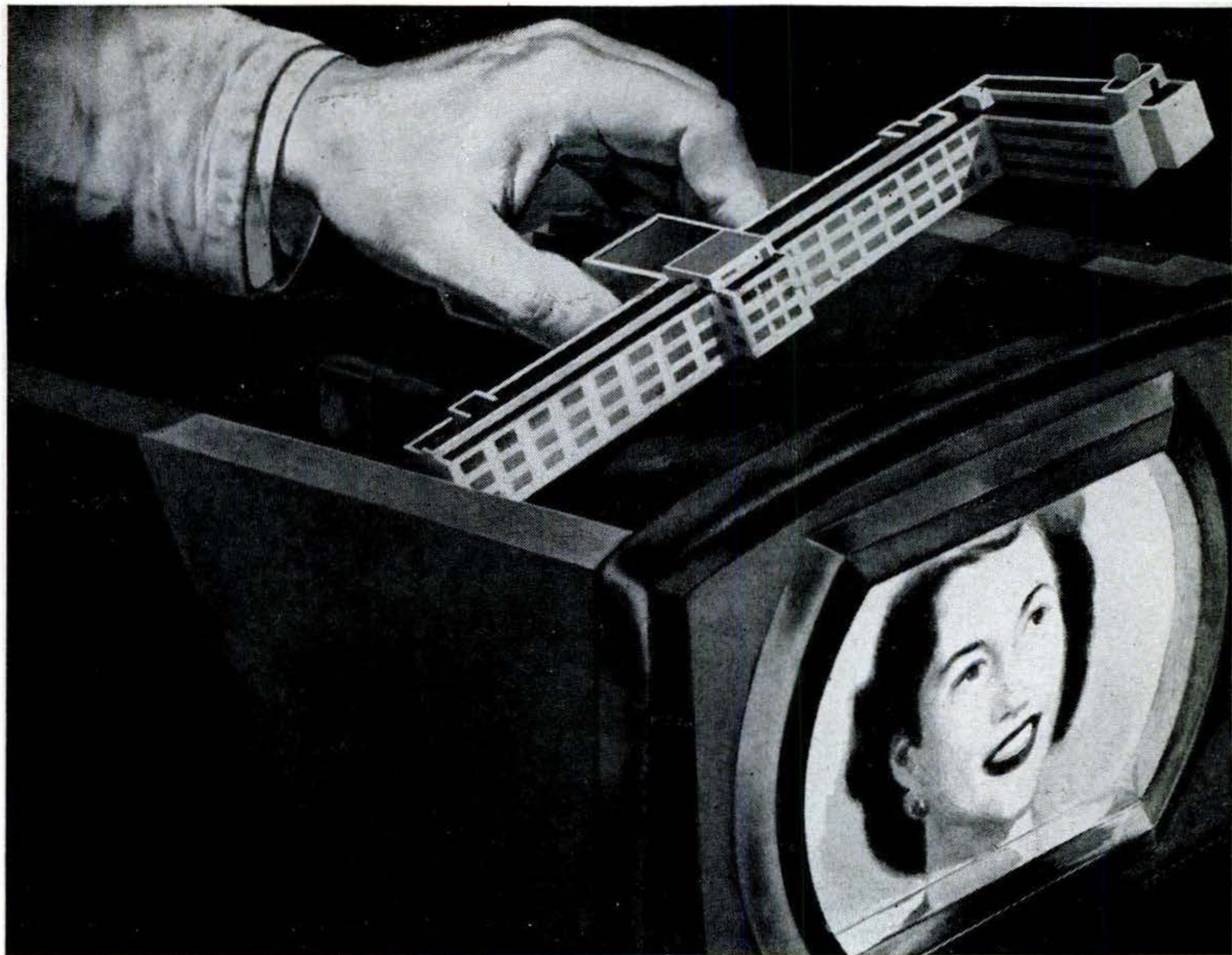

Basic research at RCA Laboratories has led to most of today's all-electronic television advances.

## *At the heart of every television set!*

**Why show RCA Laboratories inside your television receiver?** Because almost every important advance leading to all-electronic TV was pioneered by the scientists and research men of this institution.

The supersensitive image orthicon television camera was brought to its present perfection at RCA Laboratories. The kinescope, in these laboratories, became the mass-produced electron tube on the face of which you now

watch television pictures. New sound systems, better microphones—even the phosphors which light your TV screen—first reached practical perfection here.

Most important, the bulk of these advances have been made available to the television industry. If you've ever seen a television picture, you've seen RCA Laboratories at work.

\* \* \*

See the latest wonders of radio, television, and electronics at RCA Exhibition Hall, 36 West 49th St., N.Y. Admission is free. Radio Corporation of America, Radio City, New York 20, N. Y.



Through research at RCA Laboratories, today's RCA Victor home television receivers are the finest example of modern electronic engineering.



**RADIO CORPORATION of AMERICA**

*World Leader in Radio — First in Television*



# FRAM keeps 14,000,000 engines CLEAN

*Over fourteen million Motorists, Farmers and Fleet Owners use Fram Filters to Protect their Engines!*

**C**LEAN engines last longer! Dirty engines die young! *And, Fram "cleans the oil that cleans the motor."* Takes out the harmful dirt, dust, grit, sludge and abrasives that contaminate the oil and cause excessive friction, wear, breakdowns and repairs.

## THE DIPSTICK TELLS THE STORY

When the oil shows dirty on the dipstick, it means one of two things: If you don't have an oil filter, you need a famous Fram Oil and Motor Cleaner. If your car has an oil filter, you need a new Fram Replacement Cartridge—there's one to fit most every make oil filter.

Insist on genuine Fram Replacement Cartridges for top performance. You can always depend on Fram . . . world's largest manufacturer of Oil, Air, Fuel and Water Filters. Because when you install FRAM . . . you don't risk a red cent. All Fram Filters are unconditionally guaranteed! FRAM CORPORATION, Providence 16, R. I. In Canada: J. C. Adams Co., Ltd., Toronto, Ont.

*To get the name of your nearest Fram Dealer, call Western Union by number and ask for Operator 25*



## Only Fram Offers You Complete Engine Protection

Now, famous Fram Filters guard engines at every vital point. Seal out the deadly abrasives that rob miles from engine life. Remove harmful corrosives formed internally. Seal in engine performance and life.

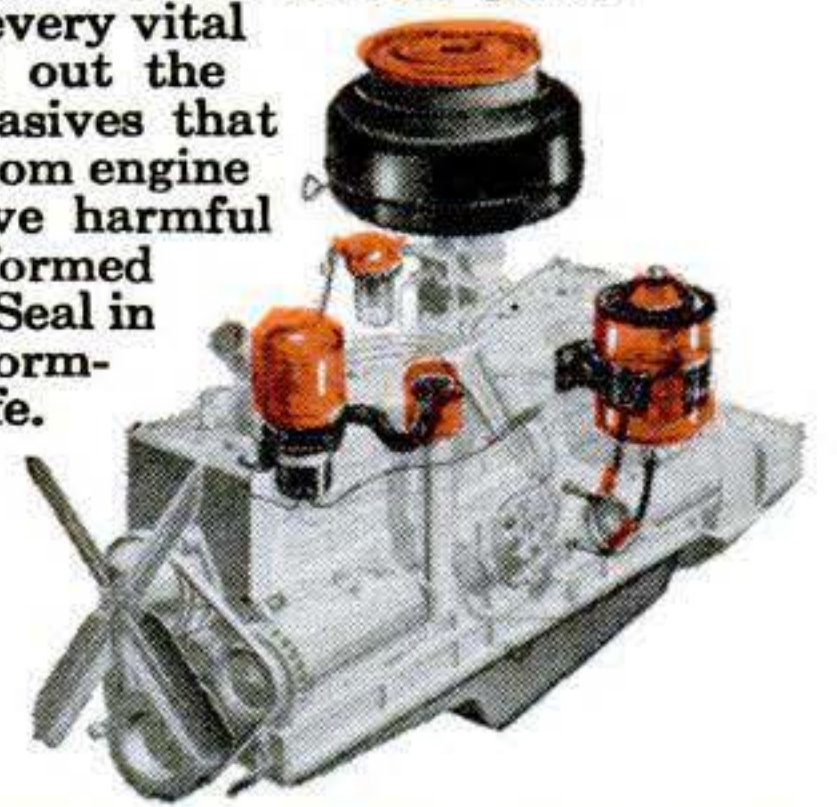

# FRAM

OIL • AIR • FUEL • WATER

# FILTERS

# Popular Science

## Highlights

### This Month

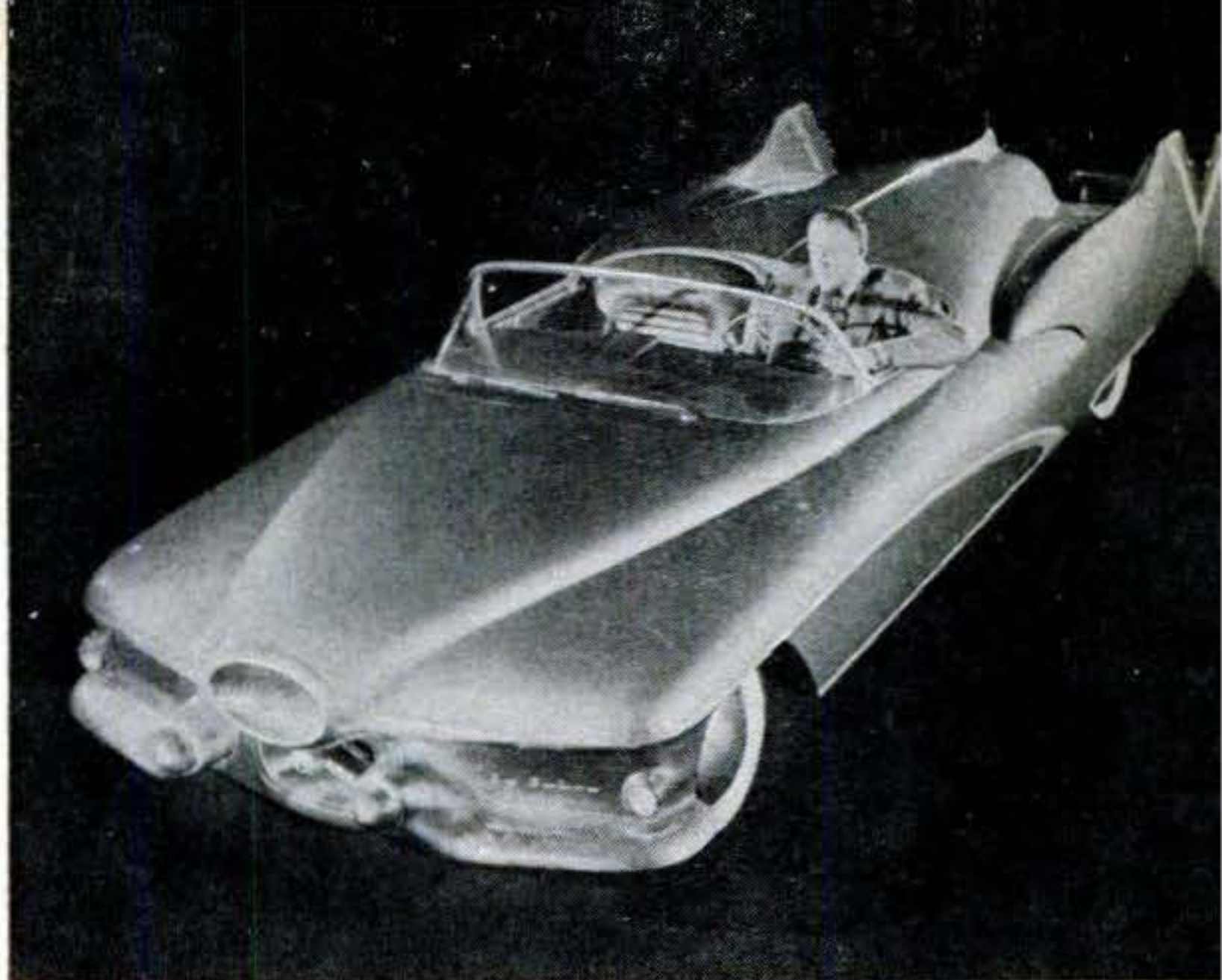

**This May Be Tomorrow on Wheels:** GM's startling 300-hp. test job is a crystal-ball look into what's in your car future. **Page 130**



**These Are War's Dirty Tricks:** And here's one being played on a South Korean mine sweeper by a Russian-type contact mine. **Page 107**

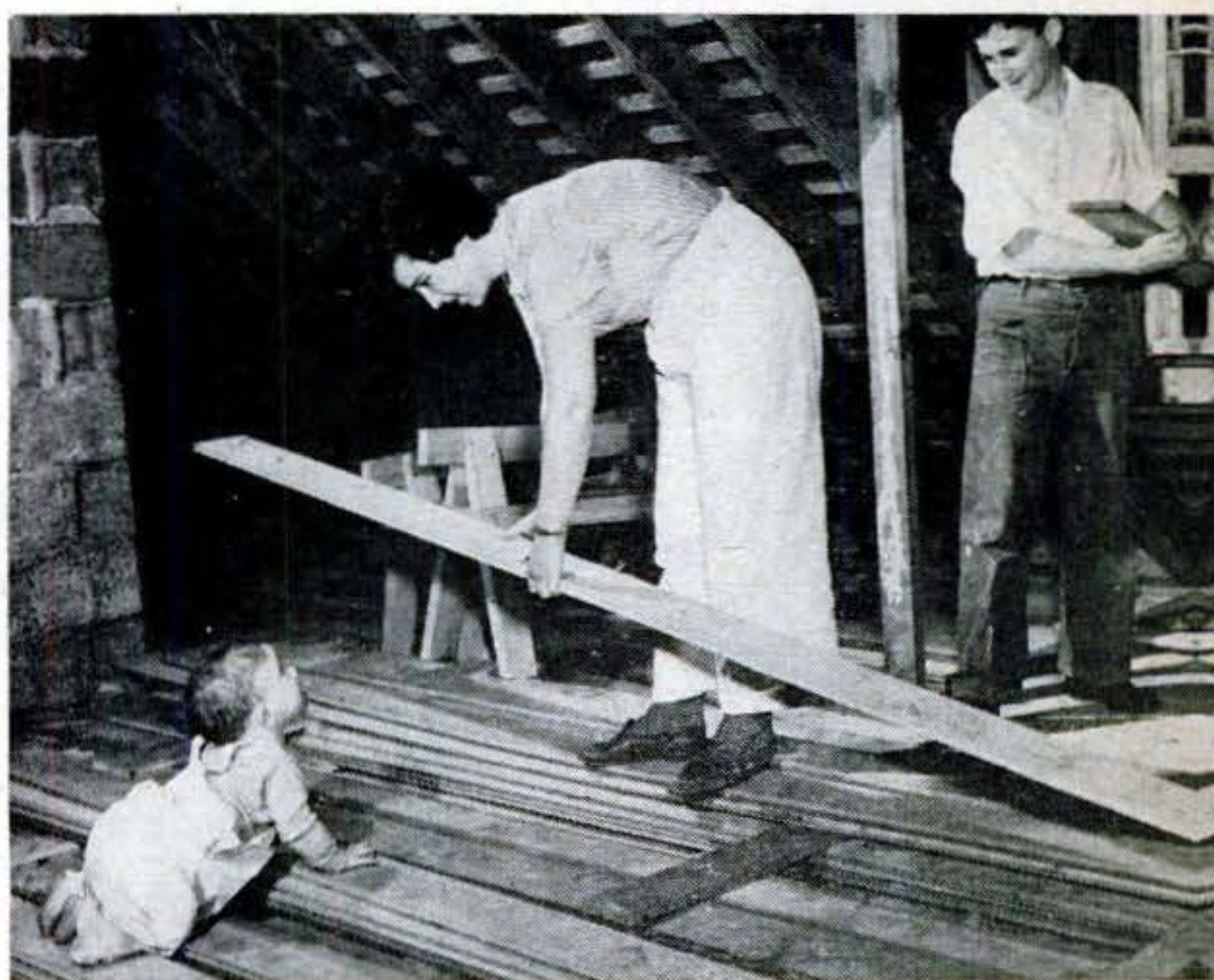

**Baby Watches an Attic Grow Up:** Here's how you can expand that bare upstairs into living quarters—and save many dollars. **Page 177**



**Ever See a Television Camera Smoke a Cigar?** One TV show really has such a talented camera—it eats pie and drinks coffee, too. **Page 106**



**Want a Flying Saucer?** Then see how easy it is to build this seagoing version that can hit 30 m.p.h. Hull cost is only \$45. **Page 226**

# Wilbur Shaw Drives



**1950 PLYMOUTH**



**1951 PLYMOUTH**

These light patterns, traced by a wheel and the car body, show (top) how the old-type shocks



The ditch really gave the car a bouncing, as you can see from this picture made in the daytime. When we took the pictures at night, the beams from a couple of flashlights traced on

photo film the movements of both the sprung and unsprung weight. Take another look at the two panels now. The rear wheels actually left the ground with the old-type shocks.



# 1951 Plymouth

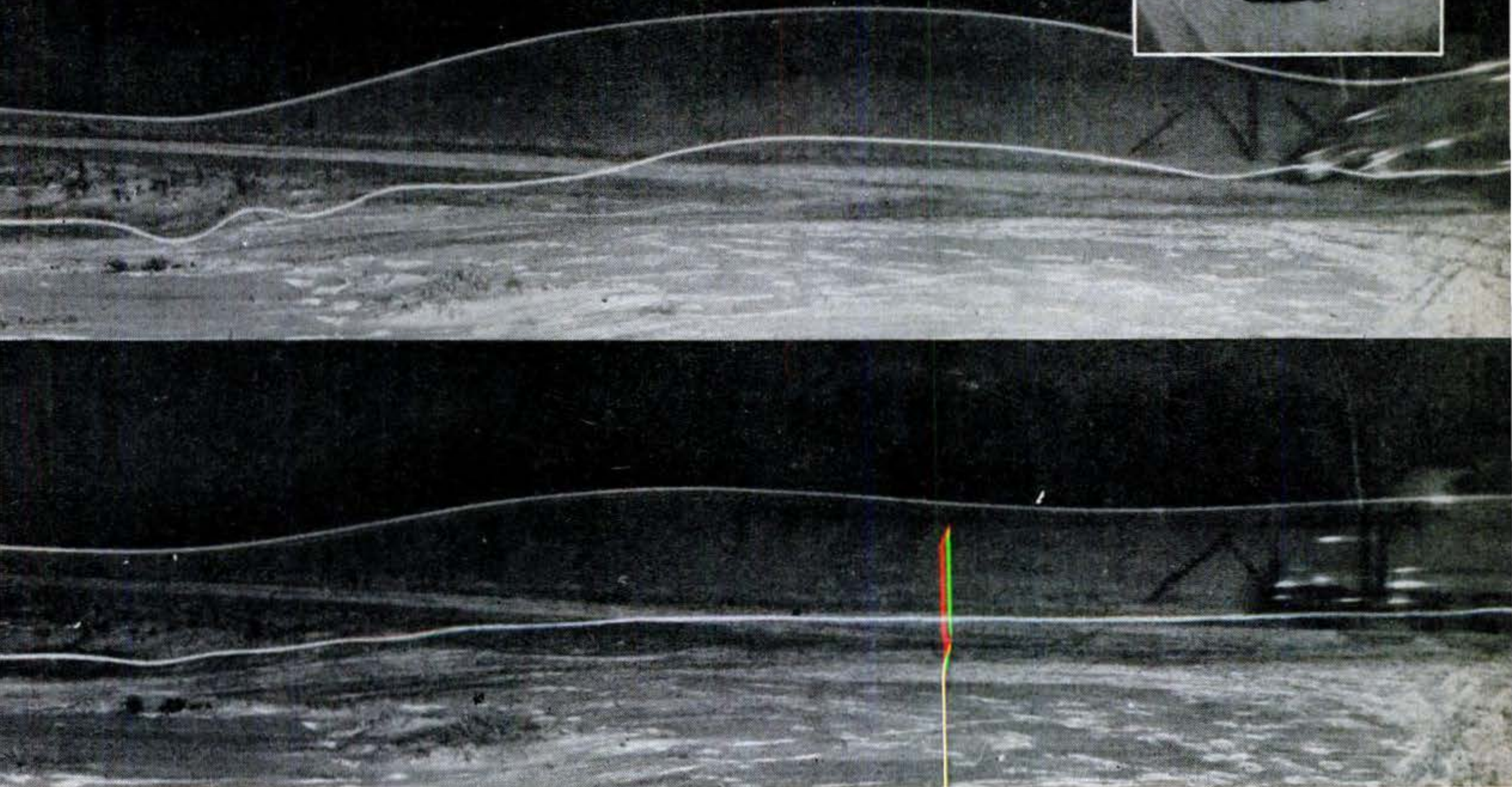

let a Plymouth bounce when it hit a ditch. Lower traces show pattern made by new ones.

**PS's self-styled Doubting Thomas gets a surprise when he tries out a new type of shock absorber at his big Speedway.**

**By Wilbur Shaw**

PS PHOTOS BY HUBERT LUCKETT

**REPORT FROM THE**



**DRIVER'S SEAT . . .**

EVERY so often an automobile manufacturer puts something in a car that makes people say, "Why didn't they think of that before?" Plymouth for 1951 has done just that. This car has a new kind of shock absorbers that take most of the

jounce out of bad roads.

I had my reservations about what could be done with shock absorbers when Plymouth offered to send me a spanking new car from Detroit to the Indianapolis Speedway last December. They sent not one car, by the way, but two—the second one was a '50 for comparison.

In the racing business we have experi-

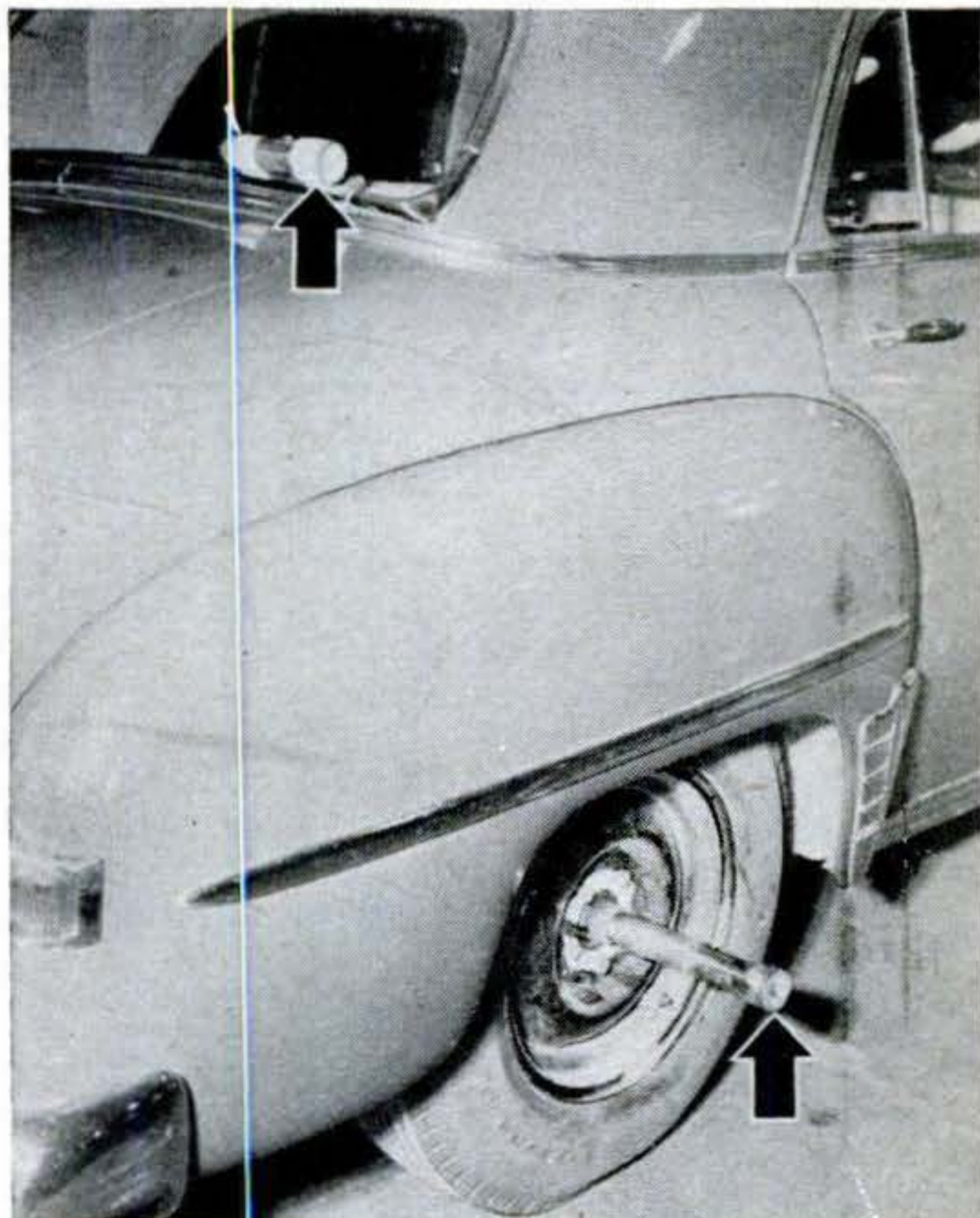

**Chrysler Engineering** figured out how to mount two flashlights (arrows) used in tests above. All Chrysler Corp. cars have new "Oriflow" shocks.

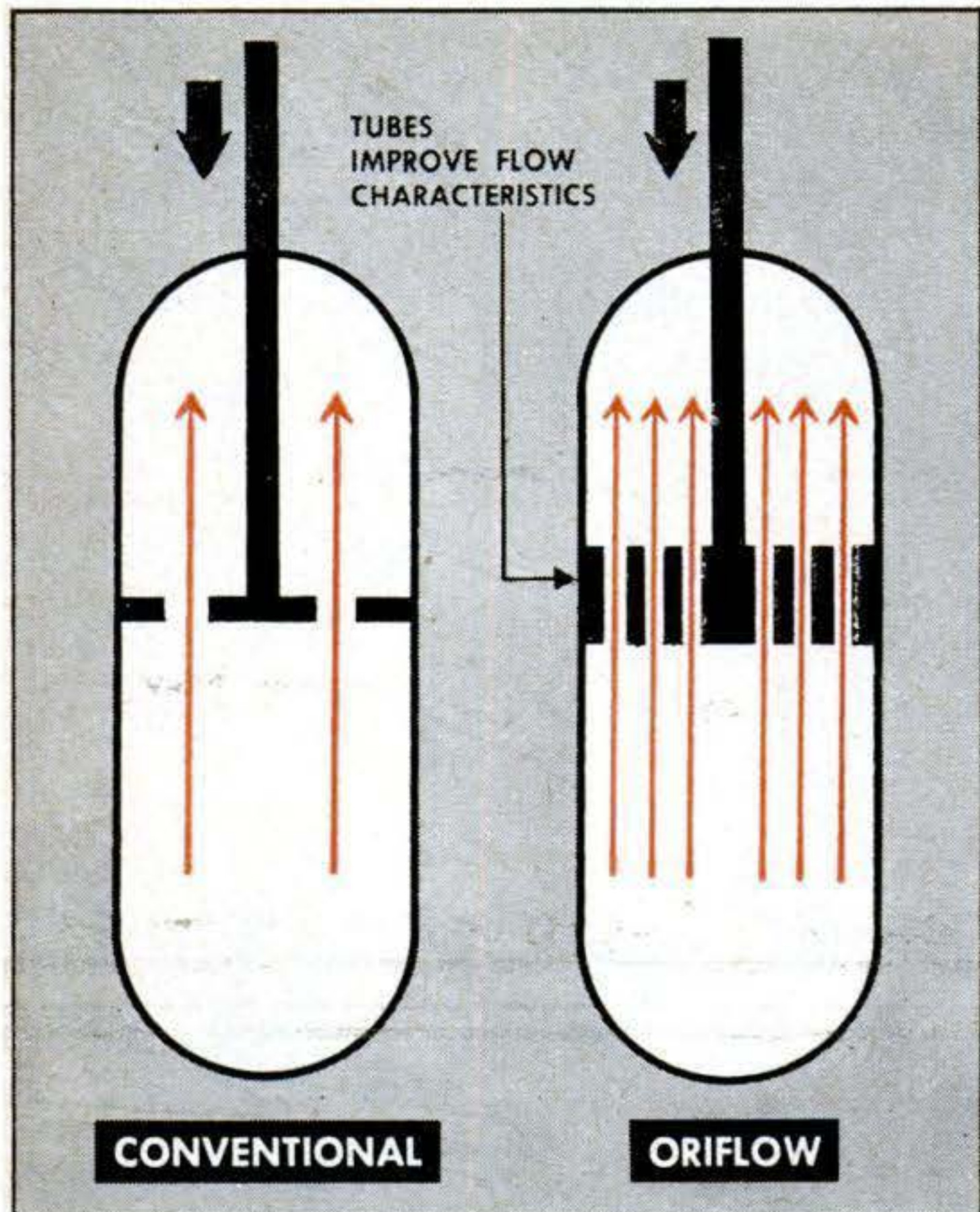

The principle involved in the Oriflow shock absorber is shown in this diagram. When car wheels hit bumps, the fluid-filled cylinders of the shocks move up and down over stationary pistons. This forces the fluid to circulate back and forth through passages in the piston. These passages restrict the flow and damp the car's springs. In conventional shocks these passages are holes in a thin plate. It's a characteristic of such plates that their resistance to fluid flow builds up fast as fluid velocity increases—as in a hard jounce on the road. So, through a relief valve in the shock's base, the flow-resistance is compromised to take bumps averaged between mild and severe ones. In Oriflow, the passages are long and tubular. Their resistance to fluid flow builds up more gradually. So they cushion a car against both kinds of bumps.

mented with all sorts of shock absorbers. The best of them relieved the drivers of only a part of the punishment inflicted by hours of pounding driving on the race track. When a race ends a driver feels as though somebody has beaten him from head to foot with a baseball bat. In a long race the shock absorbers get so hot that they crackle if you drop a little water on them.

First let's straighten out some possible misconceptions about shock absorbers. As the Chrysler Corporation itself points out, the name shock absorber is an inaccurate description. The real shock absorber in a car is the spring. It squeezes up when a wheel hits a bump. It takes the impact.

What we know as the shock absorber could be called more truthfully a spring damper. It isn't the bump in the road that gives you a rough ride. The springs take care of the bump. It's the unflexing and flexing of the spring following the bump. The bump jounces the wheel and the wheel flies up to squeeze the spring together. That stores energy in the spring.

The energy has to go somewhere. It's taken out as the spring alternately compresses and extends itself, with shorter and shorter oscillations, until finally it stops.

The "shock absorber," so called, performs the simple function of helping damp out the spring's stored energy. It shortens the time of oscillation, bringing the spring to rest faster. The shock does this by converting the spring's energy into heat and then radiating the heat to the air.

I was from Missouri when I got behind the wheel of the new Plymouth. I know that

## Facts on '51 Plymouth

SO MANY readers have written me for additional details on the cars I try out that I am adding a fact list to each report from the driver's seat. Here's the first one:

**Make and model:** Plymouth four-door "Cranbrook" (formerly the Special Deluxe).

**Engine:** 6 cyl. L head; 97 hp. at 3,600 r.p.m.; car weight per hp., 33.8 lb.; bore and stroke, 3¼" by 4"; compression ratio, 7:1; piston displacement, 217.8 cu. in.

**Engine piston travel:** (in feet per car mile at 20 m.p.h.)—2,140.

**Crankshaft bearing surface:** 34.61 sq. in.

**Torque:** 175 lb.-ft. at 1,200 r.p.m.

**Transmission:** 3-speed manual shift.

**Rear-axle ratio:** 3.9:1.

**Steering ratio:** 20.7:1.

**Radius of turning circle:** 39' 7".

**Effective brake-lining area:** 143.8 sq. in.

**Springs:** front, coil; rear, semi-elliptic.

**Weight and outside dimensions:** 3,280 lb. (est.); height, no load, 64¾"; over-all length with bumpers and guards, 193¾"; width, 73¾"; wheelbase, 118½"; front overhang, 32¾"; rear, 42¾"; tread, front, 55¾"; rear, 58⅞".

**Inside dimensions:** Seat-cushion width, front 55", rear 57"; legroom, front 40¾", rear 42½"; headroom, front 36", rear 36"; seat height, front 15", rear 15½"; vertical distance, steering wheel to seat cushion, with seat in mid-position, 5½"; front-seat adjustment, horizontal, 5"; vertical, 1⅞".

**Tire size:** 6.70 by 15.

in almost any shock I've ever seen the manufacturer has had to compromise on riding qualities. If a shock is set—or calibrated, as they say—for hard bumps, it doesn't do so well on little ones, and vice versa. So shocks are set at an in-between point. That gives a car owner maximum spring damping right at that in-between point and nowhere else.

To establish the comparison between the old and new shocks, I first drove the '50 Plymouth around the Speedway and then into a rough section of the infield. The track had three inches of snow on it. Here's some of the playback from my tape recorder:

*The track's slippery . . . I can feel a little skittishness in my front wheels . . . but like all Plymouths, this car has good road-keeping quality and fine directional stability.*

The infield, which is rough, jounced me around. I had to grip the steering wheel tight to keep my seat. There's a fairly deep drainage ditch along one of the infield roads.

"How about it?" I asked Dick Steding of Chrysler Engineering, who had come down to shepherd his cars. "Shall I try the ditch?"

He nodded.

"It's your car, remember," I warned him. I took the ditch at 15 miles an hour.

#### ***Double Whammy in the Ditch***

*I wouldn't want to do this for a living. It's rough. . . . Now we'll try it at 20 . . . wham! . . . And now 25 . . . double whammy! That's too much punishment. On that last run the spring rebound almost sent me through the roof. I almost lost control.*

I had had enough of that. I drove back to the main grandstand section of the track where we had parked the '51 Plymouth, and changed mounts. This was a sedan, one of ten models in the line. I took another turn around the track.

*The front end's restyled. A lower hood line gives you much more road visibility. There's a bigger rear window . . . the ignition switch also energizes the starter—turn the key past "on" and you're in business.*

*There are no drastic changes in this car from 1950. The instrument panel is like an airplane's . . . it's assembled in sections for accessibility . . . the seats are soft.*

Plymouth, by the way, has coil-spring inserts for the seats to accommodate extra-heavy owners. They can be had for free.

*This car has an electric windshield wiper. It replaces the vacuum type . . . the entire Chrysler Corporation line now has electric wipers. The only fault I've got to find with*

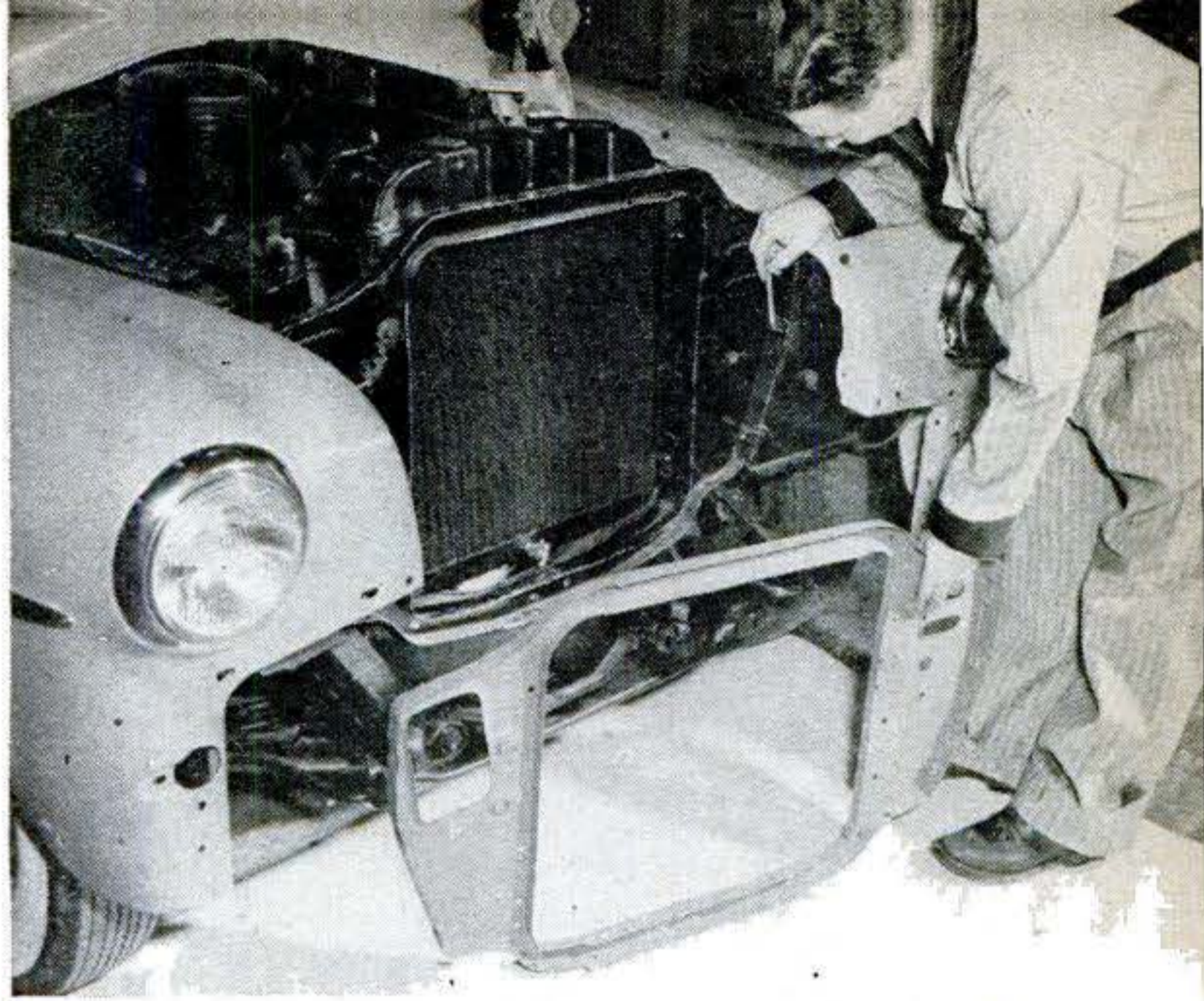

**Let's not overlook** other improvements in the '51 Plymouth. Here's another. A rigid yoke ties the entire front end of the car together for better roadability and fewer rattles.

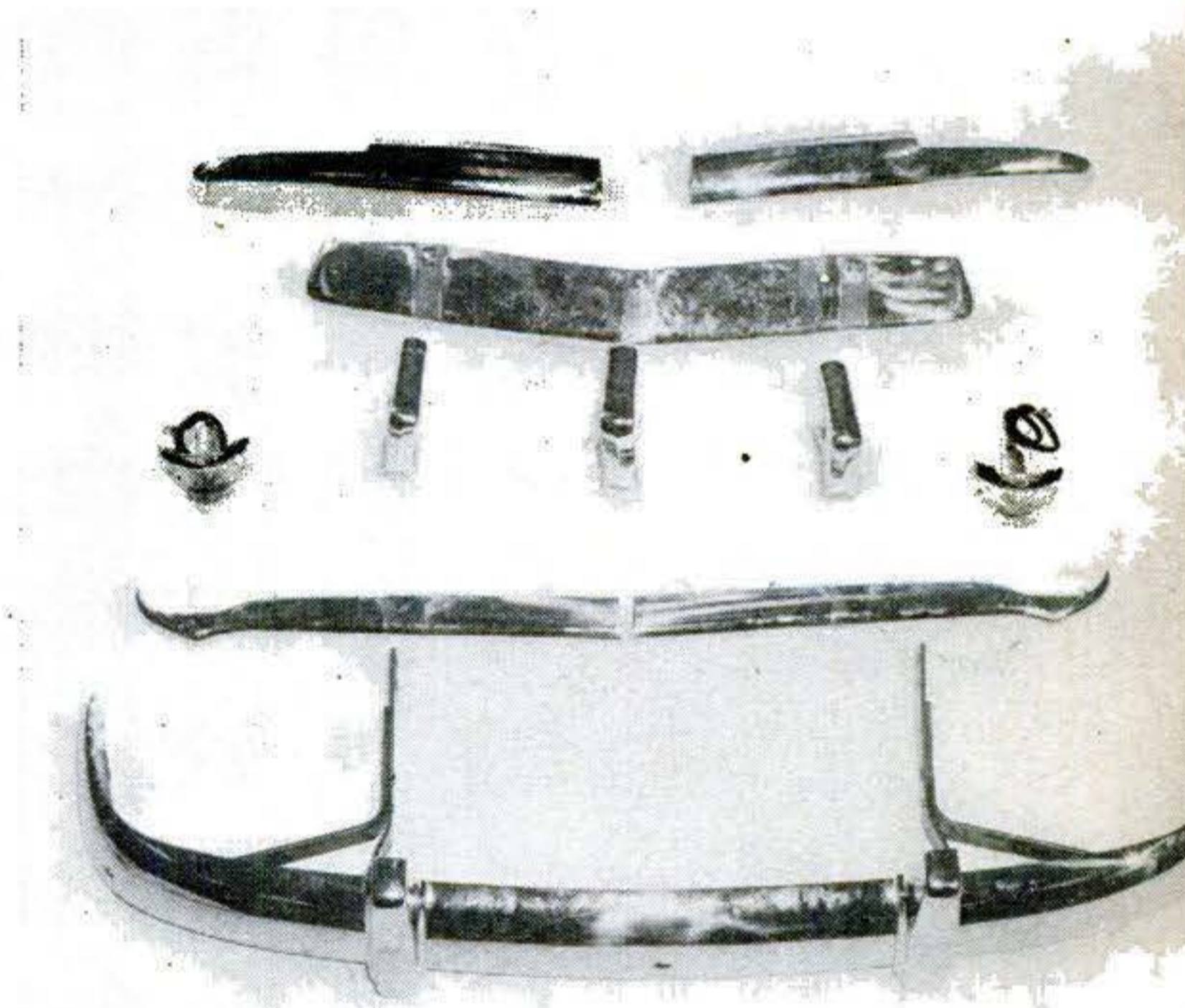

**Another thing I liked** about the car was the 10-piece grille arrangement. The parts are individually replaceable. If you bang up your front end, it will cost less to get it fixed.

**The instrument panel**, shown here with me behind the wheel, is new too. The sectional parts detach easily for accessibility. The rear view mirror is a full two inches wider.



electric wipers is that often they don't have enough speed . . . they don't sweep the windshield often enough in a heavy rain.

I don't think the sound level is as good as in the '50. There's too much travel in the gearshift-lever action, but Plymouth always has had that fault. The brakes, though . . . nobody could find fault with them.

Or the engine. Give Plymouth credit . . . they've always made an engine—and a car, for that matter—as dependable as my grandfather's old dappled gray mare. The car's fast . . . a Plymouth won a 500-mile stock car race at Darlington, S. C. . . . The shelf above the instrument panel is glossy-finished . . . it reflects too much light.

But most of the attributes of this car are . . . I'd say this car represents, most of all, dependable transportation. . . .

People are going to wonder why Plymouth isn't offering an optional automatic transmission for '51 . . . like Ford and Chevrolet . . . I understand they decided against it because the extra cost would shove Plymouth up toward Dodge in price. . . .

It was time for me to play cowboy with the shocks. I hit the bumps on the infield.

She rides better . . . no doubt about that . . . but I still get jounce . . . I'll need some more convincing . . . one thing . . . there is little or no wheel-hop. I've always got control. . . .

For an hour or so I experimented with those spring dampers. The more I drove, the better I liked them. That was fine. But what would they do on that ditch? I squared away.

Fifteen miles an hour on the dial . . . there's . . . well, it was there . . . the ditch

### This Month's Shaw-ism

It isn't a curious coincidence that the man who treasures his car gets the best price on his trade-in.



was there . . . something's wrong, hardly any jounce. . . . Evidently I didn't follow the tracks I made with the '50 job. I must have hit the ditch where it was shallower.

I tried it again, this time at 20. I was going through the same place, all right. I checked that.

The shocks keep saying the ditch isn't there . . . the car keeps its feet on the ground . . . there's no loss of control.

This was too good to be true. I tried the ditch again, at 35 miles an hour.

I'm releasing the wheel at the moment of impact—look, Ma, no hands! . . . she keeps her head like a lady.

"Well?" asked Dick Steding, as I dismounted.

I suppose I'm an irascible so-and-so. "I'll tell you in a minute," I said. I had to be sure.

I slipped into the seat of another make of car standing nearby and made for that ditch. Wham! The body hit the bumper blocks, and I took off on the rebound for a flight toward the roof. The wheel saved me. I turned around and braked to a stop.

"Well?" Steding repeated.

"The apologies of a Doubting Thomas to the Chrysler Corporation," I said. **END**



A comparison of the '50 and '51 cars (the '51 is on the left) will give you an idea of the changes that have been made in the front end.

The wheel tread has been boosted by about a half inch in front. The span between the headlights is  $54\frac{1}{4}$  inches,  $3\frac{1}{4}$  inches greater.



# New Ideas from the Inventors

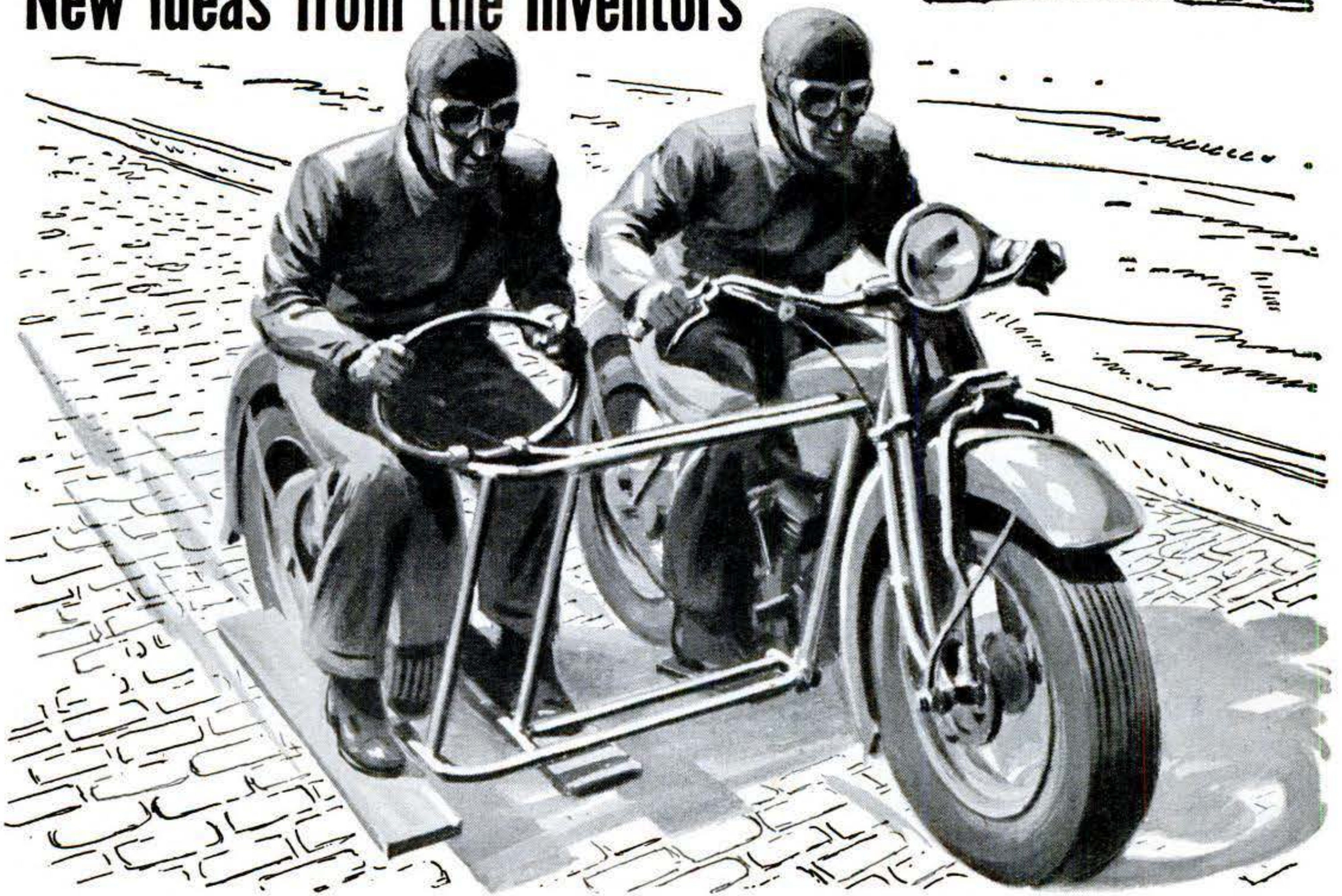

**1 Seat to Replace Sidecar.** Instead of being tossed around in a conventional sidecar, the passenger on a motorcycle fitted with this side frame would ride on a seat that is astride a third wheel. This new ar-

angement, it is said, provides the passenger with a handhold as well as a seat and allows him to brace himself against the bumps and jolts on a rough road just as well as the driver does.



**2 Stove to Save Space.** Designed for use in the cramped quarters of small apartments, this compact stove has only one set of heating elements. Mounted on a drawer-like section, they can be pulled out to serve as a three-burner range for frying and cooking or they can be pushed in to provide heat for a baking oven.

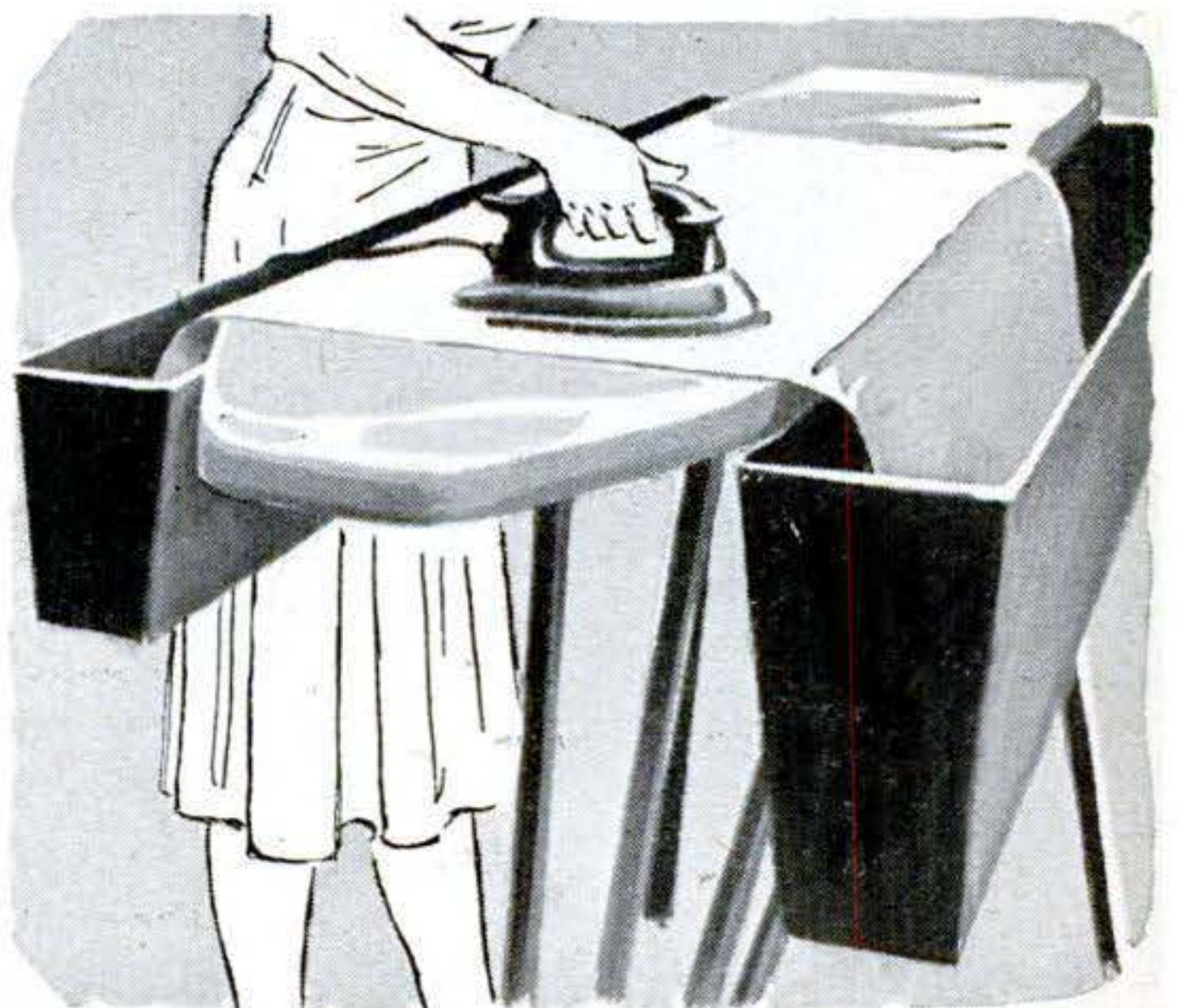

**3 Holders to Aid in Ironing.** There should be no trouble keeping large pieces, such as sheets, off the floor when they are being ironed on a board fitted with the two fabric troughs illustrated. The trough nearest the person ironing holds damp, unironed part; ironed portion is fed into the trough on opposite side of board.

**Turn the page, please, for three more new ideas.**

FEBRUARY 1951 103

## **MORE** New Ideas from the Inventors

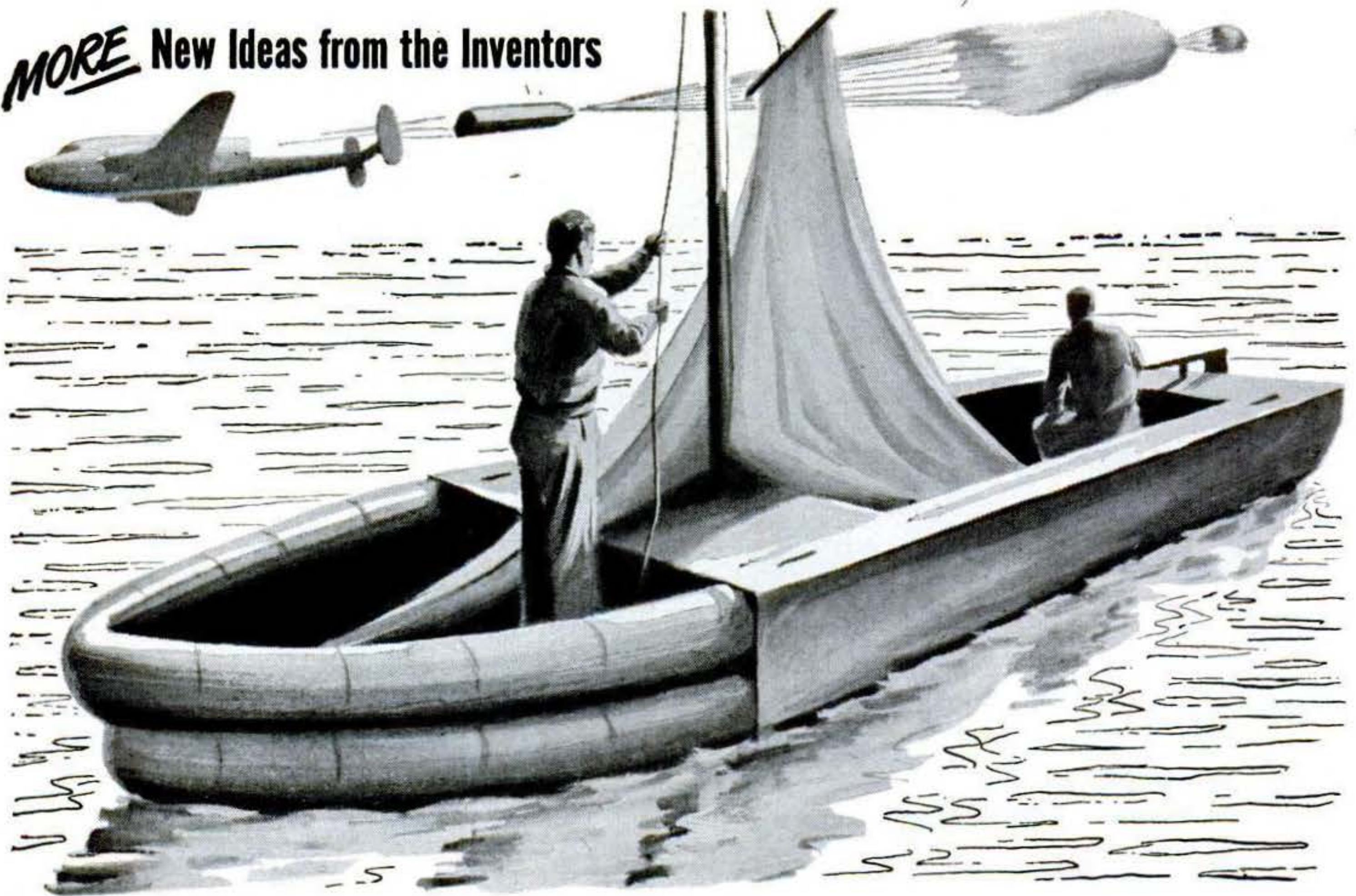

**4 Ditching Gear to Save Fliers.** Should the passengers of an airplane equipped with this proposed rescue device be forced to abandon the plane at sea, they would climb into a compartment, a part of the

fuselage, which would be pulled free and eased down by a parachute. Inverted by a self-righting mechanism, the fuselage section and an inflated, rubberized-fabric bow would form the hull of a boat.



**5 Heat to Soften Old Putty.** The old putty around windows would be easy to soften and remove with this chemically treated strip of flammable material. Having an adhesive backing, it can be stuck to the putty. When ignited with a match, it burns slowly to provide just enough heat to soften the putty for removal.

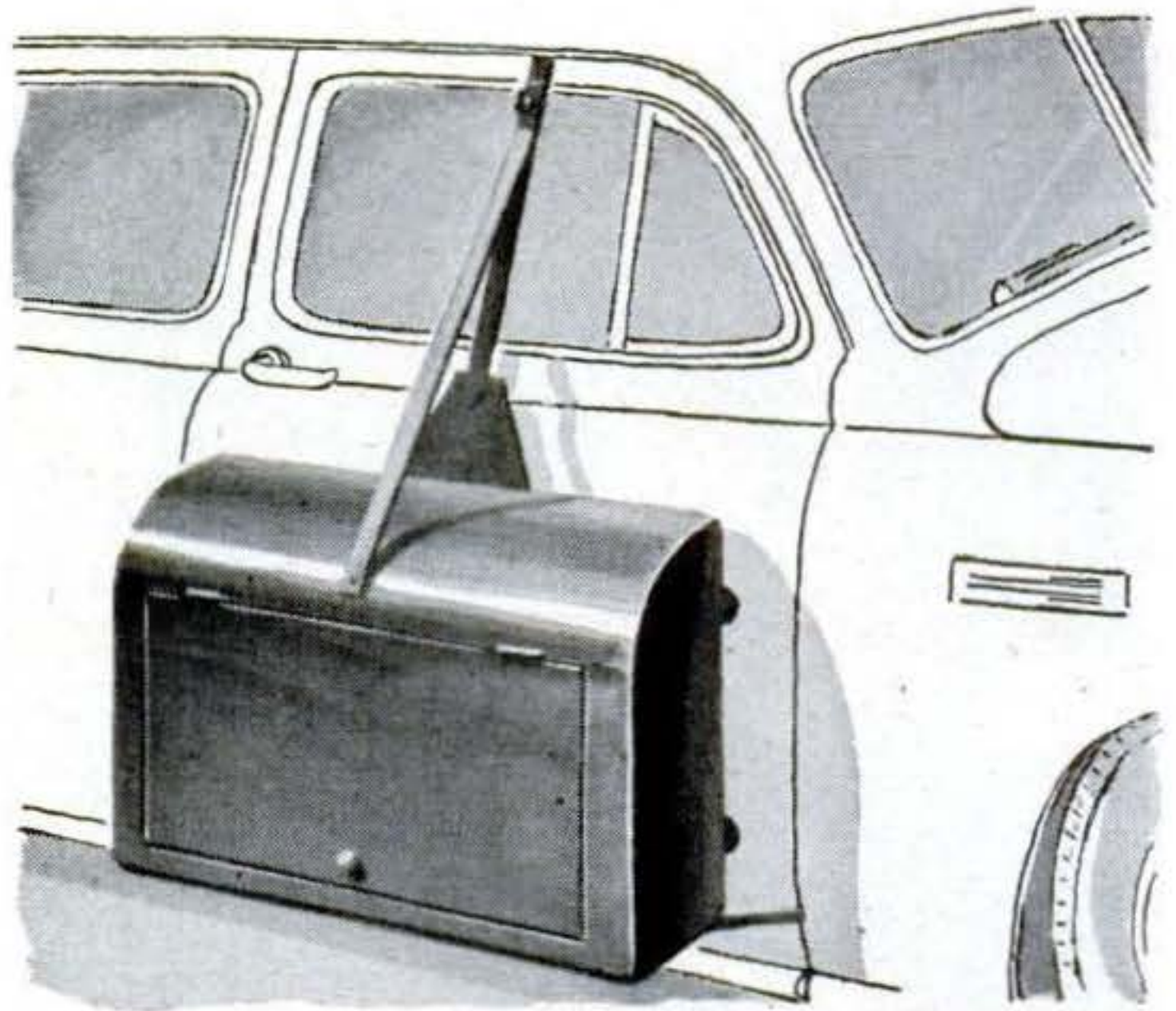

**6 Luggage Rack to Fit on Car Door.** When the modern car lost its running boards, it also lost the space for a running-board luggage rack, and bags that couldn't be crammed into the trunk became a problem. This door luggage carrier is designed to solve the problem. Suction cups and clamps hold it firmly in place.

*Patents on these inventions have been granted to: 1. H. Ritzel, New York, N. Y.; 2. L. Ham, Selma, Ala.; 3. S. Zelzer, Calumet City, Ill.; 4. B. Townshend, Croydon, Eng.; 5. R. Martines, Cranston, R. I.; 6. W. Bishman, Minneapolis, Minn.*

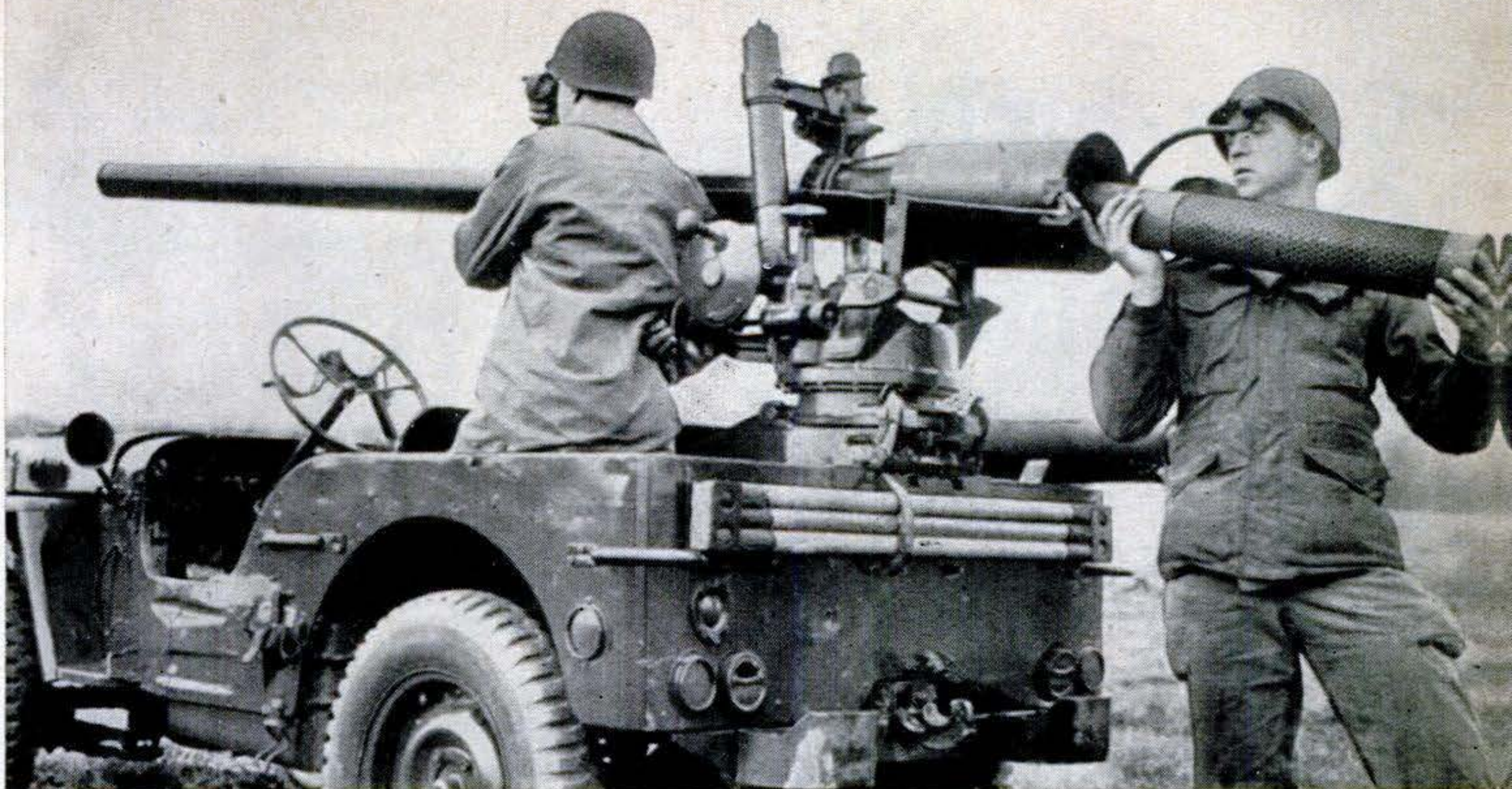

### Recoilless Rifle on a Jeep Is Newest Tank Buster

THE Army is handing another deadly weapon to its tank hunters. It is a 105-mm. recoilless rifle mounted on a jeep. Shown above being demonstrated at Aberdeen Proving Ground, it is reported able to knock

out any known foreign tank. The new rifle is a comparatively light, easy-to-handle weapon that can be operated by two men. Smaller recoilless rifles, hand-carried, are also used against tanks (PS, Oct. '50, p. 98).

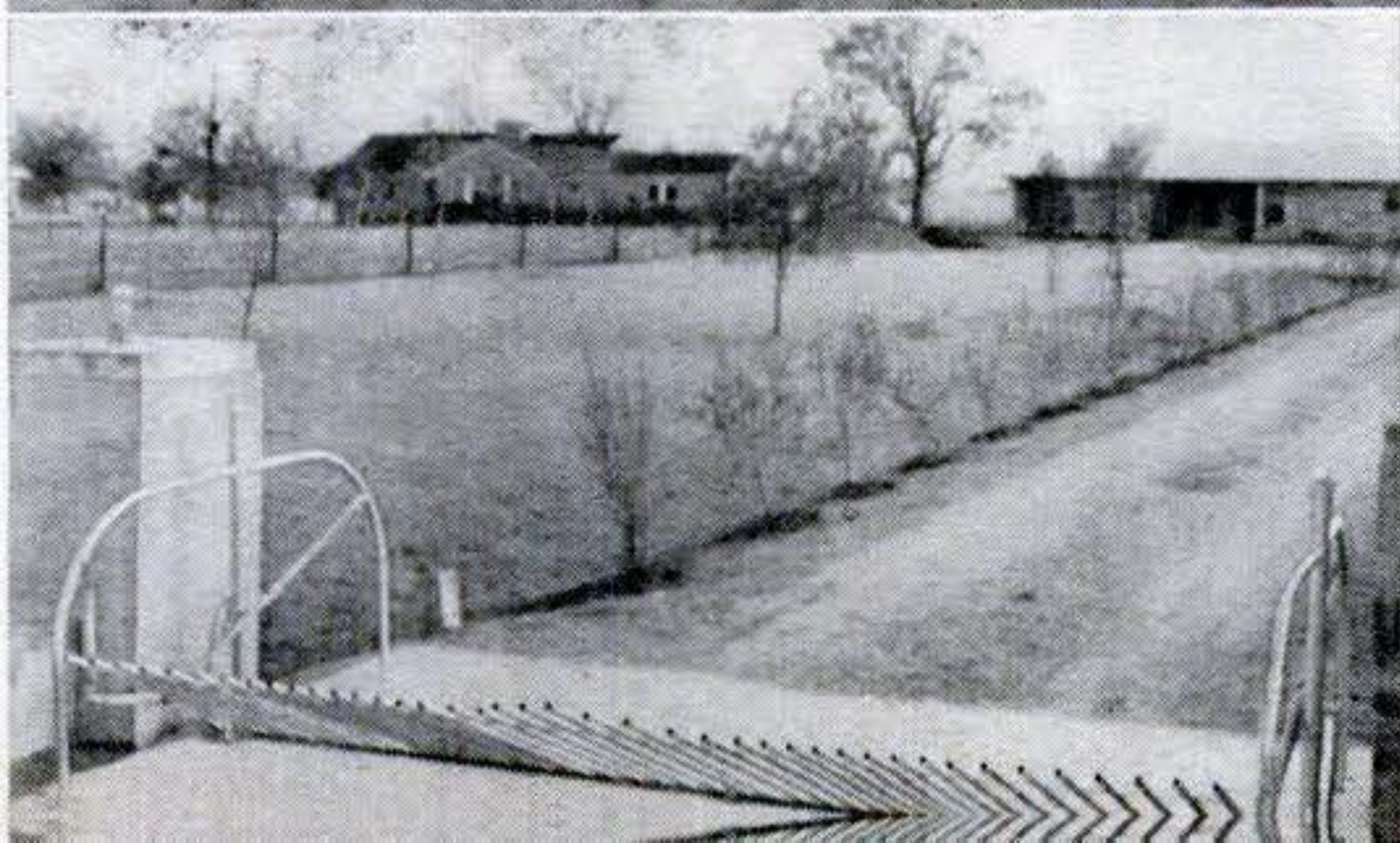
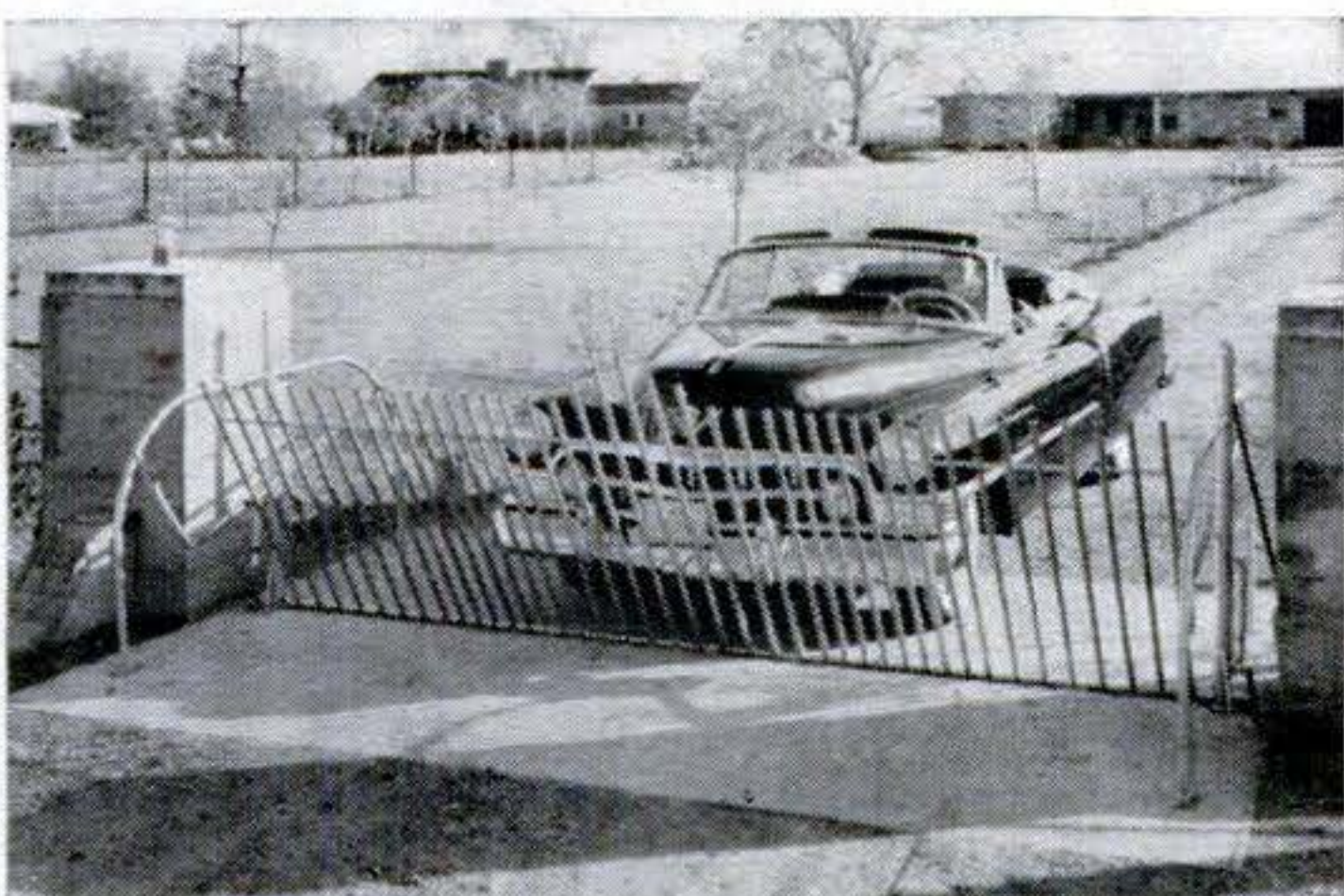

### Car Works Pushover Gate

WILLIAM BENKE got tired of jumping in and out of his car to open the gate to his west Texas ranch. So he invented the automatic gate at left. The car pushes down the gate (top photo); rides over it (center); then, after hydraulic checks hold it down, it rises (bottom). Hawley Mfg. Co., Houston, makes the Push-Over Gate.

### Heating Unit Wraps Around Anything

HEATING wire that can be wrapped around anything you want to keep warm is now available by the foot. Spring-steel sheathing makes it very flexible, so that it can be coiled around pipes or chemical vessels (below). Titan Manufacturing Co., Buffalo, N. Y., makes the units in several lengths, voltages, and heating ranges.



# Cigar-Smoking Camera Acts in TV Show

**T**HERE'S a camera that smokes cigars on one television show. It also drinks coffee, eats pie, stands up, and walks through door-

ways. For the camera plays the title role of the detective in the weekly whodunit, Dumont's "The Plainclothesman."

The neatest trick comes during the commercial, when the camera lights up one of the sponsor's Harvester cigars. This scene requires the services of three men: the cameraman, who must jockey his camera and adjust focus accurately; Kenneth Lynch (the Plainclothesman's voice and hands), who strikes the match; and an assistant, who holds the cigar and puffs through a tube.

To the audience, it looks as if the camera is smoking a cigar (below). Photo at left shows how trick is done.

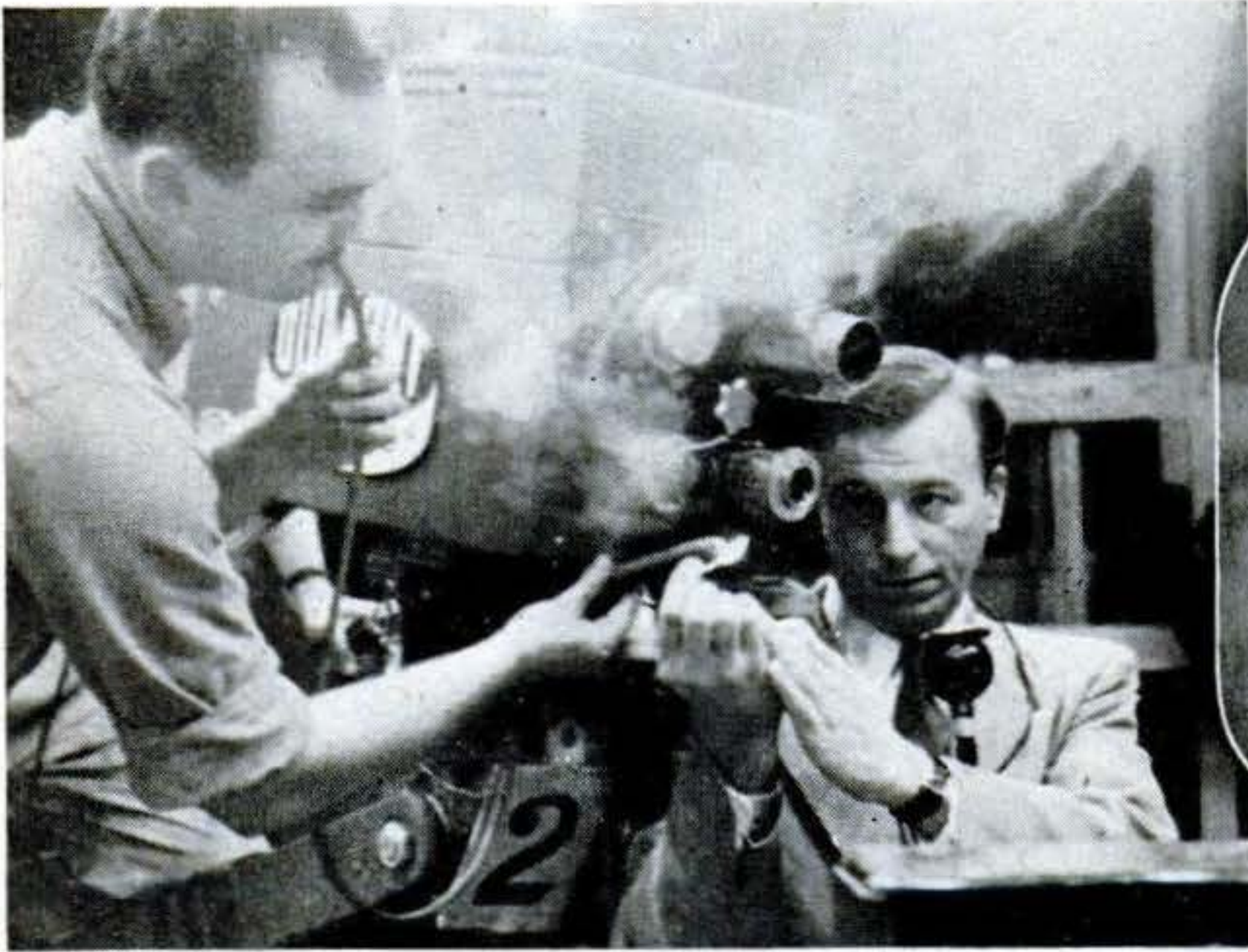

Hands of the character the camera represents belong to actor Kenneth Lynch, who crouches out of view.

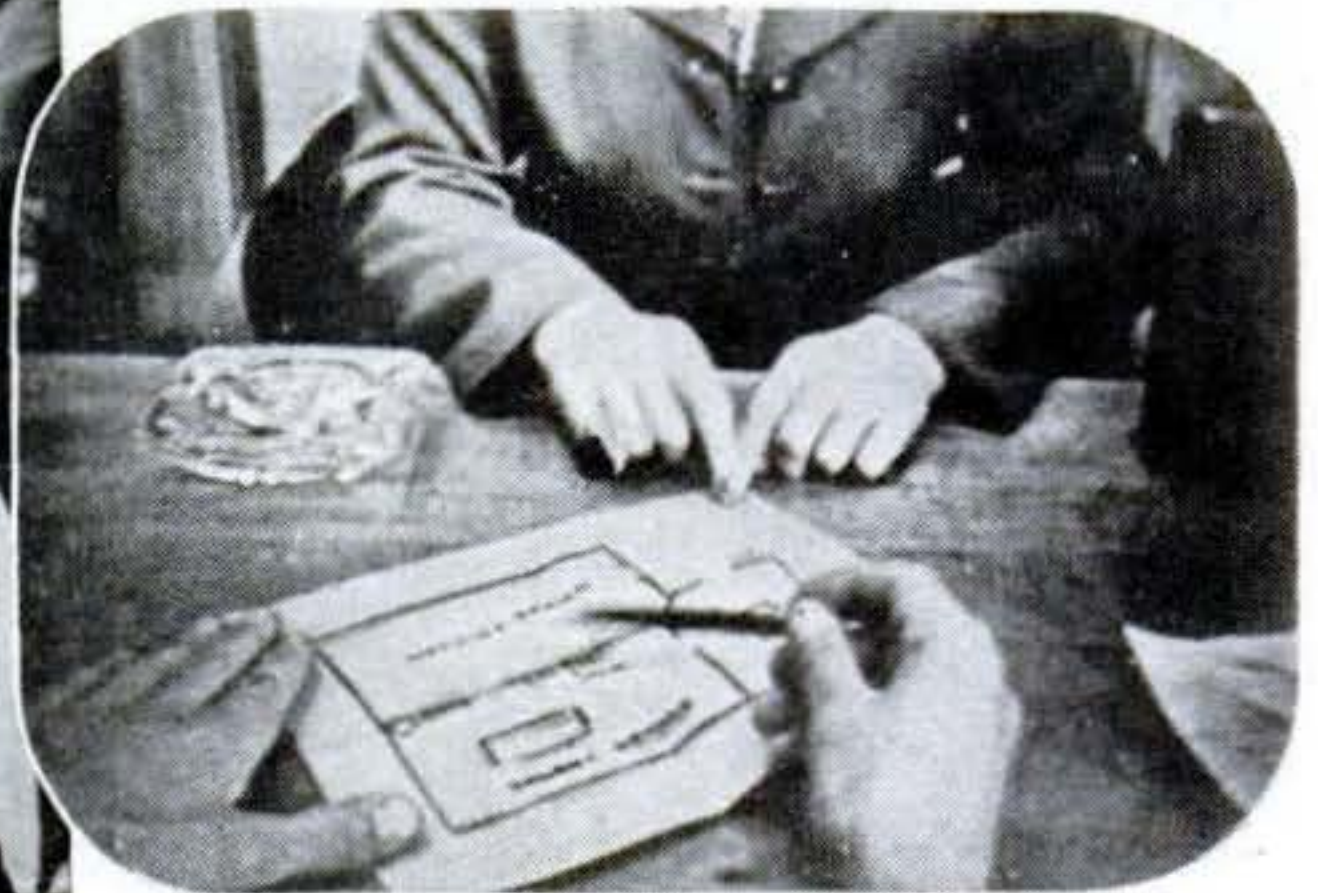

Suspect (really innocent) is shown badge (below). Hands are all you ever see of Lynch, who's also the voice.

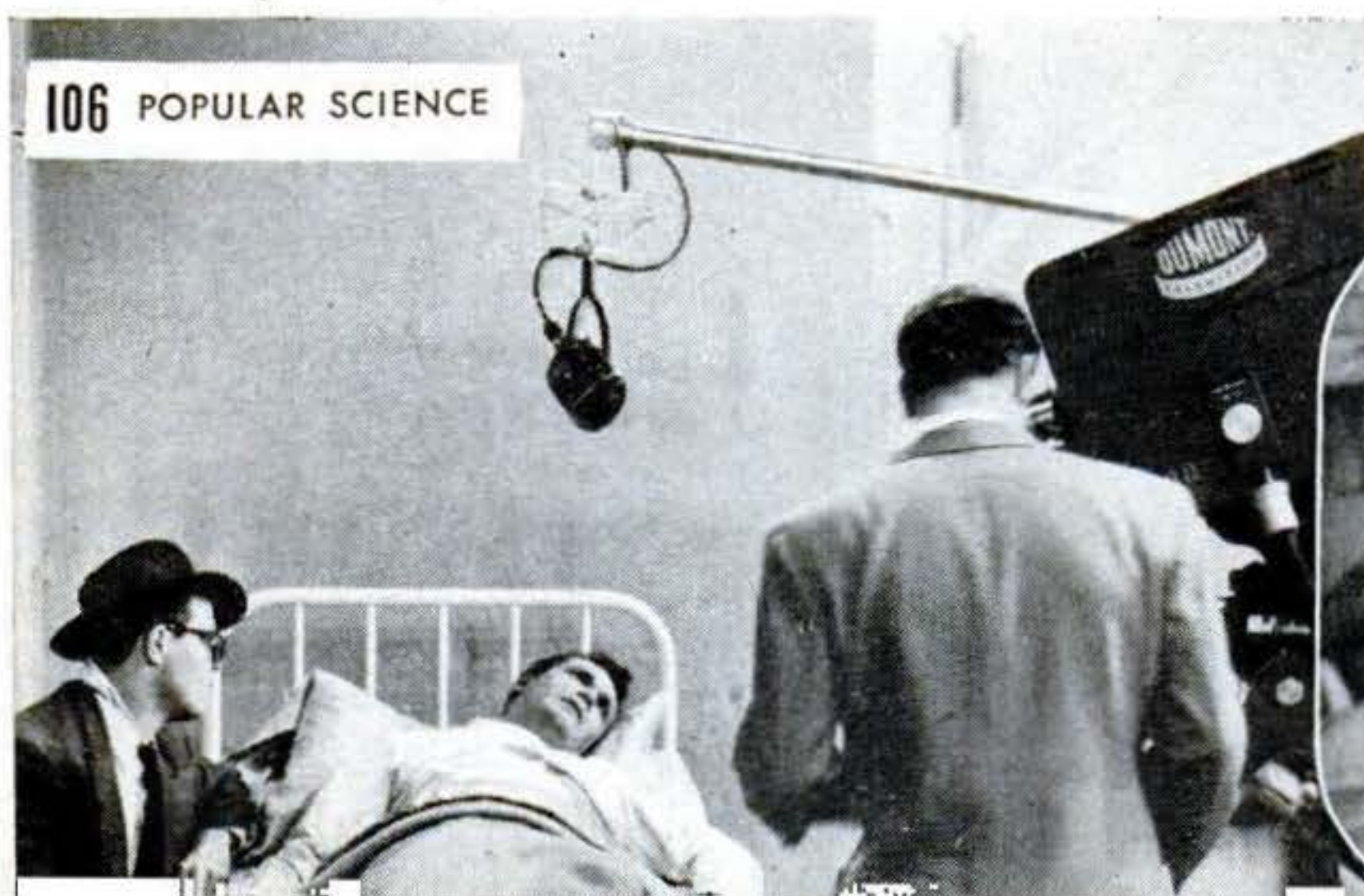

# Mines Are Dirty Tricks



**The sitting torpedoes are nasty, cheap, and deadly. Korea was a school for our sweepers, and a warning.**

**By John F. Loosbrock**

**A**N UNDERWATER mine that costs about as much as a secondhand car can sink a million-dollar ship. And mines are made to order for a Russian-style war. They are cheap, efficient, and can be planted freely by a land-based nation with little shipping of its own to worry about.

Mine-warfare men are closemouthed about their devilish devices. In fact, mines and countermeasures are under even tighter security than submarines and anti-sub operations. Both come under the Assistant Chief of Naval Operations for Undersea Warfare, Rear Admiral Charles B. Momsen.

"Swede" Momsen, a doughty old submariner himself, wryly refers to his mine-warfare men as "the dirty-trick department."

Some of them are in the bad-dream business



**Moored contact mines, above, are easy to sweep compared to tricky ground mine at bottom.**

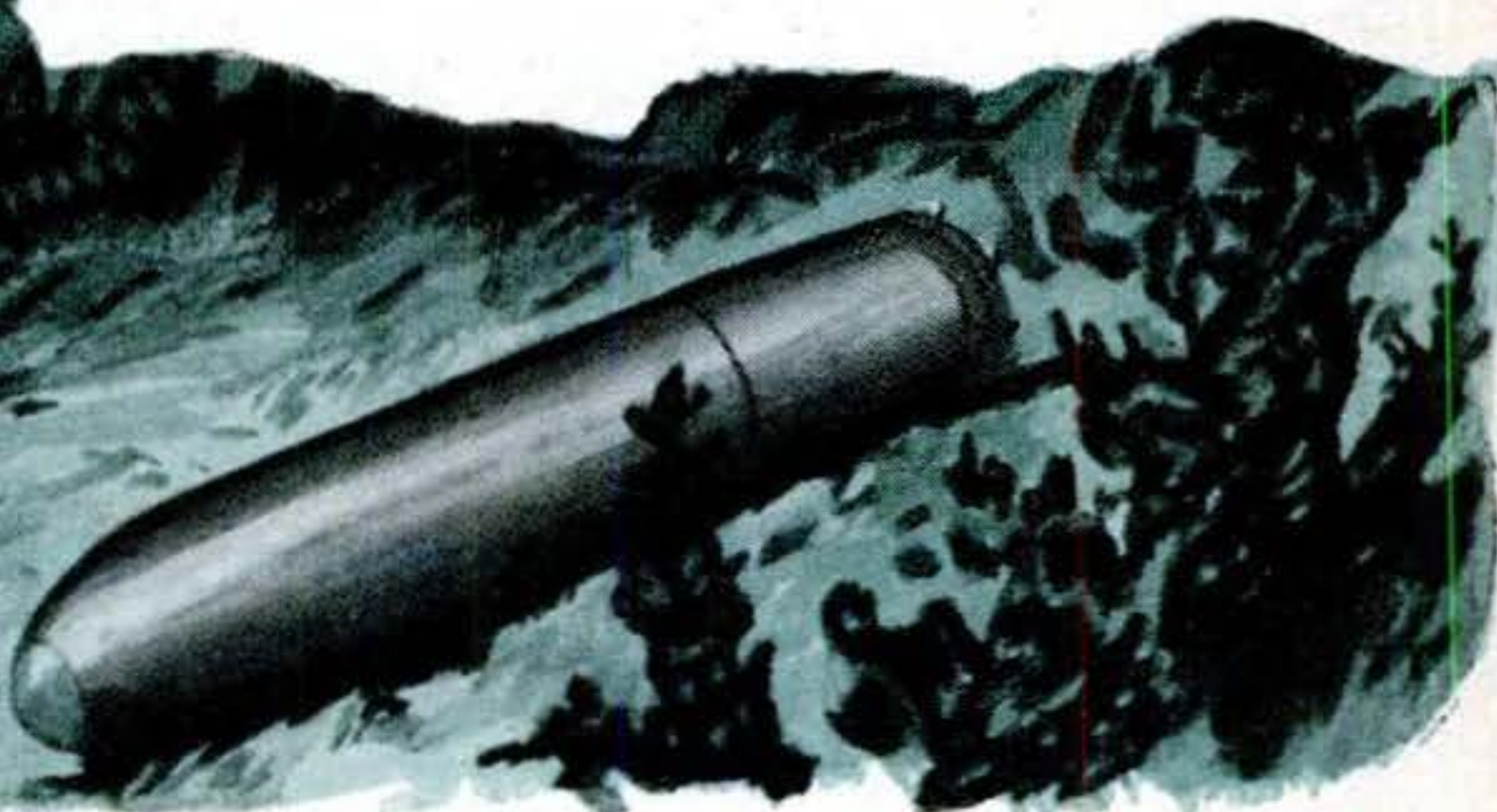

of thinking up new ways to make the target trigger the bang. Others are in what is politely called "countermeasures," meaning going out in little ships and sweeping up the other guy's dirty tricks. And some of the countermeasure men are the talent scouts who catch and cut open the live enemy mines to see what makes them tick.

Mine men are trappers, and trap-sappers, rather than hunters. They seldom get a huntsman's personal satisfaction, and they collect no "hazardous duty" pay. But the men in the super-silent service have a pride in performance rivaling that of the submariners or Rangers.

Quietly and competently ferocious, mine-warfare men claim that mines have sunk more ships per dollar than any other weapon. But, so secret and unspectacular is their work, they never get enough to do the job right—in anybody's navy.

### Hitler Missed a Chance

No nation in history, says Momsen, has ever used enough mines of the right kind, despite their deadly relative efficiency. Hitler could have bottled up Britain tighter than a quart of champagne if enough magnetic mines had been sown while they were still new, and very dirty, tricks. And there is the latest lesson of Korea, where Red mine fields halted a fleet for days. Five sweepers were lost, three of them U. S. Navy ships, but our mine people remark that the Reds thus provided a fine school for countermeasures. And, they add, once again there were neither enough mines nor enough variety in triggering.

"If we had faced a mixed bag of enemy mines," one Navy mine expert told me, "we could have lost a lot more ships."

By "mixed bag" he meant a calculated mixture of different kinds of mines. For mines are much more complicated mechanisms than the original *moored contact mine*. This was the Model-T kind found in numbers off Korea. It consists of a big metal ball loaded with high explosive, with an anchor to keep it at the right depth in the right place, and a number of projecting "horns" that make it go off when touched.

The catch is that it's been around for so long that the minesweepers know how to handle it. Sweeping moored mines is like

At right is a cutaway drawing of one Russian mine, a simple, moored contact type. How it works is shown in sketch above it.

### CONTACT MINE

Crushing acid-filled horn fires mine by electro-chemical action.

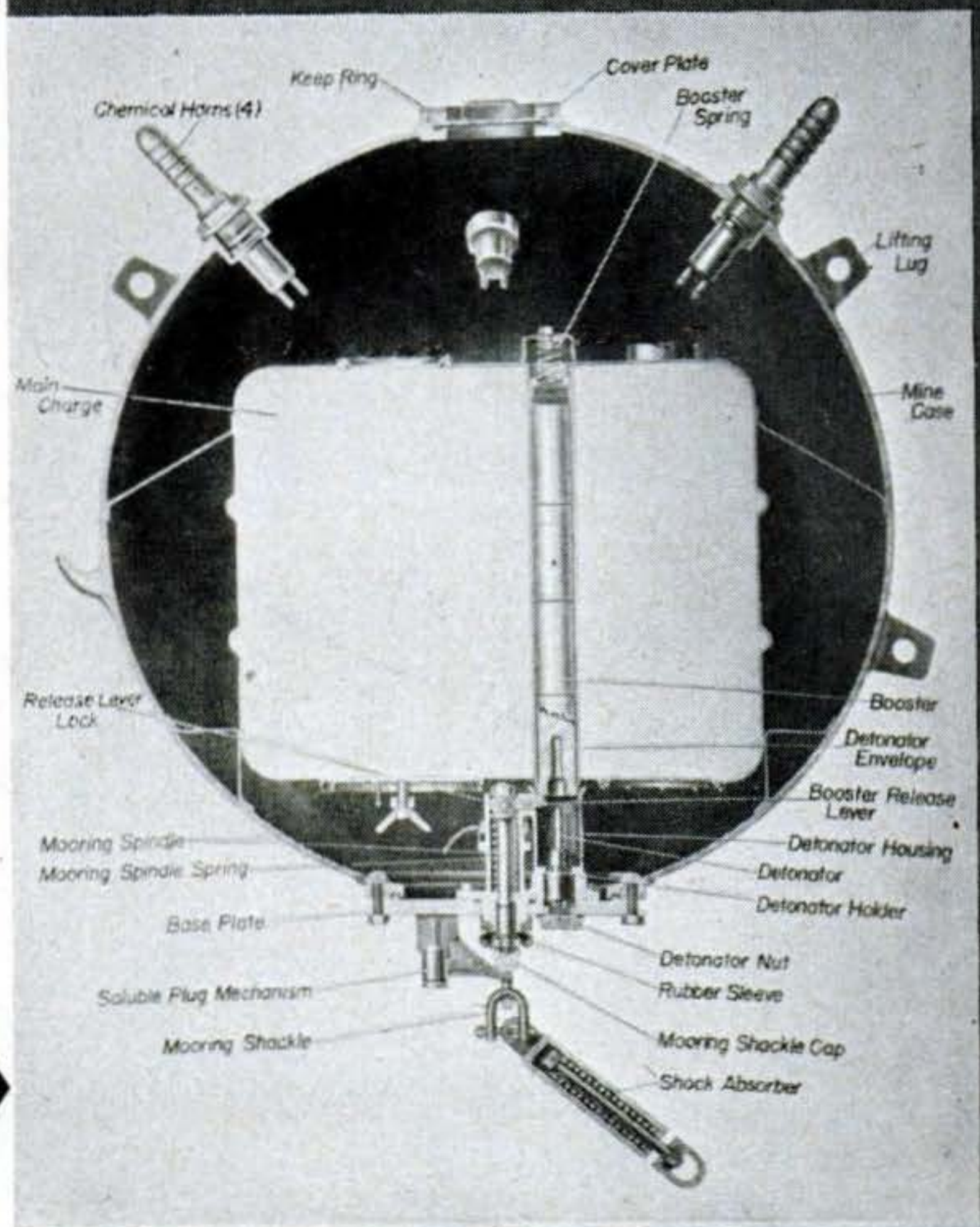
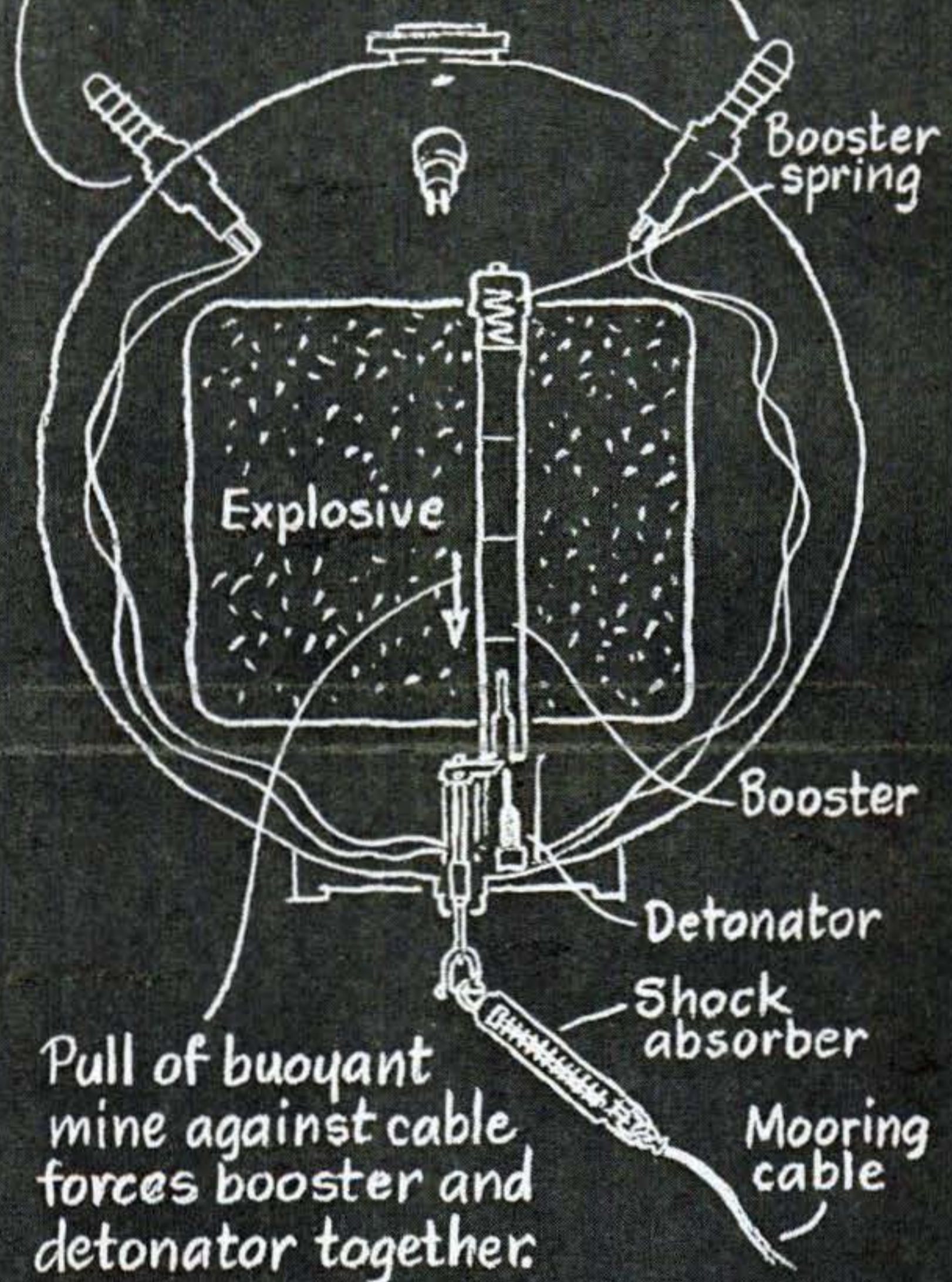

### MAGNETIC MINE

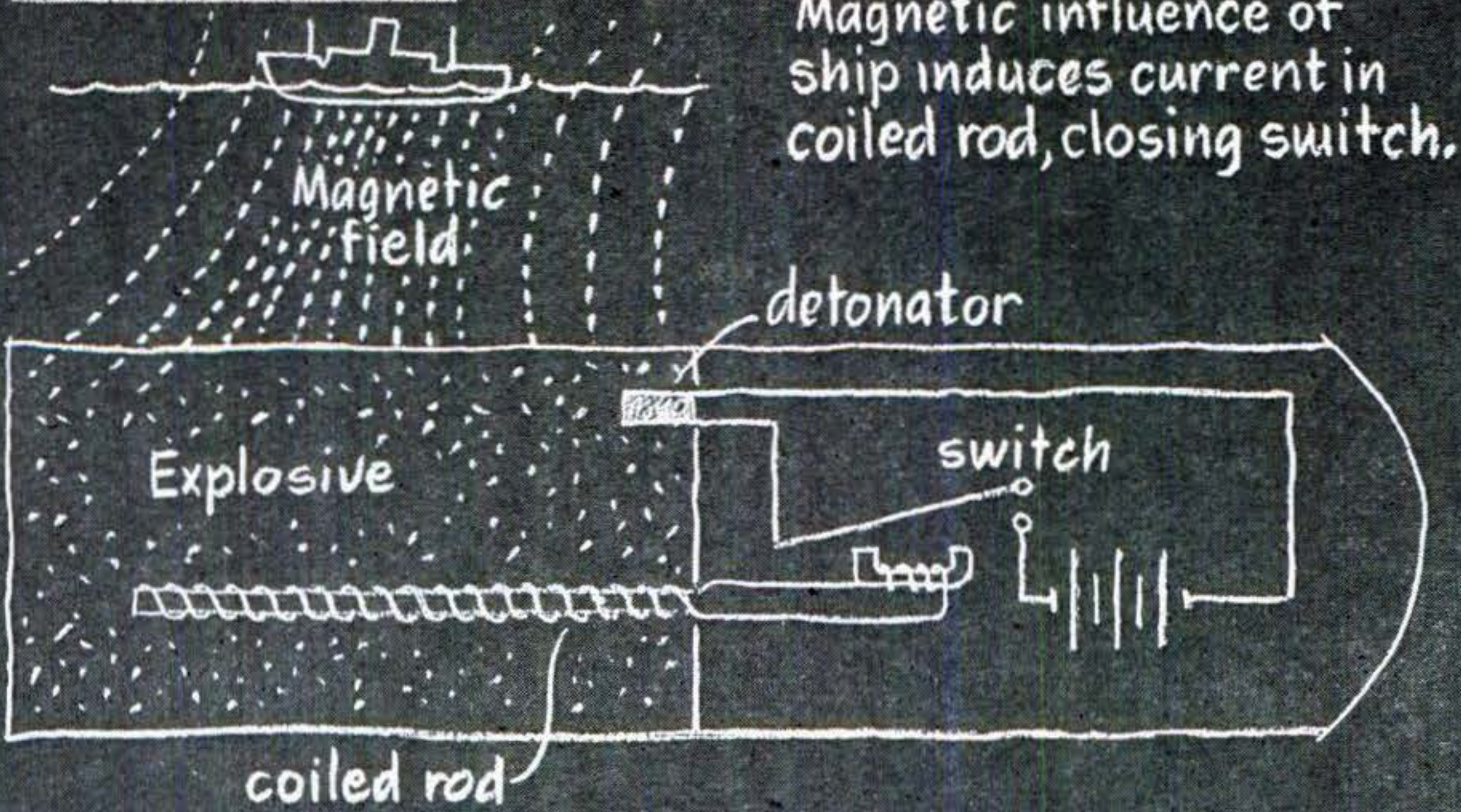

### ACOUSTIC MINE

Artificial ear "hears" ship noises. Diaphragm vibrates and switch closes.

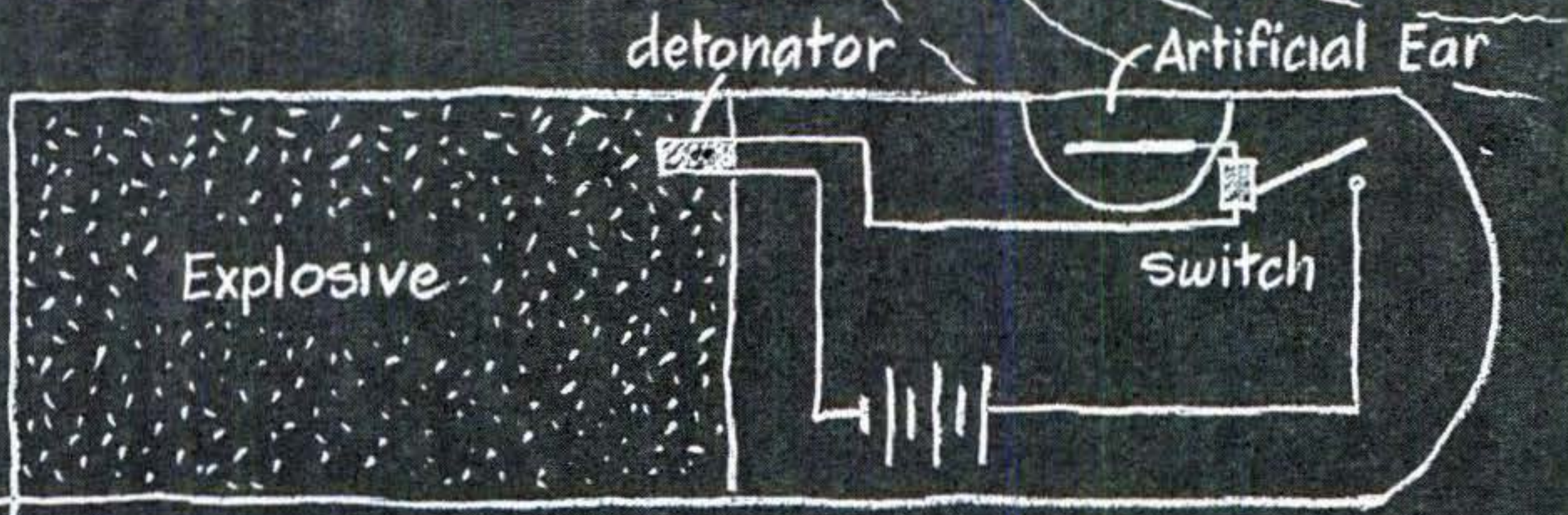

### PRESSURE MINE

Negative pressure of passing ship sucks diaphragm upward, closing circuit

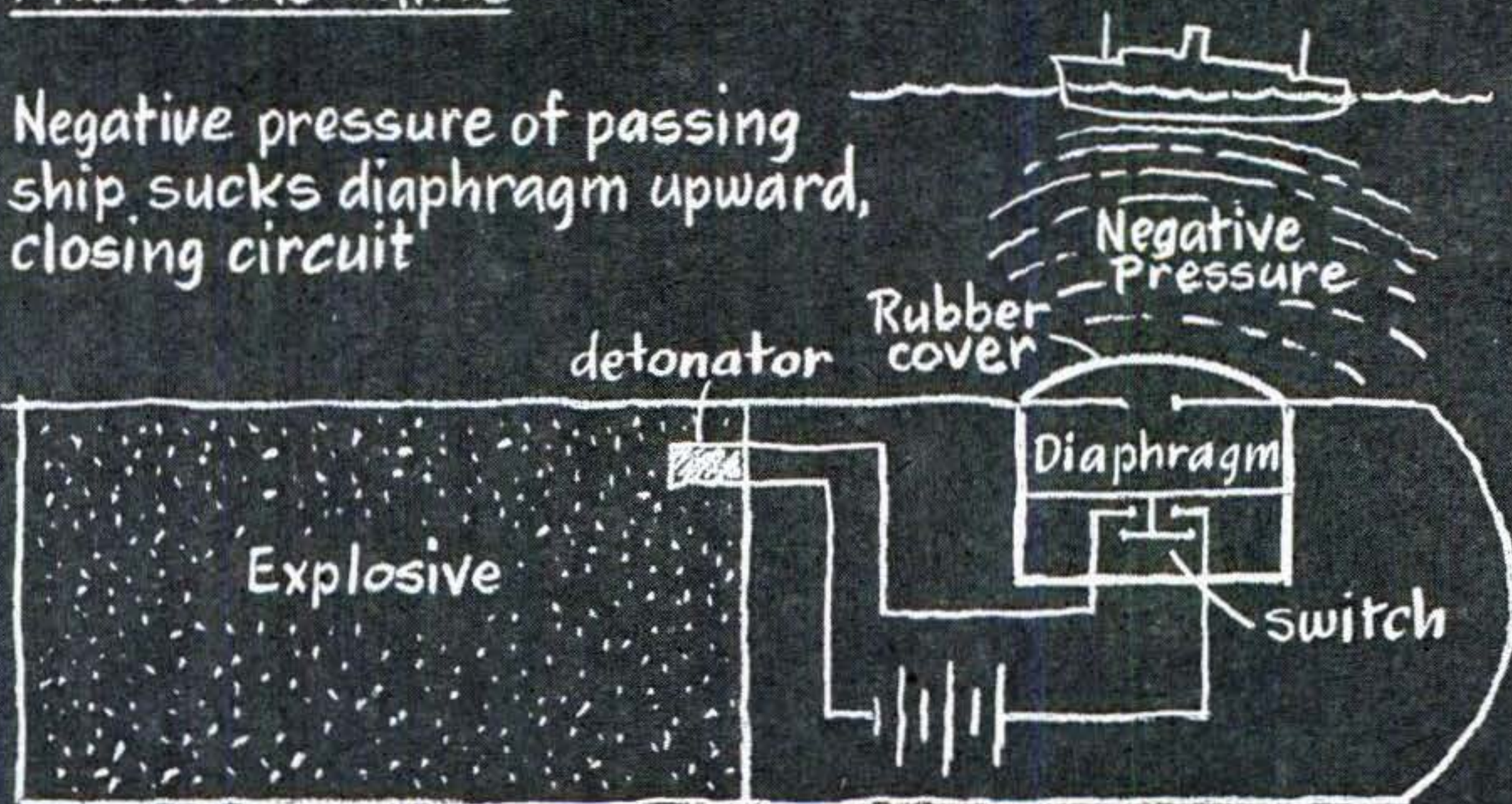

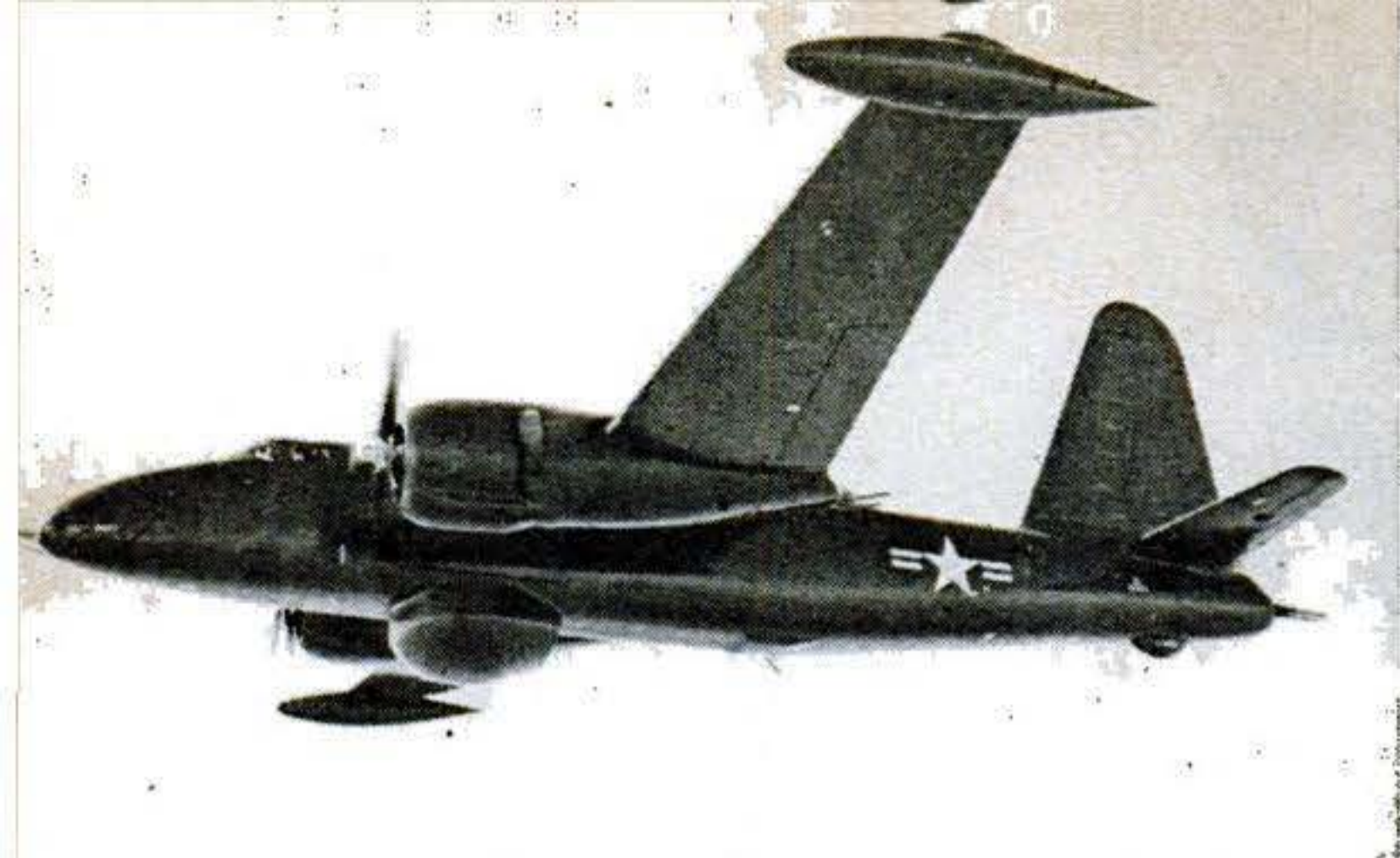

**Airplanes** like the Navy's P2V can lay ground mines in enemy waters, replenish fields as fast as swept. Parachute slows mine's fall to avoid disturbing delicate firing mechanism.



**Guppy subs** like this one can lay both ground and moored mines, dropping them through torpedo tubes. Russians' big sub fleet makes this kind of minelaying a grave menace.



**Surface minelayers** like this big job built on a cruiser hull can handle large numbers of moored mines. But they can't go into enemy waters, are largely defensive weapons.

cutting hay. Cable-cutting sweeps are dragged through suspected waters. Once the mooring cable has been snipped, the mine bobs to the surface where it can be detonated or sunk with gunfire. The sweepers move either in a wedge formation or in protective echelon, working from swept into unswept areas, like a man with a scythe.

Mine-warfare men speak a private lan-

guage. They talk of mined waters as "polluted." When you put out mines you are "infesting the area." Mines can be laid by surface ships, even little ones, or submarines. But only aircraft can maintain "contamination" of enemy waters by replenishing swept areas—a surface ship or submarine dares not go back into polluted waters.

In this deadly game of poker-for-keeps, you have two hole cards—new mines that the enemy can neither detect nor neutralize; and new countermeasures that make his most prized and deadly gadgets harmless.

Thus the comparatively simple contact mine led to mines you didn't have to hit at all. You merely had to come close. These are so-called *influence* mines that lie ominously on the bottom until their particular *magnetic*, or *acoustic*, or *pressure* trigger is tripped.

#### *Silent Sentries of the Sea*

These *ground* (as opposed to moored) mines are the truly "silent sentries of the sea." Their firing systems can be scrambled into an intricate series of actions, one complementing, or booby-trapping, or back-stopping another. Detection is almost impossible, and sweeping such ground mines is ticklish. There are several types:

*The magnetic mine* is triggered by the magnetic field of a ship. When the normal lines of force of terrestrial magnetism are distorted by a ship, the mine explodes.

*The acoustic mine* has an ear, a simple hydrophone, cocked for ship noises from propellers or engines. When these noises reach a certain volume, a switch closes and "Boom!"—you've had it.

*The pressure mine* is even more ingenious. A variation in water pressure on a sensitive diaphragm, caused by a ship overhead, closes the circuit and fires the mine.

These make tough work for the countermeasure man. Sweeping ceases to be the comparatively simple matter of cutting mooring cables. You first have to get a sample, take it apart, see what makes it tick.

In the case of the magnetic mine, first used by the Germans in World War II, luck and Nazi stupidity combined to give the British the key. Instead of sowing them in large numbers, and letting a sinking ship give the first warning, the Germans dropped them in dribbles from night-flying planes. One fell intact on a mudbank in the Thames.

That gave the British scientists who handle countermeasures their chance. An



officer went out on the beach by himself—to minimize possible casualties—took a long look and with a prayer and a guess unscrewed the activating mechanism. It didn't go off and the magnetic mine was conquered. That kind of lonely heroism is needed to neutralize and study every new type of mine.

The countermeasures were comparatively simple. Ships were "degaussed"—girdled with an electric cable that neutralized their

magnetic fields. And wooden sweepers, fitted with trailing lengths of magnetic cables, were able to detonate the magnetic mines at a safe distance from their hulls.

This points up the sweeper's problem in a field of influence mines. If you can't find them, you can let them find you. So you simulate a target to set them off. Take the acoustic mine. Since noise exploded it, sweepers went out with noisemakers—in some cases they used ordinary air hammers

## COUNTER MEASURES

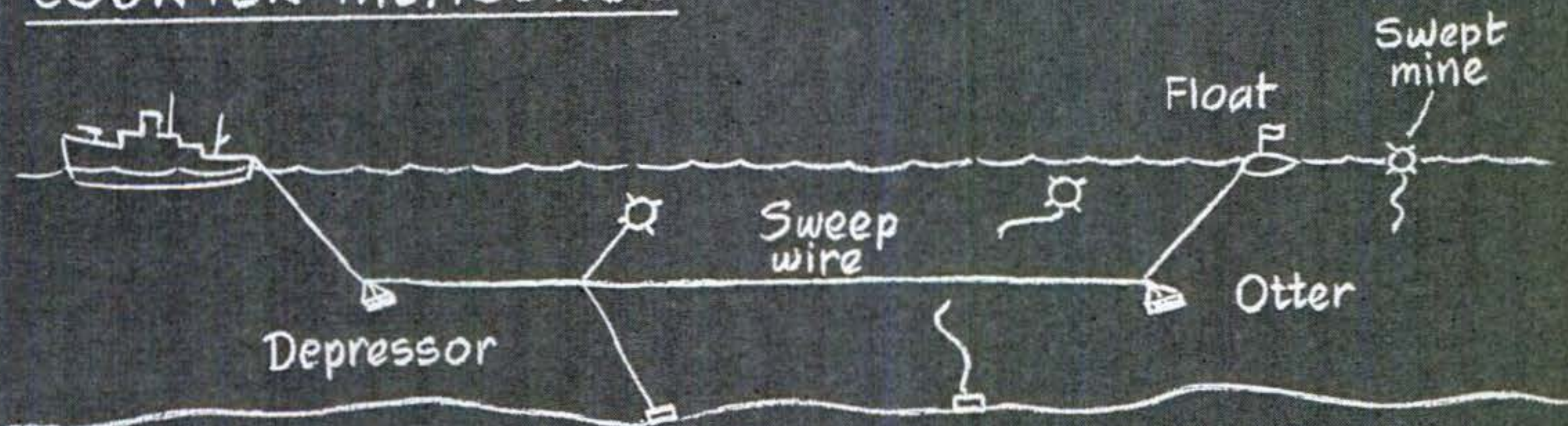

**AGAINST CONTACT MINES**  
Depressor and otter hang from rough-edged sweep wire.

If wire doesn't break cable, cutters ahead of otter will.

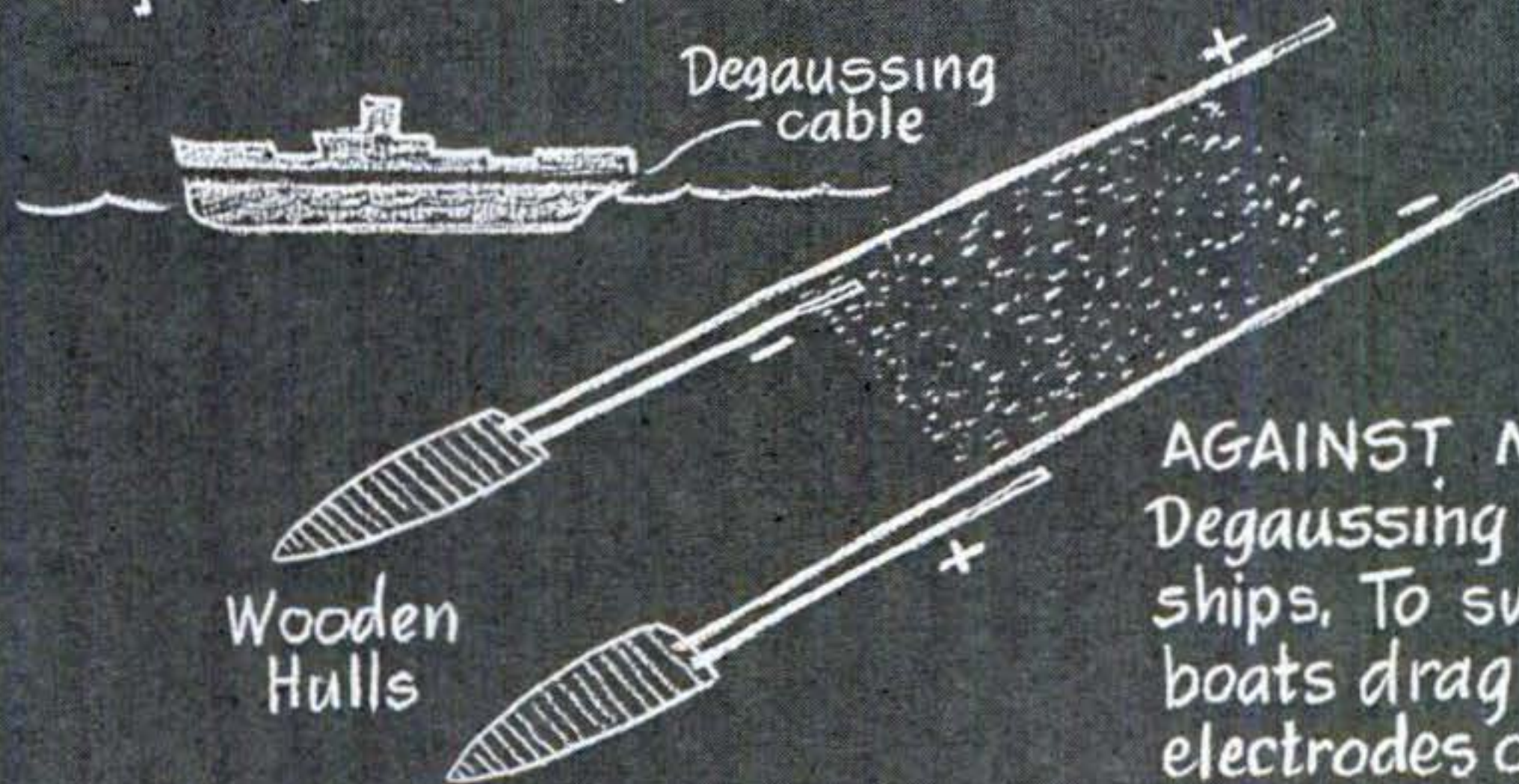

**AGAINST MAGNETIC MINES**  
Degaussing Cable demagnetizes ships. To sweep, pairs of wooden boats drag positive and negative electrodes over suspected area.

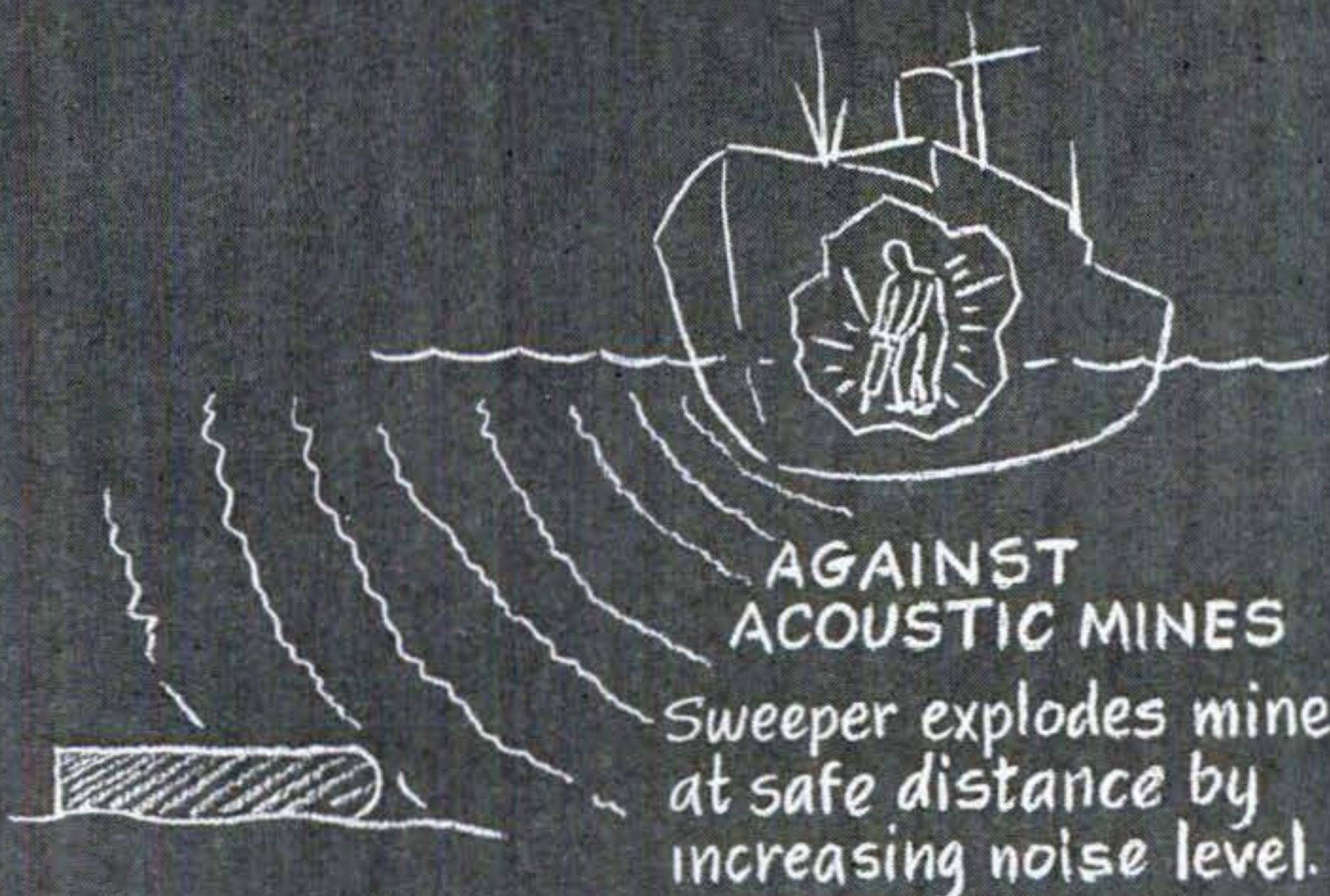

**AGAINST ACOUSTIC MINES**  
Sweeper explodes mine at safe distance by increasing noise level.

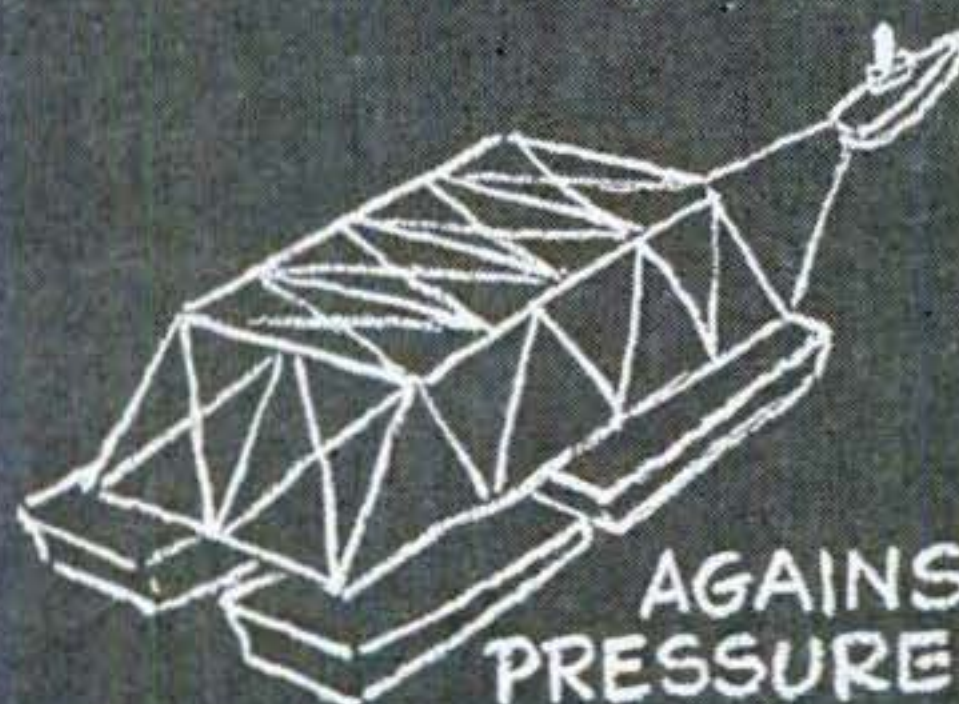

**AGAINST PRESSURE MINES**  
Hard to sweep. One way is towing big, expendable targets.

whanging on steel plates to fire them off.

The pressure mine is still a nuisance. In World War II, several sweeping methods were tried. Like wave making by squadrons of speedy small boats, and towing of big, expendable "targets." Sometimes a good storm will do the sweeping—exploding pressure mines by the natural motion of the sea. It saved lives off the Normandy beachhead.

But even more devilish are the imaginative variations on these three themes. Hitch an acoustic trigger to a magnetic mine. Ship noise cocks the trigger, and magnetic disturbance pulls it. A light, shallow-draft, magnetic-type sweeper, if not equipped with a noisemaker, can sweep all day through a field of such mines without making a safe path for heavy, noisy vessels.

Or reverse the order—an acoustic sweep will pass over unknowingly, leaving the mine cocked for a magnetic target. Then there are combinations comprising all three types in various orders.

#### *Mines that Count Ships*

Another tickler is the ship-counter—a speedometer-like mechanism that clicks off passing ships up to a predetermined number, then pulls the rug out. It doesn't do a convoy's morale any good to lose a ship from a mine after half the formation has passed by safely. The possibilities are endless, challenging the countermeasure men.

Mines are laid in three main ways; each has its own advantages and disadvantages:

*Surface ships* can carry the biggest load. But you have to use them in your own waters, and they can't replenish a field. They ordinarily lay moored mines.

*The airplane* is the only minelayer that can replenish a field. And it's better for surreptitious laying than a surface ship. The ground mine is made to order for it. But even aircraft can be spotted, by eye and by radar. And a plane shot down while carrying secret mines may tip your hand.

*The sub* is closest to the ideal minelayer. It can deposit its deadly eggs secretly, defying detection even in enemy waters. Any sub can handle mines, dropping them through its torpedo tubes.

Our own mines are cooked up by "Bu-Ord," the Navy's Bureau of Ordnance, in its Naval Ordnance Lab at White Oak, Md. To help the scientists see the problems, a large-scale "environmental" lab has been set up at NOL, where mines can be tested under actual conditions of climate and

water pressure without taking them to sea.

Countermeasures are a job for "BuShips," which operates a test station at Panama City, Fla. Crews for mineplanters and sweepers are trained at the Mine Warfare School at Yorktown, Va. Here security even forbids mention of the number of graduates. Mothballed minelayers and minesweepers are going back into service. And Admiral Momsen keeps a weather eye on the whole business. He sees a big part of his job as promoting public understanding of our special vulnerability to mine warfare.

The Air Force is a valued ally in the mining job. It was the Air Force that sealed off Jap ports during the last war, and polluted inland lakes and rivers—like the very effective mining of the Danube.

#### *Where to Strike Red Threat*

The Reds' accumulation of German mine knowledge and their big submarine fleet complicate the picture, since there are only three places at which to strike:

*On their doorstep.*

*In their area of operations.*

*While moving from one to the other.*

You can write off the last as offering the least chance of success. With the development of improved influence mines laid by subs or aircraft, it would seem logical to knock off enemy snorks, before they can get out to do their dirty work, by countermining the entrances and exits of sub pens. Defensively we'll mine our own vital ports to keep enemy subs out. And all the while we must worry about the safety of our own surface shipping, which can be lost just as surely from a friendly mine as one laid by the enemy.

The very threat of mining has indirect effects on a nation's war effort. A few mines scattered in a sensitive area, though they might not sink a single ship, can tie up vital cargo and force constant sweeping. And mines can be used to divert convoys to areas where subs can strike more easily.

Meanwhile, our own dirty-tricks department labors mightily in its double duty:

*To develop undersea weapons* that can contain or limit enemy mine operations.

*To develop the gear and know-how to detect and destroy enemy mines* along our sea routes—and perhaps in our harbors.

These are tough chores about which mine-warfare men have no illusions. But if they didn't like tough chores and knotty problems, they'd be in another business. **END**

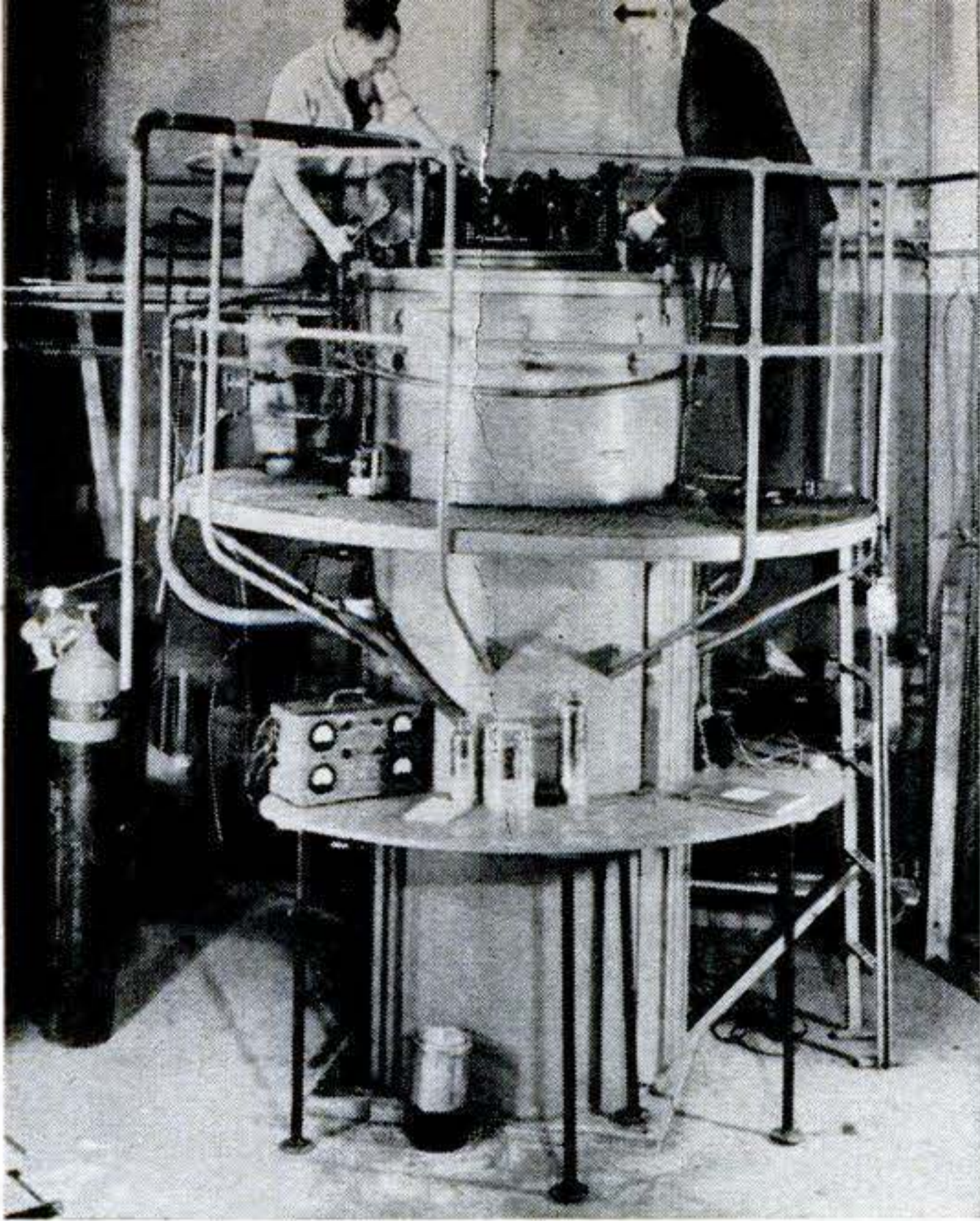

### World's Coldest "Deep Freeze"

ENGINEERS at M.I.T. have built this cylindrical "deep freeze," believed to be the largest and coldest apparatus of its kind, to study the effects of extreme cold on materials lowered into it. The tank—called a cryostat—is 30 in. in diameter, three ft. deep. It is cooled to 452° F. below zero, only 7½° above absolute zero, by a series of five "engines" driven by compressed helium. In successive stages the gas cools by expansion, then is recompressed, cooled by a heat exchanger, and allowed to expand again. The tank has a window in its lid for watching experiments.



### Probe Measures Moisture Underground

TO MEASURE moisture in soil, a radioactive probe, encircled by the protective cage above, is inserted in the ground. Formerly, moisture readings were taken by the slower process of digging up and analyzing soil samples. The new method, developed by Cornell University under C.A.A. sponsorship, works by measuring the scattering effect of hydrogen atoms on neutrons. It is expected to aid engineers in designing airports by enabling them to study the changes in soil moisture under the pavements of present airfield runways.

### Tiny, Prop-Driven Model Plane Actually Flies

IT WOULD take over 40 of these insectlike planes to weigh even an ounce. Shown at left below as it takes off on a test flight, the 2½-inch-long miniature has a reed frame, balsa wheels and propeller, paper skin, and a wire propeller shaft. A single-strand rub-

ber band propels it. Called the "Stubenfliege," or housefly, the plane was built by Wilhelm-Hubert Friese, of Berlin, Germany, who constructs very small propeller-driven planes. Alongside the tiny model, below at right, are other aircraft of Friese's.

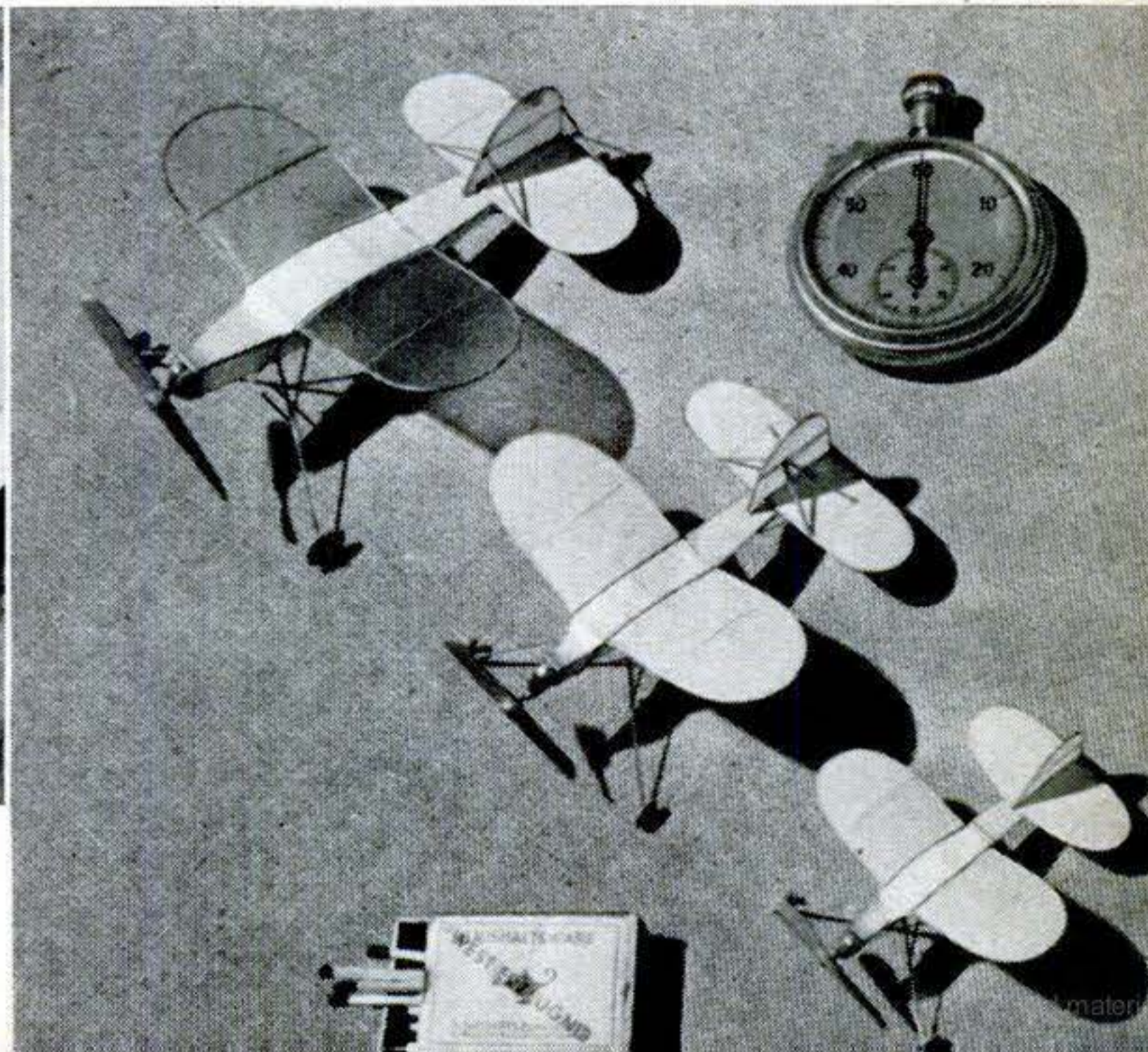

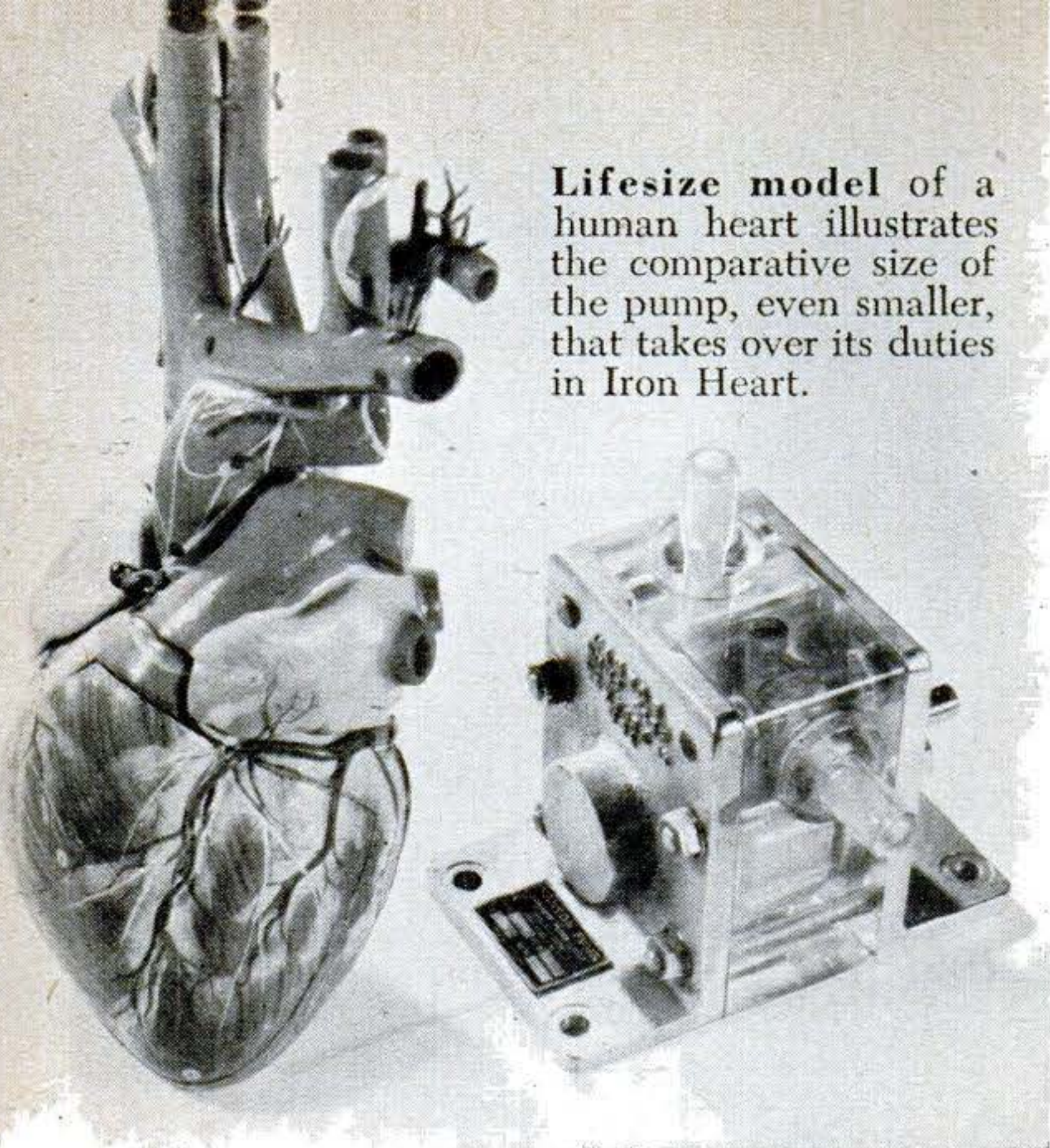

Lifesize model of a human heart illustrates the comparative size of the pump, even smaller, that takes over its duties in Iron Heart.

# “Iron Heart” Pinch-Hits For Real One

**By taking over duties of heart and lungs, a life-saving mechanical marvel makes a doctors' dream come true.**

**By Paul F. Ellis**

THE “Iron Heart” has joined the “iron lung” and other mechanical substitutes for flesh-and-blood organs.

The doctors have called in the plumbers to make a pipe dream come true. The result is a machine that takes over the heart's duty of pumping blood through the body. It stands ready for an emergency at Hahnemann Hospital in Philadelphia.

Its invention means that surgeons can now disconnect an ailing heart from the body, make the needed repairs to put it in good working order, and connect it up again. Meanwhile, the Iron Heart maintains normal circulation.

The heart is the one organ of the body that never gets a rest, aside from the brief interval between the beats of this great pump. It is no wonder that heart disease is the No. 1 killer of man.

Suppose a person's heart needs surgery to repair a flaw—say a ventricle valve that is leaking and permitting blood to flow in the wrong direction. As a result of rheumatic fever, heart damage like this is a common ailment.

There's been little the doctors could do about it—though daring surgeons have tried their best, working “in the dark” and “around corners” while the heart keeps on

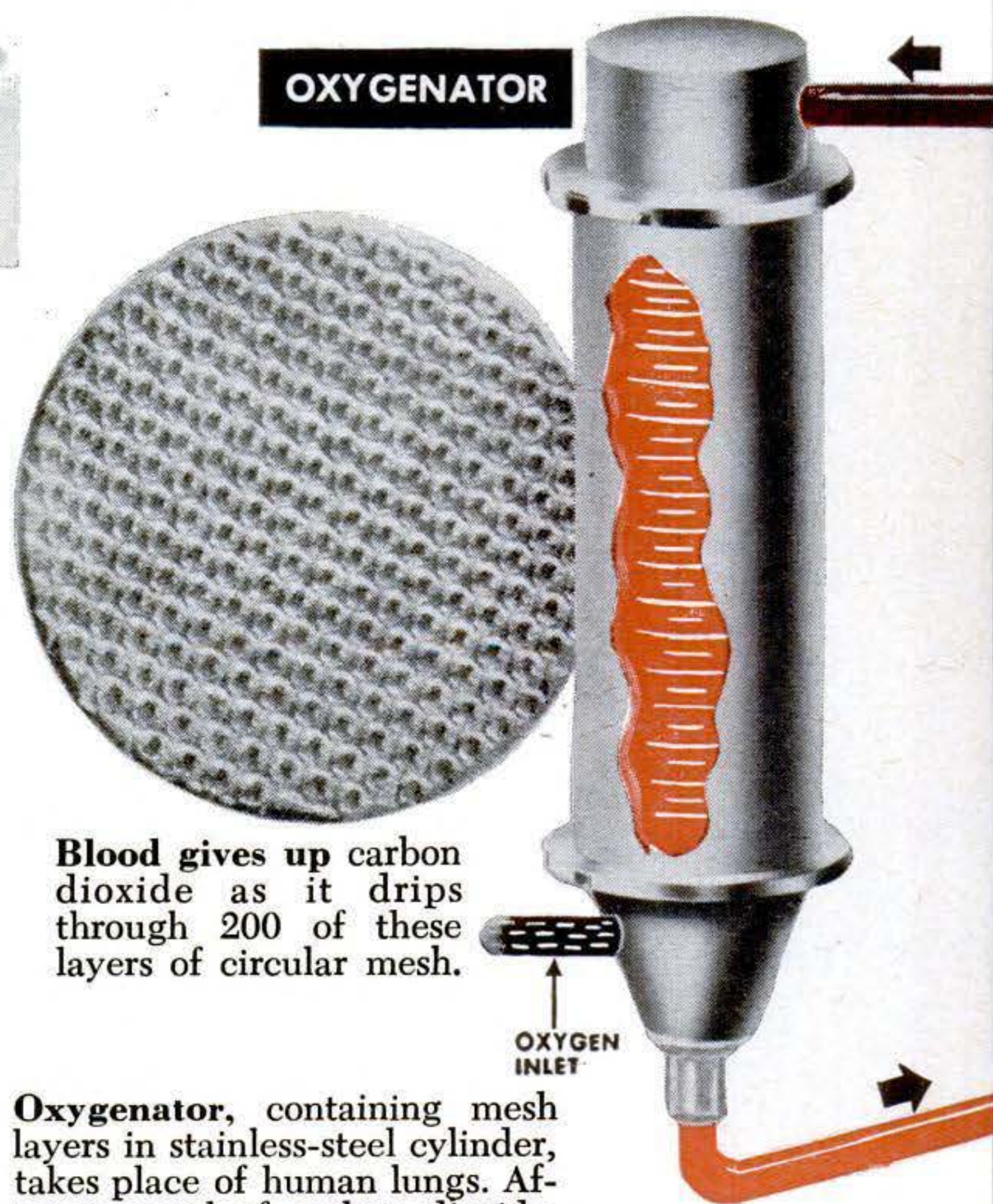

Blood gives up carbon dioxide as it drips through 200 of these layers of circular mesh.

Oxygenator, containing mesh layers in stainless-steel cylinder, takes place of human lungs. After removal of carbon dioxide, blood takes up oxygen, admitted through inlet tube at bottom.

pumping away. They have dreamed of being able to put the heart to rest, cut it open, drain it of blood, and see what they are doing while they repair it. The Iron Heart permits them to do just that.

Its use will open fields of medicine and surgery never before explored. Quite possibly a person knocked out and apparently dead of shock in an accident can be revived with the Iron Heart. Doctors say it will be invaluable, too, in heart attacks such as angina and coronary thrombosis. Frequently, a victim of the serious heart

CAROTID ARTERY  
SERVING AS INLET  
FOR RETURNED BLOOD

BLOOD FROM  
VEINS FLOWS  
TO MACHINE

GREAT  
VEINS  
TAPPED  
NEAR  
HEART

BY-PASS CLOSED  
AFTER MACHINE  
IS PRIMED WITH  
BLOOD AND STARTED

HEART

BLOOD FROM  
MACHINE RETURNS  
TO ARTERIES

FILTER

PUMP

Large diagram shows how Iron Heart is connected to patient. It taps dark-red blood from great veins near heart and returns freshened, bright-red blood to artery in the neck.

Drawing showing principal arteries and veins of human body illustrates alternative ways of connecting Iron Heart to system.

ARTERY  
IN  
NECK

VEIN  
IN  
ARM

VEIN  
IN  
THIGH

BALL  
BEARINGS

OUTLET

CHAMBER IN  
PLASTIC BLOCK

ECCENTRIC  
ROTOR

INLET

FLEXIBLE  
RUBBER  
LINER

MOTION OF RUBBER  
LINER SIMULATES  
PULSING OF HEART

How Vanton pump gently pushes blood along, without damaging fragile cells, is seen in sectional views. Blood is propelled through chamber in plastic block by wiping action of rubber cylinder, supported at its top and flexed by eccentric rotor turning within. Design keeps blood from contract with corrodible metal.

condition called coronary thrombosis may be kept flat on his back for as long as two months while nature heals the damage done by the thrombosis or clotting of blood. The Iron Heart would permit doctors to repair it themselves.

One of its most dramatic applications will be its first one, for which it was standing by 24 hours a day in the Philadelphia hospital as this was written. This was to be an attempt to resuscitate a patient whose heart had stopped beating during an operation, and who would be clinically "dead," after all present methods, such as heart massage, had failed. For although the doctors are certain the Iron Heart will work as well on human patients as it has on test animals, the inevitable risk of the initial trial must be justified by a dire emergency.

The Iron Heart is a compact mobile apparatus, no larger than a small console radio, housed in a transparent cabinet. It consists of two principal parts. One is a unique noncontaminating pump for circulating blood that contains no valves, gaskets, or stuffing glands. The pump is made of transparent plastic and is so designed as to cause no damage to blood cells. The other is an oxygenator, a device that supplies oxygen to blood circulating through it and simultaneously removes carbon dioxide. Blood flows in turn through oxygenator and pump, and the Iron Heart actually relieves the human lungs as well as the heart of their duties.

This extends the machine's usefulness to surgical cases where the lungs need to be put to rest rather than the heart. It may save the life of a patient choking to death with an asthmatic attack, or suffering from an extremely serious case of pneumonia.

#### *How Iron Heart Is Used*

To treat a patient with the Iron Heart, surgeons will open a main artery, after the machine has been primed with blood of the patient's type. A plastic tube leading from the apparatus is inserted in the artery and temporarily clamped. Another, Y-shaped tube leading to the machine is inserted in two main veins.

Then the surgeons set the Iron Heart in action. Blood is permitted to flow into the arterial system as blood from the veins travels through the oxygenator, pump, and gently back into the body. All blood is diverted from heart and lungs, except for the

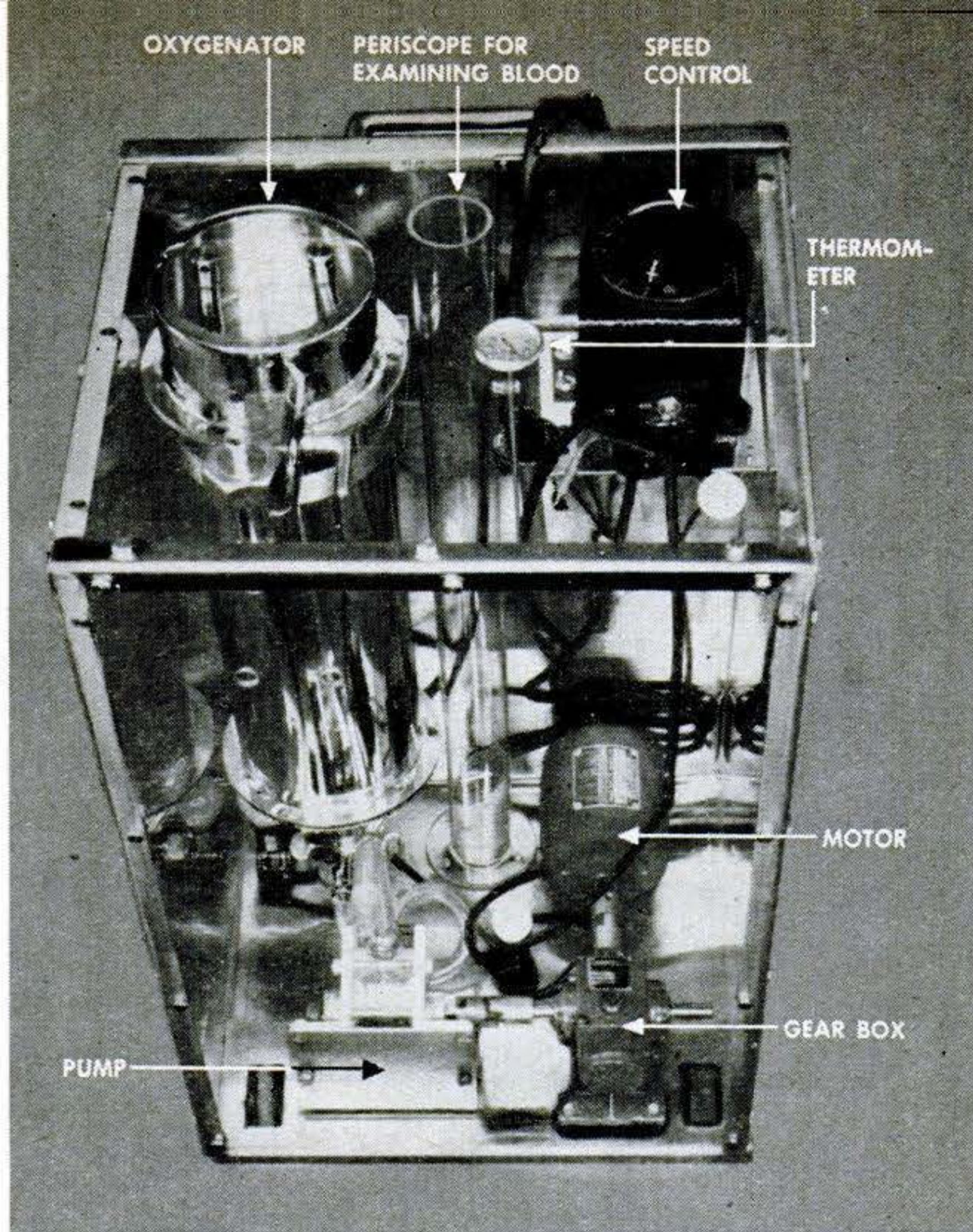

Close-up view of Iron Heart in transparent cabinet, 30 inches high, reveals principal parts. Speed control serves purpose of regulating rate at which blood is mechanically pumped.



Frisky as any pup, this dog shows no ill effects from one of experimental operations in which Iron Heart kept animals alive as long as 70 minutes prior to first human test.

coronary flow that leaves the heart muscles by way of the right auricle. The heart becomes virtually a "bloodless organ." Thus a delicate operation may be completed under the most favorable conditions.

In trials on dogs, the heart continues to beat slowly but regularly. It can be stopped

and started again without difficulty, while the Iron Lung is operating. The animals have been kept alive with the machine for more than an hour, and have then made complete recoveries.

The Iron Heart has the rhythm and "beat" sound of a human heart. It can circulate up to eight quarts of blood per minute, a comfortable 100 percent over normal human circulation of four quarts a minute.

For years, engineers and skilled craftsmen have been working toward such a machine. Major problems were designing a pump that would not damage the fragile cells of the blood; and an artificial lung able to remove carbon dioxide, and supply oxygen, without forming bubbles in the blood. The chemical industry supplied the answers to both of these problems. It furnished an adaptable design in the Vanton Flex-i-Liner Pump, which gently pushes a liquid along. And a successful oxygenator or "lung" was devised by allowing blood to drip, in a cylindrical chamber, through 200 layers of stainless-steel screen mesh of a

commercial type known as Stedman Packing. This exposes the blood to pure oxygen fed from the bottom of the device. The blood cells surrender their carbon dioxide to the atmosphere and absorb the oxygen. The mesh also avoids the air bubbles that could block the arterial flow—a hazard that has hindered other attempts to build artificial lungs.

Makers of the Vanton pump, J. J. Ashton & Company of New York, built the Iron Heart in a joint project with Drexel Institute of Technology and Hahnemann Medical College and Hospital in Philadelphia.

Other designs of machines for the purpose are currently under development at Yale University; at Jefferson Medical College, Philadelphia; and at Fels Institute of Antioch College, Yellow Springs, Ohio. Experimenters of the latter institution have just announced a simple, inexpensive type with enough pumping capacity for treatment of a child; future models may, like the Hahnemann Hospital machine, have the capacity required for adult patients. **END**

## Biggest Indoor Movie Screen Made Entirely of Plastic

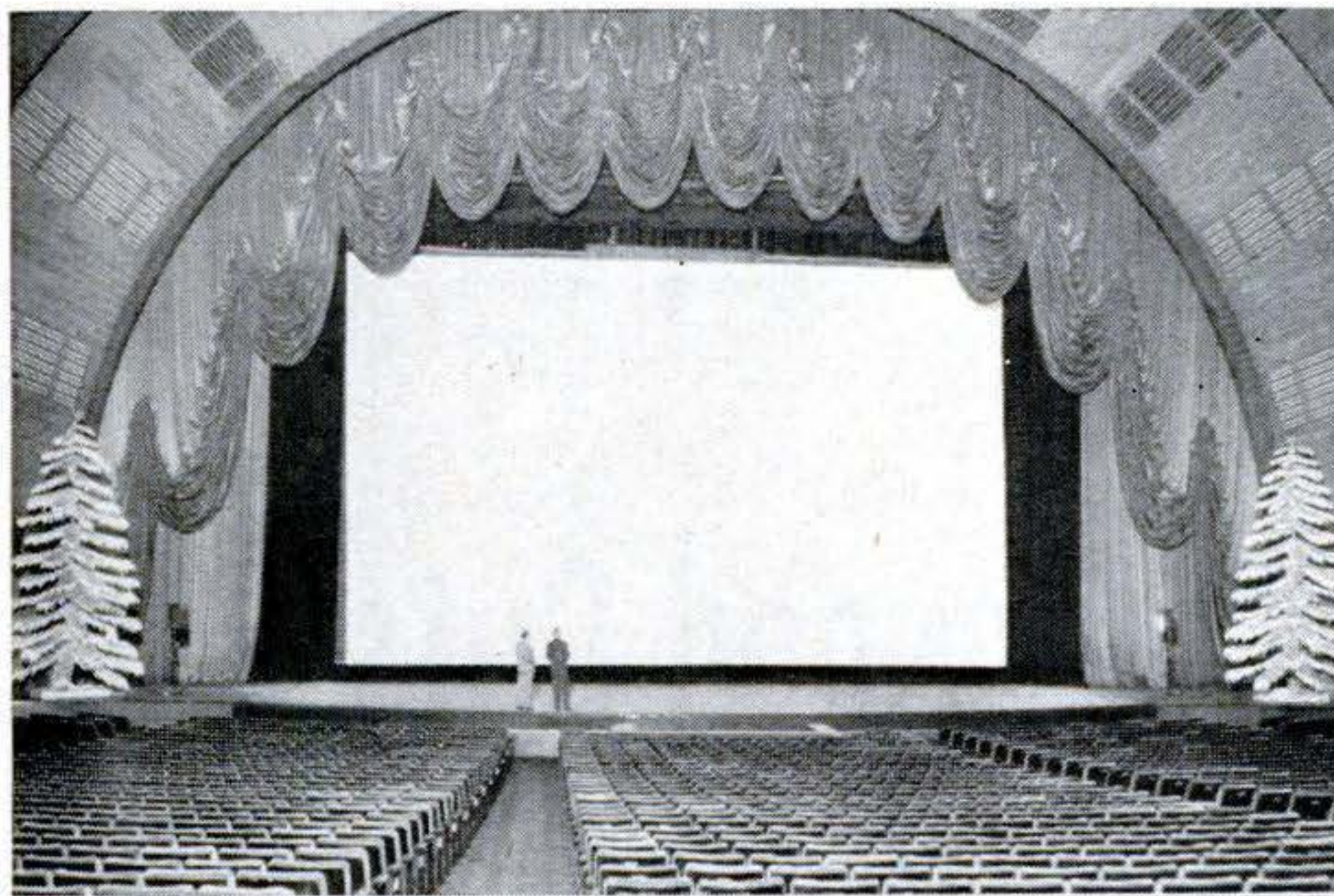

Now they're making movie screens entirely of plastic. These pictures show the first one being put up in New York's 6,200-seat Radio City Music Hall. It's 36 feet high by 60 feet wide—the world's biggest indoor screen—and is made of a calendered vinyl that won't crease, crack, burn, or mildew. The washable screen, made by Firestone Plastics Co., is perforated (below) with 10,000,000 tiny holes to let the sound through.

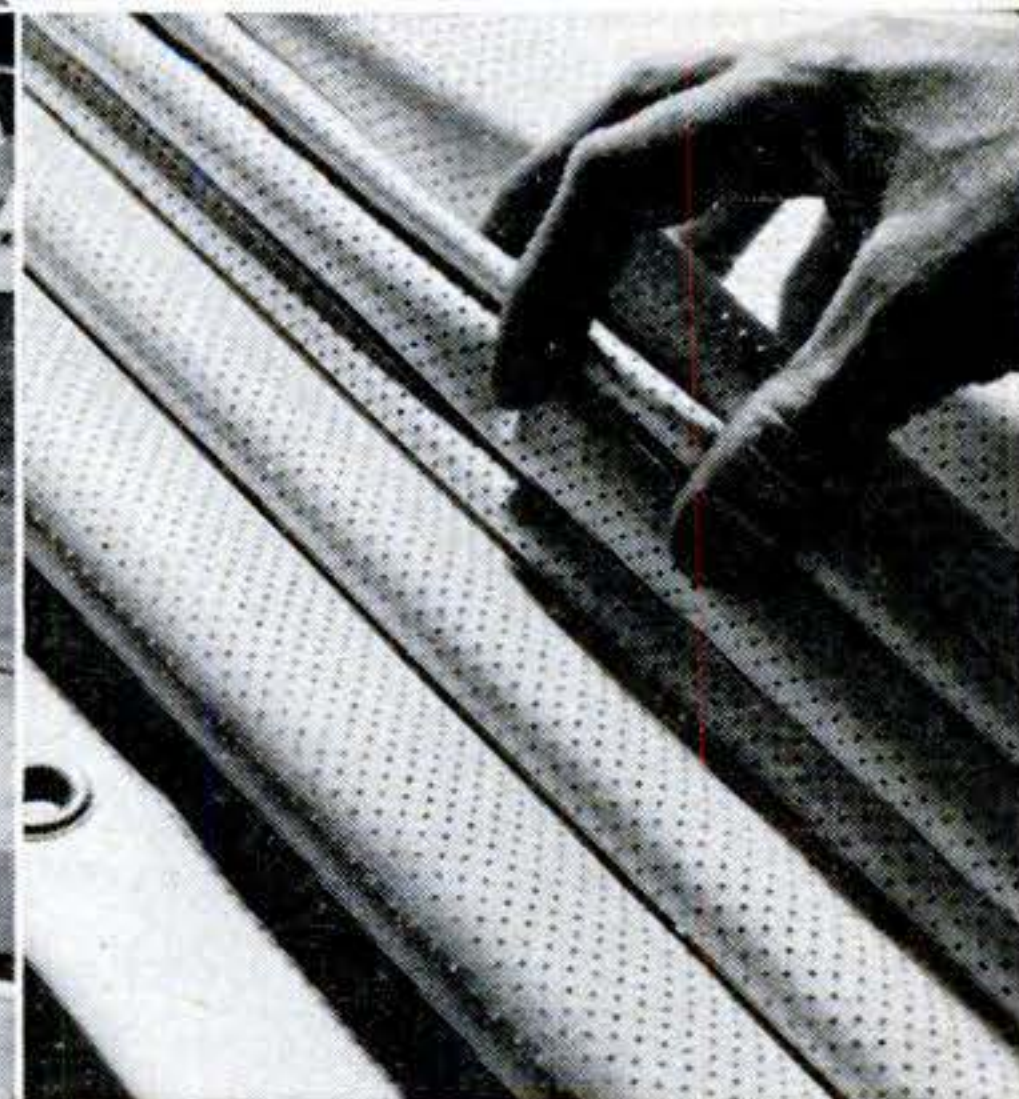



**Sailing ship** being tossed by angry seas against the rockbound coast above, won't be damaged much. For the breakers are only tap water and foaming chemical compound being whipped by wind from an electric fan. And the rugged rocks are wood and paper (left).

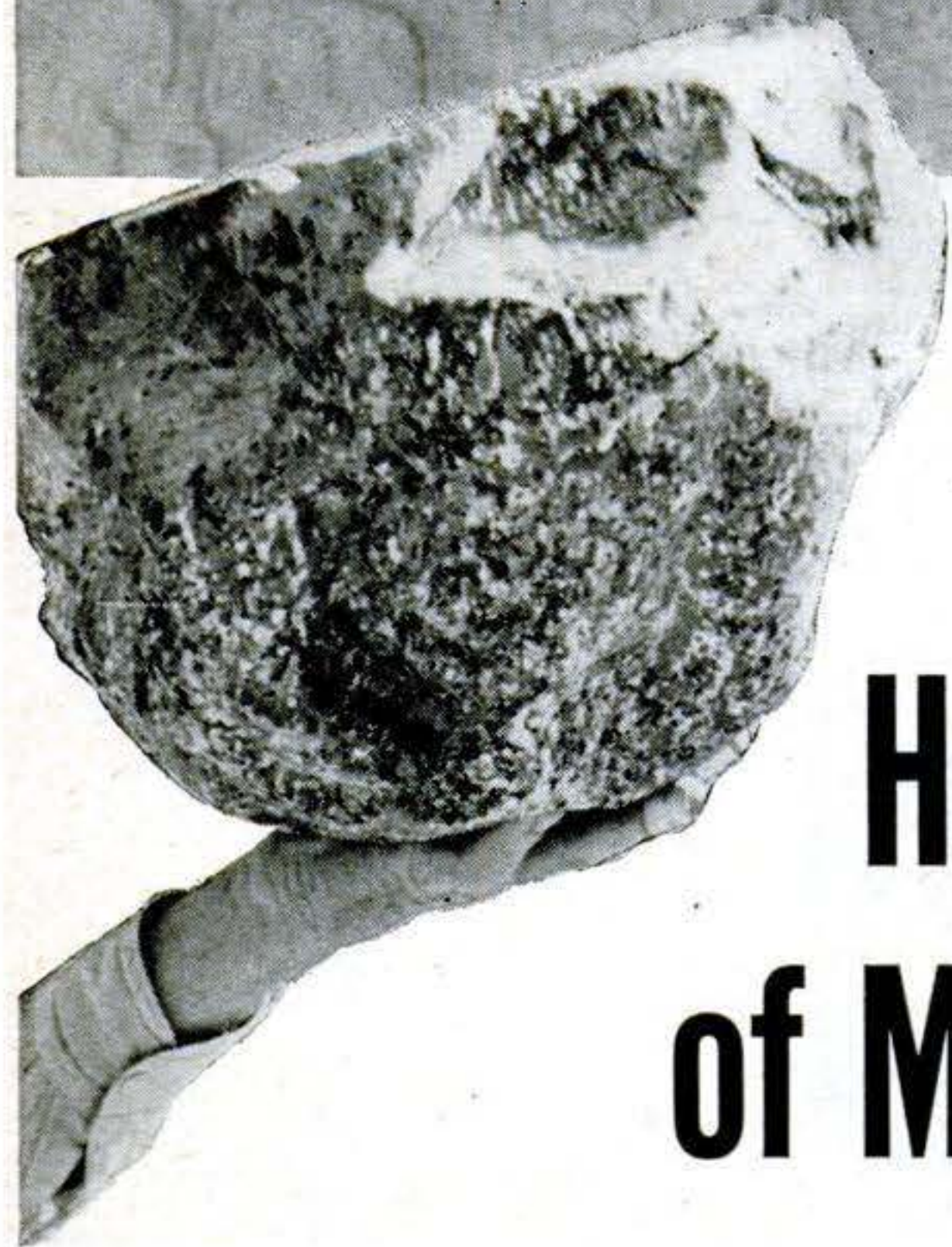

## Hollywood Cuts Cost of Make-Believe Worlds

**T**HE gadgetry and gimmickery that produce the true-to-life illusions you see on movie screens have gone on an economy budget. To cut costs while creating even more realistic make-believe worlds, eight Hollywood studios have formed the Motion Picture Research Council.

The miniature set above, depicting an impending shipwreck, made of wood and plastic, is the result of one project. In others, branches cut from trees and shrubs are

“embalmed” to withstand the hot rays of studio lamps and to retain their freshness for six months; a paste enables wallpaper to be peeled off for quick scene changes.

The Council's laboratories, with nine engineers, are spending more than \$100,000 a year to produce more realistic stage props with which to deceive the eyes and ears of movie-goers, streamline studio transportation, and improve photo techniques. On the opposite page are a few examples.



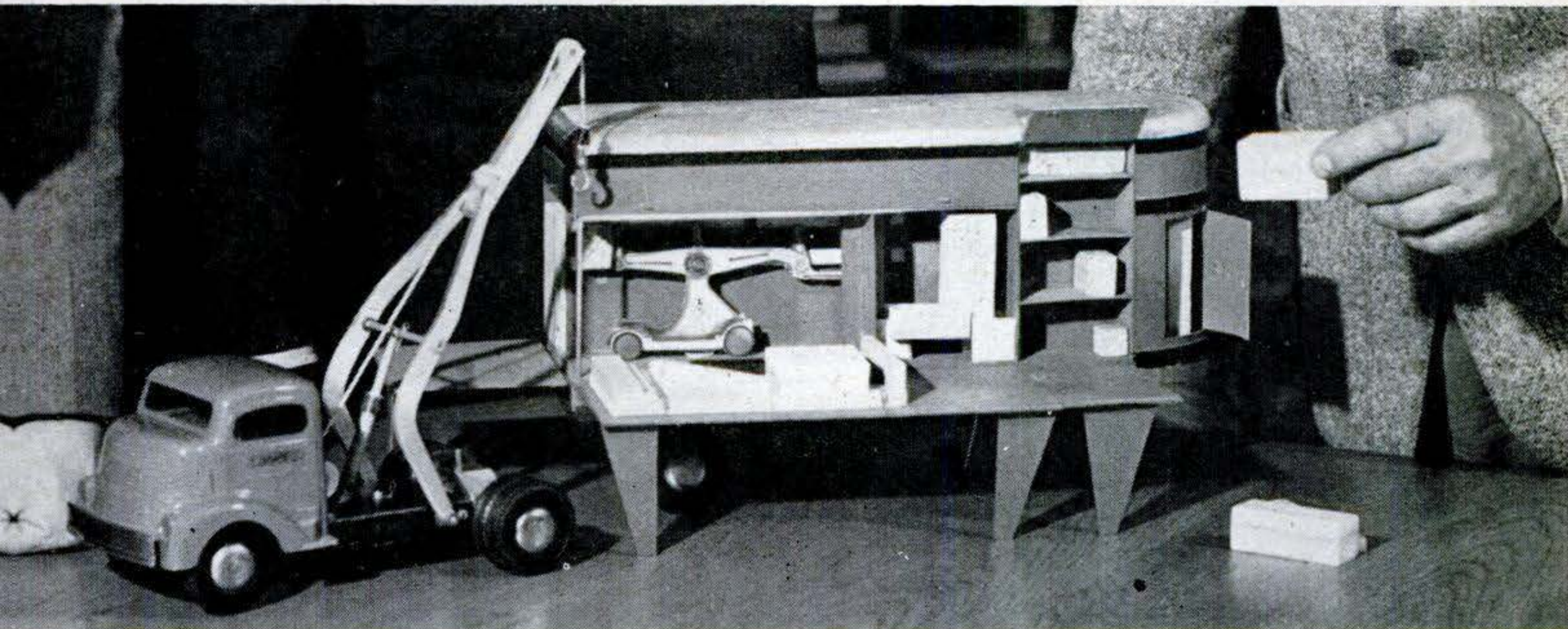

**Equipment trailer** in model form helps visualize transportation problems. Wooden blocks to scale represent equipment needed on location.

Compartmentalized construction makes efficient use of space, and hinged sides permit all-around, four-way accessibility.



**Front projection** to provide more realistic backgrounds is still experimental. Method may save costs over conventional rear projection.

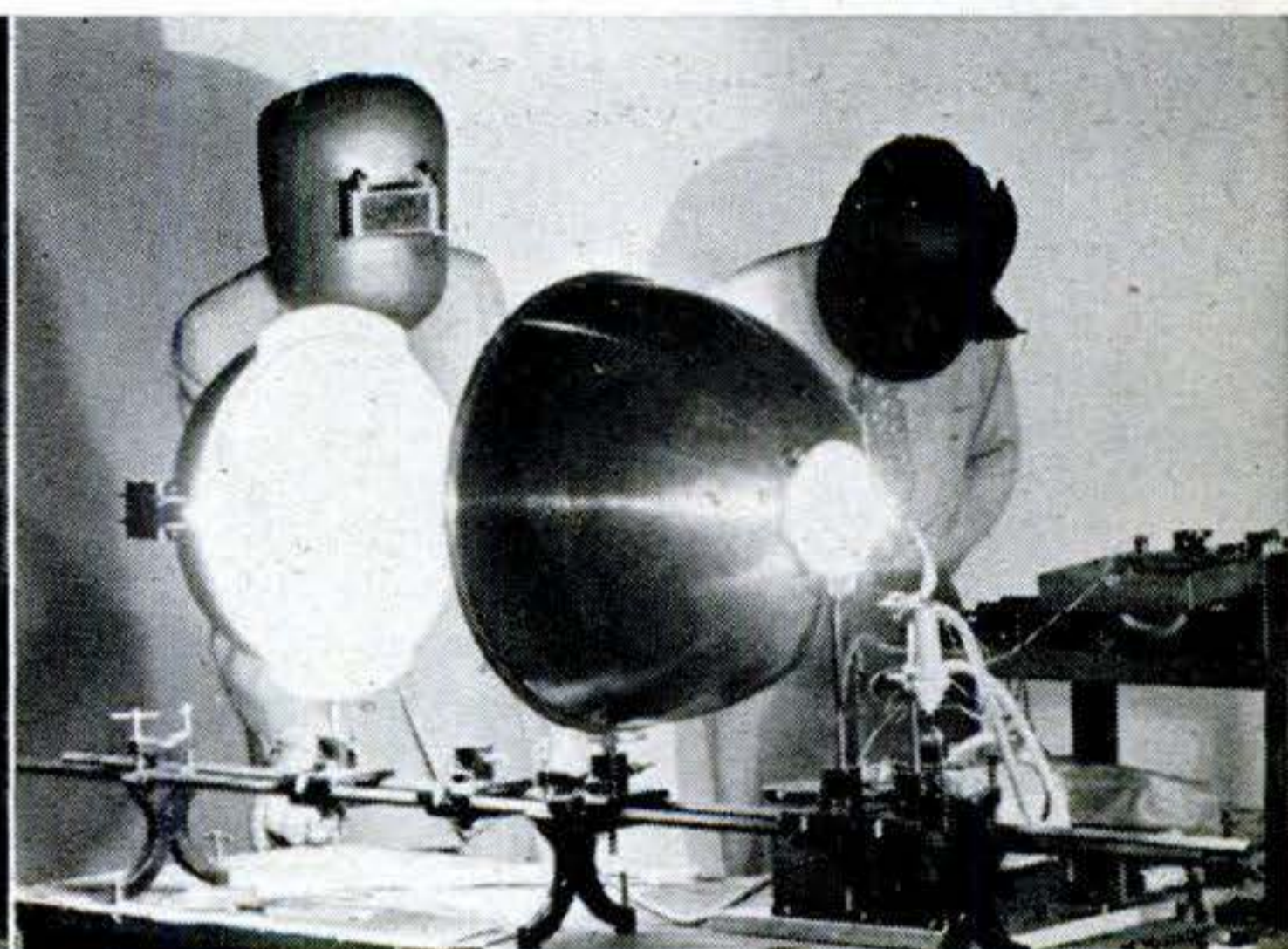

**High-intensity** mercury-vapor lamp for improved stage lighting is being tested by Council engineers. Unit at right is a reflector.



**Four men** try to buffet gale from new machine that can blow up a 200-mile hurricane. When throttle of its 145-hp. industrial engine is wide

open, the 14-blade, six-foot prop spins 1,180 r.p.m. Blower is four times as efficient as previous wind machines.



**This brand-new model of famous British Jaguar car, holder of world's stock-car speed record of**

**more than 132 m.p.h., is being introduced in the U. S. Price: \$3,875 delivered, New York.**

# New Jaguar Offers Luxury, Speed



**Known as the Mark VII sedan, it's full of gadgets. Long-exposure photo shows how steering wheel can be adjusted fore and aft over 4-in. range. Car is available with left-hand drive.**



**Sun top for fresh-air fiends is hand-adjusted panel. Car seats five; six-seater is available. Wheelbase is 120 in.; over-all length, 196½; width, 73; height, 63; and ground clearance, 7½.**

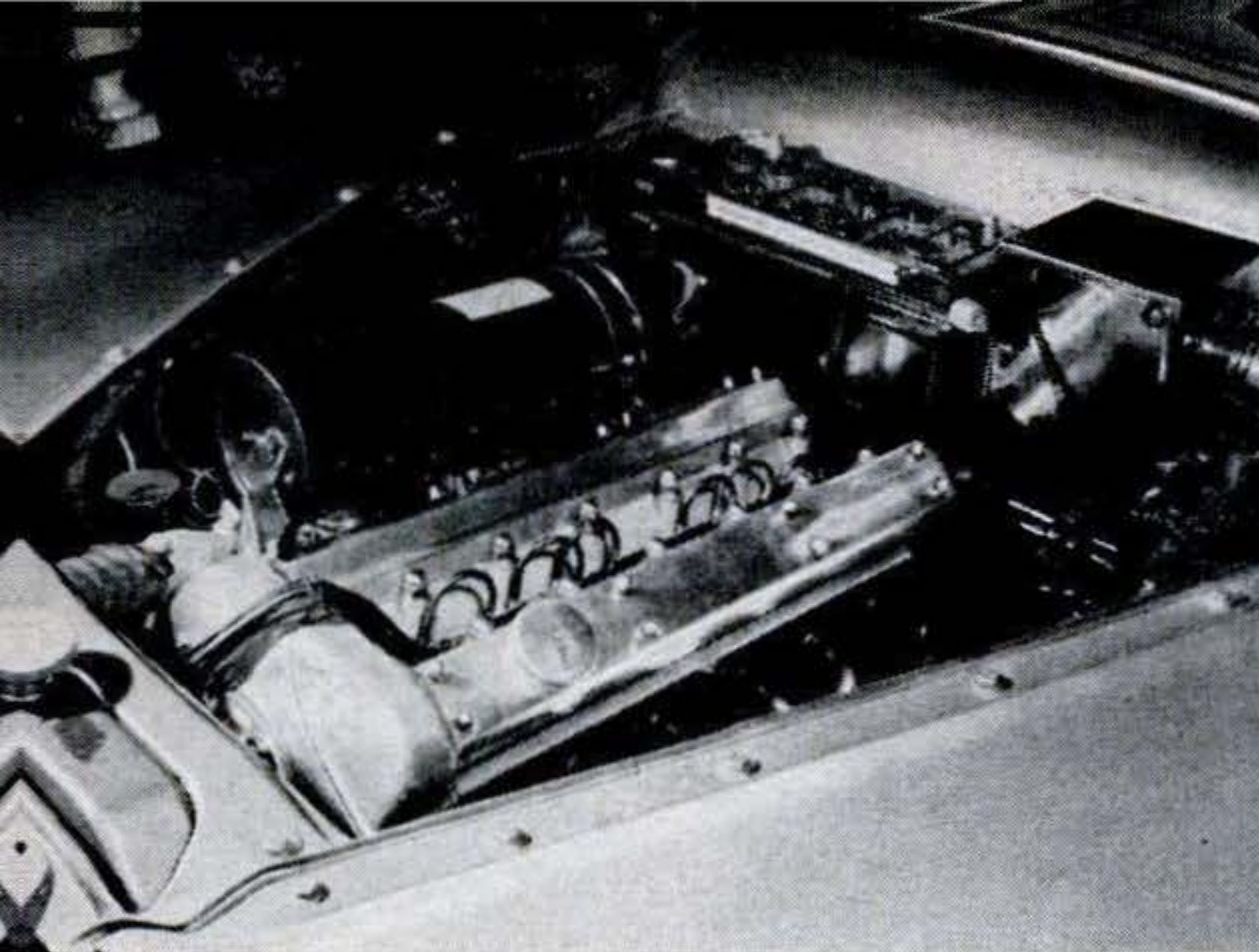

**Engine** is same 160-hp. six-cylinder job powering other Jaguars. It has twin overhead camshafts. Propeller shaft has two universals. Car has four forward speeds, winds up to 5,200 r.p.m.



**Two airplane-type fuel tanks** are located in rear fender wells. They must be filled separately. Tools in trunk are held in rattle-proof brackets. Spare tire fits in the recess at the right.

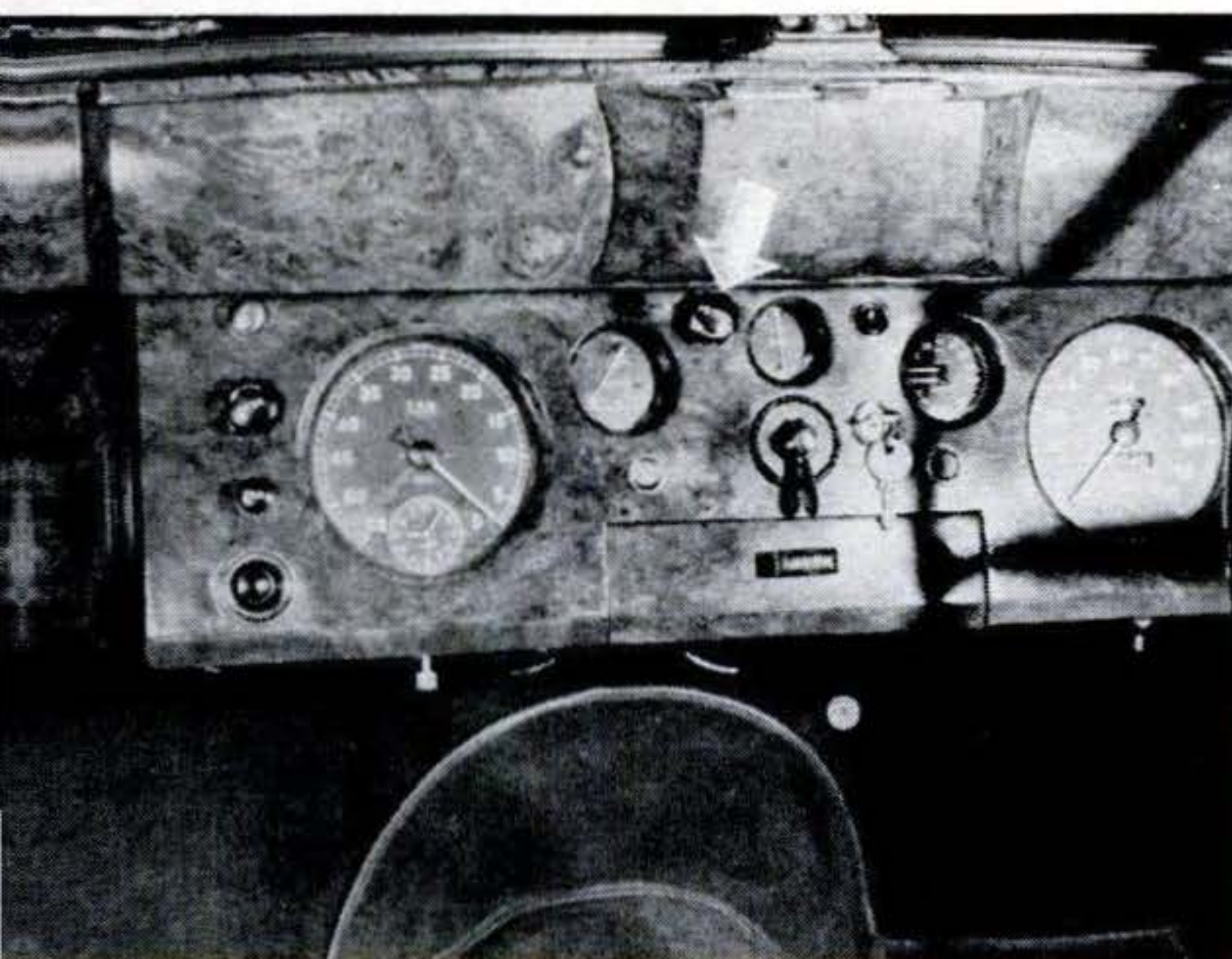

**Walnut instrument panel** has a tach (the large dial at left) and a fuel selector valve (arrow). Sedan weighs 3,300 lb. empty, gets 12-14 miles per gallon. Shift lever is on floor.



**Here's something** U. S. motormakers might well copy. Push this control and rear door can't be opened from inside. It's a safety device to keep Junior from falling out and getting hurt.

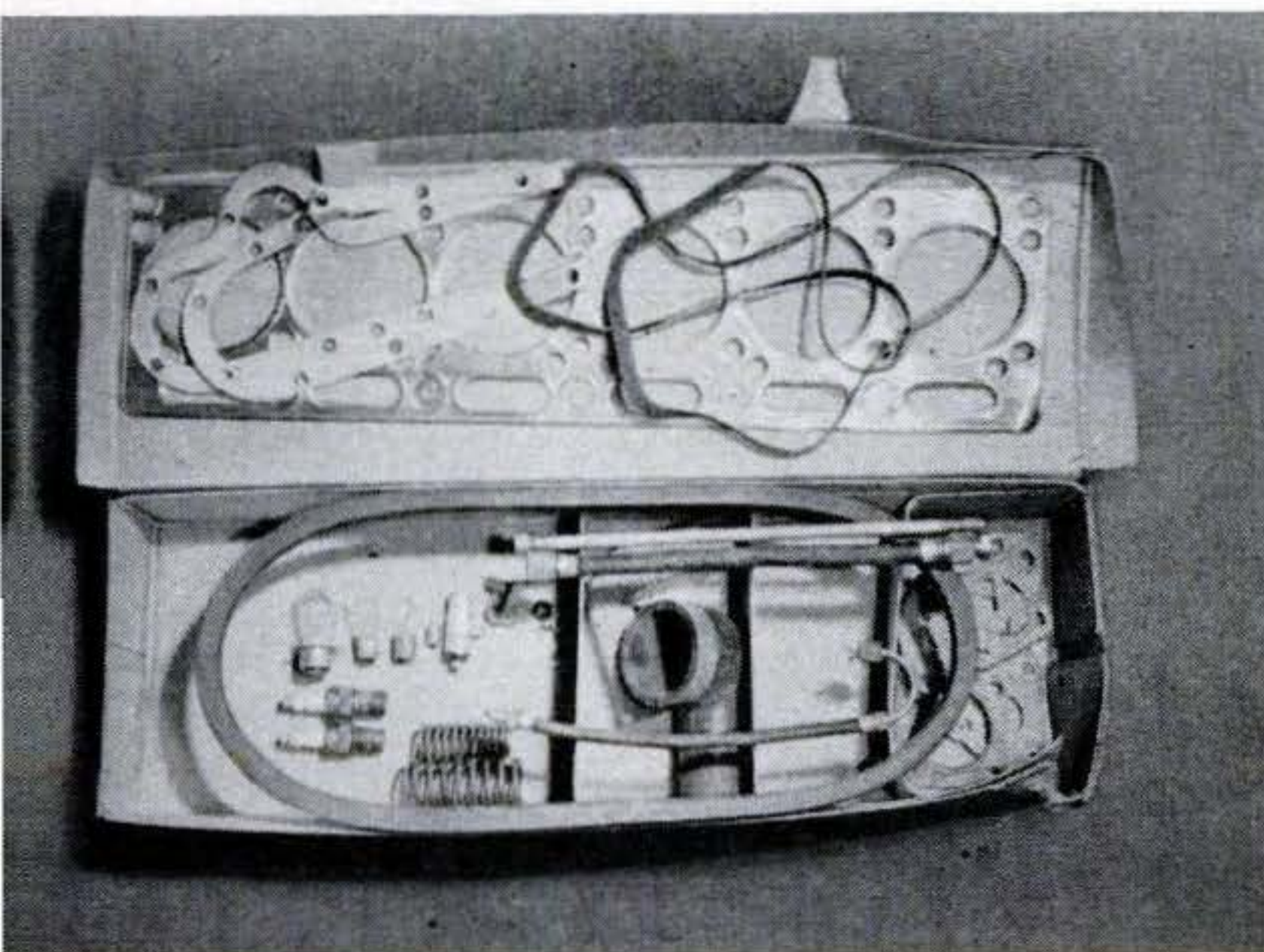

**Manufacturer** has thought of everything for American buyer. This "tour kit" contains everything from extra gaskets and plugs to a spare fan belt. Car's gear ratio in high is 4.27-to-1.



**Full set of tools** of right sizes is provided. Recessed, cushioned compartments at bottom of both front doors house open-end wrenches, still more spare plugs, other extra supplies. **END**



Screen in front of inspector, left, gives him X-ray view of carton of canned goods placed on roller platform, above. To help spot defects, sample film above screen shows typical faults.

### X-Ray Trailer Inspects Cans

AN X-RAY trailer, devised by the Army Quartermaster Corps, periodically inspects canned food in storage. Bulging or corroded

cans and deteriorated contents are detected without opening a carton. Formerly, cartons selected at random were opened, and only the outsides of cans inspected.

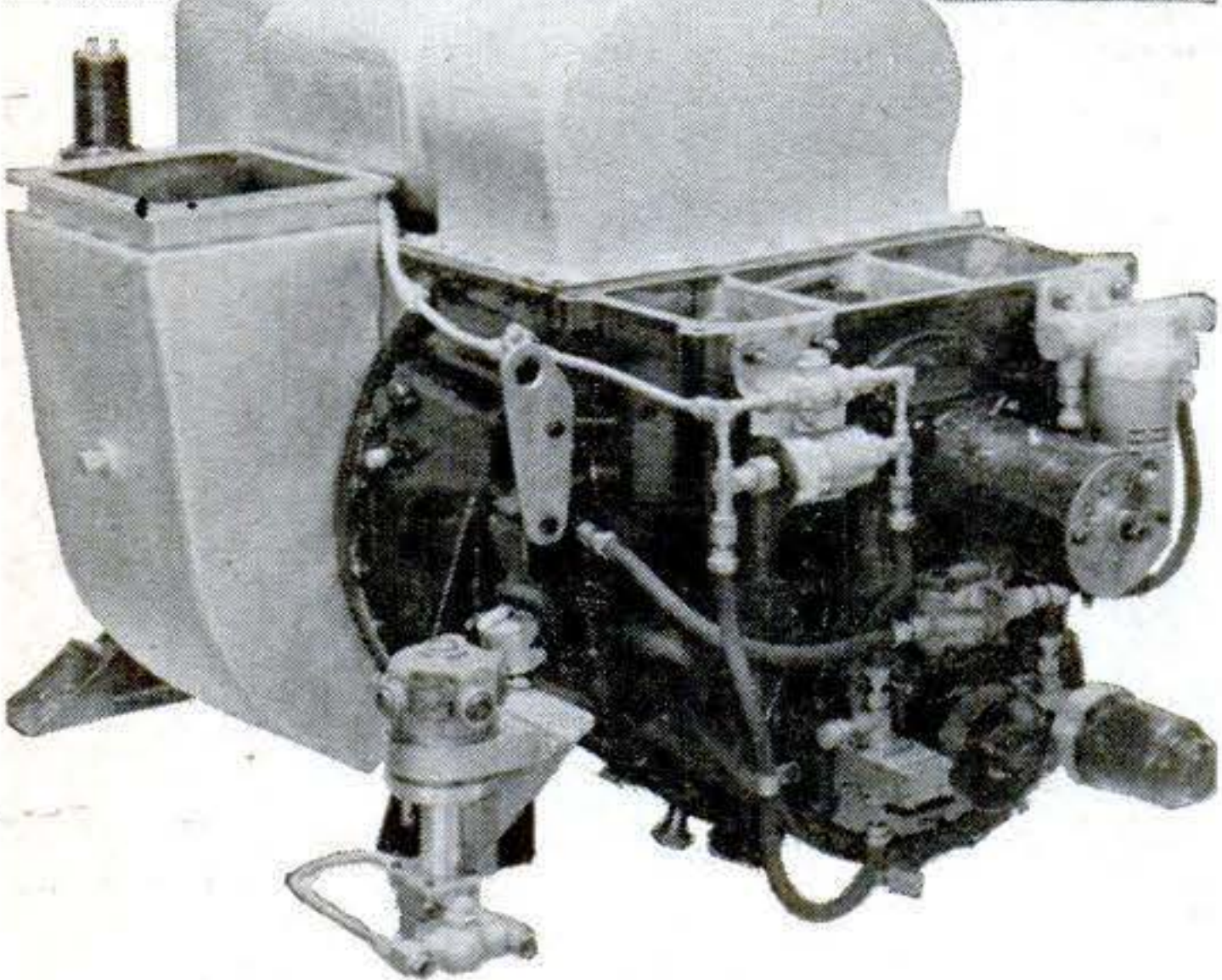

### Gas Turbines Propel Yacht

TWIN gas-turbine engines, burning Diesel oil, drive the propellers of the 60-foot yacht above. The Rover Car Company, Birmingham, England, is using the craft as a floating test bed for further development of the engine (lower view), which is of the same compact design as that of the Rover gas-turbine motor car (PS, June '50, p. 98).

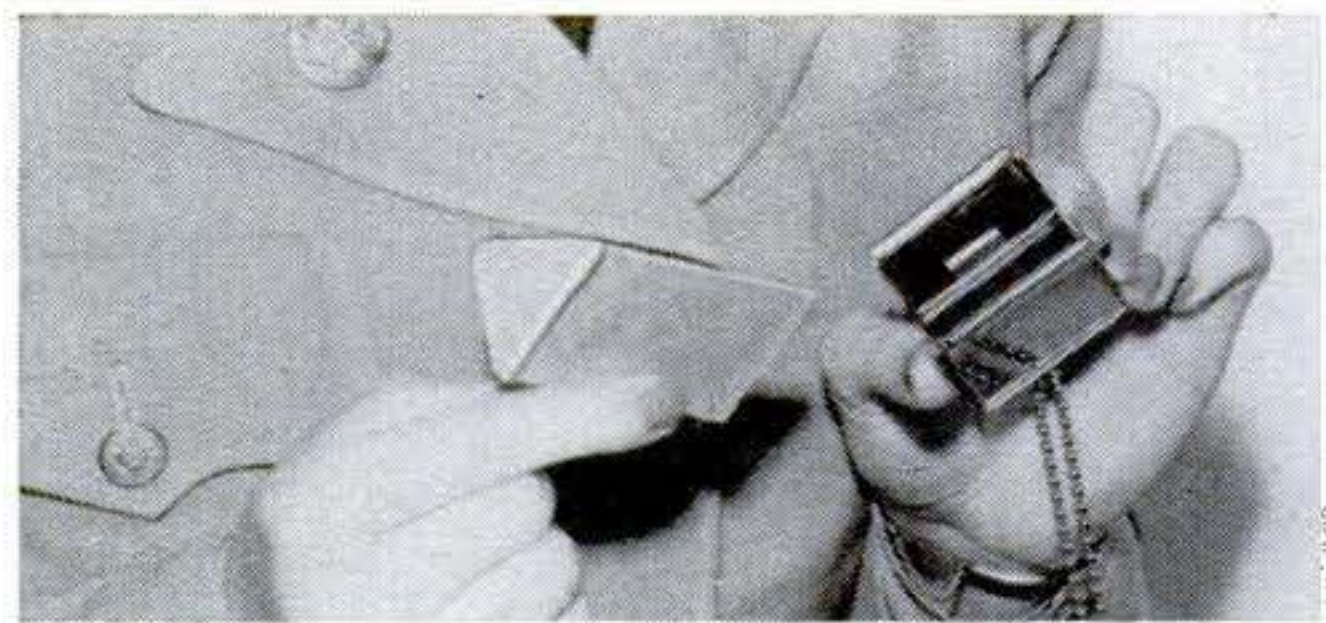

Self-developing film goes in locket, above; is removed and opened, and seen close-up, below.

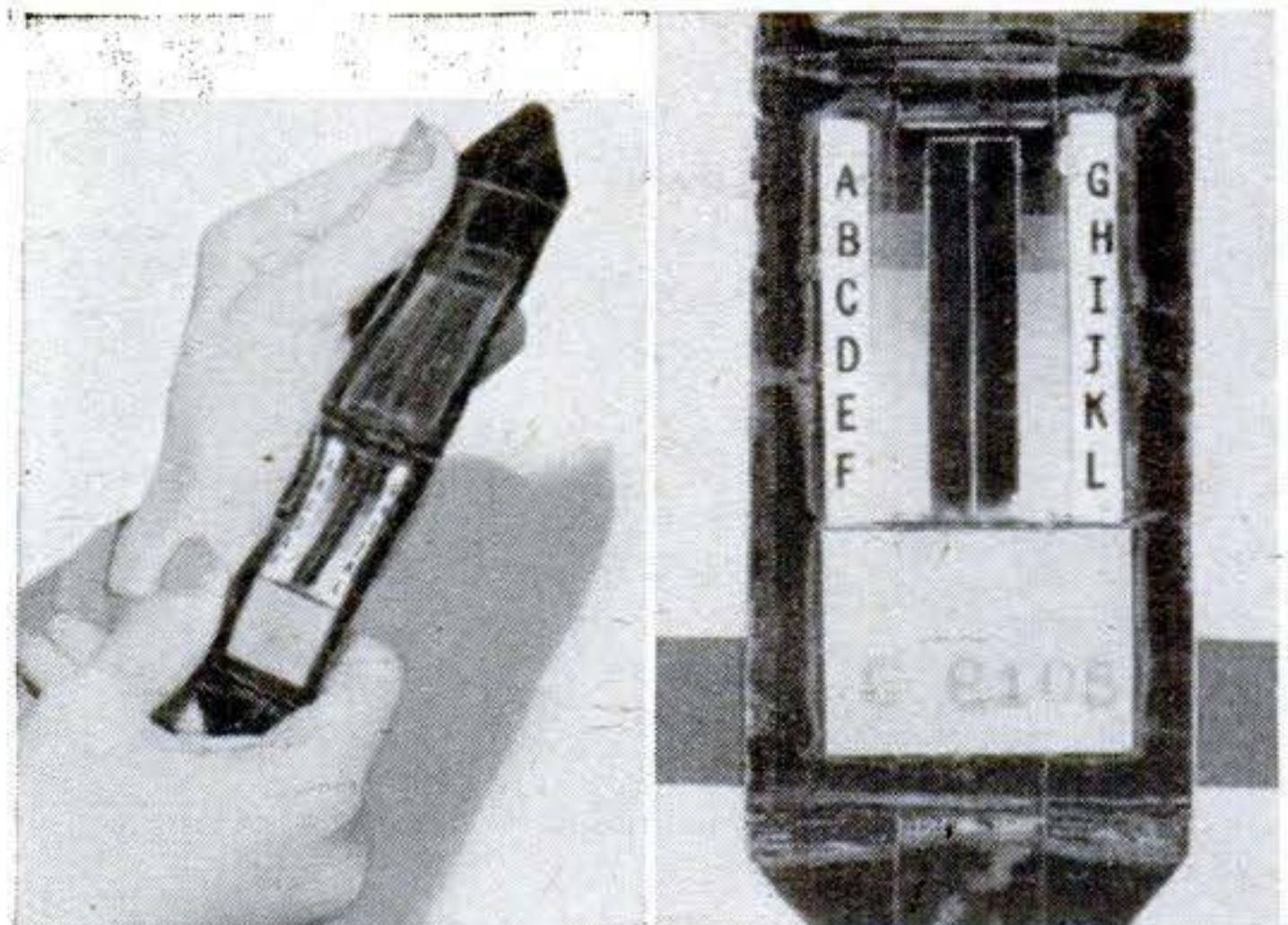

### Quick A-Bomb Exposure Test

EXPOSURE to A-bomb rays would be gauged in a jiffy by an Army film locket, worn on a chain around the neck and suited to mass production. Withdrawing the film breaks a capsule that develops it, as in a Land camera. The greater the exposure, the whiter the film strip, which is matched against a bordering scale of graduated tints.

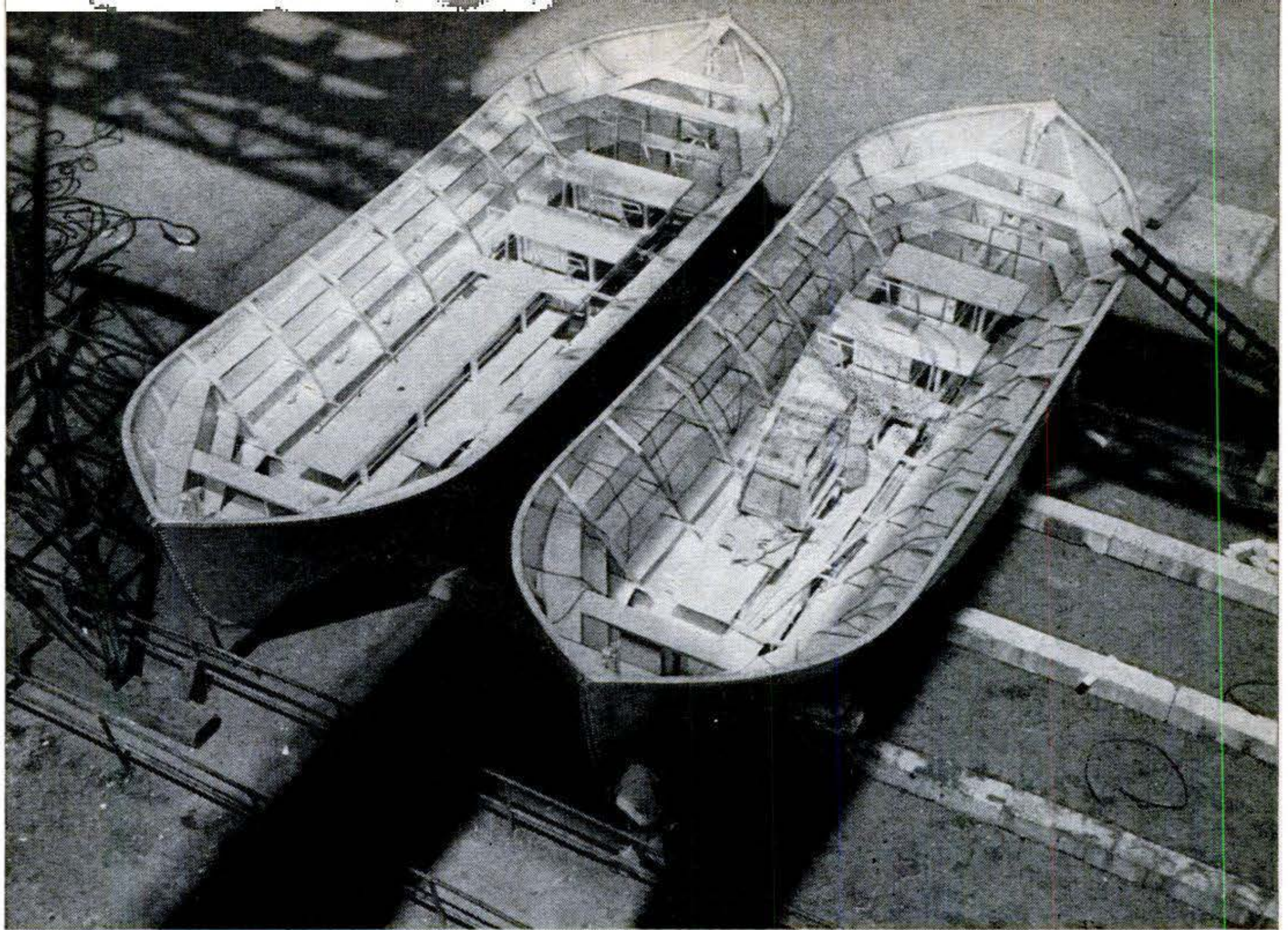

New lifeboats resemble giant pea pods next to workman visible in center foreground, above.

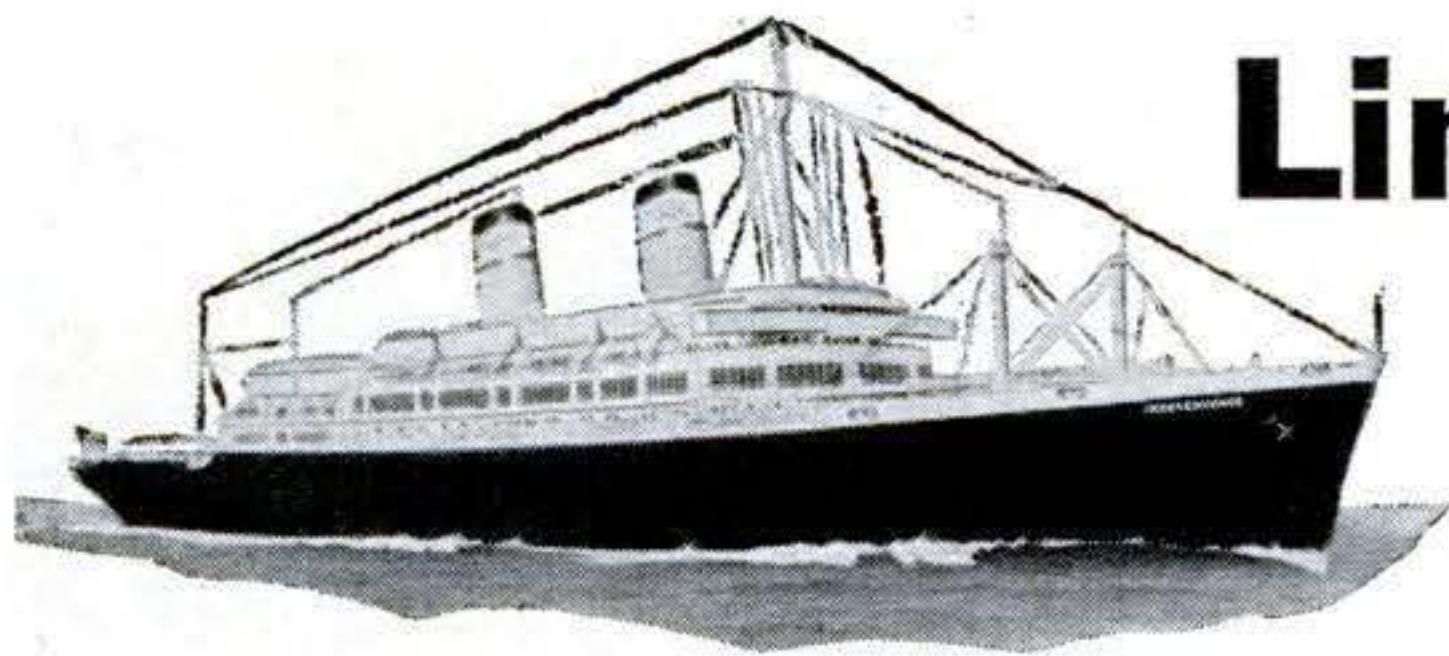

## Liner Has Biggest Lifeboats

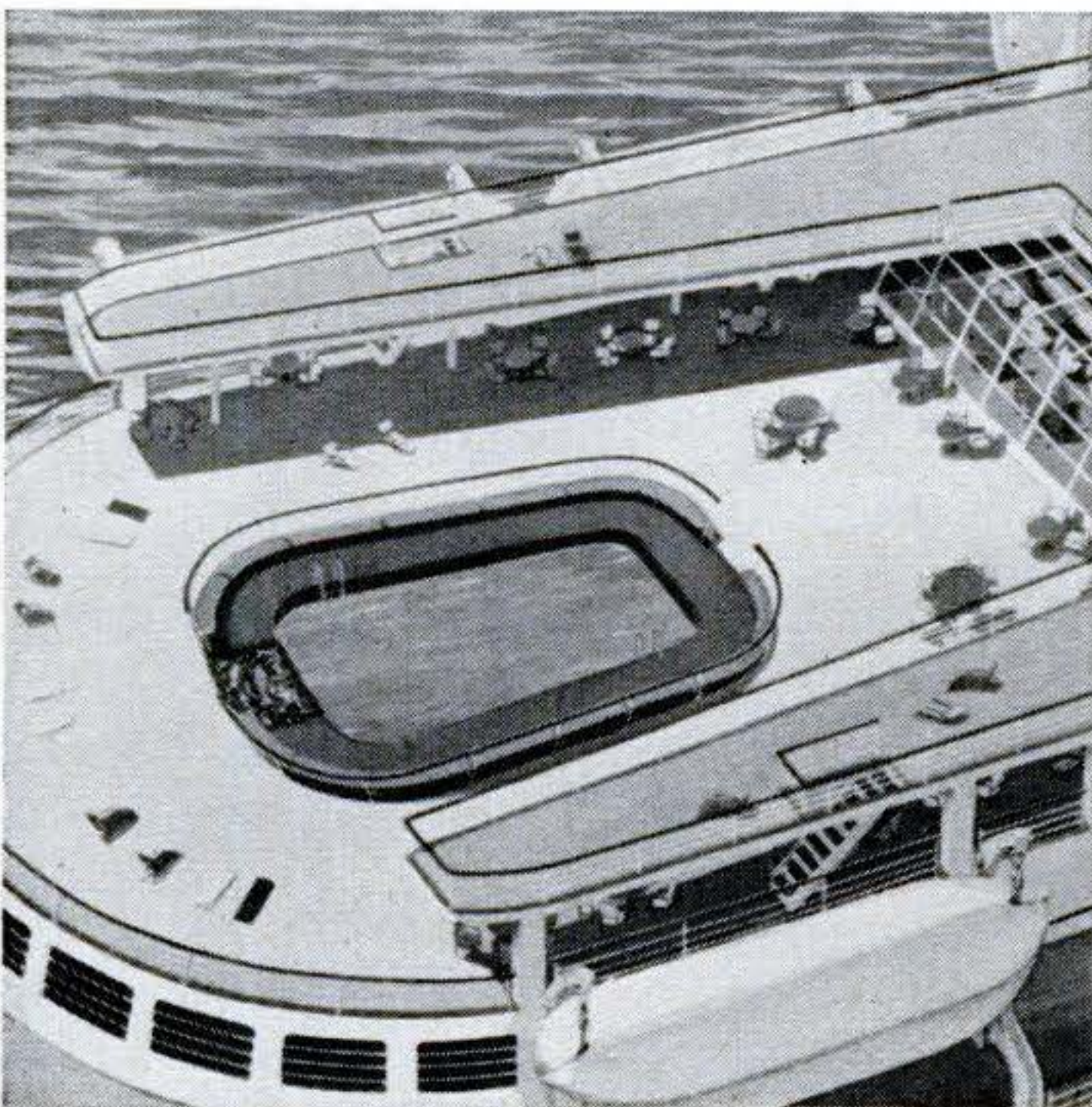

Size of the lifeboats is indicated by comparison with length of swimming pool above. The *Independence* is a twin-screw, oil-burning ship of 55,000 hp., with a top speed of 25 knots.

**A**LUMINUM lifeboats, the largest carried by any liner, are being installed on the S.S. *Independence*, a new ship scheduled to set out from New York this month on a 53-day maiden voyage to Mediterranean countries.

Weighing 6,100 lb., each of the 12 lifeboats aboard the liner has stadium-type seats. These are arranged in tiers around the sides, so that 150 persons can be accommodated. Two of the boats have radios and are motor-driven for herding the other boats together when afloat. Designed to be noncapsizable, each lifeboat has 12 watertight compartments.

The *Independence*, built by Bethlehem Steel Co., for American Export Lines, Inc., carries 1,000 passengers. It has a speed of 25 knots, and is expected to make the 4,000-mile crossing to Genoa, Italy, in 8 days. Its cruising range is 20,000 miles. All parts of the ship, including crew quarters, are air-conditioned. In an emergency, the liner can be converted to carry 5,000 troops. **END**

**By George H. Waltz, Jr.**

PS PHOTOS BY HUBERT LUCKETT



# Navy Brain Answers with Pictures

**C**OMPLEX problems can now be reduced to three-dimensional, easy-to-understand answers by "Typhoon," the latest thing in electronic brains. Built by the RCA Laboratories for the Navy Bureau of Aeronautics, the new computer is showing naval experts just how theoretical guided missiles will react in actual flight.

Up until the completion of the new \$1,400,000 calculator a few months ago, the men whose job it is to create new and better guided missiles had to spend thousands of hours at complicated computations and many months at building full-size \$100,000 test models. And when they were finished, there was no guarantee that the new missile would perform as expected.

Now, they can simply dial the design characteristics of any proposed guided-missile system into Typhoon and actually see in drawings and in three-dimensional models just how the missile will function. What's even more valuable, the design characteris-

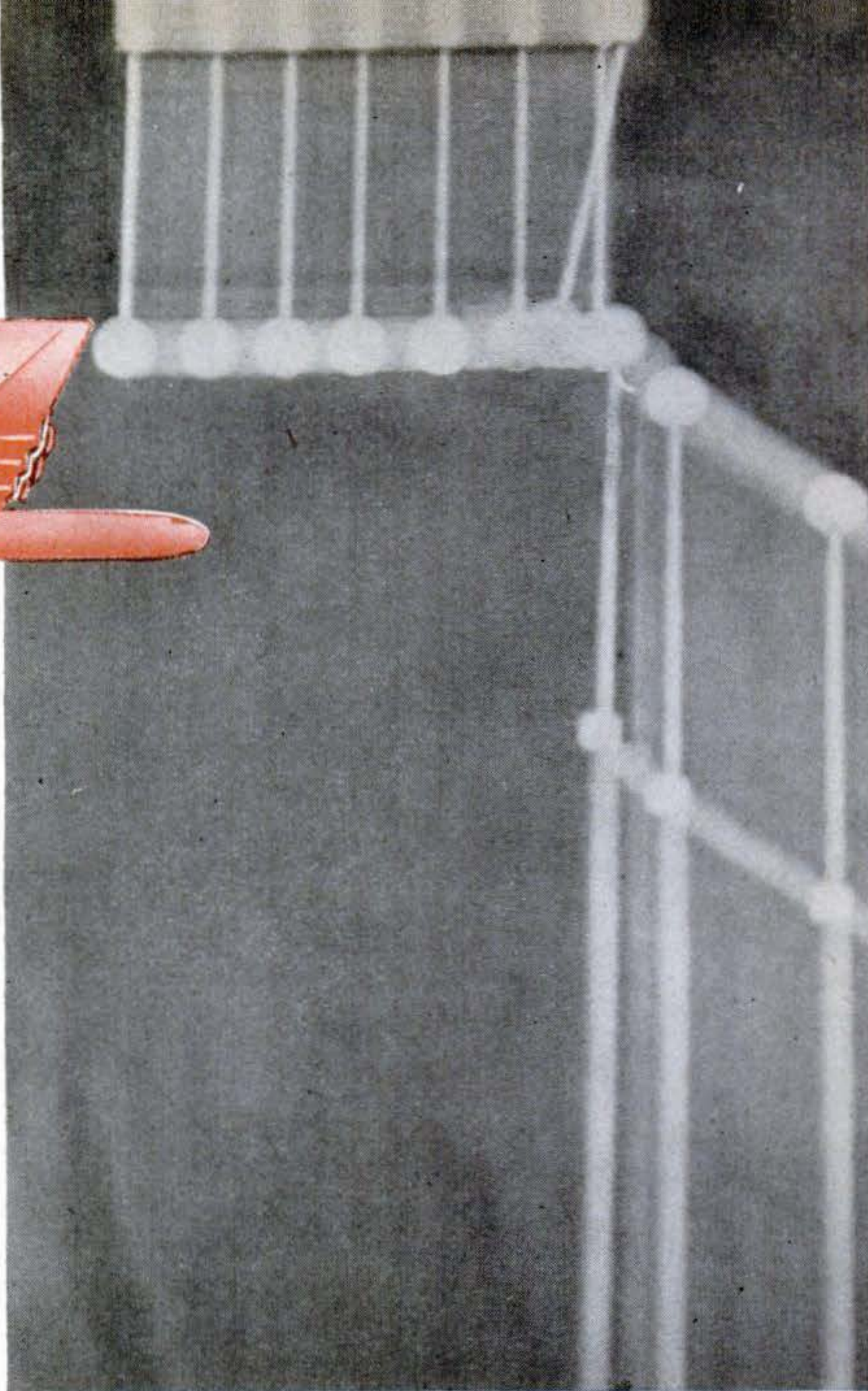

**Small-scale missile model** connected to the electronic brain simulates movements of the missile at the same time that the two balls in the trajectory model (shown above at right) trace the flight paths of the target plane and the theoretical missile under test.

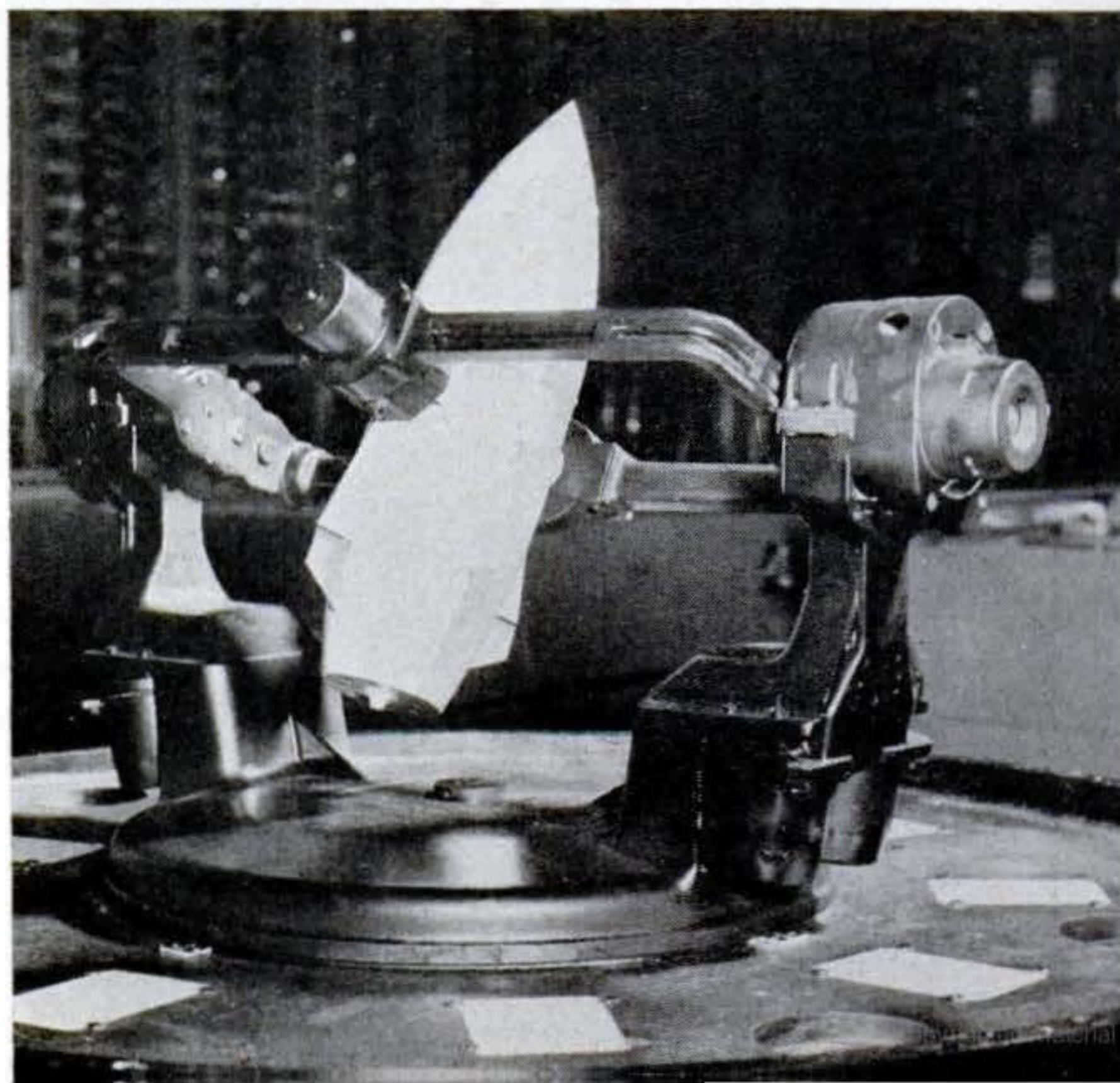

A hit (left) is shown in this multi-exposure photo as two balls trace plane and missile paths.

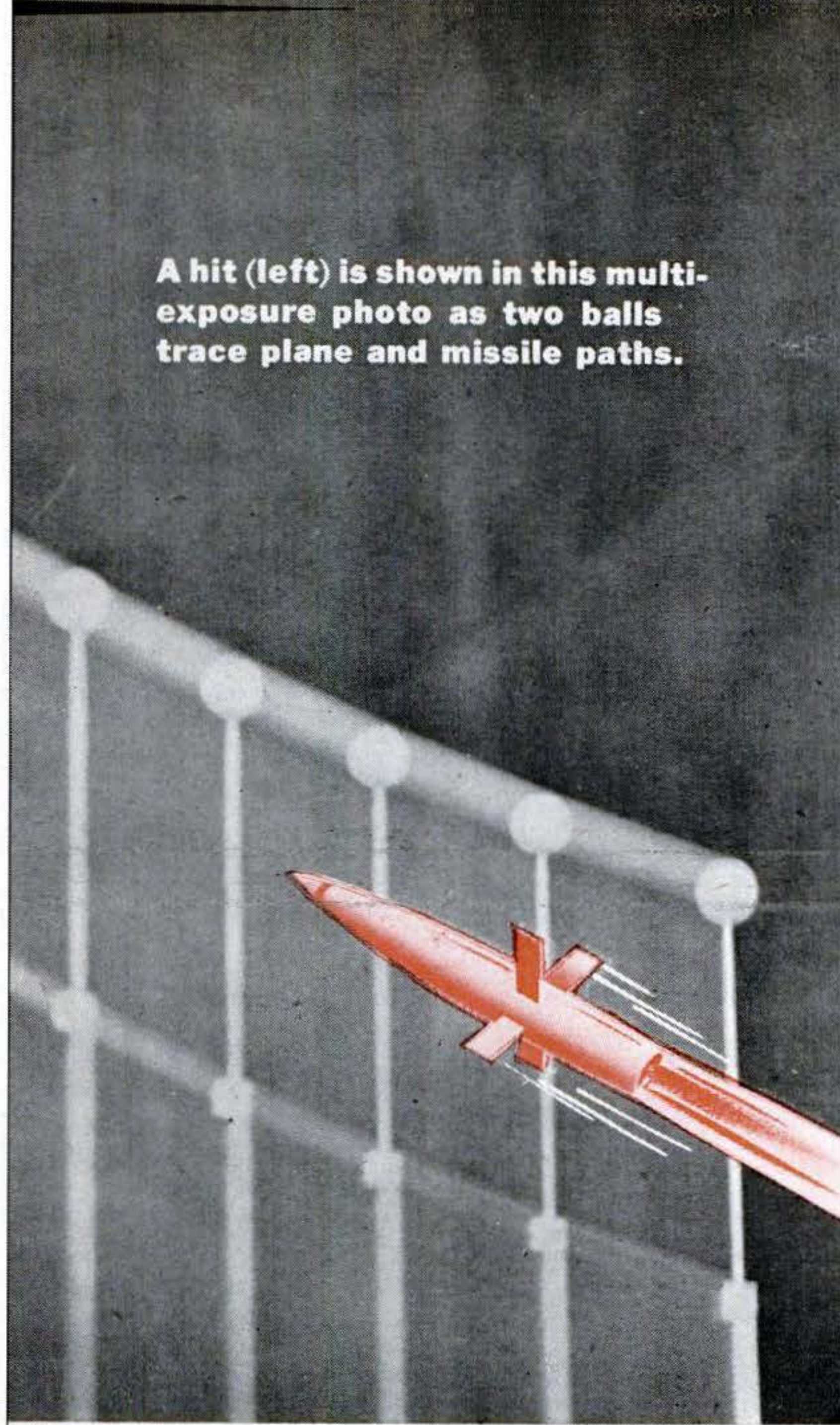

As the model receives the control signals, or instructions, from the computer, describing how best to hit the target plane without wasting time or fuel, its tiny control fins react as they would on actual missile and the model adjusts its position accordingly.

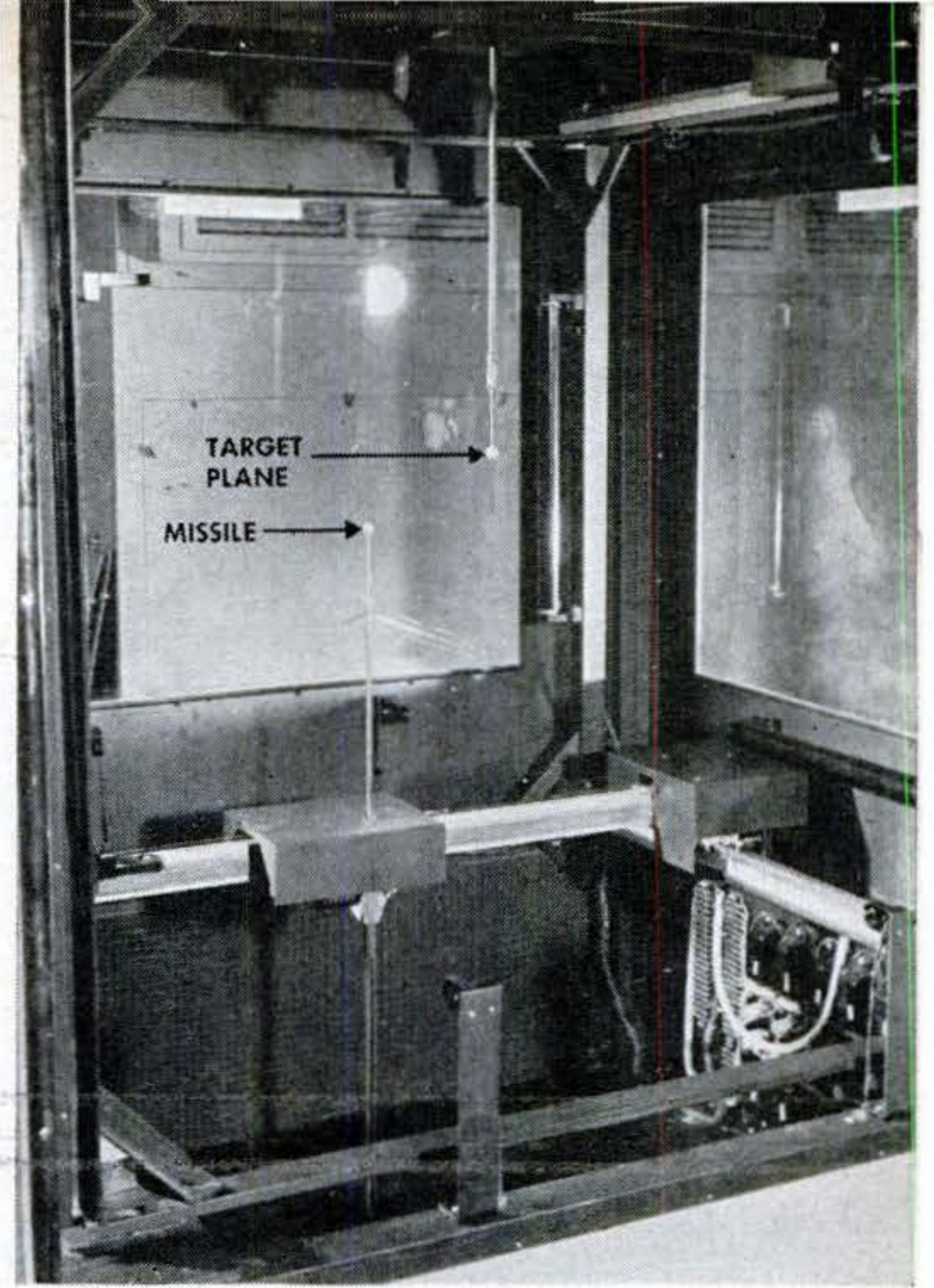
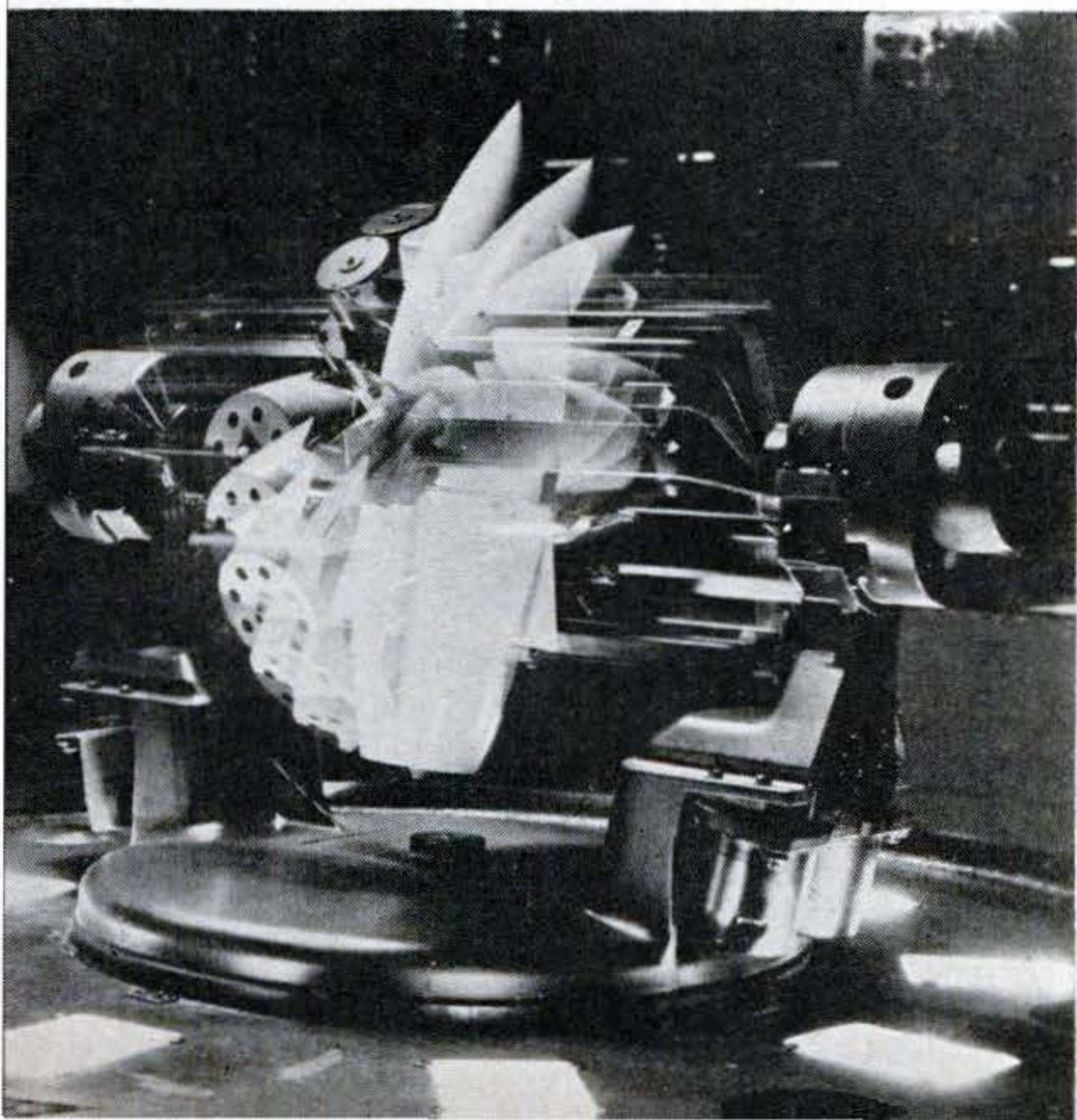

Trajectory model wired to the electronic brain gives a three-dimensional picture of the flight of the missile and the target plane it is designed to hit. Two suspended balls, lighted by ultraviolet rays so they fluoresce and can be seen in the semidarkness of the computer room, move according to instructions received from the electronic brain. In this way, the actual flight path of a theoretical guided missile can be watched and studied so that mistakes can be corrected long before missile is ever built. Computer also can be used to test airplane designs.

tics can be altered by twisting dials until the computer shows that the theoretical missile will track airplanes and score hits. And all this before a penny has been spent on costly missile construction.

#### ***Typhoon Tackles a Problem***

Most electronic brains buzz out answers that are mere figures. Not Typhoon. It actually demonstrates its answers in terms that even the layman can understand. When I first saw Typhoon operate recently at the RCA Laboratories in Princeton, N. J., the brain was set up to check the accuracy of a proposed radar-guided, rocket-propelled missile with a take-off speed of 720 m.p.h. against a bomber flying 360 m.p.h. at an altitude of 25,000 feet. Previously, 100 dials had been adjusted and some 6,000 plug-in connections had been made to feed the complicated problem into the brain.

When A. W. Vance, who developed the project, touched a red master switch on



**Pens on two automatic plotting boards** also record the paths of target plane and missile.

Board at left shows plan view while board at right shows elevation, or up-and-down view.

the long control console, the big brain went to work. As pilot lights flashed and relays clicked, two pens on each of two plotting boards—one board for the plan view, the other for elevation—began tracing out the flight paths of both the target airplane and the missile.

At the same time, two plastic balls suspended in a glass-walled booth and glowing under the illumination from ultraviolet lights, duplicated the movements of plane and missile in three dimensions. Nearby, a small-scale missile model, 12 inches long,  $3\frac{1}{2}$  inches in diameter, and complete with operating control fins, went through all the motions, gyrations, and spins that the actual missile—if there were one—would go through on a flight to the target. In 60 seconds, the entire flight, which ended in a direct hit, had been simulated and recorded.

In one minute, the new computer, largest of its kind ever built, had made 250 additions, 67 multiplications, 30 integrations, and had solved 20 aerodynamic equations. All were carried on simultaneously with continuously varying factors—a chore that would have taken two mathematicians at least five years. Besides that, the brain had provided the answer in visual, understandable form as well as on records.

How would this same guided missile perform if the plane tried to avoid the missile by diving, zooming, and turning? To find out, evasive tactics were dialed into the portion of the brain that did the thinking for the plane. As I watched the two balls and the pens on the plotting boards, the theoretical “dog fight” came to life. I could see the zigzagging target plane being hunted by the guided projectile. I witnessed the actual hit.

#### **A Check on New Theories**

With Typhoon, any guided missile problem can be run through over and over again. New theories can be tried and checked. The design of a missile can be varied for each run until the desired results are obtained. Thus, by avoiding the high cost of actual trial-and-error launching tests, the new brain can inform scientists how a missile will act under any set of conditions. It can help them to remove all the possible bugs long before the design leaves the drawing board.

Most electronic brains are either analogue computers (comparable to a slide rule) or digital computers (similar to an adding machine). Typhoon, however, is a combination of both and, by blending the two techniques in more complex forms, it achieves



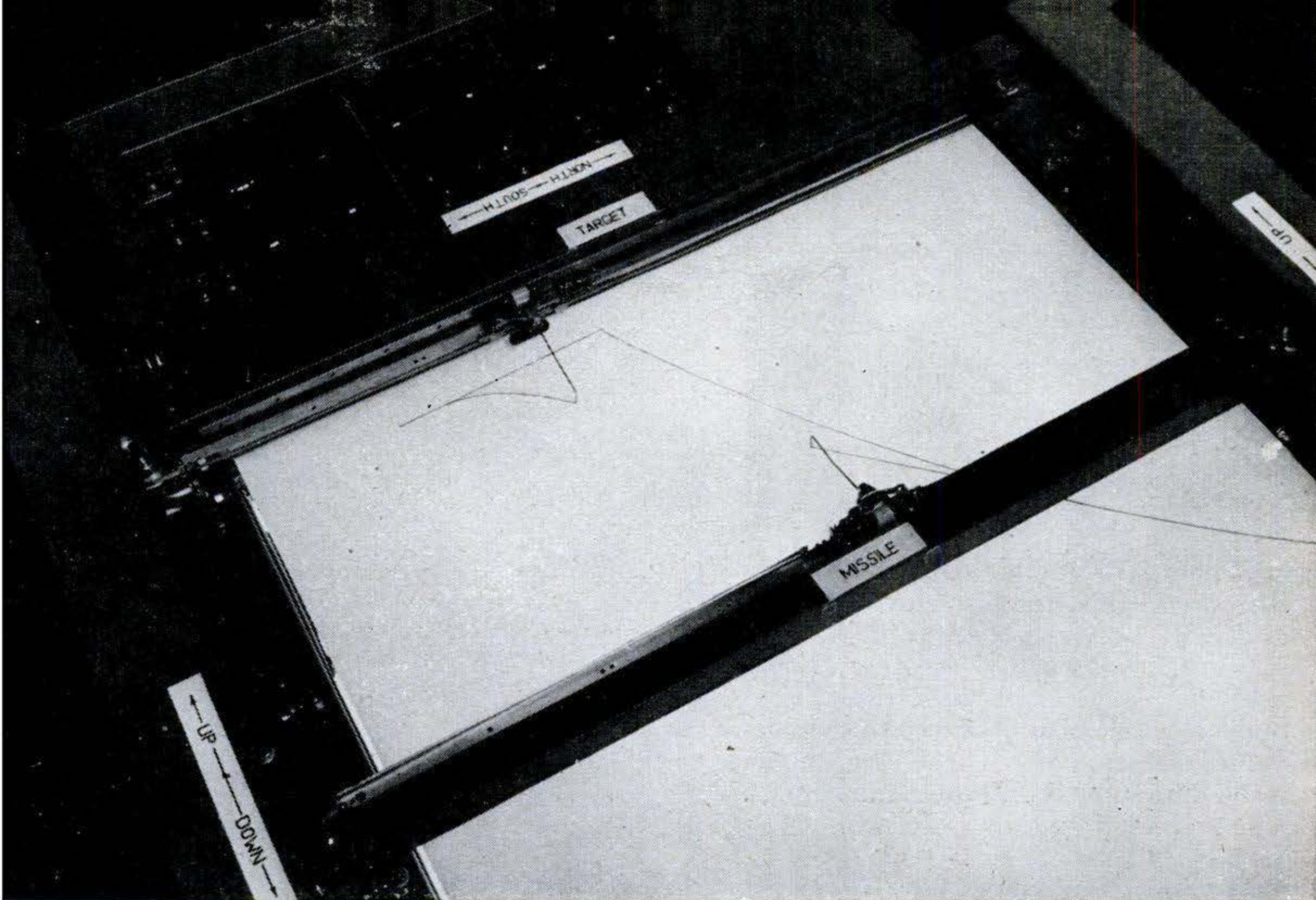

Plane is trying evasive tactics on flight being recorded here on the elevation board, but will

be hit by missile nevertheless. Other lines show previous flight, which also ended in hit.

a flexibility and accuracy unattainable by either system alone. It is exact to better than one part in 25,000.

Typhoon's nerve center consists of some 4,000 electron tubes, 600 supersensitive relays, several miles of intricate wiring, and thousands of condensers, resistors, and other components. Basically, it consists of five major sections—one for the missile, one for the system for guiding the missile, one for the target plane, one for calculating the results, and one for recording those results. It takes a staff of nine engineers and mathematicians plus six technical assistants to operate and maintain the computer. Also, since it seems that an electronic brain can get a cold in the head and not operate efficiently, the room in which the computer is housed is kept at a constant temperature of 75° F. and at a relative humidity of not more than 50 percent.

When solving a problem, the various varying factors enter the brain as voltages. These are then fed in the proper order to the components set up to add, subtract, multiply, and divide in the right sequence to provide a constantly changing answer. As a result, at any moment during a solution such things as the missile's speed, yaw, pitch, roll, and fuel supply can be read from

a bank of recorders. It is possible, for example, to determine the exact positions of each of the missile's control fins at any instant.

Although the new computer, after it is installed in the Naval Research Laboratories at Johnsville, Pa., will be used principally to solve guided-missile problems, its abilities are by no means limited to that one function. Fed the characteristics of a new supersonic airplane design, the brain can tell you if the plane will fly as expected, and if not, why not. It can be used to pre-test the hull designs for new surface ships and submarines or the streamlined shapes of bullets, bombs, and torpedoes.

#### ***Bigger Brain May Plot Defense***

And, unless its designers and users miss their guess, it will serve as a model for an even larger master calculator that will solve all the riddles connected with the successful defense of our cities and our coastlines against any possible enemy attack. The super-electronic brain they contemplate would be capable of duplicating all the possibilities of a combined land, sea, and air attack and illustrate in three dimensions the best possible methods of sure-fire defense!

END

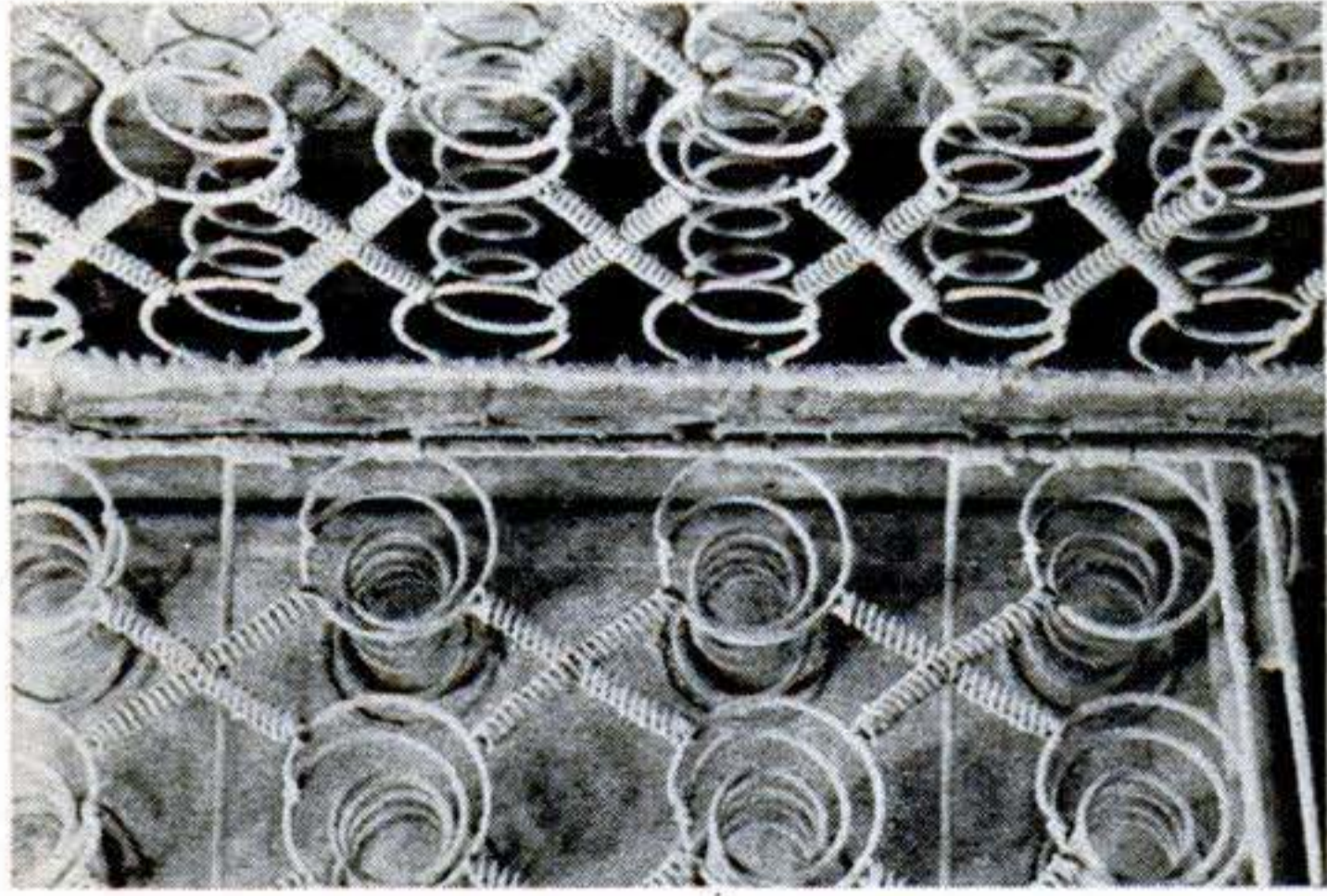

### Seat Springs Stapled to Fiber Frames

THE cost of making auto cushions is cut considerably by a new method of seat construction (above) used by the L. A. Young Spring and Wire Corp. of Detroit. Coil springs are stapled to fiber panels, thus decreasing the amount of steel used by 25 percent. Flocking soundproofs the springs, eliminates burlap, and serves as rustproofing.



### Safety Suit Protects Rocket Fuelmen

THE Air Force groundman above wears a new safety suit designed for protection when handling liquid rocket propellants. The new coverall is made from vinyl-impregnated Fiberglas that prevents the highly toxic fuels from being absorbed through the skin. Interior of the suit is cooled by circulating air or by water evaporation.

### Link Trainer Now Looks Like Plane

NEWEST version of the Link trainer, shown below, now looks less like a crateful of electronic gadgets and more like the plane whose operations it duplicates, the SNJ-5 basic Navy training plane. Built for the Navy Special Devices Center, the trainer now has twin cockpits, each with a full set of controls. The instructor actually "flies" with the student, and he can produce a variety of plane troubles for the student to overcome, by pushing any of 20 special-effects switches (PS, Feb. '50, p. 123).

Realistic flying conditions are presented by reproducing the noises made by a plane starting up and getting into the air. Looking through the double glass window, the pilot even sees cloud formations, rainstorms, and lightning flashes.

### Back Rest Makes Bench Comfortable

WIDESPREAD use of the portable back rest below should make for fewer aching backs after long sessions on backless bleachers. Made from a sheet of Masonite Leatherwood, the back rest fastens to the bench by cords and two hooks, as shown in the inset. It is waterproof, weighs two pounds. Sold by Silas Wooton Co., Denver.

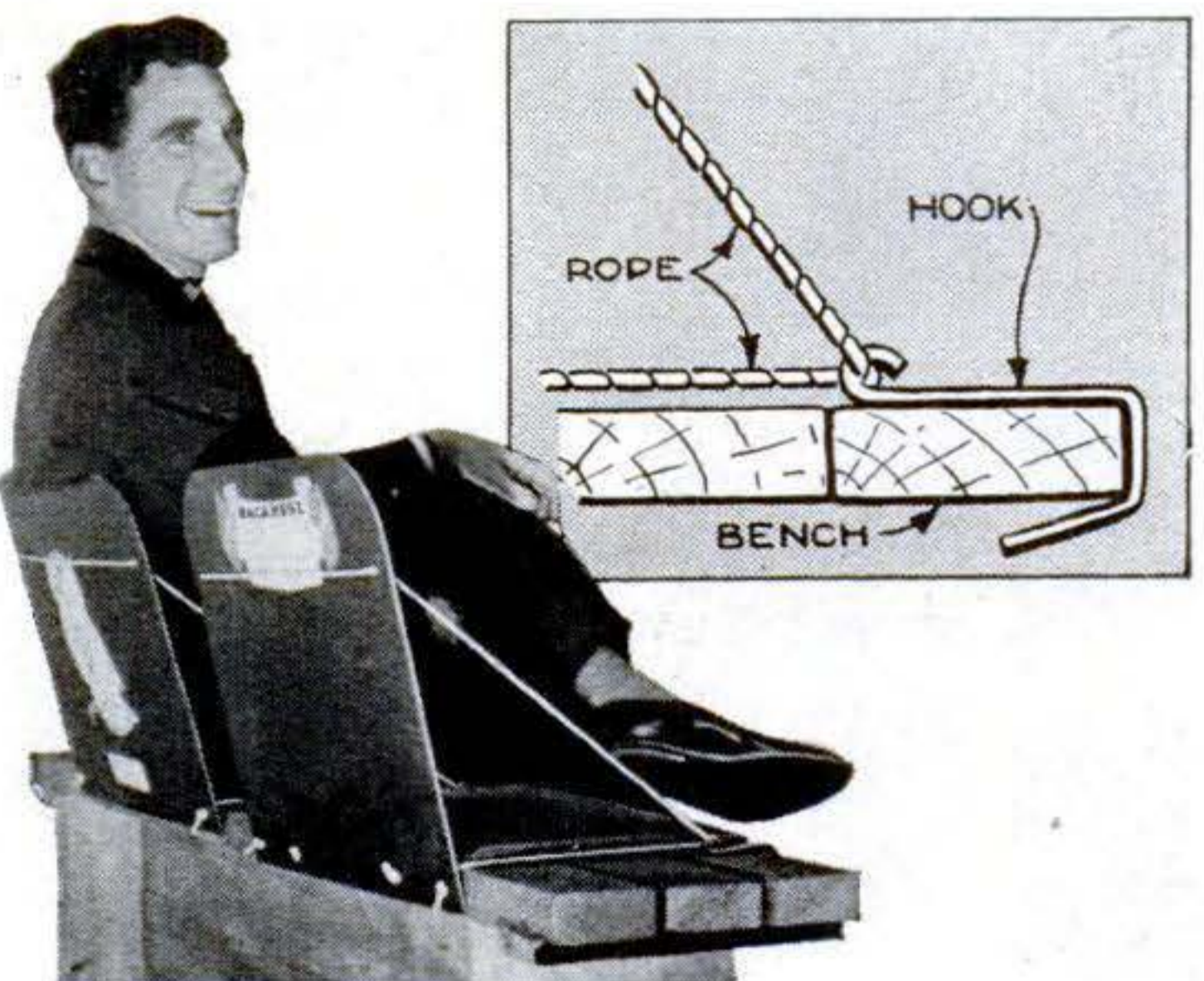

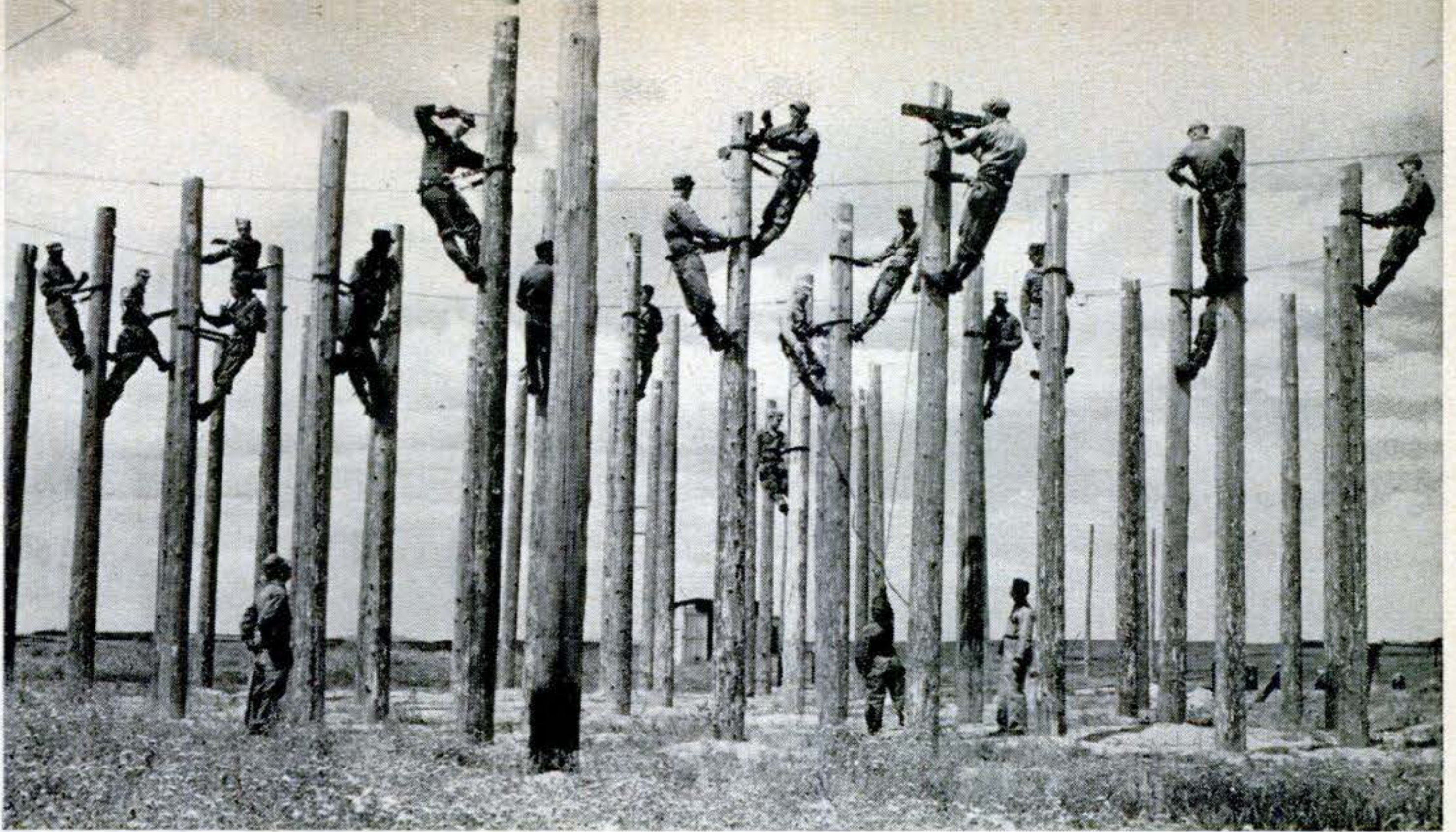

### Linemen Train on Grove of Junior Phone Poles

THIS is how you learn to climb poles in the Air Force. The grove of stub poles makes an open-air classroom for future linemen at

Warren Air Base in Wyoming. The poles last about a month—by then the students' spikes gouge them so badly they must be replaced.

### Robot Automatically Takes Refrigerator's Temperature

How cold is it inside a refrigerator? Westinghouse engineers wanted to know—without wasting all day taking the box's temperature. So they invented a machine that automatically types out the temperature at 150 different places inside the refrigerator, making 1,320 readings an hour. It can run day and night all week, or start and stop at preset times. The tabulations come out of the typewriter in sheets all ready to paste in the test book.

of thermocouples, a potentiometer, a cabinet full of relays, and an electric typewriter. A camshaft (in cabinet at right) connects the couples—which are scattered throughout the refrigerator (left)—one after the other to the potentiometer. At the same time, another set of switches "reads" the potentiometer indication for each couple. These switches operate solenoids that work the typewriter keys, typing the temperatures. The engineers can also use the typewriter manually to write in other information when they wish.

The robot recorder is made up of a bunch

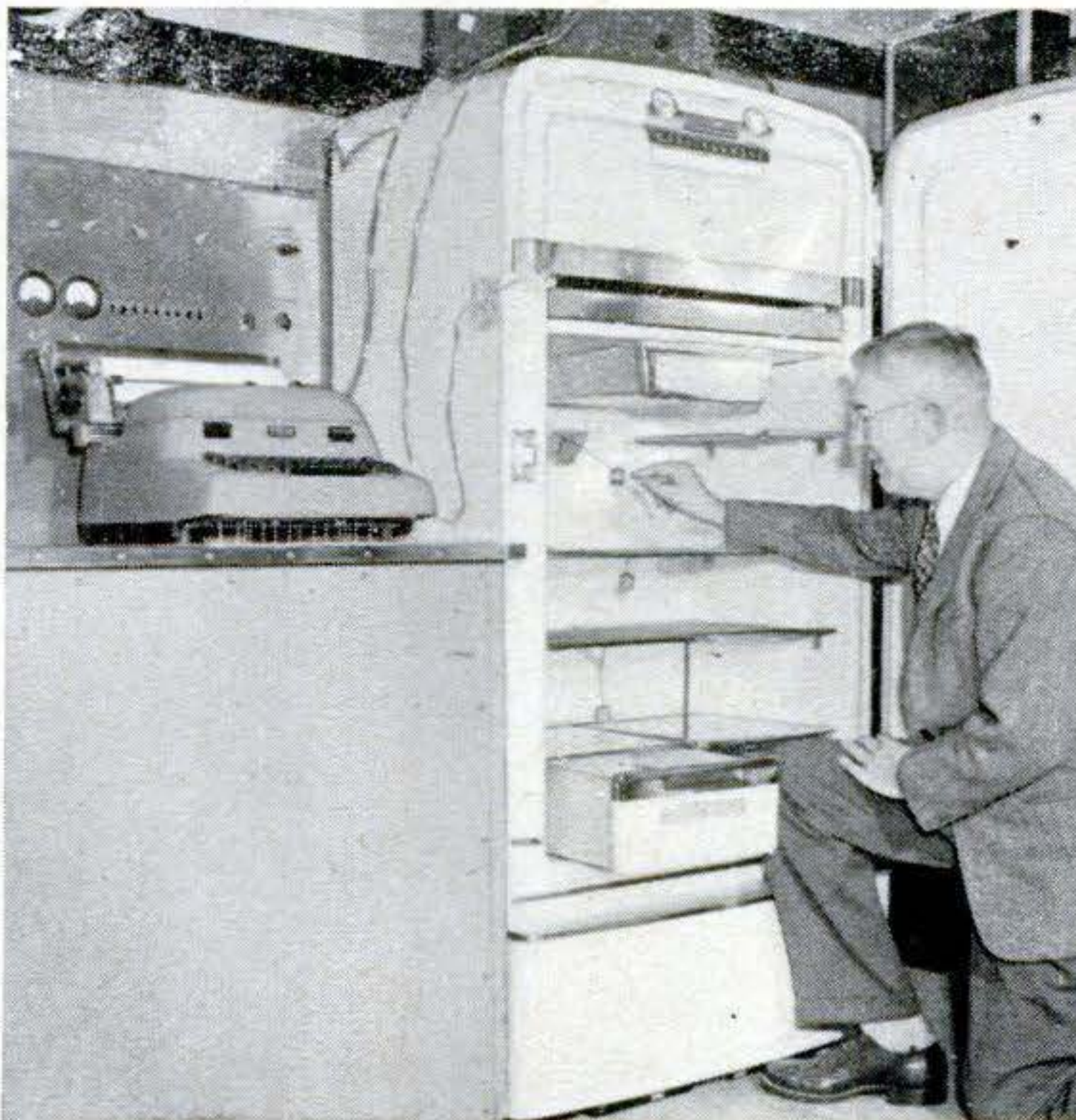

GM's Le Sabre, 300-hp. experimental car, will have dual fuel system using gasoline and methyl alcohol. Car shown is full-scale plaster model of real one, which is still under construction.

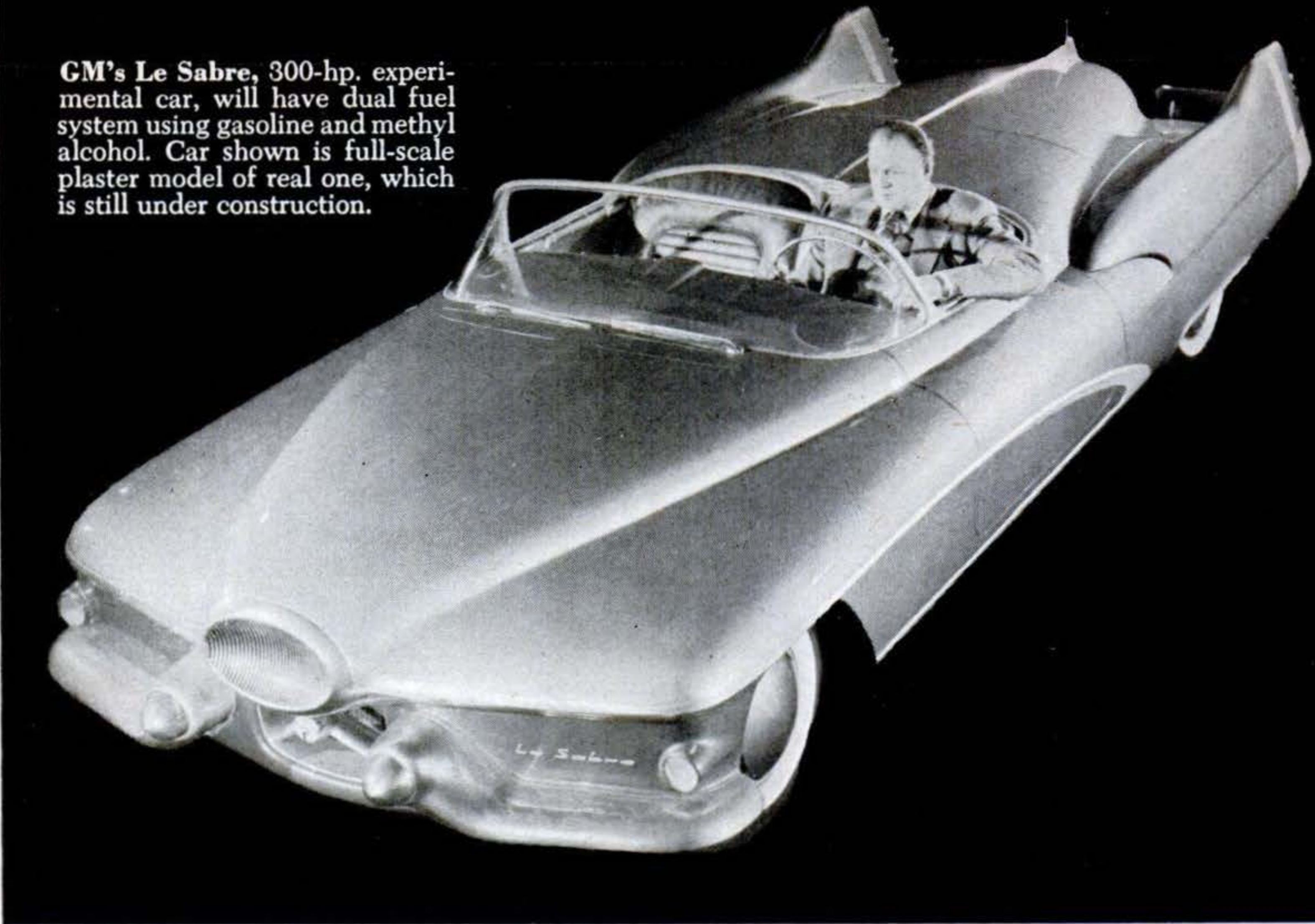

# GM Builds 300-Hp. Preview Car

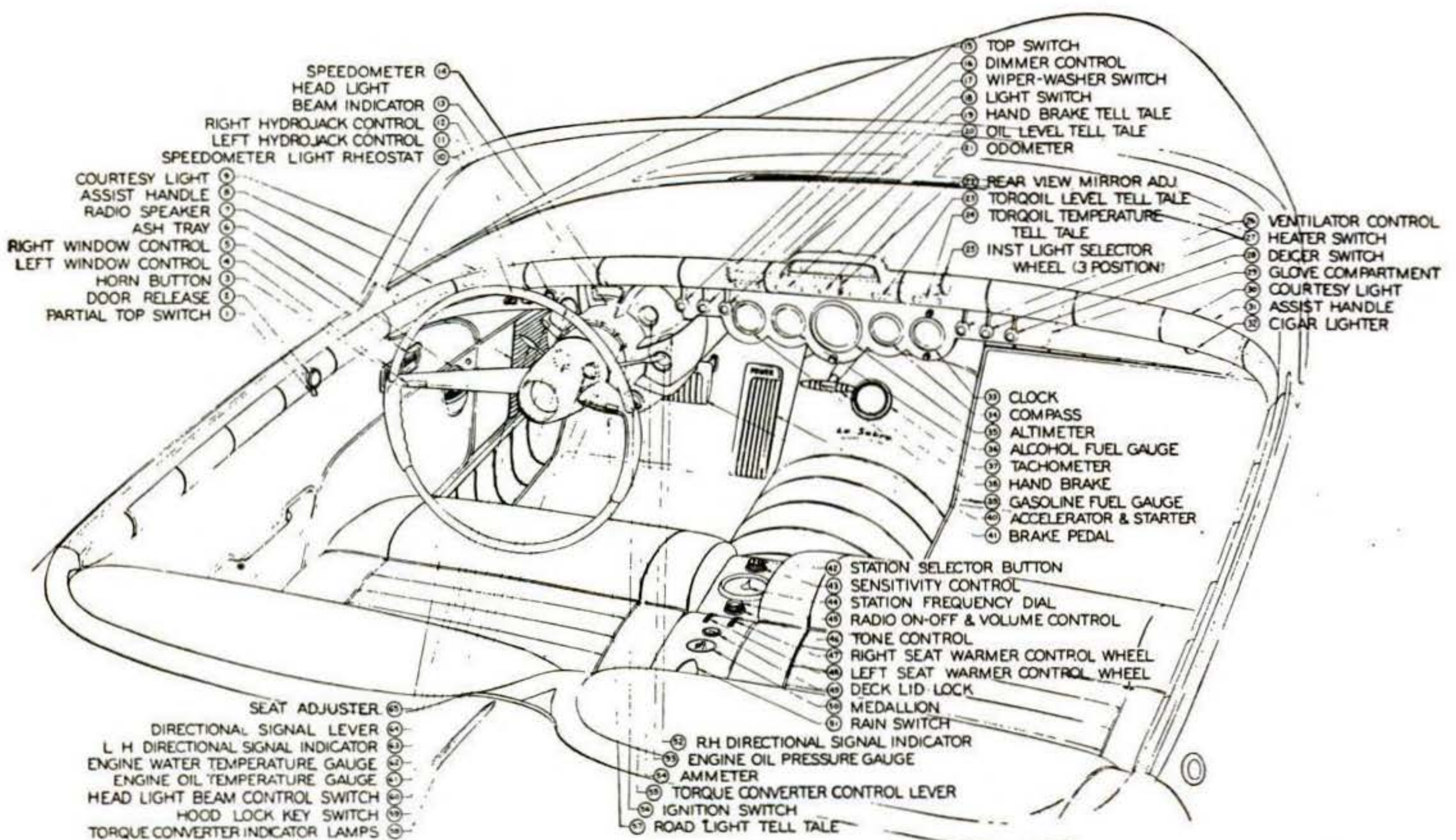

Cockpit drawing shows car's 65 different instruments and controls. Dash is crash-padded.

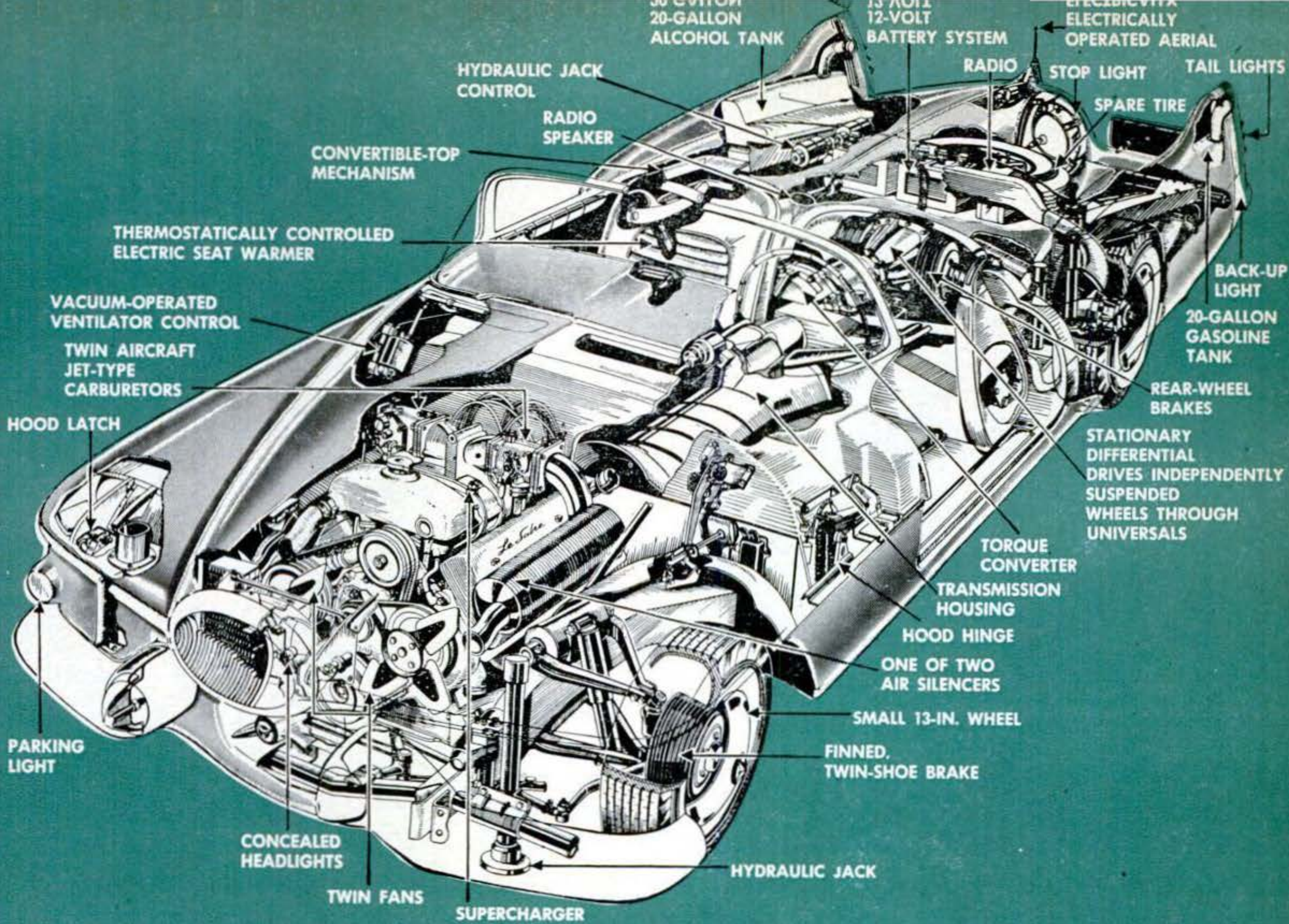

**YOU** can't buy this beauty, but you can expect to see many of its features turning up on cars in the years to come. Now being completed by General Motors, the hand-built, super-styled car will serve as a rolling laboratory for engineers to test out new ideas in design and equipment.

Its special high-compression (10 to 1) V-8 engine plus supercharger is expected

to deliver 300 hp. Built-in hydraulic wheel jacks, electric seat warmers, and a rain-sensitive switch that will automatically put up the top are just a few of today's novelties that may become commonplace tomorrow.

After all, an earlier 1938 GM version was the first U.S. car to boast an electric top, curved-glass windows, and push-button door latches—now taken for granted. **END**

**Airscoop nose** and twin-finned, jetlike tail show aircraft influence. Long, low silhouette is pro-

duced by 200-in. length, only 36½-in. height. Light for its size, the car weighs 3,000 lb.

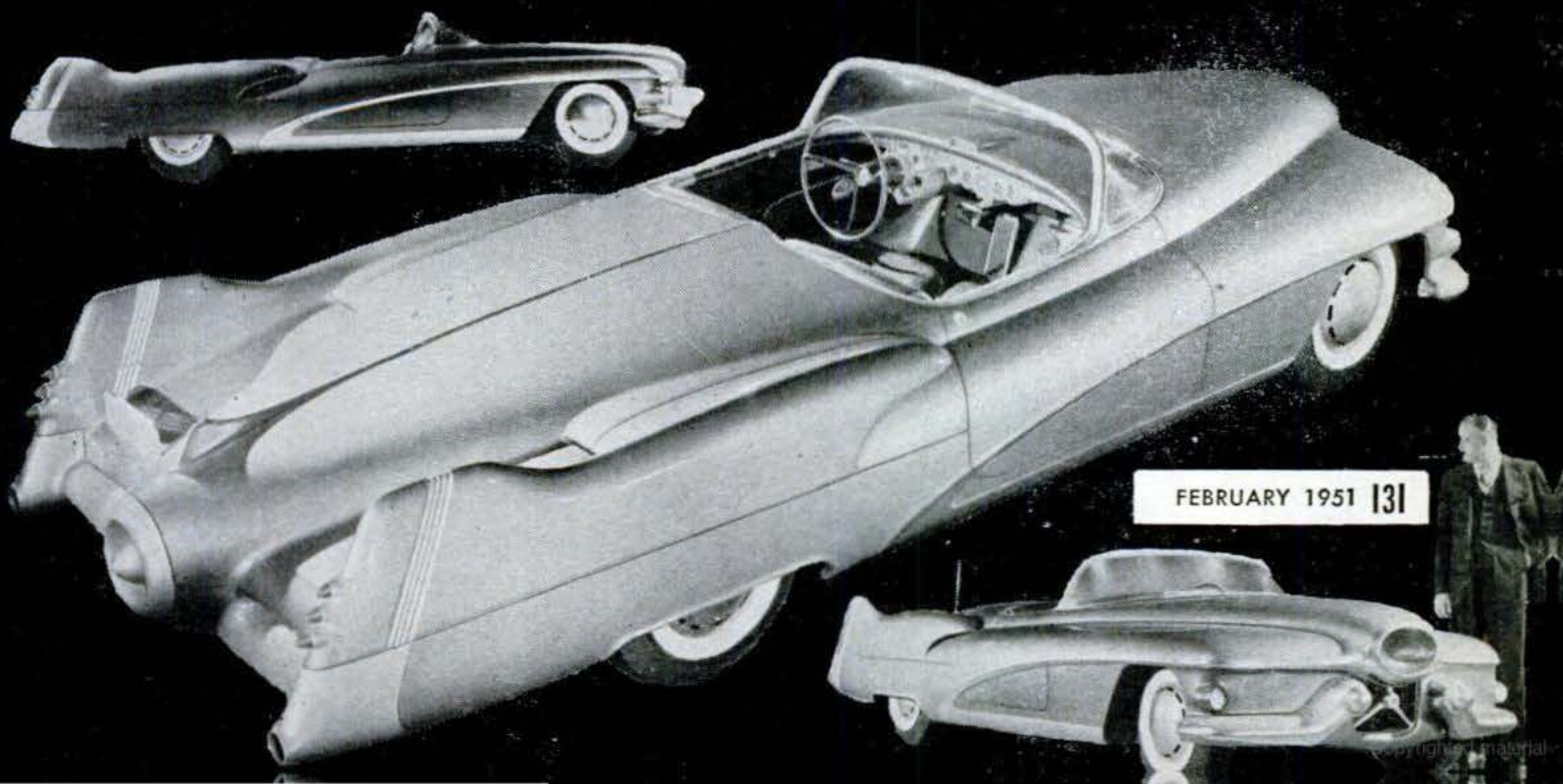



### Bailout Helmet Protects Jet Pilots

THE "Man from Mars" outfit above is the Air Force's improved crash helmet for crewmen of high-speed jets. The curved Plexiglas visor, a new feature, folds upward when not in use. When pulled over the eyes, it locks into place and prevents up-rushing air currents from tearing off the helmet during a bailout and destroying a flier's essential oxygen supply. The tinted visor also serves as a sunglass.

### Clay-Modeling Kit Has Wire Skeleton

WITH this hobby kit, even a beginner can make lifelike clay figures of animals and persons, according to Sculpture House, New York City. Heart of the set is a heavy wire armature, which is bent to any desired shape or pose. Clay is then added to this skeleton in layers, and shaped with tools included in the set. Sculpkit retails for \$3.95.

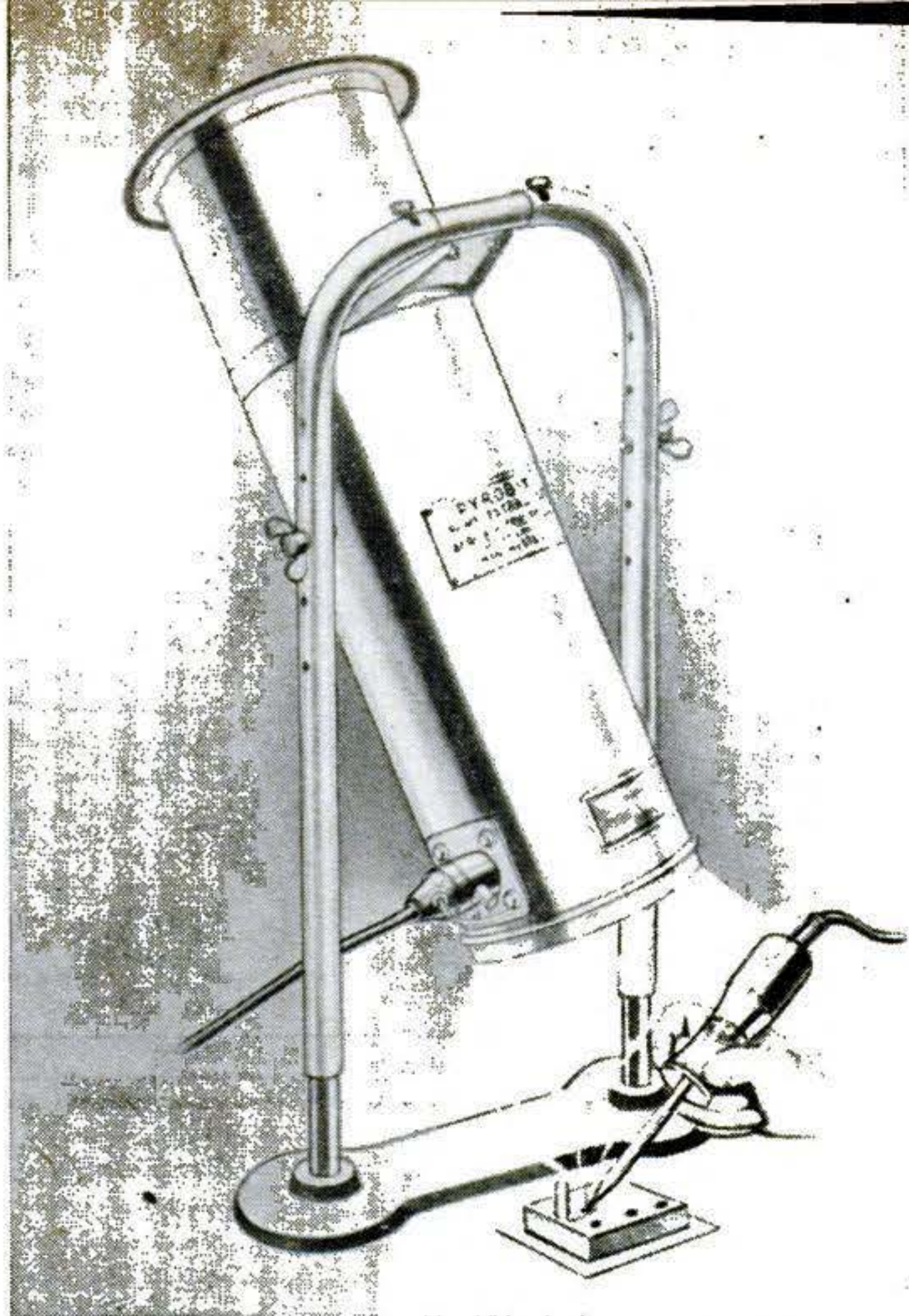
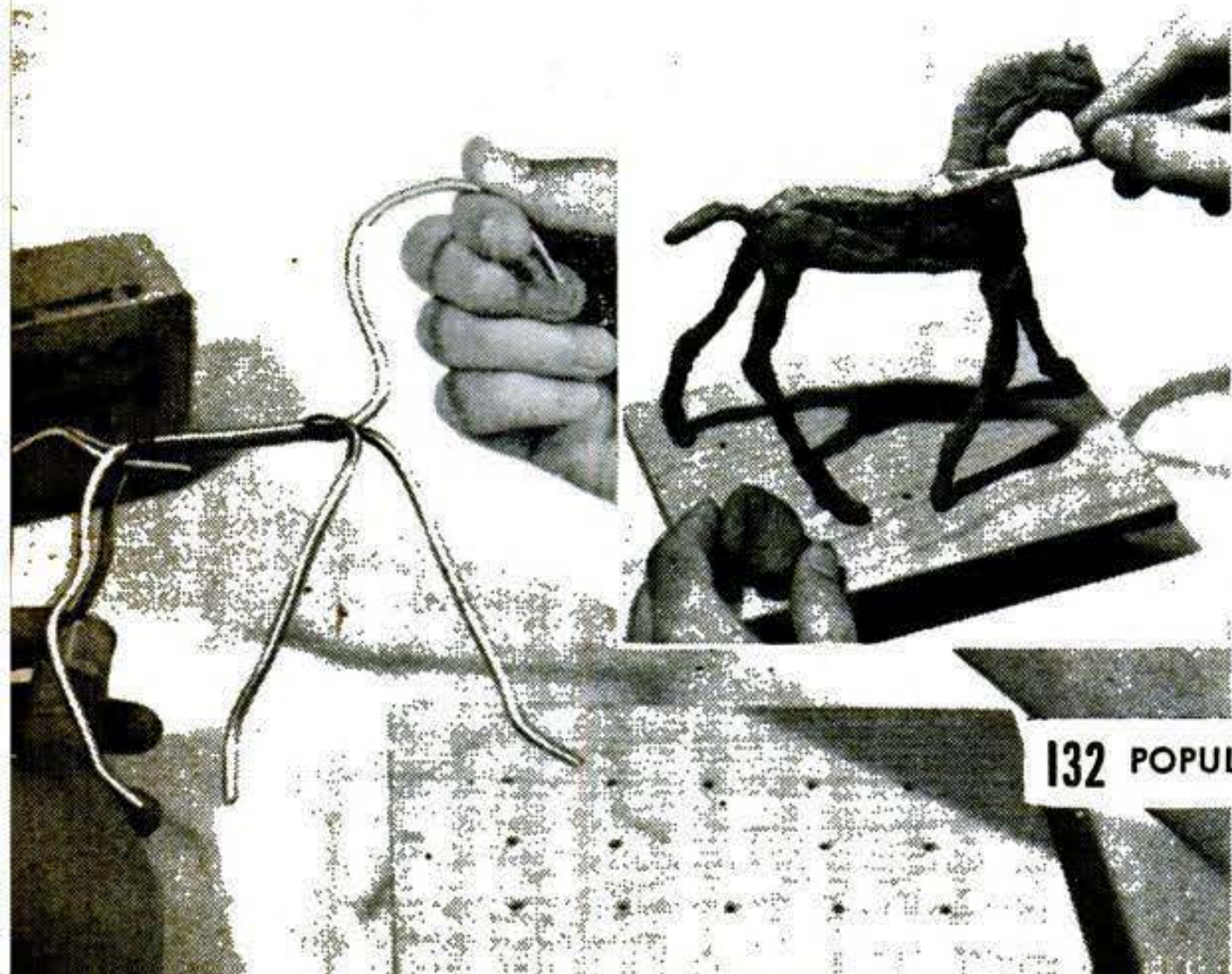

### Soldering Light Doubles as Chimney

THIS unusual combination, developed by the Acru Electric Tool Manufacturing Co., of Manchester, England, is both a worklight and an exhaust hood. Set close to the soldering or brazing work, it has a strong bulb in the lower end of the chimney that provides light and also causes a convection draft that draws obnoxious fumes away from the operator. The bench mounting is adjustable and the device has no moving parts.

### Powered Wheelbarrow Climbs Hills

MOUNTED underneath the wheelbarrow below is an air-cooled, single-cylinder gas engine that drives the rig at a moderate walking pace. The transmission includes a V-belt speed reduction and wheel-tread friction drive. Downhill, engine compression serves as a brake. S and S Vending Machine Co., San Jose, Calif., makes Pow-R-Barrow.

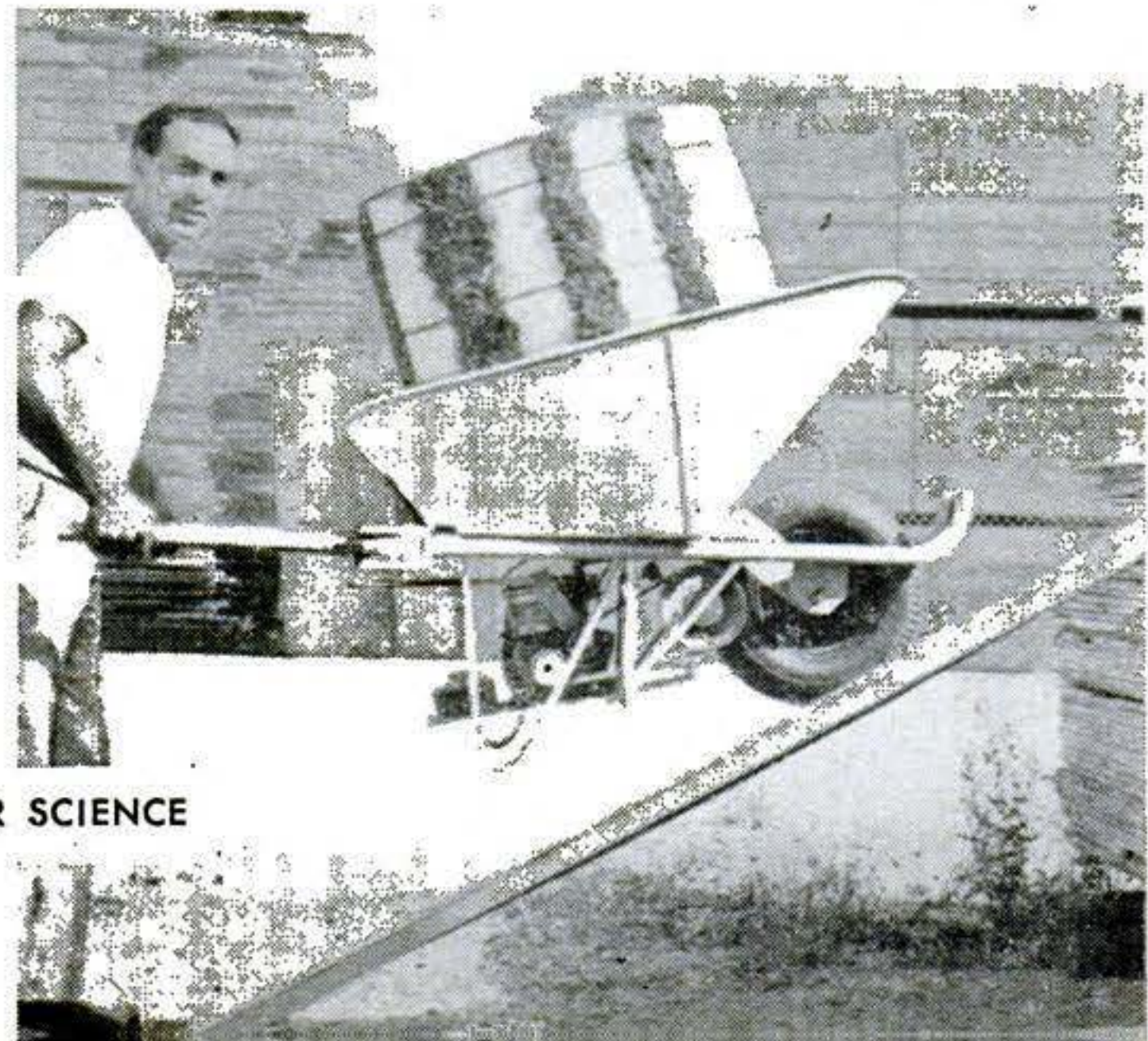

SCHEMATIC DRAWING OF  
LOS ALAMOS WATER BOILER  
(HOMOGENEOUS NUCLEAR REACTOR)

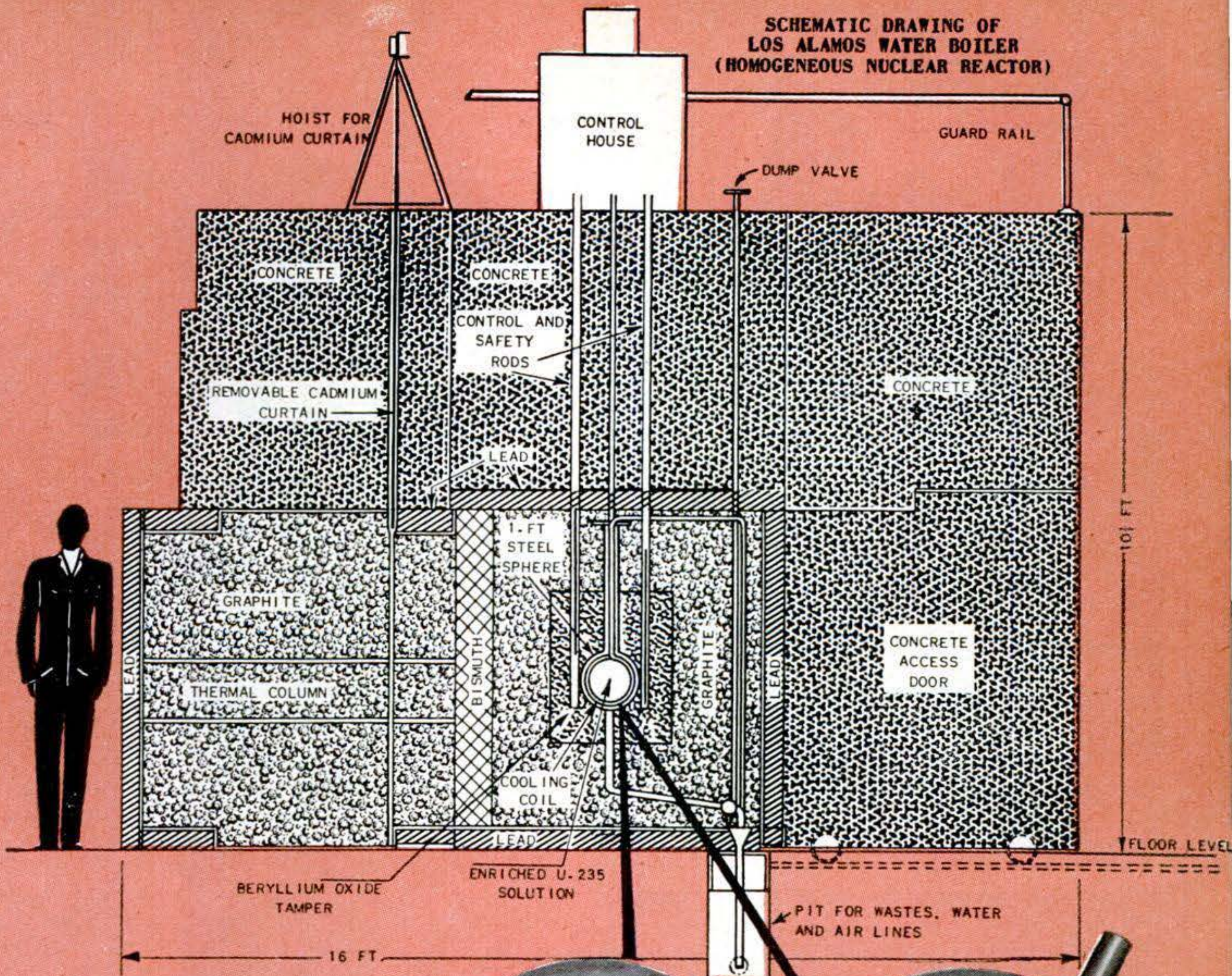

That little ball at right is an atomic furnace. Opened here, the stainless-steel sphere, 1 ft. in diameter, ordinarily is full of uranyl nitrate solution. Coil circulates cooling water. Straight pipe—called “glory hole” by Los Alamos scientists—holds material for irradiation. Drawing above shows shielding needed.

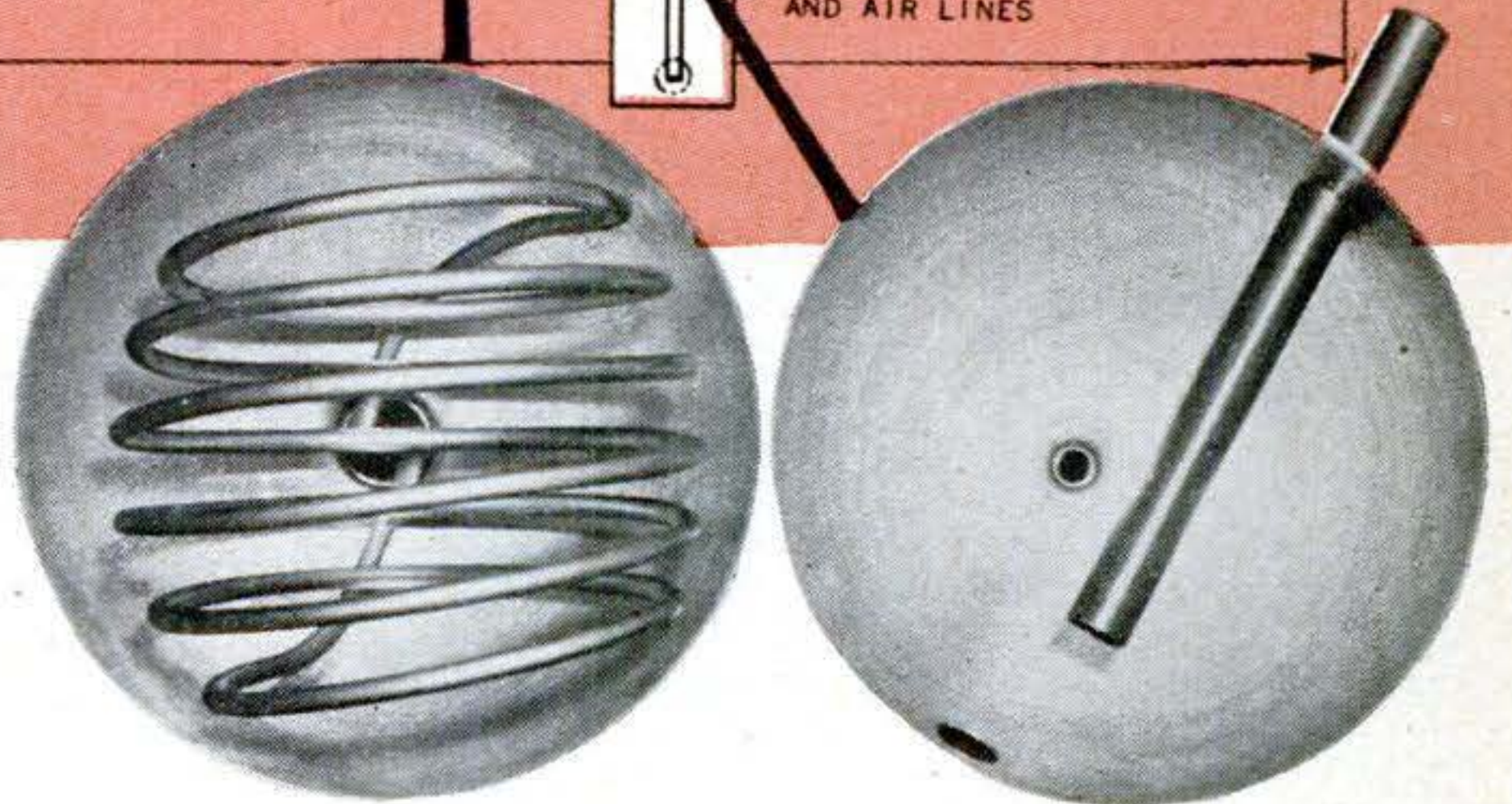

# U.S. Opens Atom-Furnace Secrets

**N**OW you can see what an atomic furnace really looks like. The pictures on this and the following pages are the first ever to show the works of an atomic pile.

Many long-secret details are now revealed on six Anglo-American piles. One (above) is only a foot across and contains less than 14 pounds of uranium. However, this tiny ball must be encased in a concrete block 16 feet square and 10½ feet high. Another, a rebuilt version of the first pile ever made, has 100,000 pounds of uranium.

Even more significant are the scientific data also released. Things like the “thermal-neutron cross section for fission” (the probability that a neutron will split an atom)—for mixed natural uranium it’s 3.9 barns (a barn is an area measurement,  $10^{-24}$  sq. cm. per nucleus), but for pure uranium 235 it’s 545 barns.

With the new information, you could build your own private atomic furnace, as North Carolina State College is now doing. But it won’t help you make bombs.

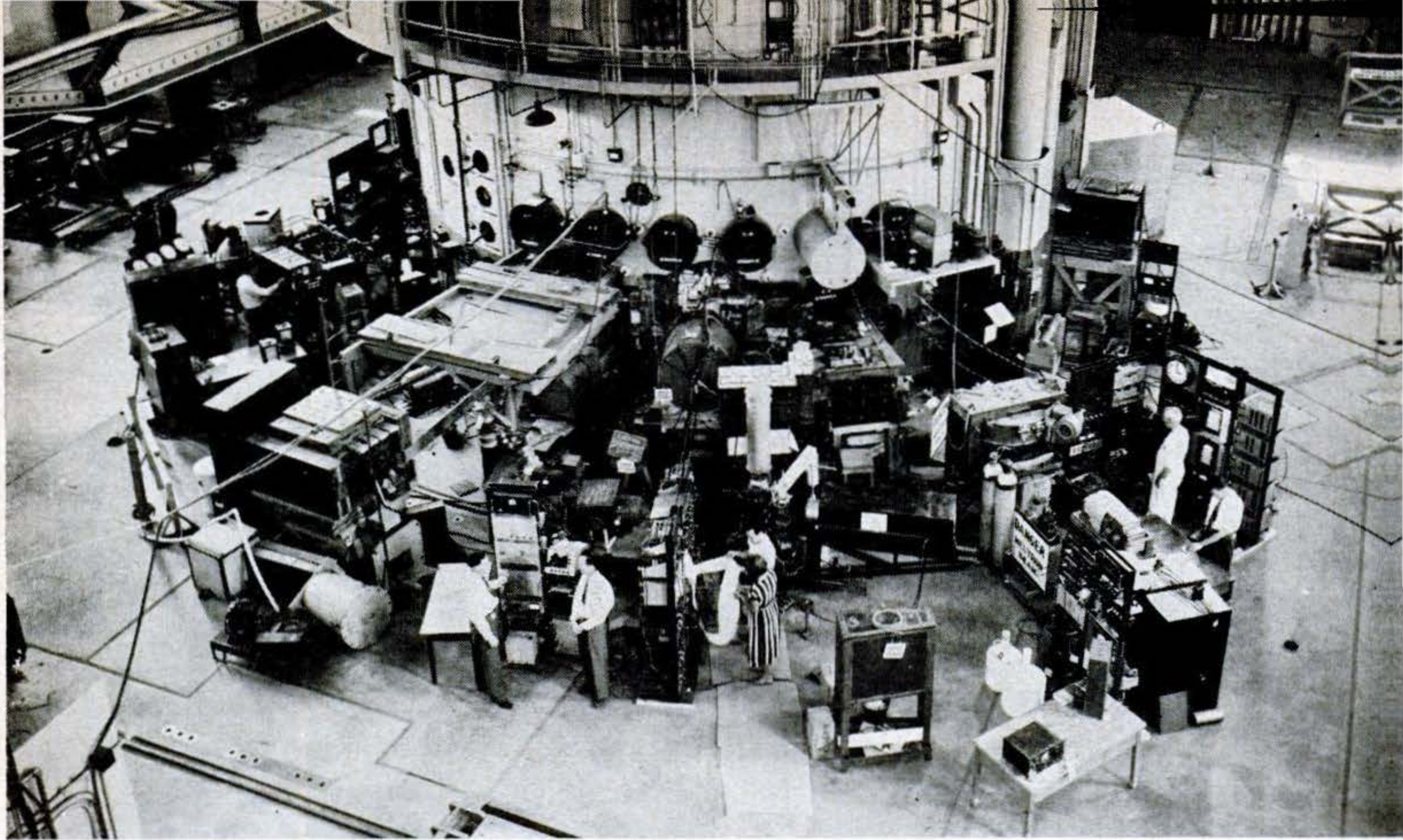

"Zeep," Canada's pile at Chalk River, Ontario, is the big smokestack-like structure above. All around it, radiating out like spokes from a wheel,

are instruments using neutrons from the pile for research. Zeep produces the most concentrated beam of neutrons of any pile known.

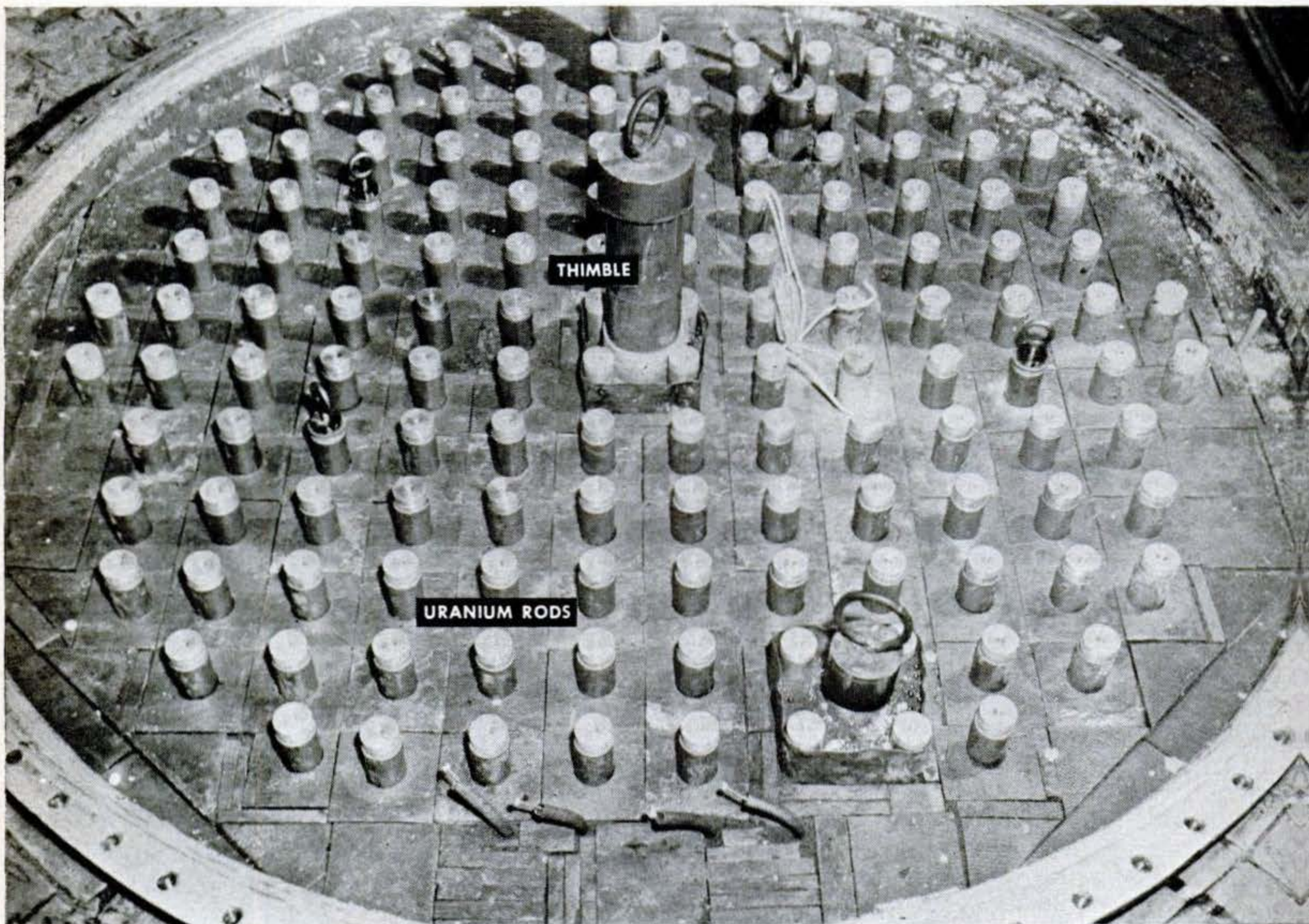

How a pile's uranium (small pipes above) is arranged—long a major secret—is shown in this photo of furnace at Argonne National Labora-

tory. It, like Zeep, uses heavy water instead of graphite to slow down neutrons. "Thimble" lowers materials inside pile for experiments.



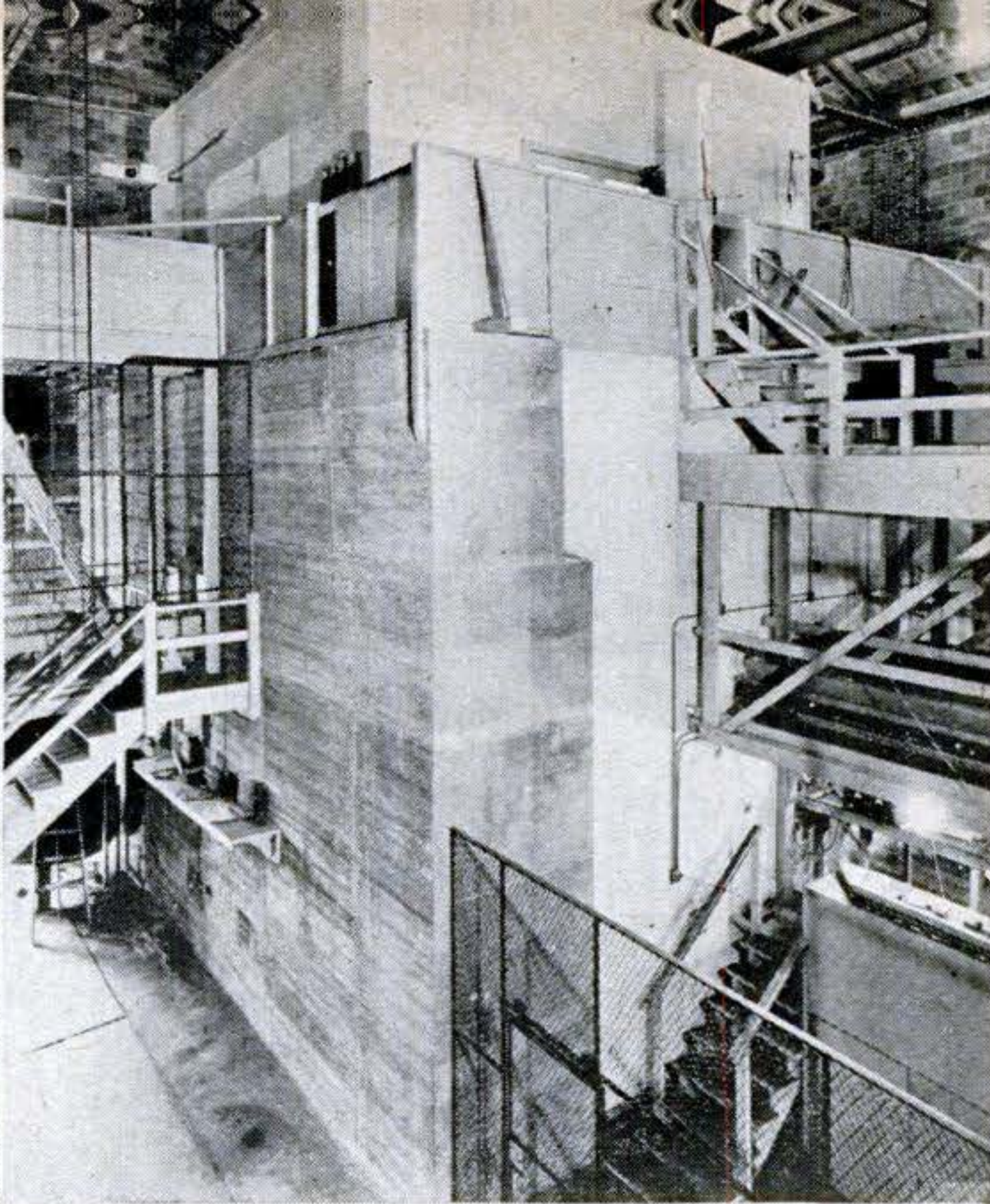
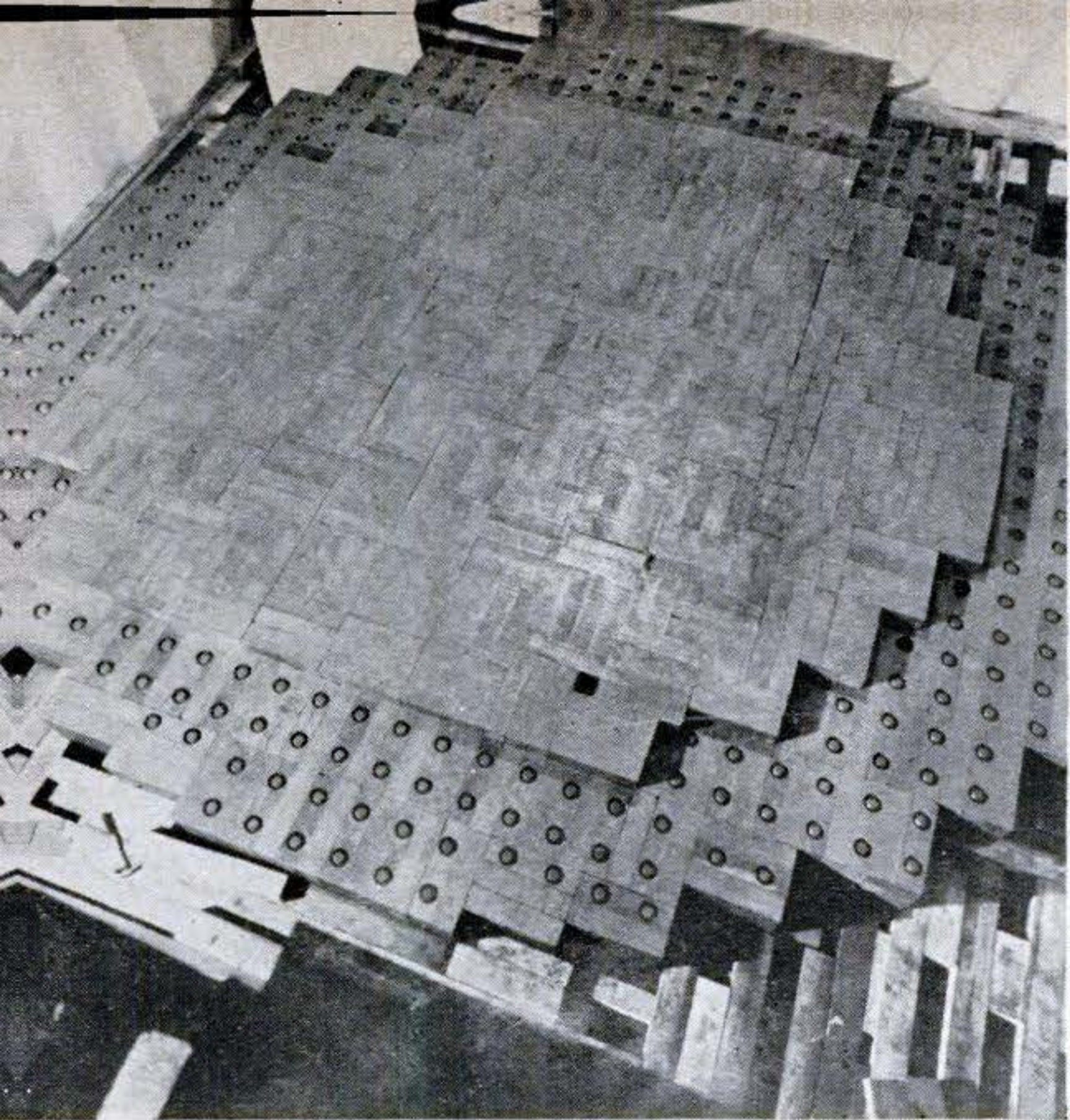

**Only photo made** during construction of world's first atomic pile—built under University of Chicago stadium—shows 18th and 19th layers of graphite bricks. Even-numbered layers had holes for uranium, odd layers were solid graphite. This pile was torn down, rebuilt outside city

**Original Chicago pile was reassembled** at Argonne, using same material but slightly different arrangement. Photo above shows outside of five-foot-thick concrete shield and control-rod supports. On top of pile is small laboratory for research with neutrons generated by pile.

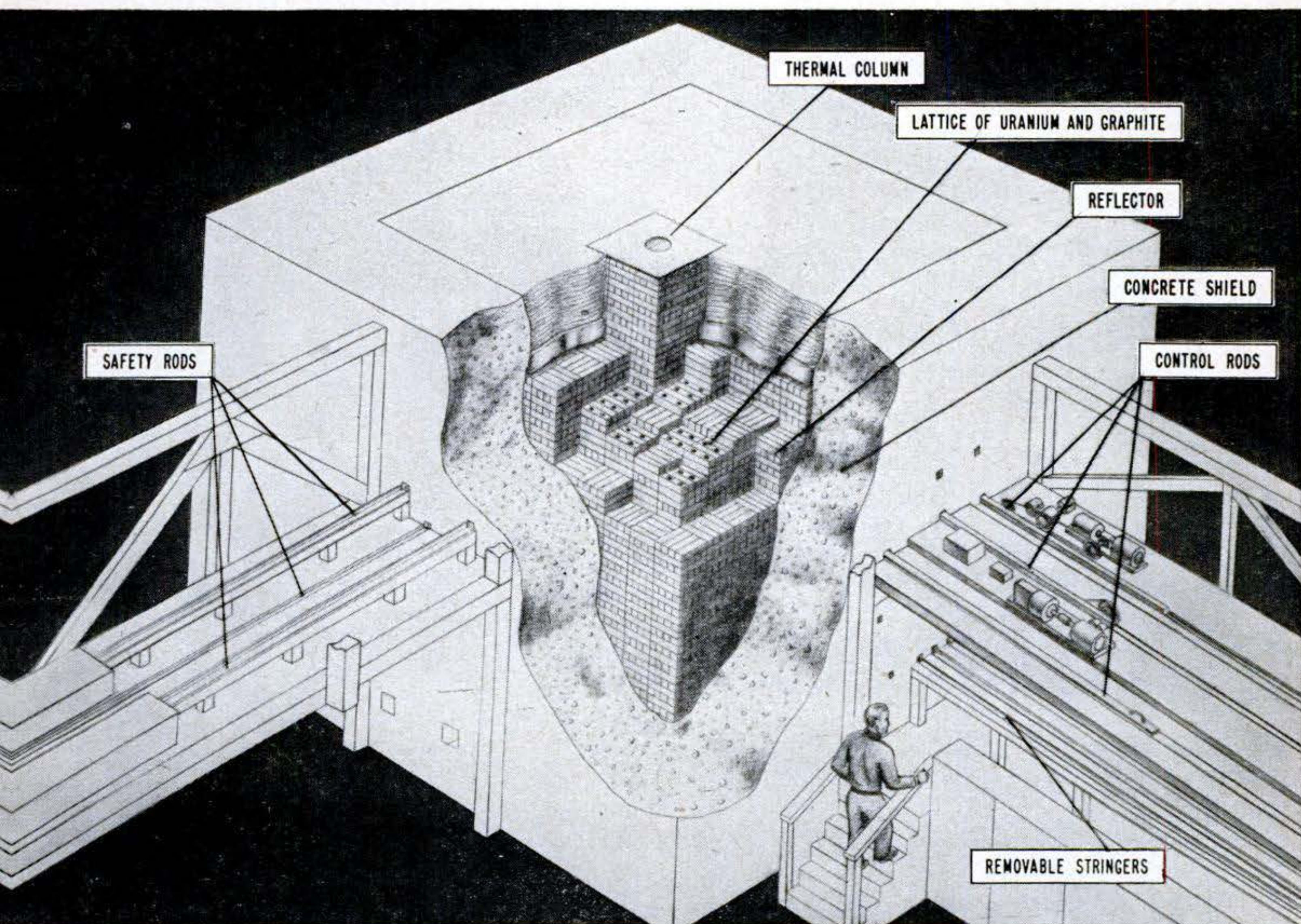

**Present design** of original pile is indicated in cutaway drawing above. "Thermal column" lets neutrons out for research purposes. "Stringers"

are simply blocks of graphite that can be removed for insertion of test materials into active section deep inside the pile.



With top up, modified German Volkswagen looks like sleek sports car. It normally seats two, but two more can squeeze in behind front seat. Engine is in rear, luggage trunk in front. Wheelbase is 94½ in.

## German Jeep Styled for Sports and Racing

**H**ITLER'S Volkswagen (People's Car) has turned up in new dress. More noted for its efficiency than beauty (PS, Oct. '50, p. 162), the rugged utility car now comes in a slicked-up version that looks like a luxury sports car and doubles as a pretty fair racer—good enough to win the 1949 International Austrian Alpine race.

The transformation is the handiwork of Wolfgang Denzel, prewar Austrian speed

driver. The engine is the same air-cooled, four-cylinder opposed type, but its horsepower has been boosted from 25 to 36. Some other innovations: dual carburetion, hydraulic brakes, heavier shock absorbers.

The car will hit 85 m.p.h. and gets 30 miles to the gallon. Its flashy body unbolts for easy removal—that's so you can quickly put back the conventional one when the old folks come calling or winter sets in.

As racing car, Denzel's souped-up version won 1949 International Auto Race over rugged Austrian Alps. It weighs 1,150 lb.





### Cadillac Has Warning Lights on Dash

PICTURED here are three spanking new cars with fresh styling and mechanical improvements to entice the buyer.

In addition to minor changes in appearance, the Cadillac, above, has something

new in the instrument group. Automatic signal lights indicate low oil pressure and generator discharge. Another warns if the car is started with the hand brake on.

That saucy rear-fender fin has been given new emphasis for 1951.



### De Soto's Power Is Boosted

HERE'S the new De Soto, with a bit more horsepower under the hood. The horsepower has been increased from 112 to 116. Styling treatment on this car typifies what the Chrysler Corp. has done to all the ve-

hicles in its 1951 stable. The hood is lower, glass area larger. The wheelbase remains at 125½ inches but over-all length has been boosted 1¾ inches to 208¾.

Like the Plymouth (see page 98), the De Soto has a new type of shock absorber.

### '51 Dodge Gives Better Vision

AND this is the Dodge for '51, with the front corner posts narrowed and the windshield widened by 2½ inches to provide better vision for the driver.

Dodge also has a glare-protected instru-

ment panel and a better engine-cooling system. A shift-free transmission is optional on six of the ten body styles. A new internal-expanding parking brake is standard equipment on some models.

Dodge also has the new "Oriflow" shocks.

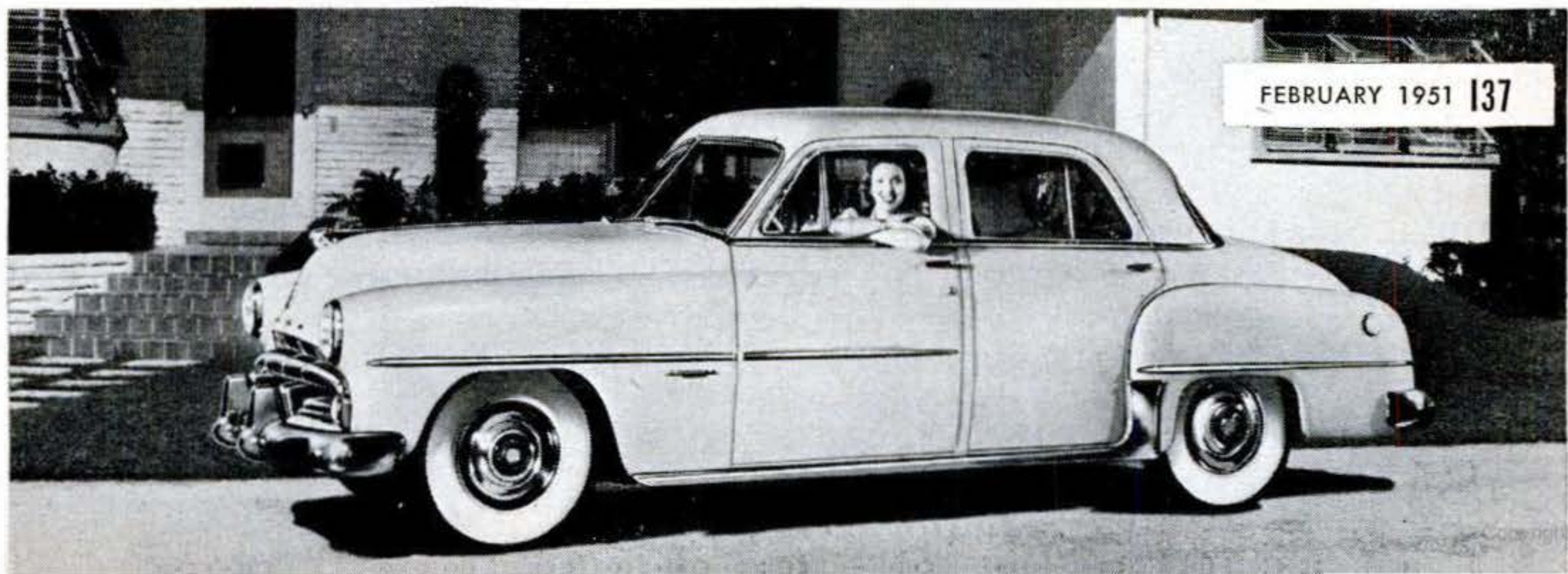



# Engine Surgery Boosts Airliner Range

**There's life in the piston engine yet. New turbosuperchargers and fuel injection are making spectacular gains.**

**By Devon Francis**

THEY took an airplane engine apart the other day in a Connecticut factory, and when they put it back together again it was a whole 1,000 horsepower stronger. Yet essentially it was the same piston engine. The 1,000 horses had been gained merely by changing some of its insides.

With that much added power in each of four engines, long-range commercial airplanes could fly five more tons of passengers and cargo from San Francisco to Honolulu. They could fly nonstop between London and New York, eliminating two refueling points. In fact, the changes give the piston engine a new and substantial lease on life in this day when jets and turboprops threatened them with obsolescence.

The changes centered in the supercharger. For years high-horsepower aircraft engines have been equipped with a

*mechanically* whirled supercharger *inside* the engine, or with a turbosupercharger turned by exhaust gases *outside* the engine, or with both. Superchargers are necessary to high-performance aircraft engines because the cylinders need more air than the pistons can suck in. Superchargers supply that additional air by compression. They help cram more air into the cylinders on take-off; and they delay a fall-off in power as an airplane climbs higher into thinner air. In addition, an *internal* supercharger acts as a sort of sub-carburetor, ramming the mixture into all cylinders as equally as possible.

## ***Fuel Injection Replaces Carburetor***

In that Connecticut factory the designers performed a fairly simple surgical operation on an engine equipped with both an internal supercharger and a turbosupercharger. They took out the internal supercharger and the regular carburetor. They added a fuel-injection system and a bigger turbosupercharger.

That put all the responsibility for super-

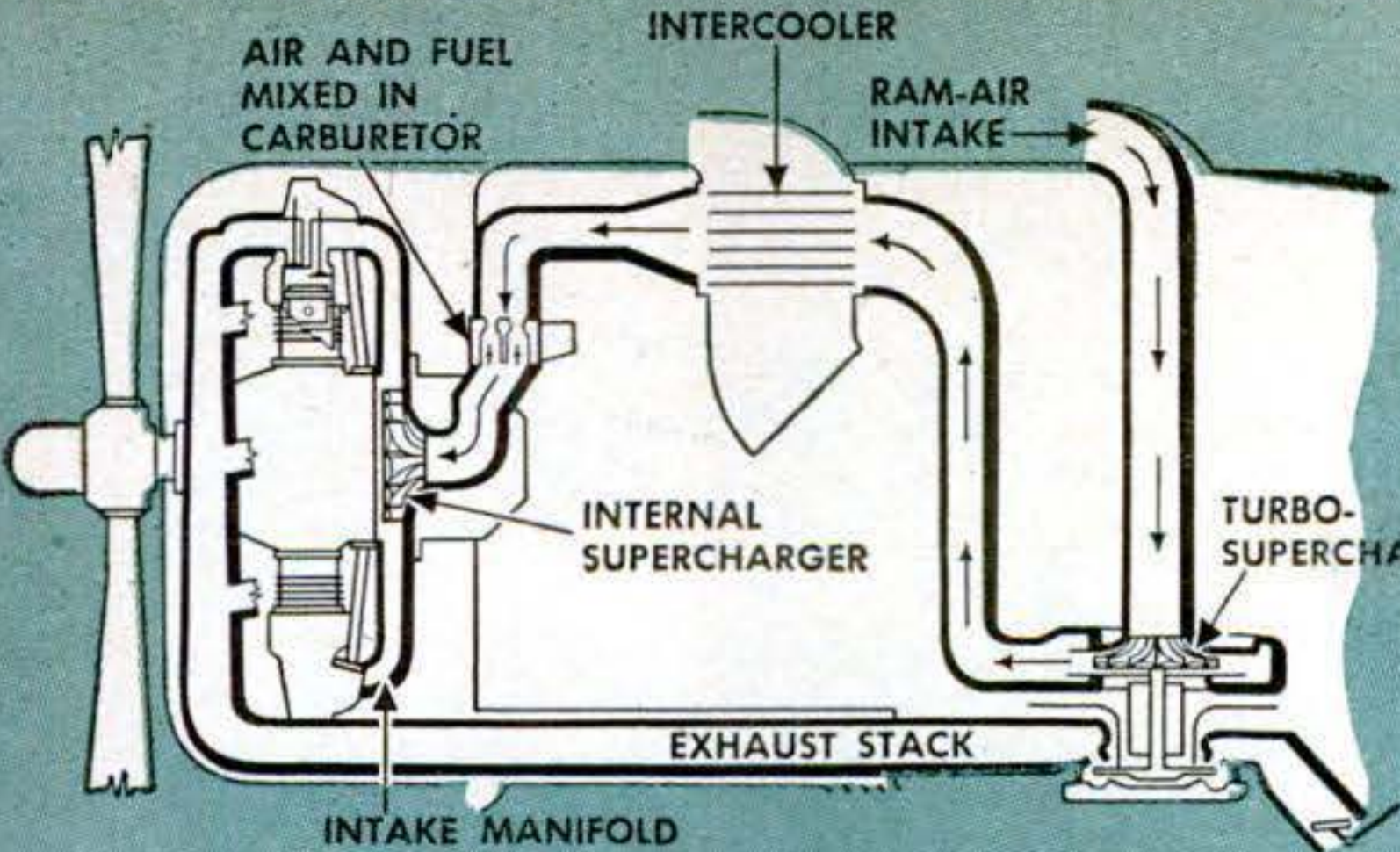

**Conventional engine** of type diagramed above sacrifices power in two ways: internal supercharger absorbs it, and cylinders get less air because of heat generated by compression.

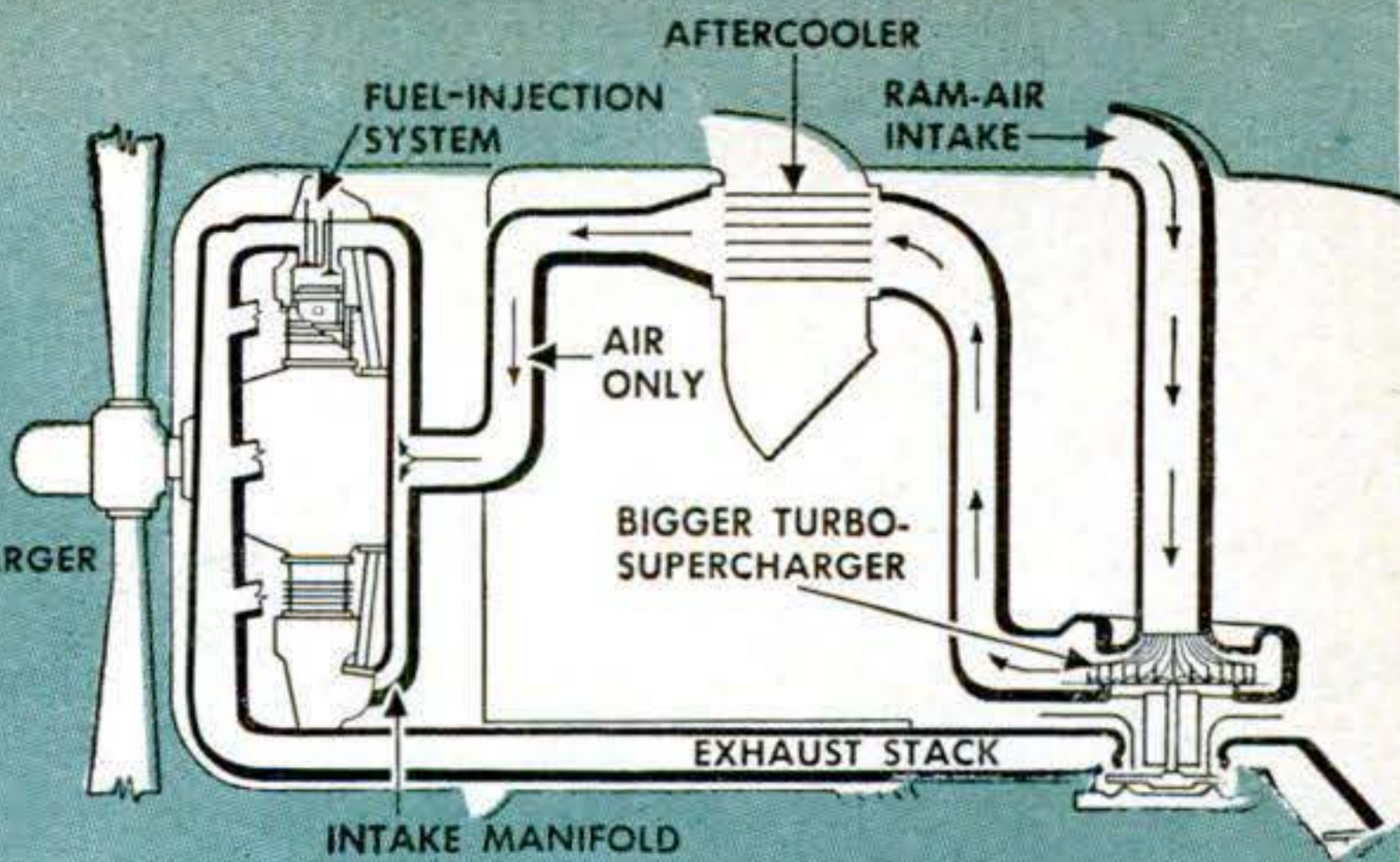

**Redesigned engine** gets added power from waste heat. Internal supercharger is removed, turbo size increased. Air charge to cylinders is denser because it is 250° cooler

charging on the new turbo. The result is dramatic.

The turbo, developed by General Electric, can deliver 350 lb. of air per minute—so much that excess compressed air can be bled off to pressurize the passenger compartment. It boosts a Pratt & Whitney 3,250-hp. engine, used in the transoceanic Boeing Stratocruiser, to 4,250-hp. for take-off. It reduces fuel consumption by a fifth. The saving in gasoline means 1,480 fewer gallons for four engines in winging from New York to London. That's 3½ tons—a spectacular payoff in weight alone.

Such savings can be put into longer non-stop flights or additional cargo and passengers. Neither the jet nor the gas turbine turning a propeller can touch the piston

**Cutaway** of typical turbosupercharger is at right; below, new turbo is shown pulled apart, with 12-in. electric fan for scale. Temperature of gases that turn turbine is about 1,700° F.

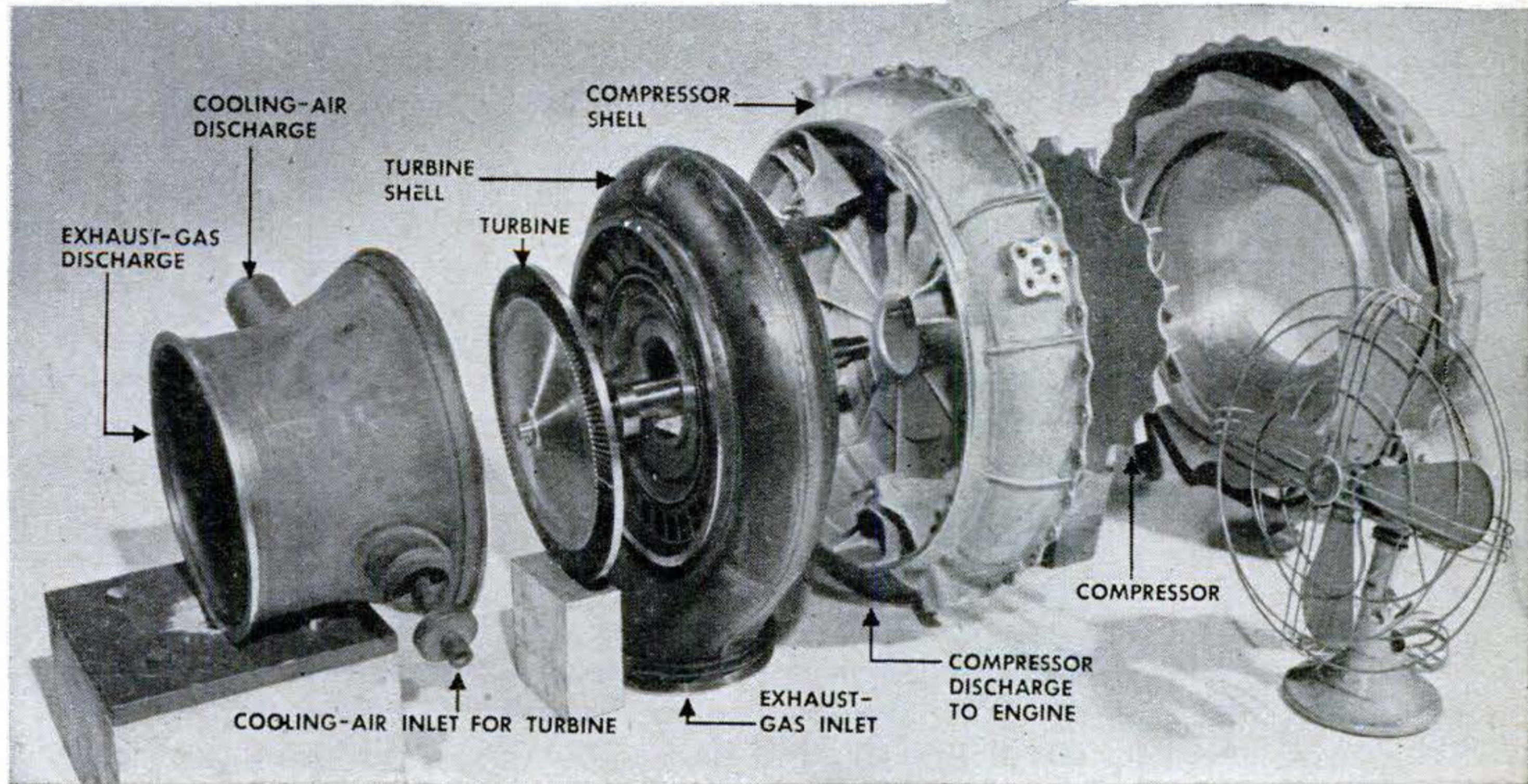
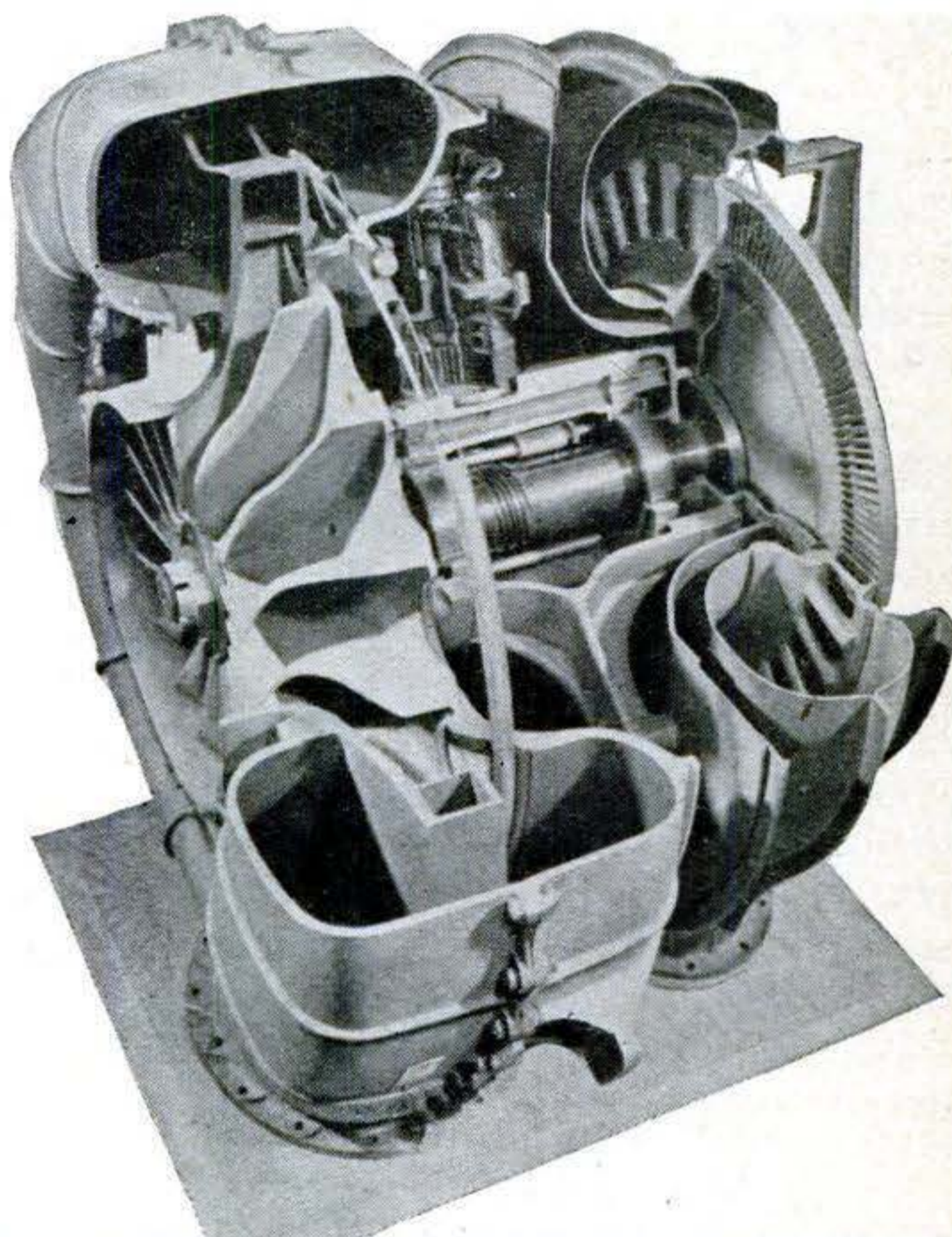

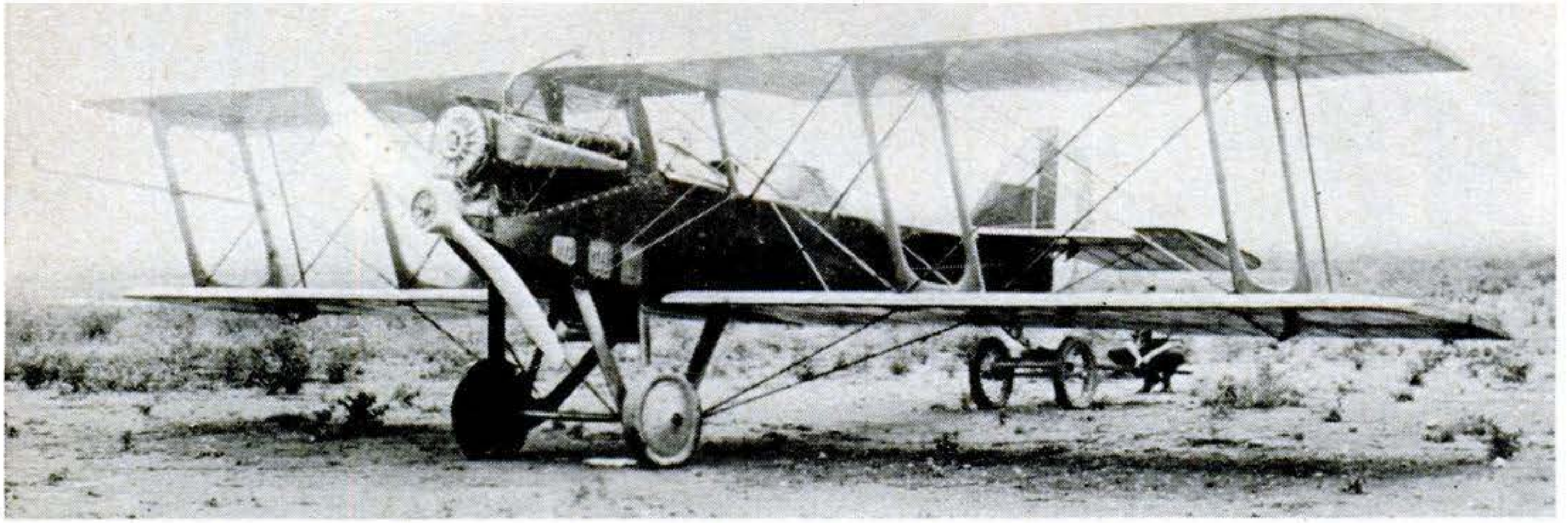

**Aircraft engines** have been supercharged for 30 years. Here is one of first GE turbo installa-

tions. Today's turbos turn as high as 22,000 r.p.m., deliver 5 atmospheres of pressure.

engine, with its new turbo, in economy. And while it's still not nearly as fast as a jet, it's faster than it was. On flights of 1,000 miles or so, the turbos let a pilot fly 40 miles farther each hour.

Where'd this power gain come from? That involves a little background on high-performance aircraft engines. Such power plants have almost always used carburetors. This means they have also had to have internal, mechanical superchargers—which have been needed not only to compress the charge, but also to mix it thoroughly and distribute it to each cylinder as evenly as possible. Even so, the top cylinders on radial engines have tended to run lean and the bottom ones to get an over-rich mixture. Both conditions shorten the life of cylinders, valves, and spark plugs.

#### *Internal 'Chargers Hog Power*

Mechanical superchargers have brought mechanical problems, too. Speeded up by gear trains to the high r.p.m.'s necessary, they have been susceptible to a "crack-the-whip" effect during changes in engine speed. This has called for special clutches and even fluid couplings to save gear teeth from the high loads that would otherwise be imposed. It has also been accepted as a necessary evil that the mechanical supercharger is a power thief that robs an engine of the type used in the Stratocruiser of some 500 hp. It takes that much energy to turn it—energy stolen from the shaft, not from the waste exhaust gases.

An additional problem has been heat. On a conventional engine, an "intercooler" brought down the temperature of the air after the turbo had compressed (and thereby heated) it. But that internal super-

charger heated it up again by further compression. The mixture was hot when it entered the cylinders. You can't cram as much hot air as you can cold into a container. Thus superchargers have in a way partly defeated their own purpose. Another drawback to this heat has been that it encouraged detonation—"pinging." This means that compression ratios, although high, have still had to be kept below the point of maximum efficiency.

#### *Higher Compression Possible*

In the new set-up, fuel injection has removed the need for a carburetor, and for the mixing and distributing functions of the internal supercharger. It has made it possible to put the complete load of compressing air onto a turbosupercharger. With heat absorbed by an "aftercooler," air from the new turbo enters the cylinders at a much lower temperature. The engine can take higher compression, and deliver more power. Careful design has licked a past drawback of big turbos: a tendency to build up back pressure in the exhaust to the point where the exhaust valves are overheated and warp or burn.

GE is not alone in working for more power from piston engines. Wright Aeronautical, like Pratt & Whitney a major piston-engine manufacturer, has developed a "compound" engine (PS, Dec. '48, p. 128). In this one, exhaust energy drives a turbo that feeds power back to the crankshaft.

Better propellers are coming along to go with the new power plants. Experimental props, still on the secret list, are now good for 550 m.p.h. That's more speed than is claimed for the world's fastest jet transport, the British Comet. END

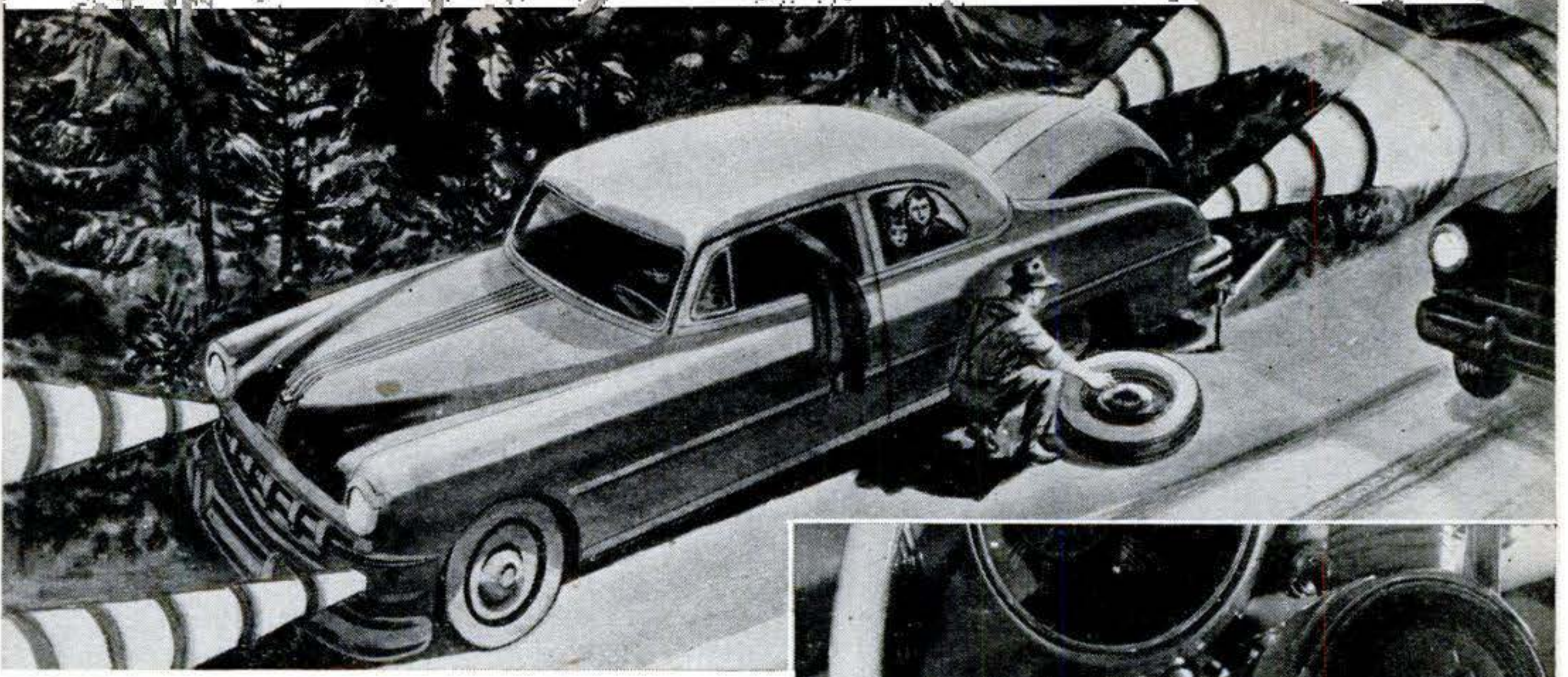

### Car Lights Flash Warning Signals

FIXING a flat tire on the highway at night is a dangerous business. Here's a device that will flash your parking lights and rear stop-lights intermittently as a warning to approaching vehicles. Attached to the steering wheel as shown at right, Sigflare also can serve as a conventional directional turn signal. A pilot lamp in the lever's translucent cap lights up when the indicator is on. In most late model cars changes in

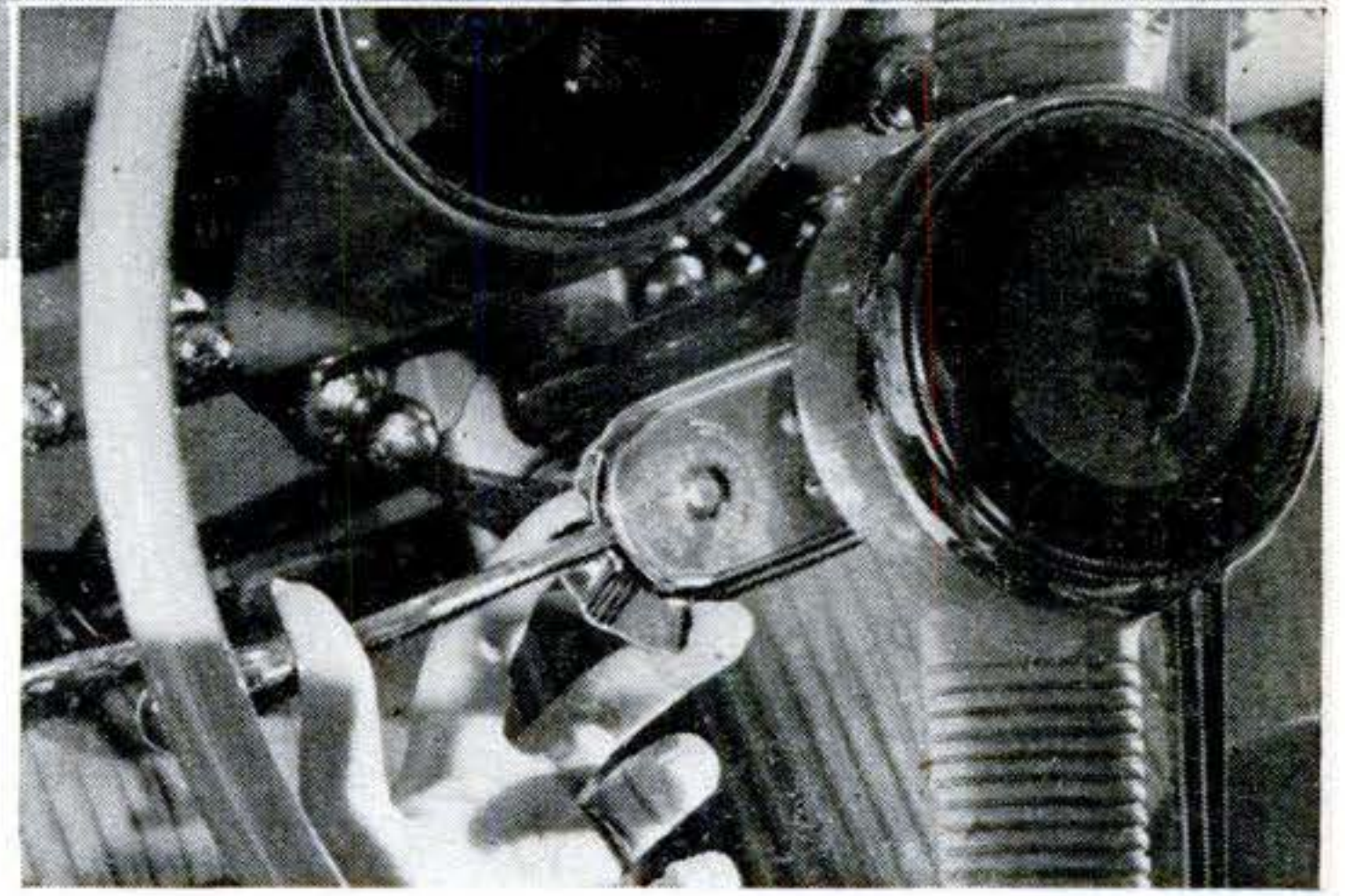

lamps and sockets are not necessary. The Signal-Stat Corp. of Brooklyn makes it.

### Streamlined Scooter Speeds Along at More than 83 M.P.H.



You don't have to spend a lot of money for speed—not the way Tony Capanna, of Los Angeles, does it. He took a single-cylinder scooter, made a few changes in the head and flywheel of its Powell four-cycle engine, and put on a streamlined cover. He then took his 190-lb. rig to a dry lake, stretched out prone to cut wind resistance, and opened up to hit 83.83 m.p.h. The alcohol-burning engine developed 13 hp. at 4,900 r.p.m. At upper right, wheels show through plywood housing.



# The Dreams

THE automobiles you see pictured here will never be built. They are dream cars from the Advanced Styling Studio of the Ford Motor Co. The studio's artists drew them as a free exercise in imagination.

Styling department is Detroit's holy of holies. Doors are locked, guarded. Inside department is *Advanced Styling*. Only Ford officials can get in there.

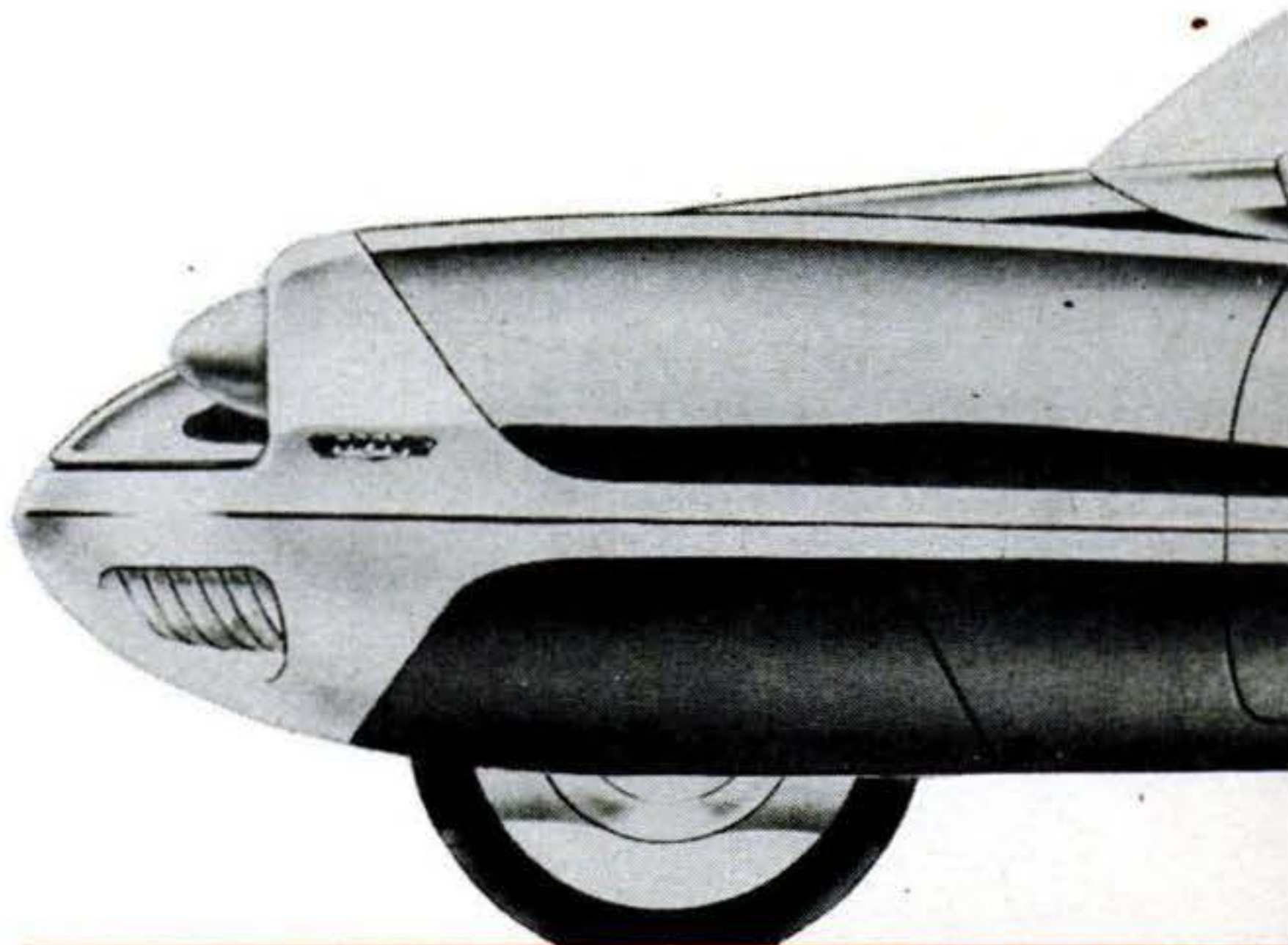
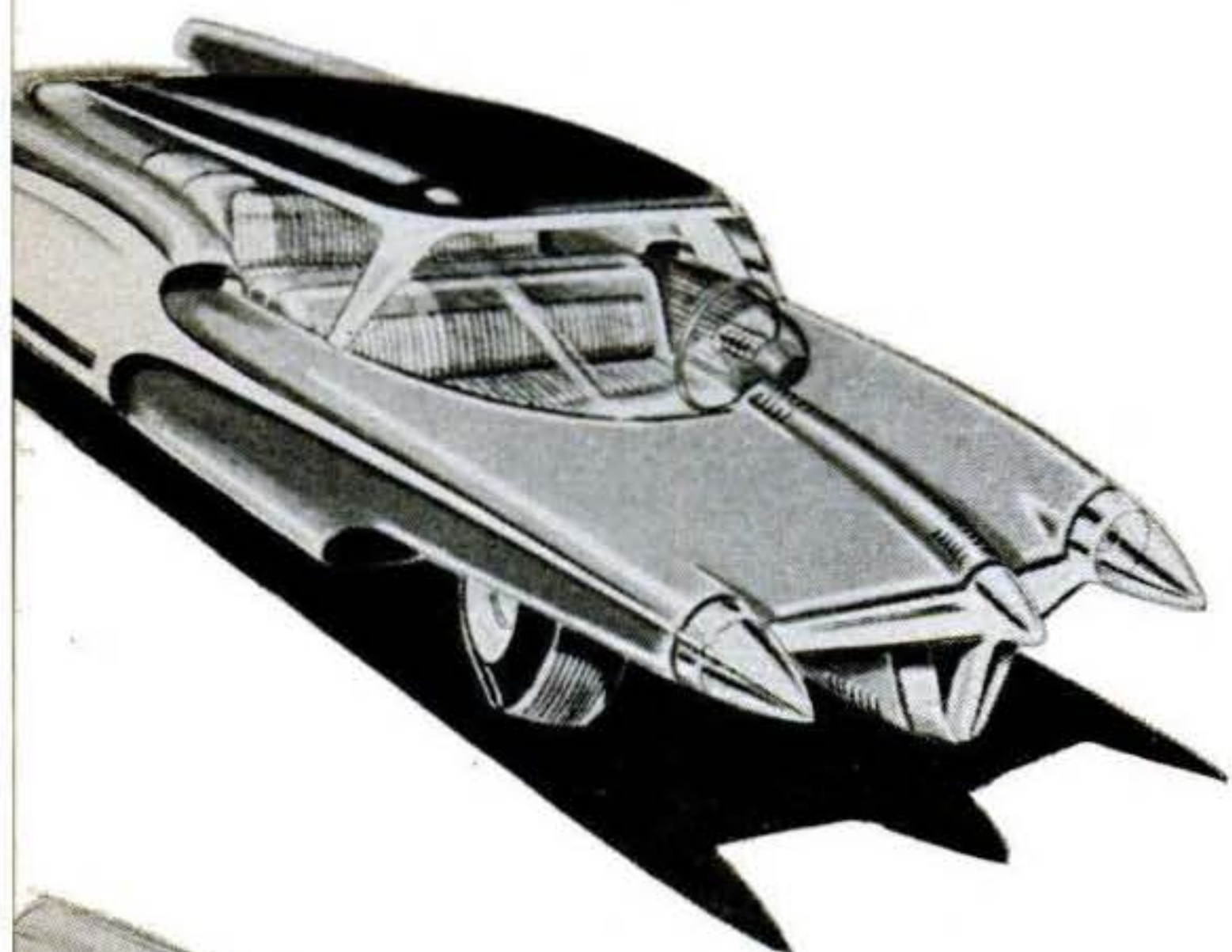

In dream car above artist was looking particularly for fresh treatment of top and door. Gil Spear, Advanced Styling supervisor, com-

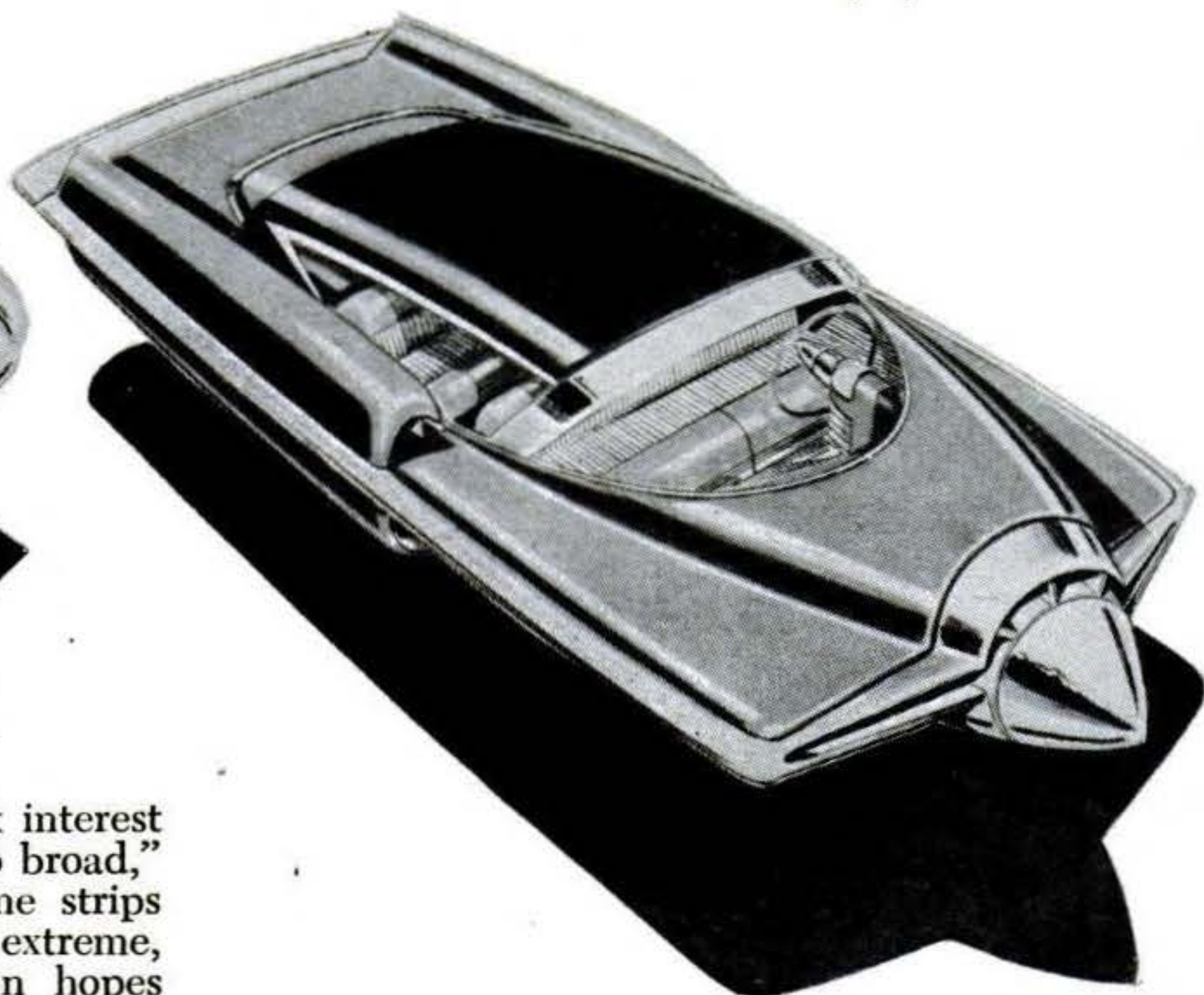
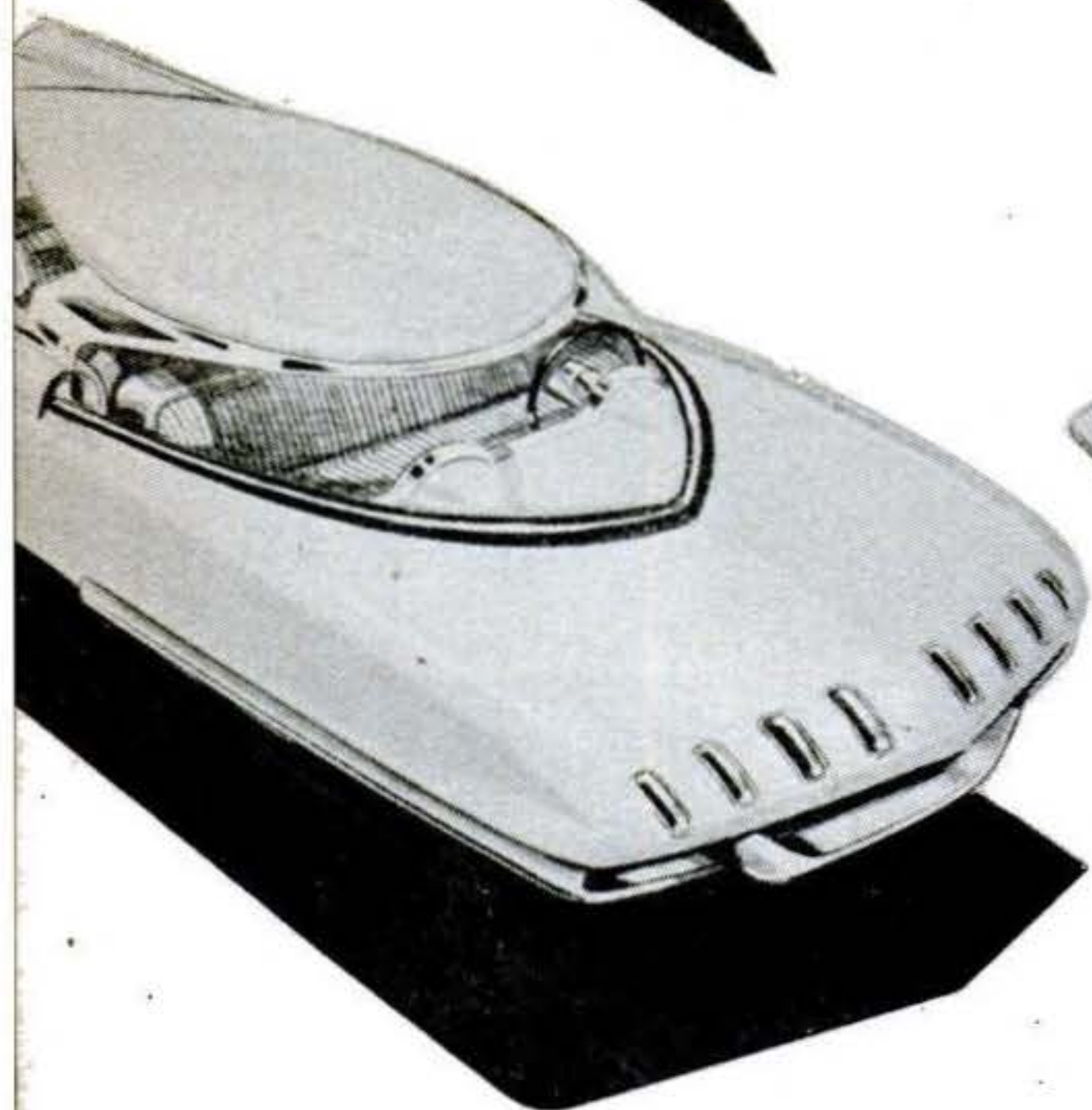

Of these three cars, Artist Spear took interest only in center one. "But the hood's too broad," he commented, "even with the chrome strips to break up its expanse." However extreme, the drawings are carefully studied in hopes they will contain new ideas.



# that Make the Fords

A dozen artists and four clay modelers dream up cars like this day in and day out. They have one of the world's pleasantest chores. Their only assignment is to produce new styling ideas. And they do—some 300

never-never dreamboat designs every year.

While these cars will never reach a production line, an idea for a fender curve, radiator grille, or top may be borrowed for a production car in 1955 or 1960. **END**

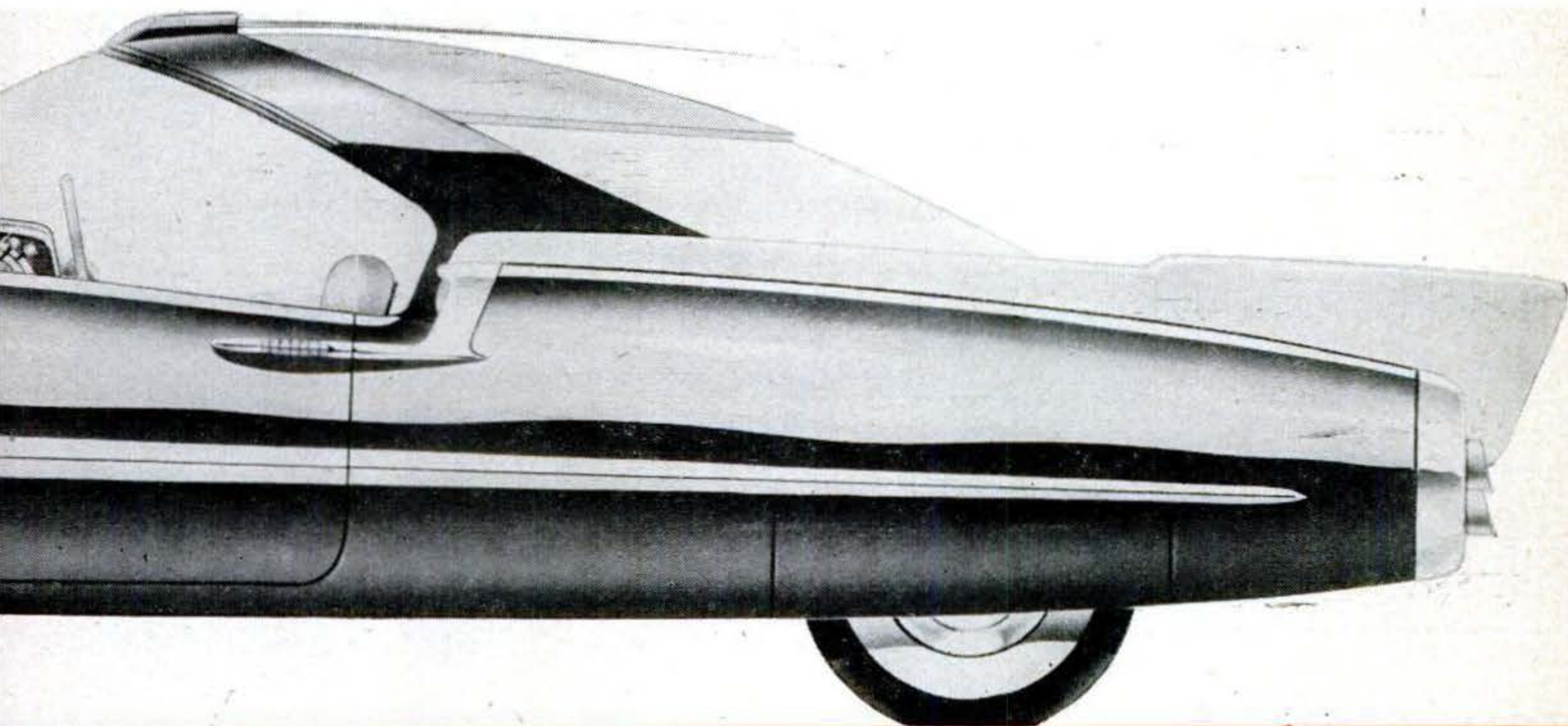

mented: "This door is low enough for a man to rest his arm on. The top has possibilities, but there is too much glass for comfort. The

tail fin is impractical. But I think the idea of admitting cooling air in front through bumper apertures is interesting."



**Design at left got no votes.** Above, Spear confers with fellow artist over clay model. If a drawing is extra-interesting, it may be put in clay to get three-dimensional perspective.

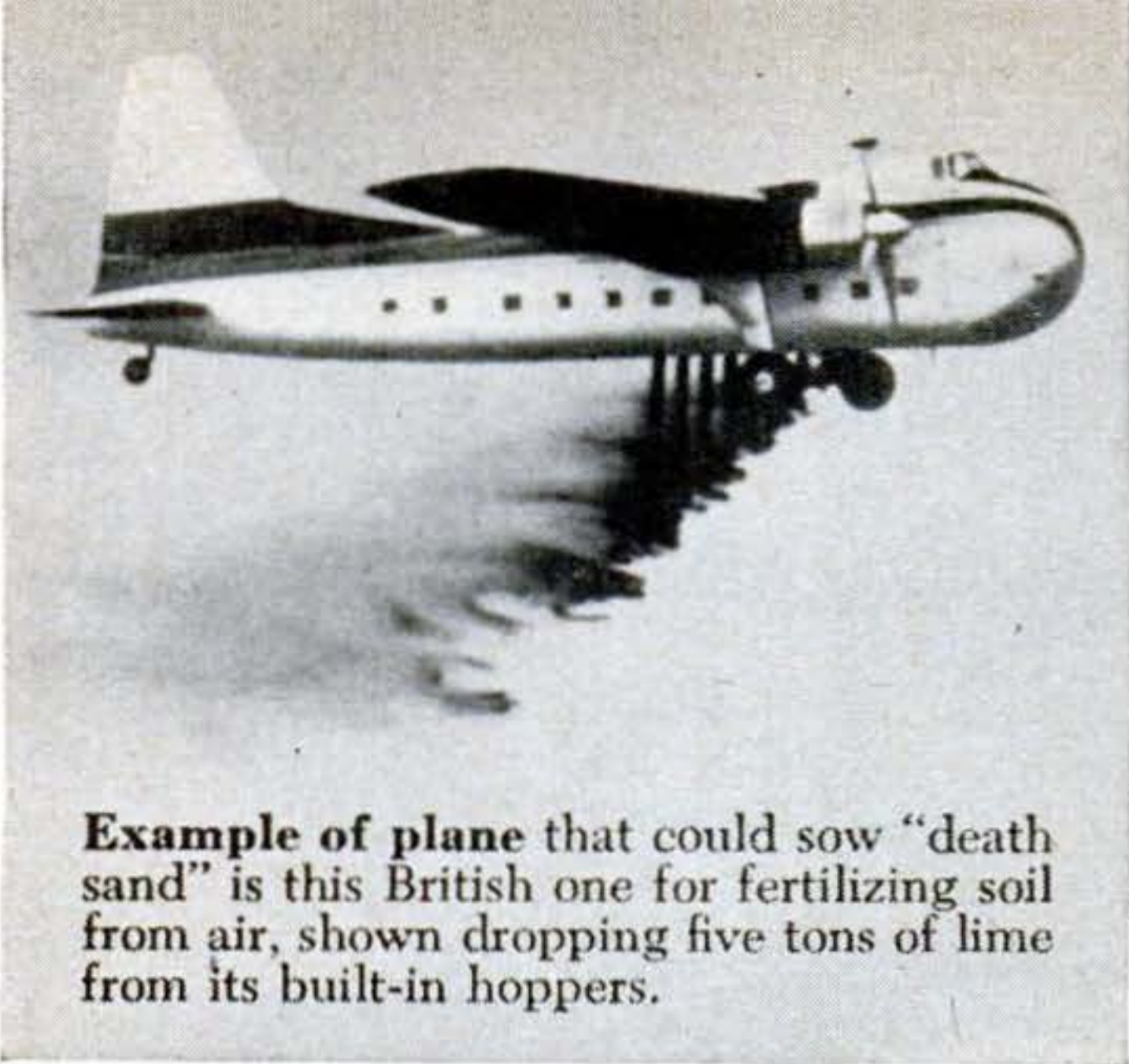

Example of plane that could sow "death sand" is this British one for fertilizing soil from air, shown dropping five tons of lime from its built-in hoppers.

# What You Should Know About "RW"

**"Death sand" and "radioactive clouds" are novel atomic weapons that may be introduced in radiological warfare.**

**By Alden P. Armagnac**

**EDITOR'S NOTE:** Best defense against a possible terror weapon is knowing just what it can, and can't do. So here are the facts about "RW," latest in atomic warfare.

UNITED STATES ARMY commanders have been alerted against an eerie new kind of atomic warfare. At any moment it may emerge from the laboratory, and make its debut in combat.

It's called "RW"—short for radiological warfare. It uses atomic weapons other than the A-bomb, such as "death sand" and "radioactive clouds."

A 12-page Department of the Army study, "Radiological Warfare," briefs commanding officers on how it may be used. Recently printed in *Officers' Call*, an official Army publication issued monthly for their

information, it's the most detailed report on RW made public to date. Here are its highlights, plus some from other sources.

Name the countries that have atomic piles, and you've listed those that could wage RW—the U. S., Canada, England, France, and Russia. For any pile will furnish the needed radioactive materials, or RW agents. Just as tracers are made for research, common materials like chalk and washing soda may be put in a pile and made radioactive for use as RW agents. Also suitable are radioactive fission products, the "ashes" recovered from a pile's spent fuel rods.

The radioactive materials come from the pile both as red, white, and black powders in aluminum cans; and as bottlefuls of solutions. They are so radioactive that a large amount would melt a metal container.

Likeliest way of using these materials in war, the Army study foresees, is to sow the ground with radioactivity. They could be loosed over an enemy target from planes, in the form of a dust or liquid spray. Settling



**Defenders' planes** attack invaders with "death sand." It would force withdrawal of men exposed to its radioactivity, thus preventing build-up of forces to break out of beachhead.



## DEATH SAND



## RADIOACTIVE CLOUD



Here are two possible types of RW weapons. "Death sand" coats ground, and its radioactivity takes effect on victims externally. It requires material emitting penetrating gamma rays.

"Radioactive clouds" of particles small enough to float in air take effect internally when inhaled. They could employ materials emitting weakly penetrating alpha or beta rays.

on the earth, an invisible radioactive film would imperil all who walked over it with penetrating gamma rays from an RW agent like radiocobalt, a radium substitute.

To spread it, Prof. Hans Thirring of Vienna proposes drying a solution of the RW agent upon sand, or metal powder. Naming the preparation "death sand," he calls it "the lightest and most transportable of all weapons of mass destruction."

Airplanes for "death-sand" attacks could resemble those used for crop dusting and spreading fertilizer from the air. A British

plane for the latter purpose has dropped five tons of chemicals in a single experimental flight (PS, Jan. '51, p. 130).

To protect occupants from the cargo's radioactivity a death-sand plane would need heavy shielding. (After calculating its weight, one scientist suggested dropping the shielding instead of the RW agent on the enemy!) But shielding could be omitted if crewless planes, under radio control from accompanying aircraft, laid the sand.

Troops in an area sprinkled with death sand will have no choice but to get out.

Standard photoflash bulb of Westinghouse SM type, below, produced "radioactive cloud" by miniature explosion of chemicals in one of experimental methods devised by Dr. Abrams.

Glass shell of bulb was removed, and experimenters applied radioactive solution to combustible charge, which forms the small black knobs seen at top of the two supporting wire elements.

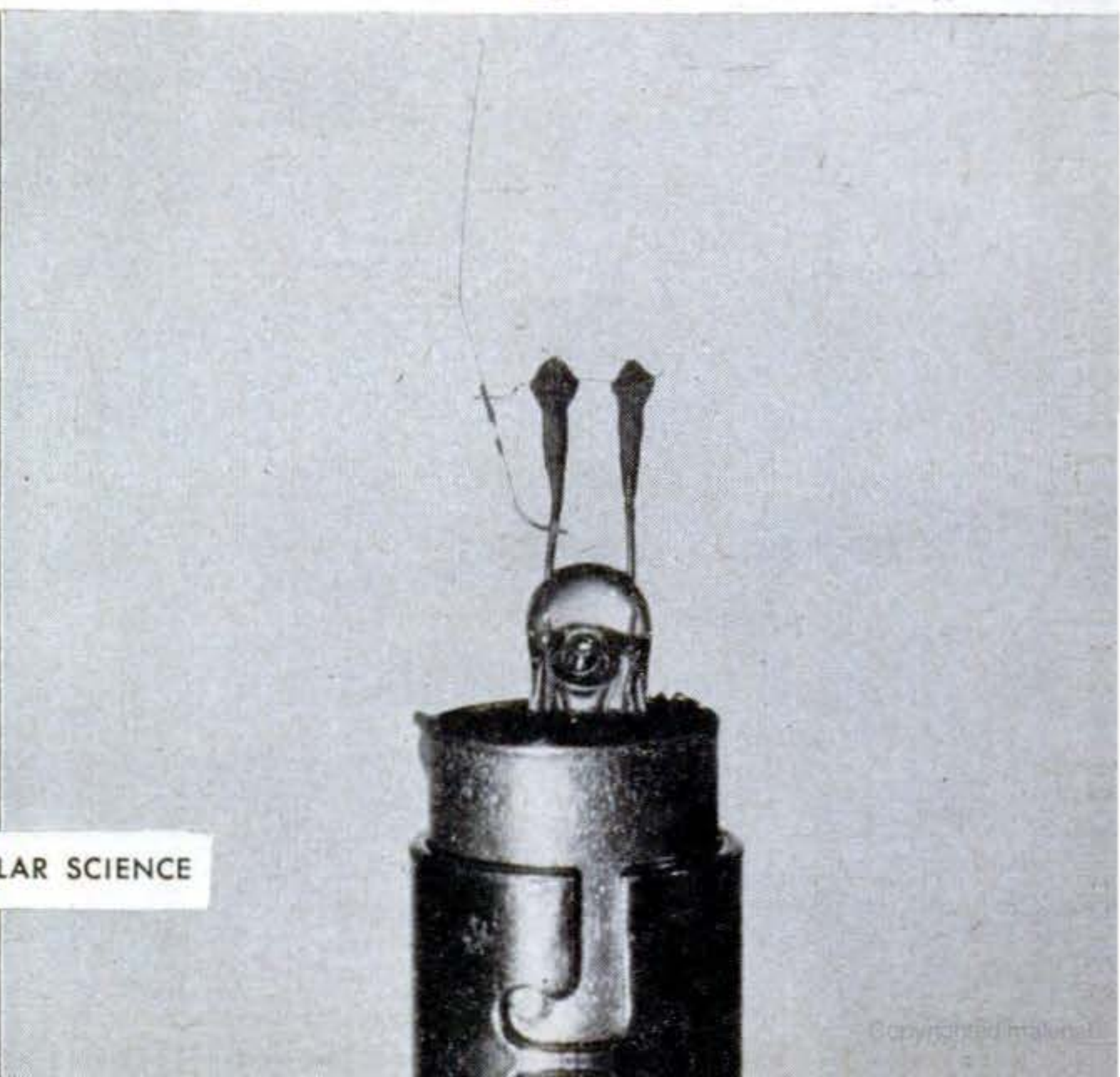

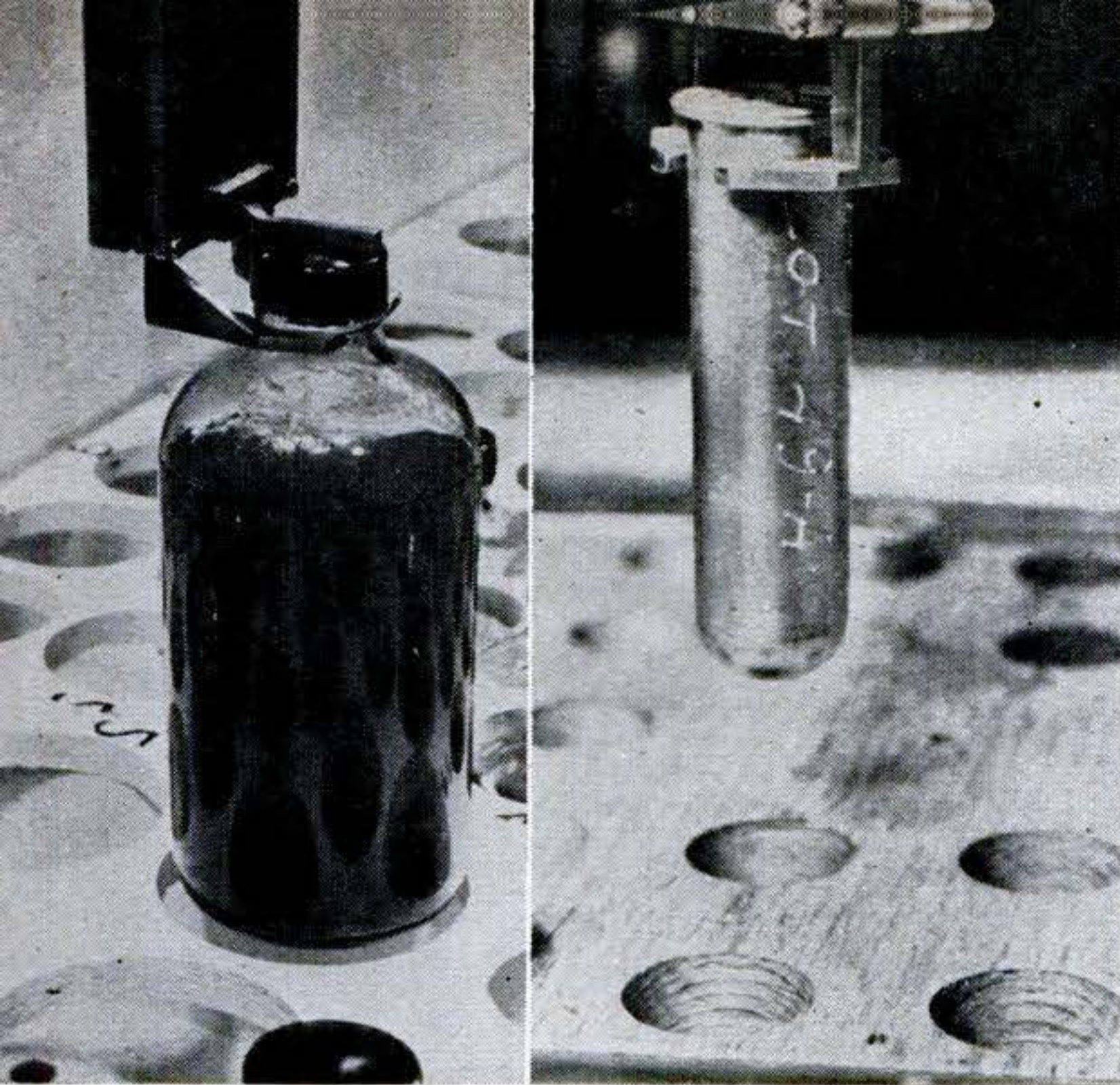

**These deadly products** of Oak Ridge pile are potential RW agents. Remote-control tongs handle intensely radioactive solution in a pint-size bottle and a dry powder in an aluminum can.

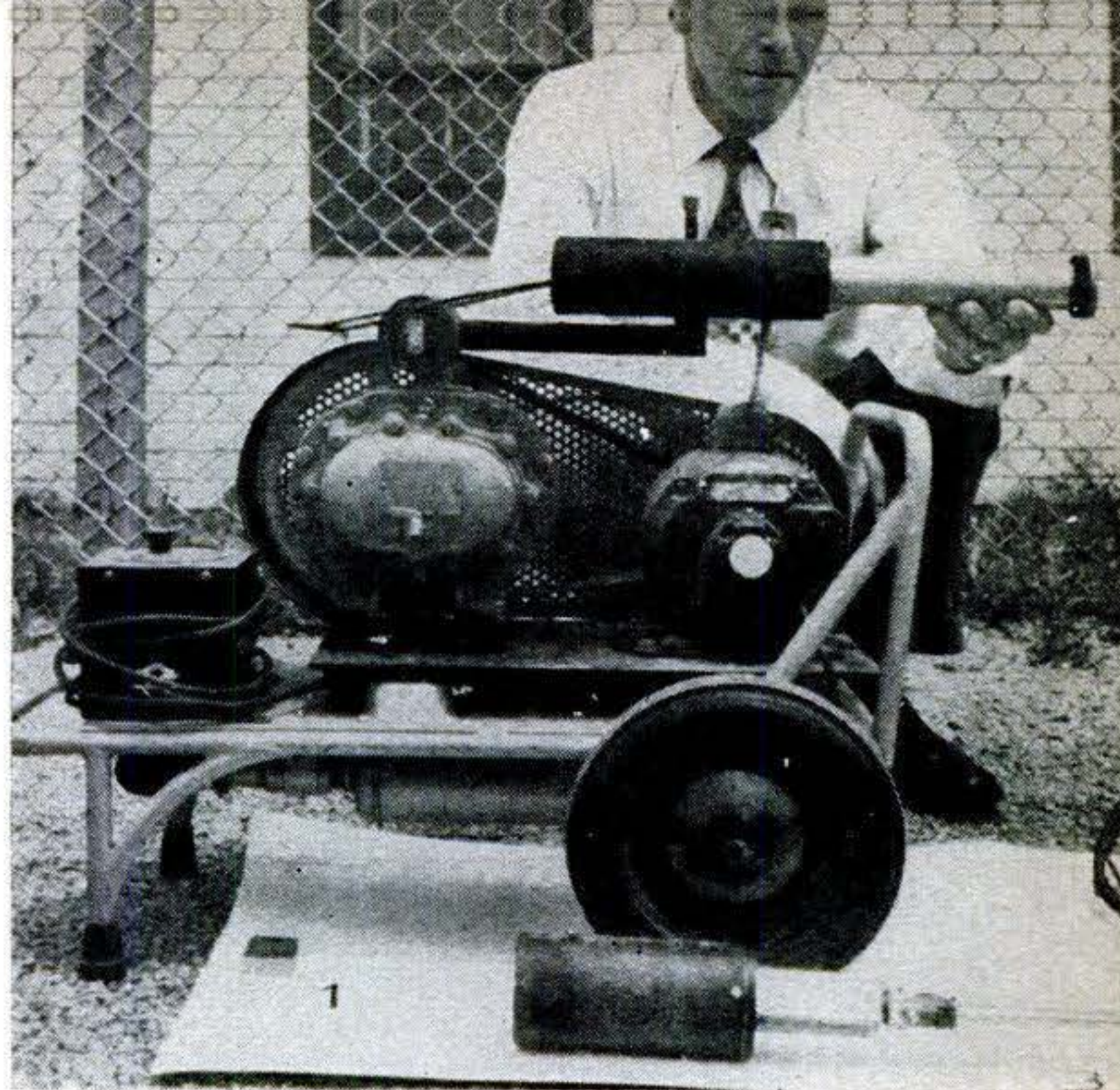

**Mobile air sampler** for detecting radioactivity could warn of RW attack. Also, warning might advantageously be broadcast by attacker himself to force enemy to abandon an occupied area.

Those who remain will receive a fatal dose in anywhere from a few hours to several weeks, depending on the intensity of the radioactivity. Like victims of A-bomb radiation, they will suffer nausea, loss of hair, anemia, and hemorrhages. But those who flee at once will suffer no ill effects.

RW has novel military possibilities. An invader could be forced by a death-sand attack to withdraw exposed troops from a beachhead, for example, and prevented from building up his forces to break out of defenders' encircling lines.

**Igniting charge** produced "radioactive cloud" of airborne particles. Actual experiment was in closed chamber. PS duplicates it, without radioactive treatment of charge, for photo below.

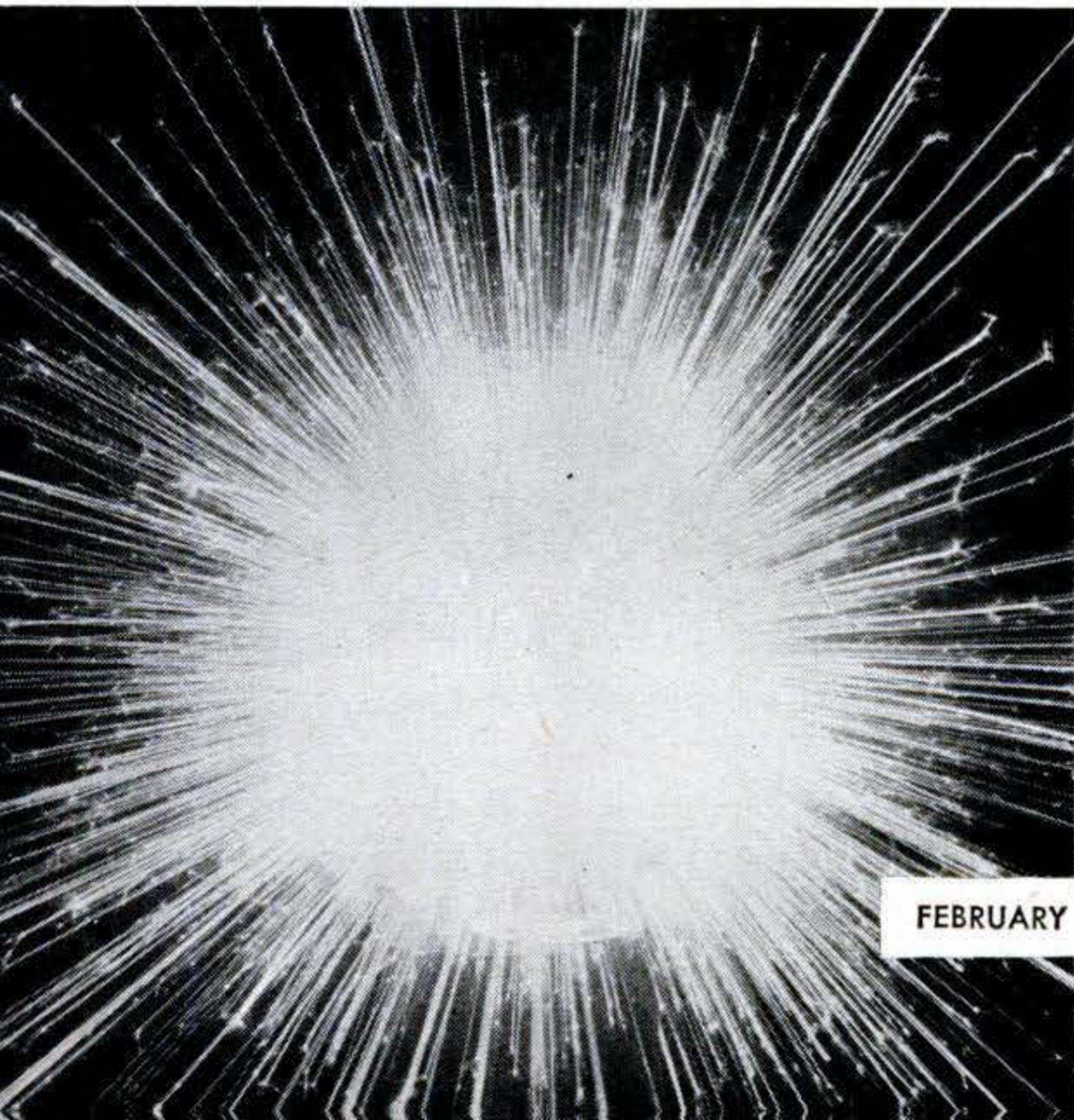

In a stalemate on a battlefield, RW could compel enemy troops to abandon a key position, permitting a breakthrough. Attackers advancing rapidly across the contaminated area would not be harmed by its radioactivity. (Conversely, a radioactive belt that could be crossed swiftly would be useless defensively.)

RW attacks on war-production and transportation centers could make an enemy evacuate factories, railroad yards, ports, and adjacent living areas, without demolishing them—and, the Army study declares, "with

**Electron microscope** shows magnified, smoke-like particles of two kinds of experimental radioactive clouds. Size lies in most difficult range of all for gas masks to filter from air.

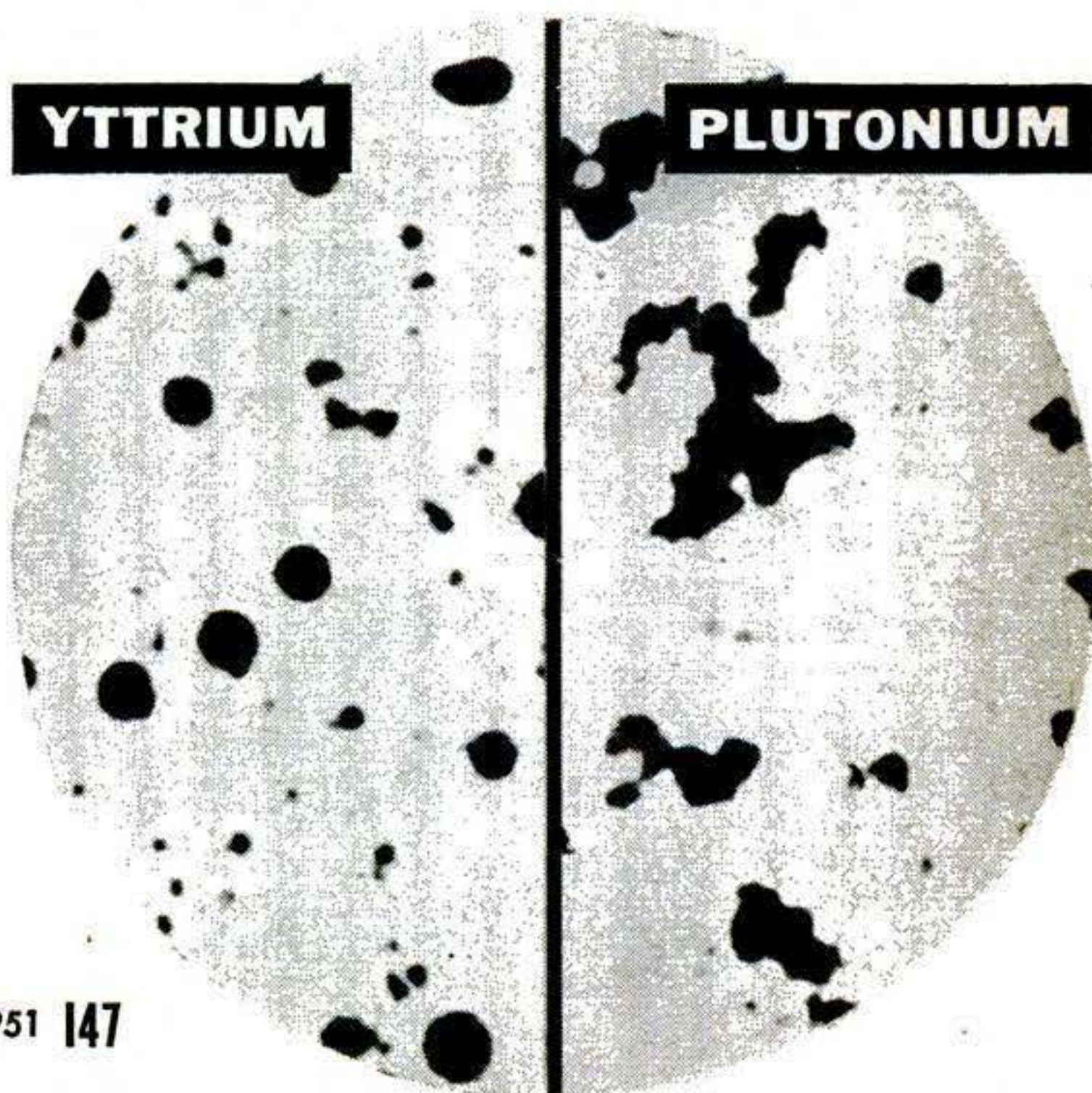



**Can guns like this fire atomic weapons?** Shells carrying RW materials may lead to the "atomic artillery" suggested as a possibility by Gen. J. Lawton Collins, U. S. Army Chief of Staff.

results comparable to strategic bombing."

Radioactivity of RW agents will die out after a time, depending on the particular one used. By choosing one of suitable half life, an attacker could make an area uninhabitable for whatever period suited his purpose—only briefly, if he expected to capture and occupy it himself.

What quantities of RW agents would be needed? An Army example assumes 430 pounds would cover an area like New York City's. Compared to the 10 pounds of pile products shipped yearly from Oak Ridge, the figure is huge, but not fantastic.

"Radioactive clouds" are a wholly different RW possibility. A low-level A-bomb burst is known to leave a deadly cloud of ray-emitting particles floating in the air. Could RW apparatus, too, create lethal airborne clouds in the open? If so, they would act as "a particularly vicious form of poison gas"—the phrase is taken from the famous Smyth Report—and serve similar purposes in close-range combat.

Casualties would result from inhaling the particles in the air. Lodging in the lungs, they would get in their lethal work at close range, and hence could emit only short-range alpha or beta rays. Some materials that do this, such as plutonium and radioactive calcium and yttrium, are among the most dangerous that can get into the body. Gas masks for protection would need filters able to strain out the particles. Otherwise the air couldn't be breathed and oxygen-fed respirators would be needed.

How to produce radioactive clouds can be described. For they've actually been

made in the laboratory, in non-military and therefore non-secret experiments.

Rats were exposed to miniature radioactive clouds to explore health hazards of inhaling the particles, by Dr. Richard Abrams and his associates at the Argonne National Laboratory. Novel ways they devised to make the clouds are described in a report awaiting publication\*, of which this writer has been permitted an advance view.

They contrived mechanical gadgets, resembling insect guns and perfume atomizers, that sprayed clouds of radioactive dusts and solutions. They exploded thin foil of radioactive metals, such as plutonium, with powerful electric currents. But their most interesting method was an explosion of chemicals.

The experimenters removed the glass shell from a midget photo flash bulb, and used a radioactive solution to impregnate its combustible charge, consisting of zirconium metal and potassium chlorate and perchlorate. Ignited in a closed chamber, this filled the air with floating radioactive particles, which took effect on rats nearby.

#### *Atomic Artillery a Possibility*

Can similar chemicals serve as a filling for RW shells, bombs, and rockets? Gen. J. Lawton Collins, U.S. Army Chief of Staff, recently cited the possibility of "an artillery piece that would fire an atomic weapon." Some took it that he meant shooting an A-bomb from a gun—but "atomic artillery" for RW seems more plausible.

Those are the possible arms and methods of RW. Its military value remains a big question mark until it is tried.

RW has glaring military drawbacks, like its delayed-action casualty effect. Even a lethal dose doesn't knock out radiation victims at once. At Hiroshima, several Japanese soldiers fatally exposed to A-bomb rays marched 20 miles with full packs the next day, although all were dead six weeks later. So a soldier who has "had it" from RW may still be a dangerous customer.

But RW's unique characteristics could give it a place in warfare. And it could be used especially effectively against those unaware of its limitations, as a psychological terror weapon. As the Army study puts it, "Radiological warfare, once a favorite subject for writers of science fiction, has passed into the realm of sober possibility." END

\*MDDC-795, "Production and Analysis of Radioactive Aerosols," to be published in *National Nuclear Energy Series, Division IV, Vol. 22G*.

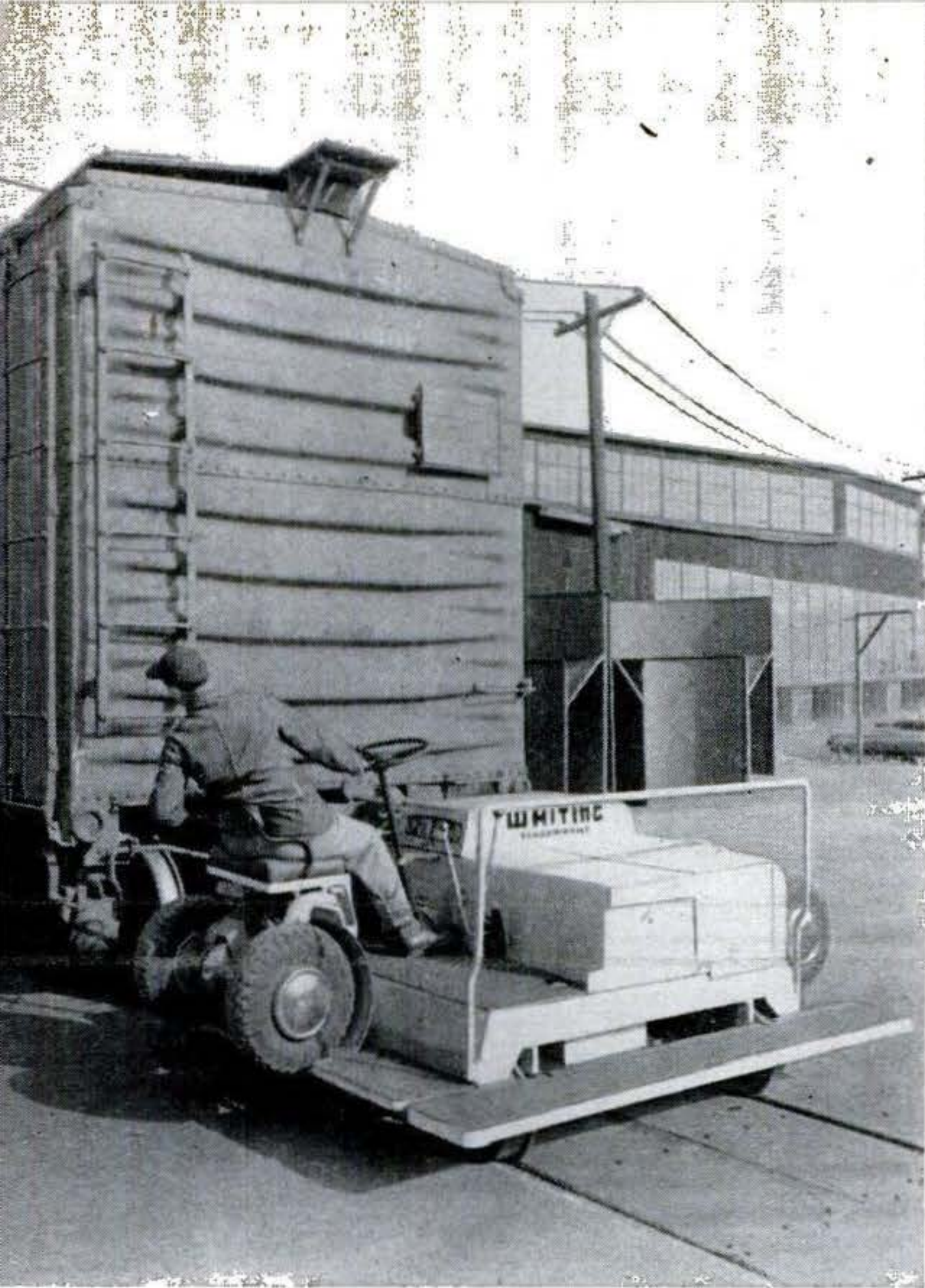

### Land "Tug" Runs on Tracks or Road

THE job of hauling and switching railway cars (see also page 152) will be simplified with a "land tugboat," shown above with its four retractable rubber wheels lowered for highway travel. Set at right angles are four rolled-steel railroad wheels. A switch from one to the other takes only 30 seconds.

The four-cylinder, gasoline-powered Trackmobile, developed by the Whiting Corp., Harvey, Ill., weighs only 6,000 pounds. But when the tractor is coupled to a fully loaded freight car, as at left, hydraulic jacking power lifts the coupling mechanism to transfer some of the car's weight to the Trackmobile, and greatly increases traction: drawbar pull runs up to 7,320 pounds.

### Spray Comb Rids Pets of Fleas

SQUEEZING the bulb of the grooming comb at right sends a spray of insect powder through the hollow teeth, distributing it evenly through the animal's coat. Made of plastic, Comb-A-Flea is sold by Mik-Tin Specialties Co., of Seattle, for \$2.

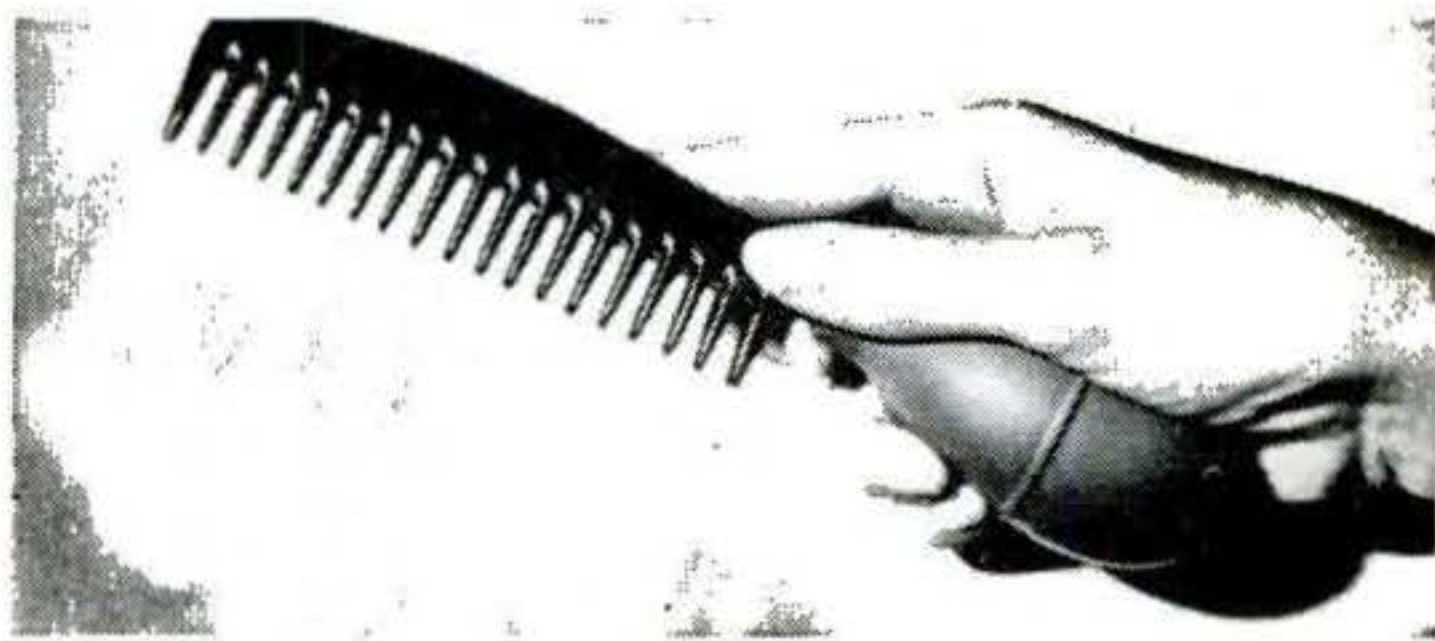

### New Crosley Has Roll-Down Windows

OTHER features of the 1951 Crosley cars are a redesigned front end and, in the Super Station Wagon shown above, basket-weave rear panels. The new oversize, nine-inch Bendix brakes are hydraulic, as are the airplane, strut-type shock absorbers. The engine has a 7.8 to 1 compression ratio.

### Humidity Gauge Is Pocket-Sized

THIS handy, pocket-sized thermometer and humidity indicator is well-protected in a Vinylite plastic housing. Setting the plastic calculator slide to the dry-bulb and wet-bulb readings provides a relative-humidity reading at a glance. The unit also can be mounted on the wall with a wick and small water container to keep the wet-bulb moist. The Tagliabue Division of the Weston Electrical Inst. Co., Newark, makes it.

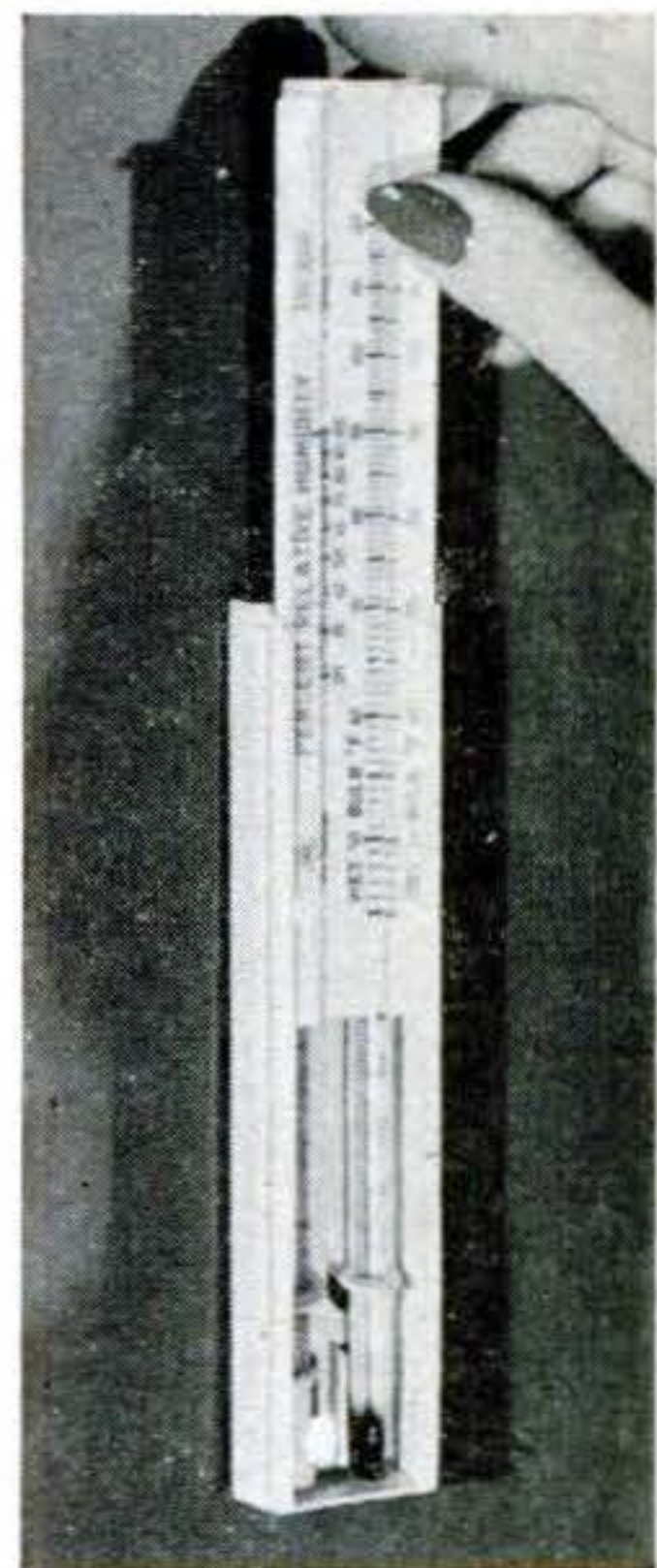

BAYONET ..... 1.00 LB.  
AND SCABBARD.....12 LB.

ENTRENCHING TOOL - SHOVEL  
WITH COVER .....2.00 LB.

HELMET WITH LINER AND COVER... 3.00 LB.

BLANKET ROLL  
BLANKET ..... 4.00 LB.  
TENT, SHELTER HALF ..... 4.25 LB.  
POLE, 5 PINS, GUY ROPE... 1.30 LB.

TWO BANDOLEERS WITH 12  
CLIPS (96 ROUNDS) CAL .30  
AMMUNITION... 5.25 LB.

HAVERSACK AND CONTENTS  
HAVERSACK (EMPTY) ..... 1.50 LB.  
CAN OF MEAT WITH COVER ..... .97 LB.  
KNIFE ..... .13 LB.  
FORK ..... .08 LB.  
SPOON ..... .11 LB.  
PONCHO ..... 2.00 LB.  
DRAWERS, 1 PAIR ..... .58 LB.  
UNDERSHIRT ..... .63 LB.  
SOCKS, 1 PAIR ..... .19 LB.  
TOILET ARTICLES, SEWING KIT,  
EXTRA SHOELACES ..... 1.00 LB.  
RATIONS, 1 DAY: 3 MEAT, 3 BISCUIT... 3.00 LB.  
TOTAL ..... 10.19 LB.

CANTEEN WITH CUP  
AND COVER... 1.57 LB.\*  
\*Add 32 oz. when full of water.

KNAPSACK AND CONTENTS  
KNAPSACK (EMPTY) ..... 1.50 LB.  
DRAWERS, 2 PAIRS ..... 1.16 LB.  
UNDERSHIRTS, 2 ..... 1.26 LB.  
SOCKS, 2 PAIRS ..... .38 LB.  
COAT, UTILITY ..... 1.50 LB.  
TROUSERS, UTILITY, 2 PAIRS... 2.20 LB.  
SHOES, FIELD, 1 PAIR ..... 3.18 LB.  
TOTAL ..... 11.98 LB.

FIRST-AID PACKET... .70 LB.

CARTRIDGE BELT  
WITH 6 CLIPS OF  
8 ROUNDS... 4.22 LB.

COAT,  
UNDERSHIRT  
2.13 LB.

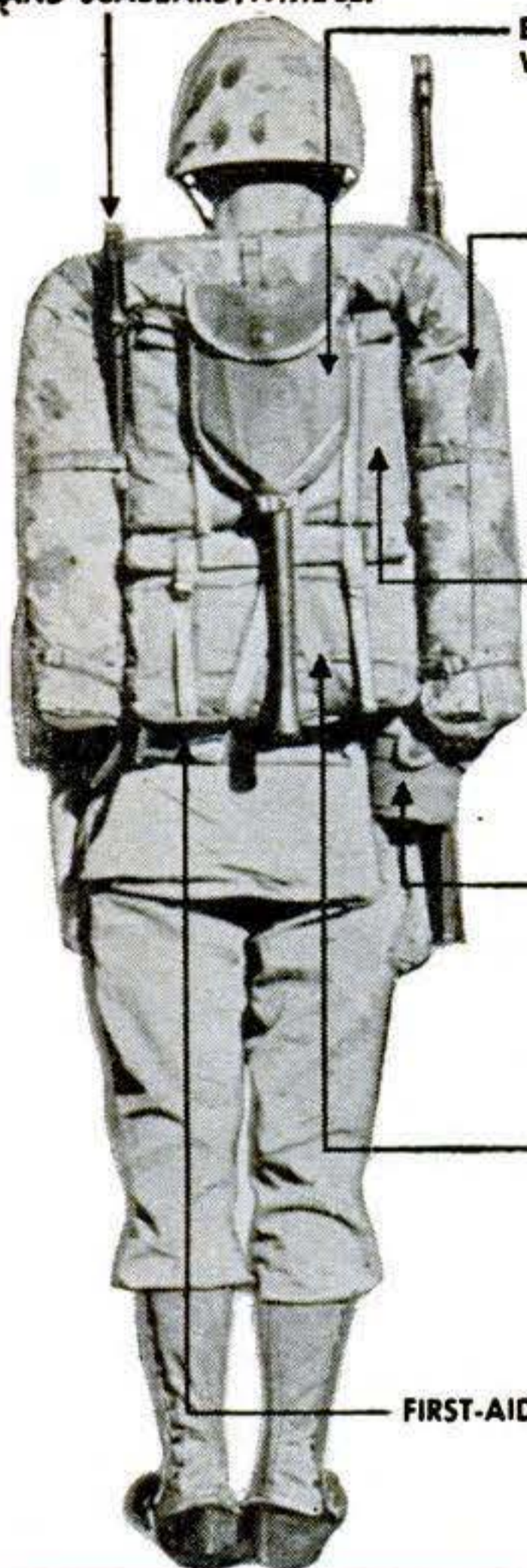

**FIELD TRANSPORT PACK  
TOTAL WEIGHT: 67.35 LB.**

RIFLE (CAL. 30, M-1)  
WITH SLING... 9.50 LB.

TROUSERS, DRAWERS... 2.08 LB.

LEGGINGS... .69 LB.

SOCKS... .19 LB.

SHOES... 3.18 LB.

# Why Marching Is Hard Work

**N**EXT time you set out on an all-day hike, toss a sack of flour across your back and fill your side pockets with rocks. By nightfall your aching bones will tell you how a foot soldier feels at the end of a day's march. What he packs to work is shown in these pictures, posed for PS by the Marines. The Army infantryman's gear is practically the same. The field transport pack is the one a doughfoot goes ashore with and carries on motor movements. The light marching pack is worn for foot movements and advancing toward combat. For fighting—except in winter—he strips down to the minimum.



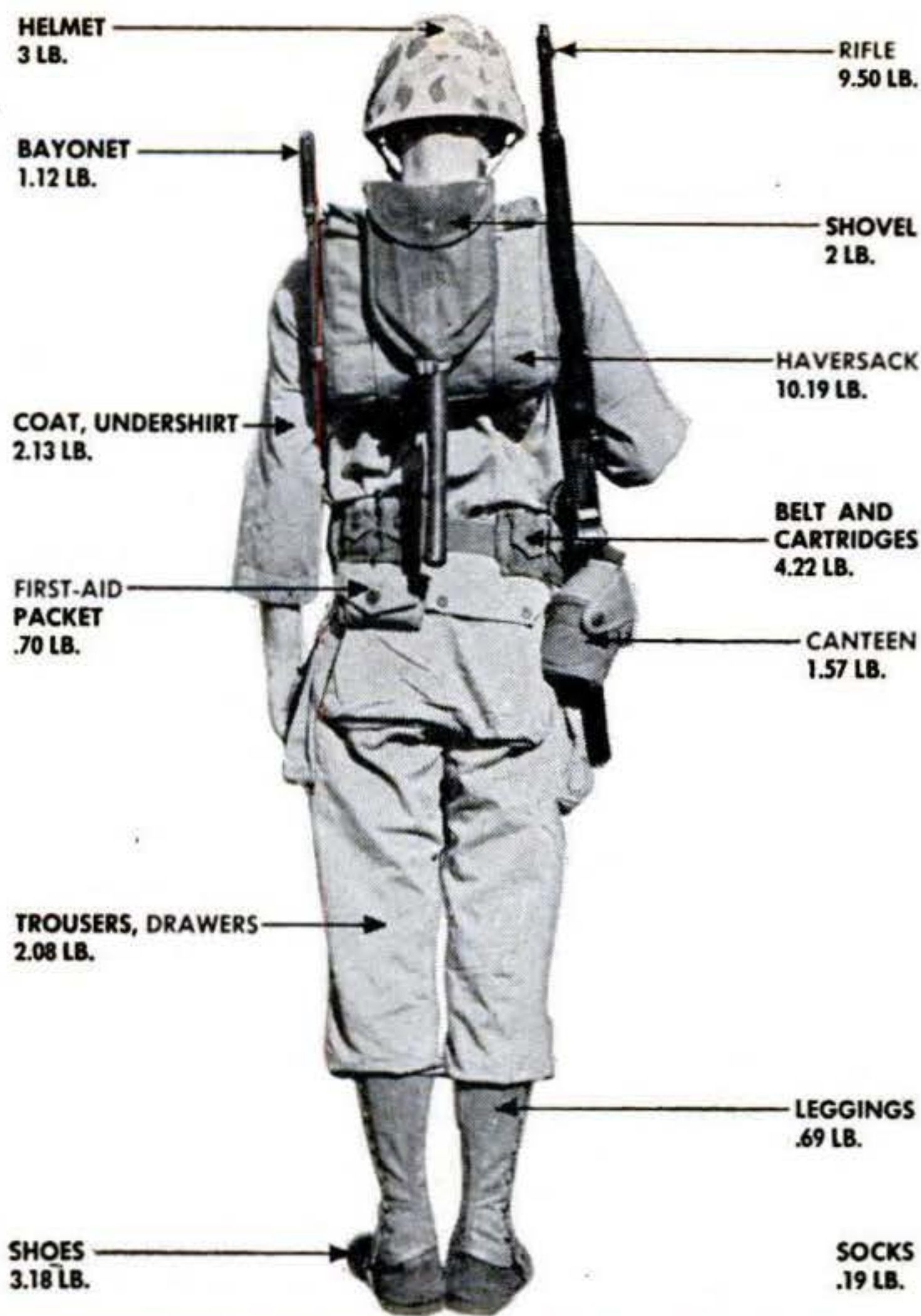

**LIGHT MARCHING PACK  
TOTAL WEIGHT: 40.57 LB.**

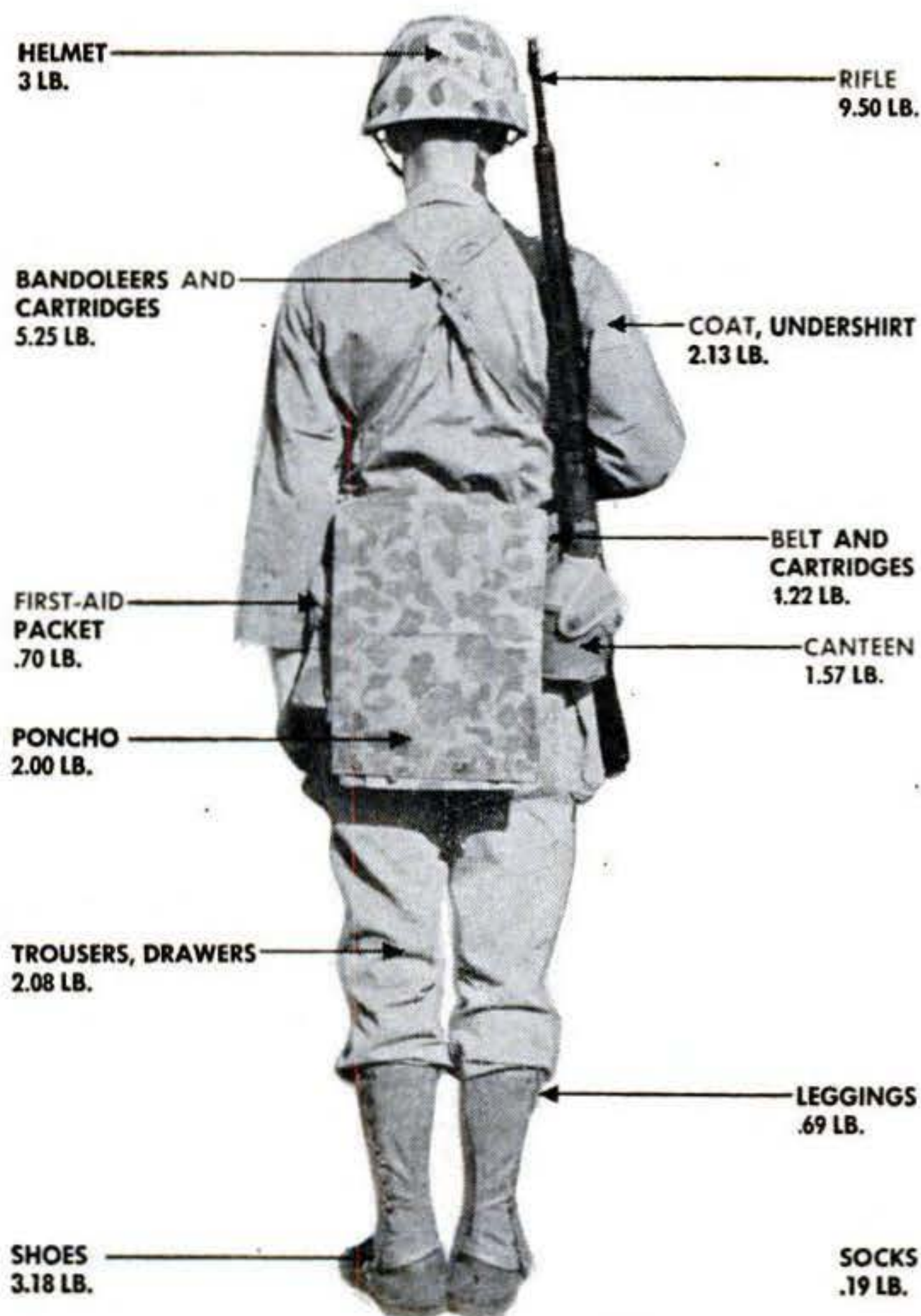

**MINIMUM COMBAT PACK  
TOTAL WEIGHT: 34.51 LB.**



### Mobile Belt Speeds Plane Loading

LOADING and unloading time at airports is said to be cut in half by use of this mobile cargo-handling unit. A 21-foot endless conveyer belt mounted on a small truck, the Mobiloader can handle a concentrated weight of 500 pounds or a distributed load of 1,500 pounds. Sage Equipment Co., Buffalo, makes it.



### Back Seat of Car Makes Crib

TRANSFORMING the rear seat of a car into a child's bed or play pen is easy with the Kiddie Sleeper shown above. Made of Vinylite, it covers and protects the seat upholstery. The unit folds compactly for easy storage, and is made by the Kaydon Manufacturing Co., Santa Monica, Calif.

### GE J-47 Jet Gets Warmer Nose

LATEST improvement on GE's powerful J-47 jet engine is special de-icing equipment. Hot air from the compressor is piped to hollow parts in the nose, such as guide vanes and support struts, preventing ice formation at high altitudes. Possibility of icing is further cut by making air-inlet screens retractable.

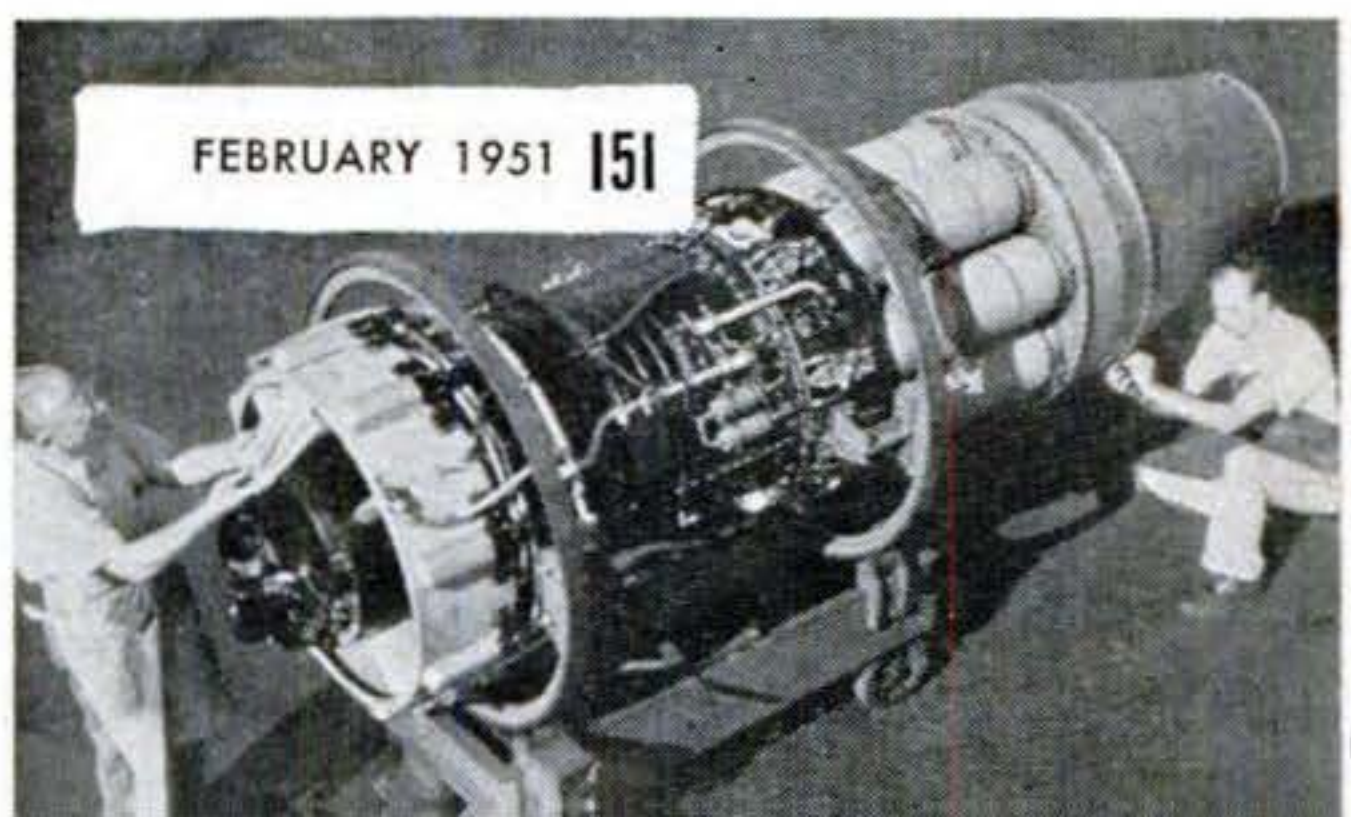

# Diesel-Electric Tractor Has Motor in Each Wheel

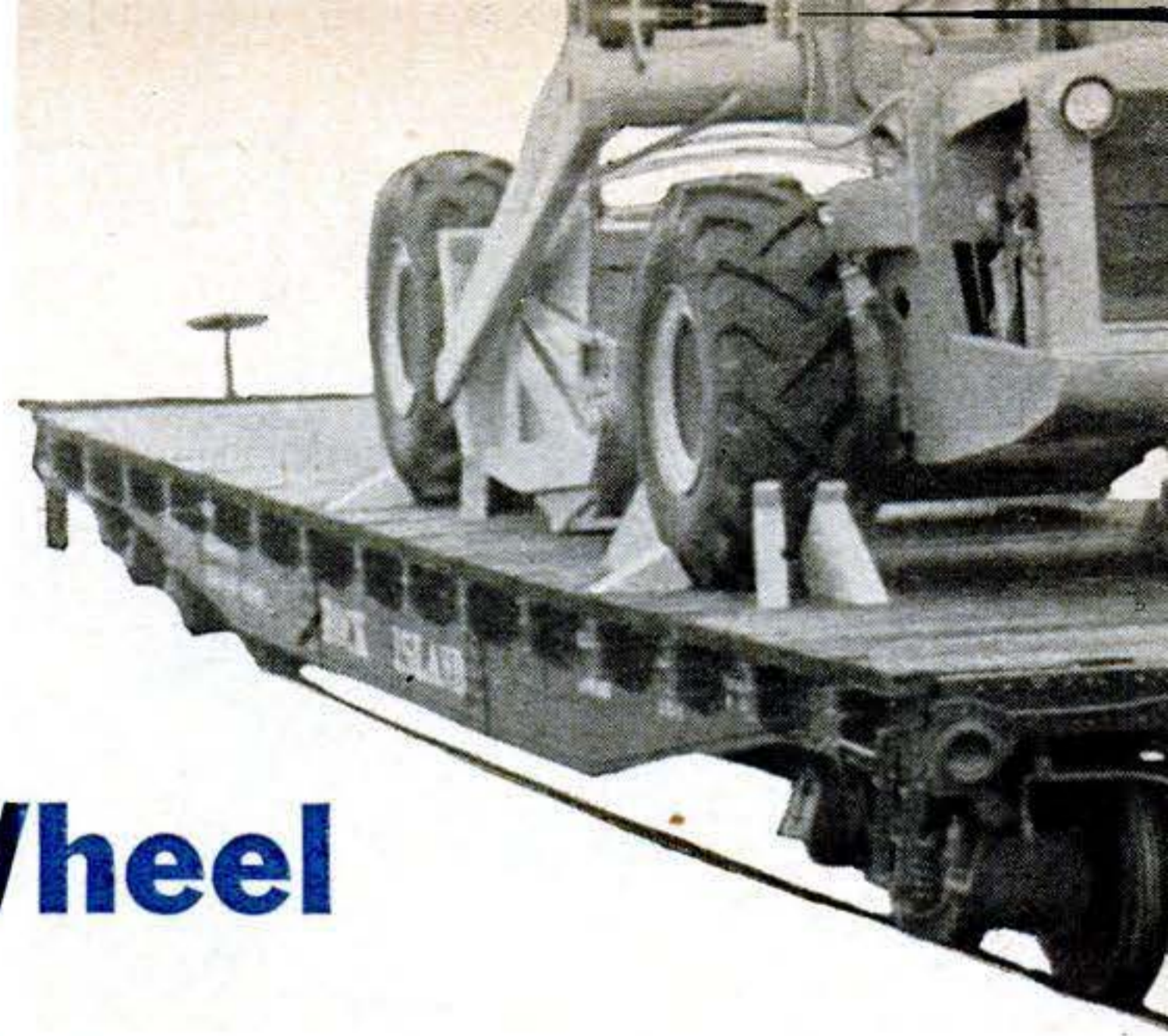

**B**Y CROSSBREEDING Gramp's battery-driven automobile with today's Diesel-electric locomotive, engineers have hatched a husky rubber-tired tractor that has no clutch, transmission, drive shaft, or differential.

Two generators hooked directly to a 186-hp. Diesel engine grind out juice that is distributed separately to a motor in each of its four wheels, to two more for front and rear steering, and to a seventh that turns a towing winch.

Fuel to the Diesel is throttled by a hand lever that seldom needs regulating after starting. A rotating controller, like a street-

car's, governs speed of the driving motors, forward and backward movement, and power braking. It's steered by push buttons.

R. G. LeTourneau, Inc., of Peoria, Ill., designed the 11-ton prime mover, called the Tournatow, for handling big airplanes on the ground. It can also be used as a switch engine in railway yards, and is being modified for heavy earth-moving equipment.

Outstanding performance characteristics claimed for the new Diesel-electric tractor are smooth starting and stopping, precise control at all speeds up to 25 m.p.h., infinite adjustment of torque to load, and a turning radius of less than its length.

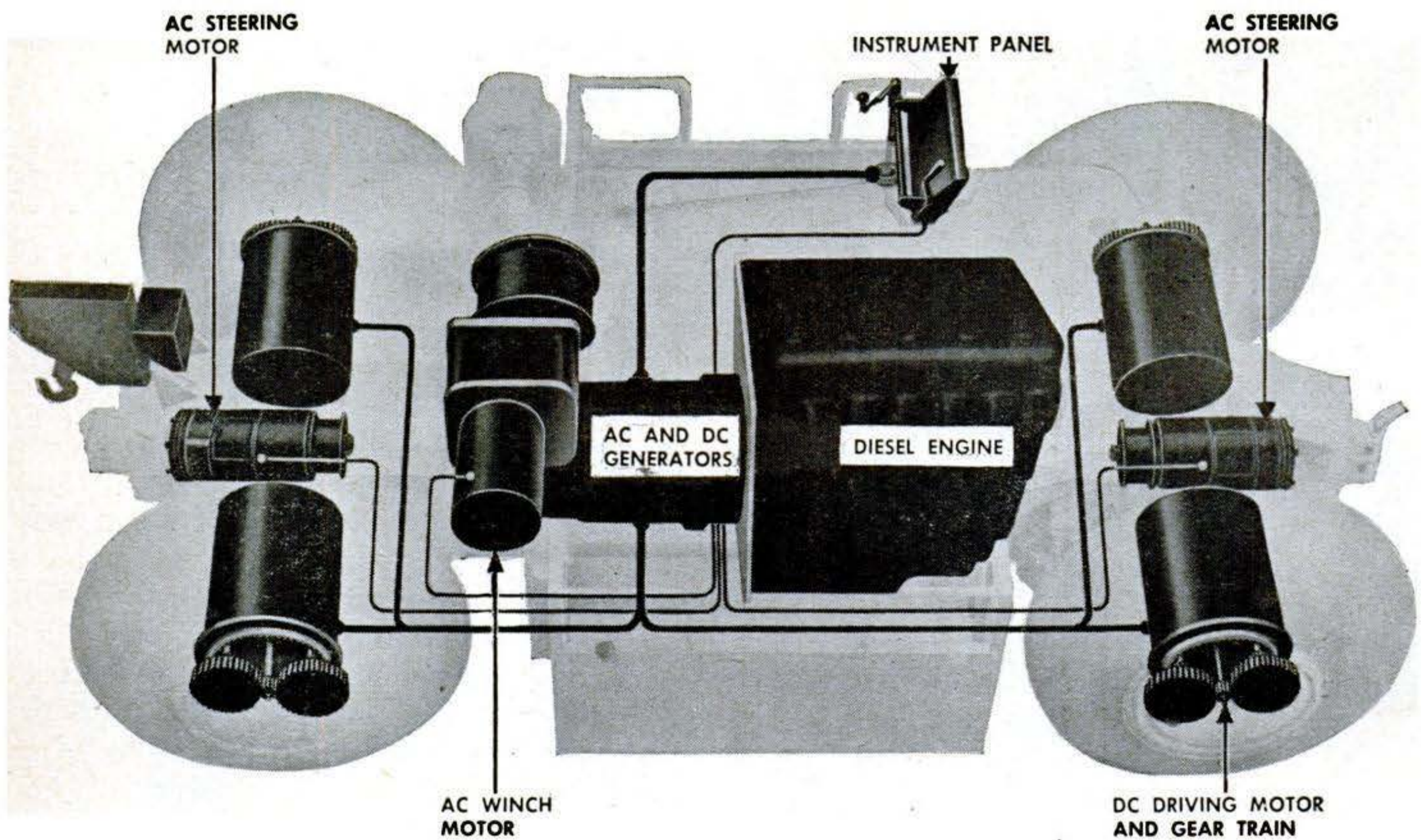

**On-the-job power units** eliminate usual mechanical, hydraulic, or pneumatic linkages between engine and wheels. Two generators—DC for main driving motors and brakes, AC for

steering and winch—are mounted in line with Diesel engine, and power is distributed direct to point of application through cables. Engine also runs an air compressor for accessories.

**11-ton prime mover drives like a streetcar,  
turns like a fire engine, and can tow 16  
times its weight in airplanes.**

Tournatow shows, at left, how it can be used to spot railroad cars in a switch yard. Less than 6 ft. high, the tractor was built low for work around and under large aircraft on the ground. In recent demonstration for Air Force it easily maneuvered a 200-ton plane about runways at Wright Field. Tires are standard aircraft 56-inchers; wheels are identical.

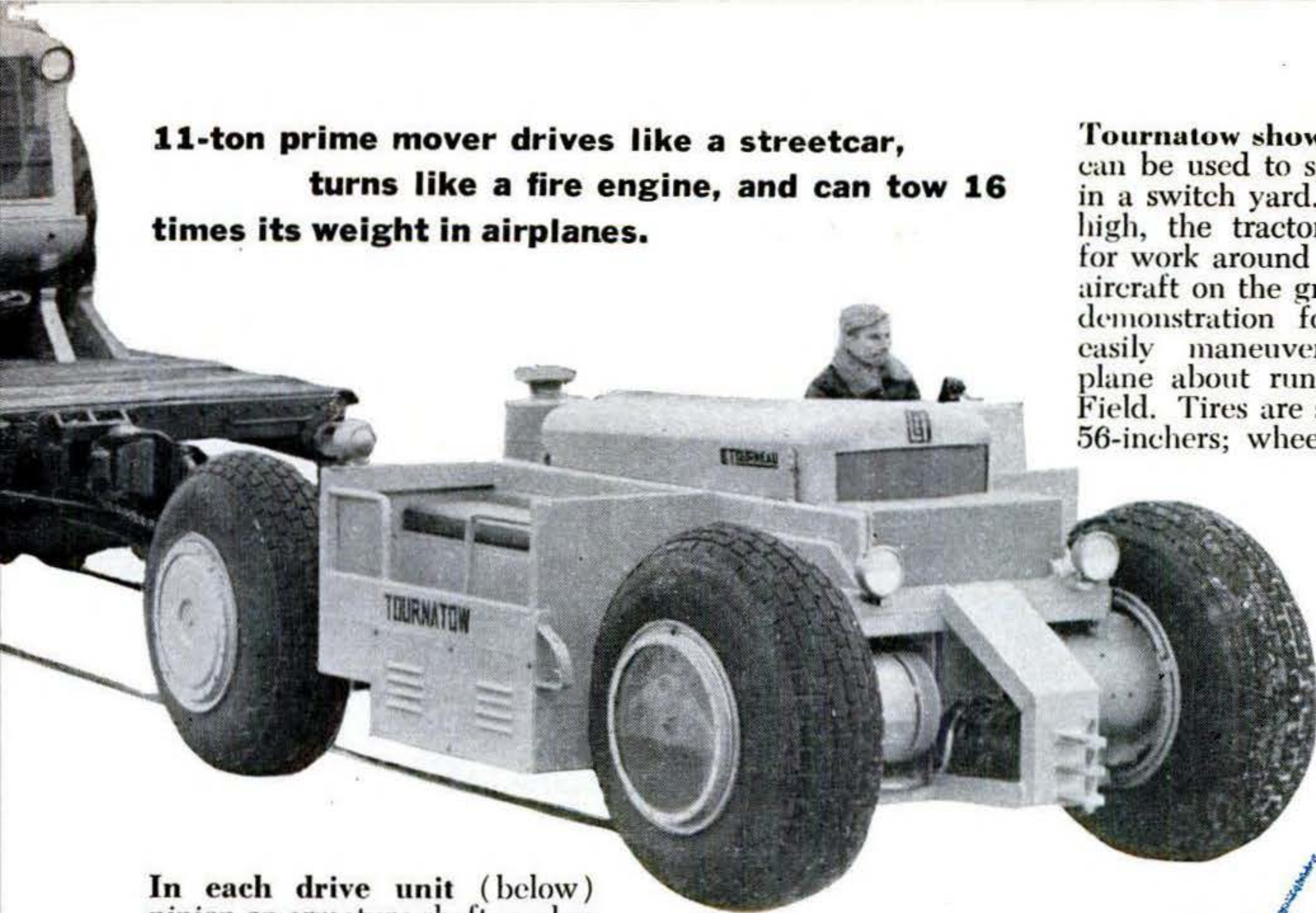

In each drive unit (below) pinion on armature shaft meshes with reduction gears, which rotate ring gear bolted to wheel.

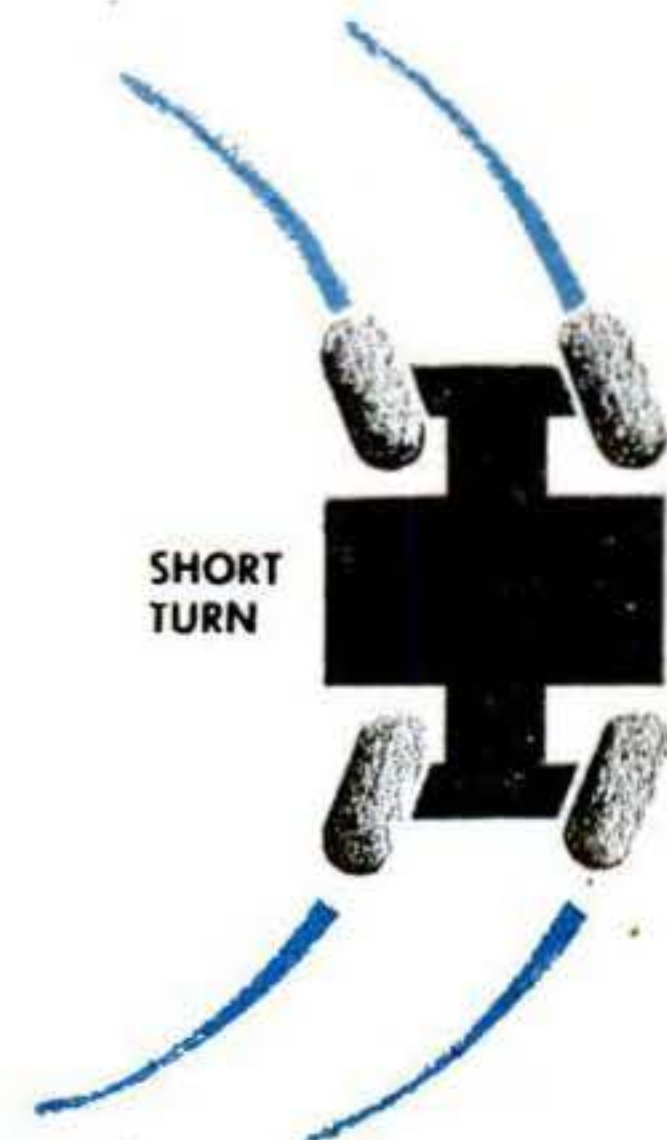
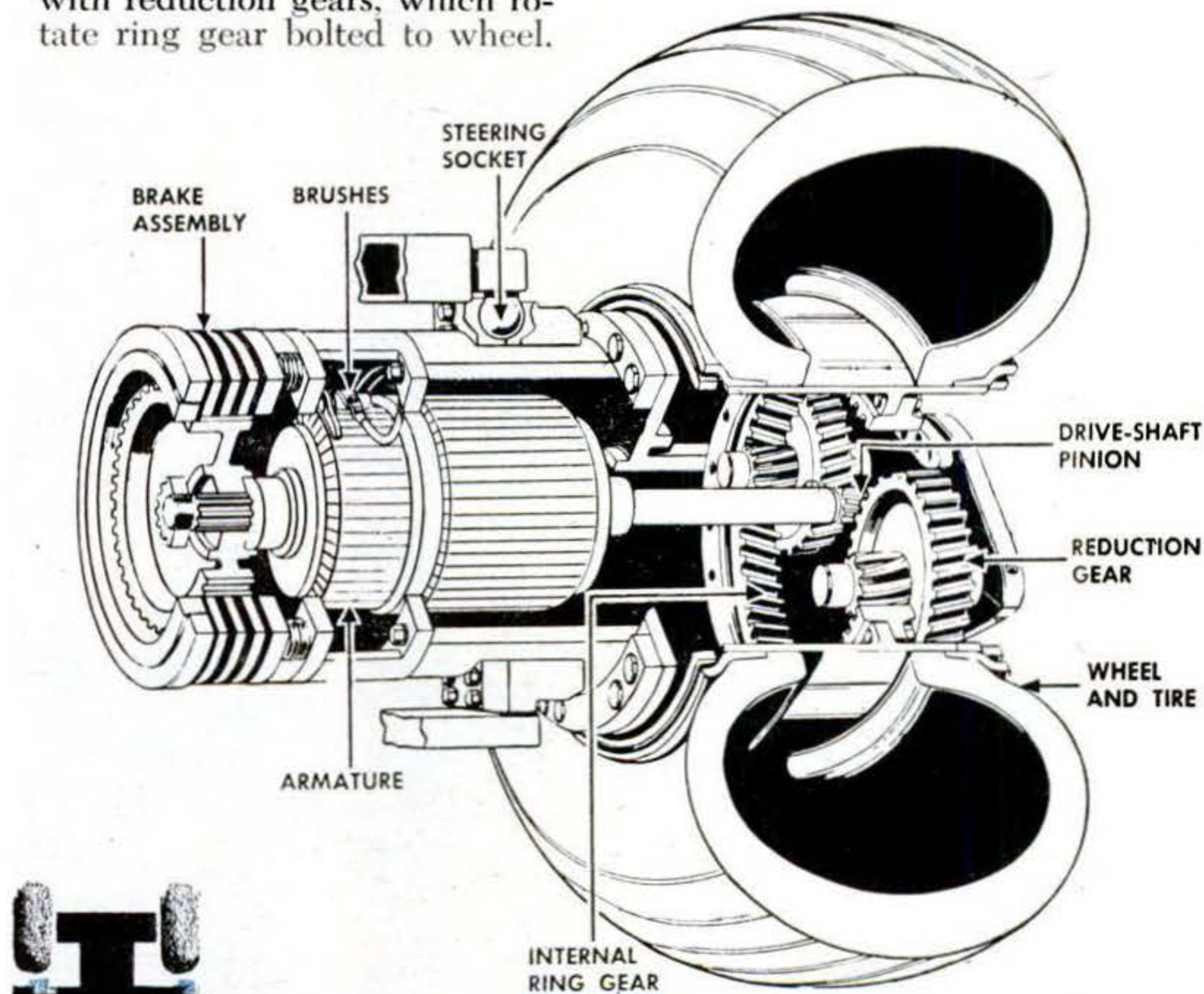

For four-wheel steering, each wheel is suspended on ball-and-socket bearing. As example of its maneuverability, 17-foot tractor turns in radius of less than 14 feet.

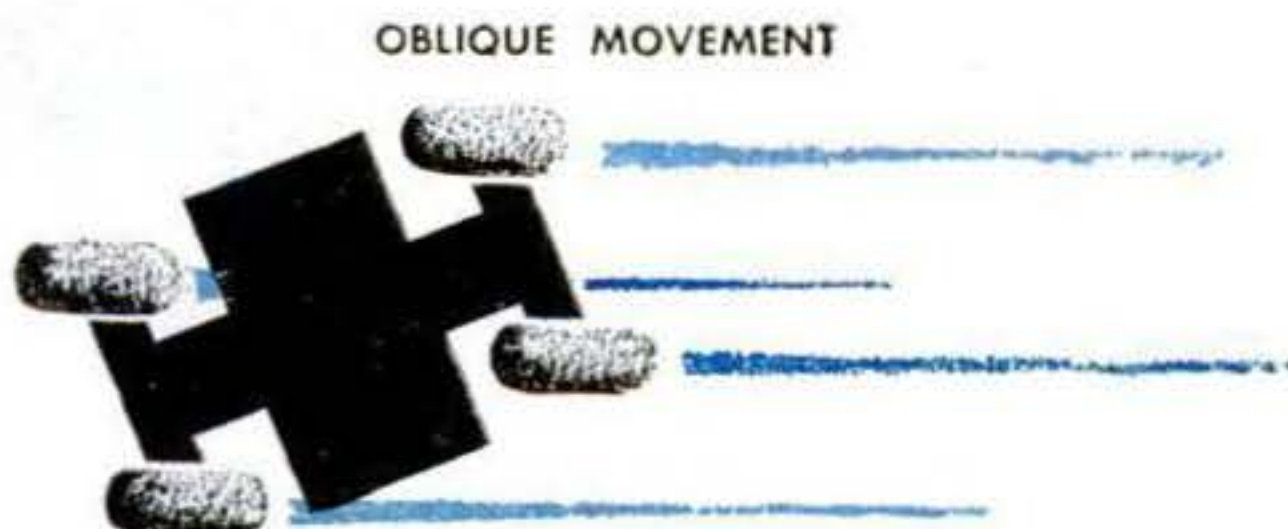

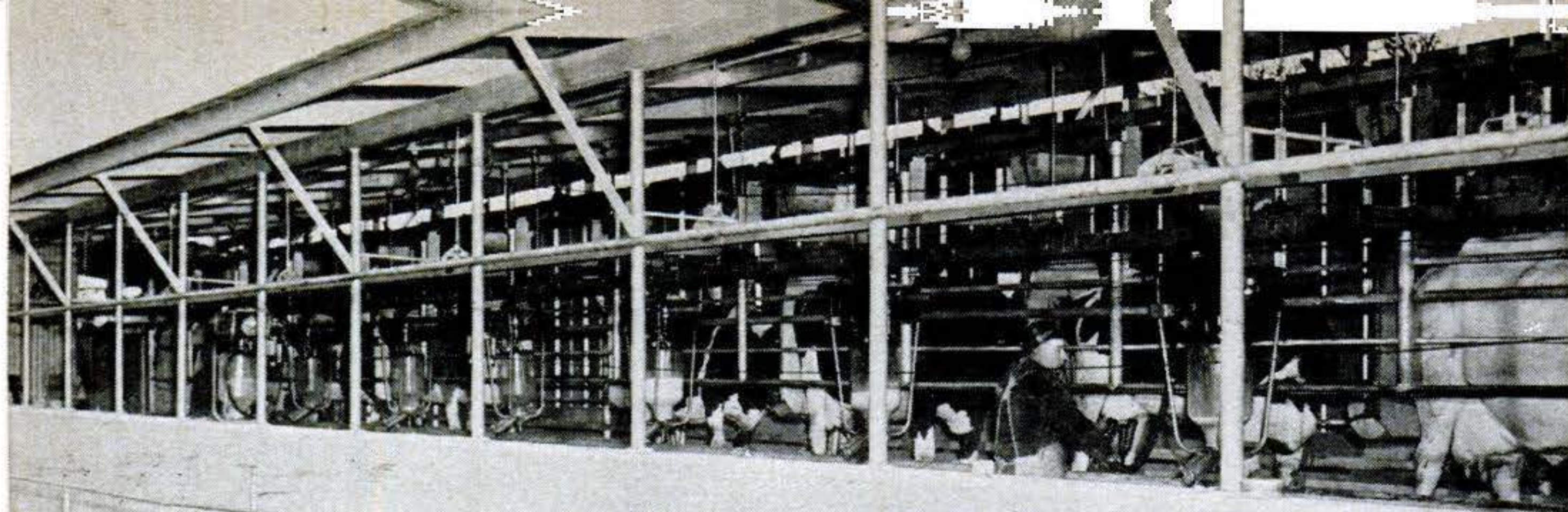

## Cow Conveyer Milks, Feeds, 100 an Hour

Ten at a time, cows move slowly down 100-ft. automatic milking conveyer at 15 ft. a minute.

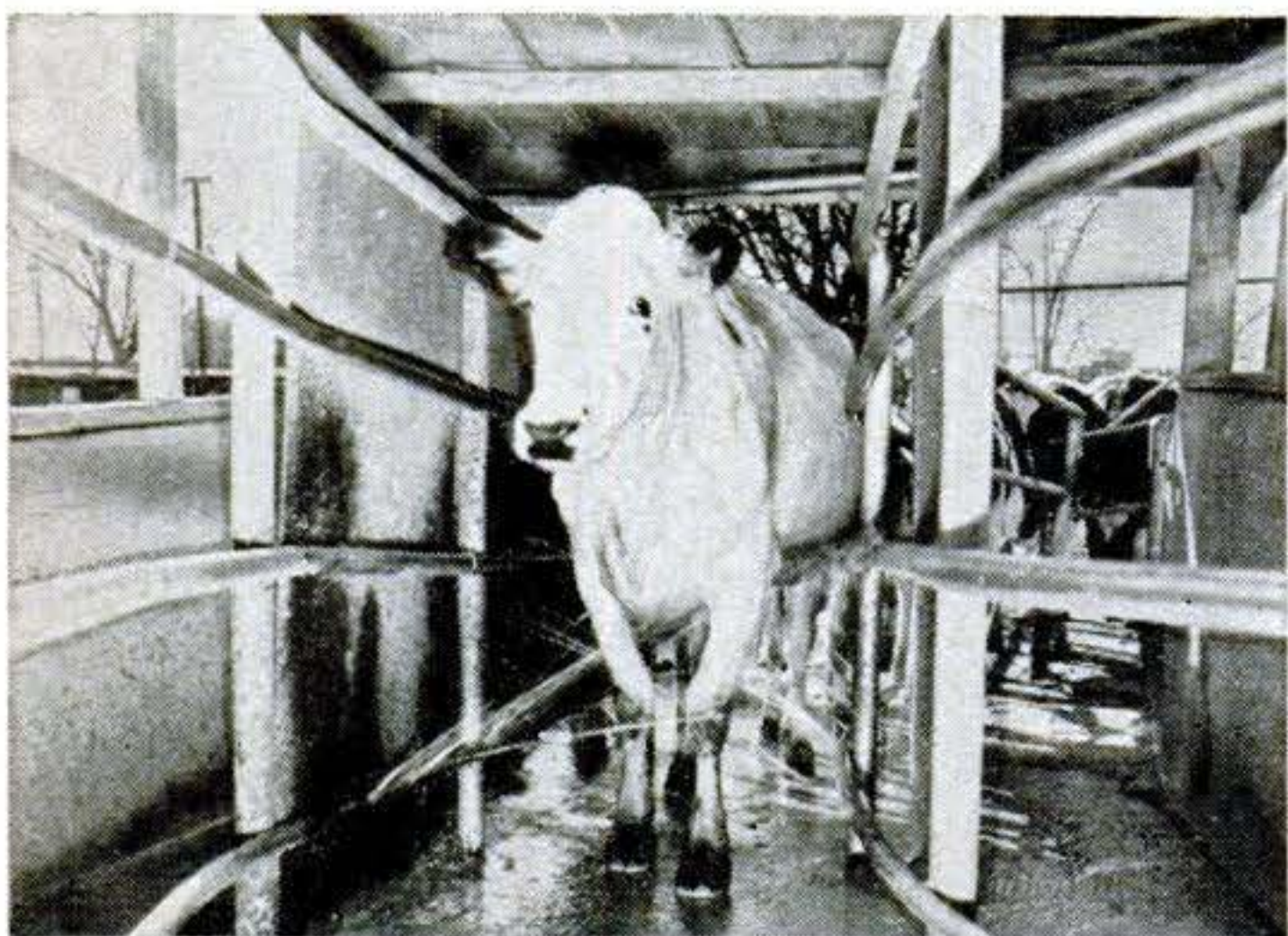

Waiting for their turn, cows queue up in single file at conveyer entrance. As each one moves up, it passes through cool-water spray from jets that washes dirt from underside of body.

**C**OWS get everything but a shave and a haircut in an automatic milking assembly line at Delano, Calif., shown above. First they get a cool bath to wash them, then a warm one to stimulate milk flow. Next, as they ride down a 100-foot moving conveyer, they munch a meal from feed troughs while vacuum pumps remove their milk.

The conveyer holds 10 cows at a time and turns out a contented one every 36 seconds. Invented by Harry Cain for Hiatt's Crystal Dairy, it requires only two attendants, one to attach the vacuum cups and one to remove them, and will handle 100 cows in less than an hour—about six times faster than two milkers working by hand.

*Photos from Southern California Edison Co.*

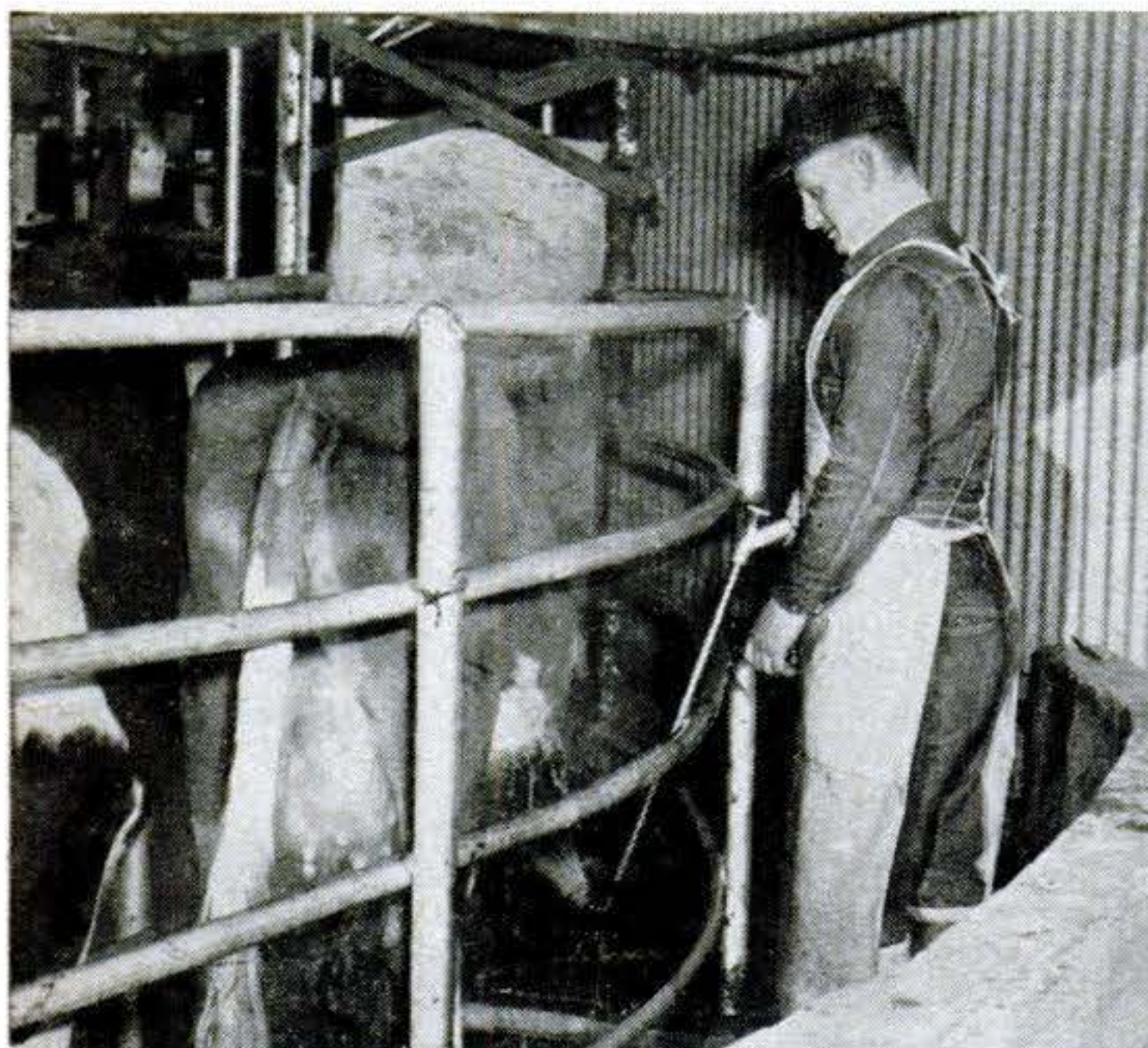

As cow enters conveyer, warm spray from up-turned jets relaxes udder and stimulates milk flow. Door containing feed trough swings down automatically to form stall and provide meal.

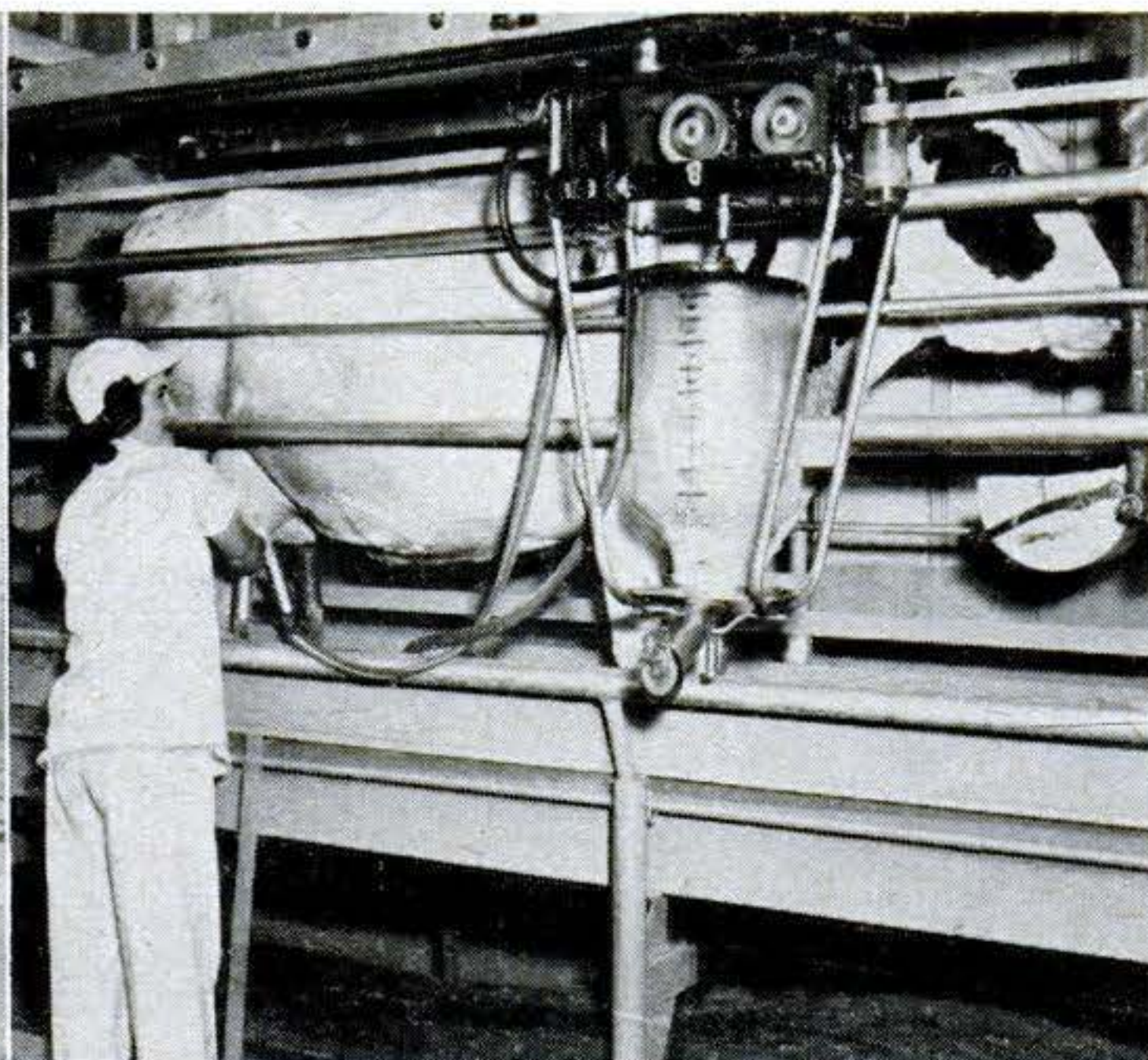

Vacuum milking machine and 5-gal. collecting jug ride rail alongside of cow, keeping pace with conveyer. At end of line, circular return rail carries machine back to starting point.



### Ring Cleats Prevent Football Spills

THE ring on the sole of the football shoe at left in the photo above is a new cleat to replace the conventional spikes shown at right. Developed at the Cornell Aeronautical Labs for the Wilson Sporting Goods Co., the self-cleaning cleat is said to prevent injuries to players from spills caused by regular cleats sticking into the ground while making fast turns.



### Safety Gloves Reflect Headlights

BY DAY, Glo-Gloves are a pair of well-tailored dress gloves in capeskin, pigskin, or calf. By night, they become a useful safety aid for a driver to signal stops and turns. The back surface of the glove is made of Scotchlite, a reflective fabric that shines brightly in the light of auto headlights two blocks behind. Glo-Glov Co., Chicago, prices the gloves at \$4.95 and up.



### Navy Develops First Automatic Pilot for Helicopters

THAT smile from a Navy helicopter pilot (above) signals success in a test of the first automatic pilot developed for the flying windmills. With both his hands off the stick, the 'copter hovers steadily 5 feet above the field. All forward, lateral, and

stabilizing controls are handled by a hook-up of five gyroscopes and parts from standard airplane auto pilots. The device was designed by engineers of the Naval Air Experimental Station, Philadelphia, who are now adding altitude and power controls.

# Not bomb wreckage—just pictures

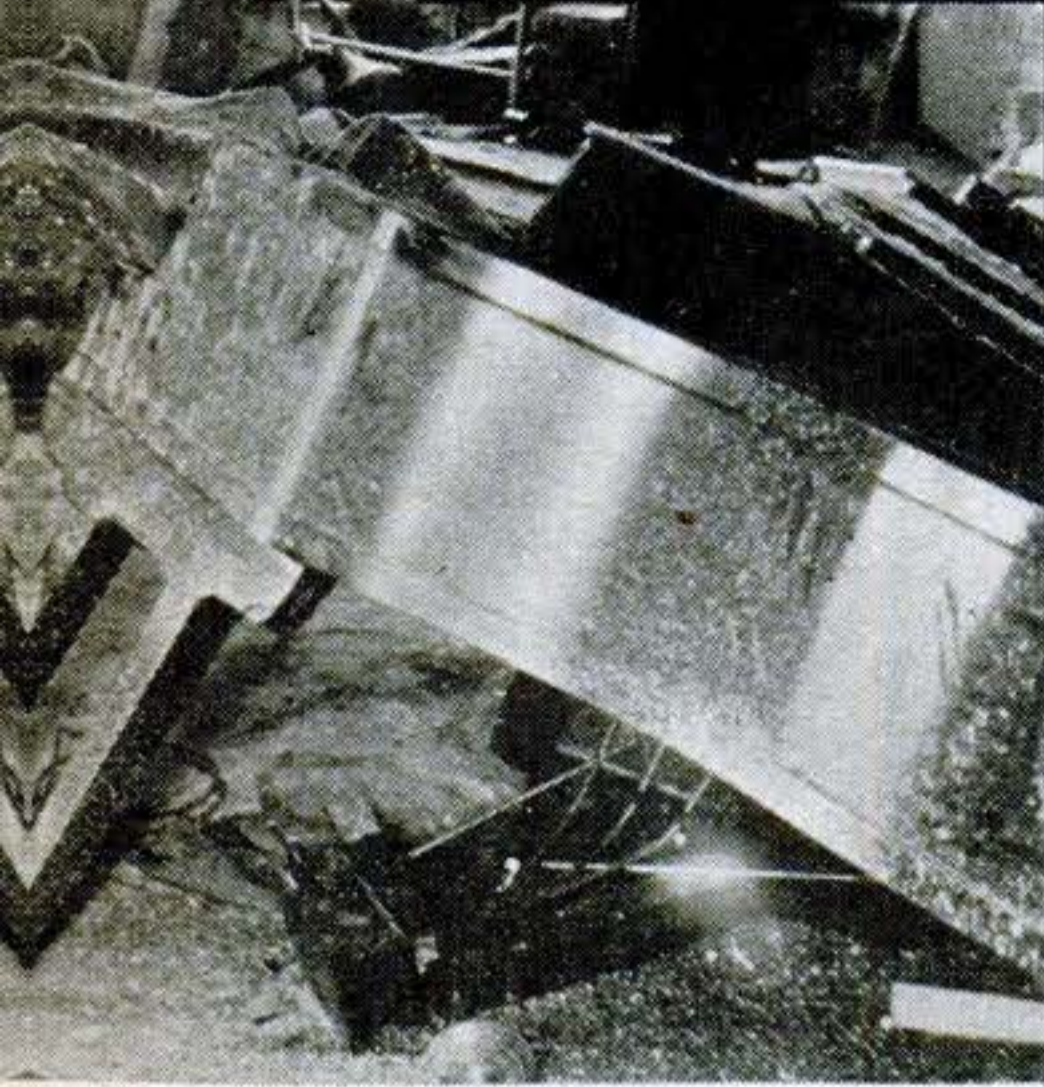

**Hot-water blast cost \$18,000 in Ohio home.**



**Someone left gas on after supper in church basement.**



**Overheated water tank wrecked brick house.**



**This was bathhouse in vets' housing project.**



**Investigators say missing tank had no safety valve.**



**Pennsylvania homeowner and ex-furnace.**

**In school below one died, 19 were hurt.**



156 POPULAR SCIENCE

**Arrow shows tank's path from cellar through roof.**



**Rest of this furnace stopped 3 floors up.**

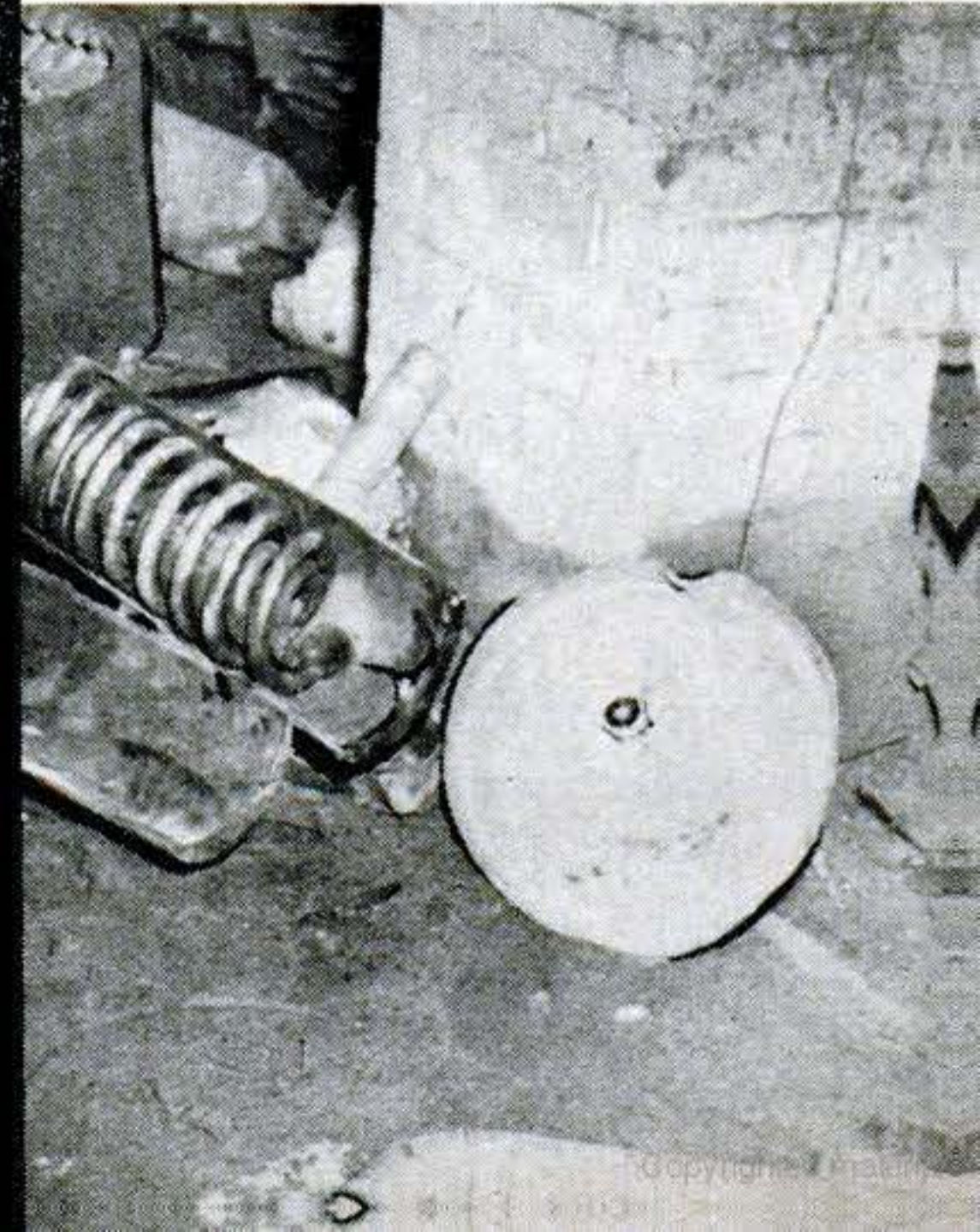

**proving that**

# Water Can Be Dynamite

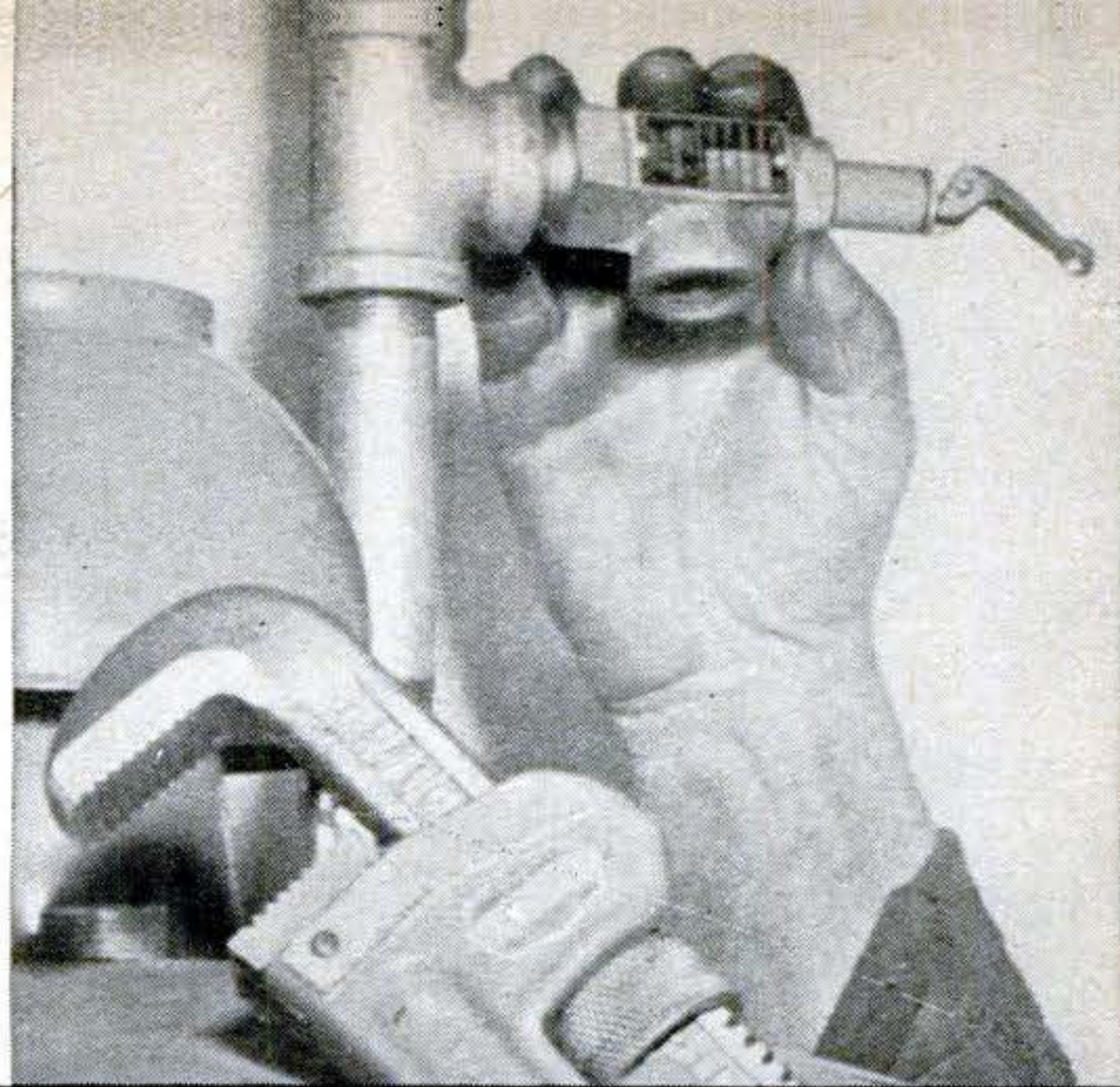

**..... But not if you do this**

**Even a 30-gal. storage tank can let go like a TNT blast unless protected against excess heat as well as pressure.**

**By William Gilman**

**DRAWINGS BY ELEANOR GILMAN**

**T**HAT harmless-looking hot-water tank down in the basement can become a live bomb quicker than you may think.

Its job is to furnish household water at around 150° F.—safely below the boiling point, yet plenty hot enough to handle dirty clothes and greasy dishes. The trouble comes when the setup doesn't have properly functioning brakes. Since water has to be under some pressure in order to flow from plumbing fixtures, it can be heated past its normal boiling point—without boiling. That's when even a modest 30-gallon tank can let go with more explosive energy than a charge of TNT.

It can happen with an apartment house boiler as quickly as with a cheap little hod-a-day pot stove or side-arm coil supplying a storage tank. The chief difference is that a cast-iron boiler flies apart like shrapnel while a steel tank is apt to soar like a rocket.

But such blasts can't happen when proper equipment is properly installed and maintained. In every case, the explosive material is what one engineer calls "water gone crazy with the heat." It's the flash into steam *after* pressure ruptures a tank or boiler that causes trouble. Sometimes, the pressure has been built up too high; other times—if the tank is old and weakened—even normal operating pressure is too great.

In either case, pressure sets the stage. The real villain is superheated water. Every

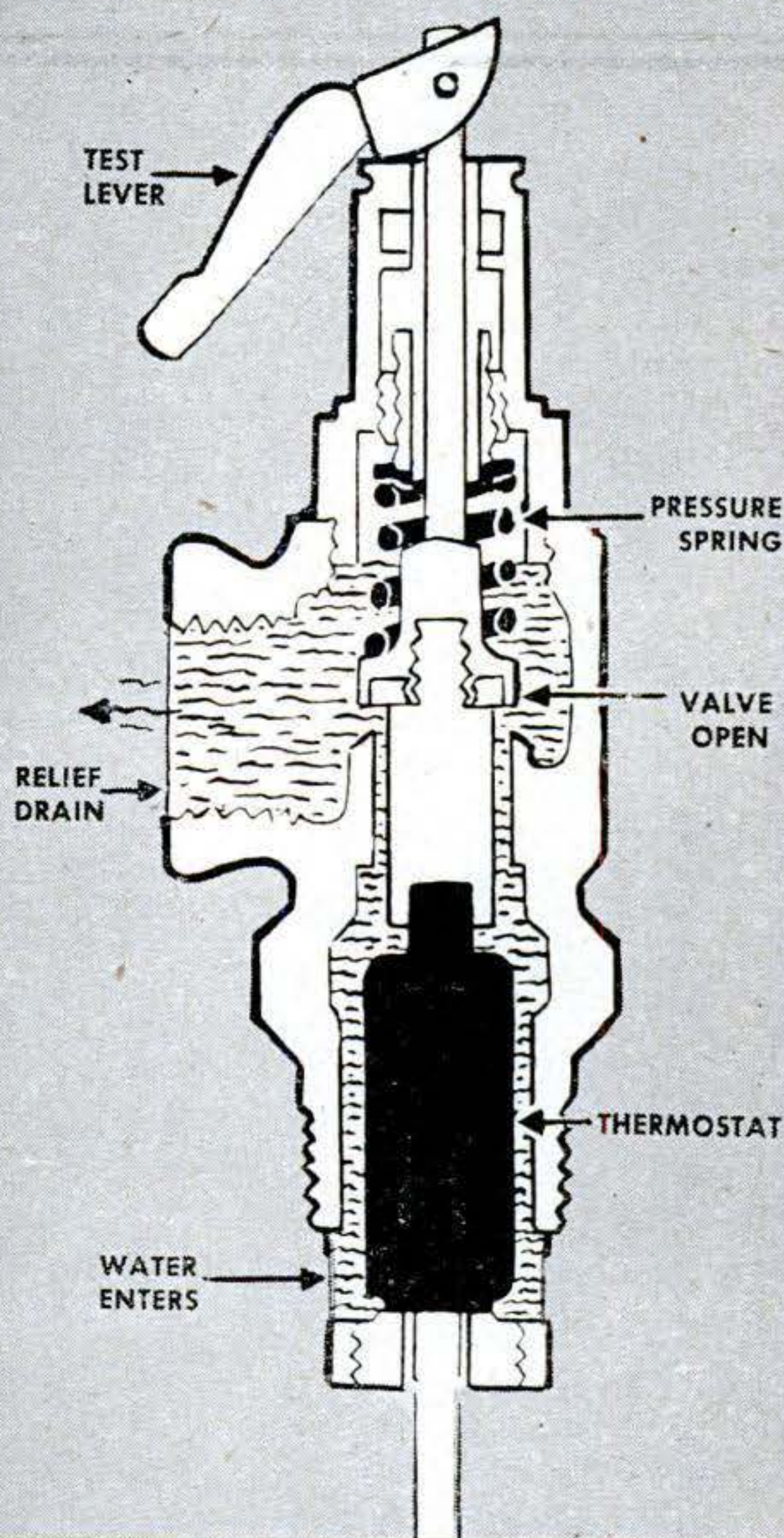

**Best insurance** against hot-water explosion is relief valve that responds to either excess pressure or temperature in tank. Photo at top shows plumber putting one into hot-water line from gas-fired heater. As shown in cutaway view, overheated water expands thermostat, lifting valve and letting water escape until temperature is brought down by cold water entering tank. Under dangerous pressure, water acts directly against spring to lift valve. Raising test lever makes sure valve is not stuck.

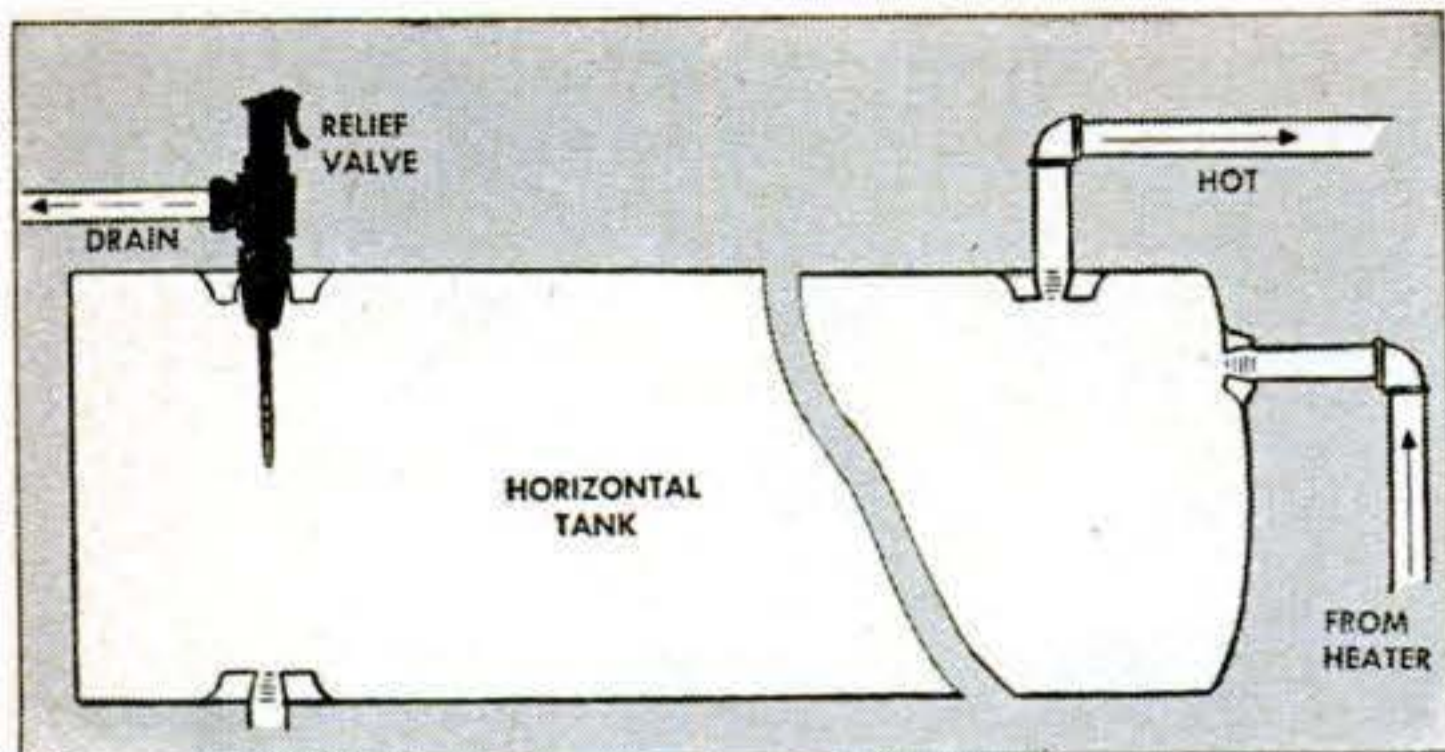

**Where to put temperature-pressure valve:** Horizontal storage tank usually has tapping into which valve can be installed as shown above. Automatic systems that both heat and store water vary in design; follow manufacturer's instructions. Sketch at right shows three approved locations for different types. In positions A and C thermostat needs tip extending into hottest water. In position B there must be no shutoff between tank and safety valve.

drop is waiting ominously for its chance to flash into normal steam. A break in the tank gives it that chance.

When blast experts are able to find enough pieces in the wreckage, they can almost always assign one of three causes to the accident.

1. The setup was a manual one. This isn't bad in itself, but whoever lit the heater fire forgot to turn it off. Like the family in a last-minute hurry to get started on a trip, or the careless baby-sitter.

2. The installation had automatic controls—but too much faith was placed in them.

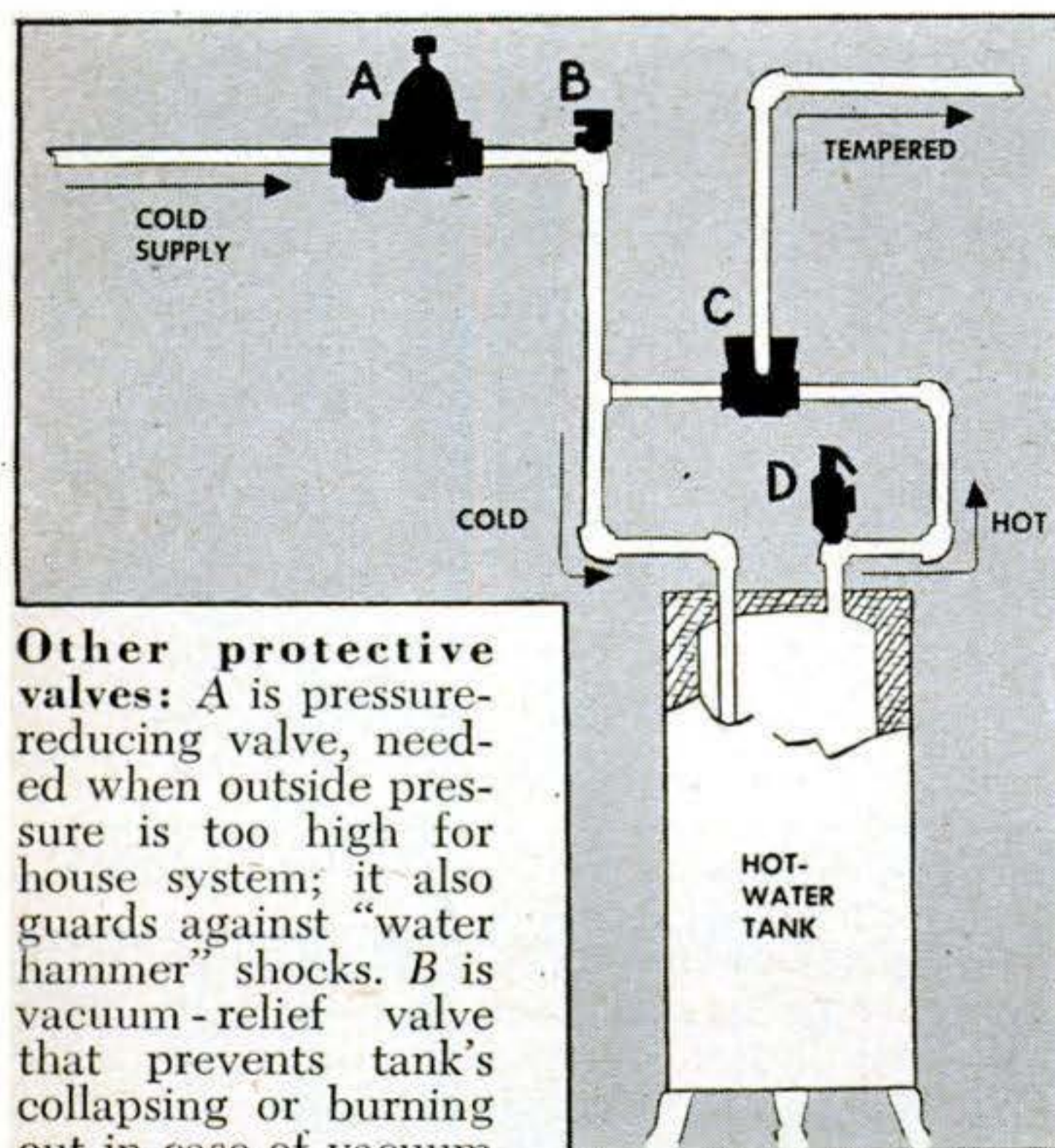

**Other protective valves:** A is pressure-reducing valve, needed when outside pressure is too high for house system; it also guards against "water hammer" shocks. B is vacuum-relief valve that prevents tank's collapsing or burning out in case of vacuum condition that can siphon water from heater. C is tempering valve that guards against scalding water reaching faucets. D is standard temperature-pressure relief valve described earlier.

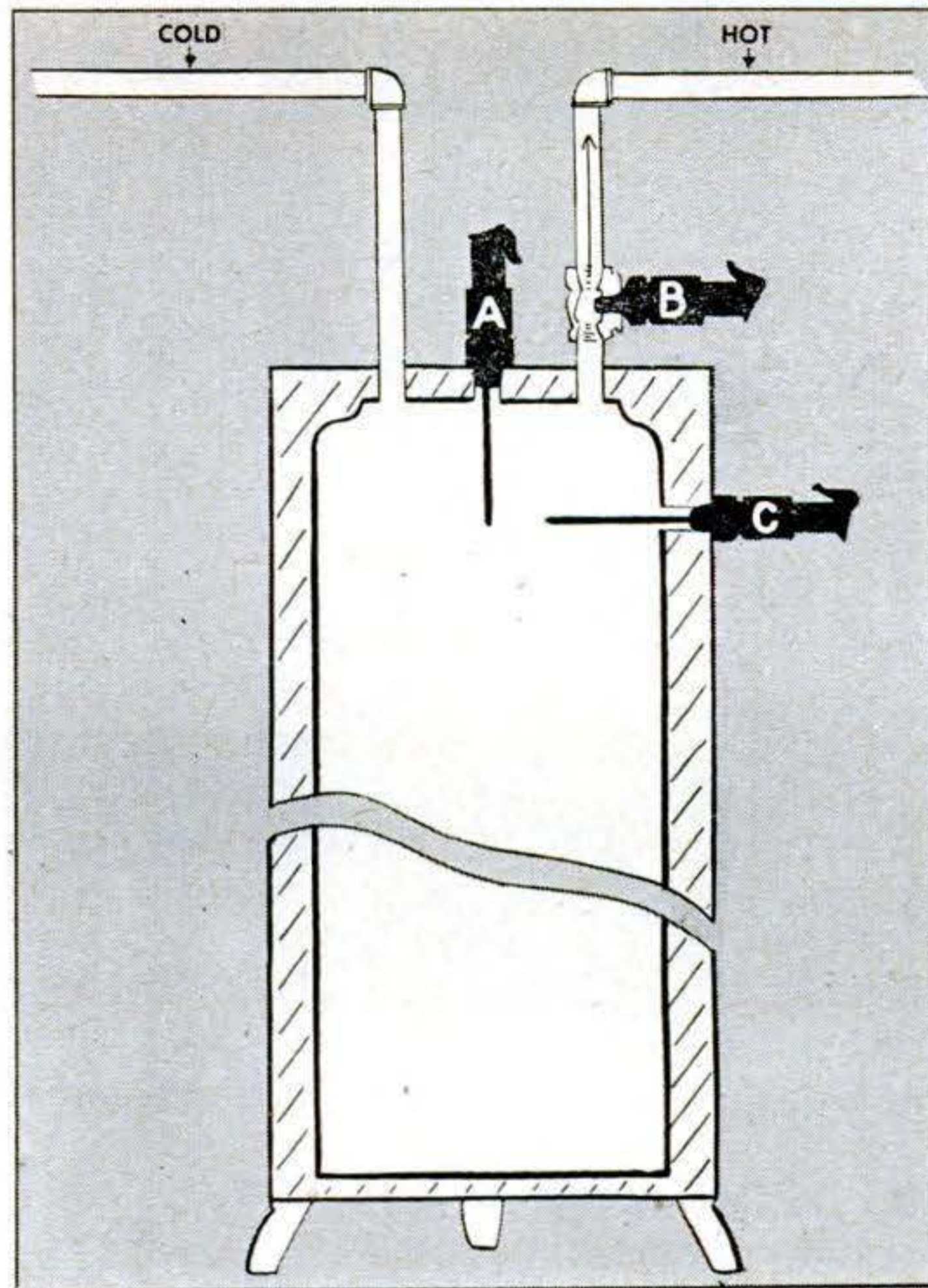

Mechanical robots are fine, but need periodic checking.

3. Or it might have just been what engineers of the Hartford Steam Boiler Inspection and Insurance Company—oldest company of its kind in the country—call a plain "goofy" setup. Like installing a check valve between the tank and its relief valve. Or plugging the relief valve to stop its leaking. Such tinkering, obviously, makes a safety valve a useless ornament.

### "Hot-Water" Earthquake

There's the case of the policeman who phoned headquarters that there had just been an earthquake. The shock came from a hot-water blast four blocks away, which caused \$10,000 damage to neighboring buildings. It all started with a dripping hot-water faucet in a hamburger stand. To save water, when he locked up at night the proprietor shut off the cold-water line to the automatic gas heater serving a 20-gallon tank. That was blunder No. 1.

No. 2 was the fact that the setup had no safety valve. And as pressure of the heating water increased, it couldn't get relief by bucking up into that closed cold-water line.

To be sure, the heater had an automatic fuel control. It *should* have shut off the gas when the water got too hot. But this thermo-



stat happened to be gummed up. So the fire kept on going, and the tank finally burst.

For every blast, there must be the two ingredients—failure of the tank under pressure, and explosive energy built up when the water gets too hot. It's usual to think only in terms of pressure. By itself, excess pressure will damage a tank and cause a watery mess in the basement. But for a real hot-water blast, the water has to be past its atmospheric boiling point.

To prove this, a dozen ordinary hot-water heating tanks were blown to bits in a hayfield near Doylestown, Pa., while a couple of hundred plumbing experts and boiler inspectors watched from a safe distance.

High spot of the bombing came with the eruption of a typical 30-gallon steel tank inside a small house. Its pressure just before the blast was 80 pounds, which is a normal safety-valve setting for a good flow of water from upstairs faucets. But the water had built up to 290°—78° above its normal boiling point.

#### **Tanks Are Urged to Explode**

To highlight the lesson, cooler water in two similar tanks was safely built up to 200-pound pressure. When nothing happened, each was urged to explode by giving it a water-hammer effect—an abrupt jolt of pressure. A rifle bullet was shot into one. With the other, an engineer just stepped up and split the tank with a sledge.

Neither tank exploded—just a gush of water rushed out through the breaks.

The Doylestown tests were staged by the Watts Regulator Company, a Massachusetts firm pioneering in safety devices, to prove that ordinary pressure-relief valves—though still a *must*—should be backed up by a temperature-sensitive safety device in case the pressure valve can't handle the situation.

What's needed is a combined temperature-pressure relief valve. The Watts patent on such "T-P" valves has now expired and many firms make them. Some have a fusible plug that lets go when water gets too hot. Latest types work on the thermostatic principle to open the valve.

After a dime-store blast 20 years ago that injured 50 persons and killed five, Washington, D. C., became the nation's first municipality to insert a temperature-control requirement in its building code. A number of other states and cities, aware of water's dynamite power, have followed suit.

The ordinary home-owner can take a les-

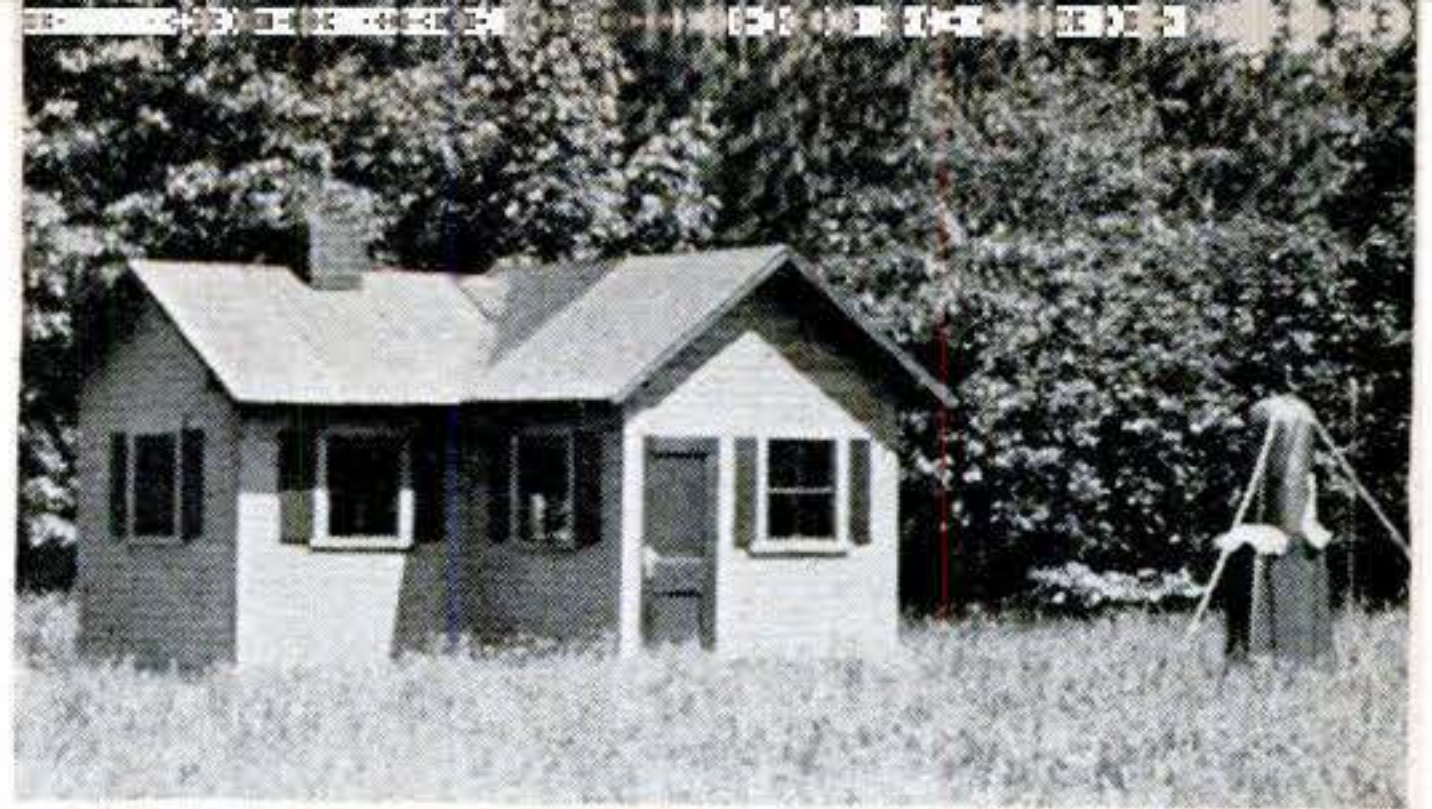

**In demonstration of water explosion, tanks in and outside a frame building at Doylestown, Pa., were subjected to varying heat and pressure.**

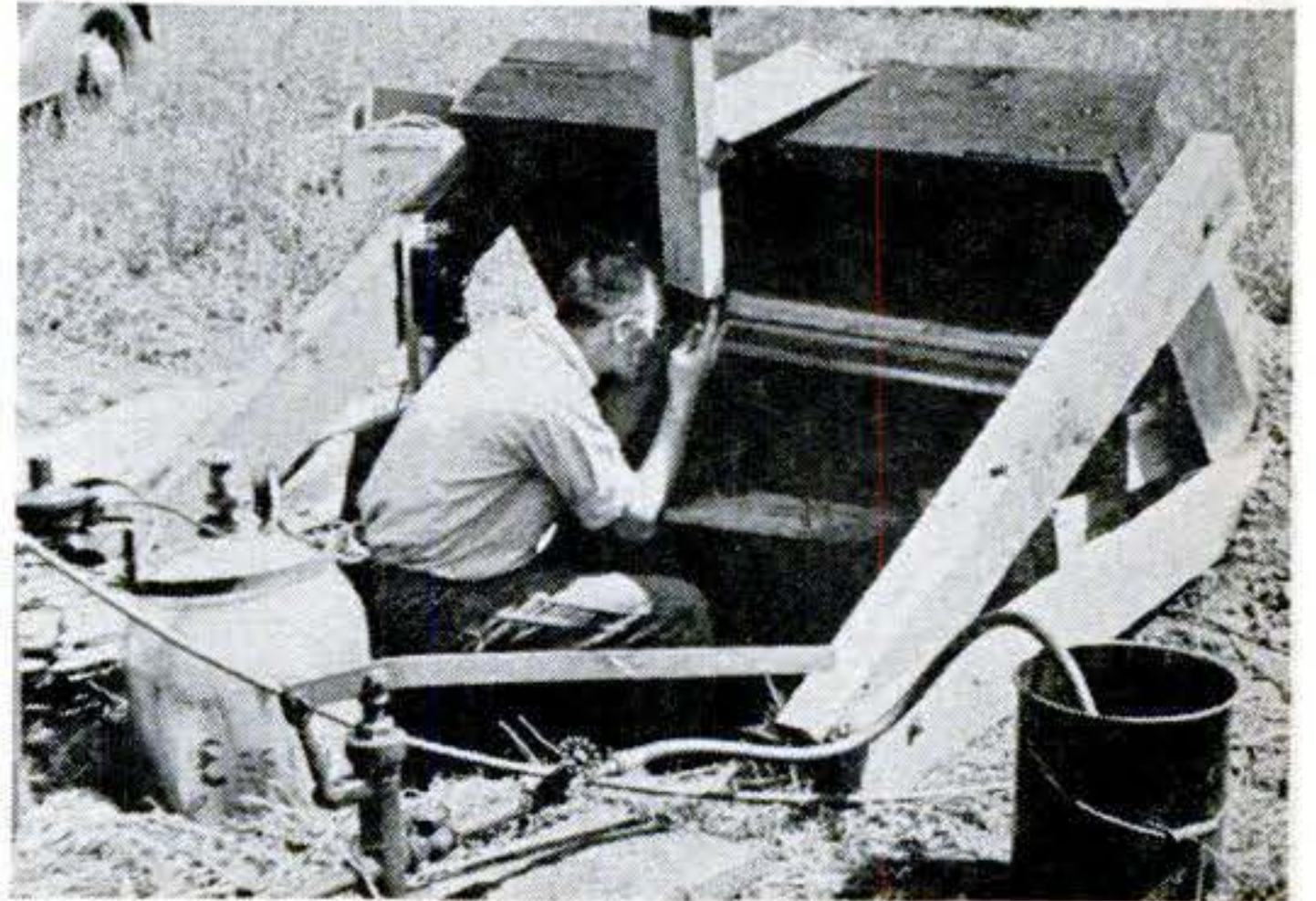

**From protected pit engineer regulates heat and pressure of water and watches remote-registering gauges as explosive force builds up in tank.**



**Building is blasted to kindling as overheated water hurls shell of storage tank 400 feet into the air and 100 yards across country.**



**Here are remains of 30-gal. tank in which water under only 80 lb. pressure was heated to 290° F.—78° over normal boiling point.**

son from industrial plants, which regularly inspect high-pressure equipment. Actually, say engineers, there's too much false security with "low-pressure" hot-water systems in residences. "Low-pressure" means simply that that's all they're built to stand. Four-fifths of the claims paid by a typical insurance company result from accidents with low-pressure equipment.

Every setup has its own pressure limit. Fifteen pounds may not be too much for a hot-water heater tested at 250 pounds and intended to operate at around 50, but it's the recommended limit for the usual low-pressure steam boiler made of cast iron. And when the low pressure becomes high—if a valve sticks, or aquastat fails, or water gauge goes haywire—something has to let go. Pressure below the rated limit may still be excessive for a particular tank—old, corroded, or weakened by past overheating.

Anything that relieves excess pressure is to the good. That's why an open system—like water gravity-fed from a spring—is generally safe because water can back up the line. But it isn't foolproof. Sediment or freezing might block the line.

Some explosions have been innocently caused by a town's desire to protect meters from overheated water backing up into them. Check valves to protect the meters also block the escape of overheated water.

#### **Best Protection Is Good Equipment**

The best protection is making sure you have good equipment installed by a plumber who knows what he's doing—and by checking it every few months. You can't just walk away and leave it. A reliable heater comes with an operating manual. If you follow instructions, you can put the heater through its paces to check.

That thermostatic valve is going on and off many times a day. By contrast, a pressure-relief valve just sits on the line waiting month after month for an emergency. To keep in trim, this robot needs exercise. Long idleness, sediment, or corrosion may cause it to get stuck. That's why its test lever should be operated every few months. If your valve is an older type, the spring can be pushed back with a knife to imitate excess pressure. If it squirts, it's okay.

The last warning—if you're lucky—comes when you turn on the hot water and get boiling water or steam. Better get the situation cured in a hurry, because you're playing with dynamite. END

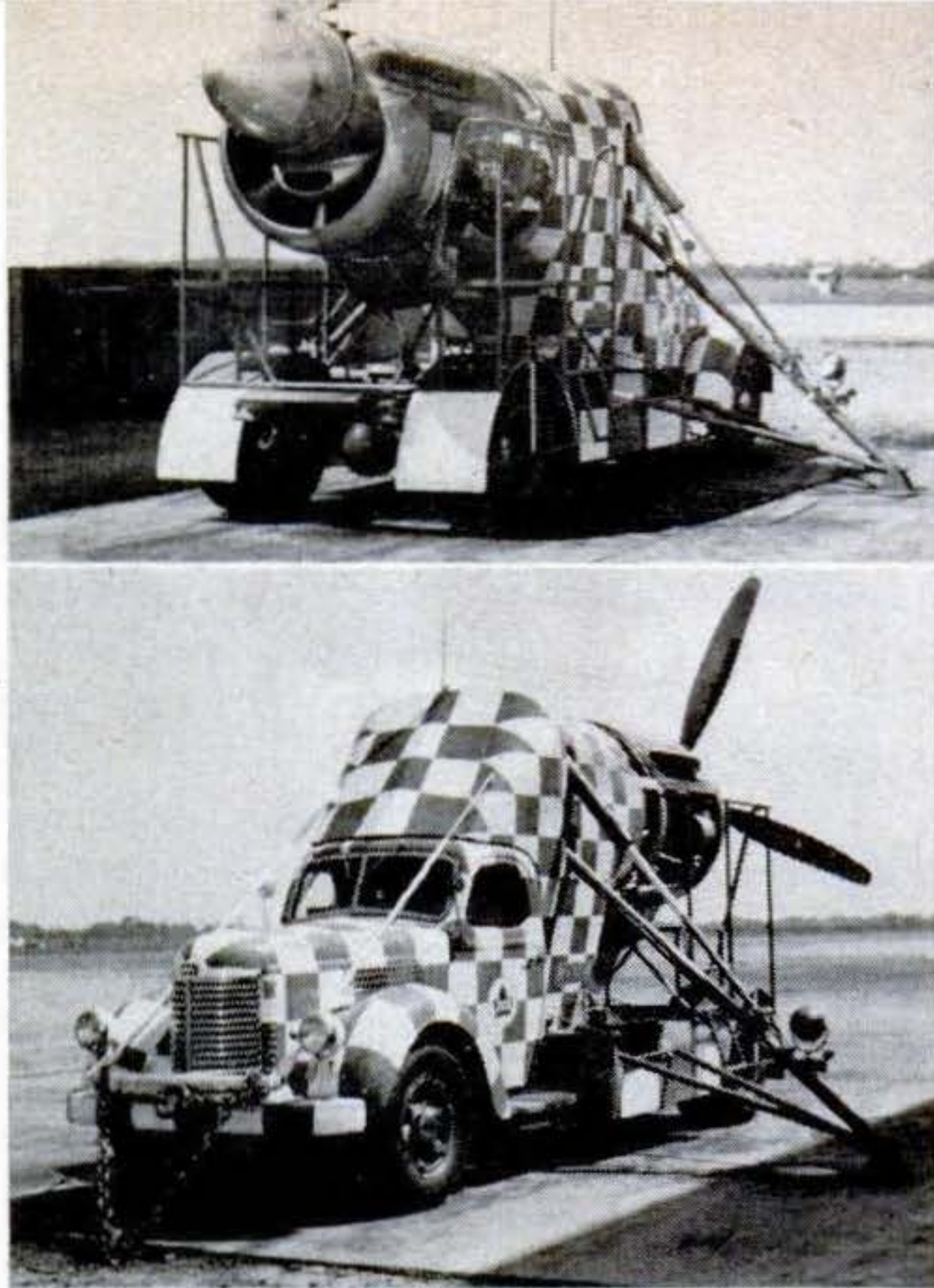

#### **What Is It—Plane or Truck?**

THE strange-looking contraption shown above is a mobile unit for testing airplane engines and props before installation aboard transports of the Trans-Canada Air Lines. A steel frame built on a three-ton truck holds the engine, which is controlled from the truck cab. The unit is prevented from moving forward by chains running to tie-down rings in the ground. Hydraulic spider legs absorb torque and stabilize truck during tests.

#### **Oversize Bandage Covers Big Burns**



DEVELOPED by the Army Medical Corps, these new oversized dressings are for burns and wounds covering large skin areas. A layer of highly absorbent gauze protects the injury, while a nonabsorbent outer layer prevents the entry of bacteria. Dressings may be worn as long as two weeks instead of requiring frequent changes. To prevent contamination, bandage is packed in a sealed plastic bag.



Much fine glassware is still handmade by expert craftsmen, as it has been for centuries.

# How Your Glassware Is Made

**By George H. Waltz, Jr.**

**T**WO opposite extremes in manufacturing—meticulous handwork by skilled craftsmen and high-speed mass production performed by automatic machines—provide the wide variety of household glassware we use each day.

Up until 1903, all types of table glassware, ranging from tumblers to vases, were either hand-pressed or hand-blown by master artisans. Then came what is considered to be the greatest single advance in the 5,000-year history of glassmaking—the perfection of an automatic glass-blowing machine that put glassmaking on the production line.

As early as 1889, the idea for a mechanical glass blower began to form in the mind

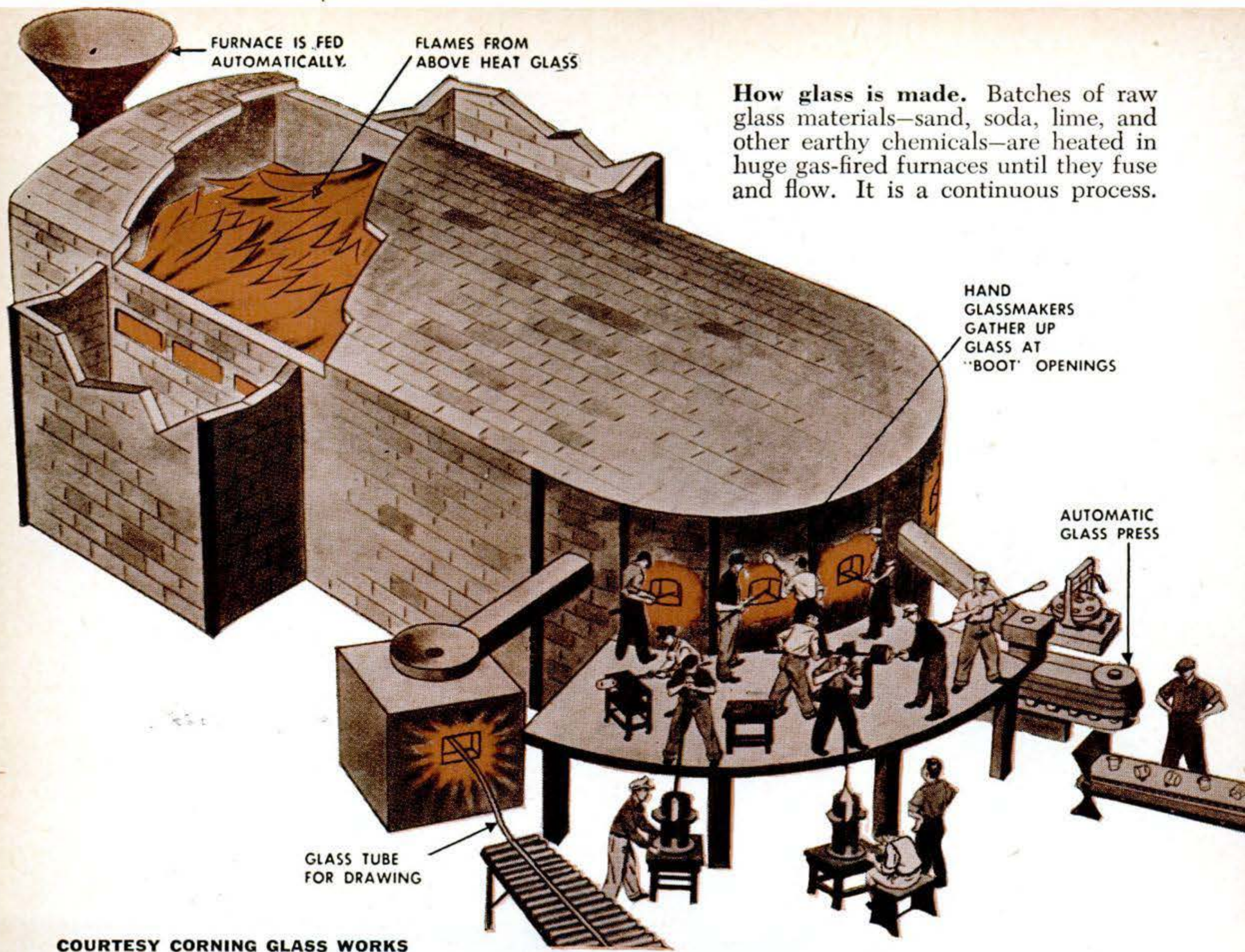

**How glass is made.** Batches of raw glass materials—sand, soda, lime, and other earthy chemicals—are heated in huge gas-fired furnaces until they fuse and flow. It is a continuous process.

COURTESY CORNING GLASS WORKS

**3** Periodic reheating in a small furnace called the “glory hole” is necessary to keep the glass at just the right temperature for working. The base of the vase, with its decorative ribs of glass, is now complete.

**4** A pontil (pronounced “punty”), which is a steel rod with a serrated tip, next is attached to the completed base of the vase with a tiny glob of molten glass. The top of the vase then is cut away from the blowing tube.

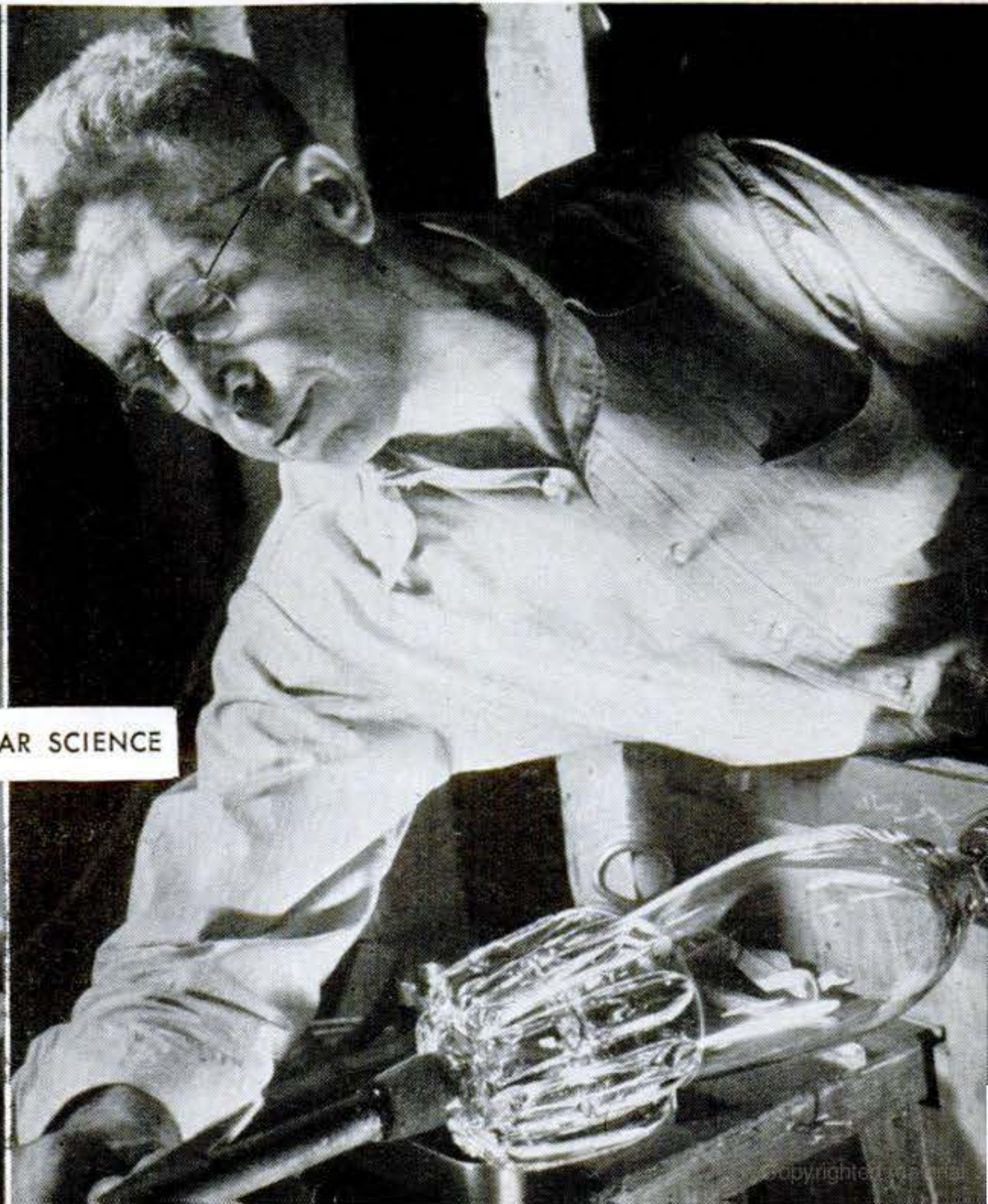
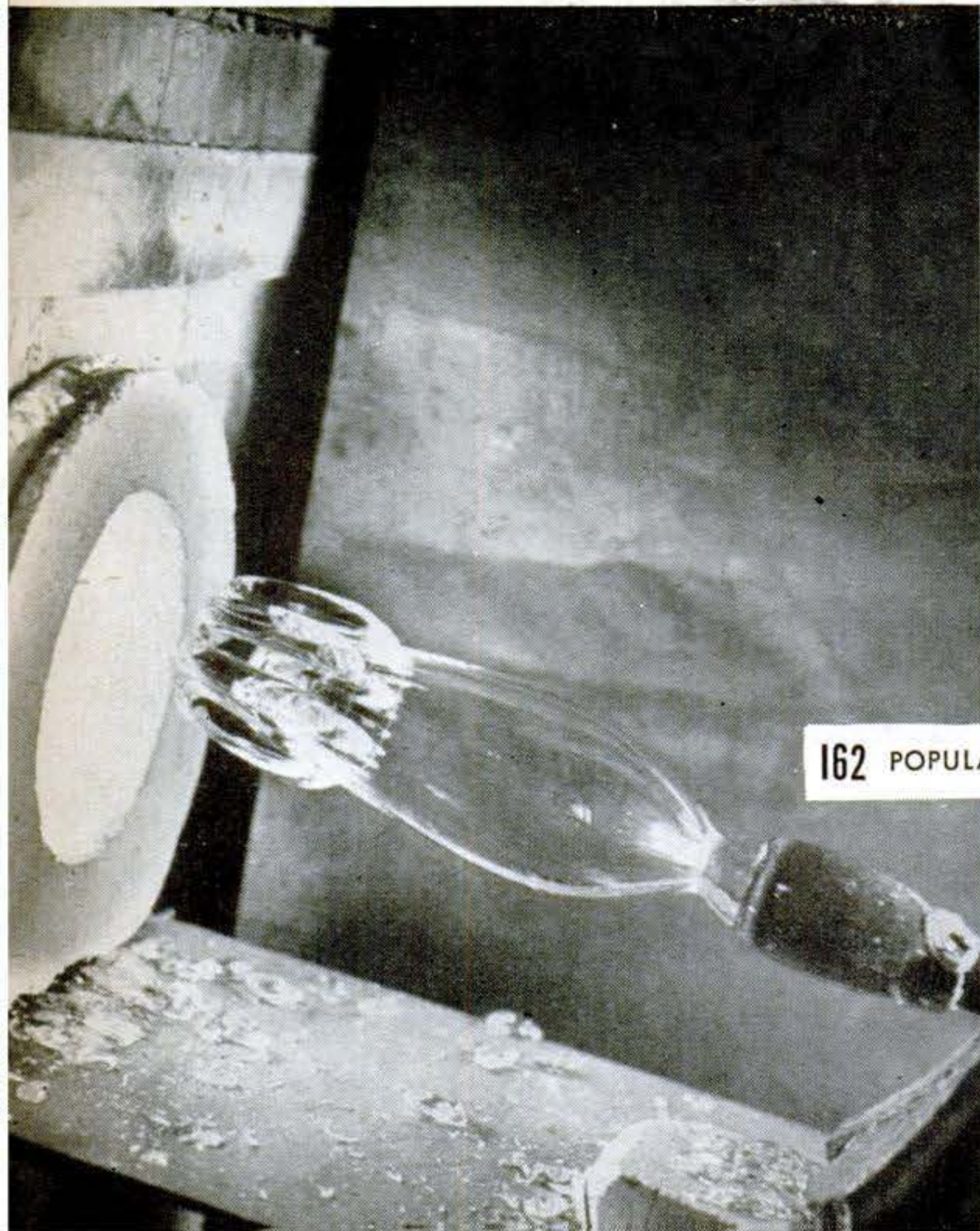



**1** Glassmakers work in teams. A "gather," or glob of glass, first is dipped up from the tank on the end of a blow tube by a man called a "gatherer." The "serviter," No. 2 man on the team, blows it into its basic shape.



**2** The master glass blower, known in the glass shop as the "gaffer," then takes over. In the case of this vase, his first job is to apply decorations in the form of glass brought to him by another assistant, the "bit gatherer."

**5** A "wood-jack," a tweezerlike tool with apple-wood tips, then is used to shape the flair of the vase. Because the wood tips burn away when brought in contact with the hot glass, they must be replaced frequently.

**6** The finished vase, after careful and slow cooling on an endless belt that travels through an annealing oven or "lehr." The annealing process takes 5 to 8 hours. These photos were made at the Steuben Glass Works.



FEBRUARY 1951 163

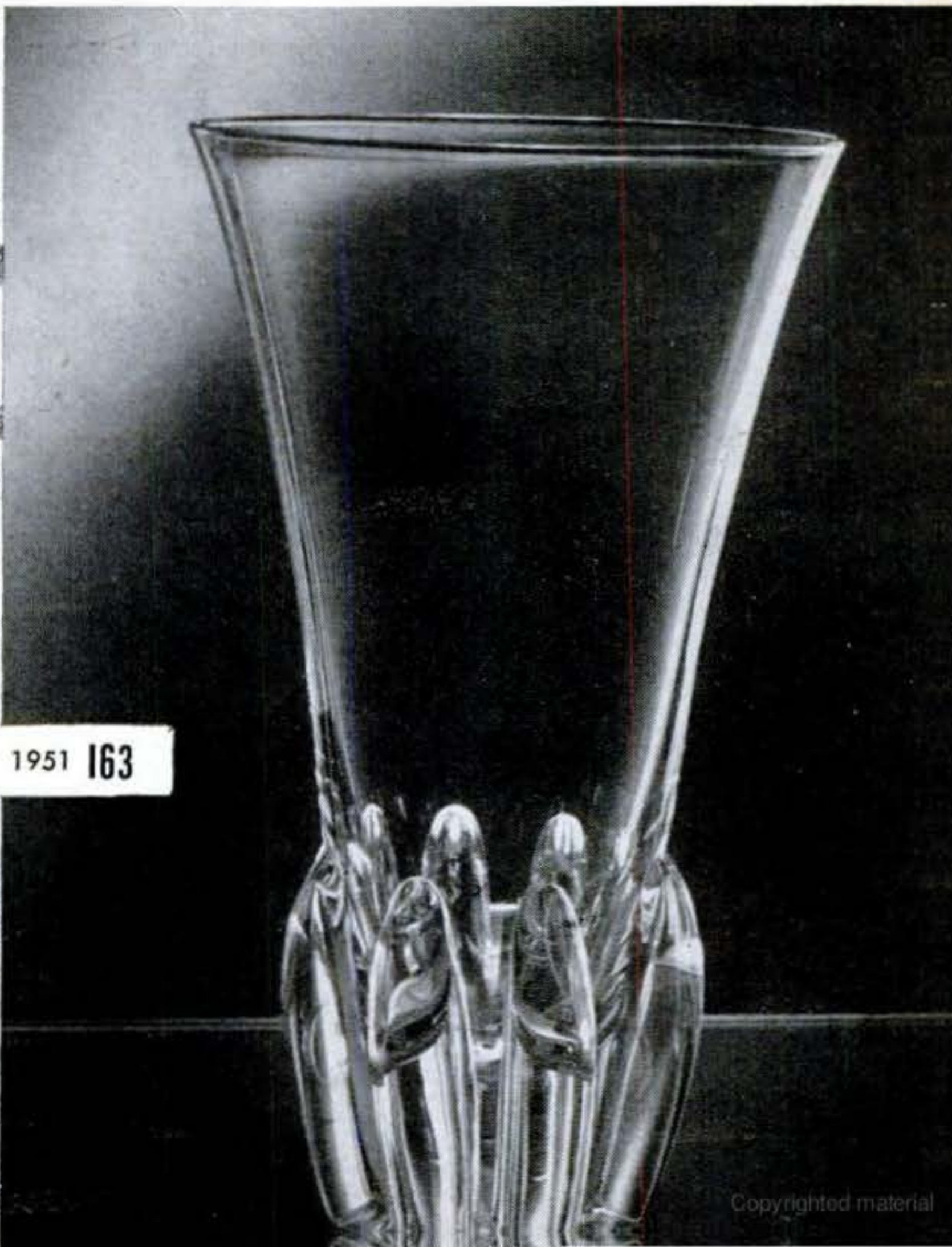

of Michael Owens, a master blower at a glass works operated by Edward Libbey in Toledo, Ohio. One day while Owens was struggling with a particularly inept crew of apprentice glassmakers, he wondered if it wouldn't be possible to devise a machine to take their places. Secretly, he designed and built a wooden working model of such a machine. When he showed it to Libbey, the boss was so impressed that he agreed to set up a company to carry on the experimental work with Owens as general manager.

### *Machine Works like Bicycle Pump*

Owens' first full-size machines were simple and ingenious—and they worked. They operated on the principle of the bicycle pump. When a piston was withdrawn, molten glass was sucked up into a metal mold from a supply pot. When the piston was pushed in, the compressed air forced the molten glass against the sides of the mold to form the desired shape. It was as simple as that, and the same basic principle is still used today in the modern machines that produce the major portion of our low-cost household glassware.

Automatic machines, however, have by no means completely replaced the master glass craftsman. Expensive glassware is still created by the same so-called "offhand" blowing methods that have been followed for centuries. At glass works like those main-

tained by Steuben Glass, Inc., at Corning, N. Y., skilled glassmakers still use the ancient processes and the crude tools of their craft to turn out decorative tableware and other glass art objects.

They still stick to the old "shop" method of glassmaking in which a master blower, known as a "gaffer," supervises five assistants. Directly under the gaffer is his "serviter" who blows the glass into its basic form. Then in order come the "gatherer" who gathers or picks up a glob of molten glass from the glass furnace on the end of a blowing rod and gives it to the serviter, the

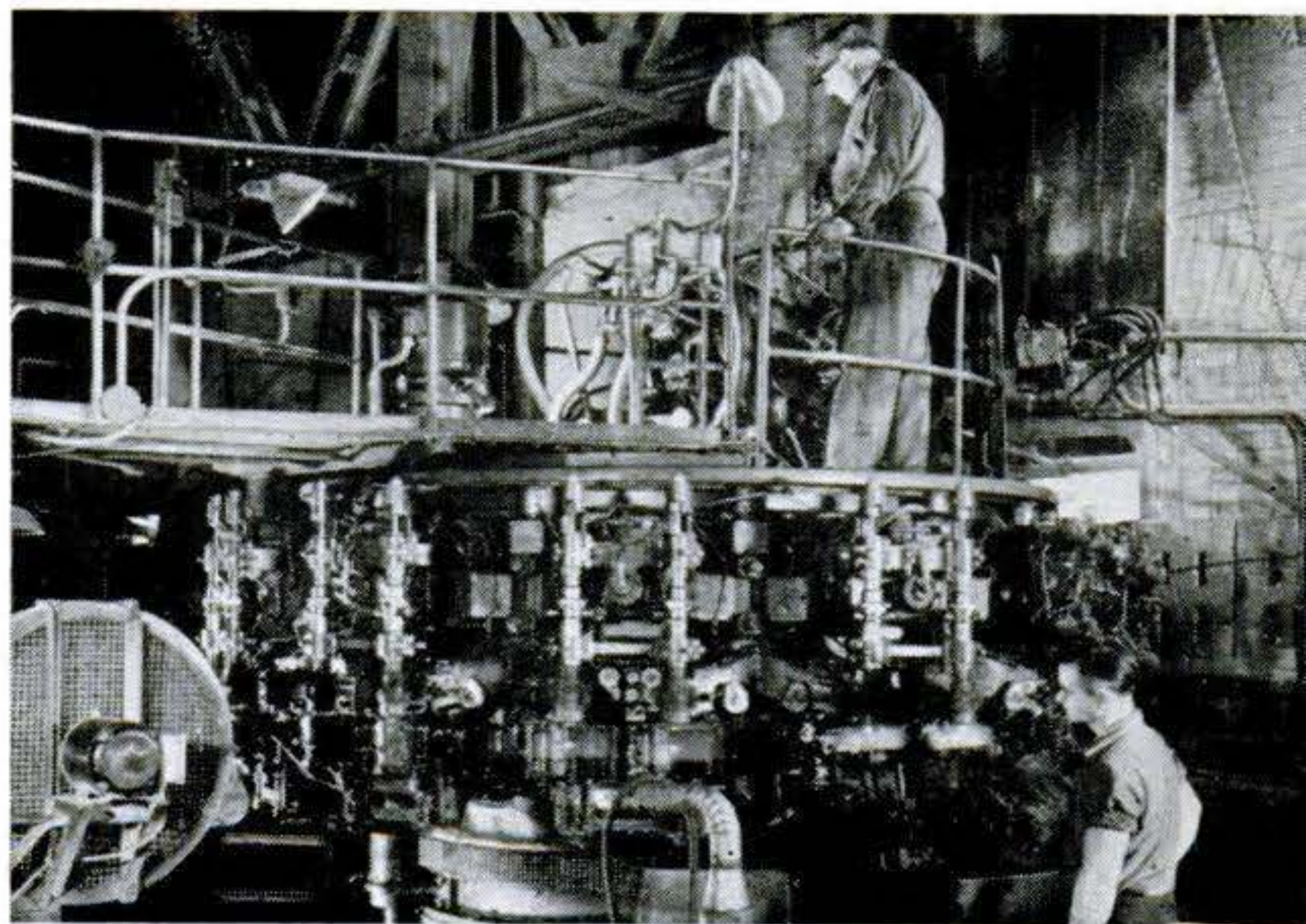

**1** Automatic mechanical blower replaces the human team in the production of inexpensive, everyday glassware. A machine such as one above turns out 24,000 tumblers a day.



**4** After annealing, glasses are carefully inspected in front of the screen of a polariscope. Polarized light from polariscope reveals any stresses that might cause breakage.

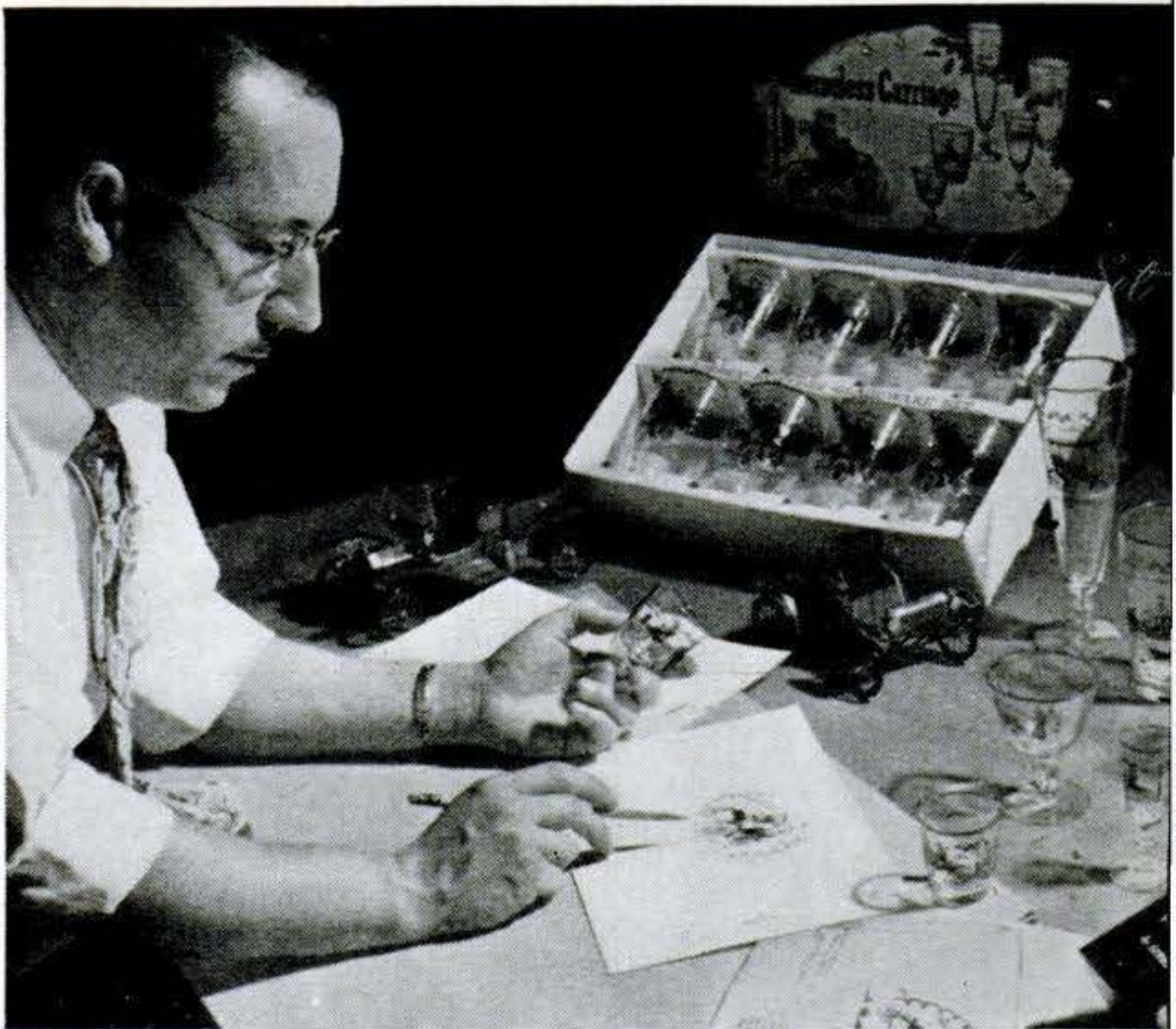

**5** Silk-screen printing is used to apply the designs to glasses in the new "Horseless Carriage" Libbey Glass line. After basic design is drawn, silk screens for printing are made.

“bit gatherer” whose job it is to gather up on a long stick called a pontil (pronounced “punty”) the small amounts of additional molten glass needed for decorations, stems, etc., the “stick boy” who holds the gathers, and finally the “carry-in boy” who carries the finished piece to the oven, called a “lehr,” where the glass is annealed.

The six men work as a team, with the gaffer calling the signals. He is the artist, the master, who carefully shapes the molten glass (or “metal” as the glassmakers call it) into its final form. His skill comes from long experience.

Glassware made by pressing, rather than blowing, is another traditional type that is still produced, but it too for the most part is now turned out on automatic machines. Many items such as heatproof ovenware, some types of lenses, and decorative ornaments are made in modern, automatic glass presses.

By blending handwork with machines, the glassmakers are making everything from cheap but attractive dime-store tumblers to expensive crystal works of art that enliven our dining tables for festive occasions and decorate our homes. END

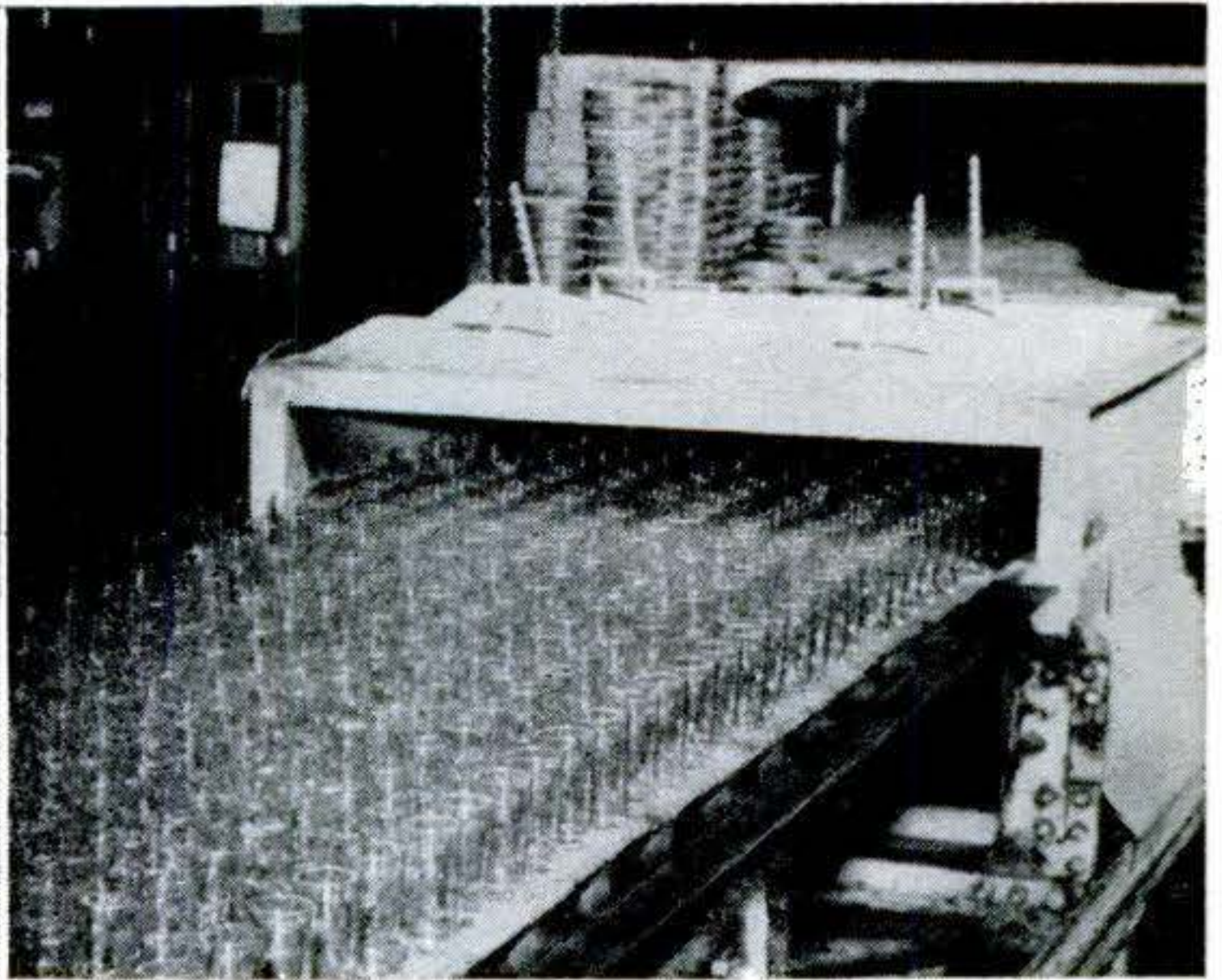
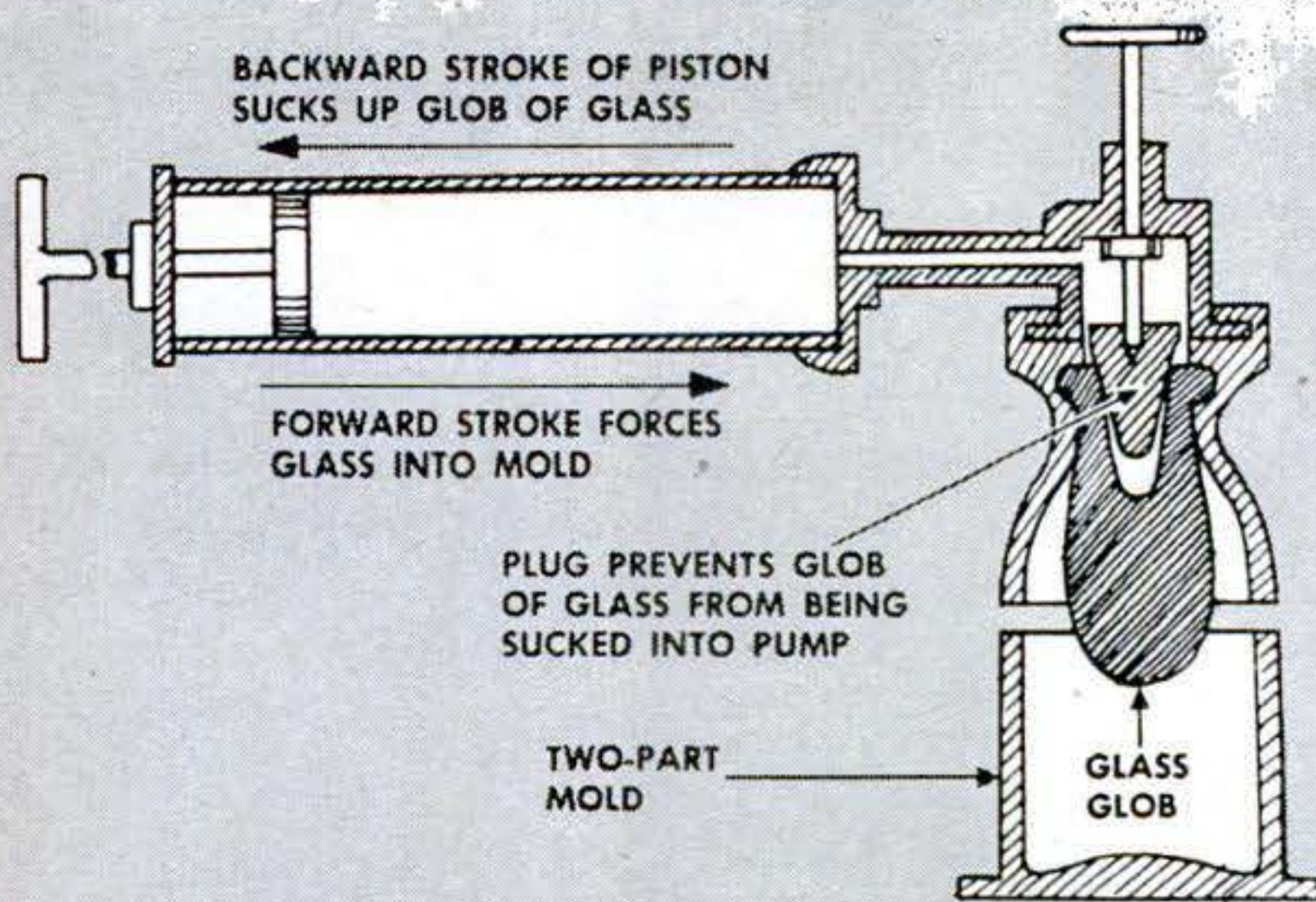

**2** Working like a tire pump, the machine sucks a glob of molten glass up from a revolving supply pot in its base and then forces it against the sides of a two-part metal mold.

**3** Annealing to eliminate any possible strains in the glass also is an important operation in the production of machine-made glassware. Cooling requires from 45 to 90 minutes.



**6** Ceramic colors are applied, one at a time, in the printer shown above. After all colors are in place, glasses are baked in oven to fuse colors to the glass. They are then re-annealed.



**7** Finished glassware as it comes from the final annealing. These photos showing the mass-production of glasses were made at the Libbey Glass plant of Owens-Illinois Glass Co.

# I'd like to see them make...

Everyone has his own pet idea of some gadget he would like to see in general use. What is YOURS? Popular Science will pay \$5.00 for each one published. Use government postcards only. Contributions cannot be acknowledged or returned.

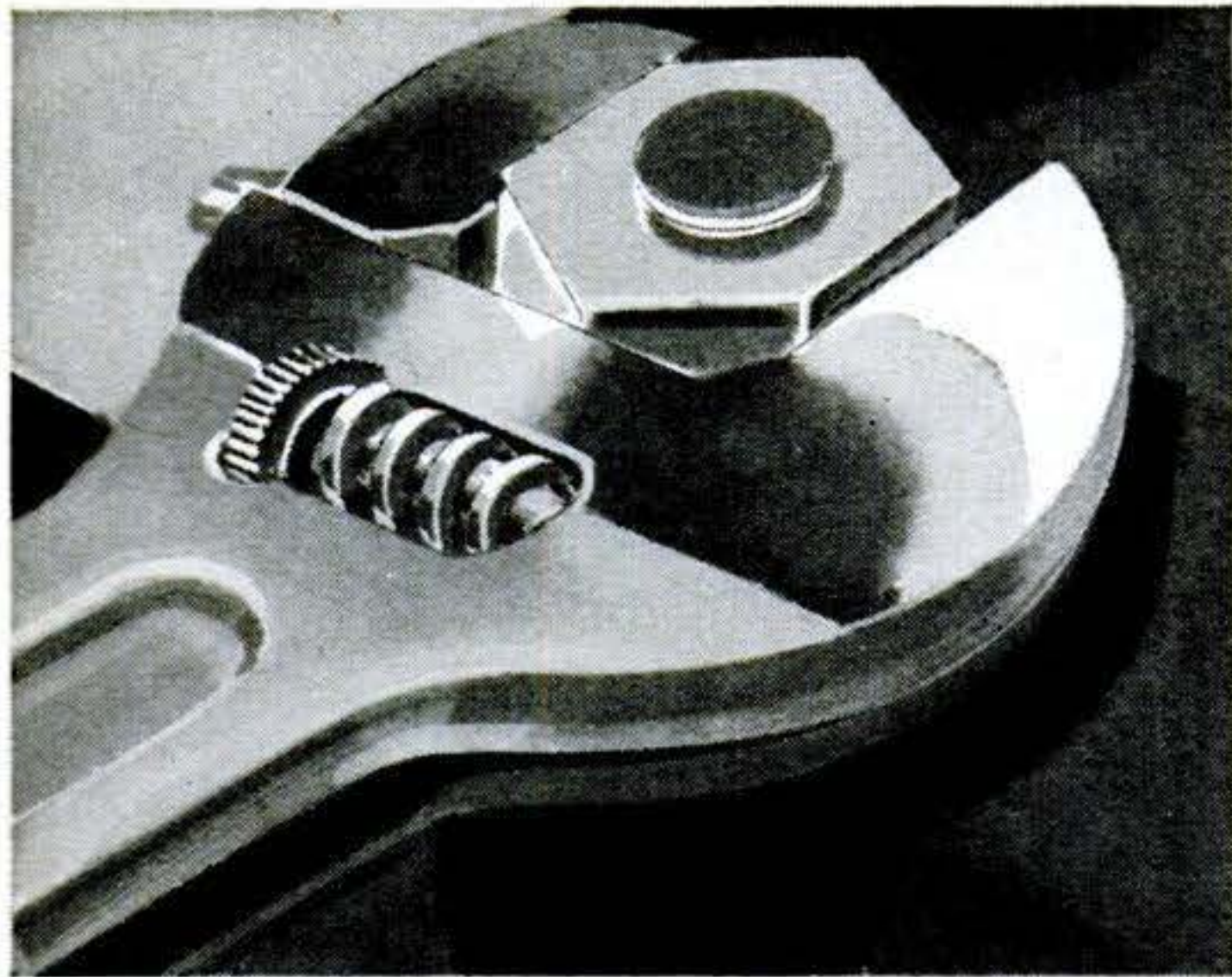

A position lock or friction drag on the thumb screw of adjustable wrenches. Such a lock would prevent the inevitable slip-back of jaws that causes slips and rounding of the head.—*Duncan Osborn, St. Petersburg, Fla.*

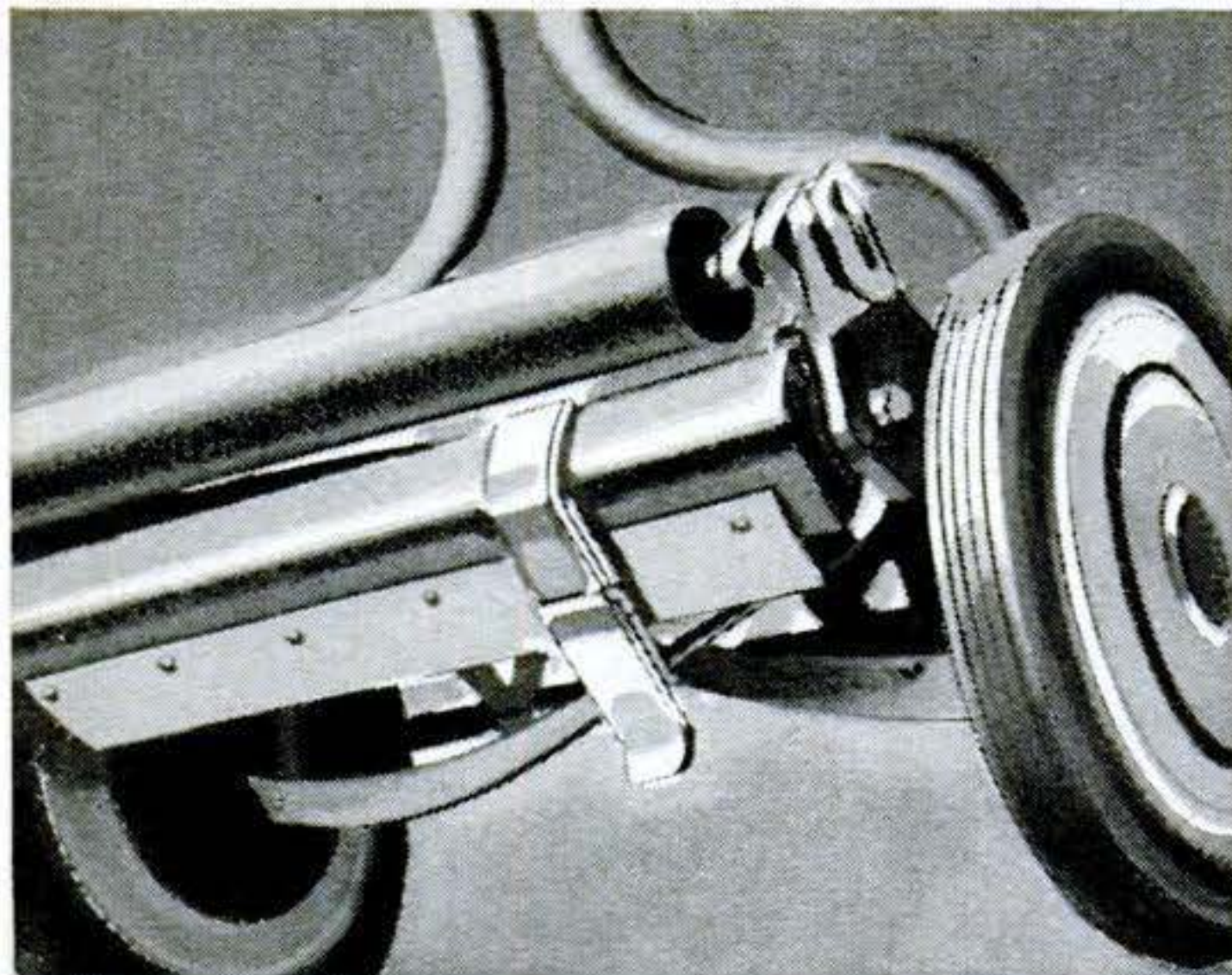

A clamp that would lock the blades of a lawn mower when it is stored where children might get at it. It should be easy to remove but difficult for youngsters to master.—*Matthew C. Godfrey, Detroit, Mich.*

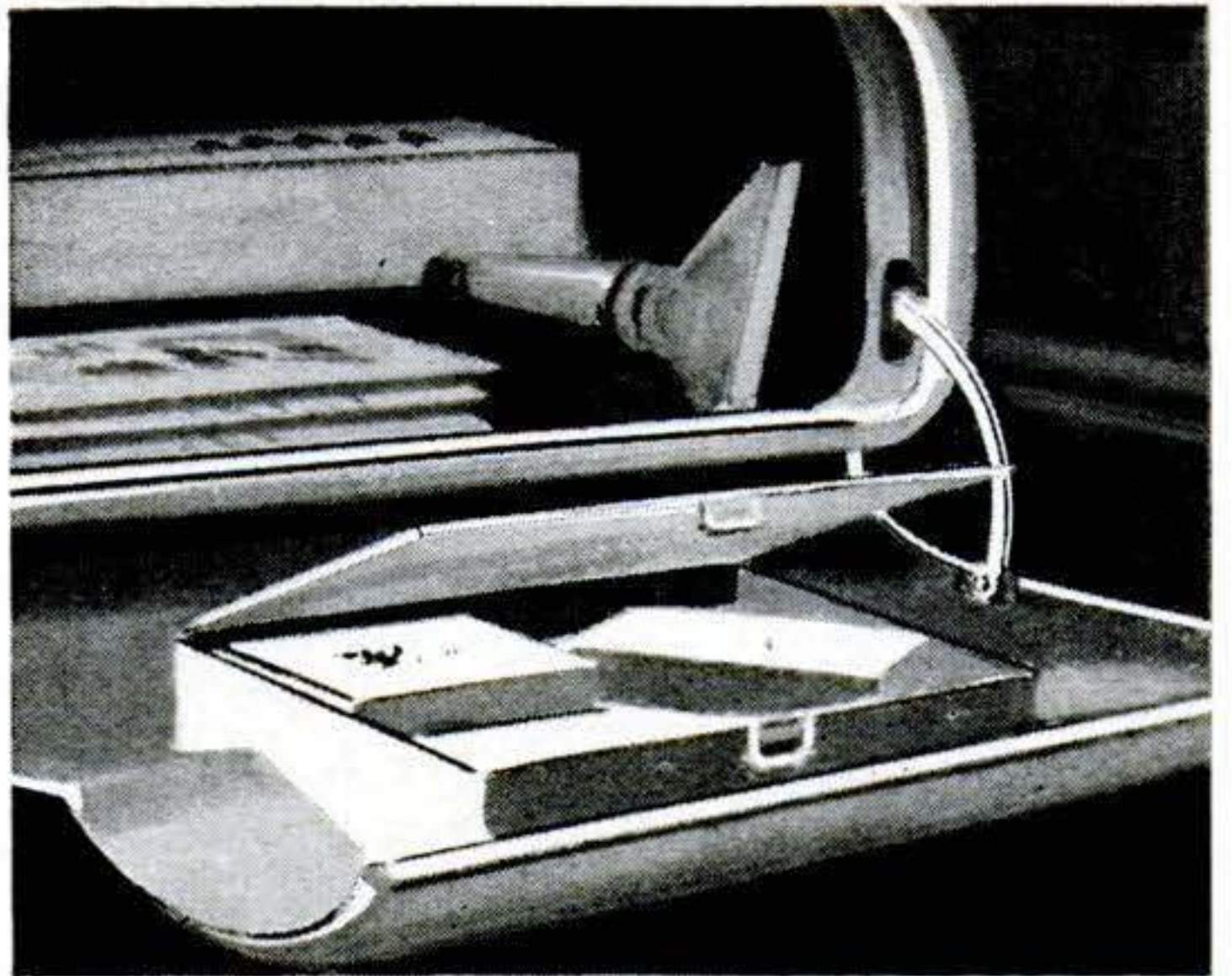

A storage box for fuses built into a car glove-compartment door. Loose fuses in the compartment never seem to be around when you need them. With this box you'd find them easily.—*Norman L. White, Athol, Mass.*



Shaving brushes and razors with magnets set into the handles. Then they could be suspended from metal shelf supports or firmly held to the sides or under the shelves of metal cabinets.—*George Perry, Fitchburg, Mass.*



Frozen foods with waxed cards dividing the blocks. This would make it easy to break the blocks in two, providing smaller portions for small families and allowing the excess to be stored frozen.—*Mrs. P. Morrell, Hampton, Va.*



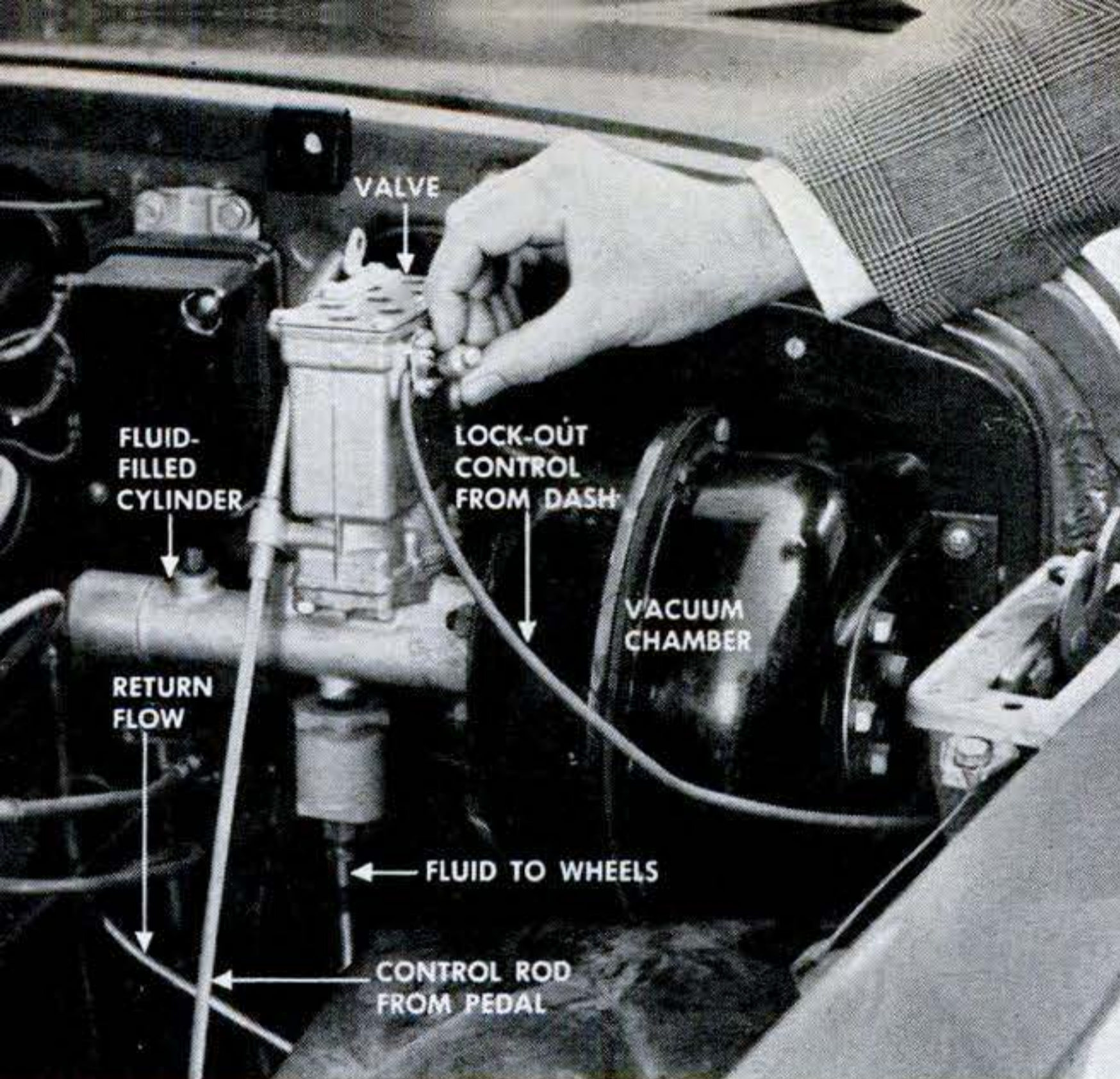

**Brake mechanism** bolts to firewall. Diaphragm in vacuum chamber drives piston into fluid-filled cylinder, sending brake fluid to wheels.

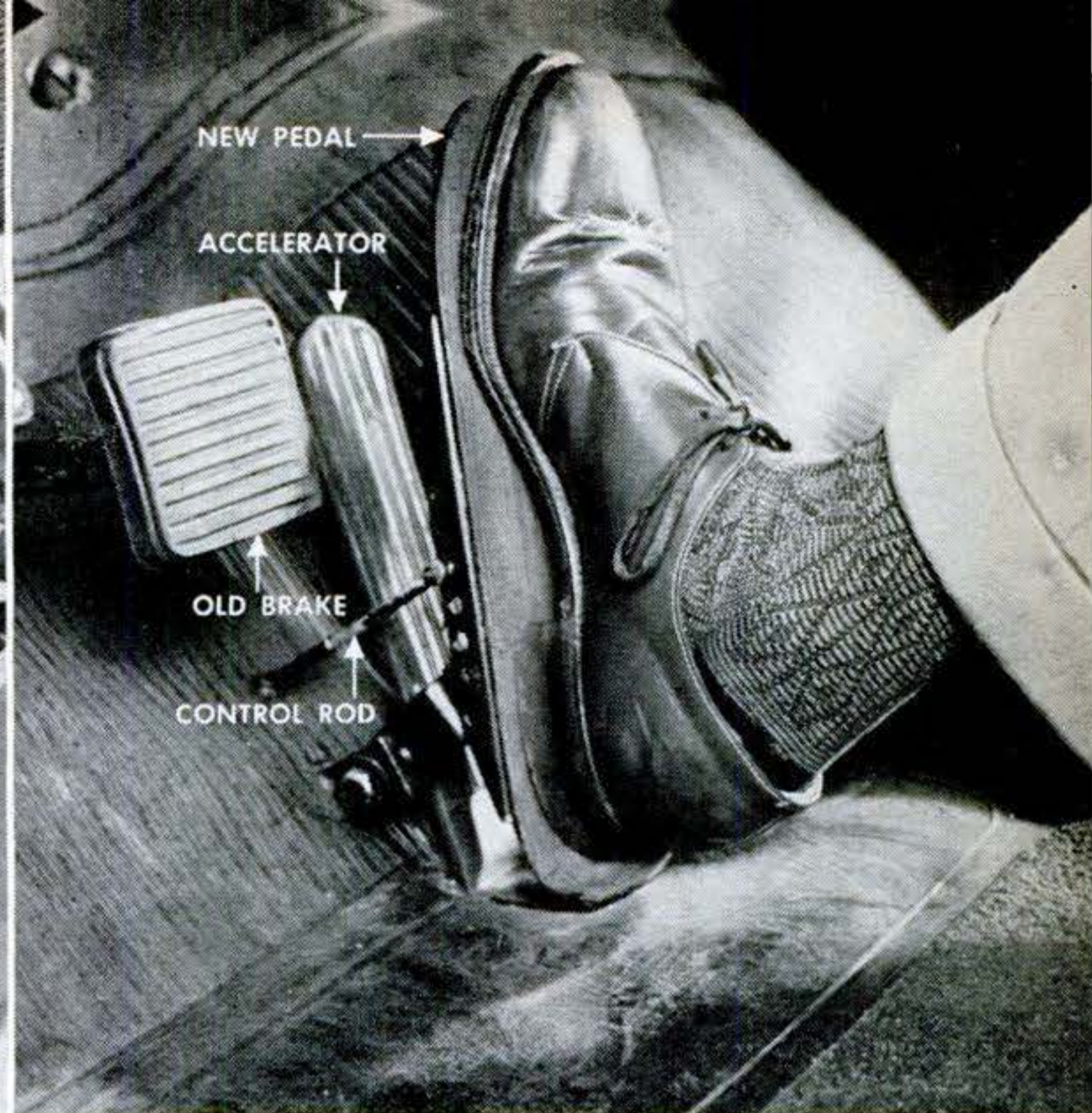

**New two-in-one pedal** is mounted over old accelerator so it can rock back and forth. Original brake is left in position for emergency use.

## New Two-in-One Foot Control Stops Car or Speeds It Up

Now you can step on the gas or put on the brakes with the same foot pedal. Press forward with your toe, and the car speeds up; press backward with your heel, and it slows down. Called Accela-Brake, it is controlled by a pedal that bolts to the car floor over the conventional accelerator and is pivoted so it can rock forward and back. Pushed forward, it presses down the accelerator. Tipped backward, it pulls a control rod that actuates a special brake mechanism installed between the master brake cylinder and the wheels.

When the rod is pulled, it opens a valve that applies vacuum from the car manifold

to a rubber diaphragm inside an air chamber. This collapses the diaphragm, driving a piston into a cylinder filled with brake fluid. The piston forces the fluid out of the cylinder and into the wheel brakes, slowing or stopping the car depending upon how far the pedal is pushed backward.

The auxiliary brake does not interfere with the operation of the conventional brake, and a lock-out control on the dash disconnects it at any time. In addition to speeding up braking time, it is also said to eliminate roll-back on hills and foot fatigue in traffic. Made by the Accela-Brake Sales Co., of Hollywood, it sells for about \$66.

## Navy Flying Boat Makes Tight Turn

THIS Martin flying boat can't quite turn on a dime, but with its hydroflaps—twin underwater rudders—it can turn in a radius one and a half times its wingspan—three times sharper than with engines alone. Designed for maneuvering in tight waters, the rudders can also be used as a brake.

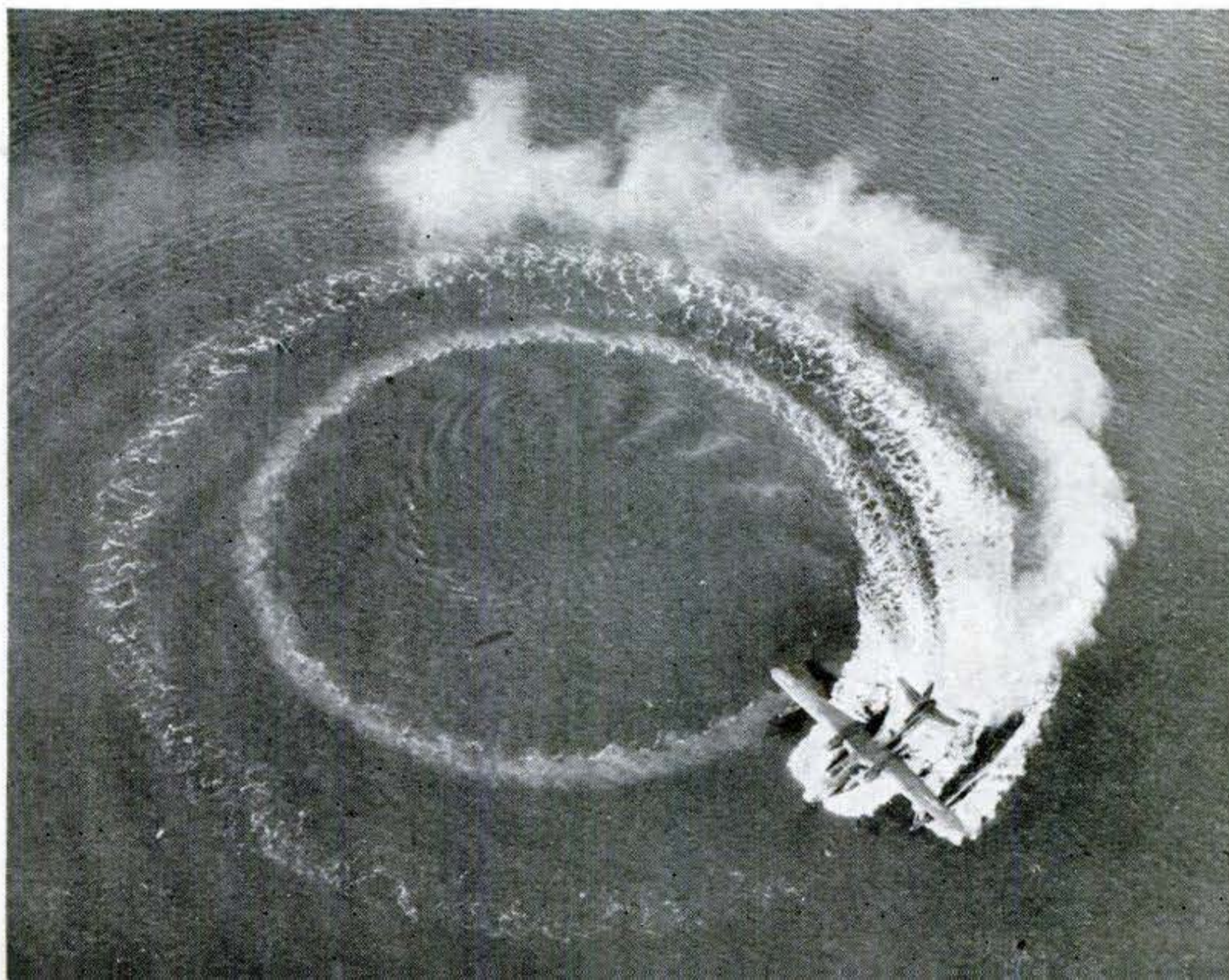

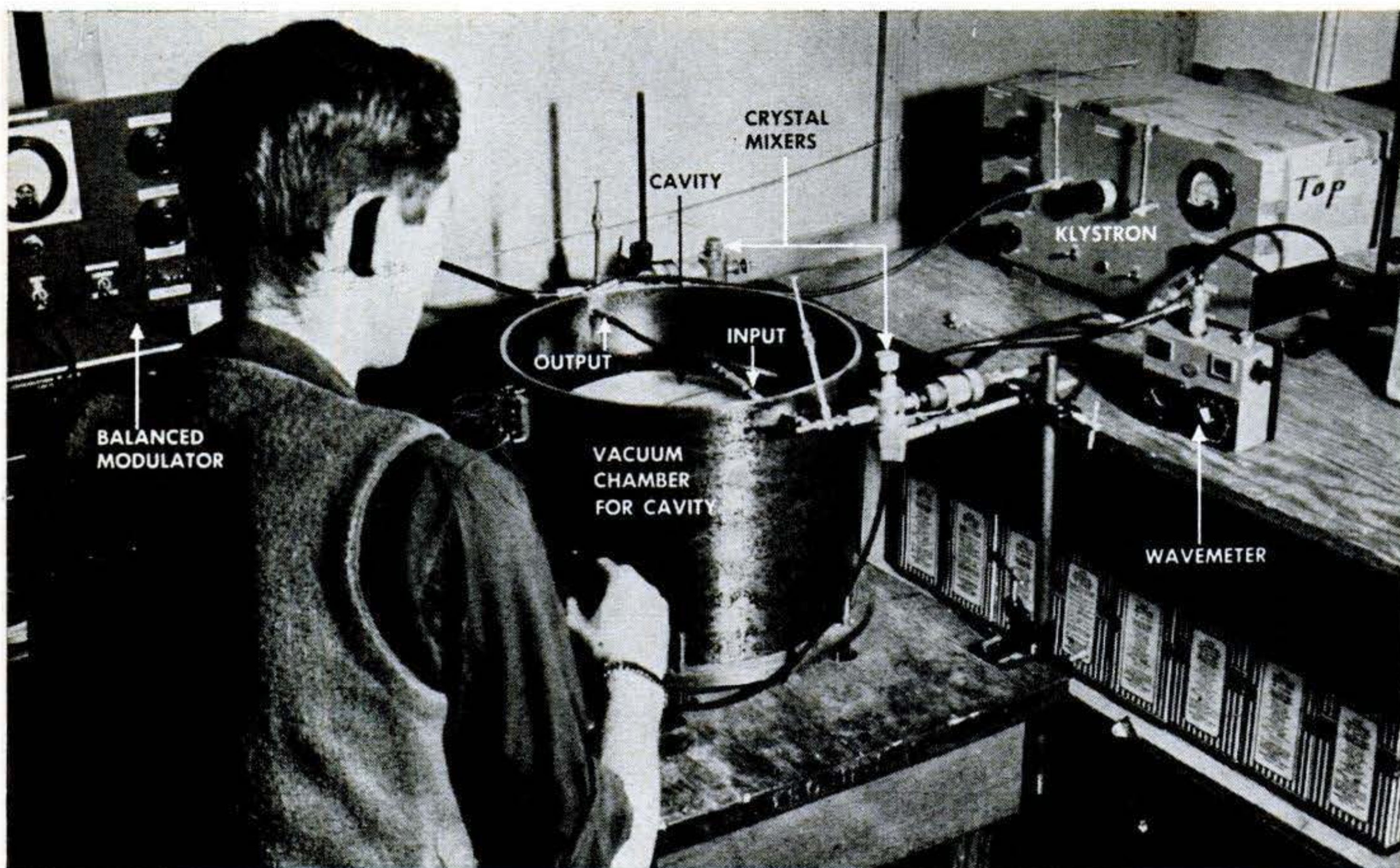

## Light Proved Even Faster than Previously Determined

THE speed of light, the magic number that affects nearly all laws of physics, is even faster than scientists thought. New experiments at Stanford University place it at 186,280 miles per second—eight miles per second higher than the old value. Even this

small change may be important in radar and Loran. The researchers actually measured the speed of a radio wave—which is the same as that of light—by finding its resonance frequency in a “cavity” whose dimensions are known to a millionth of an inch.

## Tiny Magnetrons Made for UHF TV

THIS tiny tube may be a vital part of the television sets of tomorrow. It is a miniature magnetron, adapted from wartime radar tubes for use in ultra-high-frequency TV receivers. Many—perhaps most—of future TV stations are likely to operate in the UHF region, now being used only experimentally (PS Aug. '50, p. 111). GE is already making a few of the small magnetrons, which produce  $\frac{1}{4}$  of a watt at 30 to 900 megacycles.

## Jet Noises Tried Out on Guinea Pigs

JET engines make a lot of noise—enough to pain or perhaps harm your ears. To find out more about the effect of very loud noise on human ears, Air Force scientists at the Wright-Patterson Base are learning what it does to guinea pigs' ears. The anesthetized animals (below) are placed in a soundproof room equipped with sound generators. Those are not earphones Dr. H. E. von Gierke is wearing, but muffs to protect his ears.



## Keeping the Home Shipshape

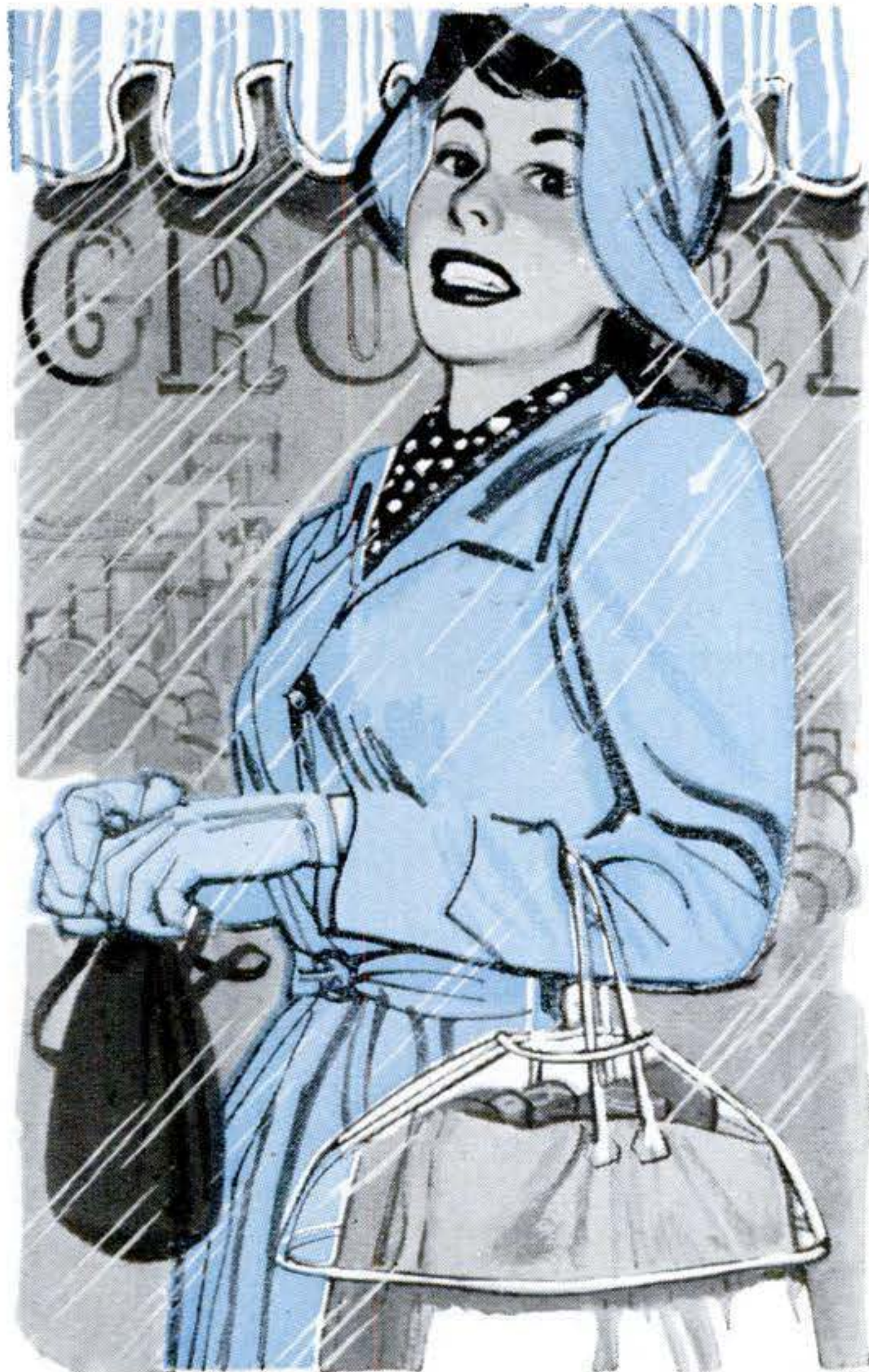

If it's raining or snowing when you leave for the market, carry along a plastic shoulder protector from your closet. It will fit over the shopping bag and keep your groceries dry.

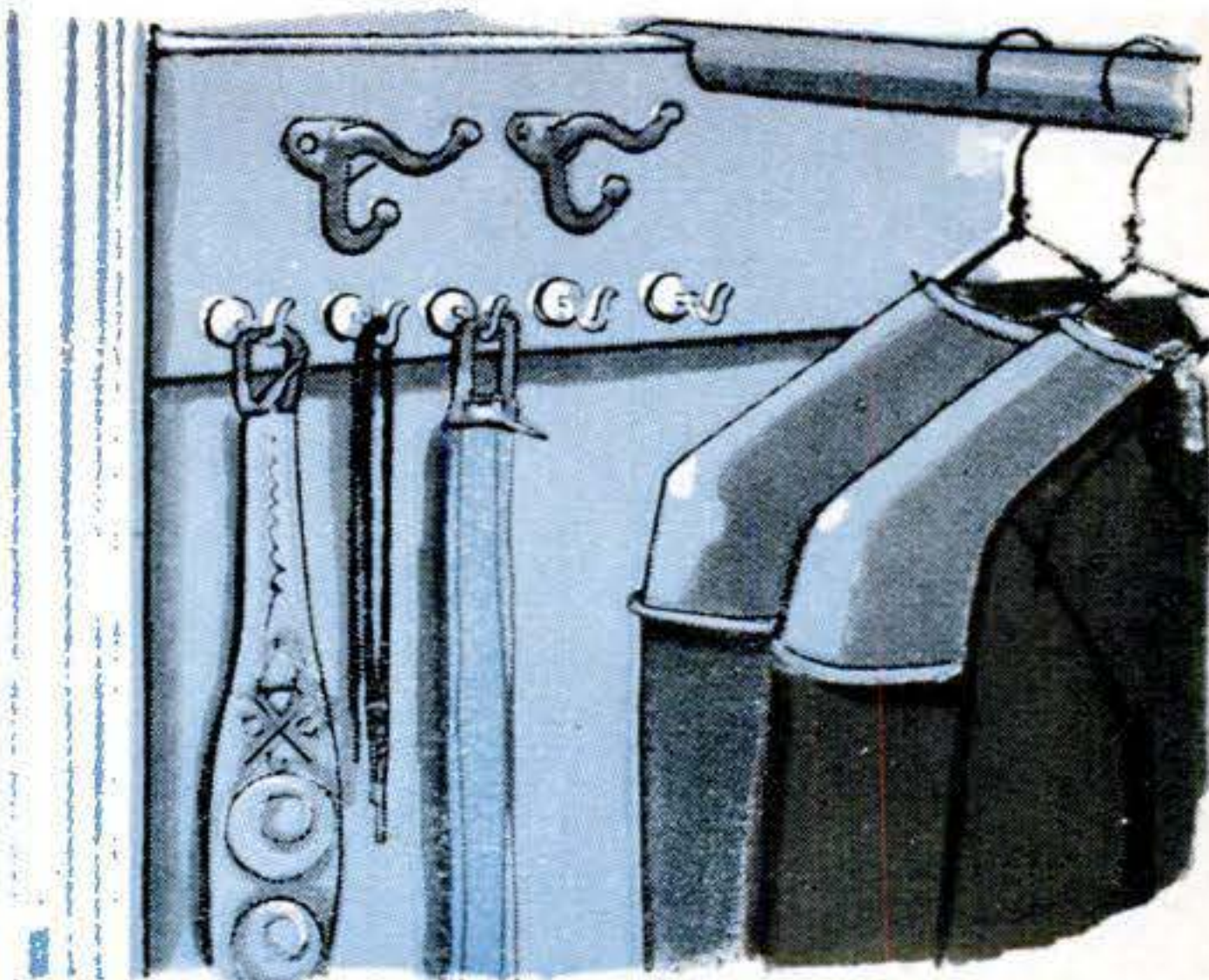

Cup hooks screwed into the wooden rail in a closet, or to the door, will hold those belts that clutter up a drawer. They'll hold suspenders and extra shoelaces as well.



You can protect your hands from abrasion when grating cheese, carrots, and other foods by wearing the heavy rubber fingers used in offices. Cover thumb and first finger.



Wood from crates and apple boxes makes fine stock for craftwork. A home-made tool like this mallet will enable you to knock them apart without damaging the wood.

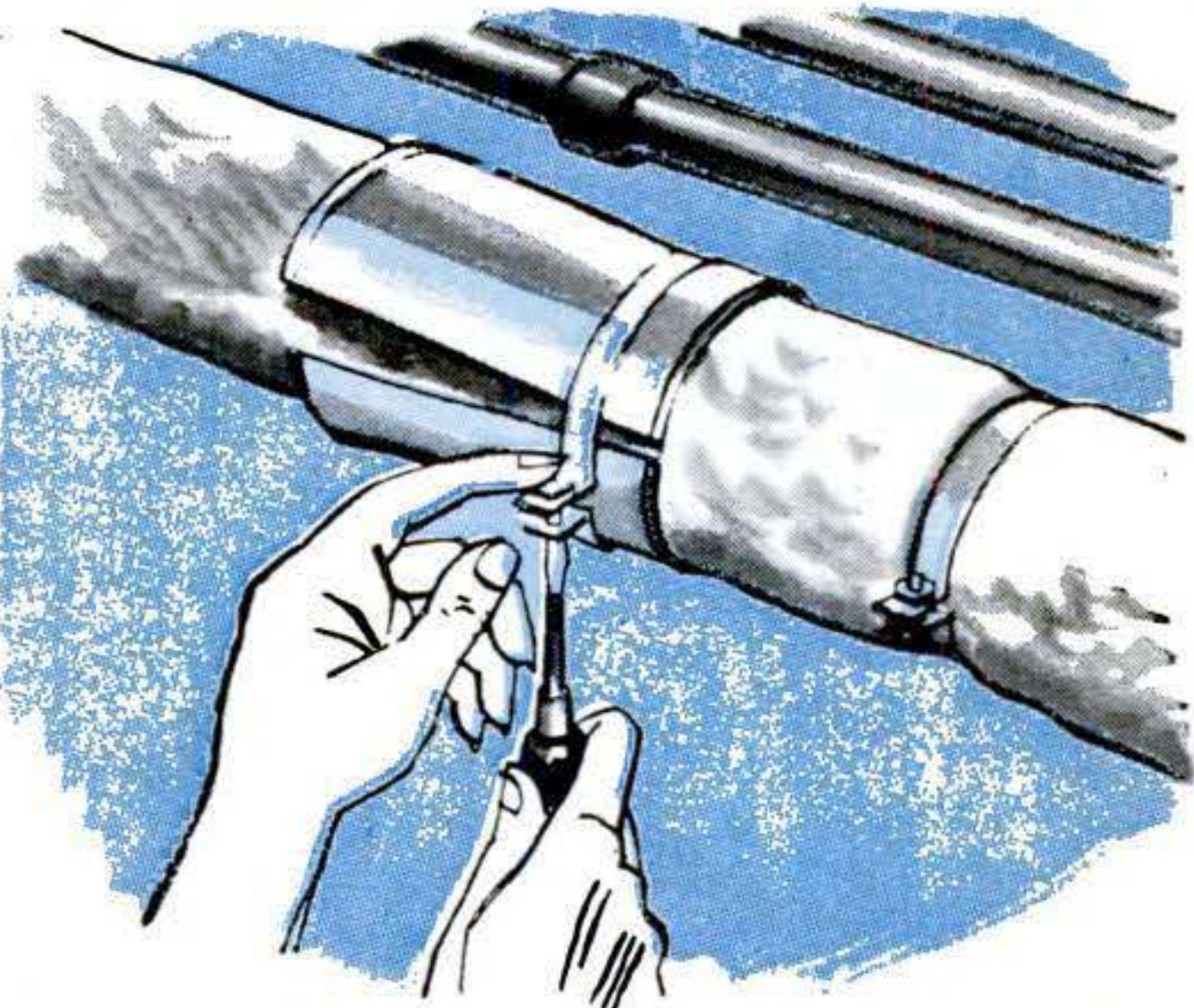

Separated joints in the asbestos on your heating pipes can be covered with tin cans with top and bottom removed. Slit them lengthwise and clamp them on with pipe-covering bands.

Please turn the page for five more suggestions.

FEBRUARY 1951 169

## Keeping the Home Shipshape



If you don't cover your porcelain-topped or stainless-steel sink with rubber pads, protect the shiny surface by putting a dishcloth under pots and pans when scouring them.



A plywood board, dividing your hamper into two sections, saves you time on washday. Keep white wash on one side and colored wash on the other, and sorting is eliminated.



You can add water to an aquarium without disturbing plants and sand if you float a board about  $\frac{3}{4}$ " thick on the surface of the water. Pour the water lightly onto the board.

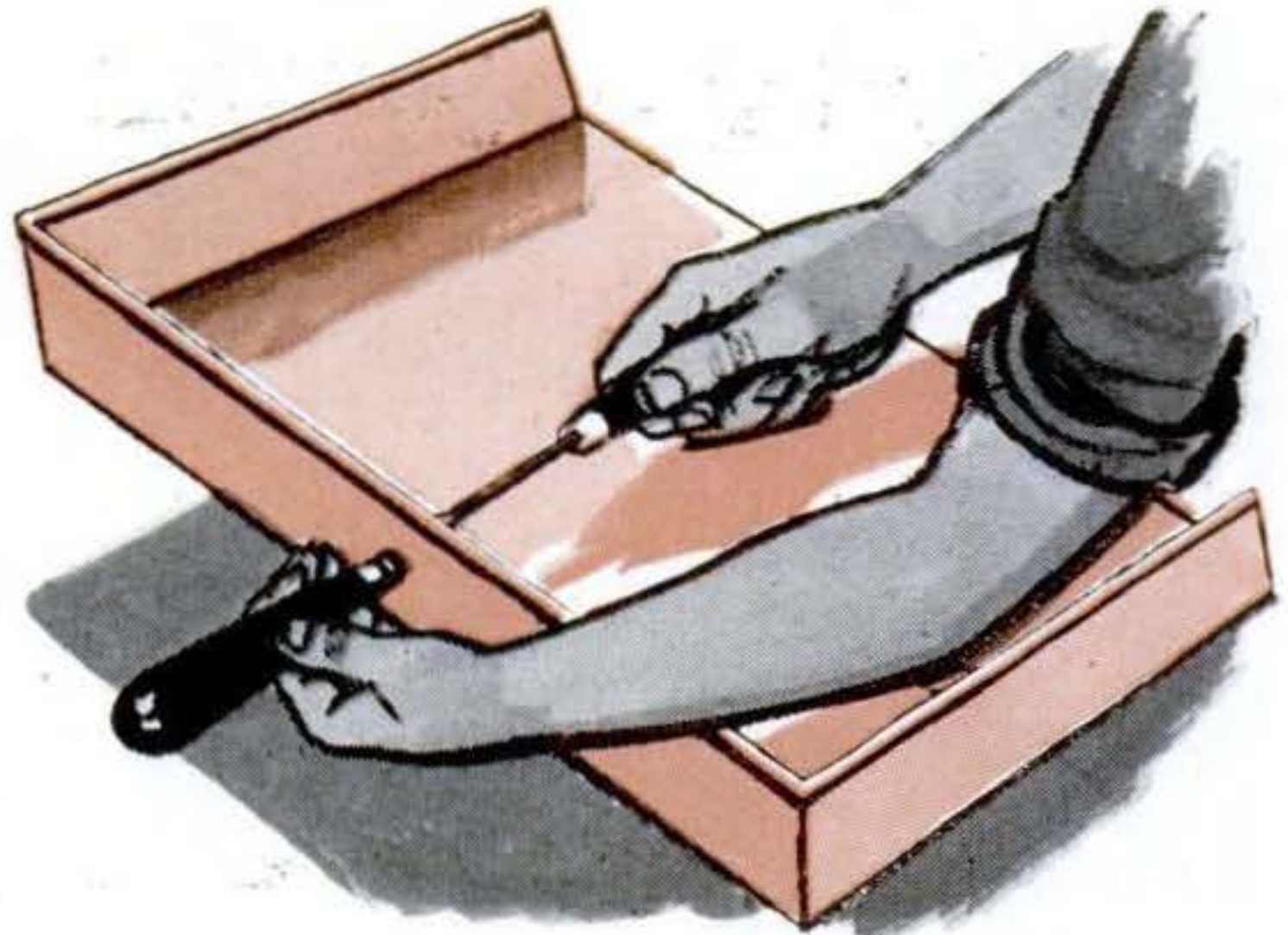

You can make a jumbo dust pan for your shop by removing the long side of a large, tin cake pan. A file handle, attached with a long screw or bolt, makes a good handle.



A storage wall of orange crates, with each bin labeled, will save a lot of last-minute hunting

for Christmas bells, Easter baskets, Halloween masks, and other holiday trappings.

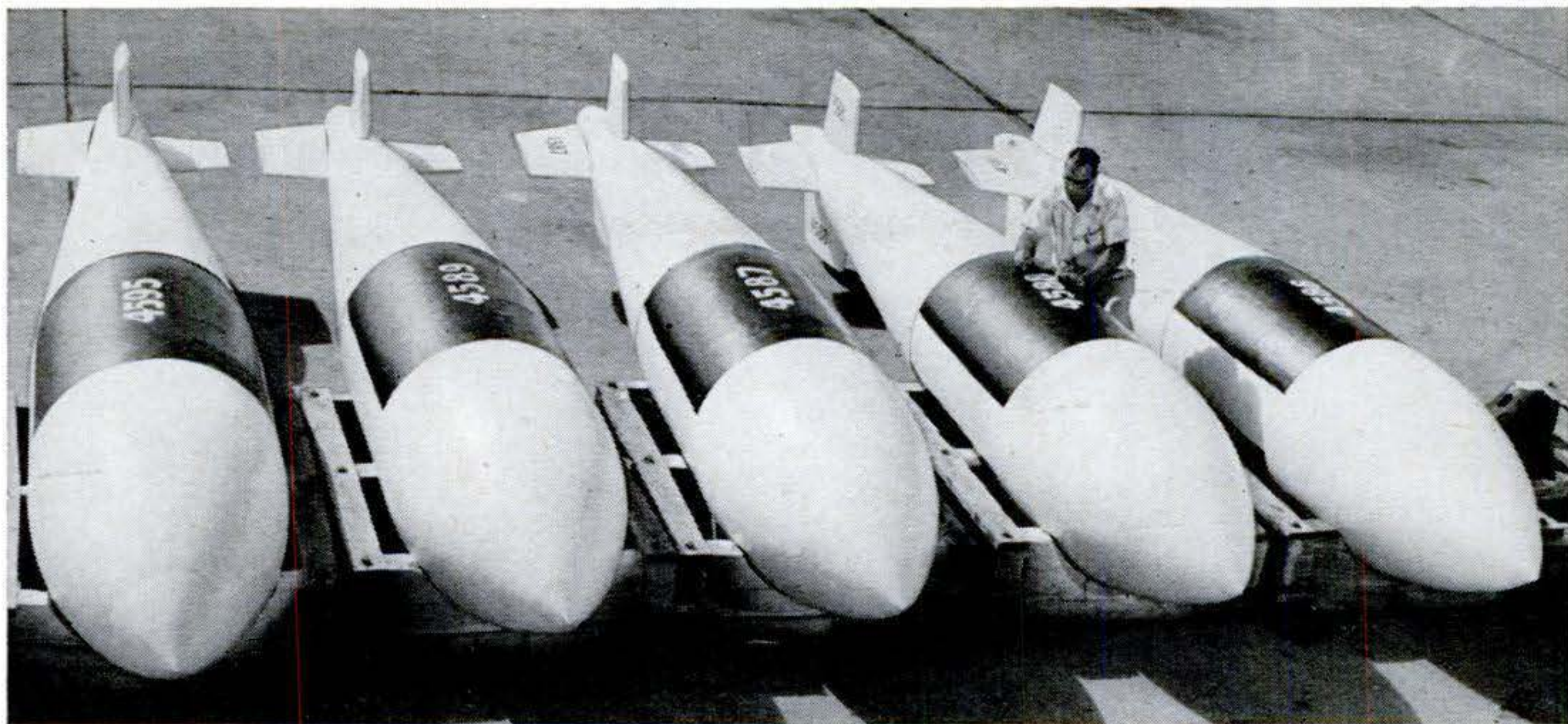

### Dummy Bombs Test B-36 Accuracy

DROPPED from a B-36 bomber, these concrete-filled, 12,000-pound, dummy bombs help tell Convair engineers just how real bombs will behave. When the bombs are re-

leased—some from as high as eight miles up—an electrical impulse sent to the ground automatically starts cameras that track the missiles, recording drop path and rotation. Depth of ground penetration is measured to tell what the explosive pattern would be.

### “Hot Stick” Takes Tank Temperature

WHEN U. S. tanks roar into battle on hot desert sands, their rubber treads must withstand scorching ground heat that often gets 34° to 39° hotter than the air above it. To take the temperature of the sand and the treads, corpsmen jab them with this special needle-nosed pyrometer that registers minute amounts of current generated by heat on a dial calibrated in degrees. Repeated jabbings show the rubber treads can withstand up to 180° F. without damage.

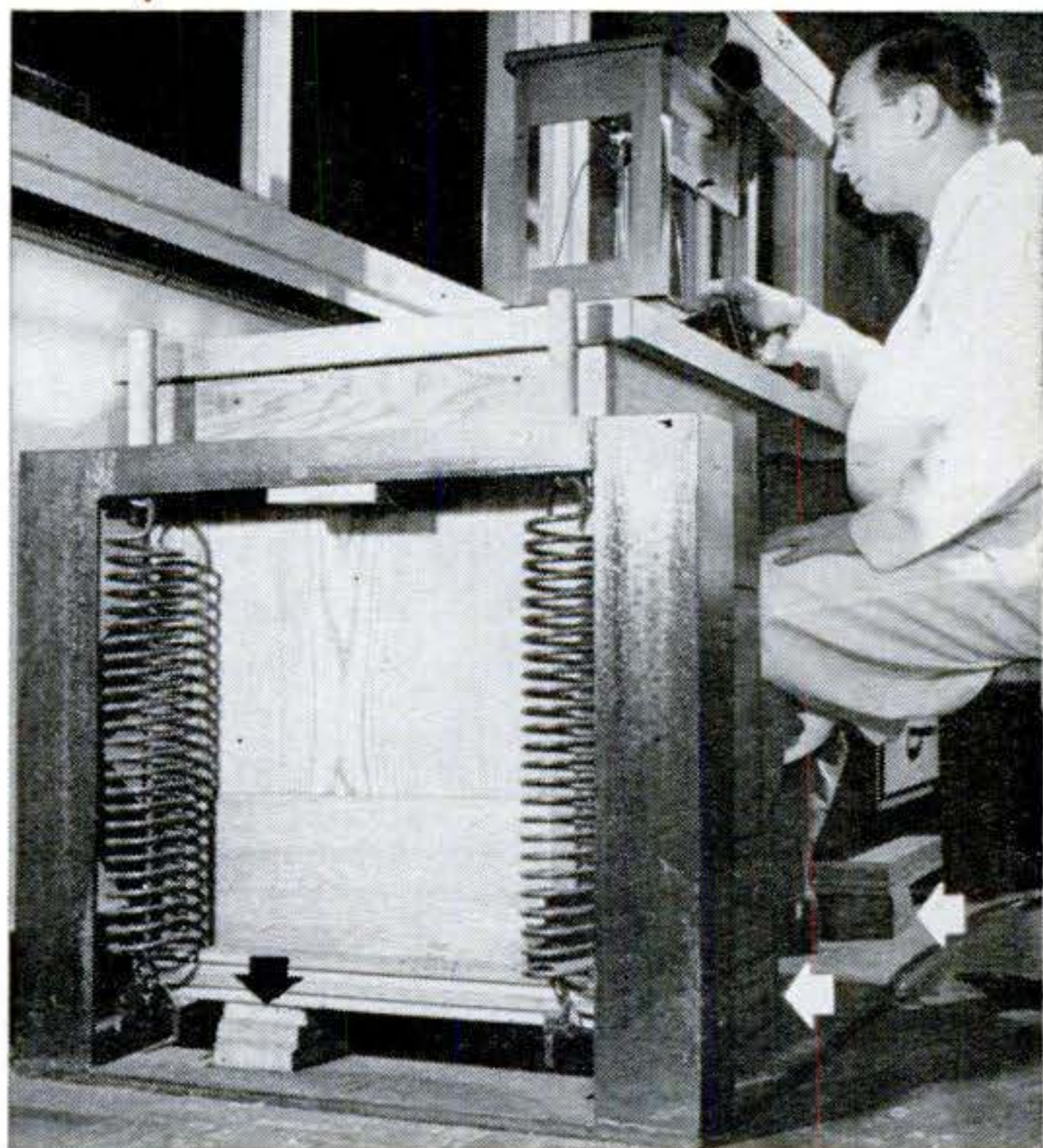
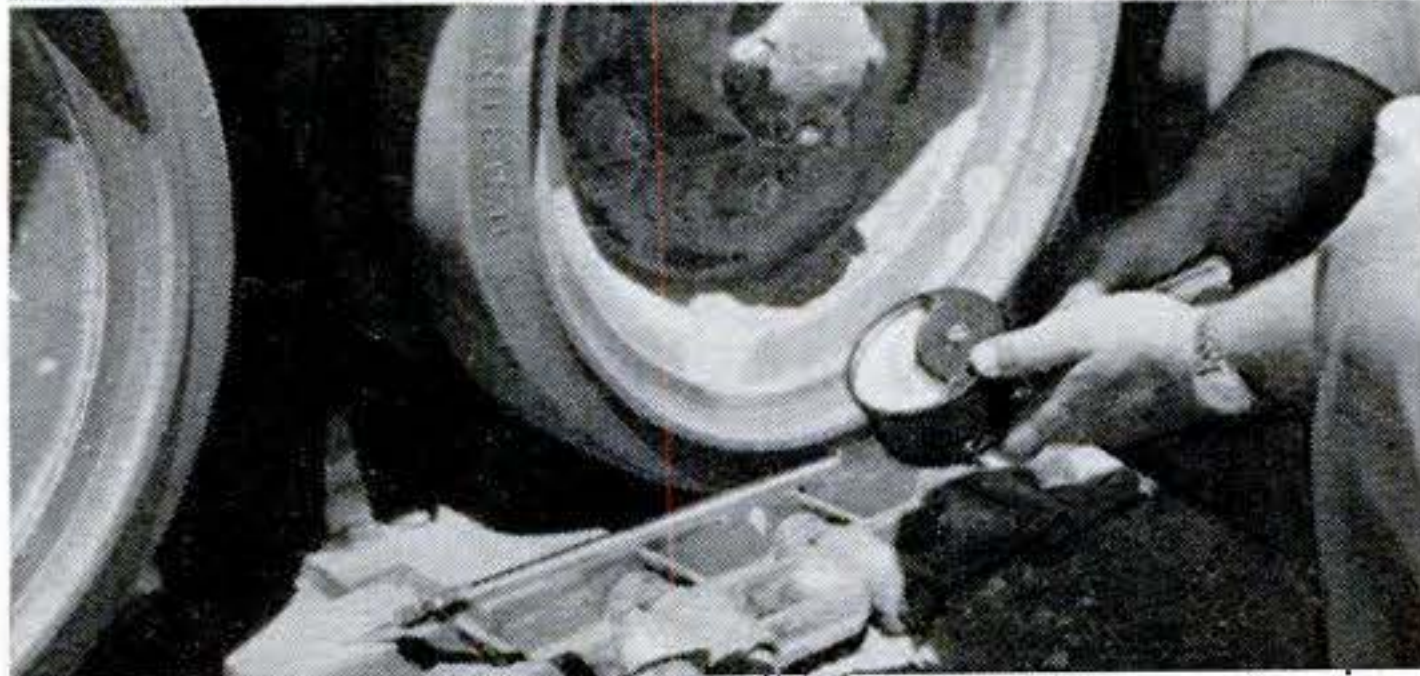

### “Floating Table” Licks Vibrations

DELICATE balance scales, placed on top of this “floating table,” are unaffected by the poundings of a nearby giant drop forge in the Westinghouse plant at Pittsburgh. Suspended from heavy coil springs and cushioned by large blocks of foam rubber (arrows), the table absorbs all vibrations before they reach the sensitive apparatus. Steel plates, bolted to the bottom, preload the table so objects placed on top do not throw the delicate balance out of equilibrium.

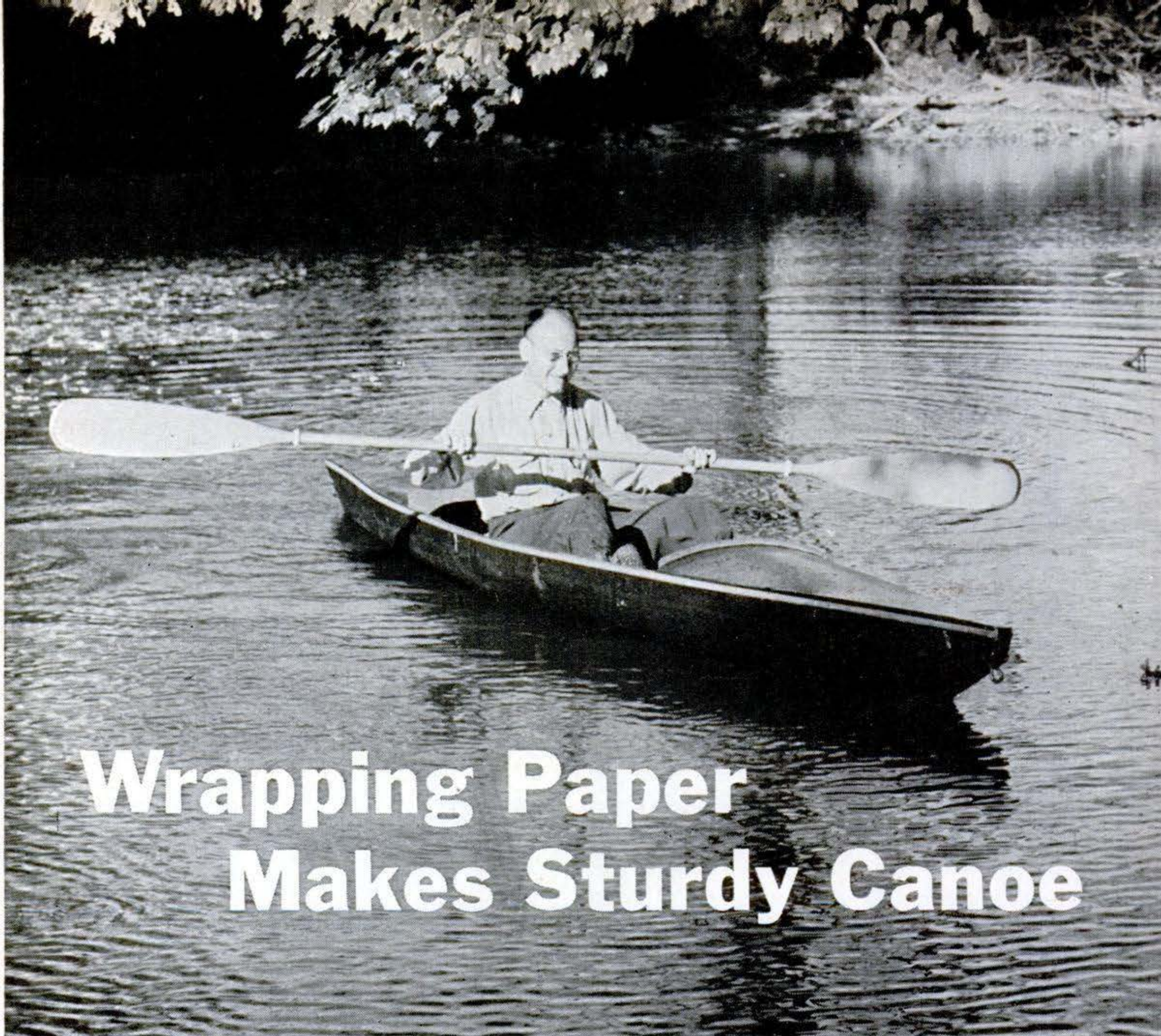

# Wrapping Paper Makes Sturdy Canoe

Paper-hulled *Shoshiman* has spent two seasons in rougher streams than the Passaic (above).

**T**HAT canoe in the picture above is made of paper. Its hull is plain, ordinary, brown wrapping paper, the kind the hardware merchant packs your nails in. Yet it is as sturdy and seaworthy as a commercial job.

If you can operate a hammer, saw, scissors, and glue brush, you can make one like it in a couple of weeks' spare time. So reports John B. Ehrhardt, suburban-weekly editor of Madison, N. J., who resurrected the lost art of paper-boat making to build *Shoshiman*, the canoe shown on these pages. He adapted the technique used in the 1870's by Elisha Waters & Son, of Troy, N. Y., who made paper boats and also paper domes for astronomical observatories (the one at West Point, installed in 1881, is still good as new).

The paper boats have no seams and little framing. You can build your own frame, or use the frame from a stock kayak kit. Besides the frame, you'll need about seven quarts of waterproof glue (Ehrhardt used

Cascophen), a dozen 18" by 24" sheets of No. 70 newsboard (a type of cardboard), 10 yards of 44-thread muslin, and lots of brown wrapping paper.

Cover the frame with one layer of newsboard, fastening it with glue and tacks. Butt the joints. Next apply two layers of paper, coating both surfaces with glue. It's easier if you cut the paper into 12" by 18" sheets and dilute the glue with about 20 percent water. The paper joints should be lapped and staggered, with wide laps around stems and keel. A layer of muslin, laid in bands from gunwale to gunwale, with the cloth doubled and the joints butted at the selvages, follows. Glue the same way as the paper. Finish with two layers of paper.

Let the glue cure for two days, then waterproof the boat inside and out with another coat of diluted glue. Wait 48 hours, and then sand and paint the hull, treating it like wood. Now you're ready to launch.

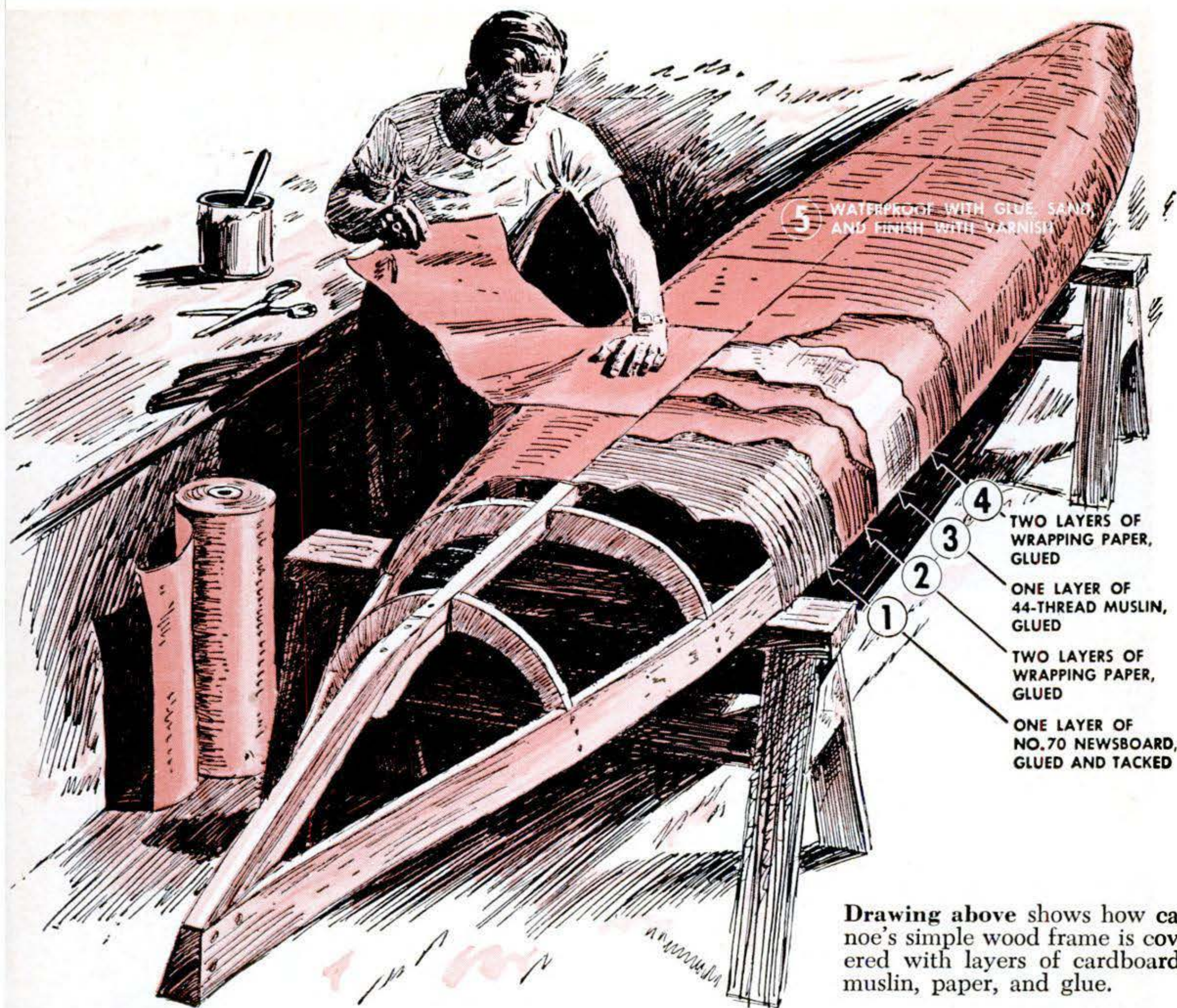

Drawing above shows how canoe's simple wood frame is covered with layers of cardboard, muslin, paper, and glue.

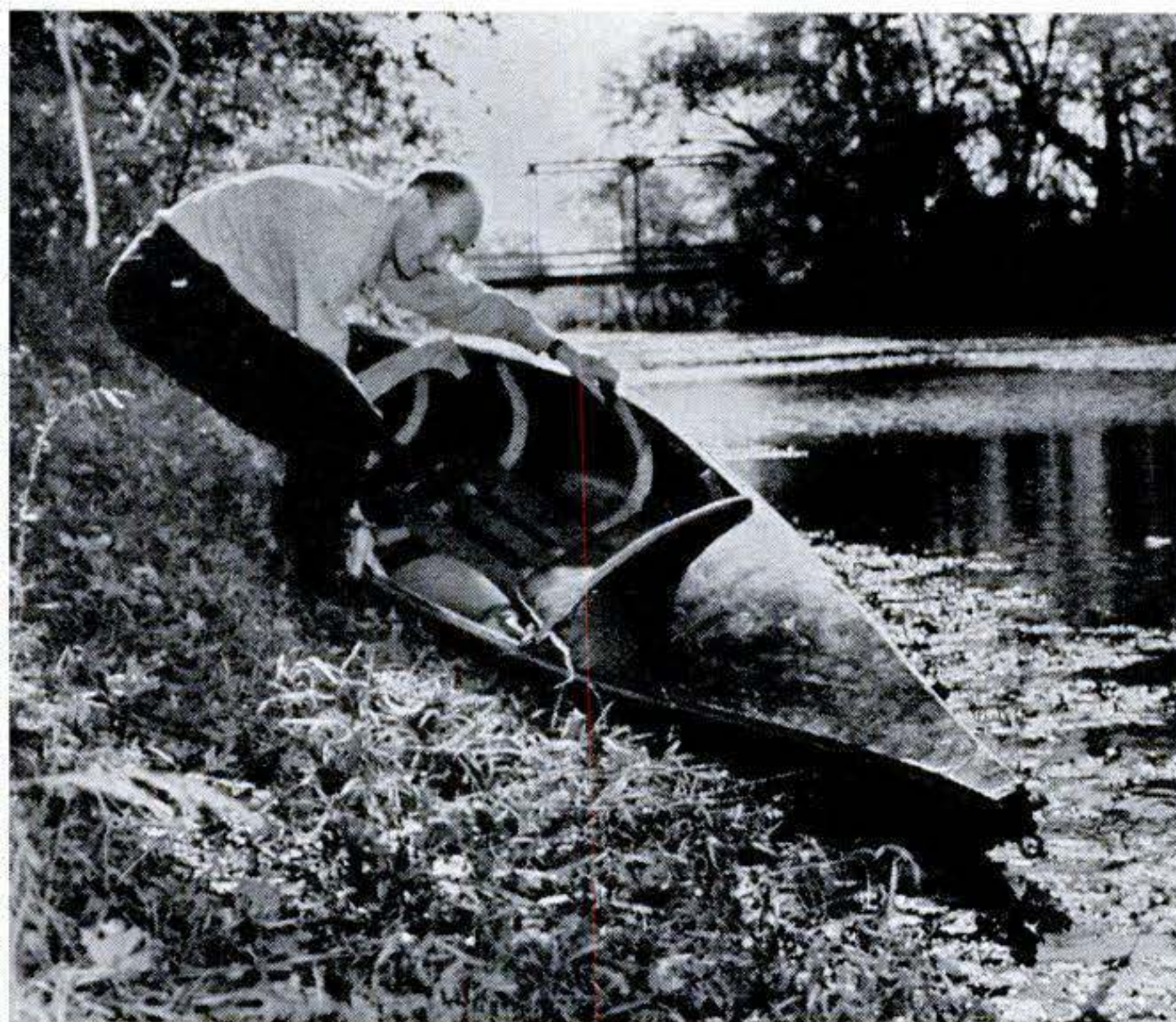

One man easily handles the paper canoe, which weighs approximately 50 pounds, similar to commercial aluminum or plastic boats. Materials cost \$45 (not including ready-made frame).

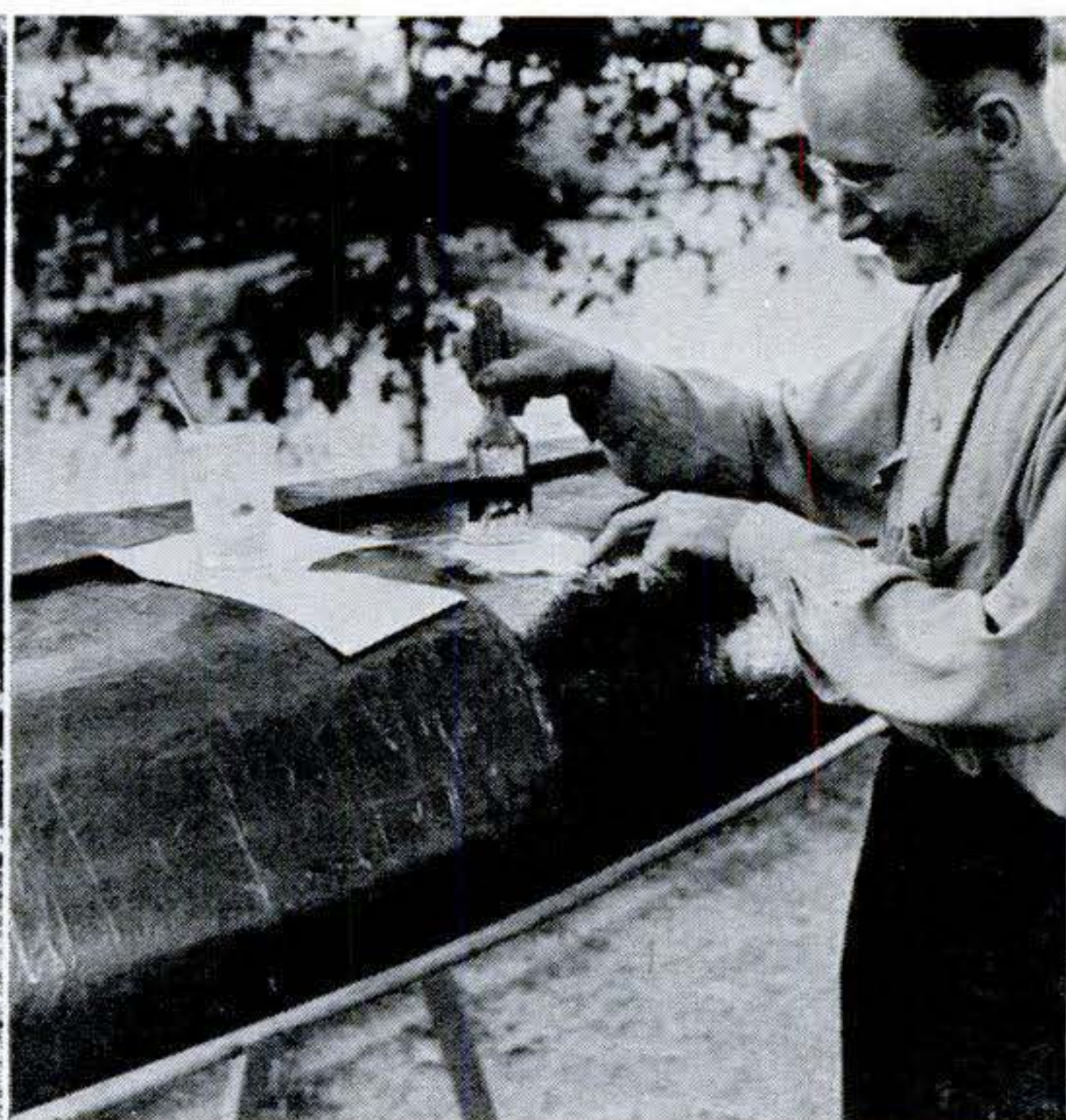

Spring a leak? Paper and glue fix that, as Ehrhardt demonstrates above. His boat, used two years, sprang its only leak when hung up on rock. That one was too minor to bother patching.

## Aids to Modern Living



**Electric Hamper Dries Clothes.** A fan in the bottom of this aluminum hamper sends a blast of air warmed by a heating element upward to hasten the drying of lingerie, towels, or diapers hung inside it. In summer the appliance can be used as a bathroom air conditioner simply by hanging damp towels inside and switching on the fan to circulate cool air. Hamper-Dri has a 110- to 120-volt AC motor. Argyle Mfg. Co., of Colchester, Ill., sells it for \$29.95.

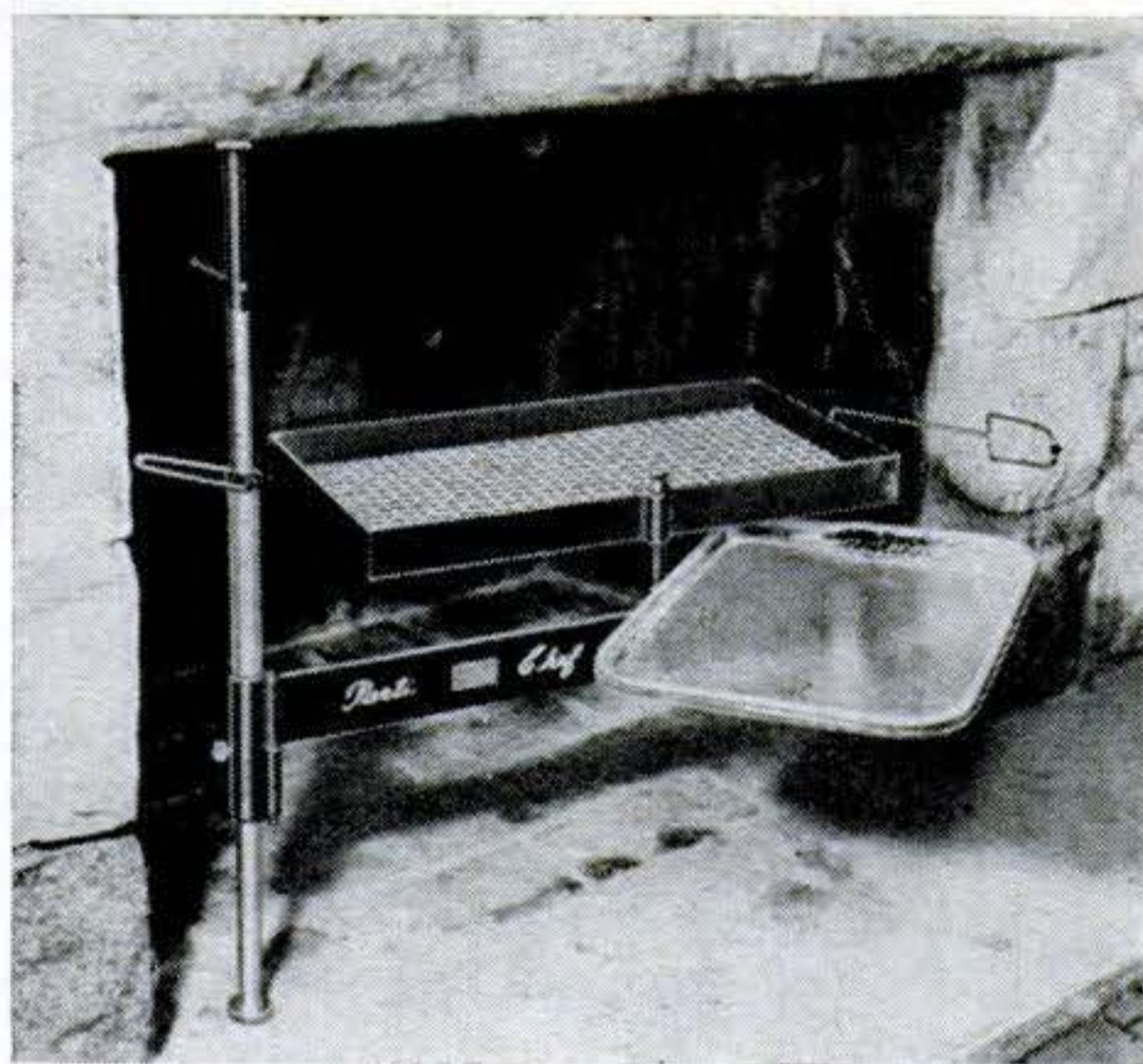

### **Barbecue for Indoors or Outdoors.**

Interchangeable posts on this grill let it be installed indoors in a fireplace or outdoors in a picnic area. A handle on the grill moves it over the fire for cooking, out to a magnesium tray for removing food. Placed on the wire grid, the tray becomes a griddle. It is sold by Lyncraft Products Co., Lake Orion, Mich., for \$19.95.



**Labels Are Easy to Mark.** For identifying frozen foods and other packages, a new self-sticking tape adheres to metal, glass, or plastic. It has a blue border and white writing surface that can be lettered with any pointed instrument. Lettering comes out blue. Sold with dispenser by the Labelon Tape Co., of Rochester, N. Y., it is priced at about 50¢.



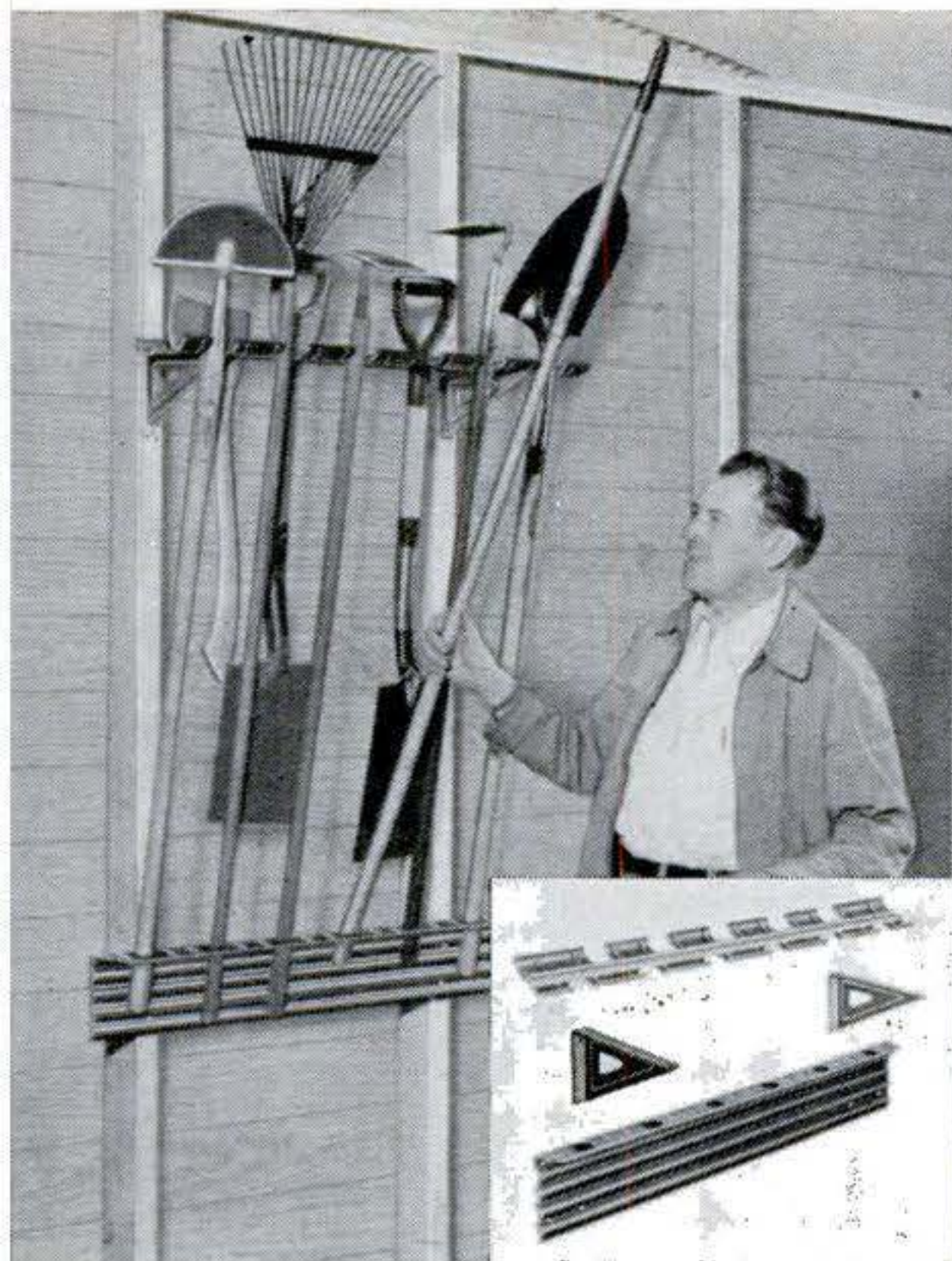

**Rack Keeps Tools Handy.** Mounted on a garage or basement wall, the rack above has room for storing six long- and five short-handled gardening or household tools. It is made by the Inland Steel Products Co., of Milwaukee, Wis. The toolholder comes with screws and bolts for easy installation.



**Tubing Stops Slamming.** As a door equipped with Hold-a-Door opens, telescoping tubes inside a sleeve pull apart. Temporary vacuum holds door open 8 to 40 seconds, then lets it close. Knife Industries, Lawrenceville, N. J., sells device for about \$3.

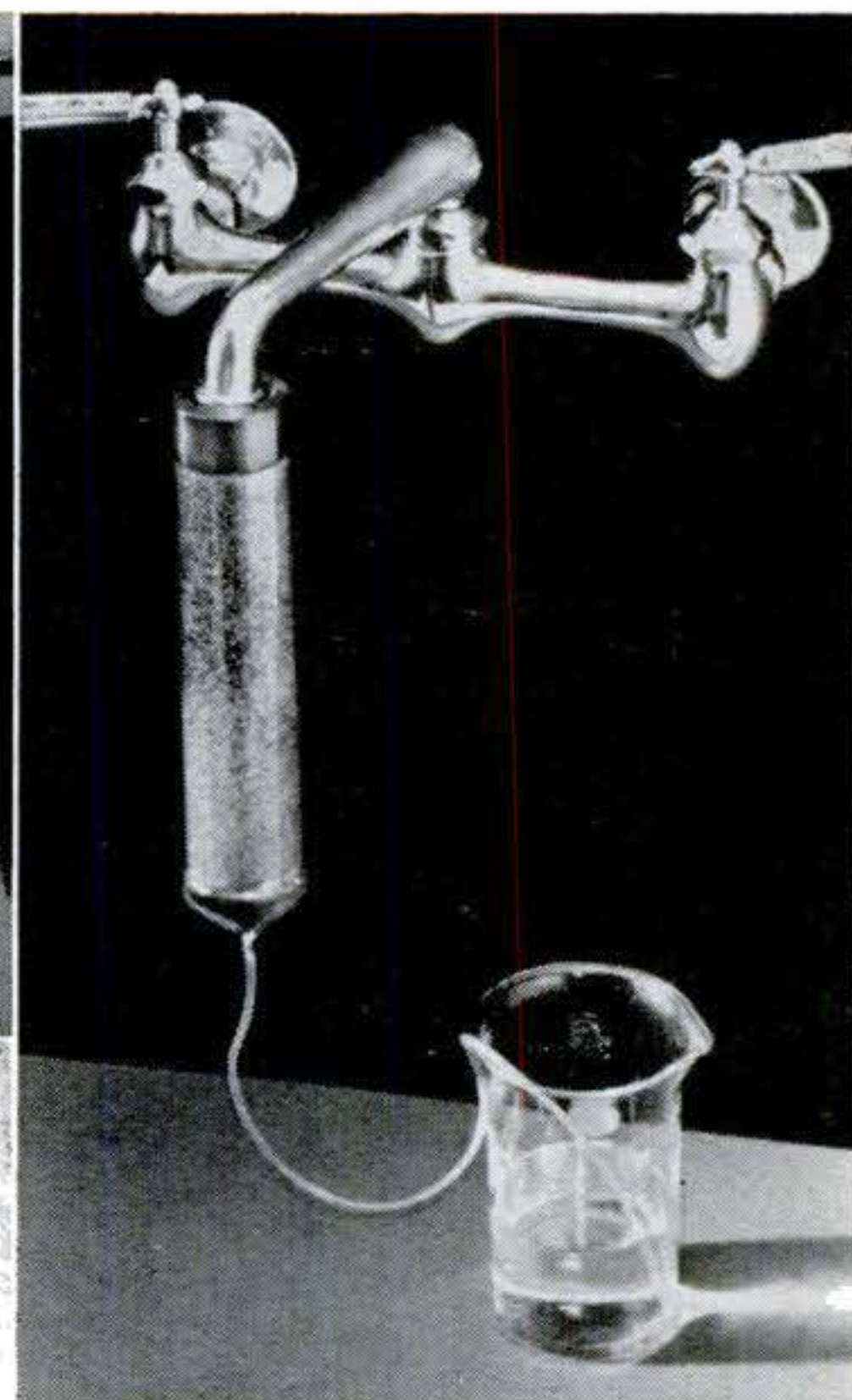

**Resins Purify Water.** Distilled water for steam irons and storage batteries can be drawn from the kitchen faucet if this refillable Filtr-Ion tube of resins is attached. Resins, blue-black at the start, turn yellow when exhausted. La Motte Chemical Products Co., Baltimore, makes it.

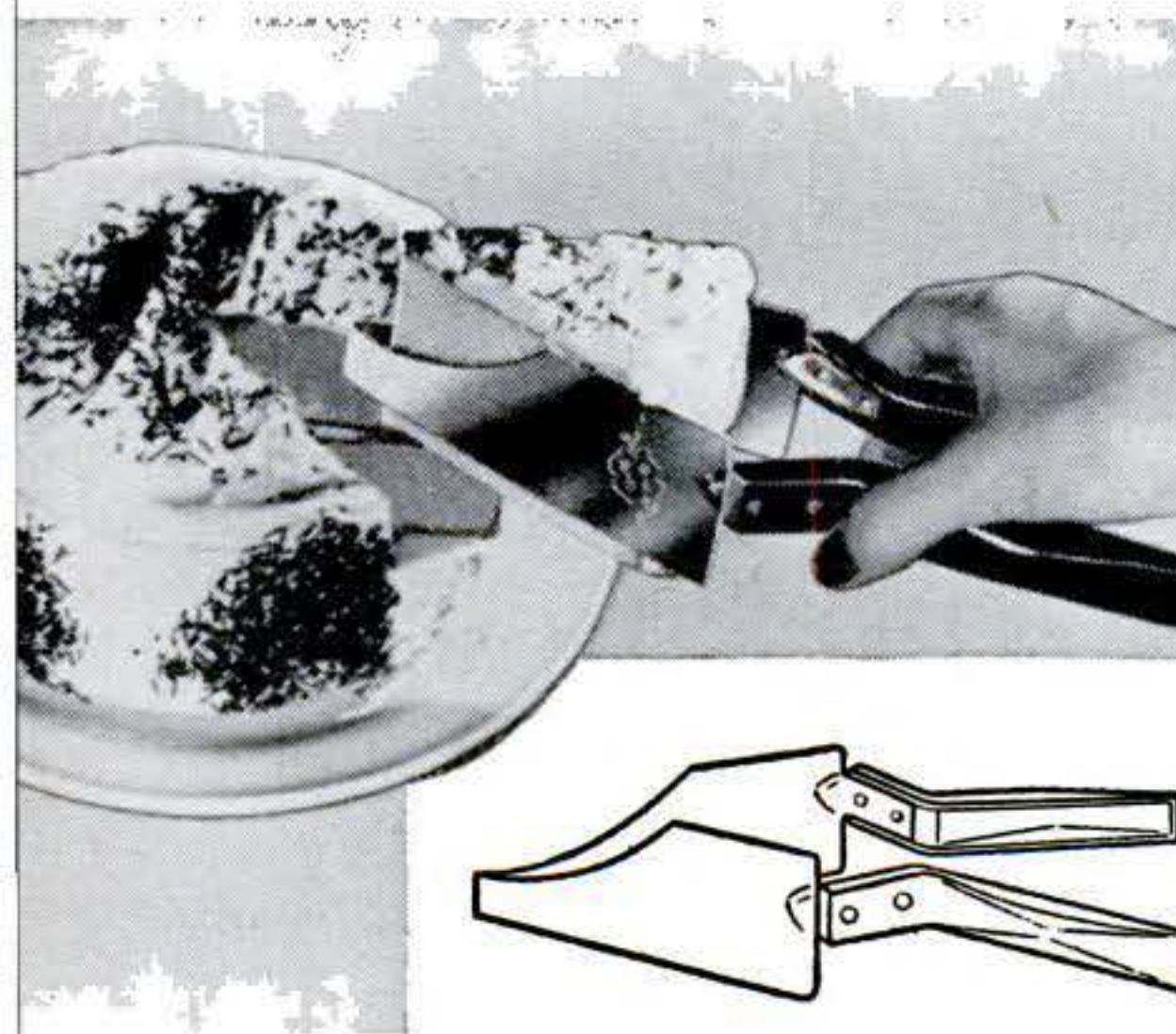

**Knife-Tongs Prevents Crumbling.** To cut and serve cake portions with one hand, spread this flexible, V-shaped cutter to the desired slice size, press its sharp edge into cake, then lift up with cake held firmly in the blade. Krag Steel Products Inc., Chicago, sells the cutter for \$2.

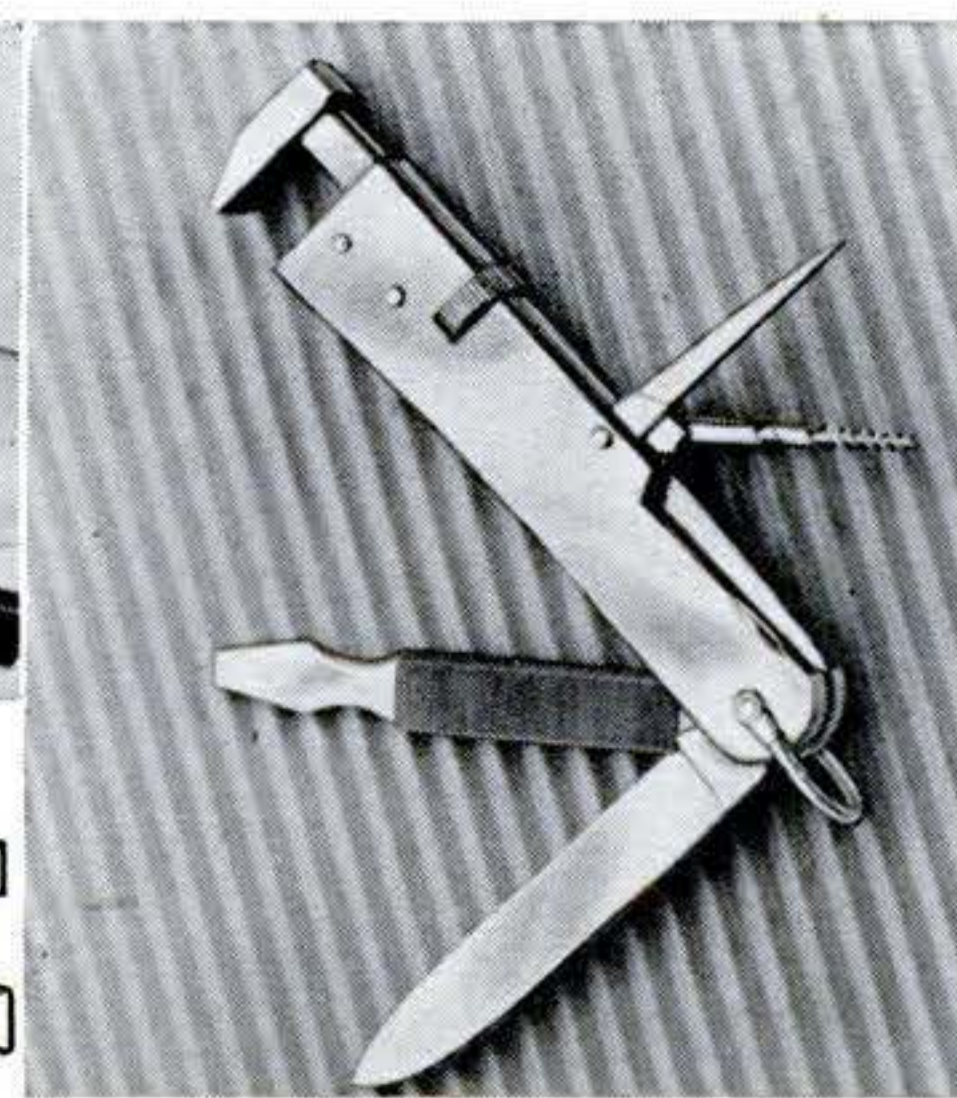

**Tool Kit Fits Pocket.** Besides having a blade, this steel knife boasts a 3/4-inch monkey wrench, a hammer, drill bit, awl, and file with screwdriver tip. Imported from Germany, the knife is 4 1/4 inches long. Hoffritz for Cutlery, New York City, prices it at \$9.95.

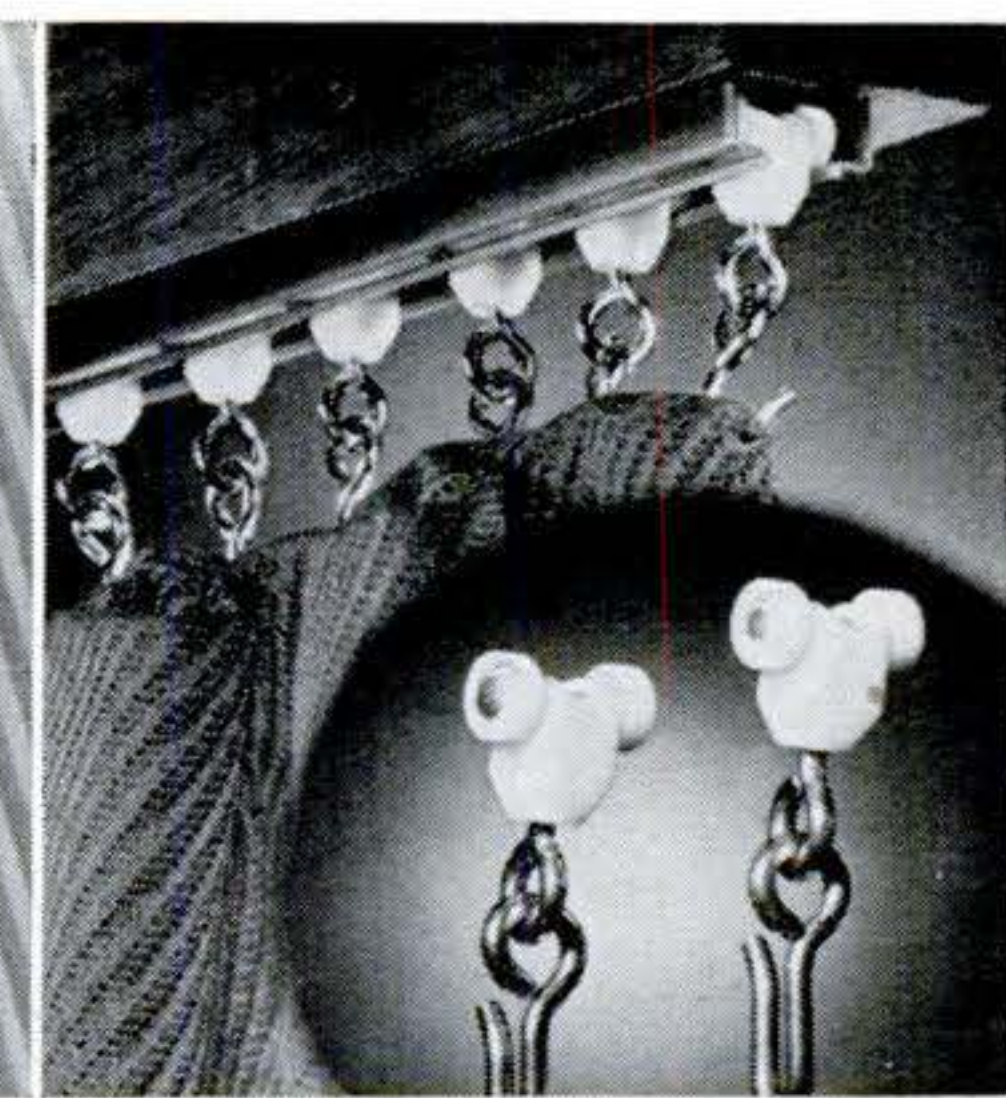

**Rollers Move Quietly.** Designed for hospitals, these plastic curtain rollers with stainless-steel hooks are said to eliminate noise when slid along a metal track. Made by Grant Pulley & Hardware Co., Woodside, N. Y., the curtain assembly can be mounted on a ceiling, or built flush with it.

# Plastic Helps Prevent Runs

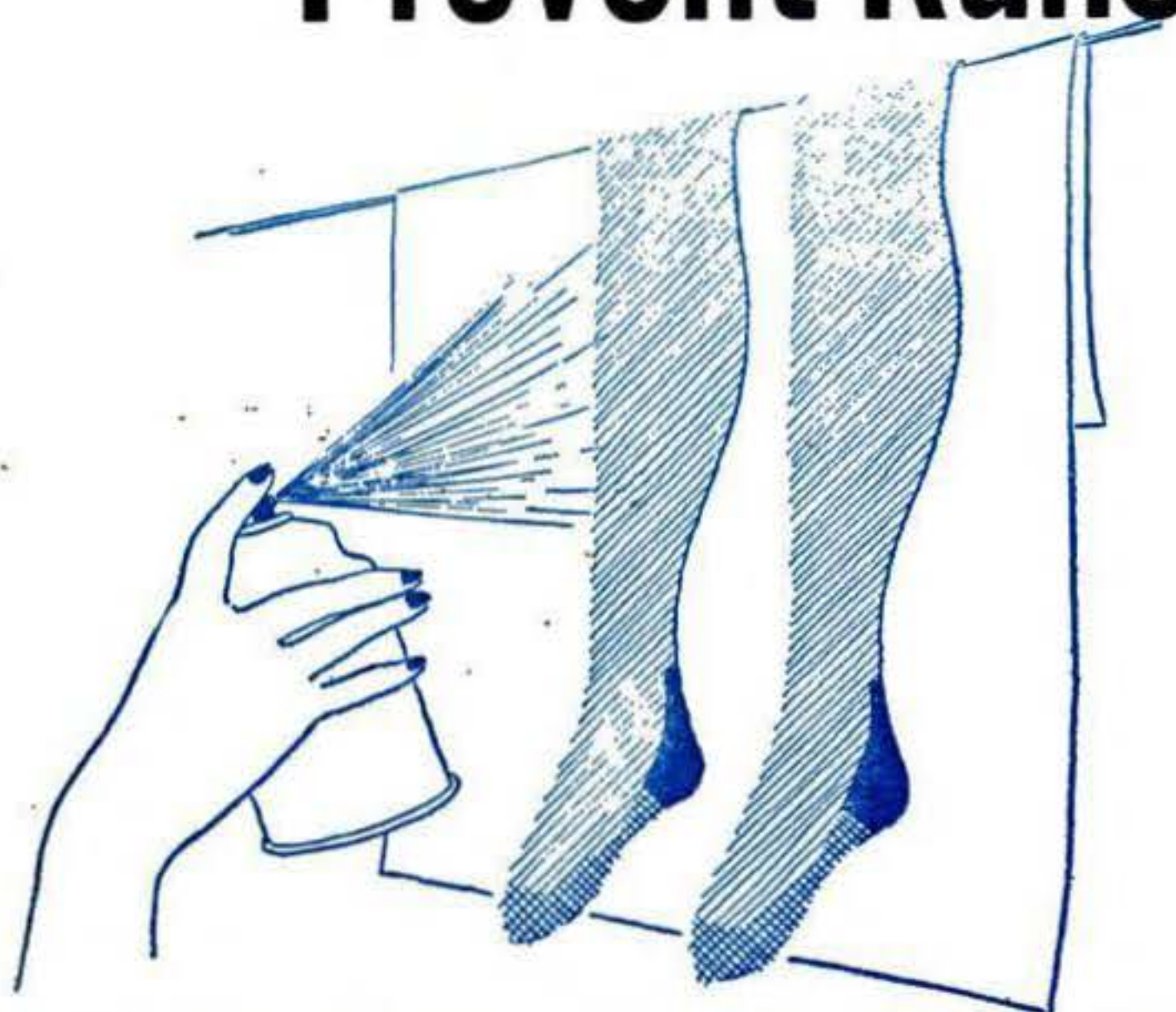

**A**N AIR FORCE mechanic (we'll get to the legs in a minute) was spraying a protective dope on fabric airplane wings when he got an idea: Maybe a similar coating would protect women's fragile stockings.

As a result, you can get a clear-plastic coating, called Nylonger, that you can spray on silk and nylon stockings in a few minutes. Packed in the new self-dispensing spray cans (PS, Dec. '50, p. 102), it coats each thread with a thin, invisible plastic film that adds strength and reduces wear. Where threads cross, the plastic "spot-welds" them together so they are less likely to unravel and cause runs if snagged.

Said to increase stocking life from two to nine times, the plastic sells for \$1.98 a can, enough for about 70 sprayings.

**Magnified views** of same stocking mesh show how threads look before treatment, below, and after treatment, at right. Photos show microscopically small threads enlarged about 50 times.

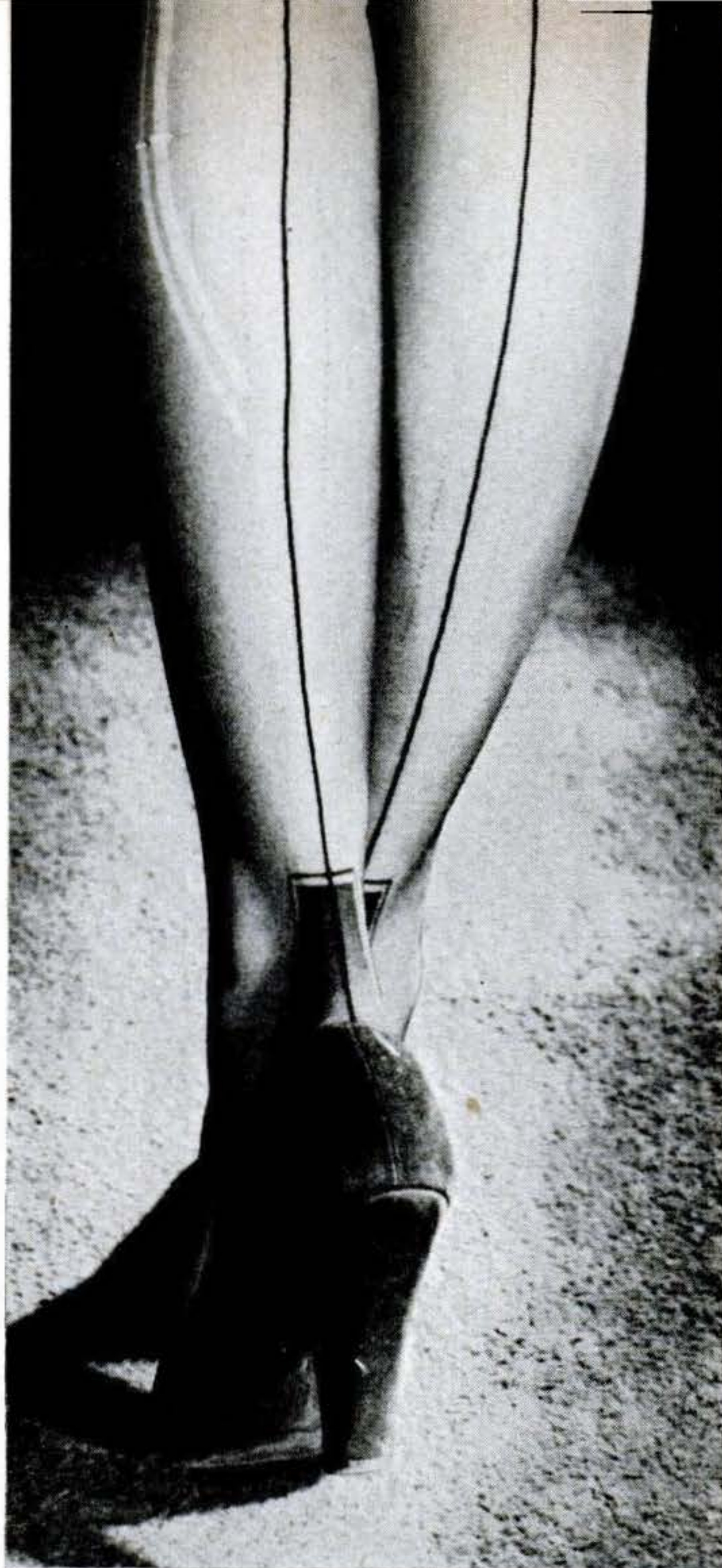

**Here's what happens** when untreated stocking is snagged. Broken threads start run that ruins entire stocking. If treated, the threads are less likely to unravel, and snag is kept small.

**In treated stocking,** threads are coated with tough, flexible film of plastic that cuts wear, increases life. Where threads cross, note tiny globs of plastic that glue strands together.

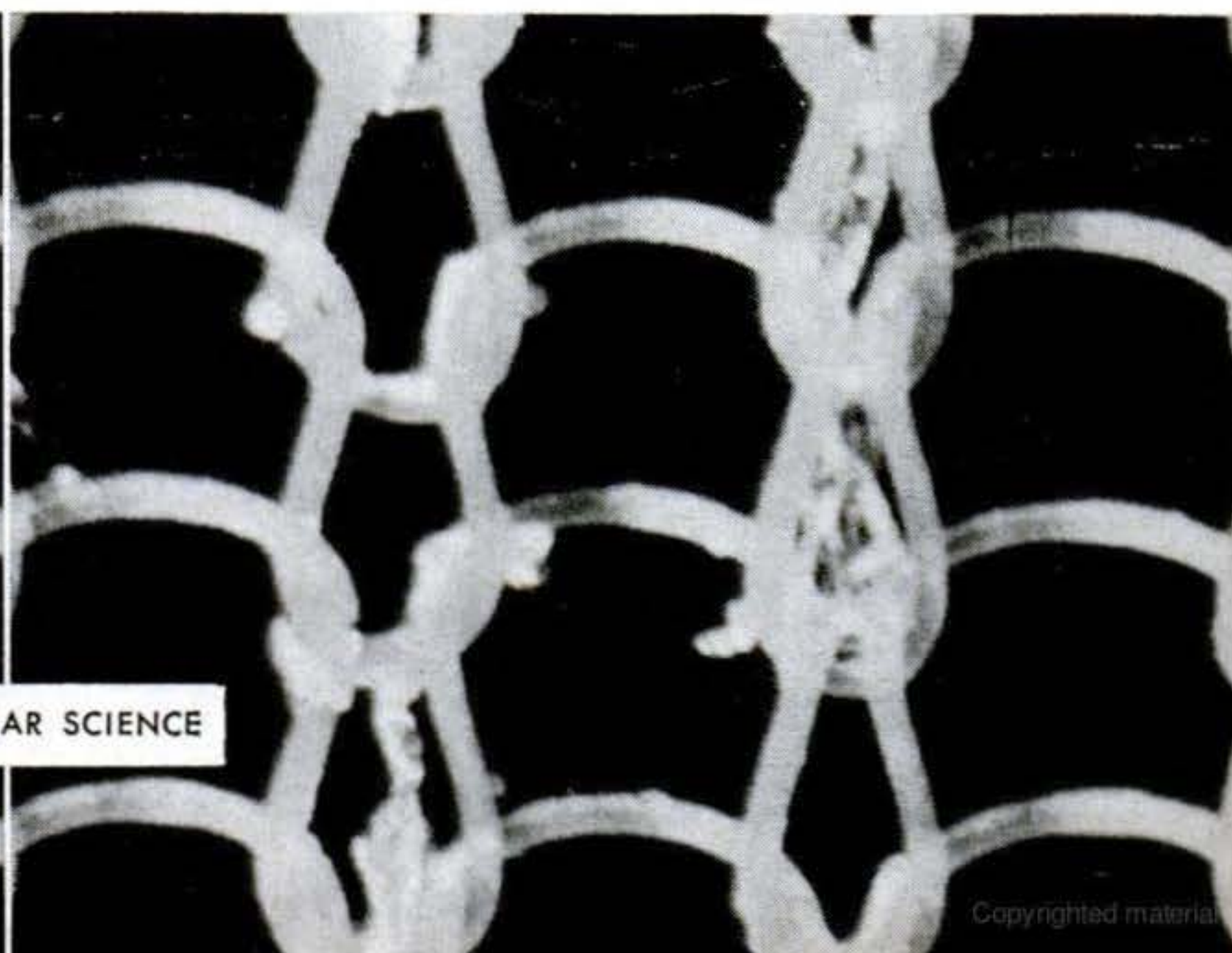
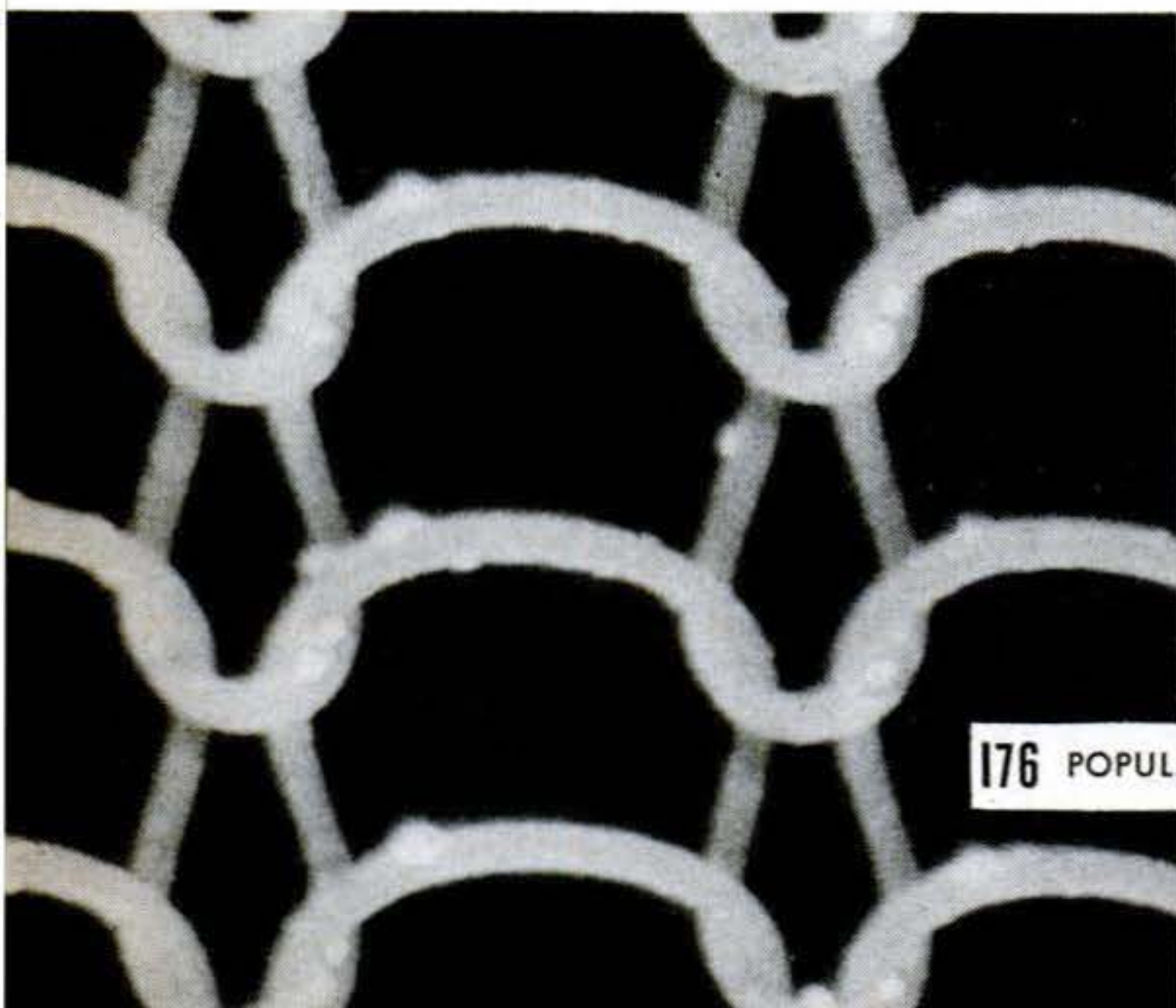

# The Inside Story of Our **Expansion Attic**

**How a young couple converted an empty attic into three extra bedrooms, and showed a cash profit on their spare-time work.**

**By Mary Ellen Goodman**

PS STAFF PHOTOS

**W**HEN my husband and I decided we would like to expand our "expansion attic" into three rooms and bath, we called in a contractor for an estimate. Then we looked at our bank account, and it didn't take a certified accountant to see that we'd have to do the work ourselves. We're glad

we did. The job was fun, and it paid off.

**What we saved.** The contractor gave us an estimate of \$2,450 for putting in three bedrooms, without the bathroom. As I total up our own costs, I find we spent \$378 for outside labor and \$520 for materials. So we saved almost \$1,500, in exchange for 300 hours of our spare time. As amateurs, we consider \$2.50 per hour for each of us pretty good pay. And we now have a sound

**An architect** representing POPULAR SCIENCE, J. Conrad Breiby (at left), helped Gerson and Mary Ellen Goodman plan the project described in this and other articles that will follow. Their baby, one-year-old Steve, looked over the blueprints of his future quarters as critically as did his parents. Below is their home as it looks now. It faces west. The plan the Goodmans chose to finish their attic appears on the next page. They expect to put small hopper-type windows in end walls of center section later on to increase light and cross ventilation.



**There was plenty of room in our attic. Now we have three**

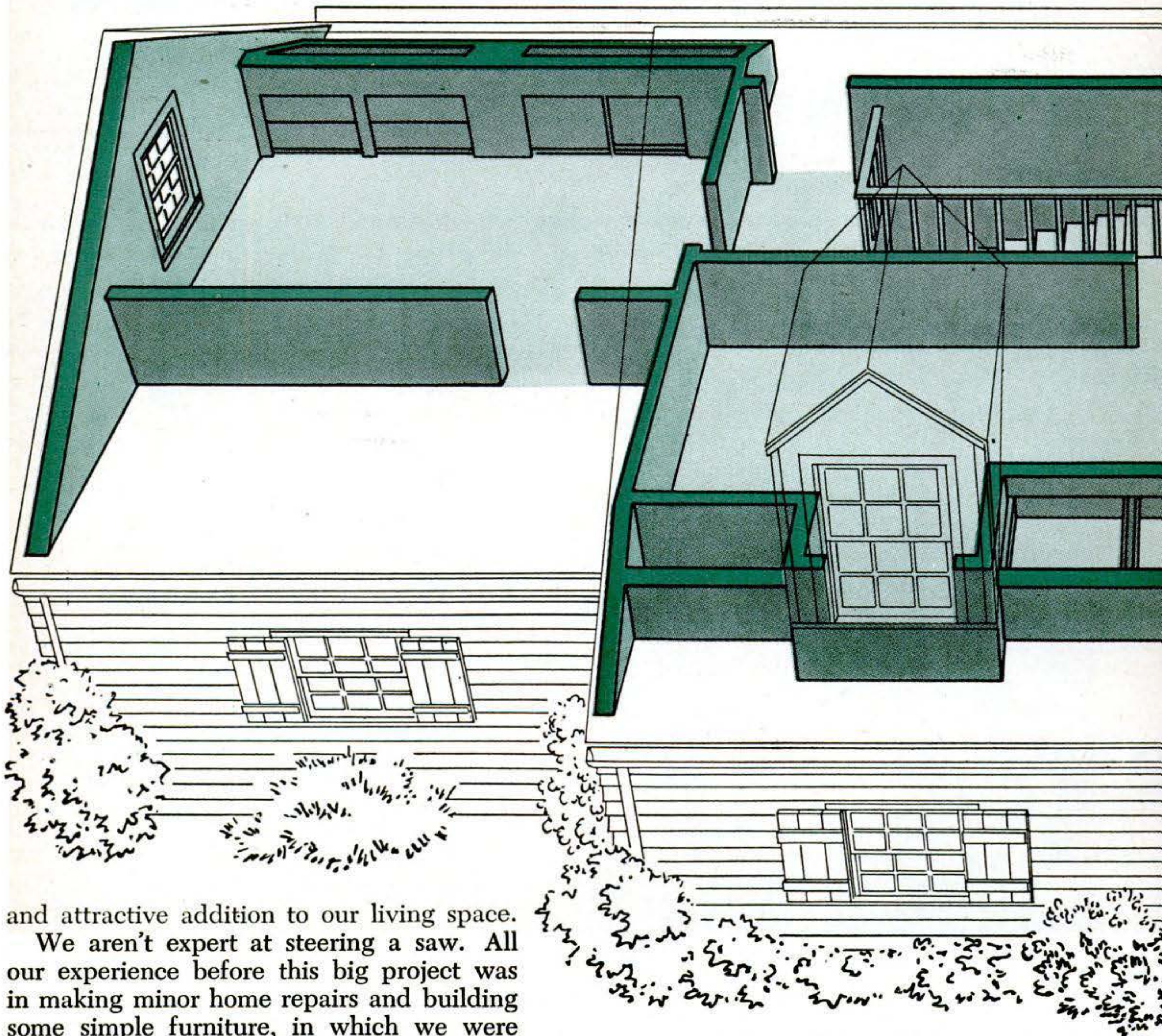

and attractive addition to our living space.

We aren't expert at steering a saw. All our experience before this big project was in making minor home repairs and building some simple furniture, in which we were aided by an elementary text on using hand tools. We have no power tools, and managed nicely without them at first. Later, *POPULAR SCIENCE* lent us an electric drill and an 8" bench saw to speed up the cabinet work. Both were a help, but we could have done the job without them.

Although it seemed big to us, this was strictly a spare-time project, done evenings and week ends. We averaged three or four sessions a week, and never put in more than three hours in any one day.

**How we began.** When we bought the house, our attic was an echoing emptiness 25' wide by 40' long, under a low-pitched gable roof, with two small dormer windows. There was rock wool between the floor

joists right over the ceiling lath, but no floor except for catwalks to the windows.

We broke down the entire job into these divisions: flooring, heating, plumbing, extra windows, insulation, partition walls, wiring, storage space, and doors. Immediately we decided that the bathroom would have to wait another year, since the plumbing was no job for amateurs (and forbidden by local codes), and the best estimate we would get was \$881. Although called an expansion attic, ours had none of the necessary piping. This had to go in before the flooring, so we contracted with a plumber to install it.

Fortunately our present boiler (we have hot-water heat) was large enough to handle the increased load. Otherwise we would

**rooms up there, plus storage space and a bathroom to come.**

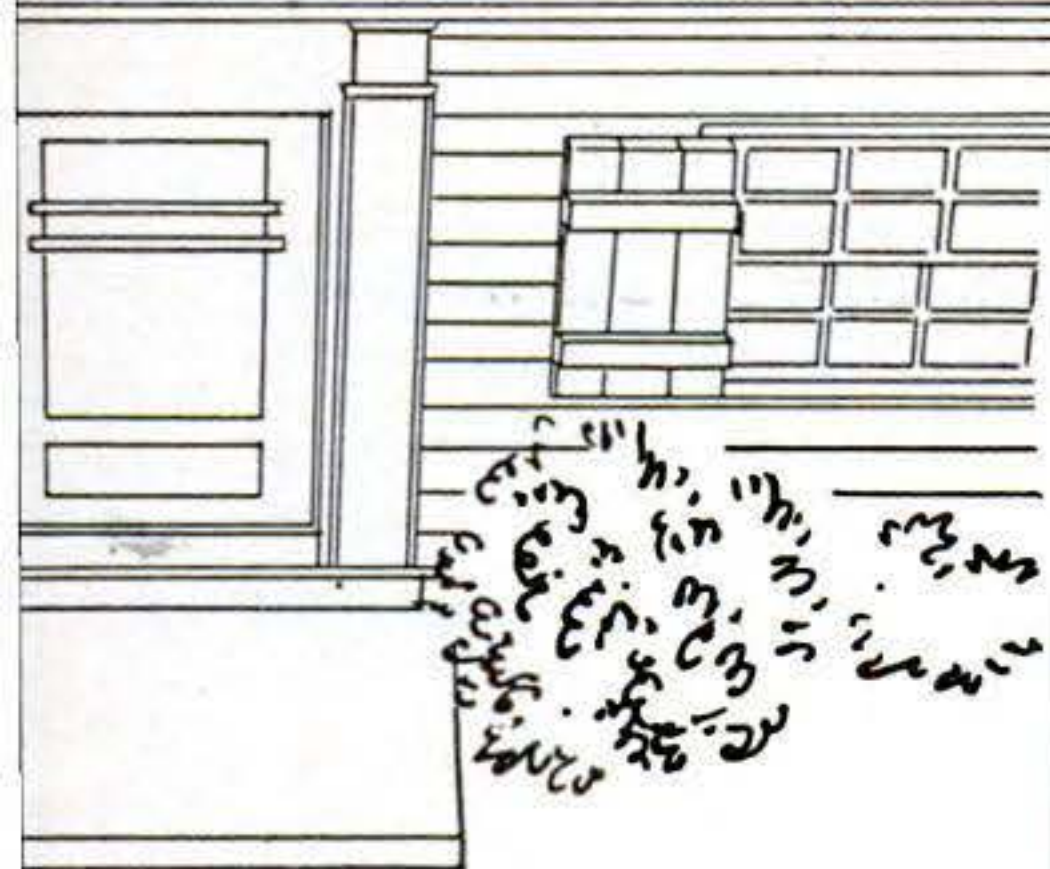
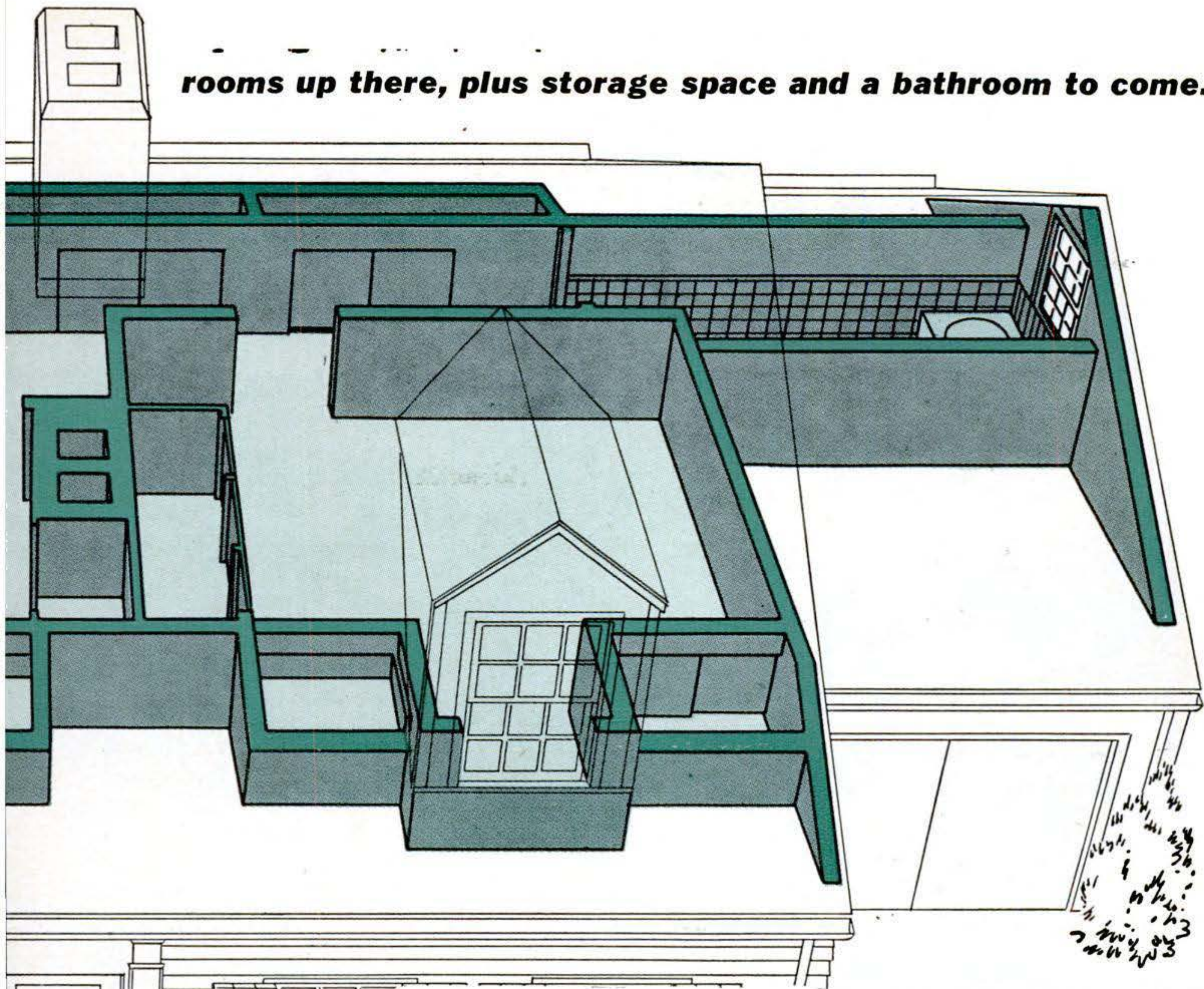

**Net gain** in our living space was the equal of a good-sized apartment. At right is an architect's-eye view of the layout we accepted.

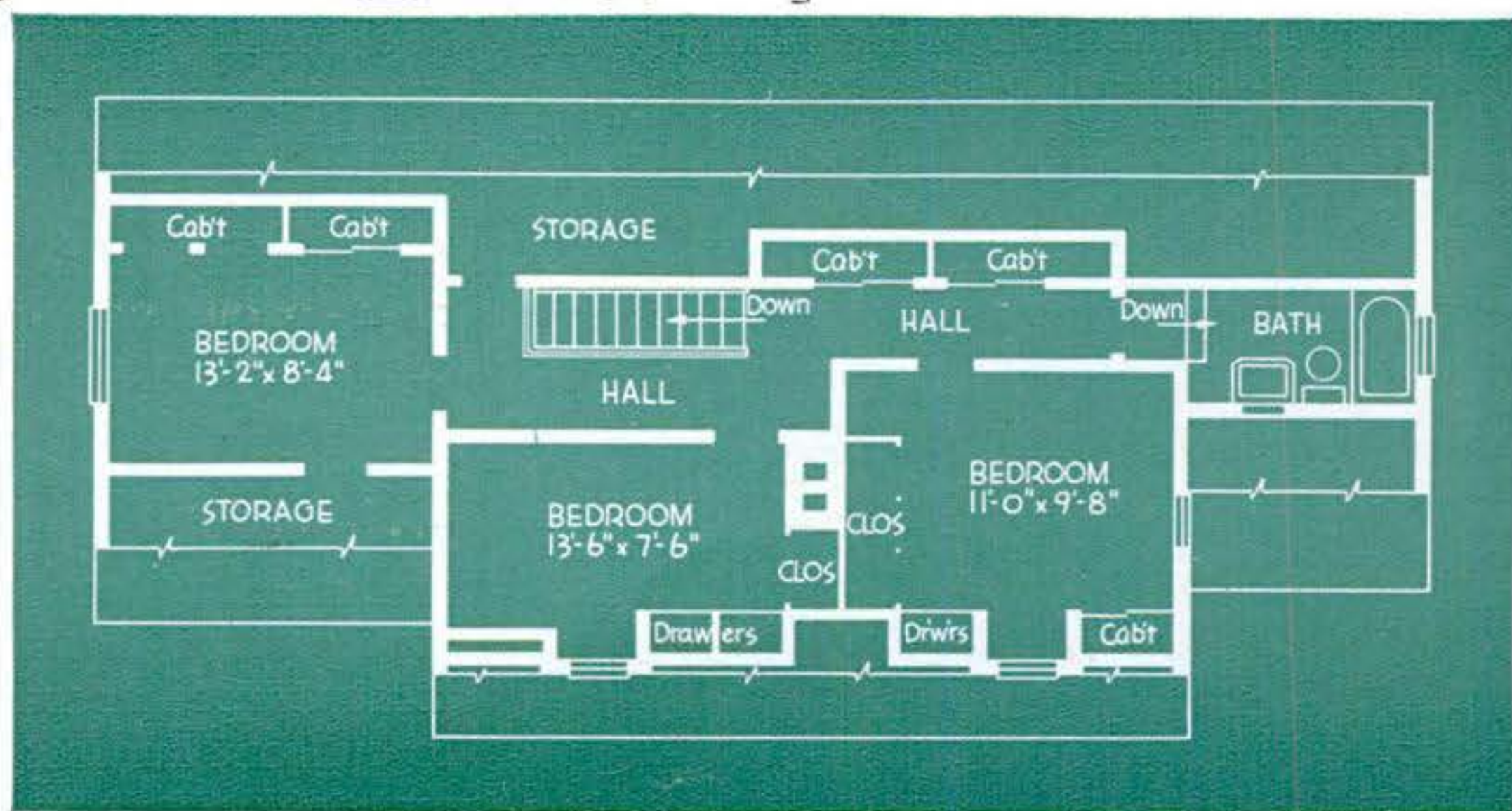

have installed electric space heaters in each room. But these are costly to operate, and might have required new feed wires, so we were lucky to have an adequate heating plant.

Throughout our planning we sought to minimize or postpone expenses in order to lighten the load on an already tight family budget. For instance, when the heating

pipes were installed, we had them capped. Thus we didn't have to buy radiators for six months, when we celebrated our grand opening by moving our little boy, Steve, into the north room. But while the plumber had the garage wall open to put in heating lines for the bathroom above, we had him install the hot- and cold-water pipes too, so that the wall won't have to be broken open

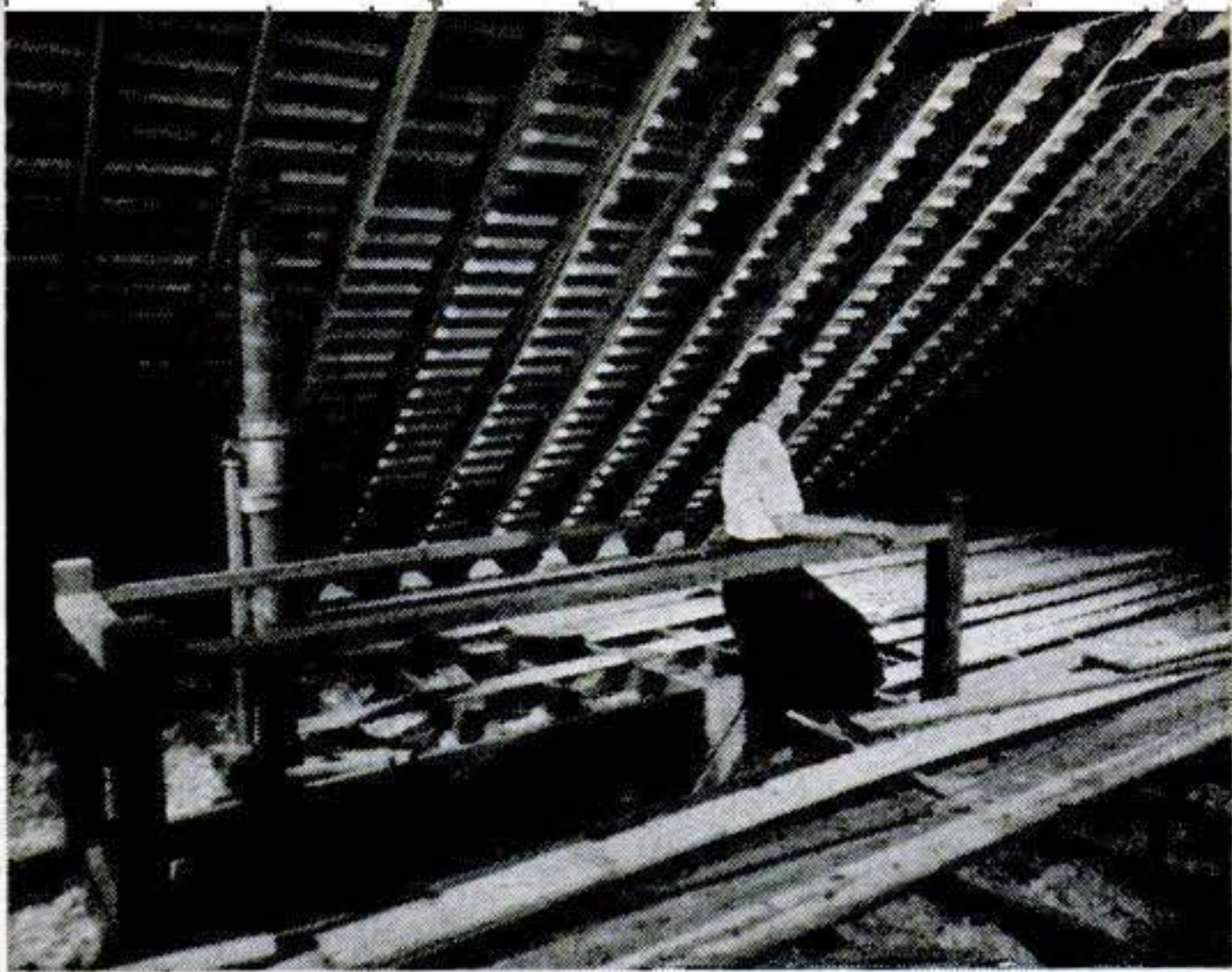

There wasn't much up there except space, to begin with. The steep roof pitch limited headroom, and rooms had to be planned to utilize what there was to the utmost. Only half the collar beams were in; we had to install the rest.



The dealer showed us how to stack flooring (which we brought in through a window) with scrap pieces between to let air circulate. This also kept the stuff from underfoot. If you walk on tongue-and-groove, edges break and the boards are then difficult to lay.



Catwalks laid to the dormers had to be torn up. The architect pointed out areas around windows and chimney where we had to set in two-by-four nailing members to support flooring adequately.

again next year when the fixtures go in.

With the pipes in, we were ready to start our own work. We planned to do everything except putting in extra windows and wiring. The windows could go in later, and the wiring had to wait until the studing was up. Before we tackled the job, we spent some time wandering through half-built houses and noting at firsthand how things were done.

**Flooring was first.** Our year-old son enjoyed crawling in the rock wool between the floor joists, and the lath ceiling beneath supported his weight nicely. Not so an adult's, as we found out when a friend stepped through it. Flooring was obviously first. We planned to put down a subfloor of 1" tongue-and-groove and finish it with asphalt tile.

To avoid tightrope walking along or across the joists, we got several broad planks that we could lay around our working area. Then we started ripping up the catwalks, an onerous job because the stuff was toenailed through the tongue. It took six hours. But we saved the pieces, and later used them elsewhere.

When we were ready to buy our first 1" by 6" tongue-and-groove pine, we told the owner of the local lumber yard about our project. He was most helpful and agreed to give us a quantity price even if we took delivery of only a little footage at a time. We bought nearly 1,000 linear feet before we were done, but we didn't want to stack (or pay for) such an amount all at once. It took us over two months of spare evenings to lay the subfloor. This was the most monotonous part of the job, but luckily it came first, while we were fresh.

Nevertheless, we made our first mistake right there. Instead of ordering flooring, we should have gone to the lumber yard and selected the boards. Taking what was sent cost us many hours of extra labor to force warped boards into shape, and we had to cull out and set aside a needlessly large amount of split or warped footage. (Ironically, the best lot was the last, so the flooring under the eaves was the neatest we laid.)

**We laid it straight.** The experts and the books will tell you subflooring should be laid diagonally. Ours isn't. We found that diagonal subflooring is supposed to strengthen the house, but our house was hanging together nicely with no attic flooring at all, so we figured it would keep on doing so. Laying those boards diagonally

Two to nail flooring, and baby made three. A wedge of tongue-and-groove stock, driven between the piece we were laying and scrap nailed to the joists, enabled us to force even warped lengths into position. Close-up below shows the way we did it.



would have been a tough job for us, and would have cost us extra lumber.

Another departure was in our nailing method. There are those who can sink a nail cleanly into the tongue and get a faultless fit over it with the groove of the next piece, but it didn't work that way for us. We kept splitting the tongues. Finally we switched to  $2\frac{1}{2}$ " cut nails, driven straight through the face of the flooring, two to each joist. These sank themselves without setting.

We started flooring under the front eaves with the old lumber we'd ripped from the catwalks. This area was planned to be storage space, which would not be covered with asphalt tile, and we preferred to use the better lumber as we worked out into the rooms proper.

The dealer from whom we bought the nails taught us our first trick. To force tongue-and-groove stock together, we used a scrap piece cut in the shape of a wedge. This was driven between the flooring and a piece nailed to the joist, the groove on the wedge fitting the tongue on the board.

We could lay two or three boards at a time this way if they were not badly warped, and could force almost any single board into place no matter how badly warped. Since time meant less to us than money, we saved short ends and knotted pieces for use under some of the eaves, so we wasted hardly any. Although it was easier to lay long boards, we sometimes cut them to minimize the warp. We tried to avoid making two adjacent joints on the

same joist, as we were told this would tend to let the floor creak.

By using  $\frac{3}{8}$ " plywood instead of pine boards, we could have had a superb sub-floor much faster, with an ideal surface for laying the asphalt tile. But our budget said "no," because plywood would have cost us almost twice as much.

**Enter the architect.** It was while we were having our flooring troubles that POPULAR SCIENCE became interested in our project and offered to furnish us an architect, a luxury we hadn't dreamed of.

This took the shape of J. Conrad Breiby, Jr., six-feet-three of rising young architect, who told us we didn't have to lay the flooring right up to the plate. He suggested we leave an inch all around to allow for expansion. He also pointed out areas around

**Partly laid,** the flooring looked like this. To warm up for the job, we first built two saw-horses like the one shown. They were fun to make, cost about a dollar apiece, and proved indispensable. Ventilating louvers in end wall were replaced with a window later on.



the dormers and chimney where the joists were not placed properly to support the flooring, and at his suggestion we set in two-by-four nailing members there.

By the time we had finished the flooring, Mr. Breiby presented us with two sets of drawings. One showed us how the attic would look as we had planned to lay out the rooms, together with many niceties we might have overlooked. The other outlined a more ideal use of the space, but called for a twenty-foot shed dormer along the back wall. We didn't feel up to building that ourselves, and it would have cost more than \$500 to have it done.

**Let there be light.** While sticking to our original plans, we nevertheless had to admit things looked dark away from the dormers. The best answer within our means seemed two ordinary windows in the ends of the attic—one in the bathroom-to-be, the other in the largest bedroom.

There was quite a debate about the installation of these windows, Mr. Breiby and the editors believing we could put them in ourselves, and we feeling that we probably could—but what if they leaked? Because of our misgivings, we finally hired a skilled carpenter, Walter Brandmeier, of Rye, N. Y. He not only put in the windows but gave us invaluable advice on other matters.

The helpfulness we encountered everywhere was perhaps our outstanding pleasure during the whole job. Everyone with whom we came in contact shared his knowledge,

and many of the suggestions offered saved us hours and—more important—dollars.

For additional light, Mr. Breiby's plans show a good idea we haven't yet been able to afford—two tiny second-story windows of the hopper type similar to those used in cellars, placed in the end walls of the central portion where the garage and north wing are set back. These would admit a little light and afford cross ventilation. We plan to have these installed at some future date.

The architect also pointed out that there is room for a 24" attic fan under the ridge peak at the south end of the house. Such a fan would boost air circulation on sultry days. We haven't bought the fan yet (and won't until summer) but we did leave a trap door through which it can be installed. A future article will describe the grilles we set into the ceiling of each attic room.

*Next month Mrs. Goodman continues her story of an attic made livable.*

### Kitchen Detergents Clean Brushes

WHEN I finish a paint job, I use this method of speedily and easily cleaning the brush. Put the brush in a clean jar or can. Place a heaping teaspoonful of a household detergent in the can. Add warm water to cover the bristles. Slosh the brush around in this mixture. Repeat with more detergent, if necessary. In a few minutes you'll have a clean brush.—Robert W. Bradford, Syracuse, N. Y.

## PLYWOOD REPAIRS

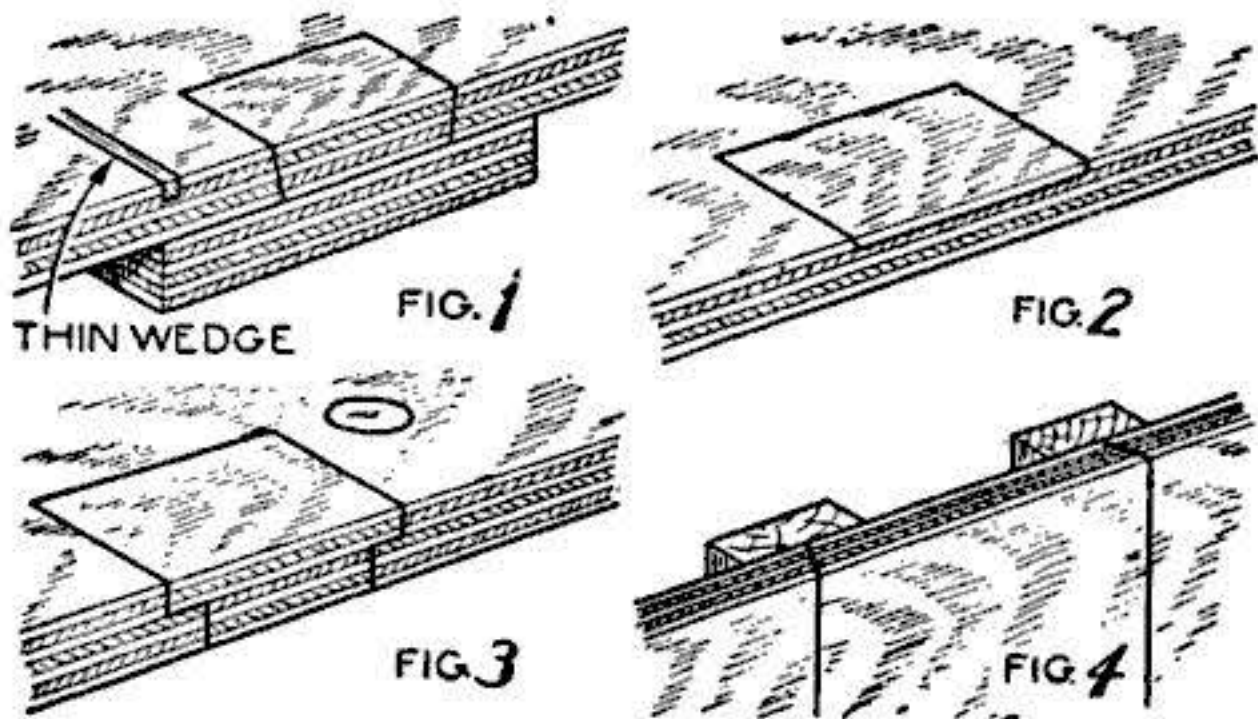

When smoothing the surface of plywood is the only repair, clean the cavity, pack with plastic composition wood or similar filler, and sand level after drying. Two or three applications are best in deep holes.

If a saw can be used and there is opportunity to put in a backing block, saw out a piece and plug with a patch having tapered edges, as shown

in Fig. 1. In many cases nails and screws can be used to reinforce the glue. Scratches can be routed and filled with wedge-shaped strips glued in and sanded flush.

Figure 2 shows a veneer patch suitable for bright finishes. Select a face veneer from plywood with a grain matching the work as closely as possible. Undercut the edges. Trace around it on the work, rout a little shallower than the veneer, and glue in the patch, scraping and sanding level when dry.

A shiplap patch for heavy plywood that can be chiseled out in steps is shown in Fig. 3. Also in Fig. 3 is a puncture patch made by boring through and inserting a plug made with a circle cutter or lathe.

When large areas are damaged, saw out the section and replace it, as in Fig. 4, reinforcing the beveled edge joints with battens behind.

FOR YOUR POPULAR SCIENCE INFORMATION FILE



# How Dry Wells Should Be Built

By Robert Scharff

**R**AINWATER rushing from roofs will damage many lawns and dampen many basements this spring—because no place has been provided for it to go. One way to dispose of it is to put in a dry well like this as soon as the ground thaws.

If there's a storm sewer in front of your house, you can of course run drain tiles to it and your problem's over. But otherwise, a dry well is the only practical solution.

Digging the hole may put some strain on your back—but aside from that the job isn't difficult. Plan a separate well for each down-

Only \$6 worth of materials are needed for a dry well like this. Cesspool blocks make ideal lining. Consult chart below for size well that you should install.

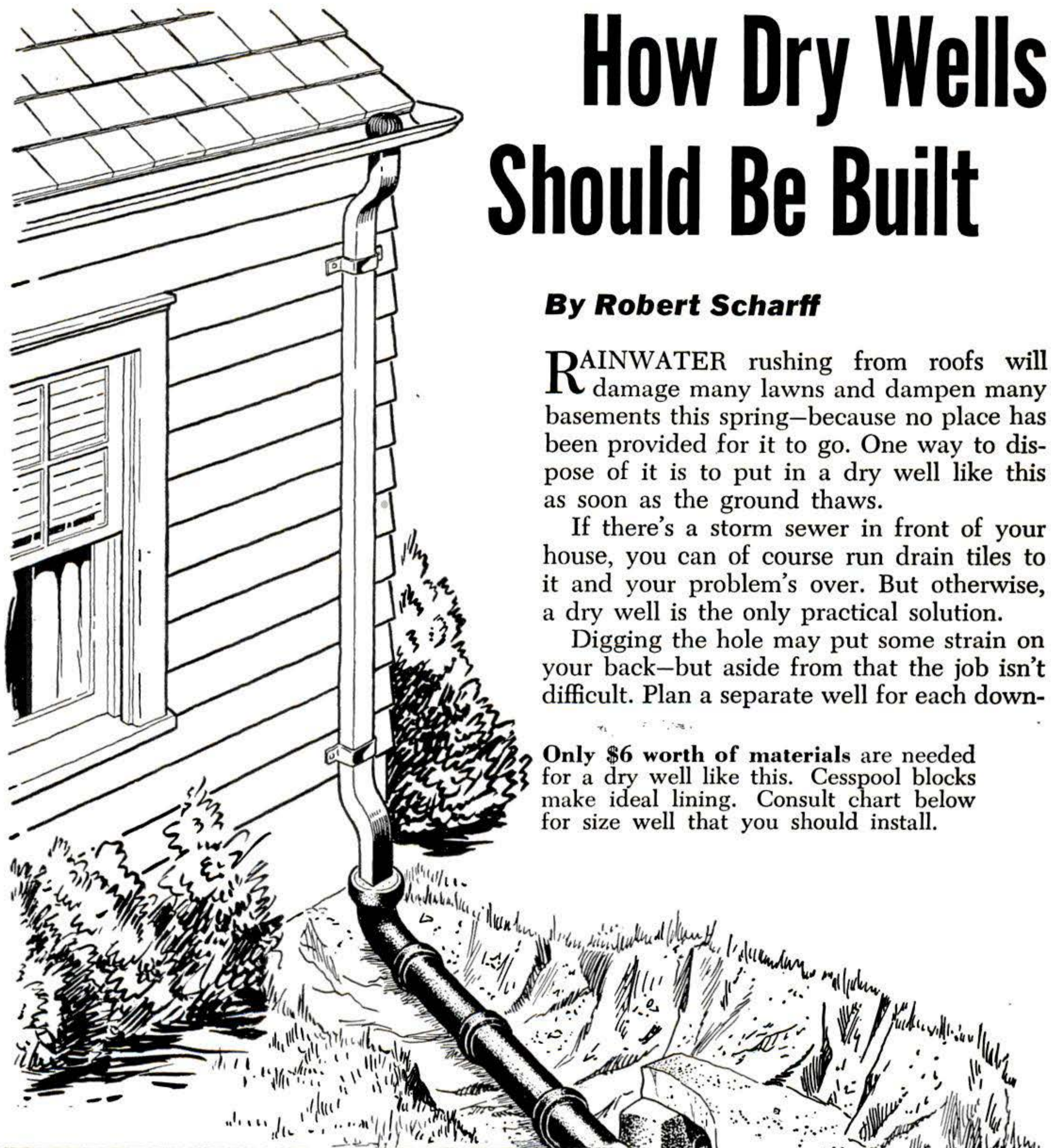

SIZE OF WELL REQUIRED IN VARIOUS SOILS

Size of Downspout	In coarse sand or gravel		In fine sand or sandy loam		In clay or loam	
	Dia.	Depth	Dia.	Depth	Dia.	Depth
3" dia.	3'	3½'	4'	5'	6'	5'
4" dia.	3'	4'	4'	5½'	6'	5½'
5" dia.	3'	4½'	4'	6'	6'	6'
2" x 3"	3'	3½'	4'	4½'	6'	4½'
2" x 4"	3'	4'	4'	5'	6'	5'
3" x 4"	3'	4'	4'	5½'	6'	5½'
4" x 5"	3'	4½'	4'	6'	6'	6'

These figures are based on an average of maximum five-minute rainfall in 23 cities.

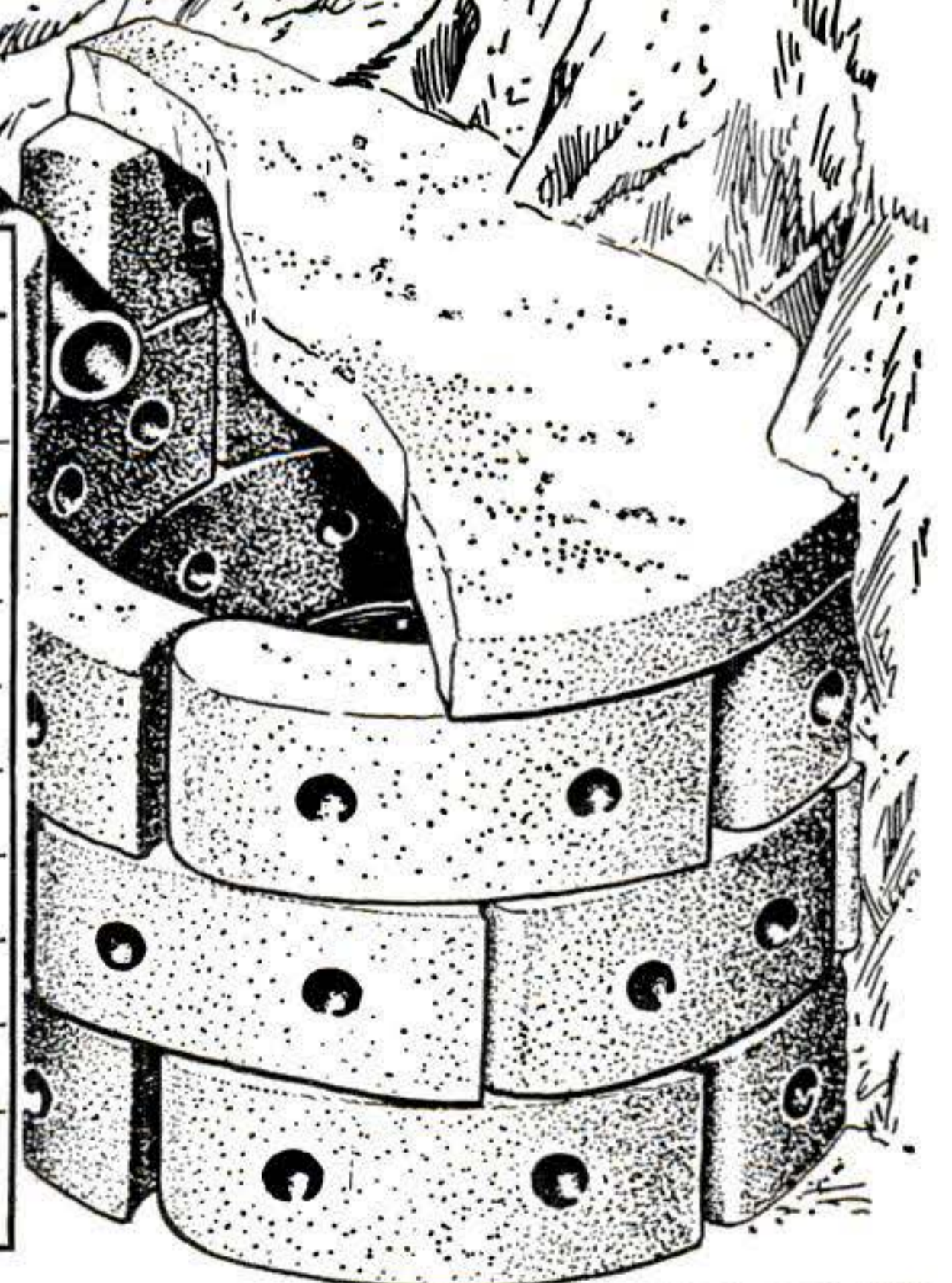

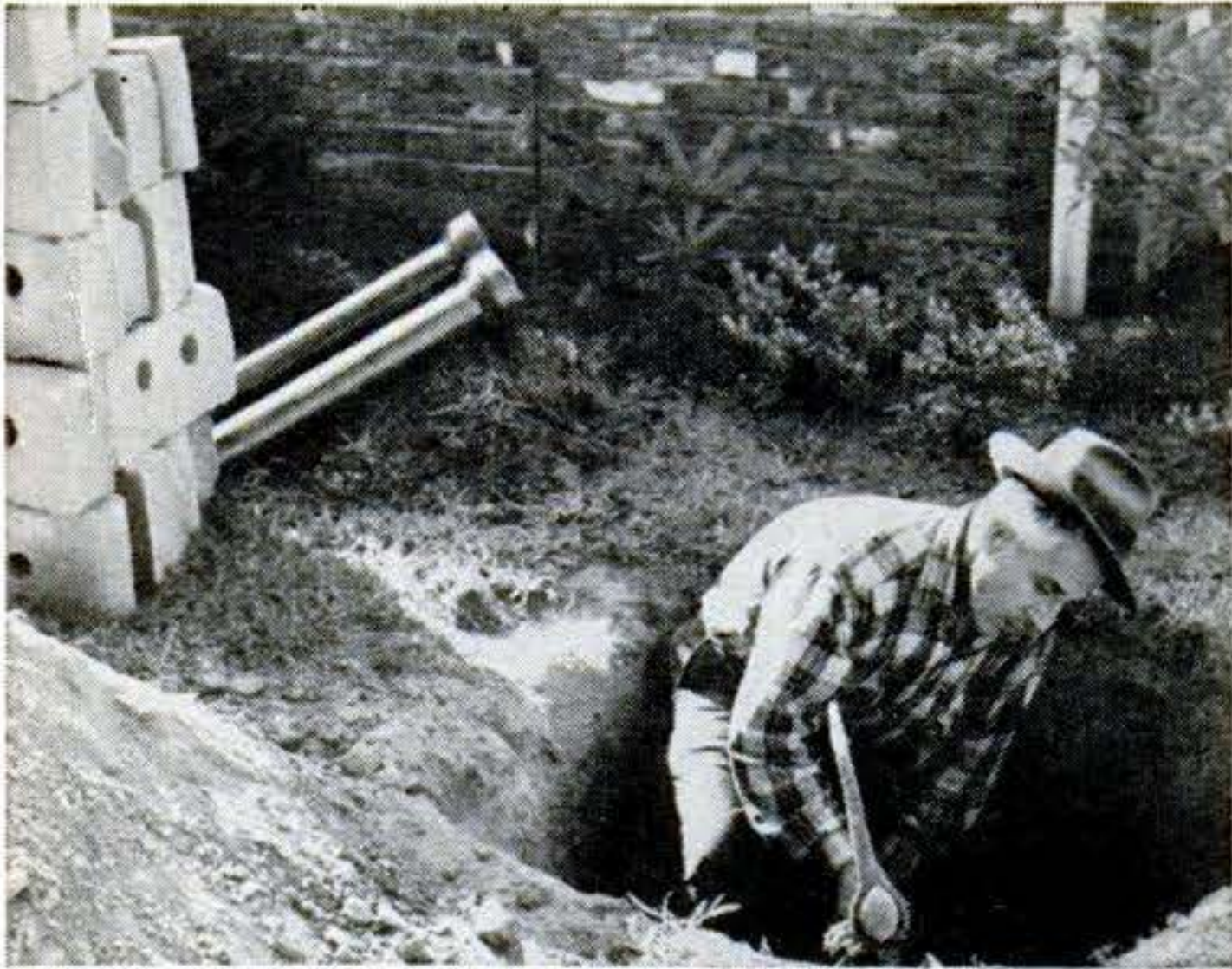

**Dig the hole** to a depth a little below house footing. Also make it deep enough to allow for at least 12" of soil above the well cover.



**Lay up the blocks** in tongue and groove style, giving well a slight conical shape. Fill the space around the outside of well with sand.



**Cement the tile joints**, using mortar made of one part cement to three of fine sand. Pack oakum into bell before working in the mortar.

spout, and locate each eight or twelve feet from the house.

Line the hole with brick or cesspool block, laid up without cement. Water will then seep through the sides as well as the bottom. Cover the well with a slab of concrete or a cesspool cover.

Use terra-cotta drain tiles to carry water from the downspout, pitching them down about 1" in each foot so the water will flow smoothly. If it's necessary to cut a tile, fill it with sand and cut with a cold chisel. The sand will keep the tile from cracking.

Before filling in the earth above the drain, try it out by letting water run through. If you find a low spot, raise the tiles there by wedging small stones under both sides. Put a wire cage at the top of the downspout to catch leaves.

For a less permanent type of well, see the drawing below. Sink the barrel into the ground about six feet, fill with gravel, connect the drain, put on a wire mesh or other cover, and shovel back the topsoil. This kind of well does a good job at first, but it eventually will clog up with leaves and other debris and become useless.

It's a good idea to connect the drainage of an automatic washer to a dry well. Thus you reduce the load placed on a regular cesspool or septic tank. Water from the roof, incidentally, never should be carried to a cesspool or septic tank. If filled with rain water, such containers can't take care of household sewage. END

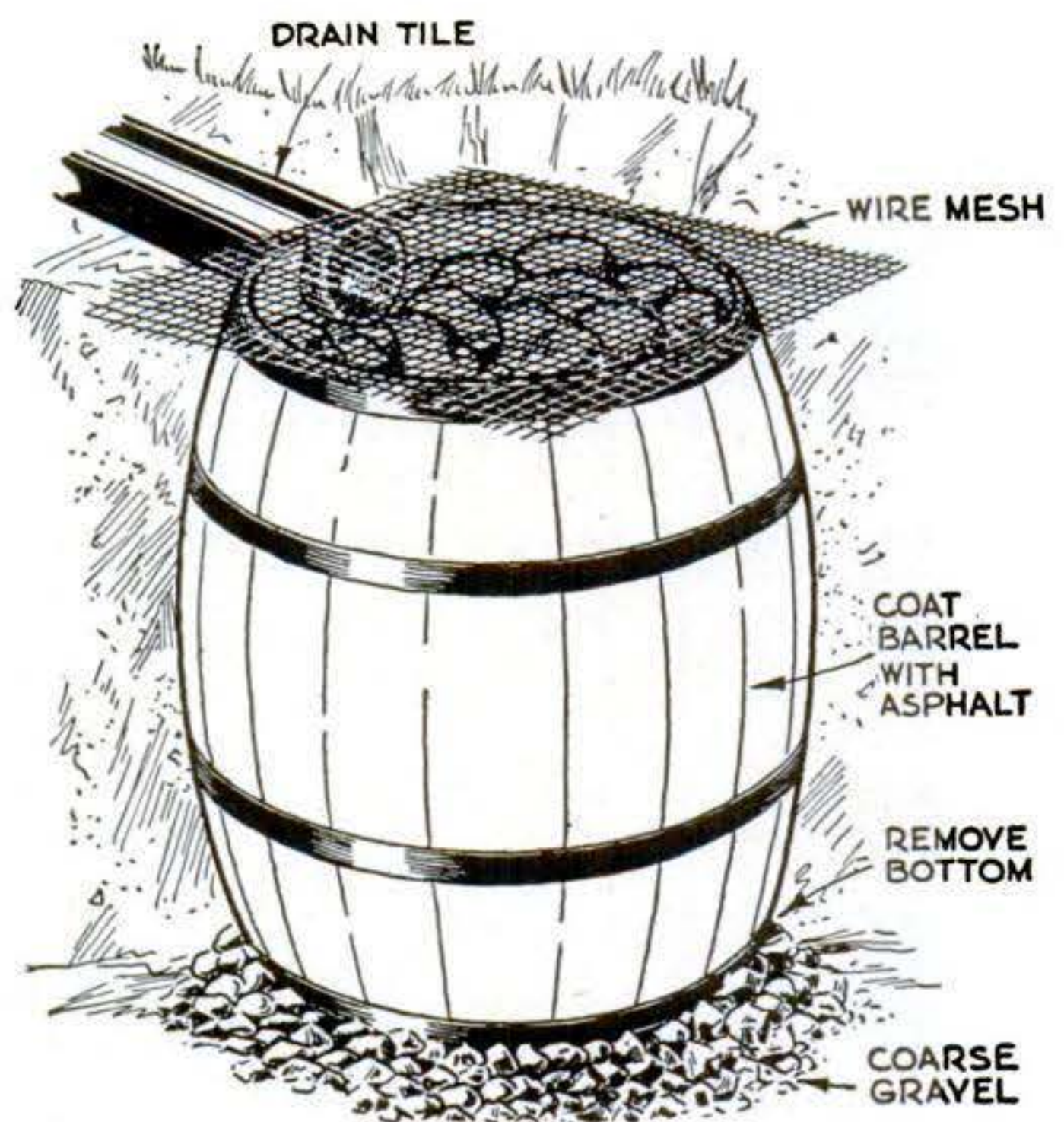

**A dry well of temporary type** can be made by removing bottom from barrel or oil drum, covering with asphalt, and sinking it in ground.

### Level in Extension Does Double Duty

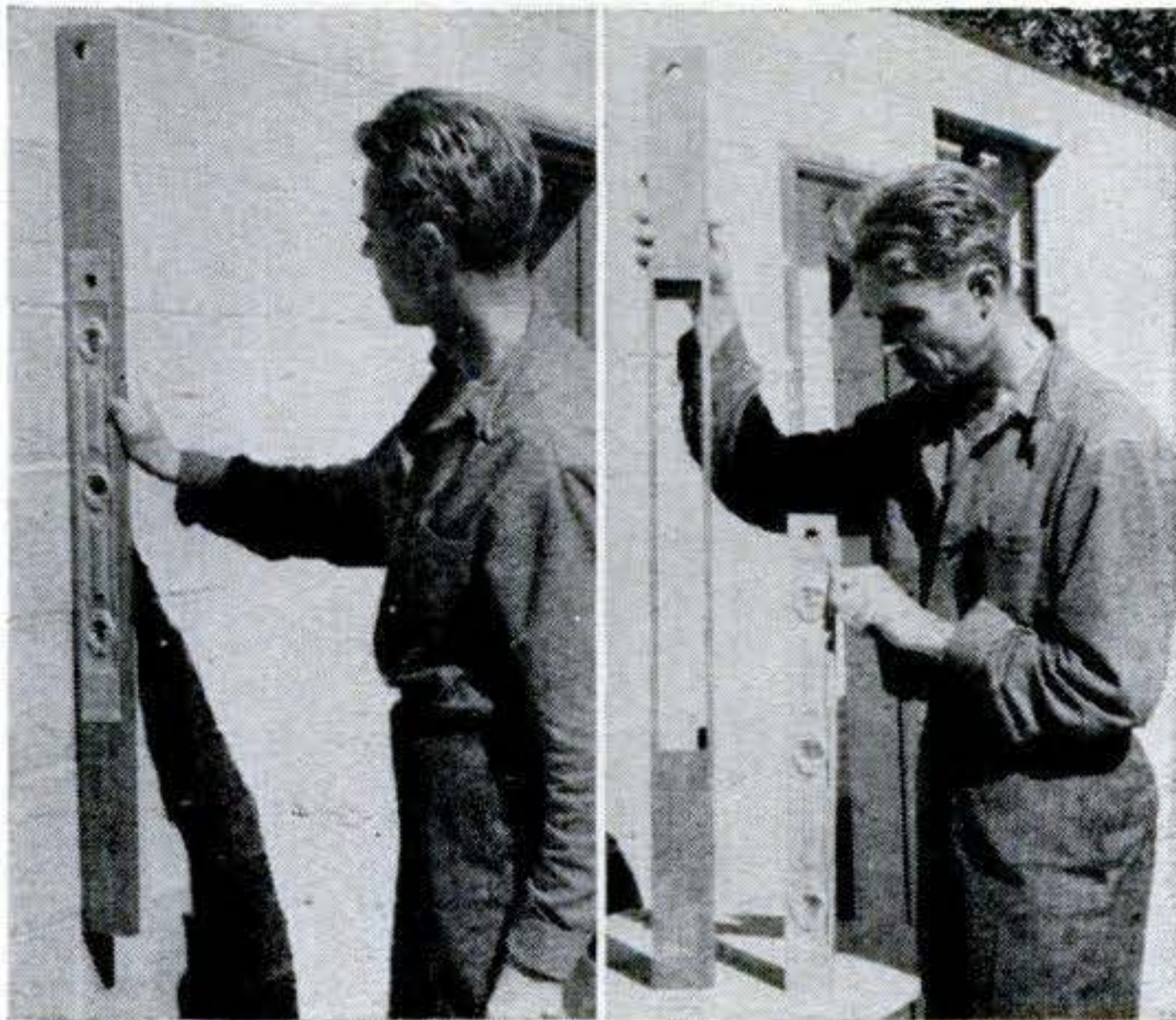

You can save the expense of two levels by nesting one in an extension frame. The photos show a 2' level in a 4' frame. I used a redwood two-by-four, making the lengthwise inside cuts on a circular saw and the cross cuts with a coping saw. Pieces of  $\frac{1}{8}$ " plywood glued to the back of the frame at each end and two screw-fastened metal strips on the front keep the level in place.—*W. G. Waggoner, Sacramento, Calif.*

### Spring Holds Tools on Rack

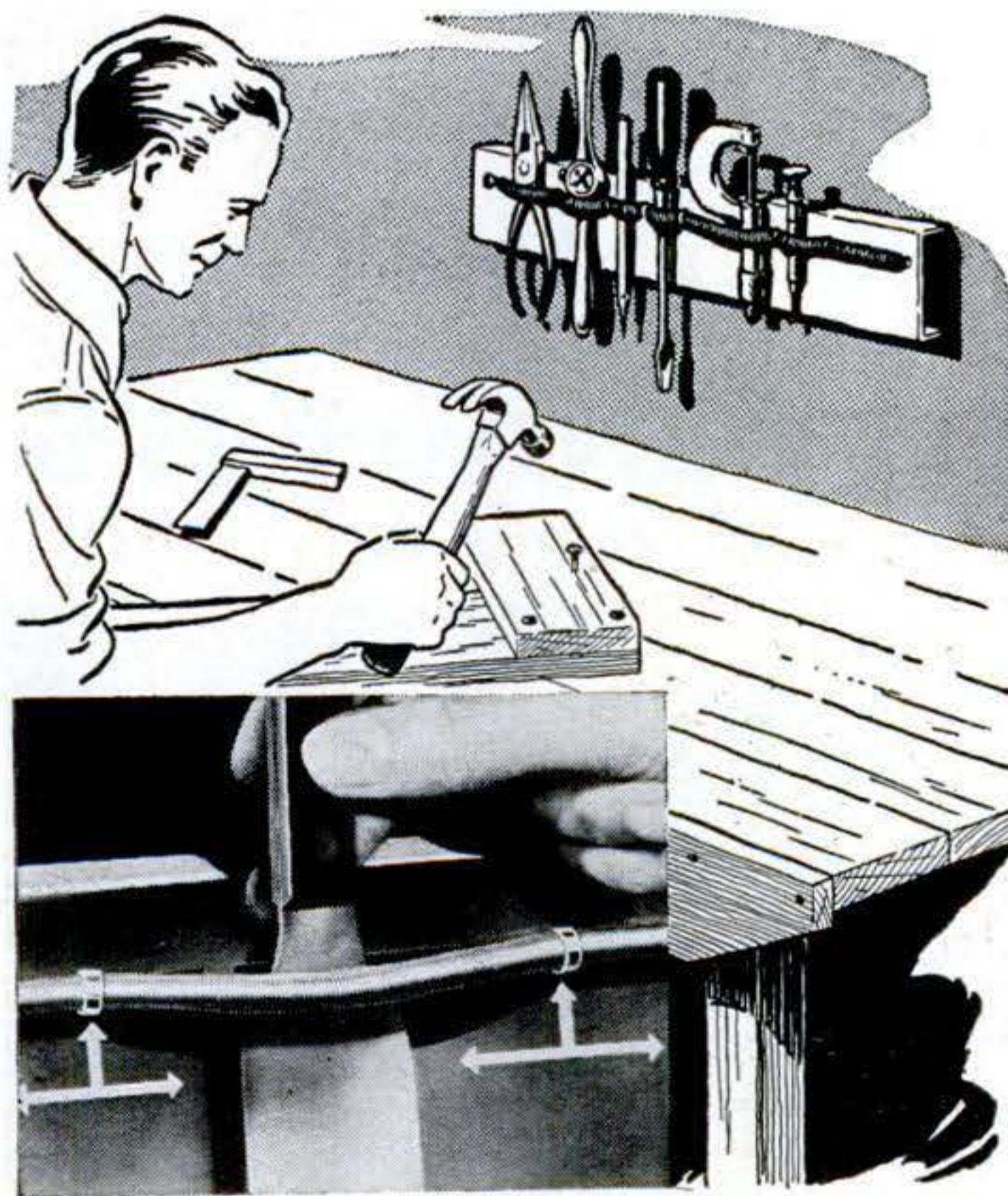

THE eight sliding ring clips on this rack can be moved to left or right to make the holding spaces the correct sizes to take various tools. The clips slide in a series of slots behind the spring. The 18" rack is sold by Hobby Hill, Chicago.

### Clips Hold Pages in Notebook

Two small spring-type clips placed on the rings of a loose-leaf notebook are convenient for holding magazine pages, drawings, photographs, and other material that you may wish to file with your notes. Material kept in this manner need not be punched.—*John J. Rea, Urbana, Ill.*

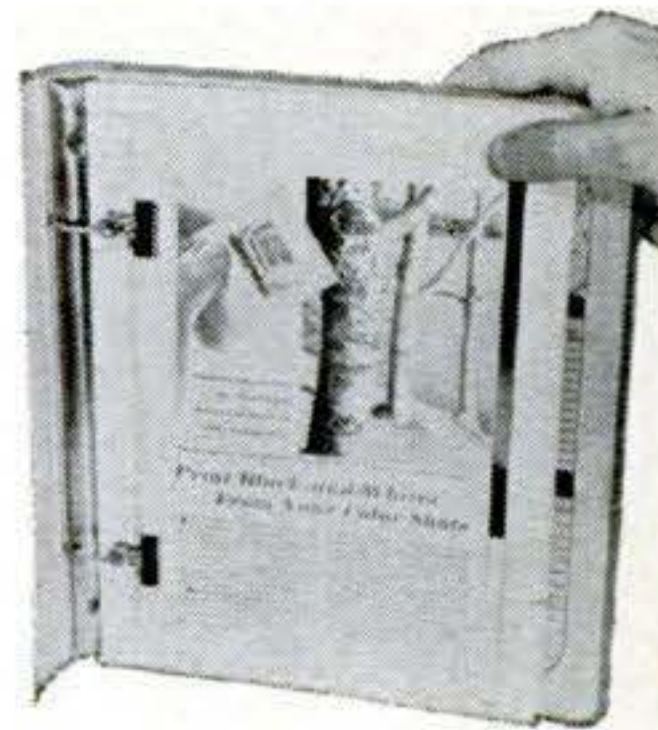

### Countersink Heads Over Tubular Rivets

IF you don't have a tool for peening tubular rivets, try a countersink. Insert the countersink in the end of the rivet and strike the countersink with a hammer.—*William B. Eagan, Louisville, Ky.*

### Clamp Helps in Sawing Plywood

SAWING a wide piece of plywood or composition board is a lot easier if you'll use a small C clamp. After you make the saw cut deep enough to attach the clamp as shown at right, you can complete the cut without binding.—*Joel Miles, Denver.*

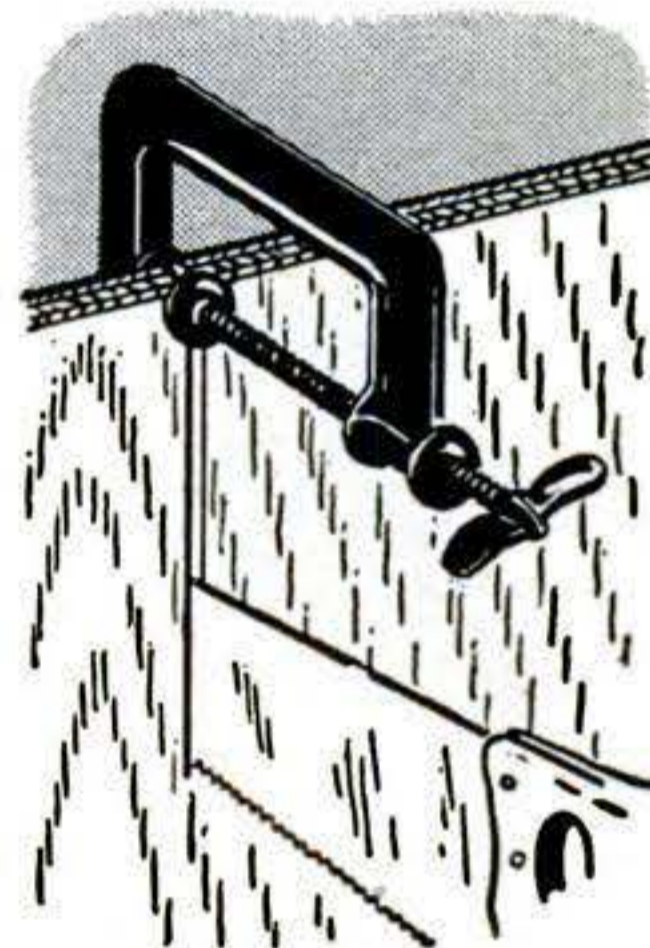

### Rubber Kit Checks Vibrations

MUCH of the noise and shock produced by machinery can be muffled with a rubber mounting kit sold by the B. F. Goodrich Co., of Akron, Ohio. The kit includes a 12" by 12" rubber pad, rubber tubes, and washer-shaped rubber snubbers. Pieces of the pad are cut to size and sandwiched between  $\frac{1}{8}$ " steel plates. Pieces of the rubber tube are cut to fit around the machine's hold-down bolts. The snubber goes over the top of the bolt and is followed by a washer and nut.

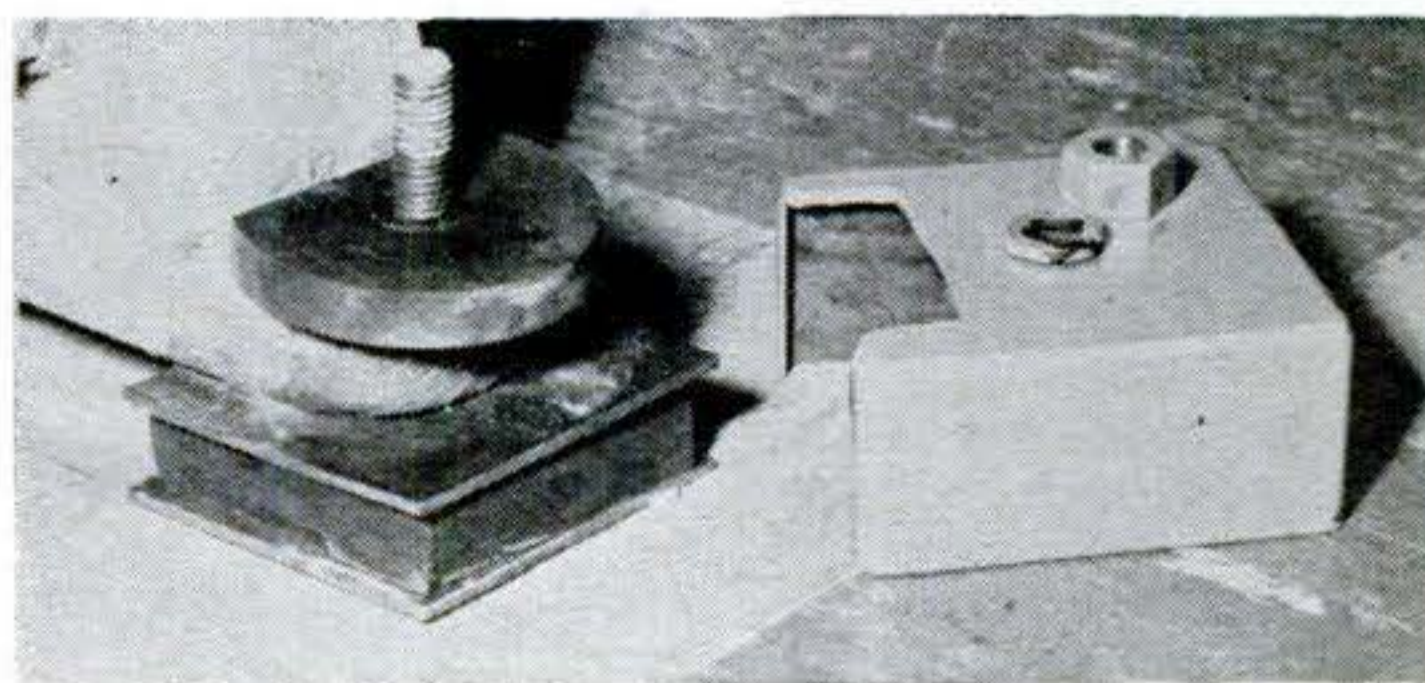

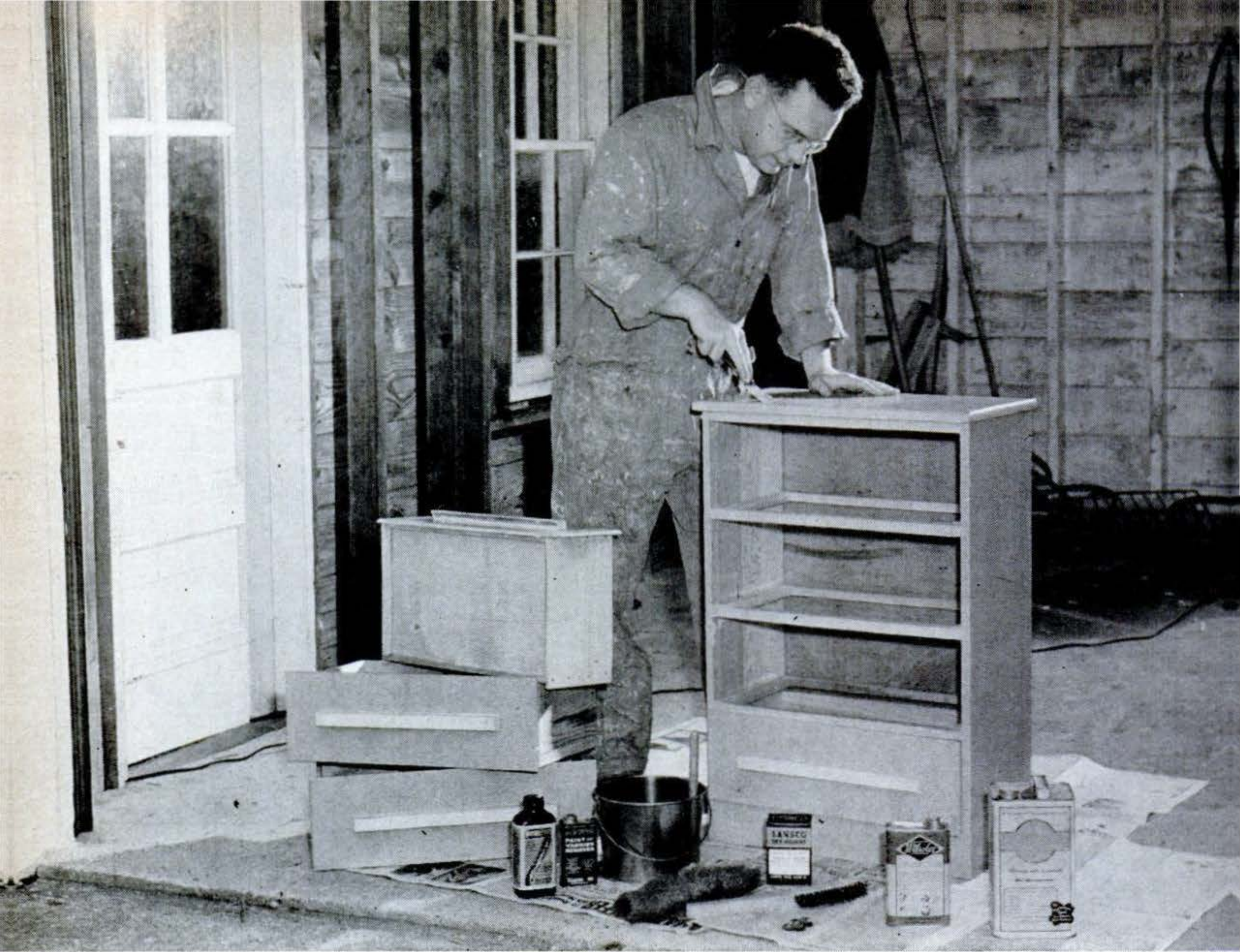

# What You Should Know About Paint Removers

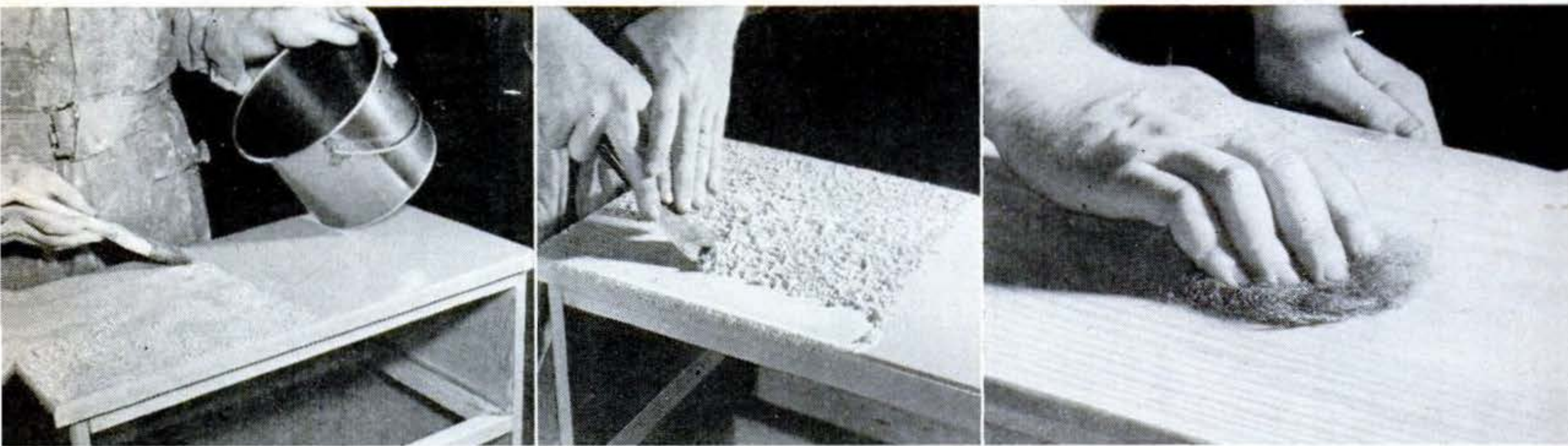

**Flow remover on** with fully loaded brush, using flat of brush (left). Brush in one direction only, not back and forth. A couple of applications may be needed to remove all the old paint. Work only a small area at a time since remover dries fairly fast. When paint surface is soft or

wrinkled (center), scrape it up with a dull putty knife, being careful not to scar the wood. Pour on more remover after paint has been removed and rub surface with No. 0 steel wool (right). This leaves the surface satiny smooth. Then wipe surface with rag and turpentine.



**Stand leg of furniture** (left) in bucket to catch excess remover and prevent runs onto floor. Semi-paste removers are better for vertical surfaces than liquid removers.

**Wear goggles** to protect your eyes when using remover on overhead work (right). Also wear them when brushing softened paint out of carvings. Brushing may splatter remover.



**Scrape softened paint** out of grooves or carvings with old toothbrush (below). Other tools that help in tight spots are a stiff-bristled brush, pointed sticks, and cotton waste.

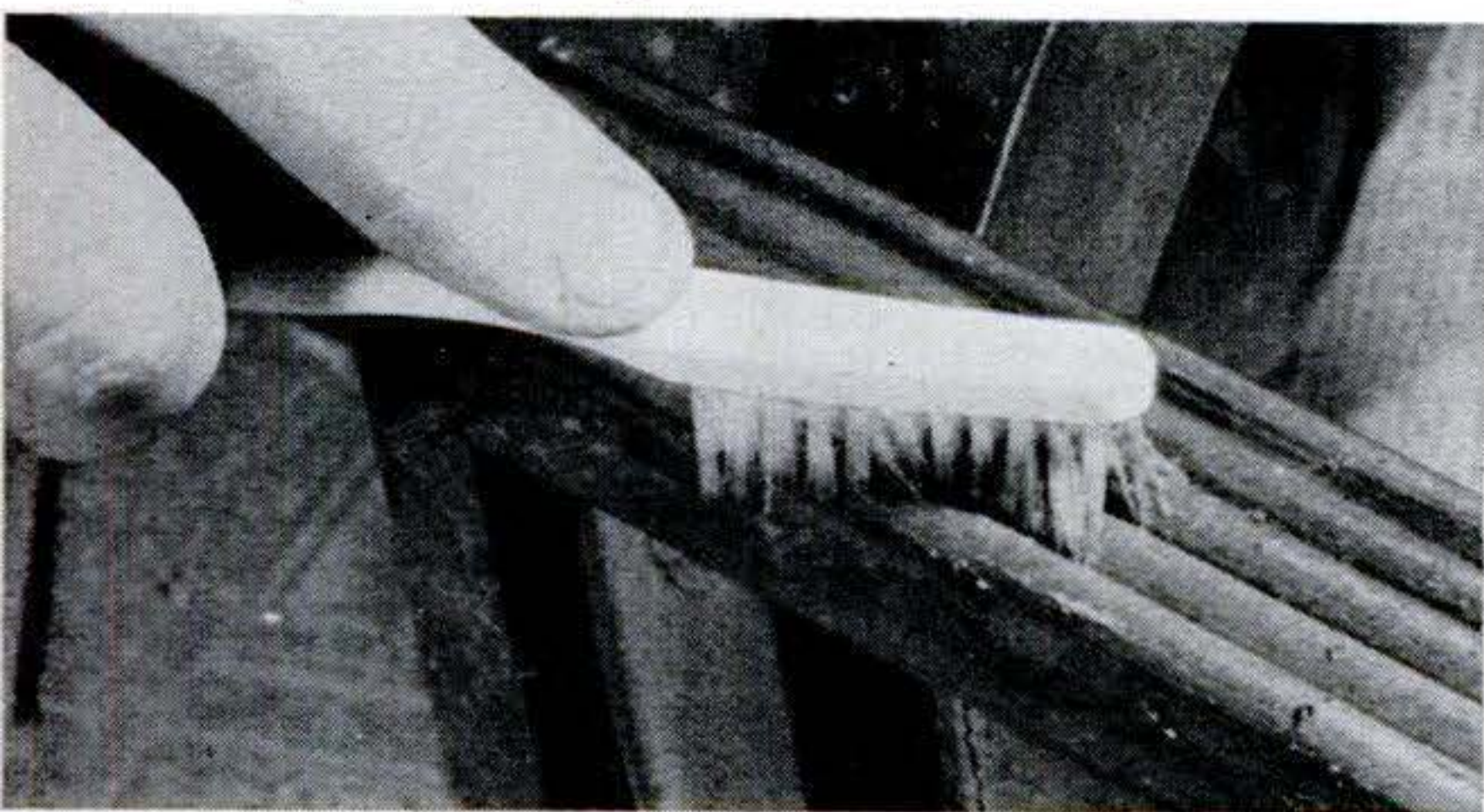

**Use new, special remover** (below) to take wax, varnish, or shellac off floors and stairs. Flow it on, scrub with No. 3 steel wool, and scrape up dissolved finish with squeegee.

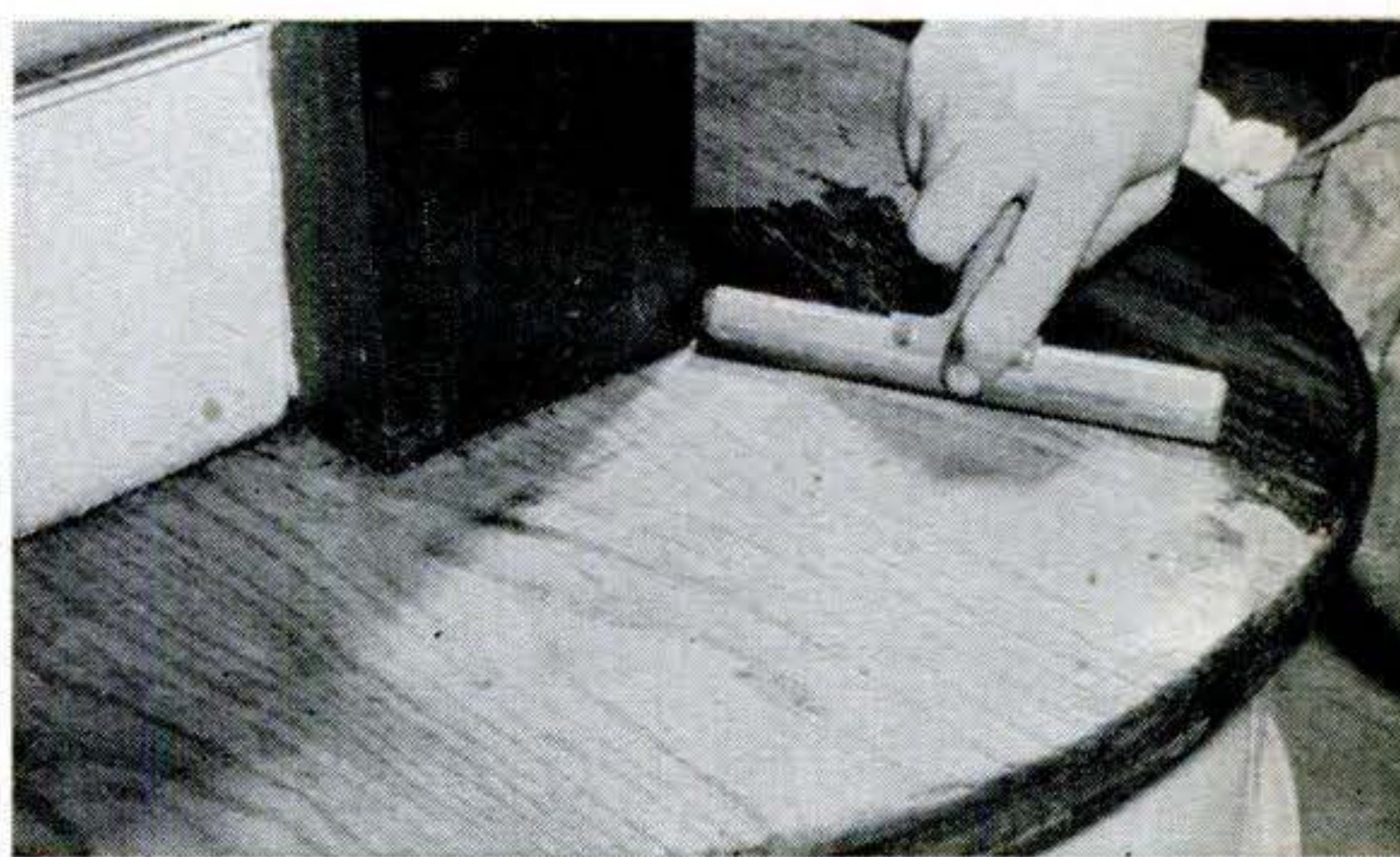

**Fast acting removers—based on powerful chemical solvents—are especially designed for their jobs.**

**By Bernard Gladstone**

PS PHOTOS BY W. W. MORRIS

**T**AKING the old finish off furniture or woodwork needn't be a messy job—if you go about it right with the right remover.

Before the manufacture of solvent-base removers, the only kinds available were the alkaline types. These still are used in industry, but the commercially prepared removers are better for the handyman. They are easy to handle and they won't attack flesh and clothing like the corrosive, alkali types.

#### *Kinds of Removers*

Today's removers can be divided into two major types—those that contain wax and those that don't. The non-wax type is available in both flammable and nonflammable removers. The wax type can be obtained as either a liquid or a semi-paste.

The liquid removers are best suited for use on horizontal surfaces such as table and desk tops. The creamy, semi-paste removers work better on vertical and overhead surfaces like door frames since they are not as likely to run and streak as are the liquid removers.

#### *Removing Waxy Residue*

Removers that contain paraffin to slow up evaporation of the solvent leave a waxy residue that must be taken off after you've finished removing the paint. A new finish will not dry and properly adhere to a waxy surface. Wiping the surface with a rag soaked in benzene or alcohol will remove the wax.

Removers that don't leave a waxy residue usually contain such chemicals as cellulose acetate or ethyl cellulose to retard evaporation instead of wax. Generally speaking, these are more expensive and slower acting than the wax type.

Nonflammable removers also are slower acting than the flammable type, but their safety characteristics make them less danger-

ous for use in a cellar shop. If you use a flammable type, be sure to keep far away from any open flame. A typical flammable remover is made up of three parts of paraffin dissolved in 50 parts of benzol to which is added 25 parts of denatured alcohol and 25 parts of acetone. *Don't take chances!*

Don't forget, too, that the commercially prepared removers of any type can be dangerous in a poorly ventilated shop. Their vapors may make you extremely ill. Work outdoors if you can. If you must work indoors, watch the ventilation.

### **Special Removers for Floors**

When you want to remove wax, varnish, or shellac from a floor, use one of the new solvents made especially for this purpose. They are not very effective on paint, but they act fast on clear finishes.

These removers leave the floor bare and clean. No after-rinse is required, and you don't have to use a filler on the floor before refinishing. Just let the floor dry and it's ready for the new finish.

This kind of remover also is excellent for cleaning accumulations of wax and dirt from inlaid linoleum.

### **Applying Paint Remover**

Removing paint takes a little more work. After you brush on the remover (use an old brush), let it stand until the paint is soft. Don't be impatient. Give the remover time to work. When the paint is soft, scrape it off with steel wool or a putty knife.

You might run into a tough layer of old paint that doesn't soften up with the first coat of paint remover. In such a case, just continue to apply remover. Sooner or later the remover will soften even the hardest paint.

If you use a dull putty knife (as shown in a photo on the first page of this article), scrape carefully with the grain. The U. S. Bureau of Standards recommends using a sharp putty knife held vertically and scraped across the grain.

### **Heat Removes Old Paint**

Painters frequently remove old, scaled, and cracked paint from the exterior of a wooden house by burning the paint with a blowtorch. The flame softens the paint so it can be scraped off. If you use this method, be careful. A fire hazard exists.

A small electric burner that softens and peels paint away is on the market. This tool

is slow, and it works best on flat surfaces.

A 250-watt infrared lamp will also soften paint so it can be scraped off. Hold the lamp three or four inches from the surface until the old paint is soft.

### **Corrosive Removers**

These are sodium compounds—such as caustic soda, soda ash, washing soda, or trisodium phosphate—dissolved in water. They are used boiling hot and are good on iron or steel, particularly where the work can be dunked in the solution. They should not be used on nonferrous metals such as aluminum, zinc, or brass.

### **Corrosive Removers Harm Wood**

Alkaline removers will take the paint off wood, but they darken most woods. Also, all trace of these solutions must be cleaned off the work after the paint has been removed. Any remover left on the work is likely to destroy the new finish.

These corrosive solutions are extremely dangerous. They attack skin and clothing viciously. When using them, rubber gloves should be worn. END

### **Radio Parts Fit Model Motors**

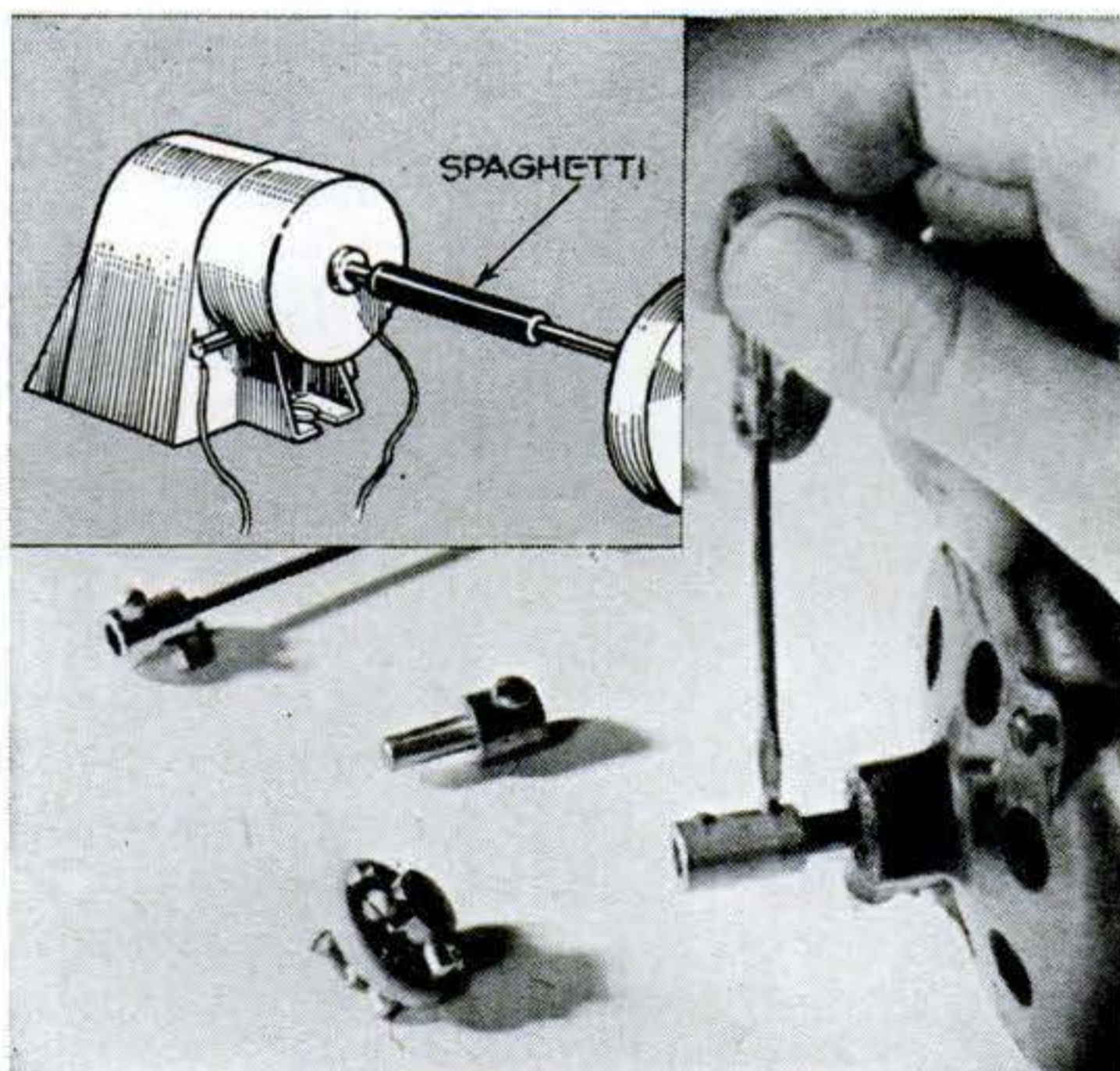

If you need fittings for small motors, try the radio store. You'll find a large assortment of good modelmaker's accessories. Practically all tuning condensers and volume controls have  $\frac{1}{4}$ " shafts. The couplings made to fit them can also be used to link  $\frac{1}{4}$ " motor shafts to models, toys, and small machines. The photo shows four of the many available types of couplings, extenders, and flexible drives. For small motors, "spaghetti" insulation can serve the same purpose.

# Lazy Suzan Rolls on Awning Pulleys

Centered on table, at right, it holds all the serving dishes for a meal. Designs are Pennsylvania German.

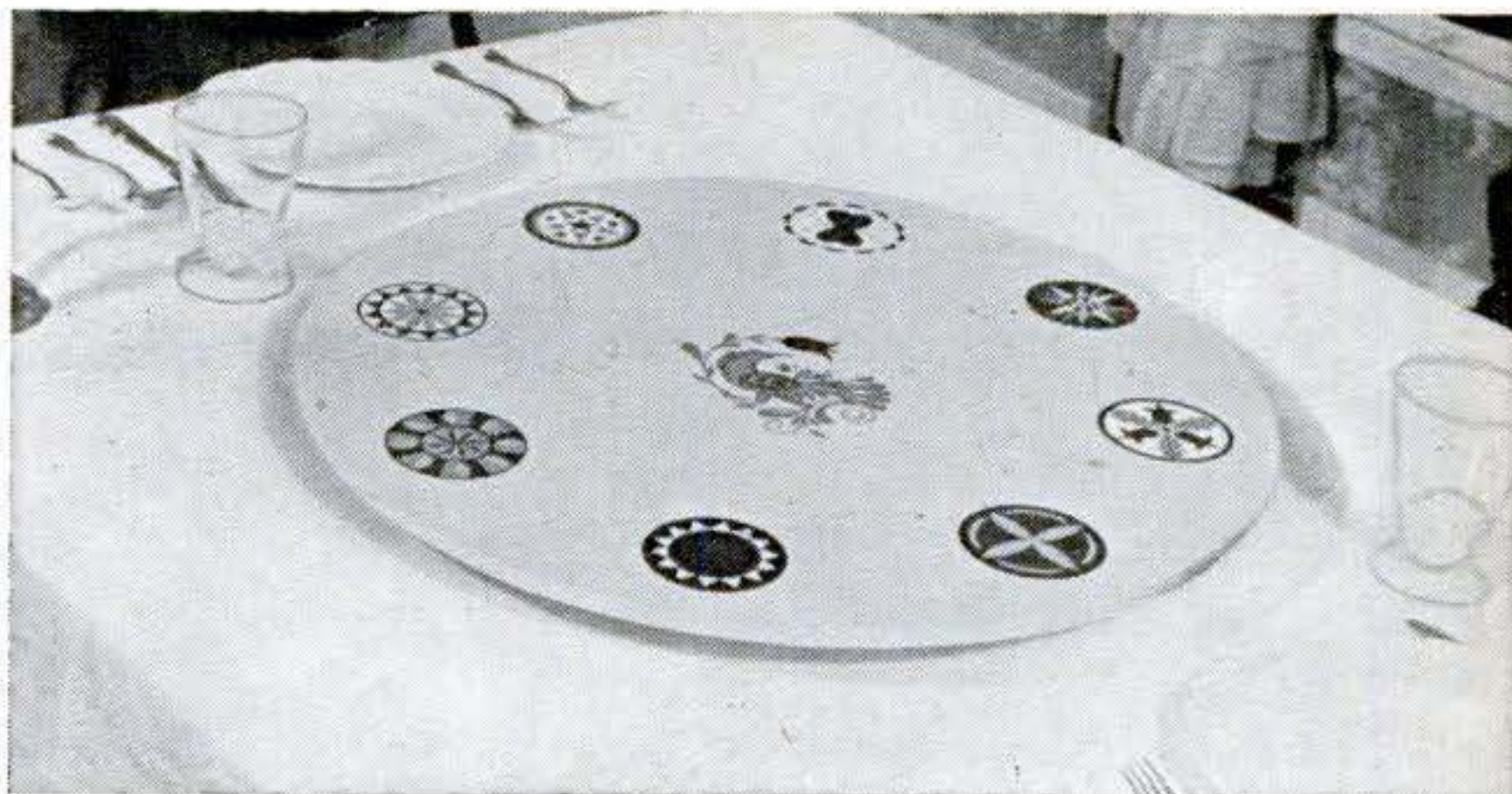

**L**AZY Susans are recovering some of the popularity they enjoyed a hundred years ago. Here's one you can make quickly.

For the rollers, remove the wheels from four or six awning pulleys. These wheels are turned true, have a diameter of about  $\frac{1}{2}$ " , and have a center hole a little larger than  $\frac{1}{8}$ ". Attach them to the center disk with roundhead wood screws. Drill holes in the edges of the disk for the screws.

Cement or tack a sheet-metal track around the outer edge of the base and under the top deck for the rollers. Sheet aluminum will give quiet operation.

Apply a sealer and two coats of enamel, sanding between coats. After putting on your decorations, spray a coat of transparent plastic on the top deck. This protects the surface from heat and liquids.—*Harold McIlvaine, Moscow, Idaho.*

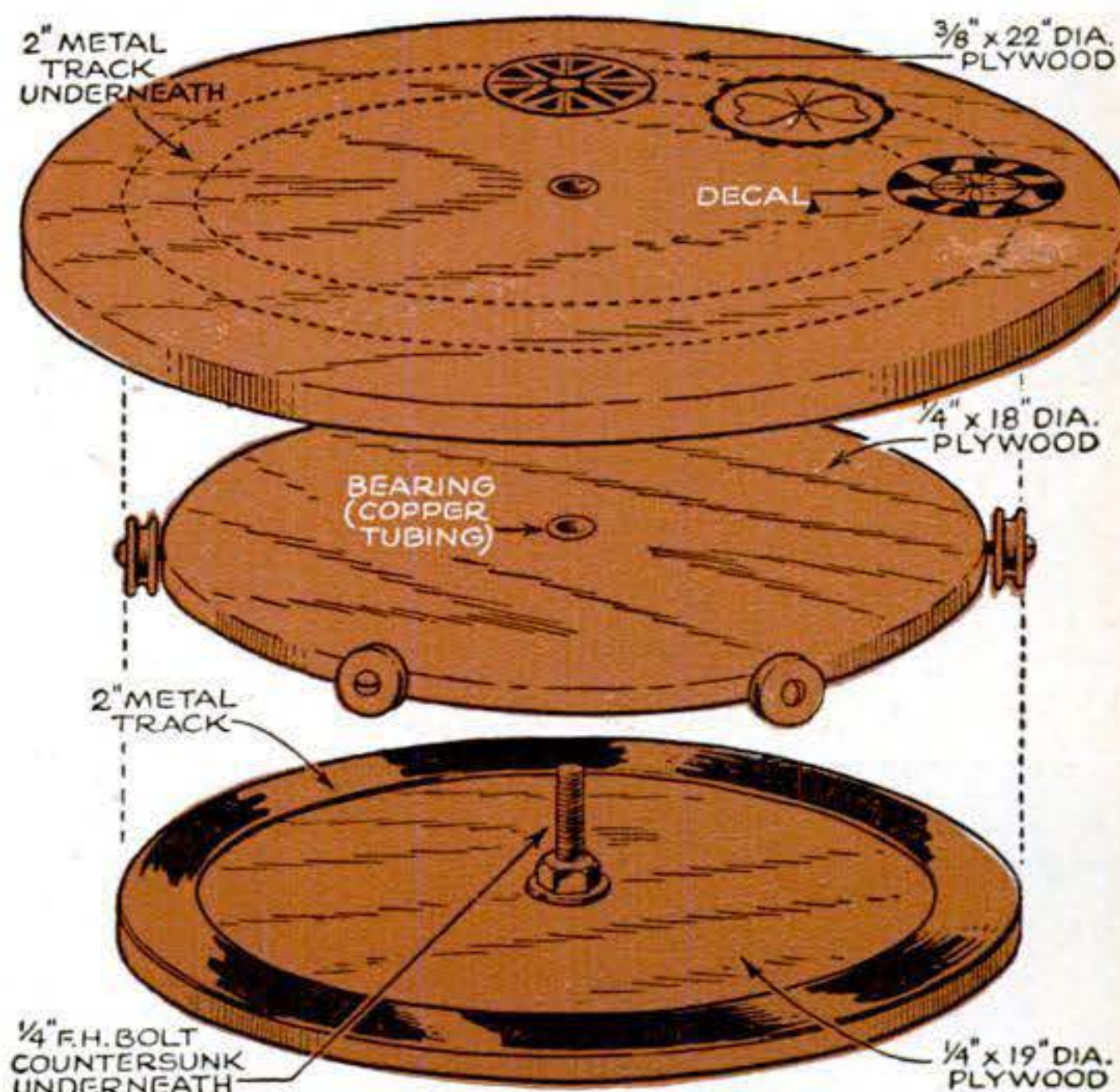

Mount at least six rollers around the center disk to give stability to Susan of this size.

## Kit Makes Oil Painting Easy



HAVE you always wanted to be a Rembrandt? And do you always turn out daubs? With this kit, says the manufacturer, the amateur can hardly go wrong. Sold by the Picture Craft Co., Decatur, Ill., for \$2.95, a 12- by 16-inch canvas is already sketched in with all areas numbered. Ready-mixed paints in vials are correspondingly numbered. An art brush is included.

## Drafting Pencils Pointed Electrically

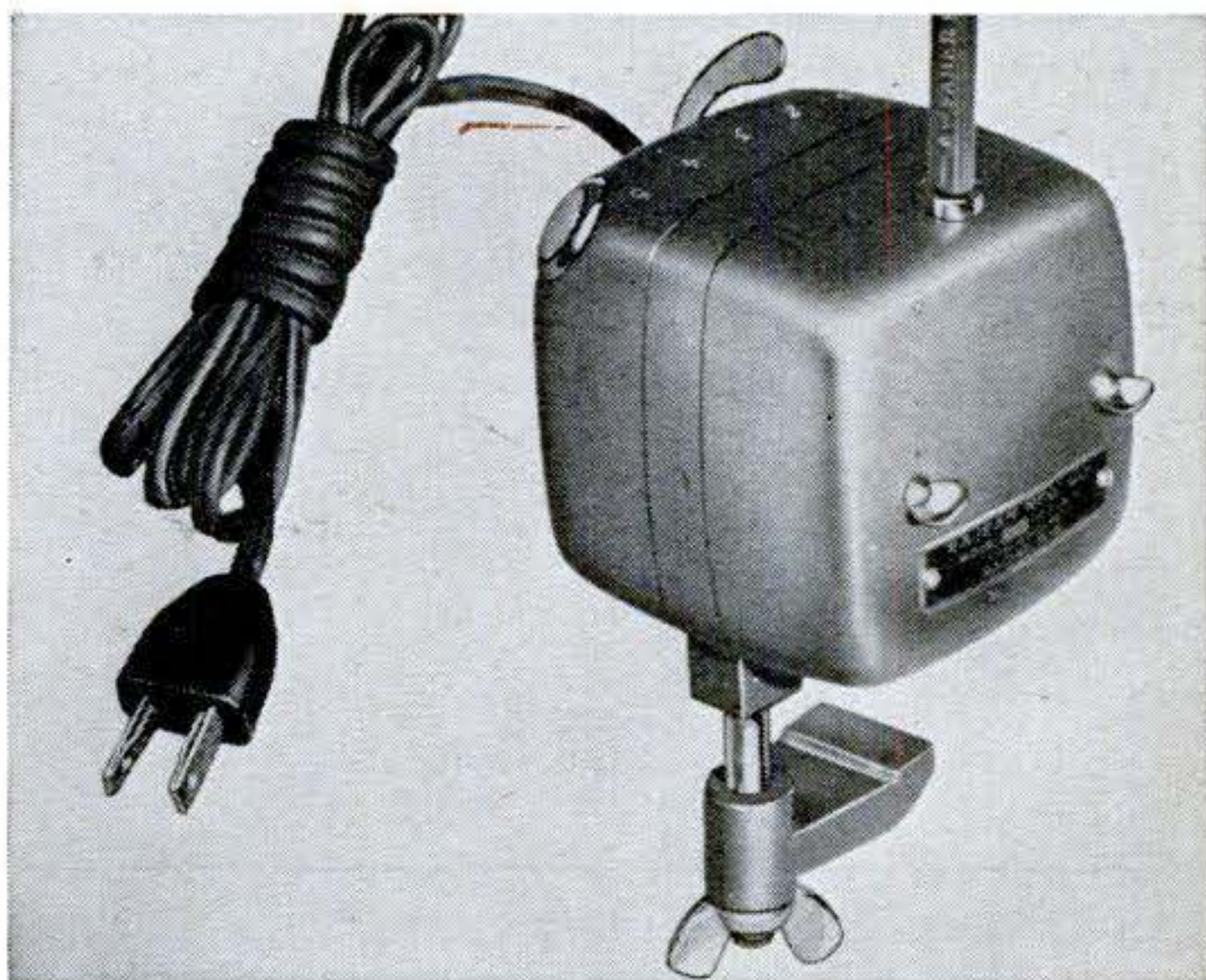

A DRAFTSMAN can get just the point he needs on his lead with this electric sharpener that can be clamped directly to the drawing board. A mechanical lead holder is inserted into the hole on top, and the curved lever set to any of five desired pencil-point shapes. The unit is made by the Rajean Manufacturing Co., Racine, Wisconsin.



A knocking engine leads Gus to a clue that helps  
Sergeant Jerry Corcoran solve a brutal murder.

# Gus Parlays a Pair of Hunches

**By Martin Bunn**

**G**US Wilson, sitting at his desk in the Model Garage office, glanced at the local newspaper Stan Hicks had brought, and stopped sipping his midmorning coffee.

A bold, black headline streamered across the top of the front page: FARM COUPLE FOUND MURDERED.

The story went on to tell how old man Bowen and his wife, both of whom Gus had known fairly well, had been murdered and





robbed the night before at their farm not far from town. A hired hand had discovered the crime when he returned from the movies at about 10:30 and had notified the State Police. By 11:45, three suspects had been rounded up and were being held for questioning. The story also said that the Bowens' 25-year-old daughter, Elaine, blind since birth, was in a hospital down in the city awaiting a series of operations that might restore her sight.

As Gus re-read the news account, he heard the repair-shop door open and close. Sergeant Jerry Corcoran of the State Police came in, stamping his feet to knock the snow off his boots.

"What are you doing here, Jerry?" Gus called through the open office door. "According to the papers, you fellows have a double murder on your hands."

"Plus a robbery," grumbled Jerry. "And things aren't going any too easy either."

"Cup of coffee?" Gus asked.

"I sure could use one," Jerry agreed, un-

buttoning his heavy coat. "I haven't been to bed yet."

When the trooper had poured himself a steaming cup of brew and settled on one corner of the desk Gus asked, "When do you suppose this thing happened?"

"That's one thing we do know," explained Jerry. "As near as we can reconstruct it, the old man got it first in the kitchen. Evidently there was a struggle and the cord of the electric clock got pulled out. It was stopped at exactly one minute after 10. Then it looks like his wife got hers trying to stop the robbers from making their getaway. Her body was in the snow outside the front door beside the driveway. Cause of death in both cases: bashed-in skulls."

"Did the murderers get much?" asked Gus.

"Don't know yet, but unfortunately the Bowens, like too many old farmers, didn't believe in banks or bonds. The rumor is that everything they had, which could have been plenty, was hidden in the cellar. Those

*Gus's crawl under the car was brief—but had given him an idea. "Hold the fort awhile," he told Stan. "I want to see Jerry over at the police barracks."*

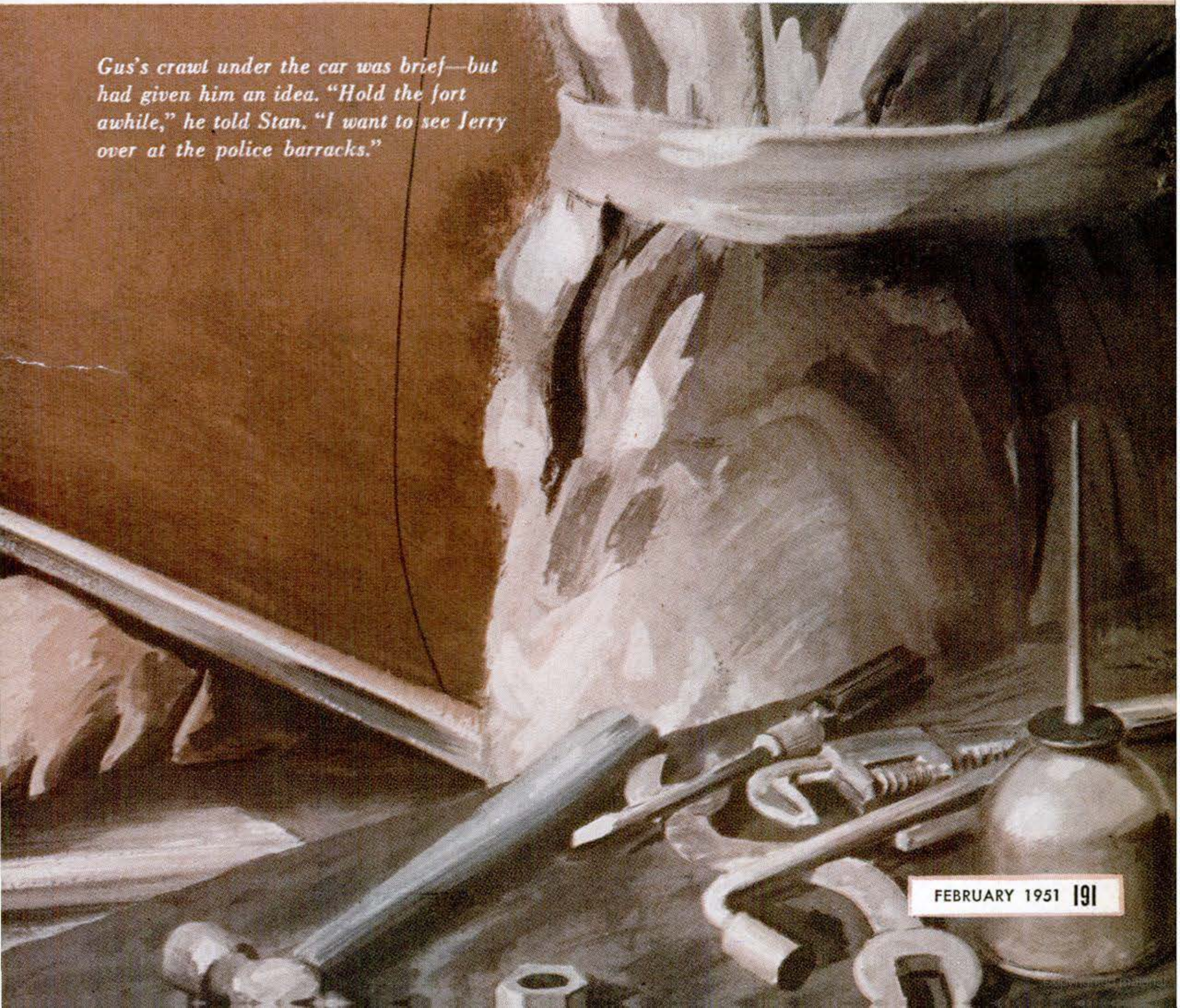



operations they had arranged for their daughter were to cost several thousand, so there must have been at least that much."

"How about these suspects?" asked Gus, pointing to the newspaper.

"Three young punks from the city," replied Jerry. "One of our road blocks gathered them in about 15 miles out of town."

Gus poured himself another cup of coffee. "Got enough to hang it on 'em?"

"Not yet. For one thing we didn't find any money on them or in their car, and they've an alibi we haven't been able to break yet."

"What's their story?" asked Gus.

"Well, if you remember, it stopped snowing last night at about 9:45, so when we got to the Bowen farm the snow on that back road was still fresh. There was just one set of tracks, made by V-type tread snow-and-mud tires, the same kind of tires we found on the suspects' car, in and out of the driveway. The Vs in the snow showed that the car had entered the drive-around from the south—that's from the town side—and left toward the north. We followed the tracks up the back road for quite a distance."

Gus nodded.

#### *Suspects Have an Alibi*

"So far, so good. Now comes the fly," Jerry continued. "Sam Trayton, who runs that all-night eatery on the main road near town, says the men we're holding stopped at his place at about 10:25."

"I don't follow you," interrupted Gus.

"Okay, let's look at the facts. We are sure that the murders were committed at about 10 o'clock. Tire marks show that the murder car sped off to the north. Yet, Trayton, who certainly has no ax to grind, says the suspects were in his place, which is south of the Bowen farm, twenty minutes later."

"Did you . . .," started Gus.

"Yes, we did," finished Jerry. "And we found that it takes a good 20 minutes to

drive south from the Bowen farm to Trayton's, so they couldn't possibly have driven north and doubled back by way of the main road—an extra 10 miles—and made it by 10:25."

"Found the murder weapon yet?"

"Nope," replied Jerry. "That's another hitch. And I'm not helping to find it sitting here jawing with you," he added, buttoning his coat.

"And I'm not solving my mystery, either," put in Gus.

"Your mystery?"

"Yeah, the mystery of the engine that knocks when it shouldn't," explained Gus, jerking his thumb toward a coupe on the repair-shop floor. "Regular customer brought it in this morning. Claims his motor only knocks when you start it, stop it, or idle it. Runs perfectly otherwise. Swears there's no knock at all under a load."

"Well, I hope you have better luck with your mystery than I've had with mine so far," Jerry grumbled as he walked toward the shop doors.

#### *Gus Tackles His Mystery*

Gus soon forgot about Jerry Corcoran's troubles when he got down to digging into his own. Gus started and stopped the engine with the mysterious knock. He idled it. He gunned it. The customer had been right. The engine ran smoothly and without a sign of a knock at high speed, but grumbled when it was idled, just after it was started, or when the ignition was turned off. When the knock was there, it sounded just like a bearing that was shot.

Stan, who'd been smoothing out the wrinkles in a fender on another car, came over to where Gus was working. He got a kick out of watching the old mechanic methodically discard one possibility after another when he was tracking down motor troubles.

"Got you stumped?" he asked with a grin.

"Not yet it hasn't," Gus grunted, walking over to his bench and picking up a long-handled screw driver. "I've a hunch this 'knock' isn't a knock at all."

Using the shank of the screwdriver as a connector, Gus proceeded to short out each of the spark plugs in turn, while the engine was idling—and knocking. The knock persisted, which was almost a sure sign that it wasn't a bearing knock.

As Stan watched, Gus rolled his creeper

**[Continued on page 242]**

# Homemade Tools from Old Auto Valves

Garages have these to give away. Take home a handful, and you'll find plenty of uses for them.



YOU'D find it hard to buy steel as good as you can get free in old auto valves. Most garages will give them to you.

Test the stem and the head with a fine file. Valves vary in hardness. You may get some the file will cut, but most are glass hard. Unless you plan to shape them entirely by grinding, these have to be annealed.

Heat the valve cherry red and immediately bury it in ashes to let it cool slowly. Some alloys don't respond readily to annealing, but since the valves cost nothing, you

can discard stubborn ones or grind them.

The stems make good shafts or pins. By grinding, or turning and filing, you can shape them into punches, countersinks, and other tools. Reharden annealed metal by heating it to bright redness and quenching in oil. Then polish with emery cloth and reheat to temper the steel, judging hardness by the flow of colors.

Valves are almost made to order for drill-press accessories, though you may want to cut the shank off to convenient chuck-

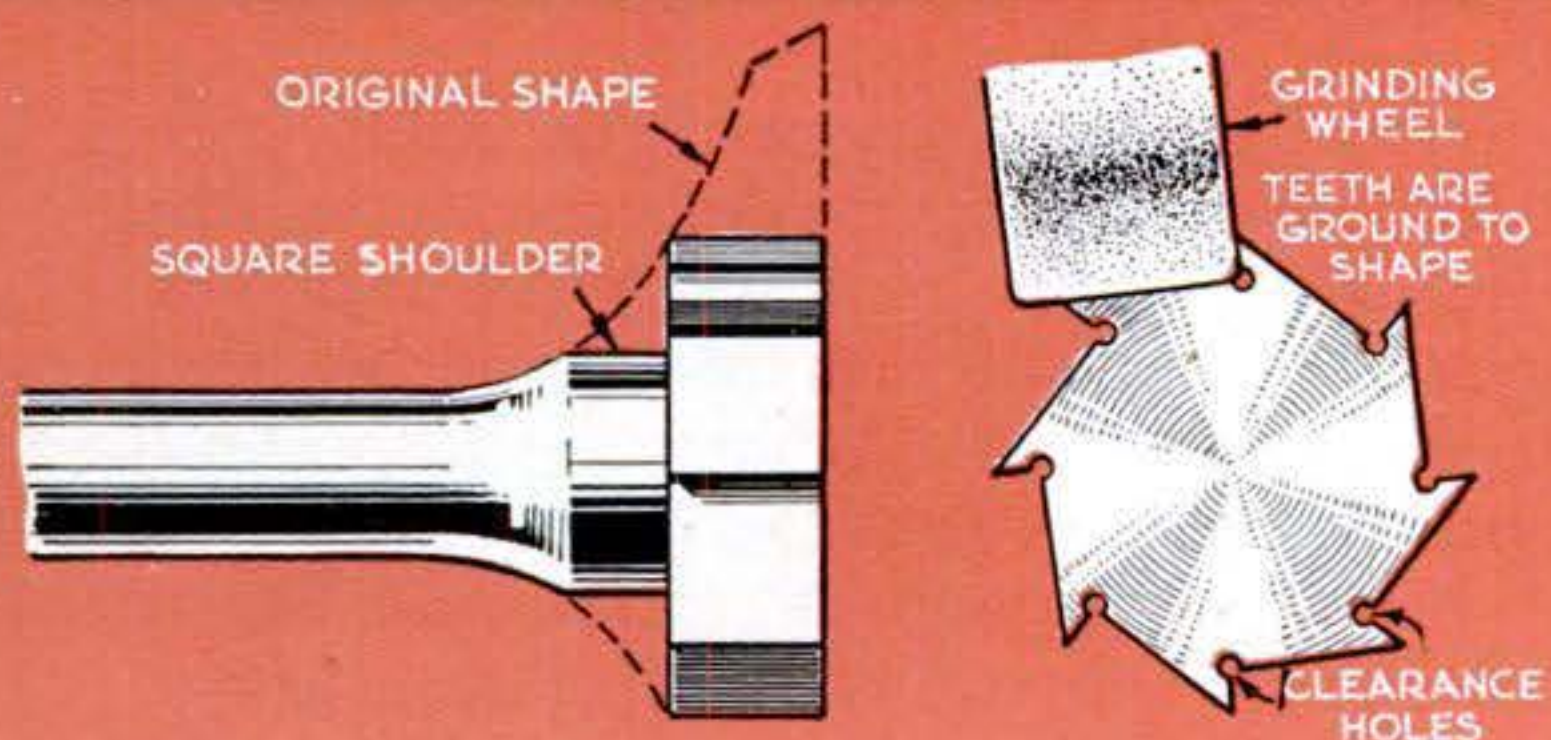

MILLING AND DADO CUTTERS

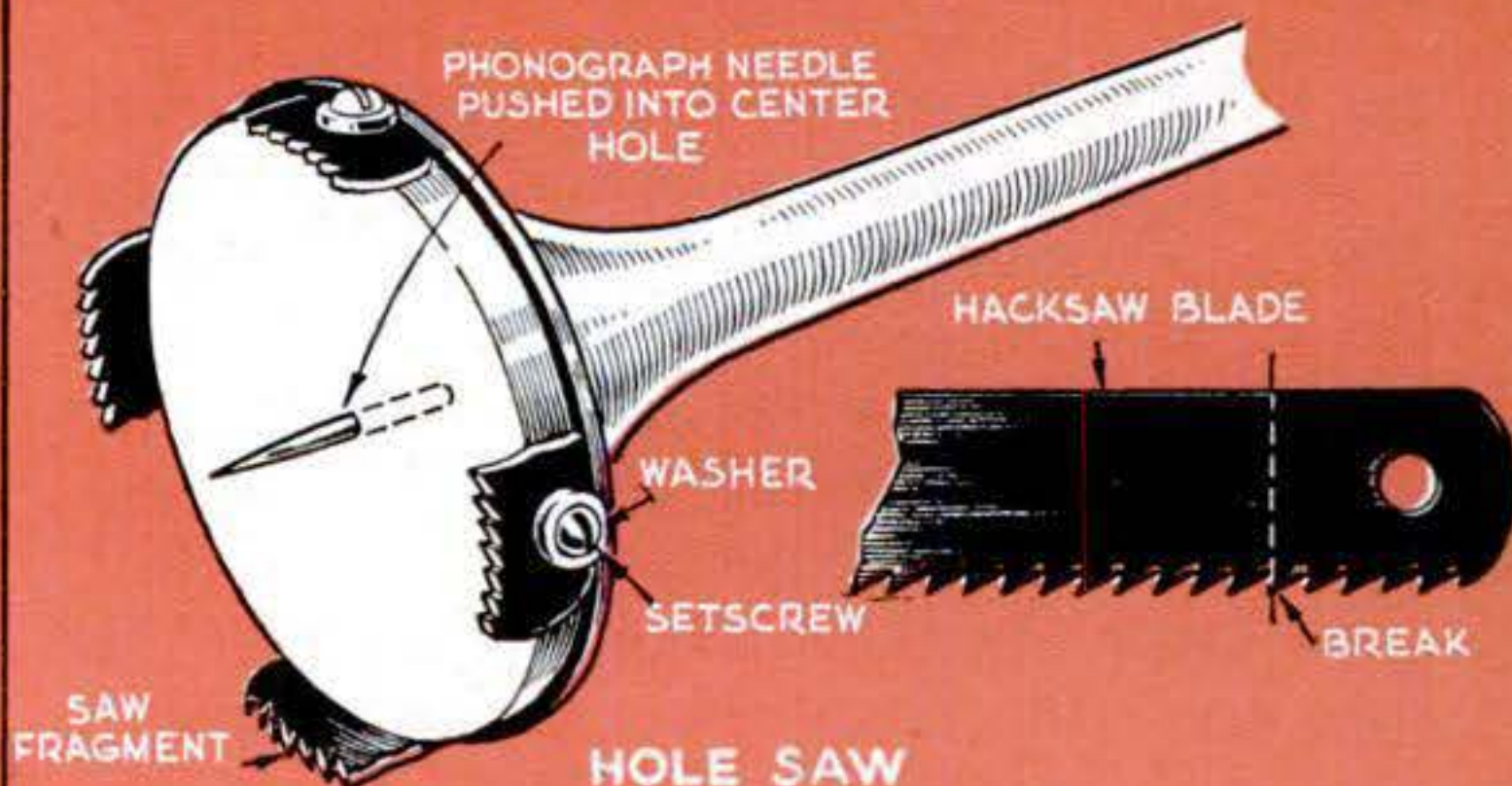

HOLE SAW

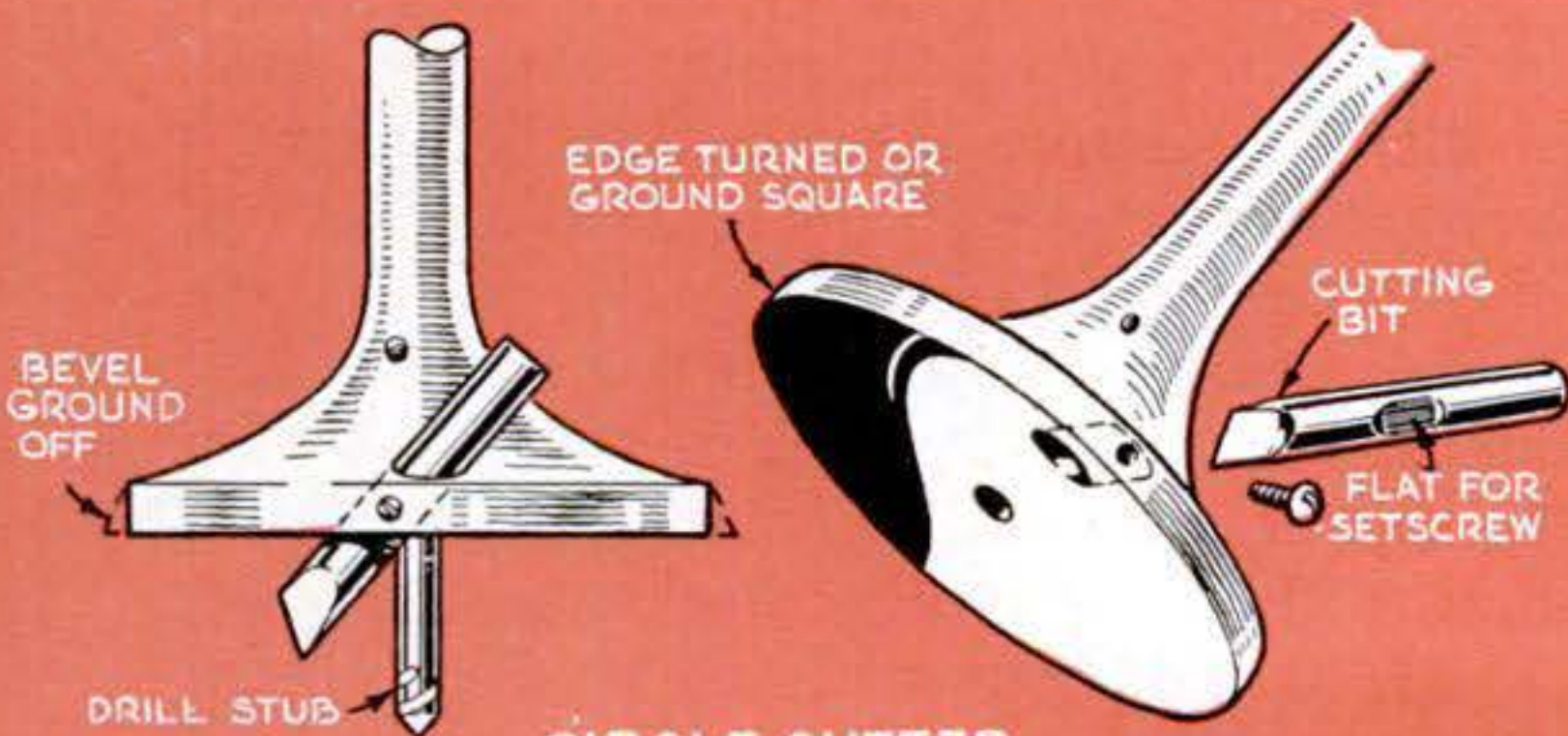

CIRCLE CUTTER

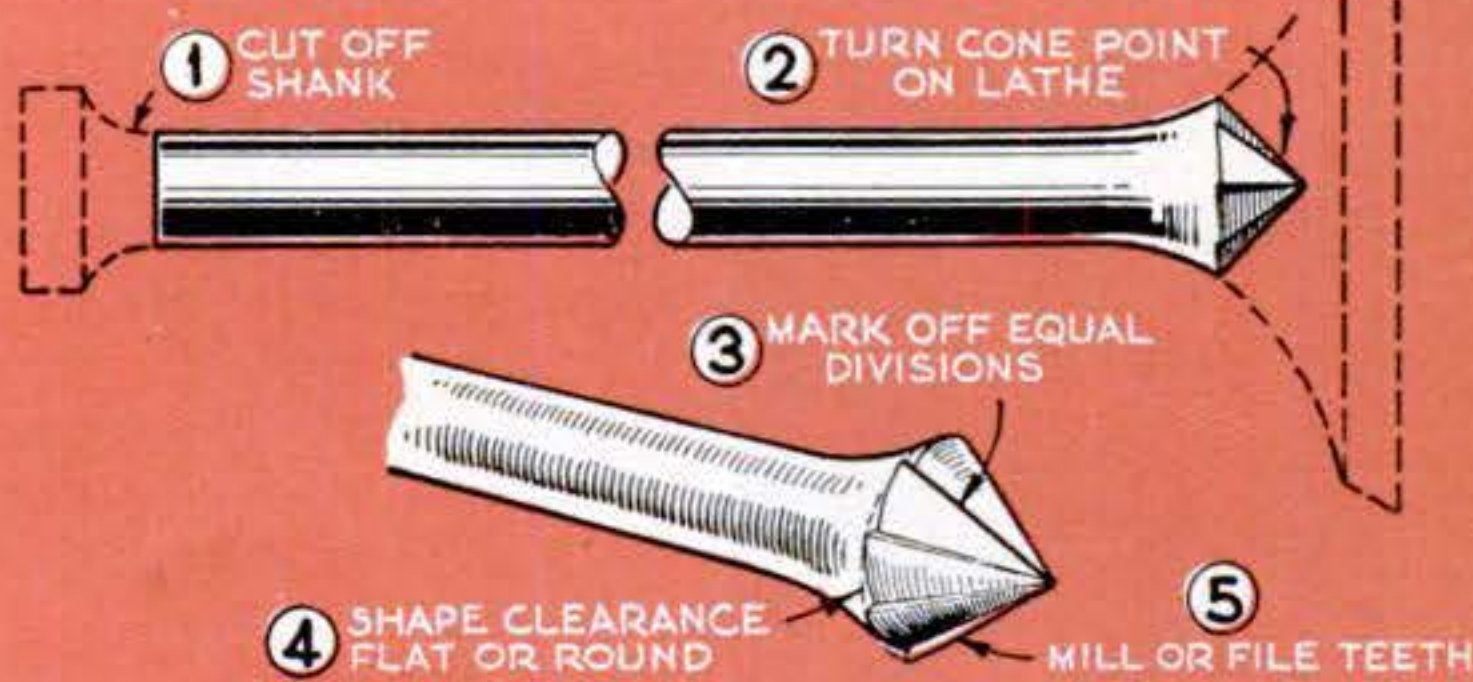

COUNTERSINK OR REAMER

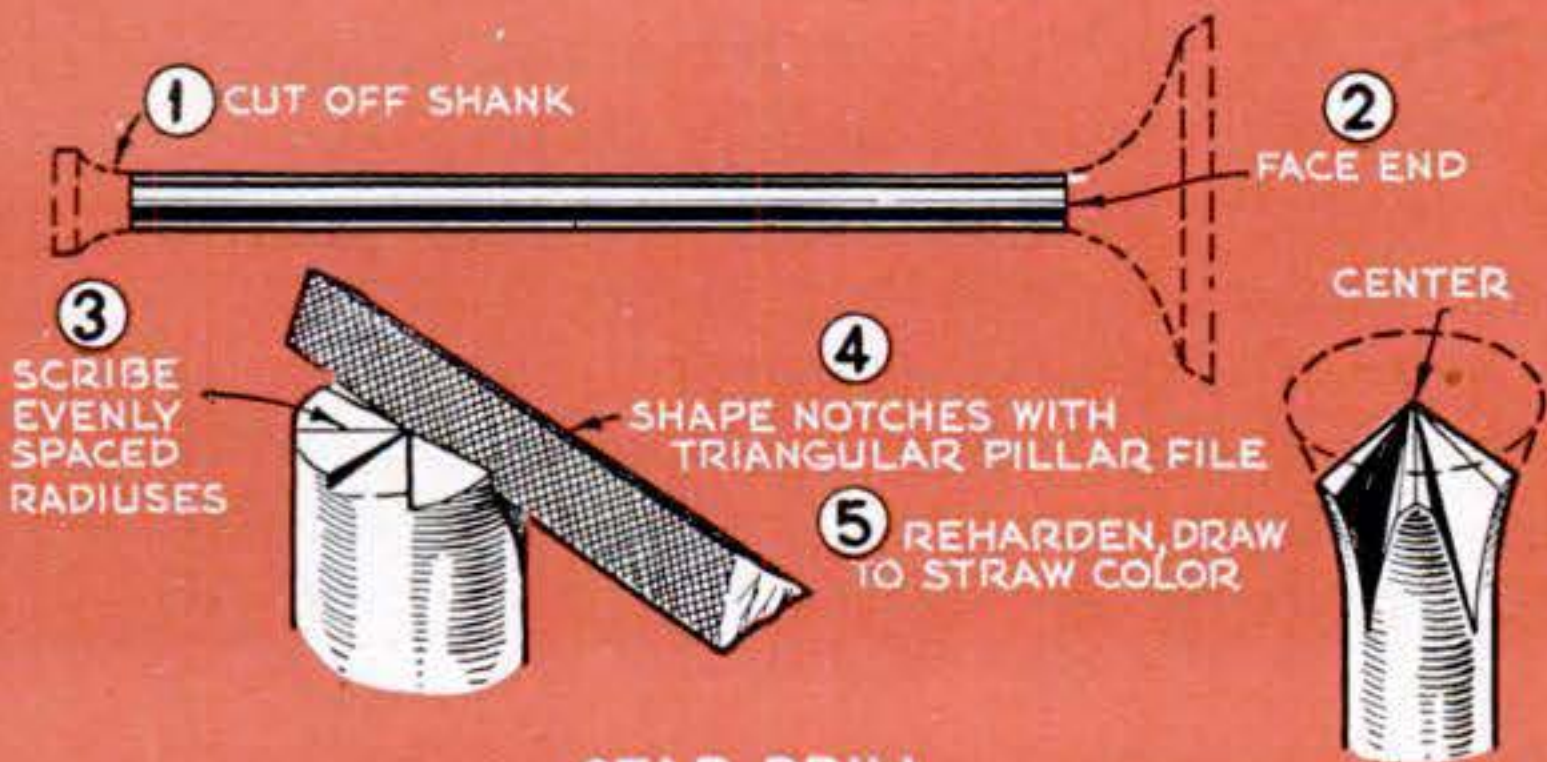

STAR DRILL

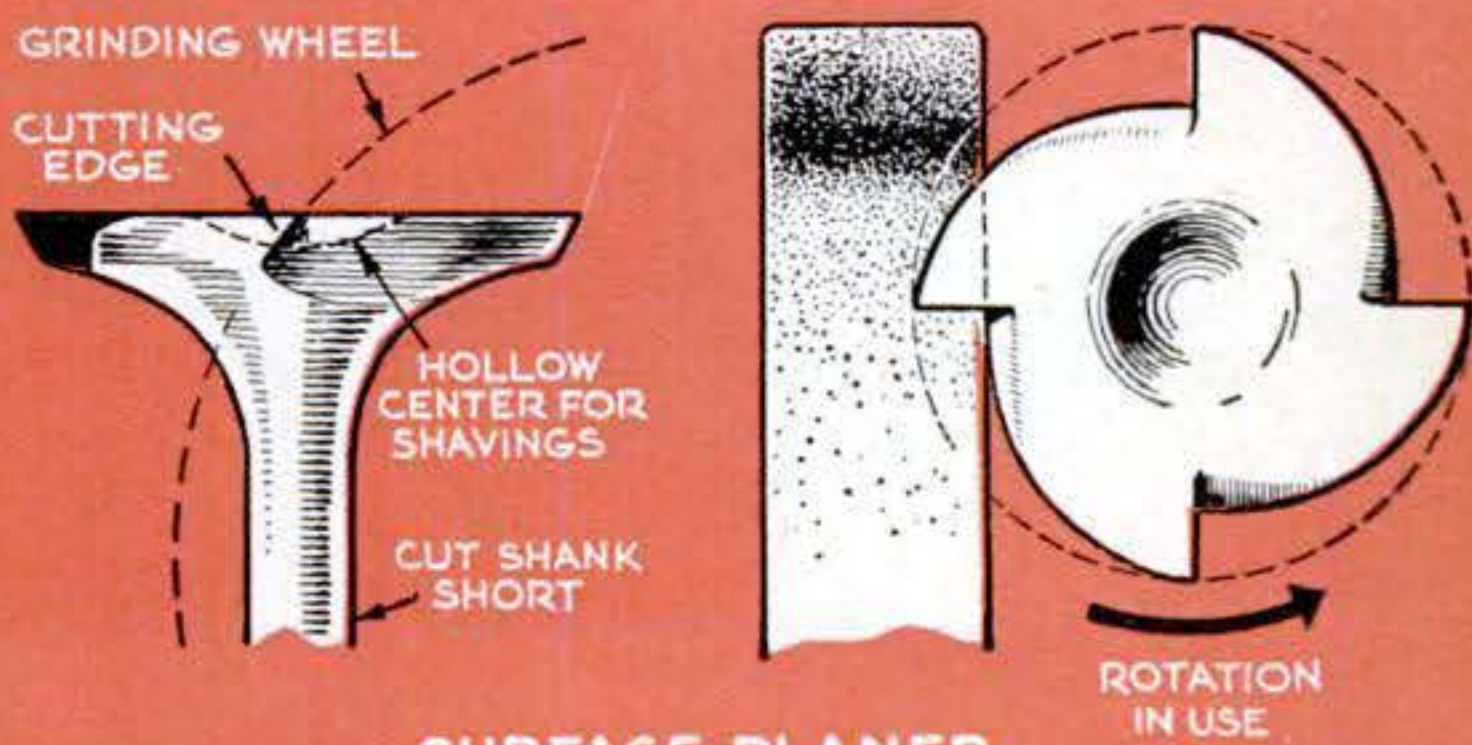

SURFACE PLANER

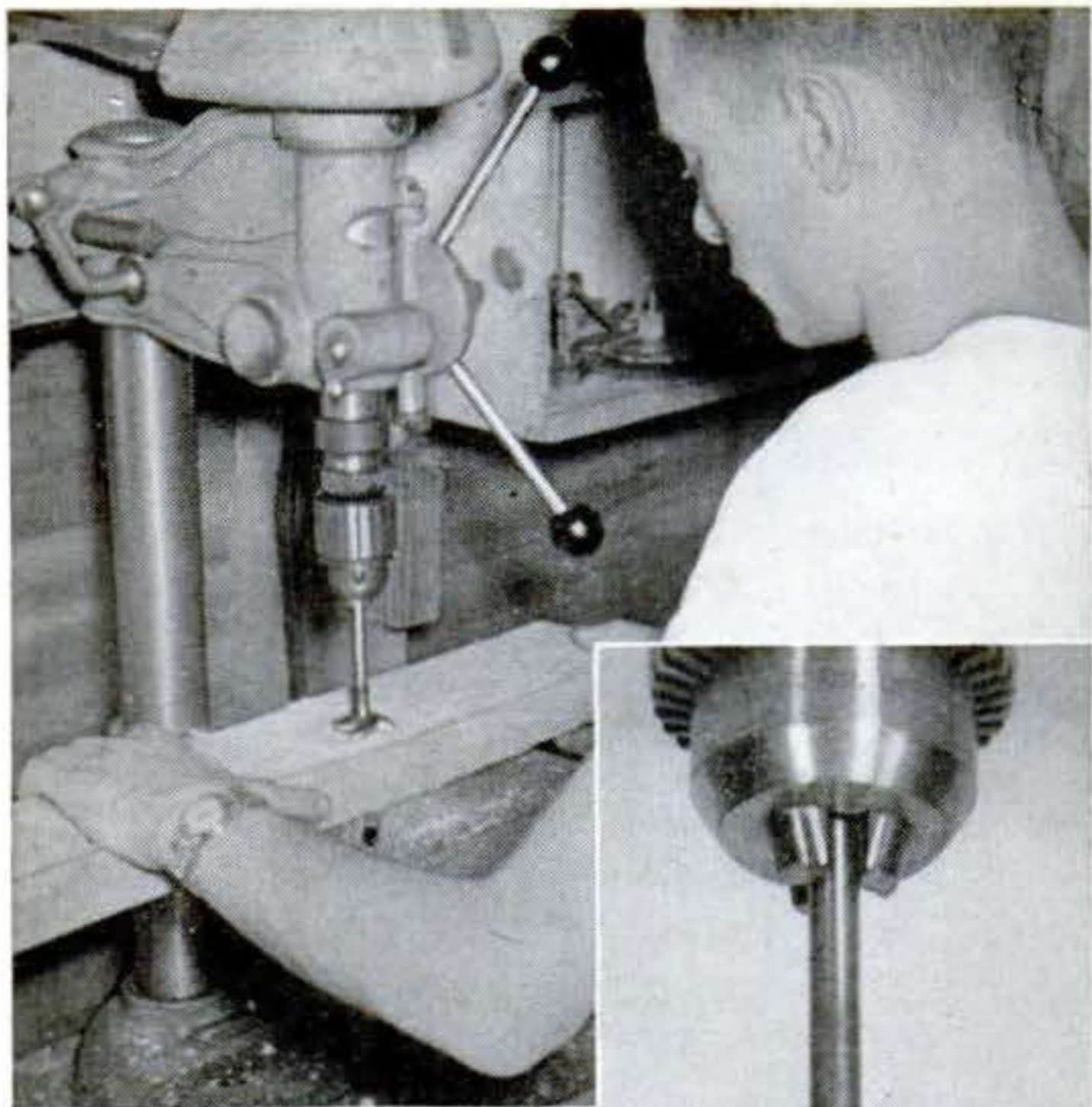

**Rotary planer** can be made from any valve. One with hollow head provides ready-made chip clearance. Edges must be sharp to rim.

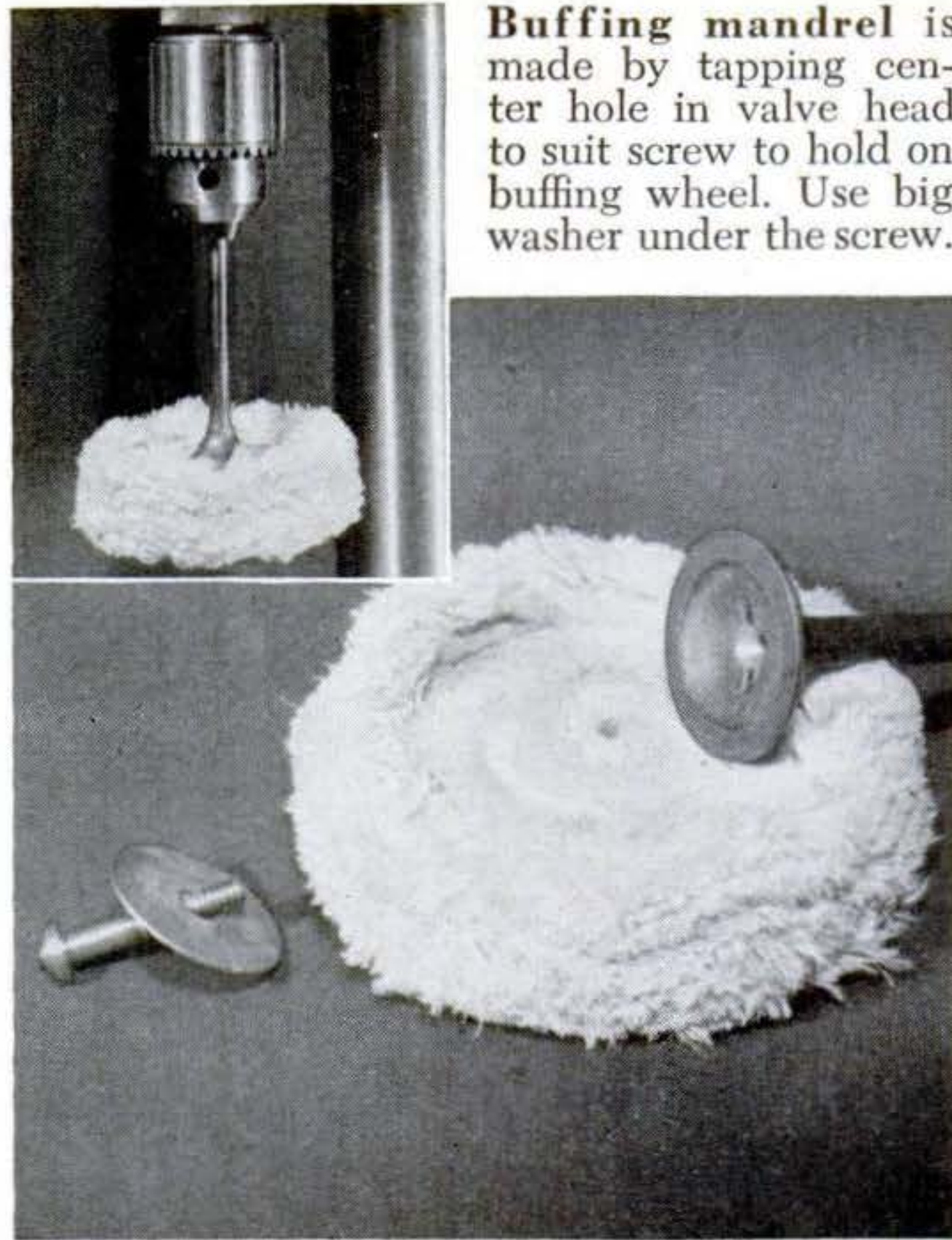

**Buffing mandrel** is made by tapping center hole in valve head to suit screw to hold on buffing wheel. Use big washer under the screw.

ing length, or get rid of a flared stem end.

**Surface planer.** Mark off equal spaces and grind four cutting edges as shown in the drawing. Finish by mounting in the drill press and lowering the head gently against a flat oil stone to lap all edges true.

**Disk sander.** Drill two holes 180° apart and file them counterclockwise (as seen from the stem side) to keyhole slots. Saw a 3" disk out of plywood. Turn in two wood screws so they catch firmly in slots.

**Hole saw.** A large valve from a truck,

airplane, or boat engine is probably best. After annealing, chuck the valve in a lathe and drill a center hole into which a phonograph needle will just fit. Turn the head to diameter, with a shoulder as shown. Drill and tap three or four radial holes.

Break off the ends of old hacksaw blades (the end teeth will still be sharp). Mount them with bolts and washers. Insert the phonograph needle to align the saw with a mark on the work. Clamp work on the drill press, remove needle, and make the hole.

**Circle cutter.** Drill a 3/16" hole in a valve head at a 45° angle, at the radius of the circle to be cut. Drill and tap a hole for a setscrew, preferably the hollow-head kind. Use a phonograph needle to center the cutter or, better still, set in a small drill held with a second setscrew under the head. The bit can be ground from 3/16" drill rod. Clamp the work firmly on wood backing.

**Dado and milling cutters.** Turn the flare under the head to leave the edge the desired thickness. Index for teeth and drill a hole at the bottom of each. File or grind, reharden, and draw to a deep straw.

**Star drills and reamers.** The flare at either end can be used to advantage. Teeth can be ground with a wheel in a flexible shaft or hand grinder, if you don't wish to anneal the stock. For accuracy, reamers should be turned to shape and rehardened afterward.—S. Palestrant, *The Bronx, N. Y.*



Sander pad snaps onto valve with keyhole slots filed in head. Cement sponge rubber to pad; attach abrasive paper with rubber cement.





## Hints from the Model Garage



**White Paint Shows Brace Slot.** In the dark it's often difficult to prop up your hood with a swinging brace because you can't see the slot. Applying a little white paint around the slot will make it stand out prominently even in poor light.

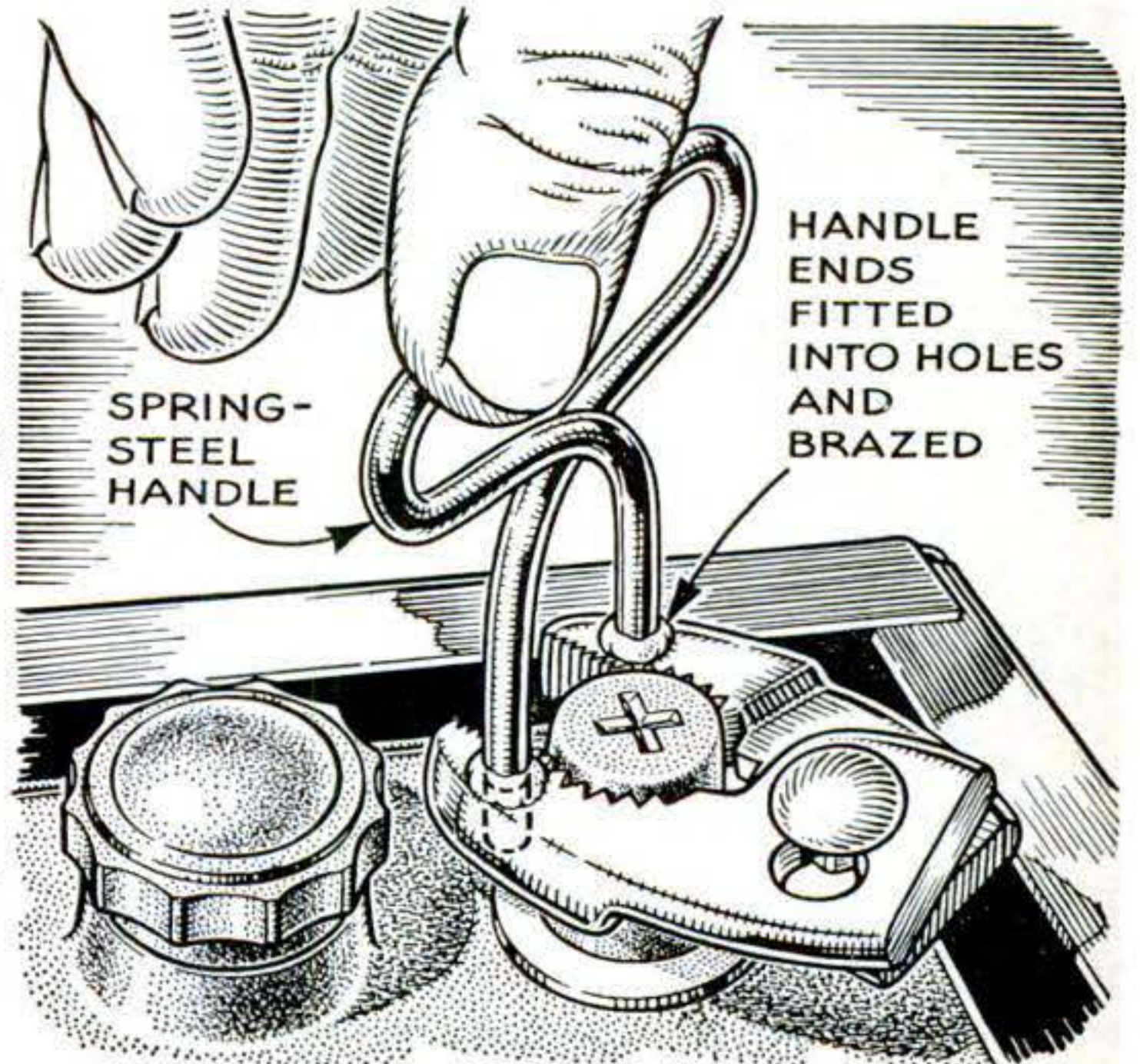

**Altered Pliers Clean Battery Post.** To make this handy tool, cut the handles from an old pair of pliers, drill two holes, and braze in a spring-steel handle. Slip the jaws over the post, rotate a few times, and the post will be thoroughly cleaned.

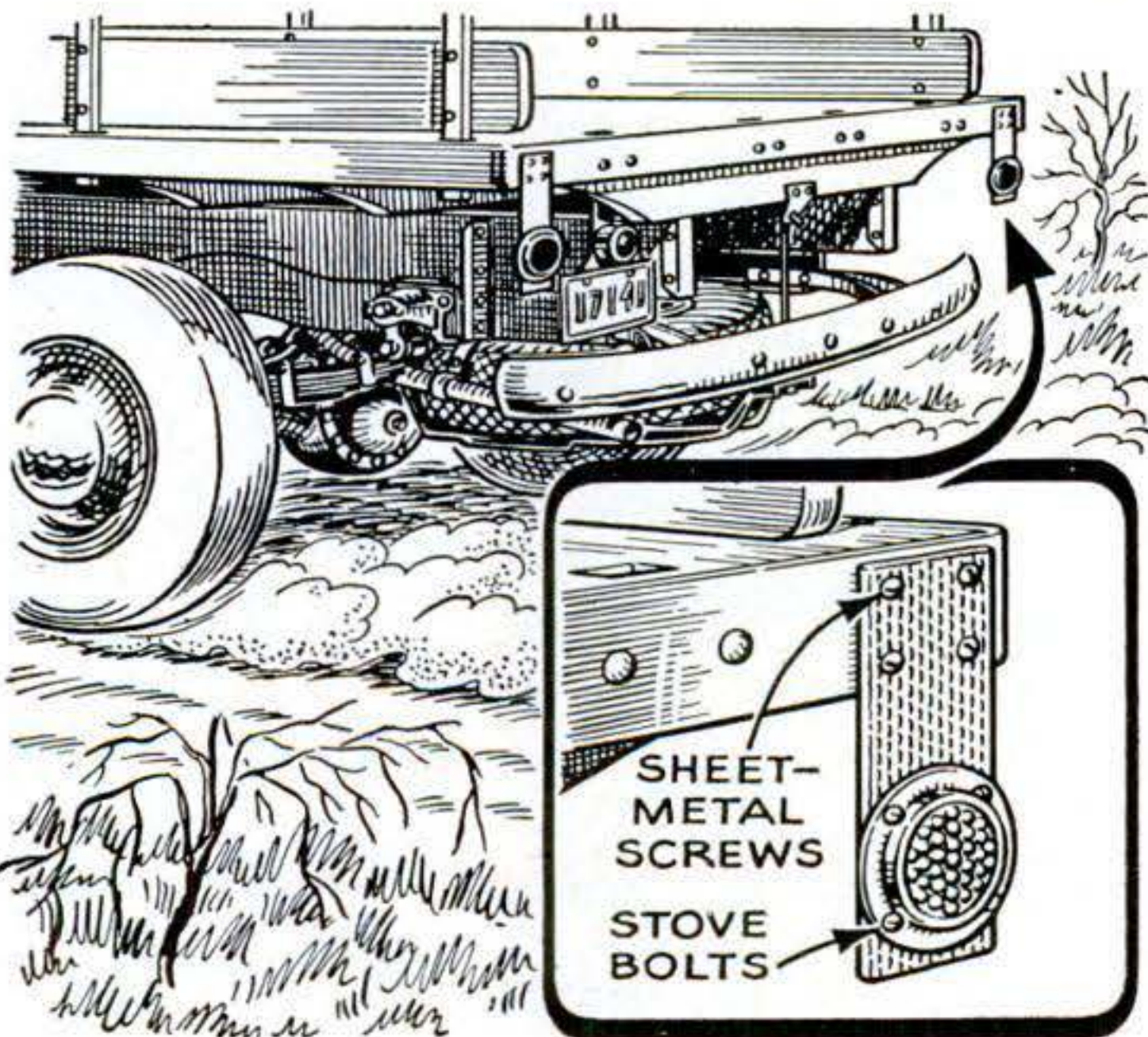

**Swinging Reflectors Escape Damage.** If you should back your truck into an obstacle, flexibly mounted reflectors will swing under the truck bed without damage. Bolt each reflector to a piece of canvas belting about 12" long and attach the other end of the canvas to the truck bed with nails or self-tapping metal screws.

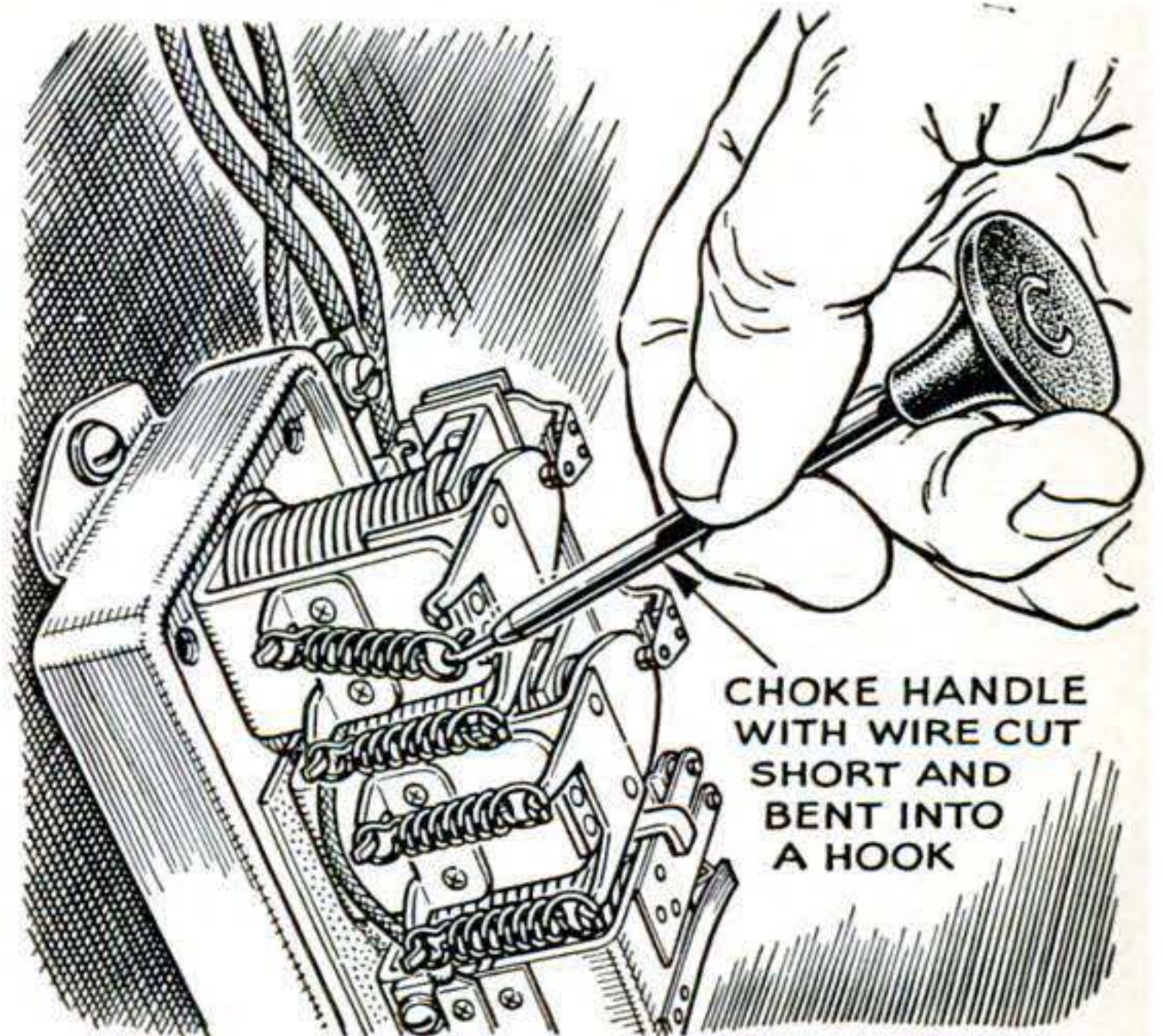

**Choke Handle Is Spring Tool.** Here's an easily made tool that Marion L. Rhodes finds handy around his shop in Knightstown, Ind. It's just the thing to hook on or off the small springs in a current and voltage regulator. Carburetor and generator springs are other possible uses. The wire is stiff enough to retain its hook shape.

Turn the page, please, for three more auto hints.

FEBRUARY 1951 195

**MORE** Hints from the Model Garage

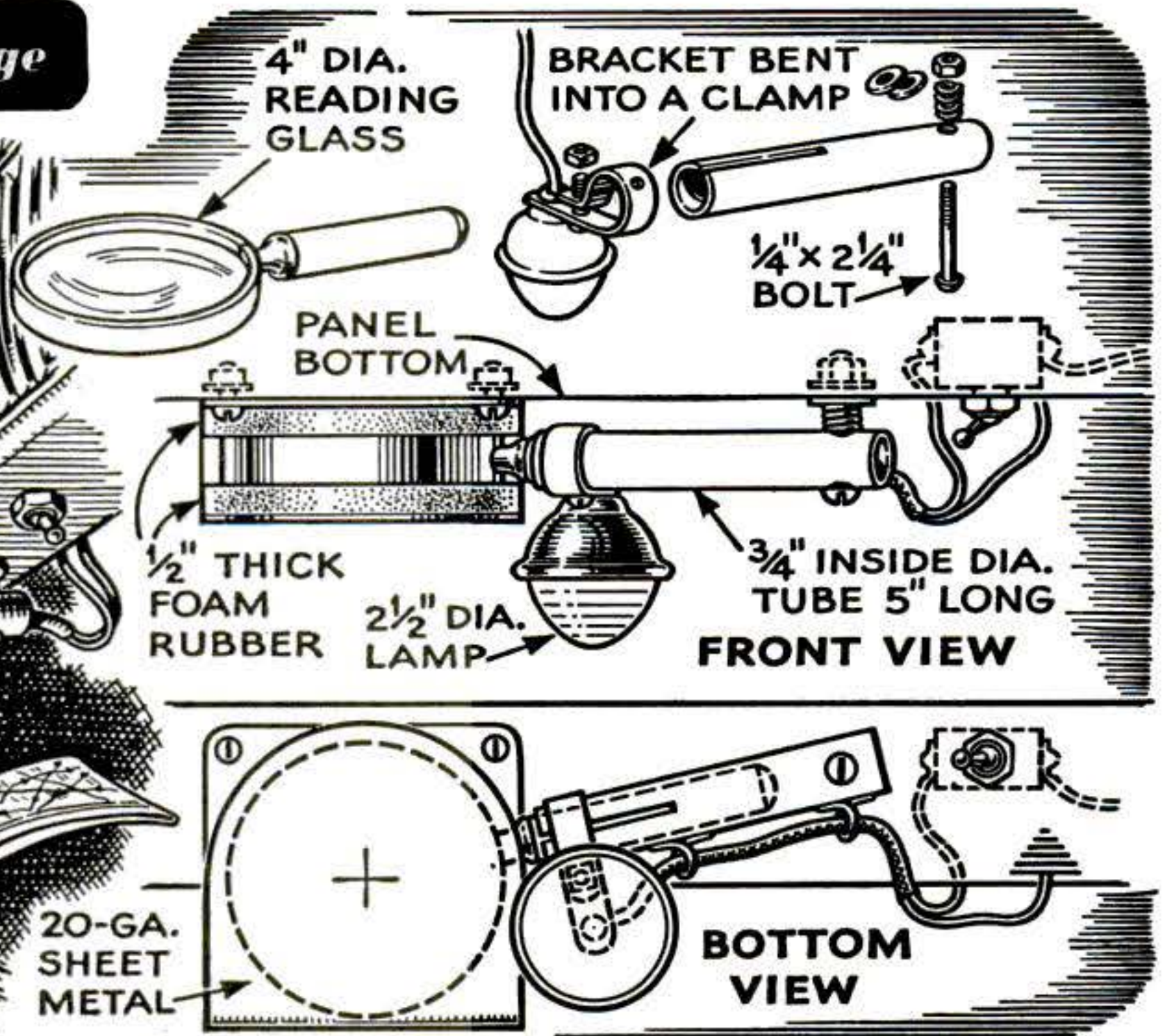
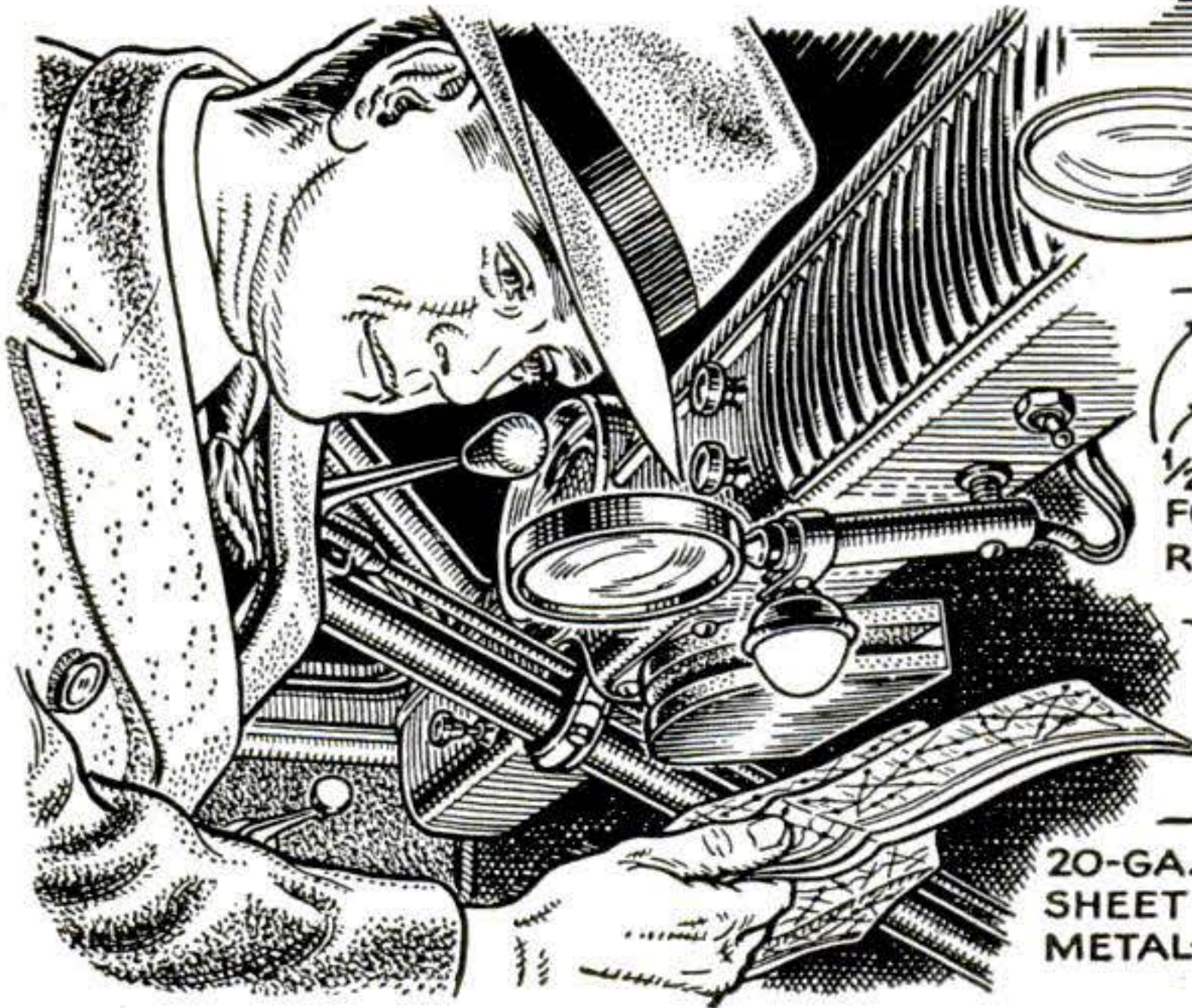

**Glass Magnifies Map Details.** A large reading glass mounted under the dash like this will help you see fine print on a highway map. Supported on a pivot, the glass swings into a pocket lined with foam rubber while not in use. This protects the lens

and keeps it clean. A truck clearance lamp clamped to the swinging arm throws light on the map. A lead can be run to the hot side of the ignition switch. For some cars you'll have to vary the setup to suit a different kind of instrument panel.

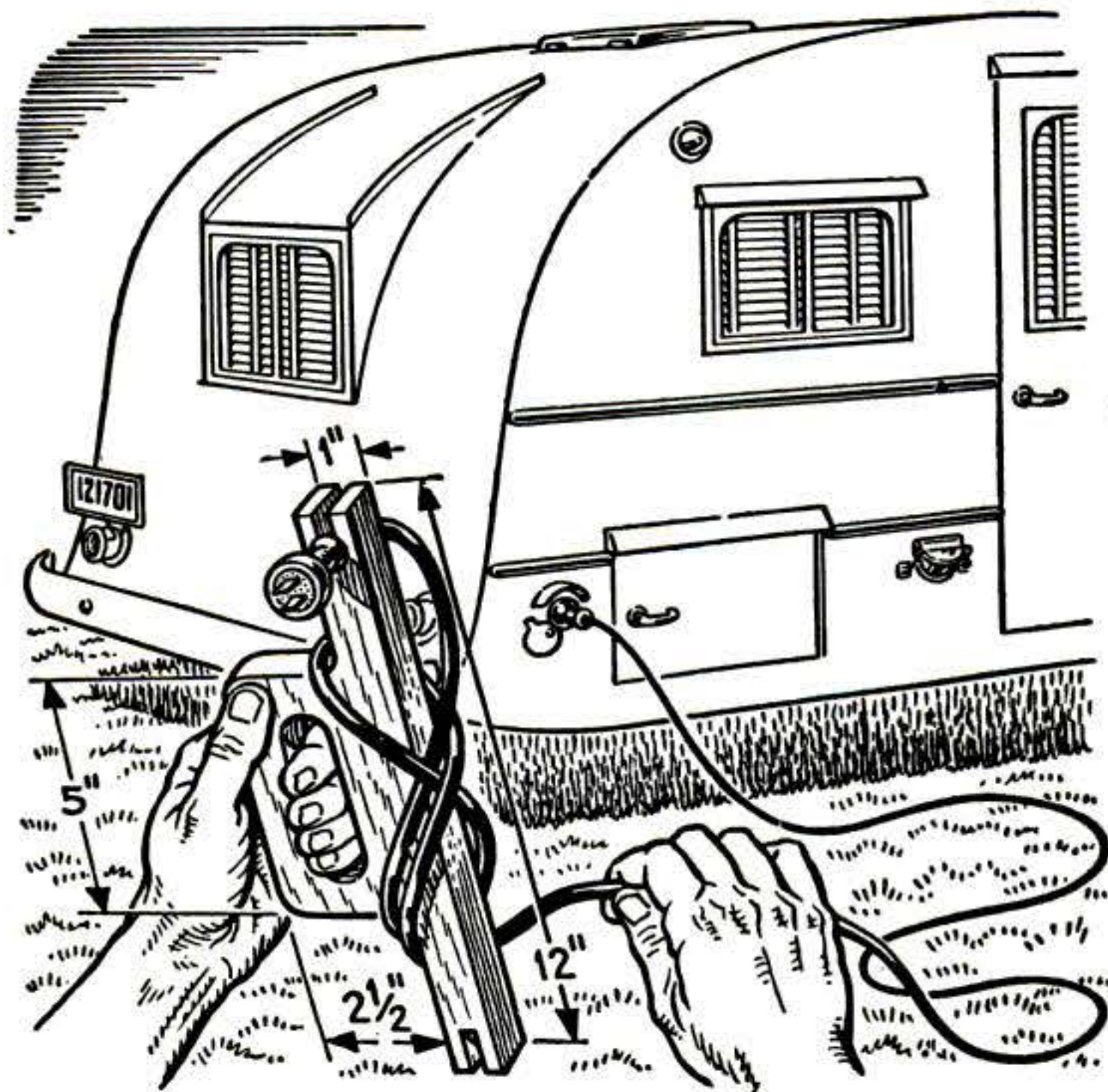

**Reel Stores Extension Cord.** House trailers are often equipped with 115-volt electric wiring circuits, but to bring current into the trailer a long and unwieldy extension cord is required. To simplify handling the cord, A. V. Malone, of Los Angeles, designed this carrier. Wind the cord as shown, each revolution forming a figure eight. The 1" slots at each end are for hooking the plugs to the carrier.

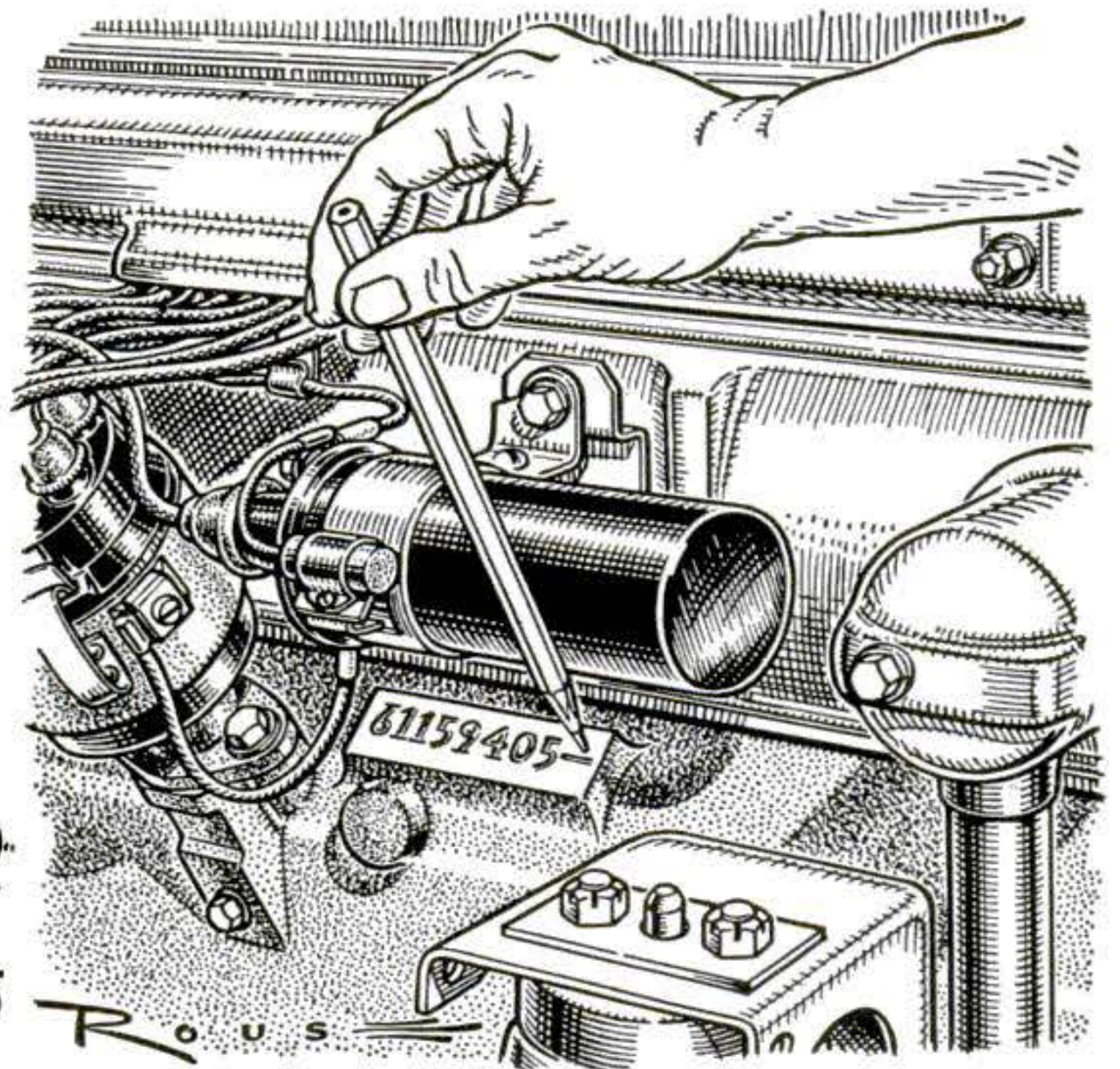

**Did You Know This?** A  $\frac{1}{4}$ " dash stamped after an engine number means that all the cylinder bores were finished .010" oversize at the factory and are equipped with .010" oversize pistons and rings. You must take this into account in overhauling such an engine. Motor makers commonly finish all bores this much oversize if one is too large for finishing to nominal size. However, such engines are not considered special.

# How Auto Horns Work

What happens when you press the button? You'll see quickly if you make these simple working models.

By Kenneth M. Swezey

Here's a working model of electric horn. Photos below show how it was built. Cone projects sound like trumpet on real horn.

THE makers of auto horns have come as far from their early baa-DOO-gah! days as have their brother engine designers. So if the horn on your new car both sounds better and carries farther, it's no accident.

Some horn developments have been purely technical, but others have turned upon the physics of sound. Designers have found, for instance, that pitch is more important than loudness (amplitude) in achieving carrying power, and that loud sounds aren't so unpleasant if they have a musical tone.

Next to fire-engine sirens, the most powerful horns today are the air-blown trumpets used on cross-country trucks and busses and

as custom accessories for passenger cars. They work like trumpets in a band, with vibrating reeds or diaphragms taking the place of players' lips.

Magnetically actuated, vibrating-diaphragm electric horns are standard on most passenger cars. They work like household buzzers. The vibrating part is connected by a rod to a thin metal diaphragm.

Horn makers also produce whistles that operate from the exhaust, and air and electric horns on which you can play tunes.

You can see how the various kinds of horns work by performing the experiments below and on the next two pages.

## ELECTRIC HORN

You can make a working model like the one above in a few minutes. Its magnet is a bolt wound with insulated copper wire. Mount this on an angle bracket.

The L-shaped armature is bent from a strip of tin. The diaphragm is a disk of stiff paper glued at the edge over a smaller hole cut in a piece of corrugated cardboard. Link the diaphragm and armature by a matchstick secured at each end with a drop of sealing wax. The current-breaking contact is formed by the bare tip of one end of the magnet wire that just touches the far side of the armature when the battery is off.

When you connect the free end of the magnet winding to one pole of your battery and the base of the armature to the other, current flows through the coil. The coil becomes magnetized and pulls the armature toward it. This breaks the circuit between armature and contact point, causing the armature to spring back again—only to be once more attracted. The sound of the vibrating armature is increased by the paper diaphragm attached to it. Tone and intensity can be adjusted slightly by changing the pressure on the contact wire. A cardboard cone held against the diaphragm will make the sound louder.

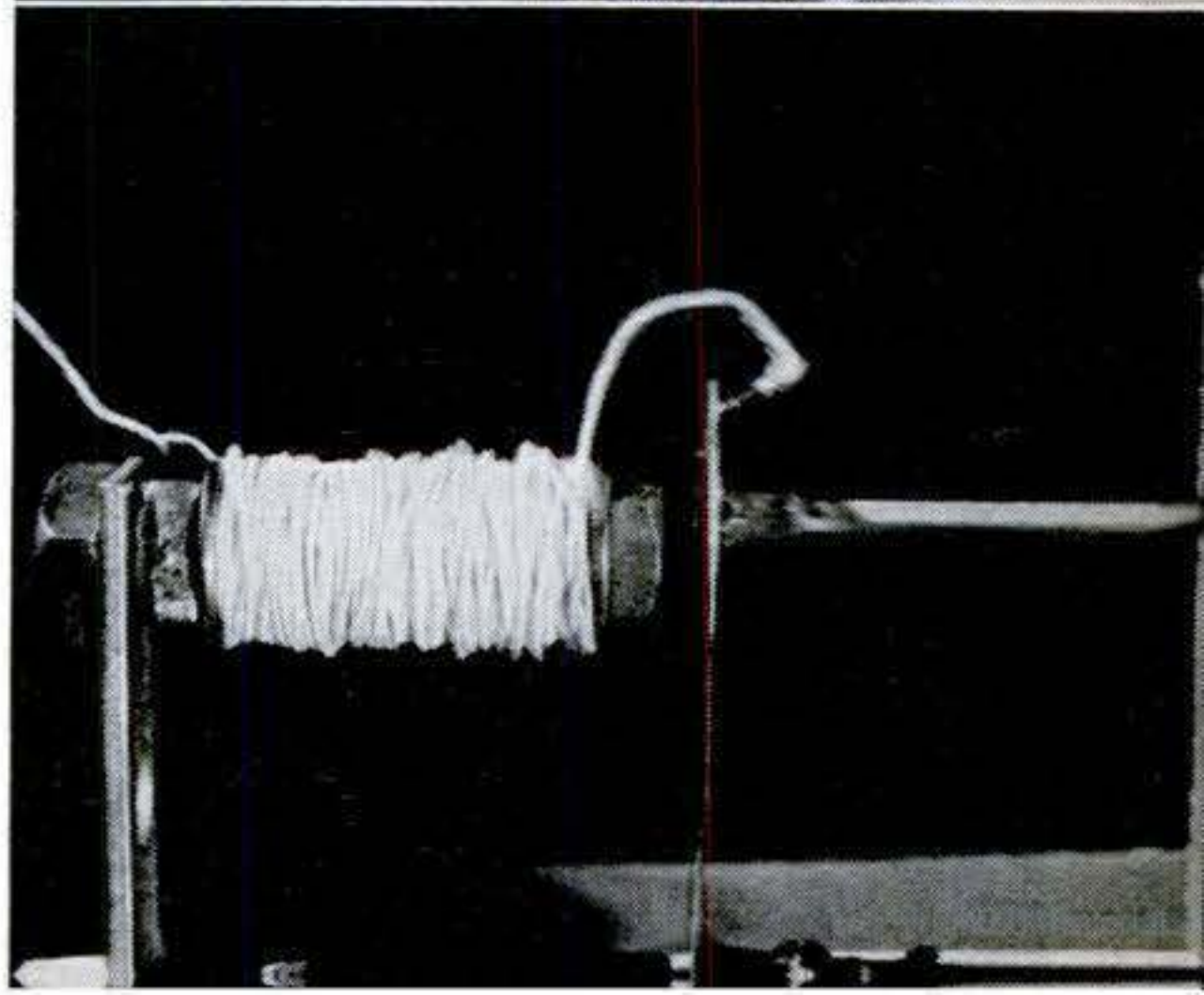
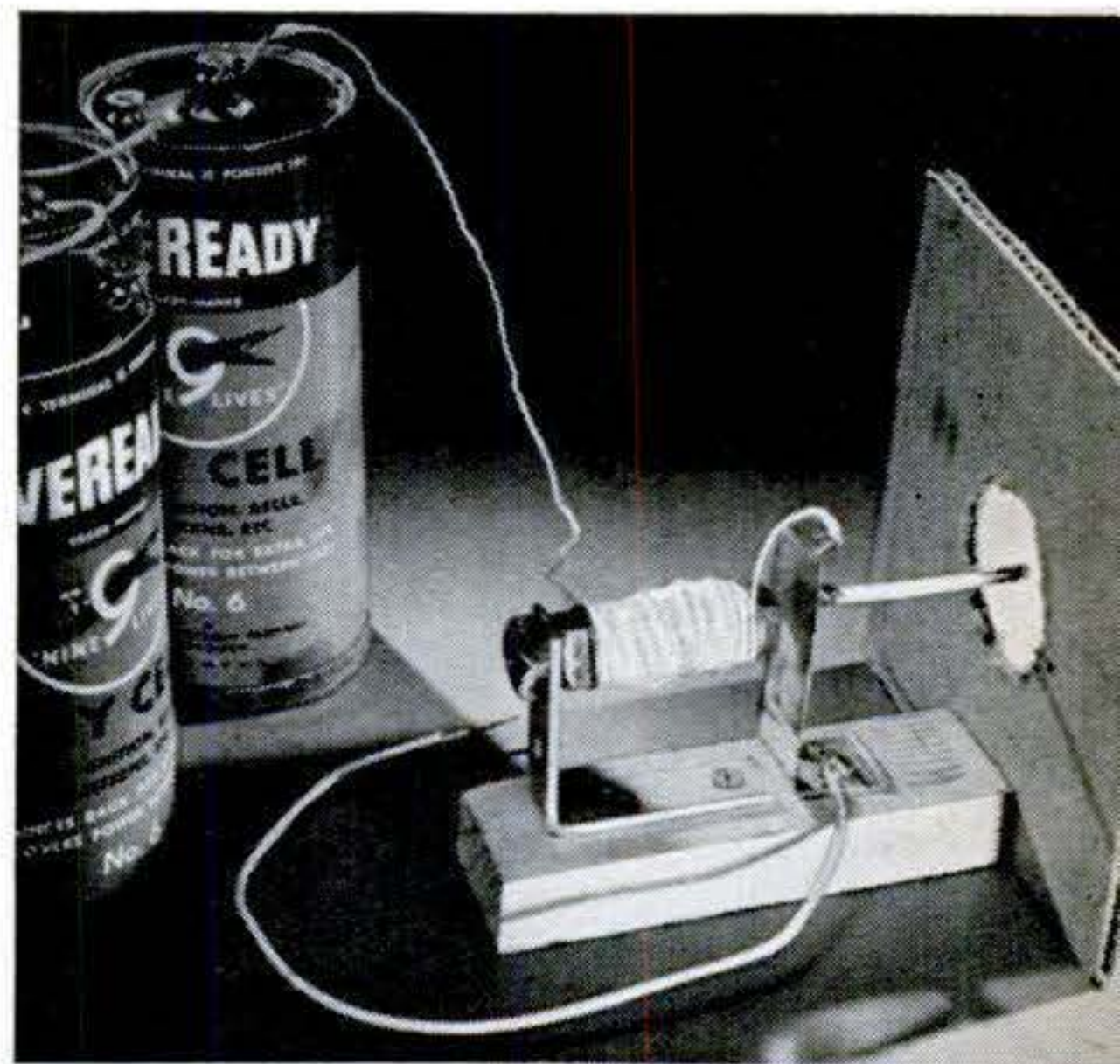



**AIR HORN** This variety produces a sound in much the same way that a tin horn or your vocal cords do. The old honk-honking horns depended upon a thin metal reed that vibrated strongly when you squeezed the bulb. Some present-day musical horns work on the same principle. More powerful air horns depend upon the vibration of a diaphragm against the end of a trumpet.

You can make a workable vibrating-reed horn from a soda straw. Flatten one end and cut about  $\frac{1}{4}$ " from each corner as shown in the diagram. Put about 2" of this end into your mouth. Then blow. Shorten the straw and you will raise the pitch. Add funnels of different sizes and shapes over the end of the straw and you will change and magnify the sound just as trumpets do on a real horn.

**KLAXON** Horns of this famous type make their OOGah sound when a studded wheel rotates against a projection on the back of a diaphragm. The wheel is turned by an electric motor or by hand through a train of gears. Pitch is changed by varying the wheel speed. You can make a model by cementing a thumbtack to the center of the bottom of an empty salt box, and rubbing a file over the point.



**WHISTLE** Whistle-type horns work like an organ pipe. A blast of air passes over a sharp edge near one end of a metal pipe. The turbulent air at the edge starts the air in the pipe vibrating at its own natural frequency, determined by the length of the pipe. You can test this principle with soda straws and bottles, as below. Combination tones can be produced by blowing over several bottles of different sizes at once.

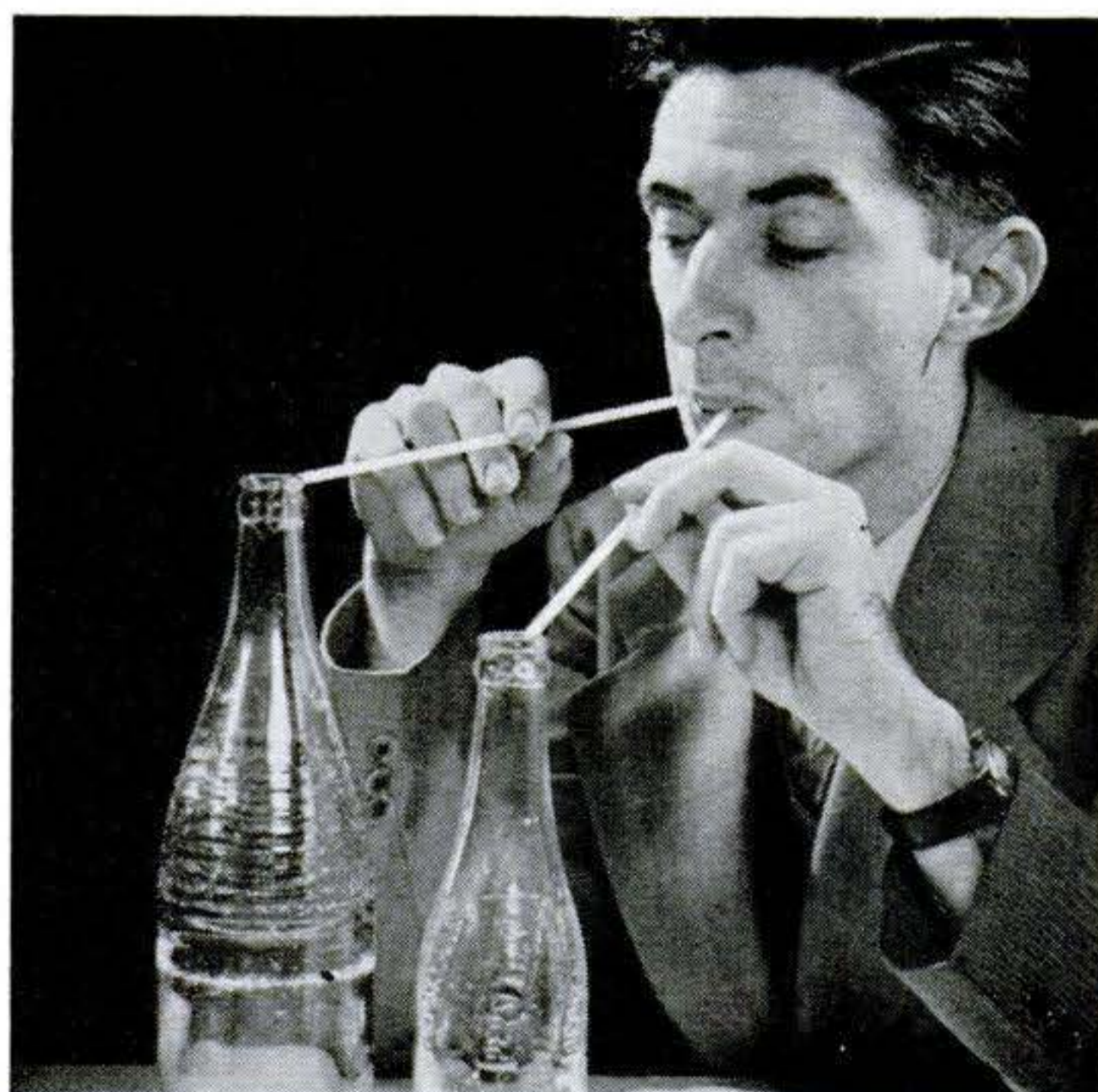





**SIREN** Now often restricted to fire engines, ambulances, police cars, and air-raid warnings, a siren produces its characteristic scream by intermittent puffs of air issuing through holes in a revolving drum or disk. A simple model will show how it works.

Punch a circle of equally spaced holes near the edge of a coffee-can cover. Mount the cover on the shaft of a small grindstone

or fasten it in the chuck of a hand drill. Blow through the holes with a straw, flattened at the nozzle end, as you turn the disk. The harder you blow, the louder; the faster you turn, the higher the pitch.

Commercial sirens usually consist of a metal drum with slots in the periphery. This revolves inside a slotted stationary drum. A fan attached to the rotating drum sucks in air at the axis and hurls it out the slots.

**How sound waves are intensified** by the use of a trumpet can be shown visually with a candle and a tin can. Remove the top from the can, hold the top a little more than the can's length from the candle, and snap

the top with your finger. The candle doesn't flicker. Now hold the mouth of the empty can near the candle, and snap the bottom of it. This time the sound waves, aimed by the can, disturb the candle flame noticeably. **END**





# Taking the Sag Out of Garage Doors

**Why struggle with them any longer?  
They will swing freely and last  
longer if you mend them now.**

**By Harry Walton**

**G**ARAGE doors fall roughly into three categories: those you can open easily, those you can drag open with a small tractor, and those you have to blast.

If you have type two or three, you won't need to be convinced that repairs are in order. Were they just beginning to drag last fall? Then the chances are a winter of scraping them over ice and snow hasn't improved their condition or your temper.

The earliest good outdoor-working weather is none too soon to fix ailing doors and to protect them against further damage from spring rains.

**Where's the trouble?** The first thing to determine is whether it's actually the

**What happens when doors are frequently left open is shown below.** Rain soaks into joints at top edge. The rail tenon pulls loose, and so do the hinge screws, letting the joint open. The sagging door drags the hinge askew.



doors that are sagging, or whether they drag because frost has caused the concrete apron to heave until it scrapes the bottoms of the doors. If the door joints are sound, the frames square, and the hinges securely attached, the apron is probably at fault. The obvious cure is to cut half an inch off the bottom edges of the doors. You can do that without taking the doors down, at the cost of considerable elbow grease and back bending.

More often, the trouble is in the doors themselves. Hinge screws rust and pull loose. Joints rot through and open, particularly at the top of the frames, allowing the outer stiles to drop until the whole frame gets out of square and drags.

**Prop it up first.** As soon as you've determined where the trouble is, decide whether the door should be wedged up or braced to realign displaced members. It's of little use to tighten a hinge permanently in the same position that allows the door to drag. Don't depend on the hinge screws to lift heavy doors back into place. Give them an assist with wedges or props, as shown in the photos.

**Tightening the hinges.** If hinge screws have pulled loose from the jamb or rusted out, slightly heavier ones may find anchorage in the old holes. It's better, though, to plug the holes with pieces of dowel, glued in. Or, if the inner face of the jamb is exposed, you can forget about wood screws. Drill right through the old holes and insert flathead bolts, with washers and nuts on the inside of the jamb.

A badly split or rotten jamb will have to be replaced, but where the damage is only under the hinge leaf, you may be able



To lift sagging bottom corner, drive in wedges like this. If open top joint doesn't draw together, close the door and drive wedges again.



Then insert long prop between the open joint and opposite jamb (above). This will close the joint, but be sure to wedge up the stile too.



Wood screws in this hinge leaf had rusted loose, leaving holes too enlarged even for bigger screws. Glue was first worked into the open joint. Then the joint was closed with a brace (top right photo). New holes were next drilled

Broken joint was clamped as shown to align the faces, the stile being raised by a wedge at



right through hinge and rail (left). Flathead bolts were inserted, and the nuts were tightened over washers on the inside of the rail. Then a metal mending plate was put on the inside of the door to help hold the joint together.

the bottom. Then holes were bored, and hardwood dowels, coated with glue, were driven in.





**Dowel-repaired joint** was reinforced with a batten. Paint was scraped off the door to give glue a good grip, batten was clamped in position, and holes were drilled through. Batten was bolted below rail edge to clear door stop.



**Right-angle mending plate**, mounted with wood screws or through bolts, is another means of tying together a re-glued joint. Use the biggest plate you can. A second plate inside the door can be held by the same bolts.

to move the hinge up or down into sound territory. If this isn't practical, consider bridging the bad section with a long piece set against the inner face of the jamb. You'll need bolts long enough to go through the jamb and the new piece.

Hinge screws are even more likely to pull loose on the door, which is more exposed to weather than the jamb. Here again you can drill the holes clear through, and use bolts instead of wood screws. Be sure to put washers under the nuts.

Sometimes the wood around screw holes is soft with rot, and even washers and nuts find no solid anchorage. Short of moving the hinge (which is sometimes impossible because the top rail isn't wide enough) your best bet is to drill new holes in other parts of the hinge leaf, away from the old ones.

**Pulling joints together.** Garage doors stand open so much that rain eventually enters the joints between the stiles. Even paint offers only short-term protection here. Eventually the water-soaked wood rots and the joint disintegrates. It pays, therefore, to make repairs before this happens.

If the tenon is loose in its socket but the wood is still sound, glue and dowels may suffice to hold it together. Work water-

resistant glue well into the joint with a knife blade or spatula. Then wedge the bottom of the door or put a prop against it from the farther jamb, watching the joint to see whether it closes. Bore holes across the joint (from the front to the back of the door) and drive in dowels smeared with glue.

The wood may be so rotten that the tenon has broken off the rail. The photos show several ways of repairing such a joint. Dowels driven in from the end will align the faces, but can't be relied on to hold the joint together by themselves. Add wooden or metal mending plates.

**Hold that shape.** It's well to give weakened joints some support by tying the bottom outer corner to the top of the hinge stile with a brace of some kind. It may be the conventional turnbuckle support shown in the photos, or a batten fastened on diagonally. Use husky wood screws, preferably brass, galvanized, or cadmium plated, to hold on a batten.

A very substantial brace consists of a panel of plywood screwed (not nailed) to the door below the window area. You can get two pieces (enough for both doors) from a standard 4 by 8 panel. Buy the  $\frac{3}{8}$ " sheathing grade instead of the more costly



**That old standby**, the turnbuckle stay, will help pull doors back into shape. If you already have stays, they may merely need tightening. In putting on new ones, remember to match the left- and right-hand threads on rods and eye.



**Plywood bracing panel** can be attached with  $1\frac{1}{4}$ " wood screws 6" apart. Glue applied to inner face all around edge adds strength and resists entrance of water. Paint plywood promptly after installation, especially along edges.

kind. Paint it well, and keep it painted.

**Rainproofing the doors.** Any wooden structure must be kept painted to withstand the weather. It pays to repaint garage doors promptly when they need it, and to use a top-quality outdoor paint. Cracks can be filled with putty or weatherproof glue.

The vulnerable top edges of the doors

need special attention. The best protection is a copper or galvanized sheet-metal cap, that you can bend up from a strip or have made at any tinsmith shop. Coat the inside of the cap and the top of the door liberally with roofing cement. Drive nails in through the down-bent sides only, not in the top, to hold the cap on. END

**Water caps** are worth installing, even on old doors. Installed on new doors, they'll save you lots of headaches. End grain on stiles takes paint poorly and consequently soaks up water that leads to rotting. Cap can be bent from

sheet metal. Smear thick layer of roofing cement on top of door and then put on cap. Drive nails through sides of cap, not through top. Bend out edge of cap, if necessary, to divert water from mending batten.



# Winter Evening Craft Projects

Tired of taking your leisure sitting down? Too early to get outdoors? The home workshop is the ideal place to spend these long winter evenings. While you're about it, why not try something different? These two projects may take you down a new road, if you've never tried metalworking or wood carving before. They're absorbing to make and nice to have—or to receive as gifts.

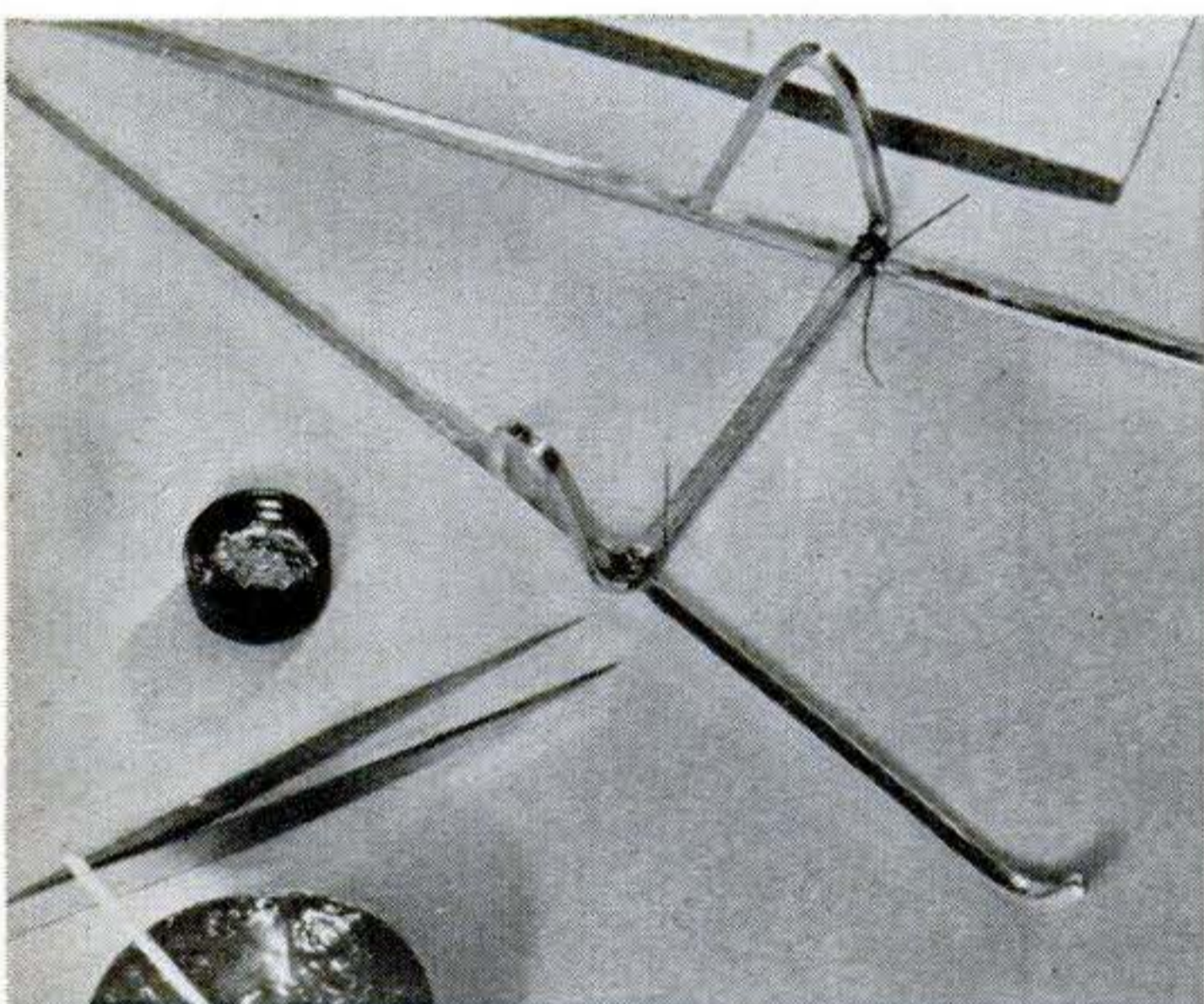
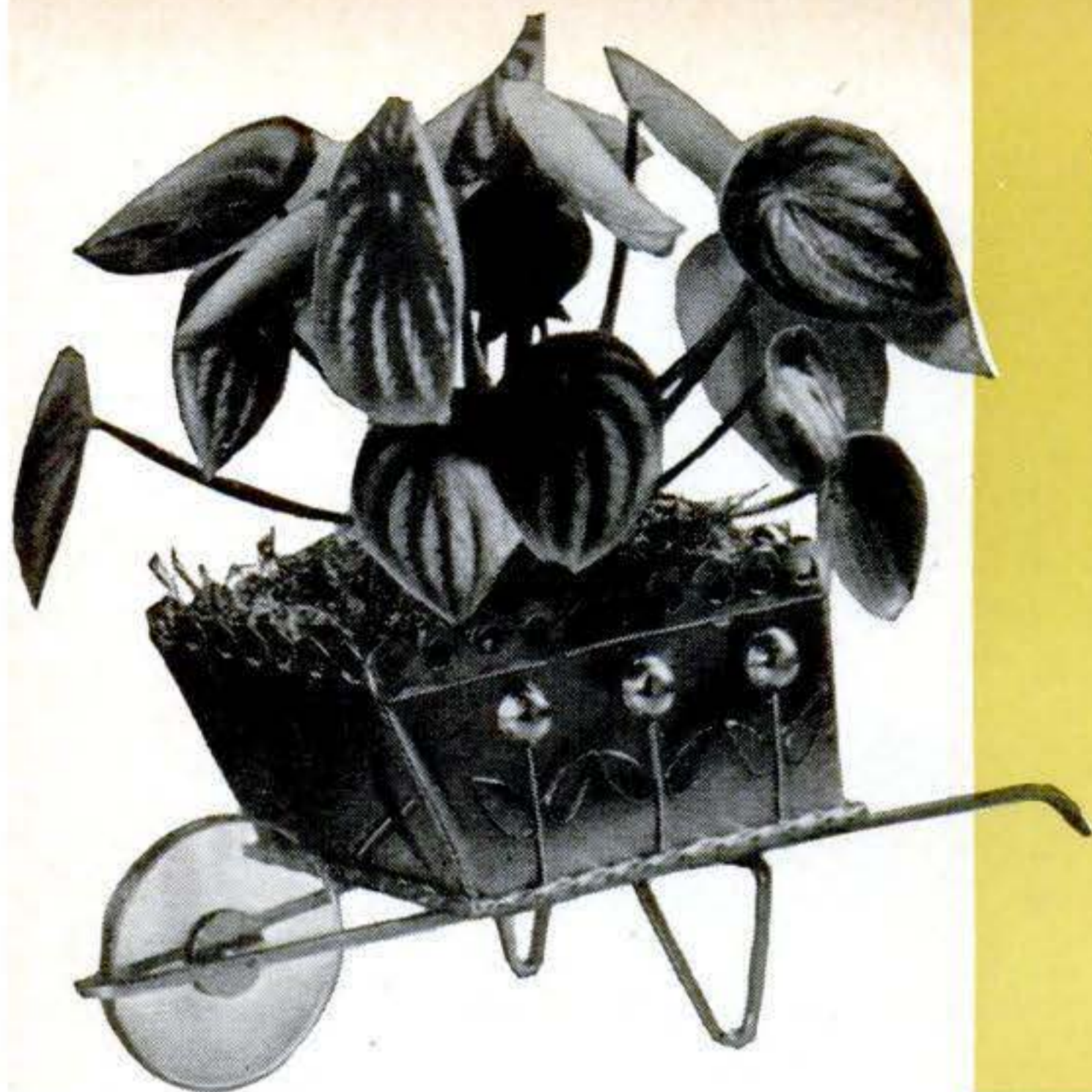

**Barrow frame** is bent into V shape. Legs, formed from one length of square brass, are held on with black iron wire for soldering.

**Wheelbarrow Planter.** Brass is the ideal material, but if you paint the piece even tin plate will serve. Bessemer rod is a fair substitute for the  $\frac{1}{8}$ " rod, and radio bus bar for the decorative twist.

Bend a 20" length of  $\frac{1}{8}$ " rod into a V, and a 10" length into a pair of legs joined by a crosspiece. Bevel the ends to fit the frame, wire on, and solder.

Drill a No. 44 hole through the frame near the front. Cut a plastic wheel with a  $\frac{3}{32}$ " hole in it. File points on a piece of  $\frac{1}{8}$ " round rod, heat to about soldering temperature, and carefully push it halfway through the disk. Hold it perfectly square until it's cool.

Form the tire from a  $\frac{1}{4}$ " wide strip of

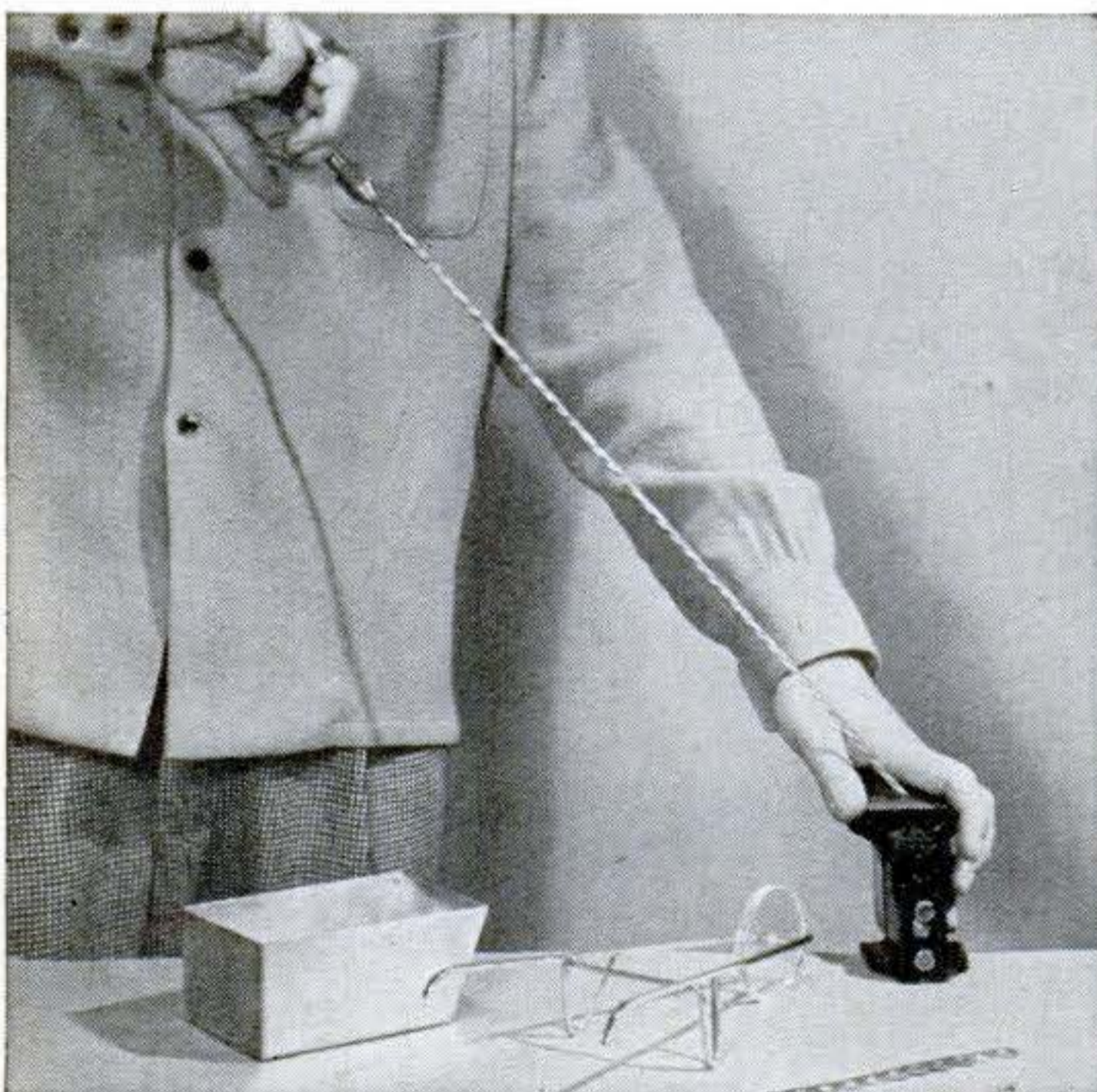

**Twisted edging** is made by clamping one end of annealed square brass in a vise and locking the other in a T-handled tap wrench. Turn to a tight spiral. Cut off and discard ends.

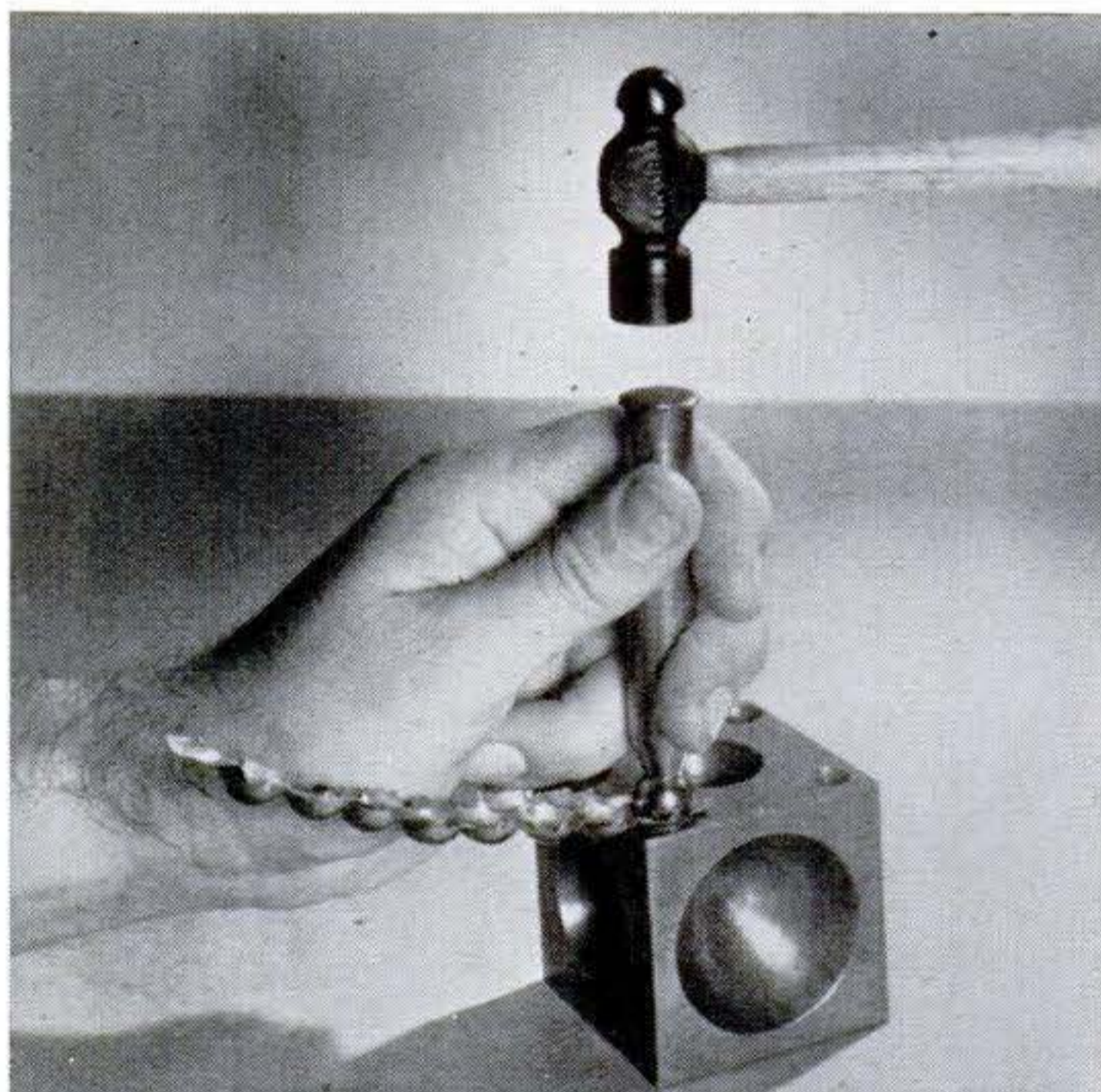

**A dapping die and punch** rapidly turn out domes for the decorative pattern. The 26-gauge copper must be annealed at least twice. Wood block and round punch will also make domes.

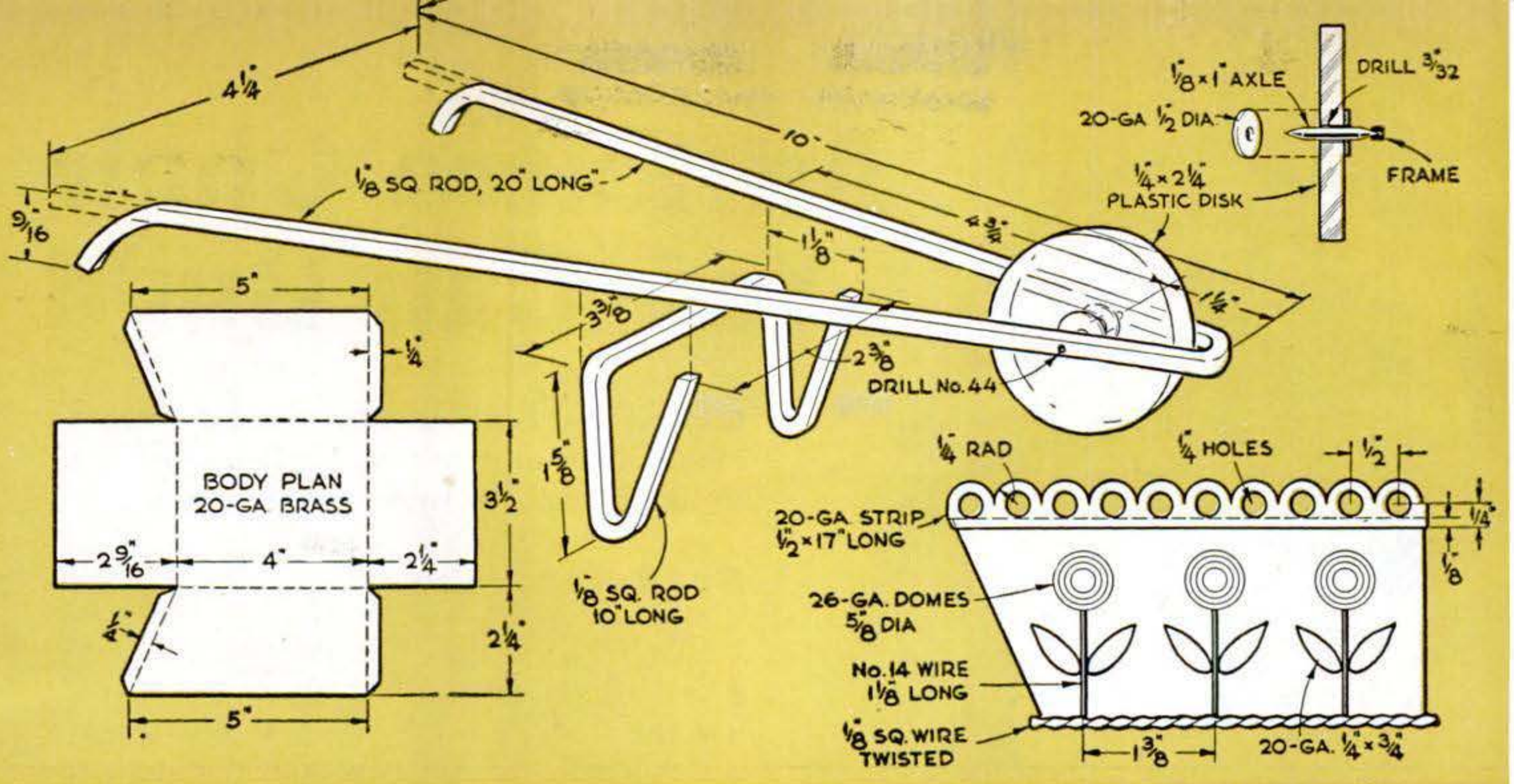

20-gauge brass, soldering the joint. Spring apart the frame enough to slip the axle in.

Lay out the body blank and decorative strip on 20-gauge sheet brass. Hammer the bends to a good fit over a wooden block. Lay bits of solder inside and heat until it flows into the joints.

Centerpunch and drill the 1/4" holes in the decorative strip, cut and file the scallops to shape, and flatten the strip. File notches at the front corners so that the hidden edge may be bent to match the slope of the front.

Bevel one end of the twisted strip, file notches almost through at the corner bends, and shape it to the body. Bevel the second end to fit the first, and solder it on.

Scour with kitchen cleanser. Then buff to

a high luster. Tin the frame and body, and sweat-solder them together.

For the decorative domes, anneal a strip of 26-gauge sheet copper. Shape on a die as shown, or over a depression in a wooden block, using a ball-tipped punch. Anneal again before forming to full depth, or the metal will crack. Cut out the domes and file the edges flat.

File a bar of solder to obtain granules you can lay alongside these pieces after placing them on the body. Then apply a torch to flow the solder under them.

Wash the barrow in hot soap water, dry, and wipe with lacquer thinner. Apply clear lacquer to preserve the polish—*Bill Luther, Los Angeles.*

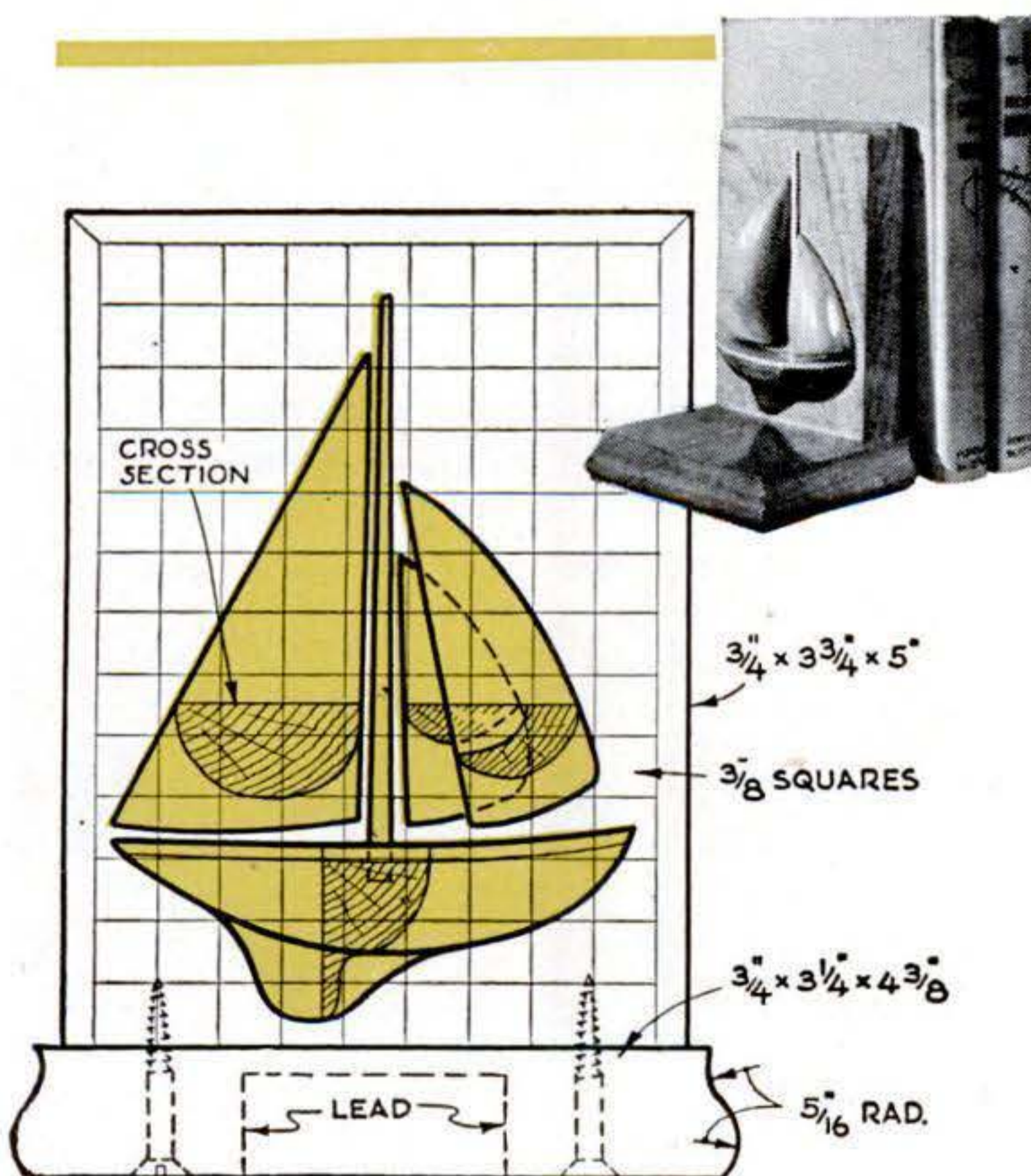

**Seagoing Book Ends.** Glance up at these from a sea story, and you'll almost hear the wind whistling in the rigging. What's more suitable for your adventure and hobby books?

Cut 3/4" stock for bases and uprights, bevel or shape the edges, and hollow the bases. Mount fishing sinkers or sheet lead inside with countersunk screws. Cover the underside with felt or blotter material.

Use dark wood like mahogany or walnut for the hull, white stock such as maple or poplar for the sails. Jigsaw these parts to outline, and glue a thin piece of white wood to the hull as a deck. Shape roughly with a rasp, or on a sander. Then work with knife, files, and sandpaper. Taper a bit of dowel for a mast, flattening one side. Glue the carving on, stain and fill as required, and varnish.—*W. Freeman, Baldwin, N. Y.*



# An Extra Chair You Can Build

Canvas webbing and hardwood framing make it strong and durable—and it's light enough to move around easily.

By Roland Cueva

**I**NDOORS or out, this webbed chair fills a definite need. During the winter, it's just the thing beside a TV set. When warm weather comes, you can take it out to the lawn or terrace, for weather won't harm it if you apply a protective finish. Materials to build it cost less than \$12.

Poplar was chosen for the legs and arms because it is easily worked, strong, and has a natural whiteness that requires no bleaching for that up-to-date finish. The seat and back frames are hardwood.

**Making the frames.** The seat and back frames are identical squares. Corners are joined by mortises and tenons, glued up and clamped. Outer edges should be chamfered so the webbing will wrap smoothly.

The structural frame holds the legs together and supports the seat frame. It is also square, but  $\frac{1}{4}$ " larger than the seat frame to allow for the thickness of the webbing. It is put together with lap joints, glued, and reinforced with screws.

**Legs are laminated.** The accompanying drawing will guide you in laying out the legs. They are laminated in two layers. Each layer is  $\frac{7}{8}$ " thick ( $\frac{3}{4}$ " would be all right, too) and there are five pieces in each leg. The outer pieces join at the top and are cut with the grain running lengthwise. The inner layer has a top segment that crosses from side to side, with the grain running that

You can dye the webbing any color you want. The leg arches are laminated for strength.

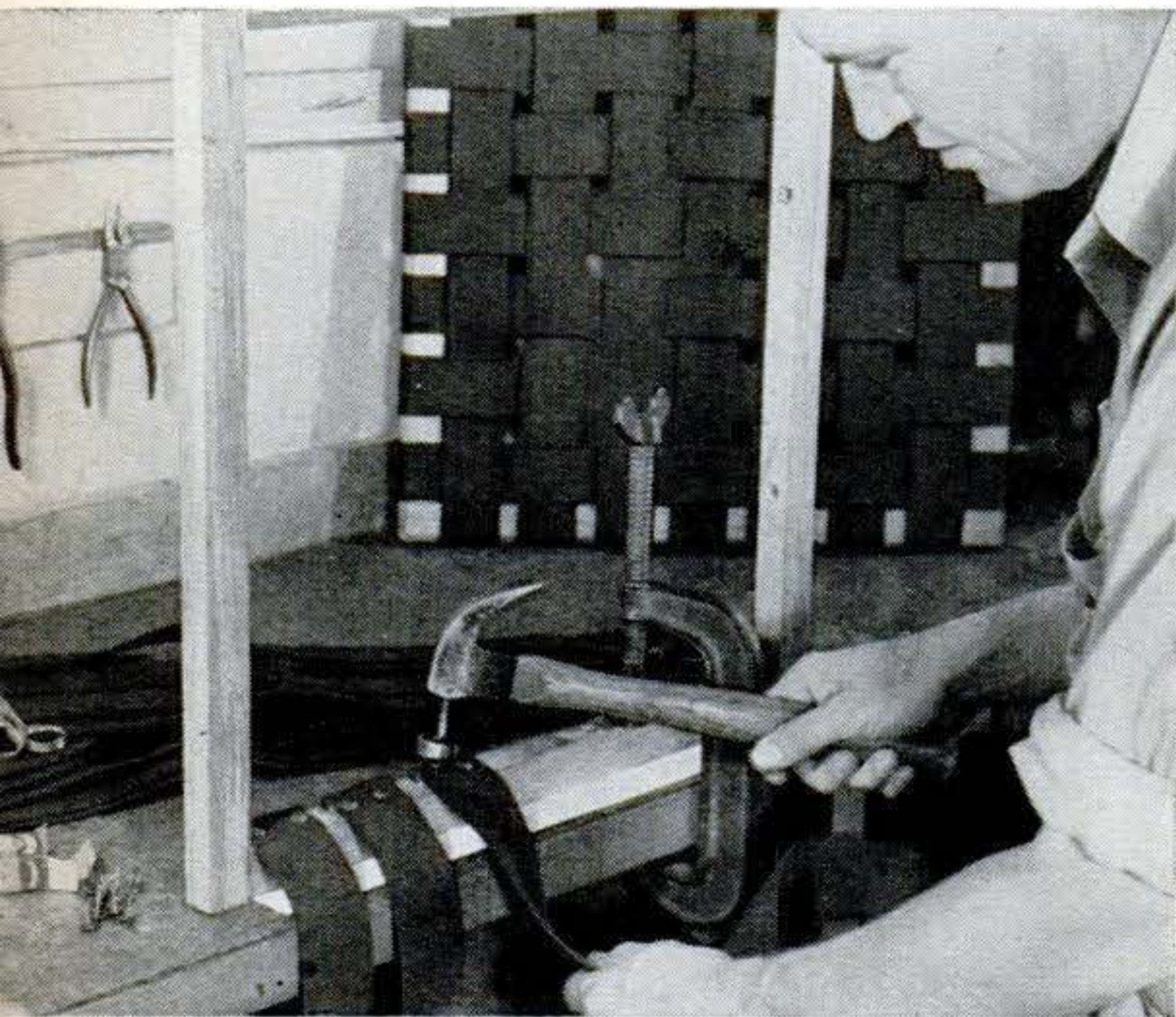

To apply webbing, clamp frame in vertical position, turn under ends of strips about  $\frac{1}{2}$ ", and fasten with upholstery nails, two to each strip. After tacking all strips on one side . . .

Clamp frame flat, pull strips tight one at a time, and tack temporarily in wide part of frame. Then clamp frame vertically, drive upholstery nails on inside, and remove tacks.

**Cross-webbing** is done same way except that the strips are woven in and out of first ones. Be sure to space strips evenly. Here upholstery nails are being driven before removal of tacks.

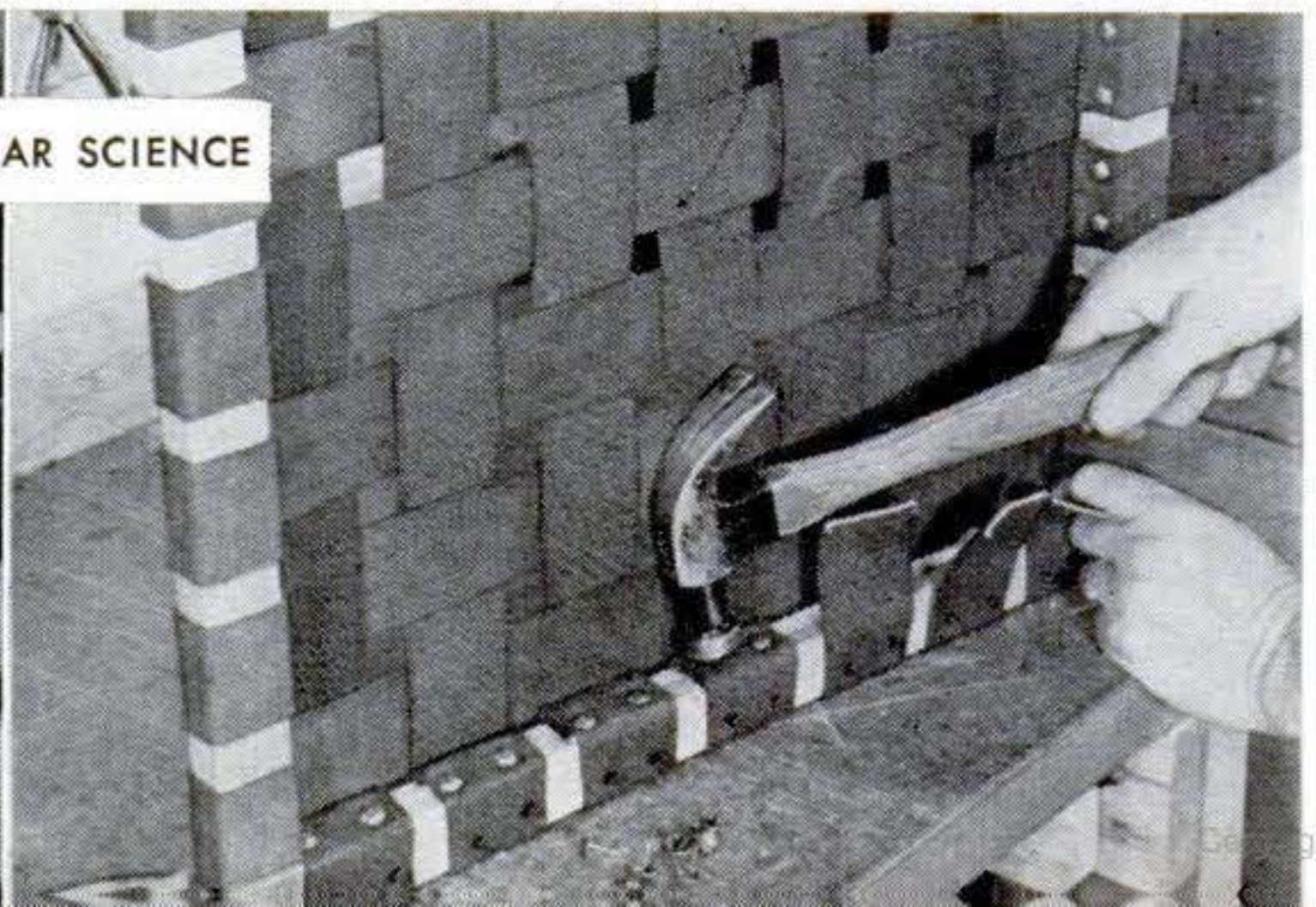
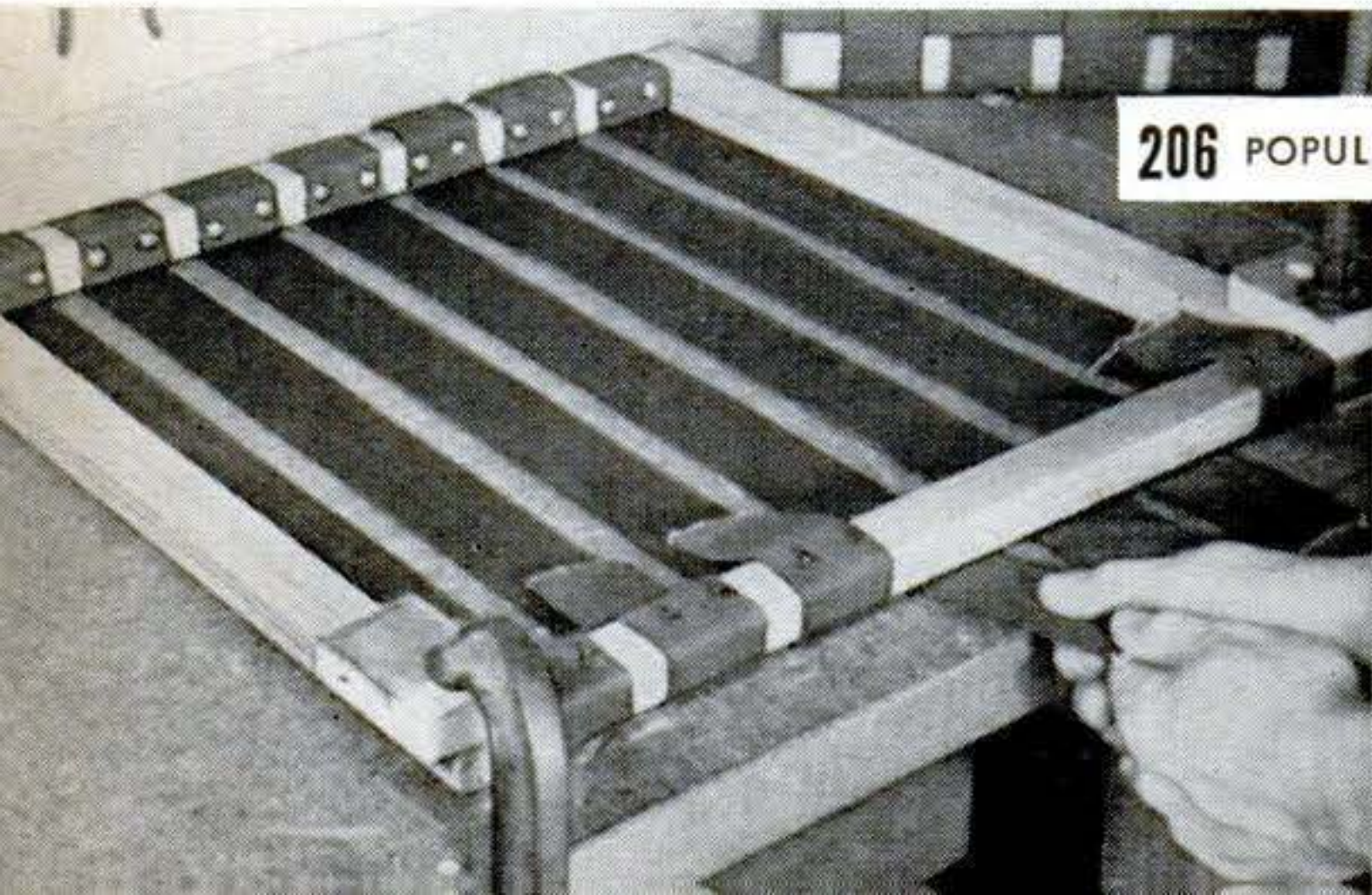



way; and two lower segments with the grain running vertically.

Assemble them with a phenolic-resin glue and keep clamped tightly for 12 hours. After removing the clamps, sand all edges smooth. In cutting the two arms, notice that the notches into which the back frame fits are inclined backward at a 12° angle.

**You can dye the webbing.** For the webbing use 2" heavy white canvas strap with selvaged edges. This canvas can be dyed any desired color with inexpensive dye available in dime stores. You'll need about 66 feet of webbing. Cut it into 28 strips 28" long.

To facilitate the webbing work, make a cardboard rule the same length as the inside of the frame and mark it into seven divisions 2" wide, starting at the end. This can be held next to the frame when the webbing is being attached, assuring accurate spacing.

**What finish?** This is up to you, but remember to apply the final finish to the side and back frames before putting on the webbing. For outdoor use, a spar varnish or enamel does well. For indoors and a really modern job, clear lacquer and wax is the thing.

**Final assembly.** Do this after all units are complete. The seat frame is attached to the top of the structural frame with six 1½" No. 8 wood screws driven from underneath and countersunk; two in front, two in back, and one on each side.

Next the arms go on, held by three screws into the tops of the legs. These screws are also countersunk and plugged with wood plugs matching the arm material. They are later sanded down and the top of each arm given another finish coat. The back is slid down into its arm notches until it rests on the back edge of the seat frame, where it is held by two or three screws driven into the latter.

END

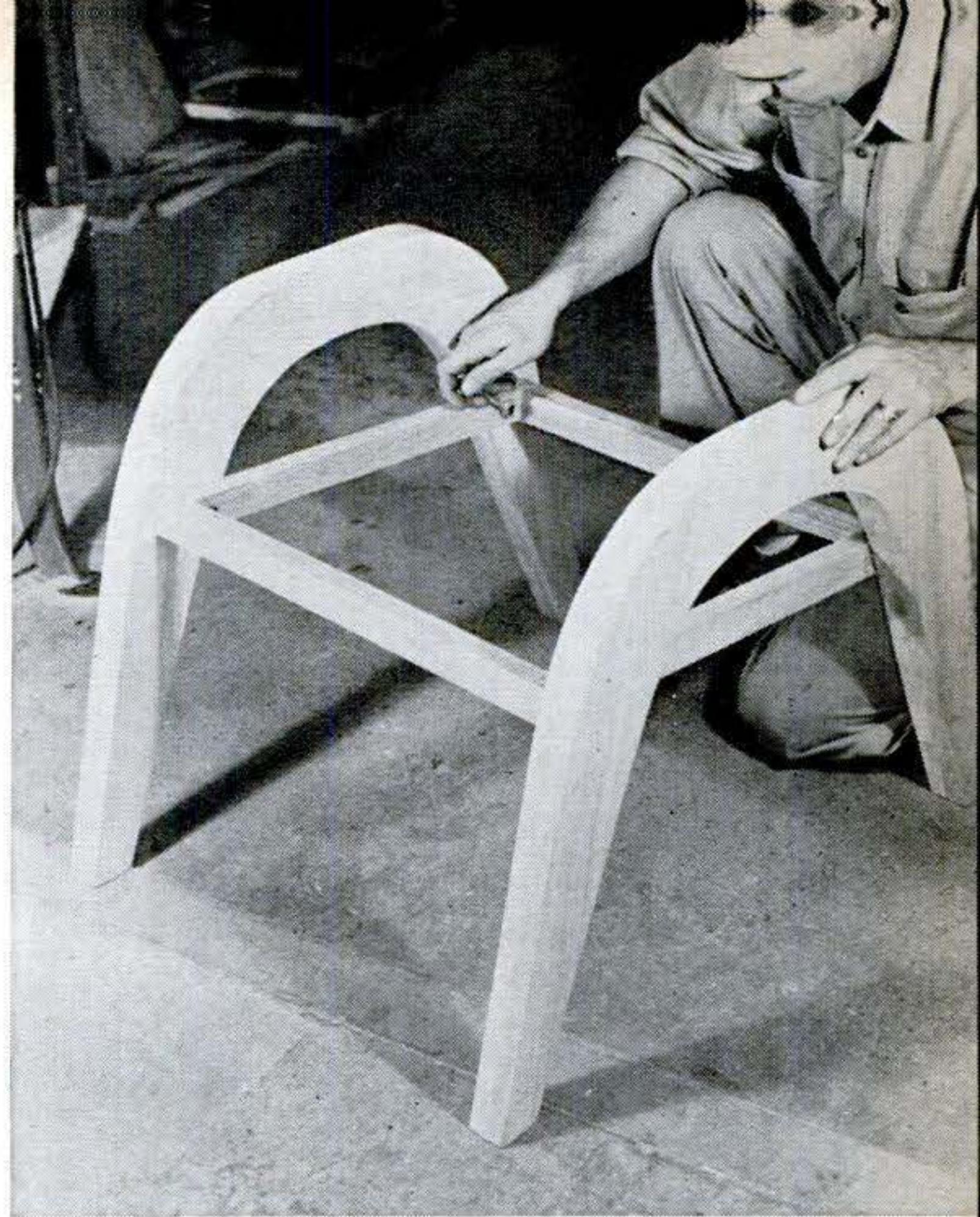

Structural frame is attached to the laminated legs with ¼" by 2" lag screws, placed inside.

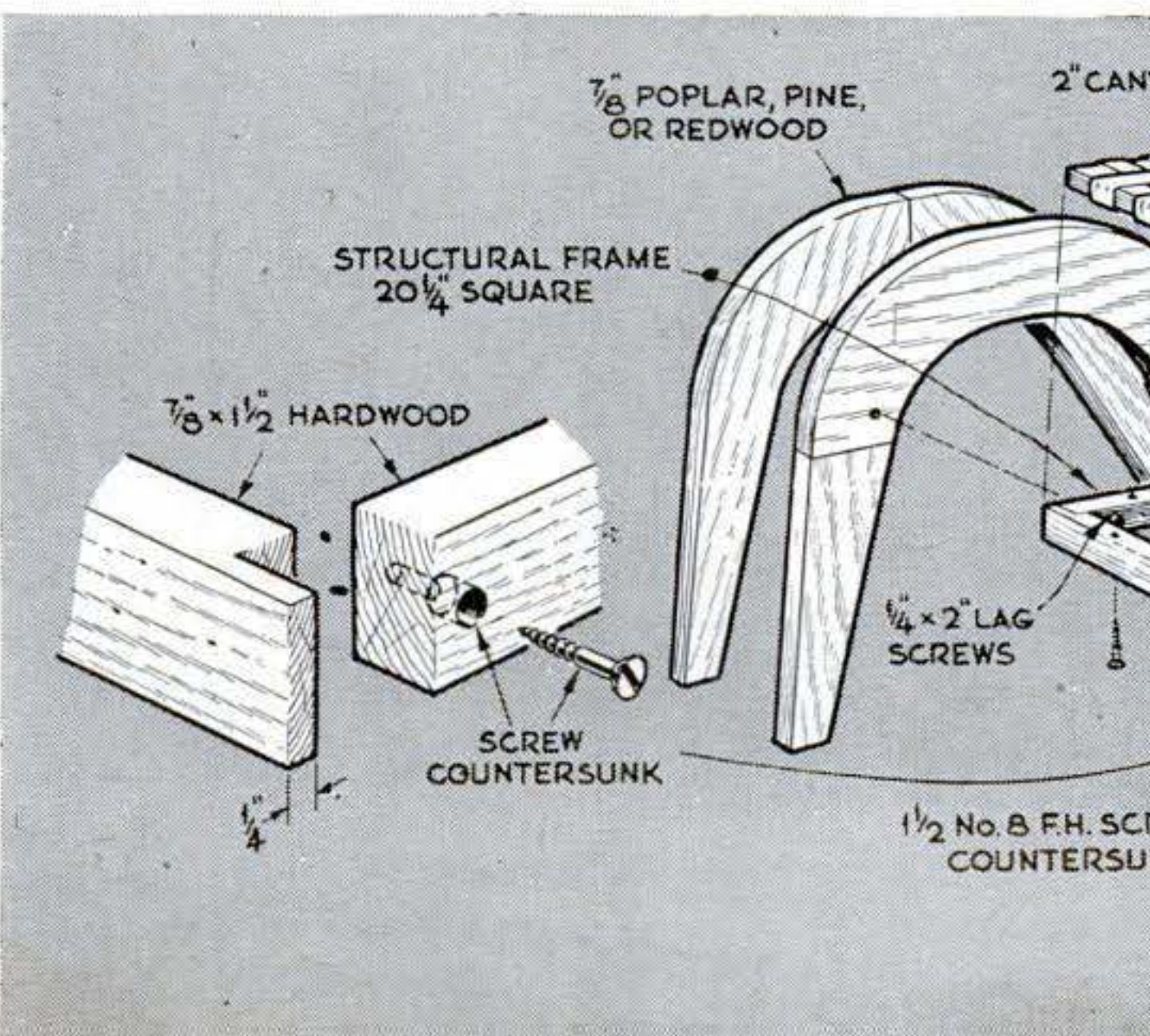
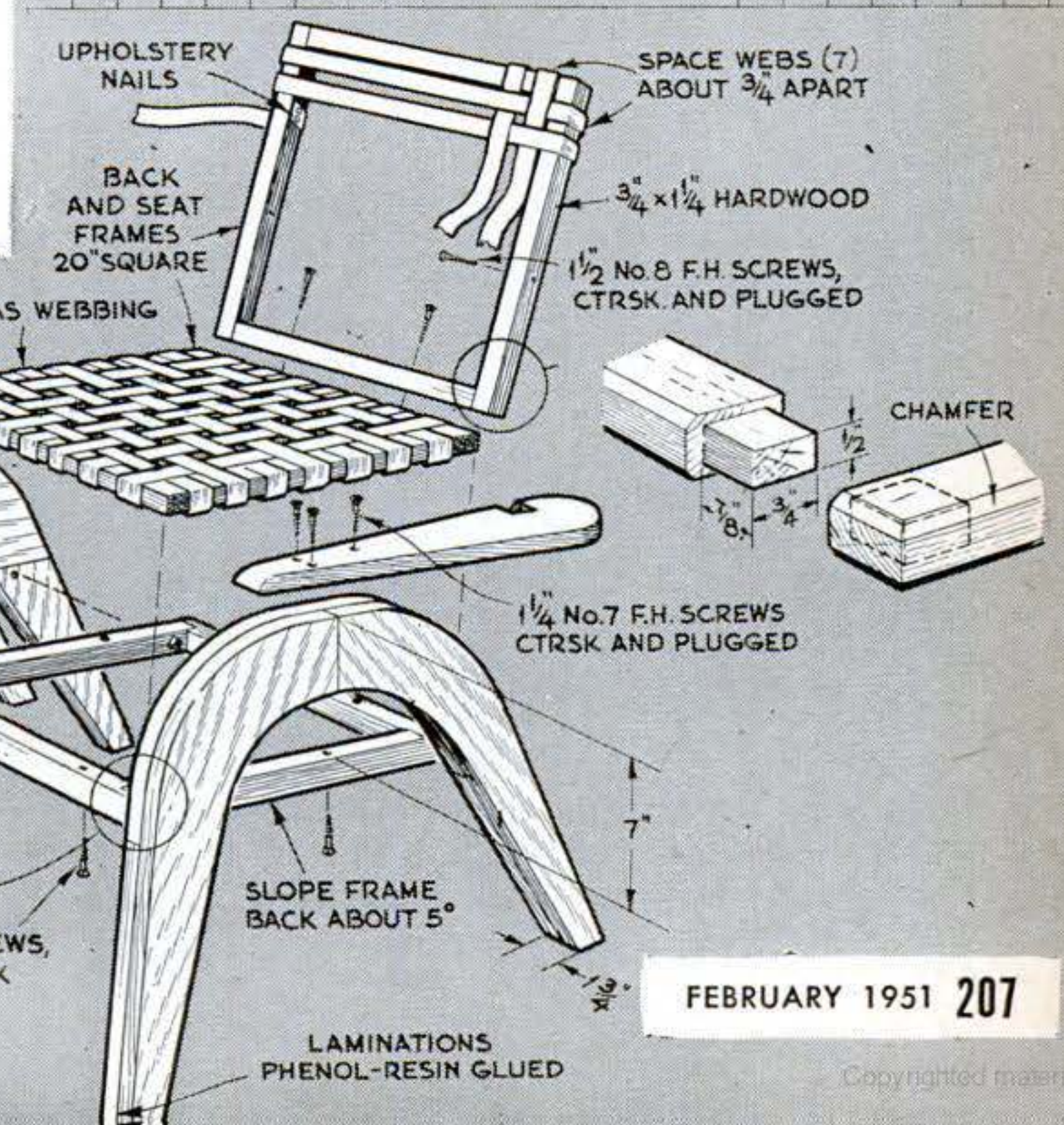
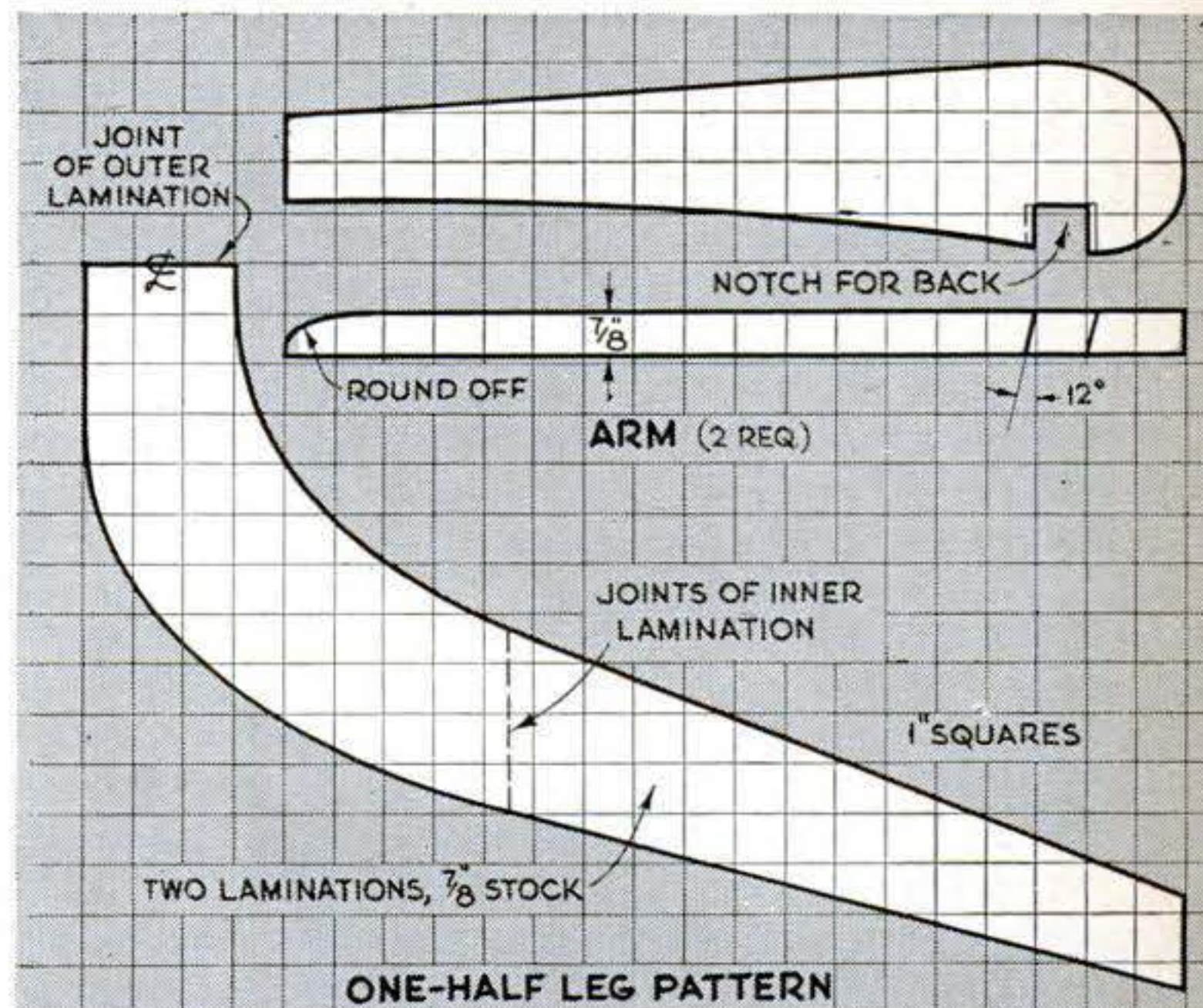

This piece of furniture is easy to build but big and solid enough to be used in many ways.

# Flooring Makes a Fine Table

By Robert Hoppough

Fluted edges of the top and the fluted legs look like shaper-cut parts, but they are really pieces of oak drawer slides.



**T**HERE'S plenty of space on this man-sized table. You can lay out a four-handed card game without crowding and still have room for drinks and ash trays. It's 36 $\frac{1}{4}$ " square—about 400 sq. in. more top

area than the average card table provides.

The handsome top is built of scrap strips of hardwood flooring. The table is big enough and heavy enough to be used in a breakfast room, a dining area, or as a typing table.

Construction is simple. Start it with the top. Cut out a 36" square of  $\frac{3}{4}$ " plywood for the bottom layer. Miter the ends of the four strips of flooring that form the border of the top. Rip the tongue off the edges of these four pieces. Screw and glue three of these border pieces to the plywood square to form a U.

Fit strips of flooring into the U, nailing them to the plywood as shown in a photo on the opposite page. Screw and glue the fourth border piece in place. Miter the ends of some oak drawer slides and nail them around the top.

Use dressed two-by-twos for the legs, sawing them so the top of the table will be 29" from the floor. Nail and glue oak drawer slides to the sides of the legs. This gives them a fluted appearance and matches the oak of the top and the slides around the edges of the top. Fasten the legs to the top

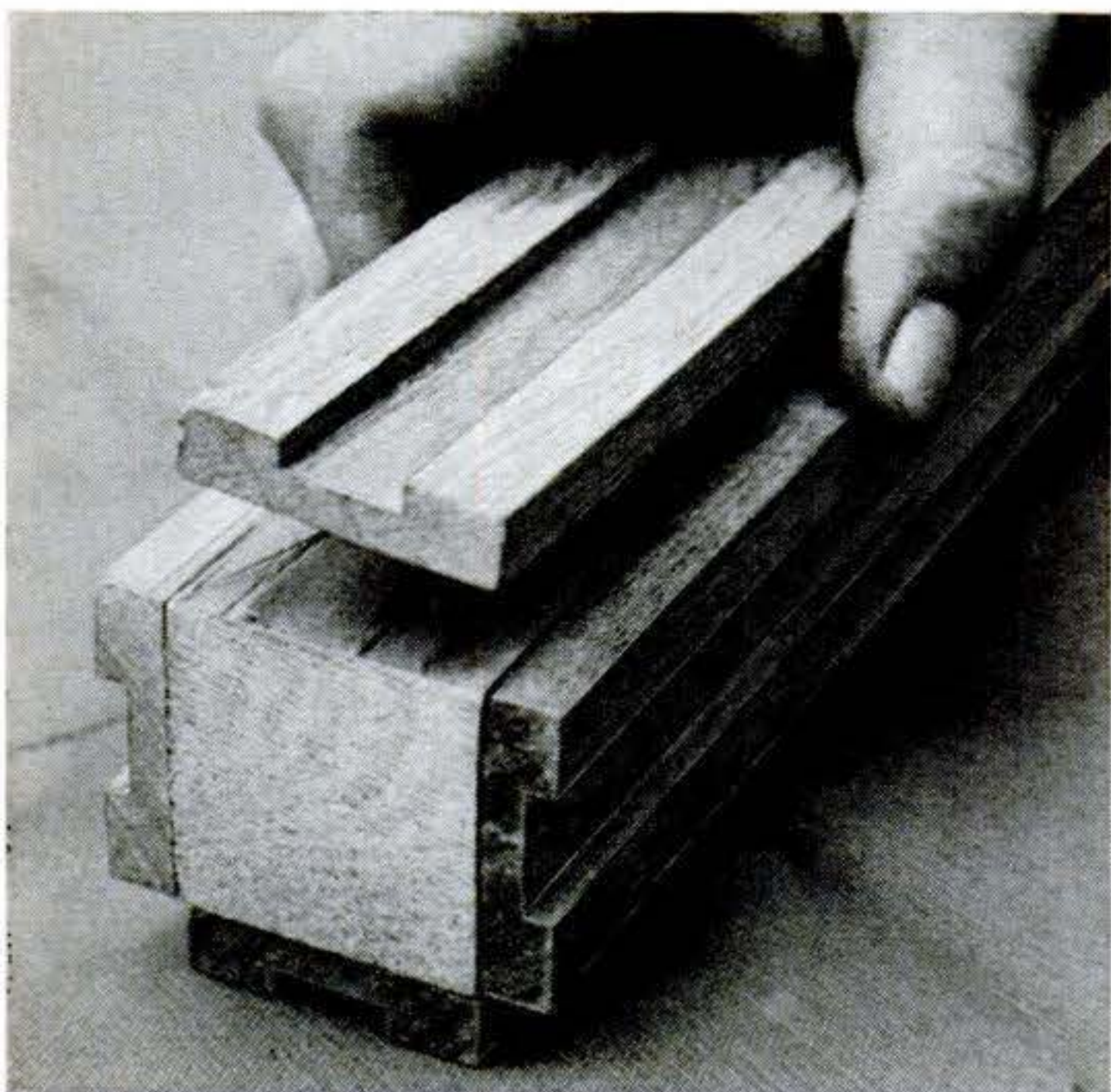

Legs are dressed two-by-twos with lengths of hardwood drawer slides nailed and glued to all four sides. Legs are doweled to table top.

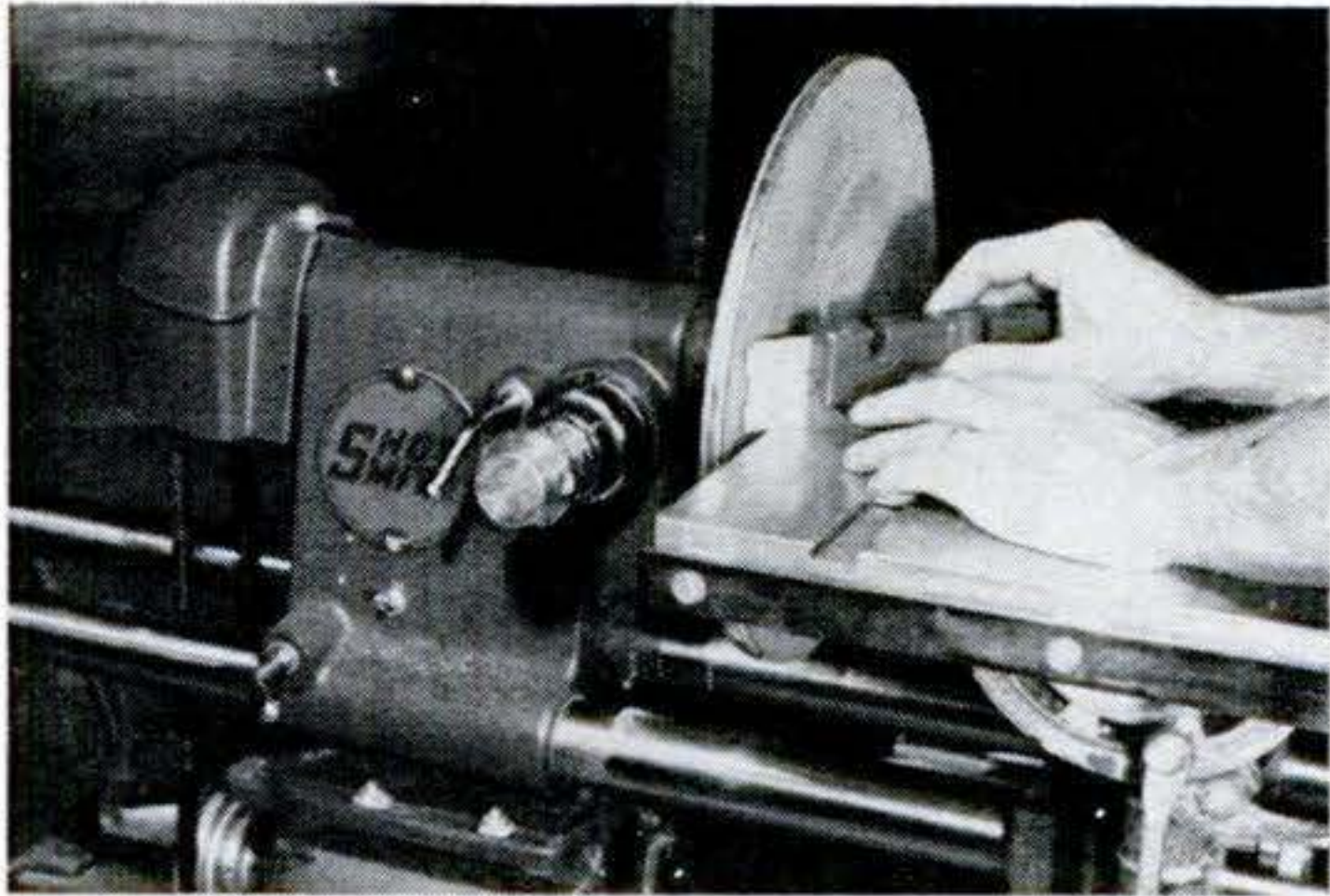

**Disk sander is handy for truing mitered pieces.** Top of legs also should be squared up before you dowel and glue them to the table top.

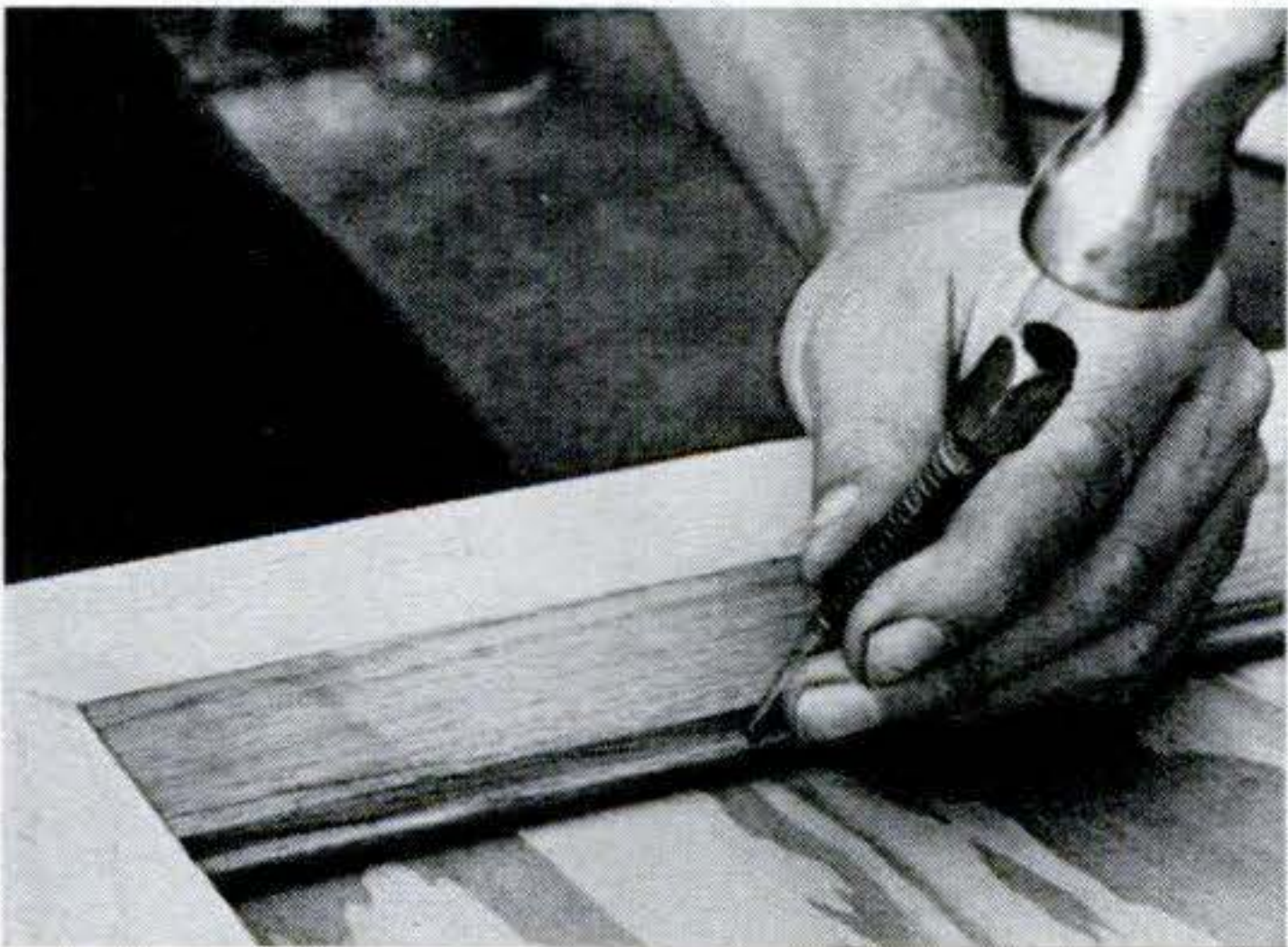

**Drive nails at angle through tongue of flooring.** That way the next strip of flooring will hide nailheads in preceding strip.

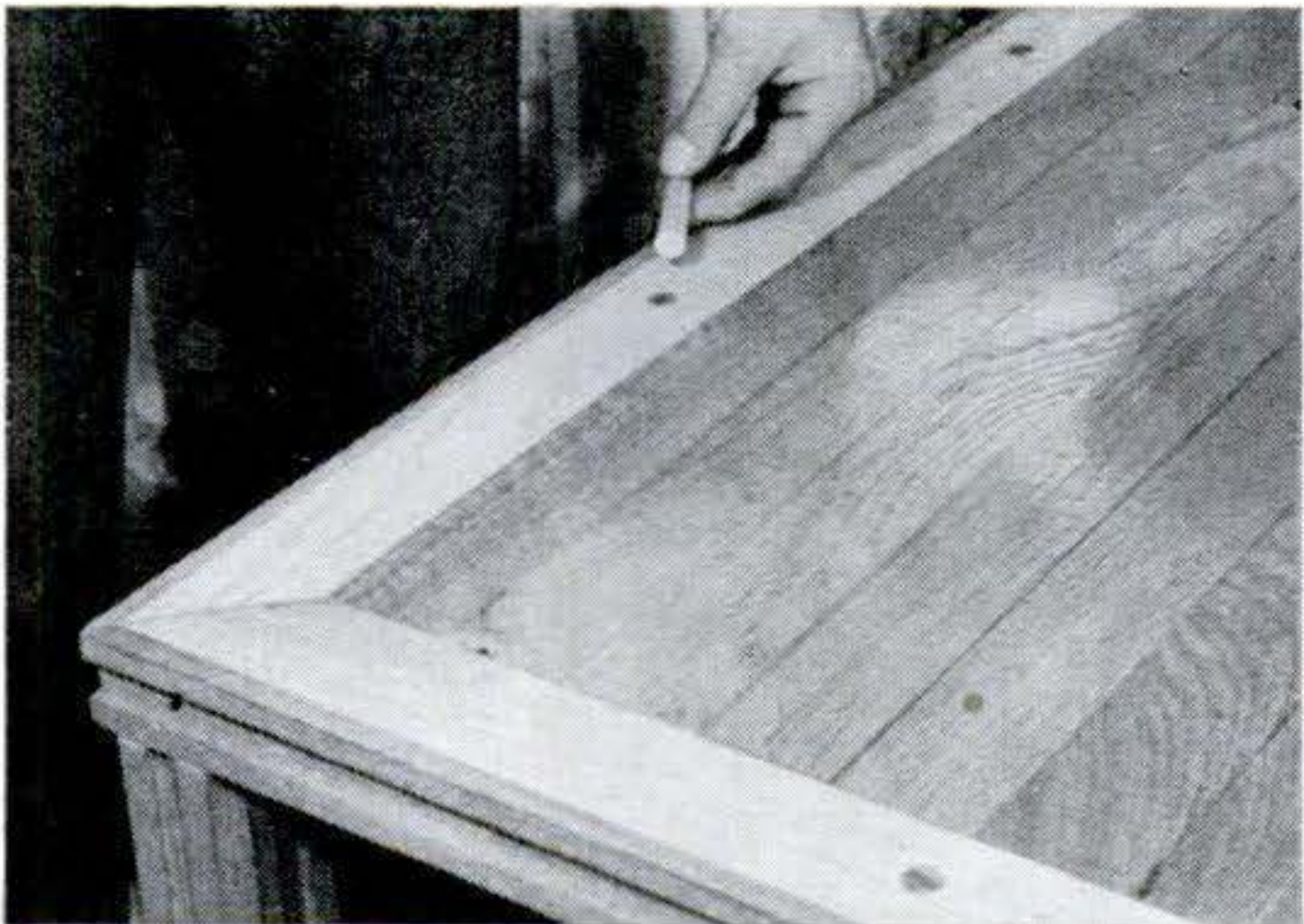

**Counterbored holes for screws that hold border** should be at regular intervals. Then plugs that hide screwheads will form a pattern.

with  $\frac{1}{2}$ " dowels and glue. Add metal angles to strengthen the legs where they meet the top.

Sanding the top may be troublesome because two of the border pieces are at right angles to the other strips of flooring. Masking tape along these edges will aid in preventing cross-grain scratches. **END**

### Shoe Bag Holds Toys on Auto Trips

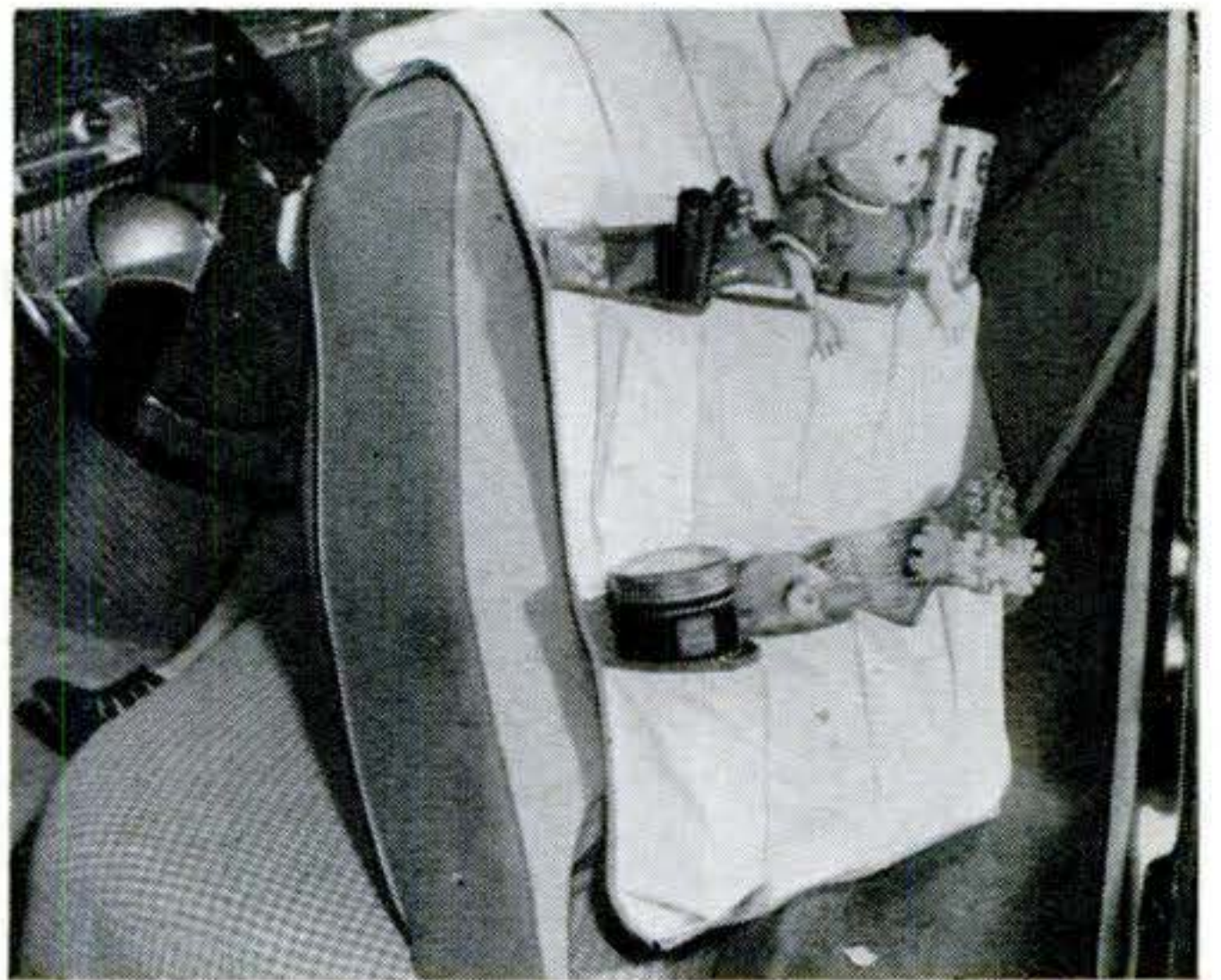

**IF YOU** take a long trip with children in the car, attach a shoe bag to the back of the front seat. It will easily hold a choice of toys to keep the children busy, and a few packages of cookies to tide them over when restaurants are far apart. Tuck in a comb and brush, some cleansing tissues, and a bottle of soapy water and you'll be all set for quick cleanups when necessary.

### Tool Unscrews Ceiling Lamp Bulbs

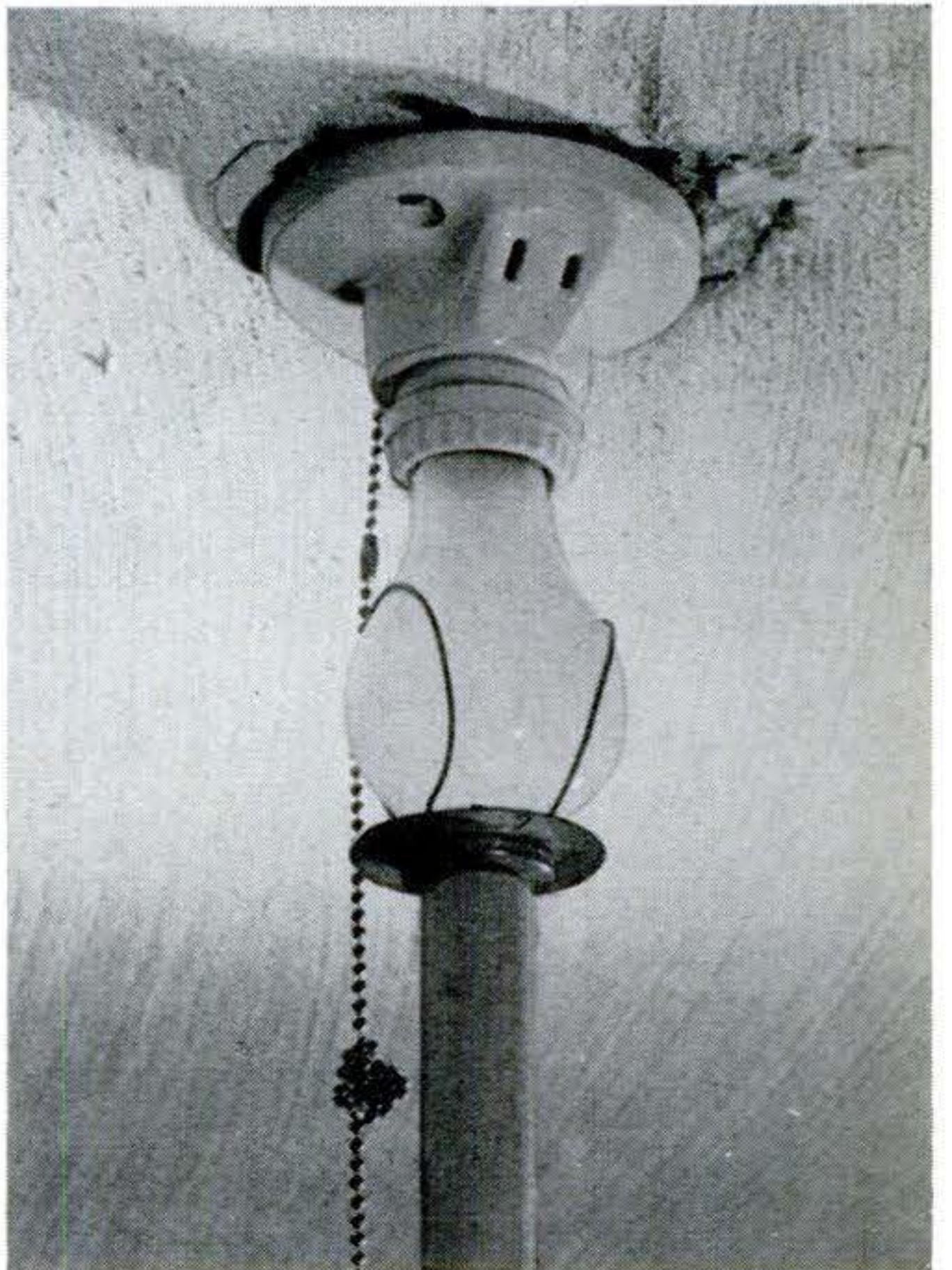

**BASEMENT** and apartment-house light fixtures are often set into the ceiling and beyond reach. The bulbs in such fixtures can be easily removed and replaced with a lampshade adapter, of the type shown, screwed to a long pole.—*Harry Waldron, Yonkers, N. Y.*

# Would a Booster Help Your TV Set?



**You have to try one to tell. But that can be done easily, and the results are sometimes really worth the effort.**

**By Robert Hertzberg**

**I**F YOU are somewhat beyond the "normal" TV range and your pictures are weak . . .

If one station that you especially want comes in poorly . . .

If you are near a transmitter but can't have a roof-top antenna . . .

. . . You should try a television booster.

It may strengthen the faint signals plucked out of the air by your antenna. A booster can be attached to your set in a jiffy. The only tool you need is a screwdriver.

If the booster decidedly improves your

pictures, you are in luck. If the images are still pale and snowy, you're not entirely out of luck; you can try boosters of other makes and possibly find a better one.

There is no way to be sure that a booster will help—except to try one with *your* receiver in *your* home. Recognizing this, many dealers will let you have one on trial. The best boosters cost only about \$30, and a satisfactory one may prove much cheaper than a new set or an elaborate antenna.

Boosters may be roughly classified according to the number of controls that have to be operated. Tunable models require the most adjustment, semi-tunable boosters need somewhat less attention, and the non-tunable need no attention at all. Most non-tunable ones and some of the others have

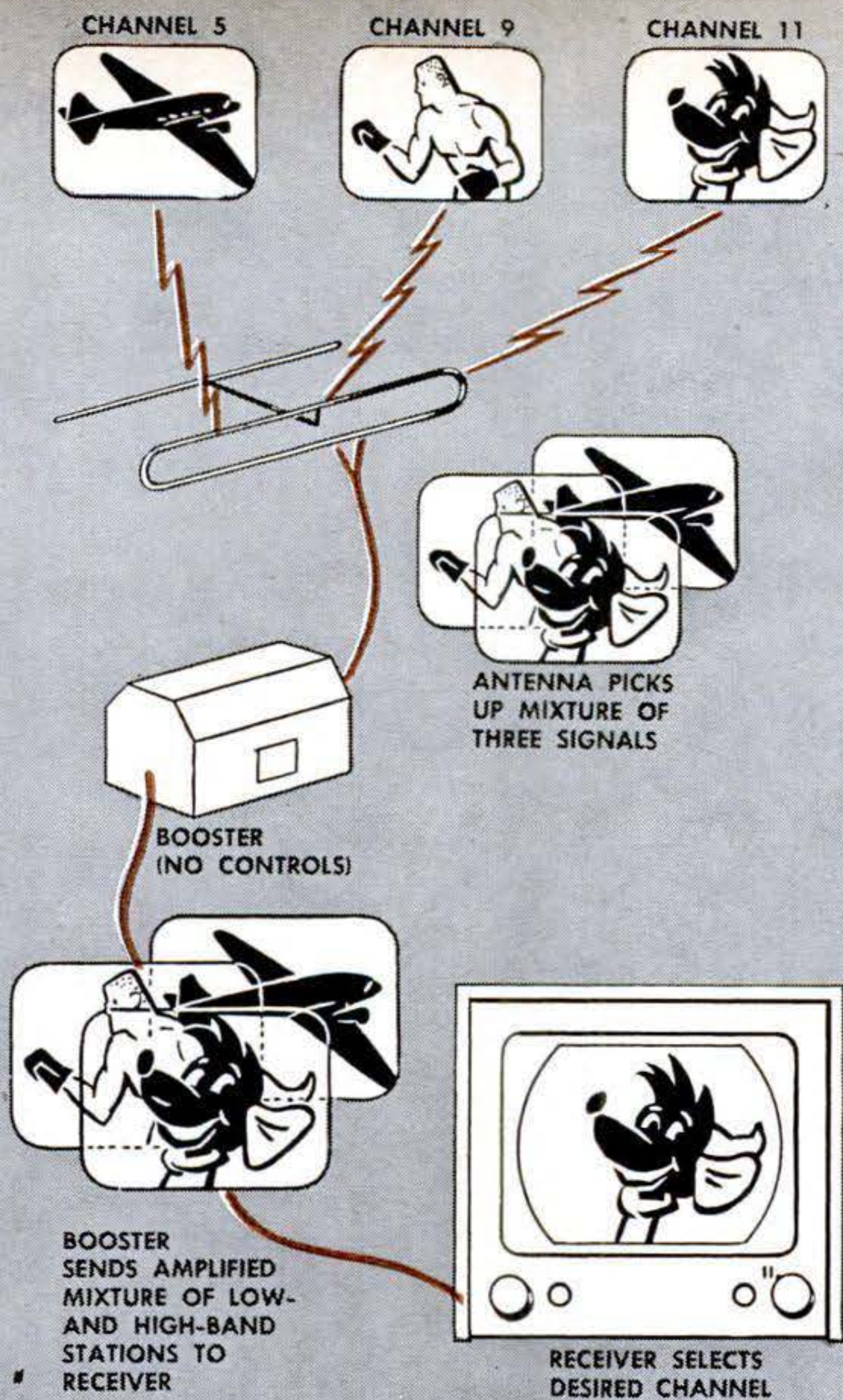

### What a NON-TUNABLE Booster Does

automatic switches that turn them on or off when the receiver is operated. In most of the automatic models the regular on-off switch is linked with an aerial change-over device that cuts the lead-in directly over to the receiver when the booster is turned off.

Generally speaking, the tunable boosters

**Simplest kind of booster** uses only one miniature tube. Others have up to four tubes. Larger models usually contain two separate amplifiers, one for low and one for high band.

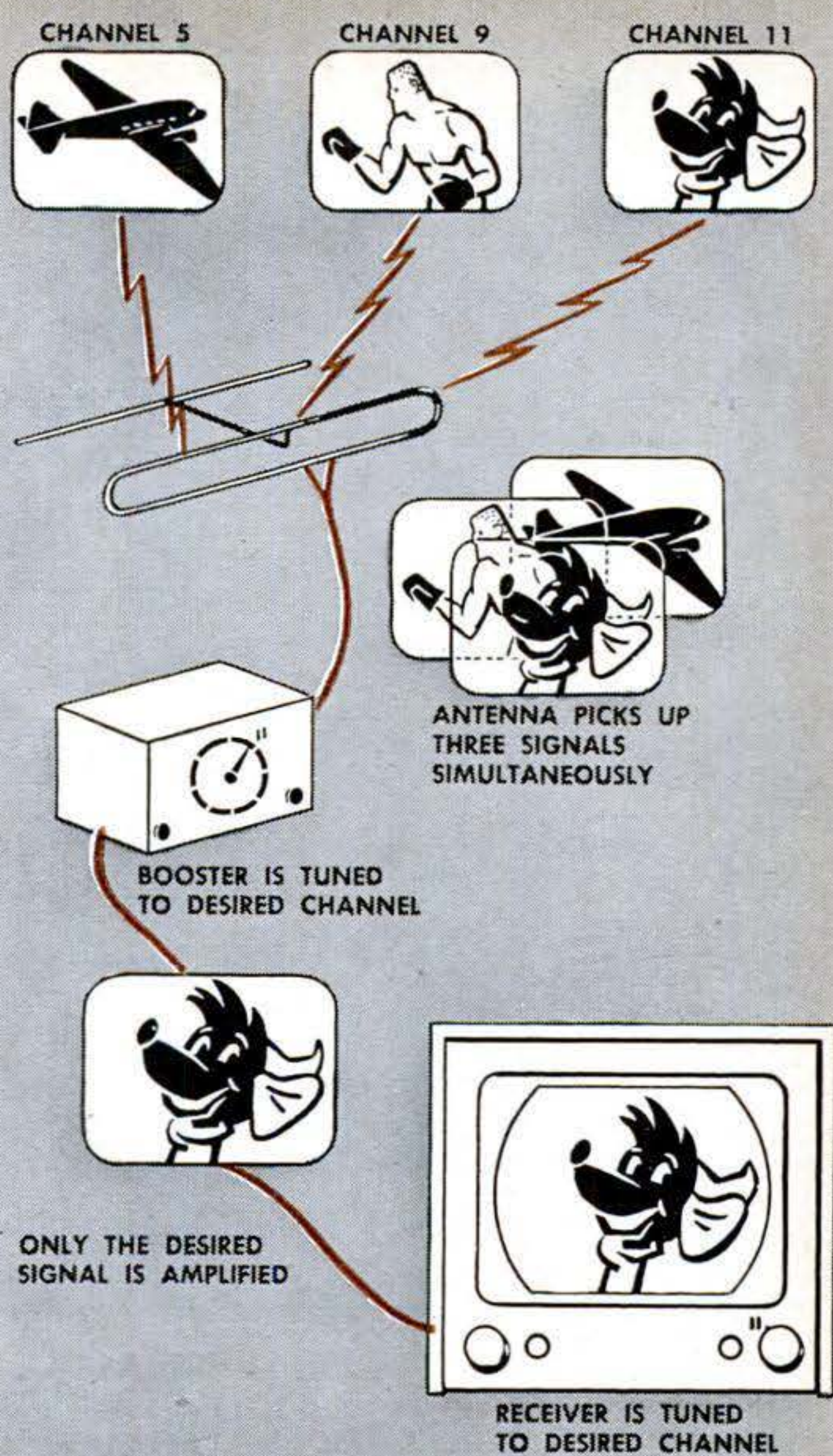

### What a TUNABLE Booster Does

are the best. They not only give the most amplification, tube for tube, but under some circumstances they make the receiver slightly more selective. The semi-tunable type runs second, and the non-tunable third. Among all three types, there is considerable variation in the uniformity of amplification. Most

**Booster is hooked up** by removing antenna leads from set and connecting them to booster's "in" terminals. The "out" terminals are linked to receiver by short piece of lead-in wire.

FEBRUARY 1951 211

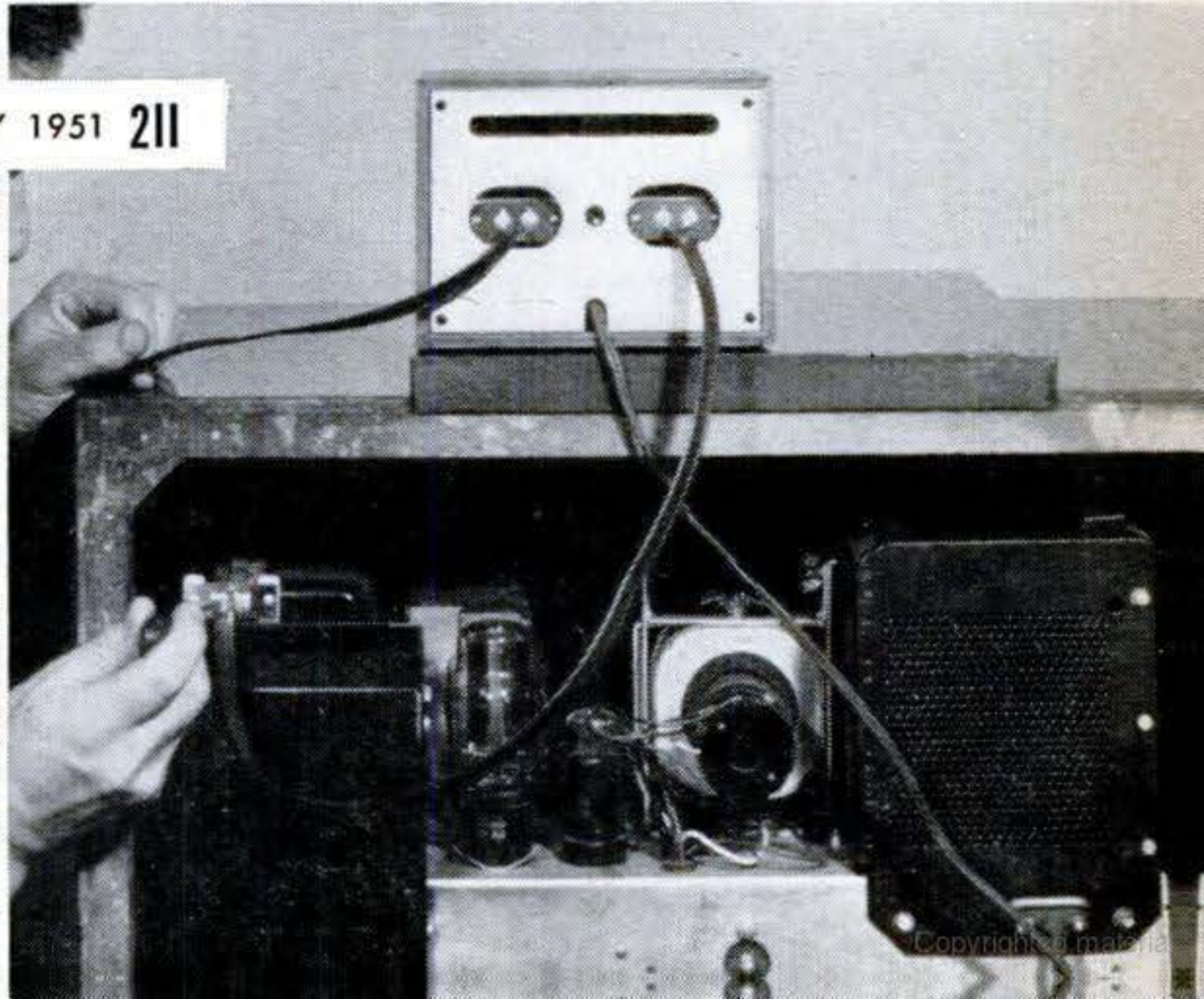
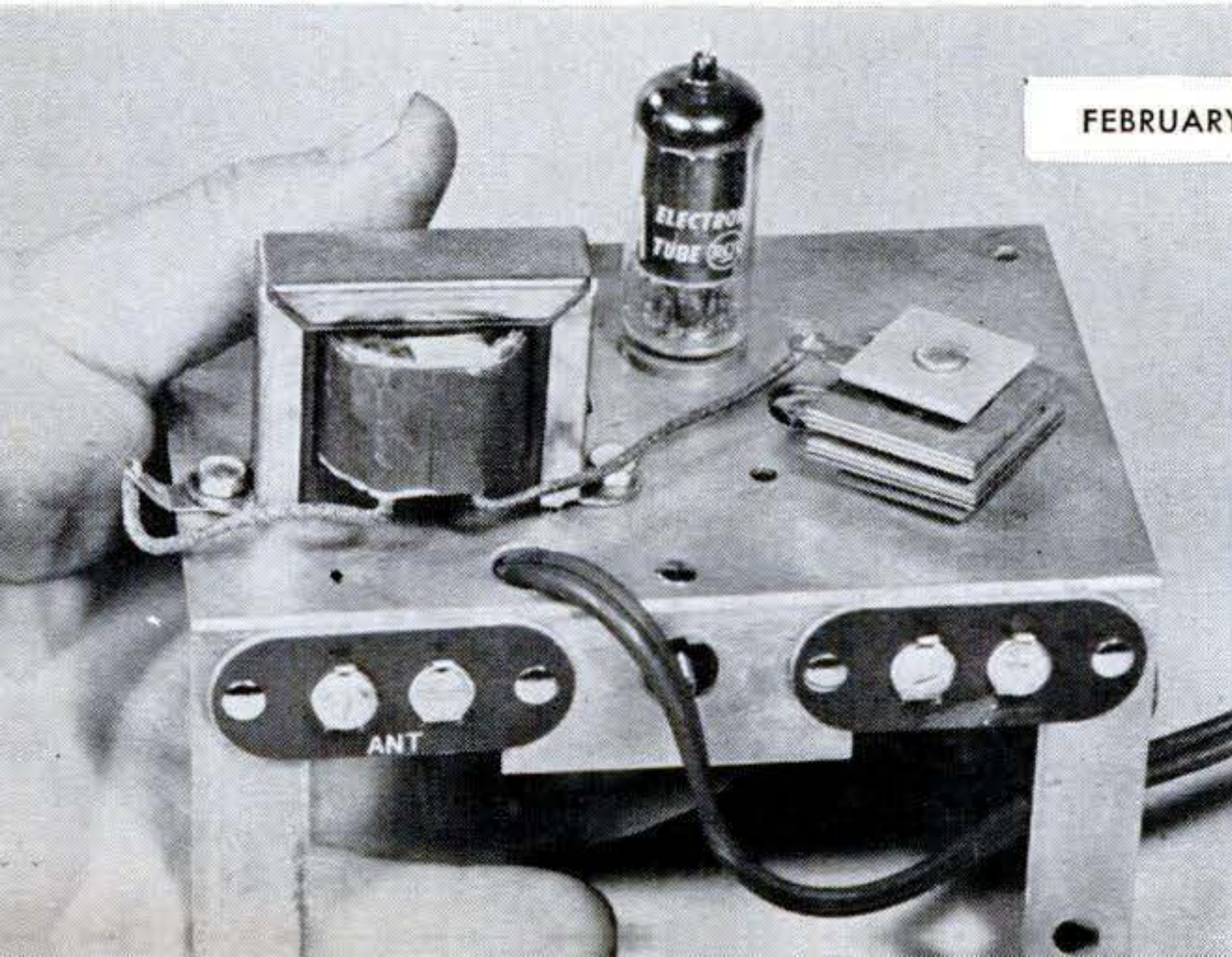



**Tunable boosters** like this generally give most amplification but must be tuned to match set.

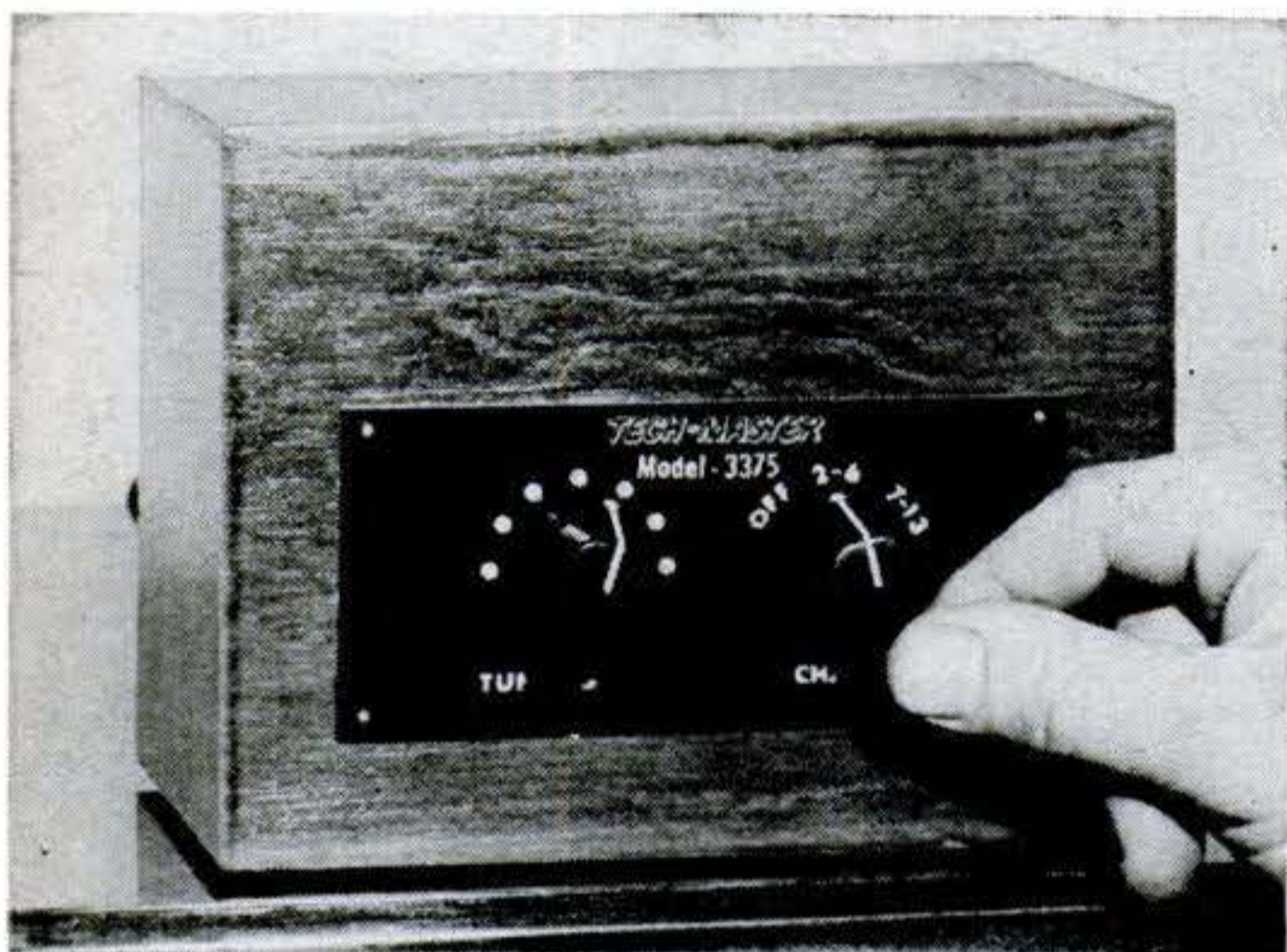

**Semi-tunable type** has switch for high or low band operation plus a fine-tuning adjustment.



**Non-tunable booster** requires no adjustment. Automatic switch makes it easiest type to use.

### Color Need a Boost?

If you need a booster now, you'll need one at least as much to receive colorcasts. In the CBS method, the illusion of color is created by means of a revolving disk composed of red, blue, and green filters. These filters hold back part of the light, so the image on the picture tube has to be pretty bright before the filters are brought into play. A booster may make the difference between gloomy shades and bright color.

boosters are better on the low bands than on the high. The same is true, for that matter, of TV receivers.

A booster also may improve your neighbor's reception by eliminating interference that is generated in your set and radiated by your aerial. A booster, connected between an offending receiver and its antenna, acts as a buffer and prevents the energy from getting out to bother others.

A factor that limits the amount of useful amplification you can squeeze out of boosters is "noise" due to electronic agitation in tubes and to other obscure sources. This shows up on the screen as irregular splotches and may spoil the "boosted" picture.

One non-tunable booster is unusual in that it is designed for mounting on the roof, close to the aerial itself. It is being used even in strong-signal areas where the down lead from the antenna unavoidably passes close to electrical devices that cause interference.

If a booster is placed near the receiver, it amplifies both the video signals and interference. But when placed between the top of the lead-in and the antenna, it amplifies the video signals but not the interference picked up by the lead-in.

*The "best" booster is the one that gives results with your set.*

If one booster amplifies signals to a certain degree, will two boosters in tandem work twice as well? A man in Pennsylvania is using this unorthodox combination with a classy antenna atop a 75-foot mast. He enjoys fairly regular reception on ten channels, including five stations that are more than 1,000 miles away!

END

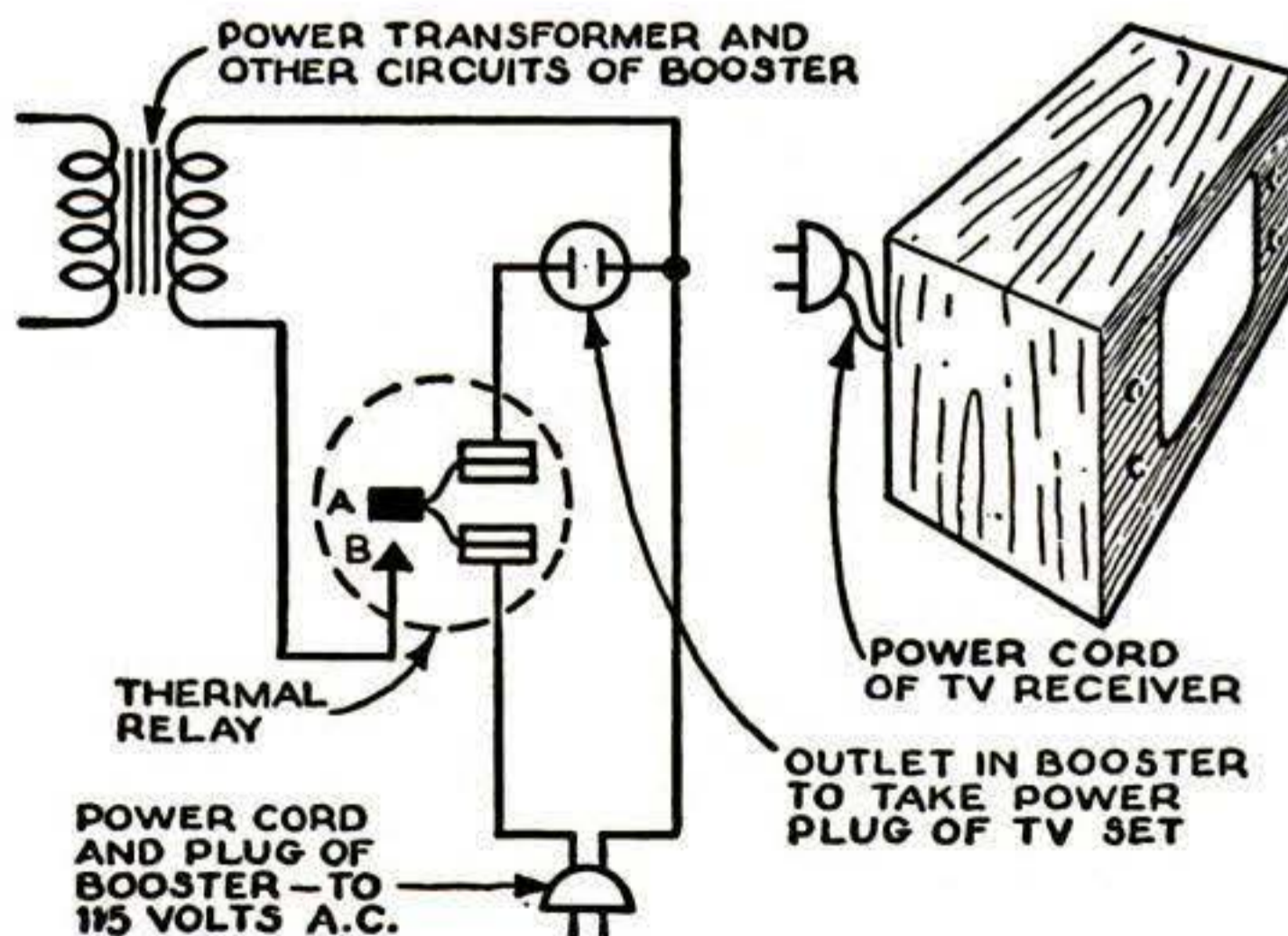

**Typical automatic switch** uses thermal relay. Contact arm, normally at A, allows current to reach receiver. When set is on, contact heats up, snaps over to B, and turns on the booster.

## Inner-Tube Strips Keep Boat Cushions From Slipping

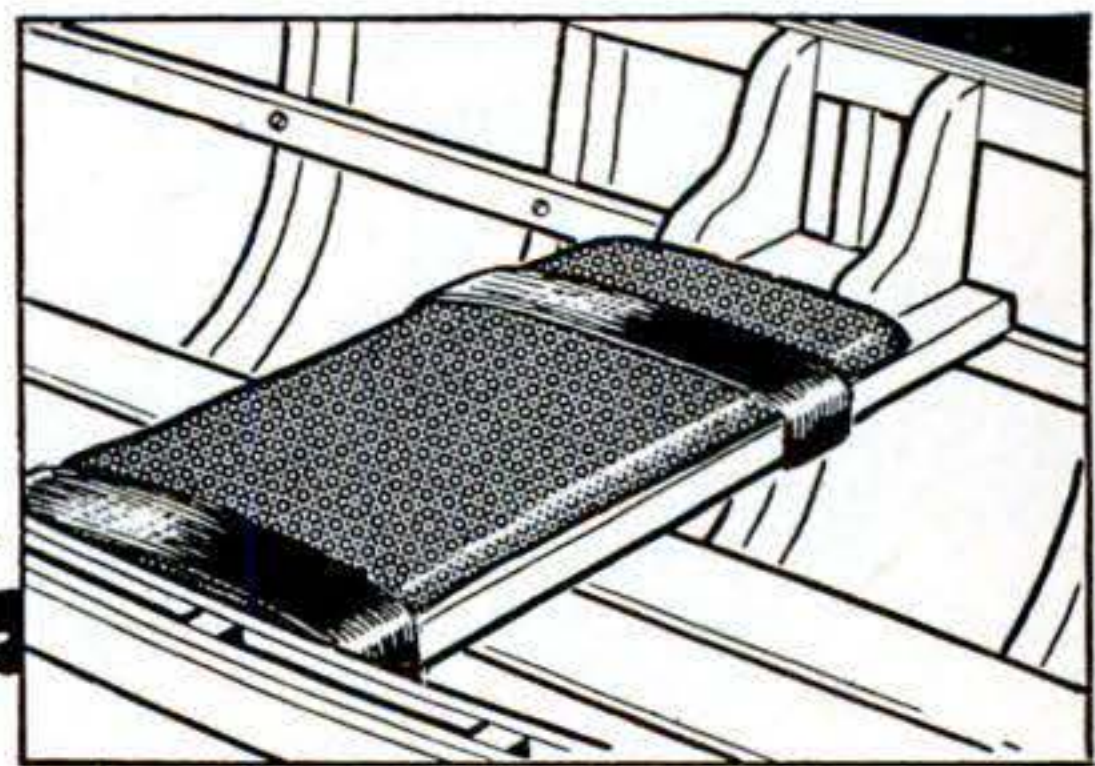

**TACK** a couple of pieces of rubber cut from an old inner tube across the seats of your boat. Slip the cushions under the strips of rubber and the cushions can't slide off the seats.—*E. Dzus, Prince Albert, Sask., Can.*

## Tinning Paint Speeds Soldering

Low-cost tinning of metal surfaces is a simple matter with this tinning paint. After old paint or other coats are removed from the metal, a coat of the tinning paint is brushed on. Heat is applied—usually with a torch—until the paint bubbles and turns brown. Then the surface is wiped with a cloth, leaving a tinned area to which solder will adhere. The paint, sold by Swiss Laboratory, Cleveland, Ohio, also can be used to tin welds. A 1-lb. can sells for \$1.75.

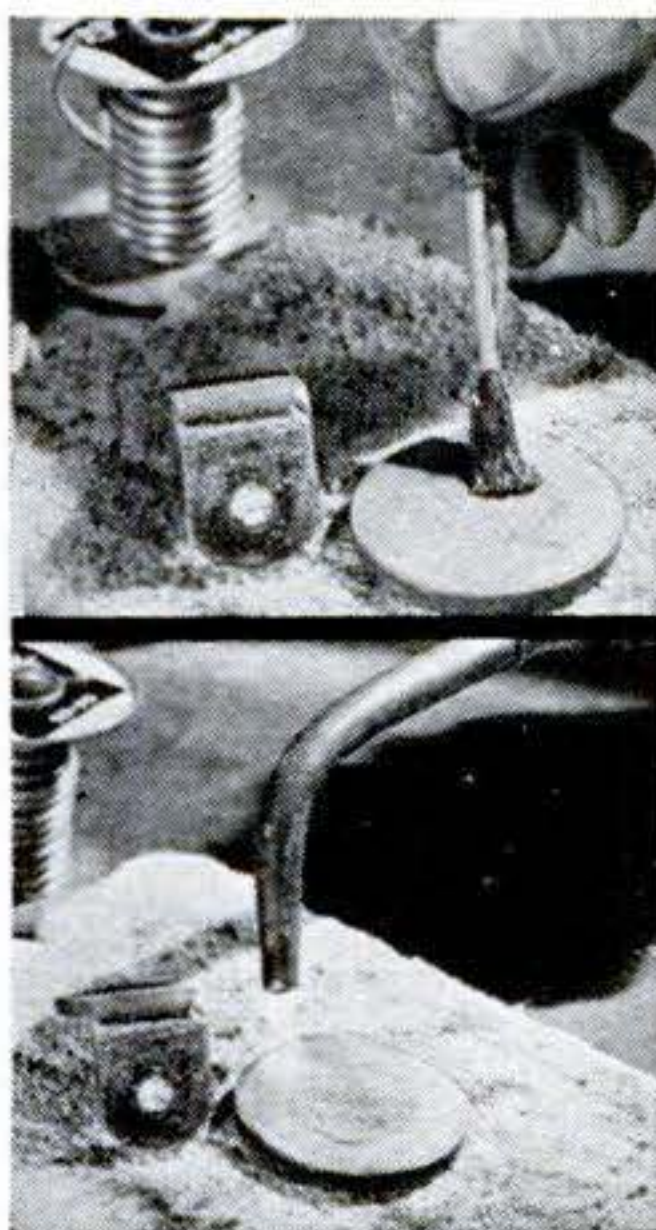

## Rubber on Hammer Saves Woodwork

WHEN you're working in close quarters, the hammer's claw sometimes mars nearby woodwork. You can prevent this by padding the claw with a piece of sponge rubber. Hold the rubber in place with a rubber band.—*Bess Ritter, Yonkers, N. Y.*

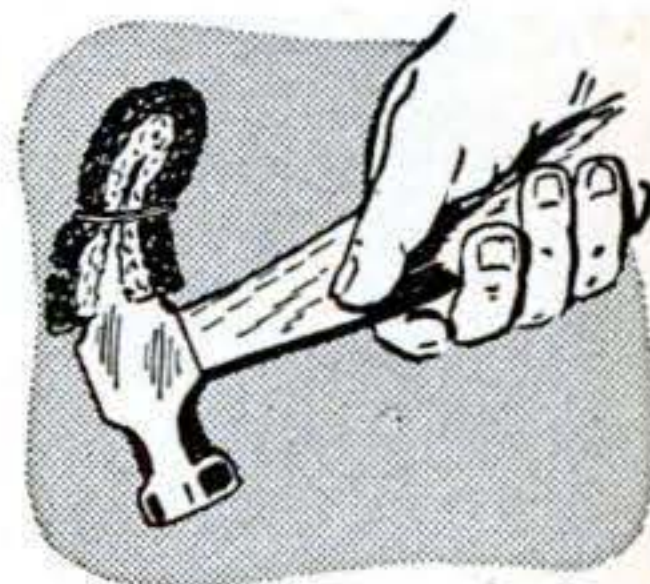

## Magnet Replaces Spring in Valve

A TINY Alnico magnet built into this check valve is said to eliminate all pressure drop in the flow of fluid. A conventional spring-loaded valve exerts maximum back pressure when held wide open, but in this unit the magnetic attraction on the disk

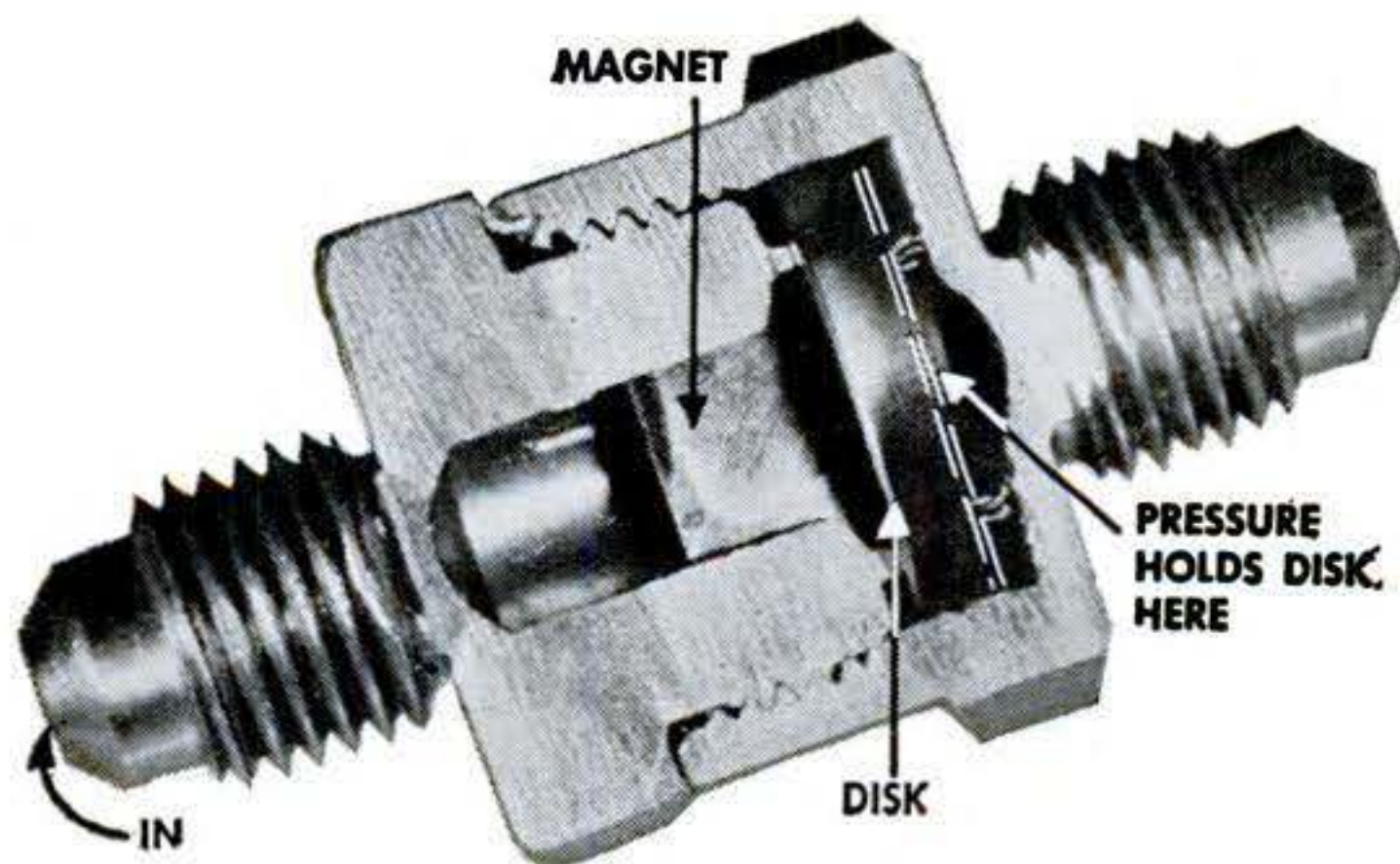

falls away to almost nothing as the disk is forced away from the magnet. Magni-Chek is made especially for use in freon and sulphur-dioxide refrigerator systems by Wagner Tool and Supply Corp., Long Island City, N. Y. Only  $\frac{7}{8}$ " in diameter and  $2\frac{1}{4}$ " long, it can be installed in any position.

## Rolling Out the Screen Wire

A PAIR of roller skates bolted to a counter bottom side up makes it easy to roll out screen wire for measurement at the C. J. Harris Lumber Company, Washington, Mo. You just lay the roll on the skates and pull.

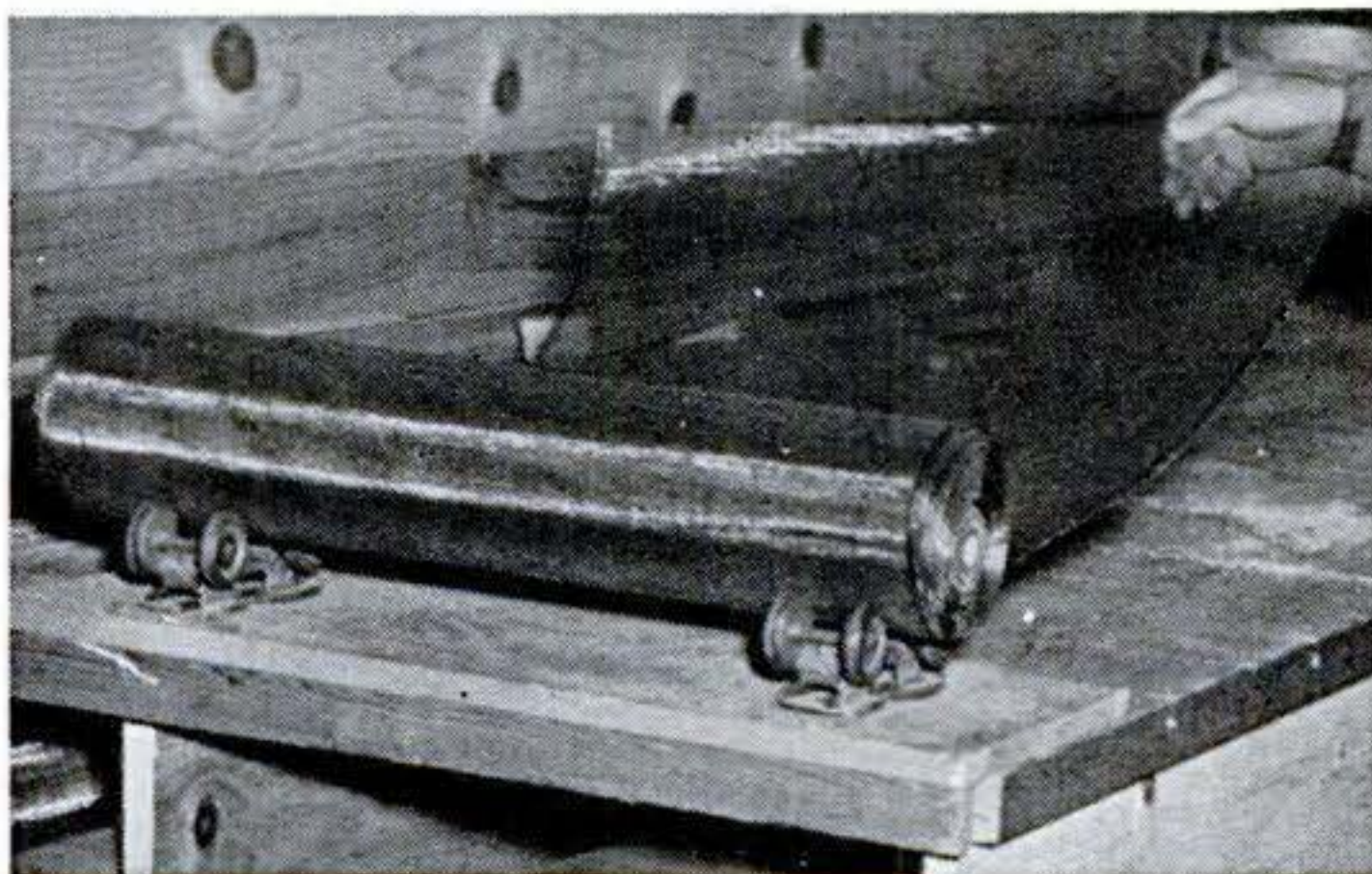

**THESE PHOTOS WERE  
SHOT AT RINGSIDE**



**Press photographer.** Matty Zimmerman, AP cameraman, leans under the ropes to picture Janiro-Graziano fight, below.

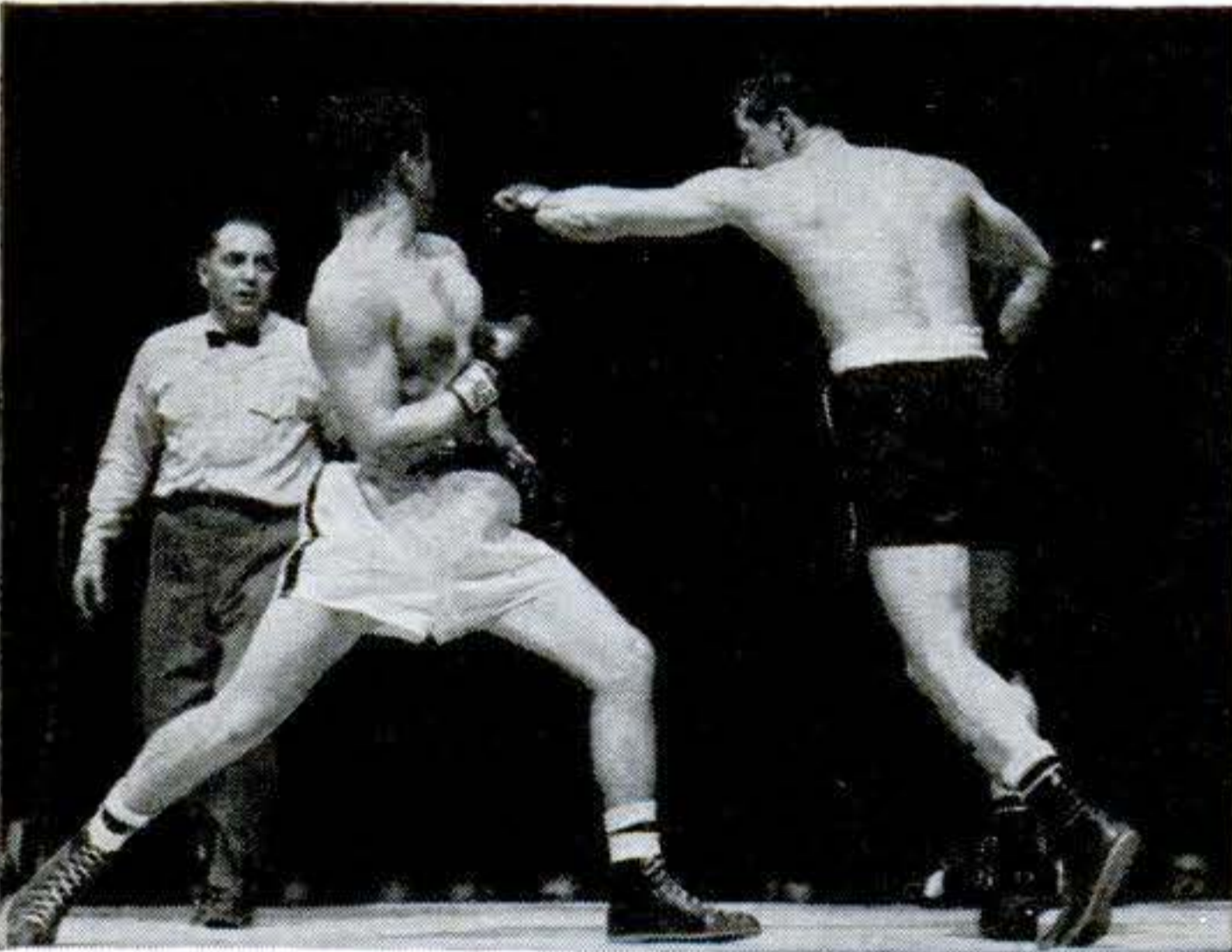

# How You Can the Fights

**Like a ringside cameraman, you must anticipate the action. For best results, shoot at 1/50 sec.—and overdevelop.**

**By R. P. Stevenson**

**N**EXT time you watch a prize fight on TV, keep one eye on the edge of the ring, and you'll occasionally see a newspaper photographer push his camera under the ropes to snap a picture.

What these men do at ringside, you now can try at home—on TV. The pictures you get may not have all the zing of ringside shots but they'll be surprisingly good.

Shooting fights is a little more tricky than other types of TV photography. For one thing, you must try to beat the fighters to the punch with your shutter finger—just as news photographers do.

**Listen to an expert's opinion:** "You can't wait until you see a fighter land a blow," says Mathew Zimmerman, an Associated Press photographer who has shot many standout photos during his dozen years as a ringside specialist. "You've got to outfigure the fighter. You must shoot your pictures in that split second when the action is in the windup stage, so you'll record it when it happens."

You may have seen Matty during fights telecast from Madison Square Garden. At





# Photograph Via Television

ringside he always has the same position—the left corner opposite the TV camera.

“The experienced photographer knows his fighters, and their style of fighting,” Zimmerman adds. “He knows pretty well when to expect the jabs, hooks, crosses, and uppercuts. He *has* to know if he is to get good action pictures.”

At ringside, a press photographer shoots with overhead speed lights focused on the ring. When he trips the shutter, these throw a brilliant flash lasting only about 1/5,000 of a second. It is this flash, and not the shutter, that “freezes” the action of the fast-moving fighters.

**TV requires slow speeds.** As you sit before your TV set, with your camera rigidly supported on a tripod, you can't, of course, resort to such superspeeds. The nature of the television image itself limits your shutter speeds to the lower brackets. But to stop the action, you obviously want to shoot as fast as possible.

Ever since television came along, photographers have been advised not to shoot faster than 1/25 second. The reason? It takes 1/30 second for each image to develop fully. Hence, at any shutter speed faster than 1/30 second your photo would show an image that lacks some scanning lines.

But shooting at 1/25 second did not satisfy Bill Morris, chief photographer of



**TV photographer.** Bill Morris, of POPULAR SCIENCE, shows you how. His photos below are of same fight shown opposite.

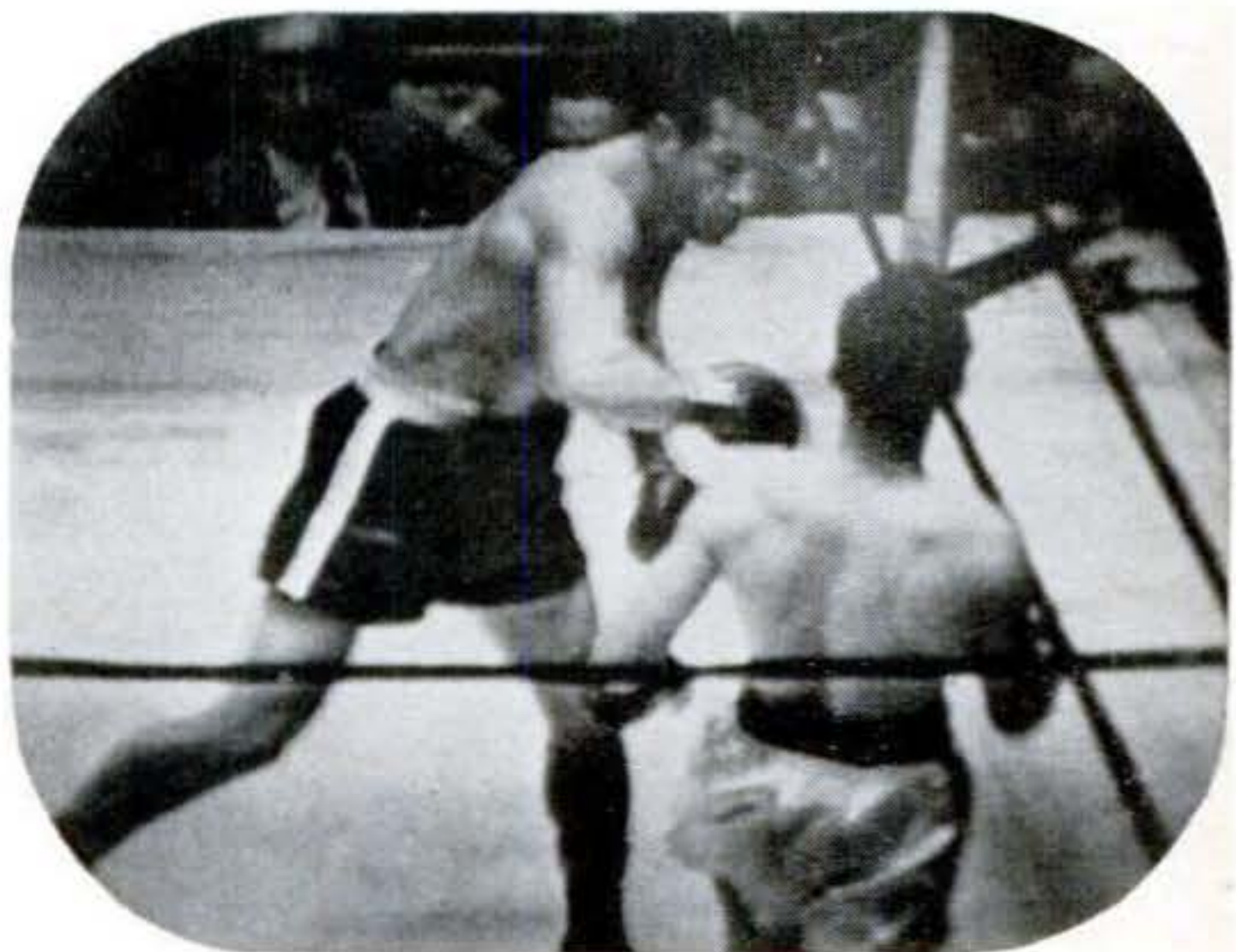

## How images are produced on your television set.

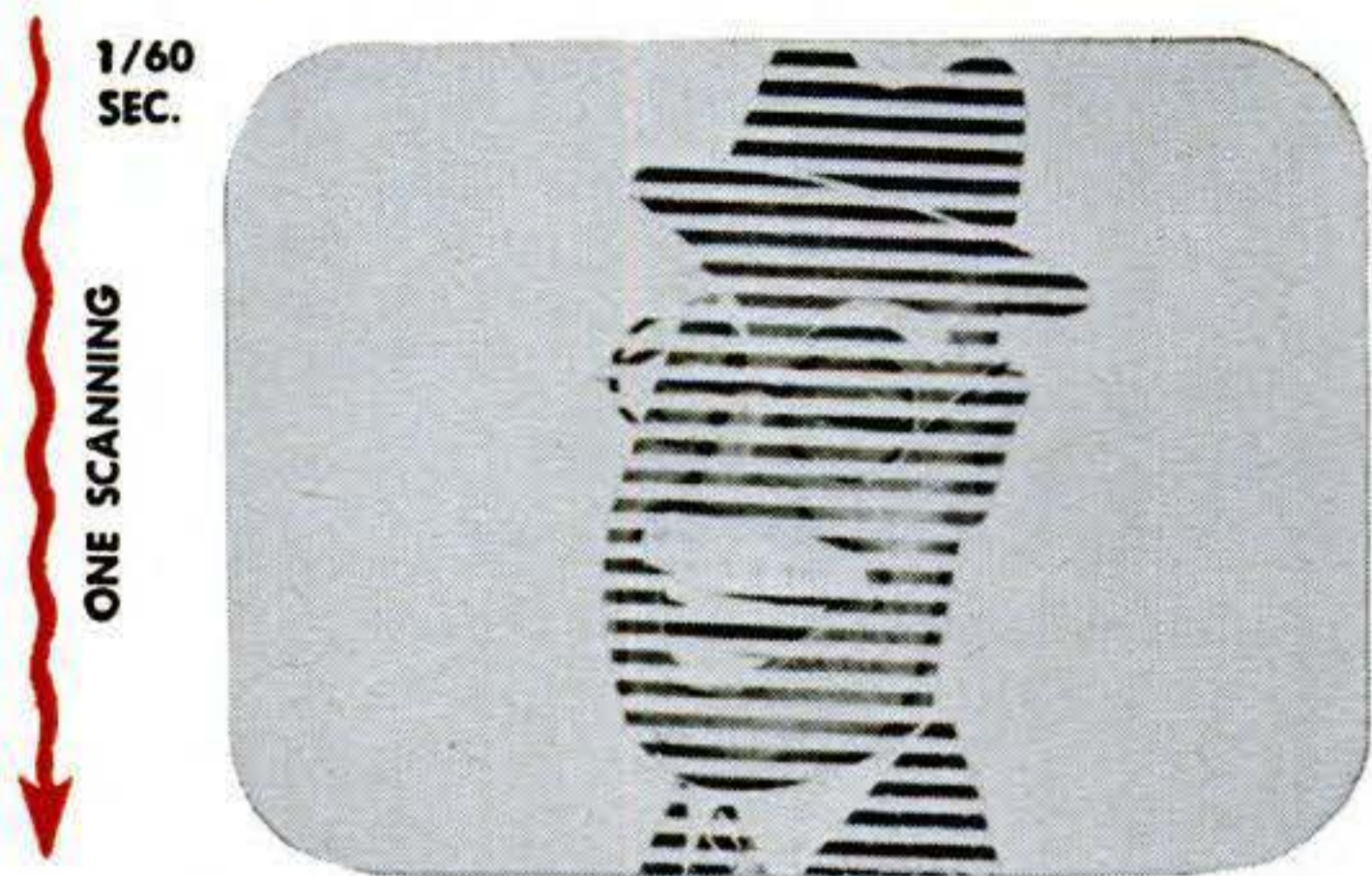

Each  $1/60$  second the scanning beam, a pin point of light, moves in slanting zigzag lines from top to bottom of tube. This produces a "field." As it moves, the beam momentarily records an image made up of tones ranging from black to white. In a single field, your eye could see a recognizable image, but with spaces between lines picture would be incomplete.

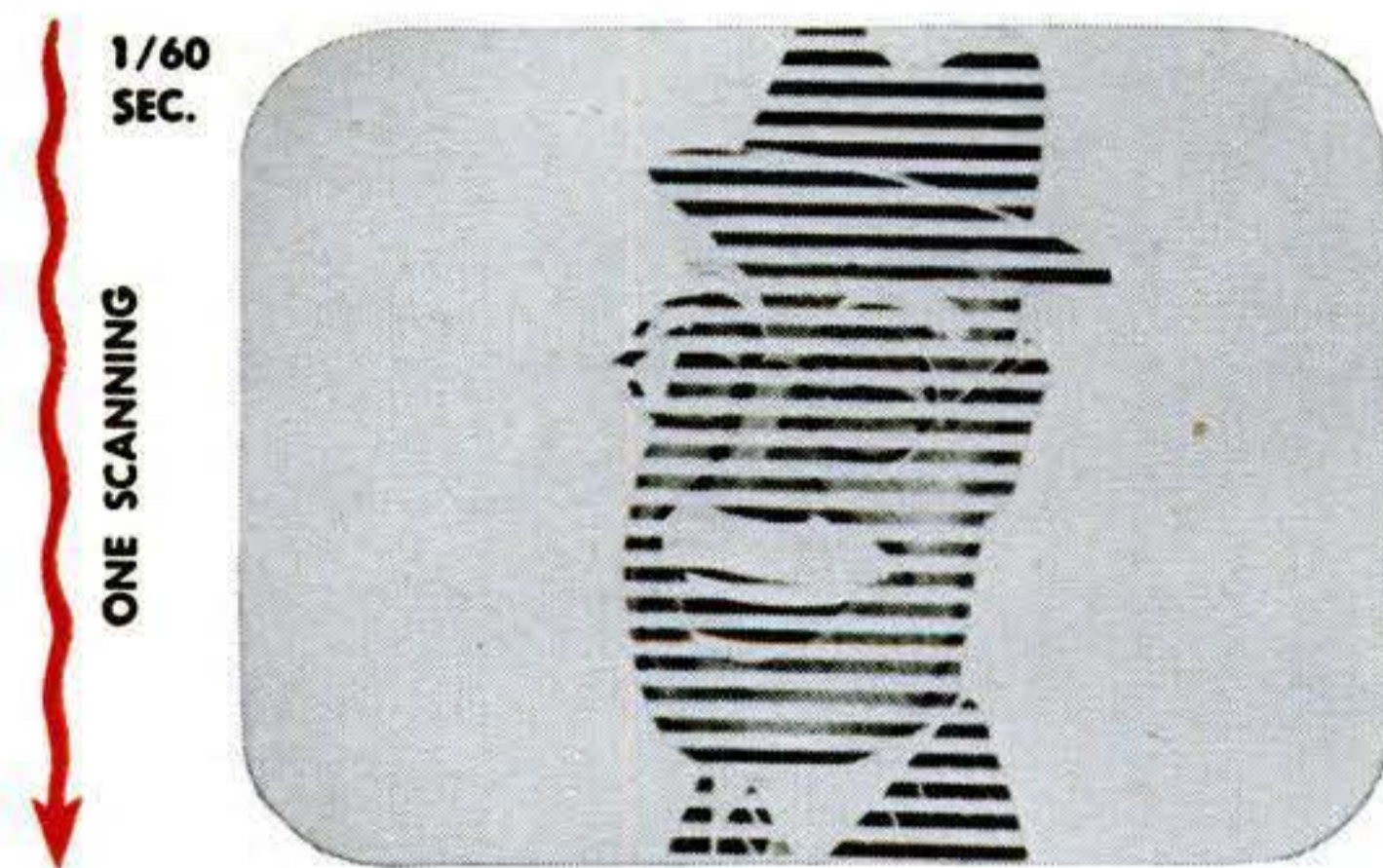

A second scanning, also taking  $1/60$  second, is needed to give a full image. This is called the "interlace." Scanning beam moves back and forth over spaces not covered first time. Consequently, the interlace lets you see parts of image you didn't see in first field. Sketches are exaggerated. Actually, there are at least 250 scanning lines in one field.



Complete TV image consists of two fields, one interlaced with the other. This is called a "frame." A new one is produced each  $1/30$  second. A succession of frames, one following the other without measurable delay, creates action you see. In effect, each frame is a still picture. Actually, there may be slight movement of image from one field to next.

POPULAR SCIENCE. At that speed he found it next to impossible to get satisfactory TV photos of fights, dancing, and other fast action. So he set out to experiment with faster speeds—specifically  $1/50$  and  $1/100$  second.

**And here are the results.** Eventually he found that  $1/50$  second at  $f/3.5$  gave him what he wanted—a good image with little or no movement. To compensate for the underexposure that results at these settings, even with Super XX and other film of equal speed, he overdevelops all his shots. Using D-76 developer, he gives his film 45 or 60 minutes of development instead of the customary 15. This formula causes no chemical fog in prolonged development, and in moderate enlargements his  $2\frac{1}{4}$ " by  $2\frac{1}{4}$ " negatives give no trouble from grain.

**Turn brightness above normal.** For all his TV shots Bill uses a  $2\frac{1}{4}$ " by  $2\frac{1}{4}$ " reflex fitted with a portrait attachment and moved in close to a 10" screen. While shooting, he turns the brightness a little above normal—but not enough to wash detail out of the highlights. He shoots with the lens open wide at  $f/3.5$ .

If your camera has an  $f/4.5$  lens, you still can probably get good fight photos by developing your film longer, say to 75 or 90 minutes. Should you be using sheet film, you can of course buy film that is far faster than the Super XX type. This will not require such long development.

**Sketches show what happens.** Why  $1/50$  second shutter speed is the most practical for stopping TV action is shown in the accompanying sketches. First, study how a TV image is formed. Then see what happens at different shutter speeds.

(This explanation refers only to between-the-lens shutters. Focal-plane shutters are sometimes used for TV shooting, but most photographers do not favor them because of their different action—a slit sweeping across the film.)

Even though some scanning lines are missing at  $1/50$  second, this makes very little difference. In moderate blow-ups, you'll never notice they aren't there. Best of all, the one scanning field and part of another enables you to get many shots without the blurs that come from fast action.

**What about  $1/30$  second?** In theory, a shutter opening of  $1/30$  second might be considered ideal, especially if the shutter could be synchronized to open and close with the beginning and completion of in-

dividual TV frames. But modern between-the-lens shutters, except for one or two unreliable ones, don't offer 1/30 second.

Actually, if you had that choice you still would be better off shooting at 1/50. At the

slower speed, your shutter opening could very easily straddle parts of three different TV fields—in each of which the subject may have moved slightly. At 1/50, you stay within two fields. **END**

### What happens when you shoot at different speeds.

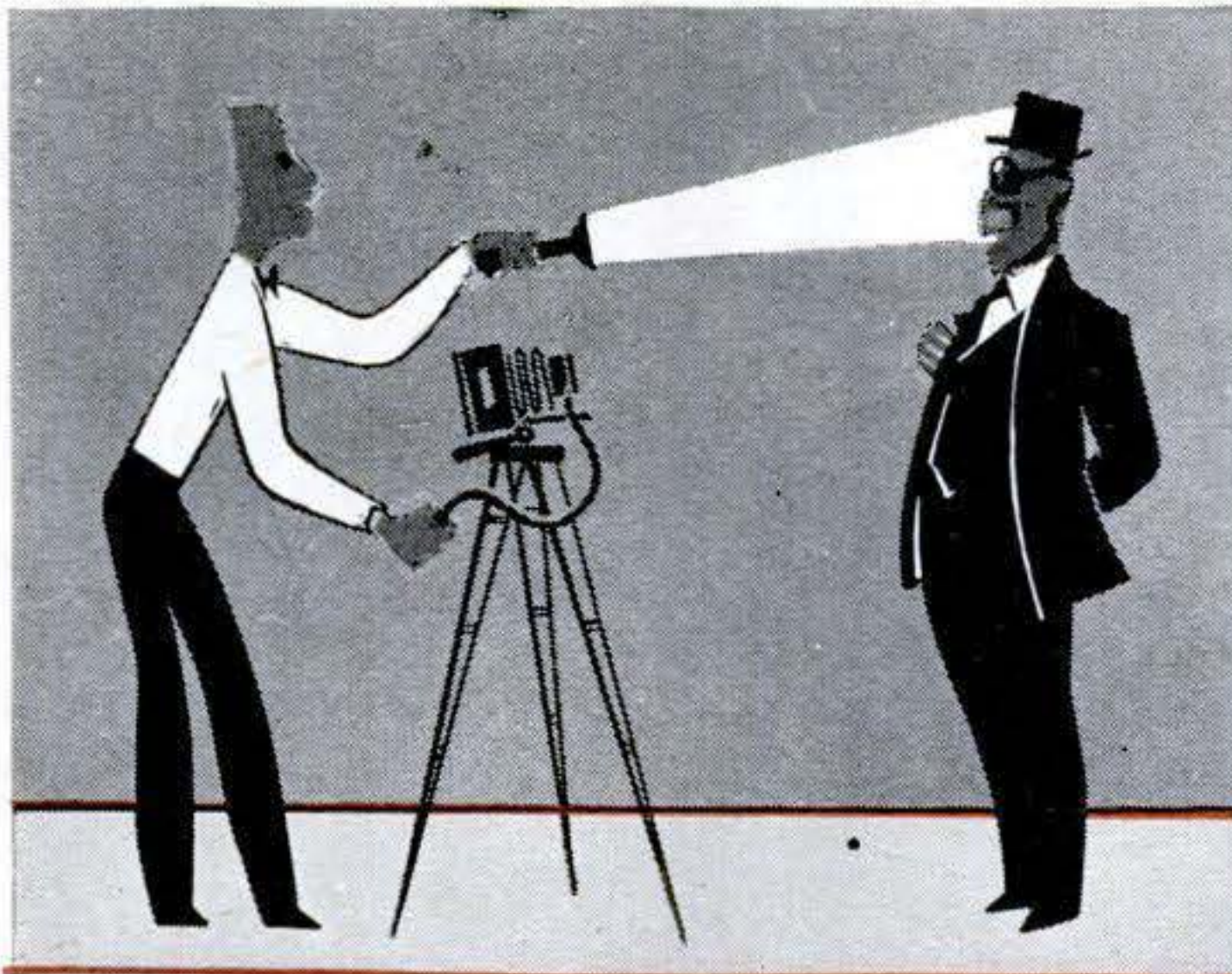

**First point to remember** is that it's a moving pin point of light, the scanning beam, that produces an image on film in your camera. Because of the rapidity with which the beam moves you may tend to think of a TV image as similar to your Uncle George—always there. But it's not. It just seems to be. Photographing a TV image is like opening the shutter of your camera in an absolutely dark room and then moving the beam of a spotlight back and forth across stock-still Uncle George, starting at his head. There's one difference, however. With Uncle G., you'd get a complete photo in one spotlight scanning from head to toe. On TV it takes two trips to fill in the picture.

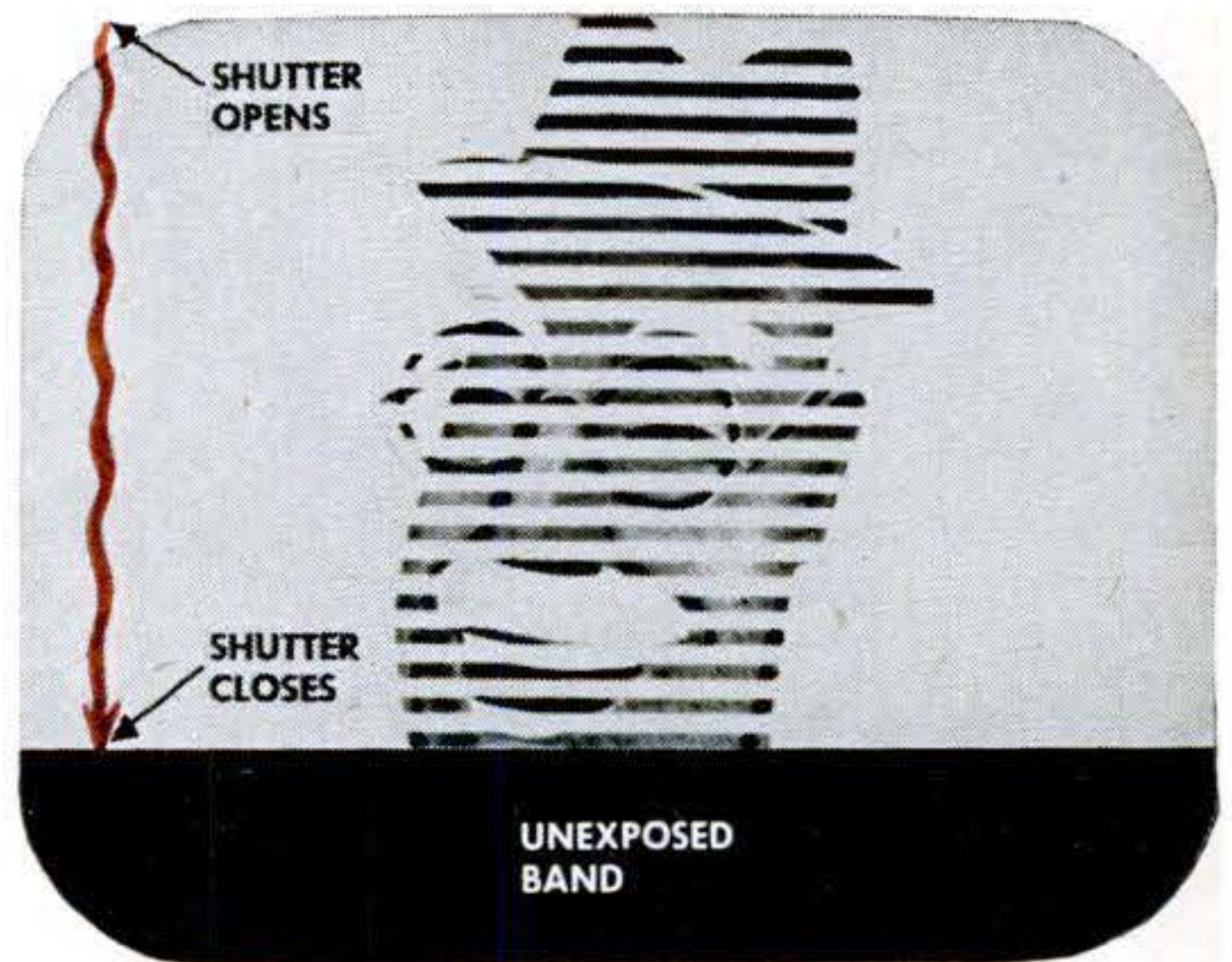

**At 1/100 second** your camera shutter doesn't give the TV scanning beam time to form even a single 1/60 second field. Consequently, an unexposed strip shows up across negative. Where strip falls depends on what point scanning beam had reached when shutter opens. The same unexposed strip would result while you are spot scanning Uncle George if you closed shutter as the beam reached his knees. You'd get no photo of his feet because they were not yet illuminated. In a 1/100-second TV photo, unexposed strip may show some detail because the scanning beams continue to glow for about 1/1,000 second after beam has passed. If there's no strip, your shutter is probably slow.

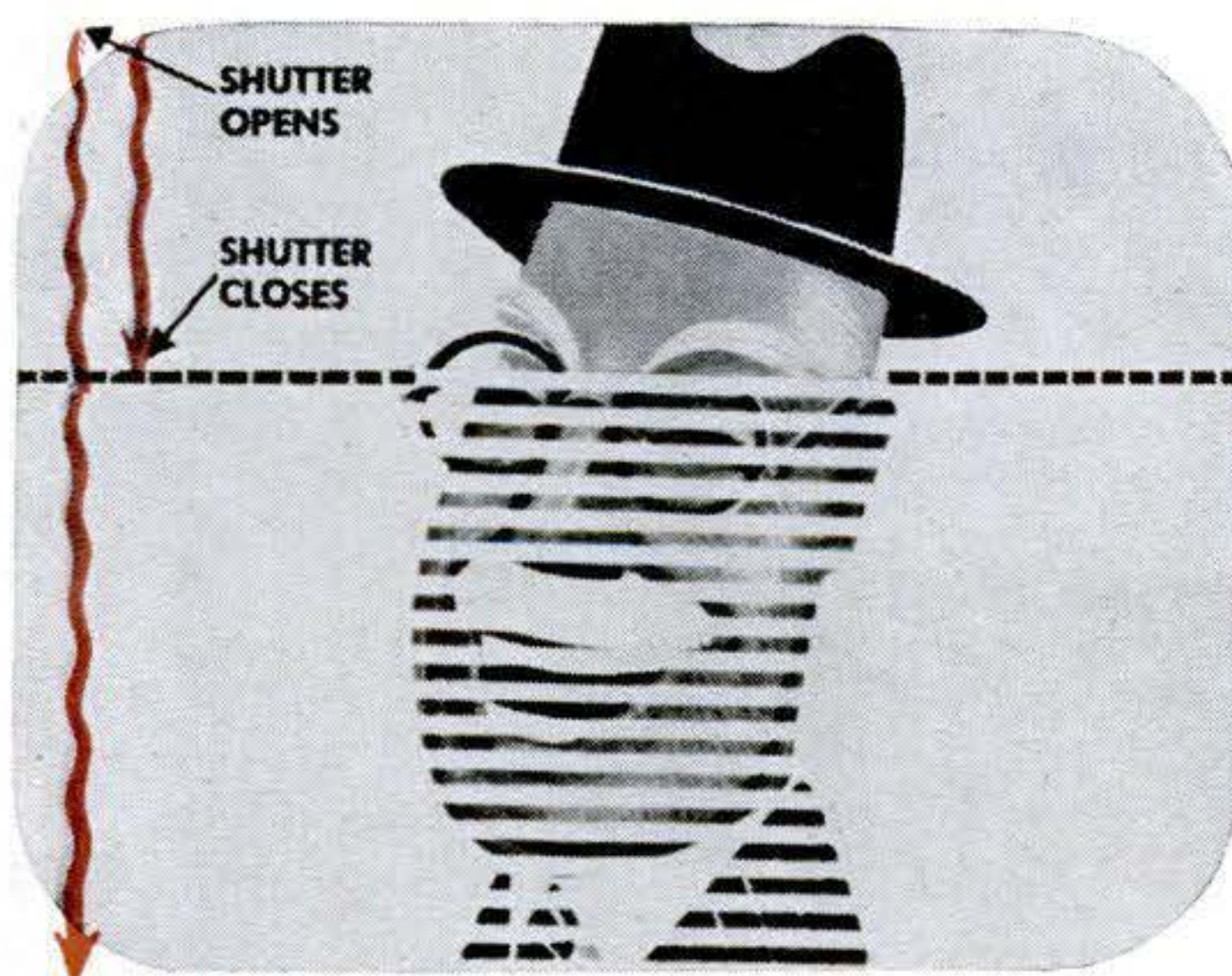

**At 1/50 second** you have the best chance of taking action TV photos without blurring. At this speed you give scanning beam time to produce a complete field and a good part of another. The amount you get of the second will depend on how accurately your shutter is working. If it is actually slower than 1/50 second, as many shutters are, you'll get just that much more of the second field.



**At 1/10 second** you must catch your subject absolutely still to get a shot without movement. During that interval, the TV scene has been scanned six times. This means you have a combination picture of six different fields, in each of which subject may have moved slightly. You'll probably have blurred result above. At 1/25 second, or better still 1/50, you reduce chance of motion.

## Home Incinerator Is Easily Assembled from Kit

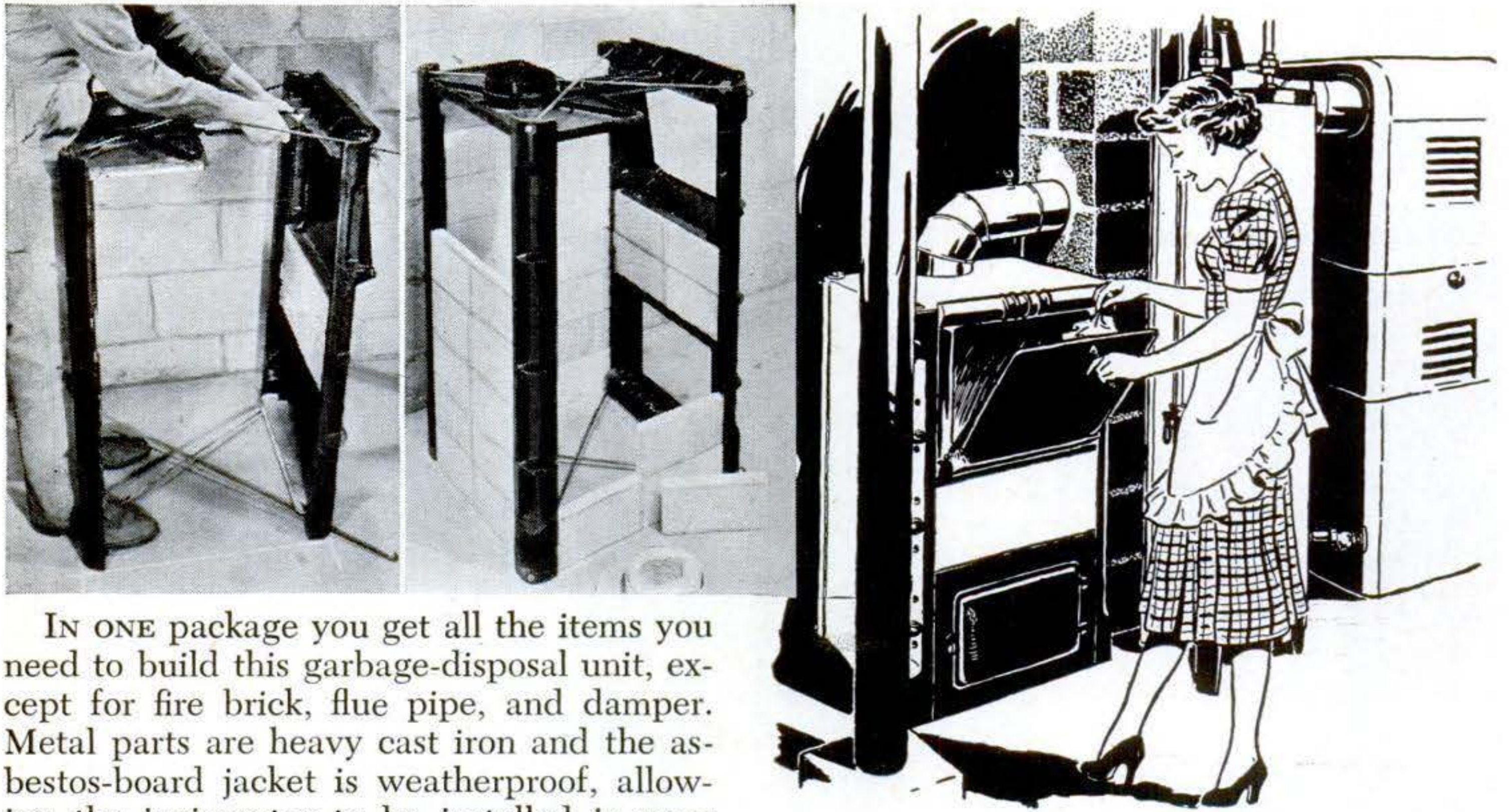

IN ONE package you get all the items you need to build this garbage-disposal unit, except for fire brick, flue pipe, and damper. Metal parts are heavy cast iron and the asbestos-board jacket is weatherproof, allowing the incinerator to be installed in your back yard or basement. According to the manufacturer, the Clear Mfg. Co., Butler, Wis., no professional masonry or mechanical skill is required to put the unit together.

### Easy Way to Store Lamp Bulbs



METAL or wooden curtain rings make convenient racks for extra lamp bulbs. Fasten the rings to a pantry or basement shelf with small wood screws inserted in the eyelets on the edges of the rings. Photoflood bulbs can be racked in the darkroom in the same manner—John J. Rea, Urbana, Ill.

### Shoptalk



"NEXT HE TOLD ME TO SCRIM THE BABY."

What are they talking about?

Where do they work? Answer below.

*They're electricians in a movie studio. To scrim the baby means to place a cloth over the lens of a small light to soften and diminish the light output.*

### Sheet Glass Is Stored Safely Between Pages of Book

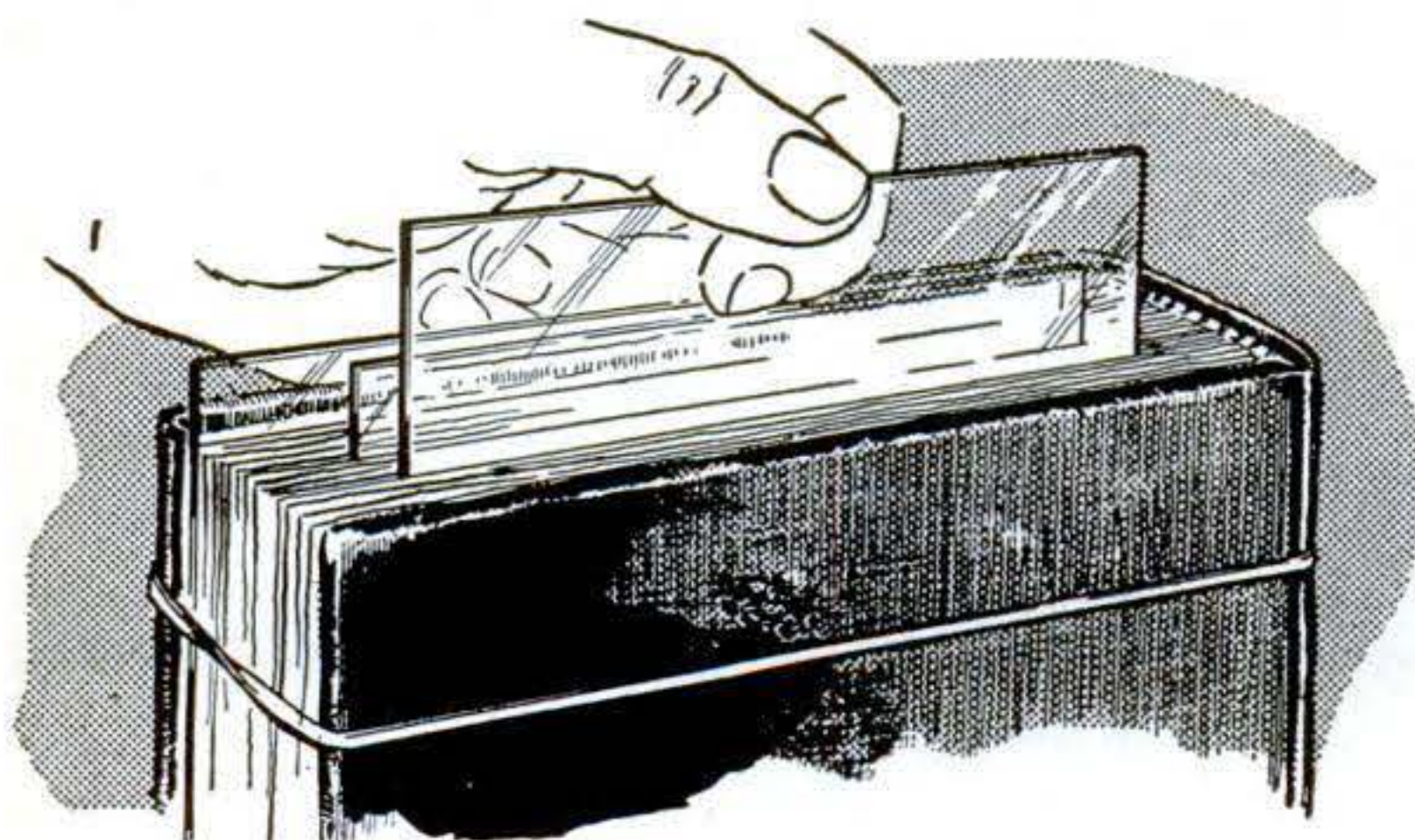

SMALL pieces of sheet glass, such as spare glass for photo and print frames, can be stored safely between the pages of a discarded book. Separate each piece of glass with a dozen or so pages. If the binding is worn and loose, a good many sheets can be accommodated without causing the volume to bulge. If it is too tight, remove enough pages to allow the volume to lie flat when closed on the pieces of glass and bound with some rubber bands.

# Magnetic Lock Fools Snoopers

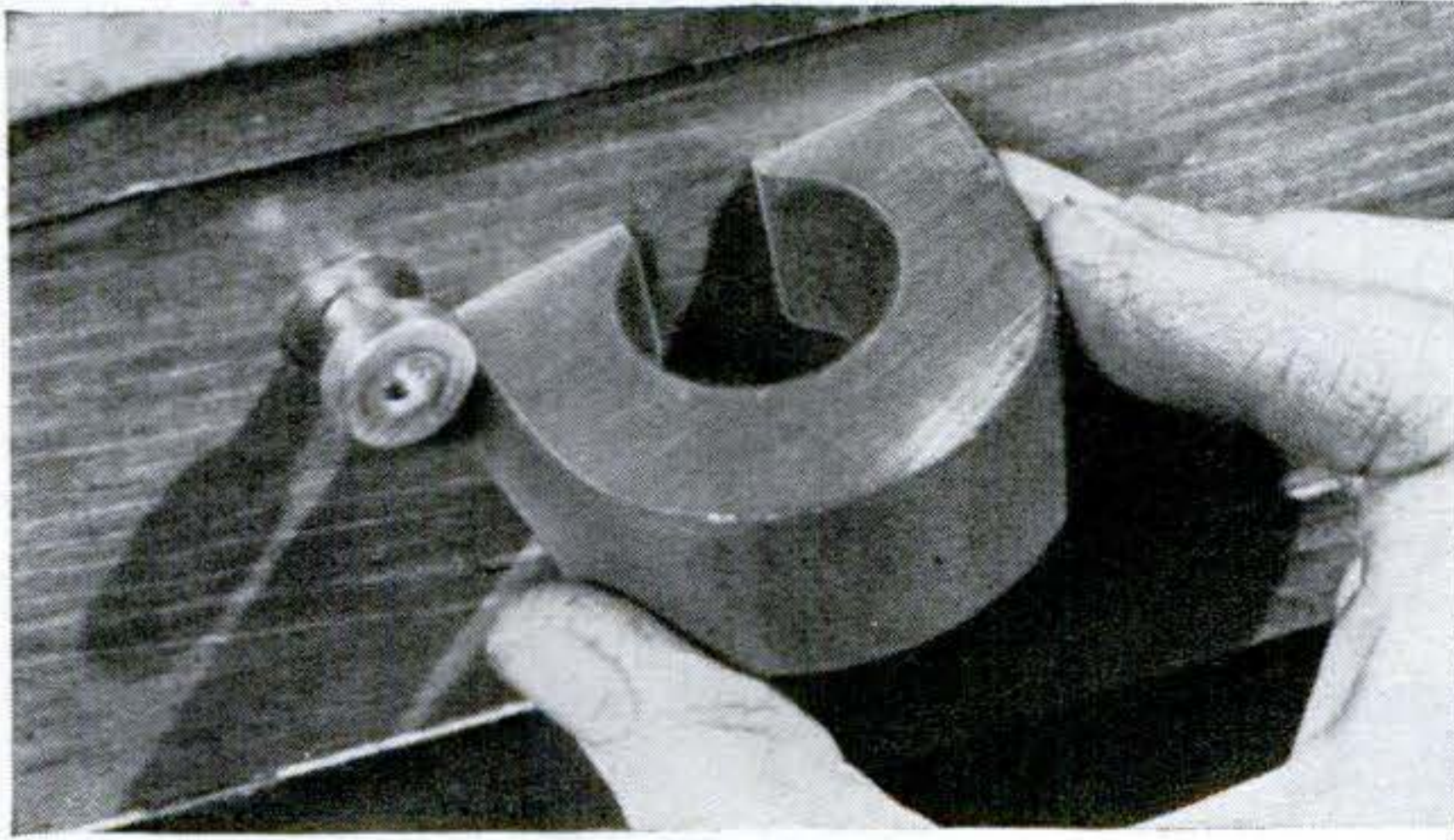

You have to know the "combination" to open a drawer or door bolted this way.

By **Walter E. Burton**

**F**IVE cents worth of hardware is enough to make a pickproof magnetic lock for any wooden door or drawer. It will baffle anyone unless he has a magnet *and knows just what to do with it.*

The latch is locked when two metal balls wedge metal vanes connected to its pivot, keeping the latch from rotating. To unlock it, you use a magnet to pull the balls away to the opposite ends of grooves routed in the inner face of the drawer front. All you need to make the lock are a few pieces of old brass and two small steel balls. Maybe you can salvage the balls from an old bearing. Any good magnet will serve as a key,

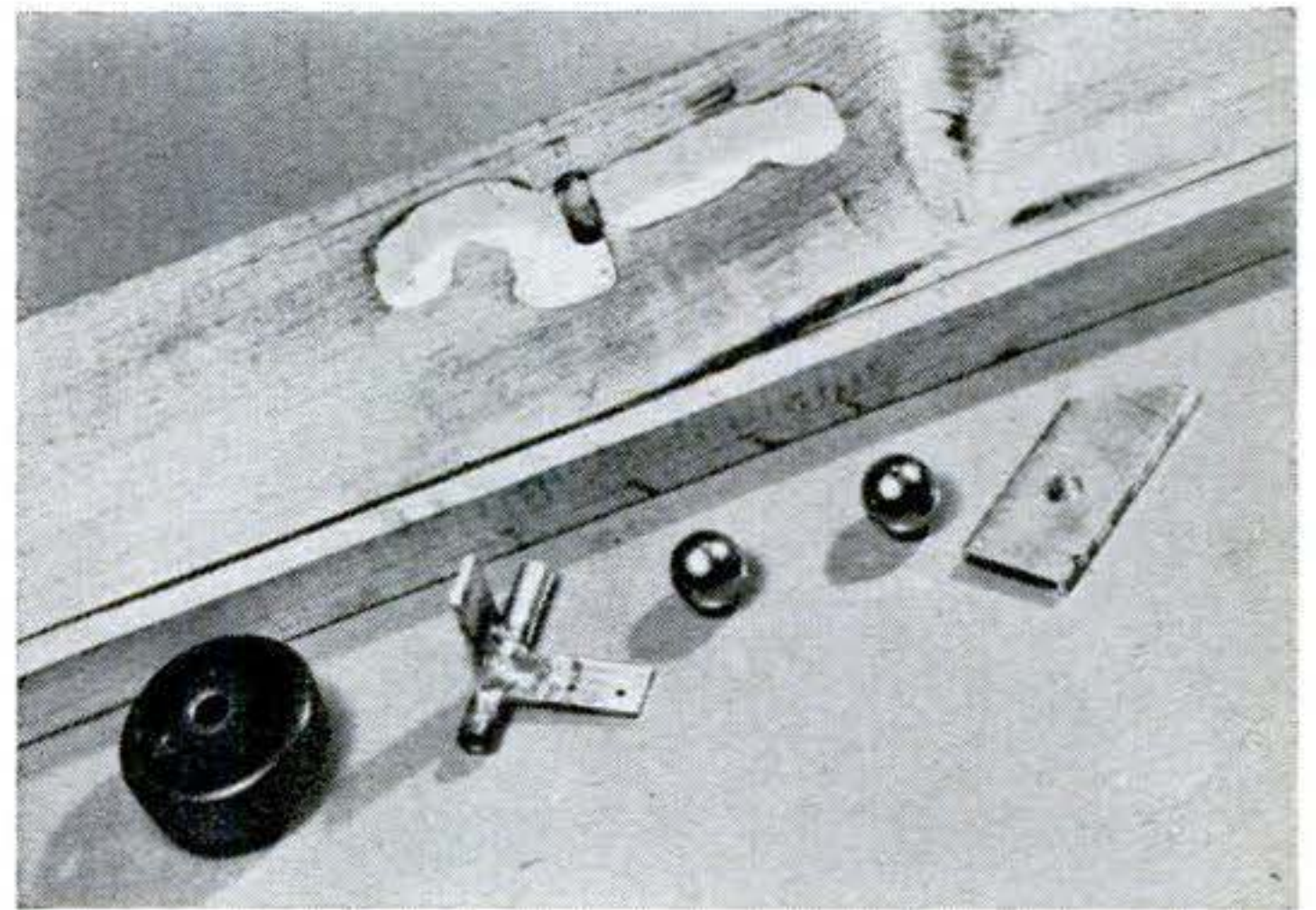
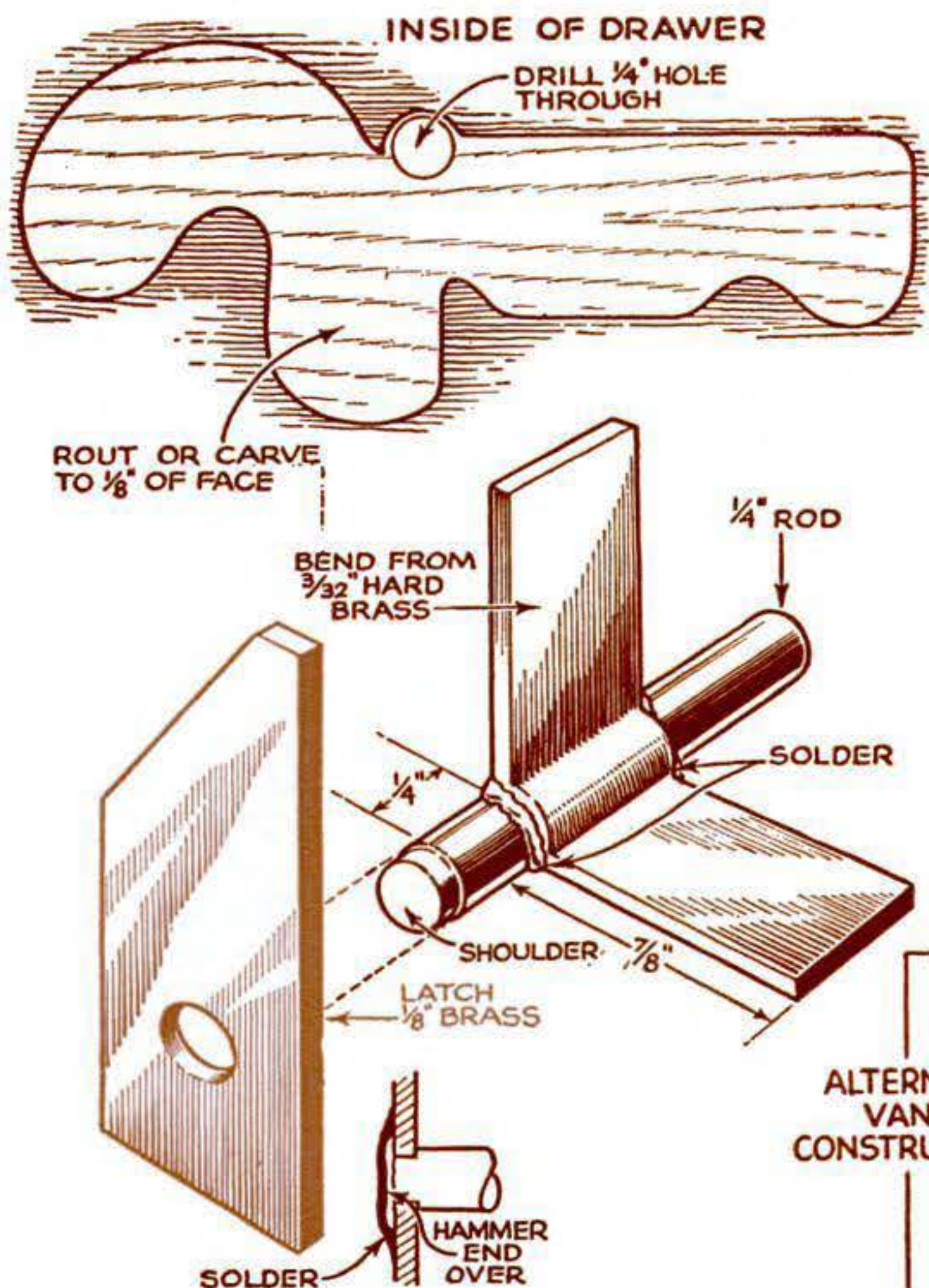

This magnetic lock is ready to be assembled. The grooves are routed to within  $\frac{1}{8}$ " of the drawer front. Construction of the latch and two ways of making the vanes are shown in the drawing.

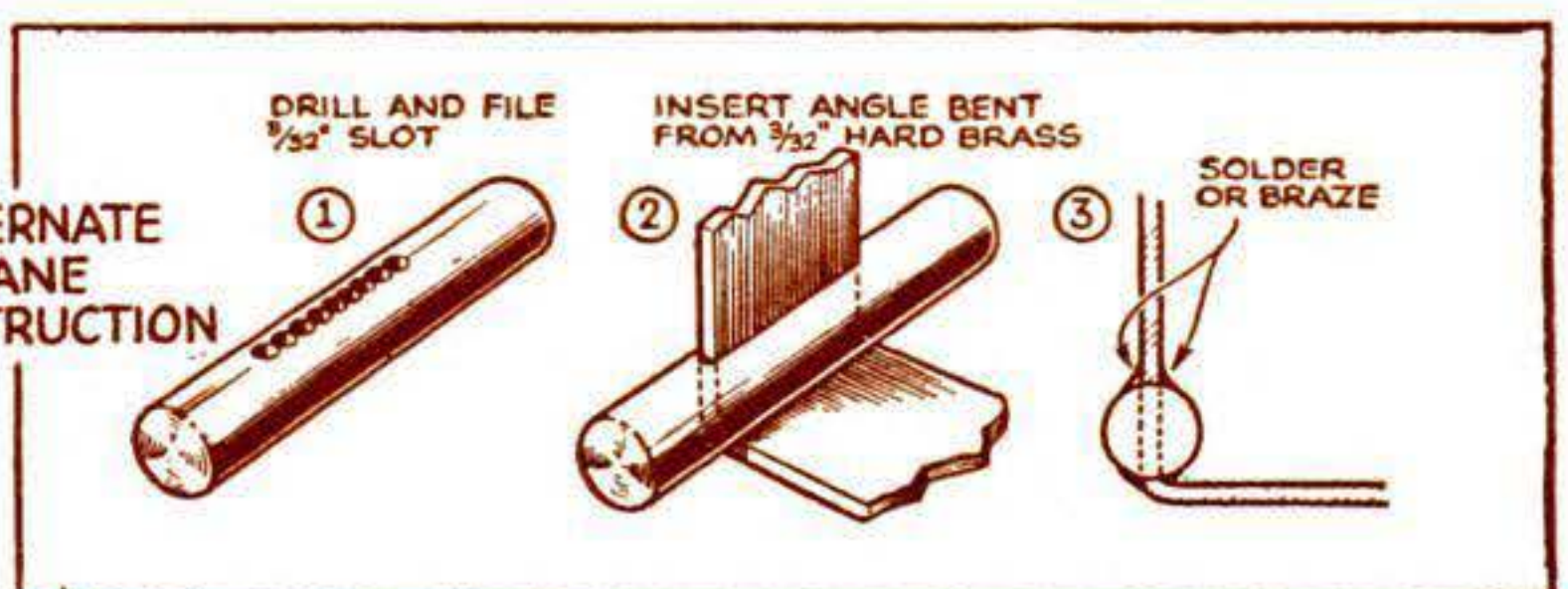

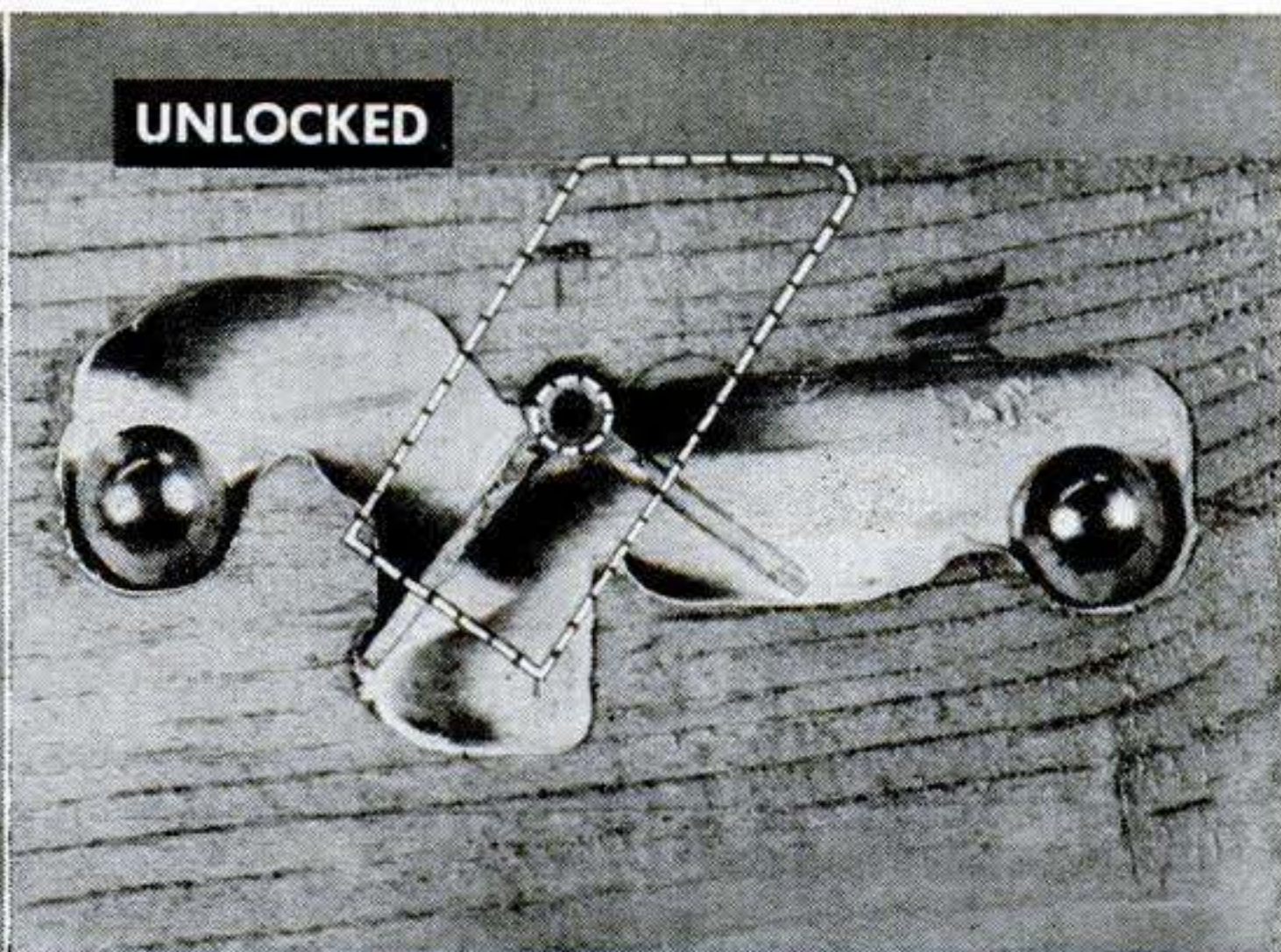
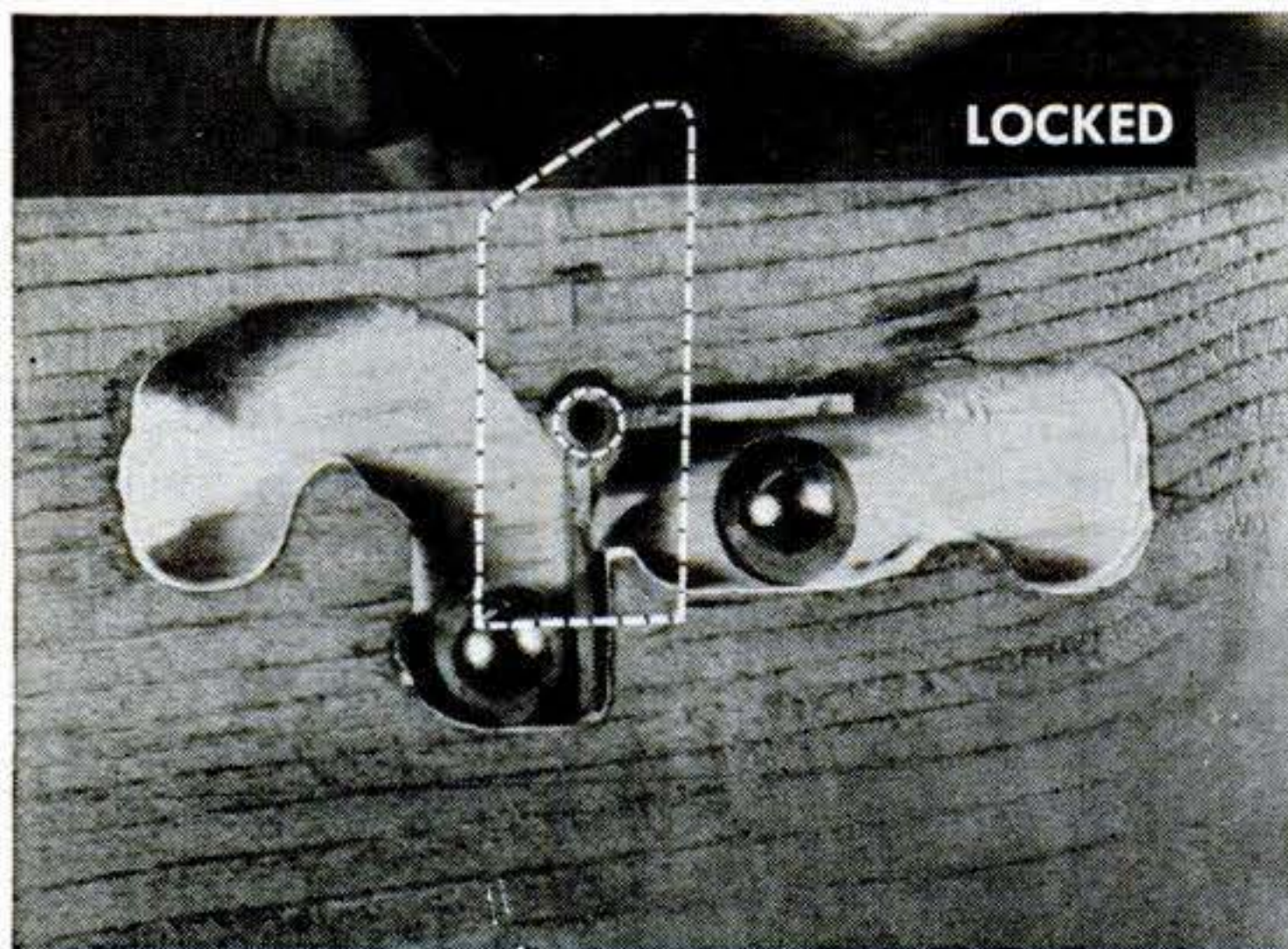

The drawer is locked when either steel ball is wedged between a vane and a side of the groove. Using two balls and grooves rather

than one secures the lock against someone who knows you use a magnet but doesn't know just what path to follow.

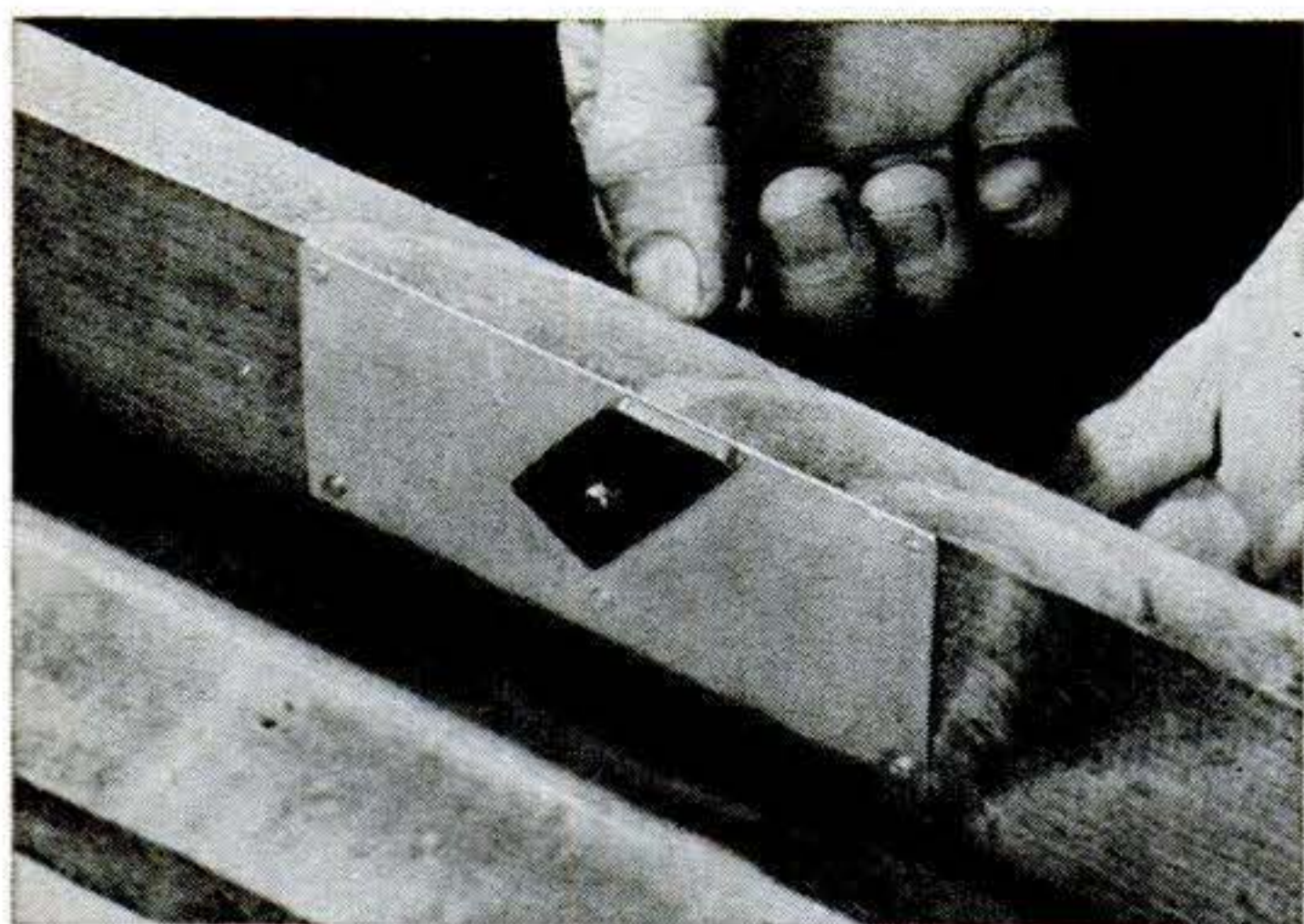

A thin brass or aluminum cover plate holds the lock parts together and provides a bearing for the bolt. The latch should engage a striker plate in the frame. Fit a decorative knob to the outside end of the bolt so you can turn the latch.

though an Alnico one is best. Don't use ferrous metal for the vanes, bolt, or cover plate.

If the front of the door or drawer you want to lock is less than  $\frac{3}{4}$ " thick, glue a block to the back. If there are grooves or mortises left by removal of an ordinary lock, glue in blocks of wood to fill them. Some cut-and-try fitting is usually necessary to get all parts to work smoothly. Inside tracks of the routed grooves should be reasonably smooth and there should be no places where a ball can become jammed. Oil each ball lightly to retard rusting.

Most magnets have well polished faces. If you find that sliding a magnet over the surface of the wood tends to scratch the finish, however, cover the magnet faces with cellulose tape. END

### Metal Strips Copy Contours

With a pack of aluminum stripes you can to copy the contour of almost any piece of work from moldings to rough stone. When the toggle clamp is in unlocked position (as in photo at right) strips can be moved up or down. When the strips are in position on the contour, the clamp is locked and the contour can be transferred to a drawing or to another piece of work. The tool is made in 12 sizes by The Ckola Company, of Minneapolis, Minn.

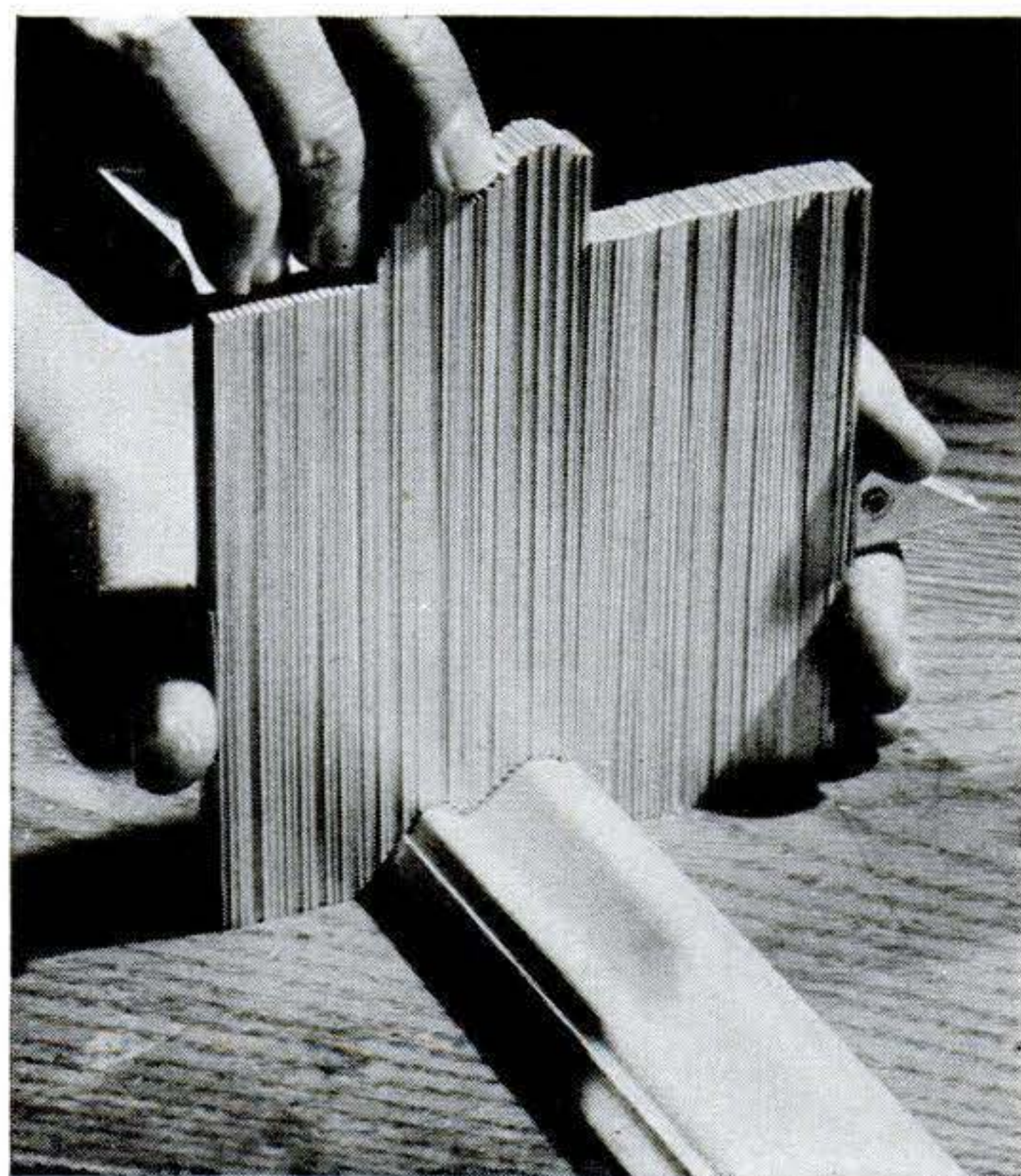

### Nylon Used to Strain Paint

INSERT a circle of wire screening in a funnel, lay a piece of old nylon stocking over the screening, and you've got a setup to strain paint. Put the funnel over a jar or can and pour the paint over the nylon.—*Bess Ritter, Yonkers, N. Y.*

# This Amplifier Sounds Big but Is Only 4" by 4"

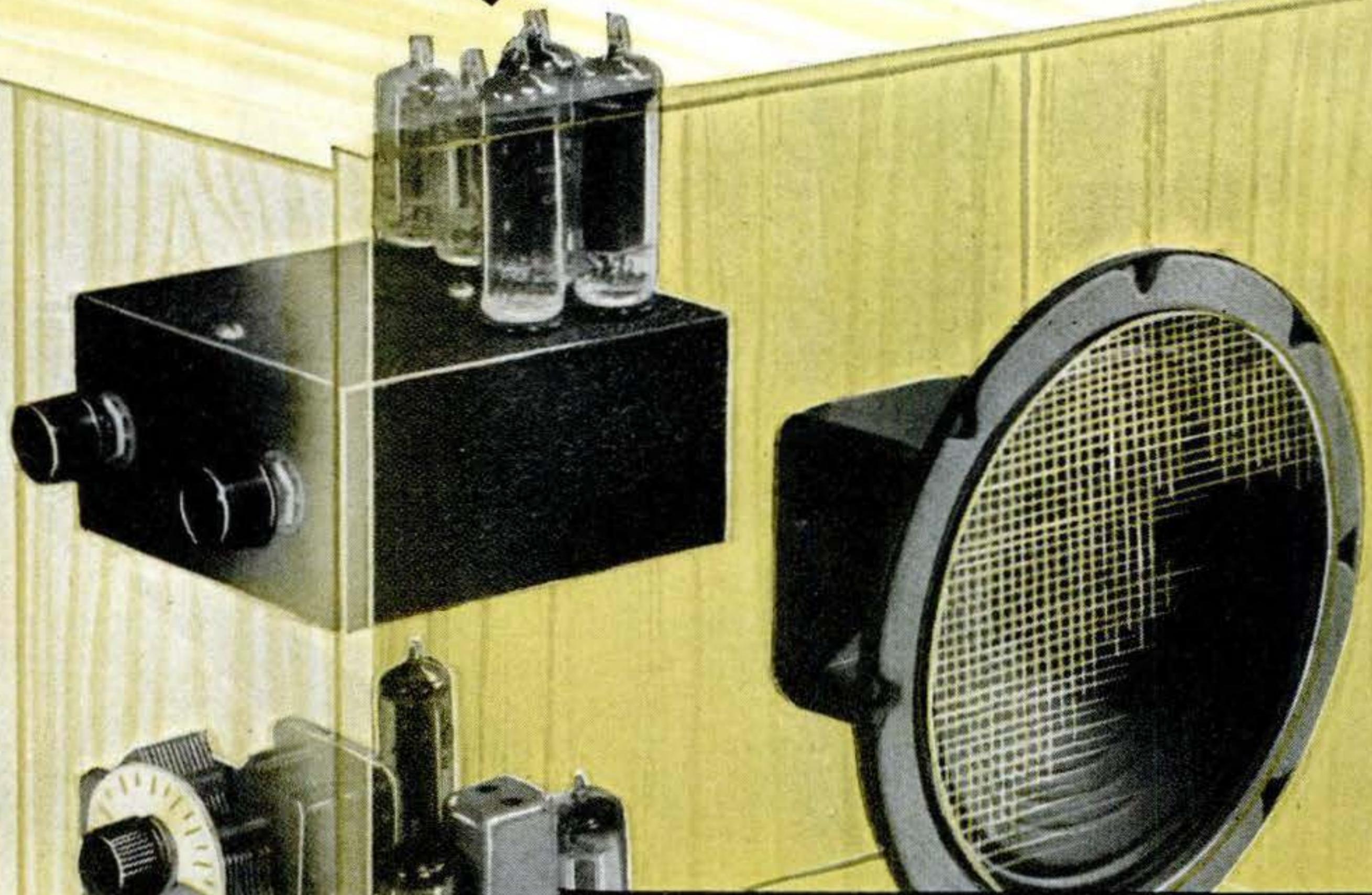

**By Noel Namtro**

**I**S SPACE precious in your house? Here's an amplifier for a record player or radio tuner that matches or surpasses the performance of most full-sized sound reproducers, *but takes up less space than a cup of coffee*. With it, you can tuck a radio-phonograph into a bookcase or end table.

Miniature parts make it possible to put such an amplifier on a 4" by 4" chassis. All told, it shouldn't cost you more than \$15 and an evening's time to build this unit. The design takes full advantage of five miniature tubes to give you smooth, undistorted amplification, and enough

**Miniature parts** make it possible to squeeze a radio-phonograph combination into a small bookcase. Details of radio tuner, center, will be given next month.

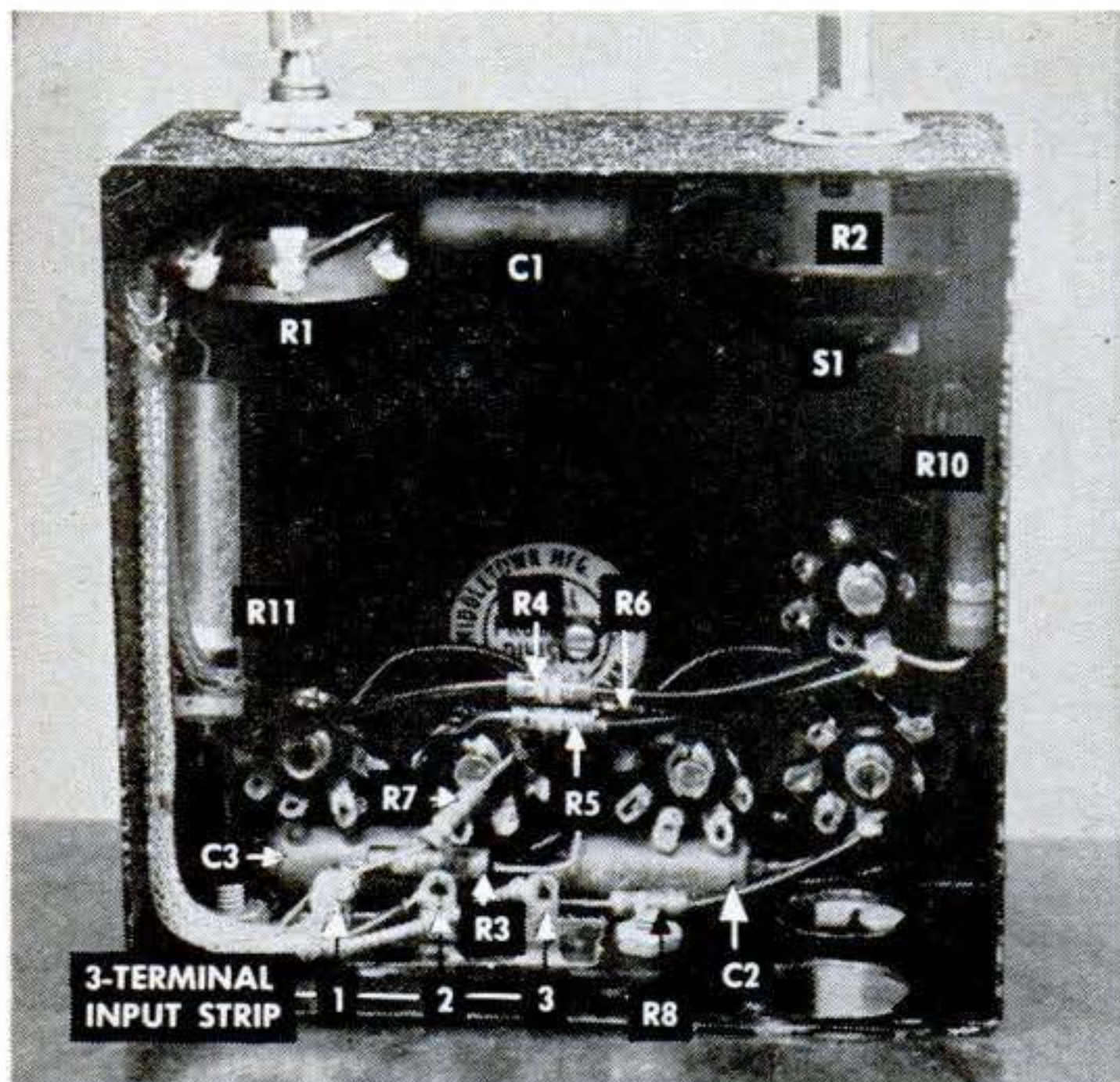

After you've drilled all chassis holes, mount the tube sockets, input strip, and controls. Wire the tube filaments in series, and connect the 6AQ6 cathodes (pins 2) together. Do the same with the 35B5 cathodes (pins 2) and screen grids (pins 6). Wire up the input terminals and volume control (R1) with shielded wire and ground the braid. Install the small resistors and condensers shown.

sound volume to fill a room. Among its features are push-pull pentode output, a phase inverter, and separate volume and tone controls.

The secret of keeping this or any other

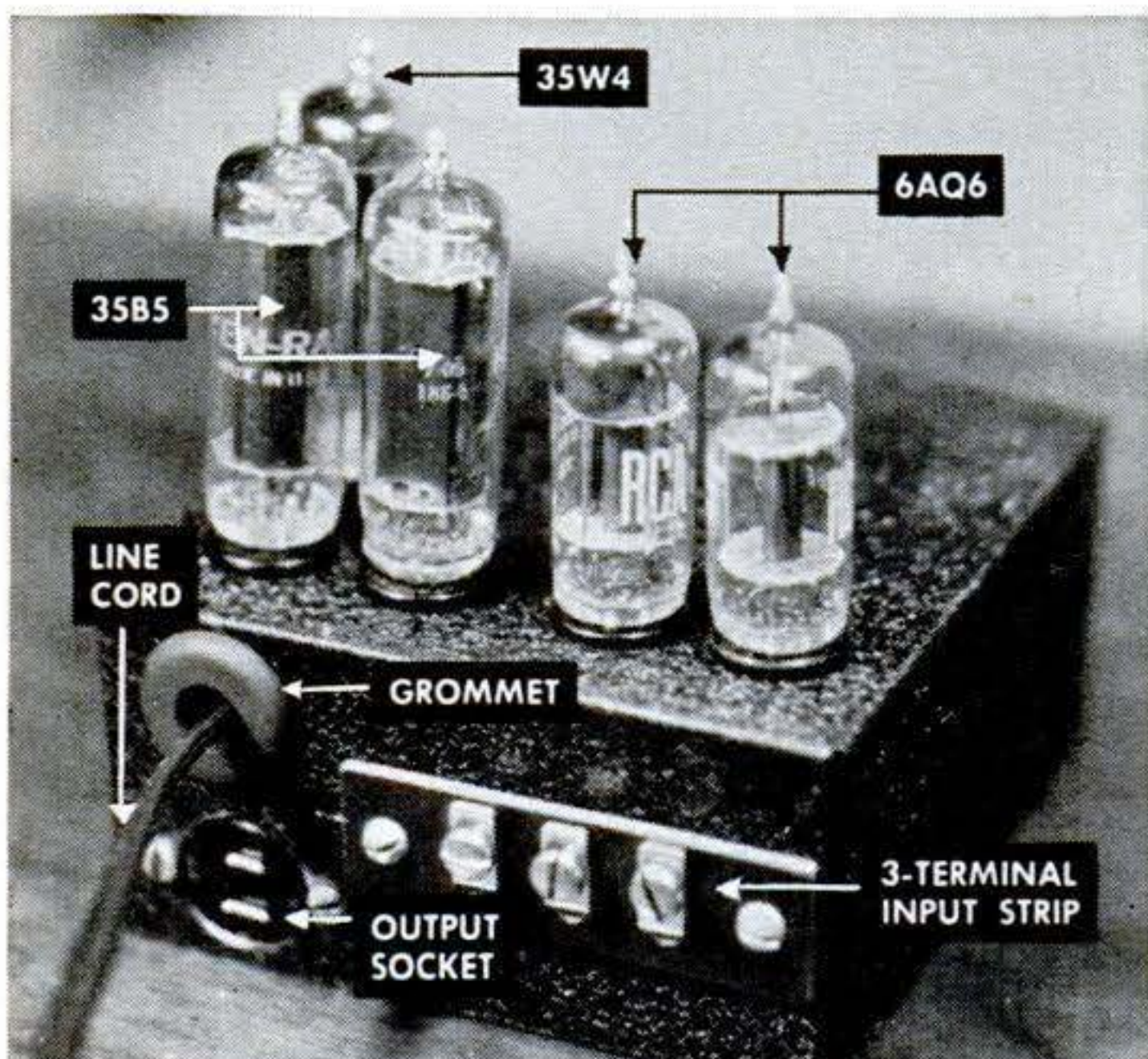

Your completed high-fidelity amplifier looks like this. You can use it with almost any permanent-magnet loudspeaker if you select the right voice-coil taps on the universal output transformer. For the input you may use a record player, microphone, or an FM or AM radio tuner. Any two of these may be connected at the same time, for as you turn volume up on one you automatically turn it down on the other.

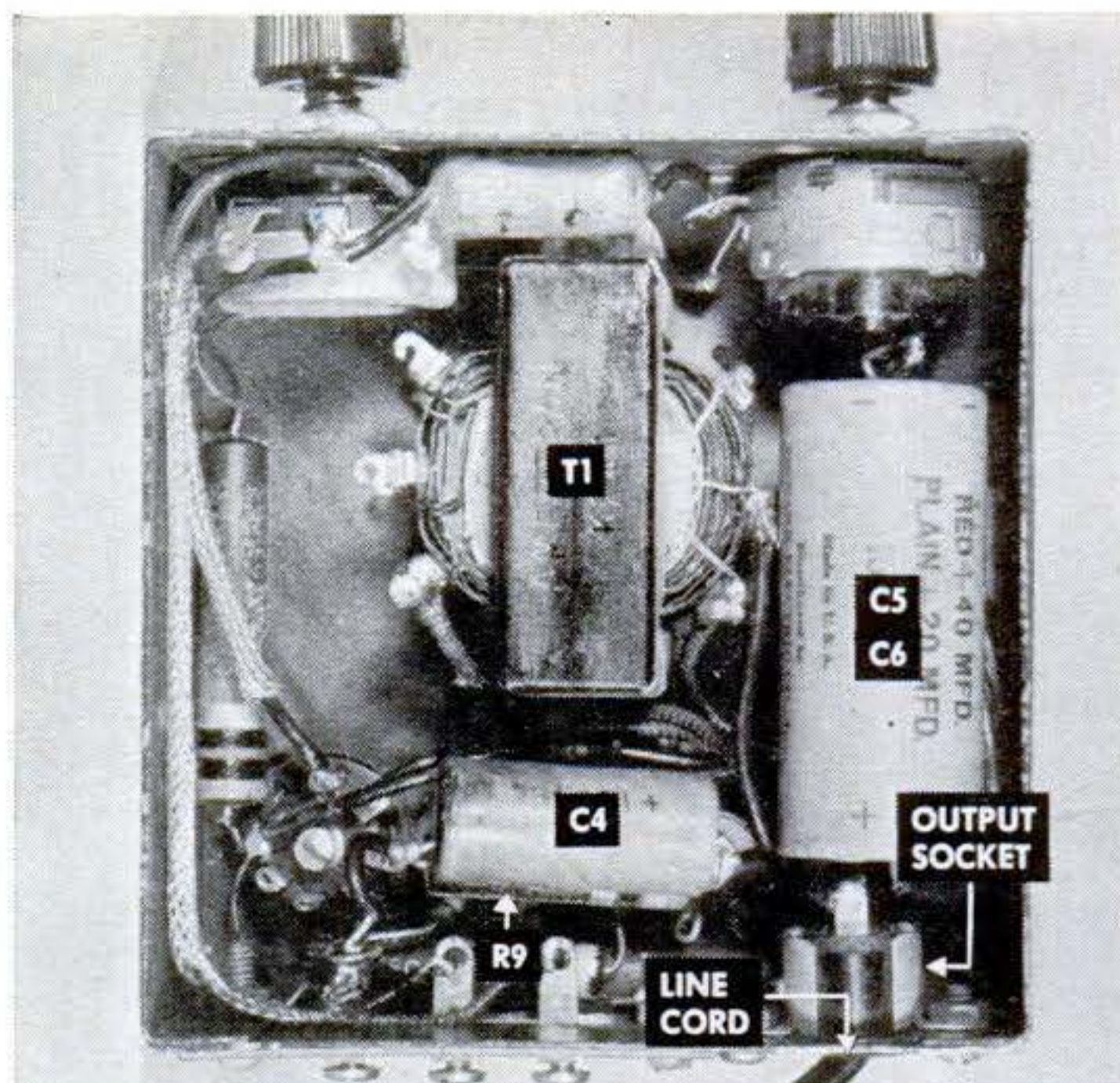

Bring the line cord through a hole in the back of the chassis, protecting it with a grommet at the point of entry. Wire one side of the cord to the switch, the other to pins 3 and 5 of the 35W4 rectifier. You can now install and wire the remaining large parts, such as the output transformer (T1) and socket, the dual-electrolytic filter condenser (C5, C6) and the remaining resistor and condenser.

electronic unit compact is to lay it out carefully and wire the parts systematically. Before you remove the miniature tubes from the cartons, stand the boxes on the chassis to determine the approximate spacing. Four of the tubes—two 6AQ6's and two 35B5's—fit in a straight line parallel to and about 1" from the rear edge of the chassis. The fifth tube, a 35W4 rectifier, is directly forward of the last tube in this line.

To seat the tube sockets, you have to drill, punch, or ream out holes  $\frac{3}{8}$ " in diameter. Some types of sockets can be locked in with clips; other types require additional holes for hold-down screws or rivets. On the back of the chassis make the necessary holes and cutouts for a 3-terminal binding post, a 2-prong output socket, and a rubber grommet to protect the line cord.

On the front, two  $\frac{3}{8}$ " holes—for the volume and tone controls—are needed. Mounting holes for the output transformer complete the drilling.

To conserve space and ease your work, proceed with the wiring in an orderly sequence. When you've finished, take a couple of minutes to recheck all the wiring. Trace the filament and line-cord connections. And look for blobs of solder that may cause shorts between the closely spaced contacts on the miniature-tube sockets.



## LIST OF PARTS AND APPROXIMATE COST

- R1: 1-meg. center-tapped potentiometer (\$1.20).  
 R2: .5-meg. pot. with switch, S1 (\$1.10).  
 R3: 560-ohm, 1/2-watt carbon (.10).  
 R4, R5: 100,000-ohm, 1/2-watt carbon (.10 ea.).  
 R6, R8: 220,000-ohm, 1/2-watt carbon (.10 ea.).  
 R7: 3,300-ohm, 1/2-watt carbon (.10).  
 R9: 68-ohm, 1-watt carbon (.15).  
 R10: 15,000-ohm, 1-watt carbon (.15).  
 R11: 10-ohm, 2-watt wire-wound (.20).  
 C1: .01-mfd., 400-volt paper (.15).  
 C2, C3: .05-mfd., 400-volt paper (.15 ea.).  
 C4: 25-mfd., 25-volt electrolytic (.50).  
 C5, C6: 20-40-mfd., 150-volt dual elect. (\$1.).  
 T1: 8-watt, universal push-pull output trans. (\$1.75).  
 S1: SPST switch on R2. (Incl. with R2).  
 Polarized output jack or socket (.10 to .50), 3-terminal input strip (.10), 7-pin miniature-tube sockets (5 req., .18 ea), 2" by 4" by 4" chassis (.50), tubes, (\$4.80), line-cord and plug (.20), misc. hardware.

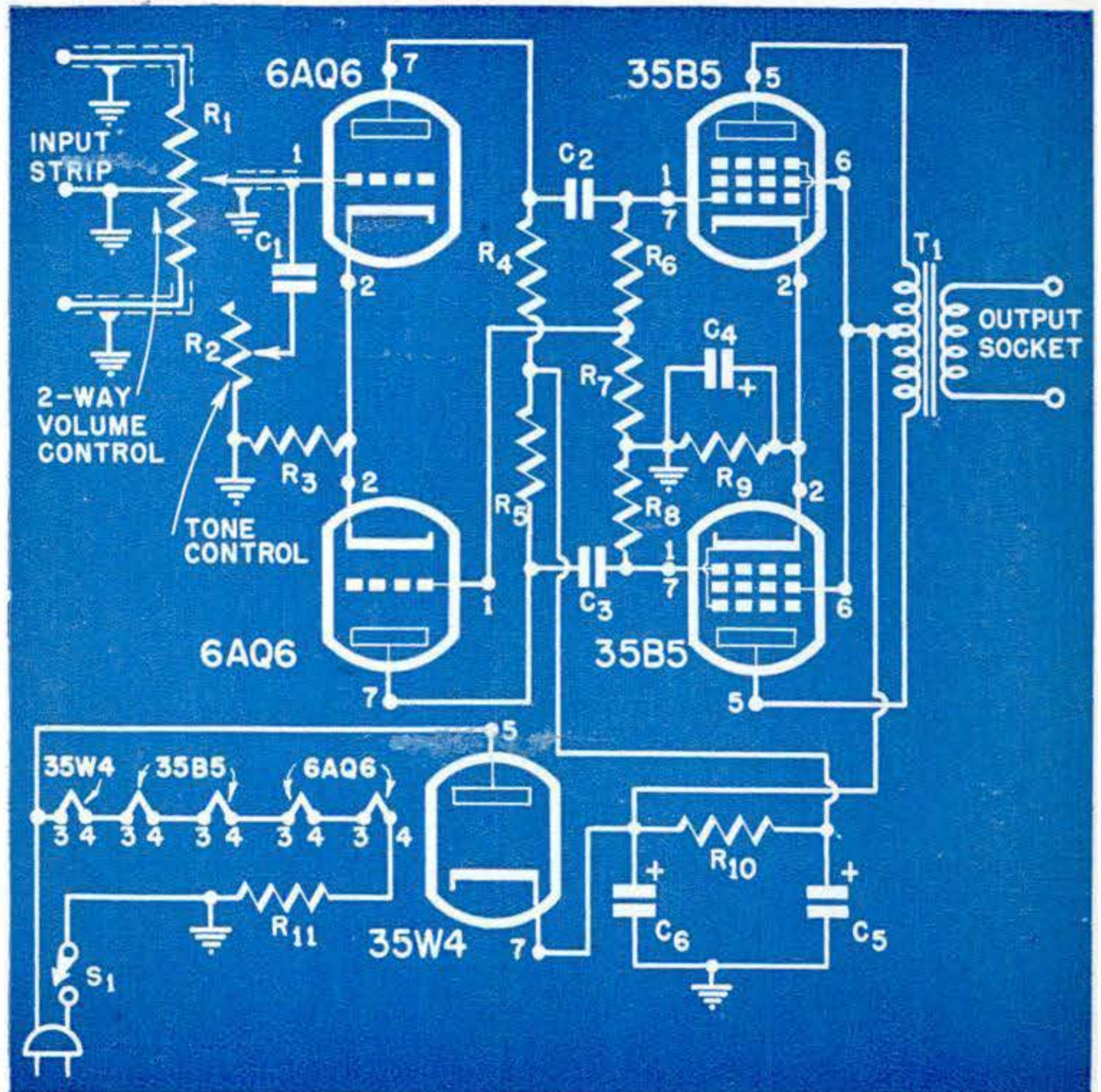

If the assembly passes this inspection, insert the tubes in their sockets, plug the amplifier into a 115-volt AC or DC outlet and connect a loudspeaker to the output socket. If the amplifier doesn't work on DC, reverse the line plug in its socket.

You can link the amplifier to a phono-

graph pickup, a radio tuner, or both. If both are used, connect one to terminals 1 and 2 and the other to 1 and 3 of the input strip. The center-tapped volume control favors one pair of terminals when it's turned to the left and the other pair when it is moved to the right. END

## PAPERING PLYWOOD

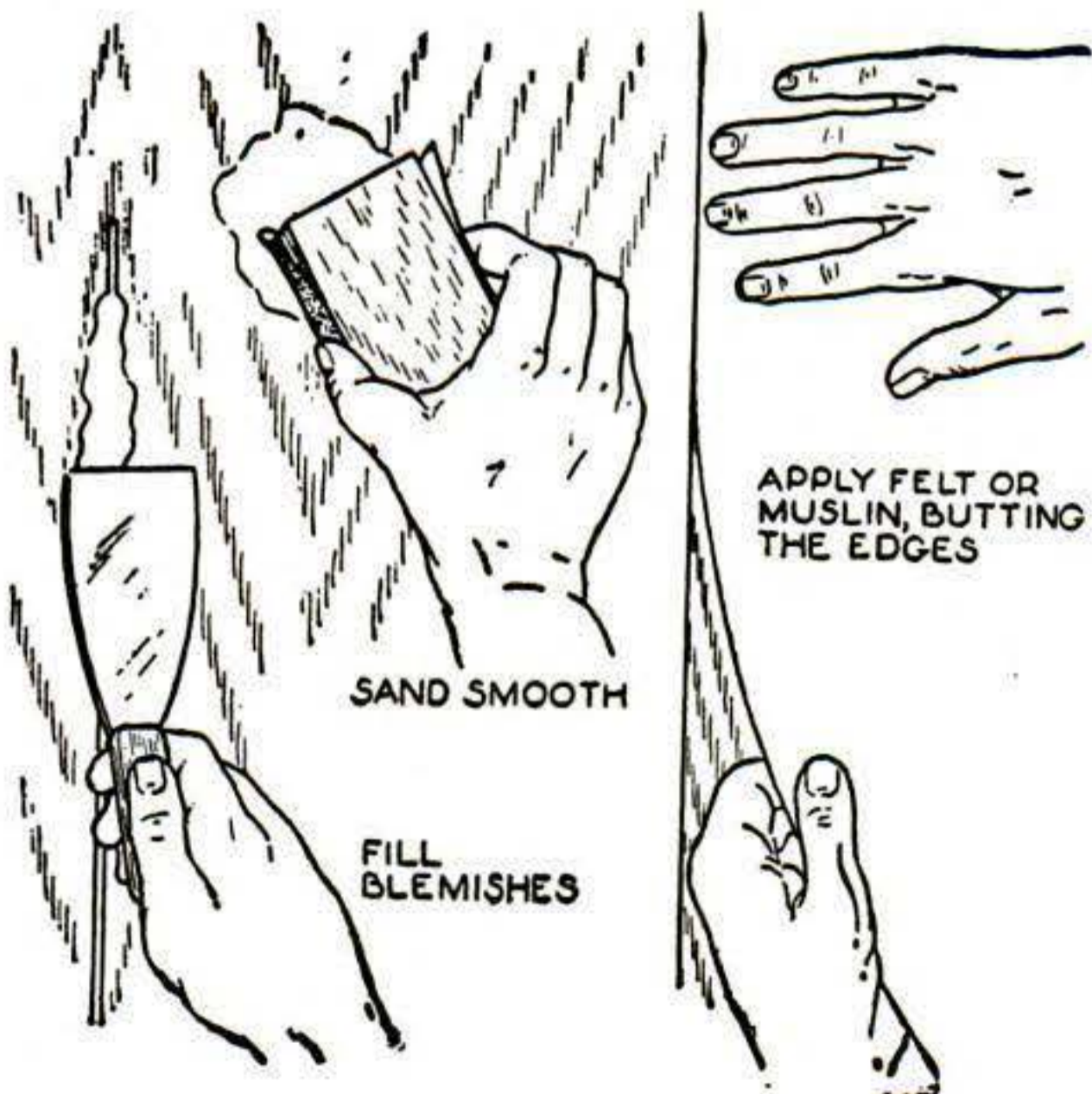

Good papering can be done over plywood only when the sheets have been well-installed and separated from studs by furring strips to insulate them from frame movement. Joints should be tightly butted or filled with solidly glued splines. Fill all nail holes, hammer marks, and other blemishes with Swedish putty or a good commercial water putty, using a small trowel or wide putty knife. When dry, sand flush.

Coat the plywood with a wheat-flour paste fortified with a gelatin glue size. Put a coating of the paste on smooth building felt and apply it to the plywood, butting the joints and rolling smooth. For the very best results use a canvas or muslin sheeting instead of felt. Hang paper over either in the usual manner, using wheat-flour paste.

FOR YOUR POPULAR SCIENCE INFORMATION FILE

## Homemade Winch Lifts Shingles



THIS handy winch was made by a roofer to hoist materials to the top of a two-story house. It consists of a hoist pulley that hooks to the top rung of the ladder, a ½-hp. electric motor, cable, and an elevator. The elevator rides up and down on the ladder and has side flanges to keep it from sliding off the ladder. A helper on the roof removes the packages from the elevator. — *George P. Metesky, Waterbury, Conn.*

## Squirted Flux Cleans Chemically



WITH a canned soldering fluid now on the market, you needn't scrape or sandpaper the parts to be joined, nor use a brush to apply flux. Squirted on the work right from the can, Divco Flux, made by Division Lead Company, Chicago, cleans by chemical action. It is said to work equally well on copper, brass, bronze, nickel, cadmium, zinc, tin, galvanized iron, and Monel. The four-ounce can sells for 50 cents.

## An Ash Tray for Pipe Smokers

A LARGE cork, about an inch and a half in diameter, cemented to the bottom of an ash tray makes a useful combination match-holder and knocker for removing pipe ashes. Cut the cork with a single-edge razor blade as shown.—*John J. Rea, Urbana, Ill.*



## My Most Ingenious Solution

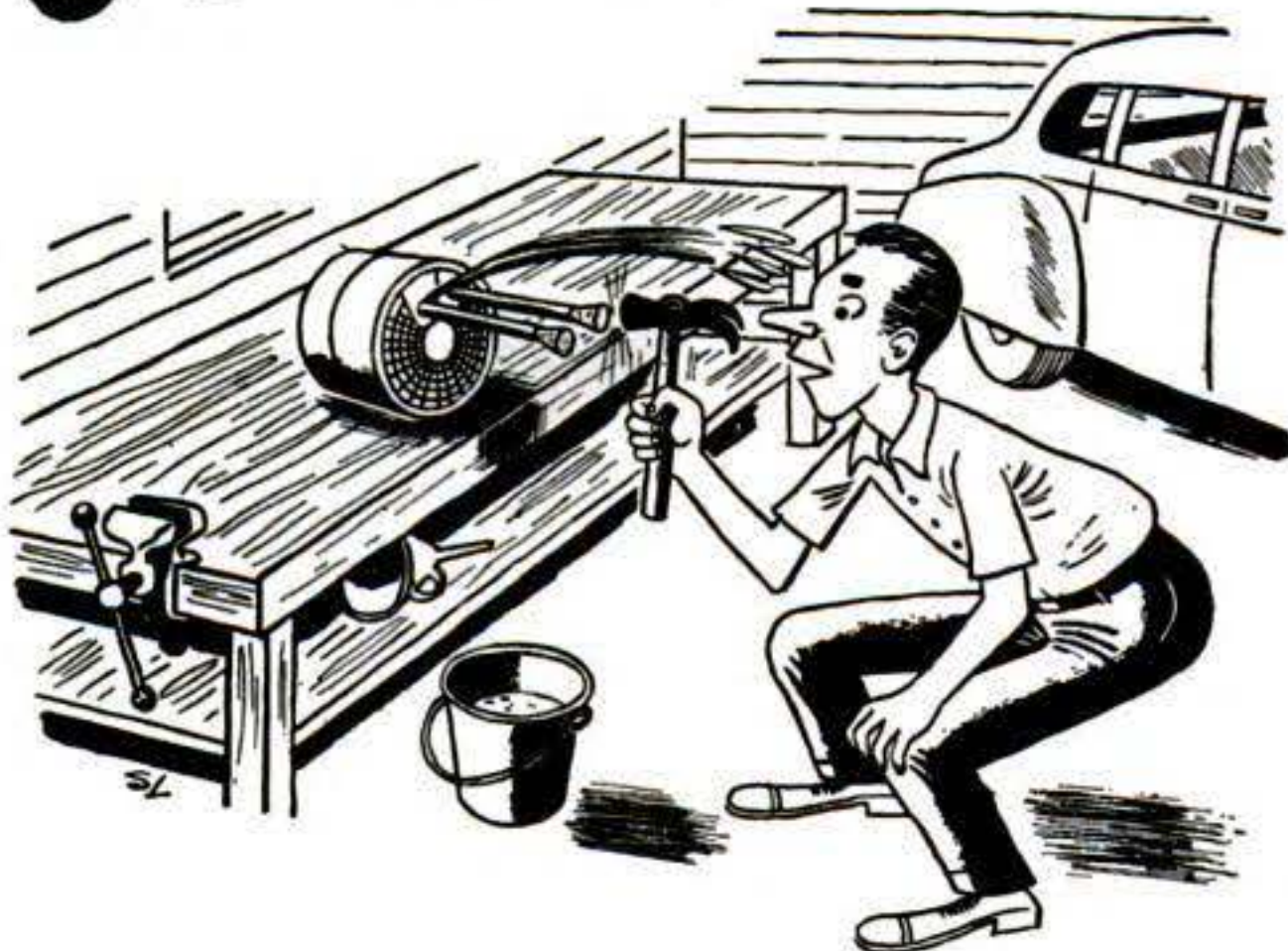

A leak in my car's hot-water heater only showed up when the engine was running. I took the heater out of the car and couldn't find the leak until I tried a simple experiment. What do you think I did?

*I filled the heater with water and plugged both connections with corks. Then I tapped one cork with a hammer. Since water is incompressible, the leak showed up immediately. A simple solder job fixed it.—Roland Nagy, Clifton, N. J.*

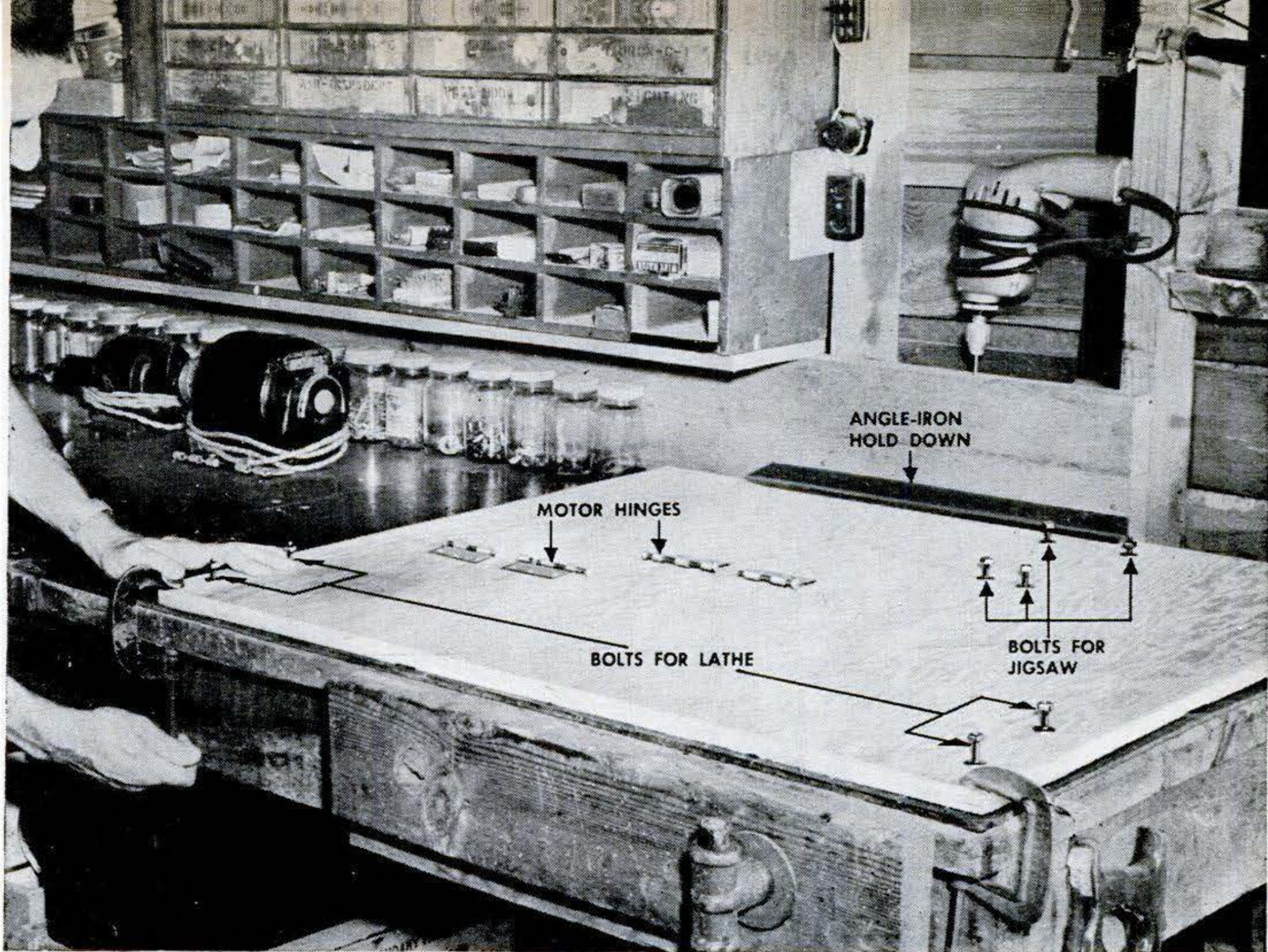

Rear edge of  $\frac{3}{4}$ " plywood panel slips under angle iron. C clamps hold front corners secure.

## Two-Faced Bench Saves Space

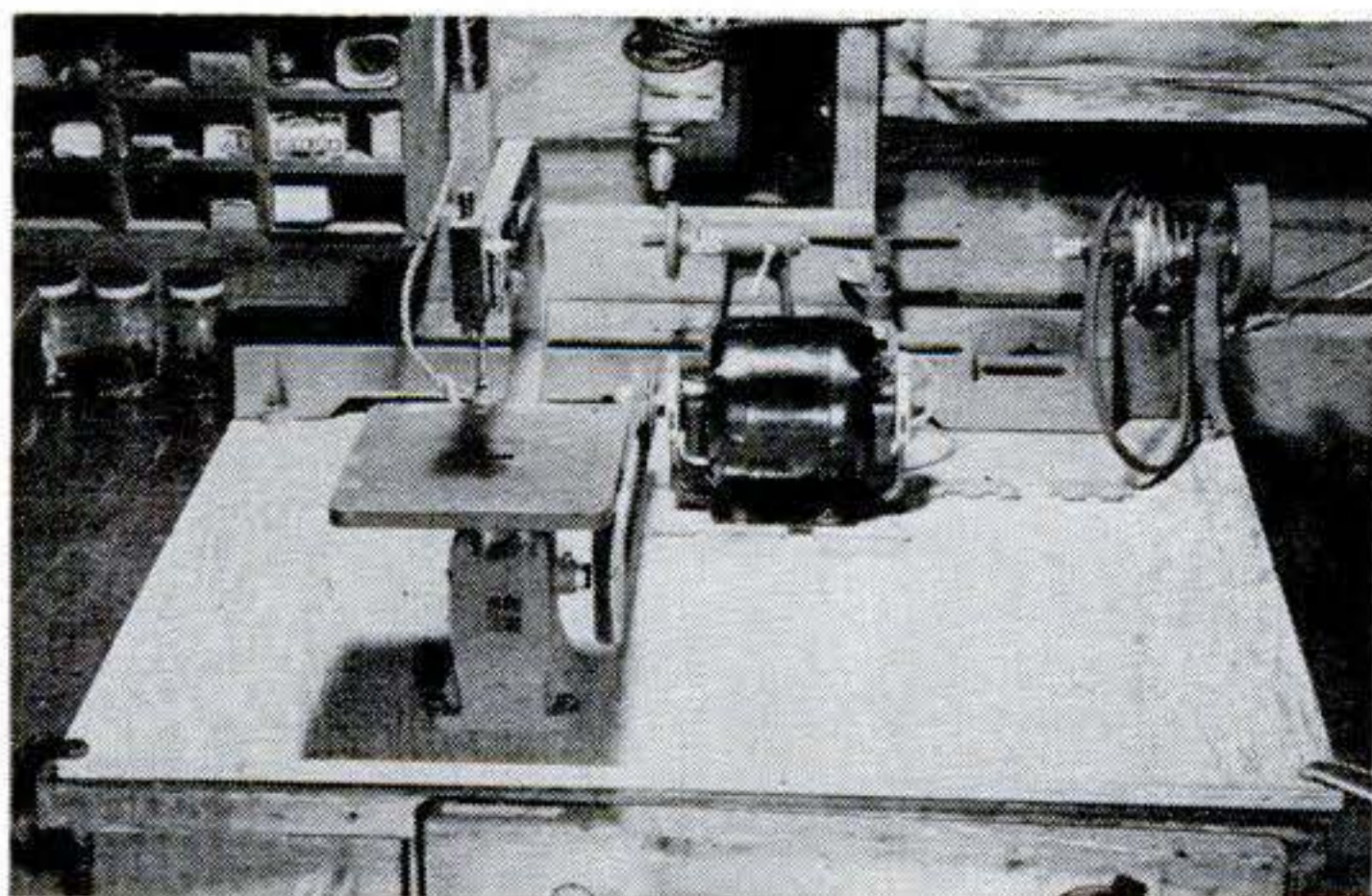

Jigsaw faces front. Note motor position. Bolt-heads are countersunk on underside of panel.

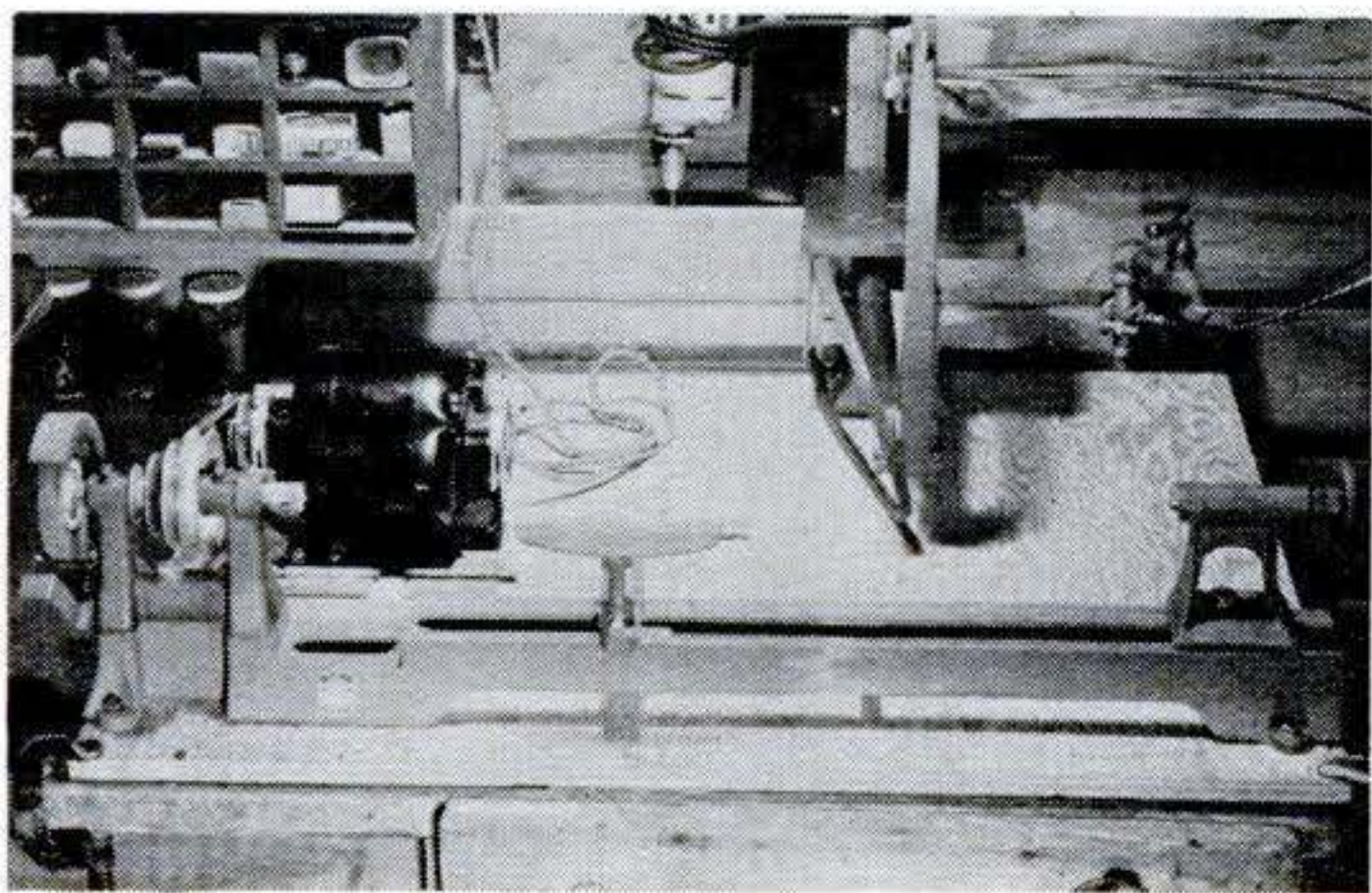

Lathe faces front. Panel has been turned 180° and motor moved. Outboard turning is possible.

**M**Y SHOP is small. Space is always at a premium. Here was my problem:

I had to mount a jigsaw and a wood-working lathe.

One solution was to build separate stands for them. But stands would take up floor space. Another solution was to mount them on top of my workbench. That meant giving up valuable working space.

What I needed was a way to mount the tools so they would be rigid enough to use; make use of the same motor; and yet be easily movable so they could be stowed away when not needed.

The answer was a portable, two-faced bench top that I secure on my regular bench. With one face toward the front, the jigsaw is ready to use. Turn the top around and the lathe is in position.

Two pairs of loose-pin hinges bolted to the bench top locate the motor. One set of hinge leaves is bolted to the motor base. By pulling the pins I can turn the motor to drive either tool. Or I can remove the motor for other jobs.

When I don't need the jigsaw or lathe, I slip the bench top under my permanent bench.—*D. B. Neagley, Merced, Calif.*

# How to Build a

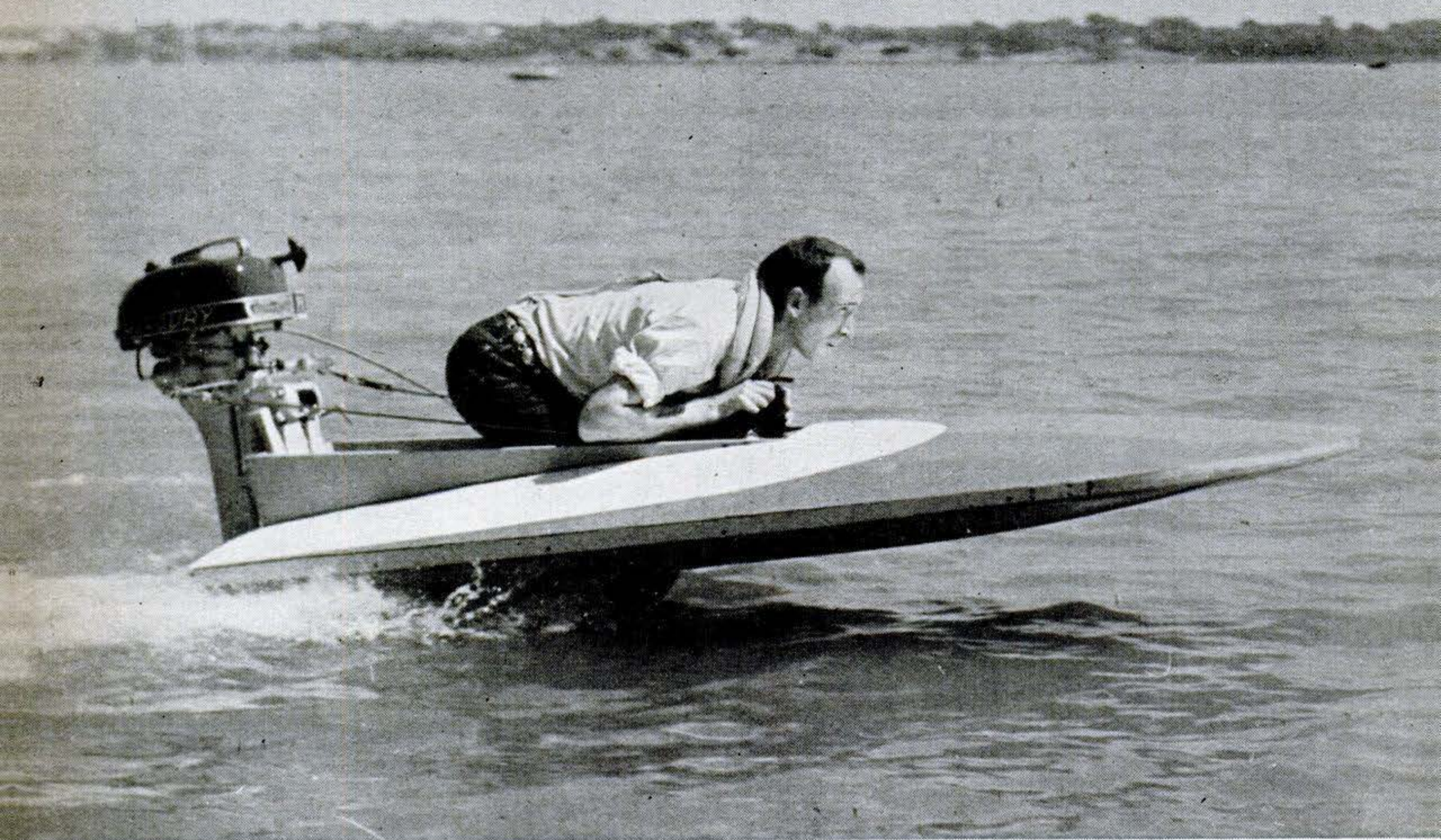

**Few sports give you the sheer thrill of speed that outboard racing does. Even a motor with low horsepower will send this hull skimming across the water.**

**By John Rogers**

**H**OW can I get started in outboard racing?  
How much will it cost?

What kind of a hull do I need?

What kind of a motor do I need?

Put these questions to any 10 drivers of

**The Flying Saucer**, shown below at rest, got its name from its disklike look when seen head on.



racing outboards and you'll probably get 10 different answers.

But here's one answer—one that you can do something about without laying out your life's savings for a racing outfit.

I built this racing hull—I call it the Flying Saucer—for about \$45, including the steering wheel and aluminum fin. With a 7½-hp. Mercury motor, I can hit 30 m.p.h.

Building the hull is simple. I made every effort to avoid difficult construction operations. As you can see from the photos, the deck beams and frames were drilled to make them lighter. This is not necessary, but if you do drill them, don't get the hull's weight below the 75-lb. minimum required by the American Power Boat Association for Class M (midget) outboard hydroplanes.

### *Accessories You'll Need*

The photos and drawings on the next six pages give detailed, step-by-step construction plans. Besides the lumber, you'll need a steering wheel, a fin, and a throttle.

I bought an aluminum fin for about \$2.

# Flying Saucer

Full throttle sends the Flying Saucer skipping over the water. The boat looks like a professional racing hull but doesn't have a step bottom. Absence of step qualifies it for stock-boat racing. Profile and plan drawings below.

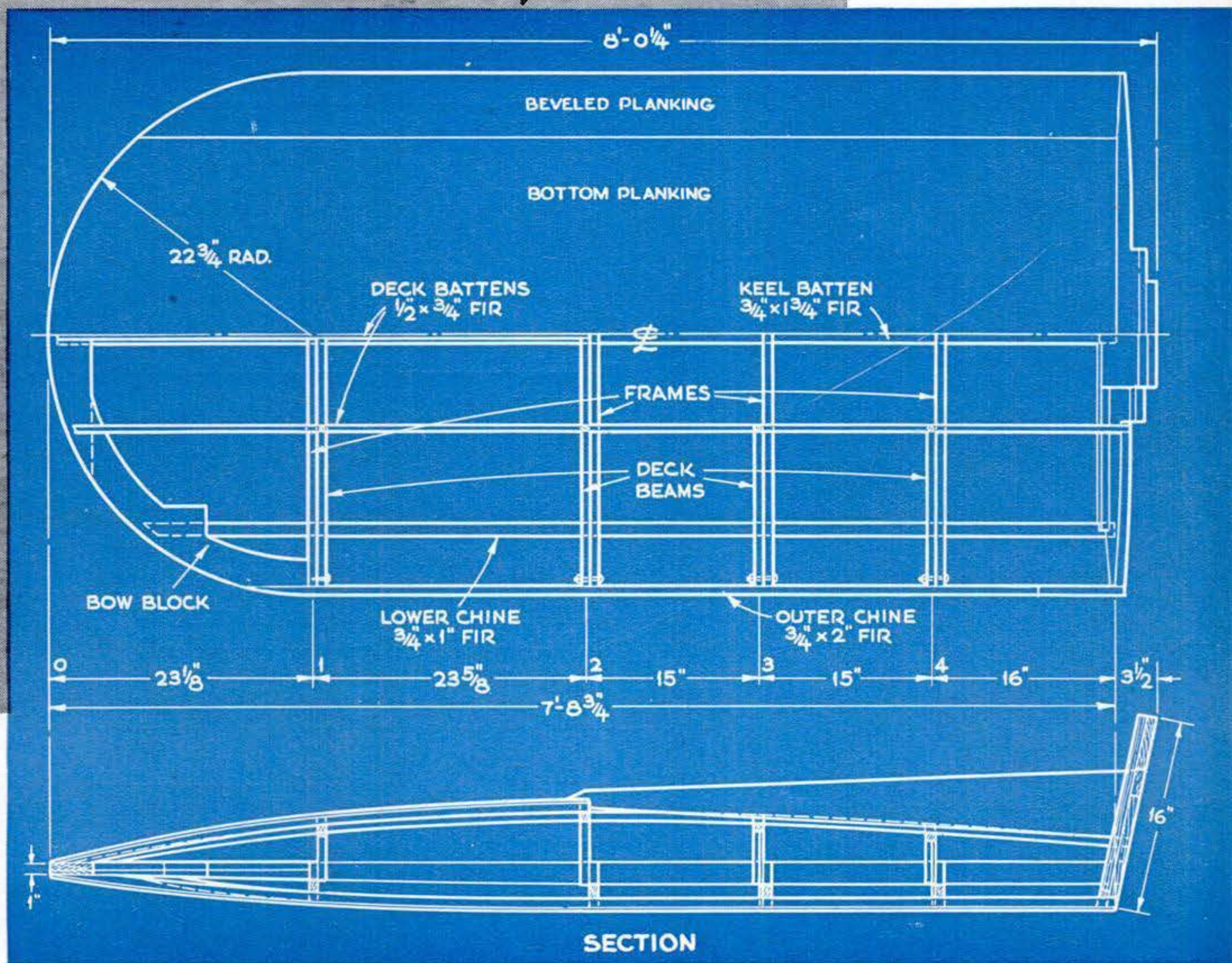

A 4" by 8" fin is the right size for this hull. The steering wheel cost \$10 and the automatic, or crash-type, throttle cost about \$6.

Screw the fin in the exact center of the keel batten. Locate it so the front of the fin is 36" forward of the transom.

### Painting the Hull

I gave the hull—except the deck—three coats of spar varnish. For the deck, I used white and flame-red auto enamel. This enamel has a high gloss and is not harmed by water, sun, oil, or gasoline. It may be waxed just like your car and sheds water like a duck. I used two coats each of red and white to give the deck a two-color job. Sand lightly between coats.

### Lumber You'll Need

- Frames: 1 piece, 1"x8"x8' fir.
- Deck Beams: 1 piece, 1"x8"x8' fir.
- Transom: 1 piece, 1"x10"x6' fir.
- Bow block: 1 piece, 1"x10"x8' fir.
- Keel batten, lower chine battens, deck battens: 1 piece, 1"x6"x8' fir.
- Outer chine battens: 1 piece, 1"x2"x8' fir.
- Bottom planking: 1 panel, 1/4"x4'x8' marine plywood.
- Deck planking: 1 piece, 1/8"x4'x8' marine plywood.
- Brass screws: 2 gross 1" No. 6; 2 gross 3/4" No. 5; 4 doz. 1 1/2" No. 8.
- Waterproof glue. Marine glue.

Turn the page for more pictures of this boat.

FEBRUARY 1951 227

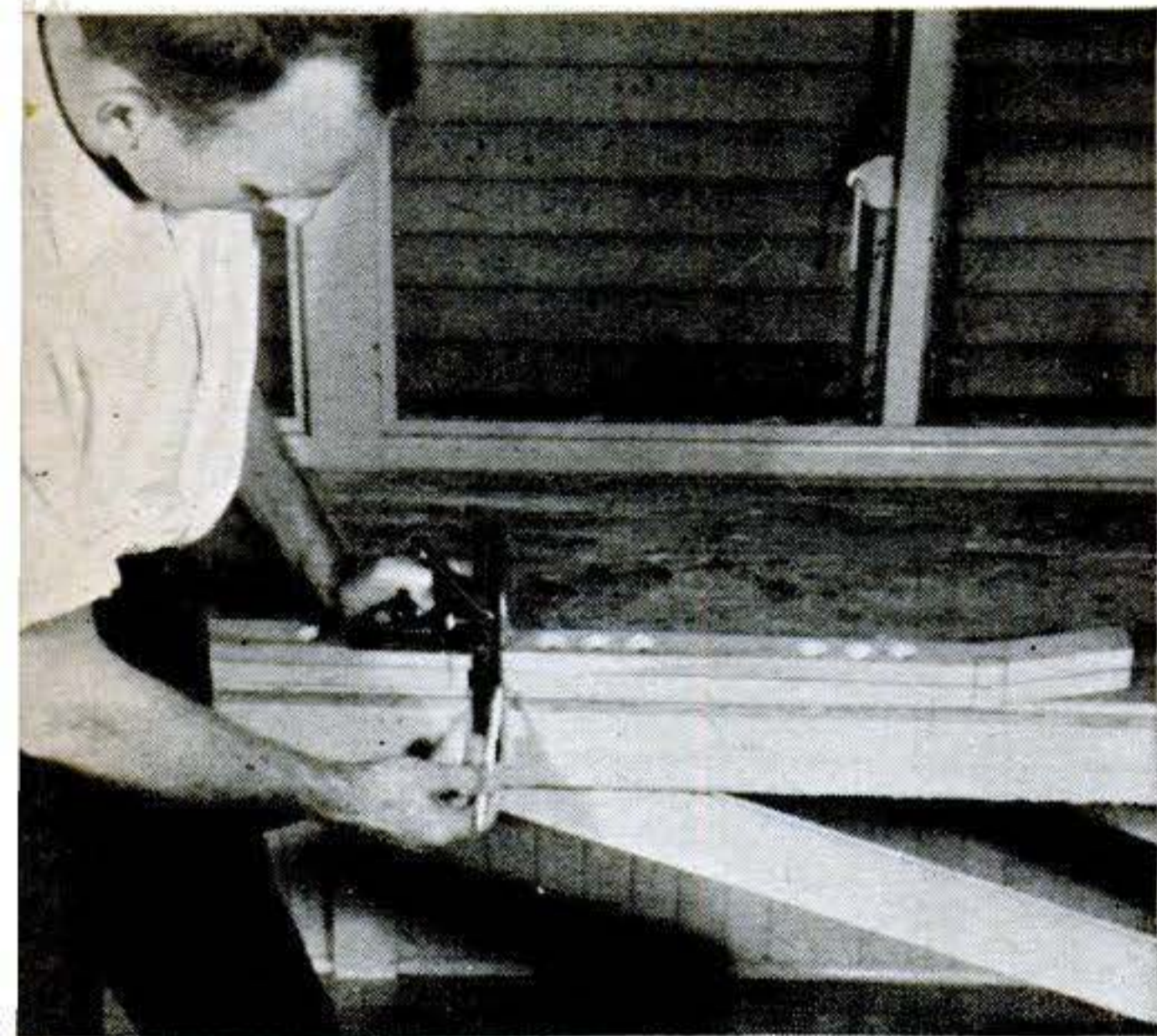

**Frames and deck beams.** The drawings with the squares give you the shape and dimensions of both frames and beams. Note that frame No. 1 measures  $1\frac{1}{2}$ " at its ends. The other frames measure 2" at the ends. This is because the outer chine battens are tapered from frame No. 2 toward the bow. After you have the frames and beams cut out, trace the location of all notches for the battens on one frame and one beam. Then transfer the locations to the other frames and beams, as shown above. That way all notches will match. Frames and beams are bolted together in one of last steps of hull assembly.

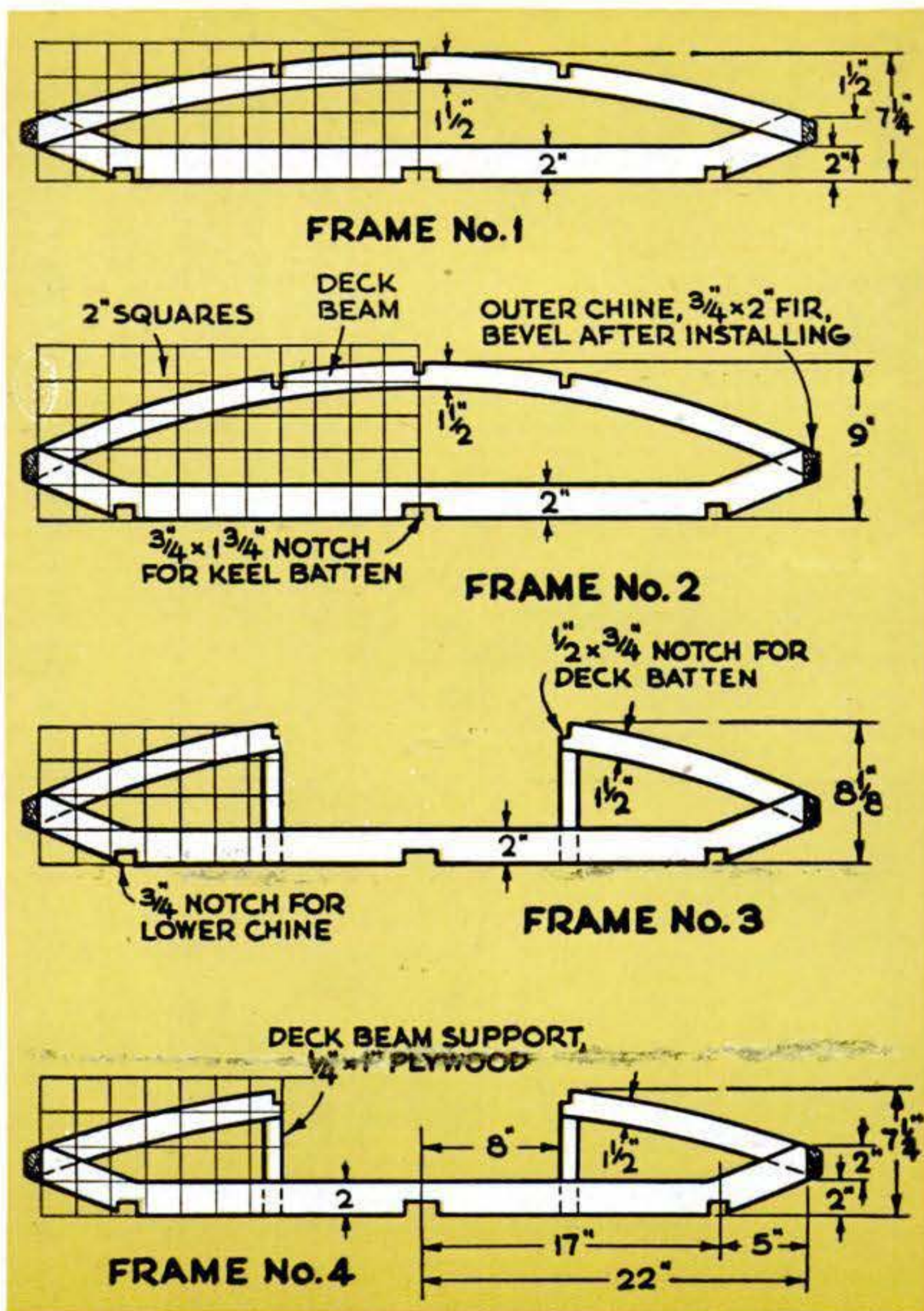

**Transom.** Lay out this stern piece from the drawing below. You have both plan and profile views. The profile shows you the  $102^\circ$  angle at which the battens meet the transom. Cut the angles carefully so the planking will be a smooth, tight fit. In the photo at right, the angle of the top of the transom is being checked. Notches for battens and chines have not been cut, but the  $\frac{3}{4}$ " by  $1\frac{1}{2}$ " strip to strengthen base of transom has been added with glue and screws. Bottom of this piece must be beveled to match angle of transom's bottom. Attach the motor board with waterproof glue and  $\frac{1}{8}$ " brass bolts,  $2\frac{1}{2}$ " long. Then build up the back of upper part of motor board with  $\frac{3}{4}$ " fir as shown, attaching the pieces with glue and bolts.

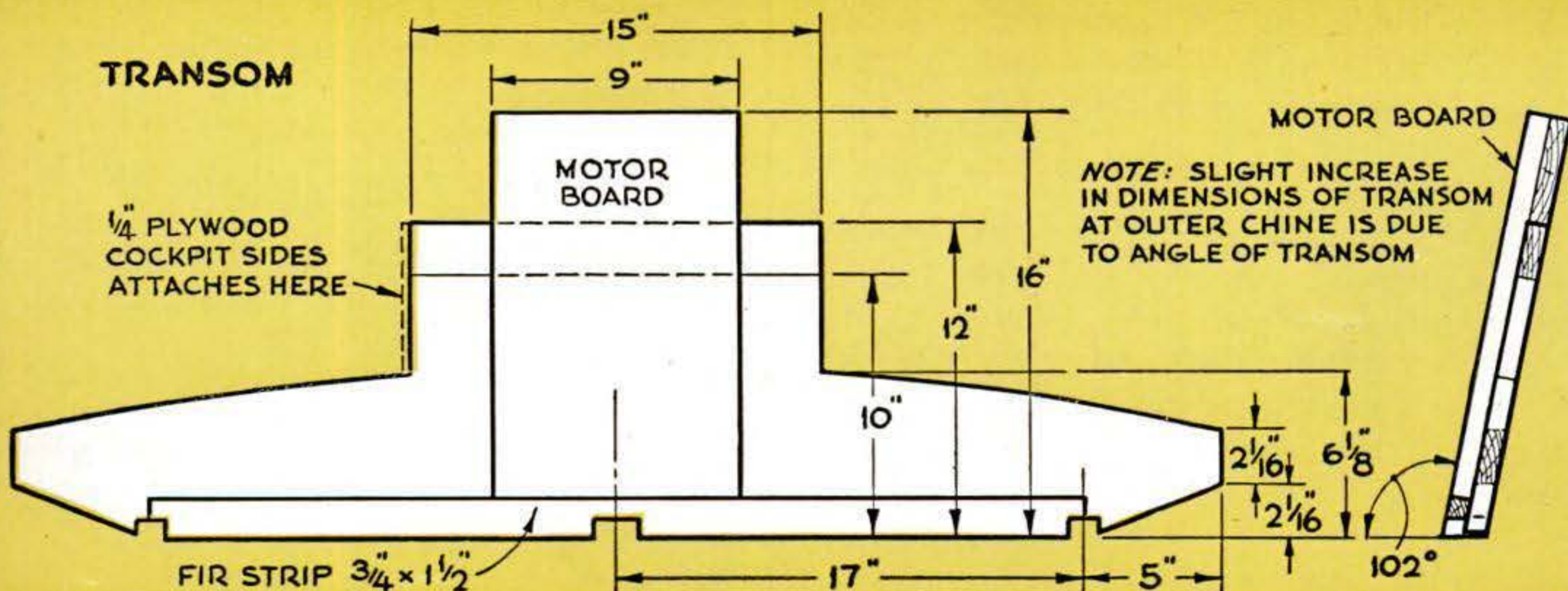
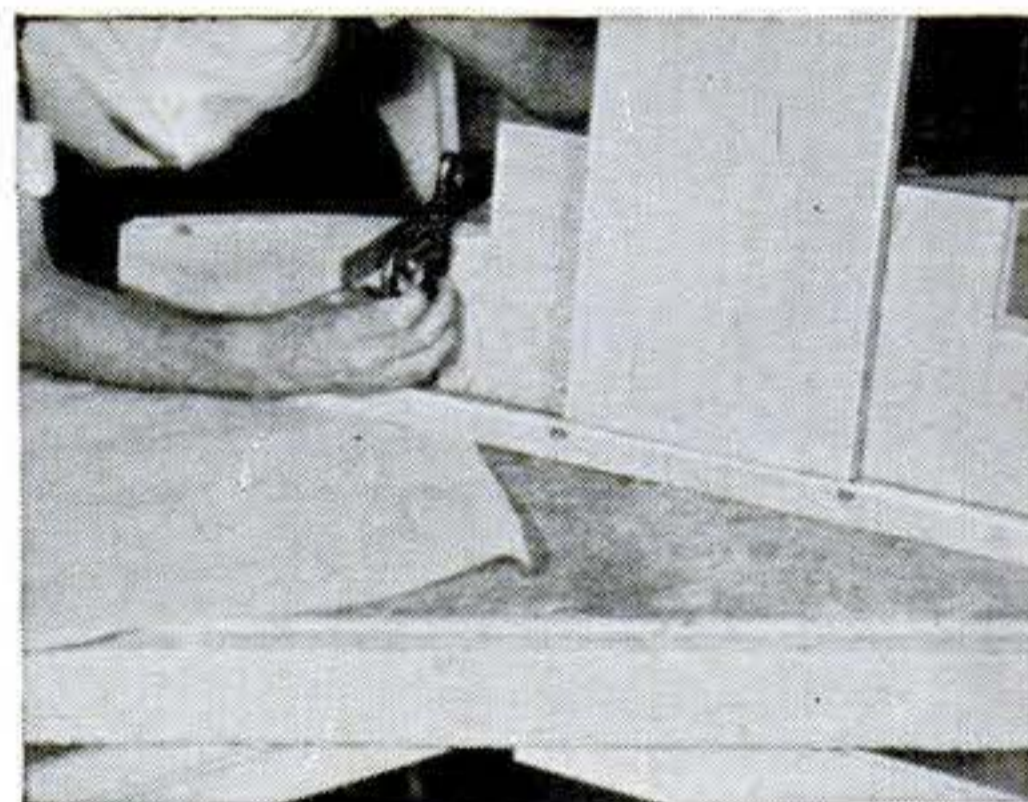

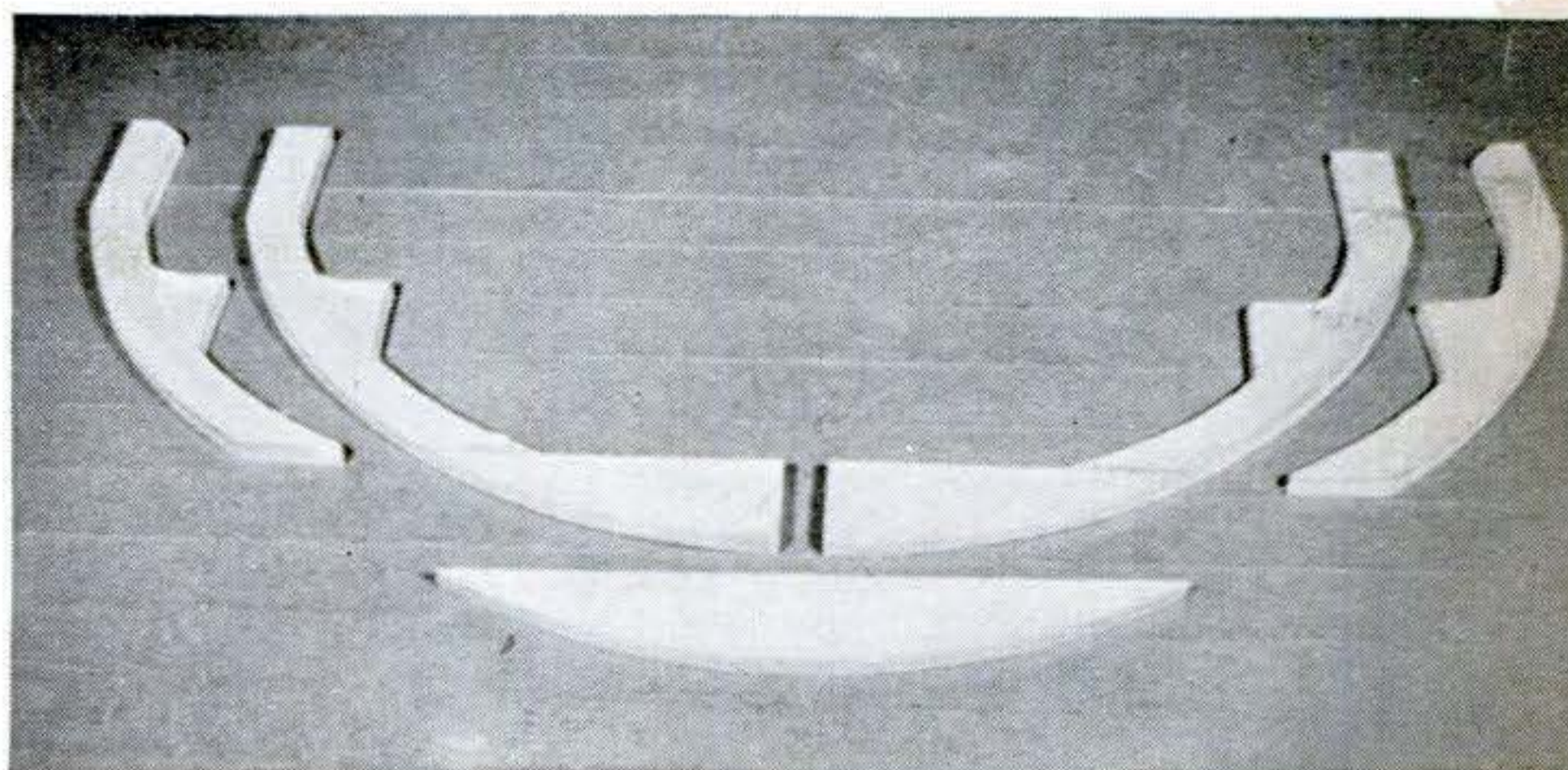
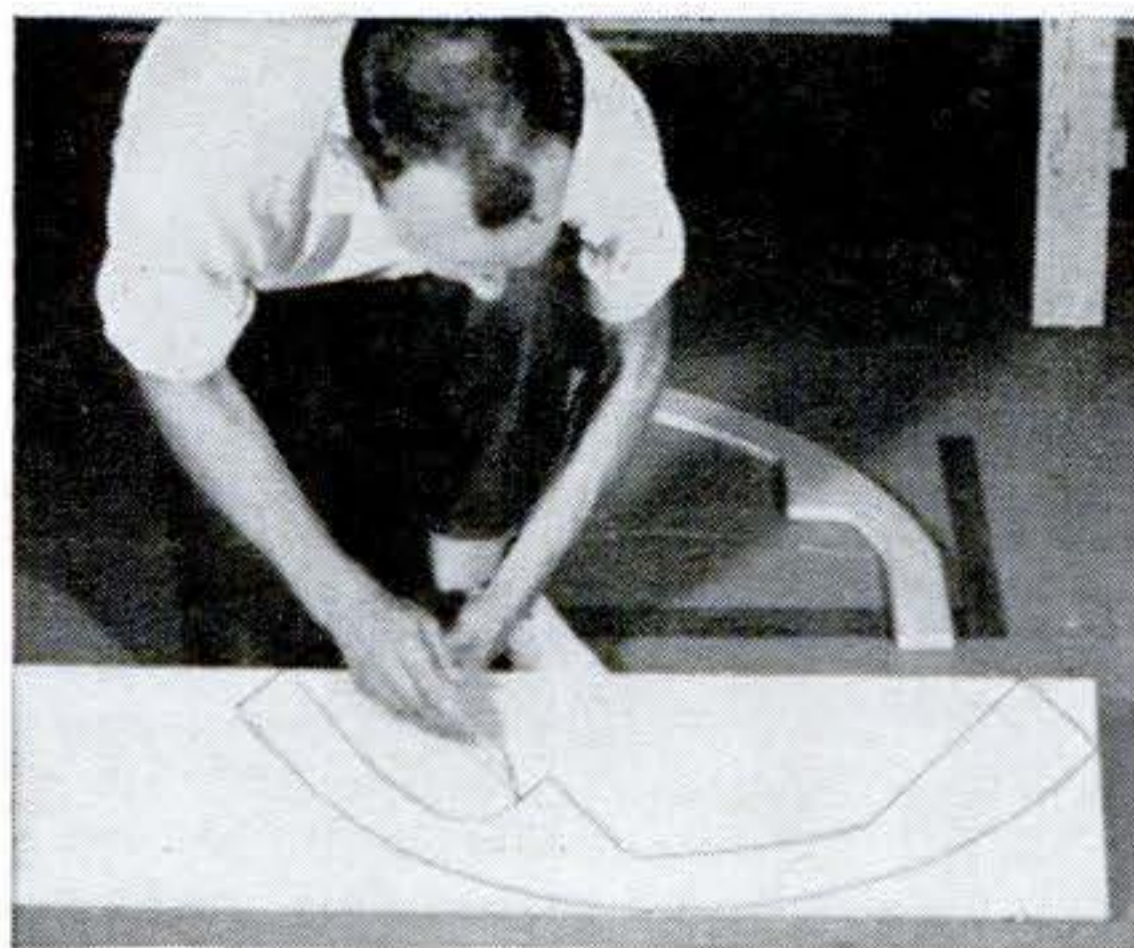

**Bow block.** This part is laminated from two thicknesses of  $\frac{3}{4}$ " fir. Five pieces, as shown above, make up the block. The drawing at right gives you the shapes and dimensions of the parts. The two main pieces can be cut from the 10" by 6' fir plank. The other parts can be cut from leftover material. Use waterproof glue and clamp the pieces together to form the block. Let the glue set overnight. The profile drawing of the frame shows how the thickness of the bow block tapers from  $1\frac{1}{2}$ " at frame No. 1 to 1" at the very front of the bow. Lay the block on a bench and taper it with a jack plane. Taper only one side. The side you taper will be the bottom of the bow block.

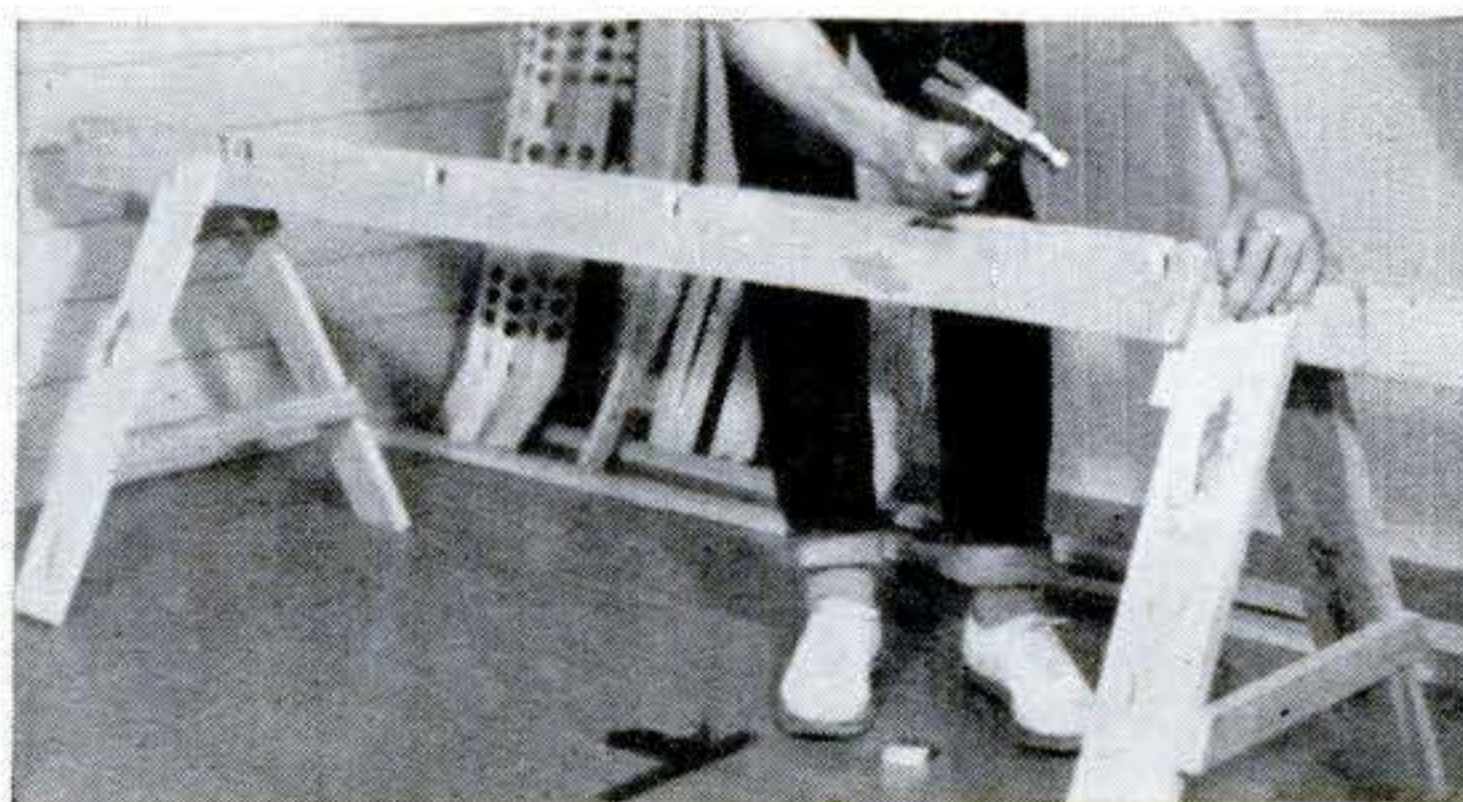
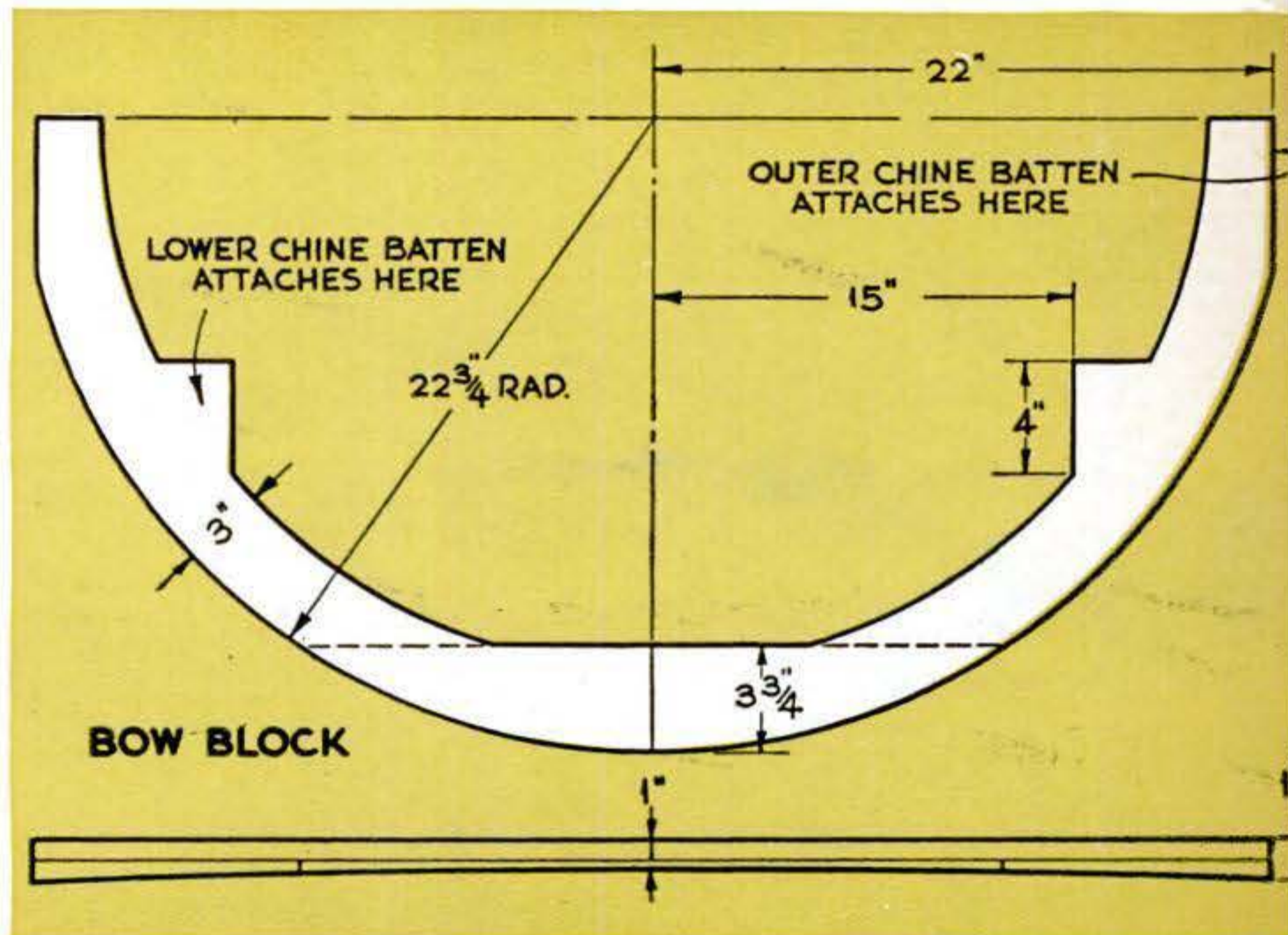

**Framing jig.** This is made from a two-by-four, 8' long. Select a straight two-by-four and lay out the notches as shown in the drawing below. The squares on the drawing show you the shape of the curve that begins at frame No. 2 and continues to the bow. Mark this curve on the two-by-four and saw it to shape. Then nail legs to the jig so it looks like the photo at left. Add the strips to support the bow block and the transom—as shown in the drawing below—and the jig is completed. Be sure the jig is level and solidly built.

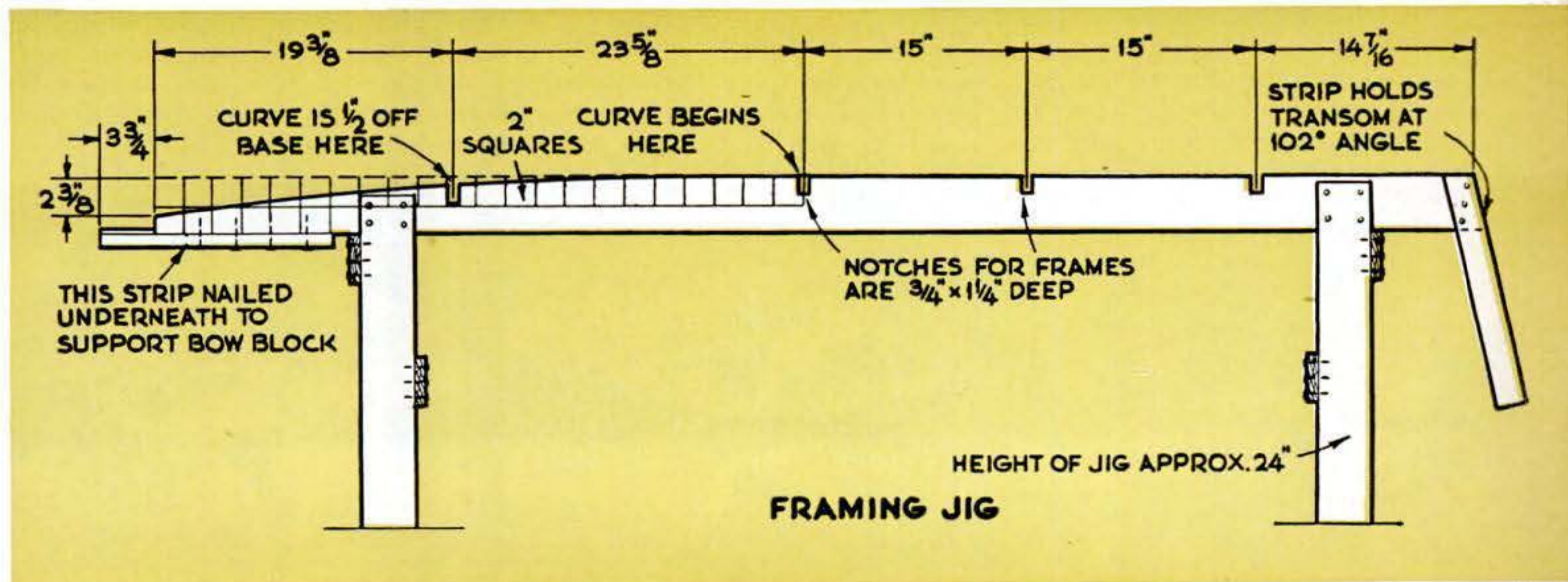

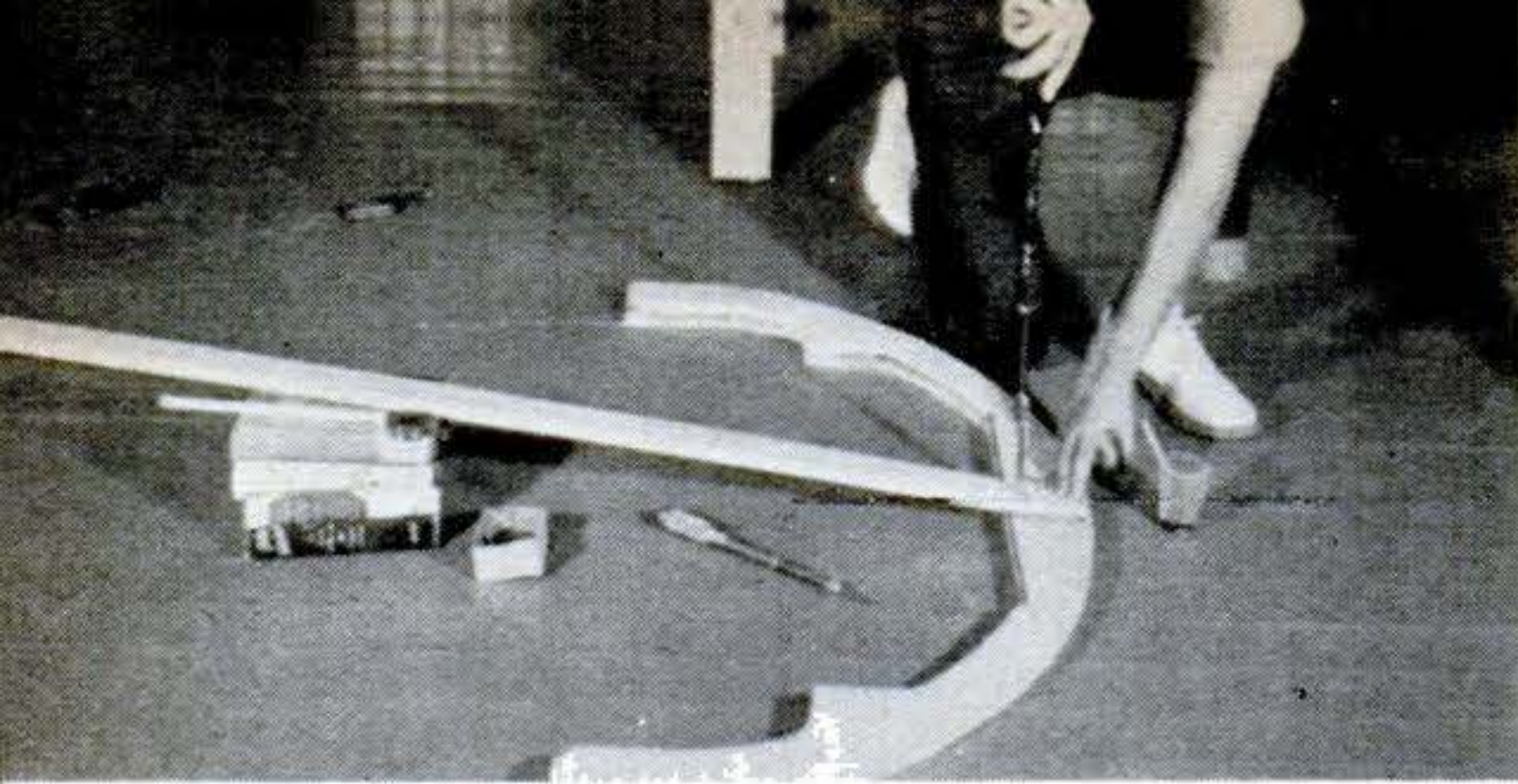

**Keel-batten assembly.** After ripping the keel batten to size, cut one end of it to a 10° angle where it meets the bow block. Lay the bow block on the floor, bottom up, as shown above. Support the keel batten and attach it to the bow block with waterproof glue and two 1" No. 6 and two 1½" No. 8 screws. Then place the frames in their notches on the jig. Clamp the transom to the support that you have nailed to the stern end of the jig.

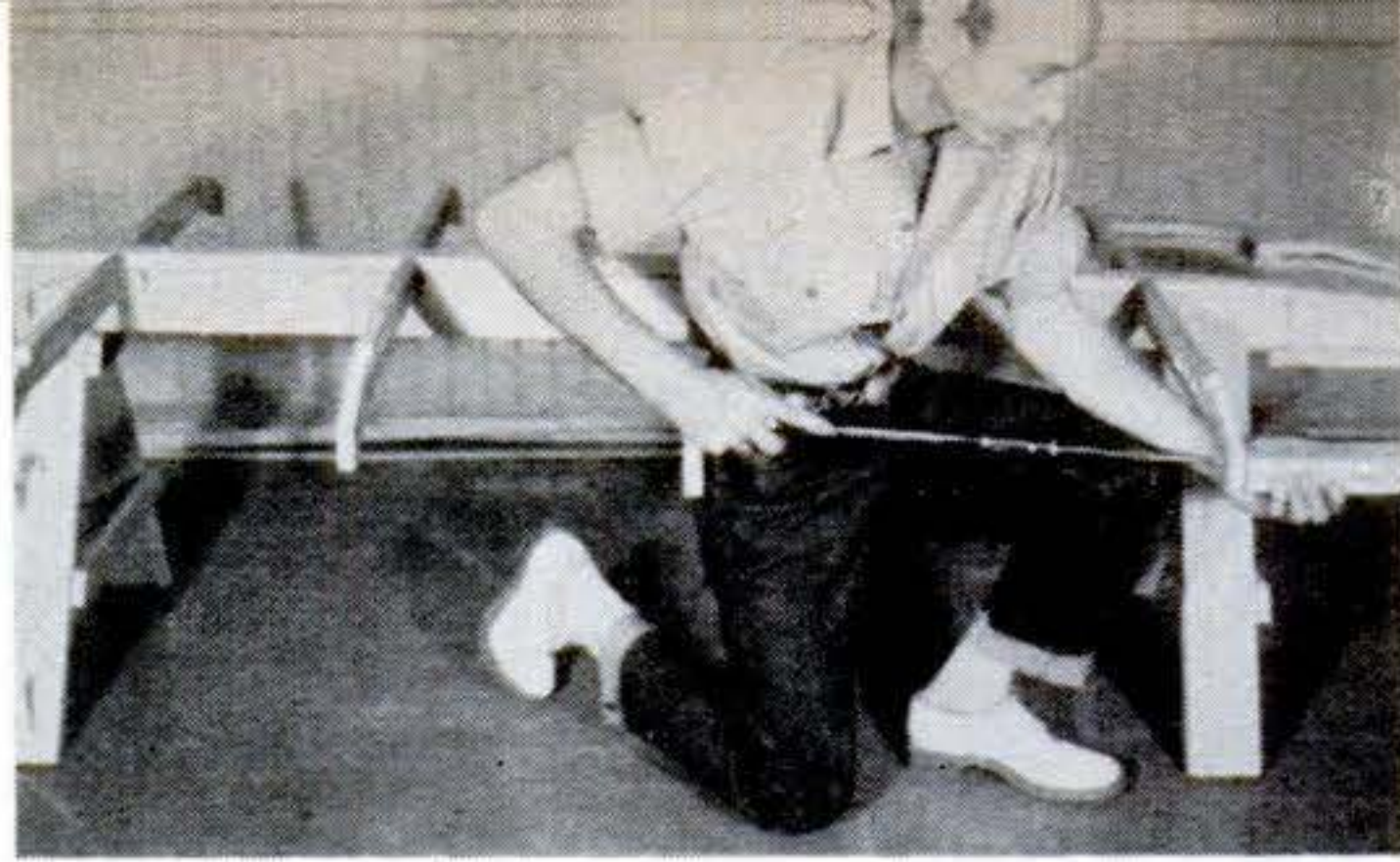

**Bow-block and keel-batten assembly.** Pick up the assembled bow block and keel batten and place the block on the framing jig. Clamp the bow block in position. Apply the marine glue to the center notch in each frame. Bend the keel batten down into the notches and clamp it. Then fasten the keel batten with two 1½" No. 8 screws into each frame. Attach the bow block to frame No. 1—as shown above—with waterproof glue and 1½" No. 8 screws.

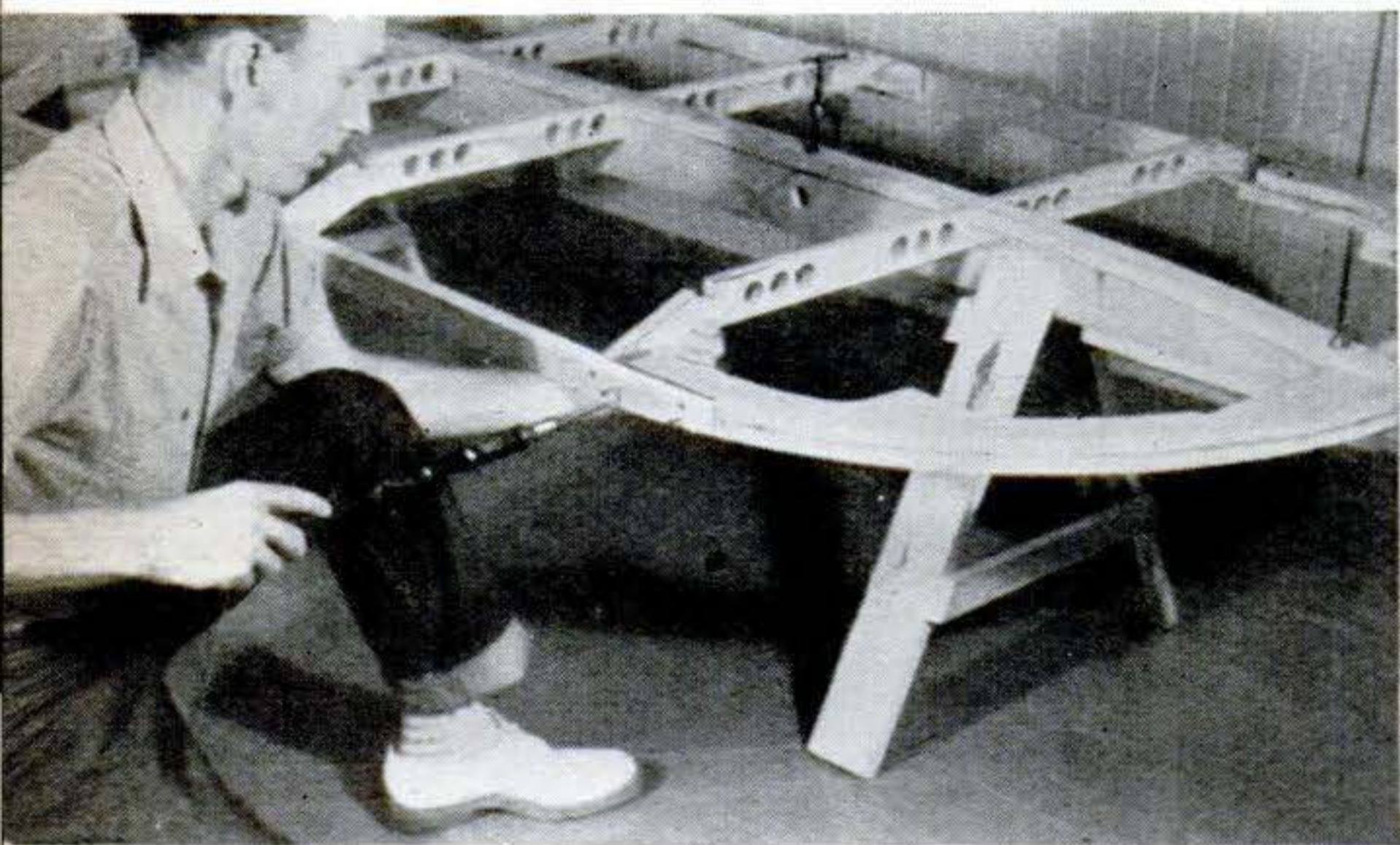

**Outer chine-batten assembly.** Mark the exact location of each frame on the outer-chine battens. Then when they are attached, the frames will be correctly placed. Excess material may be left on the stern end of the battens and sawed off after assembly. Taper the outer chine battens from 2" at frame No. 2 to 1½" at frame No. 1. Do the tapering on the bottom of these battens. The deck side remains perfectly straight. These battens extend 6" in front of frame No. 1, and are faired into the bow block. Attach the outer chine battens to the transom and to each frame, as shown in the photo at left, with marine glue and two 1½" No. 8 screws. Add two 1" No. 6 screws where the battens meet the bow block.

**Lower chine-batten assembly.** One end of these battens must be beveled 10° to fit the bow block. Apply marine glue there and clamp the beveled ends to the bow block. Then anchor the ends to the block with three 1" No. 6 screws, as shown in the photo at right. Use glue and 1½" No. 8 screws to fasten these battens to their notches in the frames and to the transom. Put one screw into each notch.

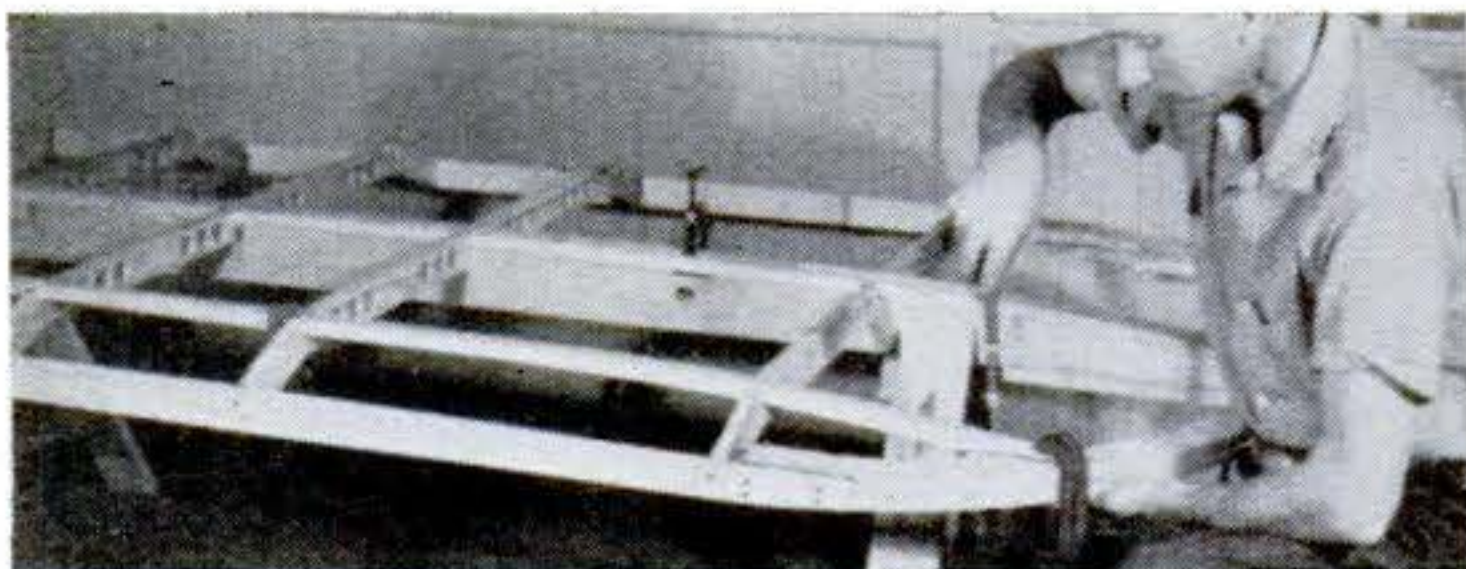

**Finishing the frame assembly.** The final step before applying the bottom planking is beveling and trimming the outer and lower chines but not the keel batten. Then the bottom planking will fit evenly. Go over the members with a

plane—as shown below—to make sure the planking will fit snugly. Center photo shows you a bow view of the completed frame assembly, while the photo at right shows a stern view. Note holes in frames to lighten hull.

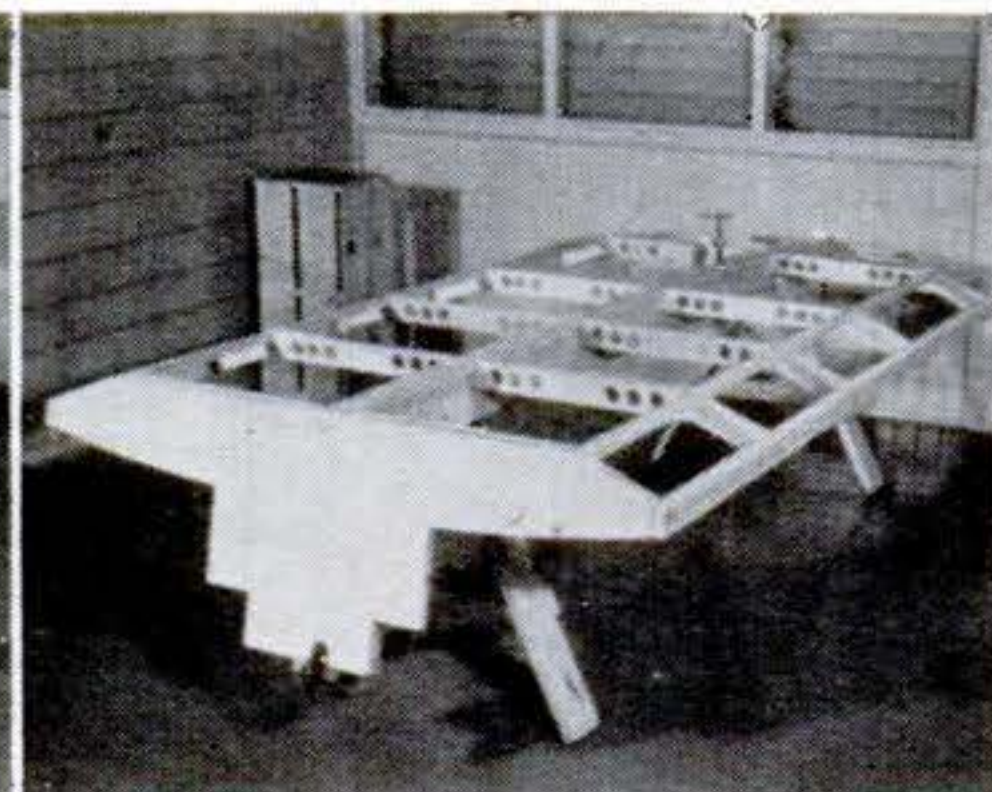
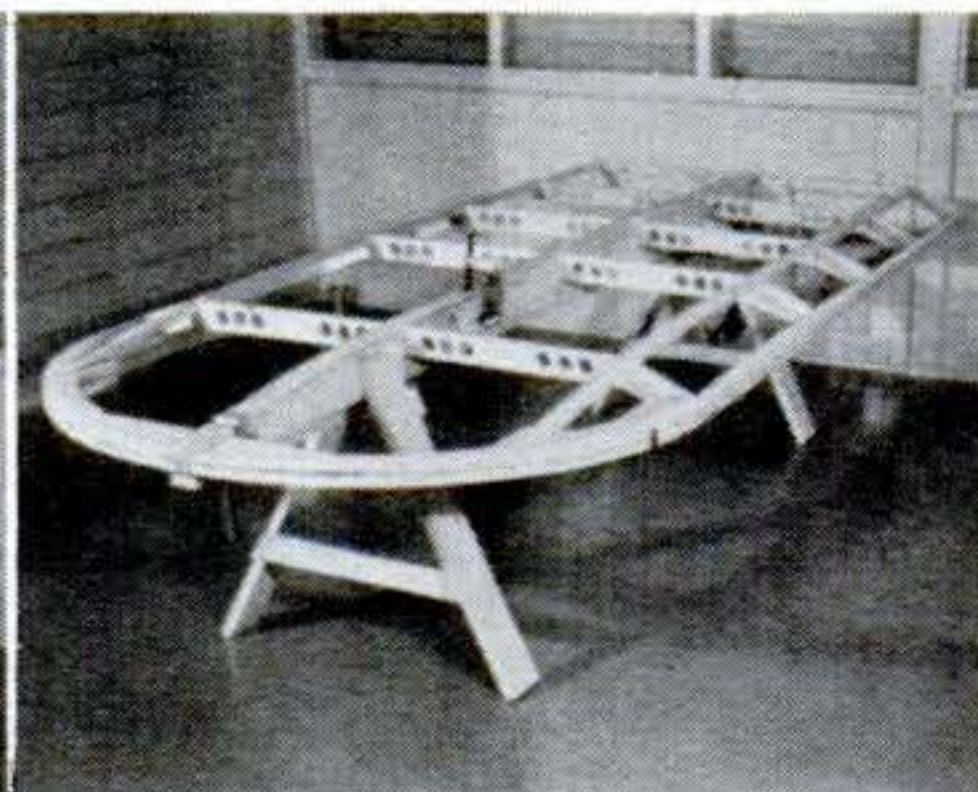
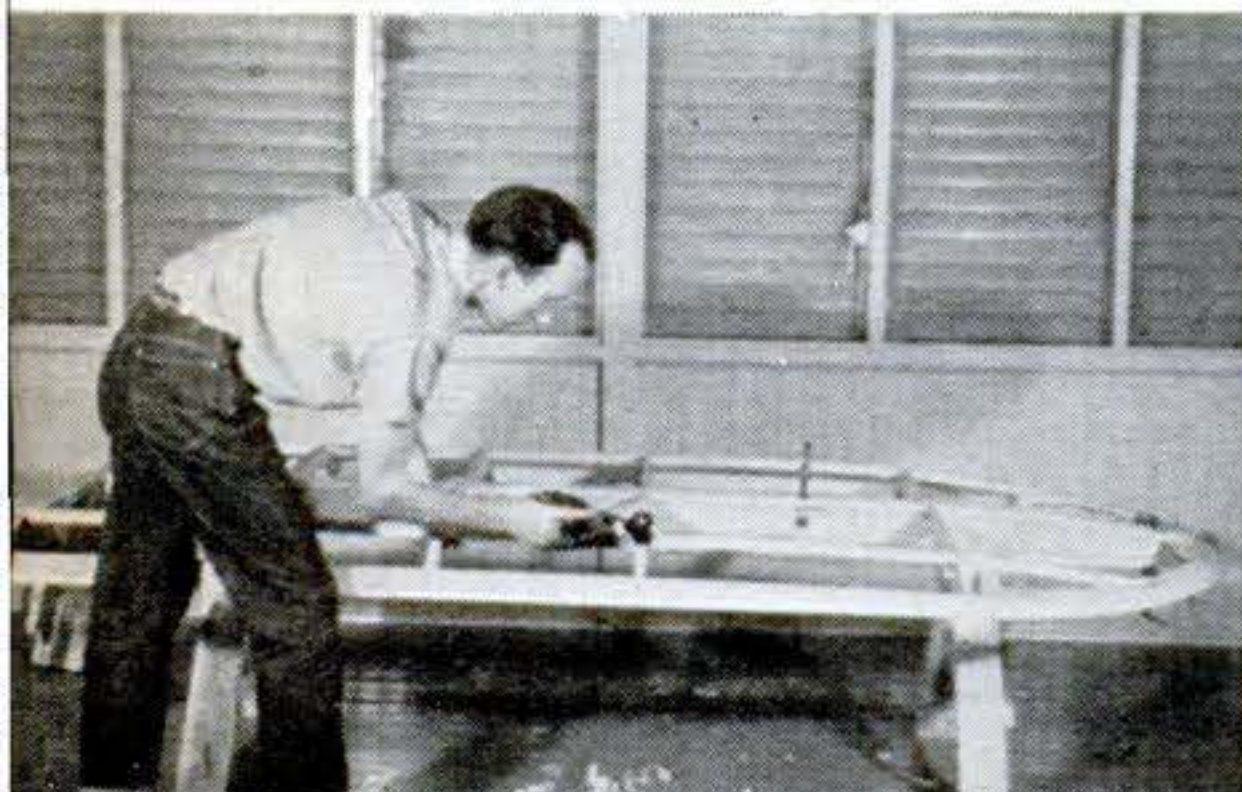



**Beveled planking.** The three parts of the bottom planking are cut from one 4' by 8' panel of  $\frac{1}{4}$ " marine plywood. Be very careful in ripping this panel; it makes the bottom planking with very little waste. Rip two strips  $6\frac{1}{4}$ " wide off the panel. These narrow pieces are attached to the frames, chines, and transom, as shown at right. Apply a liberal coat of marine glue to frames and chines. Then clamp the plywood in place. Attach to all frames, chines, and transom with 1" No. 6 screws. Space the screws 2" apart.

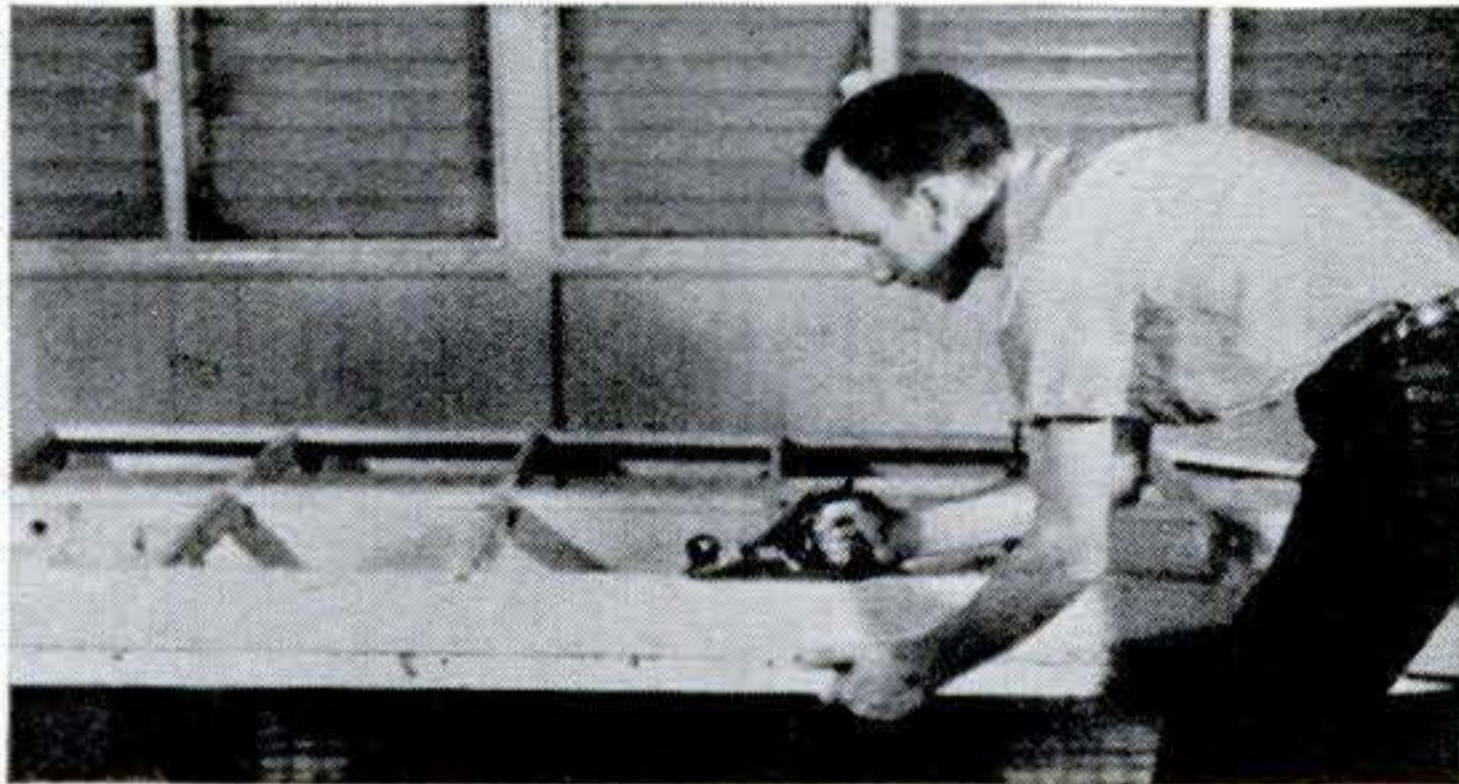
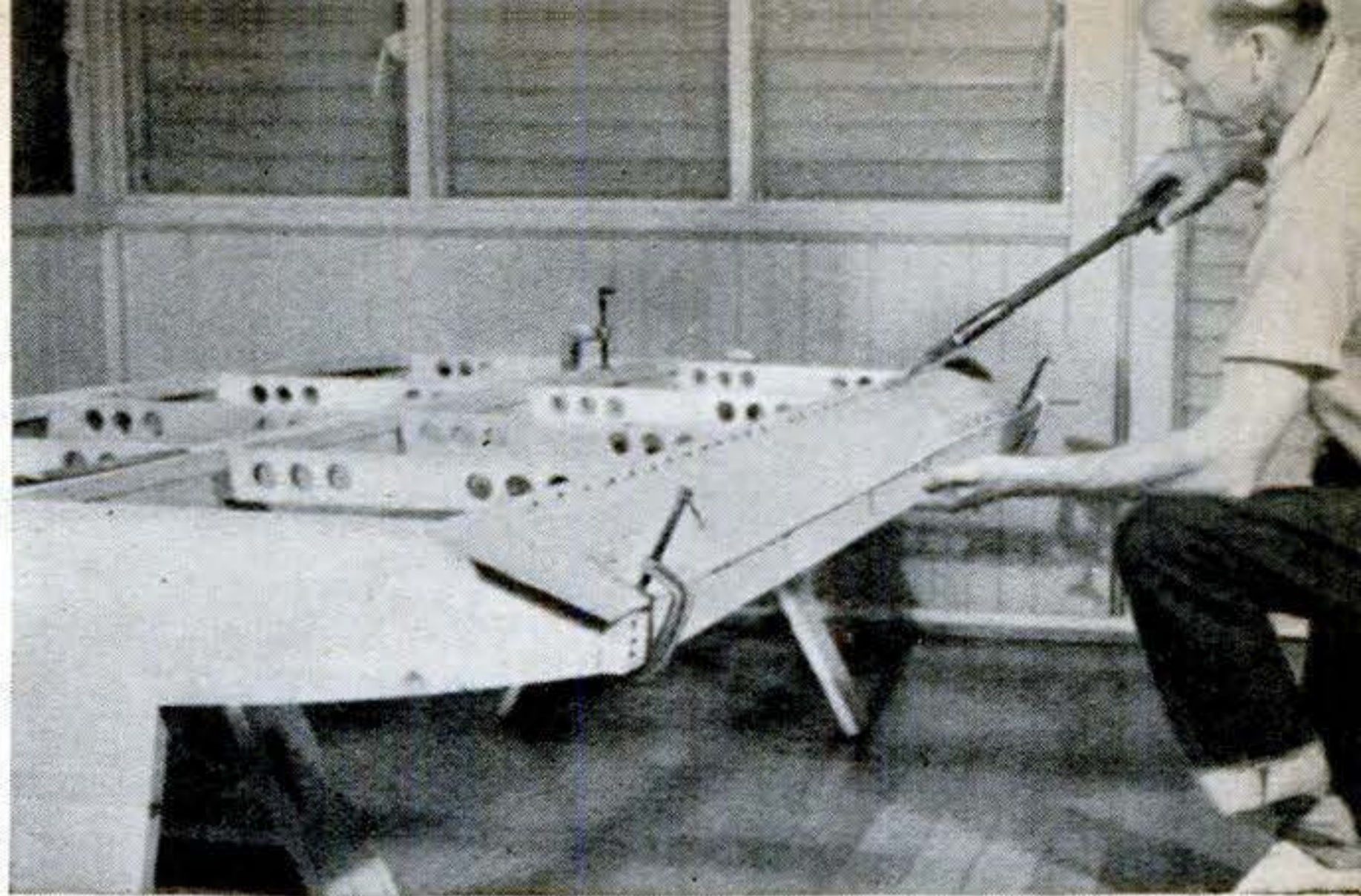

**Trimming beveled planking.** After all screws have been driven into the two narrow pieces of beveled planking, saw off the excess material at the ends of the strips flush with the back of the transom and around the curve of the bow. Hold a plane so its bottom is parallel with the side of the outer chine batten and trim off the edges of each strip until it is flush with the outside of the outer chine batten. Follow the same procedure where the plywood is attached to the lower chine batten, planing it flush as shown in the photo at left.

**Bottom planking.** This is what remains of your 4' x 8' panel of  $\frac{1}{4}$ " marine plywood. Apply marine glue to the transom, battens, and frames. Place the bottom in position and clamp it to the bow block. Use 1" No. 6 brass screws 2" apart to attach the bottom. Drive screws along the keel batten first. Then drive screws along the lower chine battens, as shown in the photo at right. Saw off the excess material at the transom and bow. Do not bevel the outside edges of this piece of plywood. Leave it square. Finally, sand the entire bottom. Start with No. 1 paper and finish with 1/2 and 1/0 paper. Brush a coat of spar varnish over the bottom, outer chines, and transom. This first coat should be thinned with turpentine.

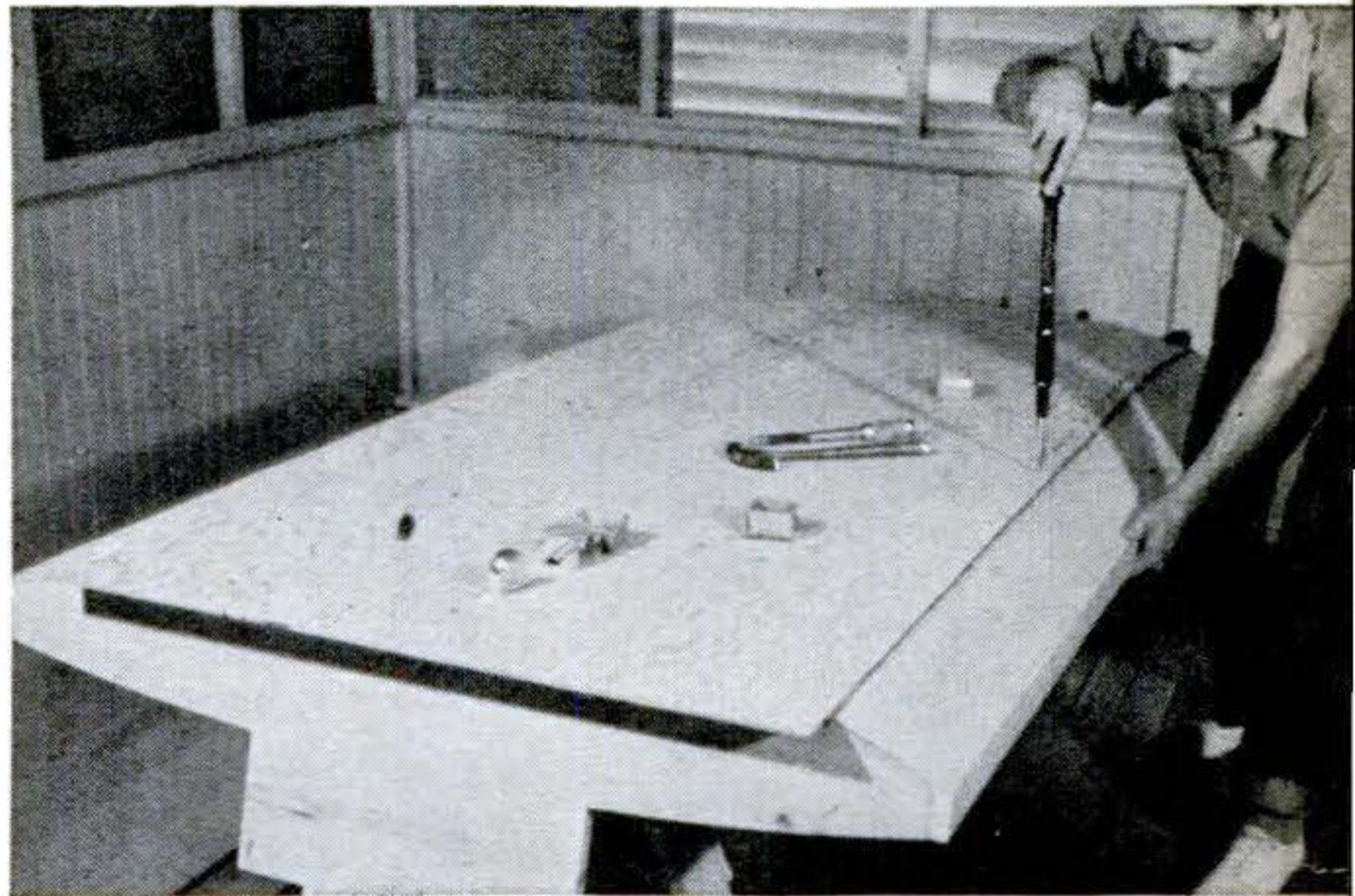

**Deck beams and battens.** With the bottom finished, turn the boat over. Bolt the deck beams to the frame with  $\frac{1}{8}$ " by  $2\frac{1}{4}$ " brass carriage bolts. Use  $\frac{3}{4}$ " No. 5 screws and glue to attach the vertical supports to beams No. 2, 3, and 4. You can see these supports in the photos below. Two deck battens run the length of the boat.

The center batten runs from deck beam No. 2 to the bow. Fit all three in their notches with glue and attach them with 1" No. 6 screws. The ends of the battens are beveled where they meet the bow block. Use a plane and sandpaper to see that battens fit flush with beams. Coat inside of hull and beams with spar varnish.

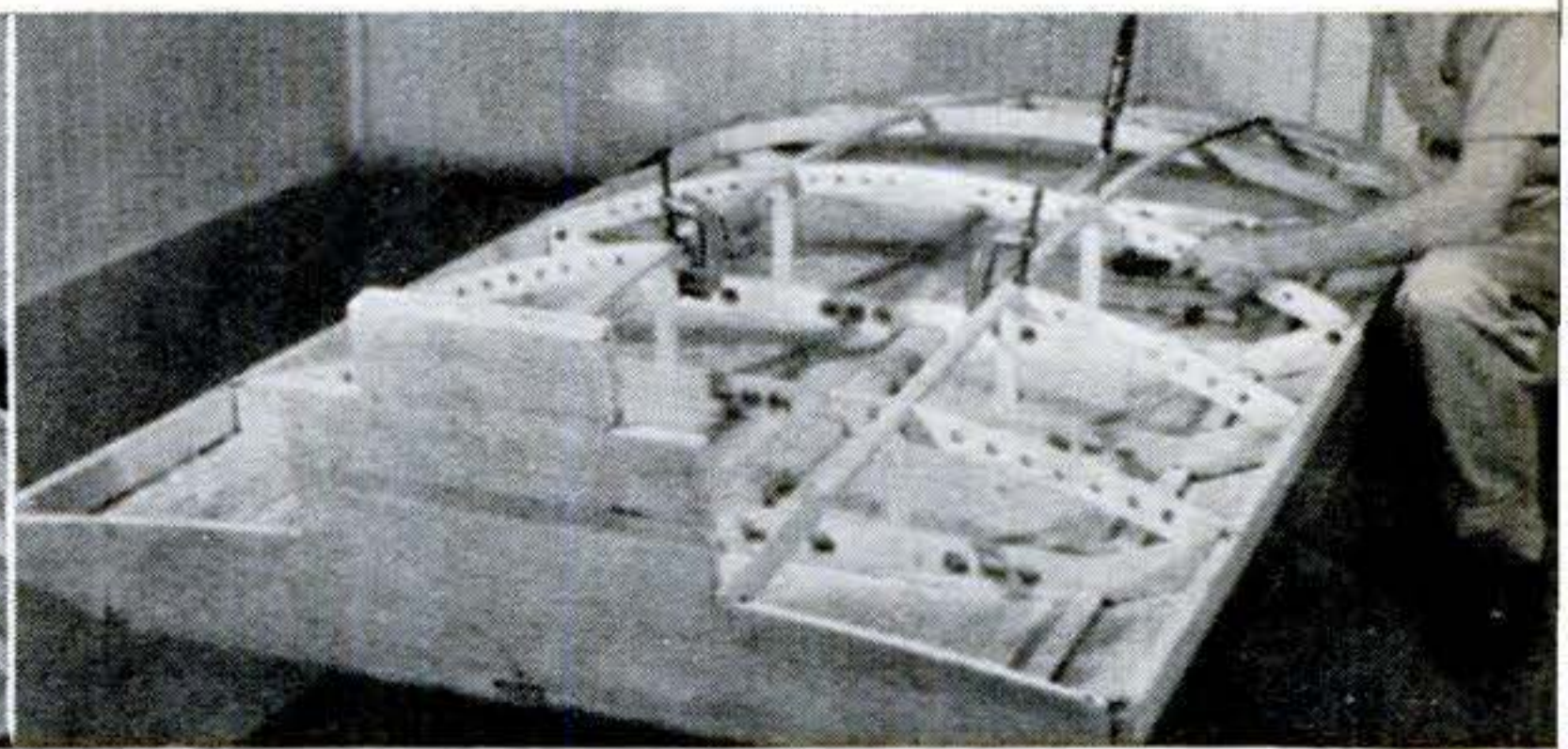
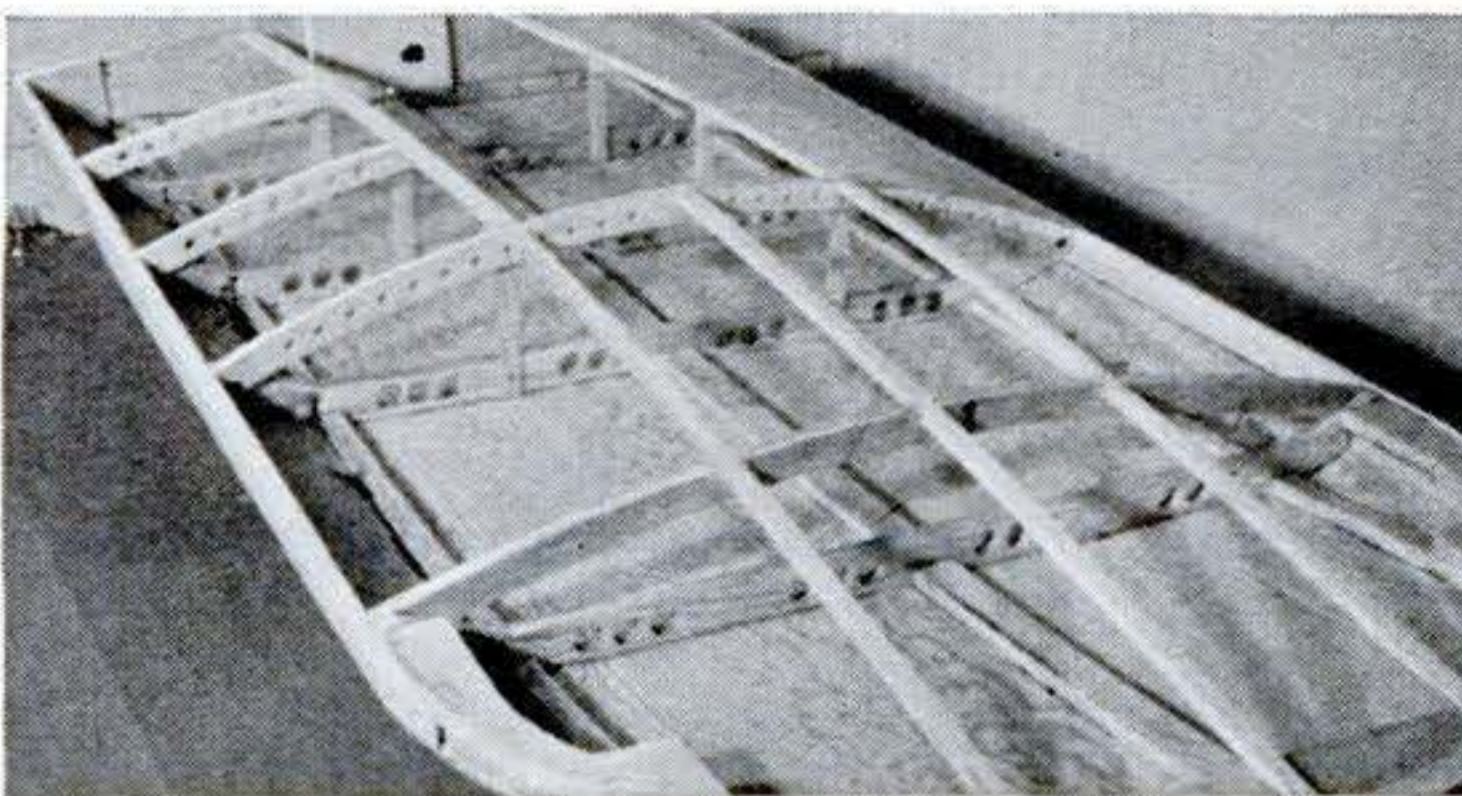

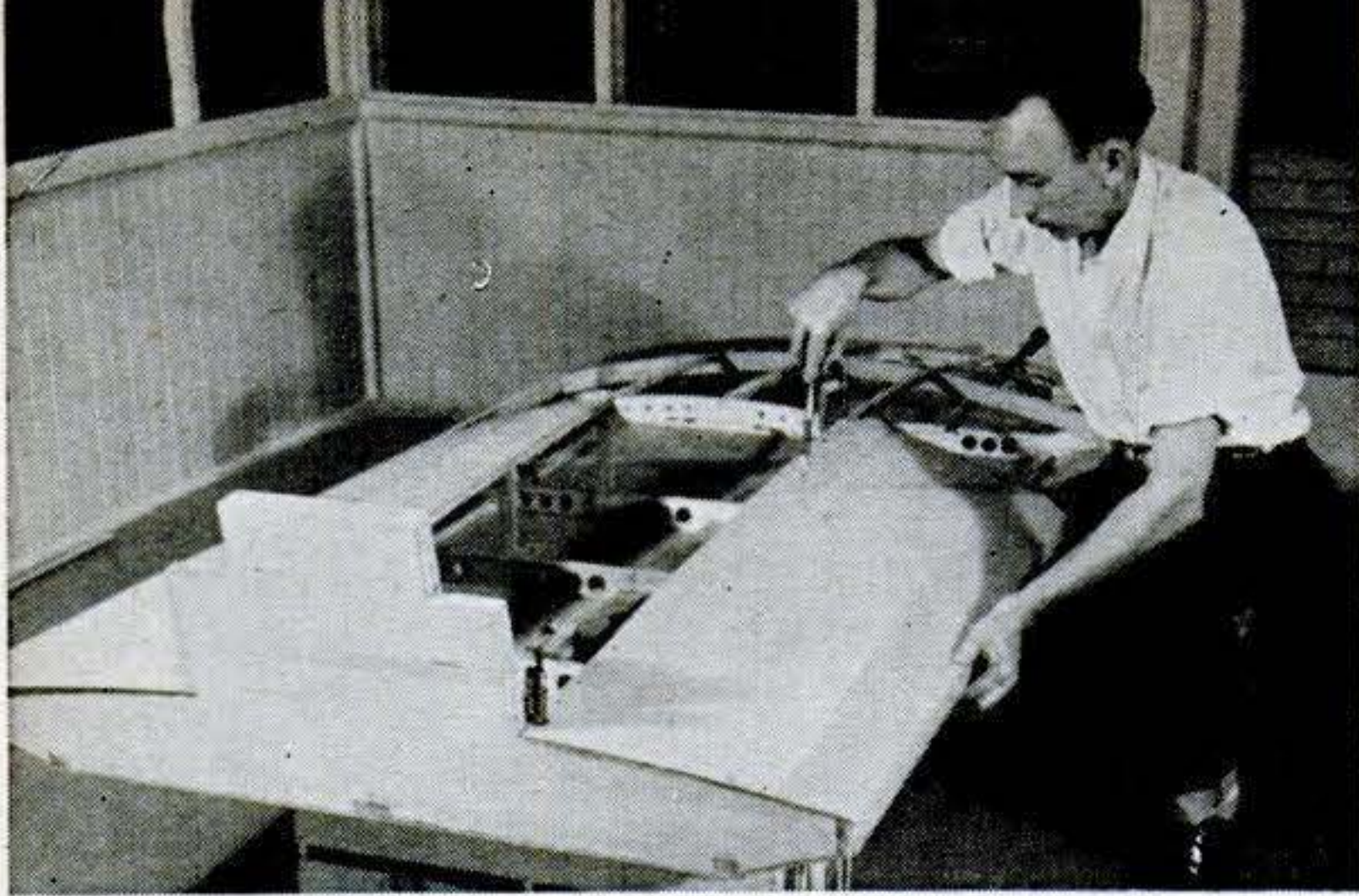

**Deck planking.** This is  $\frac{1}{8}$ " marine plywood and it is put on in four pieces. One piece goes on each side of cockpit (above) between transom and the center of deck beam No. 2. The other two pieces fit between beam No. 2 and the bow. The two forward pieces meet in the center of the center batten. Lay the plywood on the deck frame, reach under and mark the shape. Cut out with a sharp knife; sawing tends to splinter the thin veneer. Attach the plywood to beams and battens with marine glue and  $\frac{1}{4}$ " No. 5 screws. Place screws 2" apart. Leave about  $\frac{1}{2}$ " of extra plywood around the outside edges when you cut out the deck pieces. Trim off excess after plywood has been screwed in place. On the forward planking, screw it to deck beam No. 1 first, then to center deck batten, to bow block, and to other deck batten.

**Cockpit.** The sides of the cockpit are made of  $\frac{1}{4}$ " marine plywood. Apply glue to the edges of the transom and to the deck battens where those parts meet the cockpit sides. Attach the sides with 1" No. 6 screws, placed 2" apart, as shown in the photo below. To give yourself a comfortable place to crouch when you race the hull, nail floor boards of  $\frac{1}{4}$ " plywood over the frames on the bottom of the cockpit. You can make a duckboard for the cockpit bottom instead of the permanent floor boards. The bow end of the cockpit sides are notched to fit over frame No. 2. Paint the sides of the cockpit white to match rear of deck.

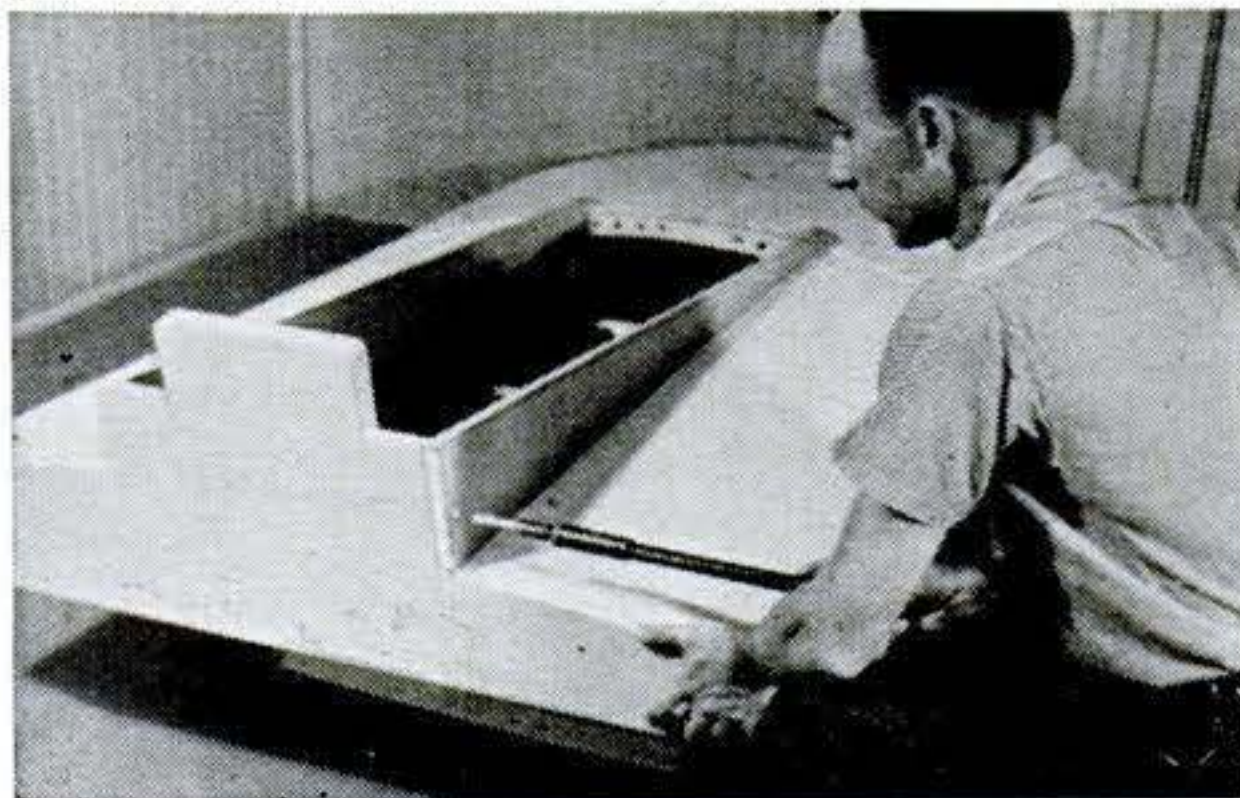

### Support Keeps Framing Square Steady

WHEN you square long boards with a framing square, the square has a tendency to rock. This can be prevented by supporting the body of the square on the board with a small metal guide mounted as shown. — William B. Eagan, Louisville, Ky.

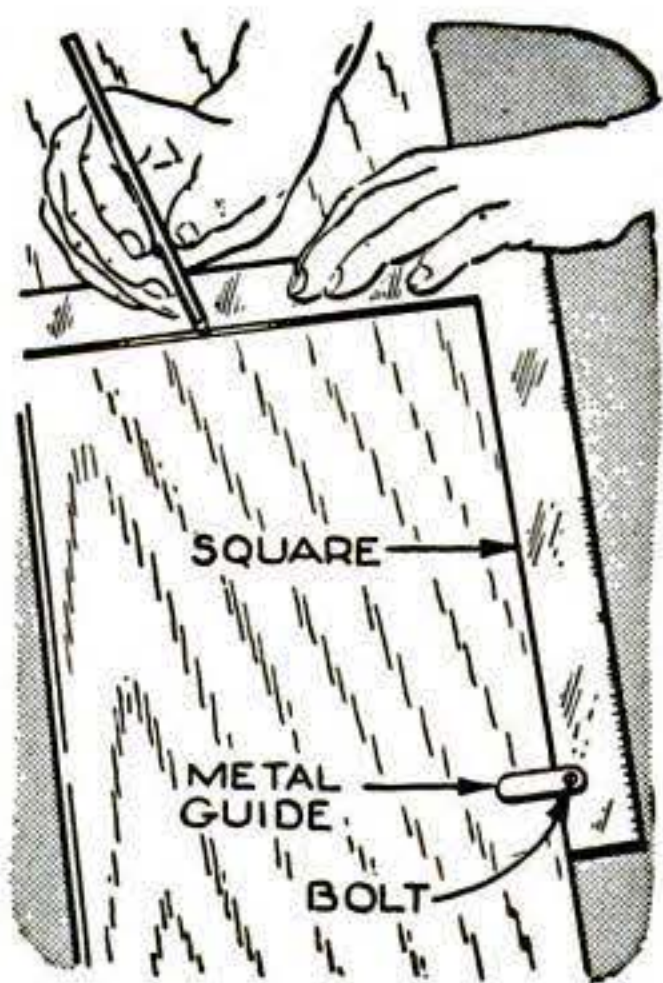

### Two Circles Square End of Board

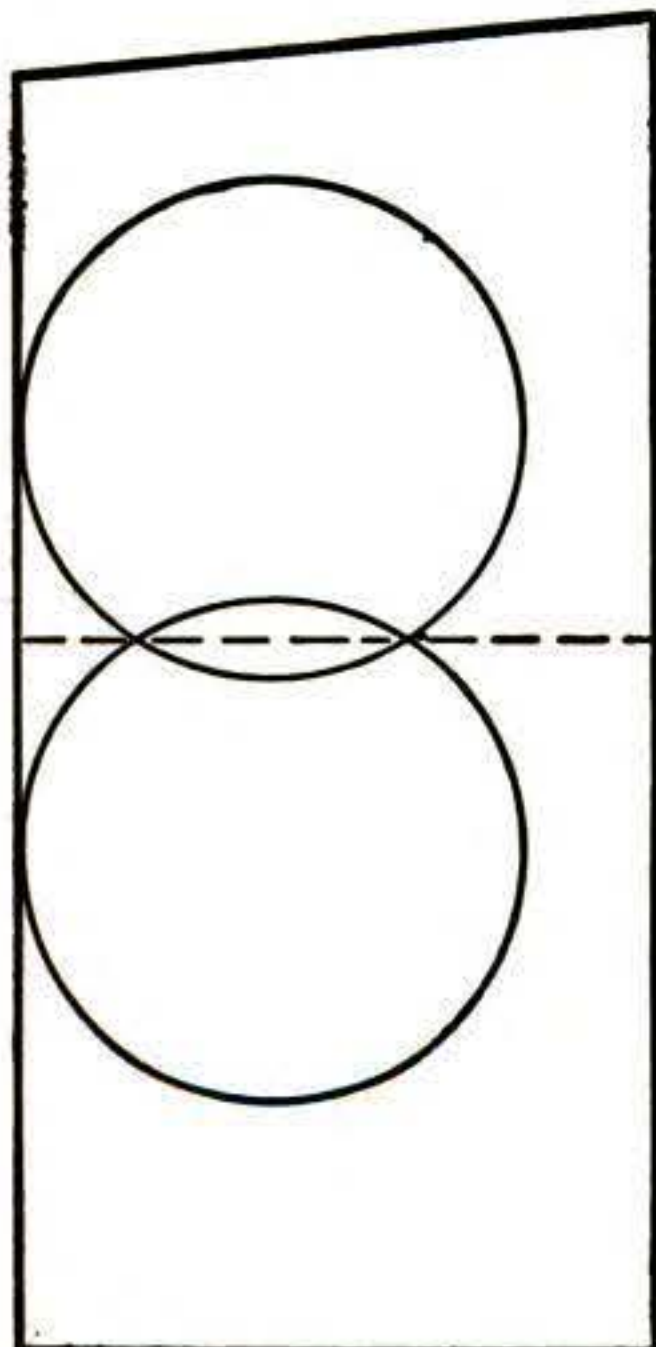

HERE'S an easy, accurate way to square the end of a board when a steel square is not available. Use a paint can—or any cylindrical object—and draw two circles that touch the edge of the board. Draw a line through the two points where the circles intersect. You'll have a line at right angles to the edge of the board. —Hugh Lineback, Stillwater, Okla.

### Detachable Car Sign Tells Business

ON WORKDAYS a sign like this will advertise your business. On holidays you can remove it. Two metal clips slip into the window ledge between the window insulation and metal, and small rubber bumpers protect the car finish. Autotach Sign Co., Rushville, Ind., makes the sign to fit practically all cars. The business name is applied to the plastic with an acrylic-base paint.

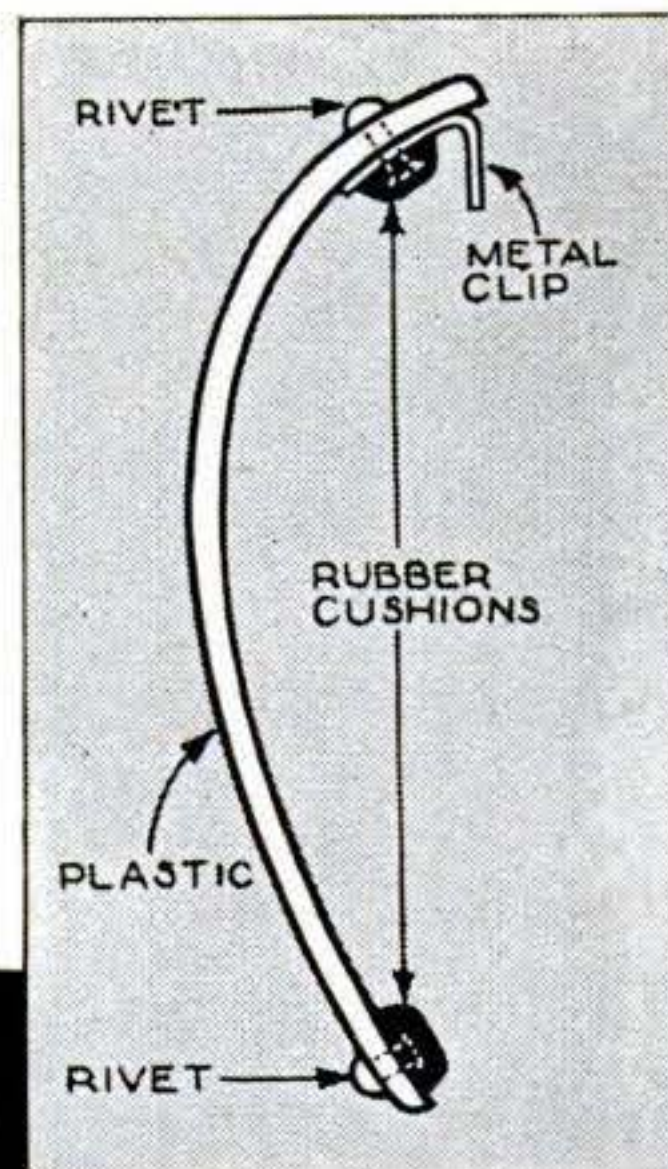

### New Flash Reflector Folds Up



A NEW flash reflector introduced by E. Leitz, Inc., of New York, collapses like an old-fashioned fan when it's not in use. Folded, the reflector slips into your coat pocket. Made of leaves of dull-finish aluminum, the reflector is adjustable in height. It was designed for use with a new model Leica.

It was designed for use with a new model Leica.

### Here's a Handy Farm Cart



AN OIL drum cut as shown and mounted on a pair of bicycle wheels makes it easy to cart chicken feed, livestock supplies, and other items around the farm of Irvin McArthur, at Lovell, Wyo. The frame was welded together from pipe and strap iron.

### Inner Tube Protects Level Bubble

I SAW a neat gimmick the other day. A carpenter had cut off a wide piece of inner tube and slipped it over his level to protect the glass when he carried the level in his toolbox. — William B. Eagan, Louisville, Ky.

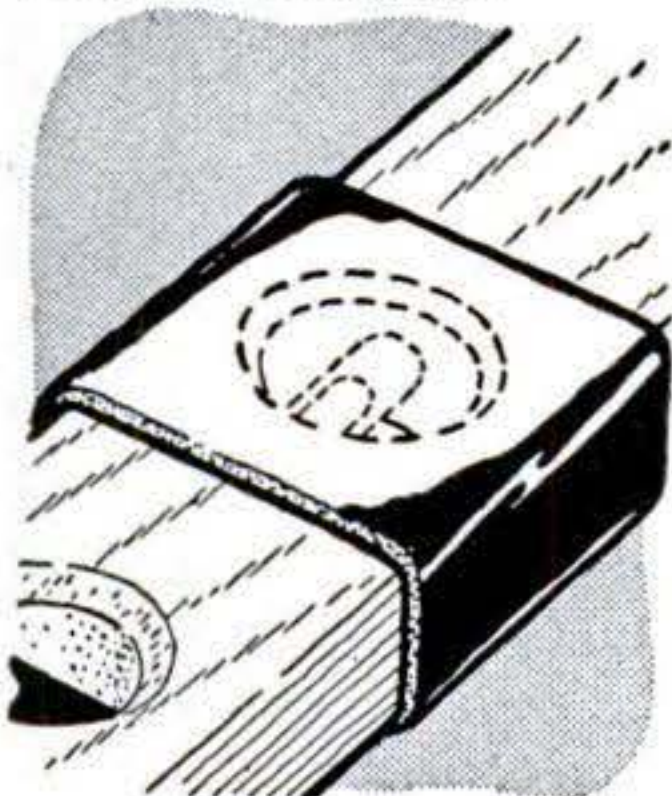

### Wear Her Photo on Your Wrist

THE kind of metal watch band shown at the right can carry a photograph. Trim a small photo, cover it with a strip of clear acetate, and secure to the band with the two clamps. — J. J. Rea, Urbana, Ill.



### Homemade Trailer Makes Handling a Sailboat Easier



THIS welded steel trailer has two unusual features. The center frame member is curved up at the front (below) like a sled runner. After the trailer is rolled into the water and the boat floated free, the trailer can be pulled from the water by a length of rope. The upcurved member keeps the tongue of the trailer from digging into the ground.

The wheels, on two leaf springs, are well to the rear (left). This eliminates sway during towing. — Tom Griberg, Moline, Ill.

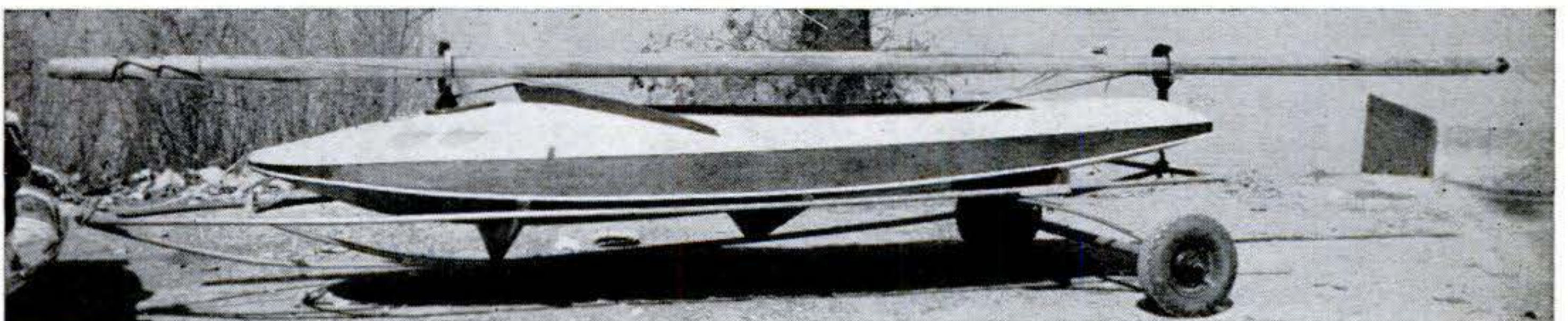

# Lathe News

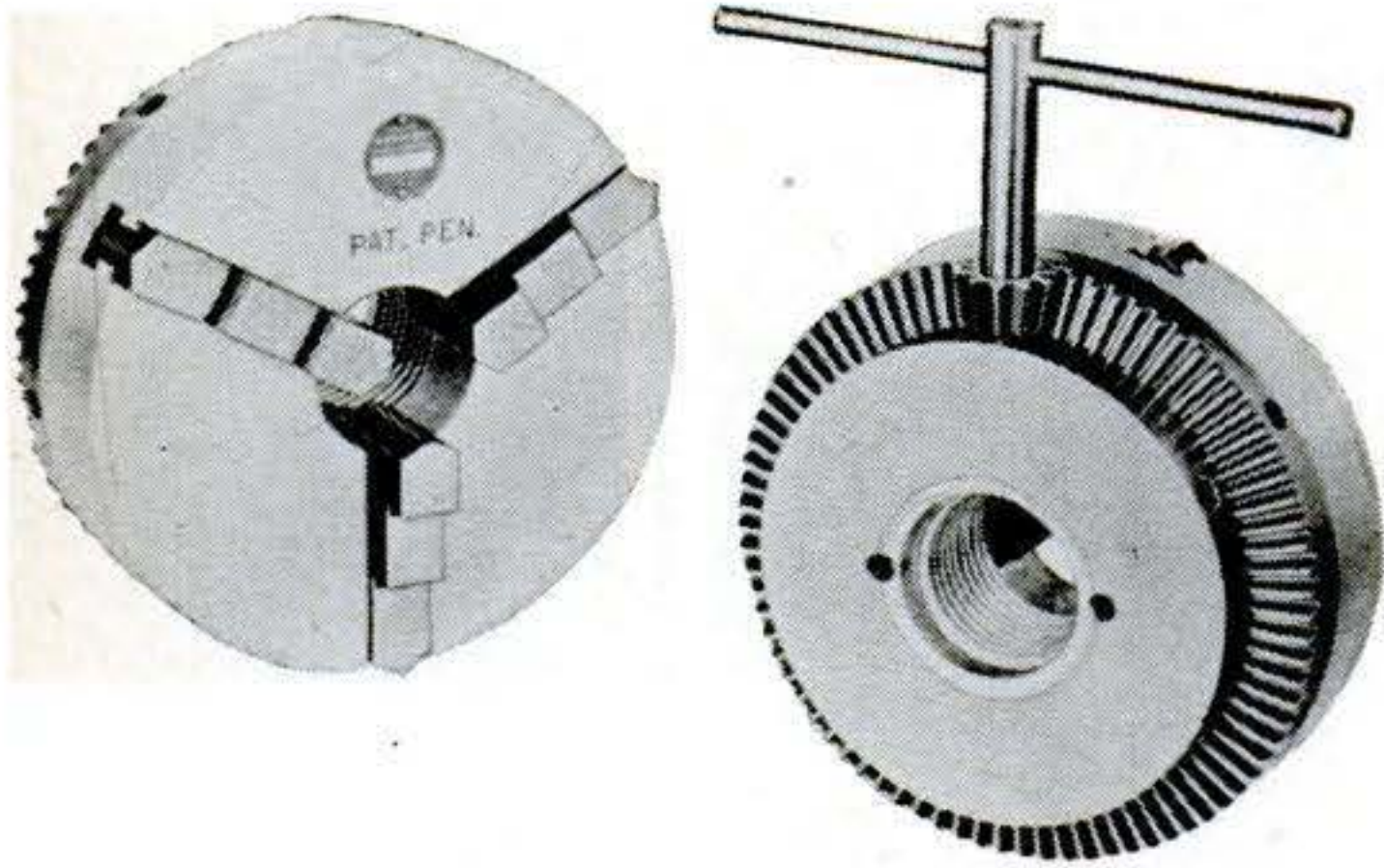

## Two-Speed Chuck.

You can lock work in place faster with this chuck. Insert the wrench in one of the six holes on the outside diameter of the scroll and rotate the scroll by lever action—by pulling on the wrench. That rapidly closes the jaws on the work. Then, to tighten the jaws, insert the wrench in one of the six other holes on a shoulder of the chuck and turn it. The maker is Westcott Chuck Co., Oneida, N. Y.

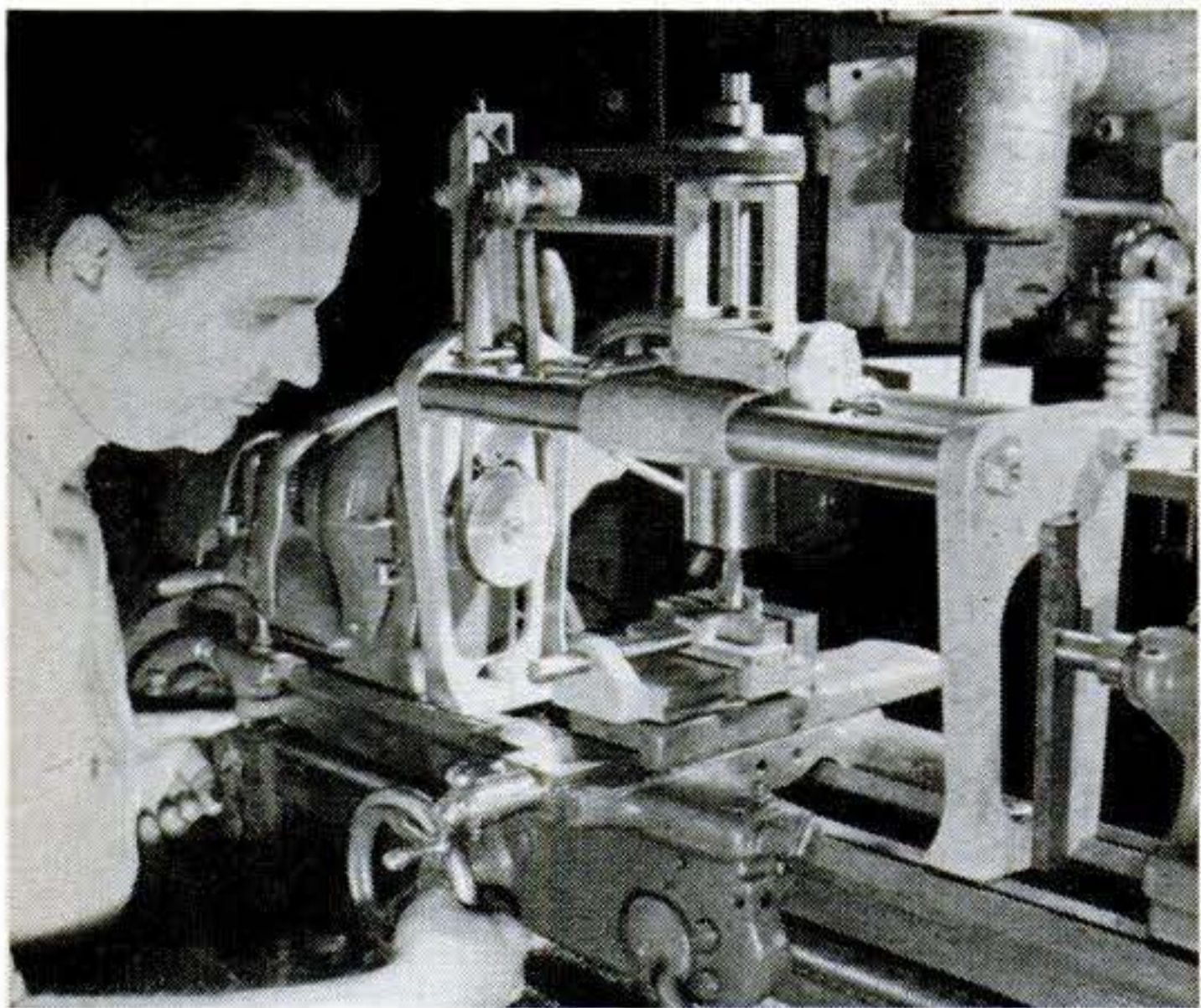

**Vertical Milling Attachment.** This miller clamps on the ways and is driven by the lathe spindle through a V belt. The lathe's longitudinal feed and cross feed advance the work, which is clamped in a vise on the cross-feed slide. The attachment, made by Montgomery & Co., Inc., New York City, will make a cut 8" long and half the distance of the cross feed. The down feed, graduated in thousandths, has 3¼" vertical travel. A T-slot table, 8" long, is available as an accessory.

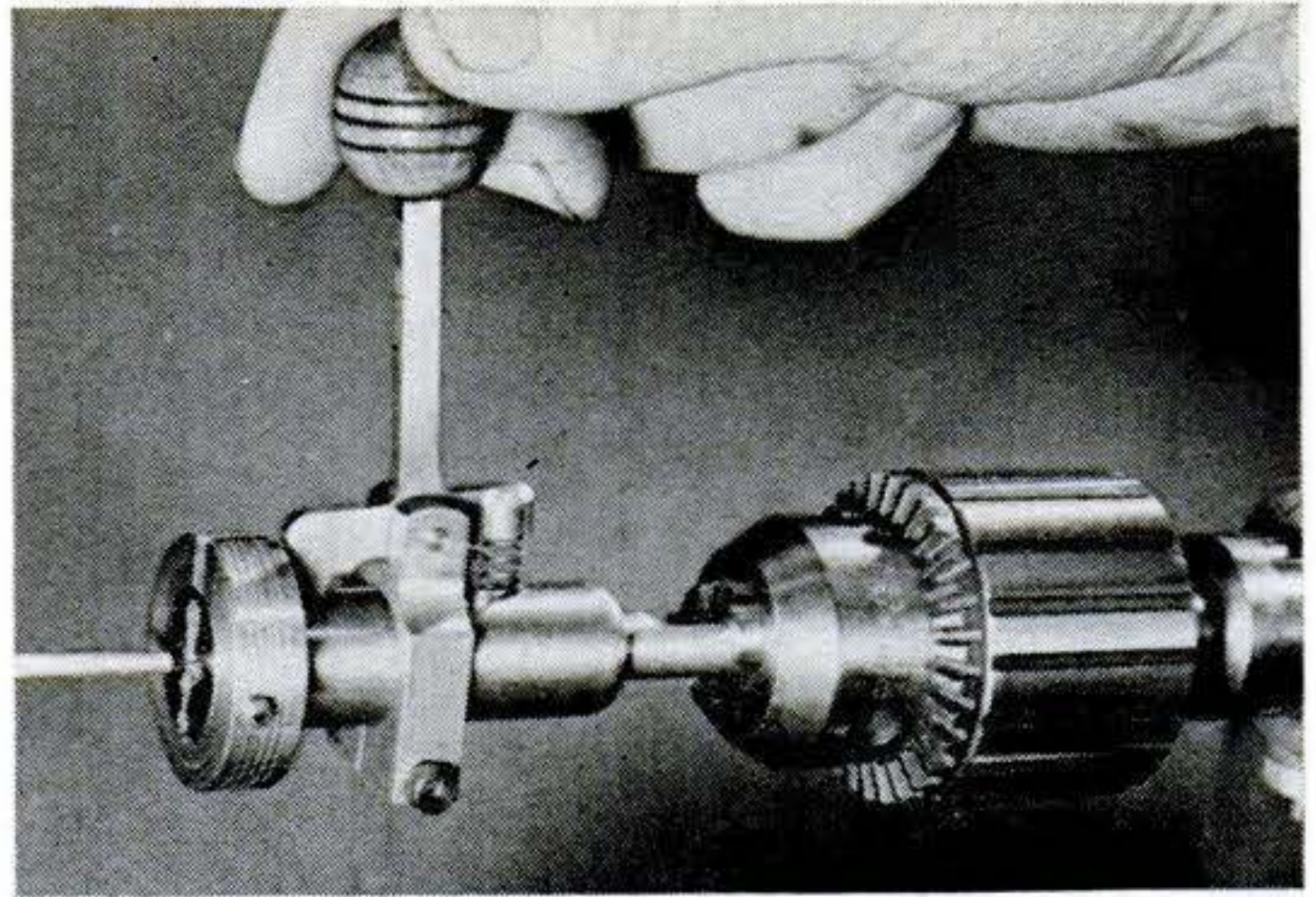

**Threading Attachment.** This tool is especially useful in threading work that has a shoulder. Pulling back on the lever lifts a latch out of the keyway, releasing the die so it is free to turn with the work. Then it won't jam against the shoulder and strip the threads. Mather and Robb, of Louisville, Ky., manufacture the Threadmaster in three sizes.

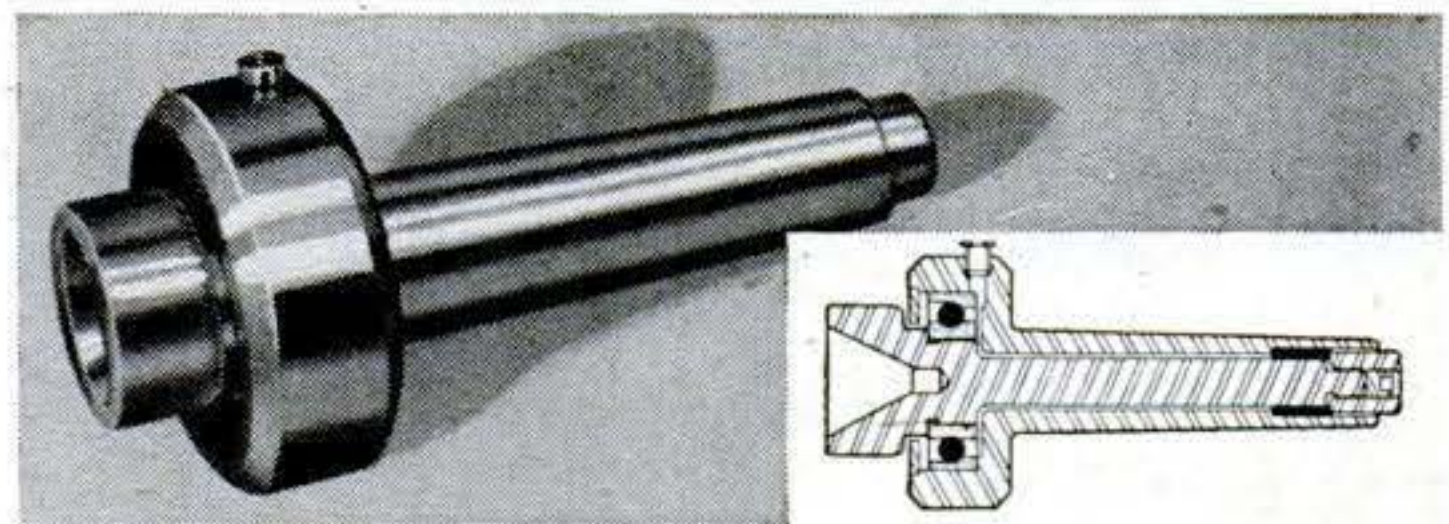

**Live Center for Centerless Shafts.** This tool comes in two sizes with top work capacities of ¾" and 1". The 60° cups of both sizes take work diameters down to 5/16". A ball bearing carries both radial and thrust loads, and a rear pilot bearing eliminates center-shaft whip. The maker is the South Bend Lathe Works.

**Carriage Spacer and Stop.** Clamped to the ways, this accessory is a time saver on repeat work. Set it before starting operations and you don't have to stop to put a scale on the work. It's adjustable from zero to 6" and it will hold a tolerance to .001". Ellwood Products Co., of Detroit, is the maker.

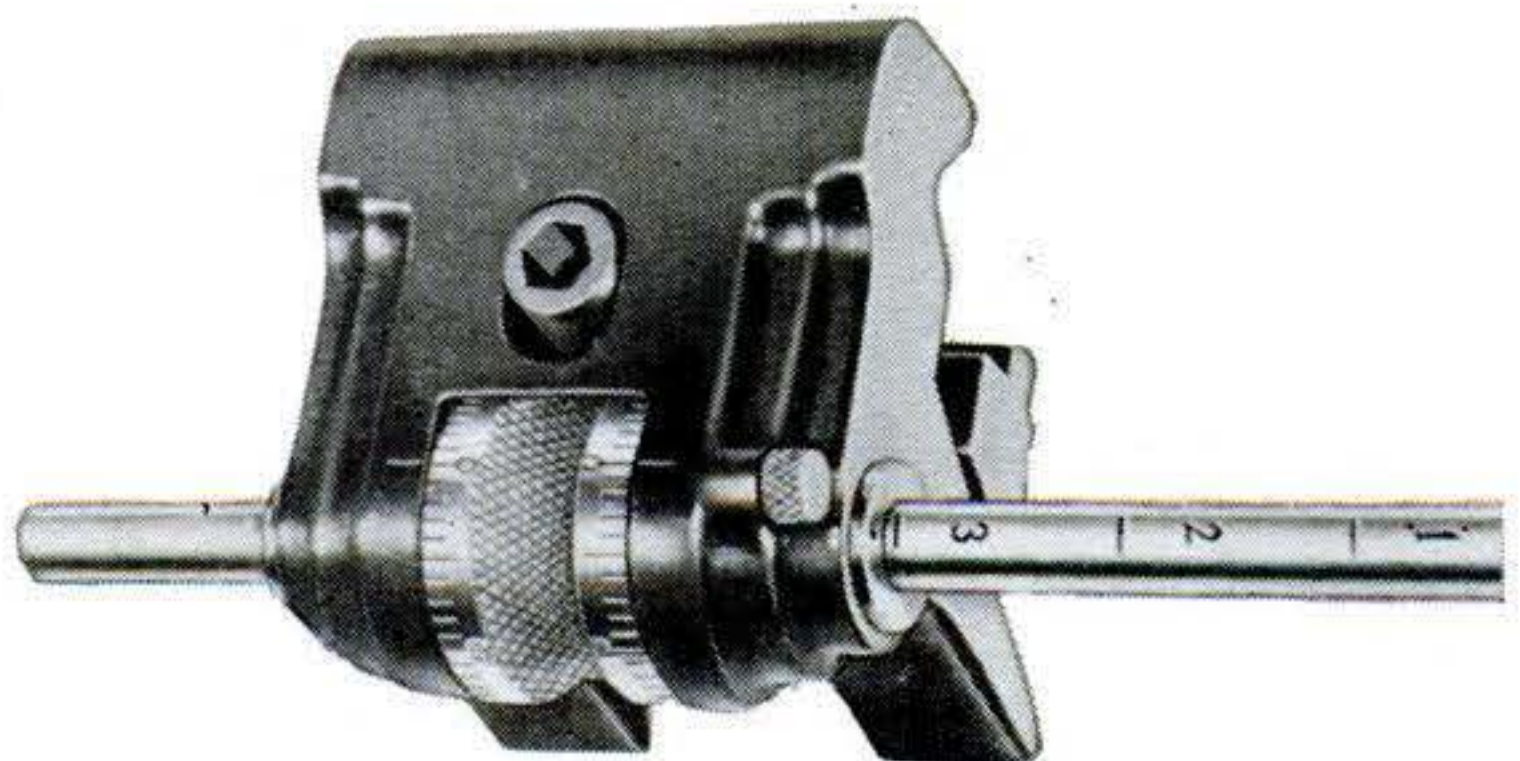



Waterproof glue seals butt joints of plywood box. The top is hinged at back.

# Sunless Garden Hastens Spring

**By building this treasure chest for growing plants indoors, you can have a head start on your neighbors.**

**By Harold and Lillian Krelove**

**I**N THE darkest, coldest room in our city home stands a box 16" high and 25" square, shaped somewhat like a pirate's treasure chest. Inside it, many seedlings and cuttings are receiving their nourishment from chemical nutrients and their life-giving light and heat from a 20-watt fluorescent "sun."

Out of this box have come many potted plants for window gardens and rooted cuttings of perennials for outdoor gardens.

**How box was built.** Our completely closed propagating unit was built after we had read reports of experimental work done by the Department of Agriculture. We used  $\frac{3}{8}$ " oak plywood throughout. Cedar or redwood is preferable, but more expensive. Butt joints were made with waterproof glue and fine nails. The shape of the top was

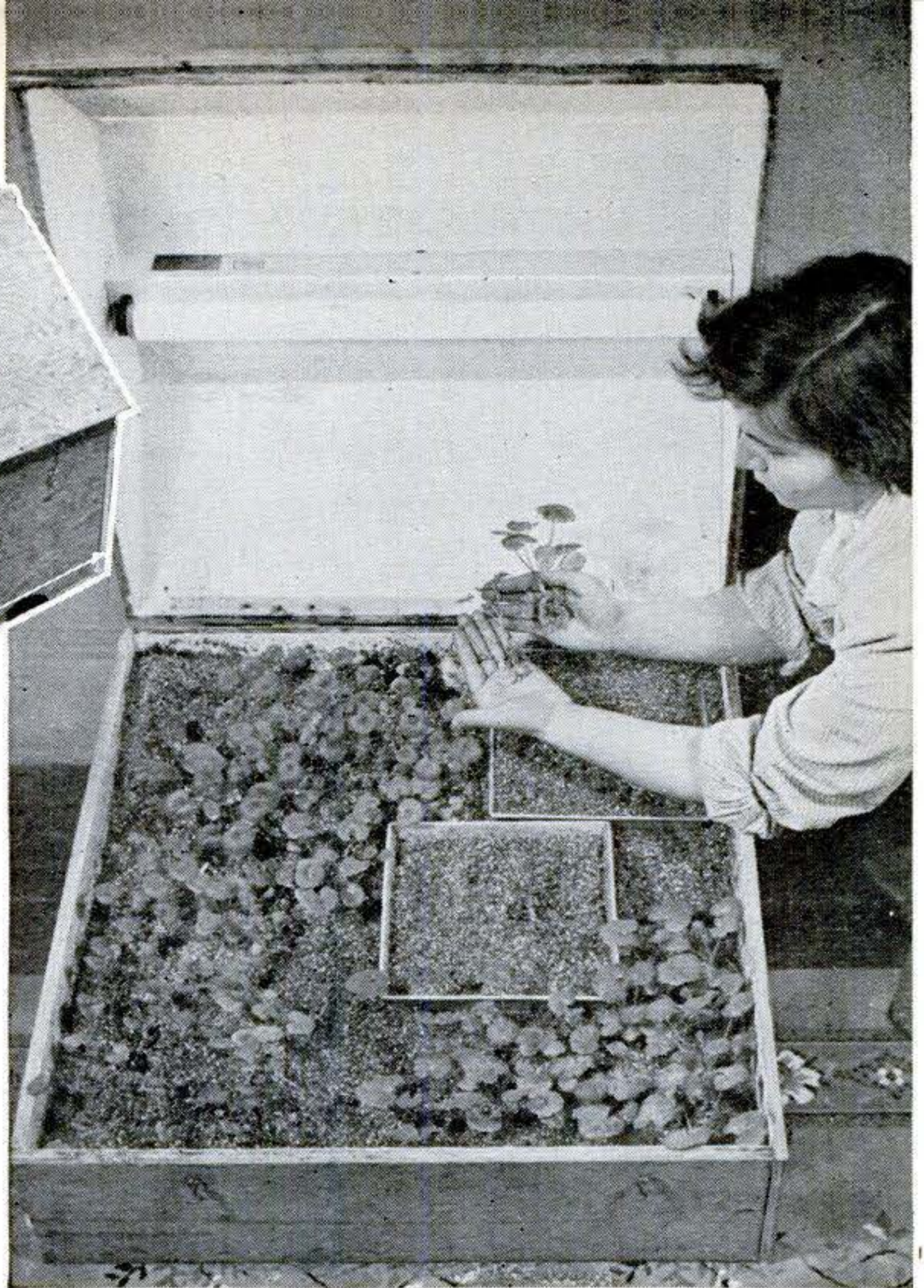

All kinds of seedlings can be grown to transplanting stage. Seeds are germinated in pans.

designed to insure the greatest possible uniformity of light intensity on the growing surface. Two coats of spar varnish were applied to the inside of the unit, and the top was given, in addition, a coat of white gloss enamel and a finish coat of spar.

**White lamp gives best results.** The fluorescent unit consists of a 20-watt channel with a 3,500° white lamp. Pink lamps produce very soft growth. With a daylight lamp, growth is slower—but sturdier. The lamp is installed 5" or 6" above the growing surface, with sufficient air space between the channel and the unit lid to prevent overheating of the transformer. Because the highest intensity of light is at the center of the tube, plants in that area grow most rapidly. But they can easily be moved around so that growth is uniform. To root cuttings, light of 500 foot-candles intensity is needed; to grow seedlings, about 750.

**What to use for growing medium.** The growing medium can be regular garden soil, sand, or gravel, but we found vermiculite to be ideal. Vermiculite is mica that has been subjected to high temperatures and pressures, forming exploded particles that are extremely porous and light. It contains no toxic material, no vegetable matter, and consequently is a sterile medium. This

SEASON	CUTTINGS	SEEDS
Feb., March, April	Softwood shrubs	Vegetables, flowers
May, June, July	Spring-blooming perennials and shrubs (after flowering)	Late vegetables
Aug., Sept., Oct.	House plants	House plants
Nov. and Dec.	Summer-blooming shrubs	Any shrubs you'd like to try

eliminates all worries as to weeds and disease. Because of the small particle size and light weight of the material, removal or transplanting of small plants is very easy and safe. One trade name for horticultural vermiculite is Terra-Lite. You can also use the kind that is sold for wall insulation.

Since this medium contains no plant food in itself, it is necessary to supply nutrients. Application of any good, commercial plant food every other week is sufficient. We

have used a solution made by dissolving Plantabbs in tap water. The vermiculite is thoroughly soaked before plantings are made. The application of the food solution, plus occasional light sprayings of the foliage, will then supply all the moisture needed at the roots and to keep the atmosphere humid. Opening of the unit for these operations provides sufficient ventilation.

**You can pack in the plants.** Because of the nature of vermiculite, plants may be grown much closer than would be possible in soil. For 2" or 3" seedlings or cuttings, 1½" to 2½" spacing is sufficient. You can germinate seed either in the unit (preferably in seed pans so each kind can be kept separate and easy to find) or outside.

The vermiculite can be piled in the bottom of the unit, or it can be put into regular growing flats. Addition of drainage material is not necessary because of the high absorptive capacity of vermiculite. For best results, operate the fluorescent lamp 24 hours a day.

As the above chart shows, you can use the box throughout the year. END

### Leader for Wire Recorders

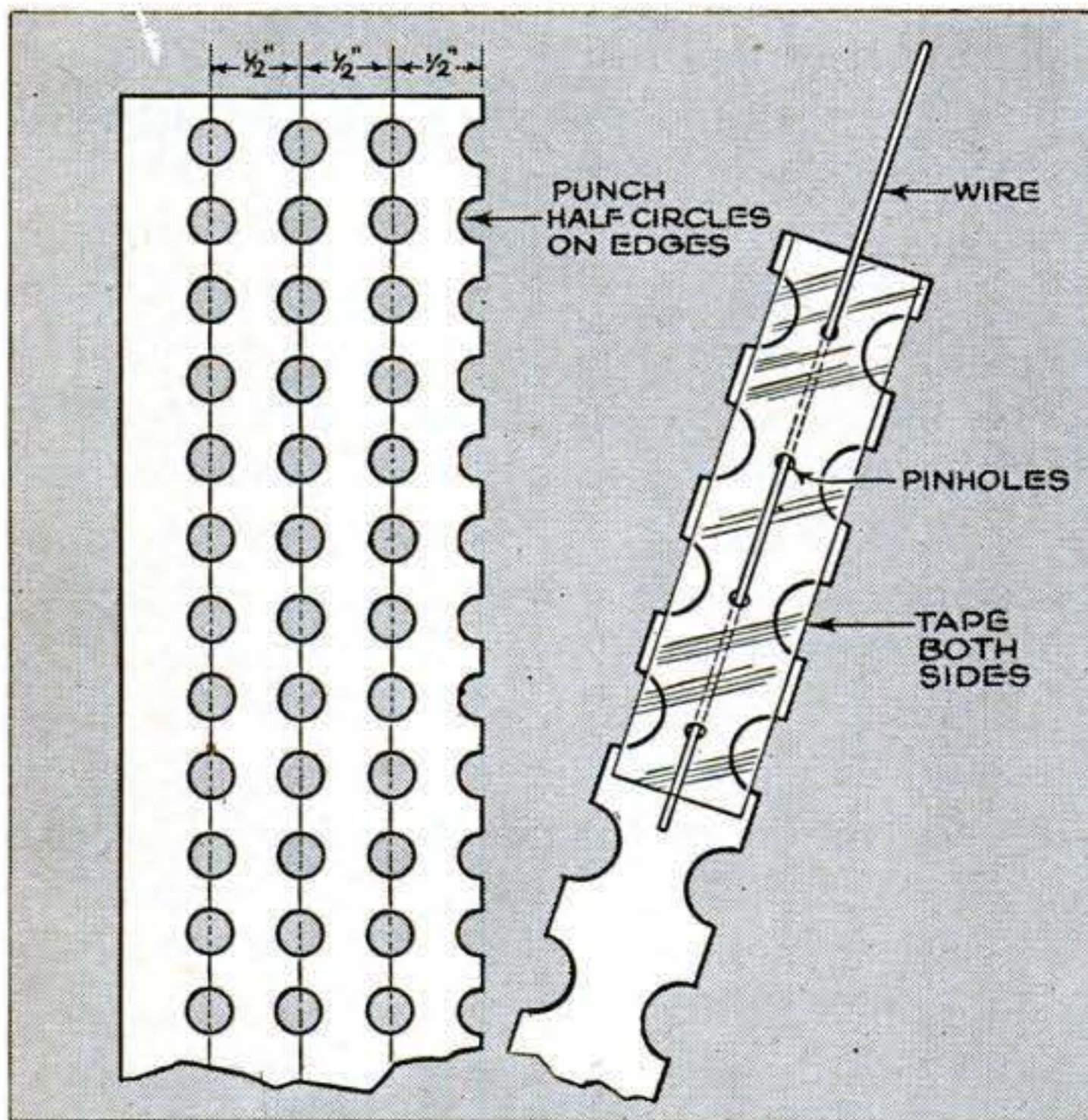

SPOILED roll film can be turned to good use as leaders for recording wire. For standard wire-recorder spools, mark the film in strips exactly ½" wide. Use a metal-edged ruler and a pin to scribe the lines. With a paper punch, make a series of holes along each line, then scissor out the strips. Punch four holes in a row in the center near one end of the leader, feed the wire through, and fasten it with cellulose tape.—Karl L. Martin, Cleveland.

### Tray for the Draftsman

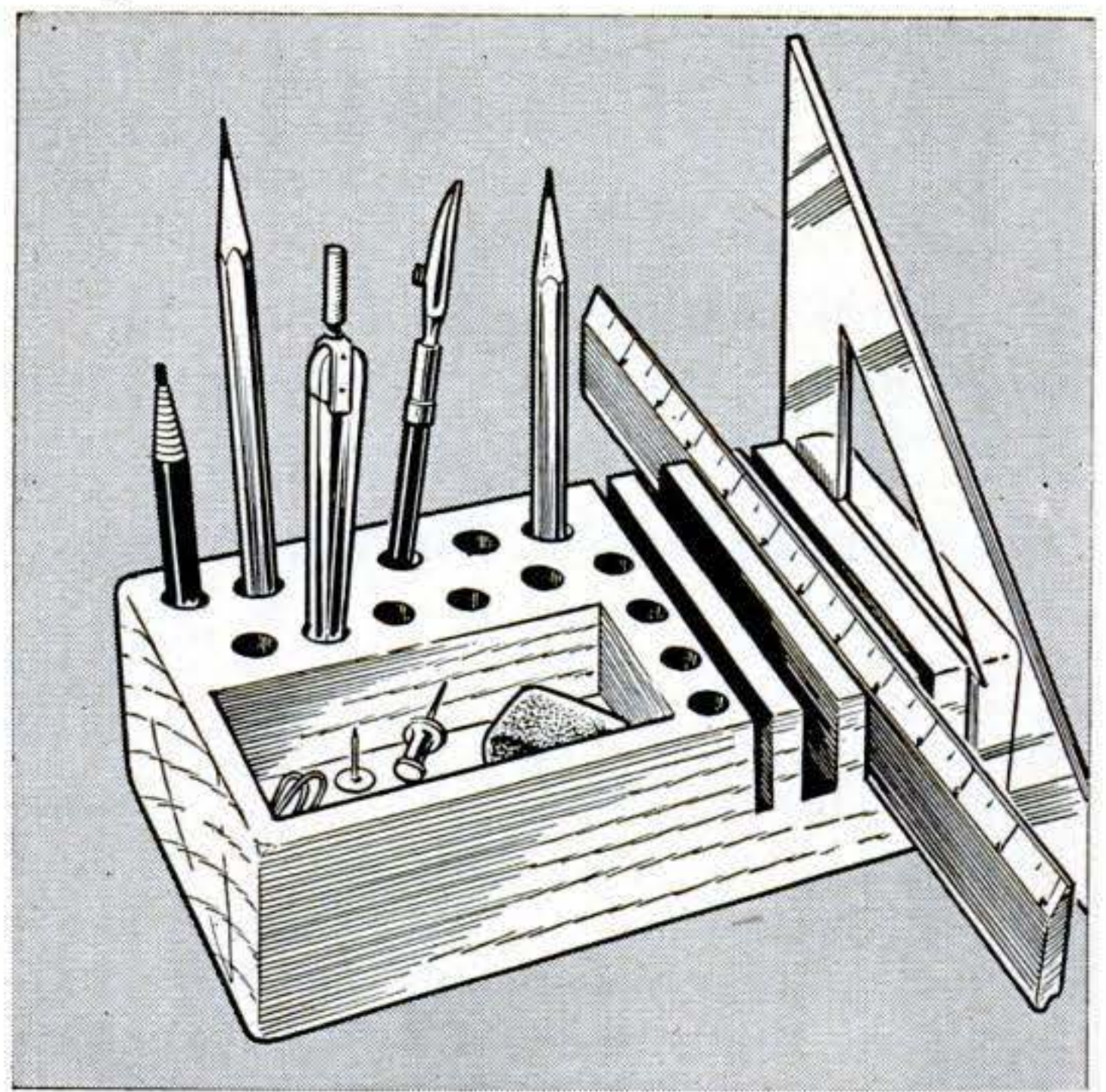

THIS combination tray and rack for drawing instruments holds everything within a 10" by 5" by 2" space. A wooden block of these dimensions is drilled to hold pencils, pens, knife, and compass, and grooved at one end to receive half-circles, triangles, and the slide rule. A deep tray is hollowed out to store erasers, pen nibs, and other small items. All equipment is kept neatly arranged, ready for use, easy to carry.—Wolfgang Wagner, U. S. Zone, Germany.

## Individual Salt and Pepper Shakers Are Easily Made

TINY salt and pepper shakers for school or work lunch boxes are quickly made from the plastic caps on ready-whipped cream containers. Drill a pattern of 1/16" diameter holes for salt and 3/64" diameter holes for pepper. Fill the shakers from the bottom and plug with a piece of cork 3/8" thick. Each shaker holds about a teaspoonful. Leave a bit of the cork projecting for easy removal.—*Jack Wilson, San Pedro, Calif.*

## This Scrap Pad Won't Get Lost

A ROLL of adding-machine paper fixed to a cabinet with a long screw and a washer provides scrap paper in kitchen or workshop. Or drill a hole in the cabinet to hold a long dowel, slip the roll over the dowel and cap with a washer and screw. Then you need remove only the end screw to replace the roll of paper.—*H. Leeper, Canton, Ohio.*

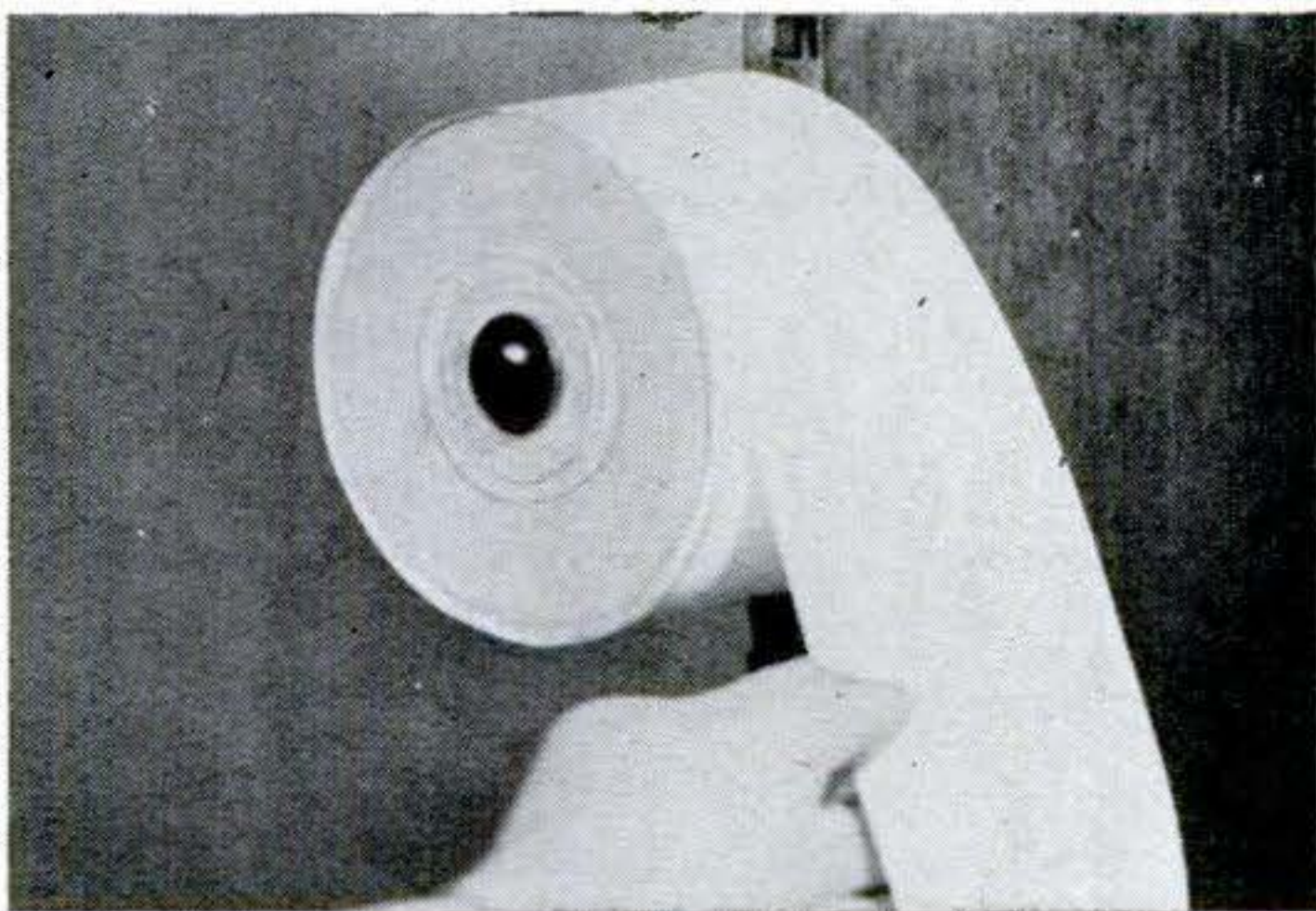

## Bookrest Bent from Wire Hanger

You can make a bookrest out of a wire coat hanger by bending it with your hands. Break off the hook and file the jagged tip smooth. Place the hanger on the edge of a table with about a third of its length projecting. Bend the projecting end down at a 90° angle. Bend a 90° angle at the opposite end, making the form shown in Fig. 1.

With thumbs at points X, bend down sides A with both hands until sides B lie almost flat on the table, as in Fig. 2. With a book on the stand, adjust side C until the book lies at a 45° angle, Fig. 3. The tip steadies the stand, which can be adjusted to hold almost any size of book.—*D. L. Johnson, Columbia, Mo.*

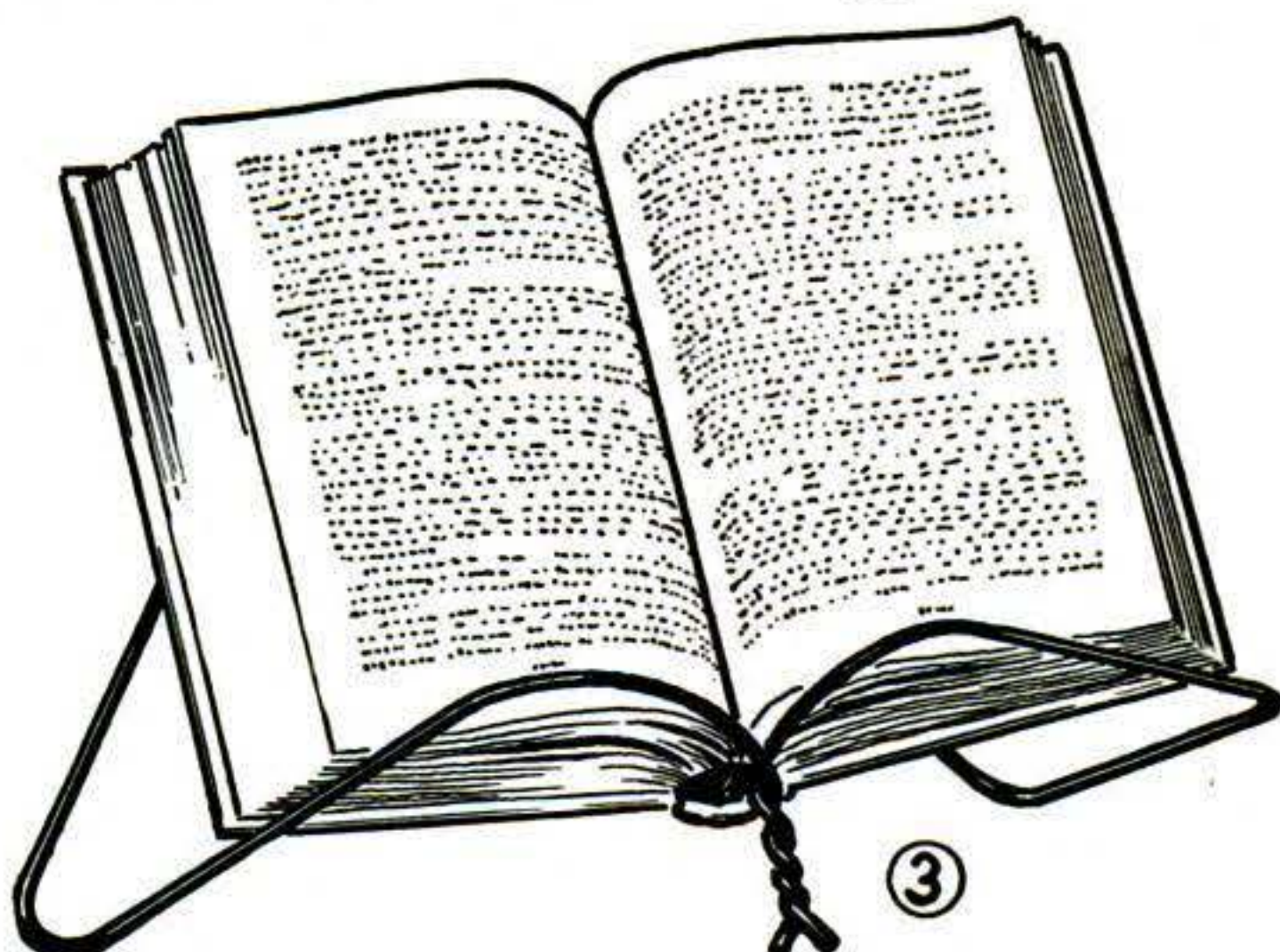
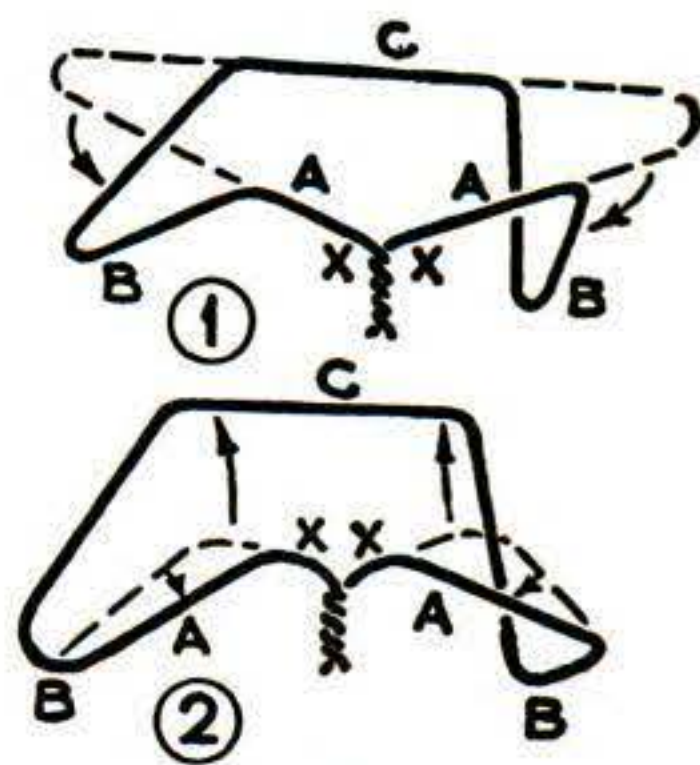

## Shoptalk:



"AND THEN WE  
SENT THE RAILS TO  
THE ALLIGATOR."

What are they talking about?  
Where do they work? Answer below.

They're steel workers. An alligator is a type of shears for cutting up scrap iron. In this case steel rails were sent to the alligator to be cut down to four or five foot lengths for use in open hearth furnaces.



## New Shop Ideas

### Drilling Radial Holes.

Your lathe can be used to index holes on a circumference and drill them on a true radius. Just mount a hand or breast drill on the compound rest as shown. With a different mounting you could also use an electric drill.

Disassemble the drill and mount its frame between centers on the hole through which the spindle fits. Then turn the outside of the spindle housing

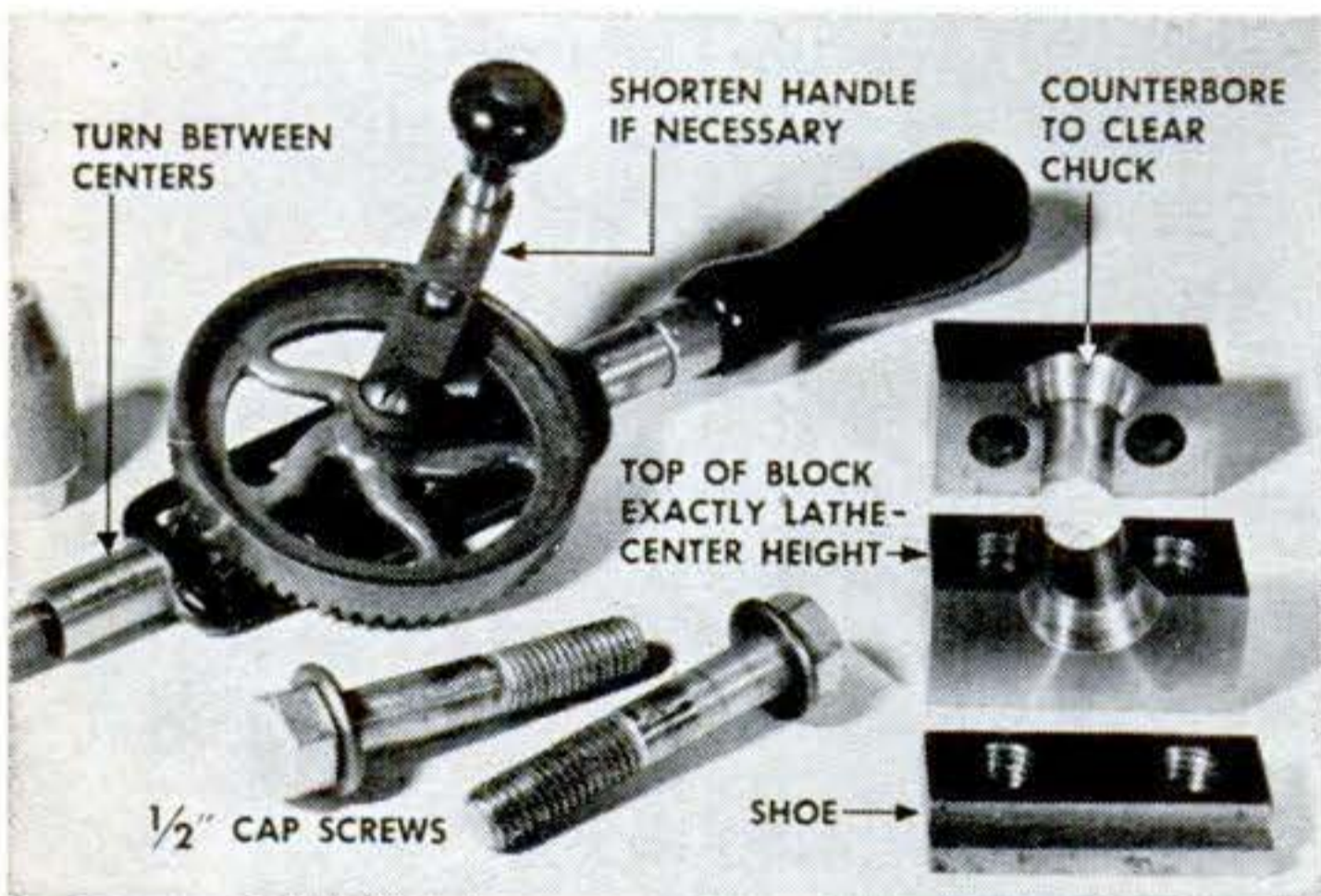
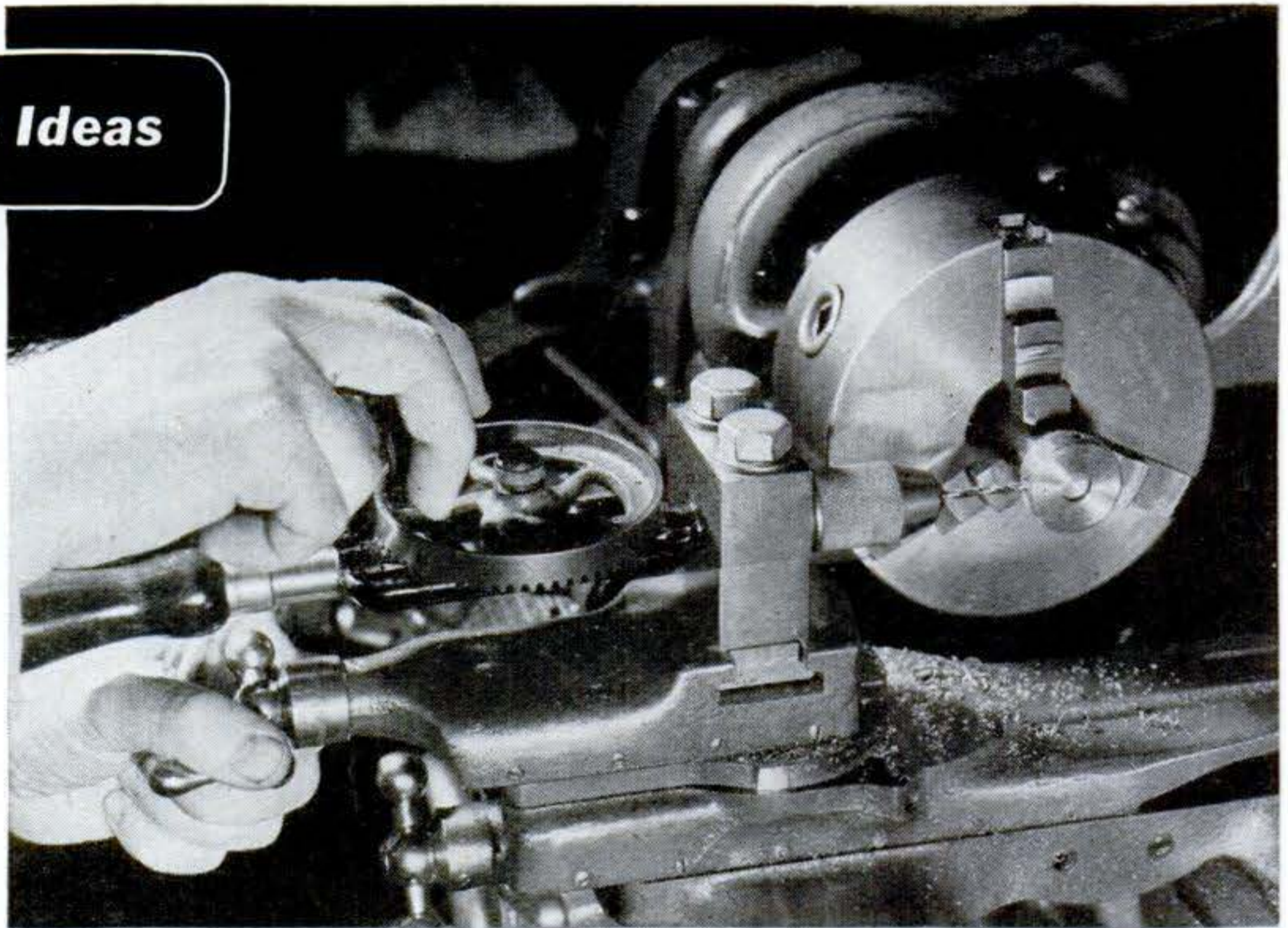

true. The drill holder consists of two blocks of cold-rolled steel, the lower one exactly as tall as the distance between the top of the compound and lathe center height.

Clamp the blocks on the compound with a shoe in the T slot. Lock the compound parallel to the ways. With a drill in the lathe chuck, make a hole a clamp-tight fit for the turned drill frame. If the drill chuck hits the holder before the jaws fully close, counterbore the blocks with a boring bar or fly cutter. Should the drill handle hit the holder, remove it and mount a knob directly on the gear.—Joseph Tracy, Manhattan, N.Y.

**Stretching Out Spaces.** To mark off equal spaces automatically on layouts or work, you need only stretch the required number of points on this tool over the length to be divided. The tool can be made with as many legs as you wish. Cut these from steel or aluminum strip and join with tubular rivets. Drill the rivet holes to a close pivoting fit, and be sure to align accurately all holes and points on each leg.—R. J. De Cristoforo, The Bronx, N.Y.

**Telling Drills Apart.** It's sometimes important to know whether a drill is carbon or high-speed steel, but they do get mixed and chuck wear often renders shank markings illegible. My solution for this is to grind the ends of all carbon drills flat, leaving those of high-speed drills pointed. This doesn't affect them in any way, and I can tell immediately by sight or feel which is which.—Jack W. Bessman, Augusta, Ga.

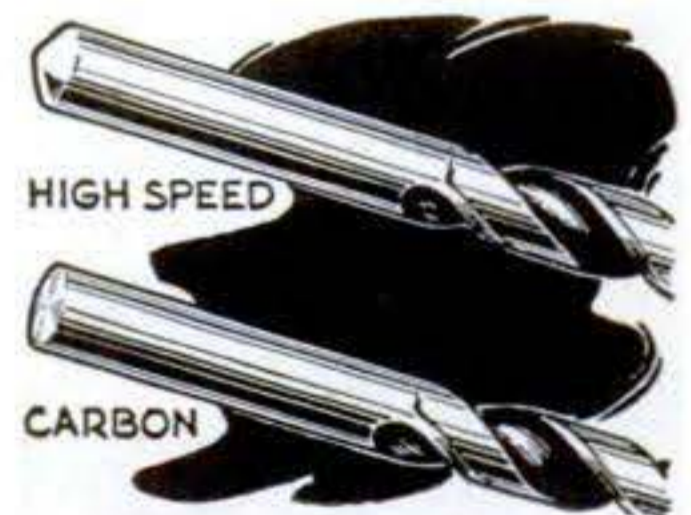

**Restoring Threads.** Running a nut onto a bolt before you saw it short can save time and temper. As the nut is unscrewed, it reshapes marred threads. If you want to file the end, do that too before removing the nut.

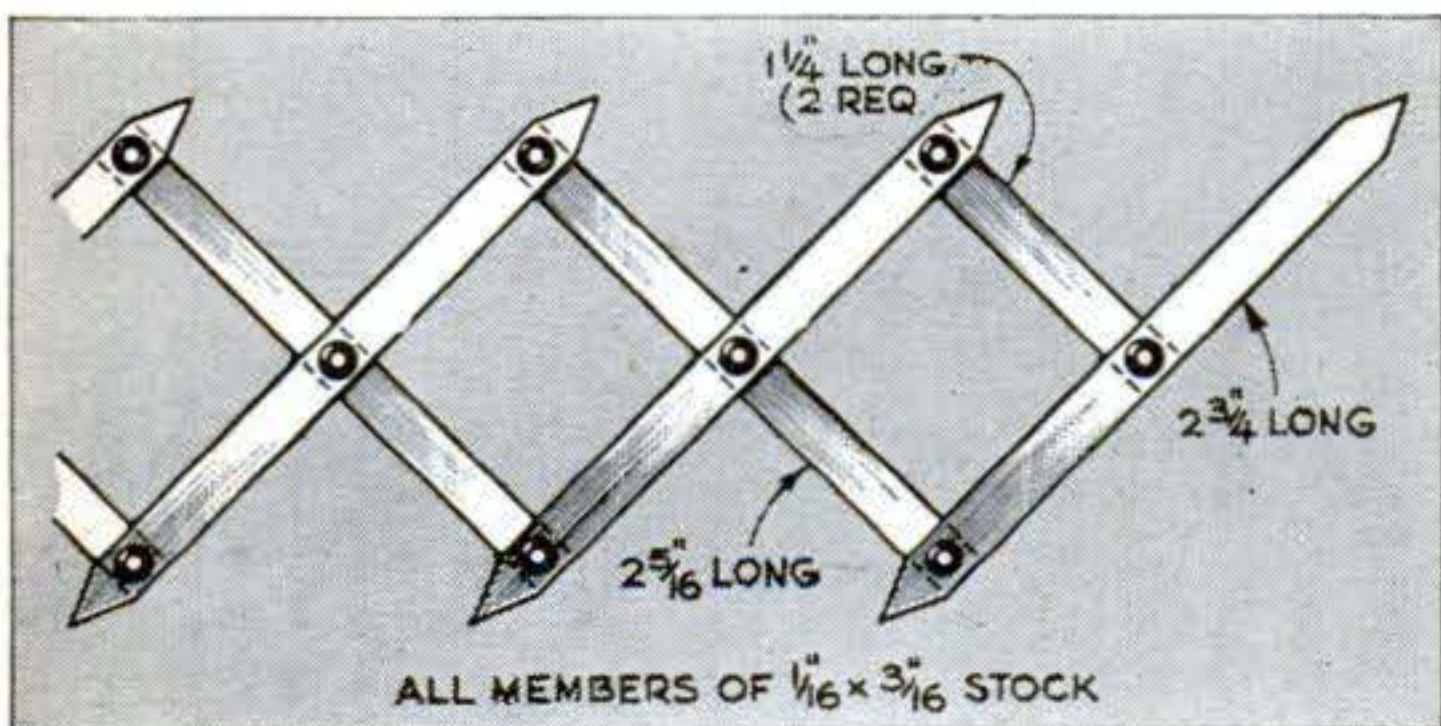



**Powered Auger Bit.** Common auger bits are dangerous to use on a drill press, for the pilot screw drags them in too fast. But if the

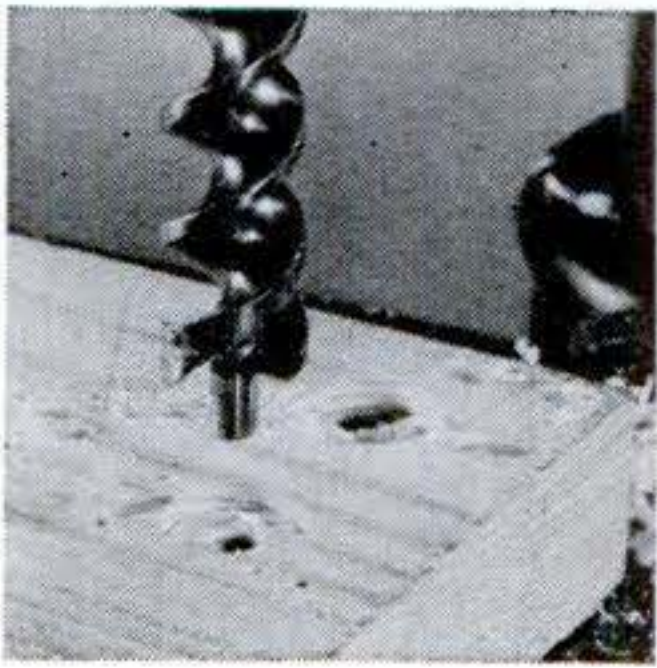

threads are filed off, the bit is no longer much use in a brace. To convert it temporarily, turn a piece of copper tubing tight on the pilot. Make holes the size of the tubing where the bored holes

are to be centered. The copper tubing is easily removed without harm to the pilot threads.—*John J. McGuckin, Ridgewood, N. J.*

**Spotting Hidden Holes.** Sheet metal, composition board, and other thin materials have to be clamped between pieces of wood if clean holes are to be drilled in them. But this makes it hard to spot holes precisely. The answer is to centerpunch the work where the hole is wanted, clamp wood to the back, and drill through both parts with an undersize drill. The drill or a piece of wire the same diameter is then pushed through to align these two pieces while another piece of wood is clamped to the front. Then drill to size through the pilot hole from the back.—*Paul Woodruff, Chicago.*

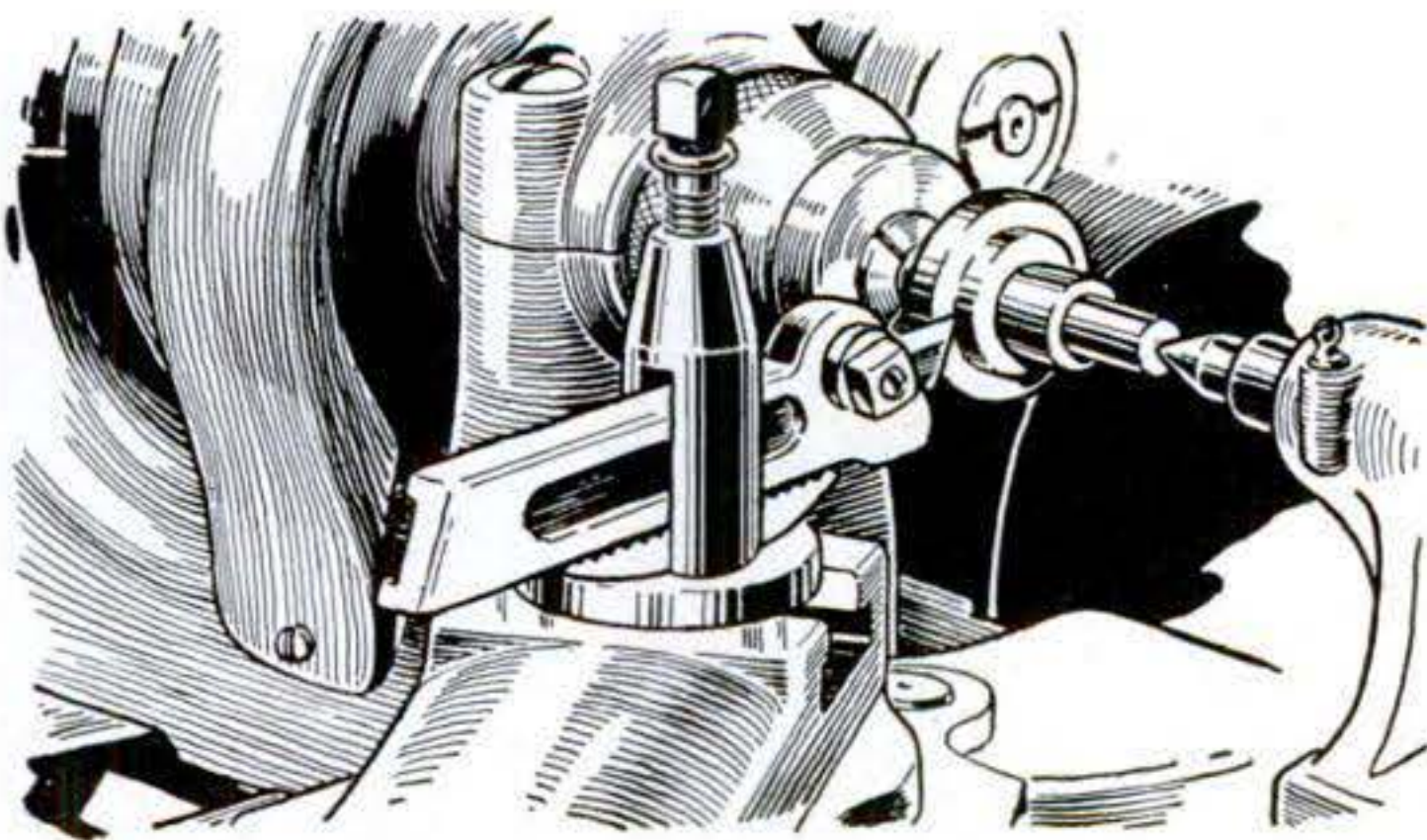

**Reducing Mandrel Chatter.** Sometimes good-sized work has only a small center hole, and so must be mounted on a small mandrel for which it is proportionately oversized. When the setup is turned between centers, considerable chatter may result.

The cure is to hold one end of the mandrel, as close to the work as possible, in a collet, and support the outer end with the tailstock center. The slight mandrel taper does no harm to the collet. Surprisingly big work can be turned on the smallest mandrels this way.—*John C. Martin, King's Point, N. Y.*

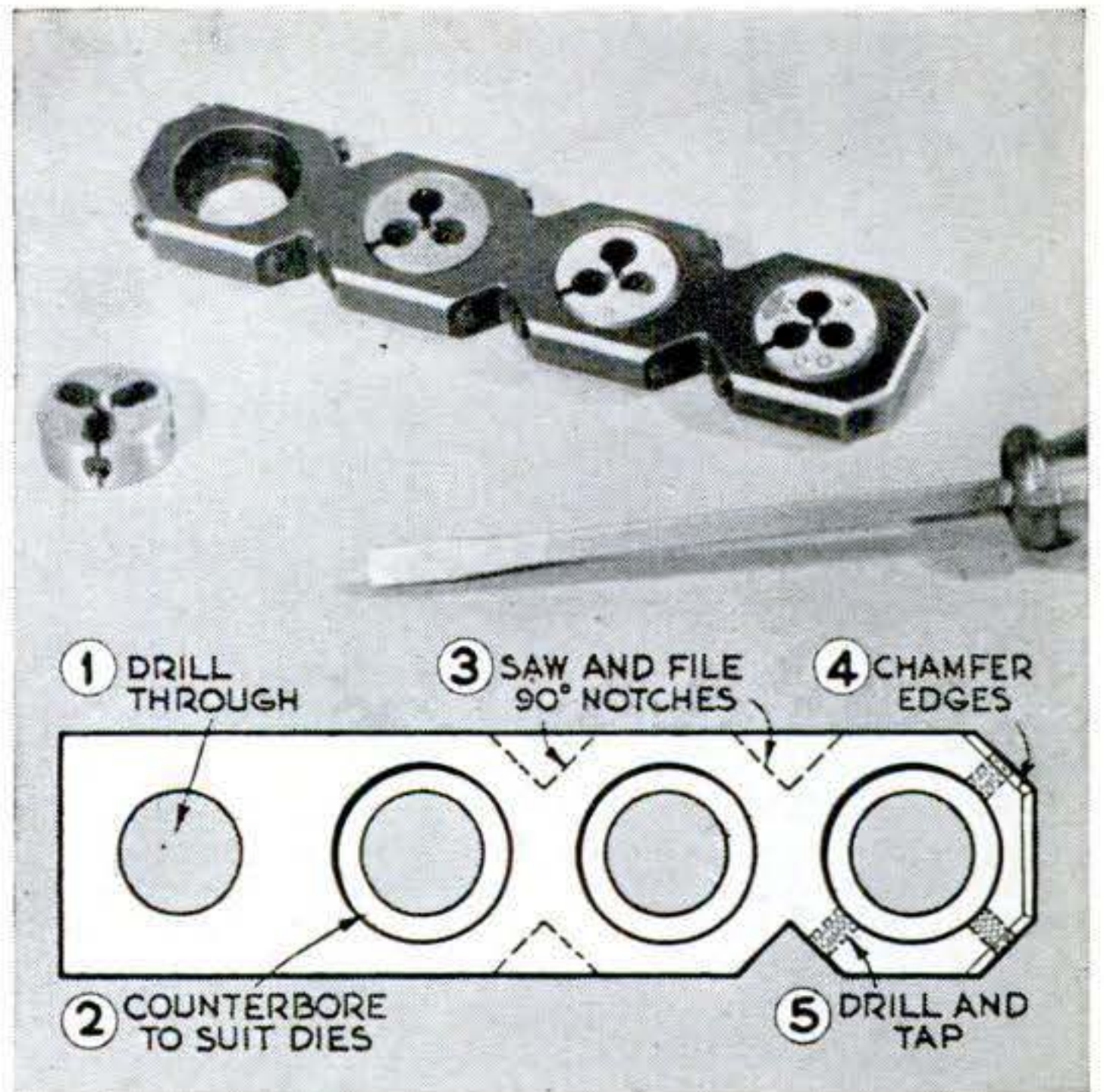

**Four-Way Die Stock.** Just pick this up and you have your most commonly needed dies ready to use. It's a good addition to a serviceman's tool kit, too, for this unit takes the place of five easily misplaced or forgotten pieces.

In a piece of steel of a thickness and width to suit the dies, drill the through holes to any convenient size. If you have a counterbore of the die diameter, drill holes to suit the pilot of the counterbore, which can then be used to form die seats.

Lacking a counterbore, you can clamp the stock to a faceplate, using a thin button to center each hole in turn, and bore the seats. Saw and file the notches, chamfer all edges, and tap holes for the setscrews.—*Floyd McGuckin, Ridgewood, N. J.*

**Deburrer and Countersink.** Until you have one, you can't guess how handy this tool can be. It deserves a place on any bench and in any repairman's tool kit. Grind a flat like that of a screwdriver on the shank end of an ordinary countersink. In an old plastic screwdriver handle, drill an undersized hole not quite to shank depth. Heat the handle by immersing it for a few minutes in boiling water, and drive the shank in.

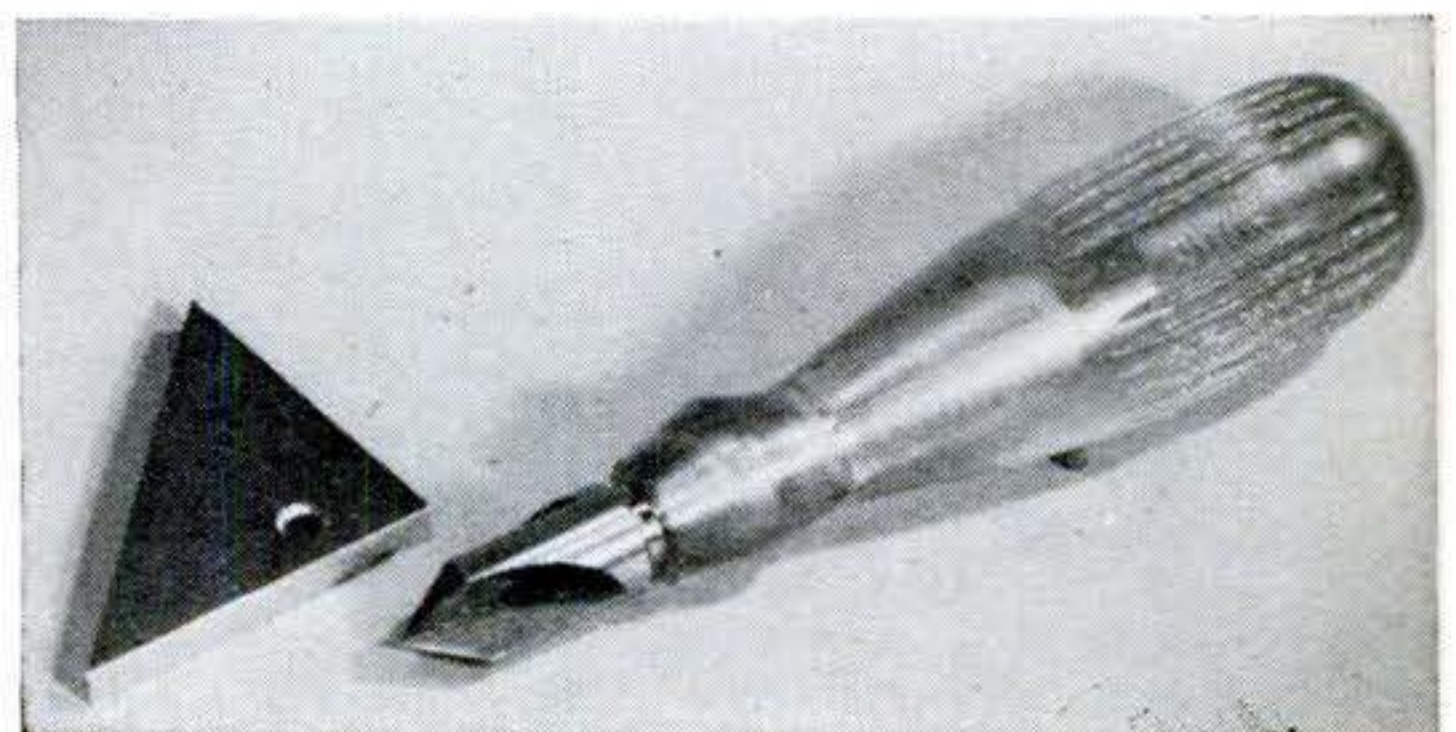

## File and Electric Drill Are Used to Cut Shoulder on Bolt

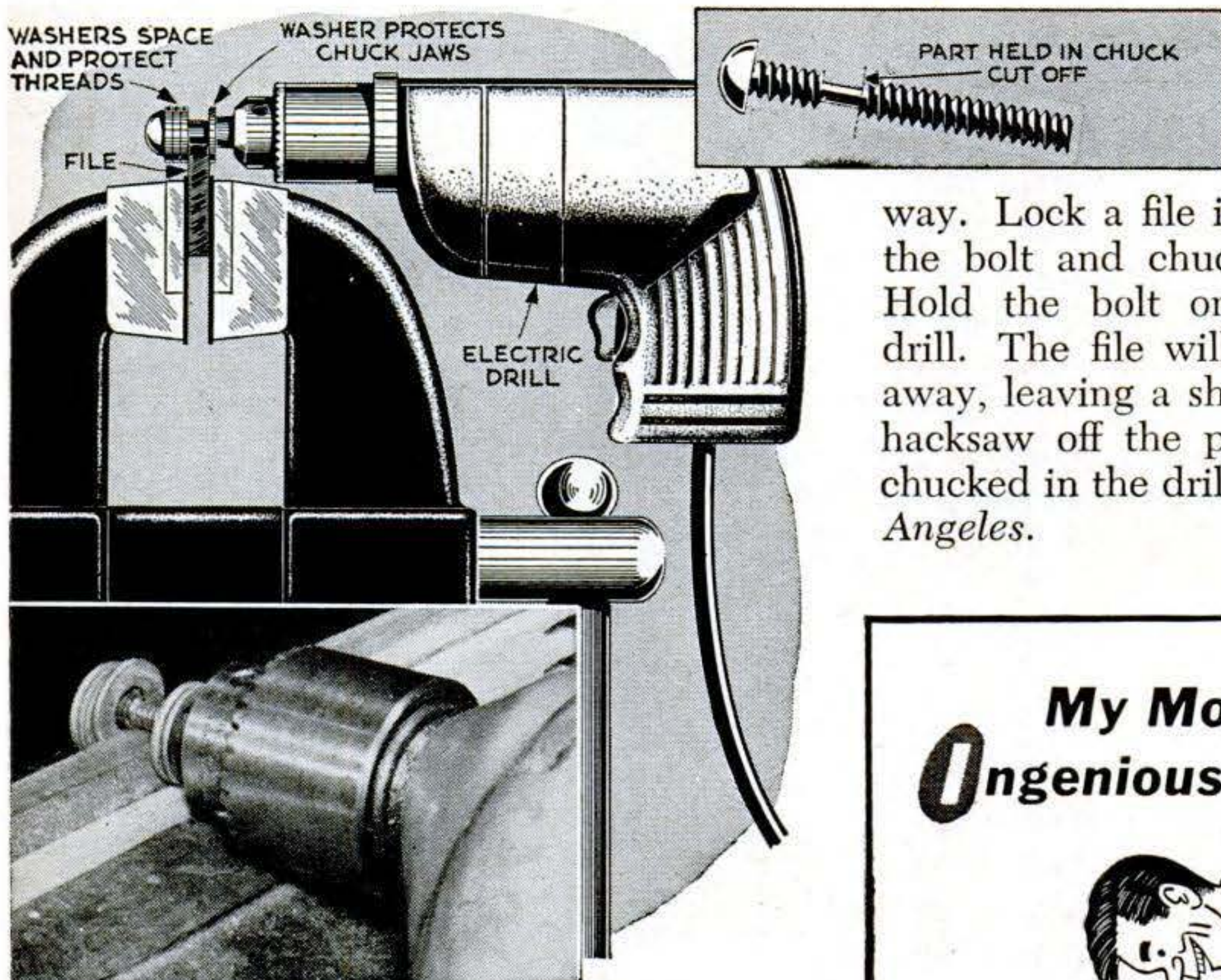

IF A lathe is not available, you can make a bolt with a shouldered end in this

way. Lock a file in a vise. Put washers on the bolt and chuck it in an electric drill. Hold the bolt on the file and start the drill. The file will quickly cut the threads away, leaving a shoulder on the bolt. Then hacksaw off the part of the bolt that was chucked in the drill.—*Charles H. Hardy, Los Angeles.*

## Simple Wall Rack Holds Scissors

A HOLDER to keep four pairs of scissors handy but still out of reach of small children can be made from two empty cellulose-tape dispensers. Open the sides and, with pliers, bend out the serrated cutting edges. Flatten each piece with a hammer. Drill a bolt hole in one piece close to the cutting edge. Place the two pieces of metal together, as shown, over a small angle bracket and bolt through the drilled piece, gripping the other between the bracket and a  $\frac{3}{4}$ " washer. Attach the bracket to the wall.



together, as shown, over a small angle bracket and bolt through the drilled piece, gripping the other between the bracket and a  $\frac{3}{4}$ " washer. Attach the bracket to the wall.

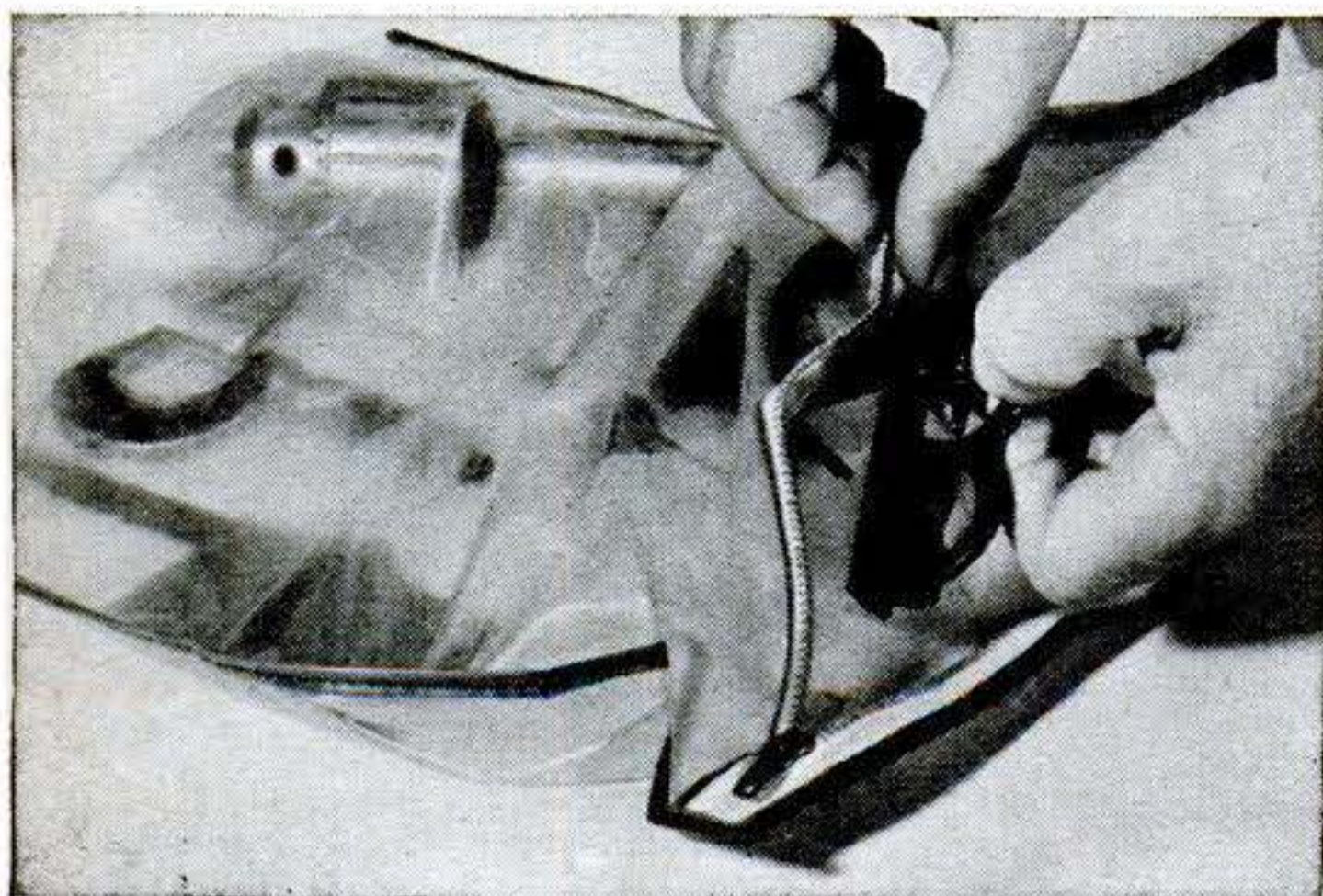

## My Most Ingenious Solution



In my work as a millwright I often have to cut holes through concrete floors and walls. In so doing, I usually run into a steel reinforcing rod. Most of the openings I make are too small to admit a hacksaw and the rods used to give me a lot of trouble. But not any more. How do you think I get by them now?

*I use an electric hand drill. I first use a small drill to put a hole through the rod where I want to break it. Then I ream it out with larger and larger drills until only a thin shell remains. A sharp tap with a hammer and cold chisel finishes the job.—*Carl Barkham, North East, Pa.**

## Bags Protect Tools from Rusting

TRANSPARENT refrigerator bags make fine moistureproof containers for seldom-used tools. They're fine for precision tools for which you don't have fitted cases. Oil the tools well before storing them in the bags.—*B. Ritter, Yonkers, N.Y.*

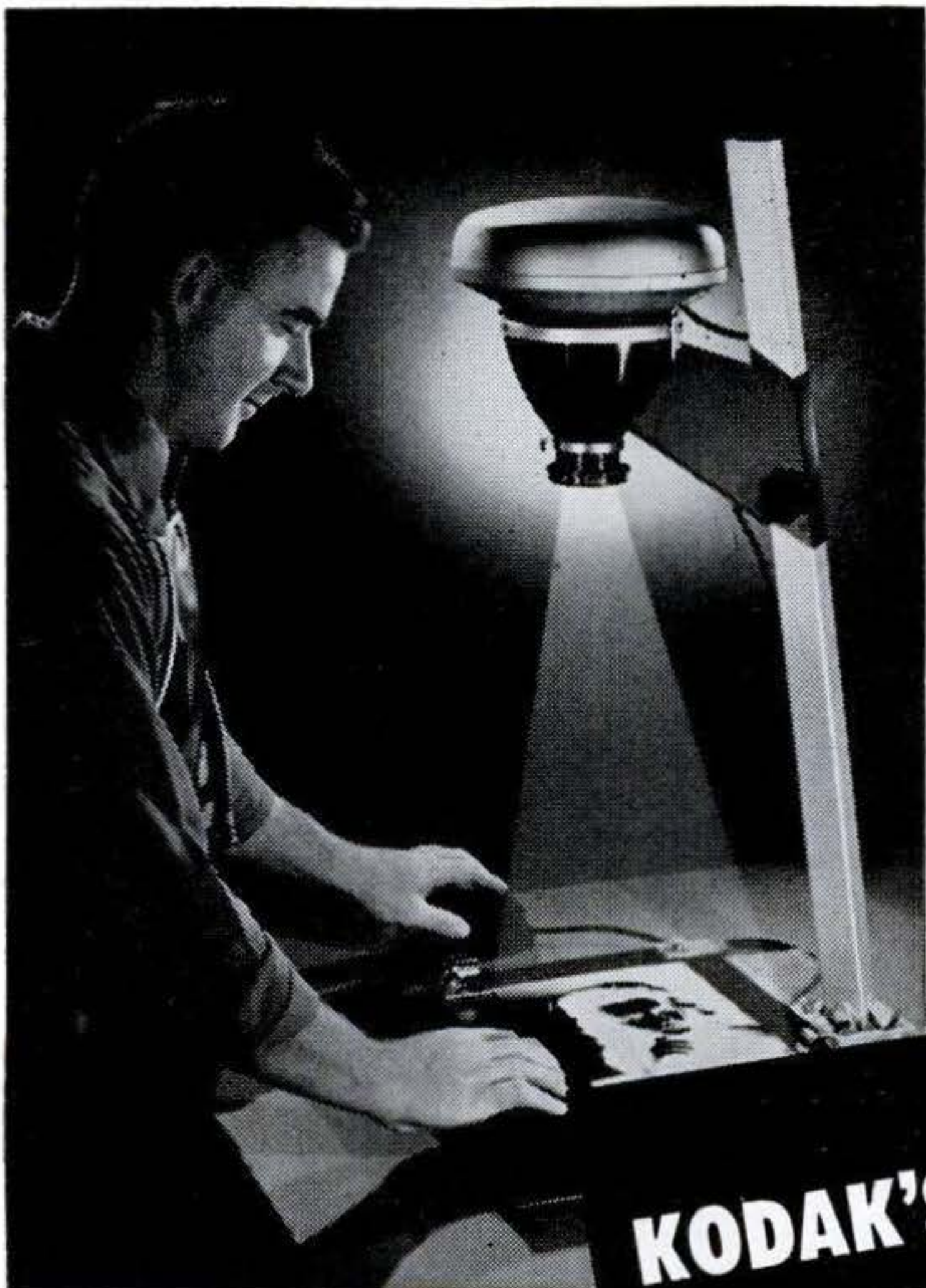

## Looking for a down-to-earth price tag?

### KODAK HOBBYIST ENLARGER—\$49.50

Complete with lens! New-type lamphouse designed so all light reaching negative is *reflected* light. New-type interior reflective coating gives remarkably *even* light distribution. Newly designed negative carrier for easier loading. Locking knobs for both elevation and focus. Enlarges up to 7 times. Kodak Enlarging Ektanon Lens,  $f/6.3$ , with click stops.

## KODAK'S MODERN "COLD-LIGHT" ENLARGERS

## Want magnificent enlarging PLUS?

### KODAK FLUROLITE ENLARGER

Circular cold-light fluorescent lamp, integrated with a new reflector design, gives you the speed and brilliance of a condenser system. Light is instant-on, instant-off . . . negative carrier tilts and rotates for control of distortion . . . base has big (17 x 21¼ x 5-inch) light-tight paper cabinet. Assembly can be used for cine-titling, photomicrography, and as view camera. Without lens—\$112.50.

**Kodak Enlarging Lenses** for the Flurolite range from the Kodak Enlarging Ektanon Lens, 2-inch  $f/4.5$  (for negatives up to  $1\frac{3}{8}$  x  $1\frac{9}{8}$  in.)—\$22.50 . . . to Kodak Enlarging Ektar Lens, 4-inch  $f/4.5$  (for negatives up to  $2\frac{1}{4}$  x  $3\frac{1}{4}$  in.)—\$56.00.

*Prices include Federal Tax*

**Prices subject to change without notice. Consult your dealer.**

**EASTMAN KODAK COMPANY, ROCHESTER 4, N. Y.**



**Kodak**  
TRADE-MARK



# Care and Feeding of Engines

BY S. P. CORP

## HOW OFTEN TO CHANGE OIL?

Within the past year there have been many conflicting recommendations on how often to change oil. One magazine article suggested that every 4000 miles is often enough under normal conditions. The point most often missed is that the average car owner does most of his driving between home and work. The engine does not have time to warm up enough. Sludge forms.

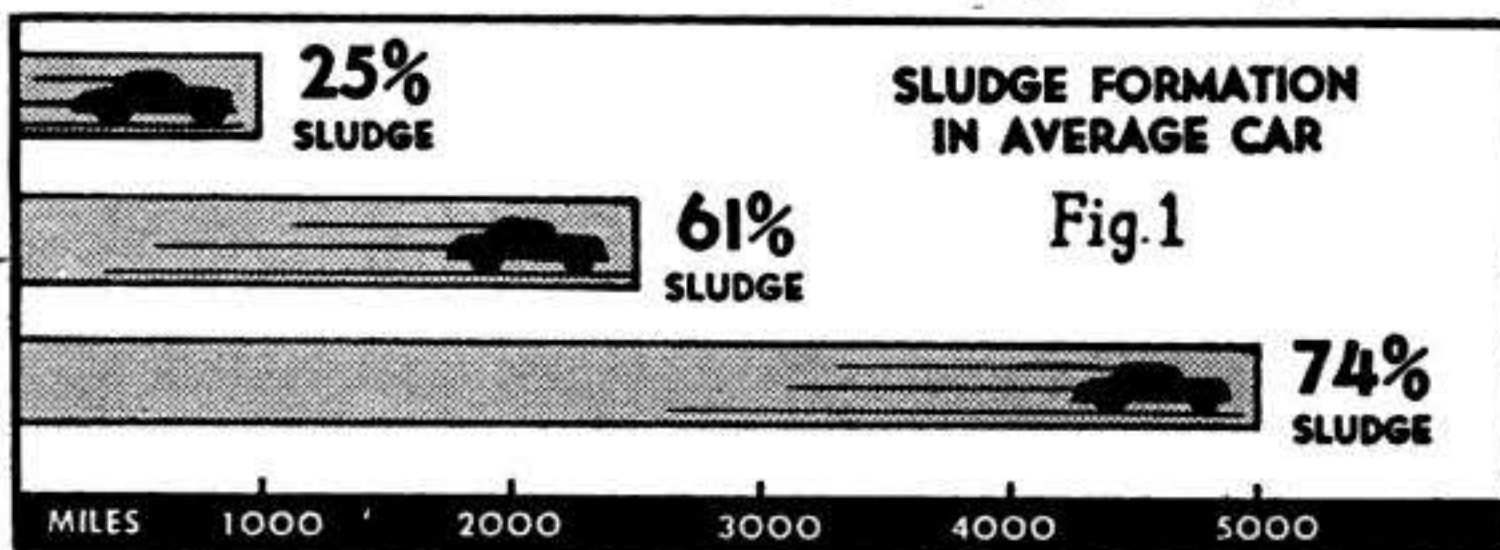

This sludge is potentially dangerous to your engine, no matter how efficient your oil filter. The best insurance against such danger is to change oil every 1000 miles.

## WHAT ABOUT TIRE PRESSURE?

Many drivers are confused by conflicting advice on the new low-pressure tires. If you were told to keep this pressure at 24 pounds, remember that that means 24 pounds in a cold tire. A tire with a cold pressure of 24 pounds may have 29 pounds when hot. If you have tires checked while hot, and have the 29 pounds pressure reduced to 24, you will be running on under-inflated tires, and will notice rapid tire wear or uneven wear. If you have your low-pressure tires inflated while hot, inflate them to 29 pounds. They will have only 24 pounds when they cool off.

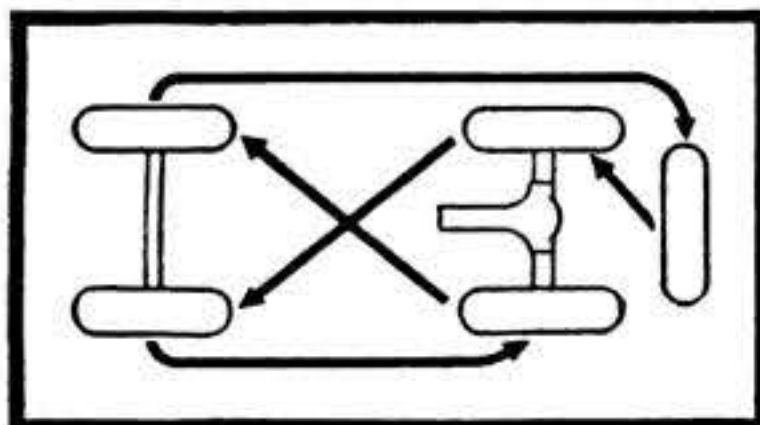

FIG. 2

## SWITCH TIRES FREQUENTLY

Due to different kind of wear on front and rear, it is important to switch low-pressure tires frequently, following the method indicated in Fig. 2.

## WATCH FOR EXHAUST SMOKE

If you buy a used car, or if your new car has gone more than 20,000 miles, watch for exhaust smoke—an indication that you need new Sealed Power Piston Rings. There is a set of Sealed Power Rings specifically engineered to do the best possible job in your engine, whatever the make, model, or engine condition. No other ring equals the Sealed Power MD-50 Steel Oil Ring for oil control, even in badly tapered and out-of-round cylinders. To save oil, save gas, and restore engine power, get new Sealed Power Piston Rings when your exhaust smokes!

## Gus Parlays a Pair of Hunches

[Continued from page 192]

over, settled his bulky frame on it, and maneuvered it and himself under the front end of the car. But he had no more than disappeared than he reappeared.

"Stan," he said as he got up off the creeper. "Hold the fort for a while, will you? I want to see Jerry over at the police barracks. I'll finish up this job when I get back." With that he grabbed up his coat and hat and disappeared through the shop doors.

Ten minutes later, the veteran garage man was escorted into the police squad room where Sergeant Jerry Corcoran had his desk.

"It's just a hunch, Jerry," Gus began, "but have you thought of the possibility that those snow tires could have been put on the murder car backwards—you know, deliberately, with the Vs pointing to the rear instead of toward the front so the tracks would look like they were going when they actually were coming?"

## The Hunches Don't Hit Home

Jerry smiled. "Sorry, Gus, but the lab boys gave that one a whirl too, but when we picked up the men and the car the tires were on with the Vs pointing forward at the top. And nobody goes around switching wheels in the dark on snow-covered roads. That job is pretty tough without a big jack like you've got at the garage. They wouldn't have had the time."

"Maybe you're right," Gus agreed grudgingly. "Just a thought. Now I've got one more screwy idea and then I'll stop playing detective and get back to work."

"What is it?" asked Jerry.

"Know that old road-commission shack just off the main road down near Trayton's place?"

"Sure," answered Jerry with a nod.

"Well just to satisfy my curiosity, Jerry, I wish you'd have a look at it. In good weather, the road-repair boys generally store some of their equipment there and always have a jack and a few tools handy for repairs. I've been thinking it might be a good spot for someone to switch wheels on a snowy night."

"Could be. Your guess is as good as anyone's right now," Jerry admitted. "But I think you're barking up the wrong clue."

Late the same evening, just as Gus was

[Continued on page 246]

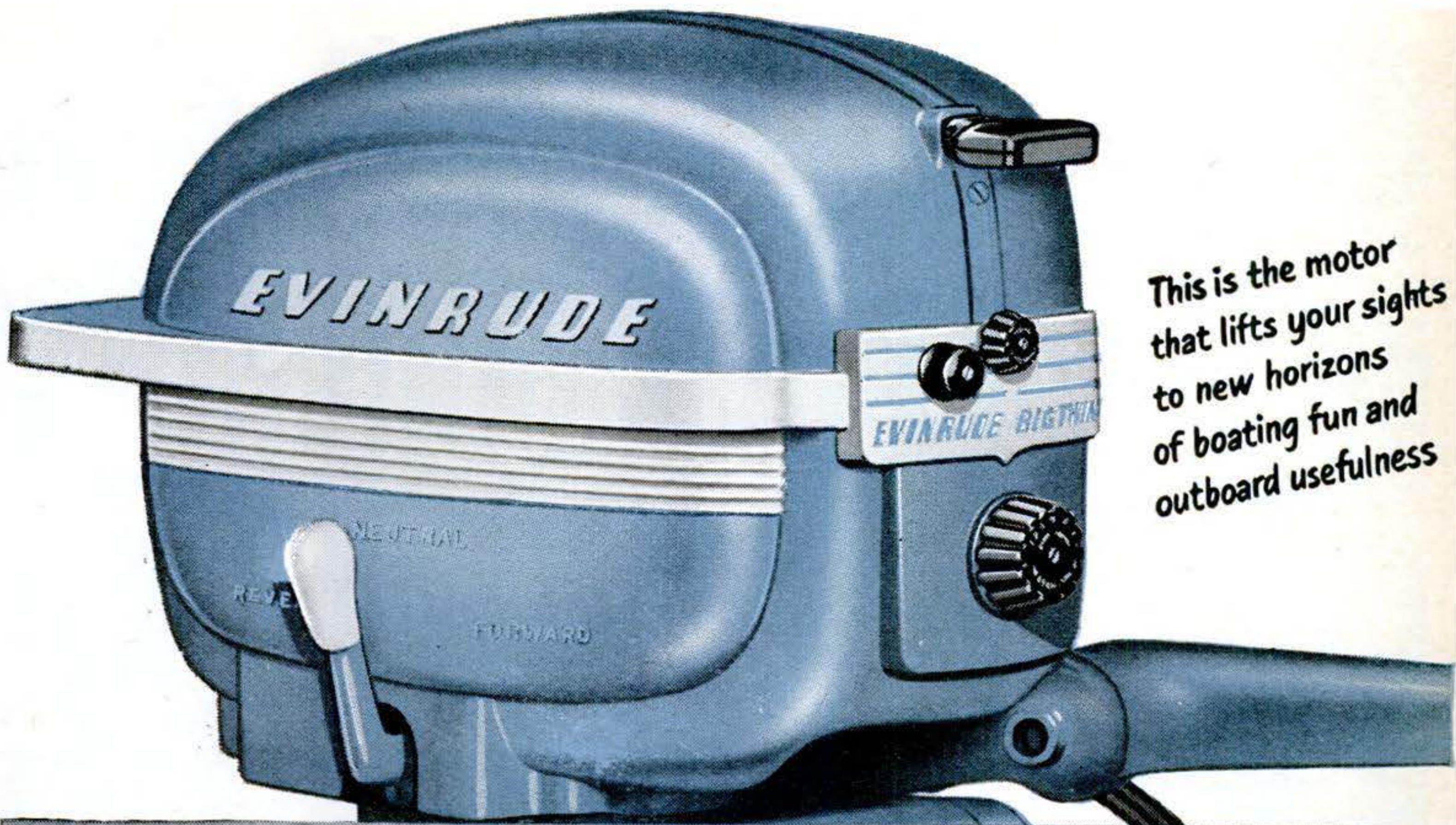

This is the motor that lifts your sights to new horizons of boating fun and outboard usefulness



**BIG TWIN**  
by **EVINRUDE**

**25 HORSEPOWER\***

**Only 85 POUNDS**

**new HANDLING EASE**

**ROTO-MATIC CONTROL**

**GEARSHIFT**

**CRUIS-A-DAY TANK**

*... it's years ahead!*

You've heard about a great new Evinrude... a motor that packs the wallop of 25 sharp and solid horsepower *in only 85 pounds*... a motor that thrusts the thrill of exhilarating speed into big boats, heavy loads... the one that takes off like a scared cat, trolls like a sweetheart, handles like a dream... and is *excitingly priced* within the reach of all! This is the one... **BIG TWIN**... it's years ahead! **BIG TWIN** gives you Simplex Starter for starting ease—and Roto-Matic Control—every speed right in your hand! Gearshift with Neutral, Forward, Reverse! Separate, big-capacity Cruis-A-Day Fuel Tank! Full range performance—less than 2 to over 30 miles an hour on able boats! SEE THE **BIG TWIN**—see the complete 1951 line at your Evinrude dealer! Look for his name under "Outboard Motors" in the yellow pages of your phone book. **CATALOG FREE**—write for it today! Address **EVINRUDE MOTORS**, 4603 N. 27th St., Milwaukee 16, Wis.

In Canada, Evinrude Motors, Peterborough, Ontario

**\$390.00**

F. O. B. Factory, Milwaukee, subject to change without notice.



\*O.B.C. Certified brake H.P. at 4000 R.P.M.



# FOR ACCURACY



**\$189.50**

for complete 5-tool unit without motor. Includes geared Jacobs chuck, 12" sanding disc, 8" saw blade, arbors, lathe centers, etc.

**T**AKE another look at the photo above. See those paper-thin strips? All four were sliced from the same piece of wood in sixty seconds *without changing the rip fence setting*. How? It's easy with SHOPSMITH. You can shift the *saw blade* as well as the fence—using SHOPSMITH's exclusive micro-feed blade adjustment.

There's not much you can do with wood strips. What's important is the speed and extreme accuracy of SHOPSMITH's fence-to-blade settings. And this is just one of SHOPSMITH's many precision features.

The disc sander, for example, feeds into the work, can be set to stop on a hairline.

The vertical and horizontal drill presses have built-in jigs, unique micro-settings. The centerless ground steel ways are stress-tested at over a ton, assure absolute rigidity and accuracy in lathe work as well as in other operations.

Add 'em all up—accuracy, capacity, flexibility, rugged construction and precision features—and you'll begin to see why SHOPSMITH is America's most popular power tool. See SHOPSMITH demonstrated at leading hardware and department stores or any Montgomery Ward store. And for complete details and specifications, mail the coupon.

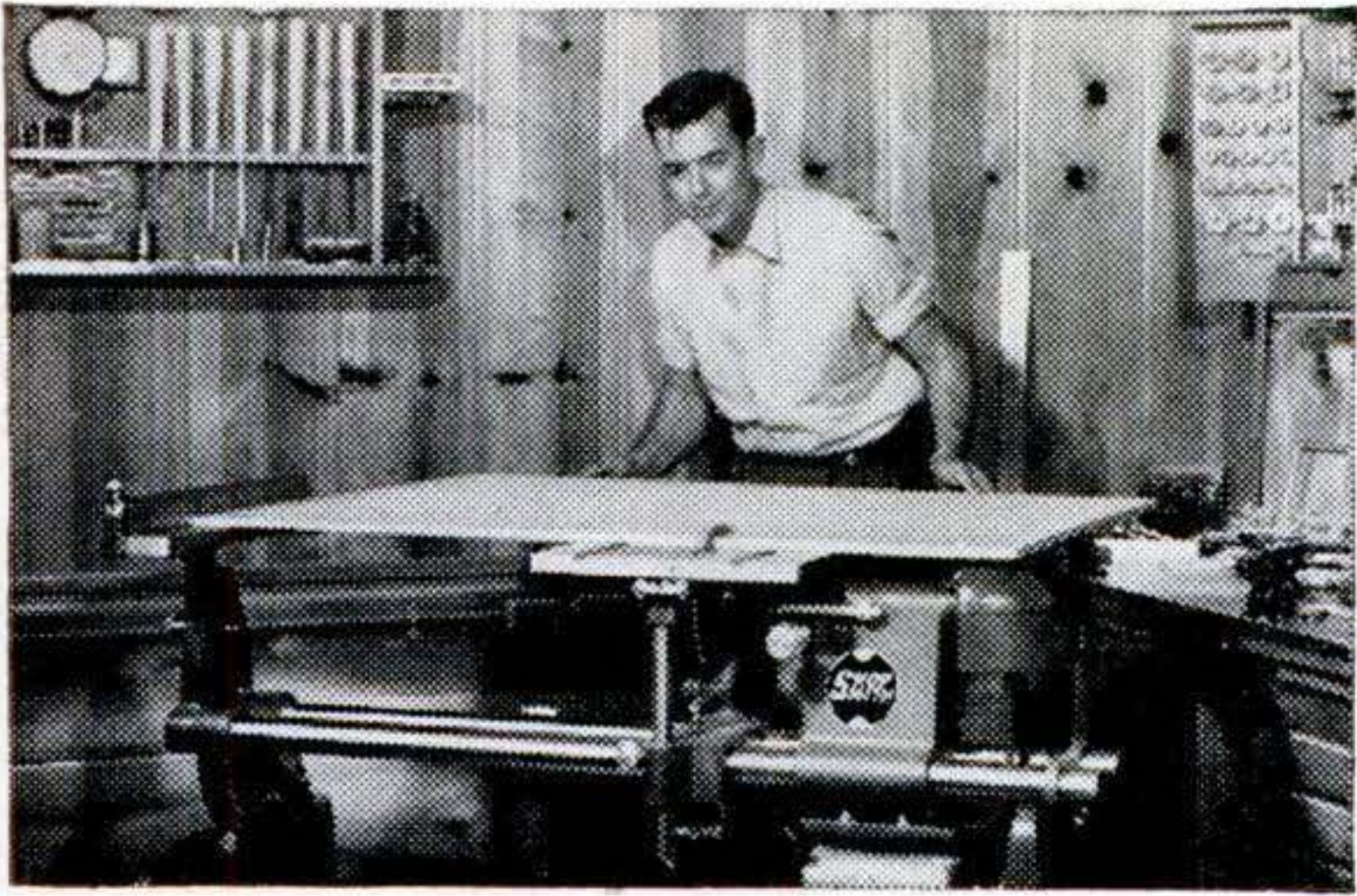

**BLADE TO FENCE—48".** You won't find many saws under \$200 that offer capacity like this. It means you can cut to the center of 8' plywood panels, handle extra-long boards, trim doors, screens, storm sash. Table tilts, raises, lowers. Maximum depth of cut 2 1/4".

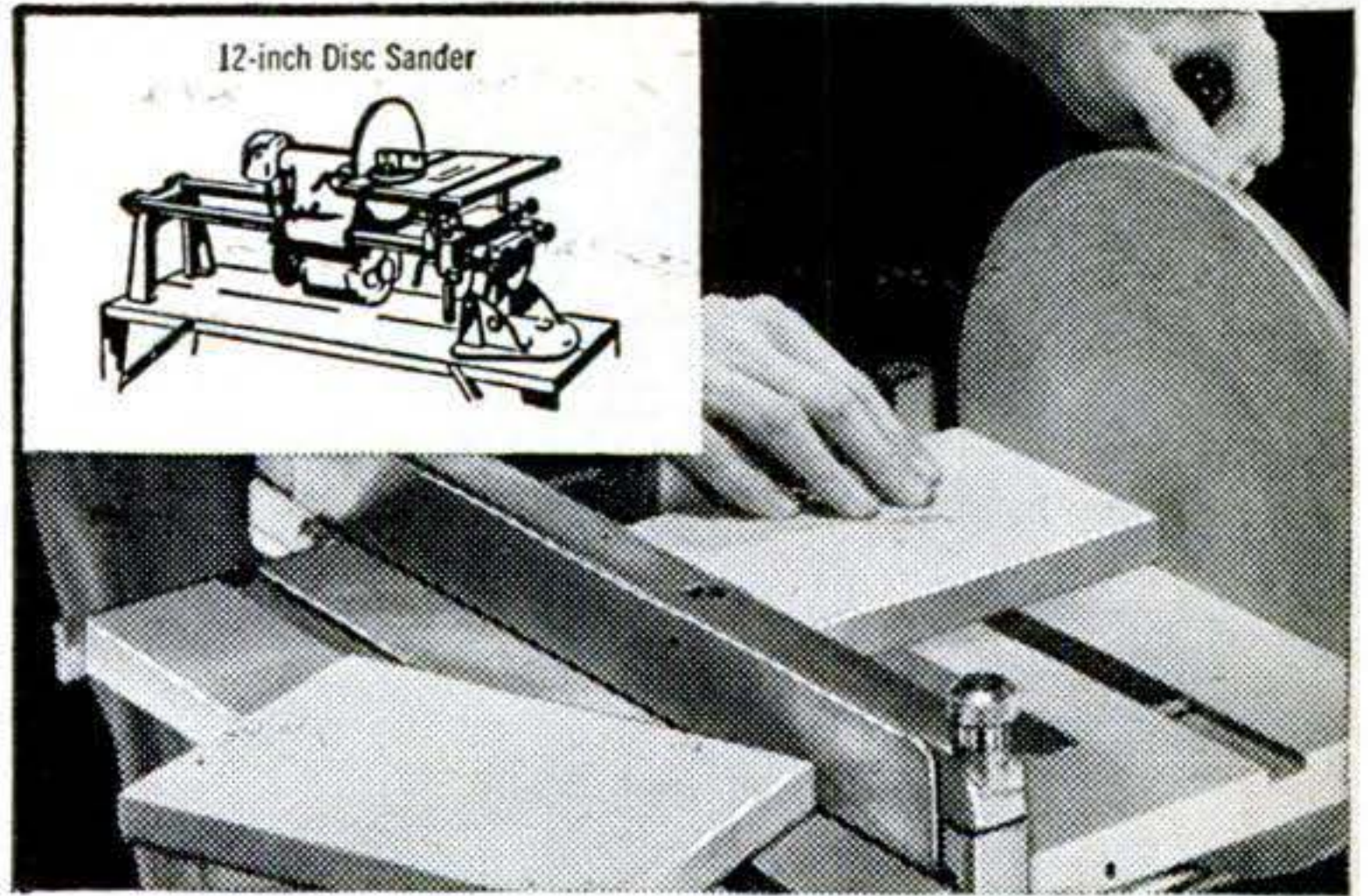

**90° ON THE NOSE.** SHOPSMITH as a disc sander is so accurate you can forget about your try square. Can be used as a jointer too. Work fed through at a slight angle (by cocking fence) comes out with a beautifully jointed edge. Sandpaper discs easily replaced.



**PERFECT DOWELED JOINTS.** No jigs required. Just lay the work flat on the table, feed drill from side. Dowel holes match perfectly. Horizontal drill is especially useful when drilling large, awkward work. Its capacity is limited only by the length of your workshop.

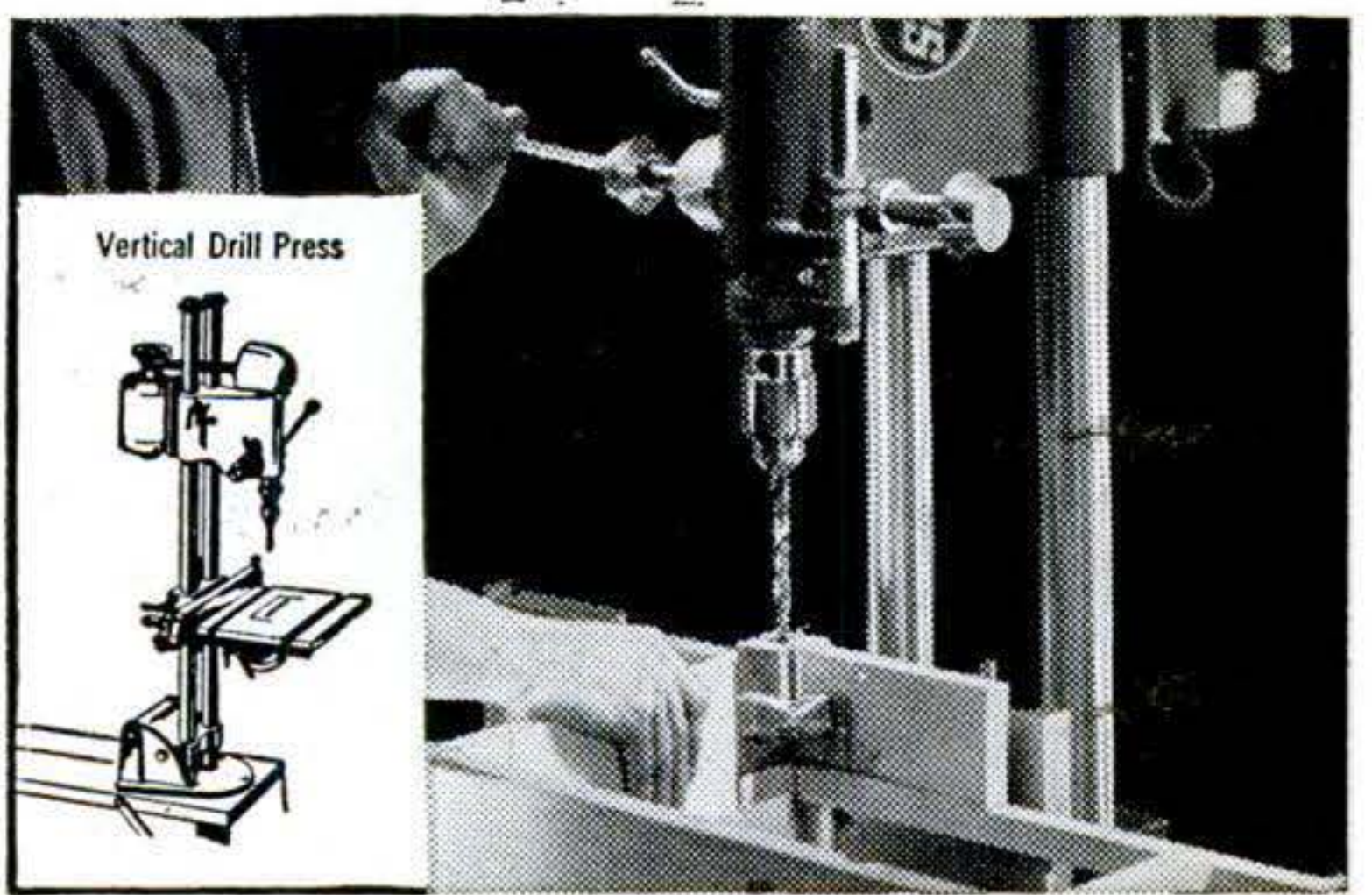

**FLOOR MODEL, TABLE MODEL.** SHOPSMITH as a drill press is both. Maximum clearance, table to chuck, 27", floor to chuck, 55". Jacobs key chuck takes drills up to 1/2" diameter. Speeds range from 875 to 3500 rpm. 4" quill feed. Easy to read, adjustable depth scale.

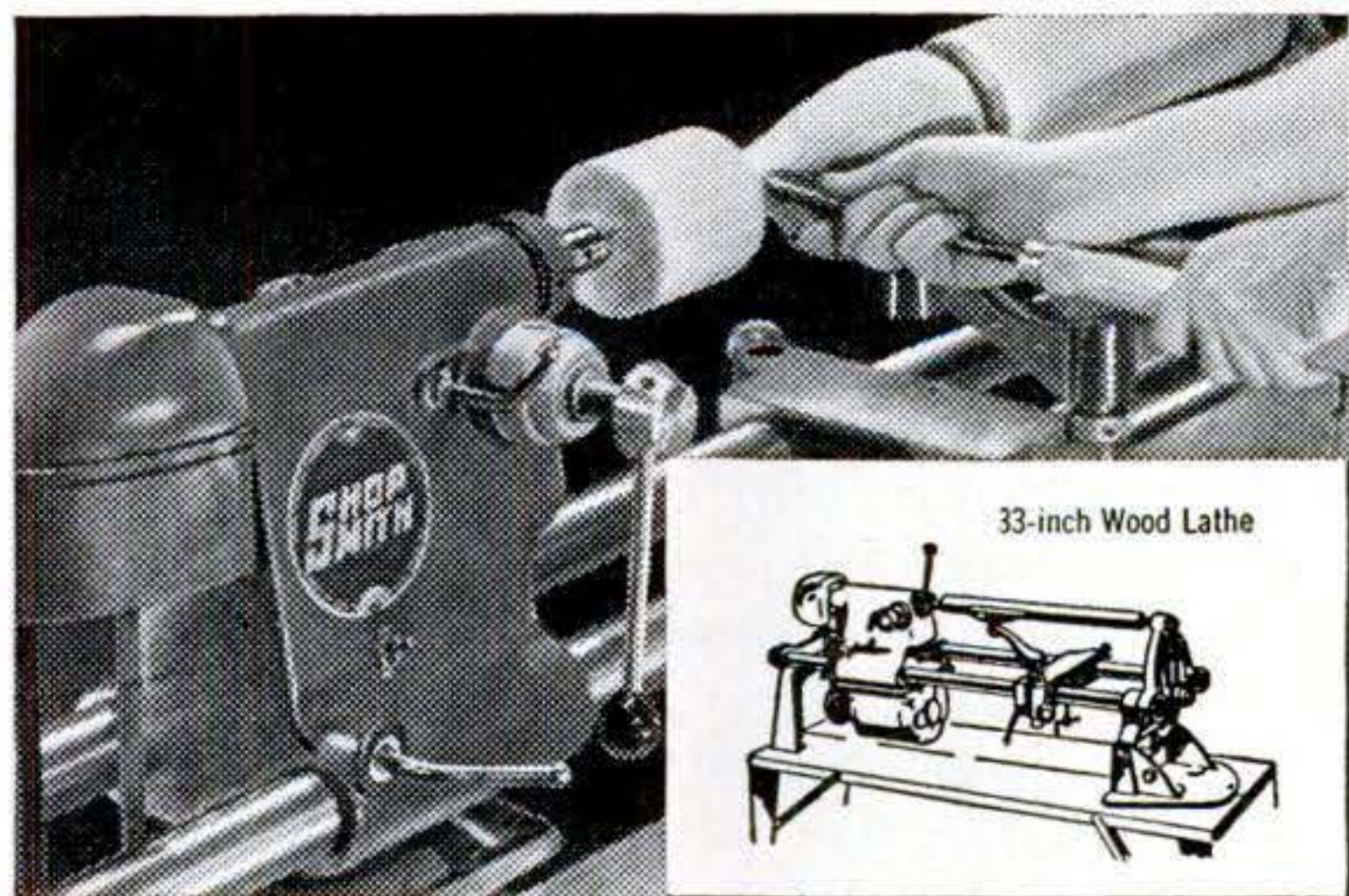

**ROOM TO TURN IN.** SHOPSMITH as a lathe has a 15" swing—4" more than most other heavy-duty lathes. It has a quick-set tool rest that always moves parallel to your work-piece. And it's the only lathe that lets you face the work while face-plate turning.

**NEW RETRACTABLE CASTERS**

... increase SHOPSMITH'S already great flexibility. They're easily mounted on any wood or metal bench. Easy to set, too, with three-stage foot levers that raise or lower unit. Your SHOPSMITH dealer has them. Complete set . . . \$11.95.

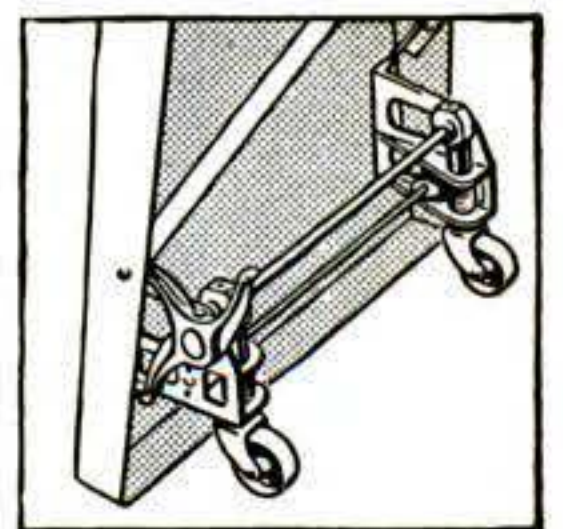

**ADDRESS:**

**SHOPSMITH, Dept. 152-A, at factory nearest you:**  
 12819 Coit Road, Cleveland 8, Ohio, OR  
 417 Montgomery Street, San Francisco 4, Calif.

Please send me the free SHOPSMITH booklet.

Name \_\_\_\_\_

Address \_\_\_\_\_

City \_\_\_\_\_ State \_\_\_\_\_

**YOU CAN TELL  
A GOOD  
ELECTRIC DRILL  
BY ITS CHUCK**



**JACOBS**

**If it's a JACOBS  
It bears the name...look for it!**

**Jacobs Plain Bearing Key Chuck...** the most widely used drill chuck in the world. You can trust the tool that has one.

**Jacobs Rubber-Flex Hex-Key Chucks** on home workshop power tools prove that their makers put quality first.



**Jacobs Rubber-Flex Hand-Tite Chuck.** One-piece RUBBER-FLEX jaw assembly holds tools true and tight. No loose jaws or springs.

**IF IT'S A**

**JACOBS**

**IT HOLDS**

The Jacobs Manufacturing Company  
West Hartford 10, Connecticut

**Gus Parlays a Pair of Hunches**  
[Continued from page 242]

about to close up shop and call it a day, the glare from a pair of headlights flashed across the garage windows and Gus heard a car stop. A few seconds later, the shop door slid open slowly. It was Jerry Corcoran, a broad grin on his face.

"You look like you swallowed something more than a canary," Gus greeted him.

"Gus, our case cracked wide open about a half hour ago," the Sergeant announced. "The suspects confessed."

"How'd you get 'em to do that?"

Jerry shoved his hat on the back of his head and perched himself on a corner of Gus's bench.

"Well, after you left the barracks this afternoon I decided to have a look at that road-gang shack, so I called up the road-commission office and got the key. Then a couple of the boys and I drove over."

Gus listened intently, stoking his pipe with shreds of tobacco.

"But the key they gave us didn't fit the lock at all," Jerry continued. "We looked through the windows and the place looked completely empty, but just to be safe, we pried the hasp loose and opened the doors for a look."

"Find anything?" asked Gus.

**Hunches Hit a Three-Bagger**

"Nothing except a burlap sack stuffed with more than eight thousand bucks in bills, a hydraulic garage jack, and a blood-stained tire iron hidden under some loose floor boards," grinned Jerry. "Those birds had planned to cache the money there until the heat was off and they were released. They'd even changed the lock. But thanks to your hunch, we not only got the money but the murder weapon as well, complete with fingerprints."

Gus grinned a satisfied grin.

"Tell me, Gus, what in the world ever gave you that hunch?"

"Remember that car with the knocking engine that I said shouldn't knock?"

Jerry nodded.

"Well, after making all the usual tests, I decided that the knock wasn't in the engine at all, but had something to do with the movement of the engine on its rubber mounts," explained Gus. "So I started to get underneath for a look. As I did, I just happened to notice that the car had snow

[Continued on page 248]



# Take a Tip From American Airlines!

USE DEPENDABLE

# CHAMPION

## Spark Plugs

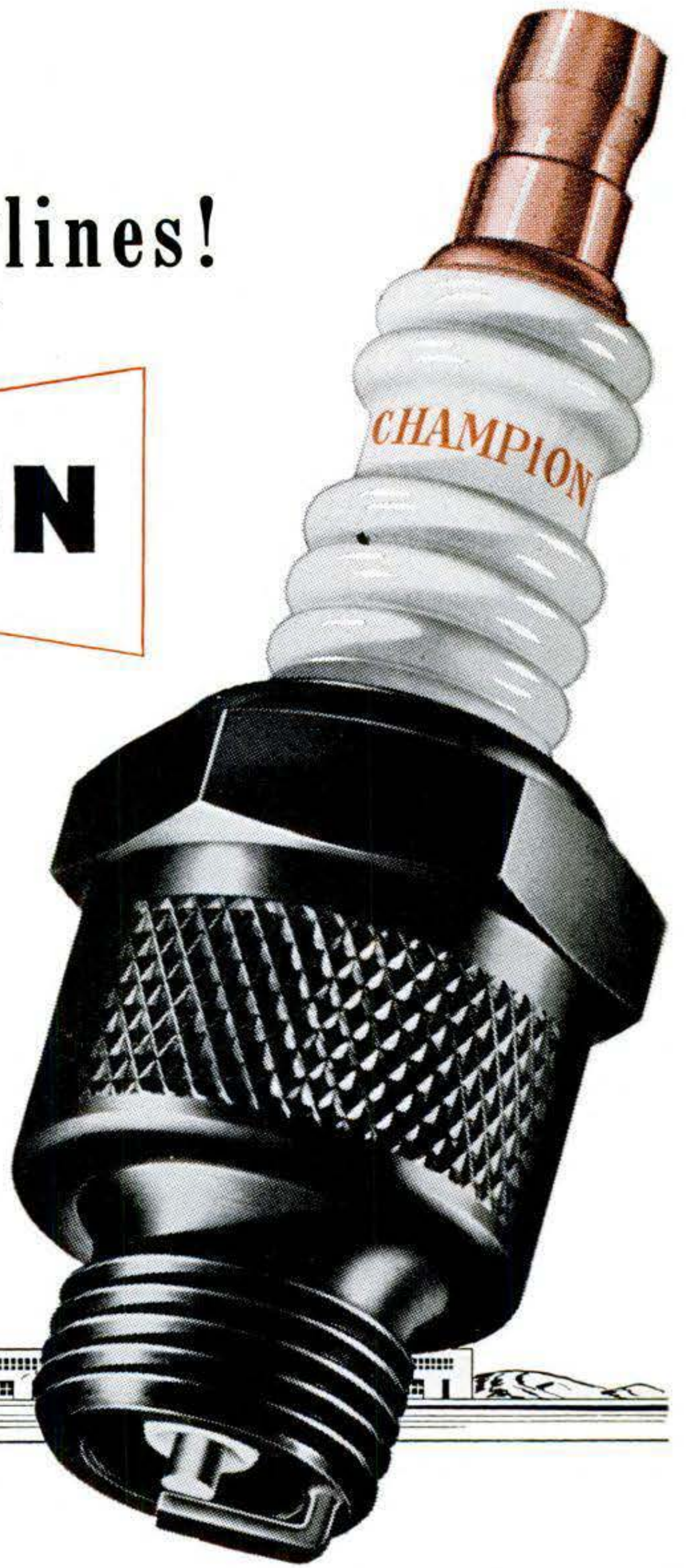

**BE A CHAMPION DRIVER**

*... Good Spark Plugs are the Key to More Power!*



Airline pilots know that the ability to get maximum engine power at a given moment is the greatest single safety factor they have. That's why 95% of the airlines fly with Champions!

Maximum engine power for passing is also a safety factor in driving. If your car lacks power, take American Airlines' word for it and install new Champion Spark Plugs.

**"AMERICAN AIRLINES** requires spark plugs that give maximum power, economy and dependability. Naturally, then, dependable Champion Spark Plugs are the approved standard for our fleet."

(signed) M. G. BEARD  
Chief Engineer  
American Airlines

CHAMPION SPARK PLUG COMPANY, TOLEDO 1, OHIO

Listen to the CHAMPION ROLL CALL . . . Harry Wisner's fast sportscast every Friday night over the ABC network

FEBRUARY 1951 247

## BUILD A BUNKROOM



## REMODEL THE ATTIC

with  
the  
**WESTERN  
PINES\***



Rugged, he-man quarters for your young buckeroos are a cinch to build with colorful, easy-to-work Western Pines\*. Or turn an idle attic into a cozy and hospitable guest room by building double-deck beds of these attractive, economical woods.

The smooth textures and straight, even grain of the woods of the Western Pines\*—the wonderful way they grip paint, stain or wax—make them a joy to use on any workshop project. Cabinets, bookcases, tables, built-in fixtures for kitchens or rumpus rooms take on beauty and character from these glowing woods. They have long been favorites with home craftsmen who take pride in turning out a variety of useful and attractive home furnishings.

### SEND FOR FREE IDEA PACKET No. 452!

Shows you how, with a little planning and ingenuity, you can work wonders all through your home with the versatile Western Pines\*—and have fun doing it. Contains new, colorful illustrated booklet, "Enchanting Homes of Western Pines," "Bunk Bedroom Details," "How to Treat Knotty Pine Paneled Walls," etc. Write to Western Pine Association, Dept. 452-L, Yeon Bldg., Portland 4, Oregon.

These are the Western Pines

- \* IDAHO WHITE PINE
- \* PONDEROSA PINE
- \* SUGAR PINE

## Gus Parlays a Pair of Hunches

[Continued from page 246]

tires and one of 'em was on the wrong way."

"Clue, or rather hunch, No. 1," put in Jerry.

"Right. Now, it also happened that the car belonged to Ed Johnson—the road engineer for this district. And that made me think of that old road-gang shack down near Trayton's."

"By the way," asked Jerry, "did you solve the mystery of Johnson's knocking engine?"

Gus reached over on his bench and picked a small stone. "Found this bedded in a mixture of dirt and road tar on the motor cradle," he explained. "When the engine rocked on its rubber mounts during uneven idling or when it was stopped or started, the engine hit the stone and caused what sounded like a knock. Soon as I pried it loose," Gus added, holding up the out-size pebble, "the 'knock' disappeared."

"Always play your hunches, don't you, Gus?" grinned Jerry.

"Have to in this game," confessed Gus. "Just between you, me, and the gas pumps out there, finding out just what ails a hunk of machinery pretty often is about three-quarters hunch and one-quarter know-how."

"Plus following all your hunches through," added Jerry.

END

## My Most Ongenious Solution



Well, I finally found another use for beer. What do you think it is?

While driving in the country, I was stopped by an electrical fire in the engine. I was stuck for a fire extinguisher until I remembered a few bottles of beer I was bringing home. I took the cap off one, shook it up, and then squirted it on the fire. That put it out.—George Rutkoski, Sugar Notch, Pa.

# HERE'S HOW YOU DO MORE JOBS

## with a DELTA® DRILL PRESS

Only Delta offers so many extra-job accessories!

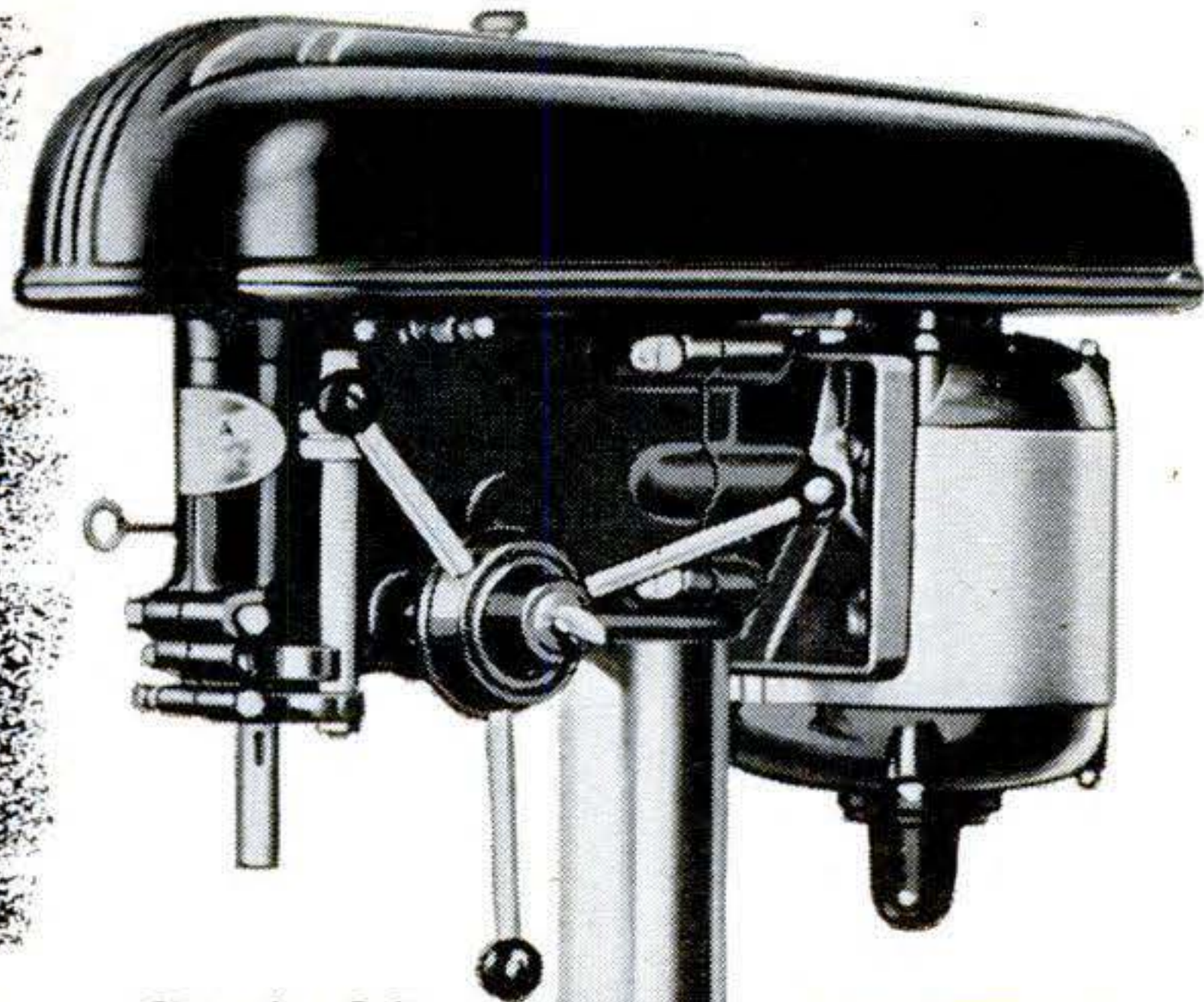

Shown is a Delta 17" Drill Press, one of 144 different models Delta offers in 14" and 17" sizes.

**DELTA**  
MILWAUKEE®

### A SPINDLE FOR EVERY JOB

You can change the spindle on your Delta Drill Press, equip it to do more jobs.

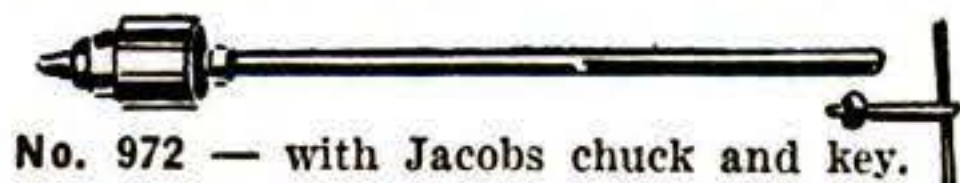

No. 972 — with Jacobs chuck and key.

No. 973 — with No. 1 Morse taper hole.

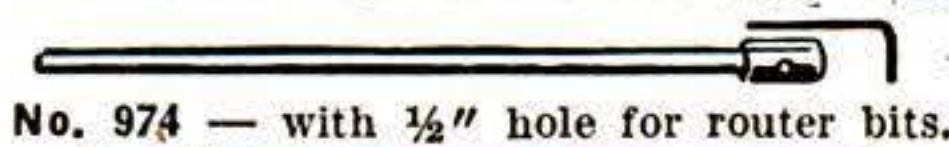

No. 974 — with 1/2" hole for router bits.

No. 977 — with pin and collar for shaper cutters.

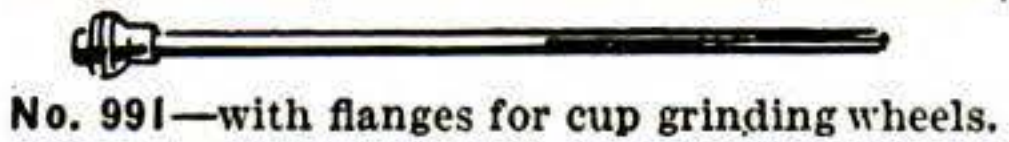

No. 991 — with flanges for cup grinding wheels.

### DRILL IN WOOD

Delta gives you a wide variety of sizes of chisels, bits, bushings for mortising; plug cutters, for cutting dowels, etc. Do straight boring, angle boring, counter-sinking.



### DRILL IN METAL

Using standard holding and clamping fixtures, you can countersink, tap, drill large holes, small holes — in round stock, thin or heavy metal.



### CUT THOUSANDS OF SHAPES

Delta No. 980 Three-Lip Cutter Set makes your drill press a Shaper. You can cut mouldings, picture frames, thousands of shapes.



### DO ROUTING

Using Delta No. 974 Spindle with Delta Router Bits, you can rout curved work, rout with pattern, cross-rout, rabbet, make round-end mortises, flute, cut rosettes.



### SAND CURVES ACCURATELY

Delta offers a big selection of sanding drums and sleeves for pattern sanding and freehand sanding of irregular curves.



### MAKE MORTISE AND TENON JOINTS

Delta No. 976 Mortising Attachment converts your drill press into an accurate mortising machine that saves time and money.

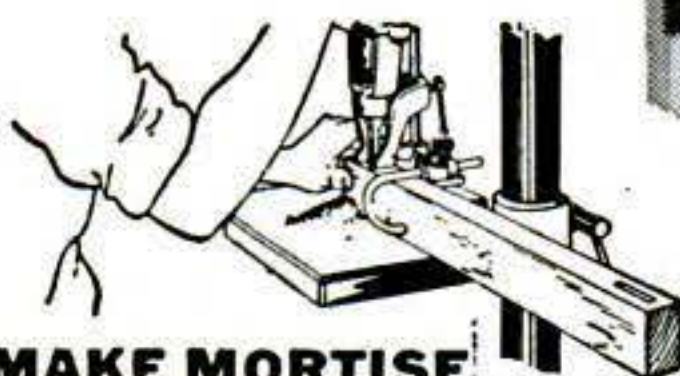

### DO MANY OTHER JOBS

Drill glass, slate, marble, paper. Mill, carve, surface, spin rivets, flute and reed turnings, cut disks, cut tenons, mix paint, do engine finishing, point dowel rods, polish and buff, etc.

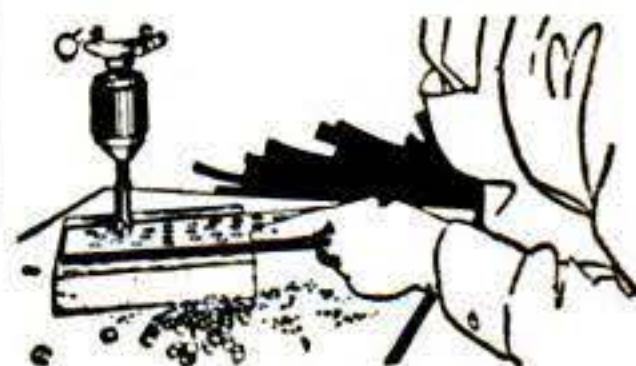

### "HOW-TO" BOOKS

suggest what to make, tell how to make it — in clear words and pictures. Available from your nearby Delta dealer, as part of his complete "one-stop" service on power tools and accessories. See him, to get the most out of your power tools — take on new jobs — have more fun — make new profits!



Look for the name of your Delta dealer under "Tools" in the classified section of your telephone directory.

**Free!**

Catalogs and bulletins on complete Delta line.



### TEAR OUT COUPON AND MAIL TODAY!

DELTA POWER TOOL DIVISION  
Rockwell Manufacturing Company  
804B E. Vienna Ave., Milwaukee 1, Wis.

Send me free catalogs and bulletins on the complete Delta line of tools and accessories.

Name \_\_\_\_\_  
Title \_\_\_\_\_  
Company \_\_\_\_\_  
Address \_\_\_\_\_  
City \_\_\_\_\_ (\_\_\_\_) State \_\_\_\_\_

B-16

DELTA POWER TOOL DIVISION

**Rockwell**  
Manufacturing Company  
MILWAUKEE 1, WISCONSIN

**NO CAR SHOULD BE WITHOUT ONE!**



**CASCO VIS-O-LITE**  
Illuminated Automatic  
**CIGARETTE LIGHTER**

Why be without the convenience of this great new Vis-O-Lite illuminated lighter that makes driving safer day and night? You can replace your old lighter with a new Vis-O-Lite in a matter of minutes with pliers and screwdriver . . . and get the advantages of an illuminated lighter—well that ends fumbling in the dark, prevents scratching dashboards. Made by the manufacturers of the original pop-out lighter that's standard equipment on 4 out of 5 cars. Costs only \$2.75 complete. The illuminated well-assembly alone (minus the pop-out unit) costs only \$1.25. Now on sale at Car Dealers, Auto Supply Stores and Service Stations.

**NO HOBBYIST SHOULD BE WITHOUT ONE!**

**LOWEST PRICE EVER... for a CASCO**



**only \$9.95 NEW CASCO-CRAFT 14 Pc. Kit**

A complete, practical power-workshop for craftsmen, hobbyists! Has accessories to drill, cut, etch, carve, grind, buff, sand, engrave and sharpen—metal, wood, glass, leather, plastic and fibre. 1001 year-round money-saving uses. AC and DC. At Dept., Hardware, Appliance, Jewelry Stores.

WRITE FOR NAME OF NEAREST DEALER

CASCO PRODUCTS CORPORATION  
BRIDGEPORT 2, CONNECTICUT



**Mechanics of Farming**



By Ladd Haystead

■ Grassland farming means better pasture grasses and legumes, more forage production, utilization of grass silage. But animal droppings on pastures have caused headaches. Plant life under the droppings tends to grow rapidly and form clumps, making an uneven surface that breaks implements. Now Fuerst Bros., 87 Nassau St., New York City, have imported a Scotch harrow called Homer's Flexible Tine that distributes the droppings, eliminates clumping.

■ Carried like a bazooka, the new one-man, portable, heavy-duty elevator shown in the photo below first takes on the job in the field of loading grain trucks. Then you can

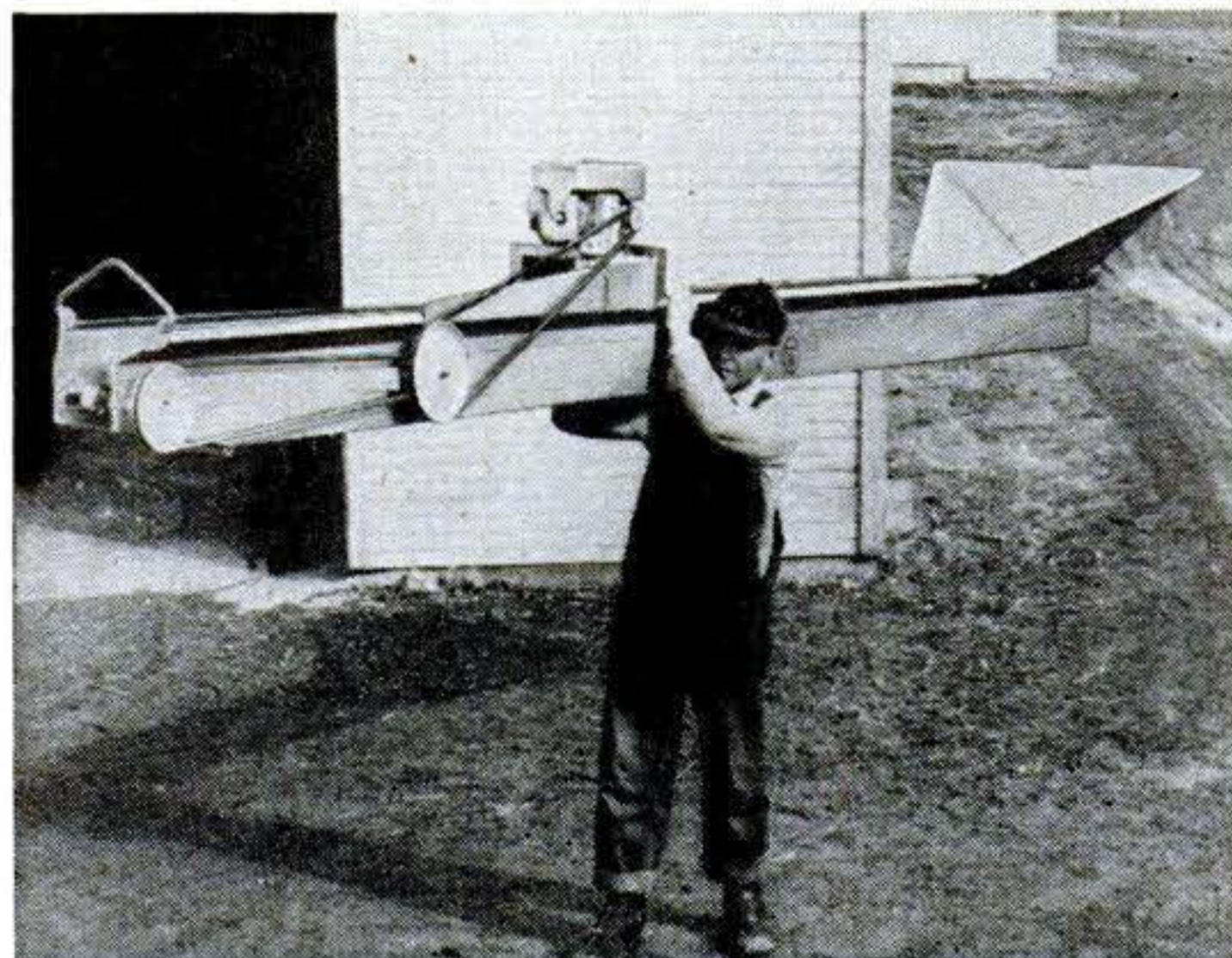

carry it in and use it to transfer the grain from truck to barn loft. Made by the Belt Corp., of Orient, Ohio, it is powered by either gasoline or electric motor, has a 20-foot reach, digs into grain without scooping, and can handle up to 600 bushels per hour of corn, oats, or soybeans.

■ The Guide Lamp Division of General Motors offers a new dual-purpose light for tractors that gives a flood of light for attaching implements, and also a red rear light for safety when moving on the highway.

■ Tractor tires, almost from their introduction, have been weighted with water to provide traction. B. F. Goodrich Co. comes up with a

The more you delay -  
the more you pay!



**KEEP YOUR CAR  
OUT OF THE  
DANGER ZONE**

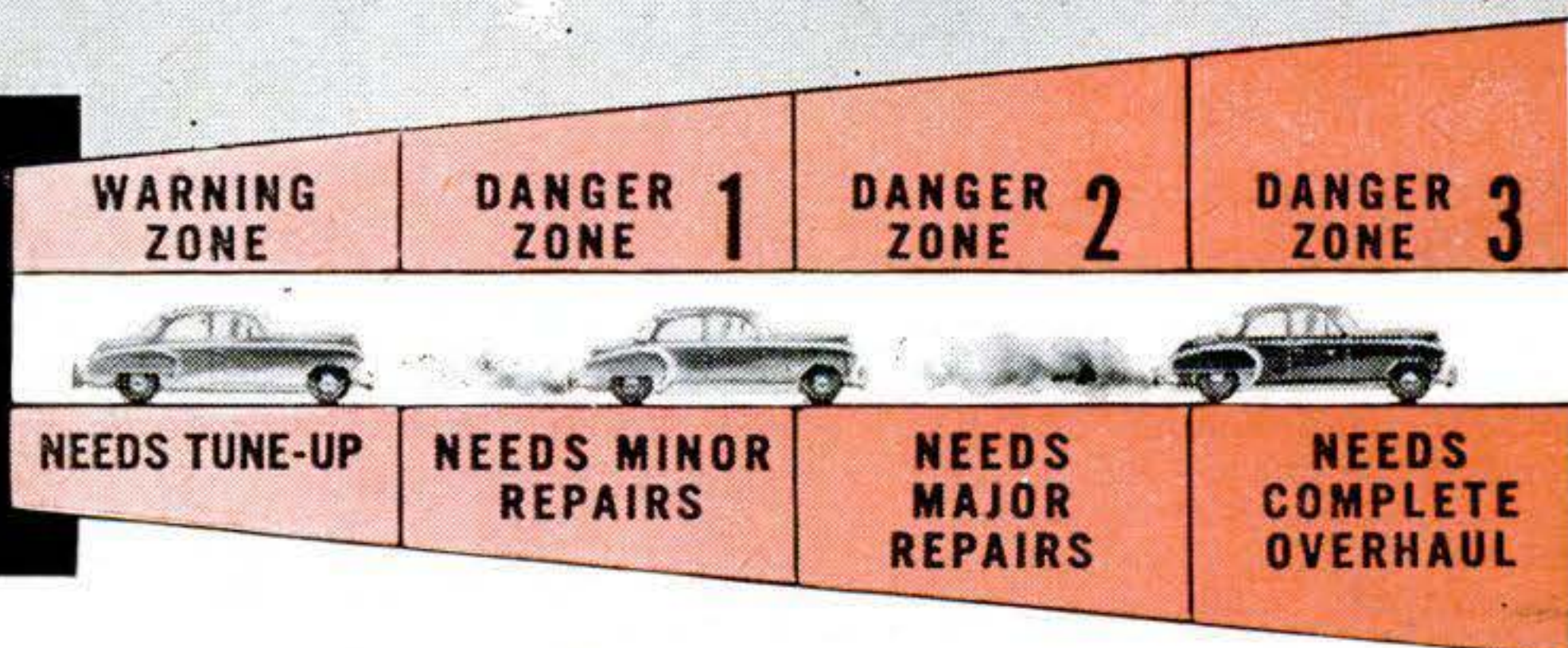

When oil-pumping starts in your car, you can be pretty sure your piston rings are wearing out. And, unless you replace them, you can be very sure you are headed for costly Danger Zone No. 3.

Piston rings are designed to take the wear—to be replaced again and again—to save your engine.

So, when your car first needs new rings, ask your motor specialist to replace them with Hastings Rings. They are engineered exclusively for replacement service. They stop oil-pumping, check cylinder wear, restore performance. The more you delay, the more you pay. Hastings Manufacturing Co., Hastings, Michigan. Hastings Ltd., Toronto.

# HASTINGS

**FREE!** Write for Danger Zone Booklet. It shows you how to save money on engine repairs.

## STEEL-VENT PISTON RINGS

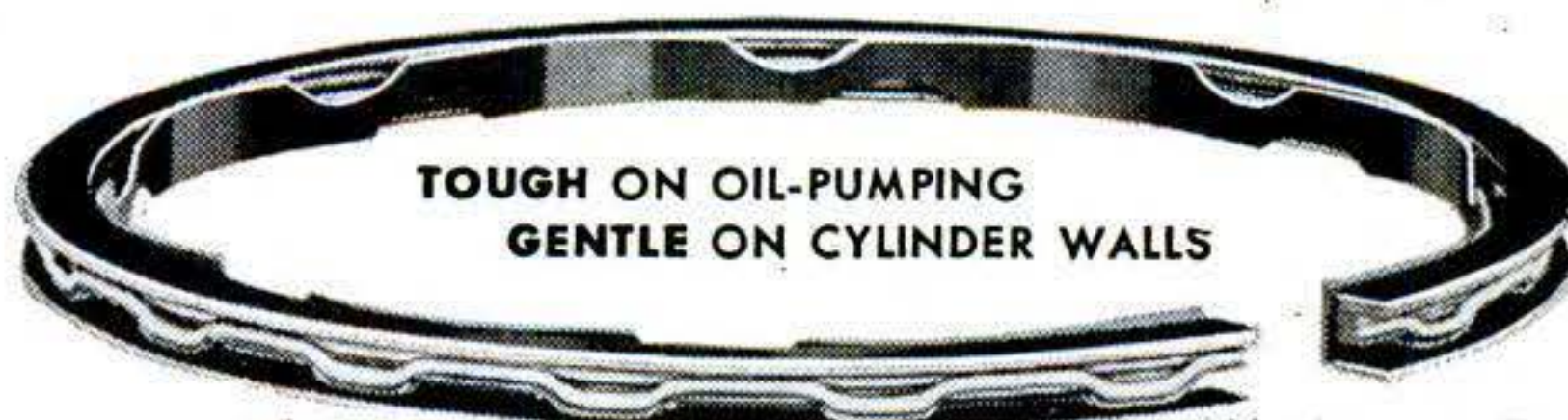

TOUGH ON OIL-PUMPING  
GENTLE ON CYLINDER WALLS

# SANDS FASTER Than 10 Pairs of Hands!

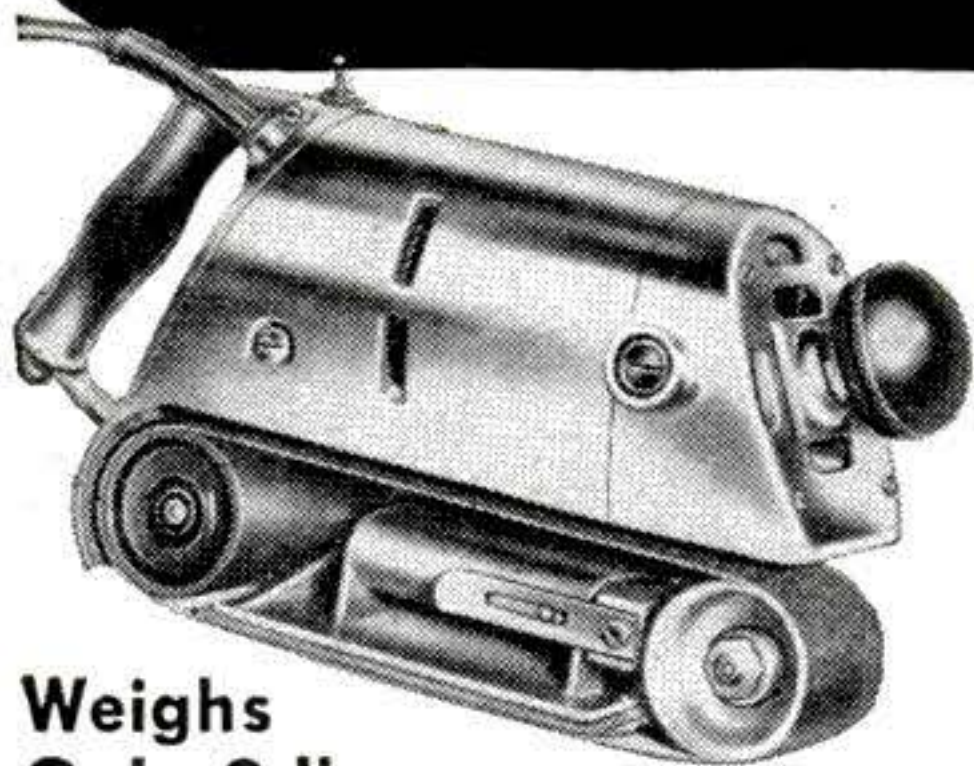

PORTER-CABLE  
**Guild**  
SANDER

only

**\$62.50**

**Weighs  
Only 9 lbs.**



**Speeds Paint Removal . . .** Used to be tough and messy to remove paint and varnish — not any more! It's easy with this powerful motor and high belt speed working for you.



**Plane-Sands Faster . . .** Another job made easy. The Guild A-2 Sander is perfect for taking off stock to close dimensions.

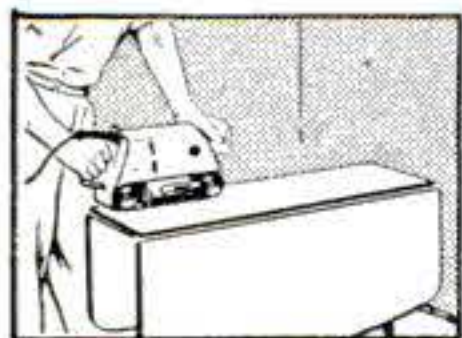

**A Whiz at Preparing for a Finish . . .** Always a uniformly fine, velvet-smooth surface. No waves or swirls — levels perfectly — cleans blemishes! And that's not all!

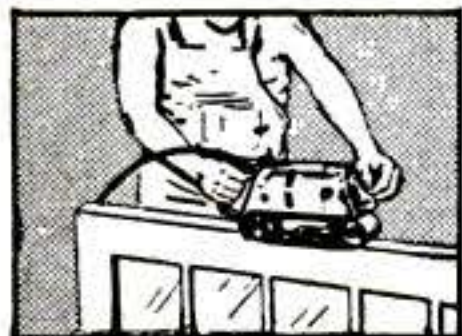

**Speeds Screen, Sash and Door Fitting . . .** And does a workmanlike job that will amaze you.

• Guild Sander does that job *fast* without hand-sanding drudgery! No bearing down — the powerful motor insures effortless, efficient cutting. So light, so perfectly balanced, Guild handles easily in *any* position. High speed abrasive belts have a variety of grits for work on wood, composition, plastic, metal, glass. Handy bench stand (extra) converts Guild Sander to a tool grinder — and to a machine for truing and smoothing butt and mitre joints.



Bench Stand

See your dealer for free demonstration.  
It'll open your eyes. Send in coupon today.

Send me literature on the Guild A-2 Sander and Bench Stand.  
Also name of my nearest dealer

Name .....

Address .....

City ..... State .....

**PORTER-CABLE MACHINE CO.**

6082 N. Salina St., Syracuse 8, N. Y.

## Mechanics of Farming

new one that provides for a cushion made of resilient rubber on the base portion next to the rim. Claim is it eliminates the bouncing caused when the water-fill is used alone.

■ University of Georgia announces a hybrid cotton that may have the vigor, yield, and other valuable characteristics of hybrid corn. Large-scale commercial production is not expected at the moment.

■ Pentachlorophenol, a fence-post spray well known to farmers, has a new use: hastening ripening of soybeans. The chemical knocks leaves off plants, permits light and air in, dries beans out faster, speeds up harvest two weeks. University of Illinois, where usage was developed, says the new method will provide earlier marketing and better prices, and allow time to plant a winter cover crop to cut down erosion.

■ An out-of-sight steering wheel--behind and under a hood--is offered by Oliver in a new tractor model for use in orchards. Nothing protrudes to catch and injure the trees.

■ Stonecliff Farm Dairy, Bradford, Vt., announces they sell milk that not only is not touched by human hands, but isn't even exposed to open air. The milk is taken from each cow by a vacuum milker, goes through pipes to a strainer unit, and down to a stainless-steel collector tank under 300 pounds pressure. After passing through a pasteurizing steam jacket, it is cooled by ice water, and the tank swung to a bottling machine. It is claimed the milk has the same flavor as if fresh from the teat.

■ When industry doesn't provide new tools, farmers make their own. Howard Morgan, young Oregon rancher, was shocked at the price of \$1 per unit for a fence post on-the-site. So he built a derrick that could be mounted on his tractor, added a 400-lb. pile-driver hammer. Cost--\$225. Powered by the extra drum of a bulldozer control, the rig set 650 regulation seven-foot posts, two feet deep in clay soil, in first week. With an outlay of \$40 for hired labor and \$10 for tractor fuel, the machine paid for itself in one week.

# "Go to the head of the class!..."



That's what my Economics teacher said when I showed him how to solve his problem.

**THE PROBLEM:**  
Find the true economical way to make a high-mileage Ford run like new again.



ASK YOUR FORD DEALER OR INDEPENDENT GARAGE. WHEN THE ENGINE YOU BUY HAS THIS EMBLEM--IT'S YOUR ASSURANCE OF QUALITY AND VALUE.

**AUTHORIZED RECONDITIONED FORD ENGINES and ENGINE ACCESSORIES**

\*Crankshaft, camshaft, bushings, valve guides, timing gears, pistons, rings, bearings, rods, valves, gaskets, studs, nuts—all completely reconditioned or replaced with Genuine Ford Parts. All work done to exacting Ford standards by authorized experts.

**RECONDITIONER'S GUARANTEE**  
90 DAYS OR 4,000 MILES



## OWN YOUR BUSINESS

### Start in Spare Time with a FOLEY SAW FILER

Here is a steady repeat CASH business you can start at home in your basement or garage, while you are working at your regular job. No experience is necessary to turn out perfect cutting saws—"the first saw I sharpened came out 100%. I think the Foley Saw Filer is a marvel of perfection," writes Clarence E. Parsons. Every saw you sharpen will bring you new customers. You will find you can make up to \$2 or \$3 an hour—\$20 to \$30 a week in your spare time as a starter.

With a Foley Saw Filer you can file all hand saws, also band and cross-cut circular saws. It is easy to operate—simple adjustments—no eyestrain. Patented jointing principle evens up all irregular teeth and makes an old saw cut just like new.

#### This Free Book Shows How to Start

##### "INDEPENDENCE AFTER 40!"

shows you how to get plenty of saws to file without canvassing, and how you can develop into a general repair shop that will be your own business. This is a helpful, practical book that tells just what to do—send for your free copy today. No salesman will call.



Send For **FREE BOOK**

FOLEY MFG. CO., 219-1 Foley Bldg.,  
Minneapolis 18, Minn.

Send me free book "INDEPENDENCE AFTER 40!"

Name .....

Address .....



### Toy House Fits Over Card Table

THE playhouse shown above is actually just an oversize paper bag that is unfolded and placed over a standard card table for support. Doors, windows, and realistic details are printed directly on the heavy flame-proof paper. The KeKo Manor playhouse, which retails for less than a dollar, is made by the Kennedy Car Liner and Bag Co. of Shelbyville, Ind. Unless play gets too rough, the house can be refolded for re-use.

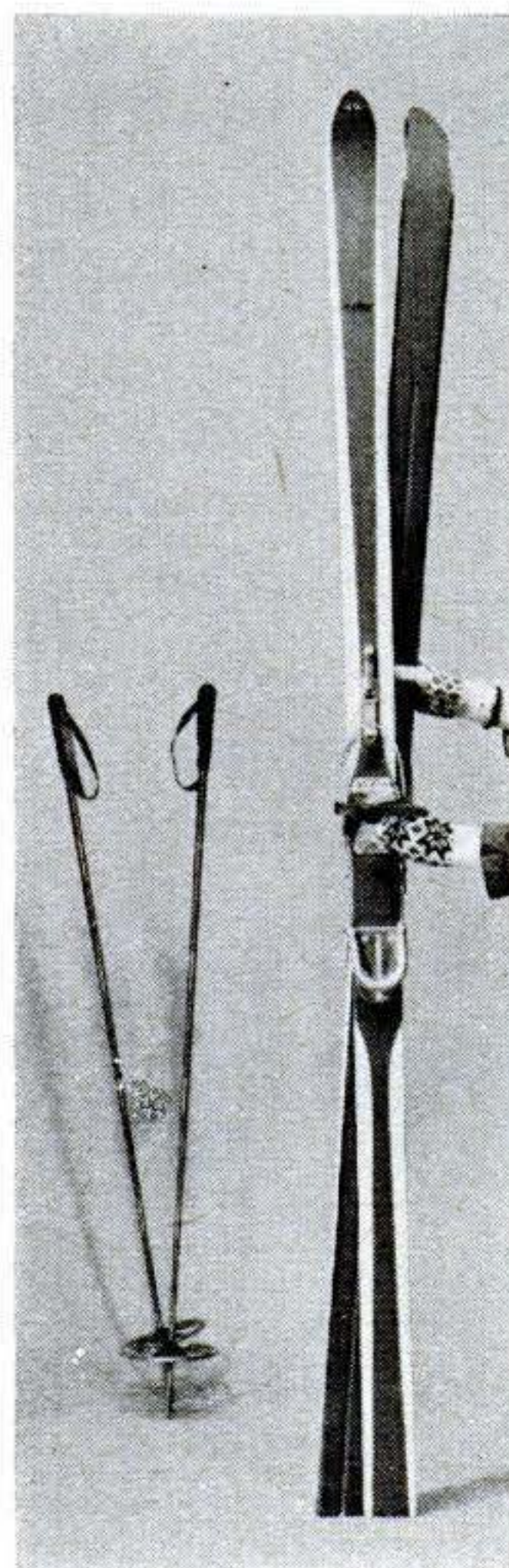

### New Glass Skis Glide Smoothly

GLASS fibers are molded with plastic to replace the traditional wooden runners in new skis developed by the Northland Ski Company. In addition to great strength, Glas-Skis are said to have complete freedom from twisting, checking, and warping—all drawbacks of the conventional hickory runners. Camber, or slight longitudinal arching, is permanently molded in. Another feature claimed for these skis is that they are not affected by extreme changes in temperature.



# NEW Low Cost QUALITY Tools!

ANNOUNCING

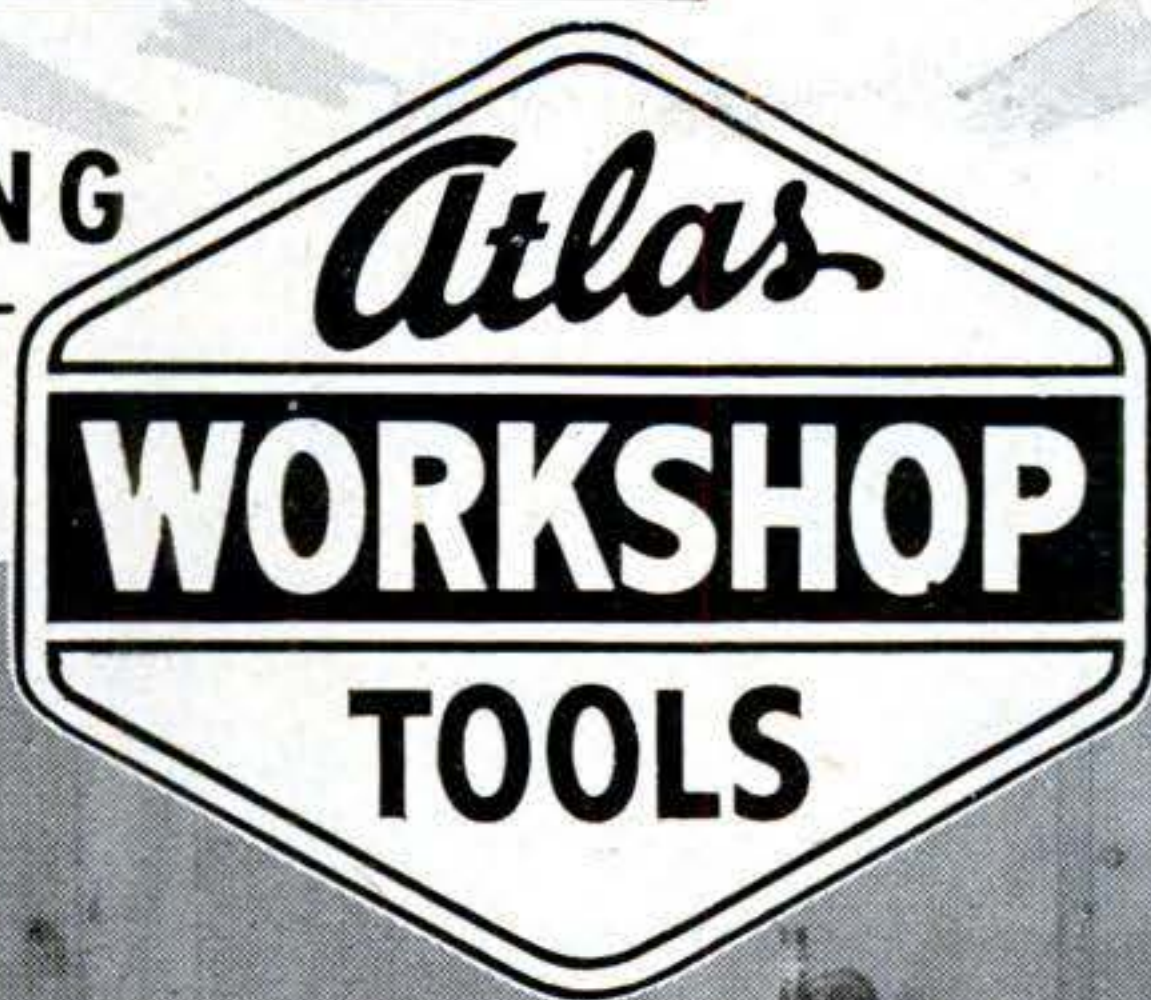

AMERICA'S NEW  
VALUE STANDARDS

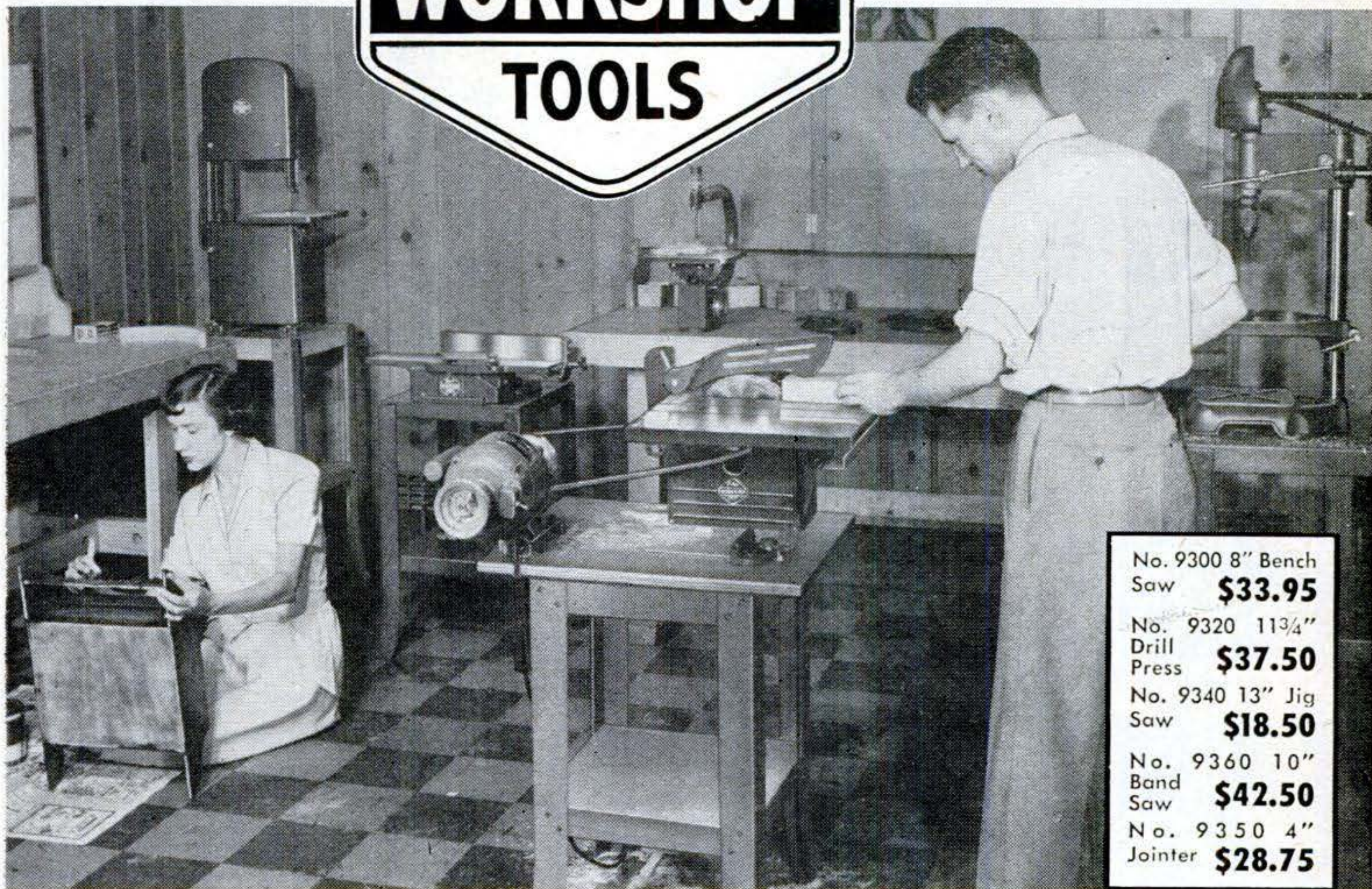

No. 9300 8" Bench Saw	<b>\$33.95</b>
No. 9320 11 $\frac{3}{4}$ " Drill Press	<b>\$37.50</b>
No. 9340 13" Jig Saw	<b>\$18.50</b>
No. 9360 10" Band Saw	<b>\$42.50</b>
No. 9350 4" Jointer	<b>\$28.75</b>

## Now Every Family Can Enjoy the Fun and Savings of a Power Tool Home Shop!

**FREE**

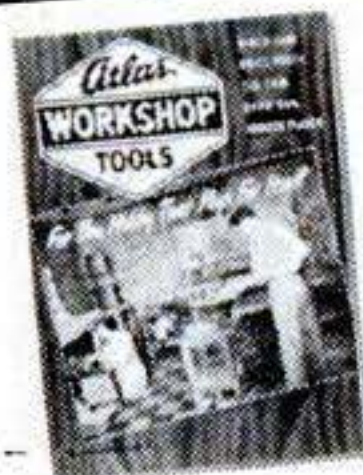

These are the first low-cost *quality* tools. If you have long wanted precision tools for your shop, but haven't wanted to spend the money for large machines, these Atlas Workshop tools will suit you to perfection. All the skill of Atlas' 40 years of precision engineering has gone into the development of Workshop tools. They give your shop *greater* versatility at *less cost* than any tools or combination tool on the market — *and all 5 can be powered with 1 motor!* See them today at the store of any Atlas or Atlas-Power King dealer. Send the coupon for complete catalog.

**ATLAS PRESS CO.**

255 N. Pitcher St., Kalamazoo, Mich.  
Please send your Workshop Tool catalog.

Name \_\_\_\_\_

Address \_\_\_\_\_

City, State \_\_\_\_\_



**ATLAS PRESS CO.**

255 N. PITCHER ST., KALAMAZOO, MICH.

DEPENDABLE QUALITY TOOLS

FEBRUARY 1951 255

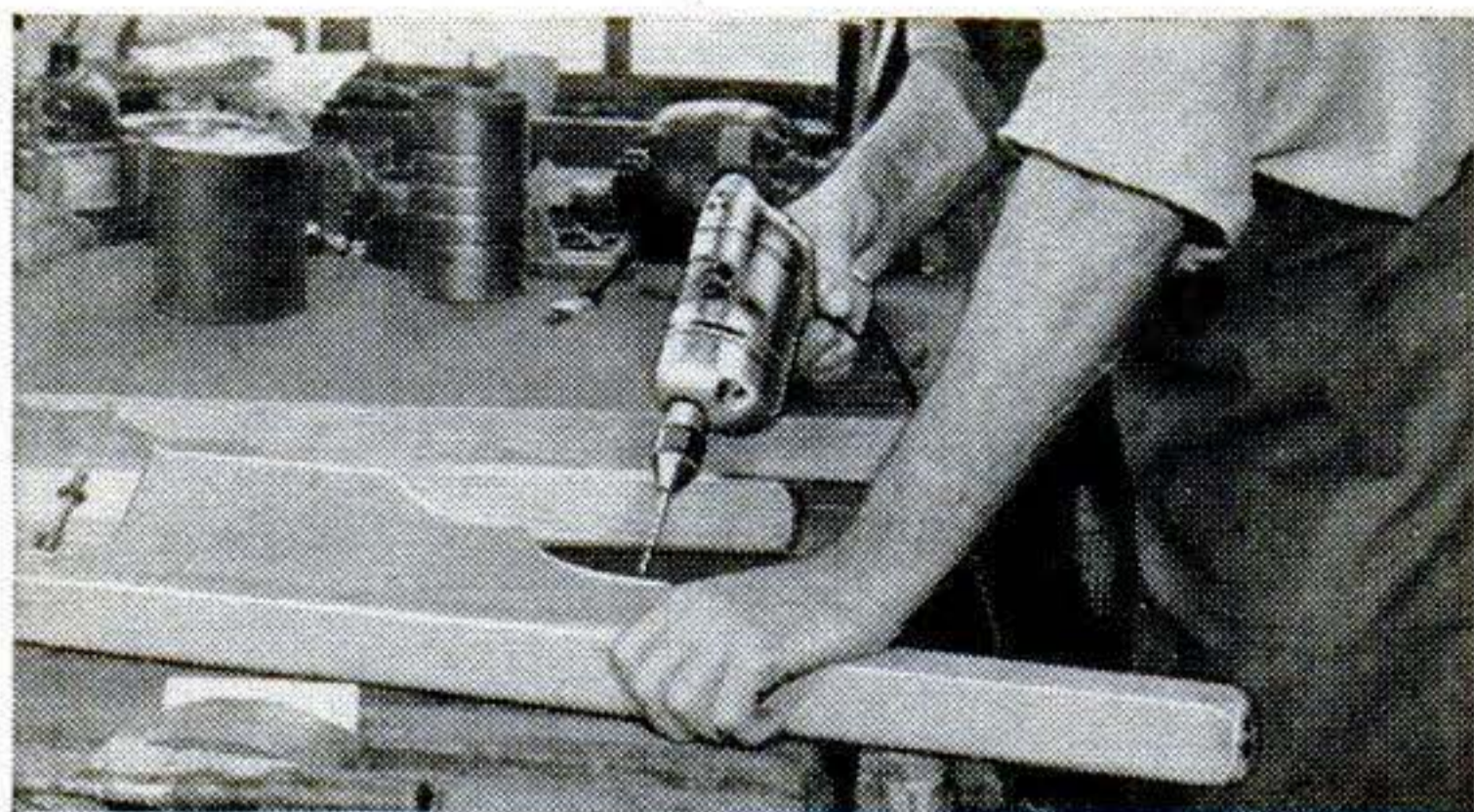

Drilling Wood, Metal, Plastics

**Zip through these home jobs  
with a HOME-UTILITY 1/4" Electric Drill  
only \$22.95 (complete)**

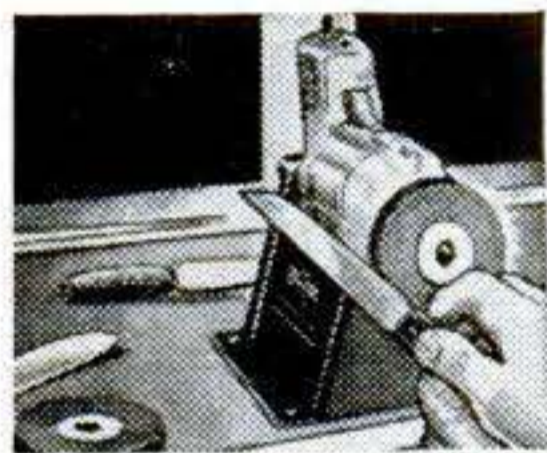

Sharpening  
Cutlery



Refinishing  
Furniture



Shining  
Pots, Pans

**MR. FIXITS, HOUSEWIVES:**

This Home-Utility 1/4" Drill is the workin'est tool you've ever seen! It's a handy fistful of power for installing hardware and fixtures; sanding down furniture; sharpening cutlery and tools; polishing cars, silverware and woodwork; shining up pots and pans; waxing furniture; knocking off old paint and rust; light grinding! Drives scores of attachments. Weighs only 3 1/4 lbs. Over a million sold. Quality-built by BLACK & DECKER, world's largest electric tool maker! Sold at leading hardware, appliance, implement, department stores. *Try One Today!*

Products of HOME-UTILITY Div.,  
The BLACK & DECKER Mfg. Co.  
Dept. H2S, Towson 4, Md.

**ELECTRIC  
HOME-UTILITY  
TOOLS**

SANDER-POLISHERS • BENCH GRINDERS  
1/2" DRILLS • TOOL KITS • LECTRO-SAWS

POWERFUL! PORTABLE! POCKET-SIZE!

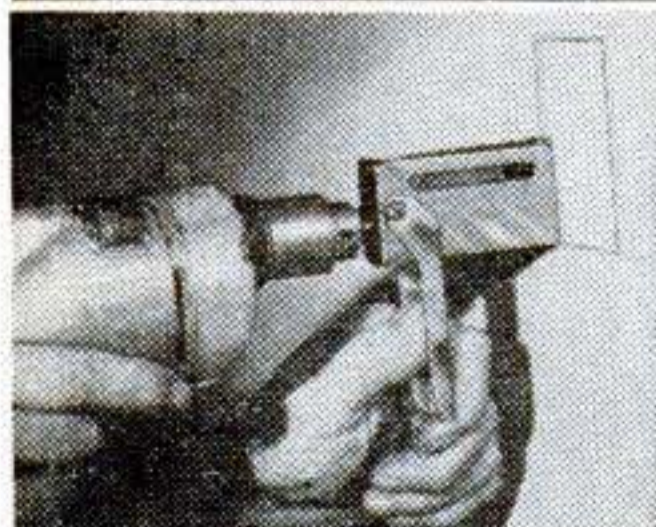

**BULL  
HACKSAW  
only \$4.95**

Fits any 1/4" electric drill or drill press. Weighs only 11 ozs.; small in size—easy to carry, easy to use. 2-to-1 ratio of drill speed to saw speed for extra power! No gears, no bearings, nothing to wear out. Full chip clearance on any wood, metal or plastic stock up to 3/4". Powerful, portable, pocket-size—a must for every home craftsman, only \$4.95.

**LIFETIME GUARANTEE:** At any time, we guarantee to put this tool in perfect working order for a handling charge of 75c.

**BERTRUM F. ENGINEERING & SUPPLY CO.**

3121 Main Street

Kansas City, Mo.

**Wall Outlets for TV Antenna Leads**

FLUSH-MOUNTING wall sockets for concealed TV antenna wiring are now available for use with single or multiple antennas. The model pictured below contains a switch that connects any one of three lead lines to the receiver. Other models provide connectors for antenna rotators. All types fit standard electrical outlet boxes. They're made by Mosley Electronic Specialties, Overland, Mo.

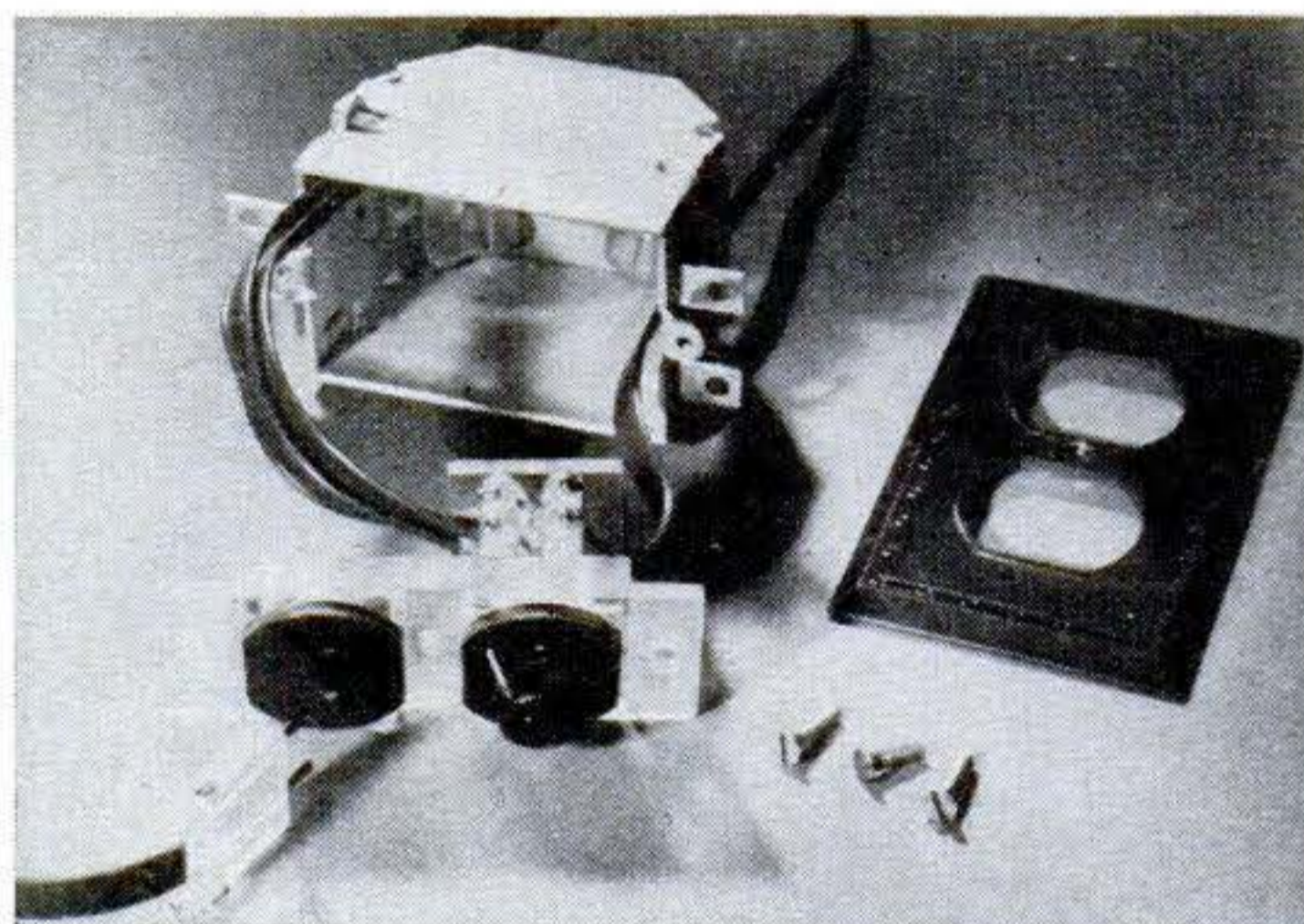
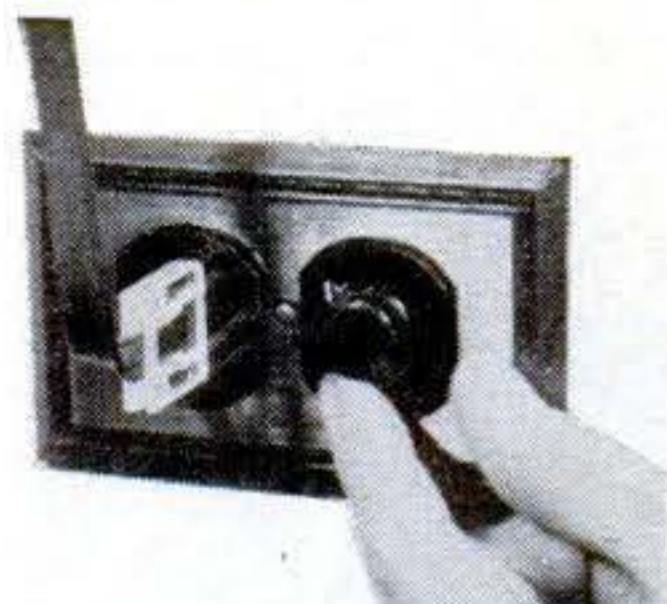

**Hose Guards You from Drill Head**

I GOT quite a wallop on the hand recently when I was using an angle-head buffer on my electric drill. I let go the buffer while the drill was still running. The buffer whipped around and the angle head hit my left hand. Now when I use the outfit, I slip a piece of radiator hose over the spindle and drill chuck and secure it with two clamps. This keeps the angle head from rotating when you take your hand off it. I made a hole in the hose so I can get in with the chuck key.—*Marion L. Rhodes, Knightstown, Ind.*

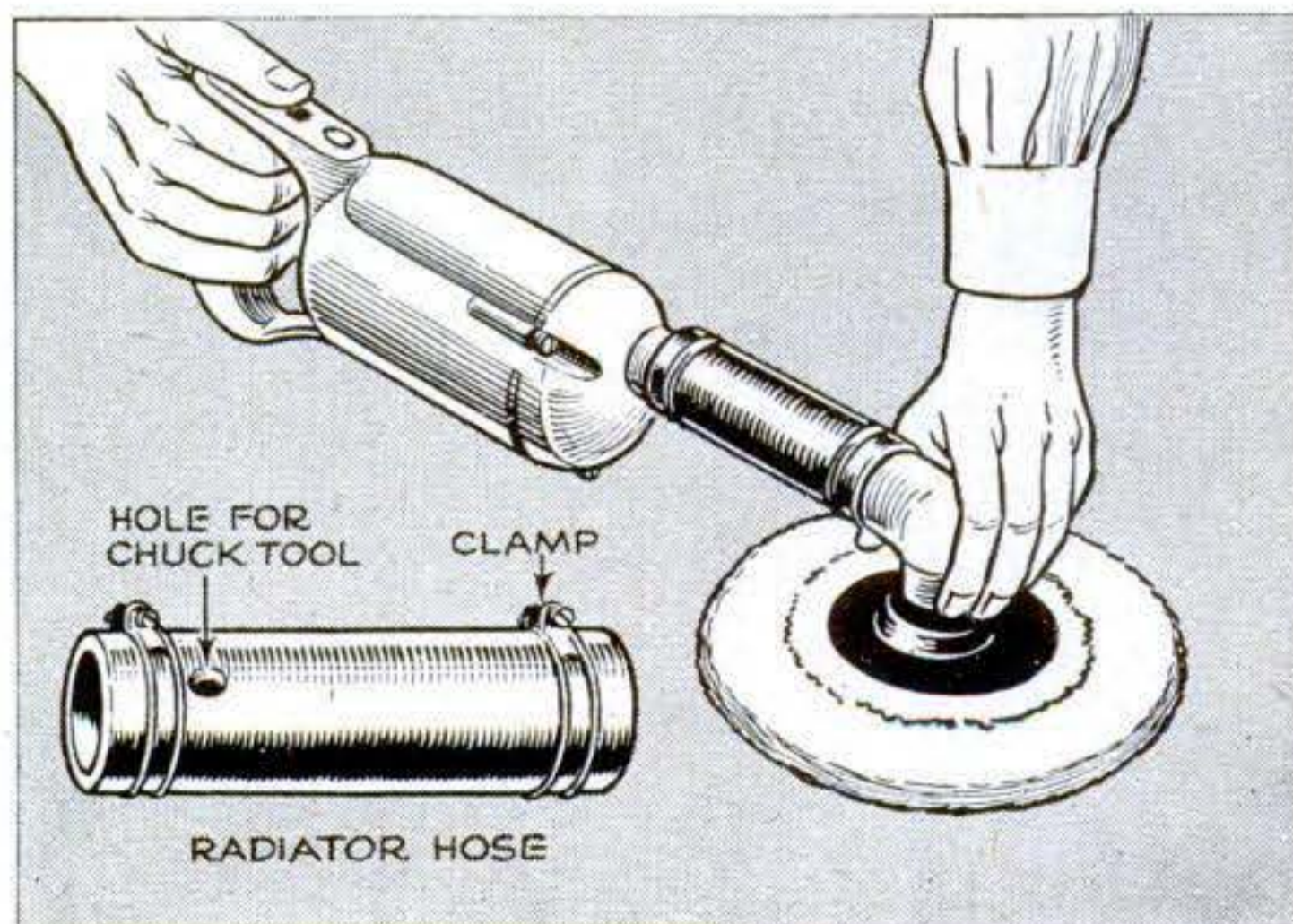

# amazing new **SAFE** circular saw blade!

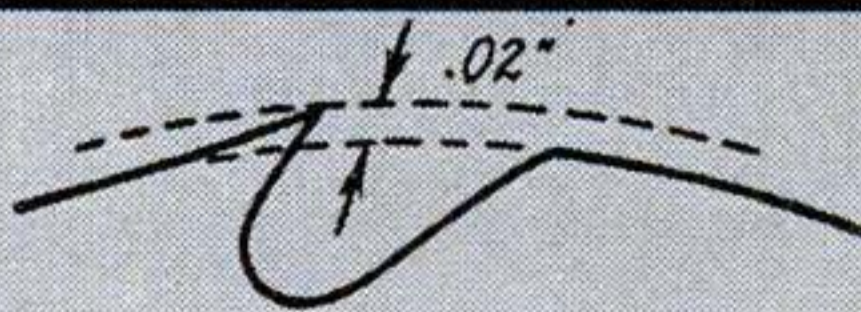

## What the PTI "Cut Control" Blade Is:

Each PTI Saw Blade has only 8 teeth instead of the customary 100. These teeth are entirely different from the conventional saw tooth — they project only 20/1000" above the non-cutting edge. Thus the cut of each tooth is "controlled" by the non-cutting edge, in contrast to the ordinary saw blade where each tooth cuts right down to its base. This relatively simple alteration in design actually works miracles in the performance of the blade.



patent pending

**CUT CONTROL**

## TESTED and APPROVED

The PTI Cut Control Saw Blade is the first and original blade of this type. (Patent Pending) Developed by one of the world's foremost saw makers — it has been thoroughly tested in leading laboratories and shops of both Europe and U.S.—with favorable reports in every instance. Letters from delighted users crowd our files:

**O.M.W., Lima, Ohio:** "Without question the finest saw blade I have ever seen! Makes sawing a pleasure. Here's my check for two more."

**L.B.E., Winnipeg, Man., Canada:** "Was unable to cause a kick-back with it."

**R.E.O., Bainerd, Minn.:** "Never saw a blade cut wood like this. Will never use any other blade."



## Takes the DANGER out of circular sawing

Here is the greatest improvement in circular sawing — since the invention of the circular saw. It's the sensational new PTI Cut Control Saw Blade that brings long-needed safety and remarkable new efficiency to this important power tool. Never before has a saw blade been subjected to such gruelling, thorough tests, to such careful checking and re-checking by leading laboratories, government agencies, universities, and industrial concerns. And never before has a saw blade made such astounding records in safety and cutting efficiency. No other saw blade today can offer you so many exclusive advantages, including:

- 1 Complete Safety From Kick-backs" — Since the teeth are only 20/1000" high — they cannot grab the wood and throw it against the operator — eliminating one of the most serious causes of circular saw injuries.
- 2 Reduced Direct Injuries — Cut Control teeth do not drag the hand into the saw. The non-cutting edge acts as an effective stop to cuts and limits their depth.
- 3 Cut Chips — Not Sawdust — Unique cutting action produces chips. Easier to clean. Eliminates fire hazard of spontaneous combustion.
- 4 30% to 40% Power Saving— Fewer teeth mean fewer cuts

to achieve same results — hence less power consumption.

- 5 Longer Life Without Sharpening — When cutting off chips — the wedge action of the tooth does most of the work — which means less wear on the cutting edge of the teeth.
- 6 More Efficient Cutting — Each tooth is backed up better against body of blade. It is therefore more rigid, less likely to vibrate — and cuts more smoothly.
- 7 Quieter Running — Fewer teeth makes saw practically noiseless when running true.
- 8 Blade Does Not Crack — Blades are made of special Vanadium Steel. In addition — controlling of cut prevents overloading of teeth, a common cause of blade cracking.

## ORDER TODAY

**SATISFACTION GUARANTEED! OR MONEY BACK!**

Here are the prices and sizes, delivered, postpaid. All blades are combination rip and cross cut. In ordering, be sure to give the diameter and bore of the blade. Send check or money order or we will ship C.O.D.

7" diameter blade \$4.95  
 8" diameter blade \$5.90  
 10" diameter blade \$7.50  
 12" diameter blade \$9.40  
 14" diameter blade \$11.40  
 16" diameter blade \$14.40

(Prices on carbide tipped blades furnished on request.)



**INCORPORATED**

Dept. PS-2

401 Broadway, New York 13, New York

Gentlemen: Rush me the following units:

Quantity	Blade Diameter	Blade Bore

Please check:

\_\_\_ Money order or check for \$\_\_\_ \_\_\_ Send C.O.D.

Name \_\_\_\_\_

Address \_\_\_\_\_

City \_\_\_\_\_ Zone \_\_\_\_\_ State \_\_\_\_\_

**new!** **1951 ALLIED**  
**RADIO & TV CATALOG**

→ **free!**

**COMPLETE  
UP-TO-DATE  
•  
EVERYTHING  
IN RADIO & TV  
AT LOWEST  
PRICES!**



**212 PAGES  
OF VALUES**

**Everything for  
Experimenters, Builders,  
Amateurs, Servicemen,  
Engineers and Soundmen..**

Save money on every Radio and TV need! Get the big 212-page 1951 ALLIED Catalog featuring the world's largest stocks of top-quality equipment at low, money-saving prices! See the latest TV releases, home radios, radio-phonos, Amateur equipment, P.A. systems and Hi-Fidelity Custom Sound, recorders, test instruments, builders' kits—plus thousands of parts, tools, books and diagrams. Get more for your money from the World's Largest Radio Supply House. Send today for your FREE 1951 ALLIED Catalog!

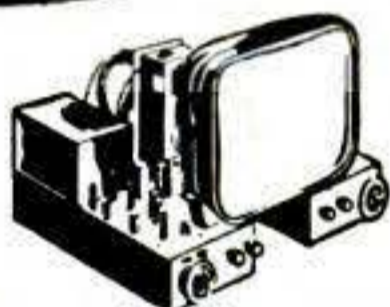

**TV, HOME RADIOS  
& RADIO-PHONOS**



**SERVICE SUPPLIES  
BUILDERS' SUPPLIES**



**AMATEUR GEAR**



**P.A. SYSTEMS  
RECORDERS**

**free  
CATALOG**  
Send For It!

**ALLIED RADIO**

**ALLIED RADIO CORP., Dept. 7-BB-1  
833 W. Jackson Blvd., Chicago 7, Ill.**

Rush FREE 212-Page Catalog No. 126

Name \_\_\_\_\_

Address \_\_\_\_\_

City \_\_\_\_\_ Zone \_\_\_\_\_ State \_\_\_\_\_

**Can You Equal This Home for \$2915**

**Shipped  
Direct  
from Our  
Mill**



*Save 30% to 40%  
on Your New Home..*

**Act Now!**

Don't pay several hundred dollars more than necessary when you build a home! Buy direct from our mill at our low factory price. We ship you the lumber cut-to-fit, ready to erect. Paint, glass, hardware, nails, etc., all included in the price—no extra charges. Plans furnished—also complete building instructions. No wonder our customers write us that we saved them 30% to 40%. Easy terms—monthly payments.

**BIG BOOK  
of  
House Plans  
in Colors  
25¢**

**Handsome Big CATALOGUE**

Pictures wonderful homes in colors at money-saving prices. Designs to suit everyone. Send 25c for catalogue today.

**LEWIS MANUFACTURING CO.**  
1311 Lafayette Ave., Bay City, Mich.

**NEW WOOD SHAPER TOOL**

**ATTACHES TO DRILL PRESS-DOES ROUTING  
TONGUE & GROOVE-NOTCHING  
INLAY—PLUS ANY TYPE OF JOINT**

Make window stiles, cabinets, doors, etc., in your own workshop. New, Low Cost Wood Shaper Tool attaches to your drill press—no expensive motors or benches. Complete unit costs less than having one shaping job done out. Write for FREE information.



**T & H Mfg. Co., Dept. SSC-2, 811 E. 31 St., Kansas City, Mo.**

**VARIABLE SPEED HYDRAULIC POWER TRANSMISSION**



It has Infinite Speeds 0 to 550 Reverse Automatic Overload Protection; Adjustable Torque up to 180 inch pounds. 5/8" Input and Output Shafts. It will handle 1/4 to 1 1/2 H.P. Motor. Case measures 7 1/2" long 7" high 6 1/2" wide. VALUE OVER \$300. Shipping Wt. 25#. On C.O.D. Orders we require a 10% Deposit. **only \$54.50 Fob. Chicago**

**DIRZIUS MACHINE SHOP "W" 1423-25 So. 52nd Ave., Cicero 50, Ill.**

**5 BIG POWER TOOLS**



RETAIL PRICE \$125.00

**FACTORY TO YOU \$59.95**

**SUPERSHOP** the PRECISION BUILT WORKSHOP. Lifetime lubricated BALL BEARINGS. All running parts precision GROUND. Compare finest production tools. BIG capacity. Amazing VALUE. Write for FREE catalog, full details, trial plan.

**POWER TOOLS, INC.**

**220 Yates Avenue  
Beloit, Wisconsin**

**MOST PRACTICAL TOOL YOU COULD EVER OWN!**

**DREMEL**

*Electric*

**MOTO-TOOL**

THE "POCKET-SIZE MACHINE SHOP"

GRINDS, DRILLS, ROUTS, CARVES, ENGRAVES, CLEANS, POLISHES, FINISHES

Approx. 27,000 RPM

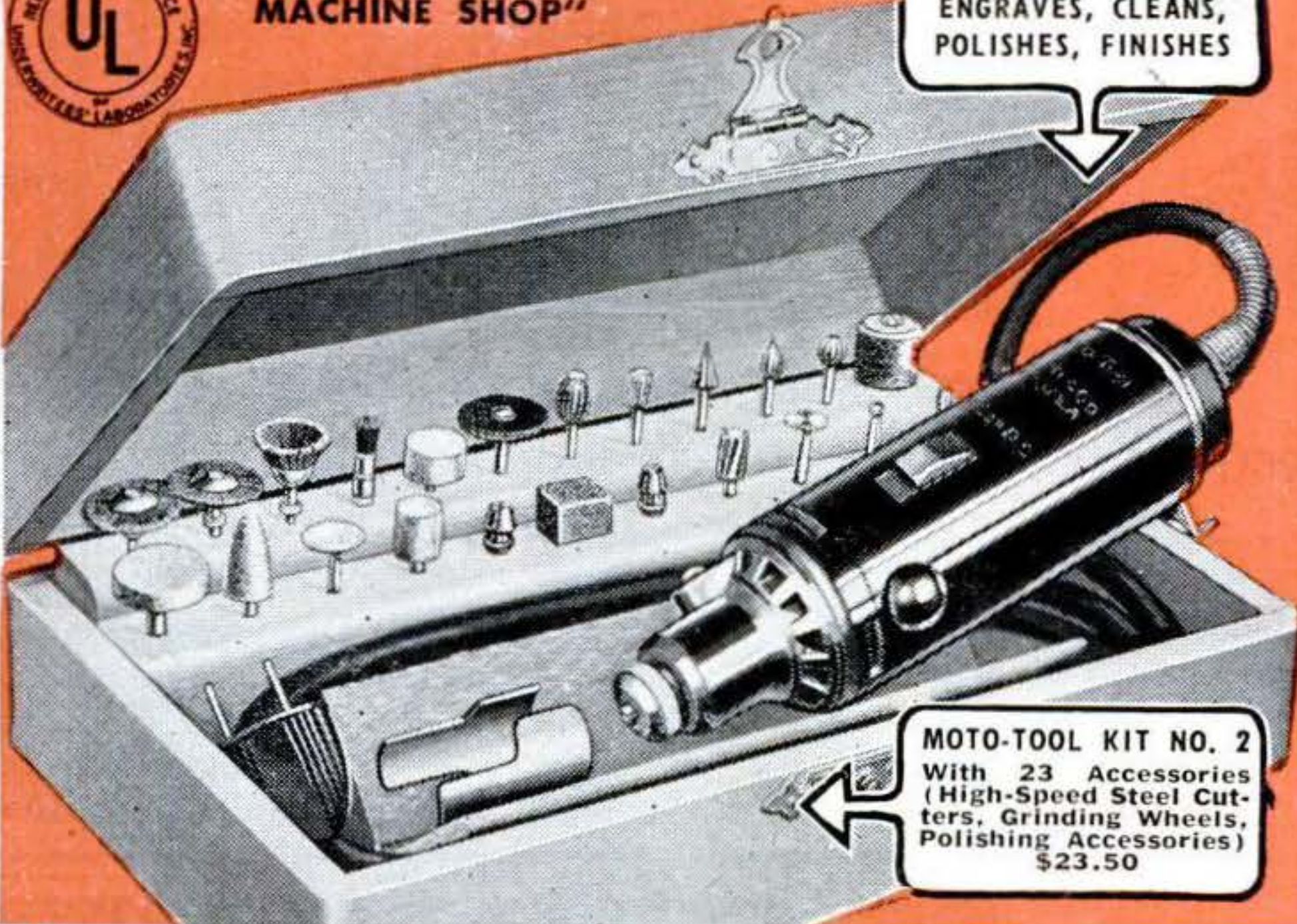

MOTO-TOOL KIT NO. 2  
With 23 Accessories (High-Speed Steel Cutters, Grinding Wheels, Polishing Accessories) \$23.50



MOTO-TOOL NO. 2 with one emery wheel point \$16.50



Great for Hobbyists

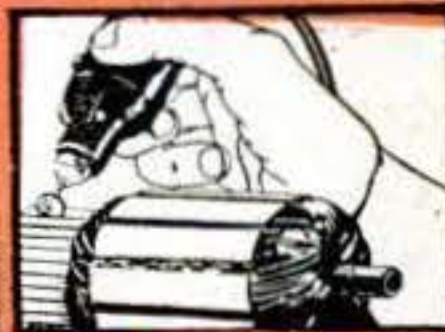

Saves Time and Labor

**ONLY DREMEL MODEL 2 GIVES APPROX. 27,000 R.P.M.—CONSERVES CUTTERS**

It's the fastest, most powerful tool of its kind! Preserves cutters by cutting cleaner—faster. Works well in wood, plastics, metal—for drilling, carving, engraving, buffing, etc. For model-making it's a *must*. For home maintenance and repair jobs you'll wonder how you ever got along without it. And for general all-round workshop operation it's a tool every craftsman finds indispensable.

We urge that you try Moto-Tool on Dremel's 5-day money-back offer. Buying the complete Kit No. 2 saves money and opens the door to years of profitable results.

**CHECK THESE MOTO-TOOL FEATURES**

- Oil-less, sealed bearings . . . Pat'd. automatic chuck lock pin . . . Oversize armature shaft, hardened, ground, polished . . . Shockproof, bakelite housing.
- Dust filtered, air cooling system . . . Dynamically balanced armature . . . Handy hanger hook.
- Sturdy 110-120 V. AC-DC motor . . . weight only 13 oz.
- A precision tool widely used in industries like Ford, G-E, Remington-Arms, Nash-Kelvinator, etc.

**IMPORTANT**

Don't confuse Moto-Tools and Accessories with so-called "bargain offers". Compare Dremel, feature for feature, with any make. If Dremel products are not superior in every way, we don't want you to buy.

**PORTABLE**

**DRILL PRESS**

Add further versatility to your Moto-Tool with this 12" high drill press. Just right for creating costume jewelry, model making, carving, routing, drilling, etc. Utilizes No. 2 Moto-Tool, which can be raised, lowered or swung in any direction. Weighs 3 1/2 lbs.



ONLY \$9.95

(Less Moto-Tool)

**FUN FOR BOYS FROM 8 TO 80**  
**DREMEL Electric COPING SAW**

CUTS SCROLLS LIKE MAGIC—SANDS AS IT SAWS



BLADE FACES 4 WAYS

FREE PROJECT PLANS

JUST GUIDE IT!

Only \$5.85 with 3 saw blades

**SAFE! AS A HANDSAW**

For home, hobby, repair work—no other tool pleases so much for so little cost. Works in any direction—delivers 7,200 strokes per minute smoothly, effortlessly. Saws through 3/4" medium-hard wood at a foot-a-minute speed. Touch-of-the-trigger, foolproof action. Only 2 moving parts, never needs oiling. Uses 110-120 v. A.C.

for 6 useful projects packed with each saw.

**BIG VALUE!**

**MOTO-TOOL KIT NO. 1**

Contains the lighter Model No. 1 Moto-Tool and 34 practical accessories (steel cutters, grinding wheels, etc.) in attractive, lacquer-finish wood case. . . . \$17.50  
MOTO-TOOL NO. 1 with one emery wheel point . . . . . \$9.85



**WHERE TO BUY DREMEL TOOLS**



Dremel Tools are sold everywhere. If your dealer cannot supply you, send remittance in full and we will ship postpaid. Or send only \$2, and pay postman balance plus postage and C.O.D. fee. **Money back if not delighted after 5 days' trial.**

**DREMEL MFG. CO., Dept. 121-B, RACINE, WIS.**

**\$\$\$ extra profits for you each month with..**

**Hobart 200 Amp. Portable Gas Drive D.C. Welder goes right to the job.**

Set up your own welding business...get the big pay, extra profit jobs with this rugged, versatile welder that can't be beat for speed, durability, or performance.

Special features include 1,000 combinations of welding heat, positive control at or away from machine, outlet for supplying emergency power. Send for data.

*Simplified arc welding*

**HOBART 200 Amp Gas Drive...world's best welder buy!**



**HOBART BROTHERS CO., Box P-21, Troy, Ohio, "One of the world's largest builders of arc welders"**



# Speed Way Speed Sander

\$34<sup>50</sup>



**Sands,  
Cleans,  
Smooths, Polishes Electrically**

Designed for industry, for professional work, this light, beautifully balanced, orbital-motion, SpeedSander is rapidly becoming a standard home appliance. With its powerful electric motor and all-ball-bearing construction, anyone can easily re-surface and refinish furniture, woodwork, metal surfaces or walls. It will quickly remove old paint, stain, or enamel down to the bare wood or metal; will sandpaper to a "piano finish"; remove rust and corrosion or "feather edge" a scraped fender. It will burnish pots and pans or with lambs wool bonnet, delicately polish fine furniture. It makes

tedious, tiresome jobs fun—saves hands! In design, convenience and efficiency it is today's finest sander regardless of price. Ask your local dealer to demonstrate it.

Write for Catalog

**Speed Way MANUFACTURING CO.**  
1864 So. 52nd Ave., Cicero 50, Illinois

**NEW!**

JUST TWIST AND RAP!  
TWIST AND RAP!

IF YOU USE A  
SCREWDRIVER OR  
WRENCH YOU NEED AN ...



**SENSATIONAL! FOR LOOSENING  
OR TIGHTENING NUTS, BOLTS  
OR SCREWS!**

An amazing new development to save tempers and skinned knuckles... hours and dollars... for everyone who works on screws, nuts or bolts. Impakdriver translates the impact from a hammer's blow into a great amount of torque and starts ornery screws, nuts or bolts with unbelievable speed and ease! And it's great for loosening or tightening in hard-to-get-at places. A simple inexpensive tool, yet it beats the toughest problems and the worst time-killers. Belongs in every tool box... mechanics, machinists, repairmen, home handymen, hobbyists, everyone who uses screwdriver or wrench. Pays for itself on the first tough job made easy!



Sold in different set combinations with specially designed attachments for Hex sockets up to 9/16" and two sizes of Phillips and ordinary screwdriver bits.

See the Porter Impakdriver at your dealers or write for folder showing all details.

**H. K. PORTER, INC., Somerville 43, Mass.**  
Porter Cutters      Porter Pruners  
PORTER-FERGUSON Autobody and Fender Repair Tools



**QUICK-ON, STAY-ON, SPEED NUTS®**  
NOW IN HANDY TINKER KIT

**SPEED NUTS**—famous throughout industry—now ready for home use. Ideal for repairing or attaching sheet metal parts on toys, appliances, etc. Kit contains over 100 parts—10 popular size nuts and matching screws. Replace threaded nuts and lock washers this fast, sure way. Tinnerman Products, Inc., Dept. 13(A), Cleveland 1, Ohio.

**ONLY \$1<sup>00</sup>**  
Including Postage  
**CASH or CHECK ONLY**

**DUAL CROSS and ROTARY FEED**

**PALMGREN** ROTARY, INDEX, MILLING  
**TABLE** No. 83

Has 8" table, 360° movement and 4" cross feed travel. Adjusting wheels and dials graduated in degrees and thousands. Slotted for bolting to table. No. 83 Priced \$49.50. No. 82 without rotary feed \$39.75.

Write for Circular No. 10  
**CHICAGO TOOL and ENGINEERING CO.**  
8396 South Chicago Ave., Chicago 17, Ill.



**HANDY CALCULATOR FOR  
WOODWORKERS.. ONLY 10c**

Just set dial, quickly solves countless problems. Converts linear to board feet, compares workability of various woods, shows bit sizes, nail specifications. Also tool sharpening tips, etc. 6" diameter heavily varnished cardboard. Send 10c to Greenlee Tool Co. 2122 Columbia Av., Rockford, Ill.



**JUST OUT!**



**1951 EDITION**

It's New! It's Different! Get world's largest Auto Accessory & Parts Catalog and save money. Over 50,000 items, including Hollywood Accessories, Hi-Speed Equipment, Rebuilt Engines, all parts & accessories for all cars & trucks. We have that Hard-To-Get part! Jam packed with bargains. Completely illustrated. Send 25c (refundable).

**J. C. WHITNEY,**

**1917-F Archer, Chicago 16**

**BUY U. S.  
SAVINGS BONDS**

**ALL NEW 1951 KING MIDGET AUTO**

**World's Lowest Priced 2 Passenger Car**  
Drive it for 75c per week. Amazing performance. Surprising comfort. All steel construction. Full accessories, top and heater. Ready to run or assemble it with our bolt together parts. Rider agents wanted, earn your car free. Send 25c for detailed literature or \$1 (refunded first order) for actual assembly book and service manual filled with photos, drawings, specifications, etc.

**MIDGET MOTORS MFG. CO.**  
ATHENS 2, OHIO



**HYDRAULIC CYLINDERS** AIR OF OIL

Large supply of new labor-saving, economical hydraulic equipment in many types and sizes. Use these positive, highly efficient, smooth pressure hydraulics on presses, arbors, lifts, loaders, power control, positioning, brakes, plastic dies, auto frame alignment, etc., etc.

**ITEM #70**—Purolator hydraulic oil filter. Permanent element type. 3/8" female pipe thread ports. Capacity, 16 gallons per minute. A \$13.00 value. **Now Postpaid 4.95**

**ITEM #4**—All steel double action hydraulic cylinder, 1 1/8" bore, 2 7/8" stroke. Clevis mounting. Will lift 1000 lbs. with 1000 P.S.I. line pressure. Perfect for positioning and feeding movements. Shpg. wt. 4 lbs. **Now Postpaid 4.95**

**ITEM #33C**—Double action hydraulic cylinder, 1 1/2" bore, 4 1/2" stroke. Clevis mountings at both ends. Uses 1/4" pipe fittings. **Postpaid 8.95**

**ITEM #32**—Double action, 1 1/2" bore, 9" stroke, will lift 1760 lbs. with 1000 P.S.I. line pressure. Wt. 4 lbs. A \$45.00 value. **Postpaid 10.95**

**ITEM #41**—Double action hydraulic cylinder, 2" bore, 6" stroke, clevis mounting at base and end of shaft. Overall length closed 12 1/2". Has 3/4" stainless steel shaft, uses 1/4" tubing fittings. Will lift up to 3100 lbs. with 1000 P.S.I. line pressure. Wt. 7 lbs. **Postpaid 12.50**

**ITEM #16C**—Double acting hydraulic cylinder, 1 1/2" bore, 26" stroke. Will lift 1760 lbs. with 1000 P.S.I. line pressure. Weight 8 lbs. \$55.00 value. **Now Only Postpaid 16.95**

**ITEM #103**—Double acting hydraulic cylinder, 2 1/2" bore, 17" stroke. Clevis mounting. Will lift 4900 lbs. with 1000 P.S.I. line pressure. 1 1/4" diam. shaft. 3/8" tubing thread ports. Overall length closed 28". Shpg. wt. 11 lbs. F.O.B. Chicago. **21.50**

**ITEM #31C**—Double action hydraulic cylinder, 3 1/2" bore, 11" stroke. Aluminum alloy cylinder wall and all steel 1 1/4" diameter piston rod. Clevis mounting at base and shaft. 19 1/2" overall length closed. Will lift 9625 lbs. using 1000 P.S.I. from Logan Heavy Duty Hydraulic Pump. Uses 3/4" tubing fittings. Value \$102.00. Shpg. wt. 11 lbs. F.O.B. Chicago. **22.50**

**ITEM #6A**—Double action hydraulic cylinder, 3" bore, 25" stroke, will lift 7070 lbs. with 1000 P.S.I. line pressure. Steel barrel, 1 1/2" stainless steel shaft. Gov't. acq. cost, \$176.00. Shpg. wt. 26 lbs. F.O.B. Chicago. **28.00**

**ITEM #42**—Double action hydraulic cylinder, 4" bore, 18" stroke. Rated lift capacity with 1000 P.S.I. line pressure is 12,560 lbs. Shpg. wt. 30 lbs. AN EXCELLENT BUY. **32.50**

HI-PRESSURE FITTINGS for cylinders and valves available at 50c ea. for 3/8" pipe and 65c ea. for 1/2" pipe.

**DIRECT CURRENT GENERATORS**

For welders, plating, truck and marine use. D.C. appliances, lights, etc. Aircraft quality—lifetime grease sealed ball bearings. Heavy duty.

**ITEM #89**—Type M-2, rated 50 Amps.—24 Volts. Mfd. by Leec-Neville Co. Shpg. wt. 32 lbs. Gov't. Acq. Cost \$176.00. F.O.B. Chicago. **NOW ONLY 16.50**

**ITEM #90**—Type P-1, rated 200 Amps.—28 Volts, 2500 RPM. Mfd. by General Electric, Ford, Delco-Remy and Westinghouse, Gov't. Acq. Cost \$300.00. Shpg. wt. 70 lbs. F.O.B. Chicago. **22.50**

**ITEM #91**—Type R-1, rated 300 Amps.—30 Volts. Mfd. by Jack & Heintz. Gov't. Acq. Cost \$380.00. Shpg. wt. 70 lbs. F.O.B. Chicago. **35.00**

Each individually packed in wooden box. Allis Chalmers MOTOR GENERATOR. 120 volt—60 cycle AC—7.82 amps. output. Input 24 volts, DC, 63 amps., 3600 R.P.M. Ideal for marine and aircraft installations, farm and factory use where AC is desired and DC available. Run unit off DC welder for handy 120 volt AC current for emergency power for oil burners, incubators, electric motors, etc. Shpg. wt. 200 lbs. An Outstanding Value. (Item #73) ..... F.O.B. Chicago **79.50**

**FREE: NEW 1951, 44-PAGE CATALOG** Listing Brand New War Surplus bargains including Aircraft Quality hydraulics, A.C. generators, pumps, welders, tanks, and many, many others. You save on everything! Write for yours today!

**HYDRAULIC SPEED REDUCER WITH FINGERTIP CONTROL**

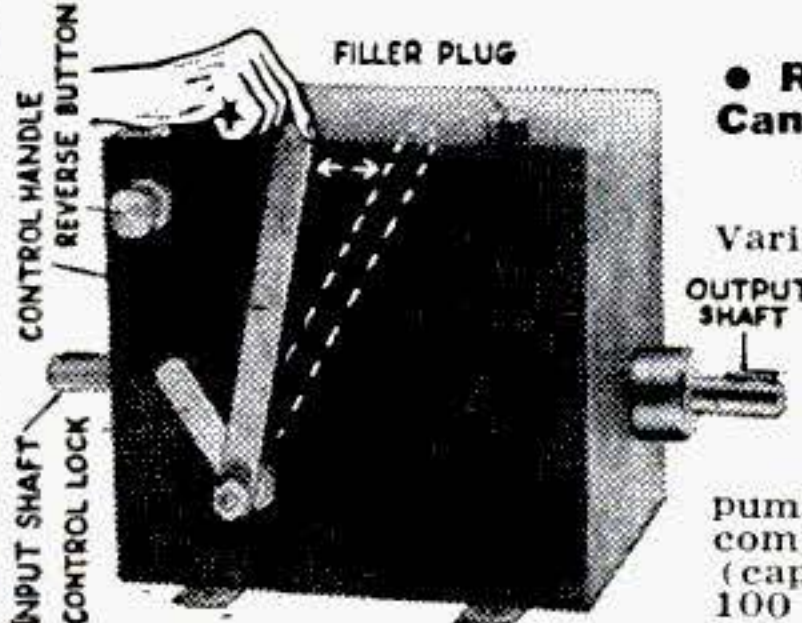

(ITEM #115)

- Reamer Drives • Midget Cars • Feed Mills • Canning Machines • Conveyors • Lathes • Milling Machines • Motor Boats • Cream Separators • Garden Tractors • Pumps • Blowers, etc.

Variable output speeds ranging from 0 to input speed now available. Merely move control handle until desired speed is attained. Then turn locking handle to maintain the setting. Internal relief valves prevent overloading. Use input power of 1/4 to 1 1/2 H.P. This Westinghouse-Oil Gear Unit converted to commercial use from 40 MM anti-aircraft traversing mechanisms consists of a variable displacement hydraulic pump feeding a fixed displacement hydraulic motor. These components are contained in a crackle-finish steel oil reservoir (capacity 2 qts.). Adjustable relief valves set at factory for 100 inch pounds of torque may be reset up to 180 inch pounds. Independent reverse control allows full output power and speed selection in either direction or rotation. Both input and output shafts measure 5/8" diam., include keyway. Input rotation is counter-clockwise facing shaft. Recommended input speeds not to exceed 750 R.P.M. Overall dimensions 7 1/2"x-7 1/2"x11 1/2". Gov't. acquisition cost, \$428.00. Shipping weight 26 lbs. Complete with 2 qts. of oil and full instructions. **Postpaid 54.50**

**NEW! STATIONARY OR PORTABLE D. C. ARC WELDER**

**250 AMPS. MODEL 252 FOR ANY WELDING JOB, LIGHT OR HEAVY**

Stop Costly Repair Bills, Weld It Yourself and Save

Designed for many years of trouble-free service. This precision engineered Direct Current ELECTRIC ARC WELDER is offered at but a fraction of its original value. It can be mounted permanently or easily transported for portable use. Does the job instantly where and when you need it. Has dial type rheostat for easy pinpoint control and a high-low range switch. Run Welder at 2500 RPM from drive pulley or power take-off of tractor, a 7 1/2 HP electric motor or a 10 HP gas engine. Use two V belts or flat belt (on pulley). If more information is desired, write for Welder Circular!

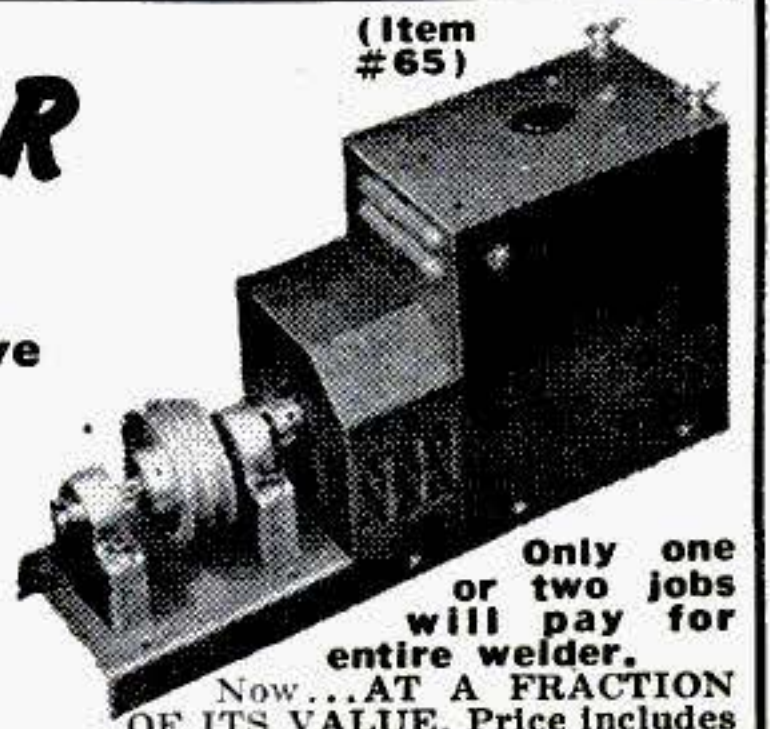

(Item #65) Only one or two jobs will pay for entire welder. Now... AT A FRACTION OF ITS VALUE. Price includes double V or flat belt pulley and instruction book. Shpg. wt. 107lbs. F.O.B. Chicago **99.50**

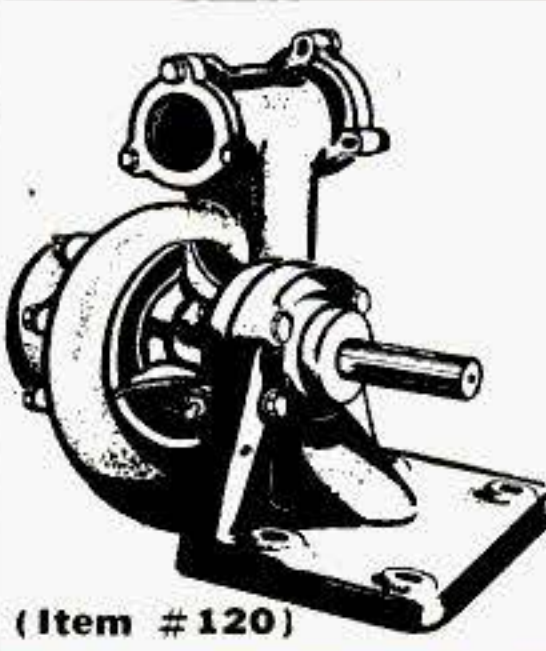

(Item #120)

**GENERAL MOTORS-ALLISON CENTRIFUGAL PUMP 200 GALLONS PER MINUTE**

- FOR DRAINING BASEMENTS • FIRE-FIGHTING • IRRIGATION • FUEL TRANSFER • SWIMMING POOLS • HOME WATER SYSTEMS • DEWATERING

This General Motors-Allison Centrifugal Pump—designed for use on U. S. Air Force Mustang fighters, now converted for commercial, home and industrial high volume pumping applications. Inlet—2 1/2" standard pipe thread, twin outlets 1 1/4" pipe thread—ball bearing supported 3/4" shaft. Easy, fast, simple priming. Rotation, counter-clockwise facing shaft. Gov't. acq. cost \$145.00. Shipping wt. 35 lbs. **39.50**

Suction Lift	Head Pressure	Gal. Per Min.	H.P.	R.P.M.
10'	65'	200	5.2	3500
10'	80'	40	1.5	2500

**SELF PRIMING ALL PURPOSE PUMP**

- Ideal For:**
- Draining Basements
  - Insecticides
  - Fuel Oil
  - Vacuum Pump—28" for Milking Machines, Lab use, etc.
  - Air Compressor—For paint spraying, etc. Delivers 4.5 CFM at 40 PSI with 1725 RPM
  - Home Water Systems
  - 4-Ball Bearings—1/2" Shaft—3/8" Ports
  - Rotate in either direction
  - Rated up to 8 GPM, 50 PSI
  - Use with 1/4 HP motor or larger, speeds from 200 to 1800 RPM
  - Useful for hundreds of applications in the home, farm and factory
  - Built by Pesco—Div. of Borg-Warner. Gov't. acq. cost \$45.00. Shpg. wt. 12 lbs. Free: Complete instructions and performance data with each pump. F.O.B. Chicago. **NOW ONLY 16.50**



(Item #51A)

**HYDRAULIC CONTROL VALVE**

**ITEM #24.** Four-way control valve with built-in relief valve, for use with one double action hydraulic cylinder, may be used with 1500 P.S.I. hydraulic system to open and close hydraulic cylinders. Shpg. wt. 8 lbs. A \$38.00 value. **post-paid 9.95**

**ITEM #26.** Four-way control valve for use with two hydraulic double action cylinders. Each cylinder may be operated independently of the other or in conjunction with the other. Oil may be locked in any of the cylinders to hold the piston at any required position. Shpg. wt. 6 lbs. A \$60 value. **postpaid 12.95**

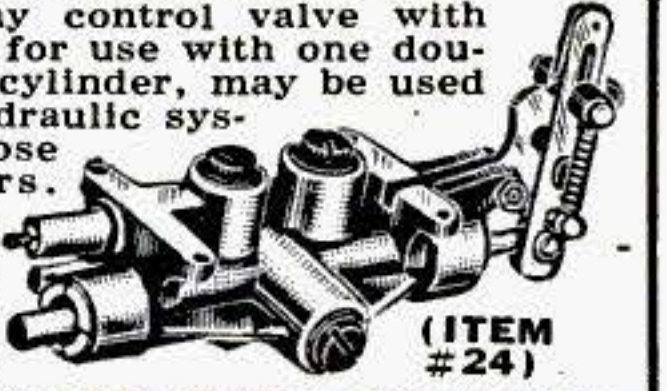

(ITEM #24)

**LOGAN HEAVY DUTY HYDRAULIC PUMP**

For operating hydraulic cylinders and hydraulic motors on tractors, bulldozers, construction machinery, lift trucks, industrial applications, etc. Delivers 10 GPM at 1200 R.P.M. at 1000 P.S.I. using 6 HP. Has a 3/4" inlet, 1/2" outlet, 3/4" shaft with flat and keyway for direct or pulley drive. Has flange with 4 bolt holes for convenient mounting. Ship. wt. 22 lbs. Overall dimen.: 7" L x 5 1/2" H x 5 1/2" W. A \$105.00 value. **FOR ONLY 22.50**



(Item #19)

**ORDER DIRECT FROM AD — SEND PAYMENT OR PURCHASE ORDER, TODAY — SATISFACTION GUARANTEED**

**GROBAN SUPPLY CO., Inc., 1507 S. MICHIGAN AVE., Chicago 5, Ill., Dept. PS-2**

**AT THE TOP OF THE CLASS**

**THE  
1951  
Cushman**



**Ride it for only 3/4¢ per mile!**

Beat expensive transportation, save your car, with a low-cost CUSHMAN. Hundreds of practical uses—ride to work, school, shop, play! Ideal for light deliveries. Easy to park, quick in traffic. Get up to 85 mi. per gal. Low purchase price, low maintenance, low operating cost—that's CUSHMAN economy.

Write for free folder and prices—Dept. 35

**Write  
for  
it!  
RIDER-  
AGENT  
PLAN**

**Cushman MOTOR WORKS, INC.**  
LINCOLN, NEBRASKA

DEALER  
INQUIRIES  
INVITED

**Send for this  
BIG NEW  
Hunt's  
WOODWORKERS  
CATALOG NO. 18**

**ONLY  
15c**

**NEW LOW PRICES**

Offers greatest selection of fine domestic and imported woods—and hundreds of woodworkers items at bargain prices!

You'll save time and money with this big, new catalog. Contains everything wood craftsman needs. Shows 32 rare and fancy woods in color...43 veneer designs...275 scroll patterns...multicolor inlays, overlays, bandings...all kinds of tools, machinery, cabinet hardware, ornaments, mouldings...and pages of valuable tips, ideas, information, instruction. Send for your copy NOW. Only 15c--refundable on your first order.



- 144 PAGES
- **QUICK DELIVERY**
- on maple, poplar, oak, mahogany, red cedar, cherry, walnut, and many others—
- all properly seasoned and kiln dried.

**MAIL THIS COUPON--TODAY!**

**CRAFTSMAN WOOD SERVICE CO.**

2729 S. Mary St., Dept. B-2  
Chicago 8, Illinois

Send me the big, new, money-saving Catalog No. 18. Enclosed is 15c--refundable on my first order.

Name \_\_\_\_\_

Address \_\_\_\_\_

City \_\_\_\_\_ Zone \_\_\_\_\_ State \_\_\_\_\_

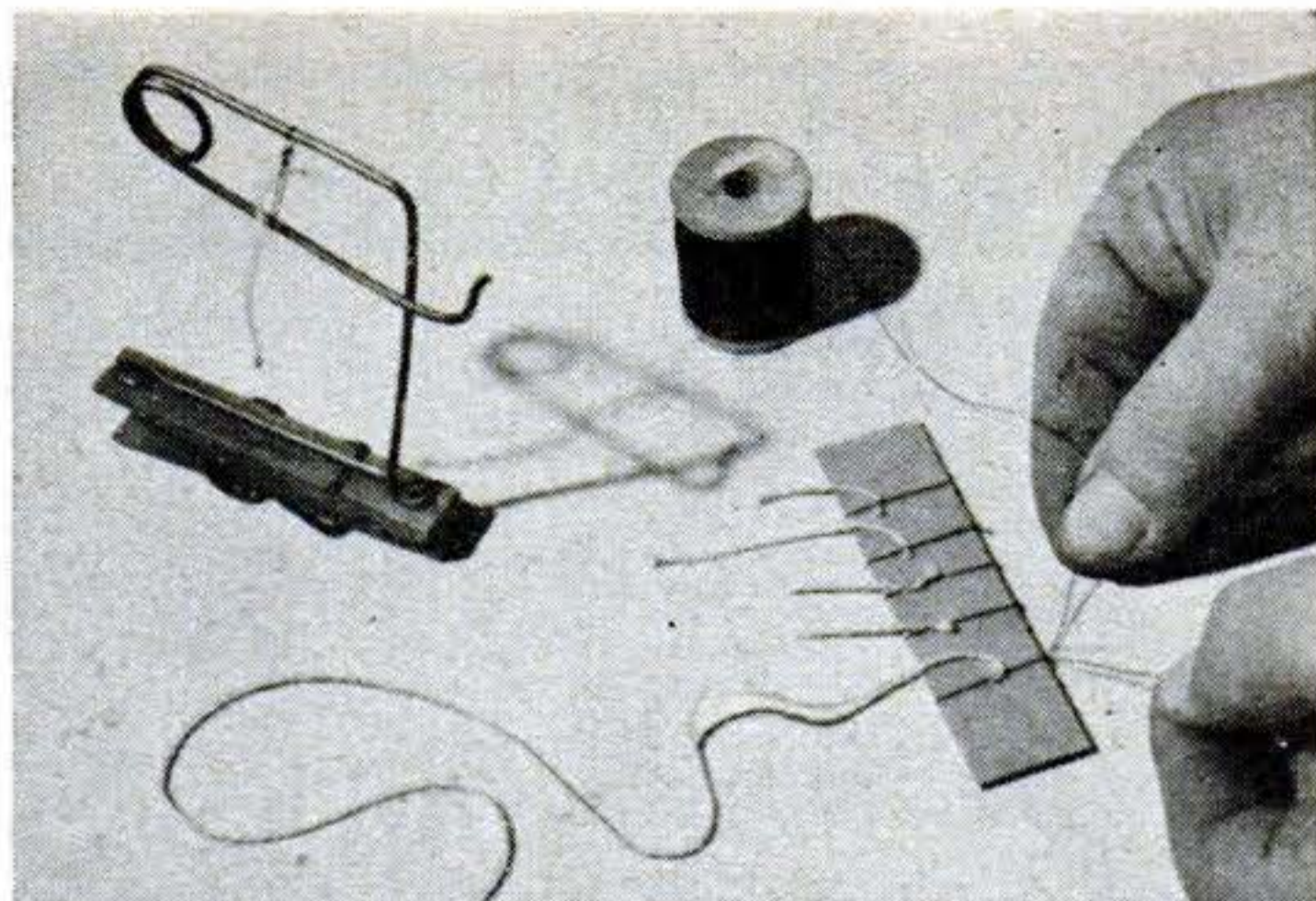

**Self-Timer Set Off By Fuse**

You can get into all the group pictures you take of your friends if you equip your camera with a simple self-timer like the one shown. A homemade fuse sets it off.

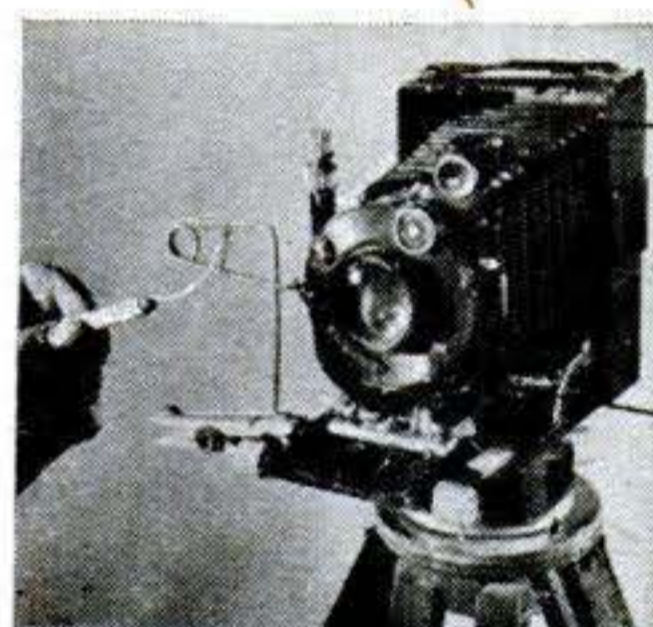

Make your timer out of a spring-type clothespin and a piece of clothes-hanger wire. Bend the wire to a spring shape as shown in the photos and form two eyes for screwing it into the clothespin.

The spring trips the camera shutter when a fuse burns through heavy thread looped around it.

You can make fuses by soaking twine in a saturated solution of saltpeter (potassium nitrate) and letting it dry. Prepare thread loops by tying them around a cardboard template. The timer can be adapted to many types of cameras.—*Louis Hochman, Sherman Oaks, Calif.*

**Half a Drill Set Saves Money**

It's always handy to own a set of drills from 0 to 60, but a full set is expensive. A money-saving wrinkle is to buy just half a set comprising every other size from 1 to 59. I find that this selection fills the bill in practically every case. When tapping a small hole, for instance, the next larger drill size will still give good threads. If you can't buy half a set, buy a full set with a friend and split it up.—*Lauren McCready, West Redding, Conn.*

**Let Oil Drain Back Before Checking**

AFTER stopping your engine, give the motor oil time to drain back into the crankcase before checking the level, if you want to get an accurate measurement. Five minutes isn't too long to wait.



# Scientists Create "TAILORED LIGHTNING" For Better Motoring

In the great engineering laboratories of The Electric Auto-Lite Company in Toledo, Ohio, a group of Auto-Lite Ignition Engineers have been probing inside engine cylinder walls, peering at "blow-by-blow" spark performances, charting the behavior characteristics of man-made "lightning" across the spark plug gap. From endless tests they've determined what your engine's ignition system needs most, and then set about producing spark plugs to fill the bill. Net result: Ignition Engineered Auto-Lite Spark Plugs . . . the spark plugs that are world famous for quality and performance.



**ELECTRICITY LEAPS** from storm clouds to top of Empire State Building as shown in this dramatic night photograph. Engineers harness electrical energy like this to "fire" gasoline in your engine.



**FRANKLIN'S KITE** experiment was first demonstration of electrical nature of spark discharges between clouds. Date: 1752.



**"FIRING PIN"** of the car engine. Your spark plugs fire as many as 15,000 fuel charges per minute with tailored precision.



**RELIABLE STARTING** is one important benefit resulting from Auto-Lite research to assure correct materials, dimensions and design.

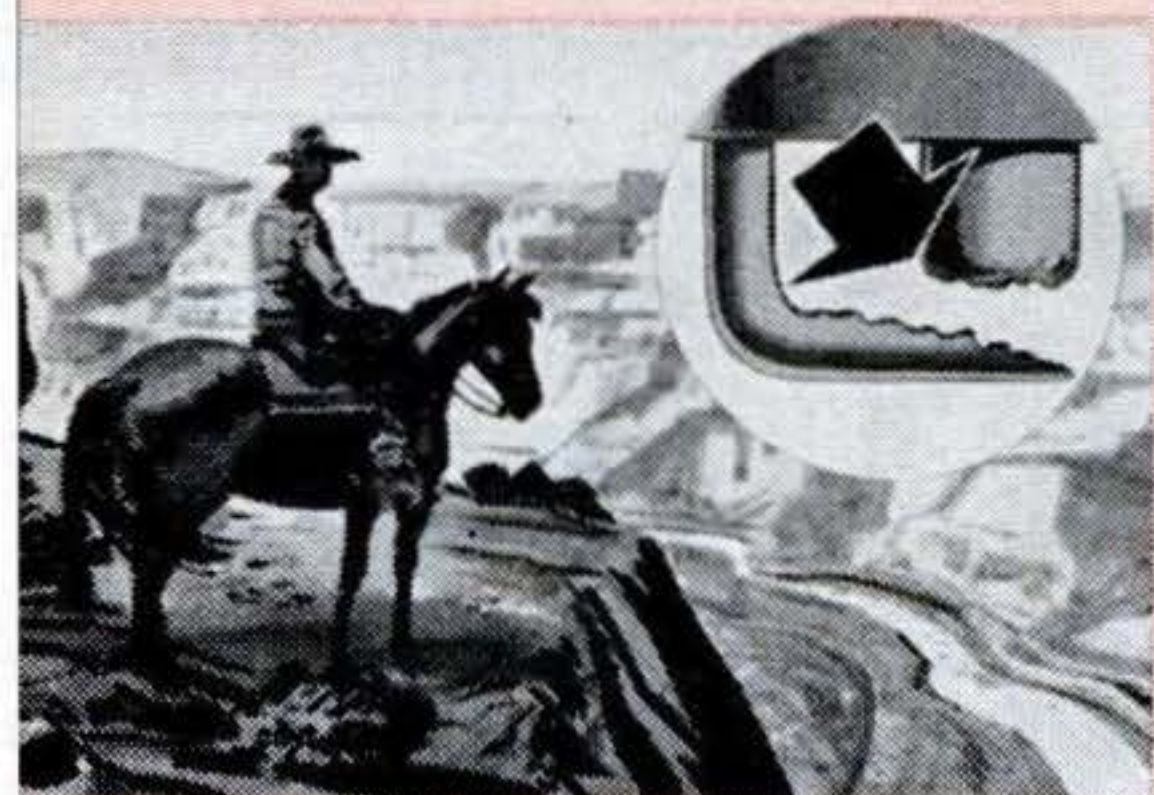

**RIVER CUTTING CANYON** resembles way surging of electricity wears away electrodes. For solution see next picture.



**TINY UNIT** called a "Resistor" permits wider initial gap setting, makes possible these advantages of Resistor Spark Plugs:

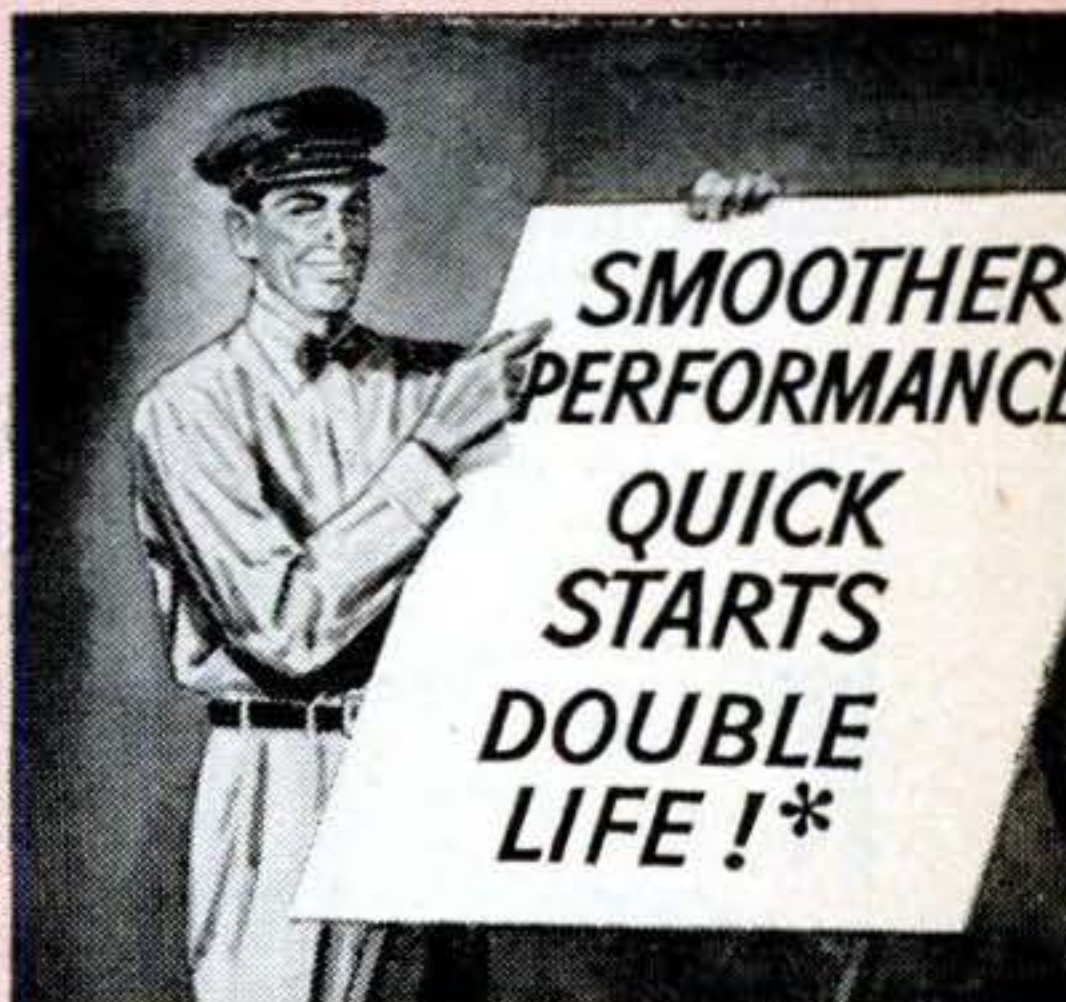

**SMOOTHER  
PERFORMANCE  
QUICK  
STARTS  
DOUBLE  
LIFE!\***

All car, truck and tractor owners benefit from the exhaustive research performed by Auto-Lite Ignition Engineers . . . the men who design the coil, distributor, spark plugs, wire and all the other parts of the complete ignition system used as original factory equipment on many leading makes of America's finest cars and trucks. You're Always Right With Auto-Lite.

**THE ELECTRIC AUTO-LITE COMPANY**  
Toledo 1, Ohio Toronto, Ontario  
Auto-Lite Ignition Engineered Spark Plugs

\*Double life under equal service conditions when compared to spark plugs without a built-in resistor.

*Ignition Engineered*  
**AUTO-LITE**  
**SPARK PLUGS**



**BUY NOW and SAVE**  
**BRAND NEW!**  
**WAR SURPLUS**

**LIGHT PLANTS**

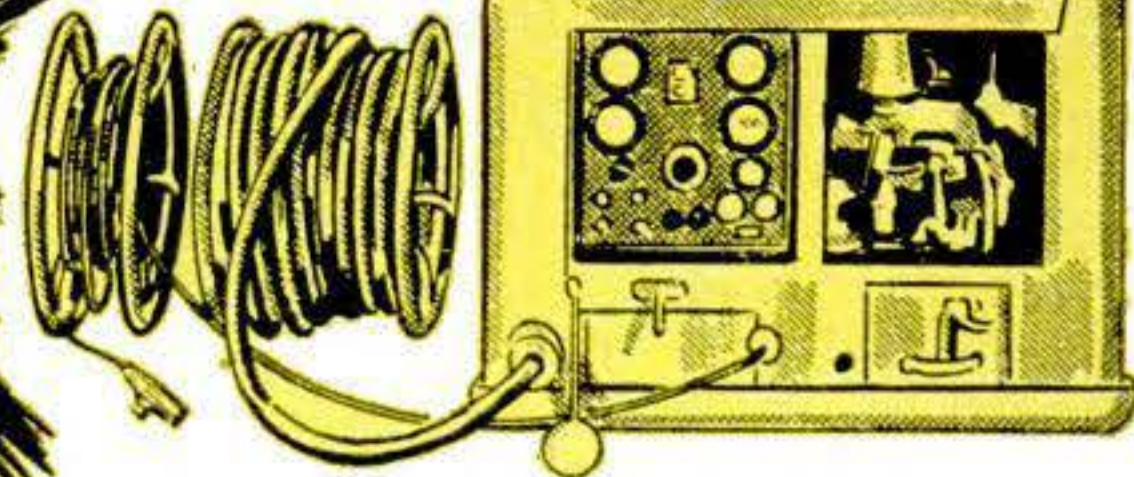

**BE PREPARED**  
**for any emergency!**

Use for: Farms, cottages, stores, garages, floodlighting, drilling rigs, refineries, house trailers, fire departments, sound trucks, yachts, tugs, construction, airports, police radios, etc.

**300 WATT**, 110-220 volt AC, 60 cycle light plant powered by 1 HP gas engine, direct drive. Mounted base weight 40 lbs. **\$89.50**  
 New, stock #409.....

**750 WATT**, 110 volt AC, 60 cycle, direct drive, air cooled, Briggs & Stratton gas engine, Model AP, Pioneer generator, radio filter, self excitor, rope start. 190 lbs., 20" long, 17" wide, 16 1/2" deep with carrying handle. New, stock #573..... **\$199.50**

**2500 WATT**, 115 volt AC, 60 cycle, single phase, ENGINE: Briggs & Stratton, air cooled, 8 1/2 HP. GENERATOR: Westinghouse or Leland, belt drive. Complete with \$30.00 worth of spare tools, instructions and fully GUARANTEED. Was formerly priced at approximately \$700.00. NOW priced for you NEW **\$345.00** at only.....

Reconditioned, **\$275.00**. To make plant 110-220 add **\$48.00** for transformer.

**3000 WATT, CONTRACTOR'S PORTABLE**, Briggs & Stratton 5 to 7 HP gas engine with Delco generator and rubber tired wheels. Rope start, weight 275 lbs. Used like new at ..... **\$220.00**

NEW **\$279.00**

**5000 WATT**, 120 volt AC, 60 cycle, HERCULES 4 cycle gas engine. Generator manufactured by Hobart Bros. Unit includes remote control cable, 150' 2-wire #6, and 150' 3-wire #18, exhaust pipe, power cable plug, KVA at 80% power factor, radio and television filtered. Unit is completely automatic. List price today **\$1900.00**. Now priced for you at **\$675.00** used, NEW **\$895.00**

To make plant 110-220 add \$72.00 for transformer.

**7500 WATT**, 110 volt AC, 60 cycle, powered by a VE 4 Waukesha 4 cyl. gas engine, Continental or Hollinsworth generator. Remote control starting. Complete with switch board. NEW..... **\$995.00**

To make plant 220 volt, 3 phase add **\$76.00** for transformer.

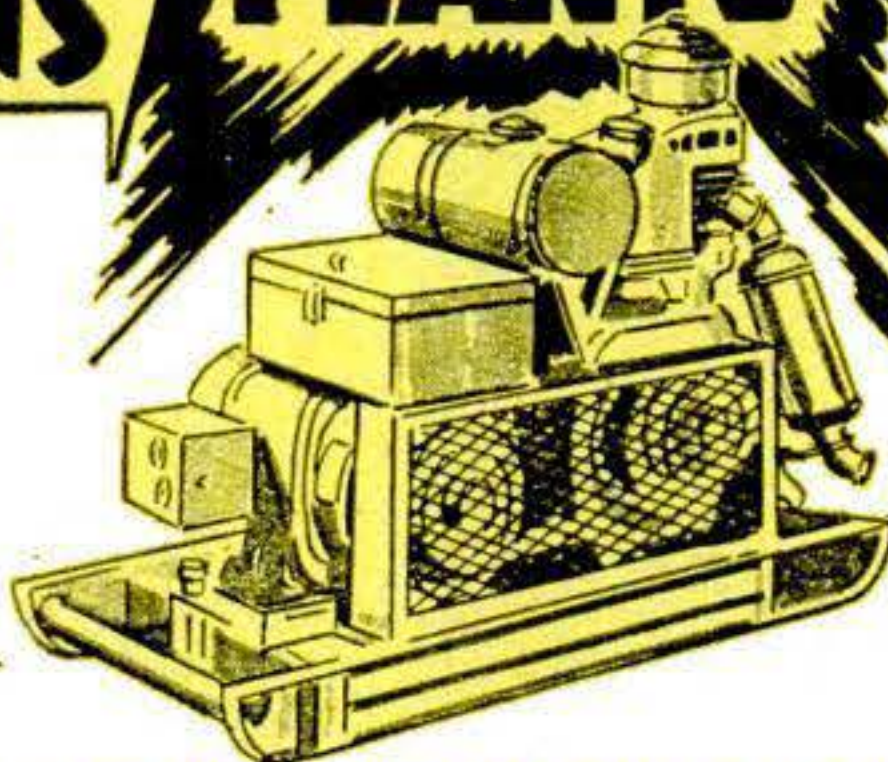

**SENSATIONAL BUYS**  
**at 50 to 75% savings**

**LIGHT PLANT BUYERS**  
**in emergency telephone collect-unit shipped same day!**

**COLD WEATHER**

**HEAT CONTROL**

Made by Minneapolis-Honeywell—a name known for the best in controls. 1000 watts—115 to 220 volts. Element length 10 ft. Range 70° to 212° Fahrenheit. Control fans, motors, furnaces. This control makes an ideal automatic combination when hooked up to the heat boosters at right! List price \$16.00. Your price **\$4.95**



**AUTOMATIC CONTROL VENTILATOR**

For BARNs, ATTICs or BASEMENTS. Increases cows milk production. 20" fan driven by 1/4 HP motor. Switches and thermostat similar to heat control at upper left included **\$89.50**

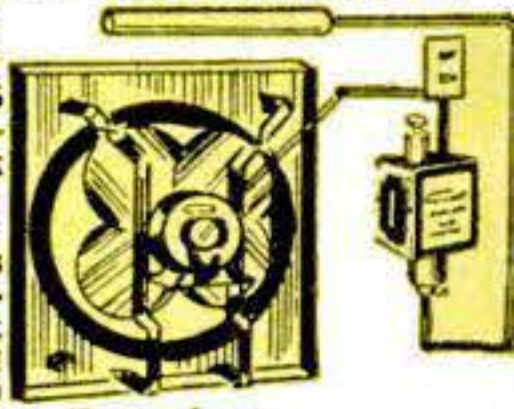

Available in other sizes.

**and other bargain items**

**HEAVY DUTY GRINDER** 1 HP, 1800 RPM, 3 phase, 220 Volt 60 cycle, 20 ft. cord, 24" Long, GUARANTEED. Mfg. by Thor & Chicago Pneu. Special SALE PRICE..... **\$29.50**

**BLOWER AND MOTOR**. Enclosed squirrel cage type for cooling, heating, suction or blowing. Ball-bearing Redmond motor, 1550 RPM. Discharge 3" x 3". Intake 5". Weight 9 lbs..... **\$11.95**

**BLOCK AND TACKLE**

70-foot 3/4 rope, 1 double block, 1 single block—both have swivel hooks, galvanized tensile strength, 4000 lbs.; No. 6 block, 3 1/2" wheel; weight 27 lbs. Value \$27.00. Price..... **\$9.95**

**C & H ELECTRIC Co.**

438 W. JUNEAU AVE.

MILWAUKEE 3, WISCONSIN

All prices F.O.B. Milwaukee. 25% deposit required on all C.O.D. orders. No C.O.D.'s under \$10.00. Use stock number when ordering. Many other bargain items not listed—write for our free circulars.

**Low Cost Way To Brighten Your Home**

New free illustrated booklet shows easy, low-cost ways to brighten cellars, attics. Use aluminum paint—the right kind. We don't make paint, but offer this book to help you get best results. Write for free booklet "Paint it Bright."



Aluminum Company of America, 1717B Gulf Bldg., Pittsburgh 19, Pa.

**Saw, Drill & Grind**

without stopping, lifting machine or changing set-ups; only one change for lathe work and sanding. No heavy lifting. Basic Emrick 5-in-1 Machine still only \$39.95. 10-day Free trial; Money-Back Guarantee. Write for FREE Catalog of entire line.



EMRICK, INC., 221 Clinton, Kalamazoo, Michigan

**Print Your Own**



Cards, Stationery, Advertising, labels, circulars, photo and movie titles, church work, tags, etc. Save money. Sold direct from factory only. Raised printing like engraving, too. **Print for Others, Good Profit.** Have a home print shop. Easy rules supplied. Pays for itself in a short time. Write for free catalog of outfits and all details.

KELSEY PRESSES, N-33, Meriden, Ct.

**BRONZE FOUNDRY**

Schools and Home Workshops Make your own castings of aluminum, copper, bronze, silver. Foundry sets are available in three sizes including 2400 Deg. F. blast Furnaces, \$22.50; \$29.50; and \$42.00. f.o.b. Kansas City. Free Circular.

KANSAS CITY SPECIALTIES CO. P. O. BOX 6022, DEPT. S-2 KANSAS CITY, MO.

**FOR FASTER WORK IN HOME OR SHOP...**

**HOLD-E-ZEE**  
 The Original AUTOMATIC GRIP SCREWDRIVERS

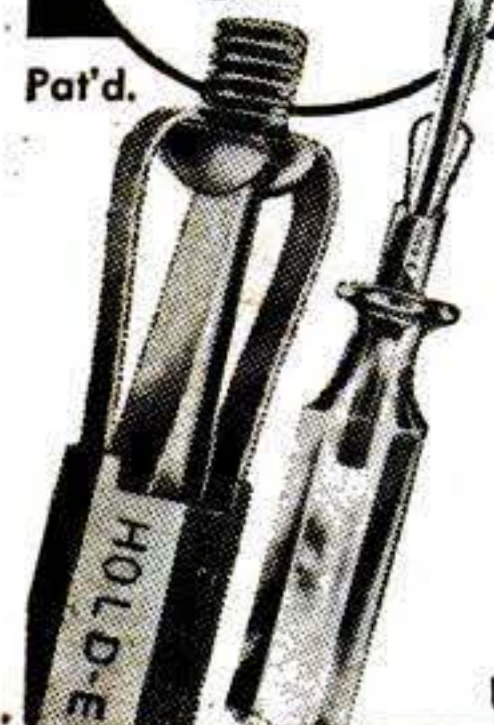

See these popular, high-quality drivers with the exclusive Gripper that holds, starts and sets up screws in unhandy places!

New Models FOR RECESSED HEAD SCREWS

At Leading Dealers Everywhere

UPSON BROS., INC., ROCHESTER 4, N. Y.

**FIX IT WITH EASY TO USE KESTER METAL MENDER**  
 GENUINE TIN-LEAD SOLDER



Write for NEW FREE 16 page booklet on SOLDERING

KESTER SOLDER COMPANY 4254 Wrightwood Ave. Chicago 39, Illinois

AND OTHER

# WAR SURPLUS BARGAINS



**JARVIS GRINDER**  
 Three phase, 220-440 volt, with flexible shaft; 3450 RPM. Totally enclosed motor.  
 1 HP List \$165... Now **\$65.00**  
 1 1/2 HP List \$195 Now **\$75.00**  
 2 HP List \$225... Now **\$85.00**  
 1/3 HP, 110 Volt stand and shaft ..... **\$39.50**



**HORNS AND HOWLERS**  
 Motor driven (not a vibrator). Heavy duty, adjustable for high, medium or low tone. 110 volt AC current. Weather proof. For alarm or signal horn on boats, school yards, factories, air raid sirens, etc. Lists at \$47.00. NEW. Four price .... **\$15.45**

## HEATING SPECIALS

**HEAT BOOSTERS**  
 Fits any 8", 9", 10" furnace pipe. 1500 RPM motor with 6' cord, mounting frame, 7" blade. Motor 110 volt 60 cycle 1550 RPM. Easy to install. Silent operation. Warm those rooms with long runs. Stock #583. Regular \$11.95. Your price **\$6.95**  
 10" ball bearing fan Mfg. by Redmond. Can be run vertically or horizontally. 110 volt AC 60 cycle motor with plug and cord. New in original box. Use it for the kitchen as an exhaust fan, heat booster, etc. High pitch blade, 1/25 HP 1550 RPM. only ..... **\$11.95**

**AUTOMATIC OIL TANK WATCHMAN**  
 No risk of oil tank going empty. Pilot light turns on when fuel level gets down to danger or minimum point. .... **\$11.95**

**PORTABLE HEATERS** for Contractors Lauson gas engine with supercharger blower **\$149.00**  
**PREVENT FROZEN WATER PIPES!** Thermostat with 60 ft. of flexible, (wrap around) lead heating cable. .... **\$19.95**



**BALL BEARING ARBORS**  
 Grinding and saw arbor, has 1/2" double end shaft, 1 1/2" long with 2" center pulley. New Departure double roll ball bearings. Right and left hand thread. Self aligning Dodge pillow block. 10,000 RPM. Bearings alone list at \$10. Complete arbor new. Stock #305 ..... only **\$5.95**

## STAINLESS STEEL TUBE

HALF PRICE—6' to 10' Lengths

SIZE	O.D.	WALL	MILL	OUR PRICE
1/4	3/16	01506	51c Ft.	Ft. 25c
3/8	11/32	01301	63c Ft.	Ft. 32c
7/16	13/32	01508	70c Ft.	Ft. 35c
1/2	15/32	01205	72c Ft.	Ft. 36c
3/4	11/16	05001	91c Ft.	Ft. 46c
7/8	1-3/16	03125	1.01 Ft.	Ft. 50c
1	1-3/16	105	1.10 Ft.	Ft. 55c
1 1/2	1-3/8	05015	1.74 Ft.	Ft. 87c
2	1-15/16	05003	2.20 Ft.	Ft. 1.10
2 1/2	2-7/16	0500	2.74 Ft.	Ft. 1.37

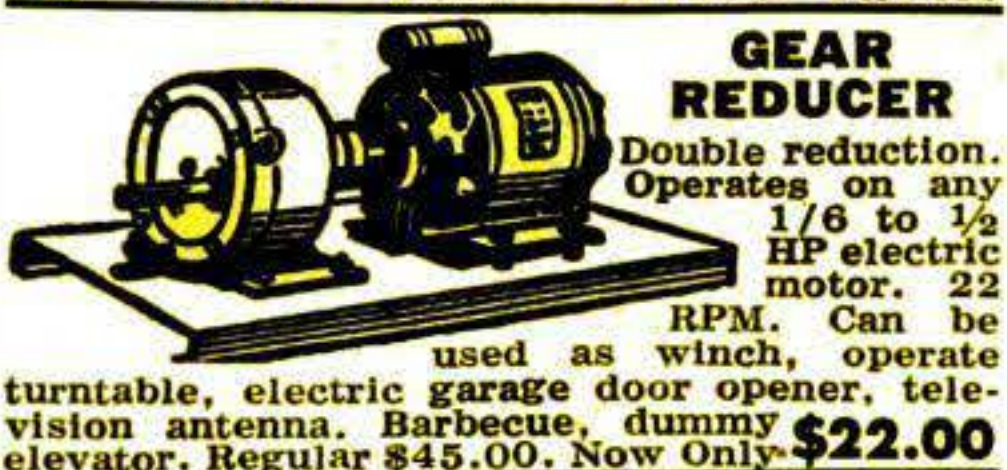

**GEAR REDUCER**  
 Double reduction. Operates on any 1/6 to 1/2 HP electric motor. 22 RPM. Can be used as winch, operate turntable, electric garage door opener, television antenna. Barbecue, dummy elevator. Regular \$45.00. Now Only **\$22.00**

**AIR COMPRESSORS**  
 Gas or electric. Awarded from government.  
 1/2 HP ..... 12 gal. tank ..... **\$ 89.50**  
 1 HP ..... 50 gal. tank ..... **229.00**  
 1 1/2 HP ..... 50 gal. tank ..... **237.00**  
 2 HP ..... 50 gal. tank ..... **264.00**  
 3 HP ..... 60 gal. tank ..... **325.00**  
 5 HP ..... 60 gal. tank ..... **385.00**  
 7 1/2 HP ..... 80 gal. tank ..... **568.00**  
 10 HP ..... 80 gal. tank ..... **642.00**

**TELEPHONE SETS**  
 Not a toy—but the real McCoy! Magneto-bell ringing set; operates 2 stations or 10! 2 tele-phones with 200 ft. wire ..... **\$19.95**

## HOT ROD SUPERCHARGER

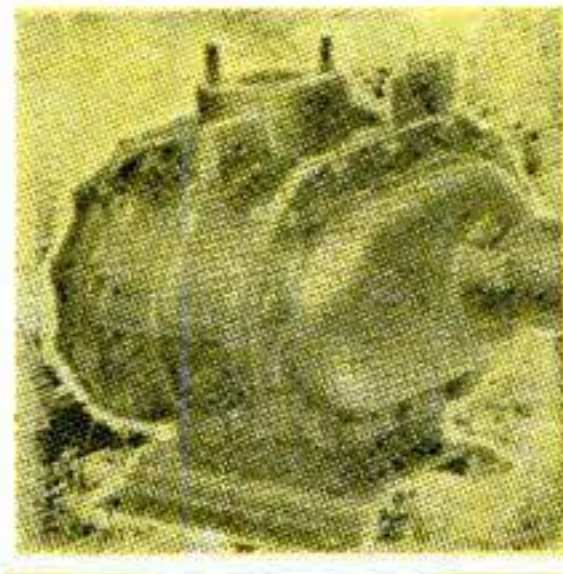

Here's a hot rod supercharger at a price you can't afford to miss. SEE HOW THIS TYPE SUPERCHARGER IS USED in PICTURE and ARTICLE on Page 67 Aug. issue of POPULAR MECHANICS. Mfg. by Borg & Warner. SPECIFICATIONS: 7 1/2" wide, 5" deep, 7" high. Weight 17 lbs. Compact and sturdy, 4 base mounting holes, 3/4" outlet, 5/8" shaft. Includes female Lovejoy coupling. Priced today at \$85. OUR SPECIAL SALE PRICE ONLY ..... **\$16.95**

## HEAVY DUTY ELECTRIC CABLE

Electric rubber cable, 16 cond. No. 18, solid, 100 ft. or more, per foot. .... **\$ .16**  
 Electric rubber cable, 10 cond. No. 18, solid, 100 ft. or more, per foot. .... **\$ .10**  
 Electric rubber cable, 4 cond., stranded, No. 18, water and oil resistant, run in parallel No. 16, 100 ft. **\$6.25**, 250 ft. **\$12.50**, 500 ft. **\$25.00**, 1320 ft. reel. **\$56.00**  
 Electric rubber cable, 3-wire, stranded, No. 10, 65 ft. with lugs. Val. \$26.00 ..... **\$19.50**  
 Electric rubber cable, 3-wire, stranded, No. 10, submarine cable, underwater, underground, overhead, 50 ft. **\$15**, 100 ft. **\$30**, 250 ft. **\$75**, 500 ft. .... **\$125**  
 Electric rubber cable, 3-wire, stranded, No. 6 150 ft. reels with 1 male connector; 2 female, crouse hinds connectors. Value \$211.00 At ..... **\$75.00**  
 Electric rubber cable, 2-wire, No. 4, 75 ft. lengths, male and female connectors. .... **\$60.00**

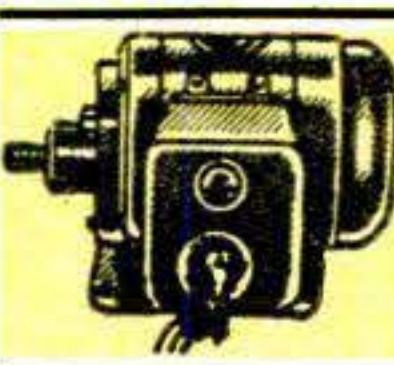

**GENERATORS**  
 300 Watt, RPM 3400, 110 and 220 volt, 1/2" shaft, **\$40.00**; 2500 Watt, RPM 1800, 115 volt, AC, **\$225.00**; 3000 Watt, RPM 2800, 110 volt DC, Delco ball bearing, 1" shaft. List \$343.00 to you at only ..... **\$99.50**

## MERCURY CLUTCHES

For Motor-scooters, Motor-bikes, Lawn Mowers, etc. Mercury centrifugal clutch for use with any small gas engine. 3" "A" belt pulley, 5/8" bore. Brand new only. Stock #400 ..... **\$8.95**  
 3/4" bore. NEW ..... **\$9.95**  
 1" bore ..... **\$10.95**  
**ROCKFORD CLUTCH** Manual, bronze throw yoke 1 1/2" bore, 1" female spline; 5" long. 5 1/2" OD. Takes to 25 HP. PRICE ONLY ..... **\$15.00**

**ALL ITEMS GUARANTEED AS REPRESENTED C & H ELECTRIC Co.**  
 438 W. JUNEAU AVE. MILWAUKEE 3, WISCONSIN

## The JIFFY metal CABINET

**YOUR ANSWER TO SMALL ITEMS STORAGE**  
 at home, office, and shop (IDEAL GIFT, TOO)



So handy to keep nuts, bolts, screws, nails, parts, washers, stamps, hobbyists' needs, etc., at your fingertips.

**THIS 32 DRAWER UNIT ONLY \$8.95 POSTPAID**  
 Stop searching, get a 32 or 64 drawer Jiffy to keep those small items that usually get mislaid. Spot welded steel, gray enamel finish, metal drawer guides. Dividers included with aluminum drawers make possible three compartments per drawer. Looks good anywhere. Send check or money order, please—no C. O. D.'s. Prices below. Your money refunded if not satisfied. Dealers write for quantity discount.

SPECIFICATIONS	WITH ALUMINUM DRAWERS	NEW SPECIAL!
<b>32 Drawer Unit</b> 6" Deep 12 3/4" Wide 15 1/4" High	<b>Dividers and Index Cards Included</b> One piece rustproof aluminum drawers for heavy service—good for work bench and industry use.	<b>ONLY \$2.95</b> <b>8 DRAWER UNIT</b> (24 compartments) <b>16 DRAWER UNIT</b> (48 compartments) <b>\$4.95</b>
<b>64 Drawer Unit</b> 6" Deep 25 1/2" Wide 15 1/4" High	<b>32 drawer - \$8.95</b> <b>64 drawer - \$15.95</b> Ohio orders add 3% sales tax. Marproof Rubber Feet included with all cabinets. <b>POSTAGE PAID</b>	<b>Specifications</b> 6" Deep, 8 1/4" High 8 Drawer 6 5/8" Wide 16 Drawer 12 3/4" Wide <b>POSTAGE PAID</b>

**KAYTEE PRODUCTS, Dept. S, Box 588, Canton, O.**

## brand NEW just off the press



**CONSTANTINE'S MANUAL FOR WOODWORKERS HOBBYISTS HOME OWNERS**  
**116 PAGE BOOK**

*a complete catalog!*

**AND REFERENCE BOOK OF WOODS, VENEERS, LEATHER, METAL, PLASTICS, ETC.**  
 This is the biggest, most complete manual we ever published. More new items, on leathercraft, decorative metals, wood finishing, hard to get items of all kinds... in addition to our power and hand tool sections, upholstery, picture frame mouldings, rare and domestic woods, veneers, lumber, inlay panels, 83 inlay designs, inlay borders, all in full natural color, plus a full color wood identification panel of 60 different woods suitable for framing. All items at lowest prices from America's Biggest Supplier to Craftsmen.

Send today for your copy of the hobbyist's most helpful book.  
 Supplying America's Craftsmen Since 1812.

## SEND FOR YOUR COPY TODAY

**FREE**  
 With each copy of our Master Manual, you get a year's subscription to Chips and Chats, a breezy bimonthly to keep you up-to-date on what craftsmen are doing.

**ALBERT CONSTANTINE & SON, INC., DEPT. PS-2**  
 797 East 135th St., New York 54, N. Y.

Enclosed find 25¢ for a copy of your "Master Manual" and a FREE one year's subscription to Chips and Chats.

NAME \_\_\_\_\_  
 ADDRESS \_\_\_\_\_  
 CITY \_\_\_\_\_ STATE \_\_\_\_\_

**SAVE UP TO 60%! GIGANTIC MAIL SALE!**

**COMPLETE BARGAIN CATALOG**  
Order from ad. Satisfaction guar.  
Or, rush card for big free catalog.

**Power Plants • Welders • Pumps • Compressors • Tools**

**WE PAY SHIPPING COSTS**



**FLEXIBLE GUY and TURNBUCKLE UNITS**

- New 12-ft. flexible steel cable with 14-in. turnbuckle.
- 7-strand 1/8" galv. steel wire cable, 1000-lb. strength.
- Hundreds uses on farms, for business, contractors, etc.
- Guy — strengthen — gates, fences, buildings, wagons, etc.
- Ideal guy for television towers, many other uses.
- Cost Gov't. \$1.10 ea.

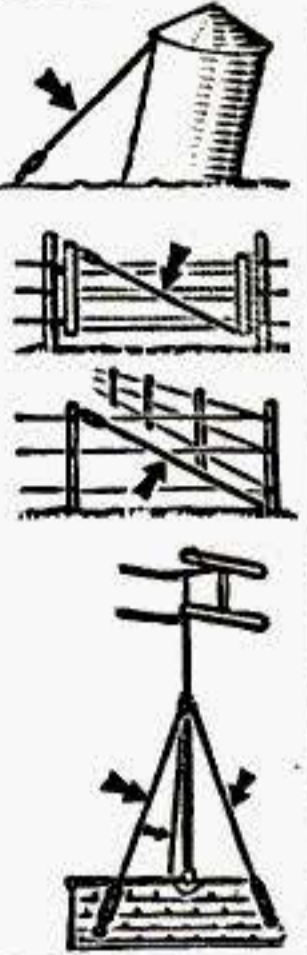

**SALE**  
10 for ..... \$ 3.89  
50 for ..... 16.47  
100 for ..... 29.32



- MISCELLANEOUS BARGAINS**  
"We pay shipping costs on everything!"
- A. Utility Clutch up to 6.5 h.p. \$13.95
  - B. V-belt Clutch up to 1.5 h.p. \$ 7.49
  - C. Hand Gas Pump 10 g.p.m. \$15.90
  - D. Army Field Telephone EE-8 \$11.25
  - E. Rural Phones (5 bar) \$12.40
  - F. City Desk Phones (Com. Batt.) \$ 4.99
  - G. Briggs 3.5 h.p. Engine \$75.50
  - H. 2-sta. phone inter com. \$11.60
  - I. 110-v. Electric Chain Saw \$94.50
  - J. Auto Compression Tester \$ 3.94

**WATER PUMPS and SYSTEMS**

Genuine brand new Burdex bronze self priming all purpose water pumps. Std. pipe threads. Will lift up to 22 ft. Pressures to 30 lbs. Up to 22 g.p.m. Other pumps up to 150 lbs.

- 1/2" BRONZE.....\$12.75
- 3/4" BRONZE..... 16.95
- 1.0" BRONZE..... 22.95
- 3/4" CENTRIFUGAL..... 6.85

**A-C POWER PLANTS (3500-watt)**

- Brand new 110-volt, 60-cycle, 3000-4000-watt. Complete with tools, spare parts, battery, full instructions.
- Push-button start. Easily made for automatic start.
- Genuine Hercules 4-cyl. 15 H.P. engine.
- Finest Hobart generator. Complete instrument panel.
- Ideal emergency (or full time) plant. For farmers, city homes, resorts, etc. 770 lbs. 19x30x48 in.
- Today's cost, over \$1,400.00. **SPECIAL..... \$485, Freight Collect**

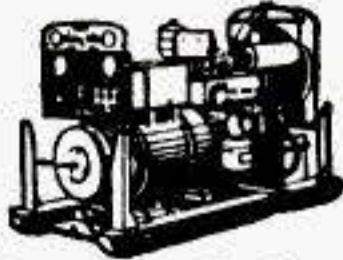

**AIR COMPRESSOR KIT**

Build portable hi-pressure (up to 150 lbs.) air unit. Basic kit consists best 1-cyl. piston compressor, stainless 12"x24" tank, 160-lb. gauge, genuine Brown paint spray gun, dust blow gun, tire chuck, 15' hose, fittings and manual \$36.90 "How to Build." Guaranteed.....



**AIR COMPONENTS**

- Compressors, Sing. Cyl. Smith. Pressures to 150 lbs. at 3 C.f.m. Top quality.....\$18.15
- Regulators, Adjustable 20 to 150 lbs. ....\$2.49
- Hose (15') Finest Rubber 1/4" fittings. ....\$1.99
- Tanks 12"x24" 400 lb. stainless .....\$8.95
- Guns, Planet dust blow. ...\$1.21
- Guns, Heavy Duty paint. ...\$8.95
- Switch, Automatic pressure, adjustable. ....\$4.95



**D-C ARC WELDER**

0-250 amps. Easy to drive with tractor, engine, etc. Professional outfit. Ready to use. Built-in controls, reactor..... **\$99.50**  
• Unit with G.E. helmet, rod holders, rods, cables, clamps, etc. **\$104.50** \$300. value.

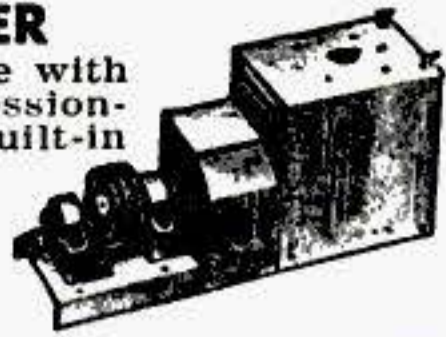

**TRACTOR WEED SPRAY UNITS**

• Wonderful buy in weed spray equipment. Bankrupt dealer's and excess inventory stock. Top quality units. Latest type. Less than factory cost. All units fully guaranteed.  
• Weed spray equipment already hard to get. Buy at once. Or send for Weed Spray Bargain Catalog.

**LOT NO. 130** All brass bottom assembly, 4-row, 14-ft. size, with 9 genuine T-jets, filter, hose, tractor mounting brackets, pressure gauge. Standard cost, \$71.50. **SALE..... \$32.90**

**LOT NO. 131** Direct drive, 3/4" bronze tractor pump. **SALE..... \$26.95**

**LOT NO. 132** Weedmaster complete spray outfit, 5-row, 17-ft. Complete with pump, jets, valves, gauge, hose, tractor mounting brackets, etc. List. **\$99.95** \$150.00. **SALE.....**

Send for Weed Spray Bargain Circular. **COMPLETE WATER SYSTEMS** Low as \$69. Write for pump circular.

**POWER & HAND WINCHES**

• Amazing Values. Jeep winches. 80 to 1 ratio. 5,000 lb. capacity. Mounts on front trucks, jeeps, cars. Cost over **\$21.95** \$150.00  
• Finest Steel Hand Winch. Powerful unit complete with 50 ft. 3,000 lb. cable. Complete with crank. \$50.00 **\$29.95** value

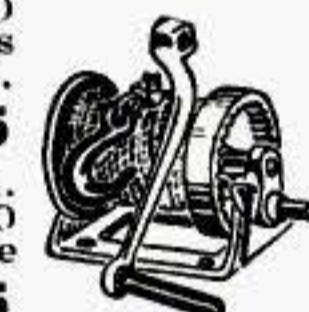

• Everything new, unless otherwise stated. Satisfaction guaranteed.  
• Write for free amazing bargain catalog—hundreds of electronic, radio, mechanical, tool, pump, other bargains.

**Burden Prepays All Shipping Charges** except on 3500-watt plant.

**BURDEN SALES COMPANY**  
824 "O" St. LINCOLN, NEBR.

**ONE-MAN SAWMILL** LOW \$50.00 AS... 50.00 DOWN

Take BELSAW Portable Sawmill right to the trees—turn out valuable lumber for local yards—do "custom sawing" for neighbors. BELSAW lasts a lifetime. No crew needed. Power with old auto engine. Beginners get excellent results. Send postcard for FREE BOOK, "How To Make Lumber."

**BELSAW MACHINERY CO**  
8462 Field Bldg. Kansas City 2, Mo.



Ask Your Hardware Store for **FULLER'S Unbreakable Amber Handle SCREW DRIVERS**

America's most popular line of moderately-priced screw drivers! Wide range of sizes. FULLER TOOL CO., Inc., 911 Faile St., New York 59  
World's largest maker of Amber-Handle Tools

**ARC WELDING FOR PROFIT OR PLEASURE**

**60 LBS. OF READY MADE PARTS** Only \$24.95

**BUILD YOUR OWN HEAVY DUTY WELDER** SAVE BUY ONLY NECESSARY PARTS

All necessary parts Ready-Made and easy to assemble. You can do all around welding on steel, cast iron and other metals after only a few hours practice. Illustrated instruction manual included. Sold on 30 Day Money-Back Guarantee! Free plans for building case.

**FREE:** Write today for fully illustrated Pamphlet S-2  
**ATOMIC ARC WELDER CO.** Gives 100% penetration. Welds are stronger than original metal. Operates on 110 or 220 AC.  
1039 So. 19th St.. OMAHA, NEBR.

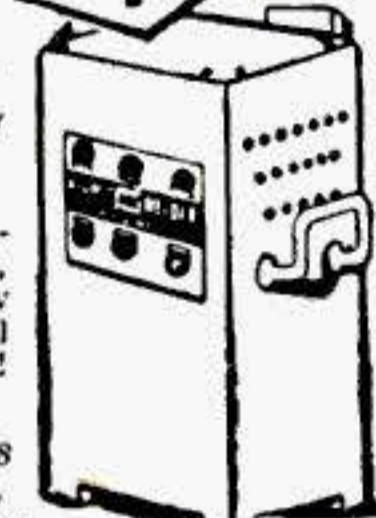

**SAW SHARPENER**

Table model, gums and sharpens rip saws, combination saws & cut-off saws. Ideal for "Skilsaw" blades. Cap. 4" to 20" diam. Complete with 1/4 h.p. motor & 1 grinding wheel & cord—\$64 f.o.b. Portland. Shipping weight, 63#. **SEND FOR FREE LITERATURE.**  
**P. T. HOBBS MACHINERY**  
8375 N. Interstate, PS-21, Portland 17, Ore.



**1951 BUZZ MASTER**

**8 MODELS — \$99 up**  
More cutting — "Tomorrow's BUZZ MASTER Today!" See the de luxe riding model. Nothing else like it. Made by the oldest firm in the business—now in our 47th year. Many special features used only on Ottawa Saws. Write today for **FREE DETAILS.**  
**OTTAWA MFG. CO., 1-101 Brush Ave., OTTAWA, KANS.**



**AMAZING NEW WOOD-TURNING TOOLS!** Outlasts Steel Up to 50 to 1!

**SHARPEN ONCE IN 12-YEARS! (UNDER NORMAL USE)**

These remarkable tools tipped with TUNGSTEN CARBIDE will astound you with their performance. They work **FREE HAND** equally well in wood, plastic or soft metals—and at the same time hold their razor-like edge almost indefinitely. Tests show that they will turn wood or plastic for days and days **CONTINUOUSLY** without showing any signs of dulling. They are the finest tools available at any price. Beautifully finished 5" blade—flush ground, polished tip—finest brass tube ferrule—9" hardwood handle—over all length 14"—25 tools to choose from: round & square nose from 1/8" to 1/2";—1/8 and 3/16 cut off; 1/2"x30° skew, spear, r. & l. skewers, turning and parting. Amazingly Low Prices! Write at once for free literature.

**JOHNS MFG. CO., DUNELLEN 3, N. J.**





**The Only SANDER with POWER UNIT  
GUARANTEED ALL DURING YOUR  
OWNERSHIP AGAINST  
BURN-OUT OR REPLACED FREE!**

**SYNGRO**  
ELECTRIC

**SANDER  
POLISHER  
MASSAGER**

Looking for a "light finishing" sander and high polisher plus a relaxing massager? Here it is—made by dependable SYNGRO . . . and the only sander of its kind that guarantees its Power Unit against burn-out ALL DURING YOUR OWNERSHIP—or replaces it Free. Also, the ENTIRE sander (not just the cord) is LISTED by Underwriters' Laboratories, Inc. Let the new, improved SYNGRO do the work at 240 strokes per second—just guide it. COMPLETE with BUILT-IN Fractional Horsepower Reactor Type Electric MOTOR, 10 sandpapers, lamb's wool and fabric pads, \$16.95.

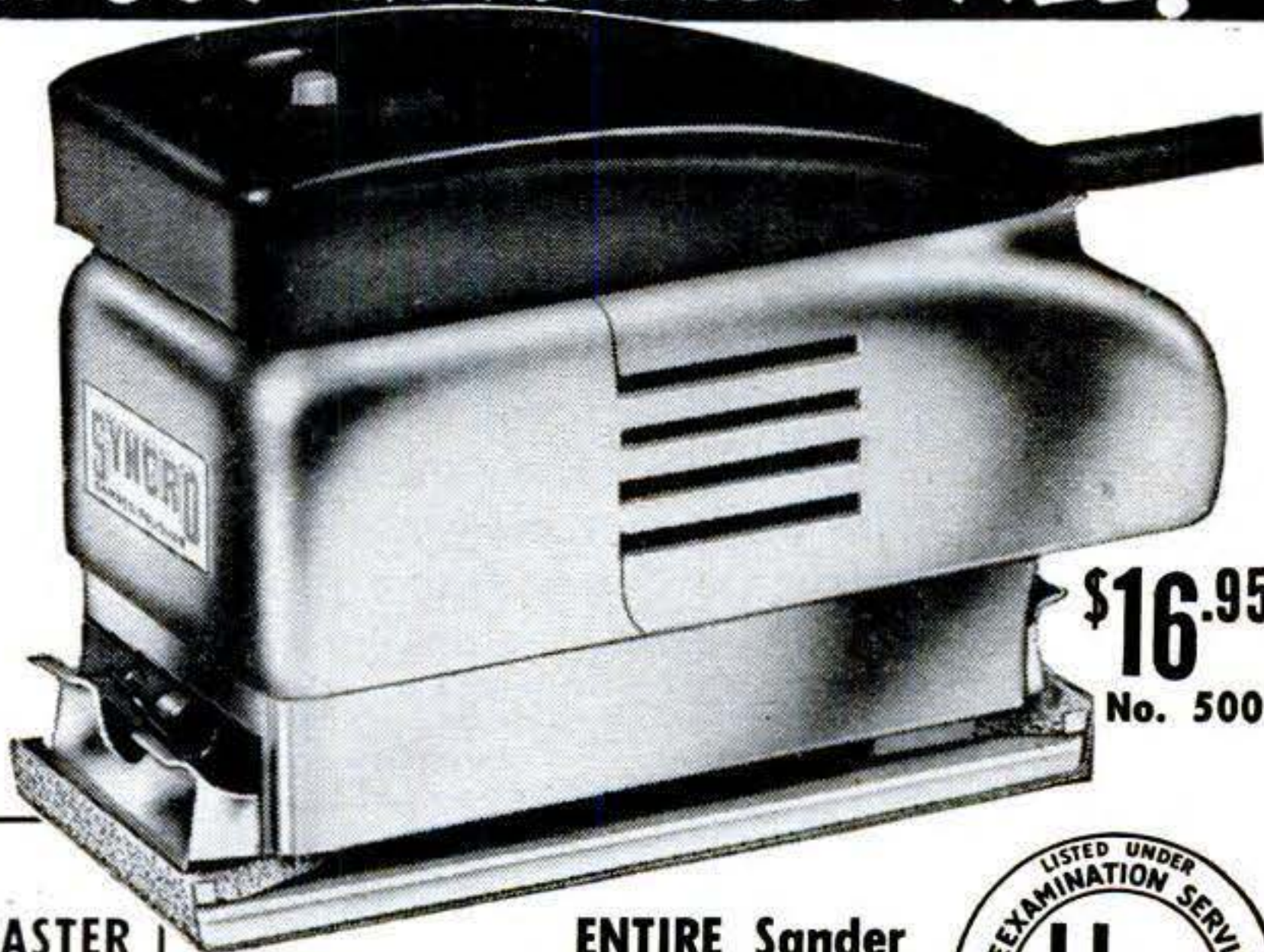

**\$16.95**  
No. 500



**ENTIRE Sander  
and ENTIRE Saw LISTED By...  
(not just the cord)**

U.S.A. model, 110-120 Volt, AC only, 60 cycle. Other voltages, cycles available. Buy at dealers. If none near send article price, we'll ship postpaid.

**SYNGRO CORPORATION, Dept. G-21, Oxford, Mich., U. S. A.**

**NEW SAFE SAW CUTS  
ONE INCH WOOD 50% FASTER  
with 70% LESS NOISE!**

No. 201

Arm in normal position

Largest, most powerful of its kind yet SAFE for kids. Ideal for Dad's shop, even apartments. Portable. Cuts any length 1" wood, thin metal, plastic. UL-Approved. Thousands sold. COMPLETE with BUILT-IN Fractional Horsepower Reactor Type Electric MOTOR, \$22.95.

**\$22.95**

**ANNOUNCING**

**NOT ONE—NOT 12—BUT  
40 DIFFERENT CUTS!**

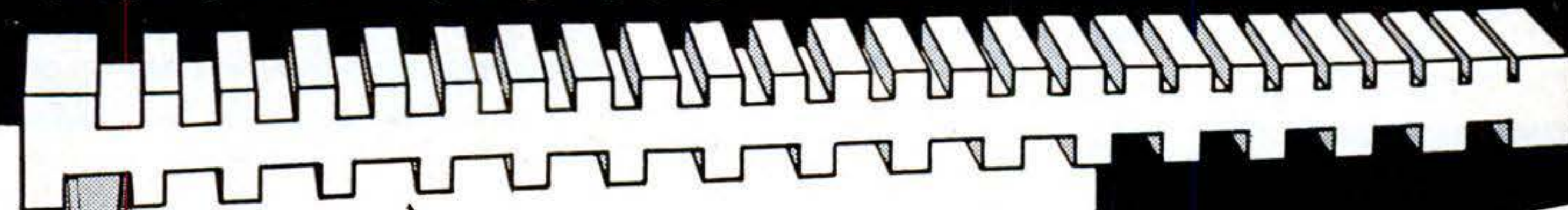

**NEW** *Warren*  
**DADO SAWING WASHERS**

Multiply the uses of your circular saw with sensationally improved Warren Dado Sawing Washers! Make smooth, parallel dados or grooves in 40 different widths with your present saw blade! Dial the width with Micromatic adjustment—in 15 seconds you're making the cut. Four simple washers—precision-made in matched sets—no vibration, no gadgets to get out of alignment. No burning, chewing—no sanding. Four sizes 1/2", 5/8", 3/4", 1"—fit all popular saw arbors. See your dealer or send coupon today—ABSOLUTELY GUARANTEED!

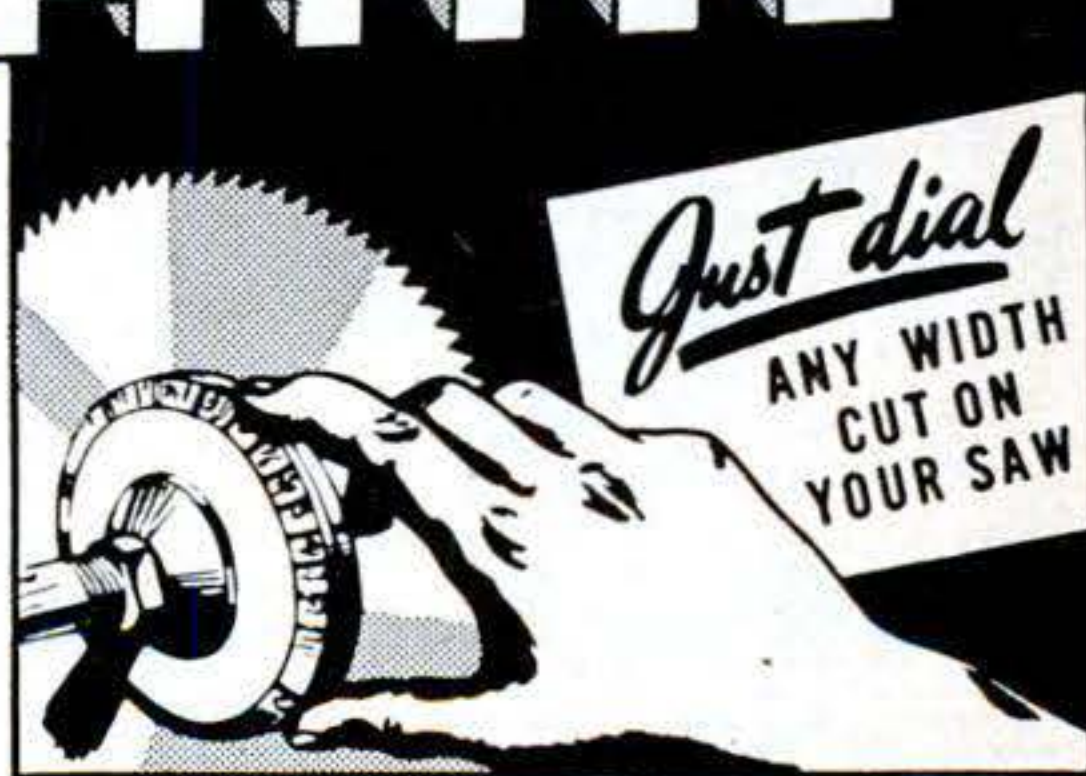

*Just dial*  
ANY WIDTH  
CUT ON  
YOUR SAW

**ONLY  
\$4.95  
per  
set**

**NO INCREASE IN PRICE!**

**WARREN DADO SAWING WASHERS CO., Dept. 42.  
70 Medbury, Detroit 2, Mich.**

Enclosed (check or M.O.) \$4.95 for one set of NEW Warren Washers. My arbor size is  1/2"  5/8"  
 3/4"  1".  Send free booklet. (PLEASE PRINT)

Name \_\_\_\_\_

Address \_\_\_\_\_

City \_\_\_\_\_ State \_\_\_\_\_

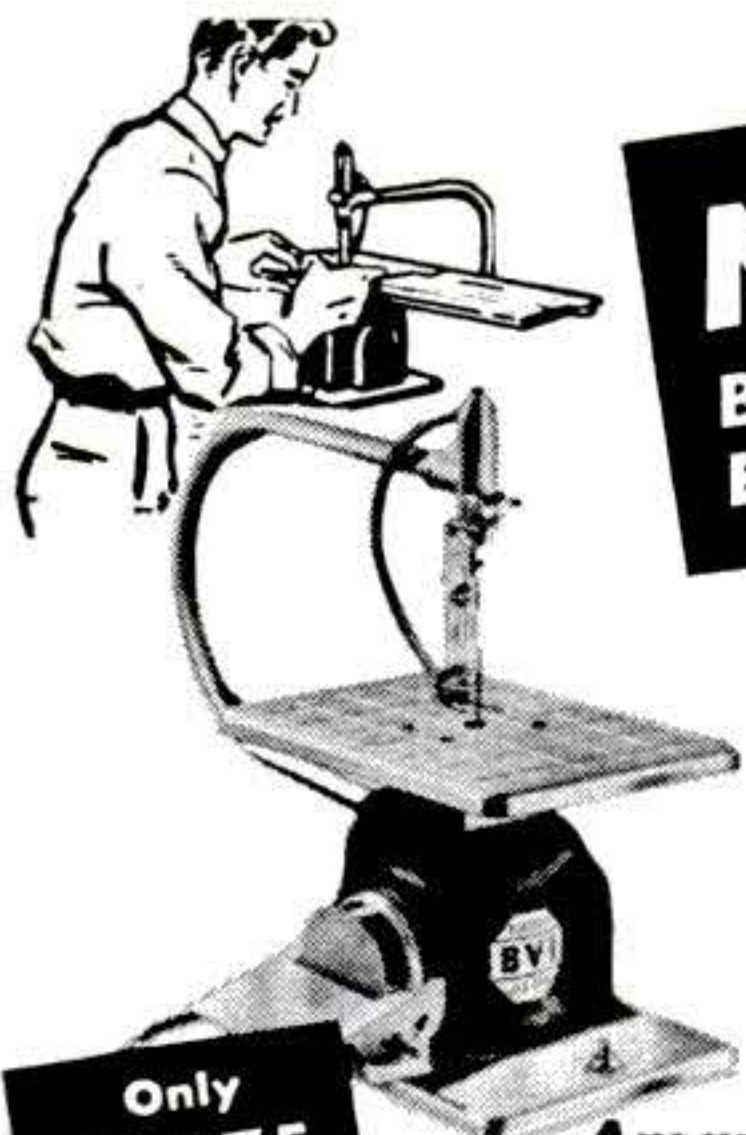

**MAKE IT  
BETTER, FASTER,  
EASIER... WITH**

**BURGESS  
electric  
JIG SAW  
SANDER  
FILER**

Only  
**\$1475**  
Complete

**Amazing New Power Tool  
with Built-In Rotary Motor...  
Perfect for Every Home Project**

You'll be delighted with the smooth, clean lines, the accurate edges and the speed with which you turn out difficult projects when you own a Burgess Jig Saw. This fine, low-cost tool saws, sands, files easily and safely in half the time it takes by hand. Not a vibrating saw! Fractional h.p. rotary motor powerful enough to cut 1/2" wood, any length, to file metal up to 1/8" thick. A "must" for every work bench. Fully guaranteed. Descriptive literature on request.

See Your Dealer, or Write: Dept. A

**BURGESS  
VIBROCRRAFTERS, INC.**

180 N. WABASH AVE. • CHICAGO 1, ILL.

Built-In Rotary Motor • "Every Direction" Saw Blade • Large, 45°-Tilt Saw Table • 3500 RPM Sanding Disc • Tilting Sanding Table • Built-In Sawdust Blower • Completely Portable. Comes with 3 Extra Saw Blades, 3 Extra Sanding Discs • 110-125 volt, 50-60 cycle, A.C.

**Earns  
\$100 a MONTH  
in spare time**

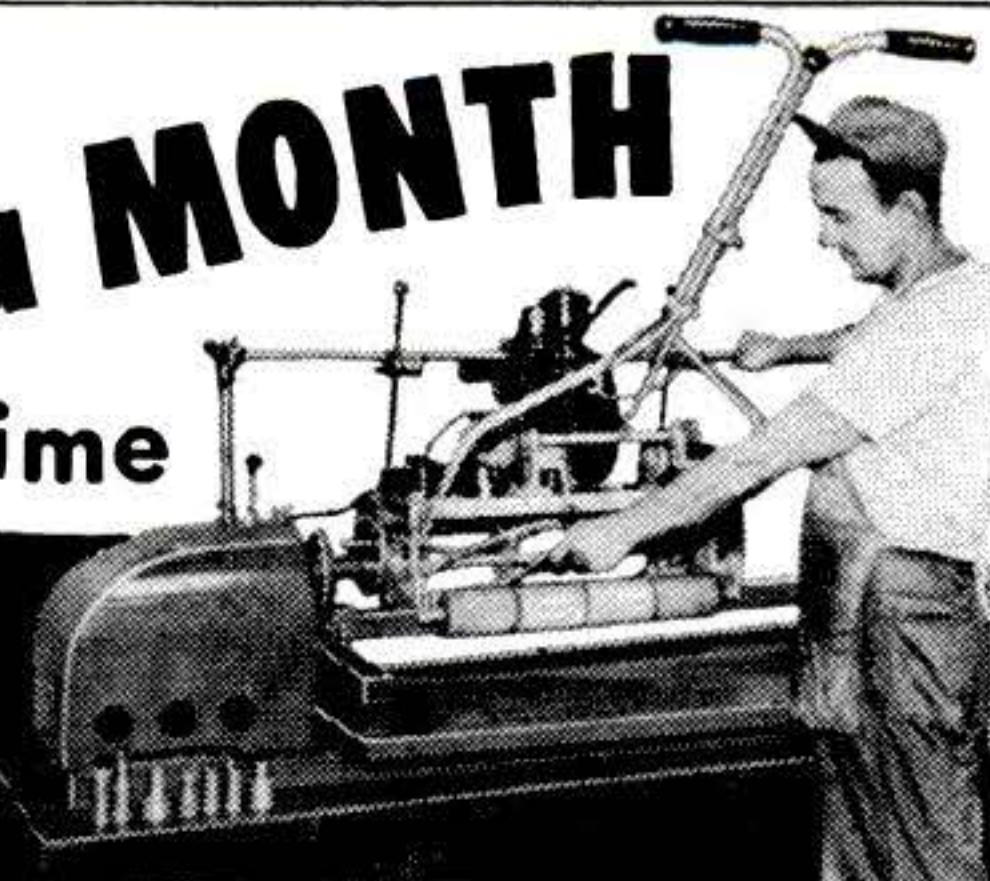

**with  
FOLEY  
LAWN  
MOWER  
SHARPENER**

"I did nearly \$100 worth of business in May, sharpening and repairing lawn mowers in my spare time"—says R. D. Fancett. "I figure I made \$100 a month," writes L. R. Michaletz. When you can sharpen 3 or 4 hand mowers an hour with the Foley Lawn Mower Sharpener, at \$1.50 to \$3.00, or 1 or 2 power mowers at \$5.00 to \$8.00 each—just figure out the possibilities for yourself! 99c out of every dollar you take in is profit.

**FREE BOOK**—"HOW TO SHARPEN POWER MOWERS" shows just how to sharpen any make of power lawn mower with the Foley. Prices \$97.50 to \$159.50—easy payment terms available. Mail coupon today—we'll also send FREE PLAN telling how to start your own business without previous experience. No salesman will call.

**How to  
Sharpen  
POWER  
MOWERS**

**SEND  
COUPON  
TODAY**

**FOLEY MFG. CO., 208-1 Foley Bldg., Minneapolis 18, Minn.**  
Send FREE BOOK "How to Sharpen Power Mowers", and FREE PLAN on lawn mower business.

NAME.....  
ADDRESS.....

**AMAZING TOOL BARGAINS!**



**SURPRISE VALUE  
100 Pieces \$1.00**  
FOR ELECTRIC  
GRINDERS

Grinding Wheels, Cut-off Wheels, Sanding Discs, Mounted Stones, Sharpening and Honing Stones, Rotary Cutting Burs, Abrasive Cartridges, Mandrels, and many other items.



**2 CIRCULAR SAWS \$1.50**  
ON 2 MANDRELS—  
ALL AT ONE LOW PRICE \$1.50  
1" diameter saws on 1/8" Mandrels. For cutting wood, plastic, or soft metals. Order at once! Send Check or Money Order. U.S.A.

**12 MINIATURE CUTTERS \$1.00**  
FOR CUTTING WOOD, PLASTIC, OR METAL



Pos. paid IN U.S.A. Actual size. Asst. shapes on 3/32" shank. For die makers, home workshop, etc.

SCHUPACK SUPPLY CO., 7331 Cottage Grove, Dept. S-21, Chicago 19, Ill.

ILLUSTRATED BARGAIN CATALOG 10c

**FILE your own SAWS... easy!**



Do expert saw filing without experience. Keep your hand saws extra sharp, true-cutting. Easy to use. Mon- COMPLETE ey back guarantee. Cash \$2.95 with order, prepaid. (COD postage extra.) WITH FILE

**A SPEEDCOR TOOL!**

**THE SPEED CORP. PS-2**

512 N.E. 73 Ave., Portland, Oregon

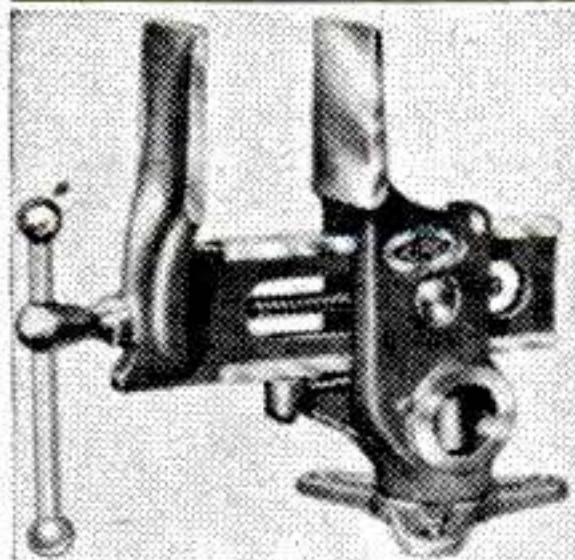

**DESIGNED FOR THE HOME WORKSHOP**

A penny postcard will bring you a folder showing in use the most versatile wood-working vise (the Versa-Vise) you ever imagined. Use it upright, flat on its side, turned to any angle! Mail a card now.

**THE WILL-BURT CO.**

Dept. PS-5 Orrville, Ohio



**Clark EXPANSIVE BIT**

**CUTS BETTER • COSTS LESS!** Accurate, fast; cuts smooth holes in hard or soft wood. Chrome vanadium steel blades, all chrome body. No. 250, 1/2"-1 1/2", \$1.69; No. 251, 7/8"-3", \$1.89. GUARANTEED. At your dealer or write

**ROBERT H. CLARK COMPANY • Beverly Hills, California**

**DO MORE PLANING JOBS \$215.00 WITH LOW-COST BELSAW**



**AMAZING 12 1/4-IN. PLANER** Does All Ordinary Planing Mill Jobs. Provides attachments for Jointing, Rabbeting, Tongue, Groove, Matching. 12 1/4 x 6-in. capacity, 3-knife solid round all-steel cutterhead. Power feeds at 24 feet per minute, 42 cuts per inch. Provides for full line of accessory attachments—Grind and Joint knives IN THE CUTTERHEAD WITHOUT REMOVING.

**BELSAW MACHINERY CO**

1021 Field Bldg., 315 Westport Rd., Kansas City 2, Mo.

**FREE BOOK**

**SHEET METAL BRAKES**

Forms angles, flanges and Pittsburgh locks. 26 gauge steel, heavier aluminum. Cam locking. Portable. can be bolted to bench, or clamped to edge of truck. All steel, reinforced. Shipped Exp. Coll. 30" size. Wt. 54 lbs., \$26.50. 36" size, Wt. 66 lbs. \$31.00. 48", Wt. 100 lbs., \$45.00. Floor mountings, portable, 32" high, \$7.00. 12" BRAKE. Fits in vise to form difficult compound bends, up to 20 gauge steel. Not illustrated.....\$12.50 PP. 24" CURVE FORMER, Capacity—16 gauge steel.....\$10.00 IRON BENDER. 1/4x2" capacity. 9 parts. All steel.....\$10.00 PP. Immediate delivery. Order direct, cash or C.O.D. or send for folder.

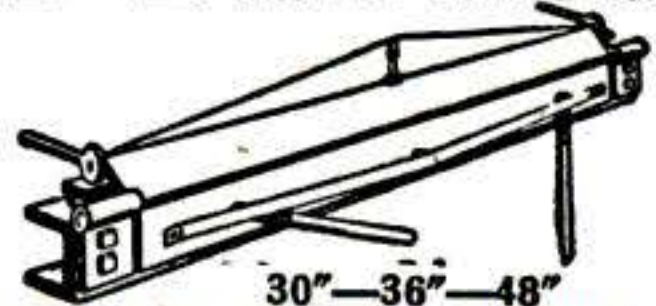

**VYKE BRAKE CO., S-1116 So. 27th St., Omaha 5, Nebr.**

# SURPLUS MACHINE SHOP TOOLS AT PRICES YOU CAN AFFORD



## HIGH SPEED STRAIGHT SHANK DRILLS

**SET 1K** 30 Selected High Speed Straight Shank Drills from 1/8" to 1/4". \$15 value. New and slightly used surplus. Priced at only. . . . . **\$2.95**

**SET 2K** 10 Different Size High Speed Straight Shank Drills from 1/4" to 1/2". Extra Long Drills. \$30 value. Priced at only. . . . . **\$3.95**

**SET 3K** 10 Different Size High Speed Straight Shank Drills from 1/2" to 1". Extra Long Drills. \$40 value. New and slightly used surplus. . . . . **\$6.95**



## HIGH SPEED MORSE TAPER SHANK DRILLS

RECONDITIONED DRILLS READY TO GO!  
PRICED ONLY FRACTION OF NEW

1/4"-.25	27/64"-.42	25/32"-\$1.20	1- 3/32"-\$2.50
9/32"-.27	7/16"-.42	51/64"-.135	1- 7/64"-.265
19/64"-.30	29/64"-.45	7/8"-.150	1- 9/64"-.270
5/16"-.31	15/32"-.45	57/64"-.155	1-11/64"-.290
21/64"-.32	31/64"-.55	15/16"-.165	1-13/64"-.300
11/32"-.32	41/64"-.90	31/32"-.180	1- 7/32"-.300
23/64"-.35	23/32"-.105	63/64"-.185	1-15/32"-.450
3/8"-.35	47/64"-.115	1"-.195	1-17/32"-.525
25/64"-.40	3/4"-.115	1-1/32"-.200	1-31/32"-.875
13/32"-.40	49/64"-.120	1-5/64"-.250	

Discounts on Quantity



## HIGH SPEED TAPER SHANK CHUCKING REAMERS

**SET 8K** 20 Different Size High Speed Morse Taper Shank Chucking Reamers up to 1/2" with No. 1 and 2 tapers. Priced at only. . . . . **\$6.95**

**SET 9K** 8 Different Size High Speed Morse Taper Shank Chucking Reamers from 1/4" to 1". Priced at only. . . . . **\$4.95**

**SET 10K** 10 Different Size High Speed Morse Taper Shank Chucking Reamers from 1/2" to 1 1/8". \$65 value. Priced at only. . . . . **\$9.95**



## HIGH SPEED STRAIGHT SHANK CHUCKING REAMERS

**SET 11K** 20 Different Size High Speed Straight Shank Chucking Reamers up to 1/2". Priced at only. . . . . **\$6.95**

**SET 12K** 10 Different Size High Speed Straight Shank Chucking Reamers from 1/2" to 1 1/8". Priced at only. . . . . **\$9.95**

**SET 13K** 15 Different Size High Speed Straight Shank Chucking Reamers from 1/4" to 1". Priced at only. . . . . **\$6.95**



## HIGH SPEED HAND TAPS



**SET 14K** 10 Different Size High Speed Standard Thread Hand Taps up to 3/4". Plus No. 6 Tap Handle (5/32"-3 1/4" Cap) Priced Complete at only. . . . . **\$5.79**



**TAP HANDLE** No. 6 (5/32" to 3/4" Cap.) Only. . . . . **\$3.19**



## HAND REAMERS & TAP HANDLE



**SET 15K** 10 Different Size Hand Reamers from 1/4"-1". Majority Brand New Plus No. 6 Tap Handle (5/32"-3 1/4" Cap) \$30 Value. Only. . . . . **\$9.95**

**SET 16K** 20 Different Size Hand Reamers as above with Same Tap Handle. only. . . . . **\$16.95**



## BRAND NEW HIGH SPEED COMBINATION DRILL AND COUNTERSINKS

**SET 17K** 8 Different Size from C2 to M1 (1/16 drill x 13/64 body to 7/32 drill x 5/8 body) 60 degree of countersink. These new countersinks sell new from 75c to \$2.50 each. Your price for this set of 8, while they last. only. . . . . **\$3.95**

## HIGH SPEED WOODRUFF KEY SEAT CUTTER

**SET 18K** 5 Different Size Cutters. Can be used as mounted milling cutter or circular saw. All with 1/2" shanks, widths up to 1 1/4". diameters up to 1 1/2". Priced at only. . . . . **\$3.95**



## BRAND NEW ROTARY FILES

**SET 19K** 7 Different pcs. High Speed 1/4" Shanks. (Complete Set for Less Than Cost of One Rotary File) . . . . . **\$4.19**

**SET 20K** 14 Different pcs. as above. . . . . **\$7.49**



## BRAND NEW MOUNTED STONES

**SET 21K** 100 stones, 3/16 shanks, rounds, points, cylinder shapes, etc. These 100 pieces. Only. . . . . **\$6.98**

## PESCO HYDRAULIC GEAR TYPE PUMP

Rated at 3 GPM @ 3750 RPM @ 1000 PSI. Female type drive. . . . . **\$8.98**



**Money Back Guarantee—All Mdse. Mixture of New and Reconditioned Tools Unless Specified Brand New—All Orders Shipped Post Paid saving you up to 25% on total delivered cost.**

**Write for Free Catalog Describing Thousands of Bargain Cutting Tools.**

**T & T TOOL 111 W. ARCHER TULSA, OKLA.**



## WOOD FASTENERS

Don't split Wood—Use "CHEVRONS" hardened steel FASTENER. Draws wood together eliminating doweling, mortising, nailing. Hammer in—"Presto"—a firm joint! No wobble, no distortion. Lends artistic appearance. Easily countersunk and concealed with wood fillers. For hard and soft woods. For mill workers, artisans, HOME CRAFTSMEN, for

making and repairing screens, doors, sash, frames, cabinets, furniture, moulding. 3/8" depth, for thickness wood up to 1 1/2". At your dealer or send only \$1.00 NOW for GIANT box, postpaid. Money back if not delighted.

E. B. PACKARD CO., Inc., Dept. PS-2, 139 Cedar St., New York 6, N. Y.



7x50  
\$36  
Illustrated

## BINOCULARS TELESCOPES

**Big Bargain Catalog Free**

**BROWSCOPE CO.**  
Dept. 2P, 24 West 45th St.  
New York 19, N. Y.

## THE BIGGEST VALUE ON THE MARKET DIRECT FACTORY TO YOU DYNAMIC SUPER-CHARGED ARC-WELDER

**DOES WELDING, BRAZING, SOLDERING, CUTTING**  
It's the finest, precision built heavy duty transformer-welder available for home, farm, or shop use. Does work you'd expect from costlier machines. EASY TO OPERATE. Do expert work; follow simple instructions. Works on iron, steel, brass, bronze, aluminum and other metals. Operates from any properly wired 110 volt 50/60 cycle AC line. Save time, Make money—Build or repair auto, home, farm or shop equipment, etc. for yourself and others in spare or full time. Comes complete Ready-To-Operate. Order today for 10 day trial on money back guarantee or write for Free Particulars. DYNAMIC WELDER CO., Dept. D3-BB6, 15 E. 23rd St., Chicago 16, Ill.



Gift of Tool Marker—Soldering Tool and Electric Torch included for prompt action at no extra cost.



OVER 50,000 SATISFIED USERS

**\$41.80 Only \$33.50 F.O.B. COMPLETE**

# BARRON Drill Press TOOLS



ROTARY WOOD  
PLANER \$7.50

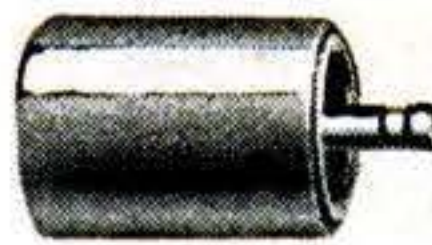

1" and 2 1/2" DRUM  
SANDERS



ROTARY SURFACE  
SANDER \$5.95



\$10.85  
F.O.B. Detroit  
ALL-METAL  
DRILL PRESS TABLE

ALL-METAL  
SHAPER FENCE  
\$9.50  
F.O.B. Detroit



ROUTER &  
MORTISING  
BITS  
\$10.50  
set of six  
1/8" to 1/2"

SHAPER  
CUTTERS  
\$5.75  
Inc. 4 Blades  
for Shaper or  
Drill Press



## 15 ESSENTIAL WORKSHOP OPERATIONS...

You can convert any standard make drill press into your most versatile, useful, low cost workshop tool. Barron Precision Tools now enable you to perform 15 indispensable shop operations—surface-plane woods and plastics—rabbet—tenon—panel—bead—groove—bevel—mortise—route—cut dovetail—sand surfaces and contours—shape—cut moldings—grind and buff. Over 200,000 Barron Tool users. Every tool sold on full 10 day money back guarantee.

See Your Dealer... Or Write Direct

BARRON TOOL COMPANY, INC.  
326 Architects Bldg., Detroit 1, Mich.

FREE  
Workshop  
Guide &  
Catalog

## CELLARS, WASH TRAYS; CIRCULATES OIL; IRRIGATES GARDENS

ORIGINAL "Type P" Pump has 1,001 year 'round uses—home, shop, garden, farm. DRAINS cellars, cisterns, wash tubs, ditches, pools. IRRIGATES gardens, lawns. CIRCULATES oil, coolant. SUPPLIES water to elevated tanks from wells as deep as 25 feet. 2400 gals. per hr. capacity. 360 GPH 75' high. 1500 GPH from 25' well. 1" suction and 3/4" discharge ports fitted for hose. Quiet, humless operation. Use 1/2 to 1/3 HP motor. Easily installed. Complete instructions furnished. DOES NOT CLOG OR RUST!

ONLY \$6.95  
postpaid if check or money order with order.



## WHICH OF THESE 4 PUMPING UNITS DO YOU WANT?

Easy to Assemble! Easy to Use!



TYPE D-3 Pump cleans 40' well or cesspool quickly! Operates in any position. Pumps 400 GPH 40' high or 1400 GPH 20' high. Complete with 1/3 HP motor \$27.95

Without motor, only \$12.95



TYPE E Pump has interchangeable direct or belt drive for all 'round use. E-4 fitted with 5" pulley. Complete, with 1/4 HP motor, \$24.95. Without motor, only \$13.95

E-3 fitted with 6" pulley. Complete with 1/3 HP motor, \$26.95. Without motor, only \$14.35

### MONEY BACK GUARANTEE

All Bronze Foot Valve for 1" hose... \$2.95  
1" Suction Hose—per foot... .38  
3/4" Discharge Hose—per foot... .22  
All prices POSTPAID if check or money order with order. West of Mississippi, add 50c for Type P; \$1.00 for other models.



TYPE C-4 Pump has Direct Drive. Ideal for plumbing fixtures below sewer line. Complete with 1/4 HP motor \$23.45. Without motor, only \$11.55



\$11.55

LABAWCO PUMPS • Belle Mead 4, N. J.

## CALENDAR WATCH

CHRONOGRAPH & STOP WATCH

Only 8.95 + 10% TAX

31-Day Automatic Calendar

A precision timepiece and chronograph at an unusual low price. Imported Swiss jeweled movement, Radium Glow 1" dial, red sweep-second hand, shock resistant case, metal expansion wristband. 1 Year Guarantee, 5-day Free Trial. Choice of white, black dial.

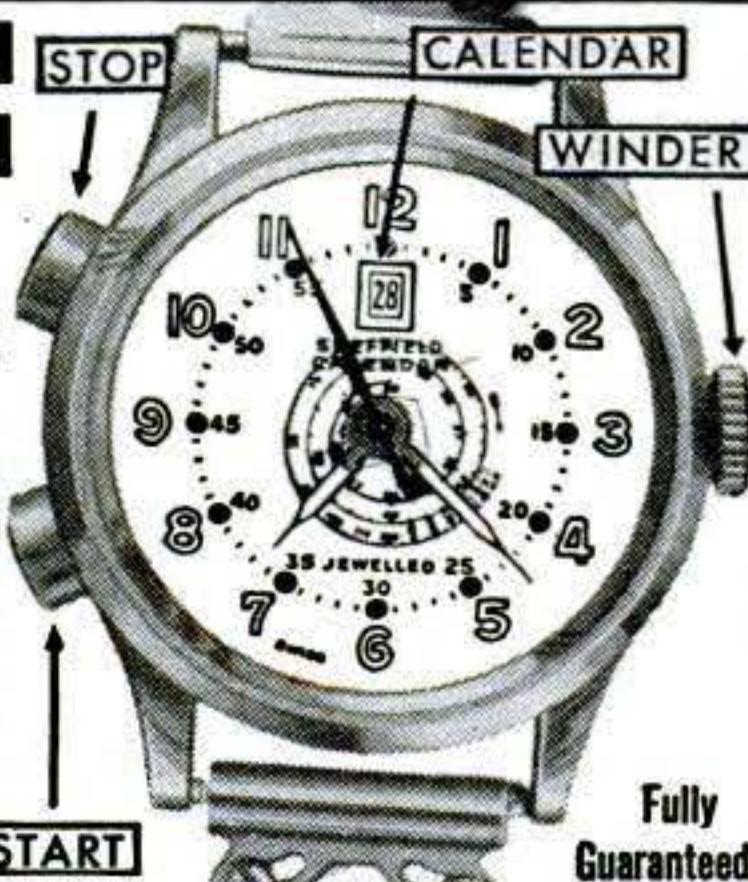

GAYLORD DEPT. SB-7, Fifth & Hamilton, Pittsburgh 6, Pa.

Send.....Watches @ 8.95 + 90¢ tax. Enclose  Check,  Money Order,  Send C.O.D. Print name, address & dial color in margin.

## USE YOUR BENCH SAW

FOR JOINTING & CUTTING MOULDINGS

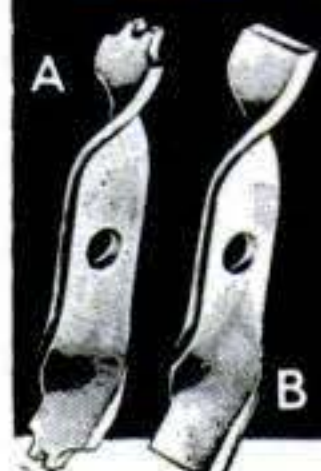

With our six inch tool steel cutters make mouldings, casings, drop-leaf tables, grooves beading and jointing. Moulding cutters, A 1 in. wide \$1.75. 1 1/2 in. \$2.25. Jointing cutters, B 1 in. \$1.75. 1 1/2 in. \$2.25. E 1 in. for drop-leaf tables. \$1.75. E 1 1/2 in. Makes 3/4 in. cove & Quarter. \$2.25. Postpaid. Guaranteed. State size hole. List & Folder free.

JOHN A. SANDSTROM  
Rt. 2-P. Clearwater, Fla.



## New WOOD SAMPLE KIT

Only \$8.50

The only wood study kit on the market. Contains 54 wood and wood products specimens size 3/8" x 2 1/4" x 5", an 84-page identifying manual with 51 magnified cross sections; a 10-power hand lens and knife. Send this ad and only \$8.50 today for delivery any place in continental U. S.

TIMBER ENGINEERING COMPANY

1319 18th ST., N. W., WASHINGTON 6, D. C.

## Aladdin Tools

Make These Cuts—And Hundreds More With Aladdin Shapers for Circle Saw and Drill Press!

CIRCLE SAW WOODSHAPER, MODEL #SA-10. (left) Solid steel. Absolutely safe—blades locked in position with screws all the way through. In ordering, state diameter of your circle saw shaft. Complete, as pictured, with 6 pair blades and tool rack, \$14.95

DRILL PRESS WOODSHAPER MODEL #60. (right) Heavy-duty shaper. Exclusive pilot bearing eliminates side thrust, chatter, vibration—assures smooth cutting action. Complete, as pictured with 6 pair blades... \$12.95

ALL ALADDIN TOOLS ARE GUARANTEED

Send cash, check, or M.O. today. Nationally Distributed by

BERTRUM F. ENGINEERING & SUPPLY CO.

3121 MAIN STREET

KANSAS CITY, MO.



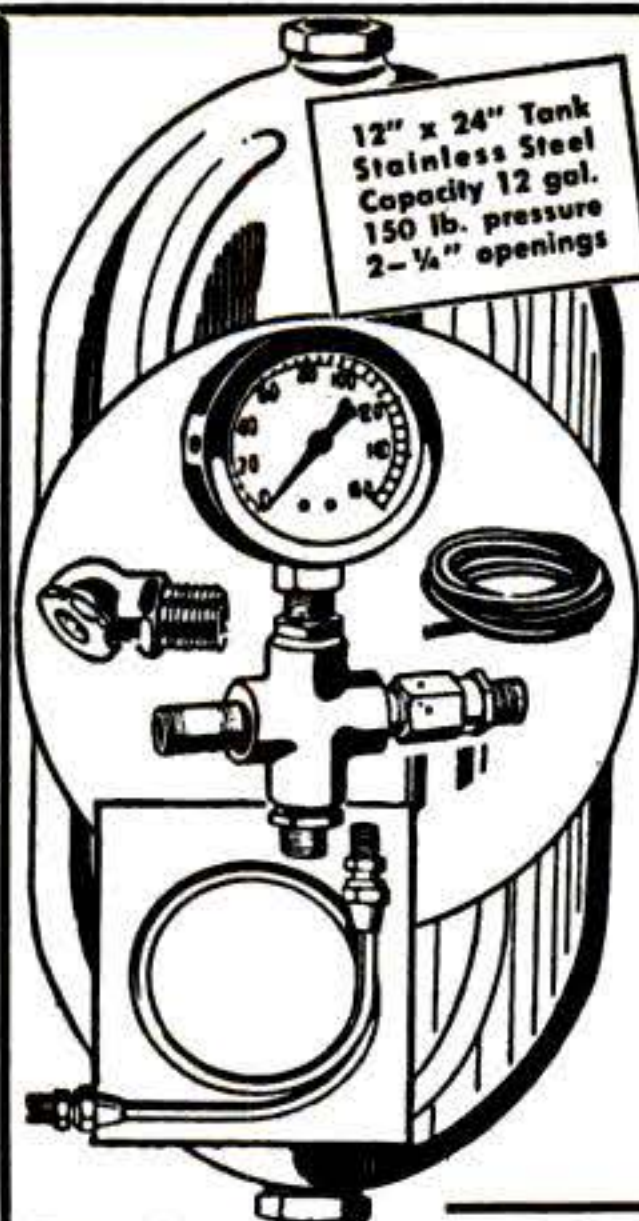

12" x 24" Tank  
Stainless Steel  
Capacity 12 gal.  
150 lb. pressure  
2-1/4" openings

# WESTINGHOUSE Air Compressor

Reg. \$60.50 . . . Only  
Model T-1 Brand New — 2 CYLINDER PISTON TYPE **\$21.50**

Operates with 1/2 H.P. Motor or equivalent gas engine.

Compressor has 2" bore, 1 1/2" stroke, ball bearing, 3.27 CFM at 600 R.P.M. Capacity up to 6.54 CFM. Size 9"x11 7/8"x6 3/8". Wt. 26 lbs. Brand New

Compressor, pressure tank, air gauge, air chuck, 20-ft. hose, pop valve, copper tubing with 4 brass flared fittings for connecting compressor to tank, 4-way cross and 3 nipples.

COMPLETE OUTFIT, wt. 52 lbs. . . . .

EQUIPMENT LESS COMPRESSOR, \$12.50

COMPRESSOR SEPARATELY, \$21.50

TANK ONLY, \$6.95

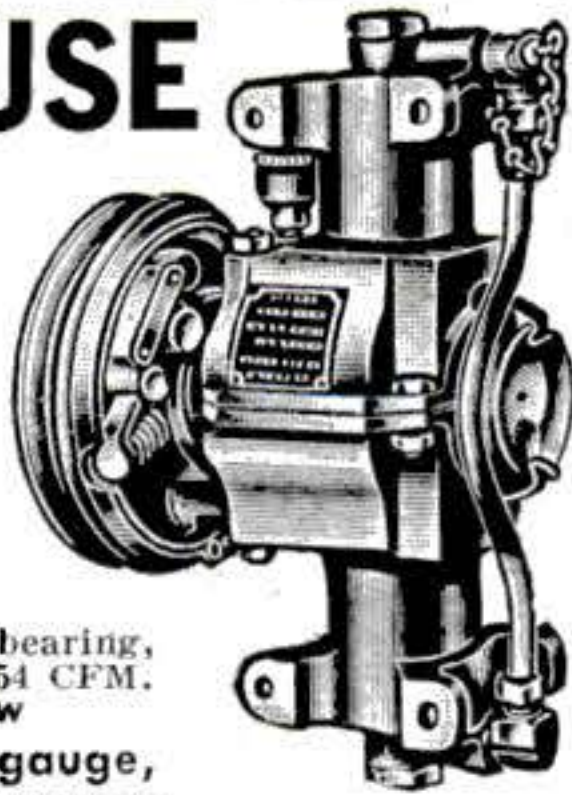

**\$32.50**

# LIGHT PLANTS

Brand New!  
War Surplus

Signal Corps  
Power Unit  
PE 197

115 volt 60 cycle A.C. single phase 5 K.W. Hobart, water cooled, 14 h.p. 4 cylinder Hercules

engine. Remote Control, complete panel board with instruments, 150 ft. automatic remote control cable with reel; 150 feet ±6 heavy duty wire with reel; housed in metal case with replacement parts and tools. Cable with reels alone worth \$400. Regular price of unit \$1900.

Shipping wt. 1250 lbs. **\$895.00**  
Our price, complete, f.o.b. Chicago

Same unit, slightly used. **\$495.00**  
Reconditioned. Fully guaranteed. . . . . less cable

2 1/2 K. W. LELAND POWER PLANT . . . . . **\$295.00**

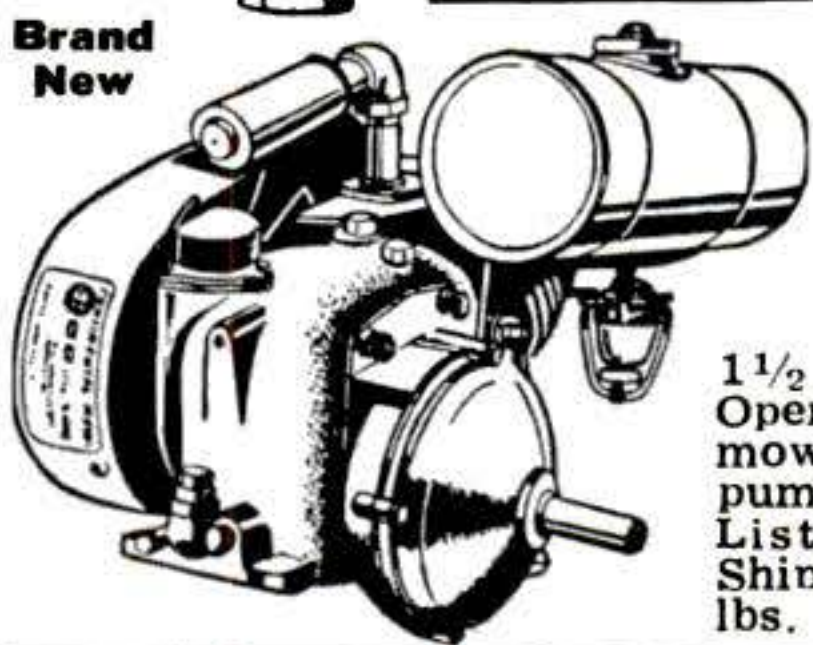
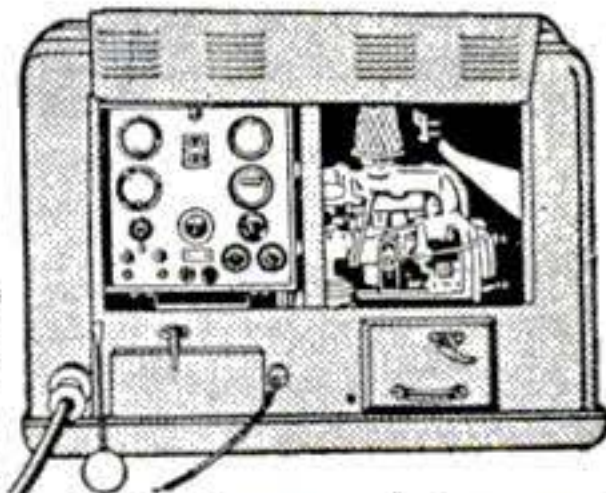

Brand New

Save nearly 1/2 on Gas Engines!

## Red Seal Continental

6 to 1 REDUCTION GEAR  
1 CYLINDER — 4 CYCLE

1 1/2 HP with 6 to 1 reduction gear. Operates at 450 R.P.M. For lawn mowers, scooters, garden tractors, pumps, compressors, generators, etc. List Price \$79.50.

Shipping weight 54 lbs. SPECIAL PRICE **\$47.50**

# AUTOMATIC COMPRESSOR UNIT

1/3 H.P. heavy duty capacitor motor. AC 110/220 volt, 60 cycle, 2x1 3/4 inch piston type compressor, splash feed lubrication. 12x24 inch tank, automatic pressure switch. CFM 2.8 at 100 lb. pressure, or 150 lbs. pressure for intermittent duty. Check valve, safety valve, air regulator with gauge and filter, 20 ft. air hose with air chuck for inflating tires, V. belt drive. Mounted on 2 wheels, ball bearing, with 2"x10" pneumatic tires. Portable with handle. Shipping wt. 90 lbs.

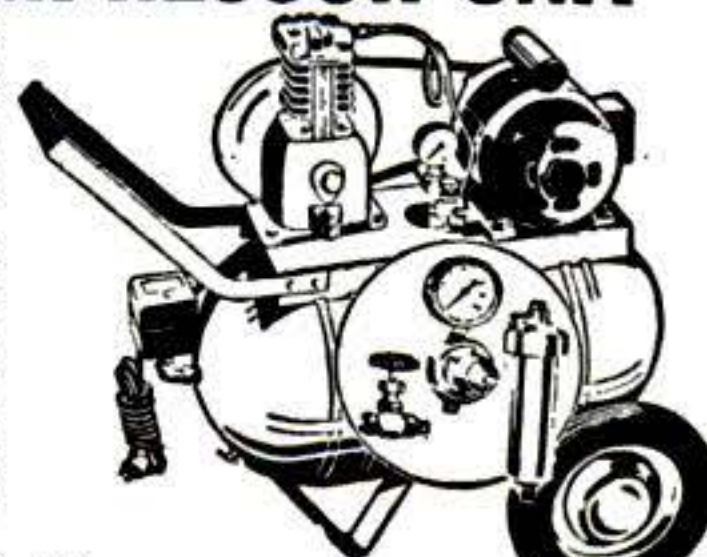

SPECIAL PRICE . . . . . **\$98.50**  
BRAND NEW

Same unit with Gas Engine **\$107.50**

# WELLWORTH V-BELT CLUTCH

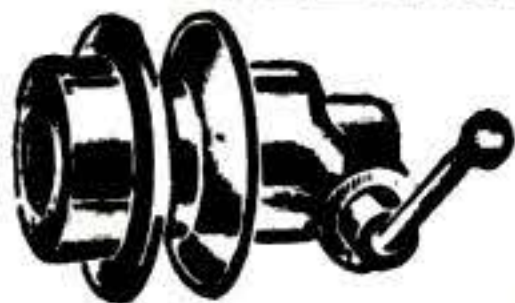

Takes starting load off engines or motors. When speed is reached, a flip of handle shifts clutch from idling to driving position. Handles "A" belts, 2.35" pitch diameter, 5/8" bore. Ideal for use with lawn mowers, garden tractors, home workshop motors, etc. 3 1/4" long. Safe, easy to mount, sealed bronze bearings, positive action. Shpg. wt. 3 lbs. **\$7.50**

SAME CLUTCH FURNISHED WITH 3/4" bore **\$8.50**

# PORTABLE ELECTRIC HAND SAW

The Zip Sawyer With ALL the Features

6 1/4" Diameter saw blade, 1/2" square arbor hole. Maximum depth of cut 2 1/8". (At 45°, 1 3/4".) Minimum depth of cut 0". Angular adjustment 90° to 45°. No-load speed, 5200 r.p.m. Full load speed, 3200 r.p.m. Amperes, full load, 8.0. Universal AC-DC motor, 110/220 volt. Dimensions: 11 1/4" long; 9 1/2" wide (ripping guide removed); 7 1/8" high (without blade). Furnished complete with 6 1/4" diameter combination blade and 10 ft. cord and plug. Wt. 11 1/2 lbs. Price . . . . . **\$39.95**



# AUTOMATIC PRESSURE SWITCH

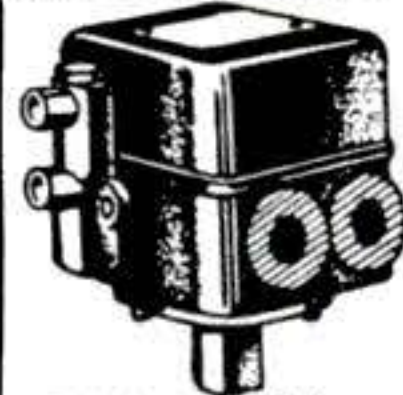

FOR AIR OR WATER  
20 to 40 lbs. **\$6.50**

125 to 150 lbs. with unloader . . . . . **\$13.75**  
1/4" check valve . . . . . **\$3.25**  
1/2" check valve . . . . . **\$4.75**

# AIR REGULATOR AND EXTRACTOR

1/4" Air Regulator, Gauge and filter. Wt. 5 lbs. New **\$8.95**

Regulator and Gauge only . . . . . **\$5.95**  
Air Filter only . . . . . **\$3.25**



# "WELLWORTH" BLOWER BARGAIN

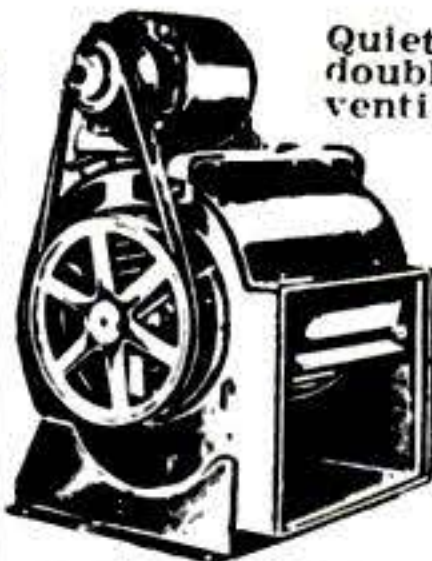

BRAND NEW  
Quiet operating. Double wheel inlet, double width blower. For heating, ventilating, cooling, air washing, exhausting and forced draft. DIMENSIONS: 10" wheel; outlet 13 1/8"x11 3/8"; inlet 8 3/4". Height 19". Width 18". Depth 16 1/2". C.F.M., 1/4" S.P. 1600; outlet vel. 1575; motor 1/4 H.P. with overload relay; cord & plug 110 v. 60 cy. A.C. Ship. wt. 67 lbs. Special price . . . **\$47.50**

Blower less motor and drive . . . **\$27.50**



CHICAGO PNEUMATIC RIVETER & CHIPPING HAMMER  
CP4X Pistol grip handle. Takes up to 3/16" rivet. Weight 6 lbs. List price \$73.00. BRAND **\$32.50**  
NEW . . . . .  
Used, like new, guaranteed . . . . . **\$17.50**



Chicago Pneumatic Lever Type AIR DRILL  
Brand New  
With 1/4" Jacob Chuck. Wt. 2 lbs. List price \$55.00 Only . . . **\$17.95**

# 6 FT. STOW FLEXIBLE SHAFT

Brand New  
3/8" Core; Ball bearing handle and arbor. Operates on 1/4 H.P. Motor at 1725 or 3450 r.p.m. \$29.00 value. Wt. 8 lbs. **\$16.50**



Prices f. o. b. Chicago. Money back guarantee. Send check or money order today. Prompt shipment.

# NEW CATALOG

Motor guide, air compressors, home and factory workshop tools, light plants, luggage bargains. Send 10c for postage.

# WELLWORTH TRADING CO.

1831 S. STATE ST. DEPT. B-2 CHICAGO 16, ILL.

# Buy Early — SAVE!! POWER MOWERS

Rotary — Reel Types  
**\$44.95 to \$129.95**

Write for Illustrated Booklet

ATLAS KEEN-MOWERS

229 Sw. Blvd. Dept. PS Kansas City, Mo.

# WELD BRAZE, SOLDER, and CUT →

ONLY **\$11.95** F.O.B. complete!

EASILY . . . QUICKLY!

No experience needed. Follow simple instructions, weld on iron, steel, bronze, brass, aluminum, and other metals. Plugs into any properly wired 110 volt A.C. or D.C. line. Make or save time and money doing repair work for yourself and others. Repair men, farmers, tinsmiths, home and auto owners, hobbyists, etc., say FOUR-WAY pays for itself over and over. Order today or send for Free details.

FOUR-WAY WELDER COMPANY, Dept. F3-BB  
2326 So. Michigan Ave. • Chicago 16, Illinois



ORDER NOW  
10 DAY TRIAL

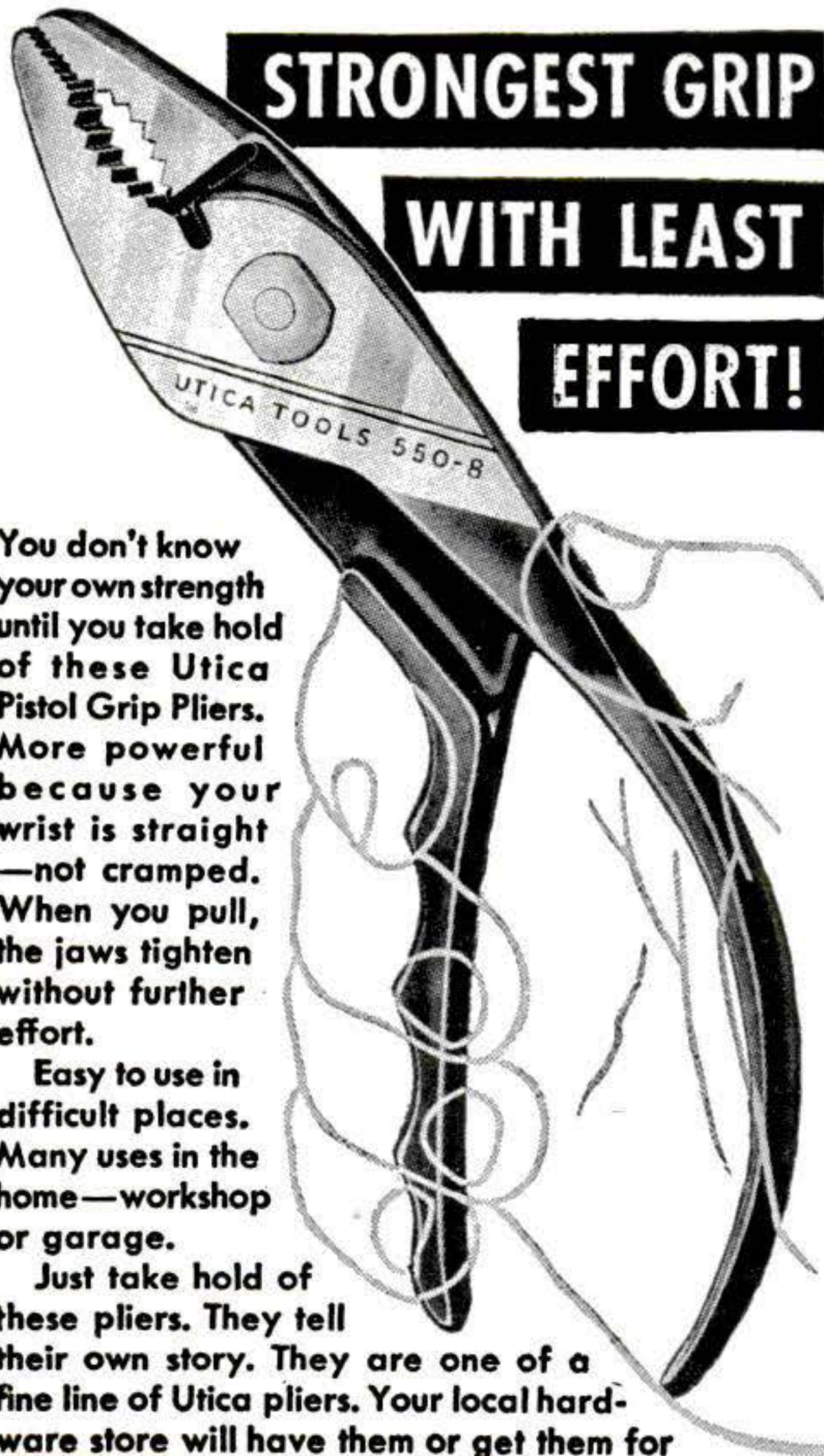

**STRONGEST GRIP  
WITH LEAST  
EFFORT!**

You don't know your own strength until you take hold of these Utica Pistol Grip Pliers. More powerful because your wrist is straight—not cramped. When you pull, the jaws tighten without further effort.

Easy to use in difficult places. Many uses in the home—workshop or garage.

Just take hold of these pliers. They tell their own story. They are one of a fine line of Utica pliers. Your local hardware store will have them or get them for you. FREE—descriptive folder on request.



**PISTOL GRIP SLIP JOINT PLIERS**

Utica Drop Forge & Tool Corp. • Utica 4, New York

#550  
\$2.20

**BIG TEETH**

... BEST FOR WHALES!



Oregon Chain with Fast-File Tooth! Best for your power saw! Speedy cutting! Fast-filing! Long lasting! Ask your dealer for Oregon Chipper Chain with Fast-File Tooth, the standard replacement chain for all saws. Or write direct to factory specifying saw make, bar length. Address Desk 152.

Oregon Chain Goes With Any Saw  
Any Saw GOES with Oregon Chain

LOOK FOR THIS SIGN →

**OREGON**  
Saw Chain Corp.  
SAW CHAIN SPECIALISTS



8816 S. E. 17th Ave., Portland 2, Ore.

**STOP  
CHANGING  
MOTOR OIL!**

End this needless expense forever with

**RECLAIMO** Today's Most Advanced OIL RE-REFINING filter FOR CARS, TRUCKS, TRACTORS & DIESELS

Continuously cleans and RE-REFINES motor oil as you drive (by utilizing motor heat)—keeps oil in high grade lubricating quality at all times!

**"RECLAIMO"**

- REMOVES SOLIDS (by filtration)
- REMOVES WATER (by distillation)
- PREVENTS Excess Fuel Dilution
- PREVENTS Acid and Sludge Formation
- ADDS Thousands of Miles to Engine Life

**MAINTAINS** Stable Viscosity **ELIMINATES** All Oil Changes  
FREE 32-PAGE BOOK "OIL FACTS" (with bonafide \$1000.00 offer on page 30), gives you the complete "Reclamo" story and details of our extraordinary 90-DAY NO-RISK TRIAL OFFER! Write for your copy TODAY!

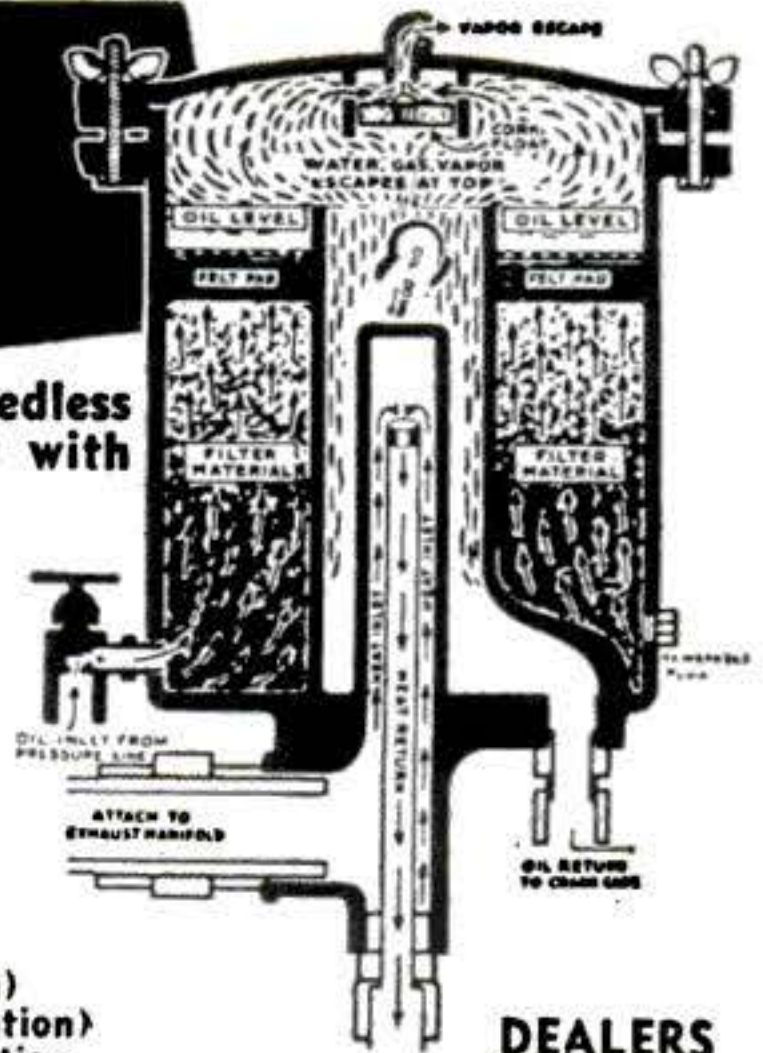

DEALERS WANTED

U.S. BUREAU OF STANDARDS, Bul. 86 States, "Oil does not wear out - mechanically."

MONEY-BACK GUARANTEE

Reclamo Sales Div., Inc.

4508 S. Logan, Dept. S-6, Lansing, Mich.

**END GENERATOR TROUBLE**

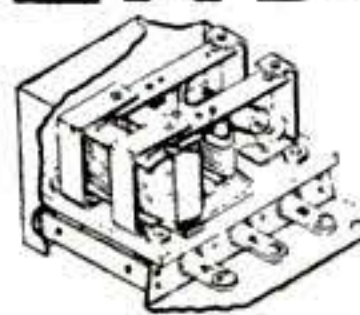

REPLACE VOLTAGE REGULATOR WITH **AMAZING** NEW WATTAGE REGULATOR  
GREATEST ADVANCEMENT IN AUTO IGNITION SINCE THE SELF-STARTER  
DRIVE WITH OR WITHOUT BATTERY  
**100,000 MILE MONEY BACK GUARANTEE**

STATE MAKE AND MODEL OF CAR AND SEND FOR FREE CATALOG

SCIENTIFIC ELECTRIC CO. P.O. BOX 2162P2 STA.H Cleveland, OHIO.

**D.C. ARC WELDER**

\$300 VALUE—ONLY \$97.50

200 Amperes Continuous Duty. Up to 250 amps. intermittent duty. Easily mounted on your tractor. Welding range from 0-up by dial type control. 1-yr. guarantee with money back 10-day trial period. Write for FREE literature. OR send 35c for PLAN "Build Your Welder from Aircraft Generator". Write today

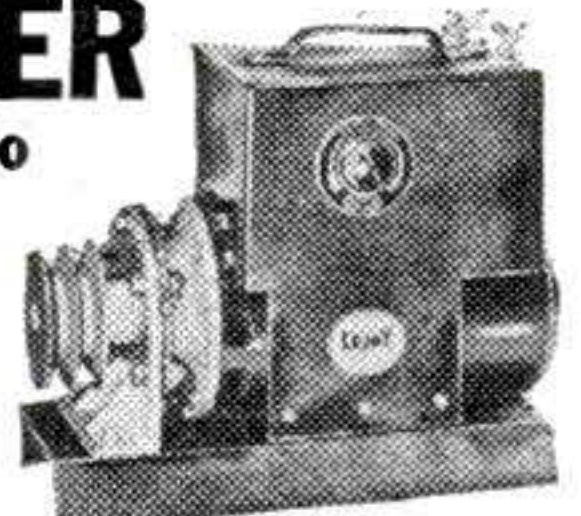

LEJAY MFG., 823 LEJAY Bldg., Minneapolis 8, Minn.

EVERY ELECTRIC DRILL

**A PORTABLE SAW**

**9.95**

with 4" "HYCARBON" Crosscut Blade

At Better Hardware Stores Everywhere

ARCO Pat. Pend.

**ARCO SAW**

Can Be Used With One Hand! Any 1/4" or 3/8" Drill a Powerful Saw in ONE MINUTE  
"ARCO-SAW" is a rugged tool with right angle gear drive (no clumsy, dangerous, direct drive with drill sideways). Works like a high priced Portable Saw.

CUTS 1-5/16", or 2x4 by turning over ONLY ARCO GIVES YOU ALL THESE FEATURES: Safety-yoke assures rigid connection and absolute safety—Big handle affords firm grip for two-hand operation—Precision one-piece gear box—Self-lubricating lifetime bearings—Visual guide and wide shoe-plate for straight, square cuts—Lowest priced, quality Replacement Blades.

"HYCARBON" 4" Crosscut or 4" Combination Blade . . . \$2.00 ea.

90-day Factory Guarantee

ORDER TODAY at your dealer or send us check or M.O. (Postpaid). C.O.D.'s—Postage extra

UNCONDITIONAL 10-DAY MONEY BACK GUARANTEE

DEALERS—Write for nearest jobber.

**ARROW METAL PRODUCTS CO.**

DEPT. PS-2, 140 WEST BROADWAY, NEW YORK 13, N. Y.



**PALLEY FAMOUS MIXES!** Prepared especially for the HOME CRAFTSMAN, HOBBYIST, INVENTOR, GADGETEER or SHOP MECHANIC.

**GADGET MIX** - Rivets, Spacers, Bolts, Screws, Gears, Wheel bearings, Springs and Clamps. No. 106, 5 lbs. . . . . **1.19**

**BEARING MIX**, No. 170A. Approx. 20 needle, Ball & Roller Bearings, New & Used. Sizes: 1/2" to 4". Some of these cost Gov't \$10 a piece. Never such a value! 5 lbs. ONLY . . . . . **1.59**

**HINGE MIX**, No. 170H. 12 pairs of Strap and butt hinges, Hasps, 1" x 1" to 7/8" x 10" in length and 8" strap. 2 lbs. . . . . **1.09**

**ABRASIVE AND GRINDING WHEEL MIX** - 50 pieces including honing stone, pencil rolls, wheels, etc. A sharp value. No. 170AG **99c**

**SPRING MIX**, No. 206 - Torsion, Compression & Tension Springs. Ass'd. sizes. A treasure trove for emergencies. Scores of springs. 5 lbs. for ONLY . . . . . **1.69**

**RIVET MIX - 3 POUNDS** - Consisting of sizes from 1/4" long to 3" long in many diameters & alloys. **1.19**

**FILE MIX** - Ten assorted Files, 4" to 12", includes 3 Vixens, half rounds bastards, mills, etc., in seconds and used but in good condition. 1 Vixen alone worth our price for entire mix. F-1 **99c**

**PULLEY MIX**, No. PM-1 - You'll want this one around. 10 micarta & metal pulleys ranging from 1" to 5" with ball and one piece bearings. These are aircraft pulleys, the best made with 100's of uses. A WONDERFUL BUY!!! **2.95**

**COUNTERSINK MIX**, No. 168. Wide assortment. Excellent condition. High speed steel. Assortment of ten 100° and 110° with pilot sizes ranging from 3/32" to 3/16" No. CM-1 **2.69**

**SCREW MIX** - 5 lbs., including assortment of wood and machine screws. Many sizes. Save dollars and always have plenty of screws on hand. **1.39**

**NUT MIX NM-1** - 3 lbs. approx. 500 nut. Anchor, Lock, Castle, Hex, Elastic Stop Nuts, etc. You'll always have plenty of Nuts in the shop. NM-1 **1.39**

**SUPER COMBO MIX** - No. SC2. Here's a real bargain. All eleven above mixes for ONLY . . . . . **14.95**

**REAMER MIX** - No. 168. Reamer assortment: Special Taper line finish Reamers. High Speed Steel. Slightly used but in excellent condition. Ten assorted sizes ranging from .168x.165 & .244x.215 to .425x.385 & .432x.403. One alone worth our selling price of ten. For set of ten Reamers . . . . . **4.49**

**AIRCRAFT CABLE**  
Rust resistant alloyed steel, extra flexible, pre-formed - 7x19 strand on reels.  
1/16" . . . . . 4¢ ft. 7/32" . . . . . 8¢ ft.  
5/64" . . . . . 4 1/2¢ ft. 1/4" . . . . . 9 1/2¢ ft.  
3/32" . . . . . 5¢ ft. 9/32" . . . . . 10 1/2¢ ft.  
1/8" . . . . . 5 1/2¢ ft. 5/16" . . . . . 12 1/2¢ ft.  
5/32" . . . . . 6¢ ft. 3/8" . . . . . 13 1/2¢ ft.  
3/16" . . . . . 7¢ ft. 1/2" . . . . . 16 1/2¢ ft.  
Stainless Steel Cable Bronze Cable  
1/16" . . . . . 7¢ ft. 1/4" . . . . . 15¢ ft.  
1/8" . . . . . 16¢ ft. 5/16" . . . . . 19¢ ft.  
1/4" . . . . . 29¢ ft. 1/2" . . . . . 36¢ ft.

**PIANO HINGE**  
Overall Width Length Price Ea.  
1 1/4" (5/8" side) 72" alum. \$1.00  
2" (1" side) 9' alum. . . . . \$1.75  
3 1/2" (1-3/4") 54" st. steel \$1.69  
**BRASS HINGE** - 1 1/4" (5/8" side). 040  
Any length at . . . . . 29¢ per ft.

Order from this Ad. All sales final. All Prices F.O.B. Los Angeles. Pay by M.O. or Check. P.O.'s Accepted from D & B firms. 1/2 deposit with C.O.D.'s.

**PALLEY SUPPLY COMPANY**  
6321 SAN FERNANDO RD.  
DEPT PS-2 GLENDALE 1, CALIF.

# SAVE UP TO 85% IN WAR SURPLUS

## NOW! MAKE YOUR OWN ARC WELDER

Here's a Real Buy! Finest precision built R-1 Generators, used on B-29's, cost the Government approximately \$400.00. Gives from 300 to 400 amps at 27 volts. Ideal for all welding, light and heavy up to 5/8" thickness. FREE complete instructions for conversion of this Generator to welding unit. R-1 NOW AVAILABLE AT



**27 95**

## Other AIRCRAFT GENERATORS

P-1 27 Volts 200 Amps **15 95** E-5A 12 to 15 Volts 50 Amps **12 95**  
1273-1A 27 Volts 75 Amps **15 95** 03 27 Volts 100 Amps **25 00**



## NEW! GEAR HEAD MOTOR

GHM-607 - Originally designed to drive large Aircraft Tow-Target reels. Powered by 24 VDC, 95 amp, compound wound motor. Rated at 2 HP. Turns 4,200 RPM and is geared down to 136 RPM at the power take-off shaft. 60 foot pound torque at

take-off. Power drive is 3/4" female adaption. Unit has magnetic clutch for instant stop control. Comes complete with operating switches and control box. **37 50**



## FIRE EXTINGUISHER

Kiddie Lux CO<sub>2</sub> Type. Built to Gov't spec. Shatter-proof, heavy case. Fully re-charged. with horn

No. 602A - 7 1/2 lb. \$35 Value. **19.25**  
No. 603 - 10 lb. A \$65 Value. . . **25.75**  
No. 601 - 4 lb. Wheel Control Type **\$14.25**  
No. 605-B - 15 lb. Wheel Control Type . . . . . **32.95**  
No. 605-C - 15 lb. New. Squeeze Grip Type. \$85 Value. . . **39.95**

Note: Weights listed are capacity extinguisher charge.

## ELECTRIC ACTUATOR

CTU-2 Foote linear actuator. 24 Volt A.C. or D.C., 8500 R.P.M., 1/6 H.P. Series wound motor, 4 1/2" stroke in 13 1/2 seconds. Compression and tension Loads up to 750 lbs. Adjustable micro switch for limits of travel. Overall length retracted 11" **Only 6 95**

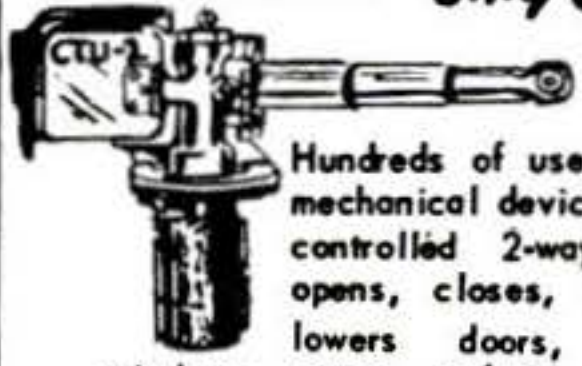

Hundreds of uses for any mechanical device needing controlled 2-way action, opens, closes, raises or lowers doors, windows, gates, valves.

**TACHOMETER** - Type C-11. Operates on direct drive with flexible shaft. Range is 0 to 4500 RPM. Ideal for use on single engine planes or boats, autos, etc. Drives direct from camshaft or at 2-1 reduction from crankshaft. . . . . **\$4 75**

**AUTO PULSE PUMP** - Ideal for fuel pump for auto or boat. 24 Volt D.C. Can be adapted to 6 Volt D.C. 1/8" standard pipe ports . . . . . **5 50**

**Sperry Aircraft Directional GYRO COMPASS**  
Dial is 360° swing calibrated 1/10" (6 min). Panel Mount 4 1/2" square with 3" luminous dial. Can be used in autos, planes, or boats by attaching one tube to intake manifold for required vacuum. Complete with reset caging knob. Gov't. overhauled - ONLY . . . . . **\$4 95**

**FOAM RUBBER**  
Moulded, pre-shaped. Can be cut to fit your chairs, boat, truck, auto or trailer seats. Ideal cushion for sports events.  
25" x 66" x 1 1/2" thick. . . . . **8.95**  
25" x 60" x 1 1/2" thick. . . . . **8.90**  
18 1/2" x 20 1/2" x 4 1/2" thick. . . . . **6.45**  
35" x 21" x 6" tapered to 4" . . . . . **11.95**

**SHEET FOAM RUBBER**  
3" Cored Stock . . . . . No. 2 1/2 compression  
Ideal for cot, bed, bunk, couch or chair.  
3" x 44" x 80" \$59.50 3" x 44" x 49" \$33.50  
3" x 22" x 80" \$33.50 3" x 22" x 40" \$17.50



## NAVY WINCH

Here's a real PALLEY BARGAIN. Designed to hold, pay out, and reel in steel cable used in towing targets. Capacity 2500 ft. 1/8" or 4500 ft. of 3/32" cable. Has gear driven rotating drum, brake band on drum, ratchet and pawl to set brake, detachable crank handle for rotating drum. Size approximately 29" x 13 1/2" x 13" . . . . . **27 95**

## MOTORS

**LEAR ELECTRIC MOTOR**. 24 volt, 6 amps, series wound reversible motor with overload clutch. Motor turns 11,000 R.P.M. Has 11 to 1 gear reduction box turning 1000 R.P.M. at take-off. Adaptable to flex or rigid drive. Limit switch box. Size 10" x 4". **\$7 95**

**SAMSELL MOTOR**  
27 volts, 16 amps  
1/5 H.P. reversible, series wound on motor. 3800 R.P.M., shaft 9/32" diameter. 12-spline. 4-1/8" x 2-3/8". **ONLY 3 95**

**G.E. GEAR HEAD MOTOR**  
Heavy Duty G.E. Gear Head Motor. 1 1/2 H.P., 24 volt DC, 125 amp reversible motor will drive reduction gear box unit 44.5 to 1, resulting in 168 R.P.M. at 5/8" diameter take-off shaft. Motor contains electro magnetic break. **UNIT COMPLETE 10 95 MOTOR 4 95 GEAR BOX ALONE 7 95**

**LEATHERETTE**  
to cover Chairs, Patio Furniture, Nooks, Auto Seats, etc. 10 colors AT A BARGAIN PRICE.  
Width Colors (per sq. yd) Price  
36" Tile Red, Brn, Black. . . . \$1.19  
36" Lt. Grn., Dk. Grn., Blue. . . \$1.65  
54" (approx) - Red, Brown, Light Blue, Ivory & Yellow. . . \$1.95

**PLASTIC LEATHERETTE**  
Water-proof and Heat Resistant plastic covering in Yellow, Chinese Red, Grey, Green, Chartreuse, Brown and Yacht Blue. Full 54" width. . . ONLY **1 95**

## NEW! 1951 CATALOG

**PACKED WITH BARGAINS!** Just Off The Presses! Bigger Than Ever! 200 Pages of NEW and SURPLUS Clothing, Tools, Camp Equipment, Electrical Supplies, Hydraulics, Motors, Pumps, Valves, Raw Stock, etc. AT UNHEARD OF LOW PRICES! Send 50¢ Today! (refunded with your initial order of \$1 or more).

**HYDRAULIC CYLINDER SPECIAL**  
Gives 20,000 lb. thrust (push pull) using 1500 PSI line pressure as obtained from our hyd. pumps. Or will produce 40,000 lb. thrust with 3,000 lb. line pressure. CAN ALSO BE OPERATED ON LOW PRESSURE AIR SYSTEMS. 4" Bore, 1 1/2" dia. piston shaft, 18" stroke, length 30 1/2". Equipped with ball bearing loaded clevis type mounting and swivel type high pressure steel pipe bracket for easy use. Ideal for road, farm & shop machinery, presses, etc. Cost Gov't \$390.00 **27 95**

We carry the World's Largest Supply of New Hydraulic Equipment featuring over 20,000 Cylinders in 61 Sizes & Types. Can also supply all accessories such as Pumps, Fittings, Valves, Tanks, Hose Fittings. Let us solve your hydraulic problems. Write for information.

**Vickers Hydraulic Transmission**  
Self contained, 2 H.P. constant torque at all speeds with variable volume reversible, piston pump (controlled by outside lever) supplying piston hydraulic motor. Automatic pressure, dash pot for smooth control. Power output R.P.M. - 0 to 1/3 input R.P.M. in both directions. Input R.P.M. 1800 continuous 4000 intermittent. Dash pot can be removed for greater R.P.M. Ideal for Lathes, Duplicator Setup on Mills, Conveyors, Small Cars, Drives, Gearing, etc. **25 00**  
4" Spline Shafts for input & power take-off . . . \$2.50 pair.

**VALUABLE GEAR BARGAINS**  
6 to 1 with screw shaft #111 . . . . . **\$4.98**  
85 to 1 (can be used for radio, antennae, etc.) **\$3.95**  
**GEAR BOXES** VTG-1 - 90° bevel gear 1 1/2 to 1 reduction, size 7" x 6". A Lifetime Value. . . . . **\$3.95**  
VTG-2 - In-line spur gear 16 to 1 reduction, thru 4 gears. Final take-off 4 1/2" dia., 26 teeth. 3/4" Alum. spur gear. **\$6.49**  
Both above gear boxes have lever control for engaging & disengaging positive clutch. Dust proof housing. Pre-lubricated bearings. Both can be adapted to Vickers Transmission.

**ELECTRONIC TRANSMISSION GEAR TRAIN**  
GT-1, approx. 50 Bronze Spur & Pinion Gears - 3/8" to 4" dia., 5 sets of 7 cluster gears, 2 complete worm and worm gear drive sets, 40 N.D. ball bearings 1/2" to 1 1/2" dia., watch springs, bushings posts, face plates, housings - Micro Switches, 2 miniature controlled clutches, etc. Gears in multiple size & sequence, identical teeth ratio, giving 100's of gear reduction combinations. **\$8 49**  
Wt. 19 lbs. . . . .

**TWO HEAT SOLDERING IRON**  
World's Hottest Iron Value!  
Two soldering irons in one with button heat control. Push the button - Select 150 or 300 Watt heat for light or heavy work. Complete with tip, bench holder, 5' asbestos cord, U.L. approved. 110V A.C. A \$15.00 Value For . . . **3.95**

# Make it yourself with **STANLEY TOOLS**

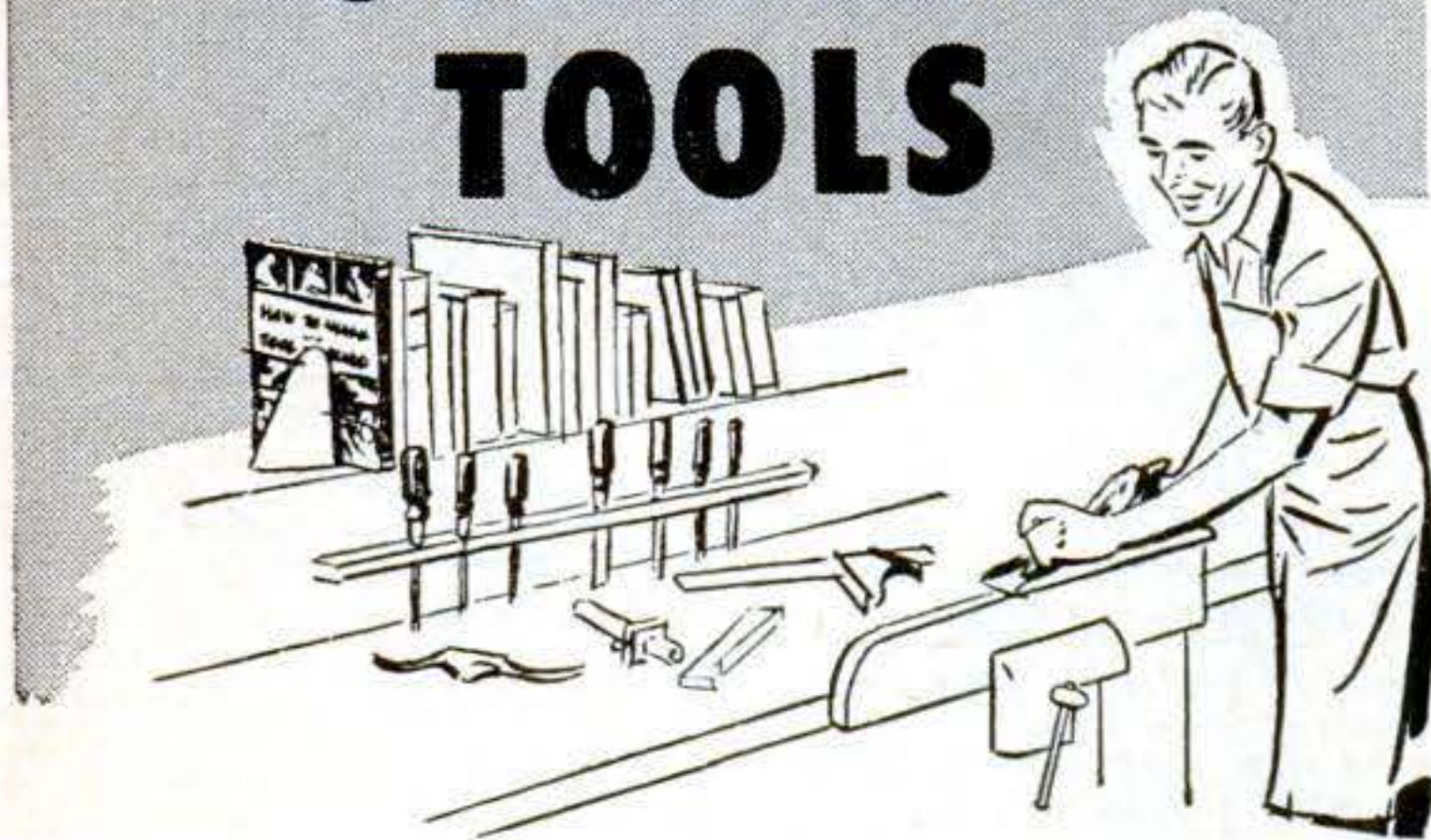

Make it yourself with Stanley Tools . . . the choice of experts. The Vise, Rule and Plane shown here are prominent in the Stanley Tool line, designed for artisans, yet priced to appeal to the woodworking hobbyist. Look for the famous trade-mark at your hardware dealer's.



### No. 700 Woodworker's Vise

Can be quickly attached to bench, table, sawhorse, almost any place where there's a small projection.

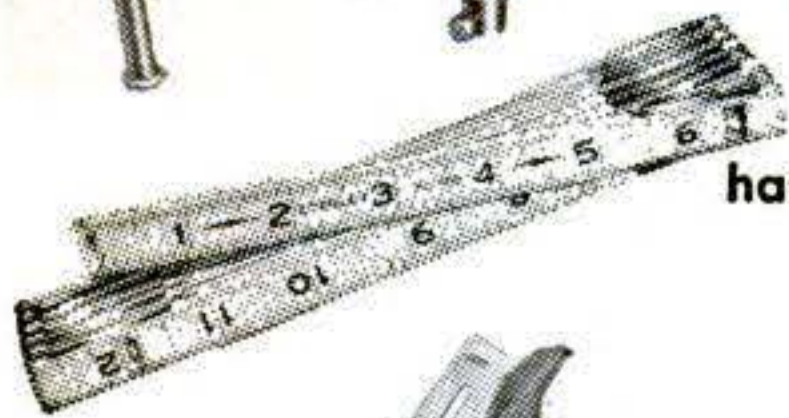

### No. 106 Zig-Zag Rule

Accurate, easy-to-read, handy-to-use. Good for long life without "stretch".



### No. 5 Plane

The world's most popular plane . . . the choice of 9 out of 10 woodworkers.

### New Projects for Your Shop

**EARLY AMERICAN DESIGNS** Easy to follow — fun to make. Two sets of 15 plans, 25c each, postpaid.



The Tool Box of the World

# STANLEY

Reg. U.S. Pat. Off.

Hardware • Tools • Electric Tools  
Steel Strapping • Steel

### ORDER YOUR PLANS NOW

Stanley Tools, 221 Elm St., New Britain, Conn.  
(In Canada: Send to Stanley Tool Co. of Canada, Ltd.,  
114 Stanley St., Roxton Pond, Quebec.)

Please send me Series A ( ) and Series B ( )  
of the new Early American Project Plans. I enclose  
25c for each set.

Name .....

Street .....

City ..... State .....

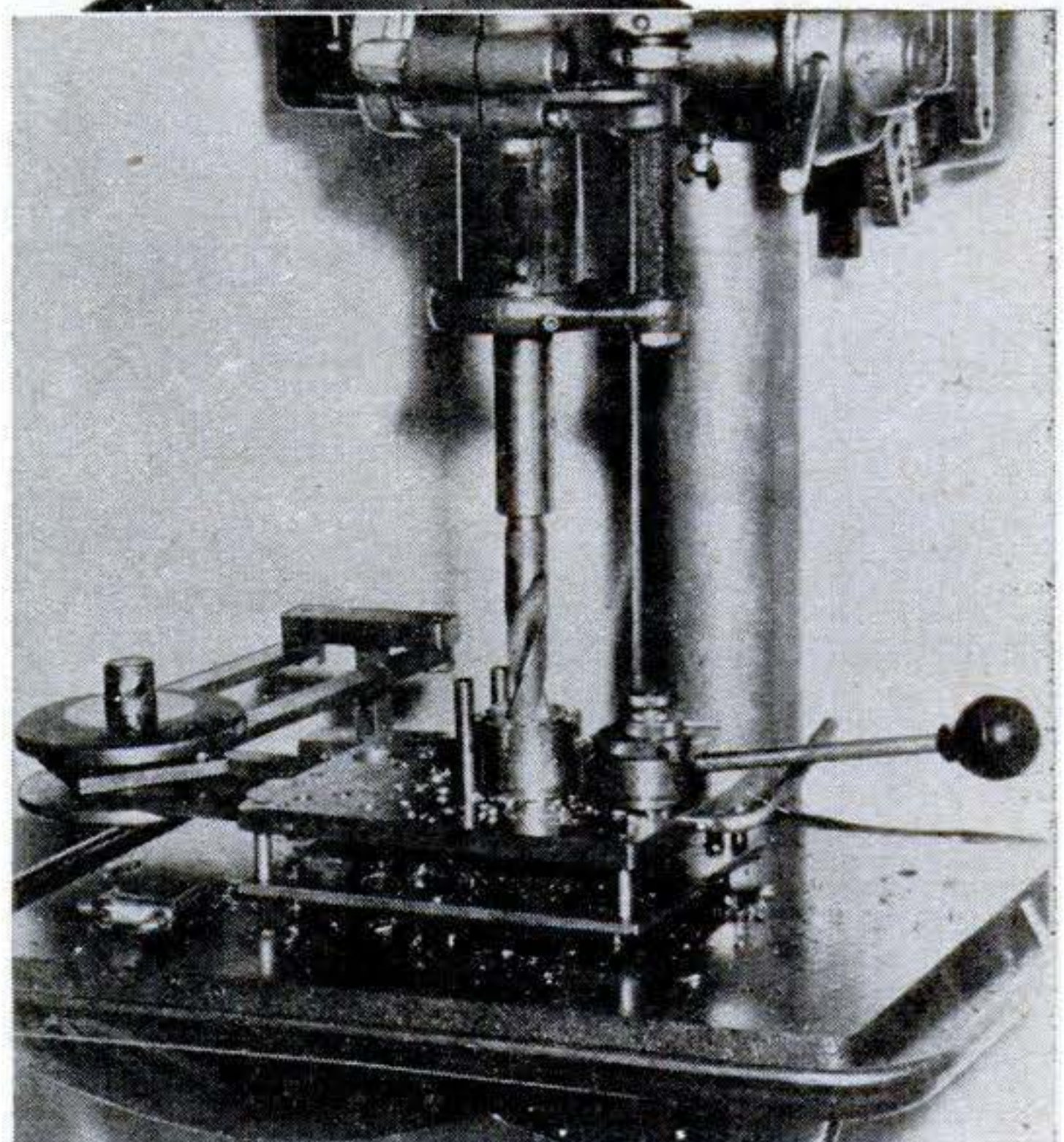
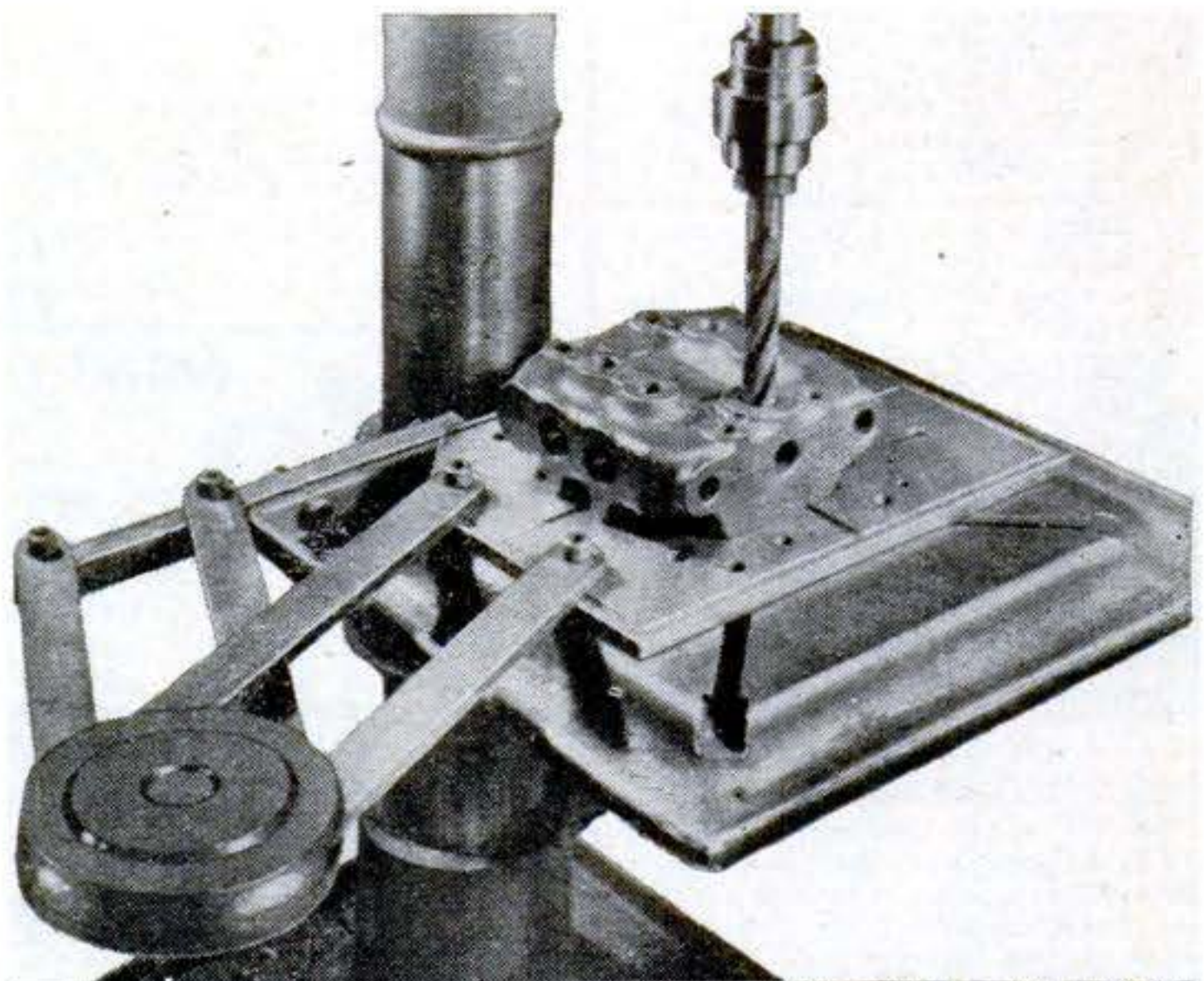

**Torque Hazard Eliminated.** This new drill-press attachment uses an ingenious system of moving arms to hold work steady. Although you can move the floating plate by hand anywhere on the drill-press table, the torque of the drill can't budge it. The attachment consists of two pairs of arms that are hinged in parallel on fixed centers at both ends and in the middle. Each set of arms is tied and hinged individually to the table at one end and to the plate at the other. In the upper photo, work is held by locating pins. In the lower photo, work is held on a cam locking plate against two pins. Torkarm Corp., Minneapolis, makes it.

# Tools

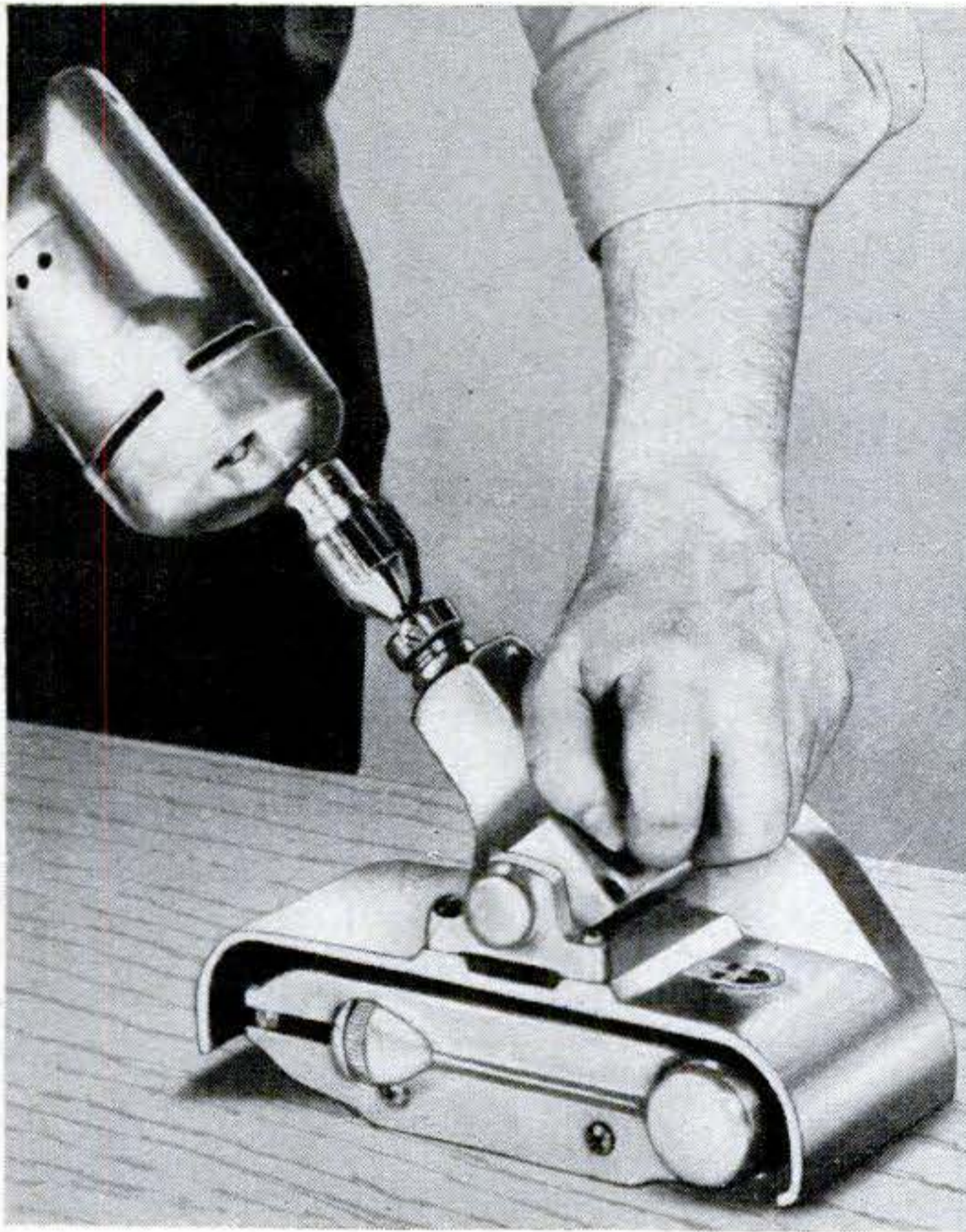

**Belt Sander Run by Electric Drill.** Latest addition to attachments for your electric hand drill is this belt sander. It weighs 6 lb., is 8 $\frac{3}{4}$ " long, and costs about \$20. The price includes light-, medium- and heavy-duty pressure pads plus two belts—medium and fine grit. Garnet, aluminum oxide, and silicon carbide belts are available. Power is transmitted from drill to sander through gears. The maker is United States Industries, of Chicago.

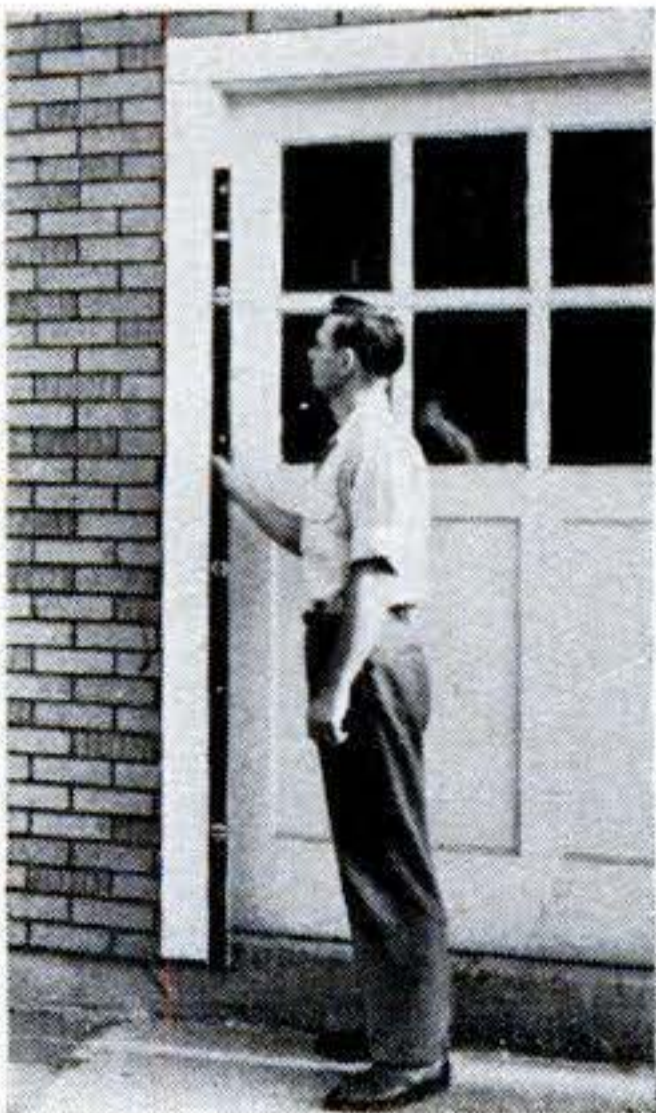

**Long Level.** The maker of this 78" level, the Simplex Level Co., of Detroit, Mich., says it is the only one like it on the market. It's all aluminum, weighs 4 lb., and is priced at \$10.85. It has adjustable, replaceable, metal-mounted spirit vials. Extra vials are 50 cents.

**MECHANICS! Buy THE BEST!**  
**STARRETT PRECISION TOOLS**  
 Made By The World's Greatest Toolmakers

## See this New **Starrett**<sup>®</sup> Universal Precision Gage

Designed for machinists, tool and diemakers and inspectors, Starrett No. 995 Universal Precision Gage combines the unique features of fine adjustment with universal adaptability to countless gaging, scribing, measuring and leveling operations.



**PLUS MORE THAN 60 OTHER  
 NEW STARRETT TOOLS  
 AT YOUR STARRETT DISTRIBUTOR**

Ask your distributor to show you these and many more important new tools — or write for Starrett New Tools Booklet.



**No. 354**  
 Vernier Height  
 Gage With  
 Slotted Base.  
 Reads Direct  
 0-6"

**No. 449** Micrometer  
 Depth Gage  
 With Flat Rods

**No. 1010** Pocket  
 Dial Indicator.  
 Reads in .001"

**No. 231** Satin  
 Chrome Micrometer.  
 No Glare Readings

**No. 11** Improved  
 Combination Square  
 With Reversible  
 Lock Bolt

**No. 1025** Pocket  
 Slide Caliper—  
 Stainless Steel

## SPECIAL OFFER TO MECHANICS



**GET THESE TWO HANDY  
 MECHANICS AIDS — ONLY 10¢**  
 "Dial Type Decimal Equivalent and  
 Tap Drill Calculator" plus "Decimal  
 Equivalents of Letter and Number Size  
 Drills"— both for only ten cents. Send  
 coupon with one dime to cover handling  
 and mailing.

**THE L. S. STARRETT CO.**  
 Dept. PS, Athol, Mass., U.S.A.  
 Here's my 10¢ for 2 calculators

Name \_\_\_\_\_ Position \_\_\_\_\_  
 Address \_\_\_\_\_  
 City \_\_\_\_\_ Zone \_\_\_\_\_ State \_\_\_\_\_

# BUILD YOUR OWN TILTING ARBOR SAW!

SAVE  
**\$50**  
OR MORE

## Exclusive GIL-BILT Build-It-Yourself Features

- No machining—build easily with hand tools only
- No blueprint reading—step-by-step pictorial plans, full scale patterns, actual photographs
- Sturdy wood, aluminum, and steel construction
- Capacity and performance of commercial saws selling for \$60 and up

## GIL-BILT 10-INCH TILTING ARBOR SAW

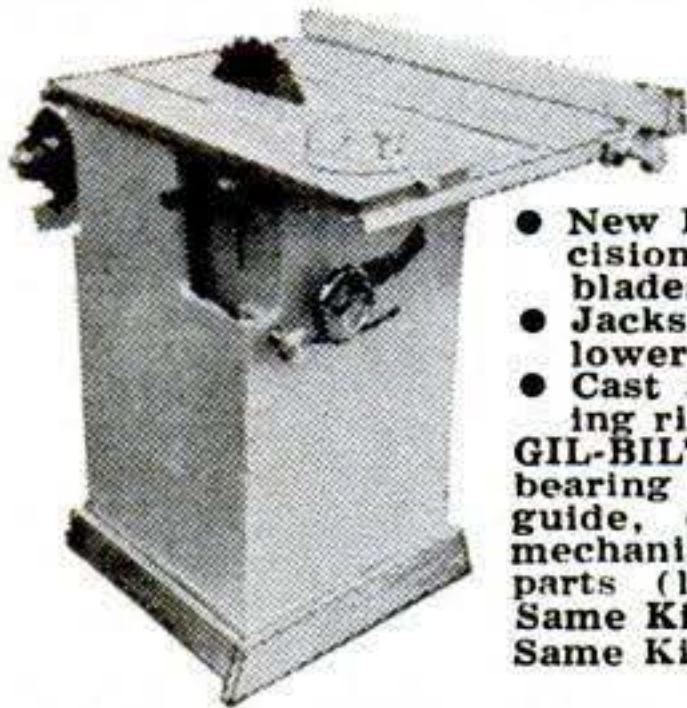

- 27x28 in. table, 13 1/2 in. capacity in front of blade
- 10 in. blade cuts 3 1/4 in. deep, tilts full 45 degrees
- Floor model 34" high table always stays level

- New Departure ball bearing arbor, 3/4" precision shaft turned down for 5/8" bore blades, alum. housing, shipped ready to run
- Jackscrew and 4 1/2 in. dia. handwheel lowers and raises blade
- Cast aluminum miter gauge and self-aligning rip fence guide

GIL-BILT Metal Parts Kit includes Plans, ball bearing arbor, miter gauge and bar, rip fence guide, dado insert, lock knobs, jackscrew mechanism and handwheel, and all other metal parts (less blade).....\$20.95  
Same Kit with 10" Combination Blade..\$24.90  
Same Kit with 8" Combination Blade..\$23.90

## GIL-BILT BELT SANDER

- 84 sq. in. sanding surface. Over 4 times the effective area of a 10 in. disc sander.
- Belt operates in either vertical or horizontal position, does all sanding operations.
- Driver drum and pulley turn on sealed New Departure ball bearings; tension drum turns on Chrysler Oilite bronze bearings.
- Spindle and tension mechanisms of cast aluminum, completely machined and assembled.
- Belt travels 1800 ft. per min. Over a MILE of straight sanding action every three minutes. Saves more "elbow grease" than any other tool.
- GIL-BILT Metal Parts Kit includes Plans, ball bearing spindle, 4 in. driver drum, 3 in. tension drum, tension mechanism, table tilt segments, rubber tires, cloth sanding belt, and all other metal parts.....\$16.95



## GIL-BILT 12-INCH BAND SAW



- Cuts to center of 24 inch circle
  - Handles stock up to 6 inch thick
  - 18x18 inch table tilts 45 degrees
  - Lower wheel and drive pulley runs on sealed New Departure Ball Bearings; Upper wheel runs on two 5/8" bore Oilite Bronze bearings
  - Upper wheel tension and tilt mechanism of cast aluminum, completely assembled
  - Upper and lower blade guides. Each has ball thrust bearing, self-lub bronze jaws.
  - Rigid cast aluminum wheels fully machined ready-to-install. Heavy rubber tires.
  - Uses standard 78 inch blades up to 3/8 in. wide.
  - Fully enclosed mechanism for utmost safety.
- GIL-BILT Metal Parts Kit includes Plans, rubber tires, aluminum wheels, 1/4 in. blade, ball bearing spindle, tilt mechanism, blade guides, table tilt segments, and all other metal parts.....\$20.00

Return Kits in 10 days for refund if not satisfied.

(Prices include postage within 600 miles. Over 600 add 5%)

Also available—Plans and Parts Kit for 8" Tilt/Table saw. Order Plans at \$1.00 each—sent postpaid anywhere in the world or write for FREE descriptive catalog.

GILLIOM POWER TOOLS P. O. Box 1-VB, Lambert Field St. Louis 21, Missouri

## ONE Tool Does 1000s of Jobs ...

### Original-Genuine **WISE-GRIP** WRENCH



LOCKS to work with Ton-Grip! Not a gadget, but a professional tool with 1000 uses. Turns rounded nuts, bolts, screws with worn slots—grips anything, even in close quarters. Insist on the genuine VISE-GRIP with Involute Jaw Curve that holds all shapes. Knurled Jaw Tips that grip to the very tip. Thin Nose, Super Wire-Cutter. With cutter—No. 7W, 7", \$2.25; No. 10W, 10", \$2.60. Without cutter—No. 7C, 7", \$1.95; No. 10C, 10", \$2.25. No. 7, 7", \$1.85; No. 10, 10", \$2.15.



Another of 1000 Uses

Order from your dealer  
**PETERSEN MFG. CO., Dept. M-2, DeWitt, Nebr.**

## New Tools

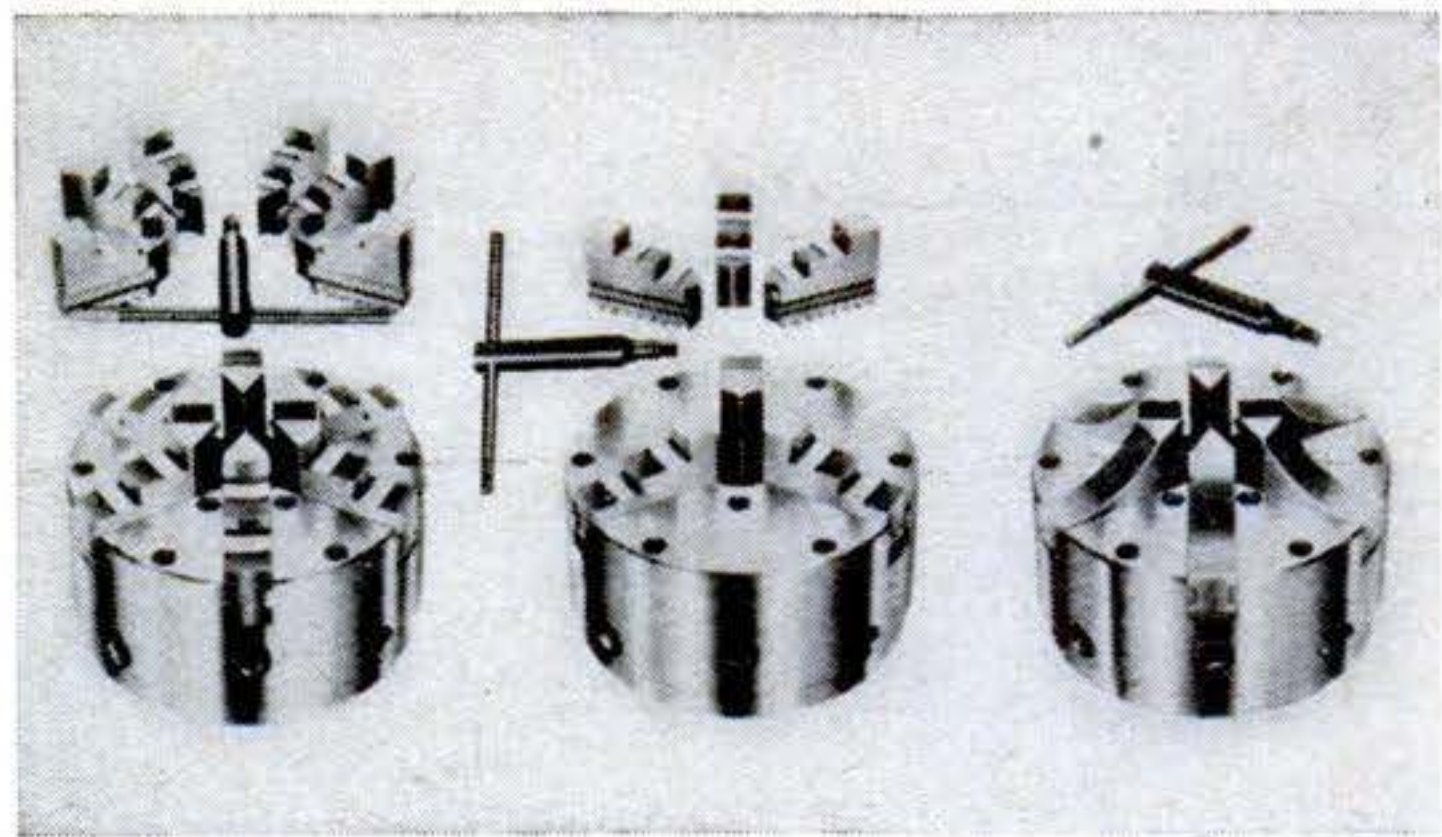

**Self-Centering Chuck.** The Buck Tool Company, of Kalamazoo, Mich., makes these chucks in three models: three- and six-step-jawed chucks for external and internal gripping, and a six-jawed chuck for external gripping only. They may be adjusted for .0005" accuracy. The jaws go in or out to grip the work like a scroll chuck. Precise adjustment is made by four opposed fine-threaded screws that operate between the chuck body and its adapter.

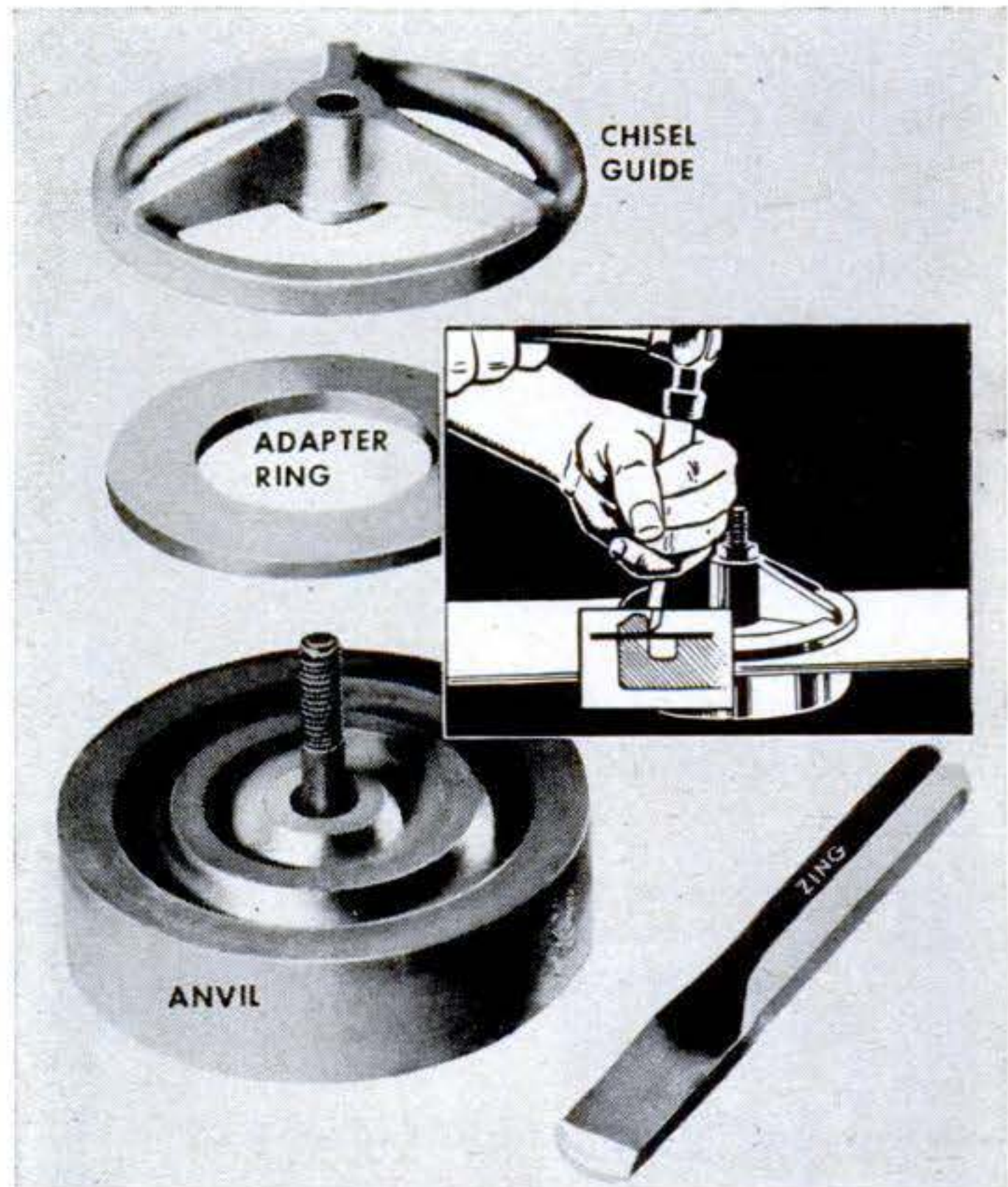

**New Punch for Sheet Metal.** Work is clamped in this punch and the specially shaped chisel used to cut out the hole. Use of the adapter ring lets you cut two sizes of holes on the same tool. The West Pacific Company, of Portland, Ore., makes the tool in various sizes, including models for round, square, and rectangular holes.

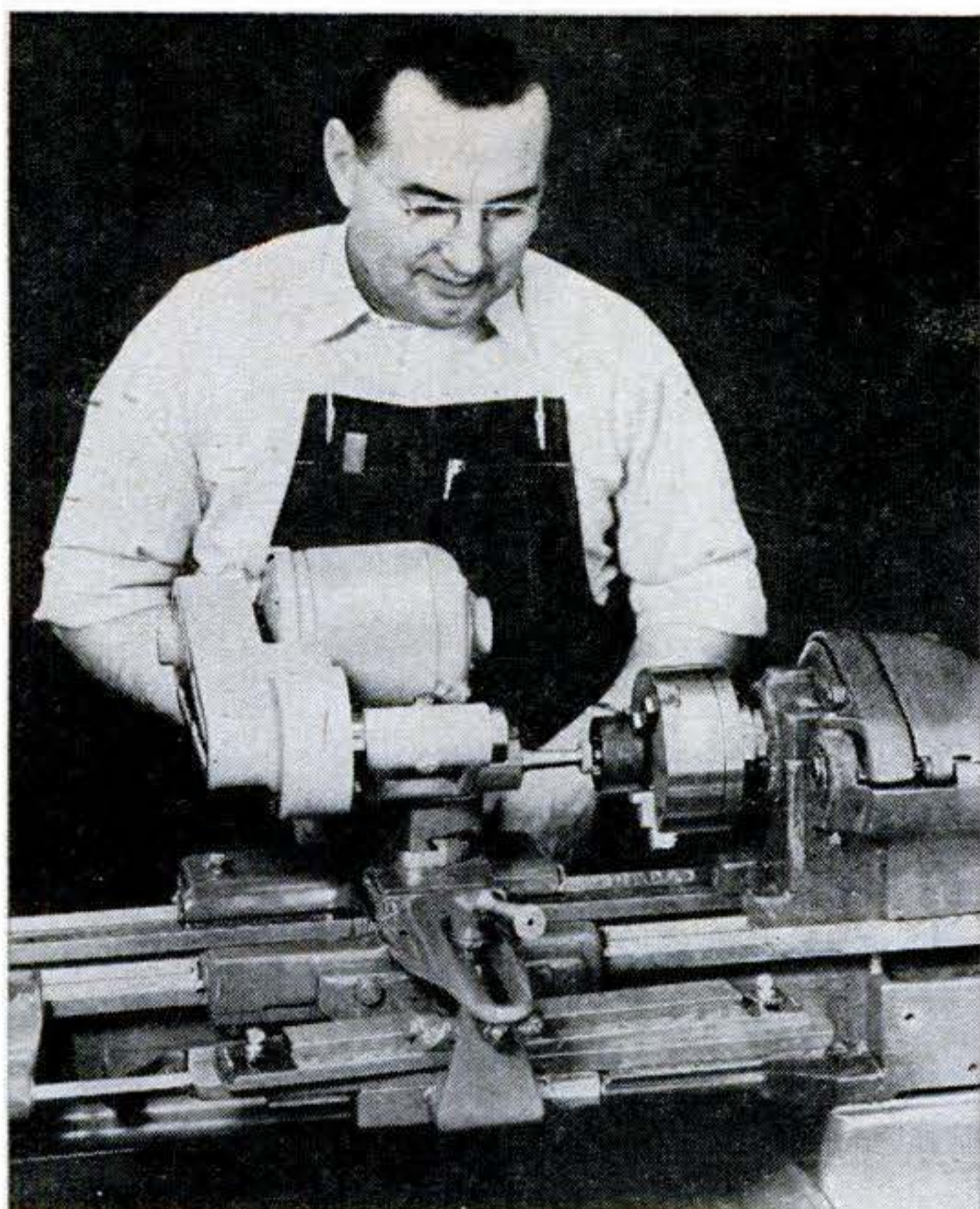

**Internal Grinder Turns 30,000 R.P.M.** This attachment for lathes and other machine tools is powered by a 1/6-hp., 3,450-r.p.m. AC motor. The motor is compound belted through an intermediate shaft to turn 30,000 r.p.m. The longest of the four arbors supplied permits grinding a hole 3/8" deep with a 1" wheel. A 1/8" chuck also is supplied so you can use mounted grinding wheels. South Bend Lathe Works, South Bend, Ind., is the manufacturer.

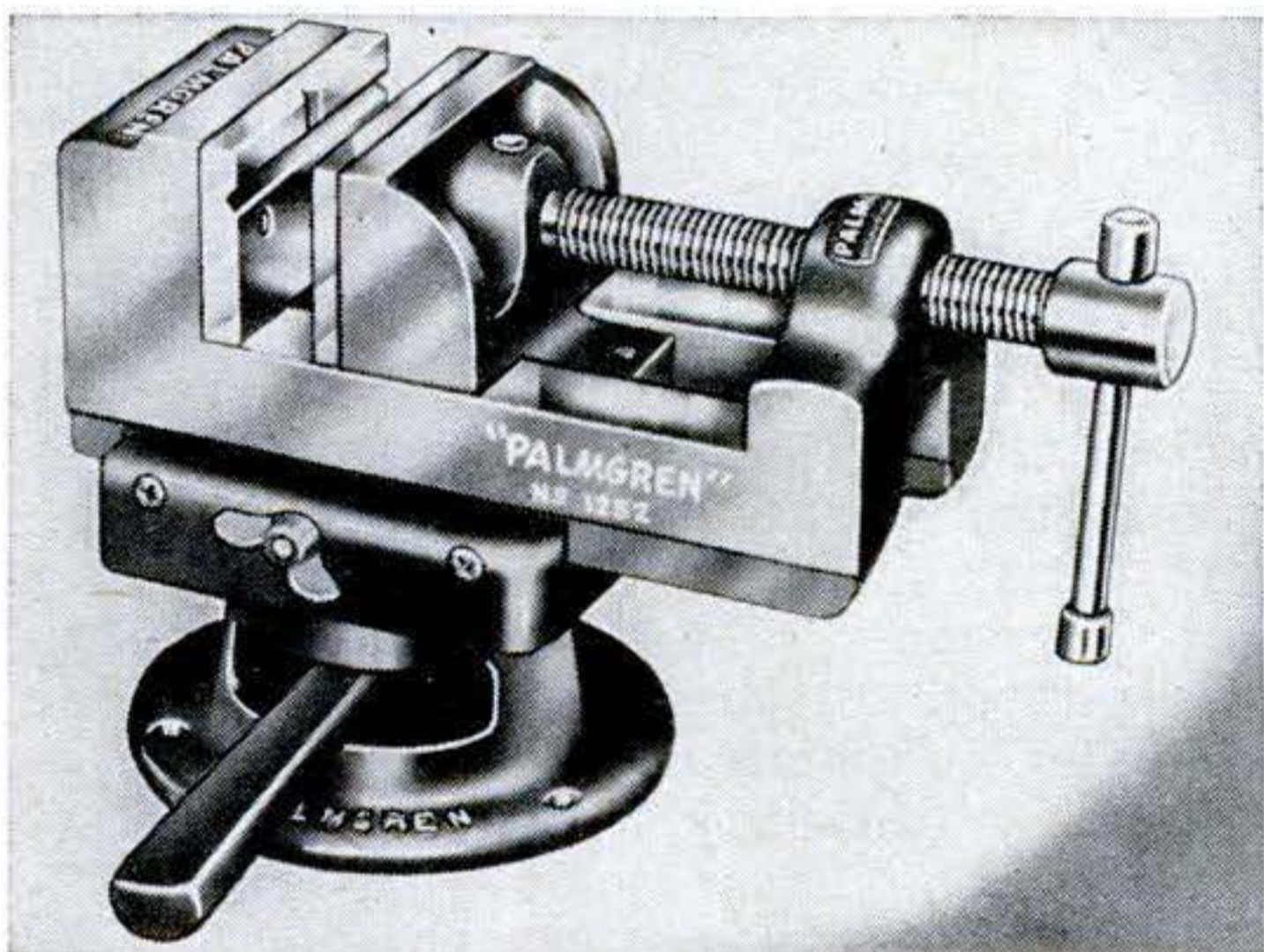

**Combination Bench and Drill Press Vise.** You can bolt this vise to a bench for general shop use, or you can mount it on the table of a drill press. It can be rotated 360° horizontally and locked at any point. The jaws are 2 1/2" wide, 1" deep, and open to 2 1/2". The maker is the Chicago Tool and Engineering Co., of Chicago.

# tough as they come!



FAMOUS  
**Snap-on**

*Vacuum Grip*

# pliers

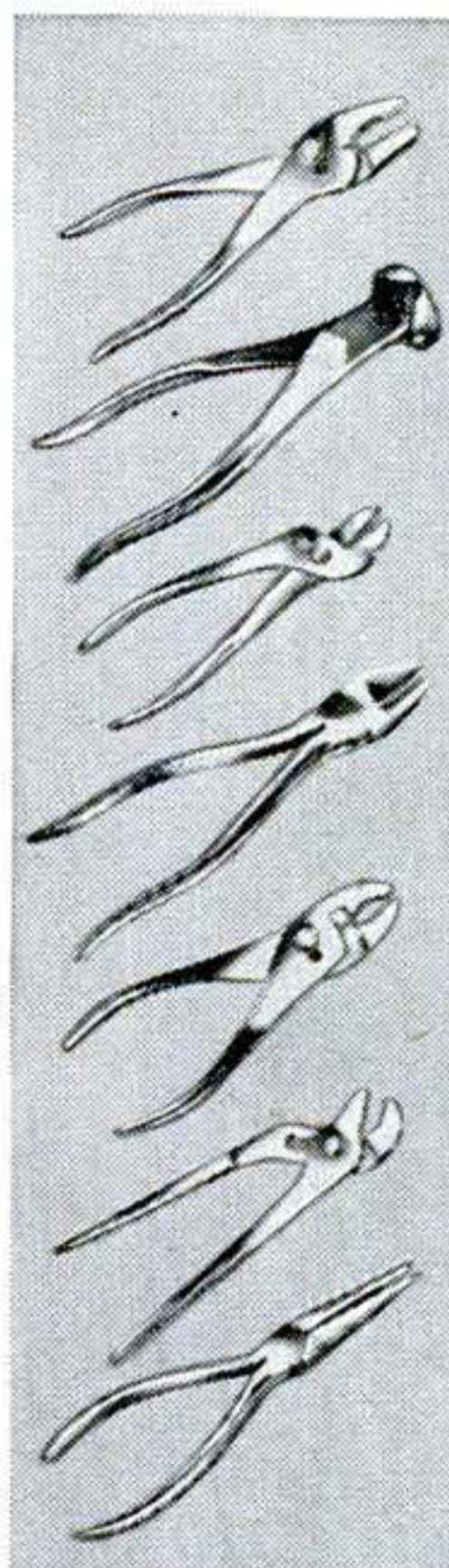

● Pick any Snap-on Vacuum Grip Pliers and you're set for years of faithful service. The way these professional pliers are designed, hammer-forged, oil-tempered, finished, inspected and tested, has just one purpose . . . to make them the finest pliers a man can buy. They handle better. They grip, twist, bend or cut better. They don't slip, in your hand or on the work. They last longer, because close-grained strength is forged and tempered into them. They're tougher.

**31 types and sizes  
to choose from**

Heavy-Duty Gripping Pliers ● Combination Pliers ● Lineman Pliers ● Diagonal and End Cutters ● Pin and Needle-Nose Pliers ● Midget Pliers ● Duck-Bill and Ignition Pliers ● Brake Spring, Brake Key, Battery, Water Pump, Snap-Ring and Cotter-Pin Pliers ● Pliers in sets, in leatherette kits, varied sizes. If you are a user of quality tools, send for the free, 104-page Snap-on catalog.

Not sold in stores. Buy from your local Snap-on man or order from factory.

**SNAP-ON  
TOOLS  
CORPORATION**  
8060-B 28th Avenue  
Kenosha, Wisconsin



FEBRUARY 1951 277

# P.S.

## Last minute news & notes...

DEADLIEST DRIVING in the world is done in Bombay, India, according to a world traffic survey made by the Danish Government. The annual fatality rate there is 769.66 per 100,000 cars and trucks. In Los Angeles (which has more cars per family than any other city in the world), the annual death rate in traffic accidents is only 27.86 per 100,000 cars; and in Milwaukee (the safest city in this respect) it is only 22.06 per 100,000 cars.

SYNTHETIC FROST can now be produced --another triumph of science over the weather. It is a chemical that has been developed in the Shell Oil Company's big agricultural research laboratory in California to aid cotton growers. If leaves get into cotton picked by machinery, they tend to discolor it. Jack Frost doesn't always nip them off in time. But growers no longer have to worry about them. They can apply this chemical to the plants now, and know that it will dispose of the leaves.

THE BIG BEVATRON being built at Berkeley, Calif., is half finished. It will be about 16 times as energetic as the most powerful cyclotron now running--Columbia's University's 380,000,000-volt proton accelerator. Protons shot out of the bevatron will travel almost as fast as light. Its builders hope to have it ready to be warmed up next year, but fear that the shortage of essential equipment will delay them.

EXHAUST GAS from an auto engine can now be made harmless. A catalytic device developed by Eugene J. Houdry, the petroleum scientist, takes both the poison and the odor out of the gases from engine to which it has been attached. It is being used already on fork-lift trucks in several large plants.

TELEVISION is being used to combat forest fires in South Africa. Pictures are broadcast from a plane

flying over the flames. Officers directing the battle against the fire thus can see what's happening and rush men where needed.

ENGINEERING is one of the nation's fastest-growing occupations, and will probably remain so, says the U.S. Department of Labor. More young engineers will be needed in the next few years than now seem likely to be graduated.

AUTO MAKERS concerned about cold stalling have found it hard to prevent mechanically. This tendency of an engine to die repeatedly after being started in cool, humid weather is caused by ice in the carburetor. So Esso has added a water-soluble substance to its gas that works like antifreeze in a radiator. Results thus far are reported to be good.

A NEW X-RAY CAMERA with an optical system such as is used in giant telescopes has been developed by the Fairchild Corp. It can be used to take pictures of the thicker parts of the body six times as fast as was previously possible. And the new camera makes possible, its makers say, quick, convenient, and cheap checks for cancer of the gastric tract, similar to the mass tuberculosis surveys now made.

ACTH, the new miracle hormone that has aided sufferers from arthritis and other ailments, also has been used successfully now to counteract the poison of the black-widow spider and the copperhead snake. And Columbia University researchers are about to begin a three-year investigation of the chemical nature and method of attack of poison ivy.

HYDRAGUIDE, a system that draws on the engine to help you steer a car, will be introduced on some of the 1951 Chryslers, its makers report.

*The Editors*



want better results  
in your workshop...



The one best thing  
for you to do  
Is use the genuine  
Franklin Glue!  
No mixing, heating,  
odor, mess:  
It costs no more;  
in fact costs less!  
It's liquid. Hide;  
keep on your shelf.  
Makes glue joints  
stronger than wood itself.

**FRANKLIN GLUE IS BEST FOR ALL WOODWORK**

Genuine HIDE glue, strongest known. Easy to use . . . no mixing, no heating. No odor. Eliminates chilled joints. Actual laboratory tests prove Franklin Glue holds more than 4000 lbs. per sq. in. and shows 100% wood failure. Spreads thin, goes farther.

Costs no more than ordinary glues. Ideal for all home uses.

If your dealer cannot supply you, send this coupon with 20¢



The FRANKLIN GLUE CO., 115 W. CHESTNUT ST. Columbus 15, Ohio

Enclosed 20c (15c plus 5c postage and handling charge) for trial tube of Franklin Liquid Hide Glue.

NAME.....

ADDRESS.....

SIX SIZES: Available in tubes 15c; quarter pints 50c; half pints 85c; pints \$1.50; quarts \$2.65; gallons \$7.50.



**Hoot  
Mon!**

# LOOK WHAT THIS LATHE WILL DO!

With this lathe and a few accessories you can turn, bore, face, thread, drill, ream, file, polish, mill, and saw all kind of metal, plastic, wood, fibre, and other materials. It is the most versatile tool you can put in your shop.

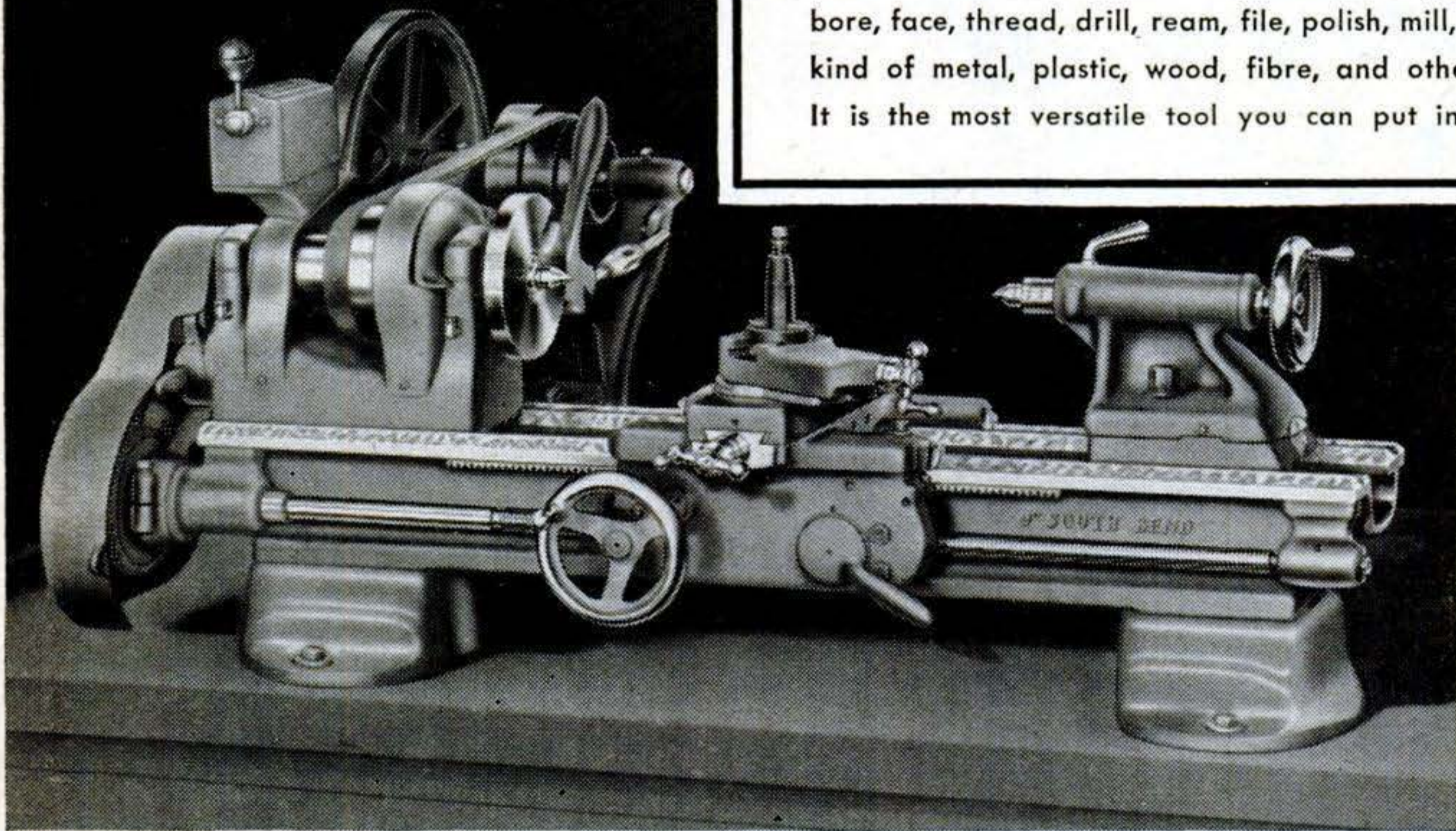

Install this fine lathe in your shop now and let it help pay for itself. Capable of a wide variety of operations, this lathe is ideal for general machine work in the small shop and for machining small parts in the large shop. A complete line of practical attachments and accessories simplify the tooling of this lathe for many special classes of work.

All sizes of South Bend Lathes, 14" Drill Presses, and 7" Bench Shapers are available on time payment terms: 25% down, balance in 12 monthly payments. Reasonable finance charges.

*Building Better Tools Since 1906*

**SOUTH BEND LATHE**  
**SOUTH BEND, INDIANA**

**Send for Information:**

- 9" BENCH LATHES
- LATHE TOOLS AND ATTACHMENTS
- TIME PAYMENT PLAN

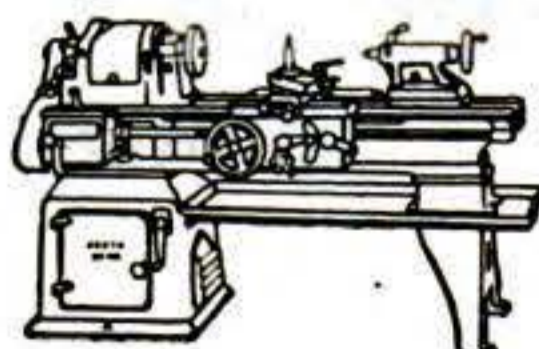

10" TO 16" FLOOR LATHES

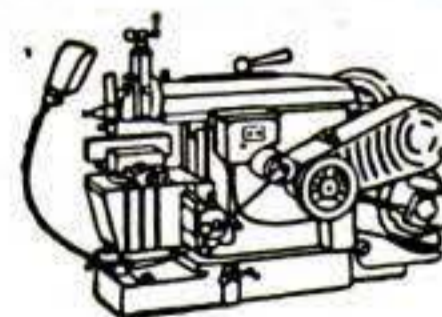

7" BENCH SHAPER



14" DRILL PRESSES

1/2" and 1" Collet TURRET LATHES

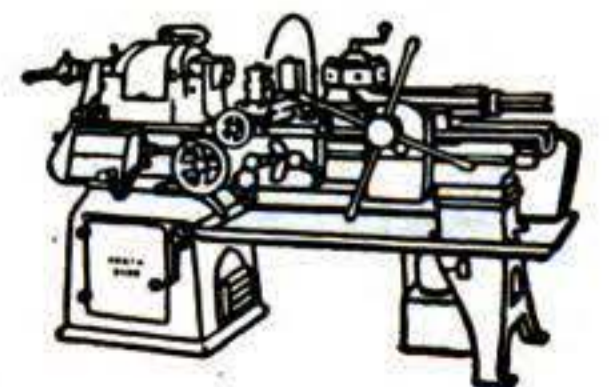

Name \_\_\_\_\_

Street \_\_\_\_\_

City \_\_\_\_\_ Zone \_\_\_\_\_ State \_\_\_\_\_

It's here!

# Greatest Home Repair Book Ever Offered!

Saves You Hundreds of Dollars a Year—Slashes High Labor Cost

THE PRENTICE-HALL

## COMPLETE HOME REPAIR HANDBOOK

1638 Pages!

THE PRENTICE-HALL

COMPLETE HOME REPAIR HANDBOOK

THE WORLD'S GREATEST BUILDING AUTHORITIES CONTRIBUTED EXPERT DATA FOR THIS MAMMOTH VOLUME

Professional methods recommended for best results in repair and maintenance of your home were contributed by:

- Anaconda Brass
- Armstrong Cork Company
- Asphalt Roofing Industry Bureau
- American Steel & Wire
- American Structural Products Company
- Black & Decker Mfg. Co.
- Brown & Sharpe Mfg. Co.
- Bendix Home Appliances, Inc.
- Cornell University
- Copper & Brass Research Association
- Crane Company
- Henry Disston & Sons, Inc.
- Delta Power Tool Division—Rockwell Manufacturing Co.
- E. I. du Pont Nemours & Company, Inc.
- Devoe & Reynolds Company, Inc.
- Delco Appliance Division—General Motors Corporation
- General Electric Company
- Institute of Boiler and Radiator Mfrs.
- S. C. Johnson & Son, Inc.
- Johns-Manville
- Minneapolis-Honeywell Regulator Company
- Norge Division—Borg-Warner
- Nicholson File Company
- Portland Cement Association
- Pittsburgh Plate Glass Company
- Philco Corporation
- Stanley Tools
- L. S. Starrett Company
- Toastmaster Products
- United States Rubber Company
- United States Plywood Corp.
- United States Steel
- U. S. Gypsum Corporation
- Victor Electric Products

30-DAY TRIAL without risk or obligation

BRAND NEW AND COMPLETELY UP-TO-DATE! 1638 PAGES OVER 1500 ILLUSTRATIONS

You'll get back the low price of this book in the very first month you own it. After that, it will save you money every month of the year. You'll save plumber's bills, carpenter's bills, electrician's bills, painter's bills, bricklayer's bills. For with this remarkable Handbook you can easily do a professional job of repairing or improving any part of your house — and SAVE UP TO 90% of what it would cost to hire the work done!

These Are Typical of the Savings YOU Can make:

- Creaky Stair Treads replaced for \$1.00 instead of \$15.00!
- Pipe Leak repaired for 5c instead of \$3.00!
- Kitchen Cupboards built for under \$25 instead of \$250!
- Screens & Stormsash built for \$70 instead of \$180!
- Wall Switch installed or replaced for \$1.75 instead of \$7.50!
- Reupholstering Sofa & Chair for \$10 instead of \$125!
- Driveway constructed for \$75 instead of \$200!
- Outdoor Fireplace built for \$45 instead of \$150!
- Vacuum Cleaner repaired for \$1.65 instead of \$10!

"SHOW HOW" ILLUSTRATIONS—MORE THAN 1500 OF THEM—GIVE YOU CLEAR EASY-TO-FOLLOW GUIDANCE. Large clear pictures, drawings and diagrams show you just where to start on any job, what step to tackle next, and how to tackle it. Full dimensions are included in every working drawing. In many instances you can do a complete job just by following step-by-step directions on the illustrations, without even referring to the text. You get complete money-and-time-saving directions on HUNDREDS of home repairs and improvements.

Here is just a glimpse of what you will find in its 1638 pages:

**INTERIOR REPAIRS.** How to repair sagging floors—How to fill cracks in floors—Laying linoleum—How to fit and hang doors—Replacing sash cords—Applying weather stripping—How to repair lamp sockets—How to replace electric switches—How to repair electric motors—Repairing leaks in piping—Eliminating noises in plumbing and heating system—Draining plumbing system—Repairing loose, cracked or bulging plaster—Replacing wall and floor tile—Waterproofing basement walls and floors—removing old wallpaper—Painting and Paperhanging.

**EXTERIOR MAINTENANCE & REPAIRS.** How to locate and repair leakage points on roofs—Roofing procedures—Shingling—Roll roofing—Repairs to gutters and leaders—Inspection and cleaning of septic tank—Patching cracks in concrete walks and walls—Removal of stains from concrete or brick—Exterior painting—How to avoid blistering, cracking, flaking, alligatoring, wrinkling on exterior paint jobs.

**FURNITURE UPHOLSTERY & REPAIRS.** How to replace defective stuffing, springs, webbing—How to pad seats—How to make cushions—Foam-rubber upholstery—Repairing broken spindles, rails, legs—Correcting sticky drawers—How to repair scratches, dents and nicks—Furniture refinishing.

**HOME IMPROVEMENTS & APPLIANCES.** Remodeling basements and attics—Constructing porch screens, storm doors and windows—Building a stairway closet—Constructing garden furniture, fences, gates, pergolas, trellises—Installing three-way push button electrical switch—Installing cooler fans in windows—Air conditioning systems—Automatic coal stoker—How to check and repair electric iron, toaster, ironer, range, vacuum cleaner, dish washer, refrigerator, oil burner—Laying a cement or concrete floor—Building concrete sidewalks, driveways, outdoor fireplace.

**WOODWORKING HAND TOOLS & MATERIALS.** How to use handsaws, screwdrivers, planes, chisels and gouges, braces and bits, scrapers, squares, levels, clamps, sharpening tools—How to identify and properly use woods and wood products—Work-

**METALWORKING HAND TOOLS & MATERIALS.** Metalworking saws, hammers, twist drills, files, pliers and nippers, wrenches, snips and shears, cold chisels, taps and dies, soldering irons, vise—Bending and forming metal—Treating and finishing metal—Fasteners for metal work.

**WOODWORKING POWER TOOLS.** Proper use checking, adjusting and maintenance of wood turning lathe, circular saw, band saw, drill press, jointers and shapers, sanders, power tool accessories—Cutting miters—Bead cutting—Reeding and fluting—Making dovetail joints—Cutting rabbets and dados—Matched shaping—Tonguing and grooving—Multiple cutting.

**METALWORKING POWER TOOLS.** Operation and maintenance of engine lathe, drill press, portable electric hand drill, power tool accessories—Roughing cuts—Finishing cuts—Facing—Boring—Tape turning—Knurling—Thread cutting—Drilling sheet metal—Countersinking—Commutators and carbon brushes.

**PLUMBING & HEATING MATERIALS.** Proper use and maintenance of all types of plumbing tools—Roughing-in materials—Determining sizes of house drains—Fittings—Selecting correct pipe size—Plumbing fixtures—Heating systems, hot water, steam, warm air—Stokers—Oil burners—Chimneys and drafts—Automatic heating control—Domestic water heaters—Radiators and convectors—Radiant heating.

**ELECTRICAL MATERIALS.** Circuits—Outlets—Indoor and Outdoor Approved Wiring Materials—Batteries—Transformers—Tools—Splicing—Methods of interior wiring—Remote-control wiring system—Use and repair of motors—Code requirements.

**CONCRETE, PLASTERING, MASONRY.** Methods of mixing concrete—Placing or pouring concrete—Cold-weather procedures—Watertightness—Composition and application of stucco—Bricklaying—Concrete blocks—Glass bricks or blocks—Plastering materials and procedures—Plaster cracks—Prepared gypsum finishes.

*How MILD CAN A CIGARETTE BE?*

"How Mild? I found the answer  
when I changed to **CAMELS**  
—they agree with my throat!"

*Dick Powell*

STAR OF FILMS AND RADIO



“Being in show business, I can’t risk throat irritation. That’s why I was so careful in choosing my cigarette. I didn’t decide on one puff or one sniff. A fast inhale and exhale wasn’t enough proof for me.

“I made what I think is the *sensible* test... my own 30-Day Camel Mildness Test. I smoked Camels regularly for 30 days and found that Camels agree with my throat. Now I *know* why more people smoke Camels than any other cigarette!”

NOTED THROAT SPECIALISTS REPORT  
ON 30-DAY TEST OF CAMEL SMOKERS...

**Not one  
single case of  
throat irritation**

due to smoking

**CAMELS!**

Yes, these were the findings of noted throat specialists after a total of 2,470 weekly examinations of the throats of hundreds of men and women who smoked Camels — and only Camels — for 30 consecutive days.



STAR of over 40 Hollywood musicals, Dick Powell's versatility has won him hard-hitting dramatic roles.



R. J. Reynolds Tobacco Co., Winston-Salem, N. C.

**Make your own 30-Day Camel MILDNESS Test  
in your T-Zone (T for Throat—T for Taste)**