

POPULAR SCIENCE

MONTHLY
MECHANICS AND HANDICRAFT



*How to
Paper a Room*

PAGE 161

25¢
May, 1951

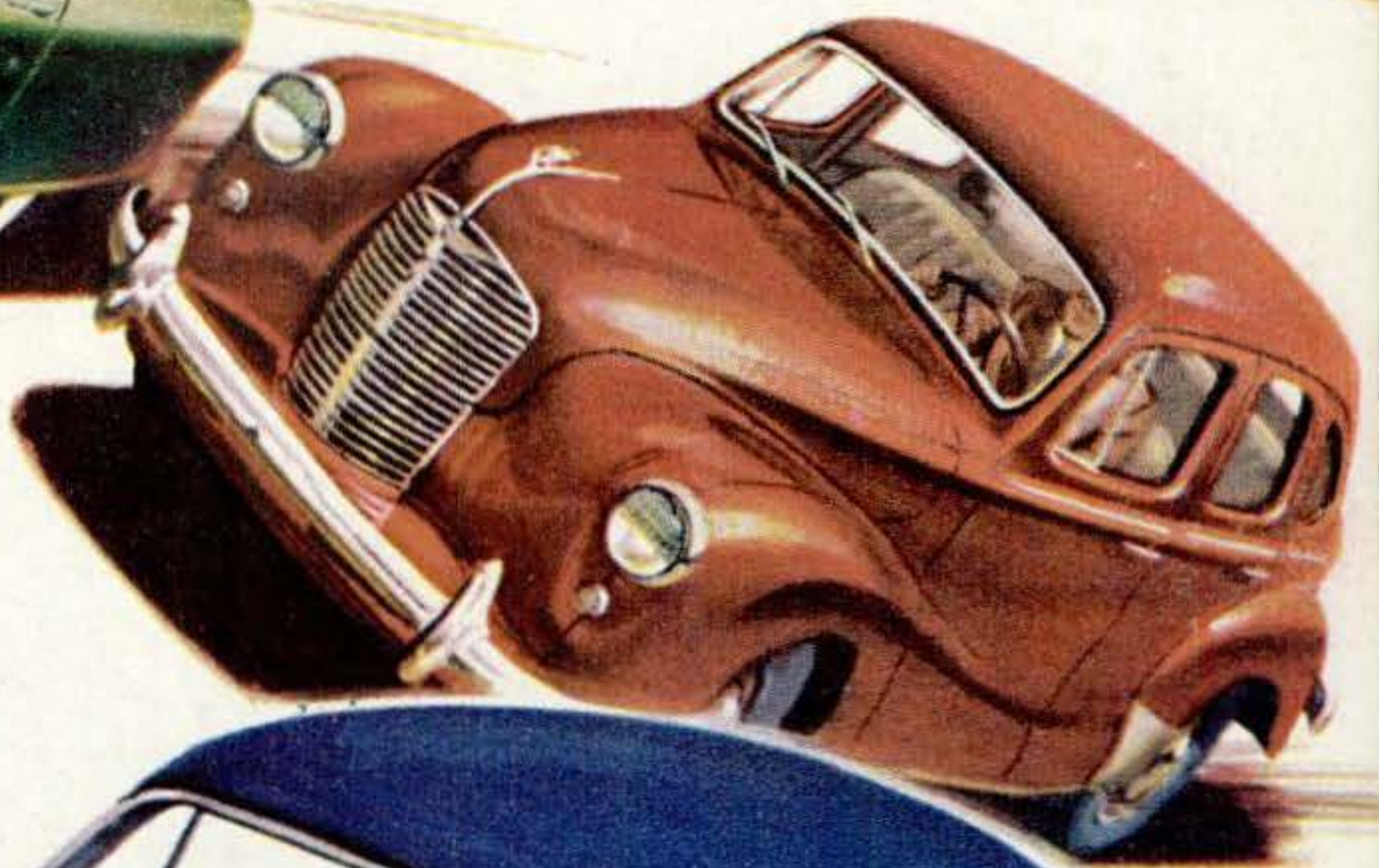

How Good Are
the "Little" Cars?

by Wilbur Shaw





POWER
on ball and roller bearings

Yes, every Kiekhaefer
MERCURY
has Full Jeweled
Power*

It's one of many big engineering differences pioneered by MERCURY that sets MERCURY apart from ordinary outboards. Full Jeweled Power means ball and roller bearing construction that gives *all* vital moving parts of the engine an anti-friction ride.

To you it means easier starts, smoother operation, more power, slower trolling and longer engine life. You get it in *every* MERCURY—and *only* in MERCURY!

*Ball and Roller Bearings Throughout



Write for FREE folder—"PICK OF THE PILOTS"

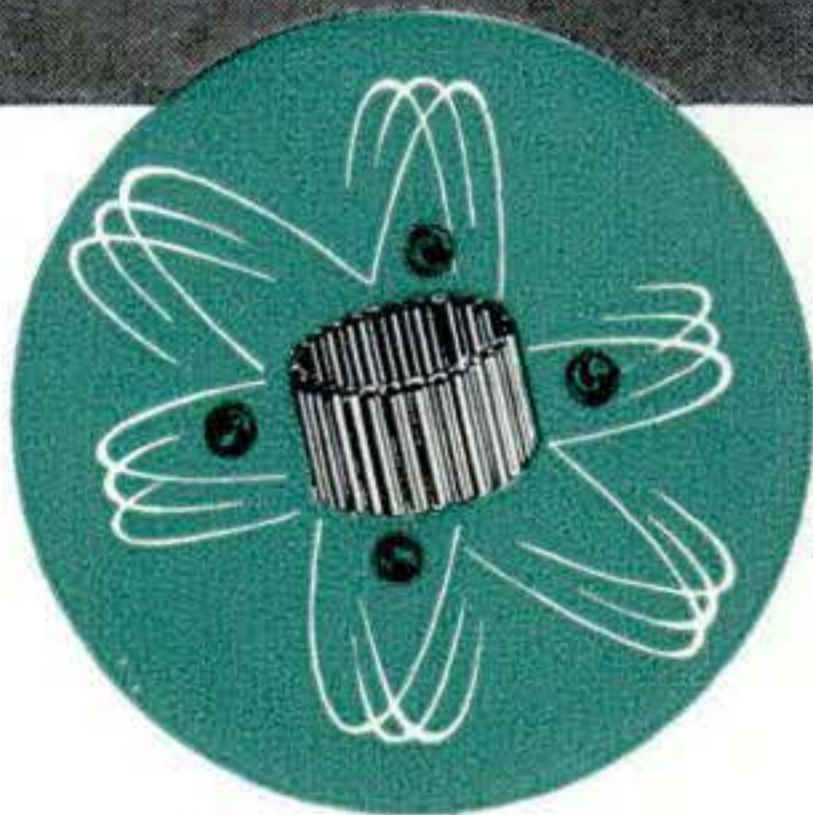

NEW HURRICANE SERIES

See your dealer for a demonstration of the sensational new MERCURY HURRICANES, the outboards that shattered endurance and speed records everywhere. Never before such ease of control, such smooth steady troll—all combined in a light outboard.

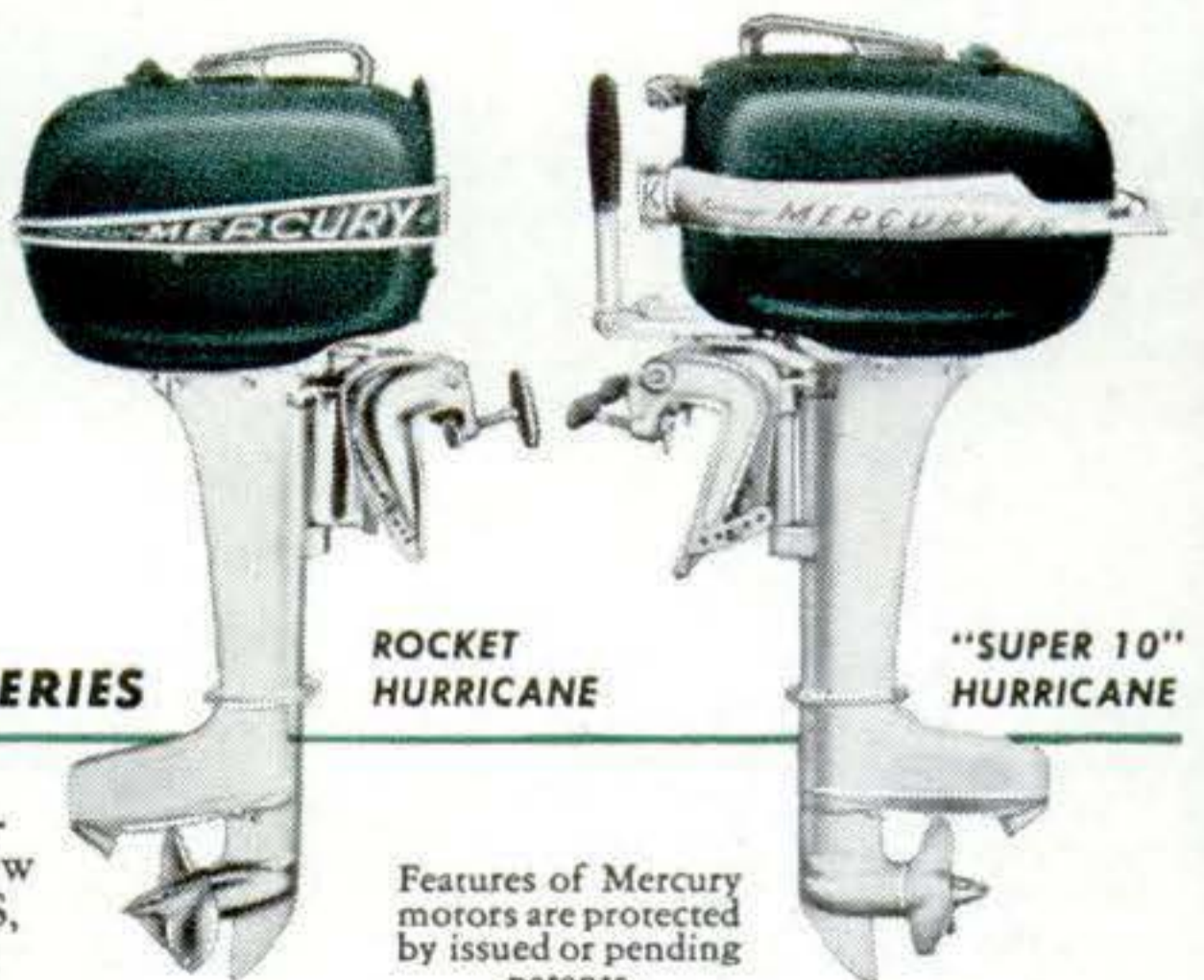

Features of Mercury motors are protected by issued or pending patents.

KIEKHAEFER CORPORATION, Fond du Lac, Wis., U. S. A.

It's FUN to Build Your Own Beautiful New Furniture

FOR EVERY ROOM IN YOUR HOUSE . . . AND OUTDOORS TOO!

Save Hundreds of Dollars with the Aid of the New WISE HOME FURNITURE BUILDER



Build this exquisite Blanket Chest for cost of lumber alone! No carving, no intricate work—use only ordinary home tools!

Complete Sets of "How-to-Build" Plans, Instructions and Material Lists, All in One Amazing Bargain . . . For Every Room, Make "Dreamlined" Cabinets and Furniture . . . Chairs and Tables . . . Storage Wardrobe Closets . . . For Outdoors, Make Fireplaces, Lawn Chairs and Much More . . . at Savings up to 75c on the Dollar!

NOW you can make your own modern, beautiful and useful furniture for EVERY room OUTDOORS, too—glorify your home with smartness and comfort—and SAVE up to thousands of dollars, with the aid of the brand-new WISE HOME FURNITURE BUILDER!

Save as much as \$50.00 on wall and shelf cabinets—save \$50.00 or more on a new "breakfast table"—save over \$100.00 on a built-in wardrobe set—save an easy \$20.00 bill on a handsome range chest—save \$10.00 on beautiful outdoor lounge place! Thrill your wife with a work-saving, space-saving Streamlined Kitchen, at savings up to hundreds of dollars—with spacious cabinets, folding work-table, built-in ironing board, ladder-cupboard—even a delightful Dining Nook for family company snacks—the very things that make a man happy to keep house, proud to entertain!

Bought Separately, These 60 Plans Might Cost You Up to \$40.00—You Save More Than 90%!

This 256-page Handbook gives you complete exact plans for constructing 60 different furniture projects for every room in your house and outdoors, too. Easy A-B-C instructions cover every detail of building bookcases, cabinets, built-in wardrobes, bunks, outdoor barbecue and chairs, drop-leaf dining table, boards, modern lamps—and dozens of other pieces that rival expensive custom-built furniture in construction, styling and finish—all at the cost of materials alone!

You might expect to pay 25c up to \$1.00 for complete construction plans for these, or about \$40.00 for all. But we bring them to you within covers of one-miracle book for only a fraction of that price!

Every Step Covered—Previous Knowledge Required!

You need no special tools or skills. Every item is designed for speedy construction. Each plan is complete with material lists. The drawings show exact shape and dimensions of every part. Dimensional drawings show each finished piece. Covers everything from use of tools to final waxing—woods, veneers, hardware—all at concealed hinges, sliding doors, hidden joints—plus Craftsmen's secrets of professional finishes—much more!

Mail Coupon for Week's FREE Trial!

Prove for yourself that THE WISE HOME FURNITURE BUILDER can save you hundreds of dollars and help you beautify your home! Simply mail the coupon for a week's FREE trial! If not delighted after 7 days, return the book and owe nothing. If you keep it, pay amazingly low price of only \$1.95, plus a few cents postage. But act fast! Mail the coupon now, before this limited first edition is exhausted!

© 1951. Wm. H. Wise & Co., Inc., 59 W. 47th St., New York 19, N. Y.

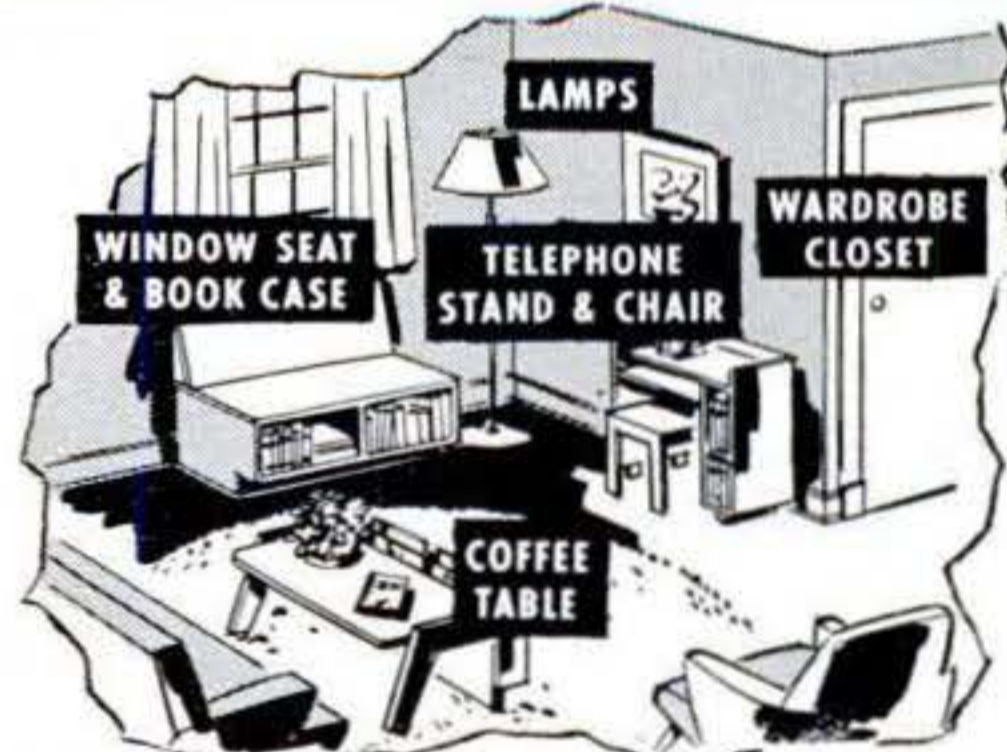

Any amateur can build this beautiful living room furniture—saving up to 75c on the dollar!

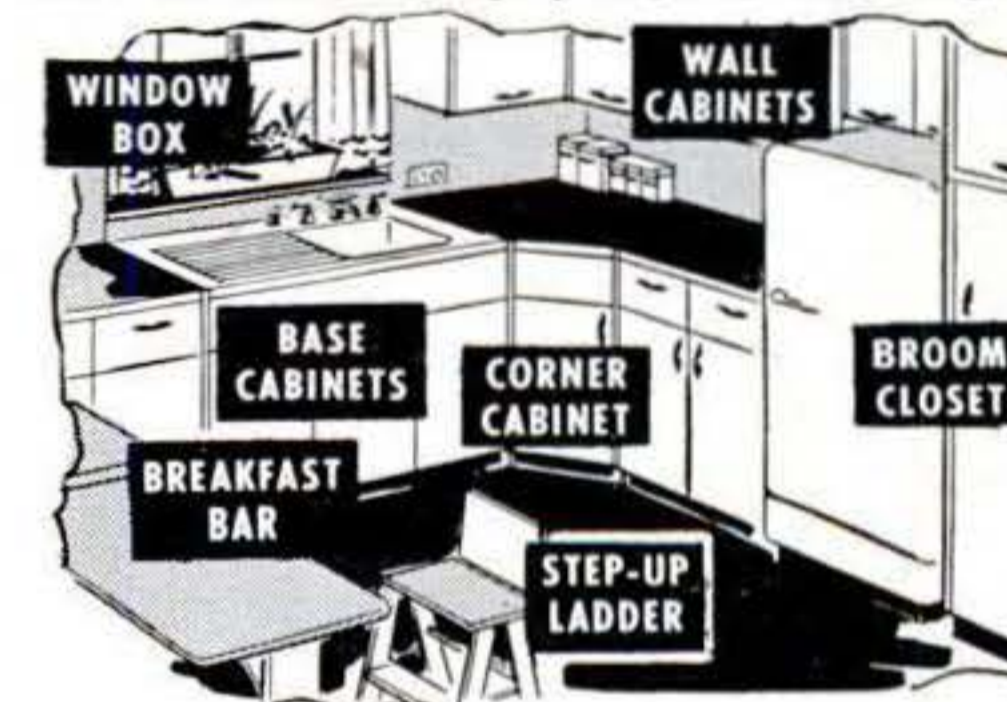

Thrill your happy wife with a modern Efficiency Kitchen that looks like \$2000—for cost of materials alone!

256 BIG PAGES—60 COMPLETE SETS OF PLANS, INSTRUCTIONS, MATERIAL LISTS AND SPECIAL POINTERS—INCLUDING CRAFTSMEN'S SECRETS OF BEAUTIFUL FINISHES—USE OF TOOLS!

Here's a Mere Hint of the Fine Furniture Pieces You Can Make:

- | | |
|--|--|
| <p>LIVING ROOM
Bookshelves; Telephone Stand & Chair; Modern Lamps; Card & Game Table; Coffee Table—and more!</p> <p>DINING ROOM
Drop-Leaf Dining Table; Wall Cabinets; Wall Chest—and more!</p> <p>BEDROOMS
Blanket Storage Chest; Built-In Wardrobe Closet; Night Stand; Built-In Bunks—and more!</p> <p>KITCHEN
Breakfast Bar; Racks; Built-In Ironing Board; Step-Up Ladder Stool; Folding Work Table—and more!</p> <p>PLAYROOM
Toy Storage Cabinet; Table Tennis Table; Drawing Table—and more!</p> | <p>HALL
Overshoe & Rubber Storage Cabinet; Telephone Wall Shelf; Broom Closet—and more!</p> <p>WORKSHOP
Work Bench; Tool Storage Cabinet; Tool Box; Shelves for Hardware—and more!</p> <p>BATHROOM
Shower Stall; Medicine Chest; Clothes Hamper; Towel Cabinet—and more!</p> <p>INET—and more!</p> <p>PORCHES
Porch Screens; Flower Boxes; Shutters—and more!</p> <p>GARDEN & OUTDOORS
Lawn Chairs; Outdoor Fireplace; Lattices; Dining Table & Chairs with Umbrella—and more!</p> <p>FURNITURE FINISHES
Rubbed-Oil; Stained; Painted, Enameled & Lacquered; Modern, Antique; Sanding, Buffing, Polishing, Waxing—and more!</p> <p>PLUS . . .
Built-In Cabinets; Combination Drawing Table & Storage Cabinet; Storm Doors; Screen Doors . . . and much, much more!</p> |
|--|--|



Build Lawn Chairs you'll be proud of—SAVE \$10 to \$20!



Build that Work Bench you've always wanted—for cost of materials alone!

Mail This FREE-Trial Coupon!

WM. H. WISE & CO., INC.
50 W. 47th St., New York 19, N. Y.

Please send me, for week's FREE trial, THE WISE HOME FURNITURE BUILDER. After full week, I may return book and owe nothing; or keep it and remit the amazingly low price of only \$1.95, plus postage.

SAVE MORE! Mail only \$2 with this coupon and we will stand all shipping charges. Same return privilege and refund guaranteed.

Name.....26
Address.....805
City & Zone.....State.....

Check here for De Luxe Edition with THUMB-NOTCH INDEX for quick easy reference, beautifully embellished with hand-tooled designs. Only \$1 extra. Same terms.



PERRY GITHENS, EDITOR

Fred O. Newman, Volta Torrey, MANAGING EDITORS Howard C. Jensen, ART EDITOR

Harry Walton, MECHANICS & HANDICRAFT EDITOR

Hartley E. Howe, Frank Rowsome, Jr., ASSISTANT MANAGING EDITORS

ASSOCIATE EDITORS: Alden P. Armagnac, Devon Francis, Richard Giovine, Robert Gorman, Sheldon M. Gallager, Herbert O. Johansen, Martin Mann, Denis Sneigr, Robert P. Stevenson.

EDITORIAL ASSISTANTS: Julia C. Bove, Carol Ennis, Doris R. Gaines, Rita K. Gilbert, Rosemary C. Knorr, Georgette Sparks, Harriet Trowbridge, Ruth Westphal.

STAFF PHOTOGRAPHERS: W. W. Morris (Chief), Hubert Lockett, Orlando Guerra (Darkroom).

ART DIRECTOR: Harry Samuels. **ART ASSOCIATES:** Herbert Anthony, Eric Karminski, Jr., Richard Meyer, Frances Cooper Daniels (Production).

WESTERN EDITOR: Andrew R. Boone (Los Angeles).

WASHINGTON EDITOR: John F. Loosbrock.

Features FOR MAY, 1951

The Cover:

Artist Ray Quigley pictures the three "little cars" racing around the Indianapolis Speedway.

How Good Are the "Little Cars"?.. 82

Ride the Speedway with Wilbur Shaw as he tries out a threesome of easy-on-the-pocketbook cars.

Model Fans Plan Dream Railroad.. 116

Put on a solid-gold engineer's cap and hop aboard for a ride over these "million-dollar" rails.

How They Make Tennis Rackets.... 123

It takes precision woodworking to give a racket its delicate balance and tremendous strength.

Torture that Makes Homes Safer.. 137

Here's what happens at Underwriters' Laboratories where they put wringers through the wringer.

World's Biggest TV Studio..... 140

There's even a camera on the ceiling of new 8H studio, most versatile of the video factories.

Model Planes Vie in Team Races.. 146

Whirling dervishes fly up to six entries at once in this exciting new kind of speed contest.

Papering a Room from A to Z..... 161

Cut redecorating costs by putting up your own wallpaper. These tips give you the hang of it.

Hidden Wear Boosts Car Costs..... 179

You can save money on your car this summer by giving it a pin-point tune-up this spring.

Ways to Dress Up Your Doorway.. 188

If your front door opens right into the weather, here are ways to cover it up with a canopy.

How to Defend Defense Metals..... 191

This is the time to start the campaign to keep your appliances fit for duty on the home front.

Coloring Your Concrete Floors.... 197

You can have rainbow hues underfoot by applying these new dyes, stains, and paints yourself.

How to Make Dutch Doors..... 209

Their swinging halves will add charm to your home, and making them yourself will cut the cost.

Oil Pipe Spans Arabian Desert..... 94

Endless Train to Speed N.Y. Traffic..... 100

Godfrey Hammond, PUBLISHER · Stephen P. Glennon, ADVERTISING DIRECTOR

EDITORIAL OFFICES: 353 Fourth Avenue, New York 10, N. Y. Manuscripts and illustrations submitted at regular rates should be so marked, addressed to "The Editors" and accompanied by stamped, self-addressed envelope. Popular Science Monthly exercises all possible care but assumes no responsibility for unsolicited material.

ADVERTISING OFFICES: NEW YORK — 353 Fourth Avenue; CHICAGO—360 North Michigan Avenue; DETROIT —820 Book Building; SAN FRANCISCO—Howard Building, 209 Post Street; PORTLAND (ORE.)—907 Terminal Sales Building; CLEVELAND—328 Citizens Building; LOS ANGELES—Granada Building.

Popular Science Monthly is published monthly at 353 Fourth Avenue, New York 10, N. Y., by Popular Science Publishing Co., Inc., Godfrey Hammond, President and Treasurer; R. C. Wilson, Stephen P. Glennon, Vice-Presidents; F. W. Briggs, Secretary. Entered as second-class matter Dec. 28, 1918, re-entered as second-class matter July 26, 1948, at the Post Office in New York, N. Y., under the act of March 3, 1879; additional entry as second-class matter at Dayton, Ohio. Entered as second-class matter at the Post Office Department, Canada. Printed in U.S.A. Copyright, 1951, by Popular Science Publishing Co., Inc. All rights reserved in the United States, Great Britain, and in all countries participating in the International Copyright Convention and Pan-American Copyright Convention. Yearly subscriptions to United States, its possessions and Canada, \$3.00 (2 years, \$5.50; 3 years, \$7.50); foreign countries \$1 per year extra. Subscribers must notify us of change of address four weeks before next publication. Be sure to give both old and new addresses, including zone numbers. Vol. 158, No. 5.



PROVED by over 1,000,000 Installations!

PERFECT CIRCLE NURLIZING slashes engine repair costs!

**NEW EXCLUSIVE METHOD OF RESURFACING PISTONS SAVES YOU MONEY
BY RESTORING WORN PISTONS TO ORIGINAL FIT AND EFFICIENCY**



Perfect Circle's new Nurlizing process greatly reduces the cost of engine overhauls by making old pistons re-usable—with absolute safety.

At last, worn pistons can be resized for close, correct fit in cylinders without danger of scuffing or scoring! This restored fit means *restored power* and eliminates piston slap—and the interrupted surface of the Nurlized piston assures better lubrication at all times.

If you have been postponing that overhaul your engine needs because of expense—you can have it done now—but insist that your Doctor of Motors Nurlize your old pistons. It will give those pistons new life—with improved performance—and save you money.

Perfect Circle



The Most Honored Name in Piston Rings

NOW!

BRIGGS SMOKES 3 WAYS BETTER*



1. Stays lighted longer . . . by 19%



2. Cleaner burning . . . by 16.4%



3. Less tar . . . by 21.6%

So today . . .

Put this
in your
pipe

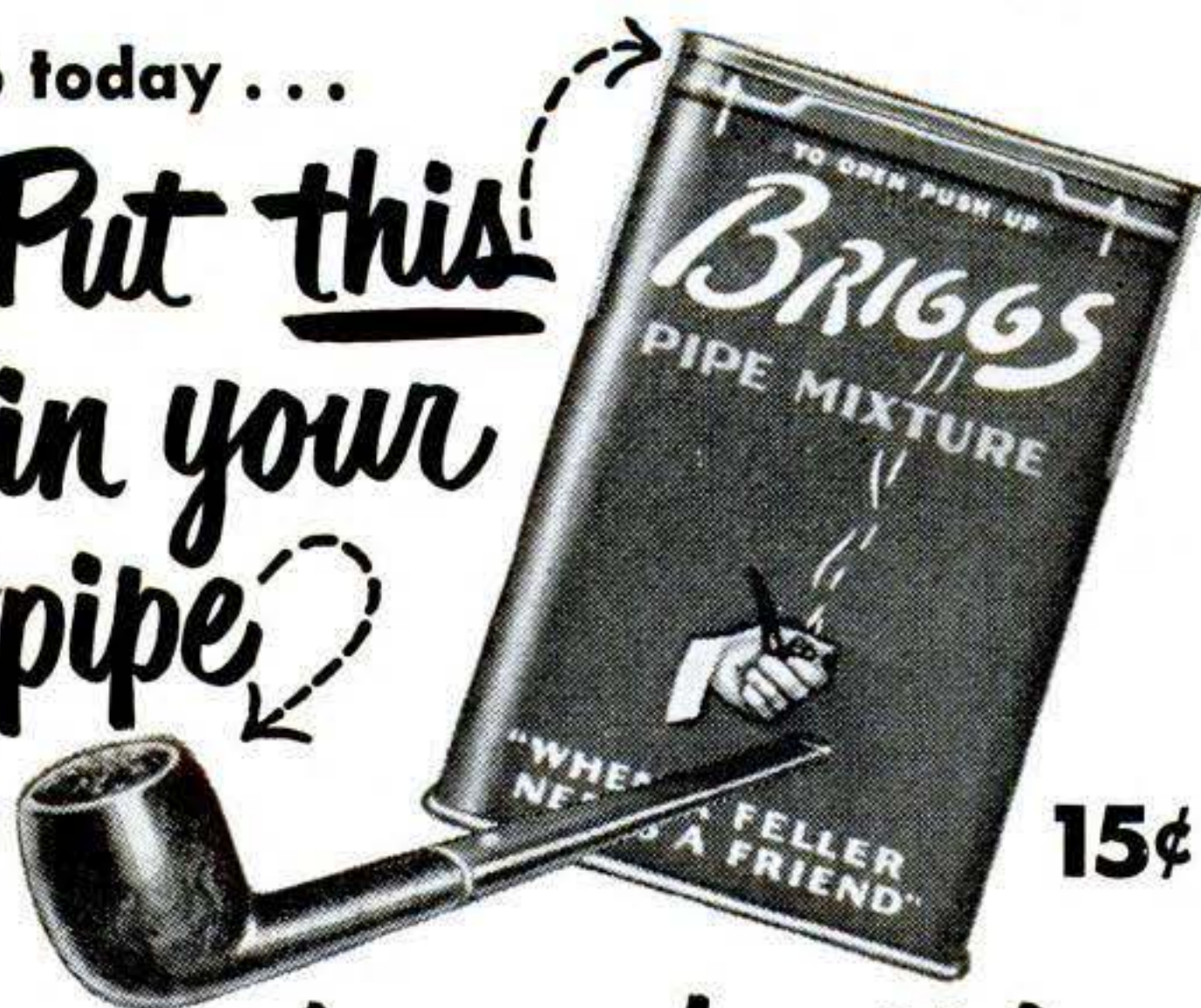

and smoke it!

*Yes, our new process makes Briggs better by actual test! Better even than the swell-smoking Briggs that proved so fine and friendly in your pipe before. And remember this: when tobacco burns steady, free and clean, that's when you enjoy *all* the goodness of Briggs' fine tobacco, aged and mellowed in oaken casks. Today—try 3-ways-better Briggs!

Also available in Canada

How They Make Plastic Figures.....	102
Mechanical Traffic Cop Rates Autoists....	104
Cannon to Hurl Billion Volts.....	108
Midgets Thrill Race Fans.....	110
How Chemists Cut Liquids with Knife..	114
Soft Drums Are Lighter, Safer.....	122
How a Gas Pump Works.....	128
Houses Built from Auto-Plant Surplus....	130
Propeller Squeezed from Hot Metal.....	133
British Build De Luxe Rescue Boat.....	134
Scorpion Stings at 700 m.p.h.....	143
New Telephone Battery Works Better....	145
Rio Gets Mountain-Top TV.....	150
Army Crates Get Tough Going-Over.....	151
Pneumatic Hand Saw Won't Kick, Grab..	152
Making Bricks on a Merry-Go-Round.....	156

Mechanics & Handicraft

Lightning vs. Television.....	167
How to Handle a Ladder.....	170
Putting a Handle on a Hammer.....	172
Flower Barrows Dress Up Your Garden..	173
Gus Tames a Runaway.....	174
Summer Driving Tips.....	182
What's This Car?.....	183
I Cover the Races.....	184
Folding Youth Bed Fits Back Seat.....	187
Jet Interceptors Dart 1,000 Feet.....	203
Colonial Wall Box Holds Ivy.....	207
Raise a Flag This Summer.....	213
Ready-Made Parts Cut Cost of Table....	214
Basement Air Cools Upstairs.....	215
Play Ball!.....	218
How to Improvise a Signal Generator....	221
How to Improve Kitchen Shelves.....	223

Departments

Letters	10
New Ideas from the Inventors.....	91
Aids to Modern Living.....	112
Keeping the Home Shipshape.....	153
I'd Like to See Them Make.....	160
Hints from the Model Garage.....	177
New Shop Ideas	216
Craftsmen at Work.....	224
Mechanics of Farming.....	230
New Tools.....	258
P.S. Last Minute News and Notes.....	262

Highballing With a Camera



The pictures and adventures of an expert photographer of railroad trains will be one of the many features of next month's POPULAR SCIENCE. Don't miss it.

This story actually happened. The man's name has been changed and this is not his photograph, but the facts are true.

"How do I feel about being Superintendent?"

Well, that story begins in Scotland . . ."

"I was an apprentice lad in a big machine shop. Just one among many. But I was ambitious and I was studying with I. C. S. Well, one day the shop started buzzing . . . the Superintendent had come in! I should explain that this was very unusual. To even an expert machinist, the Superintendent was as distant as the Deity. But I saw him walk in, with his derby hat and high collar and cravat. And as he came he asked, 'Where is Tom McDermott?' Well, that was me. And he walked right up to me and said, 'Are you the lad who's studying with the I. C. S.?' I just nodded — for I couldn't say a word. Then he laid his hand on my shoulder and said, 'Lad, stay with it . . . for if you do I prophesy that some day you will be Superintendent!' Well, today here in America I am Superintendent of a big machine shop . . . and maybe that story will give you some idea of how I feel about it."

In the files of I. C. S., stories like this are fairly common. Some day your story may be there. If you start today by filling out the coupon.



INTERNATIONAL CORRESPONDENCE SCHOOLS

APPROVED
under the
G.I. BILL

BOX 7677-M, SCRANTON 9, PENNA.

Without cost or obligation, please send me full particulars about the course BEFORE which I have marked X:

- | | | | |
|---|---|---|--|
| <p>Business and Academic Courses</p> <ul style="list-style-type: none"> <input type="checkbox"/> Accounting <input type="checkbox"/> Advertising <input type="checkbox"/> Bookkeeping <input type="checkbox"/> Business Administration <input type="checkbox"/> Bus. Correspondence <input type="checkbox"/> Bus. Law <input type="checkbox"/> Certified Public Accounting <input type="checkbox"/> Commercial <input type="checkbox"/> Commercial Art <input type="checkbox"/> Cost Accounting <input type="checkbox"/> Federal Tax <input type="checkbox"/> First Year College <input type="checkbox"/> Foremanship <input type="checkbox"/> Good English <input type="checkbox"/> French <input type="checkbox"/> Higher Mathematics <input type="checkbox"/> High School <input type="checkbox"/> Illustration <input type="checkbox"/> Industrial Supervision <input type="checkbox"/> Motor Traffic <input type="checkbox"/> Postal Civil Service <input type="checkbox"/> Retailing <input type="checkbox"/> Retail Bus. Management <input type="checkbox"/> Salesmanship <input type="checkbox"/> Secretarial <input type="checkbox"/> Sign Lettering <input type="checkbox"/> Stenography <input type="checkbox"/> Spanish <input type="checkbox"/> Traffic Management <input type="checkbox"/> Typing <p>Air Conditioning and Plumbing Courses</p> <ul style="list-style-type: none"> <input type="checkbox"/> Air Conditioning <input type="checkbox"/> Heating <input type="checkbox"/> Plumbing <input type="checkbox"/> Refrigeration <input type="checkbox"/> Steam Fitting | <p>Chemical Courses</p> <ul style="list-style-type: none"> <input type="checkbox"/> Chemical Engineering <input type="checkbox"/> Chemistry, Analytical <input type="checkbox"/> Chemistry, Industrial <input type="checkbox"/> Chemistry, Mfg. Iron & Steel <input type="checkbox"/> Petroleum Refining <input type="checkbox"/> Plastics <input type="checkbox"/> Pulp and Paper Making <p>Civil Engineering, Architectural and Mining Courses</p> <ul style="list-style-type: none"> <input type="checkbox"/> Architecture <input type="checkbox"/> Architectural Drafting <input type="checkbox"/> Building Estimating <input type="checkbox"/> Civil Engineering <input type="checkbox"/> Coal Mining <input type="checkbox"/> Contracting and Building <input type="checkbox"/> Highway Engineering <input type="checkbox"/> Lumber Dealer <input type="checkbox"/> Reading Structural Blueprints <input type="checkbox"/> Sanitary Engineering <input type="checkbox"/> Structural Drafting <input type="checkbox"/> Structural Engineering <input type="checkbox"/> Surveying and Mapping <p>Communications Courses</p> <ul style="list-style-type: none"> <input type="checkbox"/> Electronics <input type="checkbox"/> Prac. FM and Television <input type="checkbox"/> Prac. Telephony <input type="checkbox"/> Radio Operating <input type="checkbox"/> Radio, General <input type="checkbox"/> Radio Servicing <input type="checkbox"/> Telegraph Engineering | <p>Electrical Courses</p> <ul style="list-style-type: none"> <input type="checkbox"/> Electrical Drafting <input type="checkbox"/> Electrical Engineering <input type="checkbox"/> Electric Light and Power <input type="checkbox"/> Lighting Technician <input type="checkbox"/> Practical Electrician <input type="checkbox"/> Power House Electric <input type="checkbox"/> Ship Electrician <p>Internal Combustion Engines Courses</p> <ul style="list-style-type: none"> <input type="checkbox"/> Auto Technician <input type="checkbox"/> Aviation <input type="checkbox"/> Diesel-Electric <input type="checkbox"/> Diesel Engines <input type="checkbox"/> Gas Engines <p>Mechanical Courses</p> <ul style="list-style-type: none"> <input type="checkbox"/> Aeronautical Engineer's, Jr. <input type="checkbox"/> Aircraft Drafting <input type="checkbox"/> Flight Engineer <input type="checkbox"/> Forging <input type="checkbox"/> Foundry Work <input type="checkbox"/> Heat Treatment of Metals <input type="checkbox"/> Industrial Engineering <input type="checkbox"/> Industrial Instrumentation <input type="checkbox"/> Industrial Metallurgy <input type="checkbox"/> Machine Shop <input type="checkbox"/> Machine Shop Inspection <input type="checkbox"/> Mechanical Drafting <input type="checkbox"/> Mechanical Engineering | <ul style="list-style-type: none"> <input type="checkbox"/> Mold-Loft Work <input type="checkbox"/> Patternmaking—Wood, Metal <input type="checkbox"/> Reading Shop Blueprints <input type="checkbox"/> Sheet-Metal Drafting <input type="checkbox"/> Sheet-Metal Worker <input type="checkbox"/> Ship Drafting <input type="checkbox"/> Ship Fitting <input type="checkbox"/> Tool Designing <input type="checkbox"/> Toolmaking <input type="checkbox"/> Welding—Gas and Electric <p>Railroad Courses</p> <ul style="list-style-type: none"> <input type="checkbox"/> Air Brake <input type="checkbox"/> Car Inspector <input type="checkbox"/> Diesel Locomotive <input type="checkbox"/> Locomotive Engineer <input type="checkbox"/> Locomotive Fireman <input type="checkbox"/> Locomotive Machinist <input type="checkbox"/> Railroad Section Foreman <input type="checkbox"/> Steam and Diesel Loco. Eng. <p>Stationary Engineering Courses</p> <ul style="list-style-type: none"> <input type="checkbox"/> Boilermaking <input type="checkbox"/> Combust. Engrg. <input type="checkbox"/> Engine Running <input type="checkbox"/> Marine Engineering <input type="checkbox"/> Power Plant Engr. <input type="checkbox"/> Steam Engineer <p>Textile Courses</p> <ul style="list-style-type: none"> <input type="checkbox"/> Cotton Manufacturing <input type="checkbox"/> Loom Fixing <input type="checkbox"/> Rayon Weaving <input type="checkbox"/> Textile Designing <input type="checkbox"/> Woolen Manufacturing |
|---|---|---|--|

Name _____ Age _____ Home Address _____

City _____ State _____ Working Hours _____ A.M. to _____ P.M.

Present Position _____ Employed by _____

Length of Service in World War II _____ Enrollment under G.I. Bill approved for World War II Veterans. Special tuition rates to members of the Armed Forces.

Canadian residents send coupon to International Correspondence Schools Canadian, Ltd., Montreal, Canada.

Technical Training

...MEANS A BETTER U. S. ARMY

Your United States Army is the best technically and mechanically equipped Army in the world. To keep this equipment in top operating condition, your Army trains thousands of soldiers in the operation, repair and maintenance of the very modern types of equipment now serving the Army.

The men pictured below have been trained by the Army in the repair of battery commander telescopes essential to the effectiveness of the Artillery. Technically skilled men . . . trained to

do an important job . . . trained while serving in the U. S. Army.

You can apply for Army technical training . . . after finishing basic training . . . and, if you qualify for the quota of the school you choose, learn with the best. Today's Army is a man's Army . . . and there is a place in it for you.

Get the details about U. S. Army technical training schools today . . . at your nearest U. S. Army and U. S. Air Force Recruiting Station.



U. S. ARMY



THE MARK OF A MAN!

This is the mark of a man . . . the uniform cap of the U. S. Army. The man who wears it has come up to the mark, has proved his ability to be a soldier.



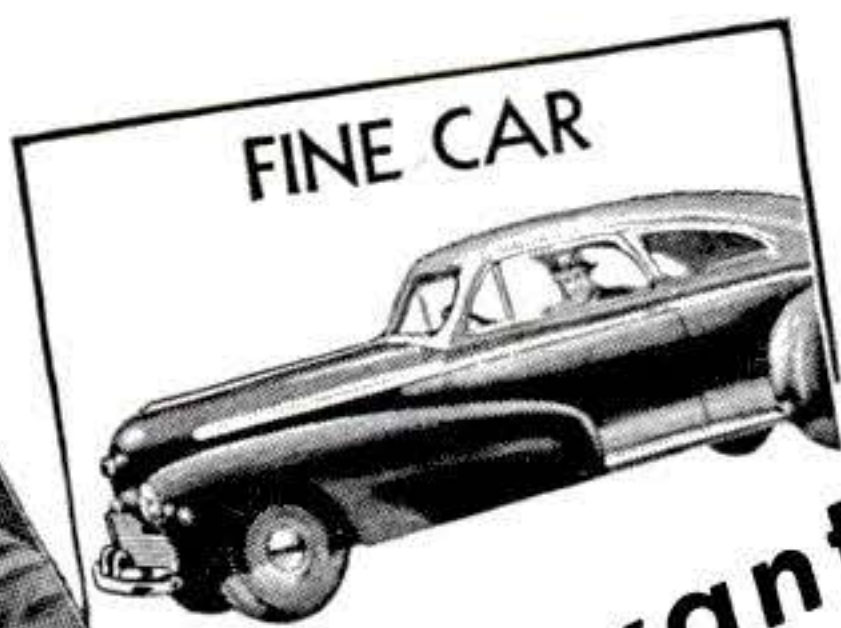

To the man who wants to enjoy
an **ACCOUNTANT'S** CAREER

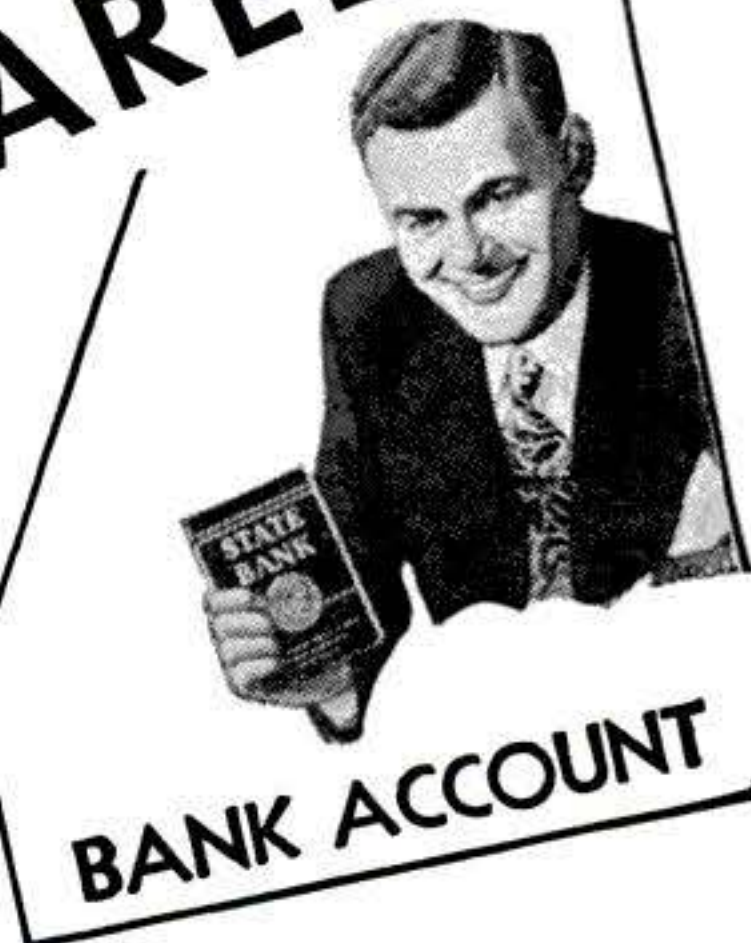

IF you're that man, here's something that will interest you.

Not a magic formula—not a get-rich-quick scheme—but something more substantial, more practical.

Of course, you need something more than just the desire to be an accountant. You've got to pay the price—be willing to study earnestly, thoroughly.

Still, wouldn't it be worth your while to sacrifice some of your leisure in favor of interesting home study—over a comparatively brief period? Always provided that the rewards were good—a salary of \$4,000 to \$10,000?

An accountant's duties are interesting, varied and of real worth to his employers. He has *standing*!

Do you feel that such things aren't for you? Well, don't be too sure. Very possibly they *can* be!

Why not, like so many before you, investigate LaSalle's modern Problem Method of training for an accountancy position?

Just suppose you were permitted to work in a large accounting house under the personal supervision of an expert accountant. Suppose, with his aid, you studied accounting principles and solved problems day by day—easy ones at first—then more difficult ones. If you could do this—and could turn to him for advice as the problems became complex—soon you'd master them all.

That's the training you follow in principle under the LaSalle Problem Method.

Over 3200 Certified
Public Accountants among
LaSalle alumni!

You cover accountancy from the basic Principles right through Accountancy Systems and Income Tax Procedure. Then you add C. P. A. Training and prepare for the C. P. A. examinations.

As you go along, you absorb the principles of Auditing, Cost Accounting, Business Law, Statistical Control, Organization, Management and Finance.

Your progress is as speedy as you care to make it—depending on your own eagerness to learn and the time you spend in study.

Will recognition come? The only answer, as you know, is that success *does* come to the man who is really *trained*. It's possible your employers will notice your improvement in a very few weeks or months. Indeed, many LaSalle graduates have paid for their training—with increased earnings—before they have completed it! For accountants, who are trained in organization and management, are the executives of the future.

Write For This Free Book

For your own good, don't put off investigation of *all* the facts. Write for our free 48-page book, "Accountancy, The Profession That Pays." It'll prove that accountancy offers brilliant futures to those who aren't afraid of serious home study. We'll also include "Ten Years' Promotion in One"—a book which has helped many men. Send us the coupon *now*.

**LASALLE EXTENSION
CHICAGO 5, ILL.**

Other LaSalle Opportunities

- Higher Accountancy
- C.P.A. Coaching
- Bookkeeping
- Law: LL.B. Degree
- Business Management
- Salesmanship
- Traffic Management
- Foremanship
- Industr'l Management
- Stenotypy
(Machine Shorthand)

LASALLE EXTENSION UNIVERSITY

A CORRESPONDENCE INSTITUTION

417 S. Dearborn St. Dept. 583-HR Chicago 5, Ill.

I want to be an accountant. Send me without obligation, "Accountancy, the Profession that Pays"—also "Ten Years' Promotion in One."

Name..... Age.....

Address.....

City, Zone & State.....



MAY 1951 7

Were the
Ancients Right--



Will Man Create Life?

DOES THE SECRET of life belong to Divinity alone?

Will Nature's last frontier give way to man's inquiring mind? Can man become a creator, peopling the world with creatures of his own fancy? Was the ancient sage right, who said: "To the Gods the Soul belongs, but to man will belong the power of Life"? Will the future know a superior, Godlike race of humans—each a genius and each the masterful creation of an unerring formula—or will Soulless beings, shorn of the feelings which have bound mortals together in understanding, dominate the earth?

For centuries, man has dared to invade realms which theology has declared sacred. He has revealed the secret of organic functions and measured the forces of mind—*now*, breathlessly, he tears at the veil which conceals the nature of life itself. Will this be his crowning achievement—or his utter annihilation?

It is one of the greatest controversies of the day. Orthodox religion pronounces it a diabolical experiment—some schools of science declare it *possible* and *justifiable*.

This Free Book

You will find an answer to the creation of life in the ageless teachings of The Rosicrucians! From the archives of this ancient but active fraternal organization, you may obtain a *free* book telling of The Rosicrucians—their age-old observances and modern activities! You may learn of many experiments and how to use them for your own development and the progress of your loved ones. If sincere, you may be one of the few to share this astounding information. Send for your **FREE COPY** of the book, *The Mastery of Life*. Address: Scribe Y.V.Y.

USE THIS COUPON TODAY!

Address: Scribe Y.V.Y.
The Rosicrucians, San Jose, Calif.

I am sincerely interested in learning the new, strange facts taught by The Rosicrucians. Please send my copy of the book, *The Mastery of Life*.

Name _____

Address _____

The Rosicrucians are NOT a religious organization.

The ROSICRUCIANS

SAN JOSE

(AMORC)

CALIFORNIA, U.S.A.

WHAT Every AUTO MECHANIC Wants to Know

A motor vehicle is a machine of many parts, each part designed and constructed for its own special function.

All good mechanics, like good doctors, should know the working theory and operation of each part and understand what causes trouble and how to remedy it.

LET AUDELS AUTO GUIDE SOLVE YOUR PROBLEMS

Every auto mechanic, helper, serviceman and operator can use a copy of AUDELS AUTOMOBILE GUIDE. The information it gives saves time, money and worry. Highly indorsed by all users. It presents the whole subject of auto mechanics from A to Z in plain language and simple terms.

This Big Practical Book gives full information with working diagrams covering the principles, construction, ignition, service and repair of modern cars, trucks and buses.

A complete Guide of 1800 pages, with over 1500 illustrations showing inside views of the working parts, with instructions for service jobs. Diesel engines, Fluid and Hydra-matic drives fully explained.

IT PAYS TO KNOW HOW TO

How to fit pistons—How to locate engine knocks—How to fit connecting rod bearings—How to service main bearings—How to recondition valves—How to time valves—How to adjust fan belts—How to adjust carburetors & chokes—How to rebuild a clutch—How to service automatic transmissions—How to service brakes—How to adjust steering gear—How to cope with ignition troubles—How to service distributors—How to time ignition—How to "tune up" an engine.

INFORMATION IN A HANDY FORM

73 INTERESTING CHAPTERS—Read this partial list of subjects on which practical information is fully given for quick reference under the headings as shown below. Ready Reference Index.

All Parts of an Automobile—Automotive Physics—The Gas Engine—Gas Engine Principles—Multi-Cylinder Engines—Horse Power—Automobile Engines—Stationary Parts—Moving Parts—Pistons—Piston Rings—Connecting Rods—Crank Shafts—Valves—Valve Gear—Cams and Cam Action—Valve Timing—Cooling Systems—Fuel Feed Systems—Dual Fuel Feed—Mixture—Carburetors—Carburetor Service—Automatic Choke—Super-Chargers—Transmissions—Special Transmissions—Fluid and Hydra-matic Drives—Clutches—Universals and Propeller Shafts

A Ready Reference

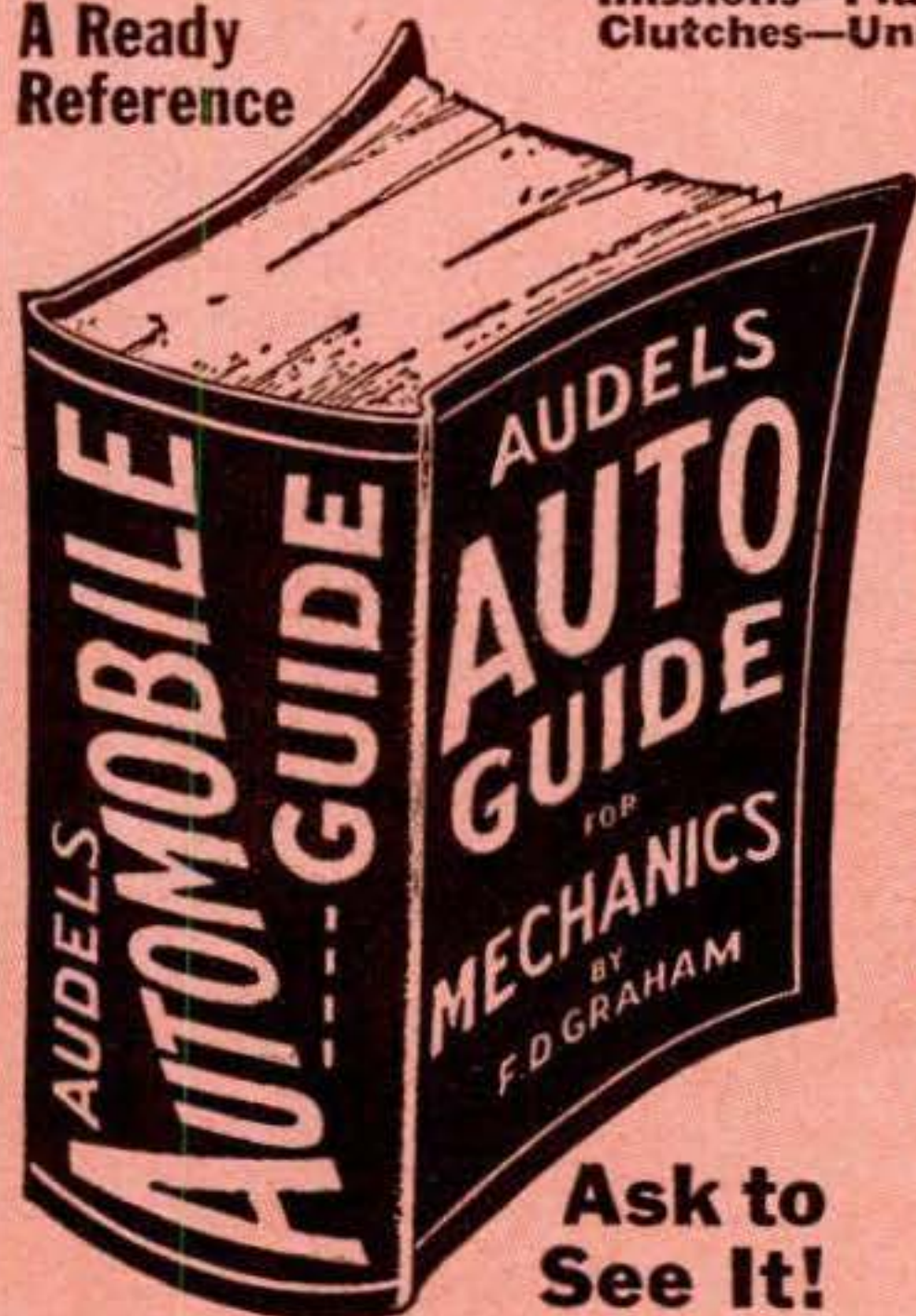

Ask to See It!

—The Differential—Rear Axles—Rear and Front Suspension—Running Gear—Brakes—Wheel Alignment—Knee Action—Steering Gear—Tires—Lubricants and Lubrication—Automotive Electricity—Ignition Systems—Magneto Ignition—Spark Plugs—Ignition Coils—Distributors—Automatic Spark Control—Ignition Timing—Generators—Starters—Generator and Starter Testing—Lighting Systems—Storage Batteries—Charging and Testing—Diesel Engines and Trouble Shooting.

7 DAYS' FREE TRIAL TO GET THIS ASSISTANCE FOR YOURSELF SIMPLY FILL IN AND MAIL COUPON TODAY.

\$ 4 COMPLETE PAY \$ 1 A ONLY 1 MO.

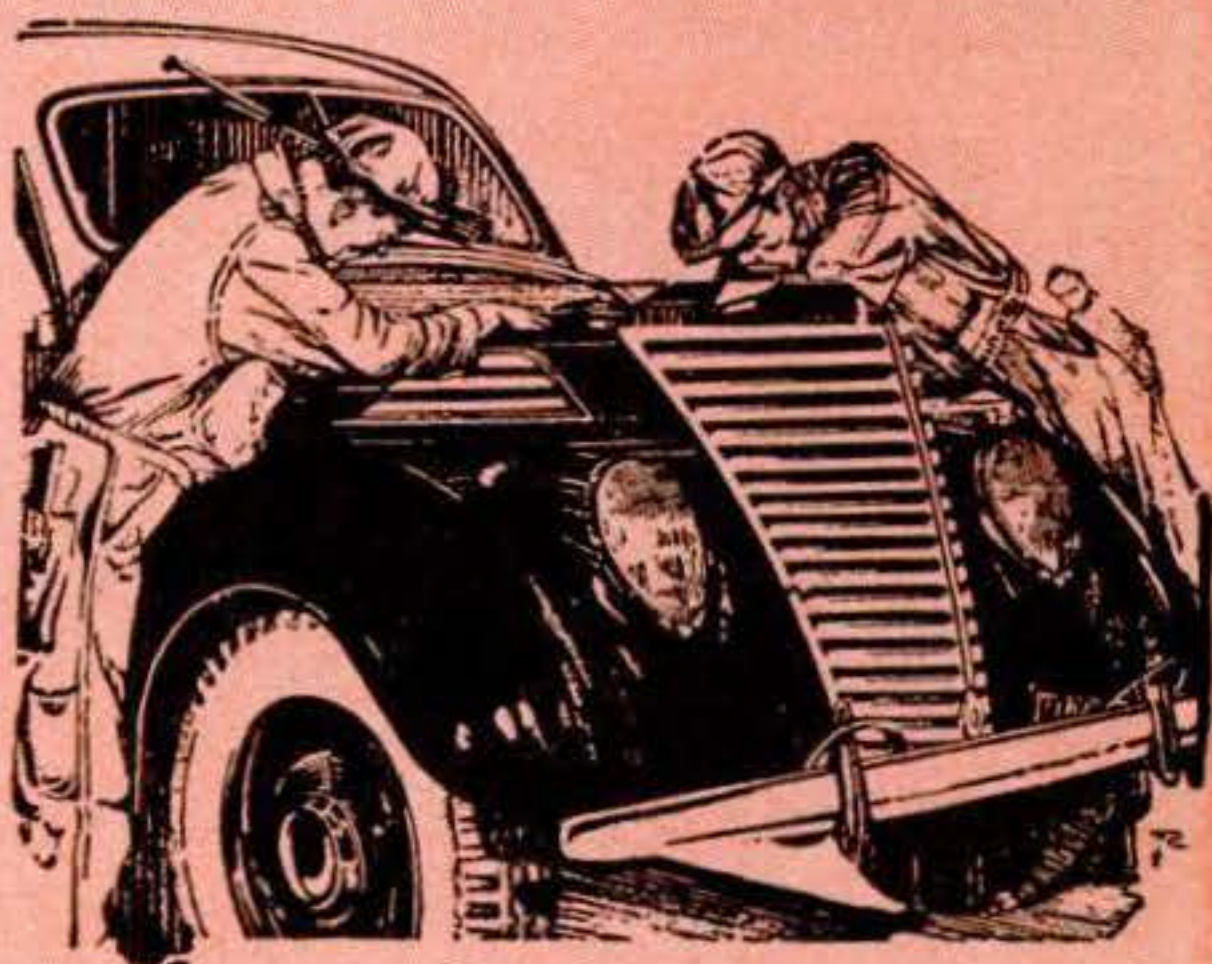

Sent on 7 Days Approval

Step up your own skill with the facts and figures of your trade. Audels Mechanics Guides contain Practical Inside Trade Information in a handy form. Fully illustrated and Easy to Understand. Highly Endorsed. Check the book you want for 7 DAYS FREE EXAMINATION. Send No Money. Nothing to pay postman.

CUT HERE MAIL ORDER

AUDEL, Publishers, 49 W. 23 St., NEW YORK 10, N. Y.

Please send me postpaid for FREE EXAMINATION books marked (x) below. If I decide to keep them I agree to mail \$1 in 7 Days on each book or set ordered and further mail \$1 monthly on each book or set until I have paid price, otherwise I will return them.

- TRUCK & TRACTOR GUIDE, 1299 Pages . . . \$ 4
- AUTOMOBILE MECHANICS GUIDE, 1800 Pages . . . 4
- DIESEL ENGINE MANUAL, 575 Pages . . . 2
- MACHINISTS HANDY BOOK, 1650 Pages . . . 4
- WELDERS GUIDE, 400 Pages . . . 1
- BLUE PRINT READING, 416 Pages . . . 2
- MATHEMATICS & CALCULATIONS, 700 Pages. . . 2
- SHEET METAL PATTERN LAYOUTS, 1100 Pages . . . 4
- SHEET METAL WORKERS HANDY BOOK, 388 Pgs. . . 1
- MECHANICAL DRAWING GUIDE, 160 Pages . . . 1
- MECHANICAL DRAWING & DESIGN, 480 Pages . . . 2
- AIRCRAFT WORKER, 240 Pages . . . 1
- TELEVISION SERVICE MANUAL, 384 Pages . . . 2
- RADIOMANS GUIDE, 914 Pages . . . 4
- ELECTRONIC DEVICES, 216 Pages . . . 2
- ELECTRIC MOTOR GUIDE, 1000 Pages . . . 4
- ELECTRIC WIRING DIAGRAMS, 272 Pages . . . 1
- ELECTRICIANS EXAMINATIONS, 250 Pages. . . 1
- ELECTRIC POWER CALCULATIONS, 425 Pages. . . 2
- HANDY BOOK OF ELECTRICITY, 1440 Pages. . . 4
- ELECTRIC DICTIONARY, 9000 Terms . . . 2
- ELECTRIC LIBRARY, 7000 Pages (12 Book Set) . . . 18
- MARINE ENGINEERS HANDY BOOK, 1258 Pgs. . . 4
- SHIPFITTERS HANDY BOOK, 250 Pages . . . 1
- REFRIGERATION & Air Conditioning, 1280 Pgs. . . 4
- MILLWRIGHTS & MECHANICS GUIDE, 1200 Pgs. . . 4
- POWER PLANT ENGINEERS GUIDE, 1500 Pages . . . 4
- ENGINEERS & FIREMANS EXAMS, 525 Pages . . . 1
- PUMPS, Hydraulics & Air Compressors, 1658 Pgs. . . 4
- ENGINEERS LIBRARY (3 Book Set) . . . 9
- MECHANICAL DICTIONARY, 950 Pages . . . 4
- GARDENERS & GROWERS GUIDES (4 Book Set) . . . 6
- CARPENTERS & BUILDERS GUIDES (4 Book Set) . . . 6
- PLUMBERS & Steamfitters Guides (4 Book Set) . . . 6
- MASONS AND BUILDERS GUIDES (4 Book Set) . . . 6
- PAINTERS & DECORATORS MANUAL, 450 Pgs. . . 2
- HOUSE HEATING GUIDE, 1000 Pages . . . 4
- OIL BURNER GUIDE, 384 Pages . . . 1

Name _____

Address _____

Occupation _____

Employed by _____

AUDEL, Publishers, 49 W. 23 St., New York 10, N.Y.

Letters



Reader Adds Own Tools

Sir:

I wonder if any home handyman agrees with the Government experts' list of the 36 basic tools a householder should have as given in your January 1951 number.

It seems to me that the most serious omissions were:

1. Hand drill and drills
2. Vise
3. Faucet seat dresser
4. Try square

To keep the list at 36, four of the following could be omitted, which although sometimes useful, are not used enough to make them considered basic: drawknife, gimlet, glass cutter, framing square, bucket, wash tub, funnel.

1. I use my hand drill more than any other tool except hammer, screwdriver, and pliers. The single gimlet listed is no feasible substitute.

2. A vise is surely a basic tool. If a bench vise is not convenient, a small vise that can be clamped to table or chair will serve most purposes.

3. Many faucets that need new washers have their seats roughened or nicked and unless smoothed will soon ruin the washer. Although seat dressers with several cutters can be purchased, many plumbers prefer to make their own out of a round emery sharpener for carving knives. They say they work better than the boughten kind. I have both kinds and use the cutter first and then the emery. To make the dresser, break the emery away from the center of the knife sharpener and cut the exposed center wire. This makes two dressers of different size which can be rotated by the hand drill.

4. A try square is more often used than a framing square.

H. M. MORLEY

Hollywood, Cal.

Rear-Door Lock

Sir:

I'm sure you will find our American car designers are as concerned about our children's safety as are the British. We don't need to *copy* the rear-door safety device of

Shavers Pick New "Gold Pack"

SCHICK INJECTOR

BLADES 5 TO 1*

Over All Others

Including Our Own Old Blades!

WORLD'S ONLY RAZOR THAT MAKES SUCH AMAZING RESULTS POSSIBLE

Now in this Complete Kit

- New Gold-Plated Razor
- 12 "Gold Pack" Blades
- New Handy Travel Case

ALL FOR ONLY

98¢



Only NEW 1951 SCHICK INJECTOR BLADES are ground to fit your injector razor *perfectly!* New surgical steel! Scalpel-sharp! So we guarantee this: EITHER YOU GET THE FINEST SHAVES OF YOUR LIFE—OR YOUR MONEY BACK, QUICK!

*HERE'S THE FULL SCORE!

on every point important to shaving!	
SMOOTHER SHAVES	5½ to 1
CLEANER SHAVES	5 to 1
SAFER SHAVES	7 to 1
FASTER SHAVES	5 to 1
MORE SHAVES per blade nearly	2 to 1

Men in 10 cities—nationwide—compared New 1951 Schick Injector Blades with whatever they had been using. About 80% of the men had a preference. Of these, the votes were in the ratios shown above.

©1951 Eversharp Inc., 350 Fifth Ave., N. Y. C.

SCHICK INJECTOR RAZOR & BLADES

World's Only Razor with Automatic Blade Changer

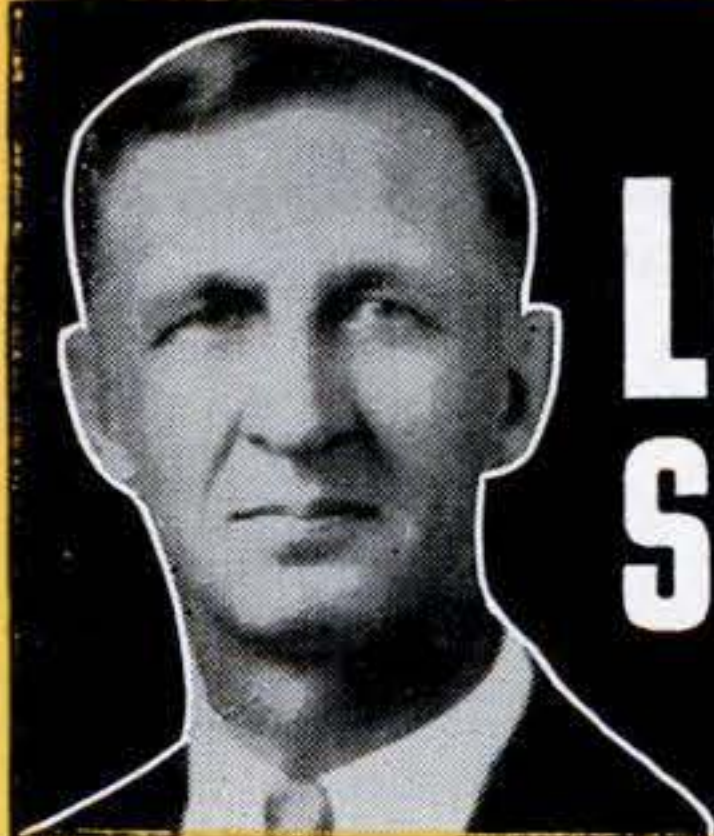

I Will Show You How to LEARN RADIO-TELEVISION SERVICING OR COMMUNICATIONS by Practicing in Spare Time



YOU PRACTICE RADIO SERVICING

You build the modern Radio shown below as part of my Servicing Course. I send you speaker, tubes, chassis, transformer, loop antenna, everything you see pictured and **EVERYTHING** you need to build this modern Radio Receiver. Use it to make many tests, get practical experience

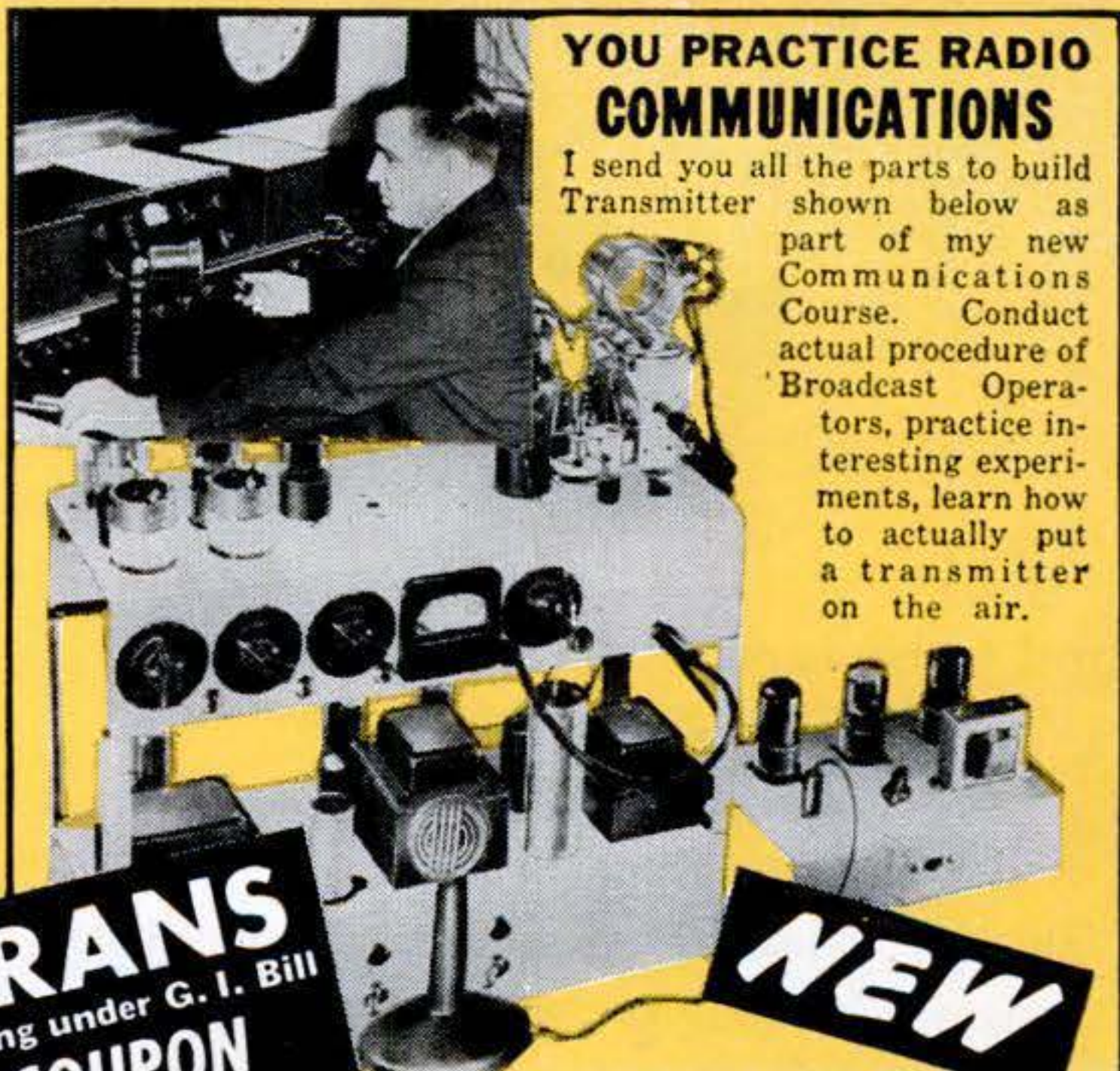

YOU PRACTICE RADIO COMMUNICATIONS

I send you all the parts to build Transmitter shown below as part of my new Communications Course. Conduct actual procedure of Broadcast Operators, practice interesting experiments, learn how to actually put a transmitter on the air.

VETERANS
Get this Training under G. I. Bill
MAIL COUPON

NEW

I TRAINED THESE MEN

"After graduating, worked for servicing shop. Now Chief Engineer of three Police Radio Stations."—S. W. DINWIDDIE, Jacksonville, Illinois.



"While learning, made \$5 to \$10 a week in spare time. Now have a profitable spare time shop."—L. ARNOLD, Pontiac, Mich.



"I accepted a position as Radio and Television Technician . . . was promoted to manager of Television Service and Installation."—L. HAUGER, San Bruno, California.



"Have my own shop. Am authorized serviceman for five manufacturers and do servicing for 7 dealers."—P. MILLER, Maumee, O.



"Four years ago, a bookkeeper on a hand-to-mouth salary, am now a Radio Engineer ABC network."—N. H. WARD, Ridgefield, Park, New Jersey



"When I enrolled, had no idea it would be so easy to learn. Have equipped my shop out of spare time earnings. I am clearing about \$46 to \$60 a month."—J. D. KNIGHT, Denison, Tex.



I Will Train You at Home with MANY KITS OF PARTS I SEND

Do you want good pay, a job with a bright future and security? Would you like a profitable shop of your own? The fast growing, prosperous RADIO-TELEVISION industry is making these opportunities for you. Radio alone is bigger than ever. 90 million home and auto Radios, 3100 Broadcasting Stations, expanding use of Aviation and Police Radio, Micro-Wave Relay, Two-Way Radio for buses, taxis, etc., are making opportunities for Servicing and Communications Technicians and FCC-Licensed Operators.

Television is TODAY'S Good Job Maker

In 1946 only 6,000 TV sets sold. In 1950 over 5,000,000. By 1954, 25,000,000 TV sets will be in use, according to estimates. Over 100 TV Stations are operating in 35 states. Authorities predict there will be 1,000 TV Stations. This means new jobs, more jobs, good pay for qualified men.

Many Soon Make \$10 A Week Extra in Spare Time

Keep your job while training at home. Hundreds I've trained are successful RADIO-TELEVISION TECHNICIANS. Learn Radio-Television principles from illustrated lessons. Get PRACTICAL EXPERIENCE experimenting with circuits common to Radio and Television. Many students make \$5, \$10 a week extra fixing neighbors' Radios in spare time. Special Booklets start teaching you the day you enroll.

Send Now for 2 Books FREE—Mail Coupon

Send for my FREE DOUBLE OFFER. Get actual Servicing lesson. Also get my 64-page book, "How to Be a Success in Radio-Television." Read what my graduates are doing, earning. Send coupon in envelope or paste on postal. J. E. SMITH, President, Dept. 1ER, National Radio Institute, Washington 9, D. C. OUR 38TH YEAR.

NOW! Advanced Television Practice

New, special TV kits furnished to build high-definition SCOPE . . . RF OSCILLATOR with fly-back power supply . . . complete TV set . . . many other units. You see pulse, trapezoidal, saw-tooth wave forms. Get valuable PRACTICAL EXPERIENCE locating and correcting TV troubles. Mail coupon for facts, pictures and prices!

**A TESTED WAY TO BETTER
PAY...MAIL COUPON NOW**

Good for Both—FREE

MR. J. E. SMITH, President, Dept. 1ER
National Radio Institute, Washington 9, D. C.
Mail me FREE Lesson and 64-page book.
(No salesman will call. Please write plainly.)

NAME.....AGE.....

ADDRESS.....

CITY.....ZONE.....STATE.....

Check if Veteran

Approved for Training Under G. I. Bill

The ABC's of
SERVICING

How to Be a
Success
in RADIO-
TELEVISION

SELF-CONTROL STARTS HERE



and to restore

CAR PERFORMANCE

OIL-CONTROL STARTS HERE

To stop oil-pumping, replace worn engine connecting rod bearings

A rubber band and a wad of paper can start real trouble—and so can worn engine bearings! Worn connecting rod and main bearings in your car engine mean disappointing performance—sluggish pick-up in traffic...lack of power on the road. *Worn engine bearings cause oil pumping!* You can't expect new piston rings to correct oil pumping when it starts at the bearings. Give new rings a chance to do their own job—replace worn engine bearings, too. Ask for genuine Federal-Mogul bearings—your mechanic knows they're *engineered* for the job of oil control!

FEDERAL-MOGUL SERVICE

(Division of Federal-Mogul Corporation)

DETROIT 13, MICHIGAN



CONTROL OIL-PUMPING

WHERE IT STARTS—REPLACE WITH

FEDERAL-MOGUL

OIL CONTROL BEARINGS

the Jaguar—we have had it for some time.

For example: To quote from the Chevrolet Shop Manual, "On the rear doors of sedans the door lock incorporates a means of shifting the remote-control link lever to provide free-wheeling or positive action on the remote control handles at the option of the owner."

ROBERT E. WILENSKY

Savannah, Ga.

Yes, but the change takes tools, time, and patience and, once made, is more or less permanent. You can't change quickly and easily from one to the other the way you can with the Jaguar's push-button arrangement.

TV Chimney Sweeps?

Sir:

In "The Best Ways to Mount TV Antennas" (Jan. '51, p. 169) you say: "Chimneys are convenient things to put antennas on." It's been my experience that the smoke and soot from a chimney collects on the antenna in the form of carbon. Carbon acts as a resistance on both the antenna and its connections and weakens reception. . . .

MERLE W. WYNN

Pittsfield, Mass.

Moisture and other chemicals in the air cause corrosion that worries TV installers even more. However, Mr. Wynn is correct in stating that soot is a problem. Carl Quirk, technical chief of Du Mont's Teleset Service division reports:

"Certain precautions should be observed in making chimney installations, particularly in weak-signal areas. If soot and grime are deposited at the point where the transmission line joins the antenna, it is possible that signal strength may be reduced because of poor electrical contact. This can be prevented by coating the contacts with a rubber-base sealer. Wherever possible the contact strip should be turned so it is not directly over the chimney opening.

"It's also a good idea to clean the contacts in the spring."

Oversize Bore

Sir:

On page 196 of the February issue, the illustration on the engine number that is followed by a dash to indicate .010" oversize cylinders and pistons appears to me to be a

THESE MEN ARE GETTING PRACTICAL TRAINING IN **ELECTRICITY**

On Real:

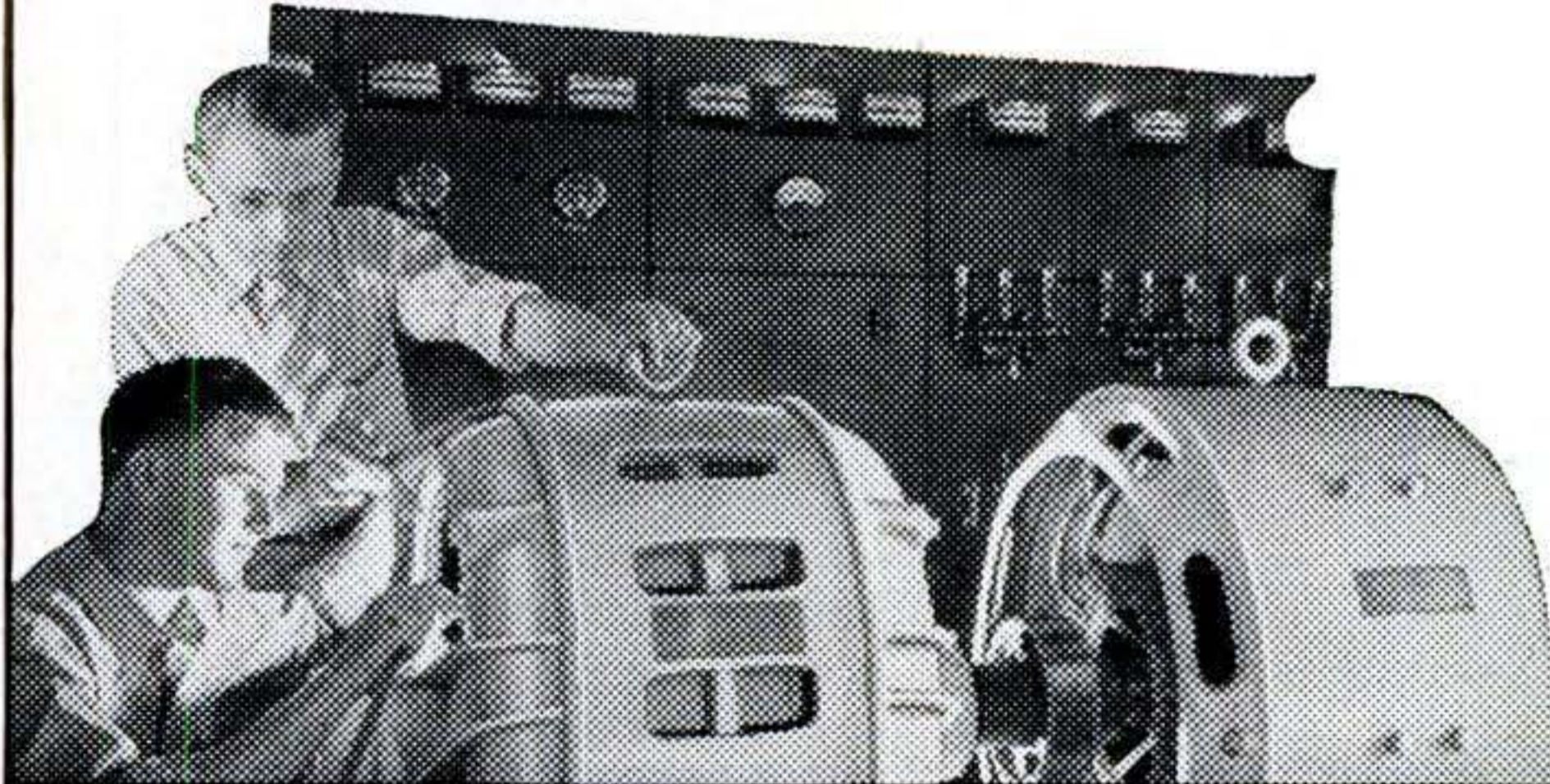

**A.C. and D.C. MOTORS
GENERATORS
SWITCHBOARDS
CONTROLLERS
WIRING JOBS
APPLIANCES
ELECTRONIC UNITS**

(Shown at left—Instructor explaining operation and testing of a large Motor Generator in our A.C. Department.)

AND **TELEVISION-RADIO**

On Real:

**TELEVISION SETS
RADIO RECEIVERS
F.M.
(Frequency Modulation)
RECORD CHANGERS
AUTO RADIOS
PUBLIC ADDRESS Systems**

(Right—Instructor helping students check the wiring and trace circuits of television receivers.)



TRAIN QUICKLY in the Great Shops of COYNE for VITAL FIELDS

ELECTRICITY—RADIO—TELEVISION—VITAL in defense program. Trained men whether 16 or up to 50 needed. TRAIN QUICKLY for better rating if drafted—Vital job in industry if not.

FINANCE PLAN for non-veterans. G.I. Approved. Special plan for men of draft age.

NOT "HOME-STUDY" COURSES! At Coyne you learn on real, full-size equipment. Trained instructors show you how, then you do typical jobs yourself. We don't teach by mail.

CLIP COUPON NOW for big new illustrated Coyne book. Check whether interested in ELECTRICITY or TELEVISION-RADIO or both. No obligation; no salesman will call. Get vital facts now!

COYNE **B. W. COOKE, Pres.**
ELECTRICAL & TELEVISION-RADIO SCHOOL
An Institution not for Profit.
500 S. Paulina St., Dept. 51-73H
Chicago 12, Illinois



**Mail Coupon for
BIG FREE BOOK!**

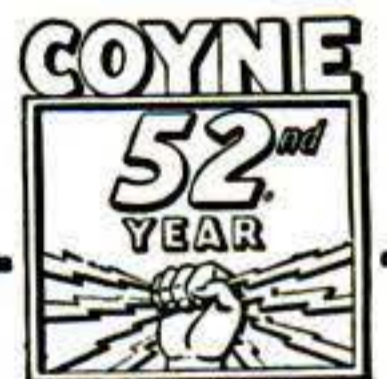

B. W. COOKE, President
COYNE ELECTRICAL & TELEVISION-RADIO SCHOOL
500 S. Paulina St., Chicago 12, Ill. Dept 51-73H

Send BIG FREE book and details of your training offer. This does not obligate me and no salesman will call. I am interested in:

ELECTRICITY TELEVISION-RADIO

NAME

ADDRESS.....

CITY.....STATE.....

ANOTHER FIRST... FOR RENAULT '51

Renault de-luxe stock sedan captures first place in International Grand Prix.

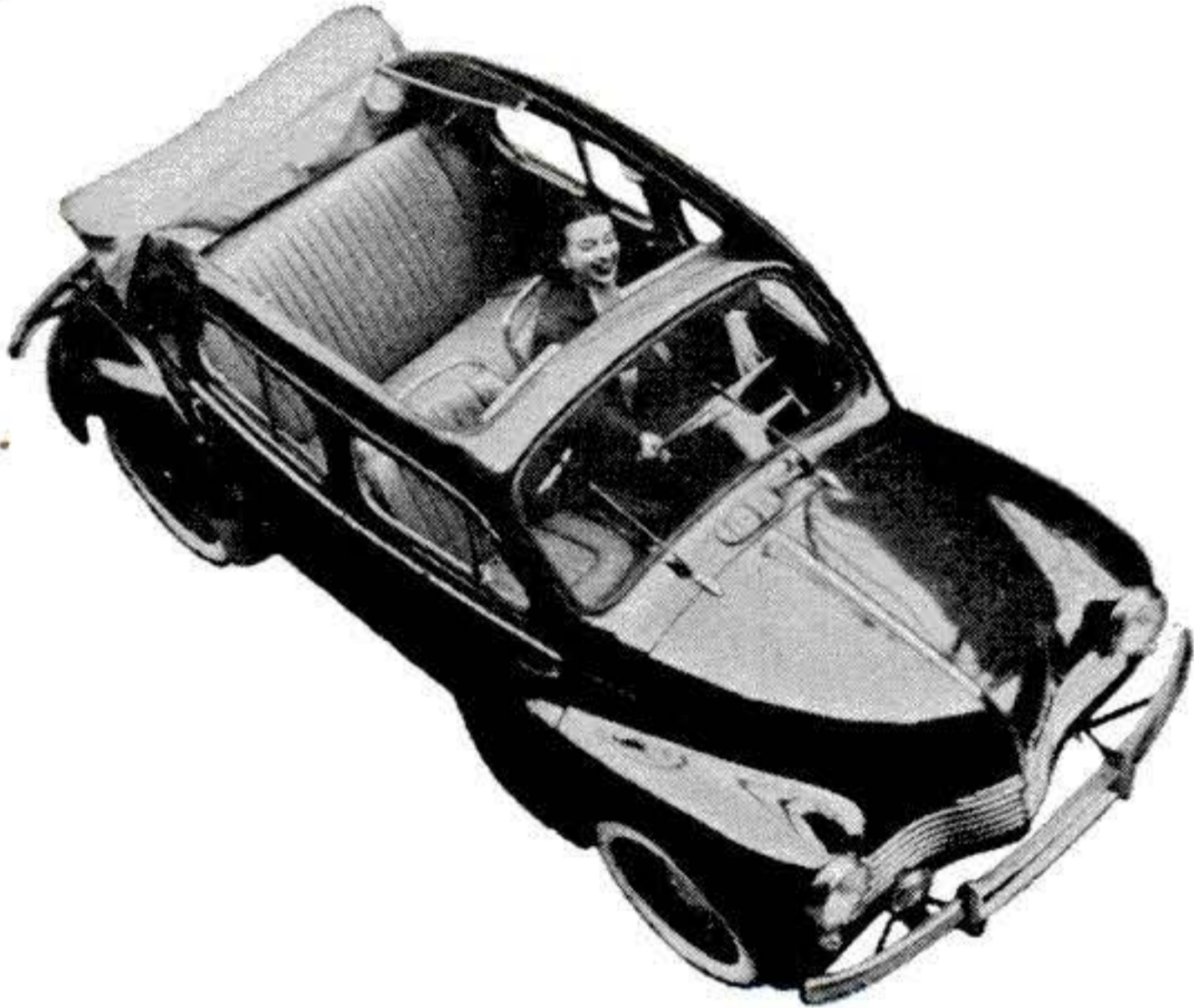

Motorists the world over, know the gruelling hazards of the International Grand Prix held annually over a closed course including every type of road, at Le Mans, France. Driving continuously for 24 hours, two non-professionals brought the Renault '51 de-luxe four passenger stock sedan first across the finish line to achieve a magnificent victory in the 1100 C. C. class.

This new Renault '51 is the only foreign car built especially for American roads. Before it was placed in production in Europe's largest automotive works, at Billancourt, France, it was tested and re-tested by crews of engineers over every kind of American road—and at every temperature from Maine's 20° below to Imperial Valley's 120° above zero.

With the engine in the rear (where it should be) this newest Renault travels 45-50 miles to the gallon. Only two quarts of oil fills the crankcase. Roll-down windows and improved wind deflectors provide ample no-draft ventilation. Its carburetor has been improved. Monocoque welded steel body construction provides greater safety and eliminates squeaks and rattles, while independent four wheel springing makes even the longest drive a pleasure.

Get behind the wheel of the new Renault '51 sedan and you will soon see why it won the International Grand Prix! An authorized Renault dealer near you—with factory service and ample spare parts . . . is waiting to give you the ride of your life in the Renault '51!

It's Smart... It's Thrifty... It's French!

4 door-Sedan Only \$1195 delivered at eight ports of entry including duty & federal excise tax

RENAULT

RENAULT SELLING BRANCH Inc.

270 Park Avenue New York 17, N. Y.
Service—239 West 66th Street. Tel. Trafalgar 7-4500

14 POPULAR SCIENCE

Buick. Whether or not this is so, I think you will find the practice limited to very few motor manufacturers, both as to the uniform .010" oversize and as to the dash.

LEE F. BERNHARDT

Fort Wayne, Ind.

The practice of finishing bores oversize is widespread throughout the auto industry, but you're right in that the amount and method of marking may vary with different manufacturers. The car PS pictured was a Buick.

Sounds Fishy, but True

Sir:

In the February issue of POPULAR SCIENCE (p. 170) you offered the suggestion of floating a board on the water in an aquarium to keep from disturbing the plants when new water is added. We feel there is an oversight made in your article. The board should be well cured in water for at least three months before using. New wood is definitely poison to tropical fish. Wood may be artificially cured in a few days by slaking a large piece of lime in water and soaking the board in it for five days. Rinse well and the board is ready for use.

TRABERT'S AQUARIUM

Columbus, Ohio

Uncured wood might prove harmful if left in the tank for a long time, but if removed immediately after filling could not possibly hurt the fish. Plywood, however, should definitely not be used.

Reader Saves Money

Sir:

May I compliment you on your book? I recently saved \$10 erecting my television aerial through your instructions ["The Best Ways to Mount TV Antennas," PS, Jan. '51, p. 169].

EVERET J. WATAHA

Linden, N. J.

Next month PS will tell you how to build a television booster.

Car Used, So Is Advice

Sir:

I am a regular reader of POPULAR SCIENCE because it gives me many helpful ideas. The

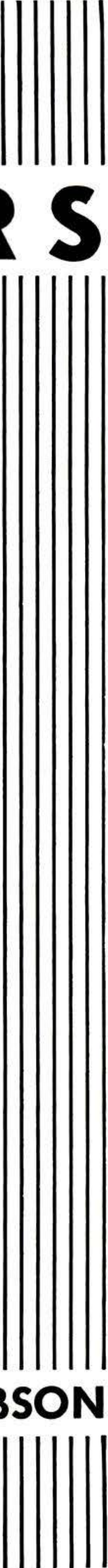

INVENTORS

Learn how to protect your invention. The U. S. Patent Laws provide that any new and useful art, machine, article of manufacture, or composition of matter, or any new and useful improvement thereof, may be patented if the act of invention is involved. Therefore, every inventor with a valuable invention should take advantage of the Patent Laws and proceed for patent protection in order to safeguard his rights.

A patent gives the inventor the exclusive right to prevent others from making, using, or selling the invention claimed in the patent for a period of seventeen years.

The Patent Laws were enacted for the benefit of the inventor to give him protection for the features of his invention which are patentable. These features must be properly and concisely set forth and claimed in a formal application for patent, in order to comply with the requirements of the Patent Laws. For that reason, unless the inventor is familiar with patent matters, he should engage a competent registered patent attorney or agent to represent him. We are registered to practice before the U. S. Patent Office and are prepared to serve you in the handling of your patent matters.

A specially prepared booklet entitled "Patent Guide for the Inventor", containing detailed information with respect to patent protection and procedure, together with a "Record of Invention" form will be promptly forwarded to you without obligation upon request.

CLARENCE A. O'BRIEN & HARVEY JACOBSON

Registered Patent Attorneys

12 - E DISTRICT NATIONAL BUILDING

WASHINGTON 5, D. C.

MAY 1951 15



...with these
Wizards with Wood

Mending something that needs gluing? Making something that needs finishing? If it's made of wood, ask for Firzite, Satinlac and Weldwood Glue at hardware, paint and lumber dealers—or mail coupon for leaflets.

Glue That's Stronger than Wood



To make things or fix things, use Weldwood Glue for all wood-to-wood bonds. Makes joints stronger than the wood itself. Mixes easily with water. Stain-free, rot-proof...highly water-resistant!

WELDWOOD[®]
PLASTIC RESIN GLUE

A MUST for Finishing Fir Plywood



Tame that wild grain with FIRZITE. Virtually prevents grain raise or checking...readies the surface satin-smooth for paint, stain or enamel. (For blond, pickled, or tinted effects on soft or hard woods, use White Firzite).

FIRZITE*

Newer than Shellac or Varnish



Pints, Quarts,
Gallons

For "natural wood" finishes on furniture, panelling or woodwork, there's nothing like Satinlac. Brings out natural grain and color beauty of any plywood or solid wood. Avoids that "built-up" look; will not turn yellow or darken with age. "Water-clear," easy to brush or spray, dries ready for next coat in 2 or 3 hours.

SATINLAC*

*Trade Marks

United States Plywood Corporation,
Dept. 253, 55 West 44th St., New York 18, N. Y.
Send me free leaflets on Weldwood Glue, Firzite
and Satinlac.

NAME _____

ADDRESS _____

main reason why I am sending you this letter is to ask you to reprint a very helpful suggestion which you printed in your April edition in 1950. It was, "How to Buy a Used Car," and it was the most important thing in buying my secondhand car. With your advice I got my money's worth dollar for dollar, instead of a lemon.

Right now many of my friends are asking me for the magazine but I lost it somewhere, so if you would be kind enough to reprint it, my friends will be overjoyed.

R. C. JACKSON

Trenton, N. J.

The article is available at most libraries, or a copy of the issue in which it was published can be obtained from the Popular Science Circulation Department.

A Warning on Sodium Valves

Sir:

Your February 1951 issue contains an article titled "Homemade Tools from Old Auto Valves" (page 193).

Under "Hole Saw" the author suggests using a valve from an airplane or boat. If someone were to get a valve from an airplane engine, he might get a sodium-filled exhaust valve, and according to instructions I received while in our Army Air Force during the last war, cutting into these valves is extremely hazardous, due to the sodium contained in them.

WM. HATFIELD

Jersey City, N. J.

PS should have cautioned readers against cutting into sodium-cooled valves, which are widely used in aircraft engines, and to a lesser but increasing extent in large truck engines. Such valves, usually identifiable by an "S" stamped on the top, contain pure sodium that ignites on contact with air. The stem should not be sawed, and cracked sodium valves should be buried for safety.

Keeps Tabs on PS

Sir:

On each issue of my POPULAR SCIENCE, I paste a tab on which I note articles I might want to refer to later... You'd be surprised how often I refer to these tabs for certain information.

SAM E. PATTERSON

Norfolk, Va.

INVENTORS

If you believe that you have an invention, you should find out how to protect it. The first step is to have a search made of the prior pertinent U. S. patents. If a report on this search indicates that the invention appears patentable you can apply for a patent, and the specifications and claims should be prepared.

The firm of McMorrow, Berman & Davidson, with offices in Washington, D. C., is qualified to take the necessary steps for you. We can make a preliminary search on your invention, advise you whether we think it can be patented, and prepare your application for patent.

Unless you are fully familiar with the U. S. Patent Laws, we recommend that you engage the services of a Registered Patent Attorney to protect your interests. The patent laws are *your* laws. A patent gives you the right to prevent others from making, using or selling the invention claimed in your patent for a period of 17 years.

Use these patent laws for your protection. Investigate whether your invention can be patented. If you have what you believe to be an invention, we suggest that you have this firm make a search for you.

Send for a copy of our Patent Booklet entitled "How To Protect Your Invention," containing information about patent protection and patent procedure. Along with this we will also send you an "Invention Record" form, for your use in writing down and sketching details of your invention. We will mail them promptly. No obligation. They are yours for the asking.

McMORROW, BERMAN & DAVIDSON

Registered Patent Attorneys

PATENTS • COPYRIGHTS • PATENTS

142-S VICTOR BUILDING, WASHINGTON 1, D. C.

How to paint a room in 1/2 the time—

WITH

SPRED SATIN
 THE WONDER PAINT

You can apply it in half the time with brush or roller. Dries in 20 minutes to a gorgeous satin finish.

- ★ Covers most surfaces
- ★ Shows no laps or brushmarks
- ★ Washes perfectly, over and over
- ★ Has no offensive odor
- ★ New deep colors, ready-mixed

The secret of this amazing paint is its exclusive *synthetic rubber emulsion* formula. The rubber film forms a tight, durable surface that dirt cannot penetrate. See your Glidden dealer today.

Send for
decorating
kit today

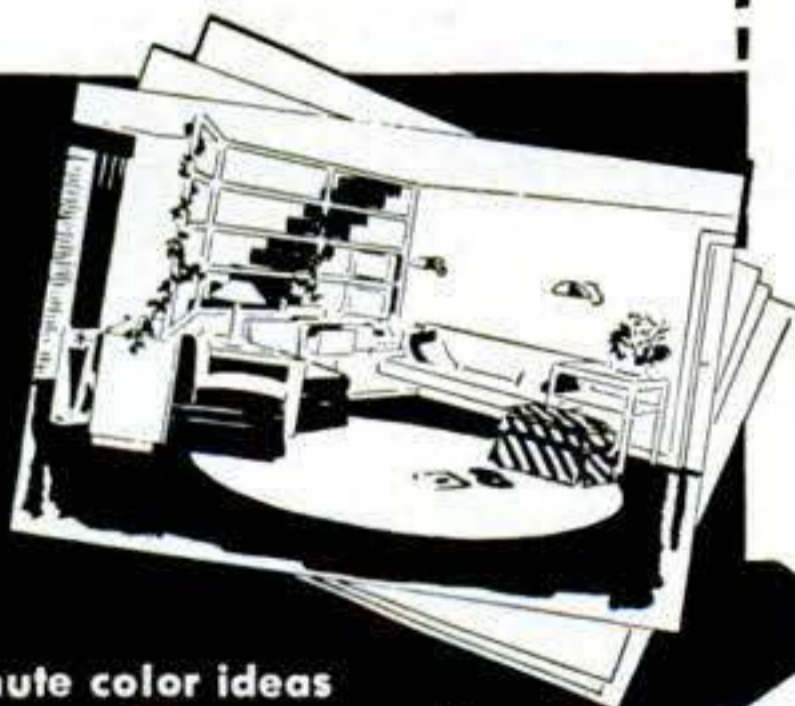

Up-to-the-minute color ideas
you can easily carry out in your own home!
Floor plans and color reproductions for 7
rooms. Practical, made-to-order
for planning home improve-
ment. Send 10 cents
(coin).

Dept. PS-5
The Glidden Co.
Cleveland 2, Ohio

Please send me your decorating kit. I enclose 10 cents (coin).
Tell me where I can buy Spred SATIN.

Name _____
 Address _____
 City _____ State _____

Stucco Spraying Can Be Your Opportunity



You can build a profitable, lifetime business with Colorcrete. Large waiting market. Work is easy and interesting. Moderate investment; high return. Large waiting market. Full instructions and liberal co-operation.

Sprayed-On Beauty

Colorcrete is modern beauty treatment for masonry surfaces—exterior and interior. Fuses to concrete, stucco, etc. Applied by air pressure. Range of many smart colors. Proven by 20 years of use on all kinds of buildings.

Write or wire for
Opportunity
Book.

COLORCRETE
INDUSTRIES, INC.
572 Ottawa Ave.,
Holland, Mich.



OUT OF PAWN

**SAVE UP TO
50%
AND MORE**

GENUINE DIAMONDS

Approx. 1/2 Carat
\$95 Tax Incl. \$200 Value

SAVE ON DIAMONDS FROM ESTATES, BANKS AND UNREDEEMED PLEDGES

MONEY
BACK GUARANTEE

All diamonds reset in
brand new modern mount-
ings. Values from \$10.00
to \$10,000.

**SEND FOR
FREE
ILLUSTRATED
Catalog**

Our Ref-
Your own bank
or any mercan-
tile agency.

BERMAN'S DIAMOND LOAN BANK
DEPT. PS-BERMAN BLDG., BALTO. 1, MD.



HYPNOTIZE

Yes. Anyone. Mystify Friends. Authentic fascinating hypnotic feminine photos show you precise spellbinding methods. Instructions reveal how easily speed hypnosis is accomplished. Self-hypnosis fully explained. Amazing results. Learn about amazing, newly developed method of mental therapy, mind-power & training while you sleep. Free catalog of hypnotism books sent on request.

Send for the exciting illustrated book "HYPNOTISM REVEALED" → \$1
 12" Phonograph Record Inducing Group-Hypnotism & Self-Hypnosis → \$5

MELVIN POWERS, Professional Hypnotist, 1324 Wilshire, Dept. 79, Hollywood 17, Calif.

A FASCINATING, MONEY-MAKING
art career
can be yours

AMERICA'S 12 MOST FAMOUS
ARTISTS SHOW YOU HOW!



Write Today
FAMOUS ARTISTS COURSE

Dept. 11-S, Westport, Conn.

FREE Send book about your home study art course.

Name _____ Age _____
 Street _____
 City, State, Zone Number _____

**NOW . . . GET EVERYTHING YOU
NEED TO LEARN AND MASTER**

TELEVISION

**RADIO-ELECTRONICS
...AT HOME!**

**Use REAL commercial-type equip-
ment to get practical experience**

Your future deserves and needs every advantage you can give it! That's why you owe it to yourself to find out about one of the most COMPLETE, practical and effective ways now available to prepare AT HOME for America's billion dollar opportunity field of TELEVISION-RADIO-ELECTRONICS. See how you may get and keep the same type of basic training equipment used in one of the nation's finest training laboratories . . . how you may get real STARTING HELP toward a good job or your own business in Television-Radio-Electronics. Mail the coupon today for complete facts — including 89 ways to earn money in this thrilling, newer field.



**Here's the
REAL THING!**

SET UP YOUR OWN HOME LABORATORY



Oscilloscope

R-F Signal
Generator

6-Tube
Radio

Multimeter

**HOME
MOVIES**

ABOVE: Build and keep a real 16 INCH commercial TV receiver. Optional after completing regular training at slight additional cost.

D.T.I., ALONE, INCLUDES BOTH MOVIES and HOME LABORATORY In addition to easy-to-read lessons, you get the use of HOME MOVIES — an outstanding training advantage — plus 16 big shipments of Electronic parts. Perform over 300 fascinating experiments for practical experience. Build and keep real commercial-type test equipment shown at left.

MODERN LABORATORIES

If you prefer, get all your preparation in our new Chicago Training Laboratories—one of the finest of its kind. Ample instructors, modern equipment. Write for details!

MILITARY SERVICE!

If you're subject to military service, the information we have for you should prove doubly interesting. Mail coupon today.

**Get BOTH of these
information packed
publications FREE!**



ACT NOW! MAIL COUPON TODAY!

DeFOREST'S TRAINING, INC., Dept. PS-5-H
2533 N. Ashland Ave., Chicago 14, Ill.

Without obligation, I would like your late News-Bulletin showing 89 ways to earn money in Television-Radio-Electronics . . . and how I may prepare to get started in this thrilling field.

Name _____ Age _____
Street _____ Apt. _____
City _____ Zone _____ State _____

De FOREST'S TRAINING, INC.
CHICAGO 14, ILLINOIS
A De VRY INSTITUTION

Using too much oil?



CHANGE OVER TO
PENNZOIL
Tough-Film PENNSYLVANIA OIL

SOUND YOUR Z



If you're paying 40¢ or more a quart for motor oil you're entitled to Pennzoil Quality...
INSIST ON PENNZOIL!



PENNZOIL MOTOR OIL AND LUBRICANTS

AT BETTER DEALERS... COAST TO COAST

Member Penn. Grade Crude Oil Assn., Permit No. 2

SPEED & POWER HANDBOOK for all cars



128 Page Library Edition Over 300 Illustrations

Direct from the California dry lake testing grounds . . . comes authentic, proven information on how to get lightning speed, super power and better mileage from any car! Illustrations and construction drawings show how to build fast stock cars, California Roadsters and 225 M.P.H. Hot Rods.

Easy, Step By Step Methods help you save by building your own dual manifolds, superchargers, hot cams, water injectors, high compression heads and mileage devices.

50 BREATH TAKING CHAPTERS TELL ABOUT: Turning techniques, Speed tricks, Economy secrets, Ingenious formulas for attaining racing speed and dynamic power. Includes information on: Racing Frames, Reciprocating Masses, Jet Engines, Wheel Geometry, Dynamometers, Also Re-styling and Customizing all cars. Learn about dual pipes, gears, fuels, porting, relieving, lowering and balancing.

THIS GREAT NEW BOOK... PLUS "1951 SPEED EQUIPMENT CATALOG," PLUS "WATER INJECTION," PLUS "150 M.P.G. BOOK"—ALL 4 ITEMS **\$1.98** post paid



150 MILES PER GALLON WITH YOUR OWN CAR

Full sized modern cars actually get over 100 miles per gallon with regular gas. This sensational book tells you how and suggests amazing economy methods. Send only 50c for book. "How to obtain 150 M.P.G." . . . plus our big 1951 Speed Equipment **BOTH BOOKS** catalog listing and picturing **50c** Post-paid hundreds of automotive items.

NEWHOUSE AUTOMOTIVE INDUSTRIES, Dept. A 5807 East Beverly Blvd. Los Angeles 22, Calif.

BRAND NEW



30 DAY FREE TRIAL

High Power BINOCULARS

Finest Precision Optics Featherlight

Money Back Guarantee

Easy Pay Plan

Leather Case Incl'd.

Free! Catalog & Book

"How to Select Binoculars"

Dealer Inquiries Invited

33 MODELS \$14.95 up

BUSHNELL Binoculars

Bushnell Bldg., Dept. P25 Pasadena 1, Calif.

STUDY AT HOME

WITH AN EDUCATIONAL INSTITUTION

Courses in **ENGINEERING**: Electrical, Civil, Mechanical, Drafting, Architectural, Automotive, Steam, Diesel, Aeronautical, Radio, Structural, Mining, Industrial, Petroleum, Marine, Refrigeration, Air Conditioning, Chemical.

Courses in **ARTS AND SCIENCES**: Philosophy; Education; Letters; Public Health; Medical Jurisprudence; Psychology; Sociology; Physics; Chemistry; Geology; Pol. Science; Theology; Law; Business and Commerce; Accounting; Mathematics; Statistics; Agriculture. Send for free catalog.

McKinley-Roosevelt Incorporated, 4610-A3, Sheridan Rd., Chicago 40, Illinois



MODEL BUILDERS!

NEW 1951 CATALOG

MODEL AIRPLANE ENGINES • GLOW

PLUGS • MARINE ENGINES • FUELS

MODEL RACERS • ACCESSORIES

CUT OUT AND MAIL TODAY

OHLSSON & RICE, INC. 3340 Emery St., Los Angeles 23, California

Please RUSH _____ copies of the NEW 1951 O&R Catalog at 15c each for which I am enclosing _____ in stamps or coins to cover handling and mailing.

Name _____

Address _____

City _____

Zone _____

State _____



Learn RADIO

TELEVISION, ELECTRONICS

by

SHOP METHOD HOME TRAINING

Let NATIONAL SCHOOLS, of Los Angeles, a practical Technical Resident Trade School for almost 50 years, train you for today's unlimited opportunities.

You receive all parts, including tubes, for building this fine, modern Superheterodyne Receiver. This and other valuable standard equipment becomes your property.

these two FREE books will tell you how



WE BRING NATIONAL SCHOOLS TO YOU!

GOOD JOBS AWAIT THE TRAINED RADIO TECHNICIAN

You are needed in the great modern Radio, Television and Electronics industry! Trained technicians are in constant and growing demand at excellent pay—in Broadcasting, Communications, Television, Radar, Research Laboratories, Home Radio Service, etc. National Schools Master Shop Method Home Study Course, with newly added lessons and equipment, can train you in your spare time, *right in your own home*, for these exciting opportunities. Our method has been proved by the remarkable success of National Schools-trained men all over the world.

You Learn by Building Equipment with Standard Radio Parts We Send You

Your National Schools Course includes not only basic theory, but *practical* training as well—you learn by doing. We send you complete standard equipment of professional quality for building various experimental and test units. You advance step by step until you are able to build the modern superheterodyne receiver shown above, which is yours to keep and enjoy. You perform more than 100 experiments—build many types of circuits, signal generator, low power radio transmitter, audio oscillator, and other units. The Free Books shown above tell you more about it—send for them today!

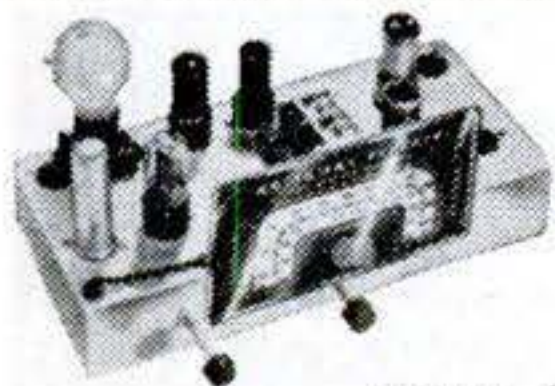

NOW! NEW PROFESSIONAL MULTITESTER INCLUDED

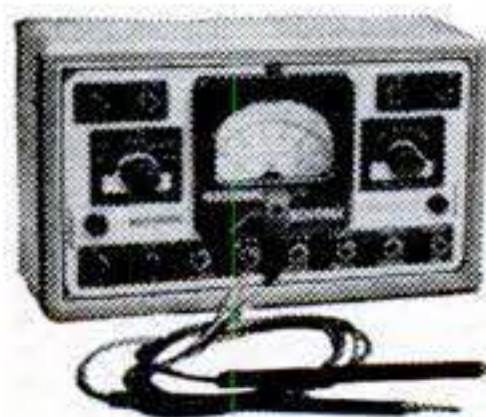

This versatile testing instrument is portable and complete with test leads. Simple to operate, accurate and dependable. You will be able to quickly locate trouble and adjust the most delicate circuits. You can use the Multitester at home or on service calls. It is designed to measure AC and DC volts, current resistance and decibels. You will be proud to own and use this valuable professional instrument.

GET THE DETAILS - SEND THE COUPON →

Lessons and Instruction Material Are Up-to-date, Practical, Interesting

National Schools Master Shop Method Home Training gives you basic and advanced instruction in all phases of Radio, Television and Electronics. Each lesson is made easy to understand by numerous illustrations and diagrams. All instruction material has been developed and tested in our own shops and laboratories, under the supervision of our own engineers and instructors. A free sample lesson is yours upon request—use the coupon below.

TELEVISION TRAINING

A complete series of up-to-the-minute Television lessons is an integral part of your course, covering all phases of Television repairing, servicing and construction.

Here are just a few of the interesting facts you learn with the

FREE SAMPLE LESSON

1. How radio receivers operate.
2. How the antenna circuit is constructed.
3. Converting signal currents into sound.
4. How the R-F transformer handles the signal.
5. How the tuning circuit functions.
6. The Radio "bands."

APPROVED FOR VETERANS
Check coupon below.

NATIONAL SCHOOLS

LOS ANGELES 37, CALIFORNIA EST. 1905



MAIL OPPORTUNITY COUPON FOR QUICK ACTION

National Schools, Dept. 5-PS
4000 South Figueroa Street
Los Angeles 37, California

(Mail in envelope or paste on penny postcard.)

Mail me FREE the book "Your Future in Radio-Television" and the sample lesson of your course. I understand no salesman will call on me.

NAME _____ AGE _____

ADDRESS _____

CITY _____ ZONE _____ STATE _____

Check here if veteran of World War II

INVENTORS

If you consider your invention to be something of importance — if you have invented any new and useful art, machine, manufacture or composition of matter or improvement thereof — you are advised to protect your invention by applying for a U. S. patent.

This firm is registered to practice before the U. S. Patent Office and is available to assist in the preparation and prosecution of your patent application.

The "Evidence of Invention" form mentioned below is offered as a convenience to you in making your disclosure to us for search purposes.

You should date and sign your disclosure and have it witnessed by two or more persons who are capable of understanding your invention.

Your disclosure should be mailed to us together with a letter authorizing us to conduct a preliminary search among previously granted U. S. patents for similar types of invention.

We then make this search and prepare a report of the probable patentability of your invention. If such report is favorable, we recommend the further course for you to take.

The "Evidence of Invention" form and booklet are suggested as conveniences to you and us in starting action on your invention.

VICTOR J. EVANS & Co. *Merlin M. Evans*
REGISTERED PATENT ATTORNEY

640-E MERLIN BUILDING, WASHINGTON 6, D. C.

PATENTS

COPYRIGHTS

We shall be glad to send you promptly and without obligation, an instructive booklet, "Patent Protection for Inventors", which was prepared to give inventors detailed information and steps to take toward patent protection—also our convenient "Evidence of Invention" form. Use address Victor J. Evans & Co., 640-E Merlin Building, Washington 6, D. C.



GIANT BALLOONS

U. S. Govt. Surplus Genuine Neoprene. Used by Govt. for weather & Target Balloons. Loads of fun for yards, pools, gym, parties. Wonderful for Advertising; Attracts immediate attention.

Pride of The Jet Jockeys U.S.A.F. STYLE BLUE LENS ZOOM GLASSES

Quality sunglasses, ground & polished for perfection. Protects vision. Reduces harmful glare. Lens life-time guaranteed. With protective case. Regular \$7.50 value.



\$2.79



TARGET PISTOL ARMY STYLE

Revolutionary new sports pistol. Looks, handles like Army .45. Extremely accurate. Fires B-B's & darts, air powered. Not a toy. With pellets and darts.

Guaranteed 1 Yr.

FREE CATALOGUE

Dept. Postage paid on prepaid orders

S-551 WAR ASSETS DIV

VOLUME SALES CO.

3828 Sunset Blvd., Los Angeles 26, Calif.

MAKE \$5 PER HOUR WITHOUT A PRINTING PRESS

PRINTING REVOLUTIONARY NEW SCREEN METHOD

PRINT colorful signs, posters, banners, fabrics, wall paper, show cards—ANYTHING! Print on any surface. NO printing press or special equipment is needed with this amazing "approved" new printing secret. 300% profit on nearly every job. Easy to learn —NO EXPERIENCE or art ability necessary. Exceptional opportunity. Complete illustrated detailed plan and colorful sample FREE—Write:

FREE complete "BIG MONEY" Plan and SAMPLE!



EARN AT HOME SPARE or FULL Time

SCREEN-PRINT COMPANY, Dept. 15
1010 So. Los Angeles St., Los Angeles 15, Calif.

MONEY for MEN ALL DATA FREE

THE PLASTEX Industry needs manufacturers on small scale and for big production of Lamp and Clock Stands. Art Goods and Novelties in Plastex and Marble imitation. Experience unnecessary. 1/2c material makes regular 10c store sellers. Rubber moulds furnished for speed production. Small investment brings good returns. We are now placing big chain store orders with manufacturers. Ambitious men have chance for real prosperity. Our Free booklet will interest and benefit you.

PLASTEX INDUSTRIES, Dept. 2, 3400 Third Ave., New York 56, N. Y.

LEARN TELEVISION RADIO-ELECTRONICS

Learn in your home. Then earn BIG PAY and SECURITY. Tremendous growth has made more jobs than there are trained men! NOW is the time to get into this essential NEW, RICH field of OPPORTUNITY. FREE placement service. SEND FOR FREE, BIG ILLUSTRATED CATALOG.

MAIL TODAY

I want complete information on how to succeed in Television, Radio, and Electronics. This does not obligate me in any way.

NAME

ADDRESS

CITY STATE

CENTRAL RADIO & TELEVISION SCHOOLS
Dept. C-5, 1644 Wyandotte, Kansas City, Mo.

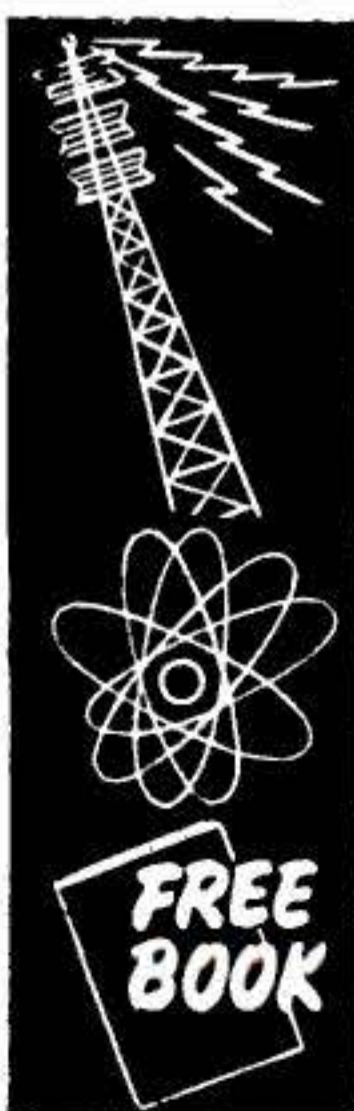

FREE BOOK

ARTHUR GODFREY SAYS:

"I.C.S. made the impossible—easy!"

You've often heard Arthur Godfrey, famed "Huck Finn of Radio," now winning new renown with his coast-to-coast "Talent Scouts" and other CBS programs. But this is the first time you've heard the star on the subject of I.C.S.:

"I had to quit high school before the end of my second year. Later in life, at the U. S. Naval Materiel School at Bellevue, D. C., I had to master a working knowledge of math, all the way from simple decimals and fractions through trigonometry, in the first six weeks or be dropped from the course. So I took an I.C.S. Course and finished at the head of the class! I.C.S. made the impossible—easy!"

As usual, the former Navy radio operator and present Lt. Commander in the U. S. Naval Reserve knows what he's talking about. As an I.C.S. graduate, Mr. Godfrey is in the best of all positions to tell you about the educational system that's served so long as talent scout for American industry.

Study his statement. Then mark your interest on the coupon and mail it today for full information on what I.C.S. can do for you!



INTERNATIONAL CORRESPONDENCE SCHOOLS

APPROVED
under the
G.I. BILL

BOX 7678-M, SCRANTON 9, PENNA.

Without cost or obligation, please send me full particulars about the course BEFORE which I have marked X:

- | | | | |
|---|---|---|---|
| <p>Air Conditioning and Plumbing Courses</p> <p><input type="checkbox"/> Air Conditioning
<input type="checkbox"/> Heating
<input type="checkbox"/> Refrigeration
<input type="checkbox"/> Plumbing
<input type="checkbox"/> Steam Fitting</p> <p>Chemical Courses</p> <p><input type="checkbox"/> Chemical Engineering
<input type="checkbox"/> Chemistry, Analytical
<input type="checkbox"/> Chemistry, Industrial
<input type="checkbox"/> Chemistry, Mfg. Iron & Steel
<input type="checkbox"/> Petroleum Refining
<input type="checkbox"/> Plastics
<input type="checkbox"/> Pulp and Paper Making</p> <p>Civil Engineering, Architectural and Mining Courses</p> <p><input type="checkbox"/> Architecture
<input type="checkbox"/> Architectural Drafting
<input type="checkbox"/> Bridge and Building Foreman
<input type="checkbox"/> Building Estimating
<input type="checkbox"/> Civil Engineering
<input type="checkbox"/> Coal Mining
<input type="checkbox"/> Contracting and Building
<input type="checkbox"/> Highway Engineering
<input type="checkbox"/> Lumber Dealer
<input type="checkbox"/> Reading Structural Blueprints
<input type="checkbox"/> Sanitary Engineering
<input type="checkbox"/> Structural Drafting</p> | <p><input type="checkbox"/> Structural Engineering
<input type="checkbox"/> Surveying and Mapping</p> <p>Communications Courses</p> <p><input type="checkbox"/> Electronics
<input type="checkbox"/> Practical Telephony
<input type="checkbox"/> Radio, General
<input type="checkbox"/> Radio Operating
<input type="checkbox"/> Radio Servicing
<input type="checkbox"/> Television
<input type="checkbox"/> Telegraph Engineering</p> <p>Electrical Courses</p> <p><input type="checkbox"/> Electrical Drafting
<input type="checkbox"/> Electrical Engineering
<input type="checkbox"/> Electric Light and Power
<input type="checkbox"/> Lighting Technician
<input type="checkbox"/> Practical Electrician</p> <p>Internal Combustion Engines Courses</p> <p><input type="checkbox"/> Auto Technician
<input type="checkbox"/> Diesel-Electric
<input type="checkbox"/> Diesel Engines
<input type="checkbox"/> Gas Engines
<input type="checkbox"/> Aviation
<input type="checkbox"/> Gas Engines</p> <p>Mechanical Courses</p> <p><input type="checkbox"/> Aeronautical Engineer's, Jr.
<input type="checkbox"/> Aircraft Drafting
<input type="checkbox"/> Flight Engineer
<input type="checkbox"/> Forging
<input type="checkbox"/> Foundry Work
<input type="checkbox"/> Heat Treatment of Metals
<input type="checkbox"/> Industrial Engineering
<input type="checkbox"/> Industrial Instrumentation</p> | <p><input type="checkbox"/> Industrial Metallurgy
<input type="checkbox"/> Machine Shop
<input type="checkbox"/> Mechanical Engineering
<input type="checkbox"/> Mold-Loft Work
<input type="checkbox"/> Patternmaking—Wood, Metal
<input type="checkbox"/> Reading Shop Blueprints
<input type="checkbox"/> Sheet-Metal Drafting
<input type="checkbox"/> Sheet-Metal Worker
<input type="checkbox"/> Ship Drafting
<input type="checkbox"/> Ship Fitting
<input type="checkbox"/> Tool Designing
<input type="checkbox"/> Toolmaking
<input type="checkbox"/> Welding Engineering
<input type="checkbox"/> Welding—Gas and Electric</p> <p>Railroad Courses</p> <p><input type="checkbox"/> Air Brake
<input type="checkbox"/> Car Inspector
<input type="checkbox"/> Diesel Locomotive
<input type="checkbox"/> Locomotive Engineer
<input type="checkbox"/> Locomotive Fireman
<input type="checkbox"/> Locomotive Machinist
<input type="checkbox"/> Railroad Section Foreman
<input type="checkbox"/> Steam-Diesel Loco. Eng.</p> <p>Stationary Eng'r's Courses</p> <p><input type="checkbox"/> Boilermaking
<input type="checkbox"/> Combustion Engineering
<input type="checkbox"/> Engine Running
<input type="checkbox"/> Marine Engineering
<input type="checkbox"/> Power Plant Eng'r's
<input type="checkbox"/> Mech. Drafting
<input type="checkbox"/> Steam Eng's.</p> | <p>Textile Courses</p> <p><input type="checkbox"/> Cotton Manufacturing
<input type="checkbox"/> Loom Fixing
<input type="checkbox"/> Rayon Weaving
<input type="checkbox"/> Textile Designing
<input type="checkbox"/> Woolen Manufacturing</p> <p>Business and Academic Courses</p> <p><input type="checkbox"/> Accounting
<input type="checkbox"/> Advertising
<input type="checkbox"/> App. Psychology
<input type="checkbox"/> Bookkeeping
<input type="checkbox"/> Business Administration
<input type="checkbox"/> Business Law
<input type="checkbox"/> Bus. Correspondence
<input type="checkbox"/> Bus. Law
<input type="checkbox"/> Certified Public Accounting
<input type="checkbox"/> Commercial
<input type="checkbox"/> Commercial Art
<input type="checkbox"/> Cost Accounting
<input type="checkbox"/> Federal Tax
<input type="checkbox"/> First Year College
<input type="checkbox"/> Foremanship
<input type="checkbox"/> French
<input type="checkbox"/> Good English
<input type="checkbox"/> High School
<input type="checkbox"/> Higher Mathematics
<input type="checkbox"/> Illustration
<input type="checkbox"/> Industrial Supervision
<input type="checkbox"/> Motor Traffic
<input type="checkbox"/> Postal Civil Service
<input type="checkbox"/> Retailing
<input type="checkbox"/> Retail Bus. Management
<input type="checkbox"/> Salesmanship
<input type="checkbox"/> Secretarial
<input type="checkbox"/> Sign Lettering
<input type="checkbox"/> Spanish
<input type="checkbox"/> Stenography
<input type="checkbox"/> Traffic Management</p> |
|---|---|---|---|

Name _____ Age _____ Home Address _____

City _____ State _____ Working Hours _____ A.M. to _____ P.M.

Present Position _____ Employed by _____

Length of Service in World War II _____ Enrollment under G.I. Bill approved for World War II Veterans. Special tuition rates to members of the Armed Forces. Canadian residents send coupon to International Correspondence Schools Canadian, Ltd., Montreal, Canada.

**\$15.95 BUYS THE
ELECTRIC SHAVER
THAT CONVINCED BARBERS**



WhiskER®

COSTS LESS YET DOES MORE!

Take the word of leading barbers—*WhiskER'S* new thin (.002") clipper blade cuts 1 to 7 day beards (even those other shavers will not touch) clean and close. Operates quietly on 110 v., 60 cycle AC; no TV or radio interference! Fast—14,400 shaving strokes per minute! Women like *WhiskER* for safely removing superfluous hair on legs and under arms. Get *WhiskER* at your Barber or Dealer. **ELECTRO TOOL CORPORATION** DEPT. 531-E RACINE, WISCONSIN

If Your Barber or Dealer Cannot Supply You
USE THIS COUPON TO ORDER

- ELECTRO TOOL CORP., Dept. 531-E Racine, Wis.
- Encl. find \$15.95 (check, m. o.). Please send *WhiskER* postpaid.
 - Encl. find \$5. Send *WhiskER* C.O.D. I'll pay postman balance plus postage.

Name _____
Address _____
City _____ Zo. _____ State _____

MAKE EXTRA MONEY

PLASTICS

LEARN AT HOME

LEARN HOW TO MAKE fast selling PLASTIC NOVELTIES FURNITURE JEWELRY SIGNS TOYS LAMPS

There are RICH OPPORTUNITIES for MEN and WOMEN with "know-how" in Plastics. Interstate's amazing new Plastics course tells and shows how to make hundreds of fast selling items out of Plastics. Gives complete training in fabrication, casting, lamination, molding, etc., in simple, easy, step-by-step language and pictures.

START A PLASTICS BUSINESS OF YOUR OWN. No other industry holds such promise for the future. You can make big money manufacturing novelties, toys, signs, etc., in your own home in spare or full time. Don't wait! Learn NOW how Interstate's Plastics Training qualifies you for success in the plastics field.

Write for FREE Information Today!

INTERSTATE TRAINING SERVICE

School of Plastics
PORTLAND 13, OREGON

(Dept. 2E)

New easy-to-follow PROJECT SHEETS

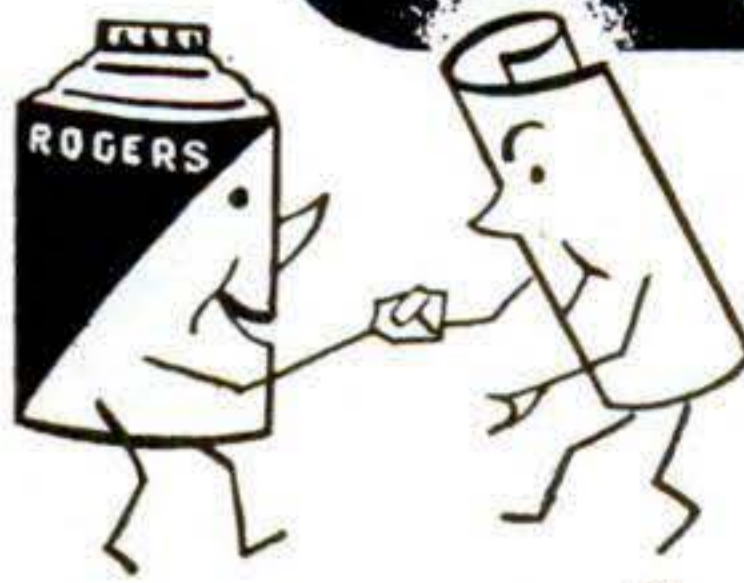

Don't miss this great offer. Send in your dime now to Rogers Isinglass and Glue Company, Gloucester, Mass.

FREE! A brand-new series of Rogers' valuable woodworking plans. These simplified instructions tell you how to make your own tables, bookcases, chairs, etc. Send 10c today and we will send you a bottle of Rogers famous liquid fish glue plus a complete set of these free plans. Rogers glue has a ton of strength in every drop! Ask for Rogers at your local Hardware Store.



LEARN RADIO-ELECTRONICS



Train for an important job in Radio, Television and Radar—with unlimited future. Spartan resident study is backed with actual construction and operation. Write Department PS-51

SPARTAN SCHOOL of RADIO-ELECTRONICS
MUNICIPAL AIRPORT • TULSA, OKLAHOMA

HULA POPPER • GETS BIG BASS

Surface popping lure. Ideal combination of noise, action, casting and hooking qualities. Pops, plunks, jerks, twitches—obeys your slightest wrist command. Rubber Hula Skirt imitates live bug. At your dealer 5/8 oz. or 1/4 oz., \$1.25. Fly rod size, 75c.



FRED ARBOGAST & Co., Inc., 2355 W. North St., Akron 3, Ohio

FREE WRITE TODAY FOR BIG FREE 1951 ARBOGAST COLOR CATALOG—FULL OF PICTURES OF CATCHES



Learn Profitable Profession in 90 days at Home

MEN AND WOMEN, 18 to 60—Many Swedish Massage graduates make big money! Large full time incomes from doctors, hospitals, sanatoriums, clubs or private practice. Others make good money in spare time. Prepare for future security by training at home and qualifying for Diploma, Anatomy Charts and 32-page illustrated Book FREE!

The College of Swedish Massage
Dept. 170E, 41 E. Pearson, Chicago 11, Ill.

High School at Home

Many Finish in 2 Years

No classes. No time wasted going to and from school. Progress as fast as your time and abilities permit. Standard H. S. texts supplied. Thousands enroll each year in this 53-year-old school. Send for FREE descriptive booklet.

AMERICAN SCHOOL, Dept. H-546
Drexel at 58th St., Chicago 37, Ill.
Without obligation, please send FREE descriptive booklet.

Name.....
Address.....

You are in demand if you can draw

Make money with your brush and pen! If you like to draw, sketch, or paint, take the Free Talent Test. No fee. No obligation. Mail this coupon TODAY!



ART INSTRUCTION, INC., Dept. 5141

500 S. 4th St., Minneapolis 15, Minnesota

Please send me your FREE Talent Test.

Name _____ Age _____
Address _____ Phone _____
City _____ Zone _____ County _____
State _____ Occupation _____

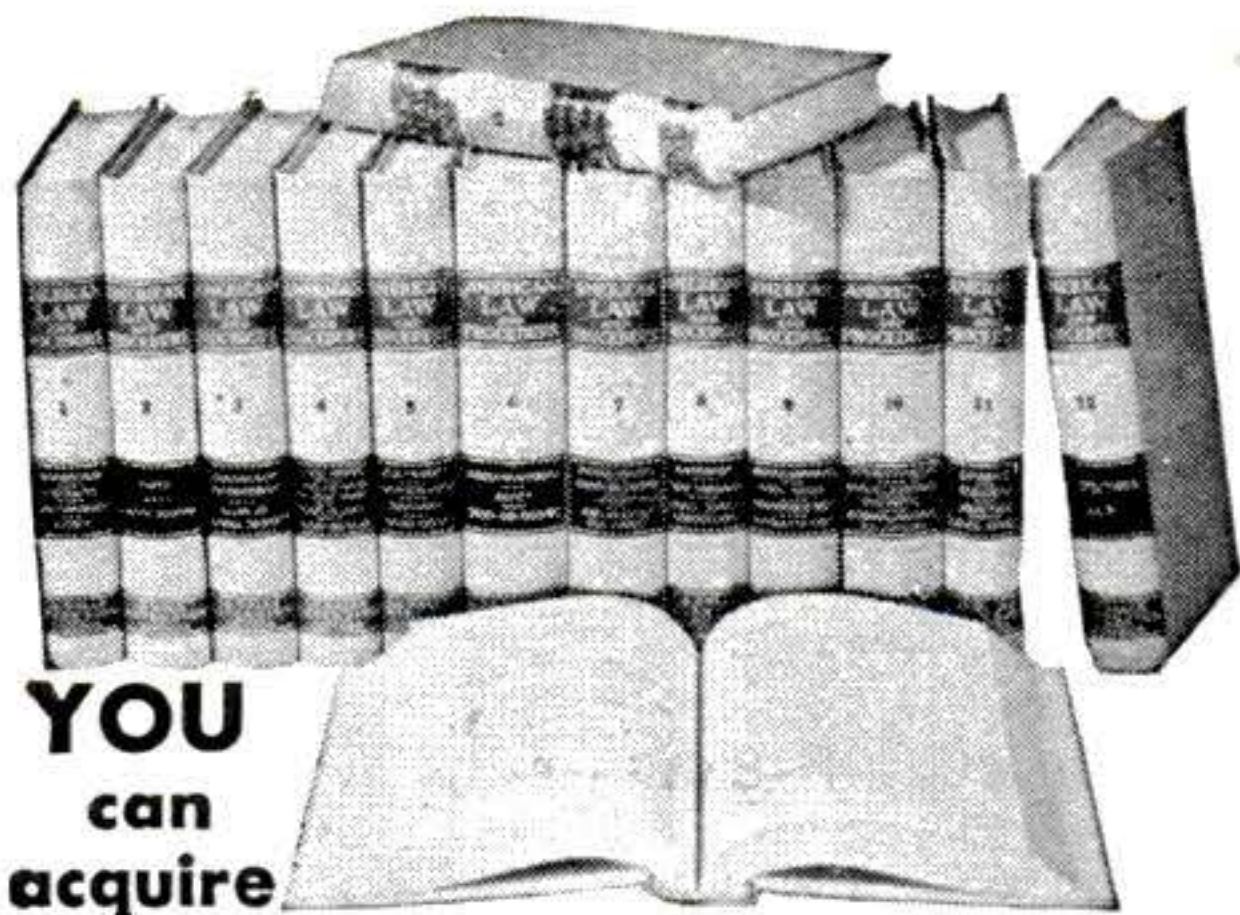

YOU
can
acquire

LAW NIGHTS AT HOME!
L L.B. DEGREE

LaSalle's famous Law Library—used as reference in many Law libraries and Law offices—has enabled thousands to master Law surprisingly fast, in spare hours at home, for business and professional advancement.

These 14 remarkable volumes, compiled by leading professors and lawyers, cover the whole basic field of Law in condensed, orderly, simplified manner.

You advance rapidly with this great library, plus special lectures furnished. We guide you step-by-step with personalized Problem Method of instruction . . . you learn by doing—handling legal problems—not by memorizing rules.

Send for two FREE 48-page booklets, "Law Training for Leadership," and "Evidence," answering questions about Law and its value to you, and telling how LaSalle Law graduates are winning rapid advancement in business and public life. Mail coupon below. No obligation.

LA SALLE EXTENSION UNIVERSITY
A Correspondence Institution

417 S. Dearborn St. Dept. 583L Chicago 5, ILL.

Send me your two FREE booklets described above, without obligation.

Name.....Age.....
Street.....
City, Zone & State.....

INVENTORS

Before you make any effort to market your invention, you should take the first steps toward proceeding for patent protection.

The usual first step is to have a search of the U. S. patent records conducted, so that I can report to you on the question of patentability.

I shall be pleased to furnish you with information relative to patent procedure upon request from you, and this will be without any obligation on your part.

PATRICK D. BEAVERS
(Formerly RANDOLPH & BEAVERS)
Registered Patent Attorney

937 Columbian Building, Washington 1, D. C.

Listen to this Record!

Speak **FRENCH**
SPANISH



RUSSIAN • GERMAN • ITALIAN
BRAZILIAN • JAPANESE

BIG OPPORTUNITIES await Americans who speak languages. Learn as a child learns—"by listening." The **CORTINA METHOD**, famous for 69 years, teaches you, right at home, to speak like a native!

VETS
FRENCH or
SPANISH
course avail-
able under
G.I. Bill.

FREE BOOK The "Cortina Short-Cut" describes this amazing method and **FREE TRIAL** offer. **WRITE TODAY.** State language interested in. Also if Veteran.

CORTINA ACADEMY Dept. 125
105 W. 40TH ST. NEW YORK 18, N.Y.

"How to Make Money with Simple Cartoons"



A book everyone who likes to draw should have. It is free; no obligation. Simply address

FREE BOOK

CARTOONISTS' EXCHANGE

Dept. 195 D, Pleasant Hill, Ohio

PATENTS PATENT
PATENTS LAWYER

GUSTAVE MILLER

REGISTERED PATENT ATTORNEY
PS-51 WARNER BUILDING
WASHINGTON 4, D. C.

ASSOCIATE EXAMINER
U. S. PATENT OFFICE 1922-1929
PATENT ATTORNEY & ADVISOR
U. S. NAVY DEPT. 1930-1947

Send for **PATENT INFORMATION** Book and "INVENTOR'S RECORD" without obligation.

PATENTS
C. A. SNOW & CO.
REGISTERED PATENT ATTORNEYS
WRITE FOR INFORMATION TO
426 SNOW BUILDING, WASHINGTON 1, D. C.

INVENTORS

Whether an invention is patentable can be substantially determined by a search of the U. S. Patent records. Without obligation, write for information explaining the steps you should take to secure a patent.

JOHN N. RANDOLPH

Registered Patent Attorney
205 Columbian Building Washington 1, D. C.

INVENTORS

IF YOU WISH TO PROTECT YOUR INVENTION, You should take steps to protect it by a U. S. Patent. Write me for "RECORD OF INVENTION" form.

CARL MILLER
REGISTERED PATENT ATTORNEY

WOOLWORTH BLDG., 35th FLOOR, 513
NEW YORK CITY

GET INTO

DIESEL-AUTO MECHANICS

Master All Phases

JOBS LIKE THESE ARE AVAILABLE TO TRAINED MECHANICS. CHOOSE THE FIELD YOU LIKE BEST

Get Complete Training

Diesel Fuel Injection
 Automotive Motor Tune-up
 Diesel Engine Rebuilding
 General Garage Mechanic
 Agricultural Implements
 Auto Engine Rebuilding
 Auto Elec. Service
 Public Utilities
 Parts Dealers
 Bus & Truck Lines
 Industrial Maintenance
 Contracting & Excavating
 Business of Your Own
AND MANY other similar openings.

As a National Schools graduate, you are trained for ALL opportunities in the Diesel & Auto Industries.

EARN WHILE YOU LEARN

With our practical Master Shop-Method Home Training, you study at home in your spare time. You receive Spare Time Work Lessons, which show you how to earn while you Learn... for extra money and experience. You Learn by DOING.

TOOLS AND EQUIPMENT

To make your training complete, we give you selected mechanic's tools and equipment, illustrated below, including all-metal tool-box—as a regular part of your instruction.

WE GIVE YOU TOOLS OF YOUR TRADE

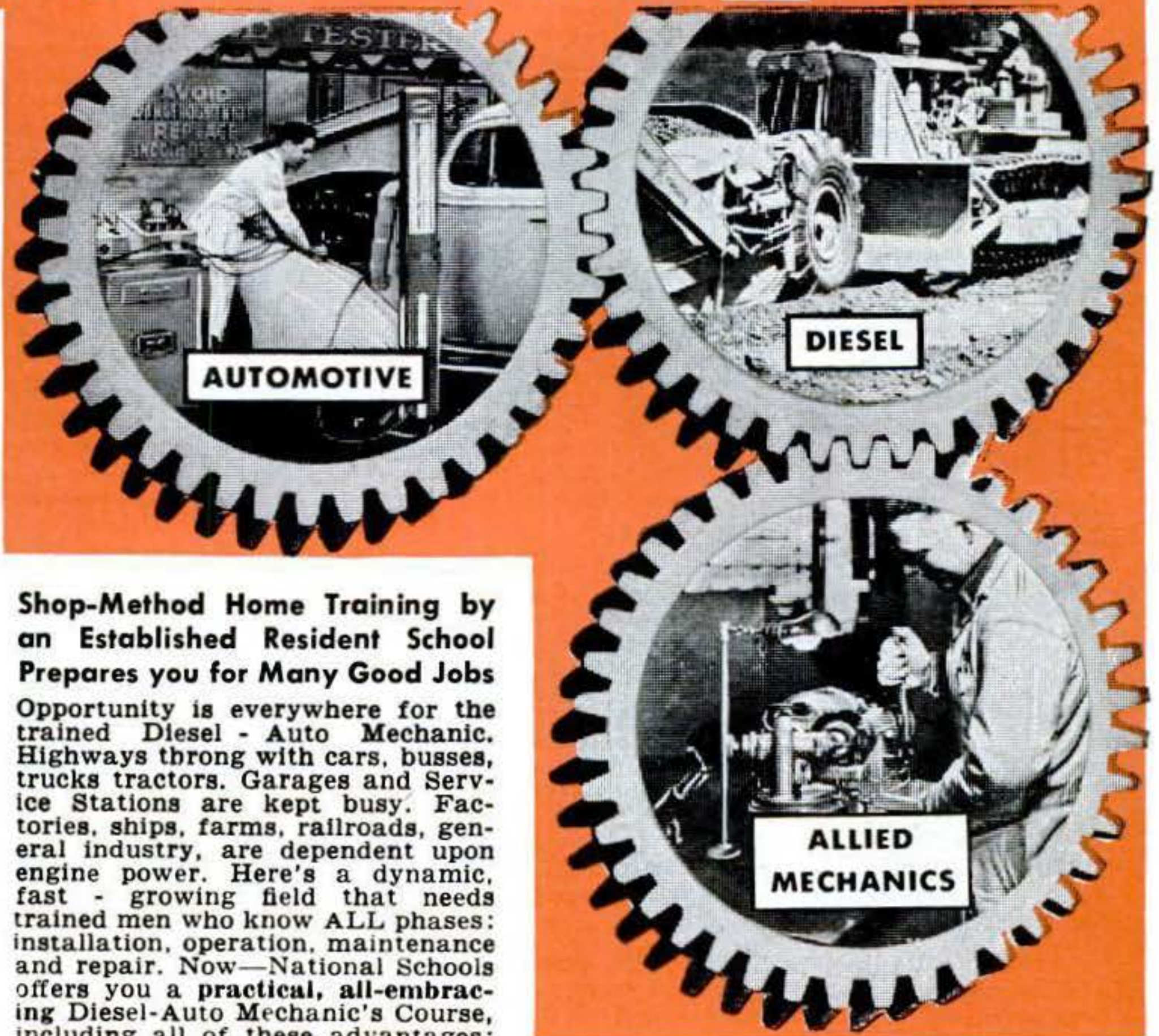
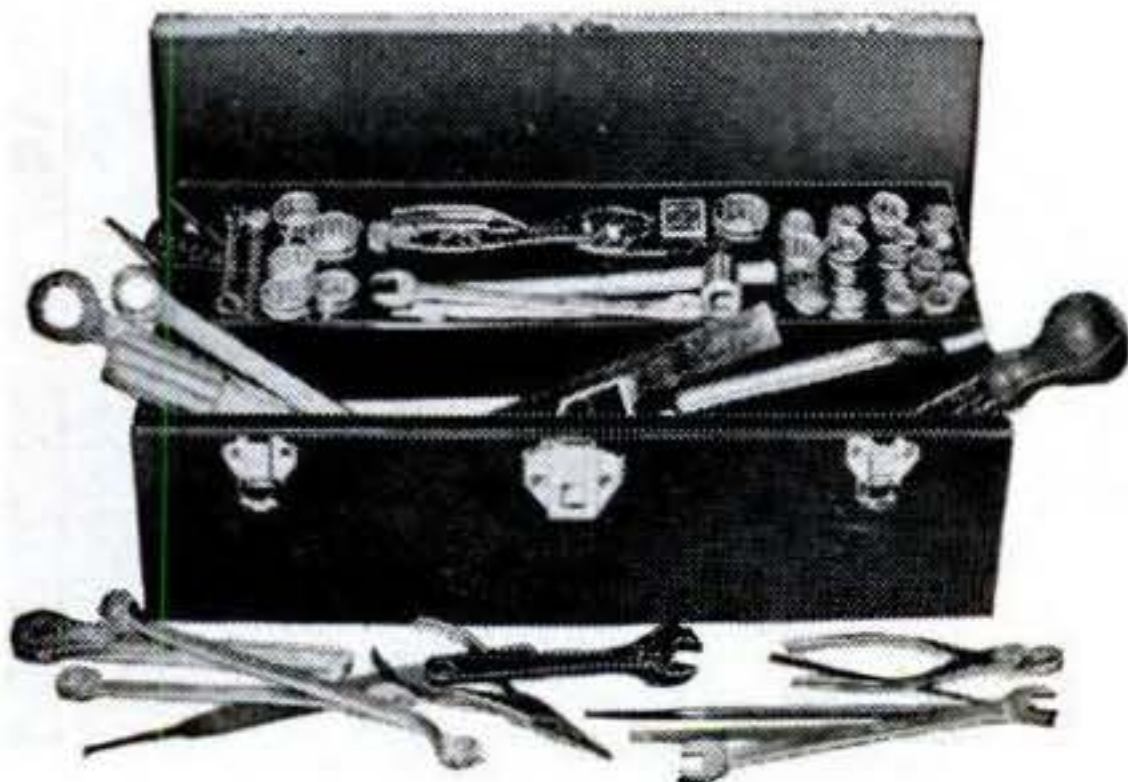

Shop-Method Home Training by an Established Resident School Prepares you for Many Good Jobs

Opportunity is everywhere for the trained Diesel - Auto Mechanic. Highways throng with cars, busses, trucks tractors. Garages and Service Stations are kept busy. Factories, ships, farms, railroads, general industry, are dependent upon engine power. Here's a dynamic, fast - growing field that needs trained men who know ALL phases: installation, operation, maintenance and repair. Now—National Schools offers you a practical, all-embracing Diesel-Auto Mechanic's Course, including all of these advantages:

Complete training, covering—Diesels, High Speed and Heavy Duty; Semi-Diesels, Gasoline and Special Fuel Engines AND Allied Mechanics.

- Basic Lesson Texts
- Diesel Installation
- Operation—Maintenance
- Diesel Chart Manual
- Spare Time Lessons
- Engine Service Manuals
- Engine Repair
- Drive Systems
- Diesel Electric Power
- Thermodynamics

TOOLS AND EQUIPMENT INVESTIGATE

Secure Full Information

NEW, ILLUSTRATED BOOK & SAMPLE LESSON SHOW HOW WE TRAIN YOU... SEND FOR THEM TODAY!

NO COST NO OBLIGATION



APPROVED FOR VETERANS
Check coupon below

NATIONAL SCHOOLS

LOS ANGELES 37, CALIF. • EST. 1905



FIND OUT NOW... MAIL COUPON TODAY

NATIONAL SCHOOLS, Dept. 5PSD
4000 South Figueroa Street
Los Angeles 37, California

(Mail in envelope or paste on penny postcard)

Mail me FREE the book, YOUR FUTURE IN DIESEL-AUTO MECHANICS, together with the Sample Lesson. I understand I may keep and use the information with no obligation.

Name.....Age.....

Address.....

City.....Zone...State.....

Check here if Veteran of World War II

Grow Flowers in Your Room!



No Soil! No Dirt!

Yes, with the marvelous Aladdin Kit of Plant Magic you can now easily grow beautiful roses, violets, carnations and tropical flowers on the window sill in ANY room, and without one speck of soil or dirt. Also big, red, ripe tomatoes, melons—in fact, almost any vegetable or flower and almost anywhere in your house or apartment or on the porch.

ONLY \$3.50 DOWN

For the Complete ALADDIN KIT OF PLANT MAGIC

This remarkable Aladdin Kit of Plant Magic includes the Wick-Flo Pottery, Sani-Lite Plant Support, the Bond Nutrient, the amazing Chemical-Plus, Feeding Wicks, Seeds and Illustrated Instructions that are so easy to follow.

Remember, you pay only \$3.50 down, and then you can pay the balance at the rate of only \$2.50 a month for 3 months. If you prefer, you can send \$9.85 cash in full and save \$1.15.

15 DAY APPROVAL! If you are not more than delighted with results in 15 days, return the kit, and your money will be refunded promptly.

MAIL COUPON BELOW!

Simply mark x in one of the squares below to indicate whether you wish to pay \$9.85 cash and save \$1.15, or whether you prefer to pay \$3.50 down and \$2.50 a month for 3 months.

Then sign the coupon with your name and address, and send it to us with your remittance. The day we hear from you, the complete Aladdin Kit will be sent to you by parcel post PREPAID.

Copyright 1951
The Nutrient Corp.

THE NUTRIENT CORPORATION

Dept. 125 Philadelphia 44, Pa.

SPECIAL COUPON

THE NUTRIENT CORP., Dept. 125, Phila. 44, Pa.

Please ship me at once by parcel post PREPAID the Aladdin Kit of Plant Magic. I have indicated in the below the payment plan I prefer.

- I am enclosing with this coupon \$9.85 payment in full, thereby saving \$1.15.
- I am enclosing \$3.50 as down payment, and will pay the balance at the rate of \$2.50 a month for 3 months.

Name.....

Address.....

City State

NEW! POLARVISION SAFETY LIGHT

A revolutionary new light discovery recently released for civilian use.

STOP HEADLIGHT GLARE

Fits All Cars & Trucks FOR SAFETY AND COMFORTABLE DRIVING

The Amazing "Ergon Glass Lens" is an integral part of the Polarvision Light. It produces a Black Light (barely visible to the eye) which counteracts oncoming headlights, street lights, etc. without interfering with your visibility. Easy to install above windshield—beautiful accessory. Light encased in high grade chrome holder. Works off car's central lighting circuit. Limited Supply. Complete (including all parts) \$6.95

Send cash, check, or money order. Guaranteed

Electronic Development Company, Dept. A5 Los Angeles 34, Calif.

No Experience Needed To PRINT YOUR OWN POST CARDS



The GEM STENCIL DUPLICATOR saves money... gets results quickly! Hundreds of uses for every type of business and organization. We ship the GEM complete with all supplies, Guide Board for accurate printing and 60-page Book of Ideas at the special low price of only \$8.50 (a \$15 value).

FREE TRIAL OFFER

Our 21st Year

Use the GEM FREE at our expense! SEND NO MONEY. Write and complete GEM outfit will be sent you postpaid. After ten days, send us only \$8.50 or return the GEM. You must be satisfied!

BOND EQUIPMENT CO.

Dept. 49

6633 Enright • St. Louis 5, Mo.

Learn ACCOUNTING BOOKKEEPING

This nationally renowned school has demand for graduates in good salary positions thru Nationwide recognition and placement service. Write Department PSB today for Big 32 page Success Book to be sent to you **FREE**



Hills BUSINESS UNIVERSITY AND EXTENSION SCHOOL

619 W. MAIN ST. OKLAHOMA CITY 2, OKLAHOMA

BOYS! MAKE YOUR OWN RADIO



Make your own simple, tubeless, batteryless Crystal Radio. SEND 25c for a GENUINE MELOMITE CRYSTAL with complete illustrated instructions for making your own set. Crystal sent postpaid with instructions and our own publication, "THE MAGIC CRYSTAL" which is full of news, diagrams, questions and answers of interest.

SEND 25c FOR YOUR CRYSTAL TODAY!

ALVA ALLEN RADIO Dept. 167 Clinton, Mo.

TASOPE PHOTO-ENGRAVING PLANTS



Establish your own profitable PHOTO-ENGRAVING business. Make cuts for newspapers printers, and advertisers. Make etched name plates, plaques etc. Instructions furnished, no experience necessary. Sold direct from factory since 1931. First five hundred cuts sold locally or by mail will pay for plant and pay you well for your time. Write for FREE catalog.

MATERIAL COST OF THIS CUT 1/4c
SELLING PRICE \$1.00 AND UP

TASOPE DEPT. PS-5, AURORA, MO.

Convert HAND MOWERS TO POWER MOWERS

Takes less than 3 hours
The Handy-Dandy Lawn Mower Kit fits any hand mower from the 16 to the 20 inch size. Complete with all necessary parts. Kits can be purchased separately, complete with engines or complete with Pennsylvania mower.

DEALERS WANTED



Also manufacturers of complete power mowers and garden cultivators.

LE CLAIRE MFG. CO.
LE CLAIRE, IOWA, Dept. PS

Earn Big Money

WRITING ORDERS

AMAZING NYLONS

Guaranteed Against
RUNS AND SNAGS

Regardless of Cause!

The world's ONLY complete, nationally advertised nylon hosiery line actually guaranteed against runs, snags or excessive wear, REGARDLESS OF CAUSE! It's amazing, but true! No matter what the cause—hard use or deliberate abuse—Kendex nylons are replaced FREE if they run, snag or become unfit for wear within entire guarantee period! Every weight from sheerest 15 denier to heavy 70 denier—all gauges up to luxury 60 gauge—all sizes, lengths, popular shades, fancy heels, black seams—full fashioned and seamless. Nothing is missing to make sure every woman is pleased. In spite of the amazing guarantee, retail postage prepaid prices are no higher than comparable quality national brands. Should free replacement be necessary, actual cost is cut in half! How could any woman possibly resist saving money and solving her hosiery problems? NOT SOLD IN STORES. Men and women wanted NOW, spare or full time, to write orders and earn big money. You can get orders even if you never sold a thing in your life!

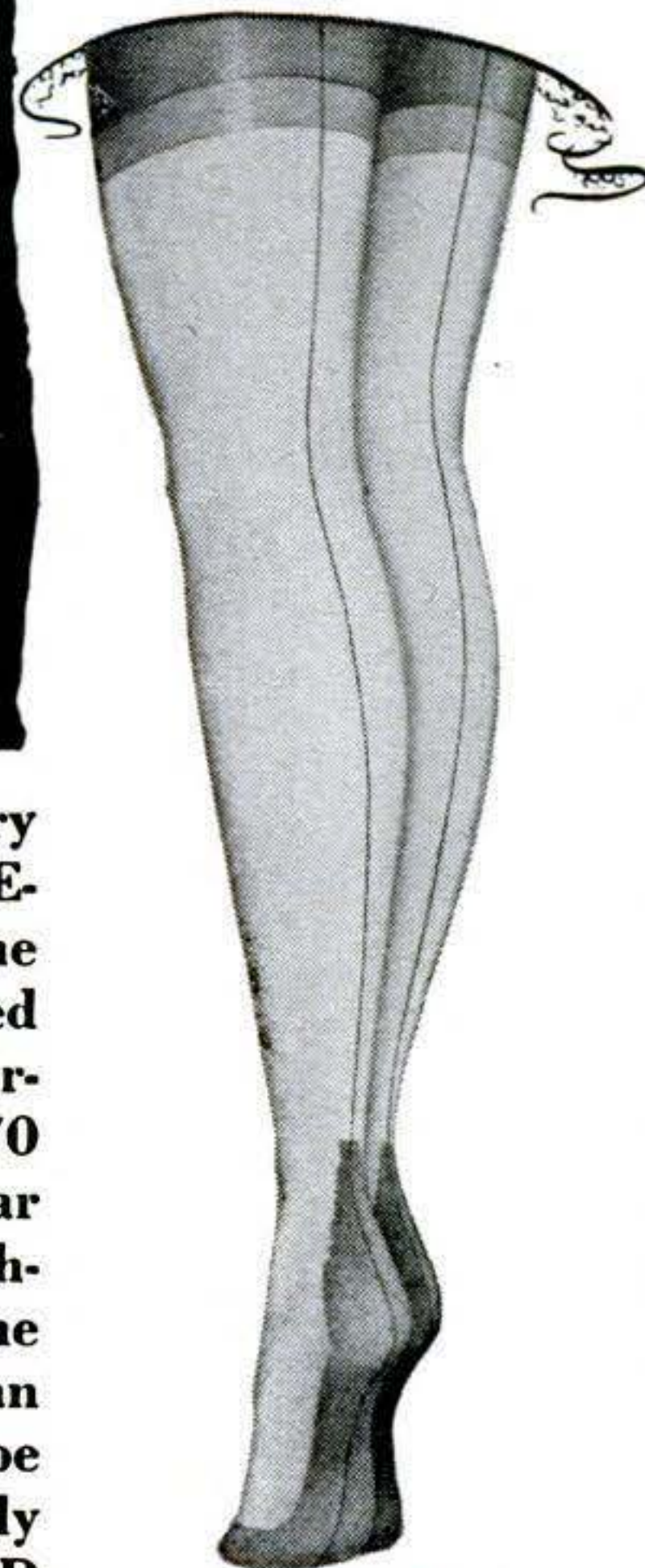

FREE SAMPLE STOCKING

Man or woman—young or old, YOU can easily earn steady income, spare or full time. No money or experience needed. We supply EVERYTHING free and set you up in business at OUR expense. Nothing to buy or deliver. Write orders. We deliver and collect. Big advance pay plus huge cash bonus that increases your earnings up to 40%! Your name and address on postcard will bring you sample stocking; self-selling sales books with FULL COLOR illustrations; 32-page sales manual showing you easy steps to success; color cards, free "door openers" worth \$1 each but which you give away free; special plan to have others sell for you, etc., etc. You can start making money the minute you receive the complete FREE outfits!

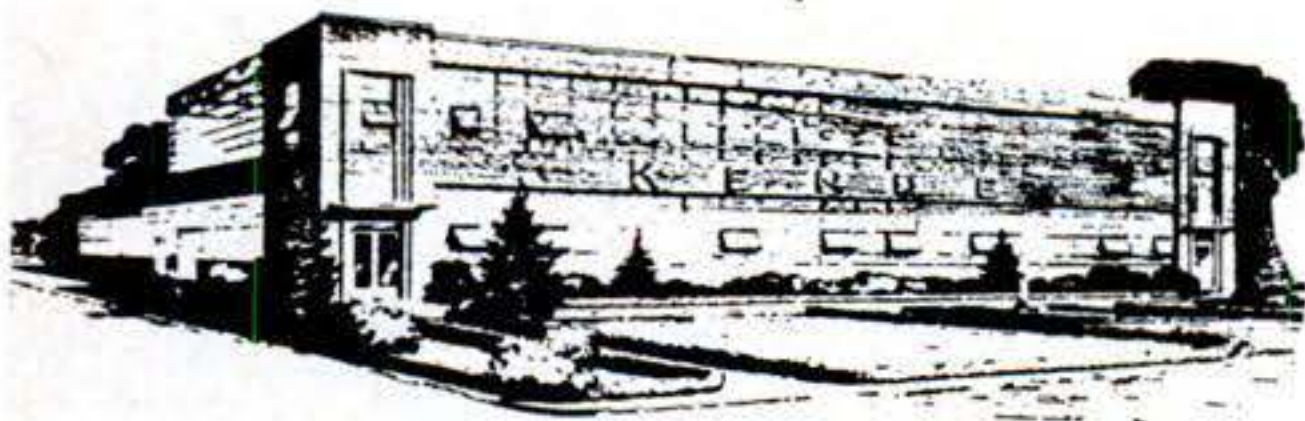

YOUR COST ONE CENT!

SEND NO MONEY. Pay nothing now or later. No obligation. Not even a promise to return outfits. Simply write your name and address on a penny postcard and mail to us. We'll immediately rush you everything you need FREE and postage prepaid. WRITE TODAY!

KENDEX CORPORATION • BABYLON 349 N. Y.

AVIATION TRAINING



The aviation industry urgently needs properly trained young men for essential civilian aviation positions. Embry-Riddle offers maximum training in minimum time. Fully accredited 8-mo. to 26-mo. courses in all aeronautical phases. Thorough, practical instruction backed by 25 yrs. experience training today's aviation leaders. Complete school campus.



Send coupon today!

Embry Riddle
 Registrar
 Address: SCHOOL OF AVIATION
 DEPT 91 MIAMI 30, FLORIDA

Please Print

NAME _____

ADDRESS _____

City _____

State _____ Age _____

I am interested in...

- A.&E. Mechanic
- Commercial Pilot
- Engineering
- A.&E. Combined Commercial Pilot
- Flying Mechanic
- Drafting & Design

Check One Veteran Non-Vet

TRAIN IN MIAMI -- AIR CAPITAL OF THE WORLD

Be an ANTENNA EXPERT

The RIGHT antenna properly erected, the transmission line correctly installed can make all the difference in TV reception. This new book shows you how to get the MOST out of the antenna system AT ANY LOCATION

You will learn how to determine the right type of antenna for the location and how to place it; how to avoid standing waves and minimize noise on the transmission line; how to match a booster amplifier to the antenna system, overcome interference, insure peak performance in shadowed or fringe areas, and much more. Complete, TESTED performance data on all antennas are included.

Get SUPERIOR results on your own TV set.

Learn one of the most important jobs in TV installation and servicing.

TELEVISION & FM ANTENNA GUIDE

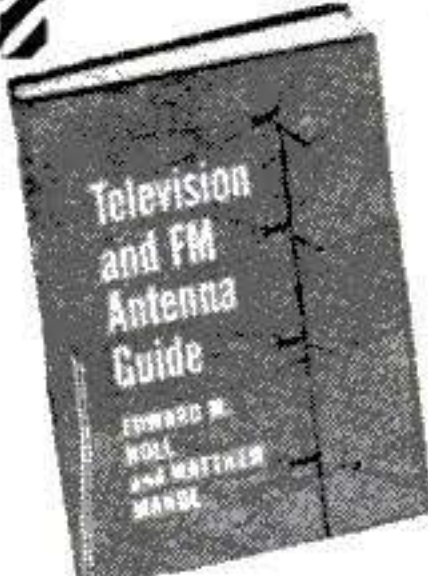

insures you the best reception from the antenna system with a minimum of testing and readjustment. See for yourself how valuable it will be to you on any TV installation or servicing job. The price is only \$5.50, and you can

SEE IT ON APPROVAL

The Macmillan Co., 60 Fifth Ave., New York 11

Please send me Television & FM Antenna Guide on approval. I will either remit in full or return the book in 10 days.

Signed _____

Address _____

PARTS FOR MILITARY TRUCKS

At A Savings. New FREE Catalog For Jeep, Dodge, Chevrolet, G.M.C., Studebaker 4 x 4—6 x 6. Drive

Brand New—Not Surplus—Complete JEEP TOPS and SIDE CURTAINS

Fits all Military Jeeps. Also adaptable to some Civilian Jeeps. Waterproof O.D. \$59.50

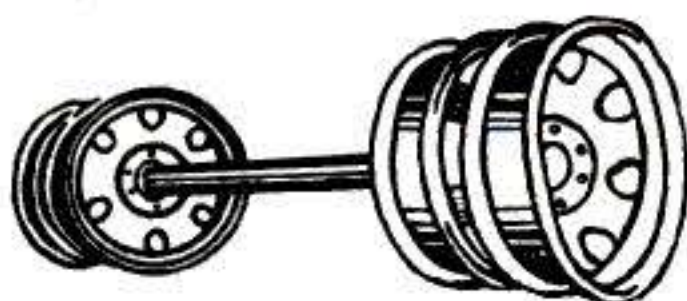

TRAILER AXLES

Heavy duty trailer axle suitable for many types of trailer construction. Also excellent for building of heavy farm trailers and wagons. It is a square type straight trailer axle complete with Timken

roller bearings, hubs and 6 hole 750 x 20 Budd Wheels. Without brakes. Axle is 2 inches square and 69 inches between wheel mounting flanges. Std. width.

With Single Wheels \$59.50 With Dual Wheels \$69.50

Hundreds of Other Truck & Jeep Parts and Supplies

All prices quoted good 30 days FOB, Kansas City 25% deposit required on all orders.



UNITED AUTO PARTS CO. INC
 1901 TROOST GR. 1800 KANSAS CITY, MO.

LEARN PROFESSIONAL TILE SETTING

at Home—Easily

VERY HIGH WAGES—GREAT & GROWING DEMAND

Get into the highest wage bracket for a lifetime! Own your own business. Requires few tools, little figuring. Light, interesting work. Even as a sideline you may earn \$75.00 a week. Learn at low cost—in your spare time—in a few weeks. Send for free details TODAY!

AMERICAN INSTITUTE OF TILE SETTING

P. O. Box 1845, Wilshire-LaBrea Sta., Dept. PS5, Los Angeles 36

Secrets of VENTRILOQUISM Now Revealed!



Easy to learn in 60 to 90 days with our Home Study Course. RESULTS GUARANTEED. Make Money! Be Popular! Have Fun! Big Opportunity! Radio, Television, Stage Appearances! For Free Information regarding price and terms, WRITE. You must state your age. Dummy Catalog 25c. FRED MAHER SCHOOL OF VENTRILOQUISM Box 36, Studio 5 Kensington Station Detroit 24, Michigan

Learn CARPENTRY BRICK LAYING

Get into the billion dollar building trades. Learn now while opportunities are greatest. Train in our completely equipped shops under expert instructors. G.I. Approved. Enroll now. Limited Classes. Write for FREE catalog.

MIDWEST SCHOOL OF BUILDING TRADES, Dept. PS-5

411 N. Center St. Bloomington, Ill.



READ ABOUT TRAILERS BEFORE YOU BUY

TRAILER TOPIC MAGAZINE

Brings you the latest in Trailer Coaches—Equipment—Accessories—Trailer Trips—Trailer Parks and many other interesting features at only—\$3.00 for 2 years.

(6 month trial subscription \$1.00)

Send your subscription to

TRAILER TOPICS MAGAZINE, (Room 1512) 28 EAST JACKSON BLVD. CHICAGO 4, ILL.

SENSATIONAL SURPLUS SALE

NAVY MAE WEST LIFE JACKETS!

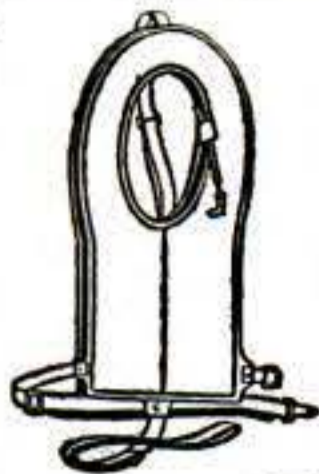

Brand new, pneumatic type. Inflate by mouth or sparklette bottle charge. Perfect for swimmers, fishermen, boaters, fliers. Be safe this summer. This small investment may save your life. **\$2.95** pp.

6 Sparklette Charges. \$.60 pp.

SLEEPING BAGS



Famous Army wool, mummy type. Brand new, 6 1/2 ft. long. 3 pieces; 100% wool zipper bag with sheet and water repellent cover. Gov't. cost, \$15.00. Weight 5 lbs. **\$9.95** pp.

ARMY MACHETTE KNIVES

18 inch keen steel blade with heavy plastic handle. Complete with sheath that clips on your belt. A bargain! **\$1.95** pp.

NAVY PHONES—VOICE POWERED

Brand new. No batteries or electricity needed. Mfd. by RCA, 1 mile range. Simple hook-up—splice 2 wires and talk. Complete, no extras to buy. Each phone has headset, adj. transmitter, chest plate, switch (on mike) PLUS 24 ft. rubber covered cable. 2 complete phones, only **\$13.95** pp.



Send check, cash, m.o. 25% dep. on COD's

GRAND-HAWTHORNE SURPLUS

1439 S. E. Grand Dept. PS-51 Portland, Oregon



Build and drive the fastest boats in the world. 3 point Hydroplanes, Runabouts, Inboard and Outboard. With our easy to use plans you save 3/4 of cost usually required. Be first. Send 25c to **Champion Boats** for illustrated catalog. P. O. Box 9038-18-E, Long Beach, California.

Prepare Now!

ENGINEERING

B.S. DEGREE IN 27 MONTHS

WORLD FAMED SCHOOL • ESTABLISHED 1884

Mechanical, Civil, Electrical, Chemical, Aeronautical, Radio (Television) Engineering, Business Administration and Accounting. Also 36-weeks diploma courses in Surveying and Drafting.

Personalized instruction. Accelerated courses. For ambitious earnest students. Preparatory department. Approved for veterans.

Graduates in Demand. Hold positions of responsibility the world over. Placement service. Future shortage of engineers indicated. Prepare now, for the civil and military opportunities ahead.

VETERANS: You may still obtain training and a college degree at Tri-State College under present G.I. Bill. Last opportunity for new students to enroll is Summer Quarter, June 11, 1951. Hundreds of Tri-State veteran graduates are holding responsible positions with unlimited opportunities for future advancement.

Extensive campus. Well equipped, modern buildings and labs. Low cost. New terms start quarterly. Enter March, June, September, January.

Mail Coupon Today

TRI-STATE COLLEGE

551 College Avenue, Angola, Indiana

Please send me free catalog and special information. I am particularly interested in courses as checked.

- Mechanical Civil Electrical Chemical Aeronautical
 Radio (Television) Business Administration Accounting
 Short Diploma Courses

NAME

ADDRESS

The 97 Pound Weakling

who became "The World's Most Perfectly Developed Man"

"I'll Prove that YOU, too, can be a NEW MAN!"

Charles Atlas

I KNOW, myself, what it means to have the kind of body that people pity! Of course, you wouldn't know it to look at me now, but I was once a skinny weakling who weighed only 97 lbs! I was ashamed to strip for sports or undress for a swim. I was such a poor specimen of physical development that I was constantly self-conscious and embarrassed. And I felt only HALF-ALIVE.

Then I discovered "Dynamic Tension." It gave me a body that won for me the title "World's Most Perfectly Developed Man."

When I say I can make you over into a man of giant power and energy, I know what I'm talking about. I've seen my new system, "Dynamic Tension," transform hundreds of weak, puny men into Atlas Champions.

Only 15 Minutes a Day

Do you want big, broad shoulders—a fine, powerful chest—biceps like steel—arms and legs rippling with muscular strength—a stomach ridged with bands of sinewy muscle—and a build you can be proud of? Then just give me the opportunity to prove that "Dynamic Tension" is what you need.

No "ifs," "ands," or "maybes." Just tell me where you want handsome, powerful muscles. Are you fat and flabby? Or skinny and gawky? Are you short-winded, pepless? Do you hold back and let others walk off with the prettiest girls, best jobs, etc.? Then write for details about "Dynamic Tension" and learn how I can make you a healthy, confident, powerful HE-MAN.

"Dynamic Tension" is an entirely NATURAL method. Only 15 minutes of your spare time daily is enough to show amazing results—and it's actually fun! "Dynamic Tension" does the work.

My Illustrated Book is Yours—Not For \$1.00 or 10c—But FREE



Send NOW for my famous book, "Everlasting Health and Strength," 48 pages, packed from cover to cover with actual photographs and valuable advice. Shows what "Dynamic Tension" can do, answers many vital questions. Page by page it shows what I can do for YOU.

This book is a real prize for any fellow who wants a better build. Yet I'll send you a copy absolutely FREE. Just glancing through it may mean the turning point in your whole life! Rush the coupon to me personally: Charles Atlas, Dept. 1-E, 115 East 23rd St., New York 10, N. Y.

CHARLES ATLAS, Dept. 1-E, 115 East 23rd St., New York 10, N. Y.

Send me—absolutely FREE—a copy of your famous book, "Everlasting Health and Strength"—48 pages, crammed with actual photographs, answers to vital health questions, and valuable advice to every man who wants a better build. I understand this book is mine to keep, and sending for it does not obligate me in any way.

Name Age
(Please print or write plainly)

Address

City State

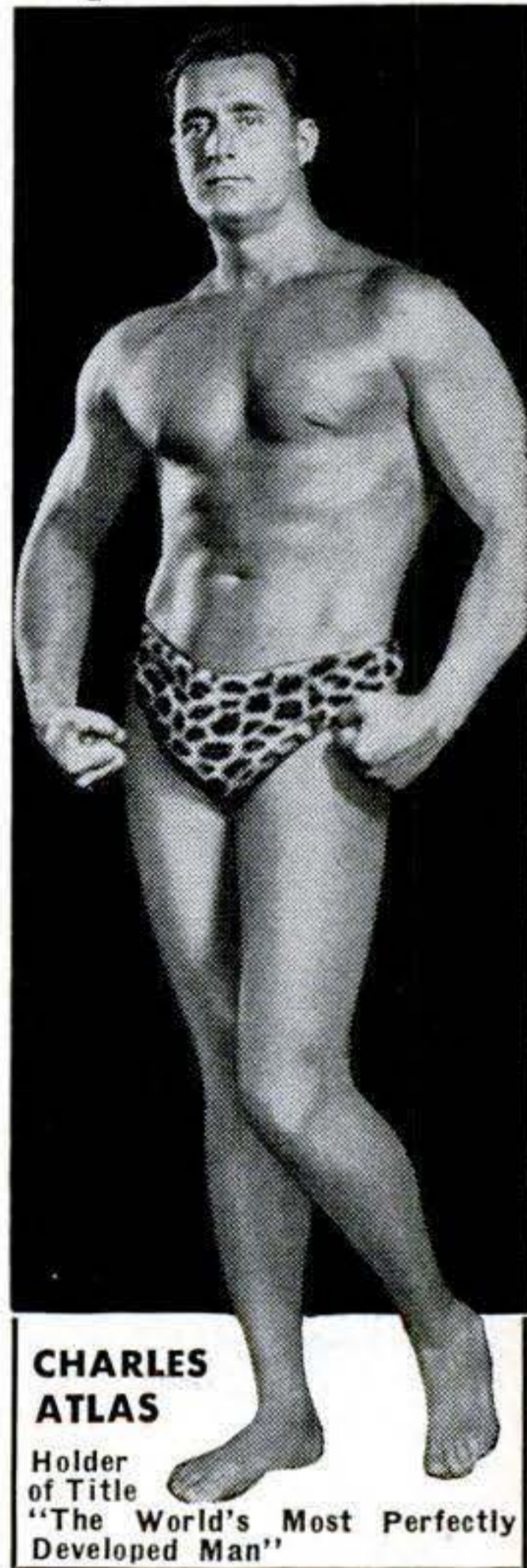

CHARLES ATLAS

Holder of Title "The World's Most Perfectly Developed Man"



Learn DRAFTING and BLUE PRINTING!

Both fields offer ambitious men remarkable opportunities for advancement. Neither profession will ever be replaced by machines. Before any production can start, plans must be drawn. Draftsmen are the first to be hired. Blueprints are essential in every shop.

CLEAR UNDERSTANDABLE TRAINING

Quickly you learn the hows and whys of successful production planning. You are sent professional drafting instruments, drafting table, equipment, etc., at no extra cost. Learn by making actual drawings.

BIG MONEY . . . ADVANCEMENT OPPORTUNITIES

Offered trained draftsmen. It is light, pleasant work paying big salaries. Drafting is the stepping stone to top managerial jobs. It is work that stimulates the mind . . . keeps one interested.

A BUSINESS OF YOUR OWN

Either as an independent drafting firm or as the operating head of a business firm producing products you created. Act now.

MAIL THIS COUPON TODAY!

CHRISTY TRADES SCHOOL, Dept. DB-904
4432 N. Kedzie Ave., Chicago 25

Mail me at once your big FREE book on Drafting and Blue Printing. Tell me how your Home Training and Professional Drafting Instruments, Drafting Table, Drafting Equipment etc. can be had on PAY AS YOU LEARN plan.

Name Age
Address City State

CAMPBELL-HAUSFELD Spray Painting Outfits



SAVE time, materials
and money

PAINT buildings, tractors,
trucks. Refinish furniture
and fenders. Inflate tires; lubricate
motors and implements.

Destroy weeds. Rid live stock and
pens of pests and parasites.

First job pays for the outfit. Then it
is yours for a lifetime of trouble-free
service. 4 models at 4 money-saving
prices. If your dealer does not have
them, write for literature and prices, giving
his name.

pressure queen

The only 4 cylinder portable. Outperforms them all for spray painting without pulsation.

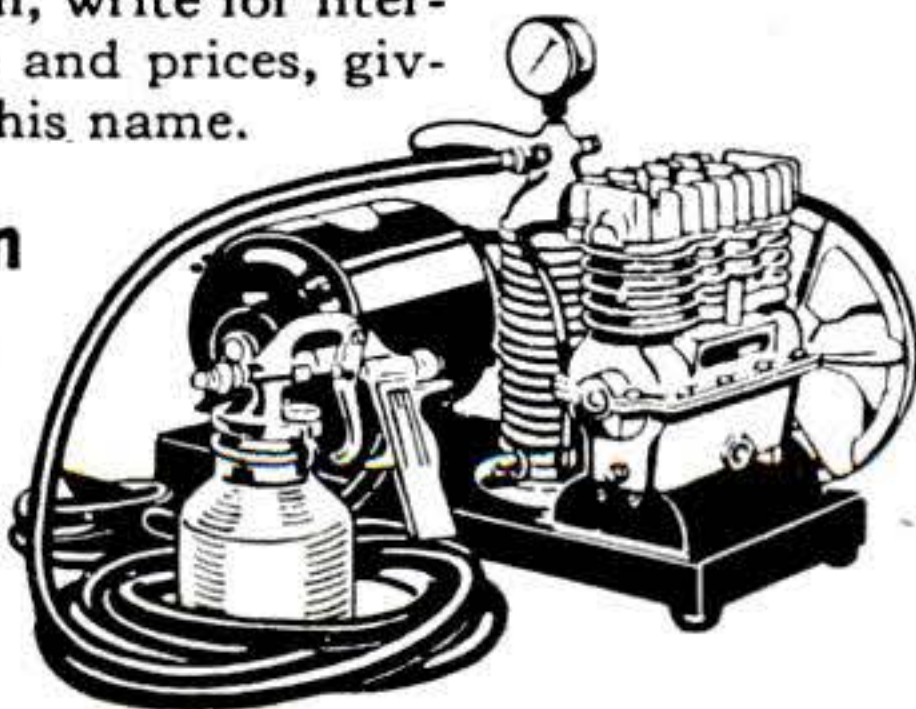

THE CAMPBELL-HAUSFELD CO.
151 RAILROAD AVE. HARRISON, OHIO



Easy and Cheap to Operate

SAVE TIME WORK MONEY!

SHAW DU-ALL

and PEPPY PAL TRACTORS

PLOW

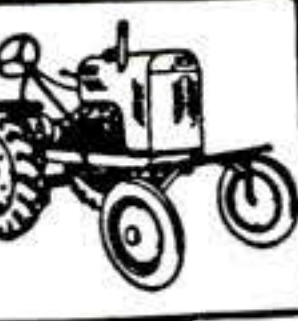

SHAW
MFG. CO.

These rugged walking or riding tractors are ideal for farm, truck garden, orchard, poultry farm. Operate on a few cents an hour. A child can handle them.

DO DOZENS OF JOBS Both riding and walking tractors quickly and easily plow, cultivate, harrow, disc, bulldoze, spray, haul, grind, saw wood, etc. **LOW FACTORY PRICES** Buy direct or through your dealer. A year's guarantee!

RIDING TRACTORS Four models from 5 to 12 H. P., 58 in. wheelbase, 36 to 52 in. wide, 24 in. plant clearance. Hand or electric starter. Walking Tractors 1 1/2 to 5 H. P.

FREE Illustrated folders giving complete details, price lists—write today.

5705 Front St., Galesburg, Kans.
668-PS North 4th St., Columbus, O.

FORD-MERC. OWNERS DUAL-POINT DISTRIBUTOR CONVERSION KIT

Greatly improve all-around performance in your 1949-51 Ford 8 or Mercury by converting your single-point distributor to a Dual-Point distributor. Complete kit—Easy to install—Do it yourself! Time-tested, proven, accepted.

ADVANTAGES

Eliminates missing, bucking. • Increased acceleration. • Smoother performance. • Longer point life. • Higher R.P.M. • All wearing parts stock Ford, obtainable anywhere. • Uses only one coil, one condenser. • Includes special breaker plate, 2 sets of points, buss bar.

EASTERN AUTO
3319 S. GRAND AVE., DEPT. P,
LOS ANGELES 7, CALIF.



ONLY
\$7.95
cash or
C.O.D.

New Advertising Machine Prints Post Cards

FREE LEARN HOW thousands of business men, in every line, boost sales in spite of conditions—with ads printed on postcards by amazing new patented **CARDMASTER** advertising machine. Low price, sold direct. Guaranteed 5 years. **SEND NAME** for **FREE** illustrated book, new money-making ideas and complete, unique advertising plans. **Cardmaster Co., 1920 Sunnyside, Dept. 165, Chicago 40, Ill.**



A "GOOD HAND" HELPS YOU SUCCEED! LEARN TO WRITE WELL

Handwriting quickly improves with our easy-to-understand picture lessons! Put your spare time to good use; send today for **FREE BOOK**, "How to Become a Good Penman", or check volumes wanted below at \$1 each: Business Writing Artistic Writing Card Writing Bird & Design Flourishing Engrossing Alphabets. **COMPLETE SET \$4.50**

TAMBLYN SCHOOL of PENMANSHIP
S. A. Ziller, Pres. 438 Ridge Bldg., Kansas City, Mo., USA

HERE AT LAST

THIS BEAUTIFUL
ACCESSORY
FOR YOUR CAR!



The most beautiful accessory for your car since the advent of chrome. Your initials in diamond-like rhinestones, set in rodium plated white metal letter mounted on plexiglass. Will add glamour and distinction to any car from a '32 Ford to a '51 Cadillac. Send check or money order for \$3.49 for three initials or \$2.98 for two initials, P.P. No C.O.D.'s please. State Initials.

SUBURBAN SPECIALTY CO., P.O. Box 3518, Phila. 22, Pa.

TUBE GIVEN WITH EVERY TIRE AT NO EXTRA COST

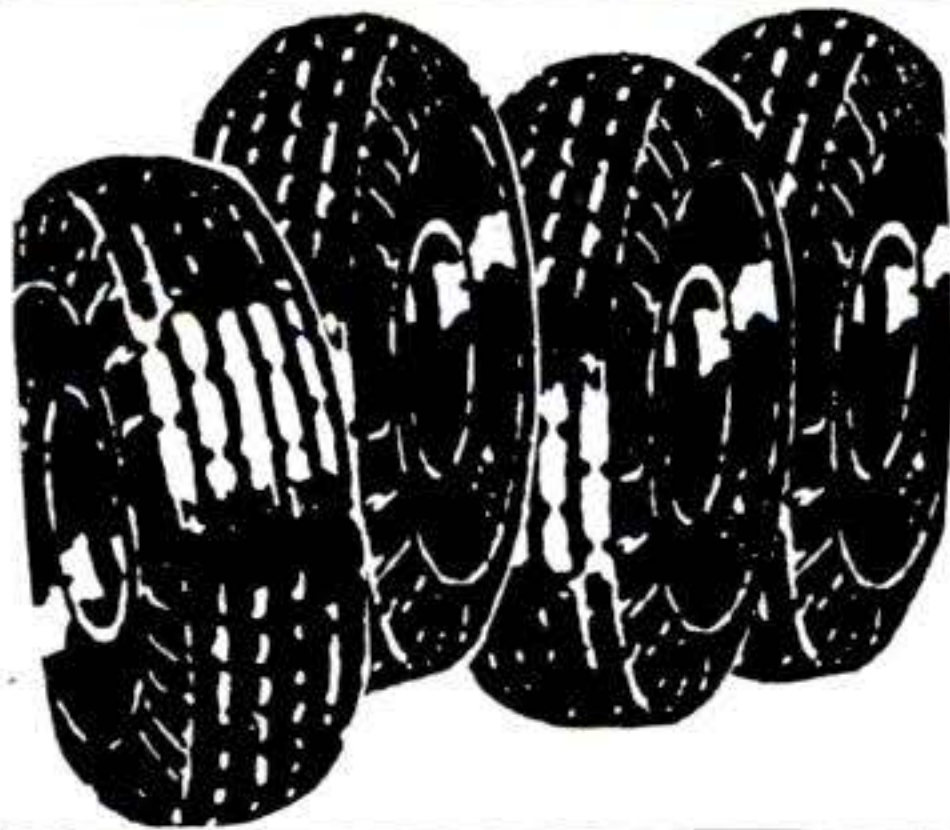

WRITTEN GUARANTEE SENT WITH EVERY TIRE YOU BUY

PLEASE NOTE: Our Tires are NOT Re-Treaded or Re-Capped We serve TRUCKS—BUSES—PASSENGER CARS

GOOD USED TIRES

WE PERSONALLY SELECT YOUR TIRES A TRIAL OF ONE TIRE WILL CONVINCE YOU.

Why Pay More

ONE QUALITY—ONE PRICE ONLY
TUBE GIVEN WITH EACH PASSENGER & TRUCK TIRE AT NO EXTRA COST—SEND THIS AD!

600-16	\$5.32	670-15	\$6.12	710-15	\$6.82	760-16	\$6.92
650-15	5.82	700-15	6.42	750-16	8.72	820-15	7.02
650-16	5.82	700-16	6.62	760-15	8.72	550-17	5.72



600-20	\$9.72	32x6(8)	\$11.72	1000-20	\$18.82
650-20	9.82	32x6(10)	12.32	1100-20	19.82
700-20	12.72	825-20	17.72	1000-22	19.52
750-20	12.42	900-20	17.72	1100-22	20.42

Thousands of tires shipped all over U.S.A. All tires shipped F.O.B. Phila. Send Check or M.O. with this ad. Dept. 5. If your size is not listed write for prices. 17 YEARS AT THIS ADDRESS.

STANDARD 834 N. Broad St., Philadelphia 30, Pa.

BE A LANDSCAPE CONTRACTOR

or a Landscape Architect. Make \$15 to \$50 a day. Compare the competition in this field to others & you'll see why we have hundreds of employed graduates from coast to coast. Course includes practical instruction here in addition to approved home study work. Write for free information



NATIONAL LANDSCAPE INSTITUTE
310 So. Robertson Dept. PS-5 Los Angeles 48, Calif.

NEON SIGN SCHOOL

Learn Neon in 12½ weeks. Many jobs open. Start at \$1.50, \$2.00 hour. We train you in Glass Blowing. Neon

Tube Bending, Color Gassing. Glass Blowers often deferred. ACME TRAINING G. I. APPROVED. Course also open to Non-Vets. FREE FOLDER explains. Write ACME NEON INSTITUTE, Dept. E-2, 330 South Paulina St., Chicago 12, Ill.



MAKE YOUR OWN!
WITH

GRIFFIN LEATHERCRAFT KITS
Best assortment of tools, materials in U. S. A. ! Send 25¢ for 116-page catalog. (money refunded first order)

GRIFFIN CRAFT SUPPLIES
SINCE 1924

5626-B Telegraph Ave., Oakland 9, Calif.

A HIGH SCHOOL DIPLOMA
the EASY WAYNE WAY

• The quick, low-cost WAYNE way to a High School education. No classes; pleasant, spare-time home training; college preparatory; standard texts; credit for past schooling. If you have finished 8th grade and are over 17 years of age, write for free catalog.

WAYNE SCHOOL
2527 SHEFFIELD AVENUE
Catalog HBA-3 CHICAGO 14, ILL.



NOW! YOU CAN EASILY Fix ANY Car IN LESS TIME... and do a better job too!



NEW 1951 Edition of Famous MoToR's Manual Shows You How To Repair—Quickly and Easily—Any Car Built from 1935 THROUGH 1951!

FREE 7-DAY TRIAL

NO job is too tough when you've got MoToR's brand-new AUTO REPAIR MANUAL. Shows how to save work on "ornery" jobs. Helps you make MORE MONEY by doing more jobs in less time! Now covers 1951 models; up-to-date information on ALL automatic transmissions and carburetors.

COMPILED FROM 150 OFFICIAL FACTORY SHOP MANUALS!

This great book—771 BIG 8½"x11" pages—brings you the complete "dope" from 150 Official Factory Shop Manuals, boiled down in simple easy-to-understand language. 2300 cut-away photos, diagrams, drawings show WHAT to do, HOW to do it. 225,000 service and repair facts! 800 car models! Now YOU can try it FREE—for 7 days.

COVERS 800 MODELS BUILT SINCE 1935!

Auburn Lafayette
Austin La Salle
Bantam Lincoln
Buick Mercury
Cadillac Nash
Chevrolet Nash
Chrysler Rambler
Crosley Oldsmobile
De Soto Packard
Dodge Plymouth
Ford Pontiac
Frazer Studebaker
Henry J. Terraplane
Hudson Willys
Kaiser and others!

Same FREE Offer On MoToR's Truck and Tractor Manual

Latest edition! Covers EVERY job on EVERY popular make gasoline truck, tractor, stock engine made from 1936 thru 1949, 961 big pages, 300,000 facts, 1400 pictures. Check proper box in coupon. FREE 7-Day Trial.



SEND NO MONEY

Mail coupon below—without money! When your book arrives—make it show you what it's got! Unless you agree it's the greatest time and work saver you've ever seen—return book in 7 days, pay nothing. Mail coupon NOW! MoToR Book Department, Desk 25, 250 West 55th Street, New York 19, N. Y.

MAIL COUPON NOW FOR 7-DAY FREE TRIAL

MoToR BOOK DEPT.
Desk 25, 250 W. 55th St., New York 19, N. Y.

Rush to me at once (check box opposite book you want):
 MoToR's New AUTO REPAIR MANUAL. If O.K., I will remit \$1 in 7 days (plus 35c delivery charges). \$2 monthly for 2 months and a final payment of 95c one month after that. Otherwise I will return the book postpaid in 7 days. (Foreign price, remit \$8 cash with order.)

MoToR's TRUCK & TRACTOR REPAIR MANUAL. If O.K., I will remit \$2 in 7 days, and \$2 monthly for 3 months, plus 35c delivery charges with final payment. Otherwise I will return book postpaid in 7 days. (Foreign price, remit \$10 cash with order.)

Print Name.....Age

Address

CityState

Check box and save 35c delivery charge by enclosing WITH coupon entire payment of \$5.95 for Auto Repair Manual (or \$8 for Truck and Tractor Repair Manual.) Same 7-day return-refund privilege applies.

BUILD YOUR CAREER IN RADIO-TELEVISION ELECTRONICS

thru this Proven Plan



Career opportunities are at an all-time high in *Electronics* — world's fastest-growing industry, and *Power*—facing an 80% expansion by 1960. This 47-year-old school offers a *realistic* plan to prepare you for a successful future.

In 12 Months become a Radio or Electronics Technician. Prepare for a wide range of career objectives. *In 6 additional months become a TV Technician.*

YOUR TECHNICIAN'S COURSES APPLY TOWARD YOUR B.S. DEGREE also complete in themselves. Military, practical, or prior academic training evaluated for advanced credit.



MILWAUKEE SCHOOL of ENGINEERING

Technical Institute
College of Electrical Engineering

Milwaukee School of Engineering PS-551
1020 N. Broadway Milwaukee, Wis.

Without obligation, send 1951 Catalog for Electrical Engineering, B.S. Degree, major in

- Power Electronics; plus Occupational Guidance Manual on:
 - Radio-TV Electrical Power Welding
 - Heating, Refrigeration, Air Conditioning
- Name.....Age.....
Address.....
City.....Zone.....State.....
 Check if World War II Veteran



BUILD CEDAR CLOSETS WITH A PAINT BRUSH

FIREPROOF!
FRAGRANT!
ECONOMICAL!
ECONOMICAL!



EASY TO APPLY

CEDAR-LUX is the cedar lining you put on with a brush. Just mix with plain water. Dries three times as hard as plaster. Lasts a lifetime. Now any man or woman can cedarize ordinary closets, boxes, trunks, recreation rooms, dens and rumpus rooms.

Not a substitute for cedar! It's the real thing! Specially prepared compound of genuine red cedar wood. Brushes on or apply with trowel or spray. Re-surfaces walls sealing all cracks and crevices where moths could breed. Cedar-Lux won't rub off on clothing. Neutralizes body odor in clothing. One pound covers 10 to 12 square feet. Light pink in color. Give your closets that clean, sweet, fresh odor of the North woods. Instructions simple to follow. Have fun! Save Money! Enjoy cedar fragrance! Make every closet a cedar closet and be free of moths! **ORDER YOURS TODAY!**

YOU MUST BE SATISFIED OR YOUR MONEY BACK

Ask your dealer or order direct.

5 lb. can \$6.95. 10 lb. can \$12.95 postpaid.

CEDAR-LUX PRODUCTS CO. Dept. PS-3, 703 Main St.
Kansas City, Missouri
DEALER INQUIRIES INVITED

SURPLUS BARGAINS FOR SPORTSMEN!

U. S. GOV'T SURPLUS



"BARGAIN BOOK"

JUST OFF THE PRESS!

Greatest Bargain Book ever offered low, low prices, terrific savings on scarce war surplus. Mail 10c TODAY - NOW - begin saving on hundreds of items for farm, home, shop, sports. Get your Bargain Book by return mail.

MAIL TODAY Only **10c**

500 BARGAINS
• FARMS • SPORTS
• HOME • SHOP

FISLER SALES CO.

723 WALNUT ST., DESK A-8, KANSAS CITY, MO.

\$600 BUILDS 4 ROOMS & BATH!

WHY PAY RENT?

For Six Hundred dollars and 30 days of your spare time you can build yourself this Beautiful Home.



Living room 10x15. Front bedroom 9x10. Back bedroom 10x11. Kitchen 8x10. Bath 5x7. Hall 3x4. Wind out steel Casement windows. Concrete block, stuccoed. \$1.00 brings you Step-by-Step Instructions. Blueprint & Material List.
L. H. Farrow, Dept. D
Box 645 Columbus 16, Ohio

START YOUR OWN

MONEY-MAKING BUSINESS

Clean rugs on customers' floors with highly efficient electric machine which is making **BIG MONEY** for others and giving them independence. Special skill or experience not required. No shop necessary. Write today for complete **FREE** information. Address:

VON SCHRADER MFG. CO., 511 PL., RACINE, WIS.

You CAN DO FINE LEATHERCRAFT

COPPER TOOLING • TEXTILE PAINTING



FREE!
BIG
ILLUSTRATED
CATALOG

Real enjoyment and pleasure of creating valuable things for your own use or to sell. It's so easy, too! Send for your free Kit Kraft Catalog today.

KIT KRAFT

DEPT. PS5 • 7377 MELROSE AVE., HOLLYWOOD 46, CALIF.

learn to HYPNOTIZE!

Command others with hypnotic power! Amaze everyone with your new spellbinding technique. New easy to master course teaches you this mystic art, quickly, expertly, professionally. Have subjects at your mercy. Make them obey your every desire. Send for this Valuable Book Now! Just pin \$1 to this ad and "25 lessons in Hypnotism" will be mailed to you postpaid. Satisfaction guaranteed or your money back.



Books Publishing Co., 56 W. 24th St., New York 10, N.Y.

WANT TO

Write Stories

FREE LESSON
shows how you
learn at home

Articles
Mysteries?



The demand for writers is creating great new opportunities and it's not as hard to succeed as you may imagine. At home, you may learn fiction writing, best basis for all fields: short stories, radio & TV, articles, business items. Palmer training is endorsed by famous authors, scores of successful graduates. Complete instruction, professional coaching. **FREE** book and lesson show how you may enjoy an ideal part-time or full-time career. Write **TODAY** (no salesman will call). Approved for veterans: advise if eligible.

PALMER INSTITUTE OF AUTHORSHIP, Since 1917
1680 N. Sycamore, Hollywood 28, Calif., Desk U-51



FULLY GUARANTEED TIRES COST LESS!

Nationally famous FIRESTONE, GOODRICH, U.S. ROYAL, GOODYEAR, and other makes. Every tire selected and inspected for your safety.

NEW TREAD TIRES GUARANTEED 24 MONTHS

600x16	9.98	650x16 (6)	13.98	650x15	11.48	670x15	11.98
600x16 (6)	10.98	700x16	12.98	700x15	12.48	710x15	12.98
650x16	11.98	550x17	9.98	700x15 (6)	14.4	760x15	13.98

GOOD TIRES GUARANTEED 12 MONTHS

600x16	4.14	700x16	5.14	32x6 (8)	8.84	825x20	14.24
650x16	4.54	670x15	4.74	32x6 (10)	10.84	900x20	13.34
650x15	4.34	650x20	7.84	750x20 (8)	8.54	1000x20	14.14
700x15	4.64	700x20 (8)	8.94	750x20 (10)	9.94	1100x20	16.14

AAA PREMIUM GRADE GUARANTEED 18 MONTHS

600x16	5.58	710x15	6.48	650x20	10.88	825x20	16.68
650x16	5.98	550x18	5.98	700x20	12.8	900x20	17.98
650x15	5.98	500x19	5.48	32x6 (8)	10.48	1000x20	18.9
700x15	6.68	760x15	6.78	32x6 (10)	12.48	1100x20	19.9
700x16	6.78	550x17	5.88	750x20 (8)	12.98	1100x22	20.9
820x15	7.48	600x20	9.78	750x20 (10)	14.4	1400x20	44.98

MILITARY SPECIAL

AA Guaranteed 12 Months—
900x16 11.98 | 1000x20 19.98
750x20 12.89 | 1100x20 21.98

MILITARY

New Tread Guar. 24 Mos.
600x16 10.98
600x16 (6) 11.98
750x20 28.98

AAA GUARANTEED 18 MONTHS
900x16 14.98 • 750x20 16.48

Passenger Tubes—Water Tested—All Sizes... \$1.50
Truck Tubes—Water Tested—All Sizes... \$3.95

Largest stock of used tires in the East. Thousands of satisfied customers. Write for sizes not listed. MONEY ORDER OR CHECK WITH ORDER.

PYRAMID TIRE CO.

1333-35 North 5th St. Dept. M., Phila. 22, Pa.



Hi Doc... IT'S MAGIC!

Do you like tricks and gadgets? Well, here's a Scotchman's MAGIC PIPE that you can smoke without filling! You'll love to do this trick over and over... it's so easy and so perplexing. A full-sized Hickory Pipe you smoke normally and naturally WITH AN EMPTY BOWL and using NO CHEMICALS! Foolproof... Baffling... The perfect pocket trick. Complete with full instructions... Just 50c. PLUS a new CATALOG of magic tricks that have been chosen for their simplicity and effectiveness, FREE with order. Or send 10c for catalog alone.

Town House Magic-1377 Union Blvd.-St. Louis 13, Mo.

URANIUM DETECTOR!



Lowest Price in Field
GEIGER COUNTER
For Radioactive Mineral Prospecting
Ready to Operate **\$32.50**

Write for complete information

ALPHA NUCLEAR LABORATORIES
Box 649-A, Asbury Park, N. J.

BE A PUBLICIST* LEARN AT HOME



*Earn \$4,000 to \$25,000 a year!

Book tells HOW. Success formula. Easy, exciting. Experience unnecessary. Secrets revealed. Age no barrier. Money back guarantee! Send \$2.00 today, to—

DICK CASTERLINE, Publicist
13022 Ardis Ave. Downey, Calif.

ORDER NOW!
5 COILZIT'S
for **50¢**
Post Paid
No COD'S.
COILZIT
Dept. S5
2557 Steinway St.
L.I. City, 3, N.Y.
(Dealers, Agents Wanted)

NEW! COILZIT Safety CORD SHORTENER
Prevent Accidents and Short Circuits

U.S. PAT. No. 2,533,341
CANADA No. 459,572

NOW!
IN A JIFFY YOU CAN SHORTEN UNTIDY ELECTRIC CORDS!

- NO FUSS
- NO BOTHER
- NO WIRES TO CUT

PLAY SAFE!
KEEP YOUR WIRE CORDS SAFE AND NEAT!

EASY TO USE!
Simply coil excess Cord around COILZIT

a little

Pyroil

makes a **BIG** difference in your car

A pint of Pyroil in the crankcase, a few ounces in the gas tank, and you'll notice a big difference in your car. Why? Because Pyroil has the extraordinary property of making ordinary oil cling to engine parts. This coating of protective lubrication eliminates friction between piston rings and cylinder walls. Pyroil stops costly wear and tear caused by metal-to-metal contact. It assures instant lubrication when you step on the starter—it prevents oil from draining off vital parts when you turn off the engine.

Yes, a little Pyroil (at so little cost) will make a big difference in the life of your car. Ask your gas station attendant to add Pyroil—add miles to your car.

Pyroil for Aircraft Engines

Use Aircraft Pyroil B for lubricating oil, Aircraft Pyroil A for gasoline.

GIVEN! An attractive Pyroil metal savings bank—takes coins up to 50c pieces. **MOTORISTS, it's yours for the asking—sent postage paid.**



Manufactured and Guaranteed by
PYROIL COMPANY,
555 Main Street,
La Crosse, Wisconsin.

Canadian Distributors:
Central Purchasing Agencies, Ltd.
Toronto, Ontario

PYROIL COMPANY

555 Main Street, La Crosse, Wisconsin

I want my car to last and run properly. Please tell me more about Pyroil and how it can accomplish this for me.

Name.....

Address.....

City or Town.....State.....





"I'M EARNING \$300 A MONTH!"

.... says Leonidas Burgoyne of Chicago, Illinois, "Expert individual instruction in the fully equipped shops of Greer Shop Training gave me the right start to get my good paying job."

GREER SHOP TRAINING.... established 1902, is one of America's largest trade schools. Over 48,000 successful graduates. You learn by tearing down, repairing and rebuilding. Day and evening classes. Mail this coupon today!

LEARN A TRADE NOW!

GREER SHOP TRAINING, Desk 311, 2230 S. Michigan Avenue, Chicago, Ill.

Gentlemen: Please send me information about trade I have checked below. (Specify if you are VET or NON-VET .

- IN OUR CHICAGO SHOPS**
- | | |
|---|--|
| <input type="checkbox"/> AUTO MECHANICS | <input type="checkbox"/> BODY, FENDER REPAIR |
| <input type="checkbox"/> DIESEL | <input type="checkbox"/> WELDING—ARC, GAS |
| <input type="checkbox"/> REFRIGERATION | <input type="checkbox"/> MACHINIST |
| | <input type="checkbox"/> PIANO TUNING |

Above courses approved for Vets and Civilians.

ALSO THE FOLLOWING HOME STUDY COURSES

- | | | |
|--|---------------------------------|-----------------------------------|
| <input type="checkbox"/> REFRIGERATION | <input type="checkbox"/> DIESEL | <input type="checkbox"/> PLASTICS |
|--|---------------------------------|-----------------------------------|

Name _____ Age _____

Address _____

City _____ State _____

GREER SHOP TRAINING

NEW! HANDY HELPER FOR SHOP & HOBBY!

Swingline
Tot 50

TACKER STAPLER

A precision-built Swingline tacker-stapler kit at a record low price! Sturdy!

Rust-proof! Durable!

Keep it fingertip handy on work-bench or in tool-box—it will save you plenty of time, work and money every day. Hinged plastic box and a big supply of staples!



IT TACKS!
screening, shelving, insulation, templates.

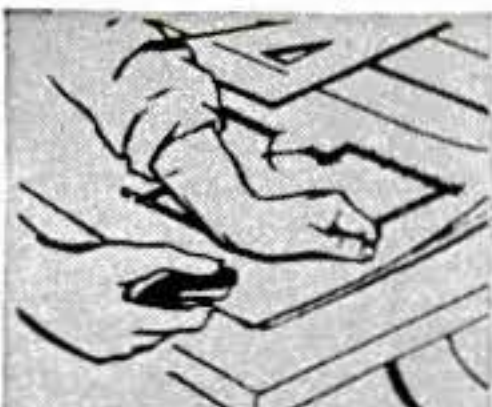

IT STAPLES!
shop notes, blueprints, holds wood while glueing.

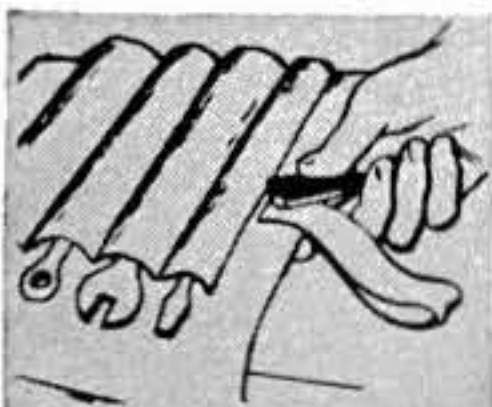

IT MENDS!
fool rolls, bags, awnings, leather, rubber items.



Only **98¢** with 1000 Staples and leaflet

Sold at Drug, Hardware, Stationery, Dept. and Variety stores everywhere.

SPEED PRODUCTS COMPANY, INC.
LONG ISLAND CITY 1, NEW YORK

1000 Refill Staples 25c

GO PLACES LEARN ANOTHER LANGUAGE EASILY - QUICKLY IN 20 MINUTES A DAY

by **LINGUAPHONE** World's-Standard CONVERSATIONAL METHOD

**FRENCH
SPANISH
GERMAN
RUSSIAN**
—any of 29 Languages

Are you letting interesting job, travel, armed services, opportunities and a whole new world of cultural advantages pass you by because you speak only one tongue? Learn at home any one of 29 languages including the Oriental—quickly, easily by the LINGUAPHONE CONVERSATIONAL METHOD. You listen—you learn—you understand—you SPEAK. "World-wide educational endorsement; over a million delighted home-study students. FREE BOOK gives fascinating facts. Write TODAY! Approved for VETERANS' Training.

LINGUAPHONE INSTITUTE

147-05 Rockefeller Plaza

New York 20, N. Y.

DOUBLE BRAKE LIFE! Automatic Adjuster

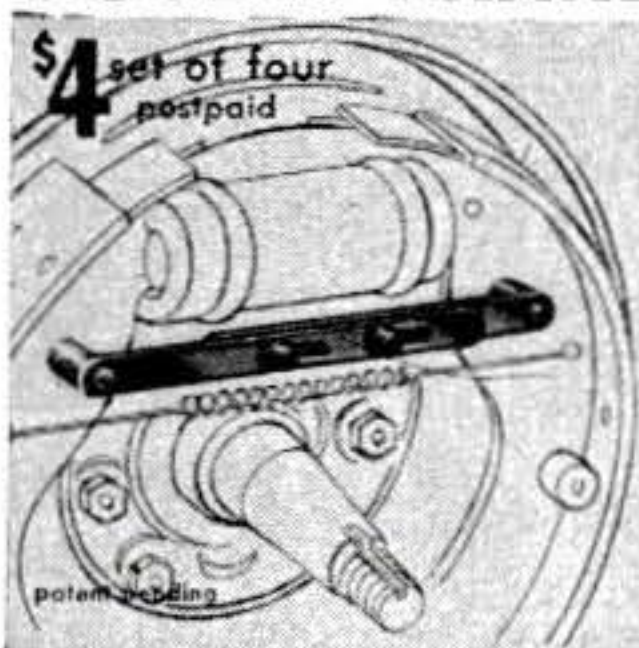

Increases brake lining life by 100% by keeping brakes in constant adjustment! Install BRAK-LOKS and BRAKES NEVER NEED ADJUSTING. Better brake performance, and safety. No adjustment, expense, or trouble. Novel Patented feature, reduces brake shoe travel, eliminates spot-wear and gives even lining contact with drum by keeping proper clearance between lining and brake drum. Soundly engineered. Tested and proven by thousands of enthusiastic auto and truck owners. Fits all hydraulic brakes. Quickly installed. Nothing to wear out—Lasts forever! Sold direct only. Send \$4.00 for set of four to:

WHOLESALE DIE CO., Dept. 2B 604 S. Marengo, Alhambra, Calif.

BECOME AN EXPERT IN

TRAFFIC

Traffic men earn \$4,000 to \$10,000 and up. Thousands of firms need experts on rates, tariffs, regulations. We train you thoroughly in spare time at home for executive traffic jobs. Personal training under traffic authorities. Placement counsel and help. Write for free 48-page book "Traffic Management—the Fast Growing Profession."

LASALLE Extension University, 417 So. Dearborn St. A Correspondence Institution, Dept. 583T, Chicago 5, Ill.

Play GUITAR in 10 DAYS

OR GET YOUR MONEY BACK!
Let Ed Sale teach you to play with his famous diagram photo system. Book contains 53 photos, 43 diagrams showing exactly how to place your fingers. Gives you 110 popular songs, words and music—along with complete, easy to learn instructions. Imagine your joy when you find after only two weeks you are playing beautiful music! Amaze your friends! Be the life of the party! SEND NO MONEY. Pay Postman \$1.95 Plus Postage.

ED SALE Dept. PS-5 **POINT PLEASANT, NEW JERSEY**

MODERN LAWN MOWER SHARPENER

**FOR LAWN MOWER SHOPS
FIX-IT SHOPS
GOLF COURSES • PARKS
101 OTHER JOBS**

Sharpens All Reel Type Mowers • Hand, Power or Gang • 10 to 20 Minutes • No Dismantling • No Extra Attachments Needed.

All reel type mowers, from 5-inch edgers to 36-inch power mowers, are quickly sharpened to extreme ends of both left and right twist blades. Handle, wheels, roller and motor remain in place when sharpening is in process. Bed knife is sharpened in same brackets. Grinding head rides on five ball bearing races. Easy to operate. Also sharpens chisels, joiner knives, planer blades. Big profit maker. Own your own business. Send Today for FREE Illustrated Bulletin No. 11-C1. Prices Subject to Change Without Notice.

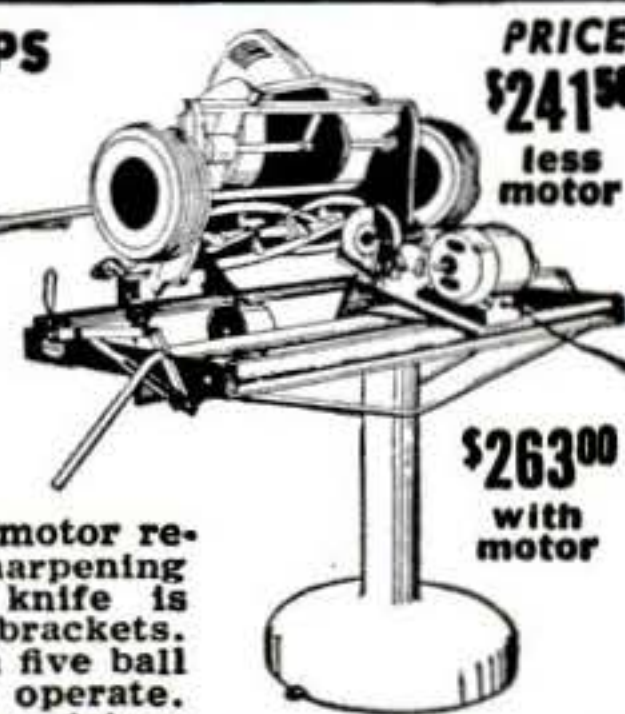

PRICE \$241.50 less motor

\$263.00 with motor

ORDER NOW
Immediate Delivery

MODERN MFG. CO. 160 N. FAIR OAKS AVE PASADENA 1, CALIFORNIA

WARNING! Your engine may have to last a long time! This spring swing to . . .

MARVEL *mystery oil*



Here's the perfect upper-lube to save the precious engine of your car — keeps valves free, ring and piston wear down. Definitely a *must* in high-compression engines, for greater pep, power and performance. Add Marvel Mystery Oil to gasoline, crank-case oil, or use in Marvel Inverse Oiler. *Be engine-wise and Marvelize now!*



Install a Marvel Inverse Oiler for proper and controlled feeding to critical upper cylinder areas. Visible supply in 1-qt. glass container.

Write for free information Dept. 105

EMEROL MANUFACTURING CO., INC. 242 WEST 69TH ST., NEW YORK 23, N.Y.

BURN WATER in your CAR
with the **AMAZING OCTA-GANE "50"**

YES, BURN WATER, ALCOHOL OR BOTH IN YOUR CAR, TRUCK OR TRACTOR

The result of years of research and development, the OCTA-GANE "50" is the only all bronze, "fog type," exhaust operated, pressure injector on the market today. It is adjustable to burn up to one gallon of water or alcohol with every 10 gallons of gasoline. Here's what United States Agricultural Department Scientists say, "THE GASOLINE MILEAGE OF NEW HIGH COMPRESSION AUTOMOBILE ENGINES CAN BE INCREASED UP TO 30% WITH ALCOHOL-WATER-GASOLINE FUELS."

Only \$24.95 postpaid (Send \$2, balance C.O.D.)
Complete unit includes all bronze injector, corrosion proof water tank and all fittings.
NARCO, Dept. OG-5 350 W. Washington Blvd., Venice, Calif.

WRITE FOR: **FREE ILLUSTRATED LITERATURE**

Which of these 2 one time WEAKLINGS PAID 10c like YOU
to become an **All-Around HE-MAN** at Home

Larry Campbell **Rex Ferrus**

In 10 Thrilling Minutes a Day? Which One Paid Hundreds of Dollars?
Rex sent me 10c like YOU should now, to start building into a Champion All-Around HE-MAN.
Larry paid me hundreds of dollars to train at my side.
Rex was a Skinny Bag of Bones. Today he is tops in Athletics, Strength, Popularity, Business.

Send NOW for my **5 PICTURE-PACKED HE-MAN BUILDING COURSES** for **10¢ FREE** and Photo Book of Famous Strong Men!

Become an **ALL-AROUND HE-MAN** — Be A Winner at Anything YOU Tackle with Progressive Power — **SPORTS! JOB! SCHOOL! FRIENDS!**

JOWETT INSTITUTE, Dept. PS-15 - 230 Fifth Ave., New York 1

A BOOK THAT SHOWS YOU 3000 ILLUSTRATIONS and DESIGNS OF MECHANICAL MOVEMENTS, DEVICES & DETAILS!

Every conceivable kind of mechanical motion and work is briefly explained and illustrated in this unusually helpful book. As far as known, the only work in existence which aims to provide side by side suggested sketches of the various methods in use for accomplishing any particular mechanical movement or work, in a form easily referred to. Every engineer, inventor or mechanic finds the need of devising, simplifying or improving some mechanical process or method. In doing this he has to rely on memory or experience. Here is a reference book of nearly 3000 MEANS AND METHODS for producing any kind of movement or work, classified and arranged for easy reference!

SUCH AS: Accumulators, Anti-friction, Ball and Socket, Bearings, Blowings, Brakes, Cams, Chain Gear, Chopping, Chucks, Circular Motions, Clutches, Conveying, Cranes, Cranks, Cutting Doors, Drilling, Eccentrics, Engines, Expanding, Filtering, Gears, Governors, Grips, Grinds, Heating, Hinges, Hydraulics, Indicators, Journals, Levers, Links, Lowerings, Lubricators, Measuring and Weighing, Mixing, Nozzles, Parallel Motions, Pipes, Pivots, Power Propulsion, Raising, Ratchets, Rotary Engines, Safety Appliances, Shafting, Signals, Slides, Sounds, Speed, Spindles, Springs, Starting, Striking, Swivels, Tanks, Traps, Turbines, Valves, Water Wheels, Winding, Wipers, etc.

If you work with machinery of any kind, you need this **ENGINEERS' SKETCH BOOK** by Thomas W. Barber—355 pages, durably printed and bound in cloth. **Price \$3.98**

Order by mail. If payment sent with order, we pay postage (or sent c.o.d. plus delivery charges, which amount to 37c). Money back if not fully satisfied.

WAVERLY BOOKS, 80 E. 11th St., Dept. SB-1, New York 3, N. Y.

Amazing New Discovery Only Experts Can Tell It from a Diamond!



Write today for the **FREE** illustrated booklet that tells the full story of the latest miracle of science—the story of a glorious jewel discovered in the laboratories of one of the world's largest corporations. Read all about the Kenya Gem that so closely resembles a diamond that only an expert can tell the difference.

More Fire! More Brilliance!

Yes, this marvelous gem has more brilliance, more fire and a more dazzling display of color than the finest diamond of equal size. You can own an unmounted Kenya gem for only \$27 (1 carat) to \$120 (4 carats); also men's distinctive rings and ladies' fashionable rings and earrings in 14K gold set with expertly cut Kenya gems. **EASY PAYMENT TERMS.**

The Cinderella of Science

Kenya gems are the sensational discovery you read about in Reader's Digest, Popular Science and Sat. Eve. Post, "the only thing on earth more brilliant than a diamond." It is a true gem, crystallized by science instead of nature.



Copyright 1950
Kenya Gem Corp.

Write Today or Send Coupon
for **FREE** Illustrated Booklet

**KENYA GEM CORPORATION, Dept. 305
Philadelphia 44, Pa.**

Mail This **FREE** Coupon Today

Kenya Gem Corporation, Dept. 305 Philadelphia 44, Pa.
Please send me, without obligation, the **FREE** illustrated booklet telling all about Kenya Gems.

Name

Address

City State

ENGINEERING DEGREE IN 27 MONTHS

Big Demand for Graduates

AERONAUTICAL, CHEMICAL, CIVIL, ELECTRICAL, MECHANICAL and RADIO ENGINEERING (including Television).

Hundreds of young men are earning engineering degrees in this recognized institution each year—continuous operation. New terms start quarterly. Many students earn a major part of their college expenses in this large industrial center.

Low tuition. Competent instruction. Thorough, intense, practical program. Modern laboratory facilities including new physics lab. and modernized wind tunnel. Individualized instruction emphasized.

Approved for Veterans. Engineering preparatory courses. Students from 48 states and 21 foreign countries. Enter June, September, December, March. Send coupon for free catalog and full information. Enroll now.

SEND COUPON TODAY

INDIANA TECHNICAL COLLEGE

651 E. Washington Boulevard
Fort Wayne 2, Indiana

Please send me free information on B. S. Engineering degree in 27 months as checked.

Aeronautical, Chemical, Civil,
 Electrical, Mechanical, Radio-Television.

Name

Address



**BOOKS!
BOOKS!
BOOKS!**

Unbelievable **BARGAINS!** SAVE UP TO 72%

Warehouse clearance sale—all brand-new books that sold originally for as high as \$5.00—now only \$1.39 each! Only limited quantities available of each title. Send no money now unless you prefer to—clip Order Coupon below and mail **TODAY!** If not delighted, return books within 7 days for **FULL REFUND!**

#901. **HOW TO MAKE MONEY**—Small Store and Independence. Every phase of successful business operation. Was \$4.00. **NOW \$1.39**

#909. **MANUAL OF HOBBIES**—Time Out For Living. Getting the most out of camping, collecting, home movies, etc. 661 pages. Was \$2.20. **NOW \$1.39**

#919. **MATHEMATICS**. All branches of practical math; with 5-place log. tables. Was \$2.50. **NOW \$1.39**

#931. **CURRIER & IVES PRINTS**. 8 natural-color American lithographs. Heavy art stock; 11" x 14", ready to frame. Were \$4.00. **NOW \$1.39**

#940. **FUNDAMENTALS OF RADIO**. Complete self training course on radio theory and building. Illustrated. Was \$3.00. **NOW \$1.39**

#944. **AMERICAN AIR NAVIGATOR**. Basic self instruction book covering all aspects of air navigation today. Was \$5.00. **NOW \$1.39**

#952. **CARTOON PACKAGE. THEY'LL DO IT EVERY TIME!** You'll love these lampoons of every type of stuffed shirt in captivity! **MERRY-GO-ROUND**. Fun-filled drawings, tales by Runyon, "Bugs" Baer, others. Were \$3.00. **Both NOW \$1.39**

#980. **ENGINE LATHE OPERATIONS**. Complete, illustrated guide to use of all tools in this highly paid field. Was \$1.98. **NOW \$1.39**

#982. **FUNDAMENTALS OF SHOPWORK**. Hand and power tools; blueprint reading. Was \$1.75. **NOW \$1.39**

#984. **HOUSE CARE AND REPAIR**. Basic manual for every homeowner! Treats plumbing, electricity, roofs, etc. Was \$1.50. **NOW \$1.39**

#986. **PLASTIC MOLD DESIGN**. How to design all types of molds and dies. Was \$4.50. **NOW \$1.39**

#988. **FUNDAMENTALS OF ELECTRICITY**. Covers all aspects of electricity! Illus. Was \$2.00. **NOW \$1.39**

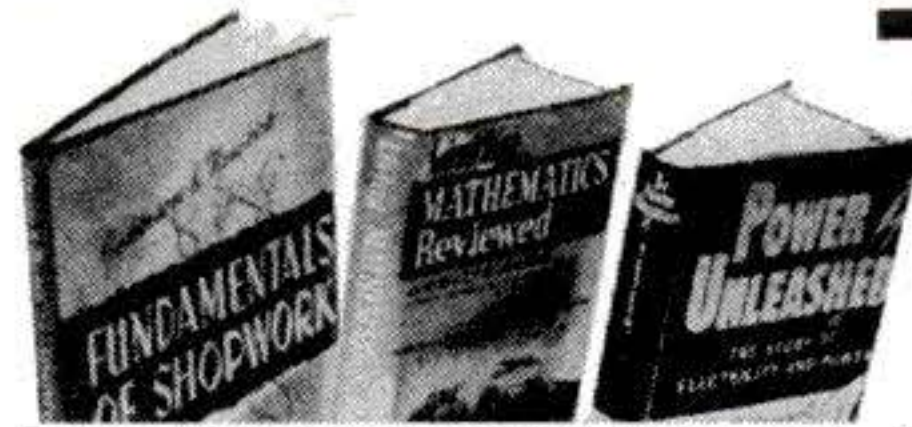

MAIL TODAY!

FOREMOST BOOKS, Dept. 551, 353 4th Ave., N. Y. 10
Please send C.O.D. books circled below. On delivery, I will pay postman \$1.39 each plus shipping charges. Books may be returned within 7 days for full refund.

#901 #909 #919 #931 #940 #944
#952 #980 #982 #984 #986 #988

NAME

ADDRESS

CITY & ZONE STATE

Check here if you remit with coupon, and we will pay postage. Same return privileges.

MONTH AFTER MONTH, YEAR AFTER YEAR, YOU SEE OUR AD. REMEMBER IT'S DANGEROUS to pay less if you want the finest matched USED tires.

GOOD YEAR Firestone

GOODRICH, UNITED STATES, GENERAL, & OTHERS, NOT RECAPS

Our policy is to select your tires so carefully, as if our very future depended on the service given by that particular tire.

FREE TUBE WITH "ALL" BLATT'S GOOD GRADE TIRES

GOOD GRADE, 16 MONTHS GOLDEN RULE GUARANTEE BOND.			
600-16 \$4.14	700-15 \$4.54	650-20 \$7.94	32x6(8) \$ 8.64
650-16 5.42	670-15 4.74	700-20 8.54	32x6(10) 9.94
700-16 5.04	710-15 4.94	750-20 8.64	900-20 13.94
650-15 4.44	550-17 4.64	825-20 15.92	1000-20 13.94

FINEST GRADE, 26 MONTHS GOLDEN RULE GUARANTEE BOND

THIS GRADE MADE THE BLATT NAME "WORLD FAMOUS,"			
MATCHED BALANCED TIRES		MATCHED BALANCED TRUCK TIRES	
600-16 \$5.49	650-15 \$5.94	600-20 \$9.94	900-20 \$18.54
650-16 6.42	670-15 6.24	650-20 9.94	1000-20 18.54
700-16 5.94	700-15 6.54	700-20 11.94	1100-20 18.54
750-16 7.94	710-15 6.34	32x6(8) 10.54	1000-22 17.54
550-17 5.94	760-15 6.54	32x6(10) 13.92	1100-22 18.54
525-18 5.54	820-15 7.04	750-20 12.54	1200-22 22.54
700-17 10.00	475-19 5.94	825-20 25.84	1100-24 21.54

900-16 MILITARY TREAD 750-20

Regular \$10.94	Regular 16 Mos. \$10.94	Regular \$10.94
Best 16.64	Best Guar. 30 Mos. 16.64	Best 16.64

BLATT BLATT BLDG., GIRARD & LANCASTER AVES., DEPT. P.S., PHILADELPHIA 31, PA. Send check or money order and this ad for rush shipment. We won't ship a tire we wouldn't use. The name to trust in rubber. PRICES SUBJECT TO CHANGE Shipments RUSHED Down South. Up North and Far West



OWN a Business

Clean and Mothproof rugs and upholstery "in the home." Patented equipment. No shop needed. Duraclean dealer's gross profits up to \$15 a day on EACH serviceman. These Nationally Advertised services create repeat customers. Easy to learn. Quickly established. Easy terms. Send today for Free Booklet—Full details.

Duraclean Co., 1-185 Duraclean Bldg., Deerfield, Ill.

TREASURE -- \$10,000

New locator detects metals, valuable minerals and buried treasure. Money-back guarantee of superiority.

Also geiger counters. Govt. reward of \$10,000 for uranium discovery. Write for FREE information.

THE GOLDAK COMPANY
1544 W. GLENOAKS BLVD., GLENDALE 1, CALIF.

CUT GEMS & JEWELS AT HOME!

Fascinating and profitable! Compact and complete—saws, grinds, sands, shapes and polishes. Professional lapidary model of heavy aluminum casting with all blades, wheels needed. Easy to master; full directions with each unit. Write: **ROCKHOUND HOBBYIST** Weighs only 35 lbs.

EQUIPMENT ENGINEERING CO., Dept. A, Box 292, Kansas City, Mo.

Personal To Women With Nagging Backache

When kidney function slows down, many folks complain of nagging backache, loss of pep and energy, headaches and dizziness. Don't suffer longer with these discomforts if reduced kidney function is getting you down—due to such common causes as stress and strain, over-exertion or exposure to cold. Minor bladder irritations due to cold or wrong diet may cause getting up nights or frequent passages. Don't neglect your kidneys if these conditions bother you. Try Doan's Pills—a mild diuretic. Used successfully by millions for over 50 years. While often otherwise caused, it's amazing how many times Doan's give happy relief from these discomforts—help the 15 miles of kidney tubes and filters flush out waste. Get Doan's Pills today!



HIGH SCHOOL IN SPARE TIME AT HOME

CAN LEAD TO A BETTER JOB IN BUSINESS or INDUSTRY

You can take subjects which have Real Job Value and still earn graduation!

• This is your opportunity to make completion of high school work for you. Your AMERICAN SCHOOL home study course can include high school subjects closely related to your present job or the kind of work you want to do later. You can qualify for high school course diploma and benefit from course subjects that will aid greatly in winning promotions.

50 Job Help Subjects from Which to Choose

Our FREE, 44-page book of detailed information lists 100 high school subjects, of which 29 are technical and 21 are commercial. Whether you work in a shop, factory, garage or office you will find subjects of practical benefit in your climb toward better jobs at better pay. Some of these are Blueprint Reading, Mechanical and Machine Drawing, Tool Making, Foundry Work, Automotive subjects, Electricity—and Bookkeeping, Accounting, Secretarial Practice, Salesmanship.

Turn Spare Time Into Money

During more than 50 years American School has helped thousands to reach higher job goals by profitable use of spare time at home—and it can help you. Others have prepared for college entrance. If you have not completed high school, check that subject on the coupon below, add your name and address and mail it right now. Or if you are a high school graduate and are ambitious to succeed in the vocation of your choice, check that subject. Your coupon will bring you the book of information, without obligation of any kind. Mail it now.

AMERICAN SCHOOL

DEPT. G-546, DREXEL AT 58th, CHICAGO 37

HOME - STUDY TRAINING SINCE 1897

Take This First Easy Step

CHECK, CLIP AND MAIL COUPON NOW

AMERICAN SCHOOL, Dept. G-546 Drexel at 58th, Chicago 37, Ill. Without obligation, please send me FREE information on training course checked below.

- | | | |
|---|--|--|
| <input type="checkbox"/> HIGH SCHOOL COURSES | <input type="checkbox"/> Bookkeeping | <input type="checkbox"/> Plastics Engr. |
| <input type="checkbox"/> Accounting | <input type="checkbox"/> Business Mngmt. | <input type="checkbox"/> Plumbing—Pract. |
| <input type="checkbox"/> Air Conditioning | <input type="checkbox"/> Contracting | <input type="checkbox"/> Private Secretary |
| <input type="checkbox"/> Architecture & Building | <input type="checkbox"/> Diesel Engr. | <input type="checkbox"/> Radio Operating & Servicing |
| <input type="checkbox"/> Automotive Engr. | <input type="checkbox"/> Drafting & Design | <input type="checkbox"/> Railway Training |
| <input type="checkbox"/> Aviation—Practical | <input type="checkbox"/> Electrical Engr. | <input type="checkbox"/> Refrigeration |
| <input type="checkbox"/> Aviation Drafting & Design | <input type="checkbox"/> Electricity—Pract. | <input type="checkbox"/> Sheet Metal |
| <input type="checkbox"/> Better Forem'nship | <input type="checkbox"/> Electronics, Indus. | <input type="checkbox"/> Pattern Drafting |
| | <input type="checkbox"/> Machine Shop Operations | <input type="checkbox"/> Shop Management |
| | <input type="checkbox"/> Mechanical Engr. | <input type="checkbox"/> Tool Making |

Name _____ Occupation _____
Address _____ Age _____
City & Zone _____ State _____

Start a Business in Your Backyard



Earn **BIG MONEY** MAKING **BUILDING BLOCKS**

General Concrete Vibrator **BLOCK MACHINE**
CAPACITY 1000 BLOCKS A DAY

only \$218 LESS MOTOR F.O.B. PLANT
SHIPPING WEIGHT 400 LBS.



Here is a business you can start on small capital—in your own backyard—that earns 100 to 150% profit, with unlimited opportunities. Make concrete or cinder blocks. Millions used for homes, factories, public buildings, garages. Sell all you make to building trade. Do it with a General—and you're headed for success.

1000 BLOCKS A DAY

The General is a high speed, power-driven block machine at amazingly low cost. Rugged all-steel construction. Simple to operate indoors or outdoors. Makes superior 3 core type block meeting all code requirements. Produces up to 1000 blocks per day. Full operating instructions and mixing formulas supplied. Write for FREE details.

Wonderful Book Written & Illustrated by Experts



GENERAL ENGINES CO.

DEPT. S-19 • 307 HUNTER ST. • GLOUCESTER, N. J.

Includes floor plans for 6 beautiful, easy to build concrete block bungalows. Shows ways to save money. How to lay blocks, lay out building lines, mix concrete, build steps, porches and concrete floors. Mail coupon at once with \$1.

Name.....
Address.....
City..... Zone... State.....

INVEST \$2.00!

BUILD SECURITY WITH YOUR OWN PART OR FULL TIME BUSINESS

Many of our representatives are making over \$5,200.00 per year taking orders for this famous Mitchell **7 LB. PERSONALIZED RUBBER DOOR MAT** With absolutely no experience or training you, or any members of your family, can start earning big money the first day you receive your sample mat. \$25 a day is common. Try our thirty day test. Take orders in spare time for the first thirty days. Keep careful records. Most of our new representatives are amazed to find they have made more money taking orders in the first month than they made at their old job.

GIANT SIZE 18" x 28"

WE MOLD IN ANY NAME OR LETTERS

For instance: Tom & Mary, The Smiths, Dr. J. Lowe, Hill House, El Rancho

COLORS
Garden Green, Black, Powder Blue, Brick Red

HOW TO GET YOUR SAMPLE & ORDER BLANKS

Send \$2.00 for full size sample stock name mat, containing 7 lbs. of rubber. We ship your sample mat postpaid together with free sales kit containing order blanks and step-by-step instructions. You have no competition. Use coupon below. Enclose check, cash or money order for \$2.00. **Money-back guarantee.**

Be an early bird. Do it today!

Attn.: Raymond Mitchell, R. L. Mitchell Rubber Co., Dept. P-5 2116 San Fernando Road, Los Angeles 65, California
I'm enclosing my \$2.00. Please send postpaid one sample personalized stock name mat, order blanks, and step-by-step information. I understand I am under no obligation.

Name.....
Address.....

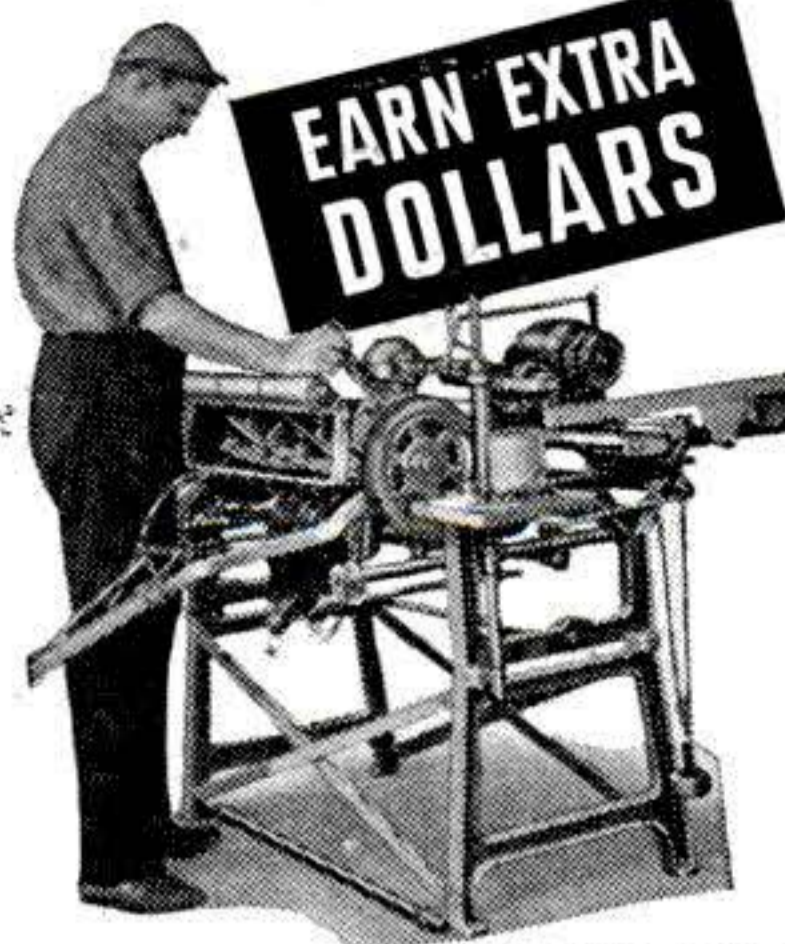

EARN EXTRA DOLLARS

IDEAL LAWNMOWER SHARPENER

Saves work, saves time, helps you earn extra dollars! Sharpens hand, power mowers without disassembling. Complete shop in one machine—equipped with Bed Knife Grinder and "lapping-in" Reconditioner. Home owners, parks, clubs, cemeteries pay good money for efficient sharpening; get your share!

WRITE NOW FOR FREE CATALOG

THE FATE-ROOT-HEATH CO., Dept. I-4, Plymouth, Ohio

DO FALSE TEETH
Rock, Slide or Slip?

FASTEETH, an improved powder to be sprinkled on upper or lower plates, holds false teeth more firmly in place. Do not slide, slip or rock. No gummy, gooey, pasty taste or feeling. **FASTEETH** is alkaline (non-acid). Does not sour. Checks "plate odor" (denture breath). Get **FASTEETH** at any drug store.



MONEY IN HAMSTERS

The new wonder animals from Syria. Often called Toy Bears. Delightful pets. Everyone wants them. Laboratories use thousands. Clean, odorless. Raise anywhere. NOW, spotted and golden breeds. We furnish breeders, equipment and manual of instructions. Write today for free illustrated literature.

GULF HAMSTERY, 1540 Basil St., Mobile 17, Ala.

MASTER MIND!



Learn Short-Cut Mathematics

Juggle figures, do baffling number tricks. Make people gasp at your marvelous lightning-quick mind. Multiply 4 figures by 4 figures without using old-fashioned multiplication! Big cloth-bound volume; fully illustrated course. Includes worked-out problems, answers, etc. Sensational bargain, only \$1.95, postpaid—or COD plus postage. Satisfaction guaranteed or refund. Order this amazing "Short-Cut Mathematics" today!

NELSON-HALL CO., 210 S. Clinton St. Dept. 4E-1 **\$1.95 Complete**
Chicago 6, Ill.

New! PRINT YOUR OWN ADVERTISING POST CARDS

ROTO-PRINT STENCIL DUPLICATOR prints and illustrates Advertising Announcements and Club Notices on 1c Government Post Cards. Also Price Lists, Labels, Order Forms, etc. Easy to use. Gets amazing results in sales and inquiries. Hundreds of uses for every type business and organization.

GUARANTEED FOR LIFETIME! Comes complete with necessary supplies, instructions, **FREE** Book of money-making ideas. **FREE TRIAL OFFER!** Write and a ROTO-PRINT will be sent you postpaid. Try 10 days—then send only \$9.95 (Low, Direct-to-You Price), or return ROTO-PRINT with no questions asked. Write NOW!

AGENTS WANTED! ROTO-PRINT CO., 211 North 7th St., Dept. C-4, St. Louis 1, Mo.



complete outfit only \$9.95

WEAR AT OUR RISK!
Money Back!
If not delighted in
10 days.

LIFETIME *Written* **GUARANTEE!**

BUY WITH COMPLETE
Confidence!
AMERICA'S GREATEST
WATCH VALUE

BUY DIRECT AT PRACTICALLY WHOLESALE PRICES
FROM ONE OF AMERICA'S LARGEST DISTRIBUTORS!

17 JEWEL AUTOMATIC
SELF WINDING, WATER-RESISTANT

ORIG. \$71.95



YOU SAVE \$47
\$24.95

Set it and forget it! Precision self-winding movement keeps 40 hours reliable time after few hours normal wear. Water-tight case, anti-magnetic; shock-built; professional sweep second hand, 17 full jeweled precision Swiss movement. Wear it at our risk... be completely satisfied! Now only \$24.95, plus \$2.50 tax.

17 JEWEL LADIES' WATCH
14 KT. SOLID GOLD

ORIG. \$59.95



YOU SAVE \$38
\$21.95

Exquisitely styled, petite watch superbly executed in 14 Kt. solid gold. Rock crystal; gold numerals. Lifetime guaranteed, 17 jewel Swiss movement; adjustable corded band; double safety catch. Limited quantities at this amazing low price. This value cannot be duplicated! Wear it at our risk and see for yourself! Only \$21.95, plus \$2.20 tax.

BULOVA
MEN'S **15 or 17 JEWEL** WOMEN'S
MOVEMENTS



Originally \$58.95
sold up to \$58

Also, **GRUEN**
BENRUS WALTHAM
ELGIN

YOU SAVE \$42

\$16.95

OUR PRICE NOW ONLY

Genuine Bulova, Benrus, Gruen, Waltham, Elgin and other famous wrist watches in latest style Yellow Gold Cases. You get these unredeemed lifetime Guaranteed FAMOUS MAKE WATCHES now at truly enormous savings because we bought out SURPLUS STOCKS of leading New York and Maryland Jewelers. Order now while they last. State make preferred. Order men's or ladies'. Only \$16.95, plus \$1.70 tax. Order now.

17 JEWEL CHRONOGRAPH

ORIG. \$71.95

- Wrist Watch
- Stop Watch
- Telemeter
- Tachometer

Precision 4-in-1 time-piece for professional scientists, aviators, engineers, sportsmen, etc. Nationally advertised. 3 multi-function dials automatically coupled. 30 min. register. Synchronized seconds, 1/5 seconds. Luminous. Instructions included. Unbreakable crystal. Only \$21.95, plus \$2.20 tax. Order now.



YOU SAVE \$50
\$21.95

17 JEWEL INCABLOCK

WATER-SHOCK-RESIST

ORIG. \$59.95

Handsome. Accurate. Sweep Second Hand; Non-Magnetic; Luminous dial. Worn by Army, Navy, Marines during World War II and praised by servicemen everywhere. Amazing value at \$14.95, plus \$1.50 tax. Order now.



YOU SAVE \$44
\$14.95

Free!

Handsome expansion band included free with your order. Write for FREE Watch & Diamond Ring Catalog. Practically wholesale prices to user direct.

TRIAL OFFER! Wear at Our Risk! Money Back if not Delighted! Order Direct From This Ad. For Self and for Thrilling Gifts. Lowest prices ever, for these lifetime guaranteed watches! Order now on famous lifetime written guarantee. Send only \$1 down payment with order. Pay balance to postman on arrival, plus postage. Or we pay postage if you enclose full payment plus tax with your order.

MARYLAND DISTRIBUTORS, Dept. 251, 501 E. Baltimore St., Baltimore 2, Md.

THE WORLD'S BEST BUY
in
low-cost transportation



DEALER INQUIRIES INVITED

- ✓ **LOW PURCHASE PRICE**
- ✓ **LOW OPERATING COST**
- ✓ **LOW MAINTENANCE**

Save your car—beat expensive transportation. Hundreds of uses for your Cushman—ride it to work, school, shop, play. Ideal for light deliveries. Automatic clutch, silent-action coil spring, dependable heavy duty brakes. Cruise at 40 m.p.h.—over 85 miles per gallon. Cushman saves time, money, worry.

Write for free folder and prices—Dept. 9S

Cushman MOTOR WORKS, INC.
LINCOLN, NEBRASKA

- AUTO MECHANICS**
- BODY-FENDER REPAIR**
- DIESEL MECHANICS**
- RADIO & TELEVISION**
- REFRIGERATION**
- MECHANICAL DRAFTING**
- BUILDING CONSTRUCTION**
- HIGH SCHOOL FOREMANSHIP**
- FACTORY MANAGEMENT**

BIG DEMAND—TOP PAY
AUTOMOTIVE MECHANICS

EASY TO LEARN AT HOME



For high wages and steady work, auto mechanics is tops! Many good jobs are waiting. Or, you can start a business. Train at home, or in our shops. If you have a trade, advance fast: Learn Foremanship, Factory Management, or finish High School. Mail coupon! (State course.)

Commercial Trades Institute

1400 Greenleaf Ave., Dept. E1-5 Chicago 26.

Veteran Non-Vet.

Name _____

Address _____

City & State _____

COURSE _____

HERE'S A REAL MONEY MAKER FOR YOUR HOME WORKSHOP



**WELDS
CUTS
SOLDERS
BRAZES
CHARGES
BATTERIES**

"LINCWELDER 60"

New Lincoln Arc Welder

Cash in on these Profitable Jobs!

Be the handyman welder for your neighborhood. Repair damaged car bodies and fenders. . . . fix toys and garden tools . . . braze and solder broken parts . . . recharge batteries.

- Simple to install...operates from 115 volt grounded circuit. (No.12 wire fused for 20amps.)
- Approved by Underwriters Laboratories.
- Comes complete with full instructions.

**ORDER
YOUR WELDER
NOW**

Fill out and mail to
**THE LINCOLN
ELECTRIC
COMPANY**
Dept. 202
Cleveland
1, Ohio

- Ship me the "Lincwelder 60" with accessories \$48.00 (Including headshield, electrodes, carbons, electrode holder, ground clamp and cable). Arc Torch \$6.25 extra.
 Battery Charging Attachment \$10.00 extra.
Enclosed is check money order
 Send me free bulletin on the new "Lincwelder 60"

Name _____
Address _____
City _____ State _____ 202.

LEOPARD SEAT COVERS SWEEP TO SENSATIONAL NATIONAL POPULARITY



**Salesmen jamming
pockets with
\$1000 bills ...
TAKING ORDERS FOR
KEY
EXPERTLY
Tailored AUTO
SEAT COVERS**

- Look at These Features**
- 7 STYLES — 7 PRICE RANGES
 - A COMPLETE LINE OF SENSATIONAL NEW DESIGNS
 - FOR ALL CARS — ALL MAKES — MODELS — YEARS

7 Styles BIG SEASON NOW STARTING!

You've heard of the tremendous demand for Leopard auto seat covers that built up overnight from one end of the country to the other when Cadillac introduced a new 1950 model with Leopard Seat Covers. Car owners are paying \$50.00 to \$60.00 and \$70.00 . . . and more for covers with Leopard design. Now you can serve that eager demand at a fraction of the cost the customers expect to pay! No wonder salesmen are making money hand over fist with this sensational new Key line!

Make big money daily. Take orders from car owners everywhere. Beat all competition with covers cut to accurate

patterns like the finest suit of clothes . . . Slick, smooth, wrinkle-free fit adds an accent of elegance to any car . . . just like an original upholstery job!

**RUSH NAME FOR FREE
OUTFIT** Give Make, Year and Model Of Your Car
Anyone working full or spare time can realize big money in this business. No need to search for prospects. **Every** car owner is one. Be the first to cash in . . . Make year around **STEADY PROFITS**. Don't put it off — get your Free Selling Kit at once for some real money. **ACTUAL SEAT COVERS GIVEN FREE TO PRODUCERS FOR OWN USE!** Write for full details!

KEY PRODUCTS CORP.

Dept. 6-E
800 N. Clark, Chicago 10, Ill.



**\$500,000.00 INVENTORY for
QUICK LIQUIDATION**

Surplus items—hundreds of them for home, shop, factory, farm and outdoor use. New items, used items, reconditioned items—all at tremendous savings—all priced for quick sale.

PAGE AFTER PAGE OF VALUES

This big catalog shows page after page of amazing money saving values. Write for your copy today. Send 10c to cover postage, mailing, etc. Write today!

**SEND TODAY FOR YOUR COPY
STARK'S**

10c

509 So. State St.
Dept. PS-5
CHICAGO 5, ILL.

operate your own business TEACH DRIVING

DUAL BRAKES For any make car. Easily installed in two minutes. No drilling of holes — no screws — no damage to car. Patented.

EXTENSION PEDALS For short people — easily installed. Eliminates difficulty in reaching clutch, brake and gas pedals.

ART OF DRIVING BOOKLET Indispensable instruction guide for students. Answers 90 safe driving questions. By Richard A. Law. **\$1.00**

Write today for **FREE** literature.
LAW SAFE DRIVING METHOD 146-09B Northern Blvd. Flushing, N. Y.

WHAM-O SPORTSMAN* **\$1.25** 45-LB. PULL!
POSTPAID

HITS LIKE A .22 RIFLE—
KILLS RABBITS, SQUIRRELS.
Powerful, silent, accurate.
For hunting, target,
routing pests.
Sportsman's choice
sold world
over!



**HUNTING
SLINGSHOT**

Heavy duty 7" ash stock.
40 steel balls, extra rubber, target.
GUARANTEED — at dealers, or send \$1.25 to
Wham-O Mfg. Co., Box 8B, South Pasadena, Calif.
* Professional model of Nat'l Slingshot Assn.
Extra steel ball ammunition, 75c for 200

TRAIN Your VOICE!

RESULTS GUARANTEED
STRENGTHEN your voice this tested, scientific way. Yes—you may now be able to improve the POWER of your speaking and singing voice...in the privacy of your own room! Self-training lessons, mostly silent. No music required. Write TODAY for Eugene Feuchtinger's great booklet "How to Develop a Successful Voice." It's absolutely FREE! You must state your age. Booklet mailed postpaid in plain wrapper. No salesman will call. Send your name and age RIGHT NOW! Prefect Voice Institute, 210 S. Clinton St., Studio D-1, Chicago 6, Ill.

GARDEN TRACTORS



S P E E D E X

Two Types

8 H.P. RIDING

2 1/2 H.P. WALKING

Exceptionally Low Prices Still In Effect. New catalog gives you full details on the famous Speedex. Illustrates many labor-saving uses. Complete descriptions.

SEND POSTCARD FOR YOUR FREE
COPY OF NEW CATALOG TODAY.

SPEEDEX GARDEN TRACTOR CO.

Box 216-D12E, RAVENNA, OHIO

P-251-32

LEARN MEAT CUTTING AT NATIONAL

Pay After Graduation

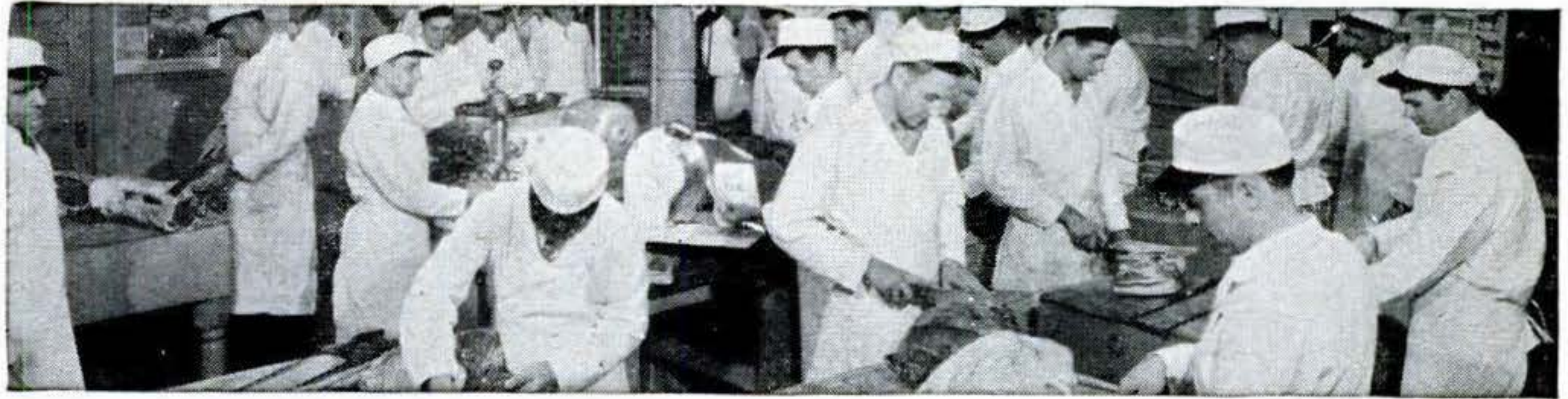

The steady dependable trade of Meat Cutting taught easily in 8 short weeks. You LEARN BY DOING under actual meat market conditions in big modern school at Toledo.

For beginners or men with experience. Get a profitable store of your own. Remember, PEOPLE MUST EAT! Big pay jobs. Free employment help. Thousands of successful graduates.

Buying, cutting, percentage, pricing, advertising, selling, etc. A complete retail meat education. National School established over 25 years. Get National training NOW. Pay your tuition in easy weekly payments

after you graduate. G. I. approved. Send coupon for FREE 52 page school catalog—TODAY.

National School of Meat Cutting, Inc.
Dept. 51-S, Toledo 4, Ohio

Send me your FREE school catalog on National Training at Toledo in Meat Cutting, Meat Merchandising and Self Service Meats. No obligation. No salesmen will call.

Name.....

Address.....

City..... State.....

() Check here if Veteran of World War II

Watch Repairing Pays Big Money Learn at home

Free Literature Tells How

Watchmakers in big demand. You train step-by-step under experts. You learn to take a watch apart—repair and put in perfect working order. 10 easy lessons. We furnish all tools, and a 15 jeweled watch. Practicemovement with first lesson.



Turn spare time into cash—perhaps a business of your own. A licensed school. Students 18 to 65 have profited by our training. Low cost.

Write Today for All the Facts—No Obligation

ILLINOIS SCHOOL OF WATCH REPAIRING
2870 Elston Ave., Dept. PS-51, Chicago 18, Ill.

CASH IN YOUR SPARE TIME

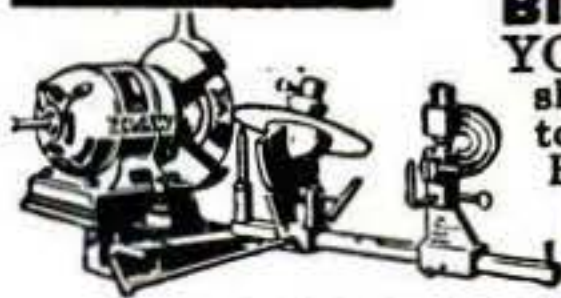

BIG MONEY IN OWN BUSINESS
YOU CAN MAKE UP TO \$40 A DAY sharpening and setting circular saws for factories, builders, lumber yards — with NEW BELSAW COMPLETE CIRCULAR SAW SHOP. LOW COST, Sharpens 4 to 5 saws per hour, no experience needed, complete instructions. Send today for FREE Catalog.

BELSAW MACHINERY CO

4404 Field Bldg.

Kansas City 2, Mo.

ELECTRIFY your SEWING MACHINE



NEW LOW PRICE!

\$12.50 1 YR. GUARANTEE

Buy direct from manufacturer and save! Kit comes fully wired. Installed in a jiffy. Fits all machines! You get these all-new parts!

- Motor & Bracket
- AC-DC 115v 60c
- Multi-speed foot control
- Cord set & block
- Easy instructions
- Steel pulley & belt

FREE, reg. \$2.95 Chrome SEWLITE given with kit. 10 DAY FREE TRIAL—ORDER NOW!

Send no money, pay C.O.D. or send money order and we'll pay postage. Please state whether wheel on your machine turns toward you or away from you. Shipping wt. 6 lbs.

SENIOR SEWING MACHINE CO.
1046 Bedford Avenue Dept. PS-24 Brooklyn 5, N. Y.

EYE-GLASSES BY MAIL

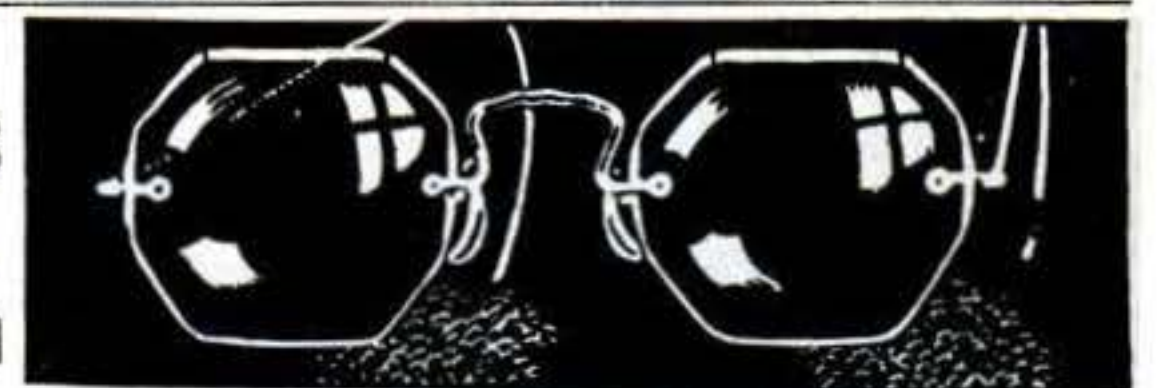

16 Days Trial

Write Today for Free Catalog. Send no Money
ADVANCE SPECTACLE COMPANY
537 South Dearborn Street, Dept. SP-4 Chicago, Illinois

GET FASCINATING NEW FREE PROFIT PLAN



Tired of monotonous, low-pay jobs — of working for the other fellow? Tap rich profits in huge NEW field. Have your own lifetime business — earn REAL money —

say goodbye forever to time clocks bosses! Become part of tremendous expanding industry — yet work right at home!

LEARN IN A FEW DAYS THROUGH PROVED, TESTED METHODS

to start earning more money with this amazing MIRACLE finish—gives a velvety, luxurious surface to radios, lamps, toys, signs, store displays,

figurines, auto dashboards—hundreds of items. FREE PROFIT PLAN offers everything you need to start at once. Fill out coupon, mail today.

PROFIT UP TO \$500 PER HOUR

SEND NO MONEY. I WANT YOU TO EXAMINE EVERYTHING WITHOUT RISKING A CENT.

BIG DEMAND FOR NEW MIRACLE FINISH. We show you every step. Filing huge year-round-demand...easy to understand instructions tell you how. Earn up to \$5 an hour spare—full time. A few cents' worth of materials—brings you dollars!

GRASP THIS OPPORTUNITY TODAY.

It's too good to miss... Fill out coupon, mail today. Get FREE sample, FREE plan, big IDEA booklet. No salesman will call! Do it NOW... be first in your community to cash in on this huge new market!

COAST INDUSTRIES Dept. 15 1004 S. Los Angeles Street Los Angeles 15, California.

INVESTIGATE TODAY!

USE COUPON FOR FREE SAMPLE

FLOK KRAFT
COAST INDUSTRIES Dept. 15
1004 S. Los Angeles St., Los Angeles 15, Calif.
Gentlemen: Please rush me all details FREE

NAME.....

STREET.....

CITY.....

STATE.....

EVEN IF YOU DON'T KNOW A NOTE OF MUSIC NOW...

YOU CAN LEARN YOUR FAVORITE
INSTRUMENT THIS EASY A-B-C WAY

• No special talent, no previous training needed. This U. S. School home-study method is so successful because you learn to play by playing real tunes by note, right from the start. And just think, you can learn your favorite instrument for only a few cents a day!

If interested, mail coupon for FREE Booklet and Print and Picture Sample. See for yourself how easy it is to learn any instrument, right at home, in spare time, without a private teacher. U. S. SCHOOL OF MUSIC, 85 Brunswick Bldg., New York 10, N. Y. 53rd Year



FREE! Print and Picture Sample

U. S. School of Music, 85 Brunswick Bldg., New York 10, N. Y. Please send me FREE Print and Picture Sample and Illustrated Booklet. I am interested in the instrument checked below.

<input type="checkbox"/> Piano	<input type="checkbox"/> Piano Accordion	<input type="checkbox"/> Tenor Banjo
<input type="checkbox"/> Guitar	<input type="checkbox"/> Saxophone	<input type="checkbox"/> Modern Elementary Harmony
<input type="checkbox"/> Violin	<input type="checkbox"/> Trumpet, Cornet	<input type="checkbox"/> Other Instrument

Name..... (Please Print)

Street.....

City..... State.....

HOW TO EARN MORE MONEY IN BUSINESS OR INDUSTRY

WHETHER YOU WENT TO COLLEGE OR NOT



Please check your fields of interest.

Better-paying management jobs aren't reserved for college graduates alone. Plenty of executives never saw the inside of a Latin book—they reached their top-paying jobs by preparing for greater responsibility in their spare time. Now, with the shortage of qualified leaders made more acute by industrial mobilization, you can prepare to fill a manager's or supervisor's job through Holmes Institute leadership training. Send for free brochure which describes methods used by successful men in better jobs.

HOLMES INSTITUTE Home Study Dept. SP-1
16th & PARK ROAD, N.W., WASHINGTON 10, D.C.

Send free illustrated brochure "How to Get a Better Job in Business or Industry." I'm interested in the following subjects:

- | | |
|--|--|
| <input type="checkbox"/> Production Control | <input type="checkbox"/> Technique of Handling People |
| <input type="checkbox"/> Business Organization and Practices | <input type="checkbox"/> Moving Ahead on the Job |
| <input type="checkbox"/> Reading Blueprints | <input type="checkbox"/> Principles of Industrial Org. |
| <input type="checkbox"/> Salesmanship | <input type="checkbox"/> Simplified Accounting |

NAME

STREET

CITY

ZONE STATE AGE

AMAZING VALUES!

AUTO SEAT COVERS

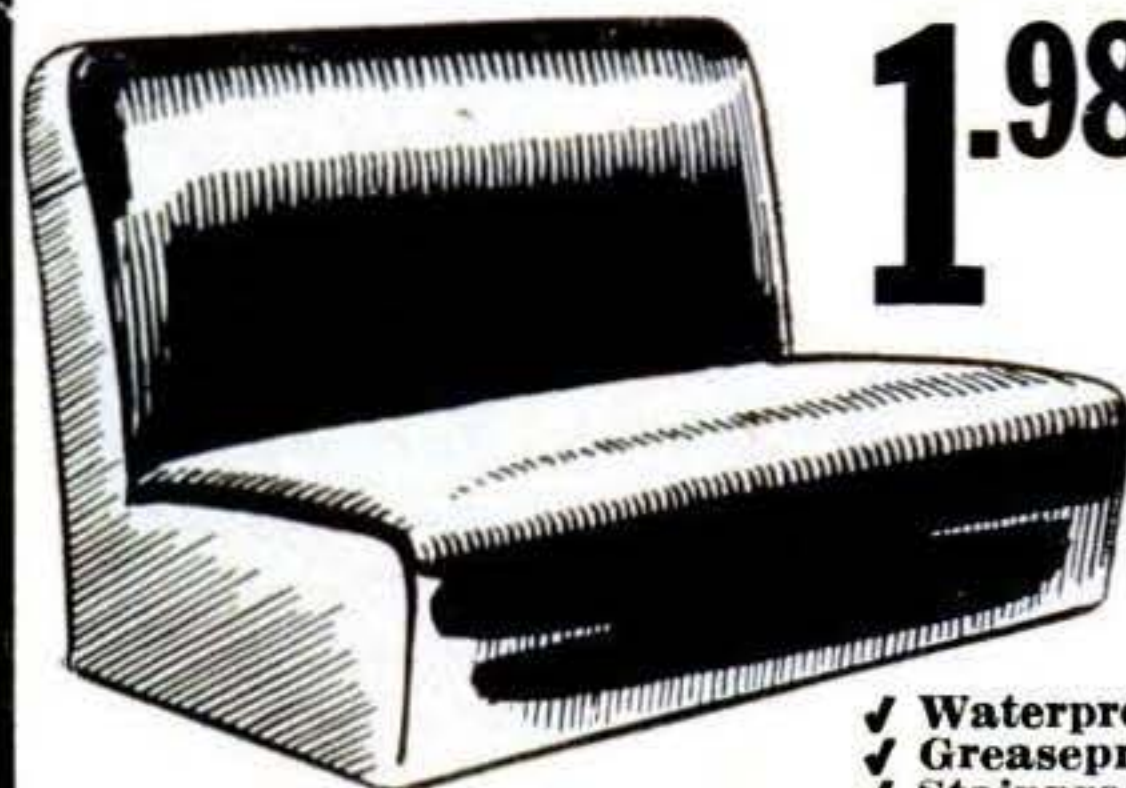

1.98 FRONT SEAT

FRONT AND REAR 3.89

- ✓ Waterproof
- ✓ Greaseproof
- ✓ Stainproof
- ✓ Non-Inflammable

"MIRACLE PLASTIC" 5 LUSTROUS COLORS

RED — BLUE — GREEN — MAROON — GREY
Also LEOPARD SEAT COVERS available.

\$2.98 Front Seat, \$5 for Complete Set!

SEND NO MONEY! Give Name, Address, City or Town, Make of Car, Year, Model (4-door, 2-door, or coupe), and your color choice. (Also state 2nd color choice). Pay Postman, plus postage. Or send cash, check, or money order and we ship prepaid. Keep 10 days. If not satisfied, return for refund!

YOUNG DISTRIBUTING CO.

Dept. PS 2605 Elmhurst Detroit 6, Michigan

When Writing to Advertisers,
Please Mention Popular Science

New Thrills for Model Railroaders!

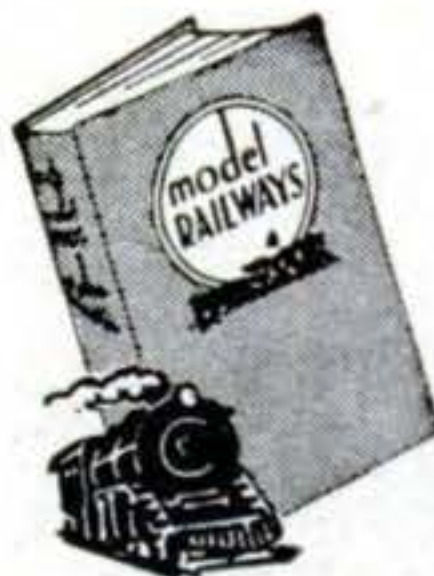

Hundreds of new ideas that will save you money and make model railroading more fun than ever! Shows how to lay your own track, how to make automatic signal systems, culverts, roundhouses, tunnels, switches and other modern railroad equipment.

It's easy to follow the clear, simple instructions and diagrams in this new book. Shows how to make freight cars, baggage cars, pullmans and day coaches. In addition, there are complete instructions and blueprints for building a Pennsylvania R. R. type locomotive.

SEND NO MONEY

Just write for your copy of MODEL RAILWAYS today, and pay the postman only \$2.49 plus a few cents postage on delivery. If you prefer to remit now we pay postage. Money back if not satisfied. Address

POPULAR SCIENCE MONTHLY—Dept. 551
353 Fourth Avenue • New York 10, N. Y.

MAIL ORDERS—Postage Prepaid—Money Back Guarantee
NEW—U. S. Surplus - Heavy Duty - HAND PUMP
One Quart - All Brass - Carbon Tetra Chloride
FIRE EXTINGUISHERS



Every One Bears Seal of Approval of UNDERWRITERS LABORATORY

Just the kind of extinguisher you see in train, plane, public bldgs., schools, etc. Every Home, Garage, Truck and Car should carry one. During this period of crisis, authorities recommend that all homes keep fire fighting equipment on hand. Nothing to do but pull out and push in the handle. Throws a powerful, constant stream. Inexpensive, effective insurance.

\$6.95
 We Pay Postage

FILLED—Ready to Use. Complete with Wall Bracket.

Everything Sold With an Unconditional Money Back Guarantee!
Universal Enterprises, 946A, S. Main, Los Angeles, Cal.
 Send for Free War Surplus Catalog. Add 3% from Calif.

LEARN AT HOME
LOCKSMITHING

YOU CAN MAKE GOOD PROFITS ALL YEAR ROUND IN FULL OR SPARE TIME!
 Locksmiths are always in big demand! Age is no disadvantage in this respected, permanent field. Learn how to make keys, fix locks, make duplicates, etc. Practical, illustrated lessons by experts show you how! All materials and special tools supplied. Send for FREE booklet.
LOCKSMITHING INSTITUTE, Dept. PS-17
 55 Park Ave., Rutherford, N. J.
 Licensed & Approved by State of New Jersey

Learn MECHANICAL DENTISTRY

A profession offering unlimited opportunities. Most modern and complete course embracing every branch from Plate to Porcelain Work, which prepares you to work for Dentists or start your own business. Individual instruction—practical training in day or night school. No books—no classes. Catalog upon request.

McCARRIE SCHOOL of Mechanical Dentistry
 207 N. Broad Street Dept. 911 Philadelphia, Pa.

SHORTHAND IN 6 WEEKS AT HOME

Famous Speedwriting system. No signs; no symbols; no machines. Uses ABC's. Easy to learn, write, transcribe. Low cost. 100,000 taught by mail. Also typing. 28th year. Write for FREE booklet to

Speedwriting
 Dept. 2605-1
 55 W. 42nd Street, N. Y. 18



'PIN-UPS'
 By BERNARD of HOLLYWOOD

JUST OFF THE PRESS!
 A Portfolio of
BREATH TAKING BEAUTIES
 Bernard's money-making work-shop secrets revealed for the first time.
POPULAR EDITION \$1.25
 68 large (11 x 14 in.) pages - POSTPAID
GIANT DE LUXE EDITION \$3.00
 132 pages with plastic binding.
 Send 25¢ for Sample Photos and Illustrated Literature
 A MUST FOR EVERY PHOTO FAN
 ORDER YOUR COPY TODAY FROM
BERNARD OF HOLLYWOOD
 9059 Sunset Blvd. Dept. S
 Hollywood 46, Calif.

C. T. C. TRAINING IN DRAFTING

PREPARES FOR PROMOTION
MORE MONEY SUCCESS



"Here I am at work making good money as a draftsman. I'm glad I sent the coupon to Chicago Tech for that Free Trial Lesson and found out how easy it is to learn Drafting in spare time at home. Today, I feel secure in my job. What's more, I feel I'm slated for promotion and more pay."

LEARN IN SPARE TIME—AT HOME!
 (or at the College in Chicago)

A few hours of pleasant home study every week—that's all. All the tools you need; drawing outfit included. This tested method—developed over 46 years of C.T.C. progress—prepares men quickly for good positions in industry.



FREE INFORMATION — SEND COUPON
 To prove to you how easy it is to learn Drafting at home by the Chicago Tech method, we will send you this FREE TRIAL LESSON. No charge for this lesson, now or later. Fill out and mail coupon, or send post card today.

CHICAGO TECHNICAL COLLEGE

E-228 Tech Bldg., 2000 So. Michigan Ave., Chicago 16, Illinois
 Mail me FREE Lesson with information about big opportunities in DRAFTING.
 Name.....Age.....
 Address.....
 City.....Zone...State.....



ART FOR A PROFITABLE CAREER

Here's How You Can Learn at Home in Your Spare Time. BE AN ARTIST

Trained Artists Are Capable of Earning \$65, \$80, \$100 AND MORE A WEEK

COMMERCIAL ART, DESIGNING, CARTOONING—all in one complete home study course. Become your own boss. Many students earn extra money while learning by doing artwork, designing posters, lettering, etc. W.S.A. now in 37th successful year. No art experience necessary, we teach you step-by-step. **TWO ART OUTFITS** included with training. **FREE BOOK**, "Art for Pleasure & Profit"—tells about our course, instruction, what our graduates say, and commercial opportunities in Art. Low tuition—easy terms. **VETERANS!** Course G. I. Approved.

MAIL COUPON FOR FREE BOOK

WASHINGTON SCHOOL OF ART
 Studio 135-A, Washington 5, D. C.
 Send me without obligation Free Book, "Art for Pleasure & Profit." No salesmen. (Please print).
 Name.....Age.....
 Street.....
 City.....Zone...State.....

MAKE BIG MONEY in Remodeling!



BE YOUR OWN BOSS

You can put **BIG MONEY** in your pocket if you get started now in floor surfacing work! Cash in on today's big demand for home-remodeling and repairs... sand new and old floors. Sell your services and *keep all the profits* from your labor! Sanders are easy to operate—no special schooling—no big investment. Earn \$35 to \$50 a day... pleasant indoor work. Send for "tell-all" booklet, "Opportunities in Floor Surfacing" enclosing 25 cents in coin or stamps to cover handling. The American Floor Surfacing Machine Co., 532 So. St. Clair St., Toledo, Ohio.

The American Floor Surfacing Machine Co., 532 So. St. Clair St., Toledo, Ohio.

AMERICAN

FLOOR MACHINES—PORTABLE TOOLS

LAW FREE BOOK



Your **FREE** copy of "The Law-Trained Man" shows how to gain prestige and greater earnings through Blackstone home law study. All instruction material furnished including 17-volume Law Library written by 65 well-known law authorities. Lawyers, judges among our graduates. LL.B. degree. Low cost; easy terms. Write today. **BLACKSTONE COLLEGE OF LAW** Dept. 125, Chicago I, Ill. 225 N. Michigan Ave. A Correspondence Institution Founded in 1890

BEAUTIFIES natural wood, pine paneling

POLISHES furniture, woodwork

IMPROVES paint jobs

PROTECTS wood and metal surfaces

The best buy For every Home



101 HANDY HOME USES!

Every home, every workshop, needs Pol-mer-ik BOILED Linseed Oil. Available at all stores. Free folder tells you how to use it. Write Dept. 604...

ARCHER-DANIELS-MIDLAND CO., Minneapolis 2, Minn.

NEW, EXCITING

A portable peep-show viewer that's an exact duplicate of an ordinary pack of cigarettes... exciting dura-life plastic. Contains 20, yes 20 full-color unretouched poses of the most beautiful Paris and Hollywood models... This is the real thing, natural pictures, sharp, clear and detailed. Be the life of the party, even show them to your best girl (she may blush—but only in admiration)!

Viewer complete, nothing to add or change, precision lens. ORDER NOW — only \$2.00 postpaid.

NOTHING LIKE IT ANYWHERE!

BETTER PRODUCTS Company

Dept. PS-5
154 Nassau Street,
New York, New York



START A BUSINESS MAKING

Concrete Blocks

New superior method makes square, true, easy-to-lay, modern blocks. Will pass building code. High production, big profits. One \$30 machine will make four 5"x8"x12" blocks per minute—1000 per day. Can pay for itself in a day. Sell blocks, or save 2/3 building cost by making and laying your own. Money back Guarantee. Send Postcard for Free Catalog.

Economy Manufacturing Company
DEPT. S. STONE MOUNTAIN, GEORGIA

TV ANTENNA KIT INSTALL IT YOURSELF

SAVE UP TO 65%—IT'S QUICK—EASY **12.95**

Special: For WEAK SIGNAL AREAS
Stacked Twin Antenna & Bars. \$13.95

EVERYTHING YOU NEED
ANTENNA • MAST • LEAD SUPPORTS • BRACKET
Complete Simple INSTRUCTIONS

SEND NO MONEY—SATISFACTION GUARANTEED

SORMANI ELECTRONIC CO. 1068 63rd St. Brooklyn, N. Y.

ANTENNA INSTRUCTION BOOKLET 50c

Locksmithing AND KEY MAKING

Now Made Easy! Practical up-to-date course teaches you how to pick locks, de-code, make master keys, repair, install, service, etc. New self-instruction lessons for every handyman, homeowner, carpenter, mechanic, service station operator, fix-it shop, hardware dealer, gunsmith. 53 easy illustrated lessons. Full price only \$4.95, postpaid; or C.O.D. plus postage. Satisfaction or refund guaranteed.

Complete course \$4.95
now only \$4.95

Nelson-Hall Co., Dept. E-1
210 S. Clinton St., Chicago 6, Ill.

If Ruptured



Do What Others Now Do—**Wear a Form Fitting MILLER Truss**

which provides natural freedom and comfort in working, playing, walking, dancing, horse back riding, swimming, when sleeping, etc. You just cannot afford to be without this protection and convenience.

Wear the **MILLER Truss** and consult your physician before deciding to keep it.

Write me today for **FREE** descriptive circular. Sent in a plain, sealed envelope.

FRED B. MILLER Manufacturer
Dept. P. S., Hagerstown, Maryland.

Save Point Repair Costs



with "PRESTO" POINT SHIELD

Presto Point Shield retards the excess current that is generated for a short interval each time the motor is started. It is this excess current running as high as eight to ten volts that "Blues" the points.

Presto Point Shield saves the cost of several sets of points. It is easily and quickly installed—merely connect in series between coil and distributor.

If your service station or dealer can't supply, order direct—only \$1.85 postpaid.

BOCK MFG. CO. 711 G WEST LAKE STREET
MINNEAPOLIS 8, MINN.

EARN MONEY IN UPHOLSTERING

BUSINESS OF YOUR OWN OR A GOOD JOB Learn at home from experts. Simplified, fully illustrated training program. Full plans for establishing your business—profits big. Fine earning opportunities also in good jobs. Upholster your own furniture at fraction of cost. Valuable booklet free. Write now.

PROFESSIONAL HOME TRAINING—TOOLS, SUPPLIES, INCLUDED

GENERAL TRADES SCHOOLS, 3810 Broadway, Dept. PS-5, Chicago 13, Ill.



NEW HANDI-HONE
"The Tool That Sharpens Tools"
The craftsman's NEWEST and most ACCURATE honing device, designed to give razor-like sharpness to all bevel edged tools. Portable, clamps anywhere. (12" high) Sliding holder permits tool to be adjusted and held firmly at any angle. Method of honing allows even wear on combination grit stone. Send \$19.50 we ship POSTPAID, or \$5.00 deposit for C.O.D. (Satisfaction warranted or money returned)

(Pat. Pending) **LEKCO INC., Dept. A5, COVINA, CALIFORNIA**



Bar Bells

BUY DIRECT FROM FACTORY **\$8.95** up

Approved and Recommended by Karl Koberle. (Foremost Ex-Army Instructor on Weight Training.) Write for free booklet and price list.

INDEPENDENT IRON WORKS
2416 E. 23rd. Street, Dept. C, Los Angeles 58, Calif.

POWER MOWERS

Powerful—Streamlined

Complete with Maytag, Power Products or Briggs-Stratton Engine—18" rotary tool-steel, fully guarded blades—cast aluminum body. Cuts grass and weeds, wet or dry—does all trimming—chops grass into fine mulch, eliminating raking. Send check with order, or specify C.O.D. Write for free information.

Only \$69.50 DEALER PRICE

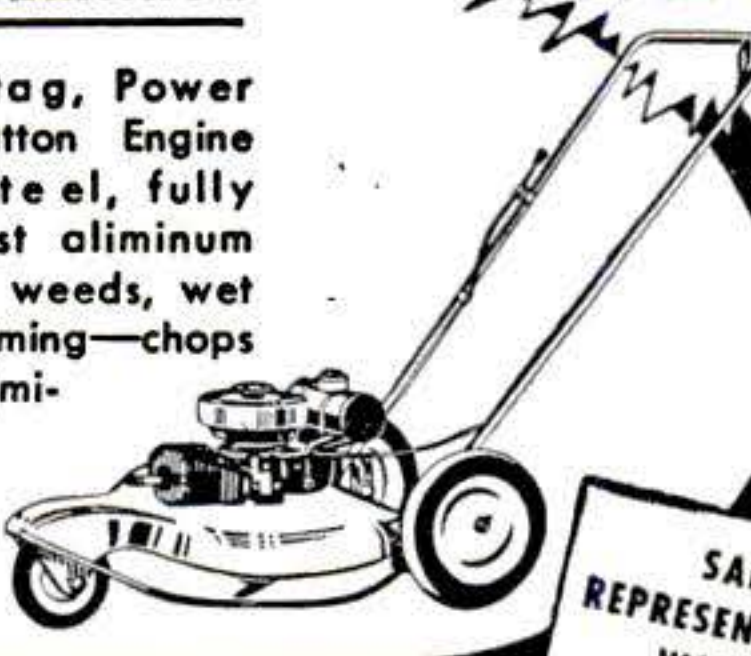

HARTMAN Corp.
1111 So. Kirkwood Rd., St. Louis 22, Mo.

SALES REPRESENTATIVES WANTED

FREE

A NEW HOME INDUSTRY



Let us show you how extremely easy and PROFITABLE it is to make beautiful and useful things out of LIQUID PLASTICS, LIQUID MARBLE, LIQUID IVORY, LIQUID GLASS, CERAMICS, ETC. . . . as easy as pouring water out of a glass! We have started THOUSANDS of people in this fascinating and very PROFITABLE home occupation! Make novelties, jewelry, gifts, artware, toys, tools, dies, gadgets, ceramics . . . a million useful things! We supply everything—MATERIALS, INSTRUCTIONS and BUYERS! Send only 25c for 1. Big catalog of 300 casting materials, molds and accessories. 2. A beautiful CASTING FREE (to show you what you can do), and 3. Actual INSTRUCTIONS on how to cast and start in the CASTING BUSINESS! VALUABLE MOLDS given FREE with orders! Send 25c today—this may be the lucky coin that will start the most fascinating and profitable phase of your life.

BILLIONS for DEFENSE!

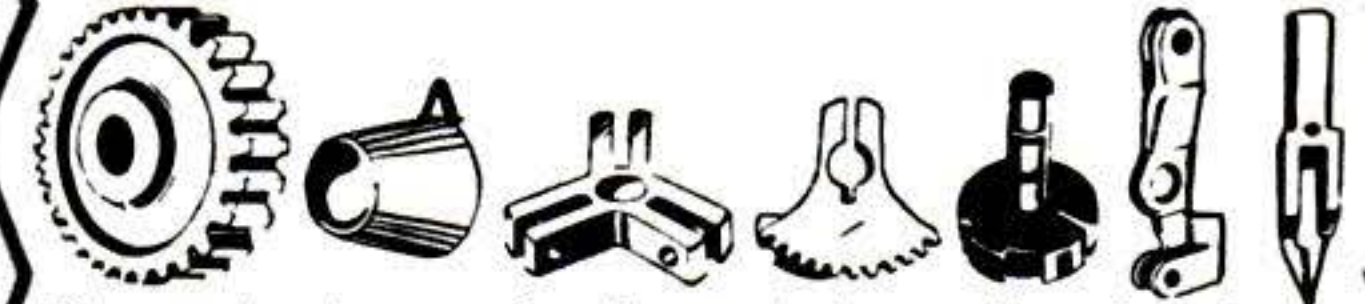

The country is preparing the greatest peace-time defensive in history . . . BILLIONS are being spent! Our liquid plastics are being used in THOUSANDS of different operations in defense work! NO SPECIAL TOOLS OR MACHINERY REQUIRED! Work can be done at home, garage, shop, etc. Full time or spare time, by the able and the disabled. We help you get defense work and instruct you in all the details! Send only 25c for our big catalog described above and details how to take part in this tremendous defense program that offers you a grand opportunity to combine patriotism and profit!

Plasticast Company (Dept. D-A)
P. O. BOX 6737 CHICAGO 6, ILL. (Write to either address) P. O. BOX 987 Palo Alto, Calif.



BRAND NEW. Quality glasses. Achromatic lens! Have precision ground optics, lightweight metal bodies. Moisture-Dust proofed.

COATED! FEATHERWEIGHT
16x50 COATED **\$69.50**

The ultimate in a fine binocular. Tremendous power. Featherweight (weighs only 31 ounces!). Precision made in every detail. COATED providing sharper, brighter images. Individual focus. Objective lens is 50mm (2 inches) across!

6x Coated (pocket model)	\$19.50
6x30 Coated	32.50
7x35 Coated (center focus)	49.50
7x40 Coated (center focus)	52.50
7x50 Coated	39.50
8x30 Coated	36.50
8x40 Coated	54.50
10x50 Coated	62.00
12x50 Coated	65.00



SIX TELESCOPES IN ONE!
15 to 40 POWER **\$29.50** COATED

American made Wollensack telescope. Instant focusing at 15x, at 20x, 30x and 40x, etc. Turn power tube to click—no guess work. Telescope measures 9" closed, 27" when extended. Weighs only 18 oz! Has rust proof chrome tubes, large 40 MM objective lens. All 12 optic surfaces are COATED. See .22 bullet holes clearly at 300 feet. Use also for astronomical observation. \$29.50 price includes tax and fine leather case. UNCONDITIONALLY GUARANTEED. Try for 20 days at our risk! If not fully satisfied return for full refund! Cash orders rushed postpaid. On C.O.D.'s include \$2.00 deposit. Add Federal tax. Prices include handsome genuine leather case and straps.

UNITED BINOCULAR CO.
9043 S. Western Dept. ARF-3916 Chicago 20

HERE'S A NEW AND VITAL BUSINESS!

LEARN ELECTRICAL EQUIPMENT SERVICING

OFFERS BIG MONEY—INDEPENDENCE

Learn in spare time at home. NEW Shop Method Training System. Work as many hours as you wish—the Electrical Equipment Technician is his own boss. It is not unusual for a technician to charge on the basis of \$5.00 to \$6.00 an hour! Command big wages!

NO PREVIOUS EXPERIENCE NEEDED

We furnish everything! Tool kits, training kits, including the famous Christy trouble-detecting ELECTRONIC KIT. Plus illustrated instructions written in simple, easy-to-understand language, chock full of photographs and drawings. Shows you how to repair factory and household electrical units. Power machinery, refrigerators, washing machines, vacuum cleaners, irons, etc. Gives you a working knowledge of electricity, house wiring, motor winding, welding, nickel plating, etc. Shows how to build power tools you need, how to solicit business and what to charge. Many report paying for their entire course, tools, etc. on earnings made at home while learning!

FREE BOOK SENT TO YOU

Send your name for FREE booklet on Electrical Equipment Servicing and instructions for paying us later from your EARNINGS WHILE LEARNING!

CHRISTY TRADES SCHOOL

DEPT. D-301 4432 N. KEDZIE AVE., CHICAGO 25, ILL.

GENUINE Mahogany BOAT KITS

First Time Ever! Expensive "Yacht" Look!



All parts pre-cut, ready to assemble. Easy to follow plans. Choice of 11' or 12' models. Also 6 other marine plywood models. 12' utility rowboat \$69.50.

For FREE catalog and name of dealer WRITE

BAY STATE BOAT CO.
23 MAIN ST., CAMBRIDGE, MASS.

YOURS to make and KEEP!
This Footstool — Boudoir CHAIR and Lawson Chair!



LEARN UPHOLSTERING



For More Pay—More Profit—OR as a Hobby!

Upholstering needs more trained men for good, steady jobs! Now you can prepare for a better paying position—or your own business—with this practical home training course—by an accredited, established school, largest of its kind in the country!

YOU LEARN WITH REAL EQUIPMENT—YOU BUILD REAL FURNITURE—YOU GET A COMPLETE TOOL KIT & ALL MATERIALS. ALL AT NO EXTRA COST!

FREE! Big, illustrated brochure, sample lessons and details of "PAY AS YOU LEARN" plan. No obligation.

SEND THE COUPON TODAY!

● **FIELD SCHOOL OF UPHOLSTERY, DEPT. P5**
39 West 19th Street, New York 11, N.Y.
● Rush FREE illustrated brochure, sample lessons and details of "PAY AS YOU LEARN PLAN."
● Name _____ Age _____
● Address _____
● City _____ Zone _____ State _____
● Check if Veteran of World War II

NEW! POLARVISION "SAFETY" LIGHT

A revolutionary new light discovery recently released for civilian use.

STOP HEADLIGHT GLARE

FOR SAFETY AND COMFORTABLE DRIVING

The Amazing "Ergon Glass Lens" is an integral part of the Polarvision Light. It produces a Black Light (barely visible to the eye) which Counteracts oncoming headlights, street lights, etc. without interfering with your visibility. Easy to install above windshield—beautiful accessory. Light encased in high grade chrome holder. Works off car's central lighting circuit. Limited \$6.95 Supply. Complete (Including all parts)..... \$6.95

Send cash, check, or money order.

Electronic Development Company, Dept. A-5, Los Angeles 34, California

"YOU ARE UNDER ARREST!"

Help Bring Crooks to Justice Through Scientific CRIME DETECTION!

We have taught thousands this exciting, profitable, pleasant profession. Let us teach you in your own home. Learn Finger Printing, Firearms Identification, Police Photography, Secret Service Methods thoroughly, quickly, at small cost. Over 800 of all American Bureaus of Identification employ I. A. S. students or graduates. We can prepare you for this fascinating work during spare time. Write today, stating age, for "Blue Book of Crime."

INSTITUTE OF APPLIED SCIENCE, 1920 Sunnyside Ave., Dept. 1365, Chicago 40, Ill.

RACE FOR OIL!

Get in the exciting race for oil on Western public land. Liberal U.S. laws allow citizens valuable oil rights. Thousands profit, some as high as \$250,000 for \$250; \$11,000 monthly for \$200. Details free. California Lease Co., Bonded Lease Broker, 7075 Hollywood Blvd., Los Angeles 28.

Learn PHOTOGRAPHY

There's big money in PHOTOGRAPHY—and an action-packed career for you. Our HOME STUDY COURSE is your spare-time SHORT CUT TO SUCCESS! Or, if you wish—PERSONAL ATTENDANCE TRAINING at our famous New York School is available with subsistence under the G. I. Bill. Our 41st year. Write immediately!

NEW YORK INSTITUTE OF PHOTOGRAPHY
Dept. "5," 10 West 33 Street, New York 1, N. Y.

FREE—Amazing Book on RHEUMATISM, ARTHRITIS

If you suffer the aches, pains and discomforts of Rheumatism, as manifested in ARTHRITIS, NEURITIS, SCIATICA or LUMBAGO, send today for the FREE Book. It reveals important facts about why drugs and medicine give only temporary relief without removing causes. Explains fully a proven, specialized system of treatment that may save you years of distress. No obligation. Write for this FREE Book today!

BALL CLINIC, Dept. 36, Excelsior Springs, Mo.

POWER MOWERS & KITS **FREE PLANS**

LOW FACTORY PRICES DIRECT TO YOU

Build your own quality mower with our LOW COST KITS. Parts. Engines. Free Plans guide you, 3 and 4 Wheel Kits, complete. Parts precision finished, ready to use. Write TODAY for Free Plans, Low Prices, Parts List and Guarantee.

3 & 4 Wheel Model 4 Wheel Direct Drive

3-WHEEL KIT NO. T-800

America's Finest Power Mowers completely assembled in 3 and 4 wheel models. Belt or direct drive. 18" and 20" sizes. Nationally known make engine optional. Latest improved features. sturdy construction and money back guarantee fully described in color folder. Write Today.

TRIANGLE MANUFACTURING CO., Box 5-6, Fort Scott, Kansas

THORESEN NATIONWIDE SALE

BUY DIRECT AND SAVE

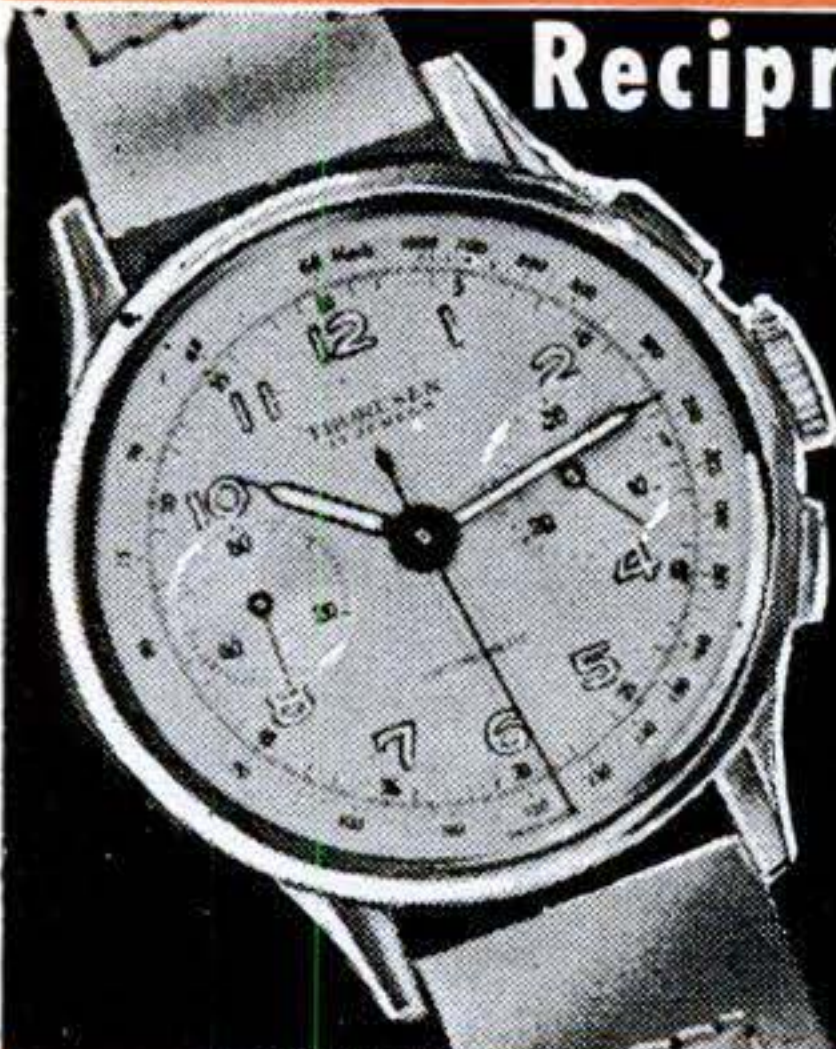

Recipro Register CHRONOGRAPH

WORLD FAMOUS SPLIT-SECOND TIMER

10 DAY FREE EXAMINATION
 A handsome wristwatch of incredible accuracy! Precision made in the highest traditions of Swiss craftsmanship. Thoresen's new RECIPRO-REGISTER CHRONOGRAPH automatically computes speeds and distances down to 1/5th second tolerances! RECIPRO-REGISTER system HOLDS the result indefinitely. It remembers for you while movement continues to keep time. Compare with other stop-chronographs and you will never be satisfied with anything less than this truly precision timepiece.

OVER 25 HIGH QUALITY FEATURES:
 • Times Planes • Times Photography • Shock-Resist
 • Times Races • Times Lab experiments • It "remembers"
 • Times Sports • Times Shop Work • 17 Ruby Jewels
 Three multi-function dials automatically coupled and synchronized for hours, minutes, seconds & 1/5th seconds. Contact clutch to start computation and brake clutch to freeze Recipro-Register result. Erases back to zero. Hairline sweep-second. Radium-active dial. Unbreakable crystal. Sturdy, yet thin case with stainless steel back. Its 17 Jewel Ruby movement is electronically time tested for accuracy. A smart, thin timepiece of functional beauty. The pride of every owner. **SAVE \$50.00—ORDER YOURS DIRECT!** Recent list price 79.95. Now reduced for quick sales to 29.95, tax paid . . . while supply lasts. Featured in Esquire and leading magazines. Instructions and gift case included. Price subject to change without notice because of international crisis. Remit 29.95, or order C. O. D. plus postage.

UNLIMITED Service Guarantee
 Exclusive of Parts
 FREE repair service ANYTIME if needed by skilled watchmakers. NO COST EVER for labor, "handling" or adjustment, provided watch is returned with all parts. FREE: Annual oiling, cleaning & timemakes service. Thoresen friends! **limetime**

Buy Direct

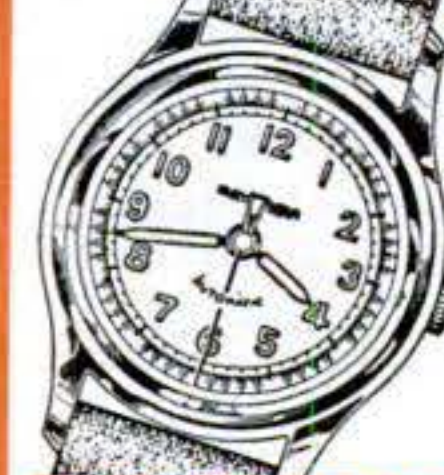

Thoresen's 17 Jewel FULL AUTOMATIC 29.88 tax paid
 De-Luxe model—fully automatic! Set it, then forget it! It winds itself as you wear it. Patented Incabloc. Anti-Magnetic. Sweep second. Luminous dial. **WATER & SHOCK** resistant. All stainless steel back case. 17 jewels. Near-miracle accuracy. Thin! Handsome! **5 YEAR GUARANTEE.** Formerly \$75.00. Thoresen's direct-to-you-price, only **—29.88—**no extras for tax. Rush! Supply limited!

WATER & SHOCK Resist Case—G. I. Style! 9.90 tax paid
 Military Style! Drop it! Bang it! We guarantee it 3 years against any and all breakage—because of exclusive Swiss INSULATOR invention. 7 jewels. Luminous hands & numerals. Unbreakable crystal. Sweep-second. Heavy Chromed. Thin, smart! Marvelous accuracy. Long satisfying service. Tax paid, only **\$9.90**
15 JEWEL Model tax paid—no extra. . . \$14.33
17 JEWEL Model (5 year guarantee), tax paid \$15.95



10 DAY FREE TRIAL

Pay price plus postage on delivery, or send check or money order and SAVE postage. Try, compare, appraise! Money back in 10 days if not pleased. Rush orders NOW!

Thoresen's De-Luxe 17 JEWEL PRECISION 14.98 tax paid
 Masterpiece of superb styling and workmanship! Streamlined 14 Karat Rolled Gold Plate case, stainless steel back. Gilt numerals, curved dome crystal. Genuine Lever 17 JEWEL Precision movement of amazing accuracy. 5 Year free service guarantee! Recent list price \$59.50. **REDUCED** for quick sales! Tax paid price—**\$14.98—**no extras!



THORESEN DIRECT SALES
 131 West 33rd St., Dept. 6 E-200, New York 1, N. Y.

AIR CONDITION Any CAR

PLANS SHOW YOU HOW . . \$1.00 • HOT OUTSIDE . . . COLD INSIDE
 Enjoy pleasure driving in cool comfort in scorching outside temperatures, with real mechanical refrigeration. (Not a dry ice or window unit.) Easily installed by anyone handy with tools. No experience necessary. Powered direct from your engine. Completely automatic. **PATENT FEATURE** controls temperature from idle to 100 mph. Build and install it yourself! Keeps your automobile comfortable, Tractor Cab cool, Truck cooled for hauling perishables. Send \$1 for your **PLANS** now. Do it today.
LEJAY MFG. CO., 523 LEJAY BLDG., MINNEAPOLIS 8, MINN.

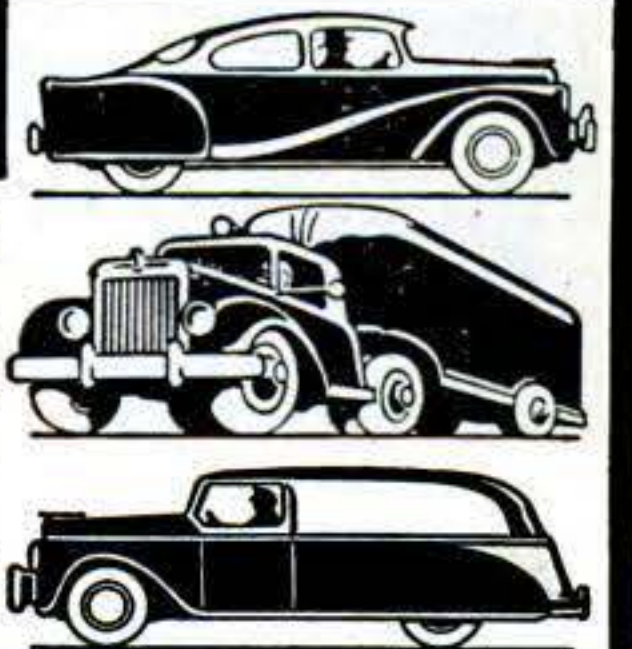

MAGIC-SCREEN INCOME PLAN OFFERS BIG MONEY, AT HOME, SPARE OR FULL TIME

Reproduce any painting, design, trade-mark, picture, printing, in full color, on any surface! Proven new method enables you to cash in on established business where Profits up to \$5.00 or more an hour are being made, right now! Examine complete Plan and equipment without risk!
 Write today for free sample — Complete free details! **Send NOW!**

CALIF. ACADEMY OF SCREEN PROCESS DEPT. 15 5100 SO. VERMONT AVE., LOS ANGELES 37, CALIF.

Communication Problems Solved! with ARMY FIELD TELEPHONES & WIRE

Construction men, engineers, farmers, and industrial men everywhere are using portable Army Field Telephones for quick, dependable 2-way to 8-way communication. These phones were built to serve combat forces reliably under battlefield conditions. Simple to install. Just string this 2-conductor wire, attach phones, ring and talk any distance up to 17 miles! Powered by flashlight batteries. No maintenance required.
ACT NOW! LIMITED SUPPLY!
 Write for **FREE FOLDER.**
 All prices FOB Sacramento. No COD (Calif. residents add 3% for sales tax.)
 Send check or money
LORIS SALES, P. O. Box 1896-A5 Sacramento, California

TELEPHONE WIRE
 All-purpose—All-weather
 This is genuine W110B Army Field Wire on original steel reels. Insulated, 2-conductor, copper-steel strands. Excellent for all types of communication. Used extensively by telephone companies, industry, engineering projects, ranches, public address systems, etc.
Grade I New, unused, excellent condition. Mile reels (wt. 160 lbs.) . . . \$19.50
 Half-mile reels (wt. 80 lbs.) . . . 10.00
Grade II New, unused, good condition. Mile reels \$15.50
 Half-mile reels 8.00

E88 FIELD TELEPHONES
 Factory reconditioned, LIKE-NEW. Ea. \$16.50
 Per pr. \$32.50
 Reconditioned, factory-tested. Ea. \$15.00
 Per pr. \$29.50
GUARANTEED

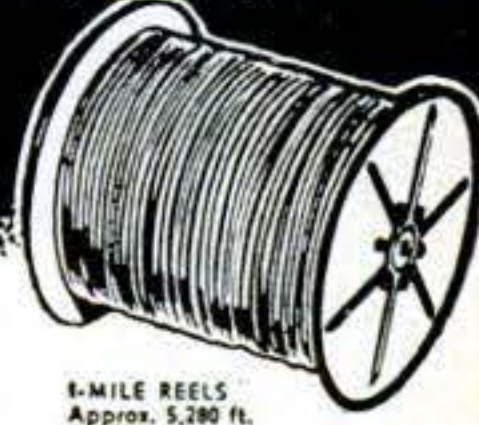

RAILWAY POSTAL CLERK GOVERNMENT CLERK MAIL CARRIER POSTOFFICE CLERK

WANT A GOVERNMENT JOB?

START AS HIGH AS \$3,450.00 YEAR

Many Early Examinations Expected. Prepare NOW! Veterans Get Special Preference! 40 Page Civil Service Book FREE Mail Coupon Today SURE

COUPON

Franklin Institute
Dept. S-80,
Rochester 4, N. Y.
(Not Government Controlled)
Gentlemen: Rush to me, FREE of charge, list of U. S. government big pay jobs. Send FREE 40-page book describing salaries, vacations, hours, work, etc. Tell me how to qualify for one of these jobs.

Name.....
Street.....
City..... Age?.....

LEARN AT HOME TO MOUNT BIRDS



Animals, Heads, Fishes, Pets; to TAN. Be a Taxidermist. Profit and FUN.

Hunters, save your valuable TROPHIES. Mount ducks, squirrels, everything. Learn to TAN for leather and furs. Wonderful HOBBY Have a HOME MUSEUM. BIG PROFITS mounting for others. INVESTIGATE NOW.

FREE BOOK With 100 fine game pictures. NOW absolutely FREE. Write TODAY.

Send Postal TODAY for FREE BOOK. State AGE. N. W. SCHOOL OF TAXIDERMISTRY, Dept. 2605, Omaha, Neb.



LET US PUT THIS MAMMOTH NEW 1951 19 1/2 - INCH Picture

MIDWEST TELEVISION
In Your Home on
30 DAYS MONEY BACK TRIAL

EASY TERMS

Don't buy any radio or television receiver until you've seen the new 1951 Midwest Line - it's the finest in 31 years.

FACTORY-TO-YOU

SEND THIS COUPON ON 1c POST CARD FOR NEW 1951 FREE 4 COLOR MIDWEST CATALOG

MIDWEST RADIO & TELEVISION CORP.
Dept. 24-M, 909 Broadway, Cincinnati 2, Ohio

NAME.....
ADDRESS.....
CITY..... ZONE..... STATE.....

FEBRUARY DRIVE 3 TO 6 DAYS A MONTH Gas Free!

Amazing discovery, tested in Engineering Dept. of leading U. S. University, reduces gasoline consumption as much as 20%—gives you up to 6 days a month gas free driving—may actually pay for itself in cash savings. Also better performance, more power, quicker starts, faster acceleration, on all cars, light trucks, tractors—any age, make or model. It can help keep you rolling if emergency gas restrictions come.

TEST IT 30 DAYS ON YOUR OWN CAR BEFORE DECIDING
No one can appreciate the astounding benefits of this new miracle development without actual day-by-day experience on the road—so we want you to try it for 30 days on your own car at our risk. Write or wire today for complete FREE details, technical explanation and 30-Day Examination Request Blank.

SEND NO MONEY

G. B. SCHUYLER, Dept. 35
1665 Mission St. San Francisco 3, Calif.

Build your own JET ENGINE!

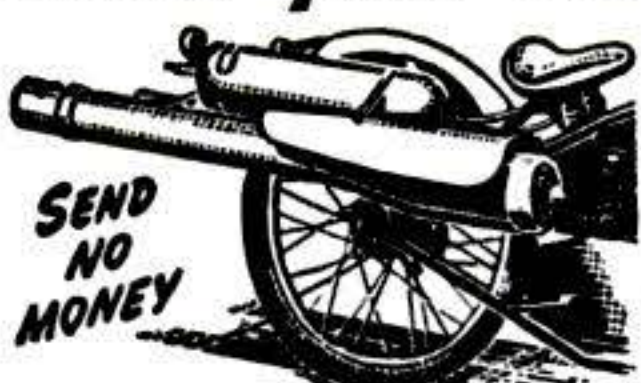

Order these plans today

1. JET PROPELLED BICYCLE. Assemble your own. Photo and instructions \$1.00.
2. HOW TO MAKE EXPERIMENTAL JET ENGINES. Seven sheets drawings with information and instructions \$2.95.
3. BOTH OF ABOVE in one order \$3.75. SEND NO MONEY. Order both at once \$3.75 C.O.D. in USA plus c.o.d. postage. Send check or Money Order and we pay postage. Get other information too. Rush Order.

J. HOUSTON MAUPIN, Dept. 66, Tipp City, Ohio

Study HYPNOTISM!
FASCINATING! Almost Unbelievable

This unusual course reveals the fundamentals of PRACTICAL hypnotism. It discloses how an expert operator performs—how he has developed his PERSONAL POWER and uses it to bring others under his domination and control. Illustrated instructions. Startling low price. Full satisfaction or refund guaranteed. Only \$2.95 postpaid... or C.O.D., plus postage. Send for "Hypnotism Course" today!

COMPLETE PRICE \$2.95

NELSON-HALL CO., 210 S. Clinton St.
Dept. 2-E-1 Chicago 6, Ill.

HIGH POWER TELESCOPES

40 Power—opens to 36 inches. Precision & Polished Lenses. Ideal for Studying Stars, Plane Spotting or Interesting Pleasures. Satisfaction Guaranteed or Money Refunded. Send Check or Money Order to

\$3.45 Post-paid

CRITERION CO., Dept. PS-6, 438 Asylum St., Hartford 3, Conn.

RUPTURE

RELIEF...OR YOUR MONEY BACK
Write now for free booklet and pictures of rupture care. You can be helped...work steady, with low cost, easy to wear Web Truss, thousands satisfied.

WEB TRUSS CO. Dept. PS-5, Hagerstown, Maryland

The HOME CHEMIST

A new book which shows how to set up and operate an inexpensive home laboratory with odds and ends of material available in every home. Many thrilling, practical, useful experiments and tests, entertaining, instructive, valuable, pointing the way to research and new discoveries. Many diagrams and illustrations. Full cloth bound \$1.49.

POPULAR SCIENCE MONTHLY, Dept. 551
353 Fourth Ave. New York, N. Y.

OFFICIALLY SCALED REPLICAS OF THE WORLD'S MOST MODERN AIRCRAFT!



MIG-15 "Russian Jet"

North American F-86 "Sabre-Jet"

Each Model Approximately 13" Long! COMPLETE IN EVERY DETAIL, these are exact solid scale replicas of the most modern combat ships now making history in Korea. Both the Russian MIG-15 and the American F-86 jets are real hobbyist collector items! Each kit includes: Completely finished Klean Karved Fuselage, Redi-Cut wings and tail, pilot, rubber wheels—EVERYTHING that's necessary to make a really proud combat plane!

Other Beautiful Solids include: only \$2.50 each
 F-51 "Mustang" F-80 "Shooting Star" plus 20c by mail
 F-9-F "Panther" F-84 "Thunderjet" No C.O.D.'s

Enterprise Model Aircraft & Supply Co., Inc.
 5107 Avenue D Dept. S-1 Brooklyn 3, N. Y.

Be a DETECTIVE

A CHALLENGE FROM WASHINGTON, D. C. Help Stop Crime! Train at home. Earn big money. Amazing training course from the NATION'S CAPITOL (center of law enforcement) by former U. S. GOVT. AGENT and NAVAL INTELLIGENCE Officer exposes actual methods used by Criminals. Write for FREE BOOK. State age.



INTERNATIONAL DETECTIVE TRAINING SCHOOL
 1701 Monroe St., N.E. Dept. 215 Washington 18, D. C.

MACHINE SHOP EQUIPMENT



● The No. 49 edition of the famous Center Tool Co. Catalog is now ready! Every workshop owner should have a copy. 240 pages full of illustrations, descriptions, and prices of the latest tools made by best known manufacturers in U.S. You pay the cost of printing—50c. We refund your 50c with your first order of \$10.00 or more. Prompt delivery on most tools. Send check or money order today!

CENTER TOOL CO.
 153 Centre Street, Dept. D, New York 13

GOLD - SILVER - COINS



Easily located with new Light-weight M-Scope Detector. Superior performance, lowest price, monthly payment plan.

FREE LITERATURE

FISHER RESEARCH LAB., INC.
 PALO ALTO CALIF.

\$ FREE COURSE! BIG PROFITS! \$

Flocks & Sandblasts



Dual Purpose Spray Gun! Uses only 25 lbs. Air Pressure!
 ● Thousands of uses in Home, Shop, Industry: Makes Auto Interiors Clean & New, Lines drawers, Marproofs lamp bases, Retinishes any object. All in colorful Flock. Etch & Frost windows, glassware, etc. Removes Paint & Rust from autos, Tools. Guaranteed! Send \$24.75 or write for free information. Complete Flocking Supplies!

BLASTO SPRAY GUN MFG.
 Dept. PS-3, 7007 Haas Ave., Los Angeles 47, Calif.

B-M POWER MOWERS

CUT HOURS OF WORK into MINUTES of PLEASURE!



Prompt Shipment
 ★ Low Factory Prices
 ★ Fully Guaranteed
 ★ Model D-3

For a quick, slick job and a smooth-as-velvet lawn, you can't beat a B-M Power Mower. Three Models of fine rotary mowers available for your special cutting needs. The D-3 (pictured here), the self-propelled P.D. models, or our light VD-1 Mower with vertical shaft engine and direct blade drive. Quick starting, dependable 1 1/2 to 3 h.p. Clinton engines. Safety features. Easy adjustments. Low factory-to-you Price. Write for **FREE LITERATURE.**

B-M MOWER CO., Box 66-PS, Blue Mound, Kansas

BUILD AN EXTRA ATTIC ROOM



...this quick, low-cost way! Use handy Gold Bond Sealed Blankets made of fireproof Rock Wool to keep summer heat out, furnace heat in. Then nail big, fireproof panels of Gold Bond Gypsum Wallboard to studs or over old material. It saws like lumber, resists moisture, won't expand, contract or warp. Seal joints with Gold Bond Perforated Tape Joint System. Decorate with Gold Bond Sunflex wall paint, or with amazing Color Texture—brushes on like paint, covers wall like plaster. For full details of these quality products, write Division W, Dept. PS-51.

Available at your local Gold Bond Lumber and Building Materials Dealer!

NATIONAL GYPSUM COMPANY
 BUFFALO 2, NEW YORK

9 BIG BUILDING BOOKS



12th Edition for **EXAMINATION**
SEND NO MONEY

Learn to draw plans, estimate, be a live-wire builder, do remodeling, contracting. These 9 practical, profusely illustrated books cover subjects that will help you to get more work and make more money. Masonry, concrete forms, carpentry, steel square, roof framing, construction, plumbing, heating, painting, decorating and many other subjects. More than 4000 pages—2750 illustrations.

BETTER JOBS—BETTER PAY UP-TO-DATE EDITION

A nationwide building boom is in full swing and trained men are needed. Big opportunities are always open for MEN WHO KNOW HOW. These books supply quick, easily understood training and handy, permanent reference information that helps solve building problems.

Coupon Brings Nine Big Books For Examination

AMERICAN TECHNICAL SOCIETY — Publishers since 1899
 Dept. G520 Drexel at 58th Street Chicago 37, Ill.

You may ship me the Up-to-Date edition of your nine big books, "Building, Estimating and Contracting," without any obligation to buy. I will pay the delivery charges only, and if fully satisfied in ten days, I will send you \$3.00, and after that only \$4.00 a month, until the total price of only \$34.80 is paid. I am not obligated in any way unless I keep the books.

Name.....
 Address.....
 City.....State.....

Please attach a letter stating your age, occupation, employer's name and address, and name and address of at least one business man as a reference. Men in service, also please give home address.

CAR OWNERS

Save gas! Cut repair bills!

NEW

Stewart-Warner MOTOR MINDER



Only
\$10⁹⁵

quickly pays for itself in savings

Now, with just a glance at your instrument panel, you know how to get more miles per gallon . . . how to spot engine trouble *in advance*. Clearly marked illuminated Motor Minder dial warns against below par performance of spark plugs, carburetors, valves, timing, piston rings, manifold and other troubles. Motor Minder gives a constant check on engine performance with the same accuracy factory-trained mechanics use in motor tune-ups. You can do it as you drive, *before* costly major repairs are required. Easily attached on instrument panel or steering post. Install it today. Save gas, spot trouble . . . and enjoy a new driving thrill!

See your local dealer or write

Stewart-Warner

Instrument Division, Dept. P-51

1840 Diversey Parkway • Chicago 14, Ill.

SAVE \$50⁰⁰ ON GASOLINE A YEAR!



\$3
postpaid

TURBO-DYNE — Designed by carburetion engineers to give: **BETTER MILEAGE — MORE POWER AND PICK-UP — EASIER STARTING** TURBO-DYNE creates a violent vortex action that swirls and atomizes the mixture of fuel and air as it leaves the carburetor. This enables

complete combustion and an even distribution of the fuel to each cylinder, which results in greater volumetric and engine efficiency. The result—**MORE MILEAGE, POWER and PICK-UP** for each drop of fuel consumed. Quickly installed between carburetor and manifold. No moving parts. Lasts forever. Satisfaction guaranteed! Models for all cars. Send make and year of car with \$3.00 to: **WHOLESALE DIE CO.**, Dept. B2, 604 S. Marengo, Alhambra, Calif.

NEW "PAINT PEN"

PAINT STRIPING TOOL
Works like a Fountain Pen
Stripes with Paint instead of Ink!

This amazing new "PAINT PEN" is a Paint Striping Tool that makes it easy to do expert striping on furniture, bikes, model planes, autos, signs, toys, linoleum, wall board, etc. Makes plain, painted walls look like tile. Paint straight, curved, circular or evenly spaced parallel lines the same way a professional painter does. Simply fill Tubular Glass Paint Fountain with any color paint and wheel tip feeds paint evenly. Tips interchangeable — jaws split apart for easy cleaning. Tool complete with tip for 1-16 inch strip only \$1.00 postpaid. Other complete tools with 1-64, 1-32, 3-64, 1-16, 5-64, 3-32, 1-8 inch tips. \$1.50 ea. Extra tips, 75c each. Complete KIT with 7 tips, \$5.00. C.O.D.'s postage collect. Here's the handiest tool in your whole painter's kit. Get yours today.



Paint STRAIGHT, CURVED OR PARALLEL LINES

Home Craftsmen

Just the tool you've been waiting for! New Paint Striping Tool gives "professional" results every time, yet simple and easy to use as a fountain pen. Adjustable guide keeps lines straight as an arrow. Just as easy to make curves or free hand designs. Adds new beauty and finished look to everything you paint. Send \$1 now!

Only
\$1.00

WENDELL MFG. CO., Dept. 25,
4234 LINCOLN AVENUE, CHICAGO 18, ILL.

DEALERS
PAINT STRIPING TOOL
packed in display cartons
of 1 doz. Fast, profitable
seller. Write for illus-
trated circular, discounts

CHRONOGRAPH WRIST WATCH

\$7.90

Plus Tax



Lifetime Guarantee
(EXCLUSIVE OF PARTS)

3 DIALS—5 HANDS—2 BUTTONS

Multi-purpose watch that measures distance, speed, time, moving objects. Used as Stop Watch or Timepiece. Has Sweep-Second Hand for full 60 Second count. Second Dial records up to 45 minutes. Third Dial then records up to 6 hours. Seconds—Minutes—Hours, all recorded automatically.

INDEPENDENT MOVEMENTS

The movement of this fine Swiss Made watch continues to run when sweep hands are stopped. For sportsmen, professional men and women—time-keeper works when other hands and dials are stopped—separate movements permit dual use at same time.

RUGGED CONSTRUCTION

Precision workmanship and shock resistant features are added to enhance the value of this watch. Sold elsewhere for as high as \$17.00. Our low introductory price is only \$7.90 plus tax. (\$8.69). Send check or money order and we prepay postage. Or sent C.O.D. plus charges. **LIMITED STOCK!**

MARDO SALES CO., 480 Lexington Ave., Dept. G-10, N. Y. 17, N. Y.



BUILD HEAVY DUTY MACHINES

SAVE UP to 90% You can build, using our practical, easy-to-read plans, all kinds of machines, for home, farm or shop—scooters, portable sawmills, metal working machines, concrete machinery of all kinds, printing equipment, woodworking machines, midget autos, dish washers, farm equipment, freezers, tractors

FREE

CATALOG HANDBOOK
183 SETS OF PLANS
VALUABLE INFORMATION

NICHOLS EQUIPMENT COMPANY
Dept. D-10
PURVIS, MISS.

"Radio For The Millions" Shows HOW TO BUILD 78 RADIOS— PHONOGRAPHS—OTHER SETS!

This giant book brings you 648 picture-diagrams plus *complete instructions* for building 78 radios and phonographs! Imagine! . . . 192 pages of step-by-step details on building an 8-tube FM set, a 2-way radio station, bicycle radio, floor lamp set, vest pocket portable, midget AC-DC set, superhet, high-fidelity amplifier, all wave receiver, home recorder, etc. What's more, there are scores of handsome cabinet suggestions, a dual turntable phonograph, tube tester and full details on "trouble-shooting"! *So order now—send no money!* When book arrives, pay postman only \$1.49 plus postal charges for handsomely bound Regular edition. If after 7 days *Free Trial* you aren't delighted, return it for full refund. Be sure to send your order today to:—

POPULAR SCIENCE, Dept. 551, 353 4th Ave., New York 10, N. Y.

See The Wonders of the Heavens!

Amazing value! Wonderful 192-page cloth-bound book, *Astronomy for Amateurs*, now yours for only \$1.00! Contains star charts, tables, telescope-making instructions, how-to-do-it ideas for astronomical equipment you can build, etc. *Supply limited!* Order today! Write.

POPULAR SCIENCE

Dept. 551, 353 4th Ave.

New York 10, N. Y.

FOR BIG MEN ONLY!



SIZES 10 to 16 **WIDTHS AAA to EEE**

We **SPECIALIZE** in large sizes only—sizes 10 to 16; widths AAA to EEE. Loafers, Wing Tips, Moccasins, Dress Oxfords, High and Low Work Shoes, House Slippers, Rubbers, Overshoes, Sox. Extra quality at popular prices. Satisfaction guaranteed. Sold by mail only. Write for **FREE** Catalog.

SEND FOR FREE CATALOG

KING-SIZE, Inc., 520 Brockton, Mass.

WAR SURPLUS OPTICAL BARGAINS

MAKE A MICROSCOPE—Get wonderful results. Own an instrument worth many times the cost to you. Simply convert a U. S. Govt. Rifle-scope (Govt. cost over \$65.00). It's easy! We show you how. No machining required. Get up to 40 Power. Scope we furnish is used but good condition . . . sent complete with extra lenses and direction sheet.

Stock #959-N \$7.90 Postpaid
SLIDE PROJECTOR SETS. Consists of all unmounted lenses you need to make the following size projectors:

Stock #4029-N—35 mm. \$2.85 Postpaid
 Stock #4038-N—2 1/4"x2 1/4" \$3.35 Postpaid
 Stock #4039-N—2 1/2"x3 1/2" \$3.35 Postpaid

10 POWER SPOTTING SCOPE—A WONDERFUL BUY! Pocket-Size! Complete with tripod and swivel head. Only 5 1/2" long—8 1/2" high on tripod. Adapted from Army telescope and worth many times our price. Has prism erecting system, achromatic objective. Ramsden Eye-Piece. Lenses low reflection coated.

Stock #955-N \$14.95 Postpaid
SIMPLE LENS KITS—Include plainly written, illustrated booklet showing how you can build lots of optical items. Use these lenses in photography and for dozens of other uses in experimental optics, building TELESCOPES, low power Microscopes, etc.

Stock #2-N—10 lenses \$ 1.00 Postpaid
 Stock #5-N—45 lenses 5.00 Postpaid
 Stock #10-N—80 lenses 10.00 Postpaid

We Have Literally Millions of War Surplus Lenses and Prisms for Sale at Bargain Prices. Numerous Types of Instruments. Too! Write for FREE CATALOG-N.
EDMUND SCIENTIFIC CORP., BARRINGTON, N. J.
 (Formerly Edmund Salvage Co.)

Bricklaying • Carpentry • Tiletsetting Plastering • Electricity • Welding

APPROVED FOR VETERAN TRAINING • FREE CATALOG

PENNSYLVANIA INSTITUTE SCHOOL OF TRADES

30th & MARKET STS. PHILA. 4, PENNA.

HAWAIIAN WIGGLER #1

Deep runner. No snag-up in pads and brush. Easy to cast. Rubber Hula Skirt acts alive. At your dealer 5/8 oz. or 1/4 oz., \$1.15 each.

WORLD-FAMOUS FISH-GETTER



FRED ARBOGAST & Co., Inc.
 2315 W. North St., Akron 3. Ohio

FREE WRITE TODAY FOR BIG FREE 1951 ARBOGAST COLOR CATALOG—FULL OF PICTURES OF CATCHES

make your own Gems 29.50 F.O.B.

All necessary lapidary equipment is furnished, including a super-charged diamond blade for sawing, and all wheels for grinding, shaping and polishing; also complete instructions. The complete equipment as shown, less motor and belt, for only \$29.50, f.o.b., Burlington, Wisconsin. Write today for information and literature.



B&I MANUFACTURING CO.
 Dept. M Burlington, Wis.

BEING PUSHED AROUND??



Why take any more nonsense from bullies, wise guys and other pests? The next time they try to act smart—give them the surprise of their lives! It's easy when you know POLICE JIU JITSU! This complete, fully illustrated course comes to you in one volume. The same as taught to police, marines, "G" men, soldiers, sailors and members of the U. S. Coast Guard. By all means, just pin \$1 to this ad and we will send POLICE JIU JITSU to you postpaid by return mail. Satisfaction guaranteed or your money back.

BOOKS PUBLISHING CO., 56 W. 24th St., N.Y. 10

New POWER MOWER

Build It Yourself And Save.

Amazing new invention makes whirl-blade mower pull and steer itself as well as cut grass and weeds. Build it yourself. Send name and address on 1c postcard for FREE building instructions . . . NO OBLIGATION.

PULLS ITSELF, STEERS ITSELF

T & H Mfg. Co., Dept. MSC-5, 811 E. 31 St., Kansas City, Mo.



Spindle & Blade



Wheel



Swivel



Parts for Pulling & Steering

All Parts Available Complete Kit or Separately.

LEARN.. CERAMIZING

THE NEW HOME ART HOBBY
 TURNING WORTHLESS OBJECTS
 into VALUABLE TREASURES



\$5 AN HOUR PROFIT
 Creating Things of Beauty

Amazing Book Tells You

How to do the work—what to decorate—what materials you need—where to buy them cheaply—how to get customers coming—what to charge—how to start a business in spare time without risking job or paycheck that can lead to future independence. You read all this without risking any money at all. Just send name.

Think of learning an artistic hobby in just a few minutes of instruction. Think of turning just 56c worth of material into an art object so beautiful that it brings you \$5.00 an hour for your spare time. Sounds fantastic—yet it's true—as you can easily prove without risking a cent of money. I have ready to mail to you a complete set of instructions so easy to follow that a child can learn this fascinating new art. Within an hour you can be "Ceramizing." The very first day you can create things of beauty from Nature's countless masterpieces of design, such as leaves, flowers, twigs, stones and shells. Preserve and beautify keepsakes such as Baby Shoes—turn 10 cent store products into art objects worth five to ten times their cost—restore and rebeautify hundreds of household articles for yourself and friends.

FREE Pay Me Nothing for this Information

This fascinating home hobby is used by many as a means of steady extra income. Fun for the whole family—and money besides. Read the entire plan—all instructions—at my risk. **DON'T SEND MONEY—JUST YOUR NAME FOR COMPLETE DETAILS FREE.** Address **R. E. Brandell, WARNER ELECTRIC** 1512 JARVIS AVE., DEPT. 25, CHICAGO 26, ILL.

R. E. Brandell, WARNER ELECTRIC, Dept. 25
 1512 Jarvis Ave., Chicago 26, Illinois

Please rush complete facts showing how I can start "Ceramizing" business at home for pleasure or profit. No charge. No obligation. All FREE.

NAME _____
 ADDRESS _____
 CITY _____ ZONE _____ STATE _____

TITANIUM Rutile

The New WONDER GEM of the century . . .

For the first time in history and as a result of intensive experimentation and research on a vital military project brilliant scientists of one of America's largest corporations suddenly hit upon the solution of the ages. The secret of how to crystallize in the laboratory a gem with a refractive index higher than and a dispersion factor greater than a **DIAMOND** was **DISCOVERED**. The discovery is **TITANIUM RUTILE** so widely acclaimed by leading reportorial mediums such as Reader's Digest and The Saturday Evening Post.

REFRACTIVE INDEX ABOUT 10% HIGHER THAN DIAMONDS

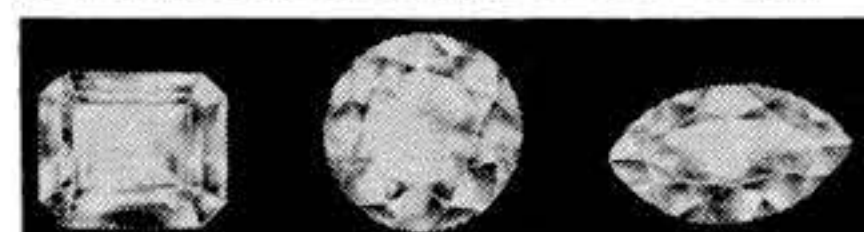

(Actual Photograph of Our Product)

Compare: Refractive Index of Rutile is between 2.62 and 2.90 as compared to the diamond's 2.42. Dispersion of Rutile ranges between 0.155 and 0.205 in comparison to the diamond's 0.025.

You are living in an age of miracles. As you know, atoms are being split. Actual basic materials are being re-arranged. Fantastic as it may seem to the layman, the secret of what has formerly been referred to as the **DIAMOND** is now known beyond a shadow of a doubt. **YOU PROFIT.** No longer need you invest large sums of money in a tiny stone the value of which is determined largely by scarcity and control. **YOU** can enjoy the beauty and prestige and the envy of your friends with a stone that no one of lesser ability than a **REAL JEWELER** working with a magnifying glass in his eye under good light can detect as not being a real **DIAMOND**. A handsome engagement ring made of our remarkable gem presented to any girl will inspire her devotion. The hundreds of dollars thus saved will go far towards building a happy, permanent home. Hudson Gem Co., sells **RUTILE** only in the cut stones. Each stone is perfectly cut with full 58 facets per **BRILLIANT** stone. By law we cannot refer to our products as **DIAMONDS** so we ask you to order them in the three most popular **DIAMOND** shapes namely the round or **BRILLIANT**, the oblong or **EMERALD** and the oval or **MARQUISE** cuts. You may order these stones for setting by your local, friendly, trusted jeweler who will be glad to verify your purchase. We do not sell mountings nor do we go in for costly catalogues nor expensive time payment plans. You get the benefit of direct to consumer possession of a valuable product which you can then have mounted and **SAVE THE MONEY YOURSELF. PAWNBROKERS—ATTENTION!** We suggest that you order a sample of this amazing product to have in your shop for comparison. Some pawnbrokers have paid out money under the impression that they were loaning on **DIAMONDS** when in reality people were offering titanium rutile. Lapidarists can make money buying cut stones from us and setting and selling complete rings. **UNCONDITIONAL MONEY BACK GUARANTEE. 30 DAY TRIAL IN YOUR HOME.** You are the **SOLE JUDGE.** In this advertisement you are assured that if for any reason whatever you are dissatisfied with your purchase from us you may, within 30 days, return your purchase for **100% CASH REFUND WITHOUT QUESTION.** Order with confidence. Select the shape you want, either **BRILLIANT** or **EMERALD** or **MARQUISE** shapes. Then select the number of carats you want, either 1, 1 1/2, 2, 2 1/2, 3, 3 1/2, 4, 4 1/2, 5, 5 1/2, 6, 6 1/2, 7, 7 1/2, 8, 8 1/2, 9, 9 1/2, or 10. Remember each **BRILLIANT** is full 58 facets. Check this with your trusted jeweler. Price \$10.00 per carat. Add 20% Fed. Tax. Send Check or Money Order (do not send cash). Everything sent postpaid. **WRITE DEPT. PS-7**

HUDSON GEM CO., 15 E. 47 St. N.Y.C. 17, N.Y.

PISTON SEAL

is "Penicillin" in your AUTO ENGINE!

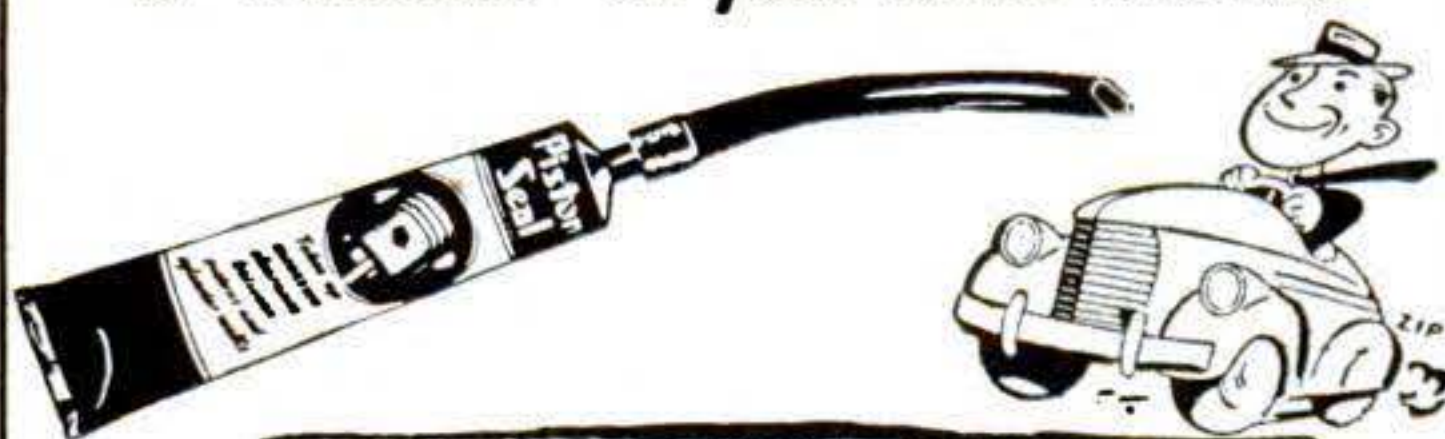

DON'T spend Big Money overhauling your car! Use Holt's "Piston Seal" instead! Exactly what's your trouble? Burning oil? Lacking power? Piston slap? Worn cylinders? "Piston Seal" effectively eliminates these ailments! By forming self-expanding pliable lubricating seal around the pistons, this amazing British product compensates for wear! Restores compression! Cuts oil loss! Checks piston slap! Lasts 10,000 miles! Cannot harm the finest engine; easily installed. The British call it a "God-send!" You will, too!



It's easy!
Remove Plugs...
Insert Rubber Tube...
and Squeeze
That's All!

**DETAILS FREE!
WRITE TODAY!**

TREGLOWN CO.,
200 West 7th St., Plainfield 3A, N. J.
RUSH details on Piston Seal—without obligation!

NAME.....
ADDRESS.....
CITY.....STATE.....

Your's... SWITZERLAND'S FINEST WATCHES

Handsome and inexpensive—choose either of these precision watches. Calendar watch tells time as well as day while the amazing 2-button chronograph gives time, measures distance, times moving objects, even measures air or ground speed with split-second accuracy. Watches have anti-magnetic jeweled Swiss movement, luminous hands and dial and sweep second hand, plus genuine leather band. Manufactured and cased in Switzerland, your choice of gilt or chrome finish. Either watch in black or white face. Gift boxed.



Unconditional One Year Guarantee add 75c for gilt finish **\$6.95** Tax Included

BL Swiss Watch Dist.
103 W. 100 St., New York 25, N. Y.

IS \$21000 A WEEK Worth a Penny Post Card?

Then RUSH postcard with name and address. Get FREE details of amazing full-and-spare-time PROFITS made by ambitious men handling new Automatic Defroster for refrigerators on FREE TRIAL basis. Learn how housewives hand you big profits when you just plug in the D-Frost-O-Matic to end defrosting mess forever. Send card for Special Offer TODAY.

D-FROST-O-MATIC Dept. PS-5
6 N. Mich. Ave.
Chicago, Ill.

NO CAR TROUBLE IS HARD TO FIND...



when you have MOTOR'S new "Trouble Shooter"
Handy, pocket-size, indexed manual lists 1760 CAUSES of car troubles and tells WHERE to look for them. Saves you hours of time and work on difficult jobs. Covers engines, clutches, brakes, ignition, etc. Section on automatic transmissions alone is worth more than price of book! Spiral binding; book stays open while you work. Just pin \$1 to this ad, with your name and address. If not satisfied, return book in 7 days and your money will be cheerfully refunded. MOTOR Book Dept., Desk 25T, 250 West 55th St., New York 19, N. Y.

WASTING POSTAGE MONEY?



Most letters mailed with a 6 cent stamp actually need only 3 cents. Don't guess about weight! Get this amazingly compact Post-Master letter scale with the cleverly concealed weighing mechanism. Instant one-hand operation. Weighs letters and parcels up to 1/4 pound, yet is only 3" tall. It has a beautiful black wrinkle finish with red trim. Very attractive for home or desk use. A wonderfully different and practical gift item. Ideal for travelers because it works anywhere, anytime.

JUST \$1.00

POSTPAID
JOY SPECIALTY COMPANY
2320-G West Hubbard St. Chicago 12, Ill.

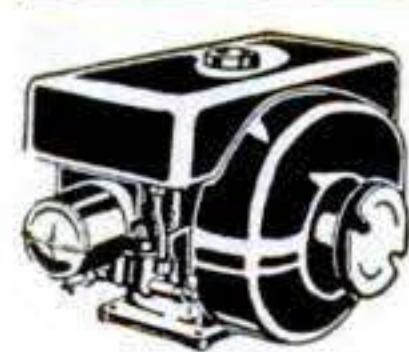

Check or \$5 Deposit
FOSTER SALES
202 Laurelton St.

Power Products Late Production \$60 Model #1000
GASOLINE ENGINES
1 H.P. "Flyweight" 18 lbs. 2-cycle Air Cooled
• NEW DEPARTURE BALL BEARINGS ON CRANKSHAFT
• WICO MAGNETO
• TILLOTSON FLOAT FEED CARBURETOR
• ALUMINUM CONSTRUCTION
COMPLETE Reconditioned \$17 NEW \$23.00
F.O.B. Springfield
Springfield, Mass., Phone 2-3313

BUY U.S. SAVINGS BONDS

SAVE UP TO 2/3 ON KENTILE INSTALLING YOUR OWN ASPHALT TILE FLOOR



FREE Instruction Book with each Order!
It's simple as A-B-C! Lay your own KENTILE floor. Beautify your recreation room, kitchen, bedroom or bath with long lasting KENTILE. Colors go all the way through—never wear out!

ONLY \$3.98 A BOX
For solid colors. (Freight collect) Choice of black or quarry red. Each box contains 80 pieces of tile (equivalent to 45 sq. feet.)
Dark marbled colors (Freight collect. Shipping \$4.69 a wgt. 60 lbs. per box.)
Light marbled colors slightly higher

Send check, cash or money orders (no c.o.d's) to
HOME, Inc. TILE CENTER
9702 Georgia Avenue
SILVER SPRING, MD.

Illustrated catalogue only 25c. (Amount will be credited against purchase.)

OIL FILTER REFILLS... 10c



Here's News! Ordinary toilet paper makes an ideal oil filter. Laboratory tests prove it cleans oil faster and better than popular makes of filter elements. All you need is a simple set of **RETLIF ADAPTER PLATES**... and you can start using ordinary toilet paper rolls in your present oil filter. For proof and descriptive literature, send name and address to:

RETLIF CORPORATION, Dept. 79
1239 No. Highland Ave., Los Angeles 38, Calif.

NEW HYDRAULIC CYLINDERS

- #3-Bore 1"-Shaft 1/2"-Length 8 1/2"-Stroke 2 1/2"-4 1/2" **\$5.75**
- #3A-Bore 1 1/2"-Shaft 1/2"-Length 10 1/2"-Stroke 5" **7.75**
- #4-Bore 3"-Shaft 1 1/8"-Length 8 1/4"-Stroke 3 1/2" **12.75**
- #4A-Same as #4 with 2 7/8" extended shaft **12.75**
- #24C-Bore 1 7/8"-Shaft 1"-Length 18"-Stroke 10" **15.75**
- #112-Bore 4"-Shaft 2"-Length 27"-Double Acting **18.50**



ALL PRICES F.O.B.

CHALK METAL COMPANY 2035 E. 46th Street, Los Angeles 58, Calif.

REAL ESTATE BE A BROKER

PAYS BIG! SEND FOR FREE, BIG, ILLUSTRATED CATALOG NOW! No obligation. Graduates report making substantial incomes. Start and run your own business quickly. Men, women of all ages, learn easily. Course covers Sales, Property Management, Appraising, Loans, Mortgages, and related subjects. **STUDY AT HOME** or in our classrooms in big cities. Diploma awarded. G.I. approved. Nationally known.

WEAVER SCHOOL OF REAL ESTATE (Est. 1936)
15 E. Pershing Road, Dept. PS, Kansas City, Mo.



LEARN MEAT CUTTING At Home - In Spare Time

Get into the vital meat industry. Concise, practical Home Training based on 25 years proven instruction methods used at National's famous resident school. Prepares you for bigger pay as Meat Cutter, supervisor, market manager or more money in your own store. Go as rapidly as your spare time permits. Diploma. Start NOW to turn your spare hours into money. Send for FREE bulletin today. No obligation.

National School of Meat Cutting, Inc., Div. O-102, Toledo 4, Ohio

ENORMOUS PROFITS CASTING AT HOME

Write today for **NEW FREE CATALOG** Learn to cast thousands of perfect figurines, plaques, book ends, ash trays, etc. Start NOW—NO EXPERIENCE. LITTLE CAPITAL needed. Earn **GREAT PROFITS** with X.L. RUBBER MOLDS. X.L. Rubber, Pts. \$2.00; Qts. \$3.50; Models and enough rubber for 3 molds... \$1.30 postpaid.

PLASTIC ARTS STUDIO 3403 S. Madison St. Dept. 3 MUNCIE, IND.



FREE FACTS SENT

IMPORTED GERMAN BINOCULARS SAVE 60% 12 1/2 MILE RANGE

PRECISION LENSES \$3.95 PLUS TAX

New, low cost binoculars from a famous German manufacturer of fine optical instruments. Center focusing adjusts to your own eye strength. Money back guarantee. Compare with glasses at \$15.00 or more! Send check for \$3.95 plus 80c tax... we pay postage, or order C.O.D.

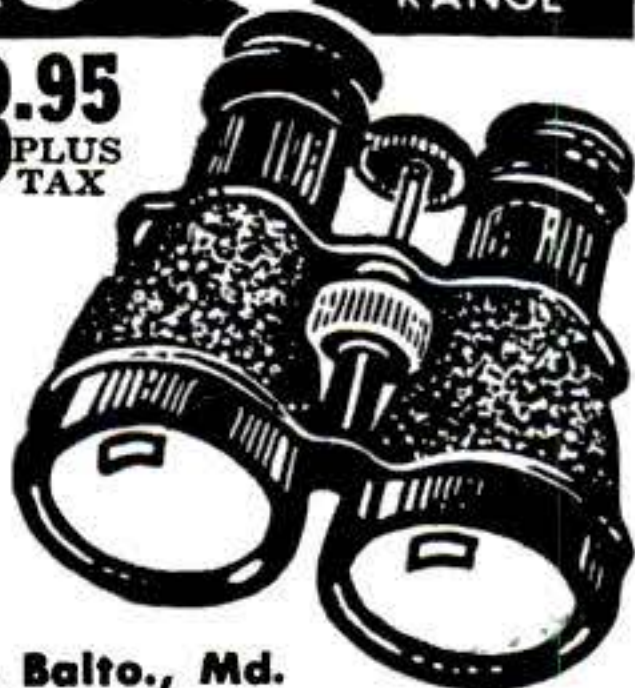

Maryland Distributors
Dept. 253, 501 E. Baltimore St., Balto., Md.

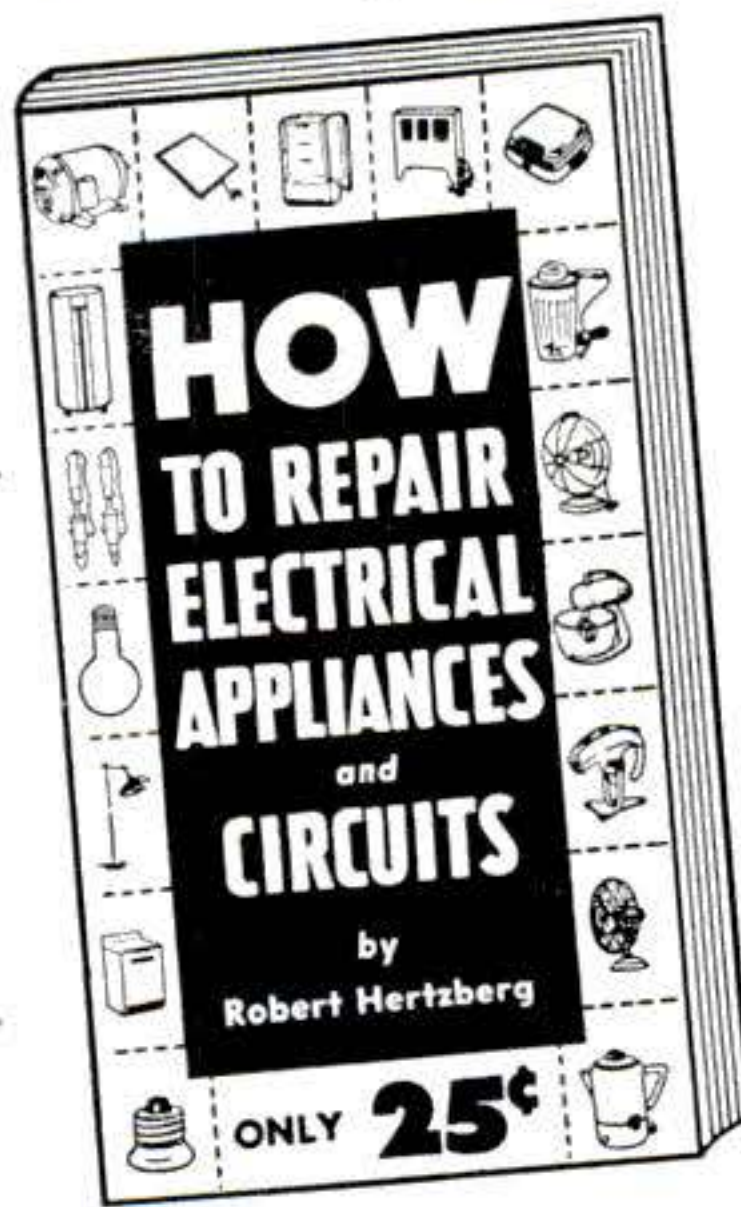

Originally published to promote the sale of our well known Model 50 Utility Tester, this 64 page book has now become "must" reading for the experimenter and technician interested in Electric Appliance and Circuit repairs.

DON'T LET THE LOW PRICE MISLEAD YOU. Although it sells for only 25c this versatile pocket edition just off the press includes 28 photographs showing how repairs are made for every electrical device from a fuse to a motor using our nationally advertised Model 50 Utility Tester. The author presents a detailed description showing how repairs are made on electric toasters, irons, clocks, fans, vacuum cleaners, machine tools, washing machines, bulbs, fluorescents, thermostats, transformers, radios, tubes, resistors, condensers, auto electrical circuits, house wiring, etc. Send for your postpaid copy today. Include 25c in coin or stamps. Mail your order promptly and we will include, at no charge, a copy of our new *Simplified Ohms Law and Wattage Chart*. **SUPERIOR ELECTRONIC CO., INC., Dept. S-1, 227 Fulton St., New York 7, N. Y.**

The easy way to paint!

Speedy Sprayer

ONLY \$32.50 LESS MOTOR

Favorite of home owners and craftsmen for 20 years! **SPEEDY SPRAYER** gives your work that professional paint finish everyone admires. Sprays paint, enamel, varnish, lacquer, etc. . . . 4 to 7 times faster than hand brushing! Lightweight, portable, uses any 1/4 H.P. motor. Improved diaphragm principle assures clean, oil-free air. You'll find dozens of time and money saving uses for **SPEEDY SPRAYER**, including spraying insecticides 2-4-D and DDT. Complete outfit, without motor, only \$32.50.

At leading hardware, lumber, and auto supply dealers. **FREE**—write for handy booklet "How to Spray."

W. R. BROWN CORPORATION
5718 Armitage Ave. • Chicago 39, Ill.

AMAZING NEW DISCOVERY!

FOR ALL CARS WITH OVERDRIVE



ONLY
\$995
POSTPAID
AND
INSTALLED

AUTOMATIC
HILLHOLDER

OVERDRIVE
COMPRESSION

6 FORWARD
SPEEDS

NO CLUTCH
SHIFTING

We enclose a Free installation certificate redeemable for cash by your garage or gas station.

THE GANE-O-MATIC PUTS TO WORK ALL THE HIDDEN ADVANTAGES OF YOUR PRESENT OVERDRIVE SYSTEM.

GANE-O-MATIC SAVES GAS, BRAKES & TIRES by allowing the use of overdrive 100% of the time and giving motor compression when in overdrive. THE GANE-O-MATIC AUTOMATIC HILLHOLDER holds your car on any hill without the use of foot or hand brakes. SIX FORWARD SPEEDS . . . three each in overdrive and regular can be selected with a flick of your finger. NO CLUTCH SHIFTING . . . up or down . . . can be enjoyed at any speed without even touching your clutch.

The GANE-O-MATIC is easily installed in a few minutes on all Ford, Mercury, Lincoln, Studebaker, Chrysler, Dodge, DeSoto, Nash, Hudson, Kaiser-Frazer, Jeepster, and other cars with overdrive.

MONEY BACK GUARANTEE: If you are not fully satisfied, we will refund entire purchase price within 30 days. Unit comes complete with illustrated installation instructions PLUS Free installation certificate. Send cash, check or money order. \$1 deposit on C.O.D. orders.

NATIONAL AUTOMOTIVE RETAIL CORP., DEPT. X-5
350 W. Washington Blvd. Venice, Calif.

Thousands Enjoy New LEFT-FOOT ACCELERATOR

**DRIVING
RELIEF!**

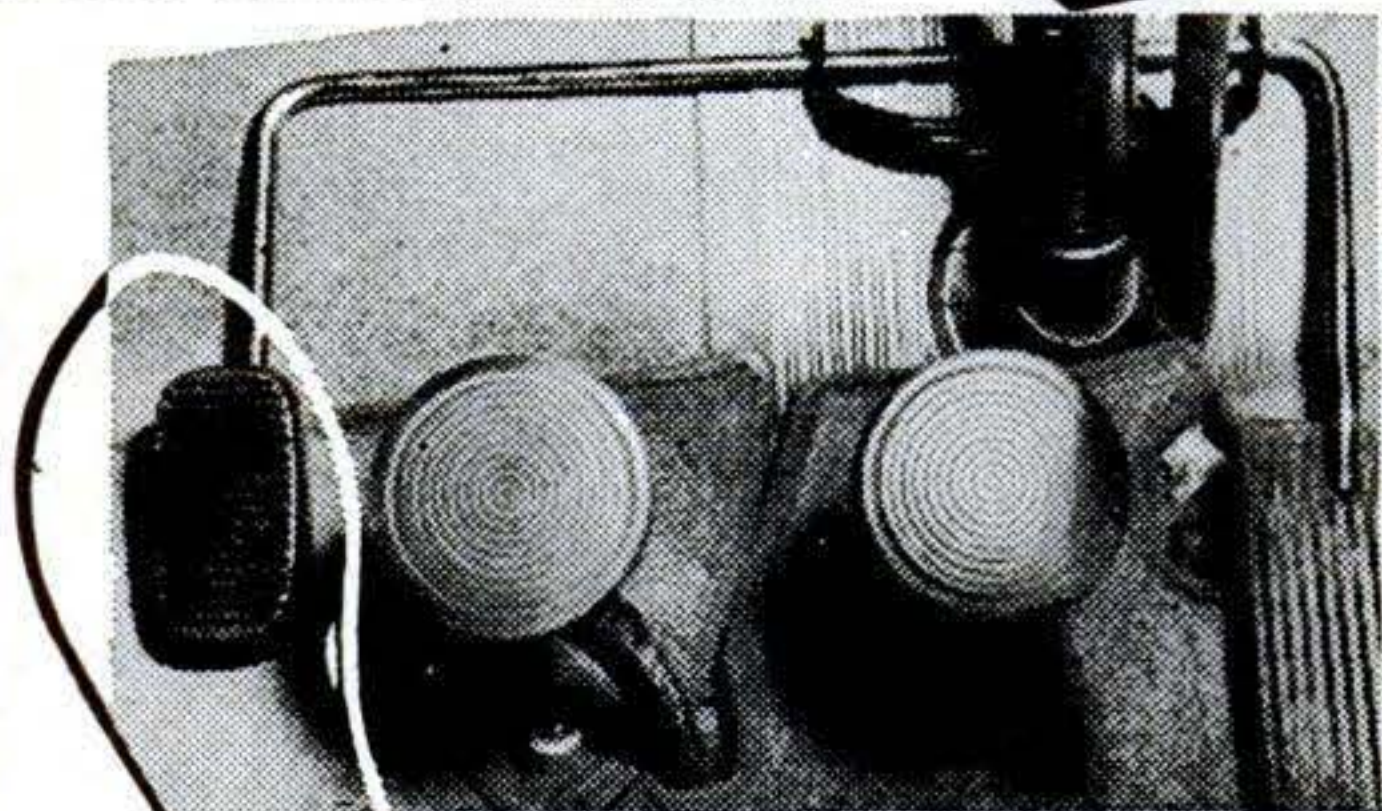

CUT driving fatigue in half with Lefty! Install this new left foot accelerator yourself in 60 seconds with just a wrench—no alterations to your car are necessary. Enjoy

relaxed comfort on long drives. Lefty lets you feed the gas with your left foot when you desire, relieves tension and fatigue in leg, back, and foot. Safe, positive and convenient. Swings out of way when not in use. Does not interfere with light switch.

Brings your car up to date. Ppd. . . . **\$5.**

SPECIFY YEAR AND MAKE

No COD's please

INVENTORS MARKETING LAB
1209-C DeYoung Bldg., 690 Market St.
SAN FRANCISCO, CALIFORNIA



FITS NEW
CLUTCHLESS
MODELS

FOAM RUBBER

FOR HOBBYISTS, CRAFTSMEN, EXPERIMENTERS



Lowest Prices—SAVE 50 %

16 x 16 x 1 1/2" . . . ea. \$1.35
16 x 22 x 1 1/2" . . . ea. 1.75
18 x 24 x 1 1/2" . . . ea. 2.00
24 x 24 x 1 1/2" . . . ea. 2.95

AUTO SEAT TOPPER PADS

Place under seat cover
24" x 60" x 1 1/2" . . . ea. \$6.45
24" x 60" x 2" . . . ea. 7.95
12" x 14" x 1 1/2" . . . ea. 1.25

Use for furniture cushion fillers, mattresses, Mattress pads, cushions. Foam Rubber is available in any size or thickness. Send For Free Price List. Immediate delivery. No C.O.D.'s. Add 10% for Postage & Handling to Above Prices. Please print.

RIOR RUBBER COMPANY, Dept. S-19
50 East 22nd St. Chicago 16, Ill.

BLOOD PRESSURE GAUGE

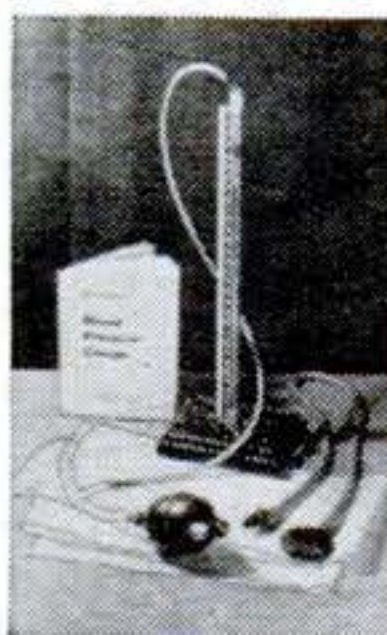

for HOME USE. **\$5.98**
Keep check on yourself! Prevent strokes, kidney damage, etc. Manual has full details on what is prescribed in 95% of All high blood pressure cases. Unit includes a Blood Pressure Gauge, Arm Bandage, Sleeve, 2 Valve Bulb, Base, Stethoscope and 25 Grams of MERCURY. Easy to operate. Complete outfit sent prepaid for \$5.98 or simply send name and address and pay \$5.98 plus C.O.D. and postal charges on arrival.

JOY SPECIALTY COMPANY
Scientific Instrument Department
2320-G W. Hubbard St., Chicago 12, Ill.
Additional information upon request

"I HAVE EARNED \$1520 AN HOUR"
AN AVERAGE OF



with Science's New Midget Miracle, the Presto Fire Extinguisher, says W. F. Wydall's, Ohio. Many others "cleaning up"—so can you! Amazing tiny new extinguisher ends fires fast as 2 seconds. Guaranteed 20 years! Sells for only \$3.98! Write for FREE Sales Kit. Merlite Industries, Inc., Dept. 115, 201 East 16th Street, New York 3, N. Y. (If you want a regular Presto to use as a demonstrator send \$2.50. Money back if you wish.)

J. W. SMITH

INFORMATION

CASHIER

PRIVATE

SHOP

YOUR OWN NAME

Or any other words, permanently engraved in glossy, black plastic. White letters and borders. Choice of 1/2", 3/4" or 1" high letters. Use on your door, gate, mailbox, shop, office, cabinets, toolboxes, etc. Photos are of actual signs. Complete with holes & screws. Weather-proof. Guaranteed never to fade, chip or warp. Order today! Immediate delivery. State size of letters wanted. **\$1.49**
Print letters. Send cash, check, M.O. No C.O.D. 15 letters or less. p.p.

DEALERS WANTED Add. letters 25c ea.
MULTI-CRAFT, Inc. 6105 N. E. Union Ave. Dept. A, Portland 11, Ore.

TEAR OUT COUPON NOW SEND 10c and THIS COUPON for YOUR Big New 584 Page Novelty Catalog



10c

of 7500 Gadgets, Tricks, Hobbies, Jokes

Send 10c for mammoth new catalog of 7500 novelties. (Each copy costs us over 50c—10c helps pay postage.) More fascinating than World's Fair. Thousands of things you never knew existed—never knew where to get. Includes novelties, tricks, jokes, live animals & pets, scientific supplies, den novelties, hobby supplies, planes & boats, looms, magic, unusual seeds, gadget time savers, cameras & optical goods, movies, projectors, lucky jewelry, religious novelties, telegraph sets, magnets, disguises, easy musical instruments, stamps, coins, puzzles, fortune tellers, radios, experimental sets, auto & bike accessories Western belts & wearing apparel, telescopes magnifiers, banks, compasses, smokers' gadgets, artists' supplies, printing sets, engines, motors, electric shockers, knives, billfolds, weird articles archery, swimming helps, 1000 fascinating books, games, locks, barometers, rings, watches, charms, imported novelties, exercisers, money savers, tools, Indian novelties, etc. Jammed & packed with funmakers & useful articles. Over 1 inch thick, 6 color cover. Send to JOHNSON SMITH & CO., Dept. 375, Detroit 7, Michigan

Here is 10c.
Rush Catalog to

Address

Classified Ads only 80c per word per insertion, payable in advance. Minimum ad 10 words. To be included in July issue, copy should be in our office by May 25th.

CLASSIFIED OPPORTUNITIES

POPULAR SCIENCE MONTHLY-351 FOURTH AVE.-NEW YORK CITY 10

1 AUTOMOBILES

"SPEED & Mileage" Manual—Famous Power Book shows how to build Speed Equipment, Racers, Fast Conversions, California Roadsters! Covers "Souping", Speed Tuning, Racing Tricks, Fuel Formulas, Economy Information, Indianapolis Methods, "Customizing"—all cars! 300 Photographs! Drawings! "Restyling Plans!"—Complete with "Hot Rod Builders Kit" \$1.98. Almquist Engineering, Milford 51Z, Pennsylvania.

NEWHOUSE now offers the world's greatest Automotive Book deal. See page 20 for details.

AUTOMOBILE History Scrapbook #1 just published! Over 250 ads and illustrations of antique and vintage automobiles dating back to 1901. Money-back guarantee. \$1.50. Wiglesworth-Chasteen, 7134-PS5 Alhambra, Mission, Kansas.

"WATER Injection." Also—Economy—Power—Methods. Free illustrated information. Neher Industries, La Verne 6, Calif.

DON'T spend big money overhauling your car! Use Holt's "Piston Seal" instead! Exactly what's your trouble? Burning oil? Lacking power? Piston slap? Worn cylinders? "Piston Seal" effectively eliminates these ailments! By forming self-expanding pliable lubricating seal around pistons, this amazing British product compensates for wear! Restores compression! Cuts oil loss! Checks piston slap! Lasts 10,000 miles! Cannot harm engine; easily installed. British call it "Godsend!" You will, too. Details free; write today! Treglown Company, 200 West 7th, Plainfield 40, New Jersey.

THOUSANDS of Speed Equipment items now ready for all makes of cars. See big Catalogue Offer on page 20.

CALIFORNIA custom accessory headquarters. Buy direct from original designers and save. Chrome dash panels, push button door-trunk conversions, chrome motor accessories, lowering kits, speed-dress-up equipment, 1951 Catalog, 40 pages, hundreds of photos—25c. Eastern Auto, 3319D South Grand, Los Angeles 7, California.

MOTORISTS—Save Gas! New Automatic Vaporizer helps your car attain more speed, power and better efficiency. Get Premium Performance with Regular Gas! Up to 25% Better Mileage! Money back guarantee. Free literature. Write today while supply lasts, only \$5.95 postpaid, C.O.D.'s require \$1.00 deposit. List make, year and no. cylinders. Vaporizer Company, Box 7033N, Station G, Los Angeles, Cal.

FREE Books . . . Don't miss the world's greatest automotive book offer by Newhouse. See page 20.

WHITE Steam Car service manual and efficiency report \$2.00 postpaid. K. Ziesmer, 3211 N. 5th St., Milwaukee, Wis.

FREE "Power Digest"—given with World's Biggest Speed Equipment Catalog showing 1000 Hot Rod Bargains—Hollywood Mufflers \$4.95. Duals \$16.90. Chrome Megaphones \$1.55. Dual Manifolds \$9.95. Racing Cams \$29.00. Water Injectors \$6.95. Accessories Galore! Postpaid 25c. Almquist Engineering, Milford 54Z, Pa. (Dealers Wanted.)

STOP headlight glare with new Polarvision light! See page 48.

"HOW to get 150 MPG." New, authentic book shows how. Full sized passenger cars go 150 miles per gallon gasoline. Also "1951 Speed-Economy Catalogue." Both 50c postpaid. Newhouse Automotive Industries, 5803-A1 East Beverly Boulevard, Los Angeles 22, California.

2 AUTO SUPPLIES & EQUIPMENT

NEW and used guaranteed parts for civilian and Army cars and trucks. Largest stock in America. Mail orders. Pioneer Auto Wrecking Company, 788 W. 13th Avenue, Denver, Colorado.

FOR free descriptive literature on alcohol-water injection for cars—trucks—tractors write Shade, Webster, New York.

FROM Speedway to Roadway! Track-proved hi-speed heads, manifolds now available for any passenger car! No special tools needed! Increase horsepower 25%! Astounding getaway! Free illustrated catalog. Speedsport, 6215-F Diversey, Chicago 39.

BRUSH Plating Outfits connect to a battery. No tanks or shop required. Free particulars. Gunmetal Co., Avenue K, Decatur, Illinois.

1951 EDITION. It's new. It's Different! Get world's largest Auto Accessory & Parts Catalog and save money. Over 50,000 items, including Hollywood Accessories, Hi-Speed Equipment, Rebuilt Engines, all parts and accessories for all cars and trucks. We have that Hard-To-Get part! Jam packed with bargains. Completely illustrated. Send 25c (refundable). J. C. Whitney, 1919-T Archer, Chicago 16.

OVERDRIVE Users: Free "Gane O'Matic," economy, information. Neher, La Verne 6, California.

AUTO Seat Saver. Protect front seat with durable, water-proof, acid-stain resistant heavy plastic cover. Elastic bands insure good fit. Specify solid or split front seat. \$1.50 postpaid. Lin-Mar Company, Box 2568A, Baltimore 15, Maryland.

NEWHOUSE—One of the world's largest speed equipment distributors, now makes amazing offer. See page 20.

AUTO trouble light. Plugs into cigarette lighter, 12 foot extension cord, \$1.20 postpaid. Trademart, Dept. 3, Box 97, Oakland Gardens Station, Flushing, N. Y.

PISTONS and Rings. All Cars any Make or year. Merryman Company, Lawndale, California.

OVERDRIVE Sig-Na-Lite for cars with overdrive or fourth speed. Indicator flashes green light when proper speed is reached. No guessing or forgetting. Saves gas, oil, motor wear. Permits "clutchless shifting." Mounts on dash. Installed in 5 minutes. \$2.95 complete postpaid, C.O.D. small fee. Quality Products, 5227 Parker Ave., Chicago 39, Illinois.

CHEVROLET Parts. Scarce motor, body, sheet metal parts. Grossman Chevrolet, Minneapolis, Minnesota.

GET our patented visor clip. Holds pencil, pad, maps, etc. years of convenient finger tip service for forty cents mailed to R. E. K. Mfg., 8530 Woodward, Detroit 2, Michigan.

MOTORIST save gasoline by Vacuumating overrich mixtures. Fits all cars. For Free particulars write Vacuumatic, Dept. 1751, Wauwatosa, Wis.

THREE New Chamois \$1.95 Postpaid. Big value—over 1,000 Square inches. Surplus Sales, 224—24th Street, Niagara Falls, New York.

VAPOJET helps save gas, engine wear, carbon accumulation and increase power with water-alcohol vapor injection. \$9.95 postpaid, \$1 deposit C.O.D. 30 day money-back agreement. Easily installed. Free details. Agents wanted. Bantel, 757-AE Venice, Los Angeles 15.

OPERATE Your Car On Propane \$1.00. Save up to 1/2 on motor fuel costs. Send for manual "Propane On Car-Truck Or Tractor" which completely explains propane carburetion, shows how simple it is to install on any car, truck or tractor. Includes photos, drawing, catalogue of equipment and special prices. Cost of manual refunded on equipment purchase. LPG Products Co., Dept. PS-5, Kearney, Nebraska.

"LIQUID-Diamond." Car cleans cleaner. Waxes brighter. Lasts longer. \$1.00 Postpaid, 50% commission. Box 394A, Union, New Jersey.

DUAL Manifolds, you can make your own! Save \$\$! Literature 10c. Gotha Automotive Specialists, Box 141-P, Harvey, Ill.

STOP headlight glare with new Polarvision light! See page 48.

SEAT covers, Deluxe, Fibre \$9.98, plastic \$17.98. Postpaid. State year, make, model. Color desired. Autolux, Dept. 9, 3834 Dolfield Avenue, Baltimore 15, Md.

3 AUTO TRAILERS

BUILD your own trailer! Plans for all kinds. Illustrated catalog 10c. Jim Dandy, 125-S, Wausau, Wisconsin.

4 MOTORCYCLES BICYCLES, SUPPLIES

RECONDITIONED motorcycles and motors. Chromium accessories. Complete stock Indian parts. Expert rebuilding. Fast service. Indian Motorcycle Sales, Kansas City 1, Mo.

47 WHIZZER motorbike engine \$7; Briggs engine \$5; Maytag \$4. Motorette \$25, midget car \$25, less engines. Four balloon tires \$3. Mailorder only. Send 25c for new catalogue number 41, just out, listing these and hundreds of other bargains in new and used midget cars, motorscooters, homebuilders parts, plans, transmissions, clutches, engines, war surplus, etc. (35c by first class mail). Midget Motors Directory, Athens, Ohio.

WHIZZER in Schwinn bike \$20; good motorscooter (twist grips) \$22.50; midget car \$15; Shaw bicycle motor \$15. Send 25c (35c first class mail) for catalog #18 jammed with other sensational bargains in wheels, motors, clutches, motorscooters, midget cars, motorettes, motorbikes, etc. Gail, 538 Erie, Toledo, Ohio.

WHIZZER (all attachments) \$25; Cushman motorscooter, extra tires, \$20; Indian motorcycle \$30 complete; Midget car \$35. Rush 25c (35c first class mail) for catalog #947 listing these and scores of other amazing bargains in motors, midget cars, motorscooters, motorbikes, motorcycles, etc. Associated, Box 1764-CS, Toledo, Ohio.

REBUILT Gasoline Engines \$9.00 to \$30.00. Cauffel Motor Industries, Temperance, Michigan.

MOTORCYCLE Magazine — Worldwide Coverage. Yearly Subscription \$2.00. Sample 20c. Motorcycle News, 5424-B Sawyer, Chicago 25.

5 AVIATION

HELICOPTER, build from spare parts almost no cost. Blueprints \$2.00. Aero-Tech, 601 Jeff., Montgomery, Alabama.

BULLET Raceplane-Homebuilt Speedy Monoplane Blueprints \$2.00. Corcraft, 80-S Maxwell, Rochester 11, N. Y.

ENGINEERING Data Interested in Aircraft, Machine, Materials, Methods, Design, formulas. A list of where to obtain over 293 free valuable books and engineering data manuals is now available. Send \$1.00 to Antoci, Box 316, GPO 1, N. Y.

7 ELECTRICAL SUPPLIES & EQUIPMENT

HAD trouble finding repair parts? Your search is ended. 25c brings 64 page illustrated catalog also containing wiring charts, Gyro Lamps, 5402B Clark, Chicago 40, Illinois.

LAMPS—Build own Originals. Parts Wholesale, any amounts. Catalogue 10c. Brown Lamp Co., No. 501, Wellston, St. Louis 12, Mo.

FREE New Catalog. Bargains in Welders, Motors, Generators, Surplus Equipment. Or, Build Your Own Kits—Save. LeJay Company, Minneapolis, Minnesota.

TWO 20 watt Fluorescent Light Fixture (open ends) \$10.00 value only \$3.95. Northshore Mfg., Wilmette, Illinois.

8 WELDING, SOLDERING, PLATING

RADIATOR Repairing Books, Supplies, Equipment, Gasoline Torch. Write for circular. Curfman Mfg. Co., Maryville, Mo.

POPULAR SCIENCE OPPORTUNITIES

GOVERNORS for any gasoline driven engines. Candee-Smith, Box 612, Riverside, California.

10 MACHINERY, TOOLS, SUPPLIES

POWER Tools. Build your own with Lewis Casting. Save up to 80%. Complete castings, material and blueprints supplied for 23 woodworking and metalworking tools. Illustrated brochure 10c. Write today. Lewis Machine Tool Co., 3217 Union Pacific Avenue, Dept. S, Los Angeles, Calif.

POWER saw users everywhere are changing to Oregon Chipper Chain with Fast-File Tooth because it cuts fast in any kind of timber and is easy to file right. Guaranteed. Fits all makes. Install an Oregon Chipper Chain on your saw. Ask your dealer or write factory. State saw make, bar length. Address Desk 156-A, Oregon Saw Chain Corp., 8816 S. E. 17th Ave., Portland 2, Oregon.

FREE Catalog. Full line hobby and light industrial power wood working tools. Guaranteed. Dealers wanted. Backus Machine Co., Chippewa Falls, Wisconsin.

ONLY \$3.95 for 2" universal lathe chuck. \$14.00 Value, check or money order. Har. Mur., 2349 Devon, Chicago 45, Illinois.

PIN Punch combination screwdriver, many uses 25c. Elmar, 115-54 197th Street, St. Albans, New York.

INDEX Heads for the lathe, drill-press, milling machine, etc. Very reasonable. Write for free folder. Long's Index Heads, Box 537, Torrington, Wyo.

TUBULAR Rivets, Tools, Washers: 23c/Size, up. Craftlines, 921-PB Cedar, Burbank, California.

BEST finish Carpenters use rigid, light weight, Vacuumgrip Weightlock Vise for holding doors/sash while dressing. Instantly attaches to finest finished floor without marring. Weight of work held, locks same in vise, instant release, thickness adjustment. No agents, no dealers, order from this advertisement, satisfaction five days or money refunded. Model 5—\$12.50, Model 9 (metal) \$15.50 (prepaid). Orders west of Rockies 50c additional. Vacuumgrip-Weightlock Vise, Box 164-PS, Thornville, O.

DRILL Grinder for twist drills, \$2.95. See ad on page 252.

13 BATTERIES, GENERATORS, ETC.

EDISON Nickel Batteries, Foolproof, Odorless, Low Prices, Sizes 37 to 600 Ampere Hour, Interesting Literature. Hawley Smith Co., Croton Falls 2, New York.

14 BOATS, OUTBOARD MOTORS, ETC.

FASTEST Boats In The World—Build Now. Complete plans available for sleek Three Point Racing Hydroplanes, Runabout and others. Send 25c now for new illustrated catalogue. Champion Boats, Box 9038, Dept. 23E, Long Beach Calif.

STEERING Wheels, windshield brackets, from \$6.95. Modern fittings "Water Skiis" at lowest prices. Complete pre-cut plywood boats. Bargains galore. Folder 10c. Marine, Box 681, Mendota, Minnesota.

NEW, used, rebuilt marine motors, Marine conversions, fittings, Free Catalog. Stokes-Marine Supply, Dept. 23, Coldwater, Mich.

FULL size, cut to shape boat patterns, blueprints, 7 1/2-38 feet. Illustrated "Build a Boat" catalog 25c (coin). "How to Build Boats" book, \$1.00. Cleveland Boat Blueprint Co., Dept. A-77, Cleveland 13, Ohio.

OUTBOARD Motor Parts, New-Used. For all makes. Save Money. Outboard Motor Mart, 309D Atlantic Avenue, Boston 10, Mass.

MARINE conversions for Ford and Jeep engines, Catalog 10c. Lehman Manufacturing Company, Department A, Newark 2, N. J.

AUTO Conversions and Parts, Marine manifolds for all engines, Your transmission converted to marine gear, propellers, shafts, struts, couplings, etc. Everything you need for your boat. Money Back Guarantee. Conversion Parts Company, 277 Adams Street, Boston 22, Mass.

MAKE Boat Pump—Use Beer Cans. Great little worker. Directions 25c. coin. R. F. Schwitzer, Harrison, New Jersey.

FREE catalog used engines, conversions. Lind Supply Company, Farmington, Mich.

BUILDING A Boat? Save Money on hard-to-get items. Send for Free catalog. Ozarka, Inc., 57 Borden Lane, Woodstock, Ill.

SAVE 2/3 cost. Assemble your own boat. We furnish parts. No experience necessary. Rowboats, Cruisers, Illustrated Catalog 25c. Midwest Boat Company, Menomonee Falls 1, Wisconsin.

TWIN Tank Boat Plans \$1.00, P-38 Tanks \$9.95. Free Picture, Twin Tank, Box 89 Merced, Calif.

15 ENGINES, MOTORS, ETC.

WINDING Data, listing 225 motors, single and three phase, \$1.00. Motor Data, Box 7631, Kansas City 3, Mo.

HOTTEST surplus list in the country. Electronics, Hydraulics, Aircraft, Gadgets. Dick Rose, Everett, Washington.

FOR Sale One 10 HP electric start (New) Onan gasoline engine, \$325.00. One 5 HP rope start (Used) \$185.00. Both 2 cylinder 4 cycle air cooled aluminum. One 3 HP motor scooter (Used) \$160.00. Murphy, Sewall Ave., Brookline, Mass.

REBUILT Gasoline Engines \$9.00 to \$30.00. Cauffiel Motor Industries, Temperance, Michigan.

MOTOR Winders, free bulletins. Winding and testing equipment. Motor Industries, Quincy, Illinois.

16 AMERICAN POLICE JIU JITSU

DEADLY Judo—Fiercest fighting technique. Trick knockouts. (Over 200 illustrated pictures.) Expert instructions—Three volumes Complete \$2.25. Variety House, Box 46-A Wall Station, New York 5.

18 BODY-BUILDING COURSES

TALLER. Be one to three inches taller. A new scientific method for permanent height increase has now been developed. Free information. Natural Methods, Box 453-S Briggs, Los Angeles.

BIG bargain, 12 Health and Muscle Courses \$2.00. (Guaranteed). Sent on approval (pay later). Order today from Sid's System, Southgate, California.

BARBELLS, build quickly, strength, muscle! Catalogue. Jackson Barbells, Springfield 7, New Jersey.

BARBELLS, Dumbbells, Exercise equipment, Courses, Free booklet. Good Barbell Co., Reading, Penna.

19 SPORTING GOODS, GUNS, FISHING TACKLE, ARCHERY

190 PROFUSELY illustrated pages antique and modern pistols, swords, daggers, armor, etc. 50c. Robert Abels, PS860 Lexington Ave., New York 21.

CAST Iron Molds—for making your own sinkers. Write for free illustrated booklet. Reading Instrument Co., Box 78, Reading, Pennsylvania.

FOURPIECE steel gun cleaning rods \$1.00 postpaid. Irving Goodman, Box 1933, Fargo, North Dakota.

OVER 500 guns, modern, obsolete. List 10c coin. Ed Howe, 26 Main, Coopers Mills, Maine.

NEW Engineered Richardson "BluGlas" Rod. At last a glass rod with the kind of action you want where you want it. Has the tip-action you need for casting of light lures and the backbone in the butt end to set the hook. Will not fade in color. Find out why the New Engineered Richardson "BluGlas" will give you more rod for the money. Write for free catalog. Richardson Rod & Reel Company, 3179 North Sawyer Ave., Chicago 18, Illinois.

SEND 10c for lists either rifles, shotguns, handguns, ammunition or send 25c for all lists. Frayseth's, Willmar, Minnesota.

DEEP-O-Bob the amazing new patented casting bobber. Permits deep fishing with casting rod. All metal construction with built in automatic reel. Regular \$2.00 value, pre-season introductory offer \$1.00. Act now and receive free line and sinker. Rush \$1.00 to J. F. Cottler Co., 1145 South Elmwood Avenue, Oak Park, Illinois.

HOW to attract fish, Secret, \$1.00. Celester, 2233 Eastern Avenue, Indianapolis 18, Indiana.

5,000 BARGAINS, firearms, binoculars, war relics, catalog 40c. Smith Museum, Runnemede, N. J.

MOLDS "For fishermen, sinker, squids, jigs, and lures" handled and hinged, quality fishing tackle, free catalogue, Sweets Molds, Tonawanda, New York, Box 163.

ANTIQUE firearms, swords, daggers, horns, flasks, Indian relics—catalogue 10c. Nagy, 8-P South 18th, Philadelphia 3, Pa.

20 FIELD GLASSES TELESCOPES, ETC.

GIANT, 100 power astronomical telescope with 6 ft. tripod (10,000 area magnification) Clear Vision, full power guaranteed, \$15.00. F. O. B. factory, Suffolk Science Service, Dept. TC, Riverhead, N. Y.

TELESCOPES, Binoculars, Microscopes—big bargain catalog free. Brownscope Company, 24 West 45th Street, New York.

"FREE" Catalogue! Thousand war surplus optical bargains, Lenses, Prisms, Telescopes, Binoculars, etc. Send \$1.00 for 10 Lens Hobbyist Set and Project booklet. G. Jaegers, 93-08—95th Avenue, Ozone Park 16, N. Y.

WAR Surplus Bargains, Binoculars, Telescopes, Sextants, Millions of Lenses, Prisms, Reticles, Eyepieces, Objectives, etc. Mail 10c for Big "Catalog CN." Send \$1.00 for Stock CN—10-piece Lens Kit and big Instruction Booklet. Edmund Salvage Co., Barrington, N. J.

SAVE 50% On New Binoculars! Free Catalog, Free book, "How to Select Binoculars." Write today! Bushnell's, 43-P25 Green, Pasadena 1, California.

REFLECTOR Telescope Kits, Refractors, Free Illustrated Bulletin, Esco Prod., 911 Willow Ave., Hoboken, New Jersey.

REFLECTING Telescopes, completely assembled, 60X, \$25.00. Guaranteed Observatory clearness. Free information. Skyscope, 475 Fifth Avenue, New York 17.

POWERFUL astronomical telescopes easily made. Perfect lenses and instructions; 100x \$3.00; 100x and 200x \$4.00; 100x, 200x and 400x \$6.00. Full power, clear vision guaranteed. Instructions alone 10c. Suffolk Science Service, Riverhead, N. Y.

ASTRONOMICAL Telescopes, binoculars, microscopes; bought, sold, repaired. Books, lists 10c. Rasmussen-Reece, Amsterdam, N. Y.

21 OPTICAL

EYE Glasses By Mail, 5th Ave. Styles, lenses replaced, Free Catalog. Send no money. Snyder Optico, 351 West 34th Street, New York City.

24 DOGS, BIRDS, PETS, RABBITS

SEE Gulf Hamstery ad on Page 40. Shows picture of Hamster.

EARN Up To \$400 Monthly Raising Angora or New Zealand Rabbits. Plenty markets, Particulars free. White's Rabbitry, Newark 35, Ohio.

MAKE Big Money! Raise Chinchilla Rabbits, Cash Markets Supplied. Write Today! Rockhill Ranch, Sellersville 16, Pa.

NATURALIST'S Catalog 10c. Chameleon 45c, Turtle 45c, Pair hamsters \$2.75, Boa Constrictor \$9.00, Gila Monster \$22.75, Quivira Specialties, Topeka 10, Kansas.

WILD red fox cubs for restocking. Also Ferrets for Rat killing. Henry Hainline, Creston, Iowa.

RAISE Guinea Pigs, Markets guaranteed. Booklet free. Taylors, B426B, Hapeville, Ga.

25 FROG RAISING

JUMBO Frog Raising, Very Profitable, information 10c. Brashears, Berryville, Ark.

"RAISE FROGS!" New book tells how! Illustrated Literature Free, Marlboro-B, Box 7002, New Orleans 19, Louisiana.

30 FARMS OTHER REAL ESTATE

OZARK Lands for all purposes, Actual river frontages, 5 acres \$90.00 and upwards. Free list and literature. Hubbard, 424-H, Minnesota Ave., Kansas City 1, Kan.

POPULAR SCIENCE OPPORTUNITIES

GOOD Farms—Ranches. Washington, Minnesota, Montana, Idaho, Oregon, North Dakota. Dependable Crops, favorable climate. Write for literature, lists describing typical farm opportunities. Specify which state. J. W. Haw, 120 Northern Pacific Ry., St. Paul 1, Minnesota.

NEW Free Summer Catalog just off press! Farm and country real estate bargains, good pictures, many states, easy terms, many equipped, business opportunities. For Special Service, state requirements, desired location. United Farm Agency, 2825-PS Main Street, Kansas City 8, Missouri.

STROUT'S Farm and Business Catalog—3084 Bargains—33 States. Mailed Free! Buy now and Save thru Strout Realty, 255-ZB 4th Ave., New York, N. Y.

FLORIDA—5 acres high dry land, near beaches, raise fruits and vegetables, only \$245.00. \$10.00 down, \$10.00 month. G. B. Potterfield, New Port Richey, Florida.

31 POULTRY AND SUPPLIES

BABY Chicks \$10.00 per 100 C.O.D. New Hampshires, Barred Rocks, White Rocks and Heavy Assorted. Prices at Hatchery. A. F. Hockman, R. 5, Bellefonte, Pa.

32 PROFITABLE OCCUPATIONS

WANT a Diesel Job? Our approved, up-to-the-minute Diesel Training Program can help you qualify for steady, big pay jobs or specialized military training. Covers Diesel, Tractor, Heavy Equipment, Easy to master. No loss of present income. Job Placement Advisory Service. Investigate! Write for information today. Interstate Training Service, Dept. 2E, Portland 13, Oregon.

\$5 HOUR Easy! Sell name plates for houses. Free Sample, order blanks. Write: National, 214 Summer, Boston Mass.

BE independent, be secure, have your own profitable business—earn \$20.00 and more a day making beautiful, fast-selling lamps at home. No equipment needed. Illustrated course teaches you quickly. Course, parts catalog, wholesale price list—only \$2. Gearon Co., Dept. 200-A-5, 27 S. Desplaines, Chicago 6, Ill.

LIFETIME income as Notary Public. Appointment assistance. Stationers, Helotes 50, Texas.

FREE book "How to Make Money With Home Workshop" describes amazing methods used by hundreds of successful craftsmen. Tells what to make. How to sell workshop output spare time. Write at once for details. Remember it's free! Craftsman, 115-B-5 Worth St., New York City.

DETECTIVES Earn Big Money. Excellent opportunity. Detective Particulars free. Write. Wagoner, P-125 West 86th, New York 24.

\$5000 FROM half acre growing Ginseng, crop bought. Particulars 10c. Associated Growers, Sperling, Manitoba.

\$40.00 WEEKLY, Made growing mushrooms. Fresh, Dried, Dominion Patent 331,583, free spawn, North American, 169Y Yonge, Toronto, Canada.

PRINT Without A Printing Press. Big Money! See page 22.

RAISE pheasants on the \$100 week plan. Little capital and space can make you independent. Free details. Great Central Game Management System, Columbus 6, Kansas.

MUSHROOMS Grown, Boxes, Barrels. Instructions 50c. Spawn \$1.00. Manureless process, \$2.00. Gordens, 553 William, Winnipeg, Manitoba.

RAISE fishworms, Profitable. Free literature, complete instructions 10c. Huffmans Ranch, Rives Junction 5, Mich.

DEFENSE welding jobs pay. Welders needed. Train quickly. VA contract. Hobart Welding School, Box P-512, Troy, Ohio.

FREE Book "372 Unusual Worldwide businesses." Work Home (U.S.A.)! Publishers-69, Carlsbad, Calif.

RAISE Redworms—Good profits. 25c in coin for complete instructions. Jewell's Worm Farm, 14633 Halsted St., Harvey, Ill.

33 BOOKS, PERIODICALS, ETC.

STRANGE Stories! Sample and illustrated literature, 25c. Stone, Lunenburg 22, Mass.

MAGAZINES (back dated)—foreign, domestic, arts, Books, booklets, subscriptions, pin-ups, etc. Catalog 10c. (refunded). Cicerone's, 86-22 Northern Blvd., Jackson Heights, N. Y.

BOOKS—Novels, Illustrated Booklets 10—\$1.00. Catalog 10c. Kogan, 1032-PS, Church Annex, New York 8.

FASCINATING Books, Booklets, Humor, games, novelties. Illustrated Folio, 10c. Aladdin Book, Dept. PS, 210 Fifth Avenue, New York 10.

FREE Book Catalog. "The Mysteries." Occultism, Yoga, Clairvoyant Research, Philosophy, Theosophy, Freemasonry. R. Jordan, 1130 Keller Avenue, Louisville 13, Kentucky.

BOOKHUNTERS! All Subjects. Send Wants! Jaher Book Service, 620-K East 178 Street, New York 57.

POCKET Book Swap—Send 12 books and \$1.00, receive 12 different. Lawrence, 120 Boylston St., Boston, Mass.

ADULT Book Bargains. Send stamp. Joseph Vallon, 63 Perry, Greenwich Village, New York 14.

BACK-date Magazines. Specific issues: years. Arkell's, Tarzana 2, Calif.

35 MAGIC TRICKS, PUZZLES, ETC.

"MAGIC-Mousie" obeys your voice! Funniest (trick) mouse you ever saw! 25c. Lewys, 4932—8th, Philadelphia.

MAGICIANS', Gamblers' secrets exposed. Cards, Dice, Punchboards, Slot Machine. Catalog 10c. Book Co., Box 671, St. Louis 1, Mo

WE supply every noted magician. Large professional catalog 50c. Holden's, P220 West 42nd Street, New York.

"VENTRILLO." Professional Voice Thrower and Catalog 25c! Box 971-PS, Philadelphia.

MAGIC package "Eztodo" unique tricks 50c. Catalog free. Magiden, 716 Pine, St. Louis, Missouri.

584-PAGE Catalog. 7500 Novelties, fun-makers, tricks, jokes, gadgets, hobbies, timesavers, animals, sports, scientific, 10c. Johnson Smith Company, Dept. 349, Detroit 7, Michigan.

500 TRICKS new 1950 edition now ready! Send only 10c for your copy, containing latest in good magic for pocket, parlor, stage. Unequaled service to magicians for 30 years. Douglas Magicland, Dept. 2, Dallas, Texas.

200 ELECTRIC stunts, 110 volts, \$1.00. Cutting Sons, Los Altos 2, Calif.

600-TRICKS, magic cards, masks, puzzles, shooting novelties, jokers monkey business funmakers, hot stuff, catalogue 25c. Andersen's, 6815-S Ardmore, Chicago 31.

VANISHING Quarter trick and catalog 25c. Sterling Magic Co., Royal Oak, Mich.

FREE Trick And Catalog 25c. Lerro's Magic, 509 80th Street, Brooklyn, N. Y.

MAGIC Monthly, Year 25c. Sample and Magic Catalogue free. Magic Shop, Minneapolis 2, Minn.

BE a Magician. Large professional magic catalog of latest tricks, 35c. Ireland, F-109 North Dearborn, Chicago.

512-PAGE catalogue of 2500 tricks, pocket, parlor, stage. World's Finest Magic. Send \$1.50 for catalogue (refunded first \$6.00 order). Kanter's, S-1311 Walnut, Philadelphia 7.

TRICKY Vanishing Card. A Sensational Trick that makes a magician of You! A Card is freely Shown, yet disappears from hand to reappear in spectators pocket. It's Free! If you send us 25c Coin or Stamps for our "Big" Catalog of 400 Illustrated Tricks, The Magician, 2463-S Kensington Ave., Philadelphia 25, Pa.

FREE Magic Tricks! Plan 10c. "Magic-Man," 4932—8th, Philadelphia.

36 GAMES, ENTERTAINMENT

PUNCHBOARDS, Tavern Games. Catalog. Webb Amusements, 4966 West Chicago Ave., Chicago 51, Illinois.

ADULT party games, twelve for 50c. Veas, Box 301, Decatur, Georgia.

37 COIN COLLECTING

COIN collectors new magazine, just out, and two wooden nickels 10c. Lawrence Brothers, Anamosa, Iowa.

GET Profit and Pleasure in collecting old coins. Send 10c for 56-page illustrated coin catalog. You'll be delighted with it. Send for it now. B. Max Mehl, 374 Mehl Building, Fort Worth, Texas. Largest rare coin establishment in U. S. Established 51 years.

FREE! Foreign coin, banknote and Coin Collectors' Illustrated Catalog to approval service applicants. Send 3c postage. Tatham Coin Co., Springfield-D50, Mass.

OLD Money Wanted. Do you know that Coin Collectors pay up to \$100.00 for certain U. S. Cents? And high premiums for all rare coins? We buy all kinds. Send 4c for Large Coin Folder. May mean much profit to you. Numismatic Co., Dept. 30, Fort Worth, Texas.

SELL Your Coins, complete list of prices paid—50c. Numismist, 105 Windsor St., Reading, Pennsylvania.

SCARCE Lincoln Cents 1913S, 1914S, 1915S, 1915D, 1921S, 1923S, 1924S, 1926S, 1913D, 1932D, 1933D, 10c each, 11 for \$1.00. Reynolds Coins, Flint 3, Mich.

COMMEMORATIVE \$1½—Columbus, Washington, Cleveland, Stone Mountain. \$1.50 ea. Illustrated Catalogue 25c. Norman Schultz, Salt Lake 9, Utah.

WANTED—1894-S Dime, Pay \$500.00. Certain 1913 Nickel \$1,000.00, 1901-S Quarter \$10.00-\$150.00. Hundreds of others, complete catalogue 25c. Worthycoin Corporation (D-318), Boston 8, Mass.

COIN collector's big magazine, just out, and rare foreign money, 10c. Roy Lawrence, Anamosa, Iowa.

50,000 COINS, medals, paper money. Lists free. Nagy, 8-P South 18th, Philadelphia 3, Penna.

COINS Bought & Sold! Unusual bargains! Valuable folder 10c. Fairway Company, Rye, New York.

40 STAMP COLLECTING

FREE! Big United States Catalog! Invaluable guide and check list. Hundreds of illustrations. Harrisco, Boston 17-B, Mass.

FREE—Cuba Roosevelt issue and illustrated catalog. Littleton Stamp, Littleton 11, N. H.

AMAZING Offer! 500 United States stamps—including commemoratives, airmails, high values to \$5.00—Only 10c to Approval Applicants!! Illustrated Bargain Lists free. Mystic Stamp Co., Dept. 55, Camden, New York.

300 DIFFERENT given free with approvals. Postage 3c. Windsor Stamps, 1435 E. 67th Place, Chicago 37.

750 FRANCE and colonies stamps 10c. Littleton Stamp Co., Littleton 26, N. H.

500 STAMPS For Only 10c! This mammoth value includes Airmails, Pictorials; stamps from strange countries cataloguing up to 25c each!! Also approvals. Mystic Stamp Company, Camden 55, New York.

200 DIFFERENT, including Roosevelt triangle, 5c to approval applicants. S. Avalon Stamp Co., Springfield, Mass.

COLUMBIANS, Trans-Mississippi, Pan-Americans, Pan-Pacific, ten other different commemoratives. All 10c with your request for US approvals. Moda Stamps, Box 251-V, C.S.A., New York 8.

FREE! Powerful Magnifying Glass. Jamestown Stamp, Jamestown 207, N. Y.

TOPS! Our book "How to Collect Stamps." Send for your free copy today! Littleton Stampco, Littleton 29, N. H.

WORLD'S Largest Stamp (7½ x 14 inches). A real curiosity! Retail for 50c, only 3c to approval applicants. Tatham Stamp Co., Springfield 50, Mass.

WOW! 203 All Different Germany 10c! Zeppelins, Semipostals, Airmails, High Values, etc. to new customers. Jamestown Stamp, Jamestown 509, New York.

500 EXOTIC Japan Stamps—10c! Kenmore, Richford J-58, Vermont.

POPULAR SCIENCE OPPORTUNITIES

UNITED States stamps nearly 100 years old. Roosevelt set, others, 40c value—only 6c to applicants United States approvals. Wakonda, Box 272-H, Jackson Heights, N. Y.

FREE—Complete set of Famous Americans, Flags, Parks and Presidentials to approval buyers. Send 3c for 15 of the above stamps plus full particulars. Triboro Stamp Company, 145 Nassau Street, Dept. 205, New York 38, N. Y.

FREE!—1,000 prefolded Hinges! Approvals, DiMilia, 72 Scholes, Brooklyn 6, N. Y.

"HOW To Recognize Rare Stamps." Free Book Illustrated! Kenmore, Richford H-58, Vermont.

PREMIUMS, prices, and service that satisfy. U. S. approvals at rock bottom prices. Foreign from 1/10 to 1/2 catalogue, mounted in books and sheets. No matter how large or small your collection is, we can help. References appreciated. Roseland Stamp Co., Dept. 9B, Spring Lake, Mich.

PAYING High prices for approvals? If your collection numbers under 15,000 try our 1c and 2c approvals. In books of 1000 different. Lots to choose from at lowest prices. Also special offer to customers. Clark, Box 544U, Muskegon, Mich.

FREE! Tiny Chinese "Midget" War set. Approvals, Seminole, Leeds 10, Ala.

FREE! Scarce Atomic Bomb Airmail! Approvals, Star Stamps, Jamestown, N. Y.

FIVE Arctic Triangles, 3c, approvals. Mitchell, Box 923, Portland, Maine.

55 DIFFERENT United States—5c, Approvals, Utechs, 1143-A North Keeler, Chicago 51.

UNUSUAL—Unheard of cancelled sets of Roosevelts and Washington bicentennials complete. All yours for fifteen cents. Bargain approvals accompanying. Park Stamp-co, Box 191, New York 21, N. Y.

STAMP Album 10c. Holds over 2,000 stamps! Foreign approvals. Glamore, Manchester, Connecticut.

FREE, Scott's International Album. Other big premiums. Full particulars with approvals. Raymax, 123X William St., N. Y. C. 38.

10,000 DIFFERENT 1c each! Gordon Davison, Box 1019, Manchester, N. H.

50,000 STAMP Grabags 25c each. Anderson, 630a Bingaman, Reading, Pa.

25 BRITISH Colonies Free with lowest priced approvals. Geo. Redmon, Capitol Heights 3, Maryland.

U. S. Catalogue Free. Contains over 500 illustrations for stamps, albums, supplies. Stone, 45 Bromfield, Boston 8, Mass.

PENNY Approvals by country. M. H. Hoerning, 102, Farmington, Ark.

UNITED States approvals complete coverage fine quality, attractive prices. Seminole Stamps, Box 1138-S, Coral Gables, Fla.

WORLDWIDE mixture 1000—50c. Bargain list free. Sibley, Mendon, Mass.

U. S. 2c Norse, fine mint, 40c. Approvals accompany. Horace Paine, Westport, Conn.

U. S. exclusively. Free catalogues. Eagle Stamps, 2221 Romine, Pittsburgh 26, Pa.

DEALERS Wholesale catalog. Postage 3c. Frankco, 5031 Queensbury, Baltimore, Md.

NO rarities, no junk, just good solid approvals for solid collectors. Dominion Stamp Company, Arlington, Va.

WE Give Away—Your Choice Latest Scotts Albums; Catalogue and available philatelic accessories. Realize—You Get These Worthwhile Rewards When You Buy From Our Better Foreign Approvals. Write Today For Full Particulars Sent With Trial Approval Selection. Americas' Stamp Service, Riverside, Calif.

FREE "Stamp Finder." Tells instantly country to which any stamp belongs. 32 pages profusely illustrated. Garcelon, Calais 18, Maine.

FLAG Stamp—Free with hygrade U. S. approvals. Weniggman's, 1933 Patterson, Chicago 13.

FREE—Illustrated Catalog! Kenmore, Richford C-58, Vermont.

MIXTURES 13c each. 100 Australia, 75 Brazil, 125 Canada, 200 Germany, 100 Ireland, 75 Mexico, 150 Switzerland, 250 World. Potter, 1314 McGee, Kansas City 6, Missouri.

NUDES Set; colorful approvals—10c! Atlas, 2830-P Eisenhower Drive, Racine, Wis.

1/2c—1c APPROVALS! Bargains galore! Cole, 43-G Rinewalt, Buffalo 21, N. Y.

PENNY Approval Bargains!—Write Dept. PSM, 1267 Tutwiler, Memphis 7, Tenn.

307 ALL Different—Only 15c! Beautiful collection: Commemoratives, Triangles, High Values, Bicolored Stamps, etc. Garcelon, Calais 418, Maine.

FREE! Big 36 page illustrated catalog of stamps, albums, packets, supplies! Ewing—Stamps, 109 N. Dearborn, Chicago 2.

FREE Stamp Zoo! Snakes, Leopard, Rhinoceros, etc.—to introduce our colorful bargain approvals. Niagara Stamps, Niagara-on-the-Lake 12, Canada.

ITALY & Colonies list of complete mint sets. 25c deductible 1st order. Benbe, 2165-83 Street, Brooklyn 14, New York.

100 OLD U. S. between 1861 and 1935 50c. Roush Stamps, 51 Chestnut, Mansfield, Ohio.

FREE—Nepal, 5 different, catalogue value 51c, to approval applicants. (We pay return postage). Frank Newman, 3539 Hartford St., St. Louis 18, Mo.

FREE: Mint British Colonies from Brunel, Nauru, Dominica, Ascensions, Solomon Islands, Caymans, Tonga, Gilbert, Ellice, Pitcairns—free with approvals! Viking, 130-P Clinton St., Brooklyn, New York.

WAR zone! Formosa, Manchukuo, Mongolia, others, 30 stamps! Rare! Only 5c! Approvals, Concord, Box 23-F, Beeville, Tex.

OLD scarce U. S. seconds on approval. Slightly defective, bargain prices. Hearnefield, Clintonhill Station, Newark 8, N. J.

FREE Collection—over 100 different stamps of world—commemoratives, animals, natives, ships, famous men, others all to approval buyers; also Scott Albums, Catalogs, Bell Stamp Service, Dept. W-3, Bell, California.

100 DIFFERENT 10c. Free Magazine. Bellet, 70 Mapledale, Hazel Park, Mich.

ARMENIA, Ten Bicolored Stamps, Value 75c. Free With Approvals, Paragon Stamps, Box 1378, Miami Beach 39, Fla.

MAGNIFICENT! Nineteenth Century U. S. Plus Civil And Spanish War Revenues, 20 Different, 10c To Approval Applicants. AAA Stamp Company, Arcade Building, St. Louis 1, Missouri.

"MONACO Nudes" 10c. Approvals accompany. Royal Stamp Company, Tamaqua 2, Penna.

LIBERIAN Triangulars, 10c with approvals. Vargo Stamp, 6044 South Fairfield, Chicago 29, Illinois.

FREE! United States—Germany occupation stamps. Approvals, Stampco, #987, Albany 1, New York.

FIRST U. S. (1847) Government Reissues 5c, 10c, plus Giant Bargain U. S. Collection—only 5c to applicants U. S. approvals. Metropolitan, Box 312K, Jackson Heights, N. Y.

5,000 DIFFERENT Stamps—\$12.50. Lists free. Beacon Sales, Maynard 3, Mass.

U. S. 797 SPA Sheet only 5c to applicants for U. S. approvals. M. Haycock, 235 86th St., Brooklyn, N. Y.

100 DIFFERENT U. S. commemoratives 75c. Larry Crick, 511—5th, Niagara Falls, New York.

42 HOBBIES, COLLECTIONS

INVENTING can be an interesting and profitable hobby. Write for complete particulars. Institute of American Inventors, Dept. 30-E, 631-E St., N. W., Washington 6, D. C.

50 DIFFERENT army embroidered patches \$1. Other bargains. Insignia Mart, 703B Broadway, N. Y. C. 3.

UNUSED matchbook covers—100 different \$1.00—Catalog 25c—Charles Edelman 1311P East 84, Cleveland 3, Ohio.

EXCHANGE Viewcards with members world over. 10c brings magazine with list members. World Viewcards, King, N. Car.

WANTED Old cigarette cards. Write Charles Bray, East Bangor, Penna.

44 ANTIQUES, RELICS, INDIAN GOODS

TEN good, or seven fine arrowheads \$1.00. Lynn Crandall, Box 697, Idaho Falls, Idaho.

4 PERFECT Ancient Arrowheads \$1.00. Fine Grooved Tomahawk \$2.00. List Free. Lear's, Glenwood, Arkansas.

46 MINERALS & PRECIOUS STONES

GEMSTONES. Mineral specimens. Every variety. Lowest prices. Postcard brings free booklet. Plummer's, 2183D Bacon, San Diego 7, Calif.

47 CAMERAS, PHOTO SUPPLIES

FREE Photographic Bargain Book packed with hundreds of sensational values in still and movie cameras, lenses and latest accessories. Super savings for you in new and used equipment. Liberal trade-in allowances, too, on your equipment. Write now for your free copy to Central Camera Company, Dept. 2-M, 230 S. Wabash Ave., Chicago 4 (Photographic Headquarters Since 1899).

BASS Says: Trading cameras a national habit since 1910. Write to Bass the old "Horse Trader." A postcard will do. Simply say: "Bass, I have and I want . . . How much will you allow me?" Satisfaction guaranteed. Bass Camera Company, Dept. AG, 179 W. Madison St., Chicago 2.

PRESS-Camera Fans: Easy to build your own 3 1/4" x 4 1/4" reversible back press camera. Complete drawing and instructions. \$2.00 postpaid. Camera Craft, 17140 Third Ave., Detroit 3, Michigan.

POWERFUL telephoto camera easily made. Trifling cost. Carl Jamer, Box 494, Manorville, N. Y.

FREE sample binder, see first, protect precious color films, mounts for all popular viewers, projectors including stereo. Porter Self-Sealing Mount Company, 2500 West Sixth, Los Angeles 5, California.

MOVIE Cameras, Projectors, Films etc. Selling out complete store, many prices below cost. Send now for big list. Swank, 614 North Skinker, St. Louis 5, Missouri.

MAKE Employee Badge Photos with Nichols Photo Identio, Bristol, Pa.

PHOTOMURALS. Your negatives or ours. Catalogue 25c. Photomammoth, 12048 Vanowen St., North Hollywood, Calif.

SELECTIONS of Western National Parks on approval. Douglas Whiteside, Yosemite, California.

48 PHOTO FINISHING

FREE reload with each order of 35mm developed and printed \$1.50. Any 8 exp. roll 40c, 12 exp. roll 60c, 16 exp. roll 75c. Bonded prints are custom Hollywood professional quality. Why gamble? Free mailers. Bonded Photo, Box 829, Hollywood 28, Calif.

FREE Mailers. Jumbo Prints 8 Exposure Roll 30c, 12—45c, 20—95c. Careful Work. Western Photo, Dept. PS51, Box 298, San Francisco, Calif.

YOUR eight exposure roll developed with three prints each good negative 50c; two each 40c; one each 30c. Reprints 3c. A few cents postage appreciated. L. A. Eastman, Bode, Iowa.

BILLFOLD photos from Picture or Proof. 12 for \$1.00. Margarida Bros., 203 Pitman St., Fall River, Mass.

50 PHOTOPRINTS, PHOTOCOPIES

24 GLOSSY Photos. Beautiful Models \$1.00. Illustrated catalog 25c, none free. Nutrix Co., Dept. D-47, 212 East 14 St., New York 3, N. Y.

PHOTOCOPY kit, instructions, \$1.00 (C.O.D. \$1.32). Wentworth Co., 1112 N.W. 18th Pl., Miami, Fla.

PHOTOCOPY Anything—Papers, books. No darkroom. 8 1/2"x11" complete \$6.95. Fotoflek, 8555 Plainfield Lane, Cincinnati 36, O.

PHOTO Stamps, 50—\$1.00. Photo or negative. Benny Mueller, North Tonawanda 2, New York.

POPULAR SCIENCE OPPORTUNITIES

51 MOTION PICTURES SOUND EQUIPMENT

LATEST Beauty Glamour Films, Sample, 8mm 50 ft. only \$3.75. 25c brings exclusive catalog of movie titles. Empire, Dept. PS-5, Box 23, White Plains, N. Y.

8-16MM. Silent-sound films. Complete rental library. All latest subjects. Free catalogue. (sample film 10c). Garden Film, 317 West 50th, New York 19.

GUARANTEED Fresh 8mm roll, magazine; 16mm roll, magazine movie film. Color, b&w. Free catalog. ESO-S, 47th Holly, Kansas City 2, Missouri.

MOVIE Camera Film: 8mm roll \$1.50. 16mm 100' \$3.00. Free processing. Better Films, 742 New Lots, Brooklyn, N. Y.

ADD "Spice" to home projection shows with colorful old-time Nickelodeon slides. 2x2. Write for Free list, Nickelodeon Co., New Fleidner Bldg., Portland 5, Oregon.

THRILLS! Action! in Exciting 8-16mm Movie Film Subjects. Big movie and equipment catalog with sample film, 25c. National Film Supply, Toledo 9-E, Ohio.

NEW 1-reel 16mm sound films low as \$3.98, formerly \$17.50; new 1-reel 16mm silents, \$1.98 up, formerly \$8.75—all first quality prints in original cartons. Used Panoram 100' 16mm musicals, \$6.89 per Dozen. Equally attractive bargains in good used feature pictures, cartoons, sports, comedies, musicals, travels. Save on new and used reels and cans, projection lamps, and other supplies. We have the biggest stock of 16mm films in the world—over 100,000 prints on hand! Write today for your copy of Blackhawk's big catalog, "Sixteen's Super Market." Blackhawk Films, Inc., 629 Putnam Building, Davenport, Iowa.

RENT 16mm, sound films 50c reel. Large selection; free catalog. U. C. Film Service, 128 Chestnut St., Roselle Park, N. J.

FREE Home Movies! 8-16mm. Lists. Waldman-Z, 209 West Jackson, Chicago.

OLD Used Films—Magazines—Cheap. George Williams Jr., 6827 Langley Ave., Chicago 37, Illinois.

SURPLUS sale 16mm sound March of Time films. Room 1501P, 6 N. Michigan, Chicago.

5,000 **NEW-Used** 8-16mm, Silent-Sound Films. International, 2120 Strauss, Brooklyn 12, N. Y.

52 MUSIC, MUSICAL INSTRUMENTS

POPULAR Piano lessons by mail. Beginners—Advanced. Play songs or money back. Free details. Stuart Piano Studio, 1227B Morris Ave., Union, N. J.

ELECTRIC Guitars, amplifiers, save 50%. Free catalog. Carvin PS, Baldwin Park, California.

MUSIC Printing Leads. Professional copies. Lowest rates. Auto-Litho, Jensen Beach, Florida.

PIANIST (Adult) Quickly improve Technique. Sightreading. Accuracy. Memorizing. through remarkable Mental-Muscular Coordination. Used by famous pianists—teachers—students—schools. Also, fascinating Classical; Modern Popular Piano Courses featuring new methods, faster progress. Also, Harmony, Composition, Arranging, Songwriting. Free Booklet, Broadwell Studios, Dept. 51E, Covina, Calif.

MUSICAL Instruments. (Specify) Liberal trade-in allowance. Repairs. Ribner's, 74 Ferncroft Road, Milton 87, Mass.

PHONOGRAPH Records Cheap. Catalogue. Paramount, FT-313 East Market, Wilkes-Barre, Penna.

53 SONG WRITERS

POEMS Wanted to be set to music. Free examination. Send poems. McNeil, Master of Music, 510-PS, S. Alexandria, Los Angeles, California.

WANTED! Poems for musical settings. Write Songwriters' Service, Clifton, N. J.

POEMS Wanted. Broadcast consideration. Sooner Song Co., 22 Northwest 8th, Oklahoma City 2.

POEMS Wanted for musical setting. Send poems for free examination. Five Star Music Masters, 646 Beacon Bldg., Boston, Mass.

SONGWRITER—Publishers Booklet "Commercial Music"—Plus Ten Valuable Musical Mailing Lists (700 Names—Addresses) \$1.00. Popular, Box 927-C, Atlanta, Georgia.

54 RADIOS, SUPPLIES & EQUIPMENT

MAKE simple, tubeless, batteryless, distance-getting crystal radios. Crystal and illustrated instructions 25c postpaid. Allen, 427-S, Clinton, Mo.

BUILD 15 Radios—only \$19.95. Learn Radio and Television at Home. Previous Knowledge Unnecessary. Nothing Else to Buy. Free Tester and Tools, Quizzes, Trouble-Shooting Lessons, Money Back Guarantee. Send check or money order; we pay postage. C.O.D.'s accepted. Order now or request further information. Progressive Electronics Co., Dept. 14, 497 Union Avenue, Brooklyn 11, New York.

FREE—Completely new 1951 Radio, Television and Electronic Buyer's Guide. Page after page of the very latest available supplies of guaranteed quality at today's lowest prices. Thousands of super-values in Hi-Fi units, recorders, television and radios, phonos, sound equipment, testers, tubes, kits, parts and books. Big stocks for immediate shipment. Send for it now! Concord Radio Corp., Dept. KE-51, 901 W. Jackson, Chicago 7, Illinois.

PICTORIAL Instructions. Midget radios. code set, tester—25c. Arthur Alena, Box 271, Wall Street Station, New York 5.

MAKE Distance-Getting crystal radio that works. Fully illustrated booklet fifteen cents. Money back guarantee. Francis, Box 5963, Cleveland, Ohio.

BECOME an Amateur Radio Operator. Fascinating hobby leads to high paying positions. Home study course. Theory preparation for passing government license examinations. Low cost. Personal coaching. Federal Electronics Institute, 45 E. Putnam, Dept. A., Greenwich, Conn.

15 **TESTED** One-tube circuits 25c, including "Radiobuilder" catalog. Laboratories, 411-T Capitol Hill, Reno, Nevada.

LITTLE Snooper, world's smallest pocket radio. No aerial required. New principle. Amazing reception on local stations. \$2.98 ppd. complete. Guaranteed. Order now. Edward Foote, 50 Elm, Cincinnati 15, Ohio.

EXPERIMENTERS, Amazing Crystal-receiver. Write, Leslie Hulet, R2, Lakewood, New Jersey.

55 TELEVISION

COLOR tone on your Television! Free information! Harvard Lab., 657S Fulton St., Brooklyn 1, New York.

IMPROVE performance. Beginner's Illustrated repairs; filter circuit. Dollar. George Paterno, Box 1351, New York City 8.

GET best reception with proper antenna. Make (or modify) your own. For your specific location. Simple plans, with do's and don'ts, 50c. Give stations desired and distances from each. Design Forum, Box 236, Charlestown, Indiana.

56 BUSINESS OPPORTUNITIES

\$5 **HOUR** Easy! Sell name plates for houses. Free Sample, order blanks. Write: National, 214 Summer, Boston, Mass.

CASH For your idea. 280 manufacturers need inventions, patented or unpatented. List free. Invention Bureau, 208-S Clinton, Oak Park, Illinois.

SELL by mail; free booklet, instructions; Manhattan House, P. O. Box 50-L, New York 28, N. Y.

GOOD Paying Business Silvering mirrors, plating autoparts, reflectors, bicycles, bathroom fixtures, etc., by late methods. No tanks or shop required, outfit furnished. Free Booklet. Gunmetal Co., Ave. E, Decatur, Illinois.

ENVELOPES addressed accurately, reasonably. Fast Service. We have capable addressers in your city. Glenway System, 5713-X Euclid, Cleveland 3, Ohio.

BE Appointed State Notary Public now! Details. Stationers, Helotes 50, Texas.

OPERATE profitable mail order business. Write Walter Service, 4159-B East 112th, Cleveland 5, Ohio.

\$25 **WEEKLY** working two hours daily. No canvassing. No Manufacturing. Lycke, Box 2471-B, Cleveland 12, Ohio.

MAKE money addressing envelopes. Our instructions reveal how. Glen Glenway, 5713 Euclid, Cleveland 3, Ohio.

VENDING Machines earn big money! An investment as low as \$10.50 will start you in this fascinating, profitable business that can lead you to the road of success and independence. Routes can be established and operated in either full or spare time with no experience needed. Write for full details and our Free catalog illustrating our nut, candy, gum and stamp vendors; also pin ball machines, music boxes, etc. Write immediately to: Parkway Machine Corporation, Dept. 9, 715 Ensor Street, Baltimore 2, Maryland.

BIG money! Spare or full time in your home. No Selling! Spray New Miracle Finishes, Plush and Suede, on signs, radios, automobiles, figurines, lamps, toys, etc. Our business is booming. Help us fill huge demand. New easy Flok-Kraft methods. Material costs few pennies. You get dollars. Free samples, complete powerful money making plan free. Write now. Coast, 1002-F, Los Angeles St., Los Angeles 15.

FABULOUS Earnings—Fascinating pastime. Growing Genuine, living miniature (Ming) Trees, New sensational Business or Hobby. Astounding information free. Dwarf Gardens, Box 355H, Briggs Station, Los Angeles 48, Calif.

A Business In Your Own Home! Our chemicals, plus free water and cheap "grocery store" materials can bring you over \$500 monthly earnings. Plans and formulas free. Western G Aircraft, Los Angeles 19.

START Mailorder Bookshop—Everything furnished, 25c brings booklet, samples, exciting ideas. General Publications, Ossining 1, New York.

RECAST old batteries into new. Latest achievements. Battery Laboratories, Minneapolis.

LEARN professional candy making profitable home business. Details free. Pate, Kissimmee 2, Florida.

TRAVEL Anywhere, Anytime. Earn \$50 up a week. Free details. Travel, La Grange 22, Indiana.

PRINT Without A Printing Press. Big Money! See page 22.

MAKE Money At Home as renewal headquarters for all magazines. Liberal commissions. No experience, no capital needed. Supplies furnished. Write for Free Catalog, McGregor Magazine Agency, Dept. 510B, Mount Morris, Ill.

"**ELECTROPLATING**—Know-How" includes baby shoe, chrome and brush plating; other lucrative fields. Learn easily. Free booklet. Joseph B. Kushner, Electroplating Engineer, Stroudsburg 53, Penna.

COSTS 10 cents—sells one dollar—complete details and sample—25c. Messina, Box 78, Brooklyn 8, New York.

\$100 **DAY** possible without manufacturing, selling! Security, 186 Rutledge, Brooklyn 11, New York.

TRADE Magazines help you to success. Get latest copies through our easy-to-get-acquainted service. More than 1200 business, professional, agricultural, automotive, educational, sport, hobby, music, television, etc. List free. Commercial Engraving Publishing Co., 34S North Ritter, Indianapolis 19, Indiana.

INVISIBLE Reweaving—big profits, big demand, easy-to-learn with low-cost complete course—nothing else to buy, ever. Details free, write today: Fabricon, Dept. K-1, 8342 S. Prairie Ave., Chicago 19, Ill.

\$124.50 **WEEKLY**, guaranteed at home sparetime. \$1.00 (Deposit), Science Syndicate, 2018 Genesee Ave., Tampa, Florida.

POPULAR SCIENCE OPPORTUNITIES

DISTRIBUTORS wanted for "Easy Grocery List." Sample—Dime. Gerlach, 3006 Reynolds, Dallas 10, Texas.

WANTED! Home Producers by manufacturers in our Clearing House Service. Become a sub-contractor, casting plastic products for these companies. Thousands of easy to make items required. Cash in at home without previous experience. For details write Plastic Service Guild, Dept. P.S., 233 Condor St., East Boston 28, Mass.

MAKE flexible molds! Cast plaques, bookends, figurines! Free sample! H. Tooker, 630-A Chestnut, Hamilton, Ohio.

MAKE Perfumes at home, write, "Carey Laboratories," 1914 Chouteau, PS-B5, St. Louis 3, Missouri.

START own business, no investment, clean upholstered furniture, rugs, automobile interiors. Instructions, formulas, dollar. Millman, 3520 DeKalb Avenue, Bronx 67, New York.

\$10. HOUR! Invisible reweaving course, steel-tool, samples. Material for life, complete \$2. Details free. Walsh, 894 Main, Buffalo 2, New York.

EXPORT-Import! Represent manufacturers! Conduct barter-exchange without capital, War-peace time big business. Buy-sell by mail. Let New York experts show you how. Uncrowded fields, Easily learned. International Trades, 246-S, Fifth Ave., New York 1.

LEARN Sewing Machine Repair, Electrify, Rent, Trade, Sell, Big profit home setup. We show you how. Motor kits, new machines, etc. supplied wholesale. Free particulars. Taylor Service Co., Hamilton PS-5, Ohio.

NATURAL Molding Latex, Extra thick. Free sample. W. Wooley, 115B Donald, Peoria, Illinois.

YOUR own profitable home business. Preserve live flowers to last forever. Spare or full time. New discovery—simple—fascinating. No experience necessary. Send \$2.00 for working equipment, instructions and valuable sales plans. Satisfaction guaranteed or money refunded. Hermansen, 210 Fifth Ave., Suite 1102, New York 10, N. Y.

MAKE Perfume—Catalogue Free—"International," 6347 Parnell—PS-5, Chicago 21, Illinois.

INCOME from local information, No selling. Write—Neherco, La Verne 6, Calif.

BUY 450,000 Articles wholesale, Directory 10c (refundable). Publishers, Box 1302-A5, Detroit 31.

BOOKKEEPERS earn \$100.00 weekly operating simplified "Bookkeeping & Tax Service." Details Free. Universal Bookkeeping, Box 664-P, Springfield, Missouri.

HOW and where to obtain Capital? Free details. Star Service, Wapakoneta, Ohio.

POPCORN Equipment, Potato Chip Outfits, Long Eakins Company, 5163 High, Springfield 99, Ohio.

LOCATE Supply Source On Anything Made In U. S. A.—\$1.00. Satisfaction or Refund. Research, 407 Washington, Shreveport, Louisiana.

METALLIZING (Plating) Equipment, Supplies, Hard-to-Get Chemicals and Anodes. Complete assemblies for plating baby shoes, jewelry, novelties and industrial products; copper, bronze, gold, silver, nickel, chrome, etc. Home workshop to production shops priced from \$79.50 complete. World's largest line of metals, onyx and marble mounts for bronzed baby shoes. Instructions furnished. Buy Direct from Manufacturer. Write for Free catalog and address of local branch. Hollywood Bronze Supply, 1624 East First Street, Los Angeles 23, California.

TO \$35.00 Weekly Spare Time. Home Operated Mail Order Business. Successful small "beginner's" plan. Everything supplied. Lynn, 5710-C Bankfield, Culver City, California.

LIQUID Rubber, make flexible molds. Free Sample. Chaney, 1130 E. 16th St., Jacksonville 6, Fla.

MAKE Rubber Stamps, Repair Dolls, Invisible Mending, Silver Mirrors, Metalize Baby Shoes. Catalogue of "40 Ideas" Free. Universal, Box 1076-B, Peoria, Ill.

\$4,000.00 PROFIT in two months. No investment. Details 50c. Charles Co., 12-BPT, Norwood, Ohio.

MAKE Tough, durable plastic—1c pound. Makes attractive floors, walls, built-ins, roofs. Build good home, \$150.00 room. Bays Laboratory, Oklahoma City 9.

DEFENSE welding jobs pay. Welders needed. Train quickly. VA contract. Hobart Welding School, Box P-513, Troy, Ohio.

COLORGLAZED Concrete Pottery made without molds. Patented method. Cemetery products, novelties, tiles. Basement leak-sealing. Money-making projects. Booklet, details free. Men only. National Potteries, Grand Rapids, "Minnesota"

FREE Illustrated course casting novelties. Genuine latex for molds. Major Chemical Co., 164 Portland St., Cambridge, Mass.

ELECTROPLATE metals, non-metals; mirror re-silvering. Inexpensive, profitable home process. Free booklet. Tyco Metals, Box 13231-W, Houston 19, Texas.

MAKE Big Money at home with Magic Pearl Finish. Free Plan, Pearl-Art, 7216 Bear, Bell, Calif.

HOME Profits with typewriter—25c. Siegel, Box 183, Knick., New York 2.

MEN, Women, Grow Mushrooms. Cellar, shed, Spare, full time, year 'round. We pay \$3.00 Lb. We paid O. Babbitt \$4,165 in few weeks. Send \$2.00 for Guaranteed Market Information Illustrated Book. Washington Mushroom Ind., Dept. 122, 2954 Admiral Way, Seattle, Wash.

OVER 700% Profit making finished photos in 2 minutes on the spot in daylight without darkroom. No experience needed. Simple directions teach you quickly. Write, P D Q Camera Co., 1161 N. Cleveland Ave., Dept. 80, Chicago 10, Illinois.

BUY Wholesale. Big-Name items average 40% below retail. Folks eagerly patronize you for big savings. Details free. Young's, Kent 1, Ohio.

YOU can better yourself in electroplating. Free details. Joseph Kushner Electroplating School, Stroudsburg 171, Pa.

CAP Pistol, patented, automatic. Out-right sale. Box 357, Flint 1, Michigan.

HOW To Set Up and Run A Mirror Shop! Resilvering Mirrors. Making Chipped Glass Nameplates. Electroplating Salts and Rectifiers. John Sprinkle V90, Marlon, Ind.

MAKE money making new greaseless doughnuts at home on electric machine. Wholesale to grocers, drug stores, cafes, hamburger shops. Send for free recipes and plans. S. Ray Company, 3605 South 15 Ave., Minneapolis 7, Minnesota.

MAILING postcards selling repeat merchandise is profitable. Everything supplied. Details free. Gordon Publishers, Box 23, Pawtucket, R. I.

BUY it wholesale. Manufacturers. Distributors. Over 850,000 items. Literature free. Olsen, 1231-B East Third St., Duluth 5, Minnesota.

EARN Money At Home With Your Typewriter! Spare time! Details free. Edwards, Publisher, 3915-PS, 12th, Des Moines 13, Ia.

FREE Book "372 Unusual Worldwide Businesses." Work home (U.S.A.)! Get surprise! Publishers-70, Carlsbad, Calif.

SPARE-Time office work in your own home for Men and Women. Free details. Business Publishing House, 127B Broad St., Boston 10, Mass.

\$124.50 WEEKLY. Guaranteed! At Home, Sparetime. \$1.00 (Deposit). Science Syndicate, Box 621, Columbus, Ohio.

QUICK Sign Painting. Use Letter Patterns. Avoid sloppy work and wasted time. Write for folder. John Rahn, B1330 Central Ave., Chicago 51.

OPERATE Profitable Mailorder Business. Particulars Free. George Lenhoff, Lincoln 1, Nebraska.

RUBBER Molds! 50 Different! Dollar up! Illustrated lists free! Castcraft Studios, 508-S Marion St., Brooklyn 33, N. Y.

MONEY making chemical novelties. Sample 25c, free literature. Boone Consultants, 1181 Wilshire Courts, Cincinnati 30, Ohio.

\$46 FROM Square Foot Plywood; Jigsaw necessary. Write: Woodart, Bridgewater, Massachusetts.

STOP Chronograph Wrist Watch Yours in One Hour—No selling—Write, Webster, Room 209, 3308 14th Street, Washington 10, D. C.

\$250 WEEK Reported! Book "505 Odd Successful Businesses" free. Work Home. Expect something Odd! Pacific-27, Ocean-side, California.

MAIL Cards. Extra income. Details. Manager, 881 Park, San Jose, California.

INCREASE mail order profit! Results guaranteed! Let nationally recognized advertising agency advertise and promote your product. For complete details write Box 5-B, Cedar Rapids, Iowa.

\$200.00 WEEKLY! Lifetime Business! Machineless cleaning, Carpets, Upholstery, everywhere. Puraclean, 17-B East 42nd., New York 17.

UNPAINTED Figurines. Illustrated List. Free. Oman, 642 Broadway, St. Paul 1, Minn.

LEARN reweaving! Free Details, Frank Harris, 4333 South Carrollton, New Orleans, Louisiana.

EXTRA Money at home casting Baby-Hand Plaques. Details. Silvercraft, Box 574-PS, Great Falls, Montana.

DOLLARS for dealers. Names, details—Dime (refundable). Home Store, 3116 Seminary, Chicago.

\$5 HOUR Easy! Sell name plates for houses. Free Sample, order blanks. Write: National, 214 Summer, Boston, Mass.

57 MONEY MAKING OPPORTUNITIES

INDEPENDENT income! Make leather belts, billfolds, purses, Big catalog and genuine steerhide keyholder, 10c. Tandy Leather, Box 397G, Tulsa, Okla.

\$5 HOUR Easy! Sell name plates for houses. Free Sample, order blanks. Write: National, 214 Summer, Boston, Mass.

DETECTIVES Earn Big Money. Experience unnecessary. Detective Particulars free. Wagoner, P-125 West 86th, N. Y. 24.

QUICK profits taking magazine subscriptions, handling greeting cards. Cas-sell Publishers Service, Westfield, N. J.

RAISE your business value, standing, as State Notary Public. Information. Stationers, Helotes 50, Texas.

EARN Money Evenings, copying and duplicating comic cartoons for advertisers. Adservice, Argyle 2, Wisconsin.

BIG Profits. Make fast-seller chenille holiday flowers, monkey trees, dolls. Literature free. Velva, Bohemia 17, N. Y.

HOME electroplating units \$8.95. Includes tank, rectifier. Free details. Reed Engineering, 620 So. Inglewood, Inglewood, California.

NEW Fascinating, money maker. Professional Glass Blowing Kit, \$5.95. Park, 170 Lovering, Buffalo, New York.

A \$100-A-MONTH hobby at home! No soliciting, no mail order, no meeting people. Easy enjoyable pastime. Details 25c (Refundable). Laura Dickson, 1006-PS Elizabeth Street, Anderson, S. C.

\$35. WEEKLY! Two hours daily! Invisible reweaving instructions and 27 other amazingly unusual ways! Walsh, 894 Main, Buffalo 2, New York.

THE Knack of making money in any job, business or profession, \$2.00. Celester, 2233 Eastern Ave., Indianapolis, Indiana.

DEFENSE welding jobs pay. Welders needed. Train quickly. VA contract. Hobart Welding School, Box P-516, Troy, Ohio.

NEW! Manufacture concrete septic tanks. Low investment—high returns. Write for information on equipment and price. Linwood Septic Tank Co., Linwood, Michigan.

BUG season here—act now! Scientific Airfoil Bug Deflector needed by every car owner. Sample and details of money-making plan \$1.00. Kaypeco, 316 West Chestnut, Louisville 2, Kentucky.

MAKE money with frogs. Particulars free! Specialties House, Whiting 13, Ind.

MAKE Money at home—Tested plans; List 3c. Heidorn, Box 184, New York 25.

CAN You Make \$40.00 A Week, typing at home, in your spare time? Write Hood's, Kannapolis 11, North Carolina. (Enclose stamped, addressed envelope).

POPULAR SCIENCE OPPORTUNITIES

MANUFACTURE Rhinestone and Pearl Jewelry at home. Latest creations, tremendous profits, no skill needed. Postcard brings illustrated catalog of settings, stones, etc. A. V. Cutt Co. Inc., 210-H Fifth Ave., New York 10, New York.

MEN, Women, Grow Mushrooms. Cellar, shed, Spare, full time, year 'round. We pay \$3.00 Lb. We Paid O. Babbitt \$4,165 in few weeks. Send \$2.00 for Guaranteed Market Information Illustrated Book. Washington Mushroom Ind., Dept. 107, 2954 Admiral Way, Seattle, Washington.

UNPAINTED Plaques, Religious Statuettes, Book Ends, Novelties, Paint them yourself for profit. Free list. Umlauf, 239 So. Luther, Detroit 25, Michigan.

\$250.00 WEEK Reported! Book "505 Odd Successful Businesses" free. Work home. Expect something Odd! Pacific-29, Ocean-side, California.

DOUBLE your Income! Beat inflation! Simple! Amazing! Details \$1.00 no stamps. Goldner, 251 Rio Grande, Salt Lake City, Utah.

58 FORMULAS, PLANS, ETC.

FORMULAS, trade secrets, for nearly everything. Catalog free. Creative Publishers, Winnetka 7, Illinois.

FORMULAS—All kinds. Latest products. Literature free. Kemico, Park Ridge 15, Ill.

LABORATORY tested formulas. Lists free. Pont, Box 635-PS, Terre Haute, Ind.

FORMULA—for amazing new glass wax and cleaner—fortunes now being made with this new formula. Instructions \$3.00. Louis Taylor, 979 Napier Courts, Nashville, Tennessee.

RAISIN wine formula, process, instructions. \$1.00 Postpaid. Verret, Raceland, La.

FREE Formula Catalog anything analyzed \$20.00. Western Chemical, Salem, Ore.

INGREDIENTS and Formulas to make auto wax polish, bubble bath, shampoo, hair dressing. Package of four trial kits \$5.00. Postage 5 lbs. Kem Products, Box 115, Moriches, New York.

MILLER'S Modern Manufacturing Formulas Make Products That Get The Business And Pay! Fifty Years Supplying The Best. Literature Free! Miller, Chemist, Tampa, Florida.

59 PLASTIC

PLASTIC supplies, materials, instructions for hobby or business. Send for free catalog. Tells about internal carving. Hays Plastics, 1310 82nd Ave., Oakland, Calif.

LUCITE, Plexiglas. Any size sheets masked Square foot (12 x 12) cost 1/16" \$1.20; 1/8" \$1.40; 3/16" \$1.75; 1/4" \$2.08. Colors add 10%. Include 10% postage. Almac Plastics, 230 Fifth Avenue, New York 1, New York.

PLASTIC Sheets, Low Prices, Immediate Delivery. 150 page instructions \$1.50 postpaid, catalog 10c. Plastic's, Box 1812, Salt Lake City 10, Utah.

PLASTIC Sheets, Rods, Tubes, etc. Free List. Plastic Supply Co., 2901 N. Grand Blvd., St. Louis 7, Mo.

HI-Profits. Internally Hand Carved Plastics. Gifts—Jewelry. Free Catalogue. Pilot Plastics, 67 B. Fulton St., N. Y. C. 7.

PLASTICS—Wholesale, retail. Sheets, rods, tubes, casting, molding plastics. Jewelry findings. We manufacture full-color carving dyes. Catalog, instructions, 10c. 25c airmailed. Gem-O'-Lite, Box 686Z, North Hollywood, Calif.

60 CHEMICALS AND APPARATUS

LUMINOUS Paints will glow in dark. Six colors. Fairmount Chemical Co., 136 Liberty St., New York City 6.

NEW Idea Chemical and Apparatus Outfits for Home Experimenting. Photo-Scales, Microscopes, Chemicals, Biological and Laboratory Supplies in Small Quantities. Catalog 25c. Established 1931. John H. Winn, 124-B West 23rd Street, New York 11, N. Y.

CHEMICALS. Many dime samples. List free. Welch, Box 1831, Long Beach, Calif.

CHEMICALS and apparatus for industrial, analytical, and private laboratories. Catalog 15c. Dept. M-26, Biological Supply Co., 1176 Mt. Hope Ave., Rochester 20, N. Y.

LEARN Chemical Analysis inexpensively. \$1.00 brings lesson with chemicals. J. H. Watters, Box 46, Bell, Calif.

ILLUSTRATED Catalog: Chemistry, mineralogy, biology, 10c. Tracey Laboratories, Evanston, Illinois.

OH Boy! New Book Of Science, Experiments, Formulas, Secret Processes, together with Catalogue of Laboratory Supplies, Only 25c. National Scientific Company, Dept. 15, 2204 W. North Avenue, Chicago 47, Illinois.

61 HELP WANTED

ALASKA—America's Frontier. \$1.00 brings 1951 Business Directory, Large Government Map giving Up-To-Date Construction Projects. Current employment information, Homestead & Highway facts, Hunting-Fishing-Game Rules, Firms hiring & application forms, Alaska Opportunist, P.O. Box 883-S, Hollywood 28, Calif.

\$5 HOUR Easy! Sell name plates for houses. Free Sample, order blanks. Write: National, 214 Summer, Boston, Mass.

FOREIGN & Latin American Employment, 1951 "Foreign Service Directory" gives Up-To-Minute Facts on Military & Civilian Construction, Government Jobs, Major Oil Listings, Aviation, Transportation, Steamship Lines, Mining, Importers, Exporters, How-When-Where to apply, application forms, Hot List Firms Hiring. \$1.00 post-paid. Global Reports, P.O. Box 883-S, Hollywood 28, Calif.

FOREIGN Employment Construction men, building trades, helpers, office men, others, interested in Foreign Projects. High wages, quarters, trans. Listings of firms actively working on U. S., Foreign, Intercontinental Projects. Send \$1 for Foreign Construction Compendium and Application Forms. Foreign Service Bureau, Dept. PS-5, Box 295, Metuchen, New Jersey. (Not an employment agency—no fees.)

IMMEDIATE opening for reliable man with car to call on farmers. No experience necessary. \$15 to \$20 in a day. Permanent. Mcness Company, Dept. 275, Freeport, Ill.

HONOLULU—Help wanted columns airmailed \$1.00; letters remailed \$1.00; 3/\$2.00; hula girl cards etc. 3/\$1.00. Certified Services, #3 Campbell Block, Honolulu, Hawaii.

\$1,000,000. CONSTRUCTION Projects Starting "World Wide." Send \$1.00 for Complete Authentic Monthly Report on construction starting in India, Arabia, Europe, Alaska, Guam, South America, Puerto Rico, Bermuda, Hawaii, United States, etc. with application forms telling you How-When-Where to apply. Line up your next job now. Global Reports, P. O. Box 883-PX, Hollywood 28, Calif.

62 AGENTS WANTED

\$5 HOUR Easy! Sell name plates for houses. Free Sample, order blanks. Write: National, 214 Summer, Boston, Mass.

DRESSES 18c; Coats \$1.00; Blouses 35c; Free Catalogue; Crown, 164-PB, Monroe Street, New York 2.

COMMERCIAL Deep Frying Course. Mock Chicken Legs, Potatoes. New and proven methods. Learn about this money-making field. \$2.50. PP. Concession, Toledo 13, Ohio.

NEW Jobs open in selling! Send name, address for five free issues of Opportunity Magazine's money-making guide, listing hundreds of companies who'll pay you well, full or part-time. No experience needed. Opportunity, 28 E. Jackson, Dept. 18, Chicago 4, Illinois.

AGENTS—300% profit selling genuine gold window letters; stores and offices. Free samples. Metallic Letter Co., 437 N. Clark, Chicago.

GOLD lacquered Window Sign Letters. Large Sizes Penny Each. New foils. Absolutely Beautiful. Free Samples, Atlas, 544 W. 79th, Chicago 20.

NYLON, Poplin, Rayon Uniforms, white and colors. Immediate Delivery, Immediate Profits. Sell to Doctors, Dentists, Nurses, Waitresses, Beauticians, Housewives. Free Sales Kit, Superior Fabrics, Dept. A-5, 3936 Market St., Phila. 4, Pa.

SELL Greeting Cards—Big Profits! Quick Sales! Catalog Free! Elfco, 432 North Wells, Chicago 10.

START Your Own Business on credit. Always your own boss. 1559 Dealers sold \$5,000 to \$28,000 in 1949; their average \$6,834. We supply stocks, equipment on credit. 200 home necessities. Selling experience unnecessary to start. Wonderful opportunity to own pleasant profitable business backed by world-wide industry. Write Rawleigh's, Dept. E-U-PSC, Freeport, Ill.

IS \$210, a week worth a penny postcard to you? Then rush card with name and address for special Free Trial Plan that sells amazing new Automatic Refrigerator Defroster "like hot cakes!" Write to Mr. Lewis, D-Frost-O-Matic Corp., Dept. PSC-5, 6 N. Michigan, Chicago 2, Ill.

PHOTO-Salesmen-Agents. Sell beautiful hand colored plastic enlargements and sensational new photo compacts, rings, bracelets, lockets, etc. Collect deposit, we deliver. Profitable sideline. Send card, for Free sample kit. Novel Portrait Co., 3343-A North Ave., Chicago, Ill.

FREE SAMPLES. Big profits showing amazing Glow-in-the-Dark specialties. House numbers, pictures, plastic novelties, ashtrays, keyholders, religious and nursery objects, etc. Madison Plastics, 303 Fourth Ave., New York 10, N. Y.

WHERE To Buy 800,000 articles direct from manufacturers. Including hundreds of scarce items. Save by buying direct. Free Literature. Glass Pub. Co., Ellwood City, Pennsylvania.

CASH in on tremendous demand for new cheap oil burner that fits in cooking-heating stoves and furnaces. Burns all kinds of oil including crankcase. Lifetime guarantee. Big profits. Be first. Write quick to Northwest Mfg. Co., 320 Main, Mitchell, S. Dakota.

NEED Extra Cash? Take orders for personal initialed belts and buckles, cap badges, tie holders, etc. Choice of 3000 emblems. Free sales kit. Hook-Fast, Box M-101, Providence, R. I.

BE A Money Maker . . . Use your home as magazine headquarters. Liberal commissions. No experience—No capital needed. Everything furnished. Write for Free Catalog. McGregor Magazine Agency, Dept. 510A, Mount Morris, Ill.

MAKE Wedding Profits. Sell invitations, napkins, matches. Samples free. Dunbar's, Middlebush 5, N. J.

FERTO-Pots: Lawn-Seeded-Ferto-Soil, 33 1/3%, collect commissions, we ship customer C.O.D. for balance. Allen Company, Pittstown, New Jersey.

YOU teach Hawaiian Woodwind in 10 weeks. Musical Instrument including course \$20.00. AE Richman, 5516 Chester Avenue, Philadelphia, Penna.

PUNCHBOARDS, Tavern Games, Catalog. Webb Distributing, 4966 West Chicago Ave., Chicago 51, Illinois.

GREETING Card bargains. Personalized Playing Cards, Napkins, Book Matches. Raum, 4154-B Fifth Street Philadelphia 40.

JEWELRY For Salesmen Distributors Direct Factory. Catalog Free. Pickcraft (c 19) Bank St., Attleboro, Mass.

MEXICAN feather pictures. Sell on sight; 200% profit! Free details; sample 10c stamps. Sylvia-SL, Apartado 9036, Mexico City.

BUY thousands of nationally advertised products direct from manufacturers and distributors. Write for "Buy Direct and Save." Service Publishing, 1420-B Investment Bldg., Pittsburgh 22, Pa.

PAINTS—All kinds, 65c gallon up. Private label. Certified Products, Louisville, Ky.

BUY wholesale 25,000 items. catalogue 25c. Matthews, 1472A1 Broadway, N. Y. C.

SELL Big Money-Maker to Men and Women. Easy handwork makes fast-selling useful articles. Sample free. Sunmade Company, Brockton 64, Mass.

MAKE Hollywood Stars Perfume at home. Big Profit. Full Information. Write Emily Mfg., PS-3, Box 319, North Hollywood, Calif.

BUY Wholesale thousands nationally advertised products at big discount. Sent free "The Wholesale Plan." American Buyers' Service, 629-S Linden, Buffalo, N. Y.

SCARCITY Line. Power mowers—\$59.95. Sensation. Special deal—delivered. Rotacut-RP, Excelsior Springs, Missouri.

POPULAR SCIENCE OPPORTUNITIES

FREE sample nylon stocking of world's only nationally advertised hosiery line actually guaranteed against runs, snags or excessive wear, regardless of cause! It's amazing but true. Every weight from sheerest 15 denier to heavy 70 denier—all gauges to luxury 60 gauge. Amazingly low prices, starting at \$1.08 prepaid for sheerest 15 denier 51 gauge. Not sold in stores. Good Housekeeping Guarantee Seal. Also complete line men's hosiery guaranteed one full year or replaced free. Full variety lingerie in crepe, satin and nylon, featuring all nylon slip at \$2.95, satin slip at \$1.58, etc. Housecoats and robes. Kendex sales people will earn one million dollars this year. Get your share. No money or experience needed. Pay nothing now or later. Just show free outfits. Write orders. We deliver and collect. Advance cash plus huge bonus. Earn money spare or full time. Become manager—appoint others to sell for you—earn steady income on their sales. Man or woman—young or old, you can earn more money than you ever thought possible. Everything you need is furnished free and prepaid, including nylon stocking, samples of materials, sales books, 36-page salesmanual, color cards, etc. Simply write your name and address on postcard and mail to Kendex Corporation, Babylon 54, N. Y.

HI-Profits. Internally Hand Carved Plastics, Gifts—Jewelry. Free catalogue. Pilot Plastics, 67 B2-Fulton St., N. Y. C. 7.

NYLONS! 100% Bonus. Largest paid today for direct selling. Essential Products Company, 210 Fifth Avenue, New York 10, New York.

SELL!! Balloons, Combs, Specialty Merchandise, Carleton House Distributors, Texas City, Texas.

NYLONS—New "2,500-High-Twist" Nylons. Direct from mill. Free sample outfits. Guaranteed longer wear, resist runs and snags 40% more. Its 40 turns per inch "High-Twist" in 2,500 threads, by Laboratory Tests prove they outwear all the others. Just few months ago it was believed impossible. We now sell more stockings than ever before. Earn \$1.00 a Box, or make more money buying dozen. Box 3 (60-15) \$3.40; (51-15) \$3.15 postpaid. Amazing New "3-Step" Plan gets orders for nylons. Hand-over Fist! Ergim Hosiery Mills, 992-PS Columbus Ave., New York.

AMAZING Christ Picture, sample, 50c. Outstanding Products, 1813 Columbus, Cleveland 13, Ohio.

\$250.00 WEEK Reported! Free book "505 Odd, Successful Businesses". Work home! Expect something odd! Pacific-28, Ocean-side, Calif.

\$5 HOUR Easy! Sell name plates for houses. Free Sample, order blanks. Write: National, 214 Summer, Boston, Mass.

63 HIGHGRADE SALESMEN

\$2600 NEXT 9 weeks—season starting. Sell Calendars, Specialties, Matches. Prospects everywhere. Advanced Commissions. Experience unnecessary. Samples Free. Continental Calendar, 542-B South Dearborn, Chicago.

WRITE 3 Words—Collect \$7.65 on 10-second Demonstration to merchants—write on glass with Amazing Magic Crayon—Presto!—5-color advertising message takes fire—glows like brilliant Neon. Three sales daily bring \$22.95 profit. Rush postcard for details.—Complete Sales Kit, Free! Maxilume Co., 125 W. Hubbard, Dept. CL-95, Chicago 10, Illinois.

BIG Money Taking Orders: shirts, ties, socks, pants, jackets, sweaters, shoes, uniforms, etc. Sales equipment free. Experience unnecessary. Nimrod, 4922-AV Lincoln, Chicago.

ADVERTISING book matches—Cash in on big demand—sell Union Label matches. Cuts for all businesses and political parties—Free powerhouse selling kit—low prices—protection guaranteed on repeat orders—Cash commissions. Superior Match Co., Dept. P-551, 7530 Greenwood, Chicago.

EARN Big Money Fast! Sell finest-quality advertising work uniforms to garages, factories, filling stations, etc. Free selling kit. Topps, Dept. 545, Rochester, Indiana.

\$5 HOUR Easy! Sell name plates for houses. Free Sample, order blanks. Write: National, 214 Summer, Boston, Mass.

MAKE over \$100.00 weekly, demonstrating and taking orders for Fun-Provoking Advertising Rubber Dollars (stretches), designs, slogans, rhymes, to clinch orders for any business, with worth-while cash deposit. Headquarters for unusual, dramatic, attention-compelling ad-specialties. Write for sales kit. Meinhardt Co., 4218 Lincoln Ave., Dept. PS, Chicago 18.

BEST Source for Nylons, Rich Supply, 215 West 98, New York 25.

AD Matches! Sell Amazing Designs—20, 30, 40 and 240-light book matches. Biggest spot cash commissions; every business a prospect. Low prices for high quality. Repeats. Start without experience; men, women; full, part time. Buy Nothing! Sales kit furnished. Match Corp., Dept. PS-17, Chicago 32, Illinois.

WANT to make real money? You can positively make \$50.00 a day and up selling a brand new item going to every type of food and beverage store, factories, Laboratories, Hospitals, etc. First time advertised. Write for Free Details today. Johnson-Hartman, 53 West Jackson Blvd., Dept. PS-5, Chicago 4, Illinois.

64 EMPLOYMENT SERVICE

FREE,—interesting mail. James Scholl, Route 6, Box 395, Birmingham 7, Ala.

67 EDUCATIONAL AND INSTRUCTION

USED Correspondence Courses and Books sold and rented. Money back guarantee. Catalog free. (Courses Bought). Lee Mountain, Pisgah, Alabama.

MEDICAL Laboratory Technicians in great demand. We train you in your own home. Catalogue free. Imperial Technical Institute, Box 973-B, Austin, Texas.

MAKE Up To \$35-\$45 Week as a Trained Practical Nurse! Learn quickly at home. Booklet free. Chicago School of Nursing, Dept. M-5, Chicago.

PIANO Tuning Pays. Learn this profitable profession at home. Our Tonometer and mechanical aids make learning easy. No knowledge music necessary. Diploma granted. Largest and oldest school—51st year. G. I. Approved. Write for booklet. Niles Bryant School, 77 Bryant Bldg., Washington 16, D. C.

BOOKKEEPERS! Increase your earnings! Operate your own simplified "Dollar-A-Week" Bookkeeping and Tax Service. Full or spare time. Details Free. No obligation. Ellis, Box 203, Cedar Grove, N. C.

LEARN Auto Body, Auto Mechanics, Refrigeration, Electrical Appliance. Write Stevinson's, 2008PS Main, Kansas City, Missouri. Established 1922.

NAMAKAGON Summer Camp, Boys. Write Don Miller, Cable, Wisconsin. Swimming featured.

START a Collection Agency business. Very profitable. Quickly learned. Write Cole & Associates, Syracuse 2, N. Y.

PRACTICAL Nursing—Learn Easily at Home, Spare Time. Big demand, good earnings. High School not necessary. Write for free facts. Wayne School, Dept. FH-2, 2525 Sheffield, Chicago 14 Ill.

YOU for President of your own credit-collection agency. Many who answered our ads now have their names on office doors. Franklin Credit, Roanoke 7, Va.

BECOME a Doctor of Psychology or Metaphysics. Teach secret of contentment, happiness. Win degree of PsD, or MsD. Solve mental worries. Free book. College of Universal Truth, 5153-K N. Clark, Chicago.

HOME Study, Drugless Therapy, Psychology, Philosophy Deg. Western University, 3693 5th Avenue, San Diego, Calif.

HIGH School—No Classes. Study at home, spare time. Diploma awarded. Write for Free Catalog HBA-2, Wayne School, 2527 Sheffield, Chicago 14, Ill.

GET a better job, win promotion the easy way! No bunk. Free information. Ward Counselors, 42-P Manchester, Springfield 8, Mass.

EARN \$10,000 annually! Learners \$2,700. Unlimited opportunities in Merchant Marine. Instruction-Employment Manual \$1.00. Refundable. Titan Company, 45 Clinton St., Newark 2, N. J.

EARN While You Learn—Day or Night Classes. Thorough courses in: Automobile Mechanics, Diesel Mechanics, Motor Tune-Up, Auto Body and Fender, Welding, Etc. Living accommodations. Veterans may earn \$210 to \$290 per month while in school including subsistence. Fully accredited to Train Veterans. Thirty-two Years' Experience Training Men. Nashville Technical College, Dept. #251, Y.M.C.A. Bldg., Nashville 3, Tennessee.

ALGEBRA, Trigonometry, Calculus. Individualized instruction. Free details. New Correspondence School, Box 27, St. Johns, Brooklyn 13, New York.

AMAZING, new, scientific way to remember. Free details. Memory Institute, P.O. Box 261-S, Staten Island #1, N. Y.

MULTIPLY Your Income! Finance, Business, Stock Market, Investment, Economics Course \$1.00. Refundable. Titan Company, 45 Clinton St., Newark 2, N. J.

WELDING training profitable. Learn quickly. Magnificently equipped non-profit school. VA contract. Hobartweld, Box P-515, Troy, Ohio.

GET dignified permanent employment—learn drafting—details free—Write Monroe Institute, PS-5—Alton, Illinois.

VOICE Secrets! Information Free! Studio, 14356A South Jersey, Norwalk, Calif.

USED Correspondence Courses and Educational Books Bought, Sold, Rented. Catalog Free. Educational Exchange, Summerville, Georgia.

BARTENDING and Management learned at home with fully illustrated lessons and equipment supplied. American Bartending School, 334 S. Wabash Ave., Chicago 4, Ill.

WORK For U. S. Gov't! Thousands of Emergency Program positions open. Men-Women. Experience usually unnecessary. Qualify Now! Start high as \$66.34 week. Free 40-page book shows jobs, salaries, sample tests. Write: Franklin Institute, Dept. T22, Rochester, New York.

SELF-HYPNOSIS. Infallible method! \$1.00. Hampton, 3121 Hamilton Way, Los Angeles 26, California.

DEFENSE welding jobs pay. Welders needed. Train quickly. VA contract. Hobart Welding School, Box P-514, Troy, O.

68 DANCE INSTRUCTION

BEGINNERS, dancers, teachers! Booklet containing beginners' simplified tap course and two professional dance routines \$1.00. Craves Studios, 19171 Birwood, Detroit 21, Michigan.

70 LANGUAGE OUTFITS

IT'S Fun Learning A Language by Linguaphone. At home, in leisure time, quickly, easily, correctly master Spanish, French, German, Russian, Oriental—any one of 29 languages through Linguaphone Conversational Method. Add to service, job, travel opportunities. Send for free book, Linguaphone Institute, 5405 Rockefeller Plaza, New York City.

72 AUTHORS SERVICE

I WANT New Writers to cash checks of \$1 to \$100 offered daily. The easiest way to write for pay. No previous experience necessary. Free Details. Saunders M. Cummings, 468-15 Independence Bldg., Colorado Springs, Colo.

BEGINNING Writers: Let us show you How to get \$1.00 to \$20.00 checks daily. Experience unnecessary. Details Free. Herwell Company, 7016-N Euclid, Cleveland 3, Ohio.

73 BUSINESS SERVICE

SAN Francisco manufacturers representative, personal service, shopping, remailing, 25c. Waterson, 25 Third Street, San Francisco 3, Calif.

74 CARTOONING, SIGN PAINTING, DRAWING AIDS

"HOW To Make Money With Simple Cartoons"—A book everyone who likes to draw should have. It is free; no obligation. Simply address Cartoonists' Exchange, Dept. 195-C, Pleasant Hill, Ohio.

BE smart. Get in Art. Let me start you Free. Nick Nichols Arts, PS, 39 West Adams, Chicago, Illinois.

POPULAR SCIENCE OPPORTUNITIES

ARTISTIC Back dated Art Magazines. Eight \$1; 36 \$3.50 postpaid. Art bargains. Catalogue 10c. Art Book Shop, Arnold 5B, Missouri.

LEARN Sign painting. 152 Lesson Course. Results Guaranteed. Stewart Sign Co., Box 287M, Pasadena, California.

DRAW Beautiful human figures. 20 lessons. 147 pictures. \$1.00 complete. Aldcroft Studios, 1206 Maple, Los Angeles 15.

75 CHALK TALK-STUNTS

CHALK Talks. Laugh Producing Program. \$1.00. Illustrated Catalog 10c. Cartoonist Balda, Oshkosh, Wisconsin.

76 TYPEWRITERS AND OFFICE MACHINES

PRINTOMATIC selffeeding Post Card printing Duplicator \$13.50. Envelope Addressing Machines \$24.50. Pittsburgh Typewriter Company, 336-G Fourth Avenue, Pittsburgh 22, Pa.

UNDERWOOD Portable Typewriter, Brand new, (Leader). Special . . . wholesale price, \$56.50. V. Luckett, 74 E. Post Rd., White Plains, New York.

RECONDITIONED Typewriter office machines. Bargains. Write Dixie Service, King, N. Carolina.

77 OFFICE SUPPLIES & EQUIPMENT

TYPEWRITERS, adding machines, addressing machines, Recorders, office equipment. Goetz's, Greencastle, Penna.

TYPEWRITERS \$27.50. Adders \$12.50. Duplicators \$10.95. Meier's, 118 Spruce, Wichita 7, Kansas.

78 RUBBER STAMPS

3 LINES 50c; Pads 35c; Signature \$2.35. Printright, Wauwatosa, Wisconsin.

79 PRINTING OUTFITS, SUPPLIES

PRINT your own cards, stationery, circulars, advertising. Save money. Simple rules. Print for others, nice profit. Raised printing like engraving too. Have home shop. Details free. Kelsey Presses, L-8, Meriden, Connecticut.

MAKE Your Own printing cuts. Self-molding process. Plexirubber, Argyle 2, Wis.

PRINTING Presses. Type Supplies. Lists 3c. Turnbaugh Service, Loysville, Penna.

PRESSES, Supplies, Paper, Catalog 10c. Printers Supply, 211-S, Springfield, Mo.

80 PRINTING, MULTIGRAPHING, ETC.

PHOTO-Offset Special; 5000—8½x11 \$14. Samples Free. Reiffe, 160-S Monroe St., New York 2.

1000 **BUSINESS** Cards \$2.50 Prepaid samples Free. Reliable Print Shop, 905 East Jefferson, Louisville 6, Ky.

PRINT Without A Printing Press. Big Money! See page 22.

PRINTING—Offset and Letterpress. Send sample of specifications for estimate. Raum, 4154 Fifth Street, Philadelphia 40.

BUSINESS Printing. Samples. Prices Free. Howprint, 723-S Eunice, Webster Groves 19, Missouri.

THREE day service on printing, multi-graphing, mimeographing. Prices, samples free. Progressive, 270-b Burkhardt, Cincinnati 15, Ohio.

BUSINESS Stationery. Low cost. Samples. Mero Products, 99 Morrison, Punxsutawney, Penna.

1,000 **PRINTING** Specials, samples, prices. Ziegler, 694 Rockaway, Brooklyn 12, N. Y.

82 PATENT ATTORNEYS

INVENTORS—Send today for booklet "Patent Protection for Inventors" giving detailed patent information and preliminary steps to take toward patent protection.—also "Evidence of Invention" form. Victor J. Evans & Co., 641-E Merlin Building, Washington 6, D. C.

INVENTORS: Without obligation, write for information explaining the steps you should take to secure a Patent. John N. Randolph, Registered Patent Attorney, 207 Columbian Bldg., Washington 1, D. C.

PATENT practice before U. S. Patent Office. Validity and infringement investigations and opinions. Booklet and form "Evidence of Conception" forwarded upon request. Lancaster, Allwine & Rommel, Registered Patent Attorneys, Suite 413, 815—15th St. N.W., Washington 5, D. C.

INVENTORS: When you are satisfied that you have invented something of value write me, without obligation, for information as to what steps you should take to secure a Patent. Write Patrick D. Beavers (Formerly Randolph & Beavers) Registered Patent Atty., 938 Columbian Bldg., Washington 1, D. C.

C. A. Snow & Co.—S-427, Snow Building, Washington 1, D. C. Registered Patent Attorneys. Write for information.

INVENTORS: Write for free brochure "Evidence of Invention." Labiner, World Building, New York 7.

INVENTORS. For "Record of Invention" form, contact Carl Miller, Registered Patent Attorney, Woolworth Building, New York.

INVENTORS: Learn how to protect your invention. Special booklet "Patent Guide for the Inventor" containing detailed information concerning patent protection and procedure together with "Record of Invention" form will be promptly forwarded to you upon request—without obligation. We are registered to practice before the U. S. Patent Office and prepared to serve you in the handling of your patent matters. Clarence A. O'Brien & Harvey Jacobson, Registered Patent Attorneys, 12B-D District National Building, Washington, D. C.

"**INVENTOR'S** Guide" free. Frank B. Ledermann, Registered Patent Attorney, 154 Nassau Street, New York.

INVENTORS—If you believe you have an invention, we can make a preliminary search on your invention and advise you whether we think it can be patented. Send for copy of our Patent Booklet "How to Protect Your Invention" and "Invention Record" form. No obligation. McMorro, Berman & Davidson, Registered Patent Attorneys, 143-R Victor Building, Washington 1, D. C.

PATENTS—Irving L. McCathran, 316 McLachlen Bldg., Washington 1, D. C. Registered Patent Attorney.

83 FOR INVENTORS

CASH For your idea, 280 manufacturers need inventions, patented or unpatented. List free. Invention Bureau, 208-S Clinton, Oak Park, Illinois.

INVENTORS: Without obligation, write for information explaining the steps you should take to secure a Patent on your invention. John N. Randolph, Registered Patent Attorney, 206 Columbian Bldg., Washington 1, D. C.

SEARCHES—Put your patent searches in the hands of a Registered Patent Attorney or Agent, as he qualifies to give a worthwhile patentability report. Record of Invention form upon request and information on patent protection. Patrick D. Beavers, Registered Patent Attorney, 939 Columbian Bldg., Washington 1, D. C.

INVENTORS—This firm is registered to practice before the United States Patent Office and is available to assist you in the preparation and prosecution of your patent application. "Patent Protection for Inventors" booklet containing detailed information and steps to take toward patent protection will be sent upon request. No obligation. Victor J. Evans & Co., 642-E Merlin Building, Washington 6, D. C.

PRACTICAL Inventions Wanted, Inventors Patent Exchange, Dept-D, Hartford 1, Connecticut.

INVENTORS: Learn how to protect your invention. Special booklet "Patent Guide for the Inventor" containing detailed information concerning patent protection and procedure together with "Record of Invention" form will be promptly forwarded to you upon request—without obligation. We are registered to practice before the U. S. Patent Office and prepared to serve you in the handling of your patent matters. Clarence A. O'Brien & Harvey Jacobson, Registered Patent Attorneys, 12A-D District National Building, Washington, D. C.

INVENTORS. For "Record of Invention" form, contact Carl Miller, Registered Patent Attorney, Woolworth Building, New York.

INVENTORS: If you have an invention for sale, patented or unpatented, write Institute of American Inventors, Dept. 30A, 631-E St., N.W., Washington 6, D. C.

PATENT Searches \$5.00, including patent copies. Same reliable search as conducted for patent attorneys. Free protection forms, 48 hour service. Patent Service Institute, 945-B5 Pennsylvania Avenue, Washington 4, D. C.

INVENTORS—If you believe you have an invention, we can make a preliminary search on your invention and advise you whether we think it can be patented. Send for copy of our Patent Booklet "How to Protect Your Invention" and "Invention Record" form. No obligation. McMorro, Berman & Davidson, Registered Patent Attorneys, 143-P Victor Building, Washington 1, D. C.

PROFESSIONAL Engineering services to determine basic engineering soundness of your idea. Licensed, Robell Laboratories, 60 State Street, West Englewood, N. J.

PATENT Searches \$5.00. 48-hour service. For free Record of Invention forms write Miss Ann Hastings, Patent Searcher, P. O. Box 176, Washington 4, D. C.

INCREASE mail order profit! Results guaranteed! Let nationally recognized advertising agency advertise and promote your product. For complete details write Box 5-A, Cedar Rapids, Iowa.

BEFORE You Spend \$200-\$300 On Patents, every inventor should read the handbook "Will My Invention Sell". It tells you if and how your invention can be sold. \$2.00. James, 229 Colorado, Pueblo, Colo.

84 INVENTIONS WANTED

INVENTIONS Promoted, Patented or Unpatented. Write Adam Fisher Company, 183-A Enright, St. Louis, Mo.

INVENTORS: Hundreds of manufacturers have requested our assistance in locating marketable new products. Complete information, free. Institute of American Inventors, Dept. 30C, 631—E Street, N.W., Washington 4, D. C.

INVENTORS—What have you, patented, patent pending to offer manufacturers? Request free booklet without obligation. Market Contacting & Data Service, 11106-B2 Longwood, Chicago 43.

INVENTIONS Wanted, Your invention and patent developed and promoted. Write for Booklet "S". Elo, Box 172, Long Island City 1, New York.

INVENTIONS Wanted, Patented or Unpatented. 20 years experience Promoting Inventions. National Service Bureau, 3132 Meramec, St. Louis 18, Missouri.

85 PATENTS

INVENTORS: Test the commercial value of your patented or unpatented inventions, quickly and inexpensively. Write for free information. Institute of American Inventors, Dept. 30-B, 631-E St., N. W., Washington 6, D. C.

PATENT searches \$5.00, including copies of closest patents. Same reliable searches we conduct for patent attorneys. 48 hour airmail service. "Record of Invention" free. Capitol Patent Service, P. O. Box 664-S, Washington 4, D. C.

89 MODELS, MODEL SUPPLIES

SHIP and Yacht model fittings: blueprints. Send 25c for illustrated catalog No. 26—Listing hundreds of items. A. J. Fisher, 1002-2 Etowah, Royal Oak, Mich.

BUILD Historic ship models, complete kits, 39c to \$9. Catalog 15c. Ideal Models, 21 West 18th, New York 11, N. Y.

SHIP Models—most complete line in New England. Kits, parts, plans, books, tools. Engines and motors. Illustrated catalog, 25c. James Bliss & Co., Inc., 220 State St., Boston, Mass.

SHIP Model and yacht supplies, complete large 64 page catalogue, 30c. Wm. Wild, 510 E. 11th St., New York City.

RECEIVE Model Airplane and Engine practically as gift. Details Free. Hobbycraft, 104C Brooklyn 30, New York.

POPULAR SCIENCE OPPORTUNITIES

BUILD, Fly, World's Most Authentic Model Airplanes. 47 Different Kits, motors, supplies. "Airplane Catalog." 10c. Clevemod, 4507TC80 Lorain, Cleveland 2, Ohio.

STEAM engines, boilers, castings. Catalog 25c. Anton Bohaboy, 2297 Price, Rahway, New Jersey.

RAILROADERS: Get new Catalog—Reference Manual, HO 50c, O 75c, Walthers, 269 Erie, Milwaukee 2, Wisc.

90 MOLDS AND MOLDING MATERIALS

MOLDING Rubber, \$2.95 qt., \$9.95 Gal. Prepaid, Plastercraft Supply Co., 3051 St. Clair Ave., Cleveland 14, Ohio.

91 HOME CRAFTSMEN

MAKE leather belts, billfolds, purses. Big catalog and genuine steerhide keyholder, 10c. Tandy Leather, Box 397D, Tulsa, Oklahoma.

LEATHER tools, lacing, supplies. Free Catalog. National Handicraft, 199 William St., New York 7.

NEW 96 PAGE Leather and Craft catalog. 1000's of items. Send 10c. Russo Handicraft Supplies, Dept. O-4, 245 South Spring, Los Angeles, California.

TURN your spare time into cash. Make quick-selling, highly profitable lamps—every home a prospect. No experience or special tools required. New 1951 56-page illustrated catalog shows shades, shade frames, figurines and bases, oil lamp converters, boring compounds, and dozens of similar items. Also all kinds of sockets, cords, pipes, harps, finials, bases, and hundreds of other parts—everything you need. Special 8-page section shows 6 beautiful lamps in kit form ready to assemble. You buy wholesale, sell at retail—make big profits. Hundreds doing it. You can, too. Send 25c today for catalog and wholesale price list. Refundable first order. Gearon Co., Dept. 500-A-5, 27 S. Desplaines, Chicago 6, Illinois.

LEATHERCRAFT Supplies, Leather & Tools. Low prices. Send 10c for catalog. Jonas Handicraft Co., (Dept. 5-P), 30 Frankfort St., New York 7.

90 ALL new, full size lawn ornament and novelty patterns, up to 20" high. Only \$1.00. Mastercraft 52S, 7041 Olcott, Chicago 31, Illinois.

LEATHERCRAFT Tools, Leather Embossing Plates, Craft Accessories, Dies. Catalogue 10c. Louis Jones Engineering Company, 1613 Main, Fort Worth, Texas.

"WALLPAPERING Made Easy"—have fun, save many dollars—get 60-page book by professional. \$1.00 postpaid. Satisfaction guaranteed. Educational, 837C Lake, Racine 5, Wisconsin.

NEW leathercraft catalogue Pleasure & Profit, new styles, Belts, Purses, Shoes, largest leathercraft school in U.S.A. G.I. approved. Send 10c for catalogue. Dept. PS-5, Apache Leather Co., 2804 E. Washington St., Phoenix, Arizona.

LEATHERCRAFT Bargains—Lacings—Tools. Byrd, 3406 Montrose Ave., Richmond, Virginia.

LEATHERCRAFTERS: Big illustrated catalog shows everything you need 10c. Arts Leather, 411 Joseph Ave., Rochester 5, New York.

LEATHERCRAFT Copper tooling. Textile painting. Make spare time profitable! Free illustrated catalog shows everything you need. Kit Kraft, 7377 Melrose, Hollywood 46, California.

HOME power tool woodworkers. Every state. Earn extra making wood parts for toy manufacturer. Maynard Toy, 13 Washington Street, Somerville, Mass.

KNOCKDOWN Cedar Chest, Lumber and Veneers. Free Price List, Giles Co., Brownsboro, Alabama.

SQUAREKNOTTERS! Make belts, hand bags, etc. Quality cord samples with catalog free. Special! Beginner's book, catalog and samples 10c. P. C. Herwig Co., Dept. P40, 121 Sands St., Brooklyn 1, N. Y.

89 FULL size Jig Saw patterns of beautiful shelves, ornaments, toys, novelties. Plus "How, Where to Sell." Only \$1.00. Mastercraft 54S, 7041 Olcott, Chicago 31, Illinois.

92 BLUEPRINTS AND PLANS

GUITAR? Build yours with Skoty's illustrated plans—\$1.00. Box 1701, Colma, Cal.

LOG buildings—blueprints, detailed working drawings, all types log building construction, \$2.00. Blueprint Standards, 6708 N.E. Roselawn, Portland, Oregon.

93 BUILD IT YOURSELF

BUILD Your Own "Tractor." Plans. Walking, riding. Free information. Ellsworth Tractor Co., D-5, Camptonville, Calif.

FREE Hot Water—plentiful—automatic—plans \$2.00. Sun Heater, Box 789, Quincy, Florida.

STREAMLINED, Built-in kitchen cabinets to fit any kitchen. Illustrated manual describes designing and construction. All for \$1.00. Thombert Company, Newton 11, Iowa.

GRANDFATHER clock building made easy. Shoptested photopack plans dollar. Kuempel Clocks, Minneapolis 16.

"CONCRETE Block Homes." 32 Page booklet on how to build, \$1.00. Other Home Building booklets, \$1.00. H. C. Lightfoot, Civil Engineer, Richboro, Penna.

CONCRETE Block Machine Plans \$2.00.—Build your own machinery from salvage. Handbook, only 25c (refundable). Free details. Kenneth Reeves, Box 3357-D, El Paso, Texas.

MINIATURE Switch, super sensitive. Thousand uses: Burglar Alarms, Automobiles, Farms, etc. Diagrams included \$1.00. Wandot Company, Box 8152, Chicago, Ill.

94 WATCH REPAIRING

CLEANING—\$1.95. Mainsprings—95c. Maximum charge—\$4.00. Watches, Glenwood, Arkansas.

"THE Modern Clock." All about clock repair. 502 pages, 173 illustrations, \$4.95 postpaid. 10-day return privilege. North American, Dept. 21E, 2018 North Avenue, Chicago 47, Illinois.

WATCHES Completely Repaired; \$3.50. Guaranteed; Berkowitz, 1265 Olmstead Ave., Bronx 61, N. Y.

WATCHMAKERS Tools, Materials, Supplies. Repairs Catalog. Gales, Box 1000, Chicago 90, Ill.

95 OLD GOLD, WATCHES, ETC.

HIGHEST Cash Paid For old, Broken Jewelry, Gold Teeth, Watches, Silverware, Diamonds, Spectacles, Platinum. Free information. Satisfaction Guaranteed. Government Licensed, Rose Smelting Company, 29-Y East Madison, Chicago.

WATCHES wanted. Any condition. Also broken jewelry, spectacles, dental gold, diamonds, silver. Cash sent promptly. Mail articles or write for free shipping container. Lowe's, 37 Holland Bldg., St. Louis 1, Missouri.

96 JEWELRY

GOLD Plated Jewelry supplies, Rhinestones, Pearls. Illustrated catalog, only 10c. Barry's, 47-M Branford Place, Newark 2, New Jersey.

RHINESTONES, jewelry settings, cameos, sequins, beads. Catalog Free. J & M Novelties, Dept. CE-4, Griffith, Ind.

LUCKY Pixie Brooch, Sterling silver with wings of beautiful colorful polished Abalone. Expert workmanship and design. Wonderful gift for Army and Navy men to give. Price \$3.00 postpaid, including taxes. (THIS PRICE APPEARED INCORRECTLY IN THE APRIL ISSUE AS \$2.00.) Specialty Sales, 18 Bath, Santa Barbara, California.

WRISTWATCHES, 7-Jewel Man's shock-resistant \$6.95. 17-Jewel Man's shock-resistant, water-resistant \$14.79. Add 10% Federal Tax. One year Guarantee. \$1.00 with order, balance C.O.D.—or send complete amount—postage free. Amsterdam Trading Company, 102-PS Ross Street, Brooklyn 11, New York.

97 TOBACCO & PIPES

SPIRAL Pipe Filters, Adjustable. Removable. Free Draft. Amazing, Everlasting, 7 \$1.00 Money Back Guarantee. 1551 Ocean Ave., San Francisco 12, Calif.

PIPE Smokers Aromatized bouqueting agents provide flavorful smoking. Information free. Cozza Manufacturing Pharmacist, Pequannock 2, New Jersey.

100 MISCELLANEOUS

DRESSES 18c; Coats \$1.00; Blouses 35c. Free Catalogue. Crown, 164-PC Monroe Street, N. Y. 2.

YOUR Leather Jacket renovated expertly. Free circular. Berlew Mfg. Co., Dept. 7, Freeport, N. Y.

OUTDOOR Toilets, Cesspools, Septic Tanks cleaned, deodorized with amazing new product. Just mix dry powder with water; pour into toilet. Safe, no poisons. Save digging, pumping costs. Postcard brings free details. Burson Laboratories, Dept. E-53, Chicago 22, Illinois.

"BUFFALO" beautifully bronzed 25c. postpaid satisfaction guaranteed. Gila Mfg., Carrizozo, New Mexico.

PLEASURE, Profit, Making Artificial flowers, Corsages, chenille novelties, dolls. Starting kits, Artflower Glaze, supplies. Business Plan, Homecrafts Catalog 10c. Clevemod, 4507TC79 Lorain, Cleveland 2, Ohio.

BUY 450,000 Articles wholesale. Directory 10c (refundable). Publishers, Box 1302-A3, Detroit 31.

BIG Malls Three Month, 25c, year Name Listed Directory \$1.00. Harvey Teeple, Decatur, Indiana.

PRESERVE live flowers to last for years without cost. Complete instructions with Surprise Gift 25c. William Wingfield, Pinewood, Minnesota.

MINERAL—Treasure Locators—Geiger Counters. Superior performance, lowest prices. Payment plan available. Free literature. Fisher Research Lab., Inc., Palo Alto, California.

IF you are nervous, write The Herbmater. Forestville 8, Virginia.

DECORATE with colored flame candles burning red, blue, green or yellow fringed flames. Patented, Marek, Taft, Texas.

SEEK Gold, Uranium, Buried Treasure. Latest low cost super-sensitive equipment. Free literature. Glen Scientific, Box 151-D, Glen Ellyn, Illinois.

PANNING Gold lesson—Catalogue Beginners supplies, Mining Books, Maps. "Where To Go". Free. Old Prospector, Box 729D2, Lodi, Calif.

SUCCESS Simplified! Become a financial wizard; a mental giant; an athletic Superman; a romantic magnet; an expert in any field! Free literature. Success Society of America, Box 5852, Cleveland 1, Ohio.

HAIRCUT—Shaving—hints and technique. Also combat Baldness. Booklet tells how. 25c. Mastrolia, 5½-AA Jane, New York City 14.

RECEIVE Giant Malls, magazines, catalogs! Three months 25c, year 50c. Waddell's Directory, 341-D East 76th, New York 21.

BARGAINS in popular merchandise. Lavana Products, 304 Boston, Nocona, Texas.

101 FOR SALE—MISCELLANEOUS

DRESSES 18c; Coats \$1.00; Blouses 35c. Free Catalogue. Crown, 164-PS Monroe Street, New York 2.

STROLLERS (Twin) Tandem narrow, unique, deluxe design for two "Stroller Age" Babies. Write—Champon's, 143 Grand, Ridgefield Park, New Jersey.

102 WANTED MISCELLANEOUS

SCRAP Mercury (Quicksilver) Tantalum—Bismuth—Tungsten. Metallurgical Products Co. Established 1909. 35th & Moore Sts., Philadelphia 45, Pa.

MERCURY—Highest prices. Free Containers. Write Mercury Terminal, Norwood, Mass.

103 FOR THE HOME

PRACTICAL electric water heater \$2.55, postpaid. Particulars free. Chas. Lehman, 1125 Evergreen Ave., New York 59, N. Y.

POPULAR SCIENCE OPPORTUNITIES

104 PERSONAL

DETECTIVE'S Opportunities. Particulars free. Write. Wagoner, P-125 West 86th. New York 24.

"HOW Can I Find Out?" You Can! Information discreetly developed. Any matter, person, problem, anywhere, Worldwide. Officially licensed, bonded service. Established 1922. Reasonable. Confidential. William Herman, 170 Broadway, N. Y.

BORROW by mail. Loans \$50 to \$300 to employed men and women. Easy, quick. Completely confidential. No endorsers. Repay in convenient monthly payments. Details free in plain envelope. Give occupation. State Finance Co., 210 State Finance Bldg., Dept. Y-14, Des Moines 8, Iowa.

LETTERS Remailed From San Francisco, 25c Each, Six Scenic Postcards \$1.00. Martin, Box 414, Alameda, California.

PSORIASIS Sufferers: Has everything failed to bring even temporary relief from scales, lesions and itching? Then write today for Free important information. You needn't invest one cent! Pixacol Company, Box 7097-S, Cleveland, Ohio.

RUPTURED? Positive comfort, no understraps, no steel, no elastic. Write Smith Manufacturing Co., Preston, Ontario.

SAN Francisco your mail received; forwarded; confidential. TBSCO., 742 Market St., San Francisco.

LETTERS Remailed 25c each. View Cards 3 for 25c. Edward Nadell, Box 345, Los Angeles 53, Calif.

LETTERS Remailed 20c each. Emly, Box 319, North Hollywood, California.

"**INTERESTING** Mails"—25c keeps your mail box full three months. Bentz, Desk-D/19, Chatawa, Mississippi.

PILES! Tormented with itching, bleeding, or protruding piles? Write for free important information. Shaf-Mey Products, Box 836-P, Cleveland 22, Ohio.

INCREDIBLE! Unprecedented! Become a mental superman overnight! Floor everybody! No studying! 'Memoprop' does all your thinking! It's uncanny! Revolutionary! Write: Bijou, Box 1727-VB, Hollywood 28, California.

MEXICAN Law. General Practice Attorney, 1203 Arizona Street, El Paso, Texas.

LETTERS remailed 25c each, Six Columbus, Ohio, postcards \$1.00. Scenic folder of Ohio 25c. No stamps. McLaughlin, 369 Welch Ave., Columbus 7, Ohio.

INFORMATION for single people by Human Relations Consultant, Dr. B. Long, Box 375, Los Angeles 53, Calif.

YOUR key to brighter tomorrows—Personal handwriting analysis revealing your true personality, character, talents, including famous people you're like. 10c. Norela, Box 1363-P, Chicago 90, Illinois.

NEW Orleans Postmark, business and personal letters remailed, replies forwarded. Details free. Richco, 1050 South Rampart, New Orleans, La.

106 ADVERTISING

ADVERTISE: 24 words, 40 Newspapers, \$3.50. Lists Free. Advertising Bureau, 10511-P Springfield, Chicago 43.

BEFORE Advertising—get instructive Ad-Guide, ratebook 10c. Ideas developed. Advertisements prepared free. Chicago Advertising Agency (Established 1900), Chicago 4.

CIRCULARS distributed in the District of Columbia—\$3.00 per 1,000. Israel Company, Dept. 7, Box 6051, Washington 5, D. C.

POSITIVE, profitable results! Free lists! Melvin, 935 North 40th, Philadelphia 4.

40 WEEKLY newspapers, 24 words, \$3.50. M. Pennebaker, Kerrville, Texas.

24 WORDS in 50 Weeklies, \$4.96. H. J. Darnell, 730 Hays, Jackson, Tennessee.

TRADEMARKS, letterheads designed reasonably. Rough sketch \$1.00. Free catalog. Burke, 2133-A McKinney, Dallas, Tex.

110 TAXIDERMISTRY

FISH Mounting easily learned. Small cost, details free. Overton H. Pledger, Box 984, Memphis, Tennessee.

TAXIDERMISTRY Supplies, Books, Instructions, Listed in Catalog, One Dime, Vandye Supply, Wessington Springs, S. Dak.

115 DRAWING & ART SUPPLIES

DRAFTING and artists' materials catalog—thousands of items—25c (deductible first \$2 order). Gordon's, 219 Madison, Chicago.

FREE Art Test. Give Age, Commercial, Box 8066, Dallas 5, Texas.

117 TATTOOING SUPPLIES

TATTOOING Outfits, Supplies, Illustrated List Free. Zeiss, 728 Lesley, Rockford, Illinois.

120 CANDY MAKING

MEN-Women—"Everybody likes Candy." Learn to make professionally at home. (Our 40th year.) Ragsdale Candies, East Orange, New Jersey.

124 TREES, SHRUBS, ROOTS, HERBS

GINSENG, Goldenseal, Hundred seeds \$1.50; thousand \$5. Dozen plants \$1.50; hundred \$9. Growing-selling instructions included. F. G. Collins, Viola, Iowa.

126 CAMPING

TENTS (pup, pyramidal, wall, umbrella, nylon mountain, etc.); camping equipment (cots, sleeping bags, blankets, rucksacks, hammocks, ponchos, etc.); tarpaulins. Low prices; free 60 page catalogue. Morsan, 10-17D 50th Ave., L. I. C. 1, New York.

131 TREASURE FINDERS

TREASURE Hunters! New 11-pound featherweight Model 101 locator for gold, silver and minerals. Money-back guarantee best available. Also Geiger Counters for uranium prospectors. Complete information free. The Goldak Company, 1540 W. Glenoaks Blvd., Glendale 1, Calif.

GOLD, Silver, Metal Detectors, Geiger Counters for Uranium, Mineralights. Sensational new fully guaranteed models. None Finer, Information Free. Detectron Co., 5631 Cahuenga Blvd., North Hollywood, California.

TREASURE—M-Scope Geiger Counters—Mineral Locators. Why buy something inferior when you can buy the best at a lower price? Backed by years of experience. Fully guaranteed by factory. Detects minerals, metals, gold, silver, coins. Payment plan available. Proven superior performance. Free 16 page illustrated booklet. Fisher Research Lab., Inc., Palo Alto, Calif.

URANIUM fluorescent test outfit \$3.75 postpaid. Central States Laboratories, 947 North Avers, Chicago 51, Ill.

137 DETECTIVES

DETECTIVE Training. Phillips Secret Service System, 1917-C North Kenneth, Chicago 39, Illinois.

DETECTIVES—Work home—Travel. Experience unnecessary. Detective Particulars free. Write. Wagoner, P-125 West 86th, New York 24.

SECRET Service, fingerprint training at home, in spare time. Write, Associated Special Investigators, Box 474, Saint John, N.B., Canada.

TRACE Missing Persons for pleasure, profit. Details Free. Arrow Publishers, 5548-D Farragut Ave., Chicago 30, Ill.

142 INFORMATION

AMATEURS—Reasonable—Charges—For Radio—Information, Hy.—Twillman, R.R. #1, Chesterfield, Missouri.

143 NAME LISTS

17,000 NAMES and Addresses \$10.00. Limited Supply. National Enterprize, 504 E. Philadelphia St., York, Penna.

MAILING Lists, All Kinds 1000 \$5.00. Dixie Service, King, N. Carolina.

144 MILITARY INSIGNIA

33 DIFFERENT Army Patches, including catalogue \$1.00. Hobbyguild, 57 Sumner Avenue, Brooklyn, New York.

INCREASE YOUR MAIL ORDER BUSINESS

LOOK AT THESE LOW RATES

80c Per Word, Per Insertion **WHITE SPACE—\$4.50** Per Line.
Minimum Ad—10 Words—\$8.00 **CASH WITH ORDER**

IF YOU SELL A PRODUCT OR SERVICE TO MEN, USE THIS EASY MEANS TO GET MORE SALES.

TO BE INSERTED IN THE JULY ISSUE, YOUR ORDER MUST REACH US BY MAY 25TH.

FREE BOOKLET TELLS YOU "HOW TO MAKE MONEY OUT OF CLASSIFIED ADVERTISING."

NOW YOU CAN HAVE A
Beautiful Lawn
EASILY, QUICKLY

MOW-MASTER not only does a beautiful job of mowing grass and cutting tall weeds, it also pulverizes autumn leaves. It keeps the lawn fresh and clean looking spring, summer and fall. Just think—a powerful 2 H.P. engine—direct drive—easy operation—triple duty and long season use, ALL in one machine. No wonder MOW-MASTERS are popular.



PROPULSION ENGINE CORP.
 7th St. & Sunshine Rd.
 Dept. PS-5
 Kansas City 15, Kansas

DELUXE MODEL SHOWN

AMERICA'S FINEST POWER MOWER

Write for illustrated folder at once.

Gentlemen: Please send me your illustrated folder, describing the MOW-MASTER Line of Power Mowers and Grind-a-Leaf attachments.

NAME _____
 ST. ADDRESS _____
 CITY _____ STATE _____

Coronado
"pose-breefs"

THE NEW BODY-MOLD TRUNKS FOR IDEAL BODY DISPLAY. WORN BY LEADING BODY BUILDERS OF THE WORLD!

Here's the perfect brief trunks for body building, lifting, swimming, physique photography and contests. Designed by champions... worn by leading body builders of the world. No bind, no boxed or chopped off appearance. Body-mold fit for tall or short men in sizes 26 to 38. Complete freedom... complete coverage. Satisfaction guaranteed. Send check or money order today. Postpaid.

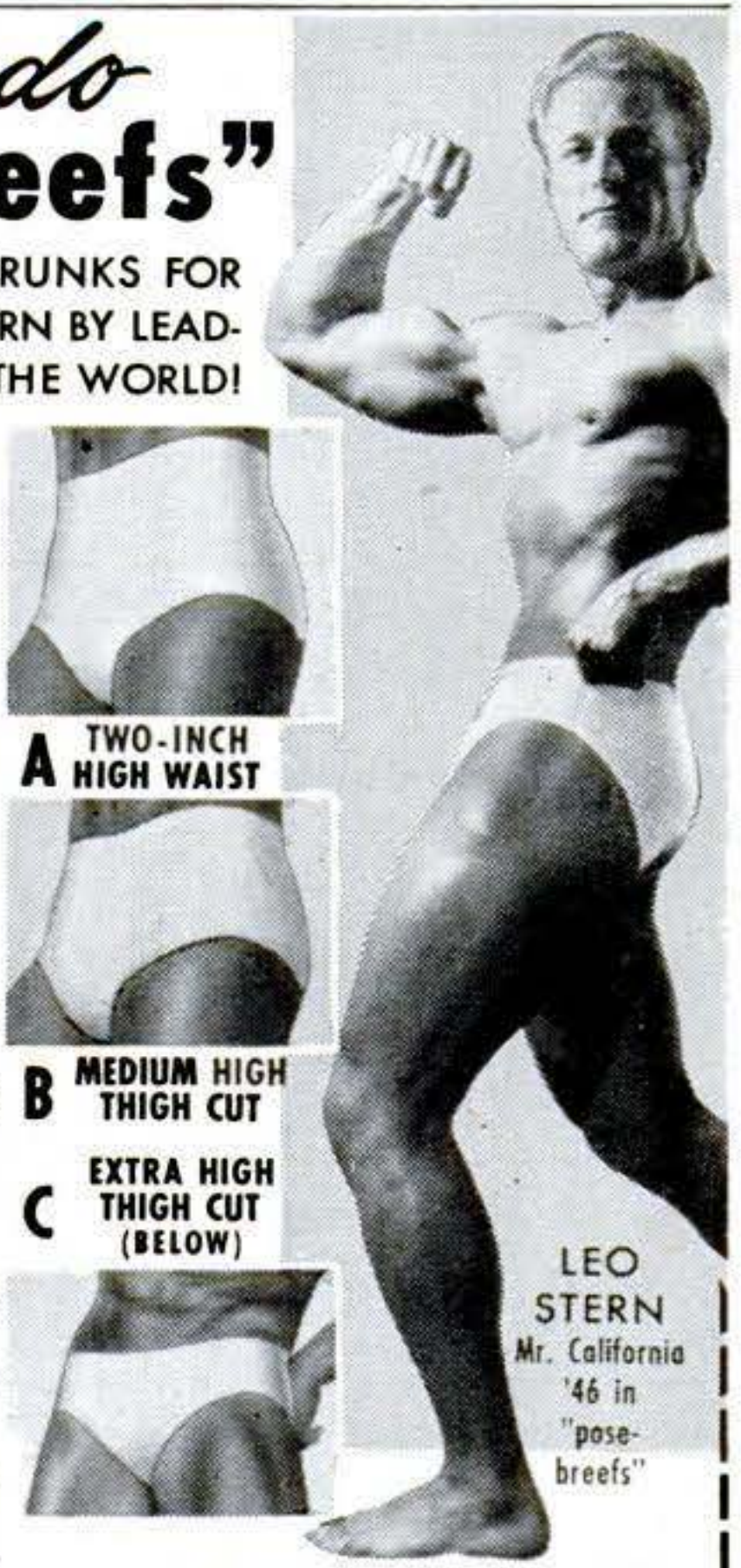

A TWO-INCH HIGH WAIST

B MEDIUM HIGH THIGH CUT

C EXTRA HIGH THIGH CUT (BELOW)

LEO STERN
 Mr. California
 '46 in "pose-breefs"

Coronado Surf Shop,
 627 8th Avenue, Dept. PS-2
 San Diego 1, California

Please send me, postpaid, Pose-Breefs as follows: (Check)

- 1. Elasticized Nylon, the very finest . . . 7⁹⁵
- 2. Elasticized Nylon and Acetate . . . 5⁹⁵
- 3. Elasticized Leopard Skin 5⁹⁵
- 4. Elasticized Satin Acetate 4⁹⁵
- 5. Workout trunks Assorted colors . . . 3⁹⁵

Please indicate three color choices:
 Style **A** **B** **C**
 Size _____

WHITE
 BLACK
 LIGHT BLUE
 ROYAL BLUE
 RED
 GOLD
 AQUA
 GREEN

Name _____
 Address _____
 City _____ State _____
 Please send your illustrated brochure

A "MUST" FOR Motorists!

Indispensable for night driving! Spots light where you need it—360° swivel. 800 ft. beam. Uses 6-volt dry battery. At hdwe., sport, electrical stores.

Delta REDDYLITE
 Electric Lantern

ELECTRIC COMPANY
 MARION, IND.

\$3.50
 less battery

BULL DOG HITCHES

Heavy Drop Forge Steel Construction. Strong — Safety-Engineered Reliable

Model No. 1-B NOW ONLY \$4.95
 Post Paid (when paid in advance)

Made for trailers with up to 2,500 pounds capacity.
 1 3/8" dia. shank Fits 1 1/4" pipe tongue

HAMMER BLOW TOOL COMPANY
 Wausau 14E, Wisconsin

FOR FAST ECONOMICAL WINTER TRAVEL BUY A

SnowCar

Four passenger 125 h.p. model as low as \$1985.00. Two passenger models—\$1550.00.

CALLAIR
 AFTON, WYOMING

ARRO-PING —the Original Arrow Sling-Shot has accuracy and power for small game or target with swift ping of an arrow. Sturdy, smoothly-made wood stock, metal-guided barrel, slender metal-tipped 12-inch arrows. Powerful rubber propulsion sends arrow 300 feet. Try skill in a new hunting thrill.

ARRO-PING CO.
 Box 25N, West End Station,
 Colorado Springs, Colo.

Postpaid, with three Arrows, \$1
 Or Arrows alone 20 for \$1

Mustang **LIGHTWEIGHT**
\$362.20
 (Fed. tax paid, at factory)

9.5 hp. 4-cycle. 3-speed. Foot-shift. Over 70 miles per gal. Over 60 m.p.h. Write for free circular.

MUSTANG, Dept. GP-86
 635 W. Colorado, Glendale 4, Calif.

TEAR GAS

100% PROTECTION

A REAL SURE-FIRE SELLER! THUGS AND THIEVES BEWARE!

Here is a tear gas pencil gun which discharges smothering clouds of tear gas to instantly stop, stun and incapacitate the most vicious man or beast. A safe and effective substitute for dangerous firearms. No permanent injury. Needed in Stores, Banks, Autos and Homes, everywhere to protect Life and Property. No skill required. Handle our tear gas as a side line and you'll soon give it full time. For a quick start send \$4.25 for complete demonstrator outfit consisting of an Automatic Pencil Gun with 10 demonstrators and 3 powerful Tear Gas cartridges fully guaranteed. Many thousands now in use. Order your outfit today. Not sold to minors.

Hagen Supply Corp. Dept. D-505 St. Paul 4, Minn.

PACKAGED BOAT KITS

**LARGEST CATALOG
EVER OFFERED!**

16 pages—80 construction and action photos PLUS specifications and performance data.

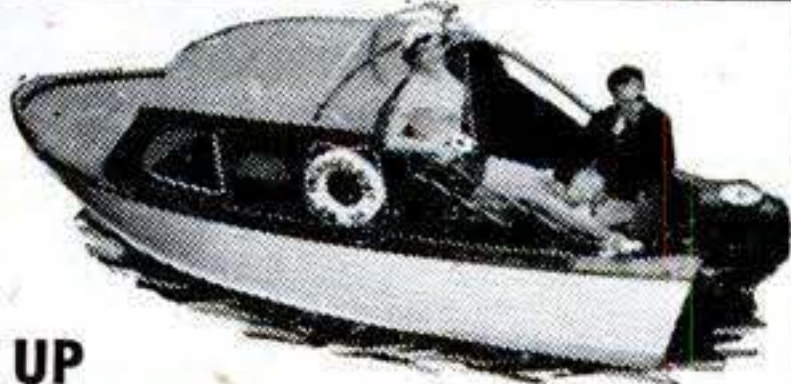

\$38.95 UP

COMPLETE LINE — SKIFFS, OUTBOARDS, RACERS, CRUISERS. 23 Models! Kits, Semi-finished and Custom-finished boats, hardware, paint.



SEND 35c FOR CATALOG

Catalog PLUS booklet on boat building, \$1.00

BOAT PATTERNS-BLUE PRINTS

Over 70 modern plans and full size patterns. Racing classes, cruisers, inboards, outboards, sail boats. By famous designers. 6' to 30'. CATALOG 35c. Catalog and boat building handbook, \$1.00.

MARINE MART-DEPT. 51-BUFFALO 7, N. Y.

CARBURETOR TOO RICH MAKES MOTORIST TOO POOR



Car owners who are wasting money and not getting proper gas mileage due to over-rich mixtures will be pleased to learn how to save gasoline by VACU-MATING over-rich mixtures. VACU-MATIC fits all cars, trucks and tractors. It is automatic and operates on the supercharge principle. Easily installed in a few minutes.

SALESMEN WANTED! Big Profits! Send name, address on penny postcard for free particulars and how to get yours for introducing.

VACU - MATIC CO.. 7617 - 1752 W. State St., WAUWATOSA, WIS.

POWERFUL

Interchangeable rifled barrels for 5 types of ammunition. .22 or .177 Cal. Hy-Score Pellets & Darts, & BB's. Small game HUNTING, indoor and outdoor TARGET shooting. The perfect gift. At your dealer now or write Dept. S-5



NO PUMPING
HY-SCORE
5 in 1
AIR PISTOL

HY-SCORE ARMS CORP., 25 Lafayette St Brooklyn 1, N. Y.

LAWN ORNAMENT-NOVELTY PATTERNS

28 Lawn Ornament Patterns, 25c. Other patterns: 15-20" high; Dutch Girl, Dutch Boy, Pirate, Bull Terrier, Mexican Girl, Mexican Boy, Dwarf, Penguin, Flower Girl, 10c each. 25 Novelty Patterns, 30c. All 62 Full Size Patterns, \$1.00 Postpaid.

FLYING DUCK

Wind revolves wings. Realistic appearance. Pattern, instructions and wing Pinion Kit; brass bearing, steel shaft, wing lugs, bolts, nuts and washers. 50c. Pattern and instructions without kit. 25c. Postpaid.



STROTHER PATTERN SERVICE
Dept. 7-BZ Box 128 Belington, W. Va.

Soap, Wash, & Rinse your car in a Jiffy!

Can also be used to wash windows, walls, boats, porches, garage floors, etc.



\$3.95
POSTPAID

Aluminum tube 3 1/2 ft. long. Built-in soap pouch . . . replaceable mop. Insert any household soap or detergent in built-in soap pouch and attach to garden hose.

Supply Limited, Order Now! MONEY BACK GUARANTEE
E. Z. CAR WASHER, 6 Bond St. (Dept. PS2) New York 12, N. Y.

Here's the Camera in YOUR Future

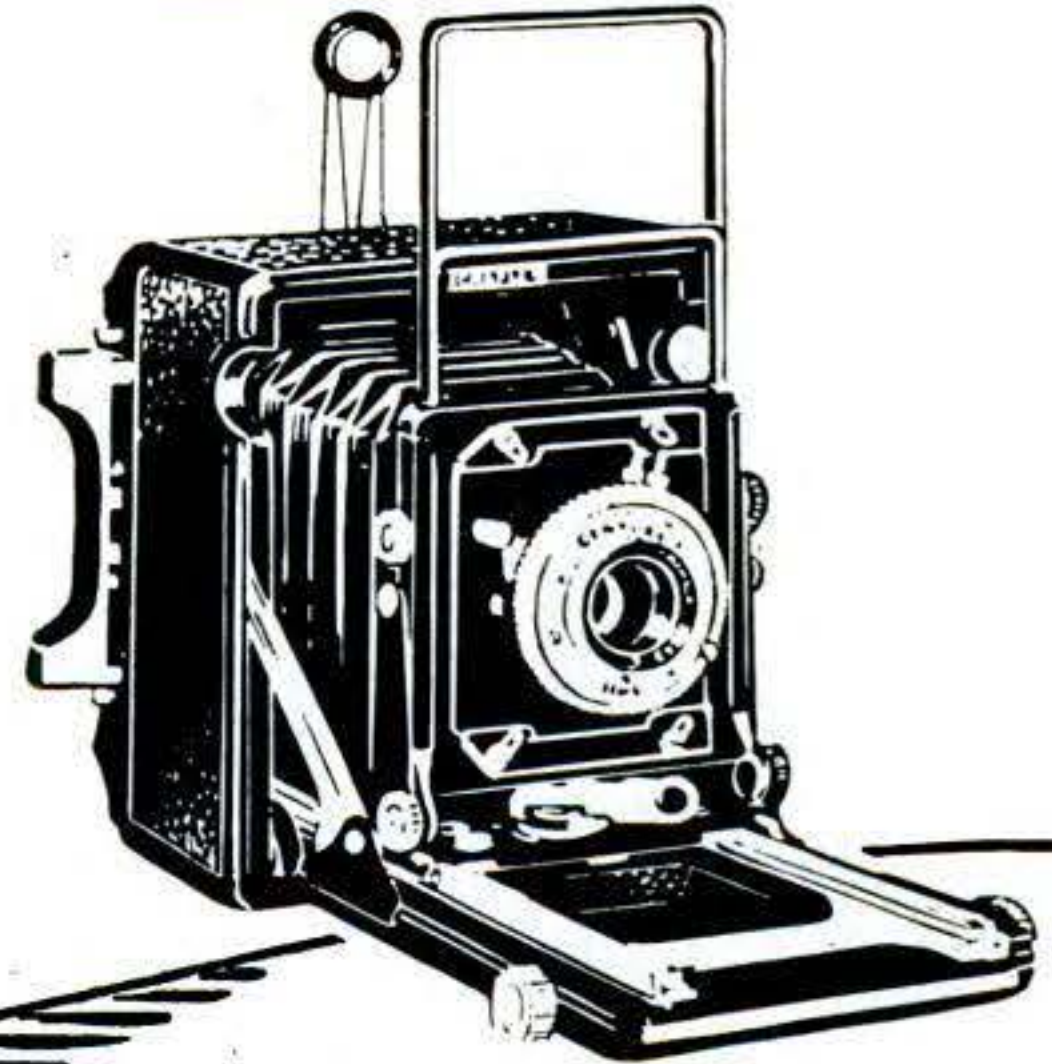

The **CENTURY GRAPHIC**
keeps pace with your skill!

A fine camera as it stands . . . ready to prove its versatility in a hundred ways. The Century is compact, efficient . . . the lowest-priced Graphic camera. It's rugged, dependable and built for your future! No matter how skilled you become, you'll never outgrow your Century, for it's designed to let you add the accessories you'll want as your technique develops . . . 120 Roll Holder, for economy with roll film . . . Graflarger, for enlarging through your camera . . . speedy Grafmatic, for action sequences . . . Grafite for flash perfection! Your dealer has the Century Graphic today, with fine coated f/4.5 lens, built-in flash sync., ground glass focus, Graflok back, complete for only \$109.50.

(Price subject to change.)



120 Roll Holder

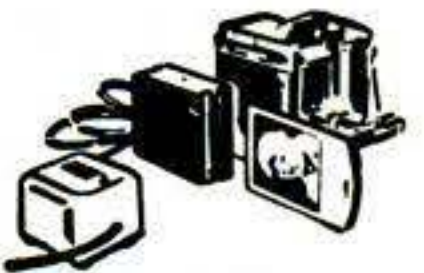

Graflarger



Grafmatic



Grafite Flash

GRAFLEX

Prize-Winning Cameras

Graflex, Inc., Dept. 82
Rochester 8, N. Y.

Please send details on:

- Century Graphic 120 Roll Holder
 Grafmatic Graflarger

Name _____

Street _____

City _____ Zone _____ State _____

WHEN GASOLINE WAS RATIONED LAST TIME DIDN'T YOU WISH YOUR CAR GOT

35 TO 50 miles per gallon?

Wouldn't a Crosley car in your garage be good insurance? Then you can count on 35 to 50 miles on a gallon of regular gasoline—150 miles of driving per week on an "A" card while most other cars are getting only 30 to 40 miles. Crosley has powerful engine with cast iron block, 8:1 compression ratio. Hundreds of improvements. And still less than \$1,000. Last time gasoline was rationed, used Crosley cars sold for over 3 times the original purchase price! See your Crosley dealer now.

FREE! 1951 Crosley Catalog! Write Crosley Motors, Inc., 2530-GW Spring Grove Ave., Cincinnati 14, Ohio.

CROSBLEY
a FINE CAR

You see them everywhere!

Assemble a

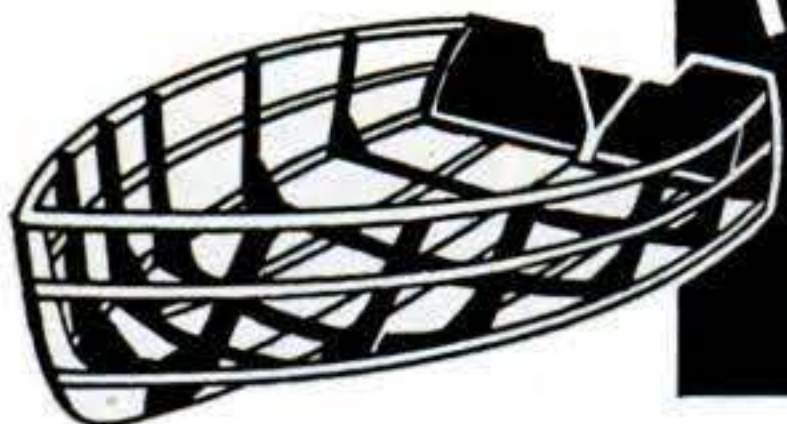

Roberts
KIT-CRAFT
BOAT

You can have a strong, fully guaranteed Roberts Kit-Craft Boat and save 50% by assembling it yourself. Finest marine materials . . . all brass screws . . . no "throw-away" jig required. All parts prefabricated!

9 NEW MODELS . . . FROM \$42.50

Prams — Cartops — Skiffs — Rowboats — Sailing Prams — Speed Hulls — Runabouts . . . 8 to 14 ft.

Send for big colorful catalog packed with dozens of action photos . . . 10c

Roberts Industries, Inc.
605 MAIN ST., DURHAM, CONNECTICUT

FOR SPORTS — FOR FUN

World's Finest "EM-GE"

BLANK PISTOL

"Shoot the Works"—safely—with this handsome blank pistol. Looks and sounds real enough for the FBI. But it can't hold regular cartridges. Six-shot magazine; safety catch. Precision-built of carbon steel. 3 1/4" long. A world-famous pistol, excellent value at..... **\$10.95**



ORDER BY MAIL
No Permit Required.
Send Check
or Money Order.
Save COD Charges

De luxe model with pearl handle \$15.00
100 blank cartridges \$1.50

J. L. GALEF & SON, Dep't. L-2, 85 Chambers St., N.Y.C.

BUILD YOUR OWN FAN



One-piece cast aluminum propellers for cooling and ventilating.

Size Inches	Polished		Unpolished		Bore Inches
	2 Blade	3 Blade	2 Blade	3 Blade	
15	\$3.00	\$4.00	\$2.50	\$3.00	1/2, 5/8, 3/4
18	3.75	5.00	3.00	4.00	1/2, 5/8, 3/4
20	4.00	5.50	3.25	4.50	1/2, 5/8, 3/4
24	4.50	6.50	4.00	5.50	1/2, 5/8, 3/4

Write for pamphlet on larger fan blades, wire guards, fan bases, shutters, pillow blocks, exhaust fan frames, etc. Shipped prepaid if money accompanies order. Dealers write for discount.

KLOPPENBORG ALUMINUM FDY. Dept. PS-551, Davenport, Iowa

NATURE'S HAIR OIL

100% PURE LANOLIN

Closest oil to natural oil of scalp. Odorless, non-greasy makes hair healthy and attractive. Most easily absorbed by skin to prevent dry scaly scalp (most common cause of dandruff). Used for years in famous hair tonics and fine face creams—NOW use 100% PURE lanolin—BE SURE YOU ARE GIVING YOUR HAIR THE BEST CARE POSSIBLE. Free booklet with order "HAIR CARE WITH LANOLIN" includes daily hair care and special lanolin dandruff treatment. Send today! 1 lb. 100% PURE LANOLIN 1 year supply \$2.95. Money back guarantee.

INITIAL PRODUCTS CO. 5856 8th Ave. LOS ANGELES 43, CALIF.

Make Money
SELLING
Eshelman
Tractors
and doing
Garden
Work

RAKES
SEEDS
CULTIVATES
HARROWS
HAULS
SPRAYS
SAWS
DOZER
MOWS
CUTS
ROLLS
PLOWS

ESHELMAN

FOR BETTER
LAWNS
and GARDENS
also POWER MOWERS
and RIDING TRACTORS
Women can operate it.



1 1/2-3.6
H.P.

as low as
\$95
PLUS
TOOLS

Free Catalog. Write
ESHELMAN CO. Dept. 119
119 Light St., Balto. 2, Md.

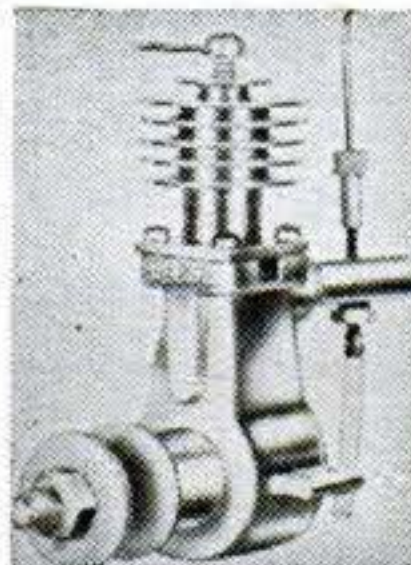

Our 391st Advertisement

REAL DIESEL ENGINE

\$2.95
● for planes, boats, midget cars
● 7500 RPM; 1/7 HP; ht. 3 1/2";
wt. 5 oz.
● comes completely assembled

You just can't beat this price for a complete precision diesel engine! Streamlined, rugged, compact. Starts quickly, easy to install, runs for years. Fast delivery if you ORDER TODAY! Send \$2.95 plus 25c postage.
Gotham Hobby Corp. Dept. S, 107 E. 126 St. New York 35

"It Measures As It Rolls"

ROLLER RULE

HANDY MECHANICAL PENCIL

\$1.29
POST
PAID

Measures Curves and Straight
Lines. Any Shape. Any
Distance. Any
Surface.

Roll head over surface.
Inches and fractions record
accurately on "Inch-O-Meter".
Excellent pencil tool! Order Now!
10 Day Money Back Guarantee!
C.O.D. (postage extra). In Calif. add
3% Sales Tax.

PENCIL SALES CO., Dept. PS-5
Room 6, 1213 E. Ocean Blvd., Long Beach, California



MAKE YOUR OWN AUTOMATIC ELECTRIC WATER HEATER

NOW
ONLY
\$19.95

Underwriter
Lab Approved



Simply screw this heater into tank or range boiler, as shown. Fits into all standard tank taps. Plug into electric outlet. 1250 watts 115 Volts A. C.

Now . . . all the hot water you want at small expense with this efficient heater. Only 1/5 the cost of a new system. No new tank or expensive plumbing required. Install in five minutes . . . economical to operate . . . requires no attention. Has adjustable built-in thermostat. Shuts off automatically when water is heated to your desired temperature . . . turns on when temperature drops. Absolutely safe. Ideal for home, store, summer cottage, greenhouse, farm, barn, stock tank, scalding, factory, etc.

ONE YEAR GUARANTY . . . money back in 10 days if not completely satisfied. Send check or money order and save postage.

COLLOID EQUIPMENT CO., INC.

46 CHURCH ST., NEW YORK 7, N. Y. WOrth 4-3877

"BB" FIBERGLAS BOATS

One-Piece. Leak-Proof, Rot-Proof. Will Never Need Painting or Upkeep. No deterioration. Great Strength, Safe. Permanently buoyant.



Send for free folder

Nine models. Row-boats, Sailboats.

BEEBLE BOAT CO., INC., New Bedford 8, Mass.

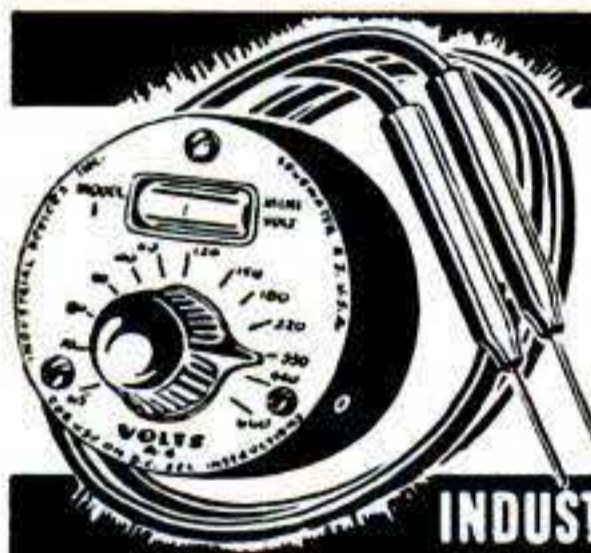

1,001 USES!

Turn the knob—read the voltage. Indicates whether AC or DC. On DC indicates polarity. Picks up 2 volt drop at 110 V. Measures from 65-660 V. Virtually burnout-proof. Guaranteed for 25,000 hours' use. Rugged! Throw it in with tools. 12" flexible test leads and prods. Not a gadget, but a proven tool. At your dealer's or postpaid. **\$3.00**

INDUSTRIAL DEVICES, INC., EDGEWATER 2, N. J.

COLORFUL TWO INCH WEBBING

It's fun to make gay furniture with Webcraft's bright webbing. Try a chair or stool. 30 colors, six textures. 20c-45c per yard. Send 10c for samples—Dept. P.S. Deduct 10c from your first order.

WEBCRAFT

Box 51 Oxford, Mass.

NOW, GET SPLIT SECOND ACCURACY . . . AT THIS SPECIAL LOW Price!



Shown 1/3 Actual Size

60-second dial; long hand indicates fifth seconds; 30-minute lapsed time recorder; side button starts and stops; fly-back from crown. HUNDREDS OF USES: Industry, Radio, Sports, Teachers, Coaches, Photographers, Doctors, Racing, Football, Swimming, etc. You must ORDER NOW to be sure of this exclusive low price: \$9.95 plus 10% tax (total \$10.95) SUPPLIES ARE LIMITED! Shipped insured. We pay postage if cash or money order enclosed. You pay few cents postage if sent C.O.D. Ohio residents include 3% Sales Tax.

ECONOMY TIME PRODUCTS, Dept. PS-5
205 Colonial Arcade Cleveland 14, Ohio
Dealers in Finer Watches for Over 50 Years

Exclusive with us
\$9.95
plus 10% tax (\$1.00)

If your work or hobby requires accurate timing, you can't afford to be without this precision, combination START, STOP and FLY-BACK TIMER. Never before offered at this low price—compare these outstanding features with Timers selling for \$18.50 and more.

- Imported Jeweled Swiss Movement
- Unbreakable Crystal ● Chrome Case
- One Year Factory Guarantee

Pre-tested, accurate and dependable with



PHEW-W

..that muck in my car?

A mucked-up oil filter can cost you plenty in engine repairs. Get in a new **Purolator* Refill—quick!**

Any filter naturally chokes up—loses effectiveness after an average of every 5,000 miles you drive.

What to do? Don't delay—get in a clean filter refill—fast. Which make? Pays to buy the best—a Purolator Micronic*. New accordion-type design gives up to 10 times the filtering area—with pores so tiny they trap particles you can't even see. Cost much? Strictly small change—\$1.38 to \$3.00, depending on car make. Purolator Products, Inc., Rahway, N. J.; Toronto, Ontario, Canada.

*Reg. U. S. Pat. Off.

PurOlator

MICRONIC
OIL FILTER

Why, sure it's **WILLIAM BENDIX**, you knew it all the time.
Co-starring in RKO's "Macao"

USE A PFLUEGER REEL



ENJOY BETTER FISHING AS LONG AS YOU LIVE

Cast lures better—place them more accurately—have instant response hooking strikes. A Pflueger Reel can give you an entirely new appreciation of fishing. The Pflueger quality guarantee never expires. Ask your Dealer.

PFLUEGER SUPREME
\$35.00



THE ENTERPRISE MFG., CO.
AKRON, OHIO
87 Years
Making Fishing Tackle

PFLUEGER
(Pronounced FLEW-GER)
A GREAT NAME IN TACKLE

Give "OLD TIMERS"

They're Perfect for FATHER'S DAY Gifts!

How thrilled he will be with these authentic, fascinating 1/4" scale models of these favorite antique autos! What fun he will have assembling these nostalgic miniatures! And, what pride he will have in showing them to friends—or decorating his desk or den with them!



1909 STANLEY STEAMER \$2.95



1910 MODEL "T" FORD \$2.50

We show only a few of the 15 famous vintage cars of yesteryear in our collection—each perfectly detailed and completely pre-fabricated. Comes with die-cast plastic parts, cast wheels, lights, horns, radiators, and easy-to-follow instructions. Which of the 15 models will you give to your Dad?



1911 MAXWELL \$2.50

1904 Olds	\$1.95
1911 Buick	2.50
1903 "A" Ford	2.50
1909 "T" Ford	2.95
1903 Cadillac	2.50
1900 Packard	2.50
1903 Rambler	2.50
1910 Internat. Harvester	2.95
1913 Mercer	3.95
1906 "Old 16" Locomobile	3.95
1914 Stutz Bearcat	3.95
1902 Franklin	2.50

SEE them at your hobby, toy, or department store, or write to us
Add 25c for postage and handling; no C.O.D.'s, please.

Hudson Miniatures' "OLD TIMERS"
SCRANTON HOBBY CENTER, Dept. 28, Scranton 10, Pa.

FANS FOR EVERY PURPOSE!

WESTAIR
The Finest in
KITCHEN VENTILATORS

In lifetime mirror finish aluminum. Cast door and frame.
MODEL 857
5 YEAR \$34.95 Save at Least 30% TO 40%
Dust and Grease Proof Motor

Reversible window Fans, Floor Circulators, Exhaust Fans, Attic Fans, Steel Blowers, All Types, The Newest in Circulators.

DEALERS INQUIRIES INVITED
FAN BLADES, MOTORS, SHUTTERS

WESTERN APPLIANCE CO., Inc.
5650 Grand River Ave. Detroit 8, Mich.

WRITE TODAY
For Free Price List and Catalog

ESTAB. 20 YEARS

Largest Stock All Type Airplane Tires In World

LOOK! NEW

6 PLY TIRE, TUBE & WHEEL

Only **\$8.95** Cash with order
Frt. Collect 9 1/2 lbs.

5/8" bearing, carrying capacity 500 lbs. 4 in. machined wheel, high speed TIMKEN bearing. Ideal for handcars, bogies or trailers. Total Height 10 1/2 in.

AIRPLANE TIRE CO.
SO. 99 HI-WAY TULARE, CALIF.

LOWER YOUR CAR

CALIFORNIA STYLE

with the Original Clark Lowering Blocks

- Far greater safety at high speed
- Less body rolling in turns
- Less front end dip on quick stops
- Lowers rear end to front end level

Complete kit only \$3.00, includes parcel post chg. 30 minutes to install—state make & year of car. Special kit for Ford & Merc 1932 to 1948 \$1.00

Over One Million In Use

CLARK HEADER CO.
6990 E. Firestone Blvd., Downey, Calif.

RE-STRING RACKETS AT HOME—EARN MONEY

Earn Money at home in spare time. It's pleasant, profitable work. No experience or skill required. Easy to learn. Full line of guaranteed **Stringing Tools, Frames, Gut and Nylon Strings**. Every item high quality.

FREE
Write today for our Catalog and Instruction Sheet.

W. A. BICKEL & CO., 803 So. Boulevard PS-5, Oak Park, Ill.

EVEREST & JENNINGS WHEEL CHAIRS

for Smoothest Performance

Special 8" Caster
UNIVERSAL

Outdoors or in, Everest & Jennings Wheel Chairs handle with ease! They fold for travel, work or play. Attractive, light and strong. All welded joints. Folds to 10 inches.

See your dealer or write for catalog

EVEREST & JENNINGS
761 N. Highland Ave., Los Angeles 38, Calif.

THE SPORTSMAN

\$249⁵⁰

plus tax
FOB Pontiac

long, low,
and lively



THE AMBASSADOR

\$249⁵⁰

plus tax
FOB Pontiac

big, rangy, and
rugged



Here's your Whizzer!

**BETTER THAN EVER
FOR FUN AND LOW-COST RIDING!**

Yes, now's the time to get your Whizzer!

Three great Whizzer motorbikes to choose from—new Ambassador, full size, fully equipped, with many luxury features; Sportsman, a low-slung beauty with great riding qualities; and Pace-maker, popular-priced motor-

bike that's complete and ready to ride.

All Whizzer motorbikes powered by the famous 4-cycle, 138 c.c., 3 h.p. Whizzer motor. Up to 100 miles per gallon, speeds from 5 to 40 m.p.h. This motor, sold complete with attachments, can make any standard heavy-duty man's bike a motorbike.

See the Whizzer line at your dealer's, or write today for free booklet.

THE PACEMAKER \$199⁵⁰

plus tax
FOB Pontiac



THE MOTOR

America's
finest
bike motor

\$109⁹⁷

FOB Pontiac



WHIZZER MOTOR COMPANY • 362 S. Sanford St., PONTIAC, MICH.

**USE
YOUR
ATTIC**

Install the
PRECISION
folding stairway
YOURSELF

Fits all ceilings. Just saw the hole in your ceiling—frame the hole with 2x6's, nail the stairway in place and cut off the stairway at the calibrated ceiling height. The Precision Stairway is simple and easy to operate. No springs, actuated by counterweights, it's perfectly balanced, raising or lowering easily with one hand. Composition safety treads on steps. Insulated door panel. Requires no attic space. Made of No. 1 kiln dried poplar with cast brass hinges, heavy cast aluminum rocker arms and brackets. Approved by F.H.A. everywhere

See your local lumber dealer or write direct today.

Manufactured by

PRECISION PARTS CORP.
Nashville 7, Tennessee



BOAT KITS Easy To Build

ROWBOATS
10 TO 14 FT.

PRAMS
\$39⁶⁰ up

8 TO 11 FT. ALSO WITH SAILS

OUTBOARDS
12 TO 16 FT.

**INBOARDS &
CABIN CRUISERS**
16 TO 23 FT.

NEW CATALOG
MOST COMPLETE EVER OFFERED

- 1 - BOAT KITS - 26 MODELS
- 2 - MARINE HARDWARE
- 3 - MARINE ENGINES
- 4 - MARINE CONVERSIONS
- 5 - PAINTS & COLOR CHARTS

► All For Only 35c, SEND COIN TODAY

U-MAK-IT PRODUCTS 703R-WHITTIER ST.
New York 59, N. Y.



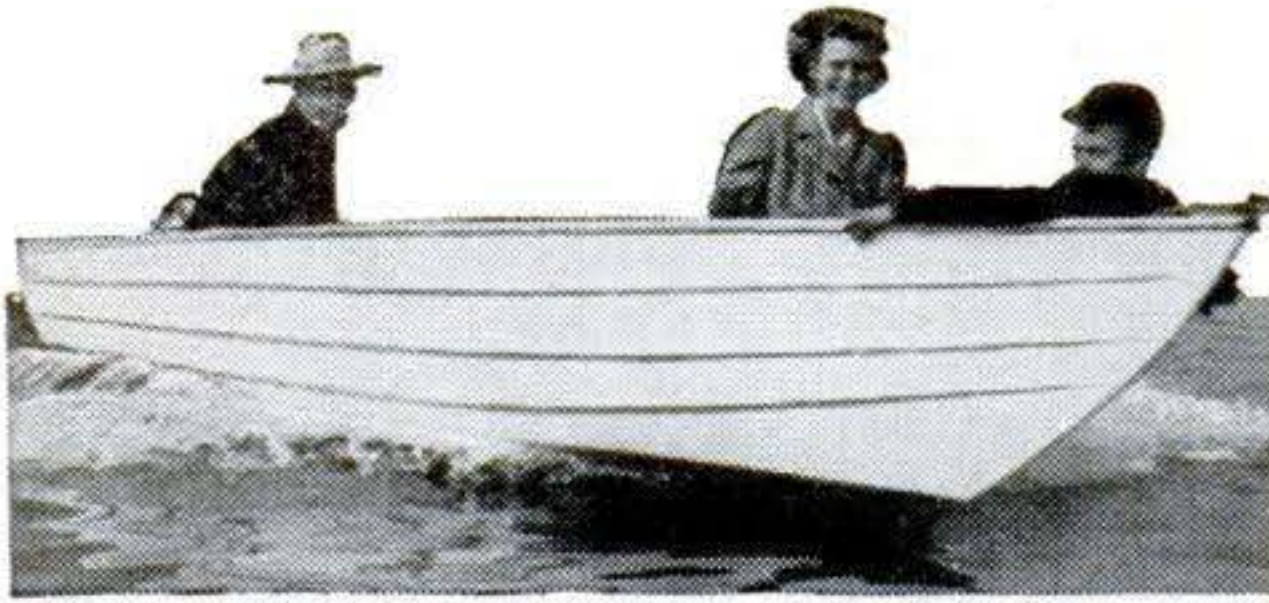

STURDY-SAFE

Get this Old Town Skiff

• In salt or fresh water — in calm or rough seas — this boat handles equally well. From Maine to Florida, sportsmen say it's dependable in all kinds of weather. Its high bows and staunch construction make it ideal for family use. Built to carry outboard motors of 2½ to 16 H.P.

FREE CATALOG shows just the model you need. Write for one today! Also rowboats, dinghies, sailboats, canoes.

OLD TOWN BOATS

Old Town Canoe Co., 745 Wood St., Old Town, Maine
PLEASE SEND ME FREE CATALOG

Name _____

Address _____

City _____ State _____

HULA DANCER • GETS BIG FISH

Small but mighty, this deadly open-water hooker is heavy enough to make long casts easier. Sinks and runs medium depth. Special "lip" gives special action — fools the wise ones. 5/8 oz. At your dealer. \$1.25 ea.



FRED ARBOGAST & Co., Inc., 2375 W. North St., Akron 3, Ohio

FREE WRITE TODAY FOR BIG FREE 1951 ARBOGAST COLOR CATALOG—FULL OF PICTURES OF CATCHES

Now, a G-E sealed beam type headlamp for BIKES!

Gives more light, does not grow dim!



Brings the same advantages to bikes as the famous General Electric "all-glass" sealed beam headlamp has brought to automobiles! Has own built-in reflector. Does not grow dim with age. Beam is five feet wide—thirty feet long. Operates on 5-volt hand-lantern battery or electrical generator used on bicycles. Now on sale at hardware and bicycle stores.

GENERAL  ELECTRIC

ELECTRICITY *Anywhere*

FOR PORTABLE, EMERGENCY OR HOME USE

ONAN Electric Plants generate 110-volt, 60-cycle current for homes, farms, cabins and resorts beyond the highline. Lightweight, portable plants cut costs, speed work for contractors. Standby plants protect hospitals, homes, civil defense units against power failure. 400 to 55,000 watts. Gasoline or Diesel-powered. Priced from \$219.00.



WRITE FOR CATALOG

D. W. ONAN & SONS INC.

6727 ROYALSTON AVE. • MINNEAPOLIS 5, MINN.

weather station



WIND SPEED, DIRECTION, TEMPERATURE

The ACI Windometer is in use by airlines, govt., yachtsmen, flyers, industry — self contained—complete precision units—continuous reading—Send for free booklet — write Dept. B-5 **\$89.50**

"Aviation's Leading Supply House!"

AIRCRAFT COMPONENTS, INC. Benton Harbor, Mich.



SPORTONE MUFFLERS

Ford & Chevrolet.....	\$ 4.45
All other popular cars.....	5.45
V-8 Dual Sets.....	15.95
Chromed Silentips.....	2.95

(Please state make & year of car on all orders.)

SANDEE MUFFLER CO.
5643 Corryne Place • Culver City, California



HOT RUNNING WATER!

Attaches easily, quickly to any standard faucet. Regulates temperature by turning faucet. Operates AC or DC. Comes with 8-ft. rubber cable and plug. Our DELUX heater has delighted many thousands of users. Send \$3.95 cash, check, or M.O.—we will ship prepaid or, if you wish, we will ship C.O.D.—you pay postman \$3.95 plus few cents postage. Order 3 for \$10—save \$1.85.
METROPOLITAN ELECTRONICS CO.
Dept. 328, 106 Fifth Ave., New York 11, N. Y.

BATTERIES START A FACTORY AT HOME

—and re-cast junk batteries into new, with and without new materials; the latest achievement. We supply complete instructions and everything needed. Big profits daily!

BATTERY LABORATORY SCHOOL
DEPT. PSM, MINNEAPOLIS 4, MINNESOTA



A BETTER KIT FOR LESS

Exclusive Ozarka Laminated rib Construction
OWN THE BEST! Build an OZARKA and SAVE 35 to 65%. All models still available—handy car-top, snappy runabouts. Send 25c for complete catalog, **\$39.50** refunded on first purchase..... and up.
OZARKA, INC. 751 BORDEN LANE, WOODSTOCK, ILL.

SUMMER AHEAD!
Install

DEPENDABLE
CHAMPION
SPARK PLUGS



CHAMPION SPARK PLUG COMPANY, TOLEDO 1, OHIO

MAY 1951 75

FISHERMEN!

FREE Beautiful Colorful Shakespeare 1951 Tackle Book and Fishing Calendar

FEATURING:

- Joe Godfrey's Fishing Calendar—Shows Best Days to Fish!
- Casting lessons, fishing tips, "Balanced Tackle" suggestions by U. S. Champion Ben Hardesty.
- "Fitting the Tackle to the Man—or Woman"—by Jason Lucas, famous angling authority.
- New Shakespeare Direct Drive Reels with LQT NYLON Gears—the tackle sensation of the year.
- Genuine Shakespeare Howald-Process Fiber Glass Wonderods. New Low Prices!
- Wexford Wonder Line, Black and "Invisible".
- The Shakespeare President—NOW built with 3 miracle materials—Carboloy, Nylon and "18-8" Stainless Steel.
- Famous Shakespeare Wondereels that Make You a Fisherman in 5 Minutes.

MAIL THIS TODAY!

Shakespeare

Shakespeare Company, Dept. PS-5
Kalamazoo 2, Michigan

Please send me your FREE 1951 Tackle Book and Fishing Calendar.

Name _____

Address _____

City _____ State _____

If You Own a Schick or Remington Electric Razor . . .

You get a closer shave and greater comfort by preparing your face before you shave. In just three seconds this wonderful lotion "sets up" your face for shaving.



1. It evaporates sticky, razor-clogging perspiration.
2. It lubricates the skin for faster, more comfortable shaving.
3. It tautens your skin—"brings out" beard for closer shaves.

That's Lectric Shave. Only 49¢, plus tax, for 3 oz.—80 shaves. Use with any make shaver. For a free month's supply send name, address to The J. B. Williams Co., (PS-2), Glastonbury, Conn.

It also lubricates shaver's cutting head for easier action, longer shaver life!

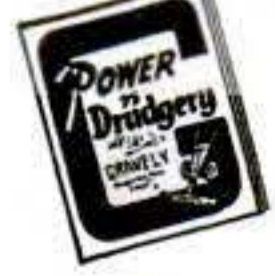

5-HP Gravelly Tractor powers 20 tools—does every lawn, garden, field job *easier, better!* All-gear drive, Reverse. "Power vs Drudgery" Booklet FREE. Write for it today!

GRAVELLY MOTOR PLOW & CULTIVATOR CO.
BOX 584 DUNBAR, W. VA.

FIELD-TESTED FOR 30 YEARS

THROWING DAGGER \$2 postpaid

This MALAYAN FIGHTING KNIFE is used for self-defense, killing game, target skill. A powerful, silent, accurate weapon. Splits 1" board at 30 ft.

Balanced to stick!



Fun, Thrills, Excitement!

Indoors—outdoors. Learn this Sport! Easy to throw accurately with our clear instructions. Beautiful, heavy-duty 10" knife. Tempered steel. Tough, rawhide-bound handle. Rare souvenir, unusual bargain. Limited quantity. Sold direct only. Send \$2 to Wholesale Import Co., Dept B 604 S. Marengo, Alhambra, Calif.

ACCURATE

Most POWERFUL patented air pistol made. Looks and feels like Luger. For Cal. .177 or .22. Game HUNTING, indoor or outdoor TARGET shooting. At your dealer, or write Dept. SA-5

NO PUMPING HY-SCORE AIR PISTOL

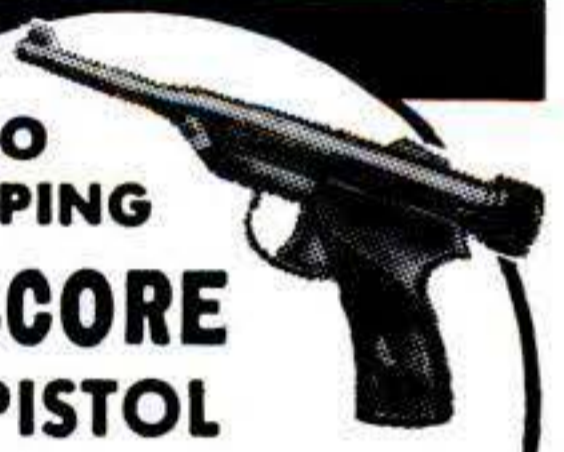

HY-SCORE ARMS CORP., 25 Lafayette St Brooklyn 1, N. Y.

ELECTRIC MOTOR BARGAINS!



1/4 HP	1750 RPM 110 Volt 60 Cy. Split Phase Type....	\$ 8.50
1/2 HP	3450 RPM 110V 60 Cy. Cap. Type	22.50
3/4 HP	3450 RPM 110-220V 60 Cy. Repulsion Induction	34.50
1 HP	1750 RPM 110-220V 60 Cy. Capacitor Type.....	52.50

Every Motor Fully Guaranteed. Write for 32-Volt Bargain List. ALL PRICES F.O.B. ROBERTS ELECTRIC CO., 849 W. Grand, Dept. 1, Chicago

17 FOOT 2 INCH **KLEPPER** FOLDING BOAT for SAIL, PADDLE or MOTOR

PORTABLE: Pack up in 2 bags for car, air, or train travel



Send for Catalogue!

KLEPPER CO.
Dept. PO
1476 Broadway, New York 18

unsinkable AERIUS



SPORT AND TRANSPORTATION ... at a saving

WHETHER you're heading for good times or going to work, get there faster, more enjoyably and at less cost... on a Harley-Davidson Hydra-Glide. Swift and smooth for long distance travel. Safe and easy to handle in city traffic. Amazingly comfortable even on roughest roads. And so thrillingly power-packed and responsive you'll think you're riding a "Flying Saucer"! Small down payment, convenient terms. Phone or see your dealer. Mail the coupon now.

HARLEY-DAVIDSON

HYDRA-GLIDE®

DEALERS WANTED: A few franchises available for the full line of famous Big Twins and the 125 Model. Write today.



HARLEY-DAVIDSON MOTOR CO.
Dept. PS, Milwaukee 1, Wisconsin

Send me free copy of ENTHUSIAST Magazine filled with motorcycle action pictures and stories; also literature on latest models.

Name.....

Address.....

City..... State.....

Tune it up **THE EASY WAY!**



TUNE YOUR ENGINE—KEEP IT TUNED.

Casite gets rid of winter's gum and goo, frees sticky valves and rings, lets the power zoom through. Casite guarantees Better and Smoother Motor Performance or Double-Your-Money-Back.

Casite in the crankcase keeps the engine free-running—gives cleaner, keener performance the whole year round.



KEEP IT RUNNING LONGER

Casite gives extra protection against engine wear, by speeding lubrication. Casite speeds the flow of No. 10 motor oil 24.3% at 50°F.—more when the engine is colder—greatly reducing start-up wear. Casite gets enough oil to the right places at the right time—cuts repair bills throughout the life of your car.

Get Casite today from your garage, service station or car-dealer.

CASITE DIVISION, • HASTINGS MANUFACTURING COMPANY
HASTINGS, MICHIGAN
Casite Division, Hastings Ltd., Toronto

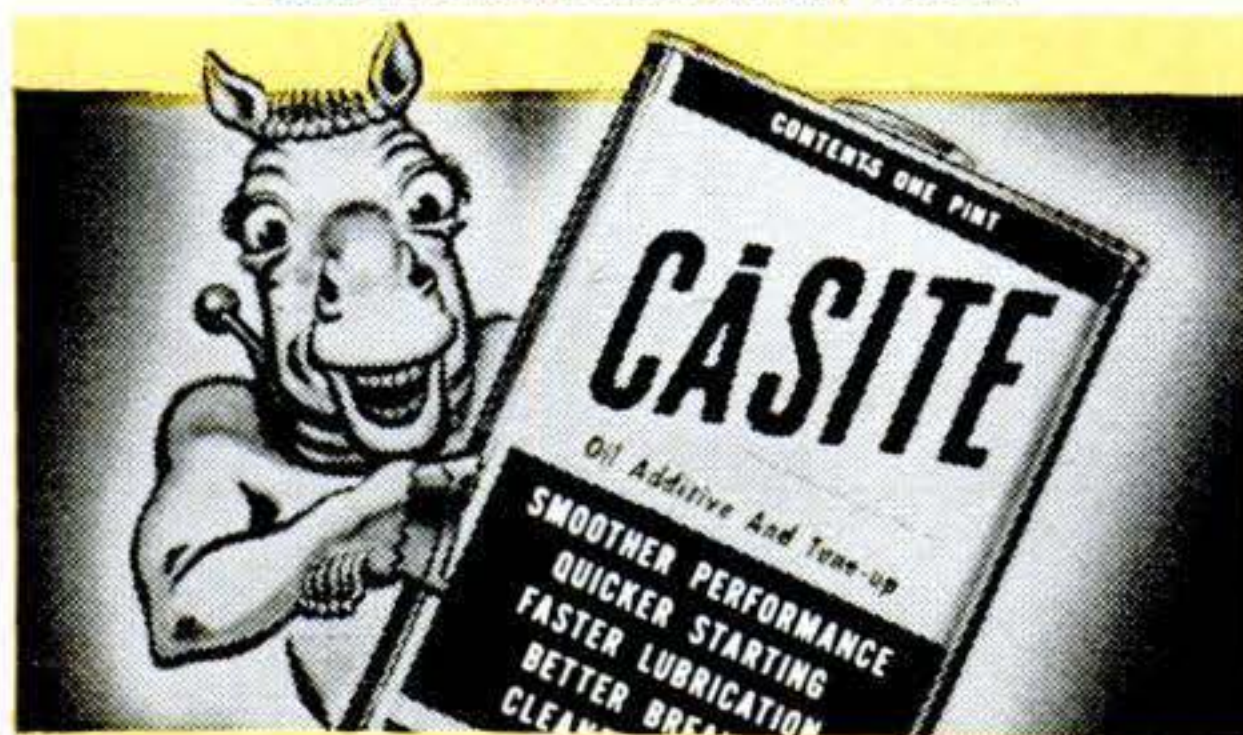

FREE! Write for your free copy of "Facts of Engine Life."

Wagemaker
GRAND RAPIDS, MICH.
WOLVERINE BOATS

More boating pleasure in your new 'Wolverine'. Rugged craft, they're built to give you lasting service. Over 50 improved models. Free literature.

WAGEMAKER CO. DEPT. 36 GRAND RAPIDS, MICH.

**ALL-NEW
SCHMID
CROSSBOW**



**ACCURATE
POWERFUL
LIKE A GUN
REAL SPORT**

Whether you are an experienced hunter or a backyard target sportsman, you'll find a real thrill when you shoot this all-new, precision built crossbow. Packs enough power to kill a bear... has bull's-eye accuracy to send the bright, feathered arrow "On Target!" every time. Economical—no costly ammunition. Fun for the whole family. Learn all about this superbly constructed crossbow and new sports thrill now. Send today for free illustrated folder. (Crossbow, complete: \$39.50—Target arrows: \$5.95 dz.)

SCHMID & CO., Dept. P2, 1513 N. Gardner, Los Angeles 46, Calif.

WHY OVER A MILLION MOTORISTS SWEAR BY THEIR HULL AUTOMOBILE COMPASSES

ONLY by installing one BEFORE you get into a mix-up on directions can you fully appreciate what Hull Automobile Compass users mean when they say: "Worth its weight in gold!" Save time, worry, miles with the ONE famous name in automotive compasses.—Write for local dealer's name, free literature.

HULL MFG. CO.
P. O. BOX 246-E5, WARREN, OHIO

Beaconlite \$6.95
illuminated
STREAMLINE \$4.95
standard (not illus.)

JITTERBUG • CATCHES MORE FISH

The old favorite. Noisy surface bait. World's best hooker—day or night. Gurgling, paddling action of the double-lobed lip makes fish strike hard. At your dealer 5/8 oz. or 3/8 oz. \$1.25. Musky size \$2.00.

FRED ARBOGAST & Co., Inc., 2345 W. North St., Akron 3, Ohio

FREE WRITE TODAY FOR BIG FREE 1951 ARBOGAST COLOR CATALOG—FULL OF PICTURES OF CATCHES

**HI-POWER
15 MILE
RANGE**
(Actual Photo)

**SPECIAL!
LOW PRICE
WHILE THEY LAST**

NEW! SPECIAL IMPORT

Our sensational purchase is now AMERICA'S BEST BUY. Beautifully engineered to precision standards. Rich-looking, all-metal rugged construction. Balanced for long-range with extra-wide field of vision. Clear sharp images. Rigidly tested and approved. **LIMIT 2 orders. UNBELIEVABLE PRICE only \$3.95 plus 80¢ Fed. Tax (Total \$4.75).**

SEND \$1 DEPOSIT—Pay postman \$3.75 plus postage charges on delivery. Cash orders sent postpaid... **SUPPLY LIMITED!**—dealers please do not apply.

Amazing Price \$3.95 plus tax
10 DAY FREE TRIAL MONEY BACK GUARANTEE

BUILT-IN Magnetic Compass
(Extremely accurate and handy)

SUPERIOR FEATURES include:

- Center "Finger-tip" FOCUS CONTROL
- Special silicone COATED LENSES (will not fog up)
- PRECISION GROUND powerful lenses
- FULL SIZE but LIGHTWEIGHT
- Large 25MM OBJECTIVES

BINOCULAR IMPORTERS, Dept. A5 158 No. Kinneloa, Pasadena 8, Calif.

Pick your ".22"



from the line that's ... "First in the Field"

"3-in-1" Auto-loaders
Fast Handling Slide Action Repeater

Accurate, Speedy Bolt Action Repeaters
Safe, Dependable "Single Shots"

Take your pick and pick a Savage or Stevens .22 caliber rifle. You'll find a wide choice of models to choose from with "First in the Field" features and values. Write for free catalog of Savage, Stevens and Fox rifles and shotguns for every shooter and every kind of shooting.

SAVAGE ARMS CORPORATION
Firearms Division, Chicopee Falls, Mass.

 **SAVAGE**

SAVAGE • STEVENS • FOX Rifles and Shotguns

SAVAGE • WORCESTER Power and Hand Lawn Mowers



OUTSTANDING FEATURES OF SAVAGE AND STEVENS ".22" RIFLES

Precision Rifled Barrels
Strong, Dependable Actions
Tubular or Clip Magazines
Large, Well Proportioned Stocks
Standard or Peep Sights

STEVENS MODEL 87—.22 cal. Automatic, the rifle with exclusive 3-in-1 feature—instantly adjustable as an auto-loader, using .22 long rifle cartridges; or as a hand operated repeater or single shot, shooting .22 long rifle, .22 long or .22 short cartridges. Simplest, most trouble-free action of any .22 auto-loader. Easily, quickly disassembled without tools. Choice of clip or tubular magazine models.

STEVENS MODEL 15—.22 cal. single shot, bolt action. A long-time favorite for the younger shooter. Now a greater value than ever. Strong, simple, hand-cocking bolt action provides maximum safety. Newly designed bolt handle directly above trigger gives fast, positive operation. Large, well proportioned, one-piece stock. 24" barrel. Gold bead front sight and open middle sight with elevator.

SPORT UNLIMITED...

Small game shooting is one of the many sport opportunities that are yours with a Stevens .22 cal. rifle. Informal target shooting, plinking and the new competitive rifle games built around "bustible" targets, offer year 'round ".22 fun." For more information, ask your dealer, local gun club official or write: Sportsmen's Service Bureau, Dept. 4206, Arms and Ammunition Manufacturers' Institute, New York, N.Y.

**NOW—a new easy way
to wash your car**

**DU PONT
CAR
WASH**

**makes the job
no job at all!**



It's a synthetic detergent... not a soap!

Here's the fastest, easiest way of washing a car! Just put a little DU PONT CAR WASH into a half pail of water, and you'll get the ideal car-washing solution, with an abundance of foam. Then, *swish, swish . . .* it

cleans away grease, oil, without harm to finish or tires. No need to use a chamois. After a good rinsing, your car drains dry and bright... *without streaks or spots.* Try DU PONT CAR WASH next time and take life easy!



DU PONT NO. 7 POLISH—gives a, "super" shine with much less rubbing. Contains "stroke-saving" methyl cellulose. Works wonders on *all* car finishes!



DU PONT SPEEDY WAX—made especially for *new* cars—and those fairly new. Cleans and wax-polishes in one easy step. Produces a dry, brilliant lustre.



DU PONT TAR REMOVER—a safe, easy way to remove tar, road oil, and tree sap from your car. Will not soften, discolor or dull the finish.



DU PONT CHROME POLISH—cleans and polishes bumpers and chrome fittings quickly and safely. Excellent also for nickel, brass, copper, and stainless steel.



REG. U. S. PAT. OFF.

BETTER THINGS FOR BETTER LIVING... THROUGH CHEMISTRY

Popular Science

Highlights

This Month



House that Auto Surplus Built: The materials for this unusual home came from surplus stock of an automobile factory. **Page 130**



The Right Way to Climb a Ladder: The first rule is to make balance and leverage work for you—not against you. **Page 170**



Pint-Size Racers Thrill Track Fans: These “three-quarter midgets” put an exciting show smack in the crowd’s lap. **Page 110**

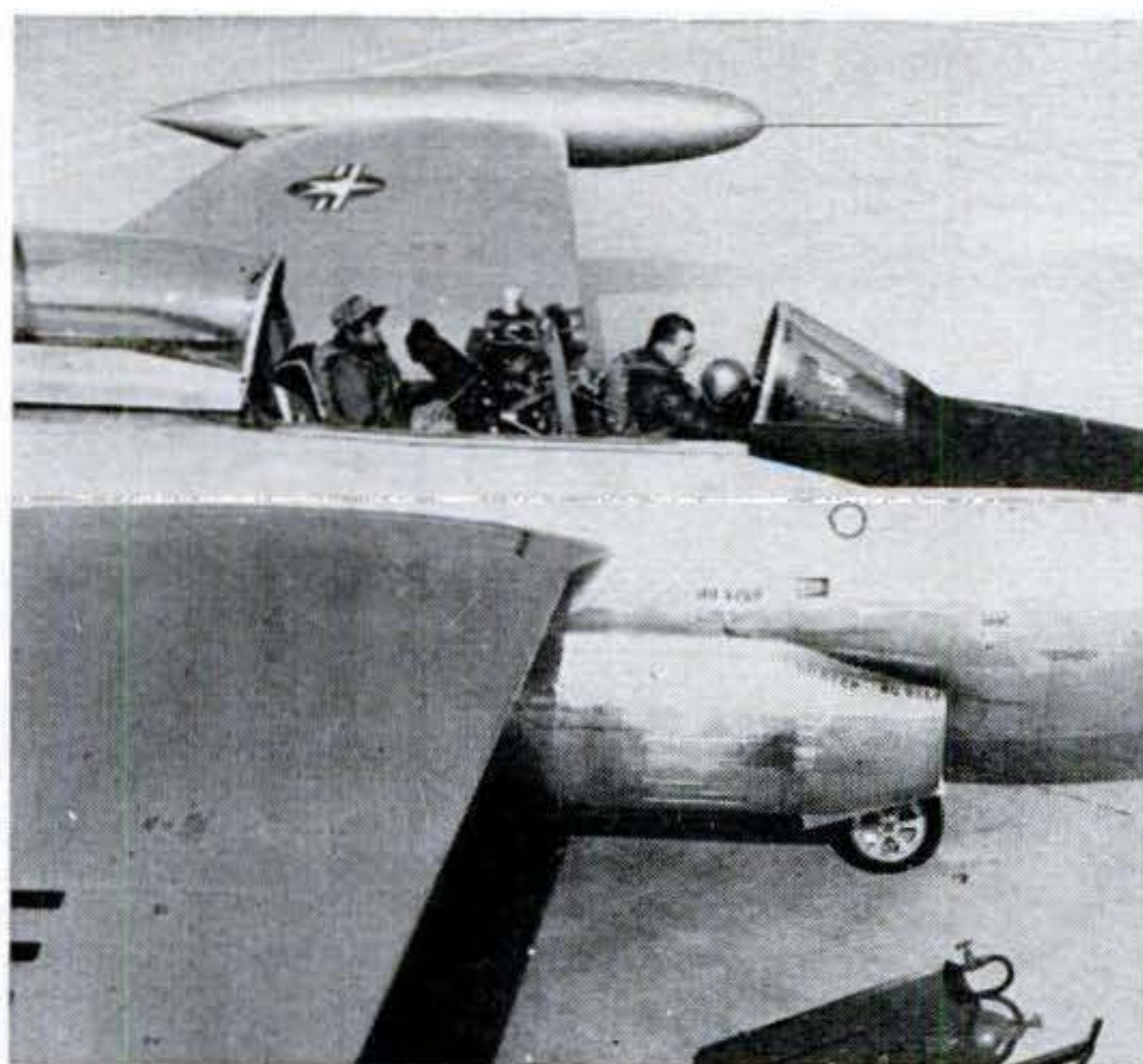

Meet the 700-m.p.h. Scorpion: The Air Force is putting its money on this all-weather F-89 jet to defend continental U. S. **Page 143**



Concrete Can Be Colorful: New dyes, stains, and paints make it easier to take the drabness out of your slab floors. **Page 197**



How Good Are the "Little Cars"?

By **Wilbur Shaw**
PS PHOTOS BY W. W. MORRIS



the Austin: refinements

REPORT FROM THE



DRIVER'S SEAT...

RISING prices and bigger tax bites out of the American pocketbook are making "little" cars look more attractive these days to a lot of buyers.

They're priced lower. They use a lot less gas. They go farther on a set of tires. They're easier to

park and maneuver. They're ideal for daily shopping. Most of them are simpler than the big cars and therefore easier and less costly to keep in repair.

So let's take a ride in three of these short-wheelbase jobs on the Indianapolis Motor Speedway and see how they perform.

Only two small cars—distinguishable from midget cars—are now made in this country. When the war ended, two of the "big three"

We sped the three little cars around the track together, led by the Austin and followed by the Rambler and the Henry J in that order.

They're easy on the pocketbook, but just how much car do you get for the lower price? Here Shaw puts three "little cars" through their paces and gives you the answers.

manufacturers were fiddling with plans for producing little cars. But they never reached the market.

The two small U.S.-made cars that have finally made their appearance were brought out within the last 18 months by manufacturers who hope to annex a bigger share of the market for their products. One is Kaiser-Frazer's Henry J. The other is the Nash Rambler. The first is a sedan, the second a convertible. Nash also makes a Rambler station wagon.

The cars are on the Speedway's northwest turn. The Austin is chugging to keep ahead. Driving the Rambler is Tommy Milton, the famous rac-

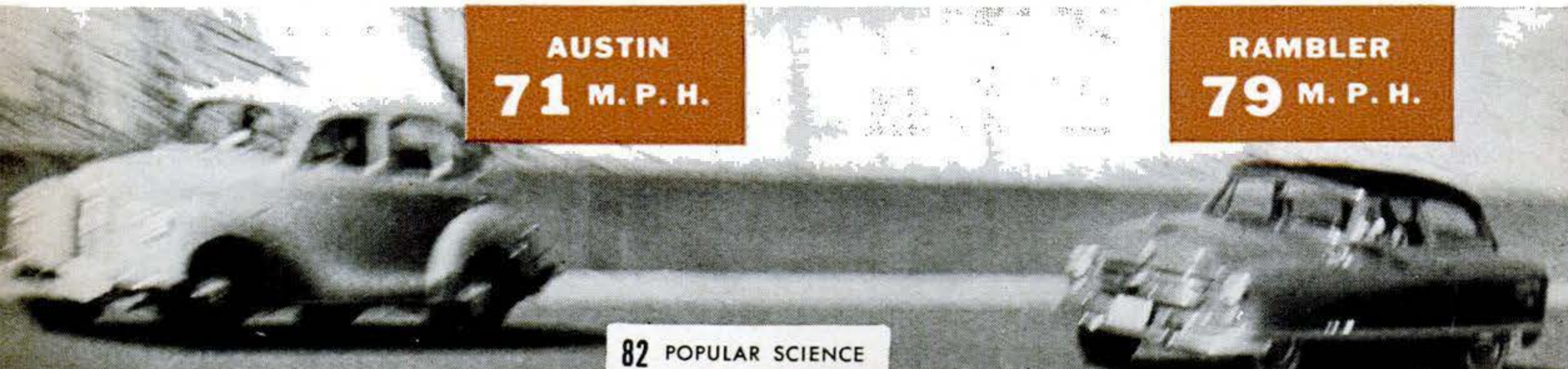

AUSTIN
71 M. P. H.

RAMBLER
79 M. P. H.

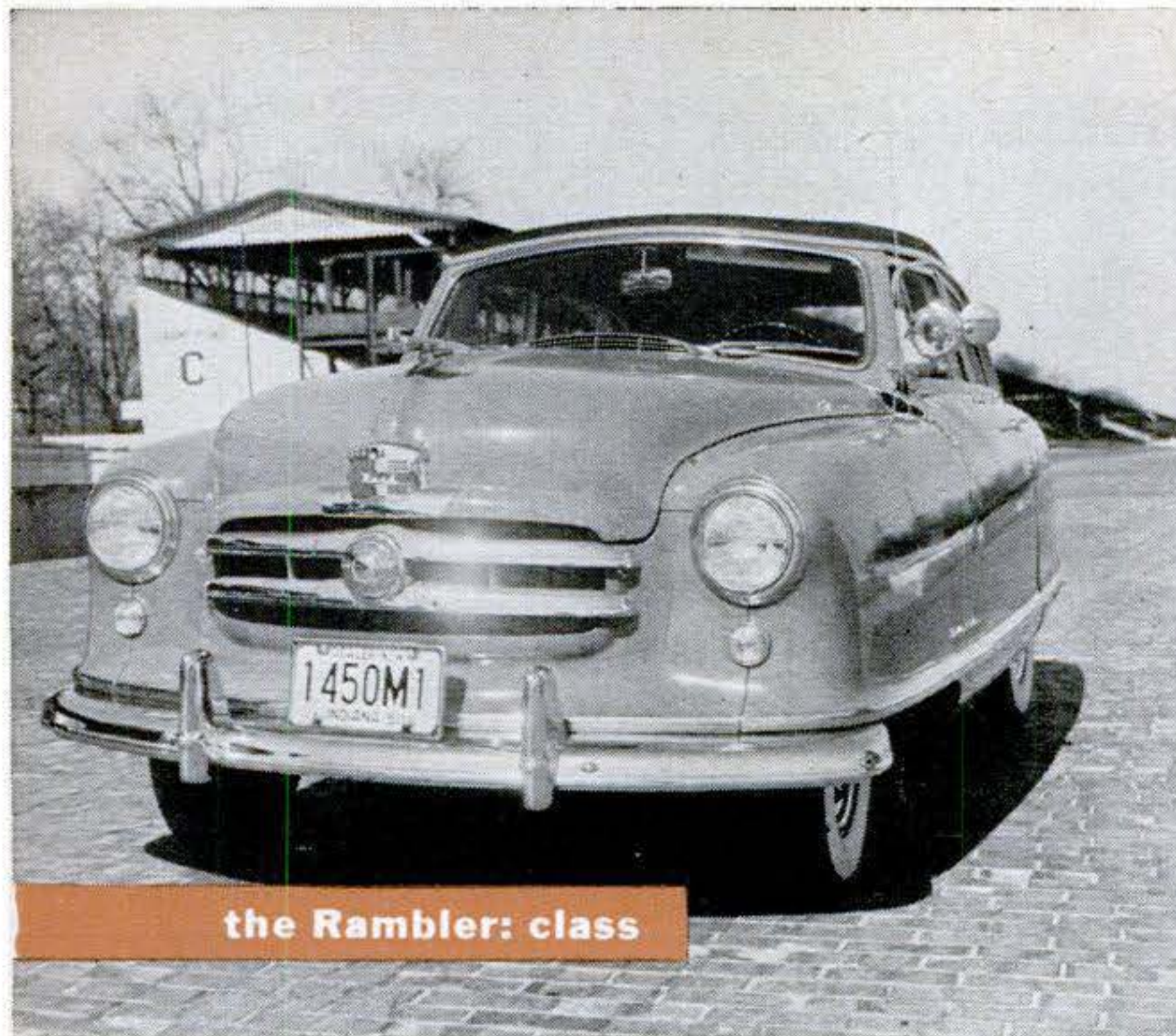

the Rambler: class



the Henry J: low cost

These cars aren't the first small jobs ever made in the U.S. My memory goes back to a lot of little cars of yesteryear—the Ambler, the Scripps-Booth, the Arrow Cyclecar, the Brush, the Saxon, and the Monroe among them.

But they weren't really small cars in those days. They'd be considered small today only because the average car is a lot heavier, longer, wider, and roomier than its ancestors.

For comparison, in driving the two latter-day revivals of the American small car, I chose a British-made Austin—which is not small by British standards. I chose it because the Austin is the most popular foreign car sold in this country.

This is the start of the playback of my tape-recorded comments on the Austin:

You don't have to jackknife yourself into

ing driver who now is track steward. POPULAR SCIENCE'S Devon Francis and Bill Morris, photographer, are in the Austin and Henry J.

the front seat of this car. There's entrance room and headroom. The over-all height is greater than in the Henry J and the Rambler. That may affect its roll in a turn . . . we'll see.

The pull-type starter switch on the dash . . . may confuse the beginner in this job . . . the starting motor makes too much racket . . .

Foot Pedals Confusing

Wups! I'm confusing the brake with the clutch pedal. The positioning of the two on the floor is bad . . . first gear is really low . . . first gear on the Austin is the reverse gear on our cars . . . this little engine races its heart out in first . . . the transmission is pretty noisy in the first three gears.

The two long straightaways and four turns on the speedway gave me a chance to see what the car would do upwind, downwind, and crosswind, though the wind was fairly light.

I do get some roll on the turns . . . as I anticipated . . . despite the fact that the track is banked . . . and there's some wind-wander in a crosswind . . . she doesn't want to keep her wheels straight . . . there's also some pitching on the bricks.

The brick-surfaced portion of the speedway in front of the main grandstands, a part of the original track that is kept for

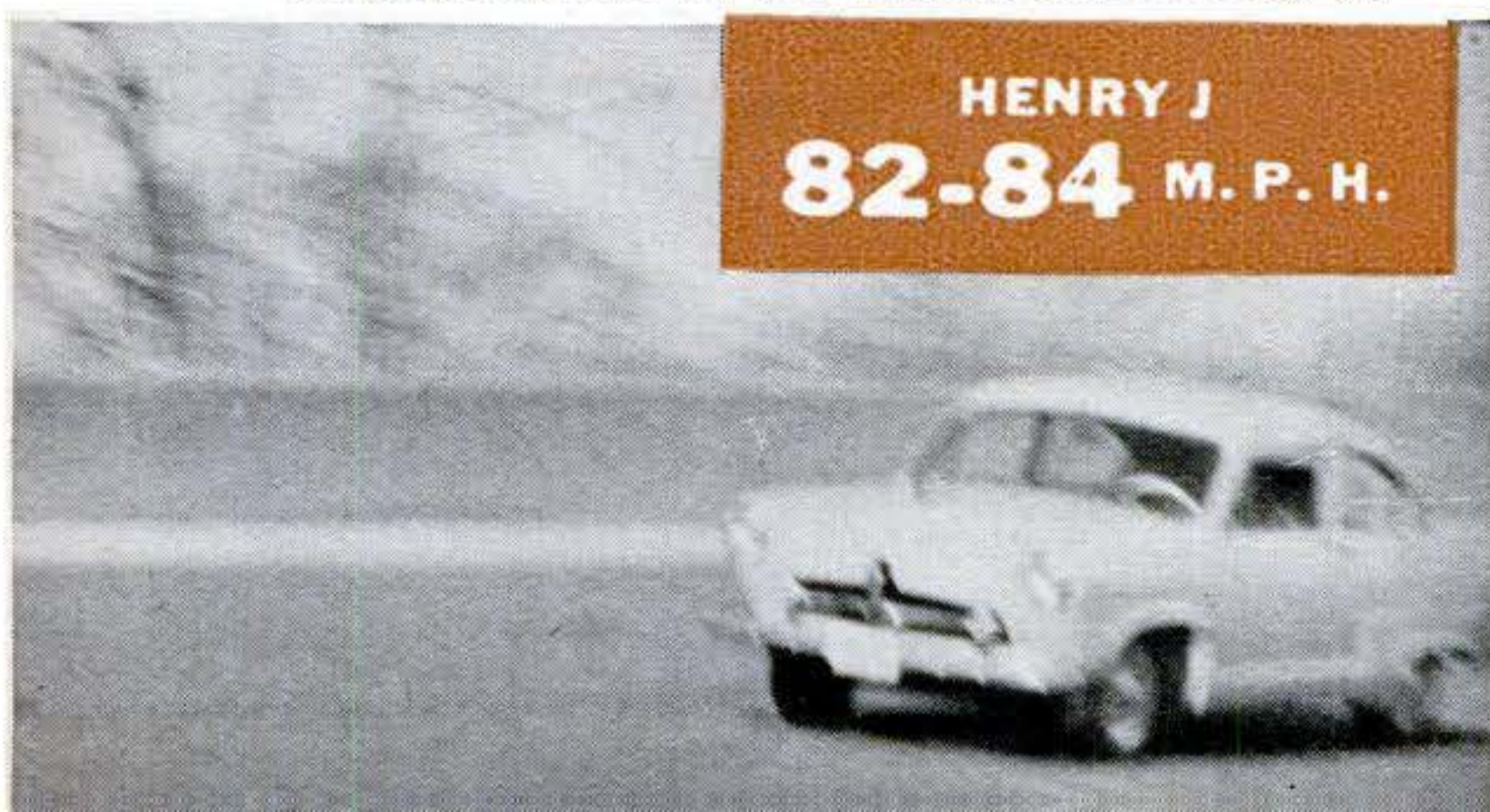

sentimental reasons, is fairly rough. The pitching, of course, was due to the short wheelbase.

I was curious as to what the Austin would do with the accelerator on the floorboard as a key to the best cruising speed. But first, I decided to see how fast that 40-horse engine would take the Austin to an indicated 60 miles an hour. A couple of times around the 2½-mile track on the stopwatch established a speedometer error of two miles an hour on the high side at an indicated 60.

I tried slow shifting and fast shifting on the acceleration, using all four forward gears, and the best I could do for 60 indicated was 34 seconds. That was pretty slow—on this side of the Atlantic. Then I opened her up. She edged up to 71 and stopped.

U. S. Standards Different

In running my eye back over what I've said about the Austin, I find that it doesn't actually reflect my opinion of the car. The Austin is a good car. It's just hard to evaluate by U.S. standards. In England, it's a pretty good-looking automobile. Over here, it's dumpy, almost dowdy, ranged alongside our cars.

Yet, it's sturdy. It has a solid feel, like a bigger car. Its sheet metal is of a heavier gauge than that in most U.S. cars. It has little refinements—like a center armrest in the rear seat and foam-rubber cushions—unknown to low-priced U.S. cars. Its great virtue—high gas mileage—comes right from its great fault (by our standards)—a tiny, low-horsepower engine.

I climbed from the Austin into the Henry J, the only U.S. car not in the midget class that can compete with the Austin in price. The Henry J I had chosen to drive was the four-cylinder. Kaiser also makes an 80-hp. six under this name. It was a stripped-down—not a de luxe—version.

You Get What You Pay For

Let's not kid ourselves about low-priced cars . . . you get what you pay for, and no more. I'd say this is America's austerity car . . . and with the times what they are . . . we may need a lot of this kind of vehicle.

I'm bothered by the shift lever . . . it's hard to get it into neutral by feel.

I had been equally bothered by the Austin lever because it was mounted on the transmission box, as it was years ago in



I looked over all three engines. The 40-hp. Austin's probably lacks the oomph demanded by the bulk of U.S. motorists. Yet I felt that this car offered most for the invested dollar.

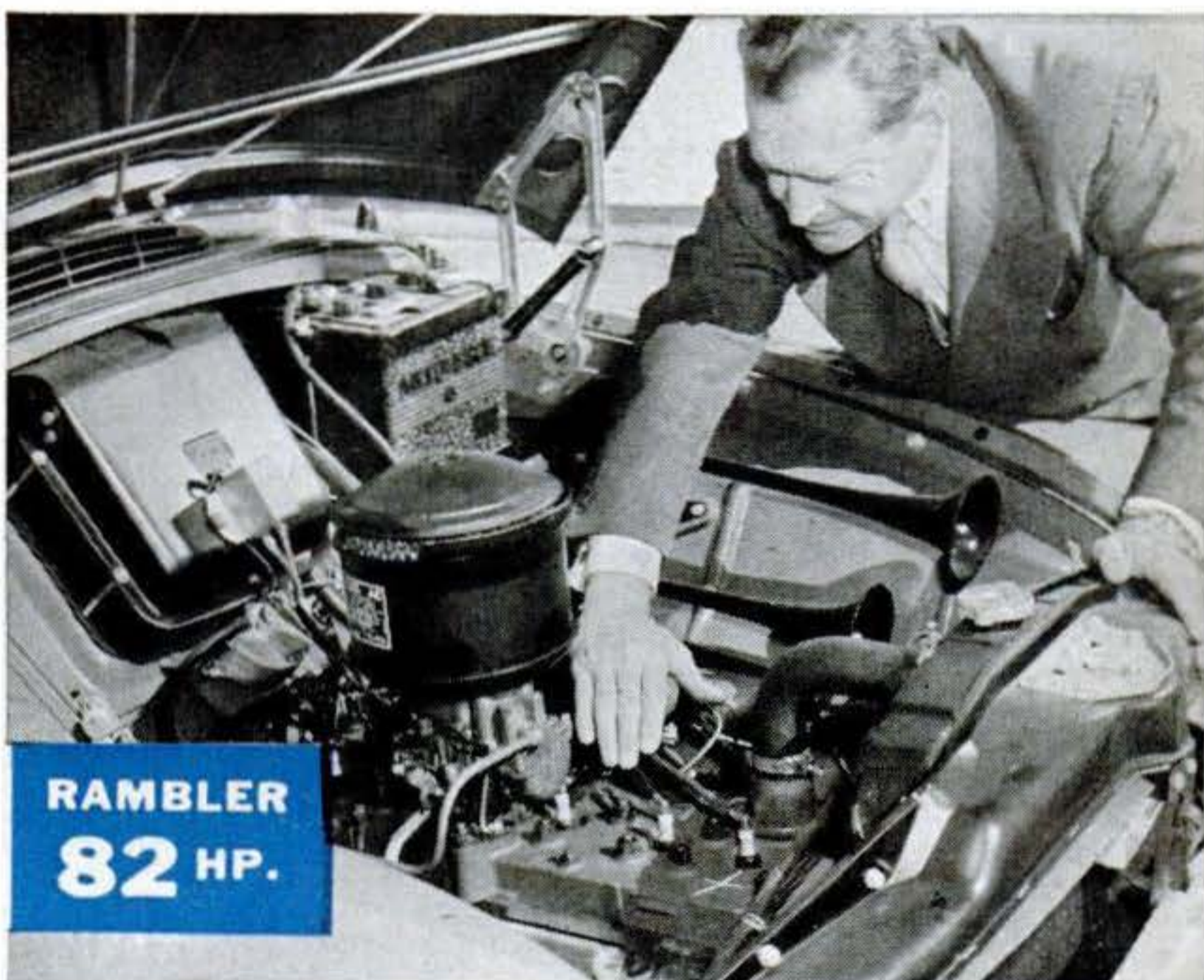

The Rambler has big-car zip and luxury. Its engine gives it a weight per horsepower of only 29.6 pounds, compared with 33.8 for the 4-cylinder Henry J and 56.2 for the Austin.

The Henry J has zip too, but it needs a silencer for its air cleaner. The engine is so short that a shroud is put around the fan to direct the air backward for proper cooling.



Facts on the Austin

Make and model: Austin A40 four-door sedan.

Engine: 4-cyl. valve-in-head; 40 hp. at 4,300 r.p.m.; car weight per hp. 56.2 lb.; bore and stroke, 2.578" by 3.5"; compression ratio, 7.2:1; piston displacement, 73.17 cu.in.

Engine piston travel: (in feet per car mile)—2,290.

Crankshaft bearing surface: 12.407 sq. in.

Torque: 59 lb.-ft. at 2,200 r.p.m.

Transmission: 4-speed manual shift.

Rear-axle ratio: 5.14:1.

Steering ratio: 14:1.

Radius of turning circle: 19 ft.

Effective brake-lining area: 72.5 sq.in.

Springs: front, coil; rear, semi-elliptic.

Weight and outside dimensions: 2,250 lb. (approx.); height, no load, 63 $\frac{3}{4}$ "; over-all length with bumpers and guards, 153 $\frac{3}{4}$ "; width, 61"; wheelbase, 92 $\frac{1}{2}$ "; front overhang, 26"; rear, 35"; tread, front, 48 $\frac{1}{2}$ "; rear, 49 $\frac{1}{2}$ ".

Inside dimensions: seat-cushion width, front, (two independently adjustable seats) 21" each; rear, 45 $\frac{1}{2}$ "; leg room, front, 41"; rear, 31"; headroom, front, 36 $\frac{3}{4}$ "; rear, 34 $\frac{1}{2}$ "; seat height, front, 13 $\frac{3}{4}$ "; rear, 14 $\frac{1}{2}$ "; vertical distance, steering wheel to seat cushion, with seat in mid-position, 6 $\frac{1}{2}$ "; front-seat adjustment, horizontal, 7 $\frac{1}{4}$ ".

Tire size: 5.25 by 16; optional replacement, 5.50 by 16.

Facts on the Rambler

Make and model: Nash Rambler two-door convertible.

Engine: 6-cyl. L-head; 82 hp. at 3,800 r.p.m.; car weight per hp., 29.6 lb.; bore and stroke, 3 $\frac{1}{8}$ " by 3 $\frac{3}{4}$ "; compression ratio, 7.25:1; piston displacement, 172.6 cu.in.

Engine piston travel: (in feet per car mile)—1,860 without overdrive.

Crankshaft bearing surface: 14.28 sq.in.

Torque. 138 lb.-ft. at 1,600 r.p.m.

Transmission: 3-speed manual shift with optional overdrive.

Rear-axle ratio: 3.778 without overdrive, 4.375 with overdrive.

Steering ratio: 20.4:1.

Radius of turning circle: 18' 7".

Effective brake-lining area: 92.1 sq.in.

Springs: front, coil; rear, semi-elliptic.

Weight and outside dimensions: 2,430 lb. (approx.); height, no load, 59 $\frac{1}{2}$ "; over-all length with bumpers and guards, 176"; width, 73 $\frac{1}{2}$ "; wheelbase, 100"; front overhang, 31 $\frac{5}{32}$ "; rear, 44 $\frac{11}{32}$ "; tread, front, 53 $\frac{1}{4}$ "; rear, 53".

Inside dimensions: seat-cushion width, front, 59"; rear, 45 $\frac{1}{4}$ "; leg room, front, 42 $\frac{1}{2}$ "; rear, 37"; headroom, front, 35"; rear, 35 $\frac{1}{2}$ "; seat height, front, 11 $\frac{1}{2}$ "; rear, 13 $\frac{1}{2}$ "; vertical distance, steering wheel to seat cushion, with seat in mid-position, 6"; front-seat adjustment, horizontal, 4"; vertical, $\frac{5}{8}$ ".

Tire size: 5.90 by 15.

Facts on the Henry J

Make and model: Henry J two-door sedan.

Engine: 4-cyl. L-head; 68 hp. at 4,000 r.p.m.; car weight per hp., 33.8 lb.; bore and stroke, 3 $\frac{1}{8}$ " by 4 $\frac{3}{8}$ "; compression ratio, 7:1; piston displacement, 134.2 cu.in.

Engine piston travel: (in feet per car mile)—2,620.

Crankshaft bearing surface: 11.697 sq. in. projected.

Torque: 109 lb.-ft. at 1,800 r.p.m.

Transmission: 3-speed manual shift.

Rear-axle ratio: 4.1:1.

Steering ratio: 18.2:1.

Radius of turning circle: 17' 6".

Effective brake-lining area: 132 sq.in.

Springs: front, coil; rear, semi-elliptic.

Weight and outside dimensions: 2,304 lb.; height, no load, 59 $\frac{5}{8}$ "; over-all length with bumpers and guards, 174 $\frac{1}{2}$ "; width, 70"; wheelbase, 100"; front overhang, 35 $\frac{11}{32}$ "; rear, 39 $\frac{5}{32}$ "; tread (identical in front and rear), 54".

Inside dimensions: seating width (door to door), front, 58"; rear, 56 $\frac{3}{4}$ "; leg room, front, 42.32"; rear, 35.6"; headroom, front, 35.76"; rear, 35.92"; seat height, front, 11.92"; rear, 10.92"; vertical distance, steering wheel to seat cushion, with seat in mid-position, 6.8"; front-seat adjustment, horizontal, 7"; vertical, 1.5".

Tire size: 5.90 by 15.



DRIVING COMPARTMENT

For its size, the Austin had a surprising amount of room in it. Controls are not as well centered as in American cars. That shelf under the panel is for small packages.

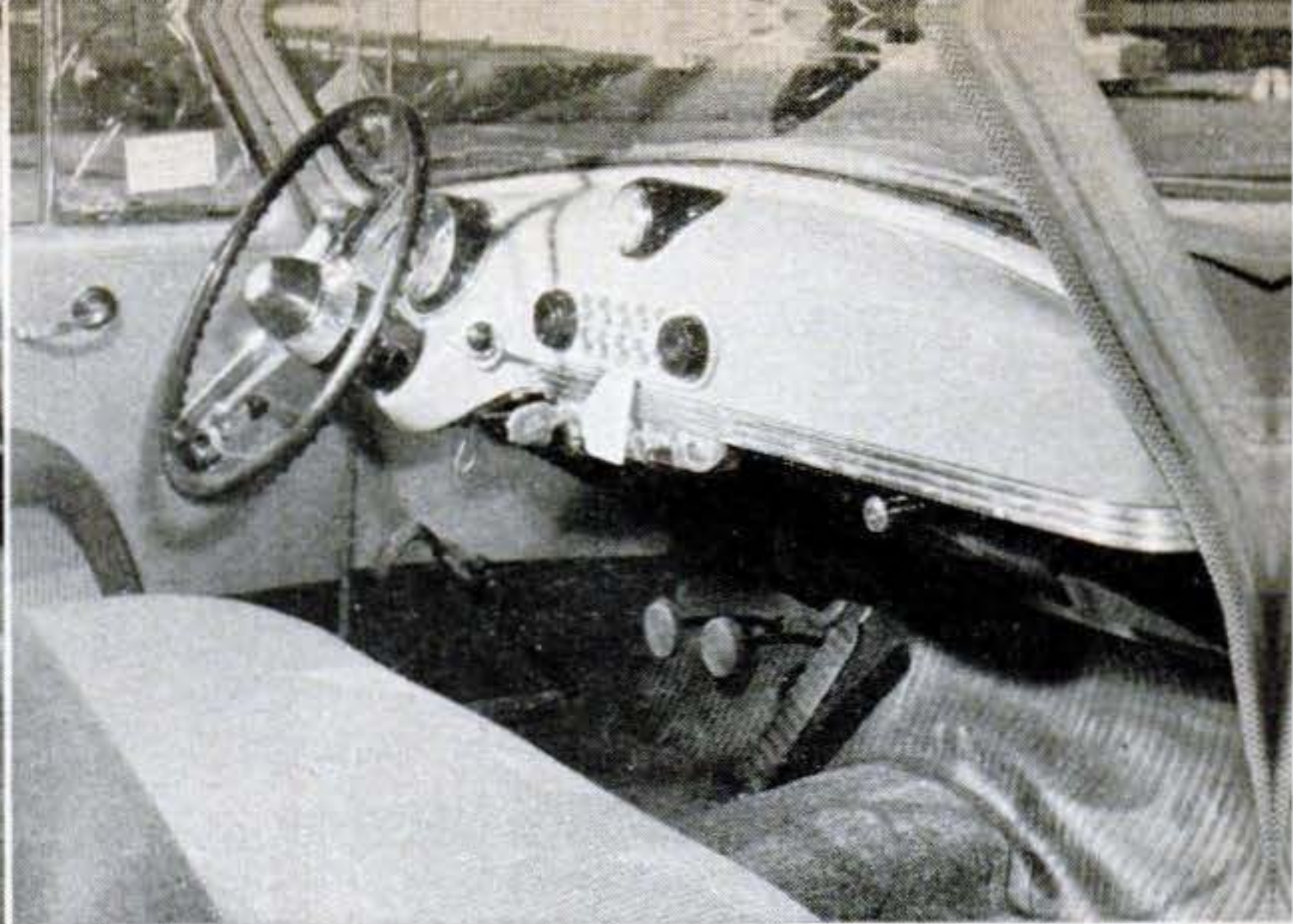

The Rambler has everything—radio, heater, electric clock, and directional signals. And it should have—for the price. Of the three little cars, the Henry J costs the least.



ENTRANCE ROOM

Devon Francis tried out the driver's entrance room in all three cars, with the adjustable seat full forward. The Austin's proved to be the best—more than 42 inches high by 26 wide.



You have to duck your head to get into the Rambler. Entrance room is only 39 by 23½. All three cars have a gas economy of about 35 m.p.g., the U. S. cars when using overdrive.



LEG ROOM

With the seats still full forward, we measured back-seat leg room with a model 5 feet, 8 inches tall. They turned out to be approximately the same—between 4 and 5 inches.



At the left is the Austin's, above is the Rambler's, at the right is the Henry J's. With the front seats full back, the model's knees had no spare room in any of the three vehicles.

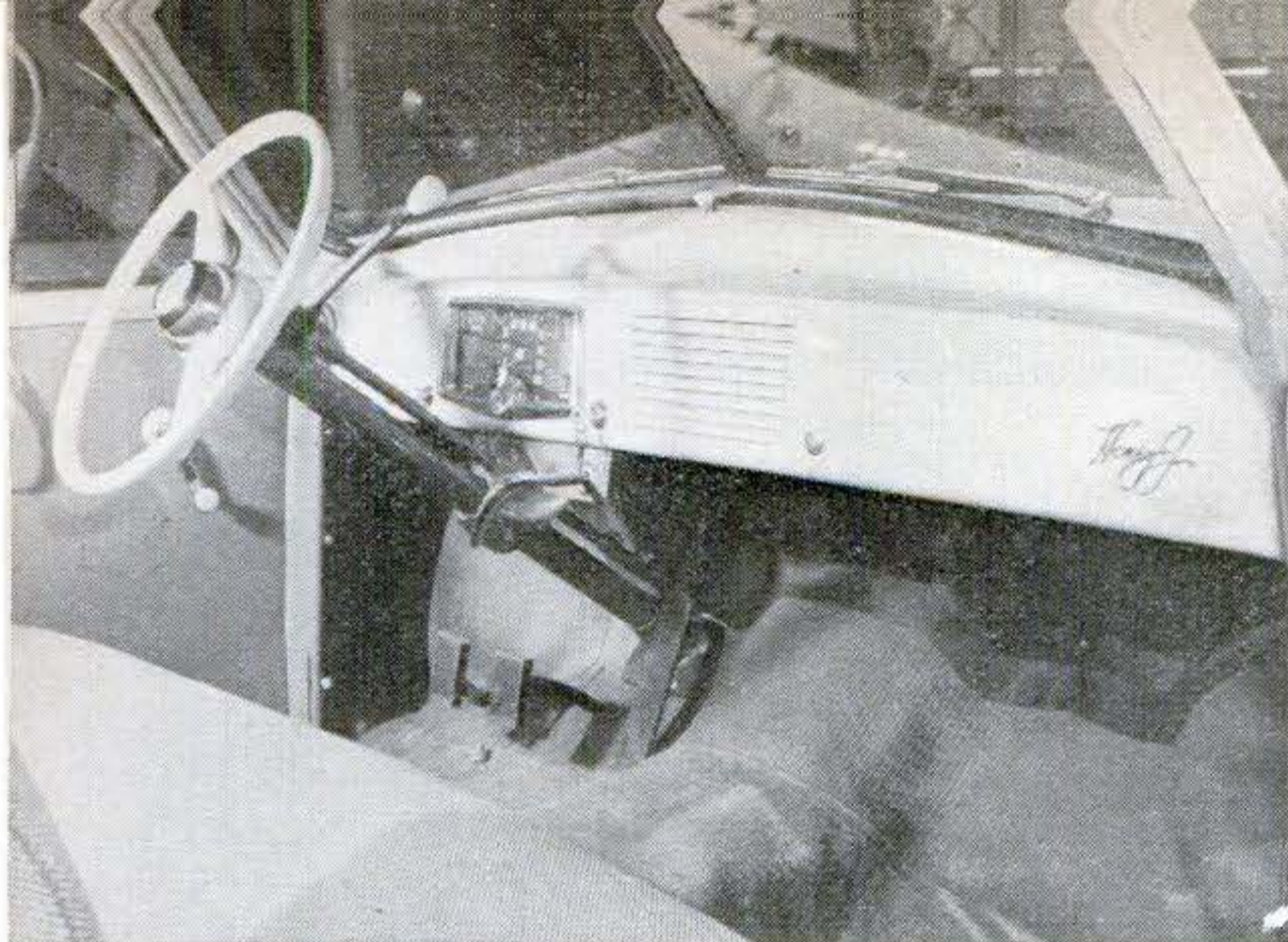

The Henry J's front compartment was the most spacious of the three. This photo is of the stripped-down, low-cost job. The pictures directly below are of the de luxe version.



The Henry J's entrance room was a bit better than the Rambler's—40¼ by 27. Both had the disadvantage found in all two-door sedans—a tight squeeze getting into the back seat.

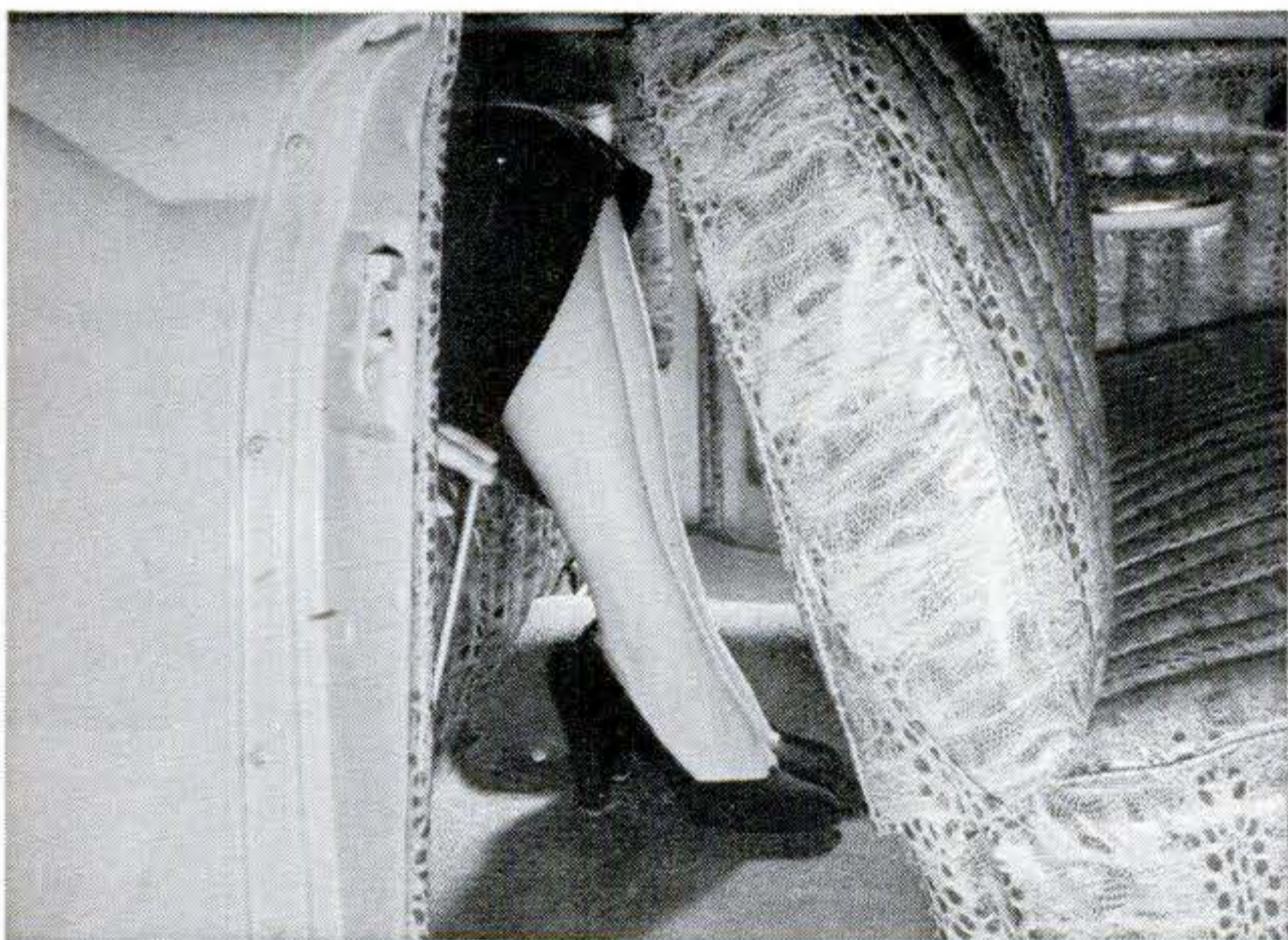

All three cars' rear seats take only two persons comfortably. Inside the Henry J's door jamb you will see a rod used to lock the back of the rear seat down for added luggage room.

American cars, instead of on the steering column.

I get very little roll on the turns . . . remarkably little pitch on the bricks, too . . . but there is no solid feel . . . I don't get any feeling of solidity in this car . . . it feels light, which of course it is . . . yet it seems to behave in the wind.

That was hard to believe because the car felt so light under me. So I made several more crosswind runs to make sure. The results were the same. I got no tendency to wind-wander.

This engine is rough . . . all fours are relatively rough . . . so was the Austin's. Your vibration level goes up as your cylinder count goes down.

A calibration showed the speedometer to be four miles off on the high side at an indicated 60, as nearly as I could judge from a jiggling needle. The speedometer reached that reading in an average of 18 seconds in four tries. The car had plenty of scat for its horsepower.

That same jiggling needle gave me an indicated top speed of between 82 and 84 miles an hour. But the vibration was so pronounced that the rear vision mirror offered only a shaky image of the track behind me.

I would say that the brakes are good . . . there is no tendency to fade in a stop from high speed . . . they're better than the Austin's . . . the Austin's were too soft. The vision from this car is well-nigh perfect . . . there's plenty of glass area.

The Henry J proved to be about what I had anticipated, no more, no less. The Henry J's chief virtue is inexpensive transportation and roominess. It *will* hold five people. More than four can't ride comfortably in either the Austin or the Rambler.

My last mount was the little Nash convertible. It belongs in the class of the Henry J and the Austin only as to size. It's *not* an inexpensive automobile. While it's the cheapest U. S. convertible, there's nothing cheap about it. It costs several hundred dollars more than either the Austin or the Henry J.

I've put more than 500 miles on one of these . . . and it's a surprise . . . it was a surprise package from the start. It's got scat . . . it has lines . . . it's pretty.

The reason for its performance is obvious—it has 82 horsepower in six cylinders for only 2,400 pounds of car.

She gets away . . . gets right away . . .

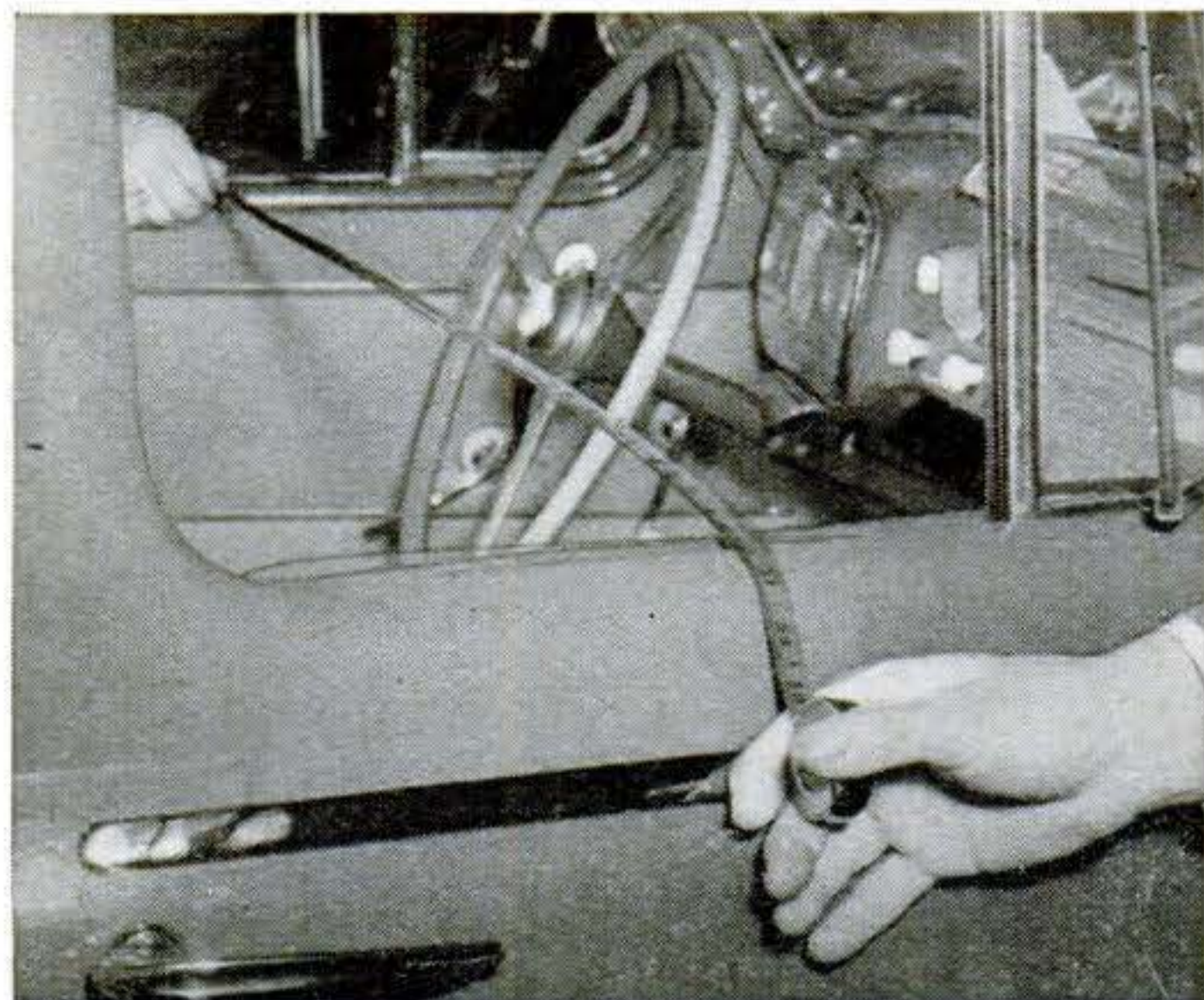

A tape measure across the driving compartment from sill to sill was the payoff on space. The Austin's measured 49 inches. The divided front seats, by the way, are both adjustable.

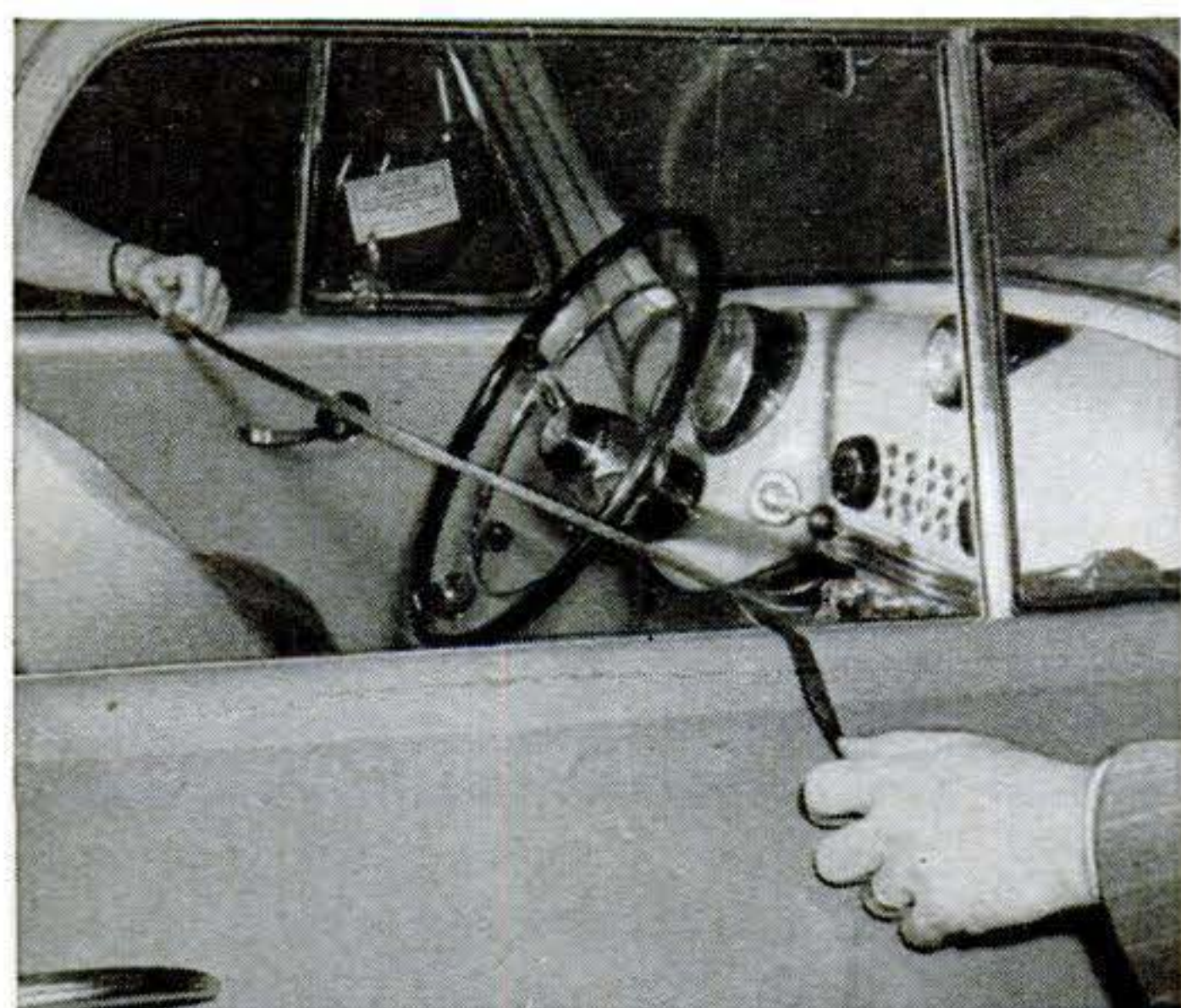

The Rambler measured 54½. Like the Henry J's, the Rambler's front seat was of one-piece design. I found that the emergency brake on the Rambler wasn't as handy as it could be.

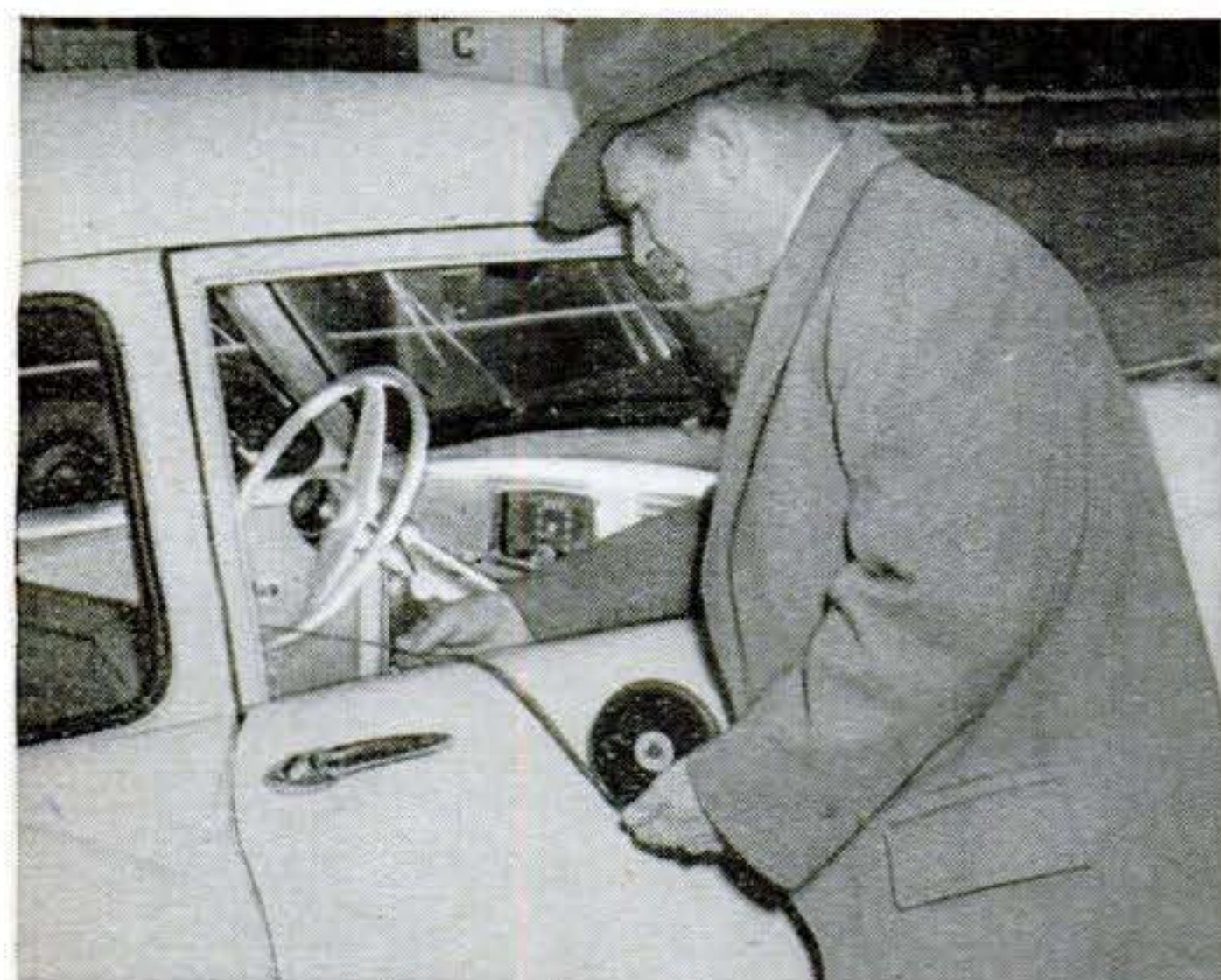

The Henry J's was 57 inches. This car comes in both 4- and 6-cylinder versions, with window vents, deck lid, special upholstery, armrests, and a vacuum-boost fuel pump as extras.

I'm on a turn at 65, with no roll . . . there's not the slightest tendency toward roll . . . that's on account of the fabric top and low center of gravity . . .

There's no wind-wander . . . there's no pitch . . . well, perhaps a trifle, on this short wheelbase . . . but nothing to bother you . . . it rides good.

The speedometer was on the button with the Austin's—an error of two miles an hour at 60. With the overdrive locked out, Devon Francis, of the POPULAR SCIENCE editorial staff, clocked me on acceleration. We indicated 60 in 21 seconds. That was slower than I had thought it would be.

There's a decided drop-off in acceleration after 65. She's going on up . . . against a headwind . . . to 74.

Runs with and against a brisk wind that suddenly had sprung up on the speedway gave me an average of 79 miles an hour. The one I drove earlier this year was faster than this one. The rear-axle ratio is 4.375:1 with overdrive.

All This and Lights, Too

You can dive into a turn with this job without getting any tire squeal . . . that's about the best recommendation I know of . . . that's a good indication of the handling qualities and the stability of a chassis . . .

You can't have everything, though. The fabric in the top flutters . . . it does make quite a noise when you get up speed. The brakes I would rate as excellent compared with good for the Henry J and soft for the Austin. The Rambler and Henry J have something else on the Austin, too . . . these lights . . . there are red lights on your panel . . . in both cars . . . to flash you signals when your oil is low or your battery is on discharge . . .

This car is as solid as a rock . . . it feels good . . . the noise level is low . . . so is the vibration level. My only real quarrel is with the rear vision . . . a fault of all convertibles. An outside rear-vision mirror on the Rambler is a must.

In aesthetics, ride, and interior appointments, the Rambler, obviously, was the class of the three little cars. It was also priced at the top, by a considerable margin. It had the convertible's traditional drawback of little or no protection for the passengers in a roll-over accident, though permanent side rails holding the top gave it more rigidity than other convertibles [PS, May '50, p. 110].



Little cars don't have much luggage space. Rambler's (center) was the smallest, Austin's

(right) the best designed. Low-priced Henry J's (left) is reached from inside the car.



This is a sample of the quality built into the Austin—foam rubber in the seats. This car has pleasant little gimmicks such as a chain on the gas-tank cap so you can't lose it.



This picture was shot through the back of a de luxe Henry J, which has a rear-opening trunk lid. Back of rear seat is locked down. This model has a divided front seat and special trim.

As for a choice among them, the buyer has to ask himself what he wants in an automobile—a high cruising speed, luxury, looks, price, trade-in value, economy, ease of handling, or a combination of only some of these and perhaps other factors?

With prices at the gas pumps on the rise, does he actually want better mileage at a sacrifice of room, or would he rather get his economy by cutting down on his driving and own a full-sized car? If he wants economy, any one of these three little cars—together with a number of other little European cars on the U. S. market—most certainly will give it to him. He can get up to 25 to 35 miles to the gallon.

Cars, like meat, sell by the pound. Manufacturers are always trying to reduce their cost-per-pound of car. The cost-per-pound of little cars is considerably beyond that of

big cars. For what value it may have in deciding *your* choice of a little car, here are the costs-per-pound of the three cars I drove. They are figured on the basis of New York salesroom prices in mid-March, 1951, including the Federal tax but not a sales tax:

Austin—69½ cents.
Rambler—80½ cents.
Henry J—59 cents.

END

This Month's Shaw-ism

The man who always beats the light deserves a nice funeral.

Willis Shaw

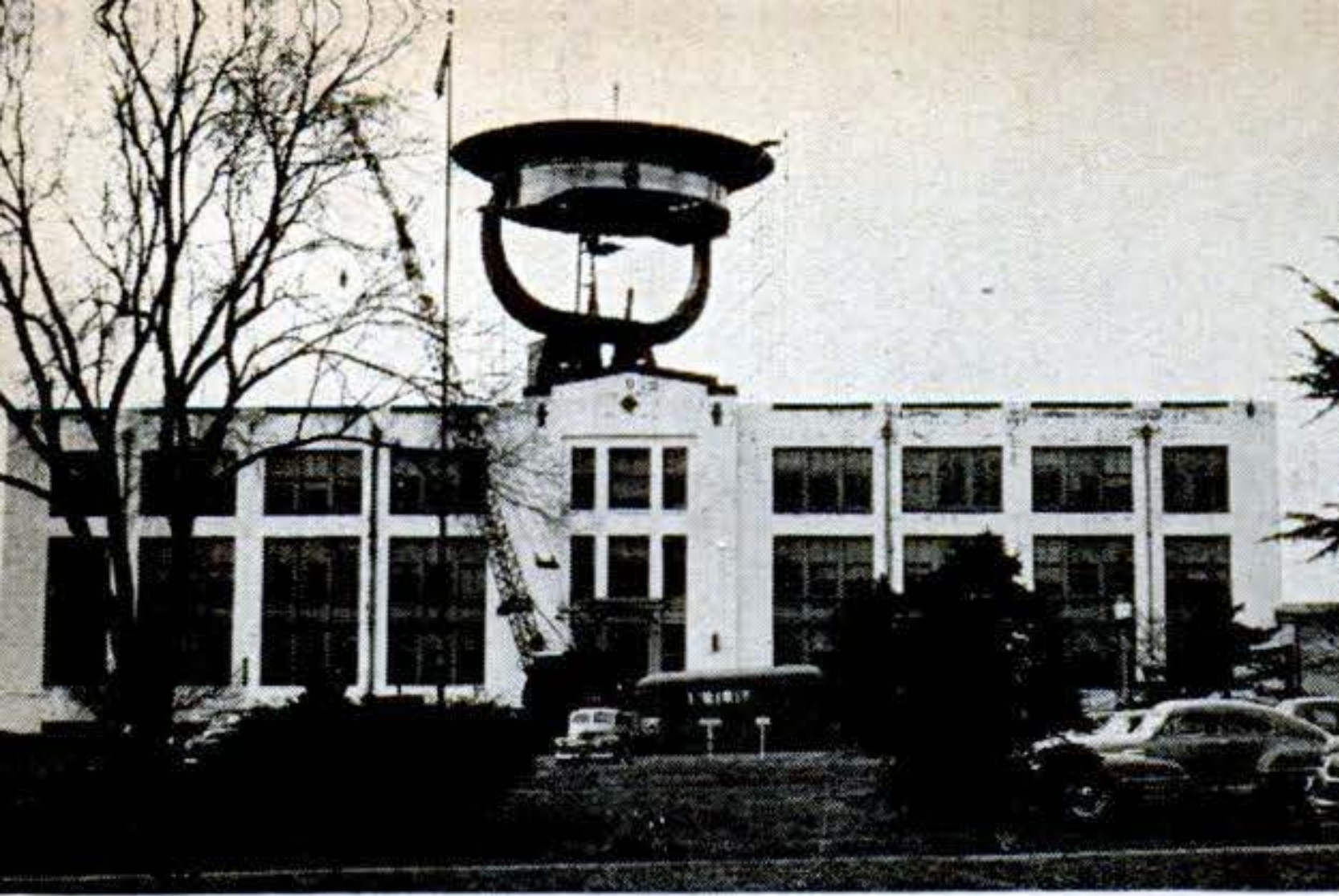

50-Foot Radio Telescope to Study Static from the Stars

WHAT looks like a gigantic chafing dish on top of the building above is a new 600-inch "radio telescope" at the Naval Research Laboratory in Washington. At right, workmen lower into place the last of 32 aluminum sections forming a concave reflector that will focus radio waves from the heavens onto an antenna in the center. Installed on a five-inch-gun mount, the reflector can be rotated a full circle and aimed vertically from below the horizon to beyond the zenith. The 75-ton instrument will extend scientists' observations of radiation from the

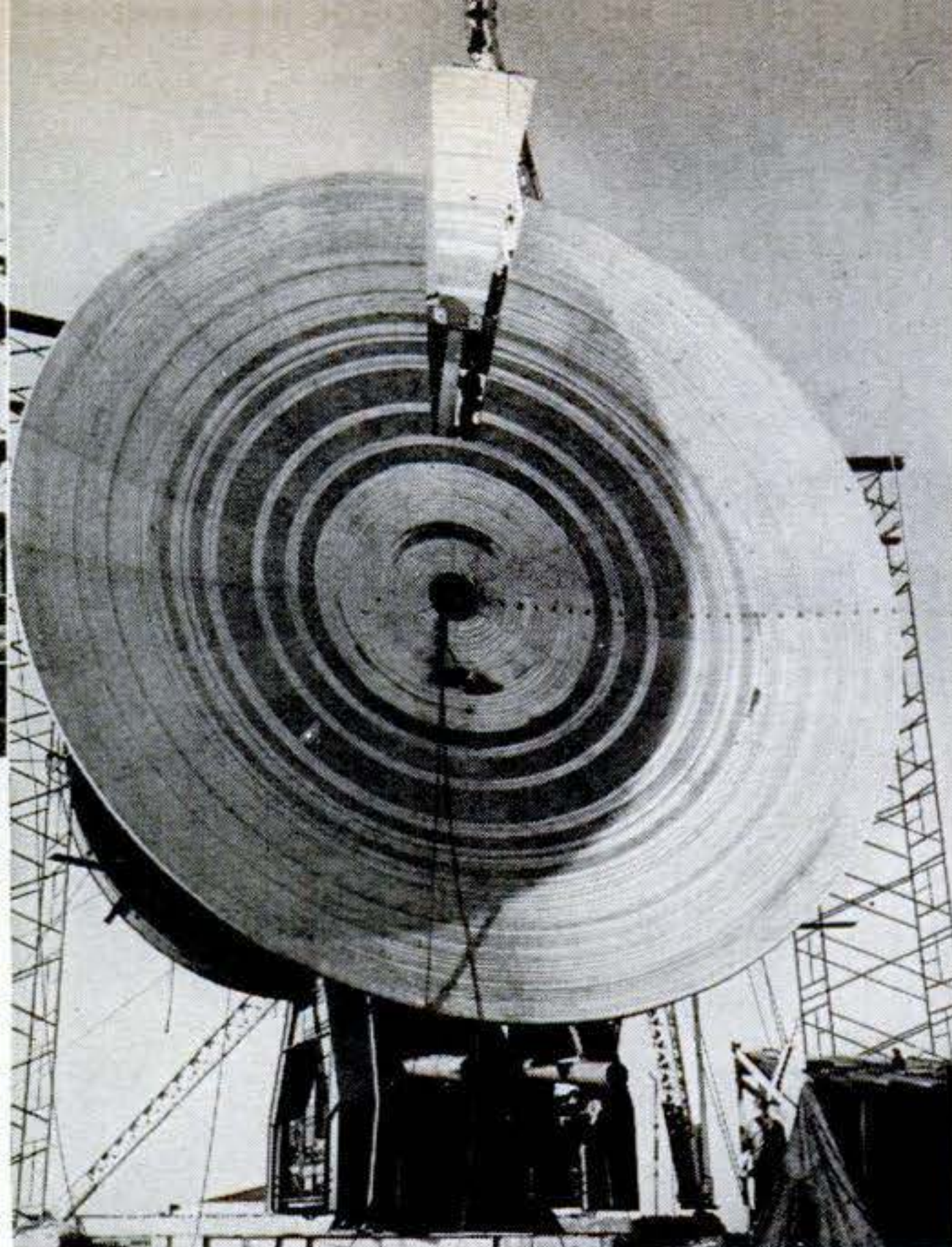

sun, moon, and stars. Their findings, besides enlarging man's knowledge of the universe, are expected to be useful in long-range weather forecasting and in predicting solar disturbances that interfere with radio communication.

Rocket Power Tested in Stand

SPEWING flame like a giant blowtorch, the powerful rocket engine at left would fly faster than sound if released. But North American Aviation engineers keep it tied to this stand in the mountains of southern California while instruments measure its power. Platforms atop the stand are used to install fuel and pressure lines, and water jets below prevent fires during guided-missile tests for the Air Force.

Catapult to Hurl Jet Aloft

TO SAVE precious seconds in heading off enemy planes detected on a radar screen, the Navy's new, batlike XF4D interceptor, below, is designed to be catapulted from a carrier deck. Expected to climb rapidly to a height of eight miles, the Douglas-built tailless jet craft has completed high-altitude test flights.

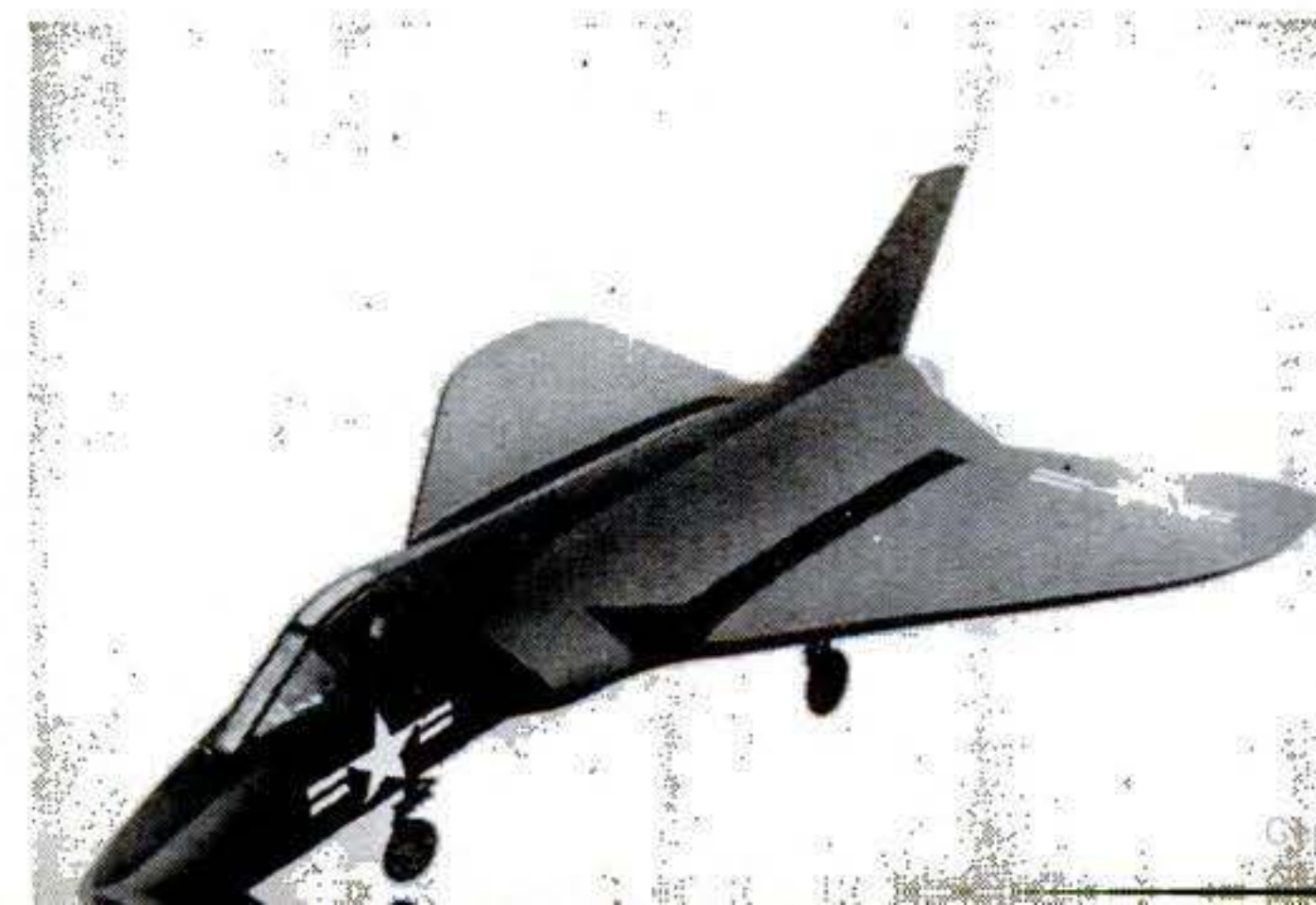
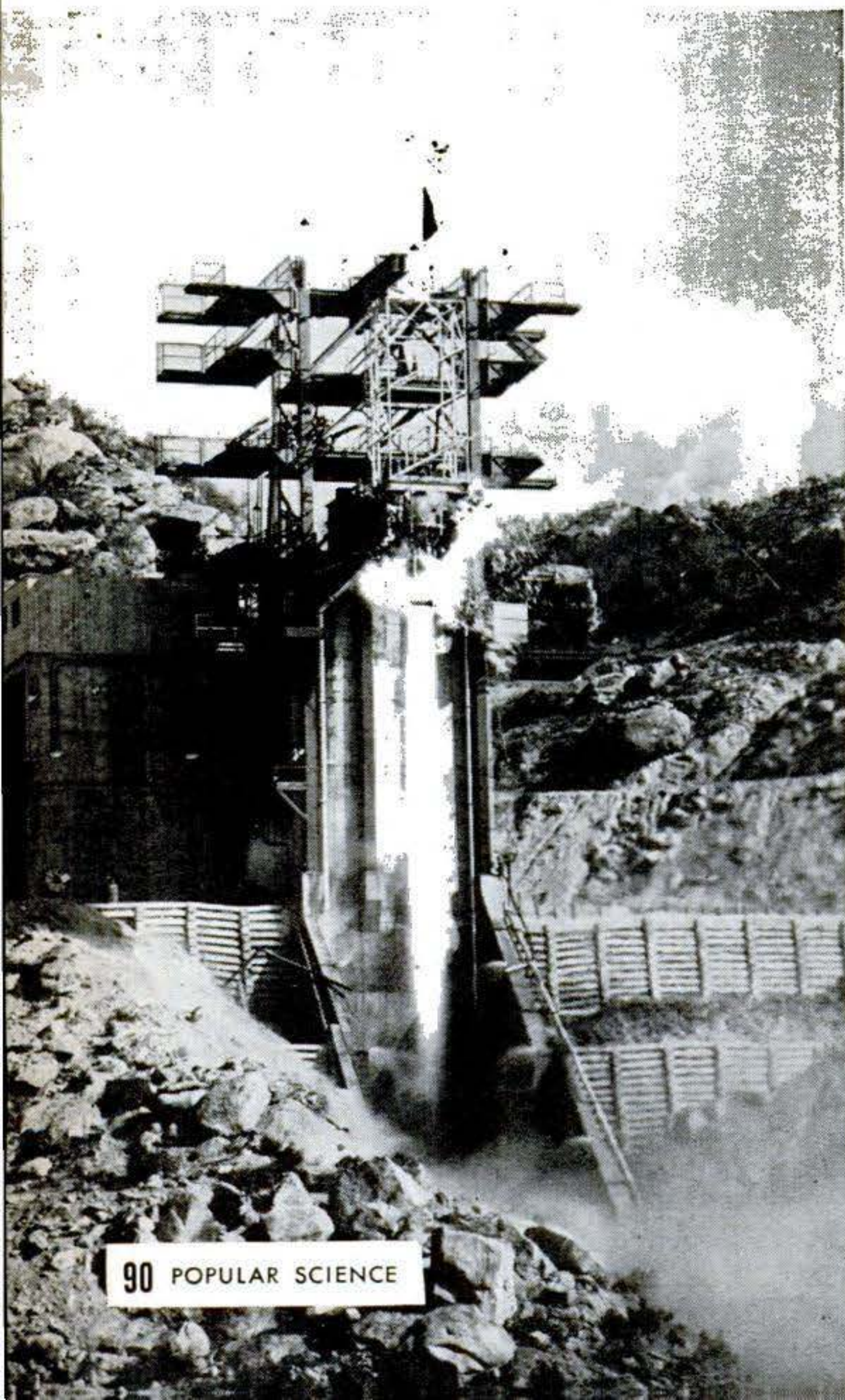

New Ideas from the Inventors

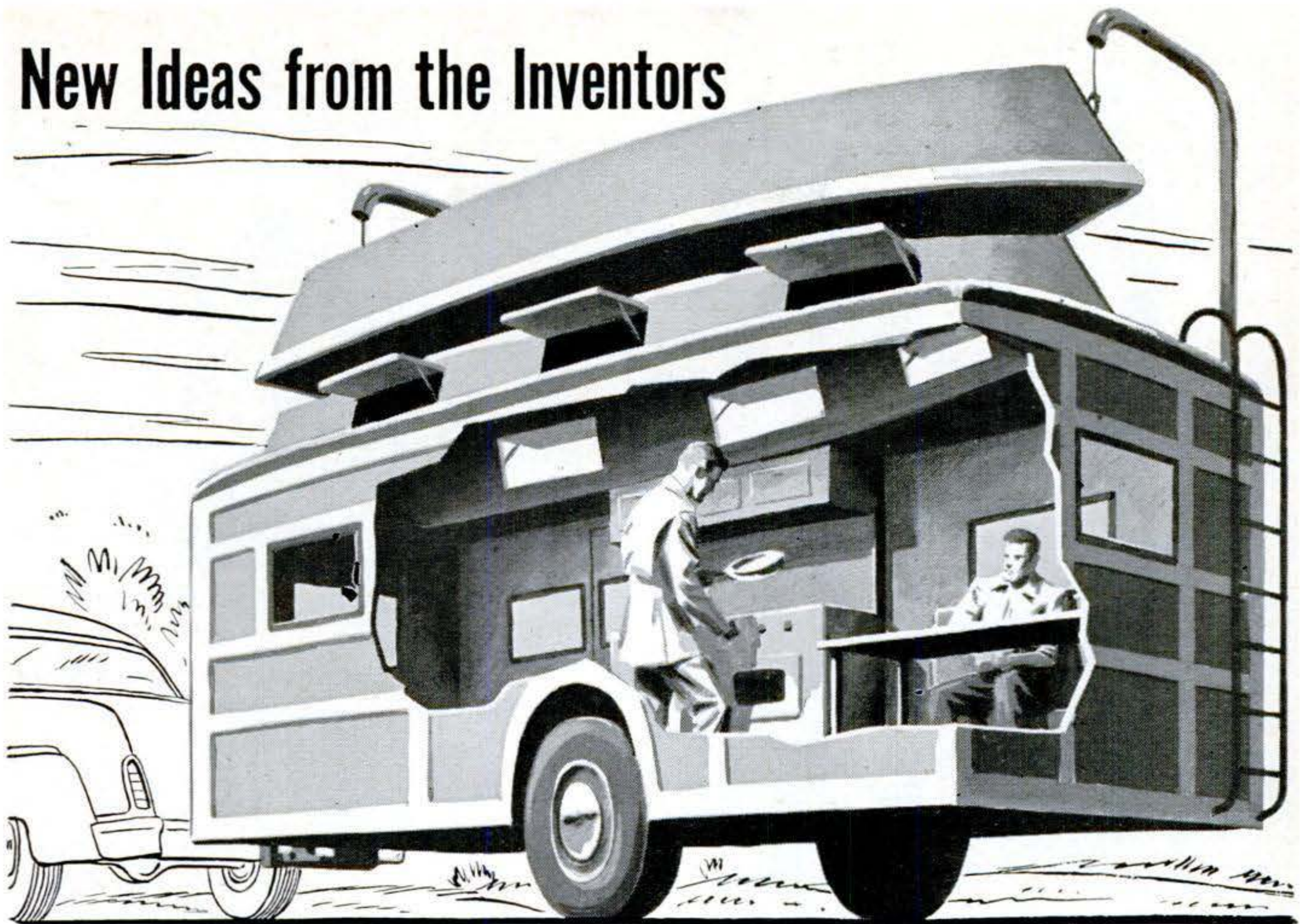

1 Trailer to Carry Boat on Roof. Designed for use by traveling sportsmen, this car trailer makes it easy to take a row-boat along on trips. The boat fits neatly over a raised section in the center of the

roof, which in turn provides additional head-room inside the trailer. A pair of davits, which can be raised when needed, makes it simple to lift the boat off the roof and lower it for use at the destination.

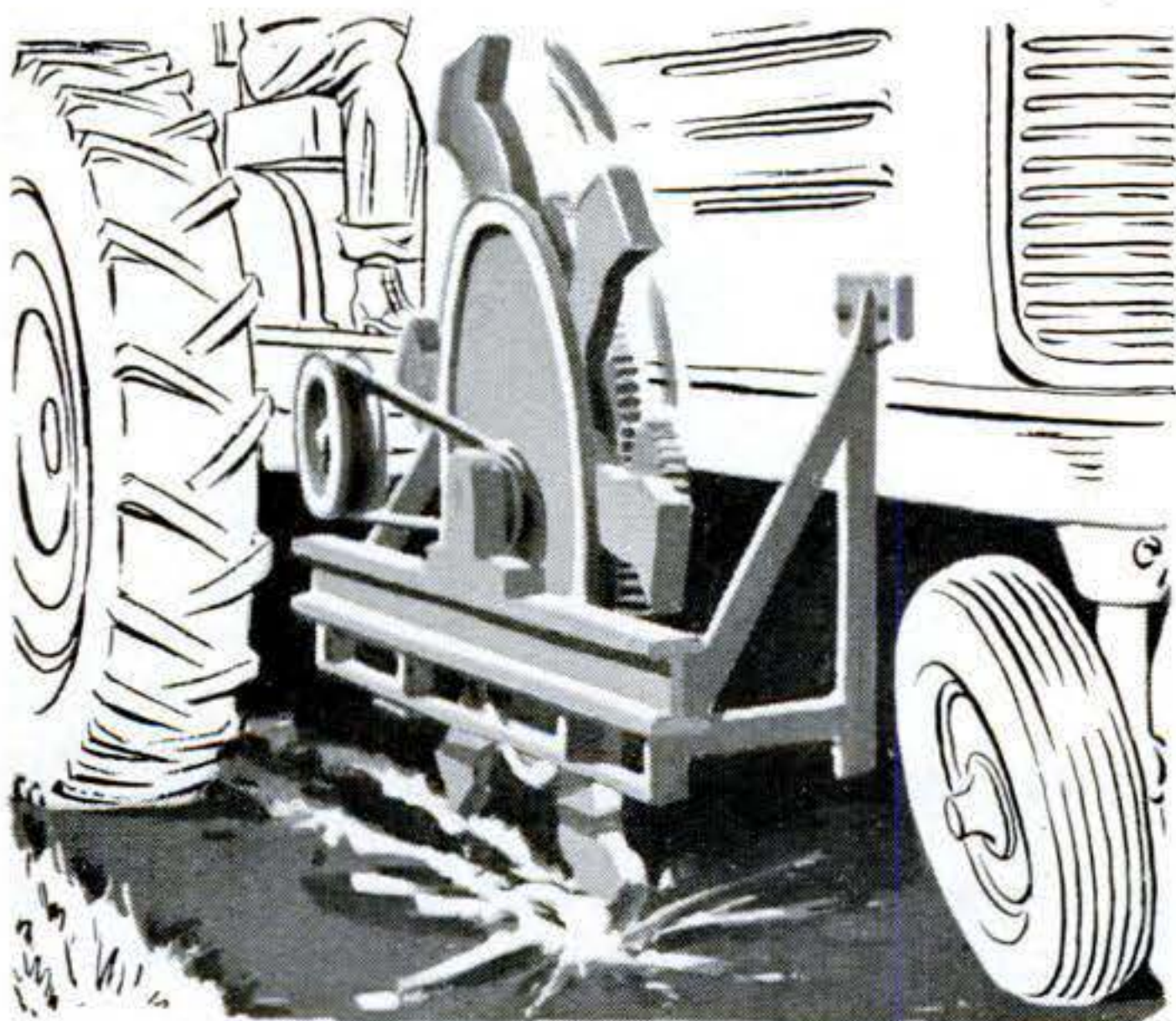

2 Rotary Hammer to Break Up Paving. Old road surfaces that are to be repaved could be broken up quickly with this device. It consists of a rotary hammer that can be mounted on a tractor and driven by the tractor's power take-off. The hammer has a series of pivoted arms that flail the paving as they rotate.

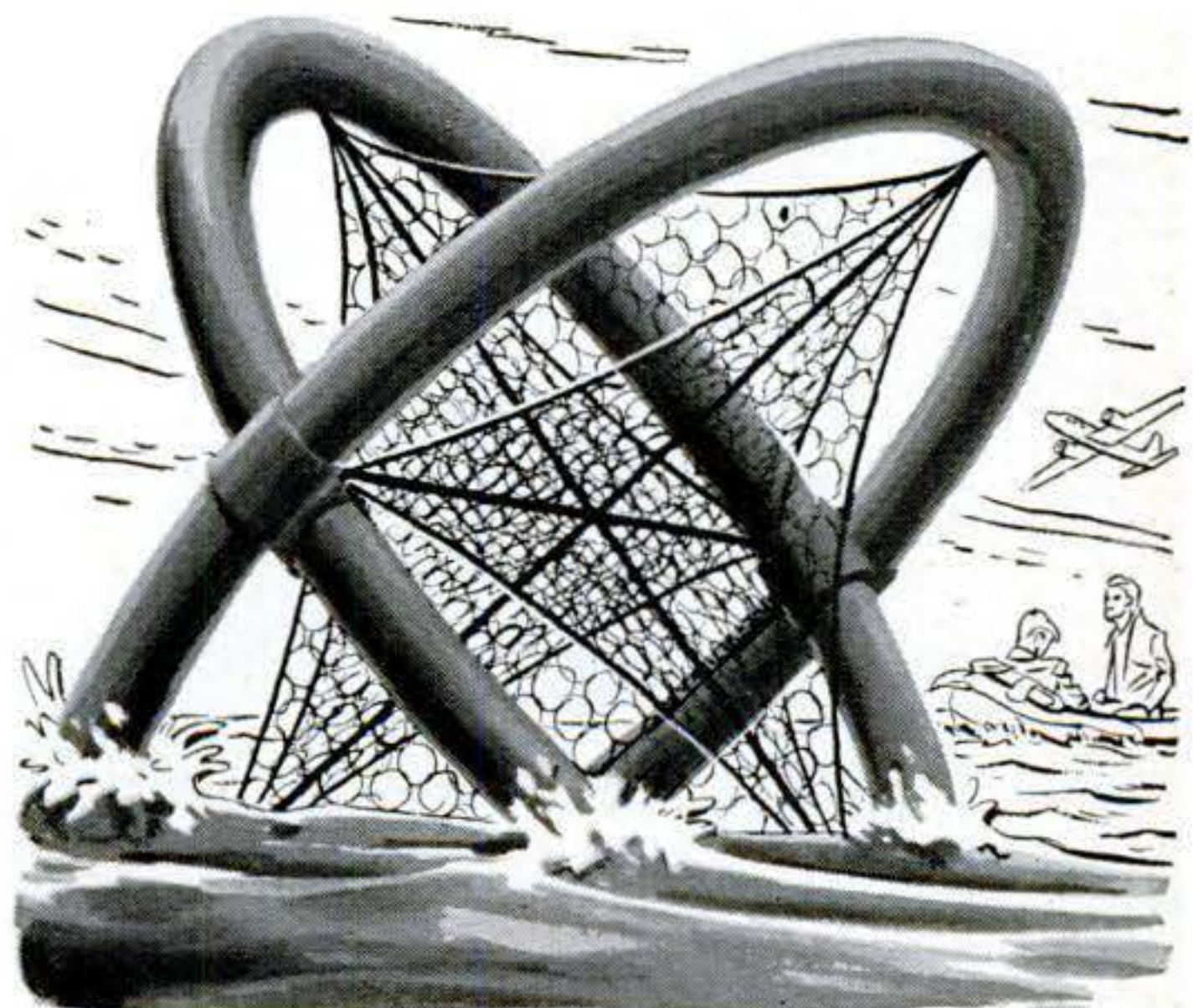

3 Radar Target to Float. This collapsible radar reflector for guiding searchers to downed fliers is supported by two circular, tubular frames that inflate automatically when the buoy hits the water. The water closes an electrical circuit to fire a powder charge that drives release pins into two gas cartridges for inflation.

Turn the page, please, for three more new ideas.

MAY 1951 91

MORE New Ideas from the Inventors

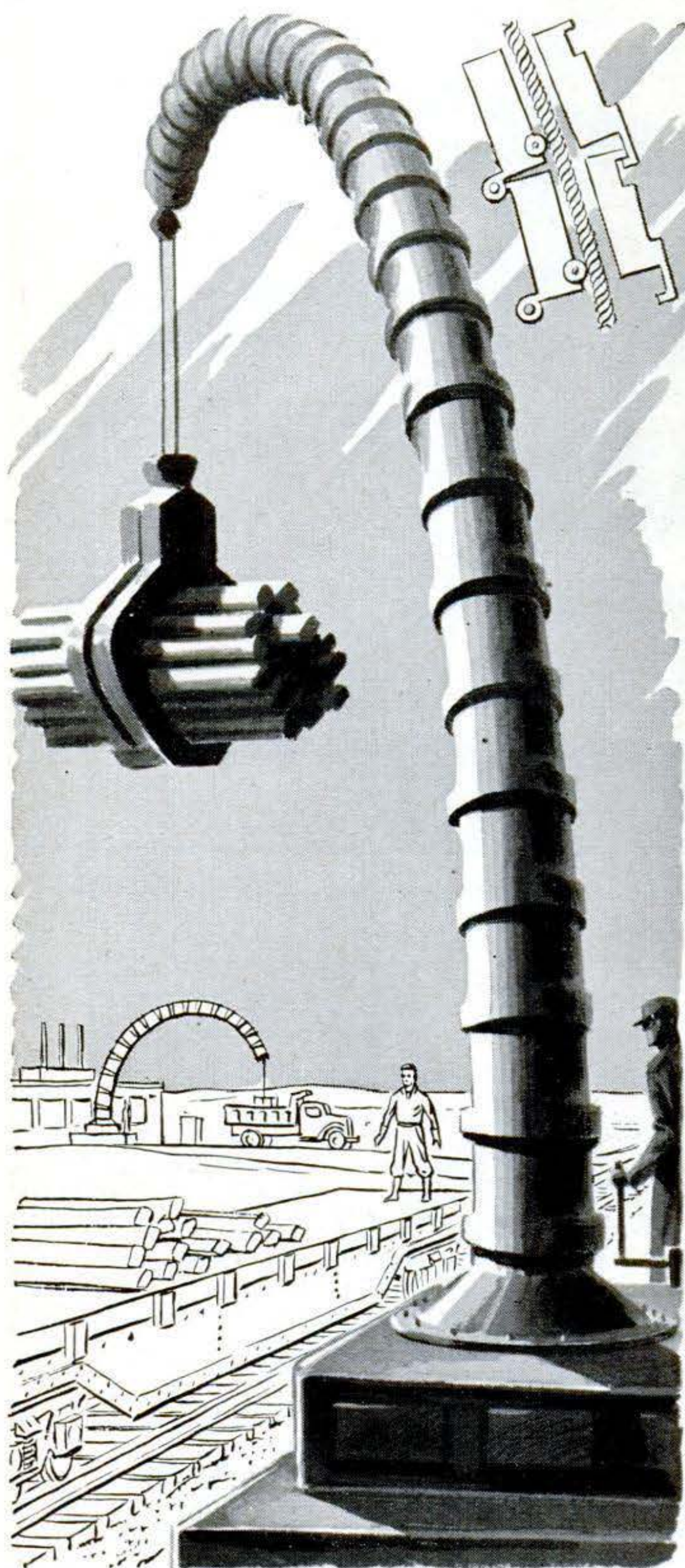

5 Hoist to Have "Gooseneck" Boom. Operating on the same principle used in many jointed toy animals, this hoist has a flexible boom controlled by a central cable. With the cable pulled taut, the boom assumes a vertical position. As the cable is payed out, the boom curves down until the full limit of its ringlike hinges is reached. The internal cable is then used as hoist.



4 Sight to Aid Gunners. Looking through this whirling stroboscopic disk, a gunner sees his tracer stream only as short dashes at intervals of known range. So instead of trying to aim the entire stream, he simply aims the dash nearest to the target plane. When the plane comes into that particular range, it flies right into the bullets' path.

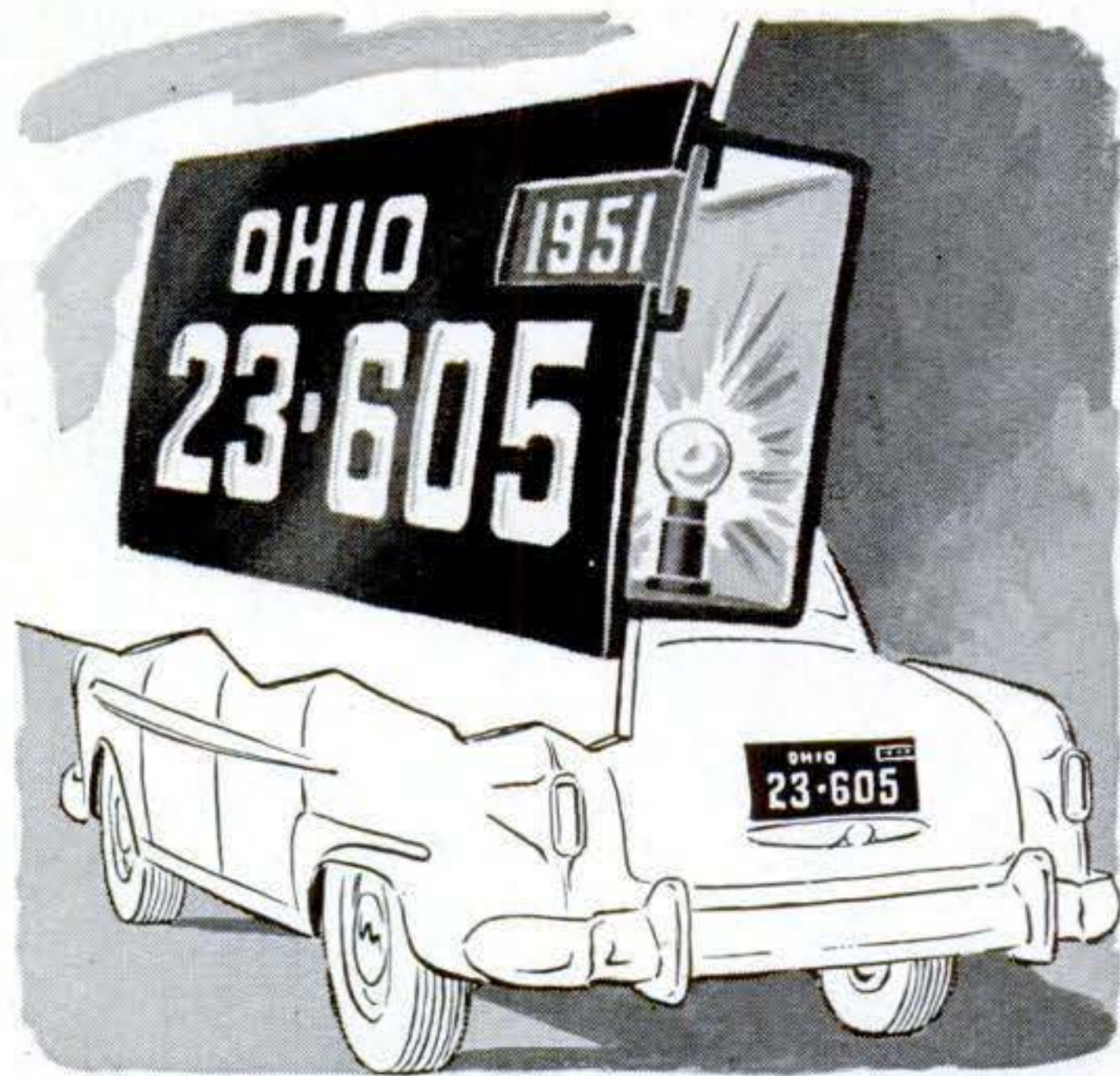

6 License to Be Part of Car. The license plate developed by this inventor is translucent with opaque numbers and is permanently installed to form an actual part of the trunk compartment. Lighted from within, the plate would be clearly visible, practically theftproof, and difficult to falsify. It would be kept up to date by installing a new insert each year.

Patents on these inventions have been granted to: 1. R. Kuns, Cincinnati; 2. A. Putnam, Chicago; 3. E. Hudspeth, Cambridge, and J. Nash, Boston; 4. E. Baker, Merced, Calif.; 5. H. Drake, U. S. Navy; 6. O. Gropper, Woodside, N. Y.

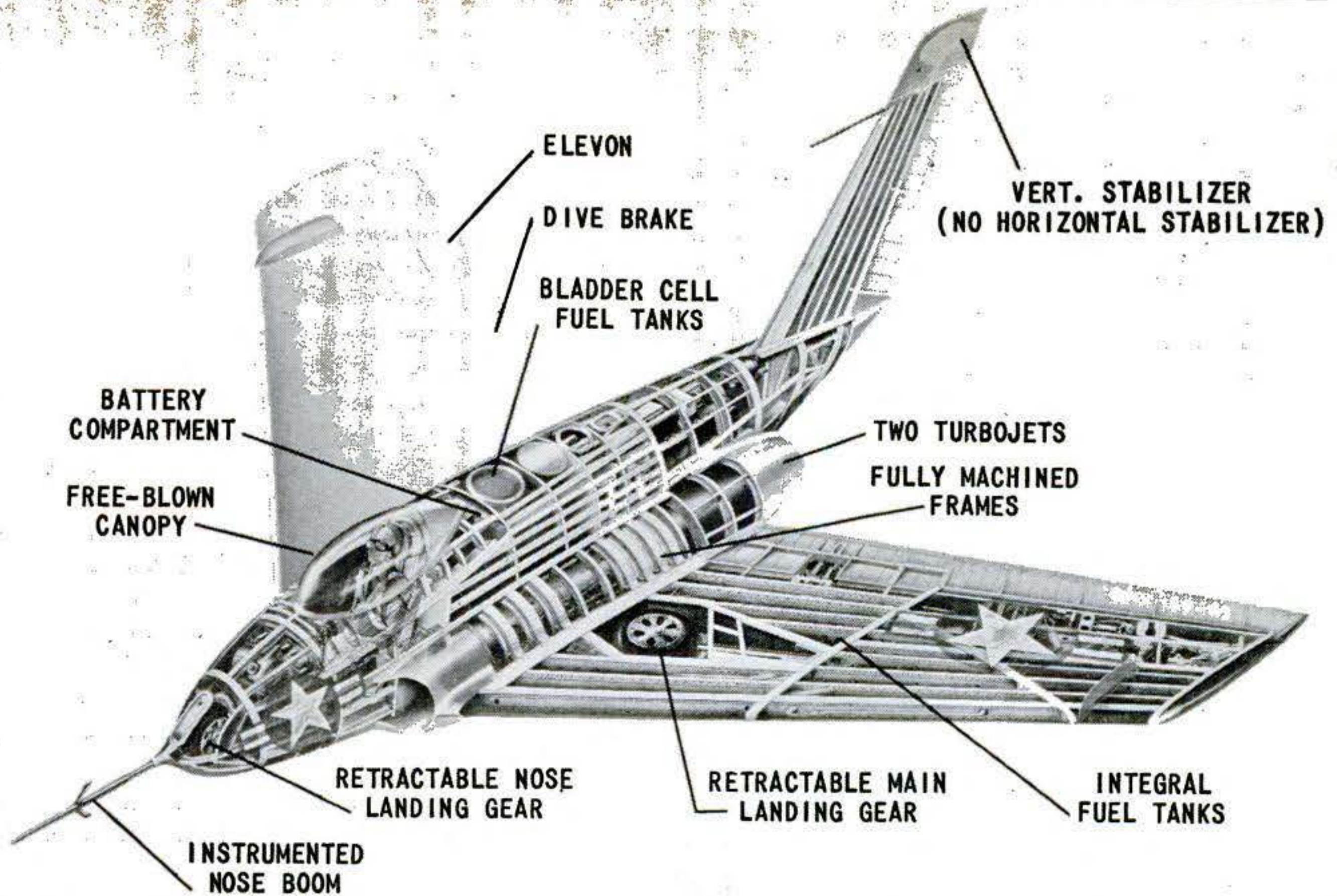

Tiny X-4 Sonic Research Plane Is Packed with Gear

HERE'S a peek at the tightly crammed interior of the Northrop X-4, one of the Air Force's flying laboratories. For the past two years AF pilots have been flying the jet research plane at Edwards Air Force Base, Calif., delving into the mysteries of

sonic flight. One of the smallest planes ever built for the Air Force, the X-4 measures only 25 feet from wing tip to wing tip, 20 feet from nose to tail. Elevons in the trailing edge of the swept-back wing double as ailerons and elevators.

Plastic Suit Stops Radioactive Dust

INTENDED for use in radiologically contaminated areas, this plastic suit will keep out water and dust particles as fine as 1/50,000 of an inch in diameter. Suit and boots are made of vinyl, with an acetate window. A mechanical filter protects the lungs, and rubber gloves allow finger movements. Lockheed designed it for the Navy.

Navy Develops Cold-Weather Boot

THE new boot, left below, is rubber inside and out. Sandwiched between is a layer of wool insulation, seen along sole in cut-away, center. Worn with only one pair of medium wool-cotton socks, this construction prevents excessive perspiration that sometimes caused frostbite with the old-style shoepac, right, that required one or two pairs of heavy wool socks for insulation.

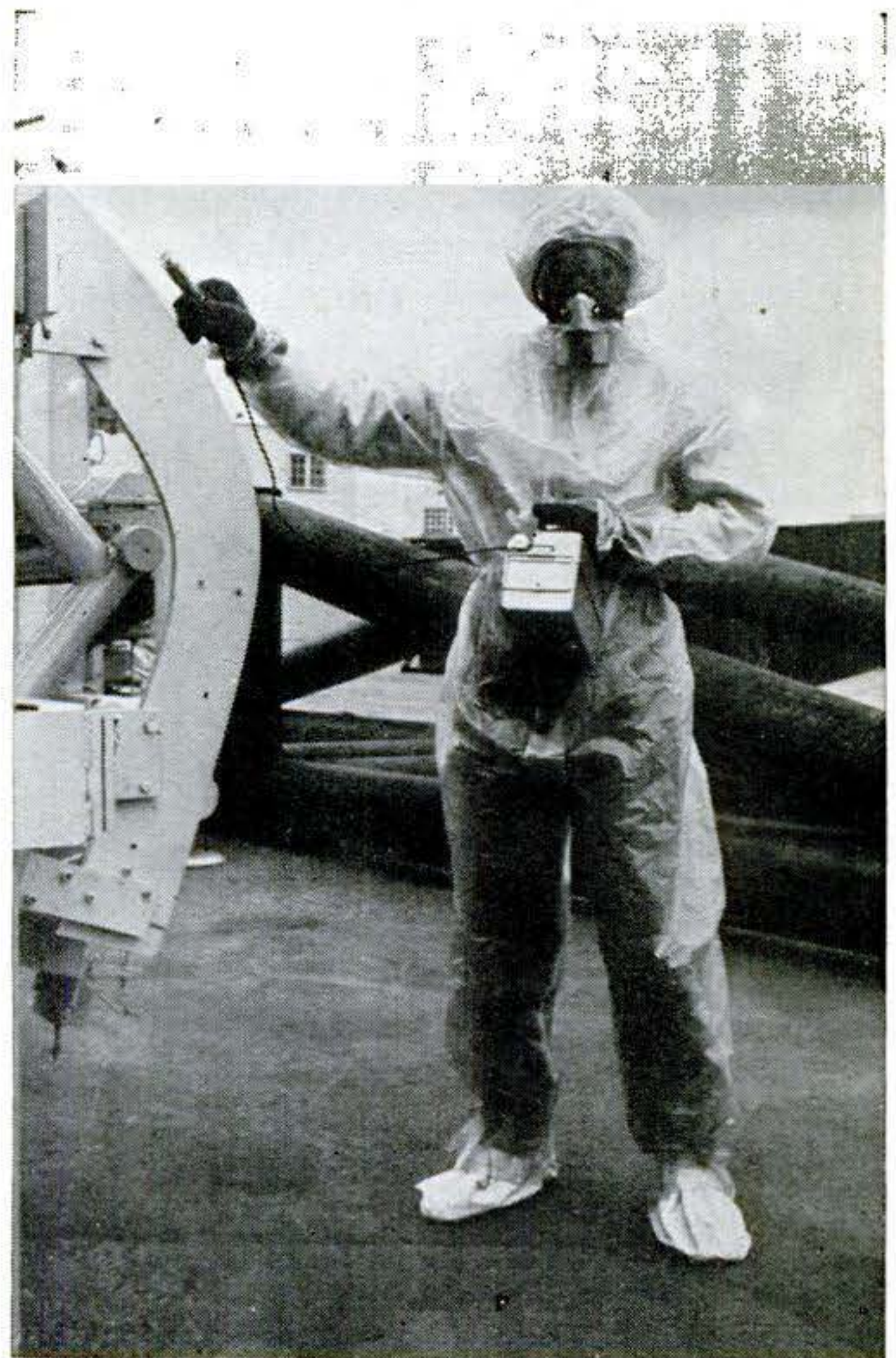



In the middle of the vast desert, welders join together the long sections of pipe that make up

Tapline. Pipeline extends 1,068 miles across varied types of terrain—almost all bad.

Arab workers operate machine that pulls length of 30-in. pipe from inside one of 31-in. size. Pipe was made in two sizes and shipped nested at a saving of \$3,000,000 for cargo space.

To save work in the field, 31-ft. sections of pipe were welded (below) into 93-ft. lengths at Persian Gulf and Mediterranean ports, then hauled across desert. [*Continued on next page.*]

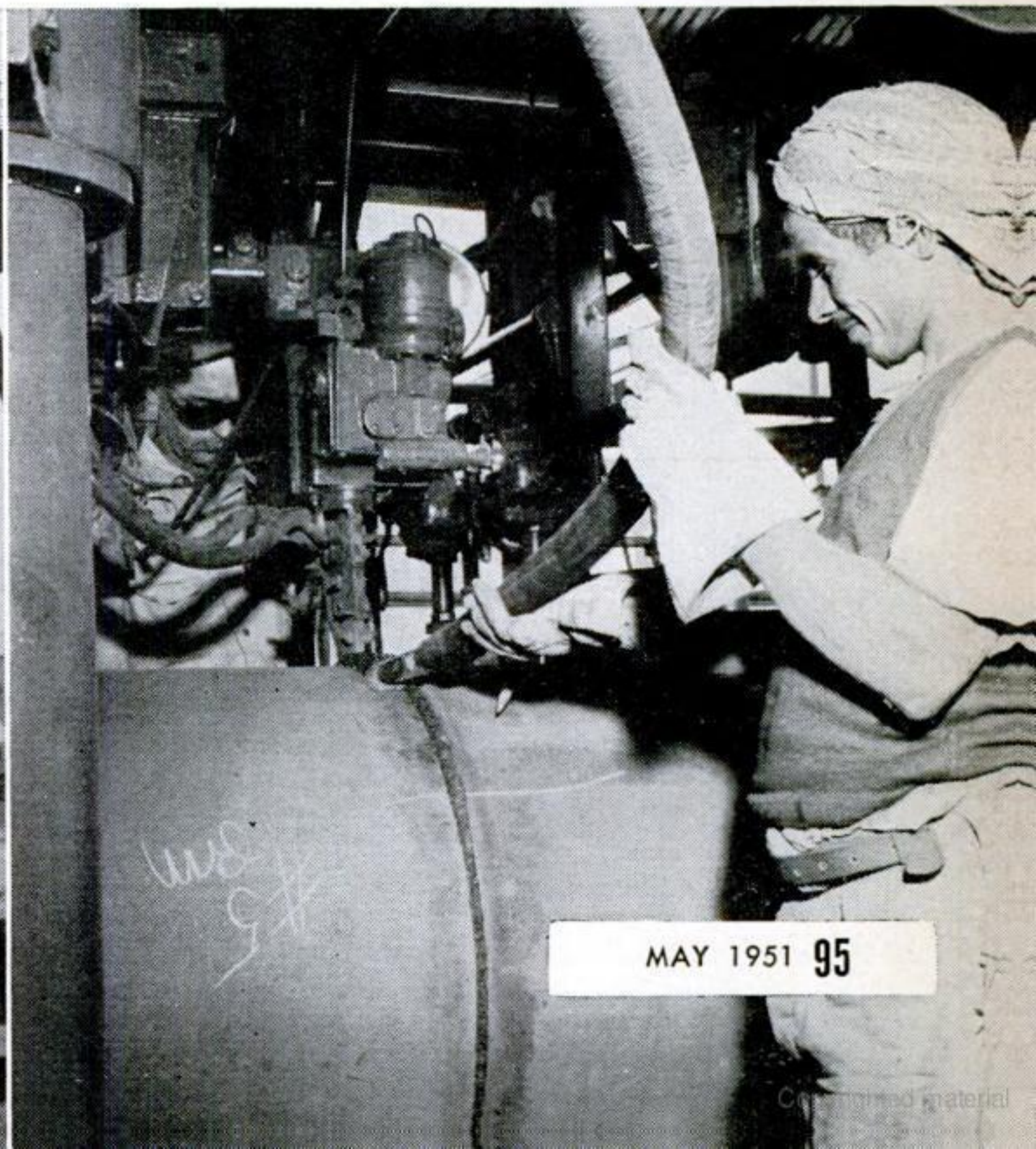
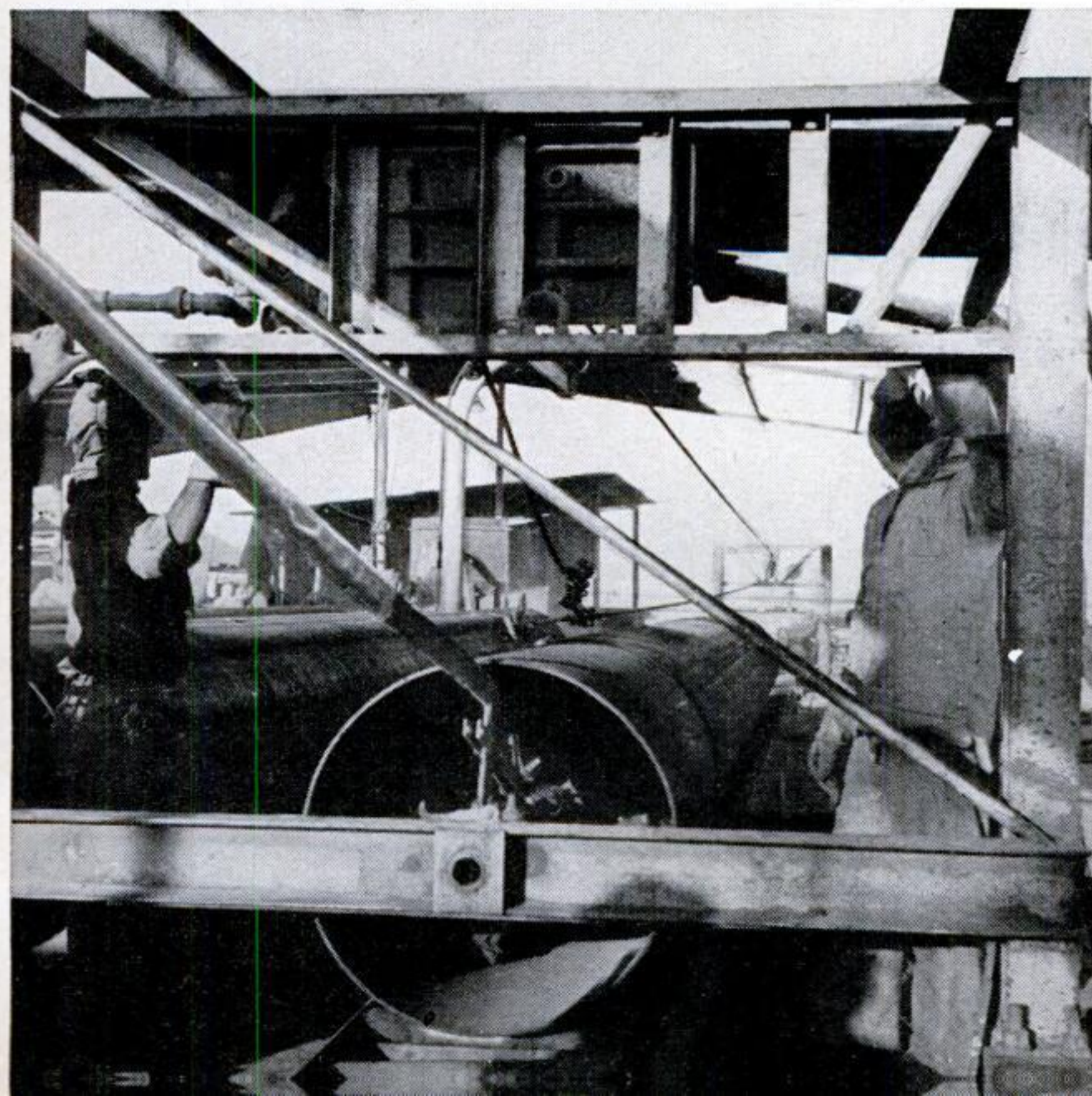



"Skyhook" carries 9 tons of pipe ashore in Saudi Arabia from artificial unloading island built $2\frac{1}{2}$ miles at sea in Persian Gulf because of shallow water and lack of docks.

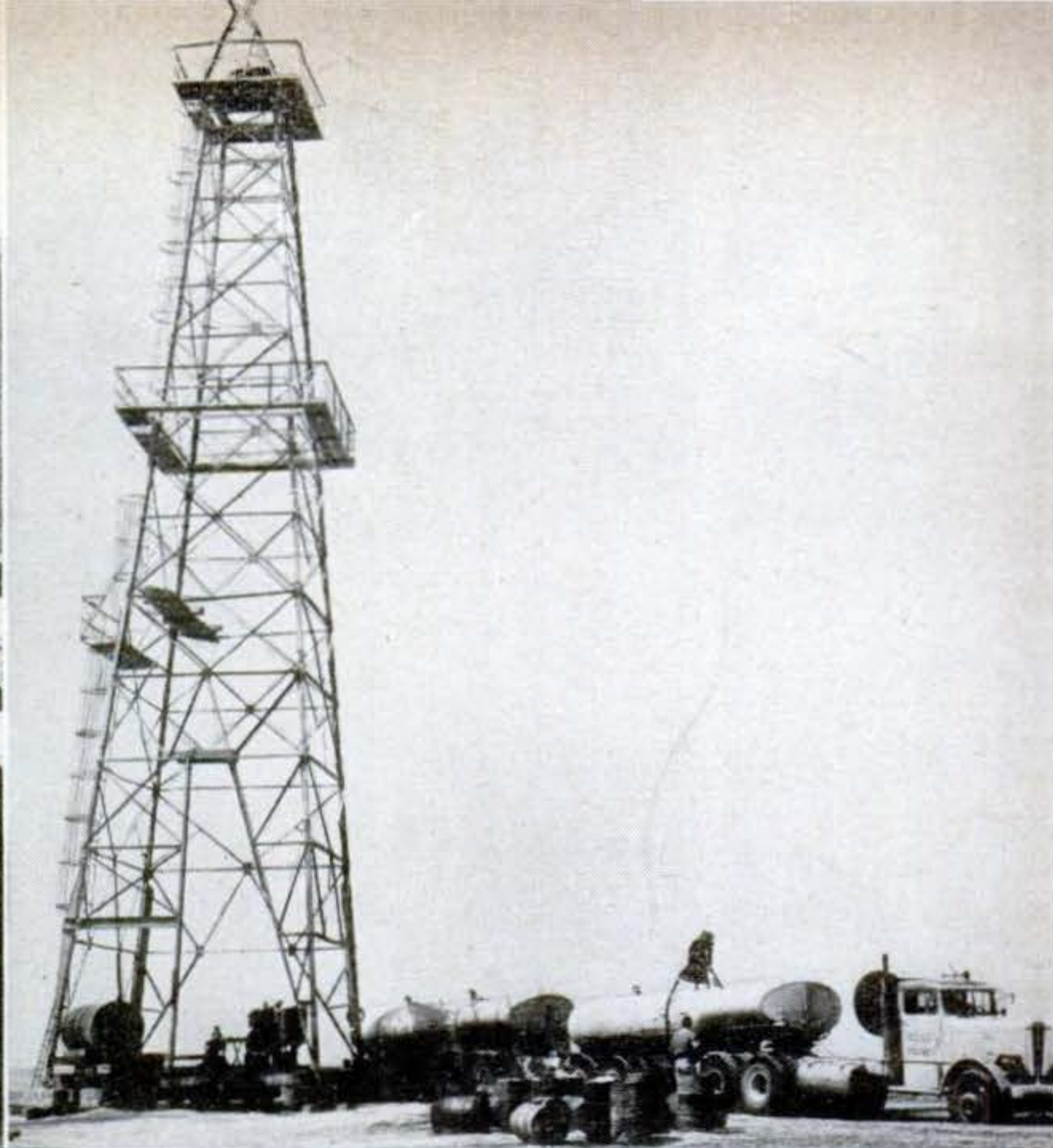

Tank trucks load up with fresh water at one of 40 wells drilled along pipeline route to supply construction crews. Man-made oases have become centers of new Bedouin settlements.

Heavy anchors hold the pipeline at point where it makes 13° bend. This section is part of Arabian-American Oil Co.'s distribution net-

work, which feeds main line of Trans-Arabian Pipeline Co. The whole system, stretching from Persian Gulf to Mediterranean, is called Tapline.



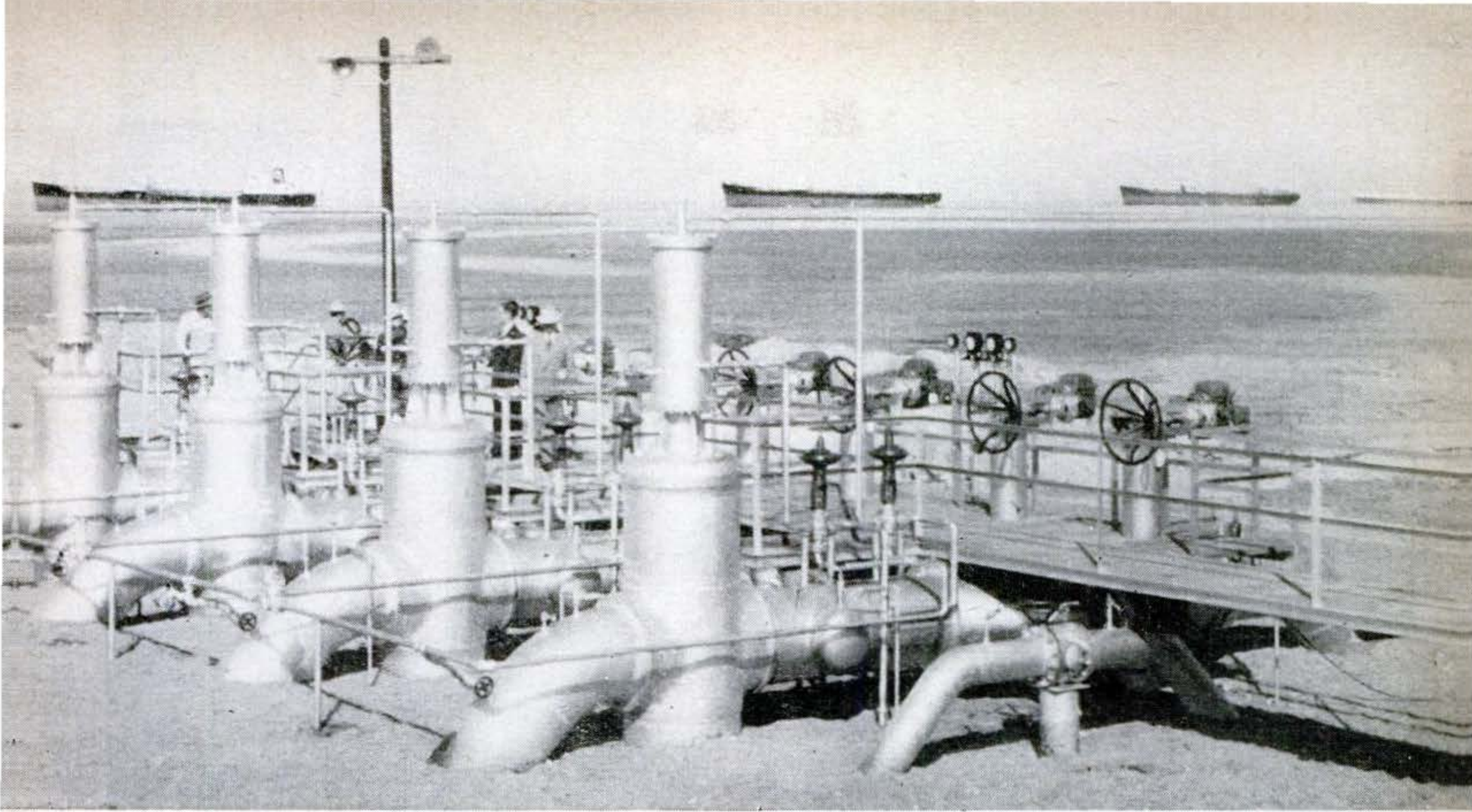

At line's terminus on Mediterranean, tankers tie up at four loading berths, spaced 2,600 feet apart, and are fed by submarine pipes running a mile out to deep-water anchorage.

Special machines wrap and lay huge pipe (below). At right, Arab adjusts one of big valves controlling oil flow. Some weigh 11 tons each.

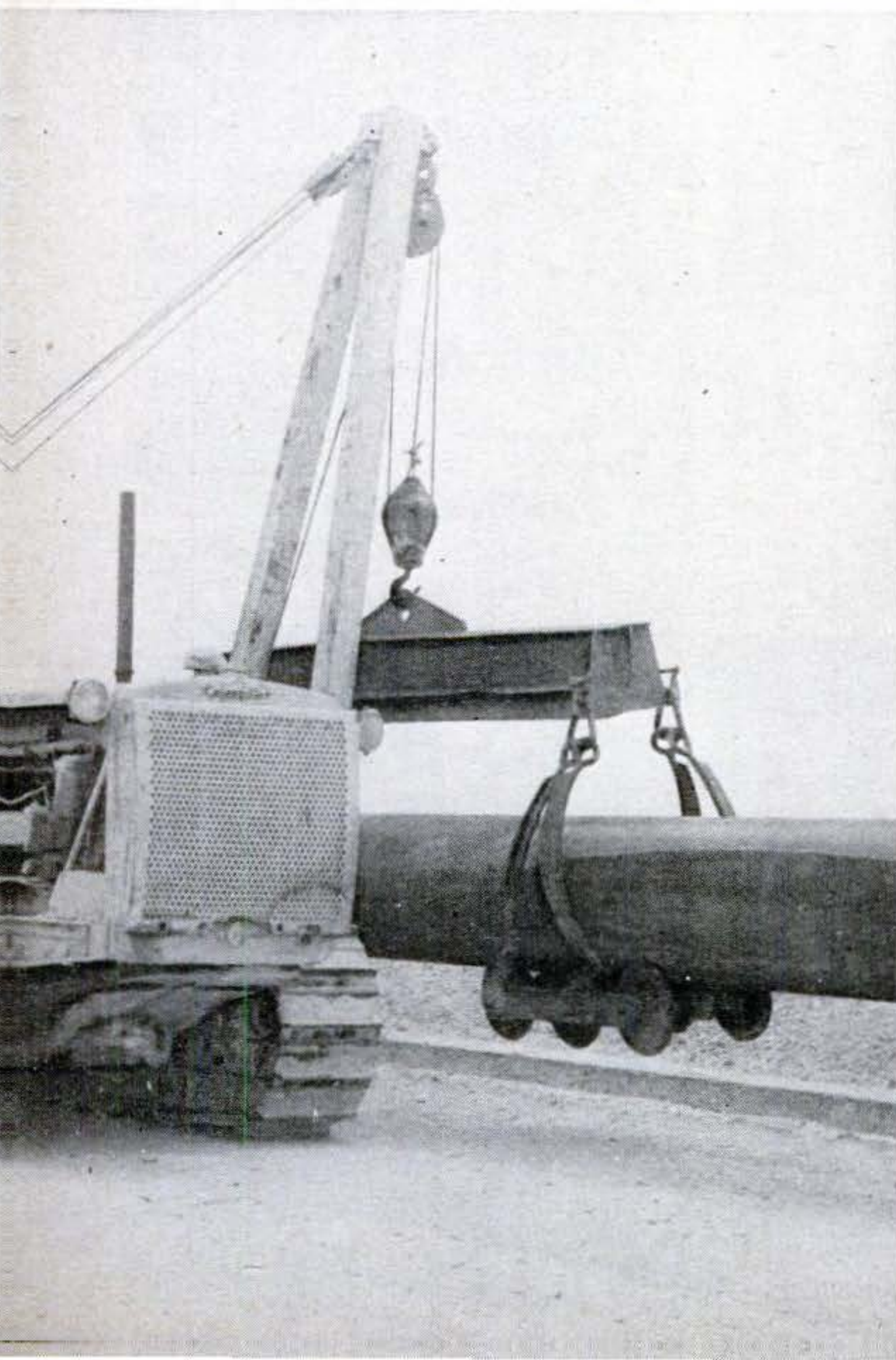

MAY 1951 97

Greenhouse Plants Grown and Transplanted in Plastic Bags

BAGS of Vinylite plastic film hold the rose plants at right, growing in a greenhouse during the off season. Bag and all, they are transplanted in summer to the outdoors and later in the year are taken in before killing frosts.

The plastic bags replace bulky and breakable pots for planting seedlings and seed, in a system originally developed for raising tomato plants by Frederick W. Stanton, Holland, Mich., grower. Successfully used both with vegetables and flowering plants, it is said to double the number of tomato plants that can be grown in a given space and increase the yield per plant.

Filled with mica, the bags are set in a long, narrow wooden trench in the greenhouse. Through openings in the bottoms of the bags, the plants absorb chemical nourishment and water pumped into the trench.

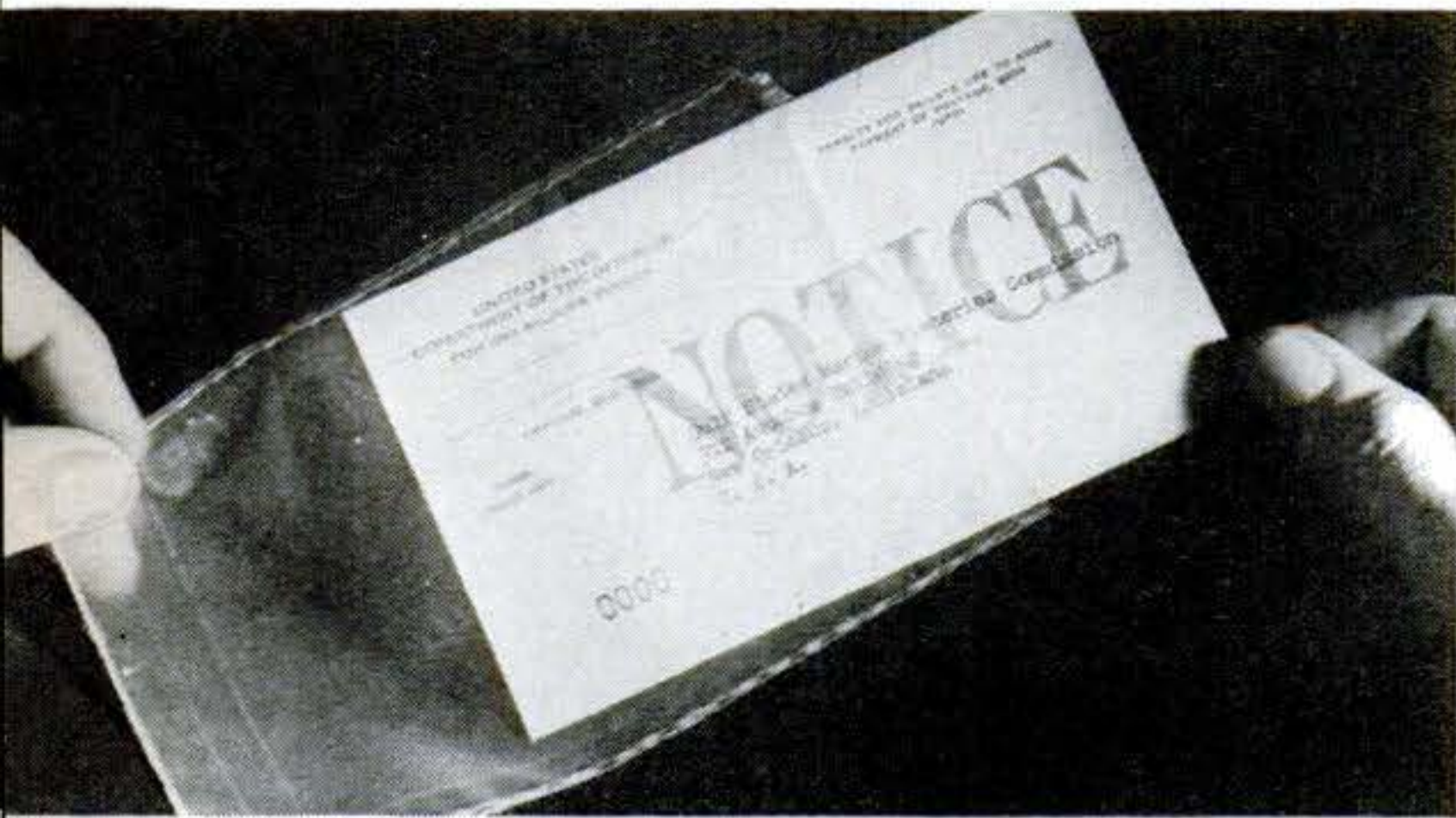
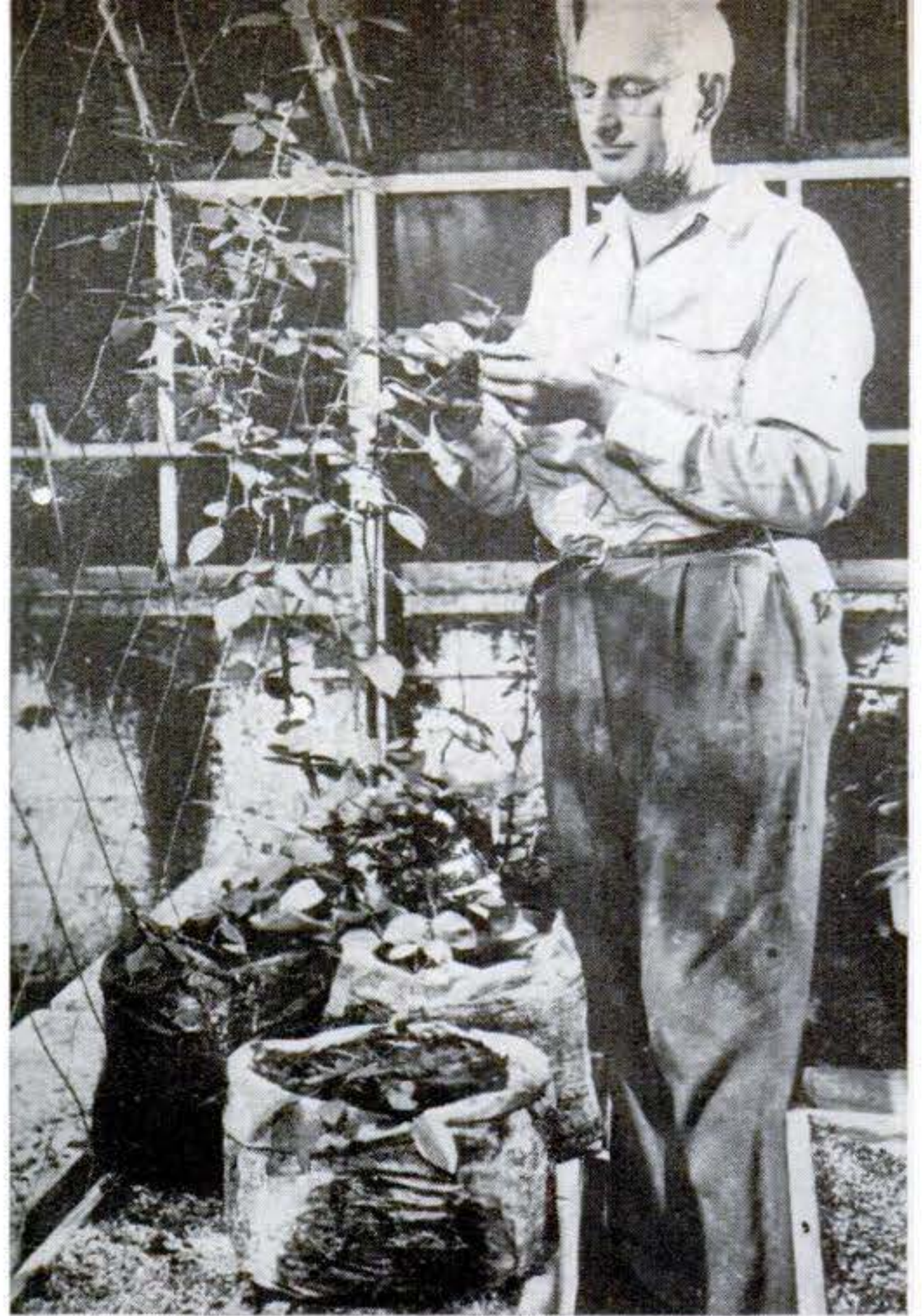

Postcards Ride Sea Currents

SEVERAL thousand postcards will be dropped into the Gulf of Mexico this year by Navy aircraft. Sealed in plastic (left), the "drift cards" will float with the currents and be cast up on beaches. Finders are asked to mail them to the Gulf States Marine Fisheries Commission at New Orleans. Thus scientists will be able to trace sea currents important to the fishing industry. Floating bottles, in which cards have been put before, are affected too much by wind.

Motors in Wheels Drive Gas-Electric "Car with a View"

FOUR electric motors built into its wheels drive a gasoline-electric car called the Symétric, introduced in Paris. A generator driven by a four-cylinder Simca motor supplies current for the transmissionless drive

and for braking, eliminating brake drums and lining. Unusual window area gives all-around view. Windows slide into the top, and doors into the floor, as below, to provide unobstructed access.

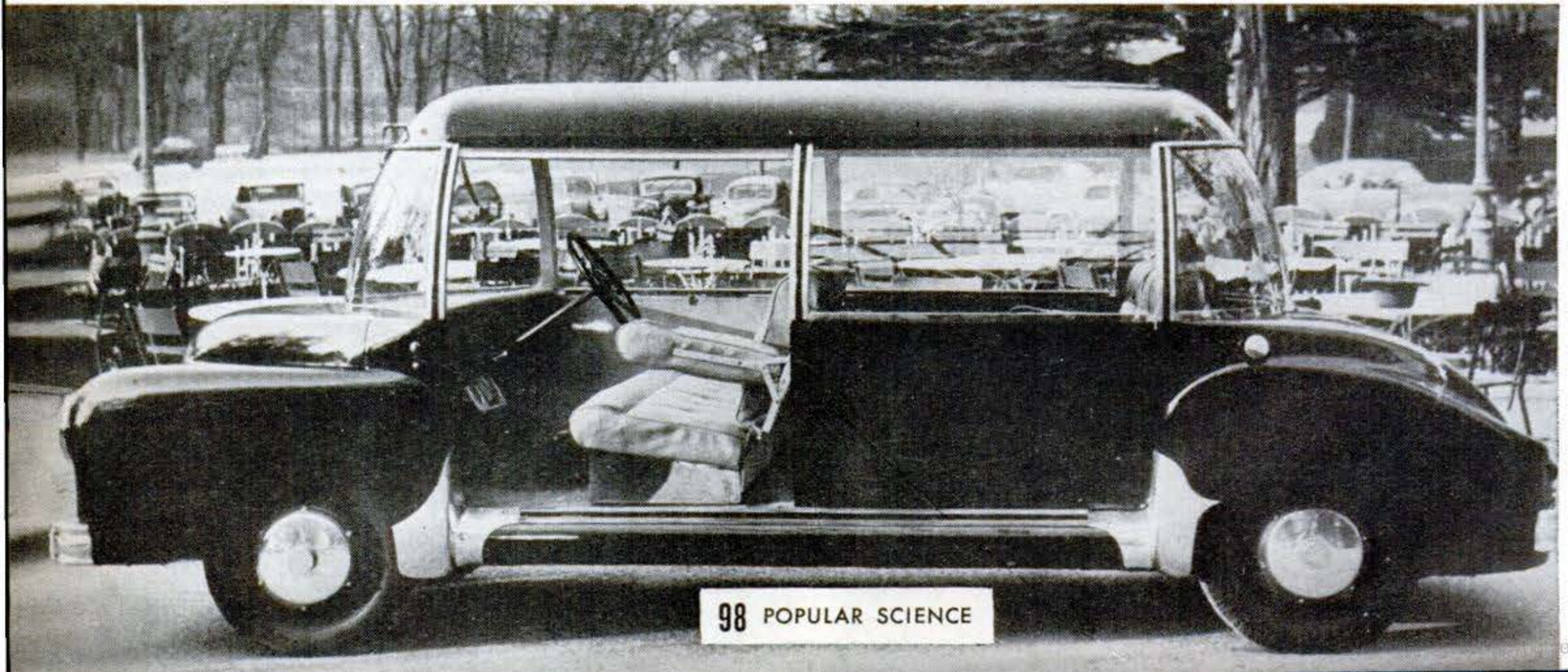

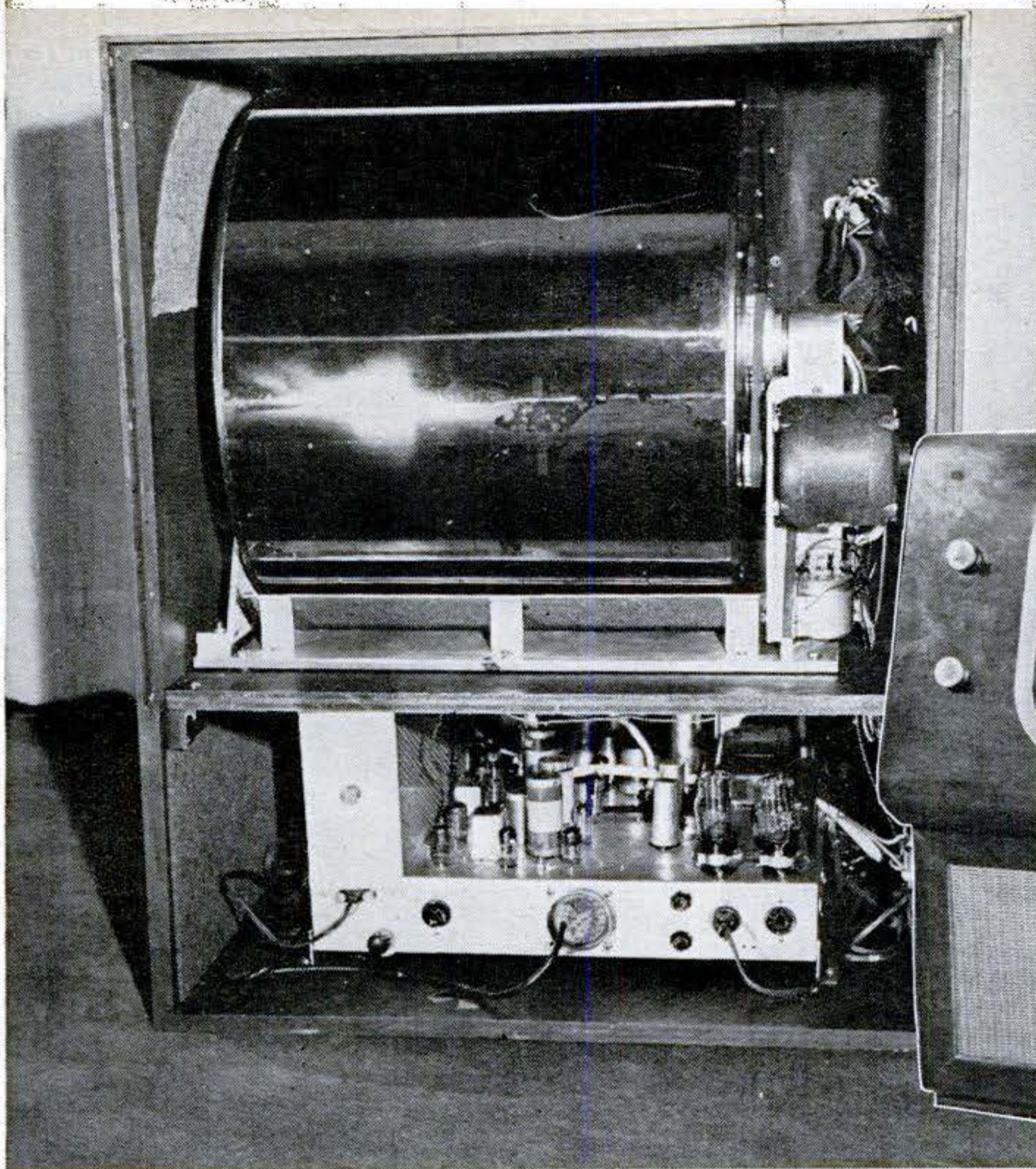

How color drum fits around TV tube is shown in back view at left. Drum motor is visible at right of drum. In front view of set (below), tube can be seen through the color drum.

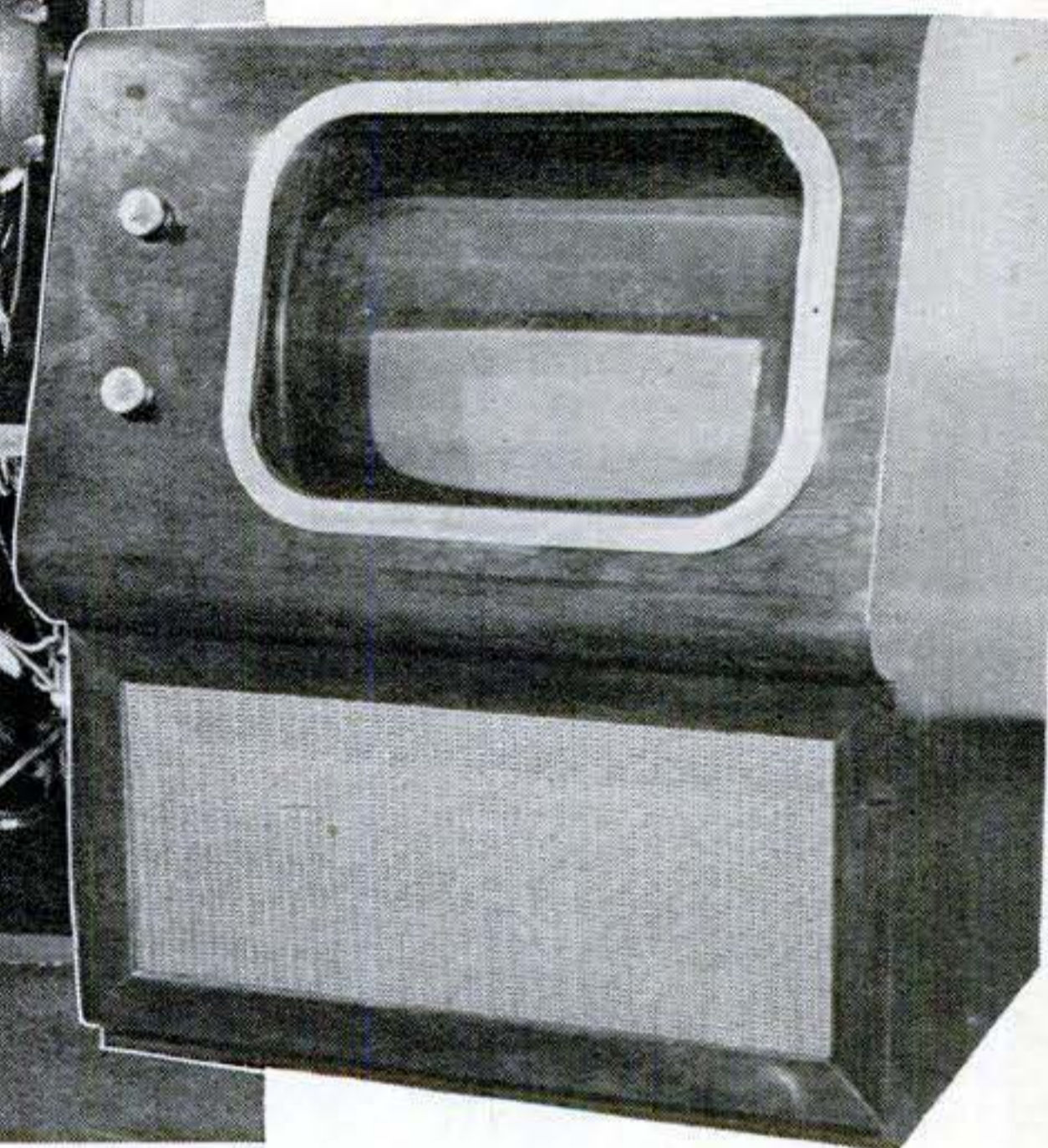

Big Pictures on Color TV Made Possible by Drum Filter

COLOR TV pictures as big as you want are now possible with the Columbia Broadcasting System's color method. Previously picture size had been restricted to about 12 inches, a limitation severely criticized by CBS opponents. Using a drum instead of a disk for the color filter turned the trick.

The picture tube fits inside the horizontal, varicolored drum, which spins around it to create the illusion of full color. The drum need be only slightly larger than the tube itself—a drum 20 inches in diameter accommodates a 17-inch tube. A disk for a tube that big would be a yard across.

300-Ton Tank for Refinery so Big It Rides Three Flatcars

IT TOOK three railroad flatcars to handle this tank—the heaviest piece of oil refinery equipment ever sent by rail. The tank, called a “49-tray depropanizer,” is 13 feet in

diameter, 120 feet long, and weighs more than 300 tons. Bridges on the route from Houston north had to be checked in advance for strength and clearances.

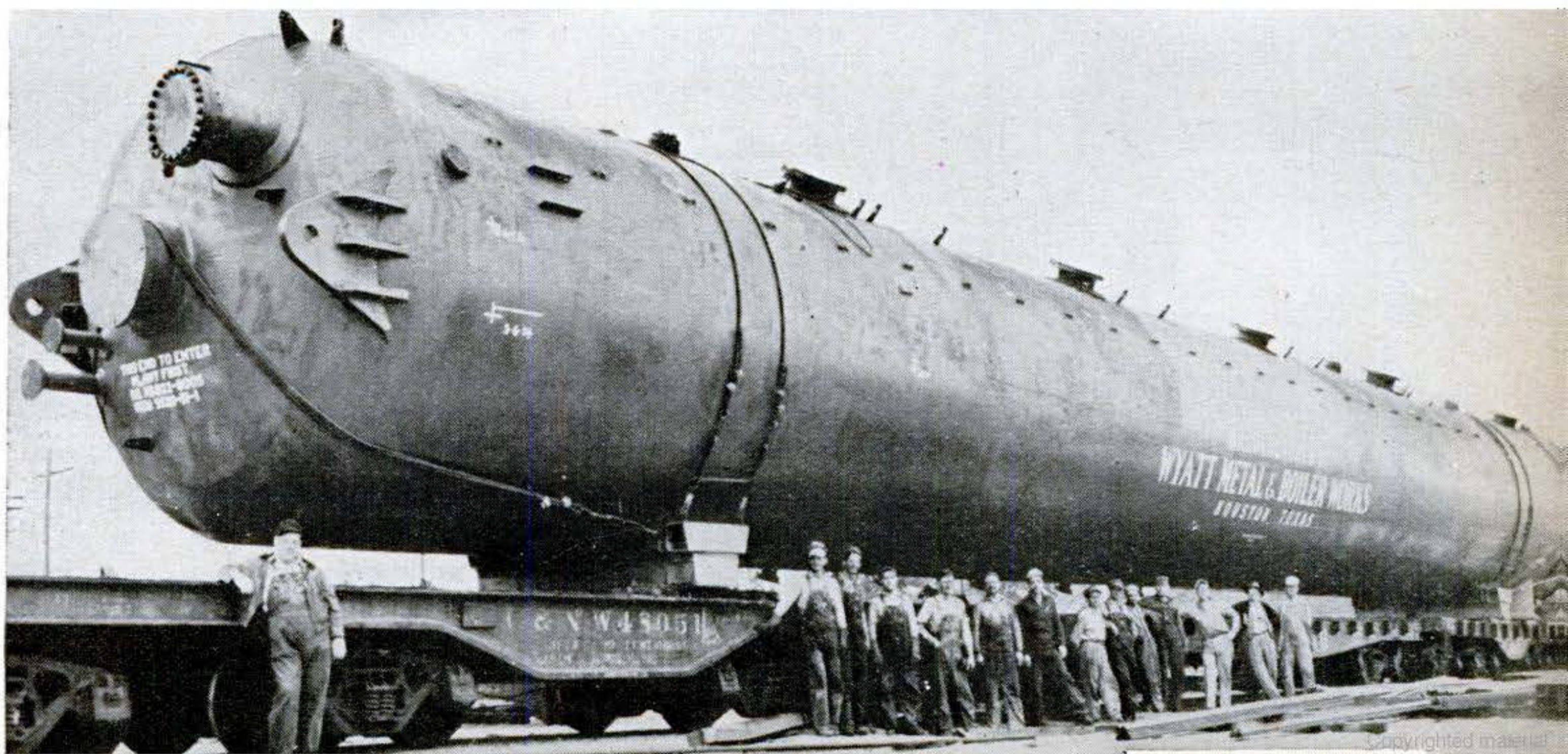

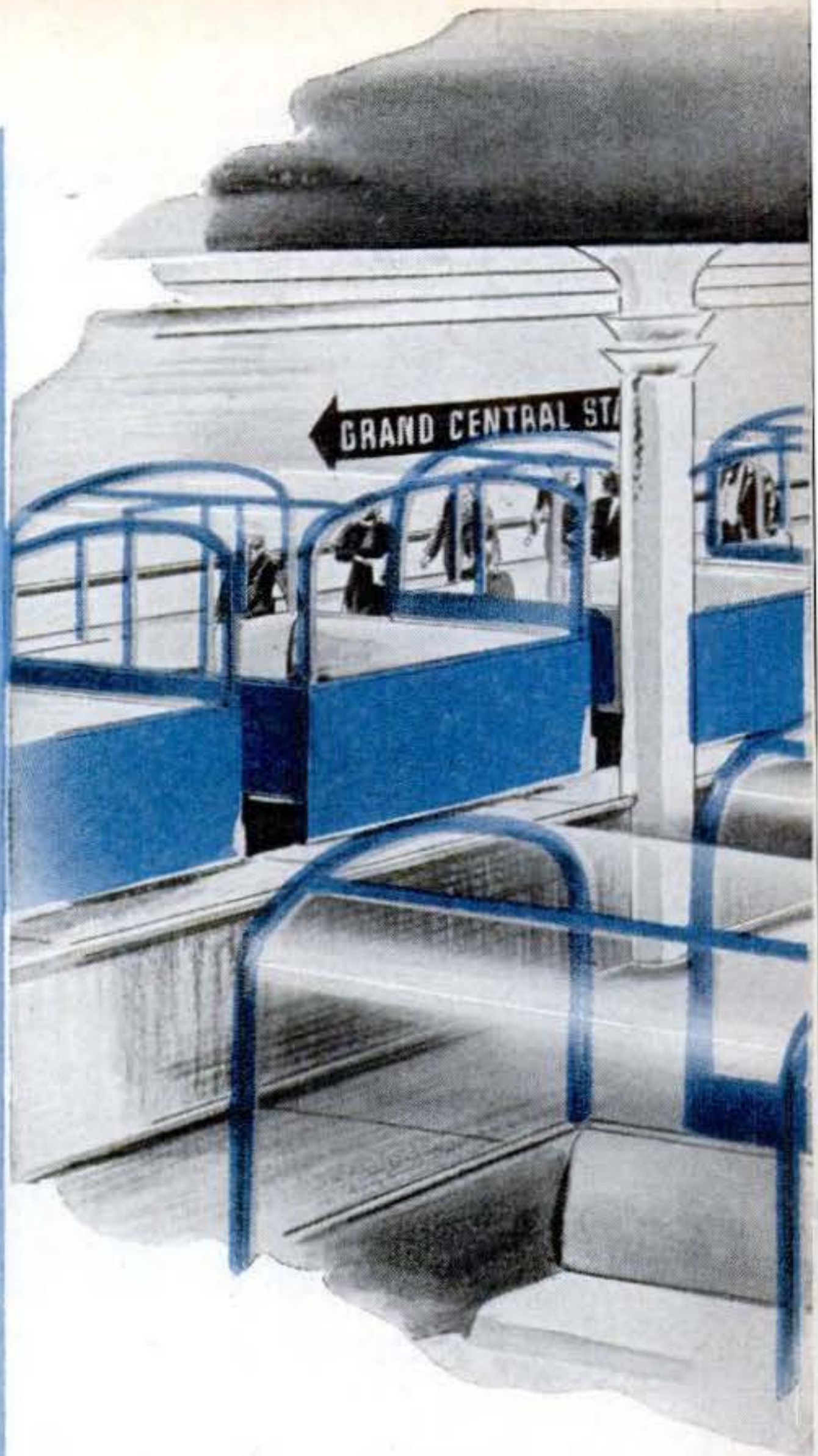
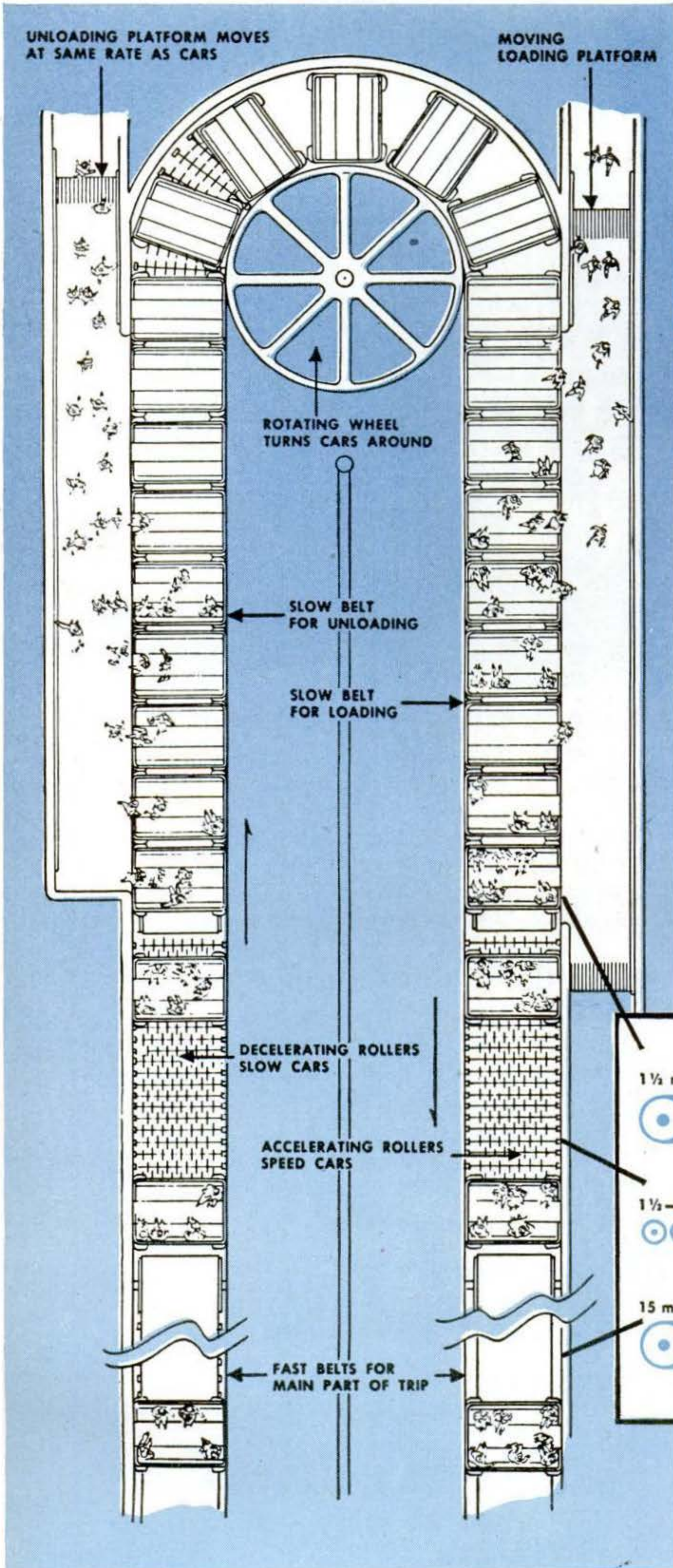

Endless Train

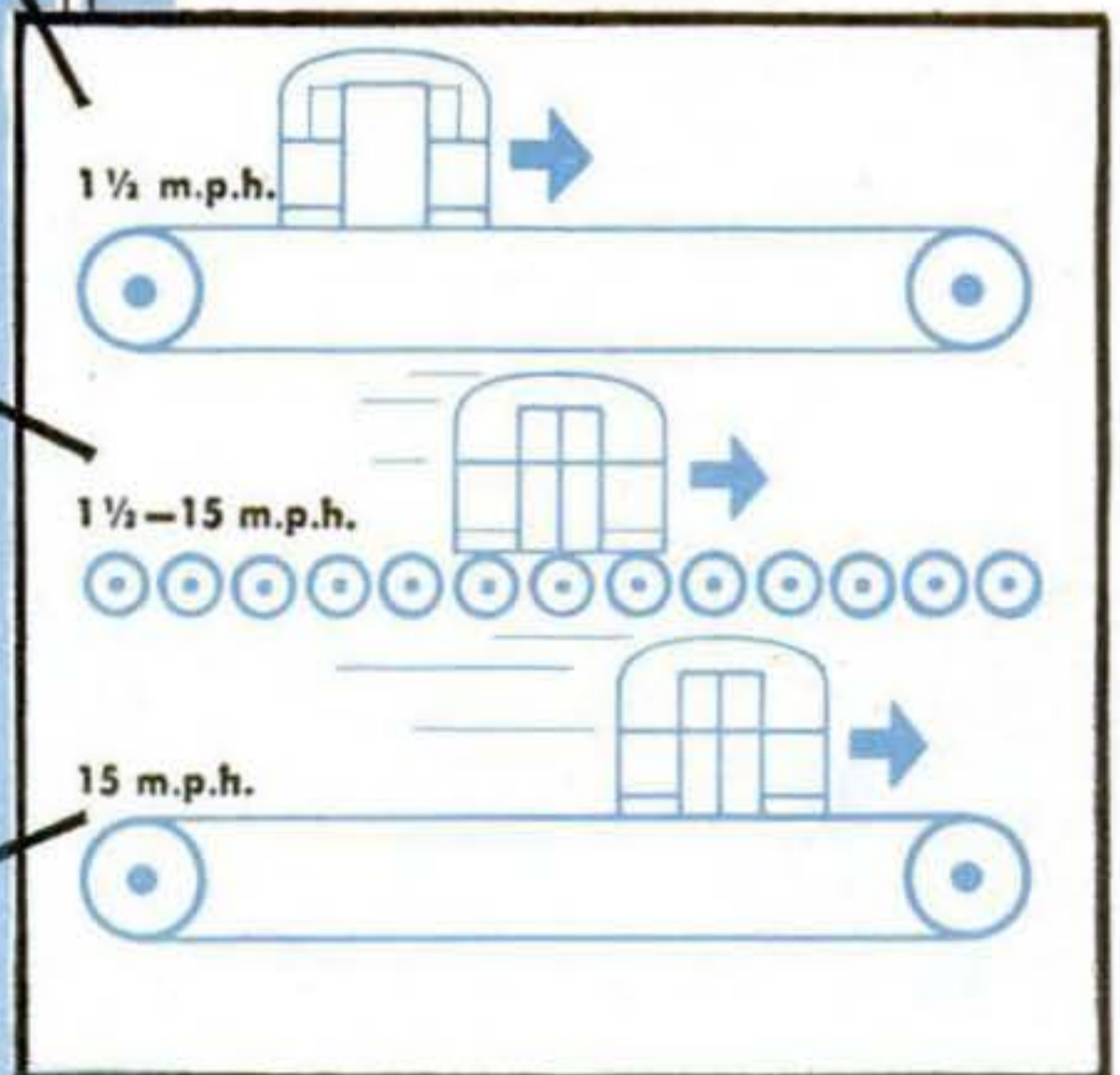

Car starts out slowly, is speeded up by rollers turning at ever-faster rates to reach the high speed of main-line conveyor. Thus, fast trip can be made safely.

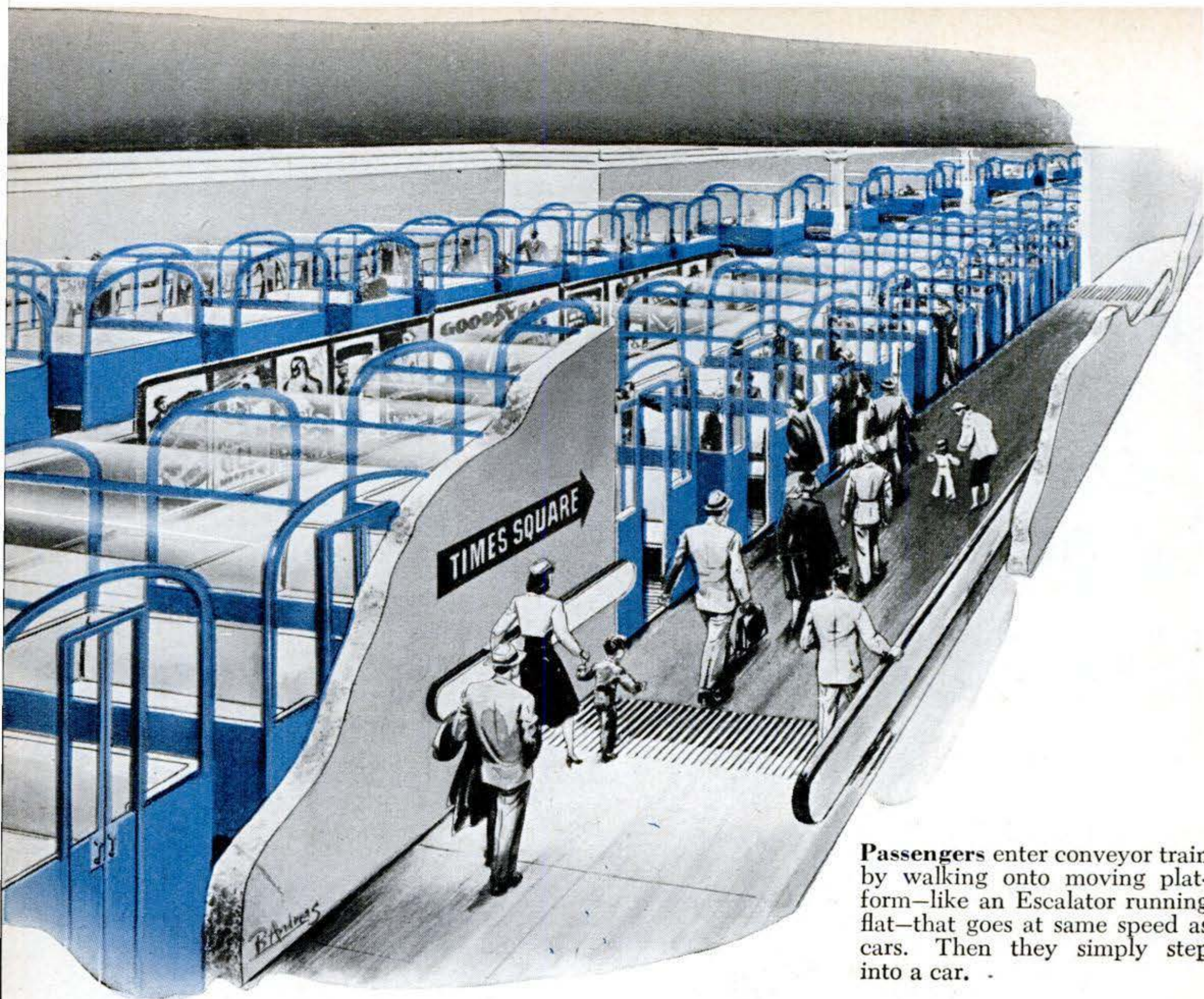

Passengers enter conveyor train by walking onto moving platform—like an Escalator running flat—that goes at same speed as cars. Then they simply step into a car.

to End New York Subway Jam

CARS riding an endless belt could carry more than 500 people a minute across the world's biggest city. Plans for them have been submitted to officials struggling with New York City's traffic congestion.

This new kind of subway train would never stop nor end. Passengers would enter its cars from a sidewalk moving a mile and a half an hour, which is slower than many moving stairways. The cars would speed up to 15 miles an hour for the trip. At the end they would slow down and be turned around by a constantly turning horizontal wheel.

Although small, this train's many little cars could carry nearly twice as many people about a third faster than the crowds transported now by shuttle trains under 42nd St. between Grand Central and Times Square.

This shuttle is one of the worst bottle-necks in New York subways, and the mov-

ing-belt system was developed specifically for use there. Its designers, Goodyear Tire & Rubber Co. and Stevens-Adamson Manufacturing Co., say, however, that it could be applied to other subways. **END**

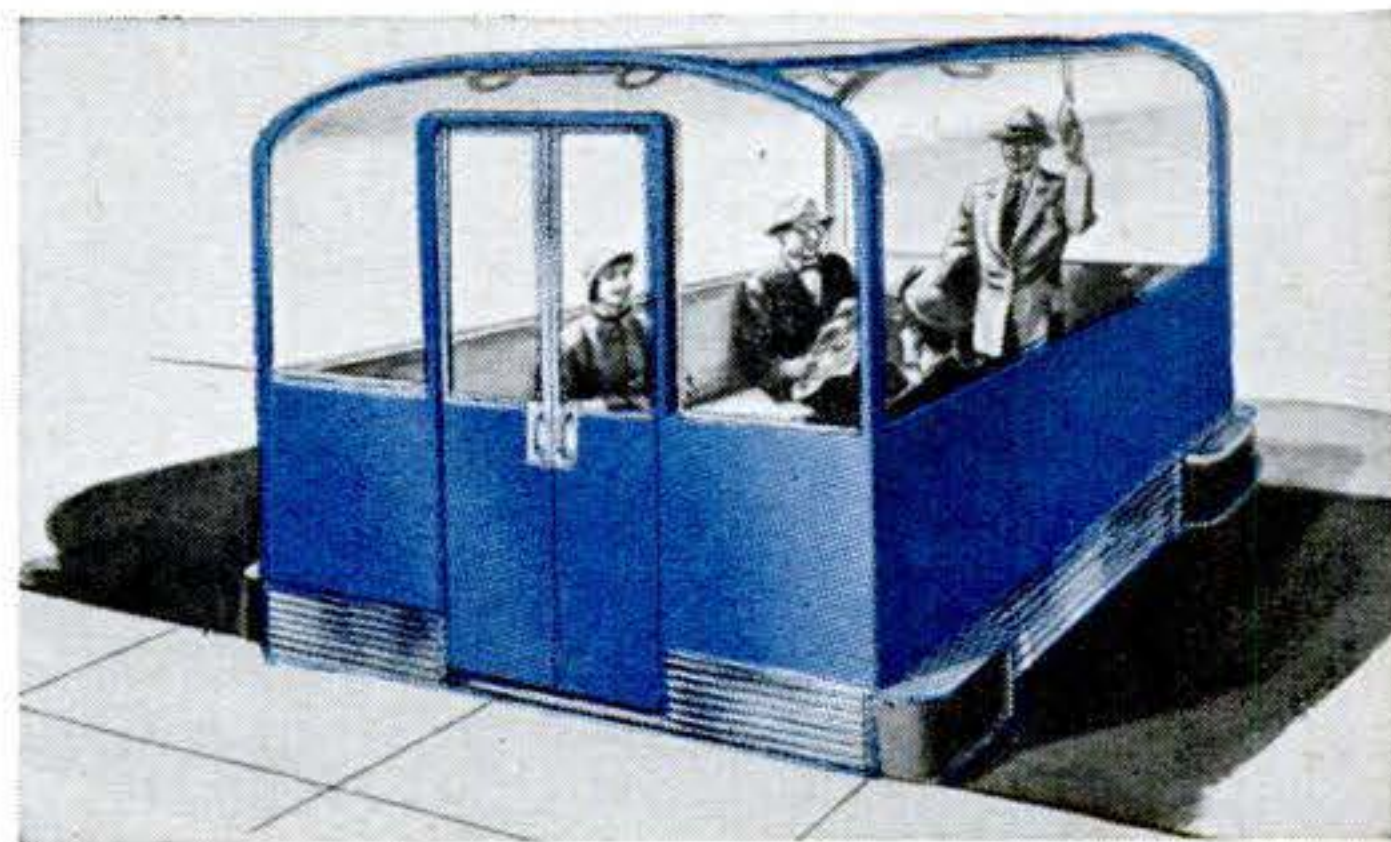

Proposed design for conveyor cars has clear-plastic top and sides. Automatic doors would be open only when car was alongside platform.



Modelmaker Cloy D. Niver, guided by artist's sketch for a premium, carves whitewood pattern four times the size of future plastic figure. Often he adds intricate touches of his own.

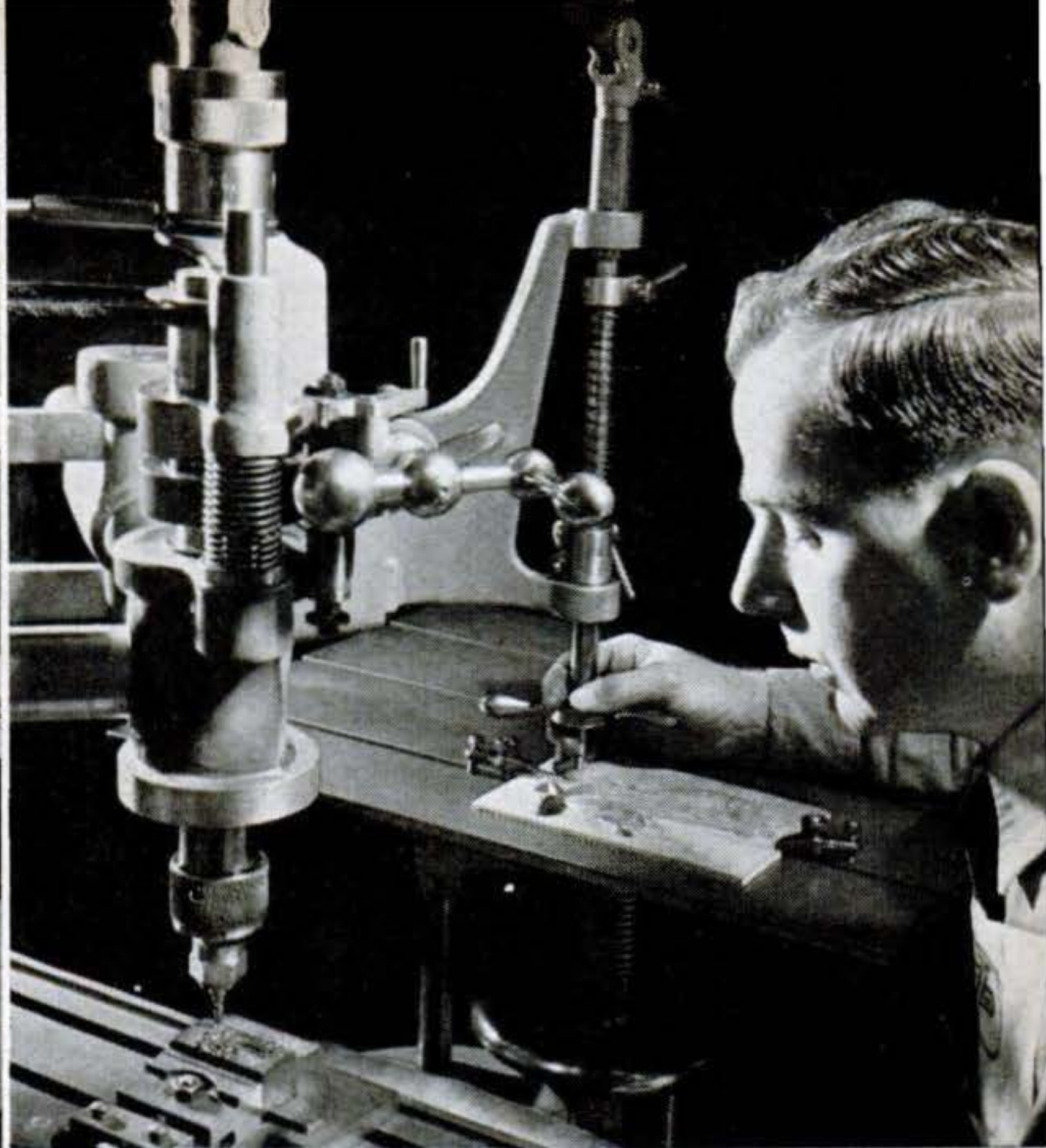

Duplicating machine follows the wood pattern (right) in routing out image one-fourth size in tool steel. Size is important, since all figures must fit later in packaging machine.

How They Make Plastic Figures

PHOTOS BY ALFRED ERIS

EVERY morning thousands of youngsters watch popeyed as their mothers open boxes of their favorite breakfast cereal. What makes it their favorite is not calories, vitamins, or crunchy-goodness—but the realistic plastic miniatures of cowboys, Indians, buffaloes, prize fighters, and skaters that come tumbling out.

These pictures tell the story behind those sales-boosting premiums: a story of skilled craftsmanship teamed up with mass-production methods.

The photos were taken in the plant of Monroe Plastics, Rochester, N. Y., a major producer in this new industry. The company is headed by a young engineer, Irwin E. Copland, who designed most of its machinery. It turns out millions of the miniatures a year in almost a hundred varied models carefully chosen by a vote of advertising and merchandising experts for their appeal to small-fry collectors.



Polisher uses diamond-burnishing compound to remove any flaws or impurities from cavities just before they go to the molding machine. Care here avoids production stoppages later.



Engraver tools minute details, such as horse's mane, into steel pattern. Tool points are specially ground for many miniatures. Finished pattern, called a "hob," is then hardened.

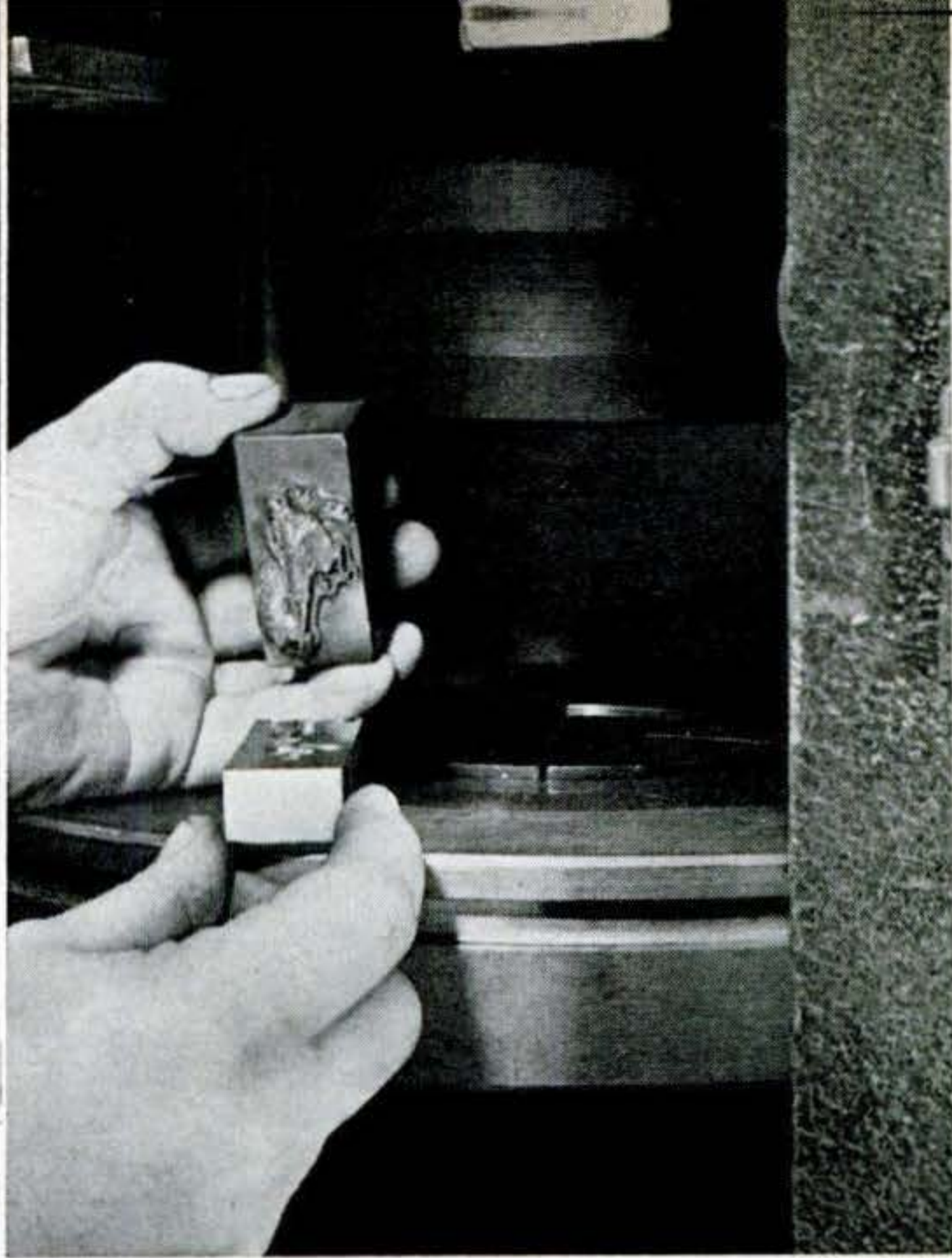

Under pressure of 100 to 300 tons, the hob is squeezed into soft steel blank (lower block). This reverse image, called a "cavity," is used as mold of figure into which plastic is injected.

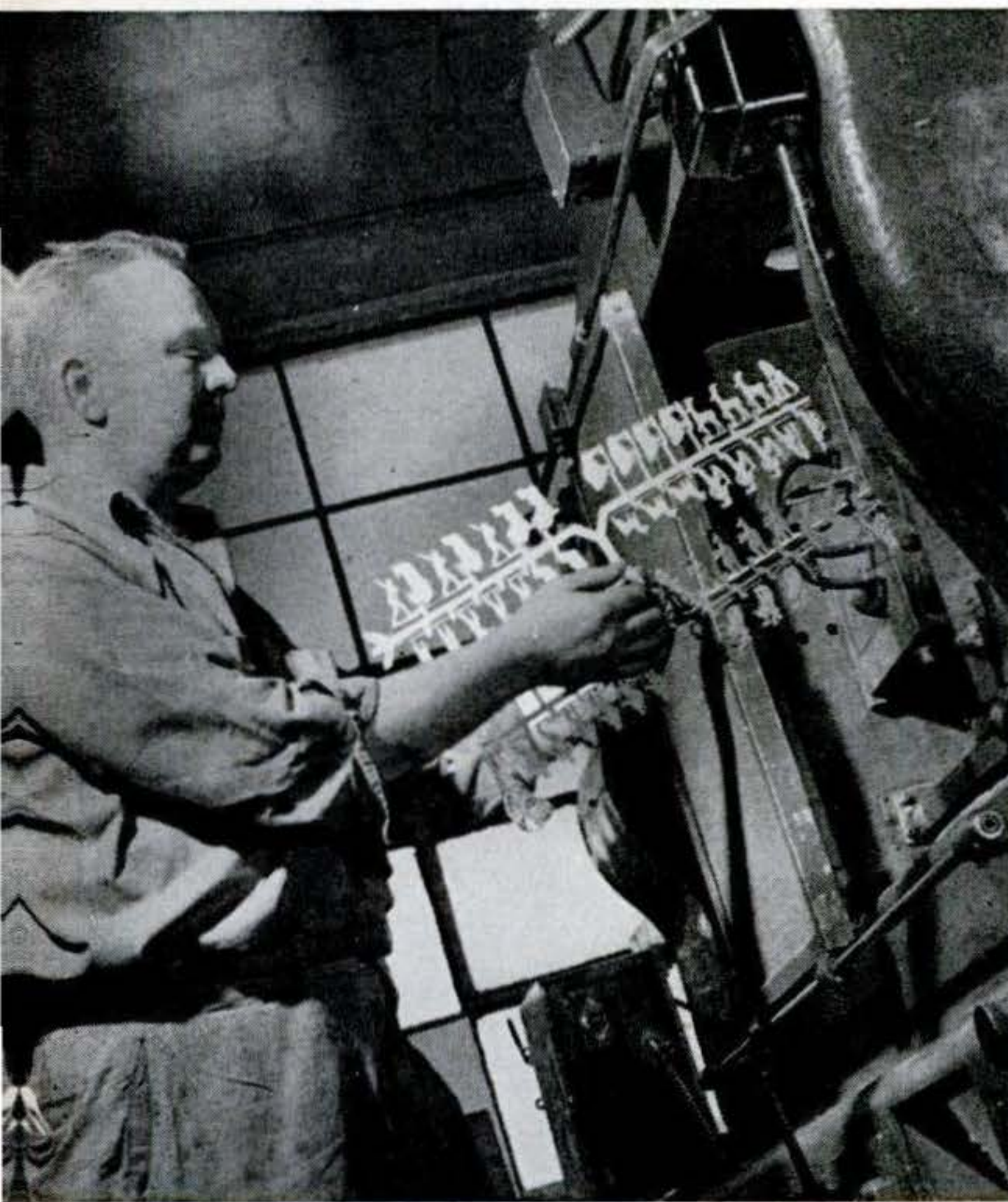

Plastic figures come out of molding machine in a group known as a "shot." They are cut apart, trimmed, and fed into a packaging machine that seals each separately in cellophane.

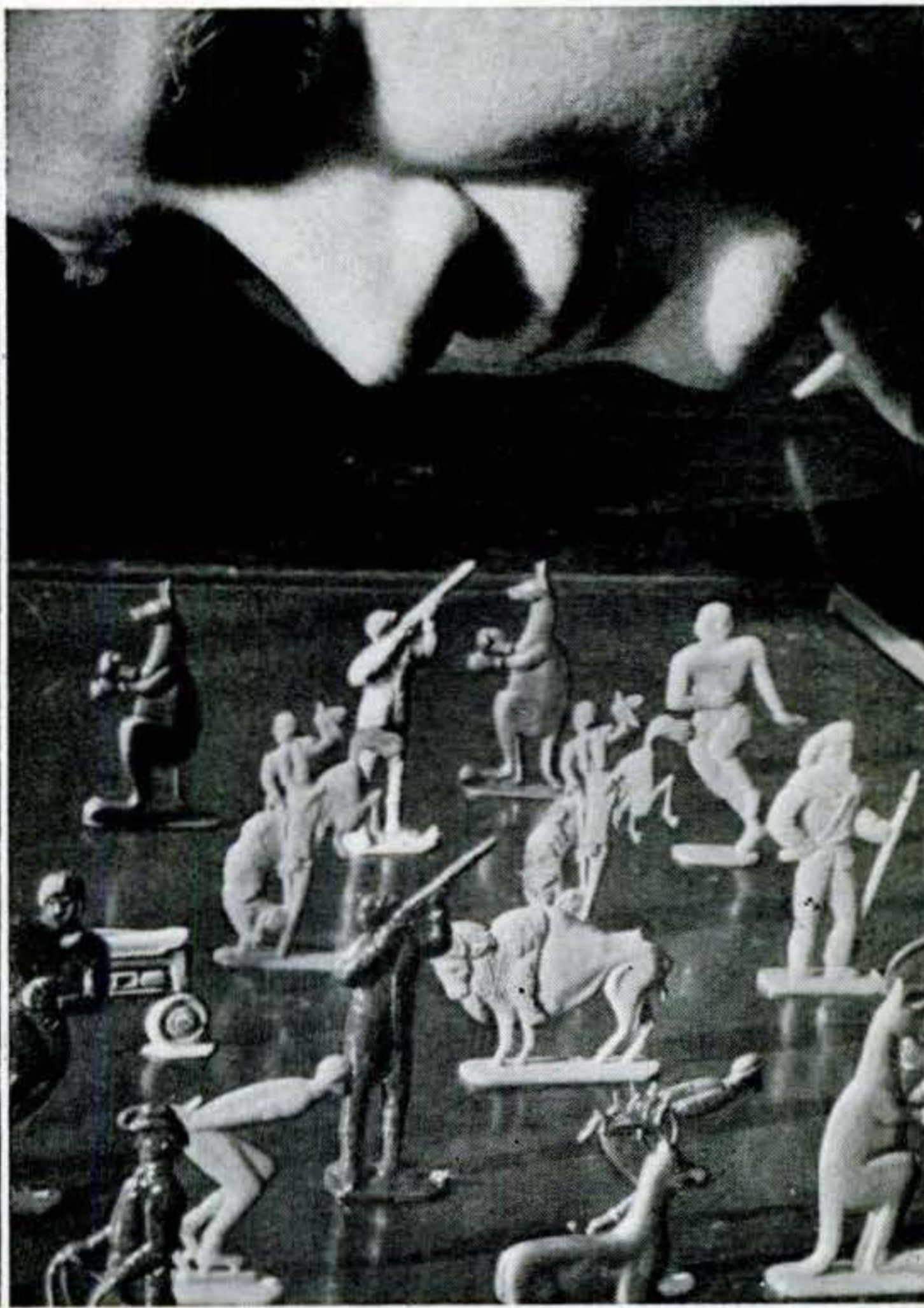

Samples of final product are checked by Irwin Copland, company head. In this group are cowboys, hunters, kangaroos, buffalo, ice skaters, football players, deer, farm tractor. **END**

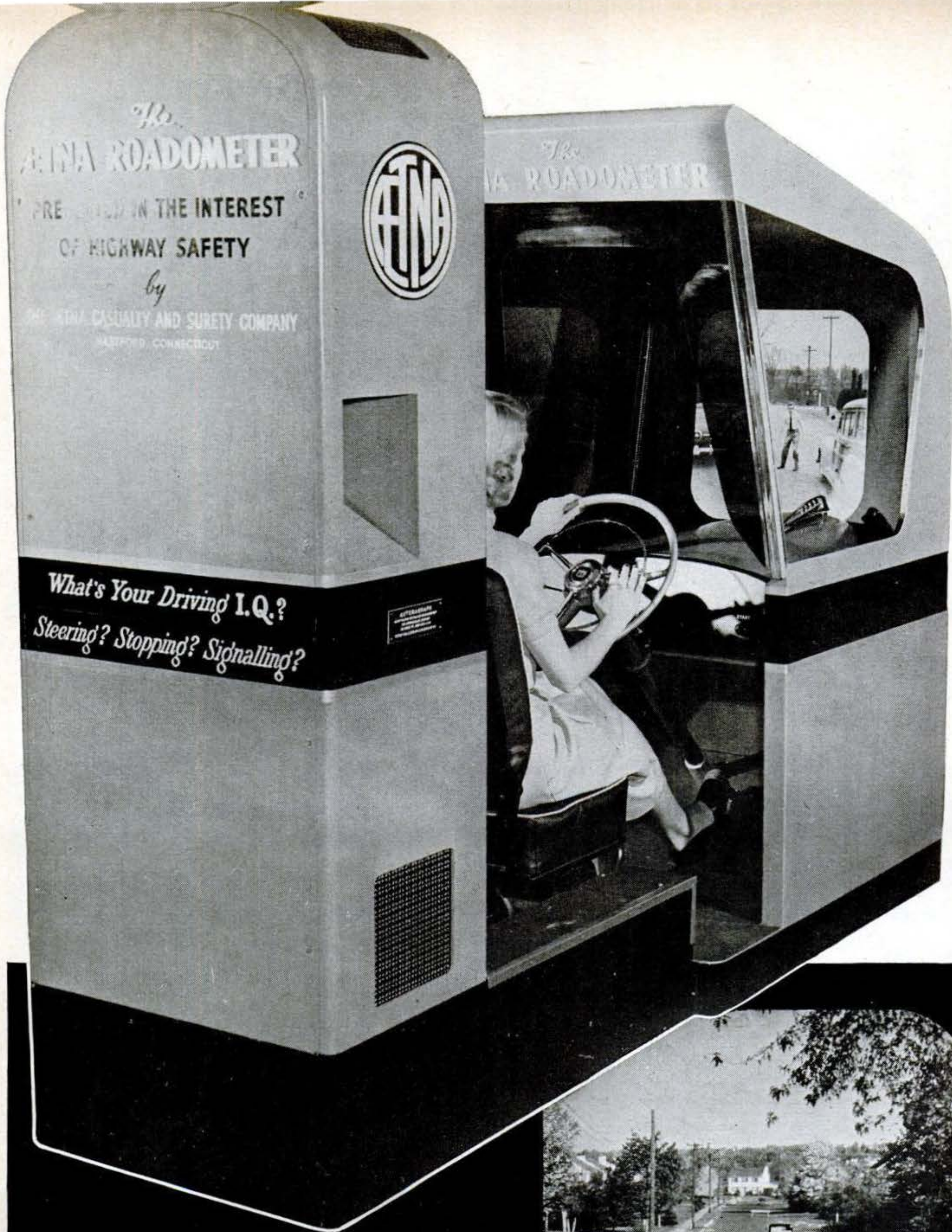

Roadometer, shown testing a "driver" in photo above, reproduces driving scenes such as those shown at right. Movie starts with view of quiet suburban street. As "car" starts, progressive emergencies are introduced. Falling box and pedestrian episodes are two of three requiring quick stops. Six other incidents are judgment tests, requiring such action as turning and blowing horn. Machine can be adjusted to take any film sequence.

Mechanical Cop Scores Motorists



Attendant removes score card from Roadometer after test. Drivers who try for better score by riding brake are penalized for hasty reaction.

By Devon Francis

PS PHOTOS BY HUBERT LUCKETT

FOR years experts in traffic safety have been trying to invent a machine that would produce a clear test of a person's driving ability. Last month just such a machine was announced.

Exhibited at the annual exposition of the Greater New York Safety Council, it has a "mechanical brain" that tots up a score for—and against—a motorist driving through a series of emergencies. Yet the driver never budges from the testing room.

The machine, called the Aetna Roadometer, was introduced by the Aetna Casualty and Surety Co., of Hartford, Conn., which collaborated with the Automagraph Co., of New York, in developing the device.

It differs from previous driving-test machines in that the driver isn't merely rated right or wrong in his reaction to an emergency. If he's wrong, it tells him just how

wrong he was—and prints the result automatically on a score card.

It tells him how well he steers, whether he goes too fast, how quickly he hits the brake pedal, whether he remembers to blow his horn at an unwary pedestrian, and penalizes him if he fails to signal.

He sits in a simulated driving compartment and "drives" along a street pictured on a screen before him by a movie projector. The illusion of a car is complete, even to a hood ornament. A box falls off a truck in his path, and he has to brake to a stop. A pedestrian pops out from between two parked cars into his way. Two cars crowd him on a curve.

The use of movie films in driver-testing is not new. Tests of judgment and steering proficiency, however, are new. So is the automatic scoring. That's done by a complex series of relays, selsyn motors, solenoid counters, and selector switches. The Roadometer can be "driven" from 16 to 40 miles an hour,



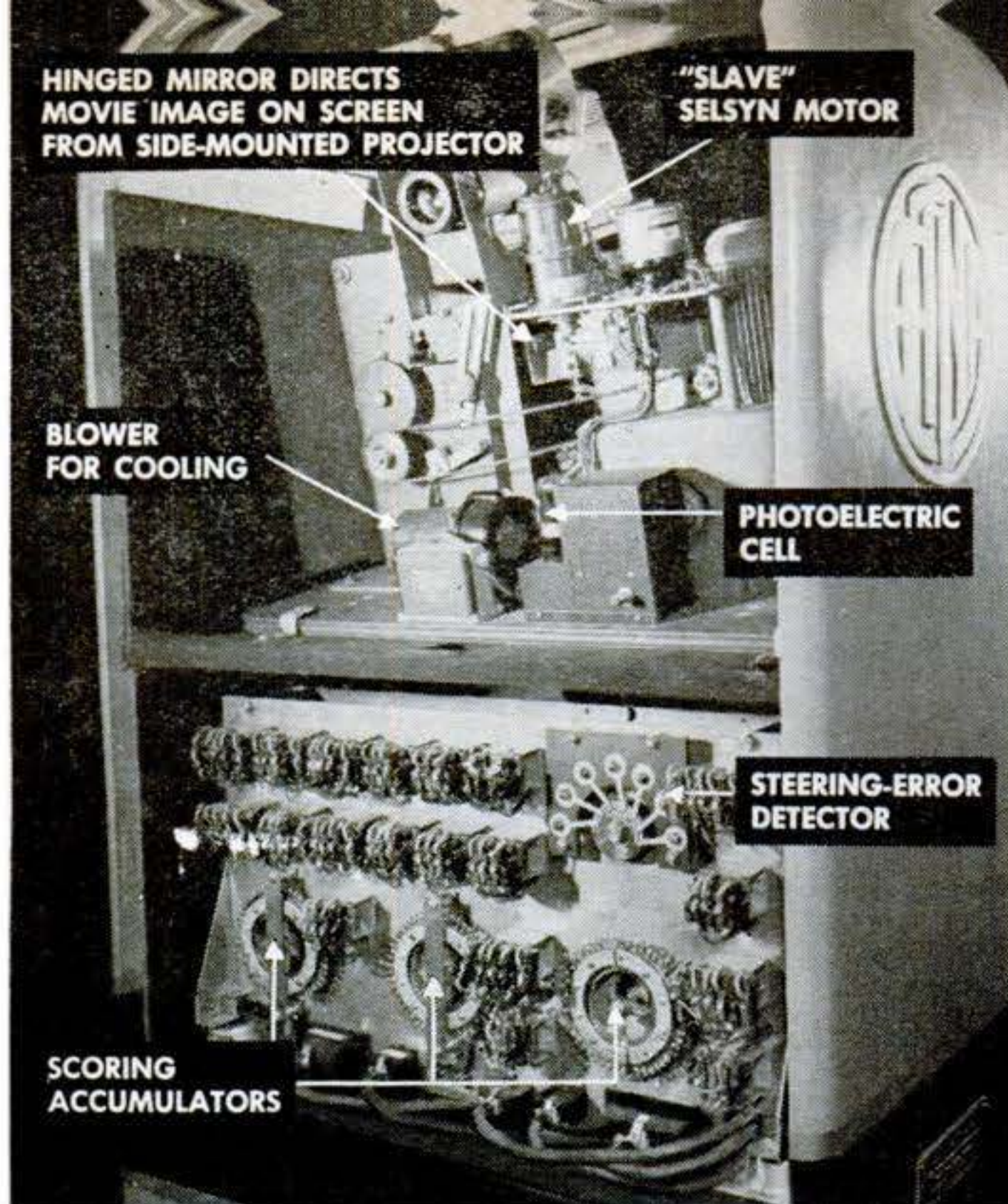

Front of control mechanism shows machine's "brains" and steering-error detector. When steering error occurs, selsyn motor, rotating for correct direction and amount of turn, becomes unbalanced with another selsyn keyed to steering wheel. This causes a "slave" selsyn to turn mirror, shifting screen image left or right in response to steering error.

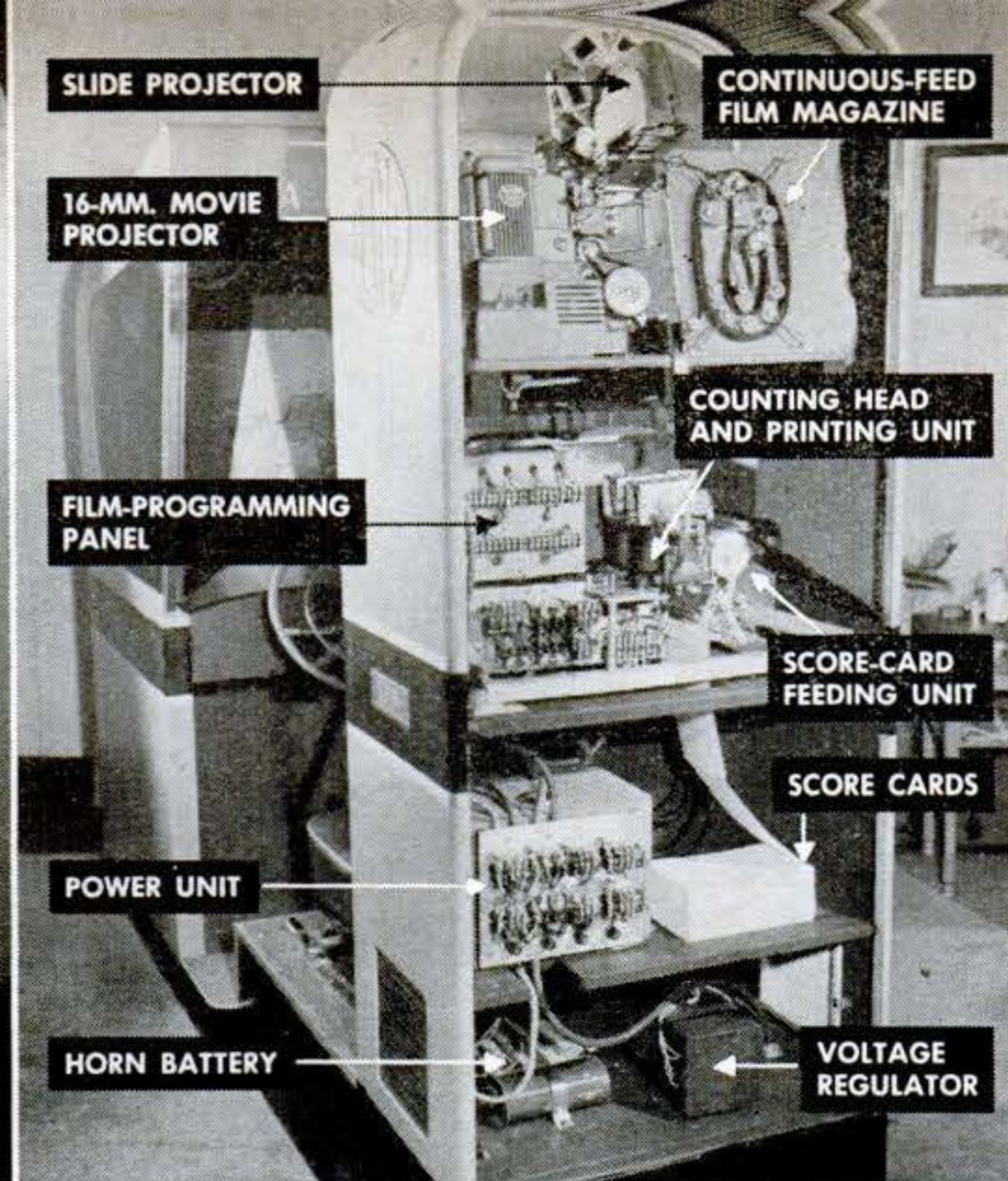

Both slide and movie projectors, together with continuous-feed device for film, can be seen in exposed back of mechanism. Film is interrupted and slide flashes on screen when driver commits error. Film runs at a rate of 16 to 40 frames a second. By changing film programming panel, machine can use films containing new sets of driving emergencies.

but it imposes harsh penalties for speeding by allowing the driver less time to meet an emergency.

The heart of this driving tester is the series of solenoid counters, or accumulators, that record, "remember," and deliver to a miniature printing plant the *degree* of error committed by the motorist.

Here's what happens within the machine to record a score when a "driver" meets an emergency: A transparent spot on the side of the film lets light strike a photoelectric cell. This advances a multi-channel selector switch to the particular contact set up for this emergency. The switch closes a series of relays, giving life to the circuits that will record what the driver does. One of two timing motors starts ticking off the interval allowed the driver to react.

The motor runs until the driver hits the brake. Now a second timing motor, together with a scoring arm on an accumulator, counts the time—in tenths of a second—ticked off by the first timing motor. This records the amount of time it took the driver to stop. Another spot on the film sets off a relay that feeds the score to a counting head, starts the printer, and clears the accumulator so that it is ready to rate the driver on the next emergency.

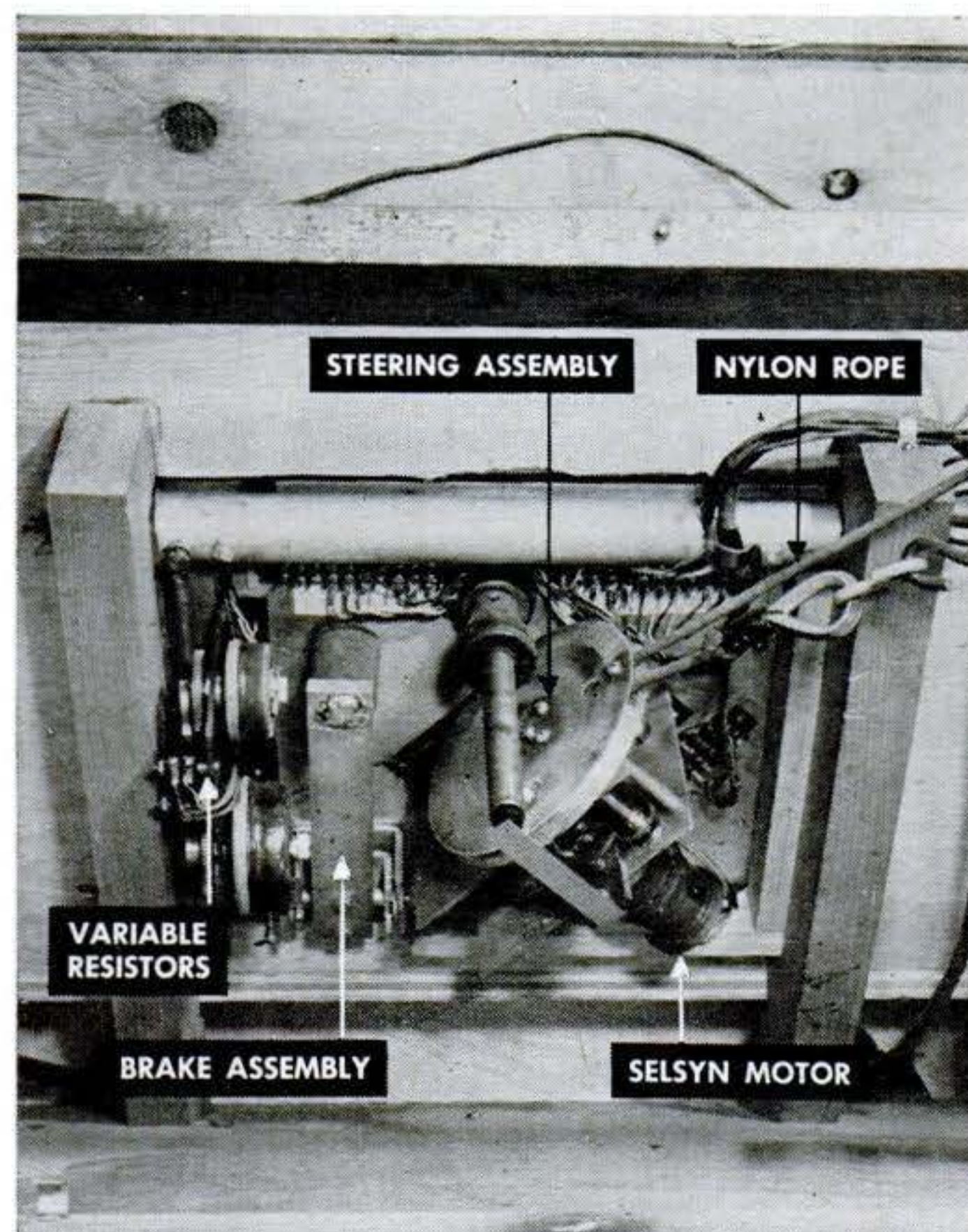

Under floorboard are accelerator, brake, steering, and horn assemblies. Resistors sense accelerator position. When brake is pressed, contact points start timing motors. Nylon rope on friction disk turned by steering wheel gives driver "feel" of turn. Machine, weighing almost half a ton, draws 10 to 15 amperes, plugs into any 115-volt outlet.

Second fuel for Crosley high-compression engine is provided by Thompson Vitameter, shown installed here on tiny motor.

Only Crosley Super Sports model is equipped with engine of 10:1 compression. Highest competitive compression in industry is 7.8:1.

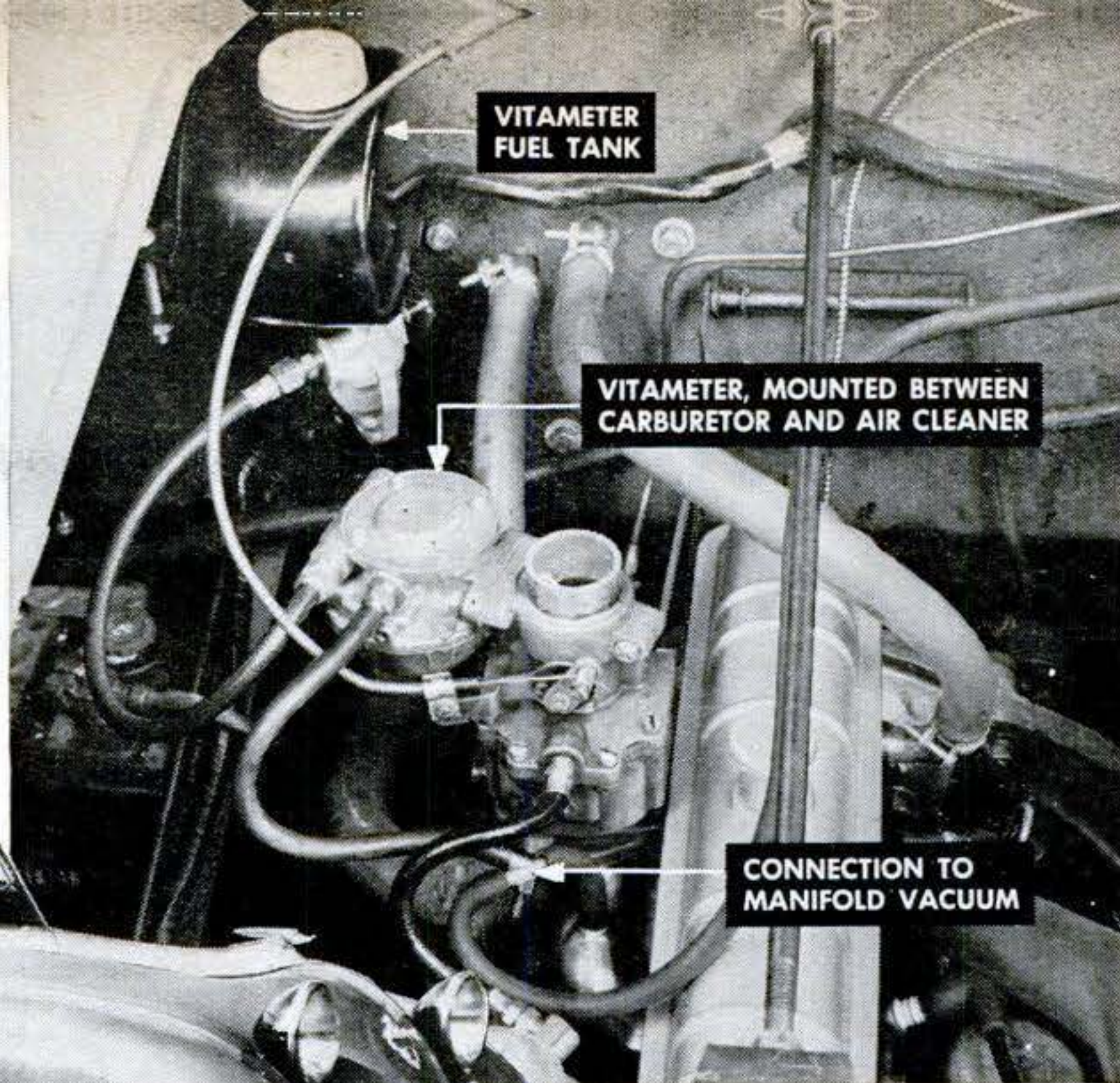
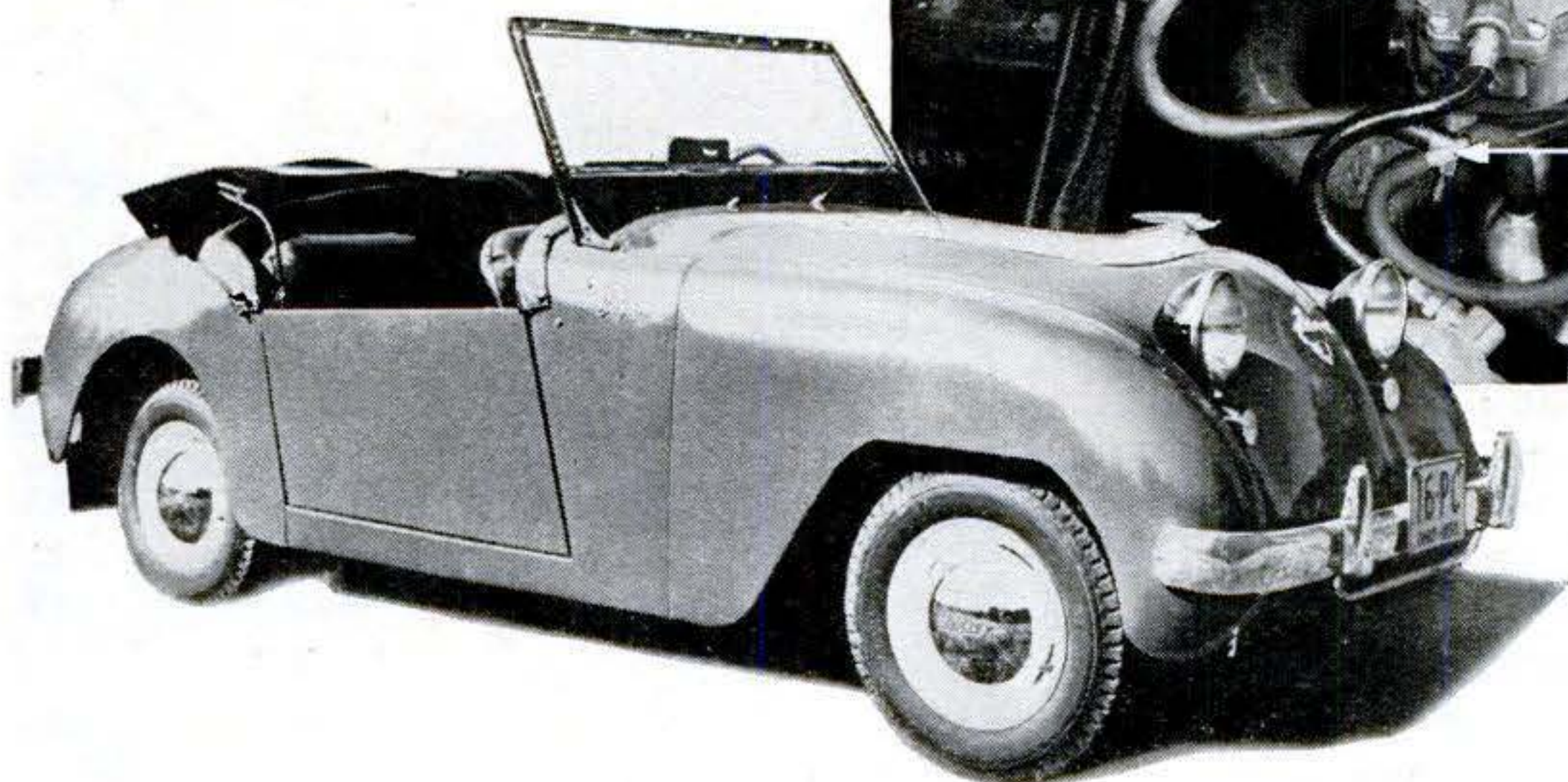

Dual Fuels Give New Crosley Highest Compression Engine

CROSLY MOTORS, the people who make the vest-pocket cars, have announced an engine with the highest compression ratio among stock U. S. cars—10:1. Oddly enough, the engine, installed in Crosley's Super Sports model, uses regular gas.

Crosley avoided premium fuel by fitting its new engine with a dual-fuel system. Under ordinary loads, the engine operates on regular fuel. When detonation—"pinging"—is about to occur, a mixture of alcohol,

water, and tetraethyl lead from a second fuel tank is automatically fed to the carburetor to be mixed with the regular fuel. This provides a non-detonating charge that insures more complete combustion and saves power waste.

With the dual-fuel system (PS, Sept. '48, p. 98), the company claims greater horsepower, better hill-climbing ability, higher speed under loads and greater economy for its four-cylinder engine.

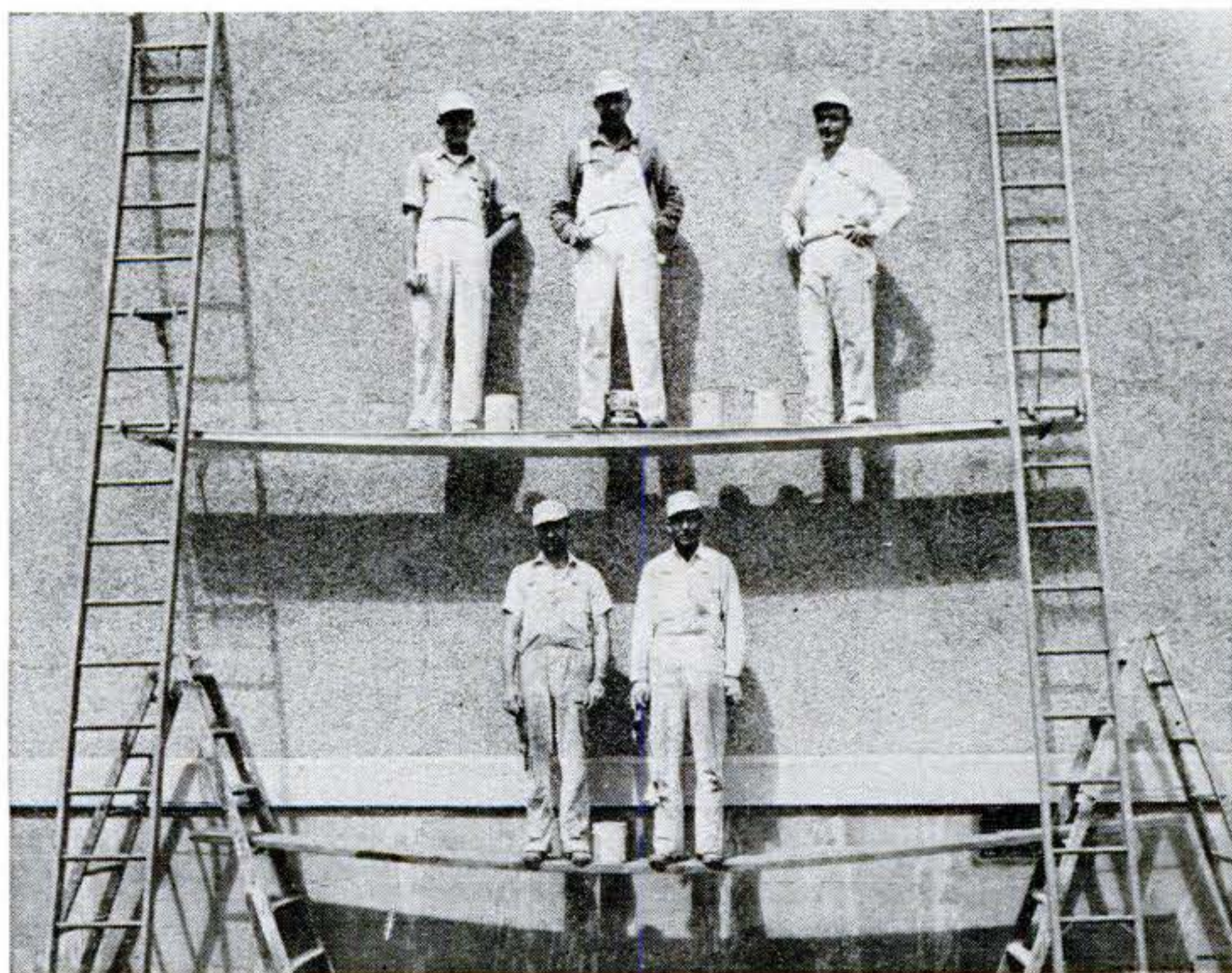

Aluminum Scaffold Is Strong, Light

THE old wooden-plank scaffold, long used by painters and carpenters, has given way to a stronger one made of aluminum channels with plywood in truss-type construction.

The new plank (upper one at left) supports three men with less sag than a conventional plank with only two men. A 24-foot length weighs only 70 pounds, compared to 230 for a solid-wood plank.

The new plank is made by the Stinson Mfg. Co., of Spokane, Wash.

'Cannon' to Hurl Billion Volts

THE mightiest of "cannon" is being assembled in the microwave laboratory of Stanford University, where trials of it are already under way. The longer it grows, the more powerful it becomes. So far it has reached a length of 80 feet. Eventually it will measure 220 feet long.

This biggest piece of "ordnance" is a linear accelerator for studying atoms. It fires the smallest of projectiles—electrons, tiniest known particles of matter. When it attains full size, probably early next year, it will hurl them at a target with an energy of more than a billion electron volts.

Only three atom smashers in the world, all still under construction at this writing, will match this power.

The Stanford cannon differs from these in its comparatively simple and economical design. Instead of whirling particles in a circle or spiral as synchrotrons and cyclotrons do, it propels them in a beeline, to boost them to fantastic speed and energy.

How the Big Cannon Works

A slender copper vacuum tube, of about six-inch over-all diameter, forms the barrel of the cannon. The "bore" is the 0.8-inch diameter of a central passage through gold-rimmed copper disks, fitted inside the tube. Electrons fed into the "breech" from a cathode tube are sped along the barrel by successive kicks from a series of Klystron tubes, which are called the most powerful vacuum tubes ever built. Speeding unhindered through an aluminum-foil window at the barrel end, the particles emerge with a "muzzle velocity" approaching the speed of light. The Stanford cannon is said to be the only electron accelerator of more than 10,000,000 volts that gets the particles out in the open where they can be conveniently counted, measured, and studied.

Scientists will use the particles to bombard experimental targets placed in their path, and will measure their energy by deflecting them around a curve with a magnet.

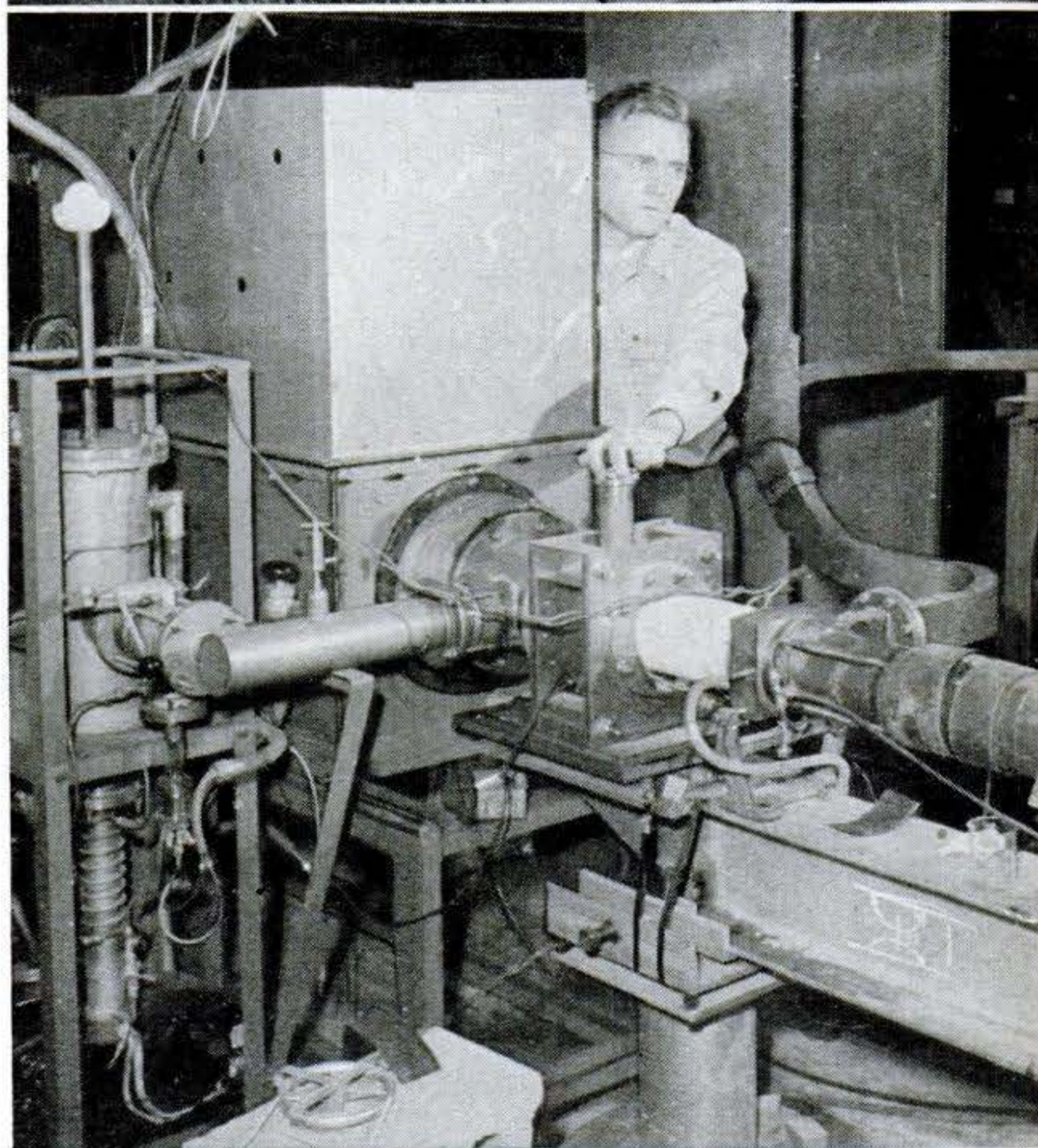
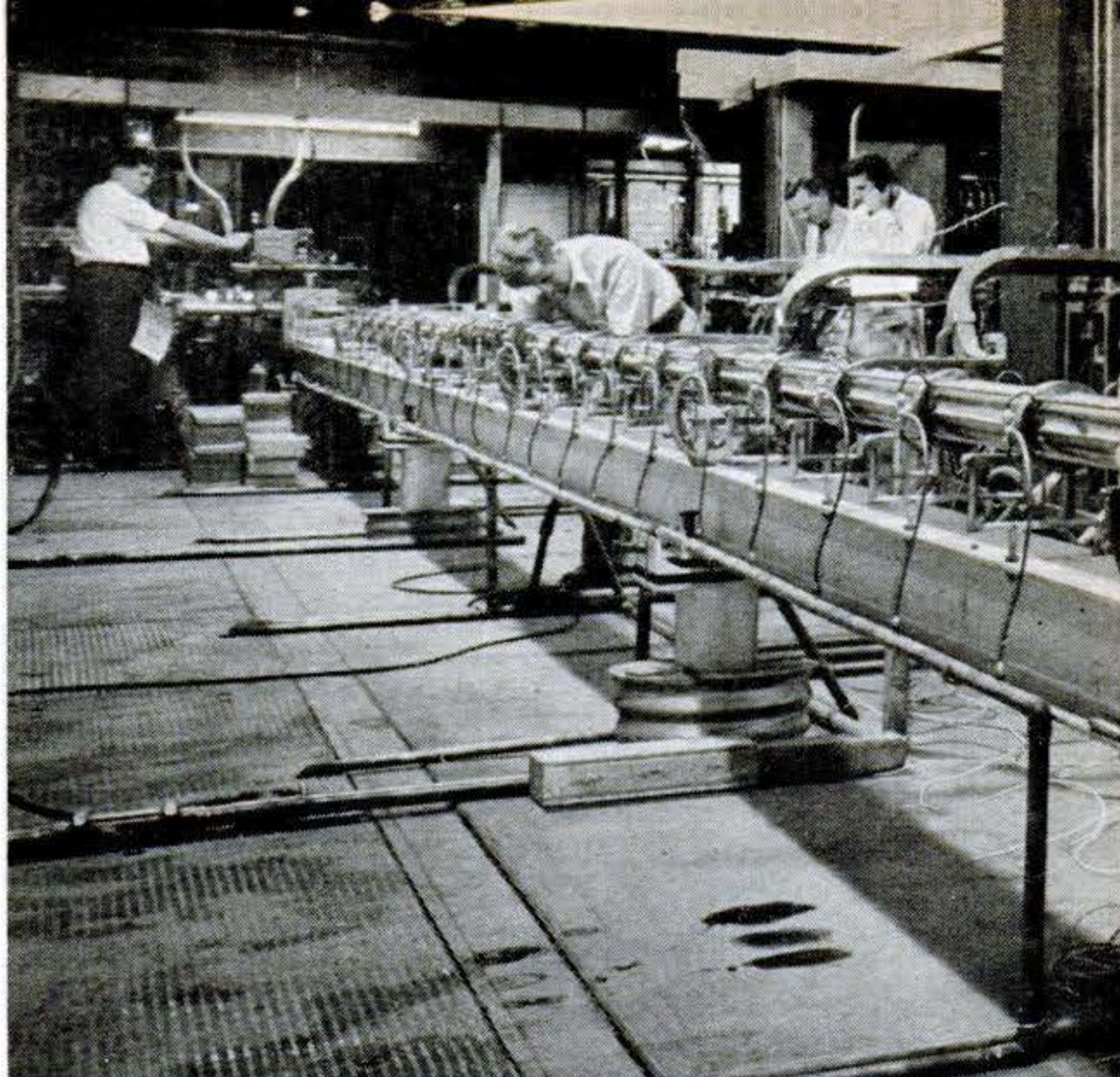

Breech of "cannon" is fed "ammunition"—electrons—by cathode tube, extreme left, through short connecting pipe. Cannon fires them along barrel extending out of picture toward right.

Although invisible, the emerging beam fogs film and registers on scintillation counters that can be used, with oscillograph recordings, to clock the electrons' speed. This may permit the first direct measurements of electrons' mass, hitherto determined by round-about calculations, and lead to discovery of new subatomic particles forming the mysterious "glue" that holds matter together.

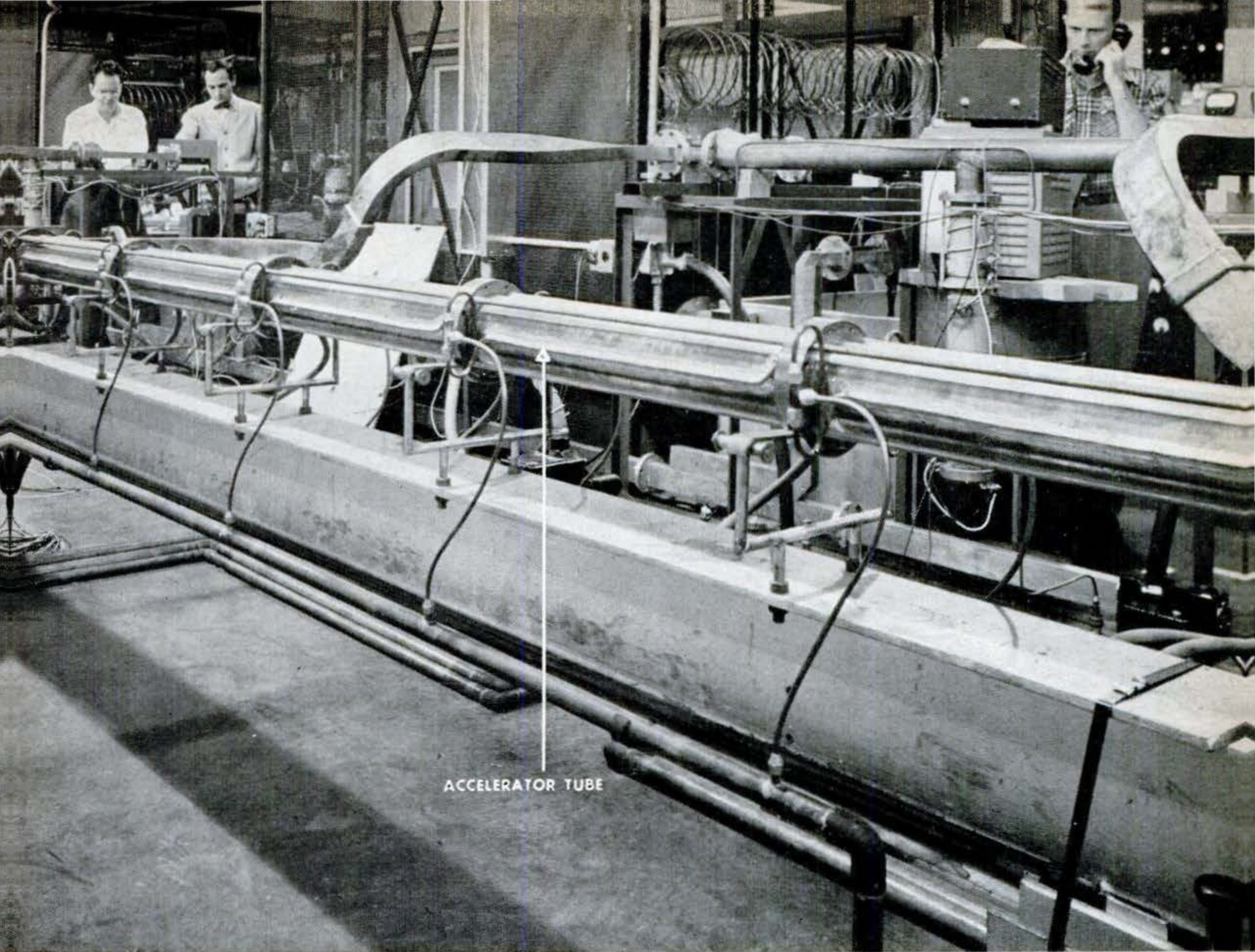

ACCELERATOR TUBE

Barrel of atomic cannon, mounted on I-beam for rigidity, has reached 80 feet of eventual 220-foot length. Concrete tunnel will enclose it to prevent escape of dangerous radiation.

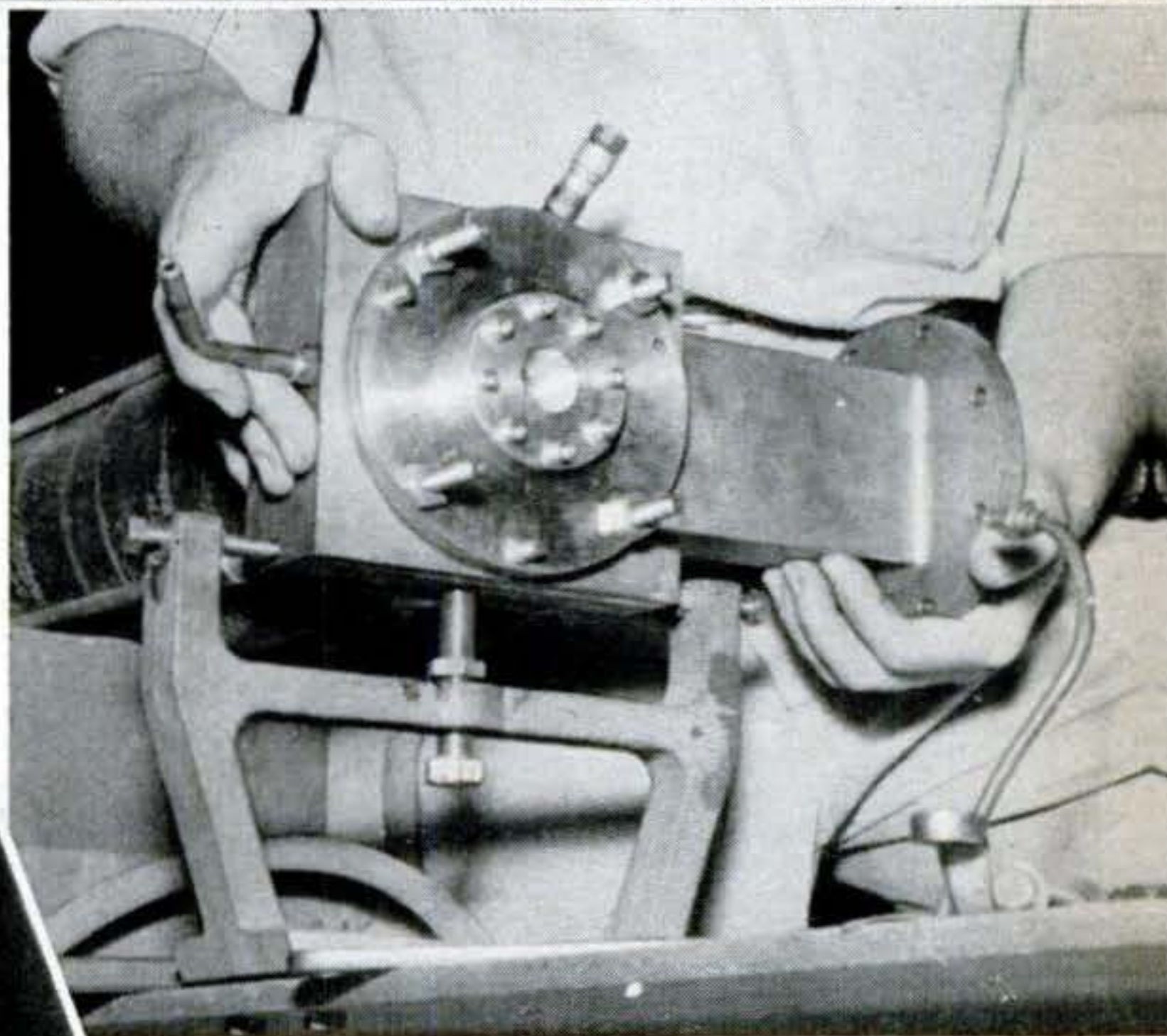

At muzzle of cannon, above, electron beam emerges through aluminum-foil window. Even at full power, it will be invisible, but readily detected. Enlargement at left shows large, circular, white imprint of beam on dental film held over window in preliminary trials. Power of 130,000,000 electron volts reached to date will be boosted to more than a billion.

END

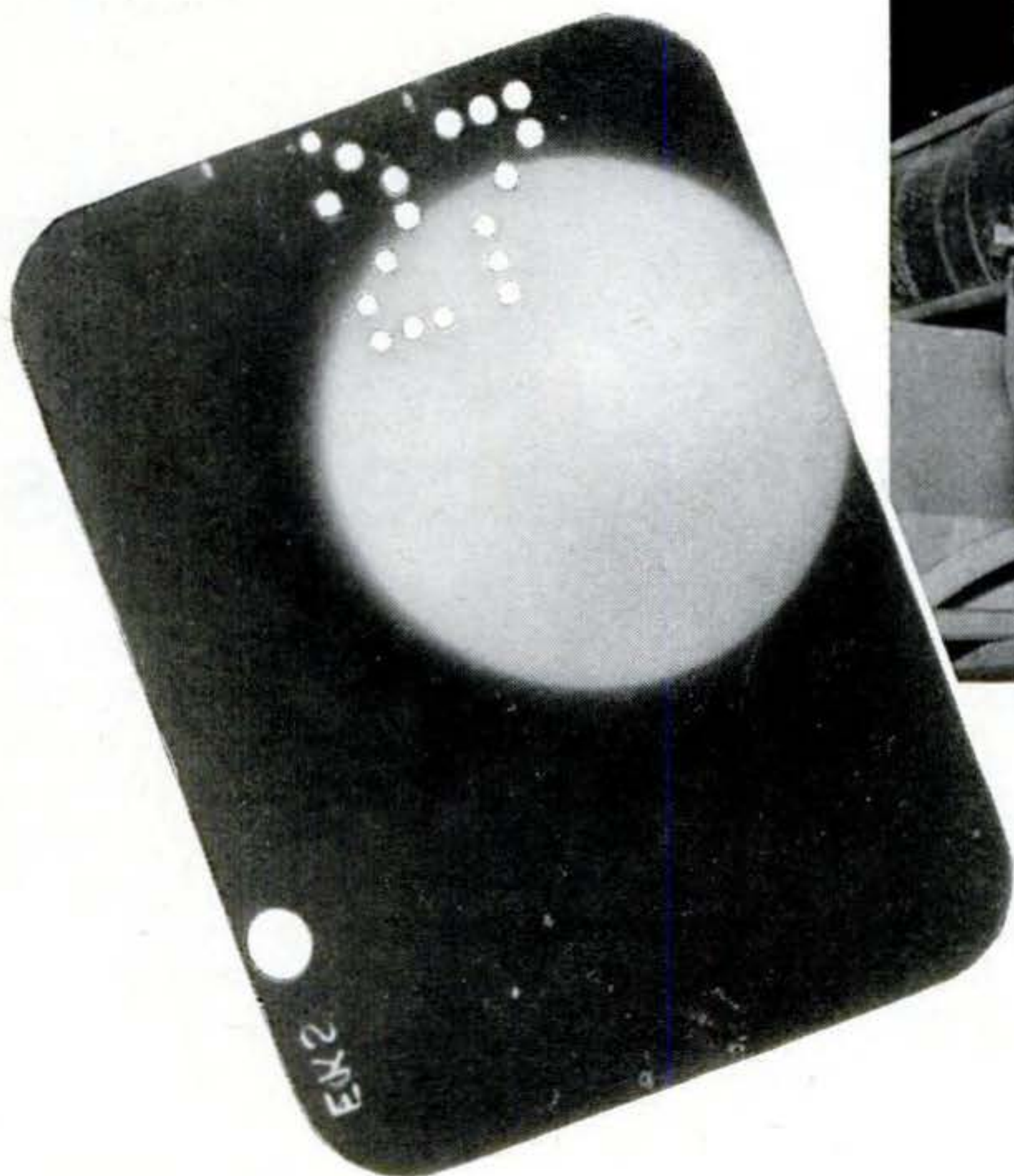

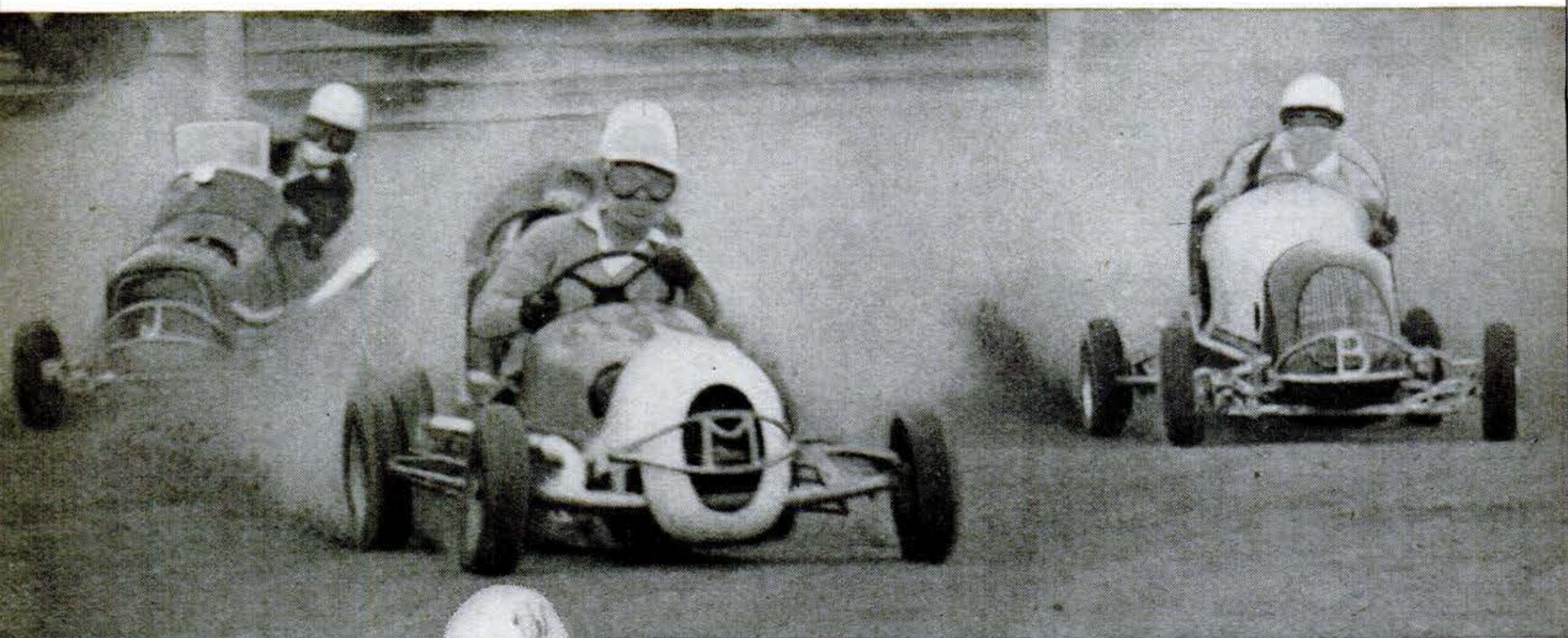

Lively moment occurs in three-quarter midget race at Tulare, Calif., as cars skid around turn, wheel to wheel. They're doing about 40. Turns are very slightly banked—about 4°.

Owners turn out motorized baby buggies like this streamlined, ground-hugging beauty. It rolls on eight-inch wheels, fitted with tires made for a cement mixer.

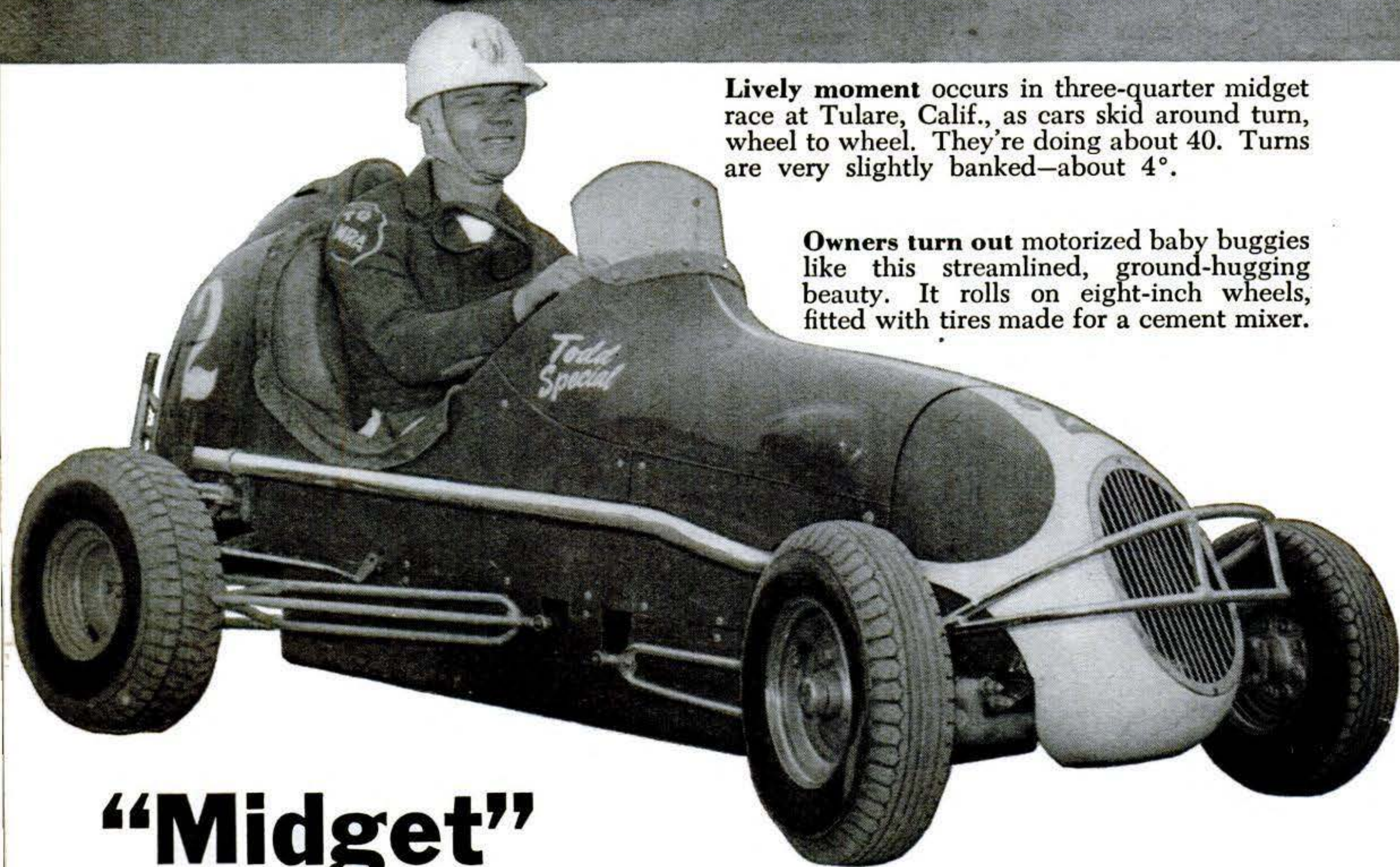

“Midget”

Midgets Thrill Race Fans

THE tiniest of racing cars are roaring around fifth-of-a-mile outdoor tracks in California. This summer, the motorized baby buggies will move indoors.

They're called “three-quarter midgets” and have wheelbases about three quarters the length of present-day midget racers. Though small, they thrill spectators with the same wheel-to-wheel jockeying. They make dusty skids on banked turns, and hit

45 m.p.h. on abbreviated straightaways. Some can do 90 on a long straight dash.

Their predecessors, the midgets, first came upon the scene in 1932. Promoters of bigger racing cars were then moving to longer tracks, some 2½ miles long, taking much of the action too far from the spectators. Midgets raced at first on tracks 1/5 mile and 1/6 mile long. Then midgets in turn went to longer tracks, some a mile long, and grew

in wheelbase, body length, and tread. Too far from the spectators, again.

To put the show back in the crowd's lap, a new group of promoters has come up with the "three-quarter midget" idea. The "three-quarter" corresponds to the original midgets in general specifications, but with newer engines instead of the old Saxons and Hendersons.

Most of the three-quarter midgets are home-built with small garage lathes and welding outfits. A handsome blue home-made job built for \$350 by Curly McLain, of San Diego, stood third in the 1950 championship class. Tops for parts cost of a homemade three-quarter midget is about \$800, and excellent ones may be bought ready-made at prices from \$800 to \$2,000. One slick \$2,000 job is powered by a 34-hp. English twin-cylinder Triumph motorcycle engine, souped-up to develop 40 hp. at 7,000 r.p.m. It weighs 460 lb. empty, is seven feet long with a 60-in. wheelbase.

Some cars use single-cylinder J.A.P. motorcycle engines of 30.50-cu.-in. piston displacement. Other owners choose the flat-head, twin-cylinder Harley-Davidson 45, the Indian twin, or the four-cylinder in-line Crosley single overhead-cam engine, sleeved down to meet specifications of the Three Quarter Midget Racing Association. Compression ratios range from 7-1 to 15-1.

In back yards and small garages around Los Angeles, ingenious mechanics try a hat-ful of dodges to build greater speed and safety into their cars. One engine burns methanol fuel, another alcohol. Racing heads soup up an engine. Plastic shock absorbers smooth out bumps.

The cars have no self-starters, and only one gear. A nudge from a truck to start them, and they're off. Curves are slightly banked to help the cars negotiate them. At that, the wooden walls are scarred by hub caps, and cars have jumped the wall.

To keep the sport from becoming only a rich man's hobby, the T.Q.M.R.A. runs the events as claiming races—but at a fixed price of \$2,000. No one is likely to pay that for a car he can buy off the track or make himself for much less. And the owners, knowing that is the most they can get for their tiny mounts, are not likely to put a lot of money into them. So both ways it helps hold down the cost of the cars.

To keep the spectators happy, the T.Q.M.R.A. is shooting for a 1/6-mile track—to bring the show to the customer. END



Motorcycle engines serve as power plants for three-quarter midgets. This tiny racer has front-mounted twin Harley, of 45-cu.-in. displacement, driving car through rear wheels.



Pit mechanic, fixing flat, inflates tire by attaching bottle of compressed air with hose. Bottle once carried oxygen in B-29 bomber. Welded wheel guard prevents hooking in turn jams.

SPECIFICATIONS

THREE-QUARTER MIDGET	MIDGET	
POWER	35-40 HP.	100-120 HP.
WEIGHT	450 LB.	850 LB.
WHEELBASE	60 IN.	72-74 IN.
TREAD	40 IN.	45 IN.
HEIGHT	35 IN.	37 IN.
COST	\$500-\$2,000	\$3,500-\$6,000

Aids to Modern Living

Board Has Gliding Top. To reach the neck and shoulders or the bottom of the garment you are ironing, you just shift the top of this board to the right or left and lock it in position. Made by Leisur-Maid Mfg. Corp., of Grand Rapids, Mich., the board folds for storage. It is priced at about \$12.

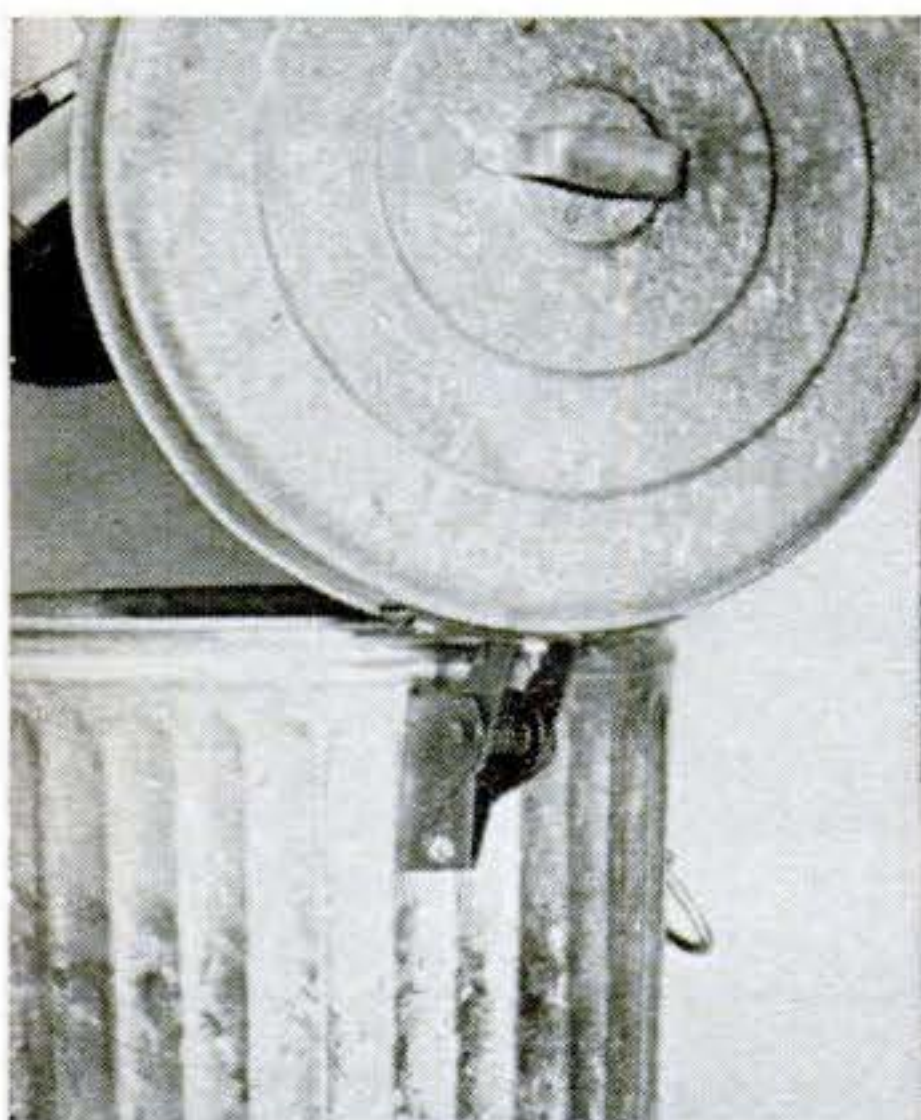

Hinge Holds Can Cover. A garbage-can cover won't get lost if this hinge is screwed on. For use on any size of can, the steel hinge is available from Melaire Distributing Co., N. Y., at about \$2.25.



Transfers Are Washable. Once ironed onto a fabric, Fabri-cals are said to withstand scrubbing. Made in many designs by Meyer-cord Co., Chicago, they are sold for 25¢ a sheet.



Collapsible Toilet Seat. This child's plastic seat folds to 4½ by 8 inches for convenient carrying when traveling. It is priced at about \$2 by the Toddler Sales Co., of San Mateo, Calif.

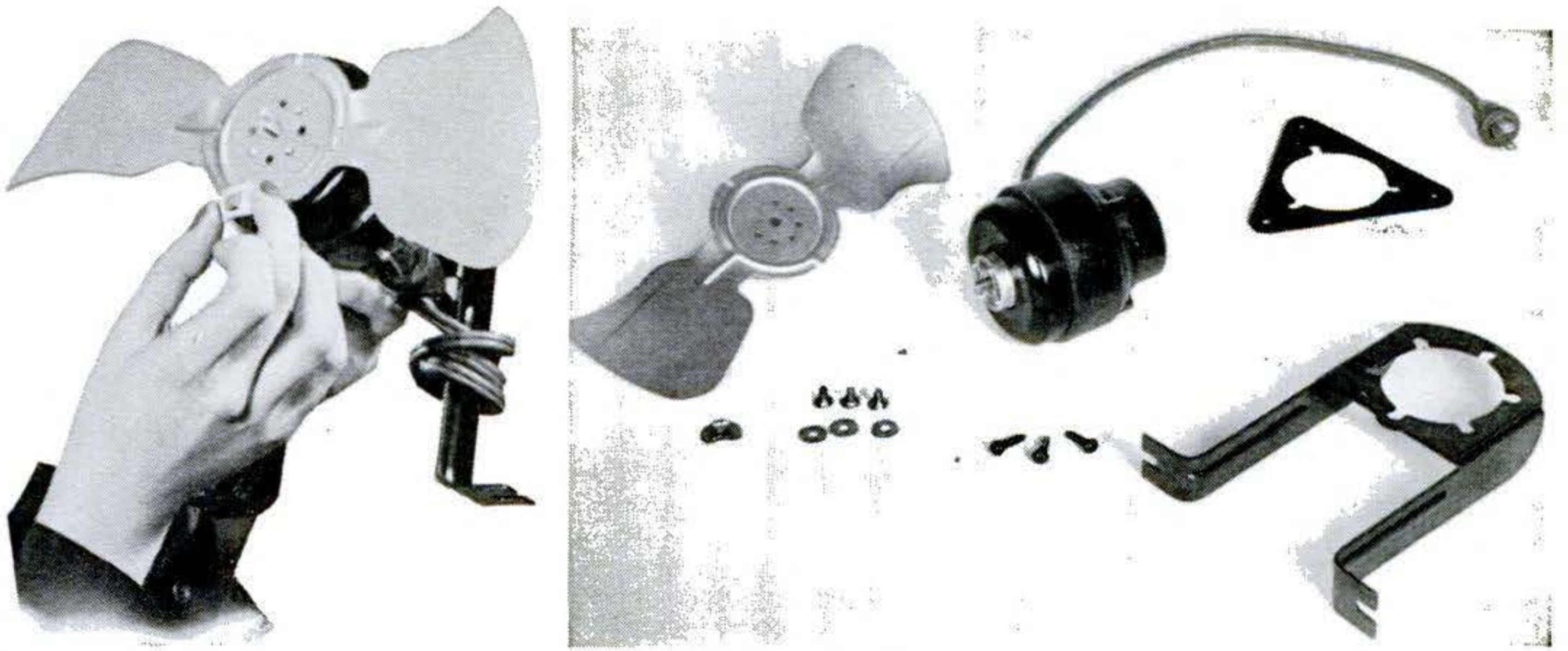

Fan You Can Assemble. Less costly than a comparable preassembled unit, a new GE kit consists of a 10-inch blade, AC motor, cord, brackets, and screws. Intended for

built-in application in kitchens or attic rooms, the kit is priced at about \$13. The fan is capable of moving 360 cubic feet of air a minute. Assembly takes 10 minutes.

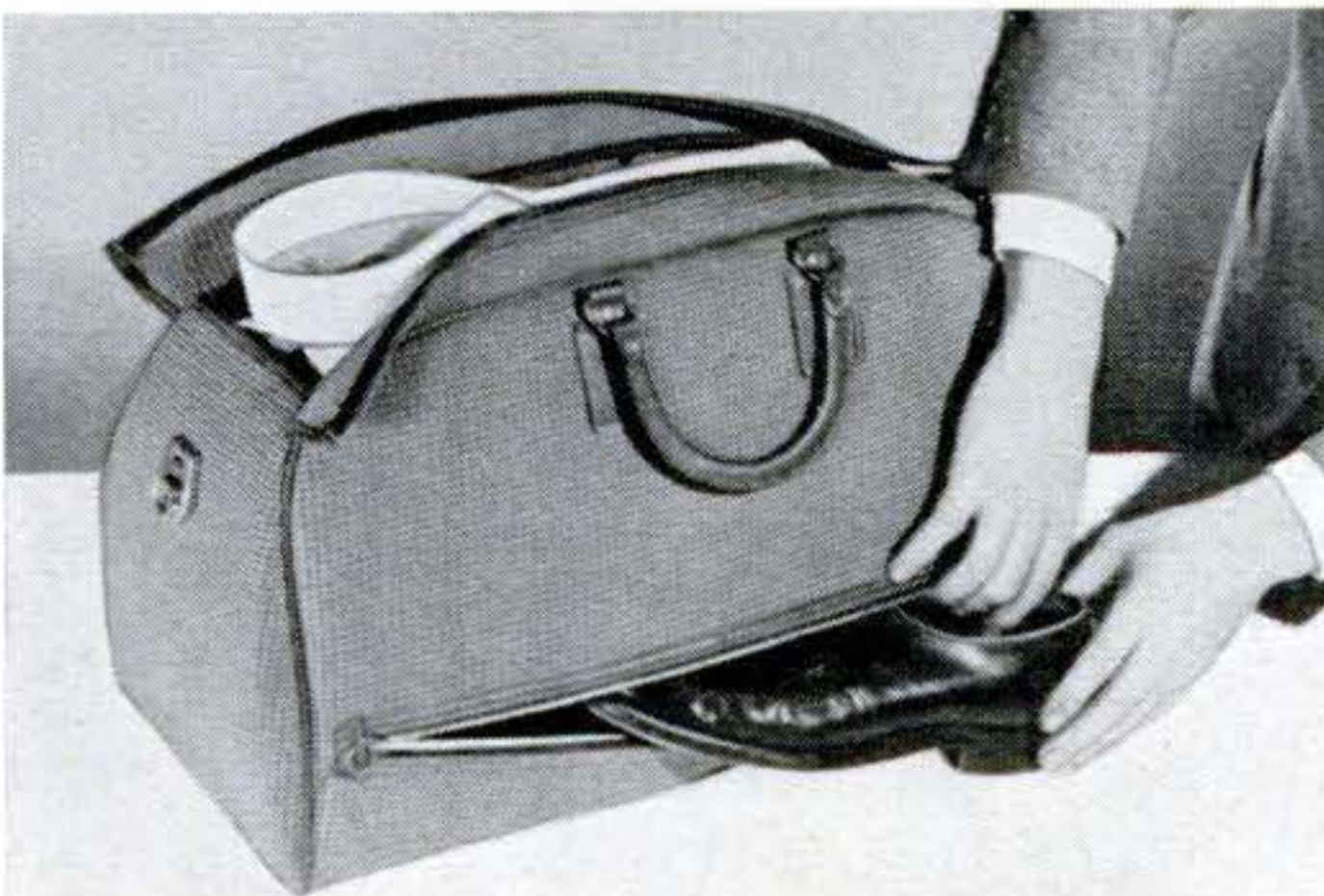

Bag Has Shoe Compartment. A zippered section in this nylon satchel keeps shoes separate from other clothing. Leed's Travel-wear Corp., New York, sells it for about \$15.

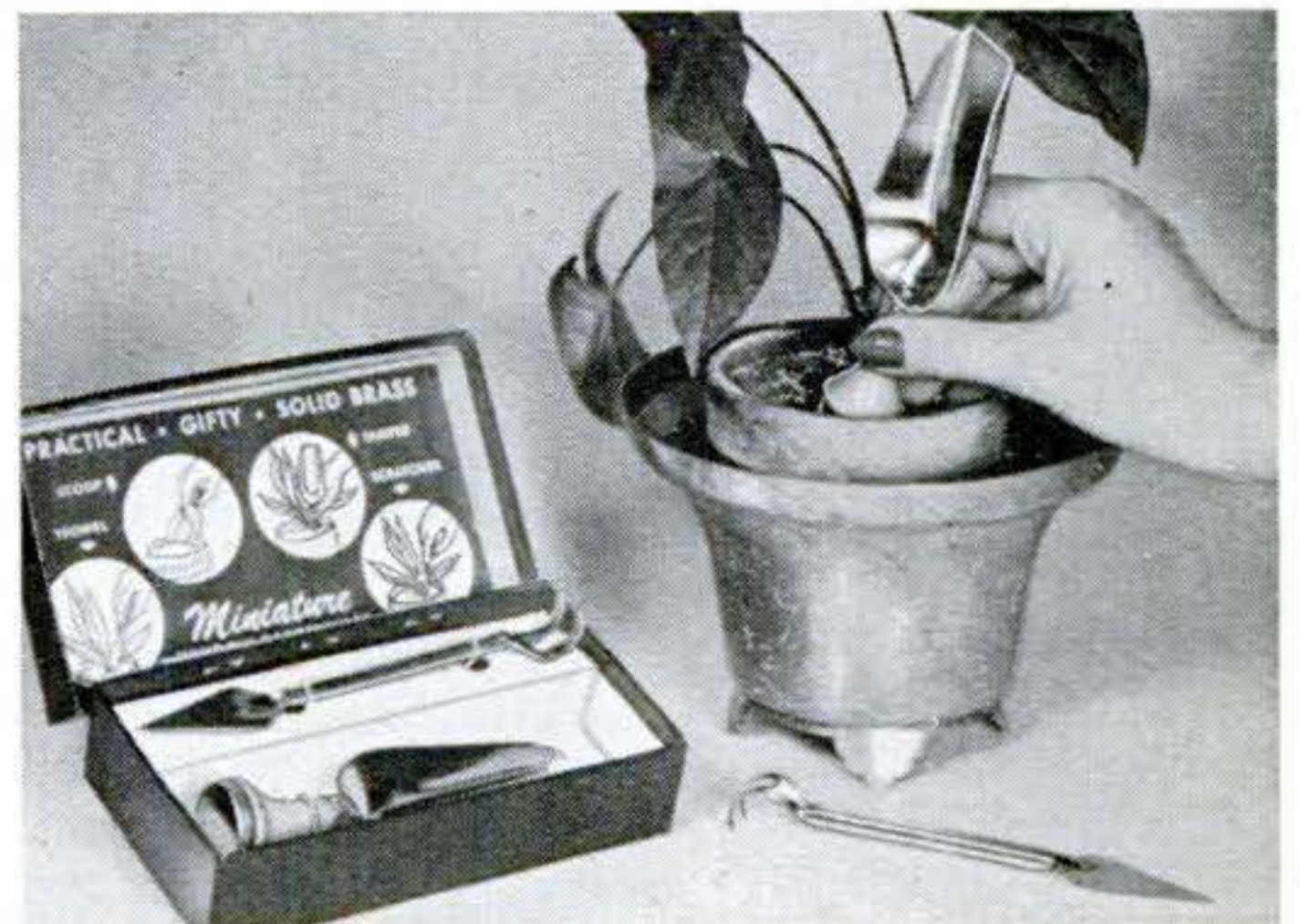

Pint-Size Garden Tools. Here's a set of small-scale tools for potted-plant and window-box gardeners. Village Store, Lake Placid, N. Y., sells them for about \$2.

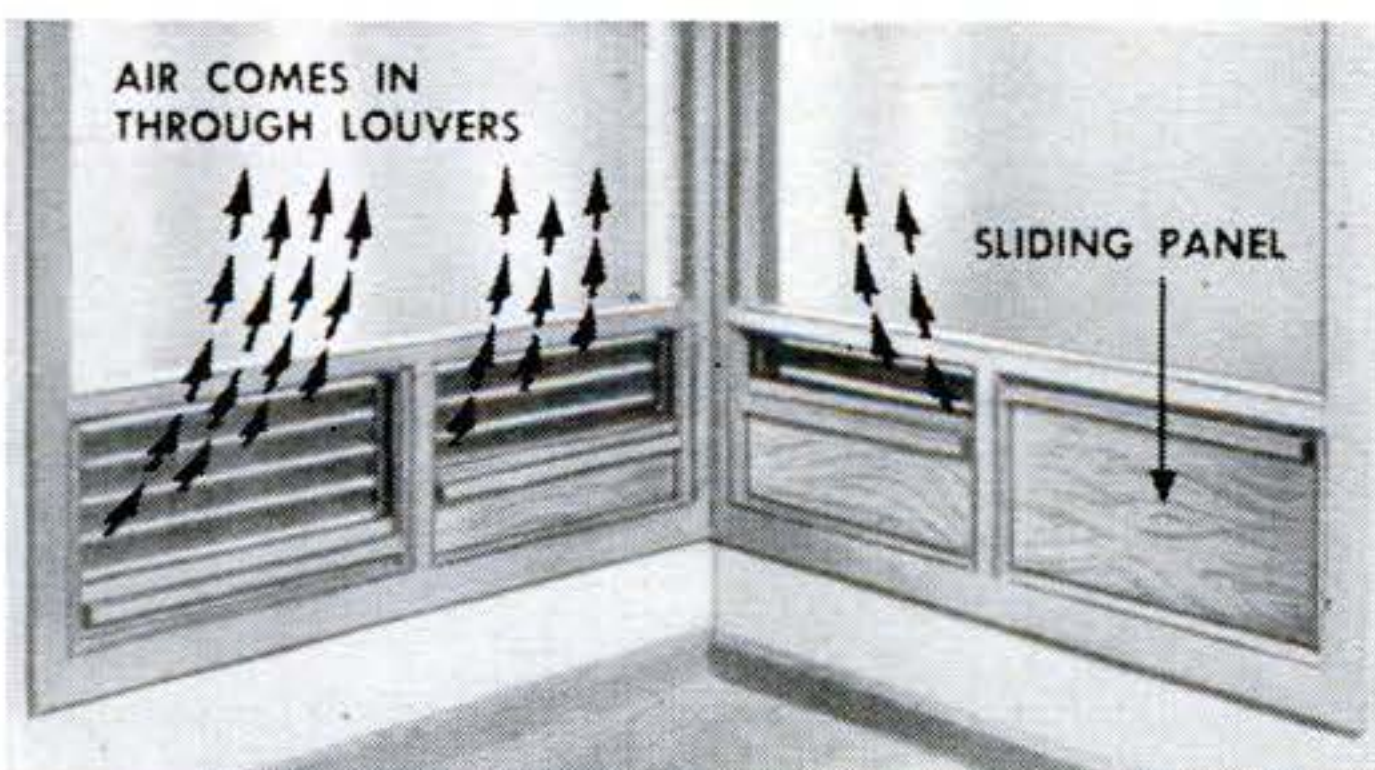

Window Has Built-In Louvers. Both fresh air and an unobstructed view are provided by this corner picture-window unit with built-in wooden louvers mounted underneath the glass. Vertically sliding panels control incoming air. Lilly-Vent, Inc., of Portland, Ore., makes it in all sizes.

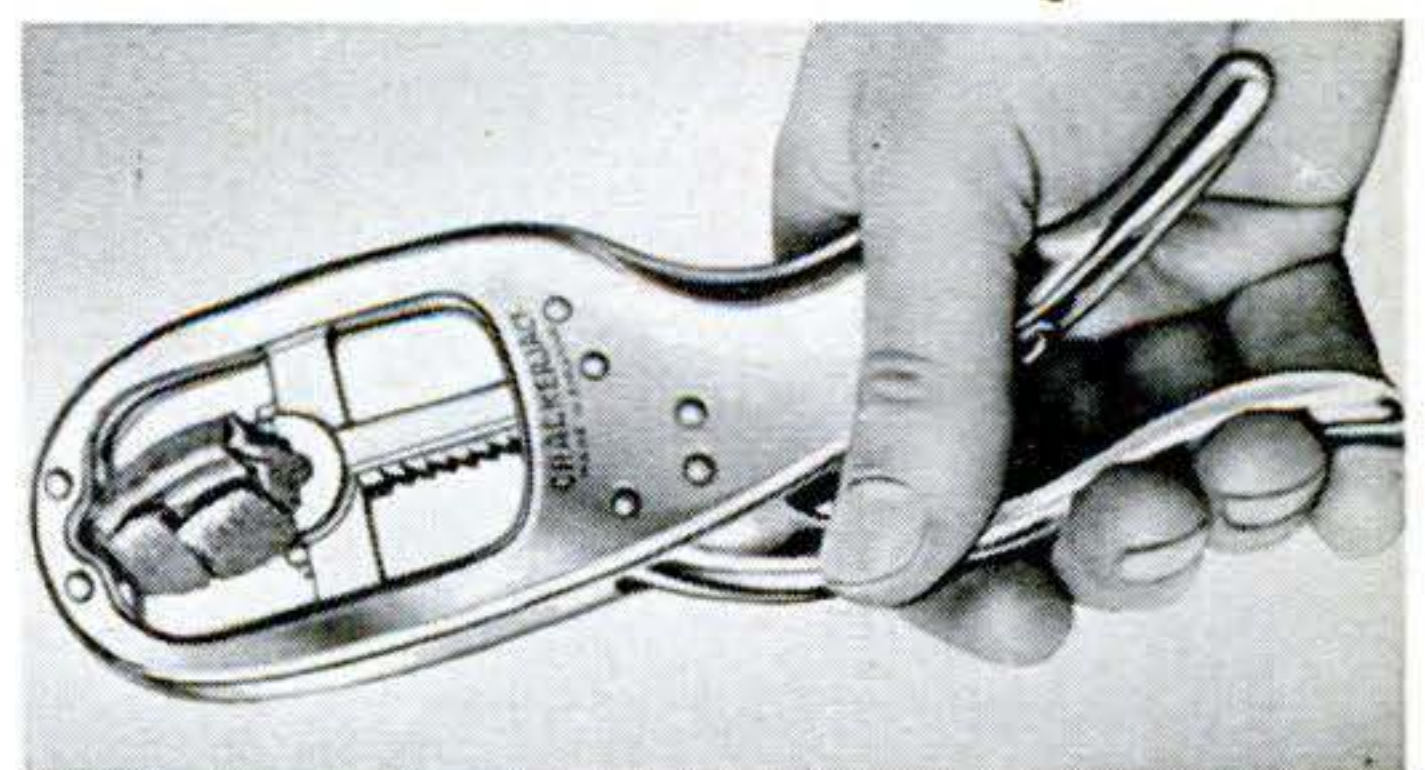

Nut Cracker Works Like Jack. With each squeeze of the lever, the crossbar holding the nut moves up a notch, applying travel-limited pressure that breaks the shell but leaves the kernel whole. Priced around \$3, the English import is available from Hoffritz Cutlery, New York City.



Chromatography strips the four tons of ox liver above of their minute fraction of vitamin

B₁₂. All this liver gives only 1/30th ounce of crystals in test tube held by British chemist.

How Chemists Can Cut Liquids With a Knife

IT TAKES all of those four tons of ox liver above to make the few crystals of valuable vitamin B₁₂ in the test tube held by this British chemist. But thanks to a chemical process called chromatography, such a fantastic extraction job becomes almost routine.

Chromatography, discovered back in 1906 by a young Russian botanist named Michael Tswett, practically lets you cut up liquids with a knife. It depends on the fact that certain materials will adsorb (pick up on their surface) other materials from solution. And the speed of adsorption depends on the particular materials involved.

Thus, when a solution containing only a tiny fraction of the stuff you want (B₁₂, for example) mixed up with lots of other stuff

is poured through a tube containing the right adsorbent, the B₁₂ will all be trapped in one section of the tube. The unwanted materials in the solution will be trapped in other parts of the tube—the faster adsorbing materials above B₁₂ and the slower adsorbing materials below.

Then all the chemist has to do is push out the column of adsorbent and cut out the section that has B₁₂. Usually he can find the stuff he wants by its color (hence the name, *chromatography*), but other identification methods can be used.

Chromatography has become increasingly important recently in much biochemical research, not just in B₁₂ extraction. In this country, vitamin B₁₂ is usually made by a fermentation process, like penicillin.



Crude liver extract is poured through big adsorption columns. Because different compounds

are adsorbed at different rates, B₁₂ fraction will collect in one small section of a column.

After adsorbing material is pushed out of tube, desired fraction, now concentrated in one

place, is simply cut out with knife. It can then be dissolved and crystallized in pure form.

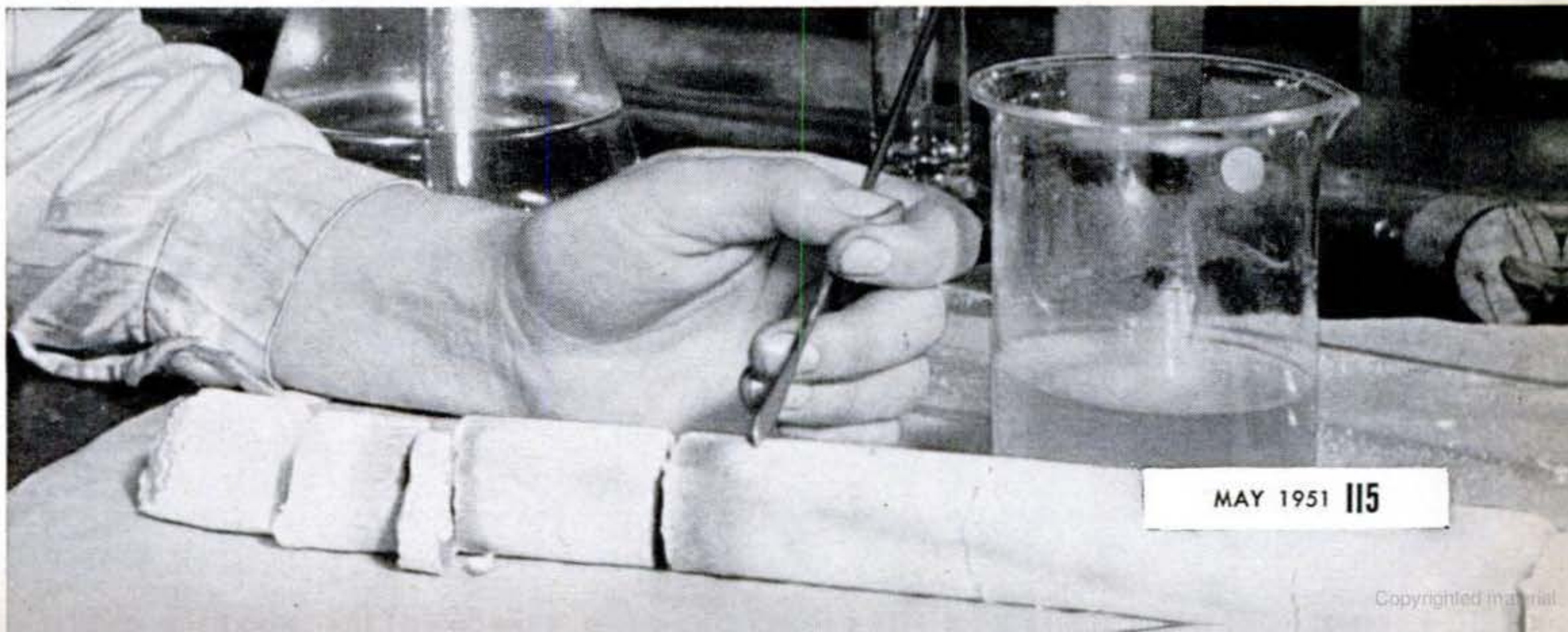



Model Fans Plan Their Dream Railroad



By R. DeWitt Miller

DRAWINGS BY WALTER POPP

MOUNTAIN snow swirled outside the cabin. Inside, around a friendly, crackling fire, sat a group of men, their minds far from the weather, the place—and reality. They were dreaming the great American dream: what they would do with lots of money to throw around.

This time the dream wasn't push-button houses or sleek sports cars. It was the Great American Plaything. Electric trains. Anyone who ever says that he has lost interest in model trains is a liar. Everybody knows that.

What these men sitting around the fire did was simply to concoct the most tremendous and incredible model electric railroad ever. It was no static, regimented railroad that

just keeps cars moving past miniature stations and through papier-mâché tunnels. This model-railroader's heaven would be an unpredictable world. There would be wrecks and landslides; rain and snow; sunlight, darkness, and dawn.

And yet it was a very real railroad—in the sense that it could be built. Every detail is within present technical know-how.

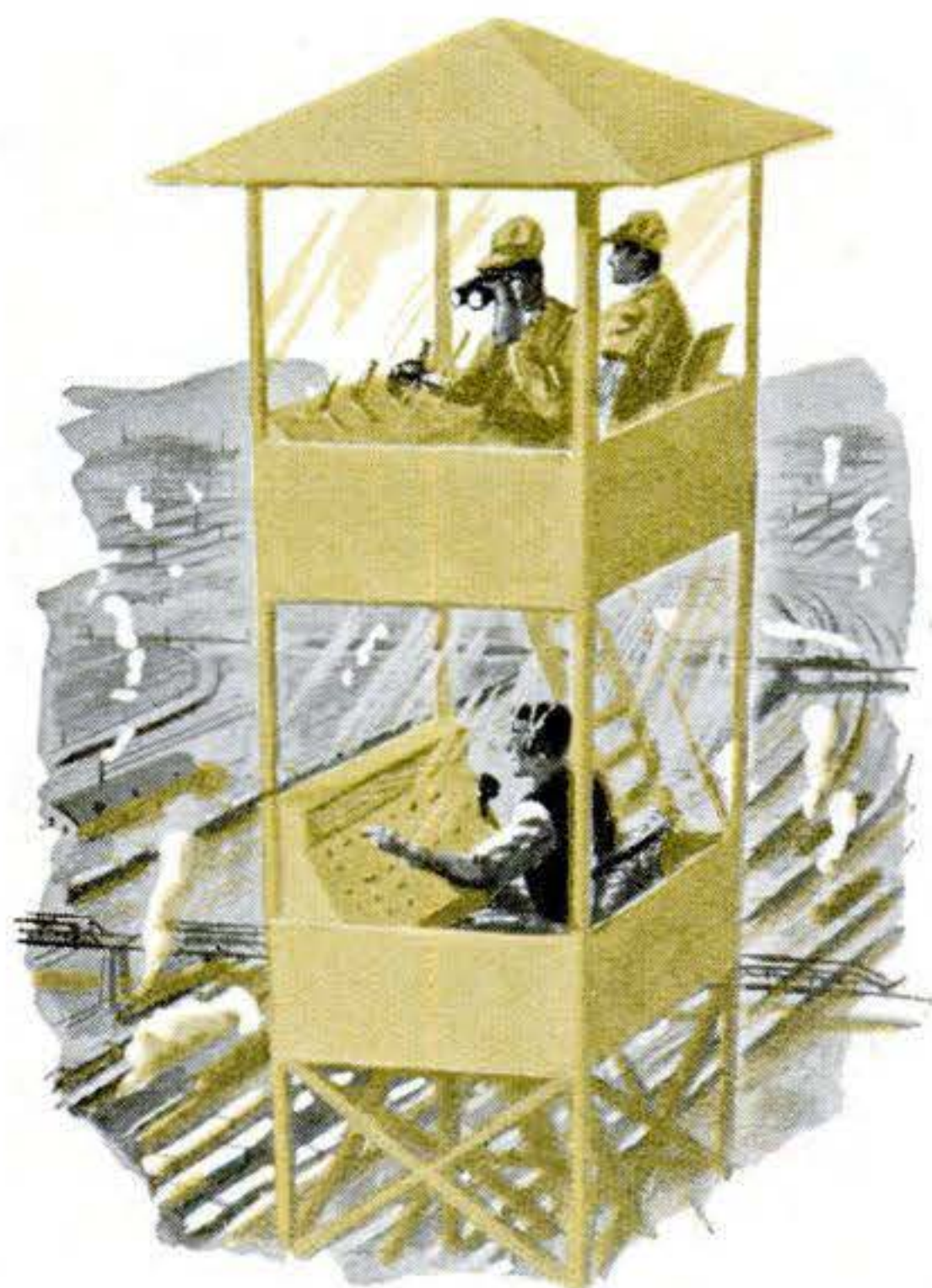

Towers house engineers above the switchmen.

Once the money is collected, the rest of the dream could become reality.

Here's how it would look:

The railroad is housed in a gigantic hangar-like building about the size of a city block, and three or four stories high. Seven feet above the floor an immense table, covering the entire area of the building, has been constructed. Mountains, valleys, plains, and deserts are built on this platform. Trap doors, strategically placed and camouflaged, give access to the surface of the table.

The huge room beneath the platform contains shops for the building and maintenance of the dream world above. A network of wires connects sections of track, control panels, switches, light systems, automatic uncoupling ramps.

Through the mountains and valleys of this miniature world run miles of tiny rails—in long straightaways and easy curves, or climbing in tortuous switchbacks across the mountains. The entire layout is built to what model railroaders call HO gauge

(tracks $\frac{3}{8}$ inch wide), which is based on a scale of approximately $\frac{1}{8}$ inch to the foot. Men and women in such a world are about $\frac{3}{4}$ inches tall. A 3,000-foot mountain towers 30 feet. Boxcars are six inches long.

Over the rails of this Lilliputian land roll dozens of electric trains. These vary in length from five to 50 cars. There are sleek streamliners, standard Pullmans, long freights, strings of coal and tank cars.

Streams and rivers flow gently beside the tracks or foam down mountain gorges. Across them tiny rails are supported on the spans of miniature bridges. The water supply is piped beneath the table.

The entire railroad is divided into blocks, or sections of track. There is a station for each of these blocks. Some of these stations are located in miniature cities, others in desolate mountain hamlets. Near every station is a tower reaching almost to the roof of the shed. These towers have two glassed-in compartments, one above the other.

In the lower compartment sits the switchman for that particular block of track. In front of him a complicated panel controls any switch in his block. The switchmen wear headphones and transmitters so that they can keep in constant communication with the engineers, repair crews, yardmen, and, of course, the dispatcher.

The top compartment of each tower houses one or more engineers. Each engineer controls one train operating on the layout. With a system technically known as "cab control," he has almost complete control of his train at any point along the miles of track in the huge shed.

Each engineer uses two controls, a throt-



Dispatcher sees control panel, not trains.

tle for adjusting speed and a reversing lever. Through binoculars he peers across the landscape, trying to keep his train in view. Often the mountains, forests, or tunnels hide it. Sometimes it enters a curtain of rain or falling snow. Then he must run his train blind, under dispatcher's orders.

The key man in the whole layout is the dispatcher—but he never sees the dream world at all. He sits in an air-conditioned, windowless cubbyhole. On his desk is the day's operating schedule and dispatching sheet. Lights flashing on a map of the entire layout show movements of each train.

Through the dispatcher's headphones pours an endless stream of information from engineers, switchmen, and maintenance crews. Into his microphone the dispatcher gives the orders that sidetrack a freight, highball the streamliner through, untangle the mess when disaster strikes.

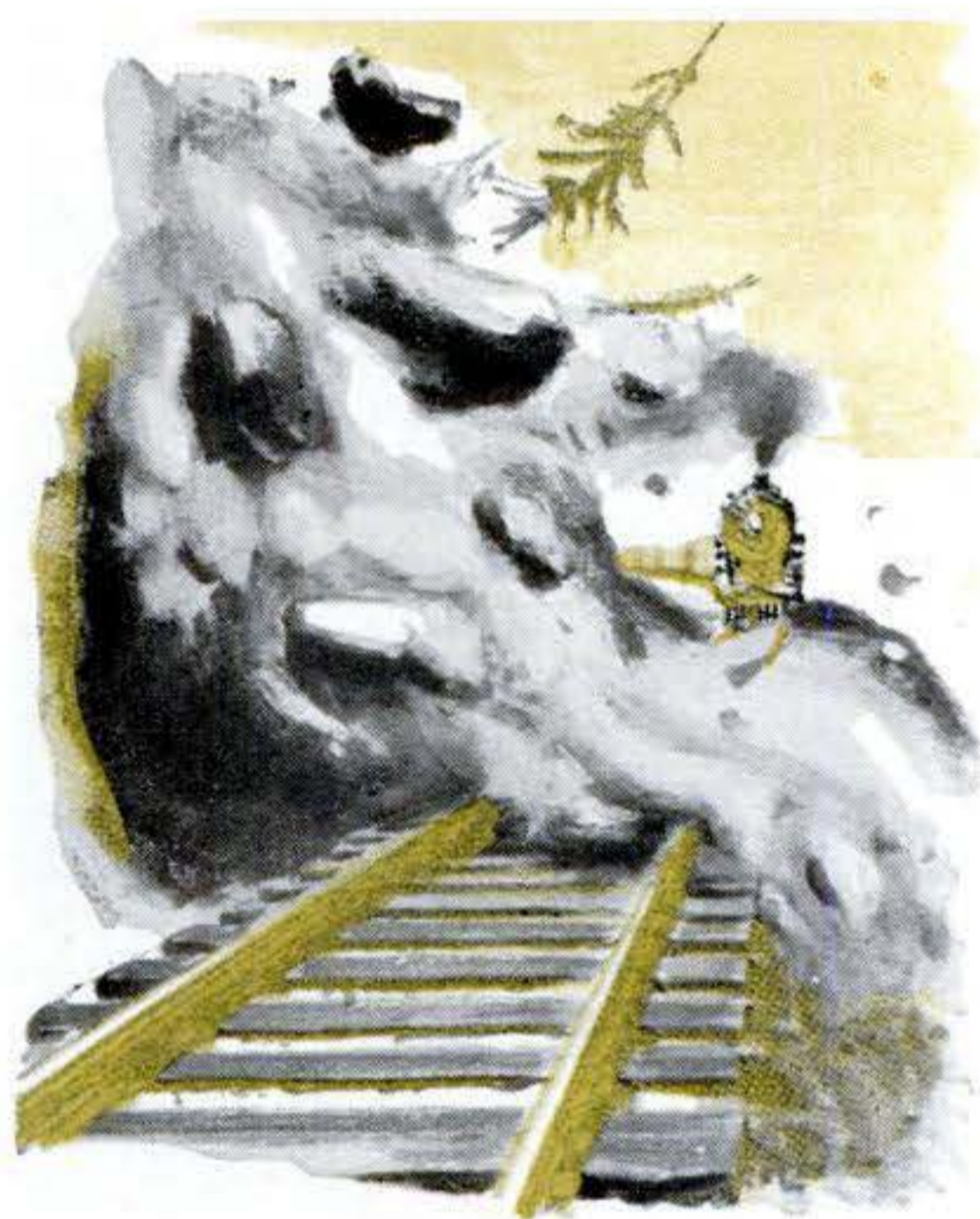

Engineers must cope with sudden landslides.

A "day" on this railroad is only four hours long. (For convenience, the dreamers decided to speed up the rotation of the earth.) All clocks and timing devices work on a six-to-one gear ratio, allowing just four excitement-filled hours from dawn to dawn.

And dawns are very real dawns. Banks of floodlights begin to glow, then slowly brighten. First the outlines of the mountains show, then the long parallel lines of rails gleam in the dimness. Tower lights in the yards wink off; lights in cities and passen-

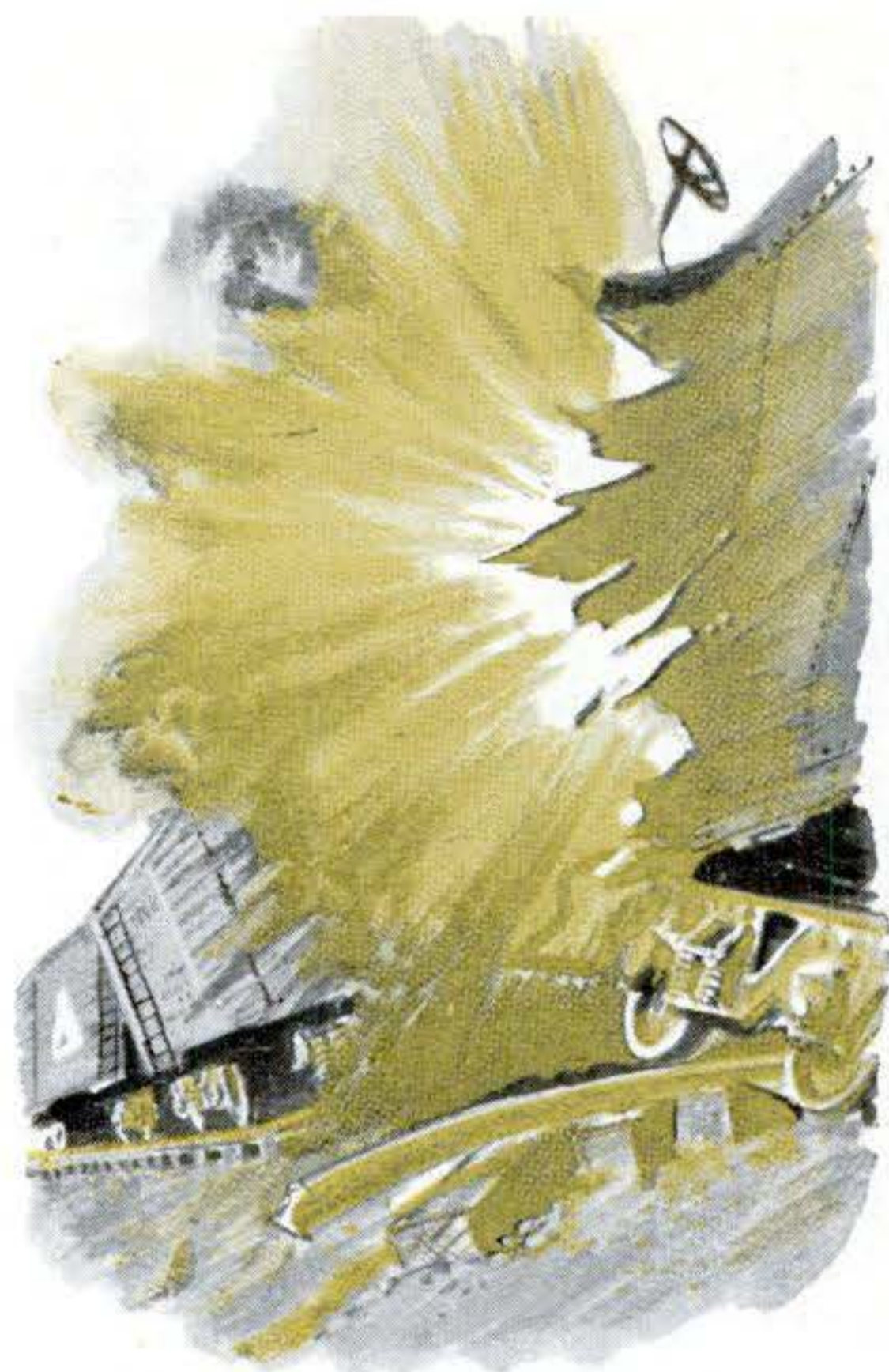

Dream's big surprise is "dynamite" train.

ger-train windows go out. Daylight comes.

Now the dispatcher, the men in the towers, and the maintenance crews know that in two hours black night will follow. Then come those 120 minutes when the engineers must stare through darkness trying to follow the tiny lights of their trains.

Each time the sponsors of the railroad gather for a contest, they face a prearranged schedule. There will be so many freight cars to be moved to their various destinations. The streamliner and fast passenger trains must travel so many miles, involving many laps around the main line. Cars must be shunted onto sidings and trains made up.

The operating schedule for each "day" will be different, but all schedules will be equally difficult. At monthly intervals during a period of perhaps a year, a different set of operators, from dispatcher to repairmen, will run the layout. The team most successful in handling its schedule will be adjudged the winner.

As to the prize . . . we're still dreaming, so money is no obstacle. Or perhaps the honor of being on the team that won the world's strangest and most elaborate game would be sufficient reward.

But that's not all. In this game, darkness and ordinary breakdown will only be minor hazards. Pre-set devices will, at times and places unknown to any of the operators, let loose torrents of rain and blinding blizzards

of snow. The rain will come from a net of sprinklers above the layout, and the snow from dry-ice chutes. Maybe we'll need miniature snow ploughs to clear drifts.

But the pre-set timing devices will have even more sinister purposes. A number of small explosive charges will be placed at strategic points around the layout. The location of the charges and the moment of explosion will be unknown.

When those explosions occur bridges and tunnels collapse and landslides bury sections of track, or perhaps bend a single rail.

Such "minor accidents" will continually upset the operating schedule. But if a train wreck is involved—perhaps a string of 50 tiny cars toppling off a shattered bridge and plunging down a 30-foot mountain into a river below—there will be real trouble.

Repairs to the right-of-way will be made by the maintenance crews. Popping up through the trap door nearest the point of trouble, they will lay temporary track, rebuild bridges, clear away landslides, put cars back on the rails. Damaged rolling stock will be taken to the shops beneath the table. Repairs will be rushed. A shortage of units might be disastrous.

It was suggested that one end of the shed be glass, to let spectators in a grandstand watch the drama of the toy-train paradise. This idea was enlarged until all the walls of the shed were windows, and the cost of op-

erations was paid for by charging admission.

Then somebody proposed that all sorts of hobbyists could be called upon. Model builders could produce miniature trucks, automobiles, farm equipment, tiny human beings—all built to scale. Garden-club members could lay out and plant fields and forests, using real grass, miniature flowers, and dwarf trees. Architectural students could design and construct buildings.

Then a man who had been pumping at the fire with a broken-down bellows said:

"Maybe we wouldn't need millionaires. Maybe just cooperation would do it."

But the discussion had already switched to a new and ultra-diabolical proposal.

Whenever the layout was in full operation, a short freight train would follow a schedule calling for almost constant movement. The boxcars of this train would be loaded with "dynamite"—small explosive charges that would be set off by any abrupt jar. Should this train be in an accident, or even be roughly handled by its engineer, *blooey!* The train would blow up, making an awful mess and taking out a lot of track.

About then the session broke up, and the drama suddenly became just a dream. But somehow it seems better to dream of things like that than the wars that most of the human race has always dreamed about.

Anyway, it was a swell idea. Somebody ought to build it. END

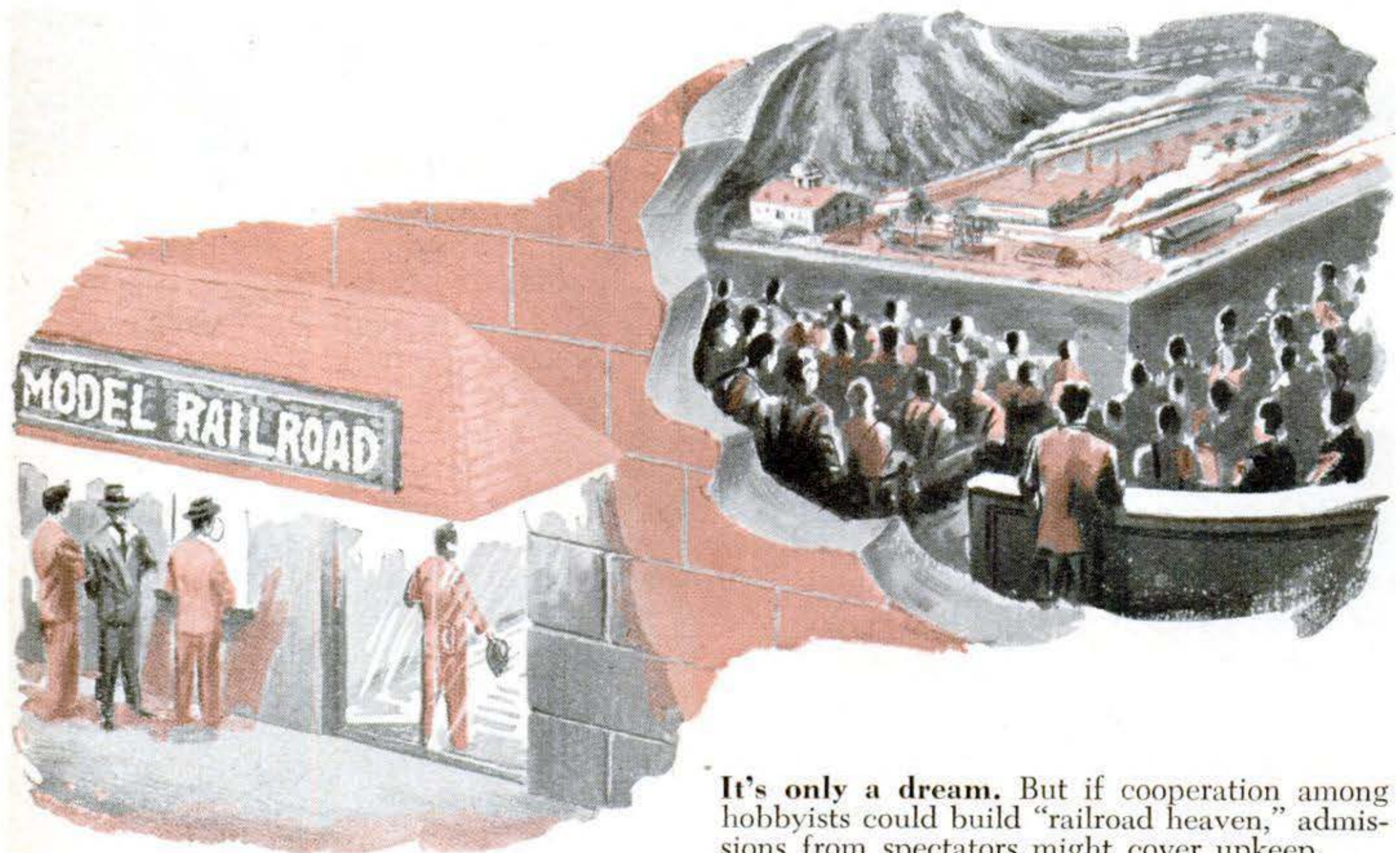

It's only a dream. But if cooperation among hobbyists could build "railroad heaven," admissions from spectators might cover upkeep.



Private Transport Flies 200 M.P.H.

ONE of the few high-wing transport planes produced in the U. S. in recent years, the Aero Commander above is powered by two 260-hp. Lycoming engines. It has a

speed of 200 m.p.h., and can carry up to seven persons in comfort. Aero Design & Engineering Co., Oklahoma City, is building the executive-type plane, which can climb 600 feet a minute on one engine.

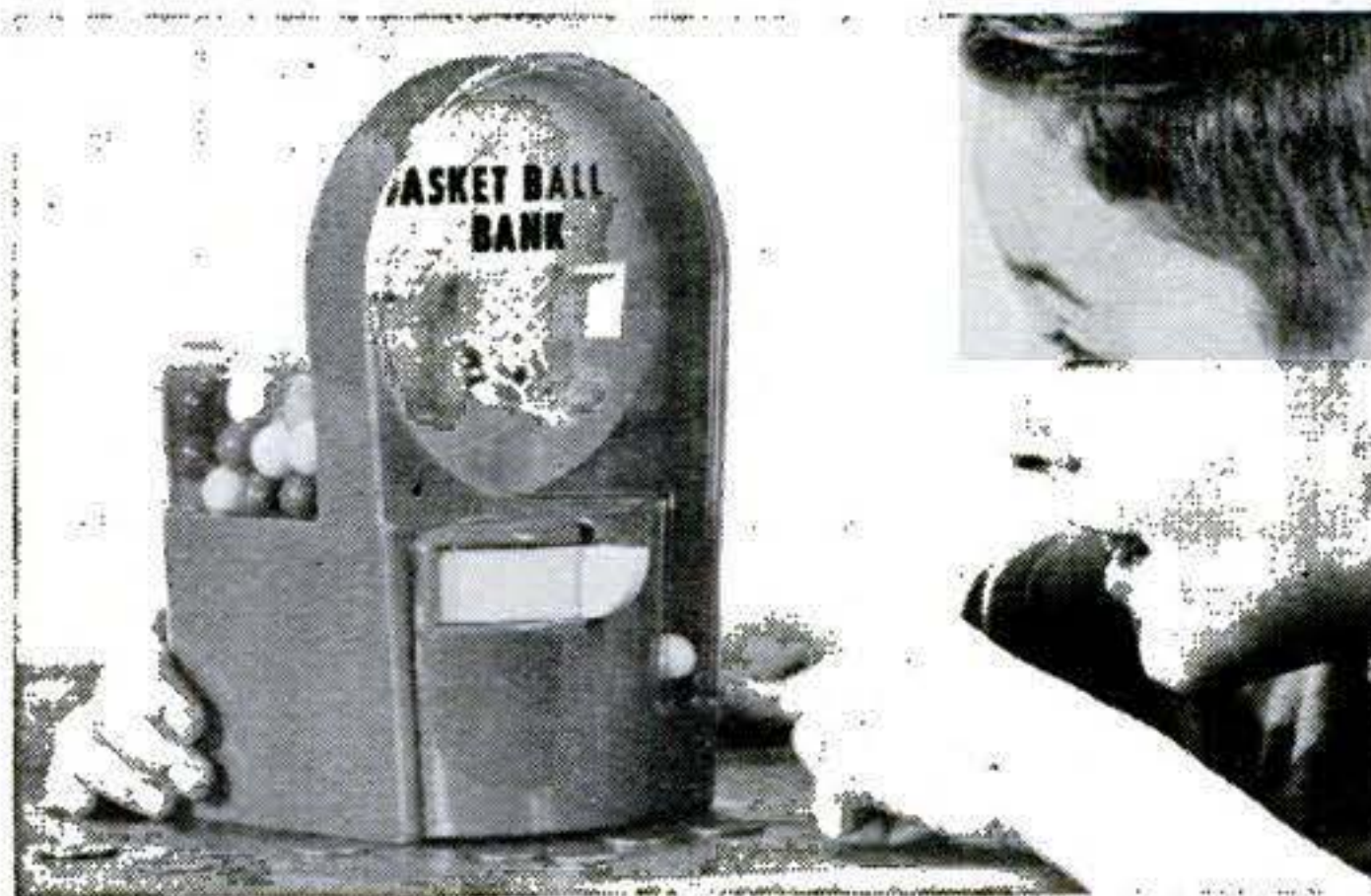

Toy Uses Bubble Gum for Basketball

A PENNY isn't enough to get bubble gum out of this new toy bank. A coin releases the ball of gum, but only into a chute. It must then be shot through a basket, like a basketball, before it comes out. Leaf Gum Co., of Chicago, makes the basketball bank.

Reds Show Off New Farm Machinery

THE world got a rare peek at Russian farm machinery during a Paris exposition recently. One machine (lower photo below) plants tomatoes or tobacco; other cultivates cotton.

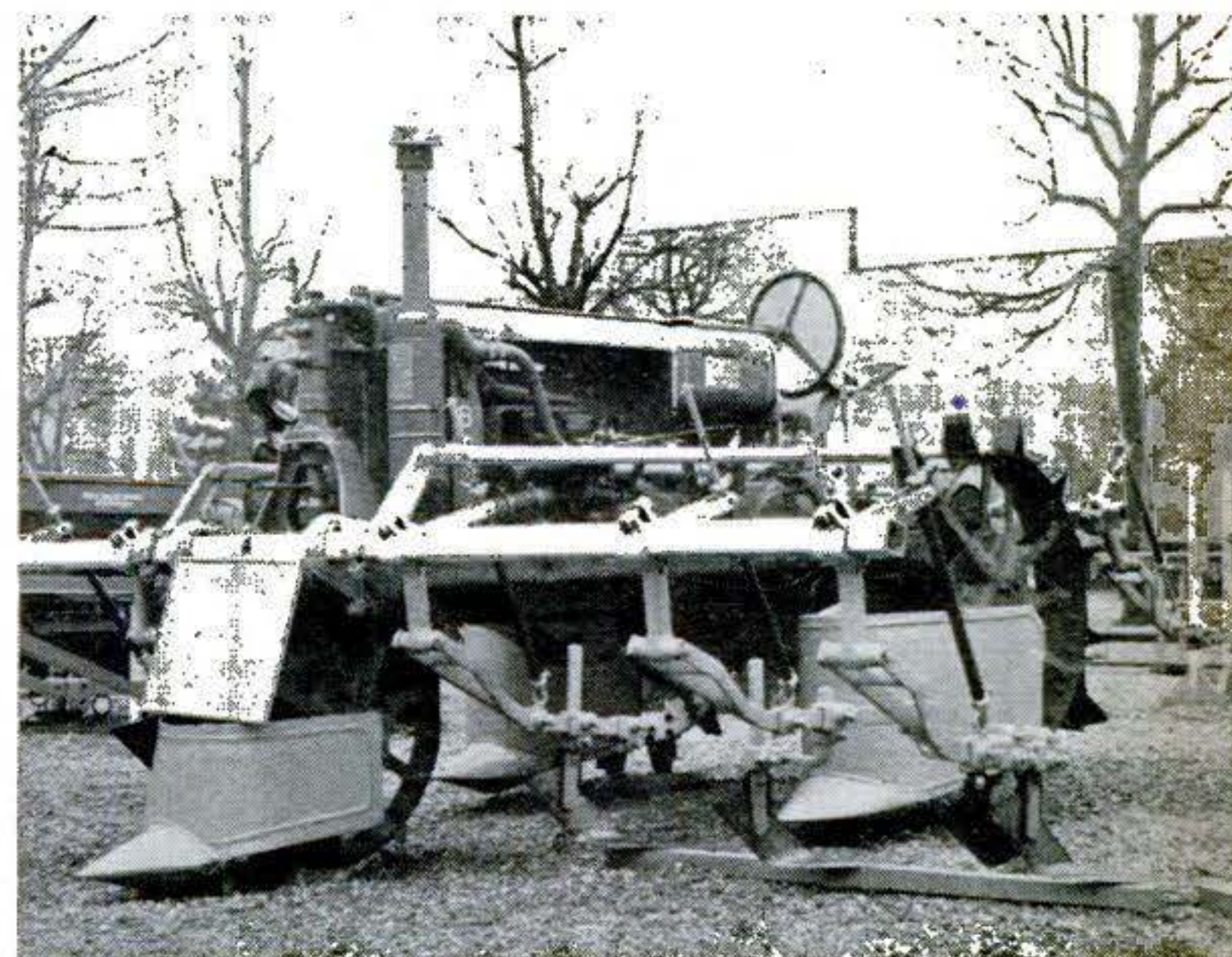

Jap Binoculars Are World's Largest

WITH these binoculars, Japanese sailors could read a ship's name at 20 miles. The world's largest, the binoculars have 75-power eyepieces. This pair is the only one remaining of 12 built during World War II. The others are in Davy Jones' locker.





New rubber drums are easily rolled around. Rounded corners facilitate handling. As yet they are made only in limited quantities.



Photo shows drum in three stages—empty, partly filled, and full. Of 55-gallon capacity, they weigh less than 30 pounds when empty.

Liquid is valved from partly collapsed drum. Atmospheric pressure flattens the container.



Soft Drums Are Lighter, Safer

FLEXIBLE drums, as flat as the proverbial pancake when empty, are going to compete with metal containers for the shipment of such items as oils, greases, fats, acids, paints, emulsions, and soaps.

The United States Rubber Co. is manufacturing the drums after nearly three years of development and testing work. Each drum is made in one piece of a cord fabric impregnated with synthetic rubber. Use of the new container is expected to save time and expense in shipping empties. More than 2,500 of them, collapsed, can be shipped in a standard railroad boxcar that would hold only 300 rigid drums.

Because the drums are considerably lighter than metal ones, the company expects them to find use in the transportation of liquids by air and for dropping liquids by parachute to ground troops.

The drums are tough, easy to lift, and can be rolled and stowed easily. They're non-corrosive, nonabsorbent, and resistant to weathering. When full, they retain their shape. They need no venting while being filled or emptied, and therefore eliminate a hazard in handling dangerous acids and combustible liquids.

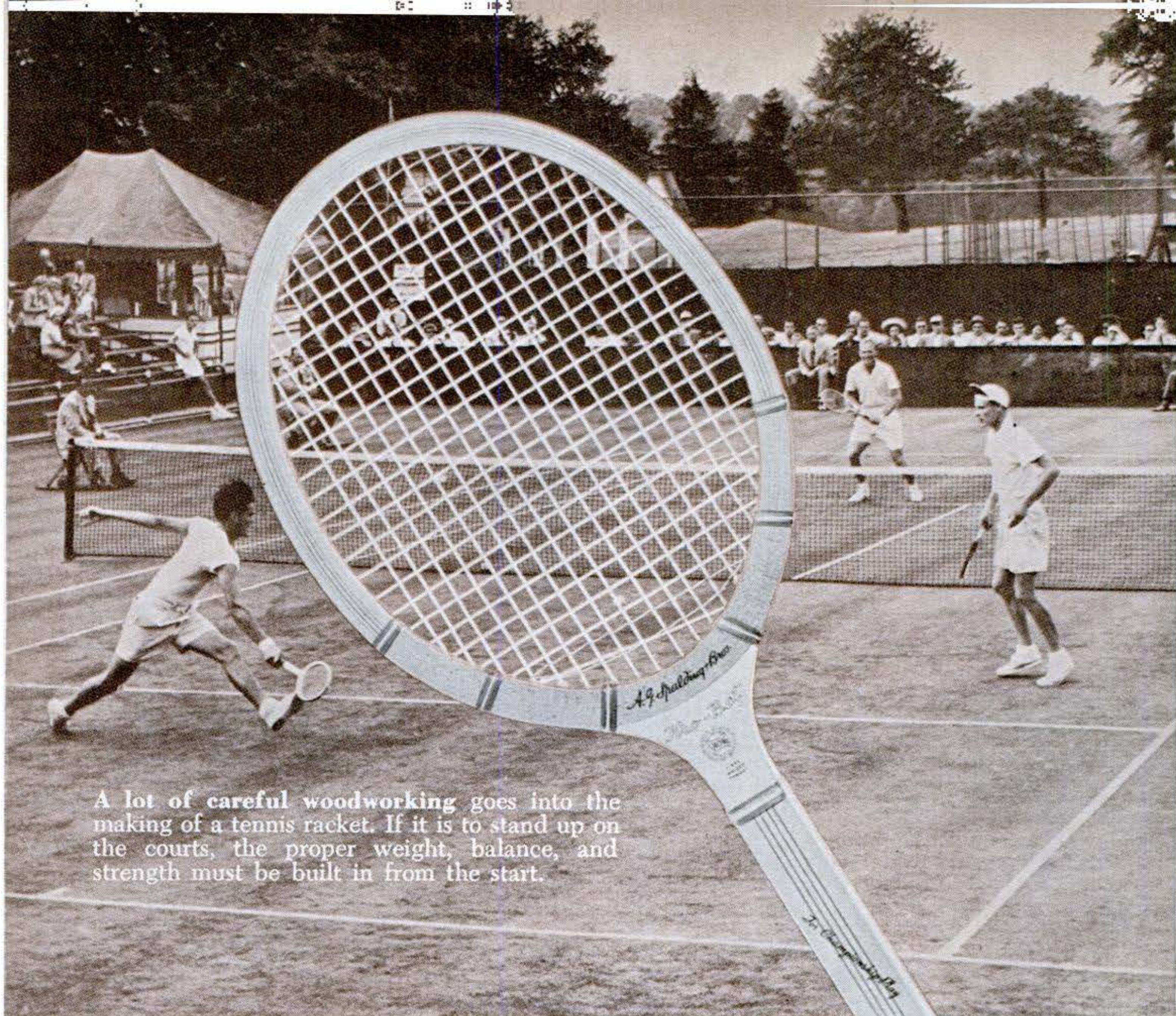

A lot of careful woodworking goes into the making of a tennis racket. If it is to stand up on the courts, the proper weight, balance, and strength must be built in from the start.

Woodworking Skill Makes Tennis Rackets

By George H. Waltz, Jr.

PS PHOTOS BY HUBERT LUCKETT

SEVENTY-EIGHT years ago, when the game was first played in England, it was called "Sphairistike" (sphere and stick). Today, it is known as "lawn tennis." But regardless of what you call it, or whether you play it on a grass, clay, composition, or indoor court, one of the prime requisites is a good tennis racket—and that means specialized skill in woodworking.

If you were to visit a tennis-racket plant, like the big A. G. Spalding & Bros. factory at Chicopee, Mass., you would see skilled workers using the industrial counterparts of the same machines that make up a well-equipped motorized home workshop. Planers, circular saws, shapers, sanders, drill presses, and routers all play an important part in the forming of a tennis racket, as do such hand woodworking operations as gluing and laminating, sanding, countersinking, wood filling, and paint and lacquer

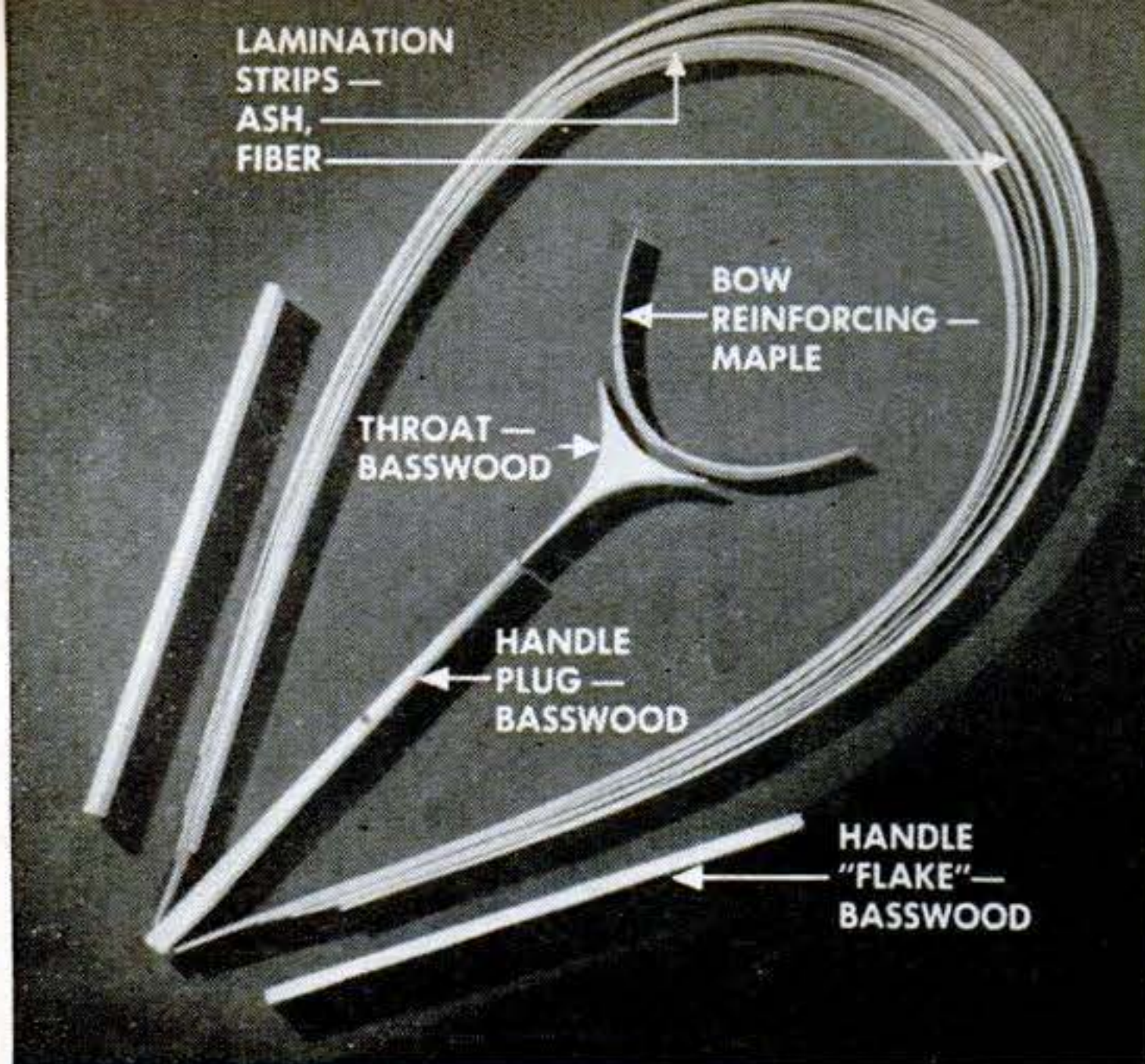

1 Here are basic parts that go into a tennis racket. The wood laminations are 64-in.-long strips cut freehand with the grain from clear, second-growth mountain-ash boards.

2 After being carefully selected for color and grain, the strips are coated with glue. Then the proper number, together with fiber strips, are bowed inside a metal strap.

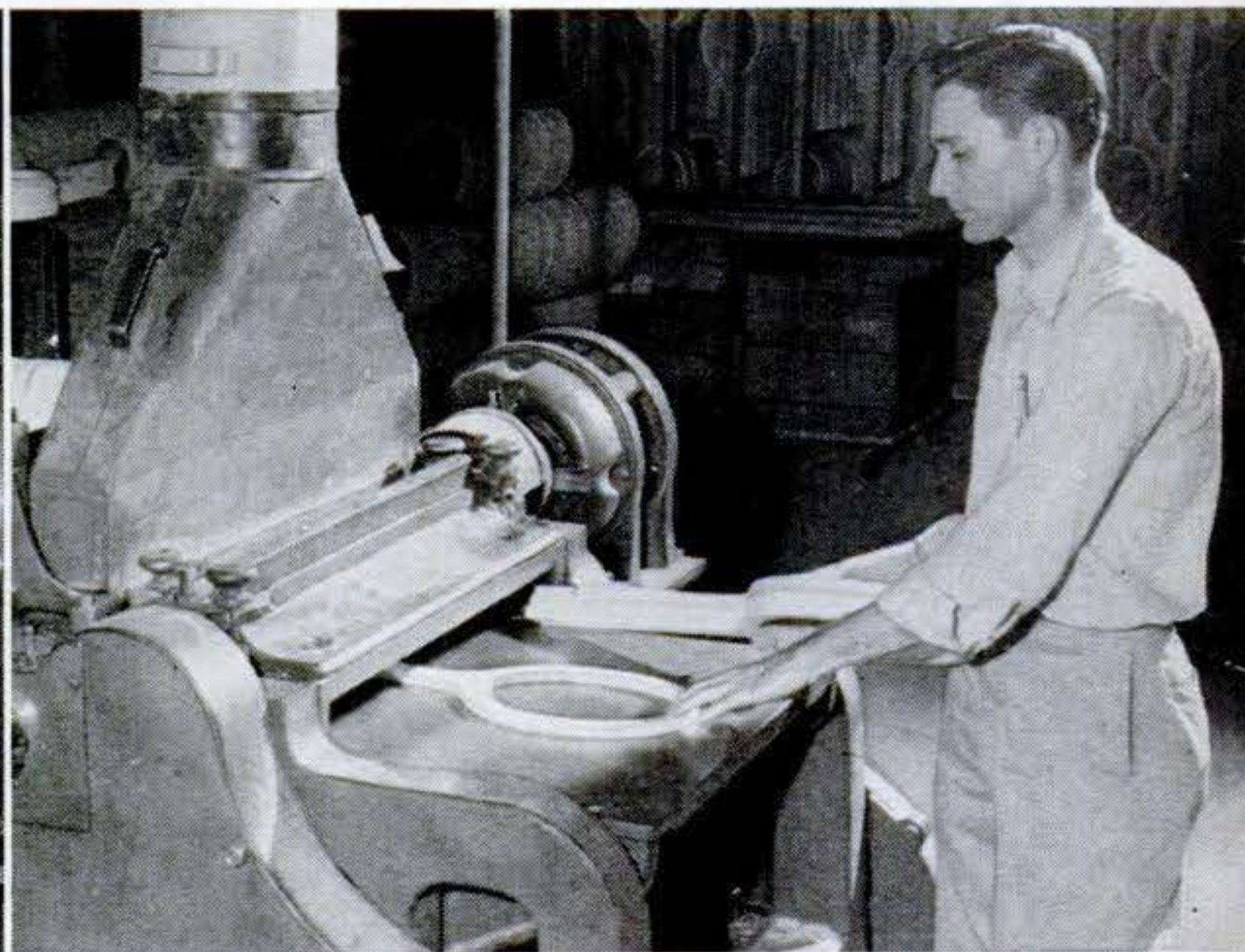
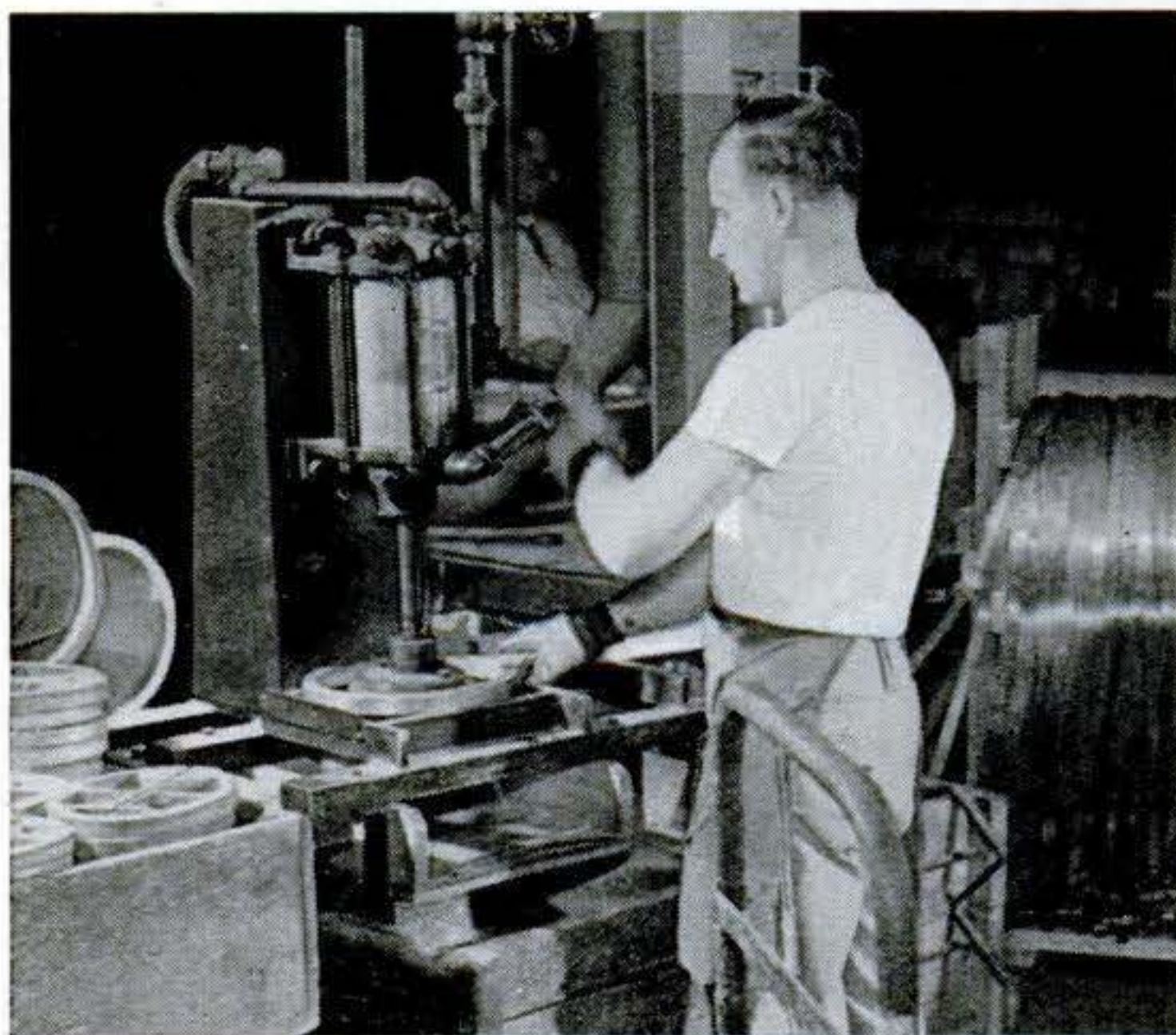

5 After 4 hours of kiln drying and 8 of air drying, the clamped form is removed and the basic glued laminated racket frame starts down the woodworking production line.

6 First, one side of each frame is machine-planed to provide a smooth working surface. Then the second side is machine-planed down to the proper frame thickness.

spraying. Except for the strings, the leather grip, and a few reinforcing pieces of rawhide and fiber, the modern laminated tennis racket is a product of wood, glue, and skilled craftsmanship.

A Spalding racket actually begins on large tracts of land in northern New England where the lumber is grown. The most important wood involved is the clear, straight-grained, second-growth ash used for the thin laminations that form the heart and muscle of the racket. It takes approximately 60 years to grow an 8- to 10-inch ash tree that will provide only enough high-quality strips for 200 rackets.

After the trees have been felled and cut

up into boards, the boards in turn are sliced up into thin strips by experienced workers who carefully follow the grain of the wood freehand as they guide the lumber through double-bladed gang saws. Carefully dried to the proper moisture content, the strips are then graded according to color and size and straightness of grain. At least six of these strips go into every laminated racket.

Once the lamination strips have been graded, the gradual building-up process of making the basic racket frame begins. Selected maple is steam-bent and cut to form the inner reinforcement for the head, or bow. The plug, or interior part of the handle, and the throat wedge, a V-shaped



3 Strap and strips then go to bending machine. Straps are placed around a metal core, and ends are attached to a hydraulic plunger. Then other wood parts are put in place.

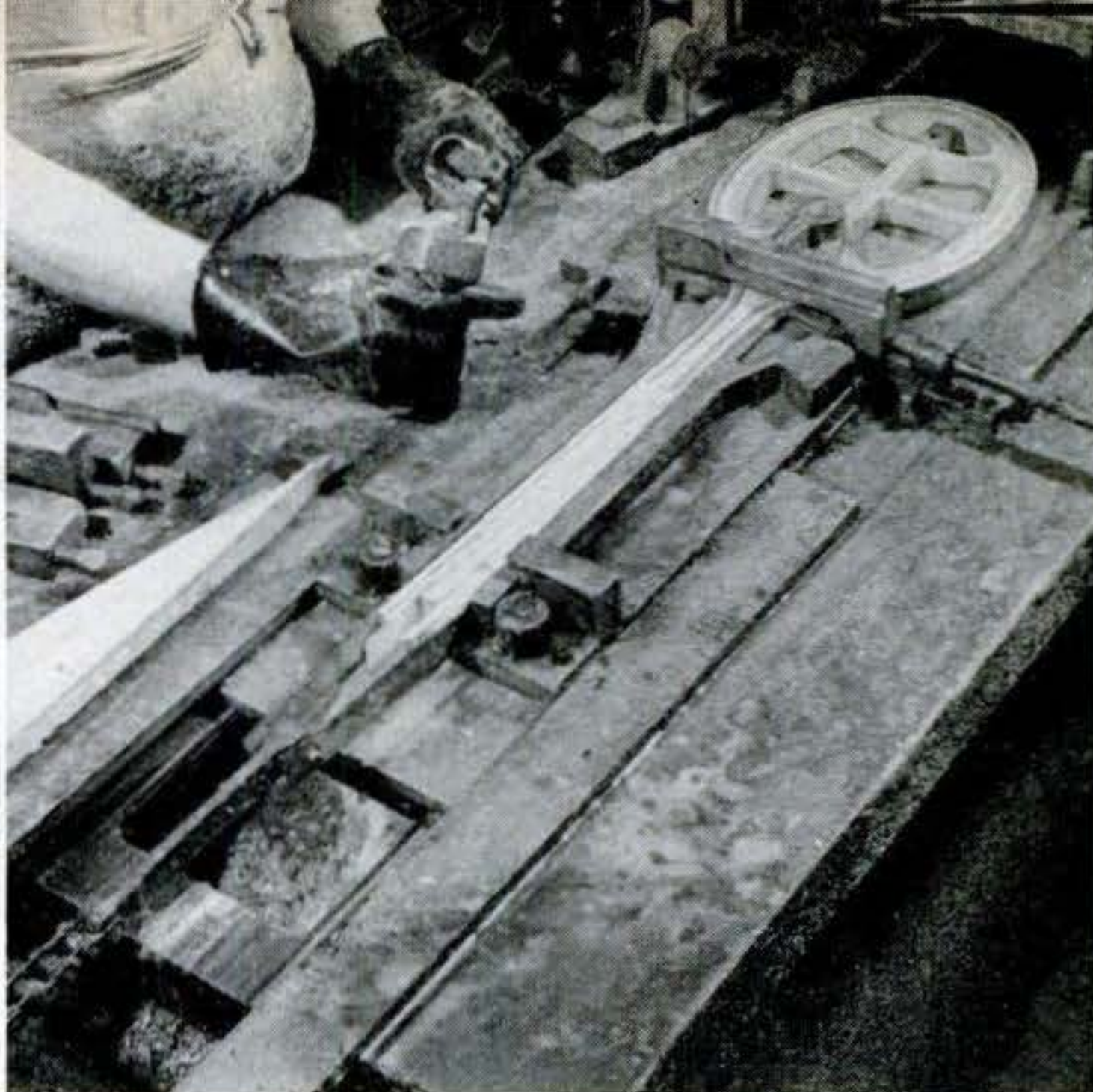

4 When operator touches a pedal, the plunger pulls strap tight and arms force the sides of the form in. Clamps are then placed on form and it is removed from machine.

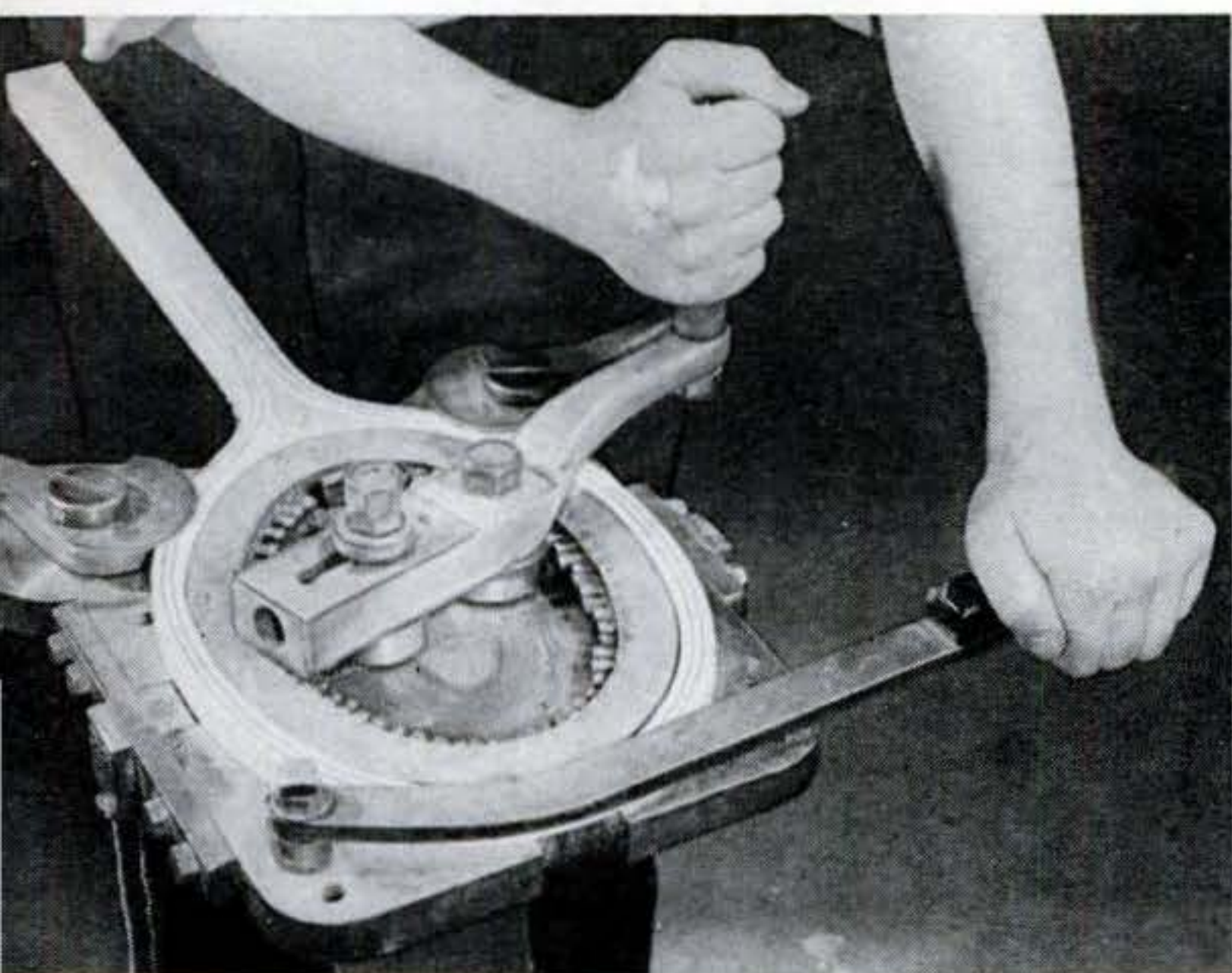

7 The locations of the string holes are marked in this jig. When frame is clamped in place, turning the handle on top of the jig forces pins out to mark inside of the bow.

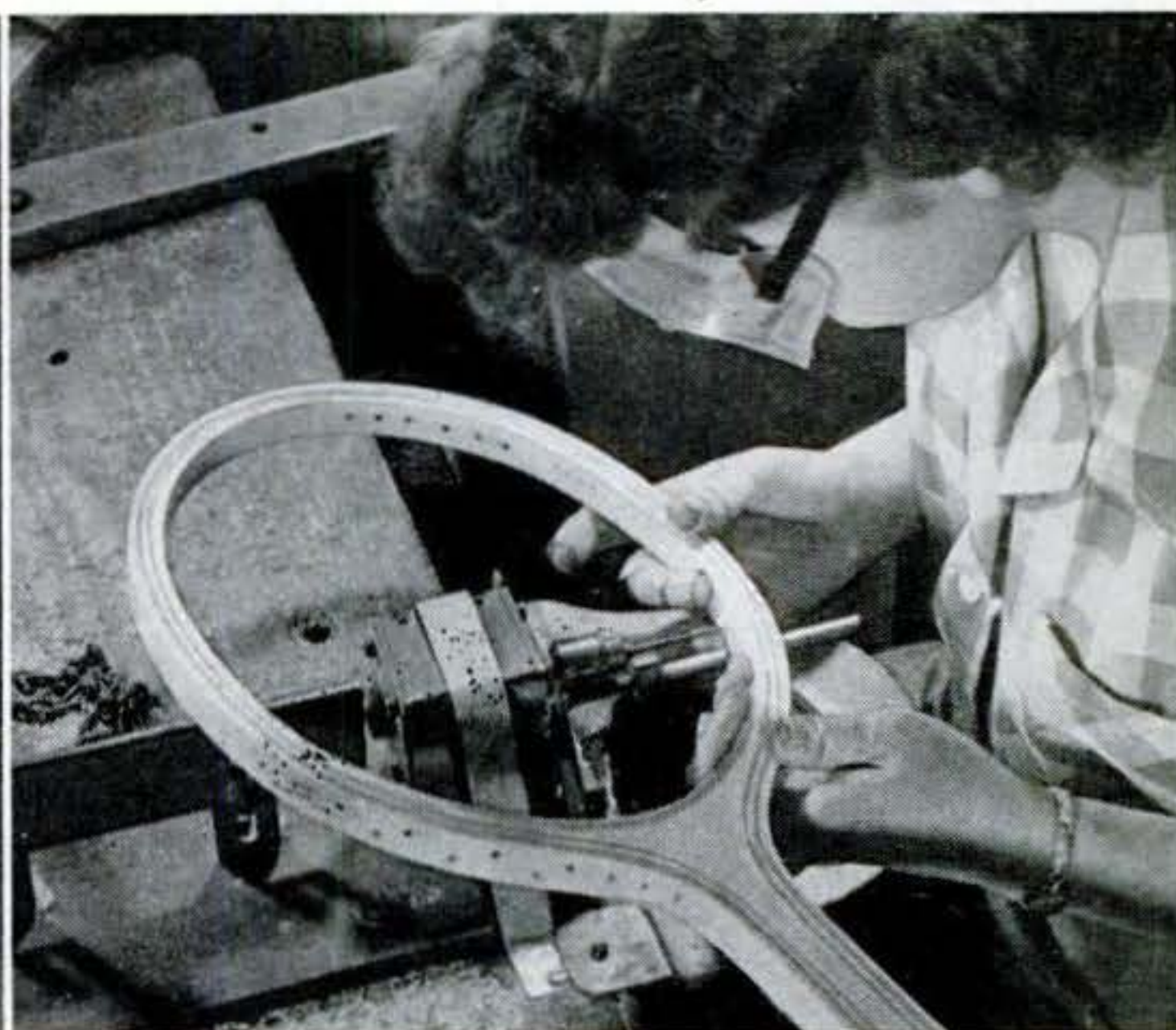

8 The holes are then drilled. No one operator drills all the holes in any one frame. Each is a specialist who has been trained to handle a specific portion of the head.

piece, are sawed from kiln-dried basswood.

Finally, these assorted pieces of ash, basswood, and maple come together at a combination bending and pressing machine where they are coated with a plastic glue and formed under tremendous pressures into the laminated racket frame. Forces greater than 1,000 pounds per square inch press the glue-coated parts together around a metal form. Screw clamps are then applied, and the form is placed in a kiln to dry the glue. After about 12 hours of kiln and air drying, the frame is ready for the various woodworking operations that will convert it into a finished racket.

In rapid order, the frame is planed to



9 After holes are drilled, grooves are routed from hole to hole on outside of the upper end and sides of the bow. These grooves will protect the strings from injury.

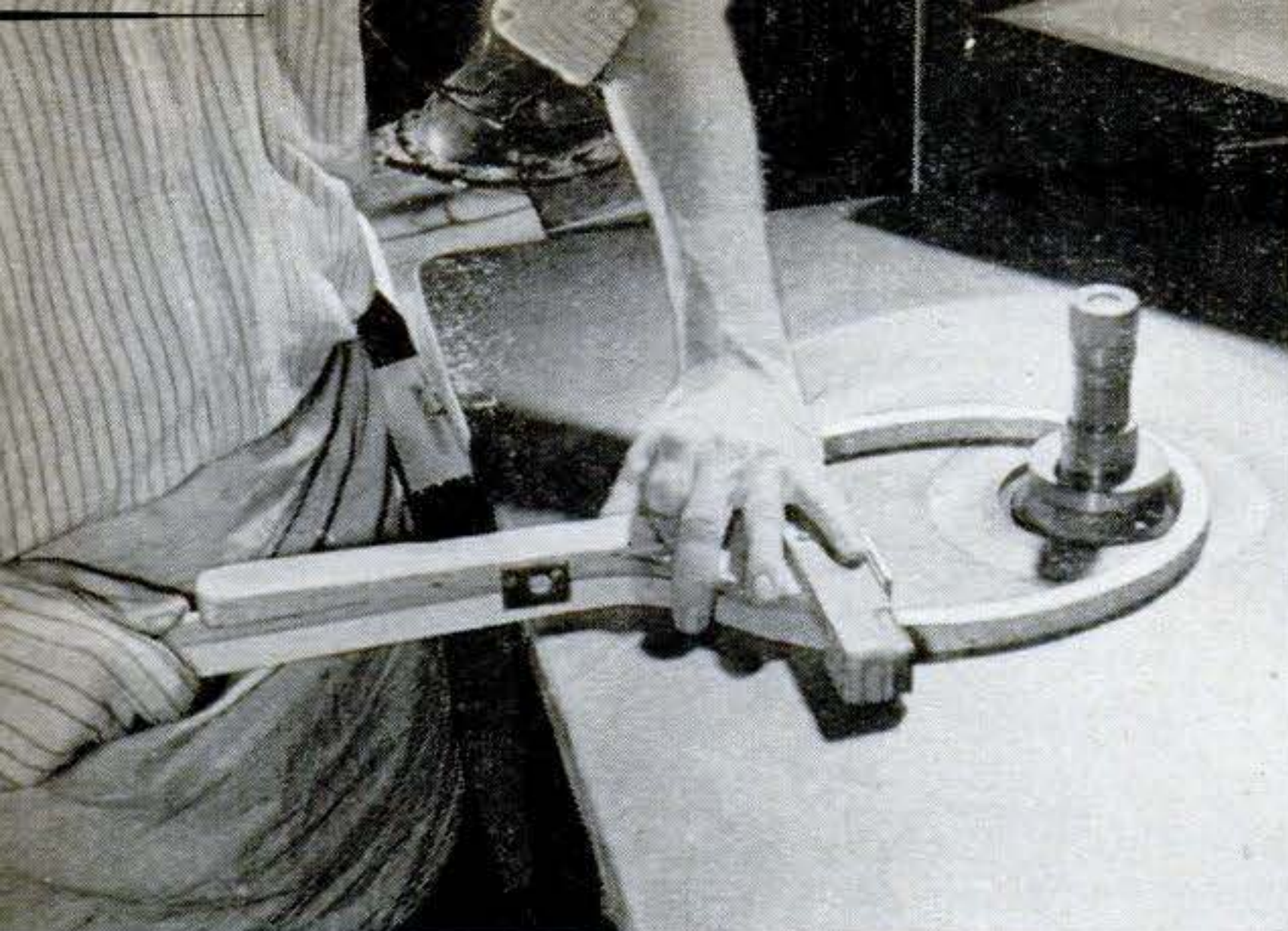

10 A vertical shaper is used to form rounded edges on the inside and outside of the bow. A guide under the revolving cutter determines how much wood can be removed.

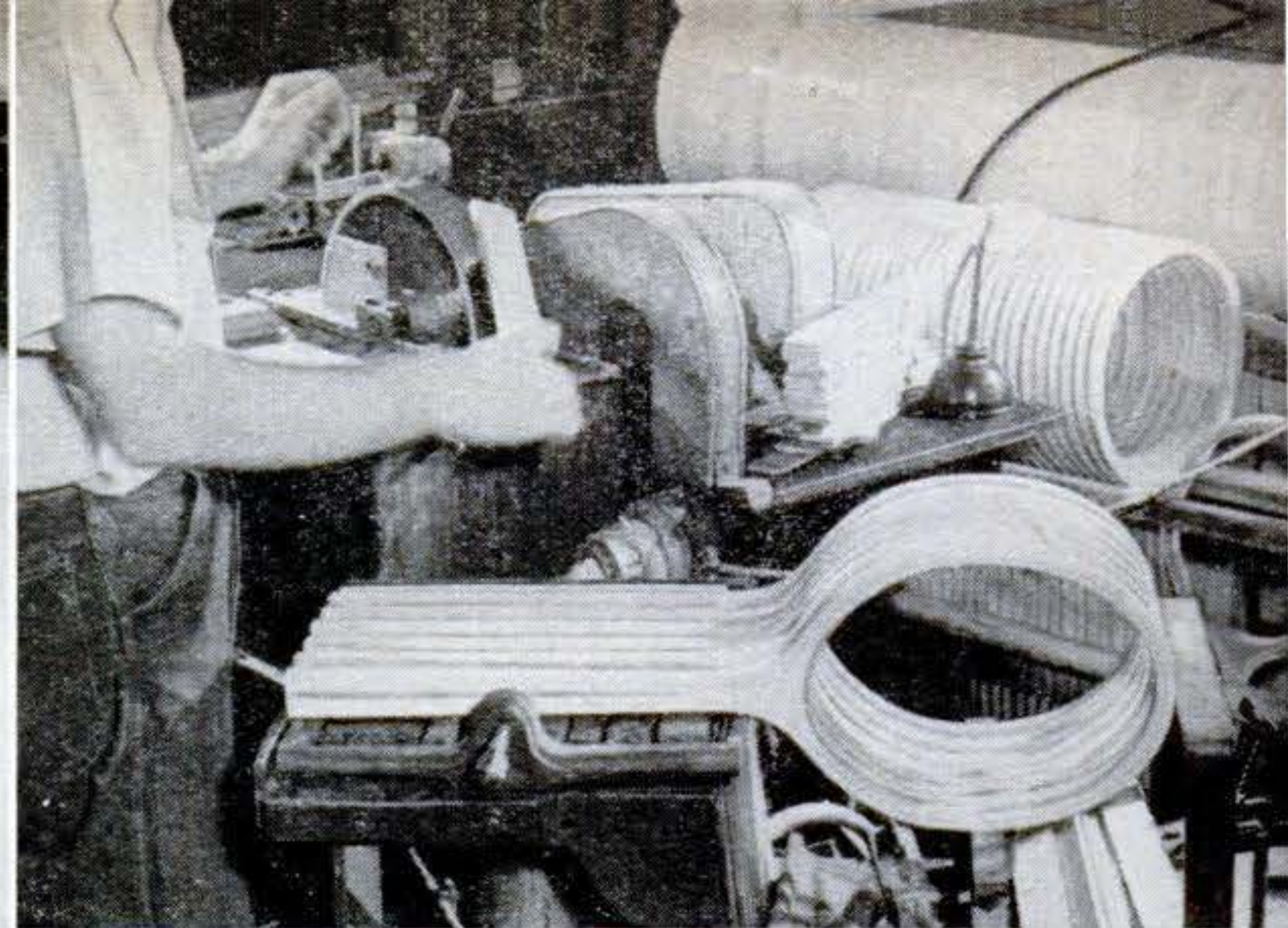

11 The side pieces on handles, called "flakes," are then glued in place. A half-dozen frames and their glue-coated "flakes" are clamped in a press and allowed to dry.

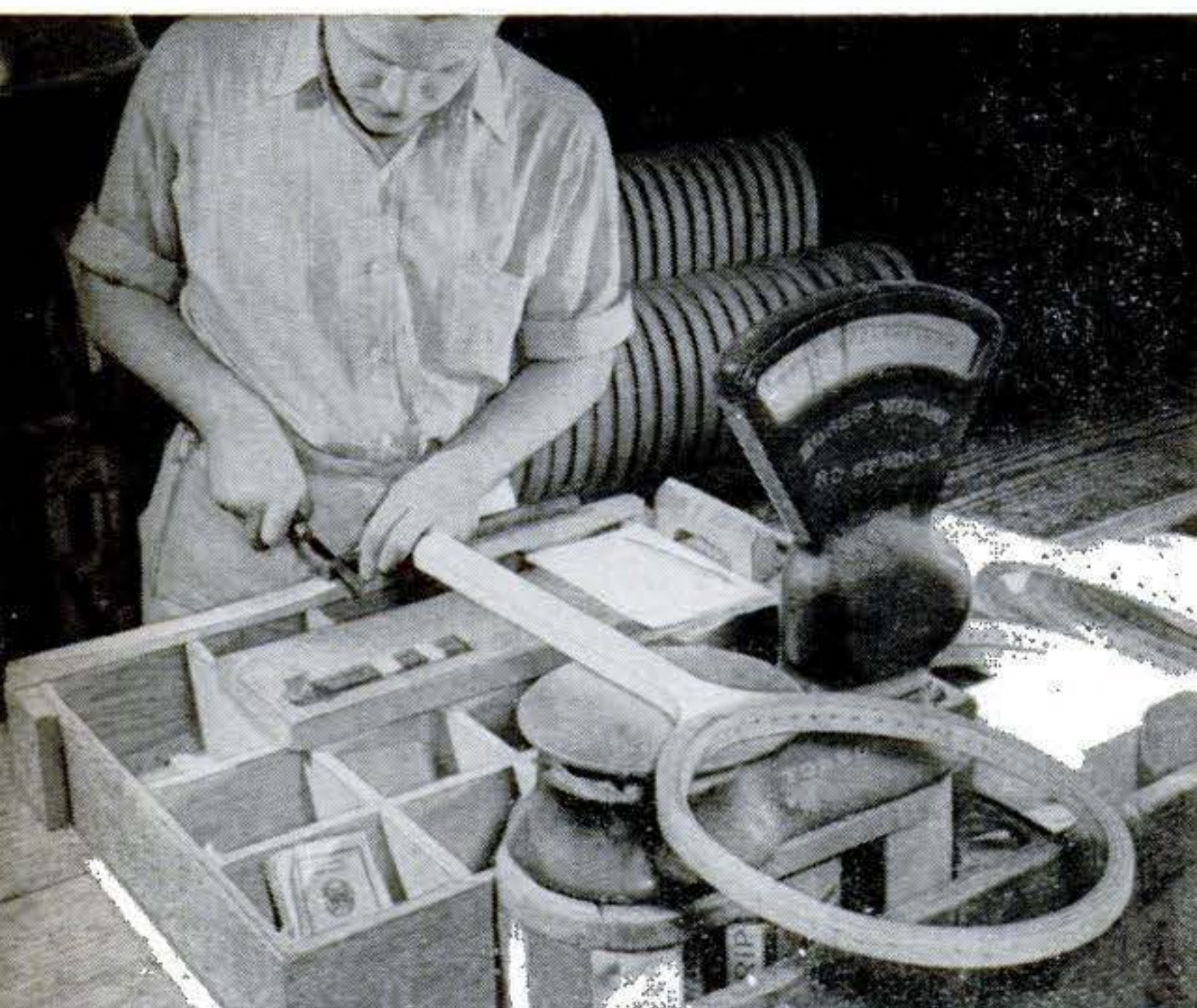

14 Weight and balance are important in a tennis racket. Here, both are checked and corrections are made by inserting a leaded rubber plug in hole drilled in handle.

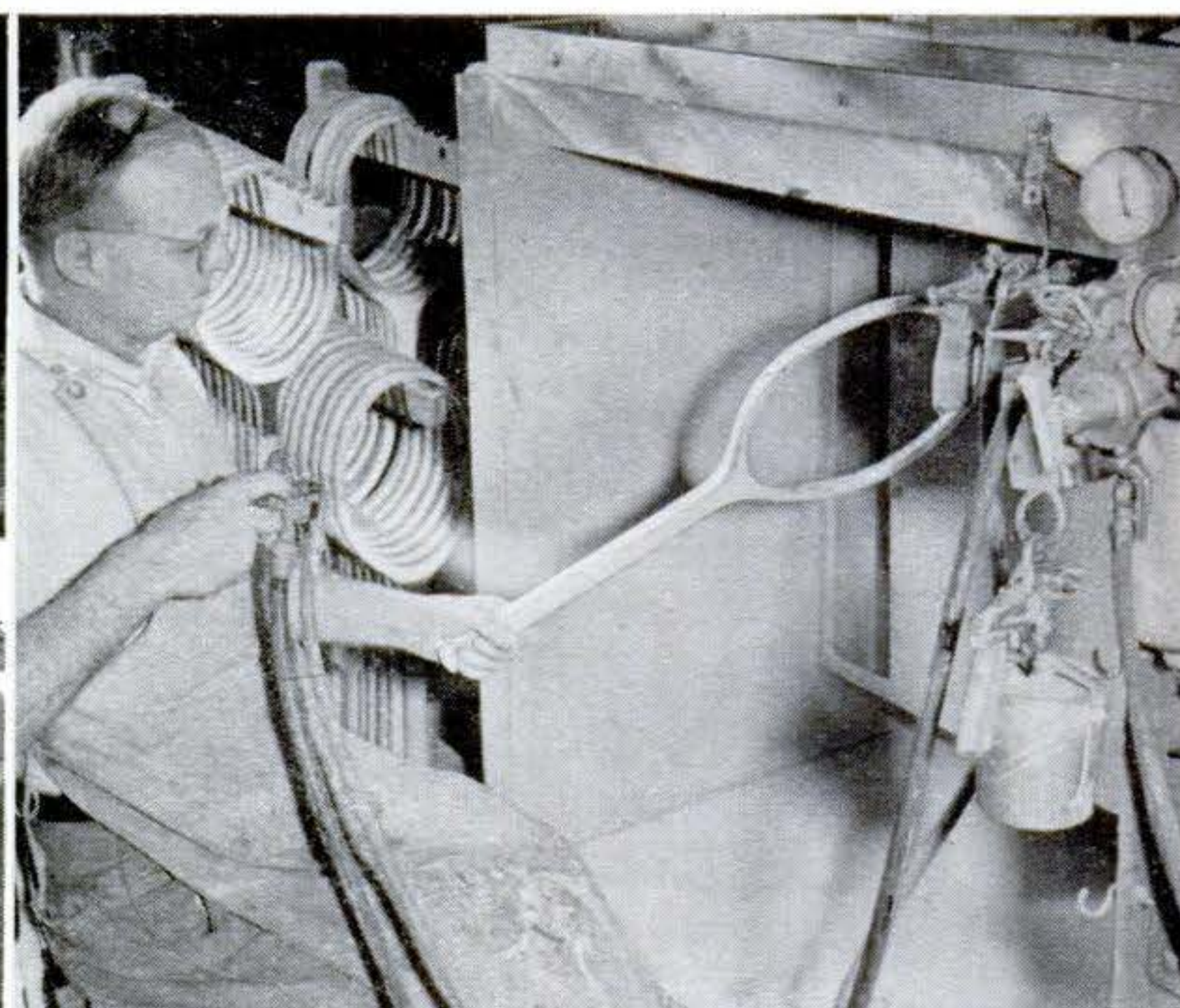

15 Finishing consists of filling the wood with a mixture of turpentine, oil, and wood flour, and then applying multiple spray coats of colored and clear lacquers.

proper thickness, the string holes are marked and drilled, the head, or bow, is beveled and chamfered to shape, the handle pieces, or "flakes," are glued into place, and the handle is formed. Although machines do much of the actual work, the hands of skilled woodworkers guide the frame through the various operations.

Weight and Balance Are Vital

Weight and balance are particularly important in a tennis racket. If either is off, a slug of leaded rubber, cut to provide the right weight, is inserted in a hole drilled in the handle butt. A wood plug holds the slug in place.

After the frame has been spray painted,

decorated, and lacquered, the leather grip is applied and the racket goes to the stringers. Here, again, deft hands place the vertical main strings and weave in the cross strings. Working with awls, pliers, and special hooks, the stringers are capable of pulling each string to a uniform tightness of between 50 and 55 pounds.

Finally, operators thread in the colored trim that you find at the top and bottom of the strings on most rackets. Oddly enough, neither this string trim nor the bindings on the racket head add any strength to the racket. They are merely decoration. Years ago, someone put them on a tennis racket and now both pros and dubs insist that they be there.

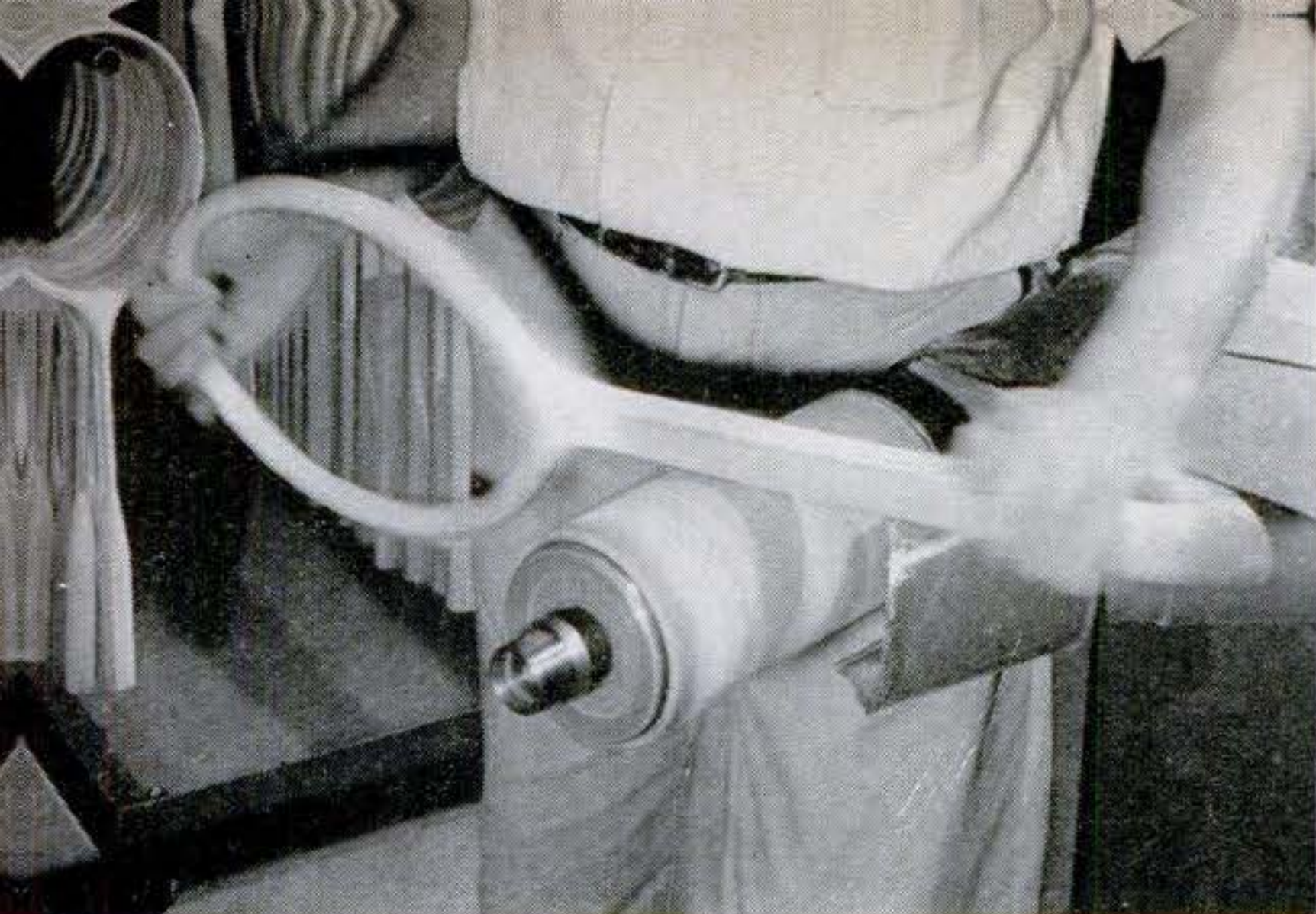

12 Final shaping of the handle and the bow is done by hand by skilled operators on cylindrical "balloon" sanders. After machine sanding, the frames are hand-sanded.



13 "Balloon" sanders get their name from the fact that their spindles are not solid, but are rubber cylinders that can be inflated to provide just the right amount of cushion.



16 After the decorative bindings and decalcomania labels have been applied, a cap is put on the butt of the handle and the leather grip is glued and wrapped into place.

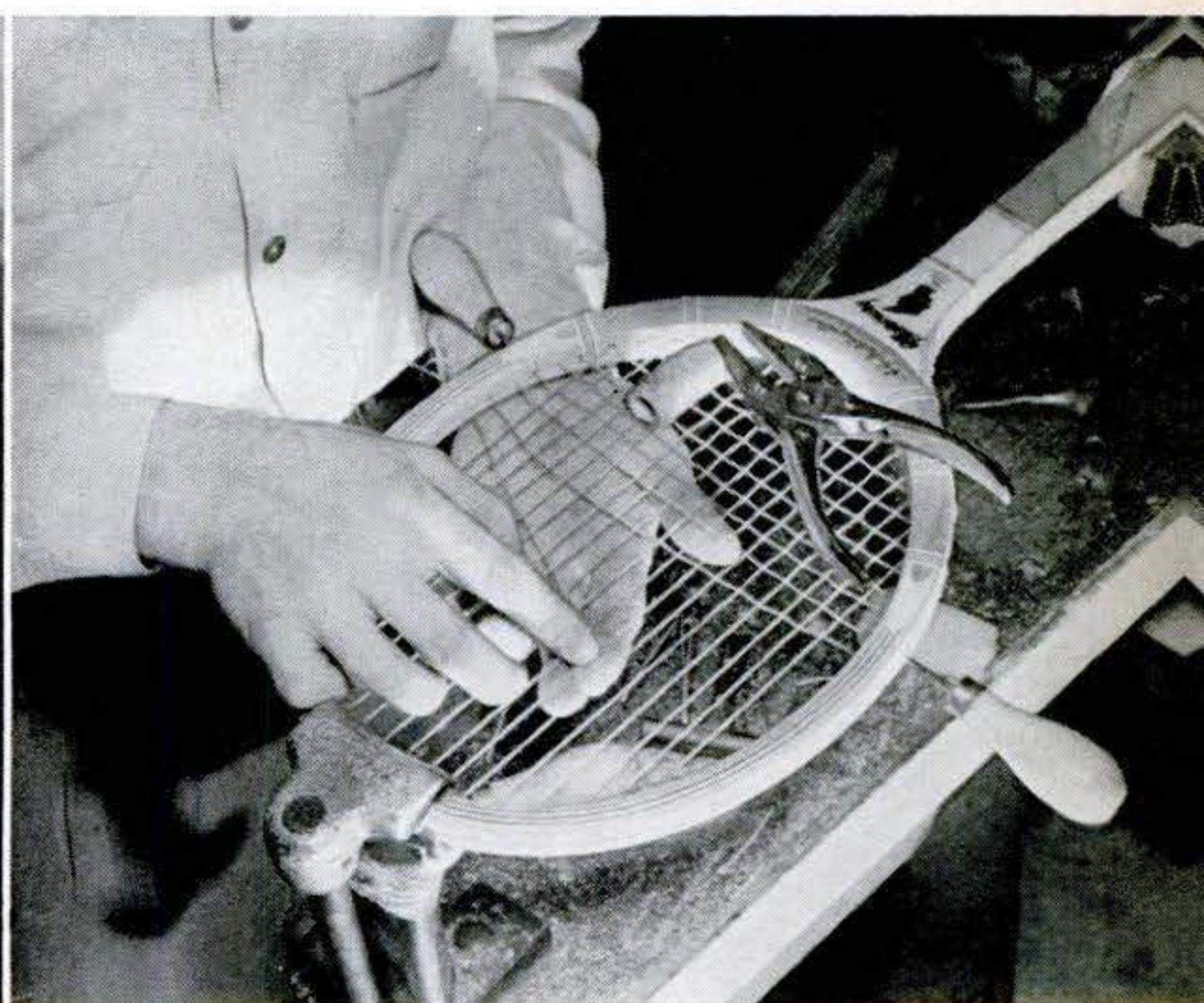

17 Stringing is final manufacturing operation. In some cases, racket is left unstrung so that the ultimate buyer can pick out the type and quality of string he desires.

18 Final inspection. When photograph was taken, there were from 70,000 to 80,000

tennis rackets on plant floor progressing through various manufacturing steps. END

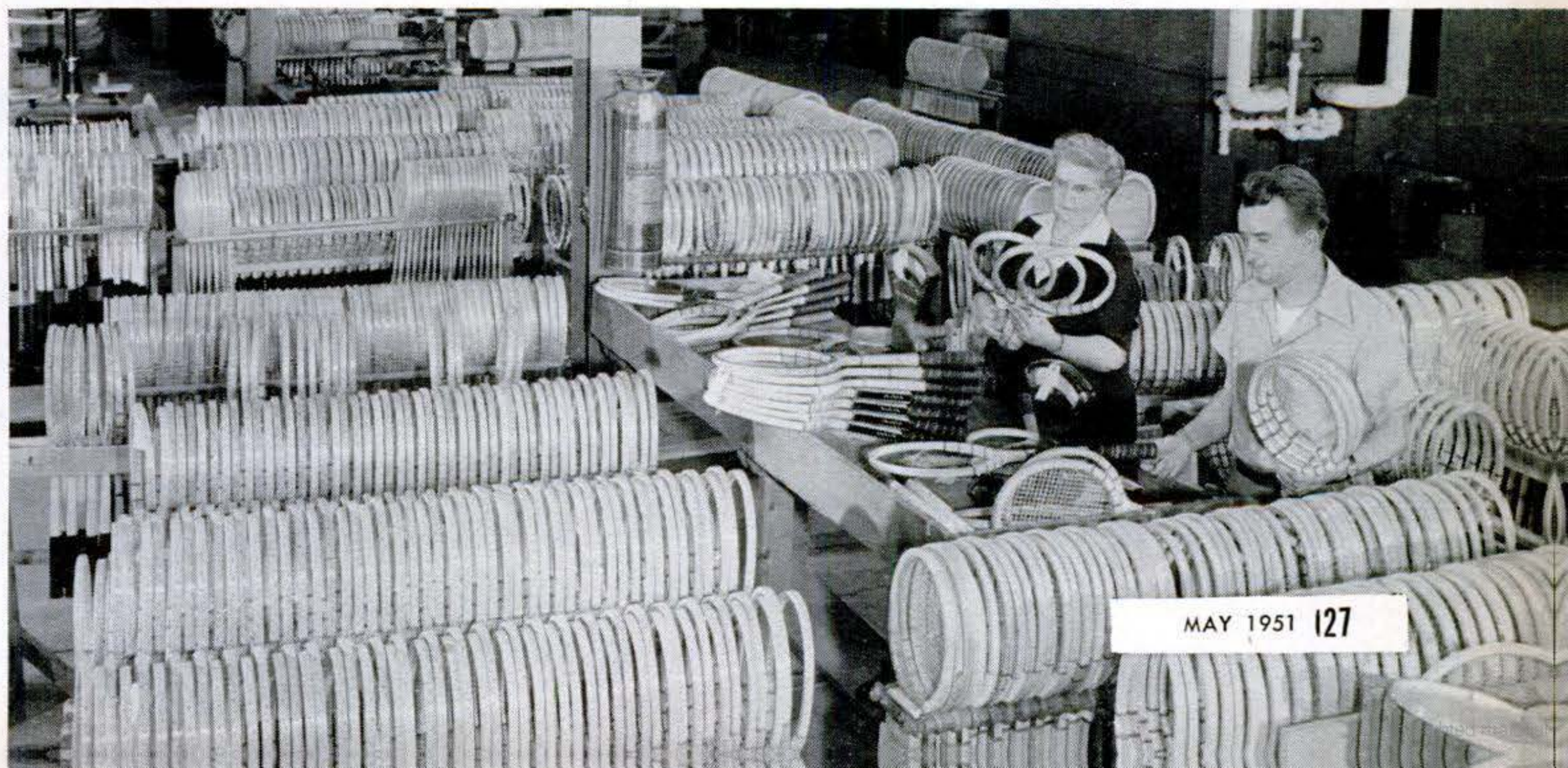

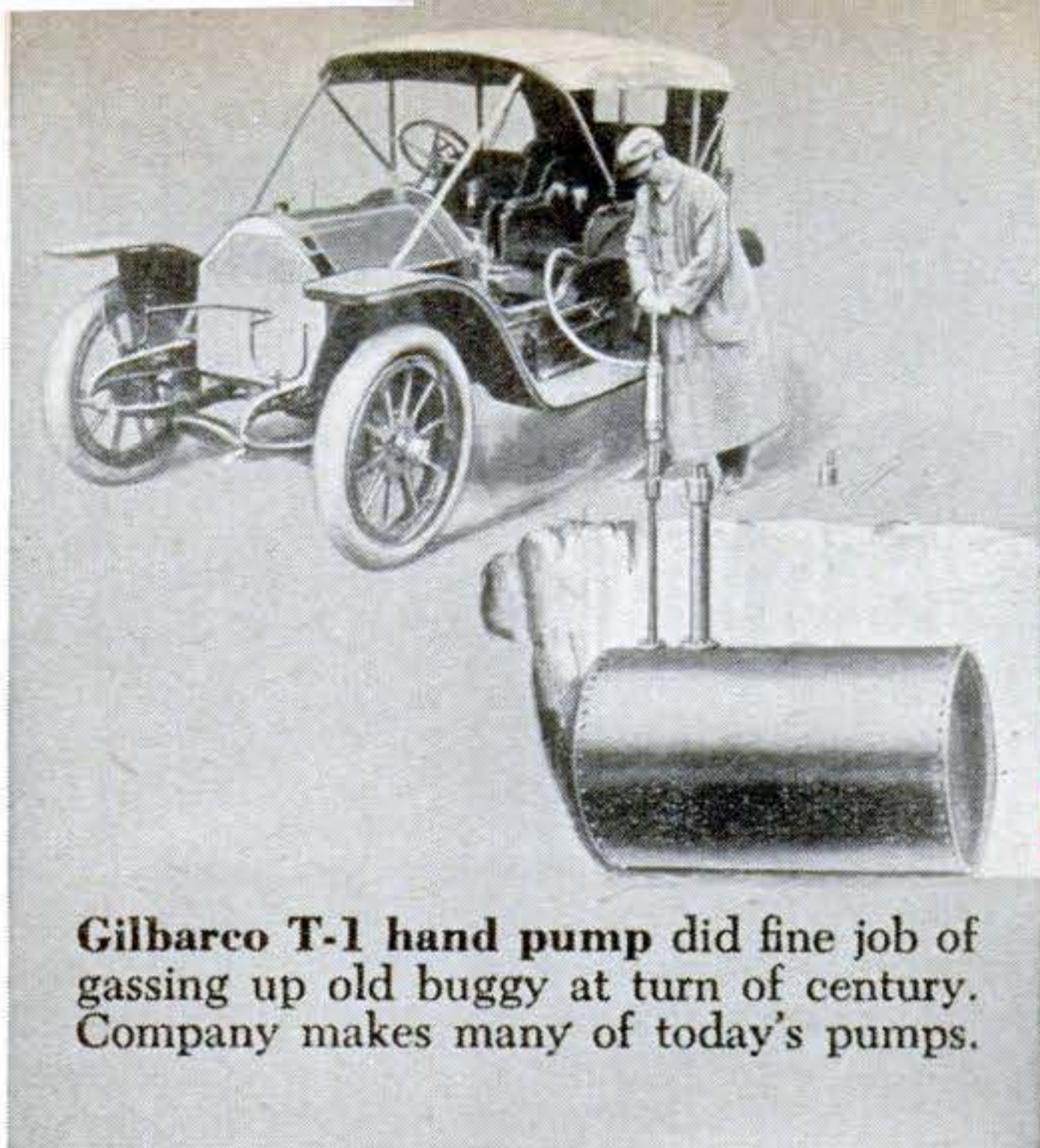

Gilbarco T-1 hand pump did fine job of gassing up old buggy at turn of century. Company makes many of today's pumps.

How a Gas Pump Works

It's a long way from the oldtime hand gas pump to the automatic machines that fill the tank and figure the price.

By Richard Giovine

DRAWINGS BY DAN TODD

EVERY time you pull into your favorite service station for gas, you make use of a tricky mechanical device whose operations have probably intrigued many of the nation's 56 million drivers. The diagram at right shows how a pump fills your car.

The attendant removes the hose nozzle from the port and at the same time turns the "This Sale" dials back to zero. An interlock switch prevents delivery of gas until all indicator dials have been returned to zero.

This action starts a $\frac{1}{2}$ -hp. motor belted to an internal-gear pump (sliding-vane pumps and herringbone-gear pumps are also widely used). As the pump builds up pressure before the nozzle is opened, a safety valve opens a by-pass that allows the gas to return to the suction side of the pump to keep pressure from climbing too high. The opening of the nozzle to start the flow of gas causes a decrease in the pressure at this point and the safety valve snaps shut, allowing the gas to flow.

From the pump, gasoline moves to the air separator—a kind of settling tank that removes air bubbles. The airfree gasoline then goes to the meter—really a kind of turbine or pump in reverse. As the gas flows through the meter, it turns a crankshaft—one turn for every gallon. These turns are then translated into gallons and dollars and cents on dials—accurate to .3 of 1 percent.

Last leg of the trip is to the top of the tank, where the gasoline sets vanes spinning

behind a glass viewer to tell the customer that his gasoline is really airfree.

As the attendant lets up on the nozzle handle, a two-way pressure-regulating valve is tripped. This traps the gasoline in the line under pressure to keep it full and minimize loss through vaporization. If too much pressure accumulates, the valve bleeds it back around the pump, thus preventing damage to the hose.

Hoses get longer and longer. Some can deliver gas to an automobile a full 16 feet away. The extra length is automatically retrieved by weighted pulleys. Nozzles are of non-sparking brass, aluminum, or rubber, and usually have a two-speed adjustment for slowing the gas as a tank nears full.

Safety-fill nozzles with automatic shut-offs protect a car from spilled gas and save waste. Flow of gas past orifice sucks air from chamber, but as long as chamber is vented by air tube to nozzle, vacuum can't build up. When level of gas closes vent, vacuum moves diaphragm that drops pivot end of lever, closing valve.

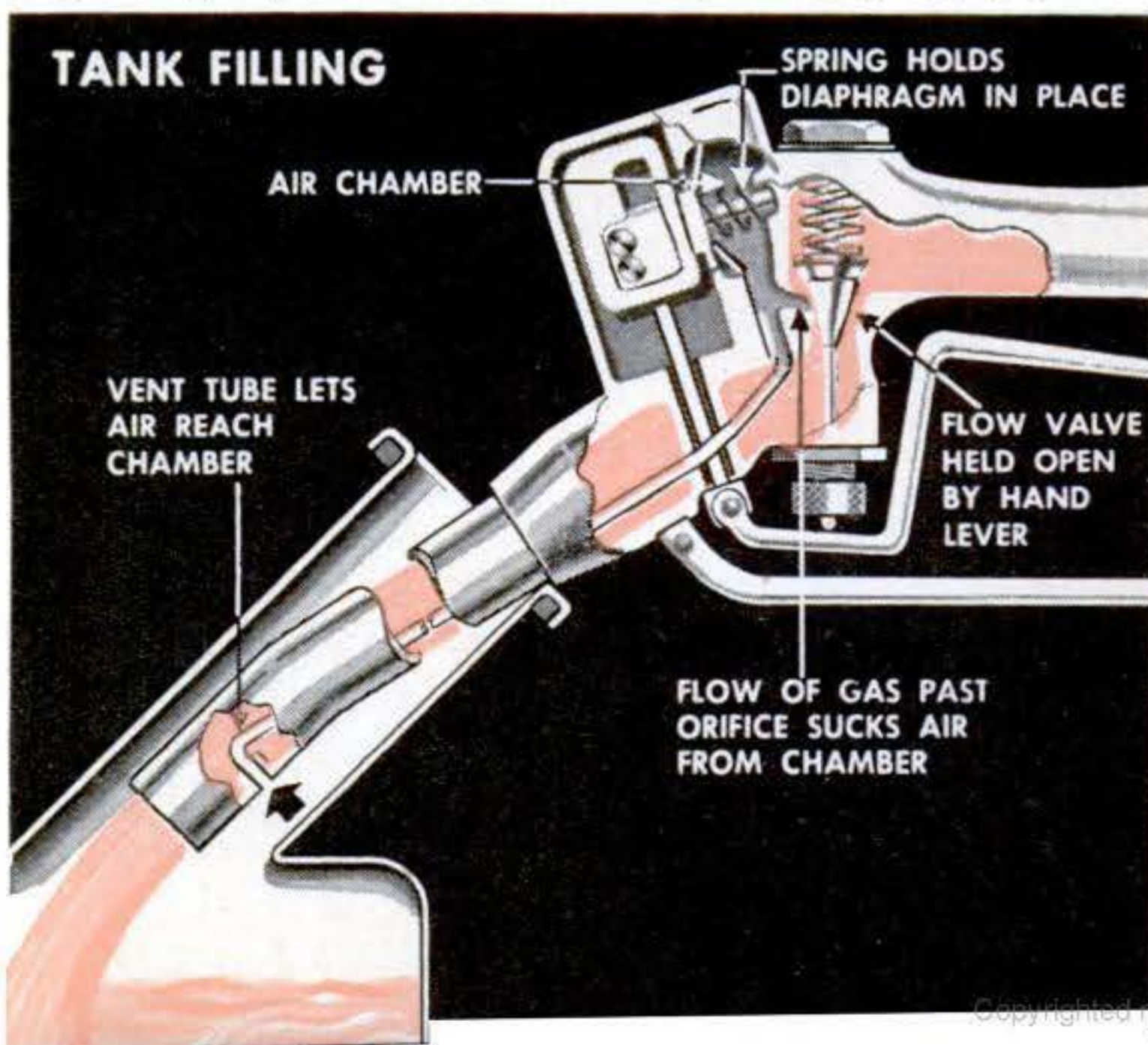

INTERLOCK RETURNS
DIALS TO ZERO FOR
EACH NEW DELIVERY

FLOW OF GAS SETS TINY
PROPELLER SPINNING

PRICE PER GALLON
CHANGES MADE
BY ADJUSTING
DIALS

TWO-WAY
PRESSURE CHECK
VALVE SNAPS
SHUT AS GAS
FLOW STOPS,
LETS EXCESS
PRESSURE
BLEED BACK

CALCULATOR DIALS
TURNED BY METER
CRANKSHAFT

ROTARY METER
HAS SINGLE
ECCENTRICALLY
MOUNTED PISTON

AIR VENT

SUMP FLOAT
RISES WHEN
LIQUID
COLLECTED
FROM VAPOR
HAS ACCUMU-
LATED,
RETURNING
IT TO PUMP

SWITCH STARTS
MOTOR AS
NOZZLE IS
REMOVED
FROM PORT

MOTOR

AIR BUBBLES AND
GAS VAPOR
ENTERING SEPARATOR
RISE TO TOP AND
PASS TO SUMP

SAFETY VALVE
ALLOWS GAS
TO RETURN TO
PUMP BEFORE
NOZZLE IS
OPENED

TANK FULL

VACUUM BUILDS UP
IN CHAMBER, PULLING
DIAPHRAGM INWARD

AS DIAPHRAGM MOVES,
ROLLER PIN AND STEM
ASSEMBLY DROPS

AIR HOLE BLOCKED
BY RISING GAS

PIVOT END OF HAND LEVER
DROPS OUT FROM UNDER
FLOW-VALVE STEM

LOSS OF LEVERAGE LETS
SPRING CLOSE VALVE,
SHUTTING OFF GAS FLOW



This Ypsilanti, Mich., house was constructed of surplus materials bought at discount from an automobile factory. It contains reclaimed lumber and bricks as well as auto-seat uphol-

stery fabrics, floor mats and, as furnishings, even surplus seats. House, including garage, is 62½ feet long. Kaiser-Frazer Corp. sells such surplus materials to public.

Recreation room is finished in easy-to-clean pyroloxin and vinyl cloth. Barenow is shown kneeling on a surplus car seat, one of four, purchased at \$25 each, used to furnish the room.



House Built

PROBABLY one of the most unusual houses every built has just been completed at 1791 Washtenaw Street, Ypsilanti, Mich. It was constructed almost entirely of surplus materials bought from an automobile factory.

The walls of one room are finished in pyroloxin and vinyl cloth, the materials used in automobile interiors, and they make cleaning an easy job.

Stairway pads are made from automobile rubber floor mats.

The living-room furniture is covered with luxurious car-upholstery fabrics.

Surplus car upholstery was made into bedspreads, rugs, and draperies.

Auto deck-lid mats insulate the walls.

Surplus car seats provided soft chairs for the recreation room.

Even the bricks and lumber that went into the house structure were recovered from auto-company surplus.

The owner, M. E. Barenow, merely took advantage of the fact that the Kaiser-Frazer Corp., at Willow Run, sells discontinued lines of fabrics and surplus materials at re-



Five-member family spent weeks removing mortar from reclaimed bricks (background) and nails from lumber. Owner Barenow and son Dick, 23, did much of the heavy construction.



Barenow (in jacket) contracted for and supervised the work his son and he did not do. He used auto deck-lid mats, surplus from 1946 Kaiser car, as an insulating material.

from Auto-Factory Surplus

duced prices to the general public. The entire Barenow family—including two daughters and a son—worked at building and furnishing the home. Mrs. Barenow and her two daughters, Nancy and Laurie, sewed the draperies, bedspreads, and covers. Barenow and his son, who is employed in the

In their living room, Mr. and Mrs. Barenow sit on canyon-rose love seat upholstered in Normandie cloth, resembling handmade needle point. This is used in the trim of the Frazer car.

Kaiser-Frazer machine shop, did most of the heavy work.

Manager of the company's retail stores, Barenow says his home cost \$22,000. But a visiting architect reported the seven-room structure couldn't be duplicated with conventional materials for \$35,000. **END**

Bedroom of pretty, 20-year-old Nancy Barenow demonstrates use of auto fabrics. Rugs are made of Bedford cloth, chair is covered with Normandie. Her skirt is seat-cover Botany cloth.





Rubber Tires Replace Steel

THIS new butterfly-shaped tire (left above) for use on corn planters is made of rubber. The high shoulders press the soil into the furrow to cover seed dropped in front of the wheel. This unusual shape is

retained even when fully inflated. The new tire, made by B. F. Goodrich, replaces similarly shaped steel wheels that tend to clog up in wet earth and slip on hillsides, resulting in uneven distribution of seed. The rubber also cushions shocks, reducing wear.

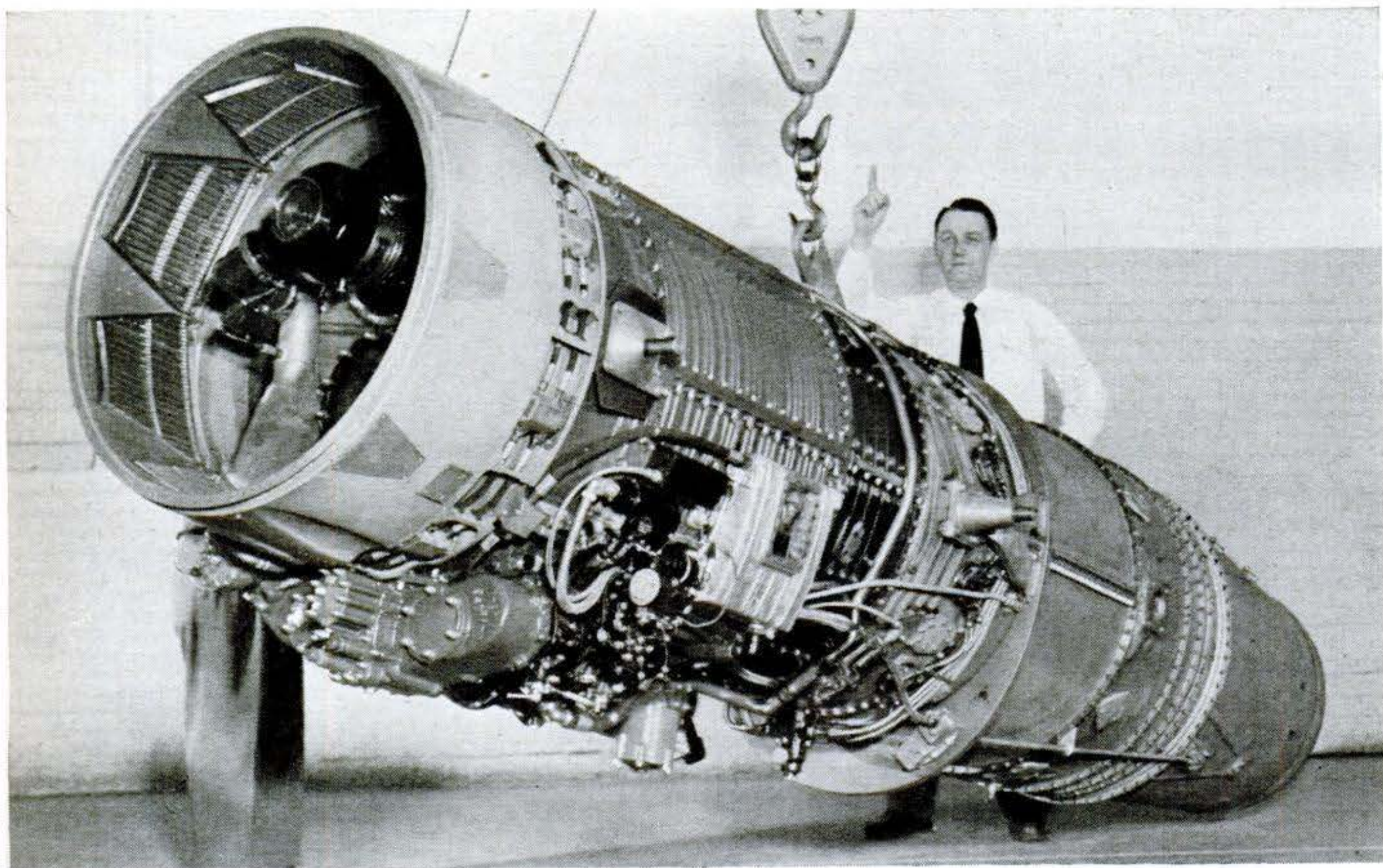

Most Powerful Turbojets to Drive B-47

THE most powerful turbojet engines being produced in the U. S. will soon be installed in the Air Force's only all-jet super-bomber—the Boeing B-47C.

The thrust of these Allison J35-A-23 engines has not been disclosed, but four of them will pack more power than the six now driving the big bomber. The reduction in

the number of engines is expected to result in weight and fuel economies and extend the flight range.

The new engines will have "cannular" combustion chambers—a big outer chamber to which air from the compressor is fed, and eight cans within it where the fuel and air are burned. The engine is 172 inches long and 37 inches in diameter.

Propeller Squeezed From Hot Metal

HOLLOW-STEEL propeller blades for high-speed combat and commercial aircraft are now being squeezed out like spaghetti. Extrusion—the art of shaping metal in a continuous form by forcing it through a die—is of course not new, but the method has never before been used to produce the complex shapes and tapered wall thicknesses required in prop blades. The process, developed by Curtiss-Wright and the Air Force, results in a stronger blade, and reduces hours of skilled handwork to a simple operation that takes only minutes.

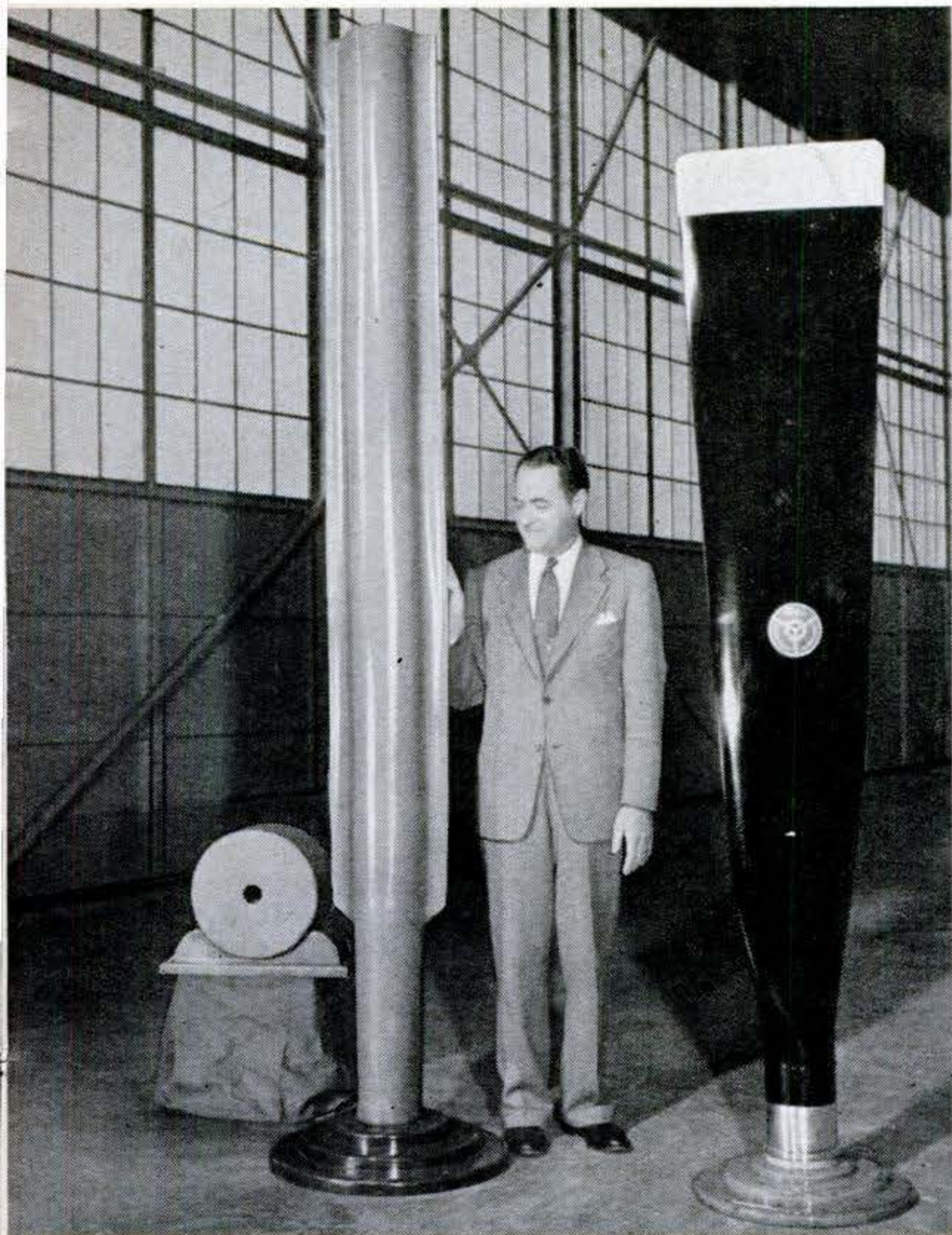

A 400-pound steel billet (left) is heated and squeezed through series of dies to produce one-piece, 10-ft. tube (center). This is flattened and formed into finished blade (right).

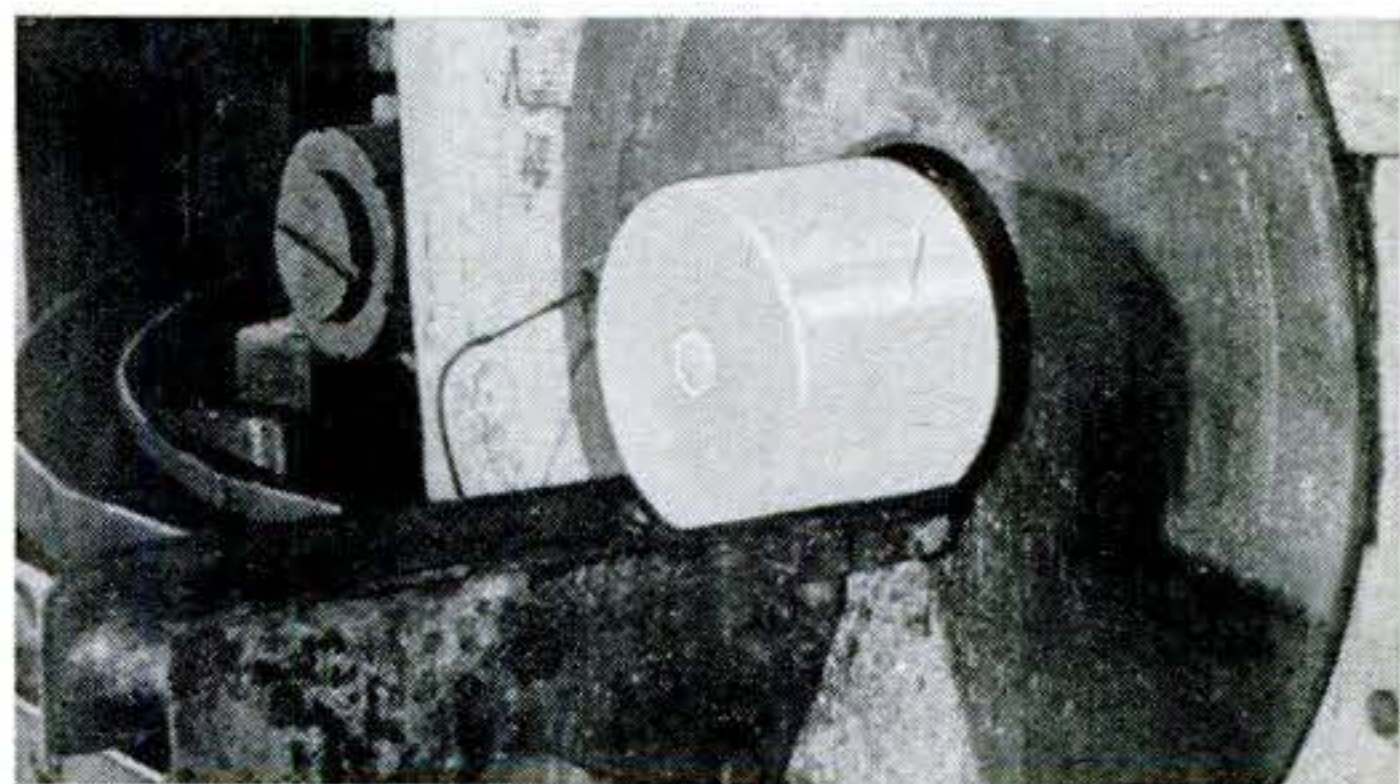

White hot, the chrome-nickel-molybdenum steel billet is being inserted into the die container of the extrusion press for the first operation. The big press is rated at 5,500 tons.

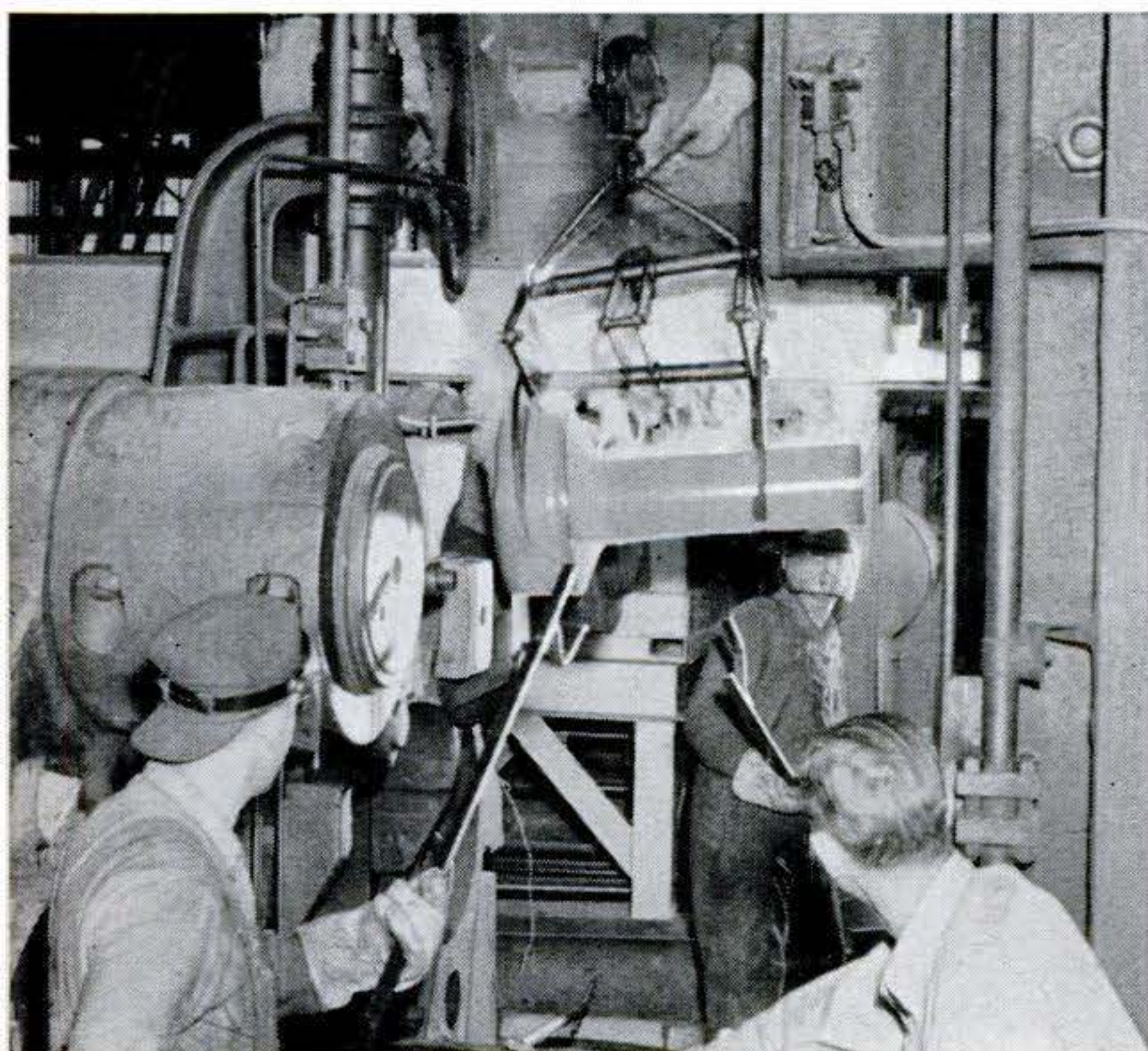

With shank formed, the partially extruded billet is reheated, and positioned for a second run through the press. Process was perfected at Air Force Development Center, Adrian, Mich.

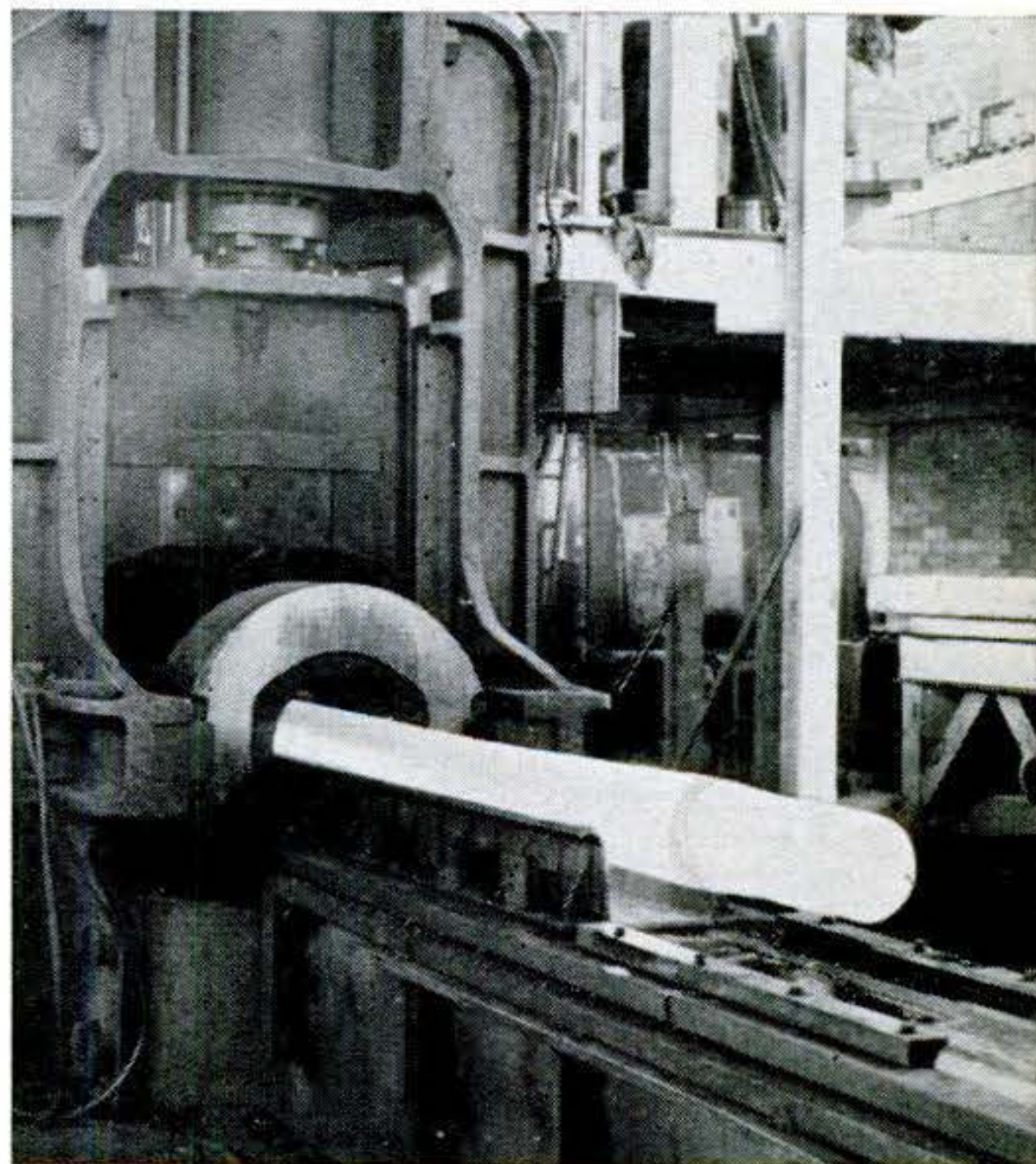

Tapered tube emerges from last extrusion step. Blade will now be flattened with dies that impart proper twist. Nitrogen pumped inside gives internal support during this forming step.

British Build De Luxe Rescue Boat

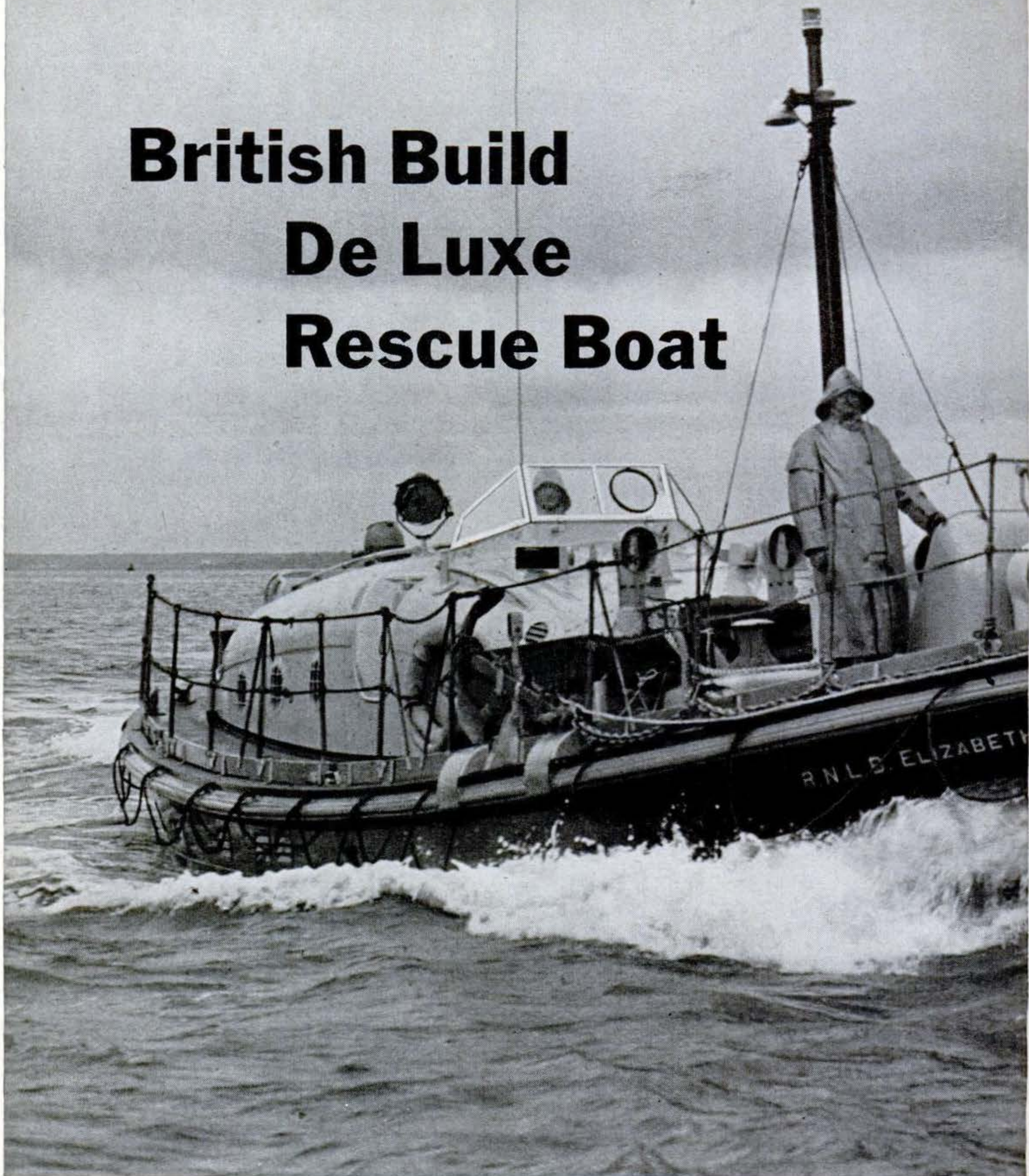

THIS salty-looking British rescue craft has everything—including the kitchen stove. One of several now in service along the British coast, it has many features not usually found on boats of this type.

One refinement is the enclosed deck cabin, made possible by the use of weight-saving aluminum for all superstructure, in-

cluding the cabin itself, the mast, a canopy over the instrument panel, and the ventilators.

The boat is 64 feet 9 inches long, with a beam of 12 feet 9 inches. She carries a crew of eight and, even in rough weather, can carry up to 95 persons.

Two 40-hp. Diesel engines, which drive

Especially designed for coastal rescue work, the Watson cabin-type lifeboat is shown under way in British waters. The boat can carry as many as 95 persons in a rough sea, has crew of eight, can run 230 miles at top speed without refueling.

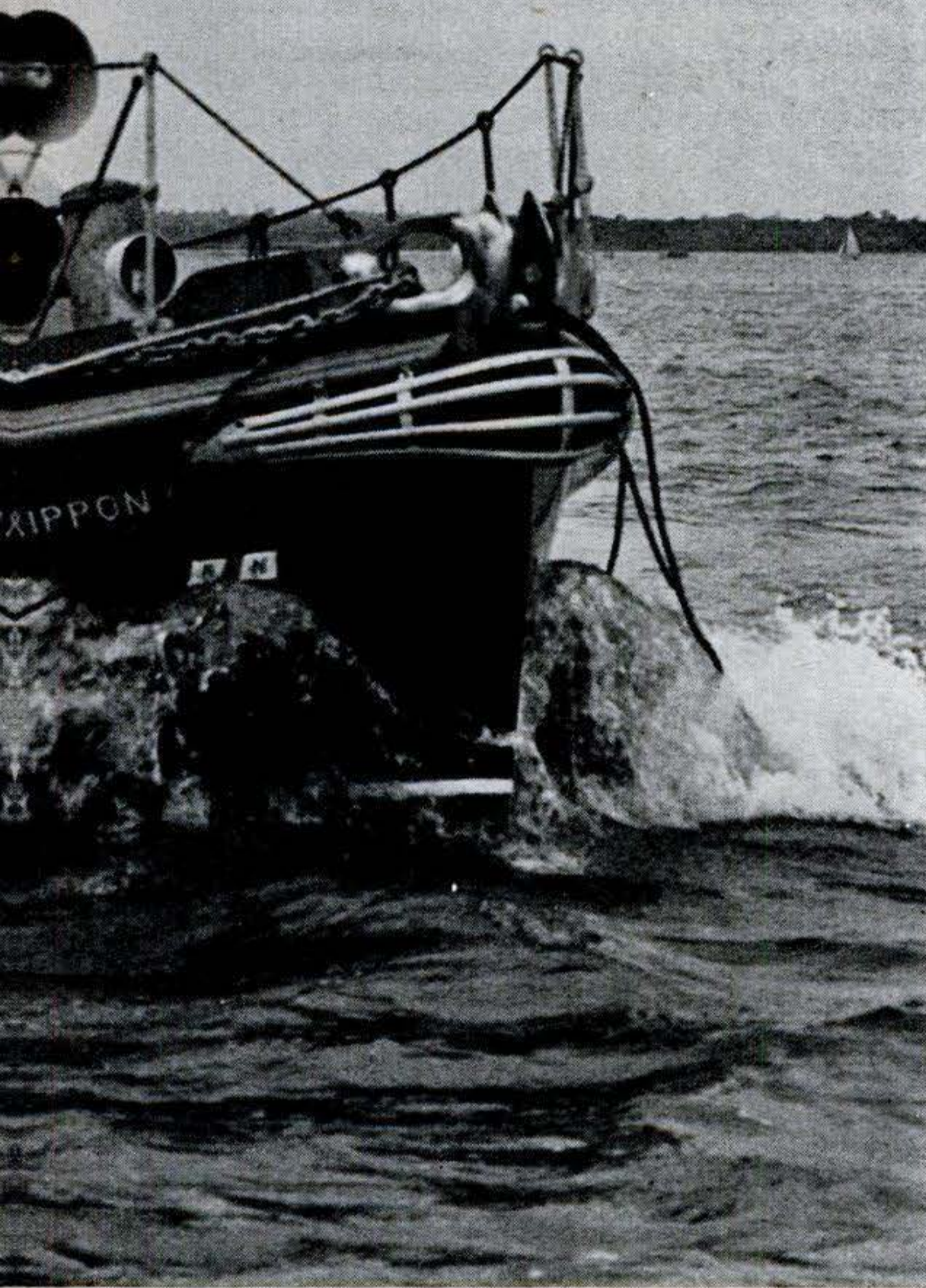

twin screws, are housed in one of nine watertight compartments.

The hollow mast serves as an engine exhaust, venting the fumes well above the heads of the crew. The lighting system is electric. She also carries a line-throwing pistol and gear that sprays oil to quiet angry waters around a ship in distress.

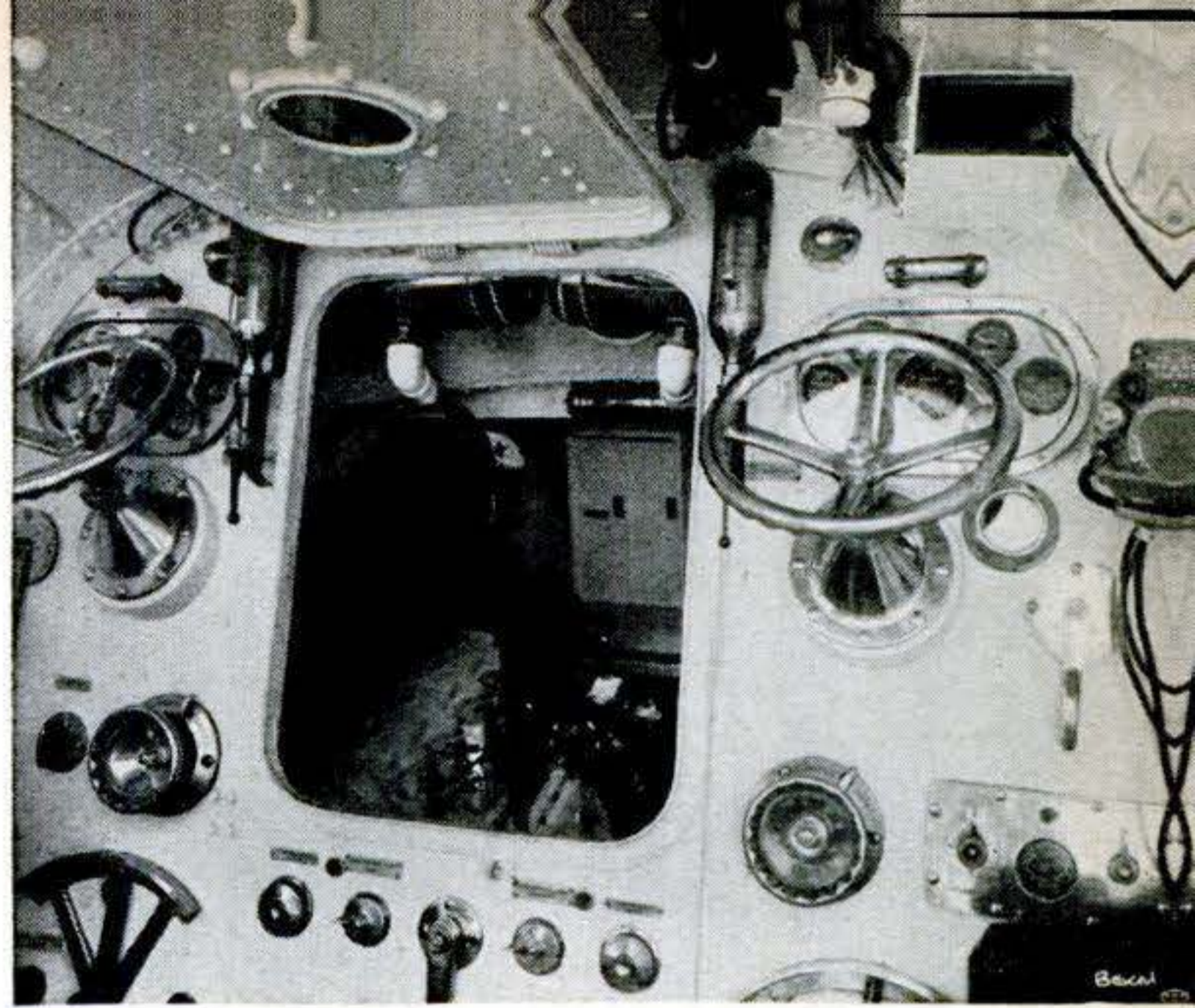

Instrument panel is protected by aluminum canopy. Open hatch shows engine room, one of nine watertight compartments. Engines are waterproofed, can run even if room is flooded.

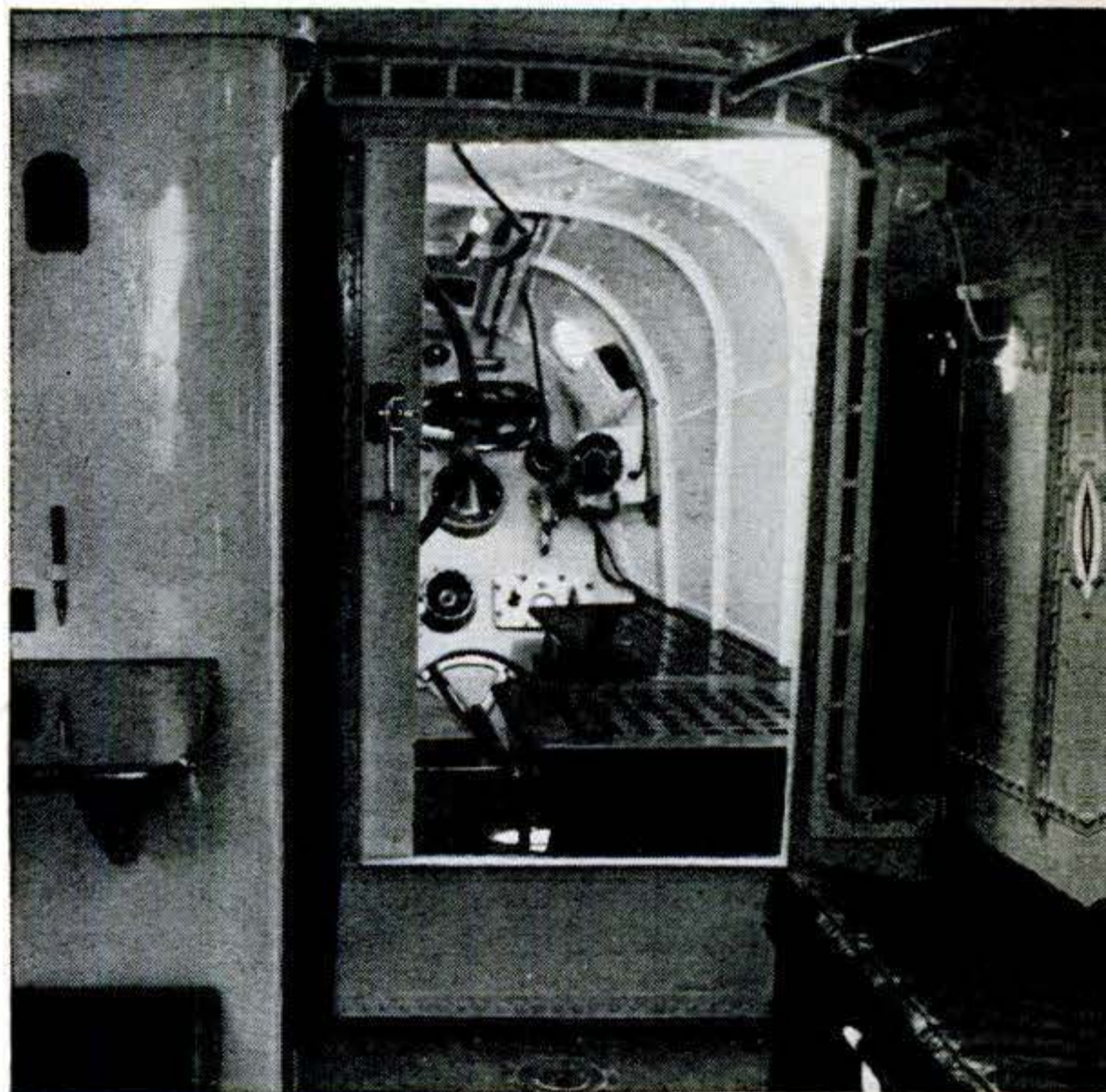

Deck cabin is equipped with kerosene stove, has two-way radio in separate compartment. Below decks is another cabin with electric fans for ventilation. Benches seat 11 persons.



Equipped for duty, with crew and gear aboard, the boat weighs 22½ tons. It is either launched down a slipway or lies afloat. Boat has top speed of 8¼ knots, carries fuel for 230 miles.

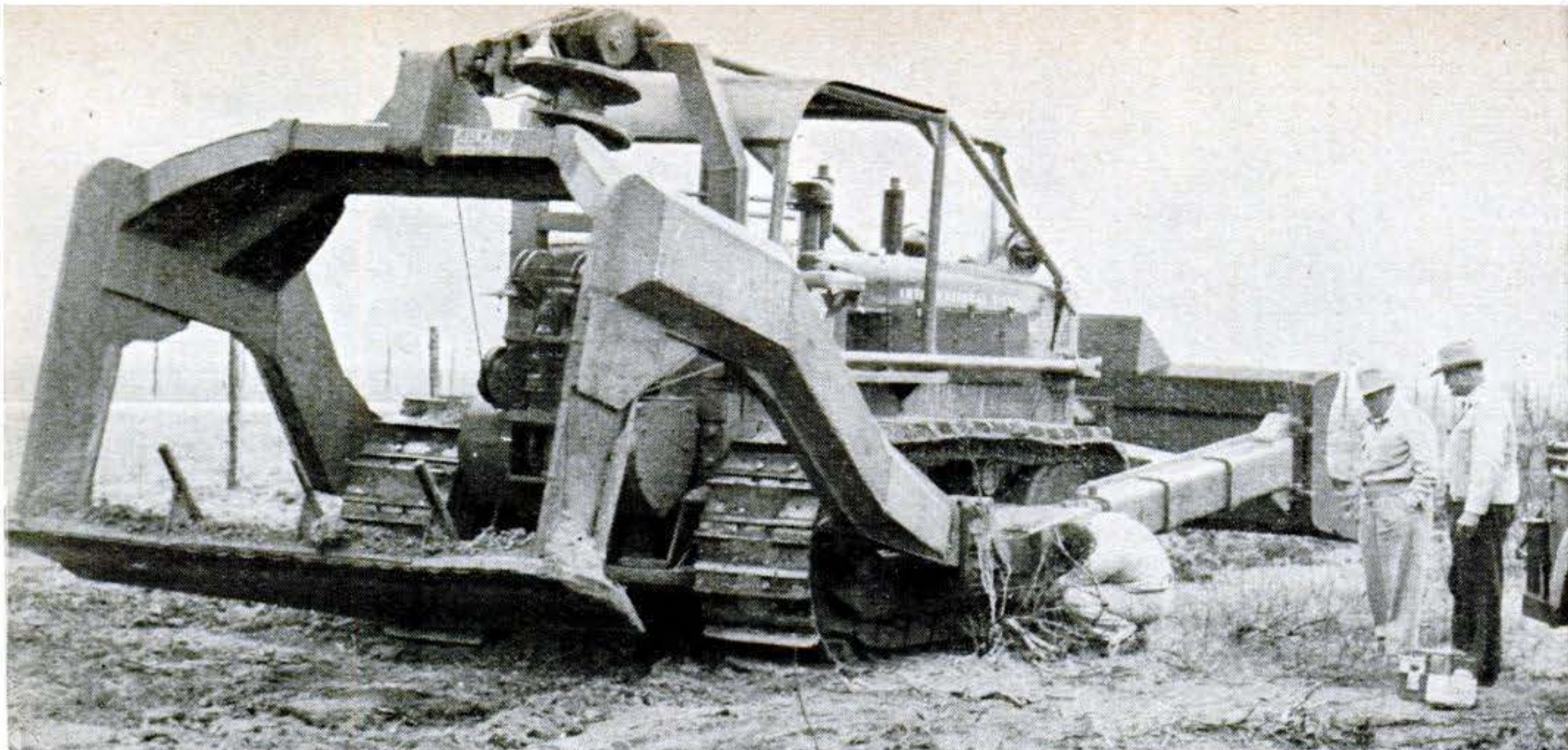

Giant Plow Helps Grow Cotton

UPROOTING mesquite and black brush, one of the largest plows ever built is transforming almost worthless uncleared land near Corpus Christi, Tex., into cotton-growing land worth \$300 an acre. Its 10-foot-wide plowshare, in foreground above, is

mounted at the rear of a powerful tractor. A bulldozer blade at the front breaks down heavy growth, and a steel canopy protects the operator from falling trees. Traveling at two m.p.h., the plow goes 22 to 26 inches deep, and clears 20 acres daily. A smaller tractor collects uprooted brush for burning.

New Phone Links Fire Fighters

MASKED firemen and their chief get two-way communication with the sound-powered Maskfone (right), developed by Mine Safety Appliances Co., Pittsburgh. Using a headset for listening, a fireman speaks into a diaphragm built into an oxygen or gas mask.

Powered by sound vibrations, the phone needs no separate power supply. It proved itself during a fire atop a Pittsburgh building. Without it, firemen would have had to descend 21 flights to report or get orders.

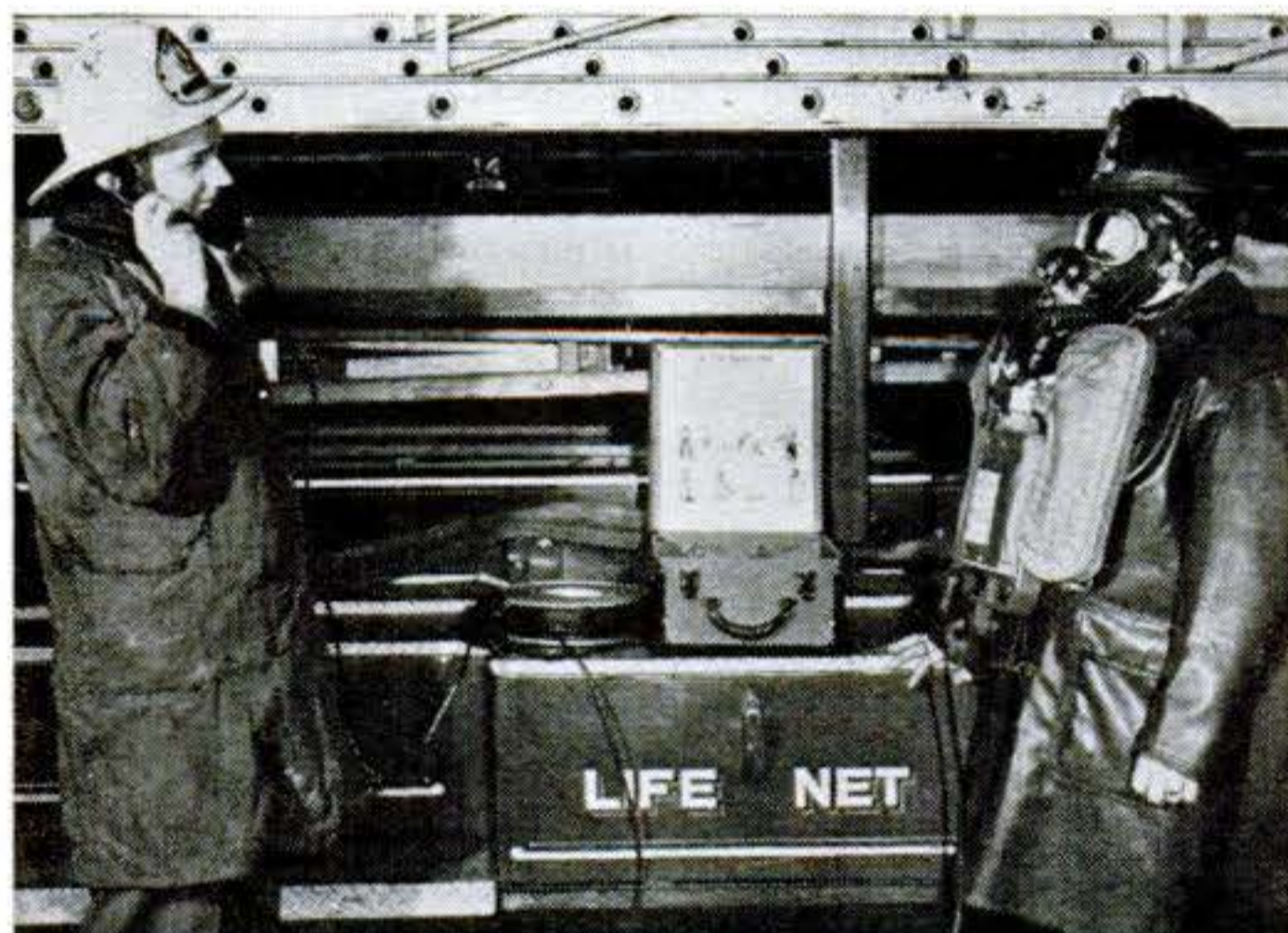

Economical Three-Wheel Truck from Germany May Set New Style

SOMETHING new in trucks is this three-wheeled Tempo, made in Hamburg, Germany, and just introduced in the U. S. Its maker claims it gets 35 miles on a gallon of gas-oil mixture, and carries a substantial load at 45 m.p.h. The economical one-ton machine has four speeds forward

and one reverse, with chain drive direct to the front wheel (left below). It has a 400 c.c. (24.41 cu. in.) water-cooled Ilo two-cycle engine mounted integrally with the front wheel—the engine turns with the wheel. A gearshift lever extends from the dash; other controls are standard.

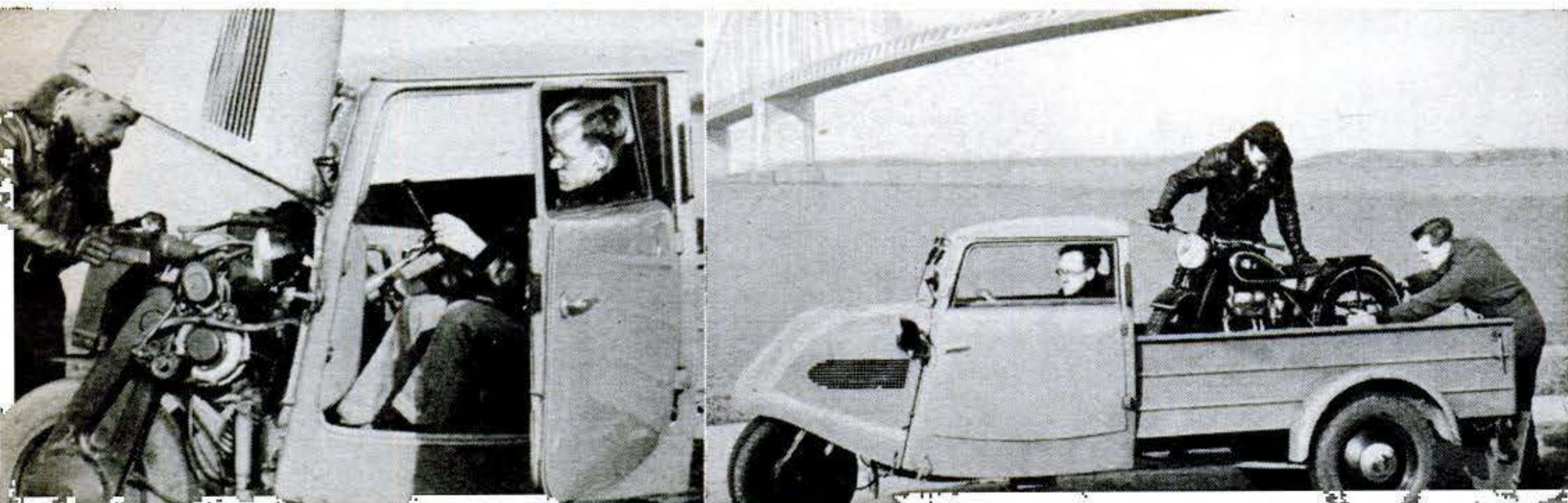

Scientific Torture Makes Your Home Safer



Rough-housing kids or careless housewives can't easily hurt a product toughened by torture in Underwriters' Labs.

By Allen Raymond

PS PHOTOS BY W. W. MORRIS

IF A budding DiMaggio, practicing his swing in the living room, accidentally whams your TV screen with a baseball bat—and nothing happens—you're not just lucky. You can be pretty sure the prototype of the set's safety mask, before it ever went on the market, proved its ruggedness by standing up undamaged under a blow of five foot-pounds from a steel ball.

Banging television sets across the screen with steel balls is only one of the scientific tortures to which household appliances are subjected by engineers of the Underwriters' Laboratories, Inc., to make sure they can take far rougher treatment than they are likely to get in normal use. Safety improvements based on those tests are reducing the risks of modern living for practically

every man, woman, and child in the country.

Four hundred thousand products have been submitted for testing to Underwriters' Laboratories—in Chicago, New York, and San Francisco—by more than 6,000 manu-



Electric flatiron is dropped on the floor at Underwriters' Laboratories to see whether a jolt affects thermostat that opens and closes automatically to keep iron at a safe heat.



Glass or plastic safety mask on TV set is tested for shatter-resistance by letting a 2-inch steel ball, hung from the ceiling, swing against it three times from 51 inches away.

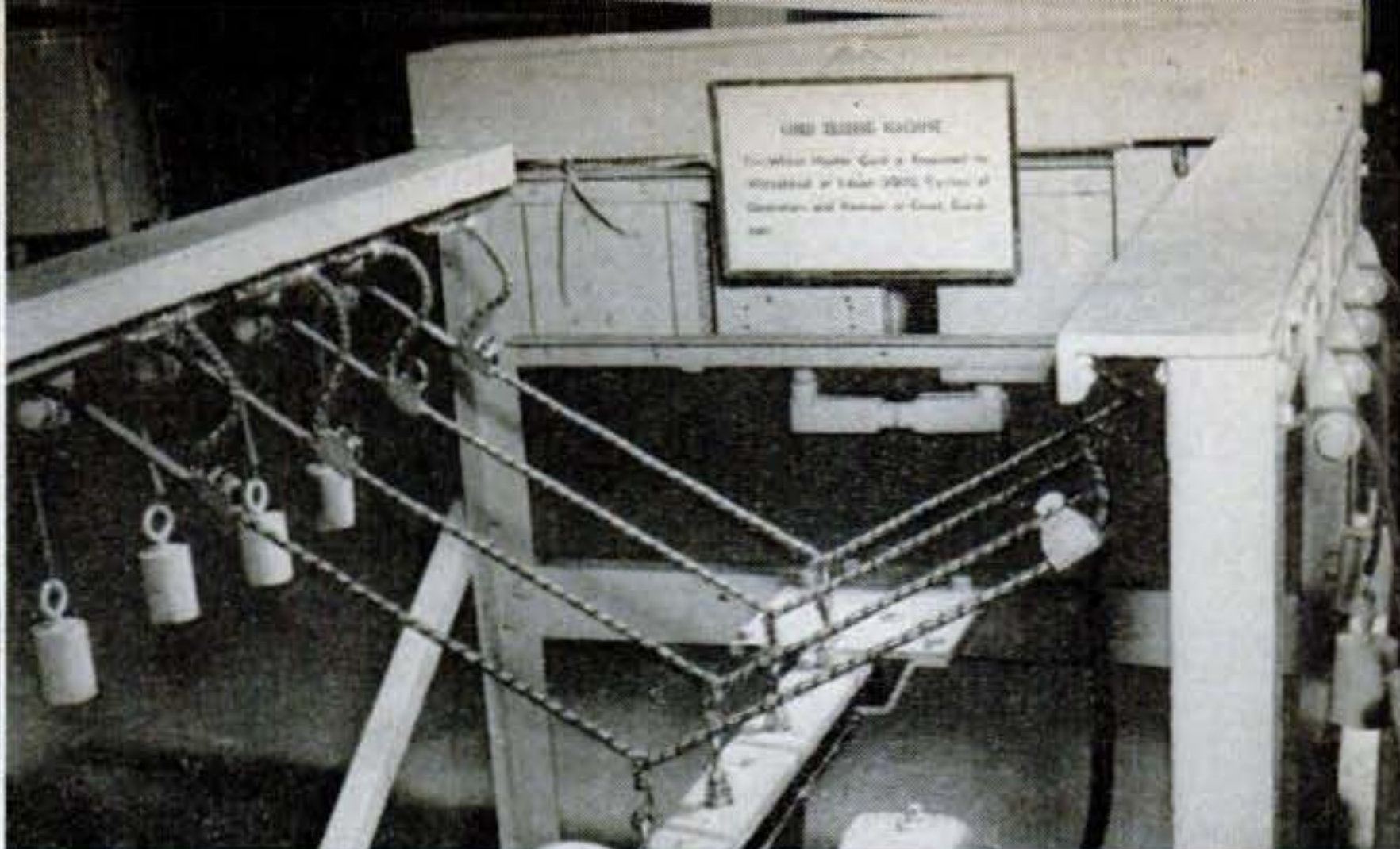

Extension cords, held taut by weights, are twisted and untwisted 3,000 times to make sure the insulation won't break down, exposing the wire and creating danger of fire or shock.

facturers in the 56 years of the organization's existence. More than half of those products are stronger and safer than they otherwise would have been: for more than half the 400,000, having failed under initial testing, have then been redesigned, retested, and approved.

Beyond testing, representatives of the laboratories have conferred over the years with manufacturers in setting up safety standards for all kinds of equipment, and have compiled those standards as reference works for the use of industry and government. Many local governmental agencies now require that such things as building materials, electrical wiring, and heating equipment meet the tests imposed by U. L. engineers.

The list of goods tested, and later periodically inspected, by Underwriters' Laboratories, is so broad that most of us use many of them daily without knowing of the meticulous effort that has gone into making them safe. On some, of course, there is the

familiar and respected "U. L." label; but on many there isn't. They include such diverse items as baby incubators and static eliminators, electric shavers and acetylene torches, matches and fire extinguishers, window-cleaners' belts and fire-retarding windows, lightning rods and the gasoline pumps installed at filling stations.

No Such Thing as "Fireproof"

Among the U. L. engineers I talked with recently in their big Chicago laboratories there is a general air of cautious conservatism in discussing their work. They shudder at talk of "fireproof" buildings or materials or of "burglar-proof" safes and bank vaults. They bear down heavily on the word "resistant" in discussing safety against hazards. Strong-boxes for valuables are "thief-resistant" within certain limits, but never "thief-proof." Tiles, flooring, doors, and the like are "fire-resistant" up to a certain point; they are never "fireproof."

A typical U. L. test for an office safe is to



Cooking range is checked for fire hazards by thermocouples attached to 20 points on stove. With oven and burners on, tester notes whether temperature anywhere exceeds the safety limit.



Washing-machine wringer is tested by pressing on safety release with a spring gauge. Rollers must snap open at a push of no more than 20 lb. or wringer is not held to be safe for use.

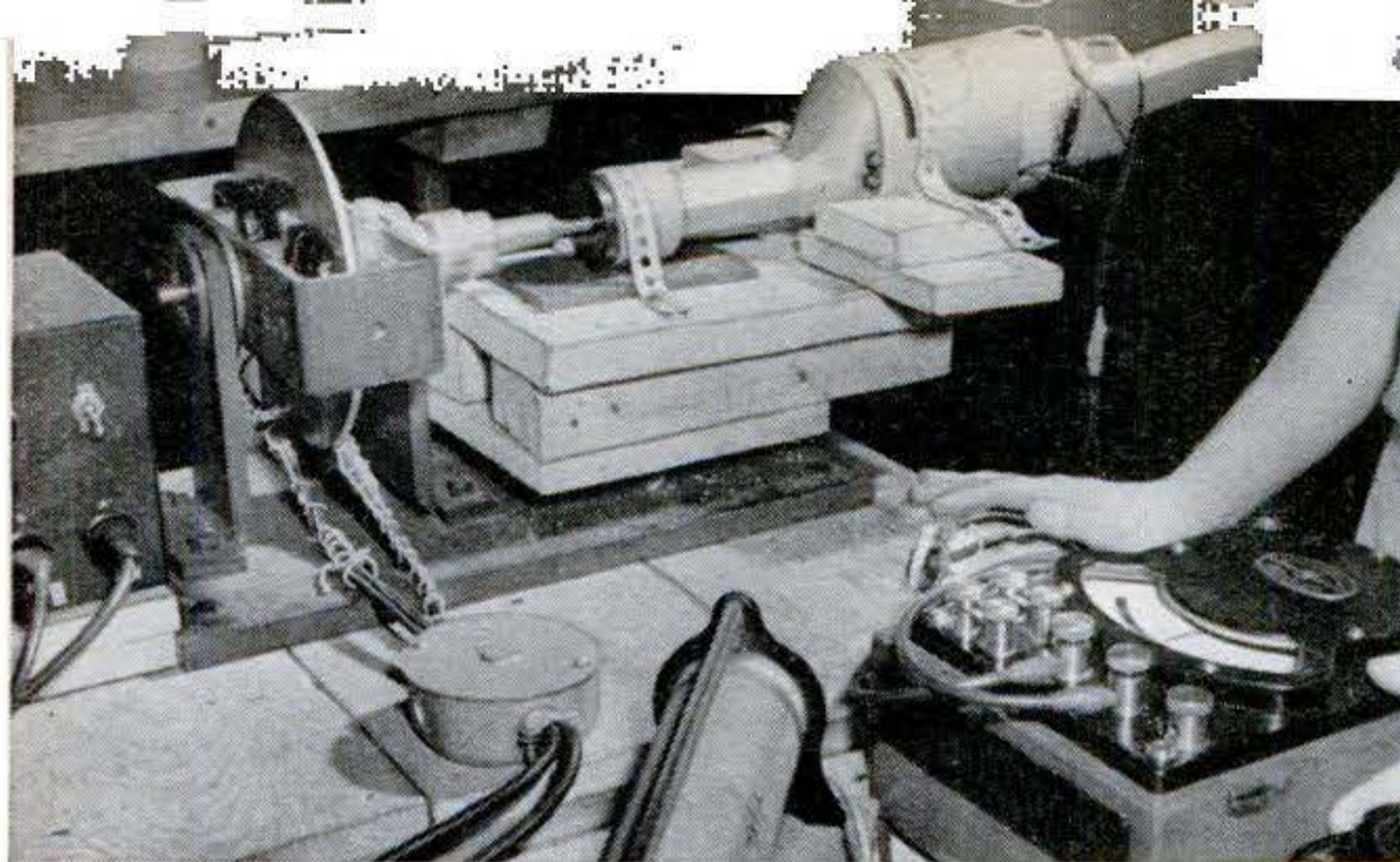

Electric drills are strapped down and run for long periods against work loads simulated by a dynamometer to see whether they overheat and how their insulating material stands up.

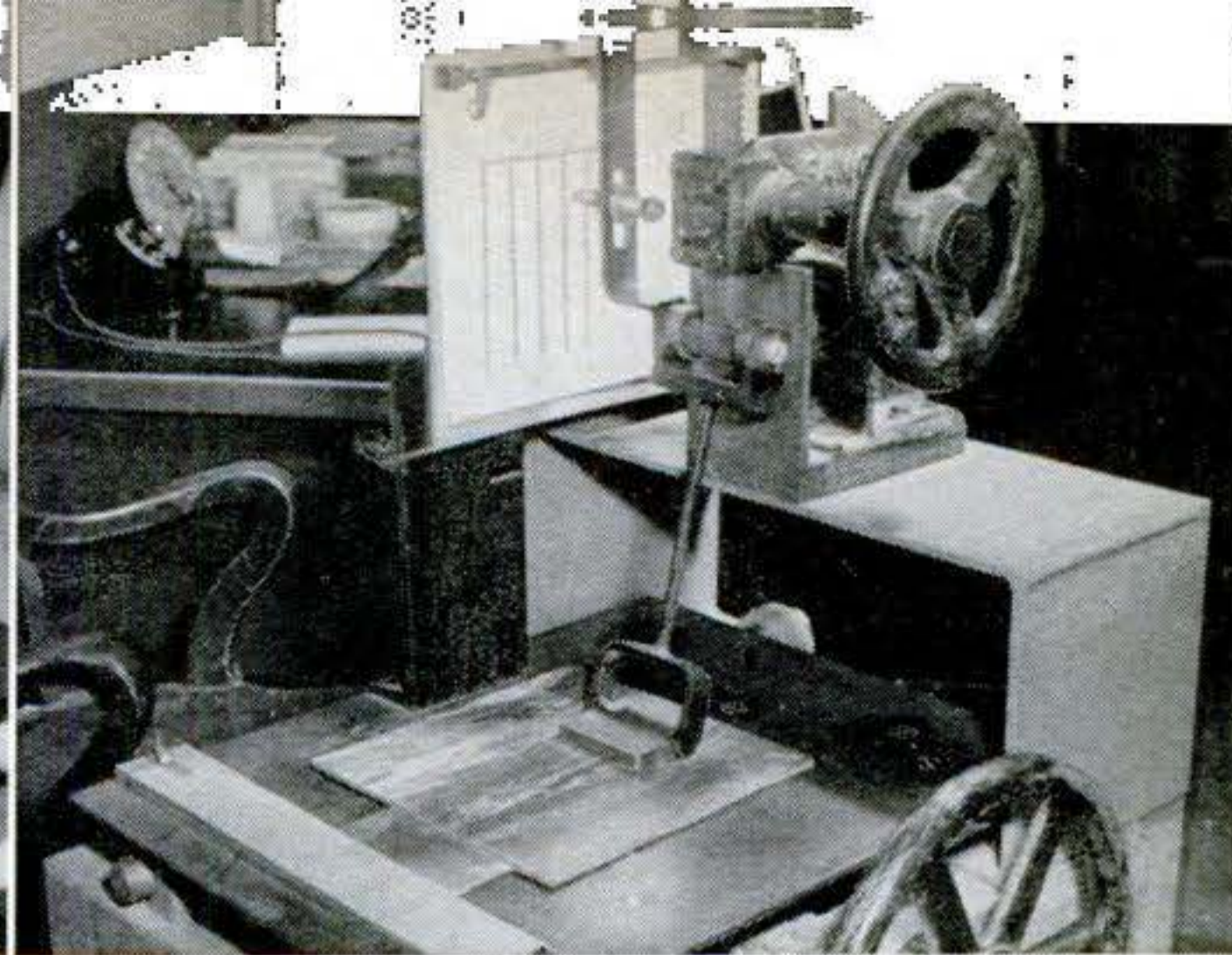

Nonskid floor wax is tried out by noting at what angle a leather-shod mechanical leg slips on a waxed surface when it is moved gradually outward under a heavy vertical weight.

drop it off a three-story building onto a pile of bricks, apply flame up to 1,000° F. to its steel walls, assault it for certain periods of time with electric drills and blow torches. If it passes, the engineers can guarantee that it can take abuse far greater than it is likely to run up against at the hands of skilled cracksmen; that, up to some definite degree of heat, records left in it will not be so scorched by outer flames as to be illegible.

A standard practice of Underwriters' Laboratories in testing household appliances is to subject them to strains five times as great as may be expected in normal use. Carelessness by householders in the use of appliances is assumed to be normal.

Occasionally, they figure, Mrs. Doakes will go off shopping and leave her automatic flatiron on the ironing board without pulling the plug. Will it set fire to the board? To find out, U. L. engineers leave flatirons, plugged in, on a sample ironing board for 500 hours at a stretch—three weeks, day and night.

The board will be charred. But if it doesn't blaze, that brand of automatic iron is considered reasonably safe from fire hazard even in the home of careless Mrs. Doakes.

The function of the Underwriters' Laboratories is not to say which particular household appliance or industrial product is better in competition with another. Practically all gadgets of nationally known brands are now on its approved lists. Its real function, rather, is to help manufacturers set and maintain high standards of safety.

Originally the laboratories were supported by the National Board of Fire Underwriters, an insurance organization, which is still a sponsor. Today the entire cost of their work is borne by the manufacturers whose products are tested. They pay on a time basis for work performed, plus the cost of materials and a share of the overhead. There is no direct profit in money—only in lives, limbs, and homes saved by scientific safety engineering. END



Pressure cooker is subjected to steam pressure of 100 lb. per sq. in., five times what it's likely to face in normal use. Pot must have lid that stays locked on under pressure.

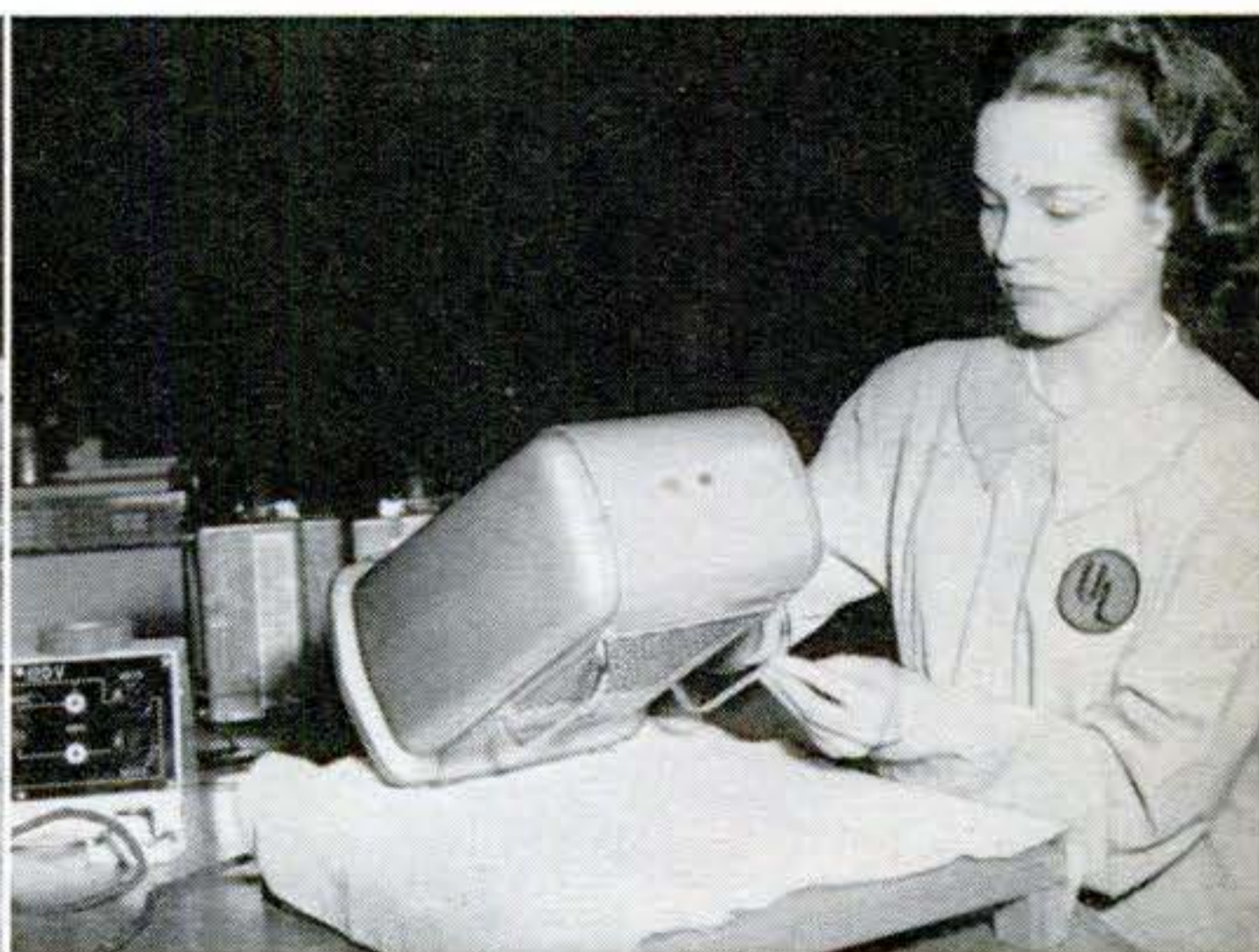

Fan-type heater is hooked up and tipped forward against a net of cheesecloth to see whether it might set fire to curtains accidentally brushed against it while in operation.

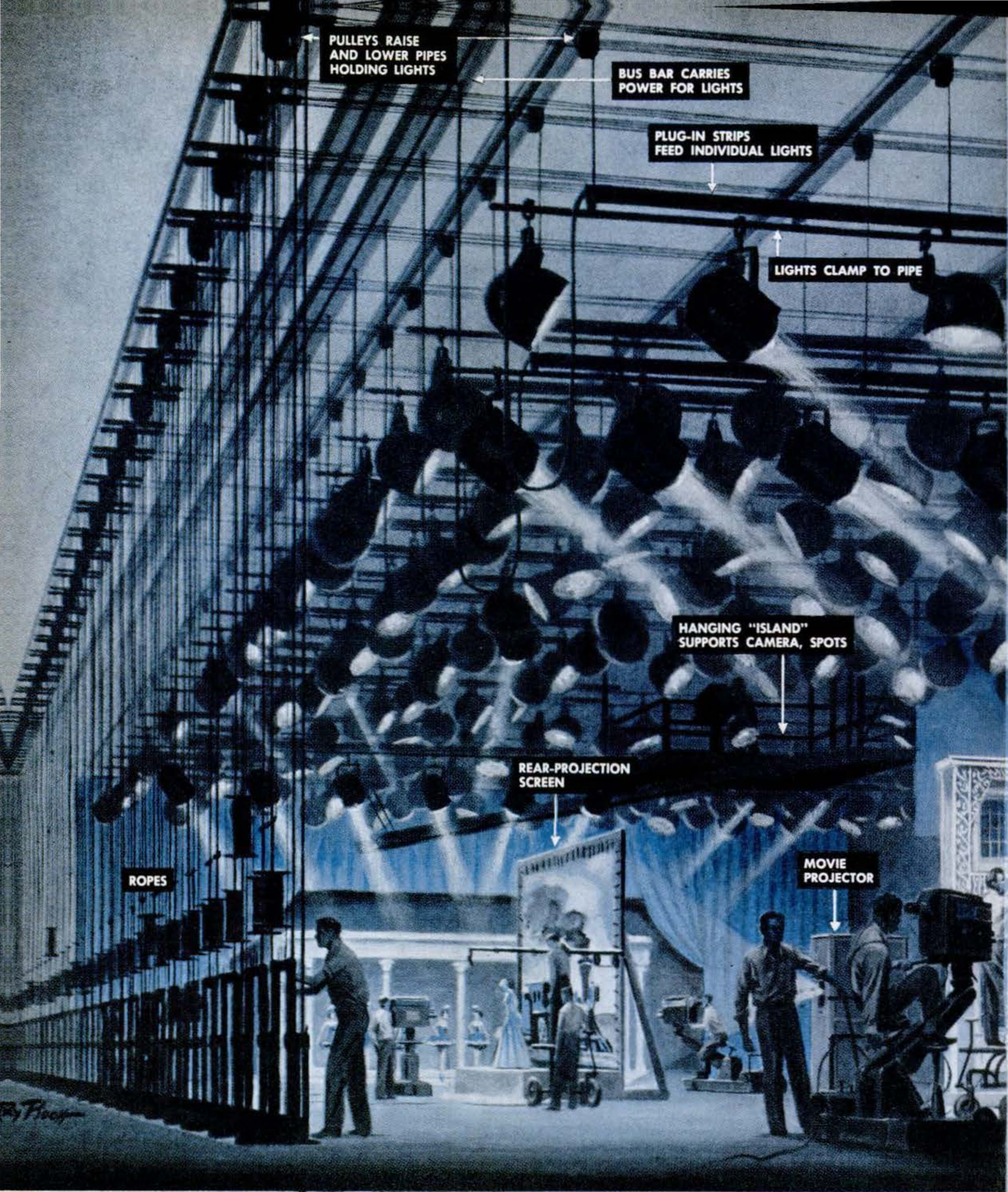

World's Biggest TV Studio

IT COST \$1,000,000, but Radio City's huge Studio 8-H has now been converted into the world's biggest and fanciest television studio. It is three stories high, 76 feet wide, and 130 feet long, accommodating several sets, six cameras—including one in an "island" hung from the ceiling—and 1,000 lights.

DRAWINGS BY RAY PIOCH

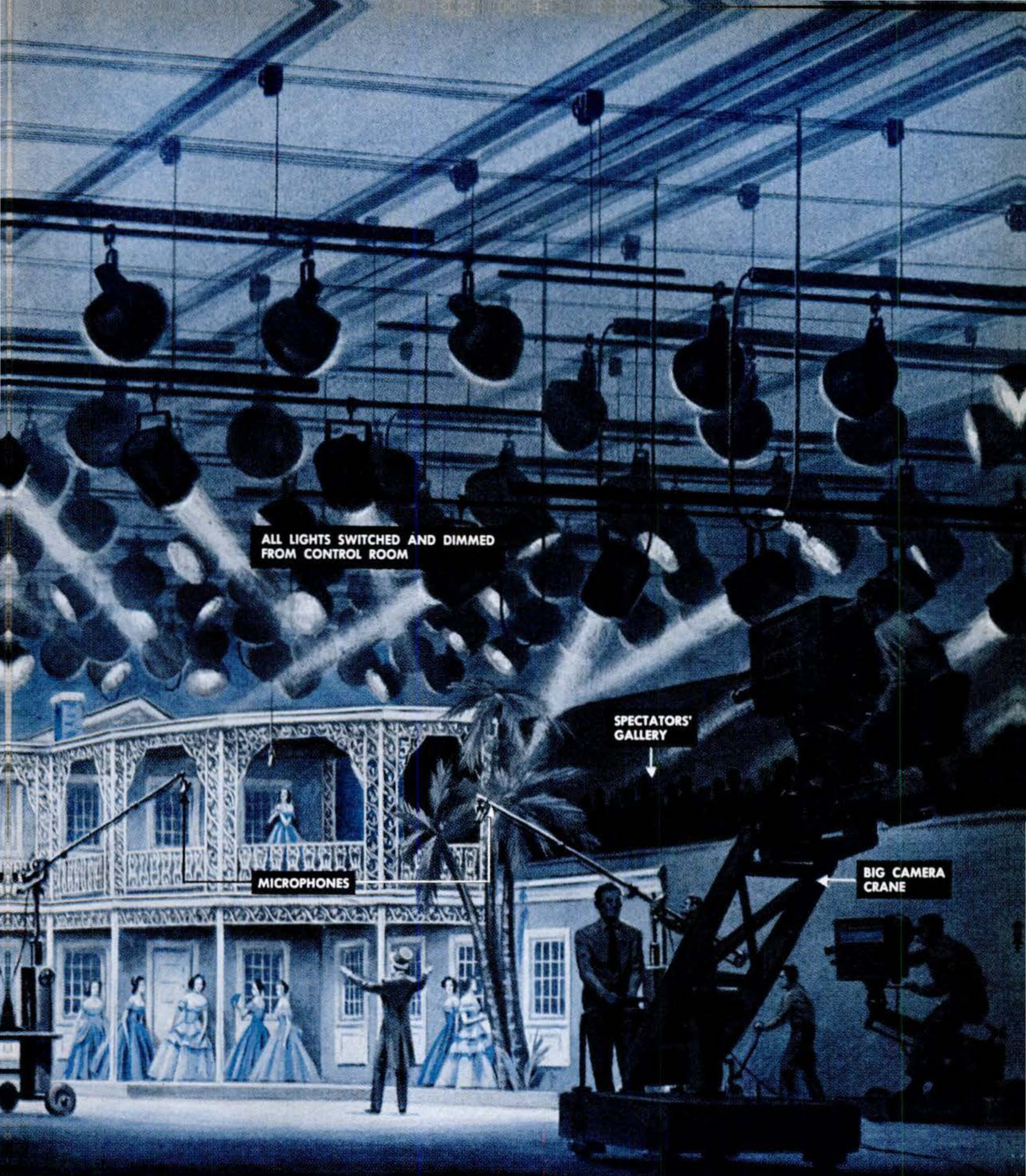

ALL LIGHTS SWITCHED AND DIMMED FROM CONTROL ROOM

SPECTATORS' GALLERY

BIG CAMERA CRANE

MICROPHONES

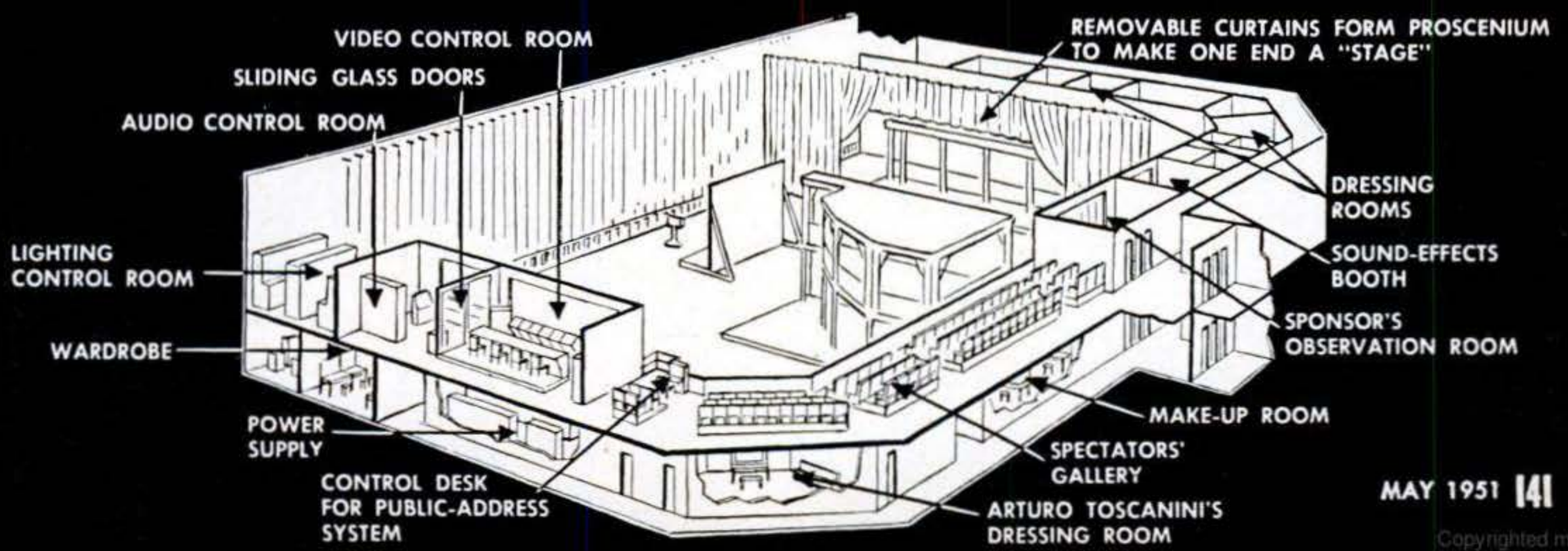



Inventor Lopez lowers his bosun's chair safely and easily just by loosening one loop of rope on the combination cleat-shackle he developed. The chair itself and the safety belt are also new types he has devised.

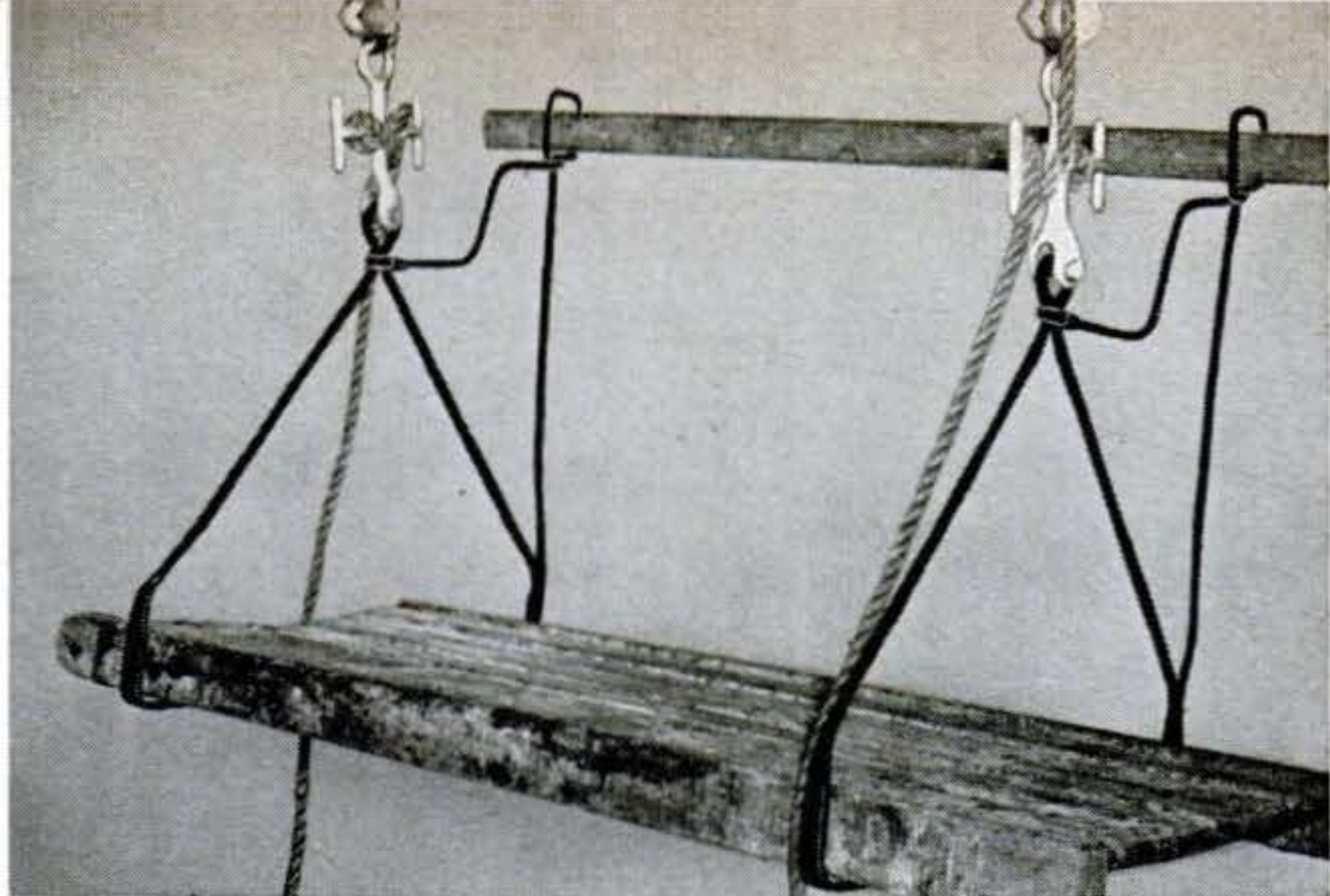

Cleat Stops Scaffold Accidents

SERAFIN G. LOPEZ, a sailor himself, knows how hard and dangerous it is to raise and lower a bosun's chair when you're sitting in it.

So he developed a combination cleat and shackle that always holds the chair safely, and yet will move easily when the rope is loosened (as shown in the drawing at left). The free end of the rope need not be knotted and unknotted every time the chair is moved, as is done now. In case the rope slips out of the worker's hand, it tightens itself on the cleat, preventing accidents. The shackle-cleat can also be used on painter's scaffolds, as shown in the photo above.



Sound Waves Wash Clothes

WASHERS that shake the dirt right out of the clothes with powerful sound waves (PS, Oct. '46, p. 75) are now being made in Germany. This portable model weighs seven pounds, works in any kind of tub, and is said to finish a load in five minutes.



Glow Tape Marks Blackout Shipments

ALTHOUGH it's nearly dark in this warehouse, the truckman below has no trouble finding his packages. They glow. Luminescent tape, protected by coatings made with Goodrich Geon resin, does it. Century Coating Co., Whitestone, N. Y., makes the tapes.





Radar eyes are hidden behind plastic nose. Huge air scoops feed twin turbojets. Tri-cycle landing gear has dual wheels under fuselage and one folding into each wing.

Scorpion *STINGS* at 700 M.P.H.

Twin jets power this Air Force interceptor equipped with radar "feelers" to seek out its prey for the kill.

HERE is the plane our Air Force is putting its money on to defend continental U.S.A. against A-bombers coming in high and fast, by day or night, in any kind of weather: the Northrop F-89 Scorpion interceptor.

Its stinger is a battery of six 20-mm. cannon, and its feelers are radar and elec-

tronic computers for navigation, spotting targets, and training its guns.

The Air Force officially describes the F-89 as an airplane "in the 600-mile-an-hour class." Reliable reports say it cruises at 535 m.p.h. and has a top speed of 706. Its two souped-up Allison turbojet engines boost the 15-ton interceptor to its service

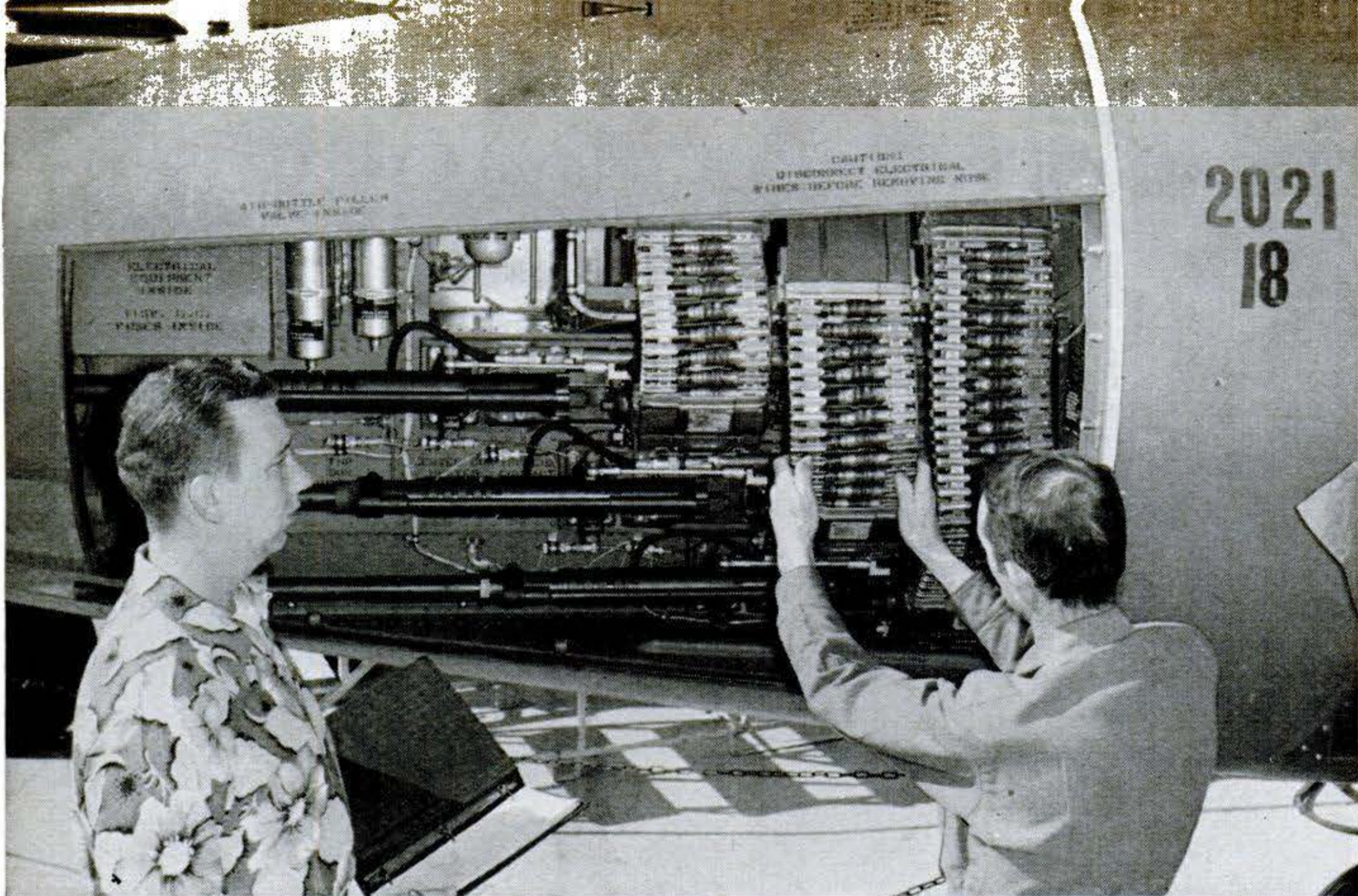

Belts of 20-mm. ammo feed three fast-firing cannon nested on each side of the nose. They

can knock down a bomber far beyond reach of last war's standard .50-caliber machine guns.

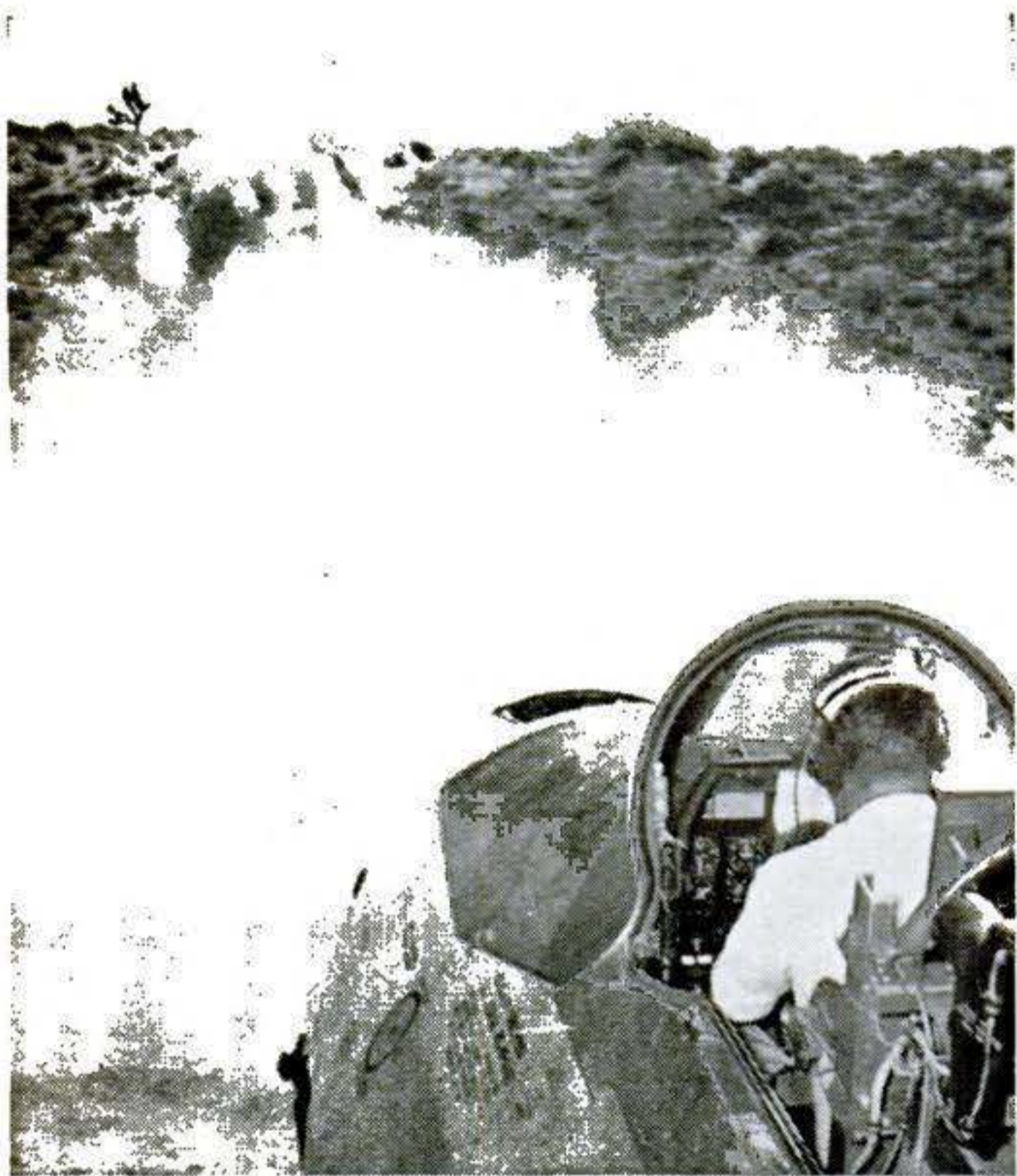

Smoky cloud leaps up as Scorpion looses its full fury against a sand dune at Edwards Air Base in California desert. Guns operate off the plane's electrical system or a battery.

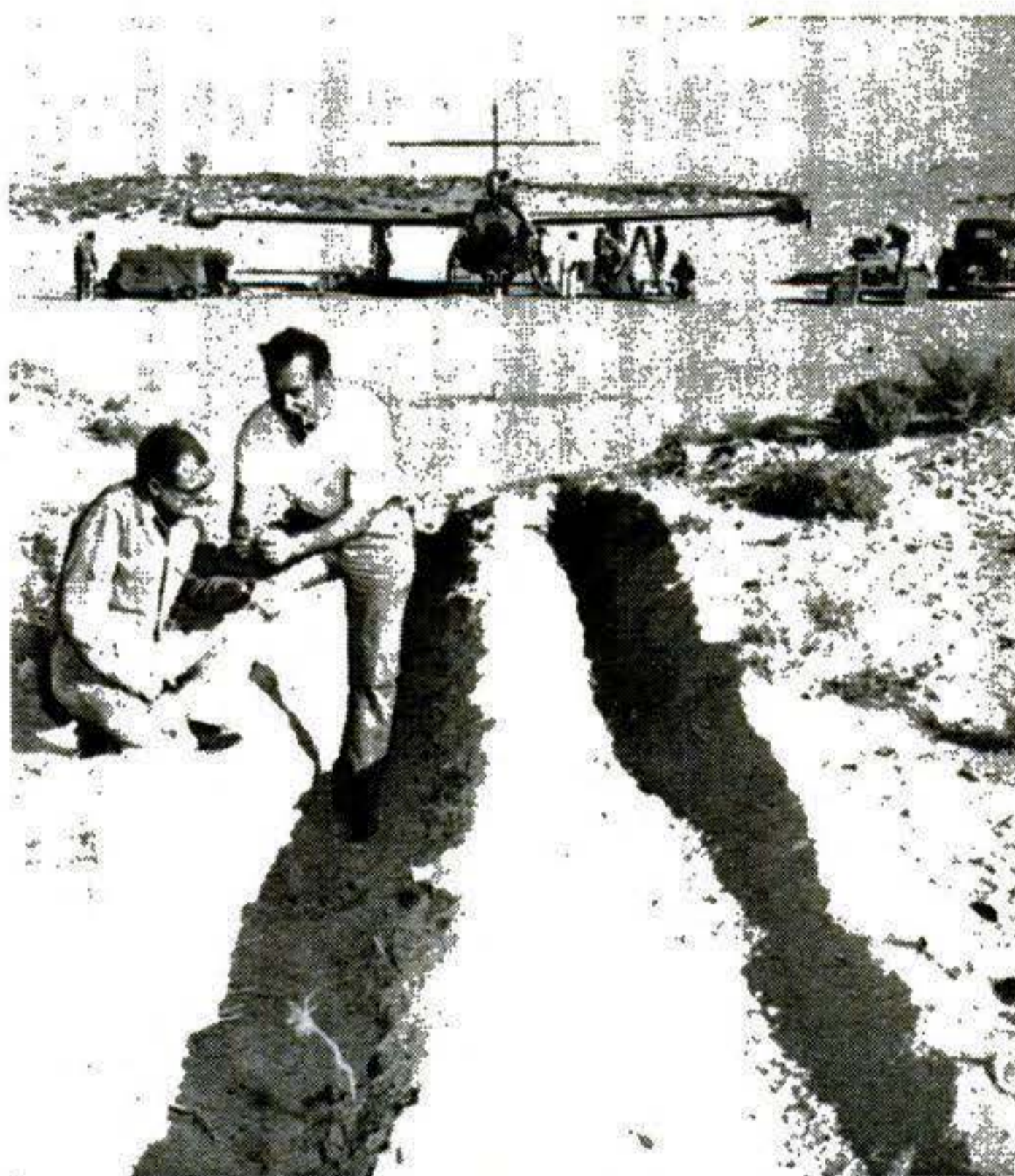

Blast from six guns cut these trenches in the sand. View of plane in background shows its thin wings, thick body, and the upswept tail that gives the deadly Scorpion its name.

ceiling of 10 miles in a matter of minutes.

Northrop engineers credit the plane's sensational performance in part to its broad, ultra-thin wing. Though it has only a 5° sweep, the power demand on the engines is no greater than that of a similar wing of 20° sweep. Decelerons on the trailing edges combine the jobs of flaps, ailerons, and air

brakes to provide all controls but a rudder.

Air Secretary Finletter recently called the big aerial destroyer our "basic defense aircraft." Test-flown last year, it has been coming off production lines at Hawthorne, Calif., in quantity since January. By summer, squadrons of Scorpions will be in service to guard high-priority targets. **END**

New Telephone Battery Works Better, Lasts Longer

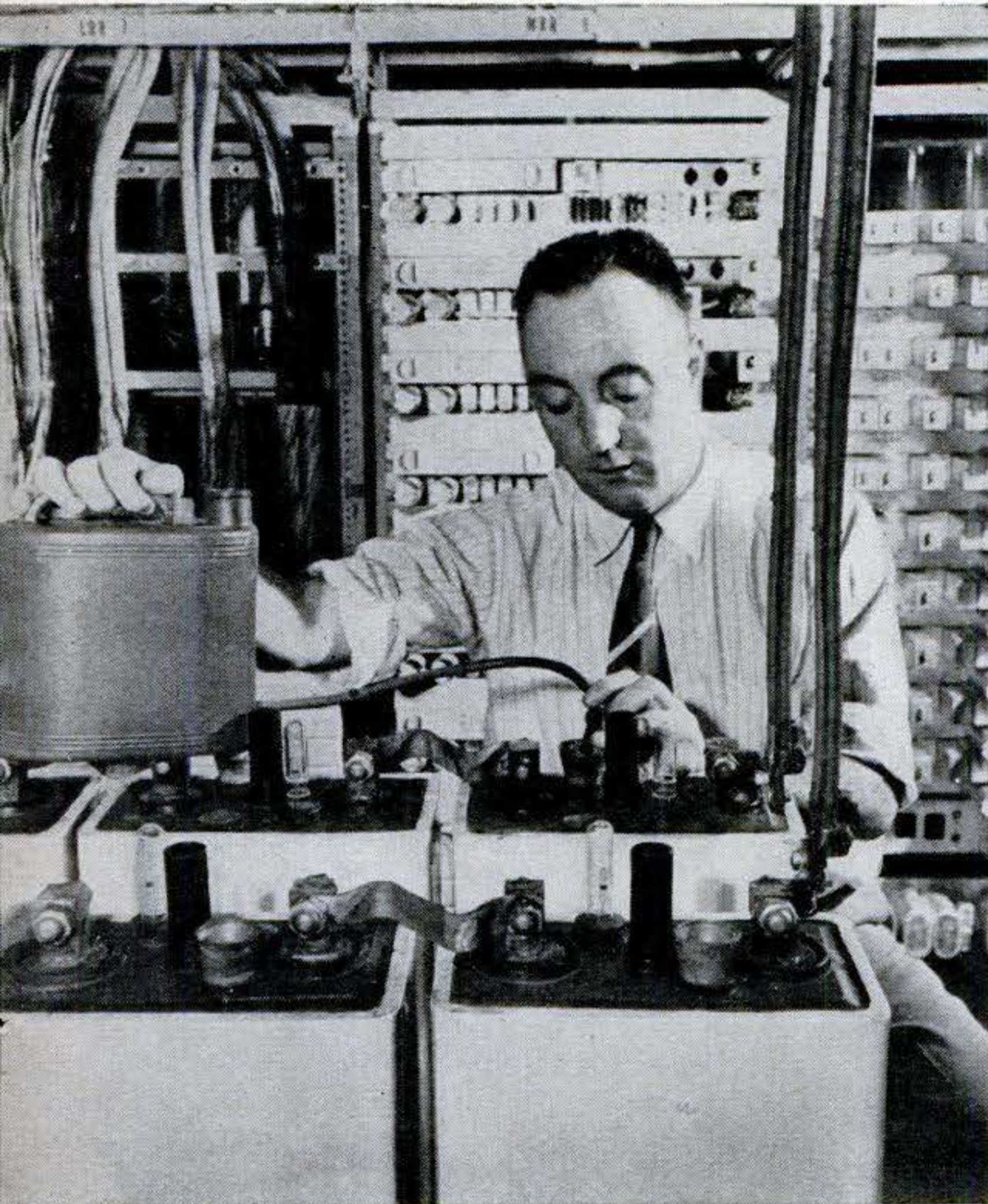

BECAUSE telephone engineers found a sniff of strange gas near a switchboard room, the Bell System is getting a new kind of storage battery. It will last 50 percent longer, run many more months without extra water, and hold its charge five times better than older types. It promises to save the phone company \$1,000,000 a year.

The strange gas in the story was stibine. The engineers, searching for the cause of a tarnish on dial switches, traced the stibine to the storage batteries kept by switchboards for emergency power. It was being formed from antimony mixed with the lead in the batteries as a hardening agent. More research showed that stibine had nothing to do with the switch tarnish, but did have a lot to do with lowering the efficiency of the batteries. By using calcium instead of antimony to harden the lead, stibine is eliminated and the better battery results.

The new battery, already in production, is designed specifically for telephone use. What about automobiles? Bell scientists won't say yes or no. But this battery is the same general type as a car battery. The rest is up to the industry and the public.

X-Ray Tester Gets Electric Eye to Speed Inspection



ELECTRIC-EYE inspection, already used to count pills and discard green oranges, can now even examine what's inside a product. A new kind of electric eye—a crystal sensitive to X rays—makes this possible. Test setups have already gauged the fullness of cans of foods (photo at left above) and spotted empty spaces in blasting fuses (right).

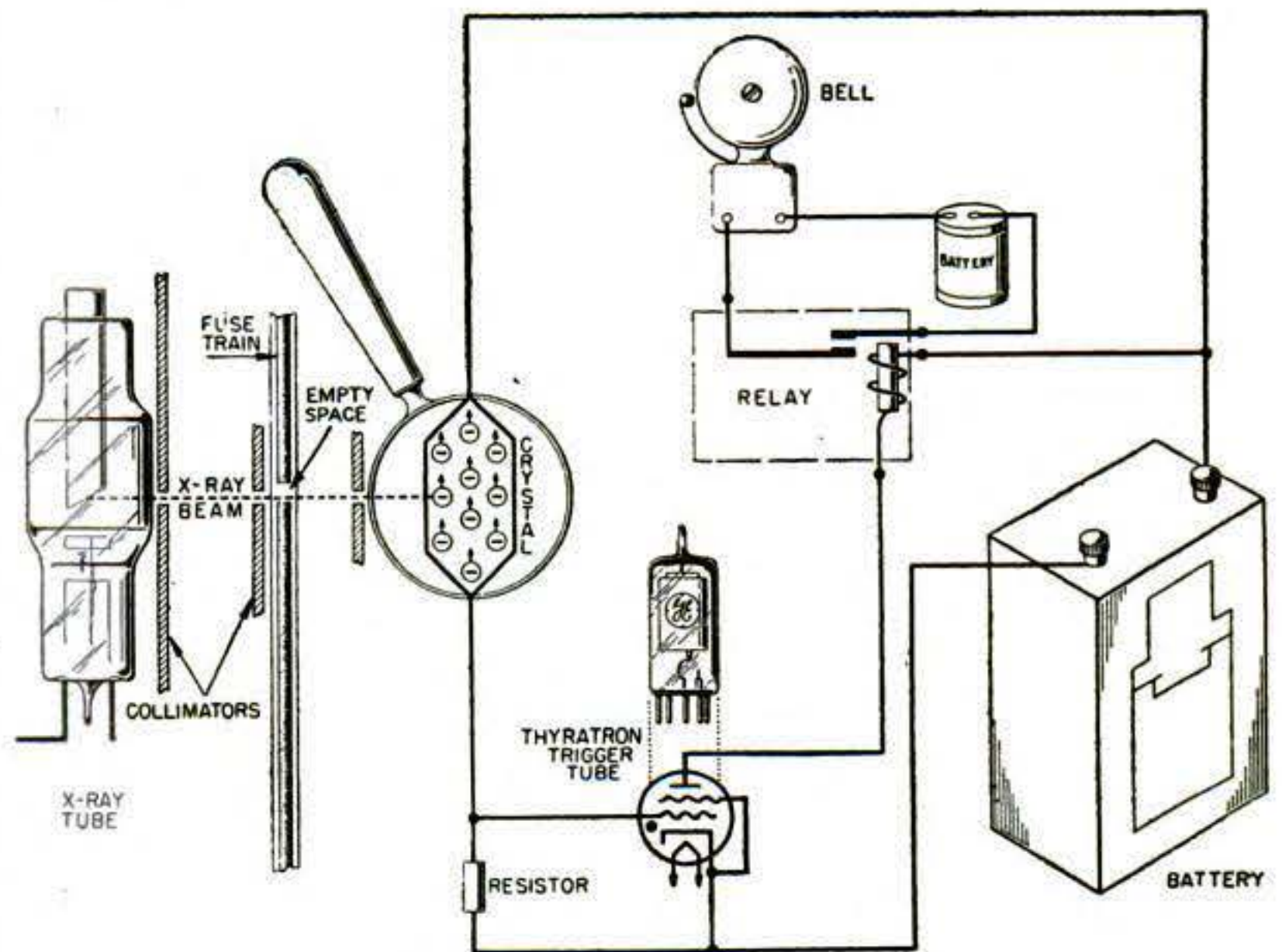

The crystals used are cadmium sulfide, "grown" by Drs. Rudolf Frerichs, of Northwestern University, and John E. Jacobs, of the General Electric X-Ray Corp. When struck by X rays passing through the product, they generate a current, just as ordinary photocells do when struck by light, and thus work an inspection signal.

Model Planes Vie in



Dodging each other takes nimble footwork as model-plane pilots, keeping within circle of

10-foot diameter, race their craft around circular course on 60-foot tethers of piano wire.

Whirling dervishes fly up to six entries at once in the most exciting kind of miniature speed contest yet devised.

Prop kicks up gale as miniature plane awaits start of race. Using syringe, Keith Storey keeps its tiny fuel tank brimful, so plane will carry every precious drop permitted by rules.

By Andrew R. Boone

YOU see several grown men wheel round and round inside a 10-foot circle. One lifts his hands high, and another ducks beneath them. Every three seconds the group dogtrots around the circuit, in a scramble that continues until 140 turns have been completed.

They're racing model airplanes. At the end of twin piano wires they hold with U-shaped handles, nifty little buzz-ships whip around a wide circle at 80 m.p.h. in a 10-mile race. After eight minutes or so, the whirling dervishes zoom their planes into a sharp climb. Props stop, and the





MODEL PLANES FLY CIRCULAR COURSE
(14 LAPS EQUAL ONE MILE)

New Team Races

PAIR OF
60-FOOT
CONTROL
LINES

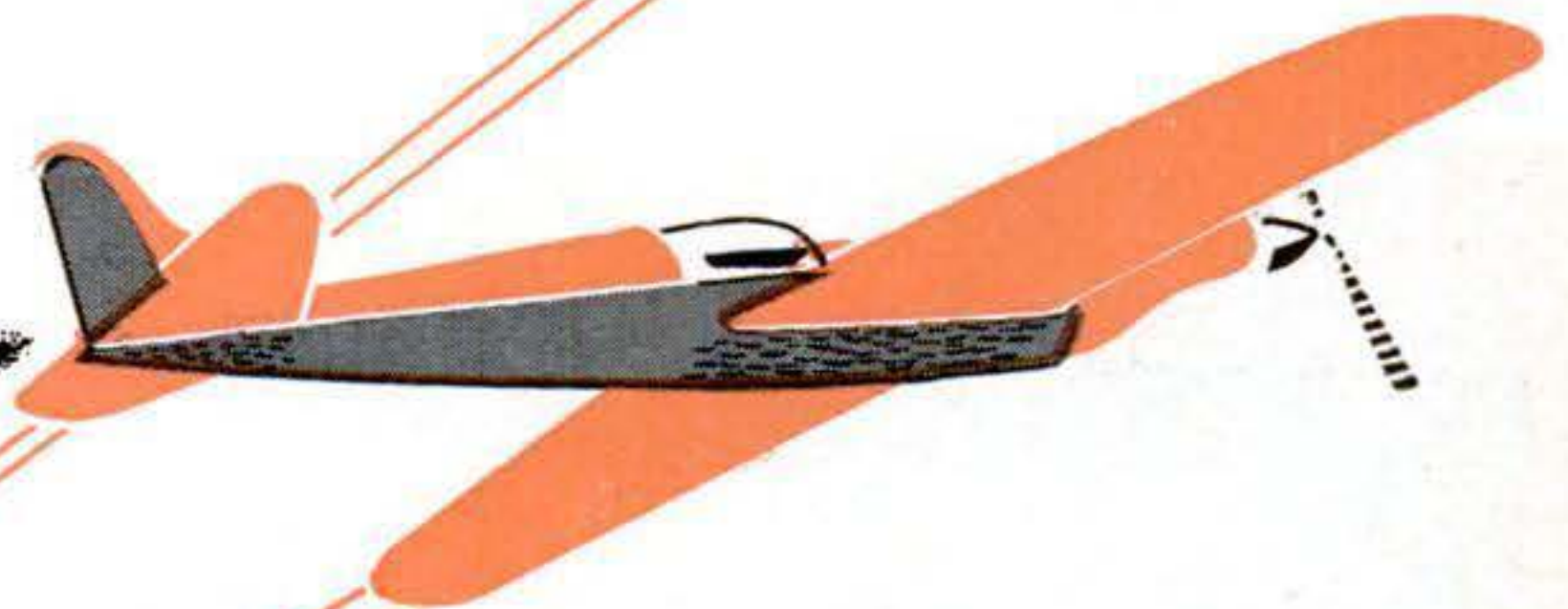

PILOTS
STAY IN
CIRCLE
OF 5-
FOOT
RADIUS

Exciting speed contests now pit buzzing model planes directly against each other in air, instead of flying and clocking one craft at a time. Control lines hold planes on circular course, cause them to climb or descend, and cut off engines to make them glide to a landing.

Take-off zone is cleared, judge gives signal, and starter trips this spring-loaded trigger. Wires operate "stooge" releases, setting planes free. They're airborne after about 15-foot run.

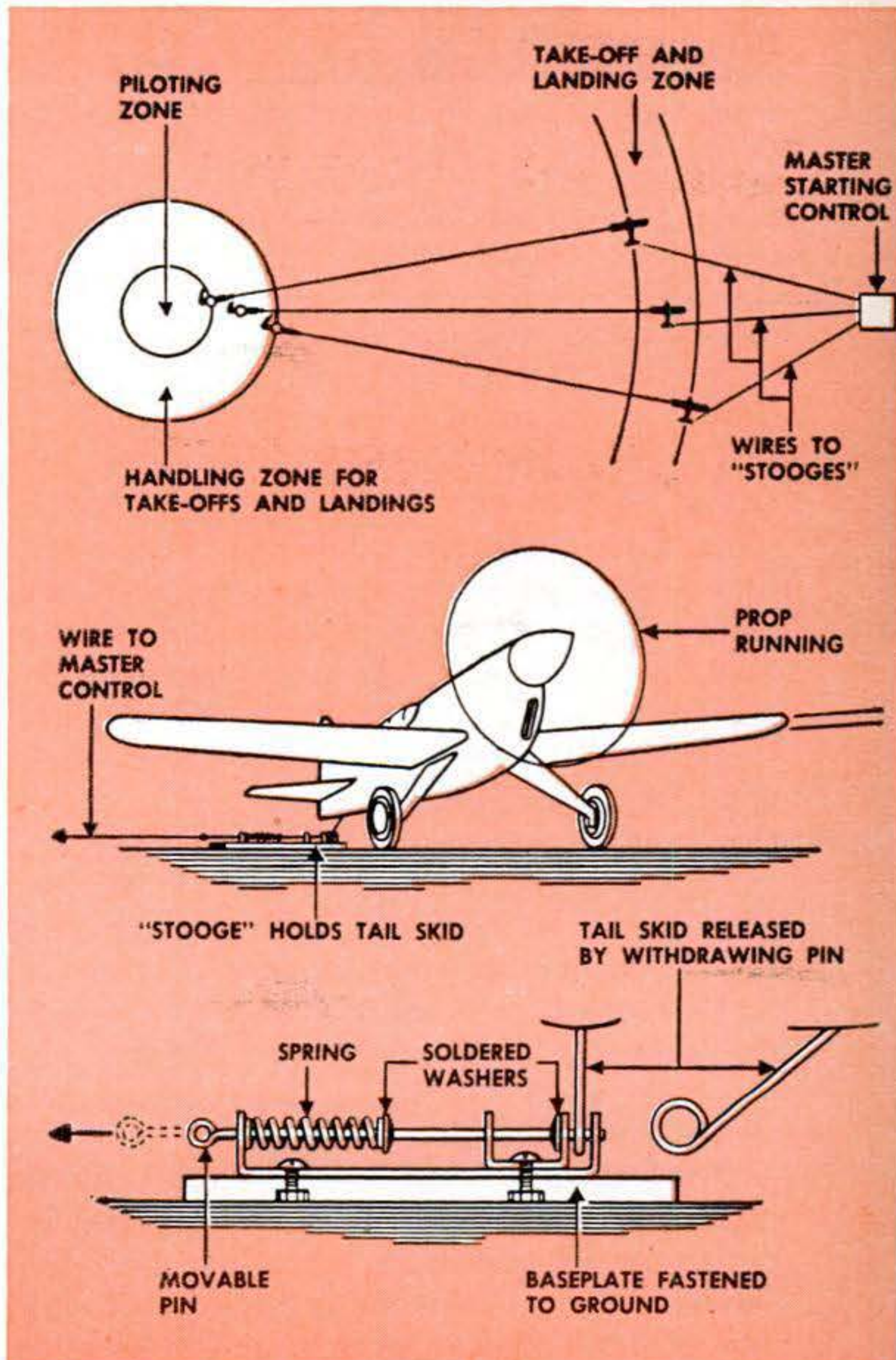

Starting line-up (top) is between outer two of four concentric circles marked on flight area, with radius of 5, 15, 65, and 75 feet. Each plane is held by tail skid on "stooge" or mechanical release (center and bottom). Master control releases all planes simultaneously.



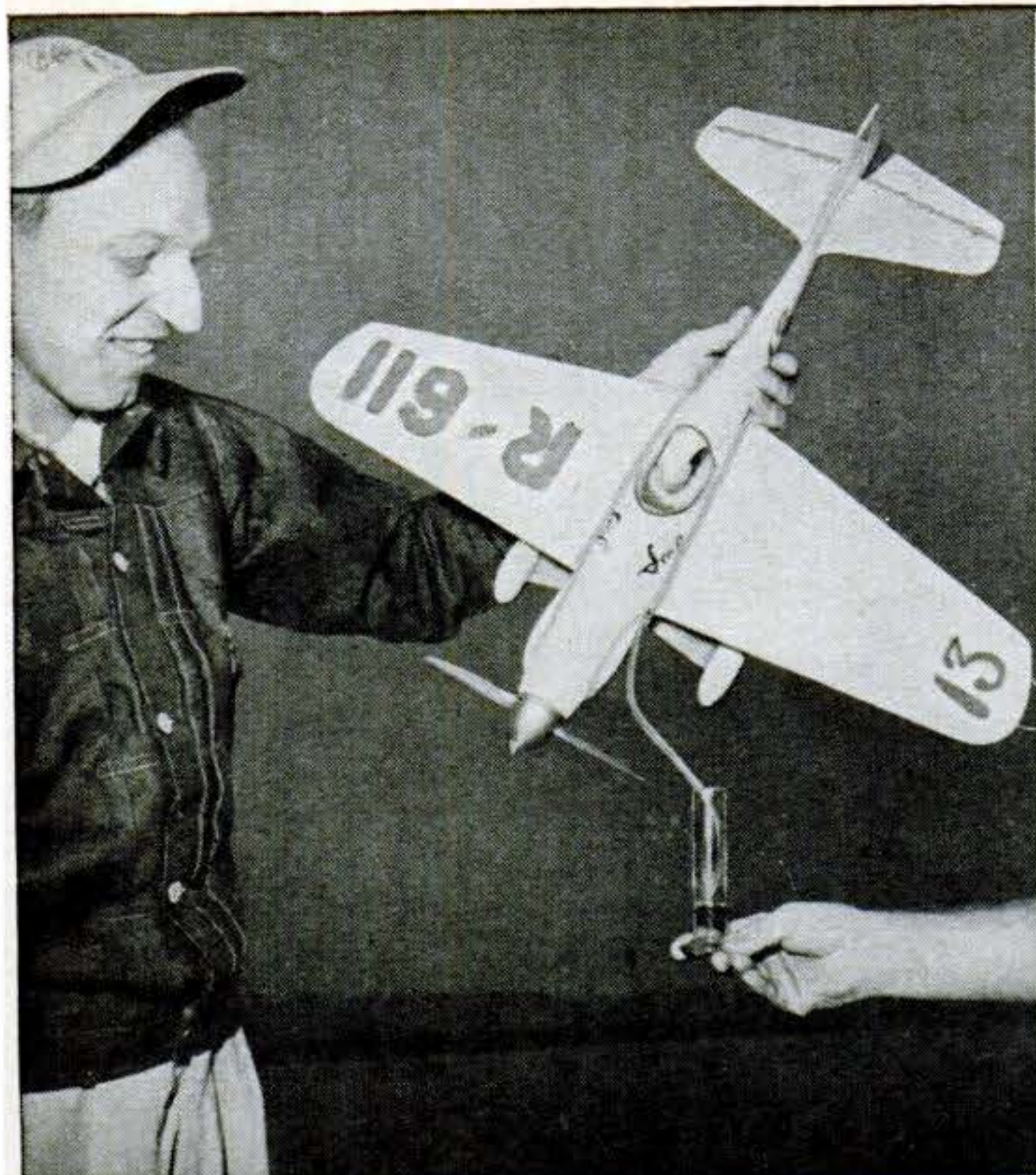

Fuel tank of one-fluid-ounce capacity is largest permitted by official rules. Judges check entries, as above, by draining contents of full tank into graduated measuring cylinder.



Flight box beside plane being fueled is owner's portable service station. Usual contents include tools, spare parts, fuel, and dry cell, hooked up as shown to heat engine's glow plug.

planes glide down to landings. Then the perspiring and dizzy pilots make for the nearest place to sit down.

This new kind of racing is the most exciting contest yet cooked up by model-plane fans. Formerly competing speedsters flew singly, in individual runs against the clock. Now as many as six racing planes may take the air at once, to vie directly with each other. Mechanical starters loose them simultaneously. Timers count their completed laps, and the first one to finish the required number is the winner.

Pilot and mechanic form a team to race each entry. In a 10-mile race, a plane may land three or four times to refuel. Then the team works fast to squirt fuel into the one-ounce tank, spin the prop, and get the ship airborne again. To date, the record is 14 seconds from landing to take-off.

Rules specify a maximum racing altitude of 25 feet. A plane may pass either over or under one it overtakes. Its pilot must tell the overtaken pilot which he is going to do. The 60-foot control lines serve not only to guide the planes in a circle, but also to maneuver them. The twin wires enter a plane's wingtip side by side, and work its elevators through a bell crank to which they are attached. Tugging one strand or the other makes the plane climb or descend.



Glow plug is tightened with spark-plug wrench. End of cylinder, projecting through bottom of plane, will be covered by streamlined fairing when model plane has been readied for race.

A spring plunger shutting off the fuel supply and engine is tripped when the elevator control is moved to extreme "up" position.

Planes needn't be scale models but must resemble full-scale racers. Wing area must be at least 125 sq. in., and engine displacement between .201 and .300 cu. in. These single-cylinder, two-cycle engines deliver $\frac{1}{2}$ to $\frac{3}{4}$ hp. at 18,000 r.p.m. Standard fuel is



Motors that balk at starting when prop is spun by hand get an assist from cart holding auto battery and starter motor. Rubber-hose fitting grips spinner and whirls model engine to life.



Checkered flag signals finish by each plane. Green flag starts race; red one flags planes down; and yellow one, when plane lands to refuel, warns others to keep clear of ground.

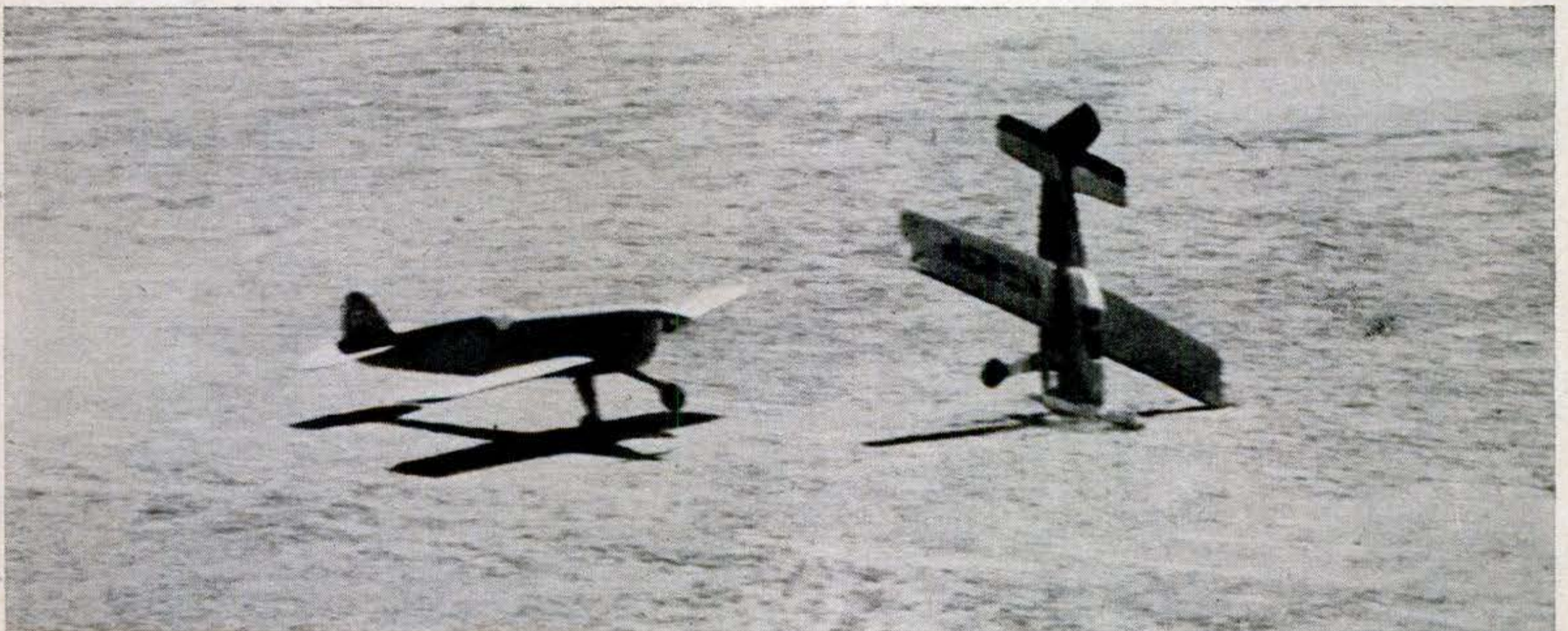

Crashes are frequent, usually immediately after take-off. Above, leading plane comes to grief, and following one is about to pile into it. To minimize such tangles, rules provide

starting line-up in order of getaway speed shown in preliminary trials, with fastest-accelerating plane in leading place; and plenty of headway, as shown in a preceding diagram.

a mixture of methanol and castor oil with nitrated elements added. For realism, every plane must carry a "pilot" fashioned to 1/10 scale.

Called "control-line team racing," the new sport dates from a meet at Burbank, Calif., some months ago, when a group of Pasadena enthusiasts tried a three-plane jump-off. Last year, for the first time, it

was included in the national meet at Dallas, Tex., and Don Post, of Glen Rock, N. J., became the first national champion. Now model clubs all over the country are scheduling similar races. The Academy of Model Aeronautics official rules have been taken directly from those of the F.A.S.T.—"First All-Speed Team" club—the original Pasadena group.

END

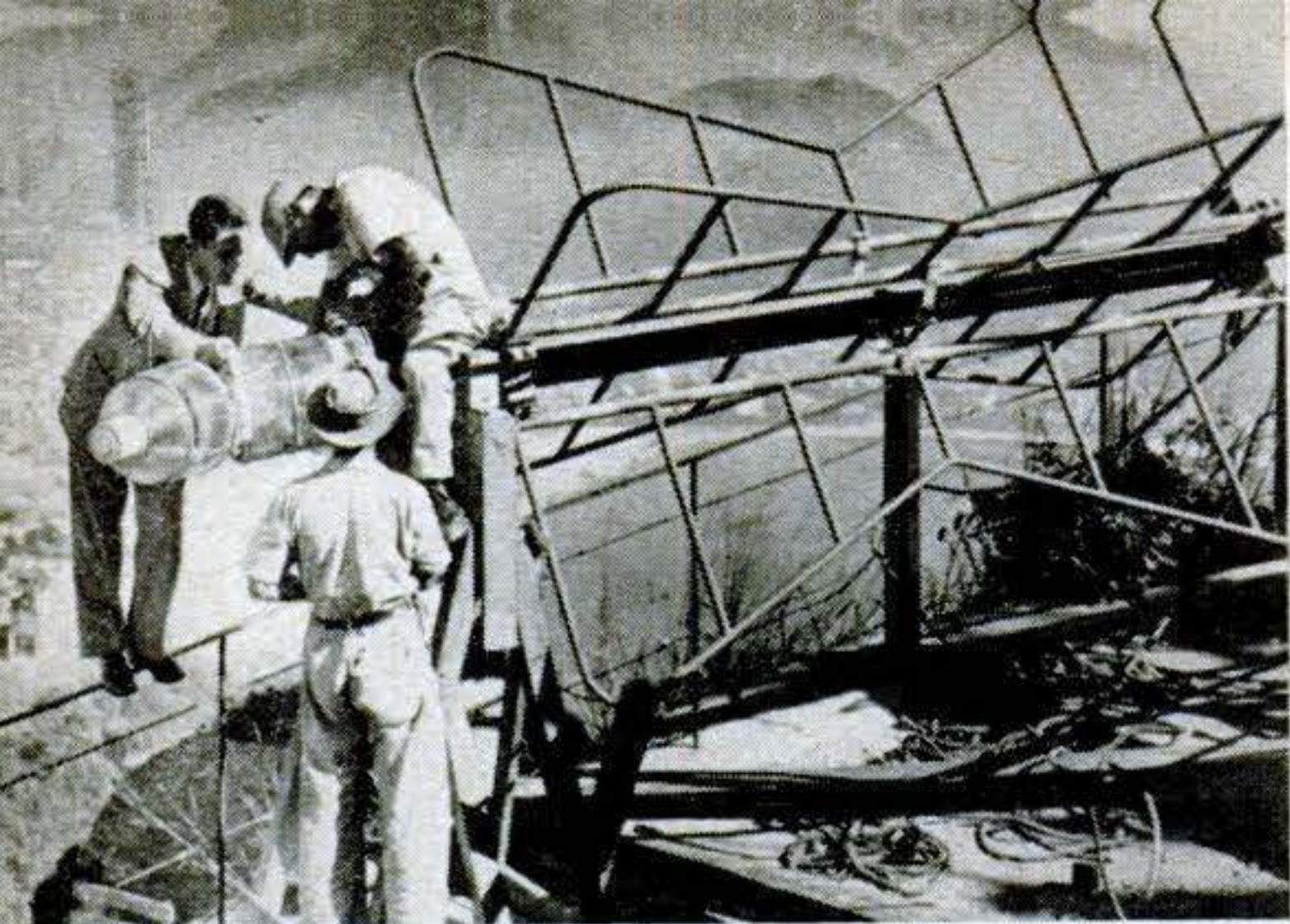

Neither the view—nor the precipitous drop—behind him seems to interest engineer supervising final adjustments to Rio's TV antenna.



Cable car, normally reserved for tourists, carried much video equipment up 1,300-foot Sugar Loaf, which cannot be reached by truck.



British TV Goes Up and Down

NOTICE anything strange about these TV antennas? That's their British accent showing. The dipole arms are vertical because British stations transmit waves vibrating vertically. Our TV uses horizontal polarization, calling for horizontal aerials.



Transmitter for first television station in Rio de Janeiro is barely visible atop Sugar Loaf mountain (top center in photo above).

Rio Gets Mountain-Top TV

THE highest place gives the longest range to a TV transmitter. In Rio de Janeiro, Brazil, that meant the top of famous Sugar Loaf mountain, which dominates the South American city and its magnificent harbor. And that is just where the antenna for TUPI-TV was placed by General Electric engineers—even though all the equipment had to be hauled up by hand, mules, or cable car. Brazil has one other station (in Sao Paulo) and several thousand receivers.



Electronic Sergeant Recruits GIs

THE recruiting sergeant has gone electronic. As soon as a prospect steps on a mat outside the Armed Forces booth in New York's Times Square, an automatic tape player (above) spiels the advantages of enlisting. General Electric made the device.



Army Crates Get Tough Going-Over

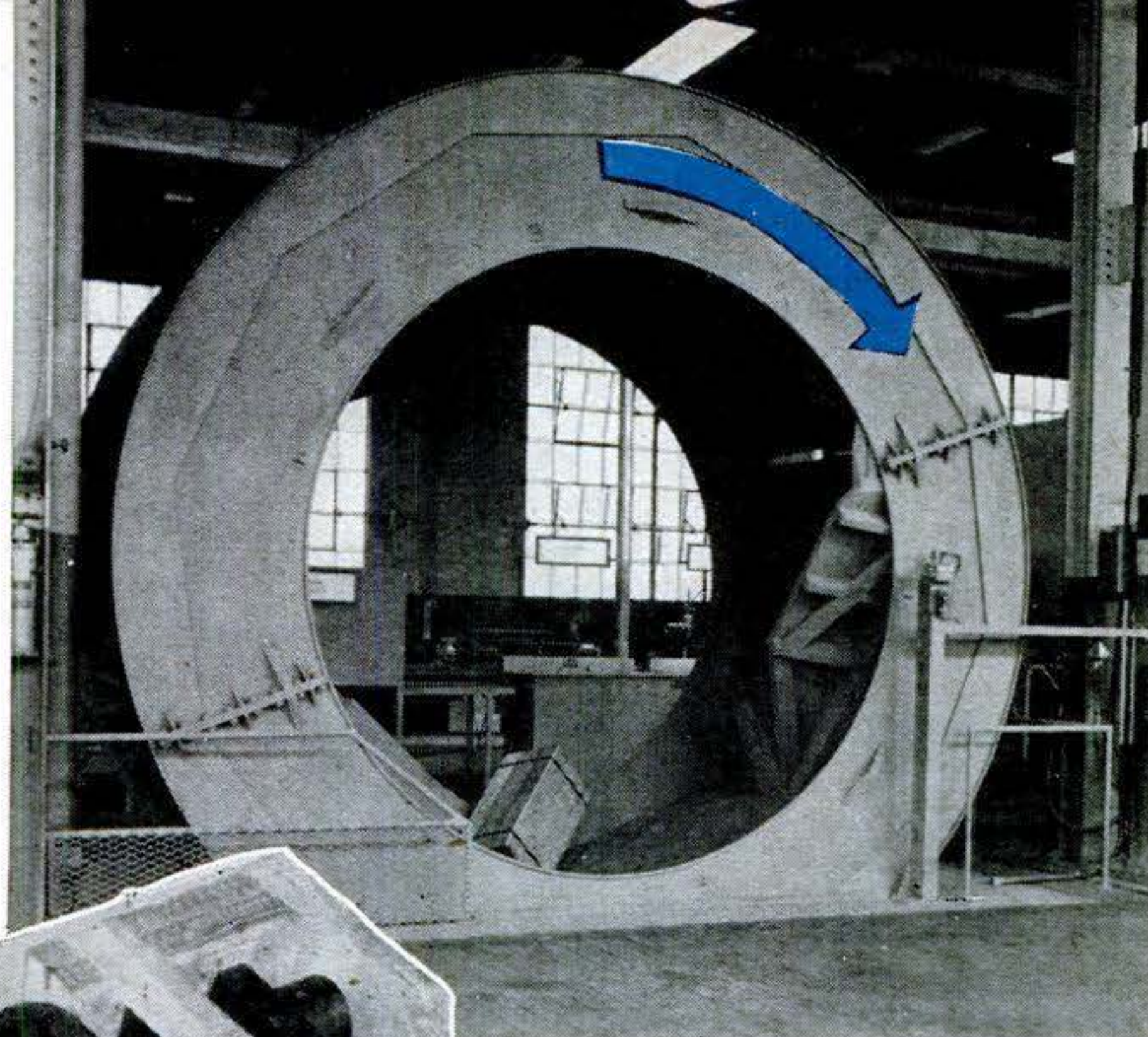

Revolving drum does a job on a crate for a crankshaft weighing several hundred pounds. At left, box has cover torn off and steel bands broken. But crankshaft is unharmed.



In incline-impact test, the crate on dolly above will be sent rolling down 40 feet of rails to smack against bottom wall at speed of 8 m.p.h.

Poorly made crate (below), after having run the gantlet, ends up a mess. Contents, which might have been rifles, would have been ruined.

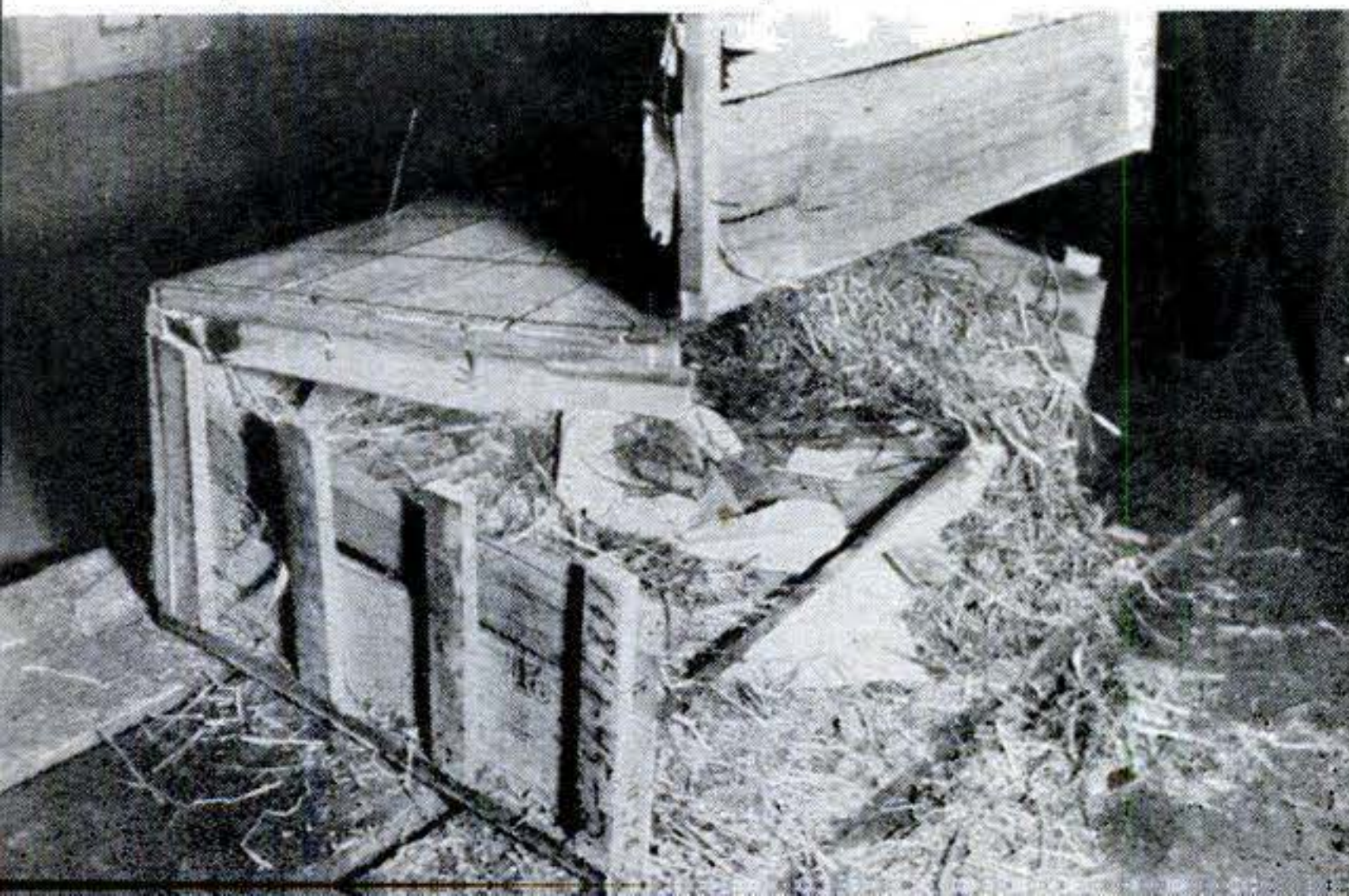

INSIDE the huge revolving steel drum above, packages in which war materials will be shipped take a beating to test their toughness.

This and other equally grueling tests are part of the work of the Engineer Research and Development Labs at Fort Belvoir, Va. Here the Army gets the low-down on various types of containers before using them to ship valuable supplies to the frozen wastes of the Arctic or the torrid hot-boxes of the tropics.

A vibration stand subjects crates to a terrific shaking such as they have to take in a railroad freight car or on a truck journey over rough roads. A giant ceiling-high press squeezes containers with a load up to 100 tons.

Besides being rugged, crates and packages must be able to protect contents from deterioration due to rust, sleet, cold, or heat. To pass, they must come through immersion in a water tank and prove their ability to withstand the man-made rigors of Arctic and tropic climatic chambers.

In early years of World War II less than half the material shipped overseas arrived in usable condition. The project has halved this loss—but the Engineers' goal is 95 to 100 percent safe arrival.

Pneumatic Hand Saw Won't Kick or Grab

THIS pneumatic hand saw works like those teeth-jarring air hammers you've seen digging up streets. One big difference, though, is that it has two 21-inch blades side by side, so arranged that one moves backward as the other moves forward. It makes 1,500 strokes a minute, but because of opposed action will not grab or kick.

Compressed air pushes forward a semi-cylindrical piston attached to one blade. As this blade moves forward, its motion is reversed by a rack and pinion and transferred to the second blade, moving it backward. At the end of the stroke, a cam trips a shuttle valve that closes air to the first piston and opens it to a piston attached to the second blade. This drives the second blade forward and the first blade backward.

The 15-pound saw will cut to any depth with a 3/16-inch kerf. Wright Power Saw and Tool Corp., Stratford, Conn., makes it.

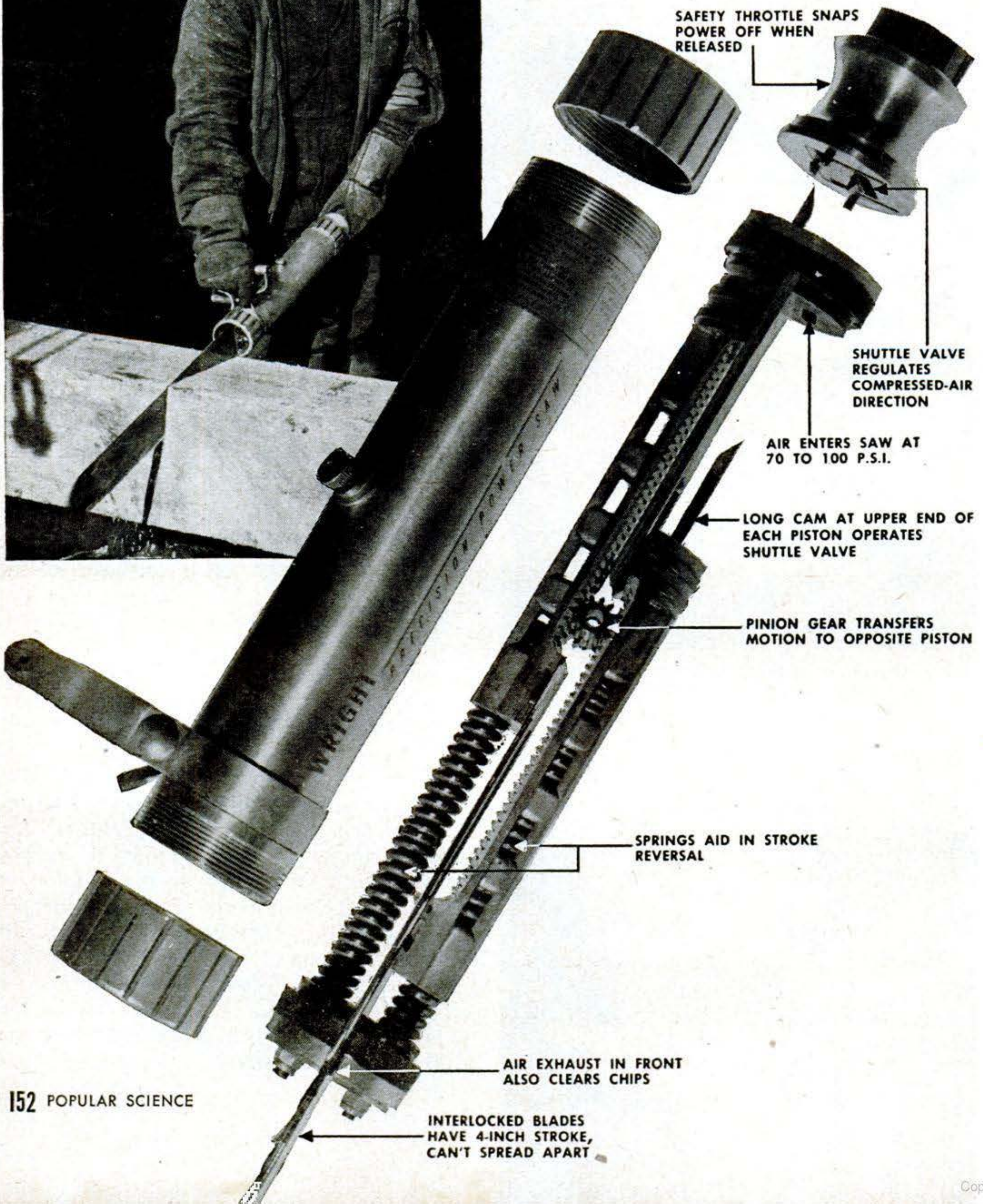

Keeping the Home Shipshape

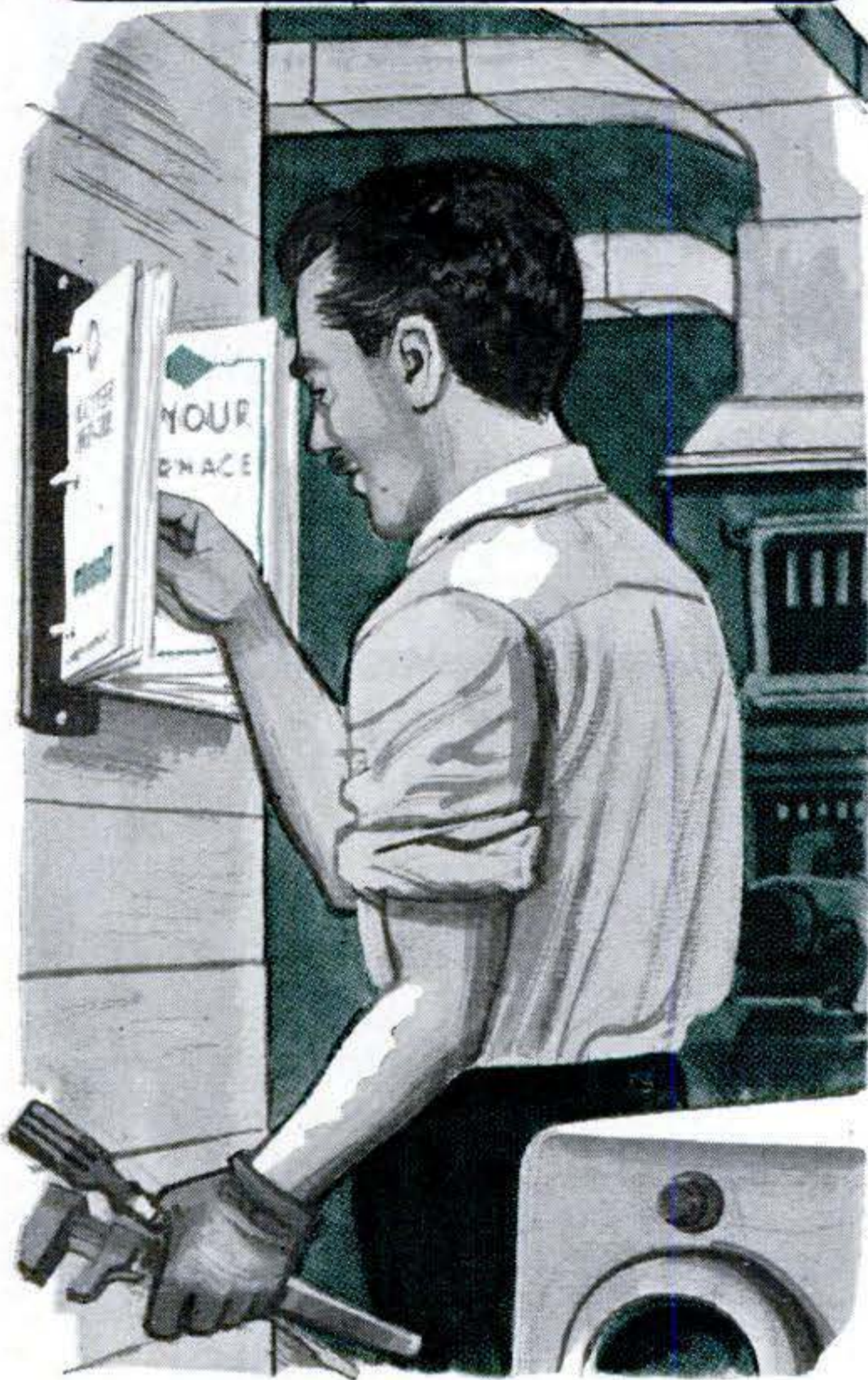

Pry off the metal spine before discarding a loose-leaf book, and mount it on a cellar wall. Its rings will hold instruction sheets for your oil burner, washing machine, and power tools.



To make low fences for flower beds, bend wire hangers to a diamond shape. Stick straightened hooks into ground, and wire together adjoining points for added strength.



To repair a plastic hose with a hose mender, first soften the end of the hose by immersing it in very hot water. Use a mender slightly larger in diameter than the inside of the hose.



Steep or narrow attic and cellar stairs can be dangerous. Fix several screen-door handles along the way for handholds and ascending and descending will be easier and safer.

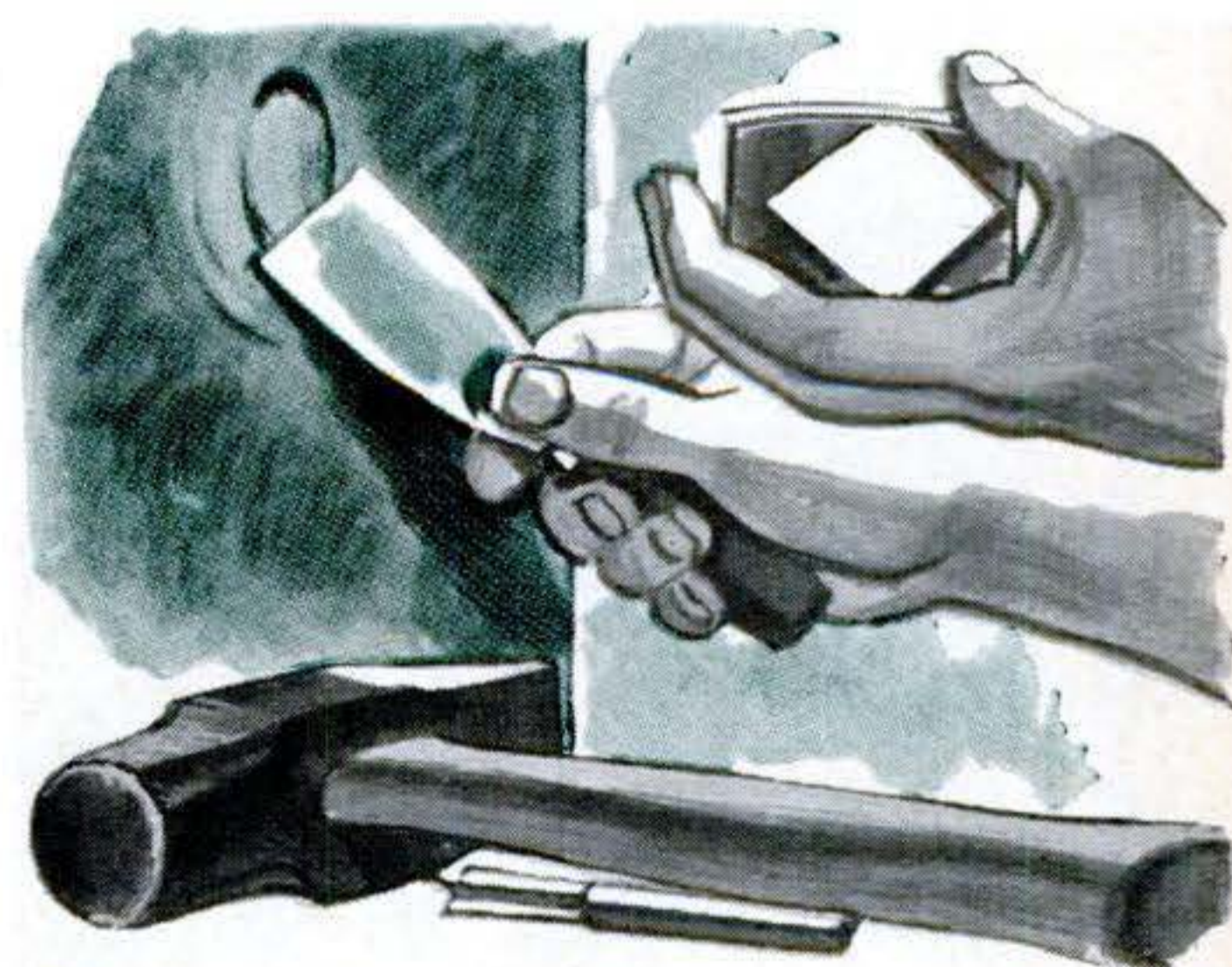

To fasten brackets to concrete walls, drill holes with a star or carbide-tipped drill, fill with plastic composition wood, and let dry. Common wood screws will hold firmly.

Please turn the page for five more suggestions.

MAY 1951 153

Keeping the Home Shipshape

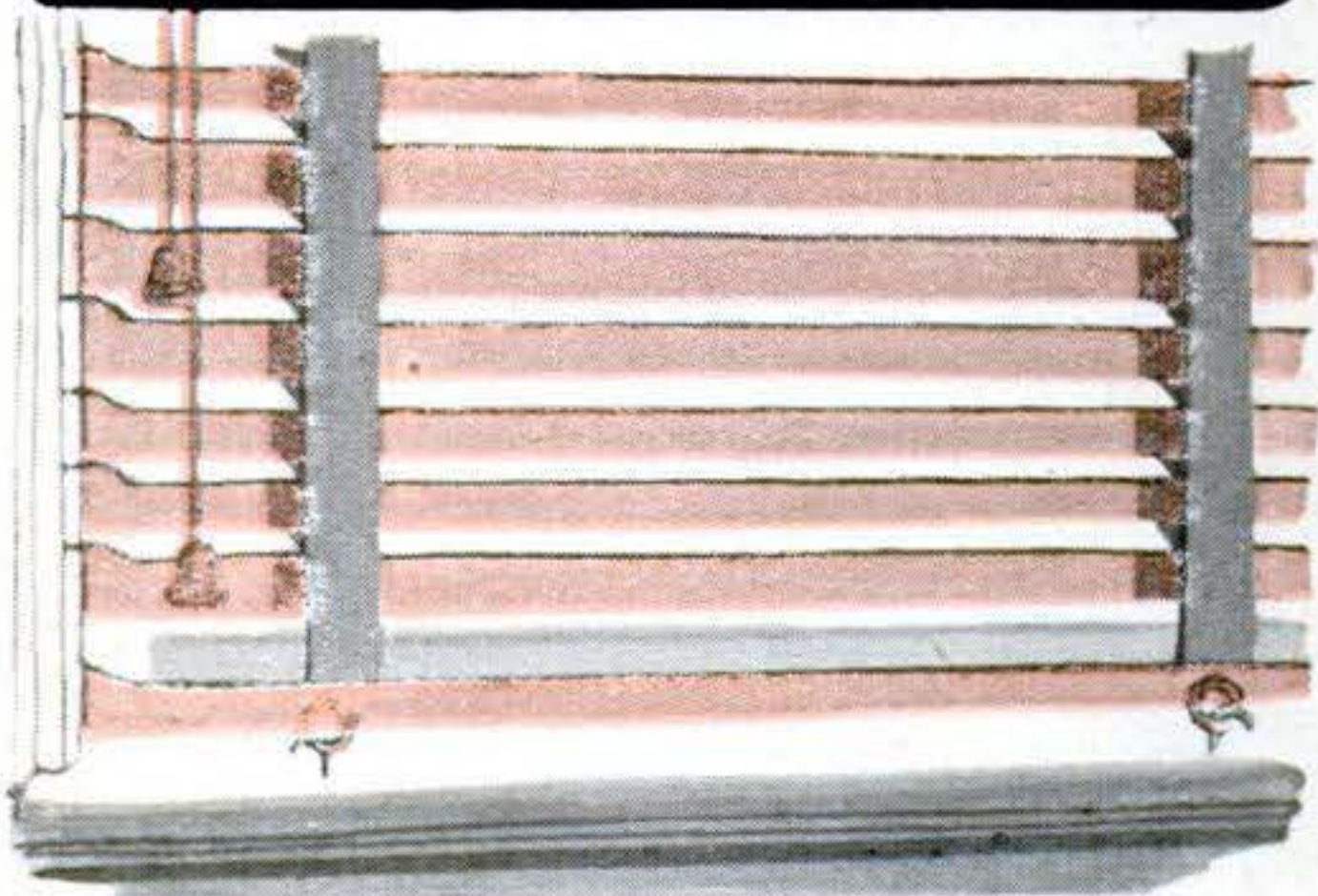

Do your Venetian blinds rattle and bang when windows are left open? Cup hooks and screw eyes between the bottom of the blinds and the sill will stop this.



To remove drip stains from asbestos shingles, use one cup of trisodium phosphate powder in a pail of hot water. Scrub thoroughly and rinse with clean water and a sponge.

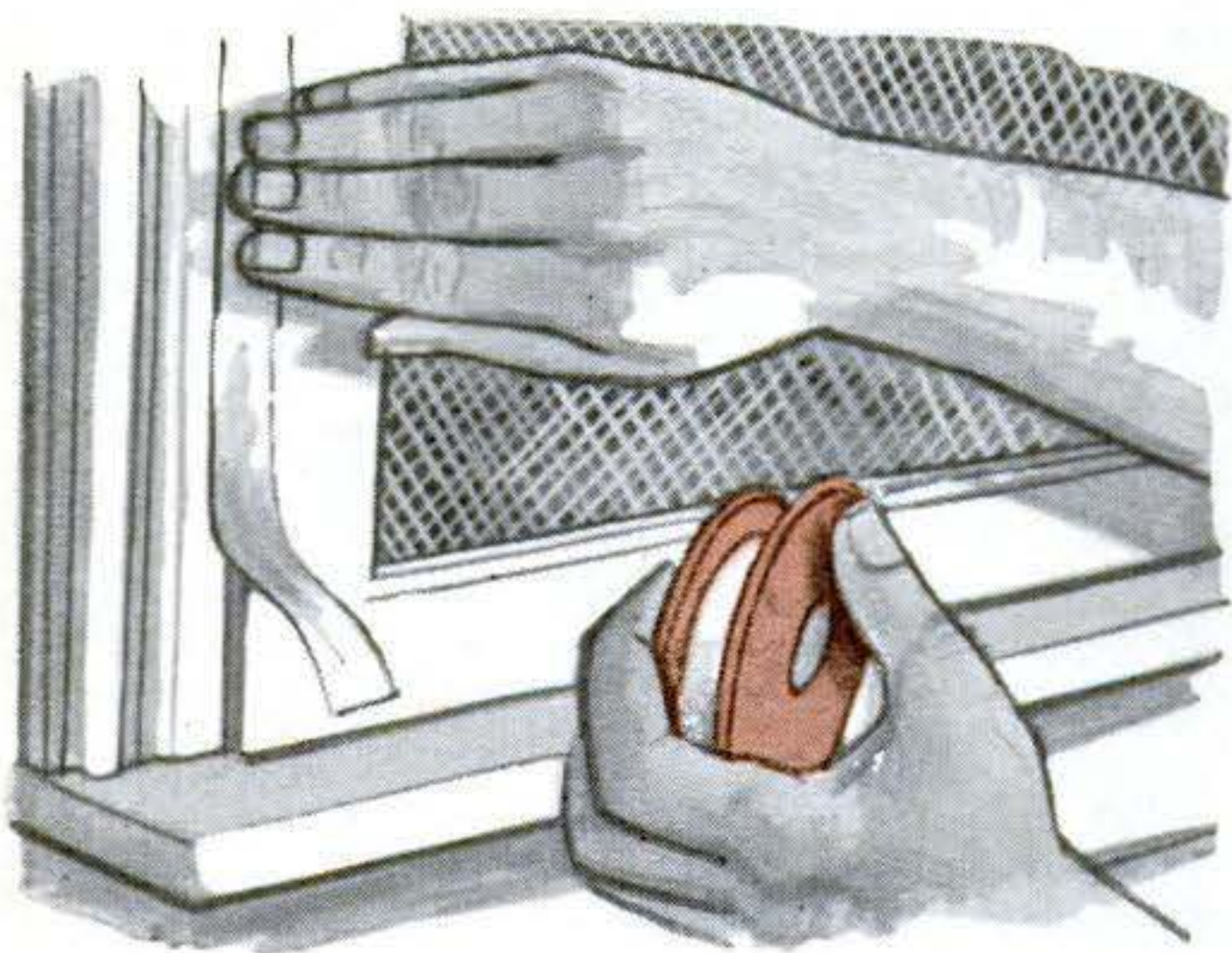

To keep insects from crawling into the house between window frame and screen, seal cracks shut with white surgical tape. It adheres well and matches white woodwork.

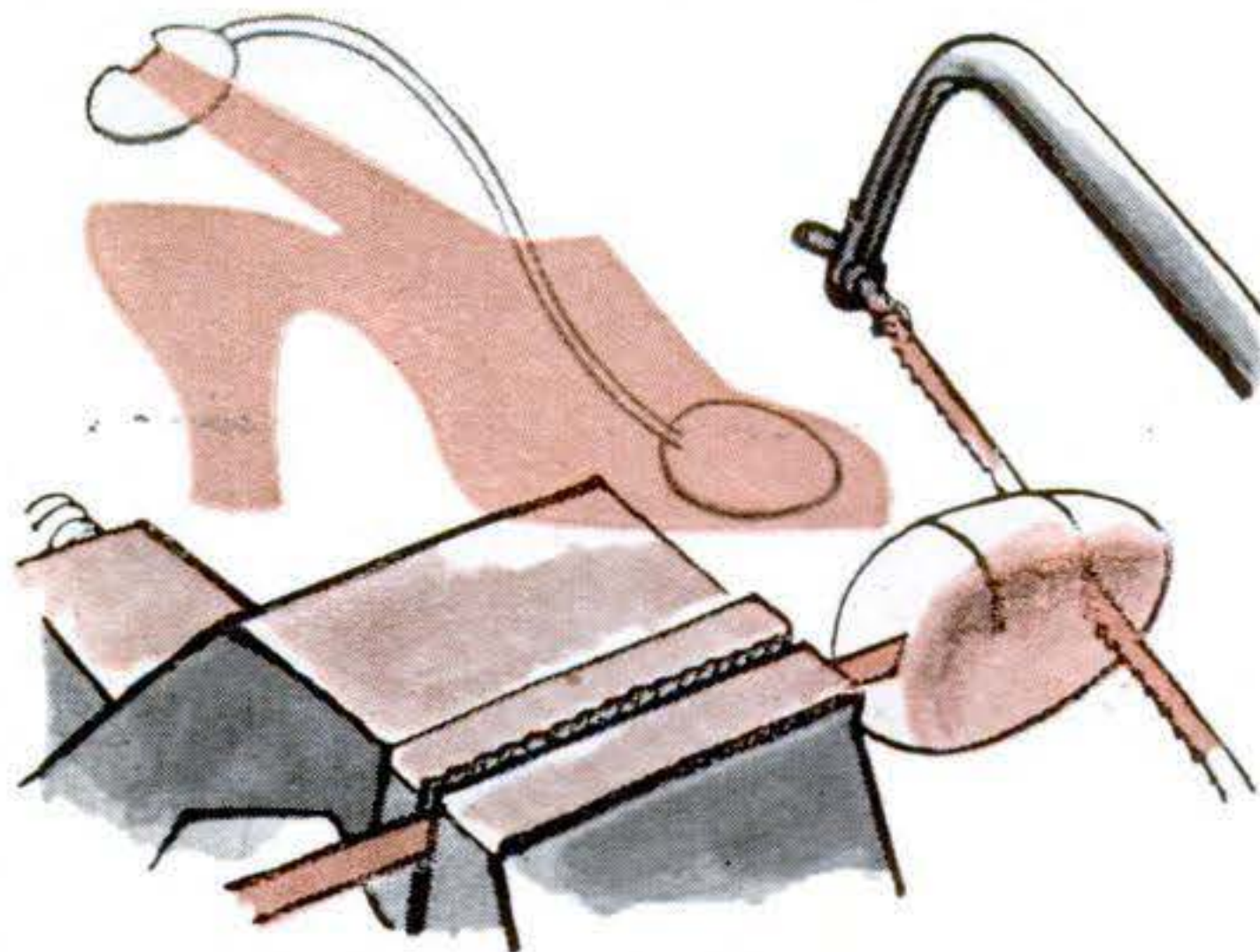

Ordinary shoe trees won't work in women's strap-back shoes. But if you alter the heel knob as shown, the strap will fit in it securely and the shoe can be kept in shape.

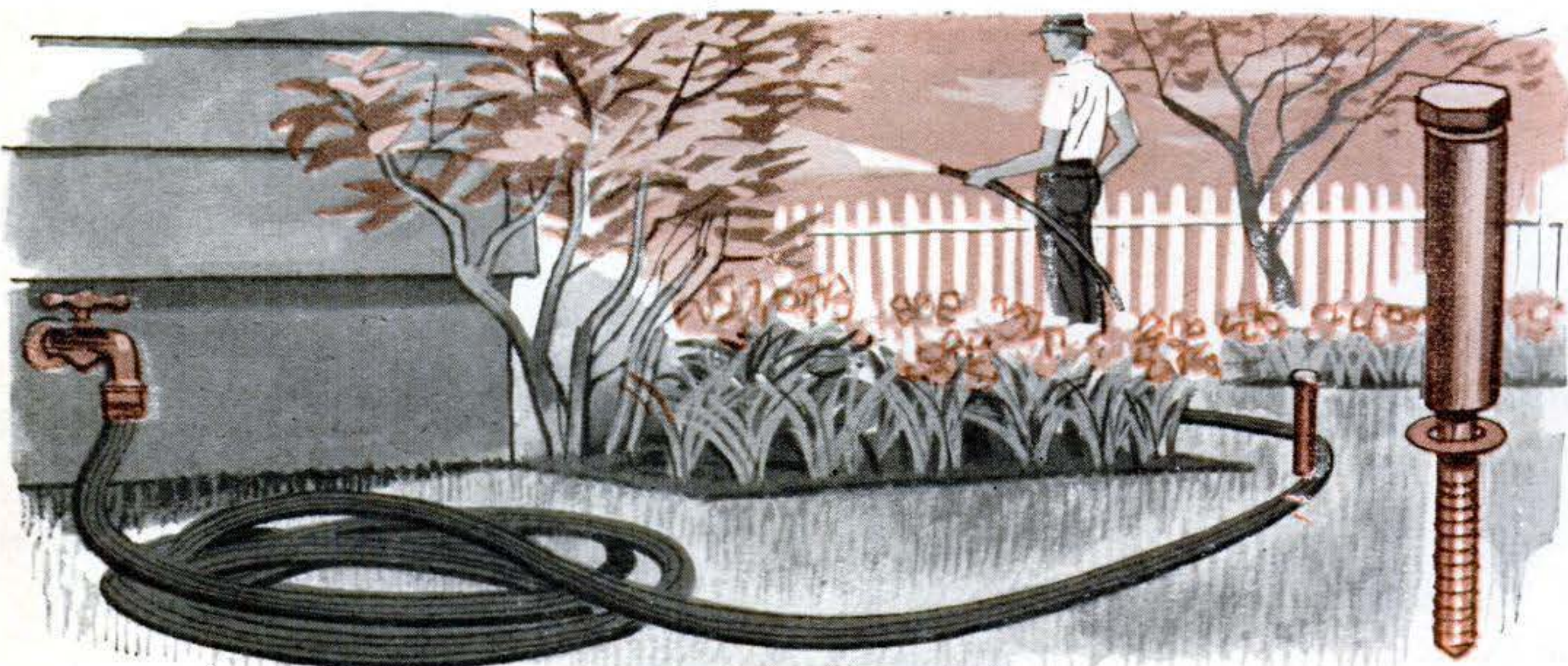

A long carriage bolt, inserted through a bit of pipe and a washer, and then driven in the

ground, makes a simple hose guide. It serves as a roller past which the hose pulls freely.



Rear Light Flashes Slow-Up Signal

IF YOU were following the car above, a flashing amber light would warn you when its driver had taken his foot off the gas and was slowing down, even though he hadn't yet applied his brakes. It's equipped with an accessory called Slo-Lite, operated by a vacuum control that turns it on when the accelerator is released. It is made by Twentieth Century Mfg. Co., of Los Angeles.

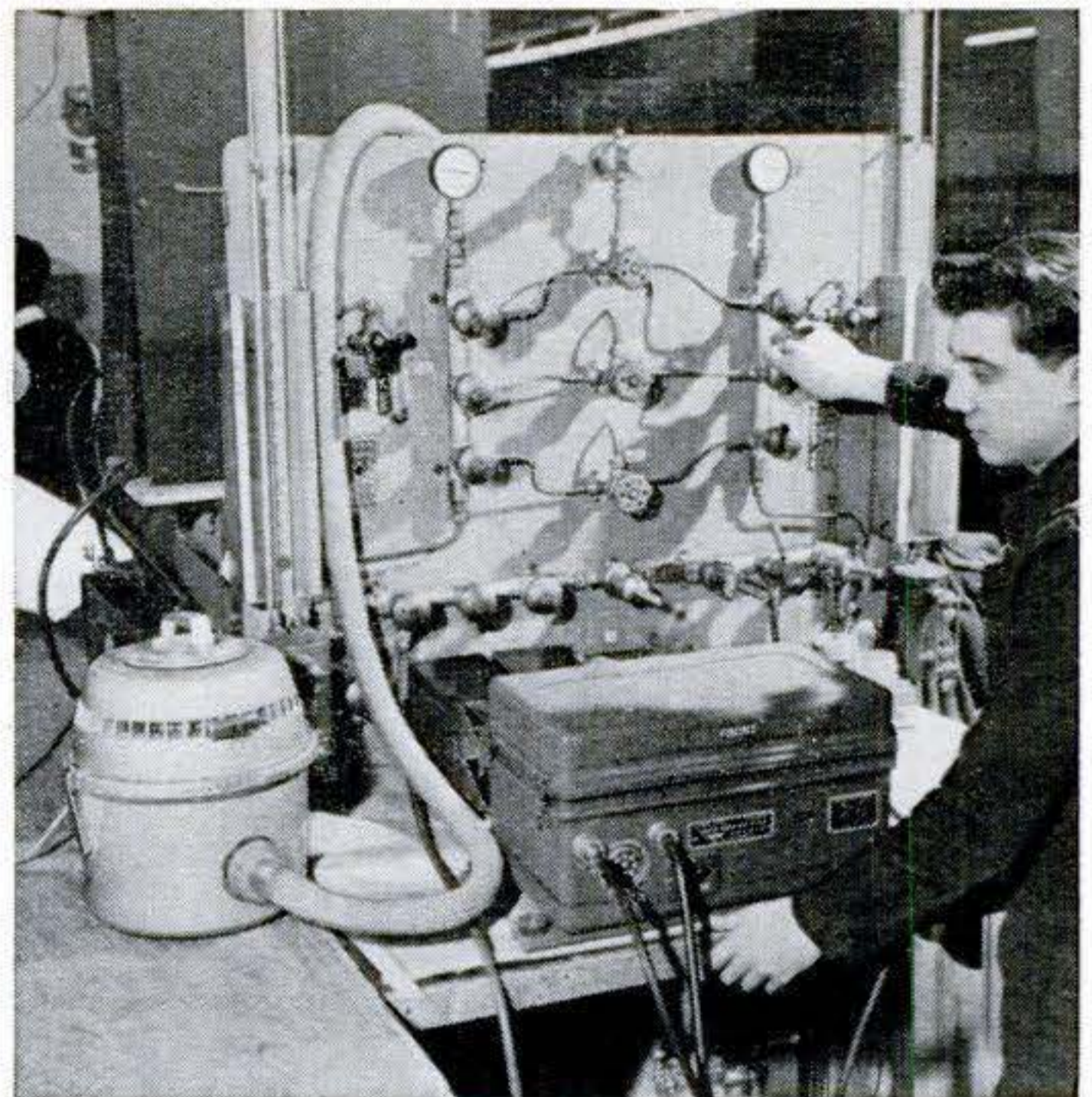

Home Vacuum Tests Waterproof Radios

THE Lewyt Corp. used to test its waterproof Signal Corps radios for leaks by dunking them in water—risking damage to valuable equipment. Now they simply hook up an ordinary household vacuum cleaner (a Lewyt, of course) to the set and pump out most of the air. If a vacuum holds inside at a specified level, the set passes. If not, the parts aren't damaged by water.

“Black Light” Illuminates Traffic Sign at Night

SHOWN below is a driver's night view of an unusual traffic sign near River Grove, Illinois. Painted with new fluorescent pigments, it looks like a conventional road

marker in the daytime. But at night invisible ultraviolet rays from the lamps above the sign cause the letters to produce a penetrating glow visible for 200 yards.

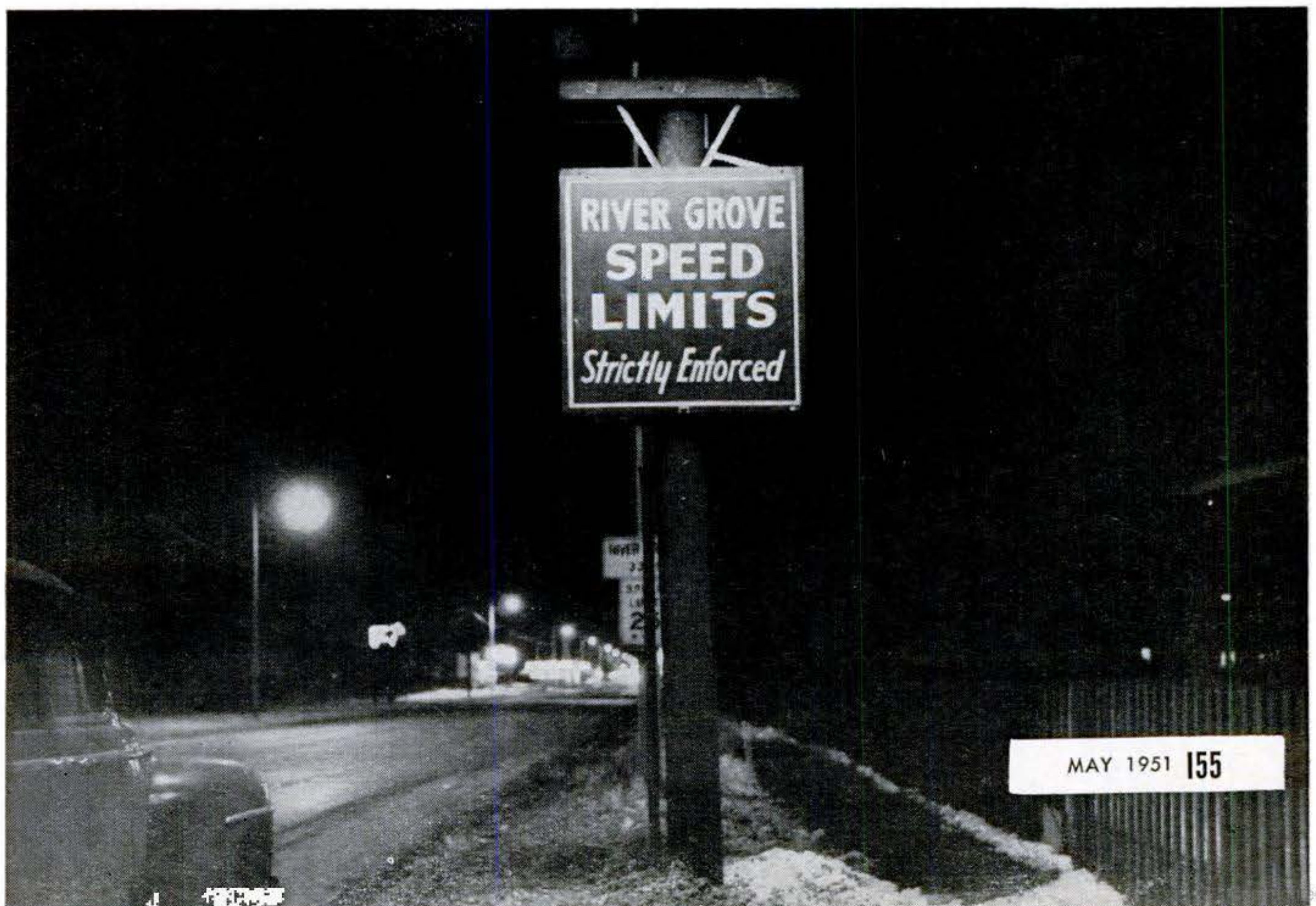

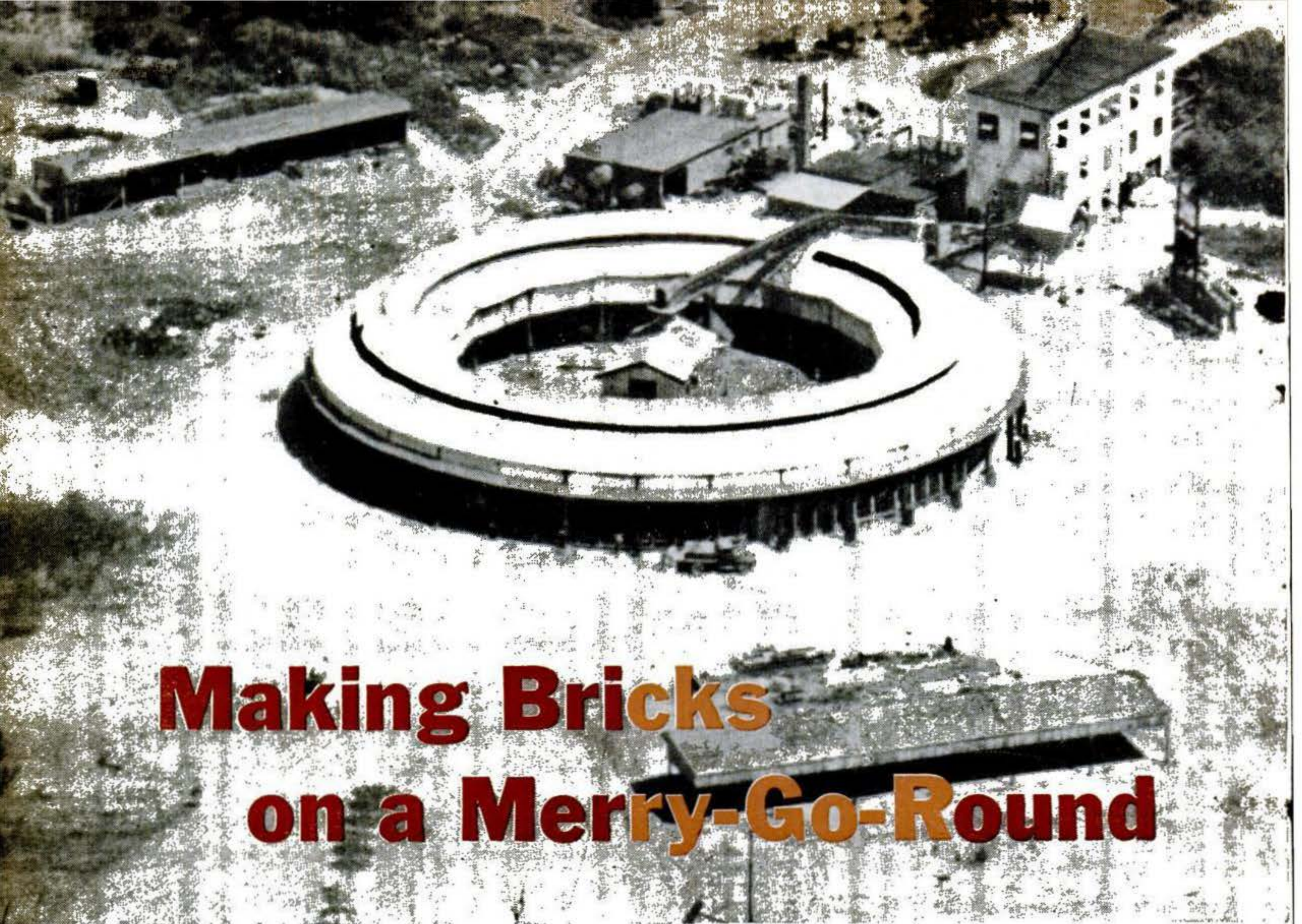

Making Bricks on a Merry-Go-Round

Circular brick factory looks like this from air. Clay dug nearby, and ground up and freed of

rocks by preparation plant in right background, rides conveyor to building at center of ring.

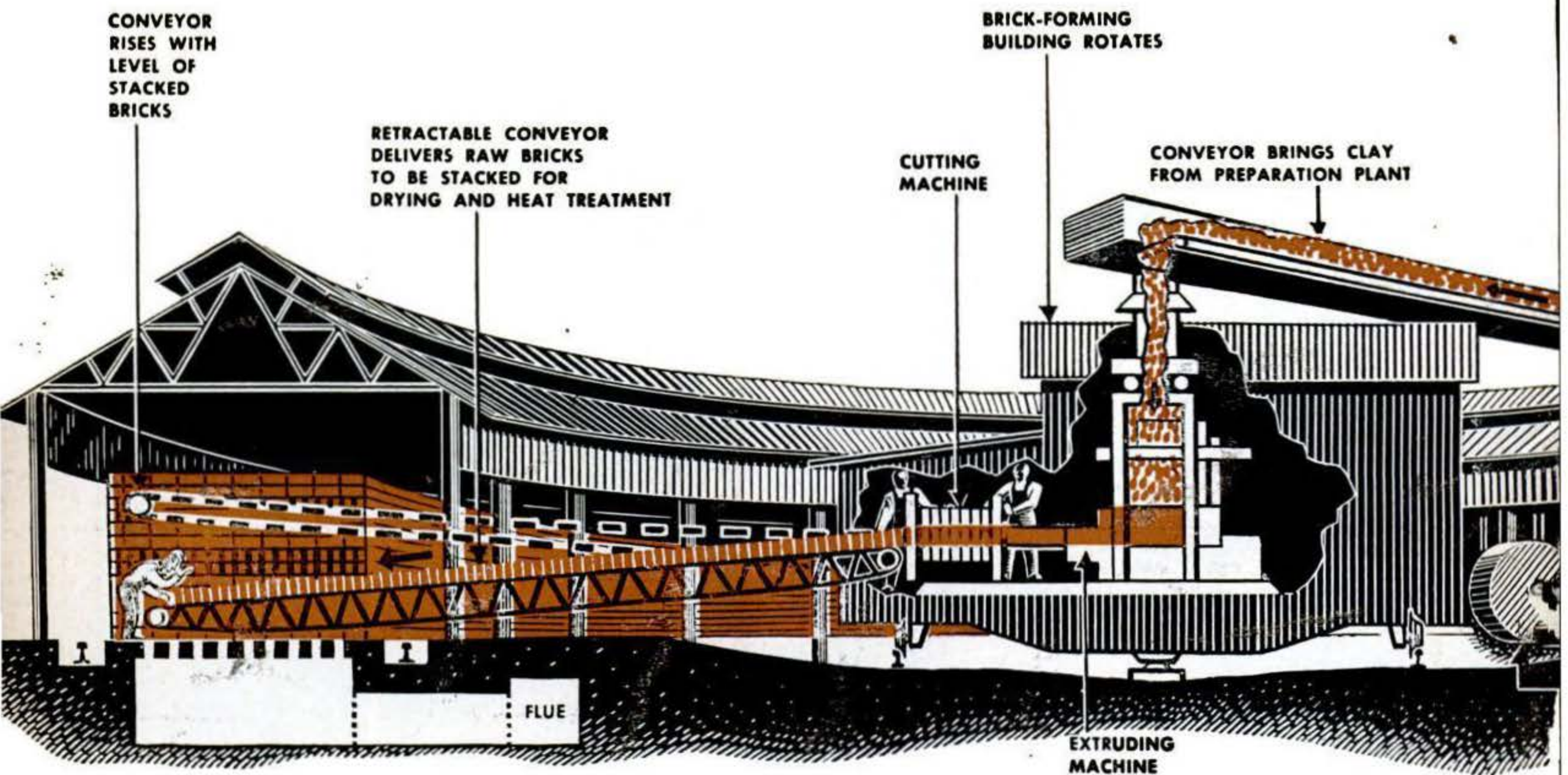

Raw bricks are made in central building, which revolves and delivers them by conveyor to each sector of ring for stacking and drying. Mean-

while, kilns of inverted-U shape are pulled by tractor around circle, baking stacks already dried. Result is assembly-line production. Photos of

Machinery travels in circles and a two-story building revolves to apply assembly-line methods in ring-shaped factory.

BELIEVED unique among the nation's 1,250 building-brick factories, a merry-go-round plant at Muirkirk, Md., has operated for 13 years almost unnoticed, since its odd design is conspicuous only from airplanes. In a ring-shaped structure of 140-foot overall diameter, traveling kilns ride a circular track to bake raw bricks to final hardness. A revolving two-story inner building forms the raw bricks from clay, and delivers them on a conveyor to any part of the ring.

Standard brickmaking machinery has been adapted to the circular assembly-line procedure. Mixed with water by the rotating knives of a pugmill, clay emerges from the extruding machine like toothpaste from a tube, and wires slice it into raw bricks. Heating in kilns serves to fuse minerals called fluxes in the clay, imparting rocklike hardness. Red bricks owe their color to oxide of iron, another common clay ingredient. At the Muirkirk plant, the Washington Brick Company produces 90,000 smooth red and textured bricks daily, selling most to contractors within 50 miles. **END**

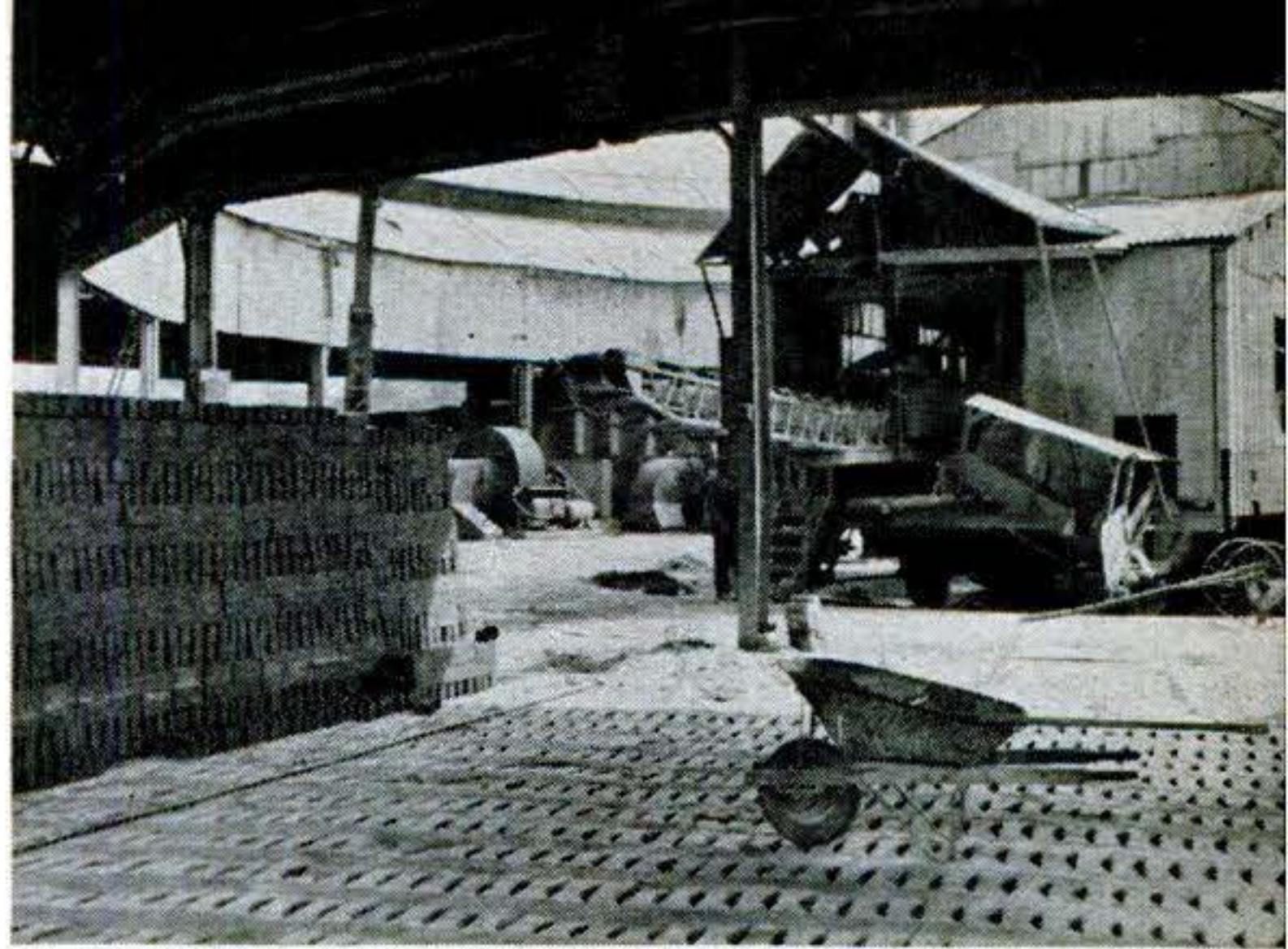

Lower conveyor of central building retracts to clear roof columns as building revolves. Then it extends to deliver raw bricks to workers, who stack them in piles as at left.

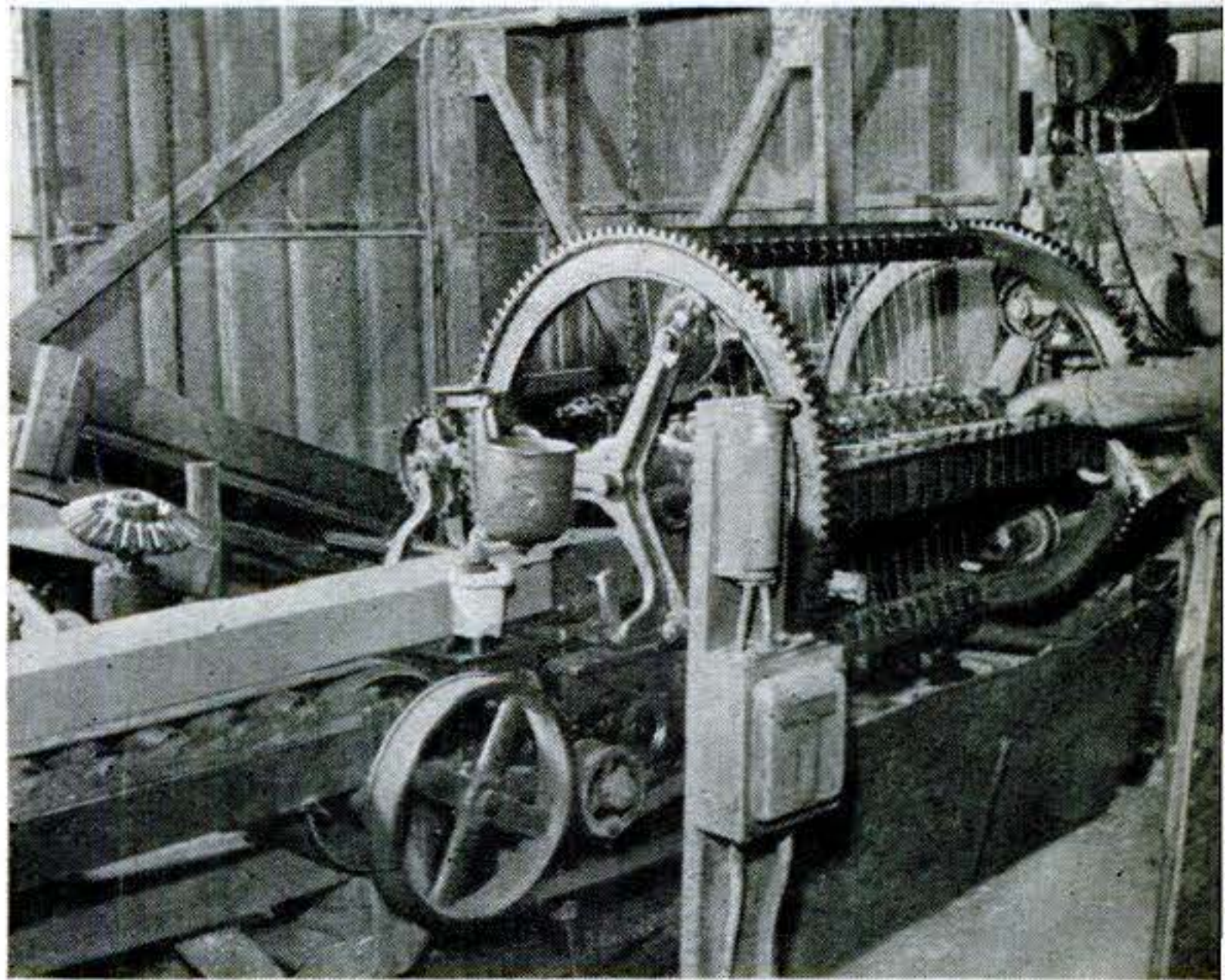

Just as wires in kitchen gadgets slice cheese or hard-boiled eggs, big cutter uses wires to slice raw bricks from a column of moist and plastic clay, seen entering from lower left.

KILNS, TRAVELING ON RAILS, APPLY HEAT TO STACKED BRICKS

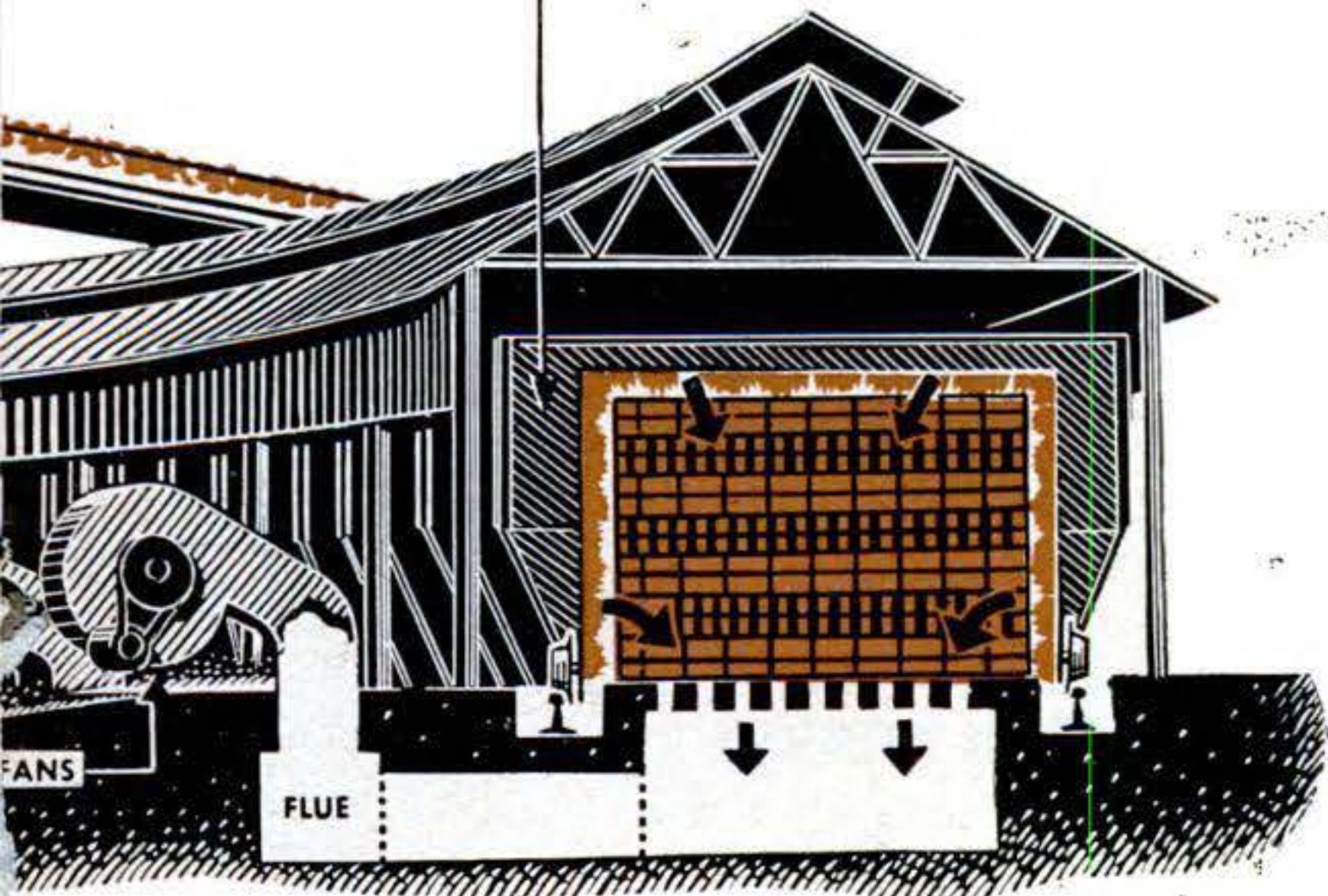

plant and data for text and drawing are from *Esso Oilways*, a publication of Esso Standard Oil Company, whose fuel oil heats kilns.



Traveling kilns (beneath roof) heat bricks 21 hours at 2,000°F. to harden them. Leftover hot air, blown through flues, dries and preheats bricks that await firing elsewhere in circle.



Big Pipes Sail to Work

SAN FRANCISCANS saw strange craft sailing in their bay recently. They were 480-ton pipes as big as boxcars. Each was a section of a pair of intake tubes that will carry cooling water 400 feet from the bay to a new Pacific Gas and Electric steam plant on shore. Bechtel Corp. engineers cast the concrete pipes on land, floated them to the right spot, and then opened valves to sink them into position.

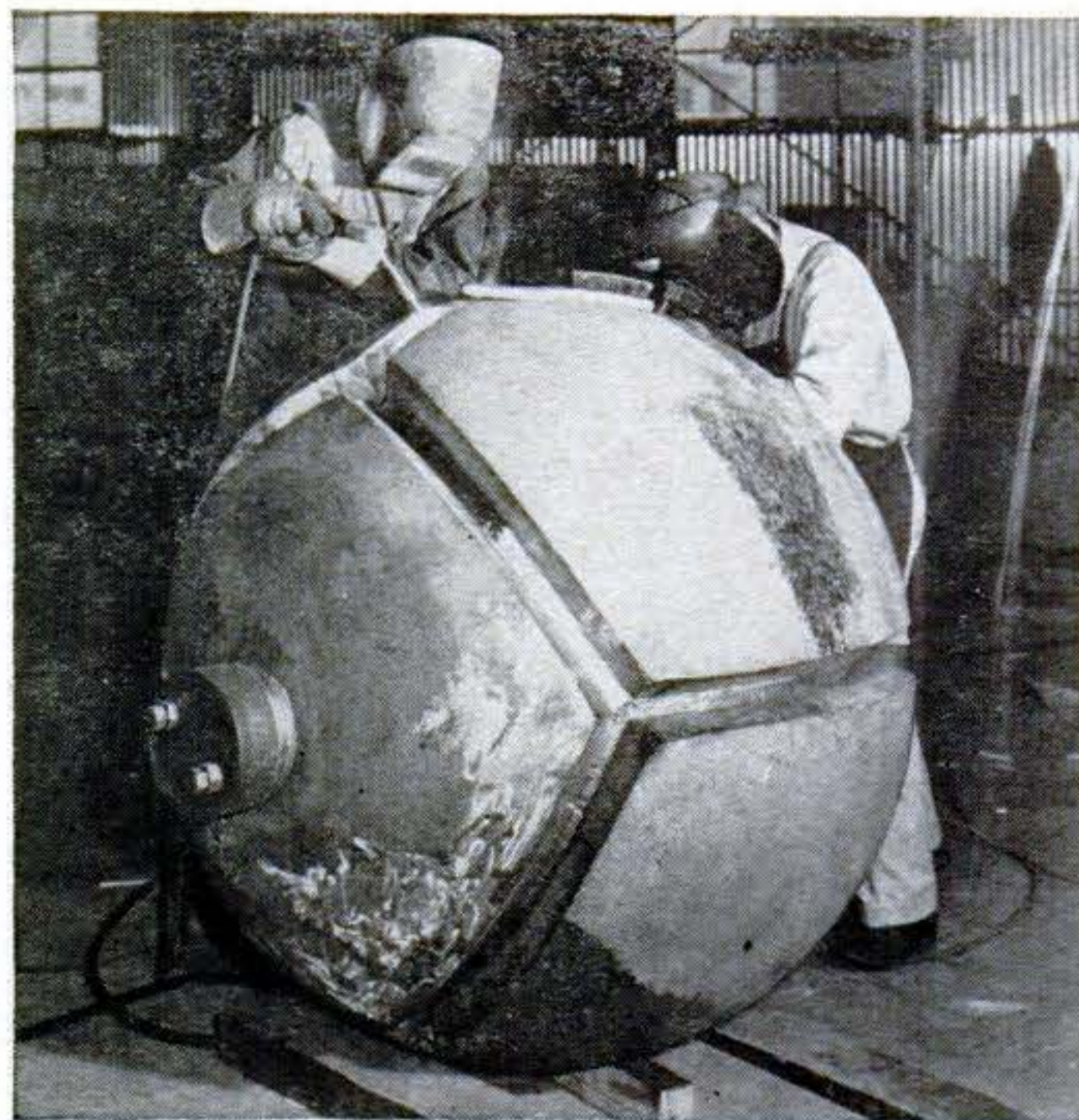

Steel Ball Stores Rocket Fuel

IT TOOK nearly a ton of welding rod alone to make this tank for rocket fuel. The tank must hold 200 gallons of liquid nitrogen—at a pressure of 5,500 pounds per square inch and a temperature of 340° below zero. Six extra-thick stainless-steel plates, pressed to the curved shape assumed by the faces of a blown-up cube, form the big ball. Research Welding and Engineering, South Gate, Calif., made the “Nitro-Sphere” tank.

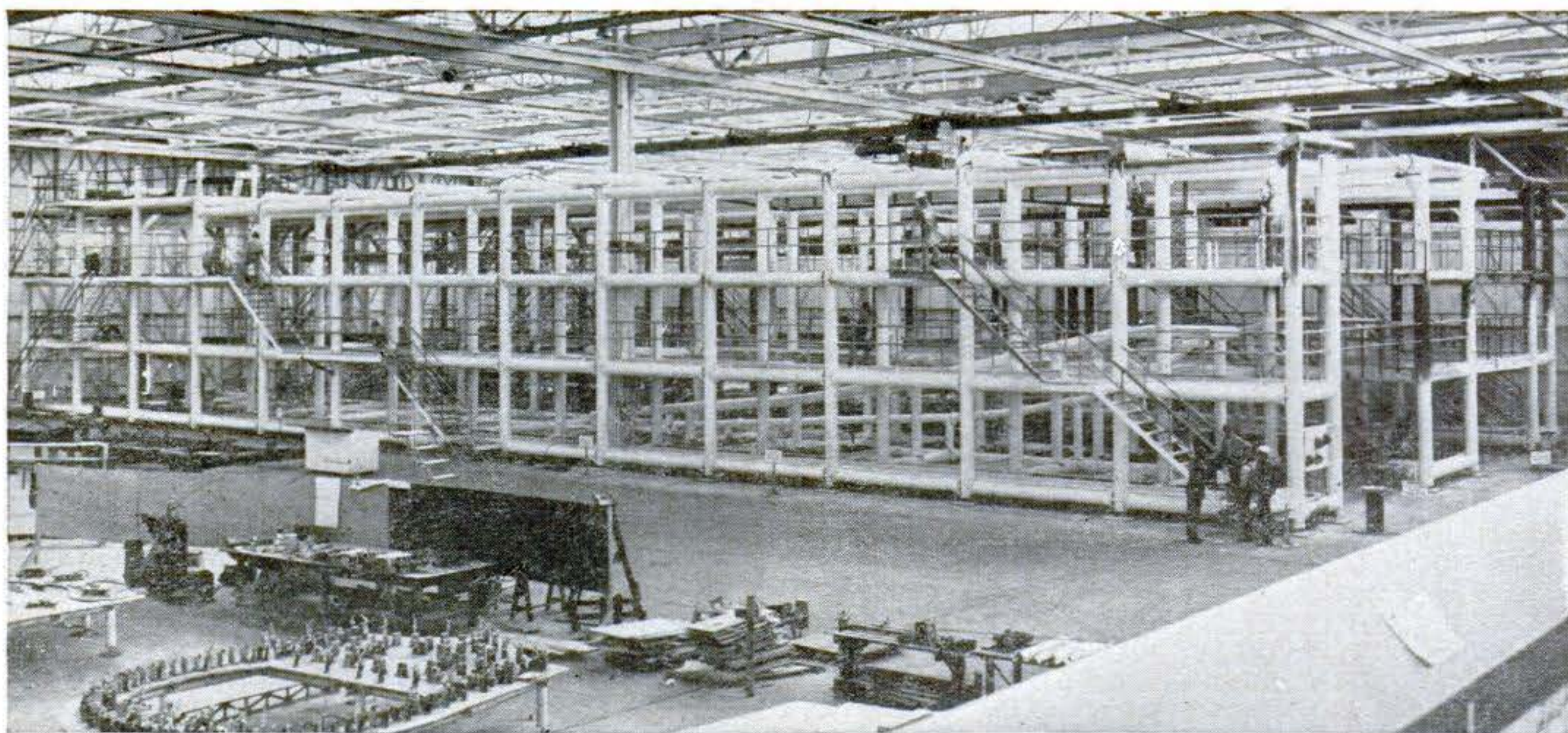

Indoor Drydock Cradles Two Big R3Y-1 Flying Boats

THIS maze of steel pipe four stories high is an indoor drydock for giant flying boats. Engineers call it a twin-hull buck. It holds two R3Y-1 turboprop planes during assembly at the Convair plant in San Diego.

Although the huge jig weighs about 1,000,000 pounds and contains 8,600 feet of 12-inch pipe, plus hundreds of feet of smaller pipe, it can be taken apart and reassembled in another location in a few days.



In stacking, scraped dishes are placed with soiled sides facing cleaning vane. Transparent glass cover locks automatically. Center rack holds silverware.

Portable Dishwasher Uses Water Like Brush

THE new James automatic dishwasher cleans by cascading a swirling two-foot-long wall of hot, sudsy water over its contents.

Hot water from a top spray first rinses dishes, then falls to the bottom where it is filtered clean again. A rotating vane then hurls waves of water against the dishes like

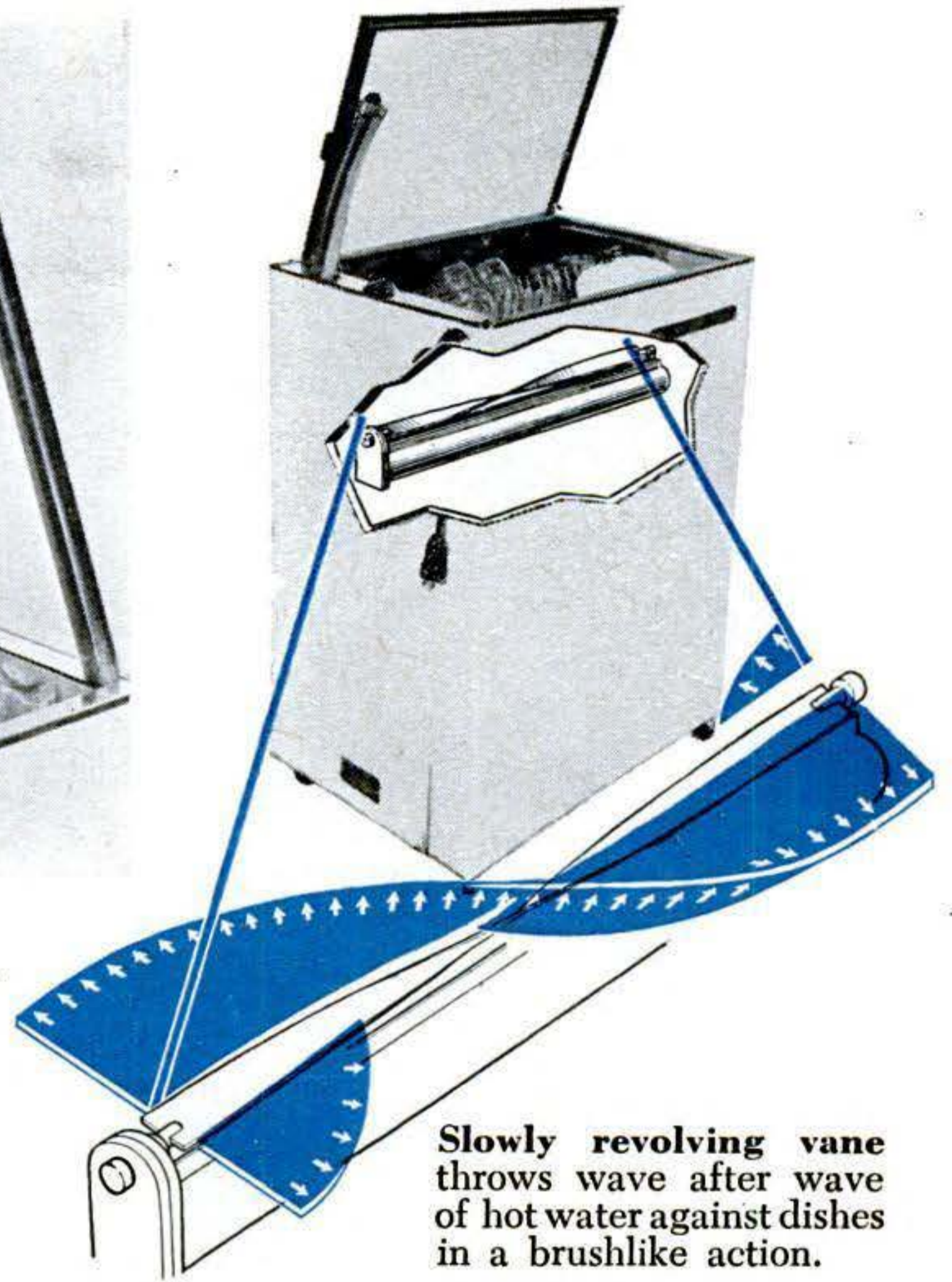

Slowly revolving vane throws wave after wave of hot water against dishes in a brushlike action.

a whirling brush. Two top sprays and two power rinses follow. The lid opens automatically to allow steam to escape to start drying. The machine uses only five gallons but recirculates them so that the dishes actually receive 500. Dale Distributing Co., of N. Y. City, sells the wheeled washer.

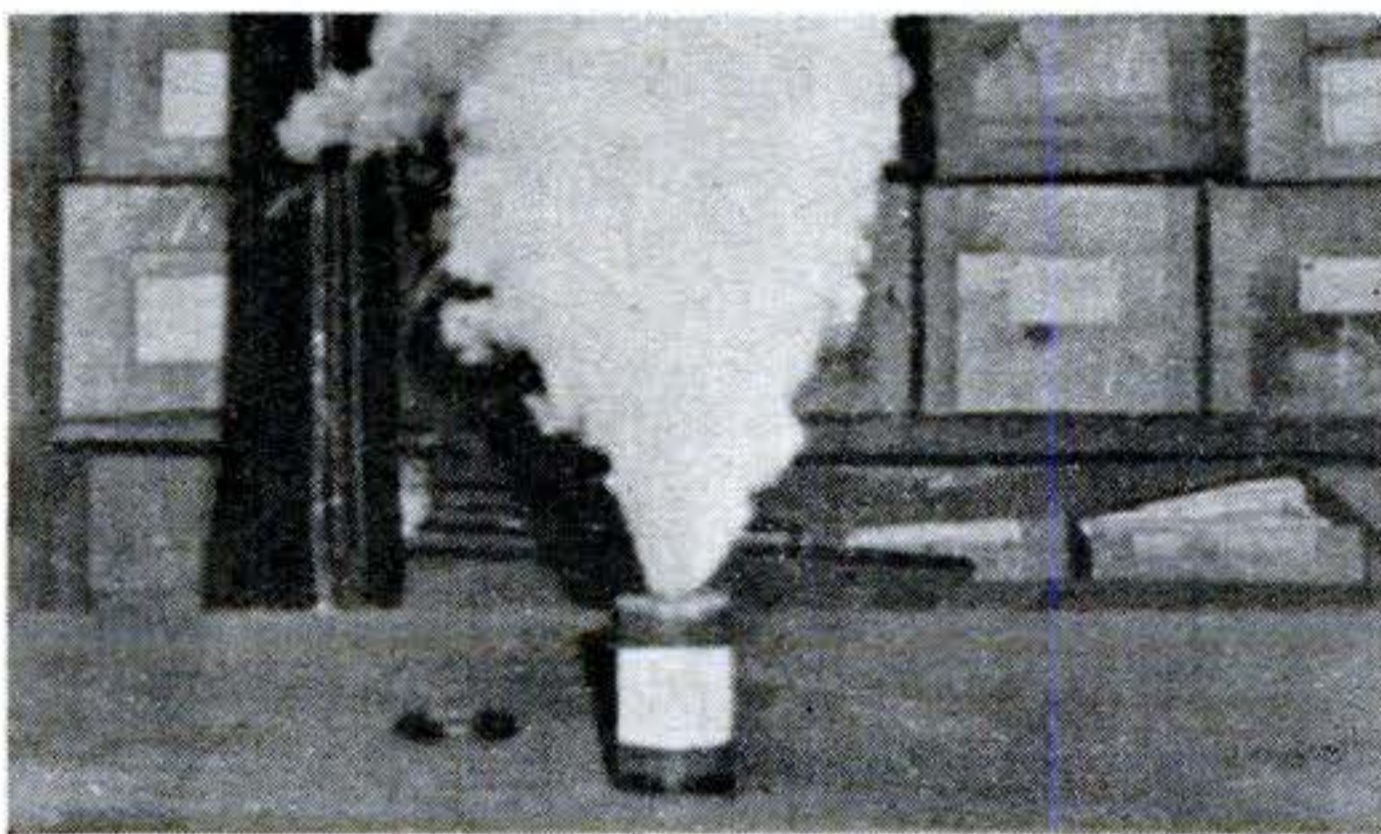

Steam Bomb Sprays Insecticide

THE new aerosol insecticide bomb above spreads DDT and chlordane crystals in a thick cloud of steam vapor and inert gases generated by dry chemicals. Set off by pulling a small tab, the cardboard Dispercide bomb is under no pressure when not in use and thus needs no metal container. Yosemite Chemical Co., San Francisco, makes it.

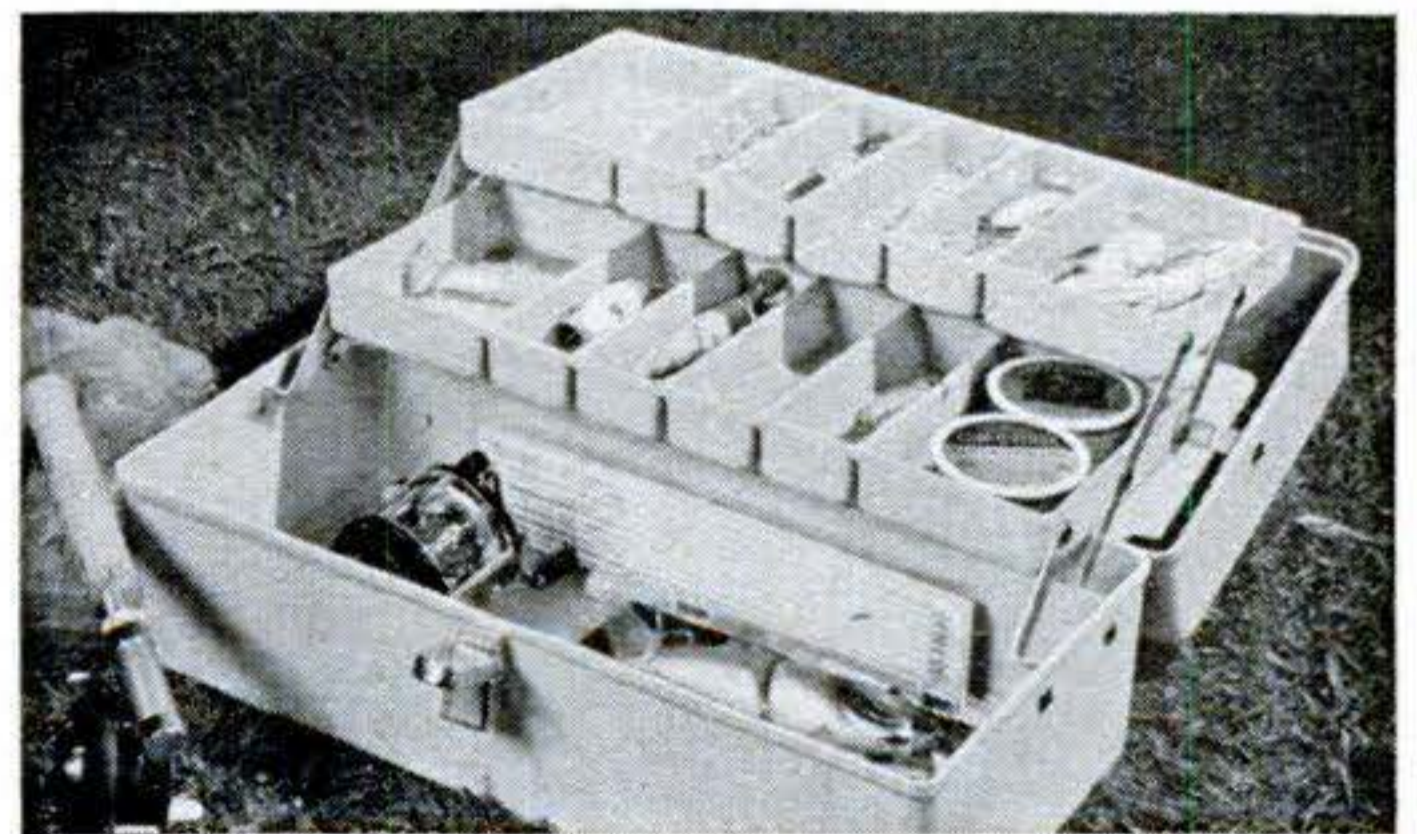

Fishing-Tackle Box Made of Glass

HERE'S a rugged fishing-tackle box that is said to be rustproof, permanently colored, and almost impossible to dent or damage. It's made entirely of Fiberglas, except for the rustproof hardware. The roomy Neptune has two cantilever trays and weighs five pounds. The Hamilton Metal Products Co., of Hamilton, Ohio, sells it for \$17.95.

I'd like to see them make...



Telephones with retractable cords. If the cords retracted into the phone base, the instrument would look neater and the twisting and snarling of the wires would be eliminated.—*Mrs. Ruth Brown, Brooklyn.*

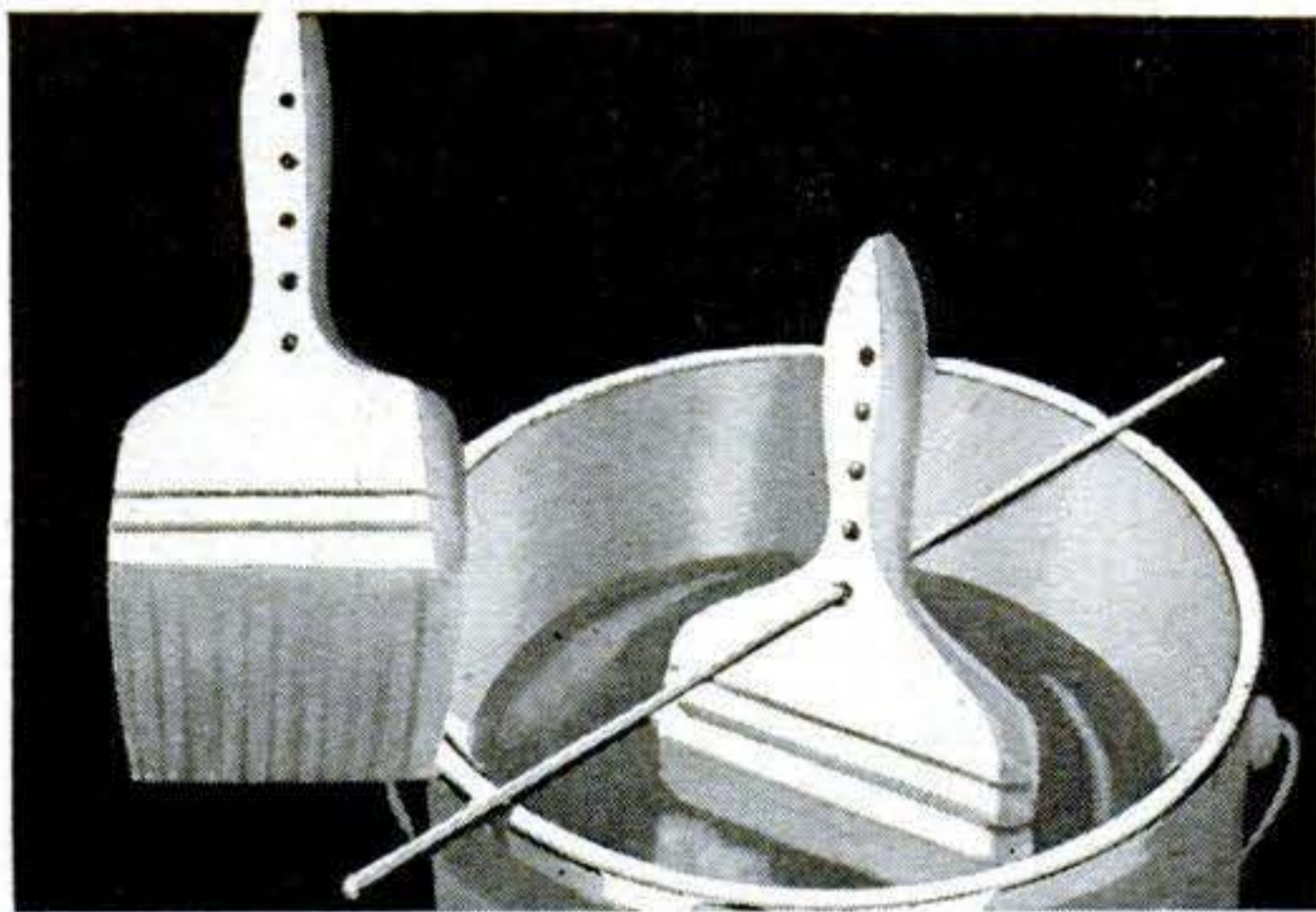

Paint brushes with holes drilled in the handles. When suspending brushes in paint or thinner, choice of holes would allow brush to be held high enough to keep it from resting on bristles.—*C. D. Brown, S. Miami, Fla.*

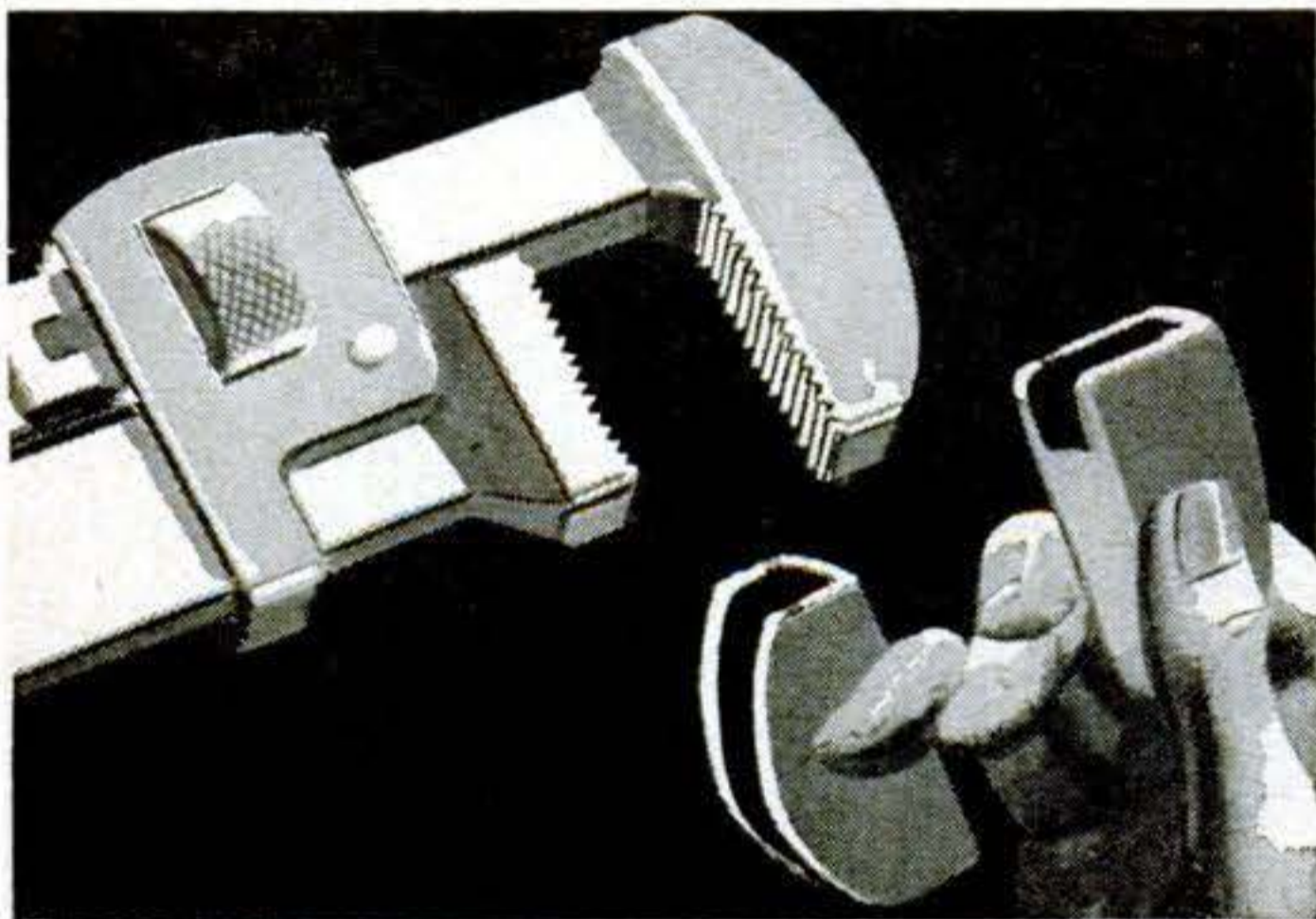

Removable rubber pads to fit over the jaws of regular pipe wrenches. Attach the pads and the wrench could be used on chromium-plated fixtures without danger of marring the finish.—*W. L. Peters, Kansas City, Kan.*

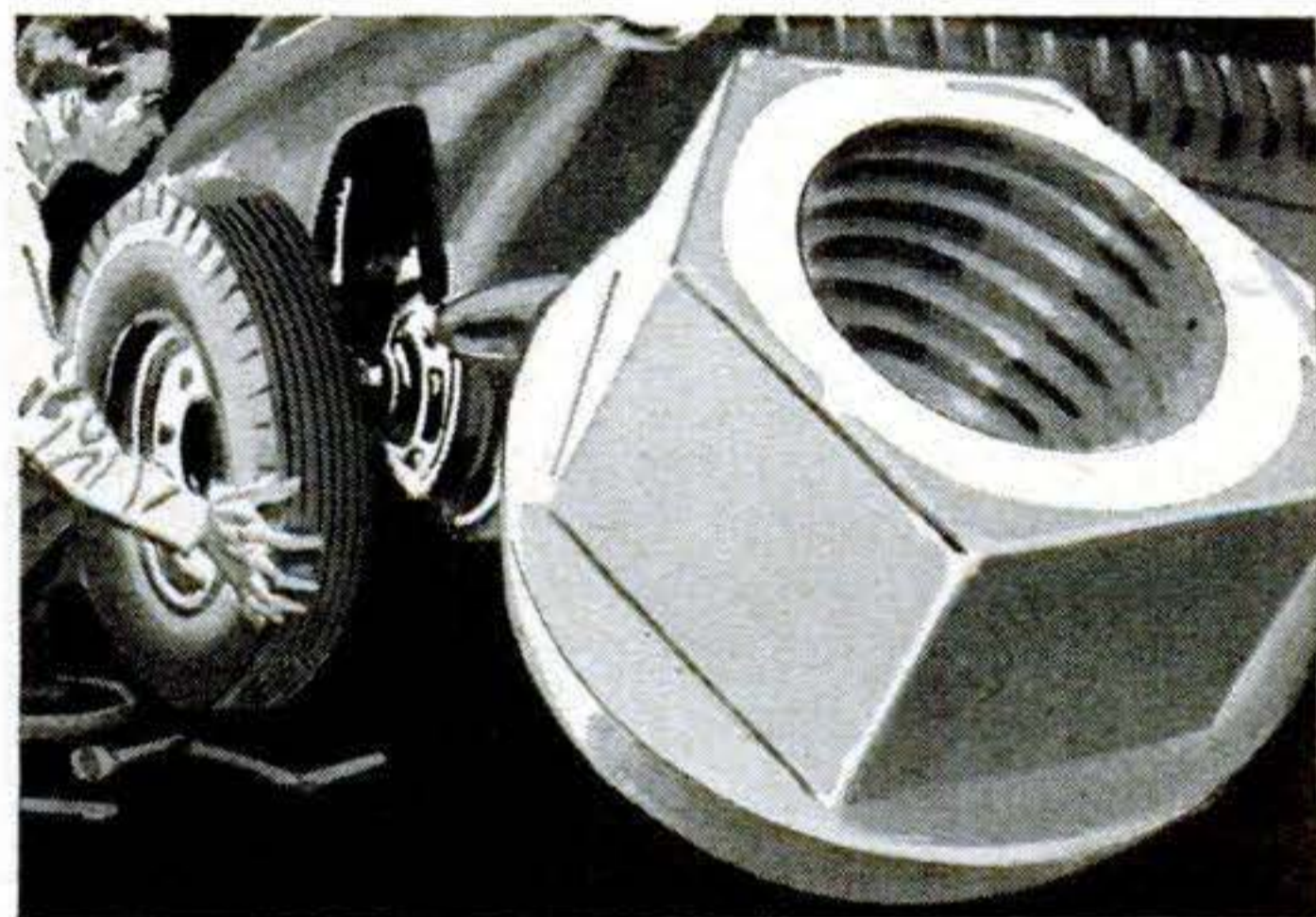

Auto wheel nuts with a flange around the centering-cone side. Then wrench won't fit if you try to install nut backwards, coned end out. A reversed nut won't center wheel, and may work off.—*J. C. Ropes, Stratford, Conn.*



A lid for electric-mixer bowls to prevent spattering. It could be made of plastic and slotted for beater shank to pass through. One large size would cover large or small bowls.—*Mrs. F. V. Winfrey, Williamsburg, W. Va.*

NOW They Make It . . .

Tire patches with tabs on the fabric separators that cover the sticky surface, suggested in Jan. '51 PS. Made by the Ace Rubber Co., Dallas, Texas, and the H. B. Egan Mfg. Co., Muskogee, Okla.



Everyone has his own pet idea of some gadget he would like to see in general use. What is YOURS? *Popular Science* will pay \$5.00 for each one published. Use government postcards only. Contributions cannot be acknowledged or returned.

MECHANICS *and* HANDICRAFT

REG. U. S. PAT. OFF.

Papering a Room

from A to Z

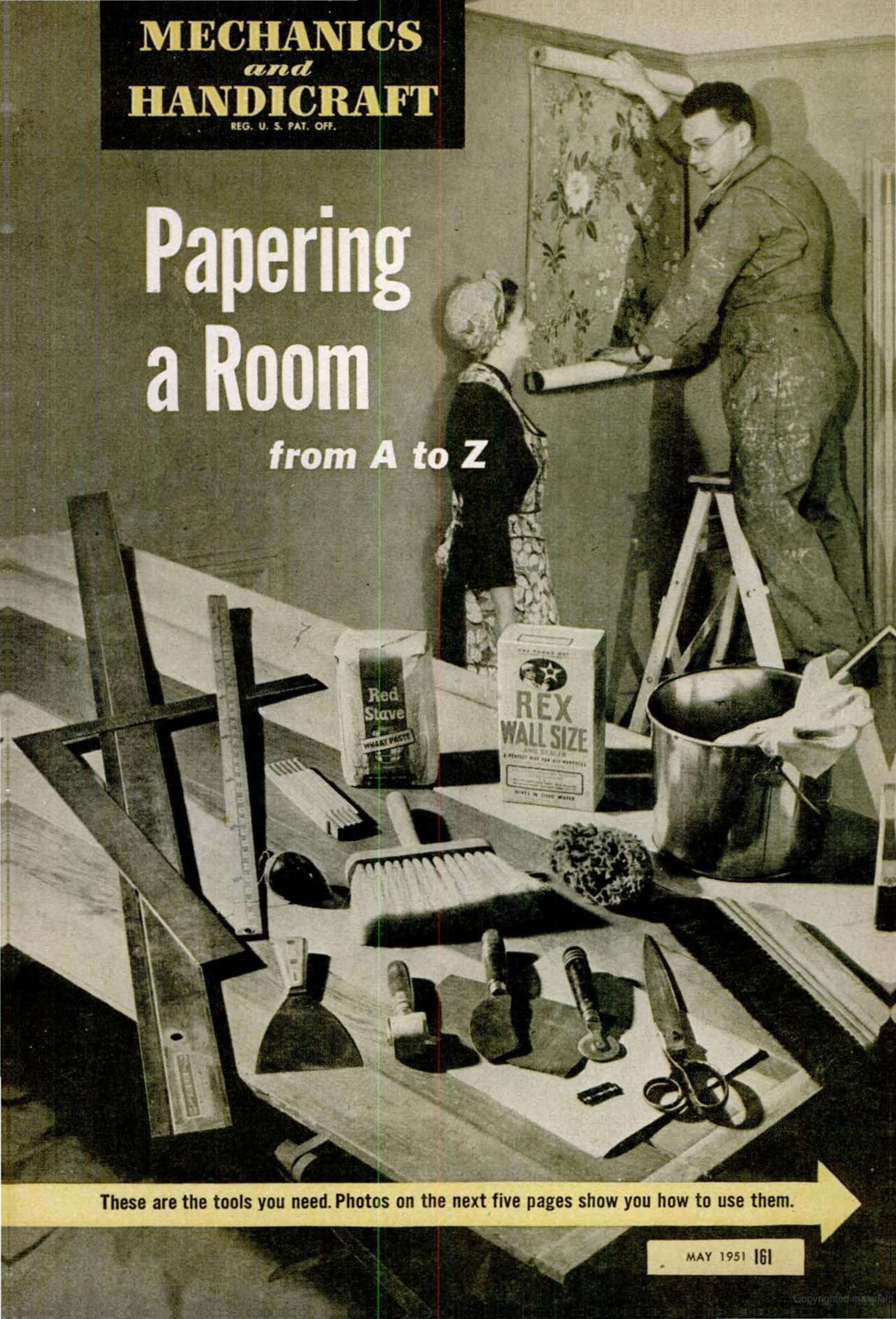

These are the tools you need. Photos on the next five pages show you how to use them.

MAY 1951 161

Putting up wallpaper yourself cuts the cost of redecorating —and it's not so hard to do, once you learn the hang of it.

By Bernard Gladstone

PS PHOTOS BY W. W. MORRIS

I HAVE just saved \$65 by repapering a hall, bedroom, and bathroom myself. There are tricks to hanging wallpaper, but these photos will show you most of them.

Preparing a wall. Fill cracks and holes with spackling putty and sand rough spots. If the surface has water-soluble paint on it—such as calcimine—wash it off. Wall-

paper will not stick well over water paint.

If the walls have a high-gloss paint on them, wash them with one part ammonia and four parts of water to dull the gloss. Then give the surface a coat of glue size.

Lining paper—a plain paper that goes underneath and keeps wallpaper from pulling apart at the seams—should be put up first if you intend to hang paper directly on fresh plaster. You don't have to use lining paper, however, when you paper



Measure wall from baseboard to ceiling and add 5" for waste. Then subtract the length of your table and mark the difference on the table. (In this case, it was 20".) You then can roll out a strip as long as the table and use the mark on the table to add the amount needed to cut strips the right length.



Determine how many single rolls you will need by finding how many square feet must be covered and dividing that figure by 30. Deduct one single roll for every three standard windows and every two standard doorways. Then tear off paper as shown, after first creasing where each strip ends.



Continue spreading paste until you've covered about 4' or 5' of the strip. Then pick up the pasted end by the corners, using your thumbs and forefingers as shown in this photo, and raise the end straight up.



Fold the pasted part back on itself as far as the pasted area extends. Smooth out any wrinkles. Slide the folded part sideways to line up the edges exactly. Then slide the folded part toward the end of the table to bring all of the unpasted part of the strip up on the table.

over old wallpaper. Be sure the old paper is tight. If it isn't or if there are several layers, apply hot water and scrape it off.

Incidentally, most wallpaper is sold in double rolls to save waste, but don't let this confuse you. You'll figure in single rolls, and if you need an odd number, your dealer will cut apart a double roll.

Tools. Those you will need are shown on the first page of this story. Many wallpaper stores will rent you the tools. A 3' by 8' sheet of plywood topped with Masonite and laid on saw horses makes a table.

Joints. You have a choice of three kinds

of seam. For a lap joint, trim only one edge of the paper and overlap it about $\frac{1}{4}$ " over the strip previously hung. For a wire-edge joint, do the same with about a $\frac{1}{16}$ " overlap. For a butt joint, follow the instructions given with the photographs. A butt joint looks much better and is only a little harder.

If you use a lap joint, start hanging paper from the lighted side of the room. Then the lapped joints won't cast shadows.

Corner cutting. Measure the distance between the last strip and the corner. Trim the next strip to this width plus 1". Hang this strip, folding 1" around the corner.

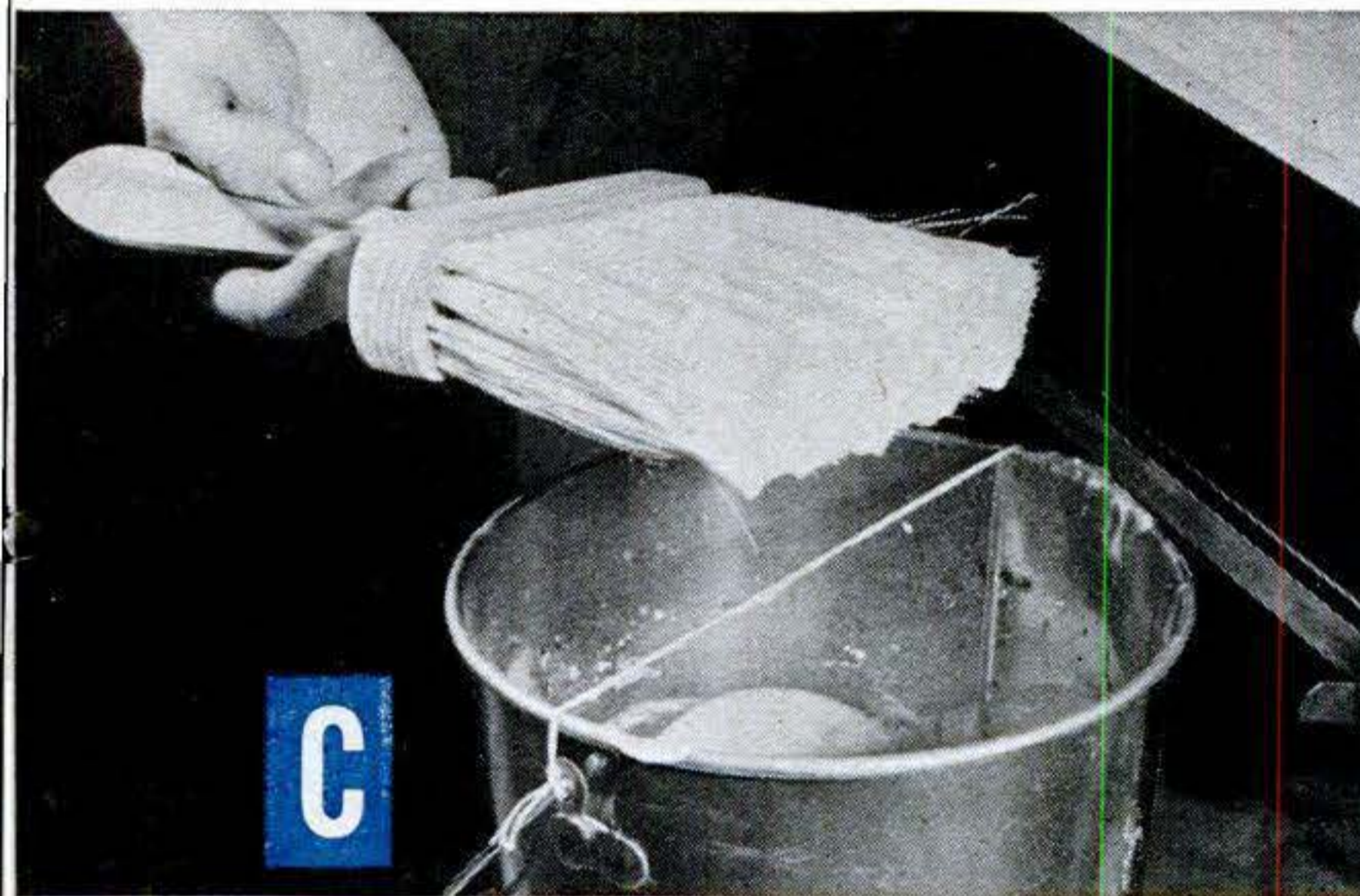

C Tie a cord across the top of your paste bucket. It will serve as a rest for the paste brush. Mix your paste according to the directions on the package. Stir it until it is smooth, creamy, and free of lumps. Then set the bucket on a box or stool near the end of the table to avoid bending.



D Square one end and an edge of the paper with a side and an end of the table. Spread the paste on evenly from right to left and from the center to the edges. Avoid running paste onto the table where it will smear the pattern. Keep a damp rag handy, and wipe off the table immediately whenever you get any paste on it.



G Apply paste to the rest of the strip and fold it back on itself as you did the first part of the strip. Bring this end down to meet the other end of the strip. Having a good table helps; you can rent one in many communities.

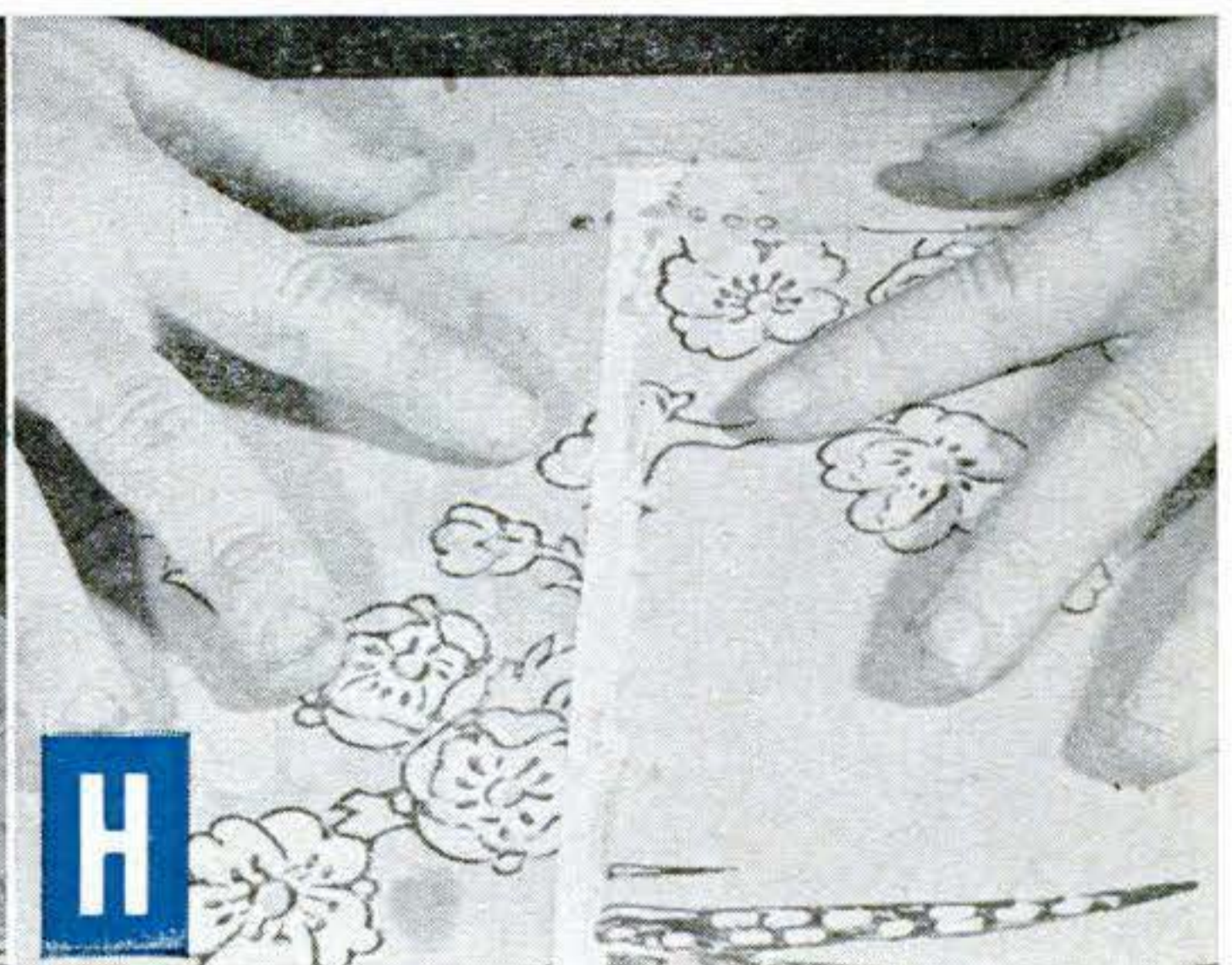

H Bring the ends of the folded parts together evenly. Then line up the edges of the folds with each other. The edges of the folds must be lined up exactly so the edges of the strip will be straight after trimming. Smooth out wrinkles or bubbles. [Continued on next page.]



I Lay your straightedge along the edge of the folded strip. Line up the straightedge with the trim marks on the paper. If there are no trim marks, measure the distance from the edge of the paper to the straightedge at each end of the strip. The straightedge must be parallel to the edges of the paper.

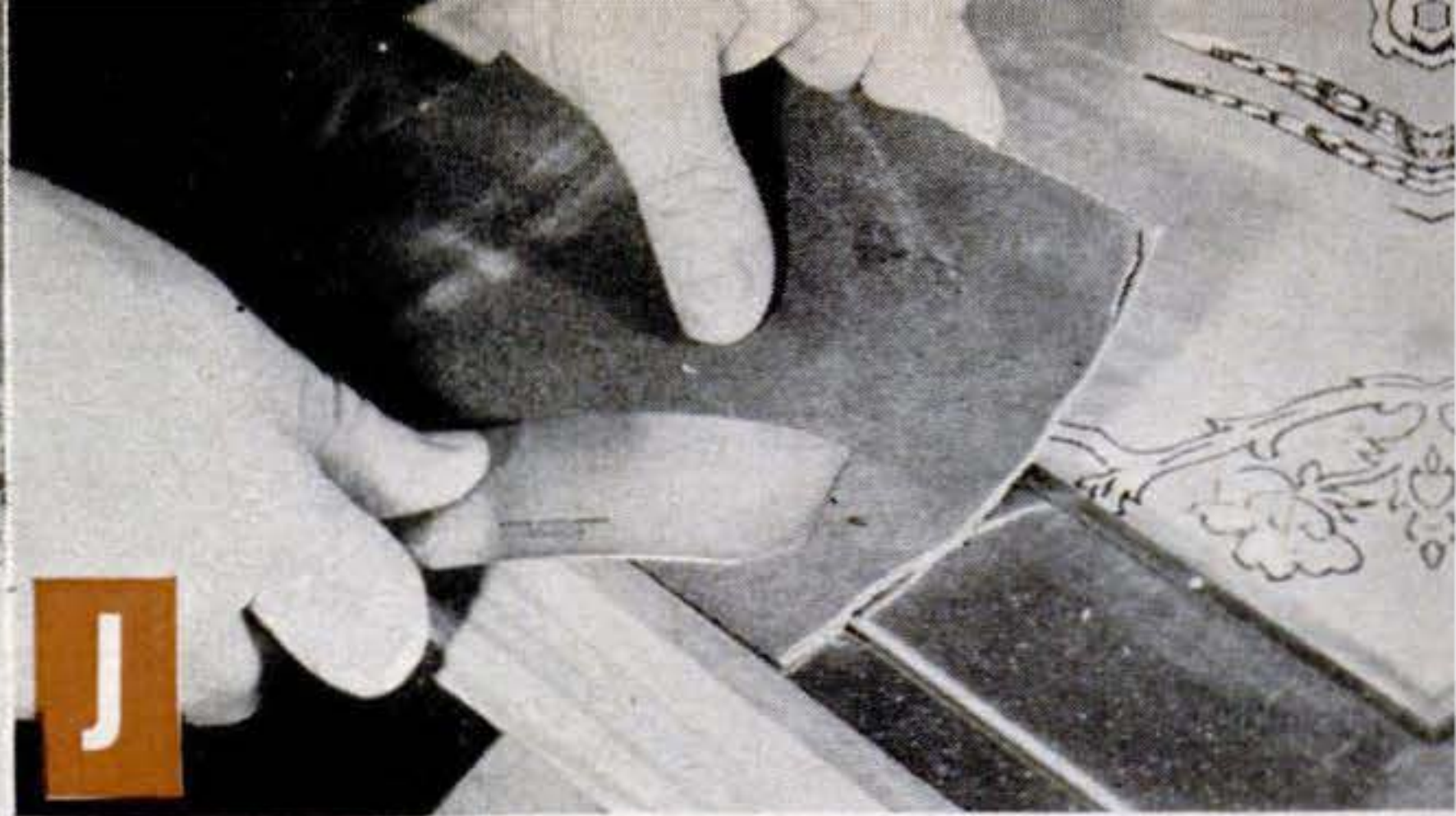

J Make sure your trimming knife is sharp. Keep a piece of fine emery cloth handy. Sharpen the knife on the cloth after you have trimmed every three or four strips of wallpaper. And keep a carton beneath the table into which you can throw wet trimmings.



M Mount your stepladder carefully, holding the strip only by the corners and supporting it with the other fingers just as you picked it up. Hang the first strip in an inconspicuous corner or next to a door or window, where a mismatch when you finish will be less noticeable.



N Place the top edge of the paper on the wall where it meets the ceiling. While still holding the top edge with thumbs and forefingers, let go with the other fingers. The lower part of the strip will drop. Catch it with your foot so the sudden jerk doesn't tear the wet paper. The bottom part will remain folded.



Q Unfold the lower fold after you have worked down to it with the smoothing brush. Reach under the fold, grasp the edge, and peel it down. With the lower fold opened, finish smoothing the strip all the way down to the baseboard.

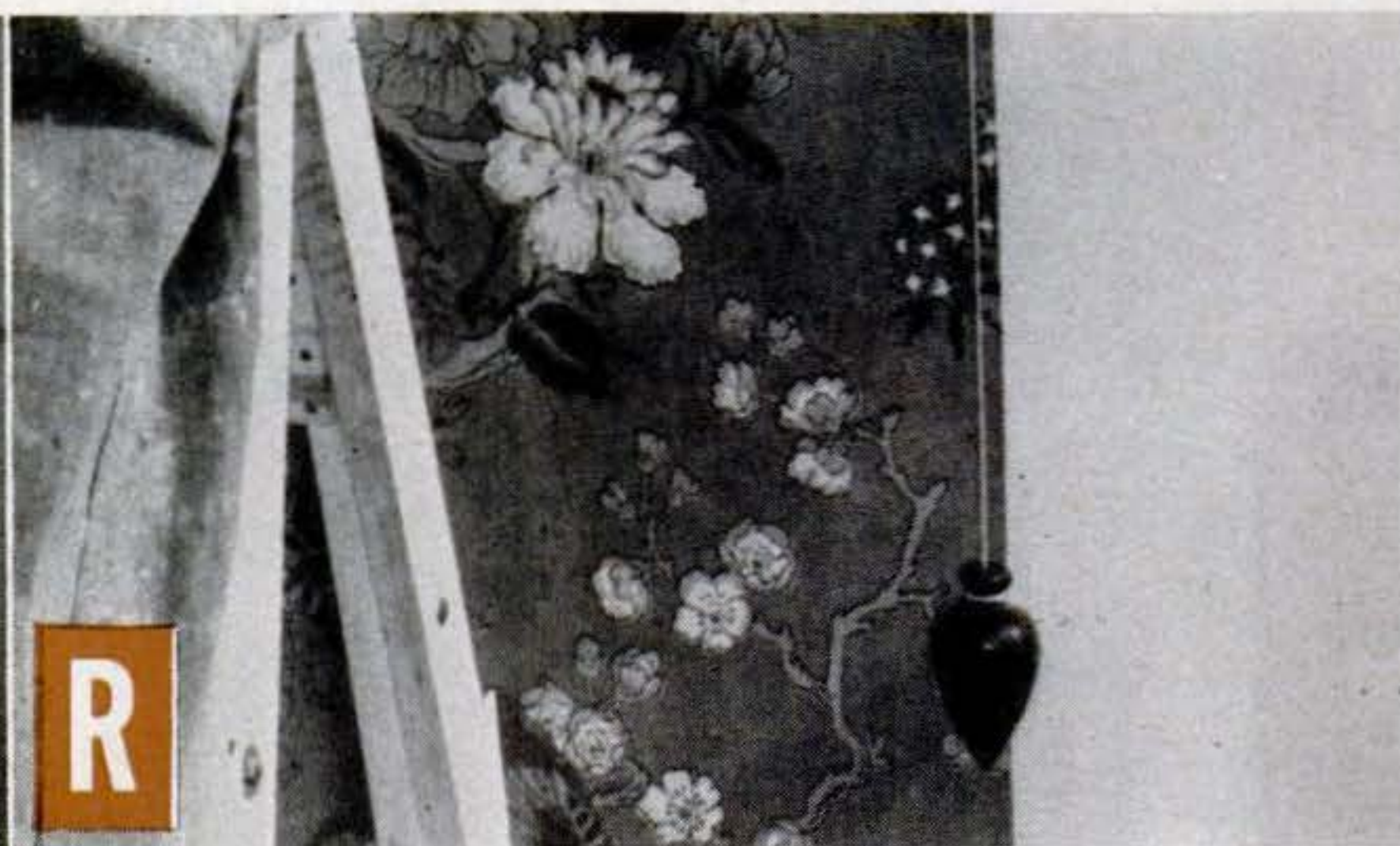

R Plumbing the first strip comes next. This is important. Frequently the starting point—a window or door frame—is not exactly plumb. The first strip acts as a guide for the whole wall. If you find that the first strip is not plumb, place your palms on it and slide it to the left or right until it is plumb.



K Press down hard on the straightedge with one hand to keep it from slipping. Hold the knife against the straightedge and keep the cutting edge perpendicular to the paper. Exert enough pressure to make the cut in one smooth stroke. Then turn the paper around on the table and trim the other edge in the same way.

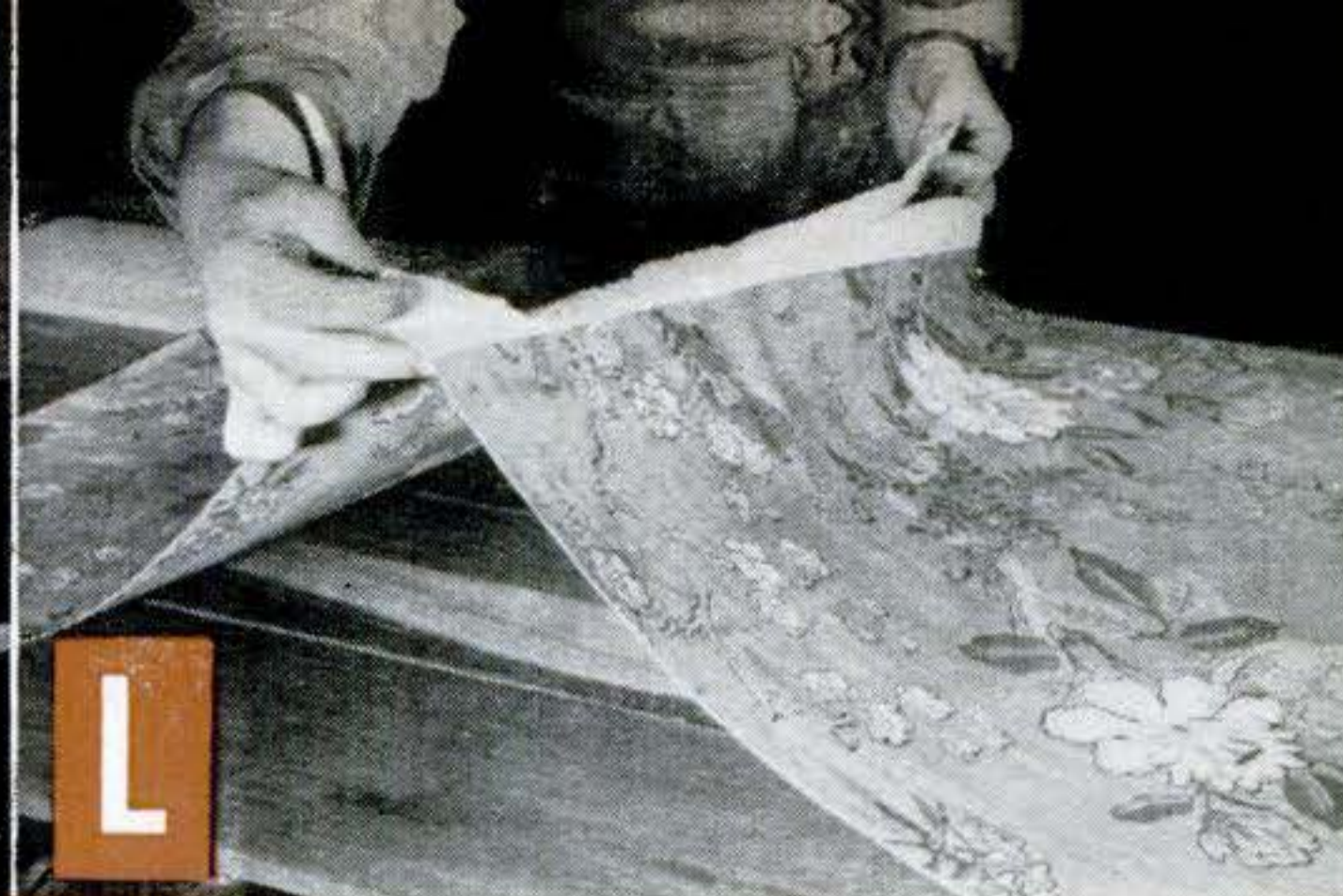

L Pick up the pasted and folded strip by grasping it at the edges right at the point where the ends meet. Peel back one end slightly and hold the corners by thumbs and forefingers. Use the other fingers to support the strip. *Warning:* Make sure the corners you pick up are the top corners of the strip.

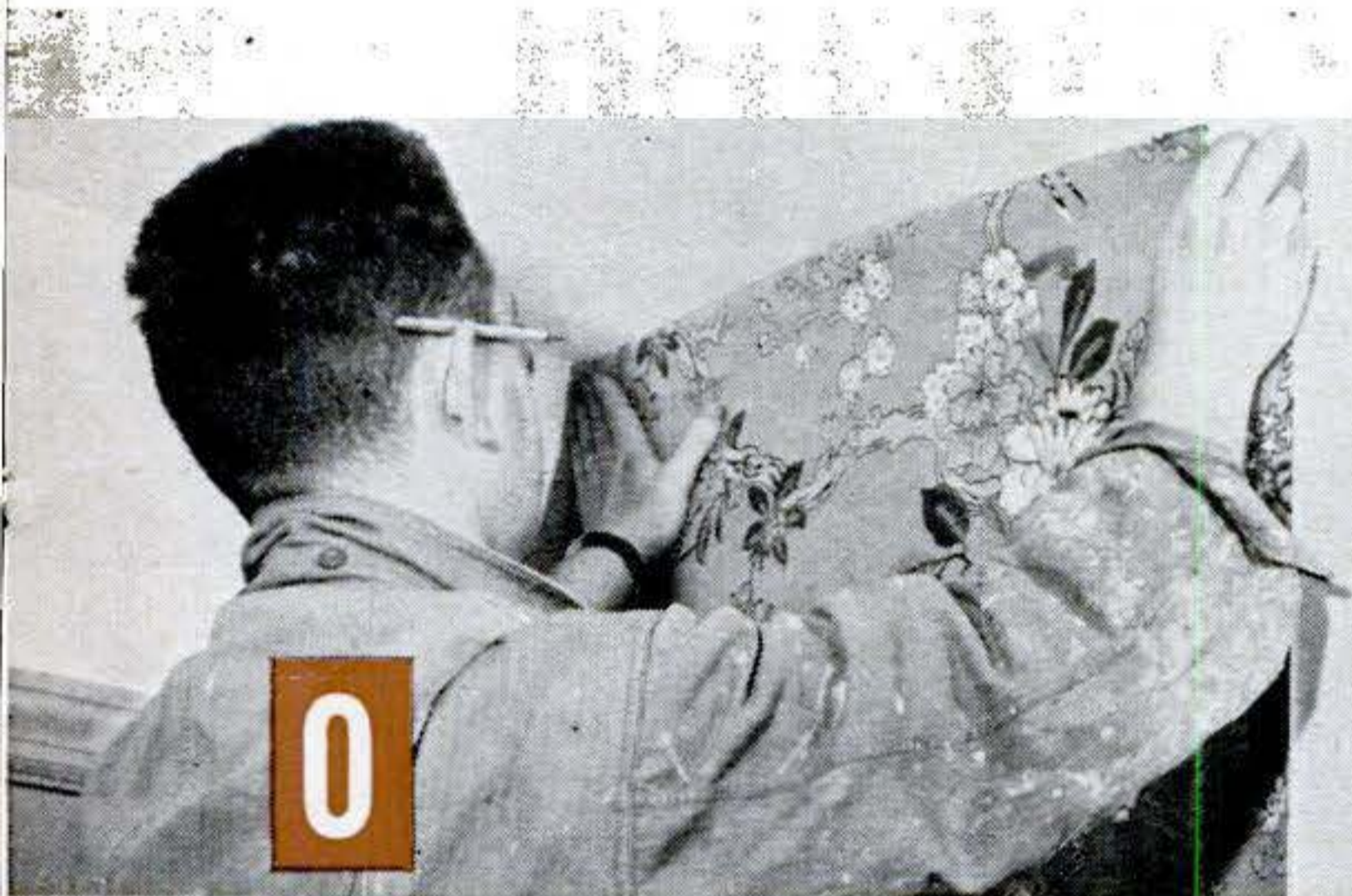

O Press the top of the paper against the wall. Lap it on the ceiling or picture molding. Line up a vertical edge with a door or window frame or a corner. Lap the vertical edge on the frame or into a corner.



P Start at the top and use your smoothing brush to smooth out all wrinkles and air bubbles. Work with diagonal strokes from the center out to the edges of the strip of wallpaper.



S Use your smoothing brush to crease the paper sharply against the top of the baseboard. In the same way, crease the paper into corners and into the angle where walls meet ceiling.



T Trim off waste by running your casing wheel along the line where baseboard meets the wall. Then trim excess at the ceiling and along door or window frames. Use a sponge to get excess paste off woodwork and the face of the paper. Clean the sponge by washing it frequently in running water. [Continued on next page.]



U

Match pattern before cutting second strip. Hold roll against strip already on wall to find point near top where pattern matches. With some patterns, you may have to waste up to half a pattern. But usually you can avoid this waste by cutting second strip from a different roll, and the third strip from the first roll, etc.



V

Measure off and cut the second strip. Paste and trim the strip. Start hanging it at the ceiling. Butt the edge of the second strip against the edge of the first, carefully matching the pattern as you work your way down. Take your time and slide the paper up or down to make the pattern match exactly.



W

Use your seam roller after you have hung three or four strips. Start at the first seam and roll each one. Roll with long strokes and moderate pressure. If you press too hard you may cause a shiny streak to appear when the paper is dry. If the roller forces out any paste, wash it off at once with your damp sponge.

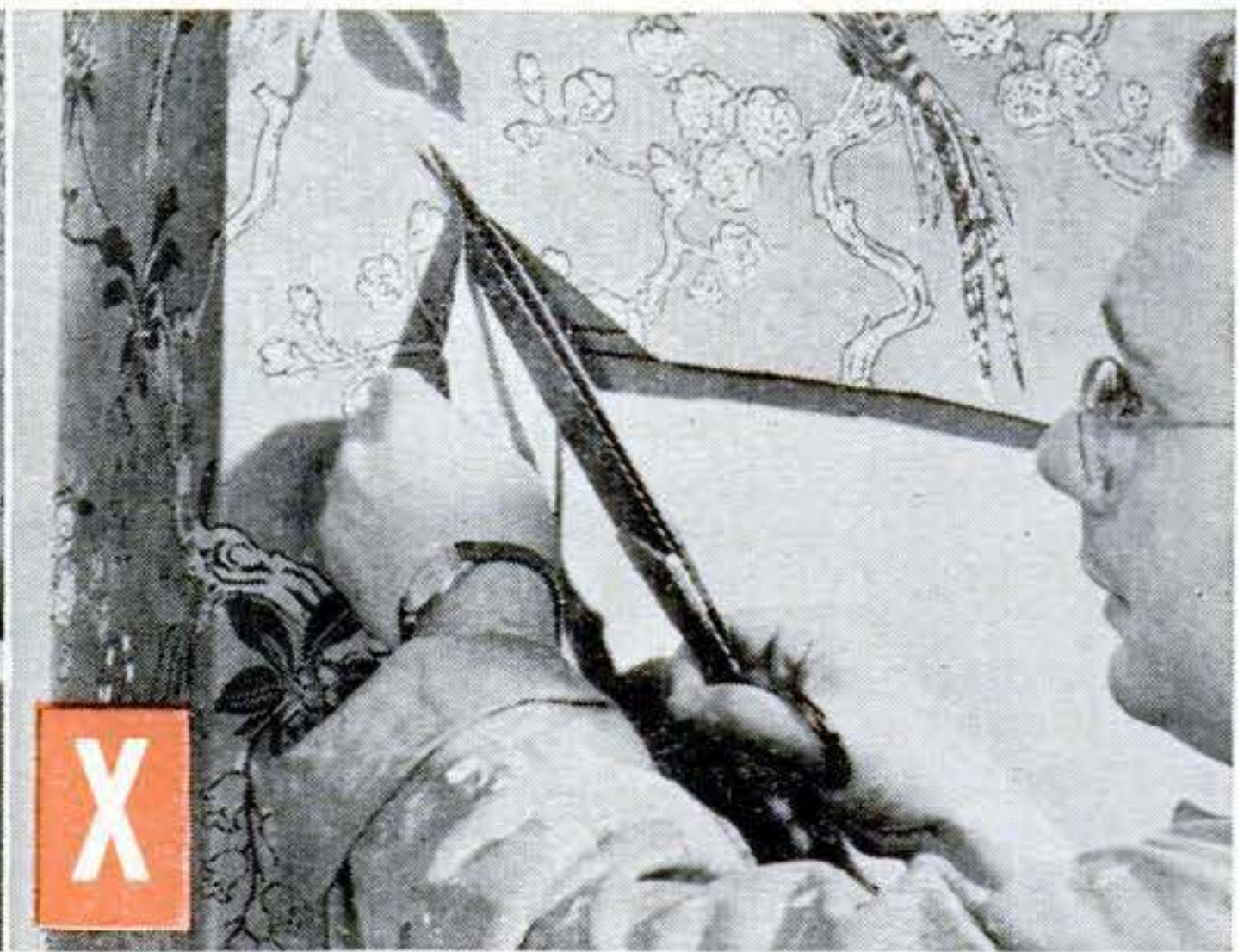

X

Trim around window and door frames with shears. Use the casing wheel to finish up trimming along the edges and tops of frames. Cut the short pieces for above and below windows from the same roll of wallpaper. Keep the casing wheel sharp by stroking it frequently on the emery cloth.

Hang ceiling paper first in rooms where both walls and ceilings are to be papered. Use a smooth wooden bar (a yardstick will do) to help support one end of the strip while your other hand works it into place. Allow the paper to lap the sidewalls about $\frac{1}{2}$ ". The paper on the walls will later cover this lap.

Press one end of the strip into place and then use your smoothing brush to smooth out the rest of the strip. Roll seams and sponge off excess paste just as on walls. An amateur should not attempt a large ceiling without a helper.

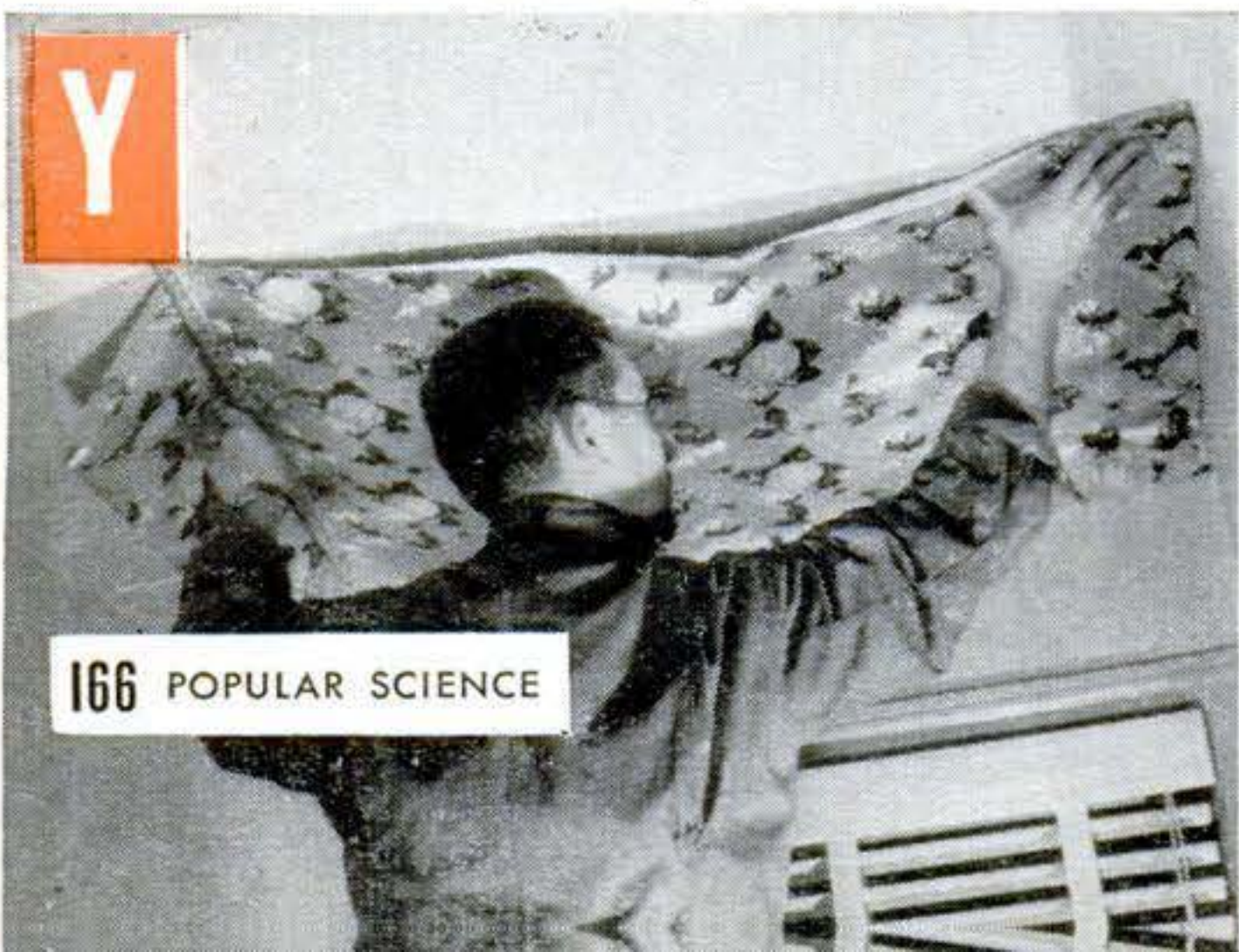

Y



Z

Lightning vs. Television

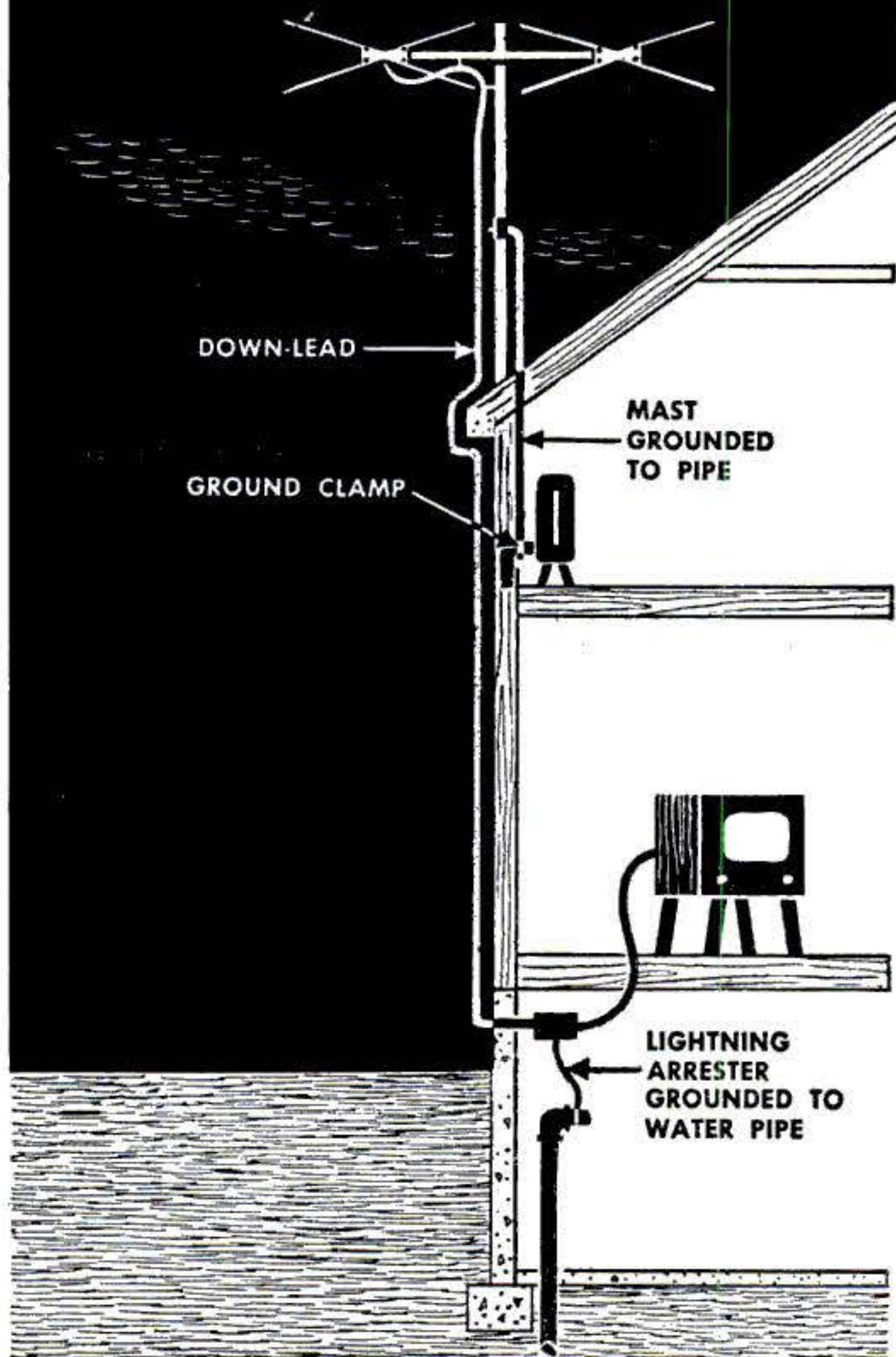

**Does the antenna endanger your home?
Can you install adequate protection?**

MANY POPULAR SCIENCE readers have worried about lightning since putting television antennas on the roofs of their homes. Here are their questions—and the answers:

Should lightning protection be provided when an antenna is put up?

Yes. It costs little, and is required by electrical codes in most communities.

Have many homes been damaged because of a lack of such protection?

No, possibly because TV antennas have been concentrated in cities where tall buildings act as lightning rods. Only fairly recently have TV antennas begun to appear in areas where the lightning hazard is great-

est. It is difficult, moreover, to determine whether a TV antenna is responsible when lightning does strike.

Should an arrester be used on an antenna mast?

No. The mast should be well connected to a good ground. A water pipe is best.

What about the lead-in?

A lightning arrester should be used with an unshielded ribbon lead-in. When a coaxial cable or shielded down-lead is used, the arrester can be omitted and the shield grounded.

Where should the arrester be put?

At the point where the down-lead enters the house. It may be either inside or outside but should not be near any combustible material. An arrester connected at the mast end of the lead offers no protection against induced charges that hit the wire below.

What kind of arrester should I use?

A double arrester that protects both leads. If you can only get the single type, use one in each lead. Underwriters Laboratories test arresters for safety and proper performance. Look for the UL label.

Can I install an arrester myself?

Yes. Most approved TV arresters are made to fit ribbon lead-in. Just slide the wire in and tighten the screws or nuts as directed. With most types, you do not have to cut the wire or even strip the insulation. The center lead or clamp must be grounded.

Is a vent or soil pipe a good ground?

No. Neither is a fire escape. (Non-conductors are often used at the joints.) But the metal frame of a building, electrical conduit, or any underground piping system is a good ground. If necessary, you can bury metal rods or plates deep in the earth.

What size wire should be used for the ground connection?

Electrical codes specify sizes from No. 14 to No. 4. The heat generated by a lightning bolt will melt almost any wire, but the wire will do its job before it falls apart. Number 14 is adequate. It should be clamped—not looped or soldered—to the ground.

Does an arrester affect a set's operation?

Some arresters may weaken the signal in some cases. Reverse the receiver's AC power plug if this happens.

Should a set be turned off during a storm?

Not unless you're the nervous type. Turning it off may reduce the chances that your set will be damaged, but does not affect an antenna's vulnerability to lightning. **END**

Dehumidifier Reactivates Itself



THERE are no chemicals to replace, nor is there any drip pan to empty, in this new air dryer. It is designed to combat condensation and mildew in basements, "crawl spaces," and cottages closed for long periods.

Humid air is drawn past a dust filter through silica gel, where moisture is adsorbed. After 90 minutes, a valve closes the dry-air outlet, and a wet-air outlet opens. An electric heater then turns on and adsorbed moisture is discharged as warm-water vapor to the outside. After half an hour, the valve shifts back to drying position. Daly, Merritt & Sullivan, of Falls Church, Va., makes it. The \$125 price includes air hose, clamps, and window panel. A humidstat controller is available.

Here's a Trick that Often Helps When You Must Glue Small Pieces

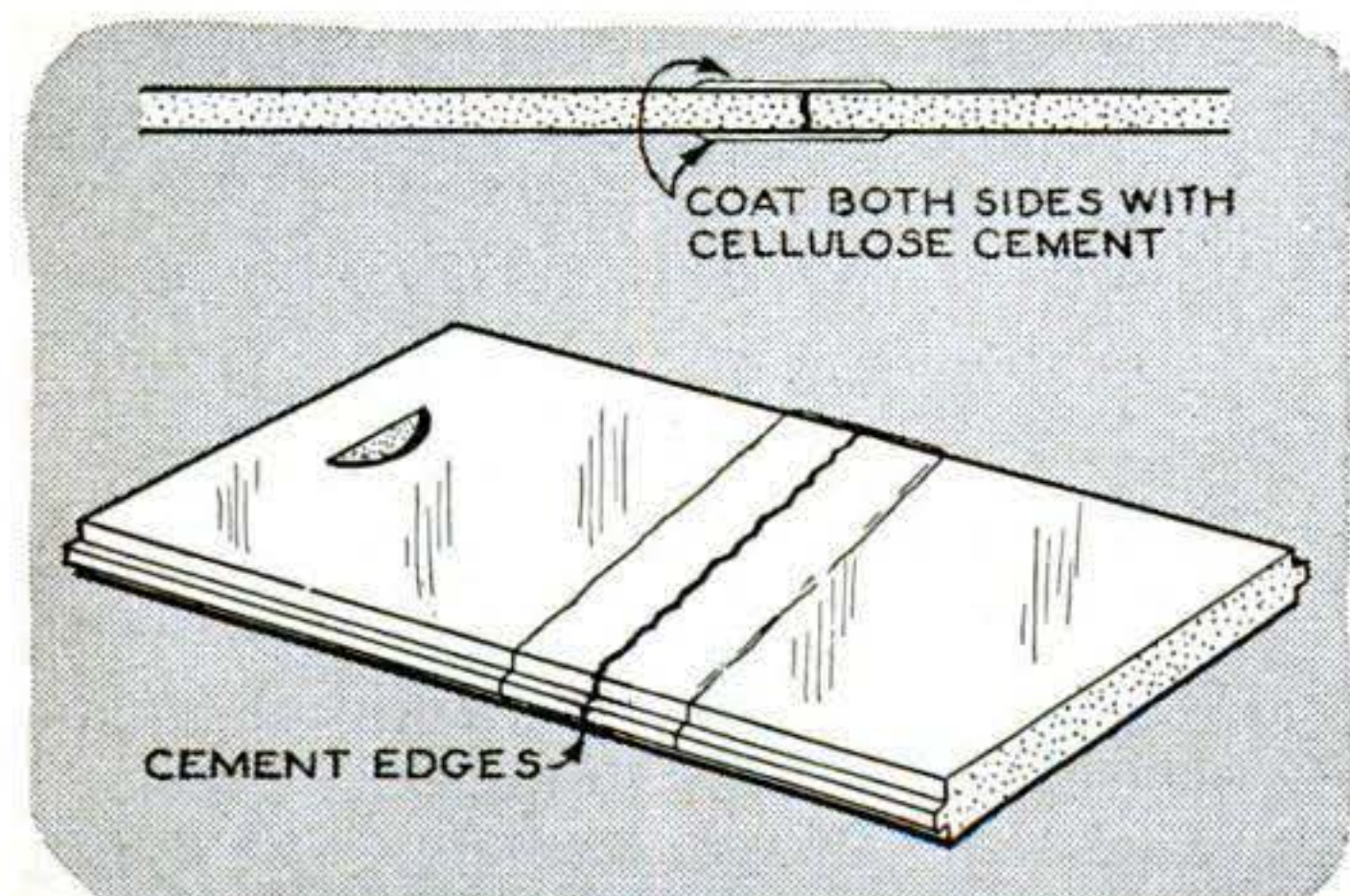

Square End Steadies Flashlight

DOES your flashlight roll away from you when you lay it down? A square bit of metal on the end will curb it. If the flashlight is made of steel or brass, solder a square of 1/16" metal on the cap; if it is aluminum, attach the metal with rivets; and if the case is plastic, cement a plastic square on it, as shown in the drawing.—Arthur Trauffer, McClelland, Iowa.



Fancy Button Makes a Drawer Pull

DECORATIVE old buttons make unique knobs for small drawers in cabinets or cosmetic chests. Metal buttons with a wire loop on the back are easiest to mount. Run a small cotter pin through the loop and add a piece of metal tubing for a spacer. The spacer shown here is an uncrimped metal eyelet, obtained at a shoe-repair shop. A bit of copper tubing would also serve. Push the cotter pin through the hole in the drawer front and clinch the ends on the inside, drawing button and spacer tight.

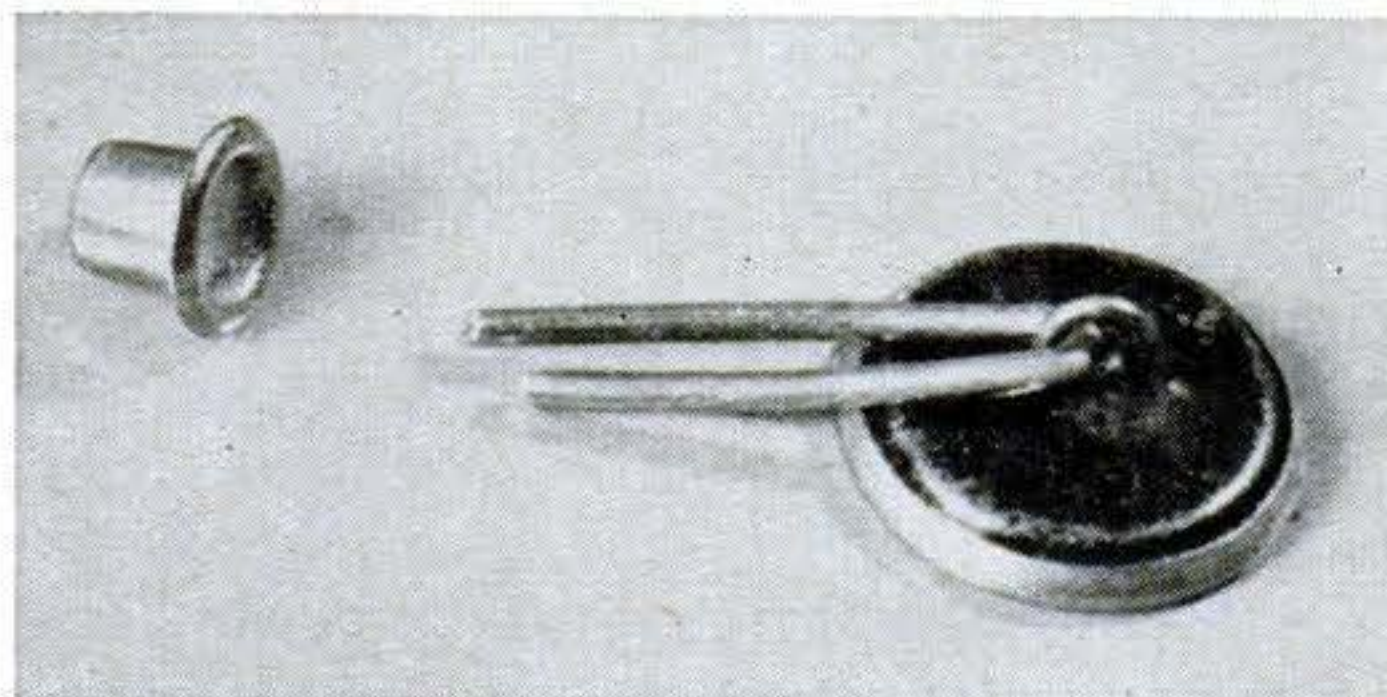
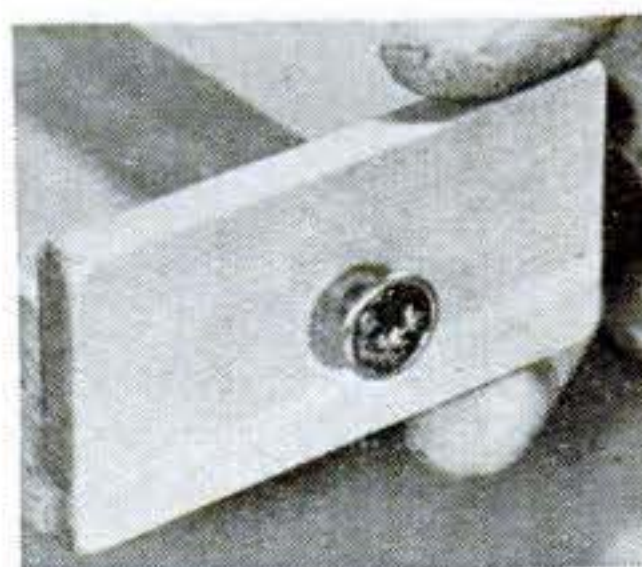

WHEN a small plastic, fiber, or wooden part from some gadget breaks, and simple edge-to-edge gluing fails to repair it, try "splinting" the joint with cement. Cement the edges and let the joint harden. Coat one side of the piece, allow it to dry, and then coat the opposite side. Repeat two or three times on both sides. This forms a thin sleeve over the break. Sand the surfaces smooth. You can also splint a piece by wrapping several turns of cellulose tape around it.—Frank Shore, New York City.

Powered Tines Pull Garden Tiller

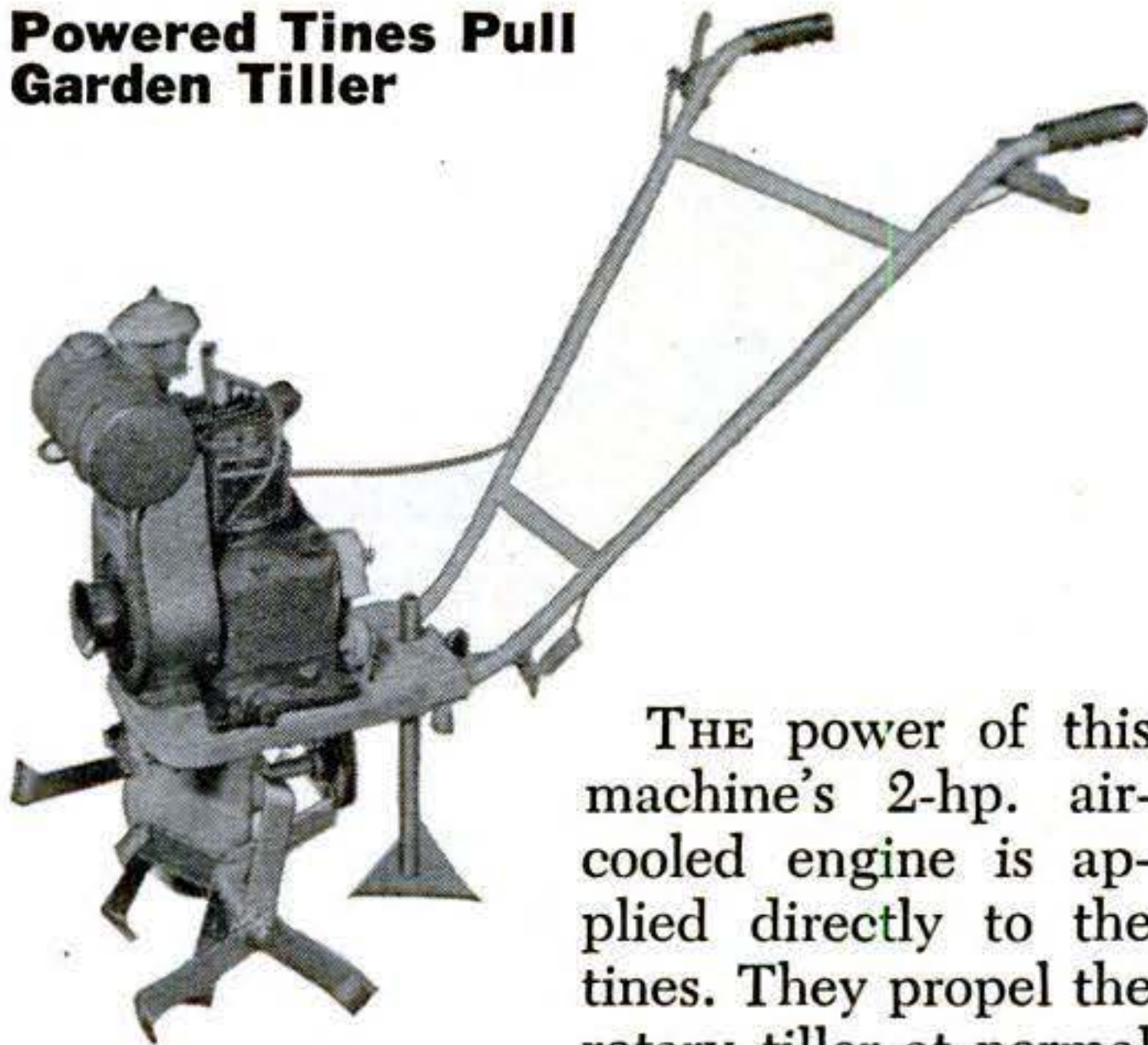

THE power of this machine's 2-hp. air-cooled engine is applied directly to the tines. They propel the rotary tiller at normal walking speed as they pulverize the soil. The tines can be adjusted from 7" to 21" in width. They can also be replaced by two wheels to convert the machine to other uses. By the use of attachments, the Garden Maker becomes a power sprayer, water pump, weed cutter, or lawn mower. The 72-lb. tractor is made by Windolph Tractor Co., of Portland, Ore.

Faucet Washer Is Thumb Guard

WHEN I use a small file to sharpen an auger bit, I slip a large rubber faucet washer over the tang of the file. It serves as a guard and keeps me from cutting my thumb on the sharp edges of the bit.—R. J. Addicks, New Britain, Conn.

Shoptalk: "I HELD THE GUN IN MY HAND, STRUNG A 20-FOOT TANDEM TO ONE SIDE, AND USED A SLAVE TO PICK UP THE BACKGROUND."



What are they talking about?
Where do they work? Answer below.

They're photographers. The speaker is describing a lighting setup. He held a flash gun in his hand with an extension cord (tandem) connecting the side light. He used a photoelectric unit (slave) to fire the flashbulb that lighted the background.

Nail Kegs Form Concrete Piers

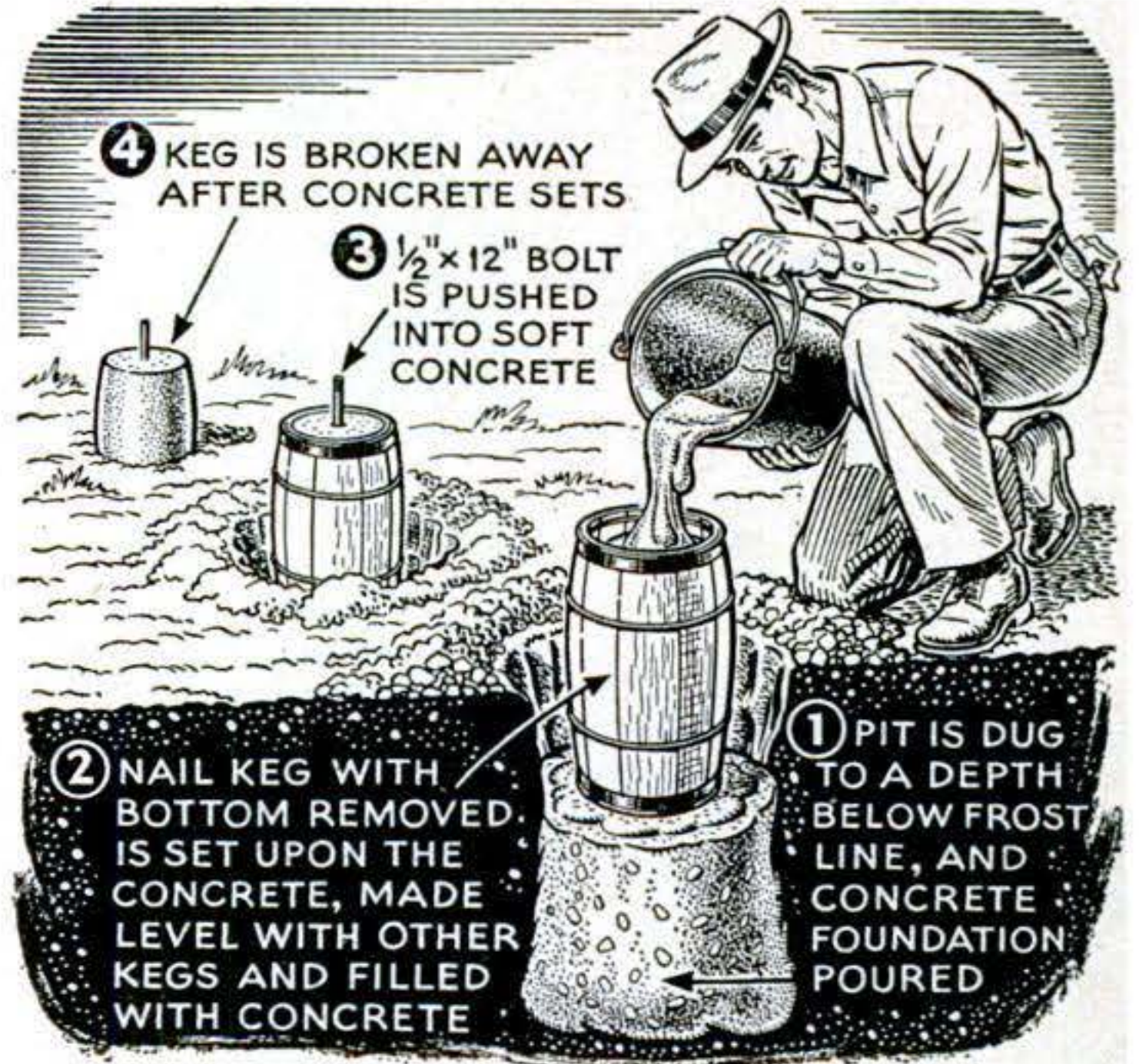

A PIER-TYPE foundation for a small building can be constructed as above. Dig below frost line and pour concrete for the sub-foundation. Before this sets, put a bottomless keg above it and pour the pier.

Screwdriver Makes an Offset Chisel

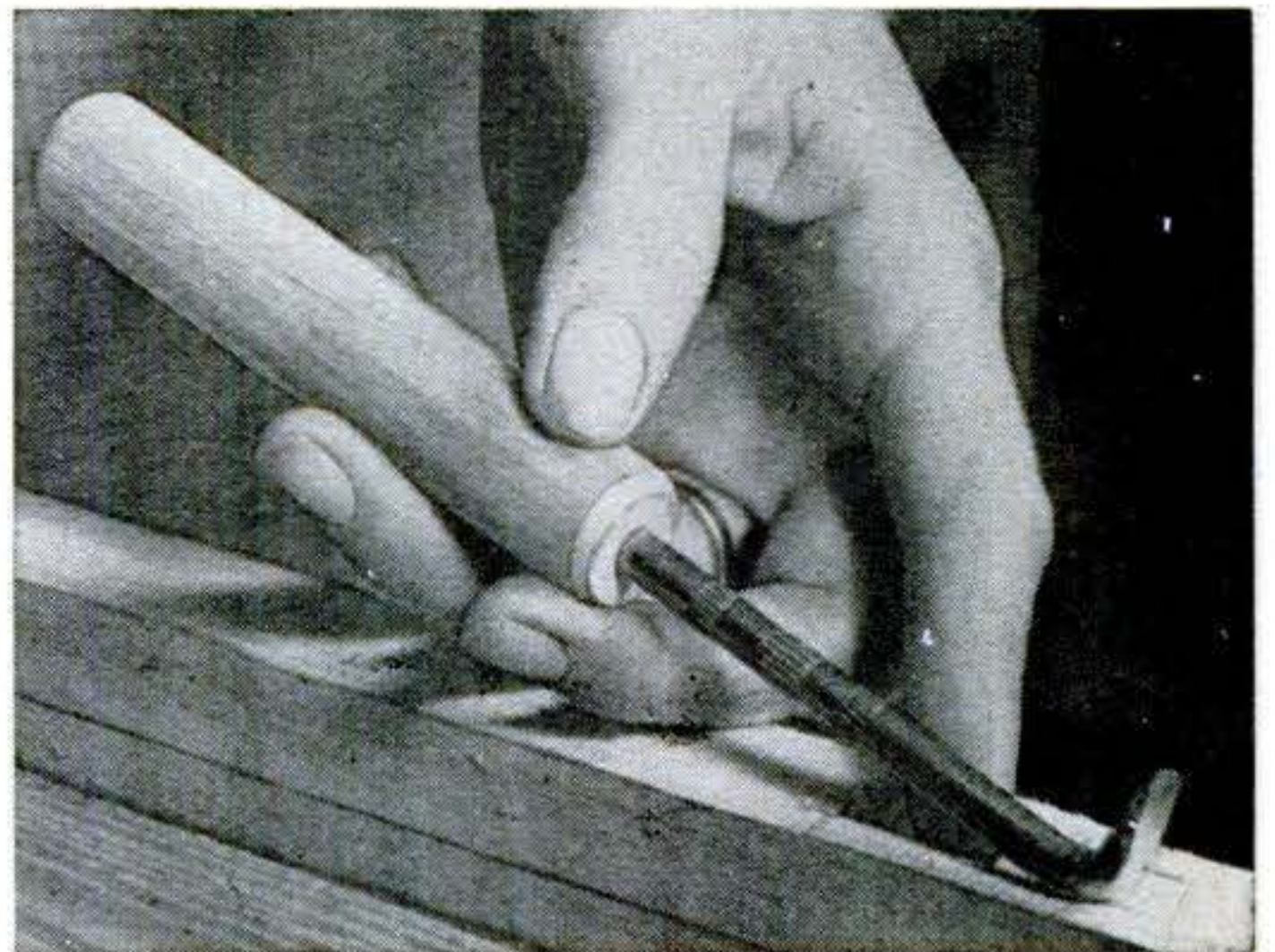

IF YOU need an offset chisel occasionally to cut around a corner or clean out the bottom of a mortise or groove, here's an easy, inexpensive way to make one out of an offset screwdriver. These screwdrivers are cheap, but will hold fairly good cutting edges. Saw off one end of the driver and file enough of a point so you can force it into a handle. File or grind the remaining tip to a chisel point. Touch it up frequently to keep it sharp.—Charles Smith, Jacksonville, Fla.

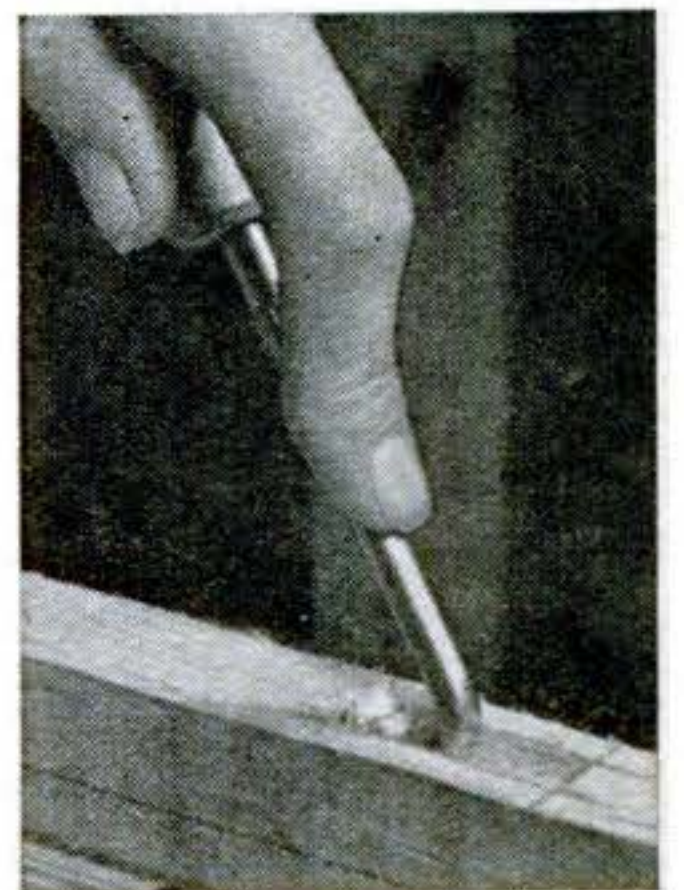

How to Handle a Ladder



Make balance and leverage work for you—not against you—in thin air.

By George H. Waltz, Jr.

PS PHOTOS BY W. W. MORRIS

1 To carry a ladder, slip your right arm through the rungs and grip the lower side-piece. Hold the other side with your left hand (inset). If the ladder is wide, you can rest the upper sidepiece on your shoulder.

4 To steady a ladder, level the base. If the ground is uneven, block up the higher foot with a large slab of wood. When working on slippery ground or concrete, tie a rope from the bottom rung to a suitable pipe or post.

5 To keep your balance, look straight ahead. Men who work on ladders say it's bad practice to look up or down. For best footing, wear heavy rubber-soled shoes with heels. Thin rubber soles don't give the arch enough protection.

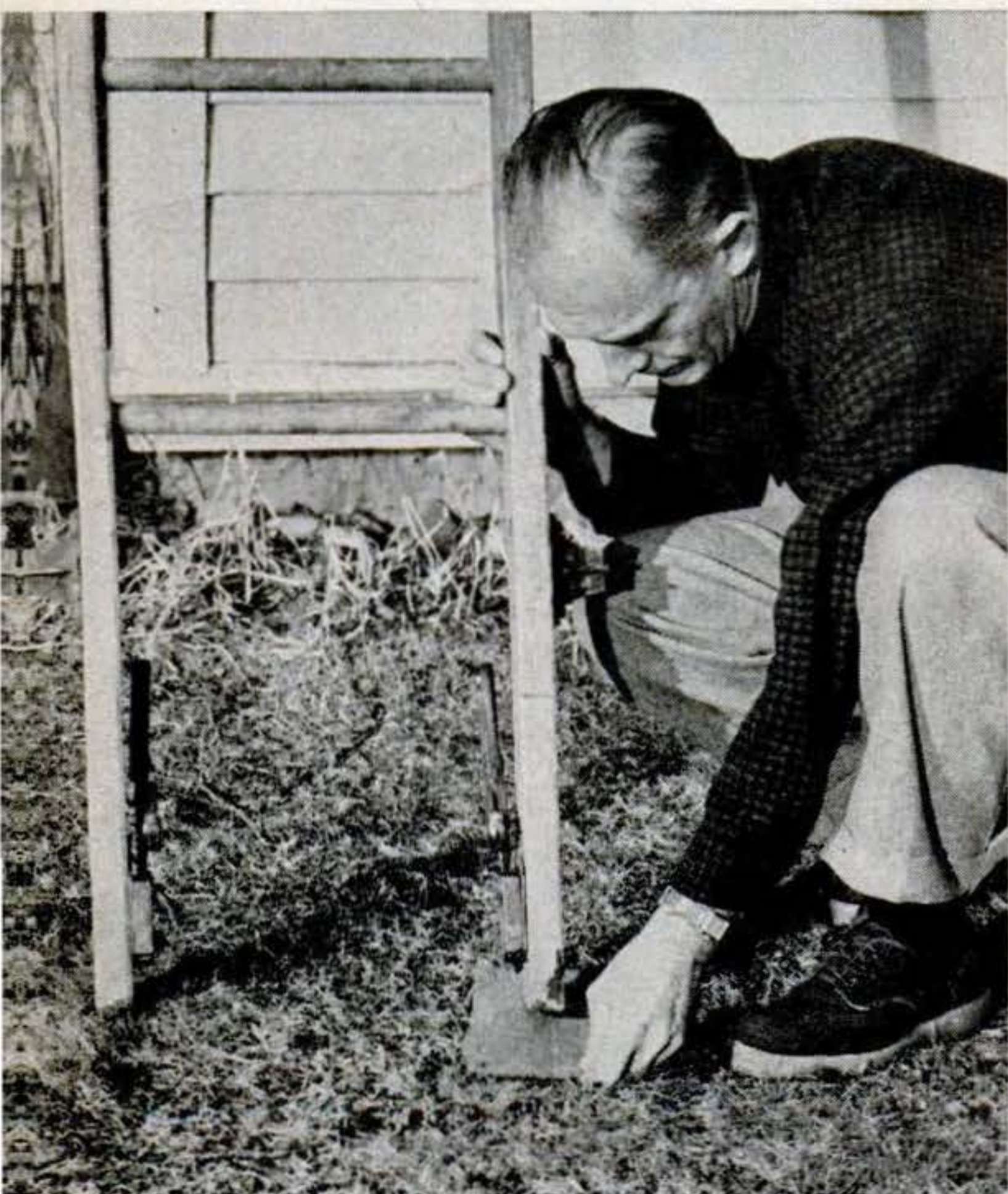



2 To raise a ladder, walk it into place. Rest the base against a projecting curb or foundation, as shown above, and move your hands from rung to rung as you walk forward. To lower a ladder, just reverse the procedure.

6 Don't try to carry heavy tools, materials, or paint pots up the ladder with you. You need both hands for safe climbing. The best way is to prepare your materials first, then pull them up after you are in position.



3 To balance a ladder, gauge the distance. The space from the foot of the ladder to the wall should be a quarter to a third the ladder length. Make sure that the tops of the uprights rest on an even surface.

7 Always try to hold the ladder with at least one hand. If your work requires two hands, hook one leg around a rung. If you must lean to one side, hook the opposite leg. Never climb higher than the third rung from the top.



Rehandling a Hammer Is 10-Minute Job

DON'T be a rhumba-beat Charlie (three smacks on the nail followed by three handle taps on the bench to reseat the hammer head). It's cheaper—and much less painful—to put on a new hammer handle than to call a doctor after you fail to duck

a flying head. You'll enjoy putting it on, and have a better tool to work with.

A hickory handle and a steel wedge will cost you about a quarter. Get a hardwood wedge, too, or saw one yourself. The photos show what to do next.



Head may be wobbly and still refuse to pull off. Quickest solution is to saw off the old handle just behind the hammer head, as above.

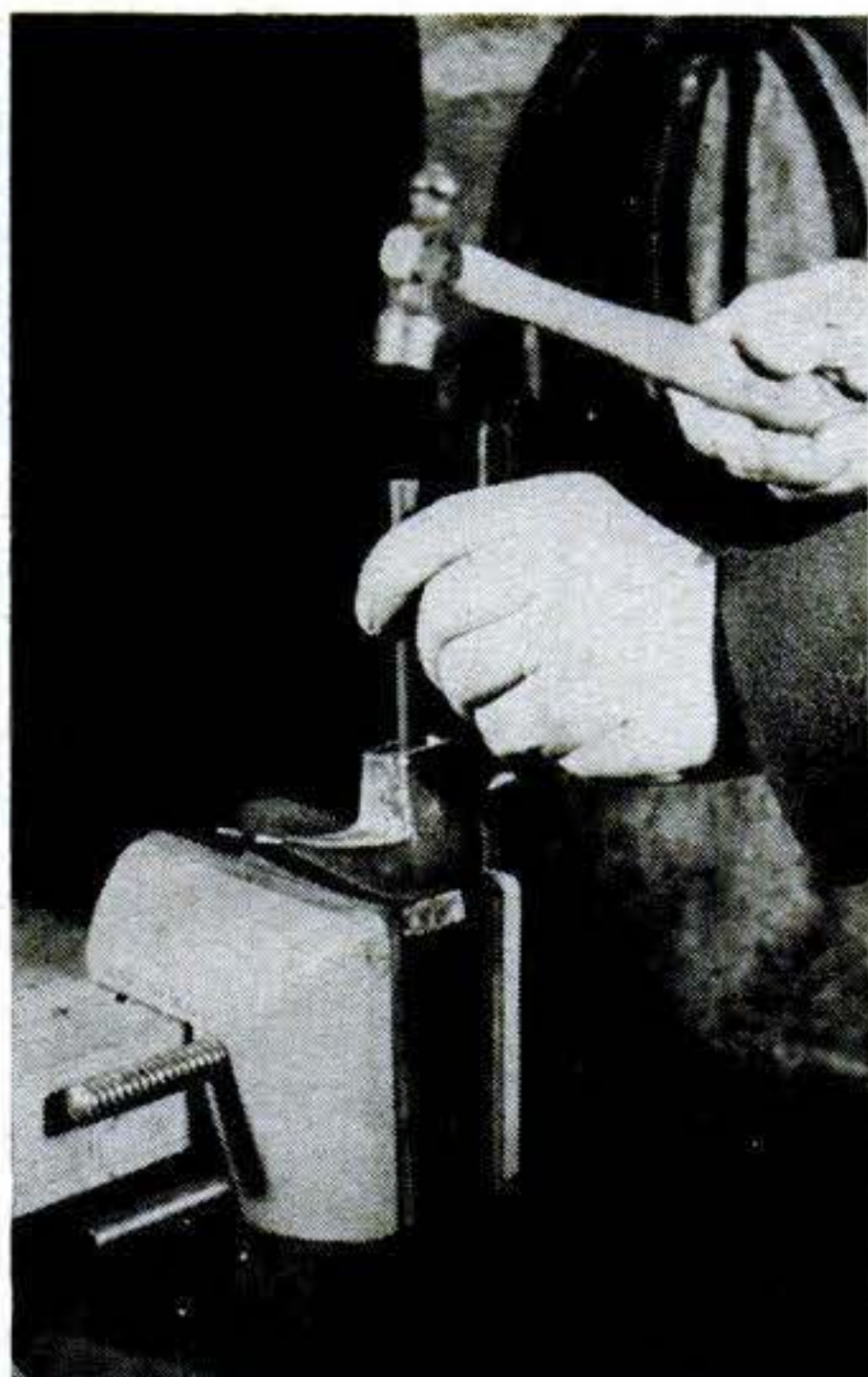

Lay the head across open vise jaws to drive out fragment of old handle in the eye. Use a flat-ended punch or a short piece of dowel to hammer on.



If the new handle isn't slotted, saw a kerf for the wooden wedge. Cut it the long way of the oval cross section of the handle, and about 1 1/4" deep.



Should new handle be tight, use rasp or knife to trim it where hammer eye turns up shavings. Wedge end won't be tight, as eye tapers out there.



After driving handle in hard, saw off excess 1/8" from head. Drive wooden wedge firmly. If it splits, drive the pieces. Trim protruding part flush.



Place steel wedge crosswise on wooden one. Start driving with light blows, with handle on a solid surface. After sinking wedge, file flush. **END**

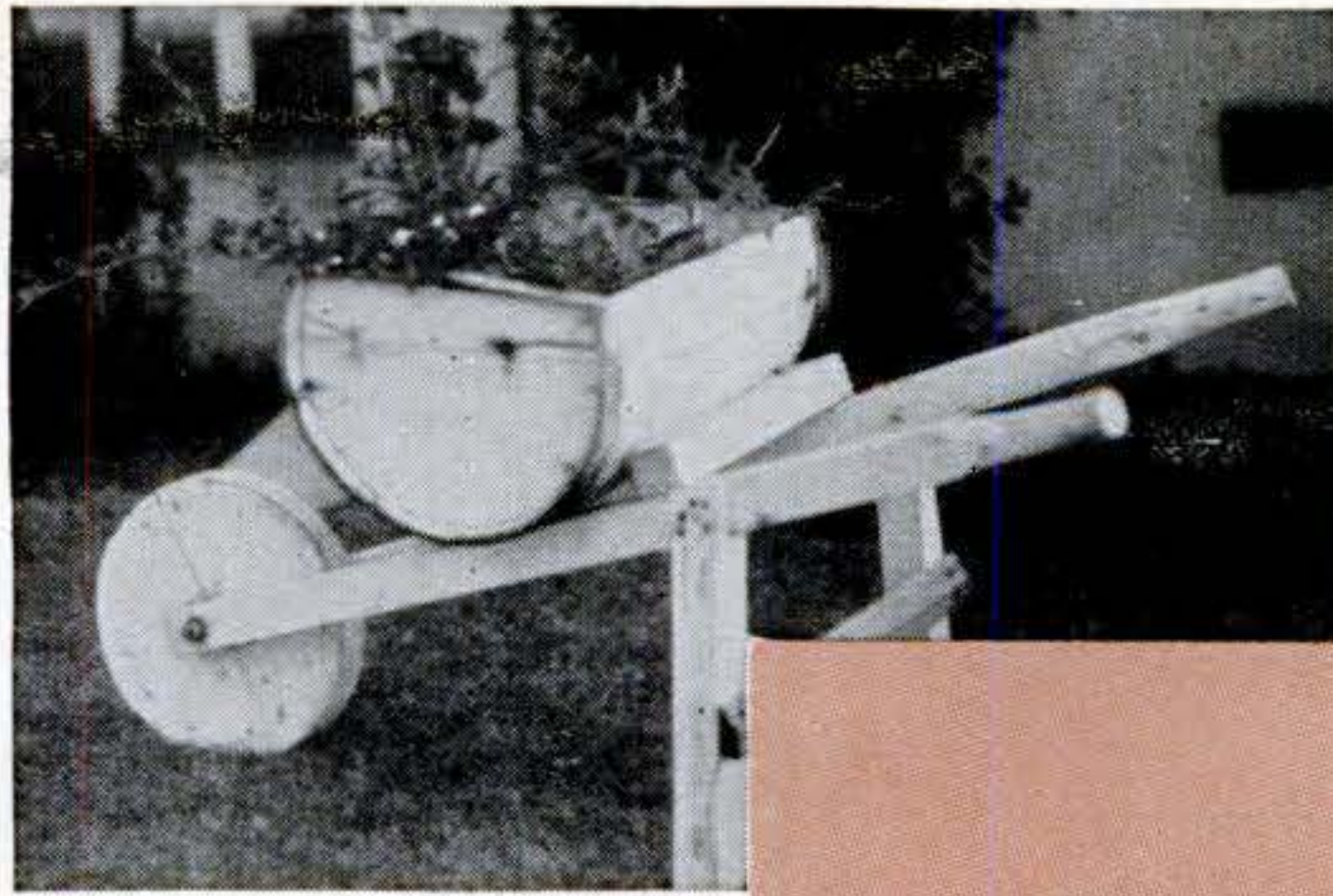

Flower Barrows Dress Up Your Garden

Even though built in a hurry, this little flower barrow (above) serves its purpose well.

Drawing at right shows a fancier project with cradle pieces screwed on to receive keg.

Old-style barrow (below) was cleaned, painted canary yellow, and decorated with decals.

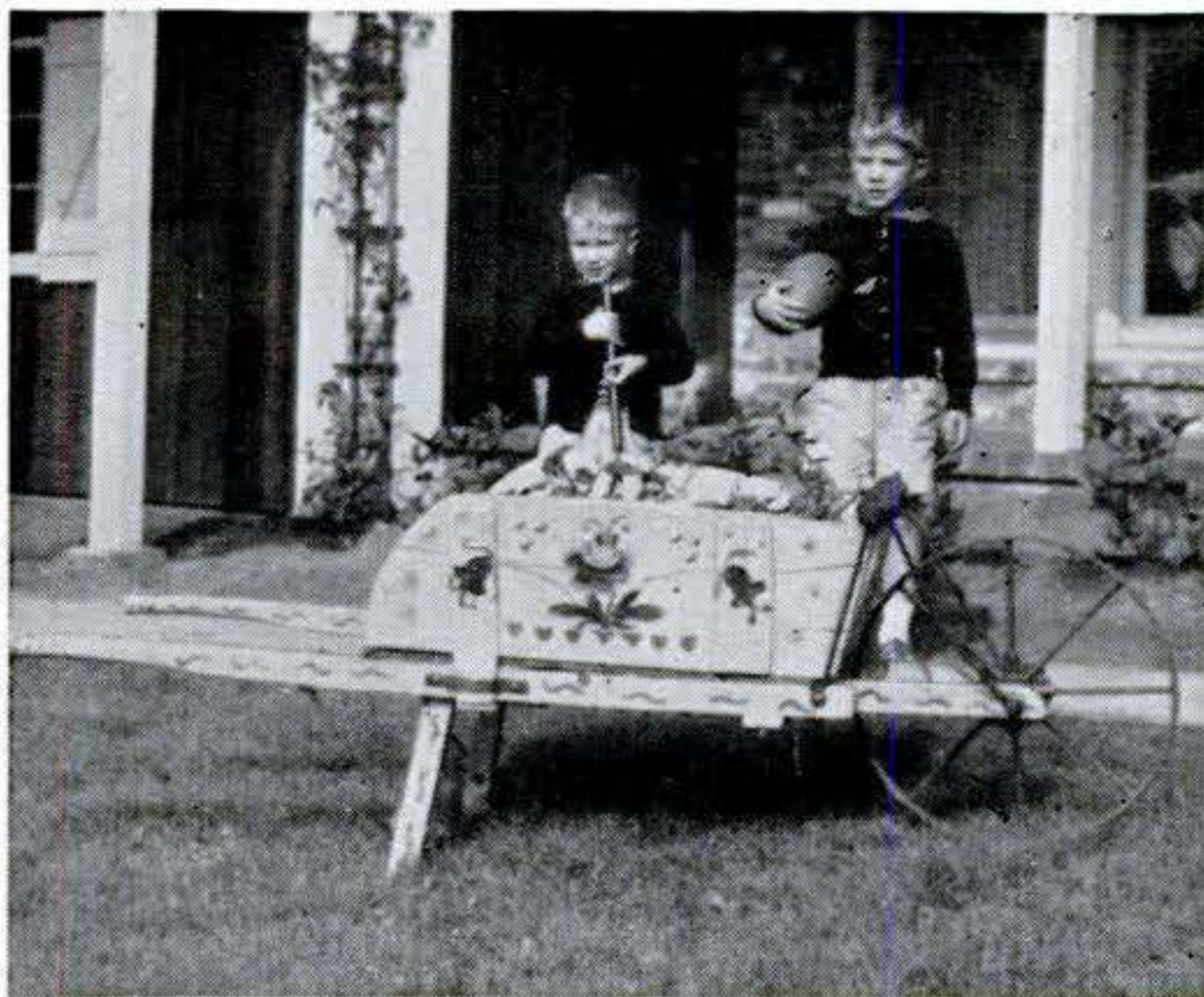
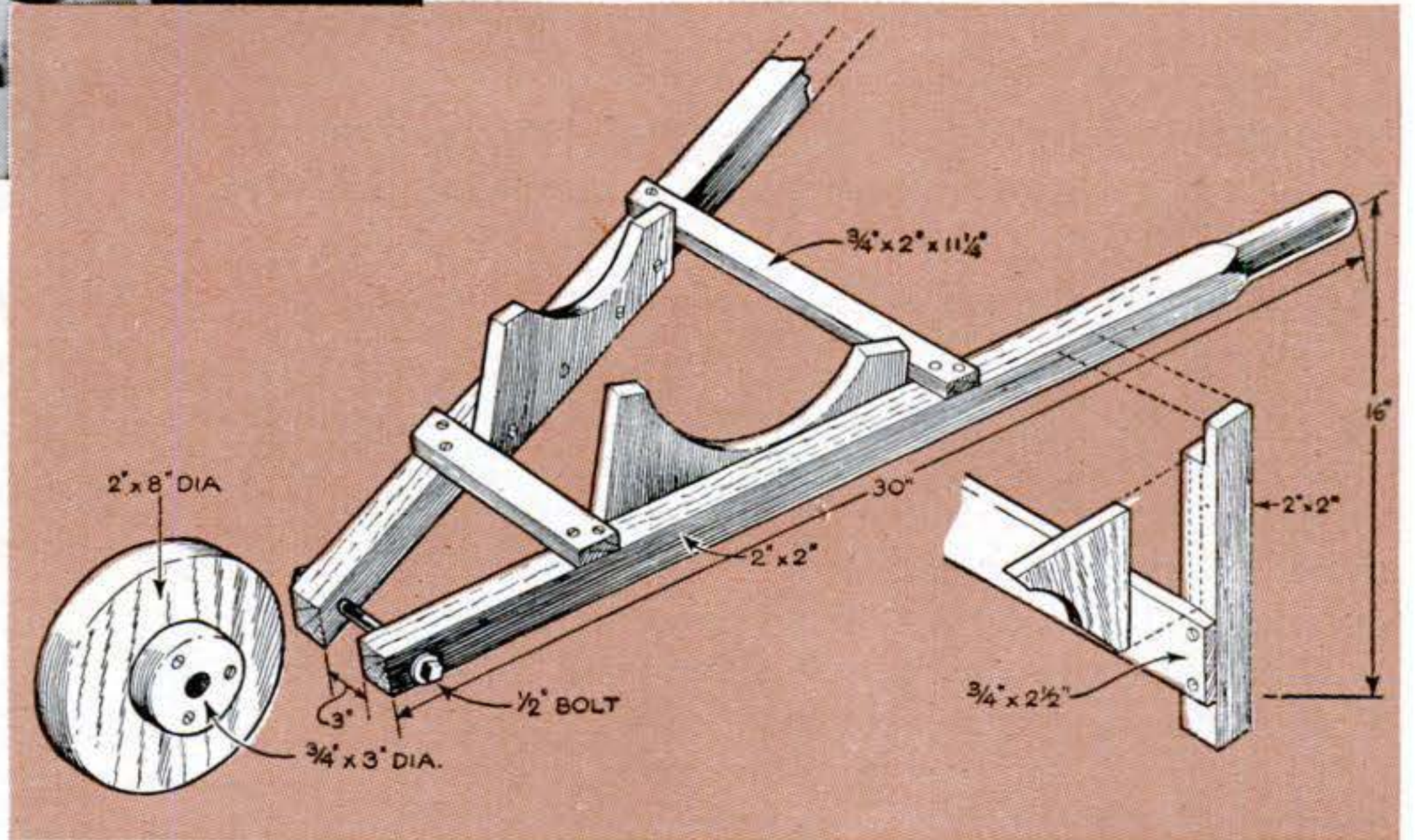

FILLED with flowering plants and spotted in a corner of the lawn, any of these wheelbarrows will add a colorful touch to your garden.

Two of them can be built with odds and ends of lumber and a nail keg. The third one is an old-style barrow that was repaired and painted.

Notice that more than half the nail keg was used. You can cut through the metal bands on the keg with a hacksaw.

For a wheel, glue up and cut an 8" disk from 2" stock. Screw hubs on each side and drill a hole for a 1/2" bolt that serves as an axle.—Hi Sibley, Nuevo, Calif.

A Simple Way to Padlock Your Bolt-Action Rifle

A BOLT-ACTION rifle may be easily padlocked. The bolt is removed and a regular wire cleaning rod—not the unscrewing type—is pushed through the barrel from the breech end. A small key-shaped piece of steel with a hole in one end, as shown in the drawing, is slipped through the slot in the rod at the

muzzle end and secured with a small padlock. The bolt then may be replaced if the rod has been cut short and a new loop formed to make it fit the breech more closely. With the rod in place, the rifle cannot possibly be loaded or discharged.—Evan Wright, Topeka.

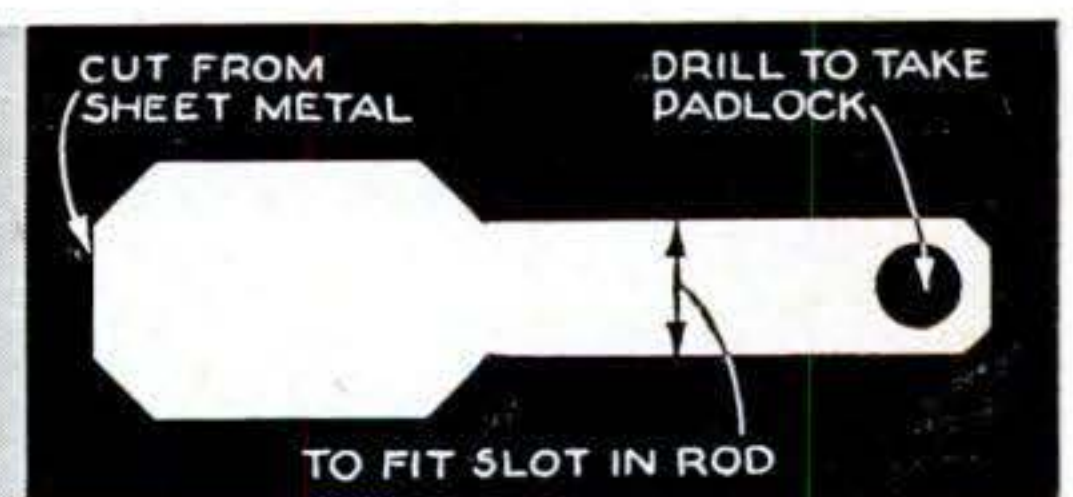

Gus Tames a Runaway

With fishing on his mind, the Model Garage owner takes a day off—and runs into a busman's holiday.

By Martin Bunn

A FEW weeks ago, on his day off, Gus Wilson left Stan Hicks holding the fort at the Model Garage and drove up to Round Lake to see about getting his fishing skiff in shape. One of the local boys always took care of the annual overhaul. After they'd talked the job over, Gus strolled over to the pint-size refreshment stand and bait store that old Tom Strong runs near the boat landing.

"Hi, Tom," Gus greeted the little old man behind the counter. "All set for a busy summer season?" he asked as he fished around in the cooler for a root beer.

"Can't rightly tell, Gus, what with all this war business stirrin' folks up."

Gus finally dredged up a bottle. As he stooped to open it the door slammed behind him. Looking up, he recognized Ken Peyton. Ken runs an amusement park down near the hotel at the other end of the lake.

"Saw your car outside, Gus," Peyton said as he pumped Gus's hand. "I need some advice."

"What's the matter, that one-horse Coney Island of yours falling apart?" Gus kidded.

"Not quite," Ken grinned, "but I've got the usual headaches that come along every year when I open up."

Gus drained the last of his drink and dropped the bottle into the case for the empties.

"It's that Ferris wheel I put in last year," Ken explained. "Remember, I bought an old auto engine from a junk yard and hooked it up with a hand clutch?"

Gus nodded.

"Ran fine all last summer," Ken continued. "Well, this morning I decided to see how she'd got through the winter. I put in the battery, filled the radiator and the gas tank—she had oil—turned on the switch, and poked the starter button. Naturally, she didn't start right off, but after a little she caught and ran smoothly enough. I turned the ignition off, and you know what happened?"

Gus shook his head.

"That fool engine kept right on running. The only way I

Gus removed the spark plugs from the Ferris-wheel engine. "Not likely that it's pre-ignition," he said, shaking his head. "They're all clean."





MAY 1951 175

RAY QUILLER



could stop her was to cut off the gas. Luckily, I've got a petcock in the fuel line."

"It's probably nothing more than a bum ignition switch," Gus said. "Want me to have a look?"

"Wish you would, Gus. I've got my car outside, and we can be over there in a jiffy."

"I'll follow you in my car," Gus put in as he followed Peyton through the door onto the landing. "Then I can leave for town right from your place."

"So long, Tom," Gus called back to old man Strong. "See you next week."

Less than 10 minutes later, Gus followed Ken's car through the newly painted wooden arch into Round Lake Park and parked in an open space behind the Ferris wheel.

"There's my runaway engine," Ken said, nodding toward the wheel. "I'll start her up and you can see what I mean."

Engine Won't Stop

The engine, still warm from its earlier run, ticked off without a sputter. After about a minute of running, Ken reached over to the small control panel he'd rigged at the rear of the engine and turned the ignition key to the "off" position.

The engine kept right on running without so much as sputtering.

"See what I mean?" yelled Ken.

"Got a pair of pliers handy?" asked Gus.

Ken reached into a small tool box on the floor of the shed, rummaged around in it, and finally handed Gus the pliers.

"I'll disconnect one of the wires at the rear of this switch," Gus explained as he went to work.

In a moment Gus loosened the small nut and pulled the wire loose. But it made no

difference to the engine—it ran right along.

"Humph," grunted Gus. "Can't be the switch after all. Okay, shut off the gas. I want to try something else."

Ken complied, and, as the engine died, Gus reconnected the lead. "Now turn the gas back on and let's see if she'll start with the ignition off."

With the ignition key in its "off" position, Ken pushed the starter button again. The starter ground away without effect.

Now It Won't Start

"Are you sure that gas is turned on?" queried Gus.

"Wide open," Ken called over the whir of the starter motor. "And the hand throttle's cracked open too."

After a few more seconds with no results, Gus reached over and turned the ignition key to its "on" position. Almost instantly, the engine took hold. Then, when Gus turned the ignition key off, it continued to purr along.

"Now, how do you like that, Gus? She'll run with the ignition off, but won't start unless it's turned on."

Gus said nothing and began tracing and examining the wires leading to the switch.

"Been having any battery troubles?" he asked finally.

"Nope," replied Ken. "Took the battery out last fall and kept it up to charge over the winter. Just put her back in place this morning. Why?"

Even Runs Without Battery

"Just wondered," said Gus. Then, using a wrench, he began loosening the nut on the battery terminal lug that led to ground. The clamp came off the post easily. And the engine never missed a beat as the cable popped loose.

"Say, what is this?" Ken hollered. "Ignition off, battery disconnected, and she still runs."

"Could be a bad case of pre-ignition," said Gus. "Let's shut her down and have a

[Continued on page 226]

Make Trouble Pay

Had any interesting car breakdowns lately? Gus wants to hear about your tough and tantalizing automotive problems. Write him about the false diagnoses as well as the cures. *Popular Science* will pay \$25 to the first sender of each usable story idea. Letters can't be acknowledged or returned. Address Martin Bunn, *Popular Science*, 353 Fourth Avenue, New York 10, N. Y.



Hints from the Model Garage

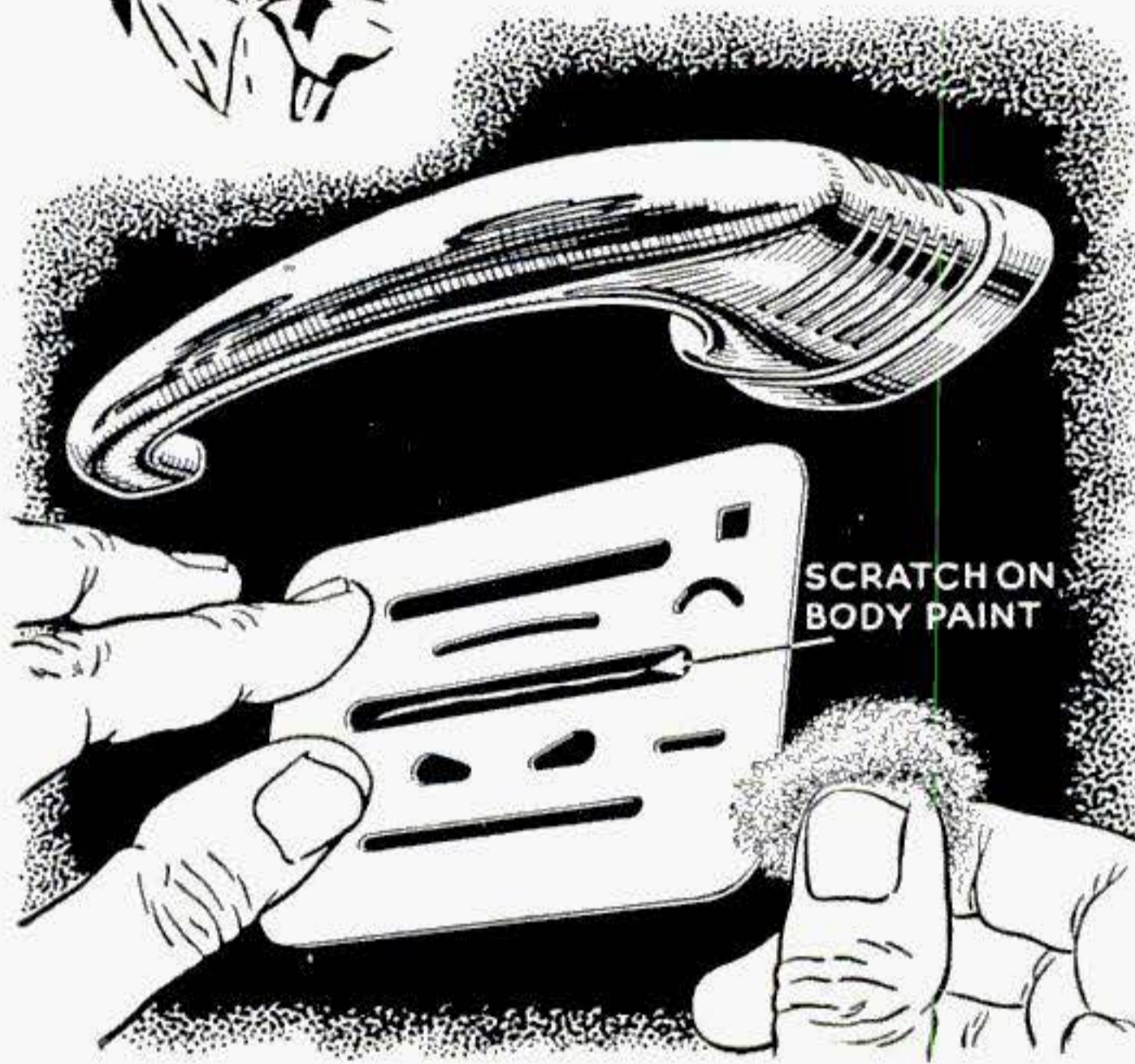

Touching Up a Scratch. A draftsman's metal erasing shield is helpful for this job. Use it to limit your steel-wool rubbing to the edges of the scratch before applying touch-up paint. Use it again if you work over the area with rubbing compound.

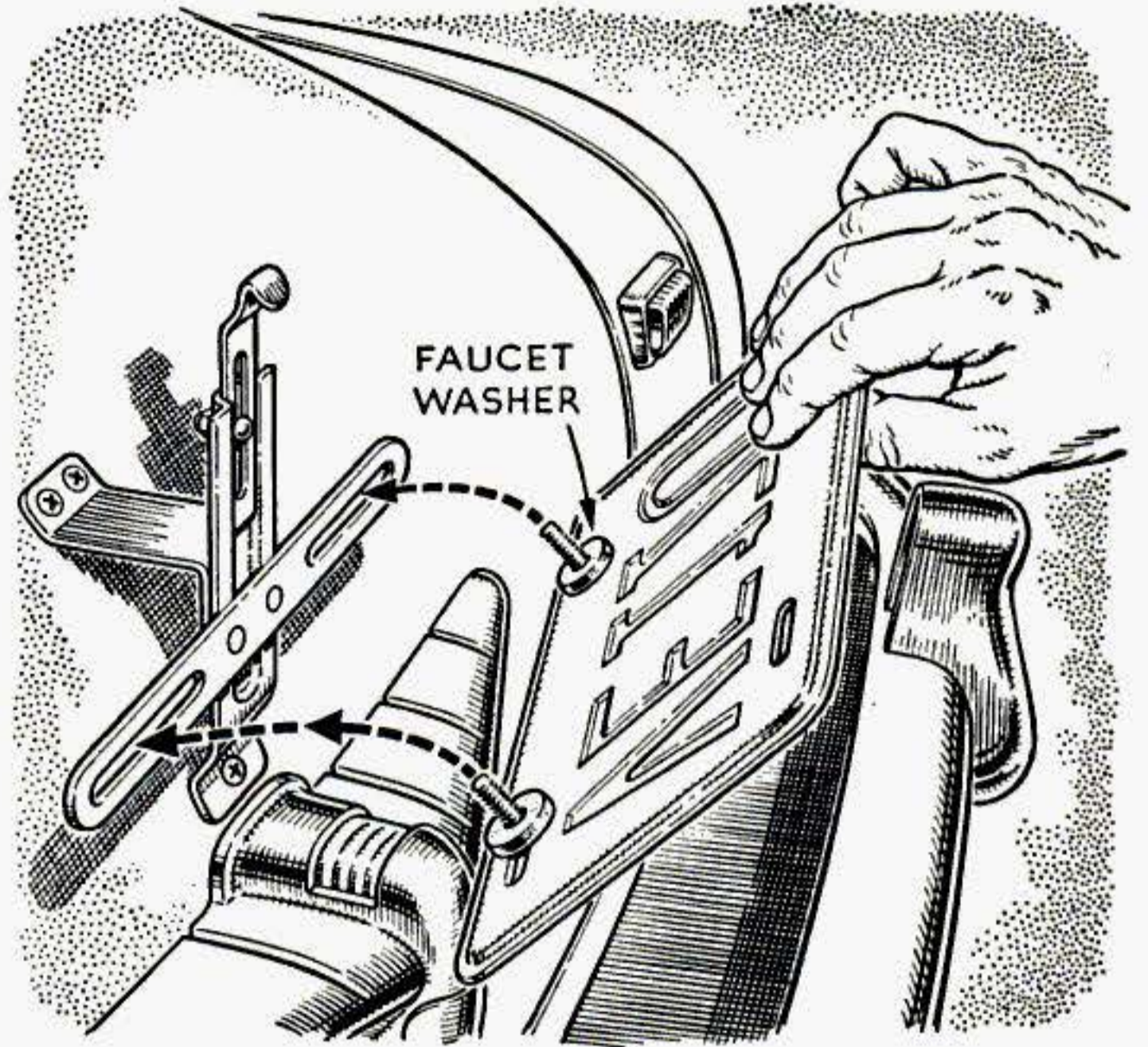

Washers Stop Rattles. A tendency of your license plates to rattle can often be overcome by mounting them with rubber faucet washers placed between the plate and bracket. Enlarge the center holes if necessary for the bolts.

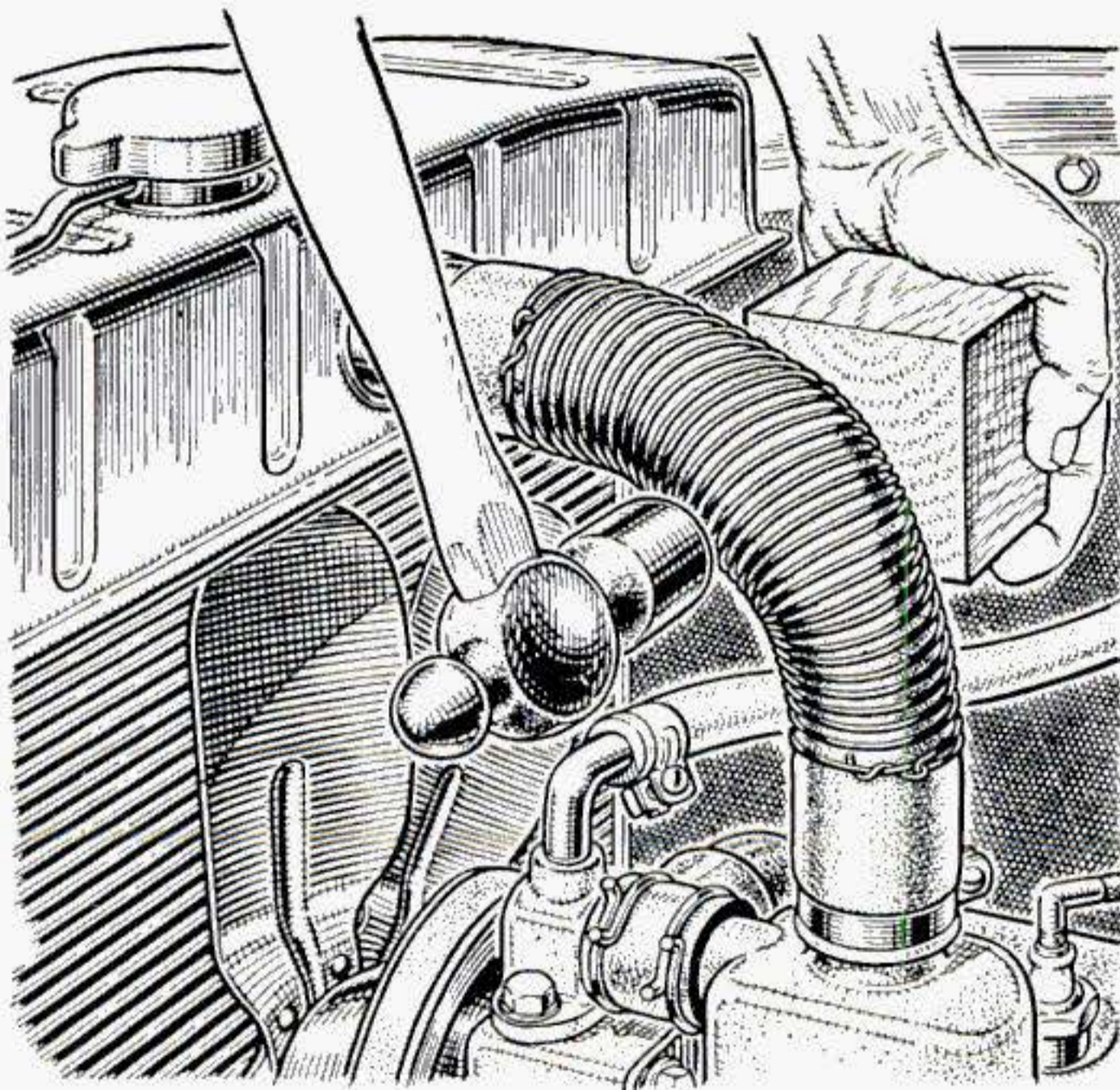

How to Curve Hose. A straight piece of rubber-and-fabric hose can be curved by wrapping it with No. 14 or 16 wire. Space the turns about $\frac{1}{8}$ " apart and anchor the ends securely. When the hose is first curved, it may still tend to collapse, but you can make it take its proper shape by pounding with a hammer and wood block.



Hinge Serves as Door Stop. An old strap hinge can be used like this to keep a garage door from blowing shut. Mount it vertically with part of one leaf projecting below the bottom edge of the door. Attach a light chain to the free leaf and the door and you'll be able to lift the hinge when closing the door.

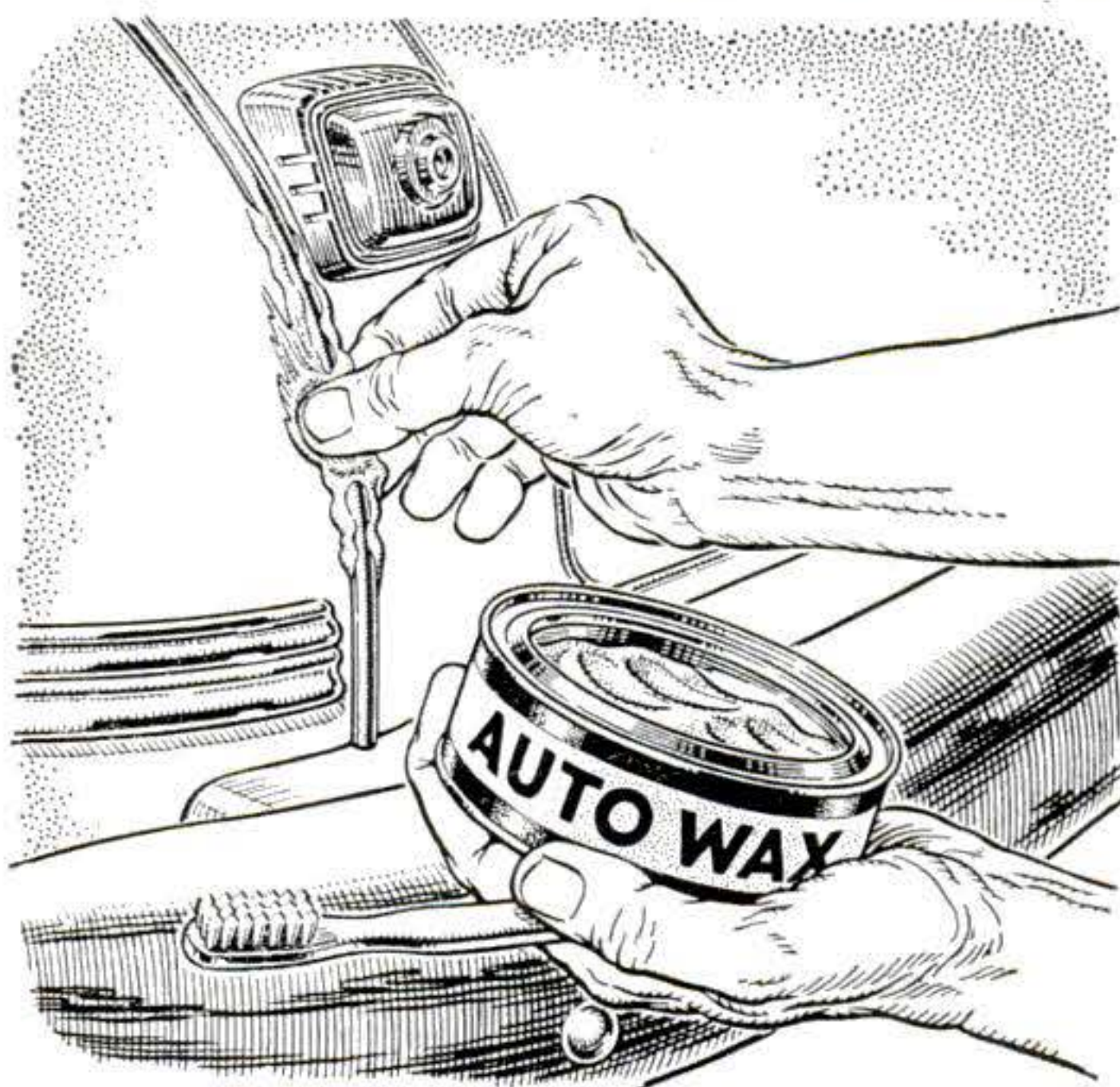

Wax in Joints Curbs Rust. While waxing your car, press a liberal amount in and around the fender welts and other joints. An old toothbrush will help force it in. Do not wipe away the wax. The excess will not be noticeable, and it serves as a good moisture seal, reducing the chances of rust forming in the joints.

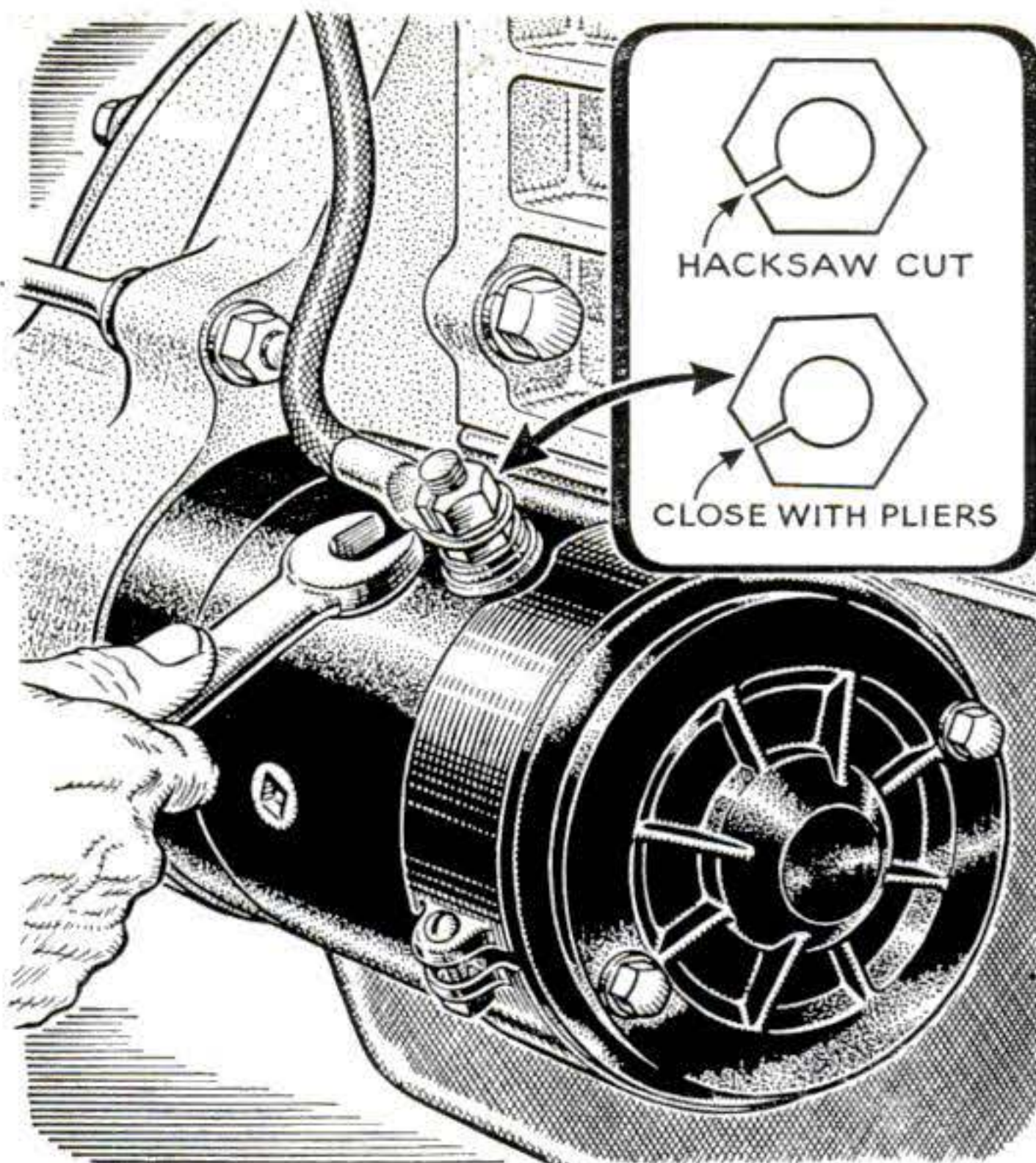

Slotted Nut Locks on Stud. If the threads of a stud are stripped or damaged, you can repair it temporarily by slotting a nut and squeezing it in place on the stud with a pair of heavy pliers. The same trick can be used for removing a stud with no unthreaded portion exposed. The threads won't be damaged by clamping the nut.

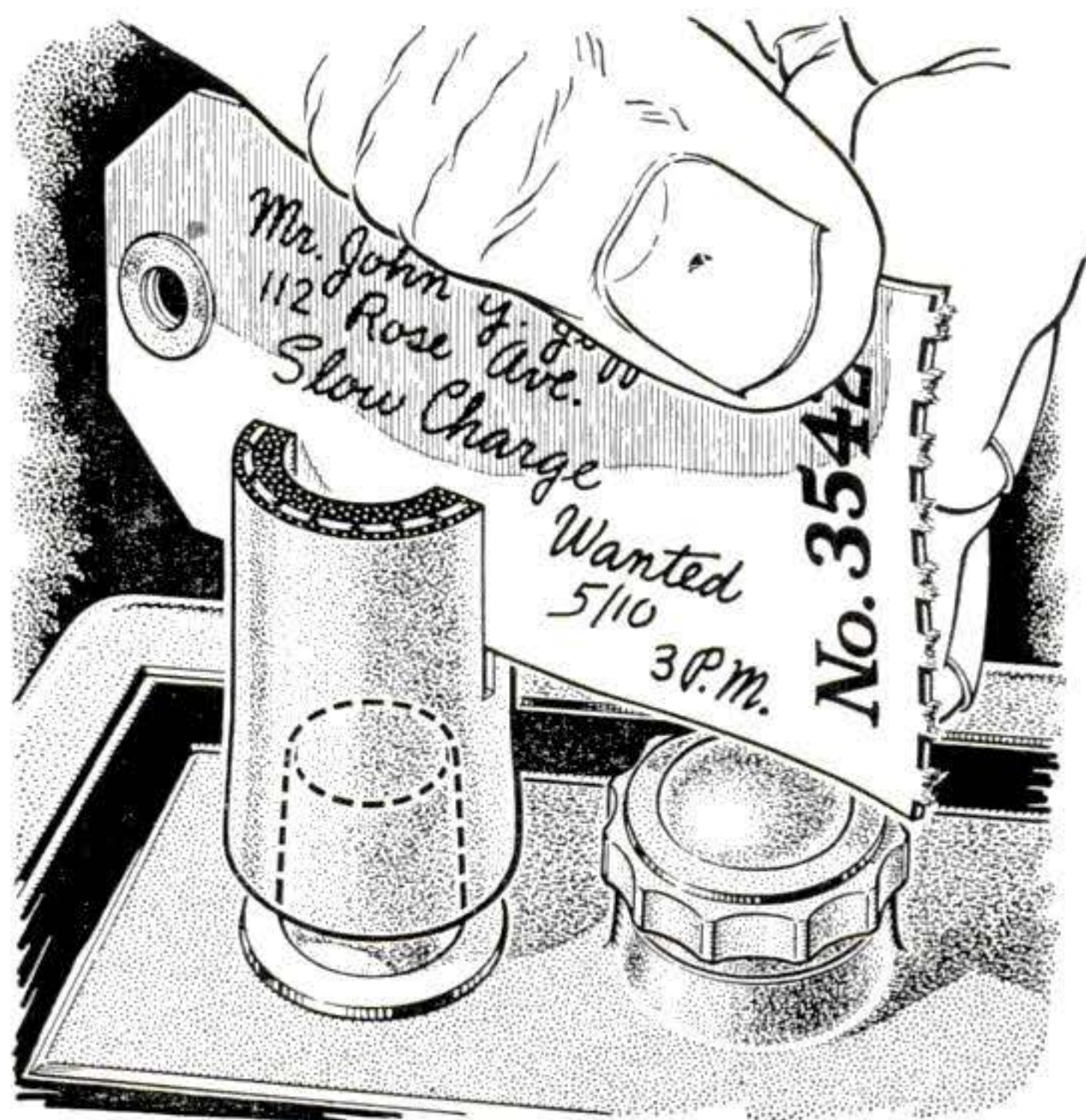

Tag Holder for Battery Shop. Short pieces of garden hose slotted at one end make good holders for customer identification cards in a battery-charging room. Hose of the ordinary size slips snugly over most battery posts.



It Pays to Clean Wiper Blades. The initial smear that wipers often make when first turned on can be avoided by occasionally rubbing a soft cloth along the blades. This will remove the accumulation of grease, dirt, and oxidized rubber.

Hidden Wear Boosts Your Car Expenses

YOU can save money on your car this summer by giving it a pin-point tune-up this spring. Hidden wear always robs an engine of power, pep, and fuel economy, but finding and eliminating it is sometimes a tricky, time-consuming job.

Such wear frequently occurs in the carburetion and ignition systems. The usual type of tune-up, or even a ring and valve job, may fail to bring back all the sparkling performance characteristics that your car

Accelerator pump must give a quick shot of fuel for good snap and pickup. Pump plunger shown was badly worn. A new leather and spring cost little. Inspect the bottom of well for dirt. Even small particles will jam the valve. Most pumps can be connected to the rocker shaft for long, medium, or short strokes to suit the driver and axle ratio. If in doubt, try each position.

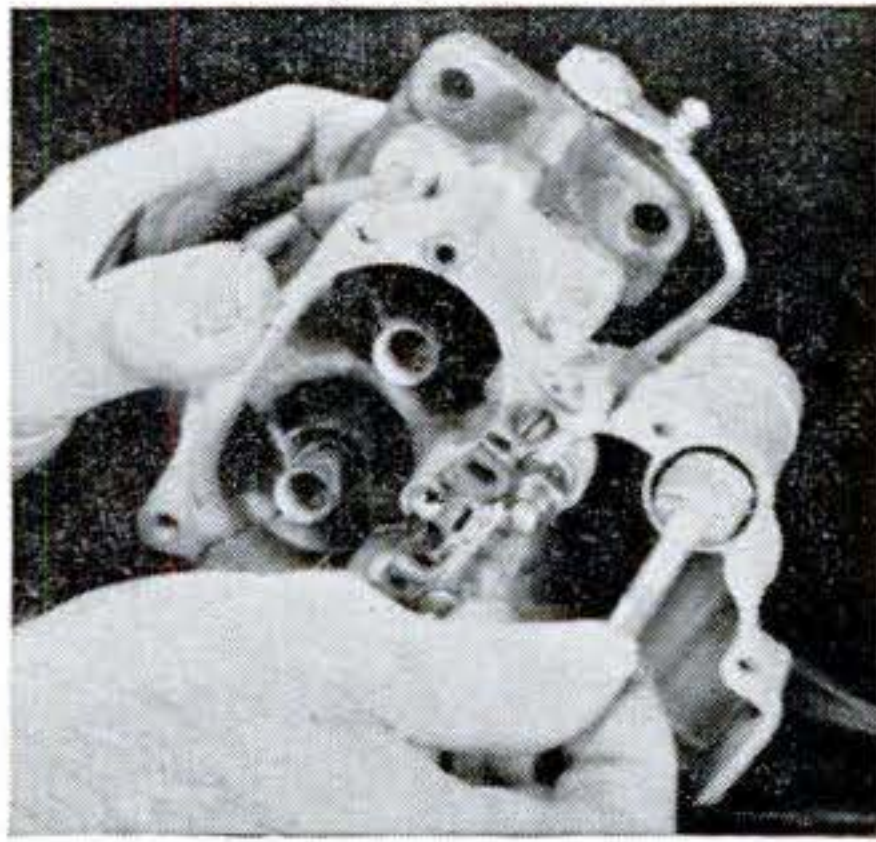

Repairing a series of worn parts in the carburetor and distributor often rejuvenates an engine.

By E. F. Lindsley *Automotive Engineer*

Anti-percolator valves vent fuel vapor from the float chamber when engine is stopped. The one shown below was stuck solid with fuel gum, causing vapor lock. Some carbs have only one such valve.

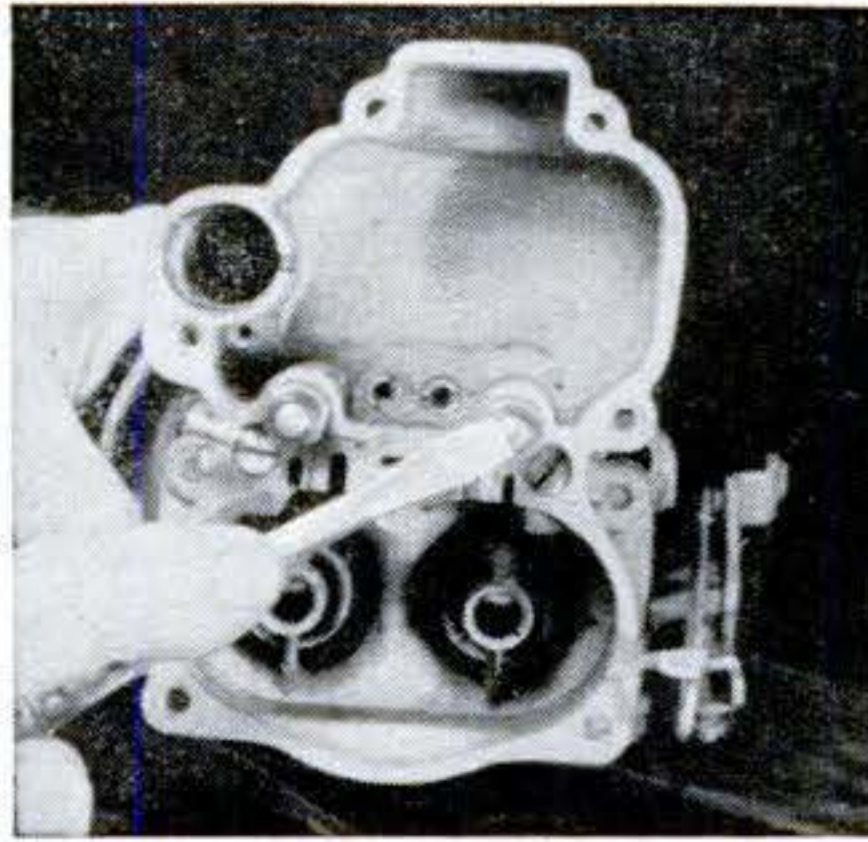

Carburetor metering starts with the float level. Pencil indicates wear on float contact. Check the float for leaks by shaking. Leaks here waste fuel, cause flooding, dripping, hard starts, and rough idling.

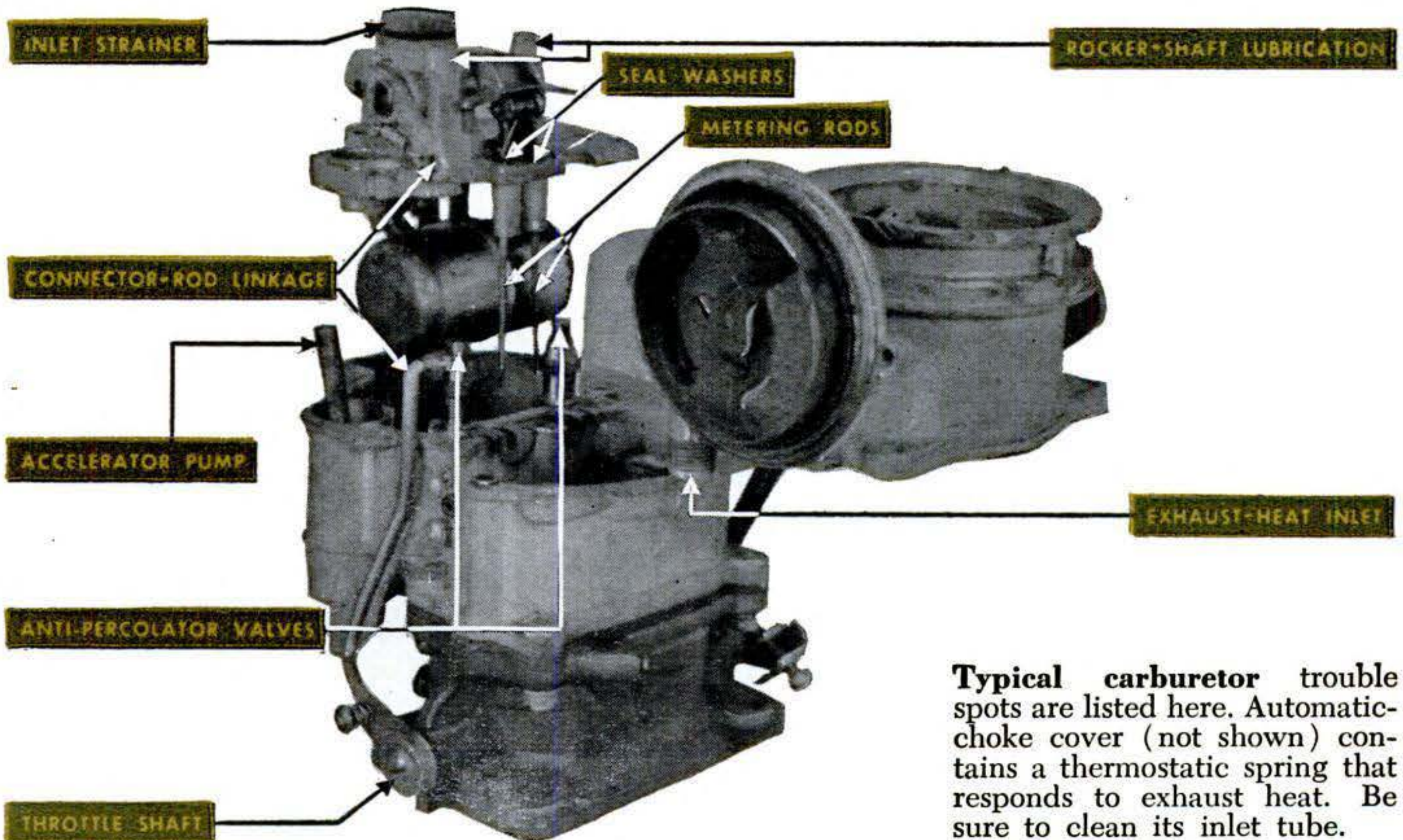
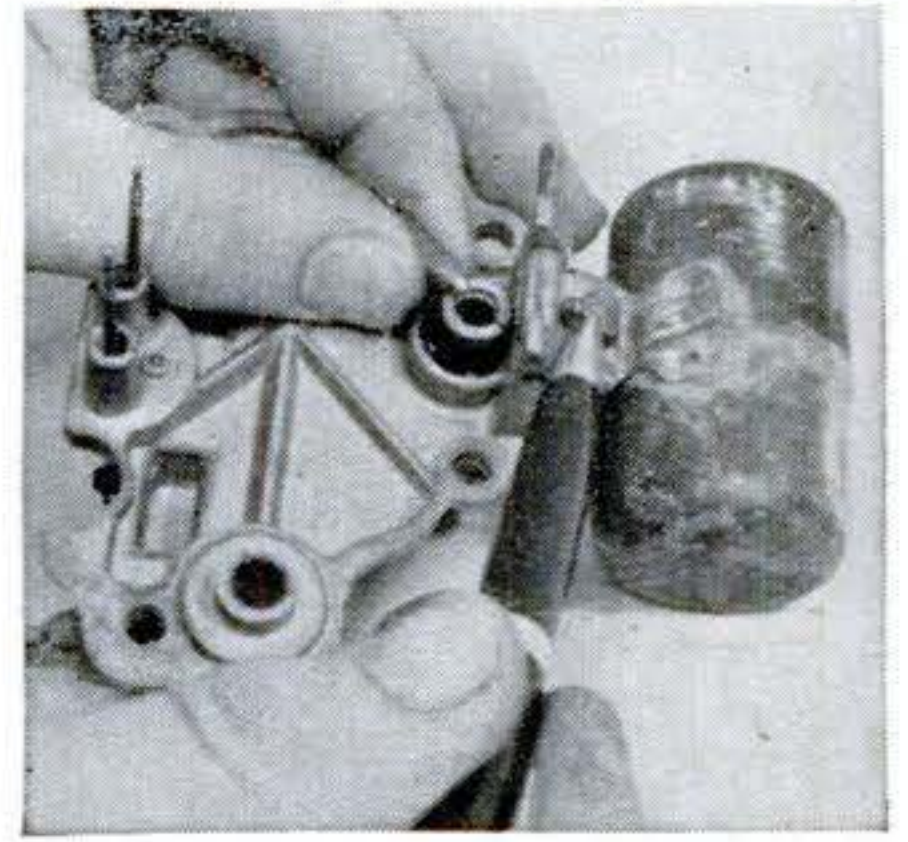

Typical carburetor trouble spots are listed here. Automatic-choke cover (not shown) contains a thermostatic spring that responds to exhaust heat. Be sure to clean its inlet tube.

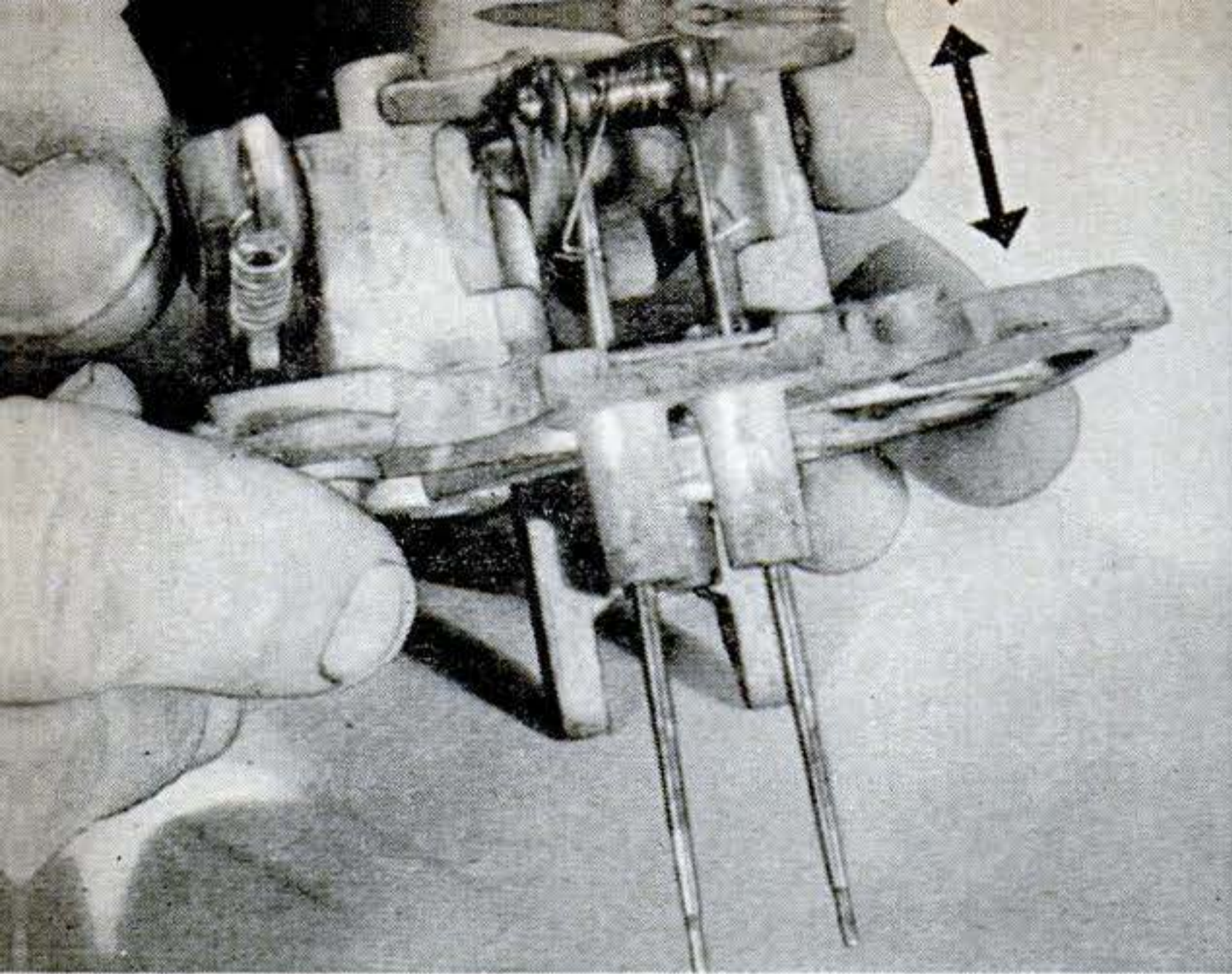

Countershaft on top is pivot point for most critical fuel-measuring system in carburetor. Excessive wear can be detected by gripping ends of shaft and rocking it in its bearings (above). If worn, this shaft cannot do an accurate job of controlling the metering rods. Shaft should be

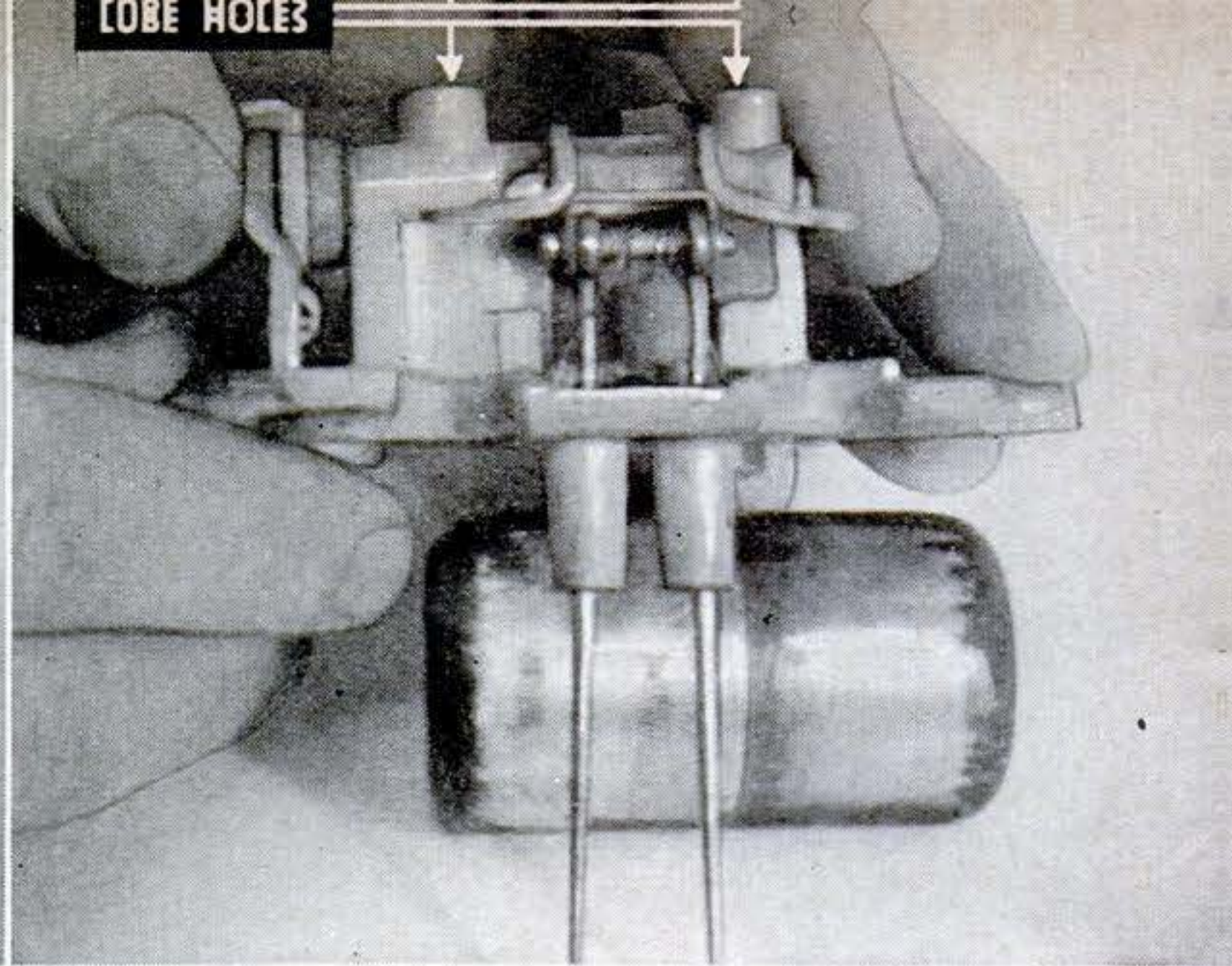

lubricated every time you have the car greased. Washing the dirt from countershaft cover will usually reveal lubricating instructions. Some require oil, some grease, and others graphite. If wear is bad, a new assembly is usually your safest bet.

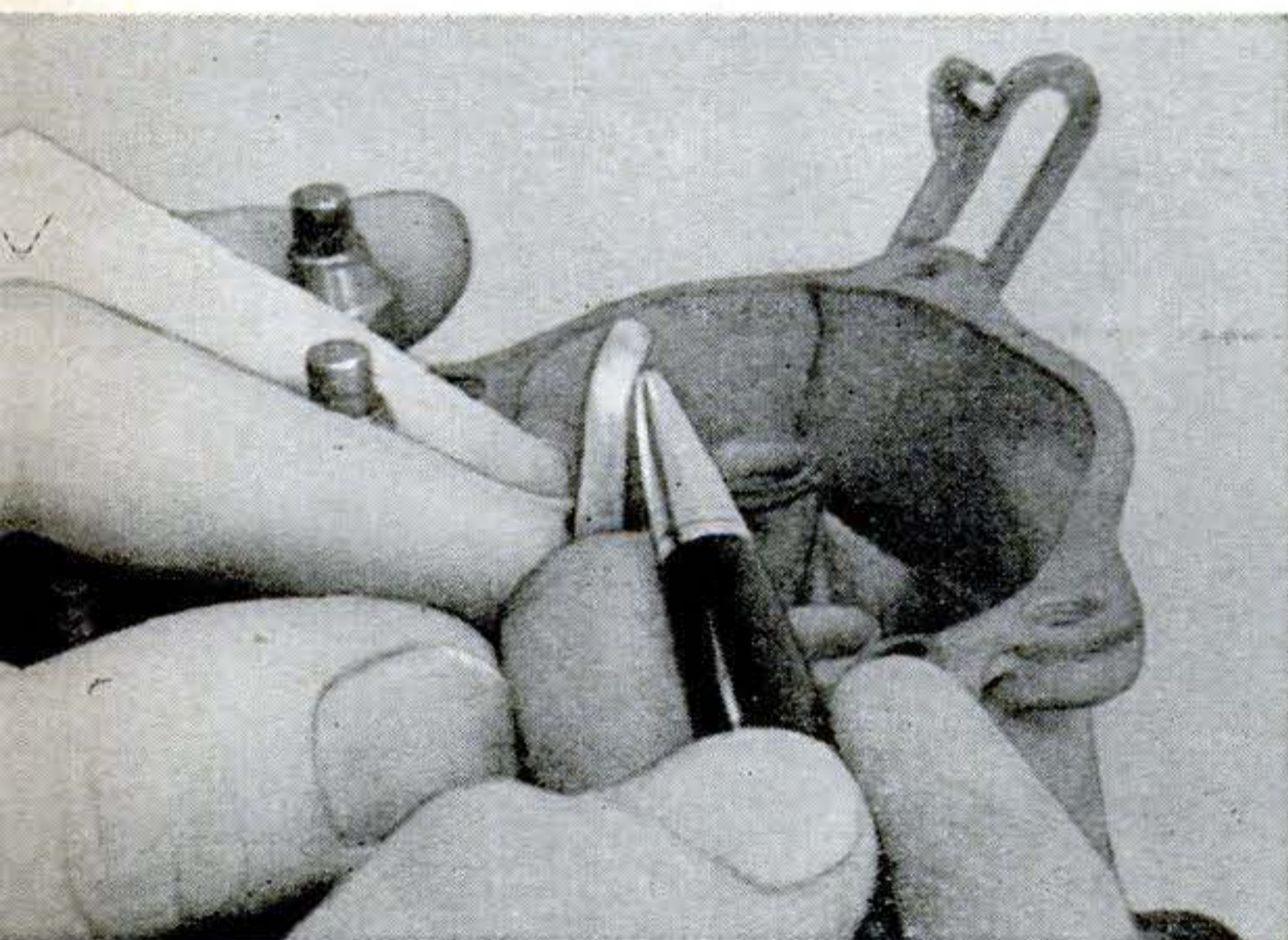

Wear on control-rod end and in linkage hole may be slight, but it's serious. New parts, re-bushing, or bending rod slightly are possible repairs. Also check foot-feed control.

In automatic choke, dirt and carbon are main source of trouble. Half-moon-shaped screen at left was almost solid with carbon, and action of

had when it was new, because of insufficient attention to the fuel or electrical systems.

In the carburetor, wear of only .001" on the jet bore and a similar amount on the metering rod can increase gas consumption as much as 10 percent. A new rod and a new jet are the cure. But this won't do the job completely if you or your mechanic overlook a badly worn countershaft bearing or a dirty automatic choke.

For it is *accumulations* of wear that rob an engine of efficiency. One worn spot may not cause trouble. But half a dozen, piled one on another along a carburetor's metering system or a distributor's timing mechanism, can keep the best of engines below par.

Tracking down and repairing or replacing such worn parts is difficult but worth while. An old car, with its lower friction losses,

lever at right was impeded. Clean choke thoroughly with solvent. A bad cover gasket will let in cold air, keeping choke closed too long.

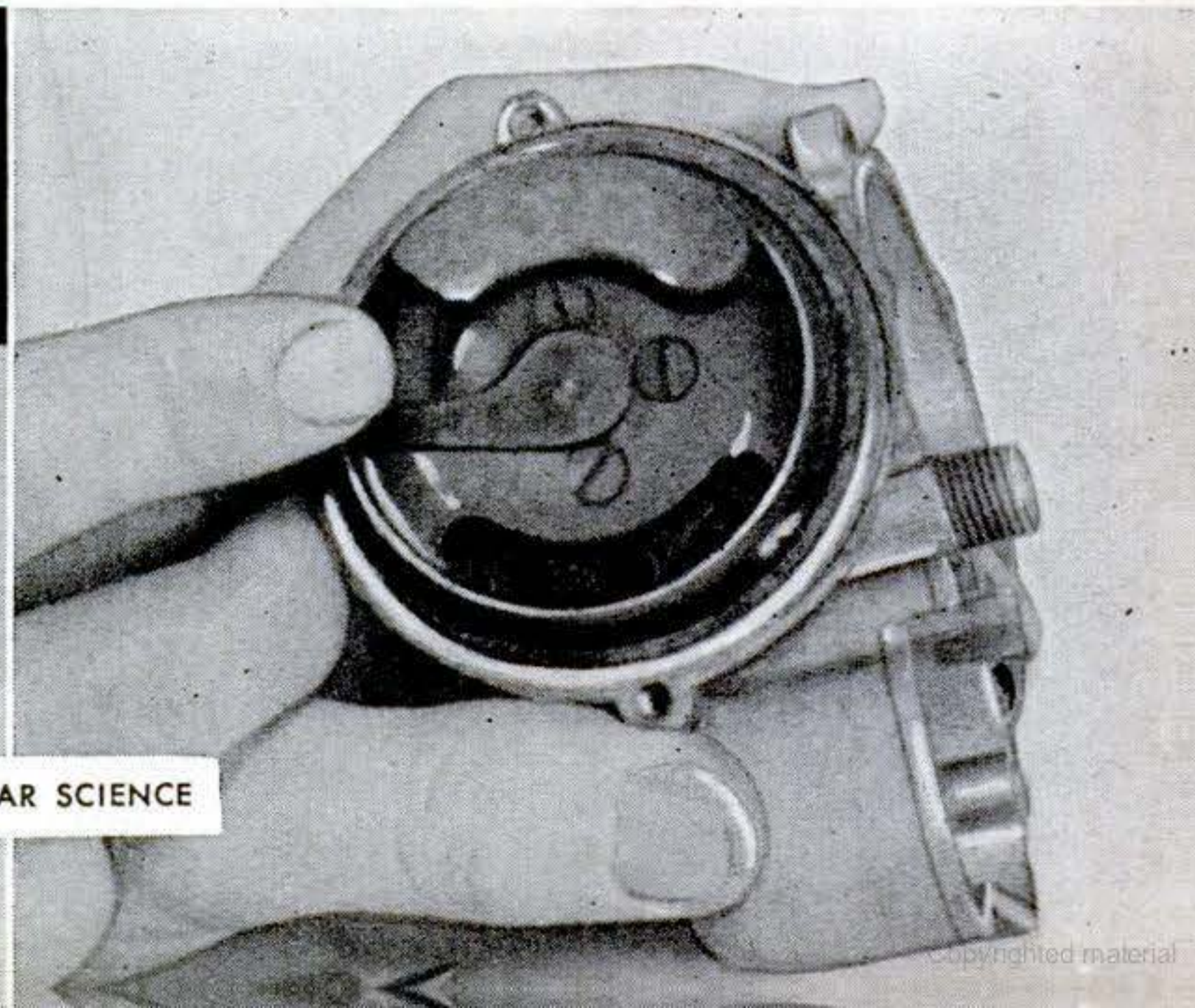
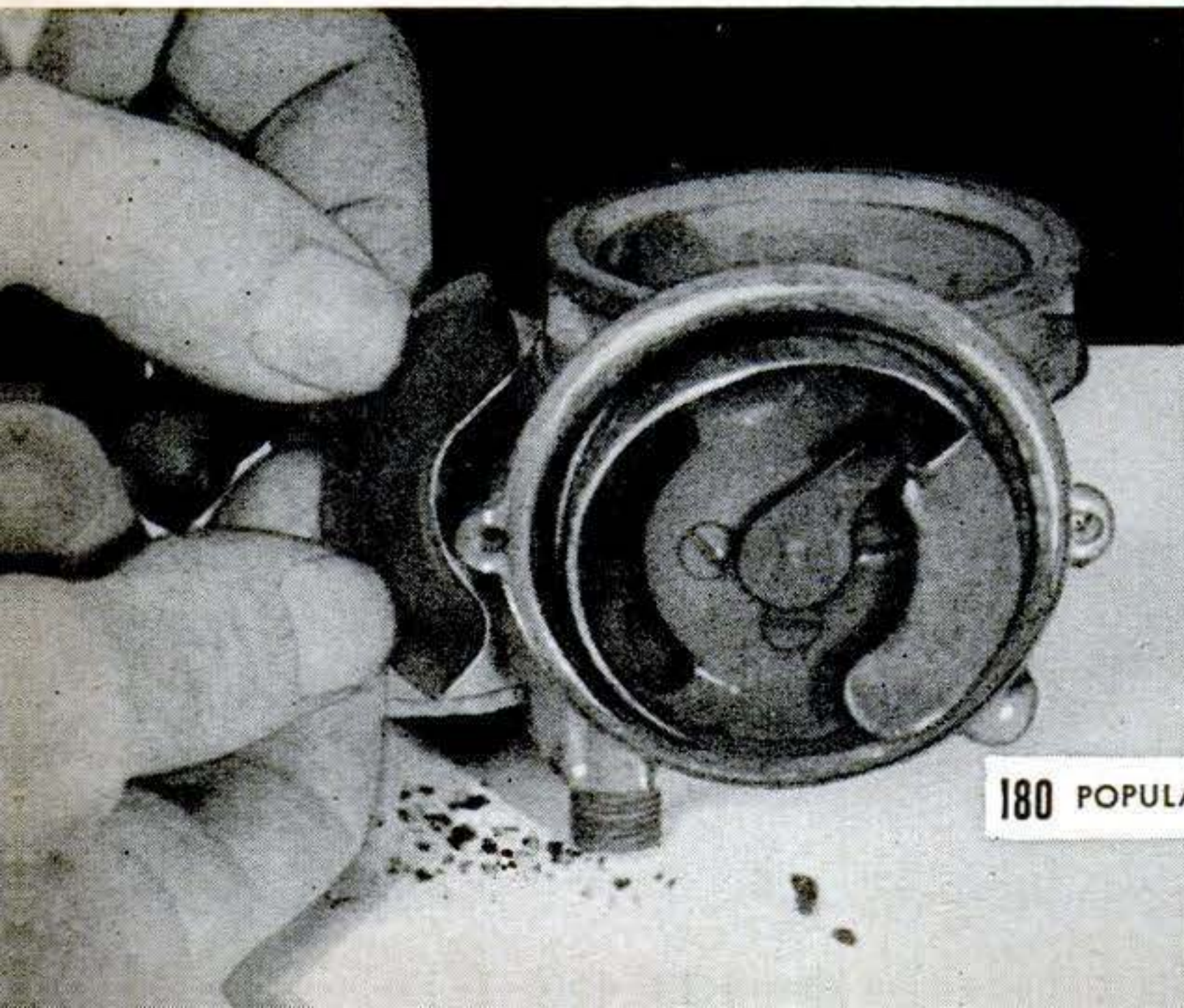

may even outrun the newest model on the road when you have finished the job.

Before you begin, however, make sure the rings, valves, plugs, cooling system, points, and fuel pump are in good condition and functioning efficiently. If they are not, your troubleshooting will count for nothing.

Your carburetor and distributor may not look the same as those pictured on these pages, but the principles are the same, and these photos show some of the pin points where age and neglect take their toll.

Cleaning Reveals Wear

Because the details you are looking for are easily lost in gum and grime, clean all the parts thoroughly. Use a brush and gum-cutting solvent.

If you have a magnifying glass, use it. Inspect all moving parts and linkages. Search out the surfaces that pivot, slide, rub, roll, bump, or contact each other in any way. Try with your fingers for sloppily fitting shafts and bearings. Poke and pry.

Wherever you spot bright and shining wear, fix it. Close up the hole, plate the shaft, or use a shim. Repair kits for rebuilding carburetors, distributors, and pumps are usually available at nominal cost.

Never remove a part until you have noted its original position. Automatic-choke covers, check valves, needle valves, insulating washers, distributor-drive keyways, and so on all have definite and specific adjustments and locations. Count the turns as you remove needle valves. Note distributor-rotor position when you remove the distributor from the engine. Make small scratch marks, file notches, draw sketches, and write down pertinent facts to jog your memory.

Don't Redesign the Engine

In most distributors, two separate systems control the cam position when the points open or close—and therefore govern the spark timing. One system depends on manifold vacuum, the other on centrifugal force. Neither can operate if the breaker plate is stuck. Under variations in speed and load this plate is constantly moving, seeking to follow a "spark loop" curve ideal for the engine. Interference with its movement, or changes of other parts in relation to the plate, will keep the engine below par.

Throughout the job, avoid major alterations. Remember, you are trying to restore the engine to its original condition, not design a new one.

END

MAY 1951 181

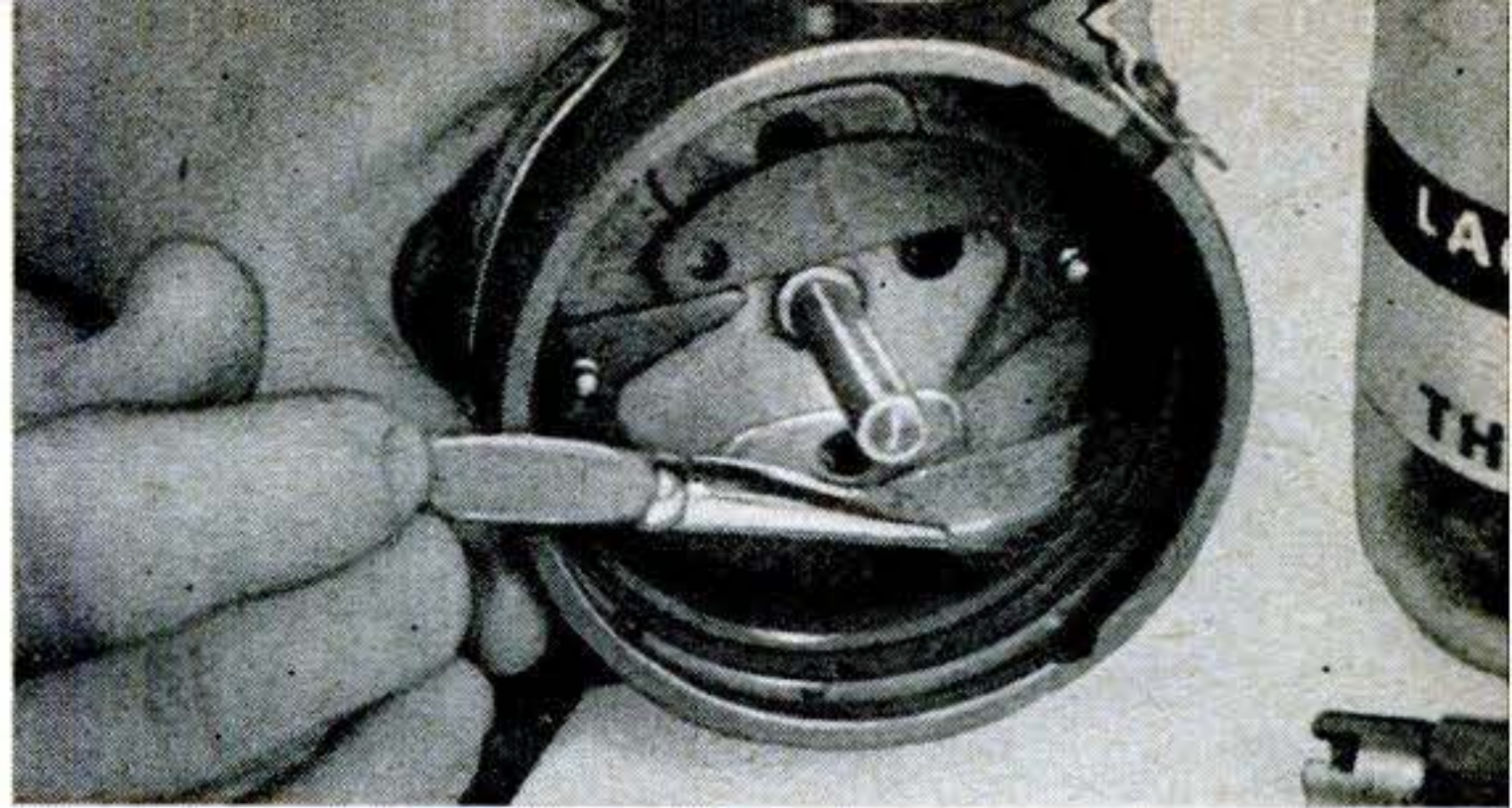

Wash out distributor with lacquer thinner and soak small parts in jar. Sticky deposits stop free movement of breaker plate and other parts.



Hardened grease may lock breaker-plate ball bearing. Wash clean with thinner and then lubricate lightly with petroleum jelly.

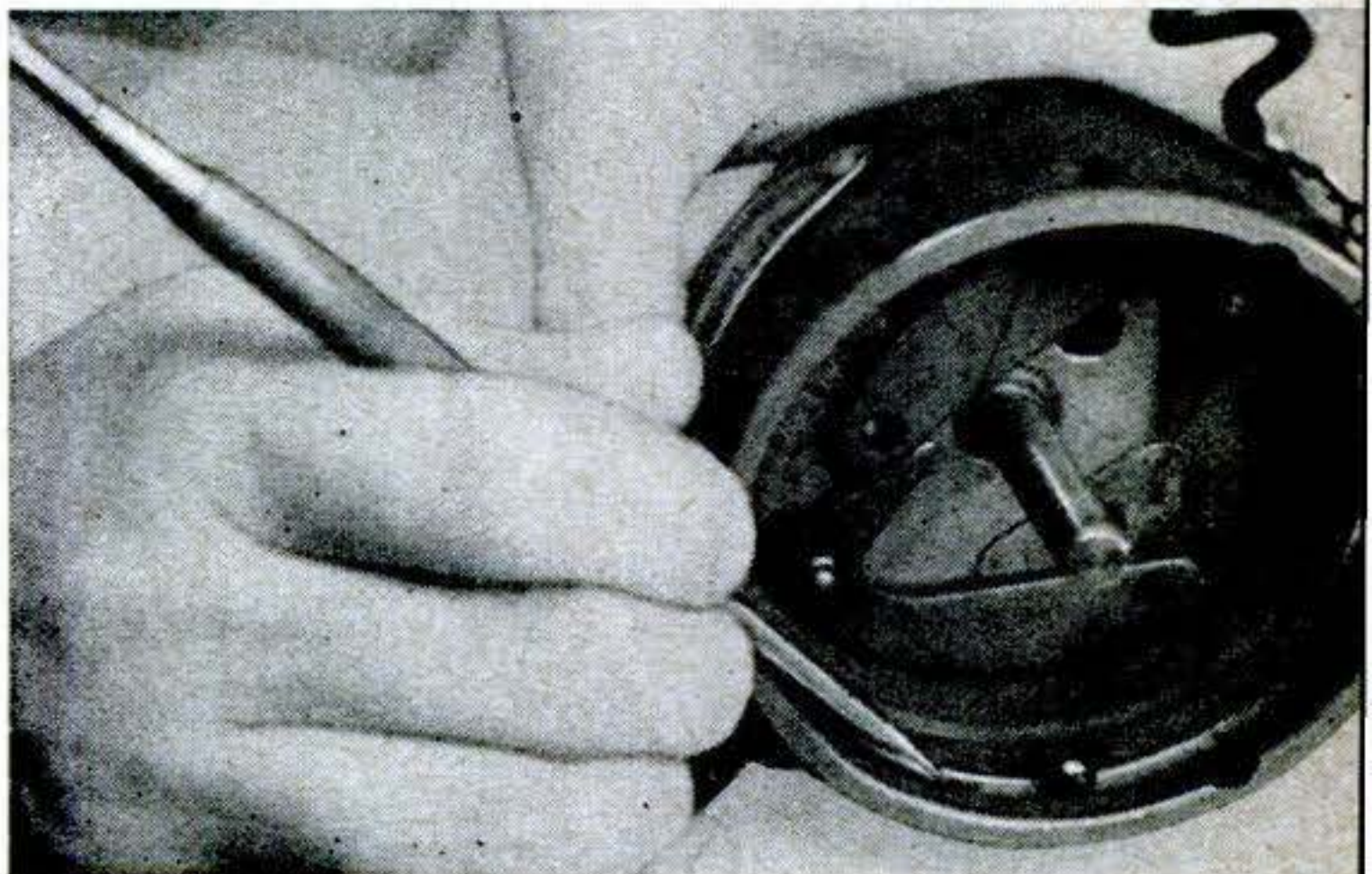

Ball bearing may wear dent in the distributor housing like this, giving uneven resistance that prevents proper spark timing. Groove liners are available for a quick repair.

Vacuum spark-control unit always suffers from crankcase vapors and rust. A manual check for a springy action and free movement does not necessarily mean the device is perfect, but it shows up worst offenders. Replace if bad.

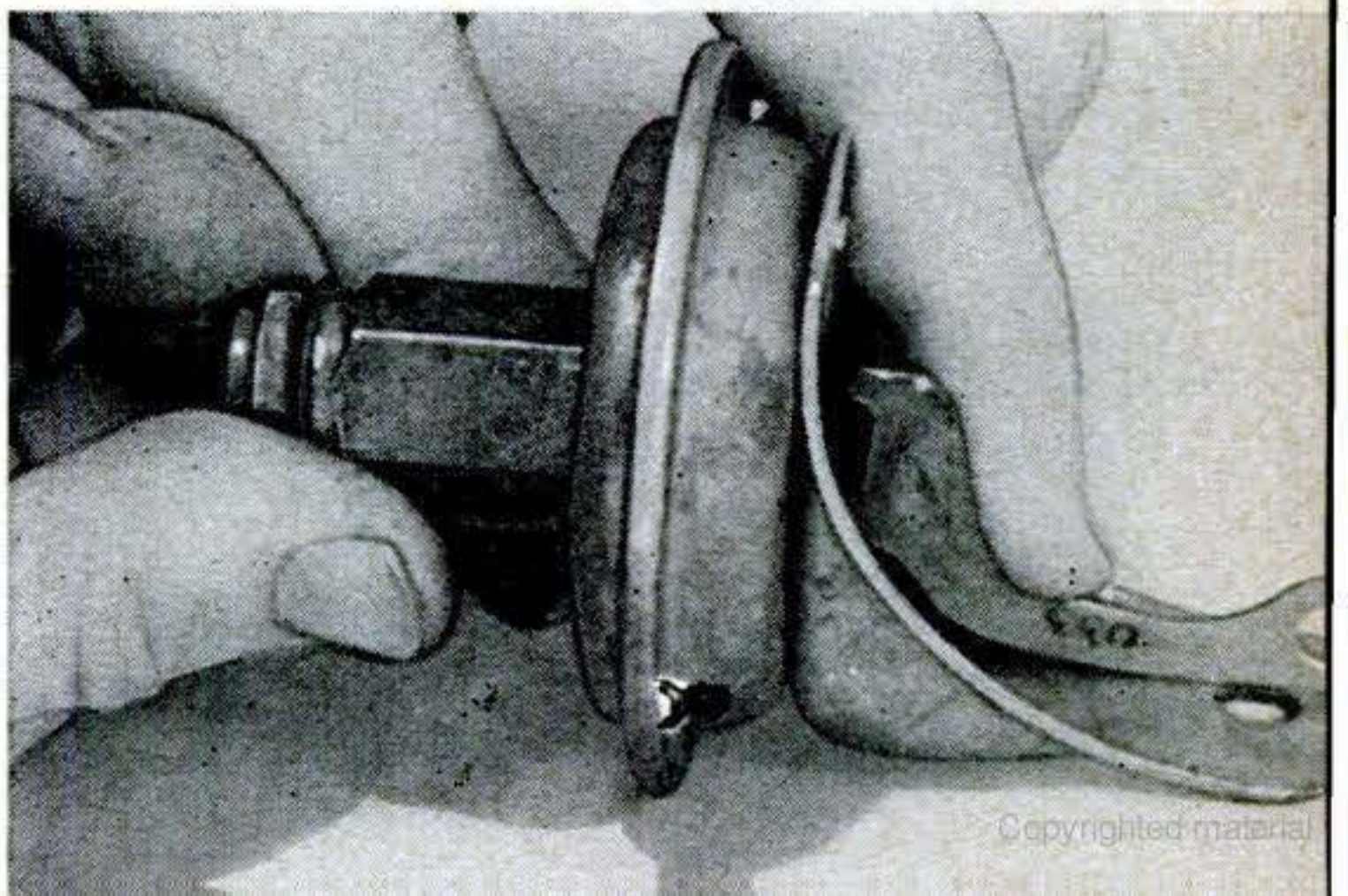

Summer Driving Tips

You'll enjoy your car longer by taking the simple precautions these pictures suggest.

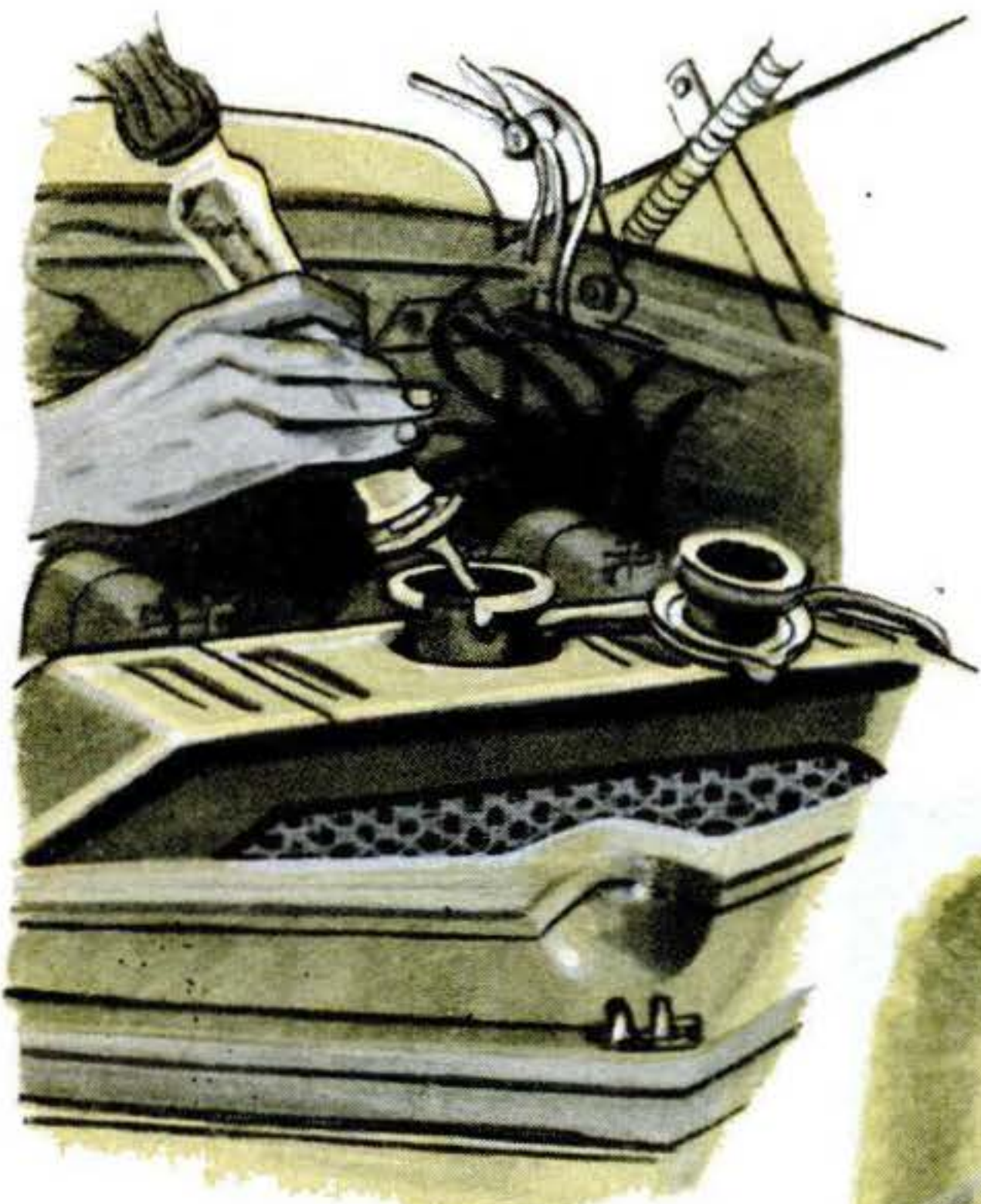

Examine the cooling water periodically by drawing a sample up into a hydrometer. If you find suspended rust particles, drain the radiator and put in a fresh dose of rust inhibitor. Summer driving conditions may tend to stimulate rusting.

Check your battery every week and add enough distilled water to keep the electrolyte level above the plates. Evaporation is far more rapid during warm weather than during cold.

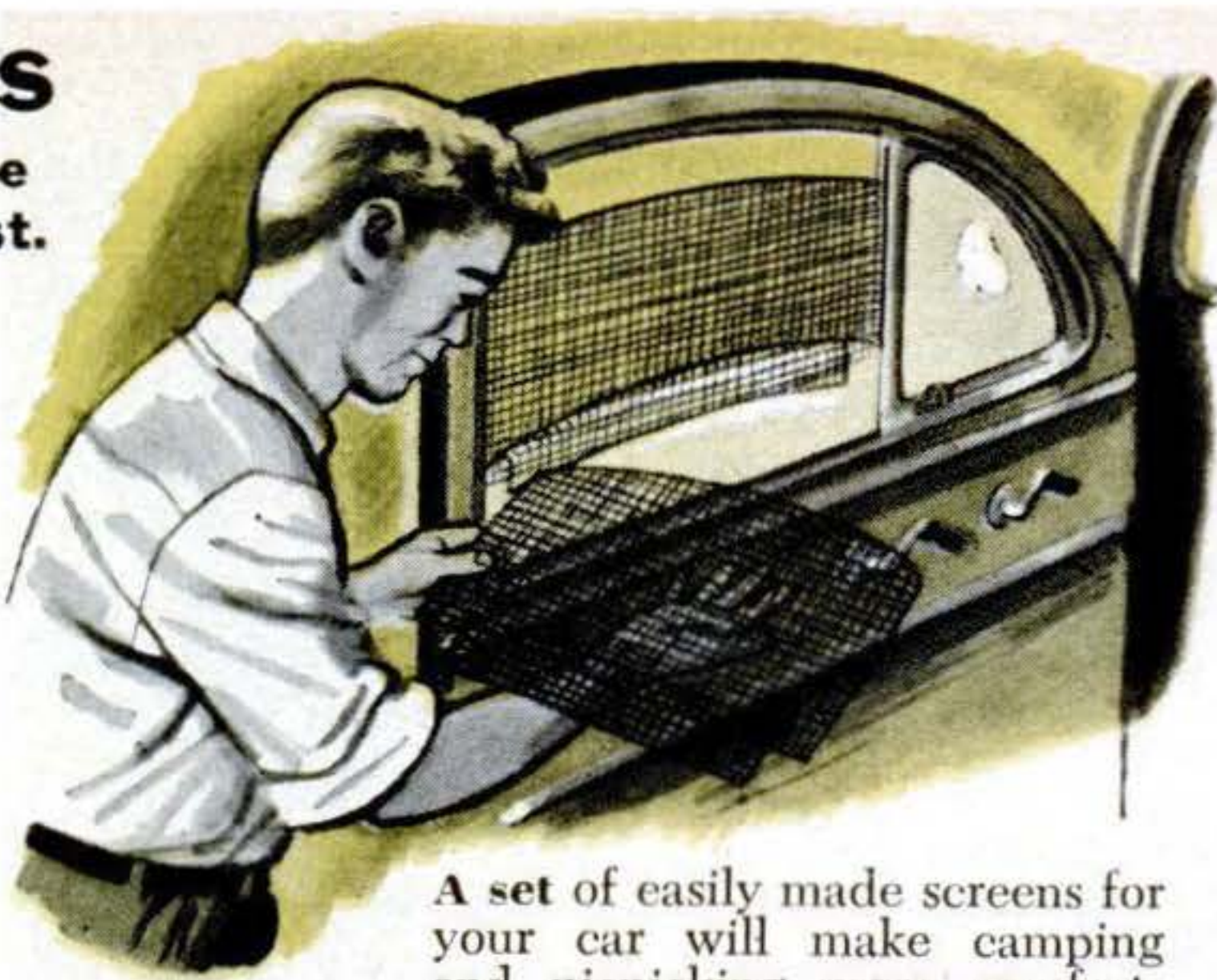

A set of easily made screens for your car will make camping and picnicking more comfortable. Cut and bend ordinary house screening as shown. A carton in the luggage compartment is a convenient spot to carry the screens.

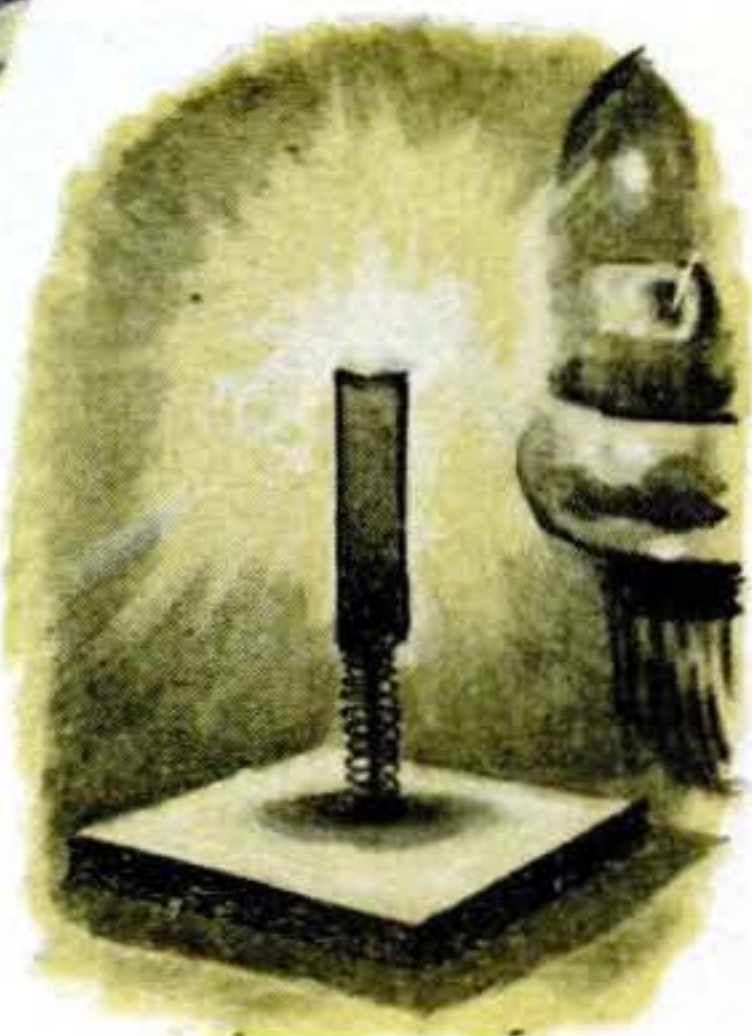

Carry a flare for emergencies. A coil spring attached to a board is a handy way to mount type of flare shown. Spring lets flare swing back and forth, making it more noticeable.

Park in the shade as often as you can—and you'll save money. Gasoline vaporizes rapidly in the direct rays of the sun. Your paint will stand up better, too.

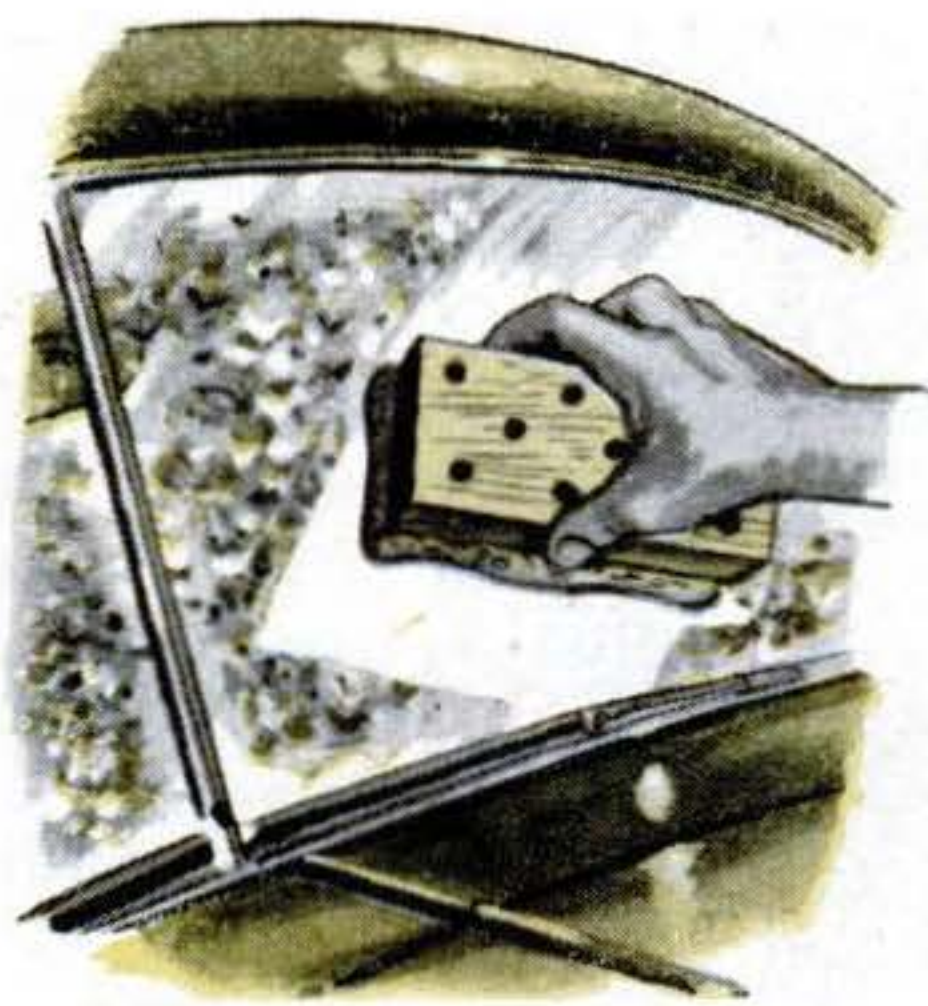

A block of wood with holes bored through it and sponge rubber cemented on one face will clean insects off windshield. Wet it before using.

What's This Car?

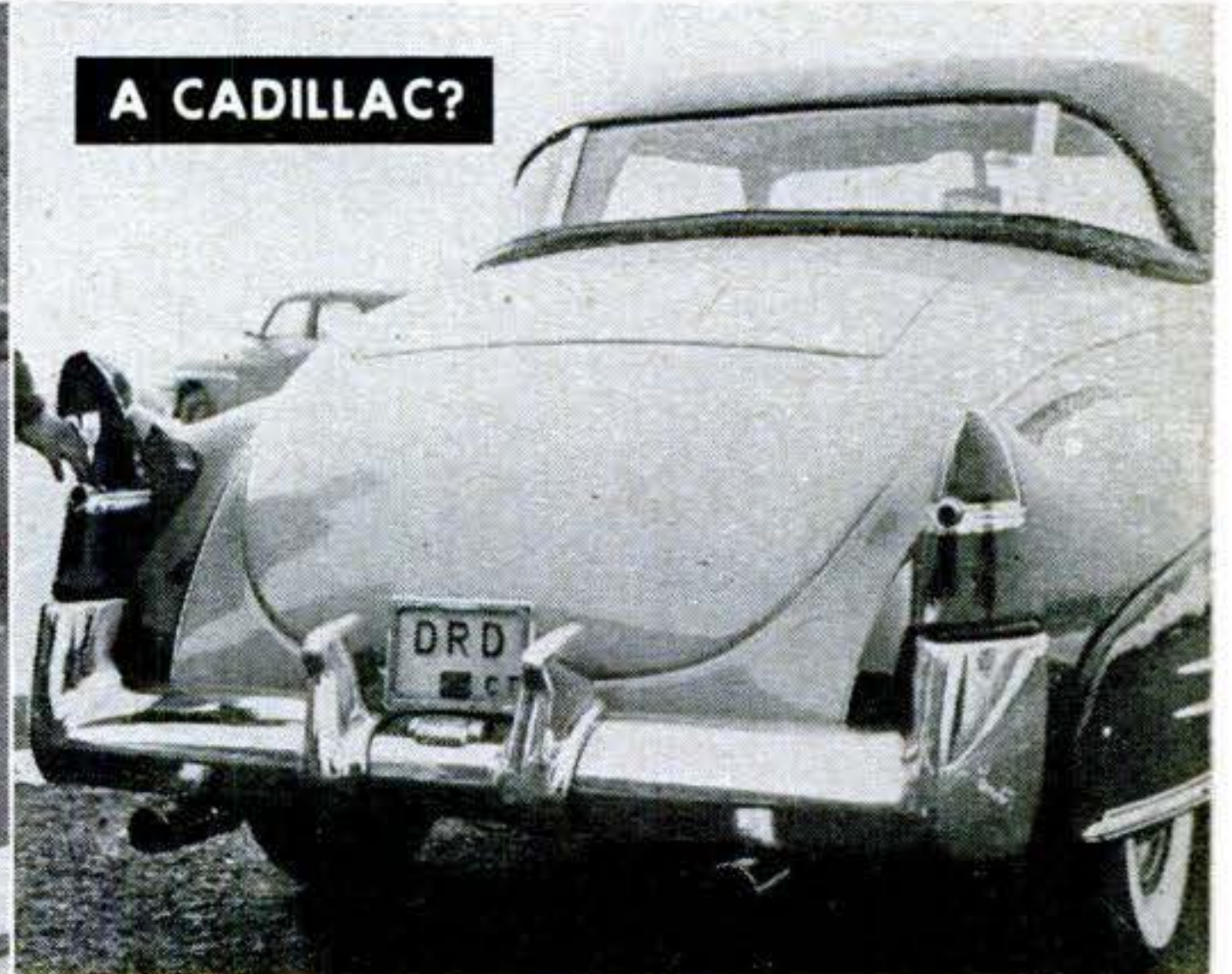
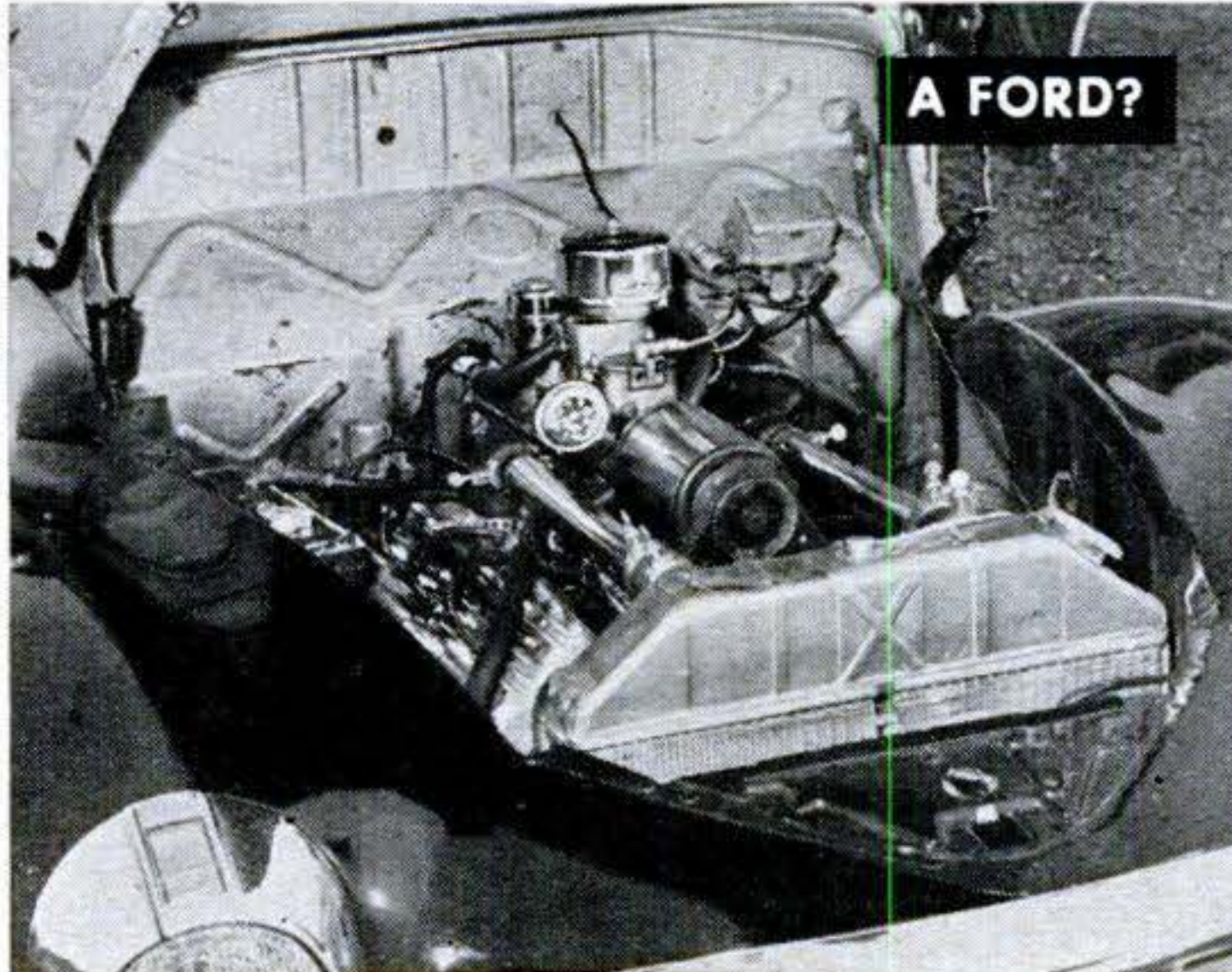

Everybody is confused when this odd but impressive job flashes by.

A QUICK glance at this car shows a Nash grille, Cadillac fishtail fenders, Cadillac bumpers, and Lincoln Zephyr wheels. Inside there's a chrome-plated Ford V-8 engine, a Mercury steering wheel, and a Lincoln Continental transmission.

Richard R. Dixon, an apprentice sheet-metal worker in East Hartford, Conn., bought the car secondhand for \$650, and has spent more than \$2,000 and 2,000 work hours rebuilding it. He rebored the cylinders, added high-compression rings and heads, substituted a stronger crankshaft, installed an aluminum flywheel—and wound up with an engine that develops 165 hp.

He switched the springs to lower the

body, moved the shift lever from the floor to the steering column, reupholstered the seats in red and white leather, applied reinforced composition leather to the top, painted the body cream and the fenders maroon, and added many accessories. One of these, as you'll see from the engine view at left, above, is a built-in vacuum gauge.

Dixon estimates his car—originally a 1939 Ford convertible—will now do 125 m.p.h. But he never has opened it up.

Bending Catch Keeps Wiper Blade On

ON MY car the wipers hang from the windshield top. On several occasions, the wind lifted a blade and swept it away. I have found that bending aside the key-type blade catch after the blade is installed prevents this.—*James H. Carll, Schenectady.*

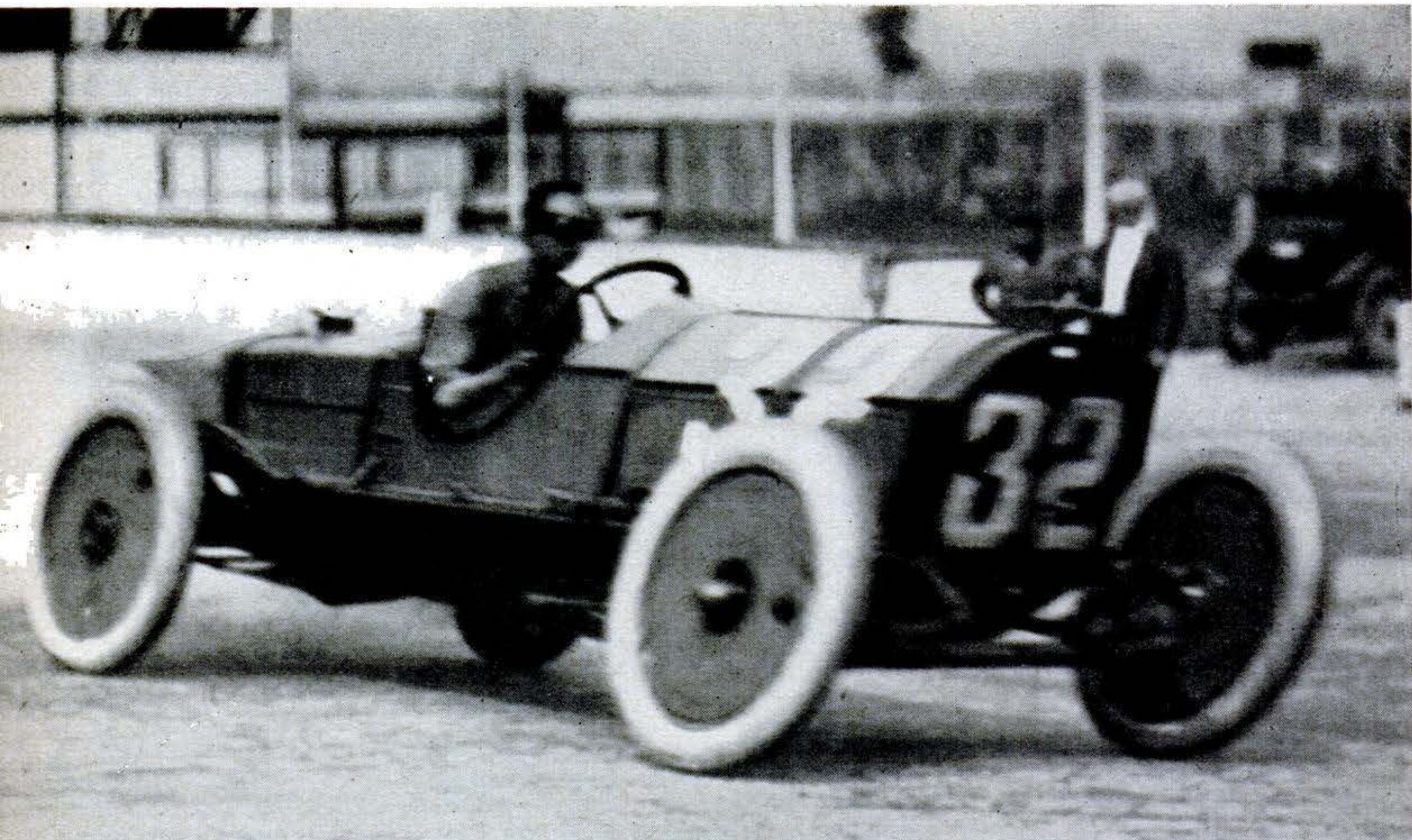

Winner of first Indianapolis 500 in 1911, Ray Harroun practices for the event in his Marmon Wasp. To replace riding mechanic who kept

driver informed of cars creeping up, Harroun installed a rear-view mirror. This is said to be the first use of such a mirror on a car.

I Cover the Races

By Paul Shideler

Chief Photographer, Indianapolis News

A veteran tells you how the Memorial Day Classic is photographed.

ON MEMORIAL DAY, 1948, Frank Salzarulo heard tires screeching while he was standing in the infield of the Indianapolis Speedway. That meant trouble, so he whipped his camera into shooting position, caught the car with the screeching rubber

Want a lift, VP? Paul Shideler, author of this article, invited U. S. Vice President Thomas R. Marshall for a ride in the belt-driven Comet Cycle Car that Paul used to cover the 1914 race at Indianapolis. Bill Herschell, Shideler's coworker, snapped the picture.



in his view finder, and snapped. Then he began looking around.

"This what you're looking for?" a bystander called, and waved a camera slide.

In his haste, Frank had tossed it 25 feet. He had followed my instructions almost too well—and gotten the remarkable picture on the bottom of the next page.

We have to be fast. Having covered the races at the Speedway since 1909, I tell photographers working with me to release the slide catch on their Speed Graphics in advance, pull out the slide just a fraction of an inch, and listen for screeching tires. Frank had been warned not to look first, but get his camera ready, then look through his view finder to see what was happening and in the same instant to pull his slide.

The photo I now prize most resulted from the sportsmanship of a gentleman named Ralph DePalma in 1912. Leading the field by more than 10 miles, with only two laps to go, DePalma's engine quit cold

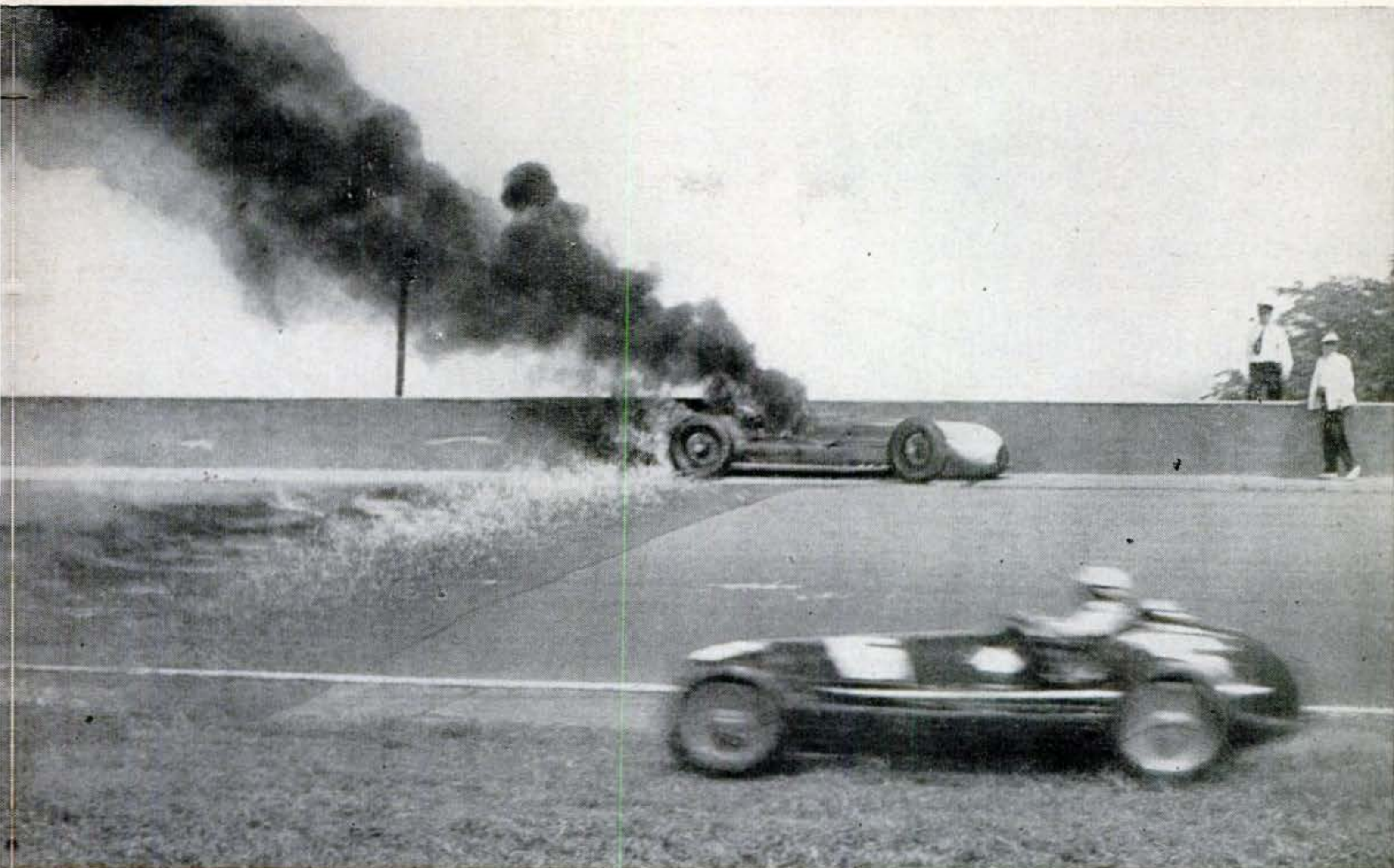

A hot finish. Accidents always make news at the races. Here is Duke Nalon's car burning after a crash during the 1949 race. To round

out the picture, George Tilford, *Indianapolis News* photographer, waited until he could include a speeding car in the foreground.

Johnny-on-the-spot. Speedway photographers have to be just that for dramatic shots like one below. The flying wheel at the upper left came

off Duane Carter's car when an axle broke in the 1948 race. Split-second action by Frank Salzarulo got both the wheel and the sliding car.

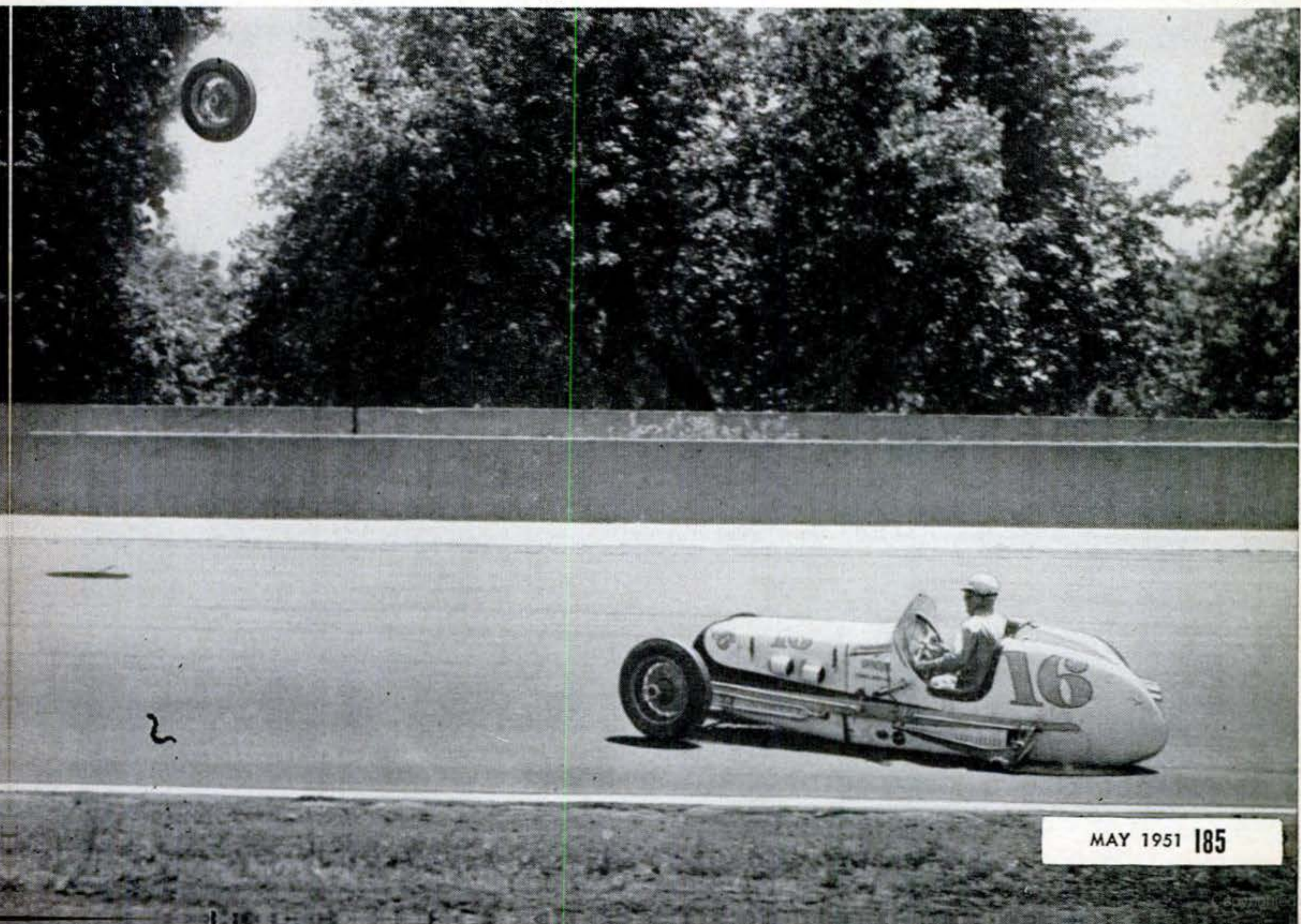

on the backstretch. But—smiling every step of the way and waving to the crowd at frequent intervals—he pushed it around the north turn and down to the finish line. There was never a better loser.

In the early days, pictures taken at a shutter speed of 1/1,000th looked like stills. So we learned to shoot at 1/500th, even though it blurred the car slightly, because that gave a visual suggestion of speed. Then, as car speeds rose, we upped our shutter speeds to 1/750th, and finally 1/1,000th, and began to swing our cameras with the car we wanted as it passed. Such “panning” blurs the background and suggests speed, yet sharpens the picture of the car.

At this year's race, our shutter speeds will be 1/1,000th of a second, and we will focus at 100 feet. If it's a bright day, we'll stop down to f/8; if dull, we'll open clear up. And we will pan the races.

Tips to amateurs. We press photographers use Speed Graphics largely because they are our standard equipment and we are used to them. Other cameras can be used. With a spring-wound 35-mm. camera with a 90- to 110-mm. lens, you might get a

couple of dozen shots out of one exciting event.

A sunshade is imperative because you never know when you'll have to point your camera into the light. And set your aperture for the shadow side of the subject. You may get halos around the object that you want, but it will be sharp.

Press coverage. Covering the Indianapolis 500 for the press requires planning and teamwork. I station one man near each of the 2½-mile Speedway's four turns, and another at the pits where cars are serviced.

Memorable moment. I have never been nearer death than I was the day the Speedway opened. Louis Chevrolet was about to win a 25-mile race. I dashed out to the middle of the track for a close-up. All the cars then burned castor oil and the smoke was terrific. I couldn't see beyond Chevrolet's car. A split second after I had snapped my picture, Bob Burman's car loomed out of the smoke coming 80 miles an hour, straight for me. He couldn't possibly veer more than a few inches. I froze in my tracks and sucked in my breath—and the car brushed my clothing. **END**

A smiling loser. Ralph DePalma pushes his car to the pits after engine failure forced him

out of 1912 race while far in the lead. This is Paul Shideler's most prized photo.

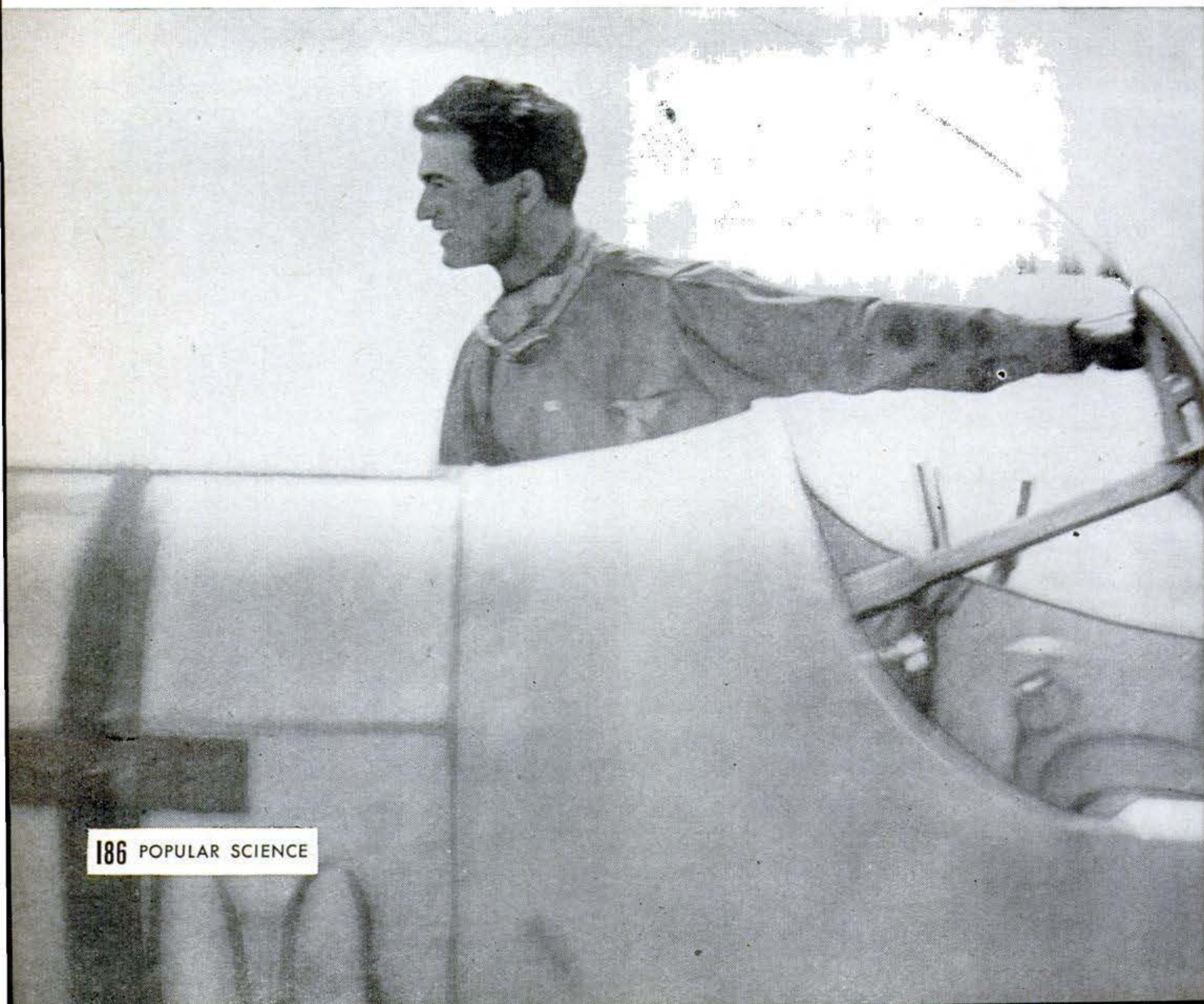



Everybody happy. Youngsters have a comfortable place to play or sleep while parents drive.

Folding Youth Bed Fits the Back Seat

HAVE you ever wanted to take young children on an overnight car trip? Or carry an awkward piece of furniture that would not quite go into the trunk? A folding platform placed ahead of the rear seat of the family sedan will solve both problems. It costs little to make, and anyone with a hammer and saw can put it together in an hour or so.

Scrap lumber about $\frac{3}{4}$ " thick can be cleated together, as in the platform shown, or you can use a piece of plywood. Cut legs just long enough to raise the platform level with the cushion. Locate them so they are braced by the cleats when open.

Platform consists of two sections hinged together. Each half has three hinged legs, the inner one located to clear the drive-shaft tunnel. Screen-door hooks lock the legs in position.

Halves hinge out like this, bringing the platform level with the rear seat cushion. In most cars, this provides enough space for a crib mattress, and you can put the children to bed.



When not in use, the platform folds flat, and stores nicely in the luggage compartment.

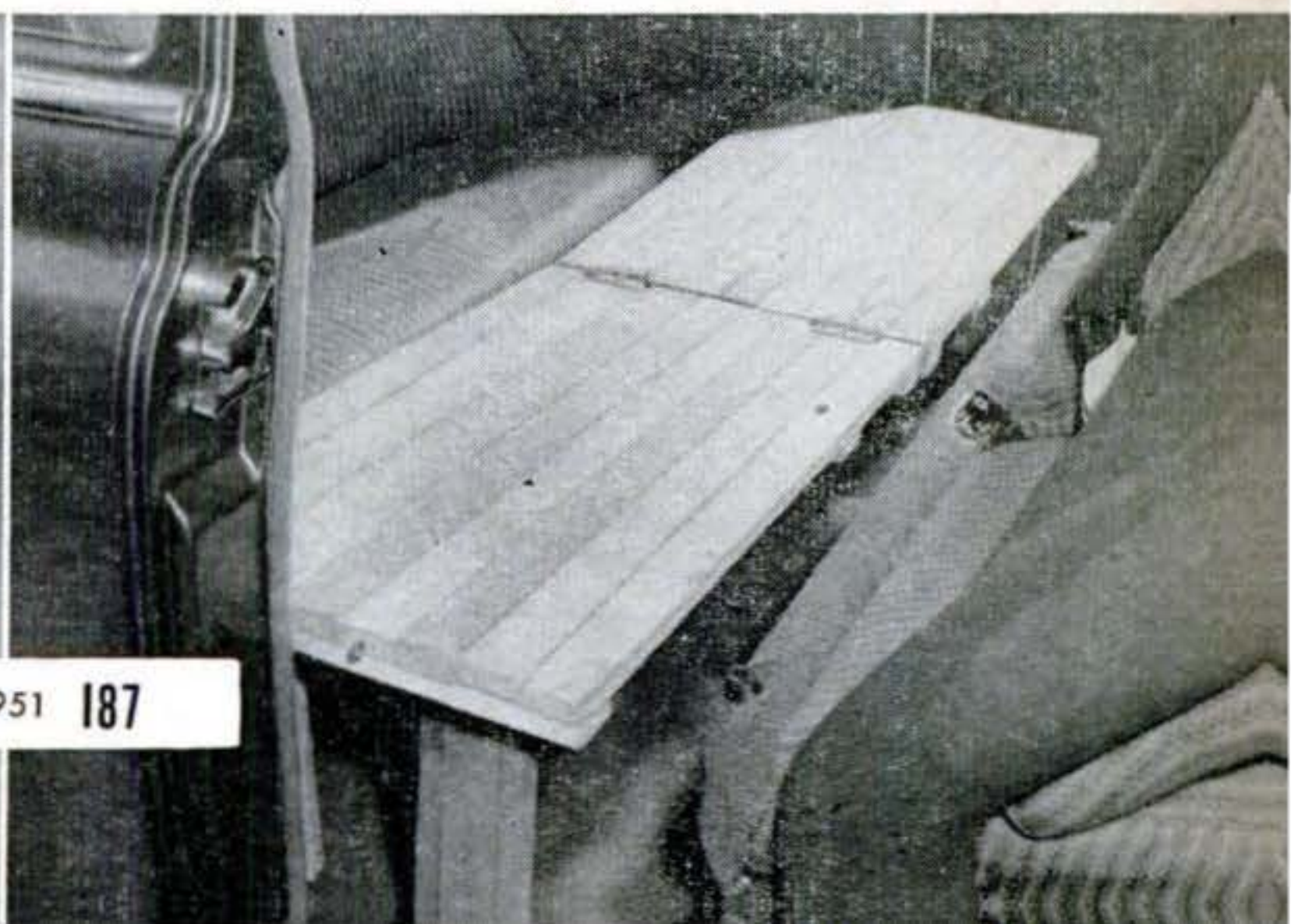
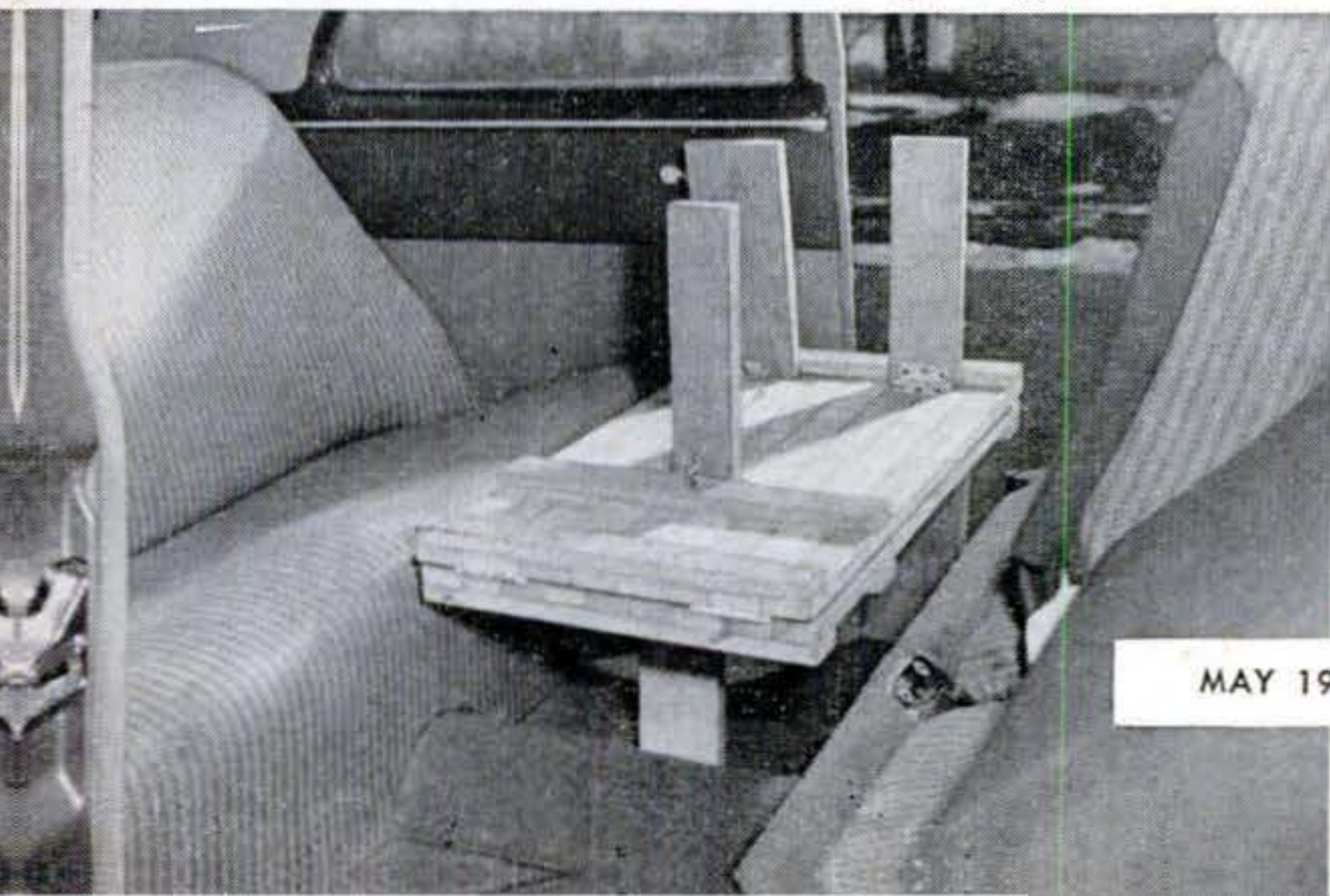

Ways To Dress Your Doorway

A canopy over the front entrance will accent it pleasingly, and as a bonus give shelter where you need it most.

DOES the door to your home open right into the weather? On such an entrance, a canopy would provide shelter while a person waits at the door, fumbles with a key, or opens an umbrella. And if your house is one of a row of look-alikes, a canopy will set it off from its neighbors.

Here are four typical houses to which canopies have been added. Note how greatly such a small addition changes the appearance of each house.

The flat-roof type, suggested for the house at the top of the page, is supported on two-by-fours and has a latticework for vines. The roof framework also may be two-by-fours, covered with sheathing or $\frac{1}{2}$ " exterior-grade plywood, with roll roofing or sheet copper over that.

The curved canopy is hung in brackets of $\frac{3}{4}$ " outdoor plywood. Its roof rafters can be bandsawed from two-by-sixes. Over its sheathing or $\frac{1}{4}$ " outdoor plywood, the same kind of shingles or other roofing that is on the rest of the house should be used.

The hip roof for the canopy shown on a two-story house is harder to build. The necessary angle cuts call for careful layout and good carpentry. Don't tackle one like this alone unless you can do finicky work.

The modern cantilever roof at the bottom of the page is supported by a 4" lally column, anchored down against wind uplift. Rafters can be butted and toenailed, or hung by strap hangers, into a framework of tripled two-by-sixes. Ideally, the other rafter ends should be extended into the house and secured to the plate, but they could be notched into a member spiked on over the sheathing.

Adequate flashing to keep rain out between the house and canopy is vital. A flat roof should have enough forward pitch to shed water, and a gutter to lead it off.—
Carl T. Sigman and William L. Ward, Jr.

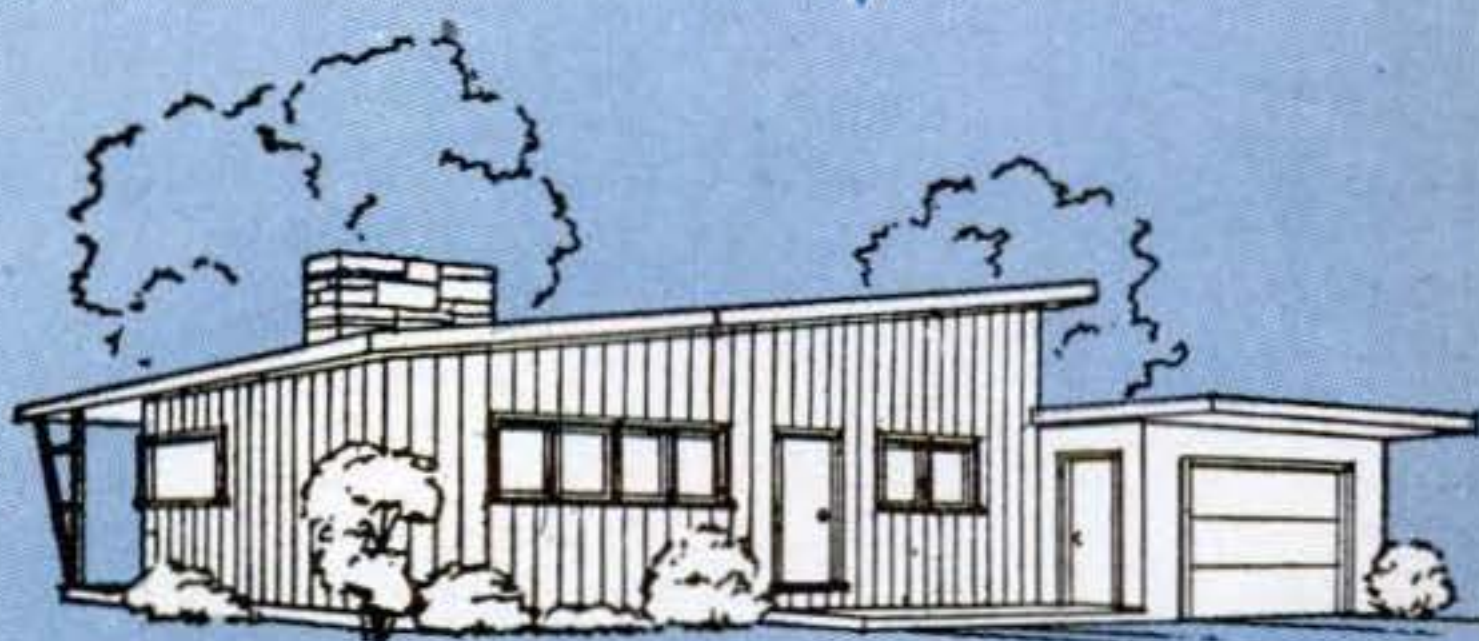

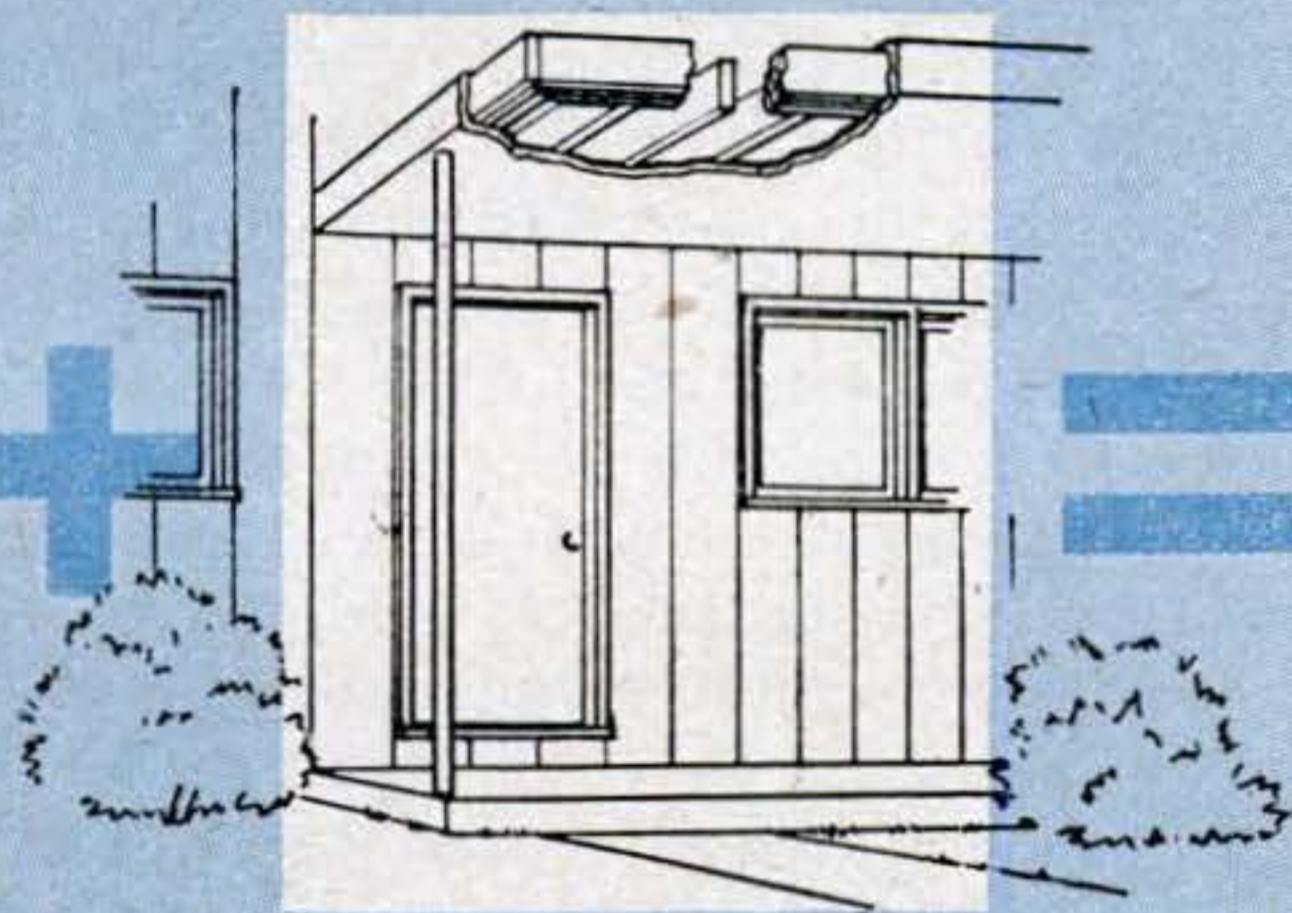
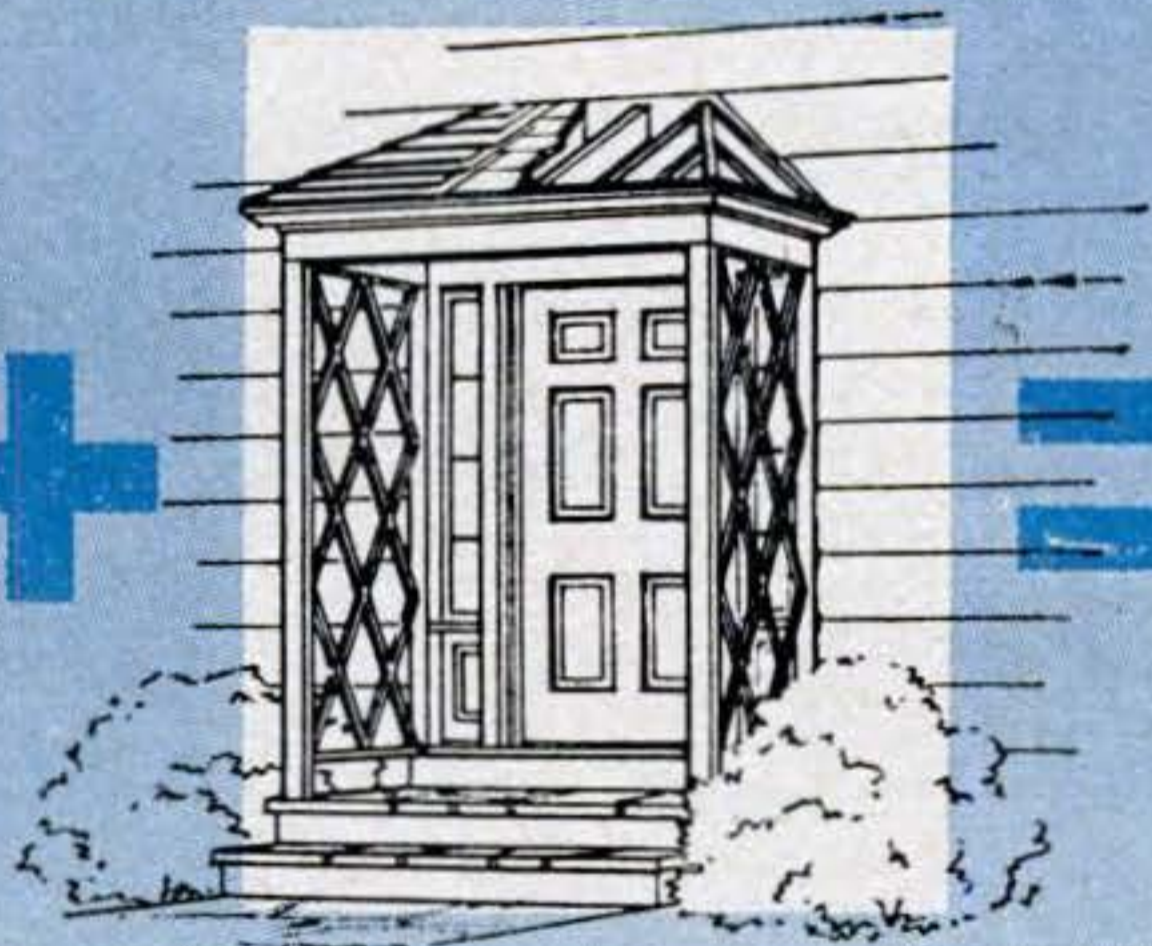
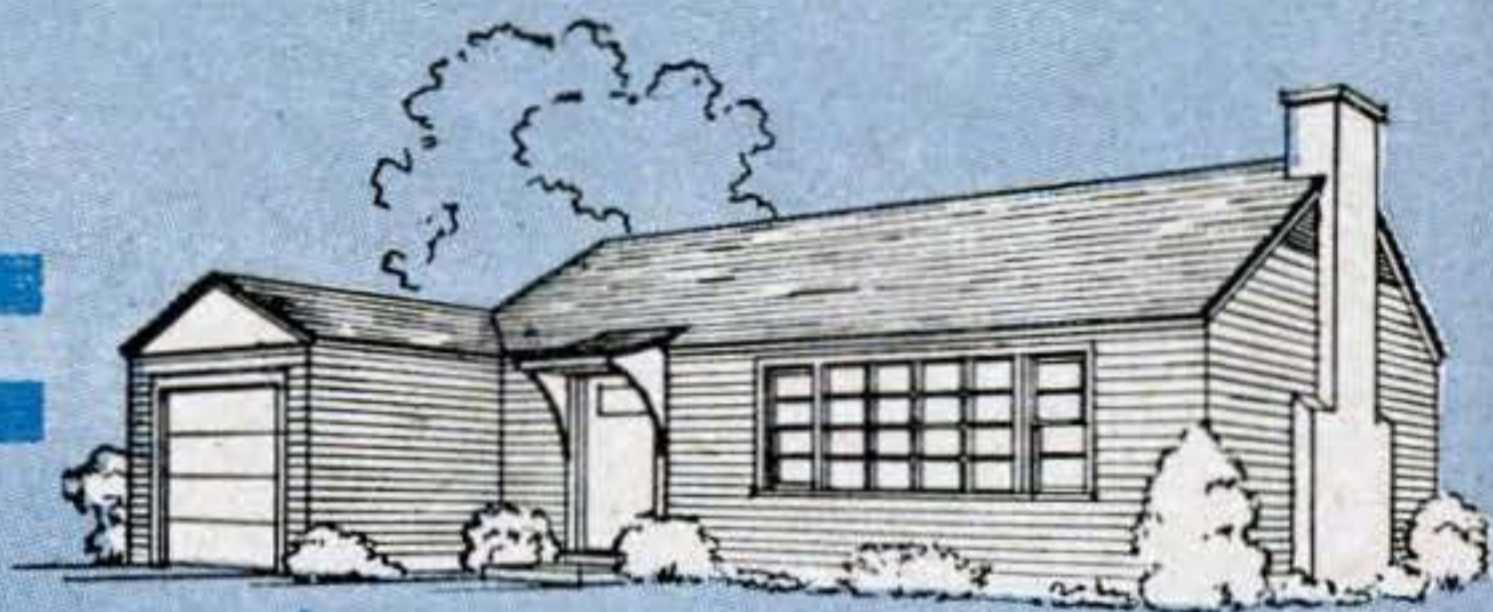
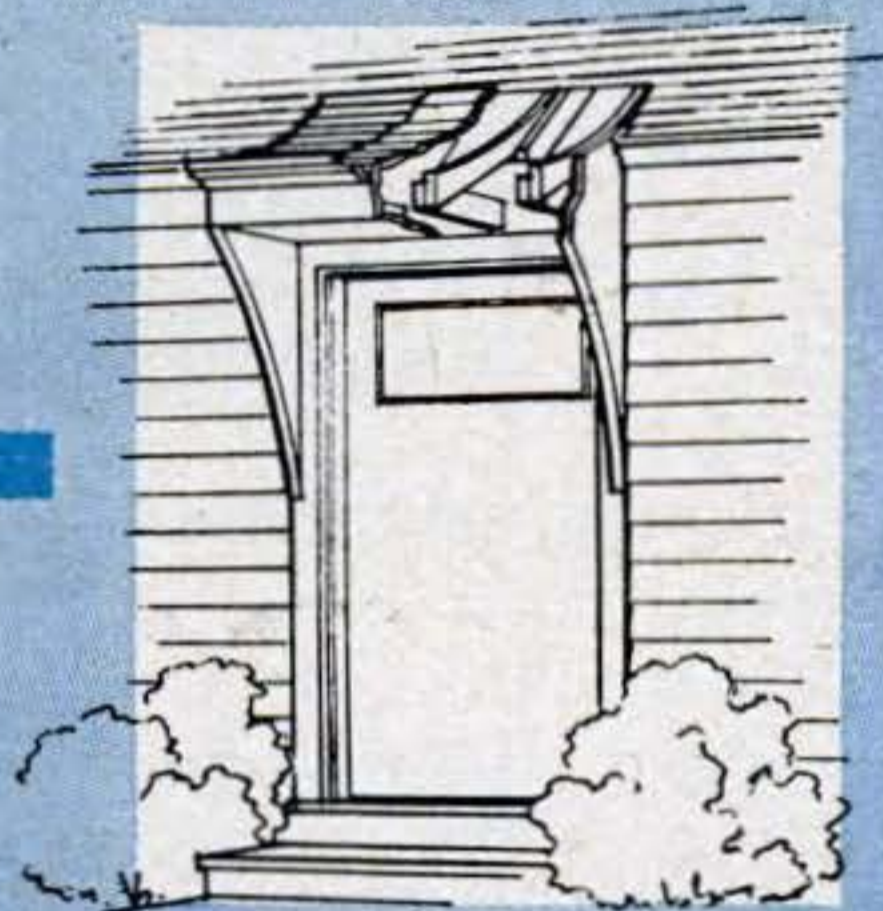
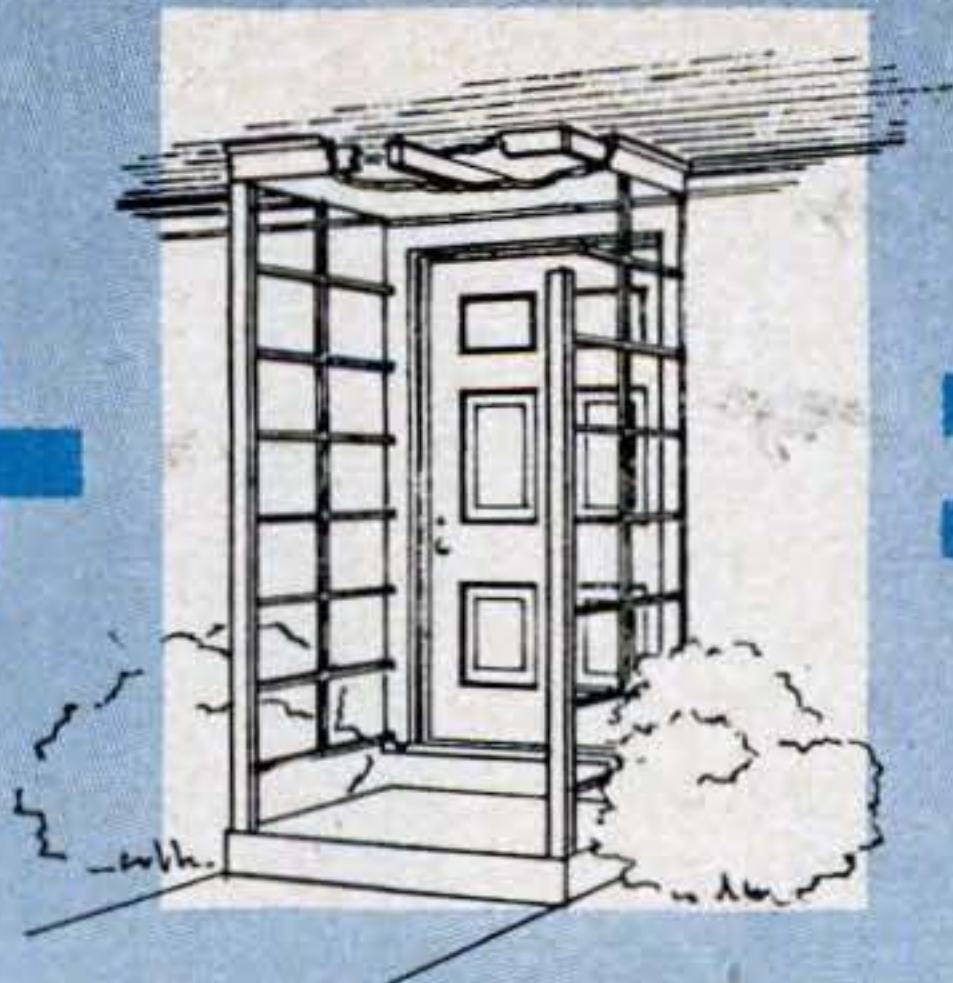

Paint Roller Buffs Silverware



WHEN my wife handed me some silverware to polish, I groaned because I had no buffing wheel. Then I took an unused sheep's-wool paint roller, slipped it on a wooden mandrel that was tight enough so that it wouldn't slip under buffing pressure, and put it between the lathe centers. I charged the wool with rouge, belted the lathe for high speed, and did the job in jig-time.—*J. C. Branstetter, San Francisco.*

License Tag Makes Back-Step Scraper



LIVING in a new house can be tough on a housewife until the lawn sprouts and garden walks are laid. To help keep our kitchen floor clean, I nailed an old license plate to the back doorstep. It makes a fine foot scraper.—*R. Woodbury, Natick, Mass.*

Your Small Wrenches Will Always Be Handy If You Carry Them This Way

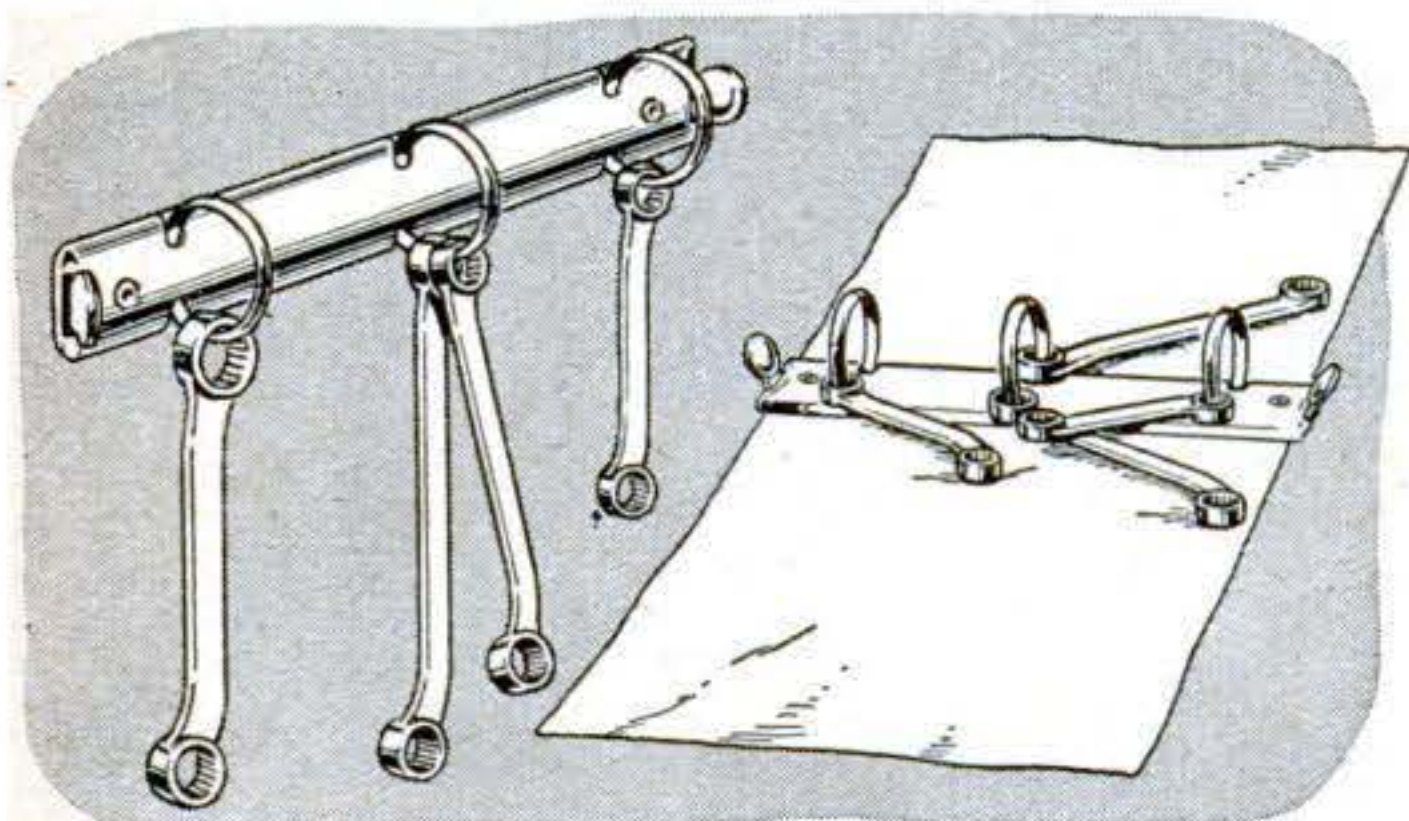

Hang Up Your Gloves to Dry Them

THIS simple wooden rack holds a pair of rubber gloves for drying. Two $\frac{1}{2}$ " dowels are fastened in a plywood base with waterproof glue. Space them about $2\frac{1}{4}$ " apart and round off the tops. They should be smoothed by wetting, allowing to dry, and then sanding to remove raised grain. Repeat until no grain-raising occurs. The base can be painted to resist dripping water.—*Walter E. Burton, Akron, Ohio.*

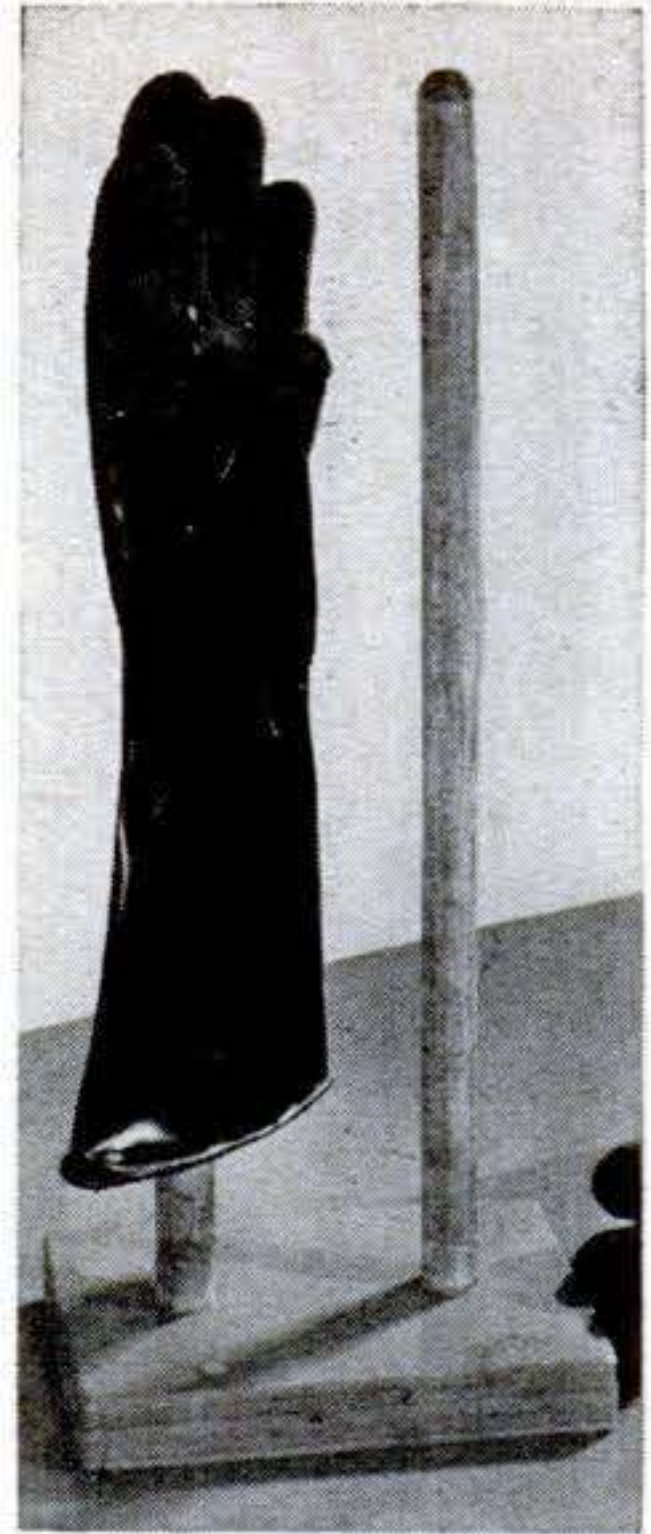

Easy Way to Display Your Prints

STAINLESS-STEEL cap strip, used for edging tile board, makes attractive frames for glass-covered prints (below). Attach two lengths of capping to the wall, spaced so that the glass just slides between the strips. Framed in this way, prints can be changed easily.—*G. H. Kuhn, Amsterdam, N. Y.*

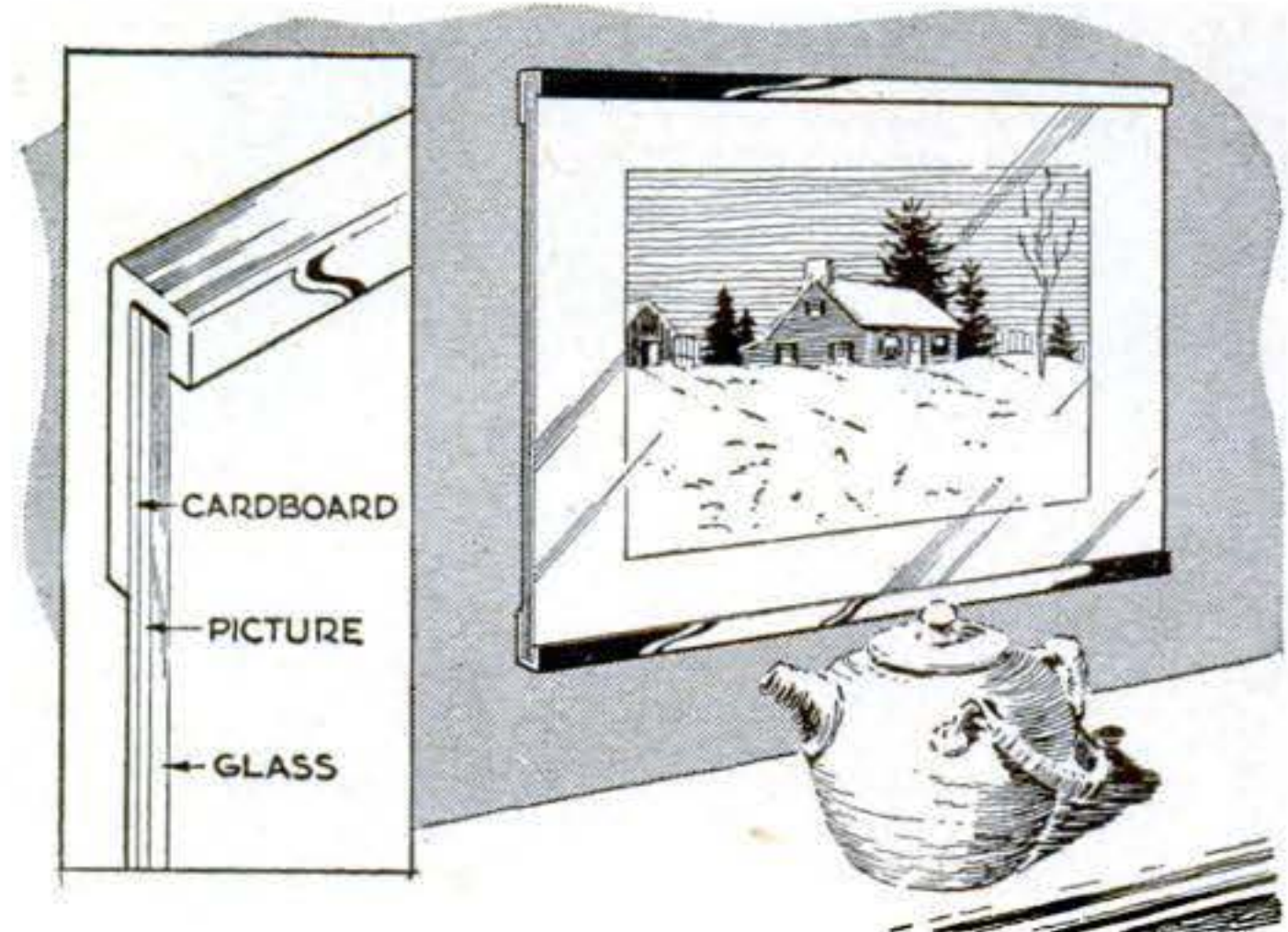

NICKEL CURBS
CARS SUFFER

Order, Effective March
Seeks to Conserve
Used Extensively in

WASHINGTON, Jan. 2
ment banned
in automob
ly 400 other

UPS lightens
Aluminum Curb

Use Forbidden
Civil

NEW ORDERS CURB

Relief Pledged in Copper Curb
Blow to Home Appliances

How to Defend Defense Metals

Conservation begins at home. Properly guarded, many of your appliances should last forever.

By Kenneth M. Swezey

THESE headlines tell a story we all should consider carefully—less steel for automobiles and refrigerators, less aluminum, tinware, and stainless steel for pots and pans, less copper or brass for civilian use, and less nickel, silver, and chrome for ornaments and household appliances.

You can help—both yourself and your country—by making your present metal articles last longer. Few metal articles except machine parts and tools that are subjected to hard use wear out in service. Instead, they corrode because they are neglected, or are worn out by bad cleaning methods. Properly cared for, most solid metal gadgets should last a lifetime. Even plated

NPA Bans Use of Aluminum in 200
"Less Essential Items" Act

ware can be kept in good shape for years to come. Making metals last longer is chiefly a matter of preventing corrosion and cleaning them properly.

Making Your Own Cleaners

Good ready-made cleaning and polishing compounds for all common metals can be bought in grocery and department stores and gas stations. If used discreetly, these should be harmless and effective. For those who like to make their own, several inexpensive and easily put together formulas that are harmless and effective are included in this article.

It also helps to know a few chemical and mechanical quirks of different metals. You can find these out by performing the simple experiments illustrated below.

Corrosion of iron and steel is caused by the reaction of these metals with oxygen and

moisture. Since the product, rust, is porous, it holds moisture and so accelerates corrosion of the metal beneath. Before rust can be stopped, existing rust must be removed. On large pieces this can be done with a wire brush or steel wool.

Iron and steel building materials, after being cleaned of rust (or when first installed), can be protected by first coating them with a metal primer and then with two or more coats of good oil paint. Tools can be protected by keeping them in a dry place and wiping them occasionally with lubricating oil, or with special oil-base corrosion preventives sold in hardware stores and gas stations.

Electrons Are Mischievous

Often corrosion is speeded up tremendously by electrolytic action. Whenever two different metals are in contact in a conduct-

Simple Tests Show How and Why Metals Corrode

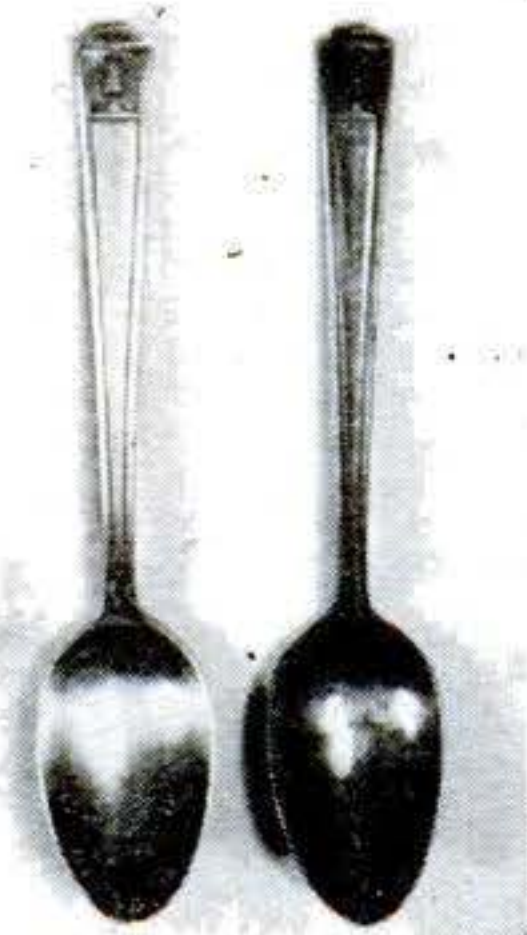

SILVER. Put a little iron sulphide into a glass jigger. Put this and a silver spoon inside a wide-mouth jar. Add a drop of dilute sulphuric acid to the sulphide. This will produce hydrogen sulphide gas. Cap jar tightly. Leave the spoon there overnight, and it will blacken, as at left. Sulphur compounds in foods and the air tarnish silver.

COPPER AND BRASS. Green film that forms is usually a carbonate caused by reaction of copper with carbon dioxide and moisture. To see this, put a polished strip of copper in each of two screw-cap jars. Pour a little water into both. To one, add a half teaspoon of baking soda and a little vinegar. Cap both jars tightly as soon as the carbon dioxide bubbling stops. Next day, the strip exposed to moist carbon dioxide will be green. The other will be bright.

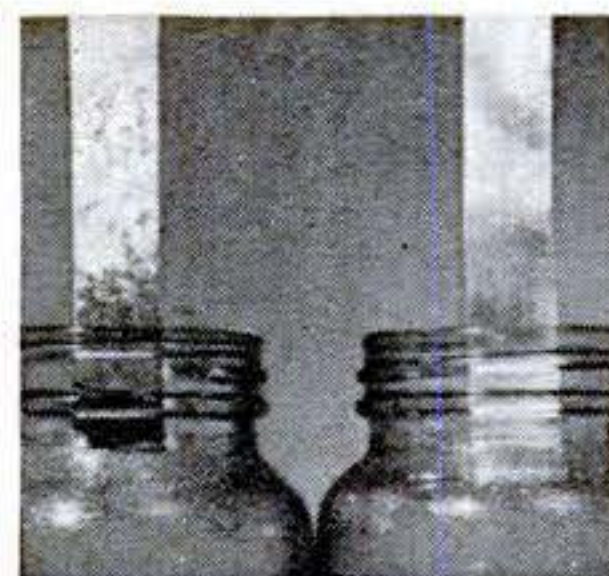

ing solution, the metals act as the plates in a battery cell, and the more active metal tends to dissolve. Tinware furnishes a good example.

Since tin is a relatively soft metal, tinware should never be cleaned with harsh scouring powders or steel wool. Food can be dislodged from a pan by soaking in hot water that contains a detergent, then gently scraping the utensil with a wooden spoon.

Some Films Are Protective

Galvanized iron—iron coated with zinc—also sets up electrolytic action when the coating is broken. But in this case the zinc, being the more active of the two metals, tends to react and spread a protective coating of zinc oxide over the iron. This protective action, however, cannot go on indefinitely. So if the zinc coating becomes worn away too much or broken, paint the article.

The green film or patina that forms on unprotected copper and brass is usually a carbonate of copper caused by a reaction with carbon dioxide and moisture. If it forms on the inside of cooking utensils, it must be thoroughly removed because it is poisonous. Unlike iron rust, however, copper carbonate protects the metal beneath from further action. Whether it is desirable on copper gutters, roofs, and decorative objects, therefore, is just a matter of taste.

Silver tarnish is caused by sulphur compounds in foods and in the air. Hydrogen sulphide from the smoke of factories causes silver to tarnish more rapidly in cities than in the country. Tarnish can be retarded by wrapping stored pieces tightly in cellophane or tissue paper.

Tests made by the Bureau of Standards indicate that tarnish can be removed from silver with less loss of metal by using the

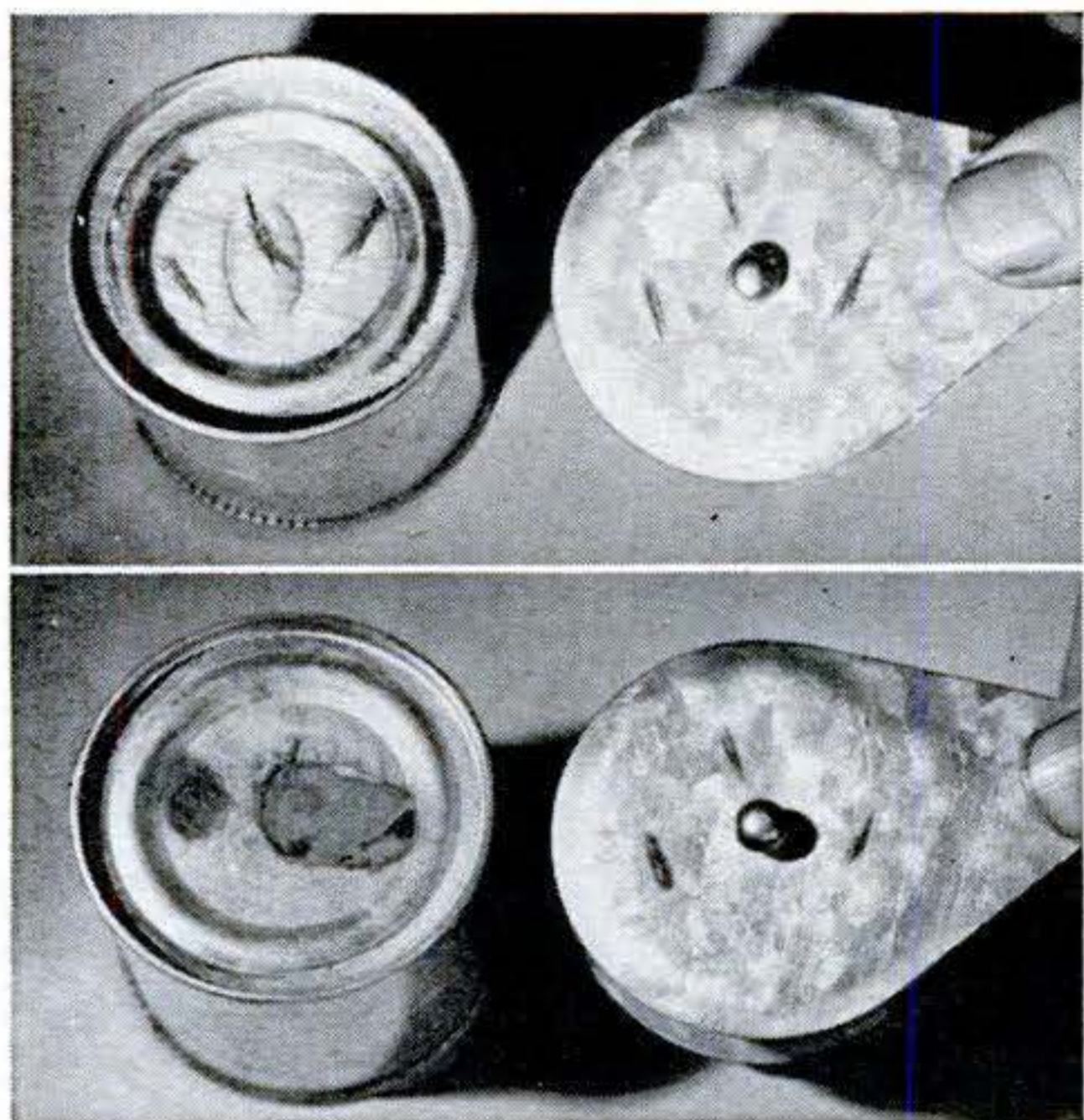

TIN AND GALVANIZED WARE. Tinware is usually sheet iron coated with tin; galvanized ware is iron coated with zinc. When intact, both coatings resist corrosion and protect the iron underneath. If coating is broken, electrolytic action occurs. But the results differ with the two types of ware. You can see this by scratching a tin can and a piece of galvanized ware (top photo) and leaving them in a damp place several days. Less active chemically than iron, tin causes iron to corrode faster than if it were *not* coated—and the scratch will spread. Zinc, being more active, produces a corrosion product that protects the iron—and keeps scratch from spreading.

STAINLESS STEEL.

A thin coating of oxide produced by heating darkens the outside of polished stainless steel. You can duplicate this by holding a polished steel strip in a candle flame. Such a coating is so thin, however, that you can remove it easily from highly polished ware with metal polish or a mild scouring powder and from less highly finished pots with steel wool.

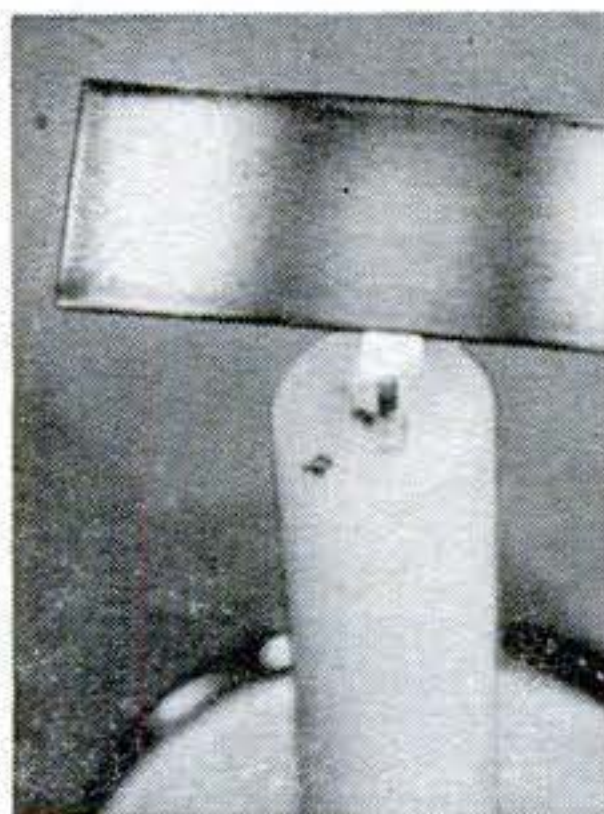

ALUMINUM. Such pots darken when alkaline substances are cooked because impure aluminum oxide is formed. They also blacken if you cook foods that contain iron, the iron being deposited. Boil water containing soda or spinach in an aluminum pan, left. You can then brighten the pan without effort by boiling water containing vinegar, right. In actual cooking, acid foods such as tomatoes or sauerkraut will do the same trick. The dissolved aluminum oxide is apparently harmless and tasteless. Iron is beneficial.

simple electrolytic method shown on this page than by laborious hand polishing. If the silver does not come up as bright as you would like it, rub it with silver polish.

Aluminum and Magnesium

Aluminum is exceedingly active chemically, and its surface oxidizes immediately in air. Fortunately, this surface film is so hard and compact that it stops further oxidation. Ordinary oxidized aluminum still reacts, however, to acids and alkalis—even weak ones used in cooking and cleaning. Alkaline scouring powders and cleaners should never be used. They darken and pit aluminum.

Magnesium is such an active metal that it rapidly acquires a dull coating, either white or gray, in moist air. Corrosion then stops. Vinegar and water will remove it.

Nickel plate and polished chromium can generally be cleaned satisfactorily with nothing more than a soft cloth moistened with warm water and a little mild soap or synthetic detergent. If this is not sufficient, use a mild scouring powder. You can make this as shown on the next page.

To clean silver: Electrolysis makes it easy to make flatware sparkle. (*But don't use it on hollow ware, knives with cemented handles, or silver with a French or oxidized finish.*) Just put the pieces in the bottom of an old aluminum pan or in a glass baking dish, the bottom of

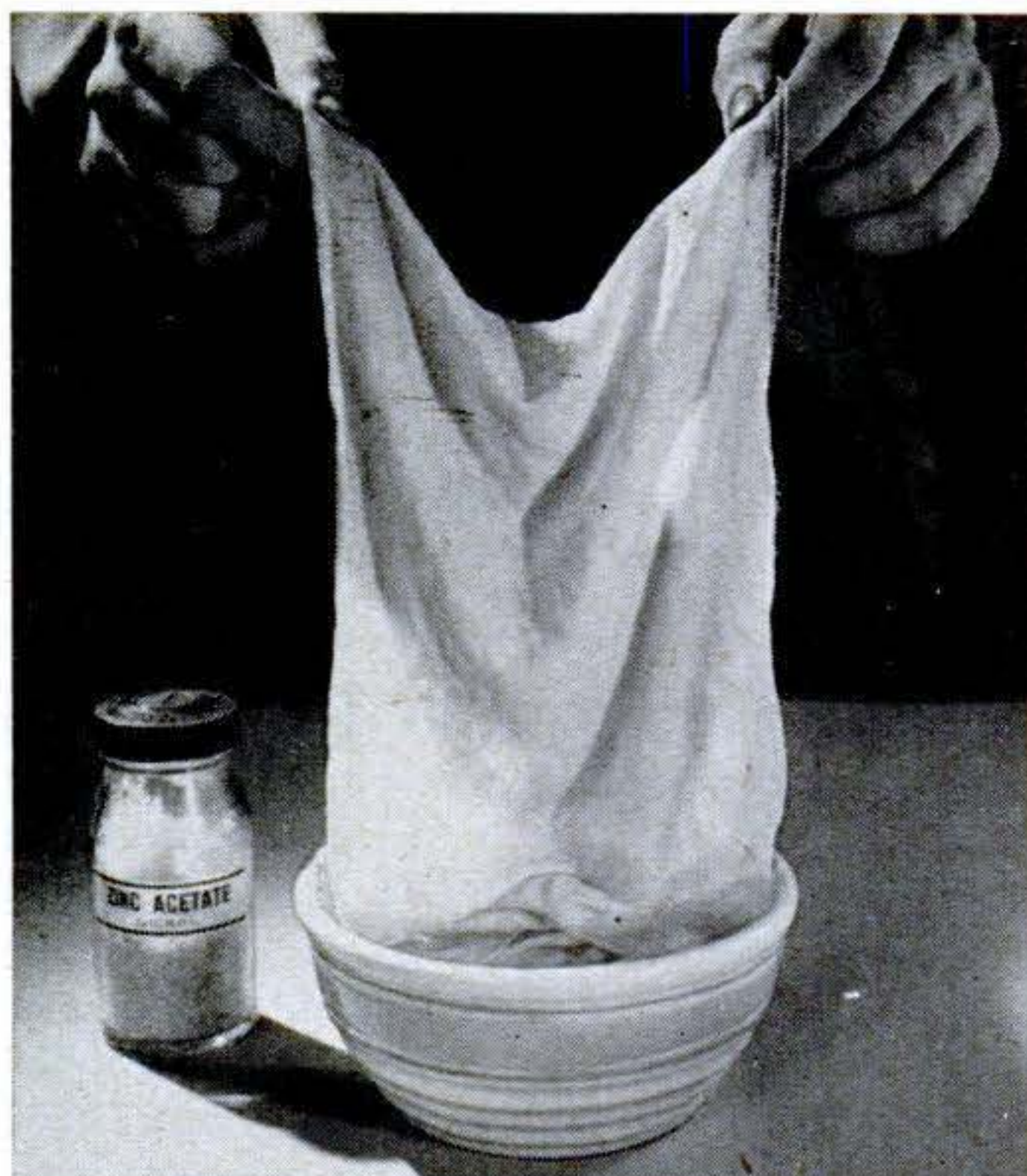

To store silver: Make a bag from cotton flannel. Soak the material in a solution made by adding an ounce of zinc acetate to each pint of water. Squeeze out excess solution and dry the bag. Silver stored in bag won't tarnish. Wash the stored silver before using it.

which is covered with a strip of aluminum foil. Pour in a near-boiling solution made by dissolving a tablespoon each of washing soda and table salt to each quart of water. When tarnish disappears, rinse the pieces in clear water and dry them thoroughly.





To remove rust from tools: In a quart of water, dissolve a tablespoon of oxalic acid or a similar amount of acid-type automobile cooling-system cleaner. Heat the solution and immerse your iron and steel tools. Use tongs or rubber gloves—the solution is caustic and poisonous. Rinse in clear water and dry the tools well after the rust has disappeared.



To make scouring powder. Measure out nine parts of whiting (from a paint store) and one part of trisodium phosphate (Oakite or Dif). Mix by shaking together in a box or bag for several minutes. This is an inexpensive, non-scratching, and effective compound for cleaning porcelain, brass, copper, nickel, chromium, and stainless steel. Wet with water.

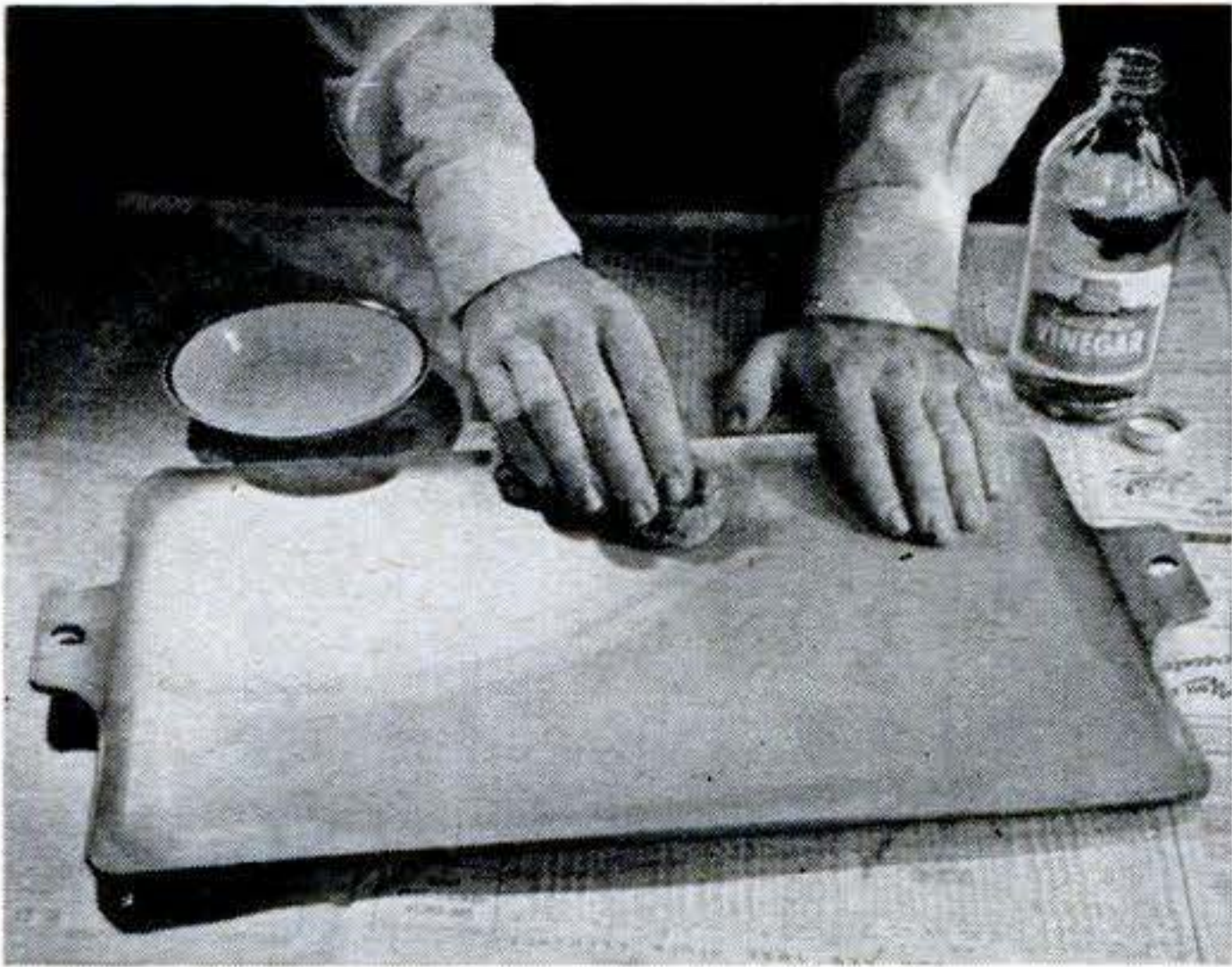

To clean magnesium: Griddles and similar articles can be swabbed with a solution made by diluting a little vinegar with an equal amount of water. Magnesium and its oxides readily dissolve in weak acids. But such cleaning is merely for looks. The coating protects the metal.

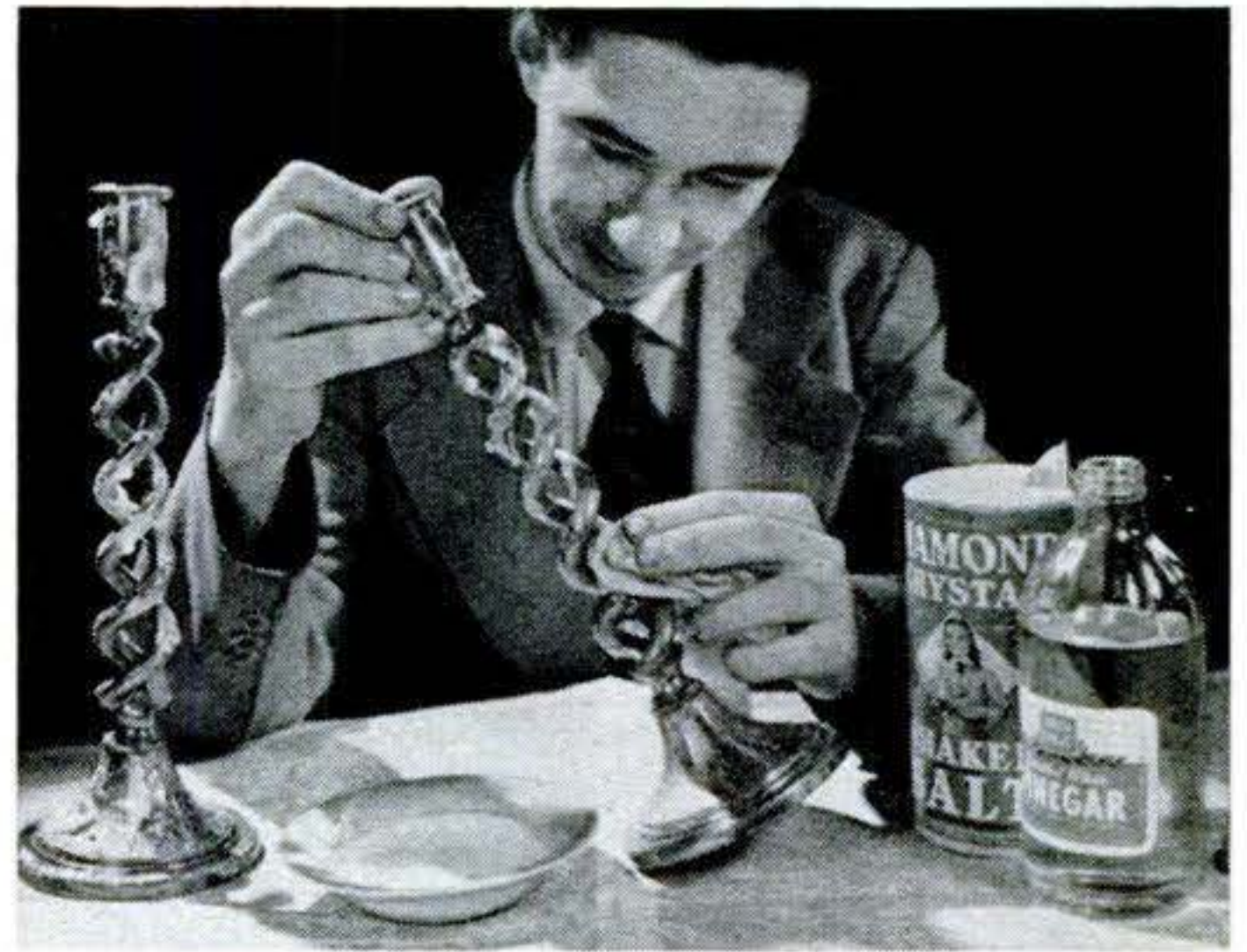

To clean brass or copper: An old reliable formula for removing tarnish is salt wet with vinegar. After the pieces have been cleaned up, brush on clear lacquer to keep them shiny.

To make silver polish: Buy precipitated chalk at a drugstore. Make a paste by moistening with household ammonia that you have diluted four parts water to one of ammonia. After rubbing off tarnish, rinse the silver.



An Easy Way to Put a Gauge on an Oil Drum

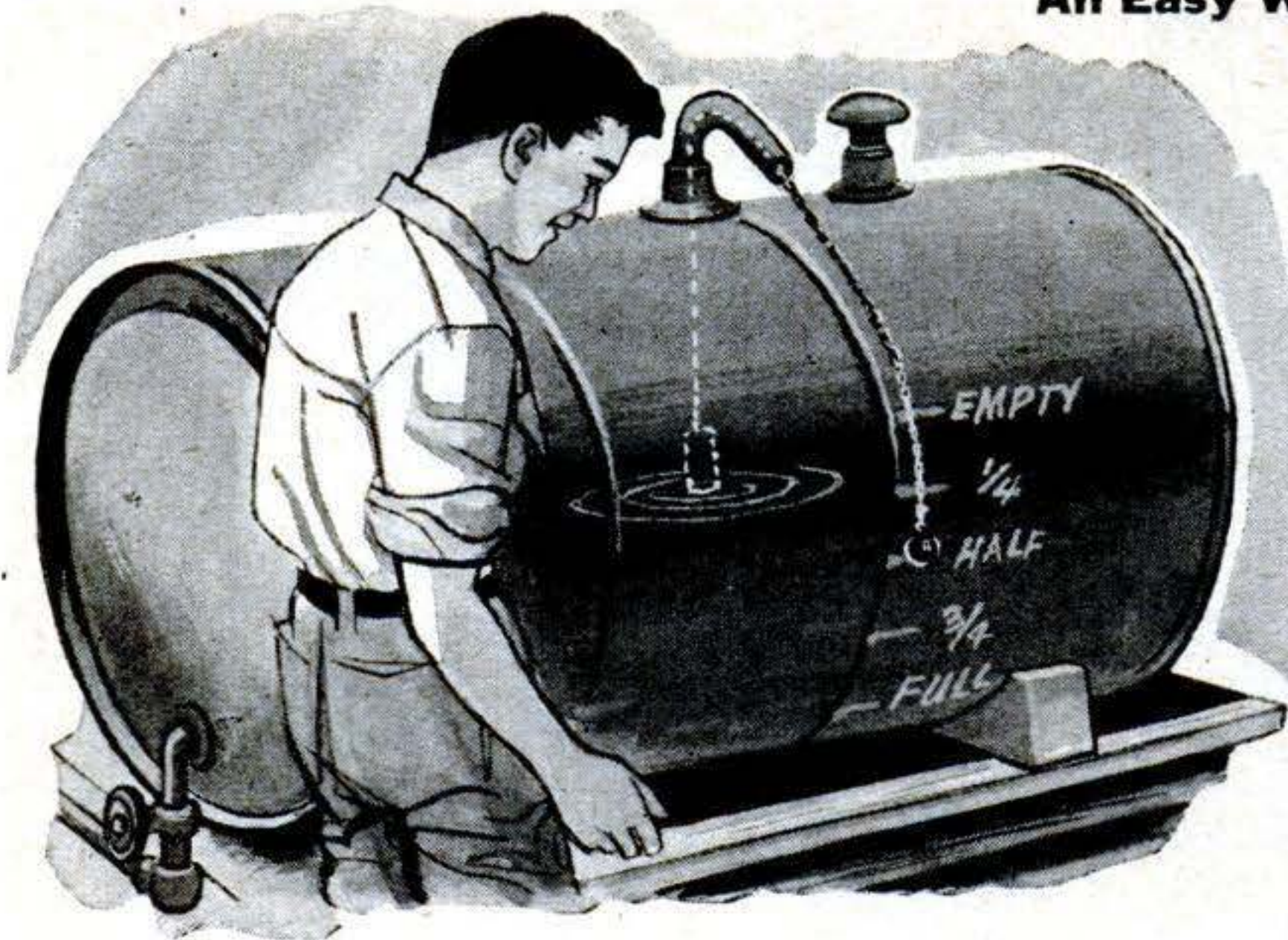

THIS indicator will help you keep track of the kerosene or oil left in a back-yard drum. Make a weighted float from a can or jar small enough to pass through the bung hole and attach it to light chain or several key chains fastened end-to-end. Slip the chain through the vent pipe and tie a counterweight to the other end. Mark the indicator position when the barrel is full and when it's empty, and estimate the in-between positions. Be sure the chain runs freely without sticking or binding.—*J. G. Schad, Evans City, Pa.*

Card Holder Clips to Drill Post

You can "file" tap-drill sizes and similar information right on your drill press. Slip the data into a plastic-window card holder and clip the holder to your drill-press post. Card holders of the type shown, made for attaching drivers' licenses to car steering posts, are available at auto and five-and-dime stores.—*H. Leeper, Canton, Ohio.*



Shop Light Moves Where Needed

THIS counterbalanced shop light gives the light you need just where you need it. It's fully adjustable up and down and side to side.

It consists of a pulley that rides along a taut supporting wire over the bench, and a weighted cord tied to the lamp socket. If the counterweight is right, the lamp stays put. Make sure there's no weight on the electric wire and leave enough slack for travel.

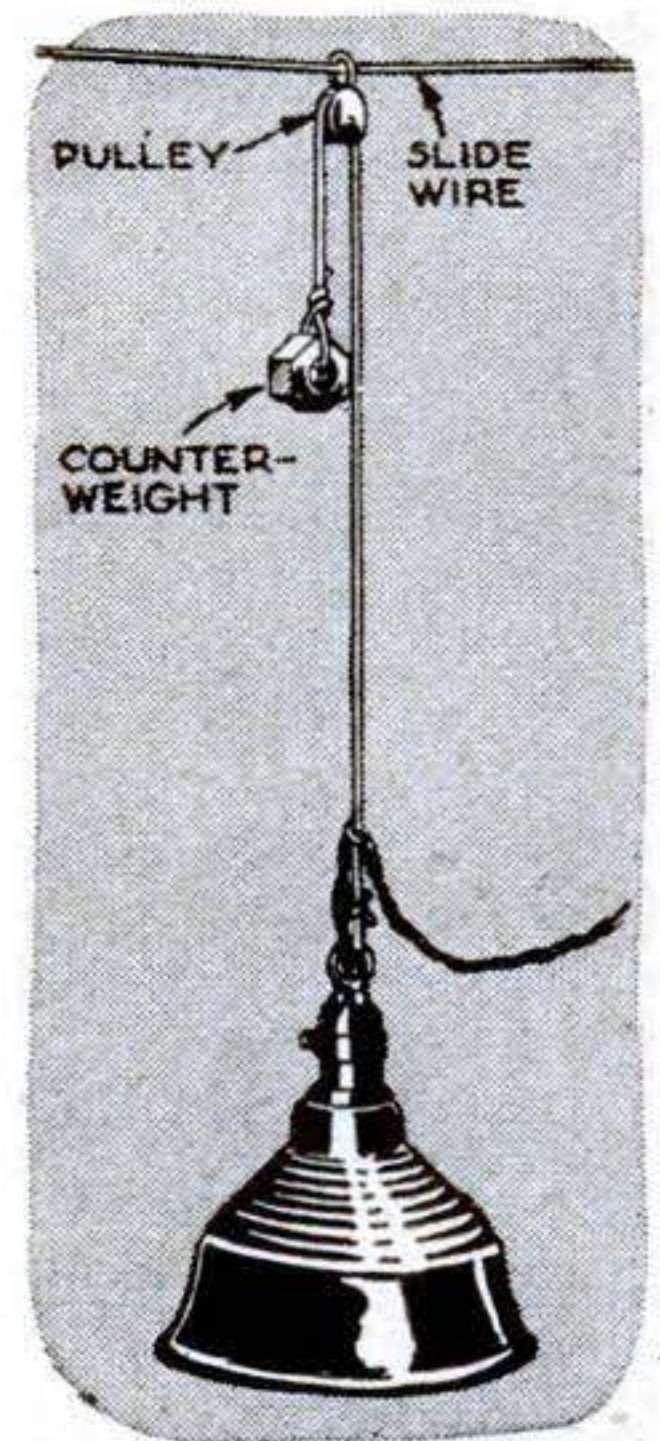

Stapler Holds Sole While Glue Sets

IT IS sometimes difficult to clamp composition oversoles properly when you attach them to shoes. A stapling gun solves the problem. Apply adhesive according to instructions, press the soles in place, and drive a row of staples part-way in. When the cement has dried, pull the staples with pliers.—*Walter Haase, Wethersfield, Conn.*

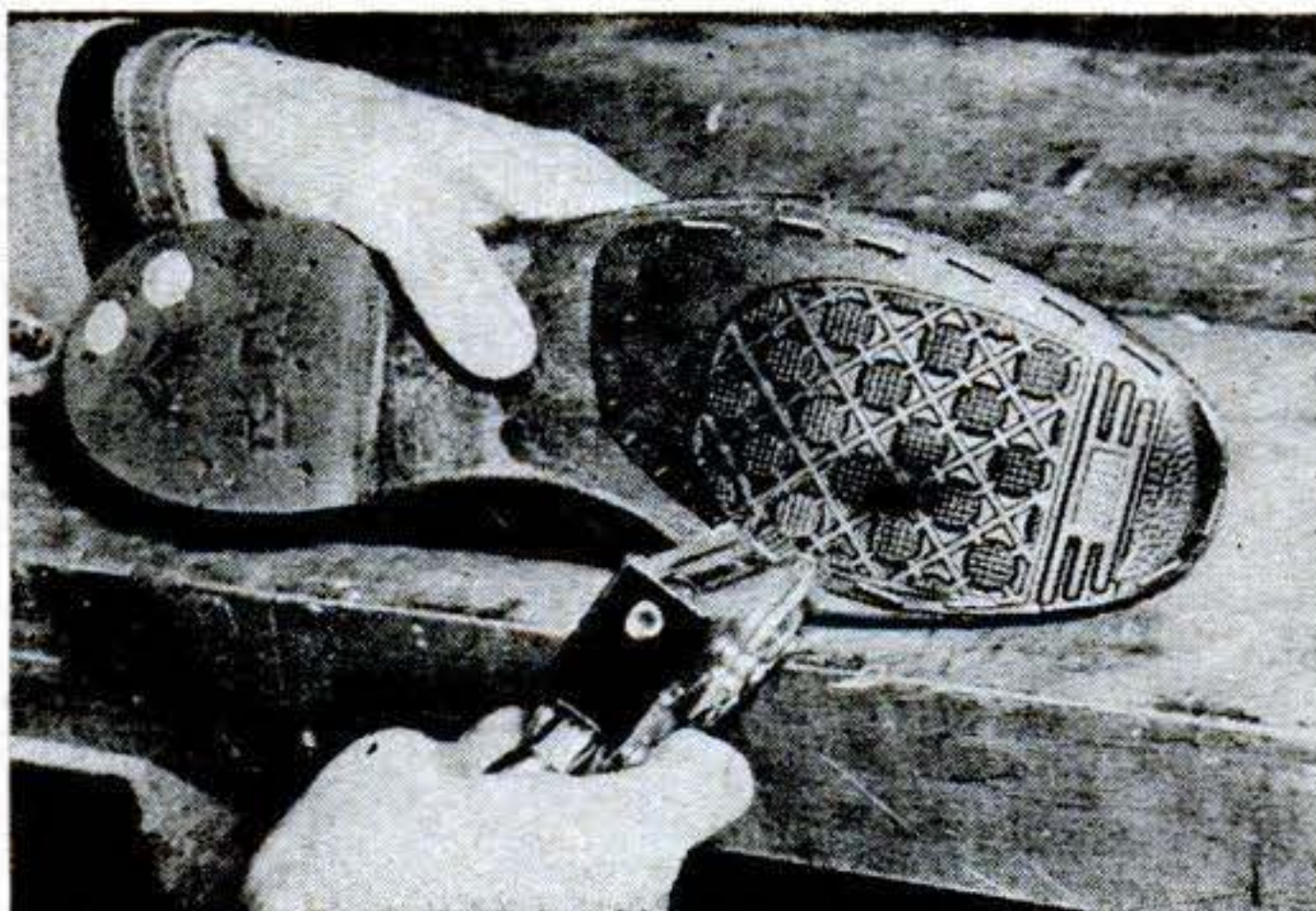

Insulation Straps Cut from Tin Cans

WHILE I was insulating my water pipes I ran out of pipe-insulation straps. So I snipped out the strips from empty fruit-juice cans. I punched an opening at one end and cut a tab at the other. These straps work as well as the regular ones, though the sharp edges have to be handled with care.—*A. J. Fauldner, Syracuse, N. Y.*

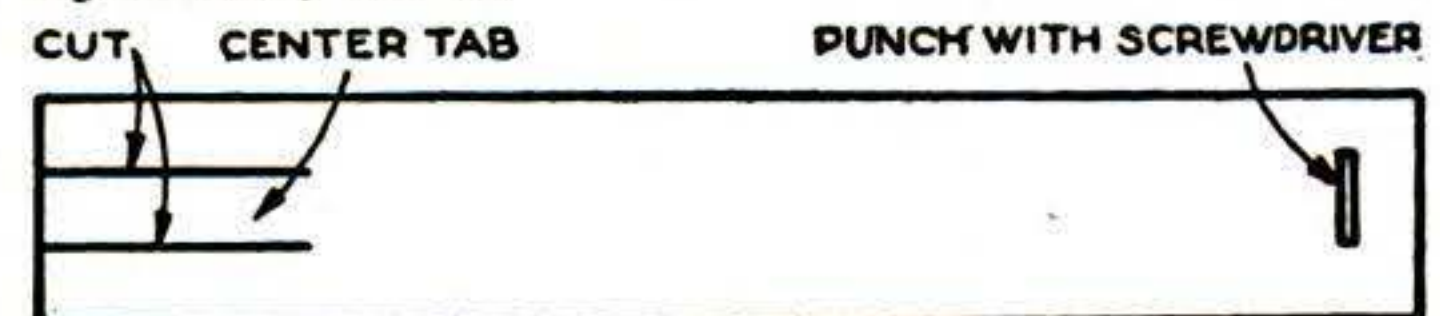
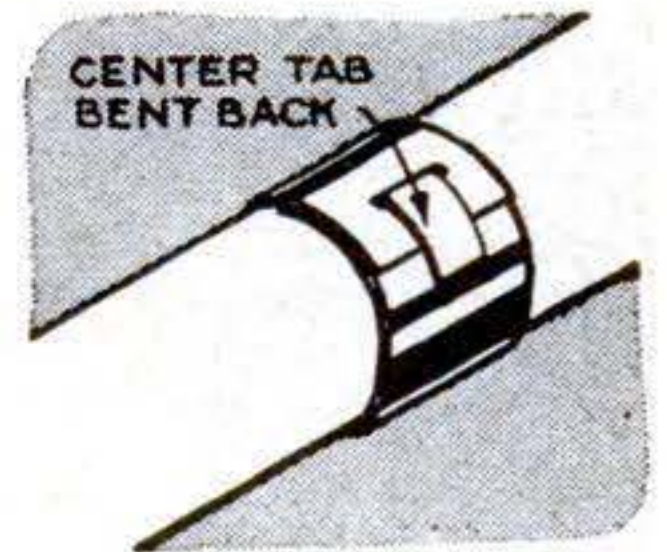



Author's living room has a slab floor, on which a soft, gray-green rubber-base paint has withstood scuffing of four children and a dog for two years.

How to Color Concrete

New dyes, stains, and paints make it easier . . . but your floor should first be cleaned and acid-etched.

By Steve Mashek

IT'S now easier than it used to be to color your concrete floors, indoors or out. To meet the growing use of slab floors, manufacturers have perfected new colorings that are both attractive and durable.

Coloring concrete floors is still a lot more work than painting wood. But when you see what the new dyes, stains, and rubber-base paints can do for your porch, terrace, sidewalk, basement, or garden path—well, you'll find it worth the trouble.

Dyes and stains give roughly similar results, but differ in make-up and application. They are popular for outdoor use where evenness of color is less important. Unlike even the best paint, they won't rub off under hard wear. But if the density and surface condition of the concrete is not uniform, or it is badly stained or spotted, the color is

apt to let such imperfections show through.

Rubber-base paints, made especially for concrete, will uniformly color any concrete surface. Such paints are excellent for the slab floors of many modern homes and for basement recreation rooms. They also may be used on outdoor surfaces.

I put one of the chlorinated rubber-base paints to a pretty severe test in my own home after a disastrous experience with an ordinary oil paint. That paint peeled, cracked, and wore off badly where the traffic was heavy. With drum and disk floor sanders, plus a good deal of elbow grease, I removed the worst of it and replaced it with two coats of rubber-base paint. After two years, this floor is still in excellent condition—and my household includes four active children and a dog.

Hardeners. There are excellent products for hardening and dustproofing concrete. They are easier and cheaper than stains or paints, but they don't do much to beautify the surface. However, you might be inter-



Spot cleaning to remove oil, grease, or soap stains can be done with a lye solution. Pour the solution on shavings or sawdust and let it

stand overnight. Then scrape the spot with a putty knife or old chisel. Repeat the treatment if the stain is stubborn.

ested in one of them for a shop or basement.

To treat a clean, dry floor, you just spill some of the hardener from a bucket and spread it with a mop or brush.

But if you want color, you must use stain, dye, or paint. Stains come in a lot of colors and can be used alternately. This enables you to make concrete look like varicolored stones. Typical dye colors are tile red, maroon, brown, and a soft green.

In rubber-base paints, many different colors are available, and by mixing these you can get just about any shade you want. My gray-green mixture is very attractive. A neighbor of mine used two gallons of concrete (light) gray to a quart of dark brown to get a neutral tan shade for his living room.

You can also tint rubber-base paints with oil colors, but there is some risk involved. If the concrete should later become damp, one manufacturer warns, the color might be affected.

That's why rubber-base paints were born. Oil-base paints peel off concrete when the concrete gets damp. Alkali is leached out of damp concrete, and softens the paint. Rubber-base paints are not affected this way.

Before a slab is colored in any of these ways, it should be cleaned and acid-etched.

Cleaning. The kind of cleaning required depends on the condition of the concrete. If your floor only needs a general cleaning, scrub it with a solution of trisodium phosphate dissolved 1 lb. to a gallon of warm water.

If your floor has oil paint on it, you'll have to remove all the paint before staining or dying. One way to remove paint is with lye.

But wear rubber gloves when you work with it. Goggles are a wise precaution, too.

Mix a solution of 1 lb. of lye to a gallon of water. Dissolve the lye slowly and be careful that it doesn't splash on you. Pour the solution on the painted concrete and let it stand an hour. Then scrub it with a stiff brush and flush the surface with plenty of clean water.

If you would rather not use lye, you can remove the paint with a floor sander. Use open-coat silicon carbide paper No. 3½-20, or No. 4-16 where there are several coats of old paint. You'll also need an edger to get close to the walls.

Even when using rubber-base paint, the makers would like you to remove all old paint. If you neglect to take off small patches that are not sticking properly, they will raise and peel when you apply the first

Dyeing. Pour dye in flat-bottomed container. Use stiff brush. Careful watching for light or glossy spots and hard scrubbing are needed.

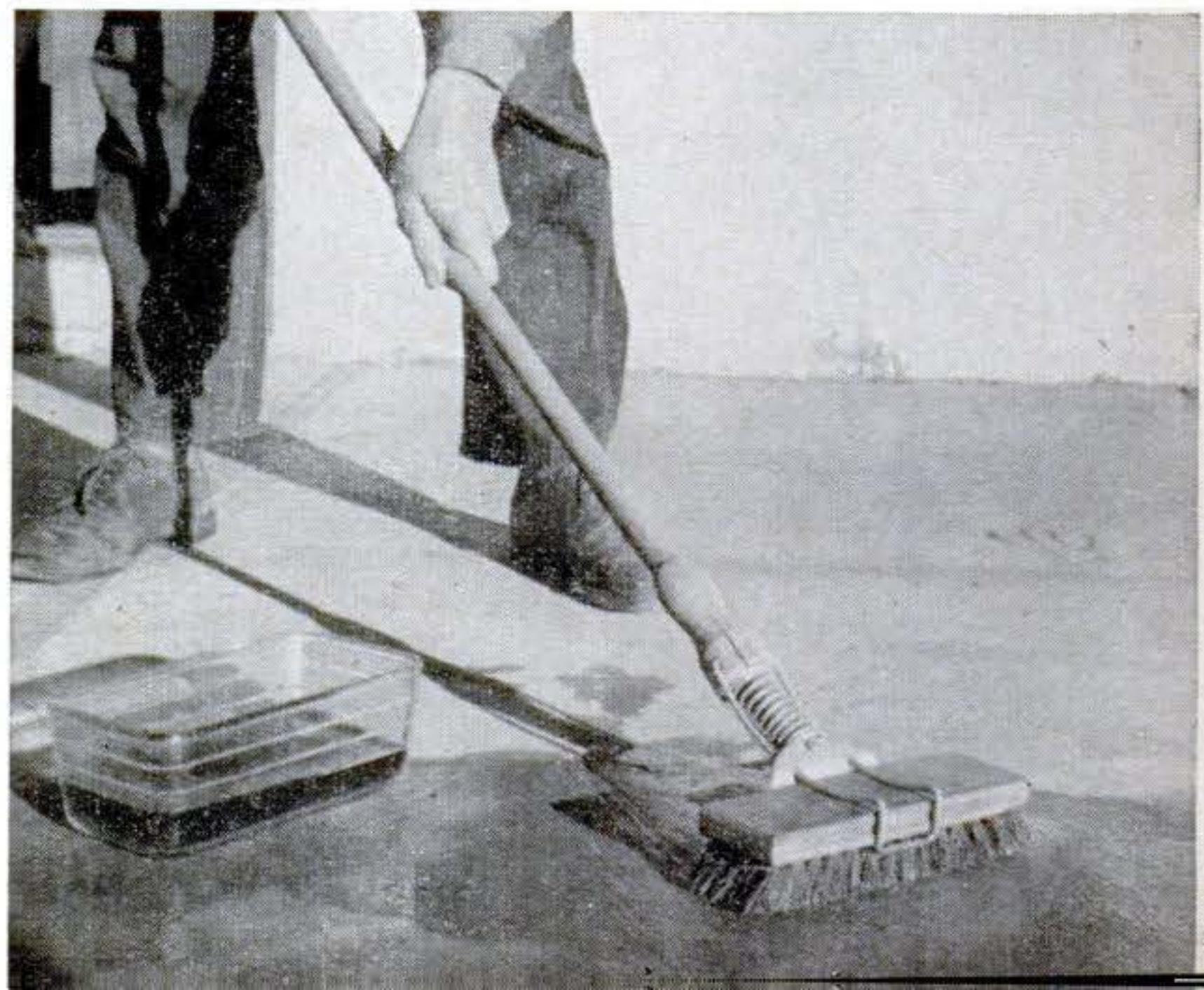



General cleaning can be done with trisodium phosphate—1 lb. to a gallon of warm water. Scrub with a stiff brush (above) and then wash

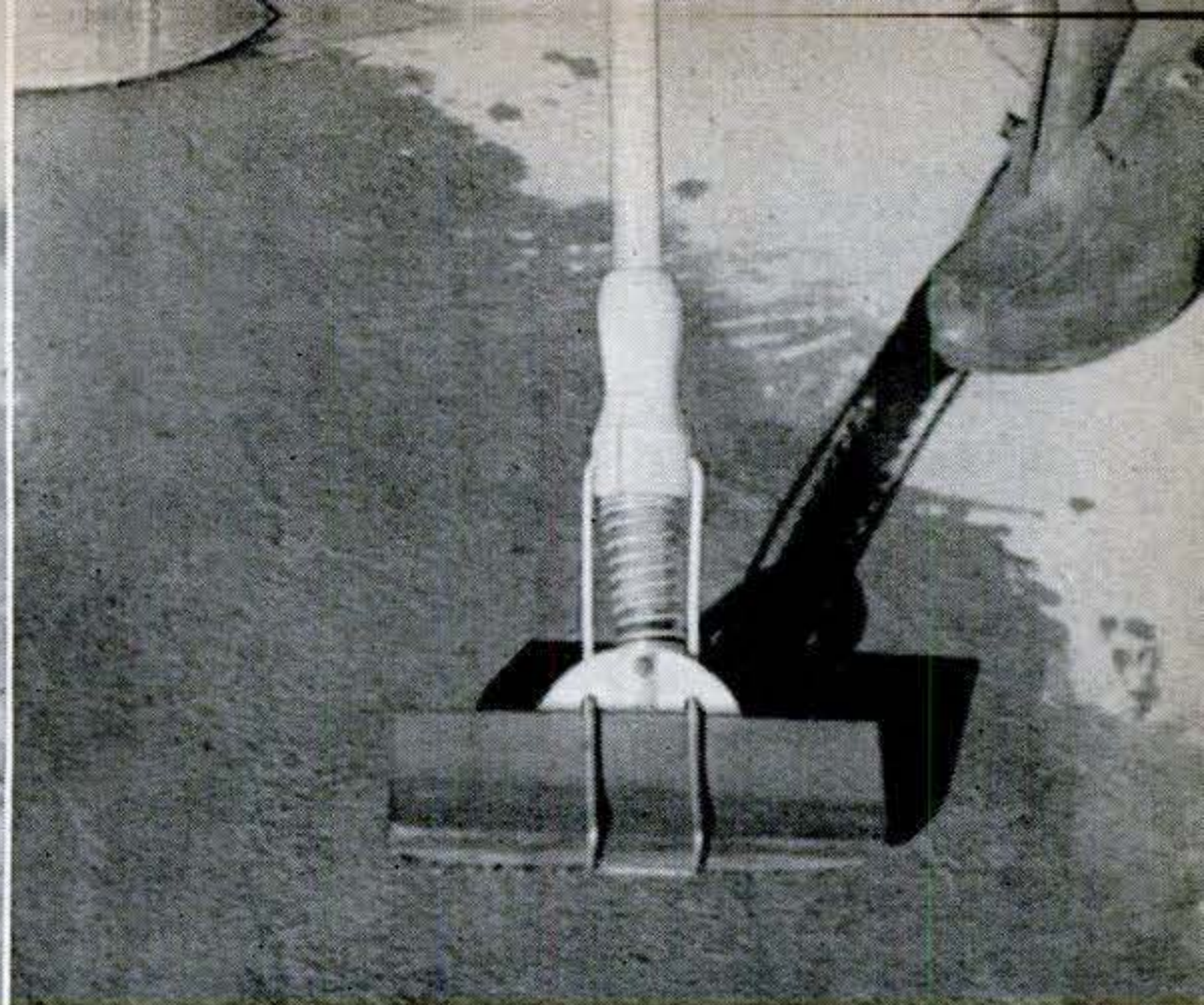

with clean water. Etching with acid (above) removes slick surface from well-troweled concrete. Wear rubber gloves and boots.

coat of rubber-base paint. If that happens, however, you can scrape such places, spot-coat them, and cover them with the second coat of paint.

Besides old paint, you may have to remove spots of oil or grease. And in a laundry room there may be spots of soap. To remove oil, grease, and soap, spread sawdust over the spot, soak it with lye solution overnight, scrape it off, and wash it with hot water.

Acid etching is the second step. This removes the slick surface and opens pores so stain or dye can penetrate the concrete and get a good grip. It is more important before staining or dyeing than it is before painting. I know from experience that you can get by without etching most concrete, but the results are less satisfactory.

One gallon of muriatic acid mixed with

2 gallons of water will etch 150 to 200 sq. ft. Mix it in an enamelware crock or a wooden bucket if possible. A galvanized bucket will do, however, if you first coat the inside with vaseline or axle grease.

Slosh the solution on the concrete and scrub it with a long-handled brush. It will fizz when it hits the floor. It should. That means it is working. Don't try to spread it too much. Work it in. You may need two or more applications. Keep it up until there are no more spots that feel slick to your touch. For small, stubborn areas, use a 50 percent solution.

When you're finished de-slicking, flush the floor with plenty of clean water and let it dry thoroughly. Outdoor slabs usually dry quickly, but a basement may take a couple of weeks.

Dyeing. Figure on 1 gallon of dye to

Staining. Apply with a paintbrush. First coat will foam. Brush it out just enough to get rid of the foam. Work to a wet edge.

Painting. Second coat of rubber-base paint is being applied to this floor. Such paint goes on very much like ordinary oil-base paints.

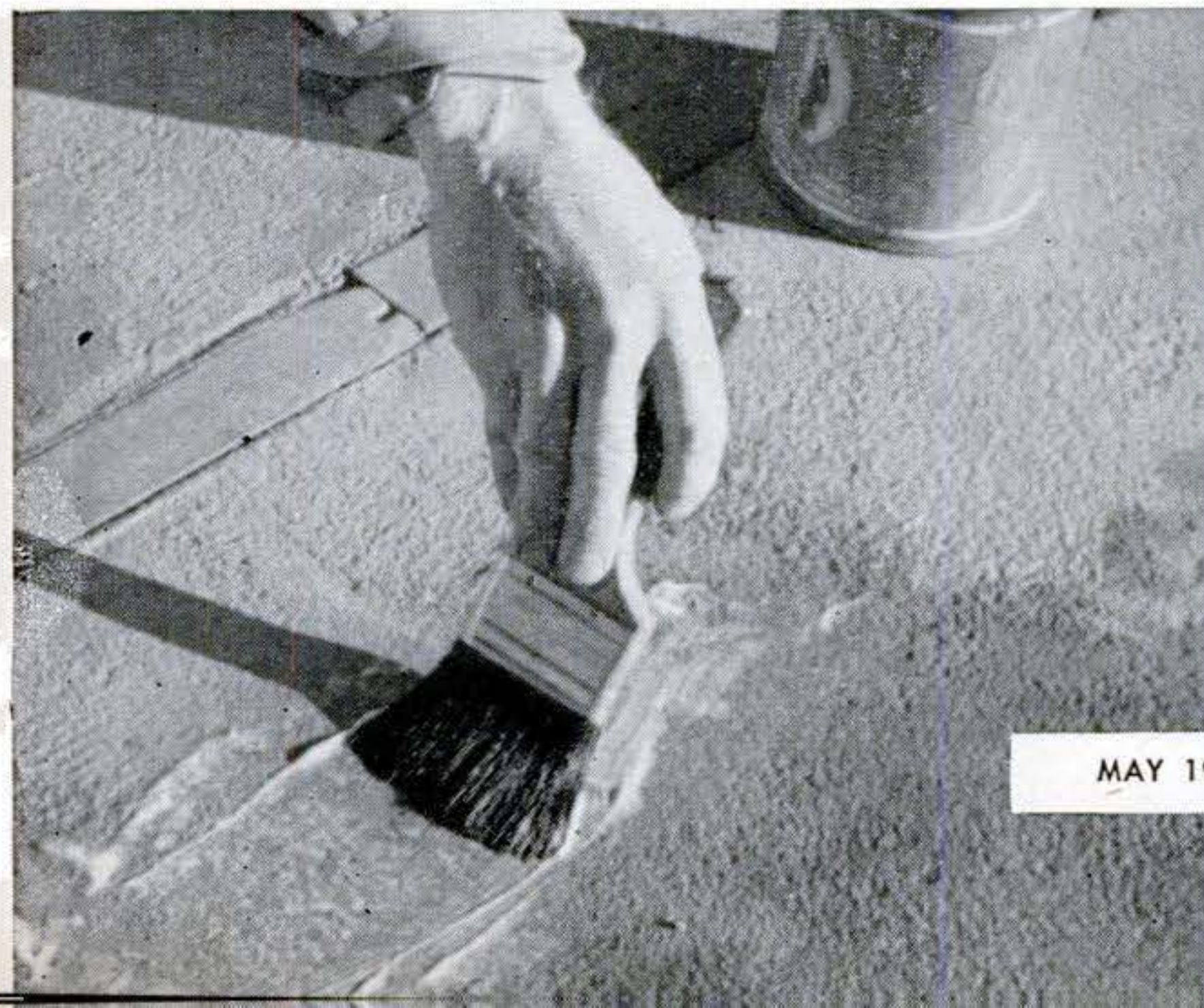

each 175 sq. ft. Pour it into a flat pan and keep it stirred. Apply it with a long-handled brush. Keep putting it on for about 20 minutes—until the first part of the floor has taken on an even, dull tone. Then go over this area again, scrubbing in more dye. This is called fixing. If any glossy spots show, scrub dye off them and into light areas.

When you have dyed the whole floor and it has dried overnight, examine it in good light. If there are any glossy spots, just rub them hard to remove the excess dye. Then give the floor a day or two to dry (give a damp basement a week).

Dressing completes the job. It comes with the dye, and can be either the standard type or what is called the no-buff kind. If you use the standard dressing, scrub it on with that long-handled brush, give it an hour to dry, and then polish it with the same brush. If the brush sticks to the surface, let the floor dry a little longer. Clean your brush in turp and let it dry before you polish with it.

The only maintenance such a floor will require is occasional dry mopping or sweeping with a floor broom. When the dressing begins to wear off after months of hard use, simply put some more on the worn spots and buff as before.

Self-polishing dressing is brushed on, a full, wet coat, and let dry overnight. A gallon covers about 400 square feet.

Staining is a three-coat job, if you use one of the special concrete stains recently put on the market. You begin by brushing on the stain, putting it on quickly. It will

foam, and you should brush out the foam and then leave it alone. To avoid lap marks, work to a wet edge, just as in painting.

Give the first coat about eight hours to dry and put on a second coat in just the same way. The finish coat, however, is a different material that is sold along with the stain. Before applying it, you should mop the stained surface with water and hose it off to remove any residue. The finish coat is spread on with a soft cloth. It completes the coloring process, and also gives protection.

Rubber-base paint goes on very much like oil paint, and requires a thoroughly dry surface. You'll need a gallon of paint to put the usual two coats on 150 to 200 square feet of floor.

In addition to the paint, you will need some of the special thinner that is supplied for it. Ordinary paint thinner or turpentine will not work. You may want to thin the first coat slightly for easy brushing. And you'll need thinner for brush cleaning.

Allow 24 hours drying time between coats and after the second coat is put on before doing much walking on the floor.

The solvent used in this paint has an odd and rather penetrating smell, but not an unpleasant one. Don't leave any food—especially anything absorbent like butter—exposed in the room or it will pick up a strong flavor from the paint while it is drying. **END**

Like to loaf in the sun on summer weekends? See PS next month for an easy-to-build lounge chair for beach or lawn.

COLORING CONCRETE

FINISH	CLEANING	ETCHING	1ST COAT	2ND COAT	3RD COAT
Dye	Cut grease and soap stains with 1 lb. lye to gallon of water. Pour over layer of sawdust, leave overnight, then scrape. Remove old paint with floor sander, or lye solution. Let solution stand 1 hour and scrub with brush.	If slab has smooth-troweled surface, scrub with 1 part muriatic acid to 2 parts water. Flush with clear water and let dry.	Scrub in with long-handled brush. Give 20 minutes to take on dull tone.	Same as first coat. Let dry 48 hours.	Scrub on dressing. After about 1 hour, polish with same brush.
Stain			Apply with paintbrush, brushing out foam.		
Rubber-base paint	Same as above, except that old paint need not be entirely removed unless it is peeling.	Etch as above if slab has a very slick surface.	Apply with paintbrush. Let dry 24 hours.	Same as first coat.	Ordinarily no 3rd coat is needed.

FOR YOUR POPULAR SCIENCE INFORMATION FILE

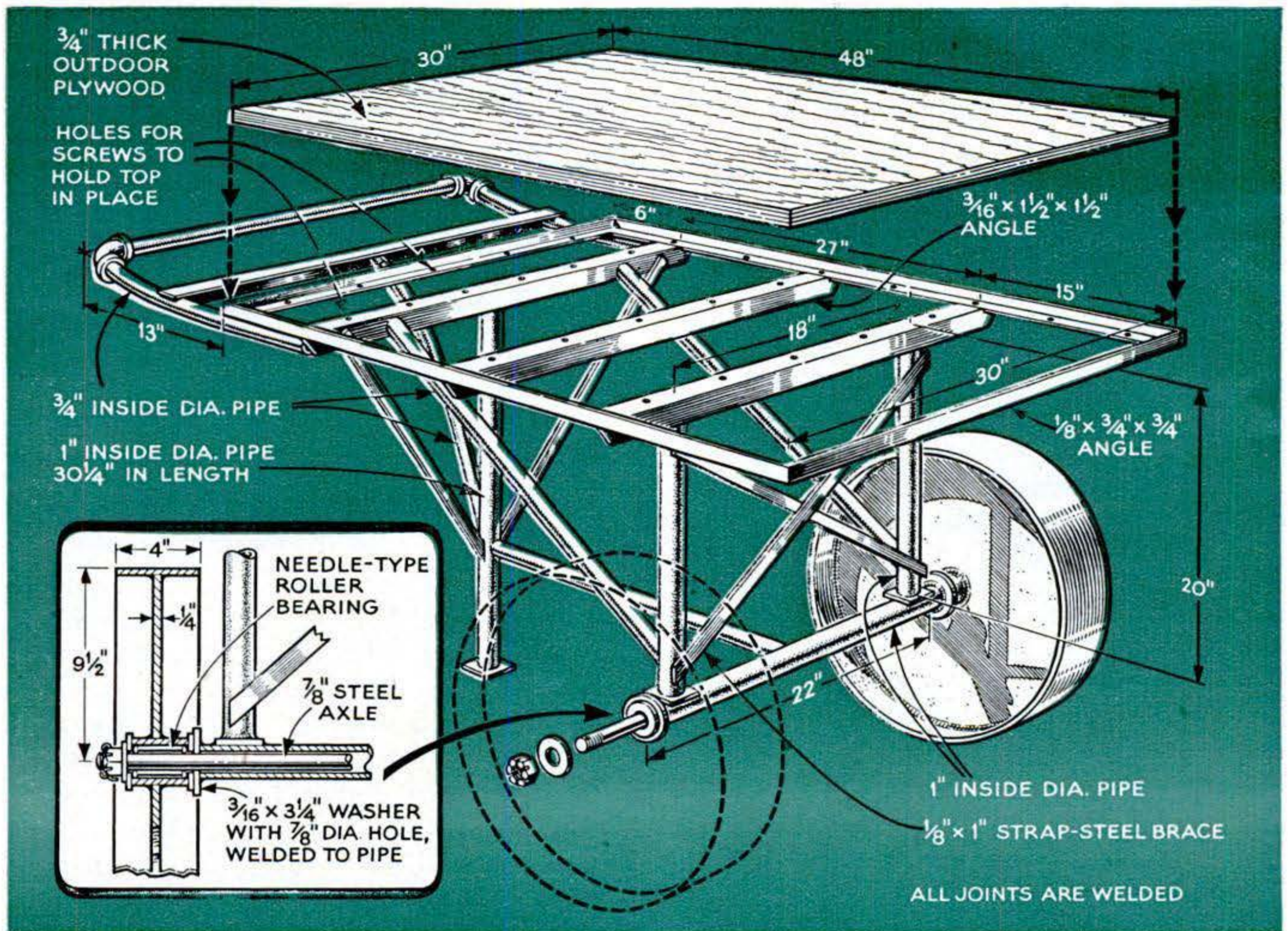

Builder's Work Table Rolls to the Job

THANKS to the roller bearings and wide-tread-wheels, this sturdy work table can be easily moved to the most convenient spot during building jobs. It was made to withstand punishment on outside jobs.

Wheels consist of steel tires 4" wide welded to disks of $\frac{1}{4}$ " steel, with housings for the bearings. The axle passes through washer flanges welded to each end of a 22" length of 1" pipe.

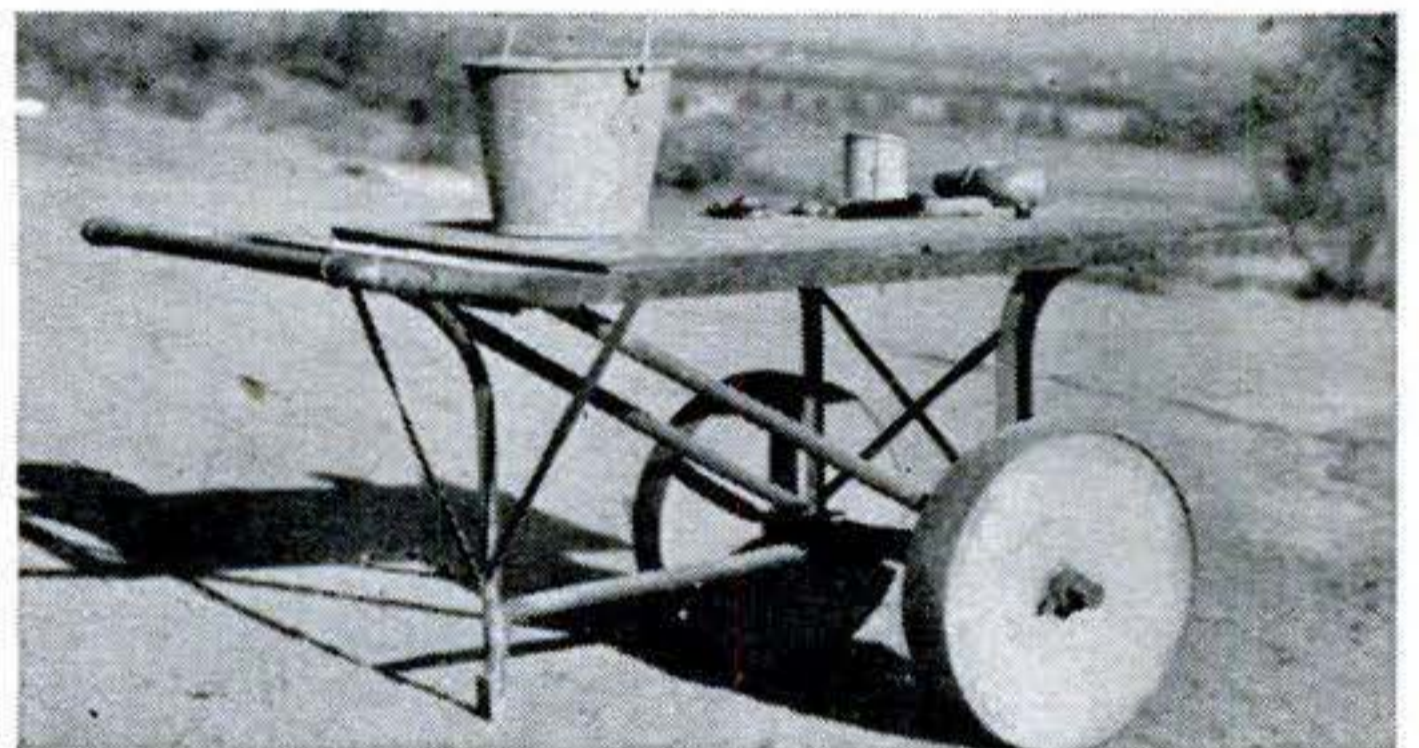

Before screwing the plywood to the frame, give all the metal a coat of red lead and paint.—Hi Sibley, Nuevo, Calif.

The Correct Way to Solder Phonograph Plugs to Shielded Wire

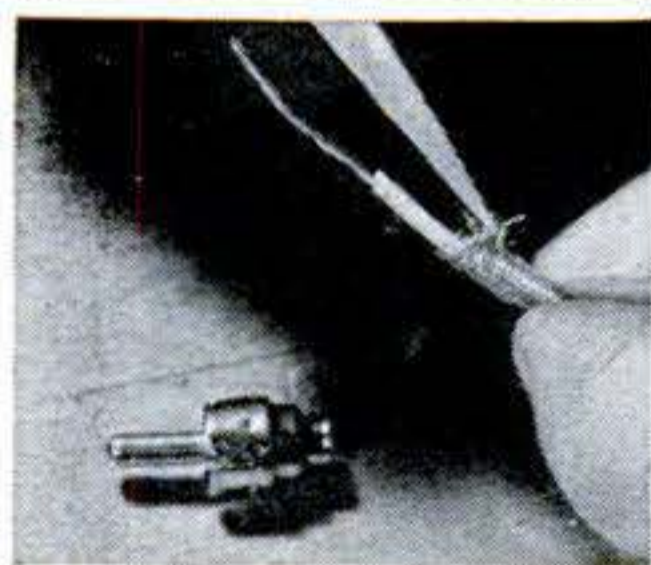

THOUGH often troublesome to the novice, soldering phono plugs to shielded wire isn't a difficult job. These plugs, although designed for linking phonographs, recorders, microphones, and amplifiers, are also handy in other low-voltage rigs where you need a quick-disconnect joint.

Cut off 2" of braid and bare 1" of the inner conductor. Flare out end of the braid with a pointed tool. Slip the plug over the

wire until the bare tip comes through the prong. Flow solder down the wire into the prong. When the conductor is firmly bonded, clip off excess wire. Then solder the flared braid to the neck of the plug.

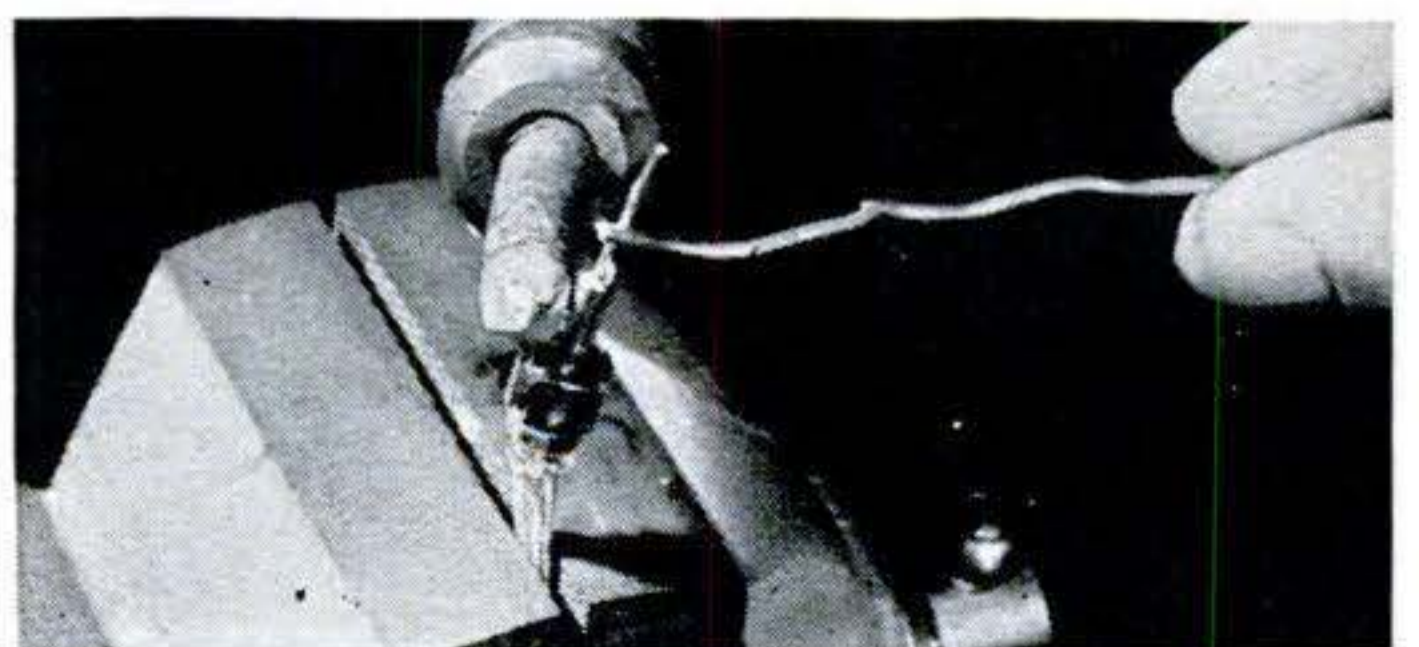

A Place to Tie Up Your Small Boat

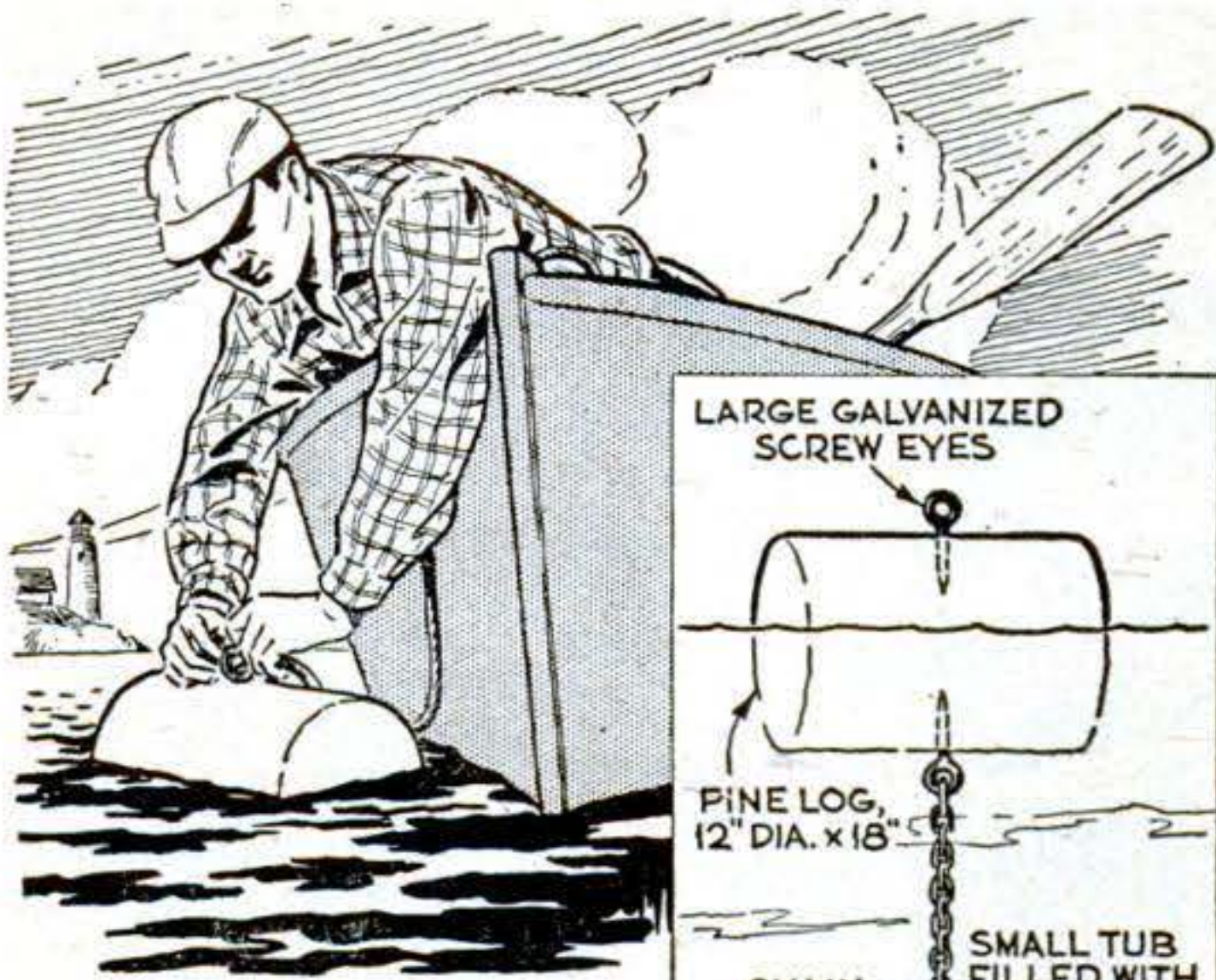

You can make this handy mooring buoy out of a pine or cedar log. Strip the bark from the log, which should be well seasoned, and give it two coats of red lead. Besides protecting the wood, the red color will stand out against the water.—*Wallace Genthner, Troy, N. Y.*

Nailing Pad Up Keeps It Handy

A SHIPPING-ROOM stamp pad, tacked to the wall above the bench as shown, won't get covered over with packages and papers, and can't be borrowed. A screw eye holds the pad closed when it isn't in use.

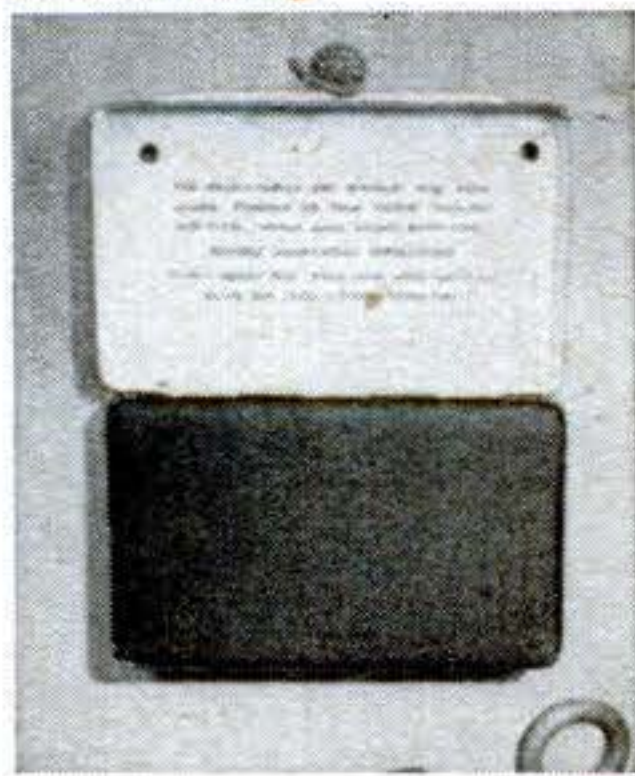

Burner Made from Cigarette Lighter

NEED an alcohol burner for your shop? You can make one out of a dime-store cigarette lighter and a small India-ink or similar bottle. Discard the bottom half of the lighter and pull out the cotton packing from the main part. Pour alcohol into the bottle and wedge the lighter in the neck. If the opening is too large, wrap tape around the lighter. When the burner is not being used, keep it covered with the original cap.—*William B. Eagan, Louisville, Ky.*



Quickly Made Game for Rainy Day

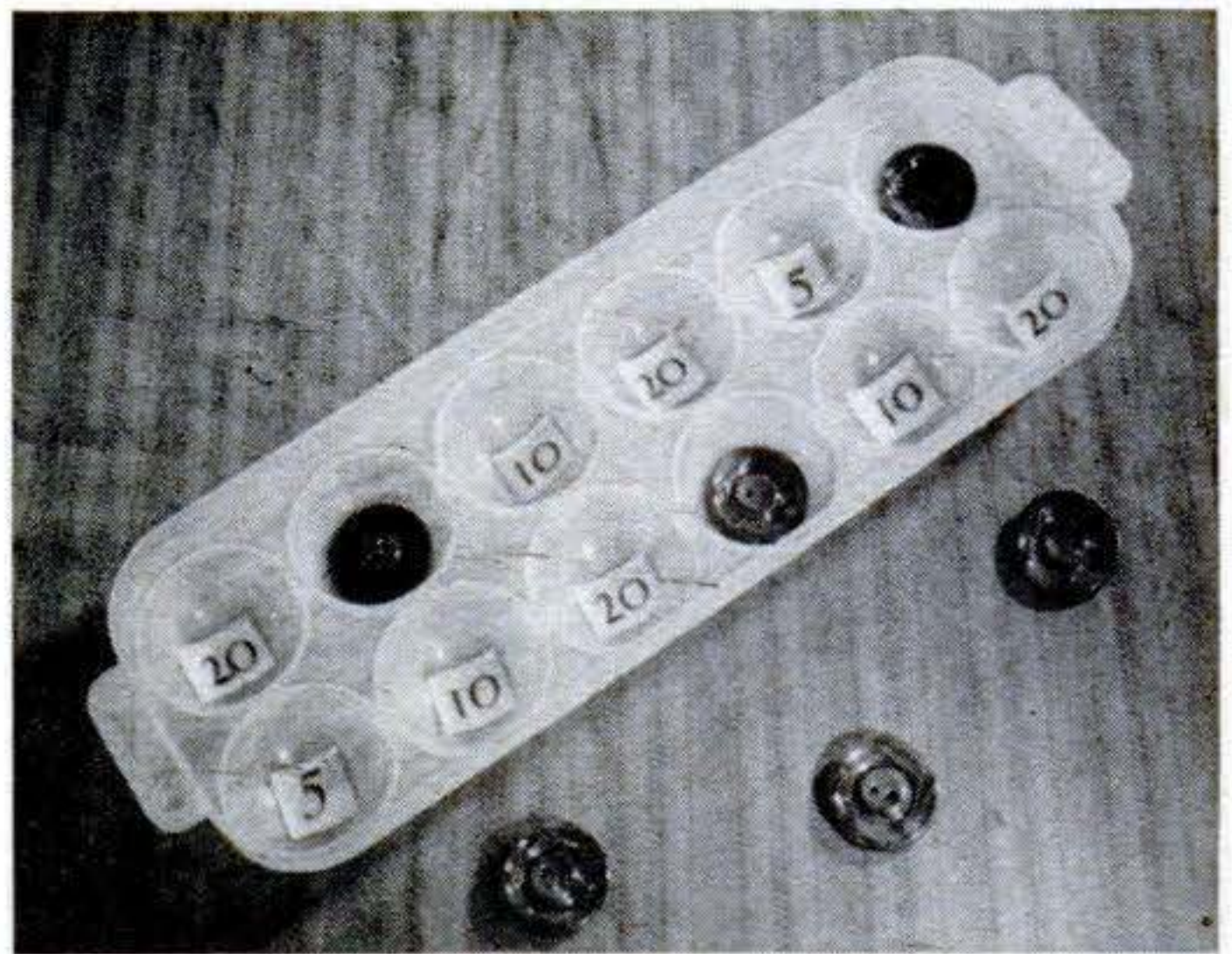

HERE'S a simple game to amuse children who must stay indoors. Cut numbers from a calendar and paste them in each compartment of a plastic egg tray. To play the game, place the tray on the floor, stand about three feet away, and toss buttons, one at a time, into the marked compartments.—*Myrtle Odland, Clarion, Iowa.*

TV Wire Replaces Handle Strap

WHEN the handle strap on my camera case wore out, I replaced it with a strip of ribbon-type television twin-lead wire. I doubled both ends of the wire and riveted them to the case.—*H. Holsten, The Bronx, N. Y.*

New Trap May Brighten TV Picture

REPLACING an old ion-trap magnet with a new or more efficient one often will brighten a TV picture. Traps are available in single- and double-magnet types. Make sure the new one matches the original. Rotate and slide the magnet on the tube neck until you get the brightest image. Then readjust the focus coil slightly if necessary to make the picture fit the frame.

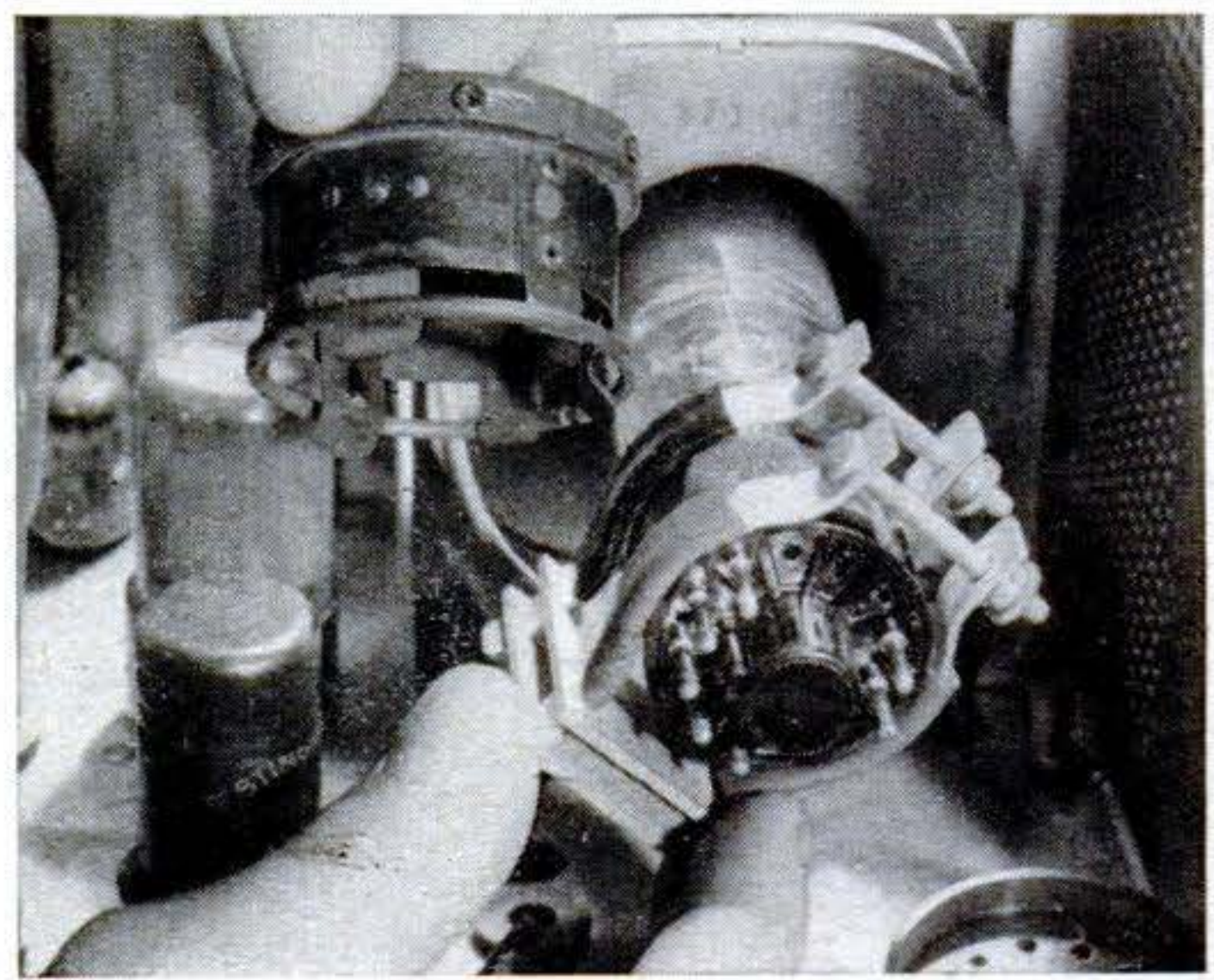

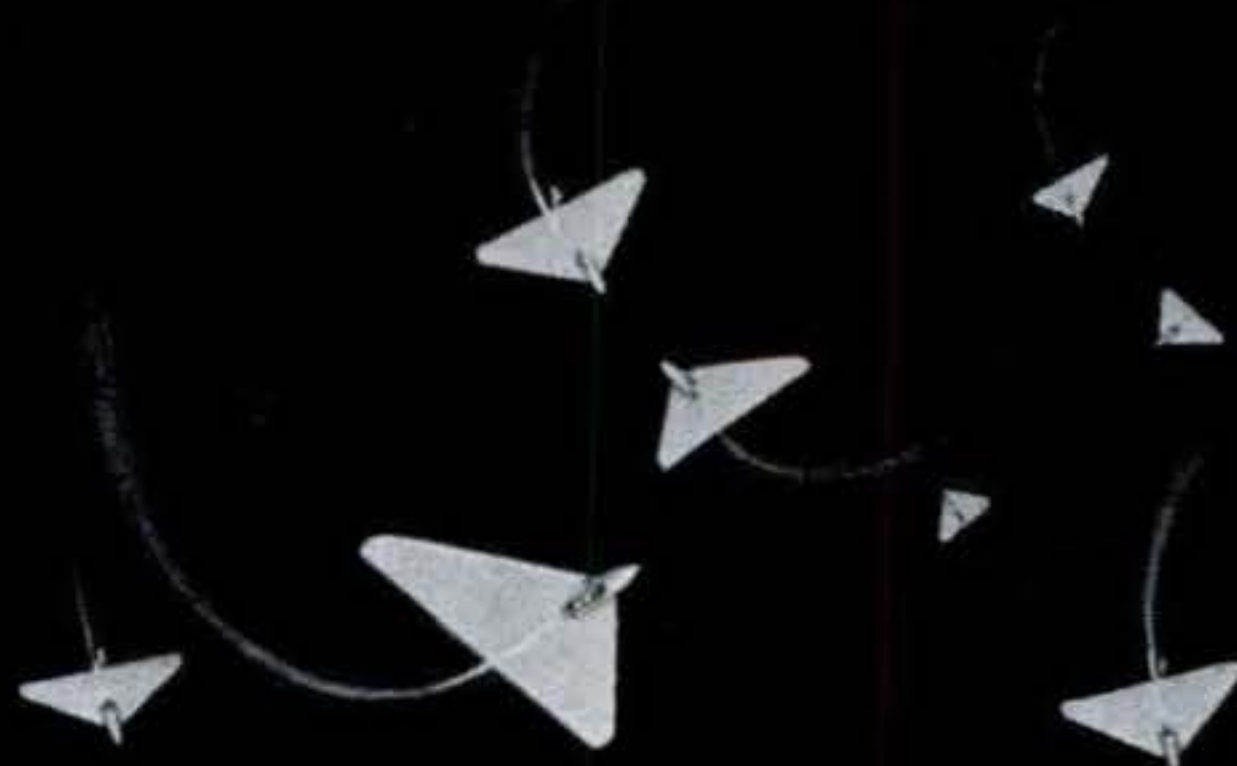

Jet Interceptors Dart 1,000 Feet

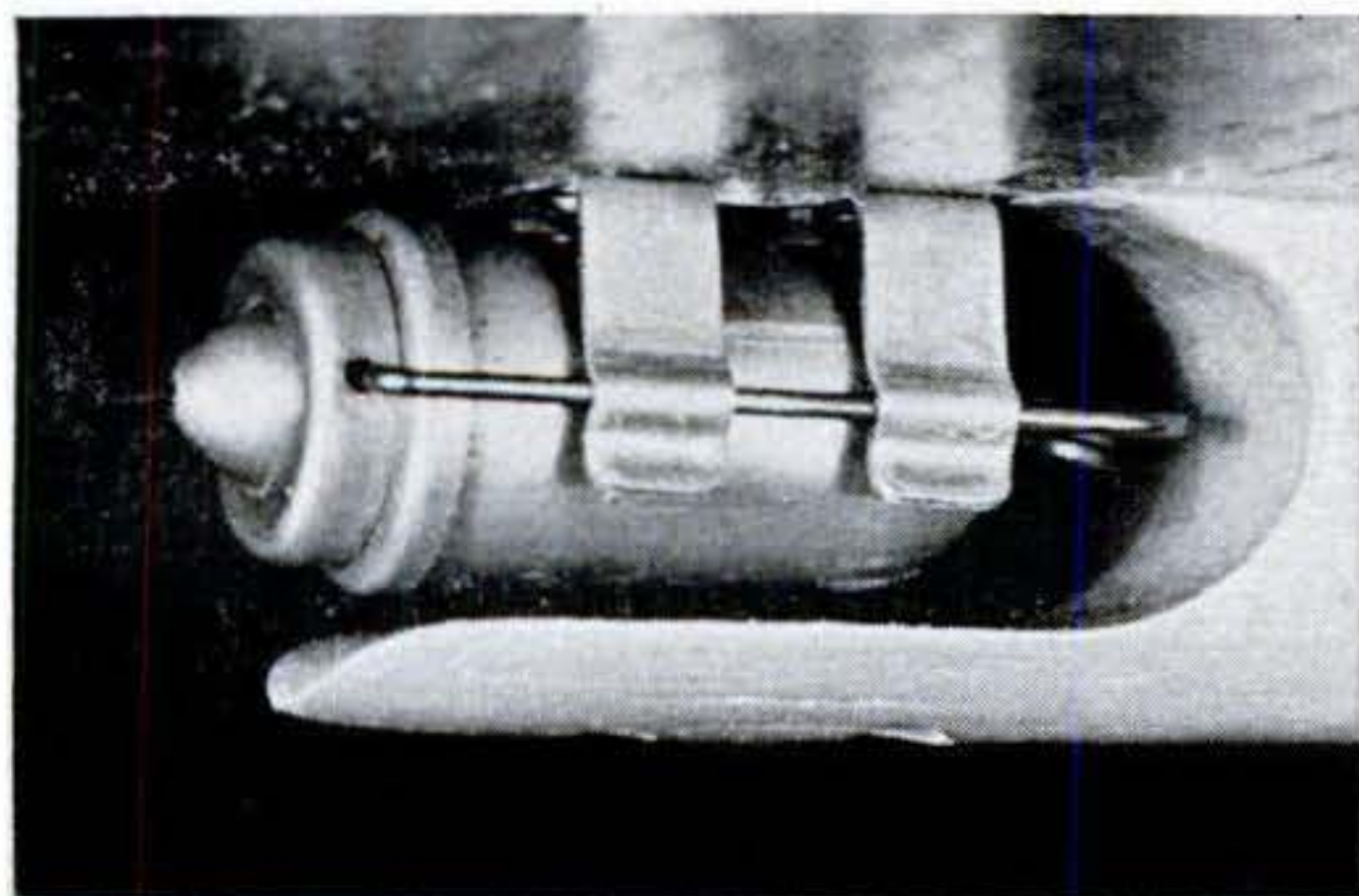

A jet engine powers the model. Loaded with a fuel pellet, the engine weighs $\frac{1}{4}$ oz. For each flight, you ignite a wick that sticks out. One pellet gives a 15-second burst of power.

Model builder's $\frac{3}{4}$ -ounce, 1-foot-wide flying triangle resembles new experimental military aircraft.

By Jack Wilson

WOULDN'T you get a boot out of seeing a jet plane that you had built yourself zoom into the sky? This model will give you that thrill—and something more. You'll have the kick of working from a design based on the delta wing, currently among the hottest experimental-aircraft ideas.

Launched with a rubber-band catapult, it whistles up some 50 feet. Then the jet engine takes over and boosts the altitude an-

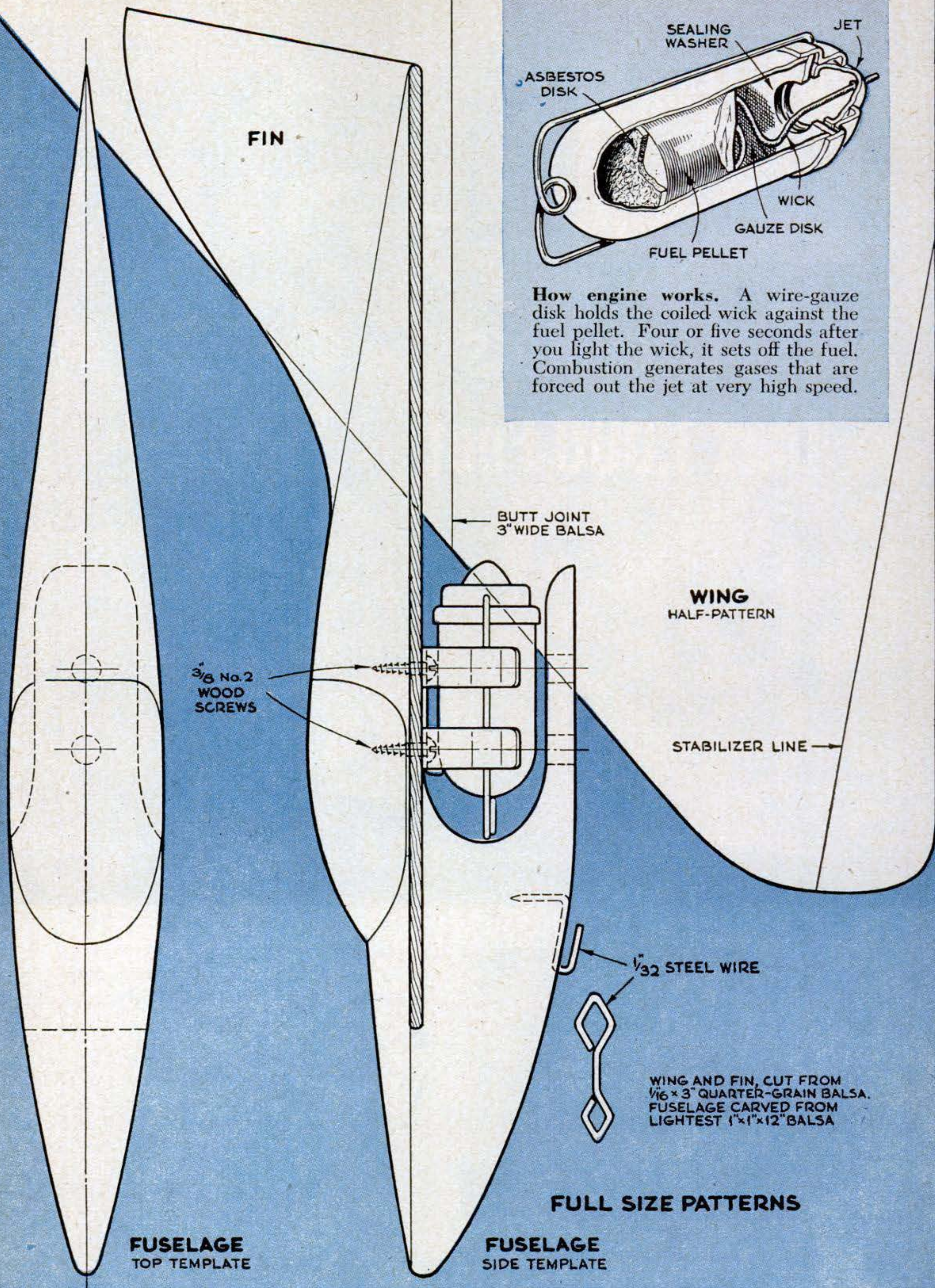

How engine works. A wire-gauze disk holds the coiled wick against the fuel pellet. Four or five seconds after you light the wick, it sets off the fuel. Combustion generates gases that are forced out the jet at very high speed.

**FUSELAGE
TOP TEMPLATE**

**FUSELAGE
SIDE TEMPLATE**

FULL SIZE PATTERNS

WING AND FIN, CUT FROM
1/16 x 3" QUARTER-GRAIN BALSA.
FUSELAGE CARVED FROM
LIGHTEST 1" x 1" x 12" BALSA

other 50 or 100 feet in swift 100-foot spirals. The flight distance averages 1,000 feet, with 2,000 not uncommon.

Its engine is a Jetex 50, an English product distributed here by American Telesco Ltd., of New York. It burns a non-explosive gas-producing pellet of guanidine nitrate.

Complete with engine, the 12" model weighs $\frac{3}{4}$ oz.

Building the model. Trace the wing and fin on 1/16" balsa, using the accompanying full-size drawings. Cut with a single-edge razor blade or sharp knife. Sand both sides smooth and round off edges. Support the sandpaper with the flat of the hand, rather than a block, to prevent scoring fine grooves in the surface.

Lay out the fuselage on the balsa block so the flat sides correspond to the straight surfaces that contact the wing. After sawing the two pieces to shape, coat the joining surfaces with cement, allow it to dry, then recoat, and pin the parts together until set.

Slip-in wings are not recommended because the high speed requires rigid cementing of the wing to the fuselage.

Form a catapult hook and loop from 1/32" steel wire. A 10-foot strand of $\frac{1}{8}$ " flat model airplane rubber makes a good beginning catapult. Later, you may want to try two strands or a loop.

Finishing. Sand the model all over with fine paper. Used dry, No. 400 waterproof paper works fine.

Apply several coats of colored dope diluted with an equal amount of thinner. Orange yellow is attractive and highly visible against either sky or foliage. An all-over coat of fuel proofer will give the model a dressy finish without adding much weight.

Is it safe? In flight, the engine case may reach a temperature of 260° F., and must be allowed to cool before handling. The manufacturer claims the jet gases do not reach flame temperature. I have found, however, that the hot case and gases of my model scorch anything they contact. Nevertheless, this model is as safe to operate as anything involving matches and flame.

Just be sure to start flights at least 300 feet from any building or dry grass.

Glide-test it first. If possible make your tests—as well as the later power flights—on a grassy field to avoid damage to the model.

Flex the wing trailing edge up to correct for too steep a glide. Add weight to the nose to correct a stall. Use rubber bands or

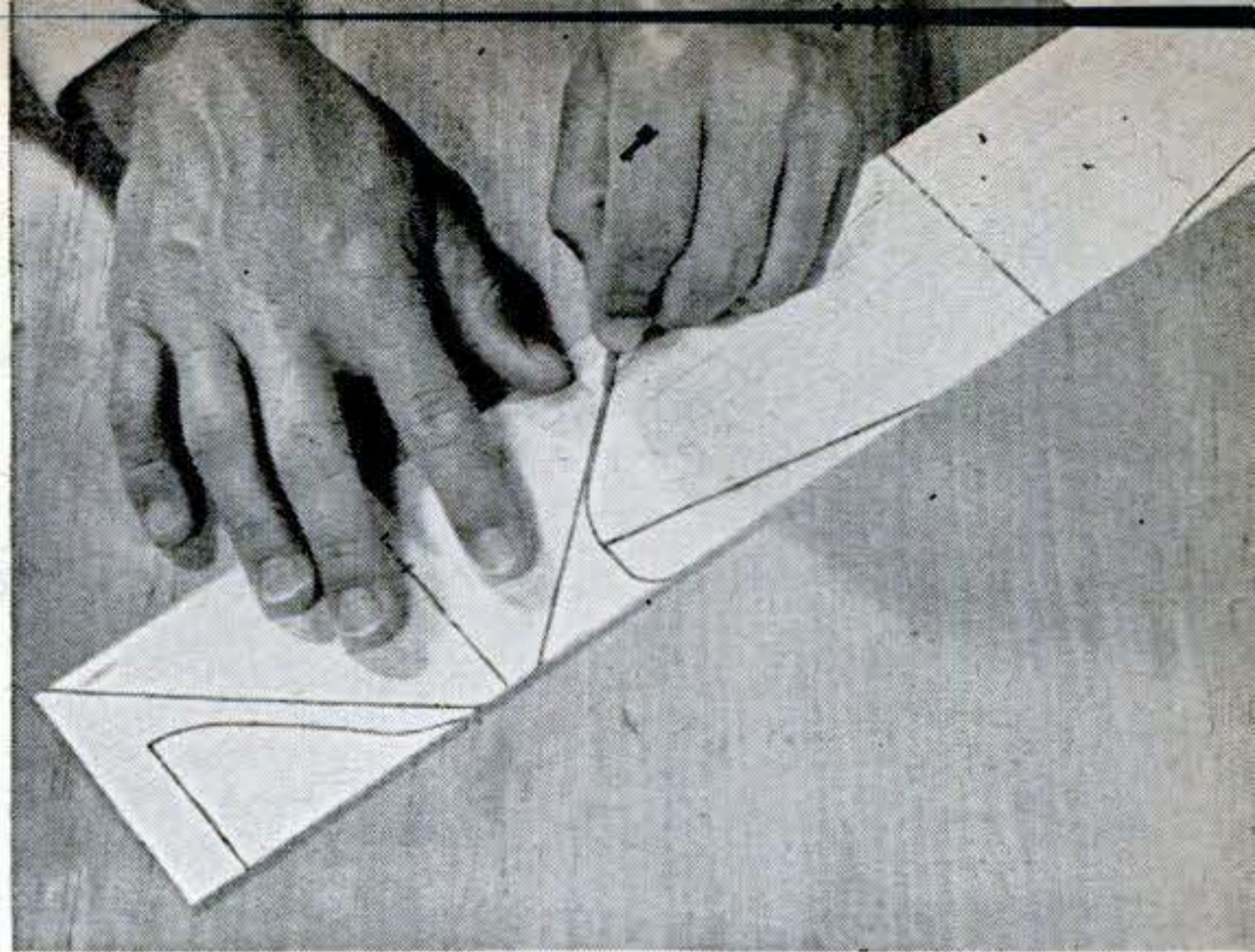

Cut wing parts and fin from a strip of 1/16" by 3" quarter-grain balsa. This is stiffer, smoother, and more speckled than ordinary balsa. Its use is a must for a warp-free wing.

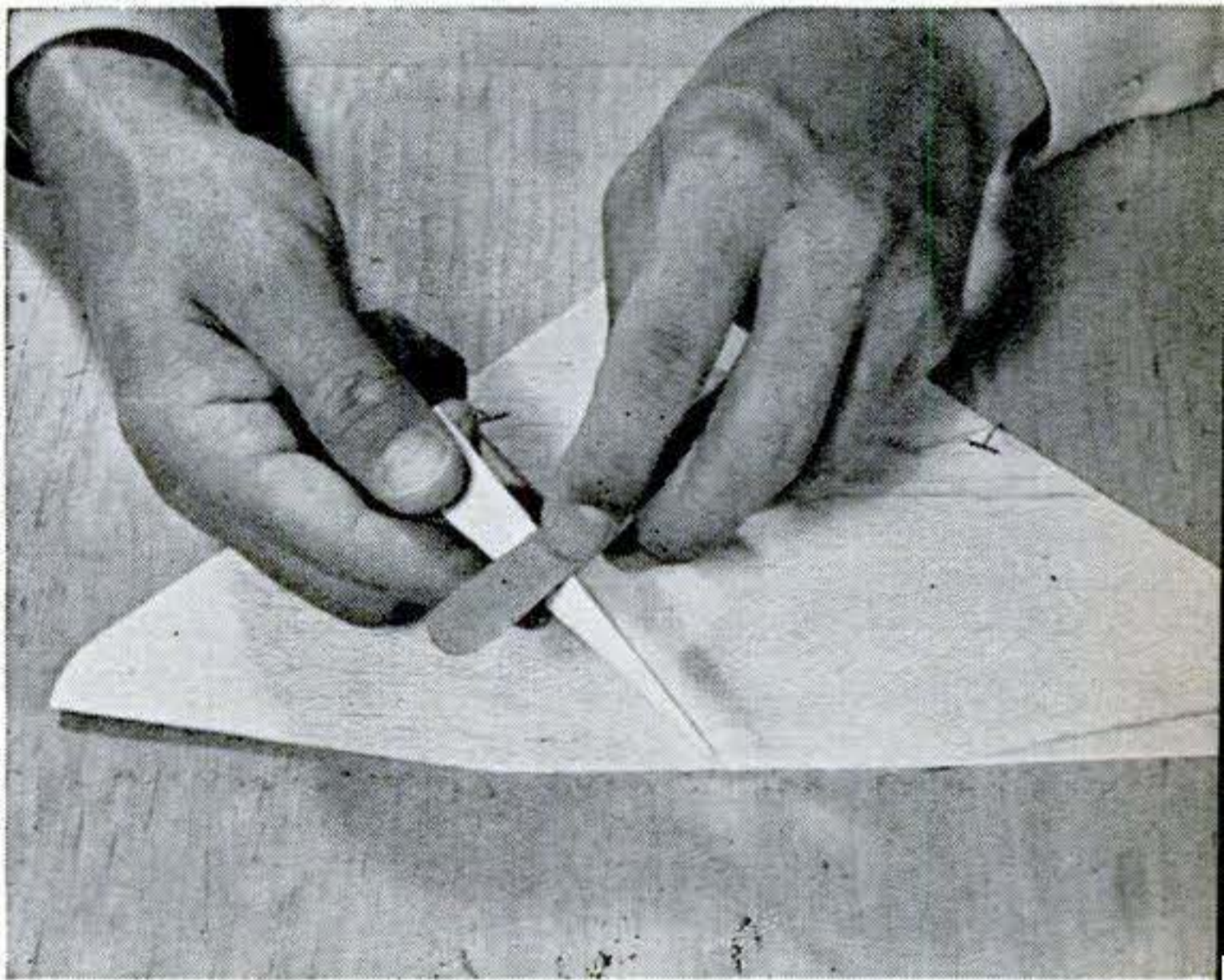

Slice off stabilizers, bevel edge slightly, and cement back on with rear edge raised $\frac{1}{8}$ ". Manicure boards are handy for such beveling. Butt-join the two wing sections with cement.

clay for temporary balancing, and embed equivalent metal weights for permanent correction. For a slight turn, raise the trailing edge on the side toward which you wish the model to turn.

Preparing for a flight. Attach your catapult to a five- or six-foot post, and release the model from near the ground, holding it near the fuselage between the thumb and index finger. Try this out before you attempt a power flight.

Bank the model opposite to the natural turn direction, and it will go into a spiraling climb, finally rolling into a gliding turn in the opposite direction. A one-length stretch of the rubber is right for the first catapult attempt. Later, for greater speed, you may increase this to three or four times the unstretched length.

Always insert the engine into the clip in

the same position to avoid changes of the thrust line.

And finally a power flight. Prepare for a catapult launch in the usual way. An instant before releasing the plane, light the wick. A convenient way of doing this is

with a burning piece of common chalk line.

The plane may slow down a bit before the jet starts to push. But when it does, you will see sudden acceleration, and the model will shoot away at dazzling speed on your first jet flight. END

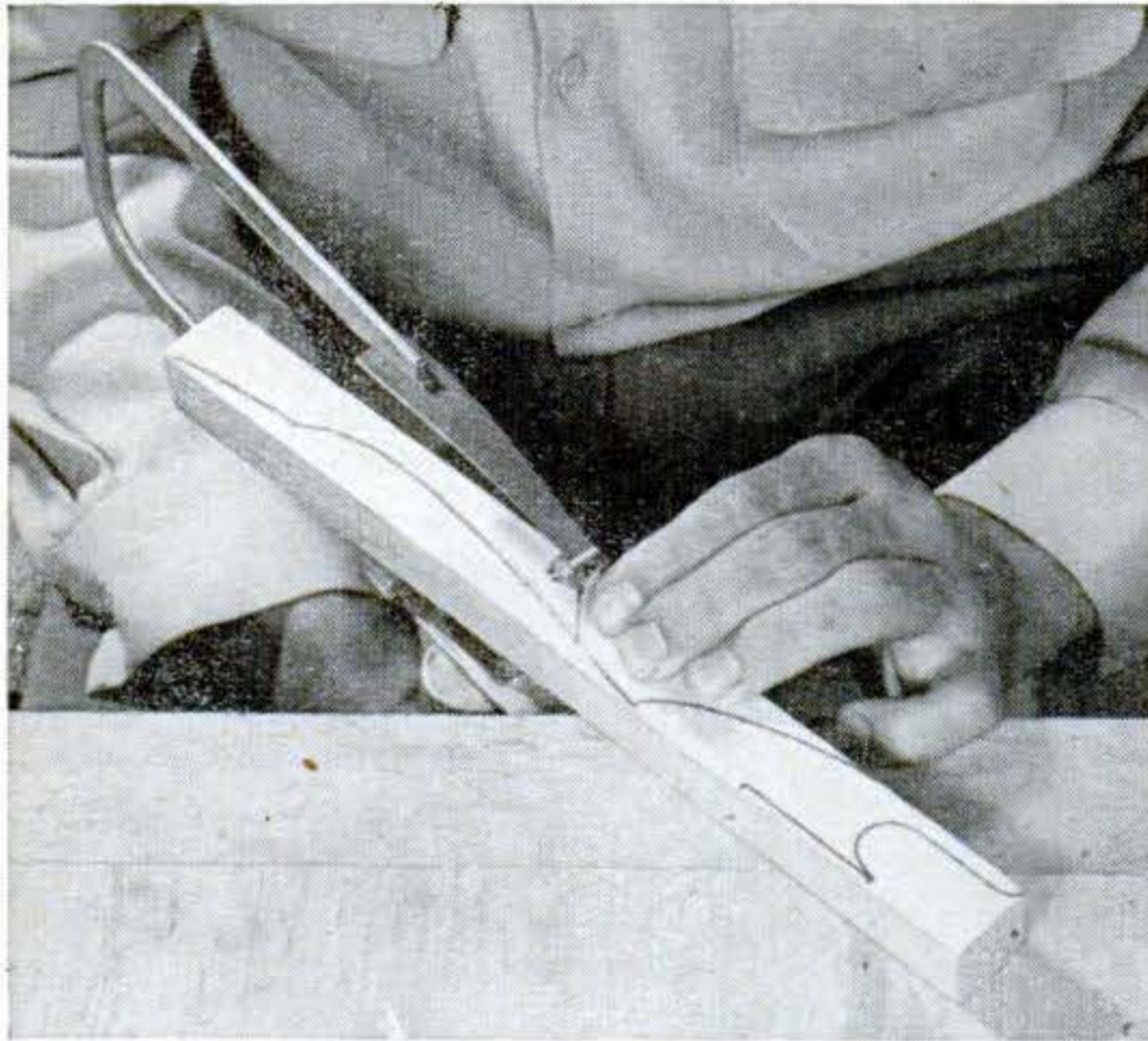

Use **lightest balsa** you can find for fuselage. Top and bottom sections are both cut from one 12" length as shown here. Jigsaw the pieces just outside the line. Then sand smooth.



Carve fuselage to follow the top template after cementing the two pieces together and marking a center line at top and bottom. Streamline with coarse, medium, and fine paper.

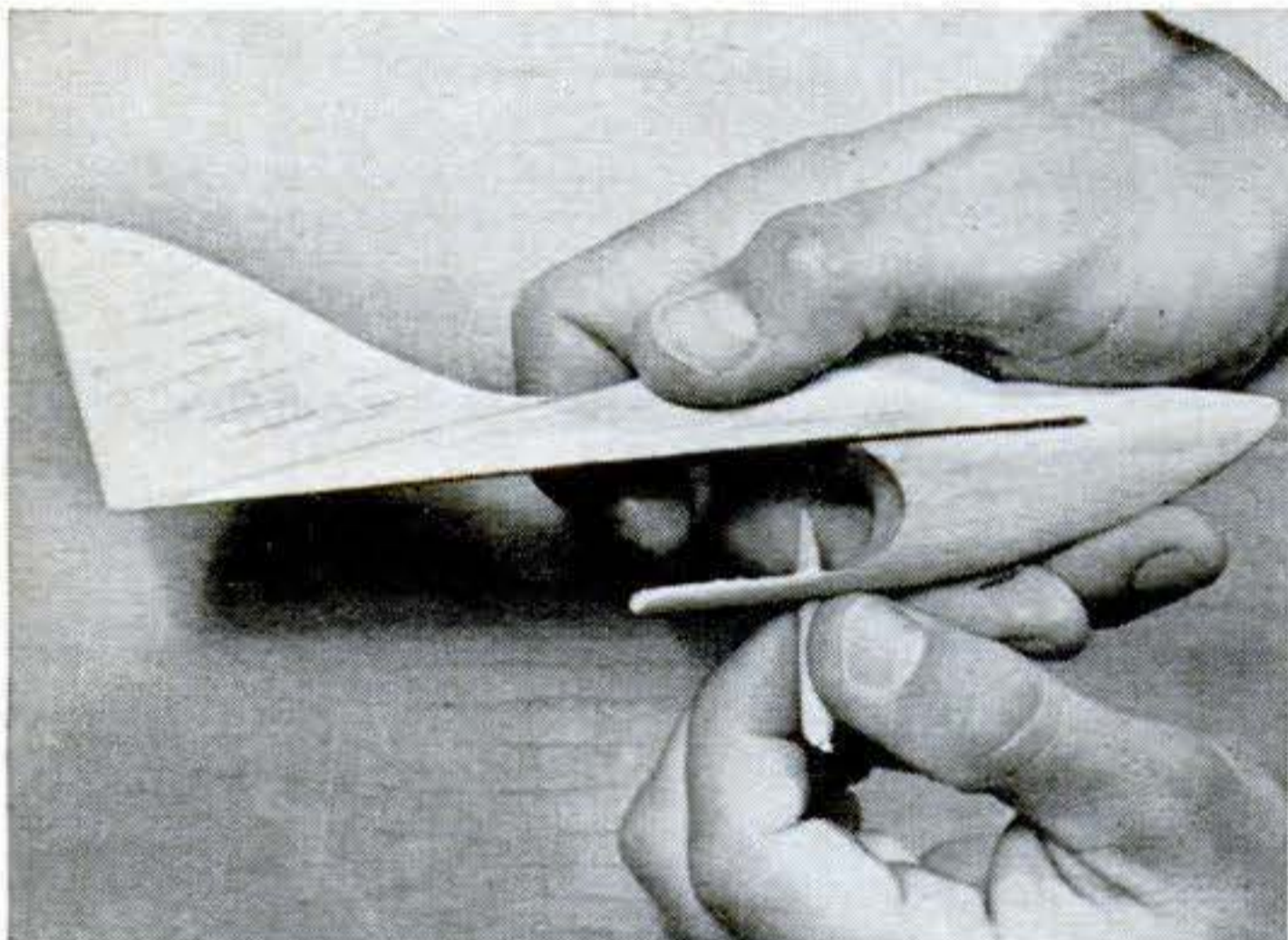

Using a twist of sandpaper, smooth $\frac{1}{8}$ " screw-driver-access holes drilled in the belly skid. Cement fin and tow hook in place with double coating for strength. Sand fin to airfoil section.

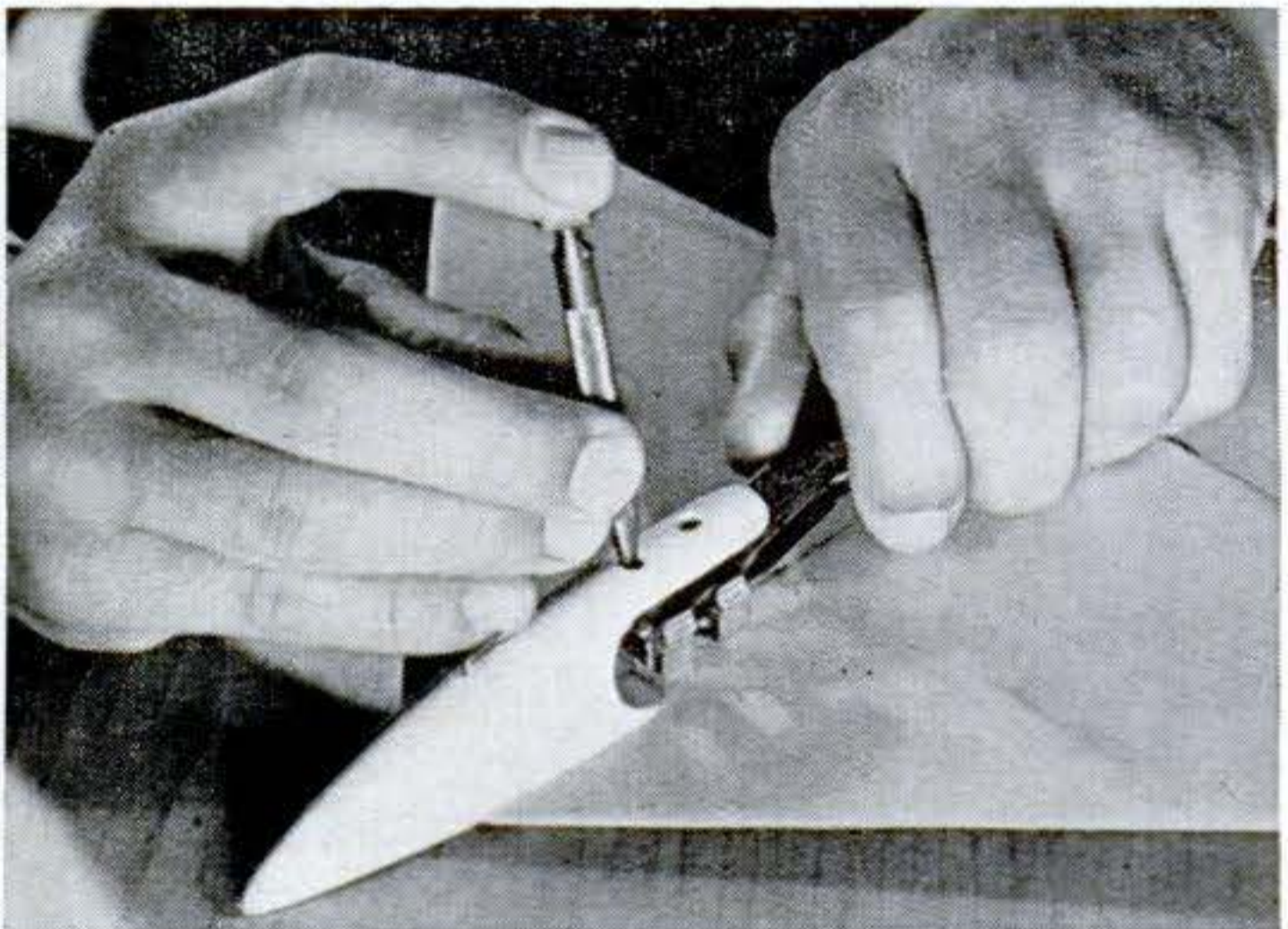

Attach the engine clips after cementing wing to fuselage. Substitute $\frac{3}{8}$ " No. 2 wood screws for those that come with engine. These will hold better. Avoid tightening screws too much.

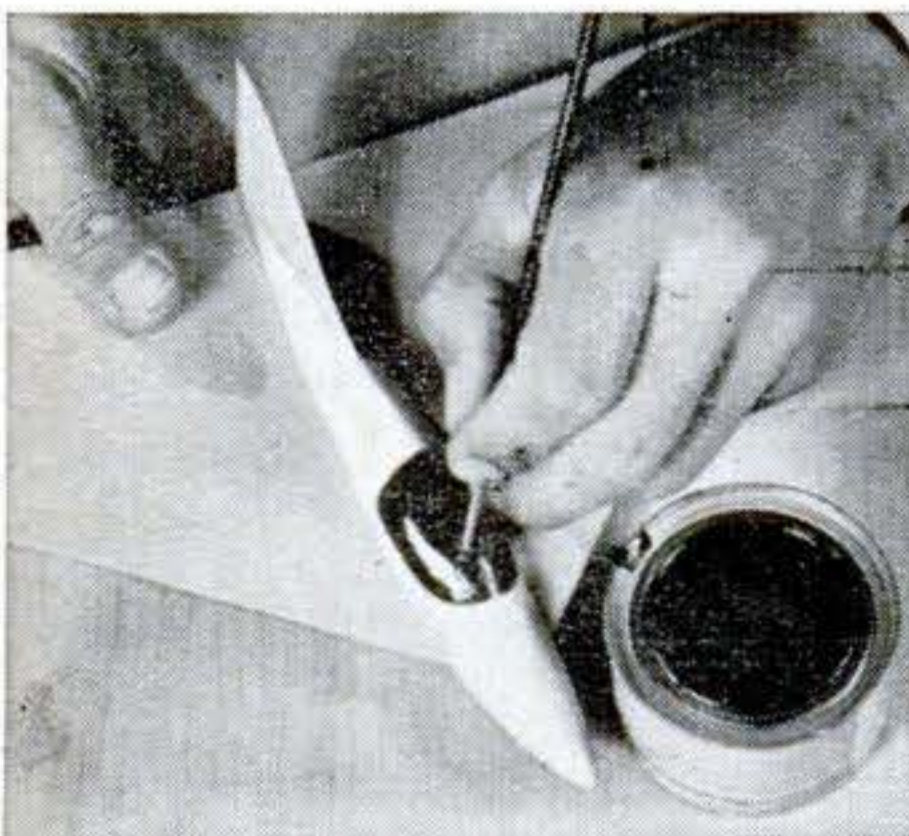

Decorating. Outline cockpit with a small brush, using black or aluminum dope. Fill in remaining area. Apply fin decals of your own choice. Protect with coat of hot-fuel proofer.

Flying tip. For sure-fire ignition, tamp wick tightly against charge and avoid sharp bends in wick. Keep protruding end of wick less than $\frac{1}{8}$ " long to prevent spark damage.



Mother Will Appreciate Woodwork Like This

This copy of a Colonial wall box for clay pipes makes an unusual ivy holder.

THE American colonists used decorative boxes like this to hold their long-stemmed clay smoking pipes. An authentic reproduction makes a handsome plant holder and the little drawer is a handy cache for house keys, playing cards, stamps, or other small items. Hence, it's a welcome Mother's Day gift.

In colonial times, the pipe box was a valued possession and often was made of fine mahogany, black walnut, or selected maple. I used old pine boards, resawed to $\frac{1}{4}$ " , to make the one shown here, but any $\frac{1}{4}$ " wood will do.

The patterns given for front and back are half-patterns, to be laid out on both sides of a center line. Any conventional method of drawer construction can be used, but be sure that the grain of the drawer front runs vertically to match the wood above it. Use a drawer pull of matching wood, or brass.

Glue and brad the parts, and then round and sand all edges on the face of the box. Finish with water-thin coats of shellac, well rubbed down, and polish to a fine gloss with a wax polish.—*J. P. Arnold, Doylestown, Pa.*

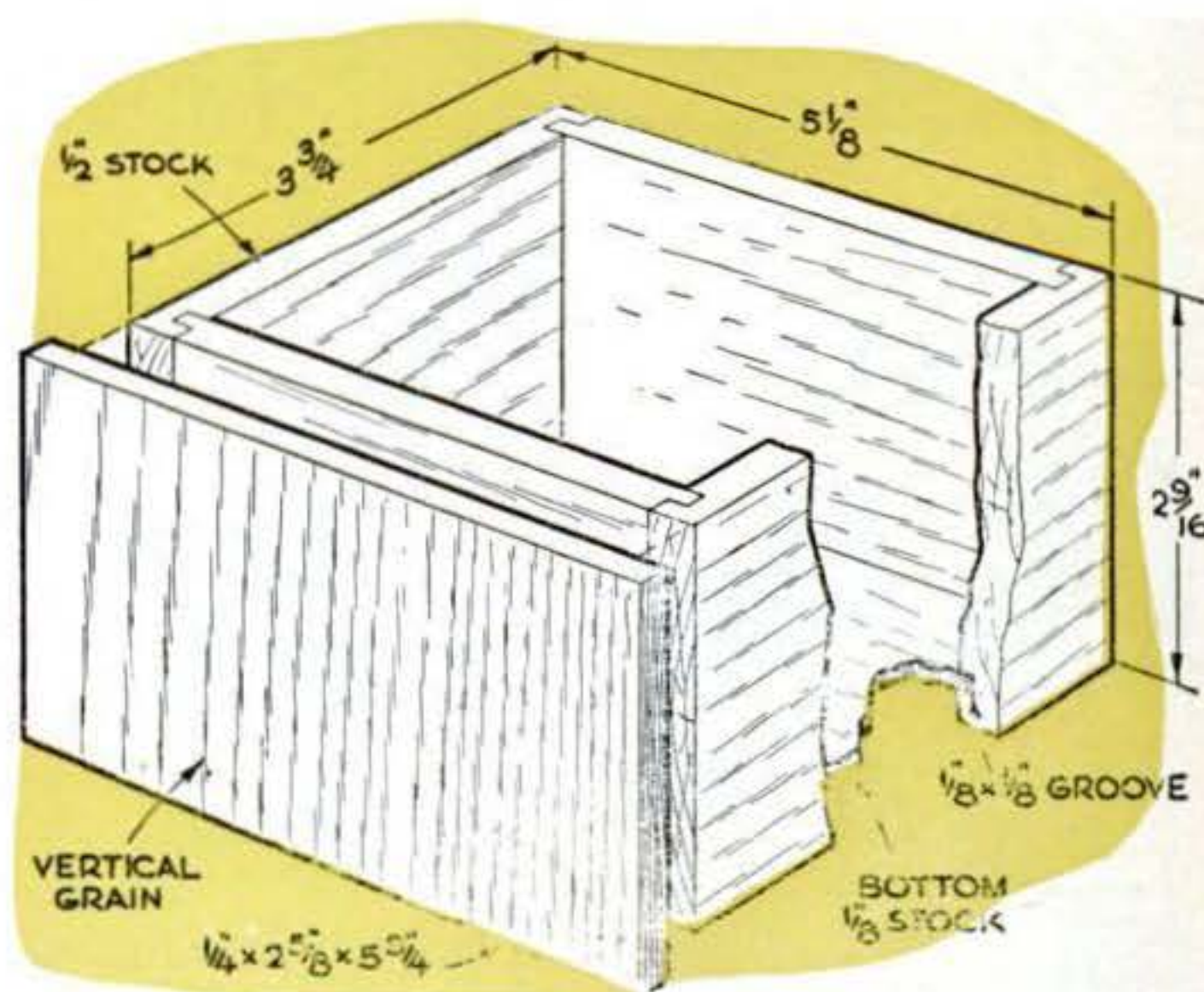
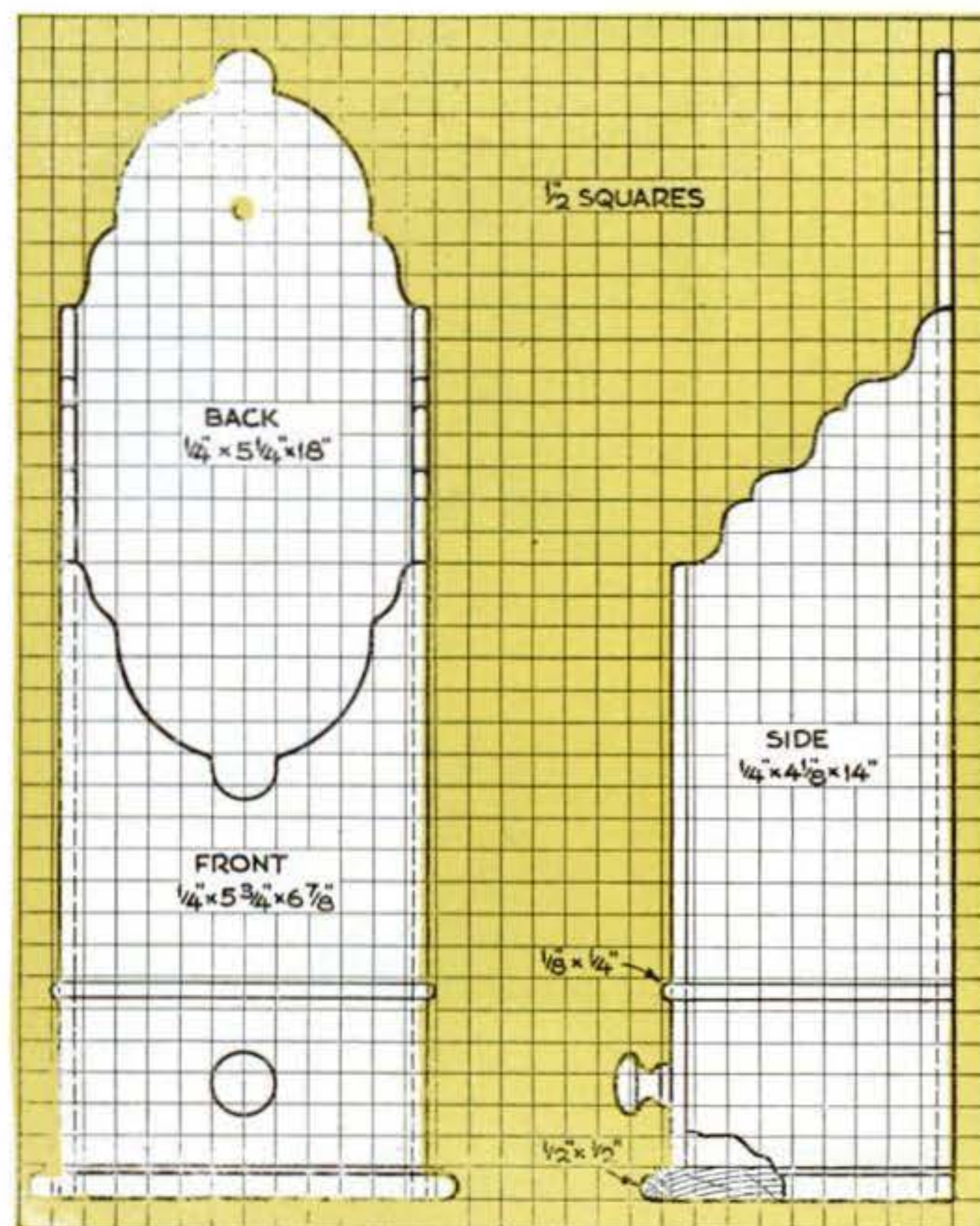
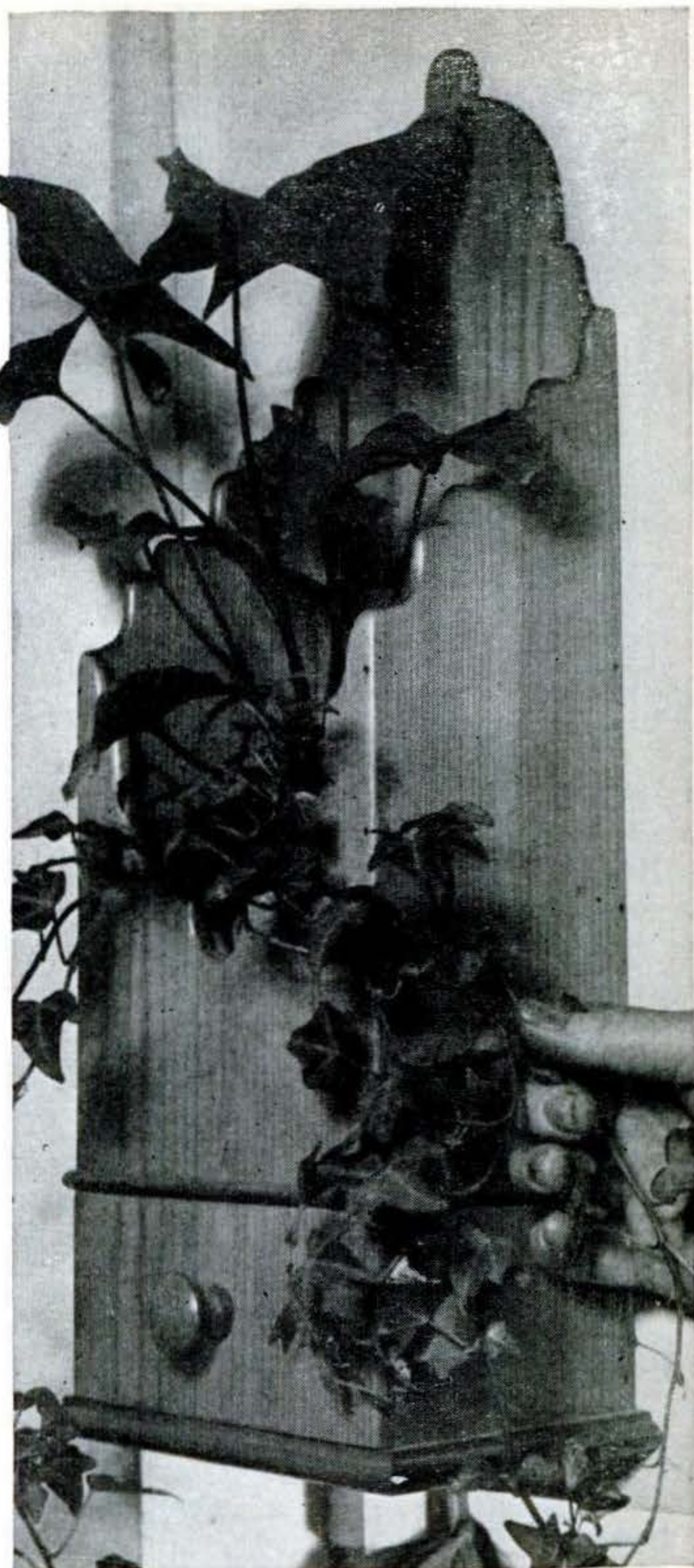

Wood Frame Supports Fan in Window

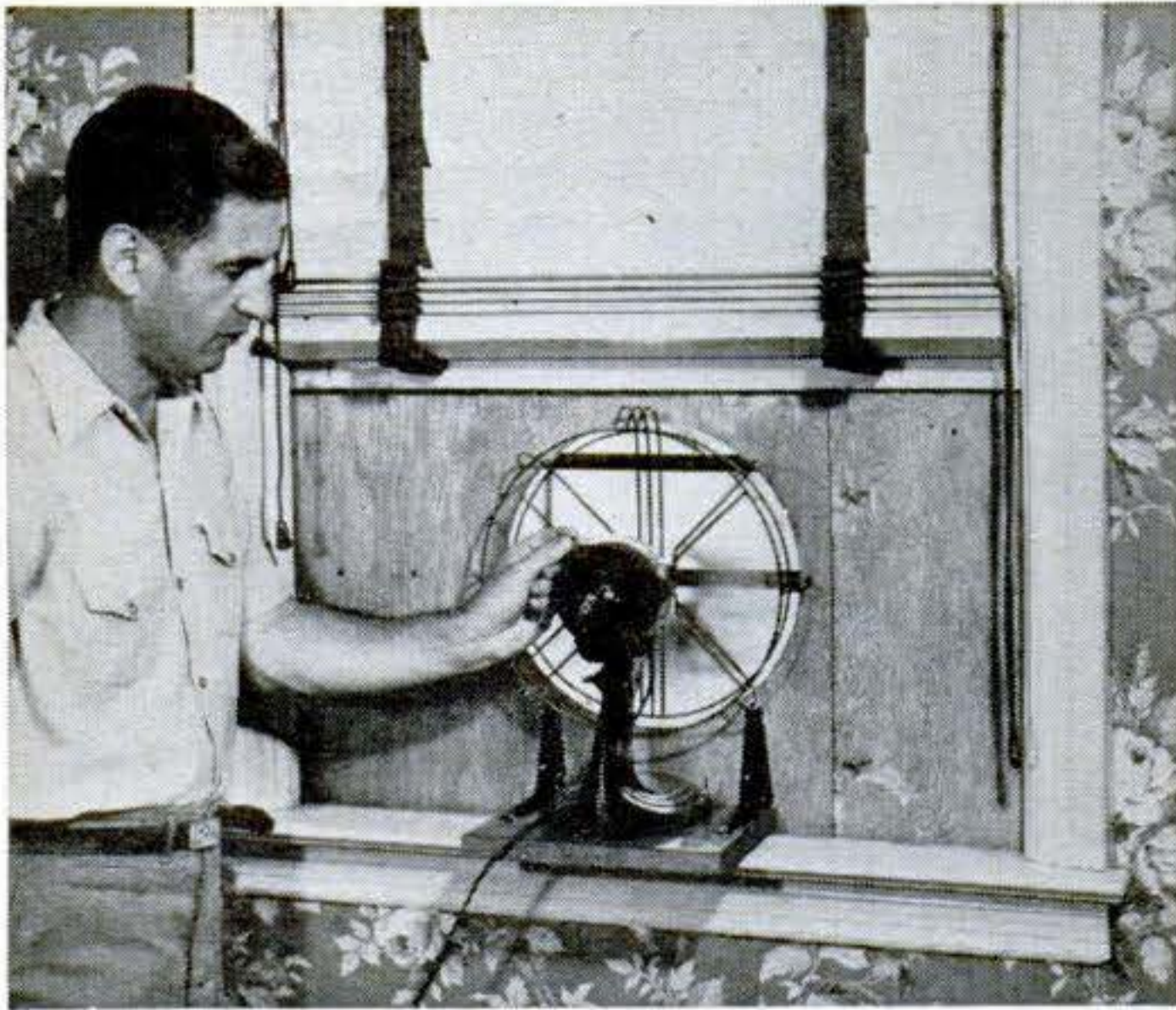

THIS summer put your bedroom fan where it will do the most good—in a window. You can mount it in a simple frame of $\frac{3}{8}$ " or $\frac{1}{2}$ " plywood as shown below. The dimensions are for a 31" window and 12" fan, but they can be easily modified to fit other sizes. Make two overlapping sections and rout slots in the smaller one so the frame can be inserted in the sash channel, widened, and locked in. Bolt the fan to a baseboard and attach the base to the frame with shelf brackets. Cushion the bottom of the base with a sheet of felt. Varnish the frame and join the sections with brass bolts and wing nuts. Run the fan at low or half speed.—*Robert Hertzberg, Jackson Heights, N. Y.*

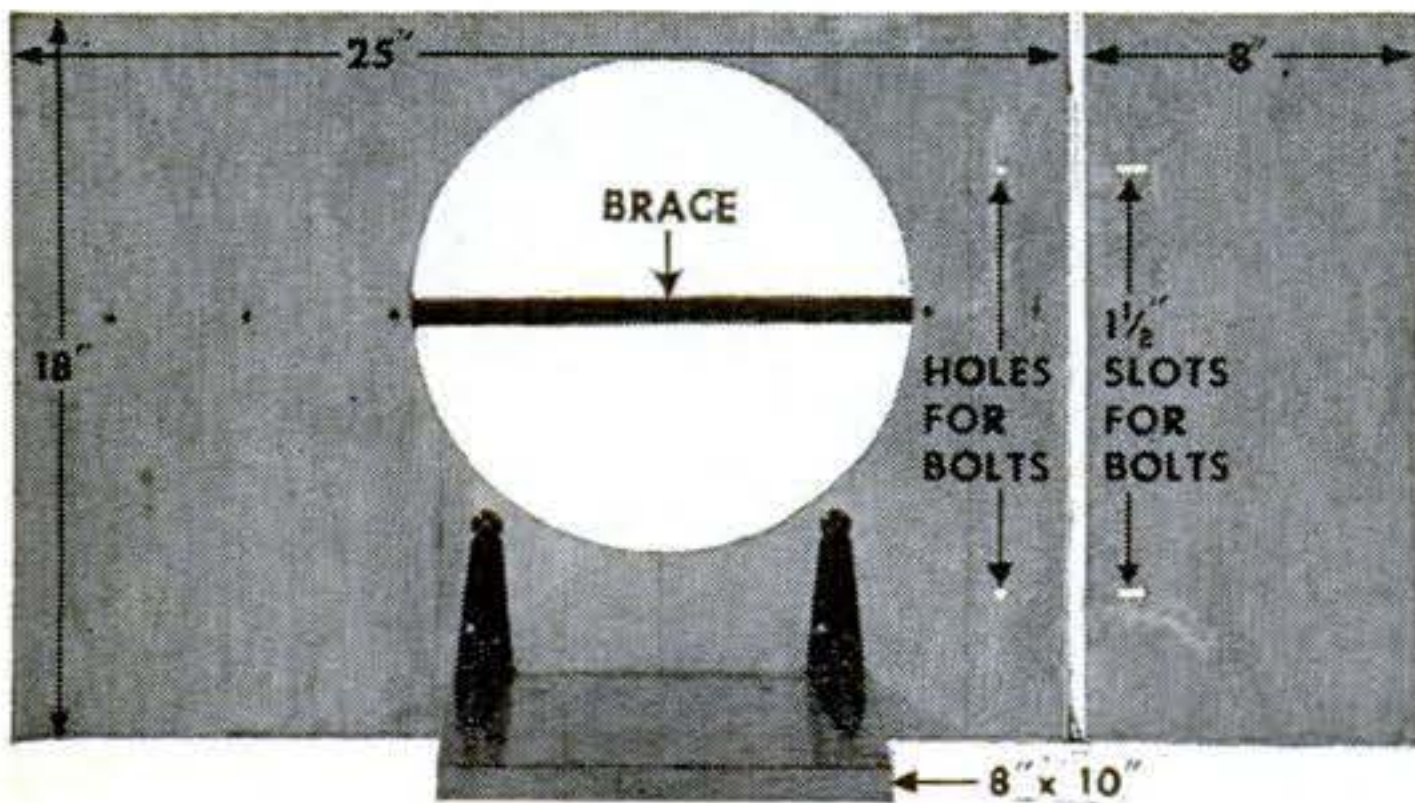

Dust Mask Is Lightweight

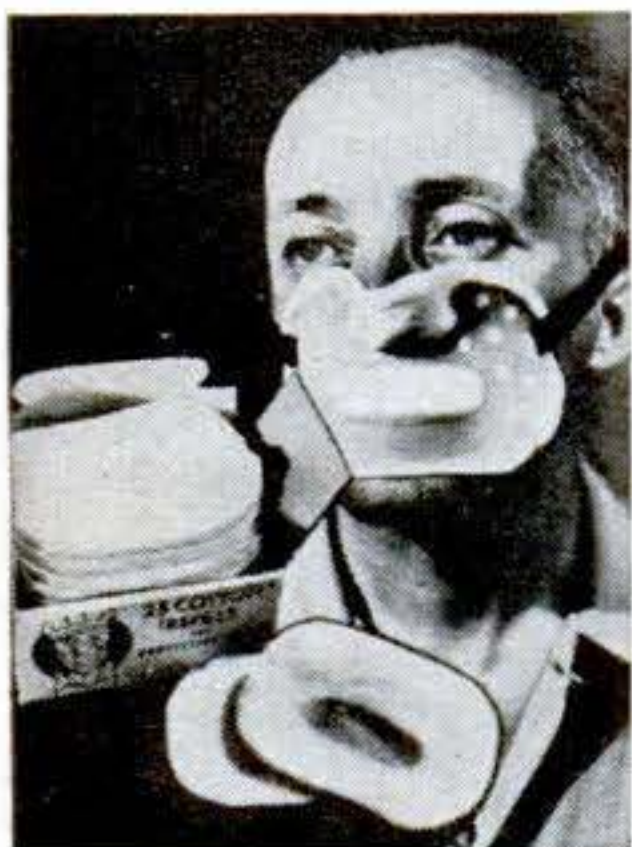

THIS $\frac{1}{2}$ -oz., 30-cent mask protects the nose and throat of workers employed where non-toxic dust is a hazard. It has an aluminum shield, adjustable headband, and replaceable filters. General Equip. Co., Phila., makes it.

Coffee Can Is Workshop Ash Tray

NEED a man-size ash receiver for your workshop? Use a coffee can. Make a lip by snipping two 2" slits and bending out the cut section. Double over the sharp edges. Water or sand in the bottom will extinguish your smokes and also weight the can.—*G. Breuker, Brooklyn.*



Parallel Bar Made from a Ladder

A PARALLEL bar can be made from an extension ladder cut into three pieces and then braced and bolted together. Legs should be bolted to stakes driven into the lawn. The small platform below this one helps little Martha Buck, of Ainsworth, Iowa, reach the bars. She won't need it when she's taller.

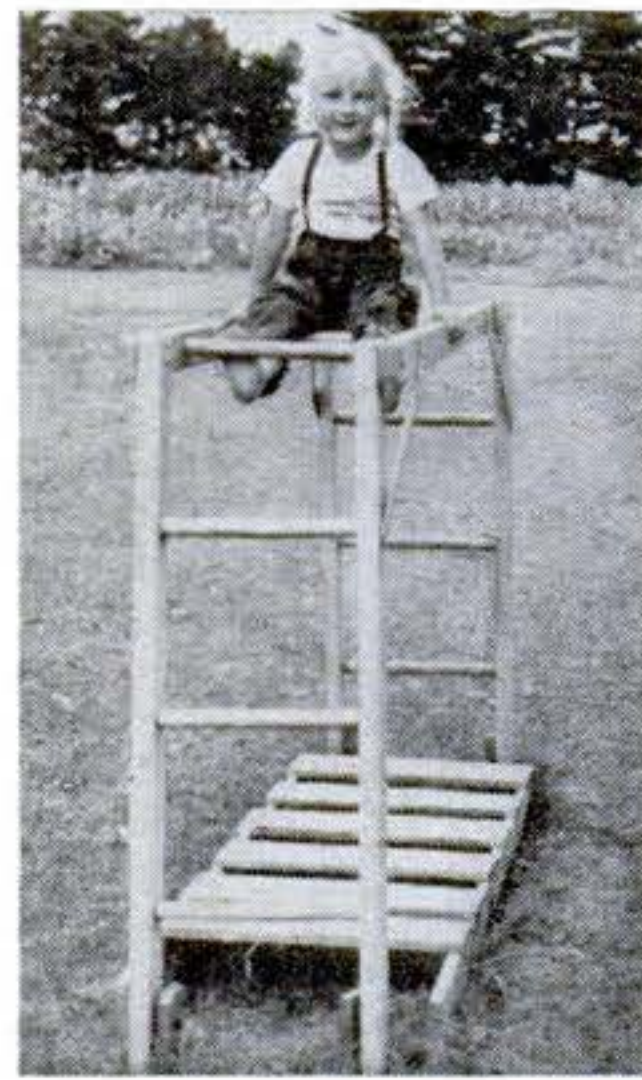

My Most Ingenious Solution



Maybe you have this same problem in your home: a 15-month-old toddler (persistent too) who likes to open cupboard doors. I solved the problem of keeping them closed very simply—without secret catches. What did I do?

I put two ordinary cupboard latches on each door, spaced as far apart as possible. The child can't open the doors because he concentrates on only one latch at a time.
—*Theodore Hall, Willoughby, Ohio.*

How to Make Dutch Doors

Their swinging halves add charm and convenience to a home.

You can make your own for much less than you can buy one.

Here's a choice of two.

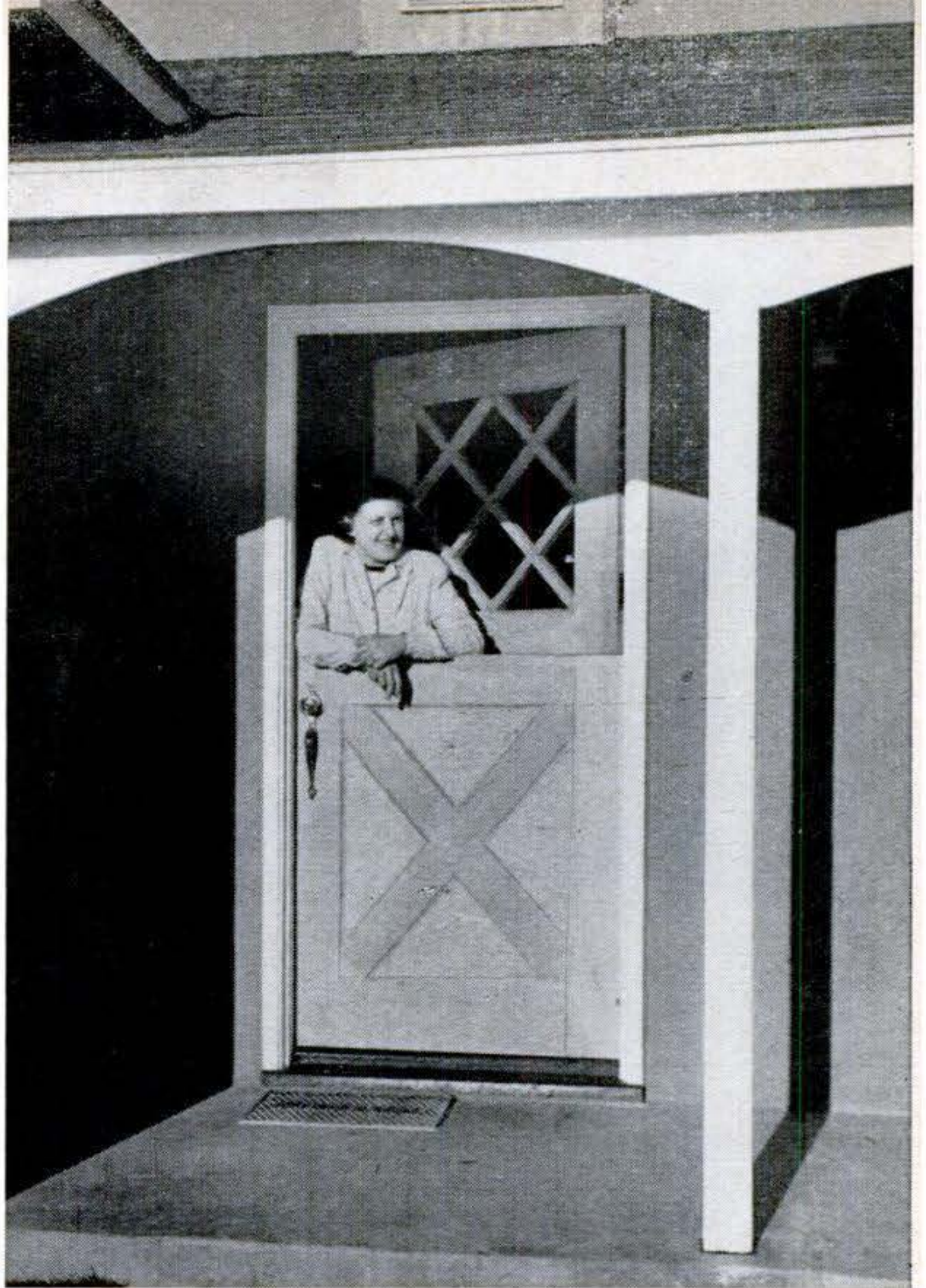

This one's challenging . . . See the next three pages for instructions on how to make it.



This one's easy . . . and fine for a modern home.

FOR the lower section, cut a piece of $\frac{1}{4}$ " outdoor plywood to the width of your doorway and the height at which you want the break. Cut a second piece $\frac{3}{8}$ " shorter. Build a frame for this lower section of $1\frac{1}{2}$ " square stock, rabbeting the top member $\frac{5}{8}$ " by $\frac{5}{8}$ ". When the $\frac{1}{4}$ " inside panel is added to this, you'll have a $\frac{5}{8}$ " by $\frac{7}{8}$ " rabbet. Cut a corresponding one of the same size in the bottom rail of the upper door half.

Assemble the frame with waterproof glue and nails. Then glue and nail the plywood to both sides of the frame, setting and filling over the nails.

Upper section. This consists of four pieces of two-by-four, lapped together. Cut a $\frac{1}{2}$ " rabbet $\frac{1}{2}$ " deep around the inner edges on the side that will face outward. The glass goes here. Cut $\frac{1}{2}$ " by $\frac{1}{2}$ " wood strips to hold it in place.

Hanging the door. Work with the door as a unit so far as possible. Install a vertical latch bolt on the inside to lock the two halves together. Use a pair of butt hinges on each section. Dress off the outer edges as necessary to make the door fit perfectly.

Glazing. Use double-strength glass. After you are sure the glass fits, apply putty all around the rabbet. Bed the glass against the putty. Set the wood strips in place and nail them to the frame, driving the nails in parallel to the glass.

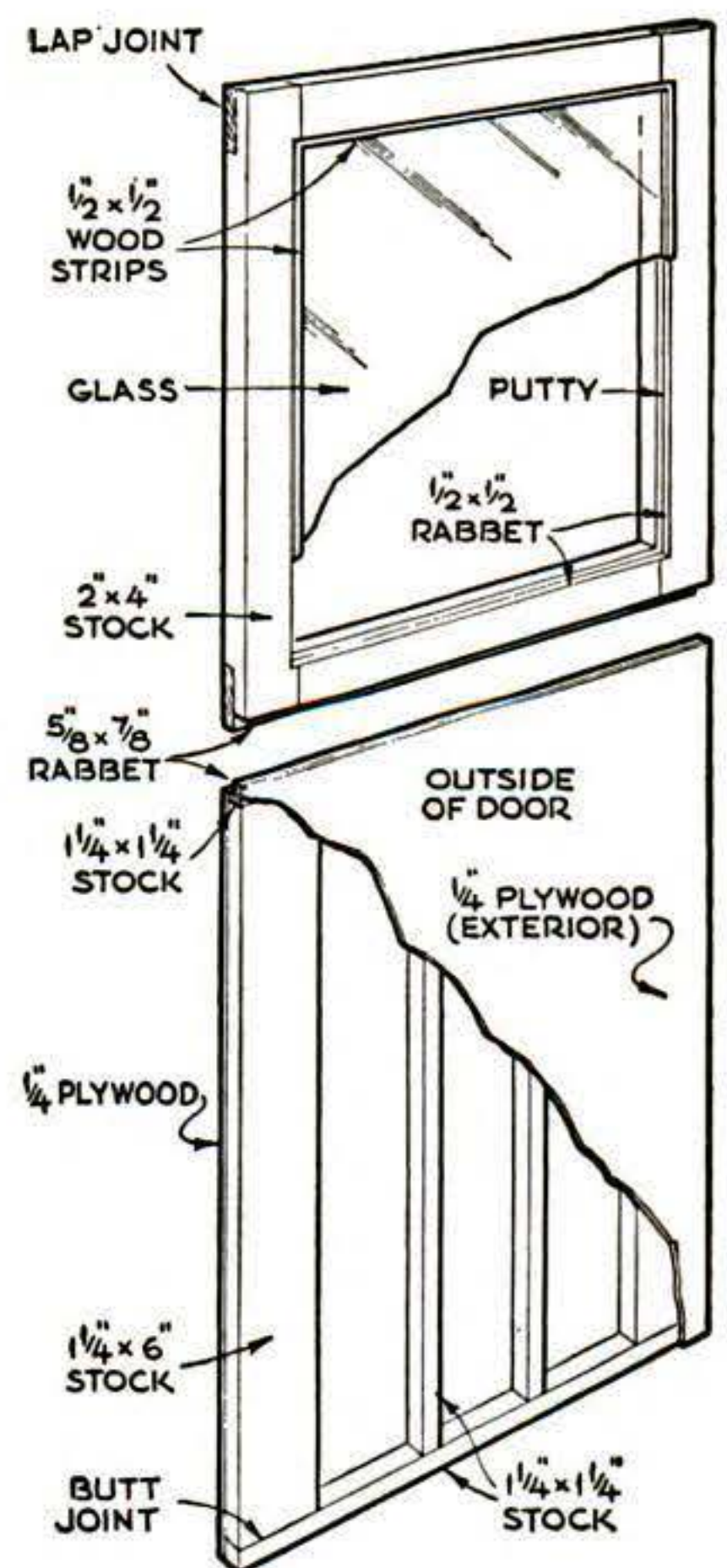

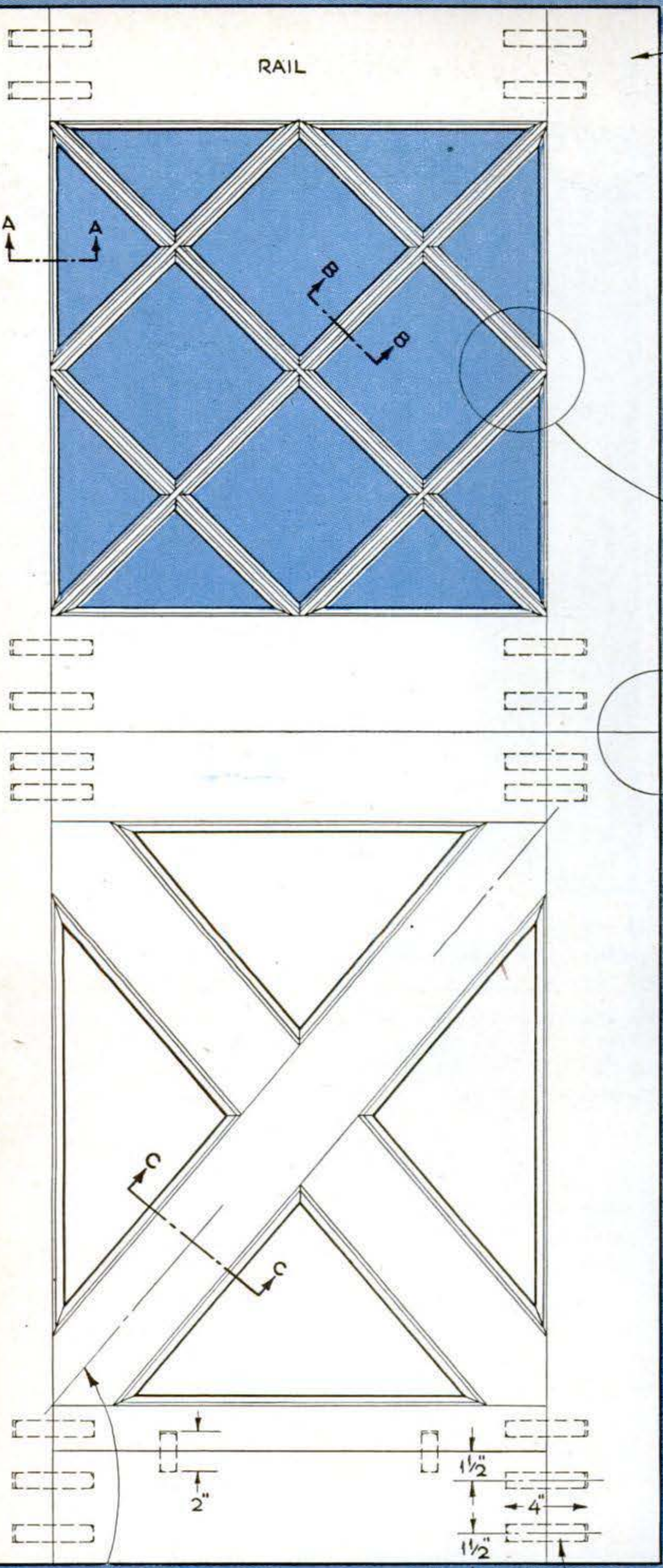

ALIGN BRACE CENTERLINE WITH FRAME CORNER TO SCRIBE BRACE ENDS

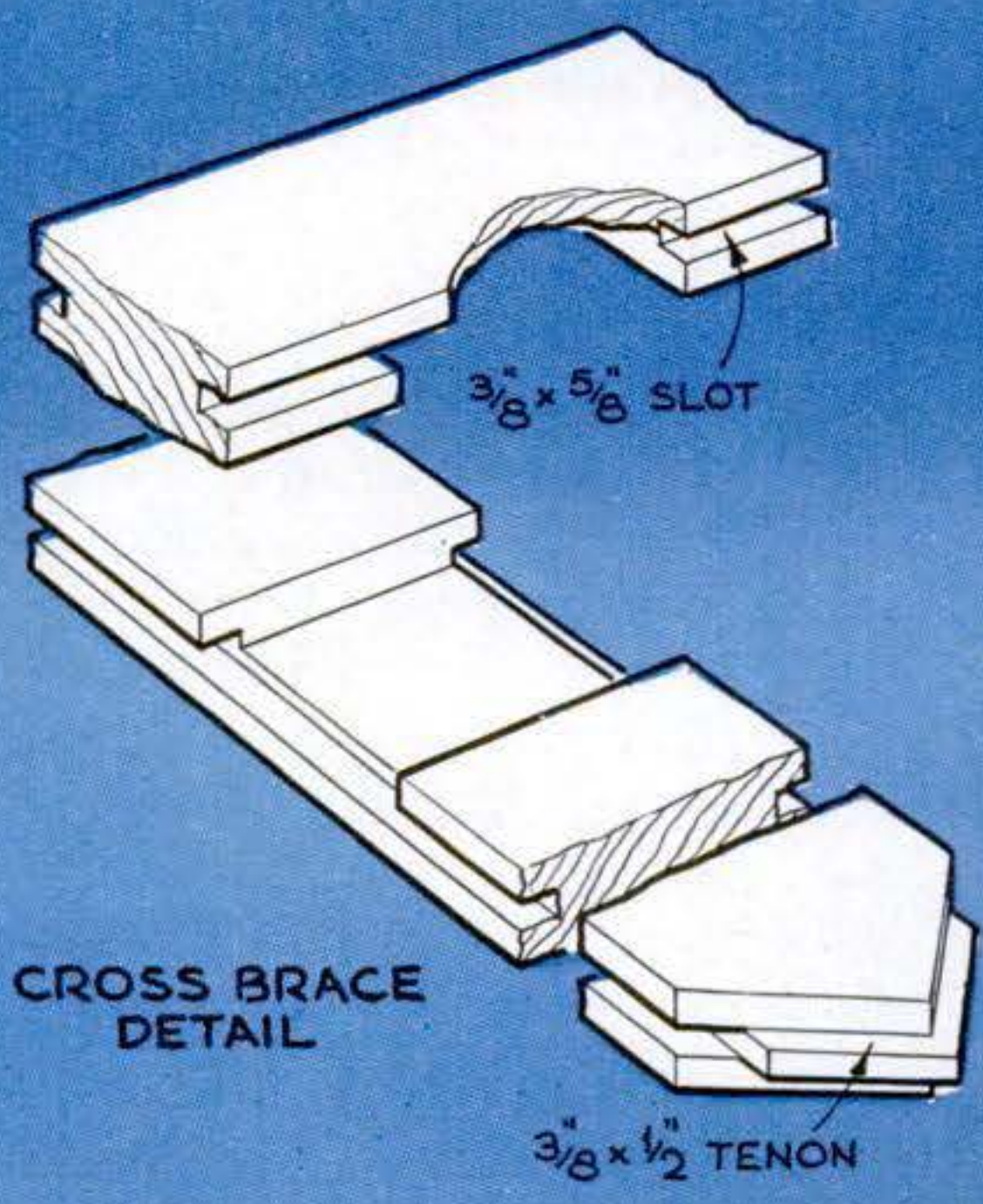
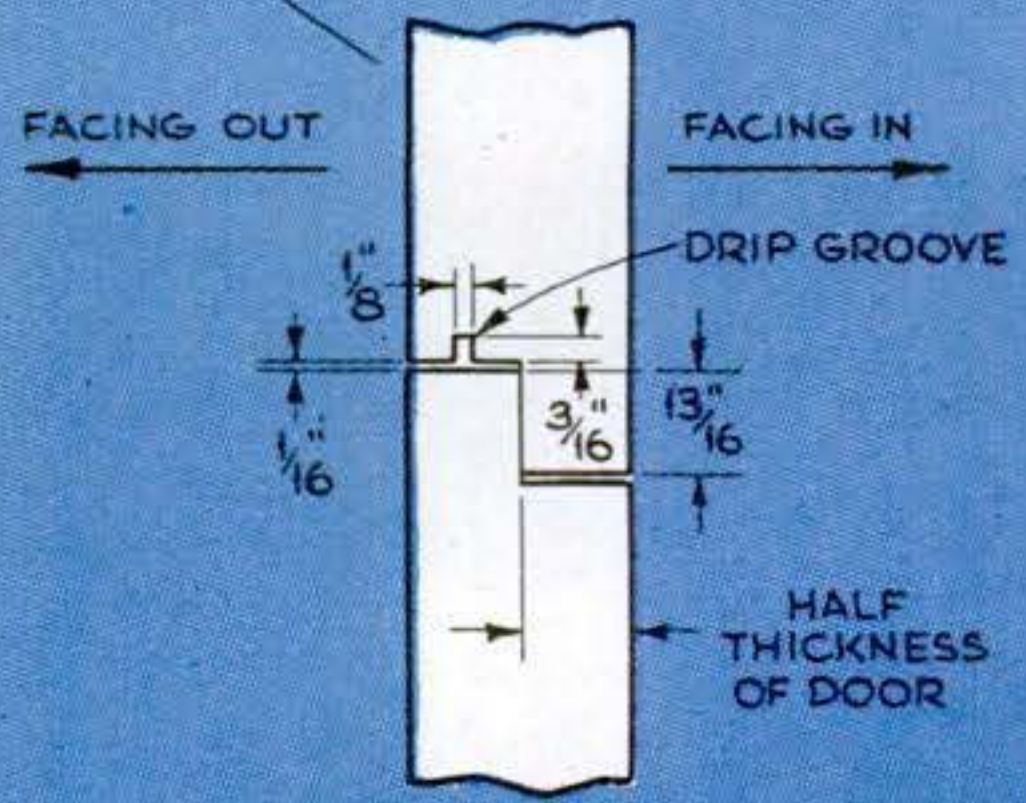
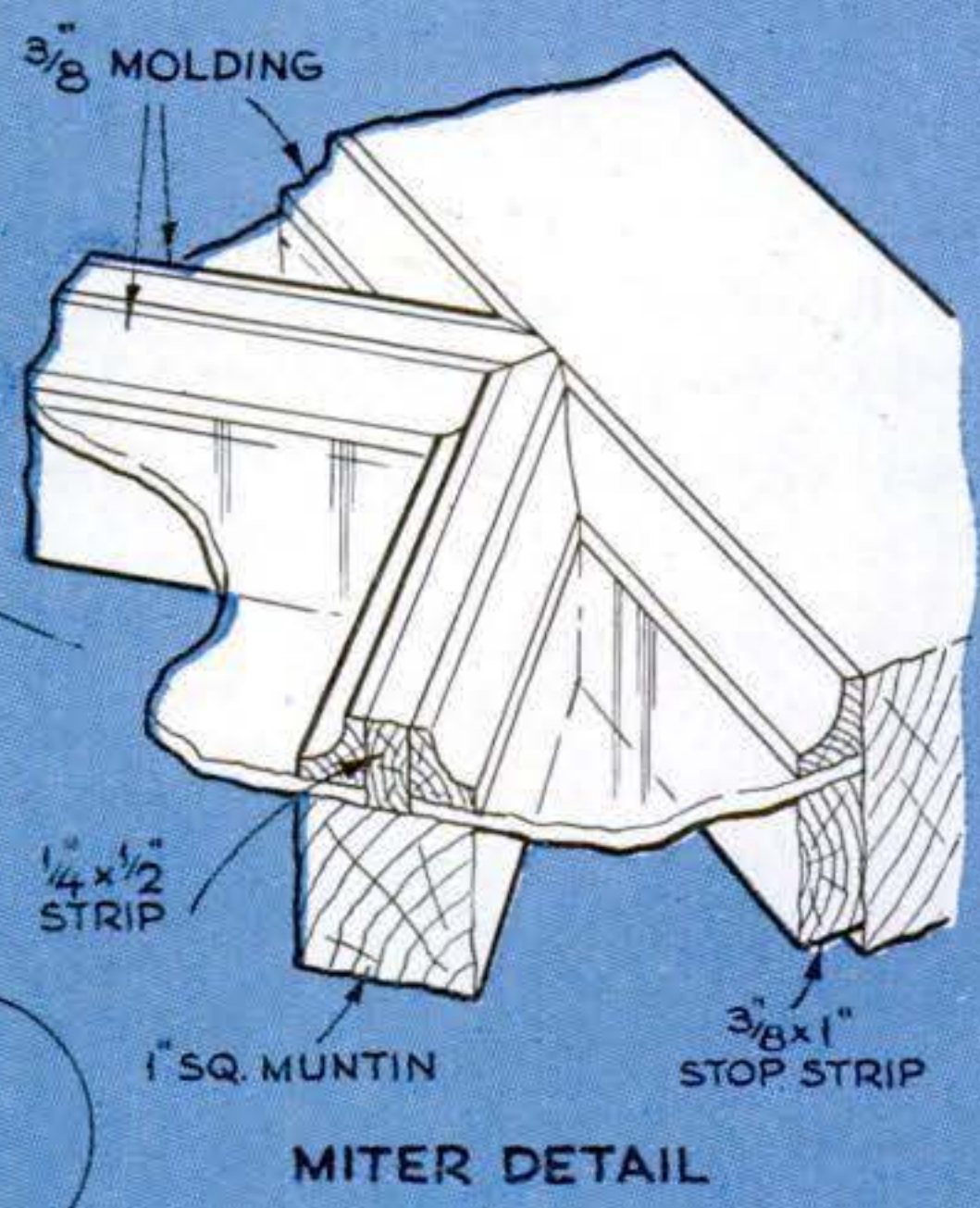
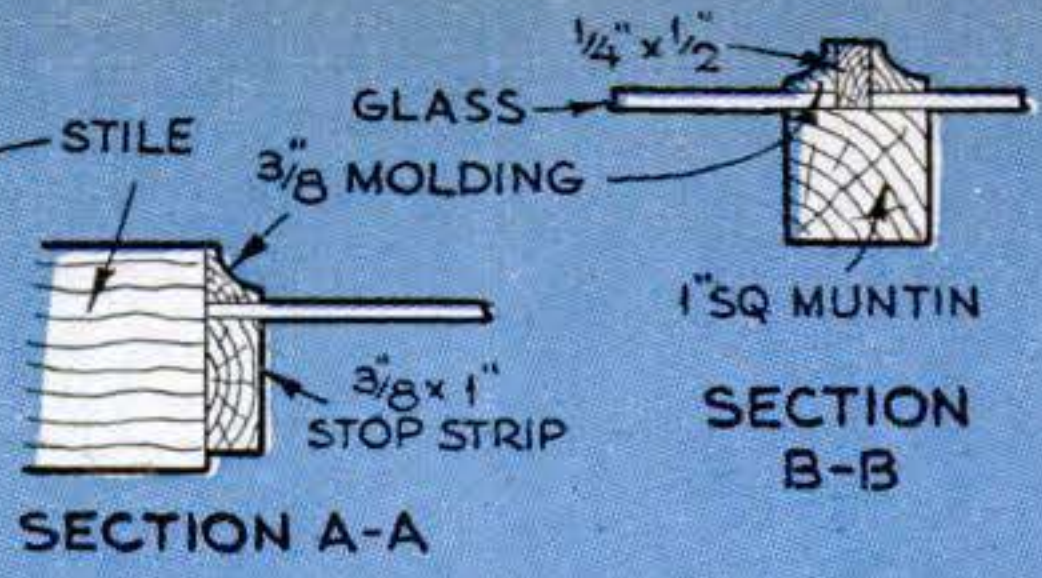
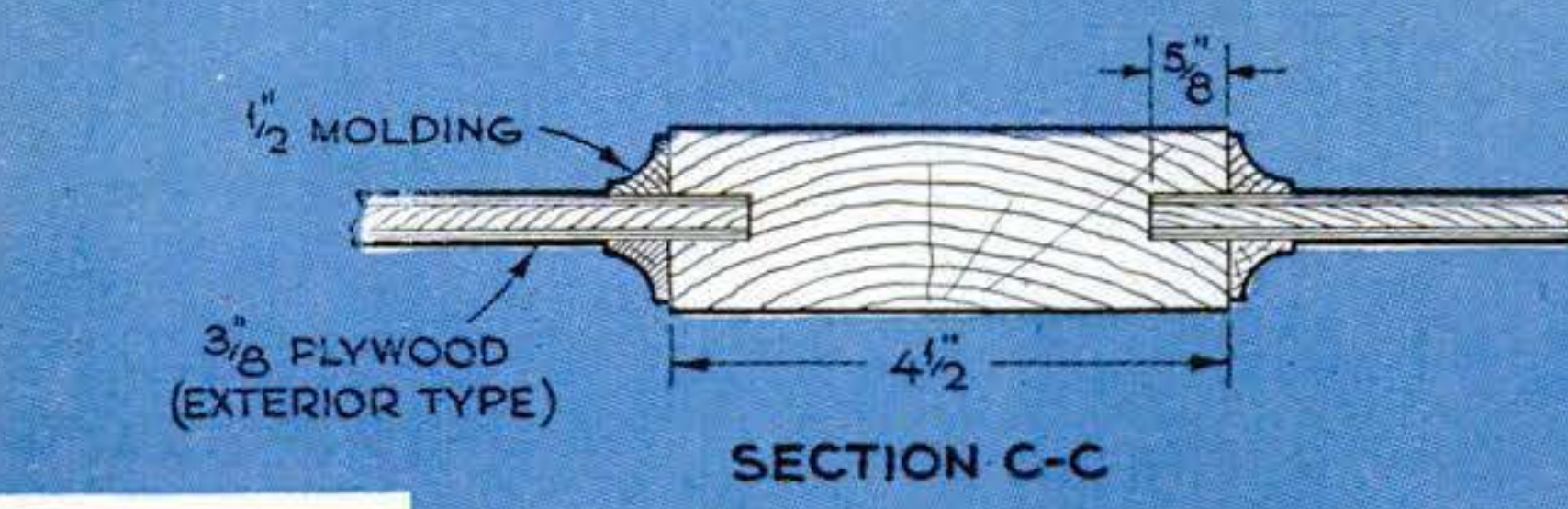

This Diamond-Light Door Displays Craftsman's Skill

TAKE measurements from your old door, allowing $\frac{1}{8}$ " extra on each side for final trimming. Allow $\frac{13}{16}$ " more in the length of all stiles to compensate for the lap of the top and bottom sections. For good proportions, make the top section a bit shorter than the bottom.

Cut the stiles and rails to length and square the ends. Lay out all parts on the floor in proper position, recheck for length, and mark adjoining pieces. In the drawing you'll notice that a 2" widening strip is doweled to the top of the bottom rail for an over-all width of 8".

Drilling for the dowels. Accuracy is important in drilling holes for the dowels. If possible, use a doweling jig for this step. After cutting the dowels to length, clamp the rails and stiles together for a dry run to see if you have a perfect fit.

Then take the bottom section apart and cut $\frac{3}{8}$ " by $\frac{5}{8}$ " grooves on the center of the inner sides of the stiles and rails. Reassemble the section to cut the cross braces. Rip these $4\frac{1}{2}$ " wide from the 2" by 6" stock.

Fitting the cross braces. Take measurements directly from the assembled framing. Draw a center line down the middle of each piece and line this up with the frame corners. Next, scribe in the corners with a knife (not a pencil). Then scribe lines where the two braces cross. Identify each piece and corner with matching marks before cutting.

Now draw lines $\frac{1}{2}$ " beyond and parallel

Plywood wedges fit into bottom panel as shown at right. Notice that outer edge of each wedge aligns with the tenons cut on ends of the braces.

Miter the cove molding into the bottom panel and nail the pieces in place after removing your clamps and dressing off excess glue and any high edges.

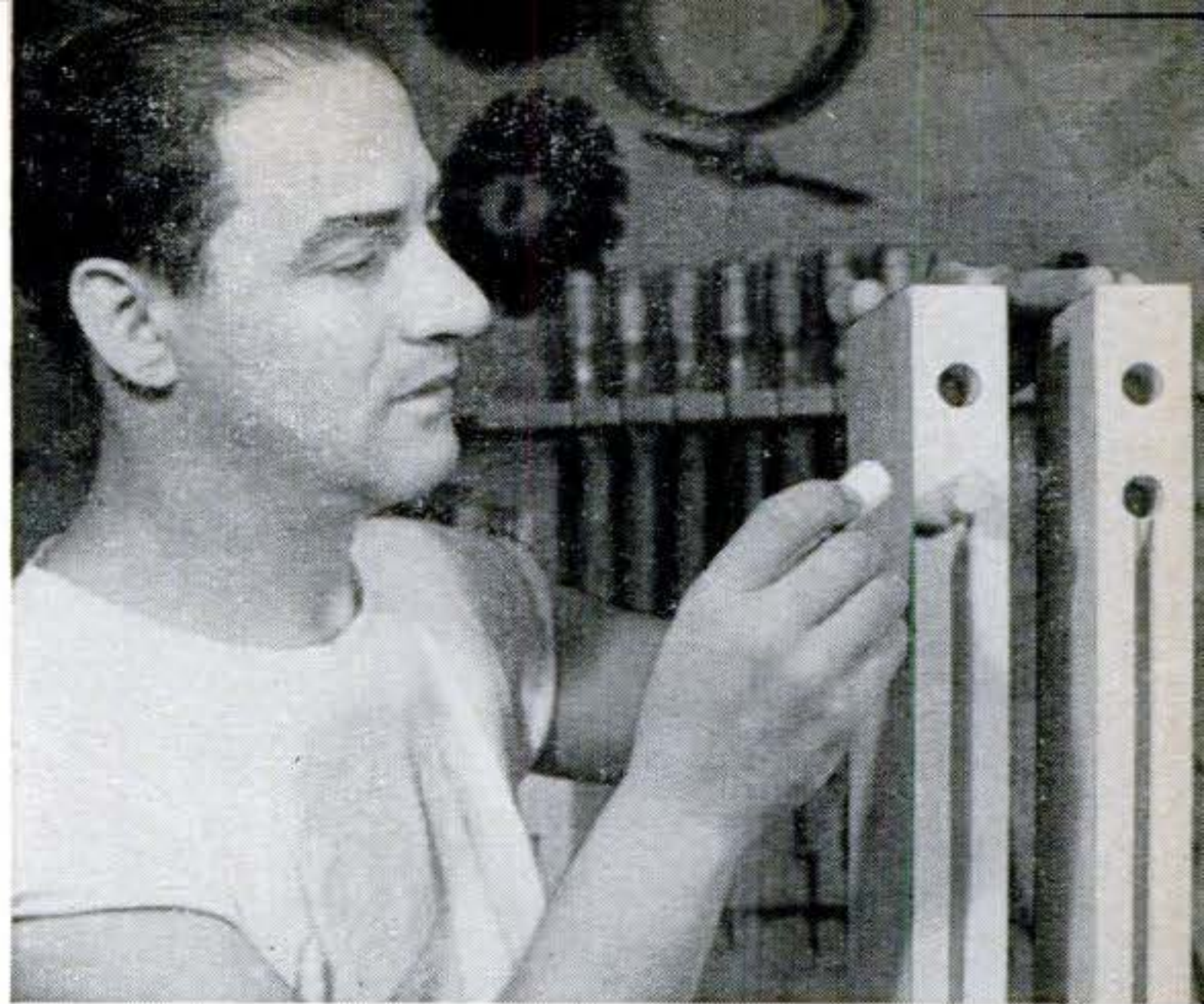
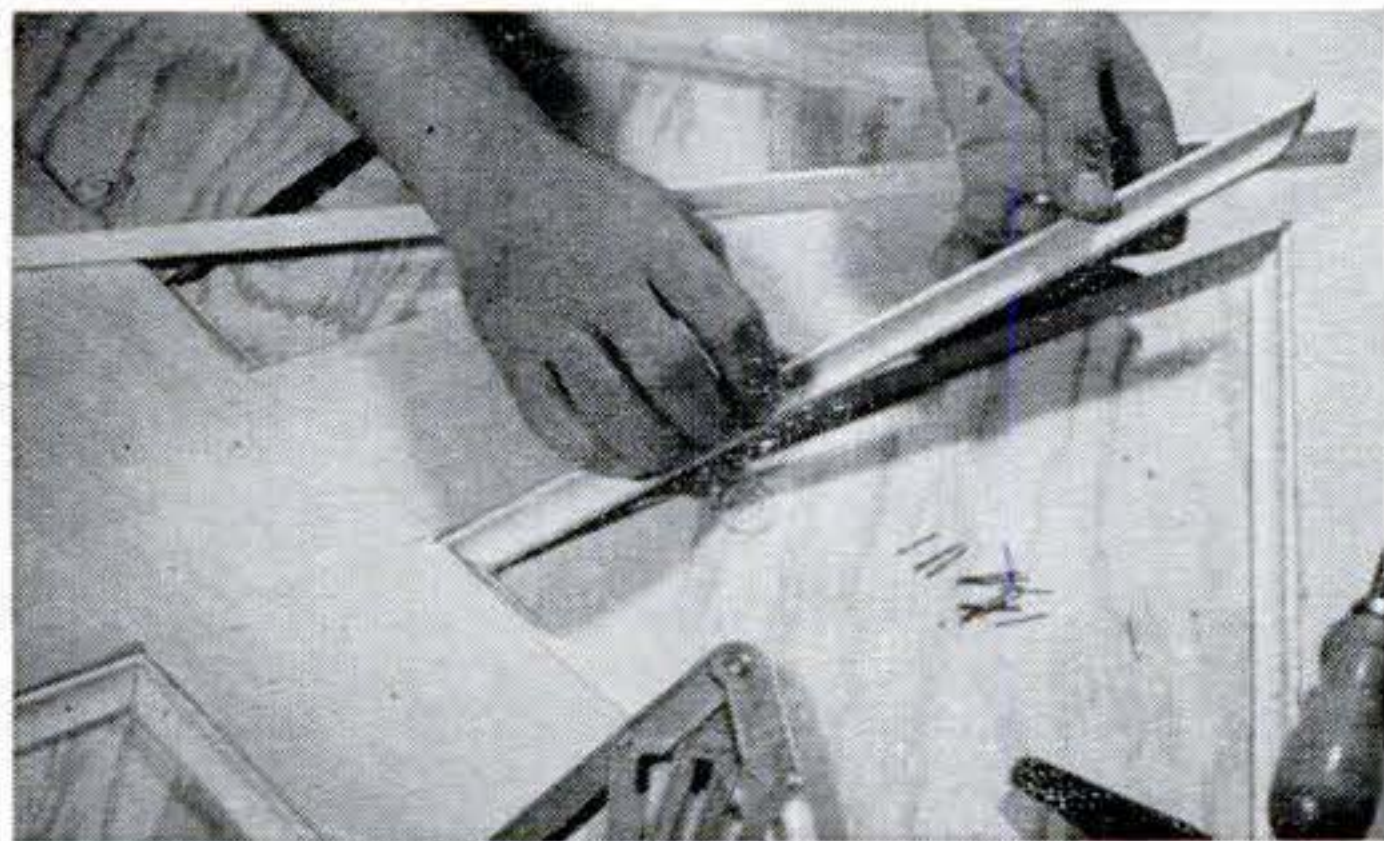

Cut $\frac{3}{8}$ " slots $\frac{5}{8}$ " deep in inner edges of the bottom-section stiles and rails. Run slots to rail ends. Stop them short in stiles (above).

to the scribed lines at the end of each brace piece. Cut on the new lines. This extra length allows for $\frac{3}{8}$ " by $\frac{1}{2}$ " tenons to secure the braces in the frame.

Half-lap the braces by cutting on the lines scribed where they cross. Be careful to get a neat fit on both sides. Run a $\frac{3}{8}$ " groove $\frac{5}{8}$ " deep along both edges of both braces and cut $\frac{3}{8}$ " by $\frac{1}{2}$ " tenons on all four ends.

Remove one stile and clamp the braces in place. Now place the entire assembly on top of your sheet of $\frac{3}{8}$ " plywood and scribe the triangular panels. Add $\frac{1}{2}$ " to the scribed

LIST OF MATERIALS

38' 2" x 6" stock	2½' x 3' panel $\frac{3}{8}$ " plywood
24' ½" cove molding	4 4" x 4" loose-pin hinges
40' $\frac{3}{8}$ " cove molding	1 door lock, 1 latch.
6½' $\frac{3}{4}$ " maple or birch dowel	



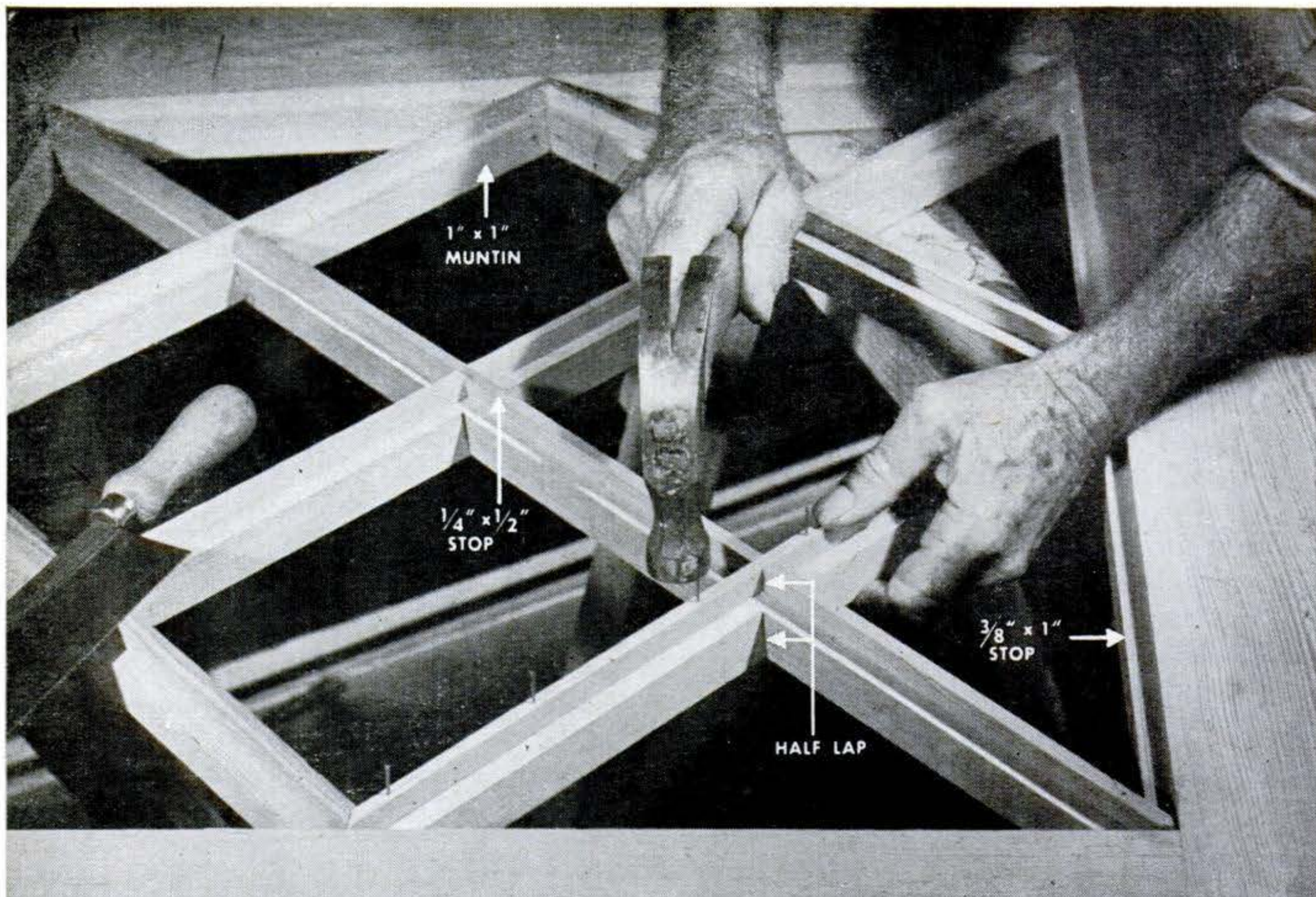

Half laps join the muntins and stop strips at points where they cross. Careful mitering is

required where the ends join the outer framing. Glue and nail the stops in place.

line around each triangle. Cut on this new line. Assembly with glue and addition of molding then completes the bottom section.

Making the upper section. Glue up the rails and stiles of the upper section before cutting the framing for the diamond lights.

On the outside of the door, 1" by 1" muntins frame the diamond-shaped panels of glass. On the opposite side, the glass is retained by stop strips and molding.

Rip the muntins and stop strips from waste left from the 2" by 6" stock. Frame the inside of the opening with $\frac{3}{8}$ " by 1" strips. Then fit 1" by 1" muntins diagonally from corner to corner, half-lapping in the center. Next locate the exact center of each stile and rail. Cut the shorter muntins so the ends are lined up with these center points. Half-lap the short muntins across the long ones.

Glue all the half laps and glue and toenail the muntins to the frame with finishing nails, set and filled. The $\frac{1}{4}$ " by $\frac{1}{2}$ " strips that run down the center of the muntins and separate the glass can be cut and fitted much like the muntins.

Cut single-strength glass to fit the sections. Then very carefully miter the cove

molding. A bevel square will help a lot in this. No putty is used, the molding being cut to a tight fit and pressed into place while nailing. When you paint the door, flow the paint into the joints.

Lapping the sections. After cleaning up both top and bottom sections of the door, make cuts for the lap where the two come together. Details are shown in the drawing.

Place a $\frac{1}{16}$ " spacer in the lap, fasten the units together with battens, and hang both units as a single door, fitting the top and bottom hinges first. Trim the edges.

Apply a sealer such as Rez or Firzite and paint the door as desired. A tubular barrel-type lock with brass fittings was used on the door shown. END

Do you overpay when you shop for wood? See "How to Buy Lumber" next month.

Shade Covers Drawing Board

KEEPING my drawing board covered with newspapers or wrapping paper proved to be a nuisance. But a discarded window shade solved the problem of keeping dust off the board. I trimmed the shade to size and attached the roller brackets to the back of the drawing board.—H. D. Cousins, Chicago.

Raise a Flag this Summer

**This two-part pole is easy to raise
—and will serve for many summers.**

HERE'S a flagpole you can put up and take down almost as easily as you raise and lower the flag itself. The pole was designed for a summer home or cottage.

It has two parts—a short post or “dead-man” to be left permanently in the ground or atop the building, and a removable pole, bolted in place. Storing it away at the end of the season is no trouble, and reduces the chances of damage.

Both parts were made of 2" by 2" stock. The post was left square, but the corners of the pole were planed off. The post was painted, the pole varnished.

Because a suitable cleat was not available, a special one was made. One of the cleat bolts goes through only the pole. The other one and a regular carriage bolt hold the pole to the post. Cleat posts were made by drilling and tapping $\frac{1}{2}$ " rod. A flat filed on the cleat rod keeps it in place when the bolt is tightened.—*John M. Avery, Dexter, N. Y.*

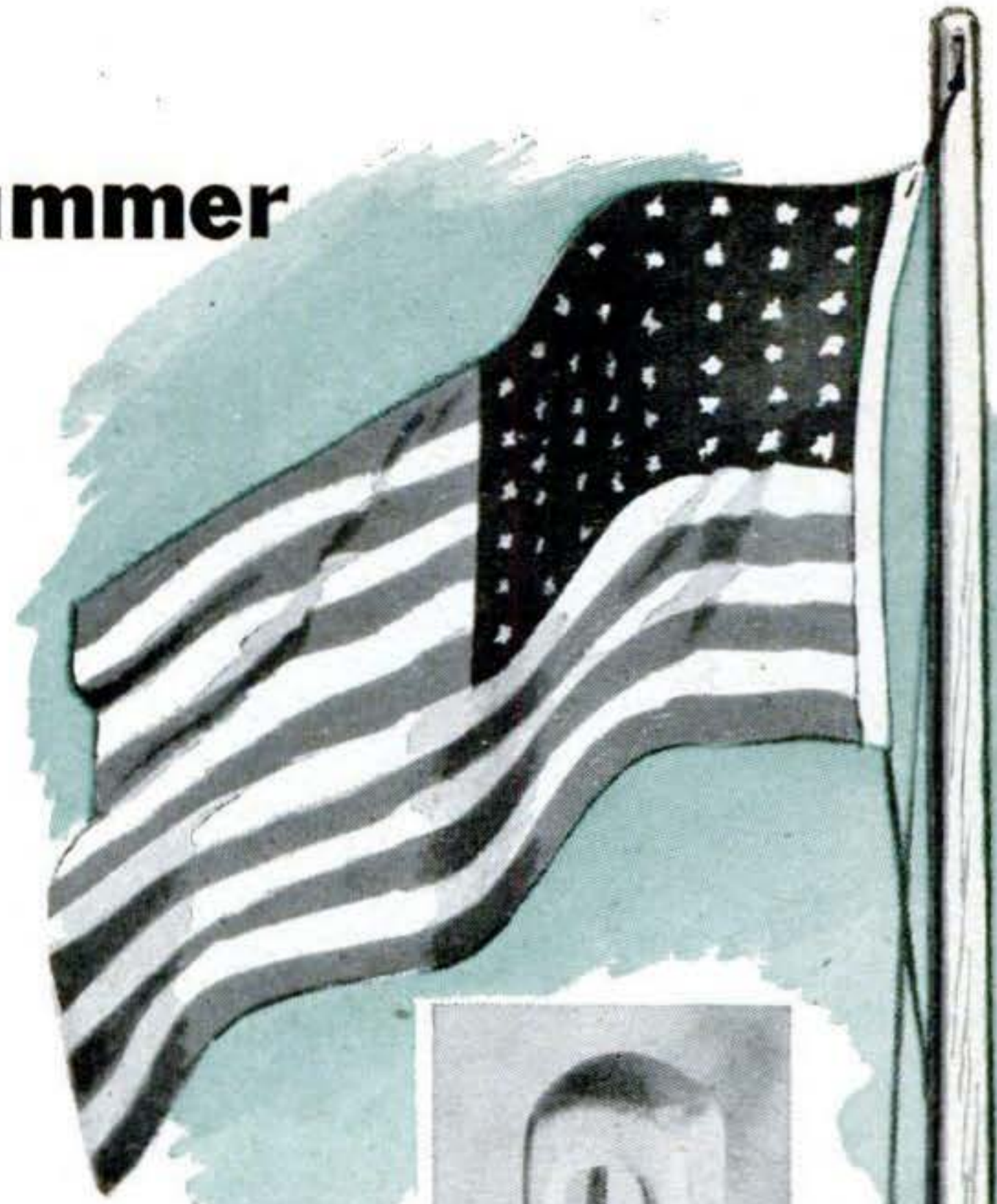

A wheel from an awning pulley is mortised into the tip of pole. This helps keep the rope from fouling.

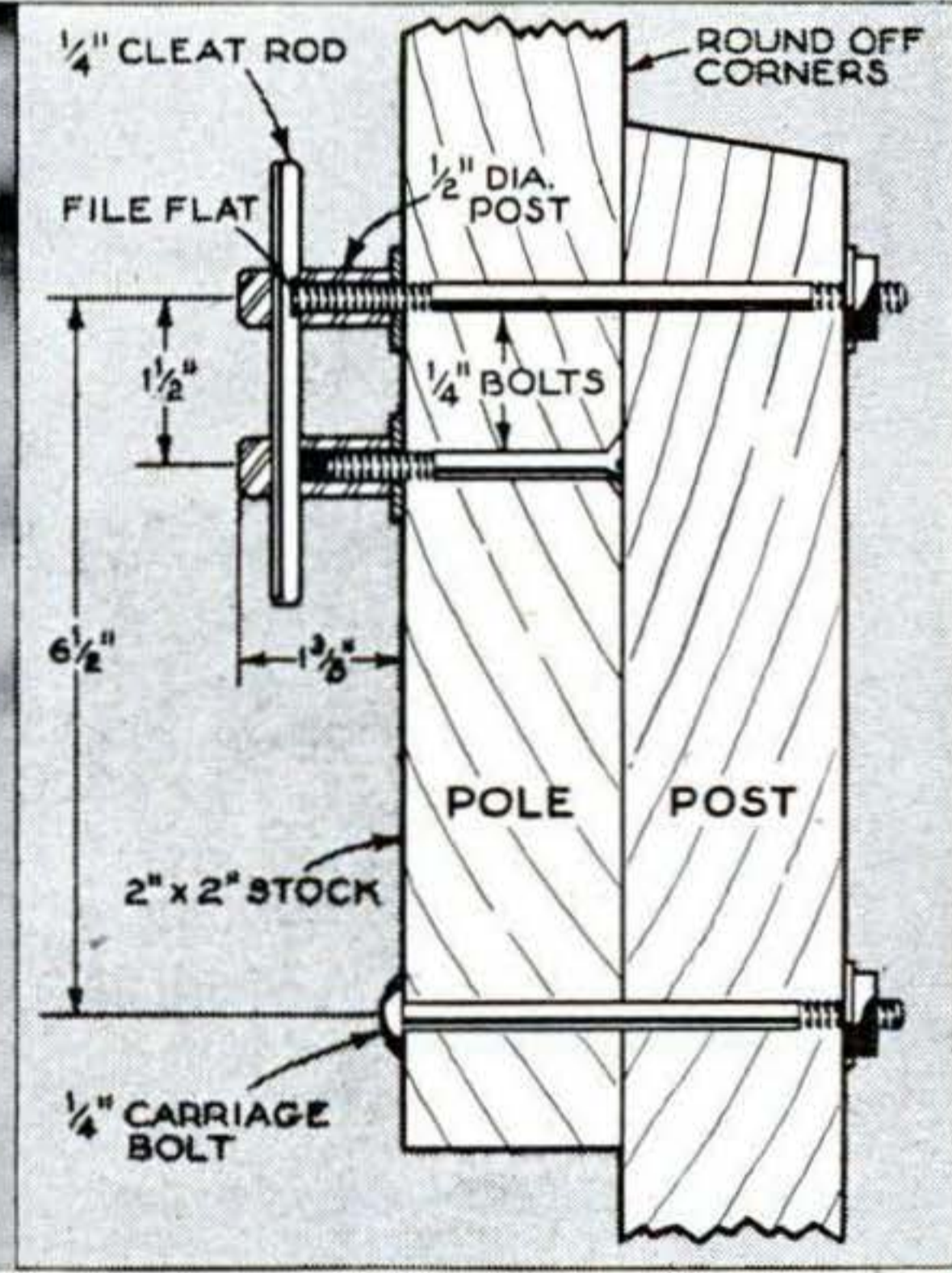
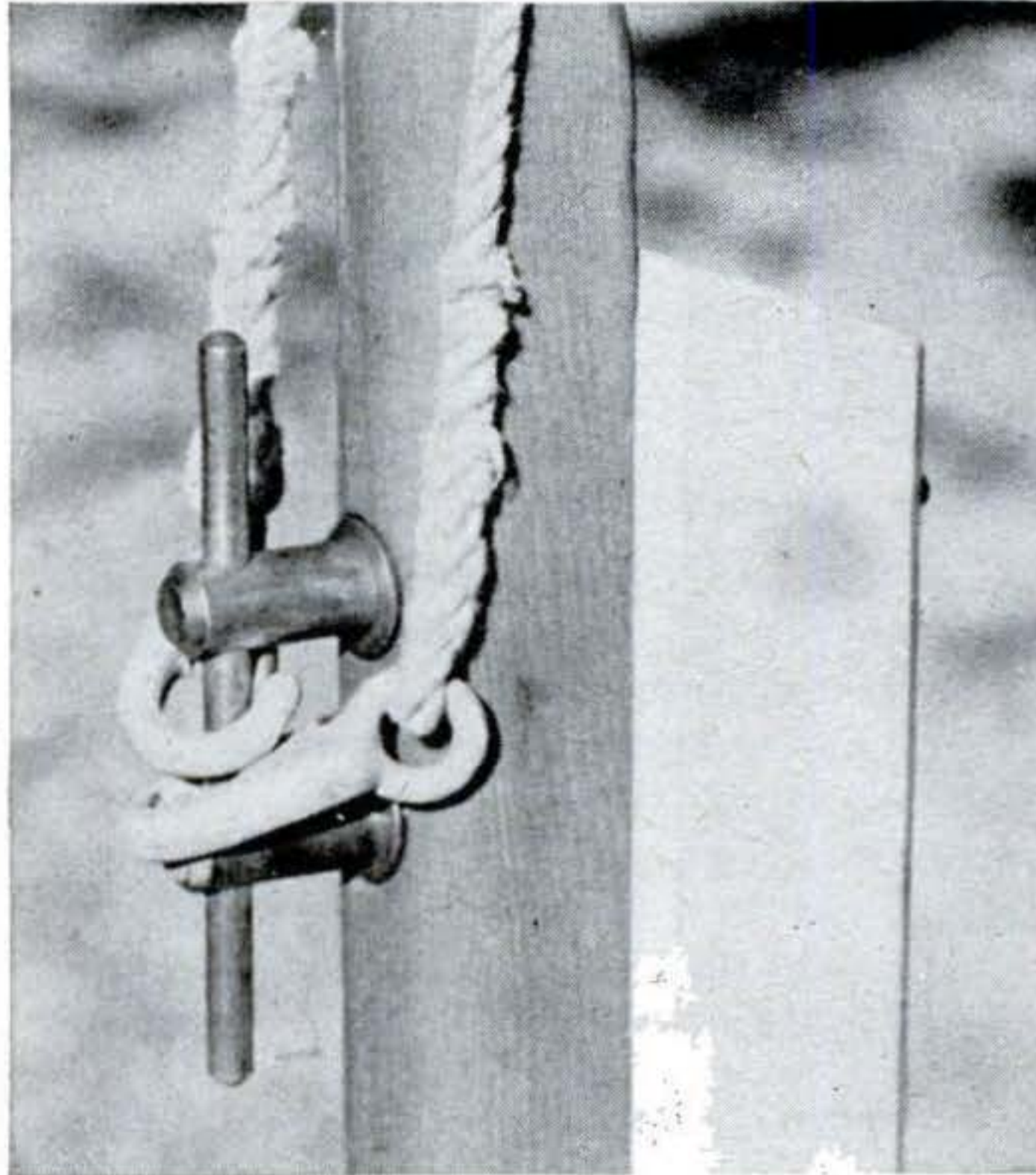

Snap fasteners, hooked into special cleat, hold flag up. They can also be snapped to cleat after flag is lowered to keep wind from banging them against pole. Drawing shows cleat details.





Its legs are made of rolling pins, coat hangers, and salad bowls.

IF YOU need furniture for your summer cottage, why not make some yourself? This coffee table can be constructed with hand tools from parts already shaped and turned.

For pedestals and legs, you'll need two rolling pins, each at least 7" long, one rolling pin at least 10" long, two wooden coat hangers, two wooden salad bowls, and some 1/2" doweling for stretchers.

Saw the large rolling pin into two 5" lengths and file two flat areas on each piece where the legs will join. If they are longer than 7", cut down the small rolling pins. Saw hangers in half for legs, as at right. Cut the doweling into stretchers 9 1/2" long. Dowels for joining the parts may be taken from the hanger cross-bars. Bore the dowel holes, apply glue to dowels, holes, and end surfaces, and join the parts. Screw the bowls to the pedestals.



Ready-Made Parts Cut Cost of Table

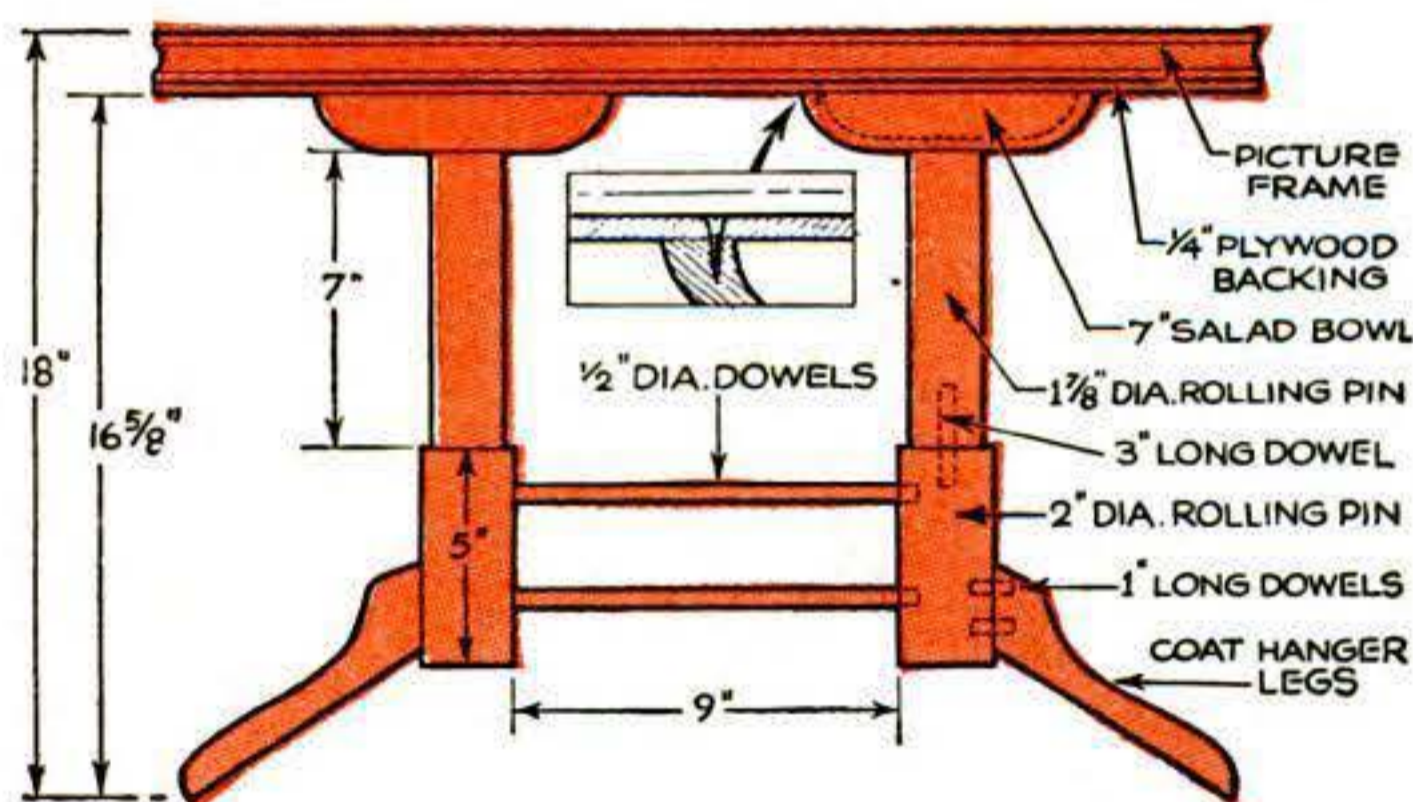

HOLDERS KEEP NEW FUSES HANDY

You won't have to hunt in the dark for new fuses if you keep replacements near the fuse boxes in holders like those below. For plug fuses, drill 1" holes in a piece of 3/4" stock; for the cartridge type, make 7/8" blind holes in a strip of 1" by 1". Empty holes will serve to remind you when your supply is running low.—Walter Haase, Wethersfield, Conn.



DRAWING-PEN RACK IS MAGNETIC

You can keep your drawing and lettering pens neatly arranged in a box by using small magnets and some lengths of iron wire, such as straightened-out paper clips. Cement the magnets to the sides of the box and place two wires across each pair. Attach another pair of magnets to the outside of the box to act as a door catch.—Andrew Brennan, Philadelphia.

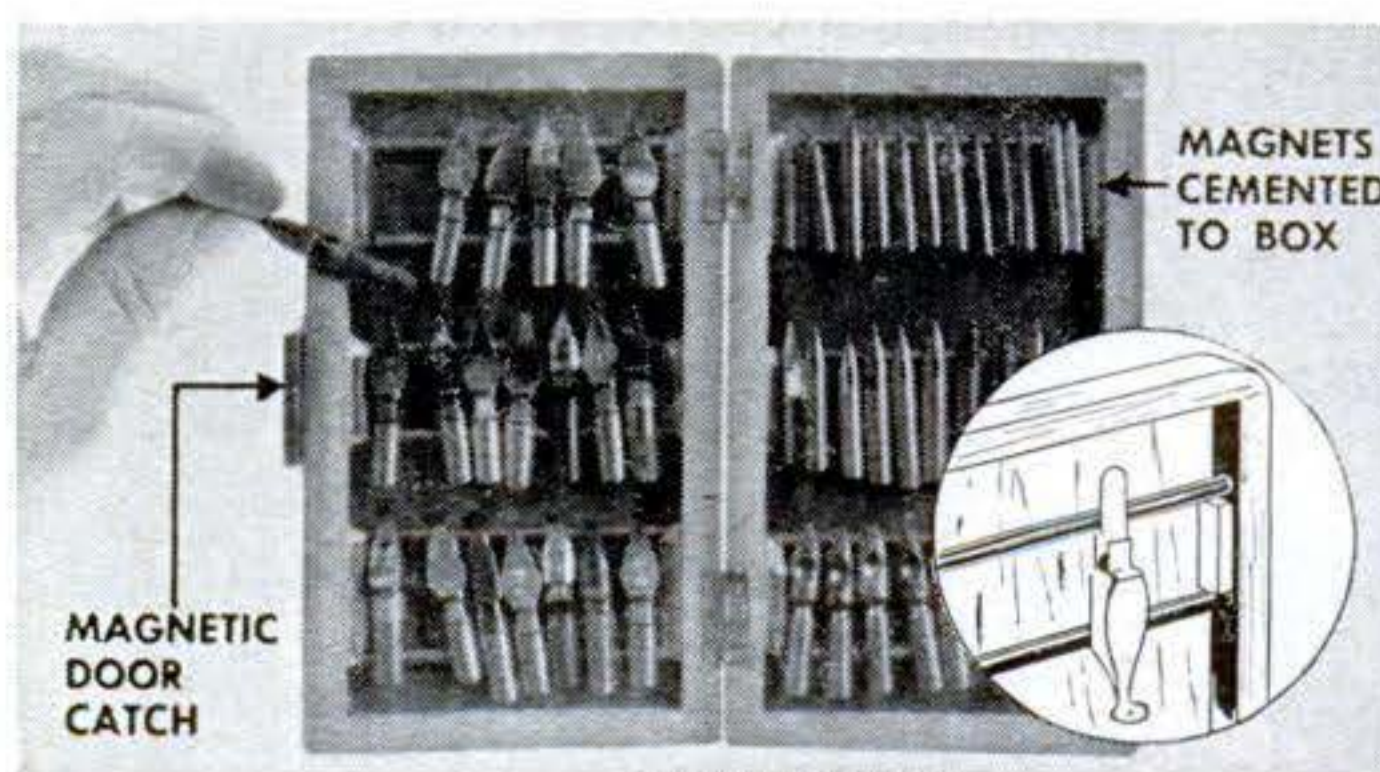

Fan-Driven Basement Air Cools Upstairs Room

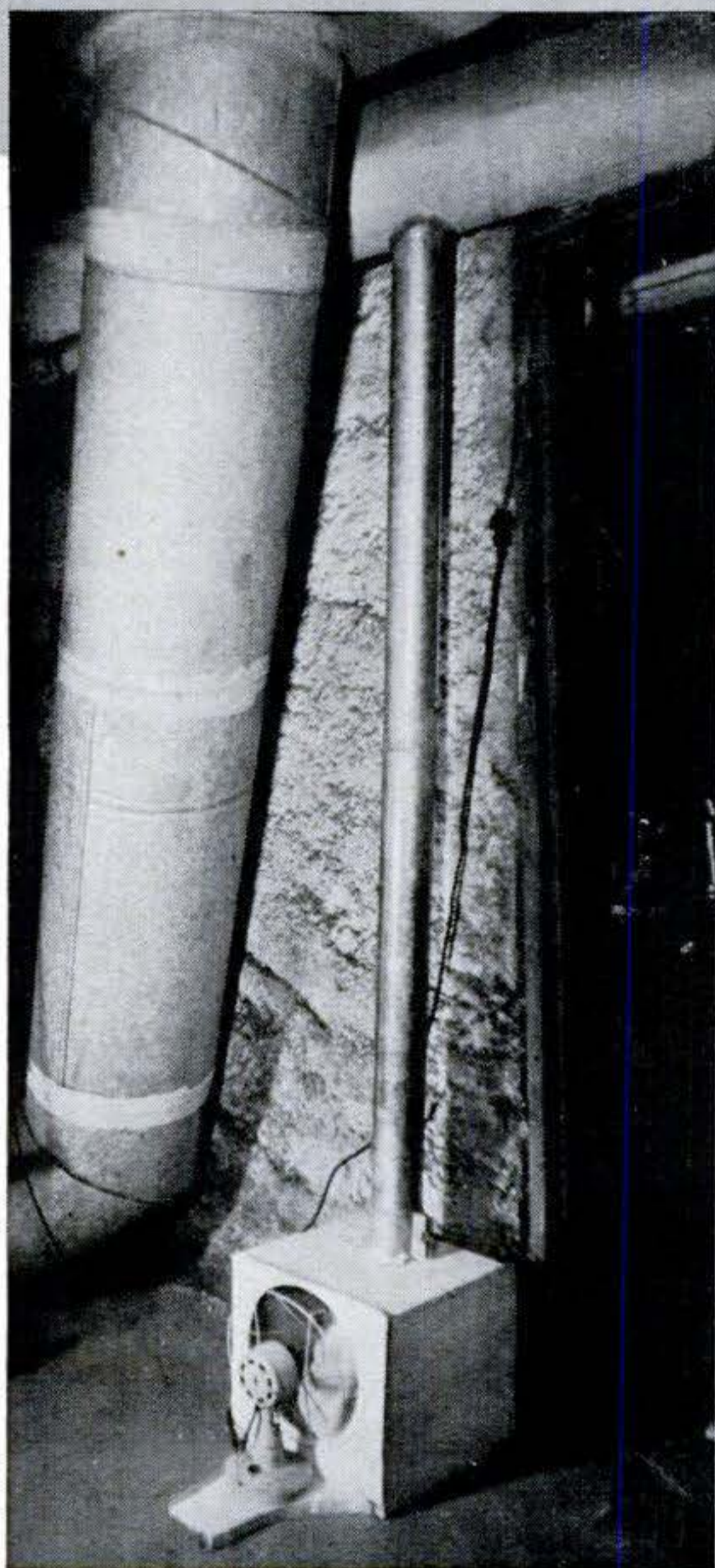

HOT-AIR FURNACE

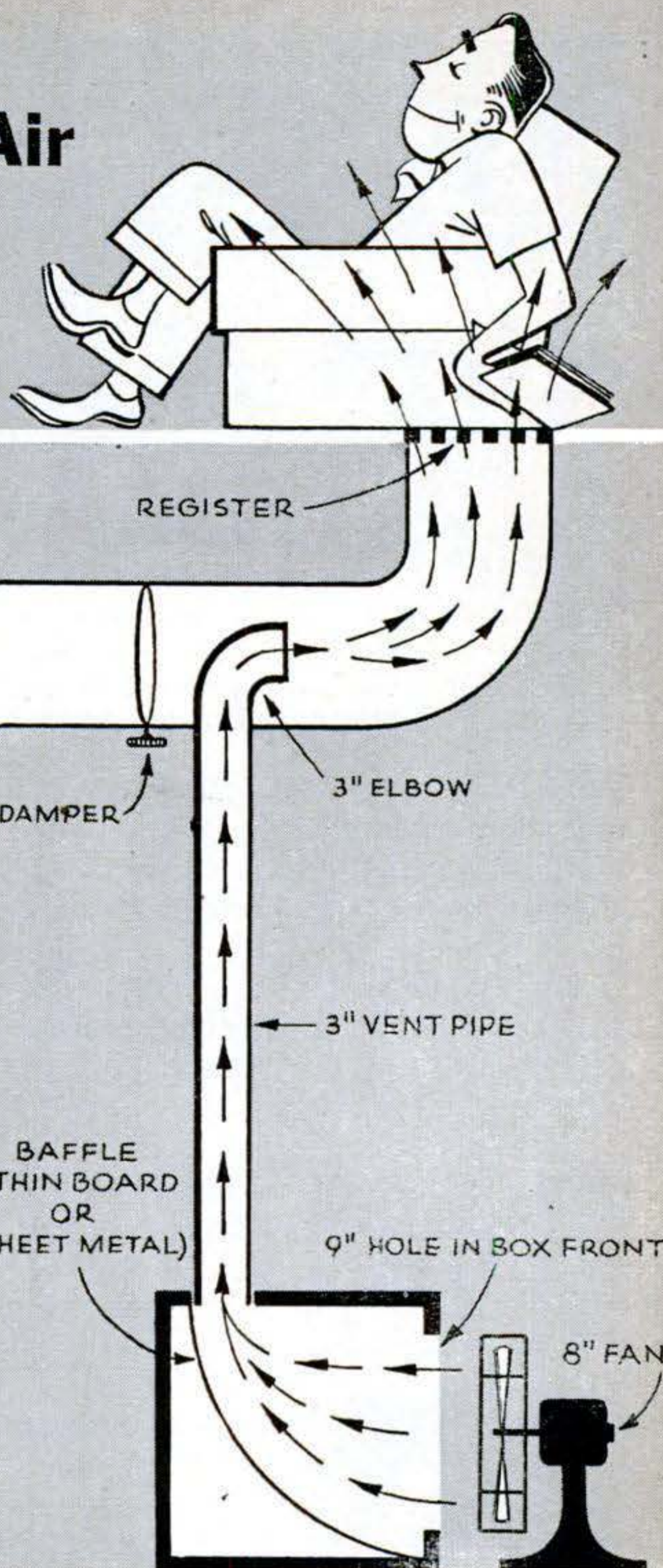

HAVEN'T you sometimes wished you could spend sweltering days in the coolth of your basement? Ray Millholland, of Indianapolis, brings that refreshing air from his basement to cool a room on an upper floor. His simple "air conditioner" can be installed in a couple of hours in any house that has hot-air heating ducts. Besides cooling the upstairs room, it reduces basement humidity.

To duplicate his setup, you'll need an 8" electric fan, a few lengths of 3" vent pipe with an elbow, and a 12" by 12" by 12" wooden box. Make the box with a 9" hole in one side and a curved baffle facing the hole to deflect the fan stream toward the top of the box. Cut a 3" hole in the top.

Fit the vent pipe into this top hole, as

shown in the drawing, and into the air duct leading to the room you wish to cool. Run the pipe in as straight a line as possible to minimize resistance to the air flow through it. Put on the elbow, inside the duct, facing toward the room. If necessary, install a damper in the furnace side of the duct to keep the cold air from leaking back into the furnace.

An old vacuum-cleaner unit can be rigged up to the vent pipe instead of the fan box. Such a blower unit may run too fast, with objectionable noise, but you can slow it down by connecting a lamp bulb in series with it.

The fan unit shown draws less than 100 watts and lowers the temperature of a second-floor room by 3° to 5°. END



New Shop Ideas

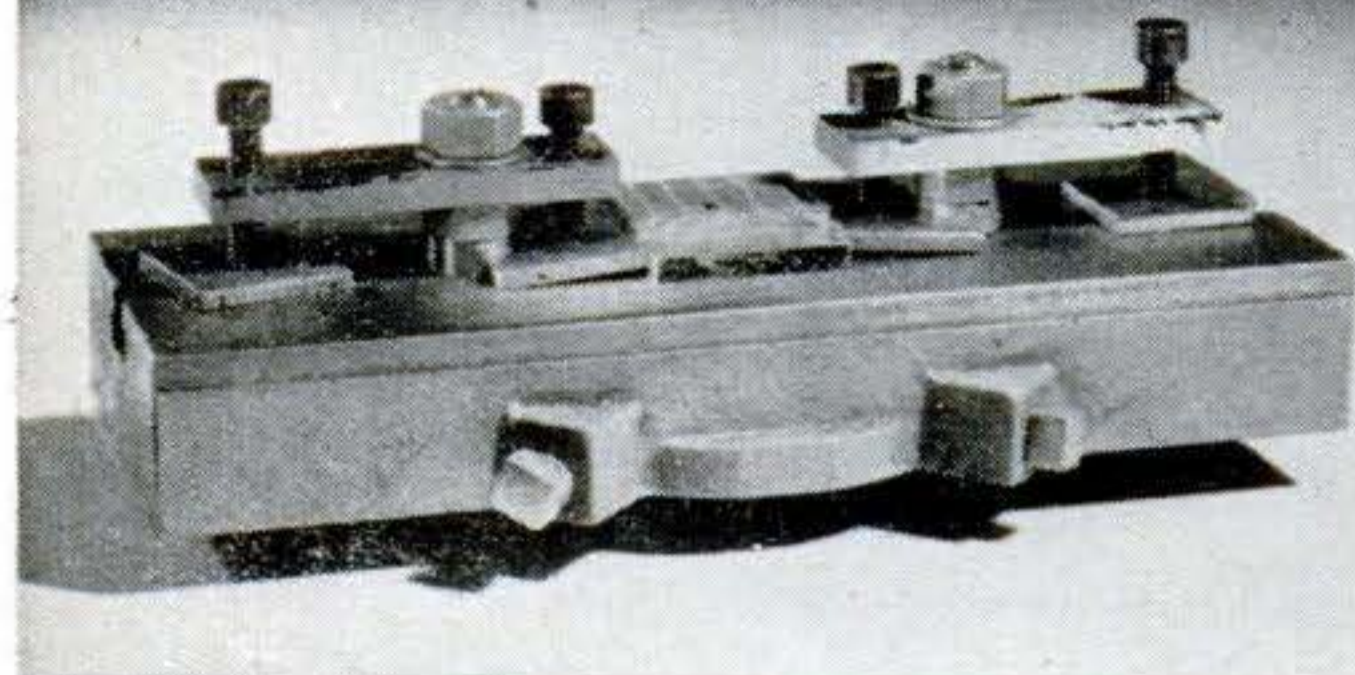

A **wedgelike grip** against the edges holds work firmly for milling. The table shown is for use with a milling attachment mounted on a lathe.

Hold-Downs for Milling. When a milling cutter must run clear across the work, ordinary clamps may interfere. The hold-downs shown grip the work firmly at the edges and do not project above it.

Each clamp calls for a plate with a bolt that enters a T slot, a collar, and two nuts, plus a piece of flat steel having a radius machined in one edge that matches that of

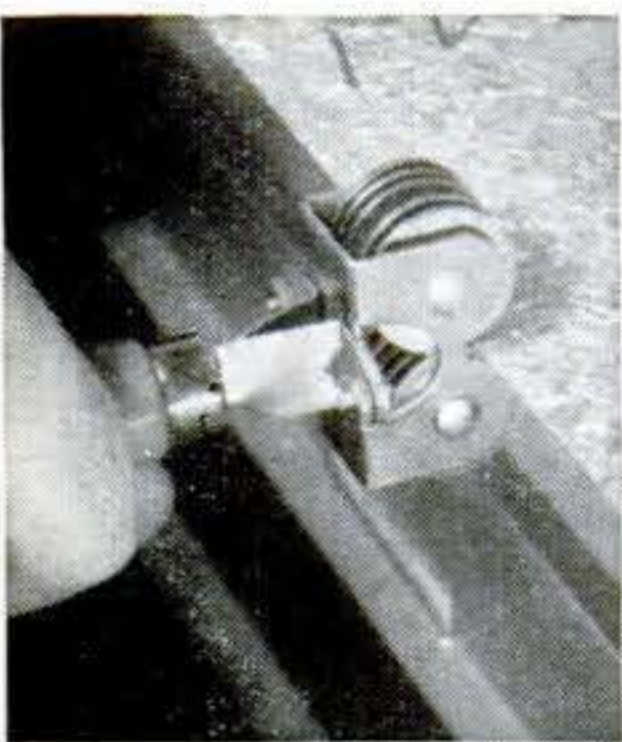

Sharpener Deburs Edges. If you work sheet metal, this gadget is handy for taking the razor edges off sheared sheets. You can buy the main part — a disk-type knife sharpener — at any dime store.

Drill a $\frac{3}{8}$ " hole about 2" deep into a file handle. Cut two strips of sheet metal $\frac{5}{8}$ " by 3", drill a hole near one end of each, and bend at 90° about $\frac{1}{2}$ " from the hole. Then squeeze the long leg of each in the vise jaws to bend it up the middle as shown. Bolt or rivet the pieces to the sharpener and force the legs together into the handle.

To use the tool, simply draw it along the edge.—*Will Thomas, Buffalo.*

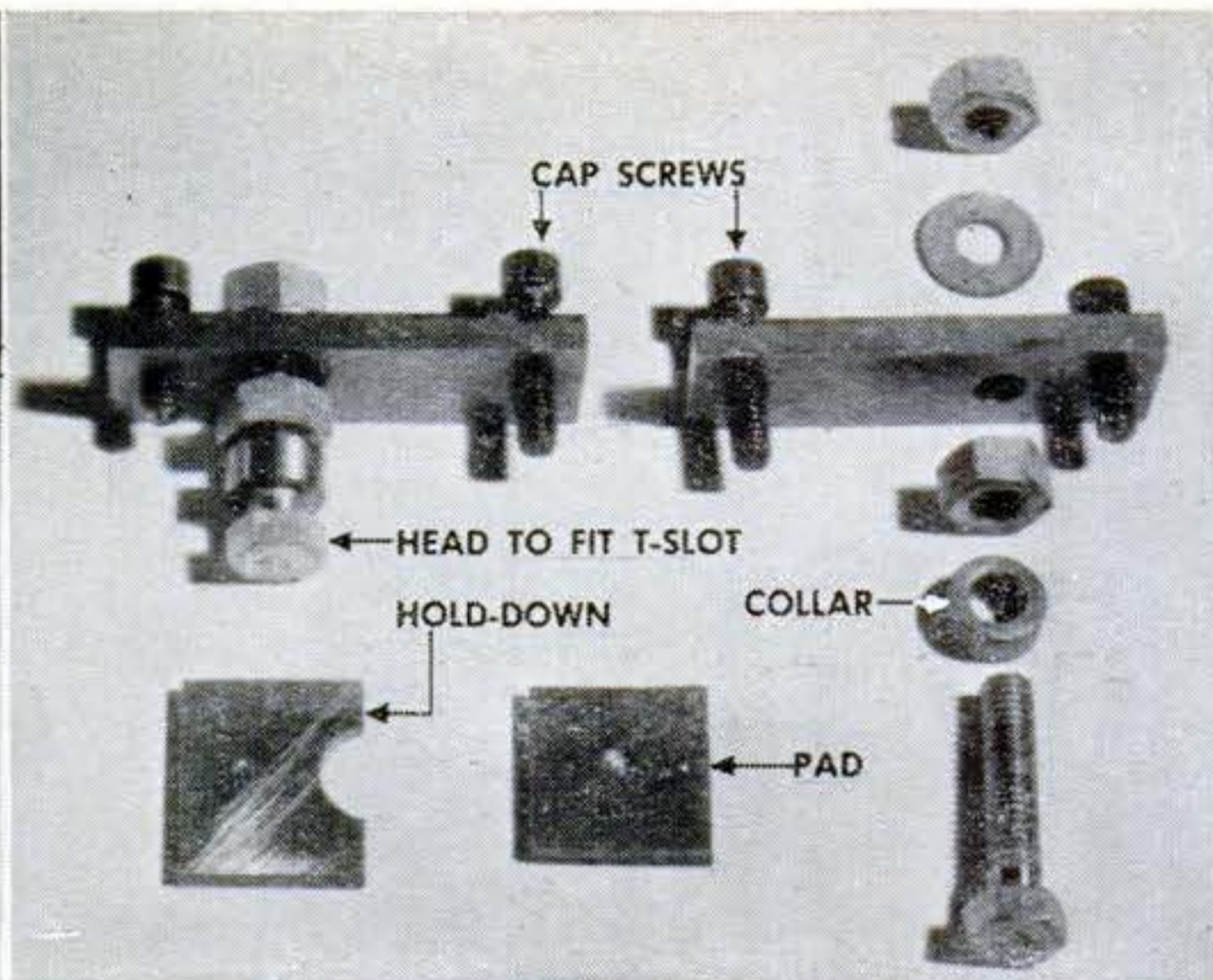
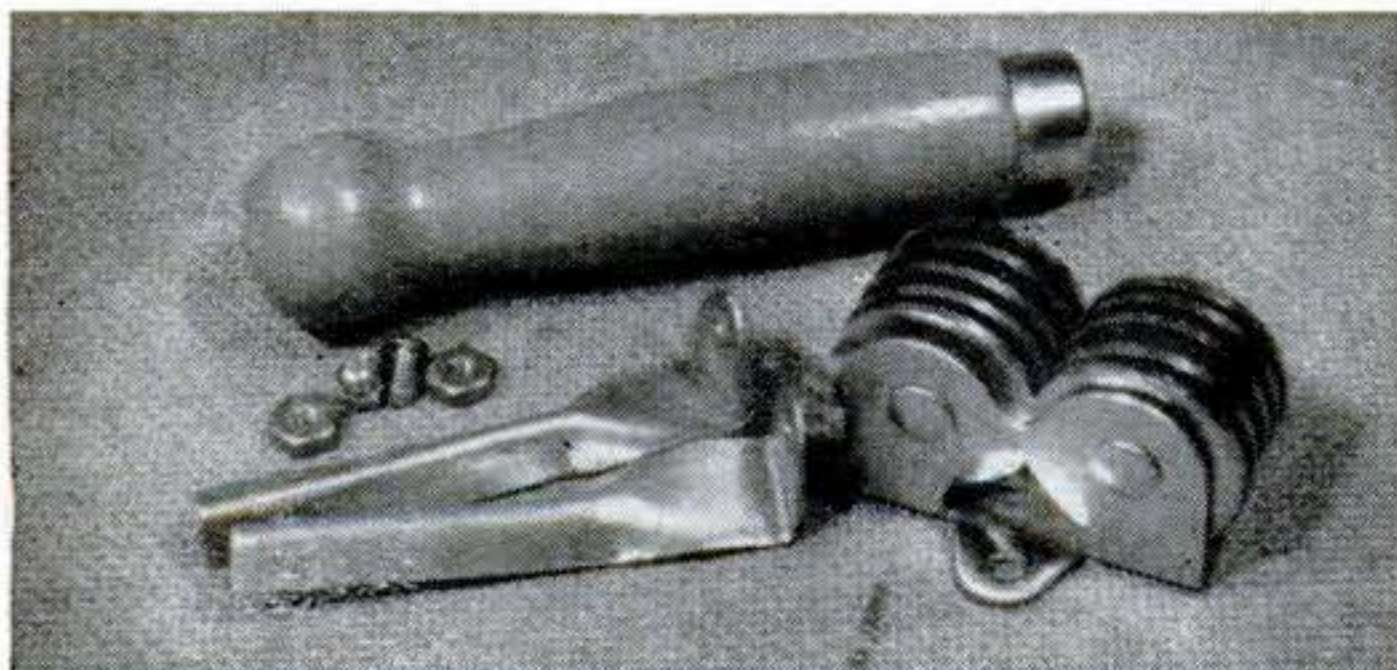

the collar. The plate must be tapped for cap screws at both ends.

With the studs tightened in the table slot a suitable distance apart, the hold-down plates are set against the collars and propped against the edges of the work. The outer setscrews, with pads underneath, are turned up snug. Then the inner screws are tightened against the sloping plates (the photo at left above shows them only partly pulled down) until the plates wedge the work firmly.—*Joseph Tracy, Manhattan.*

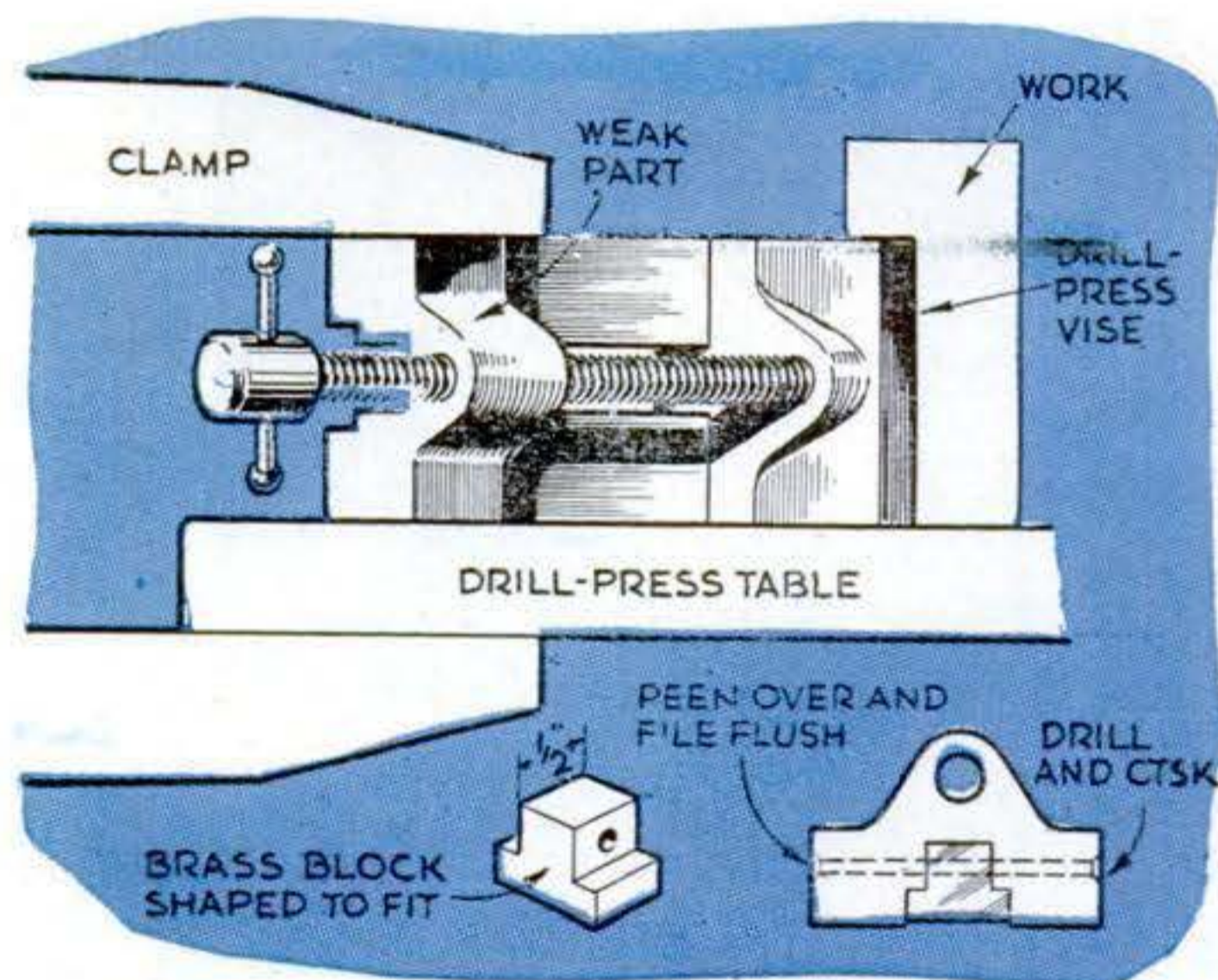

Spare the Drill-Press Vise. When you have to turn a drill-press vise on its side, with a clamp on its end as above, every twist of the clamp handle endangers the weak neck bridging the slot. A little too much muscle may crack the vise.

The little brass block shown is good insurance against this kind of damage. With it, you can clamp your vise as tightly as necessary with no fear of cracking it. Mill or file the block to a tight push fit. Drill across the vise for a brass pin to secure it.—*Herbert Pfister, The Bronx, New York.*

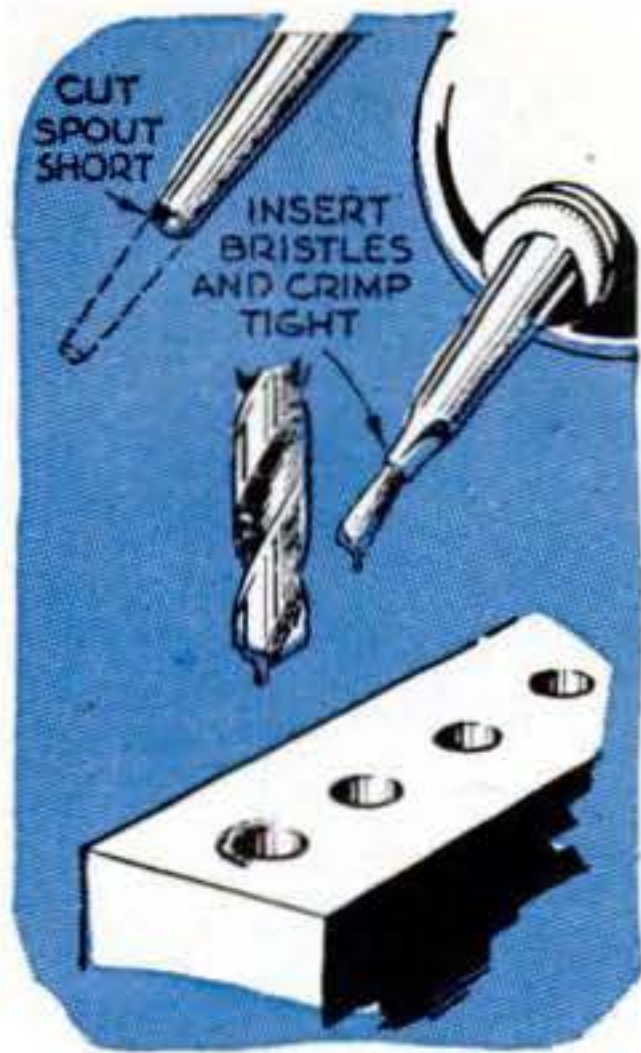

Coolant Brush. I found it annoying and messy to apply coolant on a long drilling job until I made a brush from an oil can. Cutting the spout short, I inserted some bristles, crimped the tip to hold them, and put coolant in the can. A swipe or two on the drill, whenever it was raised to clear out

chips, wiped them off the flutes and supplied just enough fluid, but not so much as to splash it around and be troublesome.—*Albert Jusak, Cleveland.*

Quickie Drill Gauge.

In grinding larger drills, you can check lip angles with two clean, new hex nuts. Line them up against a straightedge with the inside flats touching. Although the included angle is 120° instead of 118° , this is close enough for all practical purposes. —*Will Thomas, Buffalo.*

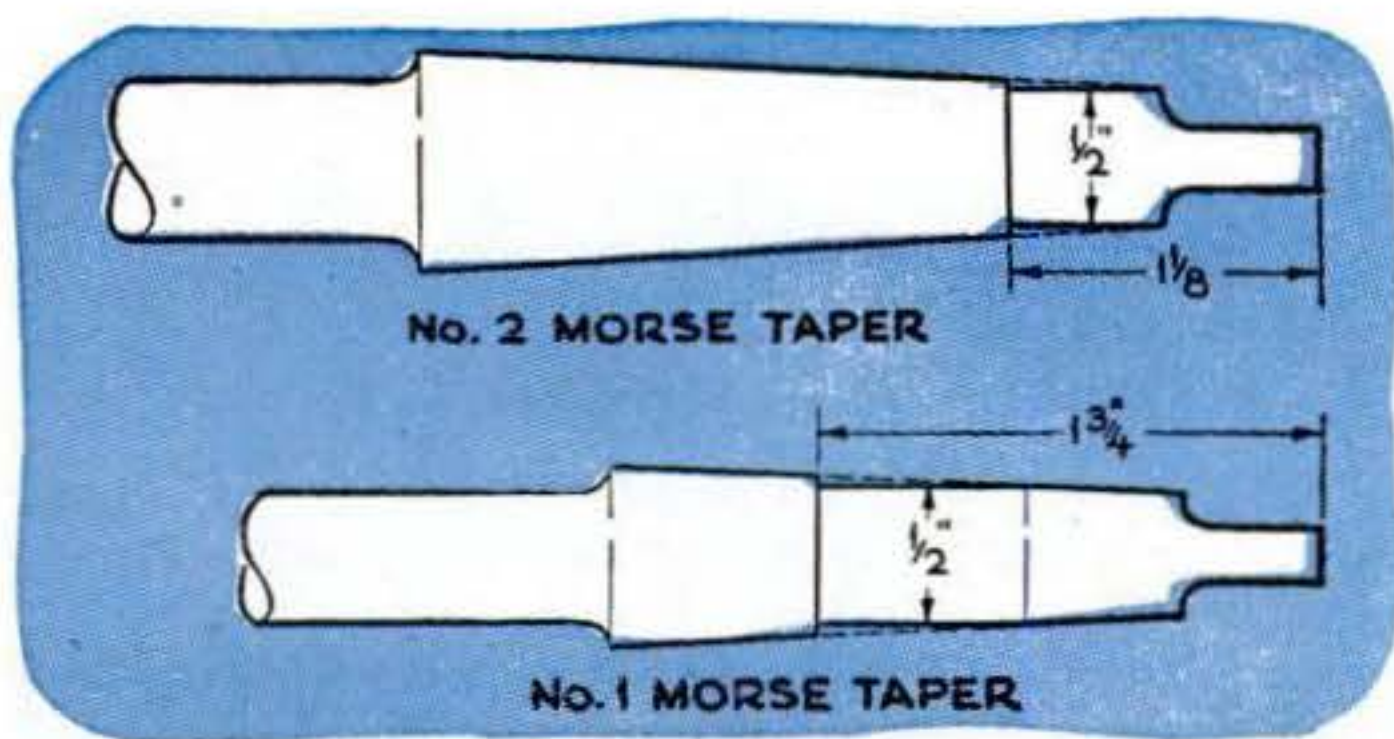

Chucking Taper Shanks. You can use drills and reamers having Morse-taper shanks in a regular chuck without spoiling them for use in a taper spindle. Grip the tool in the lathe chuck close to the shank, with the taper projecting, and support it with the tailstock center. Then turn a section of the taper to the maximum diameter the drill chuck will take. The drawing shows two sizes adapted for use in a $\frac{1}{2}$ "-capacity chuck. For safety when working with such adapted tools, use low spindle speeds and clamps.—*Bernard J. Corey, Thorold, Ont.*

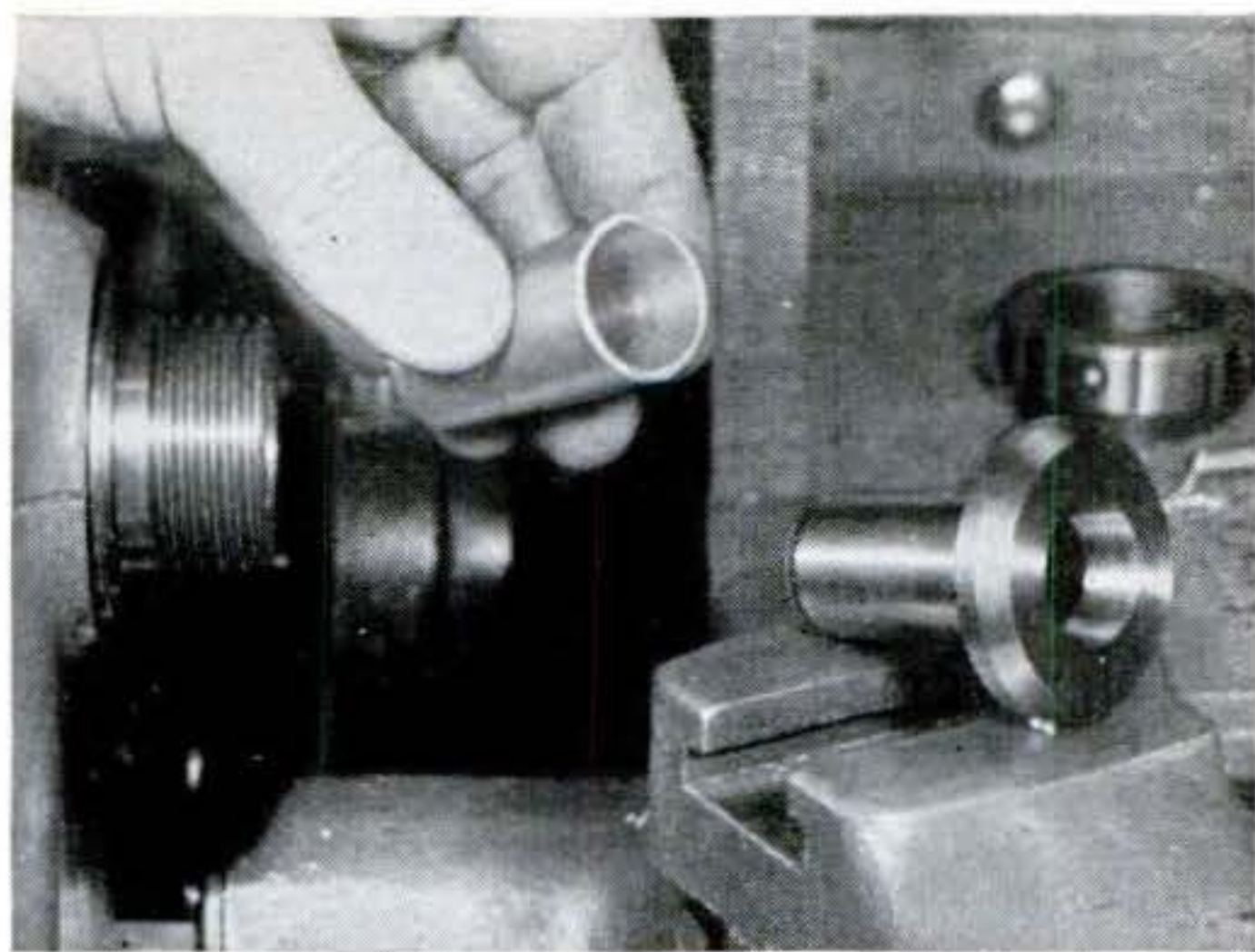

Collets Hold Stops. With a collet behind the lathe chuck, you can hold stops to locate work accurately for duplicate facing, turning, or cutoff operations. The stop need be only a short piece of stock.

The standard collet adapter has a big shoulder to facilitate its removal from the spindle. This shoulder prevents mounting a chuck. The answer is either a new adapter made without a shoulder, or another adapter with the shoulder removed. Insert it and the collet, mount the chuck, and position the stop inside, clamping it with the drawbar.—*J. C. Magee, Schenectady.*

Measuring Bores. Ordinarily, calipers are set to inside diameters, and the measurements are then read with an outside micrometer, with a probable loss of accuracy. This is eliminated if you clamp a midget indicator to one caliper leg. Adjust in the bore so that the indicator reads zero. Then set your micrometer across the calipers as shown, turn the mike thimble until the indicator again reads zero, and take your measurement off the sleeve. I find this method as accurate as the use of vernier calipers.—*Armen Bogossian, Brooklyn.*

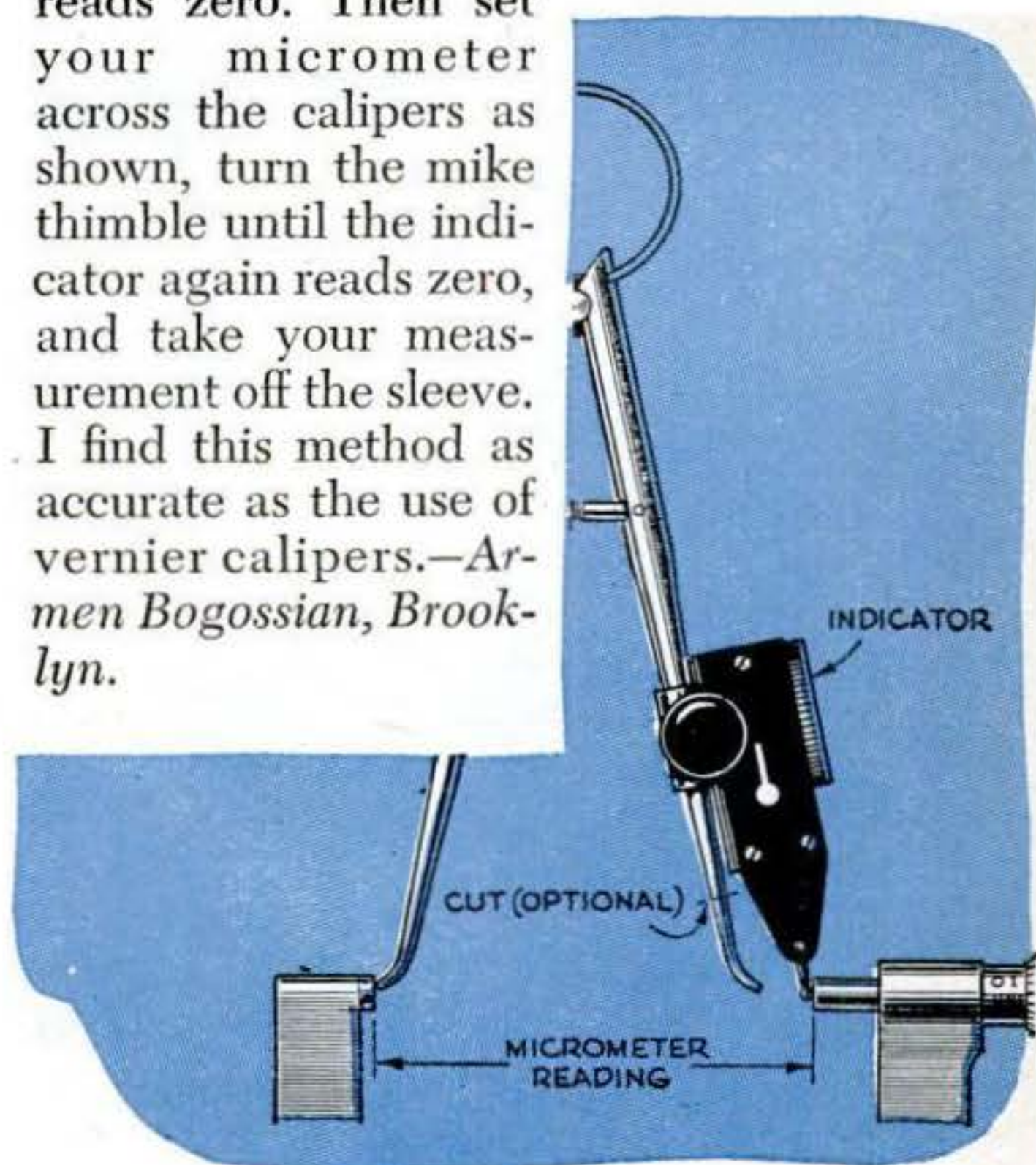



Kids always manage to get mitts, gloves, balls, and bats. Here's how you can give them bases and a diamond.

SAND-LOT baseball diamonds are, in many cases, makeshift affairs. They are roughly laid out and pieces of wood or bricks serve as bases.

But it's easy to give the young players

in your neighborhood real bags for bases and a real home plate and pitcher's plate. Laying out a diamond is simple. The drawings on the opposite page give you the dimensions for both a baseball and a soft-ball field.

Instead of the surplus utility bag shown in the photos below, you can use a gas-mask bag. Or you can sew up a bag of heavy canvas. Upholstery moss is excellent for stuffing the bases.

The bag shown below is about 10" by 14" and about 5" thick. Baseball rules specify a bag 15" square and from 3" to 5" thick. But small feet do not require that large a bag.

Home plate and the pitcher's plate are each made of two pieces of $\frac{3}{4}$ " plywood held together with nails and glue. For the spikes that hold the plates in place, use sharpened pieces of broom handle or big dowels. Bore holes for the spikes through only one piece of the plywood. Drive a nail down through the other piece into the head of each spike.

An old Army utility bag can be converted into a sturdy base.



Stuff the bag tightly with upholstery moss. Don't remove any of the tie straps or the car-

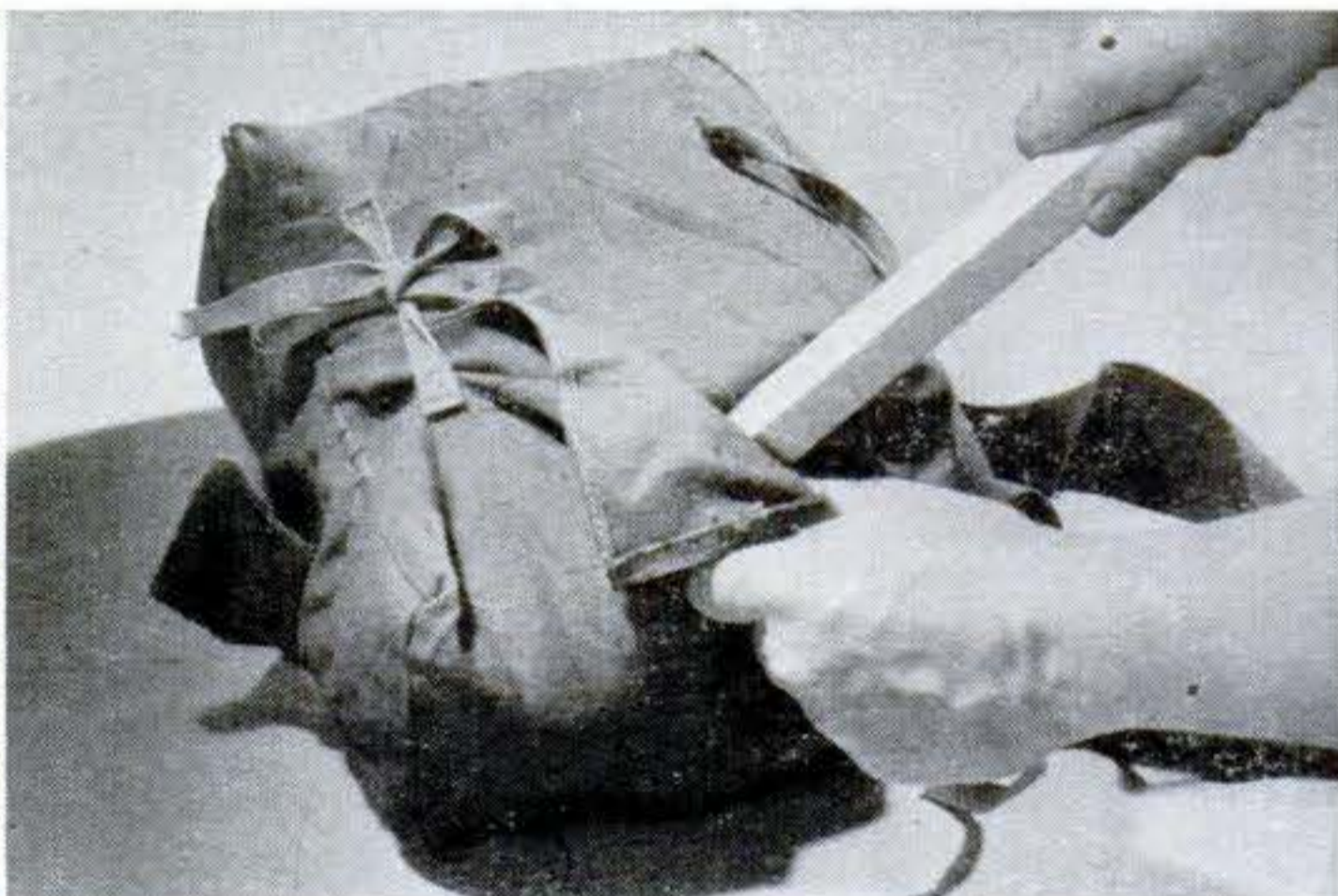

rying strap until after sewing. With one corner sewn shut, pack moss tightly into corners.



Sew the bag with heavy thread. A curved upholsterer's needle makes the job easier. Cut off

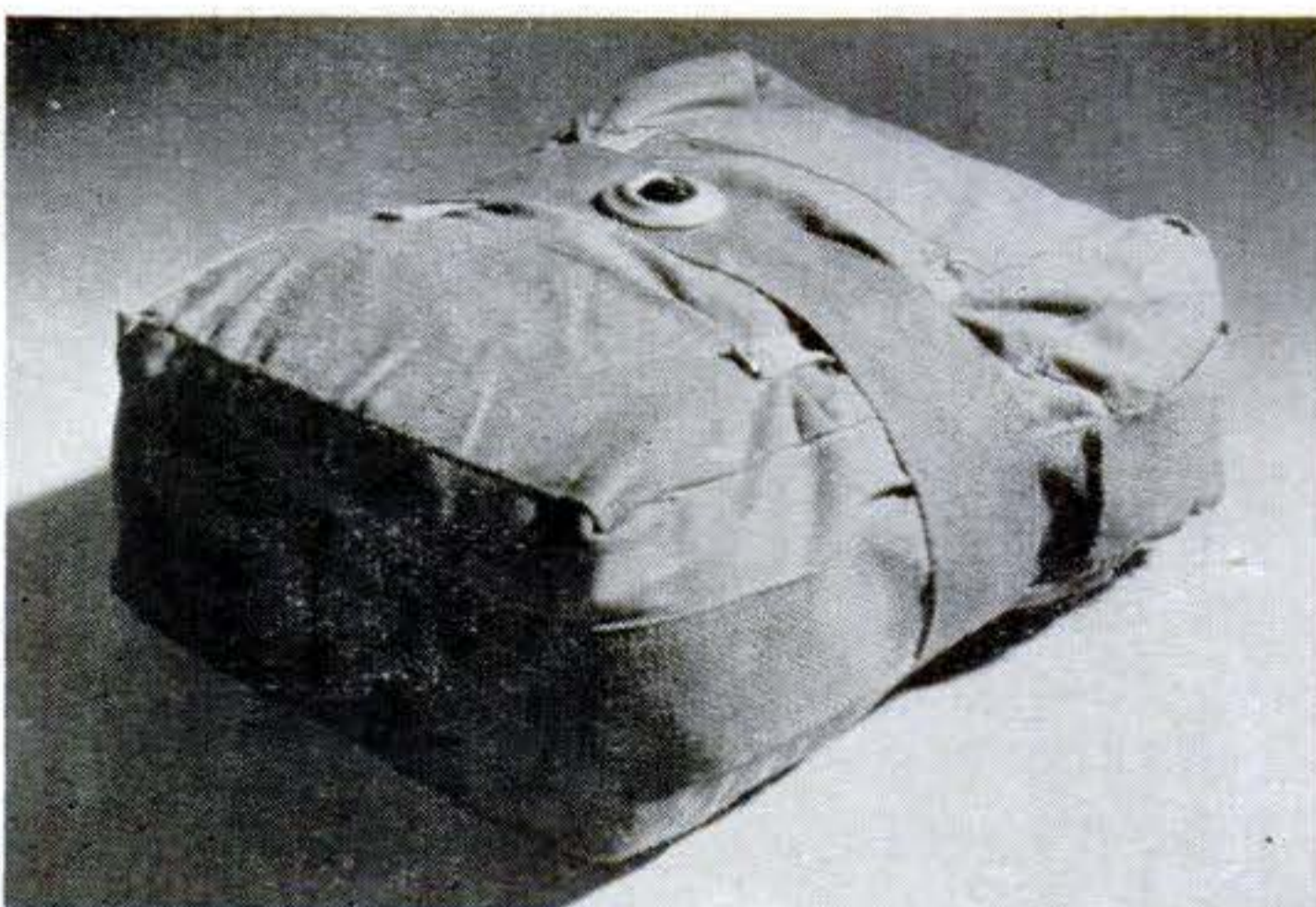

carrying strap and sew it around bag. Grommet is used to tie bag to stake driven in ground.

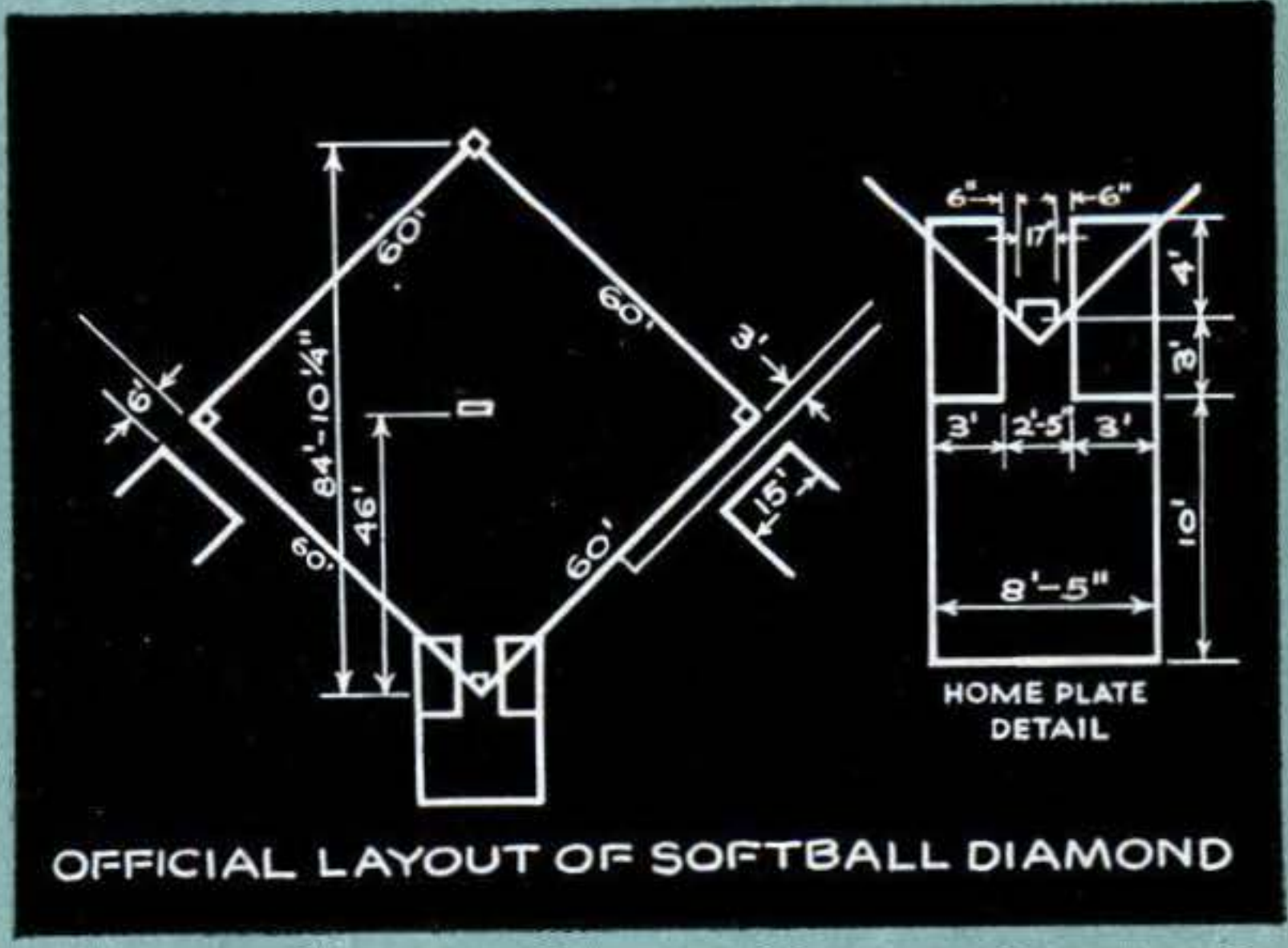
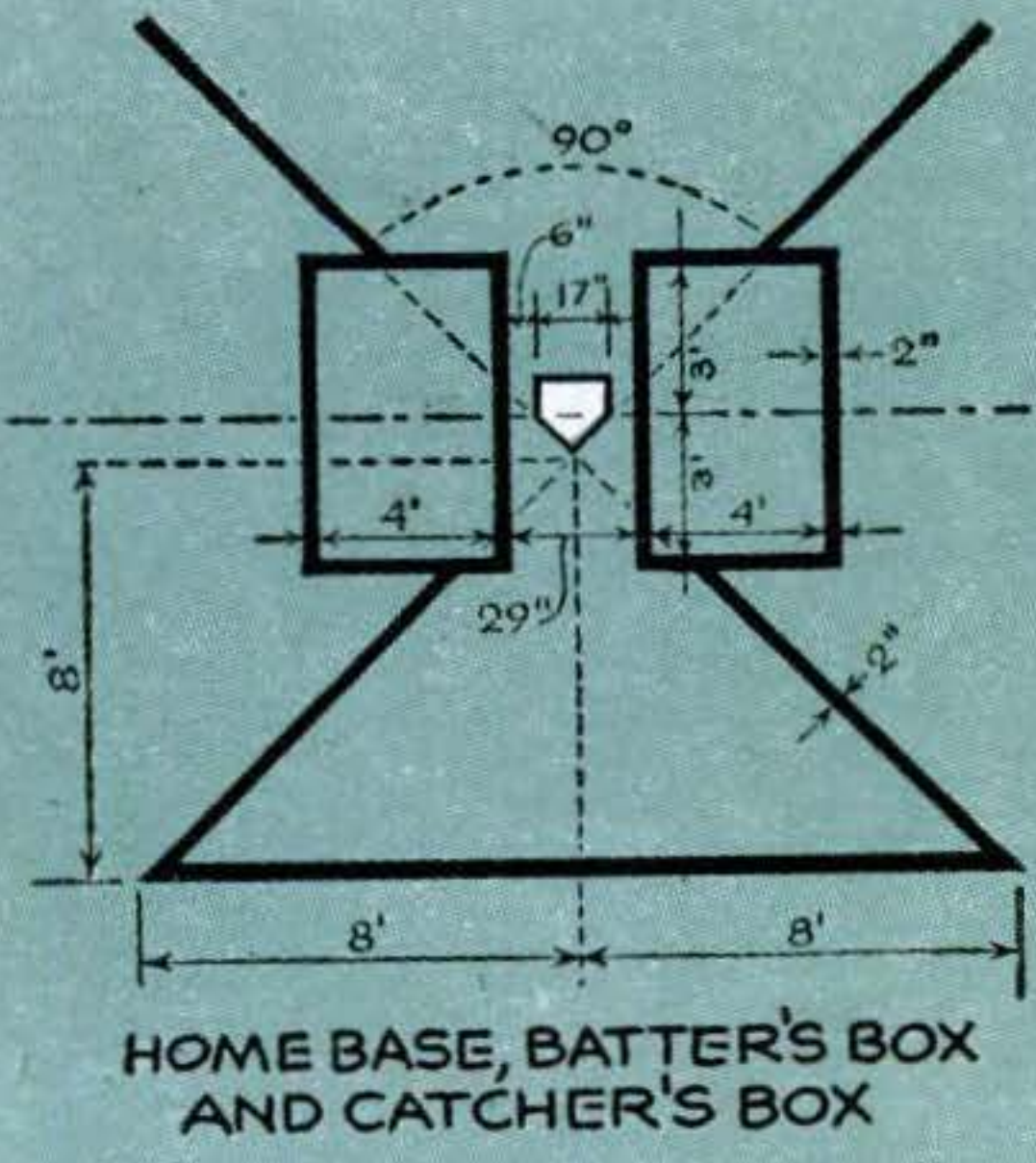
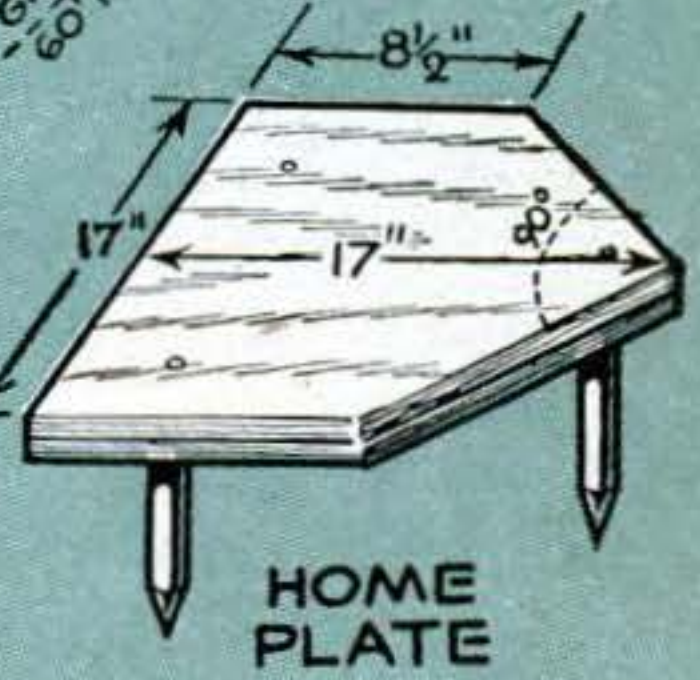
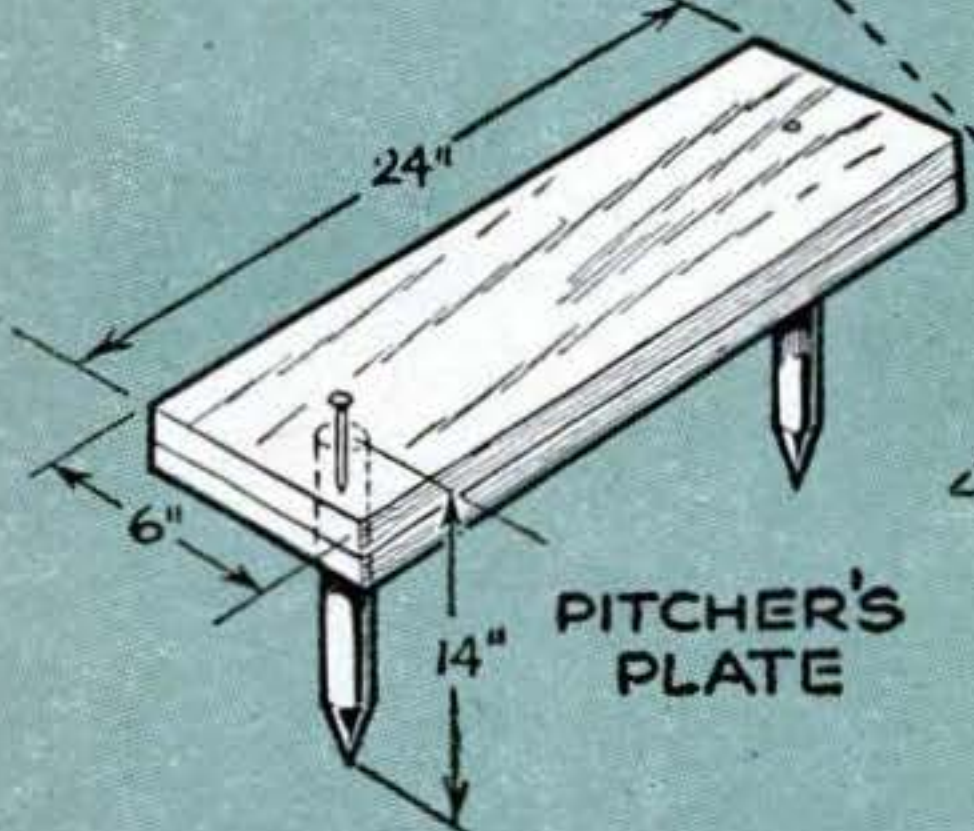
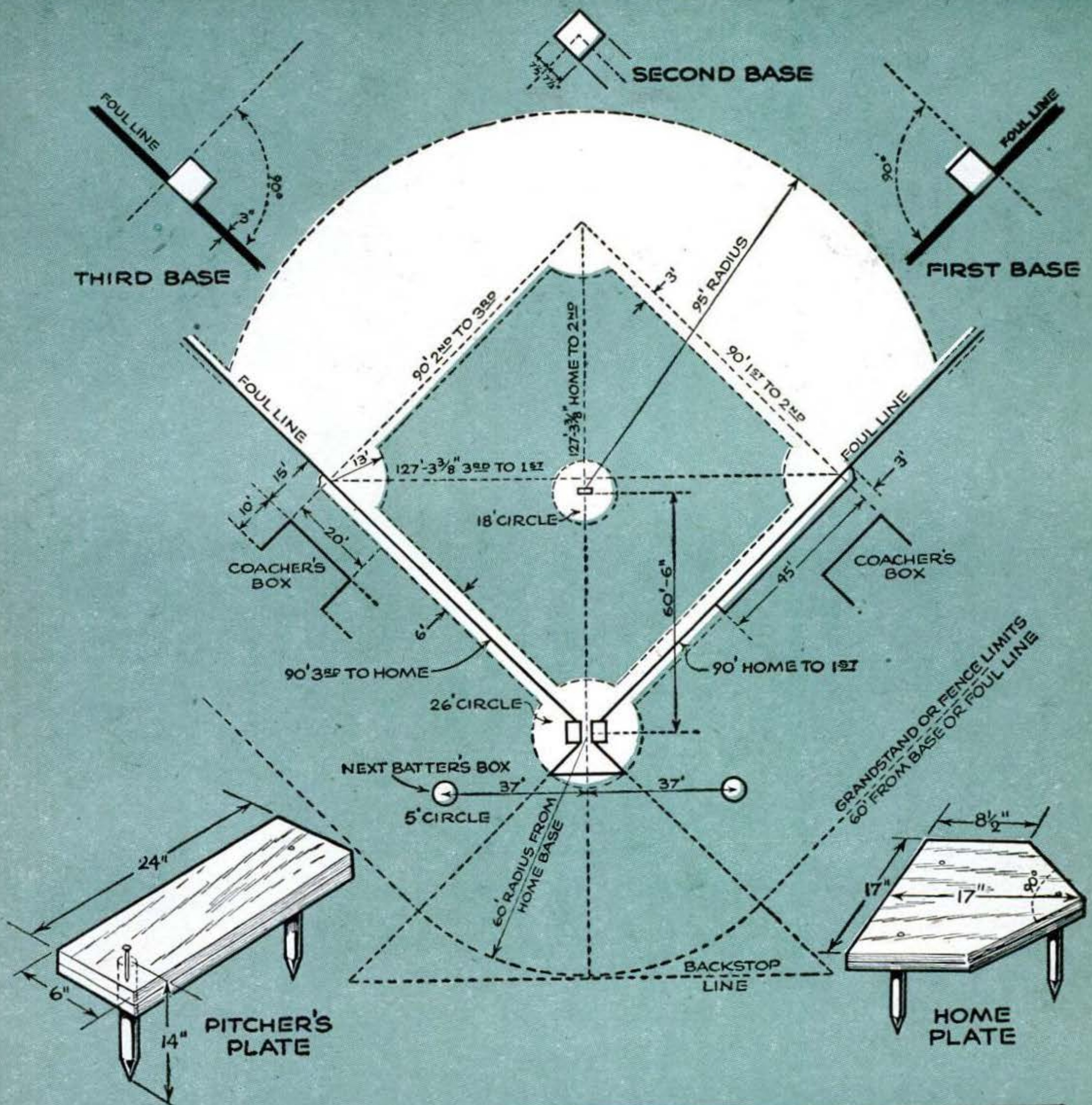

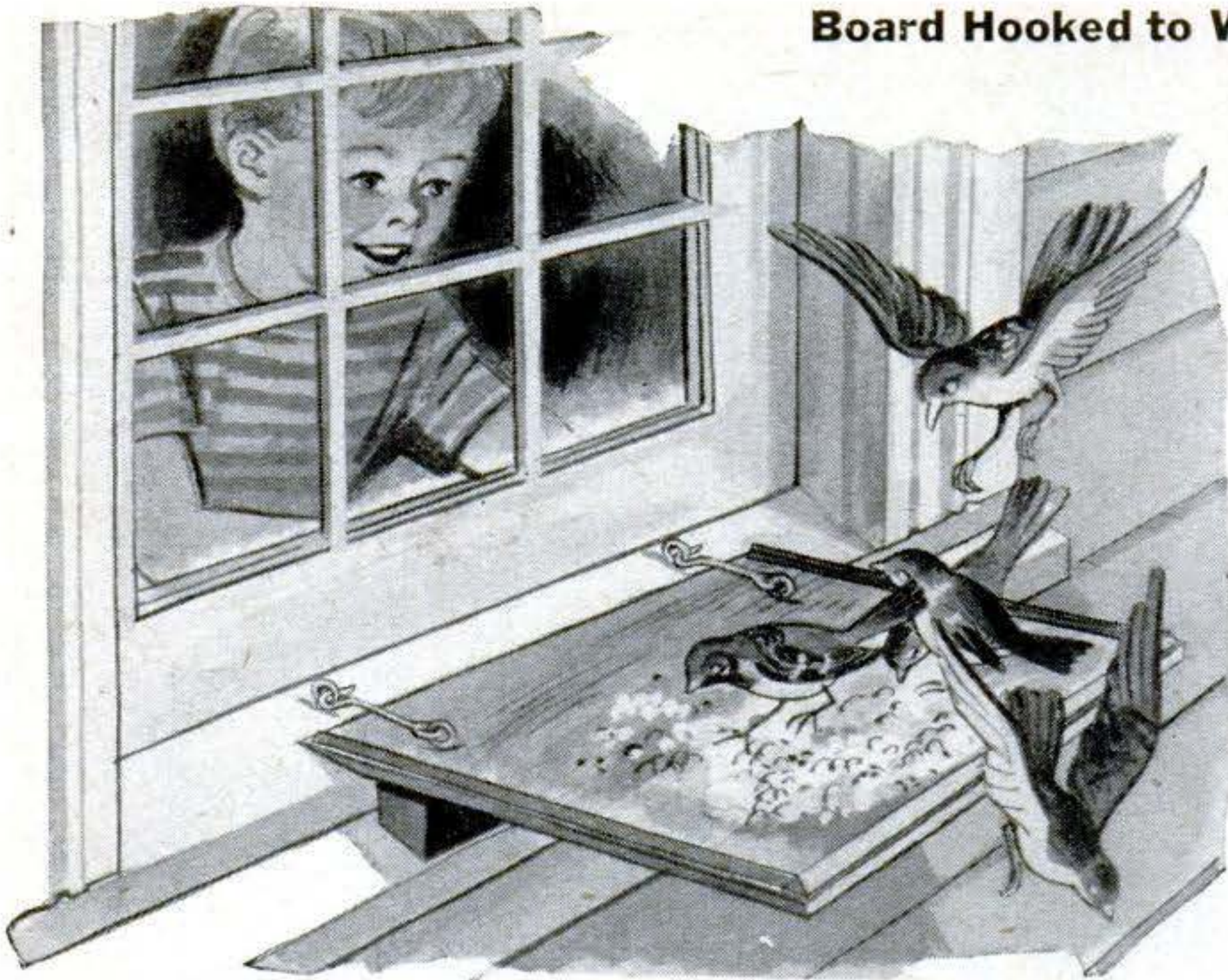

Board Hooked to Window Serves as Bird Feeder

A WINDOW-LEDGE bird feeder can be made from any fairly light, wide board—a sheet of $\frac{1}{4}$ " waterproof plywood is ideal. This one is held in place by two hooks and a pair of corresponding screw eyes in the sill. Nail a batten to the underside of the board where it will bear against the window frame and steady the tray. And tack strips of molding around the top edge to keep the seed from scattering. Finish with an outdoor paint if desired.—L. G. Gibson, Oakton, Va.

Emery Cloth Makes "Knurled" Knob

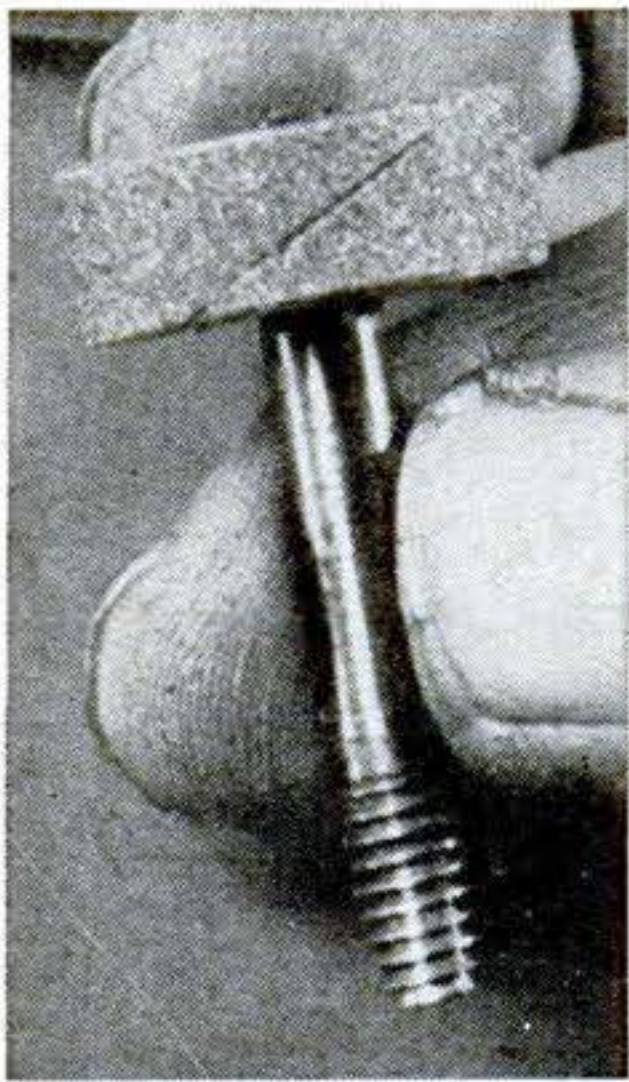

IF A thumbscrew or knob is too smooth to afford a good finger grip, cement a strip of abrasive cloth around the rim with any good cloth-to-metal cement. The photo at left shows how the ends of the cloth are cut to form a strong, neat diagonal joint.—Walter E. Burton, Akron, Ohio.

Washers Keep Drawer Knobs Tight

DRAWER knobs won't work loose if you insert washers cut from sandpaper between the knobs and the drawers. Glue two sheets of fine or medium sandpaper back to back. When the glue is dry, scribe circles of the required size with the point of an old compass or dividers, and cut them out.—Arthur Trauffer, McClelland, Iowa.

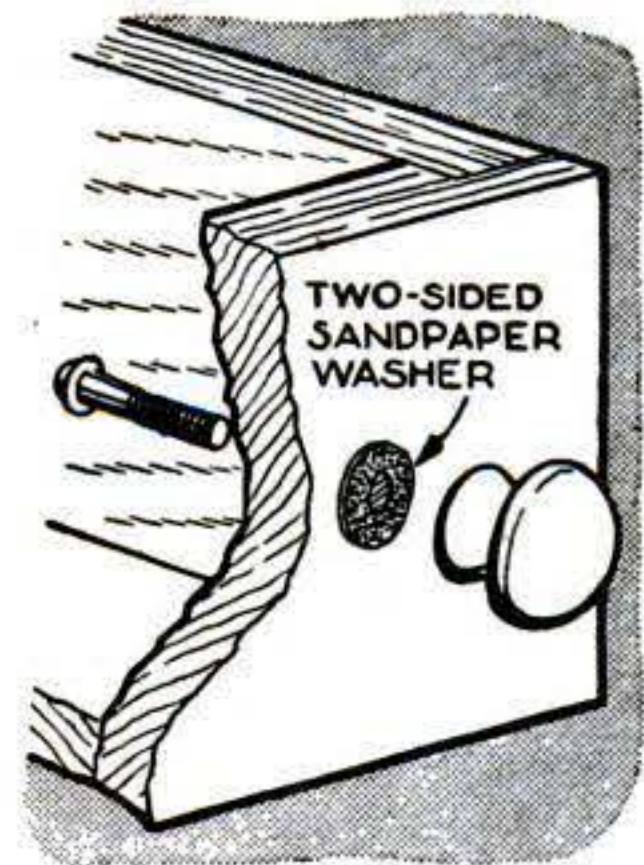

How to Make Quick, Clean Connections with Shielded Wire

WHEN you use shielded wire in your electronic hookups, you can save yourself time and get better, cleaner results by separating the inner conductors from the braid as shown in the photos below.

First, bend the wire double and spread—don't cut—the braid with a sharp pick. When

the inner wire or wires are uncovered, pull the braid straight to prevent binding and work the first wire back through the hole (center photo below). Finally, twist the braid a couple of times to stiffen it. If it's too flimsy, flow solder on it. Use braid for ground connection.

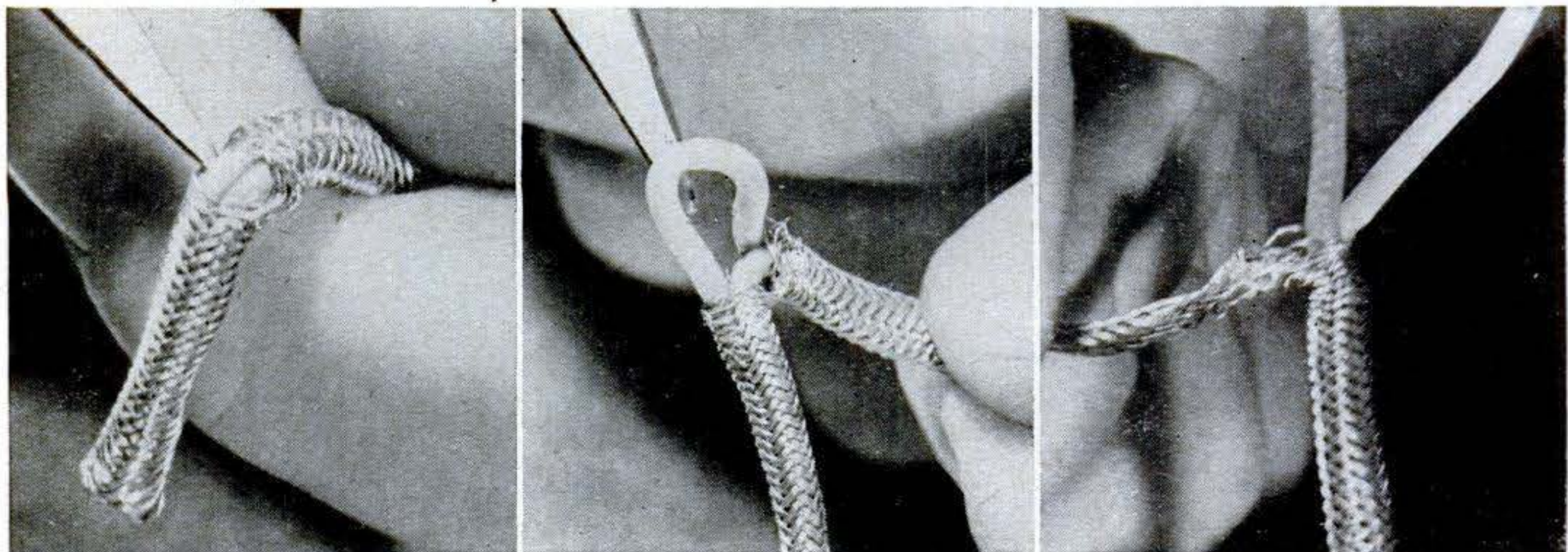

How to Improvise a Signal Generator

You can align radio circuits with a record player and another radio set.

WHEN you build or service a superhet receiver, you often run into the problem of aligning its circuits so that they will work together properly. Professionals do this with a signal generator, but it can be done if necessary by simply "borrowing" the right frequencies from a working set and using them to adjust the ailing one correctly.

Audio test. To be sure the trouble is not in the audio part of the set you are working on, you need a source of audio signals. Although these can be tapped off a "healthy" set, it's easier to get them from a record player, which supplies a clean audio signal of the right impedance and voltage. The leads from the record player that ordinarily are connected to an amplifier are used. If your player has a phonograph plug, you can separate the two leads by soldering short wires to the contacts of a matching jack.

Connect one of these leads to the chassis of the radio you wish to test and start the record player. Then connect your other lead to the grid of the output tube (point A in diagram on next page). If you're not sure which tube-base pin goes to the grid, check it in a tube manual. If you hear the record through the radio's speaker, the output stage, speaker, and power supply are functioning. Checking similarly at the grid of any other audio tube in your receiver (such as point B) will tell you whether that part is working properly.

I.F. alignment: You can then proceed to align the intermediate-frequency stages with another radio. It should operate at the same I.F. frequency as the set you wish to align. Nearly all superhets now have standardized 455-465 kilocycle I.F. circuits.

If both sets are AC-DC types, you should be sure that their power plugs are polarized the same way to avoid shorts. Plug in and turn on both sets, and connect a neon tester across the two chassis or grounds. If the tester lights up, reverse one of the line plugs. Then see what happens when you connect the tester between one chassis and a water pipe. If the neon bulb lights, reverse the power plugs of both radio sets.

After plugging the sets in properly, tune in a strong station on the one that's operating. Don't bother tuning the other one, but connect the two chassis with a test lead in which a .01-mfd. 400-volt condenser has been inserted. Put a similar condenser in a second test lead and connect one

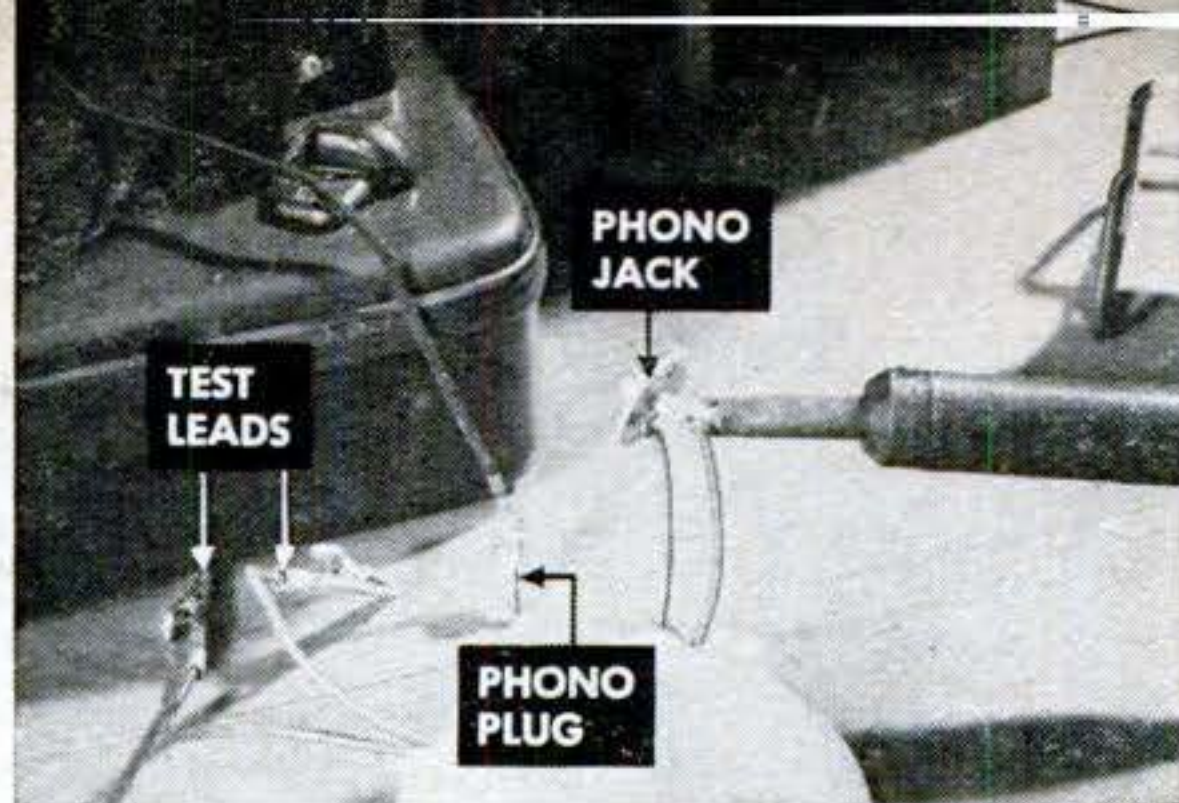

Making the test leads

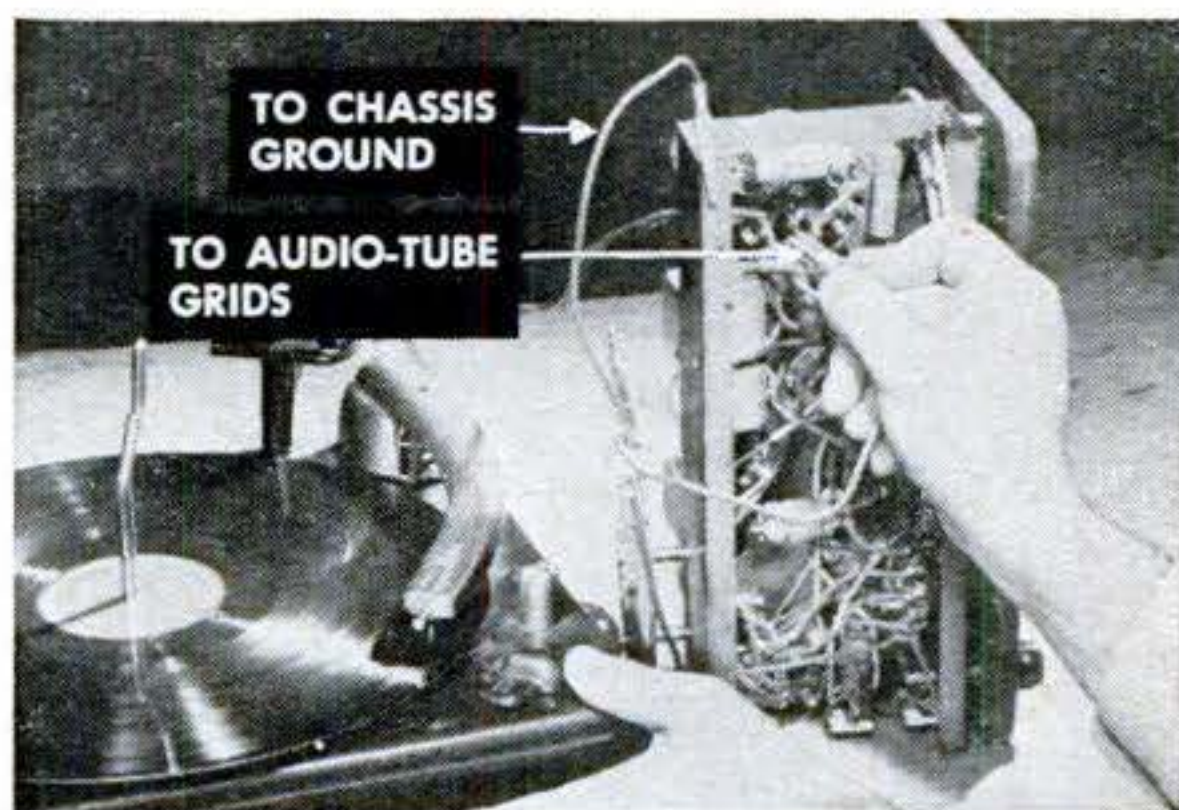

Checking the audio circuits

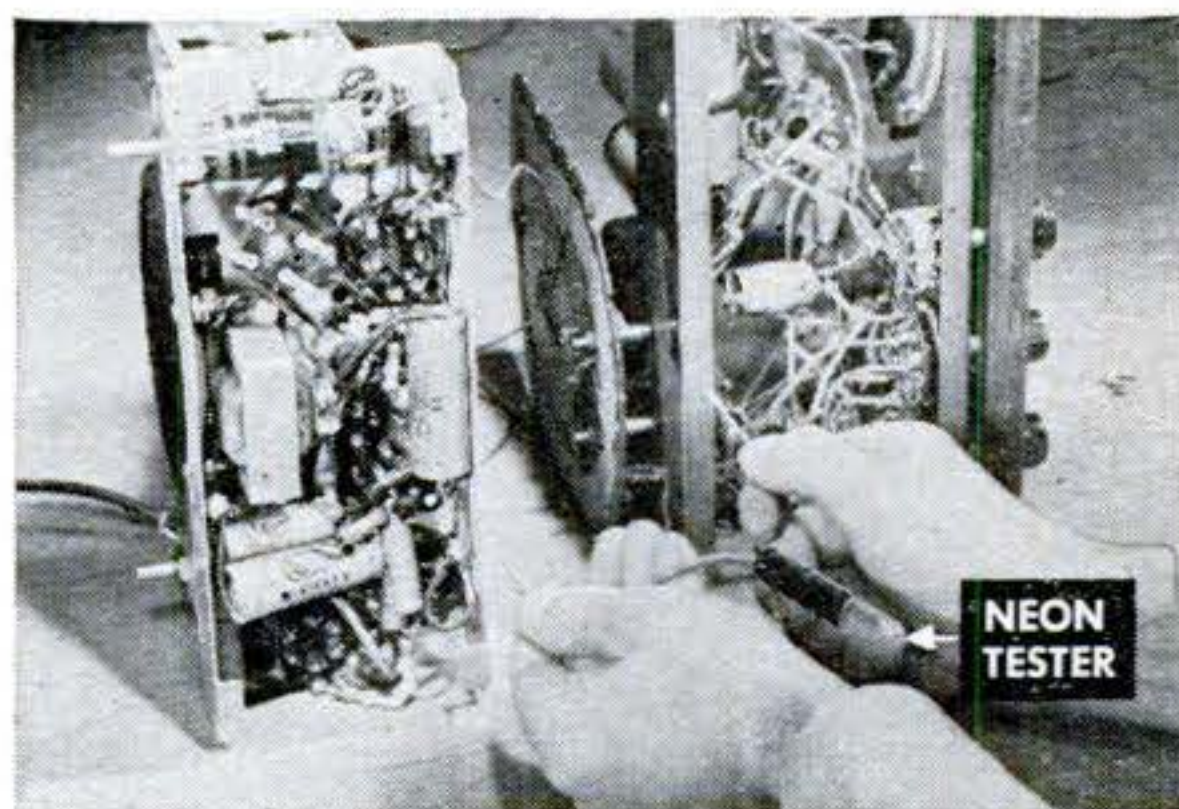

Using the neon tester

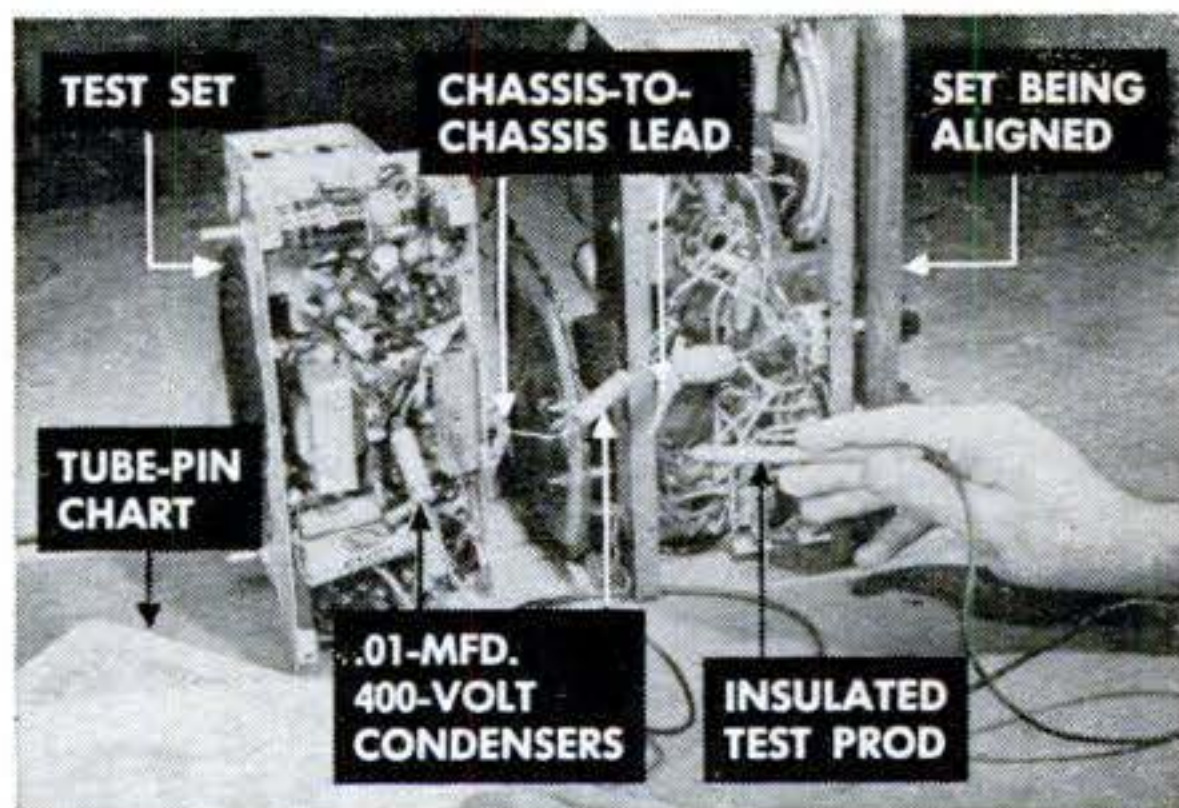

Feeding an I.F. signal

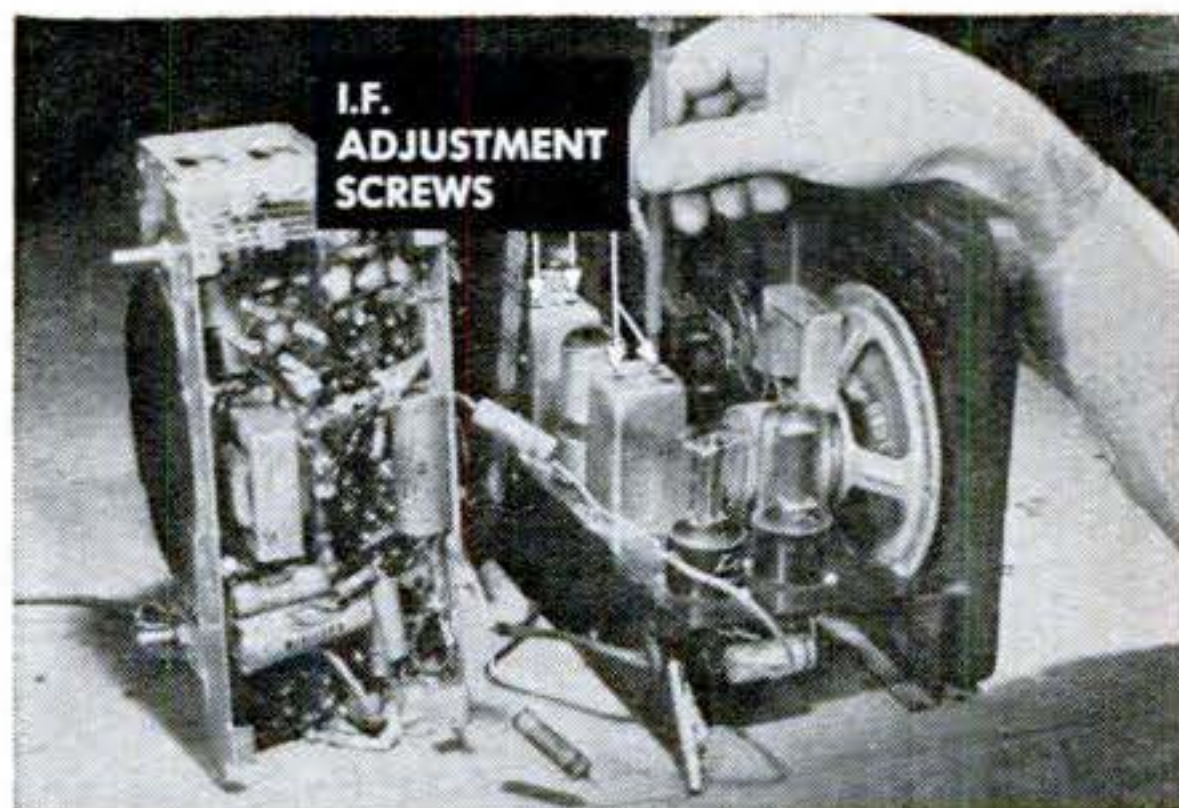

Adjusting the I.F. trimmers

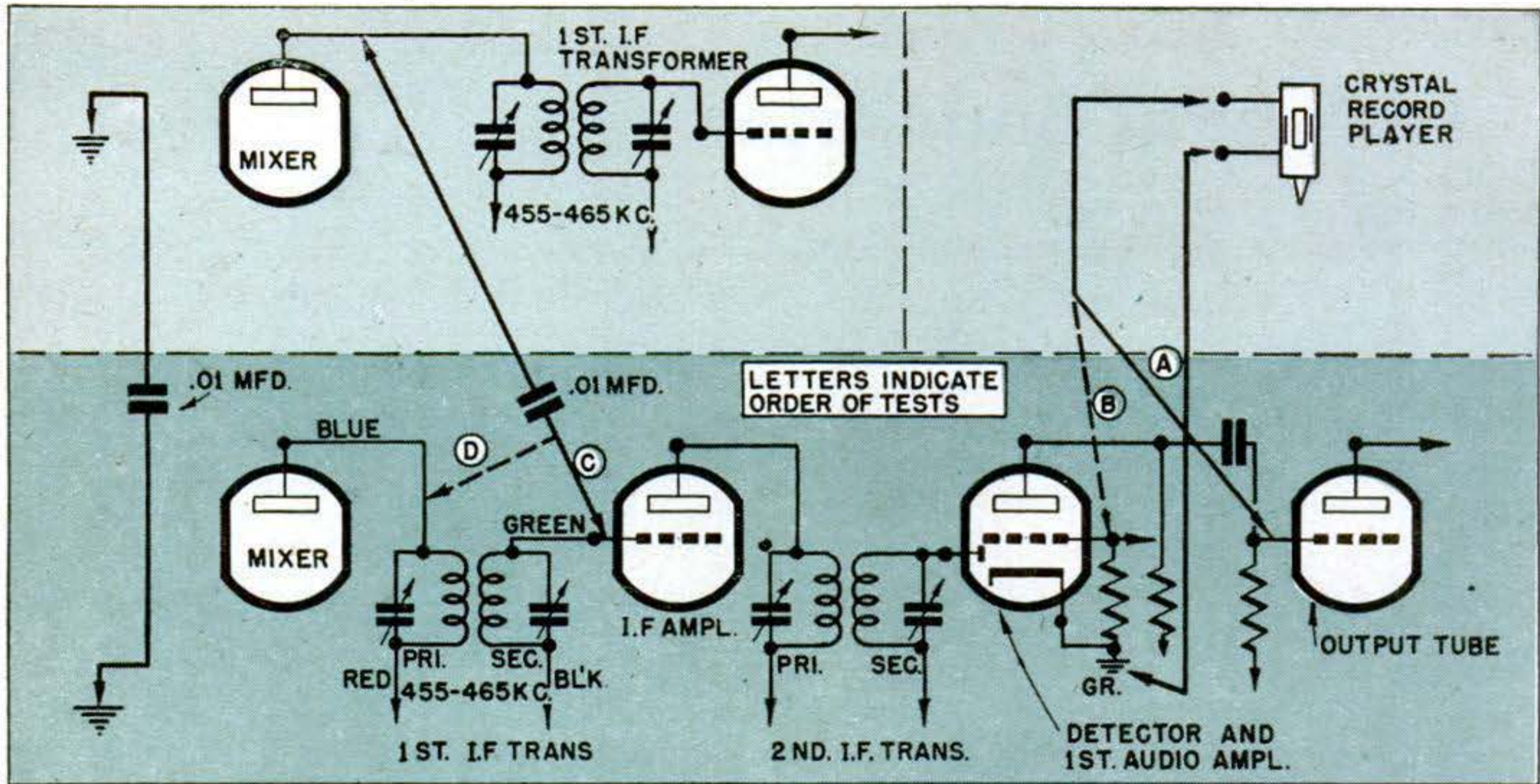

end of the lead to the plate of the mixer tube in the operating receiver. Insulate the other end of the lead and touch the grid of the last I.F. amplifier tube (point C) in the set you wish to align with it.

With a small screwdriver or neutralizing tool (a non-metallic screwdriver), adjust the trimmer screws on the following I.F. transformer. Work first on the secondary trimmer, then on the primary. This changes the frequency of the transformer and, at some point, should allow sound to come through to the speaker of the set being aligned. Adjust trimmers for peak volume.

Move the test prod to the plate of the mixer tube (test point D) and adjust the trimmers on the first I.F. transformer. If the set you're aligning has two I.F. stages, (two tubes and three transformers) you have to align the extra transformer by repeating Step C on the middle stage.

Once you have adjusted the I.F. transformers for maximum response by this method, you can put aside your improvised signal generator and do the rest of the job by ear. (For further steps in tracking and aligning a superhet, see PS, March '51, p. 236).—Joseph A. Saldana, Ft. Lee, N. J.

DEGREE TABLE

The index head or bull gear on a lathe, used with this table, makes it easy to lay out degrees or divisions of circles. For instance, if you want six equally spaced divisions, and have a 72-hole index plate, the table shows that counting 12 holes each time gives you the proper location. The table can also be used with a gear having 72, 60, or 48 teeth.

72 HOLE CIRCLE		60 HOLE CIRCLE		48 HOLE CIRCLE	
No. of Holes	Deg. Div.	No. of Holes	Deg. Div.	No. of Holes	Deg. Div.
1	72	1	60	1	7.5
2	36	2	30	2	15
3	24	3	20	3	22.5
4	18	4	15	4	30
5	14.4	5	12	5	37.5
6	12	6	10	6	45
7	10.2857	7	8.5714	7	52.5
8	9	8	7.5	8	60
9	8	9	6.6667	9	67.5
10	7.2	10	6	10	75
11	6.5455	11	5.4545	11	82.5
12	6	12	5	12	90
13	5.5385	13	4.6154	13	97.5
14	5.1429	14	4.2857	14	105
15	4.8	15	4	15	112.5
16	4.5	16	3.75	16	120
17	4.2353	17	3.5294	17	127.5
18	4	18	3.3333	18	135
19	3.7895	19	3.1579	19	142.5
20	3.6	20	3	20	150
21	3.4286	21	2.8571	21	157.5
22	3.2727	22	2.7273	22	165
23	3.1304	23	2.6087	23	172.5
24	3	24	2.5	24	180
25	2.88	25	2.4		
26	2.7692	26	2.3077		
27	2.6667	27	2.2222		
28	2.5714	28	2.1429		
29	2.4828	29	2.0690		
30	2.4	30	2		
31	2.3226				
32	2.25				
33	2.1818				
34	2.1176				
35	2.0571				
36	2				

FOR YOUR POPULAR SCIENCE INFORMATION FILE

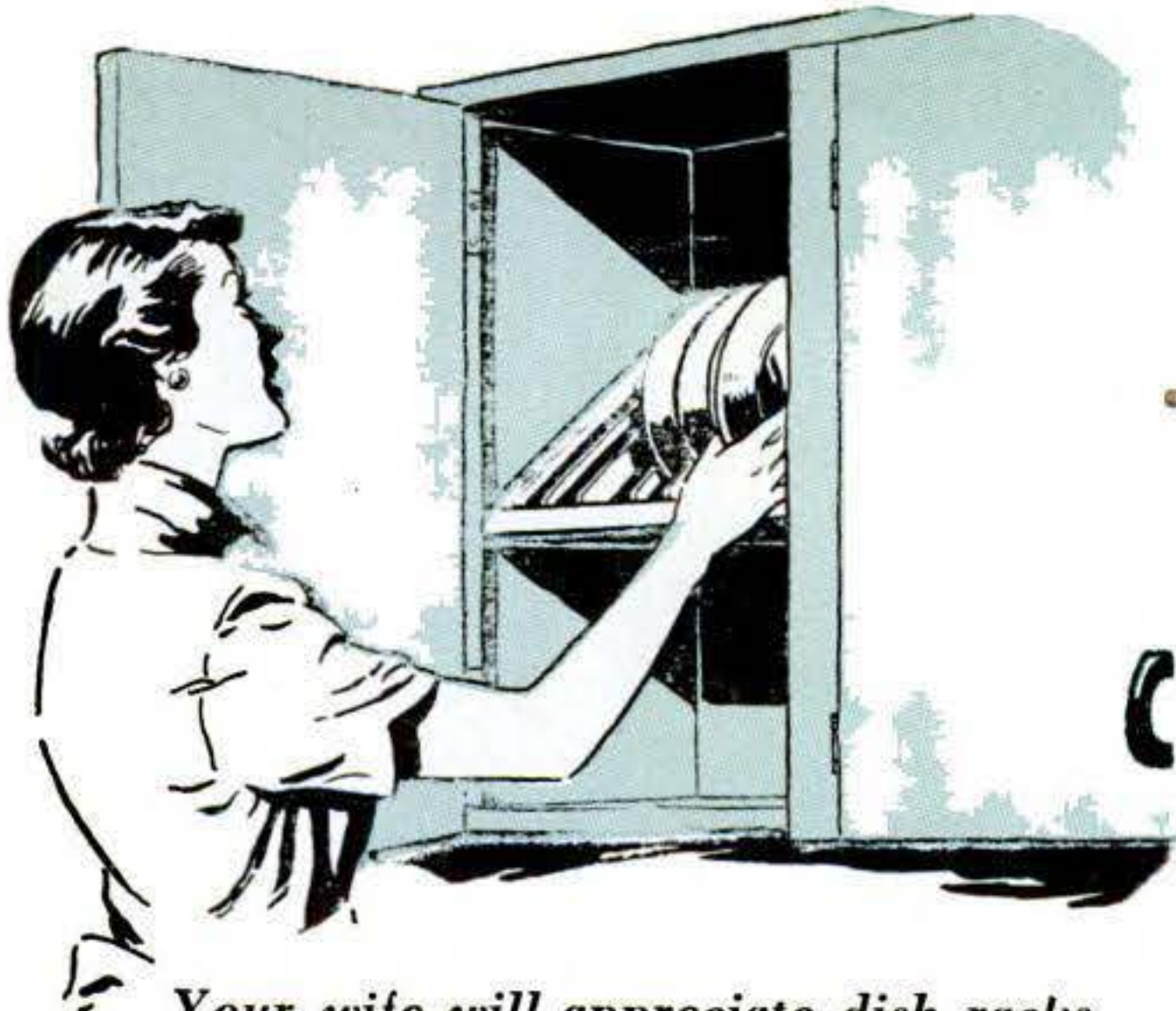

Your wife will appreciate dish racks . . .

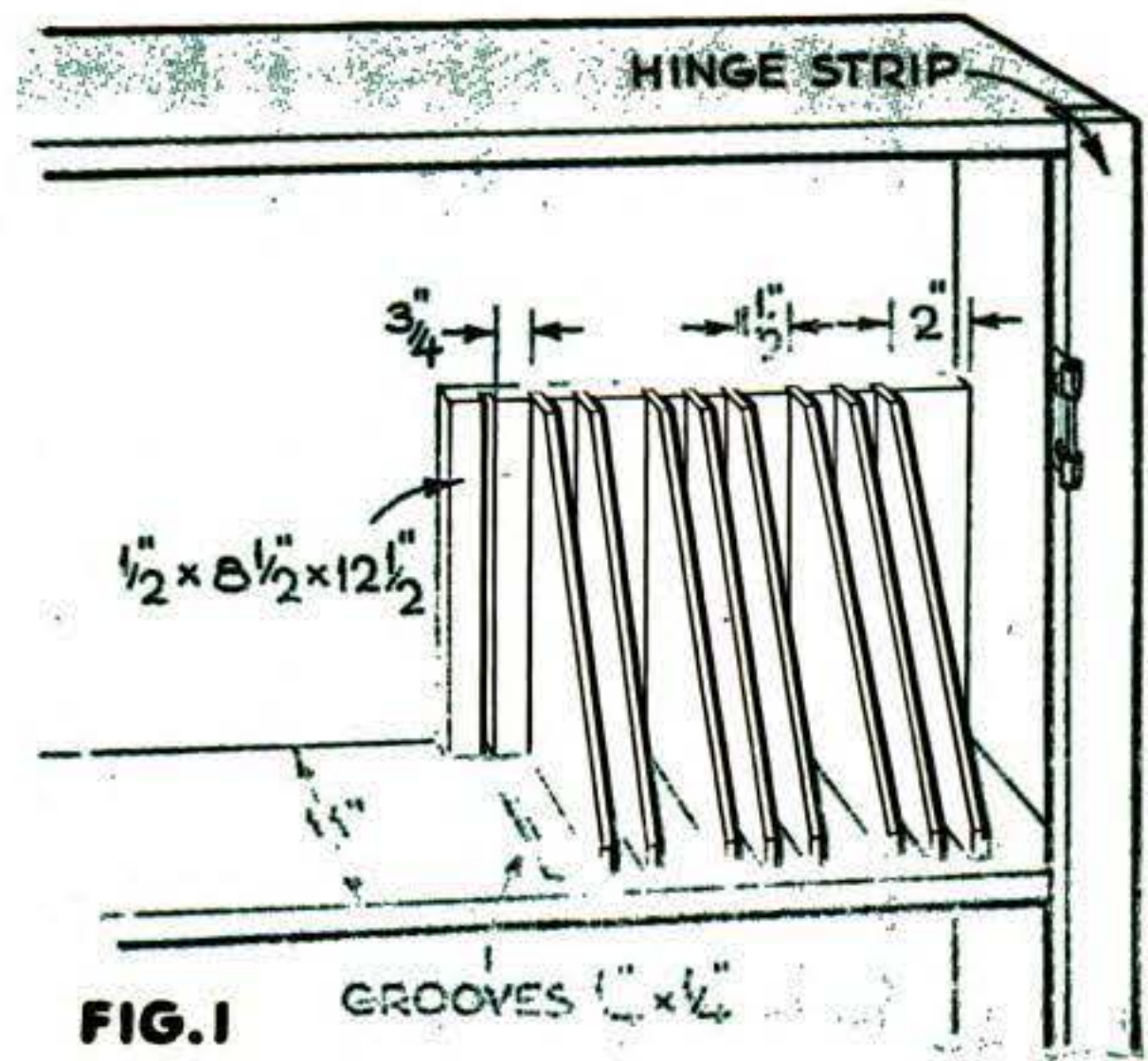

FIG. 1 GROOVES $\frac{1}{2} \times 8 \frac{1}{2} \times 12 \frac{1}{2}$ built in newly constructed shelves or . . .

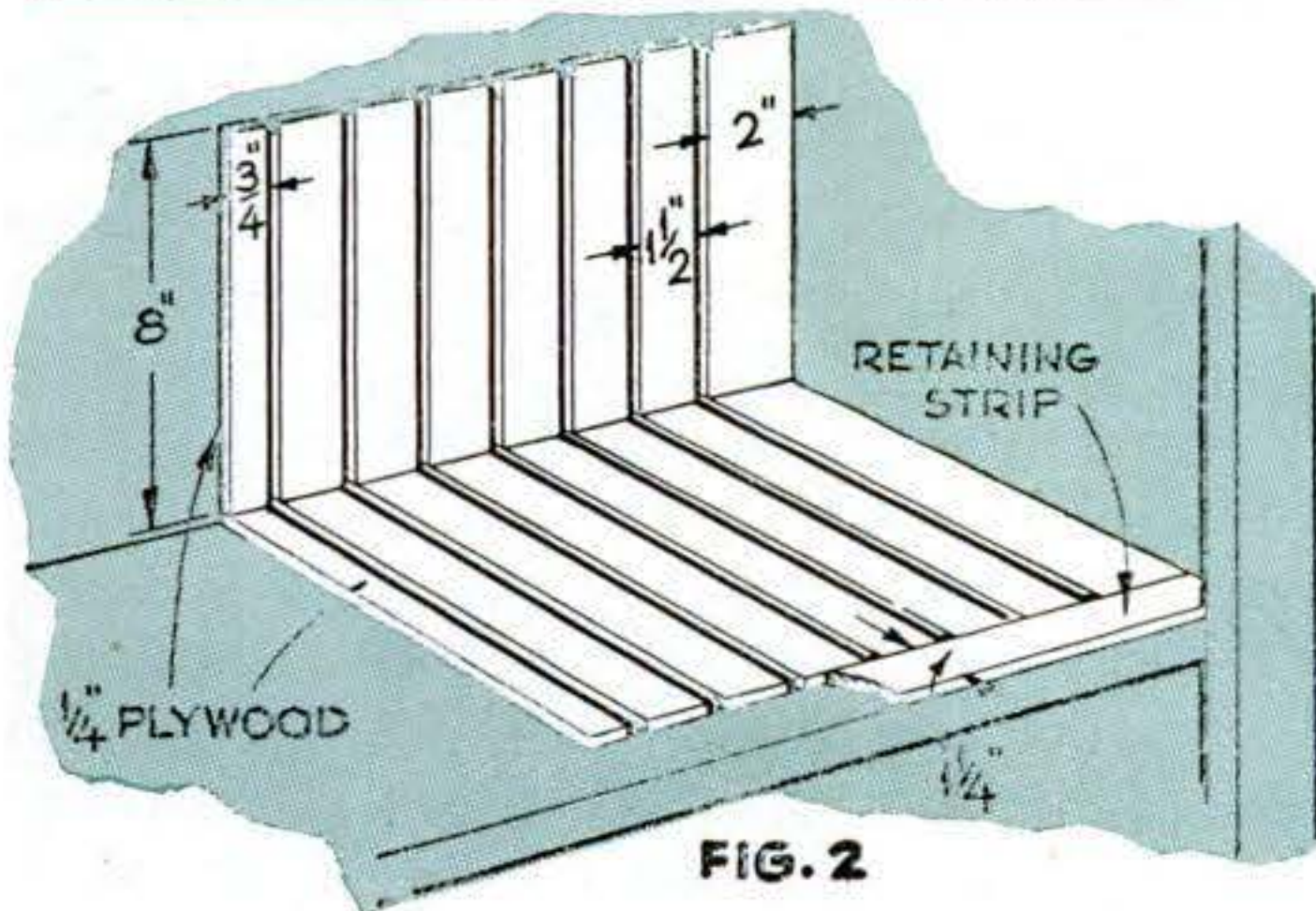
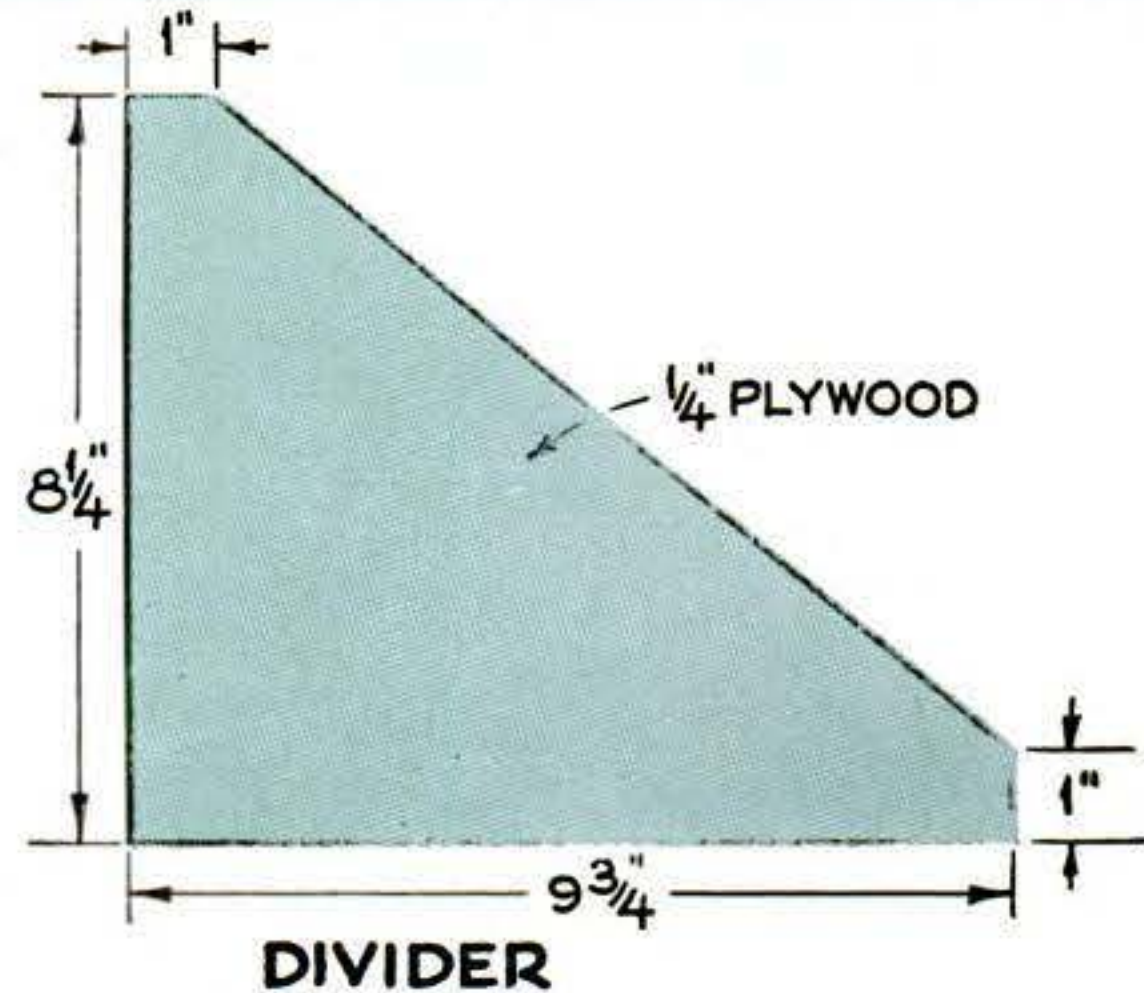

FIG. 2 . . . set into existing shelves this way.



Use these dimensions for the dividers.

How to Improve Kitchen Shelves

Dividers can be put in quickly by anyone handy with tools.

VERTICAL dividers on a kitchen shelf will make it easier for your wife to store platters and odd-size plates. Here are two ways to make them, using $\frac{1}{4}$ " plywood.

If the shelf can be removed, or in new construction, cut $\frac{1}{4}$ " by $\frac{1}{4}$ " grooves in the

shelf for the bases of the dividers (Fig. 1). Support the dividers in corresponding grooves cut in a back plate notched into the shelf. Use $\frac{1}{2}$ " stock for the back plate.

If you prefer not to disturb the shelf, you can make grooves by nailing in plywood strips (Fig. 2). Once the dividers are in place, a retaining strip keeps them there.

In either case, allow 2" space between the cabinet wall and the first divider to allow for the slight overhang of the hinge strip. Vary the dimensions if your shelf is wider or narrower than the 11" shown here.

New Plastic Surfacing Material Is Applied Like Linoleum

A NEW plastic surfacing material, called Versibond, has a flexible rubber backing. It is suitable for use on sink and cabinet tops or as wall paneling and can be readily bent or coved. Unlike the rigid laminates, it is applied by contact pressure with an ordinary hand roller. Scissors, a linoleum knife, or a coping saw easily cuts the material, which resists cigarette burns. The Ohio Rubber Co., Willoughby, O., makes it.

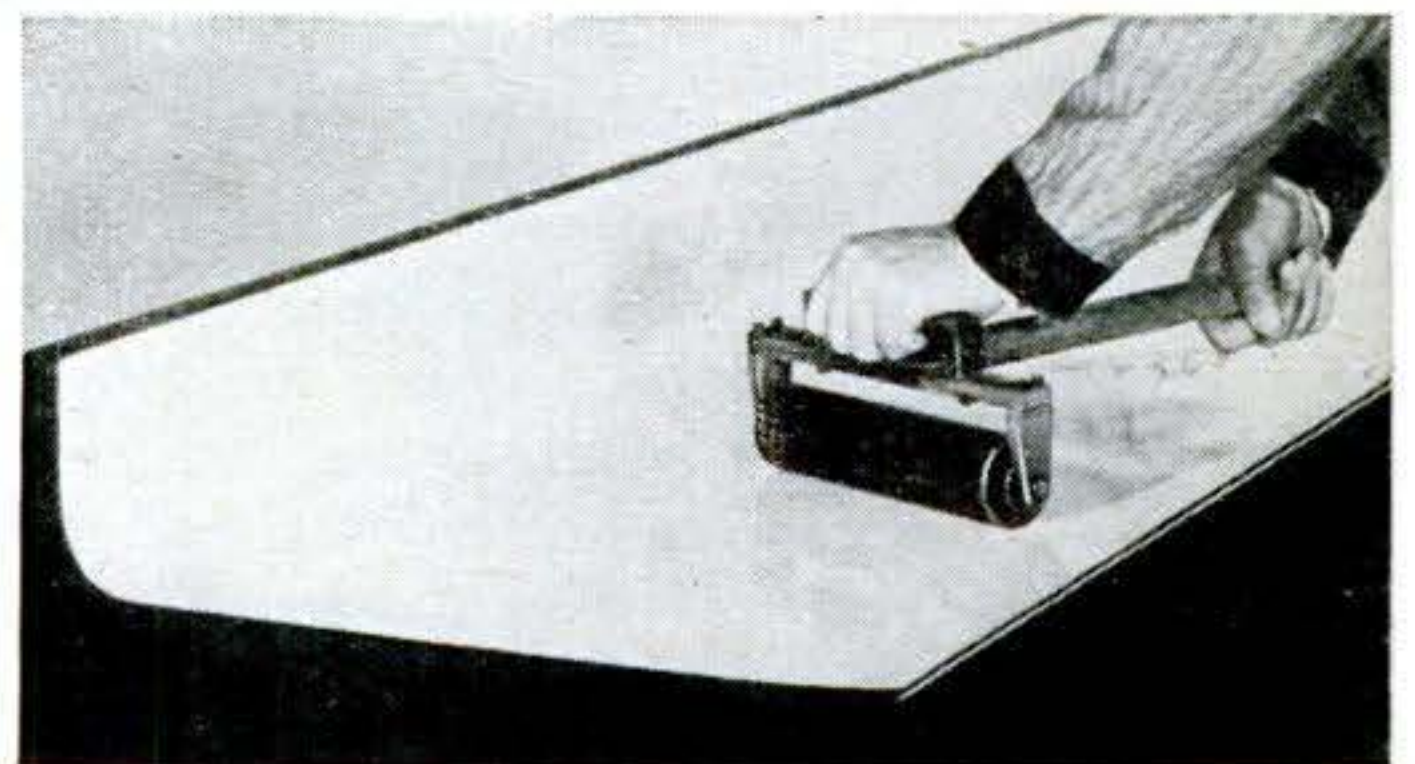

CRAFTSMEN AT WORK

Homemade Tractor. Clarence Sebring, of Altay, N. Y., built this little tractor from old parts. Sebring, shown in the driver's seat, uses the tractor on his farm. It's powered by a 2½-hp. Briggs and Stratton engine through an Indian motorcycle transmission and then through a Chevrolet transmission. It has a Model-T differential. The blade on the front can be raised or lowered hydraulically from

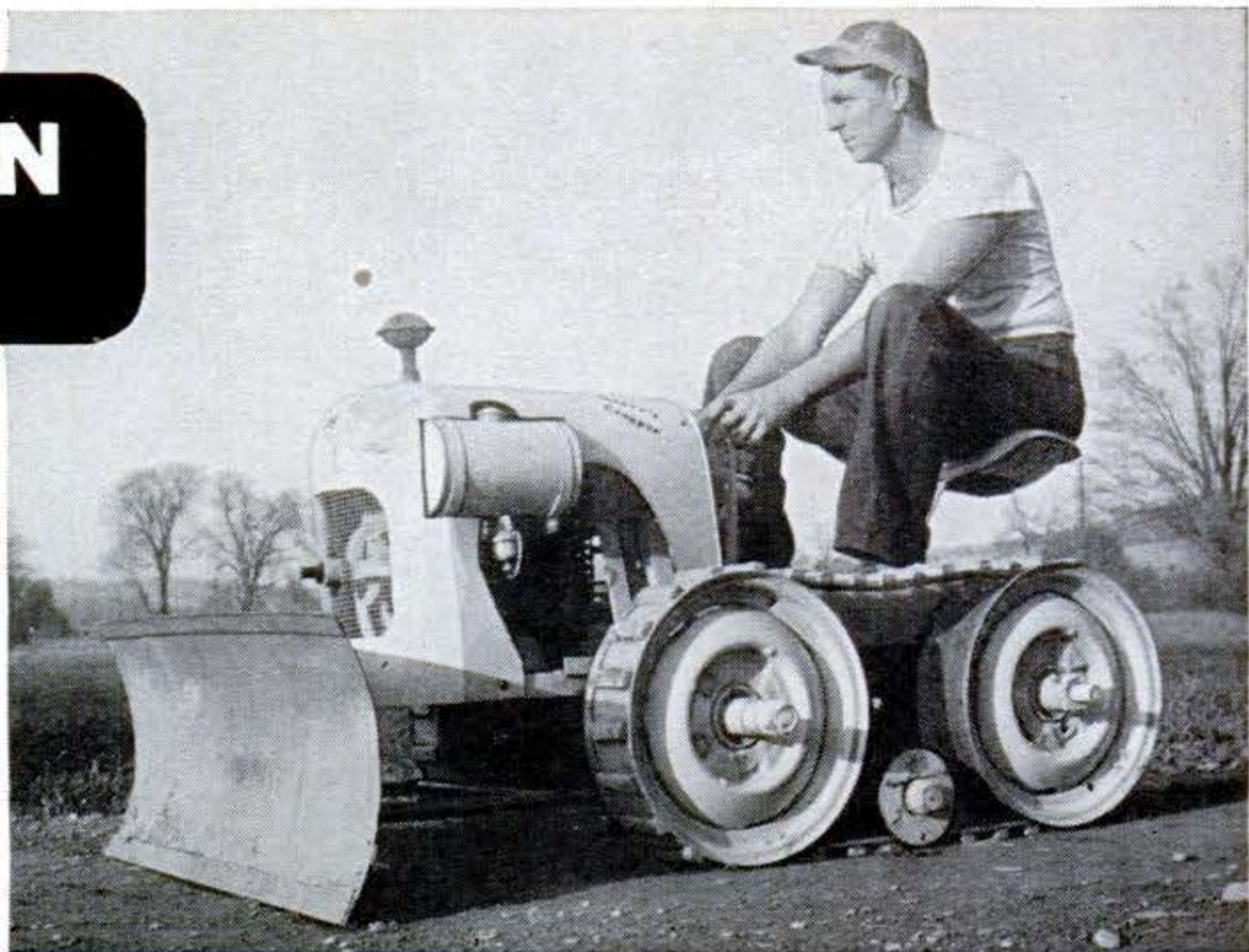

the driver's seat. Steering is by brake levers.—*Richard Carpenter, Rochester, N. Y.*

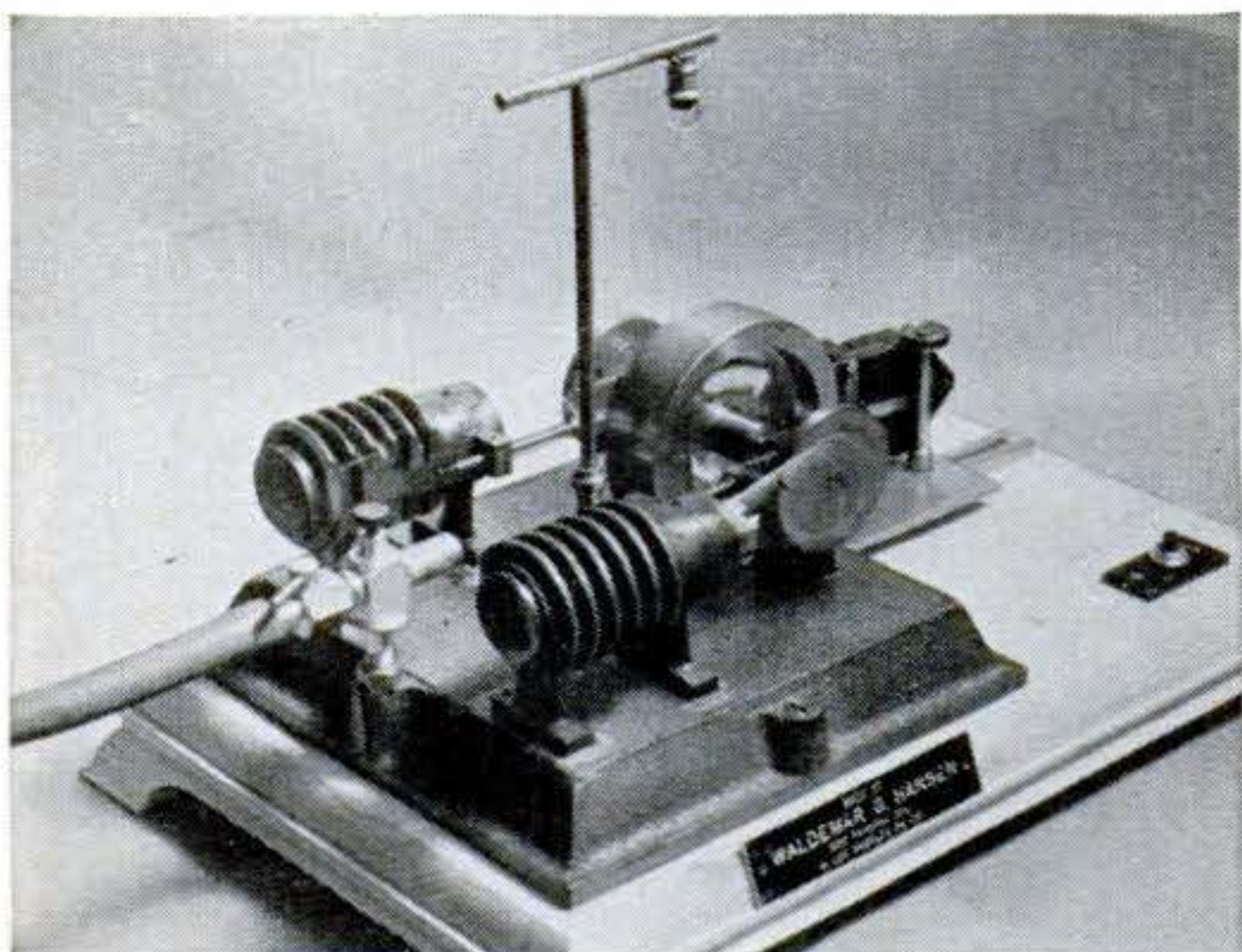

Adds Cylinder to PS Hot-Air Engine. After Waldemar G. Hansen had built six copies of a hot-air engine described in *POPULAR SCIENCE* (Feb. '50, p. 206), I became the proud owner of one of them. I watched the engine run and then suggested that we add another cylinder. I made three patterns—a bigger base, heavier flywheel, and a reversed cylinder. Hansen did the rest. The two-cylinder job starts easier, runs smoother, and powers a generator from a hand lantern to light a 1½-volt bulb. A double-jet Bunsen burner supplies heat.—*James N. Doolittle, Los Angeles.*



Signs Made with Marbles. Roy E. Swain, Huntington Park, Calif., industrial engineer, uses marbles of different colors to make signs that glow like neon under artificial light or sunshine. The marbles are held between two pieces of wire mesh that are welded together at close intervals.—*Tom Cameron, Pasadena.*

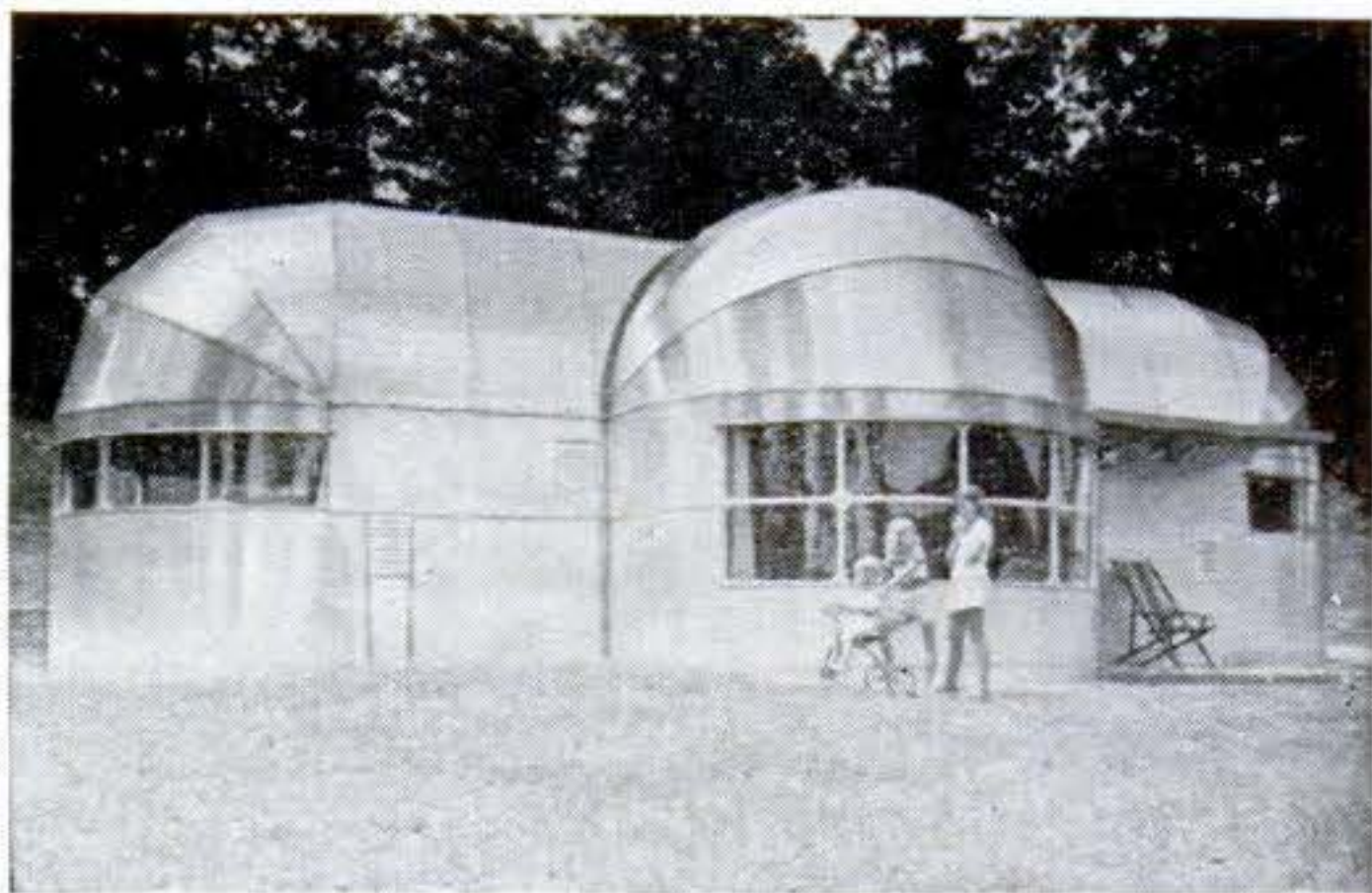

Aluminum Home Is Dustproof. This Marion, N. C., home may be an answer to a housewife's dusting problems. Air-conditioning units filter all air that enters the sealed home. Windows are plastic. Designed and built by Thomas Edison Westall, the house is as spacious as a five-room home.—*Max Tharpe, Statesville, N. C.*

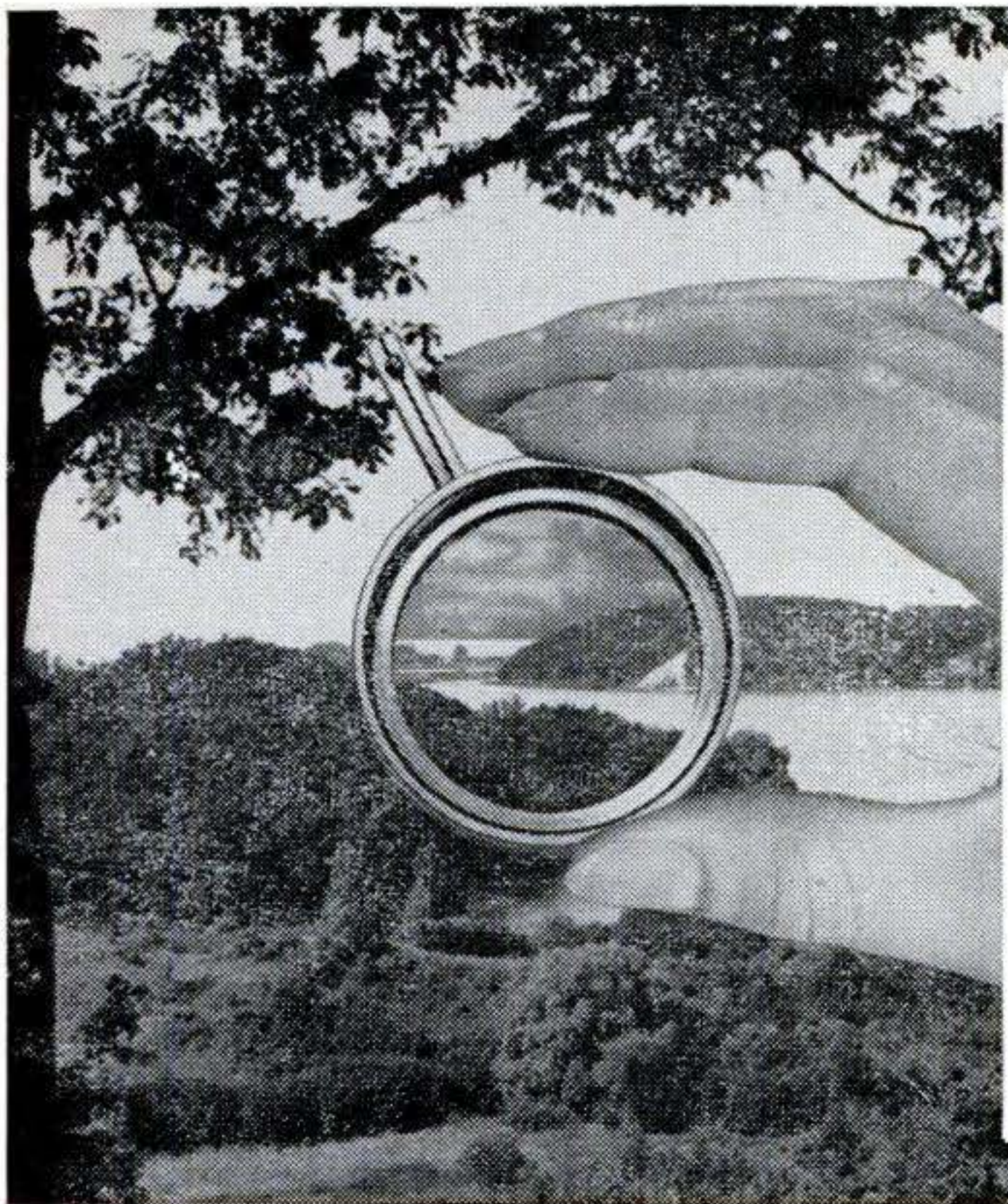

DARKEN THE SKY IN YOUR PICTURES

without changing other tones

The Kodak Pola-Screen does the trick—in color and black-and-white. Place one in front of your lens for dark, dramatic sky effects without impairing other tonal values. The accessory Kodak Pola-Screen Viewer over the indicator handle of your Pola-Screen “previews” the varying sky tones. Pola-Screens also cut surface reflections in both color and black-and-white pictures. Price of Viewer, \$6.50; Pola-Screens, from \$6.50.

PHOTO TIPS FROM KODAK

WARM UP YOUR COLOR SHOTS with a Kodak Skylight Filter

With this filter you'll wipe out the bluish cast in outdoor color shots. Use it for pictures of mountain, marine, sunlit snow scenes . . . pictures made in open shade under a clear sky and on overcast days. Keeps other colors natural-looking. Prices start at \$1.60.



SHADE THE EYE OF YOUR CAMERA for better pictures

A KODAK LENS HOOD attaches in an instant—saves snapshots from sun flare. A “must” for taking those dramatic back-lighted pictures. Useful indoors, too, for pictures side-lighted with photo lamps. Prices start at \$1.60.



“MOVE IN” FOR CLOSE-UPS of flowers and table-top subjects

Slip a KODAK PORTRA LENS over your camera lens for black-and-white or color pictures at extremely close range. Portra Lens 1+ is lowest power; 2+ is medium; 3+ is highest power. Combine them for stronger effects. Prices start at \$2.50.

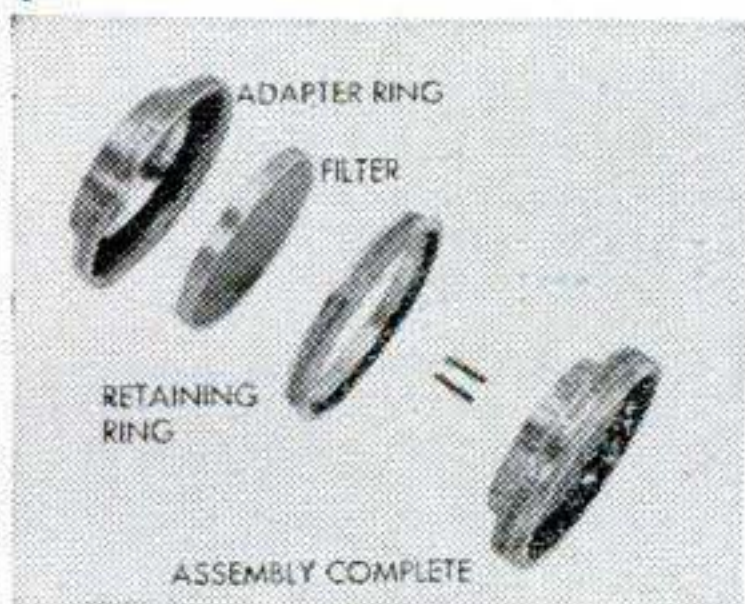
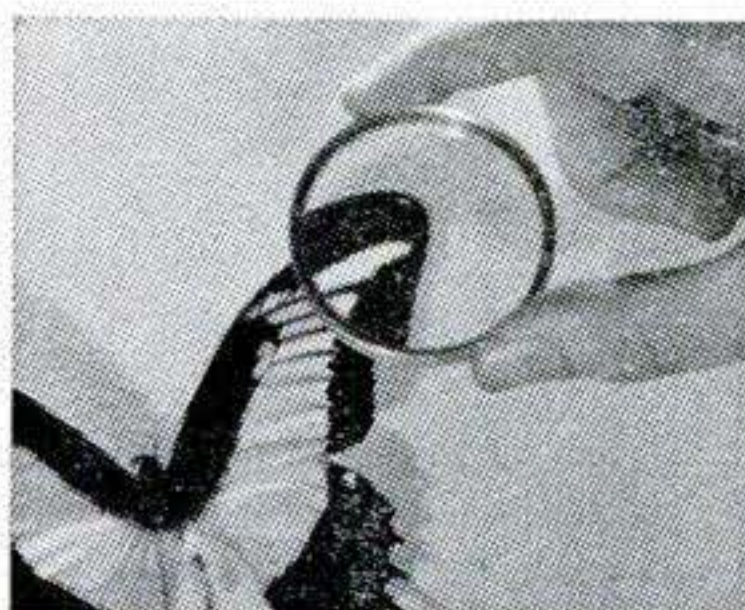

**A SINGLE
ADAPTER
RING accepts
Pola-Screen,
Filter,
Portra Lens,
or Lens Hood**

Basic unit of Kodak Combination Lens Attachments for attaching above items to camera lens. Series sizes to fit most cameras. Prices start at \$1.25.

**BE SURE TO SEE ALL THESE LENS ATTACHMENTS AT YOUR
KODAK DEALER'S. Eastman Kodak Company, Rochester 4, N. Y.**
Prices subject to change without notice. Consult your dealer.

Kodak
TRADE-MARK



The trade-marks
everybody knows



The files
everybody
likes

THAT'S a short way of saying that through outstanding quality, unsurpassed value, and wide variety, Nicholson and Black Diamond brands constitute the most extensively used files in the world.

They're the leading choice among expert mechanics, industrial concerns, tool, die and instrument makers, "veteran" amateur craftsmen, and others whose experience has afforded opportunities for comparisons.

The sweeping Nicholson guarantee of *Twelve perfect files in every dozen* carries assurance that each file is *properly shaped and balanced, accurately cut, evenly hardened* and made of the *finest steel* obtainable for the purpose. At good hardware stores everywhere.

Free Book, "FILE PHILOSOPHY" 48 pages packed with illustrations and facts about kinds, use and care of files. Write for your free copy.

NICHOLSON FILE COMPANY

49 ACORN STREET
PROVIDENCE 1, R. I.

(In Canada, Port Hope, Ont.)

NICHOLSON
FILES FOR
EVERY
PURPOSE

Gus Tames a Runaway

[Continued from page 176]

look at the plugs. Could be they're dirty."

Starting at the front end of the engine, Gus began removing the spark plugs. As he lifted out each one, he shook his head.

"Not likely that it's pre-ignition," he reported as he screwed them back into place and replaced the ignition wires. "All of 'em are clean. And from what I could see squinting through the spark-plug holes, the piston heads aren't too fouled with carbon."

"Well, what now?" asked Ken.

Still Another Question

Gus scratched his head in thought. "Look, Ken," he said, "what I'm going to do next may take some time, so if you have anything else to do go do it. No sense both of us sittin' here fuming."

About half an hour later, Ken was giving one of his workmen some instructions about minor repairs to be made on the merry-go-round when he heard the Ferris wheel engine start up. After a few seconds it stopped. Then it started up again. Ken made off in the direction of the wheel on the double. When he got there, Gus was standing beside the engine, grinning from ear to ear.

"Find the trouble?" asked Ken, puffing.

Gus nodded. "Yeah, finally. It was a short all right, not in the switch but in the wiring. It was a tough one to find, too."

Ken reached over and turned the ignition. The engine stopped just as promptly as any well-behaved engine should.

"Where'd you find it?"

Gus pointed down to the side of the engine. "I went over all the visible wiring without finding a thing. Then I just happened to examine those two wires there where they enter that metal conduit that leads them by the block."

One Question Answered

Ken looked at the two wires Gus had indicated. They now were protected with fresh tape.

"The sharp edge on the hole in that conduit had cut through the insulation on both," Gus explained. "And if you'll follow them through, you'll find that one leads from the generator, the other to the coil. As a result there was a direct connection from the generator to the coil. So no matter what position the ignition switch was

[Continued on page 228]

LAKE MEAD NORTH CHANNEL TRENT WATERWAY
 OHIO RIVER PUGET SOUND
 GEORGIAN BAY LAKE CHAMPLAIN FLORIDA LONG ISLAND SOUND
 TVA WATERWAY INLAND WATERWAY MISSISSIPPI RIVER CHESAPEAKE BAY

NOW! Thrilling new horizons for low-cost outboard cruising!



BIG TWIN by Evinrude

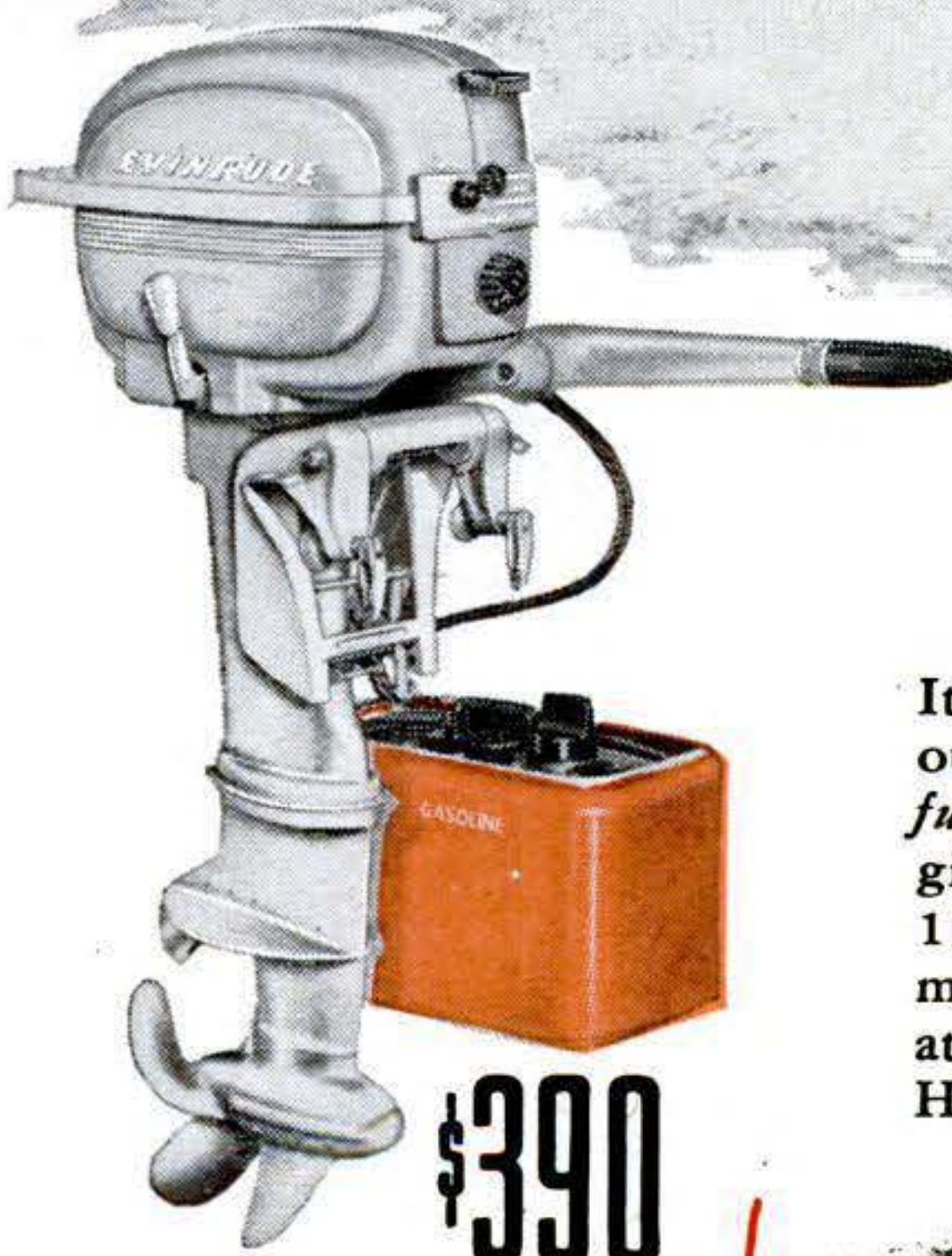

\$390

F.O.B. Factory, subject to change without notice

- 25 HORSEPOWER
- Slow TROLLING
- ROTO-MATIC CONTROL
- GEARSHIFT
- CRUIS-A-DAY TANK

It was bound to come... and it's here... the motor that makes outboard cruising not only completely practical but *tops in cruising fun!* Here's *Power* for the job... reliable *heavy-duty* power that gives the comfortable packet above an easy cruising speed of 15 miles an hour... top speed close to 20... and with two motors, close to 30 miles! Quiet, *flexible* power, superbly smooth at every speed from "wide open" right down to a drifting troll! Here's *new handling ease*... Gearshift with Neutral, Forward, Reverse... and Roto-Matic Speed Control... with complete Remote Controls available for placement at the helmsman's hand. And separate large-capacity Cruis-a-Day Tank. And ALL at the lowest price per horsepower in the field!



CHOOSE YOUR HULL... staunch runabout with shelter top or cabin boat with "all the comforts." Choose your cruising country... broad highways lead to America's loveliest cruising waters... your outboard cruiser can be trailered anywhere!

SEE YOUR EVINRUDE DEALER—let him show you the complete line of Evinrude models... Big Twin and Fastwin for cruisers, runabouts, large family boats... Fleetwin, Sportwin, Sportsman for smaller craft. Look for your dealer's name under "Outboard Motors" in the yellow pages of your phone directory. **CATALOG FREE!** Write for it today!

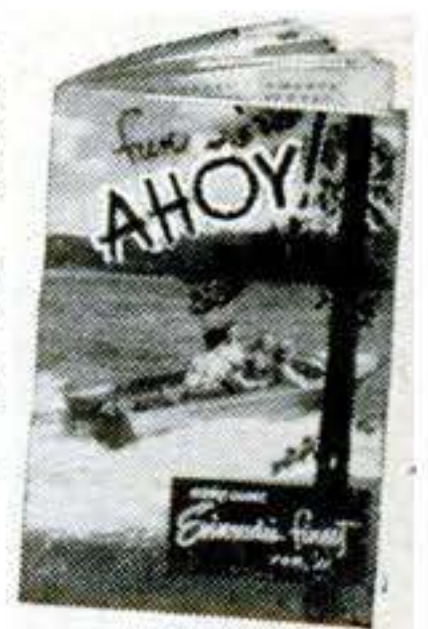

#25 O.B.C. certified brake H.P. at 4000 R.P.M. Approved high-speed operating range, 4000 to 5000 R.P.M. 

EVINRUDE MOTORS 4679 N. 27th ST., MILWAUKEE 16, WIS. In Canada: Evinrude Motors, Peterborough, Ont.

**STARRETT
"SATIN CHROME"
MICROMETERS**

Pioneered by Starrett

Satin Chrome Finish eliminates glare, resists rust and stains. Hi-Micro Mirror Finish on anvil and spindle faces—tapered frame — threads hardened and ground from solid — quick-reading figures — every thousandth numbered — many other big features at no extra cost. Furnished in handsome Sycamore case.

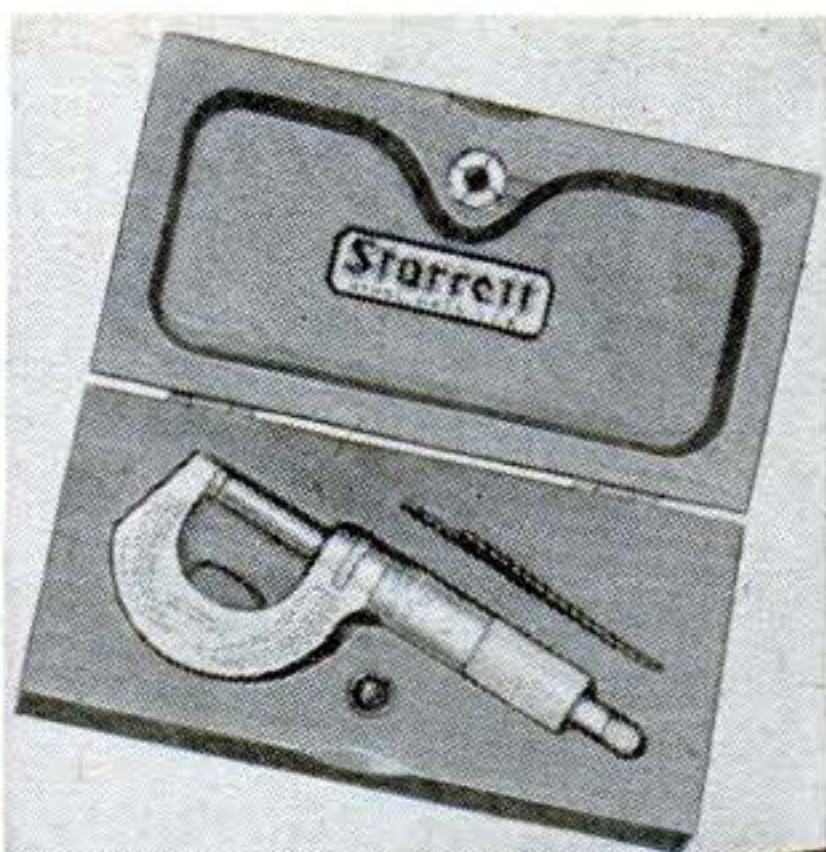

**Own These
Starrett Tools**

**Make Your
Job Easier**

**STARRETT
COMBINATION SETS**

Eight handy tools in one. Hard precision ground steel blade — easy-reading fine graduations of 8ths, 16ths, 32nds, 64ths — stock and blade seat accurately ground — patented fast-action bolt — built-in level — hardened scribe. A Starrett invention, frequently copied — never equalled.



**STARRETT
STEEL TAPES**

Tough special steel tape ribbon — sharp, bright markings that stand out clear on no-glare black ground — quick-reading figures with foot number marked beside each inch — push-button handle — sturdy case — "Standard for Accuracy" — wide choice of lengths and styles.



**SPECIAL OFFER—Only 10¢
50-Page "Tools and Rules" Book**

"The Tools and Rules for Precision Measuring" tells how to make accuracy a habit, shows the methods skilled mechanics use. 100 pictures plus reference tables. Send only one dime. Address Dept. PS.



Only 10¢

THE L. S. STARRETT CO. • ATHOL, MASS., U. S. A.

TRADE MARK
Starrett
REG. U. S. PAT. OFF.

Since 1880... Standard of Precision

Mechanics' Hand Measuring Tools and Precision Instruments
Dial Indicators • Steel Tapes • Hacksaws • Band Saws
and Band Knives • Precision Ground Flat Stock

Buy Through Your Distributor

Gus Tames a Runaway
[Continued from page 226]

in, the coil was always getting juice once the engine was started."

"Okay, but how come then she wouldn't start unless the switch was turned on?"

"With the engine dead, the coil could only get juice through the switch," Gus explained. "You see, the generator isn't even connected into the ignition circuit when you start an engine. The cutout—that's that gimmick mounted on top the generator housing—doesn't kick it in until the generator's turning fast enough to put out more juice than the battery does. Otherwise a battery would discharge back through the generator."

"I get it," said Ken. "So the short didn't feed the coil until the engine got up to speed."

"That's about it," agreed Gus. "And by the way, that tape will hold for now, but when you get a chance I'd put all new wiring in. Most of the insulation is brittle. You may want to replace the coil, too, though it seems all right. The generator may have kicked out enough juice to weaken the insulation on the primary."

"How much do I owe you, Gus?"

"Aw shucks," grinned Gus. "This is my day off. I'll take a raincheck on some rides this summer."

"Second childhood?" laughed Ken.

"Oh, not for me," replied Gus. "I've got a young niece coming to visit me in July and what kid doesn't like a Ferris wheel?"

END

Icebag Has Sealed-In Liquid

THIS lightweight plastic icebag contains a sealed-in solution, which, when frozen in a refrigerator, provides an ice-cold pack lasting about 45 minutes. Waterproof and wash-



able Freezo is divided into 10 segments to make it flexible. It retails for \$1.50, and is made by Pioneer Valley Plastics Co., Springfield, Mass.

YOU DON'T HAVE TO BE A MECHANIC TO INSTALL YOUR OWN COLORFUL KENTILE FLOOR



anyone can do it in
his spare time and
save real money!

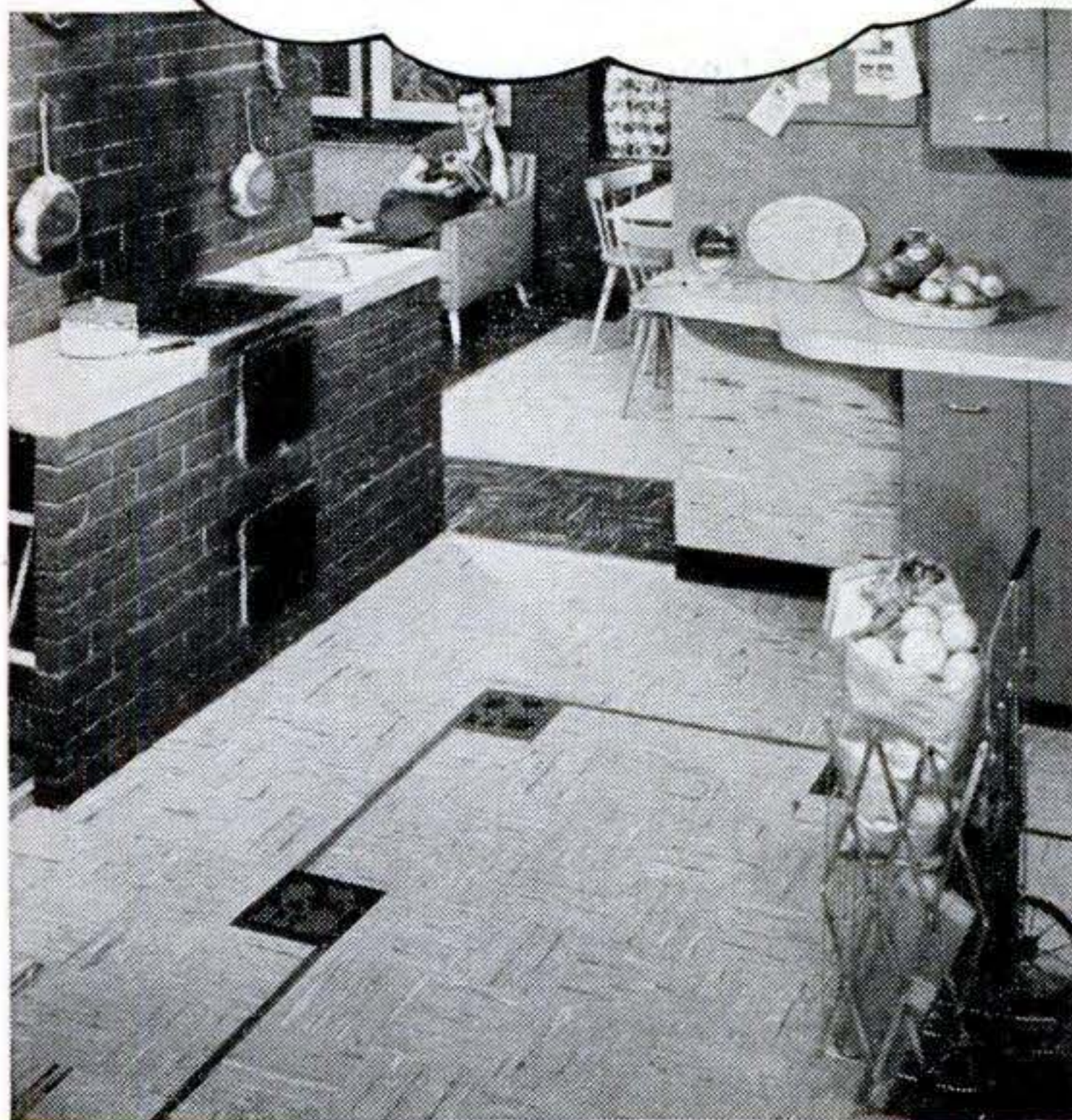

You can have a floor like this in your kitchen
for only **\$1975***

ANYONE can install their own Kentile Floor! The tough, durable squares go down one at a time... for just a small section or whole rooms at once... and colorful Kentile is ready for years of hard wear as soon as it's down. It's quick, easy, fun!

26 wonderful Kentile colors mean that you can create any design you want... match any plan. Kentile's ready-to-install decorative inserts



Or one like this in your living room
for only **\$3625***



Write for your **FREE** copy of the
Kentile Color Booklet showing all
of the sparkling, modern colors in
low-cost Kentile Floors.

make your own floor the only one of its kind.

And, when you've finished, you'll have an attractive floor that will give almost unbelievable service... modern colors that can't wear off because they go clear through to the back of each tile... simple and inexpensive to clean with just mild soap and water. And the fresh Kentile beauty needs only an occasional no-rub waxing to always look new.

**Price based on a 8' x 9' kitchen and on a 12' x 15' living room*

KENTILE.

The Asphalt Tile of
Enduring Beauty 

KENTILE, INC., 58 2nd AVE., Dept. H-1, BROOKLYN 15, N. Y.

Your Kentile dealer's low price includes adhesive, instruction booklet and this handy Ken-Kit that contains all of the simple tools needed to do a neat, long-lasting job.





Installing kitchen accessories!

HOME-UTILITY
1/4" Electric DRILL
 only
\$22.95

Makes household jobs FUN for the whole family!

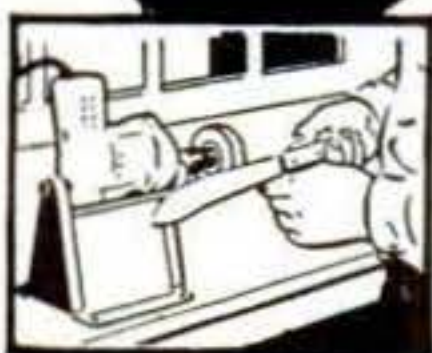

Sharpening cutlery!



Polishing cars!



Refinishing furniture!



Shining pots, pans!

You'll zip through home jobs—save on repair bills, too—when you add a Home-Utility 1/4" Electric Drill to your home appliances! It's so easy to operate that the whole family can enjoy using it to build and repair things around the house. This handy fistful of power drives scores of attachments—twist drills, wood augers, masonry bits, sanding discs, polishing bonnets, wire brushes, light grinding wheels, buffing wheels, etc.—for everything from building cabinets to waxing woodwork!

Quality-built by BLACK & DECKER, world's largest electric tool maker. Operates on AC or DC. Weighs only 3 1/4 lbs. Comfortable pistol grip and trigger switch. Over a million sold. Try one at your hardware, appliance or department store. Or, if you already have one, be sure to ask for the many attachments that make your drill even more useful!

Products of HOME-UTILITY Div.,
 BLACK & DECKER Mfg. Co., Dept. H5S, Towson 4, Md.

ELECTRIC
HOME-UTILITY
TOOLS

1/4"-1/2" DRILLS • LECTRO-SAWS
 SANDER-POLISHERS • BENCH GRINDERS

Mechanics of Farming



By Ladd Haystead

■ Because crop plants breathe during the daytime and rest at night, a new weeding technique to eliminate grass in cultivated fields has been developed in California. Light petroleum oils spread between the rows destroy the grass, but do not harm the growing crop. The reason for this is that the structure of grass is such that oil applied at any time will kill it. By morning, however, it has evaporated so that crop plants are not harmed by it.

■ One of the greatest hazards of farming is the harvest-time loss of crop--estimated by some as high as 50 percent--caused when rain comes at haymaking time or early freezes make the corn soft. Driers that appeared after the war were not satisfactory, but shown here is what may



be the answer. It is a portable jet drier that will handle better than 100 bushels of corn per hour. The machine has a GE jet and a Habco heat exchanger that develops about 30 percent more drying efficiency than previously obtainable. The machine can be adapted for overhead bins, batch, or continuous drying.

■ Isolated areas, where commercial power lines are uneconomic, may get a boost from a new power plant under development at Oregon State College. It is a portable turbine operating on gas generated by burning sawdust, hogged wood, or shavings.

■ Noted in this column last month was the destructive 15 B wheat rust. Fluorescent-lit greenhouses at the

THE MOST *Versatile* TOOL
ON YOUR BENCH...

CHANNELLOCK Pliers

Made only by
CHAMPION DEARMENT!

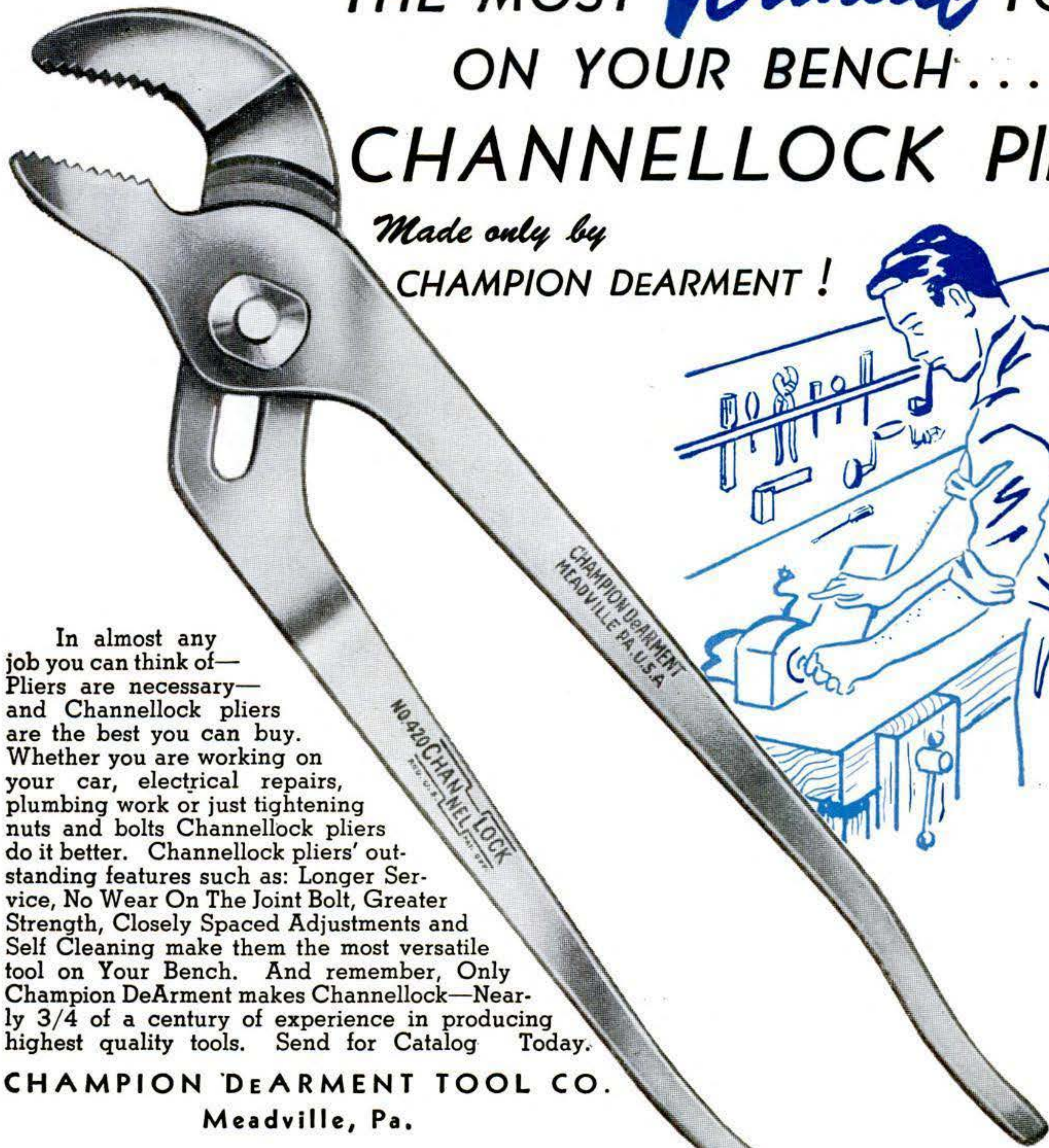

In almost any job you can think of—Pliers are necessary—and Channellock pliers are the best you can buy. Whether you are working on your car, electrical repairs, plumbing work or just tightening nuts and bolts Channellock pliers do it better. Channellock pliers' outstanding features such as: Longer Service, No Wear On The Joint Bolt, Greater Strength, Closely Spaced Adjustments and Self Cleaning make them the most versatile tool on Your Bench. And remember, Only Champion DeArment makes Channellock—Nearly 3/4 of a century of experience in producing highest quality tools. Send for Catalog Today.

CHAMPION DEARMENT TOOL CO.
Meadville, Pa.

Channellock pliers are listed in the Yellow Pages of most Telephone Directories under "Tools"

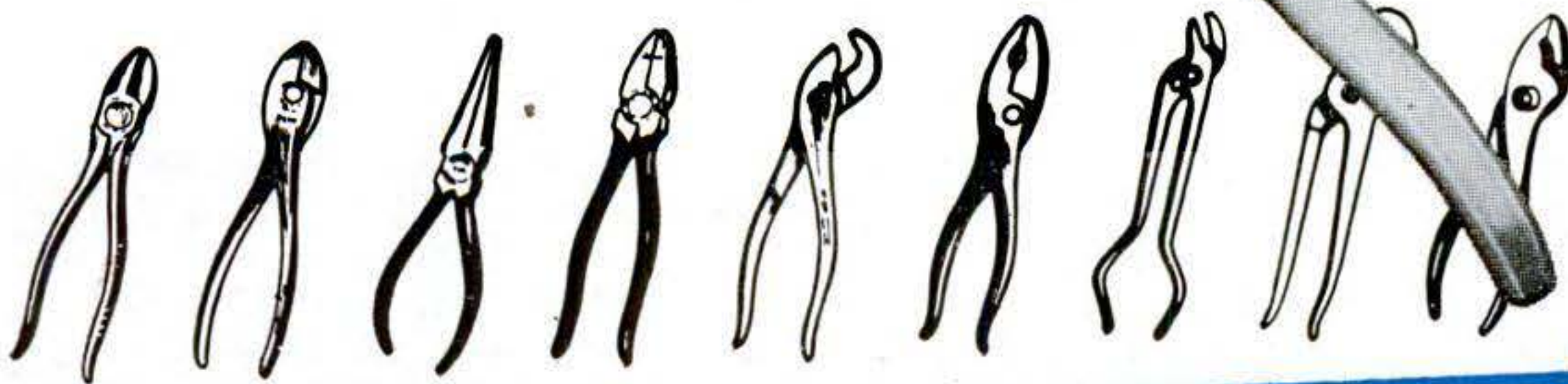

Only CHAMPION DEARMENT...

makes

CHAN NEL LOCK

TRADE MARK REG.

U. S. PATENT OFFICE

YOU CAN'T BUY

finer
screw
drivers

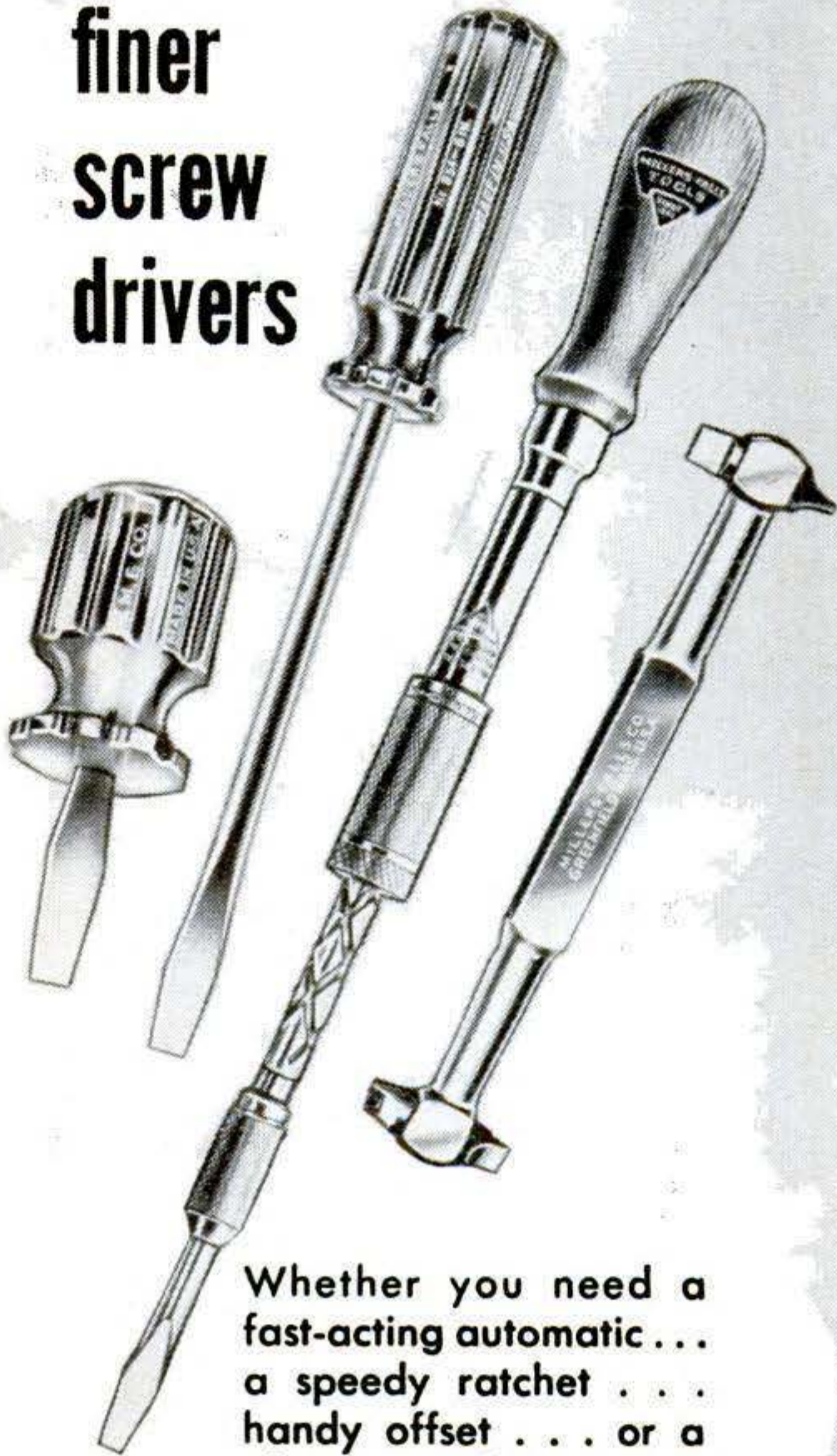

Whether you need a fast-acting automatic... a speedy ratchet... handy offset... or a plain screw driver — you can't beat a Millers Falls. Cross-ground blades of tough, high-grade steel, heat treated for long-lived hardness. Every blade torque tested. Make your next screw driver a Millers Falls — and get the best.

The Mark of Superiority

**MILLERS FALLS
TOOLS**

SINCE
1868

MILLERS FALLS
COMPANY

GREENFIELD
MASS.

Mechanics of Farming

University of Manitoba are now forcing three growths a year to test a new type of wheat that will resist this damage. Hopes for it are high.

■ At the N.Y. State experimental station in Geneva, a machine familiar to roadworkers has been converted into a farm tool that will sterilize five cubic yards of soil in two hours. Two blowtorches mounted in a revolving drum eight feet in diameter destroy fungi that cause "damping off" of seedlings.

■ "It is the judgment of many scientists that if [plant] breeding research were to be discontinued, within a decade most of the varieties of crops now grown would succumb to diseases and the result might be starvation for millions of people," says Dr. R. M. Salter, Chief, Bureau of Plant Industry, U.S. Department of Agriculture.

■ Adding high-purity oxygen to incubator air has improved the hatching of stronger and better-feathered birds in California and Utah. The theory is that eggs are starved for oxygen at higher altitudes. Further experiments will be carried on by the Linde Air Products Co. to see whether this treatment at sea level also will produce "two-day birds" at hatching.

■ Double-paned glass with a dry air space between to give insulation is gaining wide acceptance among farmers. According to Libbey-Owens-Ford Glass Co., it is being used mostly where controlled temperature and humidity is desirable, such as enclosures for livestock, poultry, and milking. In many instances a south-wall installation has been chosen to utilize solar heat.

■ Notice to flies who don't mind DDT: Coming your way is Allethrin, a synthetic that has all the killing properties of pyrethrum, but no prospective wartime shortages. Allethrin, it is claimed, will kill where alternative poisons won't. The Bureau of Entomology and Plant Quarantine says that the new synthetic will provide a reserve against possible shortages of pyrethrum, an oriental import.

You be the judge!

**NOT 5 TOOLS IN 1...NOR 10 TOOLS IN 1...
BUT 100's OF TOOLS ARE YOURS
when you own this new DELTA SAW-SHOP**

SPACE NO PROBLEM!

As little as 25 x 22 inches is all you need to set up this Delta.

NO BELTS OR PULLEYS!

One powerful direct-drive motor does all the work.

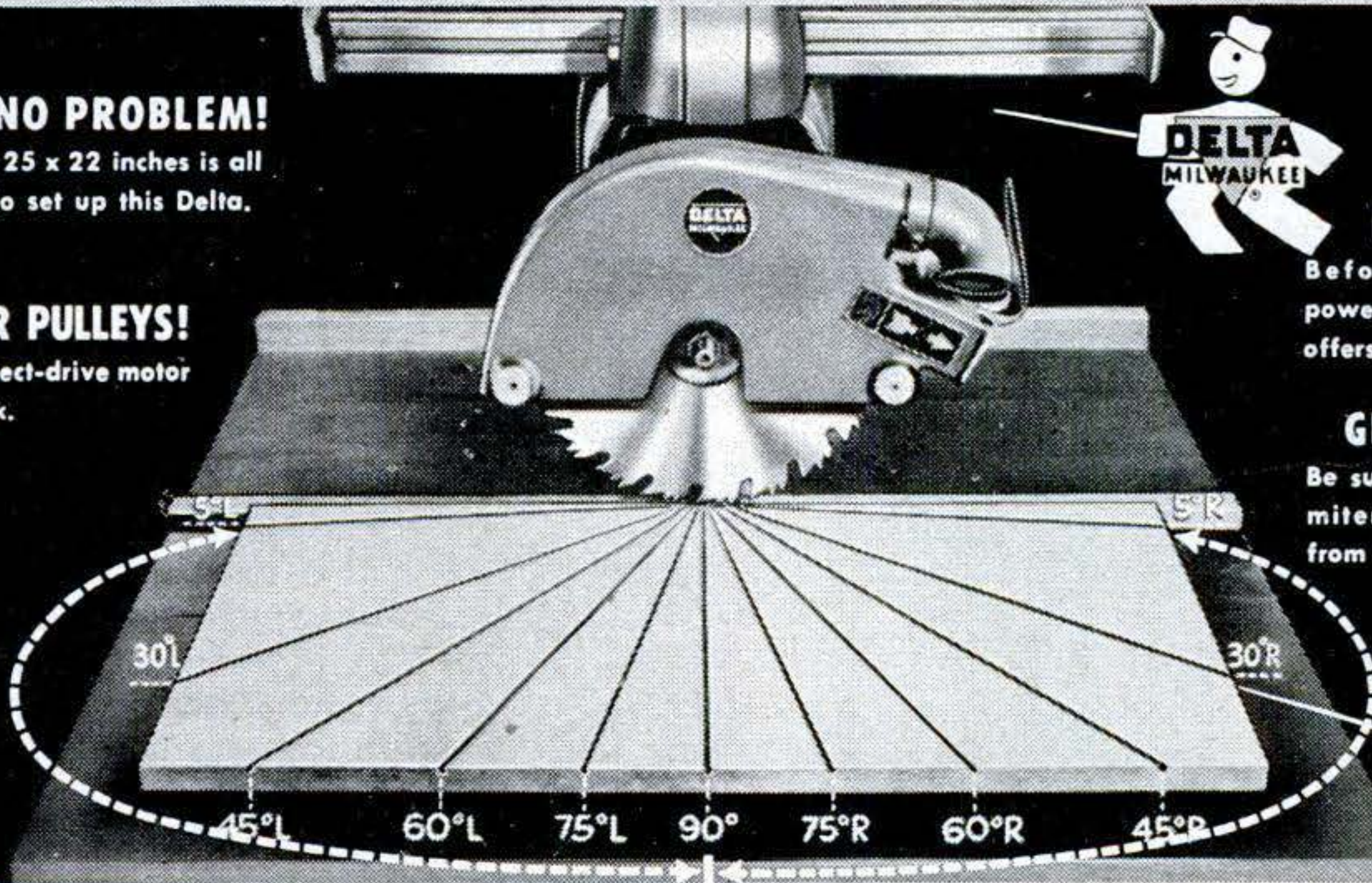

DO THIS!

Before you buy any power saw, see what it offers in miter capacity.

GET PROOF!

Be sure the saw can cut miters and angle-dado from 0° to 90° — both right and left.



The Greatest Value in Power-Tool History!
4 sizes for hobby and industrial shops

THE NEW DELTA
can do more jobs than any other all-purpose saw ever built!

Prove it to yourself in many ways: Start with the important miter test, as shown above... then measure the floor space you need... review the jobs you can do... check the time it takes to change set-ups... compare ease of operation and safety.

This Delta Saw-Shop cuts from above — you can follow layout marks easily. Even most beginners can do expert work from the start without trouble.

The Delta sets against the shop wall, out of the way. Material moves in a straight line on a level table, no matter what cut you make.

The Delta saves time, too. In just a few seconds, you change the cutter on the saw arbor — and have another efficient power tool. It's that fast!

Yes, feature for feature, job for job, the new Delta Saw-Shop is your best buy — comparison proves it! See your nearby Delta dealer today.

Prices start at \$229.50
including motor and blade Plus zone delivery charge (Subject to change without notice)

Tear out coupon and mail today!

Delta Power Tool Division
Rockwell Manufacturing Company
805E E. Vienna Ave., Milwaukee 1, Wisconsin

Send me new Delta Book, "Unlimited Applications."
 Send me Delta Saw-Shop tool catalog, M-50.

Name.....
Title.....
Company.....
Address.....
City..... (.....) State.....

IT'S SHOPSMITH FOR PRECISION

You can tell, just by looking at it, that multi-purpose SHOPSMITH is a tool of exceptional precision. And the facts prove it!

Pictured here is one of the most revealing tests a power tool can be put to. It's the dial indicator test for spindle "runout"—determines variations in the trueness of spindle rotation. Most power tool manufacturers are satisfied with variations of twenty-five ten-thousandths (.0025) of an inch. The allowable maximum for SHOPSMITH is fifteen ten-thousandths (.0015). And the records of all SHOPSMITHS, registered at time of final inspection, show an average "runout" of only eight ten-thousandths (.0008). That's real precision!

It's the same precision you find in other SHOPSMITH parts. The induction hardened spindle is machined to two ten-thousandths (.0002) of an inch. The two tubular steel ways are centerless ground to two thousandths (.002). The holes in each casting are bored simultaneously to assure perfect alignment of all parts.

But precision is only part of the SHOPSMITH story. SHOPSMITH is a rugged, heavy-duty tool—weighs over 200 pounds. It's compact—takes only 2' x 5' of shop space. It's flexible—converts from tool to tool in less than 60 seconds. And it can handle big work—has capacities equal to or greater than the most expensive, production-type tools.

See SHOPSMITH demonstrated—at leading hardware and department stores or any Montgomery Ward store. And send today for your free copy of the illustrated, 16-page SHOPSMITH booklet.

\$189.50

complete 5-tool unit
without motor.*

*Special SHOPSMITH motor
—heavy-duty, ½ h.p., ball
bearing, capacitor, 110 V,
60 cycles — \$34.50.

NEW RETRACTABLE CASTERS

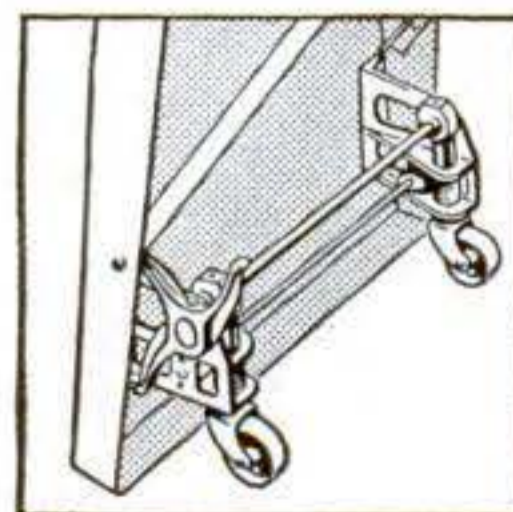

For moving, rolling or locking 225-pound SHOPSMITH. Mount easily on any wood or metal bench. Set by three-stage foot lever. At your SHOPSMITH dealer's. \$11.95.

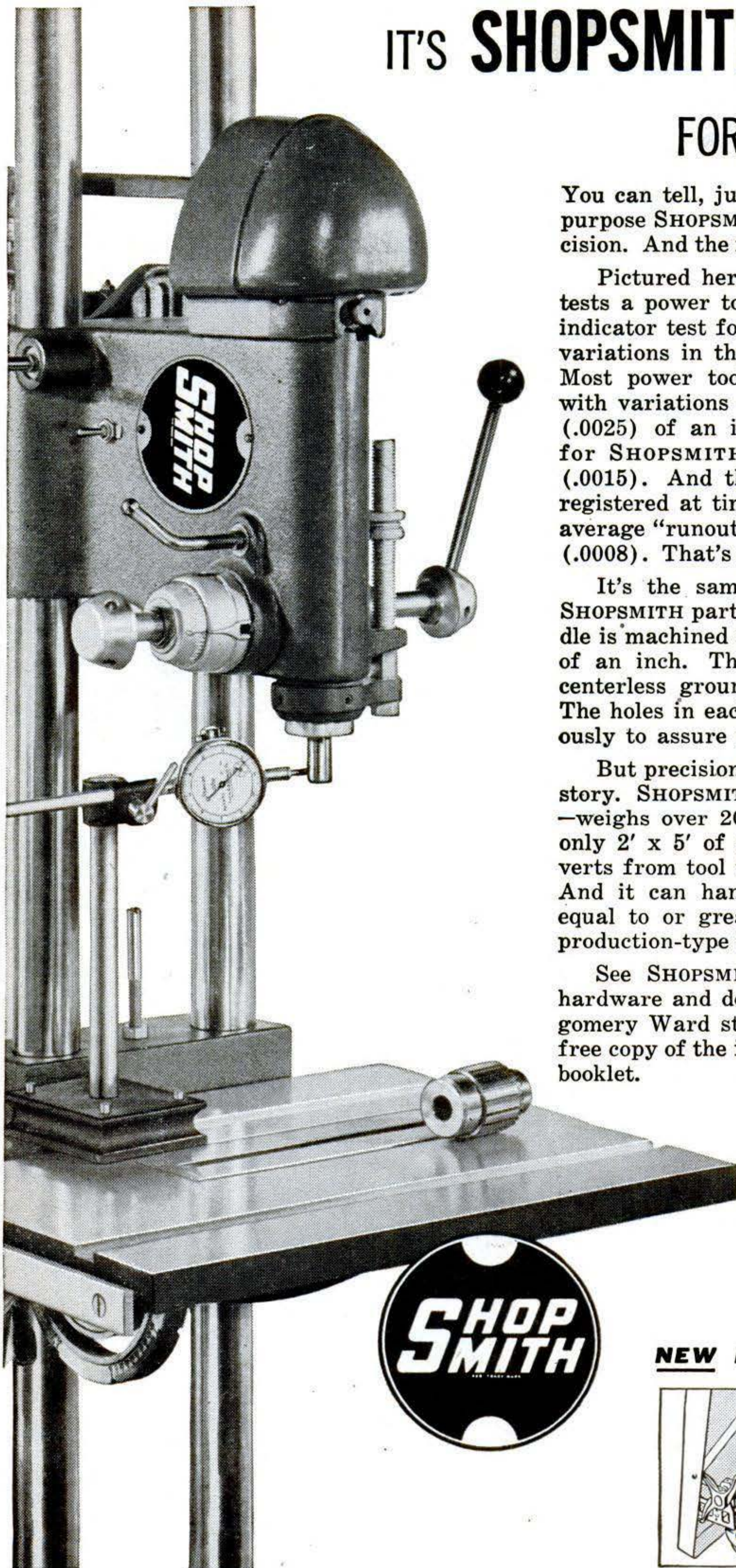

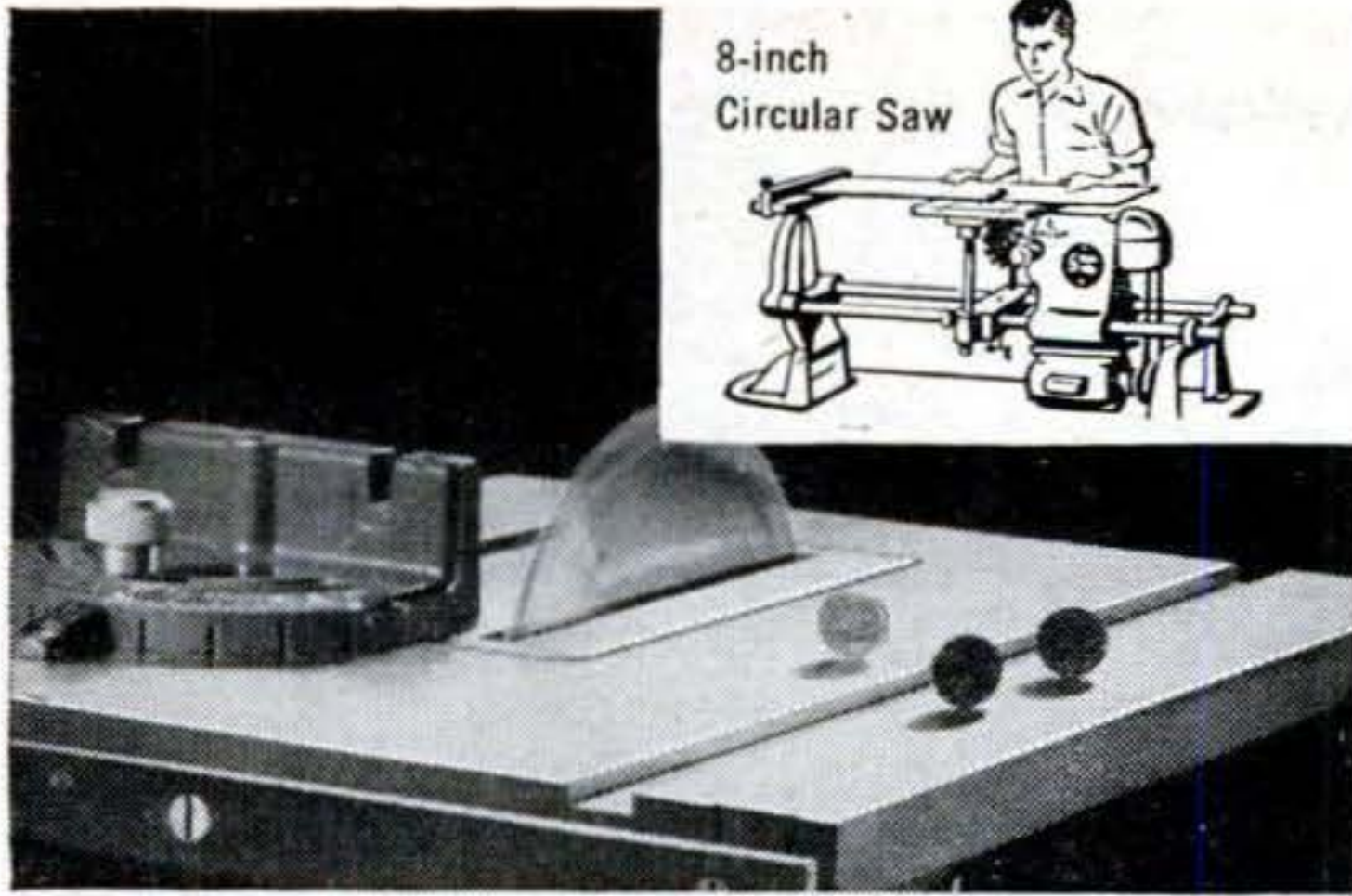

VIBRATION TEST. Nickels stand on edge while SHOPS MITH saw whirls at full speed. Quiet, vibration-free operation is due to precision construction, four ball bearings in arbor, and extreme rigidity of tubular steel ways.

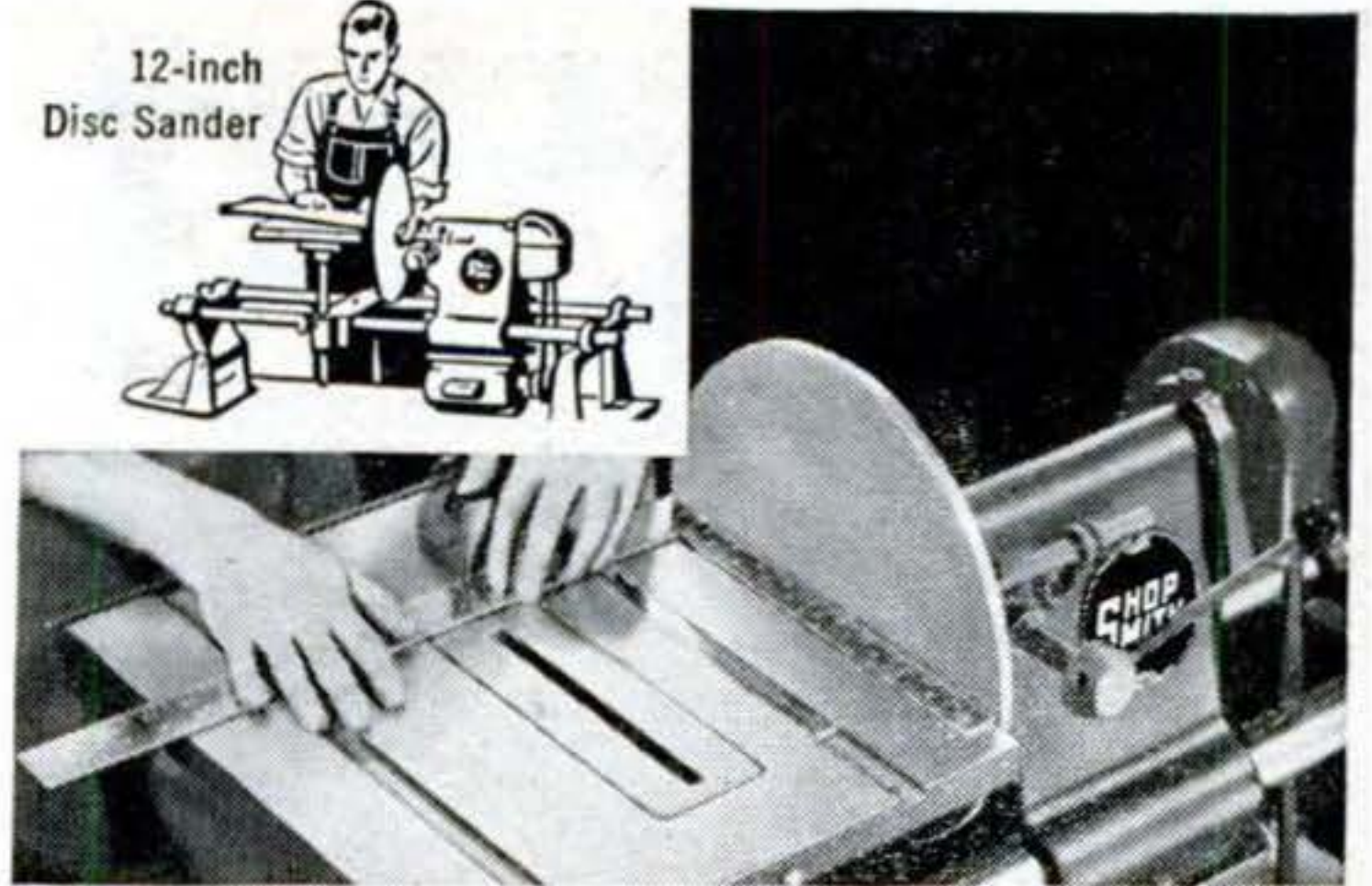

SQUARE FINISH. Carpenter's square demonstrates accuracy of SHOPS MITH as a disc sander. Accuracy is automatic because of extra-large table, micro-graduated miter gauge, exclusive feature which permits disc to be fed into work.

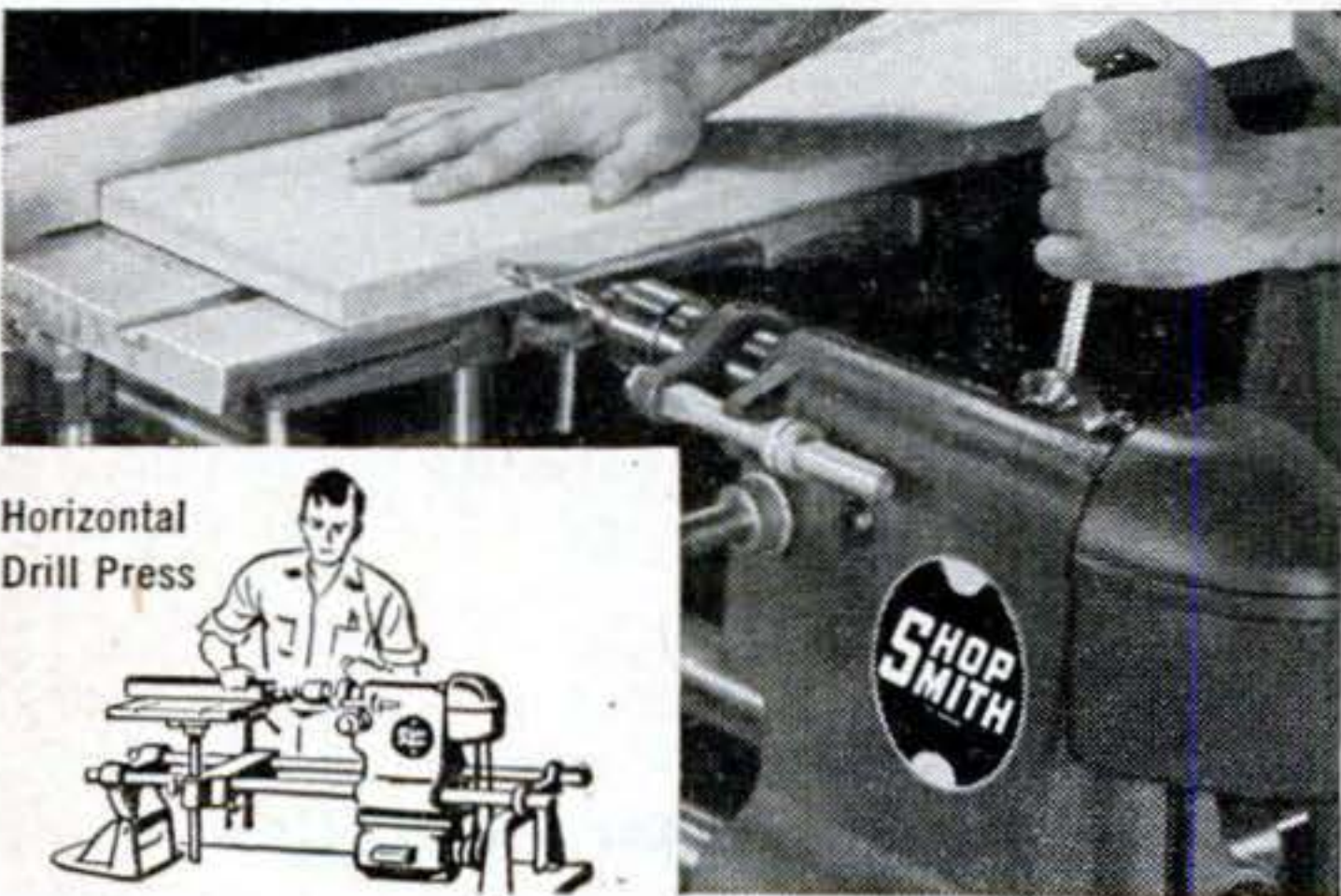

NEW AND PRACTICAL. Horizontal drilling takes the limit off the length of the work you can handle, performs drilling operations that are impossible or which require special jigs on vertical drill. 4-inch quill feed. Adjustable depth gauge. Variable speeds.

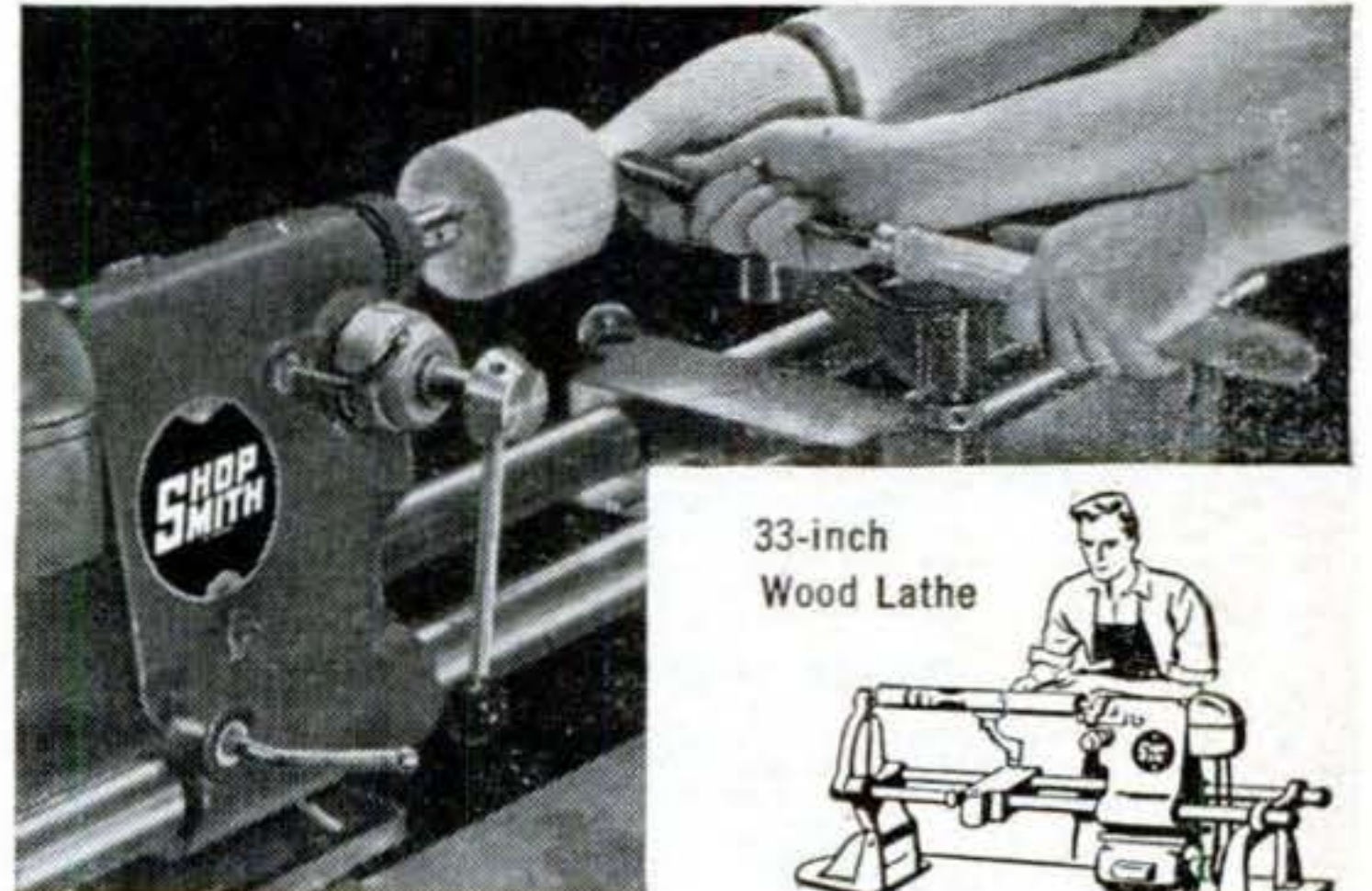

RIGID LATHE BED. In less than a minute, SHOPS MITH can be converted to a heavy-duty wood lathe with 15-inch swing, 33 inches between centers. Thick-walled centerless ground steel ways, stress-tested at over a ton, assure minimum vibration.

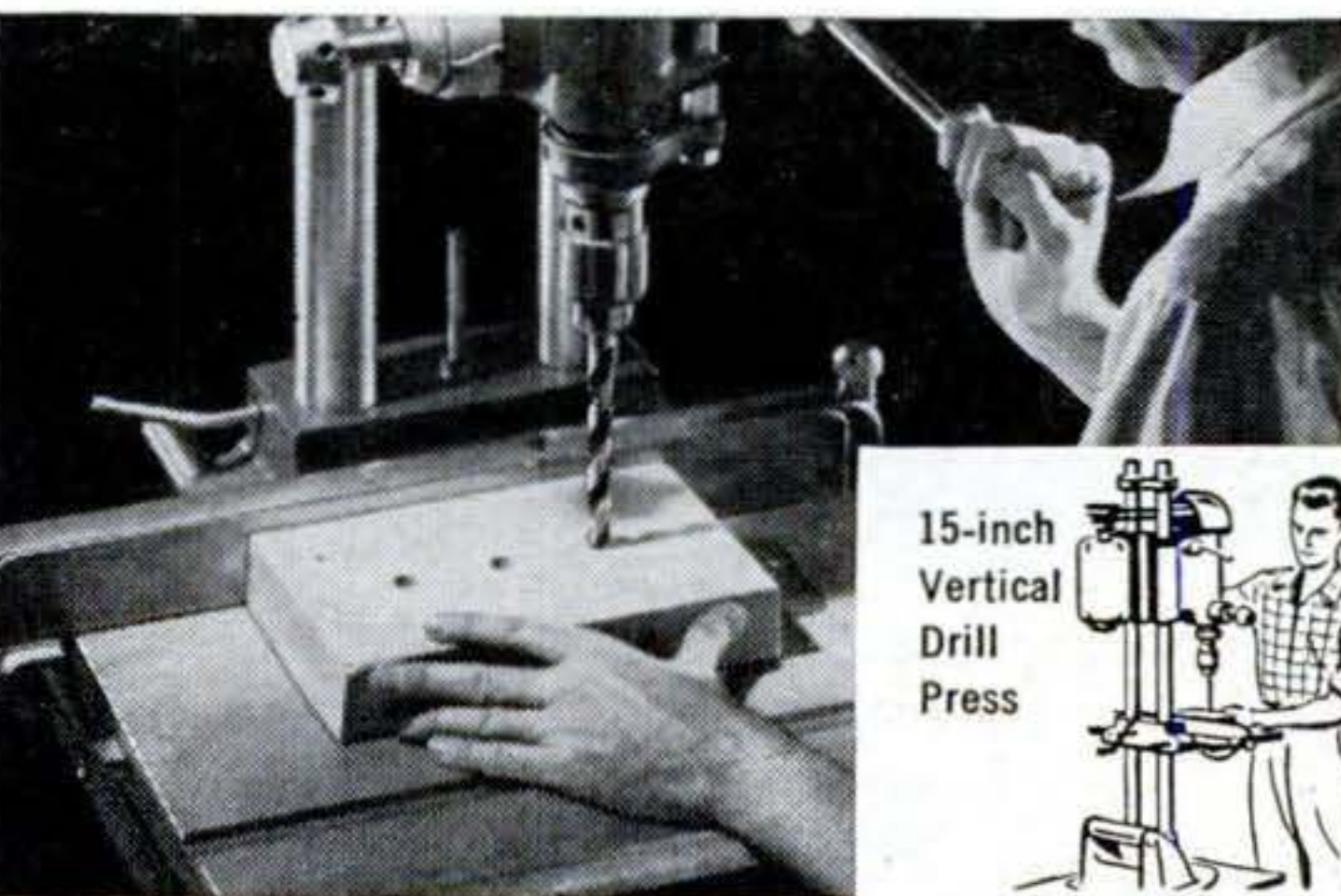

PERFORMANCE PLUS. For accuracy, capacity, precision features, you can't beat SHOPS MITH as a vertical drill press. Jacobs key chuck takes drills up to 1/2 inch. Note use of rip fence as handy guide for accurate drilling.

PRECISION-MADE SHOPS MITH IS A PRODUCT OF THE MAGNA ENGINEERING CORPORATION

GET ALL THE FACTS!

Compare before you buy. Illustrated, 16-page booklet brings you detailed specifications, describes SHOPS MITH's many operations. Send for it! It's FREE!

**ADDRESS:
SHOPS MITH**

Dept. 170-A, at factory nearest you:
12819 Coit Road, Cleveland 8, Ohio, OR
417 Montgomery Street, San Francisco 4, Calif.

Name _____

Address _____

City _____ State _____



FREE

Gigantic "Warehouse Remodeling" MAIL SALE

SAVE up to 70%!

Check these bargains:



POWER PLANTS AND GENERATORS

- **Army Homelite Power Plant:** 1500-w, 115-v, 60-c. New condition. Guaranteed. While they last. **\$259.50**
- **Kato Generators.** 5000-w, 115-v, 60-c. Single phase. Complete with 4-sheave pulley, controls, voltmeter, etc. Drive with tractor, old auto engine, New condition. Perfect. Cost over \$450. Special. **\$259.50**
- **Power Plants.** 110/220-v, 60-c. Large quantity. All types. 3, 5, 10 kw. Write for circular.
- **D-C Arc Welder.** 0-250 amps. Drive with tractor, engine, etc. Ready to use. Built in controls, reactor. Brand new. **\$99.50**
- **Build Welding Generator.** Delco-Remy, 200 amps, 30-v. Full instructions. Includes control, fan, etc. Cost \$296. **\$24.65**

We Pay Shipping Charges

WINCHES, CLUTCHES, TRANSMISSIONS, ENGINES



- **Boat Hand Winch.** Fine for boats, docks, trailers, etc. 1 to 4 ratio. 2000 lbs. **\$19.95**
- **Hand Winch.** Finest steel. Powerful, complete, with 30 ft. cable. 2500-lbs. 1 to 3 ratio. **\$29.95**
- **Hand Winch.** Dual gear ratio. 1 to 3, 1 to 9. With 50 ft. cable 3000-lbs. **\$39.50**
- **Utility Clutch.** Engine end takes 1" shaft. Drive end 3/4". Handles engines or motors up to 6.5 h.p. **\$13.95**
- **Motor Clutch.** 1/2", 5/8" or 3/4" shaft size. Up to 1.5 h.p. **\$7.50**
- **Speed Reducer.** Drive 1750. Gives 0 to 450 RPM. **\$19.95**
- **Pulley Clutch.** 3 h.p. 4 1/2" pulley, easy release. A buy. **\$7.95**
- **Gas Engine Bargains.** 1, 2, 5, 20 h.p. Write for list.

SENSATIONAL VALUE! 12-FT. FLEXIBLE STEEL GUY CABLE, 14-IN. TURNBUCKLE

Powerful 48-strand galvanized steel wire cable, 1000-lb. pull. Strong turnbuckle, 12-in. adjustment. Wonderful to guy, strengthen gates, fences, buildings, doors, windmills—secure television antennas—excellent tow cable. Cost Gov't. \$1.10 each. Special—10 for \$3.89; 50 for \$16.47; 100 for \$29.32. Frt. Ppd.



WATER PUMPS AND SYSTEMS

- **Bronze Rubber Rotor, Low Pressure Water Pumps.** Stainless steel shaft. Pipe thread. Self priming. High efficiency. 1/2", up to 25 PSI, up to 6 GPM. **\$12.75**
 - 3/4", up to 25 PSI, up to 10 GPM. **\$16.95**
 - 1" up to 25 PSI, up to 19 GPM. **\$22.95**
 - **High Pressure Pump.** Stainless steel shaft. Pipe thread. Self priming. Positive displacement. 1/2" up to 100 PSI, over 5 GPM. **\$14.50**
 - 3/4" up to 150 PSI, over 8 GPM. **\$20.95**
 - 1" up to 150 PSI, over 17 GPM. **\$27.95**
 - **Surplus Gear Oil Pump.** Cost \$35. **\$3.95**
 - **Hi-Efficiency Cent. Pump.** Garden hose thread, over 15 GPM. **\$11.95**
 - **Water System.** Automatic, finest 110-v, 60-c motor, 22' lift. 300 GPH. 30 lbs. Fresh water instantly. No tank needed. For cabins, cottages, farm homes, etc. **\$69.50**
- (Write for free pump circular. Give details your problem)

AIR COMPRESSORS AND SPRAY EQUIPMENT

- **DeLuxe Air Compressor.** Pressure to 150 lbs. Capacity to 3 c.f.m. Single cylinder, 2" bore, 1.75 stroke. **\$20.50**
 - **Build Your Own Compressor.** 1-cy. piston compressor, stainless 13" x 25" tank, 160 lb. gauge, paint spray gun, blow gun, tire chuck, 15' hose, fittings and data. **\$39.90**
 - **Stainless Steel Air Tank,** brand new, 13"x25", 400 lbs. **\$9.95**
 - **Brass Chuck Valve,** (dash pot non-chatter type-1/4", 3/8" PT) **\$3.75**
 - **Brass Adjustable Pop Off Valve,** 25 to 250 lbs. **\$1.98**
 - **Automatic Pressure Regulator** (0 to 150 lbs.) **\$2.69**
 - **Automatic Pressure Motor Switch,** on 115, off 150 lbs. **\$5.87**
 - **Finest Pressure Gauges** (air or water) specify pressure—60, 100, 160, 300 lbs. **\$1.99**
 - **DeVilbiss Air-Solvent Engine Cleaner,** \$14.95 value. **\$8.96**
 - **Home Paint Spray Outfit.** Includes gun, hose, etc. less motor. \$25 value. Special. **\$18.95**
- (Write for paint spray equipment bulletin)

- **WEED SPRAY OUTFIT** Close-out sale. Finest 4-row, complete, less barrel. \$140 value. Sale. **\$84.50**
- **5-Row.** Write for details. **\$106.50**

MECHANICAL—ELECTRICAL—ELECTRONICS

- **Rural Phone,** Magneto, 5-bar, 2500-ohm, wall type. **\$12.40**
 - **Private Phone,** Magneto, desk, per pair. **\$19.90**
 - **Acro Saw** fits on any 1/4" drill, cuts full 1-15/16". **\$9.95**
 - **Army Switchboard,** 12-line, small hotels, factory, etc. **\$33.50**
 - **Phone Insulated Wire,** twisted pair, outdoor type (100-ft.) **\$1.39**
 - **Stone Job Lot,** 12 finest Norton wheels, 1" to 4". **\$3.89**
 - **Mounted Stone Job Lot,** 4 mounted stones, 1/4" wire brush **\$2.19**
 - **Rotary File Kit Lot.** (1/4") 6 Assrt. tool steel units. **\$3.26**
 - **Electric Water Heater,** 5 1/2 gal. 110-v. 1200-w Guar. **\$49.50**
 - **Motor 2 H.P.,** 24-v. D-C. Double shaft, 4000 RPM. **\$10.89**
 - **MotorGyro,** 24-v. D-C. 10,000 RPM. Fascinating! **\$1.98**
 - **Parts Cabinet.** All steel, 4 drawer, 16 compartments. **\$2.78**
 - **Precision Hand Level.** With leather case. **\$7.95**
 - **Finest 7x50 prismatic binoculars,** tax paid. **\$45.95**
 - **Furnace Squirrel Cage Blowers,** \$25 Value. **\$18.70**
- (Hundreds other electrical-radio-mechanical-tools bargains)

ORDER DIRECT FROM AD or Write for Free Catalog!

FREE CATALOG

BURDEN SALES COMPANY

827 "O" ST.

LINCOLN, NEBR.

Wiper Scrapes Grease off Hands

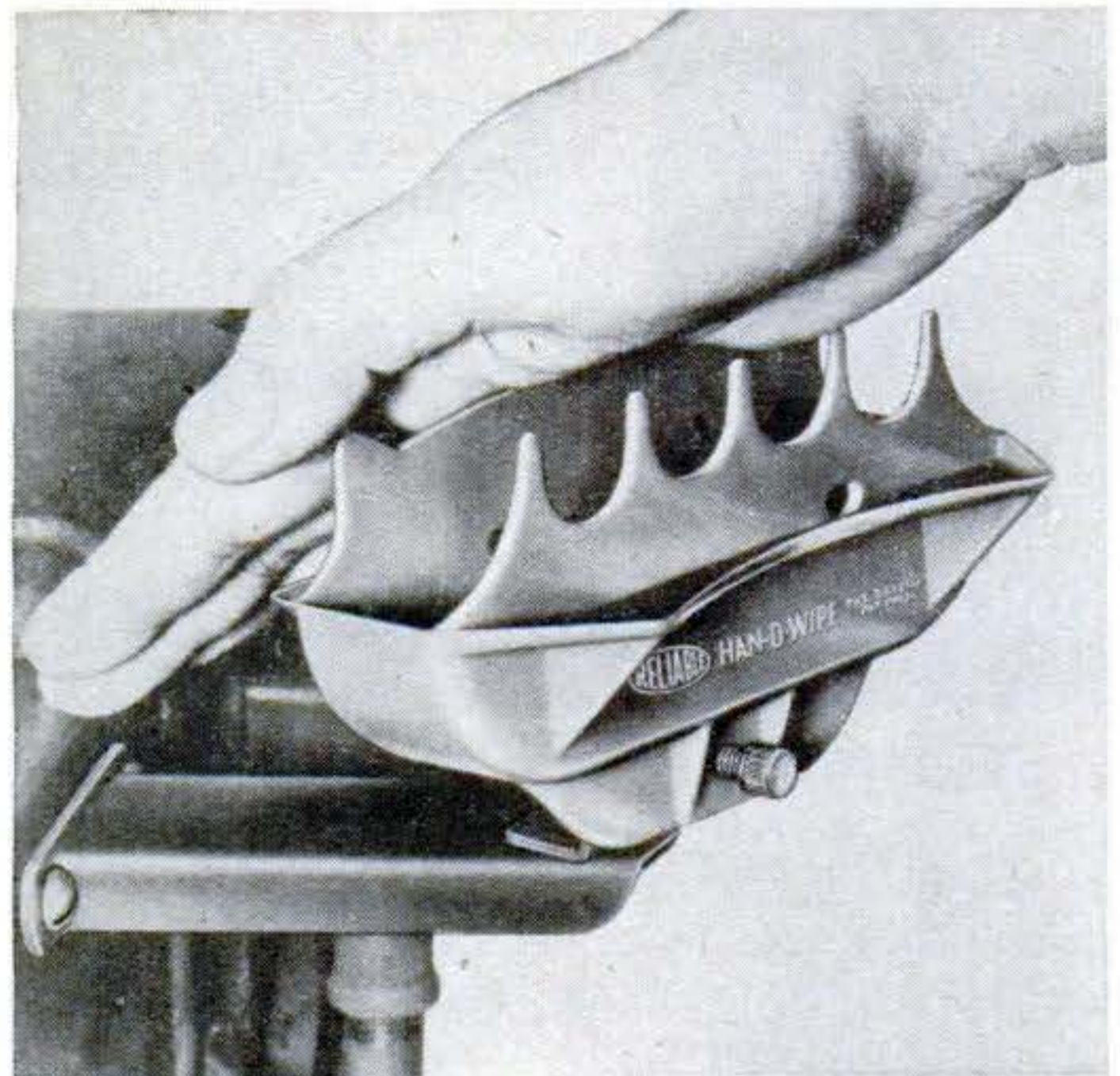

THIS plastic wiper permits a grease monkey or machine operator to free his hands of grease and oil without the use of rags. The hand is simply scraped through the Han-D-Wipe, the palm being cleared by the straight rear plate and the fingers wiped clean by the individual cut-outs. Wipings drop into the bottom of the bowl for disposal. The Reliable Machine Works, of Brooklyn, prices it at \$2.45.

Wind-Velocity Gauge for Home Use

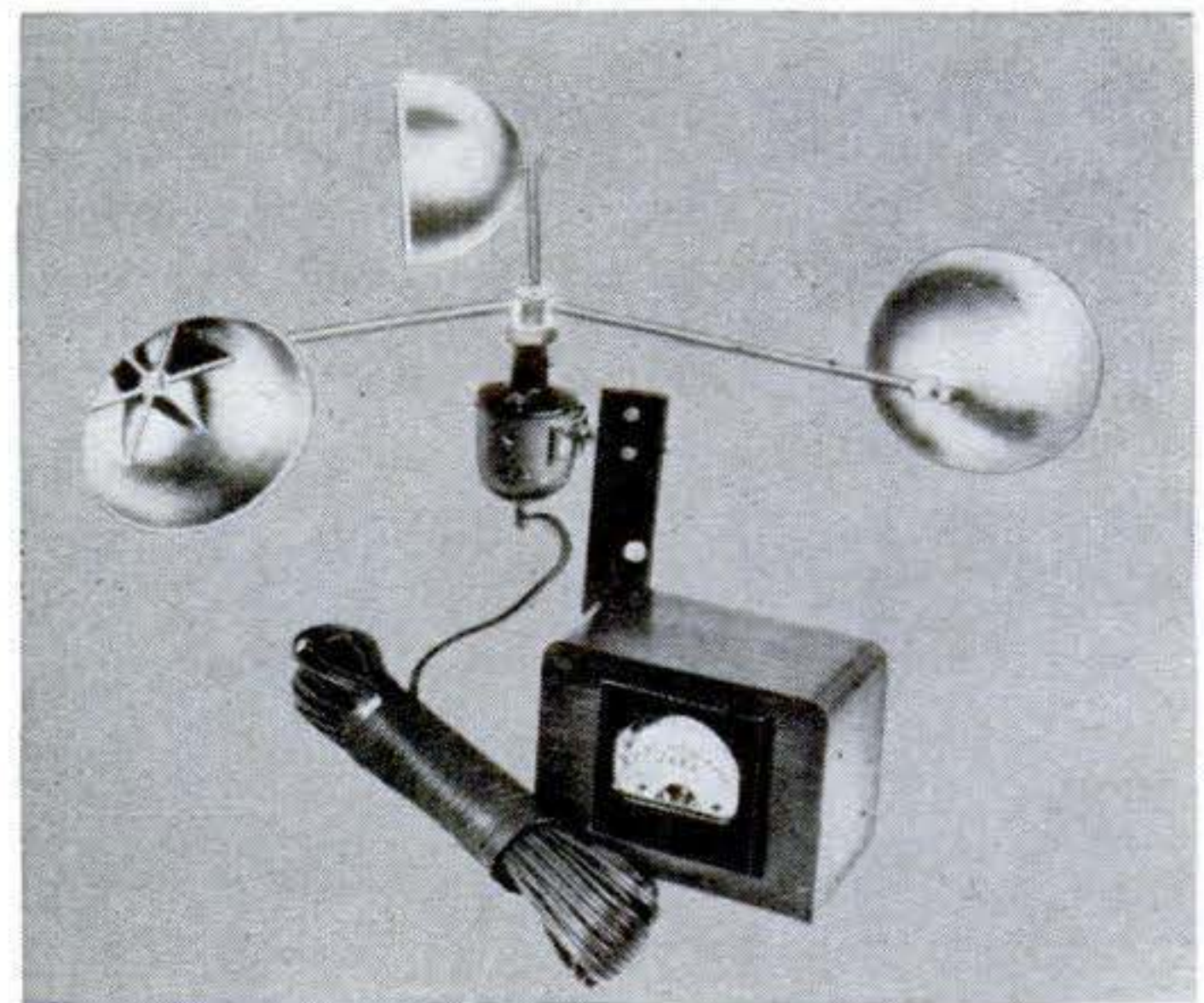

A NEW and comparatively low-cost wind-velocity meter for home use is put on the market by Batson Electronics, Inc., of Omaha, Neb. The rotor is mounted on a pole or rooftop, while the meter case may be placed on a desk or wall as far as 200 feet away. The spinning rotor generates current that, when measured by the meter, indicates wind speed—up to 75 m.p.h. The Galeage is priced at \$29.50.

The ONLY kind of screening that can't Rust, Rot or Corrode!

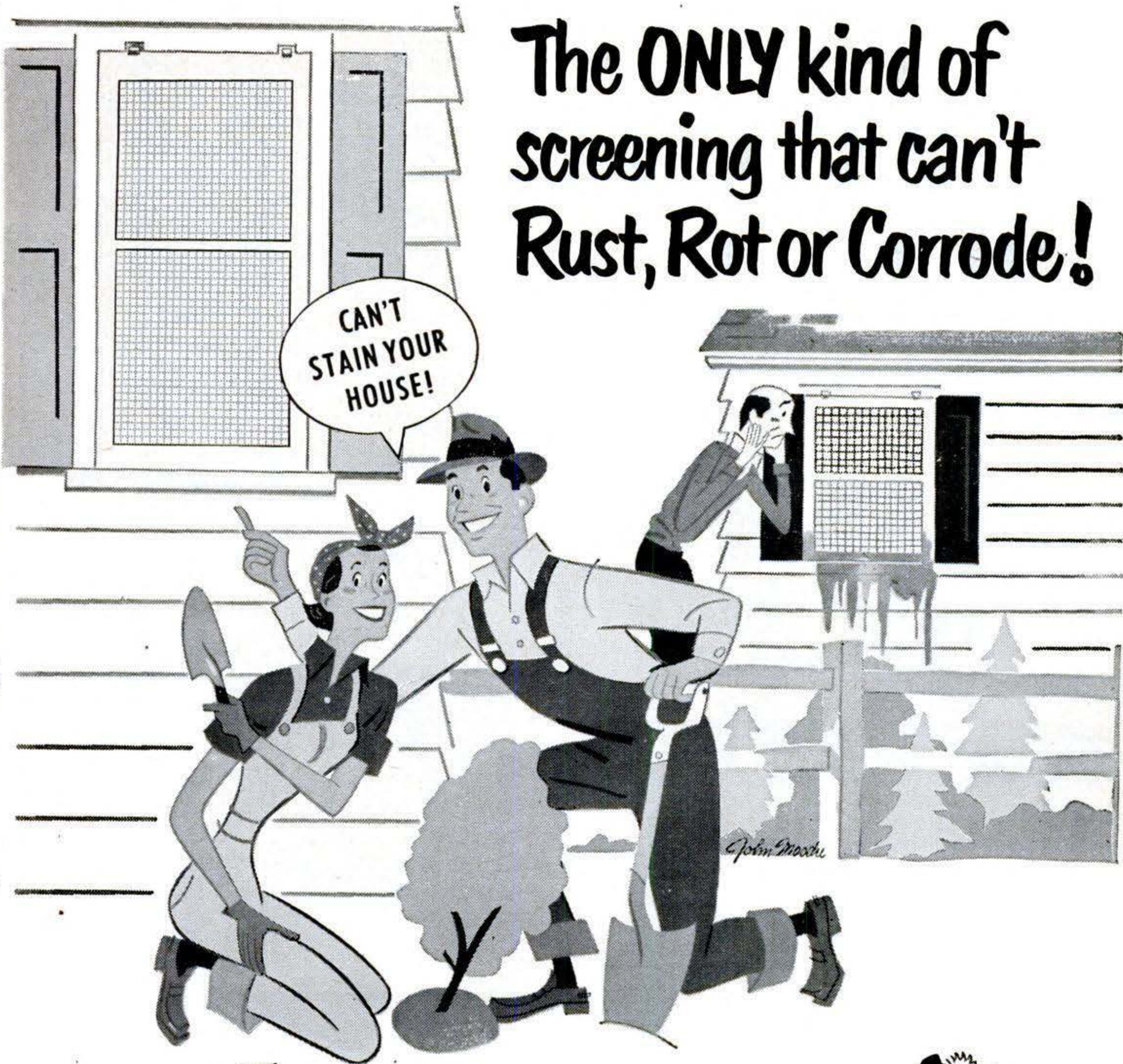

NEEDS NO PAINTING to protect it, because: Neither snow, rain, smoke, fog nor salt air can harm Lumite screening! Cleans easily with a damp cloth.



LASTS LONGER, because Lumite screening has greater resistance to blows, and because it can't rot out! It won't sag or bulge when properly framed . . . and it's easy to handle.



COSTS LESS than all but the cheapest screening! And you can leave these screens up all year 'round. Lumite is the ideal screening for every exterior use.



Buy Lumite screening at your Hardware, Lumber or Building Supply Dealer. Or write for FREE SAMPLE and descriptive folder to: Lumite Division, Chicopee Mfg. Corp. of Georgia, 40 Worth Street, New York 13, N. Y.

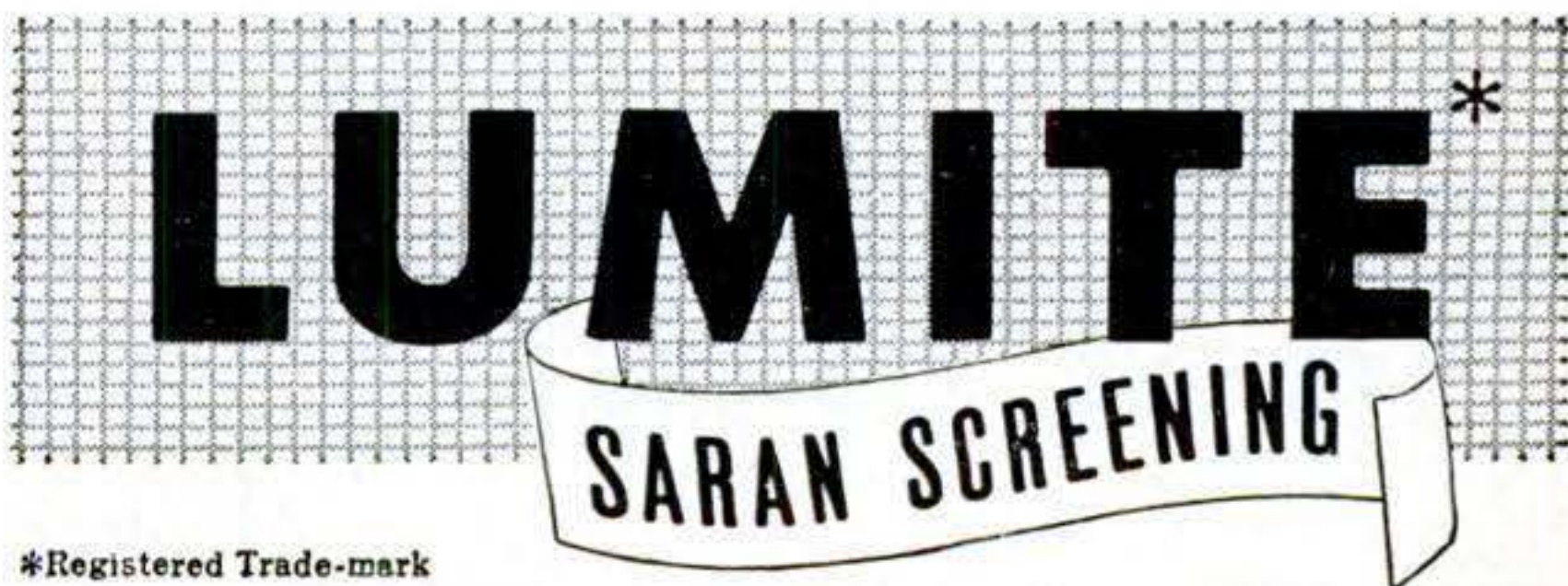

*Registered Trade-mark

Made
\$900
IN SPARE TIME

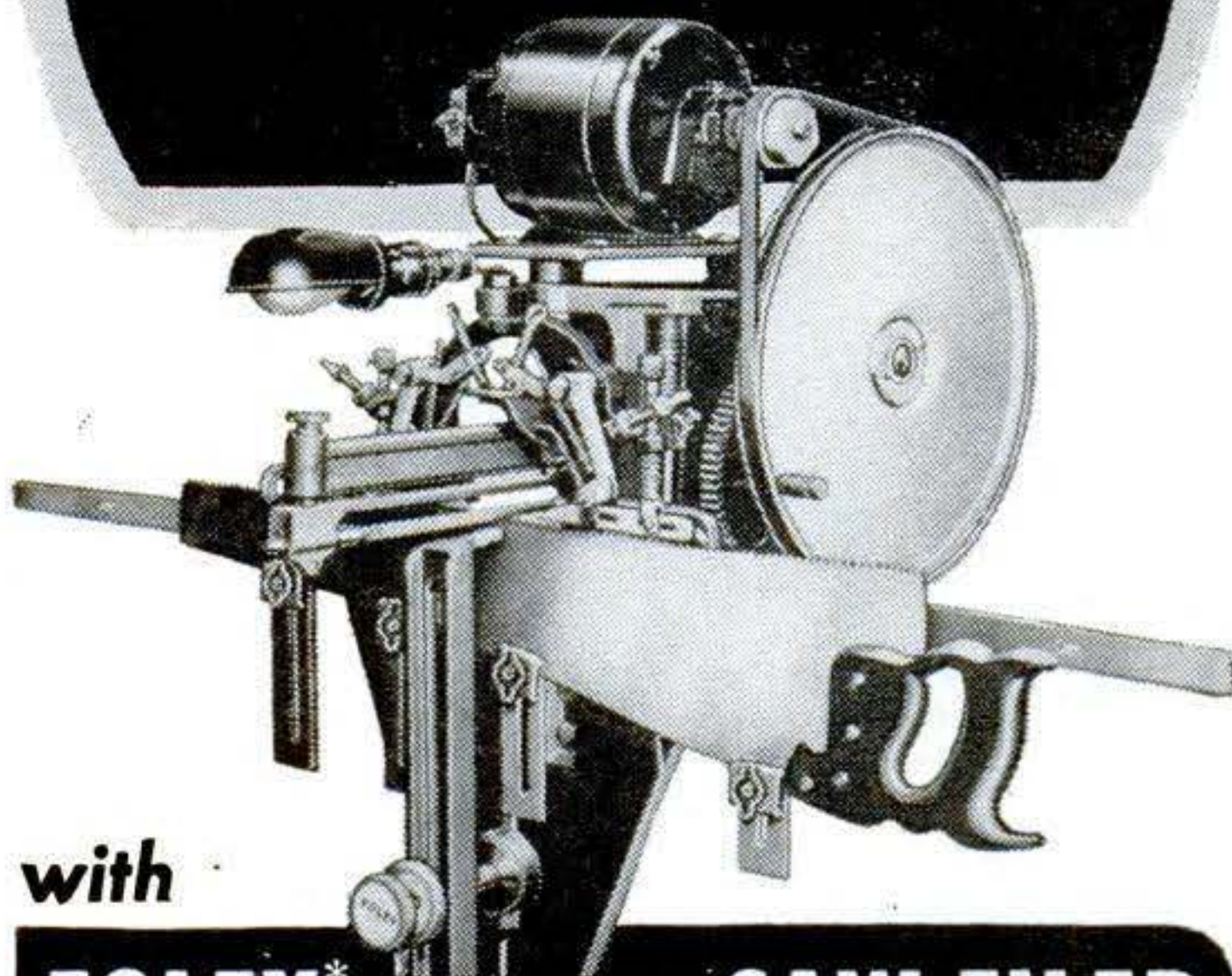

with

FOLEY* automatic SAW FILER

*Trade Mark Reg. U. S. Pat. Off.

"I did very well last year with my Foley equipment, about 950 saws and 240 lawn mowers, in my spare time. About \$900 for me."—Leo H. Mix. "I have done 4 or 5 thousand saws in my spare time in the 4½ years since I got the outfit, and they are all coming back."—says Len Crego.

Make up to \$2 or \$3 an hour in Spare Time. With the high prices of food, clothing and everything else, just think what you could do with extra money every week! With a Foley Automatic Saw Filer you can file hand, band and circular saws better than the most expert hand filer. "The first saw I sharpened with my Foley Filer came out 100%"—writes Clarence E. Parsons. Every saw you sharpen with the machine accuracy of the Foley Saw Filer is an ad that brings you more customers. Cash business, no canvassing. No eyestrain, no experience needed.

FREE BOOK

"INDEPENDENCE AFTER 40!"

Shows just how you can start at home in spare time in your basement or garage. Just think—with a small investment, no overhead, no stock of goods to carry, you can get right into a cash business—and later on develop into a full-time repair shop. Send coupon today for this practical plan. No salesman will call.



Send Coupon for FREE BOOK

FOLEY MFG. CO., 519-1 Foley Bldg., Minneapolis 18, Minn.

Send FREE BOOK—"Independence After 40".

Name.....

Address.....

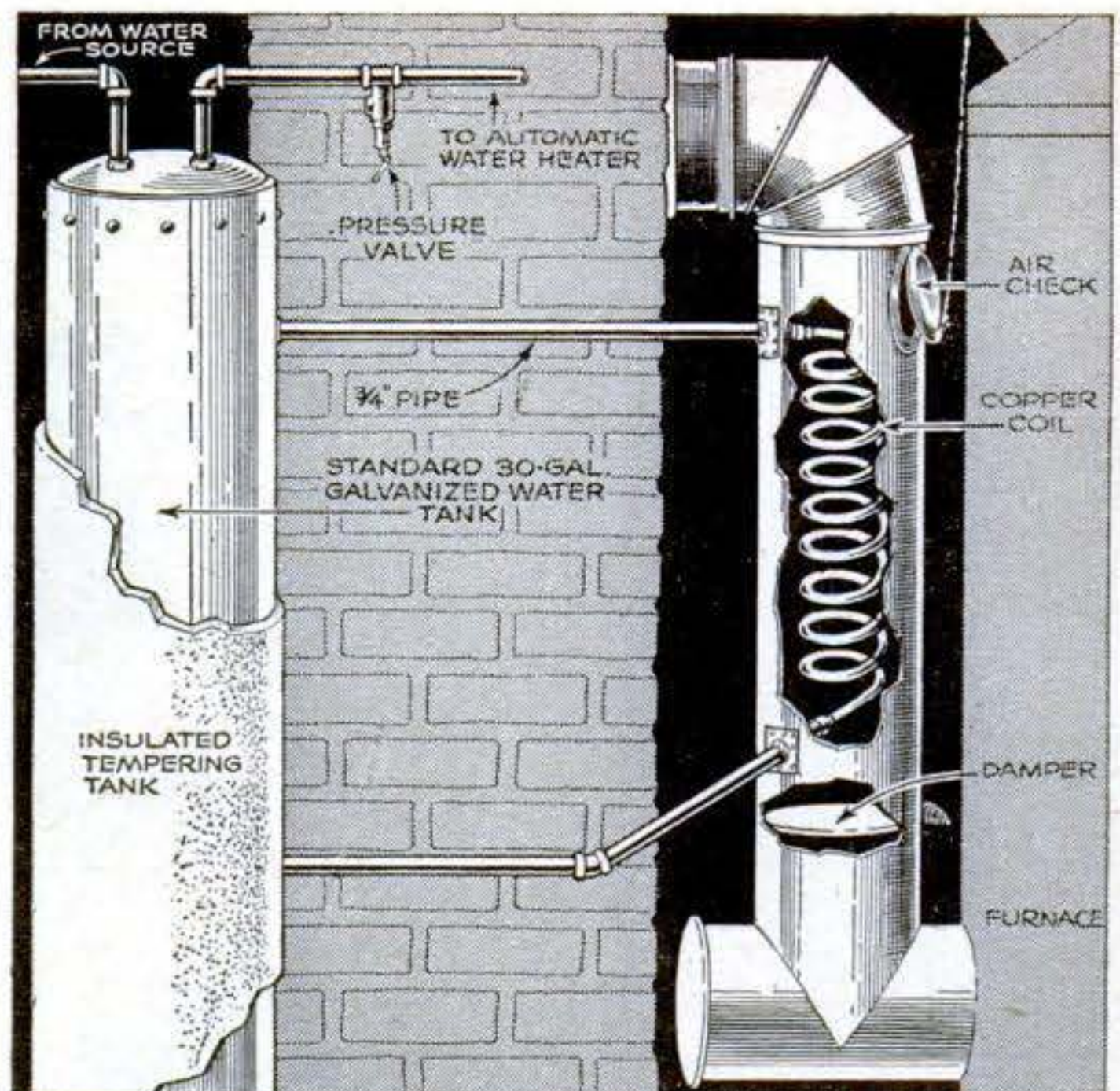

Tank Cuts Water-Heating Cost

MY AUTOMATIC water heater proved costly until I installed the setup shown. It preheats water with heat normally lost up the furnace smoke pipe and stores the heated water in a tempering tank. I placed the coil in the smoke pipe where it would not interfere with the damper or check valve. Then I connected the pipes. To make the joints smoke tight, I cut squares of tin to fit snugly around the inlet and outlet pipes and screwed the squares to the smoke pipe. I filled in any crevices with powdered iron cement.—Harold J. Pearson, St. Cloud, Minn.

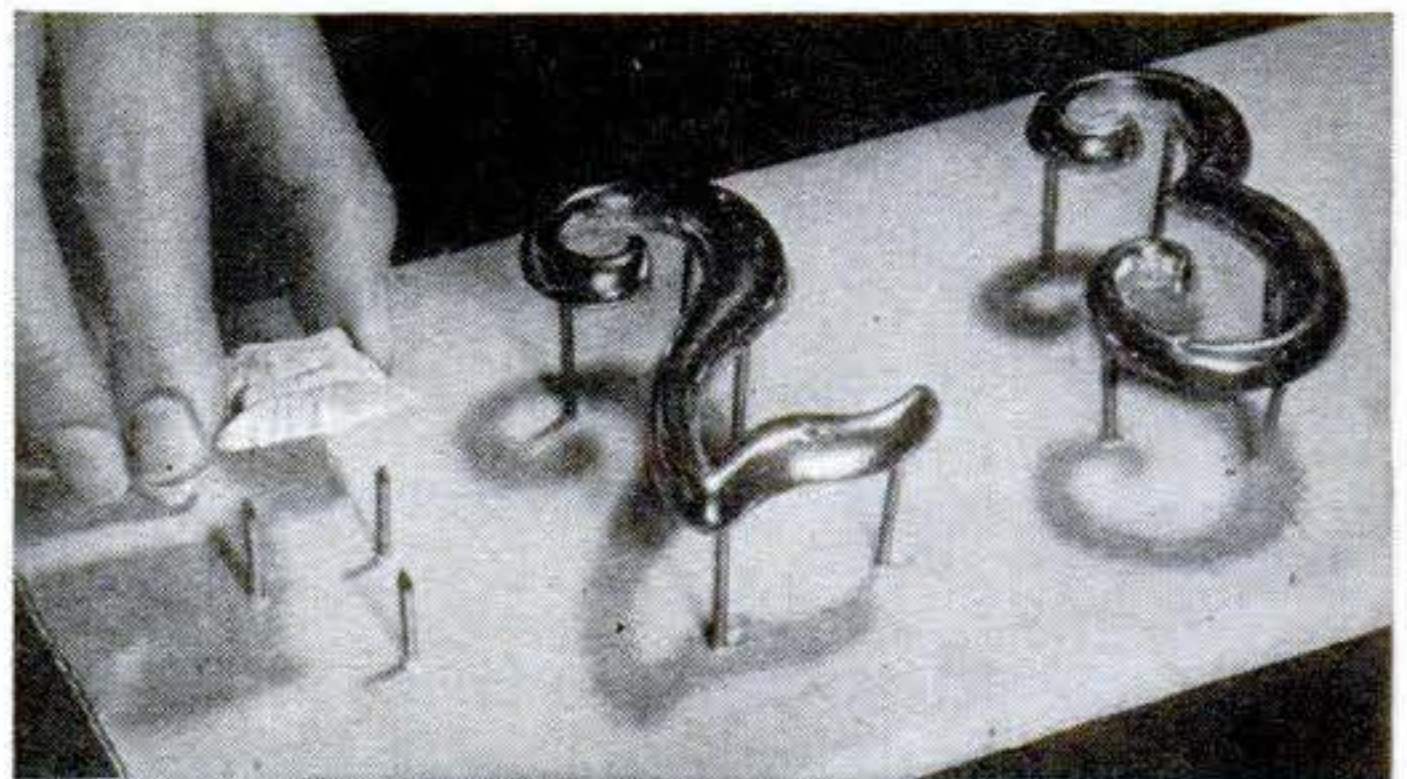

Nails Hold Parts for Finishing

WHEN drying small objects that have been lacquered or painted, it's always hard to find a convenient place to set them where they won't be marked from contact with the surface on which they rest. Setting the objects on nails upended in cardboard, and then brushing or spraying on the paint, eliminates this problem. The nails leave no trace of contact, and air can circulate all around to facilitate drying.

TERRIFIC VALUES - SURPLUS - SAVINGS UP TO 85%



Portable LIGHT PLANT

PUSH BUTTON START
500-700 watts 110-120 v. — 60 cyc. A.C. Powered by a sturdy dependable, easy starting, air cooled 1 3/4 hp. gas engine. No wiring necessary, just plug in and operate. Plenty of current for any oil burner, freezer, brooder, pump, emergency lights, etc. which require up to 700 watts. Ideal for Civil Defense, Fire Depts; trailers & camps. Complete with Voltmeter and built-in winding to charge 6 v. auto batteries. Wt. 85 lbs. Fully guaranteed. Be prepared if war or storm knocks out power lines.

(Item 24) Reg. \$275.00 value. **\$143.50**
700-800 Watt Plant (Item 44) same as Item 24, but larger generator. **\$169.95**
1000-1200 Watt Plant (Item 45) same as Item 24, but larger gen. & eng. **\$199.50**

HEATING & VENTILATING FAN

(Item 10) Easily installed in furnace pipes. Forces even heat to all rooms. Over range, removes kitchen smoke and odors. Powerful continuous duty motor, 110-120 V. A.C. Quiet, super efficient fan moves huge volume of air (400 to 600 c.f.m.) 8" Fan, wt. 5 lb. **\$6.35**; 9" Fan, wt. 6 lbs. **\$7.45**; 10" Fan, wt. 7 lb. **\$8.45**; 12" Fan, wt. 8 lbs. **\$9.45**.



Removable handle

1/2" DRILL

(Item 33) DeLuxe model — powerful, smooth running, precision built. Handles toughest jobs. Cutler-Hammer switch, Jacobs key chuck. 110-120 v. AC-DC 300-450 rpm. Alum. alloy case for high strength and easy handling. Built-in blower assures cool operation. Cap. 1/2" in steel. 1 year written guar. Wt. 11 lbs. Should be \$65. Special. **\$34.50**

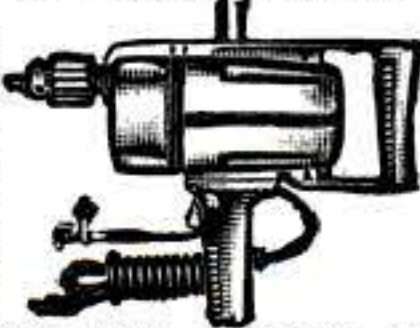

1/4" DRILL

(Item 34) Hi-power, long-life, smooth running. Alloy steel gears; built-in blower. Cutler-Hammer switch, Jacobs hand-tite chuck. 110-120 v. AC-DC 1000-1600 rpm. Cap. 1/4" in steel. 1 year guar. Wt. 4 lbs. Terrific value at **\$12.95**.

38 Pc. DRILL KIT

(Item 35) Includes above illus. guar. drill, buffers, polishing bonnet, sanding discs, grinding wheels, wood bits, steel bits, wire wheels, bench stand, paint mixer, burrs. Complete in heavy steel case. Wt. 13 lbs. 38 pc's., all highest quality. Complete kit worth \$38.50. Our **\$19.85** Spec. only...



HEAVY DUTY ARC WELDER

(Item 38) Use as portable or shop welder. 250 amps, D.C., Senior model. Made for years of trouble-free, continuous service. Will handle light or heavy jobs. Weld up to 1/2" plate using 1/4" rods. Built-in air-cooling system. Arc is easy to strike and hold, because of specially designed arc stabilizer. Hi-lo switch and dial control gives wide range of welding heats. Run welder at 2600 rpm. with tractor, jeep or 10 hp. gas engine, or 7 hp. elec. motor. Complete with instructions, guar. and double V belt or flat pulley. Wt. 110 lbs. **\$99.75**

A \$400 value at. **\$10.50**
WELDING KIT. Two 10 ft. leads, welding helmet, electrode holder, ground clamp, assorted rods. Sold only with welder at. **\$10.50**

GAUGE TESTER

(Item 27) Precision made of solid bronze by Star Brass Co. Calibrated weights (incl.) acting against hydraulic piston, provides quick accurate testing of all pressure gauges up to 3000 lbs. per sq. in. Brand new in hardwood cases. Wt. 100 lbs. Reg. \$435.00. Our Spec. **\$135.00**

HYDRAULIC HOSE

High pressure, heavy duty, complete with swivel fittings. Pipe thread connections. Ideal for farm equip., bulldozers, grease guns, airbrakes, etc. Any length. Minimum \$1 per 1/8". **INSIDE DIAMETER**, 1/4" 50¢ per ft. 3/8" 60¢, 1/2" 80¢, 5/8" 90¢.

MANUFACTURERS AND JOBBERS — Write us about your surplus items

GIANT 2000-2500 WATT PLANT

110-120 V. 60 cyc., A.C. Absolutely the best made because its heavy windings develop up to 5000 watt overload for motor starting. Skid-mounted — portable. Powered by 5 h. p. easy starting Briggs or Wisconsin engine — complete with all accessories; engine easily disconnected for other uses. Big outlet box, voltmeter, no wiring necessary. Ample current for all purposes. Factory warranty and instructions included. Wt. 220 lbs. Reg. \$585.00. Special at. **\$299.50**
GENERATOR ONLY and control box. \$169.50
Drive it with your engine or tractor

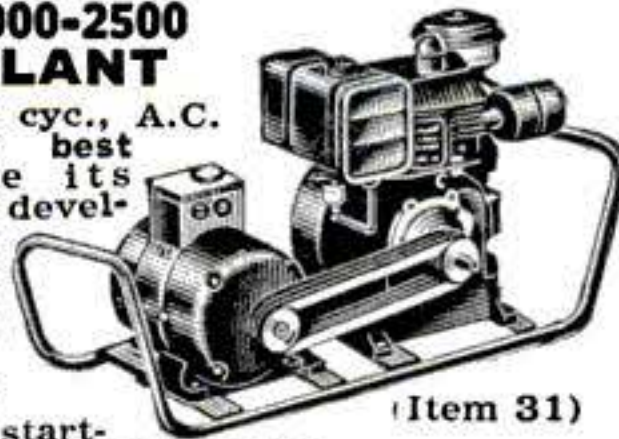

(Item 31)

ELECTRIC HAND SAW

(Item 36) Most perfectly balanced and smoothest running saw made. Advanced design provides max. power and light weight. Easily adjusted for all angles, depth and width of cut. Comes complete with 6 1/4" comb. blade, ripping guide and 10 ft. hvy. duty cord. Built-in saw-telescoping guard. 110-120 v. AC-DC. Depth of cut 2 1/8". 1 year written guar. Wt. 12 lbs. Drastically reduced. **\$39.95**

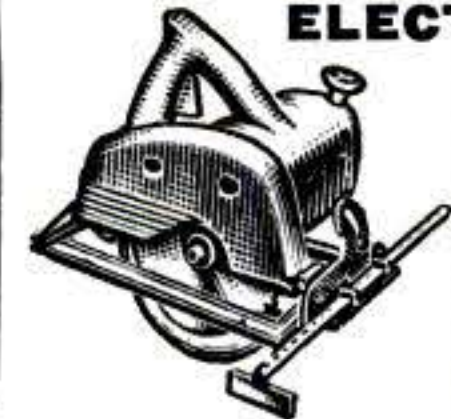

ANGLE DRILL

(Item 23) Fits into chuck of any electric or pneumatic drill or flex. shaft. Operates at any angle in a full 360° arc. Makes possible drilling, grinding, carving, routing, etc. in close cramped quarters. Makes impossible jobs easy. Made by Kett Tool Co. Complete with built-in chuck (1/4" capacity) and adjusting key. Hardened alloy gears. Precision built for heavy duty. Lists at \$39.95 — while they last. **\$9.95**

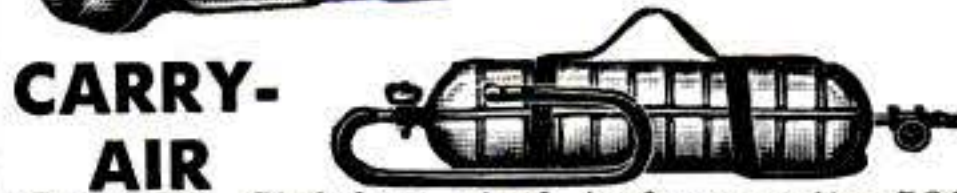

CARRY-AIR

(Item 32) Stainless steel tank — capacity 500 cu. in. at 400 lbs. press. complete with inlet and shutoff valves, press. gauge, detachable air hose, tire chuck. Fill at any service station. Carry air for tire inflation, blowing out lines, spray painting, insecticides, etc. One emergency pays back cost. Wt. 13 lbs. Worth \$20.00. Our price. **\$9.75**



POTTERS WHEEL

(Item 47) Complete, prof. equip. for making finest ceramics and pottery. Large dynamically balanced cast-aluminum reversible turntable with variable speed drive (38 to 140 rpm) controlled by foot-pedal. Built-in adjustable arm rests, water cup and wedging wire. 16x12" enclosed throwing table — ample area for largest pieces. Req. 1/4 hp. motor (not incl.). Can be set up on 20x24" table and stored on edge. Complete with pulleys, belts and instructions. Wt. 26 lbs. **\$59.95**
\$145 value at.



VARIABLE SPEED DRIVE

(Item 48) Works on variable-pitch pulley principle. Provides instant variable speed range up to 4 to 1. Rugged constr., forced lubrication. Input up to 1/2 hp. Perfect for lathes, drills, grinders, potters wheels, centrifuges, midjet vehicles, etc. Wt. 8 lbs. A terrific value at. **\$9.45**



RUBBER HOSE New genuine Neoprene Hose — outlasts ordinary rubber 3 to 1. Reinforced with super tough cotton cord plies. Flexible. Easy Flo brass couplings with standard pipe threads for quick connections, included. Pump water for irrigation, stock tanks, home, barn, fire fighting, etc. Pump Gas or Fuel Oil. Save more than 60%.



TERRIFIC VALUES!

AIR HOSE

(Item 11) 1/4" Diam. heavy duty, double braid, suitable for gas stations, spray painting, air tools, etc. 20 ft. with standard swivel couplings. Wt. 4 lbs. Reg. \$6.50 val. — only **\$2.95**. Five 20 ft. lgths. (100 ft.). Wt. 20 lbs. Only **\$13.75**.

GAS ENGINE

(Item 25) Air-cooled. 1 1/2-2 h.p. Complete with gas filter, air cleaner, governor, fuel tank. Ready to run. Speed range 2000-3600 r.p.m. 5/8" shaft. Rope start. Ideal for pumps, air compressors, power tools, generators, etc. Factory warranty and instructions incl. One of the best made. Wt. 40 lbs. Worth \$72.50. Special. **\$46.50**



HOT WATER HEATER

(Item 26) Immersion type, heavy duty, 115v. A.C. 300w. Does not require watching. Thermostat shuts off at 165°. Keeps water hot for shaving, washing dishes, etc. Made by Cities Service. Wt. 4 lbs. Worth \$9.50. Our Special. **\$4.50**



PRESSURE SWITCH

(Item 30) Penn Electric Model 110 BPO2, best made. For pumps and air compressors. Heavy duty. Will handle up to 250 lbs. press. and up to 5 h. p. Autom. unloader valve, for easy starting. 110-220 v. A.C. or D.C. 2 pole. Wt. 5 lbs. Reg. list \$17.50. Our Spec. **\$9.45**

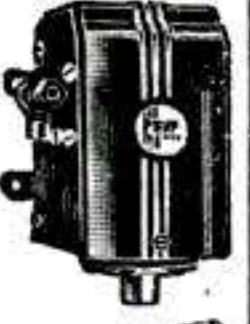

CLIP BOARD

(Item 17) Heavy Masonite, with self-adjusting spring hinge to hold up to 100 sheets of 8 1/2 x 11 paper. Push back cover for instant release. Flip cover shut and notes or drawings are protected. Perfect for pilots, engineers, students, artists, truck drivers. Wt. 2 1/2 lbs. Usually \$2.95. Spec. **\$1.10, 2 for \$2.00**



FIRE

EXTINGUISHER (Item 39) Fully charged (at 1,000 lbs. P. S. I. or more) with CO2 (carbon dioxide), the proven miracle fire fighting chemical that smothers oil, gasoline and electrical fires. Play safe; keep one in your car, garage and home. Heavy ICC approved steel cylinder, valve and 3000 lb. gauge that shows available remaining pressure. REFILLABLE at nominal cost. Hose included for emergency tire inflator or air blast. Wt. 4 lbs. **\$19.50** value. Special. **\$6.95**



GEM CUTTER

(Item 49) Complete Prof. Lapidary mach. for cutting, shaping, grinding and polishing precious and semi-precious stones. Precision built with big horiz. power driven gem cutter, built-in cutting lubricator; genuine 6" supercharged diamond saw, lap wheel, abras. whls., 2 scratch whls., 4 felt whls., grinding and polishing compounds, brushes, dop cement and sticks, cutting oil, ext. cord, asstd. gems, complete instructions. Requires 1/4 hp. motor (not incl.). Wt. 22 lbs. Worth \$99.50. Our Special. **\$39.95**



FIRE or BURGLAR ALARM

(Item 46) Completely automatic. Wind and hang anywhere. Thermostatic element sets off loud clanging bell if heat reaches 140° (setting adjustable). A fool-proof burglar or signal alarm when used with trip cord attached to door, window, invalid's bed, etc. Sturdy metal constr. assures lifetime of protection. Ideal for homes, stores, whse., gar. etc. Wt. 3 lbs. Easily worth \$20. Special. **\$4.95**



EXTENSION CORD

(Item 16) 40 ft. heavy duty, made of specially insulated No. 14 2-conductor wire. So tough that you can drive over it and yet amazingly flexible and easy to handle. Resists oil, grease or water. Extends electricity up to 400 ft. without voltage drop. Use indoors or out. Complete with heavy rubber plug and outlet. Wt. 2 1/2 lbs. Usually \$4.50 — Special 40 ft. **\$1.99** Comb: 2-40 ft. and 1-20 ft. (total 100 ft.) **\$4.95** 100 foot length (one piece) **\$4.85**



WIRE SPECIALS (Item 50) #14-2 cond. same as above, but no fittings, wt. 6 lbs. **\$4** per 100 ft.
TRENCH-LAY WIRE (Item 51) Anaconda #10-2 cond., for buried service to barns, outdoor lights, etc. Absolutely impervious to soil and moisture. Wt. 25 lbs. per 100 ft. Special surplus price. 100 ft. coils, 19¢ per ft.; 250 ft., 18¢ per ft.; 500 ft., 17¢ per ft.

PARTS WASHER

(Item 20) Store gas or carbon tet. in 5 gal. safety can. Valve releases just the right amount into washing compartment. Parts are washed and drained on a "dunking" screen — no fishing for parts. Eliminates fire-danger, waste, spillage, evaporation. Wt. 14 lbs. Reg. \$19.50 — Special. **\$5.95**



All items brand new. Prices f.o.b. Chicago area. 10 day Money back guarantee. Send check or M. O. **MASTER MECHANIC MFG. CO., DEPT. 46, Burlington, Wis.**

**SEND
FOR IT!**

1951 ALLIED RADIO & TV CATALOG

free!

**COMPLETE
UP-TO-DATE
•
EVERYTHING
IN RADIO & TV
AT LOWEST
PRICES!**



**212 PAGES
OF VALUES**

**Everything for
Experimenters, Builders,
Amateurs, Servicemen,
Engineers and Soundmen..**

Save money on every Radio and TV need! Get the big 212-page 1951 ALLIED Catalog featuring the world's largest stocks of top-quality equipment at low, money-saving prices! See the latest TV releases, home radios, radio-phonos, Amateur equipment, P.A. systems and Hi-Fidelity Custom Sound, recorders, test instruments, builders' kits—plus thousands of parts, tools, books and diagrams. Get more for your money from the World's Largest Radio Supply House. Send today for your FREE 1951 ALLIED Catalog!

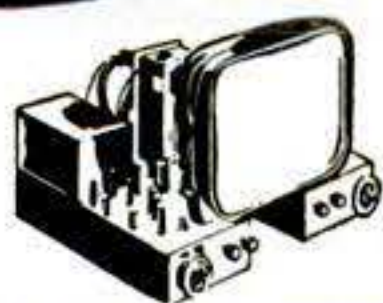

**TV, HOME RADIOS
& RADIO-PHONOS**



**SERVICE SUPPLIES
BUILDERS' SUPPLIES**



AMATEUR GEAR



**P.A. SYSTEMS
RECORDERS**

**free
CATALOG
Send For It!**

ALLIED RADIO

**ALLIED RADIO CORP., Dept. 7-E-1
833 W. Jackson Blvd., Chicago 7, Ill.**

Rush FREE 212-Page Catalog No. 126

Name _____

Address _____

City _____ Zone _____ State _____



Fire-Fighting Jeep Guards Racers

STATIONED in the dead center of a New Jersey stock-car racing track is this specially equipped fire-fighting Jeep, developed by Walter Kidde and Co., of New York City. A bank of six 75-pound-capacity cylinders, carried in the main rack, can discharge 500 pounds of carbon dioxide foam through a Multijet rapid-discharge nozzle to put out any collision blaze. For smaller fires, the Jeep carries four 15-pound portable units in the side brackets.

Baby Can't Upset Cup

THE manufacturer of this cup says that baby will not be able to upset it because of a weighted bottom. A transparent snap-on cover with small drinking holes is also claimed to help keep out dirt and baby's fingers. Westland Die and Engraving Co., of Los Angeles, prices the cup at 89 cents.



Boots Protect Wall from Ladder



WHILE painting the trim on my house, I noticed that the ladder legs resting against the asphalt siding marred the surface. I pulled an old pair of galoshes over the projecting legs of the ladder top, as at left, and that fixed it.—V. H. Lamoy, Upper Jay, N. Y.

Race Horses Shod for Speed

WHEN the ponies run at the track, most of them sport lightweight aluminum shoes.

GROBAN'S BRAND NEW WAR SURPLUS SPECIALS! UNCONDITIONALLY GUARANTEED

WE'VE MOVED TO NEW—LARGER—BETTER QUARTERS. NOTE NEW ADDRESS AT BOTTOM

GENERAL MOTORS-ALLISON CENTRIFUGAL PUMP 200 GALLONS PER MINUTE



- For Draining Basements • Fire-Fighting
- Irrigation • Fuel Transfer • Swimming Pools • Home Water Systems • Dewatering

This General Motors-Allison Centrifugal Pump—designed for use on U. S. Air Force Mustang fighters, now converted for commercial, home, and industrial high volume pumping applications. Inlet, 2 1/2" standard pipe thread, twin outlets with 1 1/4" pipe thread, ball bearing supported 3/4" shaft. Easy, fast simple priming. Rotation, counter-clockwise facing shaft. Shipping wt. 35 lbs. Gov't acq. cost \$145.00. F.O.B. Chicago Now Only

Suction Lift	Head Pressure	Gal. Per Min.	H.P.	R.P.M.
10'	75'	260	6.0	3500
10'	65'	200	5.2	3500
10'	80'	40	1.5	2500
10'	50'	140	5.0	3500
10'	30'	100	3.0	2500

39.50

NEW! STATIONARY OR PORTABLE D.C. Arc Welder 250 AMPS. MODEL 252 (ITEM # 65)



**FOR ANY WELDING JOB
LIGHT OR HEAVY**

**STOP COSTLY REPAIR BILLS,
WELD IT YOURSELF AND SAVE**

Only one or two jobs will pay for entire welder. Designed for many years of trouble-free service. This precision-engineered Direct Current ELECTRIC ARC WELDER is offered at but a fraction of its original value. It can be mounted permanently or easily transported for portable use. Does the job instantly where and when you need it. Has dial type rheostat for easy pinpoint control and a high-low range switch. Run welder at 2500 RPM from drive pulley or power take-off of tractor, a 7 1/2 HP electric motor or a 10 HP gas engine. Use two V belts or flat belt (on pulley). Price includes double V or flat belt pulley and instruction book. Shpg. wt. 107 lbs. F.O.B. Chicago

Now at a fraction of its value

99.50

BYRON-JACKSON "PUP"

CENTRIFUGAL PUMP UNIT

**\$3800.00
VALUE**

Complete With Full Engine And Pump Instructions

2 Stage Model "PUP" Pump Driven by an 8 Cylinder Model C-36 Chrysler Industrial Engine.

IDEAL FOR: Pick-up, Gathering, Fire Fighting, Salt Water Disposal, Sprinklers, Irrigation, Dewatering, Construction, etc.

Engine Speed 2400 RPM—100 HP. 600 GPM at 175 PSI—Parallel Connection. 300 GPM at 375 PSI—Series Connection

These skid-mounted Pumping Units are standard production models with parts and service readily available. Designed for a wide range of operating conditions particularly where wide variation in head and capacity are required. Twin suction and discharge ports are cast on the same side and so arranged that external piping is interchangeable for either parallel or series pumping applications. Overall dimensions, 114" L x 29" W x 62" H. Weight 4060 lbs. Now, complete with full priming equipment, operating instructions and performance data. ONLY.....

1495.00

F.O.B. Chicago

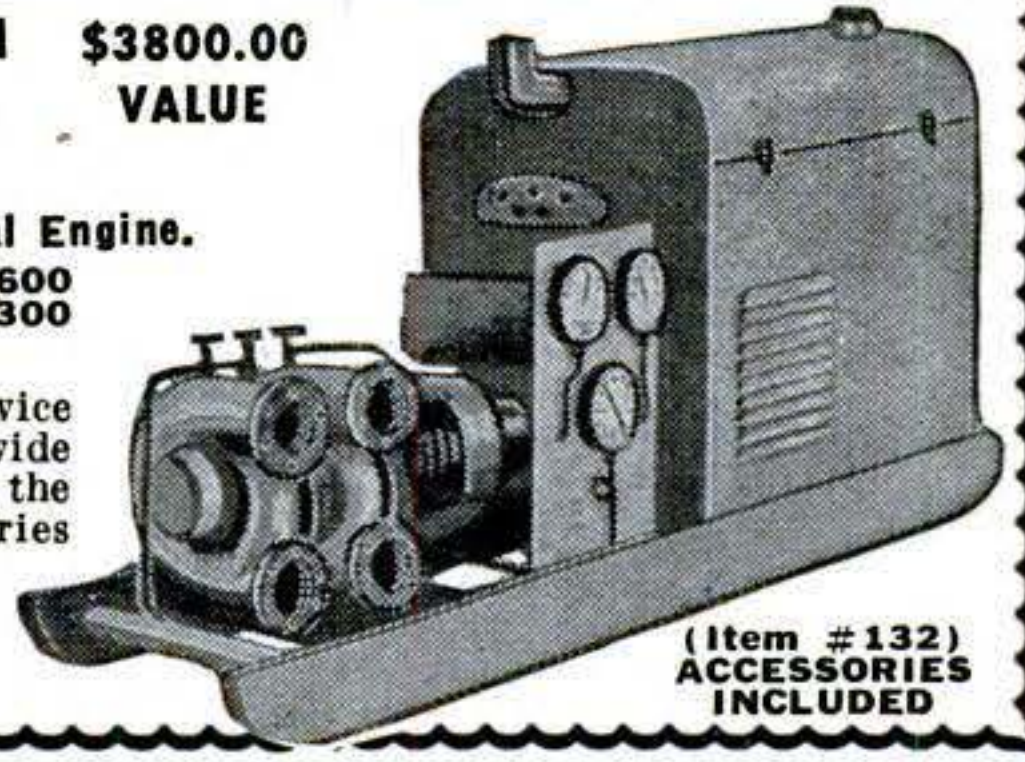

(Item #132) ACCESSORIES INCLUDED

Hydraulic Cylinders—Air or Oil

Large supply of new labor-saving, economical hydraulic equipment in many types and sizes. Use these positive, highly efficient, smooth pressure hydraulics on presses, arbors, lifts, loaders, power control, positioning, brakes, plastic dies, auto frame alignment, etc., etc.

ITEM #70—Purulator hydraulic oil filter. Permanent element type, 3/4" female pipe thread ports. Capacity, 16 gallons per minute. A \$13.00 value. Now **Postpaid... 4.95**

ITEM #4—All steel double action hydraulic cylinder, 1 1/8" bore, 2 7/8" stroke. Clevis mounting. Will lift 1000 lbs. with 1000 P.S.I. line pressure. Perfect for positioning and feeding movements. Shpg. wt. 4 lbs. **4.95 Postpaid**

ITEM #33c—Double action hydraulic cylinder, 1 1/2" bore, 4 1/2" stroke. Clevis mountings at both ends. Uses 1/4" pipe fittings. **8.95 Postpaid**

ITEM #32—Double action, 1 1/2" bore, 9" stroke, will lift 1760 lbs. with 1000 P.S.I. line pressure. Wt. 4 lbs. A \$45.00 value. **10.95 Postpaid**

ITEM #16c—Double acting hydraulic cylinder, 1 1/2" bore, 26" stroke. Will lift 1760 lbs. with 1000 PSI line pressure. Weight 8 lbs. A \$55.00 value. Now only. **16.95 Postpaid**

ITEM #103—Double acting hydraulic cylinder, 2 1/2" bore, 17" stroke. Clevis mounting. Will lift 4900 lbs. with 1000 PSI line pressure. 1 1/4" diam shaft. 3/8" tubing thread ports. Overall length closed 28". Shpg. wt. 11 lbs. F.O.B. Chicago. **21.50**

ITEM #31c—Double action hydraulic cylinder, 3 1/2" bore, 11" stroke. Aluminum alloy cylinder wall and all steel 1 1/8" piston rod. Clevis mounting at base and shaft. 19 1/2" overall length closed. Will lift 9625 lbs. using 1000 PSI from Logan Heavy Duty Hydraulic Pump. Uses 3/8" tubing fittings. Value \$102.00; Shpg. wt. 11 lbs. F.O.B. Chicago. **22.50**

ITEM #6—Double action hydraulic cylinder, 3" bore, 24" stroke, will lift 7070 lbs. with 1000 PSI line pressure. Steel barrel, 1 1/8" stainless steel shaft. Gov't acq. cost \$176.00. Shpg. wt. 26 lbs. F.O.B. Chicago. **28.00**

ITEM #42—Double action hydraulic cylinder, 4" bore, 18" stroke. Rated lift capacity with 1000 PSI line pressure is 12,500 lbs. Ship. wt. 30 lbs. F.O.B. Chicago. An excellent Buy for..... **32.50**

LOGAN HEAVY DUTY HYDRAULIC PUMP

For operating hydraulic cylinders and hydraulic motors on tractors, bulldozers, construction machinery, lift trucks, industrial applications etc. Delivers 10 GPM at 1200 RPM at 1000 P.S.I. using 6 HP. Has a 3/4" inlet, 1/2" outlet, 3/4" shaft with flat and keyway for direct or pulley drive. Has flange with 4 bolt holes for convenient mounting. Ship. wt. 22 lbs. Overall dimen.: 7" L x 5 1/2" H x 5 1/2" W. A \$105.00 value FOR ONLY..... **22.50**

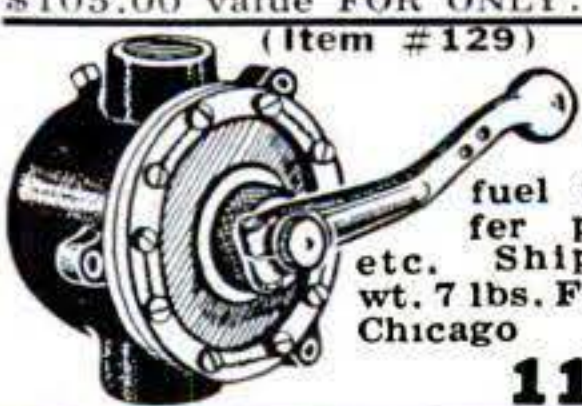

FLUID HAND PUMP

general utility hand pump. May be used as a sump pump, barrel pump,

fuel transfer pump, etc. Shipping wt. 7 lbs. F.O.B. Chicago

11.95

DIRECT CURRENT GENERATORS

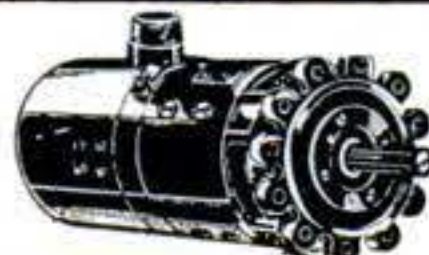

For welders, plating, truck and marine use, D.C. appliances, lights, etc. Aircraft quality—lifetime grease sealed ball bearings. Heavy duty.

ITEM #131—Brand new Electric Auto-Lite 12 volt Direct Current electric generators, rated 18 amps. Complete with blower and pulley. Use for trucks, tractors, boats, battery chargers, etc. Part No. GEF-4805A. In original sealed U. S. Army cartons. \$40.00 value. Shpg. wt. 27 lbs. F.O.B. Chicago. Now Only... **15.00**

ITEM #90—Type P-1, rated 200 Amps.—28 Volts, 2500 RPM. Mfd. by General Electric, Ford, Delco-Remy and Westinghouse. Gov't Acq. Cost \$300.00. Shpg. wt. 70 lbs. F.O.B. Chicago. **22.50**

ITEM #91—Type R-1, rated 300 Amps.—30 Volts. Mfd. by Jack & Heintz. Gov't. Acq. Cost \$380.00. Shpg. wt. 70 lbs. F.O.B. Chicago—Each individually packed in wooden box **35.00**

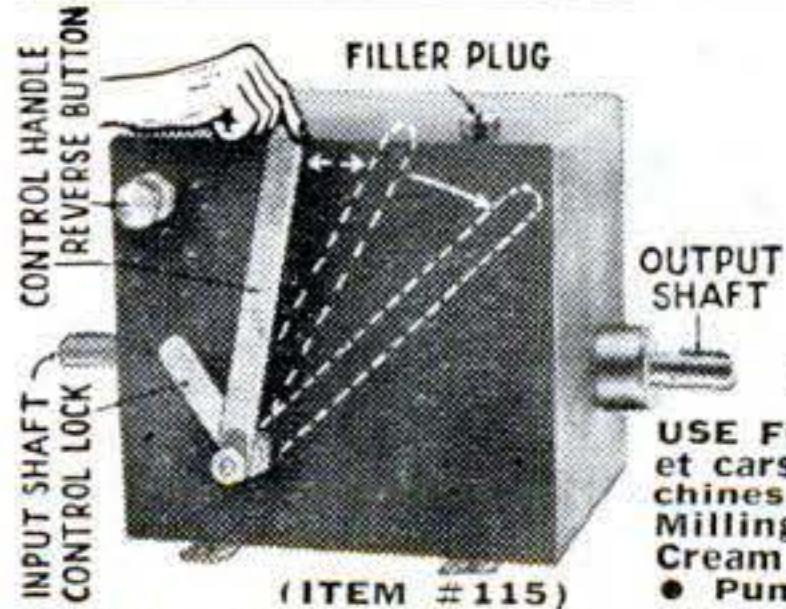

HYDRAULIC SPEED REDUCER

with FINGERTIP CONTROL

USE FOR: • Reamer Drives • Mid-let cars • Feed Mills • Canning Machines • Conveyors • Lathes • Milling Machines • Motor Boats • Cream Separators • Garden Tractors • Pumps

Variable output speeds ranging from 0 to input speed now available. Merely move control handle until desired speed is attained. Then turn locking handle to maintain the setting. Internal relief valves prevent overloading. Use input power of 1/4 to 1 1/2 H.P.

This Westinghouse-Oil Gear Unit converted to commercial use from 40 MM anti-aircraft traversing mechanisms consists of a variable displacement hydraulic pump feeding a fixed displacement hydraulic motor. These components are contained in a crackle-finish steel oil reservoir (capacity 2 qts.). Adjustable relief valves set at factory for 100 inch pounds of torque may be reset up to 180 inch pounds. Independent reverse control allows full output power and speed selection in either direction of rotation. Both input and output shafts measure 5/8" diam., include keyway. Input rotation is counter-clockwise facing shaft. Recommended input speeds not to exceed 750 R.P.M. Overall dimensions 7 1/2" x 7 1/2" x 11 1/2". Gov't. acquisition cost, \$428.00. Shipping weight 26 lbs. Complete with 2 qts. of oil and full instructions. F.O.B. Chicago **54.50**

GROBAN SUPPLY CO. DEPT. PS-5

1139 SO. WABASH AVE., CHICAGO 5, ILL.

FREE: 48-PAGE CATALOG

Listing Brand New War Surplus bargains including Aircraft quality hydraulics, A.C. generators, pumps, welders, tanks, and many, many others. You save on everything! Write today!

WAR SURPLUS AND OTHER BARGAINS

"BALTIC" SWEDISH TOOLMAKERS VERNIER CALIPER



ULTRA PRECISION—0-6" in .001 graduations. Quick, accurate depth, inside and outside measurements, fine engraving. Extra heavy rule, Rockwell C-60, lapped measuring surfaces. For the extra particular mechanic who must have the best—used and recommended by most critical experimental and research machinists at Lockheed • Douglas • Bendix • GM • RCA • General Electric. Save 50%! A \$37.50 value—only \$17.25—Leather case incl. Also a standard grade Mauser Design Caliper • made in Germany • For the production machinist, 0-6" in thousandths, the most accurate caliper of this type on the market, thousands of satisfied users—only \$12.95—Leather case included. These are both guaranteed buys. Your money back if not entirely satisfied. Order now!



RIVET SETS Universal type, case hardened tips. Set of dies will head up any brazier or round head rivet from 1/8" to 1/4". With adapters for air gun or hand use. All new... cost Government about \$27.00. Complete 15 piece set, wt., 2 lbs., \$5.00



MICROMETERS Chrome plated, precision engineered and carefully tooled to give long life. All new. 0-1" capacity ea. \$2.25. 1-2" capacity \$3.50.

HIGH SPEED DRILLS All New. Fractional & numbered. Orig. Val. \$15. Nationally known brand. Astd. sizes. Set 30, \$3.50

EXTENSION DRILLS High Speed Steel, like new Asst'd sizes from No. 1/4 to 40. Lengths from 6" to 12" Approximately \$20 value. Set of 12..... \$3.75

HIGH SPEED DRILL BITS Like New! Original value over \$16.00. 25 assorted sizes and lengths, \$2.00

DRILL GRINDER Sharpens round, square or tapered drills up to 6" long. Even an amateur mechanic can get a new, factory finish on a drill in 25 seconds. New protractor feature gives every drill sharpening angle, with 5 convenient angles already marked off. Usable with hand or power stone. A brand new development, manufactured by Ten Eyck. Shipped postpaid

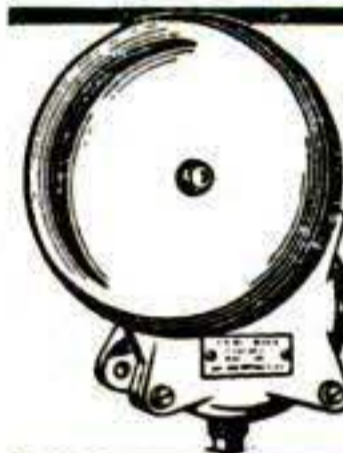

ELECTRIC BELLS—Vibrating type, high pitch. 115 V., 60 Cycle. Ideal for use indoors or outdoors—on ranches, for schools, plant installations, as signal systems, burglar alarm systems, etc. Nationally known Mfr. ALL NEW in orig. Pkgs. Solid brass clapper & 8 1/2" gong. Wt. 8 lbs. Govt. cost about \$67.50. Close out at... \$7.95 Send check, money order or cash. 25% deposit required on C.O.D. orders. All prices F.O.B. Culver City, California, unless otherwise stated. Send 25c for Illustrated Catalog.

AIRBORNE SALES CO., INC. DEPT. PSM 5-51 CULVER CITY, CALIF

EVERY ELECTRIC DRILL A PORTABLE SAW



9.95 Can Be Used With One Hand! Any 1/4" or 3/8" Drill a Powerful Saw in ONE MINUTE "ARCO-SAW" is a rugged tool with right angle gear drive (no clumsy, dangerous, direct drive with drill sideways). Works like a high priced Portable Saw. CUTS 1-5/16", or 2x4 by turning over ONLY ARCO GIVES YOU ALL THESE FEATURES: Safety-yoke assures rigid connection and absolute safety—Big handle affords firm grip for two-hand operation—Precision one-piece gear box—Self-lubricating lifetime bearings—Visual guide and wide shoe-plate for straight, square cuts—Lowest priced, quality Replacement Blades. "HYCARBON" 4" Crosscut or 4" Combination Blade... \$2.00 ea. 90-day Factory Guarantee

ORDER TODAY at your dealer or send us check or M.O. (Postpaid). C.O.D.'s—Postage extra. Ask for literature of other tools.

ARCO SAW UNCONDITIONAL 10-DAY MONEY BACK GUARANTEE DEALERS—Write for nearest jobber. **ARROW METAL PRODUCTS CO.** DEPT. PS-5, 140 WEST BROADWAY, NEW YORK 13, N. Y.

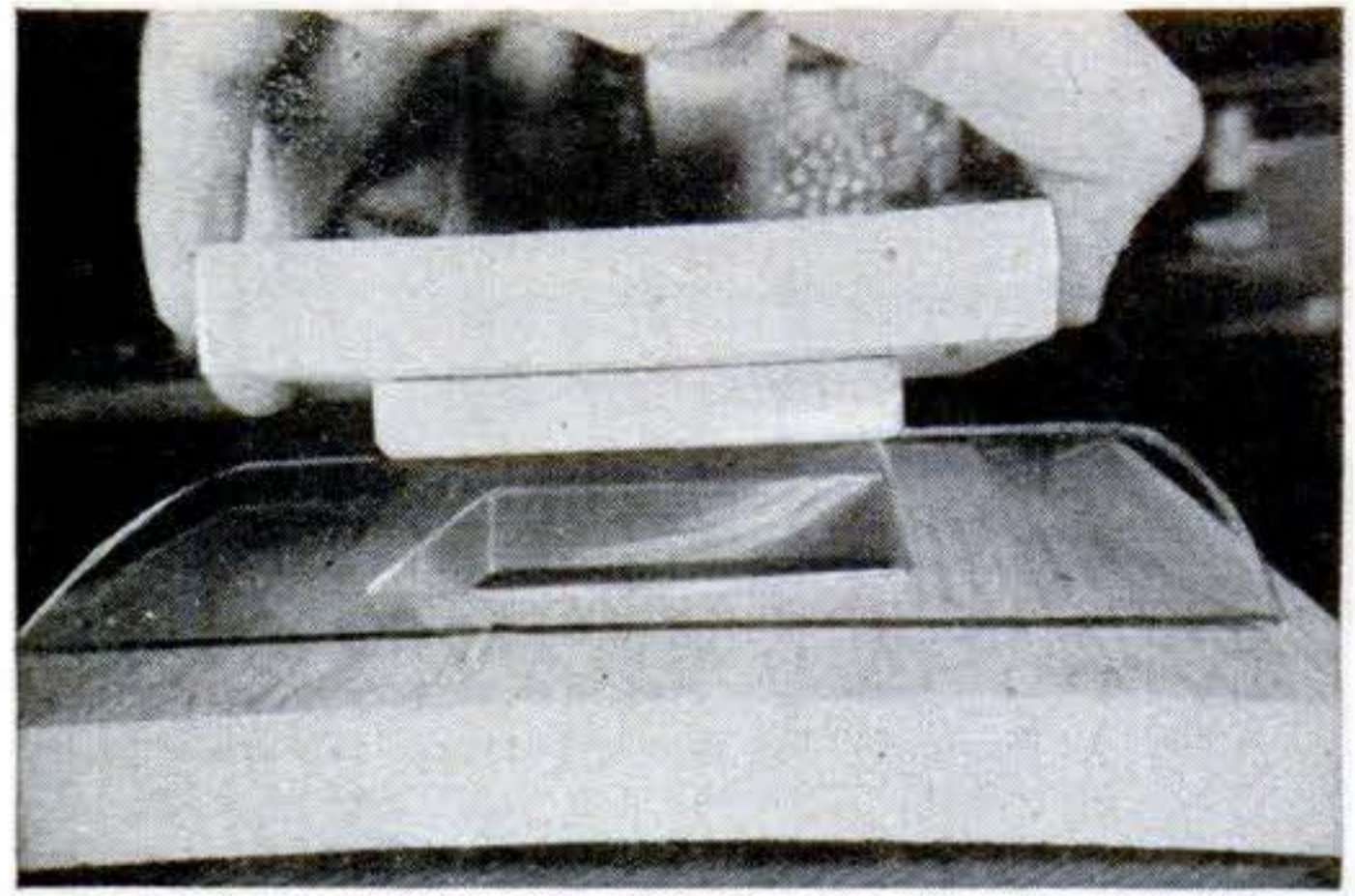

How to Make a Plastic Clock Crystal

IF THE rectangular crystal on your alarm clock is broken, you can make another of unbreakable plastic.

First you need two wooden dies. Measure the outside dimension of the old crystal and cut a hole 1/16" larger, but of the same shape, in a piece of scrap wood. Trim down the cut-out waste block 1/4" all around, and nail it to a larger piece of wood. Use 1/16" Plexiglas or Lucite for the crystal. Immerse the plastic in boiling water for a few minutes until it becomes soft and pliable. Place it over the hole in the die while still hot and smoothly and quickly press down on it with the small die block. Remove the excess plastic around the edges so that the crystal fits properly over the clock face.—William E. Danneman, Chicago.

Clamping Block Loops Up Lamp Cords

TO SHORTEN overhead lamp cords, make this little clamp from scrap wood, plastic, or hard rubber. Cut a block 3/4" by 1 1/2" by 1/2" and round off the corners. Bore two 1/4" holes in the block, with centers 7/8" apart, for the lamp cord to pass through. Bore a centered 3/16" hole through the side of the block to take a round-head machine screw 1" long. With a hacksaw, slice the block in two, edge-wise.

To shorten a cord, insert it in the block, as shown, and clamp tight with the screw, two lock washers, and a wing nut.

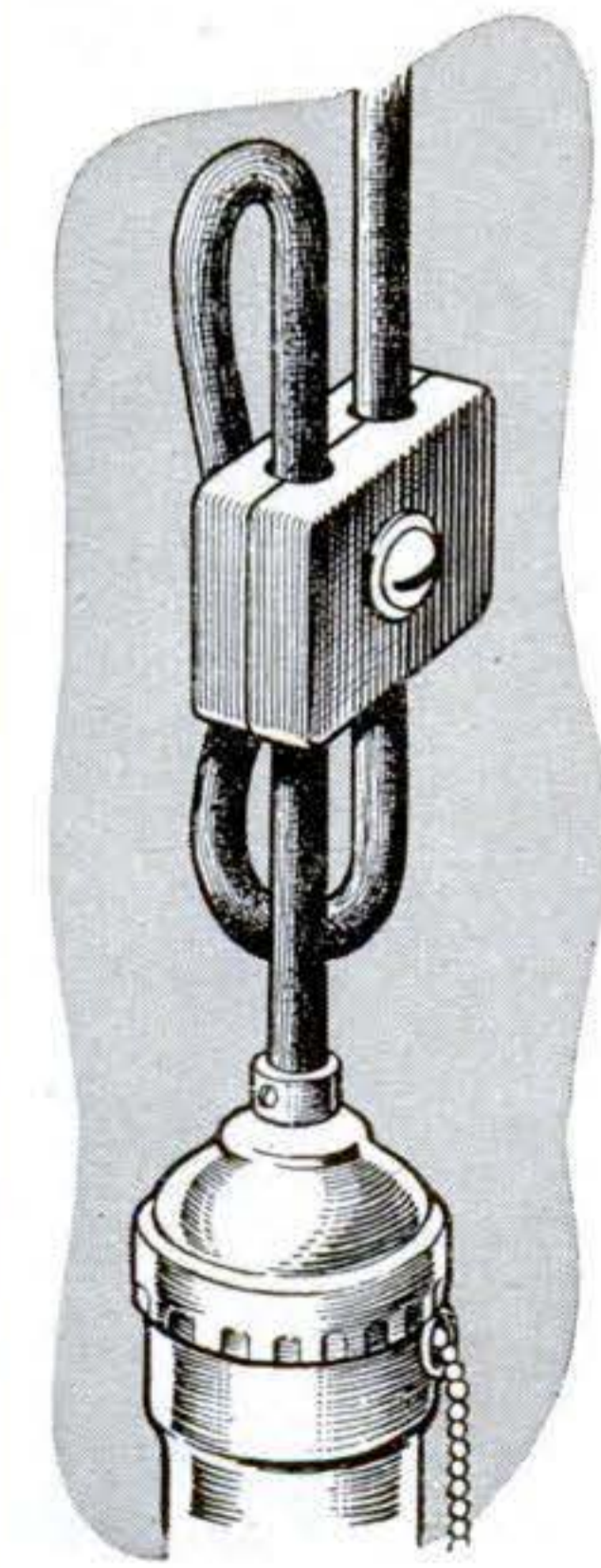

NEW TRIPLE WINDOW CONVERTIBLE TOP



\$125.00 Value!
Comes Complete
Nothing Else
to Buy. **\$49.95**

TRIPLE VISION REAR WINDOW FOLDS DOWN WITH TOP!

Rear window plus corner windows made of Crystal Clear Flexible Plastic—Blind Spots reduced to minimum for greater safety. Convertible owners can drive with top up — enjoy more vision than most closed cars. Top is of durable 3 ply waterproof material with rubber for longer wear & lasting beauty. Rear curtain has Zippers.

For Buick, Cadillac, Chevrolet, Chrysler, DeSoto, Dodge, Ford & Mercury, Olds., Plymouth, Pontiac, 1941-51, Packard & Studebaker, 1946-51. Be sure to Specify Make, Year & Model, Black or Tan Material.

New HOLLYWOOD MUFFLERS

Gives that motorboat tone. Universal fits all cars. **\$4.45** Each

TOP CYLINDER OILER

For Any Gasoline Engine, Auto, Truck, Tractor or Marine. Oil is partially vaporized in Top-Oiler, further vaporized in manifold as a fine spray. Feeds oil into engine when lubrication is needed most, during starting or idling. This dissolves gums, etc. Complete with fittings. **\$8.95** Each.



For that CADILLAC "LOOK" 'CAD' FINS

Illuminated with Light

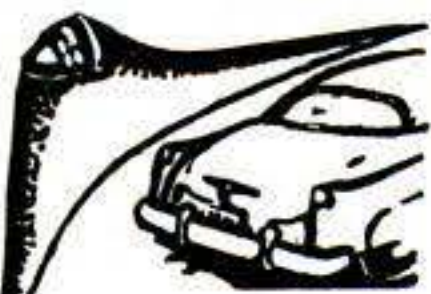

For 49-51 Ford, 49-51 Chevrolet and 49-50 Pontiac.

- Main casting made of brass.
- No holes to locate or drill.
- Can be brazed on in 3 spots.
- Wired ready for installation.
- Built-in design appearance.

Give make, year when ordering. Per Pair... **\$29.95**

Send 25% Cash With All Orders, Balance C.O.D.

1951 EDITION! It's new! Get Largest Auto Accessory & Parts Catalog and Save Money! Over 50,000 items, including Hollywood Accessories, Hi-Speed Equipment, Rebuilt Engines, all parts & accessories for all cars & trucks. We have that Hard-to-Get Part! Jam packed with Bargains. Completely illustrated. Send 25c (refundable).

J. C. WHITNEY & CO.

1917AT ARCHER AVE.

CHICAGO 16, ILL.

NEW, IMPROVED CALCULATOR FOR WOODWORKERS only 25c



Instantly gives information on lumber, nails, concrete mixes, painting materials, etc. Convenient, simple to read. Just set dial for nail specifications, to convert linear to board feet, find bit sizes for screws, compare characteristics of woods. 6" diameter heavily varnished cardboard. Send 25c, no stamps, please to Greenlee Tool Co., 2125 Columbia Avenue, Rockford, Illinois.

ELECTRIC WELDER

AC or DC 110 Volts

"The Little Marvel" All-Metal welder. 5-year written guarantee. Welds 1/8" thick metal or money back. Repairs tanks, tools, fenders, machine parts, etc. Comes complete with everything—rods, unit, eye shield, and directions. We also make a welder for 16 to 22 gauge

\$645 Complete

metal. \$3.95 complete. Transformer welder kit \$15.95. On C.O.D., postage extra.

ESSAY MFG. CO., Inc., Dept. 47, Quincy 69, Mass.

CALENDAR WATCH

CHRONOGRAPH & STOP WATCH

Only **895** + 10% TAX

31-Day Automatic Calendar

A precision timepiece and chronograph at an unusual low price. Imported Swiss jeweled movement, Radium Glow 1" dial, red sweep-second hand, shock resistant case, metal expansion wristband. 1 Year Guarantee, 5-day Free Trial. Choice of white, black dial.

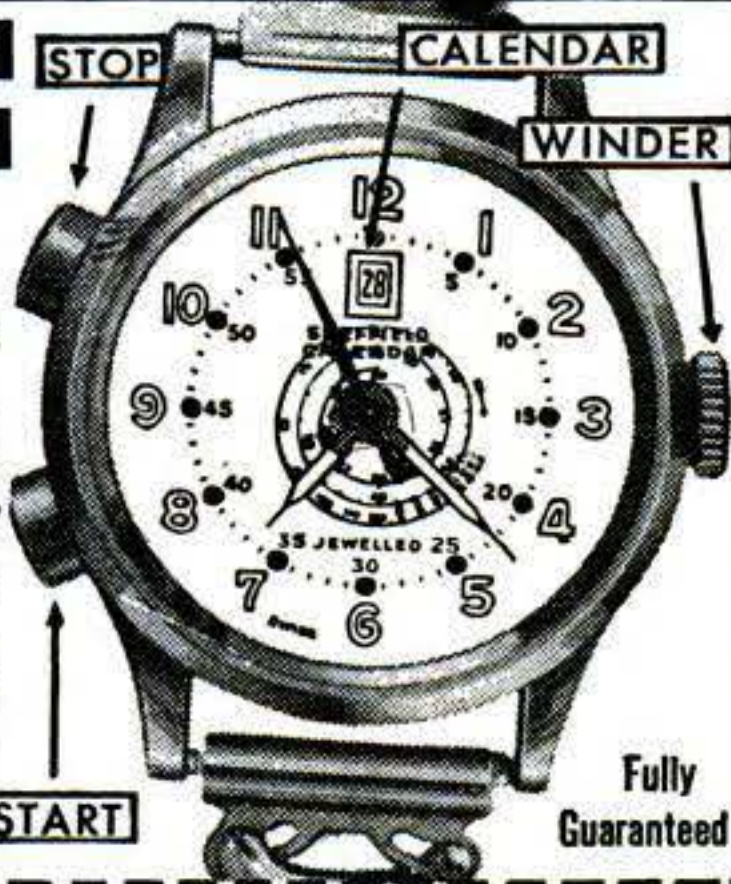

GAYLORD DEPT. SE-7, Fifth & Hamilton, Pittsburgh 6, Pa.

Send.....Watches @ 8.95 + 90¢ tax. Enclose Check, Money Order, Send C.O.D. Print name, address & dial color in margin.

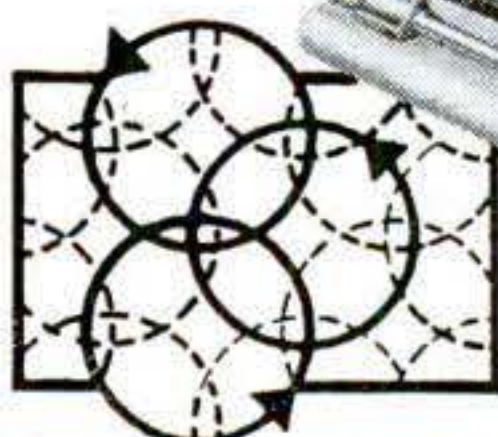

Orbital Motion—Abrasive pad has circular motion—grits move in overlapping 3/16" circles, at high speed. No marring.



Furniture—Leveling butts and mitres.



Repairs—Fitting screens, smoothing plaster patches.



Autos—Sanding primer, featheredging

PORTER-CABLE Guild Orbital SANDER

(Model 105)

Away out in front among finishing sanders! The kind of surfacing you've always wanted! And power that gives brisk cutting action . . . even when you put on extra pressure. Using orbital motion, it sands perfectly *with*, *against*, and *across* the grain. Sands equally well on wood, metal, plastic, or composition—10 times faster than hand sanding.

A Powerful Tool Only \$59.50

The Guild Orbital Sander is *not* a vibrator-type machine, but a motor-driven, counterbalanced, ruggedly-built tool designed for trouble-free, non-stalling operation in home shop or in industry.

Yes, it's *quality* throughout—priced for the home craftsman who takes pride in superior work. Sold with standard pad at \$59.50. Accessories include extra pads for contour sanding and polishing, abrasive cutting template, steel case—all at extra cost. See it—try it at your Guild Tool dealer. Or mail coupon for full details.

PORTER-CABLE MACHINE CO.
6085 N. Salina St., Syracuse 8, N. Y.

Send me full information about the new Guild Orbital Sander . . . also name of my nearest Guild dealer.

Name.....
Street.....
City..... Zone..... State.....

Manufacturers of SPEEDMATIC and GUILD Electric Tools
In Canada write: Strongridge, Ltd., St. Catharines, Ont.



NEVER-STAIN
**ALUMINUM
 RUST PROOF
 NAILS**
Saved me \$480⁰⁰

I'm glad I didn't make the mistake my neighbor did when he allowed ordinary nails to be used on the siding of his home. In less than 18 months' time — premature repainting because of rust stains and streaks cost him \$420.

That can't happen to my house because I used "Never-Stain" RUST-PROOF ALUMINUM NAILS which will NOT STAIN OR STREAK painted surfaces and last a LIFETIME. And besides, I saved a \$60 countersinking and puttying job, unnecessary when aluminum nails are used.

Be wise — if you build or remodel, specify Never-Stain Aluminum Nails. They're economical, too!



NICHOLS
WIRE & ALUMINUM CO.
 Davenport, Iowa

Roofing Felt Makes Concrete Form

AN INEXPENSIVE and quickly built form for pouring concrete underpinnings can be made from ordinary roofing felt, as shown in the drawings. Other cylindrical forms, such as fence posts and columns, can also be poured this way.—*Ralph L. Kyker, Fresno, Calif.*

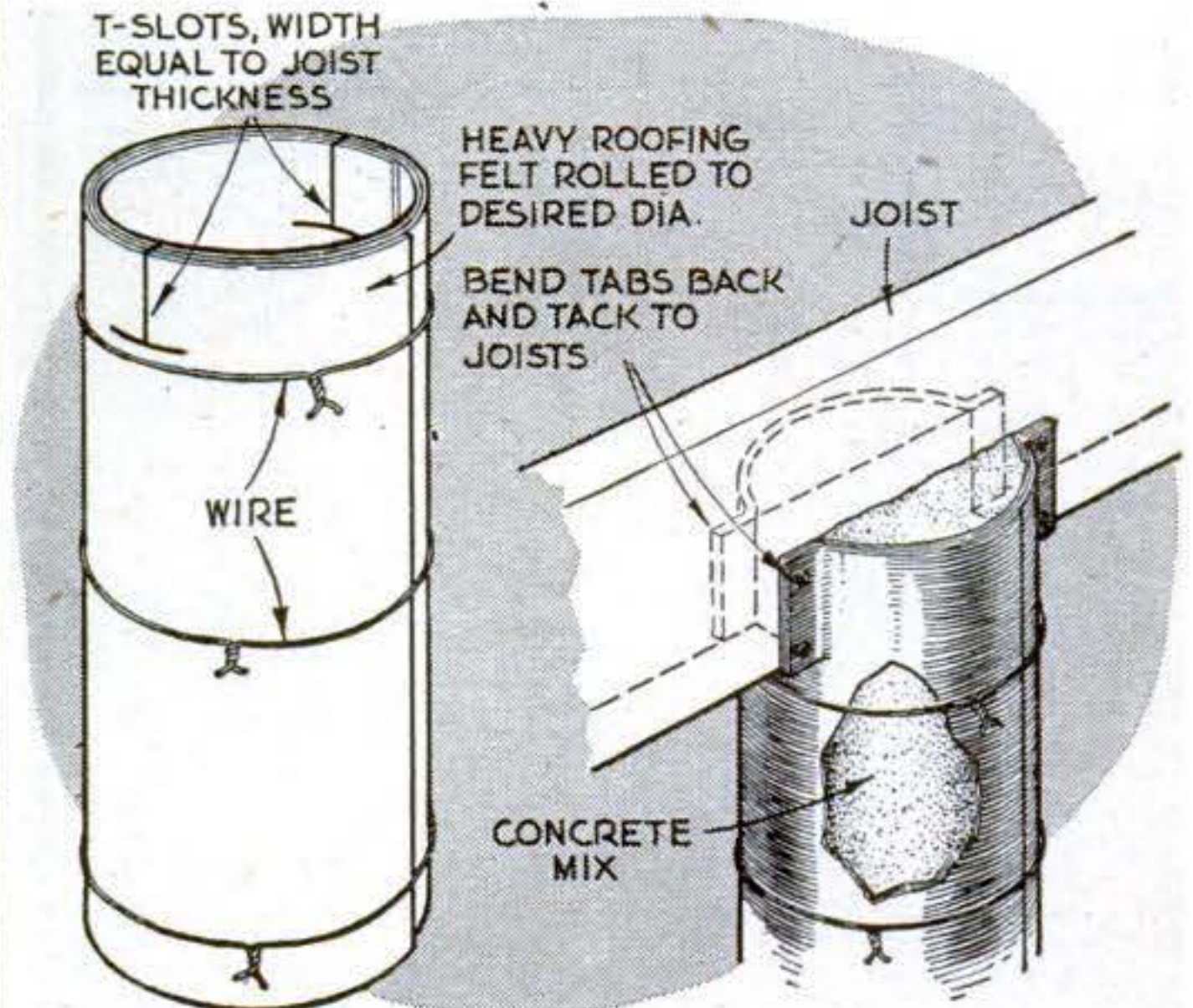

Radioactive Thread Treats Cancer

A NEW tool in the treatment of cancer is a radioactive thread that a surgeon stitches into place. Made by inserting a radioactive cobalt wire into an extremely narrow nylon tubing, the thread is said to be flexible enough to limit irritation of the tissue. After a treatment is completed, the thread is removed like a conventional suture. Dr. William J. Myers, of Ohio State University Medical Center, developed the method.

New Mold Drug Used to Fight TB

A CLOSE relative of streptomycin, and effective against tuberculosis germs that resist streptomycin, viomycin is still another addition to the powerful disease-killers derived from molds. When used in treating tubercular guinea pigs at the Mayo Foundation, researchers found that the new drug caused a definite slowing up and healing of the disease.

Birds Get Migration Tip-Off

How birds know exactly when to start their long migratory flights is still an unsolved problem. Certain physiological changes, involving the disposition of fat in the body, however, are believed to be one important factor in tipping off the birds that it is time to migrate.

AMAZING NEW WOOD-GRAIN TRANSFERS!

Transvener
**PLASTIC
 VENEER**



**FINISH
 UNFINISHED
 FURNITURE!**

**TRANSFORM
 OLD FURNITURE
 INTO NEW!**

TRANSVENEER is applied as easily as a decal —yet has the beauty of the most expensive wood veneer! 13 beautiful wood grains, marbles and leathers to choose from. It's easy, fast, low-cost, durable. Covers any smooth surface.

Write today for free sample folder!

TRANSVENEER

Division of **THE DI-NOC COMPANY**
 1005-C Public Square Bldg. • Cleveland 13, Ohio

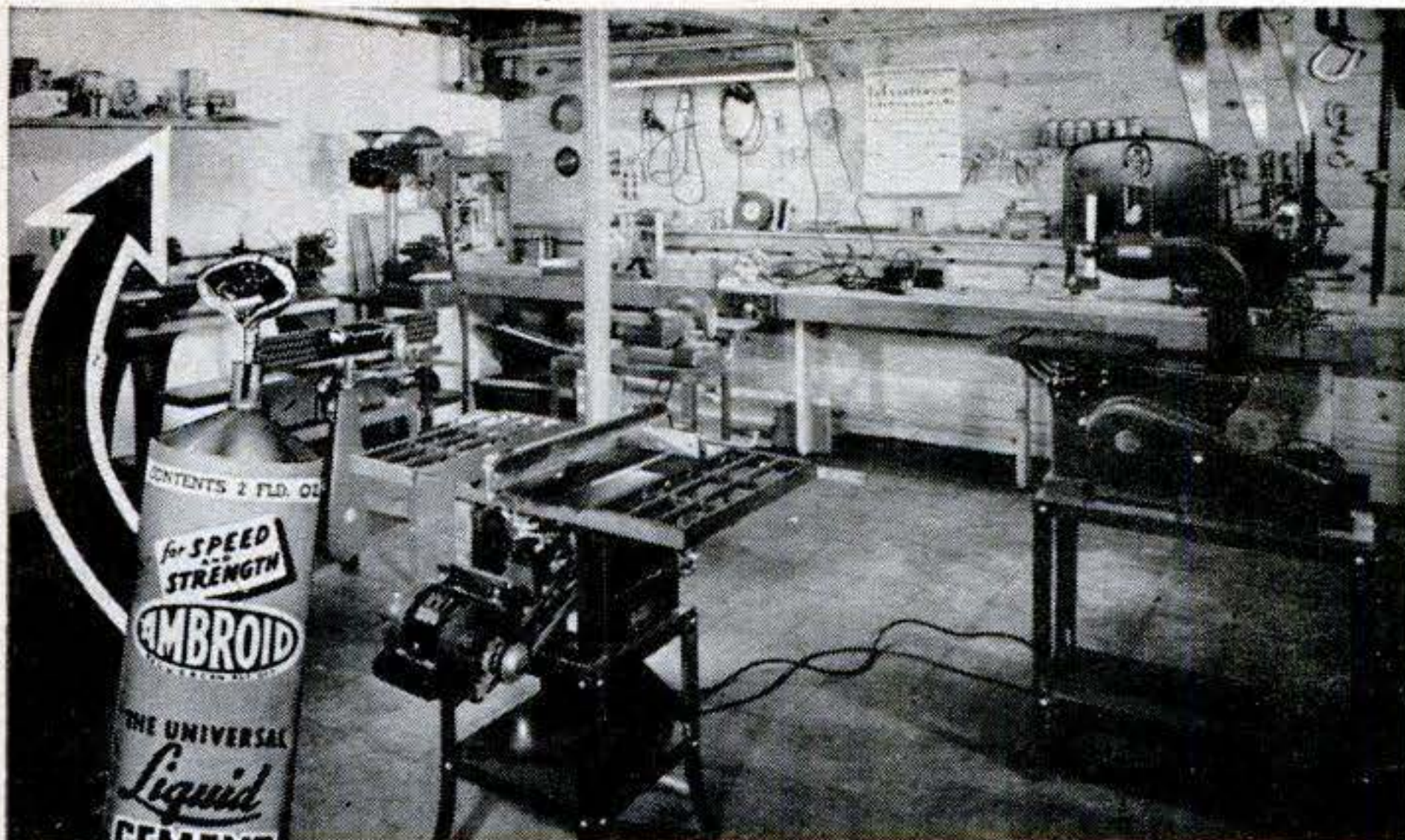

Workshop in Holiday House, representative of the best in home workshop equipment and supplies—a setting in which AMBROID is proud to be included.

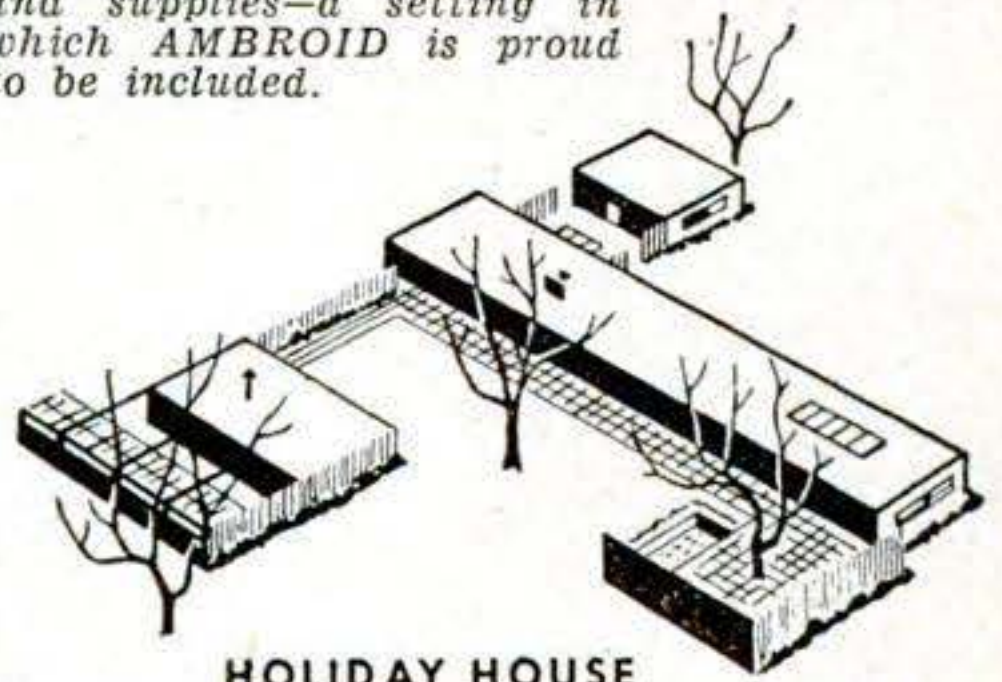

HOLIDAY HOUSE

HOLIDAY Magazine selects **AMBROID** for the hobby workshop of **HOLIDAY HOUSE**, the ultra modern luxury home featured in **HOLIDAY** for May 1951.



- Ready-to-use
- Fast setting
- Flexible
- Waterproof
- Extra strong
- Dries by evaporation—no expansion or distortion

Try Ambroid in your business, too. For over 40 years the standard industrial adhesive of its type.

Ambroid deeply appreciates the honor of being selected for the hobby workshop of Holiday House. This selection adds impressively to the approval indicated by art galleries, museums, and leading industrial concerns.

Hobbyists and craftsmen have long been aware of Ambroid's many advantages. Veteran sportsmen consider Ambroid indispensable. And around the average house, just as well as in this ultra modern workshop at Holiday House—Ambroid will prove worthy of a place of honor.

Try **AMBROID** TODAY • At your Dealer or send 25c for big 2 oz. tube postpaid.

AMBROID CO.
306 Franklin Street, Boston 10, Mass.

PYTHON Metal Bit



CONVENTIONAL LENGTH DRILL
\$3.95 EA.—3 FOR \$11.50



JUNIOR DRILL
\$2.95 EA.—3 FOR \$8.50

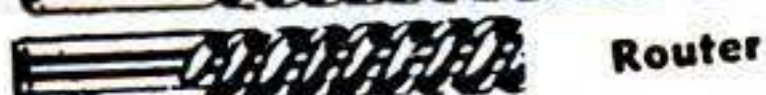

ROUTER BIT
\$1.95 EA.—3 FOR \$5.50
POSTPAID

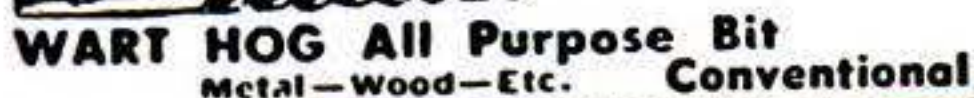

SETS WITH SPECIFY TYPE
1 Conventional
1 JUNIOR
1 ROUTER PYTHON
\$8.50 WART HOG

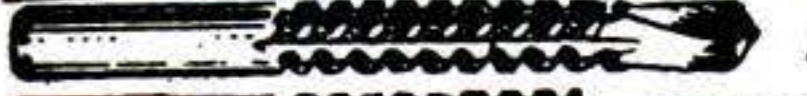
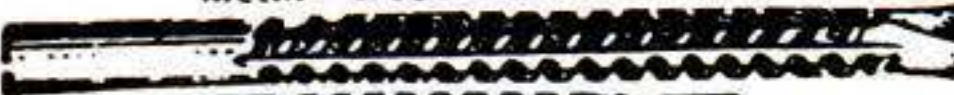

Each Bit Performs its own Function—Specify Which Will cut stainless Steel. Use side pressure and sawing action for best results on any material.

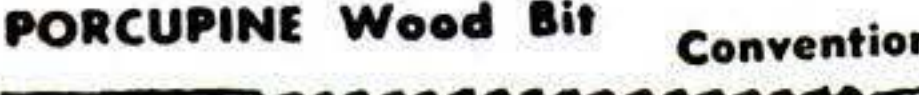

MILLER ROTARY
HI-SPEED ROPE-SAW DRILL-BIT
IT SAWS & CUTS REAMS

SAWS, CUTS, REAMS sheet metal, angle iron, pipe, wood, plastic, Transite, etc. Amazing high-speed combination bit and saw fits any 1/4" or 1/2" electric drill or slow drill press. Drills own starting hole to quickly cut, saw or ream opening. Easy to operate. Ideal for carpenters, auto mechanics, electricians, plumbers, hobby workers, many others. Abrasive resistant high speed steel. No breaking. Will withstand severe continuous use. Resharpener at no charge. 1/4" diameter. Conventional Drill length 3 1/2" with 2" cutting section. Junior Drill length 2 3/8" with 1" cutting section. Router Bit length 1 3/4" with 1" cutting section. Ground from solid. Shipped same day—money back guarantee. Discounts on quantity orders from dealers. Manufactured and distributed by

INTERNATIONAL TWIST DRILL CORP.
624 Wyandotte Rm. 831 Kansas City 6, Mo.
"Pioneers in break resistant short drills"

Aladdin Tools

Make These Cuts—And Hundreds More With Aladdin Shapers for Circle Saw and Drill Press!

CIRCLE SAW WOODSHAPER, MODEL #5A-10. (left) Solid steel. Absolutely safe—blades locked in position with screws all the way through. In ordering, state diameter of your circle saw shaft. Complete, as pictured, with 6 pair blades and tool rack. **\$14.95**

DRILL PRESS WOODSHAPER MODEL #60. (right) Heavy-duty shaper. Exclusive pilot bearing eliminates side thrust, chatter, vibration—assures smooth cutting action. Complete as pictured with 6 pair blades. **\$12.95**

Aladdin tools are of top-quality hard-to-get tool steel and fully guaranteed. A word to the wise—SEND CASH. CHECK OR MONEY ORDER TODAY!

Nationally Distributed by

BERTRUM F. ENGINEERING & SUPPLY CO.

3121 MAIN STREET

KANSAS CITY, MO.

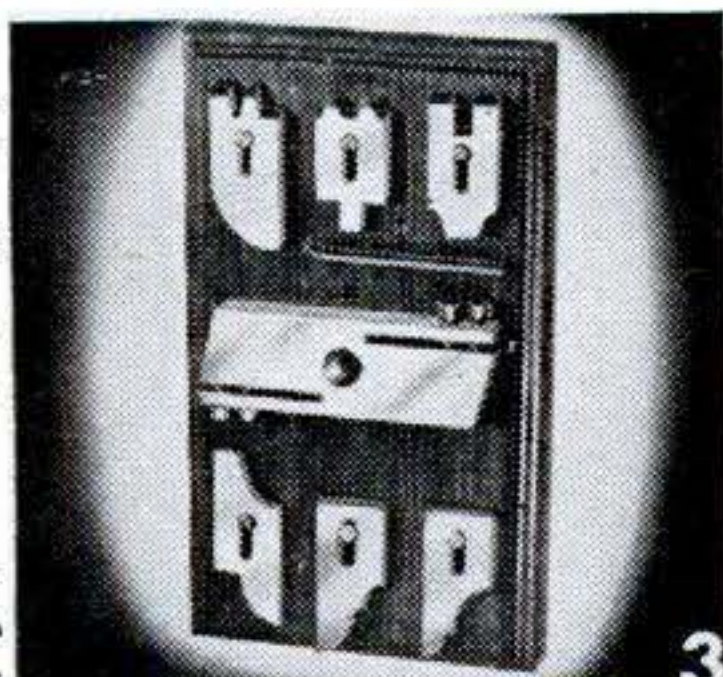
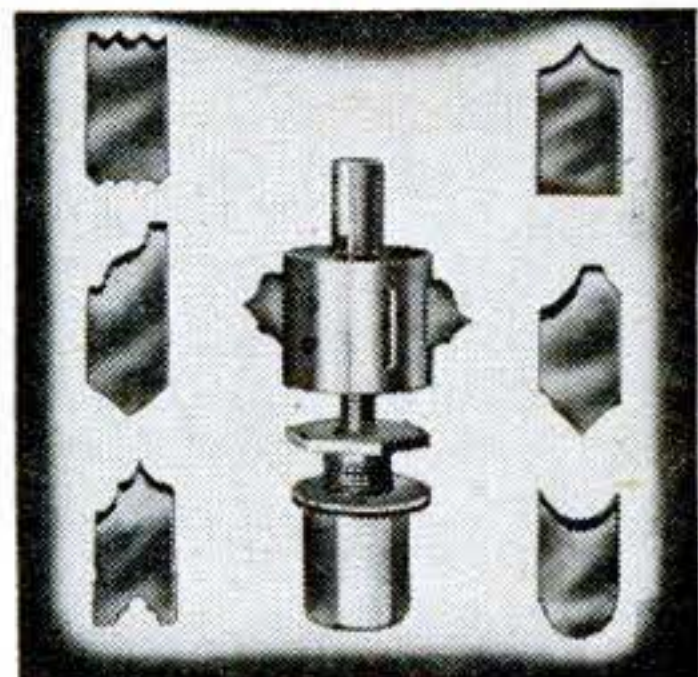

MENDS

Pottery, Toys,
Furniture, Books



It's transparent, waterproof,
flexible and durable.
Get a tube
today.



DUCO CEMENT

REG. U. S. PAT. OFF.

MAKE YOUR
Circular Saw
SAFER!

New
PTI
SAFETY
SAW BLADE

Pat.
Pending

Eliminates KICKBACKS

Working on a radically new cutting principle — this new PTI Safety Saw Blade completely eliminates dangerous kickbacks, minimizes direct injuries. Cuts smoother, lasts longer, uses 30% to 40% less power, cuts easier, is much quieter and cleaner, producing chips not sawdust. This is the original safety saw blade—tested and approved by leading laboratories, government agencies, industrial concerns. Made of tough Chrome Vanadium Steel—in sizes from 7" to 16". Costs no more than ordinary saw blades. Send *today* for FREE circular giving complete story, specifications and prices. Dept PS-5.

PTI

PTI INCORPORATED, 401 BROADWAY
NEW YORK, N. Y.

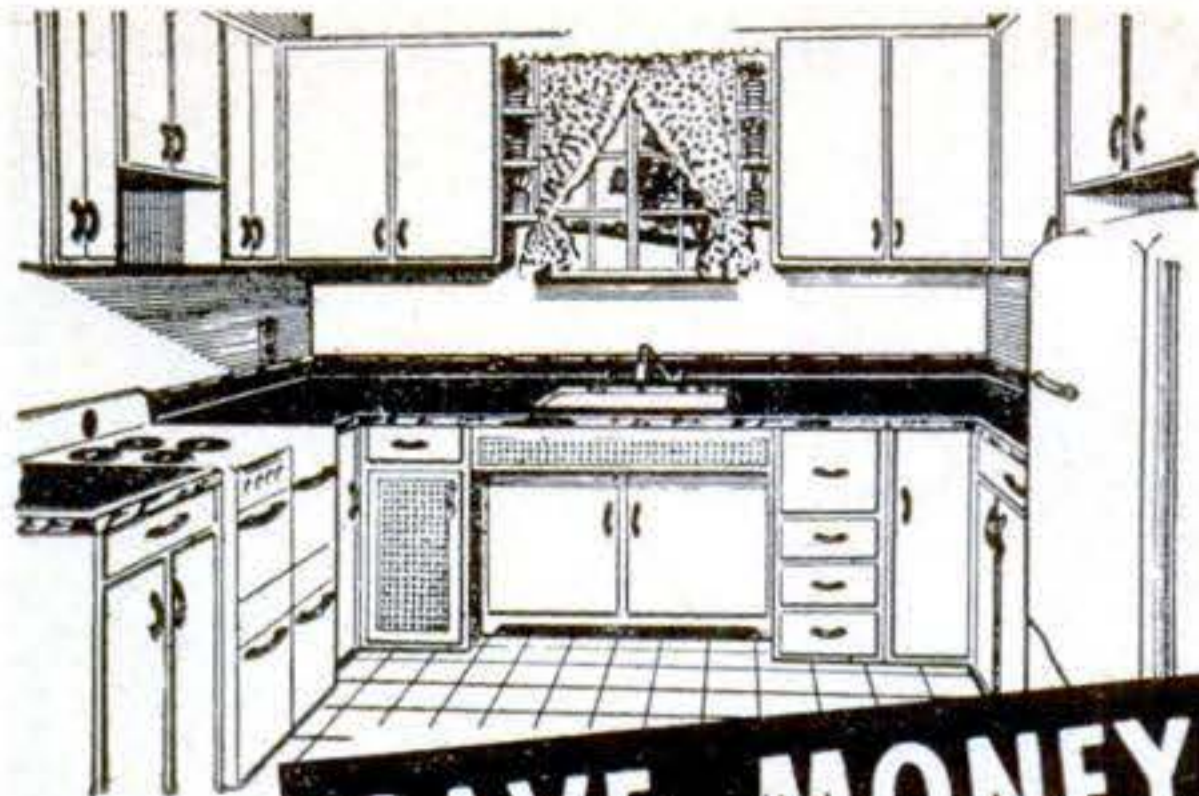

SAVE MONEY!

New method simplifies building a house, kitchen cabinets, garage and over 100 other household articles. In Reader's Digest, you may have read how the Easi-Bild* Pattern takes all the mystery out of building whatever you need.

Pattern tells how to modernize your entire kitchen using stock size lumber and Stanley Kitchen Cabinet Hardware. Send \$1.00 for Cabinet Pattern No. 201, enclose 20c additional for Pattern Book illustrating over 100 other Pattern Projects.

*Trade Mark Reg. U.S. Pat. Off. by Easi-Bild Pat. Co.

Easi-Bild Pattern Company
P.O. Box 215, Pleasantville, New York

ALL NEW 1951 KING MIDGET AUTO

WORLD'S LOWEST PRICED 2 PASSENGER CAR

Drive it for 75c per week. Amazing performance. Surprising comfort. All steel construction. Full accessories, top and heater. Ready to run or assemble it with our bolt together parts. Rider agents wanted, earn your car Free. Send 25c for detailed literature or \$1 (refunded first order) for actual assembly book and service manual filled with photos, drawings, specifications, etc.



MIDGET MOTORS MFG. CO. ATHENS 2, OHIO

Make Your Own POWER LAWN MOWER

with this DRIVE CUTTER ASSEMBLY

Constructed for those who desire to build their own mower or to replace your old cutter assembly. Complete with 18" blade and double ball bearing drive, only \$12.95

Add 50c to cover handling & shipping. No COD's

ATLAS EQUIPMENT CO., Dept. PS5
229 SW BLVD. KANSAS CITY, MO.

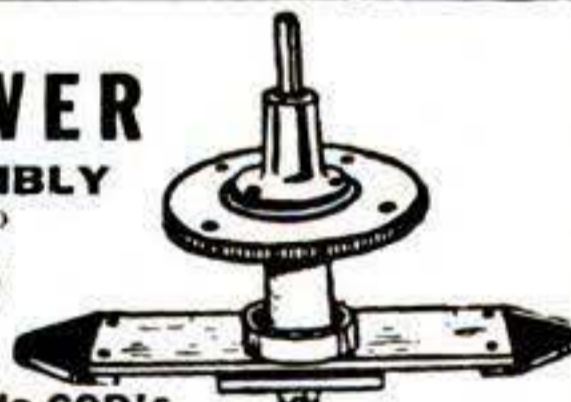

Best way to
REMOVE PAINT

WONDER-PASTE

Apply Wonder-Paste with a paint brush and let it work. Then simply strip off the old finish with a putty knife. Easy, fast. No scorched areas. No sanding. A perfect surface for refinishing. For paint, varnish, lacquer, enamel, etc. At paint and hardware stores.



The painter's
favorite!

Write for Wonder-Paste leaflet

Wilson-Imperial Company, 121 Chestnut Street, Newark 5, N.J.

SURPLUS MACHINE SHOP TOOLS AT PRICES YOU CAN AFFORD

HIGH SPEED STRAIGHT SHANK DRILLS



SET 10 Different Size High 1N Speed Straight Shank Jobber Length Drills from 1/4" to 1/2". \$25 value. Priced at only..... **\$4.49**

SET 10 Different Size High 2N Speed Straight Shank Drills from 1/4" to 1". Extra long. \$40 value. New and used surplus.... **\$7.95**

HIGH SPEED MORSE TAPER SHANK DRILLS



SET 20 Different Size High 3N Speed Morse Taper Shank Drills from 1/4" to 1". \$70 Value. Priced at only..... **\$12.95**

SET 10 Different Size 4N High Speed Morse Taper Shank Drills from 1/2" to 1 1/4". \$50 Value. Priced at only..... **\$9.95**

SET 7 Different Size High Speed Morse 5N Taper Shank Drills from 1" to 2", with No. 3, 4, and 5 tapers. At least 3 drills over 1 1/2" in size. \$125 value. Priced at only..... **\$29.95**



HIGH SPEED TAPER SHANK CHUCKING REAMERS

SET 15 Different Size High 6N Speed Morse Taper Shank Chucking Reamers up to 1/2" with No. 1 and 2 tapers. Priced at only **\$6.95**

SET 8 Different Size High 7N Speed Morse Taper Shank Chucking Reamers from 1/4" to 1". Priced at only..... **\$4.95**

SET 10 Different Size High Speed Morse 8N Taper Shank Chucking Reamers from 1/2" to 1 1/8". \$65.00 value. Priced at only..... **\$9.95**

HIGH SPEED STRAIGHT SHANK CHUCKING REAMERS



SET 20 Different Size High 9N Speed Straight Shank Chucking Reamers up to 1/2". Priced at only..... **\$7.95**

SET 15 Different Size High 10N Speed Straight Shank Chucking Reamers from 1/4" to 1". Priced at only..... **\$6.95**

SLITTING SAWS

SET 7 Different 11N Size High Speed Slitting Saws 2 3/4" dia. x 1" arbor. Thickness from .040 to .071. Cuts wood, aluminum, brass, steel, etc. \$25 Value. Priced at only.....

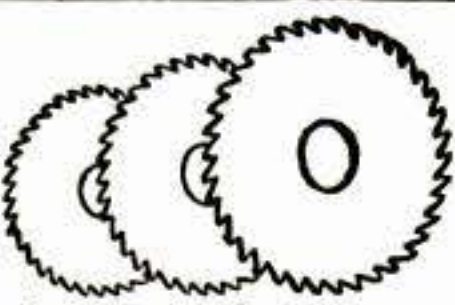

HAND REAMERS



SET 10 Different Size 12N Hand Reamers from 1/4" to 1". Majority brand new, only..... **\$7.95**

SET 20 Different Size Hand 13N Reamers as above, only..... **\$13.95**



18-PIECE GRINDING WHEEL SET

Heavy duty; brand new. Adaptable to 1/4" and 1/2" electric drills, bench and air grinders, etc. Consists of:

- FOUR—8" x 1/4" x 5/8" arbor aluminum oxide resinoid 1.20A75 grinding wheels.
- FOUR—2 3/4" x 1/2" x 1/2" arbor 60-grit Norton wheels.
- FOUR—2 1/4" x 1/2" x 1/2" arbor 60-grit wheels.
- TWO—8" x 1/8" x 1/2" arbor cut-off wheels.
- ONE—6" x 1/4" x 1/2" arbor resinoid bond wheel.
- TWO—4" x 1/2" x 1/2" arbor 130-grit Norton wheels.
- PLUS—1/2" arbor with 1/2" mandrel to fit 1/2" wheels.

Also includes spacer which allows use of 5/8" arbor wheels on 1/2" mandrel. Price post paid to you, only..... **\$7.95**

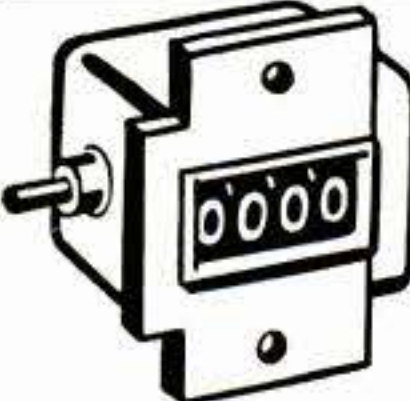

NEW VEEDER ROOT COUNTER

4-digit clock-wise rotation type..... **\$1.89**

3-digit clock-wise rotation type..... **\$1.49**

Discount on large quantity available.

BRAND NEW PUMP AND MOTOR

Pump has 1" connections, built-in relief valve, adjustable up to 1500 lbs. Max. Capacity 6 GPM.

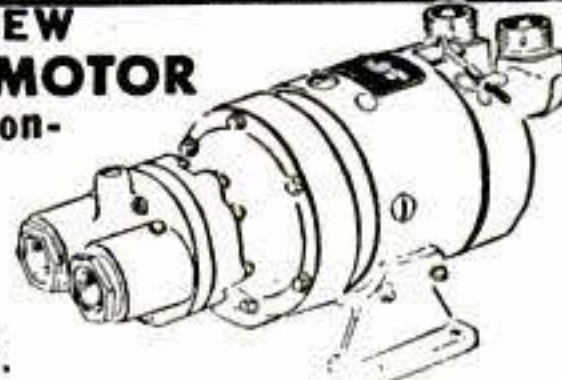

1 1/2 H.P., 24-volt motor. 4000 RPM. Can be used on 12 or 36 volts. 500 units available at quantity discounts. Both pump and motor only..... **F.O.B. TULSA \$12.95**

Money-Back Guarantee—All Mdse. Mixture of New and Reconditioned Tools Unless Specified Brand New—All Orders (Except Those Specified F.O.B. Tulsa) Are Shipped Post Paid, saving you up to 25% on total delivered cost.

Write for Free Catalog Describing Thousands of Bargain Cutting Tools.

50-PC. GRINDING WHEEL KIT



Brand new. Adaptable to 1/4" x 1/2" electric drills, small grinders, etc. Consists of:

- FOUR—3" x 1/2" x 1/4" arbor 60-grit stones.
- FIVE—1/4" shank mounted cylindrical stones.
- ONE—4" x 1/8" x 1/4" arbor cut-off wheels.
- THREE—2" x 3/4" x 1/4" arbor 60-grit wheels.
- SEVEN—1 1/2" x 1/8" cut-off wheels.
- ONE—3" x 1/4" x 1/4" arbor MX polishing wheel.
- ONE—2" x 1/4" x 1/4" arbor MX polishing wheel.
- ONE—2 3/4" x 1" x 5/16" arbor 80-grit wheel.
- ONE—2" x 3/8" x 1/4" arbor grinding wheel.
- 24—Internal type grinding wheels, all grits and sizes ranging from 5/8" O.D. to 7/8" O.D. and from 1/2" to 1 1/2" in length.
- ONE—Internal type mandrel upon which can be mounted the 24 internal type stones and any other 1/4" arbor wheels.
- ONE—plain 1/4" mandrel.

Here is a kit which by means of arbor furnished gives you fifty 1/4" arbor mounted stones. All stones first quality material. Cost new over \$35. Your cost **\$9.98** Post Paid.....

BRAND NEW MOUNTED STONES



100 stones 1/8" shanks, rounds, points, cylinder shapes, etc. These 100 pieces, only..... **\$7.98**

NEW MOTOR 1/2 H.P. 24-volt, A.C. or D.C. 22 amp., 6000 RPM, mfgd. by Delco, 3/8" shaft. Can be used on 12 or 36 volts..... **\$4.95** 500 available at discounts

BRAND NEW HIGH SPEED CUT-OFF BLADES

- 1/8 x 3/4 x 6..... \$1.49 ea.
 - 1/8 x 7/8 x 8..... \$1.49 ea.
 - 3/16 x 1 x 8..... \$1.79 ea.
 - 3/16 x 1 1/8 x 8..... \$1.89 ea.
 - 1/4 x 1 1/4 x 10..... \$1.95 ea.
- Discounts on Quantity

WOODWORKERS... Get this

CONSTANTINE MASTER MANUAL



Get the Most Fun From Your Hobby Indispensable to woodworkers. Newest, biggest edition, more pages, more color, helpful how-to-do-it articles, pre-war and new items, more bargains. Send 25c today and we will include **FREE! FULL YRS. SUBSCRIPTION** to Chips and Chats, published bi-monthly. Keeps you up-to-date on everything in woodworking, offers big money-saving bargains. Send now. ALBERT CONSTANTINE & SON, Inc. Dept. PS-5 797 East 135th Street, New York 54, N. Y.

Low Cost Way To Brighten Your Home

New free illustrated booklet shows easy, low-cost ways to brighten cellars, attics. Use aluminum paint—the right kind. We don't make paint, but offer this book to help you get best results. Write for free booklet "Paint it Bright."



Aluminum Company of America, 1717G Gulf Bldg., Pittsburgh 19, Pa.

Start Your Own Welding Business with a HOBART "Simplified" arc welder



Go after WELDING jobs that Pay Big Money!

Write today for complete details on this Profit Making Equipment No Obligation

Never before has the demand for welding been so great—the profits so large. That's why smart operators everywhere are setting up their own welding business... and you can do the same.

SIMPLY CHOOSE from our complete line, the welder that best suits your needs—gas or electric drive—portable or stationary. The big pay jobs are waiting, so don't miss this opportunity. Write today.



HOBART BROTHERS CO., Box P-51, Troy, Ohio

"One of the world's largest builders of arc welders"

SAVES SO MUCH COSTS SO LITTLE!



8" BENCH SAW



ONLY \$33⁹⁵

With two extensions, as shown, \$38.90.

Watch the savings pile up with this Workshop saw to help! Makes quick, professional work of home repairs, furniture, cabinets, shelving, toys, etc. Cross cuts, rips, mitres — saves tedious, time-taking hand sawing. Pays for itself on one or two projects alone. Send for detailed catalog today!



ATLAS PRESS CO.

555-W N. Pitcher St., Kalamazoo, Mich.

DEPENDABLE QUALITY TOOLS

HOUSEHOLD SHARPENING IS EASY...



WITH A NORTON[®] abrasives Stone!

The right stone is a NORTON Abrasives CRYSTOLON[®] #JB-8 with coarse and fine sides, oil-filled at the factory for your convenience without added cost. \$2.30 at most hardware stores.

The "know-how" on all kitchen, household, garden and shop tools is in the "HOW TO SHARPEN" Book — 32 profusely illustrated pages that take all the mystery out of sharpening. For your copy, send 10c to Dept. PS-5.



BEHR-MANNING TROY, N. Y.

Also Mfrs. of Abrasive Paper and Cloth

RESET LOOSE HINGES

with

PLASTIC WOOD

A CELLULOSE FIBRE FILLER

EASY! No skill required. Handles like putty...hardens into wood.

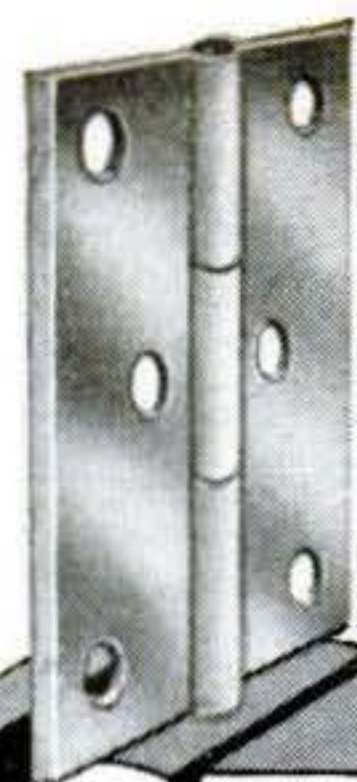

IN CANS OR TUBES

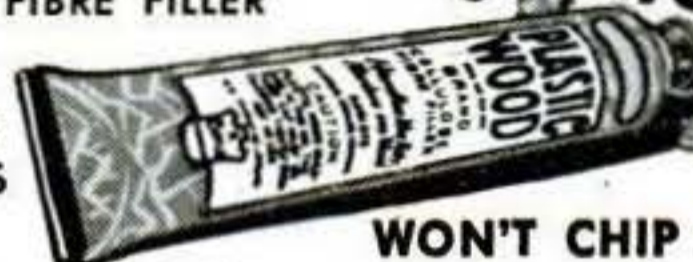

WON'T CHIP OR CRACK

P.S. Lubricate bikes, trains, skates and wagons with 3-IN-ONE Oil

NEW POWER TOOL UNITS

Amazing Values

Write for Details

EMRICK, INC., 251 Clinton, Kalamazoo, Mich.

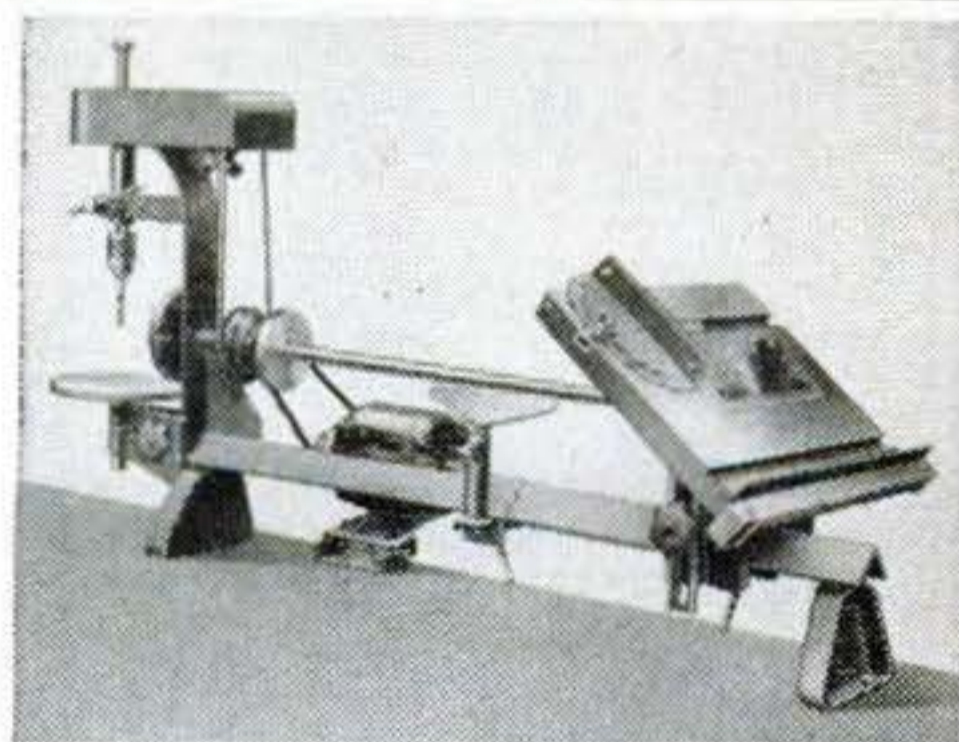

1/2" ELECTRIC DRILL \$2⁹⁵

ADAPTER takes all drill sizes to 1/2" Fits any small 1/4" Electric Drill — in just a second! Well-made and a Mighty Handy Tool

DANIELS PRODUCTS CO. P5-822 W. 22nd St., Kearney, Nebr.



Postpaid in U.S.A.

Order Now

Make lasting Metal Repairs

WITH →

FREE: "Soldering Simplified." 16 page illustrated booklet. Get your copy now.

Kester Solder Company
4254 Wrightwood Ave.
Chicago 39, Illinois



NOTHING LIKE IT AT THE PRICE
for **POWERFUL, FAST CUTTING PRODUCTION**

Model 2000—with straight-line reciprocating action that guarantees scratch-free surfaces—is a fast-cutting production sander for heavy-duty craft and woodworking projects—for hobby work, refinishing and redecorating. It gives you the added stroke and power required for furniture and cabinet making, boat building or refinishing, resurfacing large areas, sanding plastics, leather, etc. Great for building operations such as woodwork, dry wall joints, siding and other exteriors. Also does a superb wax-polishing job! Buy it, try it, compare Model 2000 with any competitive electric sander. You be the judge!

OUTSTANDING Model 2000 FEATURES

- 21 sq. in. sanding surface • weighs only 5 lbs. • easy one hand operation—just guide it • only 2 moving parts • requires no oiling • cam-type holder permits 10-second paper change • dust-proof, fool-proof, fully guaranteed • over-all size 3 1/8" x 4 1/2" x 7" • operates on 110-120 v. 60 cycle, A.C.

ONLY \$24.50

WITH STEEL CARRYING CASE AND COMPLETE ACCESSORIES

14,400 Sanding Strokes Per Minute



(PATENTED)

21 SQUARE INCHES OF SANDING SURFACE!

WHERE TO BUY DREMEL SANDERS

If your dealer can't supply, send full remittance for postpaid shipment. Or send only \$2, and pay postman balance plus postage and C.O.D. fee. Money back if not delighted after 5 days' trial.

DREMEL MFG. CO., Dept. 121-E, RACINE, WIS.



LIGHTER CAPACITY MODEL "A" FOR HOUSEHOLD SANDING-POLISHING JOBS

Housewives, homeowners, hobbyists go for Model "A". Over a quarter-million now in use! Perfect for all household sanding, polishing, refinishing. Also a soothing massager. Only 2 1/2 lbs.; sanding pad 2 1/4" x 5 1/2". Same construction features as larger Model. With 6 sheets sandpaper, sheepskin, felt pad.....Only **\$14.85**

BEFORE YOU BUY ANY SANDER COMPARE!
BE SURE YOU WILL GET A SCRATCH-FREE FINISH

ROTARY Action
About 50% cross-grain motion



ORBITAL Action
Partial cross-grain motion



ARC Action
100% cross-grain motion



DREMEL Reciprocal Action
100% WITH THE GRAIN motion for scratch-free finishes

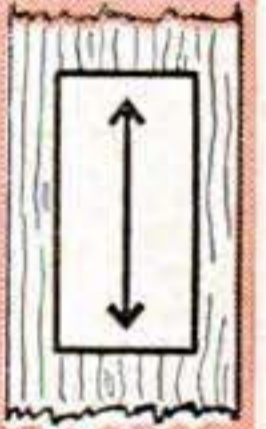

SAVE OVER 50%
ON THESE BRAND NEW WAR SURPLUS POWER UNITS



BE PREPARED for any emergency!
LIGHT PLANT BUYERS—
in emergency telephone collect—unit shipped same day!

5 KW Plant, 120 volts, 60 cycle AC. List today \$1910.00 Used \$675.00 NEW. Your price only \$895.00

BARGAIN SPECIALS !!

- Ball-Bearing Arbor ..\$6.95
- Alarm Siren or Horn \$15.45
- Mercury Heat Control \$6.95
- Barn Ventilator . . . \$69.50
- Electric Hot Water Heater, 10 gal. \$24.95
- Hot Rod Supercharger \$31.00
- MALL flexible shaft grinder \$99.50

- 2500 Watt, AC, 110 volts, 60 cycle. Slightly used but reconditioned and fully guaranteed ONLY . . . \$295.00
- NEW, same as above \$345.00
- Plants built in 1951 \$426.00
- 300 Watt, Reg. \$145, Now \$ 99.00
- 750 Watt \$232.00
- 3000 Watt DC Contractor's PORTABLE. Rubber tired wheels. 5 to 7 HP gas engine. Used like new \$220.; New \$279.00
- 7500 Watt 4 cyl. engine; New \$995.00
- 10,000 Watt Used \$1195.00; New \$1495.00
- 25,000 Watt Used \$1995.00; New \$2495.00
- 35,000 Watt Diesel, Rebuilt \$2995.00
- 50,000 Watt Diesel, New \$5900.00
- All units 10,000 and over, 1 or 3 phase 110-220 volts.

HEAVY DUTY, all purpose WINCH

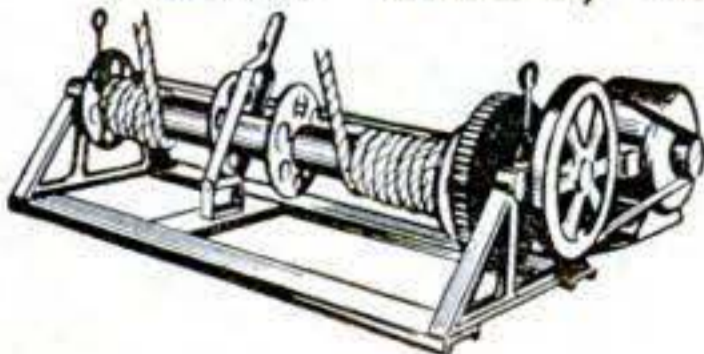

For—Contractors, Boats, Farmers, Trucks, Loggers, etc. Multiply your pulling, hoisting power tenfold. Can be driven by hand, gas, electric, or tractor take off. 10 to 1 ratio; double drum for reverse. Manufactured by Brenner. Wgt. 280 lbs. List price \$119.95 Our price \$49.50

Below are just a few of the many items we have in stock at sensationally low prices:

- Pumps
- Grinders
- Air Compressors
- Air Tanks
- Drop Cords
- Generators
- Fire Pumps
- Saws
- Winches
- Gear Reducer
- Clutches
- Motors

Write today for free catalog. Thousands of \$\$ saving buys.

C & H ELECTRIC Co.
438 W. JUNEAU AVE.
MILWAUKEE 3, WISCONSIN

Send for this **BIG NEW** Hunt's **WOODWORKERS CATALOG NO. 18**
ONLY 15c

NEW LOW PRICES
Offers greatest selection of fine domestic and imported woods—and hundreds of woodworkers items at bargain prices!
You'll save time and money with this big, new catalog. Contains everything wood craftsman needs. Shows 32 rare and fancy woods in color...43 veneer designs...275 scroll patterns...multicolor inlays, overlays, bandings...all kinds of tools, machinery, cabinet hardware, ornaments, mouldings...and pages of valuable tips, ideas, information, instruction. Send for your copy NOW. Only 15c--refundable on your first order.



- 144 PAGES
- QUICK DELIVERY
- on maple, poplar, oak, mahogany, red cedar, cherry, walnut, and many others—all properly seasoned and kiln dried.

MAIL THIS COUPON--TODAY!
CRAFTSMAN WOOD SERVICE CO.
2729 S. Mary St., Dept. B5
Chicago 8, Illinois
Send me the big, new, money-saving Catalog No. 18. Enclosed is 15c--refundable on my first order.
Name _____
Address _____
City _____ Zone _____ State _____

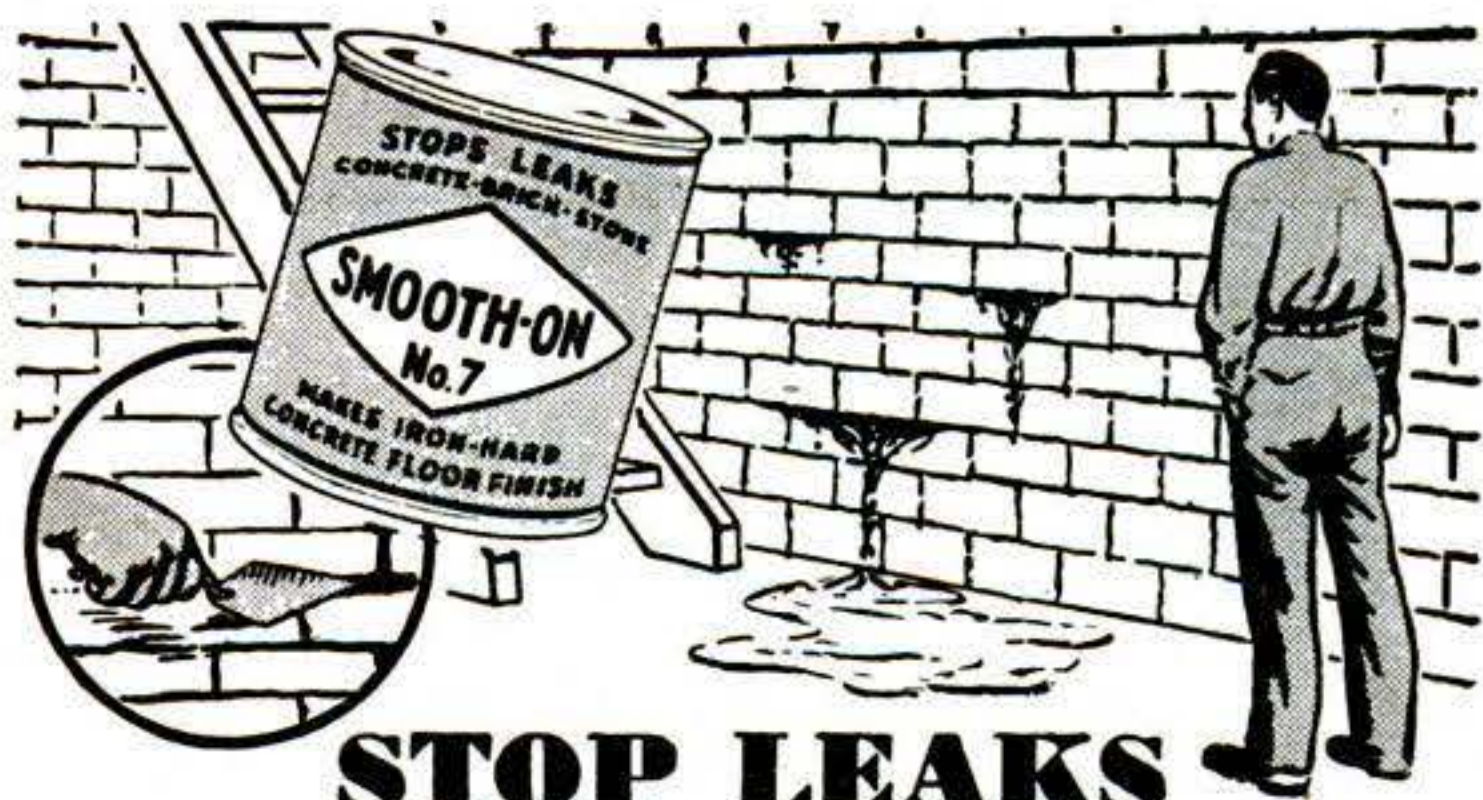

STOP LEAKS IN CELLAR WALLS

Do it with Smooth-On No. 7 Cement! Apply with trowel or stiff brush to leaky cracks, holes, porous spots, seams or other leaks in concrete, brick or stone walls and floors. The leaking will stop and Smooth-On will "stay put", for it expands slightly as it hardens. May be applied to wet or dry surfaces, indoors or outside. Use Smooth-On No. 7, too, to seal openings around pipes passing through walls. Buy Smooth-On No. 7 by name and number in 1-, 5-, 20- or 100-lb. size. If your hardware store hasn't it, write us.

FREE Leaflet and Handbook

We'll send you leaflet showing No. 7 uses, also the famous 40-page Smooth-On Repair Handbook describing other Smooth-On Cements and showing many helpful home repairs. 170 illustrations. Write today.

SMOOTH-ON MFG. CO., Dept. 58-E
570 Communipaw Ave., Jersey City 4, N. J.



Do it with
SMOOTH-ON
NO. 7 CEMENT

**NEW SENSATION
IN LOW-COST TRANSPORTATION
the CUSHMAN**

EAGLE

WRITE FOR
RIDER-AGENT
PLAN



OPERATES FOR ONLY **3/4¢** PER MILE

Your new Cushman EAGLE will give you these famous Cushman features: automatic disc-type clutch; selective gear transmission; silent action shock-absorbing springs; doubly-dependable heavy duty brakes; special heavy-duty tires for added safety and comfort. Powered by the famous Cushman "Husky" engine, the EAGLE has rapid pick-up, quick acceleration, cruises up to 60 m.p.h. — over 75 miles per gal.

WRITE FOR FREE FOLDER AND PRICES TO DEPT. 105

Cushman MOTOR WORKS, INC.
LINCOLN, NEBRASKA

Make Ur-Own ROTARY TYPE POWER MOWER

**THIS IS NOT A KIT
But A Complete Mower Assembled
As Illustrated**

\$44.95



Model 50M KEEN MOWER. Add your electric motor or gas engine. Concealed blade for safety, 3 cutting heights, 1½" to 3½". Ball bearing rubber tired wheels. 18" cut. Cuts to within ½" of sidewalk. Weight 48 lbs. America's Greatest Power Mower Value. Order Now **\$44.95**
Shipped F.O.B., K.C.

Send check or money order

Write for FREE Folder for information on "Make Ur-Own" and other models with gasoline engines or electric motors.

ATLAS KEEN MOWER

229 S.W. BLVD.

Dept. SP-5

KANSAS CITY, MO.

GRIND YOUR OWN

CIRCULAR SAWS



USE YOUR OWN saw table. Sharp- en combination, rip and hollow ground saws from 6" to 10". Makes hand filing obsolete. Saws last twice as long—and stay round—with correct tooth bevel—for cleaner work.

JIG ONLY \$8.95 with \$3.00

grinding wheel & instructions. At dealers or postpaid. Guaranteed.

"Tru-Circle" Automatic Saw Set. Sets saw teeth at 10° or more. Only \$2.95. At dealers or postpaid.

A. D. McBURNEY, 317 E. 4th St., Los Angeles 14, Calif., Dept. B-5

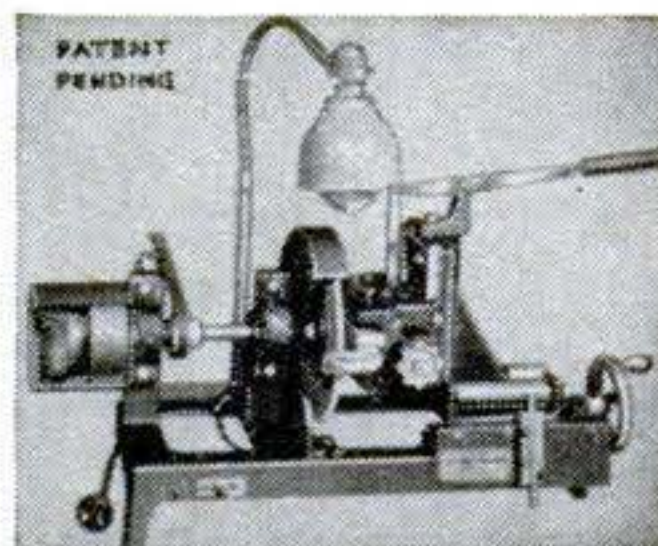

Start a NEW BUSINESS!

or Add to your present
Repair Business

SHARPEN DULL PIPE WRENCHES

PIPE TAPS & DIES
"GUM" CIRCULAR SAWS

Write for Information

J. C. MOORE INDUSTRIES

BOX S 276, Fredonia, Pa.



Another of 1000s of Uses
For Powerful

WISE-GRIP

WRENCH

PORTABLE VISE

low as **\$1.85**



No job too tough for VISE-GRIP! Jaws LOCK with Ton-Grip—hold anything. Works with speed and ease even in difficult places. Powerful grip quickly turns nuts, broken bolts and screws. Pulls headless nails—clamps parts for soldering, sawing, etc. Easily adjusts to ratchet action. With Cutter—No 7W, 7", \$2.25; No. 10W, 10", \$2.60. Without Cutter—No. 7C, 7", \$1.95; No. 10C, 10", \$2.25. No. 7, 7", \$1.85; No. 10, 10", \$2.15.

ORDER FROM YOUR DEALER

PETERSEN MFG., CO., Dept. M-5, DeWITT, NEBR.

**MAKE MONEY
SAVE MONEY
BUY
SUPERSHOP**

**15 DAY
TRIAL**

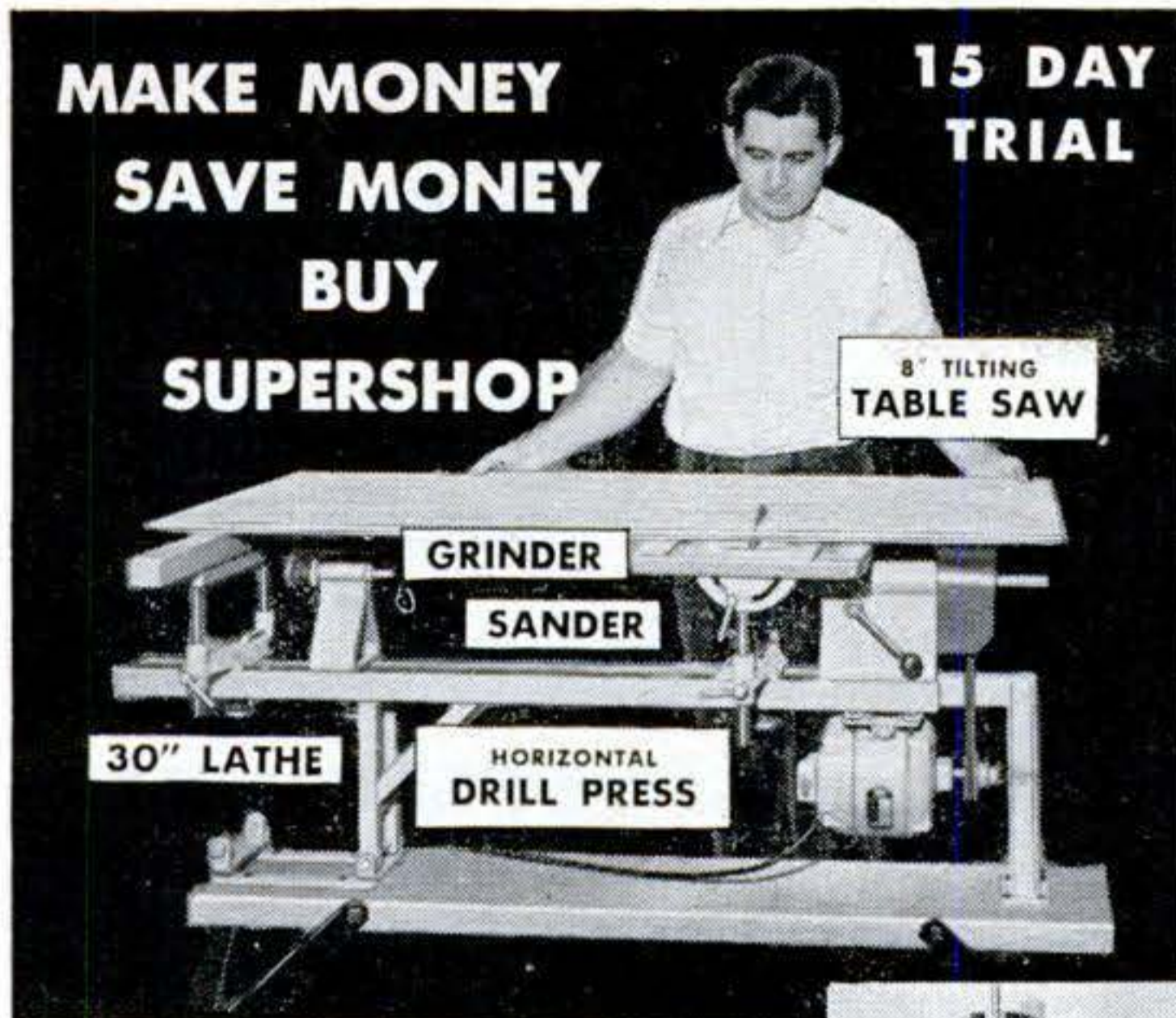

BUY SMART — \$79.95
FACTORY TO YOU

SUPERSHOP offers you a lifetime of power tool pleasure and profit. 100% ball bearing. RUGGED. Accurate. Big capacity. 15 day FREE trial. Money back guarantee. Mail postcard for FREE catalog. Buy on easy pay plan.

POWER TOOLS, INC.

223 Yates Ave.
Beloit, Wisc.

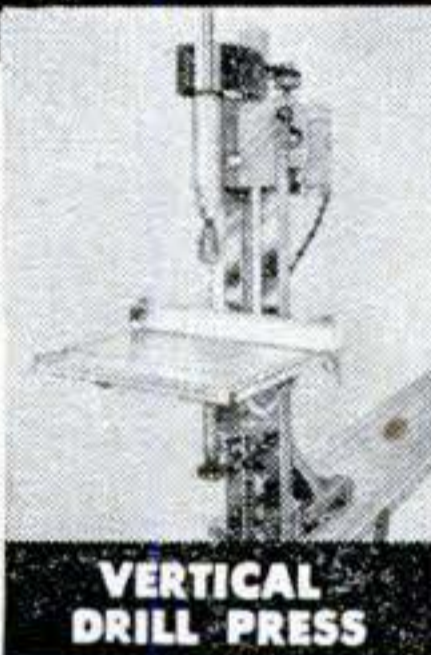

**VERTICAL
DRILL PRESS**

ALNICO MAGNETS LIFT 175-lb.

AMAZING PERMANENT MAGNETS—WILL NOT WEAKEN! NON-ELECTRIC. Retrieve guns, tackle, tools and other steel items from lake, river, plating tanks, drains or other hard-to-reach spots. Recover drills, taps, etc. from floor sweepings. Clear alley of harmful tacks, nails. Many other uses listed. Pays for itself quickly. **GUARANTEED:** Try any magnet one week. Money refunded if you are not well-pleased. Cat. No. 675 (Has a pull of 175 lbs. on a flat steel block) \$10.50. Cat. No. 650 (150 lb. pull) \$8.50. Cat. No. 600 (100 lb. pull) \$ 6.50. Cat. No. 550 (50 lb. pull) \$4.00. Cat. No. 530 (30 lb. pull) \$ 3.00. Cat. No. 17 (14 lb. pull) \$1.50. Send M.O. or check. We pay postage. Cat. No. 30—Hobbyist assortment of six medium magnets. \$ 1.50

MIAMI MAGNET CO.

3240 N.W. 27th Ave., Aviation Bldg. No. 43, Miami, Florida

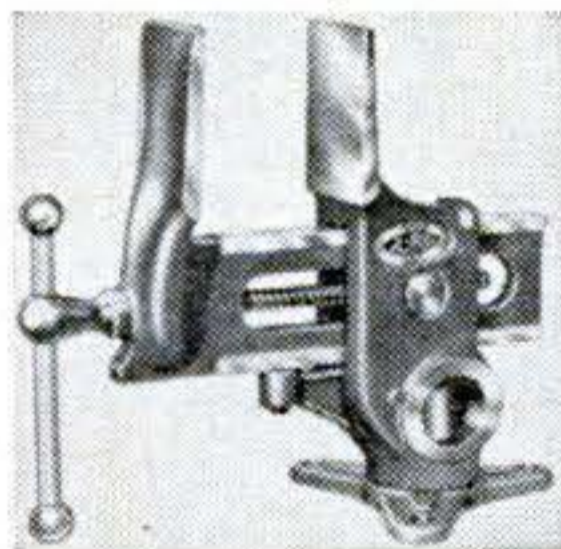

**DESIGNED FOR THE
HOME WORKSHOP**

A penny postcard will bring you a folder showing in use the most versatile wood-working vise (the Versa-Vise) you ever imagined. Use it upright, flat on its side, turned to any angle! Mail a card now.

THE WILL-BURT CO.
Dept. PS-7 Orrville, Ohio

BeMaCo Dependable

**AUTOMATIC
SAW SET**

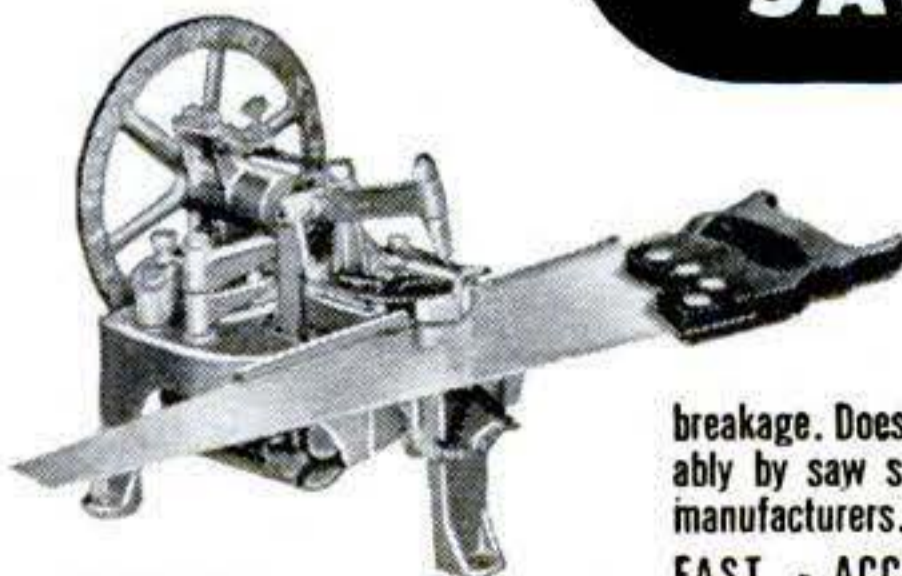

Sets 400 teeth per minute on hand or band saws 4 to 16 point. Hammer and anvil action sets teeth accurately and uniformly... No tooth breakage. Does a perfect job. Used profitably by saw shops everywhere and saw manufacturers. Every machine guaranteed!

FAST - ACCURATE - DEPENDABLE

★ INCREASES PROFITS

BEAVER MFG. CO.

800 SOUTH ISIS AVE. • INGLEWOOD, CALIF.



We're sitting pretty... for petty cash!



\$110 worth of lawn furniture for only \$47*—built with my

SKIL home shop Drill

My SKIL Home Shop Drill helped me make all this comfortable and attractive lawn furniture.

The drilling for bolts, dowels and iacing would take hours by hand—but my SKIL Drill made fast work of it. This drill is easy to handle: compact, light weight, perfectly balanced. Plenty of power for a clean, accurate job every time.

Save time and work by using a SKIL Home Shop Drill for all your projects. With SKIL Accessories this handy tool can be used to sand, polish, buff and grind. What a value! . . . yet SKIL Home Shop Drills begin at only \$19.95.

SKIL Home Shop Drills— Model 518—\$19.95; 1/4" hex-key chuck. Model 549—\$22.95; 1/4" geared chuck. No load speed: 2000 r.p.m. Overall length: 8". Weight: 3 1/2 lbs. Prices subject to change without notice.

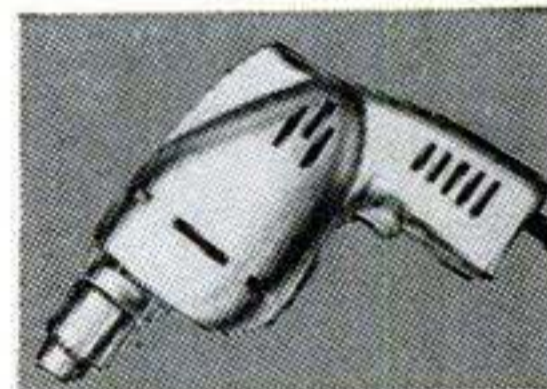

*For materials for the four pieces shown. Prices vary locally.



Made only by
5033 Elston Avenue
In Canada: 66 Portland Street, Toronto, Canada

SKILSAW, Inc.
Chicago 30, Ill.

Skilsaw, Inc., Home Shop Division, Dept. D-51
5033 Elston Avenue, Chicago 30, Ill.

FREE! SKIL-Chart No. 103 to show you how to buy the materials and build this sturdy, good-looking lawn furniture. We'll also send you full information on the complete line of SKIL Home Shop Tools. Mail the coupon today.

Name _____
Street _____
City _____ State _____

Only **STRYPEEZE**
PAINT REMOVER
is **GUARANTEED**



STAYS WET LONGER
REMOVES MORE COATS
CLINGS TO UPRIGHT SURFACES

GUARANTEE

STRYPEEZE is guaranteed to stay wet longer and remove more coats of finish per application, indoors or out, than any other remover, or your money back.

Write for
Free Circular

TRY STRYPEEZE!

Harmless to hands and surfaces. Only 70c a pint where you buy paints.

SAVOGRAN

DEPT. 38, BOSTON 16, MASS.

things
stay
stuck

WITH

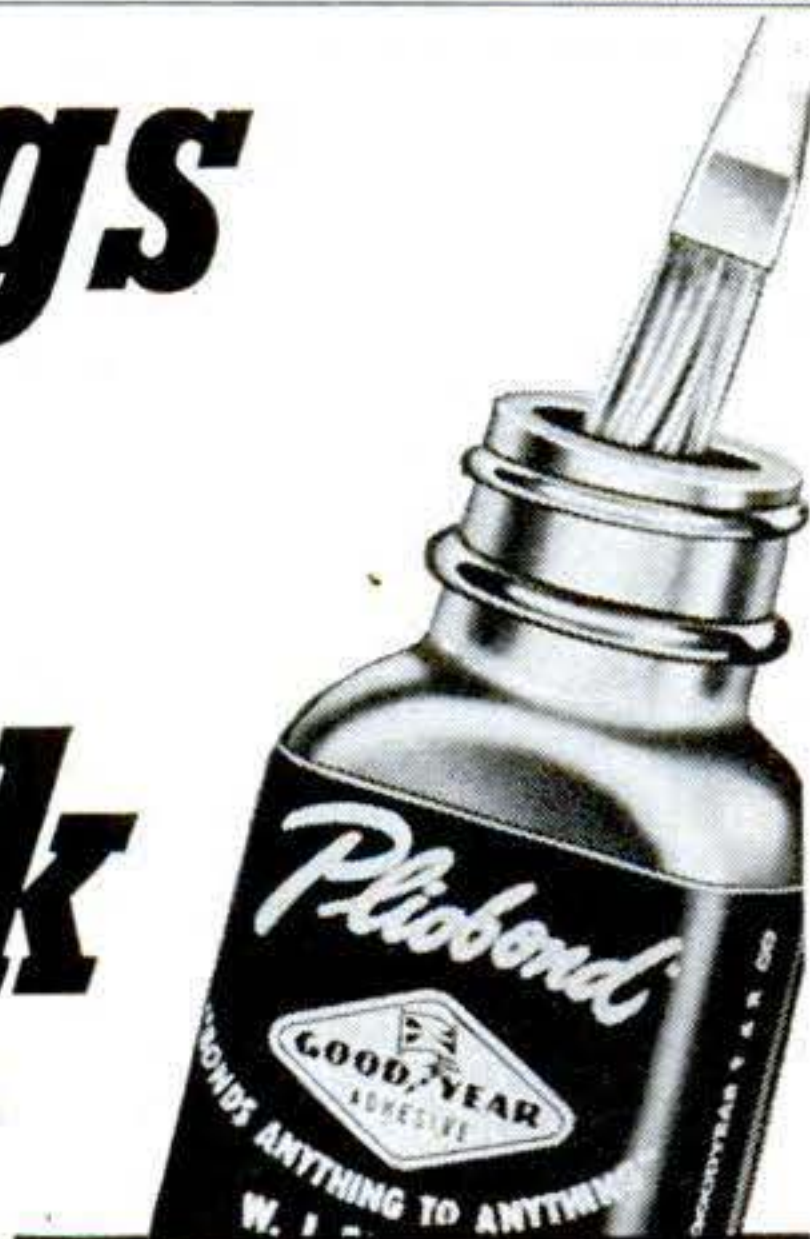

*TRADE MARK
Goodyear Tire & Rubber Co.

Many major industries depend on Pliobond* for joining all kinds of materials where the joint must be permanent. Pliobond literally "Bonds Anything to Anything." Joins metals, china, tile, wood, plastics and plastic films, glass, concrete, paper, leather, rubber, wallboard to themselves and to each other—permanently! Sets quickly; never gets brittle; stays flexible; easy to use; one adhesive for all purposes. Brush-top bottles 25c & 50c at dime stores, hobby and hardware stores. Or write.

W. J. RUSCOE CO.
AKRON 13, OHIO



QUICK-ON, STAY-ON, SPEED NUTS®
NOW IN HANDY TINKER KIT

SPEED NUTS—famous throughout industry—now ready for home use. Ideal for repairing or attaching sheet metal parts on toys, appliances, etc. Kit contains over 100 parts—10 popular size nuts and matching screws. Replace threaded nuts and lock washers this fast, sure way. Tinnerman Products, Inc., Dept. 13(A), Cleveland 1, Ohio.

ONLY \$1.00
Including Postage
CASH or CHECK ONLY

NONE BETTER!

SUPER DRILL GRINDER



Sharpens round shank drills from 3/32" to 1/2" in diameter, up to 6" long. Grinds old drills like new in 4 different point grinding angles, using hand or power grinding wheels. Money-back guarantee.

Price only **\$2.95**
At Dealers or Postpaid

Crandall Mfg. Co. 1512 W. Slauson, Dept. FB-55, Los Angeles 44, Calif.

DRAINS Cellars, Laundry Tubs;
CIRCULATES Oil; IRRIGATES Gardens

Original "Type P" Pump has 2400 GPH capacity. 360 GPH 75' high, or 1500 GPH from 25' well. Use any 1/8 to 1/2 HP motor. DOES NOT CLOG.

Only \$6.95 postpaid if cash with order. (West of Mississippi, add 50c.) **\$6.95**

SATISFACTION GUARANTEED OR MONEY BACK!

LABAWCO PUMPS, BELLE MEAD 3, N. J.



VARIABLE SPEED HYDRAULIC POWER TRANSMISSION

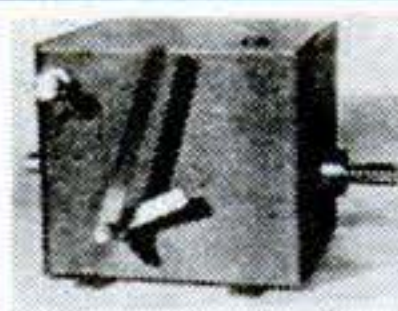

It has Infinite Speeds 0 to 550 Reverse Automatic Overload Protection; Adjustable Torque up to 180 inch pounds. 5/8" Input and Output Shafts. It will handle 1/4 to 1 1/2 H.P. Motor. Case measures 7 1/2" long 7" high 6 1/2" wide. VALUE OVER \$300. Shipping Wt. 25#. On C.O.D. Orders we require a 10% Deposit. **only \$54.50**
Fob. Chicago

DIRZIUS MACHINE SHOP "N" 1423-25 So. 52nd Ave., Cicero 50, Ill.

WELD
BRAZE, SOLDER,
and CUT

ONLY \$11.95
F.O.B. complete!

EASILY... QUICKLY!

No experience needed. Follow simple instructions, weld on iron, steel, bronze, brass, aluminum, and other metals. Plugs into any properly wired 110 volt A.C. or D.C. line. Make or save time and money doing repair work for yourself and others. Repair men, farmers, tinsmiths, home and auto owners, hobbyists, etc., say **FOUR-WAY** pays for itself over and over. Order today or send for Free details.

FOUR-WAY WELDER COMPANY, Dept. F3-EB
2326 So. Michigan Ave. • Chicago 16, Illinois



ORDER NOW
10 DAY TRIAL



WELLWORTH Air Compressor

For Farm and Home Workshops
Both valves in head, bronze bearings, splash lubrication, "V" belt drive, intake muffler and cleaner. Compressor has 2" bore, 1 3/4" stroke, 2.8 cfm up to 150 lb. pressure. Motor required: 1/4 h.p. at 100 lbs.; 1/3 h.p. at 125 lbs.; 1/2 h.p. at 150 lbs. or equivalent gas engine. Wt. 16 lbs. Replacement parts always available.

\$20.50

COMPLETE OUTFIT

Compressor, pressure tank, air gauge, air chuck, 20-ft. hose, pop valve, copper tubing with 4 brass flared fittings for connecting compressor to tank, 4-way cross and 3 nipples. COMPLETE OUTFIT, wt. 30 lbs. All Brand New Equipment.

EQUIPMENT LESS COMPRESSOR.....\$12.45

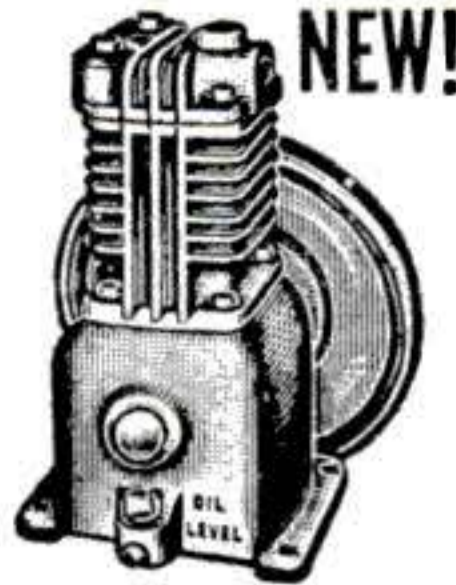

NEW!

\$32.45

LIGHT PLANTS

5 K.W.
\$2200 value
\$895.00

Also smaller size at bargain prices. Send for catalog.

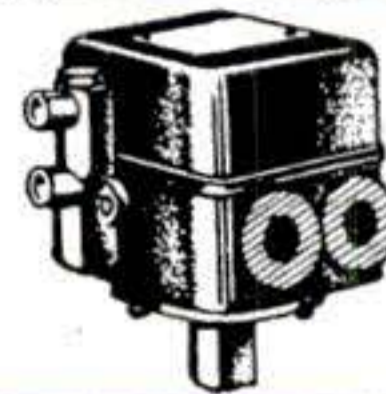
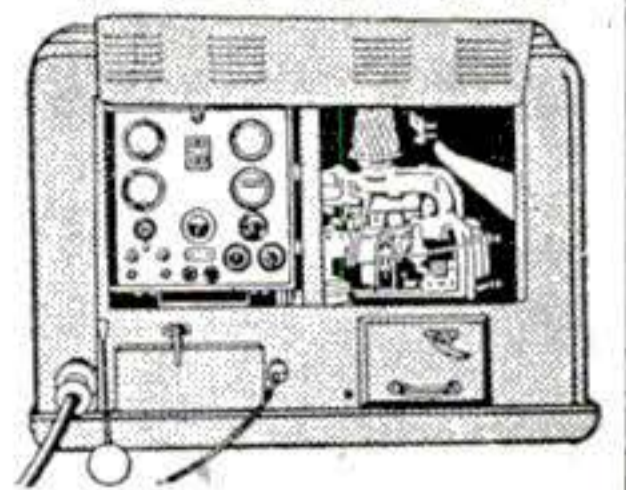

AUTOMATIC PRESSURE SWITCH

For Air or Water
20 to 40 lbs.

\$6.50

125 to 150 lbs... \$ 8.95
with automatic un-loader..... 13.75
1/4" check valve.. 3.25
1/2" check valve.. 4.75

RED SEAL CONTINENTAL GAS ENGINE

BRAND NEW. 1 1/2 HP with 6 to 1 reduction gear. Operates at 450 R.P.M. For lawn mowers, scooters, garden tractors, pumps, compressors, generators, etc. List Price \$79.50. Shipping weight 54 lbs. SPECIAL PRICE..

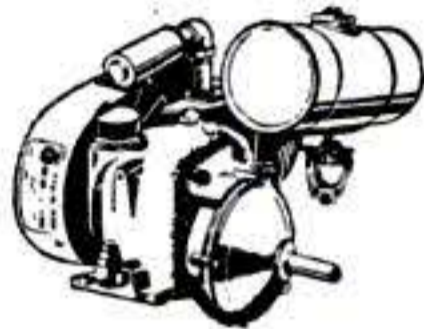

\$47.50

Same engine furnished at 2600 RPM..... **\$46.50**

WISCONSIN GAS ENGINES

Built with Special Heavy Duty Fly Wheel

at a big saving!

Model A.B., 1.7 to 3 H.P. Wt. 60 lbs. **\$76.00**
List Price, \$90.00. Special Price.....

Model A.K., 3 to 4.1 H.P. Wt. 70 lbs. **\$86.50**
List Price, \$106.50. Special Price.....

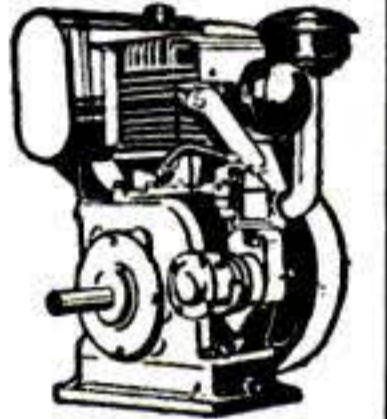

AIR REGULATOR and EXTRACTOR

1/4" Air Regulator, Gauge and filter. Wt 5 lbs. New... **\$8.95**
Regulator and Gauge only..... **\$5.95**
Air Filter only..... **\$3.25**



WELLWORTH V-BELT CLUTCH

Takes starting load off engines or motors. When speed is reached, a flip of handle shifts clutch from idling to driving position. Handles "A" belts, 2.35" pitch diameter, 5/8" bore. Ideal for use with lawn mowers, garden tractors, home workshop motors, etc. 3 1/4" long. Safe, easy to mount, sealed bronze bearings, positive action. Shpg. wt. 3 lbs. **\$7.50**

BRAND NEW SAME CLUTCH FURNISHED WITH 3/4" bore **\$8.50**

AIR TANK & ACCESSORIES

Air receiver, stainless steel. Brand New. 6"x24", 400 lb. test. Ideal for carrying on trucks, autos and wherever compressed air is needed. Equipped with 500 lb. combination air gauge and inflation valve with core for retaining pressure in tank; tire chuck, 3 ft. high test air hose. Complete outfit Shipp. Wt. 12 lbs..... **\$7.95**

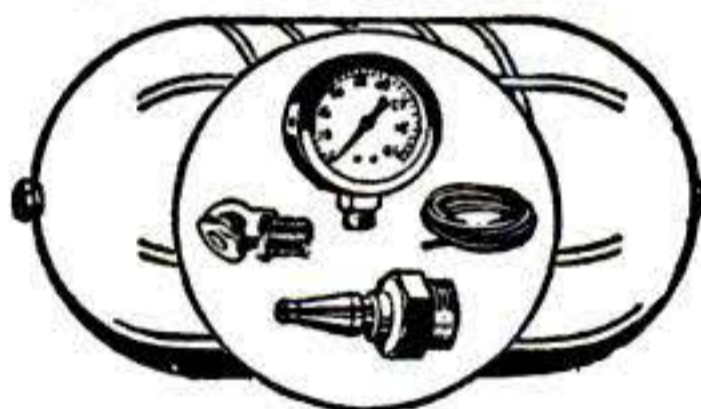

Tank only, Wt. 7 lbs..... **\$6.25**



"Wellworth" BLOWER BARGAIN

BRAND NEW Quiet operating. Double wheel inlet, double width blower. For heating, ventilating, cooling, air washing, exhausting and forced draft. DIMENSIONS: 10" wheel; outlet 13 1/8"x 11 3/8"; inlet 8 3/4". Height 19". Width 18". Depth 16 1/2"; C.F.M., 1/4" S.P. 1600; outlet vel. 1575; Wt. 45 lbs.

BLOWER LESS MOTOR AND DRIVE..... **\$27.50**
with belt and variable speed pulleys..... **\$2.50** extra
(Motor required, 1/4 h.p.)

Prices f. o. b. Chicago. Money back guarantee. Send check or money order today. Prompt shipment.

NEW CATALOG

Air Compressors, Light Plants, Home and Factory Workshop Tools. Send 10c for postage.

WELLWORTH TRADING CO.

1831 S. STATE ST. DEPT. B-5 CHICAGO 16, ILL.

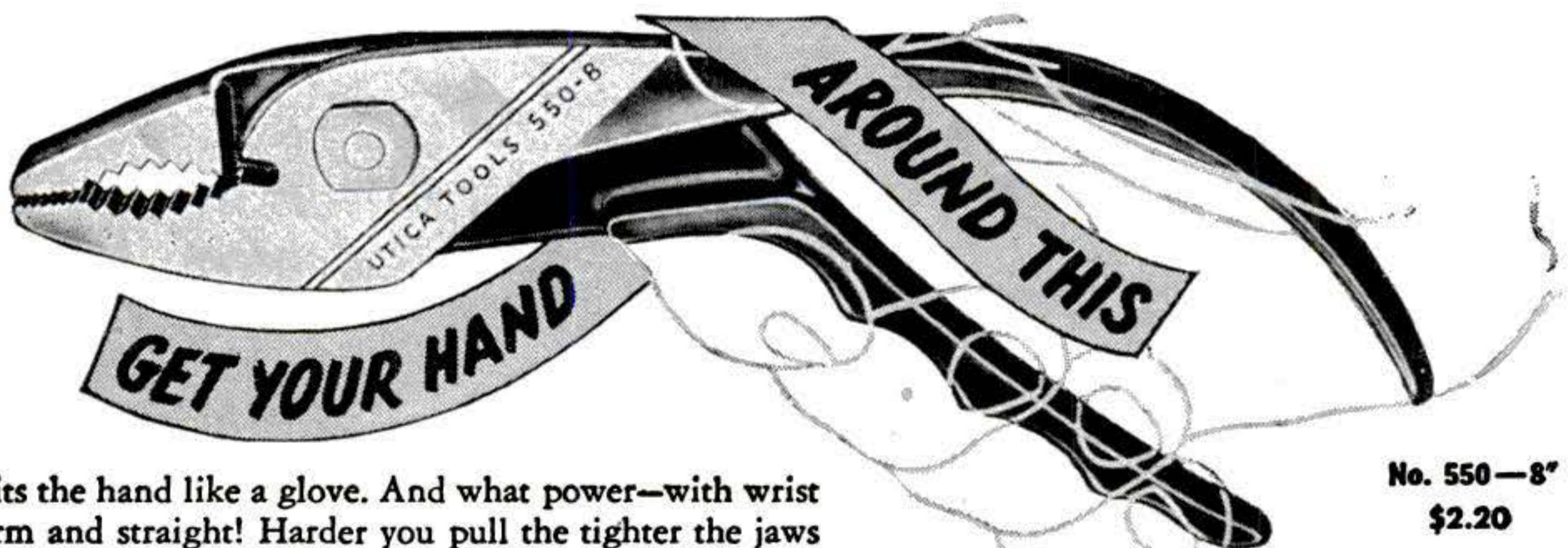

Fits the hand like a glove. And what power—with wrist firm and straight! Harder you pull the tighter the jaws bite down. Easy to handle in cramped spaces. A tool that should be in every home and workshop. FREE—descriptive folder on request. Or heft a pair at your local hardware store. One of a long line of fine tools made by Utica Drop Forge & Tool Corp., Utica 4, N. Y.

No. 550—8"
\$2.20

IT PAYS TO BUY **UTICA** QUALITY TOOLS
PISTOL GRIP
SLIP JOINT PLIERS



**Speed Way
Speed Sander**

\$34.50



**Sands,
Cleans,
Smooths, Polishes Electrically**



Designed for industry, for professional work, this light, beautifully balanced, orbital-motion, SpeedSander is rapidly becoming a standard home appliance. With its powerful electric motor and all-ball-bearing construction, anyone can easily re-surface and refinish furniture, woodwork, metal surfaces or walls. It will quickly remove old paint, stain, or enamel down to the bare wood or metal; will sandpaper to a "piano finish"; remove rust and corrosion or "feather edge" a scraped fender. It will burnish pots and pans or with lambs wool bonnet, delicately polish fine furniture. It makes

tedious, tiresome jobs fun—saves hands! In design, convenience and efficiency it is today's finest sander regardless of price. Ask your local dealer to demonstrate it.

Write for Catalog

Speed Way MANUFACTURING CO.

1864 So. 52nd Ave., Cicero 50, Illinois

Keep Brushes like New

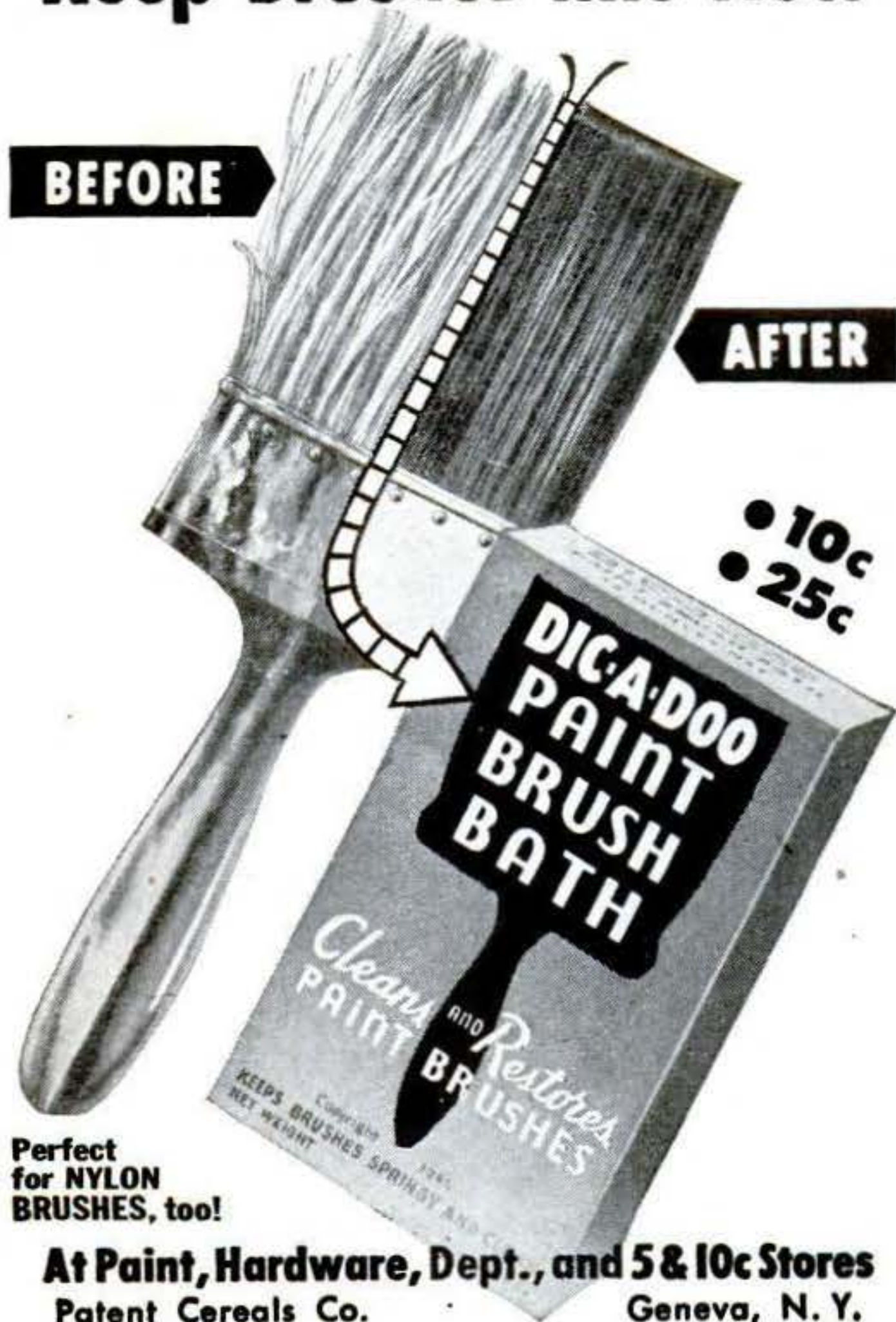

BEFORE

AFTER

• 10c
• 25c

Perfect for NYLON BRUSHES, too!

At Paint, Hardware, Dept., and 5 & 10c Stores
Patent Cereals Co. Geneva, N. Y.

BUILD YOUR OWN POWER TOOLS—TILT/ARBOR SAW



TILT/ARBOR SAW

• 27x28 in. table stays level. Blade tilts full 45 degrees. • 10 in. blade cuts 3 1/4 in. deep, jack-screw depth adjustment. • Floor model, 34 in. table height.

• New Departure ball bearing arbor, 3/4 in. precision shaft, ready to run, 5/8 in. bore blades. • Quick positioning, self-aligning rip fence guide. • Sturdy wood, steel and aluminum construction. • No machining—build easily with hand tools only. • Capacity and performance of floor saws selling for \$150.00 and up!

GIL-BILT Metal Parts Kit, includes Plans, ball-bearing arbor, cast aluminum miter gauge and bar, rip fence guide, machined lock knobs, jackscrew mechanism with 4 1/2 in. hand-wheel, and all other metal parts including every screw, bolt, nut and washer (less blade) \$20.95

Same Kit with 10" combination blade..... 24.90

Same Kit with 8" combination blade..... 23.90

If not satisfied, return Kits in 10 days for refund of purchase price.

(Prices include postage up to 600 miles)

GIL-BILT Step-by-Step pictorial plans (No blue-print reading required), full scale patterns, actual photographs for above 10" TILT-ARBOR SAW, 12" BAND SAW, BELT SANDER, 8" TILT/TABLE SAW \$1.00 each, postpaid anywhere in the world. ALL 4 Plans for \$3.00, or write for FREE descriptive catalog.

GILLIOM POWER TOOLS

P. O. Box 1-V-E, Lambert Field, St. Louis 21, Missouri

COMPLETE PLANS only \$1.00 EACH

SILVER SOLDER TORCH & KIT \$6



Joins All Metals Permanently

EQUAL TO WELDING FOR MOST PURPOSES

Do your own repairing. Kit includes one tube silver solder flux and 10 5-in. lengths silver solder alloy. Hottest ALCOHOL TORCH known. 2700° F. flame. Operates in any position, indoors or out. Torch alone \$5. Kit alone \$1.50. Complete instructions included with torch and kit. Add 25c on each order to apply towards shipping charges.

AMERICAN PRODUCTS CORP., 422 S. Dearborn St., Dept. 2-E, Chicago 5

HOBBYISTS! SHOPMEN! Special ONLY \$54.50

PALMGREN "HOBB-E" Rotary, Index, Milling Table

Ideal for Model Parts or Shop Work

Mill-Grind-Drill-Index-Route curved or straight-Rabbit and Mortise on drill press or lathe. 8" Table, 4" Cross Feed, 360° Rotation, Accurately Graduated. Bolts to table. Order NOW! SAVE \$100. Only \$54.50. Less Rotary Feed \$42.75. Write for "HOBB-E" Tool Circular.

CHICAGO TOOL and ENGINEERING CO. 8396 South Chicago Ave. Chicago 17, Ill.



SAW SHARPENER



Table model, gums and sharpens rip saws, combination saws & cut-off saws. Ideal for "Skilsaw" blades. Cap. 4" to 20" diam. Complete with 1/4 h.p. motor & 1 grinding wheel & cord—\$64 f.o.b. Portland. Shipping weight, 63#. SEND FOR FREE LITERATURE.

P. T. HOBBS MACHINERY 8375 N. Interstate, PS-51, Portland 17, Ore.

NOW—40 different CUTS with AMAZING, NEW



Warren

DADO SAWING WASHERS On Your Saw Blade

Just dial widths to cut parallel grooves perfectly smooth. No warp, vibration

or trick screws. Strengthens blade, perfect balance. GUARANTEED! At your dealer's or order direct. Give arbor size—1/2", 3/8", 3/4", 1".

WARREN WASHERS COMPANY
70 MEDBURY, DETROIT 2, MICHIGAN

ONLY \$4.95 PER SET

General SALVAGE CO.

THE BIGGEST SURPLUS BARGAIN Sale! IN YEARS BUY DIRECT FROM AD!

BUILD YOUR OWN ARC WELDER OR LIGHT PLANT

WESTINGHOUSE P-1 D-C GENERATOR

Save \$250 to \$500

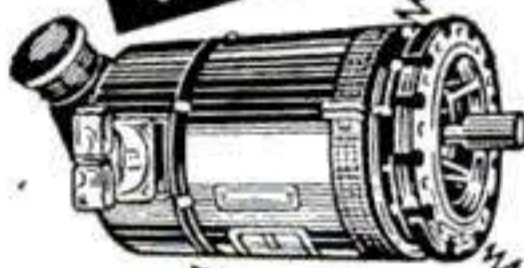

\$17.50
Instructions included. Rated 200 Amps 28 Volts 2500 R.P.M. Ship wt approx. 50 lbs. Stock No. 707

PRICE F. O. B. K. C., MO.

CONVERTS TO ARC WELDER 200-250 AMP. OR LIGHT PLANT CAP. LOAD 5000 WATTS

Stock No. 711 D.C. Generator R-1 Jack & Heints, rated 300 Amp. 30 Volts. Gov't cost \$300.00. Instruction for converting to welder or light plant incl. Only **\$25.50**

CARBON PILE Generator Voltage Regulator

For use with 24 or 32 Volt D. C. Generators. Also recommended for the P-1 and R-1 type generators in "build your own" Light plant. Complete with mounting base. Only **\$6.50**



D. C. GENERATOR. Brand new. For Farm—Home—Ranch. Delivers 430 Volts D.C. at 3450 R.P.M. Ball bearing supported. Fan cooled armature. Self lubricating bearing. #211220-A. Wt. 21-lbs **\$7.50**
Now only.

New Amplidyne Motor Generator

#5AN3INJ18A—Use as 24 32 Volt D.C. motor, pulls 1/2 H.P. or 0/60 V. D.C. Can be adapted to 110 V. A.C./D.C. 1/2 H.P. by simple changes in connections. This unit can be adapted to independent and rural lighting, power, etc. Instructions incl. (Stock #790). Gov't cost \$140.00. Wt. 30 lbs. Only **\$7.50**



ECLIPSE MOTOR & GEAR UNIT

Brand New. This is a 24 V. D.C. motor. Has 1- horizontal and 1- vertical take off shaft. Overall gear ratio to motor is 40-1, can be adapted for 2-1 or 20-1 ratio. Ideal as OVERHEAD GARAGE DOOR OPERATOR, DRIVE FOR SMALL HOIST, WELL PUMP JACK, LAWN MOWER DRIVE, DRIVE FOR POST DRILL, etc. Wt. 23 lbs. Gov't cost, \$221.00. (Instructions incl.) Only **\$9.95**

TWO WAY RIGHT ANGLE GEAR UNIT with universal mountings, 1 to 1 ratio, 90 degree angle gear drive with two 3/8" shafts extending 9/16" from body and three 3/16" mounting holes. Rated 1/3 H.P. at 1800 R.P.M. overall size 2 1/4" x 3 3/4" x 1 1/2" Stock #R-300 Data incl. **\$3.50** postpaid



Valuable Gears Bargains—Speed Reducer 10-1 or 5-1 ratio, 90 degree angle. Shaft driven 1/2" spline Shaft with 3 mounting holes 5/16". Gears held in forged and machined aluminum housing with two needle bearings, one bronze bearing, and three high speed shielded bearings. Sealed self lubricating chamber. Price **\$5.50** (Plus 35c postage)

SENSATIONAL SELSYNS

Two or more connected together, work perfectly on 110 V. A.C. For weather vanes, rotating directional antennas or controlling distance operations. Complete with diagram and instructions. Wt. 3 1/2 lbs. PER PAIR **\$6.50** Postage Paid



CUNO OIL FILTER—Brand New

Aircraft type. Filters oil without cartridge replacements. Just turn handle and cartridge is clean. Standard 3/8" inlet and outlet ports to accommodate 12 gallons per minute. STOP CHANGING OIL. Instructions **\$4.95** Post-incl.



ELECTRIC MOTOR 1/2 H.P. 27 V. D.C. R.P.M. 4000 No. 750. For Intermittent or Continuous Duty. 5/8" SHAFT, VARIABLE SPEED MOTOR. CAN BE ADAPTED TO 110 V. A.C. or R.E.A. line by simply arranging armature brush leads. UNUSED. Instructions incl. **\$5.50**

ELECTRIC MOTOR 1/2 H.P. 24 Volt D.C. R.P.M. 2500. Amp. 22 ±HCA24. Gov't cost \$75.00. Brand New. **\$4.95**

ELECTRIC MOTOR 1/4 H.P. 28 Volt D.C. R.P.M. 4000 ±2832 with simple instructions to convert to 28-32 Volt A.C. Gov't cost \$82.84. Brand New. **\$4.50**

ELECTRIC MOTOR 1/5 H.P. 27 V. D.C. 16 Amps, Reversible Series wound, 3800 R.P.M.. Shaft 9/32" diameter 12 spline, 4 1/8" x 2" x 3/8" Only. **\$3.50**

ELECTRIC MOTOR 6 VOLT D.C. Delco—New Handles 6" fan blade. Use as windshield wiper motor, hot water car heater motor, commercial or toy applications. 1/4" Dia. 1 1/8" long shaft. Size 5" long x 3". 2 mounting studs. 1200-2000 R.P.M. New **\$2.35** (plus 35c postage)

AIR FILTER HEAVY DUTY AIRCRAFT TYPE. Removes dust, lint, pollen, etc. For industry, Home, Office and Laboratories. For Forced warm air & air conditioning units. Made of heavy metallic Mesh. With metal frame. Permanent type, needs no refills. Size 4 1/2" by 6 5/8" by 2". Wt. approx 8 lbs. \$15 value. Only **\$3.50**



Brand New Wonderful ROTATOR MOTOR

For rotating Ham, TV, FM Antennas, Turntables, Telescopes, etc. Applicable for 110 V. A.C. 60 cycles or for 24 V. D.C. as reversible motor. Approx. 7 R.P.M. Free Swing, Reversible Light Weight. Rugged, quiet. Motor & Gears oil sealed. Including 3 mountings on motor. Simple instructions & diagram incl. Wt. approx. 4 1/2 lbs. Stock No. 572. \$50.00 Value Now Only **\$7.50** Post-paid

VICKERS CONSTANT DIS-PLACEMENT HYDRAULIC PUMPS. Brand New Stock No. PF-713-20. For any type liquid pumping job. 375 gal. per hr. at 3750 R.P.M. 1000 P.S.I. .410 cu. in. per rev. Gov. cost \$100.00 **\$12.50** Post-paid



VICKERS CONSTANT DIS-PLACEMENT HYDRAULIC PUMP. Stock No. PF713-25. Brand New. Powerful, compact, rated 1000 P.S.I. .507 cu. in per rev. 3750 R.P.M. 400 G.P.H. or use as motor.. **\$14.50** Post-paid

ROME C FUEL PUMP Or use as hydraulic pump or for Vacuum drawing. Rated 150 Gallon per hour at 1750 R.P.M. Has cushioned self lubricating 12 splined shaft. Ports are 1/2" std. Pipe thread. Here's non-pulsating dependable performance data incl. Stock No. RD-4550..... **\$7.50** post paid



Pesco Vacuum Air—General Purpose Pump

Here is a pump for air, fluid, pressure or vacuum. Standard 1/2" pipe thread. Delivers 300 G.P.H. at 2000 R.P.M. Runs forward or reverse. Self aligning shaft. Spline terminal for direct drive, readily replaced with a pulley. Use them for oil burners, MILKING MACHINES, COMPRESSORS, VACUUM PUMP, etc. Engineering report and instructions incl. Now only..... **\$9.95** Postage Paid

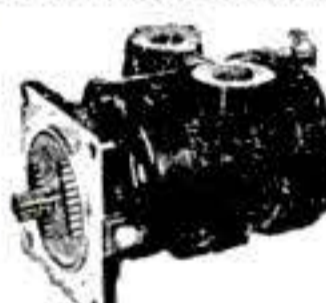

Adel Self-Priming ELECTRIC PUMP

For pumping light oils, oil burners, fluid metering, fuel pump, tool post grinder, coolant, pressure lubricating pump, etc. Double ball bearing series wound motor, continuous duty, 1/30 H.P. rated 12000 R.P.M. Applicable for 24 V. D.C./A.C. or use on 110 Volt A.C. Size 6 3/4" x 3 1/2" x 3 1/4". rated 3 G.P.H. Remove pump and use motor as high speed grinder, etc. Diagram and instructions incl. **\$9.95** Post-\$50.00 value. Only.....



THOMPSON MOTOR DRIVEN BOOSTER PUMP

Including Built in Motor. Applicable for 24 V. D.C./A.C. or 110 V. A.C. The motor is explosion proof constructed, making it ideal for pumping GASOLINE, FUEL TRANSFER, HOT WATER HEATING CIRCULATOR, USE IT AS COOLANT PUMP, FUEL BOOSTER, OIL PUMP, etc. Discharge connection is for 1" hose. Rated Capacity 300 G.P.H. Directions & Engineering data incl. A tremendous bargain! Stock No. 1200—Only..... **\$9.95**



Stratopower Constant Displacement HEAVY DUTY PUMP



For operating Hydraulic cylinders, bulldozers, Construction machinery. Lift trucks. For fuel or oil transfer. Industrial applications, etc. Delivers up to 400 G.P.H. at 3750 R.P.M. Rated 1250 to 1400 P.S.I. 3750 to 4500 R.P.M. HAS BUILT IN RELIEF AT HEAD. Rotation either direction without adjustment. Can be used as hydraulic motor. \$85.00 value. Engineering data & instructions incl. Stock #37. Wt. 8 lbs... **\$17.50**

AIR OR OIL HYDRAULIC CYLINDER

Stock No. 27 Cylinder, Air operated. Bore 2 1/2", Shaft 2 1/4", Stroke 6", one way Stroke. Can be used as snubber or Brake. Length 15". Wt. 11 lbs. Now **\$7.50** f.o.b. K.C., Mo.



Stock No. 11. Double Action 1 1/2" Bore, 6" Stroke, 5/8" Dia. Shaft. Clevis mounting base and shaft end. Capacity 1160 lbs. with 1000 P.S.I. input. Has a capacity of 1625 lbs. with our STRATOPOWER PUMP. 1400 P.S.I. A **\$9.50** \$50.00 value. Postpaid Only.....

Stock No. 12 Hydraulic Cylinder Double Action output 12560 lbs. with 1000 P.S.I. input. Gives 17584 lbs. with our STRATOPOWER PUMP 1400 P.S.I. or will produce 34160 lbs. with 3000 line pressure. Can also be operated on low pressure system. 4" Bore, 8 3/4" Stroke, 1-5/16" shaft, clevis mounting O. Gov't. cost \$300.00 **\$22.50**

Pesco Hydraulic Flow Equalizer & Pressure Balancer Valve Brand New. Guarantees equal flow and equal pressure for Two cylinders or Two systems. Capacity 360 G.P.H. 1500 P.S.I. Data & instructions incl. A \$75.00 value. Stock 1-D-397 **\$14.50** Post-paid



Brand New Hydraulic CONTROL VALVES

Four way control for use with two hydraulic double action cylinders. Each cylinder may be operated independently of the other or in conjunction with the other. Oil may be locked in any of the cylinders to hold the piston at any required position. Brand New. \$60.00 value. Only **\$8.95** Post-paid



Pesco Pressure and Relief Control Valve

Brand new. Designed with 3 ports and external pressure adjustment. Relief valve is spring loaded, and adjustable for controlling pressure regulation. Has two ports for normal flow, one for relief line to fluid supply or to pump inlet. Engineering data incl. A terrific bargain! Stock No. 575 **\$4.95** Post-Only



Hydraulic Solenoid Control Valve



BENDIX. No. 81560 24V. D.C. For remote control operation and to operate one single action or double action hydraulic cylinders with 24 V. D.C. Recommended pressure 800 to 1500 P.S.I. connections are .550"-18thd. Diagrams & Data incl. \$35.00 value—**\$3.50** ea. **\$6.50** per pair.

ADEL PRECISION #2799 Large Volume hydraulic control and pressure relief valve. 3/4" ports, spring loaded. Range 1250 P.S.I. adjustable up to 3000 P.S.I. Brand New..... **\$5.50**



Adel HEAVY DUTY VALVE #D-8660

Here's your four way hydraulic control valve for use with 2 double action cylinders. Each cylinder may be operated independently of the other or in conjunction with the other. 3/8" pipe thread connections with mounting brackets attached to body of valve. **\$8.95** Post-A \$60.00 value. Brand new



Hydraulic Accumulators—Bendix Ball Type

Dia. 5 1/2". Built to stand 2000 P.S.I. Stock #A-65. Wt. 4 lbs. only. **\$5.50**
BENDIX ACCUMULATOR. Ball Type. Dia. 10". Built to stand 2000 P.S.I. Wt. 15 lbs. Stock #A-85. Only.. **\$15.50**

VICKERS UNLOADING VALVE Brand New—By-passes full amount output of the pump while the cylinder is not in operation. Takes starting load off of electric motor driving the pump. 1/2" AC TUBE PORTS (3/4"-18) thread. Price..... **\$8.50** Post-paid

Send Check or Money Order. All Prices F.O.B.—K.C. M.O. Except When Marked Postpaid. U.S.A. Only—1/2 Deposit With C.O.D.



GENERAL SALVAGE CO., 2922 E. 27 St., Dept. 276 Kansas City, Mo.

AMAZING TOOL BARGAINS!

ALL BRAND NEW MERCHANDISE

7 HIGH SPEED STRAIGHT SHANK DRILLS \$1.00
15 Drills for only \$2.00! Order Today

Postpaid in U.S.A.
7 Popular Sizes — up to 3/8".
Brand new, ideal for home or
shop use. Fits all standard
chucks.

2 CIRCULAR SAWS \$1.50
ON 2 MANDRELS—
ALL AT ONE LOW PRICE \$1.50
1" diameter saws on 1/8" Man-
drels. For cutting wood, plas-
tic, or soft metals. Order at
once! Send Check or Money Order.

SURPRISE VALUE 100 Pieces \$1.00
FOR ELECTRIC GRINDERS

Grinding Wheels, Cut-off Wheels,
Sanding Discs, Mounted Stones,
Sharpening and Honing Stones,
Rotary Cutting Burs, Abrasive
Cartridges, Mandrels, and many other items.

12 MINIATURE CUTTERS \$1.00
FOR CUTTING WOOD, PLASTIC, OR METAL

IN U.S.A. Actual size.
Asst. shapes on 3/32" shank. For die makers, home work-shop, etc.

2 DRUM SANDERS \$1.50
With 12 Bands in Assorted Grits. 1/2" dia. x 1" long on 1/8" arbor with 12 bands
ONE DRUM, 1" DIA. x 1" LONG ON 1/4" ARBOR WITH 6 EXTRA SLEEVES \$1.00

12 MOUNTED WHEELS \$2.95
and points on 1/8" Mandrel. For grinding on plastic, wood, soft and hard metals. Regular \$8.40 List Val. ONLY \$2.95

SCHUPACK SUPPLY CO., 7331 Cottage Grove, Dept. S-51, Chicago 19, Ill.

A New ... and Better Push Drill by "YANKEE"



No. 45

With a handle that fits your hand and a flange to rest your thumb, the ALL-NEW "Yankee" Push Drill No. 45 makes quick work of drilling small holes . . . in wood or plastics. Magazine handle holds 8 drill points (1/16" to 1/64"). Improved chuck . . . drills can't pull out. Automatic return action clears chips. Buy it from Hardware Dealers and Industrial Supply Houses everywhere. Send for booklet "How 'Yankee' Tools Make Good Mechanics Better" FREE. North Bros. Mfg. Co., 219 West Lehigh Ave., Philadelphia 33, Pa.

"YANKEE" TOOLS NOW PART OF **STANLEY** THE TOOL BOX OF THE WORLD

NORTH BROS. MFG. CO., Philadelphia 33, Pa.



STOP DRIP

caused from condensation on cold water pipes. Turn idle basement space into play or work rooms. Keep store rooms dry. Just wrap cork-filled No-Drip Tape around pipes and joints. Do it yourself. Clean



and easy to apply. Roll covers about 10 feet of 1/2" pipe. \$1.69. Higher west of Rockies and Canada. Get at Hardware, Department Stores, or sent post-paid. Write for free circular. J. W. Mortell Co., 534 Burch St., Kankakee, Illinois.



HOTTER GAS TORCH
SELF CONTAINED—NO COMPRESSED AIR
Burns natural house gas or liq. petroleum at 2100° F.—1500 BTU for soldering, (silver, etc.), paint removing, bending, glass forming, etc. Precision engineered & guaranteed. \$6.90 with attachments and 5' hose \$3.45 without attachments. Specify gas used. Save C.O.D. fees. Send check or M.O. **KELLER GAS APPLIANCES**
DEPT PS-5 439 W. FOOTHILL BLVD. • MONROVIA, CALIF.

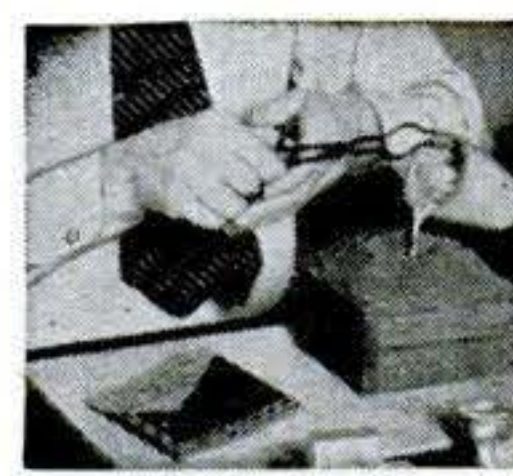

BRONZE FOUNDRY

Schools and Home Workshops
Make your own castings of aluminum, copper, bronze, silver. Foundry sets are available in three sizes including 2400 Deg. F. blast Furnaces, \$22.50; \$29.50; and \$42.00. f.o.b. Kansas City. Free Circular.

KANSAS CITY SPECIALTIES CO. P. O. BOX 6022, DEPT. S-5 KANSAS CITY, MO.

SHEET METAL BRAKES

Forms angles, flanges and Pittsburgh locks. 26 gauge steel, heavier aluminum. Cam locking. Portable, can be bolted to bench, or clamped to edge of truck. All steel, reinforced. Shipped Exp. Coll. 30" size. Wt. 54 lbs., \$26.50. 36", Wt. 66 lbs. \$31.00. 48", Wt. 100 lbs., \$45.00. Floor mountings, portable, 32" high, 30 lbs., \$7.00. 12" BRAKE. Fits in vise to form difficult compound bends, up to 20 gauge steel. Not illustrated. \$12.50 PP. 5" WIDE PLIERS forms locks, "S" slips, etc. \$2.50 PP.



Immediate delivery. Order direct, cash or C.O.D. or send for folder. VYKE BRAKE CO., S-1116 So. 27th St., Omaha 5, Nebr.

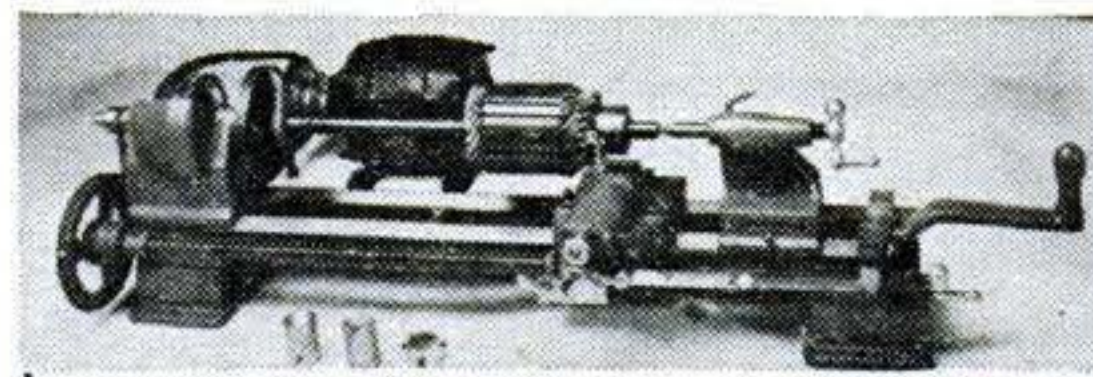

ONLY \$59.95
FREIGHT PREPAID

WE SEND YOU A LATHE—NOT LITERATURE
To Prove by Trial the Biggest Lathe Value Ever Offered
You've read about other lathes—seen attractive color photos but you can't machine a thing with words or pamphlets. We won't send you literature but we will send you a brand new, top quality lathe, freight paid. We let you see our lathe—feel it—actually machine with it while you make up your mind to keep it or shove it back in the crate and return it freight collect. And what a lathe it is! Sturdily built with bed ways machined with double V to 60°. The compound swivels 360° on a center pilot and is locked with 2 T-slot bolts. Lathe may be operated with a 1/4 h.p., 1750 r.p.m. motor. Bed length 26" with cutting range 18 1/2". 6" swing. Sent complete with hand undercutter and lever hand feed. 2 female centers, 2 male centers, driving dog, V-belt, 2 power feed belts, tool bit, face plate and dog. The lathe is precision and sturdily built to handle every metal or wood job within its dimension cap. Ideal for factories, hobby and home workshops or as armature lathe for garages. Full price freight paid only \$59.95. 10 day free home trial—you must be satisfied or return it at our expense for your money back in full. Immediate delivery while they last. Send check or money order for \$59.95 to:
HAMILTON PRODUCTS, INC., 12416 Euclid Ave., Cleveland 6, Ohio

★ ★ ★ ★ ★ SAVE UP TO 85% IN WAR SURPLUS ★ ★ ★ ★ ★
"GADGETEERS HEAVEN"

FOAM RUBBER
 Molded, pre-shaped. Can be cut to fit your chair, boat, truck, auto or trailer seats. Ideal cushions for all sports events.

18" x 19" x 4 1/2" \$6.45
 25" x 60" x 1 1/2" \$8.90
 25" x 63" x 1 1/2" \$9.95
 25" x 62" x 1 1/2" \$10.95

SHEET FOAM RUBBER
 3" Cored Stock. No. 2 1/2 compression. Ideal for cot, bed, bunk, couch or chair.

44" x 80" \$59.50 44" x 40" \$33.50
 22" x 80" \$33.50 22" x 40" \$17.50

MISCELLANEOUS SHEET STOCK
 44" x 40" x 2 1/2" thickness . \$31.00
 44" x 40" x 4 1/2" thickness . \$47.50

NEW! STATIONARY or PORTABLE D.C. ARC WELDER

300 Amps Continuous. 350 - 400 Amps Intermittent. For all WELDING - LIGHT or HEAVY!

This rugged, air cooled, precision built electric ARC WELDER - designed to weld for hours - comes complete with pulley reactor, output controls, Hi-Lo switches, rheostat. The heart of this unit is the famous R-1 generator, specially developed for B-29 Bombers, and with features no other generator has. Heavy steel frame, easily adapted to mounting on Jeep, Tractor or other power supply (10 H.P. gas or electric.) Never before offered at this low price.

9750

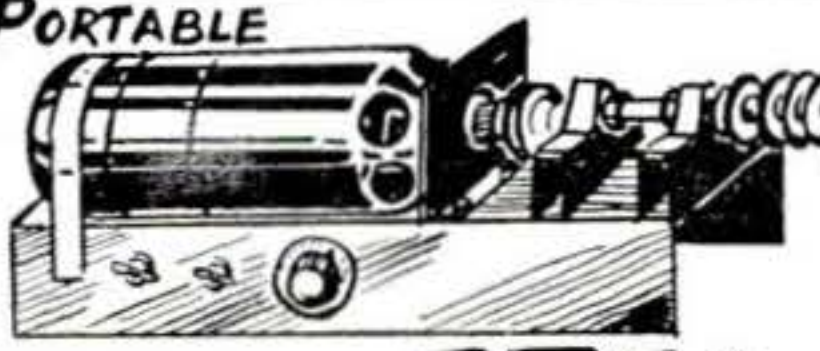

NAVY Sealed Beam LAMP
 U. S. Navy, Portable type. Has Pistol Grip and aiming sight. Makes an ideal search, spot or emergency light for your auto, boat, farm, etc.

12V. light - 4" lens . **329**
 24V. light - 5" lens . **319**

Set of 3 filters - red, green, amber. (specify type lamp) **99¢**

Genuine LEATHERETTE
 to cover chairs, patio furniture, nooks, auto seats, etc. 10 Colors - Bargain Price

Width - Colors - per run. yd.
 36" tile, red, brn., black \$1.19
 36" lt. grn., dk. grn., blue . . . \$1.65
 54" (approx.) red, brn., lt. blue, ivory, and yellow \$1.95

PLASTIC LEATHERETTE
 Waterproof, heat resistant plastic covering. In yellow . . . Chinese red . . . green . . . grey . . . chartreuse brown . . . Yacht blue. 54" wide. **195**

WRIST WATCHES Here's a real shock absorbing watch! Has jewel movement, sweep second hand, luminous dial, chrome case. GUARANTEED FOR ONE YEAR. Ideal for young and old.

NOW ONLY - 695

17 JEWEL AUTOMATIC WRIST WATCH - Swiss made men's wrist watch. A real self-winding watch . . . winds itself while you wear it. Incabloc (shock protected) movement. Silver white or black face . . . waterproof nickel chrome case. Stainless steel back. Hours marked in numerals. Genuine leather strap. Red second hand with arrow tip. GUARANTEED . . . **2595**

Add 10% Fed. Tax



NAVIGATORS LAMP
 A handy light for desk, work bench . . . chart table . . . engine room, etc. Can be used on 6-12-24-110 Volt by changing bulb. 3 ft. shaft has 4 joints to adjust position . . . **329**



CLAMP-ON LAMP
 Has adjustable ball & socket swivel head, long rubber covered cord and wall plug. All-purpose - indoor photography, floodlight, baby or large spot, personal bed reading, work bench, garage, etc. Lamp alone **129**
 5" spot reflector } **109**
 9" Parabolic reflector }

NEW TARPS HEAVY CANVAS
 Mildew and flame resistant. Cheap outside storage. They are really moving at these prices!!!

8 1/2' x 12' . . . \$12.25
 15' x 16' . . . \$28.80
 16' x 32' . . . \$63.50

RUBBERIZED NYLON tarp
 7' x 11' **695**

NEW RUBBERIZED LINEN TARP - Waterproof, weighs only 3 LBS. Ideal for BOAT or CAR STORAGE 7' x 11' . . . **595**

18 oz. TARP 6 ft. x 6 ft., O.D. Duck - Innumerable uses on any boat. Can also be used as a tent floor covering or storage protector. A terrific buy!! Used but excellent condition **495**

NOW! 1951 ILLUSTRATED - 200 PAGE CATALOG
1000'S OF BARGAINS! WRITE TODAY!

JUST OFF THE PRESSES!! IMMEDIATE DELIVERY!! ORDER NOW!!

Packed with BARGAINS in NEW and SURPLUS merchandise at UNHEARD OF LOW PRICES! Items of interest to the Mechanic, Housewife, Farmer, Airman, Manufacturer, Hunter, Sportsman and just about everyone. SAVINGS UP TO 85% on many articles in Clothing, Hand & Power Tools, Housewares, Machinery, Electrical Supplies, Metals, Rubber, Plastics, Welding Equipment, Pneumatic & Air Tools and Hydraulic supplies, such as Cylinders, Valves, Pumps, Motors, Fittings, etc. Send 50¢ TODAY! We will refund it on your first order for \$1.00 or more.

AIR CORPS BRIEF CASE
 This is a genuine piece of AAF equipment . . . Made of best grade leather in a handsome pebble finish with a light canvas liner. Has two full length map or paper compartments and three smaller pockets. An ideal case for students, salesmen, artists, etc. Full heavy duty zipper closure. 12" x 16" . . . ONLY **295**



7x50 - BINOCULAR

Here is the 7 POWER choice of ARMY, NAVY and AIR FORCES for ease in handling and tremendous image brightness. Ideal for Hunters, Yachtsmen, Sportsmen, etc. Large 50mm lenses insure utmost light transmission, plus extra wide field of vision. Individual focusing. Size 7" x 7 1/2" . . . **3395**

A \$125 Value Add 20% Fed. Tax



AF CASE
 Genuine TOP GRADE leather. Multi-compartment. Lock and straps. For artists - students, - salesmen - etc. Used but good condition. **795**



PRESSURE TANKS
 1000's of uses around the farm, shop and factory. For storage, pressure, paint and insecticide spraying, etc.

F-1 - 10" x 18" - (1000 cu. in. capacity). Stainless steel . . . **495**
 F-2 - 6" x 45" - (1000 cu. in. capacity). Stainless steel . . . **495**
 F-2A - Same as F-2 but in Corrosion resistant steel **395**
 D-2 - 6 1/2" x 24" - (500 cu. in. capacity). - Stainless steel . . . **375**
 D-2A - Same as D-2 but in Corrosion resistant steel **249**

BARGAINS in SLEEPING BAGS

100% KAPOK FILLED BAG - a real treasure for hiker or camper. Special heavy duty, water repellent outer cover . . . filled with 3 lbs. imported Kapok . . . Has 100" zipper down side and across bottom. Large head flap makes dust cover to keep bag dry and clean when rolled up. Large air mattress pocket. Zip to another bag for double-up sleeping. Wt. 7 lbs. Size 34" x 78" **1695**

MUMMY TYPE BAG Has outer cover of forest green, water repellent balloon cloth. Filled with 15% duck down and 85% chicken feathers. 3/4 length zipper. Size 34" x 77" . . . **1595**

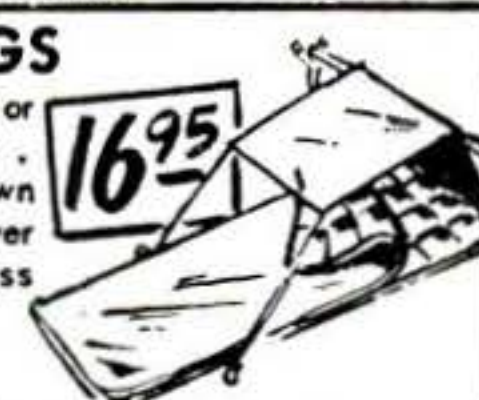

Aviators (AN-6530)
 Windproof & Dustproof
GENUINE GOGGLES
 Rubber or chamois covered frame. Clear or Green GROUND LENSES are inter-changeable. Adjustable nose bar. Ideal for flying, motor cycling, etc. . . . **219**

GO-1 GOGGLE KIT
 NEW! U.S. Navy - Has soft sponge rubber frame. 4 Polaroid lenses 2 green, 1 red, 1 clear. Perfect for racing, cycling, etc. **89¢**



TANK Dural with welded seams, 2" filler with cap, two standard pipe ports for hook-up. Visible liquid level gauge on side. For gas, oil, water or "spare" on auto . . . tractor, truck or boat. Sturdy, light. Capacity - 6 gal. . . . **495**

U.S. AIR CORPS RUBBER BOATS
 Reconditioned and ready . . . with carrying case. Safe, Lightweight, Easy to Pack and Carry. An Ideal boat for fishing or fun.

1 MAN **1495** 4 & 5 MAN **2995** 7 MAN **4250**
 with PADDLES
 Oars **295 PR.** Pump **295 EA.**



No. 151 MARCHING COMPASS
 A precision, officers' type compass of unusual accuracy. Has prismatic hair line guide for sighting a distant object and at same time reading number of degrees. Luminous dial for night. Jewel mounted needle. Canvas carrying case for belt . . . **295**



MICROPHONE
 Telephone type, highly sensitive. Excellent clear tone. This was the Signal Corps favorite. An ideal instrument for the radio "ham" and professional recording studio, broadcasting, home recording, public address, etc. A sensational buy! Complete with cord and plug **269**



SWIM FLIPPERS
 Top quality rubber. Has pebble tread bottom. Adj. heel strap . . . Re-inforced for strength. Vented for air & drainage. Ideal for diving and swimming.

Med., & Small **795** Large **895**

DIVING MASK
 Soft rubber mask fits over eyes. Heavy duty glass shield. Adj. headband.

Jr. **259** Mid. **269** Mr. **395**
 4 1/2" 5" 5 1/2"

WADING SUIT
 Makes surf and deep sea fishing a pleasure! Ideal for ranchers, oil fields, or any use where it is necessary to protect body or clothes from moisture, silt, muck, etc. . . Made of rubberized canvas. Has vulcanized seams & built-in rubber gloves and boots.

Sizes: - Small, Med., Lge. **695**

NYLON FISHLINE
 STRONG - LIGHTWEIGHT - NYLON FISHING LINE. ROT-PROOF and WATERPROOF . . . Especially treated for strength and long life. ON SPOOLS.

1500 ft.	10 lb.	\$1.59
1000 ft.	25 lb.	\$1.80
750 ft.	45 lb.	\$3.29
750 ft.	50 lb.	\$3.50
300 ft.	72 lb. Braided	\$3.79



U S NAVY INSULATED FOOD CONTAINER
 Why bother cooking on that trip? This lightweight plastic Thermal Food Container holds enough hot, fresh food for 8 people. Has 2-5 qt. removable Pyrex Baking Dishes for meat, veg. or liquids. 1-9qt. Plastic container for ice, etc. Each section individual - Case of Sturdy Plastic with carrying handle.

1095

OPEN CLOSED



PALLEY SUPPLY COMPANY
 6321 SAN FERNANDO RD.
 Dept. PS-5, GLENDALE 1, CALIF.

FISHING SPEAR
 Corrosion resistant. Ideal for spear fishing. 11" long with barbed end. Dia. of socket 1" **495 EA.** 3 for \$1.19

LARGEST FIRM OF ITS TYPE IN THE WORLD

Order from this ad. All sales final. Prices F.O.B. Glendale. Pay by M.O. or check. P.O.'s accepted from D&B firms. 1/2 deposit with C.O.D.'s.

Do
armature work
faster
a lathe!
than on

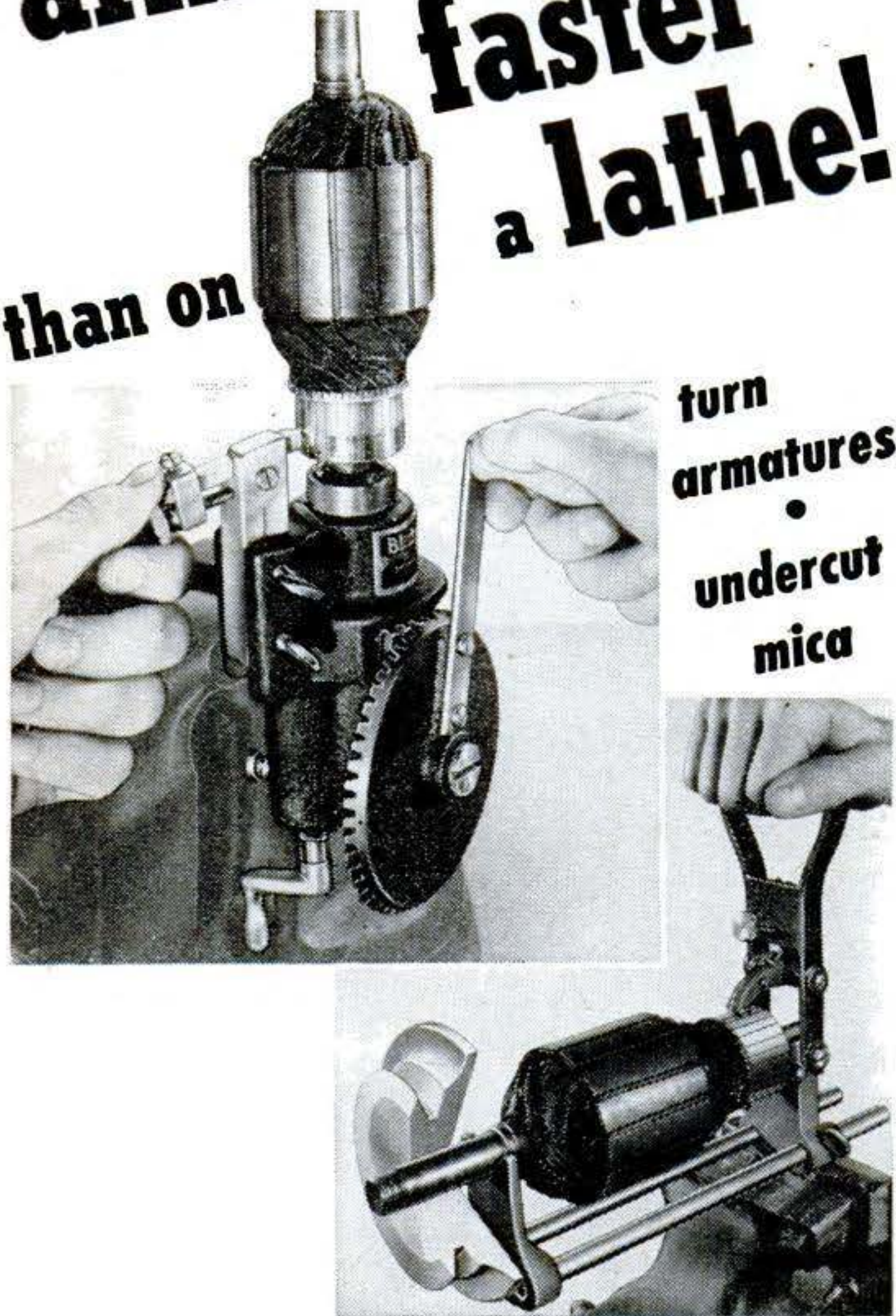

turn
armatures
•
undercut
mica



New

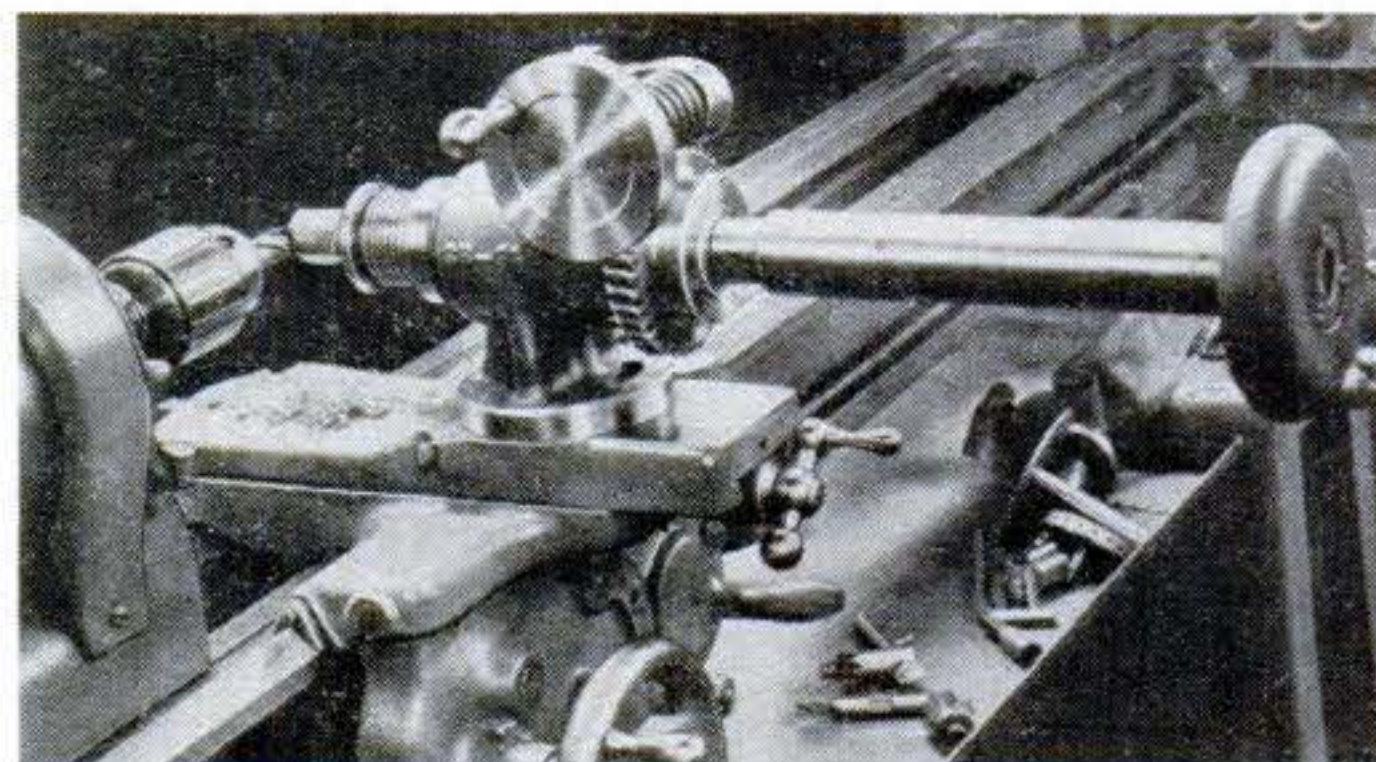

Rotary Attachment for Lathes. This attachment handles work in the horizontal plane at any angle to the lathe spindle. Accuracy of one tenth of 1° is guaranteed by the maker, Allan Mfg. Co., of Long Island City, N. Y. Among the jobs you can do with it are: drill, ream, and bore accurately spaced hole patterns; circular and radial milling; milling of cams; flycutter facing; and layout, jig, and fixture work. Used with a surface grinder, you can form many-sided punches and tools. Price is about \$80. It fits all 9" South Bend lathes and models are available for other lathes.

get
these **Snap-on**
ARMATURE RECONDITIONING TOOLS

With metal shortages, and higher electrical replacement costs, you're bound to get *lots* of this money-making work from now on! Get set to do it to perfection—faster, easier—than on a costly lathe! With this accurate, sturdy, solidly-built, time-proved tool in your bench vise you control cuts to a thousandth—shave armatures smooth as glass! Takes armatures with shafts $\frac{5}{16}$ " up to $\frac{11}{16}$ " diameter—adjusts in a moment. Fully warranted by Snap-on—foremost supplier of *professional* tools to automotive mechanics and others for over 30 years. One of 4,000 Snap-on Tools. Not sold in stores. Write for FREE catalog.

**SNAP-ON
TOOLS
CORPORATION**
8060-E 28th Avenue
Kenosha, Wisconsin

*Snap-on is the trademark of Snap-on Tools Corporation.

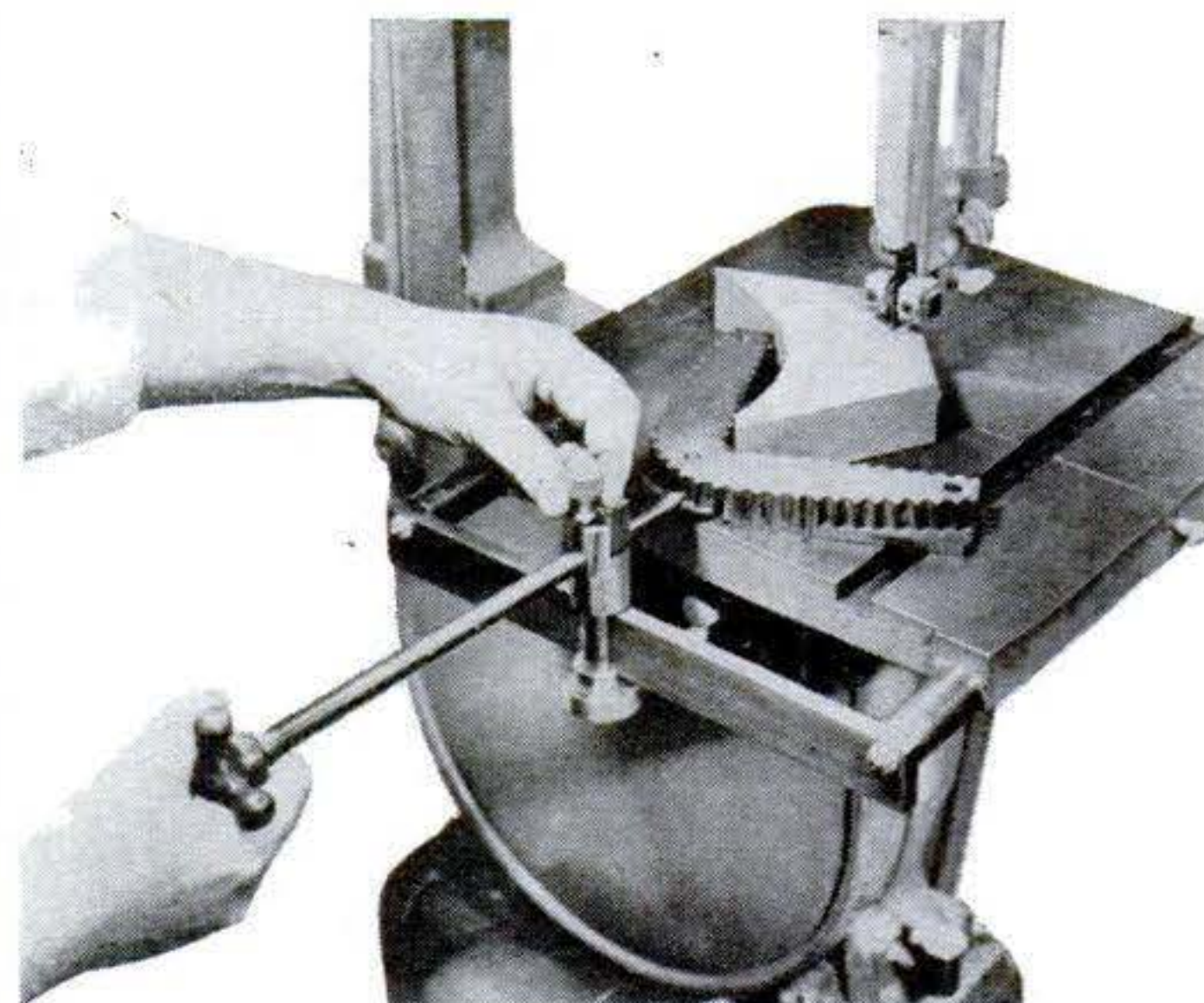

Bandsaw Accessory. Used for precise cutting of metal in irregular curves and shapes, this bandsaw accessory has screw feed, a notched jaw to hold irregularly shaped work, and an adjustable pivot on which work can be swung. The Power Tool Division, Rockwell Mfg. Co., Milwaukee, makes the attachment for its 14" bandsaw.

Tools

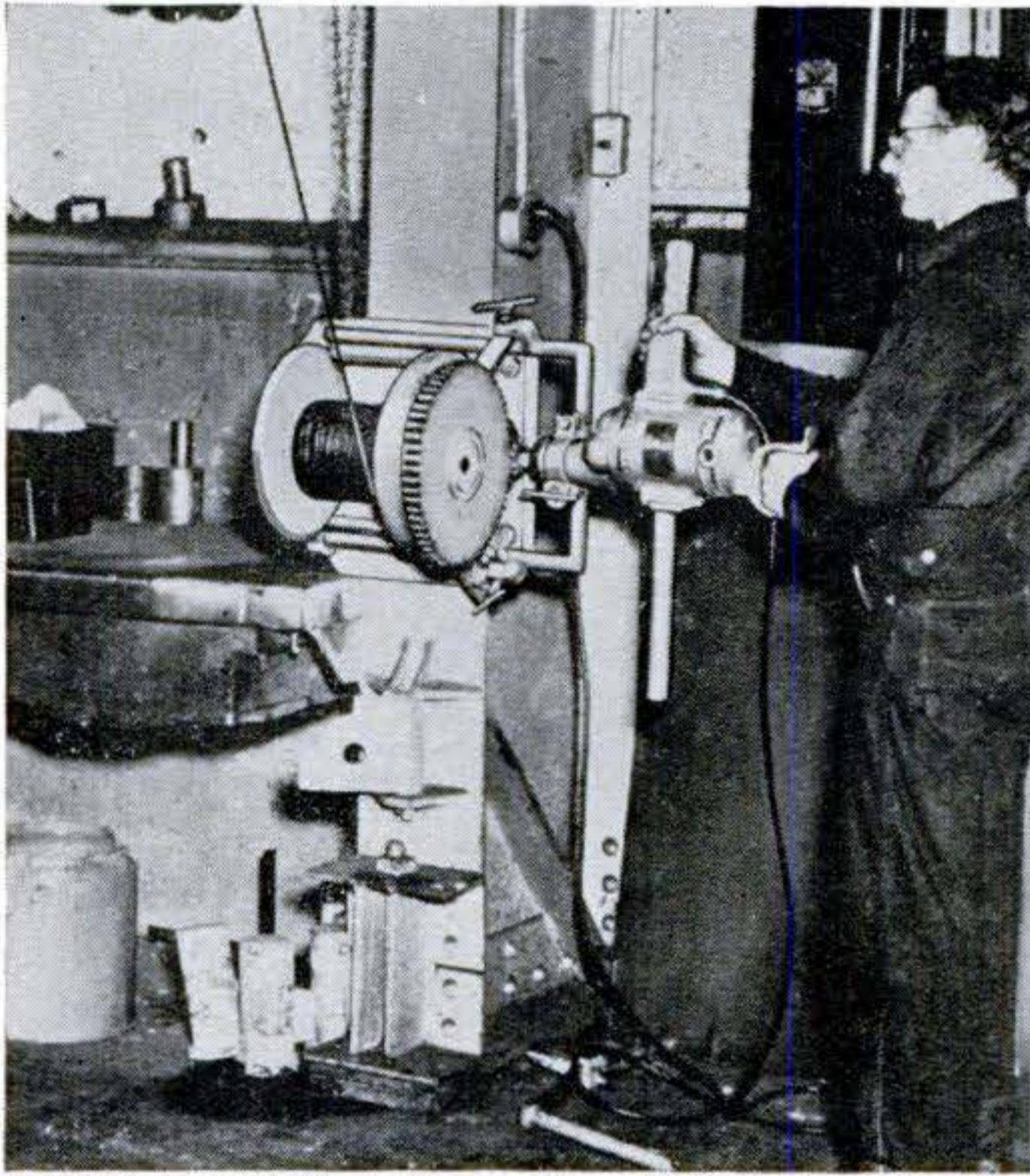

Electric Drill Powers Hoist. These two tools—a 1" drill and a winch—can be combined to give you a power hoist. The drill can be quickly disconnected for heavy-duty boring. Lifting capacity is 1,000 lb. at 10' per minute. For lowering loads, a hand lever applies a band brake. The drill is made by Skilsaw, Inc., Chicago, and the winch by American Hoist and Derrick Co., St. Paul, Minn.

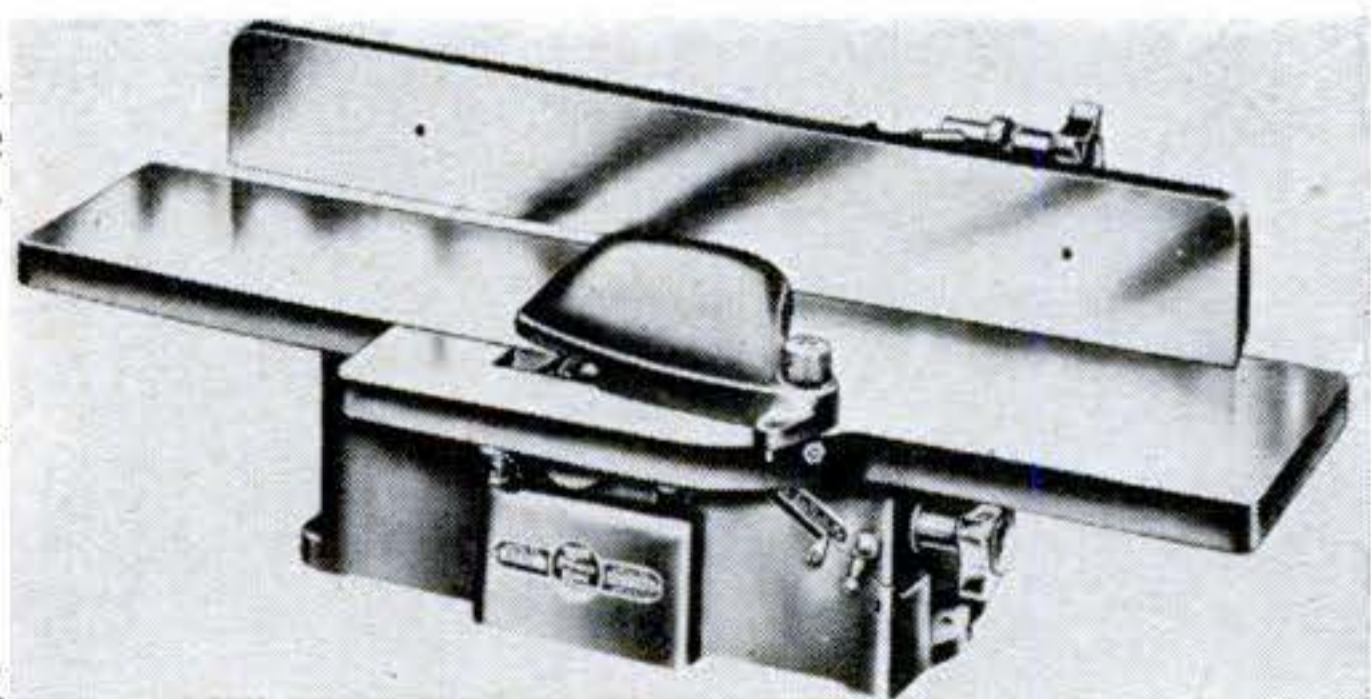

New 4" Jointer-Planer. One of the advantages of this machine is that the entire head can be removed and the blades sharpened without disturbing their setting. Specifications include a 25" table, 3" by 21" fence, and a cut 5/16" deep and 4" wide. The Atlas Press Company, of Kalamazoo, Mich., is the manufacturer.

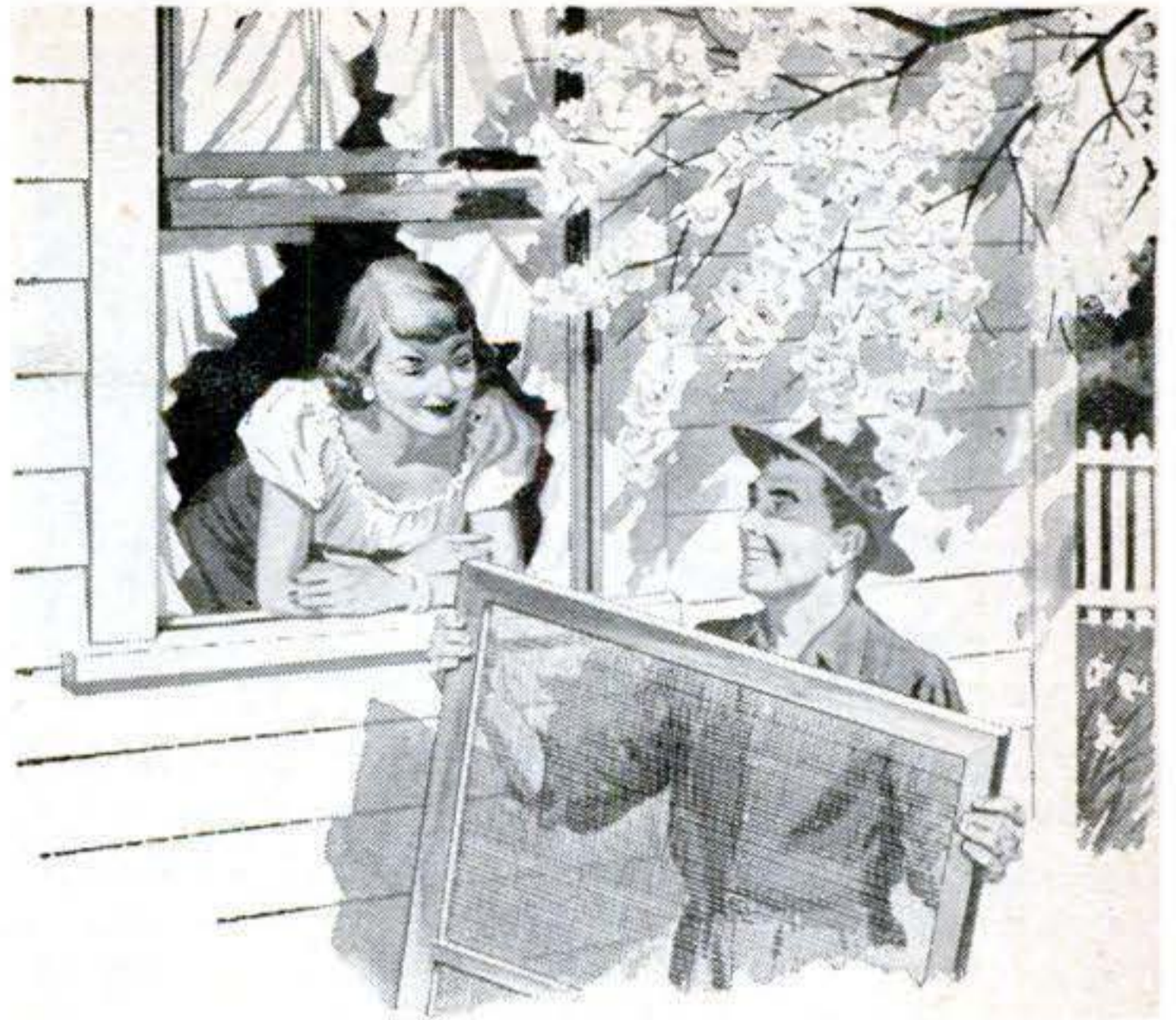

repairing old screens?

**LOOK FOR THE BEST —
Non-Staining Aluminum Screening**

When you get aluminum screening—you'll never have to clean rust and stains off light-colored siding or window sills. Because this new aluminum screening—made of the same tough alloy that goes into America's jet fighters—is protected from corrosion by an outer cladding of special, corrosion-resistant Alcoa Aluminum Alloy.

Because Alcoa and the screen weavers are co-operating on the defense effort—you may not get all the aluminum screening you need. Check with your dealer on availability.

LOOK FOR THIS TAG on screening you buy. It's your assurance of quality, stain-free screening.

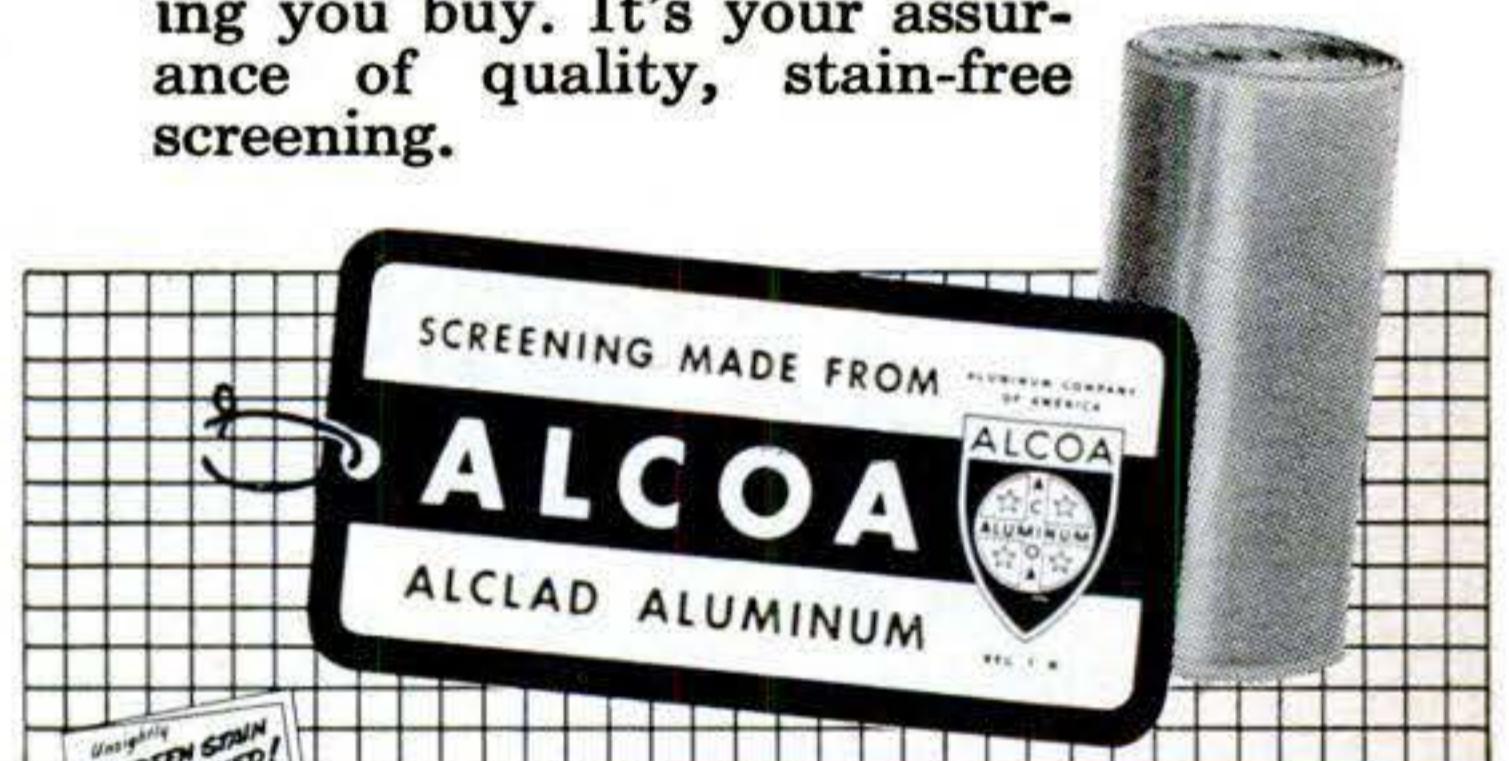

Write for Free Folder, "Aluminum Screening." Gives you easy-to-follow rules for repairing screens, reveals facts you'll want to know about aluminum screening.

ALUMINUM COMPANY OF AMERICA
831E Gulf Building, Pittsburgh 19, Penna.

best
white tape
made

ONLY
98¢*



The new "Evans White-Tape" has everything you'll find in tapes costing over \$1.50—plus.

- snow-white blade with bold, legible, jet-black numerals and graduations. Graduated in 32nds for first 6 inches.
- sturdy die-cast case heavily chrome-plated, calibrated for quick reading inside and outside measurements.
- blade $\frac{1}{2}$ " wide made of finest high carbon steel—tempered—Bonderized—enamelled—baked.
- blade replaceable in seconds—without tools—without even opening case. And Evans replacement blades cost far less.
- every "Evans White-Tape" is unconditionally guaranteed.
- exclusive Evans automatic brake gives smoother push-pull action with absolutely no "creeping" of tape into case.
- underside is white, too. Mark with ordinary pencil, remove mark with flick of thumb.
- unheard-of low price*: 10-ft. \$1.49; 8-ft. \$1.19; 6-ft. 98¢. Prices higher in far west and Canada.

Evans

Sold only through retailers.

& CO. • Newark 5, N. J.

© 7429

Makers of Evans 6-ft. Folding Rule and "Folding Yardstick"

For Better Work — FASTER — EASIER

THE
ZEPHYR
Electric Drill



only \$17⁹⁵

Handy... Speedy... Powerful. Has many uses around the home... in the shop... on the farm. Built to Last. Full $\frac{1}{4}$ " Capacity.

DRILL STANDS Add Many Uses for Zephyr Drill



Horizontal Drill Stand— for Polishing, Buffing, Grinding, etc.

Price \$1.00



De Luxe Electric Work Saver Kit

Adjustable Vertical Drill Stand— for drill press operations
Price \$10.95



Includes above ZEPHYR Drill, plus 28 accessories for buffing, cleaning, drilling, grinding, mixing paint, polishing, sanding, sharpening, waxing, and wire brushing.

Price \$26.35

At Hardware, Implement, and Building Materials Dealers, and Department Stores—or Write Direct



PORTABLE ELECTRIC TOOLS, INC.

326 West 83rd Street, Chicago 20, Illinois

In Canada: Portable Electric Tools, Ltd., 369 Danforth Rd., Toronto 13, Ont.

New Tools



Wrench Works on Rack and Pinion. Because it is only $\frac{1}{8}$ " thick, this rack-and-pinion wrench can deliver extreme pressure in hard-to-get-at spots. Over-all length is $5\frac{1}{4}$ ". The jaw opening can be adjusted from zero to slightly over $\frac{1}{2}$ ". The Colman Tool & Machine Co., of Amarillo, Texas, claims the wrench is unbreakable. It is priced at about \$1.50.

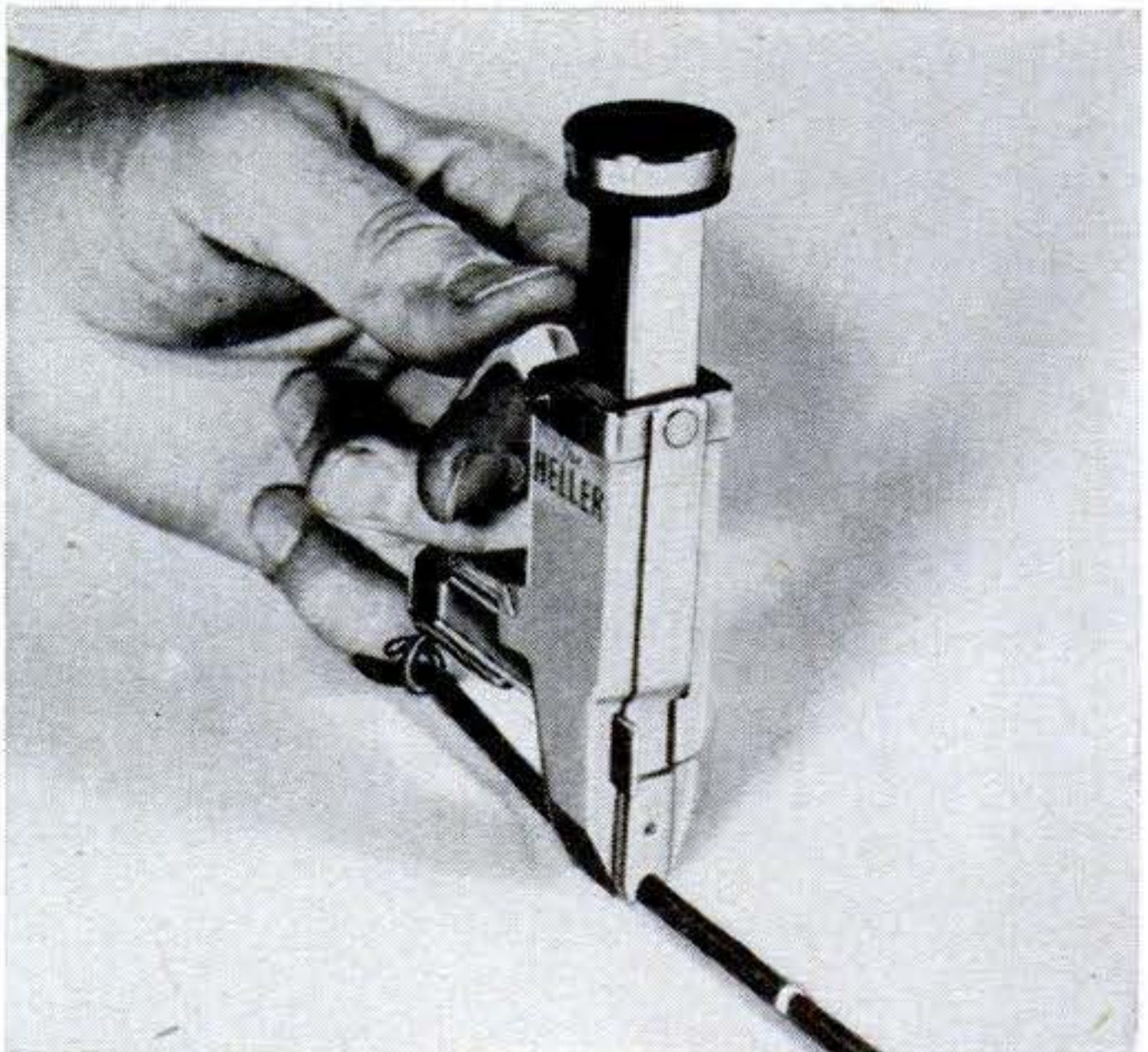

Pocket-Size Tacker for Wire. Front and rear guides of this stapler circle the wire, making it easy to draw the tool around corners. The staples penetrate plaster, composition board, and wood with as much as 64-lb. holding power. The Heller Company, of Cleveland, is the maker.

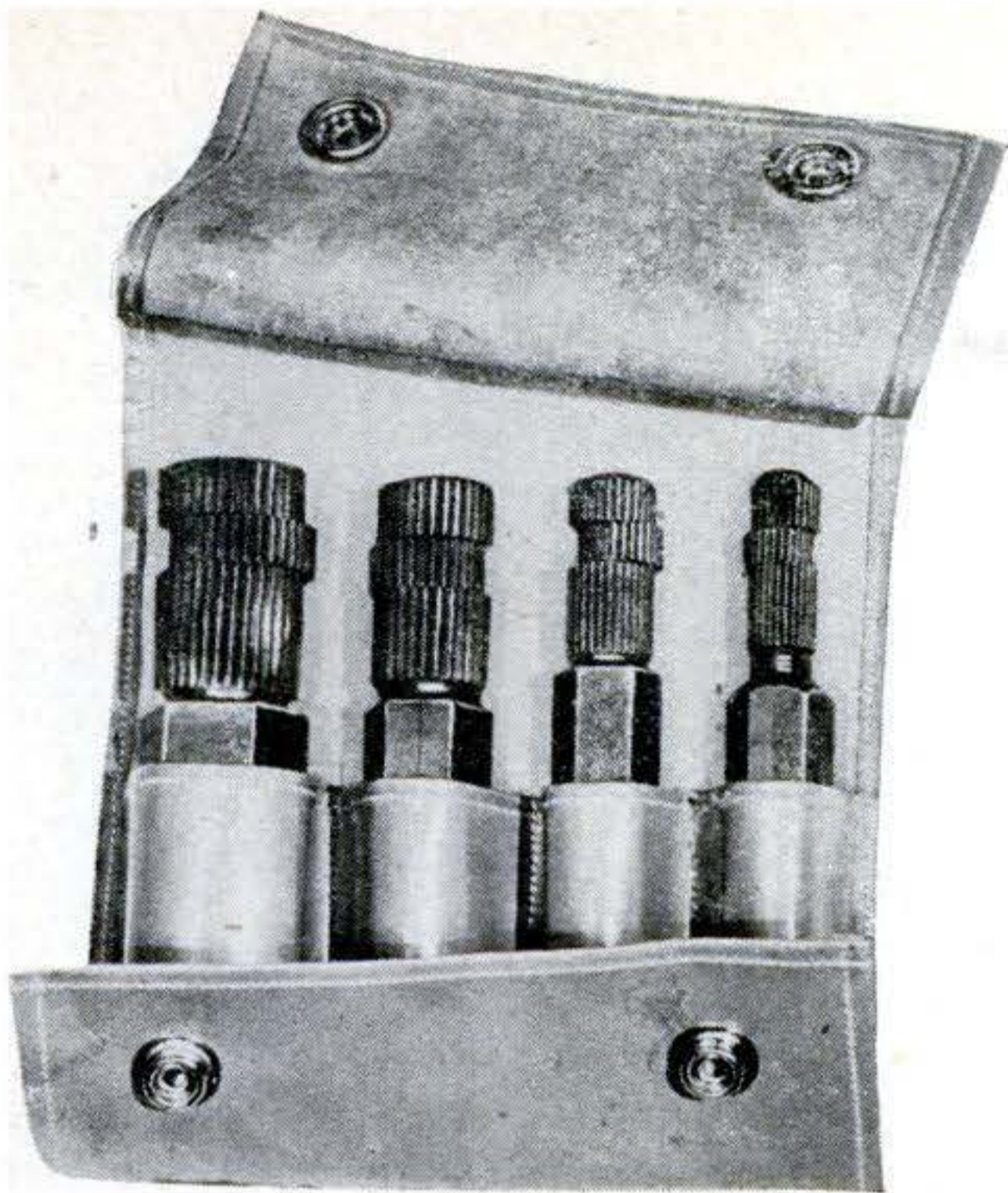

Wrenches Fit Inside Pipes. When one of these tools is inserted in a pipe and turned with a conventional wrench fitting the hexagonal section, the knurled eccentric grips the inside of the pipe. Made by the Roddick Tool Company, of Anaheim, Calif., they can be used without marring the pipe exterior. They come in 12 sizes from 1/8" to 4" and are priced from \$1.98 to \$32.50.

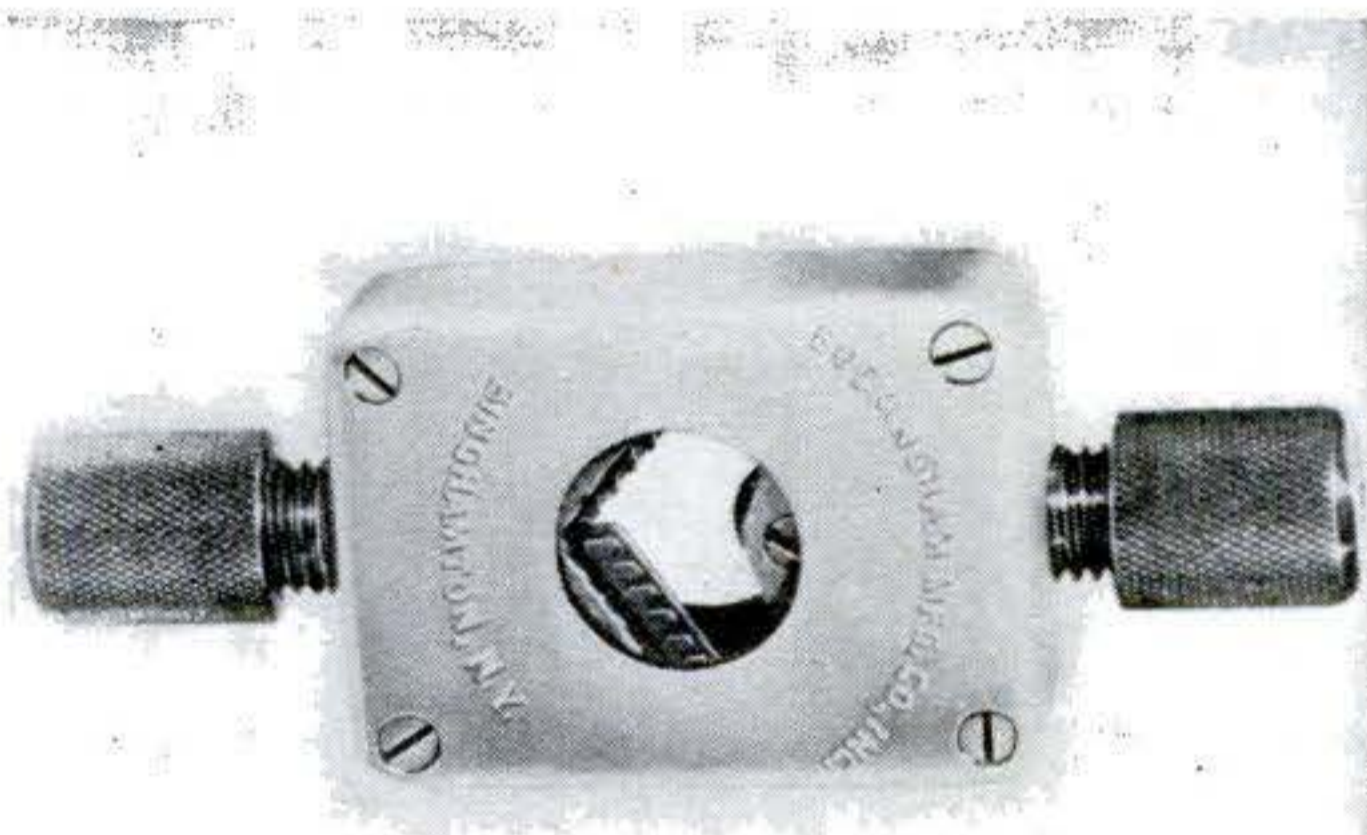

Restores Threads in Tight Spots. Because this thread restorer has a swing of only 2 5/16", it can be used in close quarters—on cylinder-head and wheel-lug studs, for example. The jaws are engaged at the bottom of the thread and turned outward. This model weighs 1 1/4 lb., and handles standard threads from 1/4" to 1" root diameter, either right or left hand. Other models take up to 4" diameter. Buckingham Mfg. Co., Binghamton, N. Y., is the maker.

**AT LAST...
THE SANDER YOU HAVE
Been WAITING
For!**



with

100%

MORE Power!

You'll jump with joy when you grab this new SYNCRO SANDER—when you see how its 100% MORE POWERFUL Stroke—sands TWICE as efficiently! Remember, too, SYNCRO alone has the famous DOUBLE ARC MOTION that sands, polishes BETTER by actual comparison! Every workshop and home needs this amazing, 100% MORE POWERFUL SYNCRO! Also perfectly wonderful for relaxing tired muscles with its powerful Double Arc Motion! Complete with BUILT-IN Fractional Horsepower Reactance Electric Motor, 10 sandpapers, polishing-massaging pads, cord. **\$19.95** Only.....



**NEW JIG SAW 70%
MORE POWERFUL—QUIET!**

Cuts any length 1" wood, thin metal, plastics yet SAFE for children! Thousands used in schools, homes, etc... QUIET... Portable... Use even in apartments... Stroke adjustable... UL-Approved... Complete with Built-in Motor, blades, cord,



\$22.95

Arm in normal position →

**THAT'S The
Name To
Ask For!**

SYNCRO
QUALITY TOOLS
ELECTRIC QUALITY TOOLS



U.S.A. Model, 60 cycle, 110-120 Volt, A.C. Other Voltages, Cycles, available. Buy at dealers or send price of article and we will ship postpaid.

SYNCRO CORPORATION
Dept. G-51, Oxford, Michigan, U.S.A.

P.S.

Last minute news & notes...

A UNIVERSAL FUEL, something that can be used in jeeps, tanks, jet planes, or what have you, is being sought by the U.S. armed forces. It would simplify supply problems, but "mechanical octanes" would have to be built into all types of engines to accommodate it. Contracts for experimental work on such engines are being let, but the outlook thus far is not encouraging.

AUTO MAKERS report that, despite the fanfare about the automatic transmissions, 200,000 more cars with overdrives (PS, April '49, p. 180) were sold in 1950 than in '49, and production of these units has continued at a fast pace this year.

VETERANS who want to go to school or take correspondence-school training should do so pronto. In most cases, the Veterans Administration reports, they will lose their educational benefits if they have not started their courses by July 25, 1951.

X-RAY PICTURES now can be developed without a darkroom and examined by a doctor 45 seconds after they are taken. It is done with a new self-developing film (PS, Jan. '51, p. 138) devised by the Polaroid Corporation. The armed forces will get it soon, and it is scheduled to be available for civilian use by the end of this year.

ELECTRIC SHAVERS, garage-door openers, and other such aids to modern living may be shelved in the next war. They send out electromagnetic radiations that the Defense Department says the enemy might use as homing signals to guide his bombers and missiles.

HOW MUCH LIQUOR an unconscious man has had now can be determined. It's done with an electrical instrument, devised at Yale, called an Alcometer. It will help distinguish between drunkenness and illnesses that

sometimes make a man act as though he were drunk when he isn't.

THE BEAVER, the high-wing monoplane built in Canada especially for bush pilots (PS, Nov. '49, p. 154), will be used by the U.S. Air Force. It won out over eight U.S. planes in recent liaison aircraft evaluation tests at the Wright-Patterson Air Force Base near Dayton.

A HIGH WIND high in the atmosphere, known as the jet stream, has been shown to be partly responsible for the weather down where we live--because it affects the pattern of lower-air movements. Canada and Sweden now are using data regarding it in their weather forecasts, and the U.S. Weather Bureau is including it among the factors on which it bases five-day forecasts.

AN ATOMIC SUBMARINE would be "a wolf that could go after its prey" rather than "a spider that must wait quietly for its victim to approach," the authorities say. Building the first one is expected to cost \$40,000,000, which is about four times the cost of a fleet-type submarine now.

A ROAD REBUILDER to reduce the need for detours has been developed in California. It uses old material in paving that is to be replaced. The asphalt is softened with a light oil, new material is added, and the road is instantly repaved as the rejuvenator moves down the highway.

IF YOU TUMBLE into icy water, don't try to save your strength by simply hanging onto something until help comes. Medical researchers say your chances of surviving will be better if you swim or struggle as much as you can as long as you can.

The Editors

South Bend LIGHT TEN LATHE

A Better Lathe for Better Work

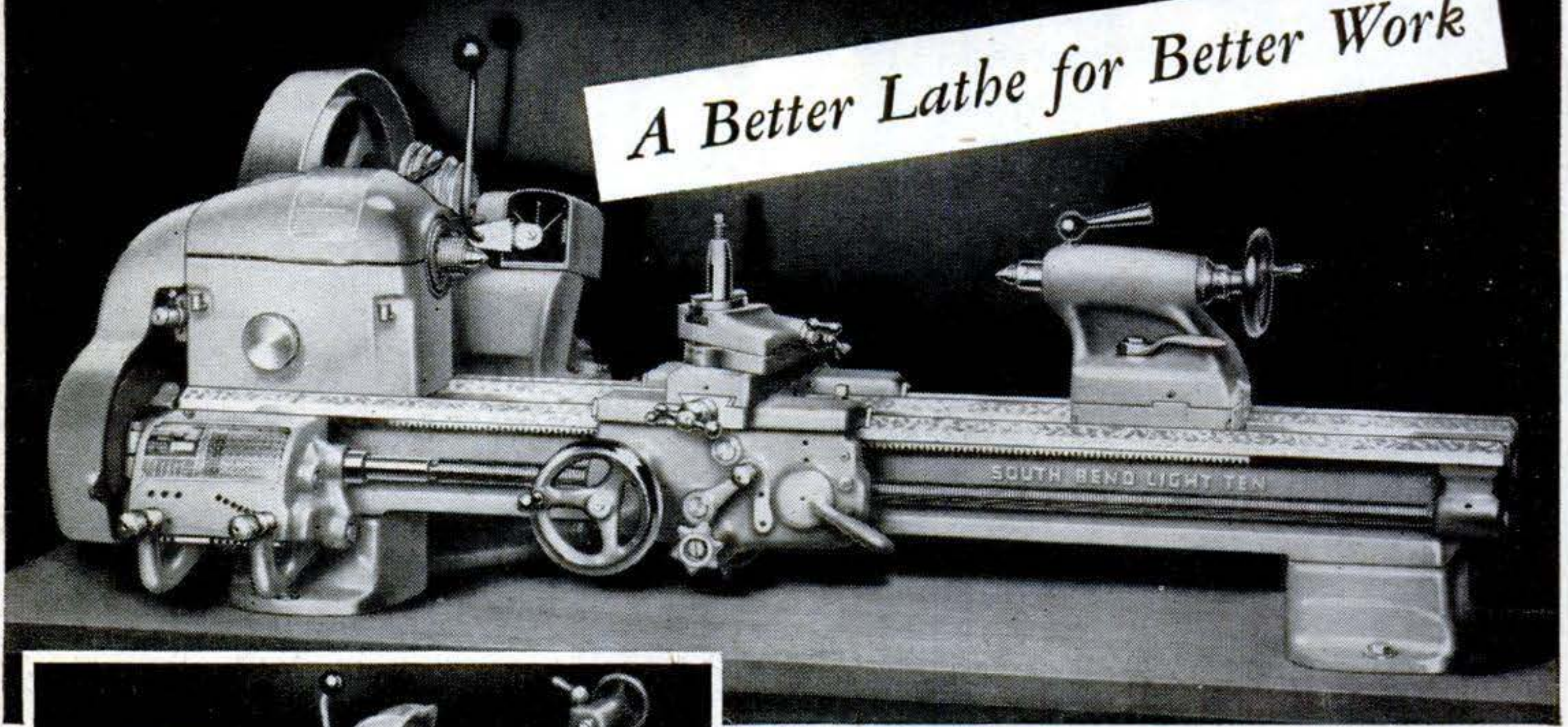

Light Ten Model A Lathe — 10" x 3-1/2'

This new Light Ten Bench Lathe is the result of forty-three years of experience in designing and building fine lathes. It is a modern precision tool having the most recently developed improvements, plus features usually restricted to larger lathes. In this lathe you get big lathe features at small lathe prices. We consider it one of the best values ever offered. The quick change gear box and universal power feed apron provide a full range of 48 screw threads, 48 power longitudinal feeds and 48 power cross feeds. Large, precision-bored bearings for the superfinished spindle insure extreme accuracy and service. The tailstock has graduated spindle and micrometer collar screw.

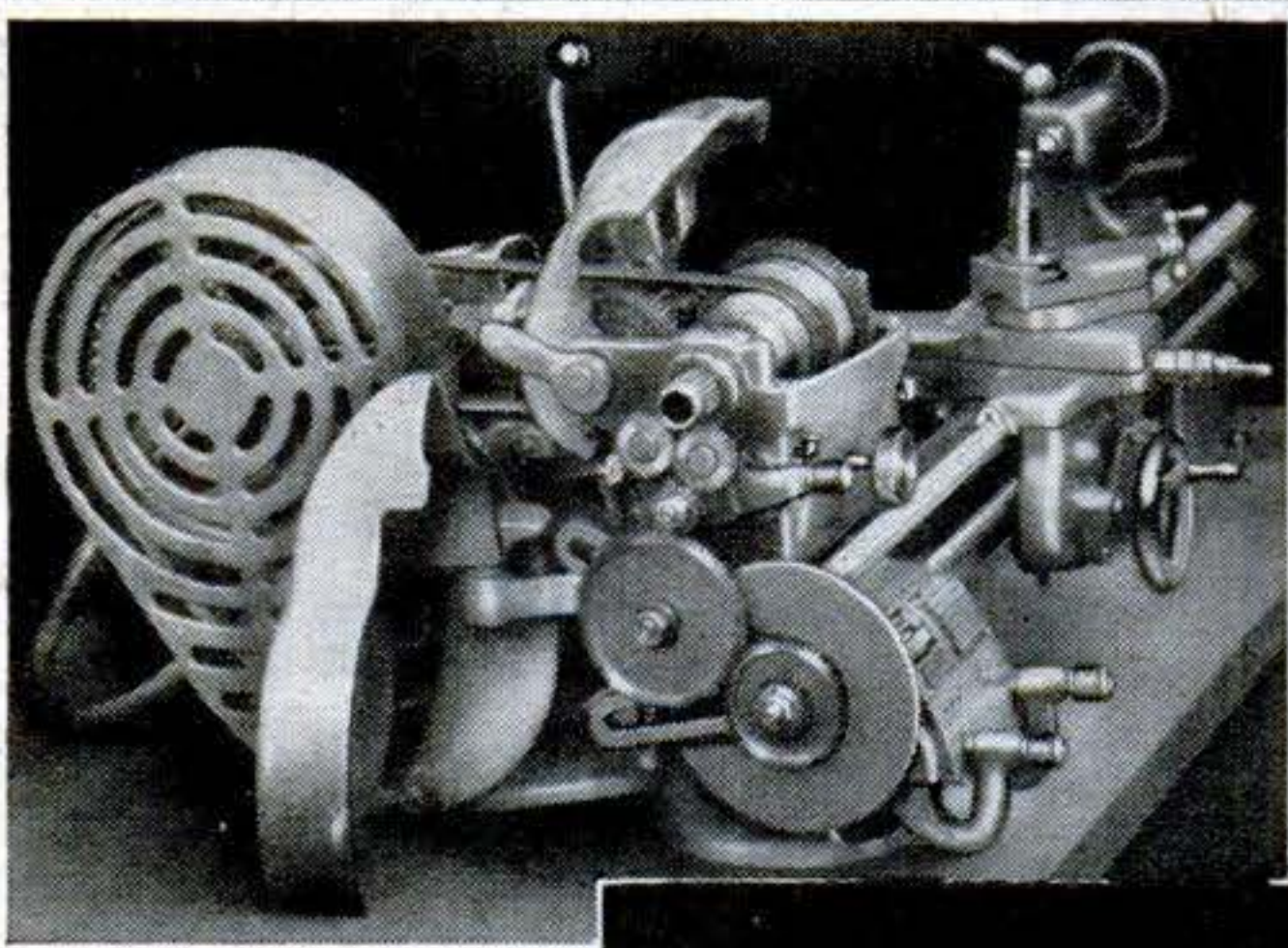

For safety, all gears and pulleys are enclosed, yet they are easily accessible.

Tailstock has 1/10" graduations on spindle and micrometer collar on screw.

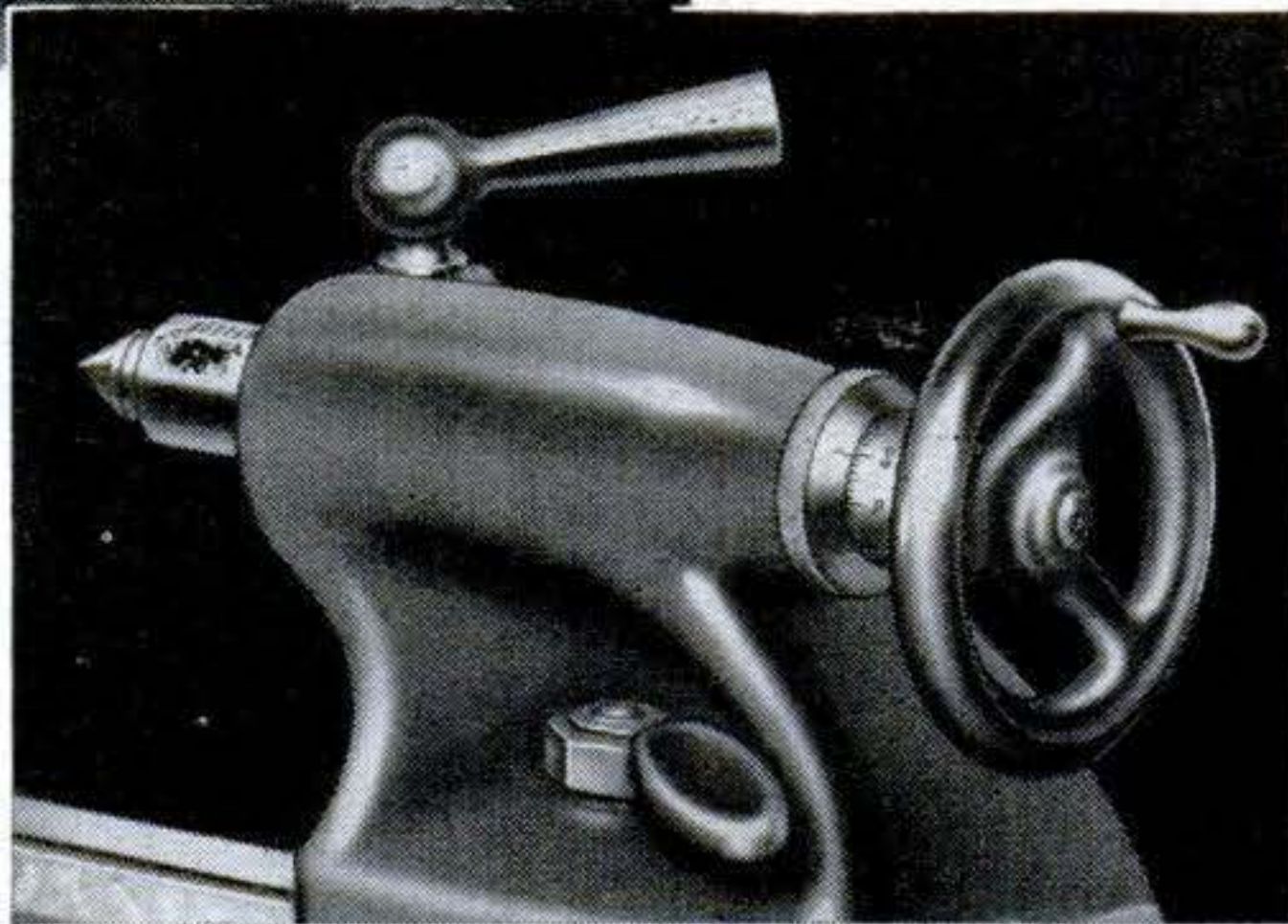

Building Better Tools Since 1906 • SOUTH BEND LATHE • South Bend 22, Ind.

Send Information Checked:

Light Ten Lathes

Lathe Attachments

New "How to Run A Lathe" book, (Enclose 25c coin or stamps)

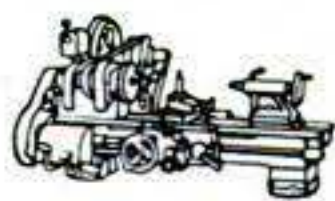

9" and 10" Bench Lathes

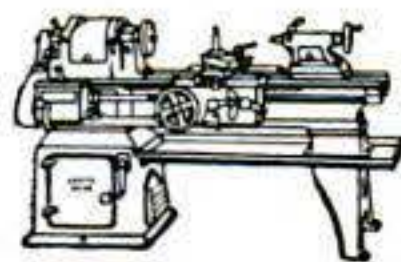

10" to 16-24" Floor Lathes

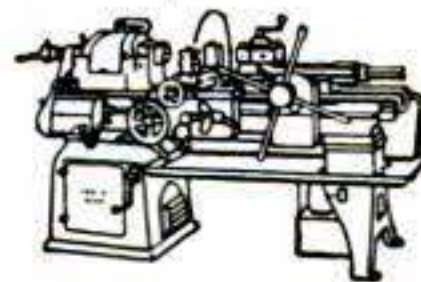

1/2" & 1" Collet Turret Lathes



14" Drill Presses

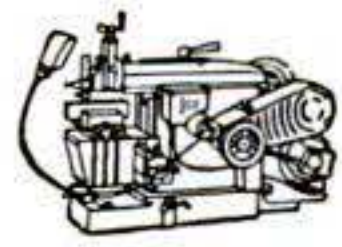

7" Bench Shapers

Name _____ Street _____

City _____ State _____



PER 1/4
ILLION
ANES
NOW
N USE

WANT TO

GANE

BE PREPARED IF RATIONING RE

**10 DAY
FREE TRIAL
IN YOUR CAR**

You can easily install Ganes
In A Few Minutes

TEST R

- ✓ BETTER MI
- ✓ EASIER ST
- ✓ FASTER PI
- ✓ BETTER ID

GANE ECONOMY CLUB

GETS YOU BIG ACCESSORY DISCOUNTS

All Gane Needle purchasers automatically become members of the Gane Economy Club and pay no dues, fees, or expenses. This organization extends big discount privileges to members on auto supplies and accessories, auto economy products and many household and personal items.

All members receive benefits which can only be offered to large, organized groups. **FULL PARTICULARS ON THE ECONOMY CLUB WILL BE SENT FREE OF CHARGE TO ALL WHO TRY GANE NEEDLES... WRITE TODAY!**

MANY GANE NEEDLE USERS REPORT FASTER PICK-UP, EASIER STARTING A

...but don't take our word for it...see for yourself! Test a Gane Needle in your car for 10 days at our expense. Then compare your mileage and performance. If fully satisfied, send us only \$1.50 per needle (8 cylinder cars take two). If not satisfied, just return the needle and you owe nothing...fair enough? Since authorities differ on the merits of Ganes and some users report no improvement, **TRY BEFORE YOU BUY!**

SEND NO MONEY! PAY POSTMAN NOTHING!

Just fill out the required information on your car in the space provided in the postage paid postcard and mail it today. Your **FREE TRIAL GANES** will be sent immediately.

WHAT MANY "WHO SHOULD KNOW" SAY ABOUT GANE NEEDLES!

CARBURETOR ENGINEERING CO.: "Tests used 3.6 gallons LESS with Gane Air-Flow Needles...a saving of 72c in ONE DAY." Otto H. Dahike, Ferguson Carburetor Engineering Co. **YELLOW CAB CO.:** "Mileage check on 4 cabs showed 10.1 miles per gallon without...12.5 miles per gallon with Gane Needles. Supply our entire fleet at once! Yellow Cab Company, Evansville 2, Ind. **TRUCK OWNER:** "The saving after needle was installed averaged \$1.00 per day." Joe D., Bellaire, Ohio. **POLICE:** "I'm equipping all the patrol cars of our police department, please rush order." **NEWSPAPER:** "The Gane Needle gives you from 2 to 4 extra miles a gallon." Tony Weitzel, Detroit Free Press.

NATIONAL AUTOMOTIVE RETAIL CORPORATION
Dept. HH-5, Venice, California

The GANE-O-MATIC Overdrive Control



A 20% discount is offered all Gane Economy Club Members on this revolutionary new automotive item. It gives all cars with overdrive the following benefits: An Automatic Hill-

holder; The Use of Six Forward Speeds; No Clutch shifting In All Gears; Motor Compression When In overdrive. **WRITE FOR YOUR FREE TRIAL GANE NEEDLE AND WE WILL ENCLOSE FREE, ILLUSTRATED GANE-O-MATIC LITERATURE.**

BURN WATER IN YOUR CAR!

The OCTAGANE "50"



Economy Club Members receive automatic 20% discount privileges on the famous Octa-Gane "50", the only all bronze, exhaust pressure operated water-alcohol injector on the market today.

U. S. DEPARTMENT OF AGRICULTURE SCIENTISTS SAY, "New high compression automobile engines can increase gasoline mileage up to 20% with alcohol-water-gasoline fuels." **WRITE TODAY FOR YOUR FREE TRIAL GANE NEEDLE AND FREE, INFORMATIVE INFORMATION ON THE OCTA-GANE "50".**

MAIL CARD TODAY AND WE WILL SEND 2 FREE BOOKS



"ECONOMY IN DRIVING"

This automotive economy manual is sent Free to all who try Gane Needles. It tells how to save gas, brakes and tires; how to gain more speed, power and better performance from any car. Written so you can understand and follow its simple, illustrated instructions, it is yours to keep whether you purchase Ganes or not. It also introduces many new and unusual automotive economy products.



"GET 150 MILES PER GALLON WITH YOUR CAR"

This new book by Ernest Newhouse tells how full sized passenger cars actually get over 100 miles on a gallon of regular gas. Mr. Newhouse is a recognized authority in the "sport car" field and his books and manuals are purchased annually by thousands of economy minded American motorists.

"Get 150 Miles Per Gallon" and "Economy In Driving" will both be sent absolutely free to all who write for Free Trial Gane Needles. Write Today... Our Supply Is Limited!



With Baseball's Big Winners...

it's COOL, MILD **CAMELS!**

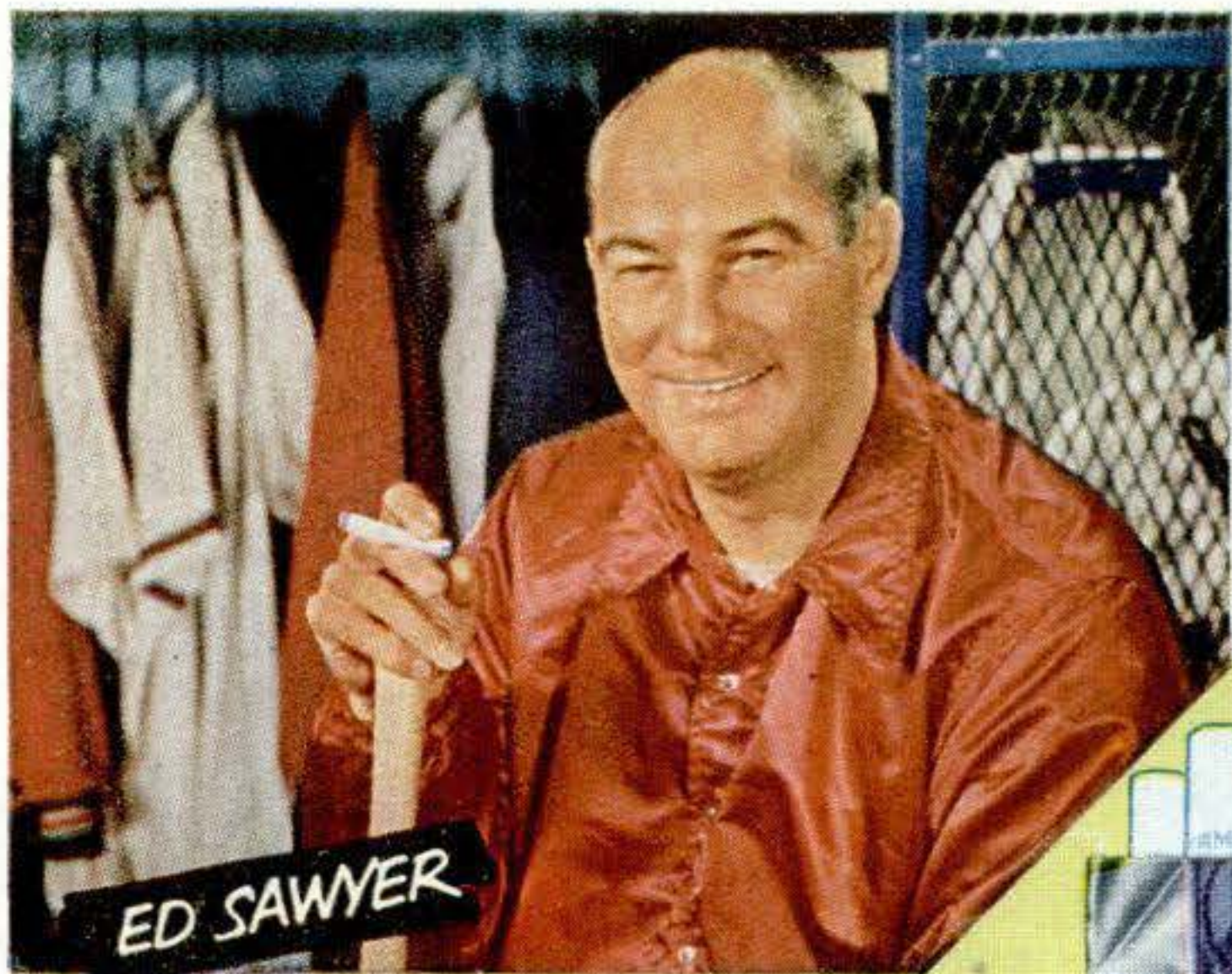

ED SAWYER

"Manager of the Year" in 1950, Ed masterminded the Phils into the pennant. "My own 30-Day Camel Mildness Test proved how mild a cigarette can be!"



JIM KONSTANTY

Most Valuable Player of 1950 in National League, Jim Konstanty says: "Camels give me the kind of flavor and mildness I find in no other brand."



VIC RASCHI

Top Pitcher of the World Champions, Vic Raschi, of the New York Yankees. "Camels are my choice for mildness. Camels never tire my taste," says Vic, opening game winner in the World Series.

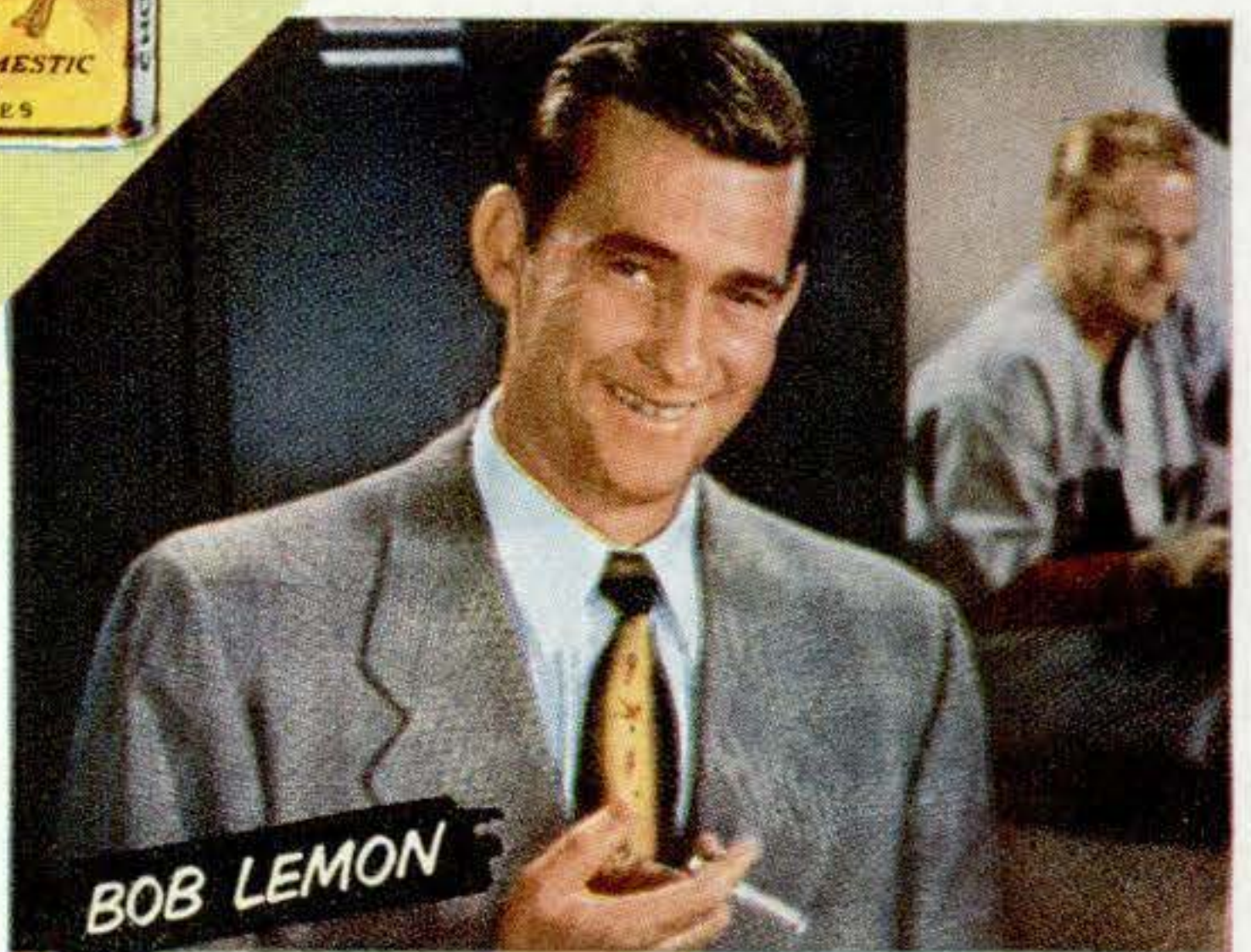

BOB LEMON

Leading Right Hand Pitcher of 1950, Cleveland's Bob Lemon, only hurler to win 20 games or more in each of the past 3 years, says: "I'm glad I made my own 30-Day Test. Camels hit the spot!"

Make the sensible cigarette test. Change to mild, flavorful Camels for 30 days. You'll know why...

MORE PEOPLE SMOKE CAMELS than any other cigarette!



Make your own 30-Day Camel MILDNESS Test in your "T-Zone"
(T for Throat, T for Taste)

R. J. Reynolds Tob. Co.
Winston-Salem, N. C.