

POPULAR SCIENCE

MONTHLY

MECHANICS AND HANDICRAFT



Wilbur Shaw Previews a
1953 BUICK
PAGE 100

25¢ October



**Making the Most
of Your Basement**

PAGE 206

SAVE \$\$\$...the

5 Day Trial—



Genuine Trans-Kleer
PORTABLE GARAGE 688

Our **LOWEST** price ever for genuine **TRANS-KLEER**—the really **HEAVY DUTY** Portable Garage. Goes wherever your car goes . . . protects your car against the ravages of Winter or Summer: Snow, sleet, rain, insects, salt air, sand, etc. Whisks on or off **QUICK** and **EASY**. Takes little storage space. Folds away like a handkerchief! **SURE-GRIP** Bottom holds it on in winter or summer! Pays for itself many times over! Do not confuse with cheap, used plastic models. **TRANS-KLEER** does not disintegrate, crack or melt! Note: It is **FIRE RETARDANT!** Thousands sold for **\$10.00**. Now **DRASTICALLY REDUCED!** Mention car make, model, year, for best fit. Order by **No. 140**. Protect your car the original **TRANS-KLEER** Portable Garage way! Special cut price . . . **6.88**



**AMAZING, NEW
CAR WASHER**

Automatically foams, cleans, rinses



Wash your car **QUICK** and easy, without back-breaking toll! The new, **MAGICAR FOAM WASHER** uses gentle foam action—protects car finish. Just attach to garden hose, turn on, watch grease, dirt, grime foam away! Then turn valve and clear rinsing water streams through. All controls right on handle—at your finger tips—no running back to spigot! No wiping needed! No soap streaking ever! So simple and easy to use! **No. 11. Only .. 3.95**

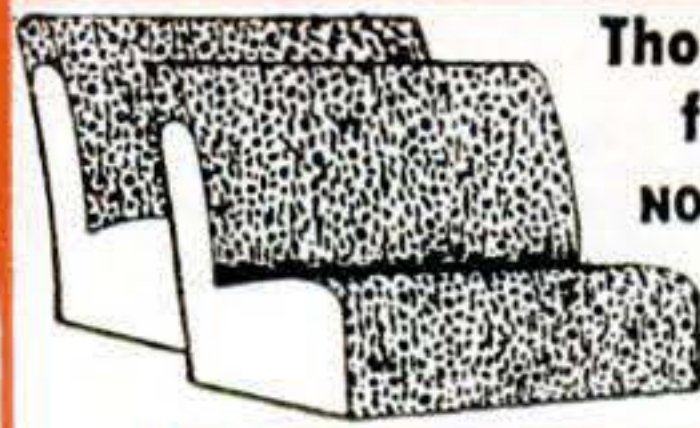

Thousands sold for \$2.95

NOW \$1.98

2 FOR 3.75

**LEOPARD
Plastic
SEAT COVERS**



**Also:
ZEBRA SCOTCH PLAIDS,
STRIPES, SOLIDS**

Any Design

1.98

2 for 3.75

TAKE YOUR PICK . . .



**Value!
\$2.95**

De Luxe Camera GADGET Bag

Wherever you go, have your photographic equipment at your finger tips! Protect your valuable camera at tremendous savings. Use the convenient, easy to carry, "International" Camera Gadget Bag. Plenty of space for flashgun, extra film, filters, everything you need to take fine pictures. Smartly styled. Heavy Duty, 16 gauge, luggage tan "Granitol." 2 spacious compartments with individual zip-pers. Size 8 1/2" x 7" x 4". Compare with gadget bags to \$7.50. Order by No. 9. Our rock-bottom price, **2.95**. Size 9 3/8" x 8" x 3" for larger cameras, same de-luxe features as above (No. 9-B), **3.95**; Size 10 1/2" x 7" x 3 3/4" extra large **4.95** size (No. 9-C)

**POWERFUL • Made in Germany
LONG RANGE—SHARP & CLEAR!**



Complete with Carrying Case

Save \$7.00—get yourself a genuine, fully guaranteed "KLAROVIS." Look thru them **ONCE** and you'll be convinced of their quality & power! Genuine **GROUND POWER LENSES** bring in distant objects & people with amazing clarity & detail. Smooth synchronized center-focusing mechanism for quick, easy adjustments. Light weight, easy to carry, yet almost impossible to break in normal use. With this power-packed instrument, distances seem to melt away . . . you'll always have a "front seat" at boxing matches, baseball, football, etc. Ideal for travelers, hunters. Included: reg. \$1.25 Flexomatic case & straps. No. 134, NOW, only **\$3.00**. **SPECIAL De-Luxe Triple Power Model with case (No. 134-B), bargain price 3.95.**

\$3.

Compare



Great Invention
for Motorists

AUTOMATIC FLASHLIGHT

Uses No Batteries!

Don't be caught unprepared in night driving emergencies . . . with dried out batteries in your flashlight! This ingenious flashlight uses no batteries. Has built-in, precision made generator operated by hand! It can be a lifesaver for motorists! Gives white beam or intermittent "stop & go" flashes to warn off other cars. Small, compact. With little care it should last a lifetime. Made by German artisans. **No. 143. Low cut price . . . \$4.95**



**NIGHT
DRIVERS!**

**STOP
Headlight Horror!**

Don't be trapped . . . blinded . . . maimed! **FILTRO-LUX** Night Driving Glasses help protect you against dangerous headlight glare! Drive all night! Look right into oncoming cars' lights, safely, comfortably! No squinting or burning eyes! **FILTRO-LUX** glasses have **THERMALLY** curved, ground and polished lenses. Meet Gov't Spec. **159-49**. Aviator style (No. 23) or Clip-ons (No. 23-C) to go over your own glasses. **BARGAIN price, \$2.88**



The **EASY** way to paint
Famous Burgess
ELECTRIC PAINT SPRAYER



- PAINTS
- DISINFECTS
- LUBRICATES
- KILLS INSECTS
- REACHES ALL OVER!

788

Moto-Matic way!

SAVE!

Money Back Guarantee!

Glorify your car!

Unbelievable value! Closing out our regularly \$2.95 seat covers for only 1.98—2 for 3.75! Made of tough, durable plastic to simulate **LEOPARD FUR, ZEBRA, SCOTCH PLAIDS, STRIPES, Etc.** Choose your favorite design! Protects new cars against grime, dust, water. For **ALL** cars, **ALL** models. **NO** sewing needed! Just slide on or off in a jiffy. Covers front, left and right sides of seat. Mention car make, year, model; also design preferred. No. 150. Out they go—one low price. 1.98 each. **TWO** for 3.75.



NATIONALLY ADVERTISED



NOW Special 495

ELECTRIC RAZOR
If blades irritate your skin—this is the electric shaver for you! Clean, cool, smooth shaves are yours. No more blades or shaving cream to buy! Actually pays for itself in a short time! Nationally advertised! Thousands in use all over America. Now you need not pay as high as \$19.95 for a fine electric shaver! Look at our **LOW, DIRECT-TO-CONSUMER PRICE**—only \$4.95. Precision made! Consumer tested! Truly a magnificent shaver, powerful, efficient! and this shaver has **FOUR** shaving edges instead of the usual one or two! Even toughest of whiskers come off clean and **FAST!** Bears manufacturer's guarantee against mechanical defects. Use it at our risk for 5 days. Here's a sure bet: you'll never use an old-fashioned razor again! Order by **No. 26**. Bargain price 4.95

Wonder of the Age!
WALKIE-TALKIES
2 WAY



TELEPHONE SYSTEM

No Batteries Needed!

NOW—a remarkable 2 way telephone system between house and garage, room to room, barn, workshop, etc.! No batteries! No electricity! Operates at considerable distances! So useful! Fun too, for all! Complete with 2 power phones and wiring—ready for use. **No. 17**. Our low price.... **3.90**

TRY AT OUR RISK!

STOP AUTO THIEVES ELECTRIC BURGLAR ALARM



Protects car, tires, gas, accessories!

Foil auto thieves! The **NEW** Pend-Electric Burglar Alarm gives you **ALL-OUT** protection against accessory, tire, gasoline and auto thieves. Protects your **ENTIRE** car even if you leave the door open! Anyone molesting your car will get the shock of his life! The "Unseen Policeman" goes into action instantly, setting off loud, screeching horn blasts—continuing for 15 seconds after car is left alone. Even the most daring thief will run for it! Easily installed with a screwdriver. Complete with wiring, instructions, screws, on-off switch. Completely **AUTOMATIC** and ultra-sensitive. A real investment in peace of mind. **No. 34**. Bargain price **3.95**



PERSONAL
• CARRY
HAND & BODY WARMER



NEW Hi-Heat Pocket Size Warmer is a little marvel. Gives warm-as-toast heat in coldest weather! **Hi-Heat** has the wonder element activated by white gasoline, naphtha or alcohol. Absolutely **SAFE**—No flame—No danger. Gives comforting heat to 24 hours. Mirror finish metal—no moving parts to wear out. Carrying case included. Ideal gift. Quality construction. **No. 21**. **2.95**

These Prices!

Try This Sprayer Now!

Don't paint it . . . **SPRAY** it the **EASY** Burgess Electric Sprayer way! No more messy brushes and back breaking toil! Just fill mason jar with your favorite paint, enamel, lacquer, insecticide or disinfectant. Push the handy button, aim and spray. Save **TIME**, save **WORK**, save **PAINT** too! And the results are simply amazing—look like professional jobs, so uniform, and no brush marks! So handy too for insecticides, garden sprays, lubricating oils, shellac, etc. Reaches hard to get at places, such as ceilings, corners; ideal for painting wicker furniture. Hundreds of uses in home, office, farm or factory! Paint walls and ceilings, cabinets, furniture, outside the house too! Spray insecticides in the home, for garden pest control, in the garden for livestock, etc.

PAINT YOUR OWN CAR! Save \$50.00 or MORE! Spray it the factory way . . . get wonderful **EVEN** coverage—no brush marks, no drippings or paint splashes! So clean, so easy, so satisfying! The Burgess is complete—ready to use—no extras. Has powerful, self contained 110 Volt A-C motor, 8 foot insulated cord and 8 oz. mason jar. Has **Rotary-Adjuster**—gives any spray, fine, heavy or thick—up to 80 lb. pressure! Guaranteed by famous Burgess factory. **No. 187**. Look at our **LOW**, reduced price, only.....**7.88**

SOLDER with a MATCH!
No costly tools, no special skill needed! Do own home, radio and auto repairs, save money, time, temper with revolutionary 2-in-one **SOLDER**—ALL in a tube! Combines pure metal solder and non-corrosive flux in an easy-to-apply paste. Solders wires and light metals with the heat of just one match! Remarkable **SOLDERALL** has long been used by biggest radio and electrical manufacturers. **No. 6**. Handy tube good for dozens of jobs, only \$1.



SHAVE UP TO 1 YEAR WITH 1 BLADE!

Even **NEW** blades shave better with this amazing machine! Tough beard or tender skin, "Blademaster" gives you from a month to a full year's smooth rotary action from **ONE** blade! Automatic rotary action simultaneously conditions all 4 edges, trims off nicks. With your **Blademaster** we include 20 Consumer Tested Blades—yours to keep **FREE** even if you should return machine. Thousands in use! Get yours. **No. 3**. Special...**2.95**

SEND NO MONEY—Try without obligation!

MOTO-MATIC COMPANY, Dept. 7-M
129 West 33rd Street • New York 1, N. Y.

RUSH the following C.O.D. plus postage, on 5 DAY TRIAL, with **GUARANTEE** of absolute satisfaction or full price back:

NUMBER	ITEM	PRICE

NAME _____

ADDRESS _____

TOWN _____ ZONE _____ STATE _____

SAVE MORE! Send check, money order, or cash with this coupon and we pay all postage. Same **MONEY-BACK** guarantee.

America's Leading New-Idea Magazine for 80 Years

Founded 1872, Vol. 161: No. 4

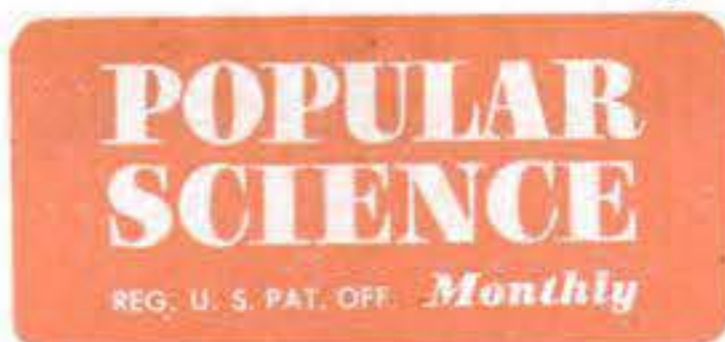

Mechanics and Handicraft

VOLTA TORREY, EDITOR • Howard Allaway, MANAGING EDITOR
Howard C. Jensen, ART EDITOR • Frank Rowsome Jr., ASSISTANT MANAGING EDITOR

SENIOR EDITORS: Harry Walton (Mechanics & Handicraft), Hartley E. Howe (Features), Martin Mann (Copy).

ART: Harry Samuels (Director), Herbert Anthony, Rolf O. Erickson, Eric Karminski Jr., Richard Meyer, Frances Cooper Daniels.

ASSOCIATE EDITORS: Alden P. Armagnac, Devon Francis, Sheldon M. Gallager, Kendall W. Goodwyn, Wesley S. Griswold, Herbert O. Johansen, Herbert R. Pfister, Denis Sneigr, Robert P. Stevenson, Ruth Westphal, Andrew R. Boone (Los Angeles).

PHOTOGRAPHY: W. W. Morris (Director), Hubert Luckett, Orlando Guerra.

EDITORIAL ASSISTANTS: Harriet Trowbridge, Julia C. Bove, Carol Ennis, Rita K. Gilbert, Georgette Sparks, Katharine W. Townsend, Jeanne Van Houten.

OCTOBER, 1952

*12 Pages about
1953 CARS*



America's most widely known sports cartoonist—Tom Paprocki (above) of The Associated Press—teams up with British scientist Prof. A. M. Low to predict what's ahead in sports. For their forecast of the coming age of mechanized athletics, turn to page 97.

Mechanical Sports Are Coming.....	97
Buick Sets New Style for 1953.....	100
1953 Cars Will Have Air Conditioning.....	105
1953 Cars Will Have Tubeless Tires.....	108
1953 Forecast from Detroit.....	111
Will They <u>Ever</u> Climb Mt. Everest?.....	118
'Space Men' Make College Men Think.....	124
Wingtip Shotguns Fire Rocket Salvo.....	128
The Crane That Saves \$2,000 a Minute.....	144
Nylon-Glass Armor Saves American Lives....	154
How to Choose Your Trees.....	166
Look What They've Done to Motorcycles.....	172
5 Ways to House Your TV Set.....	177
Homemade Meter Checks Car Battery.....	192
Gus Gets the Pitch.....	196
Snow Tires, Chains and Winter Driving.....	201
Making a Basement More Useful.....	206
How Karsh Pictures Celebrities.....	220

(More features and departments are listed on page 4.)

Godfrey Hammond, PUBLISHER • Stephen P. Glennon, ADVERTISING DIRECTOR

ADVERTISING OFFICES: NEW YORK — 353 Fourth Ave.; CHICAGO—360 North Michigan Ave.; DETROIT—820 Book Bldg.; SAN FRANCISCO—681 Market St.; CLEVELAND—328 Citizens Bldg.; LOS ANGELES—2550 Beverly Blvd.
EDITORIAL OFFICES: 353 Fourth Avenue, New York 10, N. Y.

Published monthly at 353 Fourth Avenue, New York 10, N. Y., by Popular Science Publishing Co., Inc., Godfrey Hammond, President and Treasurer; R. C. Wilson, Stephen P. Glennon, Vice-Presidents; F. W. Briggs, Secretary. Entered as second-class matter Dec. 28, 1918, re-entered as second-class matter July 26, 1948, at the Post Office in New York, N. Y., under the act of March 3, 1879; additional entry as second-class matter at Dayton, Ohio. Entered as second-class matter at the Post Office Department, Canada. Printed in U.S.A. Copyright, 1952, by Popular Science Publishing Co., Inc. All rights reserved in the United States, Great Britain, and in all countries participating in the International Copyright Convention and Pan-American Copyright Convention. Yearly subscriptions to United States, its possessions and Canada, \$3.00 (2 years, \$5.50; 3 years, \$7.50); foreign countries \$1 per year extra. Four weeks' notice is needed to change a subscriber's address. Please give both old and new addresses, including postal zone numbers.

Here's how—

*to put new life
in your tired
heating plant!*

INSTALL

TIMKEN

Silent Automatic

HEAT



Why suffer through another winter of old-fashioned heating? It's so easy to install a Timken Silent Automatic Conversion Burner now and give your heating plant—and yourself—a new lease on life!

You'll do better in every way with a Timken Silent Automatic! These thrifty burners save real money on fuel. They're clean-burning and dependable, engineered to outlast your present heating plant. Beautifully and compactly designed, they keep your basement looking neater—often give you enough extra space to build that workbench or fix up that play room. And you'll find work-free Timken Silent Automatic Heat gives you plenty of extra time to spend in your new-found space!

Convert *now* to the luxurious comfort and convenience of Timken Silent Automatic Heat! Your local dealer will be glad to help make this *your* automatic heating year!

A COMPLETE LINE OF FURNACES, BOILERS AND CONVERSION BURNERS, BOTH OIL AND GAS, FROM WHICH TO SELECT THE RIGHT MODEL FOR YOUR HOME AND BUDGET! OIL-FIRED WATER HEATERS, TOO!



MODEL OCA OIL BURNER—
The famous wall-flame burner blankets heating plant walls with a natural-burning, blue-hot flame. Special chromium steel flame rim converts oil into super-heated vapor for utmost heating efficiency. Saves up to 25% on fuel—often more—over ordinary gun-type burners!

MODEL GCT GAS BURNER—
This advance-engineered burner combines every wanted, needed gas heating feature in one smart-looking, compact cabinet. Clog-proof mono-port burner assures clean, efficient, trouble-free operation and fast heat response. Works perfectly with all types of gases.

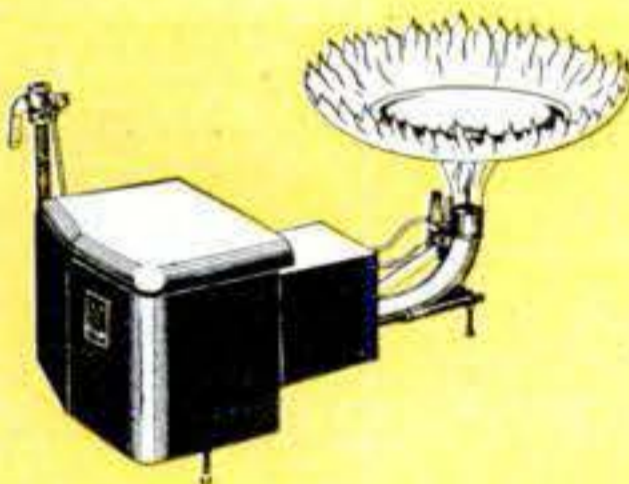

**EASY TERMS AVAILABLE!
NOTHING DOWN—36 MONTHS TO PAY!**

TIMKEN

Silent Automatic

HEAT

OIL • GAS • COAL

TIMKEN SILENT AUTOMATIC DIVISION
The Timken-Detroit Axle Company • Jackson, Michigan
The Timken-Detroit Axle Company of Canada, Ltd., Toronto, Ont.



MAIL THIS COUPON FOR FREE, ILLUSTRATED LITERATURE!



Timken Silent Automatic, Jackson, Michigan

Please mail illustrated literature. I am interested in:

PS-10

NAME _____ (type of equipment)

STREET ADDRESS _____

CITY and STATE _____

If you are a student, please check here () for special information.



**Sir Launcelot Wins
All His Duels
... 'cause
PROTO means
PROfessional
TOols!**

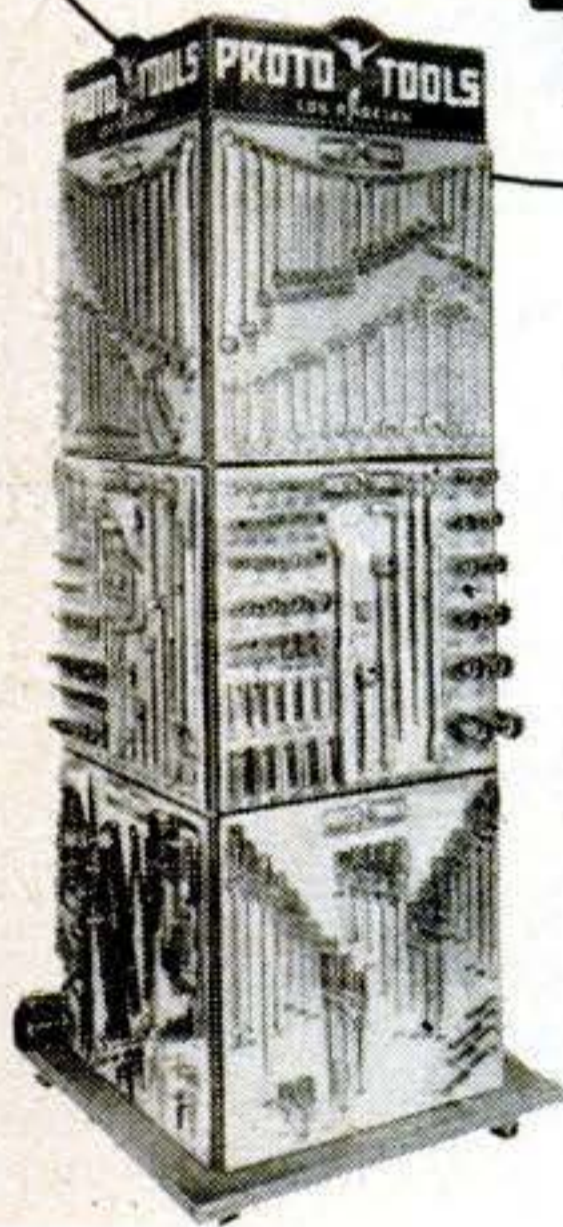

The PROTO Line
Includes Wrenches,
Pliers, Screwdrivers,
Punches, Chisels,
Sockets & Handles
and Many Others.

One reason why PROTO tools are *professional* tools is that they are made from PROTO-specified alloy steels. Known as PROTO-LOY, these special alloy steels provide great strength, hardness, toughness — and extra long life. Scientific heat treatment, advanced designs, accurate manufacture, a meaningful guarantee and completeness of line are more reasons why experts prefer PROTO. For truly *professional* tools, see your PROTO dealer. Send 10¢ for 68-page catalog to

PLOMB TOOL COMPANY
2257R Santa Fe Ave.,
Los Angeles 54, Calif.

5283



Eastern Factory—Jamestown, N.Y.

News and Pictures

Triple-Decked Air Freighter.....114
 Motor Runs on Power from Atmosphere..116
 Sportster Built in Basement.....130
 Midget Brains for Mechanical Men.....134
 Super Service for Truckers.....140
 How Electric Blankets Work.....148
 N. Y. Pier Rode 35 Miles to Its Berth.....150
 What Jets Have Done to Our Air Power..158
 Week-End Railroad Run Like Real One..163

Mechanics & Handicraft

Do You Play with Fire?.....182
 How to Make Memo Holders.....186
 TV Reception Off? Check Antenna.....188
 I Gave My Car That Continental Look...190
 How to Travel Like a Gypsy.....195
 Preventing Plumbing Freeze-Ups.....212
 Uses for Paper Cups in Your Shop.....229
 Now's the Time to Weatherstrip.....230
 New Products for the Handy Man.....235
 Now You Can Build a Transistor Radio...237

Departments

Letters 18
 I'd Like to See Them Make.....133
 New Ideas from the Inventors.....137
 What's Cooking for Cooks.....152
 P. S. Last Minute News and Notes.....176
 Hints from the Model Garage.....199
 Craftsmen in Uniform.....216
 Keeping the Home Shipshape.....218
 New Shop Ideas.....240
 New Tools.....242

NEXT MONTH

Using the Portable Saw

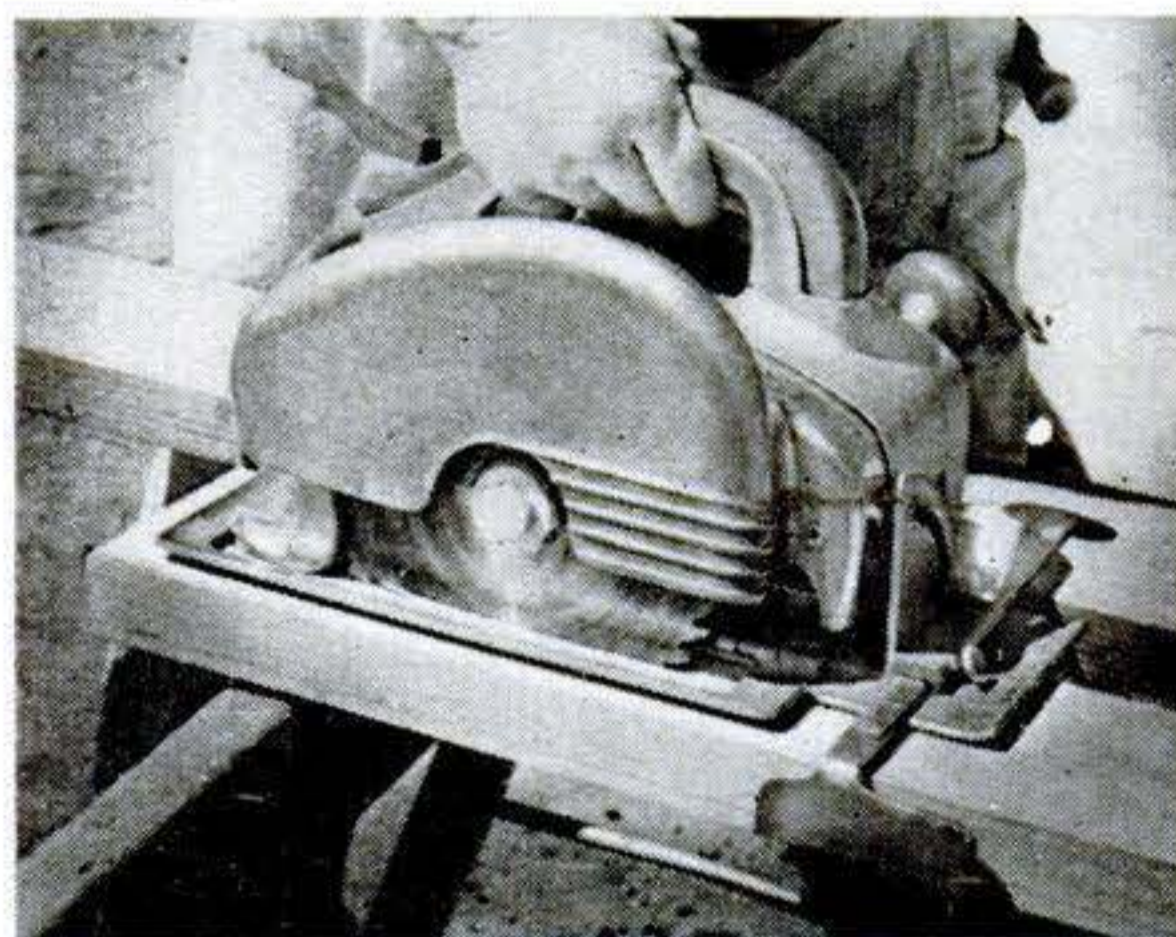

It's the tool that is catching the eyes of pro and amateur carpenters alike. Edwin M. Love tells of its "on the job" abilities and gives tips on using and caring for a portable saw in next month's PSM.

Take a tip from "Mr. Industry"

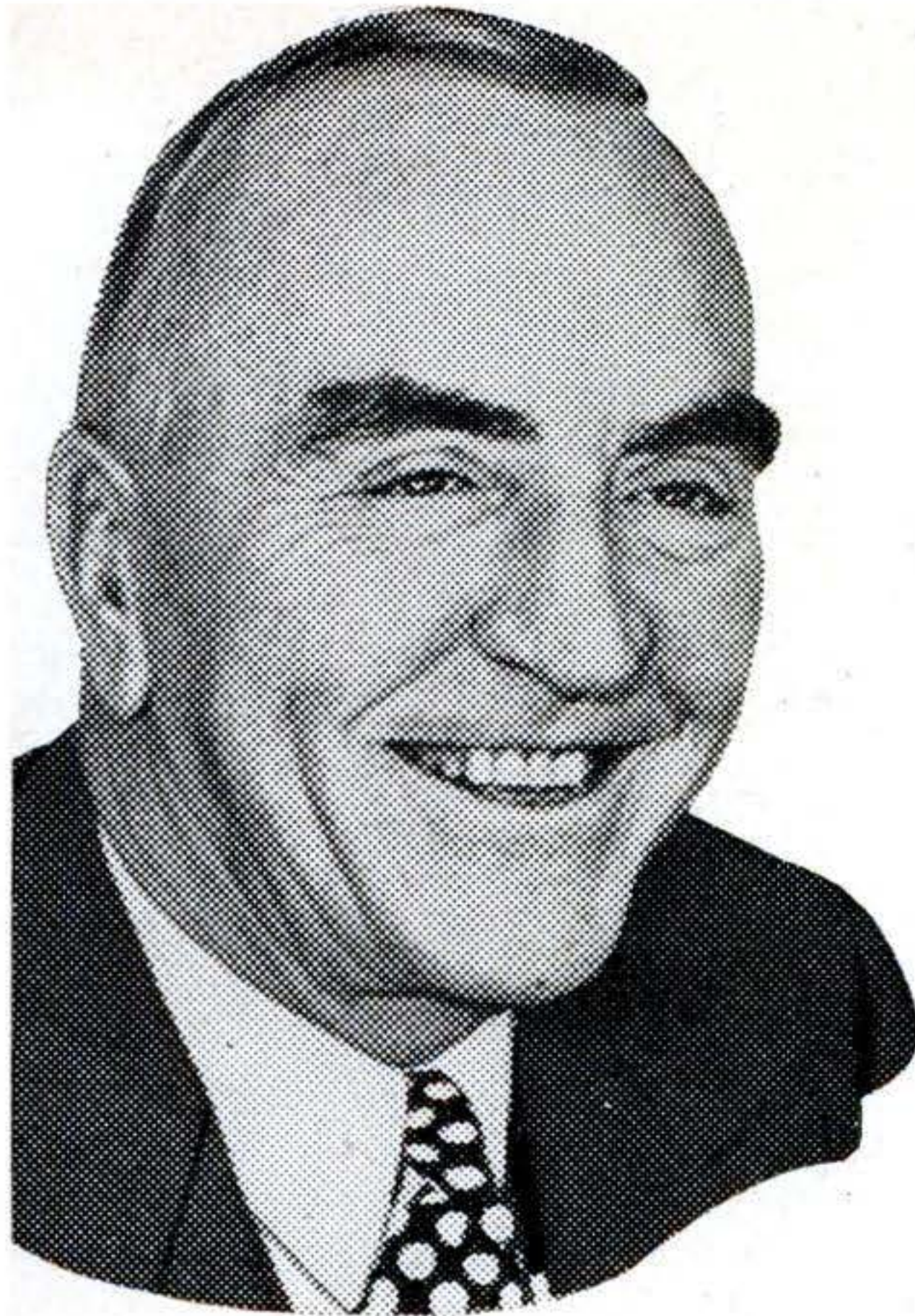

E. V. RICKENBACKER
President and General Manager of
Eastern Air Lines

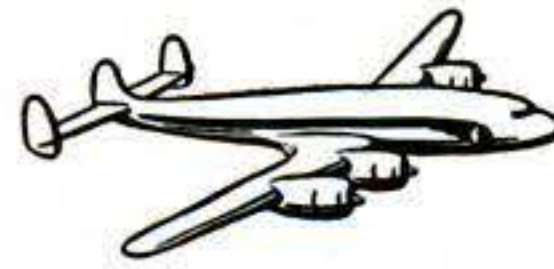

Eddie Rickenbacker cashed in on an I. C. S. course and natural leadership to win the *top man of industry* title for 1951.

Mr. Rickenbacker took an I. C. S. course in automotive engineering when he was a kid working in a bicycle shop. That was the start of the famous Rickenbacker formula for *making opportunity*, being ready when it came. Last year a *Forbes Magazine* survey—polling business executives, securities analysts and others in the world of finance—found him top man of industry for 1951. Of total votes received, his name led all others.

Hero of two world wars, top-drawer racing driver and automotive engineer, the hard-won success of the dynamic head of Eastern Air Lines is an inspiration for all who have the determination to get ahead and the intelligence to go about it in the right way. Think through, then follow through.

To *make* your opportunity—to be ready when it comes—obtain specialized training through I. C. S. With more than 400 courses to choose from, it's easy to increase *your* knowledge and aptitudes. Fill in and mail the coupon below today!

INTERNATIONAL CORRESPONDENCE SCHOOLS



BOX 7613-N, SCRANTON 9, PENNA.

Without cost or obligation, please send me the booklet about the course BEFORE which I have marked X:

Please send information about I.C.S. employee training for companies.

- | | | | | |
|---|---|---|---|---|
| <p>ART</p> <ul style="list-style-type: none"> <input type="checkbox"/> Commercial Art <input type="checkbox"/> Magazine and Book Illustrating <input type="checkbox"/> Cartooning <input type="checkbox"/> Snow Card and Sign Lettering <input type="checkbox"/> Fashion Illustrating AUTOMOTIVE <input type="checkbox"/> Automobile, Mechanic <input type="checkbox"/> Auto-Elec. Technician <input type="checkbox"/> Auto Body Rebuilding and Refinishing <input type="checkbox"/> Diesel—Gas Engines AVIATION <input type="checkbox"/> Aeronautical Engineering Jr. <input type="checkbox"/> Aircraft Engine Mechanic <input type="checkbox"/> Airplane Drafting BUILDING <input type="checkbox"/> Architecture <input type="checkbox"/> Arch. Drafting <input type="checkbox"/> Building Contractor <input type="checkbox"/> Estimating <input type="checkbox"/> Carpenter and Mill Work <input type="checkbox"/> Carpenter Foreman <input type="checkbox"/> Reading Blueprints <input type="checkbox"/> House Planning <input type="checkbox"/> Plumbing | <ul style="list-style-type: none"> <input type="checkbox"/> Heating <input type="checkbox"/> Steam Fitting <input type="checkbox"/> Air Conditioning <input type="checkbox"/> Electrician BUSINESS <input type="checkbox"/> Business Administration <input type="checkbox"/> Certified Public Accountant <input type="checkbox"/> Accounting <input type="checkbox"/> Bookkeeping <input type="checkbox"/> Stenography and Typing <input type="checkbox"/> Secretarial <input type="checkbox"/> Federal Tax <input type="checkbox"/> Business Correspondence <input type="checkbox"/> Personnel and Labor Relations <input type="checkbox"/> Advertising <input type="checkbox"/> Retail Business Management <input type="checkbox"/> Managing Small Business <input type="checkbox"/> Sales Management <input type="checkbox"/> Salesmanship <input type="checkbox"/> Traffic Management CHEMISTRY <input type="checkbox"/> Chemical Engineering <input type="checkbox"/> Chemistry <input type="checkbox"/> Analytical Chemistry <input type="checkbox"/> Petroleum—Nat'l Gas <input type="checkbox"/> Pulp and Paper Making <input type="checkbox"/> Plastics | <p>CIVIL, STRUCTURAL ENGINEERING</p> <ul style="list-style-type: none"> <input type="checkbox"/> Civil Engineering <input type="checkbox"/> Structural Engineering <input type="checkbox"/> Surveying and Mapping <input type="checkbox"/> Structural Drafting <input type="checkbox"/> Highway Engineering <input type="checkbox"/> Reading Blueprints <input type="checkbox"/> Concrete Construction <input type="checkbox"/> Sanitary Engineering DRAFTING <input type="checkbox"/> Aircraft Drafting <input type="checkbox"/> Architectural Drafting <input type="checkbox"/> Electrical Drafting <input type="checkbox"/> Mechanical Drafting <input type="checkbox"/> Structural Drafting <input type="checkbox"/> Sheet Metal Drafting <input type="checkbox"/> Mine Surveying and Drafting ELECTRICAL <input type="checkbox"/> Electrical Engineering <input type="checkbox"/> Electrician <input type="checkbox"/> Electrical Maintenance <input type="checkbox"/> Electrical Drafting <input type="checkbox"/> Electric Power and Light <input type="checkbox"/> Lineman HIGH SCHOOL <input type="checkbox"/> High School Subjects | <ul style="list-style-type: none"> <input type="checkbox"/> College Preparatory <input type="checkbox"/> Mathematics <input type="checkbox"/> Commercial <input type="checkbox"/> Good English MECHANICAL AND SHOP <input type="checkbox"/> Mechanical Engineering <input type="checkbox"/> Industrial Engineering <input type="checkbox"/> Industrial Supervision <input type="checkbox"/> Foremanship <input type="checkbox"/> Mechanical Drafting <input type="checkbox"/> Machine Design-Drafting <input type="checkbox"/> Machine Shop Practice <input type="checkbox"/> Tool Design <input type="checkbox"/> Industrial Instrumentation <input type="checkbox"/> Machine Shop Inspection <input type="checkbox"/> Reading Blueprints <input type="checkbox"/> Toolmaking <input type="checkbox"/> Gas—Electric Welding <input type="checkbox"/> Heat Treatment—Metallurgy <input type="checkbox"/> Sheet Metal Work <input type="checkbox"/> Sheet Metal Pattern Drafting <input type="checkbox"/> Refrigeration POWER <input type="checkbox"/> Combustion Engineering <input type="checkbox"/> Diesel—Electric <input type="checkbox"/> Electric Light and Power | <ul style="list-style-type: none"> <input type="checkbox"/> Stationary Steam Engineering <input type="checkbox"/> Stationary Fireman RADIO, TELEVISION, COMMUNICATIONS <input type="checkbox"/> General Radio <input type="checkbox"/> Radio Operation <input type="checkbox"/> Radio Servicing—FM <input type="checkbox"/> Television <input type="checkbox"/> Electronics <input type="checkbox"/> Telephone Work RAILROAD <input type="checkbox"/> Locomotive Engineer <input type="checkbox"/> Diesel Locomotive <input type="checkbox"/> Air Brakes <input type="checkbox"/> Car Inspector <input type="checkbox"/> Railroad Administration TEXTILE <input type="checkbox"/> Textile Engineering <input type="checkbox"/> Cotton Manufacture <input type="checkbox"/> Rayon Manufacture <input type="checkbox"/> Woolen Manufacture <input type="checkbox"/> Loom Fixing <input type="checkbox"/> Finishing and Dyeing <input type="checkbox"/> Textile Designing HOME ARTS <input type="checkbox"/> Dressmaking and Designing <input type="checkbox"/> Cookery <input type="checkbox"/> Tea Room Management |
|---|---|---|---|---|

Name _____ Age _____ Home Address _____

City _____ State _____ Working Hours _____ A.M. to _____ P.M.

Occupation _____

Special tuition rates to members of the Armed Forces. Canadian residents send coupon to International Correspondence Schools Canadian, Ltd., Montreal, Canada.

Same wires— many more voices

Connecting new multi-voice system to open-wire lines, near Albany, Georgia. With new system, 150,000 miles of short open-wire telephone lines can be made to carry up to 16 simultaneous messages economically.

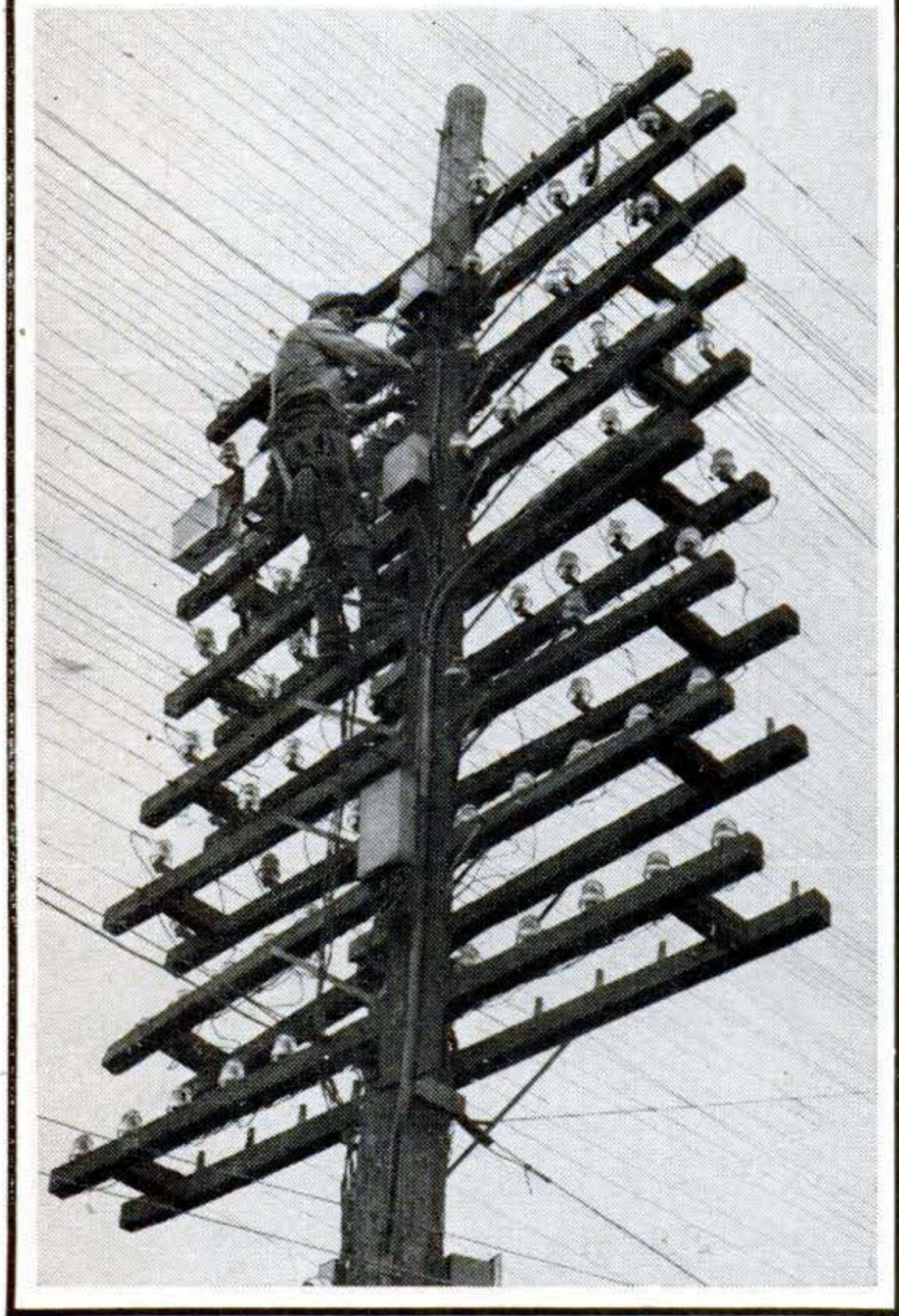

MUCH of your Long Distance telephone system works through cable but open-wire lines are still the most economical in many places. Thousands of these circuits are so short that little would be saved by using elaborate carrier telephone systems which are better suited for long-haul routes. But a new carrier system . . . the Type O designed especially for short hauls . . . is changing the picture. It is economical on lines as short as 15 miles. With Type O thousands of lines will carry as many as 16 conversations apiece.

Type O is a happy combination of many elements, some new, some used in new ways. As a result, terminal equipment takes up one-eighth as much space as before. Little service work is required on location; entire apparatus units can be removed and replaced as easily as vacuum tubes.

Moreover, the new carrier system saves copper by multiplying the usefulness of existing lines. For telephone users it means more service . . . while the cost stays low.

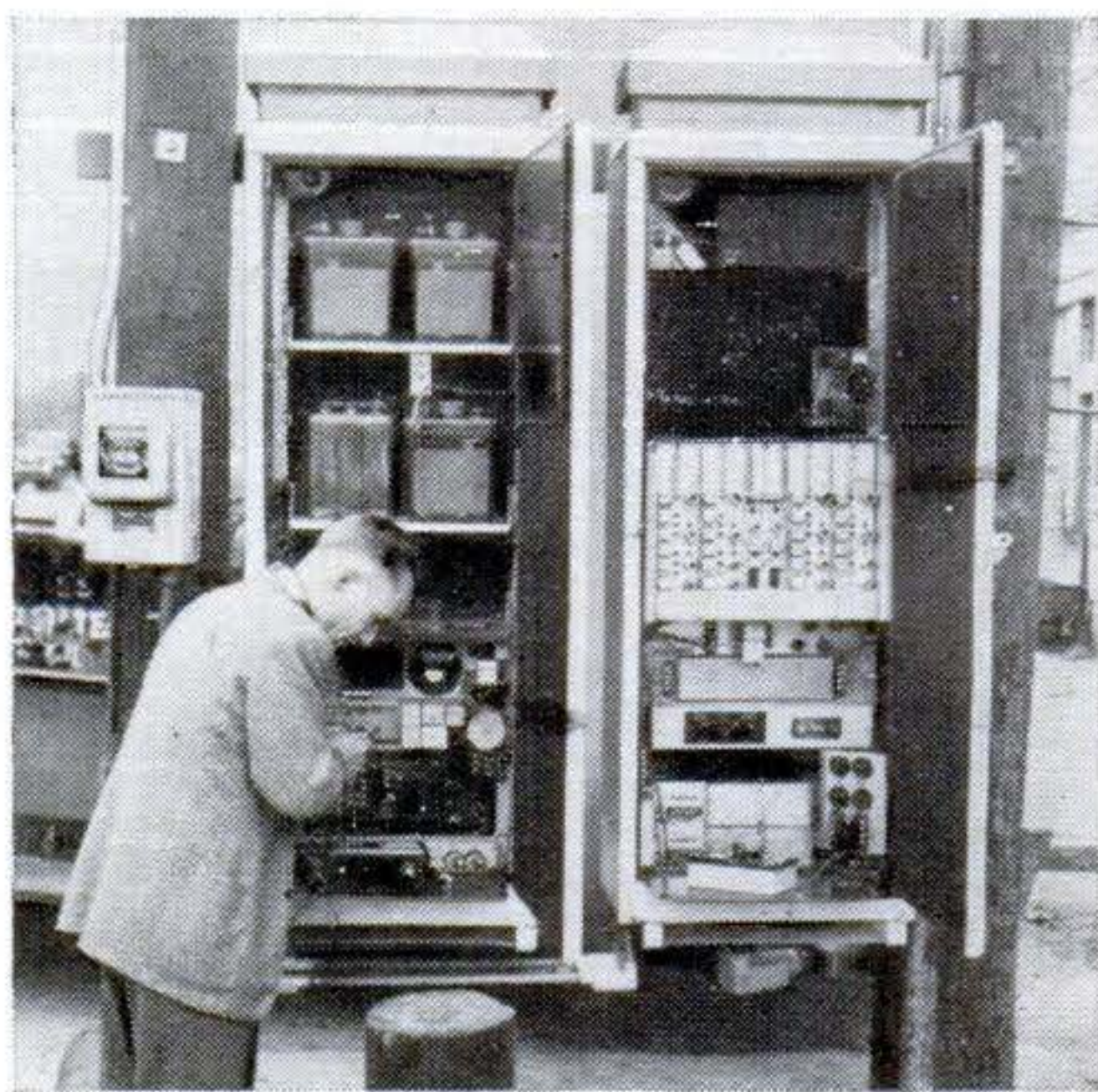

Repeater equipment is mounted at base of pole in cabinet at right, in easy-to-service position. Left-hand cabinet houses emergency power supply. System employs twin-channel technique, transmitting two channels on a single carrier by using upper and lower sidebands. A single oscillator serves two channels.

BELL TELEPHONE LABORATORIES

Improving telephone service for America provides careers for creative men in scientific and technical fields



FREE!

ON THIS AMAZING OFFER

235 STAMPS

FROM ALL OVER THE WORLD



ALL DIFFERENT!

Start NOW to Enjoy the Hobby of Presidents and Kings with These Hundreds of Exciting Stamps

YOURS FREE—these 235 fascinating stamps from all over world. Each stamp different! Total price—in Standard Catalog—guaranteed to be AT LEAST FIVE DOLLARS! Yet ALL ARE YOURS FREE if you send for Complete Stamp Collector's Outfit described below. This amazing offer bound to go "like hotcakes." So mail coupon AT ONCE!

GUARANTEED WORTH OVER \$5.00 AT STANDARD CATALOG PRICES!



CHINA AIR-MAIL — Face value \$10,000 in actual Nationalist Chinese currency!



TOGOLAND — Interesting scene of tribal native women pounding grain.



TIMBUCTOO — Shows native of French Equatorial Africa in frenzied war dance.



MADAGASCAR — in Vital Island World War II. Off coast of Africa.



UNITED NATIONS — Can be used in only one post-office in the world — UN building in New York



DJIBOUTI — Stamp shows world-famous Mohammedan shrine.



HITLER — Stamp much in demand. Getting harder to obtain all the time.



RUSSIA — This unique stamp was worth a quarter of a MILLION RUBLES!



COSTA RICA — Famous bull stamp of Central American republic.

HERE'S EVERYTHING YOU NEED TO START ENJOYING THIS MOST FASCINATING OF ALL HOBBIES

ALSO FREE while supply lasts! Unusual Anti-Communist Stamps



With Your 235 FREE STAMPS Will Come This Complete Stamp Collector's Outfit:

- 1 Stamp Album with spaces for 3500 stamps.
- 2 Book on "How to Collect Postage Stamps." Has many fascinating stamp stories.
- 3 Magnifying Glass to detect valuable details.
- 4 Special Watermark Detector; guards against "fakes."
- 5 250 Gummed Hinges to attach stamps in album.

STAMP COLLECTING opens up new worlds of fun, profit, and adventure to you. Many successful people collect stamps—presidents, kings, executives, movie stars, explorers, athletes, etc.

Now it's EASY to get started. Right WITH the 235 Free Stamps described above we will send you a Complete Stamp Collector's Outfit. If you decide to keep it, it's ONLY ONE DOLLAR. But if you DON'T think it's a big bargain, send it back—we'll refund your dollar AND YOUR POSTAGE, TOO!

The Outfit contains the five items at left . . . EVERYTHING YOU NEED to start a stamp collection that can grow in value for the rest of your life!

Examine Kit for 7 Days Without Risk!

Mail coupon and \$1 now. The complete Outfit—together with the 235 Free Stamps and other interesting offers—will be sent for a week's examination. Unless you're delighted, return it—we'll promptly refund your dollar and your postage, too! LITTLETON STAMP CO., Dept. PS-10, Littleton, N. H.



5 stamps issued by German-Occupied France to popularize idea of Volunteer Frenchmen helping Nazis fight Soviet Russia. This set (now obsolete) much sought after! FREE while supply lasts even if you decide NOT to keep Kit! So mail coupon NOW!

LITTLETON STAMP CO., Dept. PS-10, Littleton, New Hampshire

Send me, FREE, 235 foreign stamps—and a set of ANTI-COMMUNIST STAMPS, while supply lasts. Also send for 7 days' examination Complete Stamp Collector's Outfit.

I enclose \$1 as a deposit. After 7 days' examination, I may return everything (except ANTI-COMMUNIST STAMPS which I may keep FREE) and you will return my dollar AND my postage. Or I will keep everything and you may keep my dollar as payment in full.

Name.....
 Address.....
 City..... State.....

TO INTRODUCE THESE DISTINGUISHED RECORDINGS OF "200 YEARS OF AMERICAN MUSIC" THE AMERICAN RECORDING SOCIETY OFFERS YOU . . .

One of these superb 33¹/₃ rpm 10" Long-Playing Unbreakable Records

Regularly \$
\$4³⁵

YOURS FOR ONLY

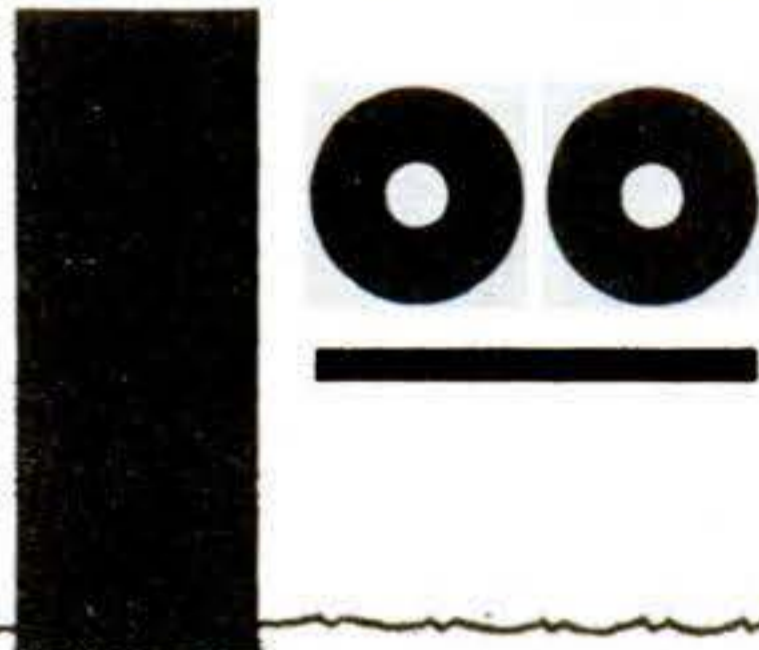

"INDIAN SUITE"
by Edward MacDowell

Ever since its first performance by the Boston Symphony Orch. in 1896 this melodic suite has been a great concert hall favorite throughout the world. Each of its five sections is based on genuine Indian themes—legends, festivals, war dances, romances, sorrows.

"4th SYMPHONY"
by Howard Hanson

The deeply expressive Pulitzer Prize-winning work by one of America's foremost composers. Since its premiere on Dec. 3, 1943 by the Boston Symphony Orch., it has been regarded as "one of the noblest works ever written by an American" (Serge Koussevitsky).

SINCE the last war a great musical awakening has electrified the music-loving world—a sudden realization that the foremost music being written today is *American music*—and that American composers have been writing enjoyable melodies, important music for *the past 200 years!*

Now, an outstanding musical organization has embarked on a program of creating high fidelity recordings of 200 years of American music. Every form of musical expression is included in this program—symphonic, choral, instrumental and chamber works, folk-music, theatre music . . . music of America at work and at play; music of America growing, laughing . . . music born of the love of liberty and the love of fun, the love of good living and the love of God. Whatever your tastes—here is music for you!

HOW THIS MUSIC CAME TO BE RECORDED

Recently, the directors of the renowned Alice M. Ditson Fund of Columbia University awarded a substantial grant which made possible the founding of the American Recording Society, whose sole purpose is to record and release each month a new full-frequency recording of American music, on Long Playing records.

AMERICAN RECORDING SOCIETY, 100 AVENUE OF THE AMERICAS, N. Y. 13, N. Y.

AMERICAN RECORDING SOCIETY, Dept. 750, 100 Ave. of the Americas, New York 13, N.Y. PS10

Send me the record checked at the right, for which I enclose \$1.00. As an Associate Member in the American Recording Society, I will receive the Society's publication which will give me advance notice of each new monthly Society Long-Playing selection which I may purchase at the special Membership price of only \$4.95 for 12" records, \$4.35 for 10" records plus a few cents for U.S. tax and shipping. However, I may decline to purchase any or all Society records offered. With each two recordings I do purchase, you will send me an additional record, *absolutely free*.

(CHECK ONE)

- INDIAN SUITE by MacDowell
 4th SYMPHONY by Hanson

Name.....

Address.....

City.....Zone.....State.....

Canadian Address: OWEN SOUND, ONTARIO

Date Changes
AUTOMATICALLY
EVERY DAY



AMAZING *New* WATCH with MECHANICAL BRAIN

• It "Remembers" • It Tells Time • It Tells Date

MEASURES SPEED • MEASURES DISTANCE • RECORDS UP TO 12 HOURS
• OVER 40 QUALITY FEATURES.

Precision Jeweled. Imported Swiss Movement. Accurate. Dependable. Push-Button Stop and Start. Red Sweep-Second Hand. Unbreakable Crystal. Triple Chrome Plated Case. Shock Resistant. Nit-Vue Radium Glow Dial. Anti-Magnetic. Times Shop work. Times Photography. Times Sports. Times Races. Times Lab. work. Times Planes. Expansion Band Included.

Compare It at \$50.00

\$8⁹⁵ PLUS 90c FED. TAX

SEND NO MONEY

ORDER BY MAIL

Save UP TO 50%

WITH THESE

SENSATIONAL
BARGAIN BUYS

Clip and Mail
This Coupon
NOW For
10 DAY TRIAL
FREE

New ELECTRONIC

WALKIE-TALKIE Communication System

Perfect for room to room, house to garage, etc. No batteries, no tubes. Complete two way telephone system. Works at amazingly long distances. Handy pocket size. Electronic voice powered. No license or permit needed. Two units complete with wire, ready to use.

NO BATTERIES

NO PLUG-IN

\$3⁹⁵ LIMITED OFFER



Now... HI-POWER BINOCULARS

Not for \$10... But Only

WITH FAMOUS
AMERICAN OPTICAL
3-POWER LENSES

\$2⁹⁸ SEND NO MONEY!

It's the bargain of a lifetime! They're light-weight, durably constructed and wonderfully clear. Perfect for sports events... traveling... theater, nature study and dozens of other uses. Styled exactly like a famous imported binocular! Perfect clarity is assured with the 3-power lenses manufactured by the world famous AMERICAN OPTICAL COMPANY. Opens to big 7"x6" size. Complete with carrying strap at this low price.



ORDER AT OUR RISK.

ALL METAL "JIFFY" CABINET

with 24 rustproof, solid ALUMINUM DRAWERS

Offers up to 72 compartments!

This handy cabinet has aluminum hammer finish in silver gray color. Each Jiffy cabinet is supplied with removable drawer dividers for use inside drawers and colored paper index labels for marking contents of drawers. Individual metal drawer guides keep drawers in free sliding position. Jiffy cabinets are equipped with rubber feet to prevent surface marring.

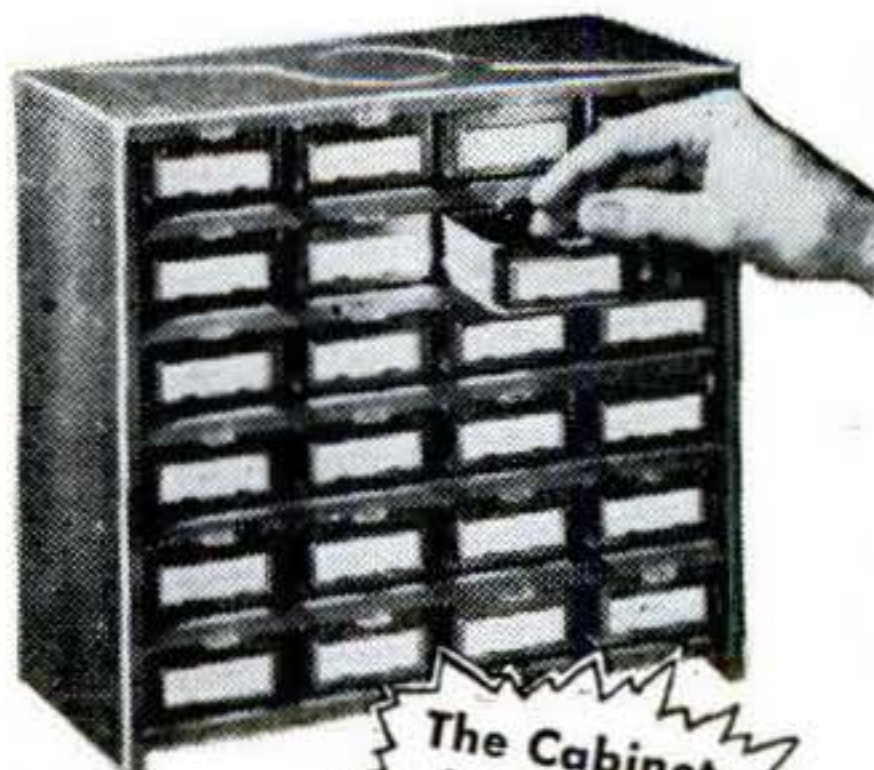

The Cabinet
of 1001 Uses
in Home or
Shop

\$9⁹⁵ SEND NO MONEY

SPECIFICATIONS
Height 12 inches
Width .. . 12½ inches
Depth 6 inches
Max. inner compartments..72

YOUNG PRODUCTS DEPT. 610 2605 Elmhurst, Detroit 6, Mich.

EVERY ITEM SOLD ON 100% MONEY BACK GUARANTEE

CHECK ITEMS WANTED

- Mechanical Watch \$8.95 plus 90c Fed. Tax
- Walkie-Talkie \$3.95
- Binoculars \$2.98
- Jiffy cabinet \$9.95

Young Products Dept. 610

2605 Elmhurst, Detroit 6, Mich.

Please rush items checked. If I'm not de-lighted, I may return my order within 10 days for full refund of purchase price.

Send items listed. I will pay postman plus postage.

I want to save post-acc. I am enclosing full payment. Same money back guar-antee applies.

NAME _____

ADDRESS _____

CITY _____

STATE _____



How these 18 Experts can help you

Get into a High Pay ACCOUNTING CAREER

LaSalle's famous staff of Accounting authorities are helping thousands prepare for fast promotions and bigger pay. They can do the same for you!

If your heart is set on a larger income and all that it means . . . better home—fine car—larger bank account—more of the good things of life. . . .

If that's your ambition and you are really serious about it, then you owe it to yourself to get the REAL FACTS about Accountancy, and the many good-pay opportunities that can be YOURS through LaSalle's famous Problem Method plan.

It matters not whether you've had a single day of experience in this field—or whether you have already started but want to climb higher. LaSalle's expert training is designed to take you from where you are . . . to where you want to be . . . in higher positions and a lifetime career of security and good income.

WHY YOU CAN'T FAIL TO GAIN

You see on this page a panel of experts who know Accounting from A to Z . . . all the way from simple bookkeeping, on up through advanced accounting, cost accounting, auditing, income tax, and coaching for the C.P.A. degree. These are only part of LaSalle's instruction staff. But what is most important to you . . .

... THESE C.P.A. EXPERTS KNOW HOW TO IMPART THEIR KNOWLEDGE TO OTHERS... HOW TO HELP YOU PREPARE QUICKLY YET THOROUGHLY FOR SUCCESS IN THIS VERY LUCRATIVE FIELD

The proof? What stronger proof could there be than



more than 3,500 Certified Public Accountants (approximately 10% of the U.S. total) who have trained with LaSalle? Or the hundreds of thousands of men and women whom LaSalle has helped qualify rapidly for more money, a brighter future, in a high-pay-lifetime career? These thousands came to us with different backgrounds of experience and varying degrees of ambition. Many have reported raises and promotions after only a few weeks of training. Thousands of them have written to say they are now earning 50% more—even *double* their former incomes—often in less than a year. These letters are published in book form for your inspection. They were written by real people, with real income, problems and ambitions—people who might be your next-door neighbor.

Yes, if you are really sincere in wanting to better your position—start your income climbing—enjoy a lifetime career of high standing and high reward—this friendly staff of experts can help you.

SEND FOR FREE SAMPLE LESSON... ALSO BIG 48-PAGE BOOK OF LATEST INFORMATION ABOUT CAREER OPPORTUNITIES

You don't have to wonder what LaSalle's Accountancy plan is like. You will be sent a free sample lesson, which does not obligate you in any way. Study it—keep it—see for yourself how simple, clear, and easy it is to master. This is an actual lesson right out of the regular training—to show you exactly how LaSalle's Problem Method has trained more than 1,275,000 men and women from all walks of life.

Also . . . the 48-page book, "Accountancy, the Profession That Pays," gives all the latest facts about the new and growing opportunities in five different fields of profitable employment.

This can be an important day in your life. A coupon like the one below has started hundreds of thousands of men and women toward a bigger job, a larger income. It can do the same for you.

Mail the Coupon Today!

FREE 48-PAGE CATALOG

LA SALLE
EXTENSION UNIVERSITY

A Correspondence Institution

417 S. Dearborn St., Dept. 1083H, Chicago 5, Ill.

Send free Sample Lesson in Accounting—also, 48-page free book, "Accountancy, the Profession That Pays" . . . all without cost or obligation.

Name.....Age.....

Address.....

City & Zone.....State.....

FREE SAMPLE LESSON



New RCA Victor record changer — easiest to play at all three speeds!

The Center is the Secret:

Just slip on the large center spindle to play "45" records *automatically*. Slip it off, and play records at other speeds.

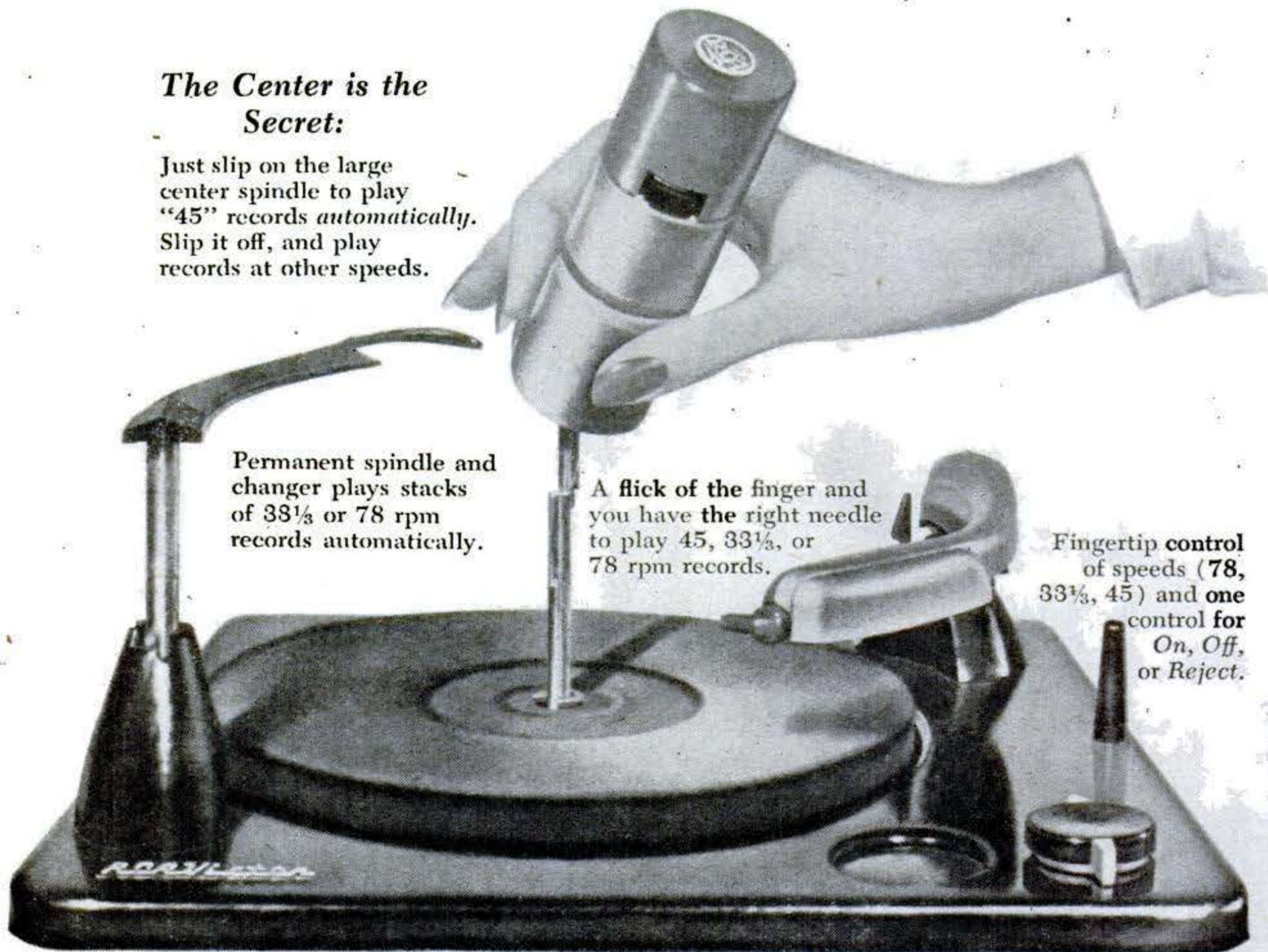

Permanent spindle and changer plays stacks of 33 $\frac{1}{3}$ or 78 rpm records automatically.

A flick of the finger and you have the right needle to play 45, 33 $\frac{1}{3}$, or 78 rpm records.

Fingertip control of speeds (78, 33 $\frac{1}{3}$, 45) and one control for On, Off, or Reject.

World's simplest 3-speed changer, this versatile "Victrola" combines new playing ease with the finest reproduction of sound. And it changes "45" records *correctly*, on the same turntable used for other speeds.

Key to this advance is RCA Victor's *slip-on* "45" spindle, which fits over the permanent spindle and locks in place. No plugs or extra gadgets. Simply stack your "45" records on this fine instrument, and play up to fourteen of them—in the order you select—at the twist of a knob. Then, when you wish, remove the

"45" spindle, flick the needle and speed controls, and the same "Victrola" changer will play records automatically at 33 $\frac{1}{3}$ or 78 rpm.

More than a year of research and engineering went into developing this versatile changer—further evidence of the leadership which assures you finer performance in any product or service of RCA and RCA Victor.

* * *

See the latest in radio, television, electronics at RCA Exhibition Hall, 36 West 49th Street, N.Y. Admission is free. Radio Corporation of America, RCA Building, Radio City, New York 20, N.Y. Tmks. ®



RADIO CORPORATION OF AMERICA

World leader in radio—first in television

KEY TO A PRACTICAL UNDERSTANDING OF ELECTRICITY

\$1 PER MO.

AUDELS HANDY BOOK OF PRACTICAL ELECTRICITY for Maintenance Engineers, Electricians and All Electrical Workers. A quick, simplified, ready reference book, giving complete instruction & practical

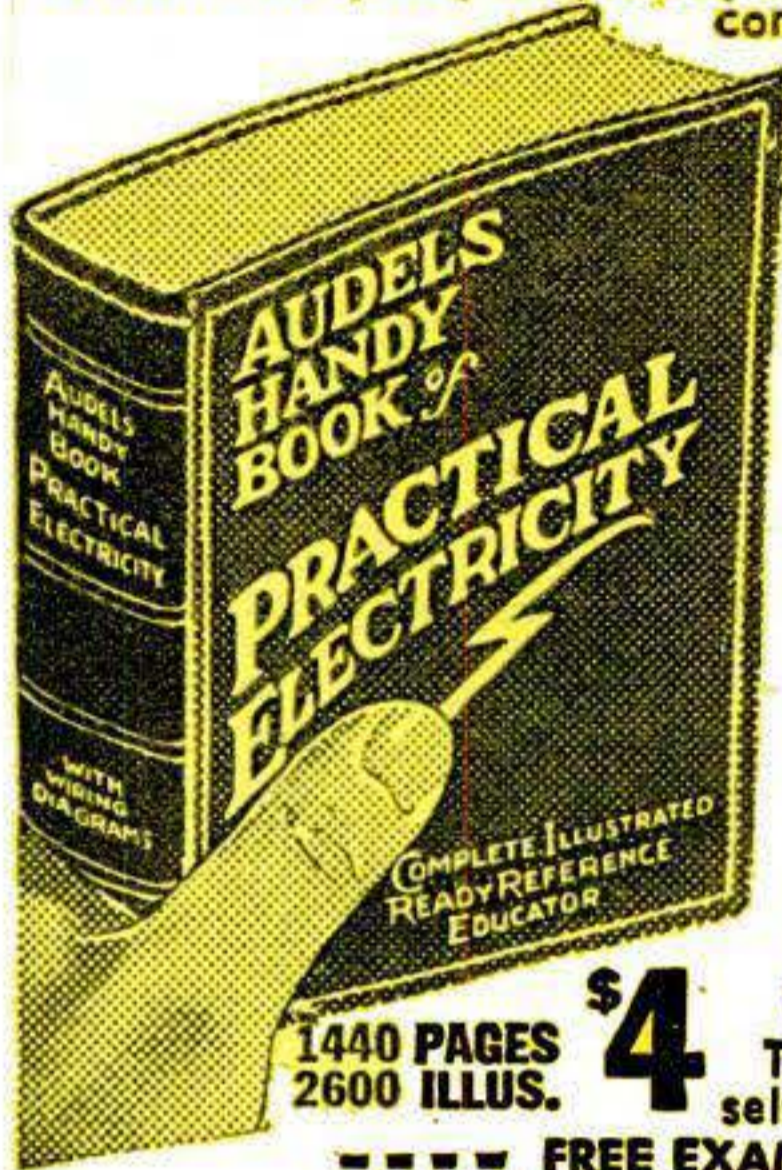

INSIDE TRADE INFORMATION ON rules and laws of electricity—maintenance of electrical machinery—A.C. and D.C. motors—armature winding and repair—wiring diagrams—house wiring—power wiring—cable splicing—meters—batteries—transformers—elevators—electric cranes—railways—bells—sign flashers—telephone—ignition—radio principles—refrigeration—air conditioning—oil burners—air compressors—welding and many modern applications explained so you can understand.

1440 PAGES
2600 ILLUS.

\$4

Indexed for ready reference. To get this assistance for yourself, simply fill in and mail the

FREE EXAMINATION COUPON
AUDEL, Publishers, 49 W. 23 St., N.Y. 10, N.Y.
Please send me "Audels Handy Book of Practical Electricity" for free examination. If satisfactory, I will send you \$1 in 7 days, then \$1 monthly until \$4 is paid. Otherwise I will return it.



Name _____
Address _____
Occupation _____

READ FOR PROFIT!

Employed by _____

AUDELS Carpenters and Builders Guides 4 vols. \$6

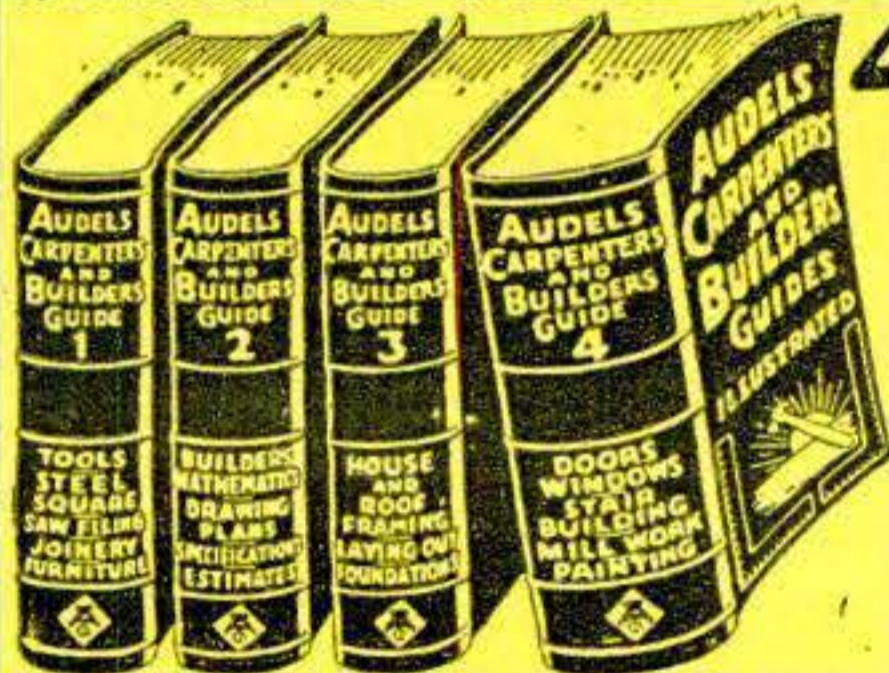

Inside Trade Information for Carpenters, Builders, Joiners, Building Mechanics and all Woodworkers. These Guides give you the short-cut instructions that you want—including new methods, ideas, solutions, plans, systems and money saving suggestions. An easy progressive course for the apprentice and student. A practical daily helper and Quick Reference for the master worker. Carpenters everywhere are using these Guides as a Helping Hand to Easier Work, Better Work and Better Pay. To get this assistance for yourself, simply fill in and mail the FREE COUPON below.



How to use the steel square—How to file and set saws—How to build furniture—How to use a mitre box—How to use the chalk line—How to use rules and scales—How to make joints—Carpenters arithmetic—Solving mensuration problems—Estimating strength of timbers—How to set girders and sills—How to frame houses and roofs—How to estimate costs—How to build houses, barns, garages, bungalows, etc.—How to read and draw plans—Drawing up specifications—How to excavate—How to use settings 12, 13 and 17 on the steel square—How to build hoists and scaffolds—skylights—How to build stairs—How to put on interior trim—How to hang doors—How to lath—lay floors—How to paint.

AUDEL, Publishers, 49 W. 23rd St., New York 10, N. Y.
Mail Audels Carpenters and Builders Guides, 4 vols., on 7 days free trial. If OK I will remit \$1 in 7 days and \$1 monthly until \$6 is paid. Otherwise I will return them. No obligation unless I am satisfied.

Name _____
Address _____
Occupation _____
Employed by _____

WHAT ALL AUTO MECHANICS WANT TO KNOW

1800 PAGES

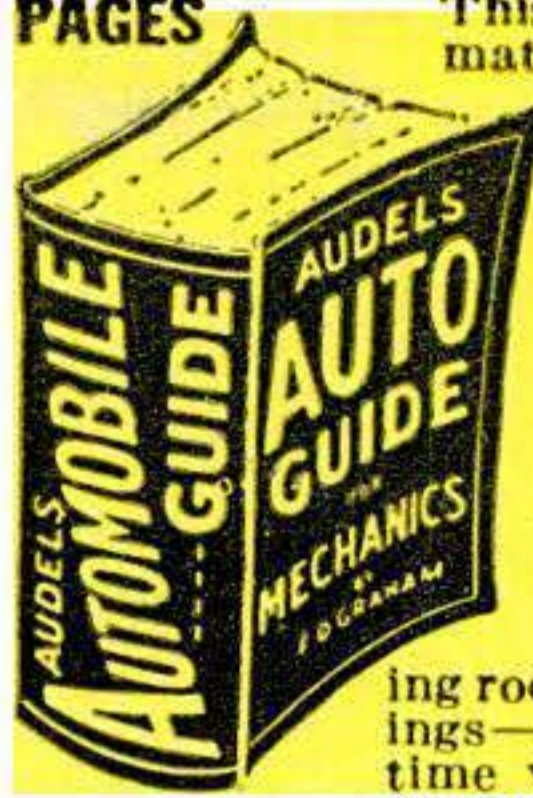

This Big Practical Book gives full information with working diagrams covering the principles, construction, ignition, service and repair of modern cars, trucks and buses.

Diesel Engines, Hydramatic & Fluid Drives Fully Explained.

A complete Guide of 1800 pages, with over 1500 illustrations showing inside views of working parts, with instructions for service jobs.

IT PAYS TO KNOW

How to fit pistons—How to locate engine knocks, How to fit connecting rod bearings—How to service main bearings—How to recondition valves—How to time valves—How to adjust fan belts—How to adjust carburetors and chokes, How

to rebuild a clutch—How to service automatic transmissions—How to service brakes—How to adjust steering gear—How to cope with ignition troubles—How to service distributors—How to time ignition—How to "tune up" an engine.



\$4 COMPLETE • PAY \$1 A MO. TO GET THIS ASSISTANCE FOR YOURSELF SIMPLY FILL IN AND MAIL COUPON TODAY.

Step up your own skill with the facts and figures of your trade. Audels Mechanics Guides contain Practical Inside Trade Information in a Handy Form. Fully illustrated and Easy to Understand. Highly Endorsed. Check the book you want for 7 DAYS FREE EXAMINATION. Send No Money. Nothing to pay postman.

MAIL ORDER



AUDEL, Publishers, 49 W. 23 St., 10, N. Y.

Please send me postpaid for FREE EXAMINATION books marked (x) below. If I decide to keep them I agree to mail \$1 in 7 Days on each book or set ordered and further mail \$1 monthly on each book or set until I have paid price, otherwise I will return them.

- AUTOMOBILE MECHANICS GUIDE, 1800 Pages \$4
- TRUCK & TRACTOR GUIDE, 1299 Pages 4
- DIESEL ENGINE MANUAL, 575 Pages 2
- MACHINISTS HANDY BOOK, 1650 Pages 4
- WELDERS GUIDE, 400 Pages 1
- BLUE PRINT READING, 416 Pages 2
- MATHEMATICS & CALCULATIONS, 700 Pages. 2
- SHEET METAL PATTERN LAYOUTS, 1100 Pages 4
- SHEET METAL WORKERS HANDY BOOK, 388 Pgs. 1
- MECHANICAL DRAWING GUIDE, 160 Pages 1
- MECHANICAL DRAWING & DESIGN, 480 Pages 2
- AIRCRAFT WORKER, 240 Pages 1
- TELEVISION SERVICE MANUAL, 384 Pages 2
- RADIOMANS GUIDE, 914 Pages 4
- ELECTRONIC DEVICES, 216 Pages 2
- ELECTRIC MOTOR GUIDE, 1000 Pages 4
- ELECTRIC WIRING DIAGRAMS, 272 Pages 1
- ELECTRICIANS EXAMINATIONS, 250 Pages. 1
- ELECTRIC POWER CALCULATIONS, 425 Pages. 2
- HANDY BOOK OF ELECTRICITY, 1440 Pages. 4
- ELECTRIC DICTIONARY, 9000 Terms 2
- ELECTRIC LIBRARY, 7000 Pages (12 Book Set) 18
- MARINE ENGINEERS HANDY BOOK, 1258 Pgs. 4
- SHIPFITTERS HANDY BOOK, 250 Pages 1
- REFRIGERATION & Air Conditioning, 1280 Pgs. 4
- MILLWRIGHTS & MECHANICS GUIDE, 1200 Pgs. 4
- POWER PLANT ENGINEERS GUIDE, 1500 Pages 4
- ENGINEERS & FIREMANS EXAMS, 525 Pages 1
- PUMPS, Hydraulics & Air Compressors, 1658 Pgs. 4
- ENGINEERS LIBRARY (3 Book Set) 9
- MECHANICAL DICTIONARY, 950 Pages 4
- GARDENERS & GROWERS GUIDES (4 Book Set) 6
- CARPENTERS & BUILDERS GUIDES (4 Book Set) 6
- PLUMBERS & Steamfitters Guides (4 Book Set) 6
- MASONS AND BUILDERS GUIDES (4 Book Set) 6
- PAINTERS & DECORATORS MANUAL, 450 Pgs. 2
- HOUSE HEATING GUIDE, 1000 Pages 4
- OIL BURNER GUIDE, 384 Pages 1

Check NOW!

You Can Look Over Any Guide In Your Own Home — Start the Easy Payments If Satisfied

MAIL THIS TODAY

Name _____
Address _____
Occupation _____
Employed by _____

Don't put in a drop of Anti-freeze

... until you've cleaned out rust with



DU PONT Cooling System CLEANSER

**It's a safe, easy way to prevent
clogged radiators that waste anti-freeze,
cause trouble and expense**

Now, before freezing weather sets in . . . before you put in anti-freeze . . . it's time to clean out your cooling system. **Du Pont Cleanser** makes the job safe, simple and thorough. You can even let the cleanser work while you're driving. And neutralizer is included in the can for a complete job. Du Pont Cleanser removes all rust—*without reverse flushing*, without fuss. Get an economical can at your service station or auto supply store today.

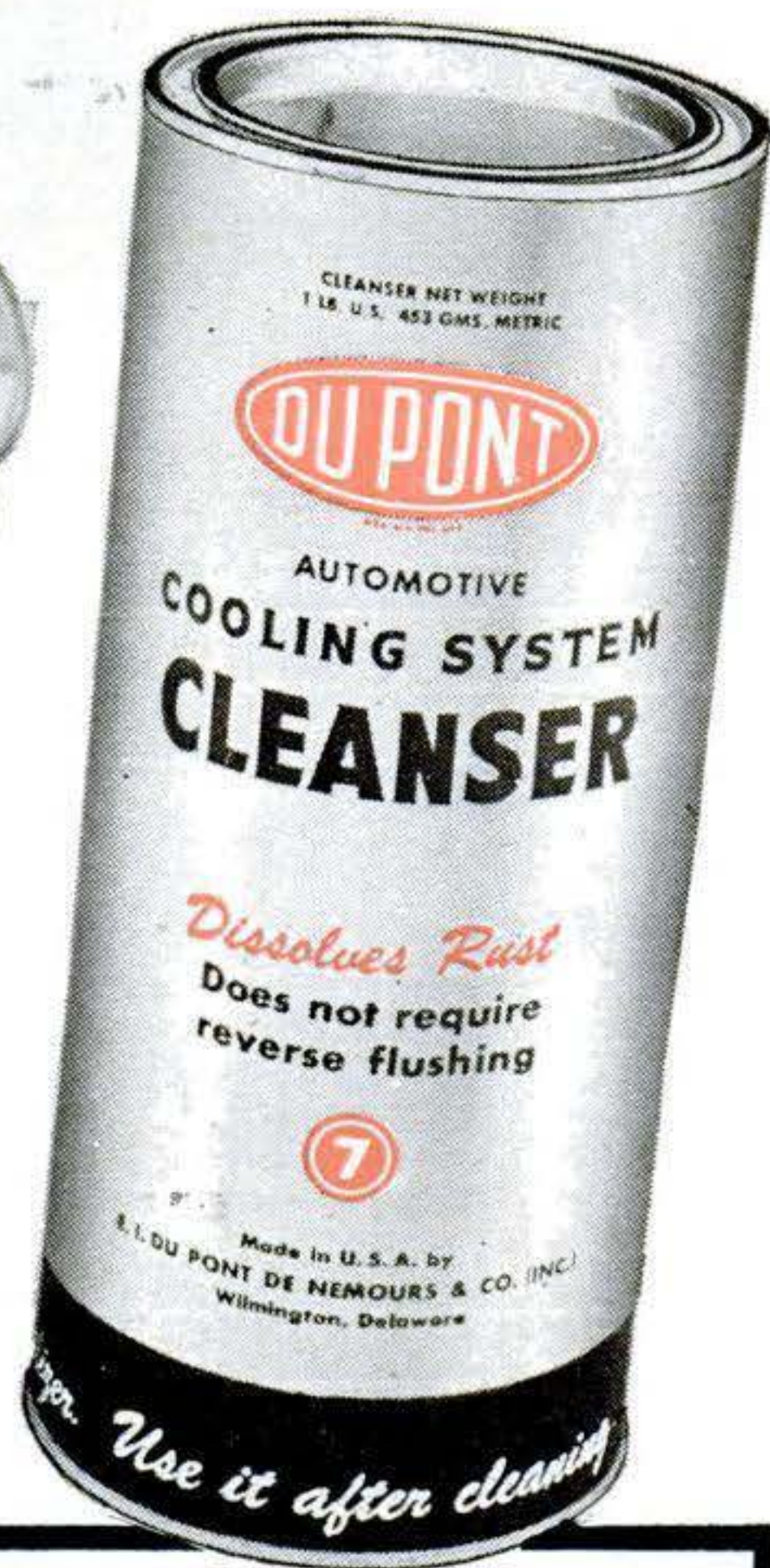

Insure against leaks that waste anti-freeze with **DU PONT COOLING SYSTEM SEALER**

Don't let radiator leaks rob you of anti-freeze. Seal it in with **Du Pont Cooling System Sealer**. Even when the cooling system is apparently water-tight, many permanent anti-freezes will "creep" and be lost by seepage through tiny pinholes. Such leaks are stopped immediately by Du Pont Sealer. It's simple to use, flows with the water and can't clog, or harm hose or metal parts.



**BETTER THINGS FOR BETTER LIVING
... THROUGH CHEMISTRY**

INVENTORS

Learn how to protect your invention. The U. S. Patent Laws provide that any new and useful art, machine, article of manufacture, or composition of matter, or any new and useful improvement thereof, may be patented if the act of invention is involved. Therefore, every inventor with a valuable invention should take advantage of the Patent Laws and proceed for patent protection in order to safeguard his rights.

A patent gives the inventor the exclusive right to prevent others from making, using, or selling the invention claimed in the patent for a period of seventeen years.

The Patent Laws were enacted for the benefit of the inventor to give him protection for the features of his invention which are patentable. These features must be properly and concisely set forth and claimed in a formal application for patent, in order to comply with the requirements of the Patent Laws. For that reason, unless the inventor is familiar with patent matters, he should engage a competent registered patent attorney or agent to represent him. We are registered to practice before the U. S. Patent Office and are prepared to serve you in the handling of your patent matters.

A specially prepared booklet entitled "Patent Guide for the Inventor", containing detailed information with respect to patent protection and procedure, together with a "Record of Invention" form will be promptly forwarded to you without obligation upon request.

CLARENCE A. O'BRIEN & HARVEY JACOBSON

Registered Patent Attorneys

22-K DISTRICT NATIONAL BUILDING
WASHINGTON 5, D. C.

OCTOBER 1952 15

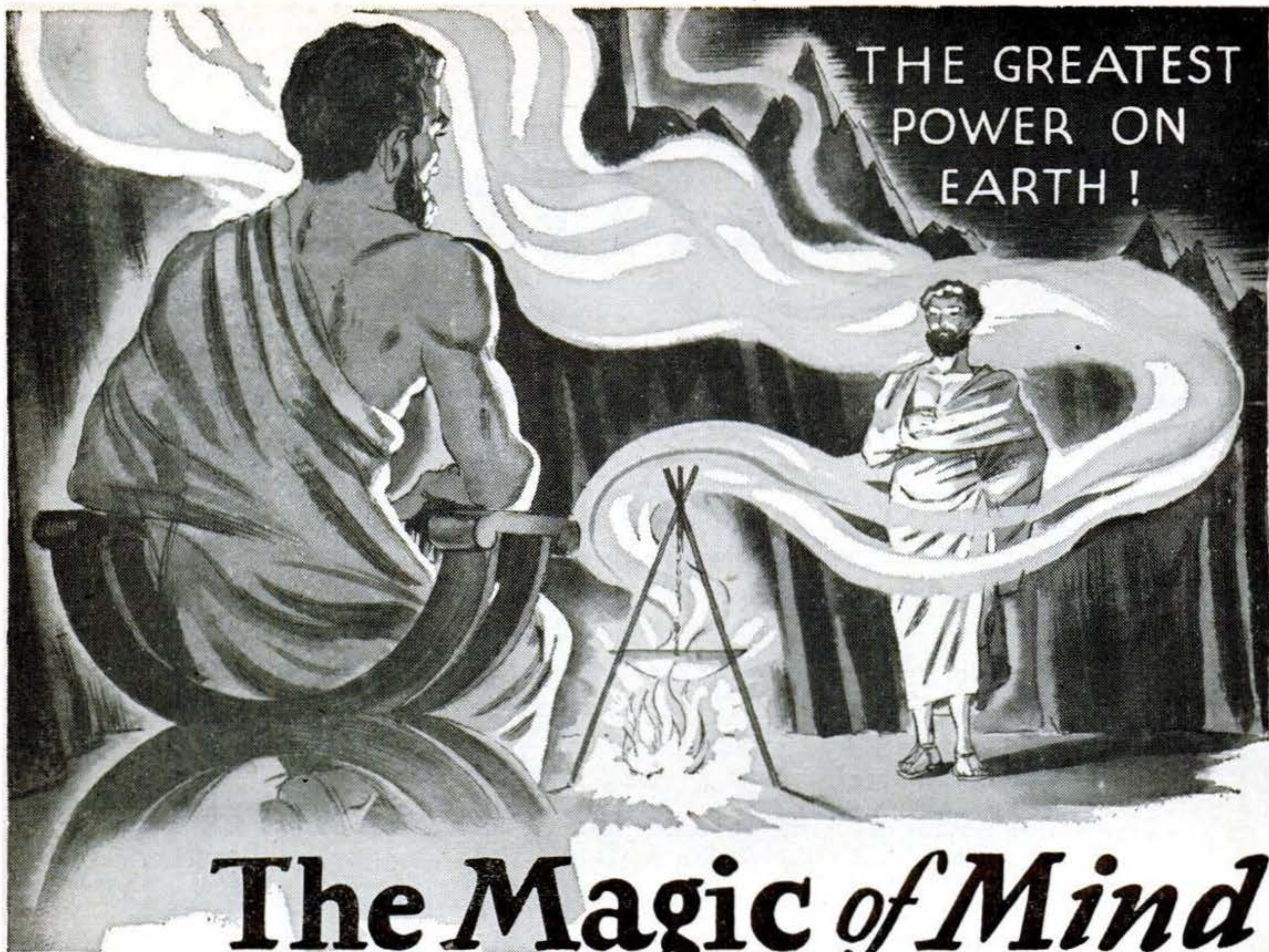

The Magic of Mind

WERE the great personages of the past victims of a stupendous hoax? Could such eminent men of the ancient world as Socrates, Pericles and Alexander the Great have been deluded and cast under the spell of witchcraft—or did the oracles whom they consulted actually possess a mysterious faculty of foresight? That the human mind can truly exert an influence over things and conditions was not a credulous belief of the ancients, but a known and demonstrable fact to them. That there exists a wealth of infinite knowledge just beyond the border of our daily thoughts, which can be aroused and commanded at will, was not a fantasy of these sages of antiquity, but a dependable aid to which they turned in time of need.

It is time you realized that the rites, rituals and practices of the ancients were not superstitions, but super-fuges to conceal the marvelous workings of natural law from those who would have misused them. Telepathy, projection of thought, the materializing of ideas into helpful realities, are no longer thought by intelligent persons to be impossible practices, but instead, demonstrable sciences, by which a greater life of happiness may be had.

One of America's foremost psychologists and university instructors, says of his experiments with thought transference and the powers of mind—"The successes were much too numerous to be merely lucky hits and one can see no way for guessing to have accounted for the results." Have you that open-minded attitude of today which warrants a clear, positive revelation of the

facts of mind which intolerance and bigotry have suppressed for years? Advance with the times; learn the truth about your inherited powers.

Let this free book explain

The Rosicrucians (NOT a religious organization) have been leaders in introducing the ancient wisdom of mental phenomena. Established throughout the world for centuries, they have for ages expounded these truths to those thinking men and women who sought to make the utmost of their natural faculties. Use the coupon below—avail yourself of a pleasing book of interesting information which explains how you may acquire this most unusual and helpful knowledge.

The ROSICRUCIANS

(A M O R C)

USE THIS COUPON

Scribe: I.R.H.
The Rosicrucians, AMORC
San Jose, California

I am sincerely interested in knowing more about this unseen, vital power which can be used in acquiring the fullness and happiness of life. Please send me, without cost, the book, "THE MASTERY OF LIFE," which tells me how to receive this information.

Name _____

Address _____

State _____

INVENTORS

If you believe that you have an invention, you should find out how to protect it. The first step is to have a search made of the prior pertinent U. S. patents. If a report on this search indicates that the invention appears patentable you can apply for a patent, and the specifications and claims should be prepared.

The firm of McMorrow, Berman & Davidson, with offices in Washington, D. C., is qualified to take the necessary steps for you. We can make a preliminary search on your invention, advise you whether we think it can be patented, and prepare your application for patent.

Unless you are fully familiar with the U. S. Patent Laws, we recommend that you engage the services of a Registered Patent Attorney to protect your interests. The patent laws are *your* laws. A patent gives you the right to prevent others from making, using or selling the invention claimed in your patent for a period of 17 years.

Use these patent laws for your protection. Investigate whether your invention can be patented. If you have what you believe to be an invention, we suggest that you have this firm make a search for you.

Send for a copy of our Patent Booklet entitled "How To Protect Your Invention," containing information about patent protection and patent procedure. Along with this we will also send you an "Invention Record" form, for your use in writing down and sketching details of your invention. We will mail them promptly. No obligation. They are yours for the asking.

McMORROW, BERMAN & DAVIDSON

Registered Patent Attorneys

PATENTS • COPYRIGHTS • PATENTS

142-B VICTOR BUILDING, WASHINGTON 1, D. C.

Letters



Dept. of Interplanetary Information

I haven't seen a "flying saucer" yet, but I'm keeping my eyes peeled. If I should see some strange object blazing across the sky, what should I do about it?

C. S. COBBER, Elmsford, N. Y.

Take a picture of it if you can. In any case, report what you have seen to the nearest Air Force base. It will help if you give an estimate of the object's speed, altitude and direction of flight.

When the flying saucers were first reported seen over Washington, D. C., a couple months ago, the Air Force ordered its fighters to hunt and shoot them down.

This is a terrible mistake. These visitors can make ships that can fly from faraway planets and weapons that could surely blow up the earth. If we make them mad, they'll destroy us, but if we let them land I'm sure the results will be peaceful.

JAMES ROSS, Saginaw, Mich.

I was having dinner one night when I suddenly looked down and noticed two bright objects resembling saucers bobbing up and down in my coffee cup. I realized



then that here on a small scale was the answer to the saucer riddle—a source of light (a ceiling light behind me) and an unstable reflecting surface (the coffee).

I'm sure this is the answer to what all those people have been seeing. Maybe.

MARY A. PIRIE, Pensacola, Fla.

Your space scale on page 85 of the August issue should give the 95-pound boy's weight as 95 pounds even on the moon—not 14.5 pounds as shown—because the sign on the scale's face says: "No Springs-Honest Weight." This means that the scale employs a mass-balance system that would automatically compensate for the differences in gravitational force and read 95 pounds on any heavenly body.

J. A. HUSEMAN, Portland, Ore.

The scales had been adjusted by the Hayden Planetarium to show in Earth pounds what a person would weigh on the moon.

Worth Considering

In your article "Which Blowouts Are Worse?" [Aug. '52, p. 159], you seem to conclude that because rear-wheel blowouts are more dangerous drivers should keep their most-worn tires on the front wheels.



This conclusion overlooks the fact that while they may be less dangerous, front-wheel blowouts are more likely to occur since the front wheels generally carry a larger part of the load. For those who seldom carry a heavy rear-wheel load, it might be advisable to put the best tires on the front.

BERNARD RIMLAND, State College, Pa.

TV Shows from Europe?

Will telecasts cross the Atlantic? How? And when?

ALVIN KOPPERS, Baltimore

Engineers believed until recently that TV's extremely short waves went through the electric roof from 60 to 300 miles above our heads like light through a window and got lost in space. But now they have found that very-high-frequency signals can be bounced off the ionosphere and made to land up to 700 miles from where they were transmitted. Nobody is sure yet what bounces the VHF signals back. It may take a few years to find out.

But even now there are several other

AMERICA'S NEWEST \$\$\$\$ HOME BUSINESS!



Real live ORANGE TREE
Full grown, but only inches high. Notice the tiny oranges you can actually pick and eat—blossoms, too. Easy to grow in any climate.

Earn Big Money — SPARE TIME!
GROW LIVING "MING" TREES

- NEW Amazing HOME-BUSINESS!
- NEW Fascinating HOBBY!



CASH IN ON ANCIENT ORIENTAL SECRETS

Never before has such a PROFITABLE OPPORTUNITY come to light. Centuries ago, Oriental royalty astounded the world by growing actual LIVING miniature "dwarf trees". These fabulously beautiful trees were desired by all other countries, but the Oriental Emperors jealously guarded their growing secrets. The death penalty was demanded if anyone grew dwarf trees, or gave away the growing secrets. However, Americans in World War II succeeded in purchasing some specimens and brought them to America—NOW THE SECRET IS OUT—and promises to be one of the most profitable spare-time home-businesses ever. Get all the facts! Mail coupon below today.

GROW THEM AT HOME! IN YOUR SPARE TIME! NO EXPERIENCE NEEDED!

Start your own Business! If you've ever planted a garden—you know the wonderful sense of accomplishment you feel. Growing actual living miniature trees is A HUNDRED TIMES MORE FASCINATING—yet, can be extremely profitable because these miniature specimens are new and rare...and anything new and rare means big prices and big profits for those offering it first.

NO LARGE INVESTMENT—NO OVERHEAD

You can start on a shoestring because you start with seeds costing "pennies", but sell trees for "tens of dollars". Mother Nature makes money for you. You don't need a lot of equipment or space either. Raise hundreds of trees in your house, yard, garage or window sill—you don't need much room.

TAKES ONLY A FEW MINUTES A DAY

NO LONG HOURS of tedious work—NO STUDYING of detailed instruction courses are necessary. Take care of dozens of trees in 5 minutes daily. Keep your present job—have TWO INCOMES instead of one. Of course, you can grow thousands full time—it's up to you.

GROW IN ANY KIND OF CLIMATE

Even if the temperature gets as cold as -10°F. or as hot as 150°F. you can successfully grow your trees year around. They are easy to protect.

SOME SOLD FOR \$1,000—EVEN \$2,000 EACH

But \$25, \$50, \$100 and more per tree is common. You pocket all the profit. YOU CAN HAVE LIVING TREES TO SELL ALMOST AT ONCE. Amazing new secret process permits you to see results immediately. No waiting months or years. Mail Free Seed Coupon Today.

Living Midget "Ming" Trees Are Becoming The SENSATION OF ALL AMERICA

Orders are coming from all over! Living Ming Trees are fashionable, smart decorations everywhere.

HELP US FILL THE HUGE DEMAND!



• FROM HOMES—They're a "must" in all homes, as well as all new modern architecture building.



• FROM INTERIOR DECORATORS—They can't seem to get enough of them for their customers.



• FROM CLUBS, HOTELS, SCHOOLS, FLOWER SHOPS, ETC.—These rare and exotic trees are extremely popular and in great demand.

IT'S EASY! TO GROW ALL KINDS OF TREES

Even a child can successfully grow valuable perfect miniature specimen trees, once they know the secrets. Lovely FIR, PINE, CYPRESS, fragrant JUNIPER, sturdy OAK, LEMON, CHERRY, ORANGE, nearly every kind. It's easy.



JUNIPER TREE—Only 12" high with a 2 foot spread — an enviable prize in any home, office, school, etc.



CYPRESS TREE — Perfect replica — only 15" high. Green the year around.

★
NATIONAL NURSERY GARDENS
Inglewood 4, California



FREE!

GENUINE SEEDS & ILLUSTRATED DETAILS

HOW TO LEARN GROWING SECRETS
SEED

NATIONAL NURSERY GARDENS

8463 So. Van Ness Ave., Dept. N-10
Inglewood 4, California

Please RUSH ME FREE SEED AND ILLUSTRATED DETAILS. I understand I am under no obligation. This is a Free offer from you.

Name _____

Address _____

City _____ Zone _____ State _____

THEY NEED YOU



A typical interview...

where Embry-Riddle students are pre-selected for essential, good-paying jobs in aviation even before their training is completed... they step right into their jobs as soon as they graduate!

...AND YOU CAN

QUALIFY IN SIX MONTHS!

EMBRY-RIDDLE OFFERS YOU COMPLETE 6-MONTHS TO 2-YEAR COURSES...NOW!

Your Career is Waiting!

The high regard of Embry-Riddle training by the leading airlines and the entire aviation industry is demonstrated time and again by the big demand for Embry-Riddle graduates.

There's an important high priority job in aviation waiting for you...however, if you do enter the services, Embry-Riddle training will definitely give you rating advantages. Thousands of Air Force men are Embry-Riddle trained.



AIRCRAFT & ENGINE MECHANICS

Vast numbers of properly trained A & E Mechanics are urgently needed. Our C. A. A. approved school with a quarter-century experience assures your quickest advancement. Embry-Riddle students learn fast with modern equipment, including jet...live aircraft, airline-size hangars.



AERONAUTICAL DESIGN AND TECHNOLOGY

Embry-Riddle's accelerated 26-mo. Aeronautical Design and Technology Course provides finest training available. Technicians with management responsibility enjoy highest salaries!



COMMERCIAL PILOT

Embry-Riddle trained pilots benefit from our years of experience with 30,000 students...the best instructors, up-to-date aircraft, superb year-round flying weather. Also Instrument and Instructor's ratings.



A & E COMBINED WITH COMMERCIAL PILOT

Airmen with dual pilot-engineering ability are needed by aviation companies and operators. Embry-Riddle combination training offers you the most in your aviation career.



TRAINING AUTHORIZED UNDER THE GI BILL OF RIGHTS

Dean of Enrollments - Dept. 91
Embry-Riddle School of Aviation
Miami 30, Florida

Please Print

NAME _____

ADDRESS _____

CITY _____

STATE _____ AGE _____

I am interested in...

- A & E Mechanic
 Commercial Pilot
 Aeronautical Design and Technology
 A & E Combined with Commercial Pilot
 A & E Combined with Private Pilot
- Check One Veteran
 Non-Veteran

TRAIN IN MIAMI - AIR CAPITAL OF THE WORLD

methods under study that may make transatlantic TV feasible.

One plan being seriously considered is to build relay stations in Newfoundland, Labrador, Greenland and Iceland, with over-water hops averaging 250 miles between them. Another plan entails a string of ships in a relay line across the ocean. A third proposal is to have the television beam relayed by airplanes flying in circles over the Atlantic at 500-mile intervals and at altitudes between 30,000 and 40,000 feet. That would be practical only for special events—like Queen Elizabeth II's coronation.

Help Wanted

All my life I have wanted to live in a camp in the woods where I could hear the wind howling. Now I have the camp—but there's no wind. It's as silent as a tomb.



A 60-foot tree blew down not 10 feet from my bed and I didn't even know there was a wind blowing.

Can you tell me how I can reconstruct it so the wind will howl and shriek?

HUGH F. KIRKWOOD, Augusta, Me.

Any ideas?

It's the Rule—Not the Exception

I disagree with Wilbur Shaw's statement in the August issue [p. 100] that the Rolls-Royce is the only car from which you could expect 90,000 to 100,000 miles without a piston-ring job.

I have personally seen three cars with over 100,000 miles which have never had the cylinder head or crankcase removed. These cars were still running well, using no oil, and carrying good oil pressure.

EDWARD MAGNUSON, Grantsburg, Wis.

Individual cars occasionally run up performance records such as you mention, but Mr. Shaw's statement was that the Rolls-Royce was the only make of car from which you could expect 90,000 to 100,000 miles on every automobile produced. That's quite a difference.

LEARN ELECTRICITY AND ELECTRONICS

ON REAL EQUIPMENT
IN THE GREAT SHOPS
OF **COYNE**



RADIO-TELEVISION

Plays a Vital Roll in Nation's Defense

HIGHER RANK— HIGHER PAY— IN ARMED FORCES

Coyne Training will help you forge ahead in the Army, Navy, Air Force. And you'll be all set for a good future when you leave the service.

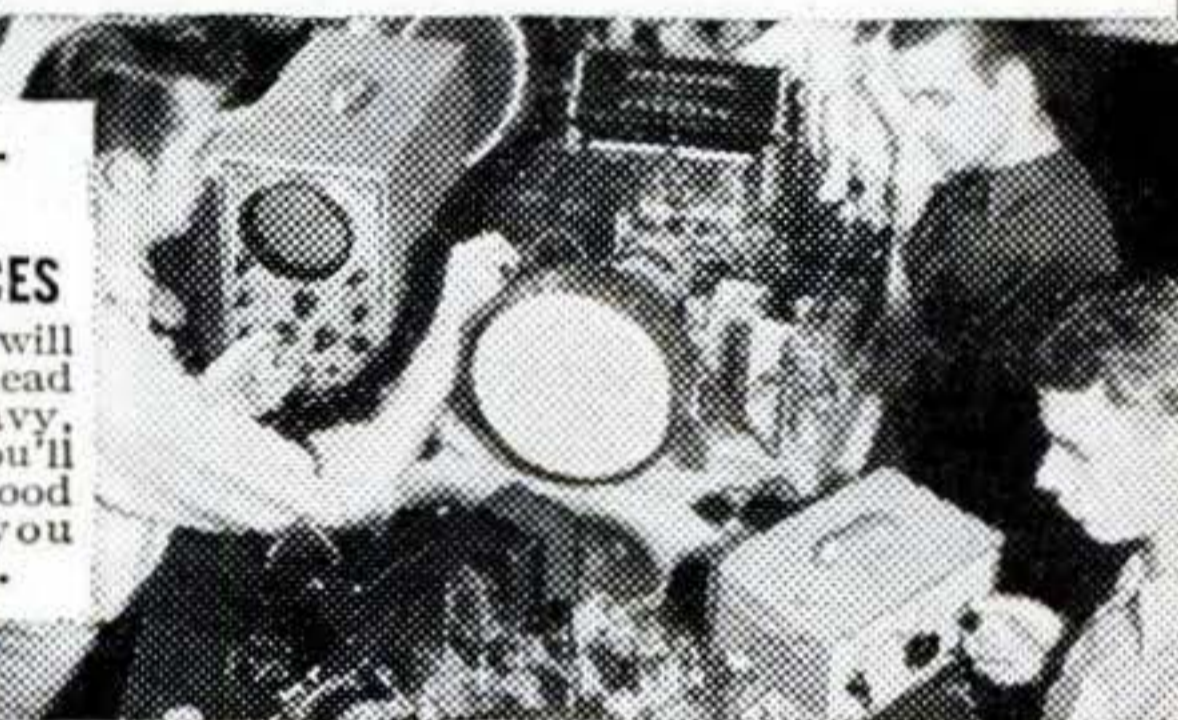

The tremendous growth of this new field is almost unbelievable. TV has been given the "go-ahead" in 1227 new communities, with 1845 new stations to be built. Unusual opportunity to get in on ground floor. RADIO—TELEVISION and ELECTRONICS are vital to our Defense Program. And they offer a world of opportunities for a real future when the emergency is over. Train quickly on actual equipment at Coyne by practical-technical methods. Get big Free Book today.

ELECTRICITY—

The Power Behind Our Defense Program

A great opportunity field and vital to Defense. Thousands of trained Electrical and Electronics men needed in good jobs with a real future when the emergency is over. Why be satisfied with a "no future" job? Get Free Book that tells how thousands have prepared quickly for Electricity and Electronics at Coyne.

TRAIN QUICKLY AT COYNE FOR VITAL FIELDS

ELECTRICITY—RADIO-TELEVISION—ELECTRONICS—VITAL in Industry and Armed Forces. TRAIN QUICKLY for better rating, if drafted—vital job in Industry, if not. Trained men whether 16 or up to 50 needed. Many men with physical handicaps can qualify. Prepare now for steady, well paid, essential jobs in A FIELD THAT ALSO OFFERS A REAL FUTURE WHEN THE EMERGENCY IS OVER.

WE TRAIN YOU IN CHICAGO

We do not teach by mail. All training is given in our Great Training Shops in Chicago, plus necessary theory. No advanced education or previous experience needed.

APPROVED FOR VETERANS— FINANCE PLAN FOR NON-VETS

Non-vets enroll now, pay most of tuition after graduation. If you need part-time work to help out with living expenses while at Coyne, we'll help you get it. Special plan for men of Draft Age.



1 You are TOLD the how and why of each job.



2 You're shown how to do typical jobs by trained instructors.



3 You DO practical job YOURSELF on equipment.

Mail Coupon for Big FREE BOOK

Whether you prefer Electricity or Television-Radio, train on actual equipment, at Coyne. Fill in and mail coupon TODAY. Paste it on a postcard if you wish. A big fully illustrated booklet and complete details will come by return mail. No salesman will call.



B. W. COOKE, President

COYNE SCHOOL

ATECHNICALTRADE INSTITUTE
CHARTERED NOT FOR PROFIT
Established 1899
500 S. Paulina Dept. 72-73H
Chicago 12, Illinois

ELECTRICITY ★ TELEVISION ★ RADIO ★ REFRIGERATION ★ ELECTRONICS

B. W. COOKE, President
COYNE SCHOOL
500 S. Paulina St., Chicago 12
Dept. 72-73H

Send your BIG FREE BOOK and details of your training offer. This does not obligate me and no salesman will call. I am interested in

ELECTRICITY TELEVISION-RADIO

NAME.....

ADDRESS.....

CITY.....STATE.....

Will her **caress test**
 tell tales
 about your hair?



**Grooms hair,
 never
 greases it**



The proof is in
 the palm of your hand!

20% more
 Cream Hair Oil
 for your money!

When she runs her fingers lightly through your hair, will you pass the test? Try your present hair tonic now, and see! Rub your palm across your hair, as she might do. Find a film of sticky oil? Think of her reaction and switch to Mennen Cream Hair Oil—lightly blended to keep each hair in place, yet never leave a trace. Contains lanolin. Helps remove dandruff scales and relieves dry scalp. Get a bottle today, and pass that caress test tonight!

MENNEN
Cream Hair Oil FOR MEN

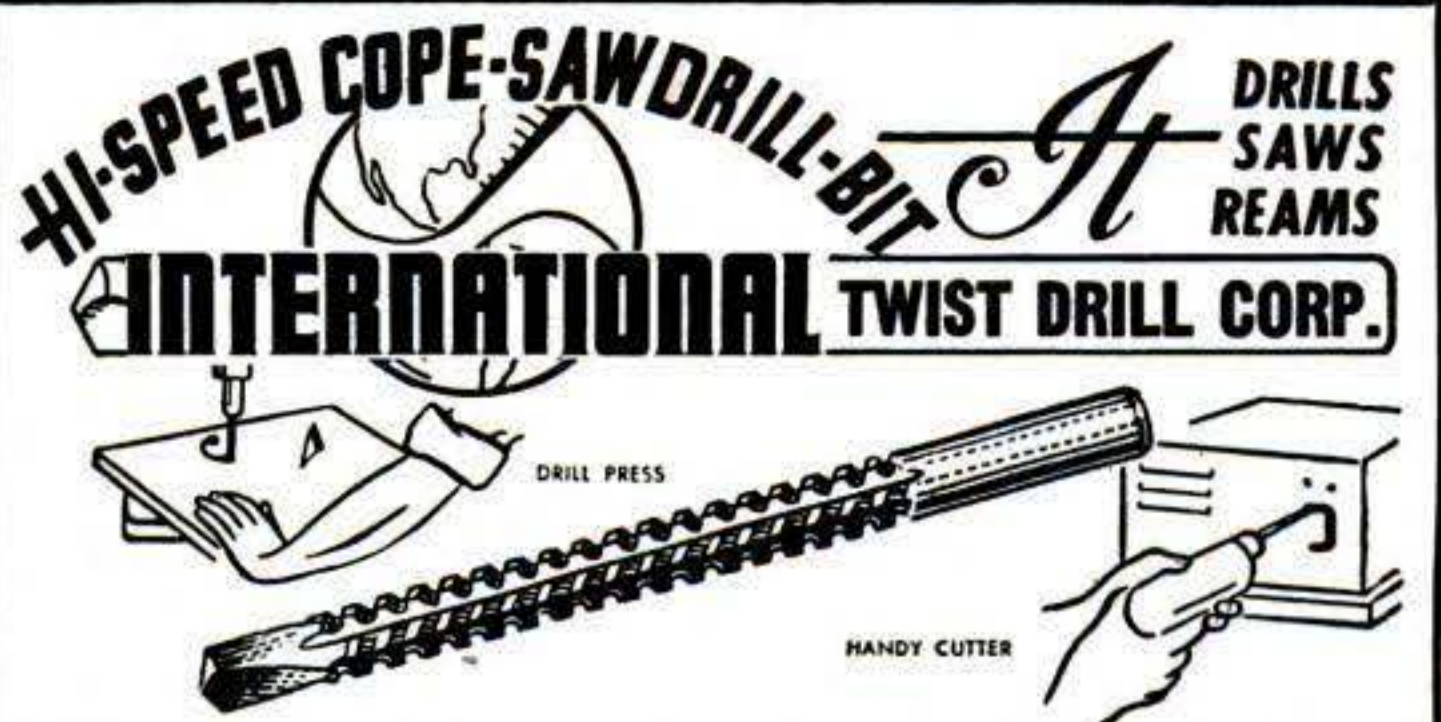

DRILL, SAW, REAM . . . metal, pipe, wood, plastic, Transite, etc. Use with any electric drill, slow drill press, lathe or milling machine. Drills own starting hole—upper part of bit is used to cut, saw or ream circles, ovals, squares or scrolls. Easy to operate. Ideal for carpenters, mechanics, electricians, plumbers, hobbyists, many others. Abrasive resistant, high speed steel. Flutes ground from solid. Will withstand severe continuous use without breaking. Resharpened at no charge. Takes place of up to \$50 in tools. 1/4" diameter, 2" cutting sections, total length 3 1/2". Also available specially designed for wood or metal and in 2 3/8" and 1 1/2" lengths. Write for details. Specify all-purpose bit. Shipped same day. Money-back guarantee. Dealer inquiries invited. SEND CASH, CHECK OR MONEY ORDER. Manufactured and distributed by: **INTERNATIONAL TWIST DRILL CORP.** 618 Wyandotte, Rm. 696 Kansas City 6, Mo.

only
\$3.95
 POST PAID

SAVE UP TO 50% AND MORE

OUT OF PAWN

GENUINE DIAMONDS

VALUES FROM \$10 TO \$10,000

TIME PAYMENTS ARRANGED

SEND FOR **FREE CATALOG**

All diamonds reset in brand new modern mountings. Sold with a written iron-clad money back guarantee. Over 100,000 satisfied customers have bought diamonds from Berman's. Our reference—your own bank or any mercantile agency.

Berman's Diamond Loan Bank
 Dept. PS —BERMAN BLDG., BALTIMORE 1, MD.

Diamonds from estates, banks, unredeemed pledges offered at substantial savings

Watch Repairing Pays Big Money Learn at home



Watch repairers in great demand. Train step-by-step in 10 easy lessons. We furnish all tools and 15 jewel watch and practice movement. Turn spare time into cash. A licensed school. Low cost. Send for FREE book today.

ILLINOIS SCHOOL OF WATCH REPAIRING
 28/0 Elston Ave., Dept. PS 102, Chicago 18, Ill.

MAKE MONEY 90 WAYS IN PHOTOGRAPHY



EARN WHILE YOU LEARN AT HOME

Famous low-cost LEARN-BY-DOING method and INDIVIDUAL attention trains you quickly at home—for profitable, action-packed career, or steady, spare-time income. Big FREE book gives full facts on more than 90 money-making opportunities in photography. Our 43rd year. Write TODAY! Also Resident Courses. Approved for Veterans.

New York Institute of Photography
 DEPT. 5, 10 WEST 33 ST. NEW YORK 1, N. Y.

SEND FOR **FREE BOOK**

Now IN YOUR OWN HOME Learn

TELEVISION RADIO

the Amazingly Effective
D.T.I. WAY

—with the aid of BOTH HOME EQUIPMENT and HOME MOVIES

NO PREVIOUS EXPERIENCE NEEDED
NOW...get EVERYTHING YOU NEED for real Laboratory-Type training AT HOME

Above: Work over **300** fascinating experiments with this equipment

What will mailing the coupon below *do for YOU?* Just this! You'll find out about one of today's most remarkable... practical ways to prepare to get into America's amazing billion dollar opportunity field of TELEVISION-RADIO-ELECTRONICS. You'll see how to get into fascinating work that pays well... that offers one of America's most promising futures... that enables you to start your own business almost "on a shoe string," if you prefer this to a job opportunity.

And above all, you'll get some **GOOD NEWS** especially welcomed by men anxious to earn **REAL MONEY** in this thrilling field. For you'll see that **NOW** you can get the kind of practical, laboratory-type training so desirable for making real progress in Television-Radio-Electronics... and **WITHOUT LEAVING HOME.**

You'll see that DeForest's Training, Inc. sends everything needed to set up your own **HOME LABORATORY.** You get and keep the same type of basic electronic equipment used in our modern Chicago Training Laboratories. You get home training that includes the knowledge and experience gained from training thousands of students first hand in Chicago. And to top it all, you use DTI's amazingly effective and exclusive home training aid—**INSTRUCTIVE MOVIES.** But why not get the complete story? Mail coupon today for information-packed literature.

MODERN LABORATORIES

If you prefer, get all your preparation in our new Chicago Training Laboratories—one of the finest of its kind. Ample instructors, modern equipment. Write for details!

MILITARY SERVICE!

If you're subject to military service, the information we have for you should prove very helpful. Mail coupon today.

1. Build over 300 fascinating experiments from 16 BIG SHIPMENTS of Electronic-Radio parts which you **KEEP.**
2. Build valuable commercial-type test equipment—as shown to the left—which you **KEEP.** This includes a quality **OSCILLOSCOPE**—a must for Television work.
3. Use a 16 mm. movie projector and new series of Hollywood produced instructive movies—a wonderful aid to help you grasp important fundamentals faster...easier...better.
4. Enjoy well-illustrated, easy-to-read lessons with handy **FOLD-OUT** diagrams.
5. Get an honest-to-goodness **EMPLOYMENT SERVICE** to help you get a good job after graduating—or assistance in starting your **OWN SALES AND SERVICE BUSINESS.** Mail coupon today for the complete details.

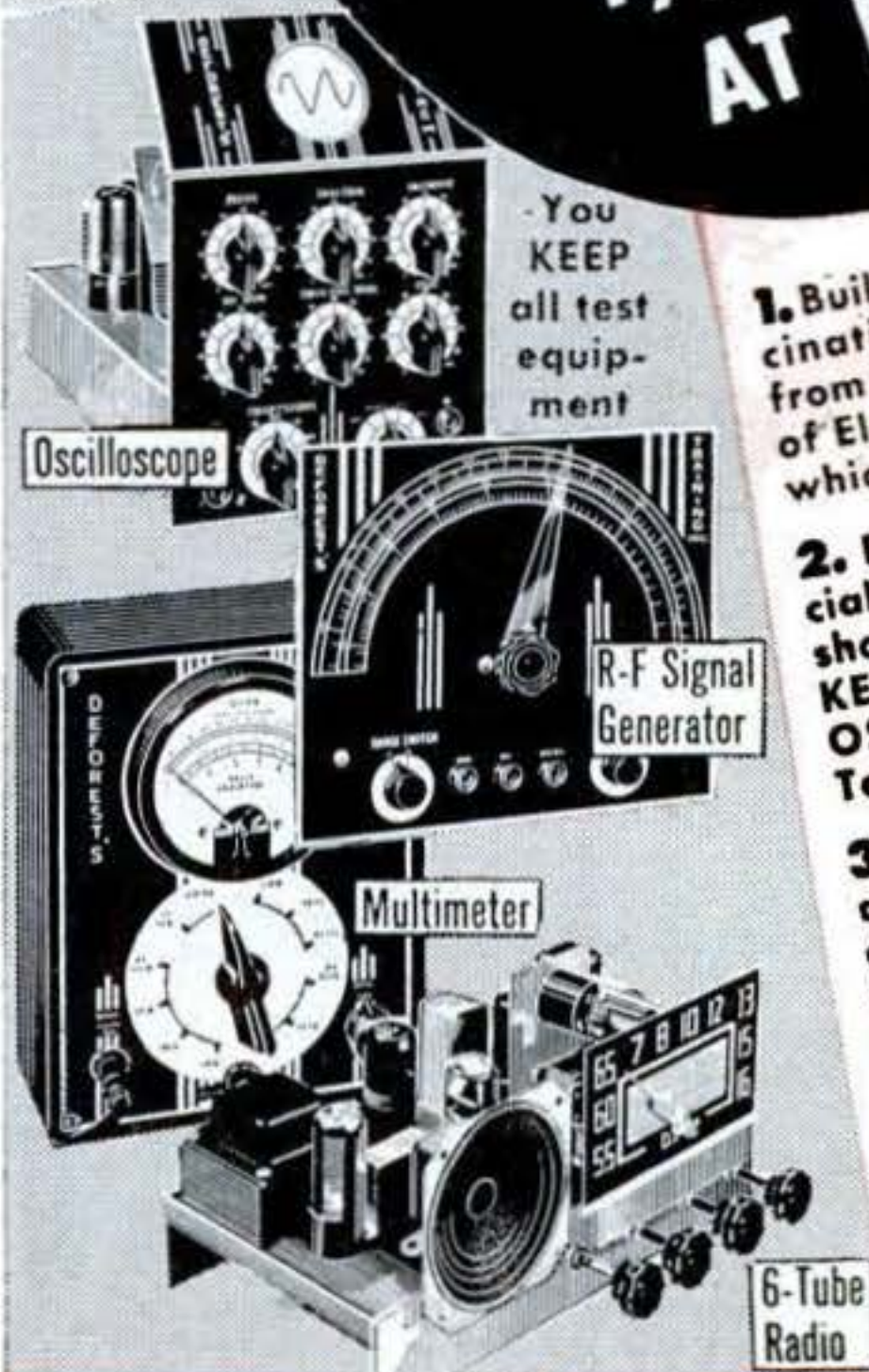

You **KEEP** all test equipment

Oscilloscope

R-F Signal Generator

Multimeter

6-Tube Radio



Build and Keep this 17-INCH TV RECEIVER—**OPTIONAL** after completing regular training at moderate added cost.

New "black" RECTANGULAR TUBE

Get **BOTH** of these colorful, information-packed folders **FREE**



Mail Coupon Today

DeFOREST'S TRAINING, INC. Dept. PS-10-1
2533 N. Ashland Avenue, Chicago 14, Ill,

I would like valuable, information-packed folders showing how I may get started toward a good job or my own business in Television-Radio-Electronics.

Name..... Age.....
Street..... Apt.....
City..... Zone..... State.....

DeFOREST'S TRAINING, INC.
AFFILIATED WITH
De Vry Technical Institute
CHICAGO 14, ILLINOIS

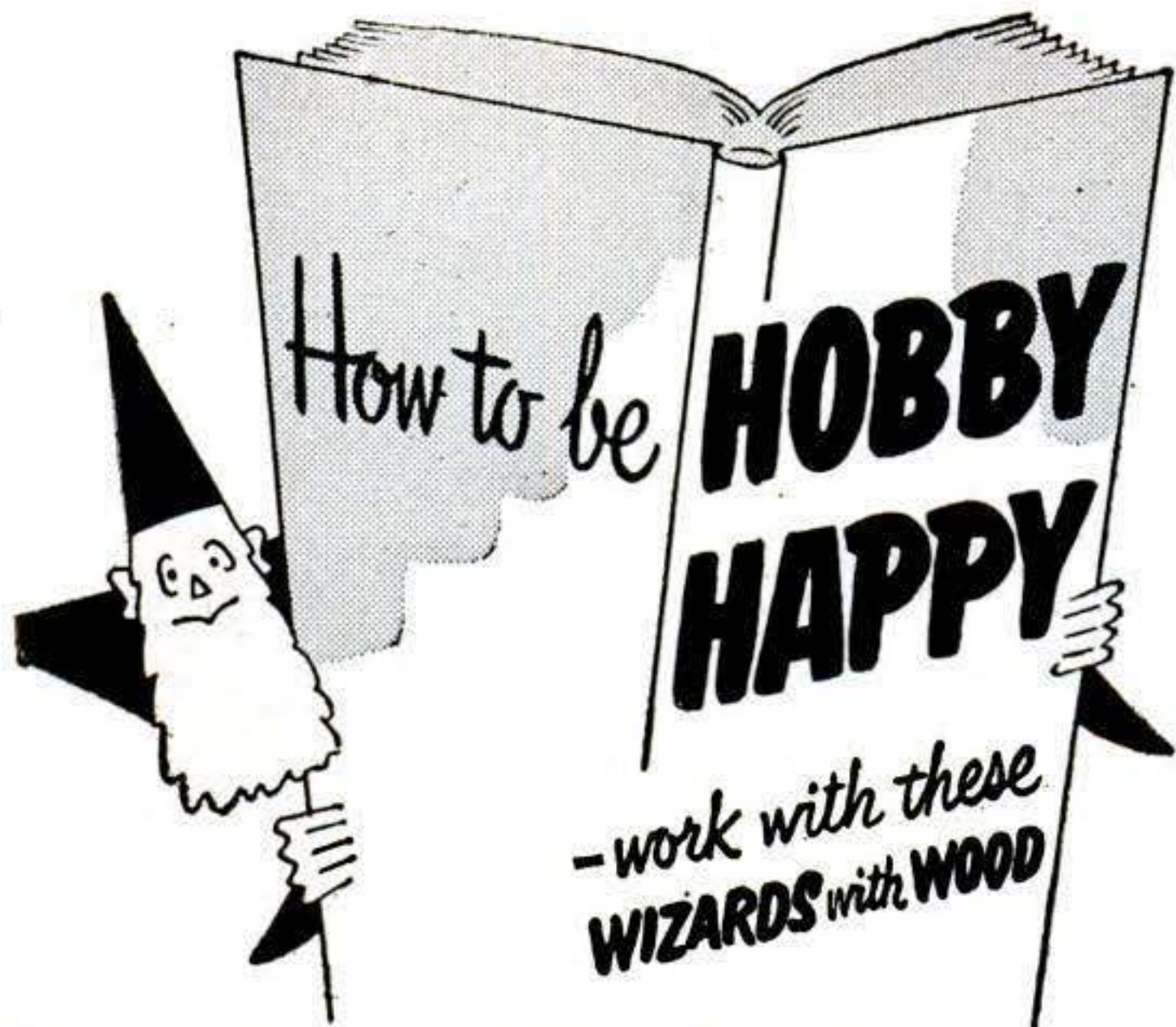

Do you make or mend things of wood? Then you want them to turn out reliably right. To succeed every time, use Weldwood Glue, Firzite and Satinlac. Ask for them at hardware, paint or lumber dealers.

Gets that blond or pickled effect—

Produce those magical "woody" effects — on hard wood or soft, plywood or solid lumber with White Firzite. For light pastel tones, tint with Colors-in-Oil. (On fir plywood stain jobs, tame that wild grain with Clear Firzite.)



WHITE FIRZITE®

Gets that Natural-Wood Finish

— without shellac or varnish. On furniture, panelling or woodwork, there's nothing like Satinlac. Brings out natural grain and color beauty of any plywood or solid wood. Avoids that "built-up look; will not turn yellow or darken with age. "Water-clear," easy to brush or spray, dries ready for next coat in 2 or 3 hours.



SATINLAC®

The Wood Glue you can rely on!

To make things or fix things, use Weldwood Glue for all wood-to-wood bonds. Makes joints stronger than the wood itself. Mixes easily with water. Stain-free, rot-proof... highly water-resistant!



WELDWOOD® PLASTIC RESIN GLUE

Pints, Quarts,
Gallons

United States Plywood Corporation,
Dept. 122, 55 West 44th St., New York 36, N. Y.

Send me free leaflets on Weldwood Glue, Firzite and Satinlac.

NAME _____

ADDRESS _____



EVERY PASSENGER TIRE UNCONDITIONALLY GUARANTEED plus TIRE INSURANCE FREE

Here's DOUBLE proof that we bear the loss if your passenger tire wears out within the guarantee period or is damaged in any way (except willfully). Don't take risks: we send FREE insurance certificate PLUS written unconditional guarantee with your order.

10% off ON TWO OR MORE USED TIRES

LOW COST QUALITY TIRES			
UNCONDITIONAL SIX MONTHS' GUARANTEE plus TIRE INSURANCE FREE			
600-16	\$3.50	650-16	\$3.75
600-15	ea.	640-15	ea.
650-15		550-16	
550-15		670-16	
		550-17	\$3.95
		475-19	ea.
		710-15	
		760-15	

BETTER GRADE PASSENGER TIRES							
UNCONDITIONAL ONE YEAR GUARANTEE plus TIRE INSURANCE FREE							
600-16	\$5.59	700-16	\$7.59	700-15	\$5.59	550-16	\$5.95
600-16(6)	6.50	600-15	5.59	750-16	12.25	550-17	5.75
650-16	5.79	650-15	5.59	550-15	5.59	475-19	5.75
640-15	5.95	710-15	6.50	820-15	7.50	760-16	7.75
670-15	5.95	760-15	6.75	670-16	6.95		

MUD AND SNOW TIRES			
TWO YEAR WRITTEN GUARANTEE			
600-16	\$6.95	900-16	\$12.95
650-16	7.50	650-16(6)	9.50
		750-20 Reg.	\$12.50
		650-15	Spec. \$15.95

EXTRA VALUE TRUCK TIRES					
ONE YEAR WRITTEN GUARANTEE					
600-20	\$10.75	750-20	\$14.50	825-20	\$21.50
650-20	11.75	32x6 (8)	11.75	900-20	19.50
700-20	12.50	32x6 (10)	12.50	1000-20	20.00
				750-20(10)	18.00

Complete line of High Mileage Tires in stock. Write for price list for sizes not listed. All prices F.O.B. Richmond.

MAIL ORDERS PROMPTLY FILLED. Send check or money order with this ad. **THE SAFTYRE CO., INC.** "FOR THAT SAFE TIRE" Dept. PS, 1801 East Broad Street, PO Box 2254, Richmond, Va.

START A SIDELINE AT HOME—Pleasant, Spare Time Work No House-To-House Selling

Pays \$5.00 Profit in One Hour

EASY TO LEARN—It costs little to start. Tested plan brings orders to you for metalized Baby Shoes. You do work on equipment we furnish. Plenty of work in every neighborhood to keep a couple making good money.

FREE Send name for details on Warner Success Plan. No charge. Learn about this interesting, profitable homework. Business booming. Write now. **WARNER ELECTRIC CO., 1512 Jarvis Ave., Dept. L-9-S, Chicago 26, Ill.**



HYPNOTIZE

Yes. Anyone. Modern speed hypnotism taught. Methods revealed. You are shown exactly what to say and do. Photo illustrated. Many interesting experiments. Self-hypnosis is fully explained. Amazing results. Detailed hypnotic tests given. Learn this exciting fascinating art. Hold your friends absolutely spellbound. Entertain. A professional hypnotist tells you his secrets.

Free catalog of new hypnotism books sent on request.

Send for the startling book "HYPNOTISM REVEALED" → \$1

78 RPM Phonograph Record Inducing Self-Hypnosis & Group-Hypnotism → \$5

Thought of using sleep for learning, self-development? Send for new intriguing book, "Mental Power Through Sleep Suggestion." → \$1

These two books are also available at all bookstores and public libraries. **MELVIN POWERS, Master Hypnotist, 1324 Wilshire, Dept. 94 Hollywood 17, Calif**



NO FROZEN PIPES

When You Use WRAP ON ELECTRIC HEATING CABLE

Protects to 35° Below Zero

No more worry, expense or inconvenience from frozen pipes! Just wrap plastic coated cable around exposed or shallow underground pipes and plug into 115 volt outlet. Maintains low heat—like electric blanket. Uses only small current. Thermostat turns on only when needed. No radio or TV interference. Low prices—complete with connections. Satisfaction or money back.

G-Q ELECTRIC SEED BED HEATER. Seeds are up in 30 hours—root cuttings in 6 days. You cut germination time 2/3—transplant 2 weeks sooner. Uses house current. Thermostat control. Easy installation. Write for catalog and FREE folder on seed bed construction.

GRO-QUICK SALES

11143-3 Morang Ave., Detroit 24, Mich.
Tuxedo 5-5828



How home study

DOUBLED my take-home pay!



"A year ago I was getting the best pay I'd ever had—on paper. But it wasn't enough. Deductions cut into it. The cost of everything we bought was higher. We weren't even holding our own.

"I had to make more money somehow, but to earn a promotion I needed training. So I mailed a coupon to I. C. S. That was the luckiest day of my life!

"I began studying every evening at home. It wasn't easy—it took work. But with every lesson I knew I was getting ahead. The course was clear, simple, well-illustrated. It related directly to the job I wanted. It gave me bedrock facts and theory plus practical application. Every question I asked got a personal answer. I wasn't held back by slower classmates but could go as fast as I wanted. I. C. S. sent reports on my progress to the plant superintendent. They must have impressed him, for just eleven months after I started he called me in and offered me a new position that *doubled my take-home pay!*"

Are you taking home all the money you need? Look over the coupon below. Choose the course that fits your needs. I. C. S. has helped 5,918,632 men and women train themselves for success, and this great school can help *you*. Mail the coupon NOW! We'll send you full information plus *free* book, "How to Succeed."

INTERNATIONAL CORRESPONDENCE SCHOOLS



BOX H-7615-N, SCRANTON 9, PENNA.

Without cost or obligation, please send me the booklet about the course BEFORE which I have marked X:

Please send information about I.C.S. employee training for companies.

- | | | | | |
|---|---|---|---|---|
| <p>ART</p> <ul style="list-style-type: none"> <input type="checkbox"/> Commercial Art <input type="checkbox"/> Magazine and Book Illustrating <input type="checkbox"/> Cartooning <input type="checkbox"/> Show Card and Sign Lettering <input type="checkbox"/> Fashion Illustrating AUTOMOTIVE <input type="checkbox"/> Automobile, Mechanic <input type="checkbox"/> Auto-Elec. Technician <input type="checkbox"/> Auto Body Rebuilding and Refinishing <input type="checkbox"/> Diesel—Gas Engines AVIATION <input type="checkbox"/> Aeronautical Engineering Jr. <input type="checkbox"/> Aircraft Engine Mechanic <input type="checkbox"/> Airplane Drafting BUILDING <input type="checkbox"/> Architecture <input type="checkbox"/> Arch. Drafting <input type="checkbox"/> Building Contractor <input type="checkbox"/> Estimating <input type="checkbox"/> Carpenter and Mill Work <input type="checkbox"/> Carpenter Foreman <input type="checkbox"/> Reading Blueprints <input type="checkbox"/> House Planning <input type="checkbox"/> Plumbing | <ul style="list-style-type: none"> <input type="checkbox"/> Heating <input type="checkbox"/> Steam Fitting <input type="checkbox"/> Air Conditioning <input type="checkbox"/> Electrician BUSINESS <input type="checkbox"/> Business Administration <input type="checkbox"/> Certified Public Accountant <input type="checkbox"/> Accounting <input type="checkbox"/> Bookkeeping <input type="checkbox"/> Stenography and Typing <input type="checkbox"/> Secretarial <input type="checkbox"/> Federal Tax <input type="checkbox"/> Business Correspondence <input type="checkbox"/> Personnel and Labor Relations <input type="checkbox"/> Advertising <input type="checkbox"/> Retail Business Management <input type="checkbox"/> Managing Small Business <input type="checkbox"/> Sales Management <input type="checkbox"/> Salesmanship <input type="checkbox"/> Traffic Management CHEMISTRY <input type="checkbox"/> Chemical Engineering <input type="checkbox"/> Chemistry <input type="checkbox"/> Analytical Chemistry <input type="checkbox"/> Petroleum—Nat'l Gas <input type="checkbox"/> Pulp and Paper Making <input type="checkbox"/> Plastics | <p>CIVIL, STRUCTURAL ENGINEERING</p> <ul style="list-style-type: none"> <input type="checkbox"/> Civil Engineering <input type="checkbox"/> Structural Engineering <input type="checkbox"/> Surveying and Mapping <input type="checkbox"/> Structural Drafting <input type="checkbox"/> Highway Engineering <input type="checkbox"/> Reading Blueprints <input type="checkbox"/> Concrete Construction <input type="checkbox"/> Sanitary Engineering DRAFTING <input type="checkbox"/> Aircraft Drafting <input type="checkbox"/> Architectural Drafting <input type="checkbox"/> Electrical Drafting <input type="checkbox"/> Mechanical Drafting <input type="checkbox"/> Structural Drafting <input type="checkbox"/> Sheet Metal Drafting <input type="checkbox"/> Mine Surveying and Drafting ELECTRICAL <input type="checkbox"/> Electrical Engineering <input type="checkbox"/> Electrician <input type="checkbox"/> Electrical Maintenance <input type="checkbox"/> Electrical Drafting <input type="checkbox"/> Electric Power and Light <input type="checkbox"/> Lineman HIGH SCHOOL <input type="checkbox"/> High School Subjects | <ul style="list-style-type: none"> <input type="checkbox"/> College Preparatory <input type="checkbox"/> Mathematics <input type="checkbox"/> Commercial <input type="checkbox"/> Good English MECHANICAL AND SHOP <input type="checkbox"/> Mechanical Engineering <input type="checkbox"/> Industrial Engineering <input type="checkbox"/> Industrial Supervision <input type="checkbox"/> Foremanship <input type="checkbox"/> Mechanical Drafting <input type="checkbox"/> Machine Design-Drafting <input type="checkbox"/> Machine Shop Practice <input type="checkbox"/> Tool Design <input type="checkbox"/> Industrial Instrumentation <input type="checkbox"/> Machine Shop Inspection <input type="checkbox"/> Reading Blueprints <input type="checkbox"/> Toolmaking <input type="checkbox"/> Gas—Electric Welding <input type="checkbox"/> Heat Treatment—Metallurgy <input type="checkbox"/> Sheet Metal Work <input type="checkbox"/> Sheet Metal Pattern Drafting <input type="checkbox"/> Refrigeration POWER <input type="checkbox"/> Combustion Engineering <input type="checkbox"/> Diesel—Electric <input type="checkbox"/> Electric Light and Power | <ul style="list-style-type: none"> <input type="checkbox"/> Stationary Steam Engineering <input type="checkbox"/> Stationary Fireman RADIO, TELEVISION, COMMUNICATIONS <input type="checkbox"/> General Radio <input type="checkbox"/> Radio Operation <input type="checkbox"/> Radio Servicing—FM <input type="checkbox"/> Television <input type="checkbox"/> Electronics <input type="checkbox"/> Telephone Work RAILROAD <input type="checkbox"/> Locomotive Engineer <input type="checkbox"/> Diesel Locomotive <input type="checkbox"/> Air Brakes <input type="checkbox"/> Car Inspector <input type="checkbox"/> Railroad Administration TEXTILE <input type="checkbox"/> Textile Engineering <input type="checkbox"/> Cotton Manufacture <input type="checkbox"/> Rayon Manufacture <input type="checkbox"/> Woolen Manufacture <input type="checkbox"/> Loom Fixing <input type="checkbox"/> Finishing and Dyeing <input type="checkbox"/> Textile Designing HOME ARTS <input type="checkbox"/> Dressmaking and Designing <input type="checkbox"/> Cookery <input type="checkbox"/> Tea Room Management |
|---|---|---|---|---|

Name _____ Age _____ Home Address _____

City _____ State _____ Working Hours _____ A.M. to _____ P.M.

Occupation _____

Special tuition rates to members of the Armed Forces. Canadian residents send coupon to International Correspondence Schools Canadian, Ltd., Montreal, Canada.

LEARN UP-TO-DATE

APPLIANCE REPAIR



MAKE GOOD MONEY at HOME!

A MODERN BIG PROFIT ONE-MAN BUSINESS CAN BE YOURS AT HOME — SPARE OR FULL TIME. New visual "shop-practice" method quickly shows you how to repair Home Freezers, Refrigerators, Vacuums, Garbage Disposals, Automatic Washers and Dryers, Motors, Fluorescent Lights, Fans, Irons—yes, even House and Industrial wiring. You can set up shop in your garage, basement, porch or attic, wherever you have a little bench space. No costly leases—no big overhead—no need to hire others—no selling—we show you how to make business *come to you*.

BIG MONEY—SECURE FUTURE—INDEPENDENCE. Hundreds of plain-as-day "How-to" photos and drawing make it easy. F. V. in N. Y. says: "I made \$800 in 3 months while studying." T. E. H. in W. Va. says: "Made \$14 a day while learning."

NO PREVIOUS EXPERIENCE NEEDED. You will get, in addition to complete instructions, my book, "How to Open Your Own Electric Appliance Business." It shows you how to start small and grow big. Everything furnished to help you build your own Big Profit business at home. Yes! We even supply you with appliance tester and tools! Write today for this amazing new Home Business Plan—It's FREE! Send no money—just your name and address.

PACIFIC TRAINING SCHOOL, Dept. S-5210
7217 S. Broadway, Los Angeles 3, California.

LAW FREE BOOK



Your FREE copy of "The Law-Trained Man" shows how to gain prestige and greater earnings through Blackstone home law study. All instruction material furnished including 16-volume Law Library written by 65 well-known law authorities. Lawyers, judges among our graduates. LL.B. degree. Low cost; easy terms. Write today.

BLACKSTONE COLLEGE OF LAW Dept. 127 Chicago 1, ILL.
225 N. Michigan Ave.
A Correspondence Institution Founded in 1890

INVENTORS

Your first step—if you consider your invention to be something of importance—is to have a search made of pertinent, prior U. S. patents. If our search report indicates probable patentability of your invention, you may apply for a patent which gives you the right to exclude others from making, using or selling your invention as claimed for a term of 17 years.

This firm is registered to practice before the U. S. Patent Office and is available to assist in the preparation of the necessary drawings, specification and claims.

Ask for a copy of our instructive booklet "Patent Protection for Inventors" and our convenient "Evidence of Invention" form. No obligation.

VICTOR J. EVANS & Co. *Merlin M. Evans*
REGISTERED PATENT ATTORNEY
740-L MERLIN BUILDING, WASHINGTON 6, D. C.

INVENTORS

Before you make any effort to market your invention, you should take the first steps toward proceeding for patent protection.

I shall be pleased to furnish you with information relative to patent procedure upon request from you, and this will be without any obligation on your part.

PATRICK D. BEAVERS
Registered Patent Attorney

937 Columbian Building, Washington 1, D. C.

INVENTORS

IF YOU WISH TO PROTECT YOUR INVENTION, You should take steps to protect it by a U. S. Patent. Write me for "INVENTION RECORD" FORM

CARL MILLER
REGISTERED PATENT ATTORNEY

WOOLWORTH BLDG., 35th FLOOR, 102C
NEW YORK CITY



PATENTS

C.A. SNOW & CO.

REGISTERED PATENT ATTORNEYS
WRITE FOR INFORMATION TO
426 SNOW BUILDING, WASHINGTON 1, D. C.



INVENTORS

Whether an invention is patentable can be substantially determined by a search of the U. S. Patent records. Without obligation, write for information explaining the steps you should take to secure a patent.

JOHN N. RANDOLPH
Registered Patent Attorney

205 Columbian Building Washington 1, D. C.

INVENTORS

Send for
PATENT INFORMATION
Book and
INVENTOR'S RECORD
without obligation
GUSTAVE MILLER
102PS Warner Building
Washington 4, D. C.

REGISTERED PATENT ATTORNEY
PATENT ATTORNEY & ADVISOR
U. S. NAVY DEPT. 1930-1947
ASSOCIATE EXAMINER
U. S. PAT. OFF. 1922-1929
PATENT LAWYER



MARVEL

Mystery Oil

- Frees Sticky Valves
- Stops Hydraulic Valve Clatter

Buy it at your favorite gas station

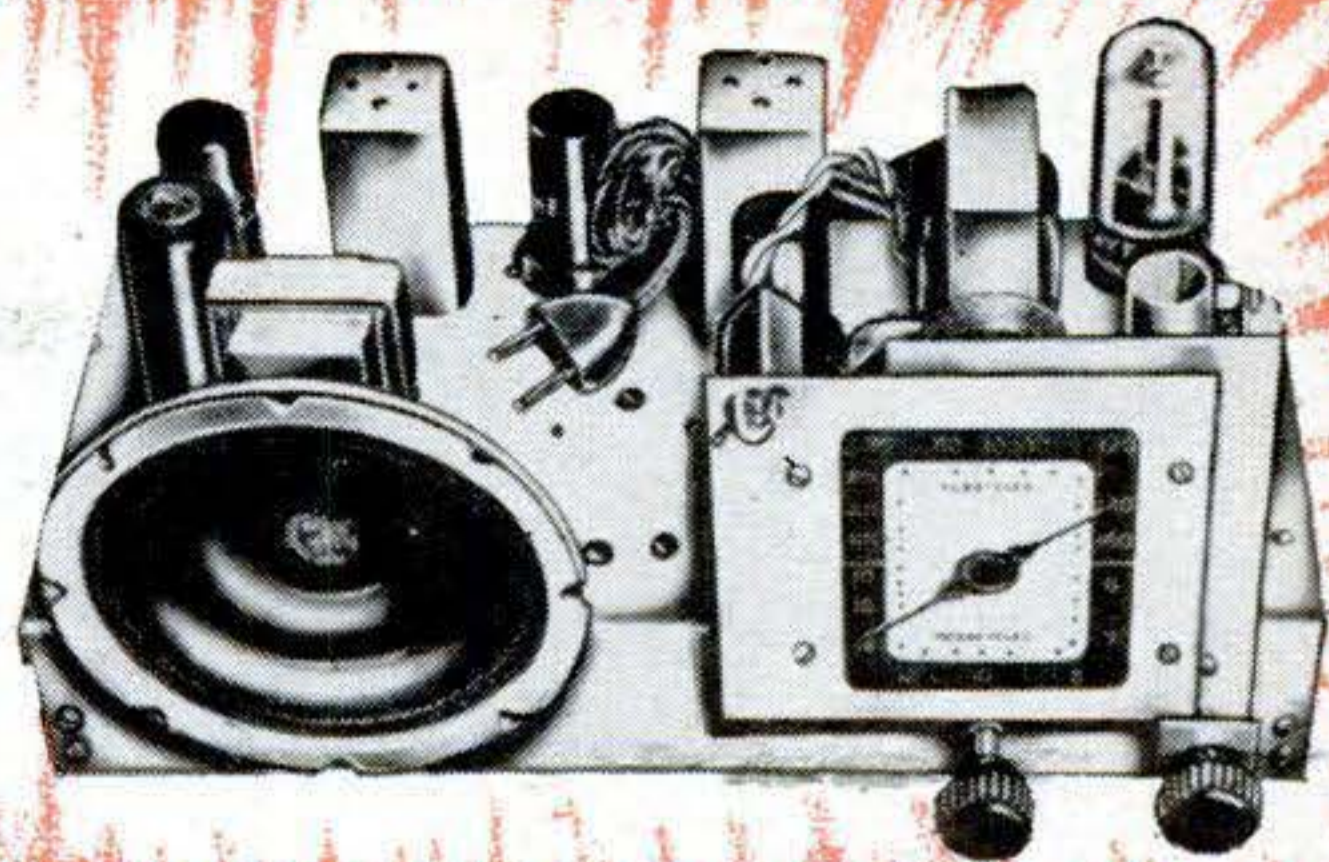

TRAIN **FASTER**—TRAIN **BETTER**—TRAIN **EASIER**
 IN 10 MONTHS—OR LESS—FOR
RADIO-TELEVISION

Our 21st Year Training Men for Greater Incomes and Security in Radio-Television

I SEND YOU
18 BIG KITS

of Radio Television parts and equipment. Much of your training will be actual construction and experimentation . . . the kind of truly PRACTICAL instruction that prepares you for your Radio-Television career.



Frank L. Sprayberry
 President
 Sprayberry Academy
 of Radio

NEW! NO OBLIGATION PLAN

You Have No Monthly Payment Contract to Sign
 Pay For Your Training as You Earn and Learn

You can get into Radio-Television, today's fastest growing big money opportunity field, in *months* instead of years! My completely new "package unit" training plan prepares you in as little as 10 months or even less! *No monthly payment contract to sign—thus NO RISK to you!*

This is America's finest, most complete, practical training—gets you ready to handle any practical job in the booming Radio-Television industry. Start your own profitable Radio-Television shop . . . or accept a good paying job. I have trained hundreds of successful Radio-Television technicians during the past 21 years—and stand ready to train you, even if you have no previous experience! Mail coupon and get all the facts—FREE!

**Valuable Equipment Included
 With Training**

The new Sprayberry "package" plan includes many big kits of genuine, professional Radio-Television equipment. You perform over 300 demonstrations, experiments and construction projects. You build a powerful 6-tube 2-band radio set, multi-range test meter, signal generator, signal tracer, many other projects. All equipment and lessons are *yours to keep* . . . you have practically everything you need to set up your own profitable Radio-Television service shop.

Earn Extra Money While You Learn!

All your 10 months of training is IN YOUR HOME in spare hours. Keep on with your present job and income while learning. With each training "package" unit, you receive extra plans and "Business Builder" ideas for spare time Radio-Television jobs. New television stations everywhere, open vast new opportunities for trained Radio-Television Technicians—and those in training. If you expect to be in the armed forces later, there is no better preparation than practical Sprayberry Radio-Television training.

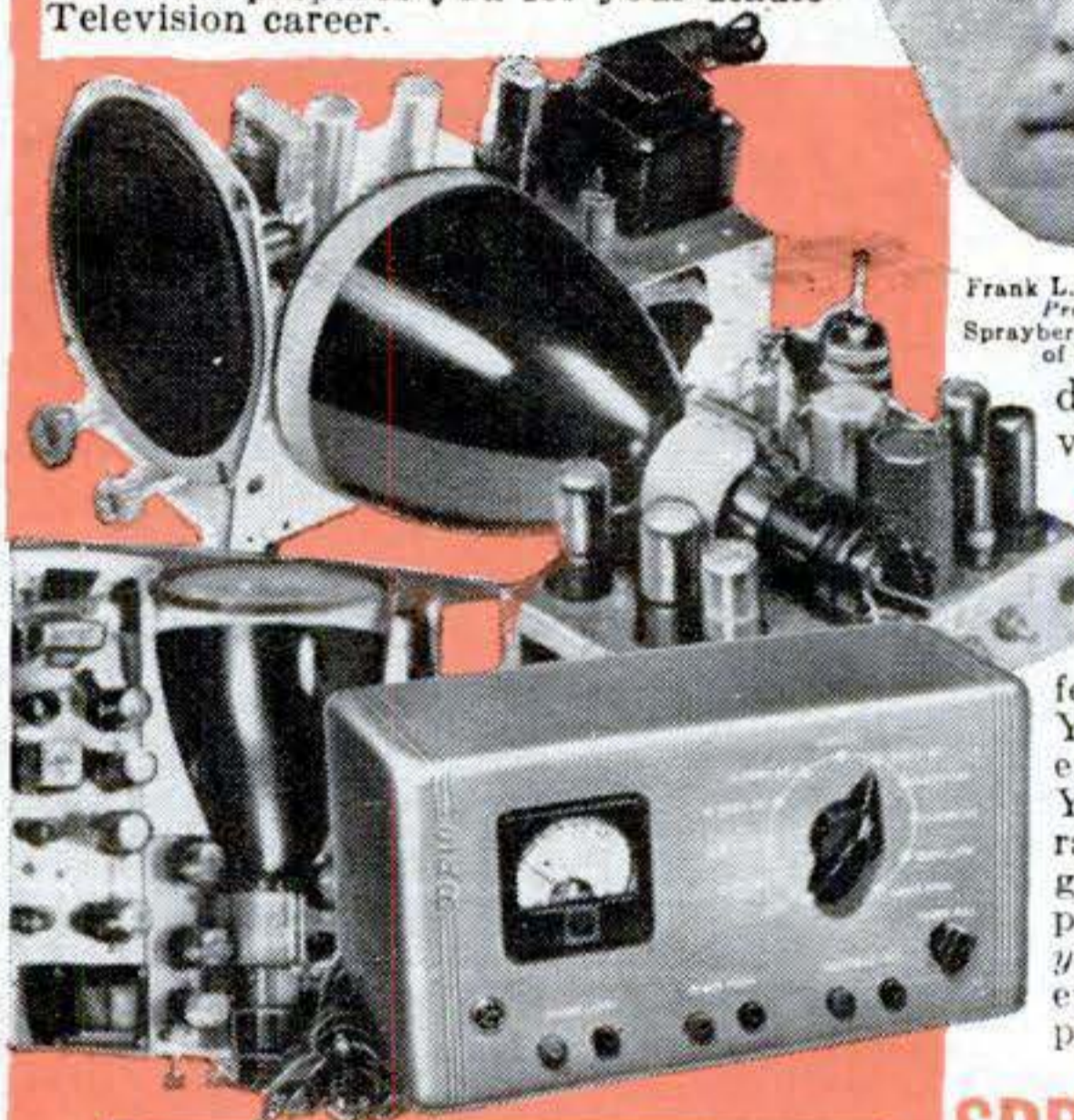

YOU BUILD the Television set and the powerful superhet radio receiver shown above IN ADDITION to the other test units shown here. (Many are not illustrated.)

Approved for Veterans under the G. I. Bill

SPRAYBERRY ACADEMY OF RADIO 111 NORTH CANAL ST.
 Dept. 550 Chicago 6, Ill.

**MAIL COUPON
 TODAY!
 NO OBLIGATION**

SPRAYBERRY ACADEMY OF RADIO, Dept. 550
 111 North Canal St., Chicago 6, Ill.

Please rush to me all information on your 10-MONTH Radio-Television Training Plan. I understand this does not obligate me and that no salesman will call upon me. Be sure to include 3 books FREE.

Name..... Age.....

Address.....

City..... Zone..... State.....

I invite you to get all the facts —
**FREE TO YOU 3 BIG
 RADIO-TELEVISION BOOKS**

Rush coupon for my three big Radio-Television books: "How to Make Money in Radio-Television." PLUS my new illustrated Television Bulletin PLUS an actual sample Sprayberry Lesson —ALL FREE. No obligation and no salesman will call. Mail coupon NOW!



NEW 1953 Electric JIG SAW

Makes thousands of articles



- Saws wood, metal, plastics
- Saws straight
- Saws zig zag
- Saws curves

5 DAY TRIAL
Money Back
Guarantee



WITH 22
FULL-SIZE
PROJECT
PATTERNS

The new, 1953 model BVI Jig Saw gives year-round enjoyment to men and boys, 8 to 80. Entirely new, greatly improved, made and guaranteed by **BURGESS**—World famous precision tool manufacturers. Professional looking projects are made with amazing ease and speed even by boys on this 100% **SAFE** jig saw! Just plug in and saw wood, light metal, fiber board, plastics—straight lines, curves, angles, every conceivable design! Turns out toys, lawn markers, furniture, book ends, book cases, cabinetry, full scale models, and a host of useful things for home, garden, workshop, den. Can also be used for sanding & filing.

POWERFUL BUILT-IN MOTOR — 3400 RPM

The sturdy, 110-125 volt motor rates **3400 RPM**—giving plenty of power to spare! Has 6 foot cord, on-off switch, 3 extra saw blades. Included at no extra cost—22 Project Patterns in **FULL** size! Remit only **12.95** for quick postpaid delivery. C.O.D.'s shipped postage collect. **5 Day Trial. Money back guarantee.** Order now to avoid disappointment!

ALL NEW
IMPROVED

3400
RPM
MOTOR

12.95

SEND NO MONEY—Try without obligation!

THORESEN'S

131 West 33rd St., Dept. 7-L-37, New York 1, N. Y.

RUSH the improved 1953 model **BURGESS** Jig Saw complete with 8 ft. plug, 3 extra saws—on **5 DAY TRIAL**. I will pay postman **\$12.95** plus shipping charges on arrival. If not thrilled, you will refund full purchase price.

Name.....

Address.....

Town.....

State.....

SAVE shipping cost! Remit **12.95** with coupon. Same money back guarantee.

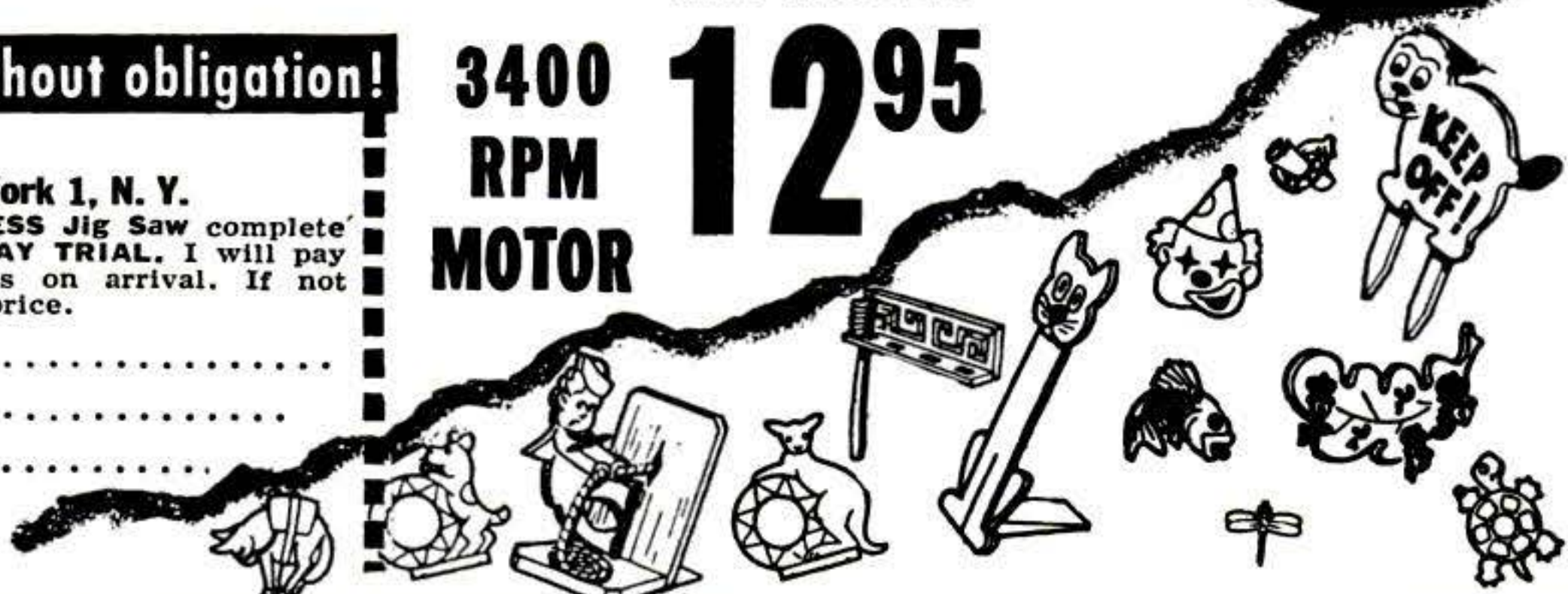

NEW IMPROVED NEON TIMING LIGHT



For quick accurate testing & setting of ignition systems. Shows up worn distributor shaft, helps locate ignition troubles. Use under actual operating conditions. Gives accurate ignition timing, synchronizes double points. Tests action of automatic spark advance. All parts easily replaced. More light output from cartridge-type neon light, 10% larger lens. Gives sharp, clear images while testing.

POSTPAID in USA
Send Check or Money Order for **\$4.50**

VACUUM AND FUEL PUMP TESTER

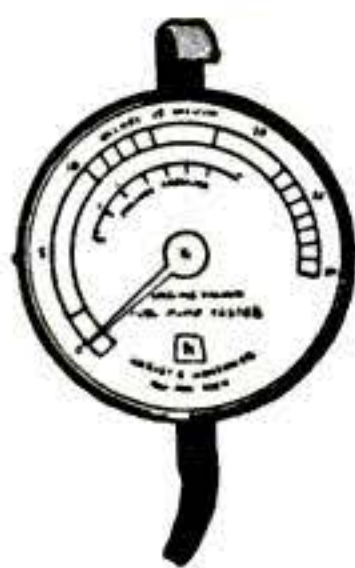

Checks valves, valve springs, choked muffler, vacuum pump and tank, vacuum gear shift and carburetor. Adjust and check carburetor under actual operating conditions. Normal vacuum range shown in green; conditions such as late ignition or valve timing, leaky manifold, etc., zoned in red. Easy-to-follow instruction manual included.

POSTPAID in USA
Send Check or Money Order for **\$6.95**

PISTOL GRIP COMPRESSION TESTER



Compact design permits testing in closest quarters. Checks condition of valves, pistons, piston rings and cylinders. Universal rubber cone fits all sparkplug holes. Full 200 lb. gauge. Finger-tip valve holds reading until released. Complete instructions & compression chart of all cars included.

POSTPAID in USA
Send Check or Money Order for **\$7.95**

AUTO-AID COMPANY
4636 St. Clair • Cleveland, Ohio

No C.O.D.s
PLEASE

FAST, HIGH-HEAT SOLDERING IRON

"Soldertron"

A must for every work bench!



- Operates on 110 volts AC or from 6 volt auto battery
- Ruggedly built for heavy duty
- Removable, non-pitting tip
- Fingertip control button
- Heats in 10-12 seconds
- Special alloy heating element
- Ceramic insulation
- Cork handle
- Iron weighs only 6 ounces
- Complete with transformer

Reg. \$13.95 value!

Include postage for parcel post
(Shipping weight 5 lbs.)

\$4.95

Send check or M.O.
(Save C.O.D. charges)

Terminal Radio Corp.

New York's Dependable Radio Supply House

85 CORTLANDT ST., NEW YORK 7, N.Y.
phone: WOrth 4-3311

TURN RIGHT

Get on the Road to a Better Job-Brighter Future with RIGHT Training —then You Can Really GO!

AMERICAN SCHOOL, Dept. G-746, Drexel at 58th, Chicago 37, Ill.

Without obligation, please send FREE and postpaid, full particulars about the subject checked below.

- | | | |
|--|---|---|
| <input type="checkbox"/> Accounting | <input type="checkbox"/> Drafting—Building Trades | <input type="checkbox"/> Plastics Engineering |
| <input type="checkbox"/> Air Conditioning | <input type="checkbox"/> Drafting—Machine Trades | <input type="checkbox"/> Plumbing—Practical |
| <input type="checkbox"/> Architecture & Building | <input type="checkbox"/> Electrical Engineering | <input type="checkbox"/> Private Secretary |
| <input type="checkbox"/> Automotive Technician | <input type="checkbox"/> Electricity—Practical | <input type="checkbox"/> Refrigeration |
| <input type="checkbox"/> Better Foremanship | <input type="checkbox"/> Electronics—Industrial | <input type="checkbox"/> Retail Merchandising |
| <input type="checkbox"/> Bookkeeping | <input type="checkbox"/> High School Courses | <input type="checkbox"/> Salesmanship—Outside |
| <input type="checkbox"/> Business Management | <input type="checkbox"/> Machine Shop Operations | <input type="checkbox"/> Sheet Metal Work |
| <input type="checkbox"/> Contracting | <input type="checkbox"/> Mathematics & Slide Rule | <input type="checkbox"/> Tool Making |
| <input type="checkbox"/> Diesel Technician | <input type="checkbox"/> Mechanical Engineering | |

NAME..... OCCUPATION.....
 HOME ADDRESS..... AGE.....
 CITY..... STATE.....

START NOW by checking, filling in and mailing this coupon. You'll get full information — No cost, No obligation!

• Today, make the BIG decision of your life. Choose the career you want and take the first easy step toward your goal. Learn how you can get the training that can put you in the bigger pay class and give you security in the years ahead. Find out how, in spare time at home, you can qualify for work you prefer, and higher pay. Or if you are already in the work you like, find out how you can win quicker promotion and a larger income.

Backed by 55 Years of Training Know-How

Since 1897 American School has helped many thousands of ambitious people toward success by providing specialized training for

commercial and technical advancement. Its study program for *you* has been prepared by experts in the subject you select and the school will give you guidance every step of the way. In time you might otherwise waste and at a cost you can afford you can prepare at home and really GO on the *right* road.

Don't Delay YOUR Start

Give serious thought to the list of training courses listed above. Pick the opportunity that interests you, check it and add your name and address. (Check more than one if you are undecided which appeals most.) Then clip and mail the coupon. Full information will be supplied without cost or obligation.

PRACTICAL, EFFECTIVE HOME STUDY TRAINING SINCE 1897

AMERICAN SCHOOL, Dept. G746, Drexel at 58th, Chicago 37, Ill.

THE SOONER YOU START, THE SOONER YOUR GOAL CAN BE REACHED

REX FERRUS, Jowett Trophy Winner, who mailed me 10c and a coupon like the one below YOU mail now!



HEY SKINNY—

How would YOU Like to GAIN

56 POUNDS OF MIGHTY MUSCLE LIKE I DID!

Through Jowett Training

I Added 7" TO MY CHEST
WHY DON'T YOU
I Put 4" of STEEL LIKE
MUSCLE ON EACH ARM
I've Broken All Records
Beaten All Contenders for
STRENGTH FEATS—WHY DON'T YOU?
says REX FERRUS—
Undeclared, Unchallenged Champion

"ASHAMED OF BEING SKINNY?"

Here's How to Do Something About It Like Rex Ferrus Did!" Says George F. Jowett, Known as World's Greatest Builder of HE-MEN

Maybe you don't want to win cups, medals, championship belts like Rex Ferrus has. But just think of how wonderful it would be to KNOW YOU CAN BE SUCH A CHAMPION—to stop being skinny, puny, jeered at and bullied. Picture yourself with Rex Ferrus' physique, muscles and HE-MAN power.

YES Sir — I can tell you from my OWN EXPERIENCE and the experience of thousands of my pupils that you CAN DO SOMETHING ABOUT IT, FAST AND EASY!

NO! I don't care how skinny or flabby you are; if you're teen-ager, in your 20's or 30's or over; if you're short or tall, or what work you do. All I want is JUST 10 EXCITING MINUTES in your home to MAKE YOU OVER.

PROVE IT TO YOURSELF—It took me years to devise my BEST by TEST 5-Way Progressive Power Method.

Send only 10c for my 5 easy-to-follow, picture-packed courses now in 1 complete volume "How to Become a Mighty He-Man." Try it for one night. Experience the thrilling strength that surges through your muscles.

George F. Jowett
"Champion of Champions"

THIS MAY BE YOUR LAST CHANCE TO GET ALL 5 PICTURE PACKED COURSES MILLIONS HAVE BEEN SOLD FOR \$1 AND MORE FOR 10c

- How to Build MIGHTY ARMS
- How to Build A MIGHTY CHEST
- How to Build A MIGHTY BACK

"You Sure Kept Your Promise to Power-Pack My Body" writes Ed L. Manfredi, Reno.

"I Gained 24 lbs. of Steel-Strong Muscle Thanks to Jowett's Wonder Course" says Rizalino Villanueva, Astoria, Oregon.

FREE PHOTO BOOK HOW to Achieve Nerves of Steel, Muscles of Iron

How to BECOME A MIGHTY HE-MAN

How to Build MIGHTY LEGS

How to Build A MIGHTY GRIP

BOTH FREE FOR QUICK ACTION!

1. Photo Book of STRONG MEN 2. MUSCLE METER

"Jowett Courses greatest in World for Building All-Around HE-MEN"
—R. F. Kelley
Physical Director

JOWETT INSTITUTE OF PHYSICAL TRAINING DEPT. PS-210
220 FIFTH AVENUE, NEW YORK 1, N. Y.

Dear George: Please mail to me FREE Jowett's Photo Book of Strong Men and a Muscle Meter, plus all 5 HE-MAN Building Courses: 1. How to Build a Mighty Chest. 2. How to Build a Mighty Arm. 3. How to Build a Mighty Grip. 4. How to Build a Mighty Back. 5. How to Build Mighty Legs—Now all in One Volume "How to become a Mighty HE-MAN." ENCLOSED FIND 10c FOR POSTAGE AND HANDLING (no C.O.D.'s).

NAME.....AGE.....
ADDRESS.....
CITY.....ZONE.....STATE.....

Famous 15 and 17 Jewel BULOVA WATCHES \$16.95 PLUS TAX

PRACTICALLY WHOLESALE TO YOU



LIFETIME WRITTEN GUARANTEE

WERE UP TO \$59.50
SAVE \$42.55

Also Choice Of
• BENRUS
• GRUEN
• WALTHAM or
• ELGIN Watches

You get these unredeemed LIFETIME GUARANTEED Bulova and other movements in latest style Yellow Gold Cases at this sensationally low price because we bought out SURPLUS STOCKS of leading New York and Md. jewelers. Order now while they last. Specify make preferred and whether men's or ladies'. Only \$16.95, plus \$1.70 tax. Order right now.

Free Trial Offer! Wear At Our Risk!

Money back guarantee in 10 days if not delighted!

SEND ONLY \$1 with order. Pay balance C.O.D. plus postage. Or we pay postage if you enclose \$16.95 plus \$1.70 tax. **FREE!** Handsome Expansion band with orders.

Maryland Distributors, Dept. 419

501 E. Baltimore St., Baltimore 2, Md., Write for Free Watch and Diamond Ring Catalog—Practically Wholesale Prices.

Lifetime Guaranteed 17 Jewel Swiss WRIST WATCH Worn by Army, Navy & Marines Originally \$59 Plus \$1.50 Tax New Incablock, Shock-Protected WATER-DUST PROOF

BE A RADIO ENGINEER

You can enter this uncrowded, interesting field. Defense expansion, new developments in electronics demand trained technicians. Study all phases radio & electronics theory and practice: TV; FM; broadcasting; servicing; aviation, marine, police radio. 18-month course equal in radio content to 4 yrs. college. H.S. or equivalent required. Begin Jan., March, June, Sept. Campus life. *Catalog.*

VALPARAISO TECHNICAL INSTITUTE
DEPT. 503 VALPARAISO, IND.

Learn MECHANICAL DENTISTRY

To make Crowns, Plates, Bridgework, etc., for Dentists. Easy practical way to learn mechanical dentistry at home in spare time. FULL EQUIPMENT OF TOOLS AND MATERIALS INCLUDED WITH COURSE. Low tuition. Easy terms. Write for FREE BOOK about this money making profession that is not affected by the machine age.

McCARRIE SCHOOL of Mechanical Dentistry
207 N. Broad Street Dept. 928 Philadelphia, Pa.

Study HYPNOTISM!

FASCINATING! Almost Unbelievable

This unusual course reveals the fundamentals of PRACTICAL hypnotism. It discloses how an expert operator performs—how he has developed his PERSONAL POWER and uses it to bring others under his domination and control. Illustrated instructions. Startling low price. Full satisfaction or refund guaranteed. Only \$2.95 postpaid... or C.O.D., plus postage. Send for "Hypnotism Course" today!

COMPLETE PRICE \$2.95
NELSON-HALL CO., 210 S. Clinton St. Dept. 2-KY-1 Chicago 6, Ill. only

WORK FOR THE



GOVERNMENT

START AS HIGH AS \$3,795.00 YEAR
Many Appointments to Be Made. Experience Usually Not Required. MEN—WOMEN. Mail Coupon Today—Sure.

FRANKLIN INSTITUTE, Dept. N-80, Rochester 4, N.Y. (Not Government Controlled) Sirs: Rush without charge, (1) 32-page book with list of U.S. Government Jobs. (2) Tell me how to get one of these jobs.
Name.....
Address..... Age?.....

Now Any AUTO REPAIR JOB Can Be a "Push-Over" for You!

Free 7-DAY OFFER!



IN LESS TIME—WITH LESS WORK—AND MORE PROFITS!



NOW, tackle anything from carburetor to rear end on ANY car built from 1935 thru 1952. And fix it quick, easy, right the FIRST time! Just look up make, model, and job in quick index of MOTOR's brand-new AUTO REPAIR MANUAL. Clear, illustrated instructions lead you step by step all the way. Covers all automatic and semi-automatic transmissions including the new Dual-Range Hydromatic, the new Power Steering.

ONLY Manual of Its Kind!

The engineer-editors of MOTOR Magazine condensed all the meat of over 170 official factory manuals for you. They dug out all the information you need—made sure every word and picture is crystal clear—and put the whole "works" into this one big 780-page book. Contains 225,000 service, repair, tune-up facts. 38,000 essential dimensions! More than 2400 cut-away photographs, diagrams, charts show what the clear text tells.

Used by U. S. Army and Navy

COVERS 851 MODELS— ALL THESE MAKES

- | | |
|-----------|------------|
| Buick | Henry J |
| Cadillac | Hudson |
| Chevrolet | Kaiser |
| Chrysler | Lafayette |
| Crosley | La Salle |
| De Soto | Lincoln |
| Dodge | Mercury |
| Ford | Nash |
| Frazer | Nash |
| | Rambler |
| | Oldsmobile |
| | Packard |
| | Plymouth |
| | Pontiac |
| | Studebaker |
| | Terraplane |
| | Willys |

Win Prestige! Earn More Money!

MOTOR's Manual makes every operation so easy that you'll find yourself tackling jobs you wouldn't think of doing before. And you'll win added prestige and more money in the bargain.

Beginners will find usable helpful guidance on every kind of repair and service job imaginable. Experts will be amazed by the time and labor-saving short cuts.

This GIANT Manual is used by Army, Navy, Technical Schools, and thousands of successful auto-repairmen. Now YOU can try it FREE for 7 days. Learn firsthand how it can pay for itself the first few times you use it!

SEND NO MONEY

Mail coupon below — without money! When your book arrives — make it show you what it's got! Unless you agree it's the greatest time and work saver you've ever seen—return book in 7 days and pay nothing. Mail coupon NOW! MOTOR Book Department, Desk 2M, 250 West 55th St., New York 19, N. Y.



Just 2 of the Many Letters of Praise

"MOTOR's Manual paid for itself on the first 2 jobs, and saved me valuable time by eliminating guesswork." — W. SCHROP, Ohio

"Instructions so clear have no trouble learning anything about any car. Now working as mechanic in big plant." — SAM ORDONEZ, California

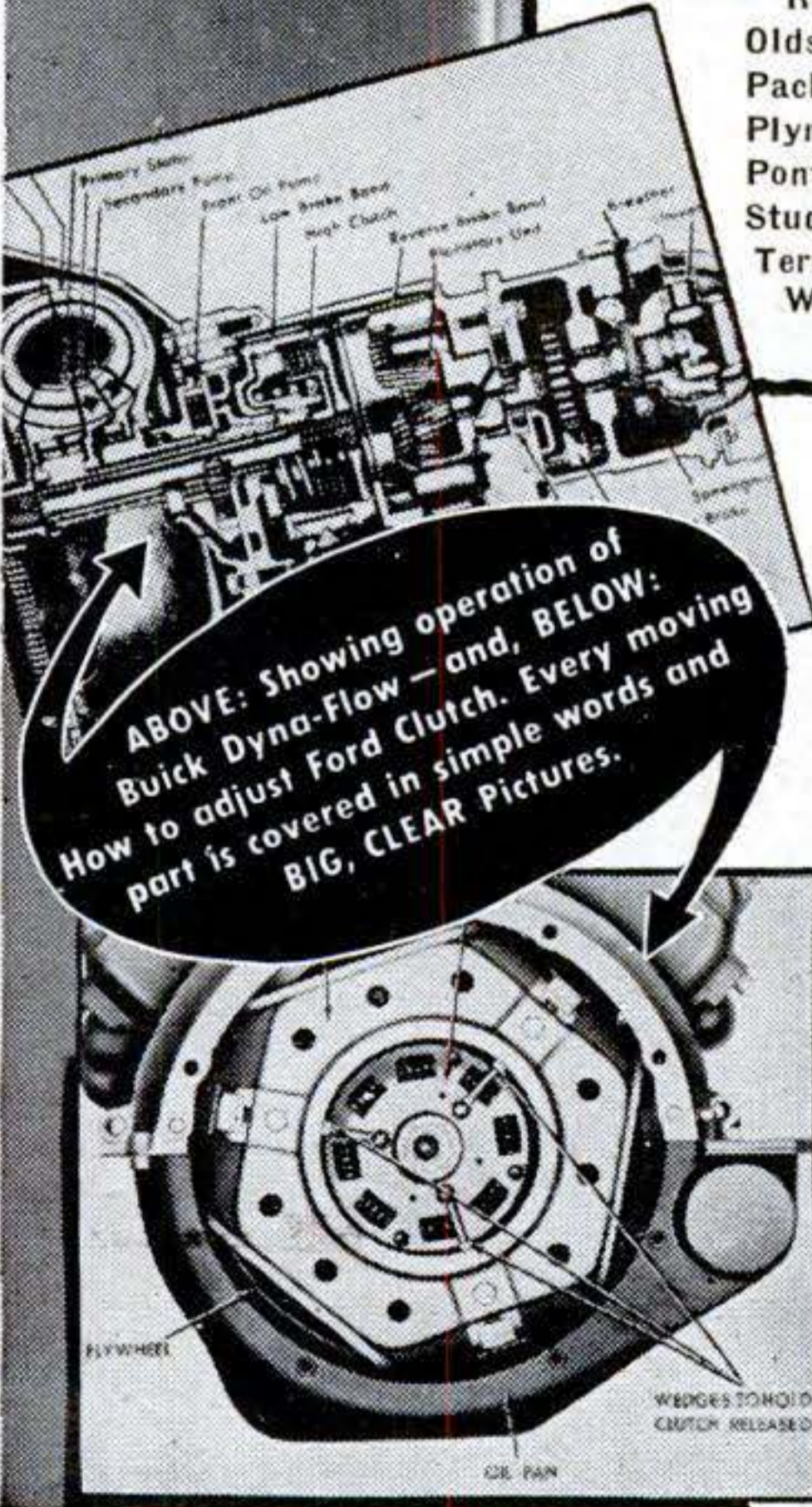

ABOVE: Showing operation of Buick Dyna-Flow — and, BELOW: How to adjust Ford Clutch. Every moving part is covered in simple words and BIG, CLEAR Pictures.

Same FREE Offer on MOTOR's New TRUCK & TRACTOR MANUAL

A "must" for mechanics, truck specialists, service stations, fleet owners. Covers EVERY job on 3058 truck and 157 farm tractor models made from 1936 thru 1951! Over 2267 pictures, 925 pages, 300,000 facts. Used by Armed Forces.

All types of Gasoline Engines, Fuel Systems, Governors, Lubrication Systems, Starters, Generators, Clutches, Transmissions, Axles, Brakes, Steering, etc.

For FREE 7-DAY TRIAL check box in coupon.



Published by MOTOR, The Leading Automotive Business Magazine.

MAIL COUPON NOW FOR 7-DAY FREE TRIAL

MOTOR BOOK DEPT. Desk 2M, 250 West 55th St., N. Y. 19, N. Y.

Rush to me at once (check box opposite book you want):
 MOTOR's New AUTO REPAIR MANUAL. If O.K., I will remit \$1 in 7 days (plus 35c delivery charges), \$2 monthly for 2 months and a final payment of 95c one month after that. Otherwise I will return the book postpaid in 7 days. (Foreign price, \$8 cash with order.)

MOTOR's New TRUCK & TRACTOR REPAIR MANUAL. (Described at left.) If O.K., I will remit \$2 in 7 days, and \$2 monthly for 3 months, plus 35c delivery charges with final payment. Otherwise I will return book postpaid in 7 days. (Foreign price, remit \$10 cash with order.)

Print Name.....Age.....

Address.....

City.....State.....

Check box and save 35c delivery charge by enclosing WITH coupon entire payment of \$5.95 for Auto Repair Manual (or \$8 for Truck & Tractor Repair Manual). Same 7-day return-refund privilege applies.

LINCWELDER

★ MAKES MONEY
★ SAVES MONEY

WELDS • SOLDERS
CUTS • BRAZES
CHARGES BATTERIES

Welds any thickness
of metal

Pays for
itself

Robert J. Maas of
Custar, Ohio, says,
"Just the savings in
cash I made last year
by repairing and build-
ing farm equipment
more than paid off the
cost of my "Lincwelder".
Don't know how I ever
got along without it."

FOR FARMS • GARAGES
REPAIR SHOPS

Fast, Easy Repairs on Cast Iron and Steel



LOWEST PRICED WELDER

"Lincwelder" AC-180-C Lincoln
Arc Welder with Arc Booster . . .
sells for only \$150* . . . less than
other welders of like capacity.
(Price varies to \$156 on West
Coast). Accessories \$20 extra.

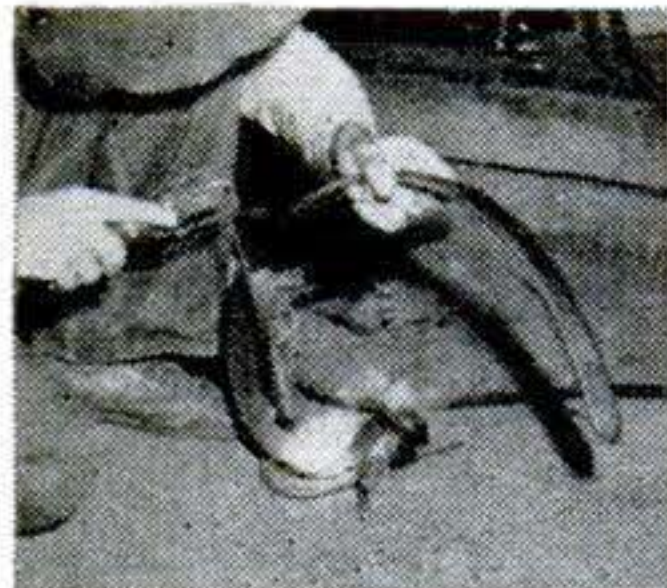

Above Left: Repairs spring tooth harrow with
simple butt weld using "Fleetweld 47" elec-
trode. Above Right: Crack in engine block is
fixed in a few minutes with "Ferroweld"
electrode.

- **Wide Range** . . . handles $\frac{1}{16}$ " to $\frac{5}{32}$ " electrodes.
- **Simple to Operate** . . . has Arc Booster for
no stick start.
- **Easy to Install** . . . operates on 230 volt
single phase line.
- **Approved** . . . by Underwriters' Laboratories.

Built by
THE LINCOLN ELECTRIC COMPANY
The World's Largest Manufacturer of
Arc Welding Equipment
Cleveland 17, Ohio

ORDER NOW

Fill out
and mail to
Dept. 204,
The Lincoln
Electric
Company,
Cleveland
17, Ohio

- Ship me the "Lincwelder" AC-180-C and accessories \$176.00.
Enclosed is check money order
 Send me free bulletin on the "Lincwelder" AC-180-C.

Name _____

Address _____

City _____ State _____

204

LINGUAPHONE

for LANGUAGES



FRENCH. GERMAN, SPANISH
RUSSIAN, JAPANESE, NORWEGIAN
—29 languages available

Learn AT HOME easily, quickly, by Lingua-
phone, World's Standard Conversational
Method. You LISTEN—you hear native men
and women speak—YOU understand—YOU
SPEAK the same easy natural way you
learned English long before you went to
school. Used internationally in schools and
colleges; a million home-study students.

Send for **FREE BOOK**
Approved for Veterans' Training

LINGUAPHONE INSTITUTE
147-10 RADIO CITY, N. Y. 20, N. Y.

EYE GLASSES by MAIL As low as \$1.95

WRITE for FREE
CATALOG with 14
LENS SAMPLE CARD

Thousands of
Customers
Est. 1939

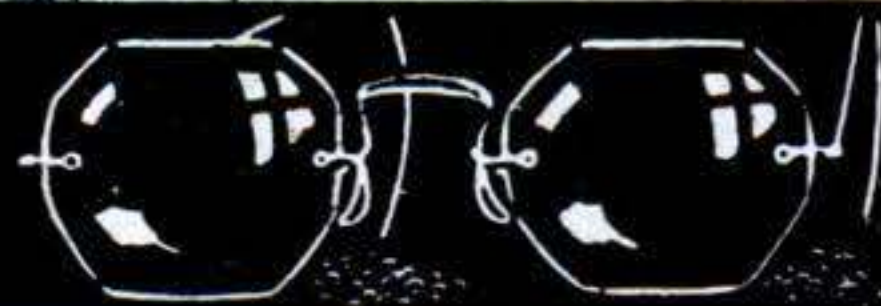

QUALITY READING-MAGNIFYING OR
BIFOCAL GLASSES FOR FAR AND NEAR
ADVANCE SPECTACLE COMPANY, Inc.
537 S. Dearborn St., Dept. SP-10 Chicago 5, Illinois

SHORTHAND in 6 Weeks at Home

Famous Speedwriting Shorthand, 120 wpm. No symbols;
no machines; use ABC's. Easiest to learn; write and
transcribe. Low cost, 150,000 taught by mail. For busi-
ness and Civil Service. Also typing, 30th year. Write for FREE booklet to:

Speedwriting
Dept. 2610-2, 55 W. 42 St., New York 36

THE ART OF DRAWING

Fascinating learn-by-doing lessons in drawing, painting,
illustrating and commercial art. Prepared for YOUR in-
struction and enjoyment in spare time at home. Purpose:
To turn amateur talent into PROFESSIONAL skill.
Cost? Surprisingly low. Send for FREE illustrated book-
let, "Building a Future" in Art. Write today.

GRANT SCHOOL OF ART Dept. B102, 225 N. Michigan
Avenue, Chicago 1, Illinois

How To Make More Money

Learn how thousands of businessmen, in every line,
are boosting sales in spite of conditions—with penny
messages—printed and illustrated in a few minutes
on government postal cards—with amazing new Ad-
vertising Machine, the patented **CARDMASTER**.
Your "today's" ideas will be read by your prospects
next morning. Not a toy, but a sturdy piece of equip-
ment, built to last. Buy direct from manufacturer
at low factory price. Guaranteed for five years.

SEND YOUR NAME TODAY. We'll send FREE
illustrated book of money-making IDEAS for your
business, complete, unique advertising plans, and 30
DAY FREE TRIAL OFFER. Just rush your name
today to: **CARDMASTER COMPANY**, Dept. 1610,
1920 Sunnyside Ave., Chicago 40, Illinois.

TRAIN AT HOME IN YOUR SPARE TIME

DON'T PUT IT OFF...MAIL TODAY!

GET THE MONEY AND SECURITY YOU'VE ALWAYS WANTED!



L. J. ROSENKRANZ, President, National Schools, the man who has trained many, many men like YOU. Men who now own successful, respected businesses of their own. Men who hold important, high-paying positions in famous companies. You CAN be a success. Mail coupon for more details.

Let Me Show You How! Mail the Coupon for My FREE Books!

Each book has page after page in color. Gives you the complete story about my proved training method...tells how quickly it can train you for a secure, high-paying job. Don't wait. Get the facts. Send today for my valuable books on Radio-Television or Automotive-Diesel. Check the coupon at right and mail it to me today. Absolutely no obligation.

NO SALESMAN WILL CALL!

I'll send you a **FREE SAMPLE LESSON TOO**, if you act fast! Shows how easy it is to learn with National Schools Home Training.



NATIONAL SCHOOLS, Dept. C-102
4000 South Figueroa Street
Los Angeles 37, California

Mail in envelope or paste on penny postal card

Send me *Free* the book checked below and the sample lesson. I understand no salesman will call on me.

- "MY FUTURE IN RADIO-TELEVISION & ELECTRONICS" OR
- "MY FUTURE IN DIESEL-AUTOMOTIVE & ALLIED MECHANICS."

NAME _____ AGE _____

ADDRESS _____

CITY _____ ZONE _____ STATE _____

Check here if you were released from the service less than 4 years ago.

Let National Schools - a resident-training school for nearly 50 years-train you at home for today's unlimited opportunities in Radio-TV or Automotive-Diesel. National Schools is one of the largest schools of its kind in the world. It has 4 big buildings of modern shops and labs. Its faculty is considered tops. You learn fast from easy lessons -all perfected under actual shop conditions. Approved for eligible vets.



Earn Extra Money while you're learning! I'll show you how!
EASY TERMS • FREE GRADUATE SERVICE
Mail coupon today-find out more!

WHICH HIGH-PAYING FIELD DO YOU WANT?

TODAY'S SHORTAGE OF TRAINED TECHNICIANS CREATES CHANCE OF A LIFETIME FOR YOU...IN EITHER FIELD!

RADIO-TELEVISION & ELECTRONICS

OR

AUTOMOTIVE-DIESEL AND ALLIED MECHANICS

JOB SECURITY! BIG MONEY! FOR YOU IN TODAY'S EXPANDING INDUSTRIES!

Think of it! With guided missiles, radar and other electronic devices so important to national defense. With big, new developments in color TV. With over 90,000,000 home and auto radios, over 12,000,000 TV sets. With more than 3100 radio stations...over 100 TV stations--and more building every day--imagine the terrific opportunity you have!

You Train at Home--In Your Spare Time

With National Schools Master Shop Home Training, you master all phases of Radio-Television-Electronics. You learn fast from hundreds of pictures and diagrams. All lessons have been developed and tested in National Schools famous shops and labs. No wonder your National Schools training is so up-to-date, practical, interesting. And so easy!

LOOK! WE SEND YOU ALL THESE PARTS! --and you keep them!



We send you lots of standard professional parts. You do lots of practical experiments. You learn step by step. Until you can build the big Superheterodyne Receiver you see above--and other important test units. Mail the coupon--today.

I TRAIN YOU FOR GOOD-PAYING JOBS LIKE THESE

Radio Station Engineer; District Service Manager; Aircraft Radio Inspector; Inspector Technician; Own your own repair shop; Service Specialist; Special Civil Service Positions; Sound Truck Operator; Complete Television Service and many others. Thousands of National Schools graduates have jobs like these. Why not you? Start your career--be sure to mail the coupon today.

Only National Schools Gives You This Professional Multi-Tester



You get this factory-made new Multi-Tester...an important instrument every Radio-TV man must have.

Attention: Men Going into the Service Soon!

With National Schools training in Radio-Television or Automotive-Diesel, you have the opportunity to get into special service classifications. That means higher pay and grade, more prestige--right away! This is important--so be sure to mail the coupon today without fail.

GREATEST DEMAND FOR TRAINED MEN IN HISTORY! NOW IS YOUR CHANCE!

What an opportunity! With over 8 million older cars needing big service and repair jobs. With defense industry having more high-paying jobs than they can fill. With the Armed Forces offering quick advancement to trained mechanics. YOU ARE NEEDED as never before! Now you can get the good pay, security, the satisfaction of doing what you want to do! Don't delay--mail the coupon NOW!

Right in Your Own Home!

You learn all about Gasoline Engines, Diesel and Special-Fuel Engines, Automotive Tune Up, General Garage Mechanics, Auto Electrical Service. You get complete training for this great, growing industry.

Yet National Schools Home Training is easy! Because it's based on actual shop methods in National Schools big resident school. Mail the coupon for more details--NOW.

National Schools Gives You All These Tools

You start out owning the tools of your trade. A kit of standard, professional tools and equipment. They're all part of your course! --And you keep them--they're yours!

I Offer You All These!

Basic Lesson Texts, Diesel Installation & Maintenance Instructions, Spare Time Lessons, Engine Service Manuals, Engine Repair Drive Systems, Diesel Electric Power Texts, Special Thermodynamic Instruction.

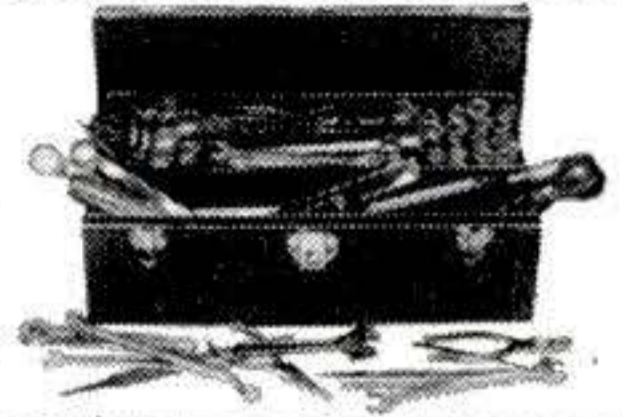

WHICH OF THESE HIGH-PAYING JOBS WOULD YOU LIKE?

- MOTOR TUNE UP SPECIALIST
- DIESEL ENGINE SPECIALIST
- FARM EQUIPMENT MECHANIC
- YOUR OWN GARAGE OR REPAIR SHOP
- GENERAL GARAGE MECHANIC
- PARTS DEALER
- AUTO ENGINE REBUILDING
- FUEL INJECTION SPECIALIST

You can have secure jobs like these. Just mail the coupon--and find out!

NATIONAL SCHOOLS TECHNICAL TRADE TRAINING SINCE 1905 LOS ANGELES 37, CALIFORNIA

New HAIR VAC

**Removes Dirt, Dust, Dandruff
Promotes Hair Health
with Electrical Massage!**



NEW IDEA IN HAIR CARE!

Yes, HairVac cleans as it massages . . . loosening and vacuuming away dirt, dust, dandruff scales, foreign matter. At the same time, its 24 vibrating rubber fingers give that healthful massage which stimulates circulation, distributes the vital natural oils, encourages softer, better-looking hair. makes your scalp feel wonderful!

- Easy, pleasant to use. Massage brush lifts out to insert sanitary filter. You'll be amazed at the amount the filter catches. After use, throw filter away.
- No lotion, no water, no soap, no goeey oil—HairVac's stimulating massage keeps your scalp in naturally lubricated condition . . . avoids the dangers of too frequent strong shampoos. Also lessens the dangers of catching colds in winter.
- For the ladies, HairVac saves wave-setting time, helps lengthen the life of a permanent . . . makes hair easier to care for, better looking.
- Very convenient for bed-patients where a shampoo is inconvenient or dangerous. Barbers use HairVac in their best scalp treatments, and to remove hair clip-pings.
- Helps improve the condition, the natural good looks, of your hair. Ideal for all the family.
- Handsomely designed by Walter Dorwin Teague. Quiet, efficient. 6-foot cord. AC only. UL approved. Fully guaranteed.

Order your Hair-Vac by mail today, direct from factory. Enclose check or money order and we pay postage. Or order COD, plus postal charges. Immediate delivery. If not fully pleased with what HairVac does for your hair and scalp, return at once for full refund.

ONLY \$14.95
including massage brush and 100 filters

REPRESENTATIVES WANTED

**The HairVac Co., Dept. 810
304 Kansas Ave. Topeka, Kansas**

**The HairVac Company, Dept. 810
304 Kansas Ave., Topeka, Kansas**

Please send me.....HairVacs at \$14.95. Also.....
extra packages of 100 filters at \$1.00 per package, and
.....additional massage brushes (for others in the fam-
ily) at \$1.00 each.

Name.....

Address.....

City and State.....

MAKE EXTRA MONEY

PLASTICS

LEARN AT HOME

LEARN HOW TO MAKE fast-selling PLASTIC NOVELTIES FURNITURE JEWELRY



There are RICH OPPORTUNITIES for MEN and WOMEN with "know-how" in Plastics. Interstate's new Plastics course tells and shows how to make hundreds of fast selling items out of Plastics. Gives complete training in fabrication, casting, lamination, molding, internal carving, etc., in simple, easy, step-by-step language and pictures. Plastics and Fabricating Kits for 23 valuable Plastic items come with training at no extra cost. **START A PLASTICS BUSINESS OF YOUR OWN.** No other industry holds such promise for the future. You can make big money manufacturing novelties, toys, signs, etc., in your own home in spare or full time. Don't wait! Learn NOW how Interstate's Plastics Training qualifies you for success in the Plastics field.

PLASTICS AND SUPPLIES FURNISHED FOR 23 VALUABLE PROJECTS

INTERSTATE TRAINING SERVICE

Dept. 2CK

Portland 13, Oregon

STUDY AT HOME

WITH AN EDUCATIONAL INSTITUTION

Courses in ENGINEERING: Electrical, Civil, Mechanical, Drafting, Architectural, Automotive, Steam, Diesel, Aeronautical, Radio, Structural, Mining, Industrial, Petroleum, Marine, Refrigeration, Air Conditioning, Chemical.

Courses in ARTS AND SCIENCES: Philosophy; Education; Letters; Public Health; Medical Jurisprudence; Psychology; Sociology; Physics; Chemistry; Geology; Pol. Science; Theology; Law; Business and Commerce; Accounting; Mathematics; Statistics; Agriculture. Send for free catalog.

McKinley-Roosevelt Incorporated, 4610-A3, Sheridan Rd., Chicago 40, Illinois

PLAY GUITAR IN 7 DAYS OR GET MONEY BACK

Let Ed Sale, top Radio Guitarist, teach you to play a song the very first day, and any song by ear or note in 7 days! His famous book contains 52 photos, 87 chord charts, etc. Shows how to tune, keep time, build chords, bass runs, dance chords, swing, etc., plus 110 Popular Songs, words and music. Surprise friends, relatives. Popularity and fun galore. **SEND NO MONEY!** Just name and address to Ed Sale and pay postman \$1.98 plus C.O.D. postage (or send \$2 with order and I pay postage. Same guarantee). **ED SALE, Studio 1801, POINT PLEASANT, N. J.**

BECOME AN EXPERT IN TRAFFIC

Traffic men earn \$4,000 to \$10,000 and up. Thousands of firms need experts on rates, tariffs, regulations. We train you thoroly in spare time at home for executive traffic jobs. Personal training under traffic authorities. Placement counsel and help. Write for free 48-page book "Traffic Management—the Fast Growing Profession."

LASALLE Extension University, 417 So. Dearborn St.
A Correspondence Institution Dept. 1083T Chicago 5, Ill.

TUBE GIVEN WITH EVERY TIRE AT NO EXTRA COST



Why Pay More!

**FALL SPECIALS—AT LOW PRICES
SAVE TIME—SAVE MONEY—SEND THIS AD
GOOD USED TIRES—NOT RECAPS
19 YEARS AT THIS ADDRESS
BE WISE—A TRIAL OF ONE
TIRE WILL CONVINCCE YOU.**



EXTRA SPECIALS—29 MONTH WRITTEN GUARANTEE

600-16	\$4.75	550-15	\$4.95	700-15 (6)	\$9.85	700-20	\$11.05
600-16 (6)	5.75	640-15	4.95	750-16 (8)	9.75	750-20	12.75
650-16	5.75	670-15	5.15	700-17	10.95	750-20 (10)	16.15
650-16 (6)	6.45	710-15	6.65	750-17	11.65	825-20	18.35
700-16	6.45	760-15	5.85	750-15	14.05	900-20	17.35
750-16	6.95	800-15	6.55	825-15	16.05	1000-20	17.85
525-18	5.95	820-15	6.55	600-20	8.85	1100-20	20.55
550-17	4.95	670-16	6.65	650-20	10.25	1200-20	23.75
650-15	5.05	760-16	6.55	32x6 (8)	10.65	1000-22	20.55
700-15	4.75			32x6 (10)	10.95	1100-22	20.55
Whitewalls	\$1.00 Extra			Military trends	750x20 (8)		14.05

Thousands of tires shipped all over U. S. A. All tires shipped F.O.B. Phila. Send Check or M.O. with this ad. Dept. 5.

STANDARD, 834 N. Broad St., Philadelphia 30, Pa.

"Last year's great literary find was Boswell's *London Journal*. This year's is Friedrich Nietzsche's *My Sister and I*. And of the two this second is certainly the greater."

The San Francisco Argonaut

Suppressed for 50 Years

MY SISTER AND I

An Autobiography and a Way of Life

By **FRIEDRICH NIETZSCHE**



ELISABETH FOERSTER-NIETZSCHE — her anomalous desires drove her great brother to an asylum, and caused her husband's suicide.

"He goes back to his younger days when lust and pride ran strong in him. He grovels again in the unrepented orgies of his youth."

St. Louis Post-Dispatch

"He is most coherent in his descriptions, devoting the great majority of passages to sensational revelations of his strange life."

Wichita (Kansas) Eagle

"... a dark, tragic, terribly compelling glimpse into hell."

Long Beach (Calif.) Press-Telegram

"... an absorbing story of one of the greatest tragedies of modern times. Its style is sufficient evidence of its authenticity."

San Antonio Express

"... it opens the way for startling insight into the author's private life. The relationship with his sister Elisabeth is delineated with candid accuracy."

Greensboro (N.C.) News

My Sister and I is a book of revelations—the supreme adventure of our civilization focused on the lives of one man and two fascinating, reckless, beautiful women. The struggle of these women to establish domination over this man—one of the greatest of the world's philosophers—brings the whole maddening fabric of our world into glittering relief.

As reviewers are pointing out, MY SISTER AND I is the most important book-discovery of our time. For a limited period we are offering the \$4 edition to the readers of this magazine for.....**ONLY \$2.95**

**CONTINENTAL BOOKS: Dept. PS
110 Lafayette St., New York 13, N. Y.**

Gentlemen: I enclose \$2.95 for my copy of the \$4 edition of MY SISTER AND I. I may return it for *full credit* if it does not *fully meet my expectations*.

NAME

ADDRESS

CITY..... ZONE..... STATE.....

Send C.O.D. I enclose \$1 and will pay balance to postman.



**YOU
can
acquire**

**LAW NIGHTS AT HOME!
L L.B. DEGREE**

LaSalle's famous Law Library—used as reference in many Law libraries and Law offices—has enabled thousands to master Law surprisingly fast, in spare hours at home, for business and professional advancement.

These 14 remarkable volumes, compiled by leading professors and lawyers, cover the whole basic field of Law in condensed, orderly, simplified manner.

You advance rapidly with this great library, plus special lectures furnished. We guide you step-by-step with personalized Problem Method of instruction . . . you *learn by doing*—handling legal problems—not by memorizing rules.

Send for two FREE 48-page booklets, "Law Training for Leadership," and "Evidence," answering questions about Law and its value to you, and telling how LaSalle Law graduates are winning rapid advancement in business and public life. Mail coupon below. No obligation.

**LA SALLE EXTENSION UNIVERSITY
A Correspondence Institution**

417 S. Dearborn St. Dept. 1083 L Chicago 5, Ill.

Send me your two FREE booklets described above, without obligation.

Name.....Age.....

Street.....

City, Zone & State.....



C2

COLORCRETE

Lifetime beauty comes out of a gun! Colorcrete is a cementitious plastic, applied by pneumatic pressure to new or old concrete, stucco, etc. Tough, tenacious, enduring. Can be washed or scrubbed. Dirty, drab surfaces become sparkling white or tinted from a range of 30 colors.

**"Building-Beautifying"
—Your Big Opportunity**

Colorcreting is a fascinating and profitable opportunity for men who want to build a substantial, long-term business. Colorcreting is exclusive. Rich in sales appeal to building owners. Income potentials are high; investment is low. We supply complete equipment, full instructions and liberal cooperation. Requires no previous experience or special ability. Write or wire for the Opportunity Book today. Be the first in your community.

COLORCRETE INDUSTRIES, INC.
572. Ottawa Ave., Holland, Mich.



MAKE CRIME YOUR BUSINESS

ON THE SIDE OF THE LAW!

Help fight crime! . . . Earn steady good pay as a Finger Print Expert, or Investigator. I.A.S. trains you—by easy, low-cost home study lessons. Learn this exciting work in spare time. Write for full details now!

OVER 800 POLICE BUREAUS...

Employ I.A.S.-trained men . . . proof of what I.A.S. can do. Write today (state age) for details. No obligation. No salesmen will call.

INSTITUTE OF APPLIED SCIENCE

Dept. 1367, 1920 Sunnyside Avenue
Chicago 40, Illinois

**IMPORT
PAYS BIG**

Opportunity to **START AT ONCE** **IMPORTING** big profit items for your own world-wide import-export business by mail order without capital, from home, anywhere; or work for others—profits unlimited, travel abroad if desired. No previous experience needed. Men, women... learn at home in spare time from established World Trader, easy step-by-step method. **FREE** details—write **NOW!** Airmail reaches us overnight. **MELLINGER CO., Suite 24A, 1717 Westwood, Los Angeles 24.**



**20 LESSON COURSE
SENT FOR NO-RISK
EXAMINATION**

**CARBURETOR TOO RICH
MAKES MOTORIST TOO POOR**



Car owners who are wasting money, getting poor gas mileage due to over-rich mixtures, will be pleased to learn how to save gasoline by **VACU-MATING OVER-RICH MIXTURES.** Vacu-Matic fits all cars, trucks and tractors. *Automatic* and operates on the supercharge principle. Easily installed in a few minutes.

SALESMEN WANTED! Big Profits

For **FREE** particulars, how you can install one on your own car for introducing, just send your name and address on a postcard to **VACU-MATIC, 7617-1945 W. State St., WAUWATOSA, WIS.**

WHAM-O SPORTSMAN * \$1.50 POSTPAID 35-LB. PULL!

HITS LIKE A RIFLE—
KILLS RABBITS, SQUIRRELS.
Powerful, silent, accurate.
For hunting, target,
routing pests.
Sportsman's choice
sold world
over!



**HUNTING
SLINGSHOT**

Heavy duty 7" ash stock.
40 steel balls, extra rubber, target.

GUARANTEED. At dealers, or send \$1.50 to
Wham-O Mfg. Co. Box 88, South Pasadena, Calif.
* Professional model of Nat'l Slingshot Assn.

**KIDNEYS
MUST REMOVE
EXCESS WASTE**

Nagging backache, loss of pep and energy, headaches and dizziness may be due to slowdown of kidney function. Doctors say good kidney function is very important to good health. When some everyday condition, such as stress and strain, causes this important function to slow down, many folks suffer nagging backache—feel miserable. Minor bladder irritations due to cold or wrong diet may cause getting up nights or frequent passages.

Don't neglect your kidneys if these conditions bother you. Try Doan's Pills—a mild diuretic. Used successfully by millions for over 50 years. It's amazing how many times Doan's give happy relief from these discomforts—help the 15 miles of kidney tubes and filters flush out waste. Get Doan's Pills today!

Now I've got a
HIGH PAYING CAREER in
TELEVISION
RADIO & ELECTRONICS
 —thanks to the famous
CRESCENT SCHOOL
 Home Study Course!



Yes, a brilliant future
 awaits you in **TELEVISION**.
 My advice is to send for the
 details now about the
CRESCENT course!

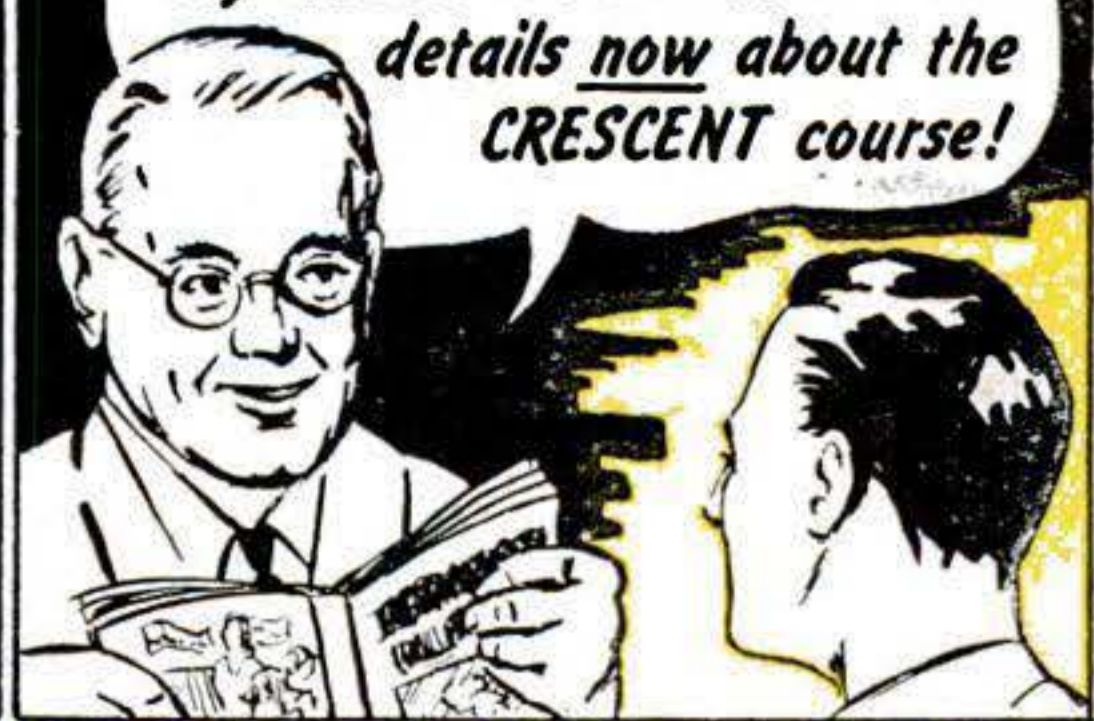

It's the **CRESCENT**
SCHOOL
FREE sample
 lesson. Boy!
 That was fast!



Gosh—I can actually earn while
 I learn with the practical
CRESCENT SCHOOL course!



Learning in my
 spare time is so
 easy with these
 illustrated,
 simplified
 lessons!

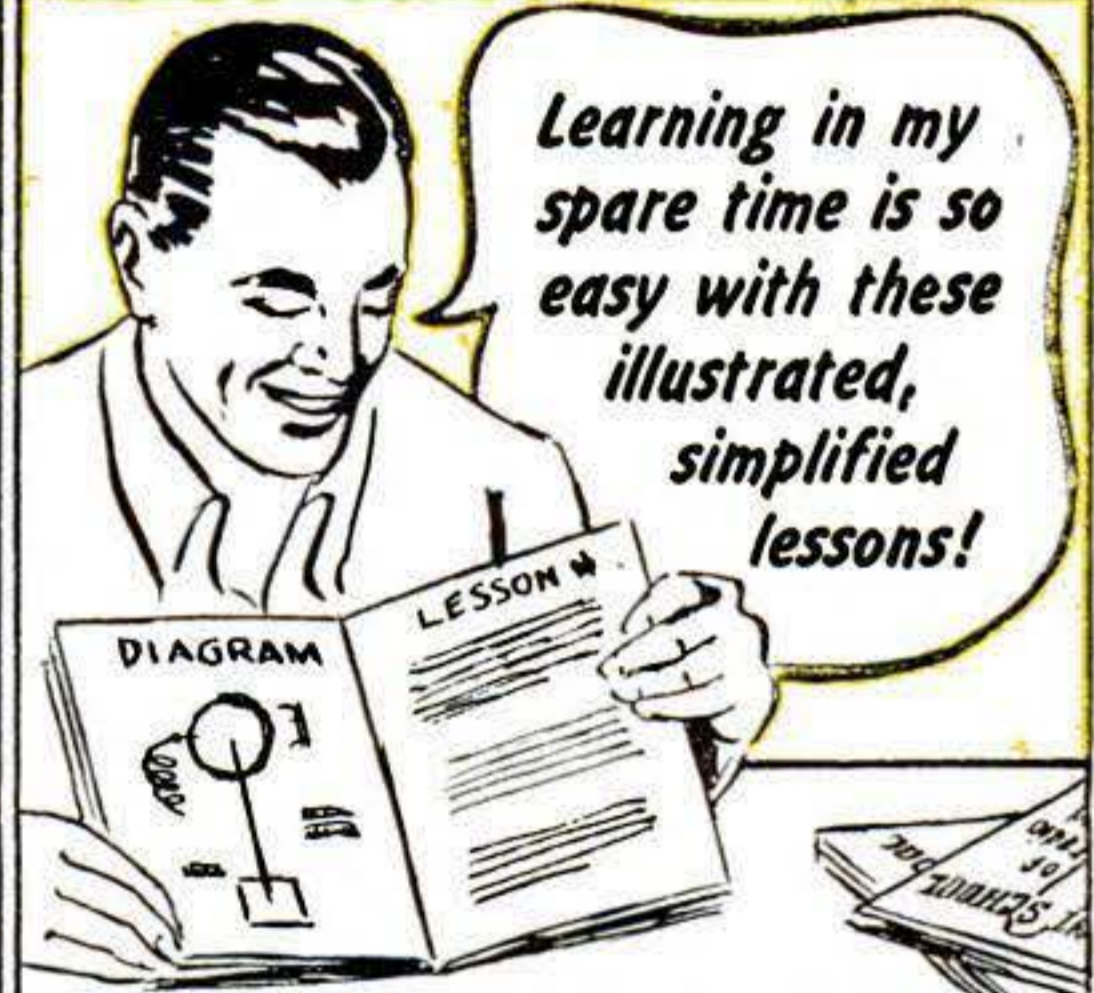

Wow! I built this swell TV
 set myself with my complete
CRESCENT kits!

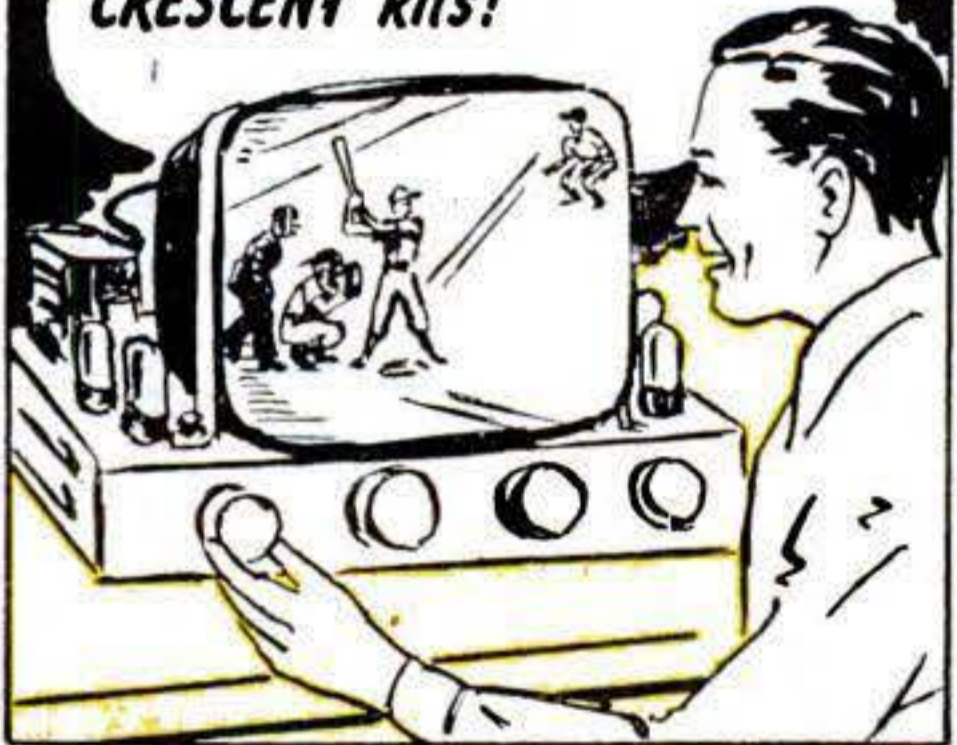

I'm sure proud of my
CRESCENT SCHOOL certificate
 ...now I can really start
 on a big career!



Imagine—my own business, a home,
 a new car—and the **CRESCENT**
SCHOOL course started it all!



Approved under the G.I. Bill,
CRESCENT SCHOOL has trained
 thousands for **BIG** careers in the
 fast-growing **TELEVISION**
 industry.



CRESCENT SCHOOL
 "One of the largest
 schools of its kind"

ACT TODAY to start on a profitable
 career in **TELEVISION!**
 Get your
 sample lesson **FREE!**

SEND COUPON TODAY!

CRESCENT SCHOOL Dept. A-10
 500 Pacific St., B'klyn 17, N. Y.

Sirs: Rush your **FREE** sample lesson and full details about
 the **CRESCENT SCHOOL** Home Study Course—at no obli-
 gation to me!

NAME

ADDRESS

CITY.....ZONE.....STATE.....



EARN MORE IN DRAFTING

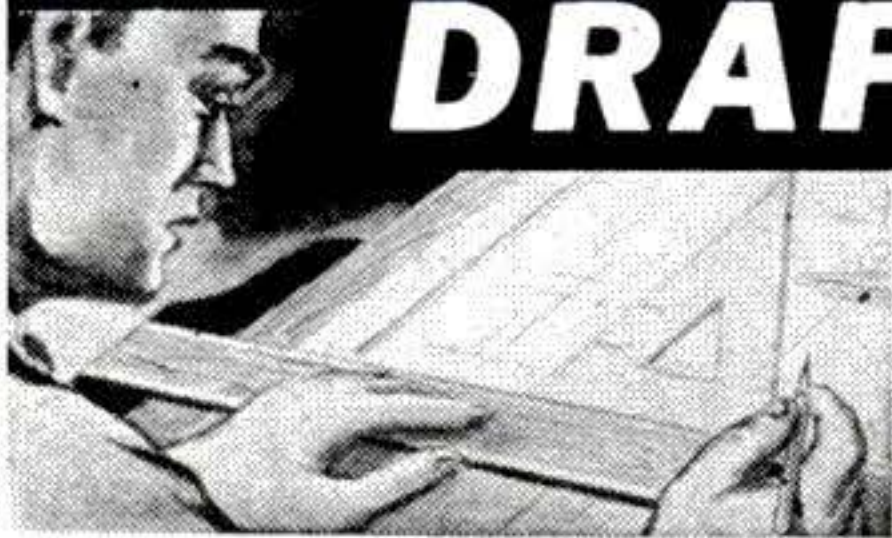

MORE OPPORTUNITIES for EMPLOYMENT and PROMOTION

"Here I am at work making good money as a draftsman. I'm glad I sent the coupon to Chicago Tech for that Free Trial Lesson and found out how easy it is to learn Drafting in spare time at home. Today I feel secure in my job because the draftsman's work comes first on any new project. And, in addition, draftsmen can't be replaced with machines. What's more, I feel I'm slated for promotion and more pay, because I see so many draftsmen advancing to high-pay jobs."

LEARN IN SPARE TIME—AT HOME!

(or at the College in Chicago)

A few hours of pleasant home study every week—that's all. No interference with your present job. All the tools you need; drawing outfit included. With Chicago Tech's help, you train yourself step by step. This tested method—developed over 48 years of C.T.C. progress—prepares men quickly for good positions in industry.



FREE INFORMATION — SEND COUPON

To prove to you how easy it is to learn Drafting at home by the Chicago Tech method, we will send you this FREE TRIAL LESSON. No charge for this lesson, now or later. Fill out and mail coupon, or send post card today.

CHICAGO TECHNICAL COLLEGE

N-220 Tech Bldg., 2000 So. Michigan Ave.
Chicago 16, Illinois

Mail me FREE Lesson with information about big opportunities in DRAFTING.

Name.....Age.....

Address.....

City.....Zone.....State.....

MATTISON SILVER ROCKET 630 CHASSIS with TUNEABLE BUILT-IN BOOSTER for better DX Reception

(increases signal strength up to 10 times).

Featuring NEW CASCODE TUNER made for UHF interchangeable tuning strips and NEW COSINE YOKE for edge to edge focus.

MADE IN MATTISON'S OWN CABINET FACTORY

36 breathtaking cabinets that blend perfectly in any setting, traditional or modern. Write for FREE descriptive brochure.

DEALERS, SERVICE-DEALERS

Here is your opportunity to become the "important" TV dealer in your area. FREE! Write for MATTISON MERCHANDISING PORTFOLIO.

"Unassembled Plan" and "\$1,000,000 Floor Plan"

When you buy from Mattison you need only one source of supply. You can buy a Chassis, a Cabinet or a complete TV Set!

FREE TO ALL! FULL LINE CATALOG

Write for Catalog and name of nearest dealer



Manufactured with integrity

Mattison Television and Radio Corp.

893 Broadway
N. Y. 3, N. Y. Dept. PS-1



LEARN TO SERVICE AND REPAIR ELECTRIC APPLIANCES

Get a Good Job—Run Your Own Business

Be the man who knows how to service and make quick repairs on washing machines, vacuum cleaners, heaters, toasters, stokers and household motors and gadgets of all kinds. Get into this pleasant, easy and good pay work. Get the sensational new book—Electric Appliance Repair and Servicing.

An investment of only \$3.00 will positively get you started in this vital field in a good-pay job or help you build up a profitable business of your own. Run it from your home. No starting capital needed. No experience in electricity required. The book explains how to diagnose and locate trouble and how to fix it. 302 Pages, 188 how-to-do-it illustrations.

FREDERICK J. DRAKE & CO., Dept. 27, 117 Green Bay Road, Wilmette, Ill.



MONEY BACK IF NOT SATISFIED

Clip this ad and mail with only \$3.00 currency, check or M. O. or we will send C.O.D. Use the book for 5 days. See how easily you can make it pay for itself hundreds of times over. Then if you are not fully satisfied—send it back and we will refund your money quick. Rush order today. Get started at once.

START A BUSINESS OR MAKE MONEY SPARE TIME

LEARN AT HOME UPHOLSTERING

Easy to learn at home—in a few months! Easy to start a shop, or earn spare-time profits! Make money as you train. Complete tool set, all materials to build ottoman, included with illustrated lessons. Low terms. Write for valuable booklet today!



COMMERCIAL TRADES INSTITUTE
1400 Greenleaf Ave., Chicago 26, Ill.

Dept. U1-10



HAVE MORE FUN TRAVELING

DINSMORE AUTO COMPASSES are a constant source of information, interest and education. Passengers love it! Saves time, worry. No back-track, no wrong turns. Quickly installed. You'll enjoy every minute of driving with America's first and finest illuminated auto compass. Fully jeweled with micromatic compensator. If your dealer cannot supply, order direct. Only \$5.49 postpaid.

FREE Folder on compasses for the hunter, camper, fisherman, sailor, plus a history of the compass, "Pants, Knives and Compasses." Send for your copy today.



An Ideal Gift

FITS ALL CARS

DINSMORE INSTRUMENT COMPANY

1804-39 Kelso St.
Flint 1, Michigan

A "GOOD HAND" HELPS YOU SUCCEED!

Your Name beautifully written, plus special pen-point for shaded writing, Only 10¢

LEARN TO WRITE WELL

Handwriting quickly improves with our easy-to-understand picture lessons! Put your spare time to good use; send today for FREE BOOKLET, "How to Become a Good Penman," or check volumes wanted below at \$1 each: Business Writing Artistic Writing Card Writing Bird & Design Flourishing Engraving Alphabets. COMPLETE SET \$4.50. Ask for price list of penman's supplies.

TAMBLYN SCHOOL of PENMANSHIP
S. A. Ziller, Pres. 438 Ridge Bldg., Kansas City, Mo., USA

Illustrated BOOKLETS

HERE THEY ARE, illustrated comic booklets just off the press. Good clear illustrations. Send \$1 for 12 booklets and receive FREE two of the larger size 32 page books. Rush a buck for all 14 books to,

AL'S PRINT SHOP
216-D W. JACKSON BLVD. CHICAGO, ILL.

New Co-op Economy Club May Save Millions for Nation's Motorists.....

OVER 1/2 MILLION MEMBERS PAY NO DUES OR FEES...ENJOY ALL CLUB BENEFITS

By Raymond J. Carpenter

LOS ANGELES, August 20 (GEC)—Less than 22 months ago a group of Los Angeles wholesalers started a new, cooperative Auto Economy Club. These businessmen believed that it would be mutually profitable to share their earnings with the car owners and householders of the nation. Now, in less than two years, the Gane Economy Club boasts of a membership in excess of half a million and it is continuing to grow like wildfire. Car owners from every state in the union, from Canada and most U. S. territories are saving thousands of dollars by using club recommended economy methods and special club discount privileges on both automotive and household products.

Why the Economy Club Was Formed

The businessmen who founded the GE Club realized that if they could develop a following of loyal, cooperative club members they could: 1. Eliminate the middleman. 2. Do away with product advertising expense (in today's economy it costs more to sell a product than to manufacture it). 3. Cut merchandise costs greatly by buying in greater volume.

Why the GE Club Is Sweeping the Nation

Since thousands of dollars are saved through club cooperative buying and selling, this profit is shared with club members in the following ways: 1: Members can buy hundreds of outstanding automotive and household products at discounts ranging from 10% to 40%.

2. Members get a free full year's subscription to the "Economy News," big club magazine. This magazine features:

A. Hundreds of pictures and descriptions of new, tested products for your car and home... all at big club discounts.

B. Stories and technical information from leading national sources on such subjects as: "How To Increase The Re-Sale Value Of Your Car"; "How To Get Up To 42 Miles Per Gallon From Any Car"; "How To Beat The Auto Repair Racket"; "How To Drive 16,000 Miles Without Changing Oil."

3. As a new club member you can start at once to enjoy special "Buy Without Money Privileges." This plan allows members to get absolutely cost free their choice of hundreds of items listed in club catalogs.

Club Membership Is Open to All

The many benefits of this giant new cooperative club are available to anyone who drives a car. Members are from every walk in life: housewives, business men, secretaries, tradesmen, etc. All have the same opportunity to share the auto economy secrets developed through club research and money saving benefits made possible by club volume purchases.

Club Can Benefit 50 Million Motorists

Club officials estimate that a five million club membership will be reached within the next 24 to 36 months and will continue to expand and grow.

'Buy Without Money Plan' Amazes Club Members

It's hard to believe, but it's true... any club member can buy any or all the hundreds of items shown in the club magazine and in club merchandise catalogs without paying one red cent. This revolutionary merchandising plan gives all club members the opportunity to save hundreds of dollars if they wish by merely HELPING GET NEW, QUALIFIED CLUB MEMBERS. It's easy... you don't buy or sell anything... you just invite your friends to join the club and share its many benefits.



Shown here: Club Surprise Package of credit checks, certificates and money saving coupons sent free to all new member's.

A "Cost Free" Club

Though Club members can save many, many dollars through special club discounts, they are required to pay no dues or fees of any kind. After making the club's registration deposit a club member can enjoy all club benefits thereafter without ever paying one solitary cent. (The \$1 deposit will be refunded upon the return of the membership card and the new member "surprise" package complete.)

Club Life Membership Card Is Yours for the Asking

The official Gane Economy Club membership card shown here will be issued, registered in your name and sent to you postpaid in the big, valuable New Member's Surprise Package as soon as your registration deposit is received. WRITE TODAY!



This photograph shows just a few of the hundreds of automotive parts and accessories available to Economy Club members at big discounts. Club's amazing "Buy Without Money Plan" enables members to buy any or all items in club catalogs without spending one cent.

How Club Members Save Money Through Special Discount and Gift Offers

All new Economy Club members receive a big club "Surprise Package" along with their life membership card. This package contains FREE Gas Coupon, FREE Credit Checks, FREE Credit Memorandum, FREE Gift Certificates, FREE Money-Saving-Coupons, FREE Trial and Premium offers.

FREE GAS COUPONS—This special Economy Club coupon may be used the same as cash in purchasing gas at your favorite service station. Station owners then may use these coupons to buy merchandise from the club wholesale department.

FREE CREDIT CHECKS—Credit checks, Credit memorandums, money saving coupons and discount certificates ranging from \$1 to \$12 in value can be used the same as cash in purchasing many outstanding automotive and household items.

FREE TRIAL OFFERS—Club officials have arranged for many household and automotive products to be sent (pay no deposit, pay postman nothing) to club members cost free so that they can "Try Before They Buy."

Memberships Issued "On Approval" Only

When your membership card and Club Surprise Package arrive, browse through its fascinating contents at your leisure. Read the "Economy News," the club magazine, and other interesting material. Examine the valuable credit checks, money saving coupons and free trial certificates. Then, if you do not believe that the club offers you a great opportunity... give up

CLUB MEMBERS SAY:

MR. J.K.H., NEWARK, NEW JERSEY, SAYS: "I think your discount club is the greatest thing since television. I want memberships for my two brothers, as I figure I've saved about \$13 on auto accessories already."



MRS. HARRY L.S., PROVO, UTAH, SAYS: "Your 20% discount on household items has sold me on buying most of my Christmas presents through the club."

MR. ALBERT R.E., FORT WORTH, TEXAS, SAYS: "Don't know how you do it...your Economy Club deal is the best \$1 value I've ever seen."



your membership by returning the complete package within 10 days AND YOUR REGISTRATION DEPOSIT WILL BE PROMPTLY RETURNED

OFFICIAL CLUB APPLICATION FORM

GANE ECONOMY CLUB, DEPT. CP-10
6238 Wilshire Blvd., Los Angeles 48, Calif.

Gentlemen: Please send me my surprise package and club membership card entitling me to all club discount privileges and benefits.

I enclose \$1 (cash, check, stamps, or money order) to cover the registration deposit.

I understand that, if not completely satisfied, I may return the club package within ten days and my deposit will be refunded.

PLEASE PRINT PLAINLY

NAME _____

ADDRESS _____

CITY _____ ZONE _____ STATE _____

LET ME PROVE I Can Make YOU a New Man!

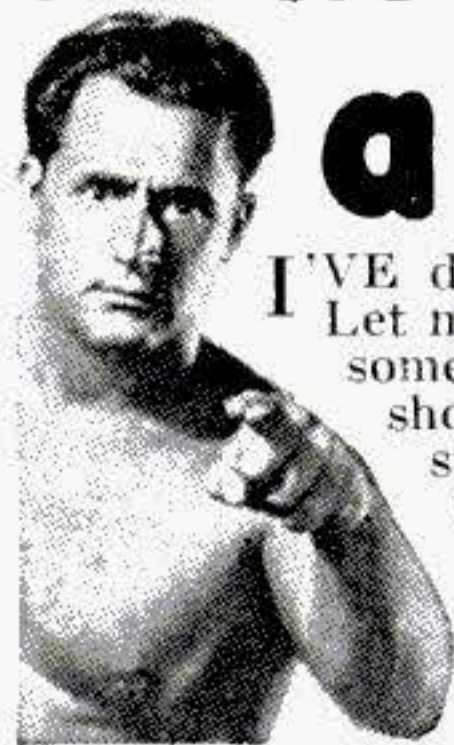

Charles Atlas — winner of title "World's Most Perfectly Developed Man"

I'VE done it for thousands of other fellows. Let me prove I can add solid inches of handsome, rippling muscles to YOUR arms, legs, shoulders, back . . . make you an outstanding specimen of strength and self-confidence. My secret of "Dynamic Tension" does it in just 15 minutes a day. You'll be amazed at the results and so will your friends.

FREE—My 32 Page Illustrated Book is Yours—Not for \$1 or 10c—But FREE

32 pages packed with valuable advice, actual photographs of fellows who became new men almost overnight . . . with "Dynamic Tension."

Book can mean turning point of your life. It's yours—ABSOLUTELY FREE. Send for it TODAY. Address me personally: CHARLES ATLAS, Dept. IX, 115 East 23rd St., N. Y.

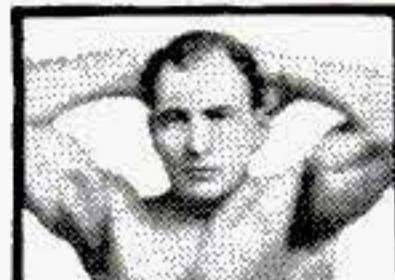

5 INCHES OF NEW MUSCLE
"My arms increased 1 1/2"; chest 2 1/2"; fore-arm 7/8"
C. S., W. Va.
"Have put 3 1/2" on chest (normal) and 2 1/2" (expanded)."
F. S., N. Y.

CHARLES ATLAS, Dept. IX
115 East 23rd St., New York 10, N. Y.

Send me—absolutely FREE—your famous book, "Everlasting Health and Strength"—32 pages, crammed with photos, answers to vital questions, valuable advice. I understand book is mine to keep, and sending for it does not obligate me in any way.

Name _____ Age _____
(Please print or write plainly)
Address _____
City _____ State _____



**MEN! TRAIN NOW FOR
A BIG PAY FUTURE IN
DIESEL
& SCIENTIFIC MOTOR TUNE-UP**

- Diesel Construction
- Diesel Engine Repairman
- Diesel Operator
- Industrial Maintenance
- Auto Engine Rebuilding
- Bus & Truck Maintenance

Be a Trained Diesel Man

Go places with DIESEL! Farms, factories and power plants, trains, ships, trucks, busses all use DIESEL POWER . . . all need DIESEL-trained men! You can start your DIESEL training at home, in spare time, with tested, proved U E I training. Course includes practical work on Diesel engines under skilled instructors. You learn the operation, maintenance, servicing of all types of Diesel engines, PLUS Scientific Motor Tune-up.

ACT NOW! If you have mechanical ability, you'll like Diesel! High School diploma not necessary. Write now for FREE book, "EARNING POWER IN DIESEL." Act Today!



MAIL NOW FOR FREE BOOK!

UTILITIES ENGINEERING INSTITUTE, Dept. DM-16,
2521 Sheffield Ave., Chicago 14, Ill. (Founded 1927)
O. K.! Rush, without obligation, FREE Book on DIESEL.

NAME _____
ADDRESS _____
CITY _____ ZONE _____ STATE _____
 Check here for information if under 17.



EVERYTHING IN LEATHERCRAFT

For Beginners - For Professionals
For Advanced Hobbyists



America's Most Complete Stock of Kits, Leathers, Tools, Supplies

It will pay you to get acquainted now with LARSON Leathercraft. Easy-to-Assemble kits for beginners require no tools or experience to make belts, billfolds, purses, gloves, woolskin animals, etc. Complete stock of moderate-priced tooling leathers, top-quality calfskins, tools, supplies for advanced hobbyists and leatherworkers. Send 10c TODAY for big illustrated catalog. J. C. LARSON CO., 820 So. Tripp Ave. Dept. 2026, CHICAGO 24, ILLINOIS

COMPLETELY ASSEMBLED READY FOR IMMEDIATE USE 60 POWER TELESCOPE \$3.95

VARIABLE EYEPIECE 20 x 40 x 60—BRASS BOUND

NEW! Three telescopes in one. 3 different magnifications. 20 power for ultra-bright images with 40 and 60 power for extra long range. Guaranteed to bring distant objects, people, sports events, ships, moon, stars, etc. Most powerful for anywhere near the money. 5 Sections. Closes to 1 ft. long. Contains 4 ground and polished lenses. Also used as a powerful compound microscope. Directions included. Mass production enables us to offer this instrument at amazing price of \$3.95. Nothing Else to Buy. We pay postage. Get yours now.



CRITERION CO.
Dept. PSB5

331 Church St.
Hartford 3, Conn.

\$5000.00 IN PRIZES DRAW MY HEAD

1st & 2nd PRIZES

COMPLETE \$130 ART COURSE 80 OTHER VALUABLE PRIZES

Your Drawing Judged and Answered. Take this test and try for a thrilling prize. Discover if you have profitable Art talent. You may gain a lifetime of happiness and high earnings if you mail your drawing today. Amateurs only. Our present students not eligible. Copy this girl 4" to 6" high in pen or pencil. Mail to us. None returned. Winners notified. New \$5,000 contest each month. Your drawing will be entered in Contest for month in which we receive it. Send your drawings now with your name, address, age and occupation. Enter today.



WALLER ART EXCHANGE Studio 158, 1000 N. Charles St. Baltimore 1, Maryland

MASTER COURSE IN

HYPNOTISM

SECRETS REVEALED!
Actual methods, techniques of master hypnotists . . . how to hypnotize suitable subjects QUICKLY—stage and clinical methods—how to control subjects AFTER they awaken—help break tobacco, other habits. Self-hypnosis. Group hypnosis. Entertain with amazing stunts for fun or profit. See-how photos, step-by-step instructions tell you how! Money-back guarantee. FULLY PHOTO-ILLUSTRATED . . . \$2 (complete) EXTRA! Unique "ALARM-CLOCK MIND" instruction folio and HYPNOTIC CATALOG included. Order "Hypnotism Course" today!

Complete \$2



POWER PUBLISHERS, Dept. PS-13, 790 Broad St., Newark, N. J.

RUPTURE-EASER

Reg. in U. S. Pat. Off. (A Piper Brace Product)



Right or left
Side \$3.95



Double
\$4.95

NO FITTING REQUIRED

A strong, form-fitting washable support. Back lacing adjustable. Snaps up in front. Adjustable leg strap. Soft, flat groin pad. No steel or leather bands. Unexcelled for comfort. Also used as after operation support. For men, women and children. Mail orders give measure around the lowest part of the abdomen. Specify right or left side or double. We Prepay Postage Except on C.O.D.'s.

PIPER BRACE CO.

811 Wyandotte, Dept. PS-102

Kansas City 6, Mo.

Become an ELECTRICAL or MECHANICAL ENGINEER IN 36 MONTHS

- ★ Bachelor of Science Degree
- ★ Engineering Associate Certificate, 12-18 Months
- ★ Service Preparatory Courses, 3-12 Months

The growing shortage of trained engineers and technicians offers greater opportunity for ambitious young men. By 1955 there will be at least two positions for every graduate. Enroll NOW and earn your B. S. Degree in 36 months. Each of three levels of study is complete in itself. Technician courses can also be applied as one-third of the degree program. Faculty of specialists. Military, practical or academic training evaluated for advanced credit. Terms open JANUARY, APRIL, JULY, OCTOBER.

CHOOSE FROM THESE 15 PROGRAMS

- General Preparatory Course — 3 Months
- SERVICE LEVEL — 6 to 12 Months**
 - Electrical Service
 - Welding Operator
 - Refrigerator Service
 - Heating Service
 - Radio-Television Servicing Course
- TECHNICIAN LEVEL — 12 to 18 Months**
 - Radio and Television
 - Electrotechnics
 - Welding
 - Electronics
 - Air Conditioning
 - Mechanical
- ENGINEERING LEVEL — 36 Months — B. S. Degree**
Choice of functional electives: Production Sales or Research. • ELECTRICAL ENGINEERING — ELECTRONICS OR POWER MAJORS. • MECHANICAL ENGINEERING.

MILWAUKEE SCHOOL OF ENGINEERING

NONPROFIT • FOUNDED IN 1903

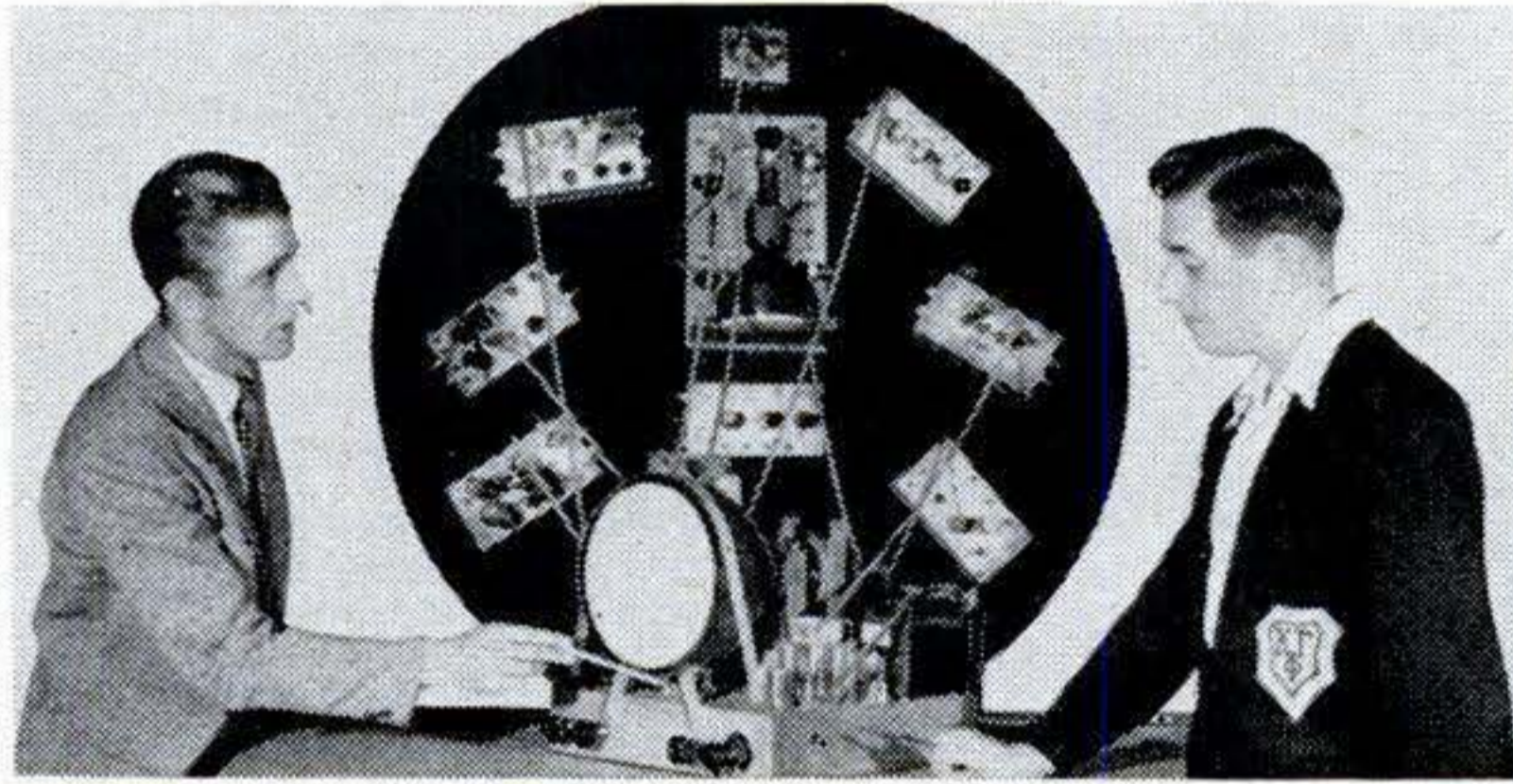

Milwaukee School of Engineering
Dept. PS-1052, 1025 N. Milwaukee
Milwaukee 1, Wisconsin

Without obligation, send catalog and information on.....
(Name of Course)

Name.....Age.....

Address.....

City.....Zone.....State.....

If veteran, indicate date of discharge



Authenticast MODEL SHIPS AND TANKS

5180 WALKER BULLDOG \$1.75 A.G.C. 11 \$1.85

5012 CENTURIAN \$2.00 5207 JOSEF STALIN III \$2.00

COMET METAL PRODUCTS CO., INC.
Richmond Hill 18, N. Y.

Included in complete NEW Authenticast Catalog listing over 800 minutely detailed, accurately scaled miniature models. More than 200 ships, tanks, planes, and railroad accessory sets are illustrated. Newest tank models in current production are available in Authenticast scaled replicas—Send for YOUR colorful 24 pg. Vol. III today—\$.35.

LEARN MEAT CUTTING AT NATIONAL

Pay After Graduation



The steady dependable trade of Meat Cutting taught easily in 8 short weeks. You LEARN BY DOING under actual meat market conditions in big modern school at Toledo.

For beginners or men with experience. Get a profitable store of your own. Remember, PEOPLE MUST EAT! Big pay jobs. Free employment help. Thousands of successful graduates.

Buying, cutting, percentage, pricing, advertising, selling, etc. A complete retail meat education. National School established over 25 years. Get National training NOW. Pay your tuition in easy weekly payments

after you graduate. Get all the facts. Send coupon for FREE 52 page school catalog—TODAY. G.I. Approved.

National School of Meat Cutting, Inc. (G.I. Approved)
Dept. 51-K, Toledo 4, Ohio

Send me your FREE school catalog on National Training at Toledo in Meat Cutting, Meat Merchandising and Self Service Meats. No obligation. No salesmen will call.

Name.....Age.....

Address.....

City.....State.....



A SIMPLE WAY TO BE AN ARTIST

TRIAL PLAN makes it easy to start

Let us **PROVE** we can teach you to draw at home in your spare time!

You don't need previous art training. You don't have to risk a big sum of money. WSA now offers you its famous, complete, and modern home study course in **Commercial Art, Designing and Cartooning**—the same high calibre instruction that has started thousands to profitable careers in art.

Only WSA Offers You This 38-Year Proven Method:

Trial plan proves you can learn at home in spare time. We teach you from the beginning step-by-step. Many students begin to earn extra money even before they finish the course. Qualify for well paying positions in this interesting field.

Two complete art outfits included. You get the first one when you enroll—with all the material you need to start. Don't delay. Take your first step now toward drawing for money and pleasure.

MAIL COUPON FOR FREE BOOK

WASHINGTON SCHOOL OF ART
Studio 1310F, Washington 5, D. C.
Send Free Book, "Art for Pleasure & Profit."
No salesmen. (Please Print)



Name.....Age.....
Street.....
City.....Zone.....State.....
Course G.I. Approved for Eligible Vets

NEW PARKING GUIDE

• **MAKES PARKING EASY \$1.98 ea.**

By giving you a guide over a front headlight so you will know the front end clearance of your car... a great safety aid when backing into a parking place!

• **DRESSES UP YOUR CAR**
BEAUTIFUL LUCITE ROD
Glow at night
CHROME PLATED BASE
For lasting beauty

• **EASY TO INSTALL**
All you need is a screwdriver. No wires to connect. It picks up light from the headlight.

MONEY BACK GUARANTEE

If returned in 10 days. Order one or two today! Send no money, pay the postman or enclose cash, check or money order and we pay the postage anywhere in the U.S. Florida orders add 3% sales tax.

Jobbers, Dealers write, wire or call for sales information.

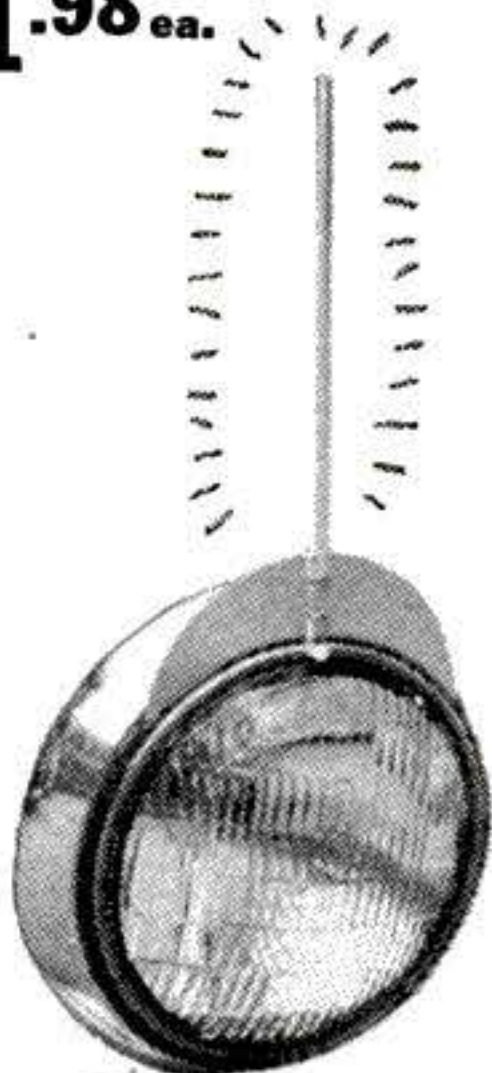

ON A HEADLIGHT

KEHOE MFG. CO.
DEPT. 101 FT. MYERS, FLA.

BOYS-IT'S FREE!

... NEW, EXCITING 16-PAGE BOOK on magic and marvels of chemistry

Shows you how to amaze friends with eye-opening tricks of chemical magic... like

changing water to blood and blood to stone. Tells you how to do many fascinating home experiments and shows you the big, new Chemcraft outfits.

Describes fun, thrills, adventure you can have with a Chemcraft chemistry outfit of your own. Send now for free copy to Porter Chemical Co., 51 Prospect Ave., Hagerstown, Md.

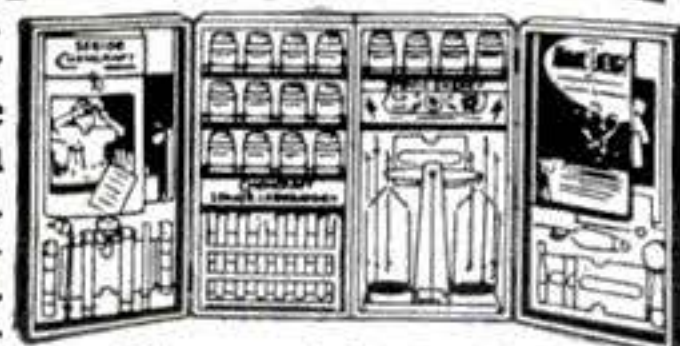

Chemcraft Senior Lab.

HEY FELLAS! ask Dad for **CHEMCRAFT**

\$2.95 EACH OR 2 FOR \$5.00!



Upright Telephone complete with cord in Tested and Guaranteed condition. For Inter-comm. or extension. Complete List of telephone parts, switchboards, handsets, magneto and dial telephones, etc. Write for List.

TELEPHONE ENGINEERING CO.

DEPT. 1, MAIN BLVD.

SIMPSON, PA.

HOTTER GAS TORCH



SELF CONTAINED - NO COMPRESSED AIR

Burns natural house gas or liq. petroleum at 2100° F.—1500 BTU for soldering. (silver, etc.), paint removing, bending, glass forming, etc. Precision engineered & guaranteed. \$7.90 with attachments and 5' hose \$4.45 without attachments. Specify gas used. Save C.O.D. fees. Send check or M.O. **KELLER GAS APPLIANCES**

DEPT. PS-10

439 W. FOOTHILL BLVD. • MONROVIA, CALIF.

ELECTRIC MOTOR BARGAINS!

1/2 HP 1750 or 1975 1 1/2 HP 3450 4750 RPM
2 HP 3450 6500 3 HP 3450 7750 RPM
All prices Heavy Duty, Repulsion Induction and Capacitor Types. 110-220 Volts, 60-cycle. Single-phase. Standard Makes (G. E., Wagner, Le-land, Westinghouse, etc.). Rush your order TODAY—large stock of motors—1 & 3 phase. 32-v. direct current bargains. Prices f.o.b. **ROBERTS ELECTRIC CO., 849 W. Grand, Dept. 35, Chicago, ILL.**



12 Months Driving for \$4.95

A new tire guarantee with each used tire. Positively Not Re-Caps—Every Tire Machine Inspected

600-16 \$4.95 Two for \$9.50 650-16 \$5.50
670-15 \$5.95 700-15 \$5.95

Send this ad with order. Mail orders rushed on receipt of check or money order for the size desired.

Dept. A
West Park Tire Sales, 14018 Beech Ave., Cleveland, O.

CALIFORNIA LAND!

The surge of population westward gave California 50% population increase in the past 10 years. This makes land values soar. We search out land you may acquire with small steady payments; as little as \$50 down. Many say: "Better than money in the bank!" Our free pamphlet may be your future fortune. Write for it today!

Farm and Ranch Service Co.

7075 Hollywood Blvd.

Los Angeles 28, Calif.

DO IT TODAY! SWITCH TO

MILD

KENTUCKY CLUB

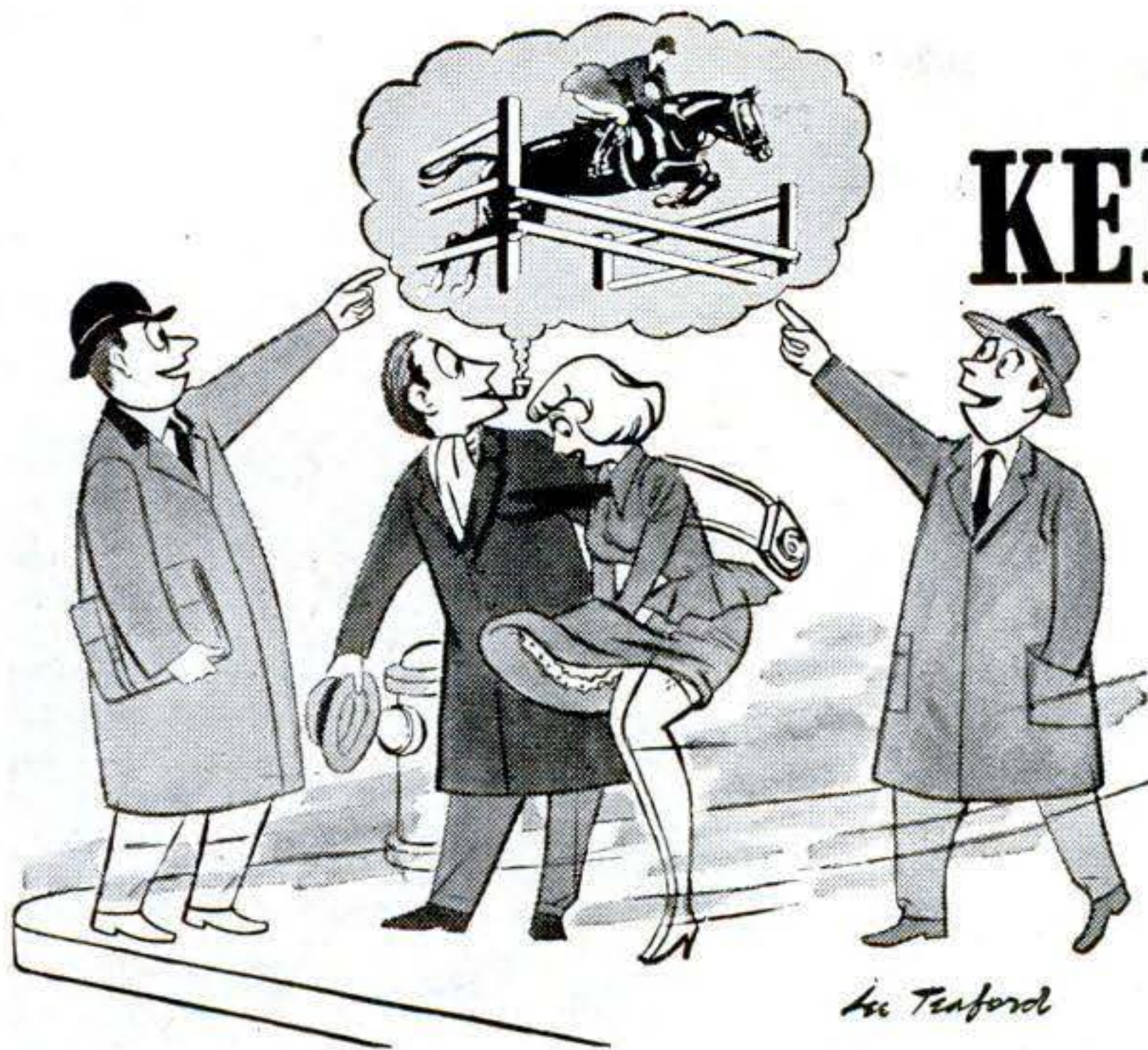

"Look! Another man switched to Kentucky Club—the thoroughbred of pipe tobaccos."

Notice how much better your pipe tastes—how much fresher your mouth feels when you switch to Kentucky Club. Look for the blue tin with the picture of the red-coated rider. Send for free catalog showing fine pipes and how to get them at big savings. Mail Pouch Tobacco Co., Wheeling, West Va. Dept. 101



AMAZING NEW TRAINING PLAN I PREPARE YOU AT HOME FOR BIG PAY JOBS IN TELEVISION RADIO ELECTRONICS WITHIN MONTHS!

L. C. Lane,
B.S., M.A.
Pres. RTTA &
Pierce Schools

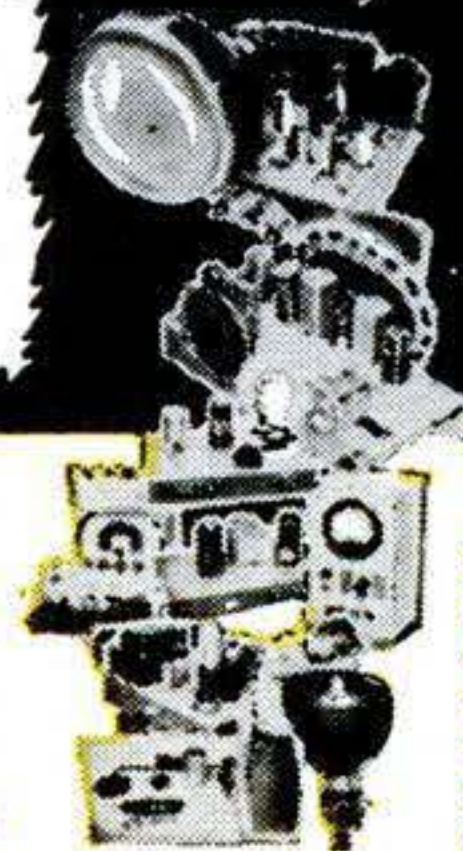

YOU BUILD
AND KEEP
**BIG
SCREEN TV
RECEIVER**

EXTRA FEATURES THAT MEAN MORE MONEY FOR YOU!
Thousands of new job opportunities will be available for you right in your own state, with the lifting of government restrictions on new TV stations. My simple, successful methods can PREPARE YOU NOW to take your place in America's booming TELEVISION and Electronics industries... help you get the success and happiness that you always wanted out of life. You learn the practical easy way by using actual parts and equipment. Then after you finish your training for a position as a full-fledged TV Technician — where you can write your own ticket and choose from dozens of fascinating careers — I don't stop there! I continue to train you — AT NO EXTRA COST — to qualify for even better pay in the BETTER JOBS that demand FCC licenses, with my...

**AT NO EXTRA COST!
YOU GET A ROUND TRIP TO
NEW YORK CITY**
FROM ANYWHERE IN THE U.S. OR CANADA—I pay your way to New York and return, PLUS 2 FREE weeks, 50 hours of advanced instruction and shop training at the PIERCE SCHOOL OF RADIO & TELEVISION. You use modern electronics equipment, including student-operated TV and Radio stations. You go behind the scenes of New York's big Radio-TV centers, to study first hand. And I give you all this AT NO EXTRA COST! (Applies to complete Radio-TV course only.)

PLUS... all illustrated units, including Super-Het Radio Receiver, R.F. Signal Generator, Combination Voltmeter - Ammeter - Ohmmeter, C - W Telephone Receiver, AC-DC Power Supply. Everything furnished including all tubes, and big TV tube.

FREE FCC COACHING COURSE
PREPARES YOU AT HOME FOR YOUR FCC LICENSE
THE BEST JOBS IN TV AND RADIO REQUIRE AN FCC LICENSE
Given to every student at NO EXTRA COST after TV Theory and Practice is completed.

NOW! Advanced FM-TV Training
For Men Who Know Radio
Prepares You For Higher Pay Jobs In A Few Months
COMPLETE theory and practical training course... complete with kits including large screen TV receiver.
FCC License Coaching Course Included FREE.

VETERANS!
If eligible under new G.I. Bill (discharged after June 27, 1950) — CHECK COUPON BELOW!

EARN EXTRA MONEY IN SPARE TIME
Make as much as \$25.00 a week in your spare time while learning — repairing Radio-TV sets. Many of my students pay for their entire training from spare time earnings almost from the very beginning... start their own service business.

MAIL
**COUPON
TODAY**
NO SALESMAN
WILL CALL

BOTH FREE! Send for my illustrated booklet and trial lesson

RADIO-TELEVISION TRAINING ASSOCIATION
1629 Broadway, Radio City Station, New York 19, N. Y.
Approved as a Correspondence School under the laws of the State of New York



Mr. Leonard C. Lane, President
RADIO-TELEVISION TRAINING ASSOCIATION Dept. P-10
1629 Broadway, New York 19, N. Y.

Dear Mr. Lane: Mail me your NEW FREE BOOK and SAMPLE LESSON that will show me how I can make BIG MONEY in TELEVISION. I understand no salesman will call.

NAME _____ Age _____
ADDRESS _____
CITY _____ ZONE _____ STATE _____
I am interested in: Radio-TV Advanced TV-FM
VETERANS! If qualified under G.I. Bill, check here



START YOUR OWN BUSINESS,

FULL OR PART TIME

Don't work for "small wages." Get in on the Big Money by learning Electrical Appliance Repairing NOW in your spare time. Learn it the simple, easy way by working with your hands building, testing, checking. We supply you with valuable Kits that will give you that all-important "know how."

More men are needed immediately. Millions of refrigerators, motors, washing machines, irons, vacuum cleaners, house wiring need fixing. This demand must be met! Rush name today for **FREE ILLUSTRATED BOOK** and special form for paying us later from cash earnings!

CHRISTY TRADE SCHOOL
4432 N. Kedzie Ave. Dept. D-2001 Chicago 34

ELECTRIFY your SEWING MACHINE

NEW LOW PRICE! \$10.50 1 YEAR GUARANTEE

Buy direct from manufacturer and save! Kit comes fully wired, installed in a jiffy. Fits all machines! You get **ALL-NEW PARTS**

- Motor & Bracket
- AC-DC 115v 60c
- Multi-speed foot control
- Cord set & block
- Easy instructions
- Steel pulley & belt

FREE . . . reg. \$2.95 chrome SEWLITE given with every kit.

10 DAY FREE TRIAL—ORDER NOW!
Send no money, pay COD or send money order and we'll pay postage. Please state whether wheel on your machine turns toward you or away from you. Shipping wt. 6 lbs.

SENIOR SEWING MACHINE CO.
197 Clifton Place Dept. PS-40 Bklyn. N. Y.

EASY TO LEARN CODE

Learn or increase speed with an Instructograph—the Radio-Telegraph Code Teacher that takes the place of an operator-instructor and enables anyone to master code without further assistance. Available tapes from beginners alphabet to typical messages on all subjects. Speed range 5 to 40 WPM. Always ready—no QRM. Thousands have "acquired the code" with the Instructograph System. Write today for convenient rental and purchase plans.

INSTRUCTOGRAPH COMPANY
4701-P Sheridan Road, Chicago 40, Illinois

Do You Make These Mistakes in English?

MANY persons say "between you and I"—use "who" for "whom"—don't know whether to use one or two "e's" or "m's" or "r's." Every time you speak or write you show what you are. A command of effective English brings you added advantages, better opportunities.

You can improve your English through Sherwin Cody's 100% self-correcting invention. If you are ever embarrassed by mistakes in grammar, spelling, punctuation, or pronunciation, write for **FREE** book "How You Can Master Good English in 15 Minutes a Day." No obligation. **SHERWIN CODY COURSE IN ENGLISH, 1810 B & O Bldg., Rochester 14, N. Y.**

BUILD A \$15,000 A YEAR FUTURE!

IN THE EXCITING NEW BUSINESS OF LAUNDERING VENETIAN BLINDS

There is big money to be made cleaning Venetian Blinds and a permanent, fast growing, Lifetime Business, besides.

An amazing new kind of business of your own in a field that is growing like mad. Millions of Venetian Blinds need laundering at regular intervals.

With our new patented machine, you can start small—using your basement, garage or utility room to begin with. You can expand as your business increases by leaps and bounds. Income up to \$200.00 daily already being made by others. Small investment for equipment starts your own lifetime business—and monthly payment plan permits you to pay for it as you grow.

FREE Get all the facts about this sensational new kind of machine that launders blinds so fast that your charges are unbelievably low. People would rather send blinds to you than do the work themselves. Yet, you make 700% profit on every blind you clean. Get names of successful owners near you. Get details of the full amazing plan without obligation. Be first in your territory to start a business that has brought \$15,000 PROFITS the first year to others. Wire today or send name on postcard.

VENETIAN BLIND LAUNDRY EQUIPMENT CO. INC.
442 N. SENECA ST. DEPT. 1210 WICHITA 12, KANSAS

REAL ESTATE

BE A BROKER

PAYS BIG! SEND FOR FREE, BIG, ILLUSTRATED CATALOG NOW! Graduates report making substantial incomes. Start and run your own business quickly. Men, women of all ages, learn easily. Course covers Sales, Property Management, Appraising, Loans, Mortgages, and related subjects. **STUDY AT HOME** or in classrooms in leading cities. Diploma awarded. Write TODAY for free book! No obligation.

WEAVER SCHOOL OF REAL ESTATE (Est. 1936)
Suite 300 Law Bldg. Dept. PS Kansas City, Mo.

STUDY TO BE A DOCTOR of Psychology or Metaphysics

Obtain a Ps.D., Ms.D., or Ph.D. degree. Be a Teacher, Lecturer or Accredited Practitioner. Teach others how to achieve Health, Happiness and Contentment. Chartered by State. Write for **FREE** book telling how.

THE NEOTARIAN COLLEGE OF PHILOSOPHY
Desk 5, Pickwick Building Kansas City 6, Missouri

SAVE 50% & MORE! GENUINE DIAMONDS

Buy diamonds and diamond jewelry half-priced from Kaskel's, America's foremost Pawnbroker. Every diamond is re-set in a luxurious new mounting... graded according to nationally accepted standard... and bonded to this effect. For over 70 years, we've served over 1,000,000 satisfied customers from all 48 States.

10 DAY UNCONDITIONAL MONEY-BACK GUARANTEE
References: Your bank, or any Rating Agency.

KASKEL'S, 9 Columbus Ave., N. Y. 23, Dept. K8

SEND FOR BIG FREE ILLUSTRATED CATALOG

LOW PRICES
on these powerful **NEW 1953**
MIDWEST TELEVISION
Super Powered for **"FRINGE" AREAS**

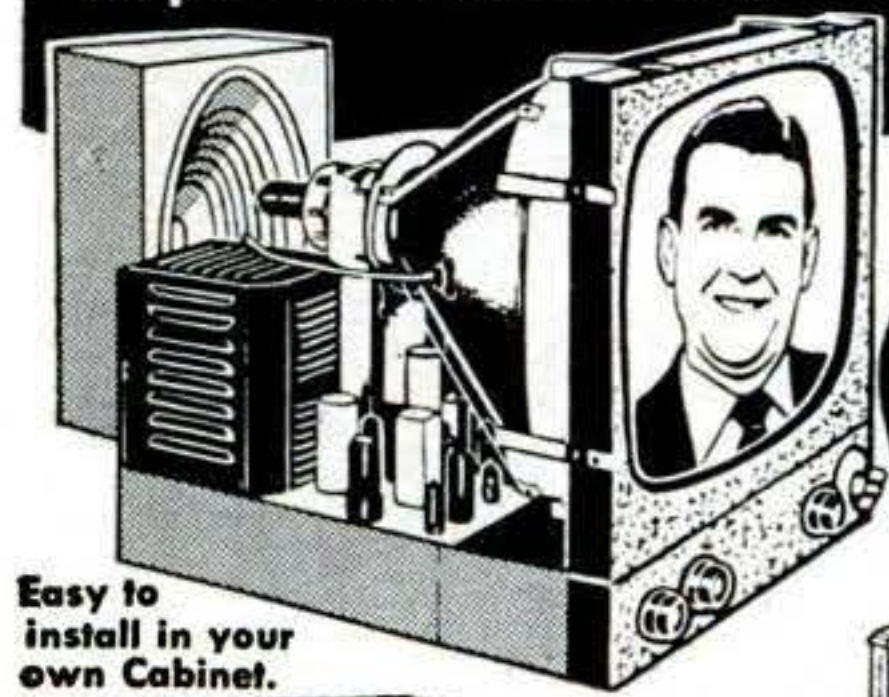

Easy to install in your own Cabinet.

Mammoth
20-Inch
Rectangular
PICTURE



30 DAYS TRIAL EASY TERMS



Midwest offers a sensational new 1953 line of beautiful consoles and complete chassis for easy installation in your own cabinet. Mammoth 20-Inch Television at low Factory Prices, and on 30 Days Trial.

Buy **DIRECT** from the **MIDWEST** Factory and **SAVE!**

SEND THIS COUPON For FREE MIDWEST 1953 Catalog	MIDWEST RADIO & TELEVISION CORP.		
	Dept. 25B,	909 Broadway, Cincinnati 2, Ohio	
	NAME _____	ADDRESS _____	
	CITY _____	ZONE _____	STATE _____

ENGINEERING DEGREE IN 27 MONTHS

Big Demand for Graduates

AERONAUTICAL, CHEMICAL, CIVIL, ELECTRICAL, MECHANICAL and RADIO ENGINEERING (inc. TV and Electronics).

Hundreds of young men are earning **B.S. ENGINEERING DEGREES** annually in this recognized institution—year around operation. New terms start quarterly. Many students earn a major part of their college expenses in this large industrial center.

Low tuition. Competent instruction. Thorough, intense, practical program. Modern, well-equipped laboratories including new physics laboratory and modern wind tunnel. Individualized instruction emphasized.

Gov't approved for G.I.'s. Engineering preparatory courses. Students from 48 states and 21 foreign countries. Enter December, March, June, September. Send coupon for free catalog and full information. Enroll now.

SEND COUPON TODAY

INDIANA TECHNICAL COLLEGE

6102 E. Washington Boulevard Fort Wayne 2, Indiana

Please send me free information on B. S. Engineering degree in 27 months as checked.

Aeronautical, Chemical, Civil, Electrical, Mechanical, Radio-Television.

MODERN LAWN MOWER SHARPENER

Service departments of leading Lawn Mower manufacturers use the Modern Lawn Mower Sharpener. One lever moves lawn mower into grinding position. Gasoline and oil remain in engine while sharpening, no dismantling of wheels, roller or handle. The Modern is a precision bed knife grinder—no extra grinder to buy. Imitated but never equaled—Compare before you buy. If it isn't a Modern it can't be Modern (Prices subject to change without notice)

WRITE FOR FREE BOOKLET 11D

\$263.00 with motor F.O.B. PASADENA

MODERN MFG. CO.
160 N. Fair Oaks - Pasadena 1, Calif.

NEW! EXCITING! JET EXHAUST CUT-OUT

Now your car can sound off those exciting, dynamic tones—easily controlled mechanically from your dashboard. Channel your exhaust through special pipes or muffler without removing your original muffler. Easily installed, **MONEY BACK GUARANTEE**

Send \$4.95 check, cash, money order (postpaid) or C.O.D. plus postage to:
FUR SALES, 1031 E. 63rd St., Chicago 37, Ill. Dept. PS

MAKE YOUR WILL NOW \$2.00

Forms composed by reputable attorney. You need only fill in a few spaces and have witnessed.

Legal in any state, money refunded if not satisfied. No C.O.D. orders. Order by form number only. No. 1—All to husband. No. 2—All to wife. No. 3—Portions to wife and children. No. 4—Portions to husband and children. No. 5—(Spouse Dead) Portions to children.

LEGAL FORMS CO., DEPT. P.S., WILLOUGHBY, O.

ILLUSTRATED CARTOON BOOKLETS!

SAY FELLOWS, BE THE LIFE OF THE PARTY WITH THESE SMALL ILLUSTRATED CARTOON BOOKLETS OF COMIC CHARACTERS! **10, ALL DIFFERENT, \$1 POSTPAID SORRY NO POSTAL G.O.D'S!**

REGINALD SALES
210 L Fifth Ave., New York, N. Y.

Our 550th Advertisement REAL DIESEL ENGINE

\$2.95

- for planes, boats, midget cars
- 7500 RPM; 1/7 HP; ht. 3 1/2"; wt. 5 oz.

• precision machined for smooth operation You just can't beat this price for a precision diesel engine! Streamlined, compact, easy to install. Thousands of satisfied users all over the world. Fast delivery if you **ORDER TODAY!** Send \$2.95 plus 25c postage.

Gotham Hobby Corp. Dept. S, 107 E. 126th St. New York 35, N.Y.

Bargain of the Year!

524 DIFFERENT GENUINE STAMPS 50c

This Sensational Collection of Unusual Postage Stamps Includes:
Hungarian Triangle Bird Set; Spain's Goya Nude; Albania Roosevelt-Churchill Issue complete; Leonardo da Vinci's Mona Lisa in Original Colors; South Molucca (Dutch Nation) 3 gorgeous sets; MacArthur Issue; United Nations Set; Indonesia U.N. Set; and more! To introduce our bargain price, we are giving away a **FREE** different stamps cataloging.

STAMPEX CO.

"How to Become a Mail Order Millionaire"

Read the inside facts about hundreds of "little fellows" who are running Mail Order businesses from their homes—many making \$20,000 and more every year! Learn how small investments (\$16.80 in one case!) have mushroomed into profits of thousands. This incredible reprint from *Mechanix Illustrated* will be sent absolutely free, along with details showing how you can quickly master the secrets of getting orders and money in your daily mail, in a business that's all yours. Rush name today. A postcard will do.



SENT FREE!
RUSH NAME ON POSTCARD TODAY

The L. W. SURVEY 7070 North Clark Street, Dept. 310 Chicago 26, Ill.



SEND FOR THIS FREE!

Make money. Know how to break and train horses. Write today for this book FREE, together with special offer of a course in Animal Breeding. If you are interested in Galting and Riding the saddle horse, check here () Do it today—now.

BEERY SCHOOL OF HORSEMANSHIP
Dept. 5810 Pleasant Hill, Ohio

WALKIE TALKIES \$4.99 Set of 2

POCKET SIZE



—ELECTRONIC VOICE POWERED
No tubes, batteries, adjustments, license or permit needed! Guaranteed to work anywhere up to 1/4 mile with extra wire. Swell for room to room—garage to house, etc! Your own private, talk-listen phone. Not war surplus. Brand new. Guaranteed. Two complete units with wire —READY TO USE!

SEND \$1.00 deposit and pay postman \$3.99 plus postage charges or send \$4.99 for postpaid delivery. Sold only by mail from:
MIDWAY COMPANY, Dept. WPS-10 Kearney, Nebraska

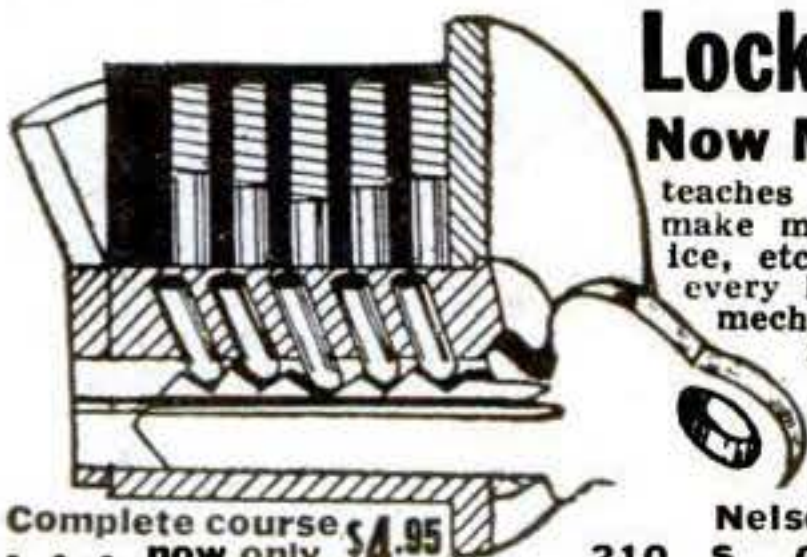

Locksmithing AND KEY MAKING

Now Made Easy! Practical up-to-date course teaches you how to pick locks, de-code, make master keys, repair, install, service, etc. New self-instruction lesson for every handyman, homeowner, carpenter, mechanic, service station operator, fix-it shop, hardware dealer, gunsmith. 53 easy illustrated lessons. Full price only \$4.95, postpaid; or C.O.D. plus postage. Satisfaction or refund guaranteed.

Nelson-Hall Co., Dept. KY-1
210 S. Clinton St., Chicago 6, Ill.



30 DAY FREE TRIAL

High Power BINOCULARS

Finest Precision Optics
Featherlight
Money Back Guarantee
Easy Pay Plan
Leather Case Incl'd.

33 MODELS
\$14.95
up

BUSHNELL Binoculars

Bushnell Bldg., Dept. P50
Pasadena 1, Calif.

FREE GUIDE "How to Select Binoculars"

NAME _____ CITY _____
ADDRESS _____ STATE _____

DON'T LET THEM BREAK YOUR

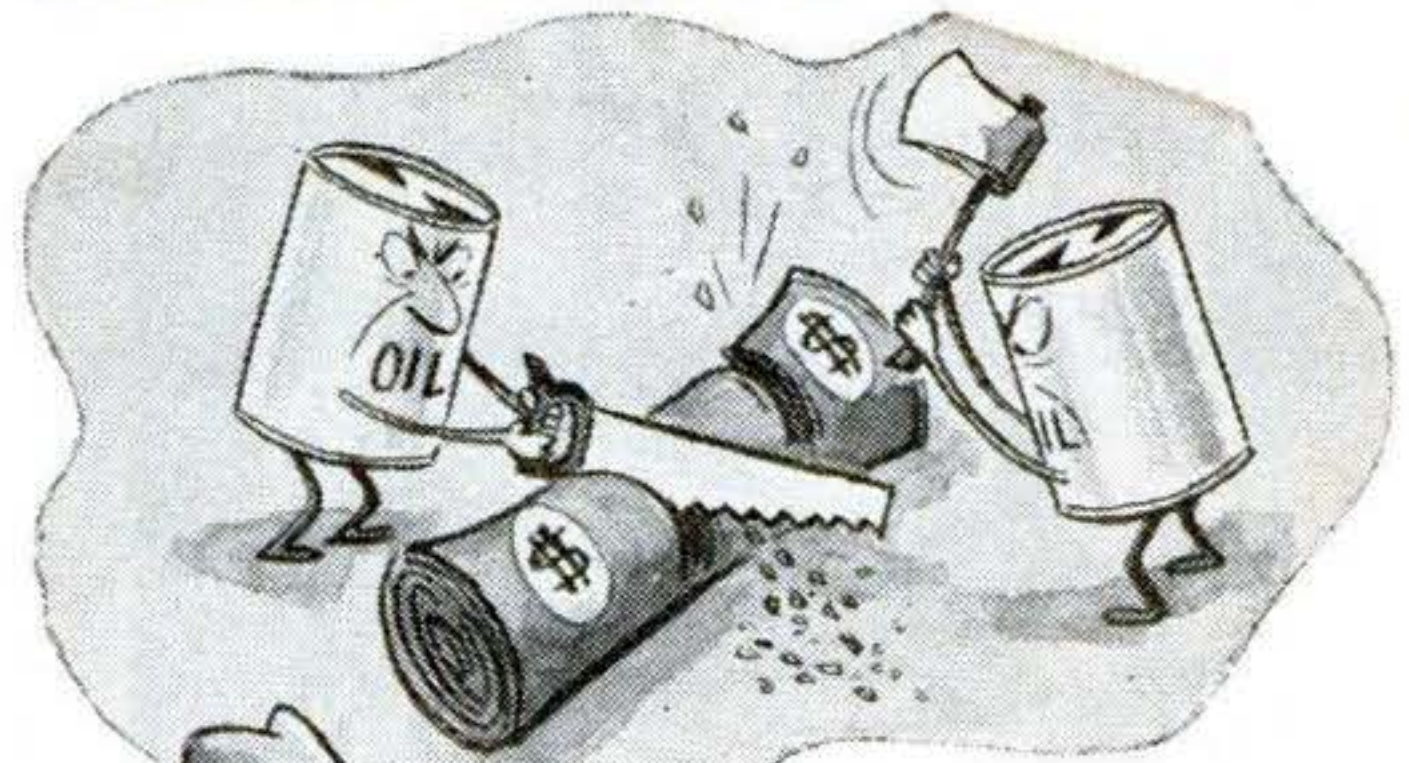

Sound your **Z**
SWITCH TO



ADD LESS OIL BETWEEN CHANGES

Excessive oil consumption can make driving needlessly expensive. Now is the time to change to Pennzoil and get quality motor oil that lasts longer. Pennzoil is specially refined from 100% Pennsylvania crude, the best and most stable known, with *THE Tough-Film* that safeguards your engine from sludge, varnish and carbon. By keeping pistons, rings and valves clean and smooth-running, you use less oil with Pennzoil no matter how hard or fast you drive! Change over now...

at this sign...



GIVES ALL ENGINES AN EXTRA MARGIN OF SAFETY
Member Penn. Grade Crude Oil Assn., Permit No. 2

PENNZOIL® MOTOR OIL AND LUBRICANTS AT BETTER DEALERS . . . COAST TO COAST

"How to Become a Mail Order Millionaire"

Read the inside facts about hundreds of "little fellows" who are running Mail Order businesses from their homes—many making \$20,000 and more every year! Learn how small investments (\$16.80 in one case!) have mushroomed into profits of thousands. This incredible reprint from *Mechanix Illustrated* will be sent absolutely free, along with details showing how you can quickly master the secrets of getting orders and money in your daily mail, in a business that's all yours. Rush name today. A postcard will do.



SENT FREE!

RUSH NAME ON POSTCARD TODAY

The L. W. SURVEY 7070 North Clark Street, Dept. 310 Chicago 26, Ill.



SEND FOR THIS FREE!

Make money. Know how to break and train horses. Write today for this book FREE, together with special offer of a course in Animal Breeding. If you are interested in Gaiting and Riding the saddle horse, check here () Do it today—now.

BEERY SCHOOL OF HORSEMANSHIP
Dept. 5810 Pleasant Hill, Ohio

WALKIE TALKIES \$4.99 Set of 2

POCKET SIZE

—ELECTRONIC VOICE POWERED

No tubes, batteries, adjustments, license or permit needed! Guaranteed to work anywhere up to 1/4 mile with extra wire. Swell for room to room—garage to house, etc! Your own private, talk-listen phone. Not war surplus. Brand new. Guaranteed. Two complete units with wire —READY TO USE!

SEND \$1.00 deposit and pay postman \$3.99 plus postage charges or send \$4.99 for postpaid delivery. Sold only by mail from:

MIDWAY COMPANY, Dept. WPS-10 Kearney, Nebraska

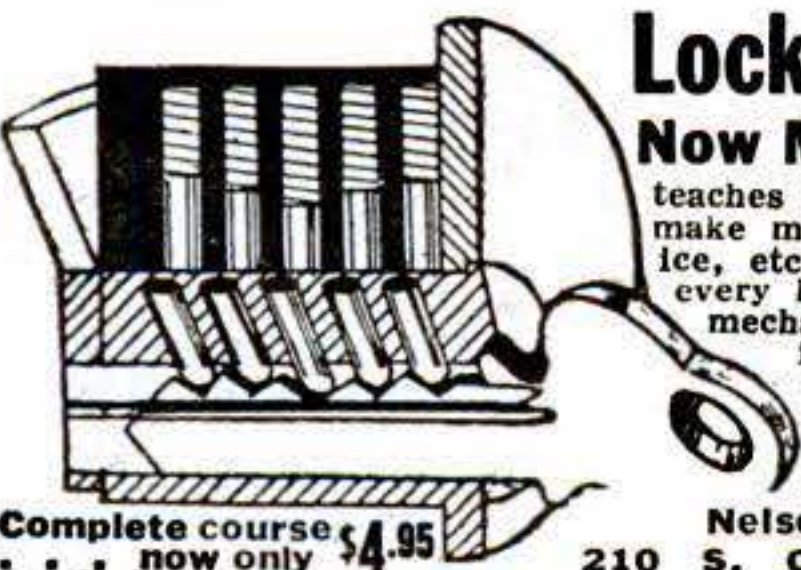

Locksmithing AND KEY MAKING Now Made Easy!

Practical up-to-date course teaches you how to pick locks, de-code, make master keys, repair, install, service, etc. New self-instruction lesson for every handyman, homeowner, carpenter, mechanic, service station operator, fix-it shop, hardware dealer, gunsmith. 53 easy illustrated lessons. Full price only \$4.95, postpaid; or C.O.D. plus postage. Satisfaction or refund guaranteed.

Nelson-Hall Co., Dept. KY-1

210 S. Clinton St., Chicago 6, Ill.

BRAND NEW

30 DAY FREE TRIAL

High Power BINOCULARS

Finest Precision Optics
Featherlight
Money Back Guarantee
Easy Pay Plan
Leather Case Incl'd.

33 MODELS
\$14.95 up

BUSHNELL Binoculars

Free! Catalog & Book
"How to Select Binoculars"
Dealer Inquiries Invited
Bushnell Bldg., Dept. P50
Pasadena 1, Calif.

FREE GUIDE "How to Select Binoculars"

NAME _____ CITY _____

ADDRESS _____ STATE _____

DON'T LET ADDED QUARTS BREAK YOUR BANKROLL...

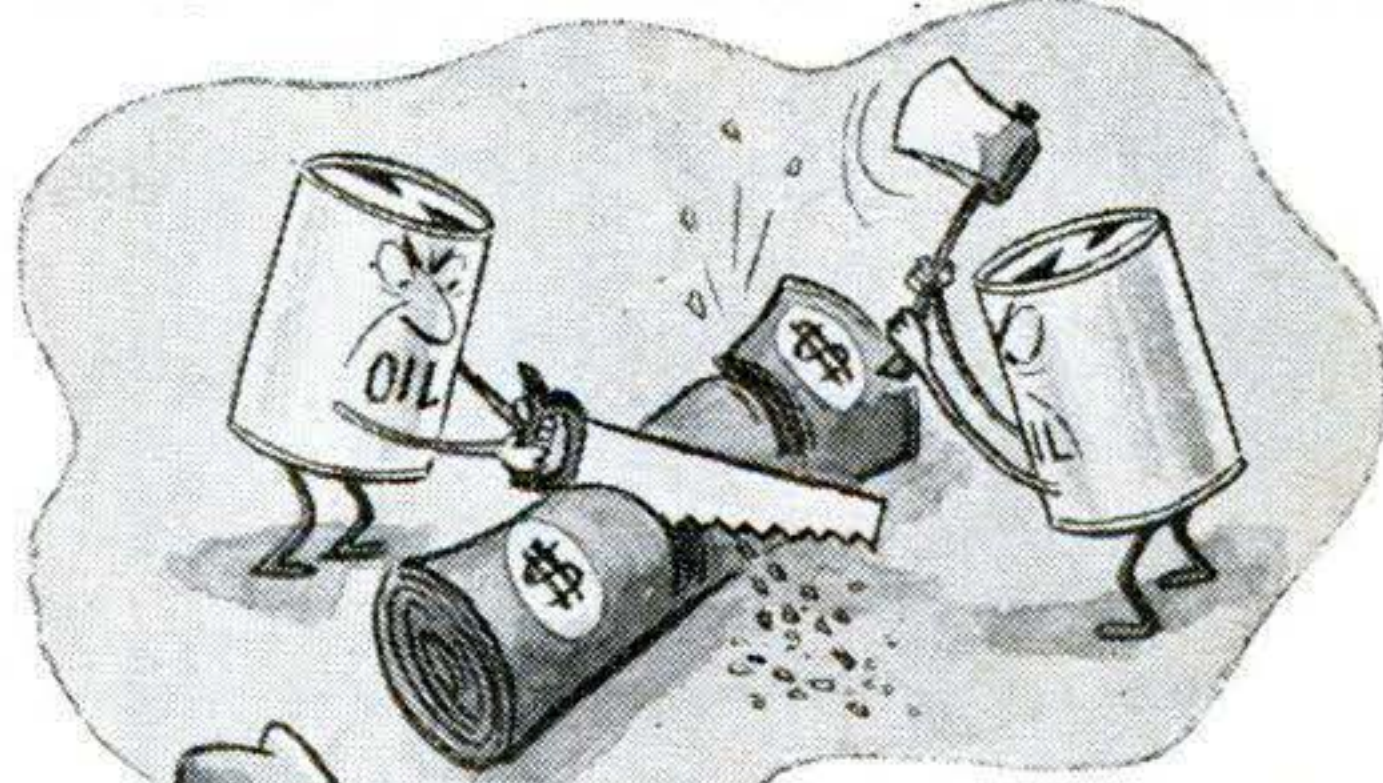

Sound your **Z**

SWITCH TO



ADD LESS OIL BETWEEN CHANGES

Excessive oil consumption can make driving needlessly expensive. Now is the time to change to Pennzoil and get quality motor oil that lasts longer. Pennzoil is specially refined from 100% Pennsylvania crude, the best and most stable known, with THE *Tough-Film*® that safeguards your engine from sludge, varnish and carbon. By keeping pistons, rings and valves clean and smooth-running, you use less oil with Pennzoil no matter how hard or fast you drive! Change over now...

at this sign...



GIVES ALL ENGINES AN EXTRA MARGIN OF SAFETY

Member Penn. Grade Crude Oil Assn., Permit No. 2

PENNZOIL® MOTOR OIL AND LUBRICANTS AT BETTER DEALERS . . . COAST TO COAST

NEW LOW PRICES

on these powerful **NEW 1953**

MIDWEST TELEVISION

Super Powered for "FRINGE" AREAS

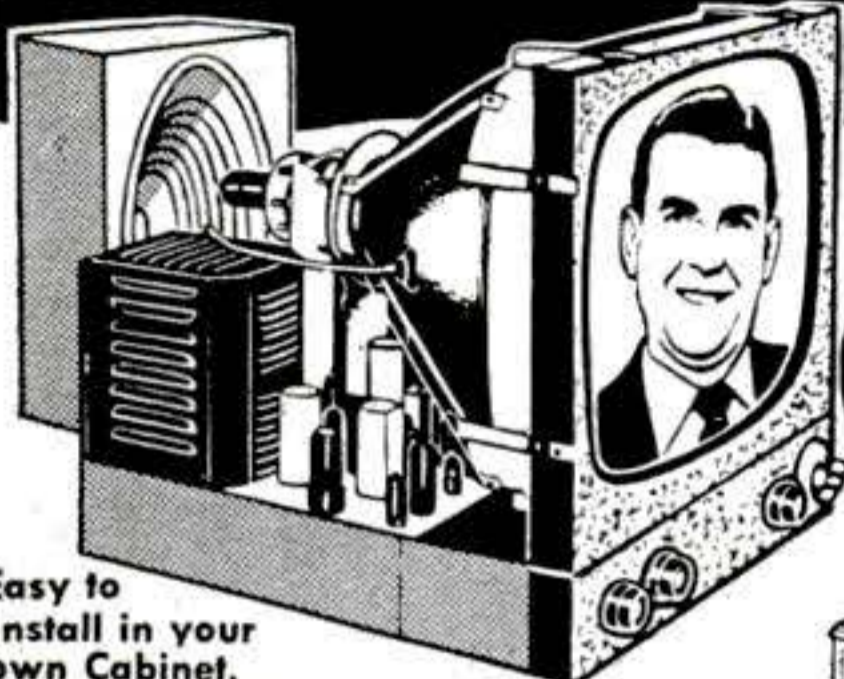

Mammoth
20-Inch
Rectangular
PICTURE

Easy to install in your own Cabinet.



30 DAYS TRIAL EASY TERMS



Midwest offers a sensational new 1953 line of beautiful consoles and complete chassis for easy installation in your own cabinet. Mammoth 20-Inch Television at low Factory Prices, and on 30 Days Trial.

Buy **DIRECT** from the **MIDWEST** Factory and **SAVE!**

SEND THIS COUPON For FREE MIDWEST 1953 Catalog	MIDWEST RADIO & TELEVISION CORP.		
	Dept. 25B,	909 Broadway, Cincinnati 2, Ohio	
	NAME _____	ADDRESS _____	
	CITY _____	ZONE _____	STATE _____

ENGINEERING DEGREE IN 27 MONTHS

Big Demand for Graduates

AERONAUTICAL, CHEMICAL, CIVIL, ELECTRICAL, MECHANICAL and RADIO ENGINEERING (inc. TV and Electronics).

Hundreds of young men are earning **B.S. ENGINEERING DEGREES** annually in this recognized institution—year around operation. New terms start quarterly. Many students earn a major part of their college expenses in this large industrial center.

Low tuition. Competent instruction. Thorough, intense, practical program. Modern, well-equipped laboratories including new physics laboratory and modern wind tunnel. Individualized instruction emphasized.

Gov't approved for G.I.'s. Engineering preparatory courses. Students from 48 states and 21 foreign countries. Enter December, March, June, September. Send coupon for free catalog and full information. Enroll now.

SEND COUPON TODAY

INDIANA TECHNICAL COLLEGE

6102 E. Washington Boulevard
Fort Wayne 2, Indiana

Please send me free information on B. S. Engineering degree in 27 months as checked.

- Aeronautical, Chemical, Civil,
 Electrical, Mechanical, Radio-Television.

Name.....

Address.....

MODERN LAWN MOWER SHARPENER

Service departments of leading Lawn Mower manufacturers use the Modern Lawn Mower Sharpener. One lever moves lawn mower into grinding position. Gasoline and oil remain in engine while sharpening, no dismantling of wheels, roller or handle. The Modern is a precision bed knife grinder—no extra grinder to buy. Imitated but never equaled—Compare before you buy. If it isn't a Modern it can't be Modern (Prices subject to change without notice)



WRITE FOR FREE BOOKLET 11D

\$263.00
with motor
F.O.B.
PASADENA

MODERN MFG. CO.

160 N. Fair Oaks - Pasadena 1, Calif.



NEW! EXCITING! JET EXHAUST CUT-OUT

Now your car can sound off those exciting, dynamic tones—easily controlled mechanically from your dashboard. Channel your exhaust through special pipes or muffler without removing your original muffler. Easily installed. **MONEY BACK GUARANTEE**

- MADE OF HEAVY PLATE STEEL
- UNIVERSAL—FITS ALL EXHAUSTS

Send \$4.95 check, cash, money order (postpaid) or C.O.D. plus postage to: **FUR SALES, 1031 E. 63rd St., Chicago 37, Ill. Dept. PS**

MAKE YOUR WILL NOW \$2.00

Forms composed by reputable attorney. You need only fill in a few spaces and have witnessed.

Legal in any state, money refunded if not satisfied. No C.O.D. orders. Order by form number only. No. 1—All to husband. No. 2—All to wife. No. 3—Portions to wife and children. No. 4—Portions to husband and children. No. 5—(Spouse Dead) Portions to children.

LEGAL FORMS CO., DEPT. P.S., WILLOUGHBY, O.



ILLUSTRATED CARTOON BOOKLETS!

SAY FELLOWS! BE THE LIFE OF THE PARTY WITH THESE SMALL ILLUSTRATED CARTOON BOOKLETS OF COMIC CHARACTERS! **10, ALL DIFFERENT, \$1 POSTPAID** SORRY NO POSTAL G.O.D.S!

REGINALD SALES

210 L Fifth Ave., New York, N. Y.

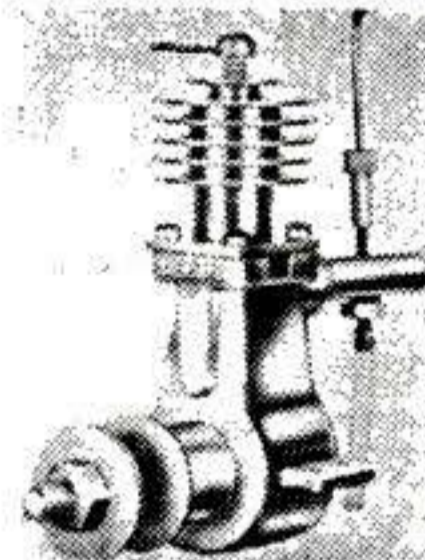

Our 550th Advertisement REAL DIESEL ENGINE

\$2.95 • for planes, boats, midget cars • 7500 RPM; 1/7 HP; ht. 3 1/2"; wt. 5 oz.

• precision machined for smooth operation You just can't beat this price for a precision diesel engine! Streamlined, compact, easy to install. Thousands of satisfied users all over the world. Fast delivery if you **ORDER TODAY!** Send \$2.95 plus 25c postage.

Gotham Hobby Corp. Dept. S, 107 E. 126th St. New York 35, N.Y.

Bargain of the Year!

524 DIFFERENT GENUINE STAMPS 50c

This Sensational Collection of Unusual Postage Stamps

Includes: Hungarian Triangle Bird Set; Spain's Goya Nude Duchess; Albania Roosevelt-Churchill Issue complete; Da Vinci's Mona Lisa in Original Colors; South Molucca's (a new nation) 3 gorgeous sets; MacArthur Issue, U.P.U. issue, United Nations Set; Indonesia U.P.U., and hundreds more! To introduce our bargain approvals 524 ALL DIFFERENT stamps cataloging over \$11.00 for only 50¢!

STAMPEX CO., 116-HP Nassau St., NYC



MEN! send for this MONEY-MAKING OUTFIT FREE!

MAKE \$15⁰⁰ IN A UP TO DAY

Do you want to make more money in full or spare time . . . as much as \$15.00 in a day? Then write for this BIG OUTFIT, sent you FREE, containing more than 150 fine quality

fabrics, sensational values in made-to-measure suits and overcoats. Take orders from friends, neighbors, fellow-workers. No experience needed. You'll say it's the greatest way to make money you ever saw.

PERSONAL SUITS TO WEAR

Pay No Money! Send No Money!

Our plan makes it easy for you to get your own personal suits and overcoats without paying 1c, in addition to your big cash earnings. This offer is limited. Rush your name and address for big FREE OUTFIT—today!

**W. Z. GIBSON, INC., Dept. M-520
500 S. Throop Street, Chicago 7, Illinois**

TASOPE PHOTO-ENGRAVING PLANTS



MATERIAL COST OF THIS CUT 3/4c SELLING PRICE \$1.00 AND UP

Establish your own profitable PHOTO-ENGRAVING business. Make cuts for newspapers, printers, and advertisers. Make etched name plates, plaques etc. Instructions furnished, no experience necessary. Sold direct from factory since 1931. First five hundred cuts sold locally or by mail will pay for plant and pay you well for your time. Write for FREE catalog.

TASOPE DEPT. PS-10, AURORA, MO.

Secrets of VENTRILOQUISM Now Revealed!



Easy to learn in 60 to 90 days with our Home Study Course. **RESULTS GUARANTEED.** Make Money! Be Popular! Have Fun! Big Opportunity! Radio, Television, Stage Appearances! For Free Information regarding price and terms. WRITE. You must state your age. Dummy Catalog 25c. **FRED MAHER SCHOOL OF VENTRILOQUISM** Box 36, Studio 10 Kensington Station Detroit 24, Michigan

BATTERIES START A FACTORY AT HOME



—and re-cast junk batteries into new, with and without new materials; the latest achievement. We supply complete instructions and everything needed. Large daily profits.

BATTERY LABORATORY SCHOOL
DEPT. PSM, MINNEAPOLIS 4, MINNESOTA

High School at Home

Many Finish in 2 Years

No classes. No time wasted going to and from school. Progress as fast as your time and abilities permit. Standard H. S. texts supplied. Thousands enroll each year in this 55-year-old school. Send for FREE descriptive booklet.

AMERICAN SCHOOL, Dept. H746
Drexel at 58th St., Chicago 37, Ill.
Without obligation, please send FREE descriptive booklet.

Name.....
Address.....



More cars and trucks come factory-equipped with **FRAM** Filters than any other make

Today more than 15 million engines are being protected by Fram Filters! What better proof can there be that Fram filters best by actual test? Fram gets your oil cleaner, cleans it faster, keeps it clean longer . . . to keep your engine running better, longer, cheaper! Always insist on Fram when you have your cartridge changed. And, if your car isn't equipped with a filter, better have a Fram Oil & Motor Cleaner installed . . . to save your engine's life!

GUARANTEED BEST!

You don't risk a cent when you install a Fram Cartridge in your oil filter. They're guaranteed best you ever bought or your money back!



Call Western Union and ask Operator 25 for the name of your nearest Fram dealer. Do it now!

FRAM CORPORATION
Providence 16, R. I.

FRAM
OIL • AIR • FUEL • WATER
FILTERS

OLDSMOBILE'S

FAMOUS 160 HORSEPOWER

"ROCKET" ENGINE



PROTECTED BY...

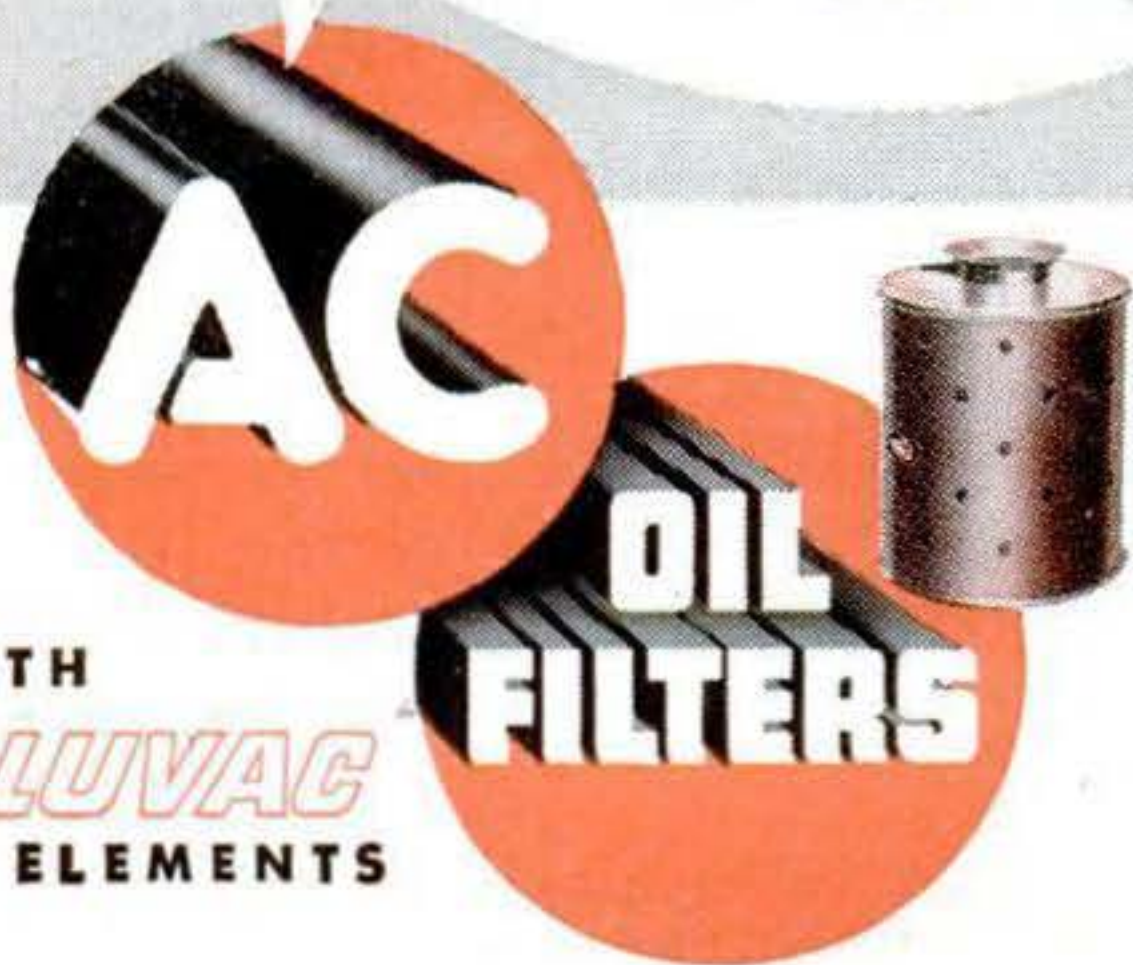

Olds engineers wisely protect every working part of the Rocket engine with an AC Oil Filter and Aluvac Element. Here's why—

- 1 ALUVAC keeps oil clean . . . removes particles as small as 1/100,000 of an inch
- 2 ALUVAC has greater filtering area . . . it's ten times greater than ordinary elements
- 3 ALUVAC has no harmful chemicals . . . won't destroy detergents in heavy-duty oils
- 4 ALUVAC is dependable . . . resists harmful acids, gasoline, water

There's an AC Aluvac Element made to fit the oil filter on most every car!

AC SPARK PLUG DIVISION  GENERAL MOTORS CORPORATION

OWN Your Own Business

\$5 per hour



service men at National Price Guide charges. Easy to learn . . . quickly established.

DURACLEAN cleans by absorption! No scrubbing, soaking or shrinkage. Dirt and grease vanish . . . matted pile rises . . . colors revive. Furnishings used again same day.

DURAPROOF resists moths and carpet beetles. Your service backed by a National Money Back 4 Year Warranty.

We furnish enough material to return your total investment in War-proof Business. **EASY TERMS.** Send for **FREE** booklet **TODAY.**

DURACLEAN CO.
2-180 Duraclean Bldg. Deerfield, Ill.

250 POWER

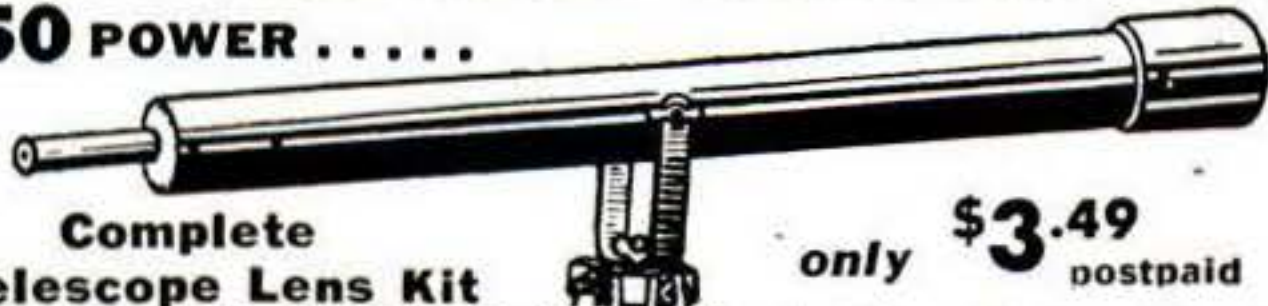

Complete Telescope Lens Kit only \$3.49 postpaid

Conquer Space, Explore the Universe, Planets, Moon Craters, New Stars, etc. Complete Lens Kit consists of 80 inch focal length ground and polished objective lens, eyepiece lenses for 50 POWER, 100 POWER, 150 POWER, 200 POWER, 250 POWER, and all necessary lens fittings. Easy to make from simple step by step instructions. (Tripod and mount not included.) Money back guarantee.

BUSSE SALES CO., Hartford, Conn., Dept. PS-7

PRECISION-MADE DRAFTING SET

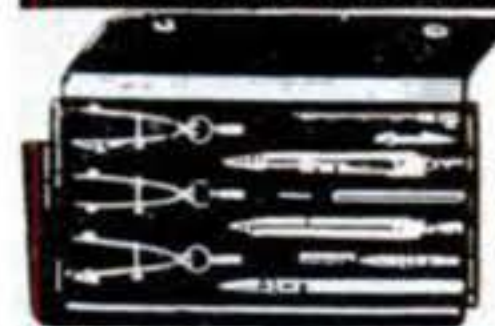

Imported From Germany
Excellent master-crafted from top-grade nickel plated brass. A 13-piece set with everything the draftsman needs. Includes 3 bows, compass, dividers. You save more than \$10! Set regularly \$20.00!

\$6.95 ppd.

TINKERS PARADISE • 163 GREENWICH ST., N. Y. C.



MAKE UP TO \$40 EVERY DAY

That's what you'll be saying when you line up with our company—full or spare time. We pay you every day for listing delinquent accounts for collection—secured from doctors, dentists, business firms, merchants, etc. No selling, demonstrating or collecting! Chance to become District Manager. **WRITE TODAY**—if you are between 30 and 65. Both men and women wanted!
UNITED FINANCIAL SERVICE OF AMERICA
254 PLYMOUTH BLDG. MINNEAPOLIS 3, MINN.

\$ FREE COURSE! BIG PROFITS! \$

Flocks & Sandblasts



Only \$24.75 complete

Dual Purpose Spray Gun! Uses only 25 lbs. Air Pressure!

• Thousands of uses in Home, Shop, Industry: Makes Auto Interiors Clean & New, Lines drawers, Marproofs lamp bases, Refinishes any object. All in colorful Flock, Etch & Frost windows, glassware, etc. Removes Paint and Rust from Autos, Tools. Guaranteed! Send \$24.75 or write for free information. Complete Flocking Supplies!

BLASTO SPRAY GUN MFG.
Dept. PS-10, 7007 Haas Ave., Los Angeles 47, Calif.

Wheels Wheels



Wheels Wheels

- 5" Disc Wheel 5/8" Tire 5/16" or 3/8" sleeve 30c ea.
- 6" Disc Wheel 5/8" Tire 5/16" or 3/8" sleeve 35c ea.
- 7" Disc Wheel 3/4" Tire 3/8" sleeve 45c ea.
- 8" Disc Wheel 1 1/8" Tire 1/2" sleeve 70c ea.
- 7" Disc Wheel 1" Tire 1/2" ball bearing 80c ea.
- 8" Disc Wheel 1 1/8" Tire 1/2" ball bearing \$1.00 ea.
- 8" Disc Wheel 2" semi-pneum. T. 1/2" B.B. \$1.35 ea.
- 10" Disc Wheel 1.75 semi-pneum. T. 1/2" B.B. \$1.50 ea.
- 12" Disc Wheel 1.75 semi-pneum. T. 1/2" B.B. \$1.85 ea.

Above wheel prices includes hub cap. Plus Postage. C.O.D.'s accepted.
AXLES—Sizes 5/16 in., 3/8 in., 1/2 in.—Cut to size—End holes drilled.

UNITED WHEEL STAMPING CO.
12131 S. PEORIA STREET PS-10 CHICAGO 43, ILLINOIS

PAINT STRIPING TOOL

Works Like a Fountain Pen
Stripes with PAINT instead of INK!

New Master Painters' STRIPING TOOL makes it easy to do expert striping on furniture, bikes, model planes, autos, signs, linoleum, toys, wall board, etc. Makes plain, painted walls look like tile. Paint straight lines, curved, circular or evenly spaced parallel lines the same way a professional painter does. Simply fill Tubular Glass Paint Fountain with any color paint & wheel tip feeds paint evenly. Tips interchangeable — jaws split apart for easy cleaning. Tool complete with tip for 1-16 in. stripe only \$1 postpaid. Other complete tools with 1-64, 1-32, 3-64, 1-16, 5-64, 3-32, 1-8 in. tips, \$1.50 ea. Extra tips, 75c. Complete Kit with tool and 7 tips, \$5.00. Handiest tool in painter's kit. Get it now. C.O.D.'s postage collect.

\$1.00

POST PAID



Tubular Glass Paint Fountain

A Visible Paint Supply

DEALERS
Paint Striping Tool

Packed in attractive Display Cartons of one dozen. Fast, profitable seller. Write for illustrated circular, discounts.

WENDELL MFG. CO.
 4234 N. Lincoln Avenue
 Dept. 2-S, Chicago 18, Illinois
 Paints Curved, Circular or Straight Lines

Thumb and Finger Rests. Easy to Guide Tool
 Guide Keeps Lines Straight
 Knurled Wheel Distributes Paint

SEND FOR GIANT 1952 BOOK ON ELECTRIC TRAINS

Huge, 48-page catalog filled with full-color pictures of American Flyer Trains and accessories. Authentic scale models, superbly detailed, with 2-rail track, smoke and "choo-choo." Wide variety of remote-control, action-packed equipment. Send 10c to **Gilbert Hall of Science, 345 Erector Square, New Haven, Conn.**

FREE CRAFT CATALOG



120 PAGES... Craft Supplies, Tools, Designs, Instruction Books from America's Largest, Most Complete Handcraft Stock.

Send for your free copy NOW!

GRIFFIN CRAFT SUPPLIES

5626-B Telegraph Ave. • Oakland 9, Calif.

EASY TO ASSEMBLE BOAT KITS 30 MODELS

NEW 18 FT. OUTBOARD CABIN CRUISER

Other models 8 to 23 Ft. Rowboats, Outboards, Inboards



NEW CATALOG Only 35c, SEND COIN TODAY
U-MAK-IT PRODUCTS 703R-WHITTIER ST. Bronx 59, N. Y. City

A BETTER SHAVE Money Back Guarantee

Would you invest \$1.00 to learn how to get a better, smoother and cleaner shave every time you shave for the rest of your life—with no more razor cuts, nicks, burns and none of the ill after effects caused from improper shaving? Then send \$1.00 today for the Shave-Ease System and reasons why you should use the Shave-Ease System of Instructions for shaving. They are the most logical and simple instructions ever offered to men who shave with a safety or straight edge razor and they are positively guaranteed to give you the best shave you ever had or money back. So if you want to really enjoy your shaving—Send \$1.00 today.

SHAVE-EASE SYSTEM
 6605 Hollywood Blvd.

Dept. E-6
 Hollywood, Calif.

40,000,000 IN DAILY USE

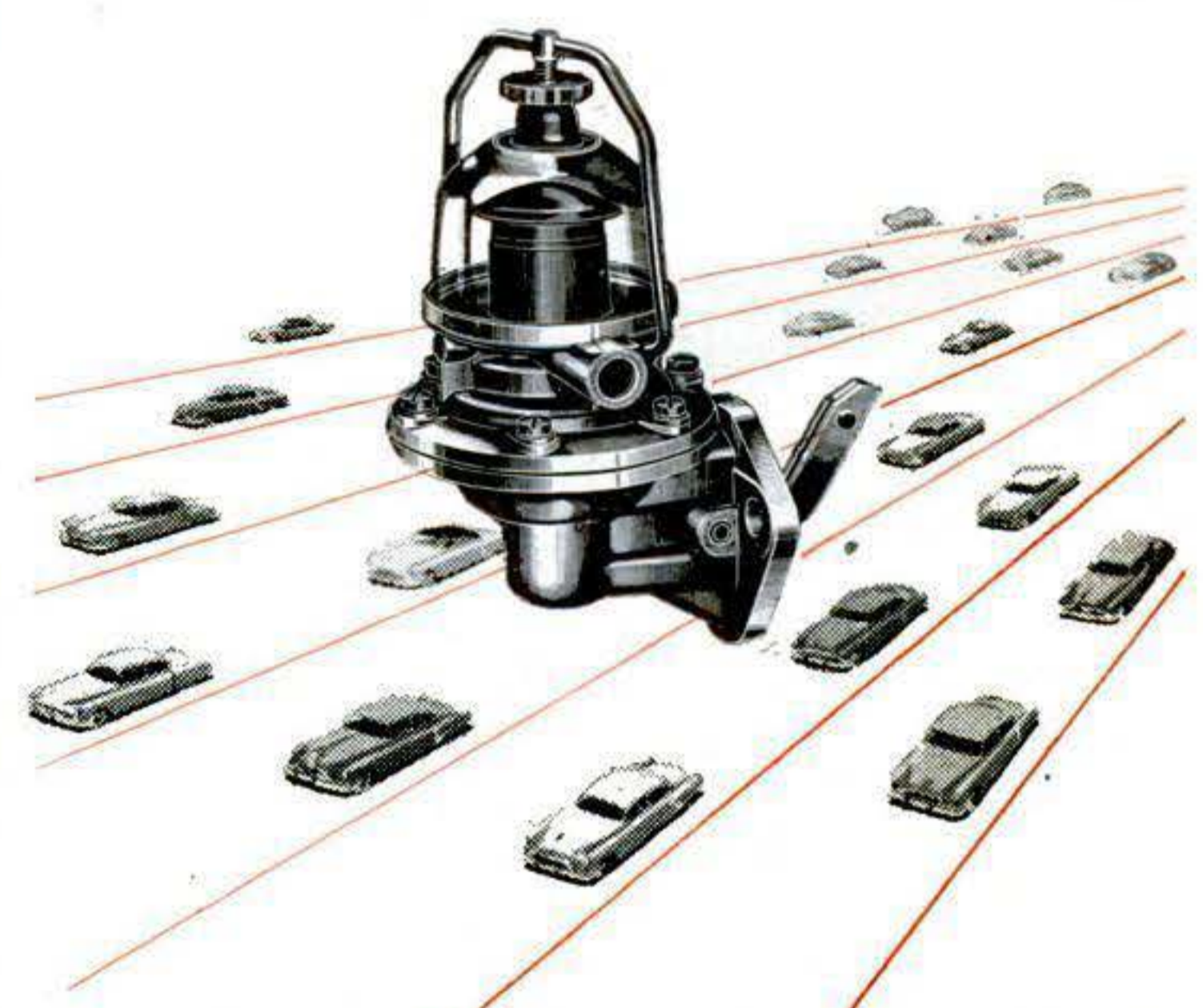

Wherever you drive on the highways of America, more than 90 per cent of the cars and trucks you see rely upon AC Fuel Pumps for a steady supply of fuel.

More than 40,000,000 in daily service testify to the popularity of AC Fuel Pumps, among engineers and owners alike.

Since AC introduced fuel pumps, 25 years ago, more than 100,000,000 have been built, establishing an unparalleled record for reliability the world over. There's none better.

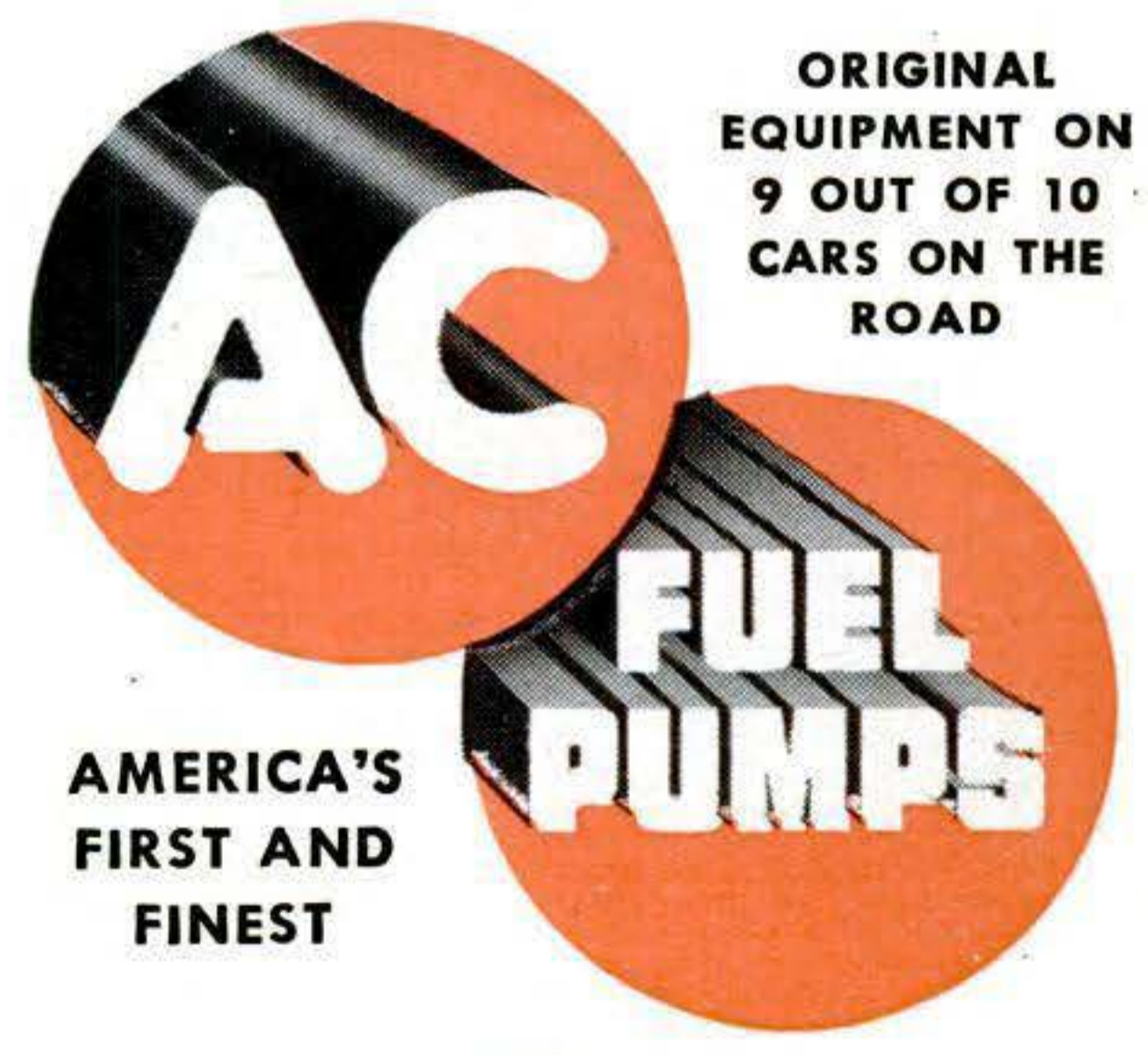

ORIGINAL EQUIPMENT ON 9 OUT OF 10 CARS ON THE ROAD

AMERICA'S FIRST AND FINEST



AC SPARK PLUG DIVISION

GENERAL MOTORS CORPORATION

OCTOBER 1952 49

Superior's New Model 670-A

SUPER-METER

A COMBINATION VOLT-OHM MILLIAMMETER PLUS CAPACITY REACTANCE INDUCTANCE AND DECIBEL MEASUREMENTS

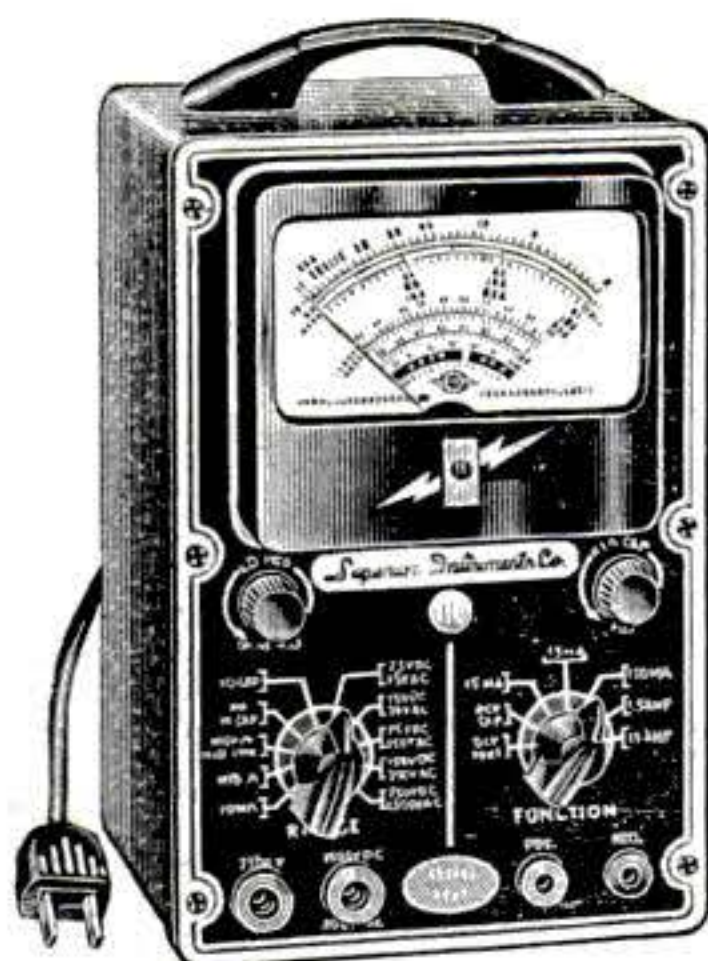

SPECIFICATIONS:

- D.C. VOLTS:** 0 to 7.5/15/75/150/750/1,500/7,500 Volts.
- A.C. VOLTS:** 0 to 15/30/150/300/1,500/3,000 Volts.
- OUTPUT VOLTS:** 0 to 15/30/150/300/1,500/3,000 Volts.
- D.C. CURRENT:** 0 to 1.5/15/150 Ma. 0 to 1.5/15 Amperes.
- RESISTANCE:** 0 to 1,000/100,000 Ohms 0 to 10 Megohms
- CAPACITY:** .001 to 1 Mfd. 1 to 50 Mfd. (Quality test for electrolytics)
- REACTANCE:** 50 to 2,500 Ohms. 2,500 Ohms to 2.5 Megohms
- INDUCTANCE:** .15 to 7 Henrys 7 to 7,000 Henrys
- DECIBELS:** -6 to +18 +14 +38 +34 to +58

The Model 670-A comes housed in a rugged, crackle-finished steel cabinet complete with test leads and operating instructions. Size 6 1/4" x 9 1/2" x 4 1/2".

ADDED FEATURE: The Model 670-A includes a special **GOOD-BAD** scale for checking the quality of electrolytic condensers at a test potential of 150 Volts.

\$28.40
NET

SOLD ON EASY PAYMENTS AT THE NET CASH PRICE

No interest or carrying charges added.

MOSS ELECTRONIC DISTRIBUTING CO., INC.
Dept. B-36, 38 Murray Street, New York 7, N. Y.

Please rush 1 Model 670-A SUPER METER. I am enclosing the down payment of \$7.40 and agree to pay balance, \$3.50 per month for 6 months.

Name.....
Address.....
City.....Zone.....State.....

UNLIMITED OPPORTUNITIES IN ENGINEERING

DEGREE IN 27 MONTHS

Study Engineering in this world-famed school, established 1884. Demand for our graduates exceeds supply. Growing shortage of engineers. No field offers greater opportunities for responsible, lucrative positions.

Bachelor of Science Degree in Mechanical, Civil, Electrical, Chemical, Aeronautical, Radio (Television) Engineering; Business Administration and Accounting. Also 36-weeks certificate courses in Surveying and Drafting.

Personalized Instruction. Accelerated courses. Non-essentials eliminated. For ambitious, earnest students. Earn your degree in the shortest possible time. Preparatory courses. Placement service.

Extensive Campus. Well equipped, new and modernized buildings; up-to-date labs. Low cost. New terms start quarterly. Enter September, January, March, June.

Mail Coupon Today

TRI-STATE COLLEGE

5102 College Avenue, Angola, Indiana
Please send me free catalog and special information. I am particularly interested in courses as checked:

- Mechanical Civil Electrical Aeronautical
- Radio (Television) Business Administration Accounting
- Short Diploma Courses

NAME.....
ADDRESS.....

NEW AUTOMATIC DEFROSTER

ONLY \$7.95 YOU MAKE UP TO \$4 ON EVERY FAST SALE!



Millions of defroster attachments sold at \$12.50 and \$9.95. Now - with new guaranteed HOLWIN at \$7.95 demand reaches new high peak. Men selling as many as 10 and 12 a day - right now. Your profits big - as high as \$4.00 cash on every sale. Converts any old style refrigerator into automatic defroster in 10 seconds. Just plug in. Terrific demonstrator. Women crazy for it at this price.

NO CHARGE for complete selling kit and offer of sample demonstrator. Rush name. If you've ever sold anything you'll clean up with HOLWIN. All mailed Free. Send name today for \$140-a-week opportunity. **DEFROSTER SALES CO., 415 LaSalle St., Dept. H-9-S Chicago 10, Ill.**

FREE SEND NAME
Don't buy until you're satisfied. Rush name for free sales kit. Offer of demonstrator sample to all who answer this ad. Sales skyrocketing every day. Rush name for big money.

MASTER MIND!



Learn Short-Cut Mathematics

Juggle figures, do baffling number tricks. Make people gasp at your marvelous lightning-quick mind. Multiply 4 figures by 4 figures without using old-fashioned multiplication! Big cloth-bound volume; fully illustrated course.

Sharpen up Your Brain Power

Includes worked-out problems, answers, etc. Sensational bargain, only \$1.95, postpaid or COD plus postage. Satisfaction guaranteed or refund. Order this amazing "Short-Cut Mathematics" today!

NELSON-HALL CO., 210 S. Clinton St. Dept. 4-KY-1 Chicago 6, Ill.

\$1.95 Complete

HYPNOTISM

Learn to apply this tremendous POWER. Develop will-power, self-confidence, self-control. ANYONE can master this exciting profitable profession in short time by training at home, with **GUARANTEED RESULTS. DON'T DELAY...** Write to America's oldest Hypnotic school for free information now—today!

INSTITUTE OF APPLIED HYPNOLOGY
Dept. 210, 120 Central Park So., N. Y. 19, N. Y.

PROFITS MAKE YOUR OWN RUBBER MOLDS

WRITE TODAY FOR NEW FREE CATALOG

Learn to cast thousands of perfect figurines, plaques, book ends, ash trays, etc. Start TODAY!

NO EXPERIENCE GREAT PROFITS

X. L. Rubber Pts. \$2.50
Qts. \$4.00 (postage extra)
Models and enough for 3 molds \$1.50 prepaid.

PLASTIC ARTS STUDIO 3403 S. MADISON ST. DEPT. 3, MUNCIE, INDIANA

REMOVE TREE STUMPS

You can remove ugly tree stumps and beautify your yard with amazing fast-acting STUMP-RID. . . . Easy to use chemical compound; eliminates digging, grubbing and chopping. Send only \$1.00 for enough STUMP-RID to remove a large stump. Postage prepaid on cash orders. Satisfaction guaranteed.

JOHN'S CO. • Dept. H1, Girard, Illinois

HOW TO DRAW CARTOONS THAT SELL



LEARN NEW EASY METHOD AT HOME!

Earn money in spare time drawing cartoons for magazines. This book shows you step by step HOW to draw and WHERE to sell cartoons! Author is a leading cartoonist who reveals his tested method in easy-to-follow form that EVERYONE can learn!

5-DAY FREE TRIAL—ACT NOW!

Send no money! Order "CARTOONING" book, pay postman \$1.98 plus COD charges. Examine for 5 days, if not delighted, return book for FULL REFUND. If check or money order is enclosed, WE PAY POSTAGE. Order NOW!

BLAFER PUBLISHING CO.
Box 1709, 175 Fifth Ave., New York 10, N. Y.

Vip's HAIR TYPES



CAESAR SALAD. Oil your salad . . . *not your hair!* Give your hair IDEAL care. IDEAL'S new secret agent grooms without matting or gluing . . . makes thin hair look thicker, thick hair look *naturally* neat. Not animal, vegetable or mineral oil. *You can't see it, feel it, smell it!* Put IDEAL on . . . it's gone! All that's left is all-day grooming.



Get New Fitch
Ideal
Hair Tonic

"GREATEST GROOMING DISCOVERY
SINCE THE COMB"

THIS . . . **GUIDE** 120 PAGE FOR AMBITIOUS MEN **FREE!**

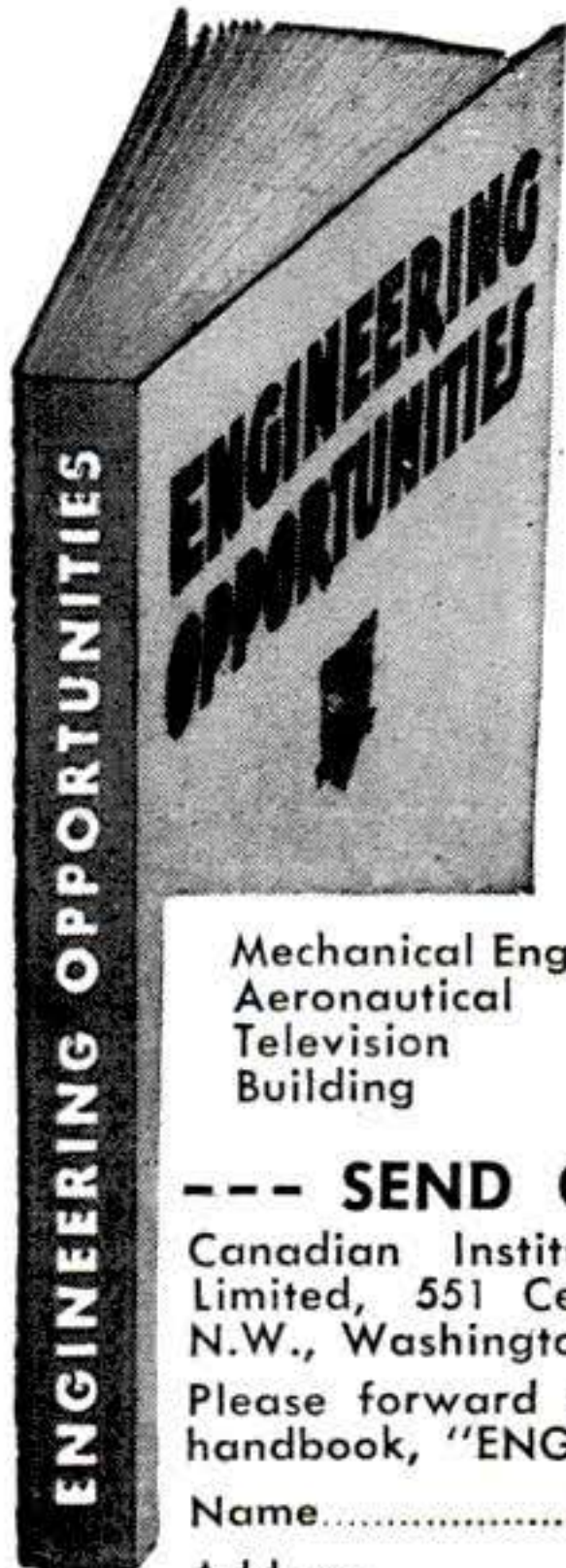

Have you had your copy?

120 pages of guidance to best-paid positions. Up-to-the-minute information for men who want to climb to the top. Tells how to get promotion, security and better pay through home study courses. This handbook "Engineering Opportunities" is free and entirely without obligation. Send the coupon. Make this your big year! Describes over ninety courses including:

Mechanical Eng.	Electrical	A.F.R.Ae.S.
Aeronautical	Radio	A.M.I.C.E.
Television	Automobile	B.S. (Pure
Building	A.M.I.Mech.E.	Science)

--- SEND COUPON TODAY ---

Canadian Institute of Science & Technology Limited, 551 Century Building, 412, 5th Street, N.W., Washington, D.C.

Please forward free of cost or obligation your handbook, "ENGINEERING OPPORTUNITIES".

Name.....

Address.....

Course interested in..... Age.....

Canadian Address: Canadian Institute of Science
551 Garden Building, 263 Adelaide St. W., Toronto, Ont.

Defense Plans Mean Bigger Pay
for Good Machine Shop Men!

Now You Can Be a
MASTER MACHINIST!

GET bigger pay in this ESSENTIAL field! Learn shop work quickly—with big home study and reference course, the thoroughly revised American Machinists' Library. 6 Volumes, 2987 Pages, 2900 Pictures

How to operate lathes, drills, other machine tools; turning, boring, grinding, gear cutting, jigs and fixtures, drilling and surfacing, punches and dies, and MUCH MORE! Timely information on airplane assembly fixtures. Illustrations show every operation clearly. The facts are up to date. Brings you the extra "know-how" that means difference between "just another machinist" and



FREE 10-Days' Examination

a Master Machinist. Invaluable help for anyone—from apprentice to shop executives. Packed with short-cuts. Will help to put you in big-pay class and to rate as an ESSENTIAL worker. Send no money. Mail coupon for 10-DAY FREE TRIAL. Note special price, easy terms.

McGraw-Hill Book Co., Dept. PS-10-52
327 West 41st St., New York 18, N. Y.

Send for 10 days' FREE trial, the American Machinists' Library. If not satisfied I will return books. Otherwise I will send \$4.75, plus postage, then; and \$5 a month for 5 months. (Reg. price \$35.75; you save \$6.)

Name.....

Home Address.....

City & State..... PS-10-52

WE'LL PAY POSTAGE if you enclose \$4.75 first payment WITH coupon. Same return privilege for full refund.

The **NEW Model 50 UTILITY TESTER**
FOR REPAIRING ALL ELECTRICAL APPLIANCES-MOTORS
an all-around electrical trouble shooter

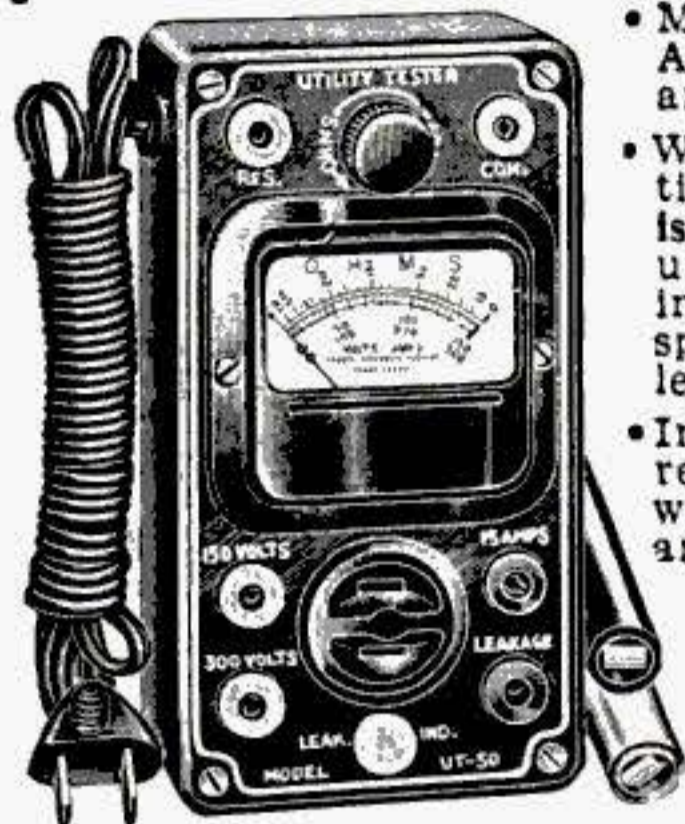

- Measures A.C. and D.C. Voltages, A.C. and D.C. Current, Resistances, etc.
- Will measure the current consumption while the appliance under test is in operation. The appliance or utility may be plugged directly into the front panel receptacle. A special pair of insulated clip-end leads is included for motors, etc.
- Incorporates a sensitive direct-reading resistance range which will accurately measure all resistances commonly used in electrical appliances, motors, etc. This range will enable continuity checks and tests for shorts and opens.
- Will test thermostats, radio tube filaments, bulbs, fuses, fluorescents, condensers, switches, field coils, circuit breakers, lighting systems, etc.

Handsome round cornered molded bakelite case 3 1/8" x 5 7/8" x 2 1/4". Complete with all test leads and instructions.

\$13⁹⁰

SHIPPED ON APPROVAL
No Money With Order - No C.O.D.

Try it for 10 days before you buy. If completely satisfied send \$3.90 and pay balance at rate of \$2.00 per month for 5 months — **No Interest or Carrying Charges Added.** If not completely satisfied, return to us, no explanation necessary.

SUPERIOR ELECTRONIC CO., INC.

Dept. D-36, 227 Fulton Street, New York 7, N. Y.

Please rush 1 Model 50. I agree to pay \$3.90 within 10 days after receipt and \$2.00 per month thereafter.

Name.....

Address.....

City..... Zone..... State.....

MONTH AFTER MONTH, YEAR AFTER YEAR, YOU SEE OUR AD. REMEMBER IT'S DANGEROUS to pay less if you want A-1 Used (Not Abused) Tires. If It's Your Family's Safety, Look Beyond the 'Price Tag' VETS & SERVICEMEN TAKE 10% ON 1 TIRE OR MORE

GOOD YEAR Firestone

GOODRICH, UNITED STATES, GENERAL, & OTHERS, NOT RECAPS DOUBLE WARRANTY & UNCONDITIONAL GUAR. ON PASS. TIRES BEFORE YOU ORDER, READ THOSE TOP LINES AGAIN!

Our policy is to select your tires so carefully, as if our very future depended on the service given by that particular tire.

FREE TUBE WITH EVERY GOOD GRADE AND FINEST GRADE, TRUCK & PASSENGER TIRE

GOOD GRADE GUAR. 20 MONTHS, (NOT JUST 6 OR 12 MOS.)			
600-16	\$4.14	820-15	\$5.44
650-16	5.42	700-15	4.54
700-16	5.04	670-15	4.48
650-15	4.44	710-15	4.68
760-15	5.04	550-17	4.64
600-20	\$7.14	32x6(8)	\$8.64
650-20	7.94	32x6(10)	9.94
700-20	8.54	900-20	13.18
750-20	8.64	1000-20	13.78
825-20	14.78	1100-20	13.94

FINEST GRADE, 30 MONTHS GOLDEN RULE GUARANTEE BOND (NOT JUST 24 MONTHS) THIS GRADE MADE US WORLD FAMOUS

30 MOS. GUAR. TRUCK TIRES			
600-16(6)	7.38	475-19	5.08
650-16	5.98	640-15	5.08
650-16(6)	8.28	670-15	5.68
700-16	6.48	710-15	5.88
750-16	9.78	760-15	6.08
525-18	5.08	800-15	6.58
550-17	4.98	820-15	6.68
650-15	5.38	670-16	6.38
700-15	5.58	760-16	7.58
600-20	8.78	1100-20	19.58
650-20	10.28	1200-20	23.28
700-20	11.48	1000-22	19.58
825-20	14.78	1100-22	20.48

Buy the 'Right' Truck Tires for 'Your' Job. Thousands of the Best Fleetowners Depend on Us. Std. Guar. 20 Mos. Rugged Guar. 32 Mos. MILITARY MUD-SNO TREAD 750-20Std \$10.78 750-20Rugg \$16.24 600-16 " 6.48 600-16Rugg 9.95 900-16 " 10.58 900-16Rugg 15.68

FACTORY REBUILT SNOW-TRED TIRES, 30 MO. GUAR. "New Tire Traction" Tread Not Worn. Perfect Casings. 670-15 760-15 650-15 600-16 700-16 \$11. 710-15 820-15 700-15 650-16 800-15

BLATT BLATT BLDG., GIRARD & LANCASTER AVES. DEPT. PS, PHILADELPHIA 31, PA. Send check or money order & this ad. We won't ship a tire we wouldn't use. Blatt Name famous in tires since 1915. Shipments RUSHED Down South, Up North and Far West

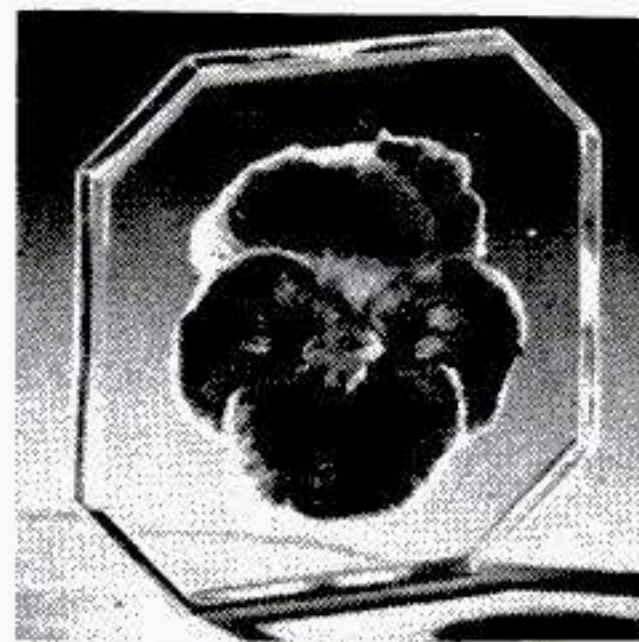

REAL PANSY COASTERS
Make Them at Home

EASY - FUN PROFITABLE

Now create new and truly different gift articles like the beautiful pansy coaster shown—made by embedding real pansies in Castolite—the "magic" liquid casting plastic. With our simple step-by-step method you



can make hundreds of valuable articles, including smart costume jewelry, chic Hi-Style buttons, colorful key tags, tie-clasps, cuff links, plaques, tiles, many other things. Send 25c for Big Castolite Creations Manual. FREE with Manual, inspiring New Home-Success Plan. Write:

CASTOLITE CO., Dept. L-2, Woodstock, Ill.



GROW MINIATURE TREES

Grow authentic, LIVE dwarf trees! Fascinating hobby! Fabulous profit!

SEND FOR FREE SEED & INSTRUCTIONS!

MINIATURE NURSERY CLUB

Dept. 6, P. O. Box 18696, Rimpau Sta. Los Angeles 19, California

TREASURE -- \$10,000

New locator detects metals, valuable minerals and buried treasure. Money-back guarantee of superiority.

Also geiger counters. Govt. reward of \$10,000 for uranium discovery. Write for FREE information.



THE GOLDAK COMPANY

1544 W. GLENOAKS BLVD., GLENDALE 1, CALIF.

LAWN ORNAMENT-NOVELTY PATTERNS

28 Lawn Ornament Patterns, 25c. Other patterns: 15-20" high: Dutch Girl, Dutch Boy, Pirate, Bull Terrier, Mexican Girl, Mexican Boy, Dwarf, Penguin, Flower Girl, 10c each. 25 Novelty Patterns, 30c. All 62 Full Size Patterns, \$1.00.

FLYING DUCK

Wind revolves wings. Realistic appearance. Pattern, instructions and wing Pinion Kit; brass bearing, steel shaft, wing lugs, bolts, nuts and washers, 50c. Pattern and instructions without kit, 25c.



STROTHER PATTERN SERVICE Dept. 7 CT Box 128 Bellington, W. Va.

RUPTURE

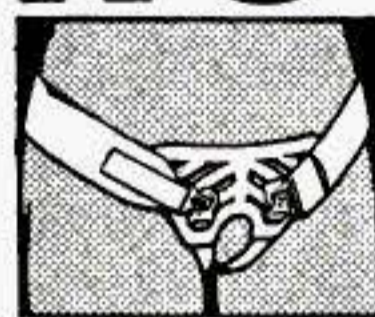

RELIEF...OR YOUR MONEY BACK

Write now for free booklet and pictures of rupture care. You can be helped...work steady, with low cost, easy to wear Web Truss, thousands satisfied.

WEB TRUSS CO. Dept. PS-10, Hagerstown, Maryland

FIX CARS?



New "Trouble Shooter" Spots ANY Car Trouble—FAST!

Put your finger on just about EVERY cause of car trouble—by turning to index in MOTOR'S amazing NEW "TROUBLE SHOOTER." Helps track down noises, knocks, breakdowns; includes cross-section pictures. Covers 2000 causes of car troubles—engines, clutches, brakes, ignition, etc. Valuable for beginner or experienced mechanic. Section on automatic transmissions. SEND NO MONEY, TRY BOOK AT OUR RISK. MOTOR Book Dept., Box DW, 250 West 55 Street, New York 19, N. Y. Pay postman \$1, plus 43c C.O.D. chg., on delivery. Use 7 days. If not delighted, your \$1 back. (SAVE 43c C.O.D. cost by sending \$1 now.)

EAT ANYTHING WITH FALSE TEETH

If you have trouble with plates that slip, rock and cause sore gums—try Brimms Plasti-Liner. One application makes plates fit snugly without powder or paste, because Brimms Plasti-Liner hardens permanently to your plate. It relines and refits loose plates in a way no powder or paste can do. Even on old rubber plates you get good results six months to a year or longer. **YOU CAN EAT ANYTHING!** Simply lay soft strip of Plasti-Liner on troublesome upper or lower. Bite and it molds perfectly. Easy to use, tasteless, odorless, harmless to you and your plates. Removable as directed. Plate cleaner included. Money back if not completely satisfied. If not available at your drug store, send \$1.25 for reliner for 1 plate. **PLASTI-LINER INC., Buffalo 11, New York — Dept. 41-J**

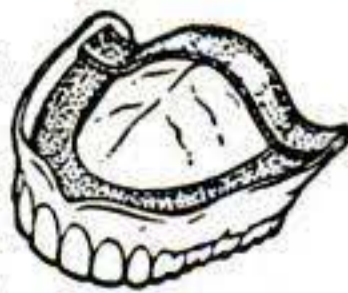

BRIMMS PLASTI-LINER
THE PERMANENT DENTURE RELINER

'How to Make Money with Simple Cartoons'



A book everyone who likes to draw should have. It is free; no obligation. Simply address

FREE BOOK

CARTOONISTS' EXCHANGE

Dept. 1910-D, Pleasant Hill, Ohio

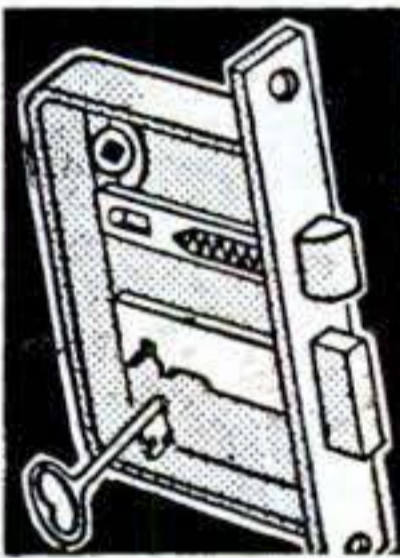

FIX LOCKS

Learn Locksmithing and Keymaking from Experts in Your Spare Time at Home! Age or physical handicap no disadvantage. Year-round, steady income in this permanent, respected field. Full or part time. Practical, illustrated lessons show you how to make money even while learning! All materials and special tools supplied. Send for FREE BOOKLET.

LOCKSMITHING INSTITUTE, Dept. PS-34
15 Park Ave. Rutherford, N. J.
Lic. by State of N. J. V.A. Approved



Pesco Positive Displacement Hydraulic Pump

Gear type. No. 1P-349. Rated 1500 PSI, .227 cu. in. per rev. 1 GPM at 1500 RPM. Operating speed, 3750 RPM. Splined shaft. Rotation either direction with slight adj. 3/4" pipe ports. Mtg. flange. Size, 5-9/16" x 3 1/2". Used, guaranteed service—

able. Wt. 4 lbs. **ONLY \$9.95**
Above Pump complete with spline fitting & 8" V-belt pulley for power take-off, or elec. motor. **\$12.95**

Order From This Ad! Prices F.O.B. St. Louis. Include postage with check or M.O. **MONEY BACK GUARANTEE!** **FREE CATALOG**
Dept. O, Box 4525, Ed. Aguado Trdg. Co. Plaza Sta., ST. LOUIS, MO.

BUY U.S. DEFENSE BONDS

LUXURIOUS CONTOUR CHAIR BUILD IN ONE EVENING

If you can use a hammer, you can build this smart, comfortable, scientifically correct chair in a few hours. All parts furnished in complete kit. Adjustable positions, plastic upholstery, four colors—red, blue, green or brown. Modern, healthful, relaxing, for den or living room. Send order, with choice of color, \$5 check or money order, balance C.O.D. Money back guarantee.



Complete Kit **\$34.95**

BESTE CRAFT CO., BOX 3701A, BALTIMORE 14, MD. f.o.b. Baltimore



BUILD A BIG PROFIT BUSINESS AT HOME. I'll show you how. —NELS IRWIN
Director of Instruction

COVERS Plaster, Fabric, Metal, Wood, Plastic, Rubber... any surface



NOW 1001 items can be "PAINTED with SUEDE" for Profit and Pleasure!

MAKE \$5.00 to \$10.00 PER HOUR and More!

Read What Others Say About Flok-Kraft

"Got \$52.50 for those 7 trunk interiors for about 4 hours work. \$7.50 per trunk." J. O., Mo.

"Received the flok-kraft outfit and everyone that saw it is very enthused. I only had it about thirty minutes and got an order for a hundred dollar job." Mr. C. H. Maryland



PROFESSIONAL SECRETS CAN BE YOURS

At last, secrets of this amazing miracle finish can be yours! Huge profits waiting to be tapped in tremendous new field. Flok-Kraft gives a velvety, luxurious surface to radios, lamps, toys, signs, store displays, figurines, auto dash boards—a thousand and one items to be seen on every hand easily and quickly beautified, enriched, increased in value with Flok-Kraft. Make old objects beautiful—saleable, make new things worth much more with this soft, rich covering that can be applied to any surface, even if old or worn.

YOU CAN LEARN IN A FEW DAYS

Make to \$5.00—yes! even \$10.00 and more per hour. Fully detailed Flok-Kraft instructions—complete and easy to understand—every point explained—shows you how to start on the road to big money, full or spare time.

WE FURNISH EVERYTHING YOU NEED TO START

You also get complete Flok-Kraft kit of materials and equipment that enables you to start at once. Add to your income from your regular job or begin to build a successful business of your own and do it all, right in a corner of your basement, garage, service porch, kitchen or living-room.

GRASP THIS LIFETIME OPPORTUNITY TODAY

I'll arrange to send you the complete outfit—everything you need to start—for leisurely, no-risk examination right in your own home. You owe it to yourself to investigate. Fill out and mail the coupon below for FREE details, Sample, Plan, etc. Do it today! Everything I send you now is FREE of charge and post-paid. Airmail is faster.

COAST INDUSTRIES, Dept. IA
1006 S. Los Angeles St.
Los Angeles 15, Calif.

YOURS TO EXAMINE WITHOUT RISK!!

Complete instructions, full starting kit of materials, equipment, complete, full details on how you can start your own business, spare or full time—EVERYTHING sent you to EXAMINE AT OUR RISK!

SEND NO MONEY! JUST YOUR NAME AND ADDRESS

Coast Industries, Dept. IA
1006 S. Los Angeles St., Los Angeles 15, California

FREE! Booklet, Sample, Plan!



Gentlemen: Please rush me FREE details, sample, etc., I understand that everything you send is free and that I'll be under no obligation now or ever.

NAME _____ STREET _____ CITY _____ STATE _____

Learn this Profitable Profession



**IN 90 DAYS
AT HOME**

Money-Making Career Open to Men and Women, 18 to 60

Hundreds of men and women between 18 and 60 make \$10 to \$20 in a single day giving scientific Swedish Massage and Hydro-Therapy treatments. There is big demand from doctors, hospitals, sanatoriums and clubs. Graduates earn large full time incomes from these or in private practice in their own offices. Others make good money from home treatments given in spare time. Learn this interesting, money-making profession in your own home, through our home study course. Same instructors as in our nationally known resident school. You can win independence and prepare for future security by qualifying for your Graduation Certificate. Course can be completed in 3 to 4 months. Many earn while they learn. Begin your training at once.



NEW 32-PAGE BOOKLET FREE

Fill in the coupon below (please print name and address) and mail it for your FREE copy of 32-page Information Booklet. If you act at once we will include Anatomy Charts and Success Booklet which supply additional information you should have. All will be sent postage paid.

THE COLLEGE OF SWEDISH MASSAGE
Dept. 270M, 41 E. Pearson St., Chicago 11, Illinois

Please send me FREE and postpaid New 32-Page Illustrated Booklet, Anatomy Charts and Success Booklet at once.

Name.....Age.....

Address.....

City.....State.....

**YOU ARE
IN DEMAND**
if you can draw!



ART INSTRUCTION, INC.

Dept. 10142 • 500 South 4th St.
Minneapolis 15, Minn.

Please send me your FREE Talent Test.

Name.....

Address.....

Age.....Phone.....

City.....Zone.....

County.....State.....

Occupation.....

Make money with your brush and pen! If you like to draw, sketch, or paint, take the FREE Talent Test. No fee. No obligation. Mail this coupon TODAY!

SAVE UP TO 50% BY DOING YOUR OWN HOME REPAIRS

**NEW BOOK
MAKES IT
EASY!** **ONLY \$1.49**

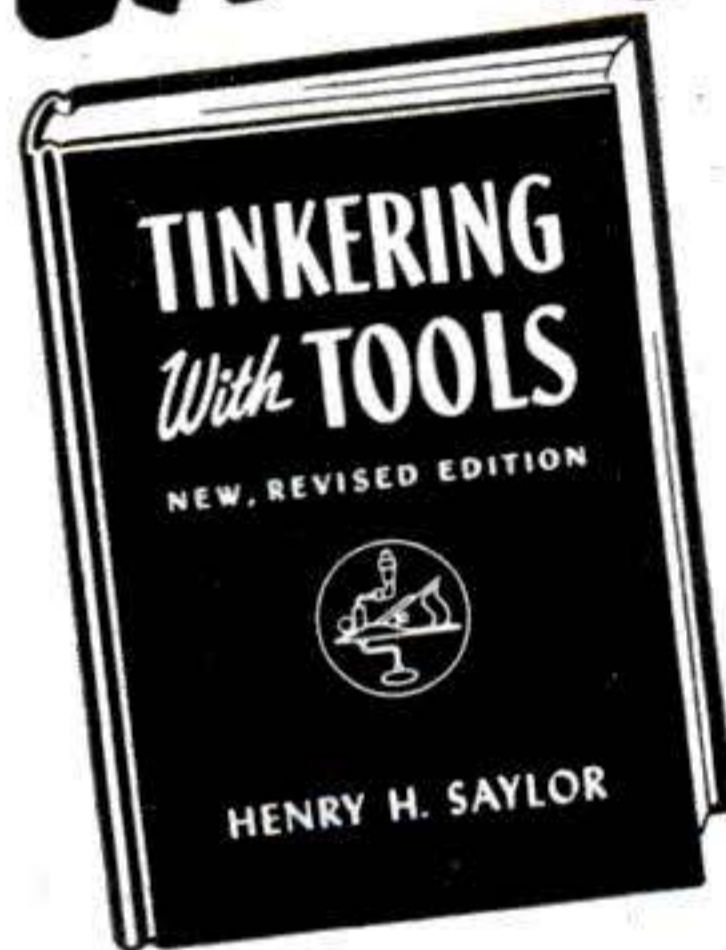

You can save up to 50% on home repairs — and have lots of fun besides — if you follow the simple, easy-to-understand instructions in TINKERING WITH TOOLS!

Tells you everything you need to know to cut repair bills—how to refinish floors and furniture, how to repair electrical appliances, and plumbing fixtures, how to lay sidewalks, shingle roofs, plaster walls, renew sash cords and hundreds of other repairs and improvements around the house! Never before has so much valuable information been crammed into one big cloth-bound volume to sell for only \$1.49! Books of similar size usually sell for \$2.50 or more!

SEND NO MONEY NOW!

Just mail coupon below and pay postman only \$1.49 plus mailing cost for this DeLuxe edition. If, after 7 days' examination, you wish to return book for any reason, we'll gladly refund every cent you paid.

MAIL COUPON TODAY!

POPULAR SCIENCE—Dept. 1052
353 Fourth Avenue, New York, N. Y.

Send me the new 260-page cloth-bound book, TINKERING WITH TOOLS. I will pay postman only \$1.49, plus postage, on delivery. If dissatisfied, I may return book within 7 days for full refund.

NAME.....

ADDRESS.....

CITY.....ZONE.....STATE.....

If you remit now, we will pay postage. Same refund guarantee.



MASTER WATCHMAKING

At Home - NOW!

Learn *professional methods* of watch repairing without leaving home or job... enjoy a profitable hobby... or prepare for a new career. The easy-to-follow Sweazey System shows you step by step how to fix watches from start to finish. It's fascinating! Can easily lead to a business of your own.

Tools, Supplies and Equipment all Furnished

CSW's Master Course brings you everything you need to learn watch repairing at home. Included are: practice watches... professional equipment—such as watchmaker's lathe and staking tool... 200 more tool and supply items... 51 special texts... and other aids to assure complete, practical, professional instruction.

CSW HAS BEEN TRAINING MASTER WATCHMAKERS SINCE 1908

Why not be one of our successful graduates? Learn how Chicago School's streamlined training can speed *your* success. Previous experience unnecessary. Get the facts now!

SEND COUPON TODAY!



CHICAGO SCHOOL OF WATCHMAKING

Founded 1908

1608 MILWAUKEE AVE., CHICAGO 47, ILL.

FREE SAMPLE LESSON!

CHICAGO SCHOOL OF WATCHMAKING

1608 N. MILWAUKEE AVENUE, DEPT. 4102. CHICAGO 47, ILLINOIS

Please send free sample lesson and full information on home study course in Master Watchmaking.

(This offer limited to USA and members of Armed Forces overseas. Other plans available for foreign students.)

Name _____

Address _____

City _____ Zone _____ State _____

Improve Your NIGHT DRIVING Vision INSTANTLY



with
**Litenite
NIGHT
DRIVING
GLASSES**

Now you can IMPROVE your NIGHT vision and ELIMINATE 94% of dangerous GLARE at once with this amazing new invention—LITENITE NIGHT DRIVING GLASSES. These remarkable glasses are made of special amber lenses that let through INFRA-RED light. INSTANTLY you see more clearly! Headlamps of oncoming cars look like soft, amber lights—yet everything else is in sharp focus. Amazing, unbelievable until you actually put LITENITE on!

Eliminates
GLARE
•
Relaxes
Eyes

Not This—But This



LITENITE are NOT sun glasses but scientifically developed NIGHT LENSES used by airplane pilots to see more clearly through darkness and haze. Wonderful also for TV, NIGHT sports, WALKING at night. Beautifully made with 24 KARAT GOLD-PLATED AVIATION frame, comfort temples, adjustable nosepiece, wide-angle lenses. FREE! Rich-looking Leatherette Carrying Case. Try AT OUR RISK, for full week. MONEY BACK if you don't say night driving is a pleasure! Send check or money order—Sorry, no CODs. REGULAR Style only \$2.98. CLIP-ON Style for use over prescription glasses—\$2.25. State STYLE and whether for MAN or WOMAN.

CONSUMER SALES CO., 516 Fifth Ave., New York 36, N.Y., Dept. 170

150 DIAGRAMS and HOW TO READ THEM

150 DIAGRAM BOOK

FREE

For Examining Coyne's Great 5-Volume Set On

ELECTRICITY

HERE'S a valuable book of 150 Electrical and Radio wiring diagrams with charts and instructions. Practical information you need to win security and promotion. It's yours FREE merely for examining Coyne's 5-Volume Set on Applied Practical Electricity on 7-day's free trial. This 5-Volume Set COVERS EVERYTHING ELECTRICAL from home appliance repairs to advanced AC-DC motors and equipment. Thousands of diagrams and photos... written so both "beginners" and "old-timers" can easily understand.

7-DAY'S FREE TRIAL Send for 5-Volume Electrical Set on 7 day's FREE TRIAL. We'll include Shop Prints Book FREE. If you keep the set, send just \$3 after 7 days and \$3 a month until \$15.95 plus postage is paid (cash price: \$14.95). Or return the set in 7 days and owe nothing. Either way, Shop Prints Book is yours to keep, FREE! Mail coupon AT ONCE!

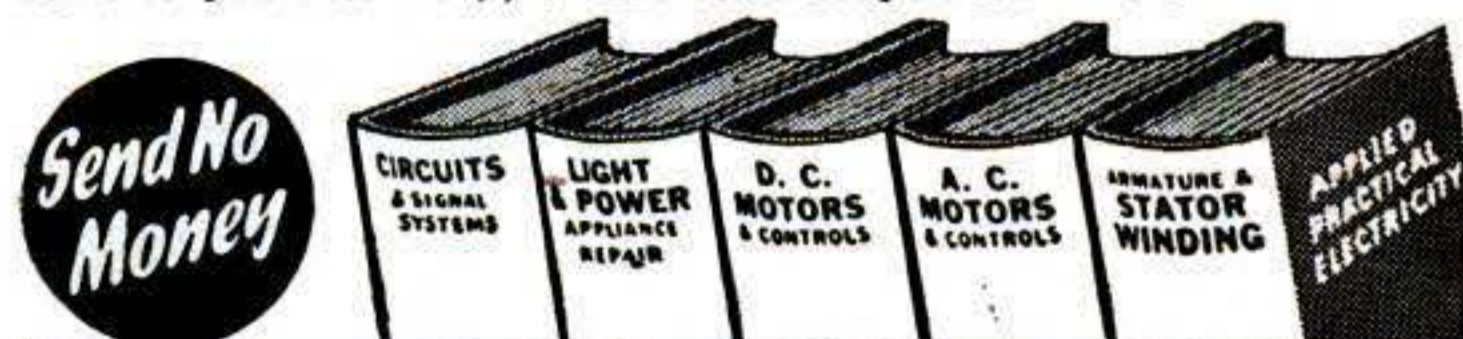

FREE COUPON { NOT AN ORDER - JUST A REQUEST TO SEE BOOKS

Educational Book Publishing Division
COYNE ELECTRICAL & TV-RADIO SCHOOL
500 S. Paulina St., Dept. A2-R8, Chicago 12, Ill.

Rush 5-Volume Electrical Set for 7 day's FREE Trial per your offer. Include Shop Prints Book FREE.

Name _____ Age _____

Address _____

City _____ Zone _____ State _____

Check here if you are enclosing \$14.95. We pay postage. 7-day Money Back Guarantee.

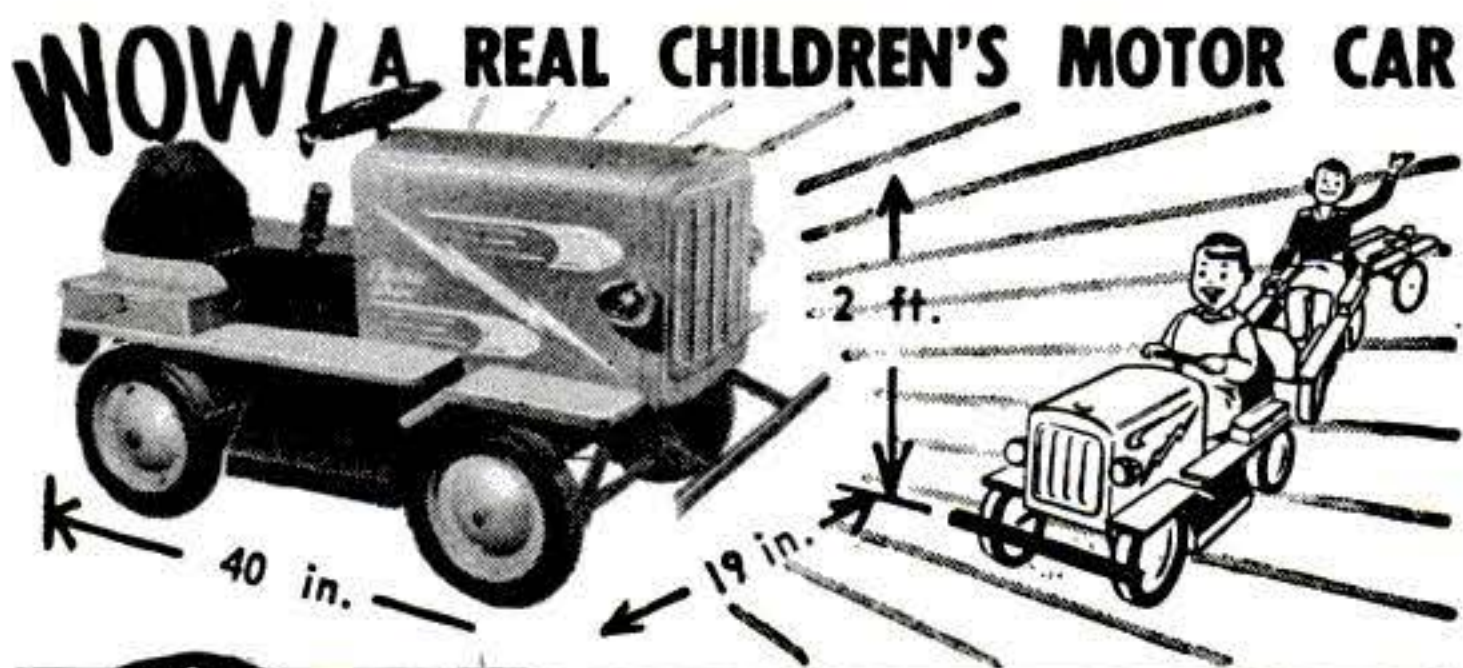

WOW! A REAL CHILDREN'S MOTOR CAR

THE EXCITING NEW Powercar JUNIOR ELECTRIC MOTOR DRIVEN

RUGGEDLY BUILT FOR LONG LIFE . . . PLENTY OF POWER FOR TOWING OTHER VEHICLES
 The POWERCAR Junior drives up or down hills easily, runs at a limited speed of approximately 5 miles per hour . . . Is strong enough to tow several other children's vehicles . . . provides dozens of opportunities for constructive, educational play and original thinking. Mechanically, the POWERCAR Junior steers and drives like a big car, weight is evenly distributed, close to the road, takes corners safely . . . has reverse shift for easy parking and maneuvering; the semi-pneumatic tires ease the jolts and take the bumps, yet they need no air.

POPULAR SCIENCE
 Editors thought so much of the POWERCAR Junior that they ran a feature story in the September issue, Page 136.

Auto Battery Powers Cars for Kids

The same kind of motor that starts your car drives baby hot rods at a brisk walk.

A FELLOW who was so handy with his mitts in high school that he built an eight-tube radio set without a diagram is now building electric-powered cars for kids to play with.
 Detroit-born George Ford (no relation to Henry) calls his automobile for . . .

SAFE OPERATION! • Runs only while driver holds his foot on pressure switch • Stops in a few feet when foot pressure is released • Positive action hand brake • Safe operating speed — no faster than a brisk walk • No dangerous inflammable fuel — no combustion to produce red hot surfaces • No high voltage electricity — impossible to receive electric shock • No carburetor, ignition controls, or other complicated adjustments • Stops and starts by electric action. Will not run without a driver • Satisfaction guaranteed or Full Purchase Price Returned.
 Send For Full Information About Children's Motor Vehicles and Special Offer.

MYSTIC RIVER SALES COMPANY
 Dept. Q-10 Mystic, Conn., U. S. A



HOT WATER
 From ANY COLD WATER FAUCET!

INSTANTLY—Yes, you can now have continuously running HOT water with the JET INSTANT HOT WATER HEATER, in kitchen, summer cottage, camp, office, factory or farm.

Regulates from LUKEWARM to REAL HOT with a turn of the tap. A cinch to attach . . . No tools needed. 110 Volt AC DC. Durably constructed of gleaming chromed steel and porcelain. 8 foot U.L. Cord.

10 DAY MONEY BACK GUARANTEE!

Send only \$1.00 deposit, balance C.O.D. plus postage. Send \$4.98 and we pay postage. THE JET must give you satisfactory service!
SUCCESS PRODUCTS, 246 Roebling St., Dept. H-787, Brooklyn 11, N. Y.

SAVE MONEY TEST YOUR OWN RADIO AND TELEVISION TUBES AT HOME!!!



CONDUCTANCE TUBE TESTER

No Tube Manual or knowledge of tubes necessary—Tests All Tubes—100% accurate for direct shorts, opens, burned out tubes. Buy it—Try it—If not satisfied, return in 5 days—Money cheerfully refunded.

\$4.98

SEND NO MONEY — ORDER C.O.D. plus postage, or send check, cash or money order & we pay postage.

E-Z TESTER CO.
 (Dept. PS-10) MACON, GA.

Pat. Pending
ALSO AVAILABLE!
CONDENSER TESTER
 Checks Shorted, Open and Leaky Condensers . . . \$6.98



Bar Bells

BUY DIRECT FROM FACTORY **\$8.95**
 Write for free booklet and price list up

INDEPENDENT IRON WORKS
 2416 East 23rd Street, Dept. "C"
 Los Angeles 58, Calif.

INVENTIONS Wanted At Once

If you want to market, or sell, your invention for cash or royalties, Write for our Free Booklet. Send no drawings. We also welcome hearing from firms, or private capital, wishing to review inventions in any field. We will be glad to send notice of our clients inventions.

GLOBAL MARKETING SERVICE
 1404 Mitchell Street Dept. 5D Oakland 1, Calif.

FREE—Amazing Book on RHEUMATISM, ARTHRITIS

If you suffer the aches, pains and discomforts of Rheumatism, as manifested in ARTHRITIS, NEURITIS, SCIATICA or LUMBAGO, send today for the FREE Book. It reveals important facts about why drugs and medicine give only temporary relief without removing causes. Explains fully a proven, specialized system of treatment that may save you years of distress. No obligation. Write for this FREE Book today!
BALL CLINIC, Dept. 36, Excelsior Springs, Mo.

AVOID SEPTIC TANK TROUBLES

d-CON Rid-X

Prevent Clogging, Back-ups, Offensive Odors in Septic Tanks, Cesspools, Outdoor Toilets. One Treatment lasts months. Guaranteed. \$1.69 at Hardware and Drug Stores.
 d-CON Co., Inc., Chicago 11, Ill.

When Writing to Advertisers, Please Mention Popular Science

FREE! GET BIG 34-PAGE CATALOG

NORTHROP AERONAUTICAL INSTITUTE
 1525 E. Broadway, Hawthorne (Los Angeles County), Calif.

Tells how to train for AVIATION CAREER in Aeronautical Engineering and Aircraft & Engine Mechanics

Name _____ Age _____
 Address _____
 City _____ Zone _____ State _____

PARTS FOR MILITARY TRUCKS

FOR JEEP, DODGE, CHEV., GMC, STUDEBAKER, 4 WHEEL DRIVE AND 6 WHEEL DRIVE. ALSO PARTS CATALOG. WRITE

AXLES FOR TRAILERS

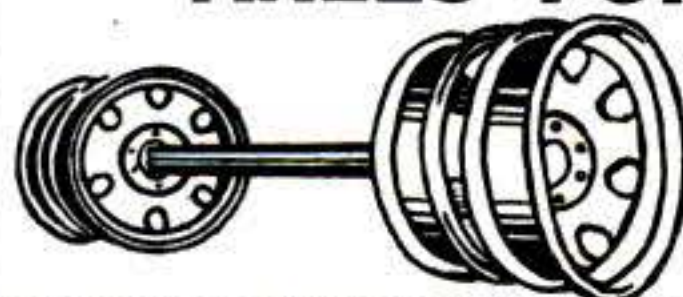

(Surplus) Heavy Duty axles suitable for building of many types of trailers, farm wagons, etc. Standard width straight axle, 2 inch square and is complete with Hubs, Timken bearings, 6 Hole

750x20 or 825x20 wheels, without brakes, only..... **\$69.50**

Dual Wheels.....add **\$15.00** extra

NEW JEEP TOPS and CURTAINS

Military type, easily adapted to civilian type Jeep. Complete top & back curtains, side curtains, snapon doors, 5 windows. Waterproof.

\$69.50

OD color. 25 lbs. FOB, KC.....

All prices quoted good 30 days FOB, Kansas City

25% DEPOSIT REQUIRED ON ALL ORDERS



UNITED AUTO PARTS CO. INC

1901 TROOST-GR.1800-KANSAS CITY, MO.

MANAGEMENT PRODUCTION

Production experts earn big money. Thousands of firms need them. We train you thoroughly at home in spare time for management positions. Previous experience unnecessary. Personal training under supervision of production management authorities. Placement counsel and help. Write for FREE book "Industrial Management."

LASALLE Extension University, 417 So. Dearborn St. A Correspondence Institution, Dept. 1083IM, Chicago 5, Ill.

REAL PISTOL MAKES LOUD BANG!

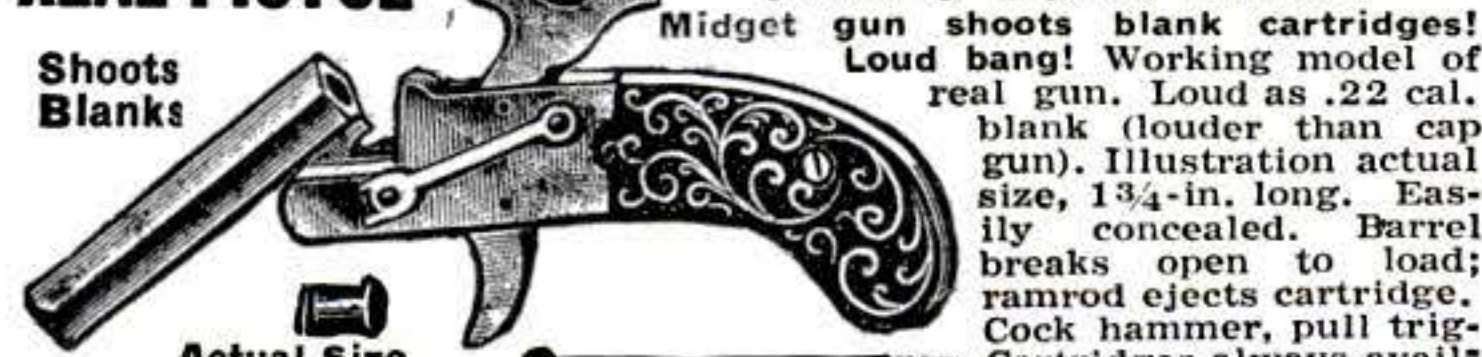

Shoots Blanks

Midget gun shoots blank cartridges! Loud bang! Working model of real gun. Loud as .22 cal. blank (louder than cap gun). Illustration actual size, 1 3/4-in. long. Easily concealed. Barrel breaks open to load; ramrod ejects cartridge. Cock hammer, pull trigger. Cartridges always available. Loop for attaching to chain. Nickel plated, design handle. (Get 2 for \$3.75). EACH ONLY..... **\$1.95**

JOHNSON SMITH COMPANY, Dept. 596, Detroit 7, Mich.

Send 10c for Big Catalog of 3000 Novelties, Gadgets, Funnakers, etc.



TALK—SING—PLAY OVER YOUR RADIO

with the real Radio Mike! Attaches in a jiffy—full instructions given! Swell for "parties"—"cut in" on or "kid" regular network programs or put on your own broadcasts! Amaze your friends—real fun. Beautiful Metallic Plastic 6 in. high!

12 RADIO BROADCAST LESSONS GIVEN with each mike SEND NO MONEY Just pay postman \$3.99 COD plus postage or send \$3.99 and we pay postage! Radio Mike is available only from us by mail—guaranteed.

Midway Co., Dept. MPS-10, Kearney, Nebr.

MEN! Do You Suffer FROM

Pains in Lower Back, Hips and Legs; Low Vitality, Nervousness, Irritability, Night-Rising, Bladder Trouble, Forgetfulness, Sleeplessness; Weak, "Worn-Out" Feeling and a General Decline in Health? If so, then send for our Free "facts" booklet containing much information of value to you. Booklet is mailed together with Questionnaire Blank in plain wrapper. Don't Delay! Send for your copy Now! NO OBLIGATION.

MAIL THIS COUPON

MILFORD SANITARIUM, Box PS
MILFORD, KANSAS

Gentlemen: Please send me your Free "Facts" Booklet.

NAME.....AGE.....

ADDRESS.....

CITY and STATE.....

"WHAT A Wonderful Easy Way to Learn Music!"



START PLAYING RIGHT AWAY—

Even If You Don't Know a Single Note Now!

FREE BOOK Tells All About This "Easy As A-B-C" Way

Imagine learning to play music RIGHT AWAY! Yes—piano, guitar, accordion, or any other instrument. WITHOUT stirring from your home! WITHOUT the bother and expense of having a private teacher! WITHOUT spending months doing boring scales and exercises! And all at a cost of only a few cents per lesson—and a few spare minutes per day!

THEY ARE PLAYING—SO CAN YOU!

Samuel Moses, Mt. Vernon, Tenn.: "After a short time I could sit down and play pieces in a hymn book. Now entertain at parties—play at church, dances."



Lawrence Weik, famous band leader: "Got my start in music with your Course. How easy it is to learn to read notes and play an instrument this 'teach-yourself' way."

Mrs. Dallas B. Kerk, Lodgepole, Nebr.: "Never dreamed I would ever play. Didn't know a note. Today I play delightful pieces, after only 2 months."

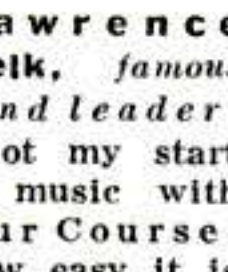

Takes "Mystery" Out of Music

No wonder over 850,000 people have taken up this famous home-learning method! Takes the "mystery" out of music. Explains everything step-by-step—so clearly even a child "catches on" at once.

EVEN IF YOU DON'T KNOW A NOTE NOW—you'll soon be playing so well that family and friends will be amazed. No months of "preparation." Start right in on simple pieces—REAL music—by NOTE.

FREE BOOK

Why keep missing out on the fun of music... the good times, interesting new friends? Mail coupon for FREE 36-page book and a Free Copy of our simple "print-and-picture" Lesson-Sample. No obligation; no salesman will call on you. U. S. School of Music, Studio B-1510, Port Washington, N. Y. (Special Reduced Prices on instruments to our students.) We are now in our 54th successful year!

U. S. School of Music, Studio B1510, Port Washington, N. Y.

Send me FREE BOOK and FREE Lesson-Sample. No obligation—and no salesman is to call upon me. I'm interested in playing

(name instrument).....

I do I do not—have instrument now.

Name..... (please print)

Address.....

City.....State.....

(Please state Zone No. if any)



FREE BOOK

**"TOOK IN \$217
FIRST 10 DAYS"**

Some make more, some less...

We help you to start Your
Own All-Year Business

Make Big Money! With our easily operated, highly efficient wall washer, Chas. Stelle took in \$217 gross in first ten days. E. L. Goss took in more than \$10,000 in one year. E. C. Taber wrote, "I made \$400 gross in two weeks." And no wonder—this machine washes walls 6 times faster and better than by hand.



Your Money-making Opportunity. We want more men to go into this profitable business for themselves and enjoy independence. Customers everywhere—homes, offices, schools, churches, hotels, etc. What you take in is mostly profit. No need to rent shop or office; operate business from home.

Lose no time. Get all facts without obligation

FREE BOOK! MAIL COUPON TODAY!

• **VON SCHRADER MFG. CO.**
• 2031 "W" Pl., Racine, Wisconsin
• Send at once (no obligation) your **FREE** booklet containing information about your **WALL WASHING MACHINE** and how I can start my own permanent, profitable business.
• Name _____
• Address _____
• City _____ Zone _____ State _____

BENJAMIN SUPER CO₂ GAS PISTOL
NEW! Different



**SAFE • NON-TOXIC • HI-POWER
ACCURATE • ECONOMICAL
CONVENIENT • PRACTICAL**

Easy to operate—Uses low cost Soda Cartridges. Shoots Cal. .177 Benjamin H-C Pellets & Darts or BB. Write Today for Illustrated Folder of All Models Benjamin Air Rifles and Benjamin Air Pistols.
\$15.00
Benjamin Air Rifle Co., 852 Marion St., St. Louis 4, Mo., U.S.A.

**World's Greatest Hobby
For Men and Boys!
Get This Free Book. It
Tells How You Can Learn to**

GET THIS FREE BOOK



Learn At Home
Men, Boys, Hunters, Fishermen, mount and save your lovely wild-game trophies. Be a Taxidermist. Mount Birds, Animals, Heads, Fish, Tan skins. YOU learn easily, quickly in spare time. Have a grand home-museum. The finest and the greatest hobby known, for sportsmen. Fun, real profits.
FREE BOOK
Yes, **FREE**. Beautiful strange, valuable Book, telling all about Taxidermy. Contains over 100 beautiful game-pictures. And it's yours **FREE**, if you rush your request. You can mount all kinds of wild-game, and common specimens too. We can positively **TEACH YOU**. So **GRASP** this opportunity. **RUSH** letter or postal for this amazing **FREE BOOK**. Don't delay. State your **AGE**.
N. W. SCHOOL OF TAXIDERMY, 2610 Elwood Bldg., Omaha 2, Neb.

FANS! BLOWERS!
ALL TYPES ALL SIZES

FOR HEATING, VENTILATING, COOLING, ETC.
• HIGH VOLUME • PRECISION BUILT • QUIET
• HEAVY GAUGE STEEL • OVERSIZE BEARINGS
DIMENSIONS: 10³/₄" wheel; outlet 11⁵/₈" x 12 5/16"; Height 17¹/₂"; width 20¹/₂".

BLOWER less Mtr. & Drive **\$26.95**

Blower, complete with Mtr. & Drive **\$44.95**

Kitchen Ventilators, Exhaust Fans, Attic Fans, Blowers, Heat Boosters, \$7.95 up, Desk Fans, Window Fans, Blades, Guards, Shutters, Motors, etc.

Free illustrated catalogue, dealer inquiries invited
EDWARDS BROS. ESTAB. 20 YEARS

WESTAIR FAN AND BLOWER CO.
5650 Grand River Ave., Dept. S, Detroit 8, Mich.

STOPS FOGGY WINDSHIELDS
NEW Chemical Mitt

Amazing Discovery! Autoists wild over new FOG-STOP Windshield Cleaner. Simply glide over windshield chemically-treated Mitt—at once glass sparkles crystal clear. Blurry mist, frost, sleet, snow disappear like magic. Stops fogging. Sells like wild!

SAMPLES FOR AGENTS Sample offer sent immediately to all who send name at once. Hurry. Postcard will do. **SEND NO MONEY—just your name.** KRISTEE CO., Dept. 712, AKRON 8, OHIO

NEW! SUCTION CELLAR DRAINER

Capacity 300 GALLONS per Hour!
No more hand-pumping or bailing of flooded basements when you have DRAINMASTER. Just connect to a handy faucet with garden hose, submerge in flood water, run another length of hose to open drain or out a window, DRAINMASTER does the rest. Solid brass, no moving parts to wear. Drains fish ponds, boats, swimming pools, trenches, tanks, etc. **ORDER TODAY!** Be prepared for flood emergency.
\$3.95 postpaid
Money-Back Guarantee
M. P. White Co., Dept. 2-PS, 55 Stuart St., Boston 16, Mass.

BRAND NEW NYLON STORAGE COVERS
for outdoor storage of cars, boats, machinery, equipment, etc.
Strongest, lightest covers ever made. New DuPont Nylon 2-ply with fused waterproof coating on nylon cloth. Folds away easily. Secured with heavy elastic. Protection against wind, rain, sun, salt-air, mildew, etc. 15-day money-back guarantee. Not to be confused with plastic covers selling for less!
Nylon tarps to order with brass grommets, 8c sq. ft.

Lightweight only 5 1/2 lbs.
Extra Large Size for Cad-dy, Linc., etc. \$2.50 extra
Give Standard Size Car Model **\$16.95** plus 70c postage

DEFENDER TEXTILE CORP., 317 Canal St., Dept. PS, N. Y. 13, N. Y.

TRUSS WEARERS
Here's good news! **FREE** Penny demonstrator — proves that greater safety and comfort can be yours immediately. No obligation. Send postcard for details.
ACTIVE MAN TRUSS CO.
549 W. Randolph St., Dept. PS-10, Chicago 6, Ill.

**MAKE MONEY FAST
Now Till Christmas!**

SELL EVERY BUSINESS
Exclusive "Greetingletters"
Here's a money making opportunity that's **RED HOT!** Sell business firms, banks, professional men our exclusive, distinctive **CHRISTMAS LETTERS**... attractively designed and written Christmas Greetings in letter form. Big selection. Extra liberal profit for you on every fast, easy sale. Prospects everywhere. Other money makers! Complete eye-catching sales outfit **FREE**. Rush name today!

Big Self-Selling Outfit FREE
Rush Name and Address Today!
**The SUCCESS Corporation, Dept. D-7
158 W. Magnolia Av., Ft. Worth, Tex.**

SENSATIONAL OPTICAL BARGAINS

MAKE YOUR OWN ASTRONOMICAL TELESCOPE



Build instruments worth up to \$600.00. Kits include Mirror Blank, Glass Tool, Pitch, Abrasives, Diagonal, Eye Lens, etc. Order dia. desired.

Stock #	Size	Pstpd. Price
70,003-N	4 1/4"	\$ 7.00
70,004-N	6"	11.00
70,005-N	8"	18.00
70,006-N	10"	28.00
70,007-N	12 1/2"	49.00

SLIDE PROJECTOR SETS Consists of all unmounted lenses you need to make the following size projectors:
 Stock #4029-N—35 mm. \$2.85 Postpaid
 Stock #4038-N—2 1/4"x2 1/4" \$3.35 Postpaid
 Stock #4039-N—2 1/2"x3 1/2" \$3.35 Postpaid

SIMPLE LENS KITS—Include plainly written, illustrated booklet showing how you can build lots of optical items. Use these lenses in photography and for dozens of other uses in experimental optics, building TELESCOPES, low power Microscopes, etc.
 Stock #2-N—10 lenses \$ 1.00 postpaid
 Stock #5-N—45 lenses 5.00 postpaid
 Stock #10-N—80 lenses 10.00 postpaid

Order By Stock No. Send check or M.O. We have literally Millions of War Surplus Lenses and Prisms for Sale at Bargain Prices. Numerous Types of Instruments, Too! Write for FREE Catalog-N
EDMUND SCIENTIFIC CORP., Barrington, N. J.

SMALLEST .22 AUTOMATIC \$37.50



.22 VB Bernadelli Baby Automatic. Meets sportsmen's demand for Pocket Automatic using .22 LONG or SHORT cartridges. State preference. Packs a punch! Easy to carry. Weighs 9 oz. 6 shot magazine. 2 1/8" barrel. 4 1/8" overall. Blued. Non-projecting sights. Orders must state "I am not a minor, alien, fugitive from justice, under indictment, or been convicted of a crime of violence." Shipped F.O.B. C.O.D.'s and overseas orders cannot be accepted. Mail Orders Only. Satisfaction or Money back!
UNITED ARMS, 9043 S. Western Ave., Dept. FA-1455, Chicago 20.



HE-MAN VOICE!

STRENGTHEN your voice this tested scientific way. Yes—you may now be able to improve the POWER of your speaking and singing voice . . . in the privacy of your own room! Self-training lessons, mostly silent. No music required.

FREE BOOK Write TODAY for Eugene Feuchtinger's great booklet "How to Develop a Successful Voice." It's absolutely FREE! You must state your age. Booklet mailed postpaid in plain wrapper. No salesman will call. Send your name and age RIGHT NOW!
PREFECT VOICE INSTITUTE
 210 S. Clinton St. Studio KY-1, Chicago 6, Ill.

NO TANKS USED
 NEW SIMPLIFIED METHOD
 SUCCESS IN THE
 ELECTROPLATING
 BUSINESS



MAKE MONEY in Your Own ELECTROPLATING BUSINESS!

NOW, using NEW plating kit, it's easy to electroplate any object. Complete kit and instructions on plating metallic and non-metallic objects, with nickel, copper, silver, gold, etc., plus full data on obtaining all the business you desire and make BIG

MONEY full or spare time. ONLY \$5.95. SEND NO MONEY—everything sent COD plus postage—OR send \$5.95 now and receive it postpaid. Money back in 7 days if not satisfied. M. Z. NATIONAL SALES CO., 113-C West 42 St., N. Y. 18, N. Y.

Refinish
 TOOLS
 SILVERWARE
 HOUSEHOLD ARTICLES
 JEWELRY
 BABY SHOES
 AUTO PARTS, ETC.
 like new!

SHIP MODEL KITS



Largest supply in New England. Fittings — Blueprints — Books. All prices. Write Dept. PS52. BIG ILLUSTRATED CATALOG 25c

JAMES BLISS & CO., INC.
 342 Atlantic Ave., Boston 10, Mass.

120 Years in Business

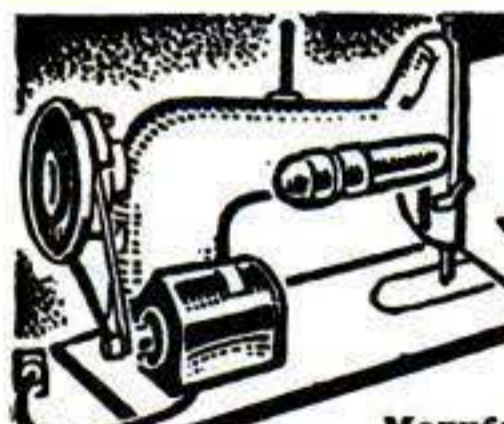

POWER PLANT ELECTRIFIES YOUR SEWING MACHINE

\$20 VALUE now only \$9.98

Manufacturer offers the first professional power plant kit—fully wired—easily installed in seconds. Fits all machines. FREE with each order—a \$2.95 chrome SEWLITE. Amazing Button Holer, Darner, Appliquer, Quilter attachment.

- Easy instructions
- Motor & Bracket (AC-DC 115V 60C)
- 7-speed foot control
- Cord Set and Block
- Steel Pulley & Belt

State whether wheel on your machine turns toward or away from you. Remit check or money order. If C.O.D., send \$2.00 deposit. FREE CATALOG OF HARD-TO-GET SEWING MACHINE PARTS & ATTACHMENTS. Parker Sew-

ing Machines, Dept. 66—1548 Park Ave., N. Y. 29, N. Y.

How to get more mileage out of your motoring dollar

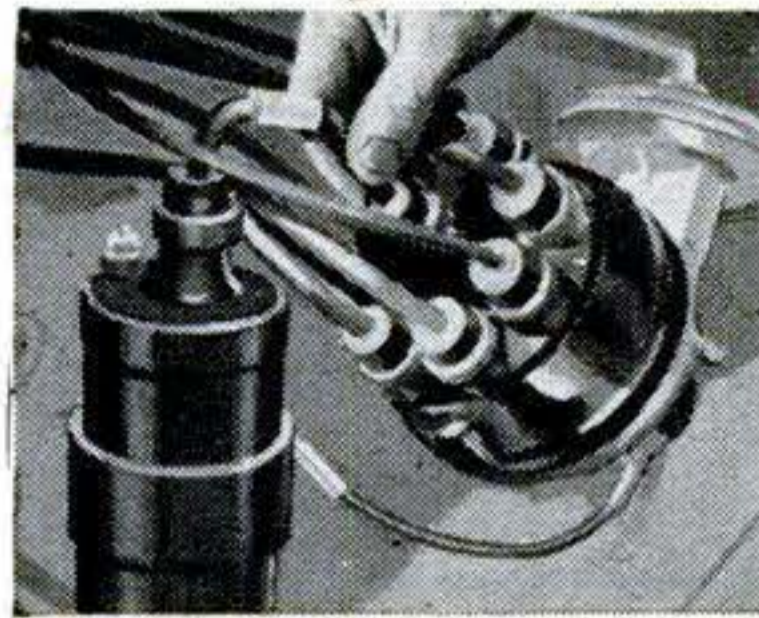

WATCH FOR LOOSE OR FRAYED WIRES destructive car fire. Watch for bad insulation, loose connections, spots where wires may be rubbing against sharp metal edges. Keep several spare fuses in glove compartment, too.

Check your car's wiring—and you may avoid road breakdowns, battery failure or a

Clutch facings will not take a "riding"

. . . your pocketbook will suffer an unnecessary drain if you "ride" the clutch. "Holding" on hills with the clutch is

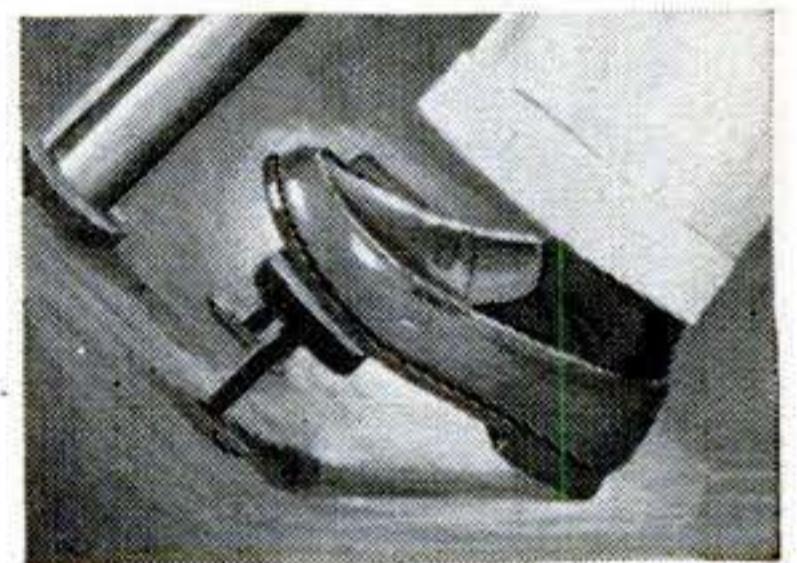

wasteful, too. Use your clutch only for starting and shifting...it will last longer...save you money.

CLUTCH PEDAL IS NOT A FOOT REST



REPLACE CLOGGED OIL FILTER

Keep a fresh oil filter on the job. Your oil filter can trap more than 2 pounds of sludge and abrasives in 5,000 miles of normal driving—may get so choked up it can't filter out harmful abrasives any more. Before that happens, install a fresh Purolator* Refill. Purolator's matchless, accordion-pleated, plastic-impregnated element gives up to 10 times more filtering area . . . traps gritty particles as tiny as .000039" in diameter . . . saves you expensive engine repairs. Yet a Purolator Micronic* Refill costs as little as \$1.60.

*Reg. U.S. Pat. Off.

Check your oil filter every time you change your oil

PurOlator
 (ENGINEERED FOR EVERY MAKE OF CAR)
 Micronic OIL FILTER



NEW
AUTOMOTIVE
DISCOVERY!



The Amazing
NEW
POLAR-
VISION
LIGHT

Actually
SEE IN
THE DARK!

STOP
HEADLIGHT GLARE
STOP Windshield ICING
and FOGGING too!

BEAUTIFUL
RICH-
LOOKING
ACCESSORY

All vital elements en-
cased in precision
"air-tight" chrome
case - sealed and
guaranteed a lifetime.
All equipment and
copper cable included.
Easy to install - no
holes to drill.

ORDER
BY MAIL
NOT sold in
stores

Fits All Cars & Trucks
Lets you DRIVE IN SAFETY & COMFORT

NEW revolutionary discovery

"Ergon Lens" and other elements produce a BLACK RAY—
(almost invisible to the eye) that shines down on your
windshield. This ray COUNTERACTS THE GLARE from
oncoming headlight street lights, etc. PREVENTS WIND-
SHIELD FOGGING AND ICING TOO. WORKS LIKE MAGIC!

FULL MONEY BACK GUARANTEE

This new product resulting from years
of research and testing secret light
formulas. Send only \$1.00
for C.O.D. delivery.



COMPLETE PRICE
\$6.95
POST
PAID
Dual kit (inc.
passenger side
mounting) \$11.95.

ELECTRONIC DEVELOPMENTS, Dept. A-10
Box 775, Portland 7, Oregon

Enclosed find \$ _____
Please Rush Polarvision Light:
 Post Paid C.O.D.

Name _____

Address _____

City _____

State _____

U.S. NAVY PELORUS SIGHT

Boat owners, surveyors, farmers, contrac-
tors, pilots, scouts, and others will find
this precision "bearing taking" instrument
extremely practical. Sighting tube is grad-
uated through 360°. Fixed positions can
be determined for true or relative bear-
ings. Gov't cost more than \$50.00.
Like New

postpaid **\$4.95**



ALTIMETERS



Pioneer sensitive altimeters. Range
0-35,000 ft., calibrated in 100's of
feet. Barometric setting adjustment.
No hook-up required... for auto
or aircraft installation.

Used, Good **\$12.95**

U.S. Navy surplus altimeters. Range
0-10,000 ft. Adjusts to sea level
setting of terrain. Requires no
hook-up for auto or aircraft instal-
lation.

BRAND NEW **\$7.95**

GENERATORS 115V-AC

FOR AUXILIARY LIGHT PLANTS
NOW... here's the buy of the year.



Brand new Eclipse Generators in the original box. These
generators have an AC output of 115 volts, 10.4 amps, 1200
watts, single phase, 800 cycles at 2400 R.P.M. They also have
DC output of 28.6 volts, 60 amps. The unit has a spline drive
shaft and is self excited. It will serve as a dependable 115V-
AC auxiliary light plant when driven by a gasoline engine for
farms, cottages, flood lighting, trailers, boats, or wherever
power is not readily accessible. Shipping wt. ONLY
55 lbs. Gov't cost more than 10 times selling **\$29.95**
price. F.O.B. Pasadena

All Equipment F.O.B. Pasadena • Enclose Full Amount with Order

C and H Sales Company

Box 356-OS East Pasadena • Pasadena 8, California

Do Your OWN CAR UPHOLSTERING!

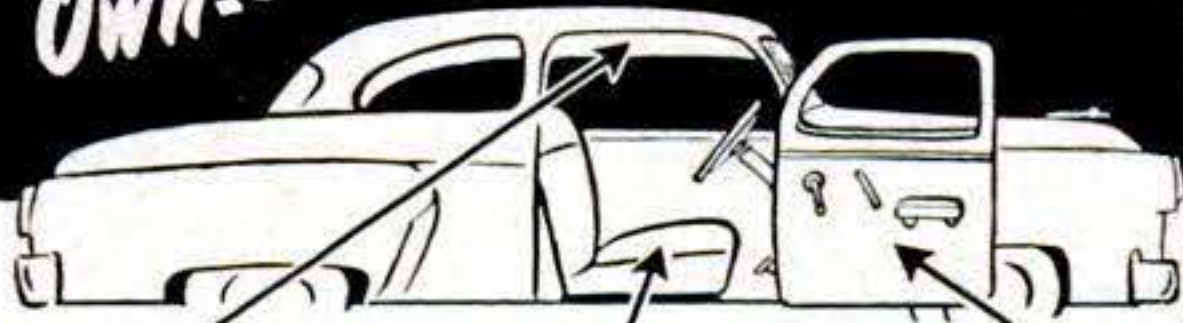

*HEADLINING *SEAT COVERS *DOOR PANELS

Now, you can reupholster your own car and others.
Save money on your own car—make good money on
others. 20,000,000 auto owners pay for seat covers, door
panels, headlinings, tops, etc. every year. Get started
by making your own car beautiful. Complete step-by-
step illustrated instruction manual only \$2.00—money
order, check or C.O.D., plus charges. Satisfaction or
money refunded in 7 days. Free literature.

PURIFOY UPHOLSTERY SERVICE

P. O. Box 3042

602-A South State Street Jackson, Mississippi



**AMAZING NEW
POCKET SIZE RADIO**
NO TUBES, BATTERIES OR ELECTRIC "PLUG-
INS" NEEDED. "TUNES IN" MOST LOCAL
RADIO STATIONS with STATIC-FREE CLEAR
TONE. Has new perma-crystal diode and TINY
SELF-CONTAINED SPEAKER PHONE—A mar-
velous real tiny pocket size radio to take with you
anywhere you go—FOR REAL FUN AND ENJOY-
MENT. GUARANTEED TO WORK and should last
for years! SEND \$1.00 (cash, mo, ck) and pay post-
man \$3.99 C.O.D. postage or send \$4.99 for p.p. deliv-
ery. COMPLETE ready to play. By mail only from:
MIDWAY COMPANY
DEPT. PPS-10 KEARNEY, NEBRASKA

BEING PUSHED AROUND??



Why take any more nonsense from bullies, wise guys and
other pests? The next time they try to act smart—give
them the surprise of their lives! It's easy when
you know POLICE JIU JITSU! This complete,
fully illustrated course comes to you in one vol-
ume. The same as taught to police, marines, "G"
men, soldiers, sailors and members of the U. S.
Coast Guard. By all means, just pin \$1 to this ad
and we'll send POLICE JIU JITSU to you post-
paid by return mail. Satisfaction guaranteed or your
money back.

BOOKS PUBLISHING CO., 56 W. 24th St., N.Y. 10

Reduce RADIO NOISES



SIMPLY PLUG Radio or Appliance cord

into Noise Eliminator and plug into wall socket. Enjoy recep-
tion FREE from many distracting noises. Send No Money, pay
postman \$1.25 each (2 for \$2.00) plus postage or send cash
and we'll mail postpaid. Try 5 days, money back if not de-
lighted. Many hundreds of satisfied users. Send for yours today.

MERIT SALES, DEPT. K-27 **\$2.00**

4225 Eldone Dr.

Baltimore 29, Md.

make your own Gems 29⁵⁰ F.O.B.

All necessary lapidary equipment is furnished,
including a super-charged diamond blade for sawing, and
all wheels for grinding, shaping and polishing; also com-
plete instructions. The complete equipment as shown,
less motor and belt, for only \$29.50,
f.o.b., Burlington, Wisconsin. Write
today for information and literature.

B&I MANUFACTURING CO.

Dept. M Burlington, Wis.



COMPLETE NEW FALSE PLATE IN 24 HOURS

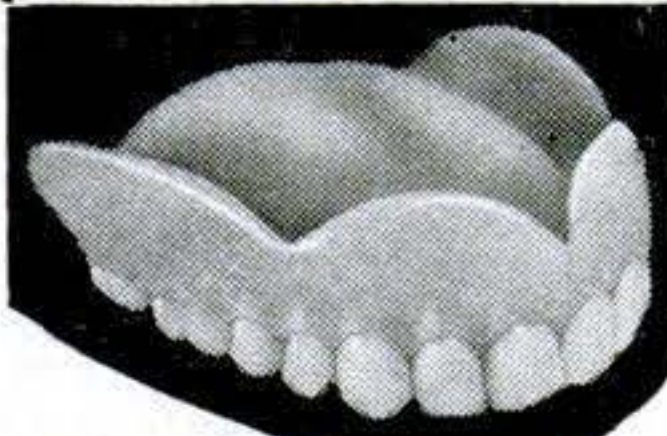

FROM YOUR OLD
NOW LOW AS... **\$15⁹⁵**

New process transforms
old, broken or loose plates
into new lightweight plastic plates.

NO IMPRESSION NEEDED. Let us help you enjoy life again. You will
marvel at this revolutionary new method. Using your own old plates.
we will remake them completely in only 24 hours. Missing teeth are
carefully matched and replaced. Work is done on an absolute **MONEY**
BACK GUARANTEE. Quit Suffering!

SEND NO MONEY —Just rush your name and address for full
FREE DETAILS. If your teeth are loose,
we'll tell you how to tighten them before duplication. Act now.
Tru-Grip Dental Labs., 7th Fl., 127 N. Dearborn, Dept. 177, Chicago 2, Ill.



"This proves Wildroot Cream-Oil keeps hair well groomed even if you have cowlicks!"

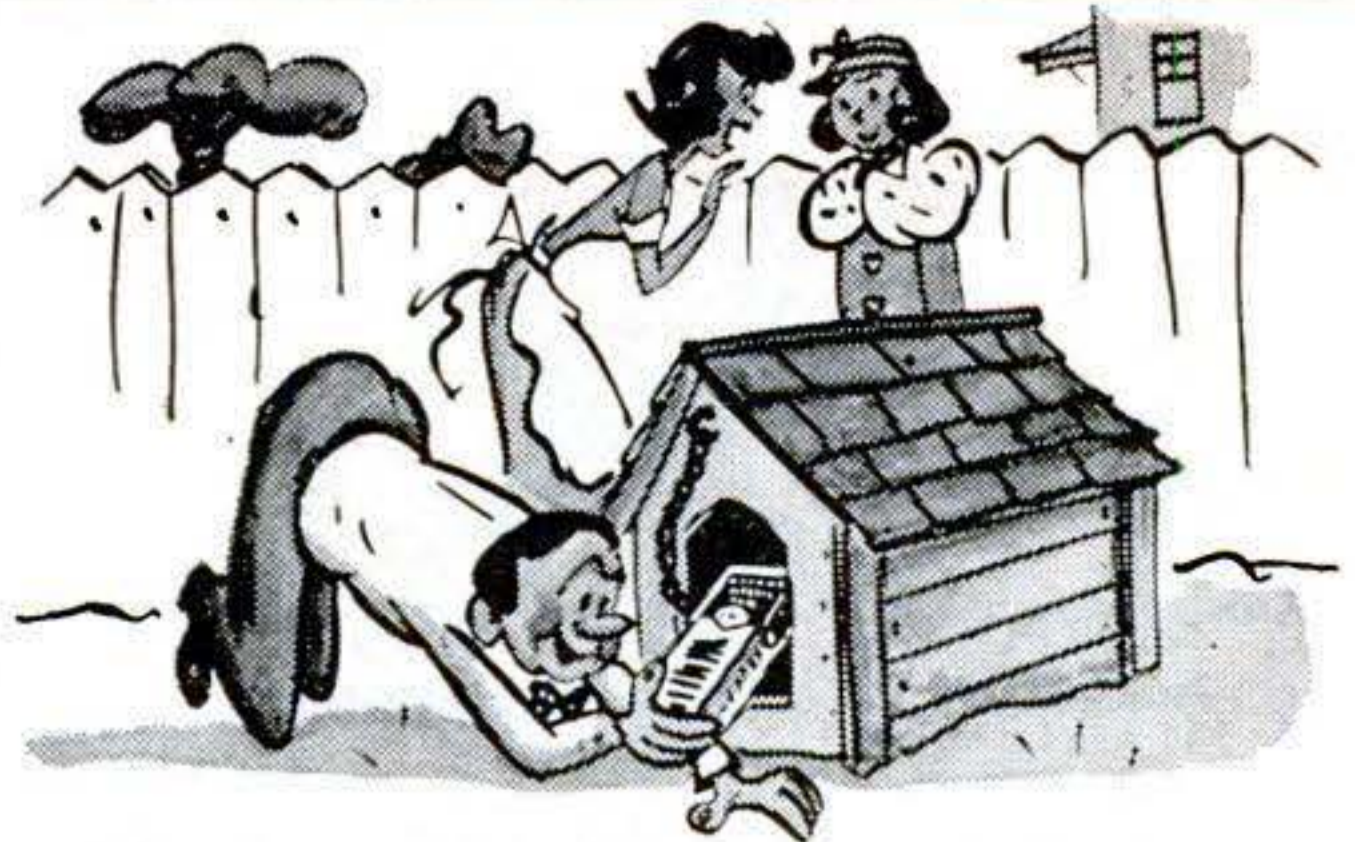

"He keeps his Wildroot Cream-Oil there because it's his hair's best friend"



"Since using Wildroot Cream-Oil I look twice as good!"

REAMER KELLER

YOUR HAIR'S
BEST
FRIEND

America's
Favorite
Hair Tonic!

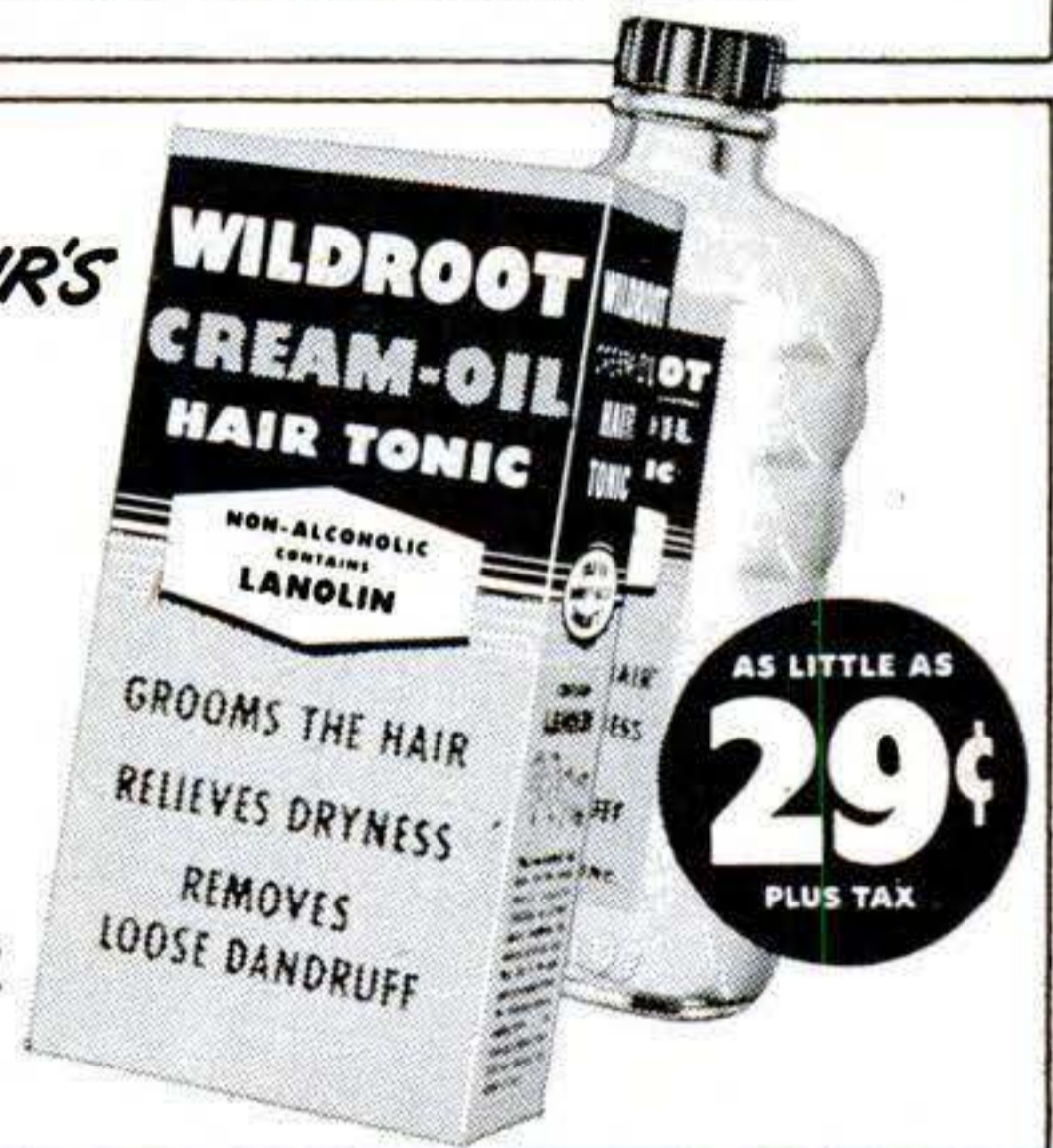

LEARN — Trades that Pay More

WATCHMAKING or ENGRAVING

Trades You Enjoy — — by HOME STUDY

WRITE TO

Don't let a lay-off catch you. START NOW TO LEARN THESE HIGH-PAYING TRADES IN YOUR SPARE TIME. Earn extra money as you learn, repairing clocks and watches, or engraving silver and jewelry. YOU WILL BE BUILDING YOUR OWN BUSINESS RIGHT AT HOME.

KANSAS CITY SCHOOL OF WATCHMAKING

ADMIRAL & TRACY

KANSAS CITY 6, MO.

Wiring Repairs Made EASY!

MOTOR'S Brand-New Guide Shows How to Do ANY Wiring Repair—on ANY Car Built from 1941 THROUGH 1952!

DO expert wiring repairs—FAST—with MOTOR'S new AUTO WIRING guide! Covers 525 models—ANY wiring job on ANY car, 1941 THRU 1952. Official factory diagrams tell WHERE to look... HOW to "breeze" thru wiring repairs on Chassis; Convertible Tops; Signals; Dome Lamp Circuits; Hydraulic Transmissions; Overdrives; Window Regulators, etc. Saves time, work. 200 BIG 8 1/2" x 11" pages. SEND ON MONEY. Just mail name and address to: MOTOR Book Dept., Box W210, 250 West 55th St., N.Y.C. 19, N. Y. Pay postman only \$3.75 plus C.O.D. charges. Use 7 days. Money back if not delighted. (Or SAVE C.O.D. charges by sending \$3.75 now. Same Money-Back Guarantee.)

AMAZING IMPROVED ELECTRIC SPRAYER MAKES HOME PAINTING EASY

Why wear yourself out using Expensive old-fashioned brushes. MISTIFIER SPRAYER quickly, smoothly and evenly sprays glossy enamels, lacquers, insecticides, mothproofers and oils. All in one self contained unit that requires no compressor, motor or accessories. All metal non-corrosive parts makes this unit a LIFELONG useful tool. Sturdily constructed weighs only 2 lbs., uses standard replaceable Mason jar. Spray volume is adjustable. 80 POUNDS PRESSURE, fingertip control. AC-110 volts. FOR PAINTING, SPRAYING, DISINFECTING, MOTH PROOFING. MISTIFIER SPRAYER works wonderful when painting wicker and all other furniture, cars, metal cans; par-



SPRAY FURNITURE



PAINT AUTOS

titions, concrete brick-work, rough wood, boats, wagons, screens, cabinets, Venetian blinds. Wonderful for Mothproofing clothes, rugs, drapes, storage closets, etc. MISTIFIER is Safe and Easy to use.



10 DAYS
FREE
TRIAL
LIFETIME
GUARANTEE

ONLY
9.95

Complete—
No Extras
To Buy

We Guarantee that MISTIFIER SPRAYER will apply paint smoothly, quickly, easily—or return it within 10 days for full purchase price refund. Only \$9.95 Postpaid or sent C.O.D. plus postage. Full Instructions. Order Now.

IMPERIAL SALES, Dept. S-495
480 Lexington Ave., New York 17, N. Y.



SEND NO MONEY
MORE THAN 4000 PAGES
2750 PICTURES

9 BIG COMPLETE BOOKS BUILDING, ESTIMATING, CONTRACTING

Examine this Up-to-Date Edition for 10 days. See how these nine books supply easily understood training that will help you to get a better job and make more money, or start a profitable business for yourself. Think what a BIG help it will be to have them handy for use in solving all sorts of building problems.

Learn to draw plans, estimate, do all-new construction and modern remodeling to meet fast growing demand. More than 4000 pages of practical, pay-raising information with 2750 helpful illustrations, on such subjects as blueprint reading, concrete forms, masonry, carpentry, steel square, electrical wiring, plumbing, heating, painting, and hundreds more.

In our more than 50 years we have never offered more complete building information. Send the coupon TODAY.

(A year's consulting privileges with our engineers now given with these books without extra cost.)

AMERICAN TECHNICAL SOCIETY—Publishers Since 1898
 Dept. G720, Drexel Ave. at 58th St., Chicago 37, Ill.

I would like to examine your 9-Volume Set of Building, Estimating, Contracting Books. I will pay the delivery charges only, but if I choose I may return them express collect. If after 10 days, use I prefer to keep them, I will send you \$3 plus postage and pay the balance at the rate of only \$4 a month until \$34.80 has been paid. Include consulting service as offered above.

Name _____

Address _____

City _____ State _____

Please attach letter giving employer's name and address (if self-employed give business man reference). Men in service please give home address.

CORTINA
makes it FUN to



SPEAK FRENCH-SPANISH

RUSSIAN-GERMAN ITALIAN-BRAZILIAN-JAPANESE
 "Learn by Listening" to CORTINA RECORDS, at home, the NATURAL way — quickly, easily, cheaply.

Only 15 Minutes a Day!

The CORTINA method, famous for 70 years, teaches you to speak like a native. THOUSANDS have found it the most fascinating, most effective way to learn languages for Pleasure, Business, Travel, Culture. INVESTIGATE!

Send For FREE BOOK!

Illustrated 32-page book, "The Cortinaphone Short-Cut" sent FREE. No obligation. Tells just what you want to know. Interesting. Get it!

ALL NEW RECORDINGS ON UNBREAKABLE RECORDS

WRITE TODAY

CORTINA ACADEMY (Est. 1882)
 Suite 1210, 105 W. 40 St., N. Y. 18, N. Y.

Please send me — without obligation — your free book. I am interested in (check)

- French Spanish German Italian Brazilian
 Russian Japanese

Name.....

Address.....

City..... State.....

VETS! Check if NOW eligible under G. I. Bill.

LAWNMOWER SHARPENER OPERATORS

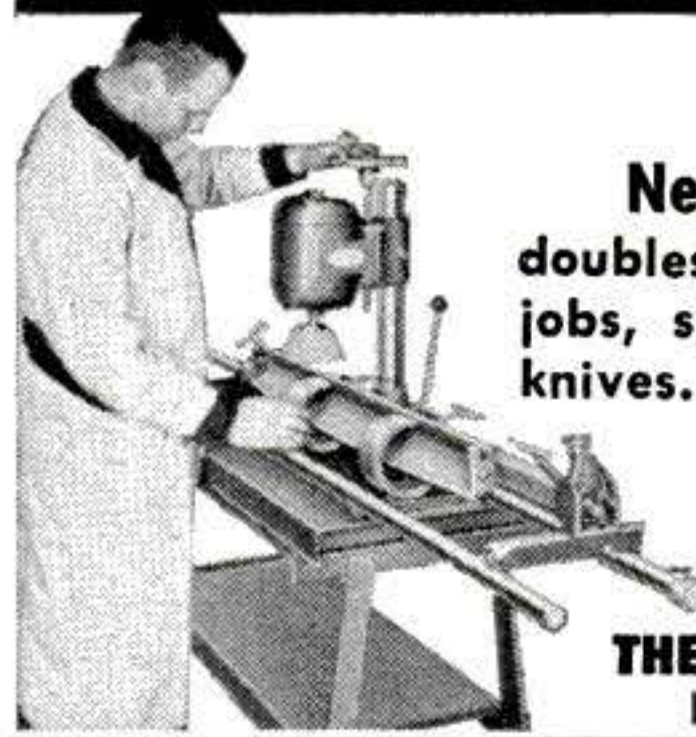

Increase your output... Year 'round business!

NEW BED KNIFE GRINDER

sharpens all STRAIGHT EDGE TOOLS

New Ideal Bench Grinder

doubles your output of sharpening jobs, speedily grinds straight blade knives. Sharpens all kinds of straight edge tools and ice skates. Write for FREE, fact-filled folder.

THE FATE-ROOT-HEATH COMPANY
 Dept. PS-10, Plymouth, Ohio



LEARN TO DANCE \$1.00

Why be a lonely, unpopular wall-flower? Learn all the smart dances from the most modern to the old favorites—at home, in private without teacher, music or partner. So simple even a child can learn quickly. Tap dancing, Waltz, Collegiate, Samba, Rhumba, Jitterbug and many others, including illustrations. Complete course only \$1.00. Also, delightful old square dances with illustrations for \$1.00. Get each Separate or both for \$1.98. If you order both take your choice of FREE-DREAM BOOK or LOVE LETTERS. C.O.D. orders 25c extra and Postage. Superior professional taps, both toes and heels \$2.98 prepaid or C.O.D. plus shipping charges. State size, large or small.

ROLLDEX, P. O. Box 516, Dept. D-85, Safety Harbor, Fla.

\$750 BUILDS 4 ROOMS & BATH!

WHY PAY RENT? For Seven Hundred Fifty Dollars and 30 days of your spare time, you can build yourself this Beautiful Home.



Living room 11x15. Front bedroom 9x11. Back bedroom 10x12. Kitchen 9x11. Bath 5x8. Hall 3x4. Wind out steel Casement windows. Concrete block, stuccoed. \$1.00 brings you Step-by-Step Instructions, Blueprint & Material List. L. H. FARROW, Dept. D Box 645 Columbus 16, Ohio

POCKET "TOOL-CHEST" \$2.98

7 HANDY ALL-PURPOSE TOOLS
 Complete With Leatherette Case Man-Sized! Convenient!
 • A Saw • An Awl • A Tack-lifter • A Recessed Screwdriver • A Chisel • A Small Screwdriver • A Large Screwdriver Twist!—And 7 Tools Are Ready To Use! Yours... Guaranteed for \$2.98 Postpaid.
MAIL MART, PS10, 27 East 22nd St., New York

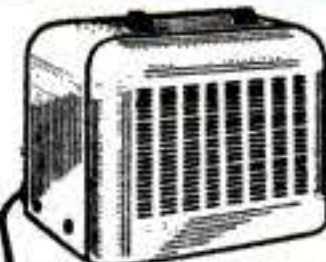

Save time. Save your energy. Be in 2 places at once. Use the Famous

INTERCOM

your personal intercommunicating system.

Perfect for Home—Shop—Farm. Talk or listen at either end. USE AS PAGING SYSTEM. Hundreds of uses. Indoors or out. IDEAL BABY-SITTER room to room, house to house. Use between WORKSHOP—KITCHEN—GARAGE—ATTIC—BASEMENT—BARN—STOCKROOM—etc.

Grey baked-enamel finish. Built Rugged. Lifetime Service. Perfect reception to 1,000'. Not a kit. Not a cheap gadget, but a Professional System, ready to plug in. UL appr. AC-DC, 115V.

Usually 34.95 now ONLY **19.95** Complete. Brand new. Guaranteed.

Includes 2 two-way units, each 6x5x4 1/2", wall plug, 20' inter. cable, easy instr. Only 19.95. Add 90¢ post. (Addit. cable between units, 5¢ ft.) This is a TERRIFIC VALUE. Order now. Send check or M.O. (\$2 dep. for COD's) EASTERN PRODUCTS CO. Dept. P, 1170 Bway., N.Y.C. 1



FORCED AIR

INSTALL IT YOURSELF AND SAVE UP TO \$200

CONVERT YOUR GRAVITY FURNACE TO MODERN QUICK FORCED AIR HEAT. INSTALL McLARTY FANS IN YOUR COLD AIR PIPES. NO SHEET METAL WORK REQUIRED. SIMPLE ELECTRIC CONNECTIONS. LOWEST COST SYSTEM TODAY.

McLARTY SYSTEMS 2608 DICKMAN RD. BATTLE CREEK, MICHIGAN

In Canada Write WINNIPEG SUPPLY & FUEL WINNIPEG, MANITOBA

FREE CIRCULAR

FREE!

COURSE of INSTRUCTIONS

Yes, we'll teach you at home how to make the most beautiful things you have ever seen! Everything from novelties, gadgets, beautiful jewelry, gems, machine parts, lures, models . . . ALL without tools or machinery! The **PLASTICAST PROCESS** is as easy as pouring water out of a glass! Learn how to MANUFACTURE countless useful and attractive things with Liquid Plastics, Liquid Marble, Liquid Ivory, Liquid Glass, Liquid Clay, Plaster, Stone, Wood, Metal and Compositions . . . all taught to you FREE!

SUCCESS GUARANTEED

The **ONLY** limitation is your imagination! No special talent, no previous experience, no special tools or machinery required! We not only **TEACH** you how to make these things but we show you how easy it is to dispose of your production, even selling part or all of your output to us! We will actually **PUT YOU IN BUSINESS OVERNIGHT AND GUARANTEE YOUR SUCCESS!** Yes, we'll set you up in the most fascinating business you ever dreamed of! In just a short time you'll be manufacturing sensational products of endless variety... it's all very fascinating and simple!

HOW TO START

Just send 25c for our big 56 page catalog which elaborates on the **PLASTICAST PROCESS**; we will include your first book of instructions **PLUS** complete details of the most amazing offer that will ever come your way! Do it today...don't delay anything that can be so important to your future!



SOME OF THE BOOKS AND LESSONS WAITING FOR YOU!

IN BUSINESS OVERNIGHT! SUCCESS GUARANTEED!

Illustrated at the left are just a few of the **THOUSANDS** of useful and attractive things we teach you how to make without any tools or machinery . . . simply by **CASTING!**

You can start your own **HOBBY AND NOVELTY SHOP** in your own community. We will actually put you in business, supply you with **ALL** the merchandise you need and **GUARANTEE YOUR SUCCESS!**

Or you can start your own **PLASTICS FACTORY** and manufacture an **ENDLESS VARIETY** of beautiful and useful things for others to sell! Either way, we supply all the materials and instructions!

Send 25c for Full Particulars and Big Catalog!

We have **THOUSANDS** of unusual products and materials of immense interest and value to inventors, mold, die, tool and model makers, hobbyists, craftsmen and to every ambitious individual seeking to create wealth and security with his own two hands in a **FASCINATING ENTERPRISE!**



PLASTICAST CO.

WRITE TO NEAREST OFFICE

Dept. A
 P.O. BOX 6737, CHICAGO 80, ILL.
 P.O. BOX 987, PALO ALTO, CALIF.
 CANADIAN READERS: Please send 35c to: Canadian Ind. Plastics, 1056 1/2 W. Pender St., Vancouver, B. C.



BE VITAL TO INDUSTRY DRAFTING TODAY'S ESSENTIAL JOB



IT'S EASY WITH CEI TRAINING & COACHING AT HOME OR AT THE INSTITUTE IN CLEVELAND

There is a growing, desperate need for draftsmen—the key men in all industry. CEI can quickly give YOU the necessary technical skill. Bigger income, jobs, and opportunities are yours with a CEI diploma. Thousands have succeeded. So can you! CEI guarantees to train you until you qualify. Write today! No obligation—no salesmen.



Home of the Cleveland Engineering Institute, specializing **EXCLUSIVELY** in Engineering Drafting.

CLEVELAND ENGINEERING INSTITUTE
 EXTENSION DIVISION PS10B
 6300 EUCLID AVE., CLEVE. 3, OHIO

Aeronautical Mechanical
 Training in Cleveland

NAME.....
 ADDRESS.....
 CITY..... STATE.....

Paste on 2 penny postcard

CLEVELAND ENGINEERING INSTITUTE
 6300 EUCLID AVE. CLEVELAND 3, OHIO

CEI success book

YOUR CHOICE OF TWO ESSENTIAL FIELDS

Mechanical



Aeronautical



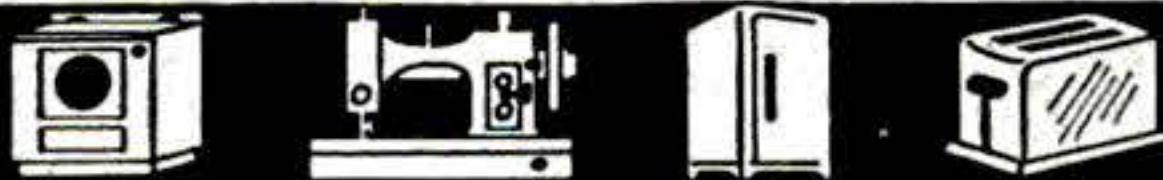

Electrical Appliance Repairs MADE EASY

New Repair Manual Covers EVERY Repair on ALL Home Appliances

NO repair job is too tough with the help of this big new Guide. TELLS and SHOWS how to service ALL home appliances. SAVE MONEY keeping your own appliances like new—or MAKE MONEY with a home repair shop of your own... full or spare time.

OVER 850 "how-to-do-it" pages, packed with pictures, drawings, diagrams. Sectional charts locate "trouble spots" in a jiffy... make it easy to dismantle and reassemble appliances correctly. A-B-C directions tell "why" as well as "how" Book covers fundamentals of electricity for beginners. Over 150 manufacturers supplied the servicing and repair data.

FREE 10-DAY EXAMINATION—Coupon will bring you "Electrical Appliance Servicing" to examine FREE—without obligation. Mail it NOW!

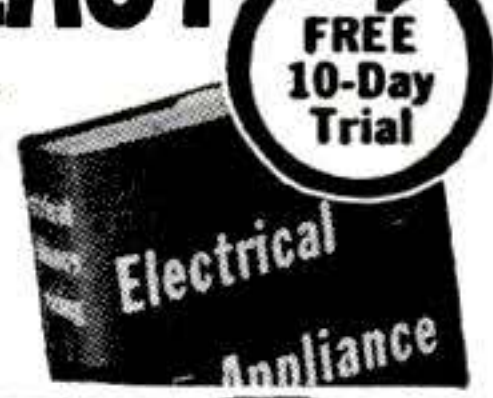

Covers ANY Service or Repair on:

- Irons • Toasters • Heaters • Vacuum Cleaners • Sewing and Washing Machines • Refrigerators • Air-Conditioners • Fans • and much more.

McGRAW-HILL BOOK CO., Inc., Dept. PS-10-52
327 West 41st St., New York 18, N. Y.

Send Crouse's Electrical Appliance Servicing for 10-DAY FREE EXAMINATION. If not satisfied I will return it—pay nothing. Otherwise, I will keep it—send only \$2.50 (plus small delivery charge) then—and \$3.00 a month for 2 months to complete payment.

Name.....

Address.....

Employed by..... PS-10-52

City..... Zone No. (if any)..... State.....

WE'LL PAY DELIVERY if you enclose \$8.50 (check or M.O.) WITH coupon. Same 10-day Return Privilege, for full refund.

New Amazing Invention—"Magic Art Reproducer"

DRAW THE FIRST DAY!

NO LESSONS! NO TALENTS!

You Can Draw Your Family, Friends, Anything From REAL LIFE—Like An Artist Even if You CAN'T DRAW A Straight Line!



Complete for only **\$1.98**

FREE! "Simple Secrets of Art Tricks of the Trade"

This valuable illustrated guide is yours FREE with order of "Magic Art Reproducer." Easy ABC art tricks that anyone can follow on different techniques, effects, proportions, perspectives, shading, color, animated cartoons, human figures to use with "Magic Art Reproducer" for added touches to your drawings.

SEND NO MONEY! Free 10-Day Trial!

Just send name and address. Pay postman on delivery \$1.98 plus postage. Or send only \$1.98 with order and we pay postage. You must be convinced that you can draw anything like an artist, or return merchandise after 10-day trial and your money will be refunded.

Norton Products

Also Excellent for Every Other Type of Drawing!
• Human Figures • Outdoor Scenes, landscapes, buildings • Still life, vases, bowls of fruit, lamps, furniture, all objects • Copy photos, other pictures, portraits, etc. • Copy blueprints, designs, decorations, etc., for woodwork, machine, for needlework, crocheting, knitting • Copy all cartoons.

Yes, anyone from 5 to 80 can draw or sketch or paint anything now... the very first time you use the "Magic Art Reproducer" like a professional artist—no matter how "hopeless" you think you are! Anything you want to draw is automatically seen on any sheet of paper instantly! Then easily and quickly follow the lines of the "picture image" with your pencil... and you have an accurate original drawing that anyone would think an artist had done. Also makes drawing larger or smaller as you wish. Anyone can use it on any desk, table, board, etc.—indoors or outdoors! No other lessons or practice or talent needed!

Have fun! Be popular! Everyone will ask you to draw them. You'll be in demand! After a short time, you may find you can draw well without the "Magic Art Reproducer", because you have developed a "knack" and feeling artists have—which may lead to a good paying art career.

Dept. 4410H, 296 Broadway New York 7, N. Y.



Before You Buy Your Trailer—READ...

TRAILER TOPICS MAGAZINE

It brings you the latest in Trailer Coaches—Equipment—Accessories—Trailer Trips—Trailer Parks and many other interesting monthly features at only—\$3.00 for 2 years.

(6 MONTH TRIAL SUBSCRIPTION \$1.00)

TRAILER TOPICS MAGAZINE (Room 1582)
28 East Jackson Blvd., Chicago 4, Ill.



BOYS! MAKE YOUR OWN RADIO

Make your own simple, tubeless, batteryless Crystal Radio. SEND 25c for a GENUINE MELOMITE CRYSTAL with complete illustrated instructions for making your own set. Crystal sent postpaid with instructions and our own publication, "THE MAGIC CRYSTAL" which is full of news, diagrams, questions and answers of interest.

SEND 25c FOR YOUR CRYSTAL TODAY!

ALVA ALLEN RADIO Dept. PS-10 Clinton, Mo.



Find HIDDEN TREASURES

GEIGER COUNTERS for Uranium Detection (see at left). **TREASURE DETECTORS** for gold, silver, etc. Lightweight, ultra sensitive. None finer at ANY PRICE.

INFORMATION FREE.

Detectron co.

5631 Cahenga, No. Hollywood, Calif.

RUPTURED?

Get Relief This Proven Way

Why try to worry along with trusses that gouge your flesh—press heavily on hips and spine—enlarge opening—fail to hold rupture? You need the Cluthe. No leg-straps or cutting belts. Automatic adjustable pad holds at real opening—follows every body movement with instant increased support in case of strain. Cannot slip whether at work or play. Light. Waterproof. Can be worn in bath. Send for amazing **FREE** book, "Advice To Ruptured" and details of liberal truthful 60-day trial offer. Also endorsements from grateful users in your neighborhood. Write:

CLUTHE SONS, Dept. 14, Bloomfield, New Jersey.

Wonders Through The MICROSCOPE



A new book which tells you all about **MICROSCOPY**. Turn an inexpensive microscope on hundreds of specimens within a stone's throw of your front door and you step off into a new world of wonders. Complete Manual for amateurs. How to use equipment, secure specimens, take photomicrographs, etc. Numerous illustrations. Full cloth bound \$1.49 DeLuxe.

POPULAR SCIENCE MONTHLY, Dept. 1052

353 Fourth Ave.

New York 10, N.Y.

POWERMASTER* HUNTING CROSSBOW postpaid \$18.95 with 3 arrows

KILLS ALL BIG NORTH AMERICAN GAME-DEER, BEAR ETC.



New metal alloy reg. 80 lb. pull, 33" bow. Shoots arrows like bullets. Beautifully finished 34" heavy duty hardwood stock. Crafted to meet highest archery requirements. As large manufacturers we can mass produce this \$45 value crossbow for only \$18.95. Precision trigger action, flat trajectory, pinpoint accuracy. Hunters knock down game at 200'. Cocks easily. Beginners shoot more accurately than professional archers. Silent, this powerful weapon permits extra shots at game. Adaptable for harpooning. Includes 3 arrows, instructions. Extra arrows 60c ea. **MONEY BACK IF NOT COMPLETELY SATISFIED.** Send \$18.95 in check, cash, or M.O. to **TECHRITE CORP., Box F12, South Pasadena, Calif.** *Professional Model of National Crossbow Ass'n.



CUT BUILDING COSTS 2/3! Make Your Own Concrete BLOCKS and BRICKS To Use or Sell

New superior moulds make absolutely square, true, easy-to-lay blocks which will pass any building code. Production is fast . . . easy. One durable \$30 machine will make four 5"x8"x12" blocks per minute—1,000 a day. Pays for itself in one day! Sell blocks for big profit . . . or save 2/3 building cost for yourself. **POST CARD BRINGS FREE FOLDER.**

ECONOMY MFG. CO. DEPT. S STONE MOUNTAIN, GA.

A POSTCARD CAN PUT YOU IN A FINE BUSINESS!

Rush Card TODAY for FREE SELLING OUTFIT Get in highly profitable, repeat-order shoe business! Sell amazing line of Air-Cushion Innersole comfort shoes to friends, neighbors, fellow workers. Dress, sport, work and safety shoes for men, women. Never sold in stores. Make \$10 to \$75, as much as \$200 monthly just in spare time. No investment. Send card TODAY for **FREE SELLING OUTFIT!** **CONSOLIDATED SHOE SYSTEM Box CD-34 Chippewa Falls, Wisconsin**



HOLLYWOOD BRONZE SUPPLY BRONZED BABY SHOE MOUNTINGS

Are NOW AVAILABLE wholesale from our Eastern Distributor to give you **FASTER Service at LOWER Costs!** Send orders or requests for **NEW Price Lists** to: **HOLLYWOOD BRONZE SUPPLY of OHIO 15400 MILES, CLEVELAND 28, OHIO**



Asbestos Gloves for HOT Jobs

Handle hot things with safety. Wear Industrial's famous 200-14 asbestos gloves. Made of 2 1/2 lb. Underwriters Grade cloth that resists burning. Big roomy cut, airy and comfortable. One piece construction with no seams at wrist or working edges to burn or pull out. Furnished lined or unlined. Over 40 years experience in designing safety apparel made these dependable gloves. Many styles. Write for catalog.

INDUSTRIAL GLOVES COMPANY A Corporation

To be Sure of the Genuine Demand This Trade Mark **1422 Garfield St., Danville, Ill. In Canada: Safety Supply Co., Toronto**

Money-Making Jobs...

ALL AROUND YOU!

BE YOUR OWN BOSS! Big Money waiting for you today in floor surfacing! Hundreds of prospects near you! The floor next door may be your first job—and business mushrooms as folks tell others. Earn as high as \$50 and more a day sanding floors with an easy-to-run American Machine. Pleasant indoor work—steady the year round. A sound opportunity to get in something for yourself and be *your own boss!* No schooling—no experience needed. Only small investment in sander gets you started to success! Send coupon for "money-making booklet" entitled "Opportunities in Floor Surfacing"—enclose 25c in coin or stamps to cover handling.



AMERICAN FLOOR MACHINES



The American Floor Surfacing Machine Co.
532 So. St. Clair St.
Toledo 3, Ohio

Enclosed find 25c in stamps or coin for booklet "Opportunities in Floor Surfacing", telling me how I can start my own floor sanding business.

Name.....
Street.....
City..... State.....

FREE BOOK AND ACTUAL SAMPLE

Screen Print, Dept. 1A
 1010 So. Los Angeles St.
 Los Angeles 15, California
 Dear Mr. Nowak: Please rush me FREE BOOK,
 ACTUAL SAMPLES, and your amazing new PRINTING PLAN

Name _____
 Address _____
 City _____ State _____

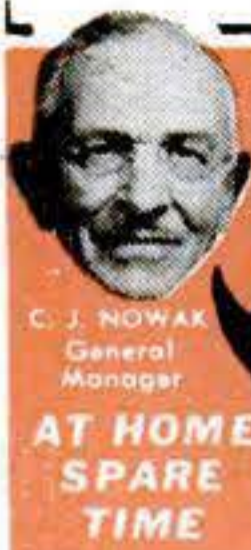

IT'S AMAZING! I'll show you how to make up to \$12.50 per hour
PRINTING WITHOUT A PRINTING PRESS

AMAZING NEW COLOR PRINTING METHOD
 A fascinating new miracle-way to print—a secret method that lets you print colorful signs, posters, banners, drapes, wallpaper, flags, glass, fabrics—ANYTHING without an expensive printing press or costly equipment. This new process is revolutionizing the entire printing industry—it's one of America's fastest-growing businesses—it's your "chance of a lifetime" to make Big Money Now! Be the FIRST in your area to profit. The secret can be yours—just mail the coupon above today!

EASY TO LEARN! NO EXPERIENCE NECESSARY!
 Simple fascinating method! No artistic ability needed. It's possible for anyone (young or old) to make up to \$50 PER WEEK printing in SPARE TIME alone—AT HOME!

START YOUR OWN BUSINESS—BE YOUR OWN BOSS
 Wouldn't you be happy if you could take only one hour of your time and \$1.00 worth of materials—and sell your printing for \$15 or more. It's that easy! It's amazing! Your home can be your office—No selling because there's a huge demand everywhere. **GOVERNMENT CONTRACTS AVAILABLE TO BID.** Biggest opportunity in America—costs you nothing to receive all **CONFIDENTIAL FACTS**—Mail coupon today!

SCREEN-PRINT DEPT. 1A
 1010 S. Los Angeles St., Los Angeles 15, California

Print paper of all kinds
 PRINT BANNERS
 PRINT FABRICS
 PRINT INSTRUMENTS
 PRINT SIGNS FOR SALE
YOU CAN PRINT ANYTHING WITH
SCREEN PRINT

The MAN who is a
MOTHER to
 Millions!

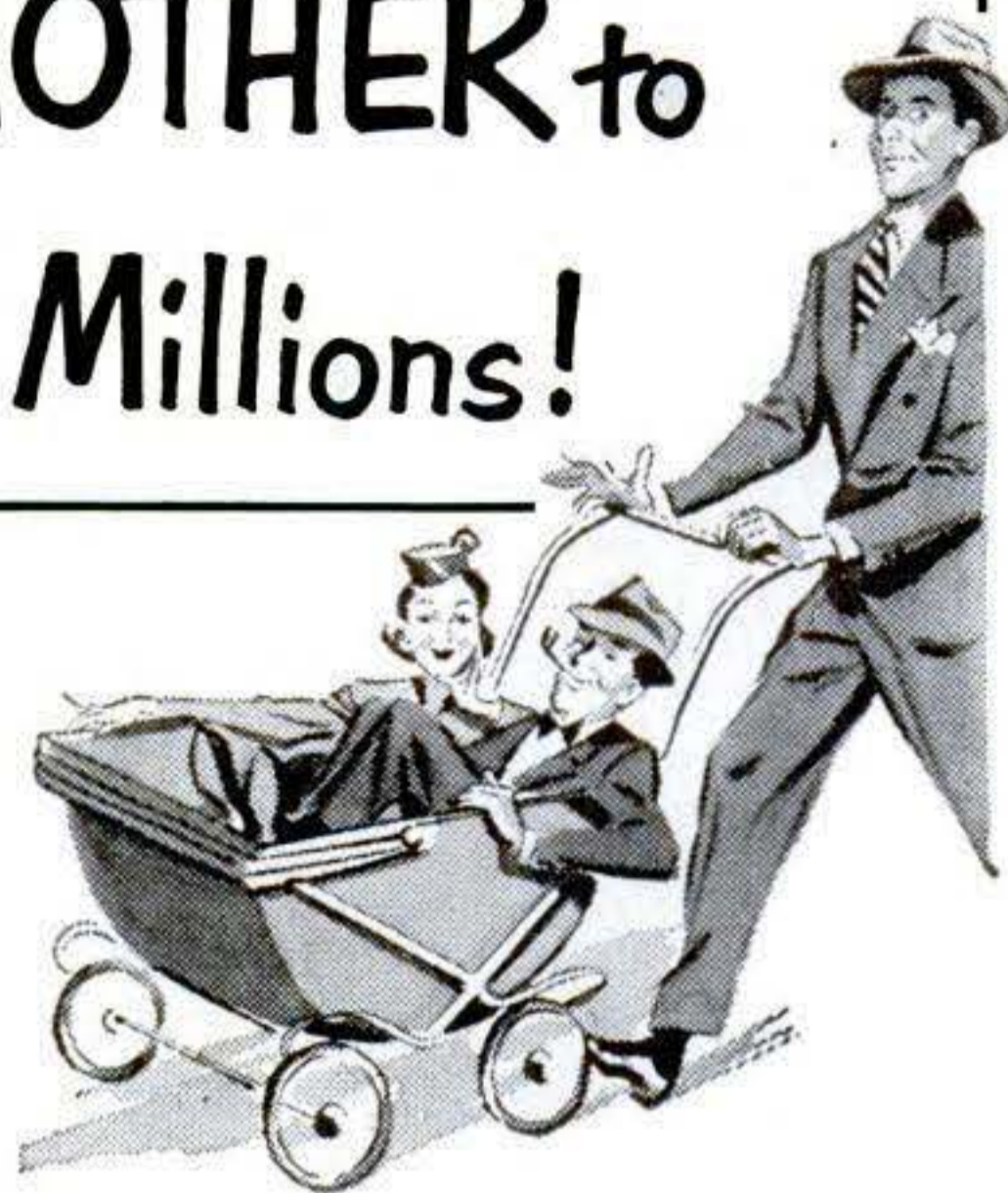

Few mothers ever tried harder to make their children happier and more contented than this particular man who plays such an important part in *your life*.

He is the maker of the good things America enjoys. He is the manufacturer whose whole livelihood depends upon your liking, wanting and buying what he has to sell.

He, and thousands like him, all try to outdo each other in competition for your favor!

They make endless effort to bring you better products, new ideas, finer quality, lower prices, smarter styles, and greater conveniences!

They take pride in what they make—pride in their names, and in their family of users—you the consumer! For you, the buyer, are the boss in this land of brands!

Remember the brands you see advertised in this magazine—and buy where you see them featured.

Brand Names Foundation

INCORPORATED

A NON-PROFIT EDUCATIONAL FOUNDATION
 37 WEST 57 STREET, NEW YORK 19, N. Y.



'52 FORD

The ablest car on the American Road!

BIG OPPORTUNITIES OPEN IN THE METAL TRADES



- * Drafting
- * Tool & Die Designing
- * Tool & Die Making
- * Machinist Trade

Only 60 school days - 360 Hours - of practical Shop Training or Mechanical Structural or Aircraft Drafting

Allied will train you easily and quickly for these Important Trades and place you on a Good Paying Job.

Inquire about our **PAY AFTER GRADUATION PLAN**

Write for **Free Books** a postcard will do!

INDICATE PREFERENCE - RESIDENT or HOME STUDY

ALLIED SCHOOL of MECH. TRADES
 1338 S. Michigan Ave. Chicago, Ill.
 408 ALLIED BLDG.

WAR SURPLUS BARGAINS

WAR SURPLUS BARGAINS

\$500,000.00 INVENTORY for QUICK LIQUIDATION

Surplus items—hundreds of them for home, shop, factory, farm and outdoor use. New items, used items, reconditioned items—all at tremendous savings—all priced for quick sale.

PAGE AFTER PAGE OF VALUES

This big catalog shows page after page of amazing money saving values. Write for your copy today. Send 10c to cover postage, mailing, etc. Write today!

SEND TODAY FOR YOUR COPY

10c

STARK'S 509 So. State St. Dept. PS-10 CHICAGO 5, ILL.

If Ruptured



TRY THIS!...

If you can obtain relief by holding back your rupture or ruptures in this manner—I CAN HELP YOU!

Write today for my valuable FREE information which is based on 23 years of practical experience.

FRED B. MILLER, Mgr.
Dept. P, Hagerstown, Maryland.

MONEY for MEN ALL DATA FREE

THE PLASTEX Industry needs manufacturers on small scale and for big production of Lamp and Clock Stands; Art Goods and Novelties in Plastex and Marble imitation. Experience unnecessary. 1/2c material makes regular 10c store sellers. Rubber moulds furnished for speed production. Small investment brings good returns. We are now placing big chain store orders with manufacturers. Ambitious men have chance for real prosperity. Our Free booklet will interest and benefit you.

PLASTEX INDUSTRIES, Dept. 2, 3400 Third Ave., New York 56, N. Y.

PUMP WATER FAST!

DRAIN WASH TUBS, CELLARS, CISTERNS IRRIGATE—FILL TANKS—DRAW WELL WATER

Pumps 2800 GPH. 420 GPH at 75' High or 1600 GPH from 25' well. Sturdy, Rustproof Alloy Metal, Six Blade Impeller. Uses any 1/8 to 1/2 H.P. Motor Will not leak or clog. Fits any garden hose. Immediate Money Back Guarantee. Send Check, M O, or C.O.D. **895** IN U.S.

MOORE MANUFACTURING CO.
SWEDESBORO 2 NEW JERSEY

Buy DIAMONDS at Wholesale Prices

Benefit from Loan foreclosures and Estate liquidations. Values from \$50 to \$10,000.00.

Write Dept. B.

CITIZEN'S Diamond Brokers

195 Mitchell St. Atlanta, Ga.

Save up to 50%

Write for FREE Catalog Est. 1914



UNI-COATED*!

Brand New, top quality glasses. All have precision ground optics, durable lightweight bodies. Moisture and dust proofed. Achromatic!

Featherweight!

16x50 \$69.50
27 Ounces

The ultimate in a fine binocular. Tremendous power. Featherweight (weighs only 27 ounces). Precision made in every detail. UNI-COATED*, providing sharper, brighter images. Individual focus. Objective lens is 50mm (2 inches) across.

ALL are UNI-COATED*

Same Model CENTER FOCUS with individ. focus right eye.
10x50—\$49.50 12x50—\$59.50

UNITED BINOCULAR BARGAINS!



- 6x30 16 oz. Economy 4 1/2"x6".....\$27.95
- 7x35 All round use. 5"x6 1/2"..... 42.95
- 7x35 Center Focus 5"x6 1/2"..... 46.95
- 7x35 German World's Lightest 14 oz!
Center Focus 57.50
- 7x50 Brilliant-6 3/4"x7 1/4"..... 36.00
- 7x50 Center Focus 6 3/4"x7 1/4"..... 39.50
- 8x30 Well-Balanced 31.50
- 8x30 Center Focus-4 1/2"x5 1/2"..... 37.50
- 8x30 German "Whisper Weight" 11 oz.
Center Focus 39.50
- 8x40 More Power-5 1/2"x6 3/4"..... 39.50
- 8x40 Streamlined 24 oz!..... 49.50
- 10x30 18 1/2 oz!..... 39.50
- 20x56 German 9 1/2"x6"-27 oz! Center Focus 99.50

6X-10X POCKET

ALL 3 ARE UNI-COATED*!, precision PRISM Binoculars. Superb craftsmanship. Superior in every detail.



10x They are News \$24.95
WEIGHS 7 1/2 OZ.! Palm sized. Full 10 Power. Color corrected. Achromatic lens. Perfect balance. Another UNITED first in revolutionary binocular developments.

6x DUO-TONE \$16.95
Illustrated. Weighs only 4 1/2 oz. Provide an excellent field of view!

7x ALL CHROME \$19.95
Sturdy. Precision made. Sharp, clear vision! Sale priced.

SIX TELESCOPES IN ONE!

15 to 40 POWER



\$30.75
COATED

American made Wollensak telescope. Instant focusing at 15x, at 20x, 30 and 40x, etc. Turn power tube to click—no guesswork. Telescope measures 9" closed, 27" when extended. Weighs only 18 oz. Has rust proof chrome tubes, large 40mm objective lens. All 12 optic surfaces are COATED. See .22 bullet holes clearly at 300 feet. Use also for astronomical observation. \$30.75 price includes fine leather case. Tax FREE!

20 POWER Weighs Only 7 1/2 Ounces!



2 1/2 Times stronger than binoculars used by the U. S. Armed Forces! UNI-COATED*! Pocket size. 8 3/8" closed, 13 1/2" extended. Easy to hold. . . . Easy to focus. NOT A CHEAPLY MADE TOY TELESCOPE but an all metal, precision machined (threaded fittings throughout) precision made Achromatic telescope. View distant objects (even miles away) brighter, clearer, sharper detail than ever before. Introductory price \$8.95 Tax FREE!

UNI-COATED* Assuring users that applications of magnesium fluoride have been applied to the interior sides of the VITAL front and rear ACHROMATICS assuring users brighter, clearer, sharper images than ever before.

FROM 3 CONTINENTS come UNITED'S "BEST-BY-TEST" binoculars and telescopes. Above are from America, Germany and where not indicated from American influenced Japan where skilled German optical craftsmen tutored local optical workmen in advanced optical techniques. It explains why the quality is so high and the price so low.



UNITED Seal of Quality etched into your UNITED Binocular is proof they are BEST-BY-TEST. It is your GUARANTEE OF SATISFACTION. INSIST upon it!

30 DAY FREE TRIAL

If not fully satisfied return for full refund. Cash orders rushed postpaid, on C.O.D.'s include \$2.00 deposit. Add Federal Tax. Prices on all of above binoculars include handsome genuine leather case and straps. SAVE by buying direct from UNITED "America's Outstanding Binocular Retailer."

FREE CATALOG

FREE! 36 page—3 color binocular catalog listing over 60 different style binoculars, the Best By Test from 3 continents! UNITED has served over 100,000 Sportsmen. Buy UNITED and SAVE.

UNITED BINOCULAR CO.
United Bldg., 9043 S. Western Ave., Dept. ARF-7416, Chicago 20
Display Sales Rooms open 9:00-3:30 Mon. thru Fri. DEALERS WANTED

NOW READY!

First Underslung Miniature Model — Ready to Build!



Collectors' Model KIT

1914 REGAL Colonial Coupe \$3.95

Recent magazine featured fascinating story of this celebrated antique auto—and now YOU CAN BUILD YOURS from our authentic scale model kits! When complete—measures 8 1/2" in length! It's the first underslung model kit ever made! All die-cut parts are of the finest materials—with die-cast plastic radiator, die-cut metal hood with louvre details. History of car, also step-by-step instructions included. Order now for yourself or as a gift for every hobbyist on your Christmas list!



1904 OLDSMOBILE — \$1.95

CHOICE OF 17 MODELS \$1.95 TO \$3.95

OTHER Models not shown: Maxwell \$2.50; Buick \$2.50; 1910 "T" Ford \$2.50; Rambler \$2.50; 1903 "A" Ford \$2.50; Franklin \$2.50; Int. Harvester \$2.95; Packard \$2.50; Stutz Bearcat \$3.95; Columbia \$2.50; Mercer Raceabout \$3.95; Cadillac \$2.50; "Old 16" Locomobile \$3.95.

FREE! Write for a Copy of Our 4-Color Folder!

hudson miniatures OLD TIMERS

"Originators of Antique Autos in Miniature"

SCRANTON HOBBY CENTER, Dept. 28, Scranton 10, Pa.

Take it easy with this... **2 H.P. SNOW BLOWER**

Powerful! Adjusts to dry or wet snow!

one of 15 attachments available with

GEORGE LAWN & GARDEN TRACTOR

Health Saver, Money Saver, 12 months a year! Fully guaranteed! Compare with others at \$50 to \$75 more. Write for folder 31.

GEORGE GARDEN TOOL DIV. Community Industries Assn. Sullivan • Illinois

TRACTOR ONLY WITH 2 H.P. ENGINE \$119.50

SNOW BLOWER \$29.50

14 OTHER TOOLS \$4.50 to \$42.50 F.O.B. SULLIVAN

GROWS HAIR AGAIN

Help grow good, abundant, luxurious hair again with "APPLETONE HAIR AND SCALP OINTMENT." This famous hair specialists' formula is for falling hair, loss of hair, bald spots, dandruff, alopecia, tetter, itchy and irritated scalp and all externally caused hair and scalp affections. Apply it in privacy of your home, at your own convenient time and least expense. Complete hair growing kit, including postage, tax and mailing \$5.00. Or generous size jar of hair ointment \$2.00. Send cash with order or C.O.D. Pay postman.

Appletone Drugs Laboratories
DEPT. #2, 9339 JOS. CAMPAU DETROIT 12, MICH.
Druggists. Write for Agency

FAMOUS Battle Saber

\$2.95 POST PAID

A TREASURE FOR COLLECTORS

Ideal for mounting on wall decoration. Two sabers can be attractively crossed. Made in Solingen from finest German steel. Length 27 1/4".

FREE ... if you order now! Handsome black leather scabbard trimmed in shining steel. Money back guarantee. No C. O. D.'s please.

Carried in battles of the past. Used also as bayonet on famous 1867 Rolling Block Rifles.

WINFIELD ARMS CORPORATION
409 East Pico Blvd., Room SS-10, Los Angeles 15, Calif.

BULLET BLADE

SWEDISH STEEL *Knife* 2 FOR \$1 post paid

Ideal for tackle box, dressing small game, novelty letter opener. Tempered 1 1/2" blade locks in shell. Get one for yourself, your boy!

WINFIELD ARMS CORP.
Distributors for Western Arms Corp.

409 East Pico Blvd., Room SS-10, Los Angeles 15, Calif.

WAR BARGAINS

SURPLUS Over 200 terrific ALSO FACTORY SURPLUS VALUES!

SEND FOR FREE Catalog

SIoux FALLS SURPLUS STORE
SIoux FALLS, S.DAK.

DAN LURIE
"America's Most Muscular Man"
—on television's "Big Top."

FAMOUS DAN LURIE BARBELLS

with 4 courses—low factory prices

50 lb. set...	\$ 8.48	150 lb. set...	\$20.48
100 lb. set...	13.98	200 lb. set...	25.98

Order by Mail; 50% with order, bal. C.O.D. Extra wts. 13c per lb., F.O.B. plant

DAN LURIE BARBELL CO.
1701-S10 Pitkin Ave., Dept. 270-K, Brooklyn, N. Y.

V-PLEX AUTOMATIC CLUTCHES

Get smooth pickup for your power mower, motor scooter or garden tractor... with only throttle control. Prevent stalling engine, cut belt wear, permit no-load idling. Easily installed on 1/2, 5/8, 3/4" gas engine shafts. Factory-tested. See dealer or write for folder. PS 10

V-PLEX CLUTCH DIVISION — Hagerstown, Indiana

WARN HUB CAP MAKES 2 JEEPS OUT OF 1

Ends front wheel drag on 4-wheel drive Willys vehicles; Army 3/4 Ton Dodge, Chev. Saves gas up to 5 miles per gallon, tire wear, front axles, increases speed and power. Stops shimmy—front wheels coast out of gear! 4-wheel drive handles, performs, climbs like 2-wheel. Install or remove WARN HUB CAPS in 10 minutes. Polished aluminum, guaranteed. Rush check, M.O., or C.O.D. Write for circular.

\$20.00 Prepaid U. S., Canada

WARN MFG. CO. P. O. Box 6064-B Seattle 88, Wash.

BE A ROCK HOUND

"PRETTY" ROCK?—OR \$25,000 JADE NUGGET! . . . WOULD YOU KNOW THE DIFFERENCE?

Some people walk by a fortune every day! Do YOU? By picking up a "certain" rock.....or maybe just polishing one, your whole future may be changed! GEM KRAFT opportunities are unlimited! No previous experience needed. Thousands are "Rock Hounds" for fun. NOW, GEM KRAFT shows YOU how to PROFIT UP TO \$6 AN HOUR, spare or full time! NEW PLAN sent FREE to all interested in this new and profitable home business. Write NOW! Air Mail reaches us overnight.

GEM KRAFTERS, Dept. 3A 1717 Westwood Blvd., Los Angeles 24, Calif.



HAPPY THE COWBOY

THE VENTRILOQUIST'S DUMMY

ONLY \$2.98

complete

You and your kids will think he's wonderful. He's Happy, full of life, all of 19" high. A real cowboy, colorfully dressed wearing hat, washable plaid shirt, western pants and boots. You can make him "talk". Just pull the string

in back of Happy's head, and his lips move so that your voice seems to come right out of his mouth. You and your children will enjoy playing ventriloquist with Happy at home and at parties, too. Rush your order today! Send no money. C.O.D. you pay postage and handling charges. Remit with order, we pay postage.

**NOVELTY MART — DEPT. PS-10
59 EAST 8th STREET NEW YORK 3, N. Y.**

NEW! CHEAP! OIL BURNER

AMAZING HEAT INVENTION



BIG CASH DISCOUNT. SLIPS INTO ANY COAL STOVE, RANGE OR FURNACE.

**\$14.75 for Stoves
\$29.50 for Furnaces**

Quick, intense heat by finger-tip control. Cheaper than coal. No more shoveling coal or ashes. **SENT ON TRIAL.** Prove it pays for itself quickly by what it saves. \$1 bonus for testing. We'll let you try one in your own home for one month. Send no money. Write for details today.

NORTHWEST MFG. CO., 361-M, Main, Mitchell, S. Dak.

WIN with MAGIC CARDS



This special deck of playing cards with secret code on back of each card tells YOU what each card is when lying face down. Easy directions explain code and how to do many kinds of "Magic" tricks. Use same deck for usual card games, such as poker, bridge, etc. Only \$2.98. Get a deck today. **SEND NO MONEY.** Send Name and Address. Pay postman on arrival only \$2.98 plus postage. Address

**HOLLISTER-WHITE CO., Dept. 451-M
3016 W. Van Buren St. Chicago 12, Illinois**

ILLUSTRATED COMIC BOOKLETS

POCKET SIZE!



THEY'RE TERRIFIC! PACKED WITH RARE CARTOONS and GOOD CLEAR ILLUSTRATIONS AS YOU LIKE IT. RICH IN FUN and HUMOR. **20 BOOKLETS** ALL DIFFERENT, SENT PREPAID FOR \$1 IN PLAIN SEALED WRAPPER. NO C.O.D.s.

NATIONAL, Dept. 478, BOX 5-STA. E, TOLEDO 9, OHIO

Sensational Device Tests Eyes



SAVE up to \$15.00 on Glasses! Big news to the millions of Spectacle Wearers and Prospects. Means Freedom from Outrageous Prices. Sold on Money-back Guarantee.

MAKE BIG MONEY QUICK—FREE SAMPLE KIT!

Show it to friends and others. Let them use it Free and watch their amazement over this Self Testing system. Here is a great new opportunity in a tremendous new field of unlimited possibilities. Spare or full time. No experience needed. Write for Free sample kit.

G. G. Optical Co., Dept. A-144, 20 E. Delaware Pl., Chicago 11, Ill.

WHY PUT UP WITH THIS

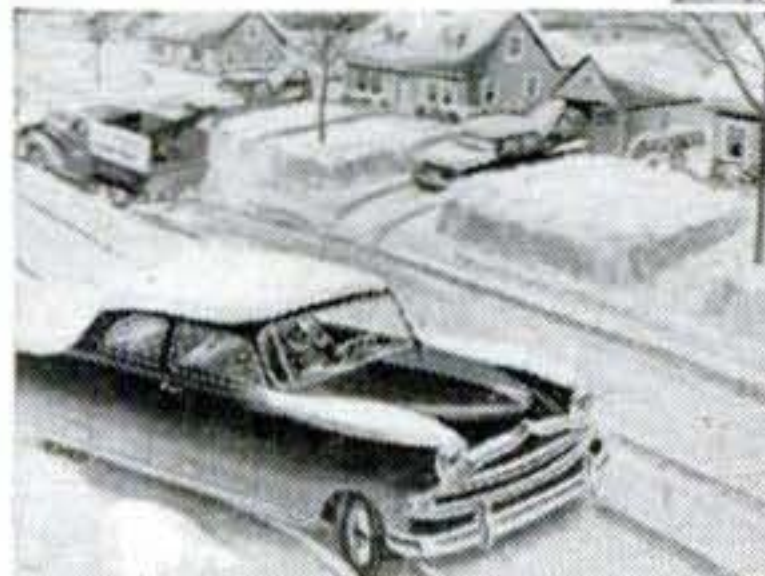

WHEN YOU CAN START LIKE THIS

Thermostat automatically cranks up unattended engine whenever it needs warming. Engine actually runs; thus warming itself evenly in the natural way (from the inside, out). Uses its own self-generated heat.

WORLD FAMOUS

Redi-Warm

TRADE MARK

AUTOMATIC ENGINE TENDER

ADAPTABLE TO ALL MAKES OF CARS AND TRUCKS

At last the luxury of knowing your car will start as easily on a sub-zero morning as it will on a summer day. With a Redi-Warm Automatic Engine Tender in your car, it makes no difference where you park — how long you park. No plug-ins — no smudge pots — no spark boosters. Just touch your starter, and you're off in a jiffy.

HELPS PROTECT 10 VITAL POINTS

1. Keeps motor block warm
2. Keeps lubricating oil warm and fluid
3. Keeps starting motor warm
4. Extends life of battery! Keeps it charged!
5. Keeps transmission grease warm
6. Keeps generator in better condition
7. Keeps ignition points from corroding
8. Rewarms car interior
9. Keeps windshield clear of frost
10. Keeps windshield wipers from freezing tight

WRITE FOR FREE BOOKLET

- Keeps engine always at starting temperature regardless of weather.
- Car cannot be started while Redi-Warm is set for operation; thief-proof — fool-proof — extends battery life.
- Saves wear on engine; saves gas ordinarily used in choking.
- Saves time — saves temper — eliminates costly towing charges.
- Pays for itself over and over.

RETAIL PRICE **\$24.95**

Order Through Your Dealer or Order Direct

CRAY-LINCOLN ENG. & MFG. CO.
NO. WALPOLE, N. H.

Make 100% to 150% Profit!

MANUFACTURE BUILDING BLOCKS
In Your Own Back Yard

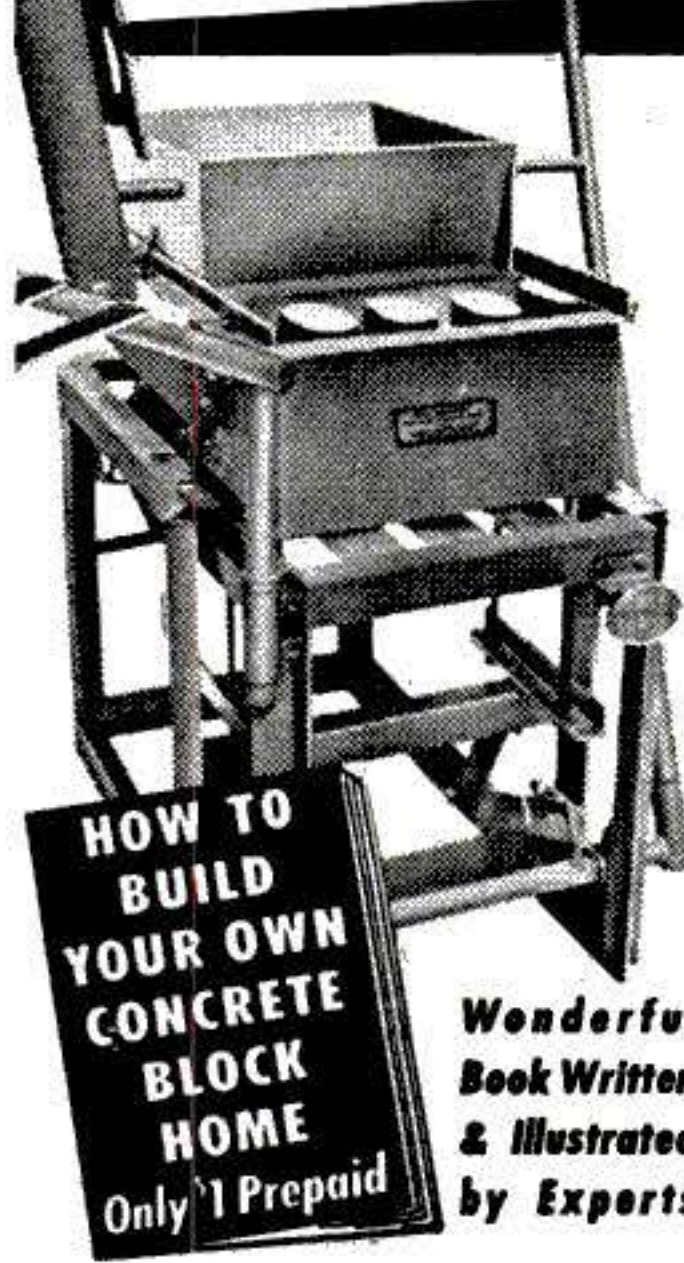

AMAZING GENERAL BLOCK MACHINE
CAPACITY 1000 BLOCKS PER DAY
only \$218 LESS MOTOR
F.O.B. PLANT
SHIPPING WEIGHT 400 lbs.

Here is an outstanding opportunity for men of vision and small capital. Cinder and concrete blocks are in great demand. Millions used for homes, factories, public buildings. Sell all you produce at 100% to 150% mark-up.

PEAK BUILDING DEMAND!

The General Block Machine is amazingly practical, foolproof. Simple to operate indoors or outdoors. Rugged all steel construction. Vibrator mounted in sealed ball bearings. Produces up to 1,000 blocks per day Superior 3 Core Type that meets all building code requirements. Can produce 4 x 8 x 16, 8 x 8 x 16, 12 x 8 x 16 blocks. All materials obtainable anywhere. All operating instructions and mixing formulas supplied. Full details FREE without obligation.

Wonderful Book Written & Illustrated by Experts

HOW TO BUILD YOUR OWN CONCRETE BLOCK HOME
Only \$1 Prepaid

GENERAL ENGINES CO.

DEPT. S-102 • 307 HUNTER ST. • GLOUCESTER, N. J.

Includes floor plan for 6 beautiful, easy to build concrete block bungalows. Shows ways to save money. How to lay blocks, lay out building lines, mix concrete, build steps, porches and concrete floors. Mail coupon at once with \$1.

Name

Address

City . . . Zone . . . State . . .

SAVE MONEY • SAVE FUEL • BE WARMER

STORM WINDOWS

OF GENUINE **DUPONT** CELLULOSE ACETATE

5 WINDOWS
5 for \$6
POSTPAID



- **CLEAR AS GLASS**
No cloudy vinyl plastic effect—but as transparent as the windows it covers.
- **INSTALL IN MINUTES . . . FROM INSIDE**
Scissors and Scotch tape are all you need. No climbing ladders for outside installation! No marring of window sills with tacks. Simply tape on . . . as easy as mending a page!
- **PERMITS AIRING OF ROOMS**
Just lift off tape when open window is desired . . . Replace when window is closed.

100% AIRTIGHT — Used by the U.S. Gov't. Fit any window. Roll size 36" x 288". Sheets easily taped together to cover wider windows. Completely waterproof . . . Instructions furnished. They'll pay for themselves many times over in fuel savings alone. Fill in and mail the coupon TODAY.

SEND NO MONEY!
Pay Postman YOUR MONEY BACK IN FULL IF RETURNED IN 10 DAYS

T. C. TOR, 2113 Bellevue St. Phila. 40, Pa., Dept. PS1

GENTLEMEN: Please ship immediately () rolls (ea. roll 36" x 288") — at \$6. per roll of TOR Plastic Storm Windows . . . ea. roll enough for five average size storm windows — with instructions.

() I will pay postman \$. . . plus few cents postal collection fee.

() Am enclosing payment here-with (saving collection cost)

Name

Address

City

CAR OWNERS!

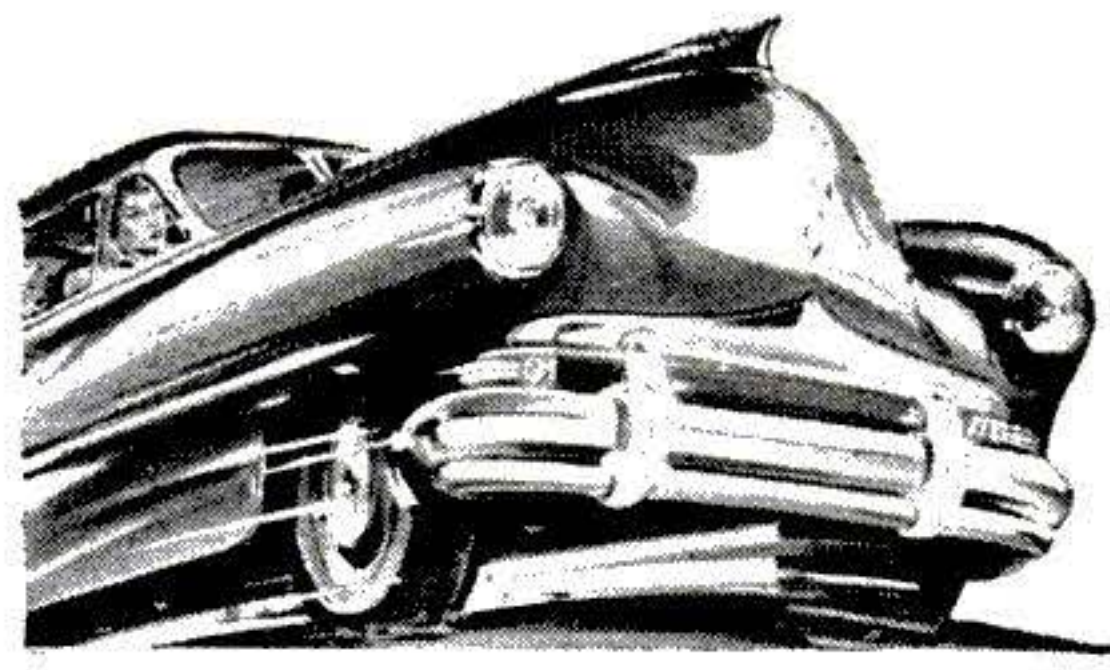

First 12 Pages Alone of New Auto Book Can SAVE You Over \$86.00!

Popular Science Experts Help Keep Your Car's Value Up — Repair Costs Down!

Now ready! "HOW TO TAKE CARE OF YOUR CAR"—big, new "show-how" manual that helps you save hundreds of dollars repairing your own car regardless of make or model! Simple "do-it-yourself" instructions help you prevent 95% of costly car break-downs! Make many necessary repairs and adjustments at no cost or for just a few pennies! Save on gas, oil, tires, paint jobs, motor and body repairs—everything fully illustrated in 5 colors!

SAVE hundreds improving your car's performance and appearance, modernizing your garage, and making scores of other improvements!

EXTRA! Save untold troubles and disappointments when buying a used car. Buyer's Guide on Pp. 168-172 makes it practically impossible to get stuck with a "lemon."

256 BIG PAGES!
750 PICTURES!
851 NEW IDEAS!

ONLY \$2.49

SEND NO MONEY! All you do is merely detach Coupon below and mail in now. Enjoy week's FREE trial! Balance of edition going fast; we may never again be able to offer book at low bargain price of \$2.49! Paste Coupon to 2-cent postcard—mail TODAY!

POPULAR SCIENCE, DEPT. 1052
353 Fourth Ave., N. Y. 10, N. Y.

Please send "HOW TO TAKE CARE OF YOUR CAR" in edition checked below. I will pay postman \$2.49 plus postal fees. If not satisfied, I may return book within 7 days for refund of purchase price.

De Luxe Edition only 50c extra.

Name

Address

City . . . Zone . . . State . . .

Check here if you remit now. We will pay all shipping costs. Same return privilege.

Fistula Is Real Threat

FREE BOOK—Explains Other Related Ailments

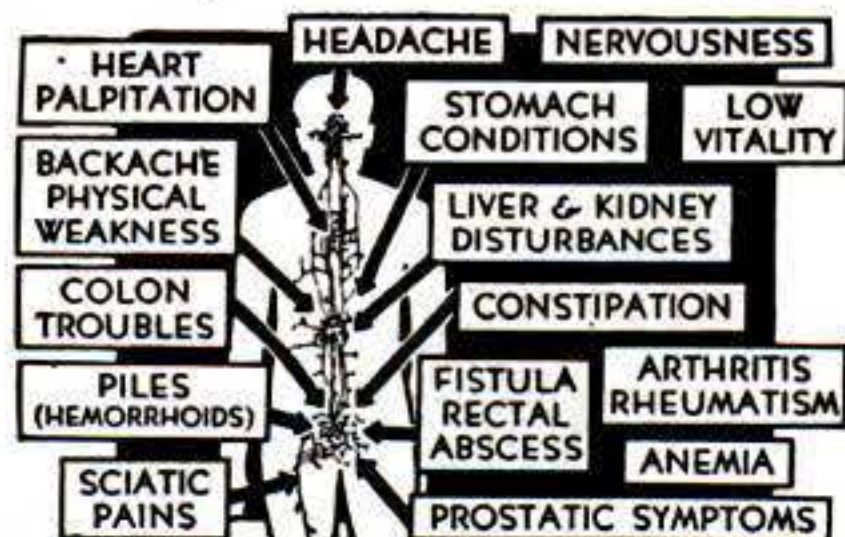

40-page FREE BOOK—tells facts about Fistula, Rectal Abscess, Piles and other rectal and colon disorders; also related ailments and latest corrective treatments. Thornton & Minor Hospital, Suite 1049, 911 E. Linwood, Kansas City 3, Mo.

Build your own JET ENGINE!

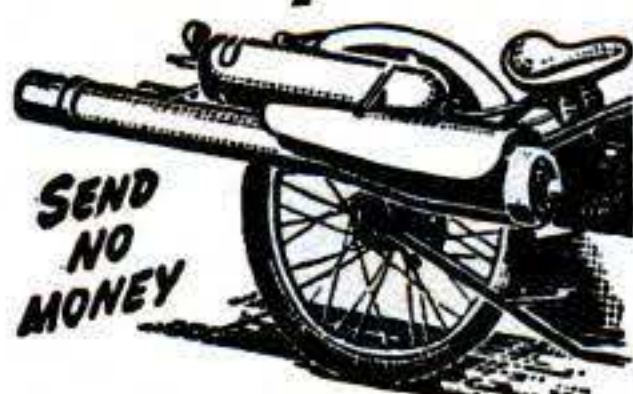

SEND NO MONEY

Order these plans today

1. JET PROPELLED BICYCLE. Assemble your own. Photo and instructions \$1.00.
2. HOW TO MAKE EXPERIMENTAL JET ENGINES. Seven sheets drawings with information and instructions \$2.95.
3. BOTH OF ABOVE in one order \$3.75. SEND NO MONEY. Order both at once \$3.75 C.O.D. in USA plus c.o.d. postage. Send check or Money Order and we pay postage. Get other information too. Rush Order.

J. HOUSTON MAUPIN, Dept. 66, Tipp City, Ohio

ELECTRIC SHEAR SHARPENER

Over 85,000 Sold—It Must Be Good



Genuine Carborundum wheel ideal for shop or home use. Send remittance with order and shipment will be made at once, prepaid to your door, complete with electrical goods catalogue. Motor driven \$9.75 complete with vise

WILLIAM MARVY COMPANY, Dept. 80
479 St. Peter Street St. Paul 2, Minn.

AMAZING NEW CHEMICAL MAKES

OLD BUMPERS LIKE NEW!

NOT A PAINT! NOT A POLISH! Looks like expensive chrome plating! Wonderful new chemical puts chrome-like finish on car bumpers, door handles, trim, etc. No electricity—no plating tanks—no acids needed. Just smooth it on and watch it gleam. Takes a brilliant polish JUST LIKE CHROME—so simple a child can do it. REFINISH BUMPER IN 10 MINUTES! WORKS LIKE MAGIC—finish lasts for years. Increases resale value of your car and adds NEW beauty to other chrome plated or metal items. TRY AT OUR RISK! SEND NO MONEY! Just send name and address. Pay Postman amazing low price of \$1.50 plus few cents postage for each kit ordered, or send cash and we pay postage. Try kit 10 days. If not delighted return for instant refund! Bumper Re-Nu, Rm. 42, Box 147, Hamtramck, Mich. \$1.50

Ball-Bearing SPEED WHEELS



JUVENILE WHEELS (No bearing, solid tires)			
4"	40c	6"	65c
5"	45c	7"	75c
(Semi-pneumatic tire, ball bearing)			
8 x 1.25.....	1.85	10 x 1.25.....	2.20
8 x 1.75.....	1.95	10 x 1.75.....	2.30
8 x 2	2.20	10 x 2.00.....	2.65
12 x 1.75.....	3.45		

INDUSTRIAL WHEELS

Lug Base, Semi-Pneumatic tire			
5 x 1.75.....	3.65	10 x 2.00.....	6.10
6 x 2 SW	3.45	10 x 2.75.....	5.15
6 x 2.00.....	4.00	12 x 2.00.....	6.90
8 x 2.00.....	5.20	12 x 3.00.....	9.20
8 x 2.50.....	5.40	16 x 4.00.....	15.15
Smooth Base, Pneumatic tire and tube			
8 x 3.00.....	11.00	12 x 4.00.....	12.10
10 x 2.75.....	6.80	4.00 x 8.....	13.10
10 x 3.50.....	10.55	14 x 4.50.....	13.40

Dealers, Jobbers, and Manufacturers! Our new prices will interest you.

No c.o.d. orders. Prices F.O.B. our plant.

JIM BROWN TOY COMPANY

1093 HOME AVENUE

AKRON 10, OHIO

GET THE WORLD'S LEADING TV & RADIO CATALOG

FREE

236 VALUE-PACKED PAGES

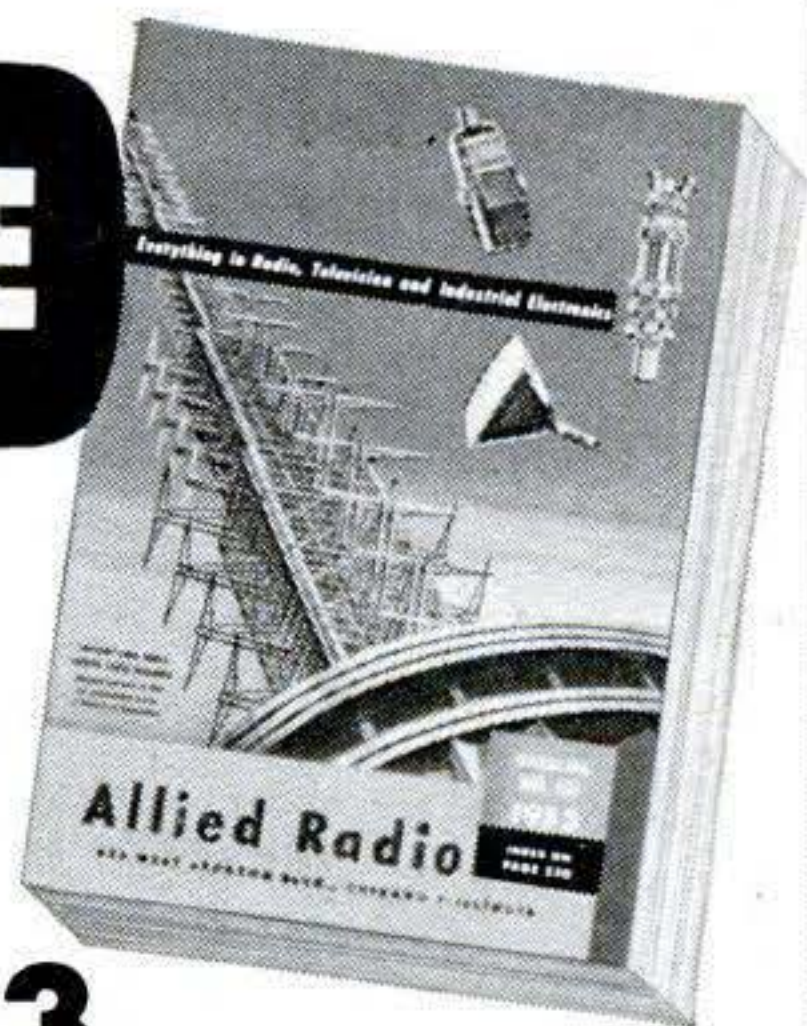

1953 ALLIED BUYING GUIDE

Save on Everything in TV & Radio!

Everything for Experimenters, Builders, Amateurs, Servicemen, Engineers and Soundmen

Get the big 236-page 1953 ALLIED Catalog featuring the world's largest selections of latest top-quality electronic equipment at lowest, money-saving prices. See the newest in TV, home radios, Amateur Equipment, Hi-Fidelity sound, P.A. systems, recorders, test instruments, builders' kits—plus thousands of parts, tubes, tools and books. Get more for your money from the World's Largest Radio Supply House. Send today for your FREE 1953 ALLIED Catalog!



FREE CATALOG

SEND FOR IT TODAY

ALLIED RADIO

ALLIED RADIO CORP., Dept. 7-K-2

833 W. Jackson Blvd., Chicago 7, Illinois

Rush FREE 1953 ALLIED 236-Page Catalog

Name _____

Address _____

City _____ Zone _____ State _____

Get into...

PLASTIC LAMINATING AT HOME!

Sensational New
**"ONE MAN
BUSINESS"**
..pays \$10 to \$20 profit
for each dollar of cost.

Make \$20 to \$30 a day by our
MAGIC MAIL PLAN... get
orders and cash from your mailman!

Here's the newest and most fascinating of all home-operated businesses. For the first time, a simplified machine brings the fabulous profits of Plastic Sealing and Plastic Laminating within the reach of the small operator. Can be

operated in a corner of the kitchen, basement, or garage. And any man or woman, regardless of age, education, or experience—can learn this interesting work in a few minutes of reading—can turn out professional jobs after one hour's practice.



TWO EXCITING FIELDS FOR BIG PROFITS!

No house-to-house canvassing. No face-to-face selling. We not only supply the equipment you need for the work, but also show you exactly how to cash in big daily profits from two big demand fields.

A FORTUNE IN PLASTIC SEALING

Millions of people want to protect valuable cards, photographs, documents and papers against wear, soil, and damage. By our MAGIC MAIL Plan you get this business through the mails. Open envelopes and take out money and orders. Details of this plan will amaze you. It will be sent free. Just mail coupon.

ENORMOUS PROFITS IN LAMINATING

A creative, artistic business. Gift shops sell your entire output. Just a few of thousands of giftwares illustrated on this page. Beautiful colors. Endless designs. Exclusive "one of a kind" appeal brings sales at ten to twenty times the cost of materials. Beautiful illustrations and instructions for making these artistic novelties sent free.

The opportunities in Plastic Laminating are so big that space here does not permit even skimming the surface. To get any idea

FREE at all of the size of these markets and your place in this sensational business you must read the details. See for yourself how easy it is to do the work—how you can put plastic sheets into your machine and take out a fortune—how money and orders come to you in the mail—how gift shops clamor to get more and more of your creations—how you can start with one machine and build up a big production plant with others doing the work—how you can get money and business from every State in the Union—how you can achieve independence without study or experience.

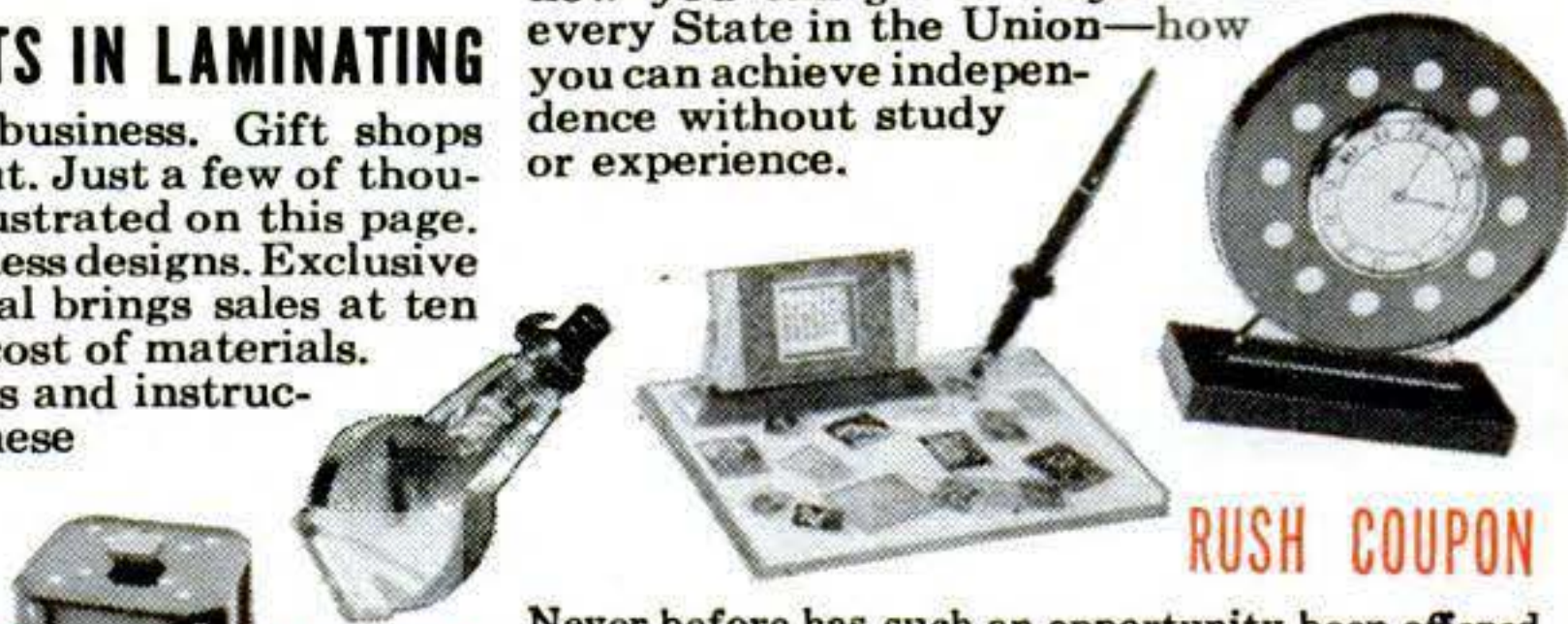

RUSH COUPON

Never before has such an opportunity been offered the small, home-operator—an opportunity to gain complete personal independence in a big money business of your own. Don't lose a minute. Get the facts at once. All information, fully illustrated with pictures, is free. Send the coupon—or send your name on a penny postcard. There is no charge now, or at any other time. We may be limited in the number of Warner Laminators that can be made up, so don't put this off. Send for the information on this exciting opportunity today.

WARNER ELECTRIC CO.,
1512 Jarvis Dept. L-9-P, Chicago 26, Illinois

WARNER ELECTRIC CO. Dept. L-9-P
1512 Jarvis, Chicago 26, Illinois

Rush complete information with illustrations showing the things I can make and the money possibilities in Plastic Laminating. All this is free. I do not pay a penny now or at any other time. No salesman is to call. Send all facts by prepaid mail. Be sure to tell me how I get orders and money from my Postman by your MAGIC MAIL Plan.

NAME _____
ADDRESS _____
CITY _____ ZONE _____ STATE _____

**\$5-\$10-and \$20 BILLS
COME TO YOU IN THE MAIL**

By our MAGIC MAIL Plan you sit at home, send out mail, and get back money and orders. Additional profits in supplying local people with lifetime protection for

SNAPSHOTS—IDENTIFICATION CARDS—DISCHARGE PAPERS—DRIVERS' LICENSES—SOCIAL SECURITY CARDS—VOTERS REG. CARDS—MENUS—BIRTH CERTIFICATES—CREDIT CARDS—BIRTH AND WEDDING ANNOUNCEMENTS—RAILROAD PASSES—IMPORTANT DOCUMENTS OF ALL KINDS.

Lifetime protection. See how laminating protects against wear, soiling, and moisture damage with its smooth, flexible, plastic covering on each side. **LIFETIME PROTECTION** needed for valuable or sentimental objects of all kinds—even a priceless whisp of hair can be laminated. Think of the countless thousands of profit items for your Laminating Press.

**Thousands of
Beautiful Art Creations**

No one yet has been able to list the thousands of gorgeous articles that can be made by Laminating as explained in our Free Information. Just a few are

COSTUME JEWELRY—CIGARETTE BOXES—JEWEL CASES—GLOVE AND HANDKERCHIEF BOXES—CUFF LINKS—NOVELTY BUTTONS—TRAY—CANDLESTICKS—COASTERS—CLOCK CASES—LAMP BASES—PICTURE FRAMES—BOOK ENDS—PAPER KNIVES—KEY CHAIN CHARMS—CHECKERS—CHESSMEN—ADVERTISING SIGNS—NAME PLATES—BOOKMARKS—BELT BUCKLES—TIE RACKS—KEEPSAKES OF ALL KINDS.

Classified Ads only 80c per word per insertion, payable in advance. Minimum ad 10 words. To be included in December issue, copy should be in our office by October 23. No cancellations accepted after October 15.

CLASSIFIED OPPORTUNITIES

POPULAR SCIENCE MONTHLY-351 FOURTH AVE.-NEW YORK CITY 10

1 AUTOMOBILES & MIDGET CARS

"HOW to buy speed equipment without money." No selling. Information free. Newhouse Automotive Industries, Los Angeles 22.

SAVE—California Custom Accessories headquarters. Buy direct from original designers. Chrome dash panels, electric push button door-trunk conversions, fender skirts, dual mufflers, lowering kits, speed-dress up equipment, 40 page catalog. Hundreds of photos—25c. Eastern Auto, 3319D South Grand, Los Angeles 7, Calif.

1953 EDITION. It's new! It's different! Get world's largest Auto Accessory & Parts Catalog and save money. 100 pages. Over 50,000 items, including Hollywood Accessories, Hi-Speed Equipment, Rebuilt Engines, all parts and accessories for all cars and trucks. We have that Hard-To-Get part! Jam packed with bargains. Completely illustrated. Send 50c (refundable). J. C. Whitney, 1919-EA Archer, Chicago 16.

BUY racing heads, dual manifolds, Hot coils, etc., without money. Information free. Newhouse Automotive Industries, Los Angeles 22.

NON-Profit organization supplies automobile literature—old, new, foreign. Glossy photos, service manuals, data books, engineering papers; free motor magazines. Contact auto "nuts" everywhere. Write today; get on free mailing list. Auto Maniacs, Inc., Stockbridge, Michigan.

MAKE your own Polyester-Fiberglass Auto body. Catalog 10c. Gem-O'-Lite, Box 686P, North Hollywood, Calif.

CROSLY parts hard to find? We get 'em for you. Tires recapped. Club bulletin reveals owner experiences, opinions. Eye-catching windshield decal, identification card, etc. Write: Crosley Car Owners Club, 304 North Poplar, Charlotte, N. Car.

SPEED equipment from the World's largest firm. 25c for huge catalogue. Newhouse Automotive Industries, Los Angeles 22.

"HOW To Buy A Used Car." Over 100 easy-to-perform tests in one Book. A complete Guide. Only \$1.00. M. Kaminsky, Box 570-S, Mt. Vernon, New York. Satisfaction Guaranteed.

2 AUTO SUPPLIES & EQUIPMENT

1953 EDITION. It's New! It's Different! Get world's largest Auto Accessory & Parts Catalog and save money. 100 pages. Over 50,000 items, including Hollywood Accessories, Hi-Speed Equipment, Rebuilt Engines, all parts and accessories for all cars and trucks. We have that Hard-To-Get part! Jam packed with bargains. Completely illustrated. Send 50c (refundable). J. C. Whitney, 1919-T Archer, Chicago 16.

NEW and used guaranteed parts for civilian and Army cars and trucks. Largest stock in America. Mail orders. Pioneer Auto & Truck Parts Company, 788 W. 13th Avenue, Denver, Colorado.

BRUSH Plating Outfits connect to a battery. No tanks or shop required. Free particulars. Gunmetal Co., Ave. K, Decatur, Illinois.

"SPEED, Custom, Racing Equipment"—Wholesale, Retail! "Souping Manual"—Catalog 25c. (Circular Free). Almquist Manufacturing, Milford 44Z, Pennsylvania.

LACHAPPELLE'S Treatment. (Patented.) For \$3.00, puts babbitt-type bearings on the pistons. Free data. Ferns Products, 8120-D Walnut Dr., Los Angeles 1, Calif. For Agent distribution contact, Dillon, Box 323, Bridgeport, Ohio. Canadian distribution, Master, Box 3, Station C, Hamilton, Ontario. Cuban distribution, Luis Izaguirre, San Carlos 178, Cienfuegos.

SPEED Equipment Catalog offers faster acceleration, extra power for all makes of cars. New 1952 Catalog shows world's best "souping" accessories. Speed tables. Send 50c (refundable with 1st order). Bell Auto Parts, 3633 Gage, Bell 1, Calif.

HI-Compression Heads \$18.95 up. Most Cars. State Model. Auto Parts Service, West Salem 3, Ohio.

BE Independent, save money. Grind crankshafts without disassembling engine. New hand operated tool \$3.75. Literature. L. D. McGee, 719 Cascade, Wenatchee, Wash.

"120 DIFFERENT Ways To Increase Gasoline Mileage" \$1.00. Holloway, Box 225, Bijou, California.

GM71 Discarded injector parts wanted. Hogen, 7120 Carnegie, Cleveland, Ohio.

INCREASE! Gasoline mileage Three to Five more miles per gallon. Guaranteed Gasoline Vaporizer, also Increases Power. Easier starting. \$3.50. Turb-O-Vane, Stockton, Calif.

ILLUMINATE your powerglide or dynamometer, information free. Gaiser, Box 25B, Kokomo, Indiana.

SEND for Free Life Membership Card, Economy Methods. "Water Burners of America." La Verne, California.

CARBURETOR Too Rich makes motorist too poor. New invention saves gas "Vacumating." For free particulars, sample offer, write Vacuumatic, Dept. 1946, Wauwatosa, Wisconsin.

"HELL'S Bells" in your automobile attract attention! Provoke laughter, amazement. Free literature, "Winco's", Box 9525, Dallas, Texas.

LIQUI-Moly. For quick delivery Airmail your order. One-half pint can \$1.15 Postpaid. P. L. Howland, 130 Collier, Mulvane, Kansas.

UNIVERSAL Top Oiler—supplies vital upper cylinders your favorite tune-up oil. Protects your engine, new pep and power. \$6.95 complete, ppd. M-F Auto Accessories, Dept. P, 5323 Commercio Way, Woodland Hills, California.

CHEVROLET Owners: Stop tappet noise with Kaye Tappet Silencers. Quality product. Easy to install. Money back guarantee. Complete set \$5.95 Postpaid. Kaye Products; 1321C So. Layton Blvd., Milwaukee 15, Wisconsin.

HYDRAULIC jack repair kits. Repair your own. Send for prices. Jack Parts Company, 2000A South Claiborne, New Orleans, La.

AMAZING new patented product restores compression, reduces oil burning, adds new life to engine. Motaloy actually metal plates worn pistons, rings, valves. No tools needed. Safe, economical. Guaranteed 200,000 miles! Details Free! Garden State Sales, Inc., 201 E. 5th Street, Plainfield 6, New Jersey.

SIRENS, Air Horns! Free accessory catalog; McCanna, 200-PS East 21st, New York 10.

NEVER Change Your Oil! Full details free. Thousands of users. You'll be amazed! Dept. TH, Henderize, Inc., 5667 Freepoint Blvd., Sacramento, California.

AUTOMOTIVE Tool Salesmen get our catalog. Popular tools for body shop, glass, trim mechanics. Douglass Tools, 5251 Pat-tison, St. Louis 10, Mo.

3 AUTO TRAILERS

BUILD your own trailer! Plans for all kinds. Illustrated catalog 10c. Jim Dandy, 125-S. Wausau, Wisconsin.

4 MOTORCYCLES, BICYCLES AND SUPPLIES

"BUZZZZ" Magazine. Describes, Illustrates Motorcycling Completely. \$2.00 year. 20c copy. 5424-B Sawyer, Chicago 25.

RECONDITIONED motorcycles and motors. Chromium accessories. Complete stock Indian parts. Expert rebuilding. Fast service. Indian Motorcycle Sales, Kansas City 1, Mo.

FOUR cylinder Henderson motor \$20. 45 Harley \$10, others as low as \$3. Harley motorcycle \$20. Four airplane tires \$3. mail order only. Send 25c for new catalogue number Fifty, just out listing the above and hundreds of other bargains in new and used midget cars, motorscooters, motors, parts, plans for homebuilders, etc. (35c by first class mail). Midget Motors Directory, Athens, Ohio.

REBUILT Gasoline Engines. \$17.00 to \$37.00. Cauffiel Motor Industries, Temperance, Michigan.

WHIZZER \$20; Servicycle (good tires) \$20; Motorbike conversion kit \$25; Cushman motorscooter \$25; Harley twin \$25. Rush 25c (35c first class mail) for catalog #952 listing many other amazing bargains in motors, midget cars, motorscooters, motorbikes, etc. Associated, Box 1764-CS, Toledo, Ohio.

CHAINS for English Bicycles 95c! Guaranteed. General Products Co., 15 Park Row, New York 38, New York.

5 AVIATION

PROPELLERS, plans, supplies, for snow sleighs-air boats. Catalog 20c. Banks-Maxwell, Box 3301G, Ft. Worth, Texas.

6 BATTERIES, GENERATORS, ETC.

EDISON Nickle odorless storage batteries. 12 to 600 ampere hour. Any voltage. Long guarantee. Literature. Hawley Smith Co., Croton Falls 2, New York.

7 ELECTRICAL SUPPLIES & EQUIPMENT

LAMPS—25c brings bargain parts catalog containing instructions for electrifying oil lamps, vases, etc. Gyro Lamps, 5402B Clark, Chicago 40.

TELEPHONES—Telephone Wire. Solve communication problems with Army Field Telephones. Anyone can install, operate. Free folder. Loris Sales, Box 1896-A, Sacramento, Calif.

FREE—War Surplus Catalog—Bargains Galore. Welders, Motors, Generators, Hydraulics, Pumps, Kits for assembling your own, other items. Save. LeJay Company, Minneapolis, Minnesota.

LAMP Supplies — Wholesale — any amounts. Prompt shipment on all parts for repairing and building lamps. Illustrated catalog 15c. Brown Lamp Co., No. 501, Wellston Sta., St. Louis 12, Missouri.

8 WELDING, SOLDERING

A.C. Welders, Lowest Prices. Four sizes. Free literature. Holgerson's Service, Canton, Kansas.

ACETYLENE Welding Outfits new \$49.00; used \$29.00; Arcwelders \$49.50; Eagle Welding, Dept. 42, 5085 Broadway, Chicago 40, Ill.

9 MACHINERY, TOOL SUPPLIES, ETC.

FREE! Complete catalogs of precision tools for any job. Big stocks—famous brands: Lufkin, Starrett, Brown & Sharpe. Immediate delivery. Wide selection. Write for your copy today! Mid-City Hardware & Supply Co., Dept. PS, 318 South Halsted Street, Chicago 6, Illinois.

FIRST quality Imported precision measuring tools. Free information and prices. The International Importing Co., P.O. Box 1307, Oroville 3, Calif.

POWER tools, equipment wholesale prices. Free bulletin. Homecrafters Cooperative, Grand Rapids 6, Michigan.

POPULAR SCIENCE OPPORTUNITIES

INDEX Heads for the lathe, drill-press, milling machine, etc. Very reasonable. Write for free folder. Long's Index Heads, 2117 East B Street, Torrington, Wyoming.

GIVE Dad screwdriver set for Christmas or birthday. Useful, inexpensive. Postcard brings circular. William A. Hinds, 625 No. Broadway, New Philadelphia, Ohio.

10 ENGINES, MOTORS, ETC.

WINDING Data, listing 225 motors, single and three phase \$1.00. Motor Data, Box 7631, Kansas City 3, Mo.

MOTORS 1/2 horse \$15.00. 3/4 \$22.00. 1 \$35.00 A.C. generators 750 watt \$38.50. 3000 watt \$125. Butler, 1885 Milwaukee, Chicago 47.

REBUILT Gasoline Engines, \$17.00 to \$37.00. Cauffiel Motor Industries, Temperance, Michigan.

GEARHEAD Motors 1/2 H.P. Standard Motors with six output shaft speeds, the motor of 1,000 uses. Write for literature. Vine, Hill & Co., Box 35P, Swanton, Ohio.

11 BOATS, OUTBOARD MOTORS

FULL size, cut to shape boat patterns, blueprints, 7 1/2-38 feet. Illustrated "Build a Boat" catalog 25c (coin). "How to Build Boats" book, \$1.00. Cleveland Boat Blueprint Co., Dept. A-77, Cleveland 13, Ohio.

NEW, used, rebuilt marine motors. Marine conversions, fittings. Free Catalog. Stokes Marine Supply, Dept. 23, Coldwater, Mich.

OUTBOARD Motor Parts—New—Used for all makes. Send stamp for price quotation, listing parts needed. Outboard Motor Mart, Inc., 229D State Street, Boston, Massachusetts.

CURE that leaking boat with Fiberglass-Plastic covering. Ends caulking and painting. Nationally approved process. Easily applied, complete instructions. Industrial Plastics, 3807 Harrison Street, Oakland 11, California.

SAVE 2/3 Cost. Assemble your own boat. We furnish parts. No experience necessary. Rowboats, Cruisers, Illustrated Catalog 25c. Midwest Boat Company, Menomonee Falls 1, Wisconsin.

MARINE conversions for Ford and Jeep engines. Catalog 10c. Lehman Manufacturing Co., 972A Broad St., Newark 2, N.J.

OUTBOARDS—Complete plans all types. Racing, sporting, fishing. Circular 25c. E. G. McCrea, Designer, Box 141-E, North Hatley, P.Q., Canada.

CONVERT Fords and Jeep to 100% marine engines with Osco's world famous Convo-Kits. Deluxe catalogue 25c (coin). Oscomotors, 3627F Lawrence, Philadelphia 40, Penna.

BUILD Beautiful Fiberglas-Plastic Boats without using molds. New patented method. Write Speedcraft, 2450 Emerson, off Square Lake Road, Pontiac, Michigan.

APPLY Polyester-Fiberglas coating to your boat. Permanent protection. Catalog 10c. Gem-O'-Lite, Box 686-O, North Hollywood, Calif.

PLANS: Inboard-outboard runabouts, cruisers, sail. Wood, plywood, welded steel. Advise requirements. John B. Clark, N.A., 329 Kenmore, Bay Village, Ohio.

12 BODY-BUILDING COURSES, JIU JITSU & ATHLETIC EQUIPMENT

100 TRICK Knockouts for self defense. \$1. 1c each. Lincoln, 529 Main, Evanston 2, Illinois.

REVOLUTIONARY New Lift Exercisor—Stretch-A-Wate. Fraction cost barbells. Free booklet. Stretch-A-Wate Co., Sappington, (St. Louis, Missouri.)

BARBELLS. Dumbbells. Exercise equipment. Courses. Free booklet. Good Barbell Co., Reading, Penna.

14 FIELD GLASSES, TELESCOPES

REFLECTOR telescope Kits: Aluminized Mirror, Diagonal, Eyepieces, Mounts, Complete Kit. Free Bulletin, Esco, 911 Willow Ave., Hoboken, New Jersey.

WAR Surplus Bargains. Binoculars, Telescopes, Sextants, Millions of Lenses, Prisms, Reticles, Eyepieces, Objectives, etc. Mail 10c for Big "Catalog CN." Send \$1.00 for Stock CN-10-piece Lens Kit and Big Instruction Booklet, Edmund Scientific Corp., Barrington, New Jersey.

BINOCULARS, telescopes, microscopes. Our 20th year of leadership in optical values. Bargain catalog free. Brownscope Co., 24 West 45th St., New York.

POWERFUL astronomical telescopes easily made. Perfect lenses and instructions; 100x \$3.00; 100x and 200x \$4.00; 100x, 200x and 400x \$6.00. Full power, clear vision guaranteed. Instructions alone 10c. Suffolk Science Service, Riverhead, N. Y.

"FREE" Catalogue! Thousand war surplus optical bargains. Lenses, Prisms, Telescopes, Binoculars, etc. Send \$1.00 for 10 Lens Hobbyist Set and Project booklet. G. Jaegers, 691 West Merrick Road, Lynbrook, New York.

TERRIFIC Values. Binoculars, Telescopes, Microscopes \$3.95 up. Request Free Money saving Catalog, Criterion, Hartford, Conn., Dept. S7.

BUILD Your Own Microscope—200 power. Complete Castings, Mounts, Lenses. Screws Instructions—Kit \$14.75. Free Illustrations. Esco, 911 Willow Ave., Hoboken, New Jersey.

REFLECTING Telescopes, completely assembled, 60X, \$29.75. Guaranteed Observatory clearness. Free information. Skyscope, 475 Fifth Avenue, New York 17.

SAVE: Free 36 page, 3 color binocular catalog, 60 different models. United Binoculars, (A-6516), 9043 S. Western, Chicago 20.

SAVE! Save! New Binoculars! Free Catalog, Free Book, "How To Select Binoculars". Write Today! Bushnell's, 43-P40 Green, Pasadena 1, Calif.

GENUINE German imported trade stamped binoculars high powered lightweight \$3.89 each. Agents Invited. Jewelry, 1127 Main, Hartford, Conn.

POCKET Surveying Instrument. Free Literature. Write Kivco, 4037 Windsor, Pittsburgh, Pa.

POWERFUL Telescopes easily made. Lenses, erecting, focusing tube, instructions for making 40X, 100X, 200X and 400X telescope \$5.00. Telescopic Camera Co., Manorville 5, New York.

GIANT, 100 power astronomical telescope with 6 ft. tripod (10,000 area magnification) Clear Vision full power guaranteed. \$15.00 F. O. B. factory. Suffolk Science Services, Dept. TC, Riverhead, N. Y.

AMAZING prices. New precision binoculars, telescopes and laboratory microscopes. French, German and Japanese. Free trial. Folder "Binocular Selecting", catalog free. Prentiss Importers, Mercury Bldg., West Los Angeles, Calif.

MICROSCOPE Sale... Zeiss dissecting, German Laboratory, Reichert Spencer, Rasmussen-Reece, Amsterdam, New York.

BRAND New Binoculars, 7x50 coated Binoculars with pigskin case \$33.00. 7x35 central focus with pigskin case \$42.50. Our own import allows these very low prices. 10% deposit with order. Money-back guarantee. Kern Binoculars, Inc., Dept. OS, 170 Fifth Avenue, New York 10, N.Y.

15 SPORTING GOODS, GUNS, FISHING TACKLE, ARCHERY, TRAPPING

120 PROFUSELY illustrated pages, antique pistols, swords, daggers, armor, etc. 50c. Robert Abels, PS860 Lexington Ave., New York 21.

SAVE on Gunsmithing, Jap Conversions, Scopes, Loading Tools. Catalog 10c. Cougar Arms Company, 587 Ferris Street, NW, Grand Rapids, Michigan.

5,000 BARGAINS, firearms, binoculars, war relics, catalog 50c. Smith Museum, Runnemede, N. J.

SEND 10c for lists either shotguns, rifles, handguns, ammunition or send 25c for all lists. Frayseth's, Willmar, Minnesota.

FISHERMEN—make your own sinkers with our molds. Free illustrated booklet. Reading Instrument Co., Box 78, Reading, Penna.

AMMUNITION, American-foreign and obsolete. New guns. Dime for list. Central Sports, Delphos 25, Ohio.

HUNTING guns from \$10.00. Kentuckies, Western guns, Colts, Antique-Modern Bargain List, 25c. Ed Agramonte, 201 Warburton, Yonkers 2A, N. Y.

OVER 500 guns, modern, obsolete. List 10c coin. Ed Howe, 26 Main, Coopers Mills, Maine.

17 DOGS, BIRDS, HAMSTERS, RABBITS & PETS

EARN Up To \$400 Monthly Raising Angora or New Zealand Rabbits, Plenty markets. Particulars free. White's Rabbitry, Newark, Ohio.

MAKE Big Money! Raise Chinchilla Rabbits, Cash Markets Supplied. Write Today! Rockhill Ranch, Sellersville 16, Pa.

RAISE Mink; Free booklet, pen. plans, inside "secrets" feed care. Mink are money makers. Investigate today. Lawrence Molgard, Brigham City 13, Utah.

RAISE Guinea Pigs. Profitable Occupation. Free booklet. Taylors, B426B, Hapeville, Georgia.

YOUNG Parrots—make fine talkers. Herb Miller, 1911-N, Lubbock, Texas.

PANDA hamsters, the spotted kind, pets and breeders also Syrian Golden. Fred Battersby, 430 N Fourth Street, Vineland, New Jersey.

NATURALIST'S Catalog 10c. Chameleon 55c. Trio hamsters \$4.75. 35 Mexican jumping beans \$1.00. 200 Mealworms \$1.00. Quivira Specialties, Topeka 10, Kansas.

TEACH your cat to use the bathroom toilet. Booklet of simple instructions, 25c. Fur, Fin & Feathers Pet Shop, 222B Highway 101, Encinitas, Calif.

SALE Tame Red Squirrels, Raccoons. Dewey H. Balch, Castleton, Vermont.

WOOD-Ducks Orders filled until February twentieth! Eggs in season. Bernard Ohnmacht, 2307 Butler, Lafayette, Ind.

GOLDEN Hamsters, Pedigree Stock, Breeders, Laboratory or Pet Stock Shipped express Anywhere. Price list free. Charles E. Bowser, Smoke Run, Pa. Dept. H.

19 FARMS, OTHER REAL ESTATE

FARM Ranch Opportunities, favorable conditions, Washington, Minnesota, Montana, Idaho, Oregon, North Dakota. Literature, farm descriptions, specify which state. J. W. Haw, 120 Northern Pacific Railway, St. Paul, Minnesota.

NEW Strout Catalog Just Out! Farms, Homes, Businesses, 31 States. Coast-to-Coast, bargains galore. Mailed Free. Our 53rd year, World's Largest. Strout Realty, 255-ZB 4th Ave., New York 10, N. Y.

CALIFORNIA Ranch Lands. 50c to \$5 acre minimum bid. Farm-ranch-hunt-fish-retire. 10c brings illustrated land catalog, outline maps. Tax Land Sales, Box 2350BX, Hollywood 28, Calif.

TOURIST Courts, Motels, Resorts, Farms, ranches, income property, homes, stores, coast to coast service. Parkway Realtors, Silver City, New Mexico.

FLORIDA, New Lake County development adjoining Ocala National Forest. Best fishing, hunting. Safe from bombs. Nice homesites \$245 at \$10 monthly. Folder free. Winfree Vernor, DeLand, Florida.

20 TREES, SHRUBS, ROOTS, HERBS

FRUIT Trees! Stark Bro's sensational new "Dwarfs". Also standard size, exclusive patented, trade-marked varieties produce abundant, larger, better apples, peaches, pears. All fruit faster growing, quicker bearing. Also beautiful ornamental trees and shrubs. Get giant new Color-photo Catalog Free. Stark Bro's., Dept. 30003, Louisiana, Missouri.

POPULAR SCIENCE OPPORTUNITIES

21 POULTRY & SUPPLIES

SENSATIONAL Bargain! Assorted heavy chicks \$6.90—100 postpaid! Positively no Leghorns! No Cripples! No Culls! Send check or money order! Prompt shipment! Live delivery! We pay postage! In business over 25 years. Atlas Chick Co., Dept. P.S., St. Louis 3, Mo.

RAISE pheasants on the \$100 week plan. Little capital and space can make you independent. Free details. Great Central Game Management System, Columbus 6, Kansas.

22 PROFITABLE OCCUPATIONS

DETECTIVES Earn Big Money. Excellent opportunity. Detective Particulars free. Write, Wagoner, P-125 West 86th, New York 24.

BE independent, be secure, have your own profitable business—earn \$20.00 and more a day making beautiful, fast-selling lamps at home. No equipment needed. Illustrated course teaches you quickly. Course, parts catalog, wholesale price list—only \$2. Gearon Co., Dept. 200-A10, 27 S. Desplaines, Chicago 6, Ill.

\$40.00 WEEKLY. Made growing mushrooms. Fresh, Dried, Dominion Patent 331.583, free spawn, North American, 169Y Yonge, Toronto, Canada.

WANT A Diesel Job? New Opportunities to increase income. Higher Pay. More Money. We can help you qualify. Tools, Shop method home training. Write today! Diesel, Tractor, Heavy Equipment Division, Interstate Training Service, Dept. 2K, Portland 13, Oregon.

"HOW to Make Money With Home Workshop" describes amazing methods used by hundreds of successful craftsmen. Tells what to make. How to sell workshop output spare time. Write at once for details. Craftsman, 115B10, Worth Street, New York City.

\$10,800 PROFITS! Your own Mailorder Business! No Capital Risk! "Success Plan" (worth \$2) Free! Write today! Treasury, 149 Storer, New Rochelle P-4, New York.

\$5000 FROM half acre growing Ginseng. Crop bought, Particulars 10c. Associated Growers, Sperling, Manitoba.

GROW Mushrooms. Cellar, shed, and outdoors. Spare, full time, year round. We pay \$3.50 Lb. We paid Babbitt \$4,165 in few weeks. Free Book, Washington Mushroom Ind., Dept. 101, 2954 Admiral Way, Seattle, Wash.

EXTRA money—Boys-Adults: Distribute sales literature—orders will follow. Repeats. Fleming Co., 319 W. T. Waggoner Building, Ft. Worth, Texas.

BUY Wholesale thousands nationally advertised products at big discount. Sent free "The Wholesale Plan." American Buyers' Service, 628-S Linden, Buffalo, N.Y.

FROM Basement To Big Time—In four years I went from basement lathe models to \$120,000.00 gross sales per year. I could have done it in two years if this booklet I am offering you, on how to do it, had been available. It covers development, manufacture, sales, finance and business records. Send \$2.00 today for what cost me \$20,000.00 to learn. Send now to Clay Manufacturing Co., Box 199, Northfield, Minn.

PARAKEETS—\$4000 year from 100 pair. Instruction book, Equipment plans, \$1.50. Cesco, Box 9305, Fort Worth, Texas.

SAIL Ho! Be a Merchant Seaman. Enjoy World Travel, big pay. Send Now for Free Information, Seaways, Box 1231, Baltimore 3, Maryland.

TYPISTS—Profitable business at home. Complete copyrighted information, 50c. Gaunt, 827-T Irving Park, Chicago 13, Ill.

SEVERAL Mailorder Money Making Homework offers. Address Jenkins, Lucasville, Ohio.

RAISE Ginseng! Roots bring fortunes. Free information. Fezler, Patchogue, N. Y.

PARAKEETS—Amazing Profits! Easy! Care, breeding instructions 25c. Anderson's, 1321 E. Kaley, Orlando, Florida.

FREE Book "505 Odd, Successful Businesses." Work home! Expect "Odd"! Pacific—37C, Oceanside, Calif.

YEAR round home business, learn mold-making, plastercasting, painting, instructions, Rubber Models, Paints, Hobby Shop, 410 So. Detroit, Toledo, Ohio.

23 BOOKS & MAGAZINES

AMAZING new adult book bargains. Send stamp, Paul Vallon, 63 Perry, New York 14, New York.

MAGAZINES (back dated)—foreign, domestic, arts, Books, booklets, subscriptions, etc. Catalog 10c. (refunded). Cicerone's, 86-22 Northern Blvd., Jackson Heights, N. Y.

ADULT Books—Illustrated Comic Booklets, 10 for \$1.00, 24 for \$2.00. All Different. Free gift with each \$2.00 order. V. M. Rogers, Dept. PS, Box 14738, Cimarron Station, Los Angeles 18, Calif.

BOOKHUNTERS! All Subjects, Send Wants! Jaher Book Service, 620-K East 178 Street, New York 57.

FREE catalog, 400 popular books. Bargain prices. Books Publishing Co., 56 W. 24th, New York 10.

HYPNOTISM Now easy to learn. Photographed, guaranteed course \$2.00 complete. Full details free. Power Publishers, 790 Broad, Newark 2, New Jersey.

ATHEIST books. Catalogue free. Truth Seeker Co., 38 Park Row, New York 8.

BOOKHUNTERS! Scarce, unusual, miscellaneous books supplied. Atlantic Book Service, 2 Lawrence, Charlestown 29, Mass.

BACK-Date magazines, Specific issues; years. Arkell's, Northridge, California.

WANTED! Loving Care & Shelfspace for Sensational Book Bargains! Free Catalogue! Old Prof's Bookshop, Pontiac 15, Michigan.

ENJOY Inexpensive reading. Used books 9—\$1, 20—\$2, 32—\$3. Satisfaction guaranteed. Schollmeyer, Box 48, Brooklyn 25, N. Y.

USED pocket novels, 8 for \$1.00. Stamp brings list, Trunkat, Glenshaw 3, Penna.

USED Books Supplied, Catalogue free. Balliol, Box 85, Station "K," Toronto, Canada.

INTERESTING adult books—novelties—illustrated comic booklets 24—\$1.00, catalogues 10c. Kogan, 1032PS Church Annex, New York 8.

FASCINATING Books, 24 Real Illustrated Humor Booklets \$1.00. Foreign Art. Novelties, Illustrated Catalog 10c. Aladdin Book Co., 210-PS Fifth Avenue, New York 10.

FREE Copy "Hobby Digest" magazine. Postoffice Box 52, Detroit 21, Michigan.

MINIATURE Locomotive, bi-monthly magazine about live steam model railroads—tells "how-to" build, pictures of engines, cars, track set-ups, club news, Exciting, educational family hobby. Send \$3.00. Miniature Locomotive, Box 305-G, Reseda, Calif.

BOOK Bargains: Particulars, Send Stamp, Arkay, Box 2052-PS, Los Angeles 53, Calif.

HARD-To-Find Books Supplied. Send wants. Pierce's, Winthrop, Iowa.

NATIONAL Geographic Magazines 1888-1952 Any Issue. Periodical Service, Box 465-PS, Wilmington, Delaware.

"THE Man From Mars." 25c. Christian Evidence League, Malverne, New York.

"HOW To Buy A Used Car." See Automobiles—Classified.

24 GAMES & ENTERTAINMENT

"PIXIE Packets" for children 7-14. A different craft kit each month. Yearly subscription \$6.00. Entertaining, educational, excellent gift. Write for free literature, Pixie Packets, Dept. S-4, Ralston, Nebraska.

NOVELTY surprises every month. Fun for all! Join for \$5.00 per year. Novelty-of-the-Month Club, Box 121, Cincinnati 29, Ohio.

25 MAGIC TRICKS, PUZZLES, ETC.

MAGICIANS', Gamblers' secrets exposed. Cards, Dice, Punchboards, Slot Machine. Catalog 10c. Book Co., Box 671, St. Louis 1, Mo.

LATEST Magic for pocket, parlor, stage. Catalogue 500 Tricks, only 10c. Unequalled magic service for 30 years. Douglas Magicland, Dept. 2, Dallas, Texas.

MAGICIAN'S illustrated catalog and free trick 35c. Terry's Magic Studio, 6606 Durycourt, Brooklyn 19, New York.

512-PAGE catalogue of 2500 tricks, pocket, parlor, stage, World's Finest Magic, Send \$2.00 for catalogue (refunded first \$8.00 order). Kanter's, S-1311 Walnut, Philadelphia 7.

FREE trick and large illustrated catalog—35c. Lerro's Magic, 8111 Fifth Avenue, Brooklyn 9, N. Y.

GUARANTEED Magic tricks! Catalog free. Newton Magic Company, Bonham 8, Texas.

MAGIC Monthly, Year 25c. New 1952 Magic Catalogue 10c. New Joke Lists 5c. Magic Shop, Minneapolis 2, Minnesota.

LATEST Magic. Big illustrated Catalog 10c. Top Hat, 529X Main, Evanston, Ill.

"DUNNINGER'S Tricks"—Not A Catalog! 125 Mystifying Tricks (card, coins, etc.) Easy-to-do, explained, Send \$1.00 Now! Loyal, 4014-L Amindson Avenue, New York 66.

TRICKS, Funmakers, Puzzles, Jumbo Catalog 15c. Andersen's, 6815S Ardmore, Chicago 31.

26 COIN COLLECTING

GET Profit and Pleasure in collecting old coins. Send 10c for 56-page illustrated coin catalog. You'll be delighted with it. Send for it now, B. Max Mehl, 374 Mehl Building, Fort Worth, Texas. Largest rare coin establishment in U. S. Established 51 years.

SET nine Japanese invasion notes for U. S. \$2.00. Illustrated coin catalogue 25c. Shultz, Salt Lake 10, Utah.

FREE! Foreign coin, banknote and Coin Collectors' Illustrated Catalog to approval service applicants, Send 3c postage. Tatham Coin Co., Springfield-50, Mass.

SIXTY Indianhead cents \$2.00. Sayers, 1000 E. Unaka, Johnson City, Tenn.

WHAT Are your coins worth? Amazing Fell's United States coin book. Everything on every single coin minted—Worth, value, how to sell, speculating, investment; other valuable facts on coins. Clothbound, 150 illustrations. Send no money. Pay postman only \$1.50 (plus postage) or \$1.50 postpaid (refundable). Order now! Fell Publishers, 386S4 4th Ave., New York 16, New York.

OLD Money Wanted. Will pay Fifty Dollars for nickel of 1913 with Liberty Head (not Buffalo). We pay cash premiums for all rare coins. Send 4c for Large Coin Folder. May mean much profit to you. Numismatic Co., Dept. 30, Fort Worth, Tex.

OLD Coins Wanted: Highest Prices Paid, Large Illustrated Buying Catalog, 50c; Selling Price List, 25c. Richard Algire, 713 Holmes, Lima, Ohio.

FREE! Coin Collector's new magazine and wooden nickel. Lawrence Brothers, Anamosa, Iowa.

INDIAN Penny with catalog, 10c. Brunk, 3530 Osceola, Chicago 34, Illinois.

28 STAMP COLLECTING

FREE! Powerful Magnifying Glass. Jamestown Stamp, Jamestown 202, N. Y.

FREE—Illustrated Catalog! Kenmore, Milford C-58, New Hampshire.

200 EXOTIC Japan Stamps—10c! Kenmore, Milford K-58, New Hampshire.

AMAZING Offer! 500 United States stamps—including commemoratives, airmails, high denominations to \$5.00—Only 15c to Approval Applicants!! Illustrated Bargain Lists free. Mystic Stamp Co., Dept. 55, Camden, New York.

POPULAR SCIENCE OPPORTUNITIES

FREE—Complete set of Famous Americans, Flags, Parks and Presidentials to approval buyers. Send 3c for 15 of the above stamps plus full particulars. Triboro Stamp Company, 145 Nassau Street, Dept. 210, New York 28, N. Y.

300 STAMPS For Only 10c! This mammoth value includes Airmails, Pictorials; stamps from strange countries cataloguing up to 25c each!! Also approvals. Mystic Stamp Company, Camden 55, New York.

POLAR Bear Triangle; Giant George Washington Six Colored Ecuador, Arctic Triangle, first American commemorative, Corsica, Devils Island, others. Everything free with approvals. Capital Stamps, Little Rock 10, Ark.

PENNY Approvals—Also advanced material. "Juno", 1267 Tutwiler, Memphis 7, Tennessee.

FREE Stamp Collection:—100 different stamps from Europe, Africa, Asia, Scandinavia, Balkans, etc., 3c to approval applicants, Tatham Stamp Co., Springfield 50, Massachusetts.

1,000 UNIQUE Colorful attractive mounted stamps 1c-2c each. Rushed. Niagara Stamp Co., Niagara-on-the-Lake 72, Canada.

"HOW To Recognize Rare Stamps." Free Book Illustrated! Kenmore, Milford H-58, New Hampshire.

WOW! 203 All Different Germany 10c! Zeppelins, Semipostals, Airmails, High Values, etc. to new customers. Jamestown Stamp, Jamestown 509, New York.

U. S. Army & Navy Heroes on Stamps: 10c with United States approvals. Locust, Box 305-A, Harmon-On-Hudson, N. Y.

200 DIFFERENT, including Roosevelt triangle, 5c to approval applicants. S. Avalon Stamp Co., Springfield, Mass.

333 UNIVERSALLY Different, 25c Penny Approvals. 1000 Different, \$1.00. Seifert, Box 1672, Reading, Penna.

FREE Bahawalpur Jubilee set to approval applicants. Lighthouse, Box 1516, Colorado Springs, Colorado.

YOURS! Three Liberia Triangles. Seychelles, Mauritius, Albania, Airmails, Africa, etc. Everything 10c with approvals. Rodman, 450 Locust Avenue, Burlington, N. J.

18 VALUE Pictorial Set. Free to approval buyers. Pleasure Stamps, 1865A—52nd, Brooklyn 4, N. Y.

327 DIFFERENT Stamps 25c! Including Early Canada, Newfoundland, British Colonies, Vatican, Red Russia, Hitler Heads, Indian States, Animals, Airmails, French Colonies, rarities, unusuals. Every stamp different. Rare bargain only 25c with our Bargain Approvals. Money back guarantee. Niagara Stamp Co., Niagara-on-the-Lake 62, Canada.

FREE, Scott's International Album. Other big premiums. Full particulars with approvals. Raymax, 68-X Nassau St., New York 38.

50,000 STAMP Grabags 25c each. Anderson, 630a Bingaman, Reading, Pa.

25 ARGENTINE stamps 25c. Cheque or M.O. Casilla 2861, Correo central, Buenos Aires.

FLAG Stamp—Free with hygrade U. S. approvals. Wenigman's, 1933 Patterson, Chicago 13.

ALBUM! Capacity over 1000 stamps! Only 10c! Stampmart, Hartford 1, Conn.

312 MIXED U. S. only 10c to "Gold Nugget" approval applicants! Nothing like them. Kessel's, Folsom, California.

MYSTIC Treasure Mixture 1111. Fascinating world \$1.00. Long Beach Stamp Company, Long Beach, New York.

PAY Check Gone? Are you paying too much for approvals? Try our books of 1,000. Priced at 1c and 2c each. Reference appreciated. Roseland Stamp Co., Dept. 9-A, Spring Lake, Michigan.

90 DIFFERENT U. S. 30c with Approvals. Faith, 1339½ Westminster Ave., Alhambra, Calif.

LOOKING for Bargains? Try our 1c & 2c approvals mounted in books of 1,000. We believe in both quantity and quality. First try will satisfy. Clark, Box 544-U2, Muskegon, Michigan.

BREAKING Collections. Super Medium advanced approvals. McWhorter, 6440B Union, Chicago 21.

6 IONIAN Island Stamps Free—Approvals. WBPS, Box 758, Wilkes-Barre, Penna.

EXTRA Bonus—Your Choice Latest Scotts Albums; Catalogue and available philatelic accessories. Realize—You get these worthwhile Bonuses When you buy from our better Foreign approvals. Write today for full particulars sent with trial. Approved selection. Americas' Stamp Service, Riverside 2, Calif.

RARE octagonal stamp, giant triangle, gorgeous diamond also mammoth and midget stamps given to foreign approval buyers. Gifts with purchases including Scott's International \$6.00 album, also latest Scott catalogues. Plymouth, Dept. A-3, Bell, California.

300 DIFFERENT United States—\$5.00. Approvals. Utechs, 1143A North Keeler, Chicago 51.

SAN Marino Collection Free—25 Different. Old and New issues, Airmails, Commemoratives. High Values—absolutely Free with approvals. Viking, 130-PP, Clinton St., Brooklyn, New York.

100 UNITED States Stamps commemorating historical events \$1.00. Frank Jancowski, 3588 Frederick Street, Detroit 11, Michigan.

FINE Approvals. Fast, personal service. What countries do you prefer? I'll send their stamps. Milton Skinner, 438 Locust, Long Beach 12, California.

BIG bag mixed stamps. Enormous quantity, \$1.00. Longacre Shop, 583p Sixth Avenue, New York City 11.

UNIQUE Philippines souvenir sheet #515 5c with approvals. Mitchell, Box 923J, Portland, Maine.

CANADIAN Collection Free—Includes early Victorian Issues—Jubilees—High Values—Commemoratives—Special Issues—Newfoundlands—Pictorials, etc., etc. together with Philatopic Magazine all free. Send 5c postage. Empire Stamp Company, Dept. PR, Toronto, Canada.

DEALERS Wholesale catalog. Postage 3c. Franksco, 5031 Queensbury, Baltimore, Md.

300 DIFFERENT given free with approvals. Postage 3c. Windsor Stamps, 1435 E. 67th Place, Chicago 37.

PENNY Approvals by country. M. H. Hoerning, 102, Farmington, Ark.

½-1-2c APPROVALS. Bargains Galore! Cole, 43G Rinewalt, Buffalo 21, N. Y.

TEN dandy sets, 10c. Approvals. Faszold, 423a Cameron, St. Louis Co. 15, Mo.

40 DIFFERENT U. S. 10c. Pricelist free. Seidenberg, Appleton 944, Wisconsin.

100 DIFFERENT U. S. 25c. Approvals. Buckeye, Box 53, Mansfield, Ohio.

GIANT Approvals. Thousands Different at 1 and 2c. Wahl's Stamp Exchange, 7008K Farragut Ave., Chicago 31, Ill.

FREE—"German War Issues", cataloguing \$10.82, to approval buyers. Royal Stamp Company, Tamaqua 2, Pa.

1000 FINE Mixed U.S. Stamps 25c. Wright, 201 Mealey, Hagerstown 2, Md.

ITALY—100 Different 5c with Approvals. DeRespins, G.P.O. Box 771M, New York 1.

TRUMAN, Stalin stamps plus worldwide packet free to approval applicants. Conquistador, 15½ Troy Road, Schenectady 9, N. Y.

TERRIFIC Bargains! Approvals ½c-5c. Gaines, 716-B South Sixteenth, Mattoon, Ill.

US 797 SPA Sheet only 5c to applicants for US Approvals. M. Haycock, 235 86th St., Brooklyn 9, N. Y.

FREE! Rare. Colorful Spanish Morocco Set (complete), with temptingly-priced approvals. "PSG", 195 Park, Lewiston, Maine.

FREE Sample—Interesting informative. Illustrated! National Stamp News, Anderson, South Carolina.

NICARAGUA Sports, Costa Rica Agriculture sets 10c with approvals. Seminole Stamps, Box 1138, Coral Gables 34, Fla.

APPROVALS ½c up from 33,000 collection. Chur, Box 245, Buffalo 12, New York.

GREAT Free Offer—Weird mosquito stamp, thrilling bicycle race, gorgeous orchid, colorful native drummer, gigantic diamond airmail, stamp albums, all to our approval buyers. Bell Stamp Service, Dept. W-4, Bell, California.

FREE! Monaco nude set 3. This popular set offered to new approval applicants. M. Moulblow, Box 278, East Northport, New York.

WONDERFUL Offer 7 complete mint sets only 10c with approvals. Reich (S26), 4647 Kenmore, Chicago 40.

59 STAMPS including Ships, Animals, Locomotive, 6c. Ransom, 1333 Pontiac, Ann Arbor, Michigan.

FREE 25c worth from first U. S. Foreign approvals. Stampinggrounds, Glastonbury, Conn.

ANGOLA! Beautiful multicolor bird set plus 100 different stamps, 10c to approval applicants. Sunset, Dept. 695, Box 47, South Gate, California.

WHOLESALE lists—bargain collections, accumulations, singles—mailed for 10c (refundable). Largentiere Company, 6462 83rd Place, Forest Hills 79, New York.

OLD scarce U. S. seconds on approval. Slightly defective, bargain prices. Hearnfield, Clintonhill Station, Newark 8, N. J.

TRUMAN, MacArthur, Hitler, Mussolini Commemoratives; free to "Approval Buyers". William Deems, Ravenswood, W. Va.

MAMMOTH Grabbags. Big Variety 25c each. Monjar Fairmount, Cincinnati 14, O.

307 ALL Different—Only 15c! Beautiful collection: Commemoratives, Triangles, High Values, Bicolored Stamps, etc. Garcelon, Calais 418, Maine.

TRIANGLE—Diamond—Midget—Giant—Roosevelt—Hitler—Others. Everything 3c with approvals. Thrifty Company, Silver Spring, Maryland.

EXCITING!! Odd!! "Queer Countries" Packet—3c with approvals! Saxon, Vista, California.

SUPERB Approvals. Stamps ⅓ to ⅛ catalog. P. G. Beals, 125 Tremont St., Boston, Mass.

FREE "Stamp Finder." Tells country to which any stamp belongs. 32 pages profusely illustrated. Garcelon, Calais 19, Me.

FREE! Obsolete U. S. Occupation set. Request selections finest attractive priced stamps ever offered. Riedell, Greensburg, Penna.

FREE \$1.00 \$2.00 \$4.00 \$5.00 U. S. Requested Approvals. Southern Stamp Co., Box 70, Miami, Florida.

100 DIFFERENT Spain 25c. Penny approvals included. Reed, Box 980, Chicago 90, Illinois.

FIFTY different United States; Commemoratives, Airmails, etc., all for 10c. Ed. Keller, Library 2, Penna.

OPPORTUNITY! Gorgeous lot with Triangles, Diamonds, Giants, Midgets, Flags, Airmails, and Railroad Stamps. Also Guiana, Djibouti, Mongolia, Angola, New Caledonia, Etc. Everything only 10c to Approval applicants. Evden, 58 North Montgomery Street, Valley Stream 1, N. Y.

302 DIFFERENT 25c Approvals. Schmitt, 730 South Jackson, Green Bay, Wisconsin.

FREE U. S. illustrated catalogue for stamps, albums, supplies. Stone, 45 Bromfield, Boston 8, Mass.

SPANISH mint airmails \$10.00 Scott value for \$1.00. Abyssinia 20 different \$1.00. Spain 30 complete mint sets different \$2.00. Juan Galé, Avilés, Spain.

POPULAR SCIENCE OPPORTUNITIES

309 DIFFERENT—25c. U.S. Presidents On Foreign Stamps. Washington, Lincoln, Adams, immortalized on spectacular 3 colored San-Marino commemoratives—a unique historic issue! Landing of Columbus! Angola "Bird Study" course in brilliant colors! Dozens of other fascinating items in giant collection of 309 All Different Stamps—all for 25c. With your request for approvals. Ocean Stamp Co., Box 64-P, Homecrest Sta. 29, Brooklyn, New York.

250 STAMP hinges and 10 different Argentina free with approvals. Jaydee, 218 West Dickinson, Grand Rapids 7, Mich.

29 ANTIQUES, RELICS & INDIAN GOODS

SELLING 500 Historical Firearms, 20,000 Indian Relics, Collectors Cartridges, Coins, Confederate Money.—Revolutionary War, Civil War, Indian Wars Flintlocks, Muskets, Blunderbusses, Kentucky Rifles, Revolvers, Pistols, Swords, Ramrods, Bayonets, Bulletmolds.—Arrowheads, Tomahawks, Gempoints. — Mounted Birds, Squirrels, Deerheads, Steerhorns, Percussion Caps, etc. Send 35c for illustrated catalog. Heike, Wenona 38, Ill.

SPECIAL: 10 Indianheads, \$.78—5 Arrowheads, \$1.23—Tomahawk, \$3.68—Scalping knife, \$1.88.—Sword, \$14.88—Bayonet, \$1.98—Geode, Pyrite, Molybdenum, Galena, Agate, Jasper, Selenite, Fossil, Gastropod, Crinoidstem, Chalcopyrite, each \$.48.—Heike, Wenona 28, Illinois.

30 MINERALS & PRECIOUS STONES

GEMOLOGY Books! Catalog 10c. Atlantic Books, 2 Lawrence, Charlestown 29, Massachusetts.

WYOMING Gem Agate 1 pound \$1 postpaid. Thayer Products, Box 394, Alcova, Wyo.

GEMCUTTING. Silvercraft authority. Illustrated magazine tells how. Cut rocks, make jewelry. 150 ads illustrating equipment, offering gems for collectors, cutters. Postal brings literature. Lapidary Journal, Drawer D, Palm Desert, Calif.

TEN N. Mex. Minerals \$1.50; six fluorescent \$1.00; Fools Gold \$.25. Literature. Prospector, Winston 5, New Mexico.

GEMS. Precious and semi-precious, genuine, from world-wide sources. Deal Direct, no overhead, save money. Catalog 10c. Hill Co., 5450-K Portland Rd., Salem, Ore.

GEMSTONES. Mineral specimens. Every variety. Lowest prices. Postcard brings free booklet. Plummer's, 4720 Point Loma Ave., San Diego 7, Calif.

31 HOBBIES, COLLECTIONS

INVENTING can be an interesting and profitable hobby. Write for complete particulars. Institute of American Inventors, Dept. 30-E, 631-E St., N. W., Washington 6, D.C.

33 ARMY patches, collar ornaments, Campaign ribbons plus introductory surprise, only \$1.00; prices 10c. Hobbyguild, Box 71, Sta "A", Brooklyn, New York.

WANTED—Cigarette, tobacco cards. Write Charles Bray, East Bangor, Penna.

MINIATURE felt baseball pennants 16 for 25c, one for each American and National League team. Hart Processing, Marine City, Michigan.

GET acquainted offer, 50 different Matchbook Covers 25c, free lists. Yeingst, 502-A Parkway, Harrisburg, Penna.

AMAZING hobby—Collect authentic armed forces insignia, ribbon bars, embroidered patches, naval rates; fascinating assortment of 57 for only \$1; special gift free with order. Pritt Co., Dept. S-10, 14 West 27th Street, New York City.

ART Studies for your morgue. Figure drawing, Famous paintings, Famous statuary, Animals in pen technique, Animals pencil and photos, Foliage and Scenery, \$1.00 each. Wonderful courses, drawing, cartooning, lettering. Send for catalog. Art Book Shop, Arnold 5, Missouri.

UNUSED matchbook covers—100 different \$1.00—36 page Catalog 25c—Charles Edelman, 1311P East 84, Cleveland 3, Ohio.

SEND for our interesting hobby literature. Collector-Hobbyist, Box 864, Denver, Colorado.

COLLECTORS—Genuine fern plant fossils \$1.00 postpaid. Fossil Exchange, 4340 Water St., Wheeling, West Virginia.

TROPICAL Fish—information 25c. Clarke Enterprises, Dept. A, Box 413, Janesville, Wisconsin.

MAKE Leathercraft your hobby. Enjoy working with leather. Your leather belts, billfolds, purses make ideal gifts or possessions. Free Catalog. Tandy Leather, Box 397-D, Tulsa, Oklahoma.

32 PHOTO FINISHING, PHOTOCOPIES, ETC.

OIL coloring photographs can be a fascinating hobby or profitable sideline for those with artistic talent. Learn at home. Easy simplified method. Send for free booklet. National Photo Coloring School, 835 Diversey Parkway, Dept. 1744, Chicago 14, Illinois.

YOUR eight exposure roll developed with three prints each good negative 50c. Two each 40c. One each 30c. Reprints 3c. A few cents postage appreciated. L. A. Eastman, Bode, Iowa.

ROLL Developed and 4x6 or 3 1/4 x 4 1/2 oversize glossy Velox prints, 8 exposure 40c, 12 exposure 60c, 16 exposure 80c. Clemet Photo Service, 1318 West Columbia Avenue, Philadelphia 22, Pa.

ENLARGEMENTS! Eight 5x7's or five 8x10's, \$1.00. Wilart Enlargers, Box 967, Little Rock, Arkansas.

NEW Photo Xmas Cards, Sample Booklet 15c. Margarida Bros., 203-A Pitman Street, Fall River, Mass.

FREE Mailers, 8 contacts 30c, jumbos—40c, 12—45c, Jumbos—55c, reprints—4c, jumbos—5c. Western Photo PS102, Box 298, San Francisco 1, Calif.

JUMBO Album Prints, 8 Exposures \$.40, 12—\$.50, 16—\$.60. Photoshop, Box 362, Ishpeming, Michigan.

PHOTOGRAPHY for pleasure or profit. Learn at home. Practical basic training. Long established school. Free booklet. American School of Photography, 835 Diversey Parkway, Dept. 1727, Chicago 14.

NEW—16 oversize contact prints or 8 jumbos in album, 25c with this ad. Album Studios, Dept. S, Weatherford, Oklahoma.

IMPORTANT documents photo copied—wills, service discharges, diplomas, birth certificates, etc. \$1 per copy per page. Quick Copy Service, 175 W. Jackson, 411, PS, Chicago, Illinois.

33 MOTION PICTURES, SLIDES SOUND EQUIPMENT

GUARANTEED Fresh 8mm roll, magazine; 16mm roll, magazine movie film. Color, b&w. Free catalog. Eso-S, 47th Holly, Kansas City 2, Missouri.

8-16MM. Silent-sound films. Complete rental library. All latest subjects. Free catalogue, (sample film 10c). Garden Film, 317 West 50th, New York 19.

MOVIE Camera Film: 8mm roll \$1.50, 16mm 100' \$3.00. Free processing. Better Films, 742 New Lots, Brooklyn, N. Y.

RENT 16MM sound films 50c reel. Large selection; free catalog. U. C. Film Service, 128 Chestnut St., Roselle Park, N. J.

PRICED Like Wholesale and just released—these new 1-reel Blackhawk movies—16mm sound (300'), \$11.95 plus 25c postage—8mm silent (150'), \$2.98 plus 15c postage. Four railroad films: "Super Chief", "Western Pacific Fast Freight", "Golden Arrow" (London-Paris), "California Zephyr"—and "Bathing Beauties—Then and Now". Hundreds new-used 16mm sound, silent, 8mm bargains. Good used 16mm sound projectors—Bell and Howells, Ampros, Victors—often available \$129.95. Reels, cans, supplies like wholesale. Big new 24-page catalog free! Blackhawk Films Inc., 1115 Putnam Bldg., Davenport, Iowa.

LIST 16MM Sound Films All Types. Norman Dunn, Holland, Mich.

5,000 NEW-Used 8-16mm. Silent-Sound Films. International, 2120 Strauss, Brooklyn 12, New York.

GOVERNMENT Surplus 35mm official military recognition Slides—black and white; four ply mounted; each numbered, identified, cataloged. Equipment of various nations; boxed in three classifications: 360 Slides, Naval Vessels—350 Slides, Merchant Ships—245 Slides, Armored Vehicles, \$5.00 per classification; all three \$10.00 Postpaid U.S.A. Fair Sales, Lima, O.

TAPE Recorders, Tapes, Accessories Unusual Values. Dressner, 624 East 20th Street, New York City 9.

WILD Life Films. Exciting, dramatic action in the natural habitat of fierce beasts of the jungle and forest. In 8mm or 16mm & 2"x2" slides. Beautiful Color or B&W. Write for Free illust. literature. Wild Life Films, 5151B Strohm Ave., No. Hollywood, Calif.

STEREO Fans! Stereo slides galore—also Precision Stereo Viewer \$2.95—10 Academy Award winning Stereo slides—\$4.00—Stereo Lockslide mounts, mounting service—Send 25c for complete catalog & sample slide. Horner-Cooley Prod., Inc., 6112 Selma Ave., Hollywood 28, Calif.

U. S. Secret Weapons in 3rd dimension. 10 full color views complete with viewer. \$1.00 postpaid. Stereo-Color Corporation, 1317 Commerce Bldg., Rochester 4, New York.

34 CAMERAS, PHOTO SUPPLIES

BASS Says: Trading cameras a national habit since 1910. Write to Bass the old "Horse Trader." A postcard will do. Simply say: "Bass, I have and I want... How much will you allow me?" Satisfaction guaranteed. Bass Camera Company, Dept. AG, 179 W. Madison St., Chicago 2.

INSURED and guaranteed repairs at trade prices. Camera Repair Corp. of America, 225-C Broadway, New York 7.

ADD "Spice" to home projection shows with colorful old-time Nickelodeon slides. 2x2. Write for Free list. Nickelodeon Co., New Fleidner Bldg., Portland 5, Oregon.

PHOTOGRAPHY for pleasure or profit. Learn at home. Practical basic training. Long established school. Write for booklet. American School of Photography, 835 Diversey Parkway, Dept. 174C, Chicago 14, Illinois.

WHOLESALE Photographic Supplies. Cameras, Films, Projectors, Enlargers. Write for Free Catalog. Capitol Photo Supplies, 2428 Guadalupe, Austin, Texas.

HANEEL Stereo Camera, while they last. \$10.00, guaranteed—Easy to operate, perfect results, send cash or 25% deposit. Keys Stereo Products, 3823 East 7th Street, Long Beach 4, California.

35 MUSIC, INSTRUMENTS & SONG WRITERS

WANTED! Poems for musical settings. Write Songwriters' Service, Clifton, N. J.

POEMS Wanted to be set to music. Free examination. Send poems, McNeil, Master of Music, 510-PS, S. Alexandria, Los Angeles, California.

POEMS Wanted for musical setting. Send poems for free examination. Five Star Music Masters, 646 Beacon Bldg., Boston, Mass.

POPULAR Songs. How to write and sell them. Write for free booklet Successful Songwriting. Gateway Songs, Box 2470, Hollywood 28, California.

POEMS Wanted for musical setting on percentage basis. Broadcast consideration. Sooner Song Co., 22-PS North West 8th, Oklahoma City 2.

POEMS Wanted! Opportunity Knocks! Nationally Known Song Writer composes music to your song poems. Send poems today for free examination and free copy of "Song Writing Secrets". Melody House, Dept. PS, Box 19007 La Tijera Station, Los Angeles 43, Calif.

SWISS Musical Movements. First Quality. \$2.50. Spielman, 131 West 42nd, New York 36.

POPULAR SCIENCE OPPORTUNITIES

YOUR Words and our music—a winning combination! Send poems. Free examination. Song Promotion Guild, 350-S Broadway, New York 13.

SENSATIONAL Free Booklet, "How To Write and Sell Songs." Get the facts first. Poems examined Free. Reliable Music Service, Box 430-B, Hollywood 28, Calif.

SONGWRITERS! Send poems, songs. Music Service, 243 West 72nd St., PS, New York 23.

MUSIC printing, for samples, rates write Auto-Litho, Jensen Beach 2, Florida.

NEW, Simplified, Rhyming Word List \$1.00. Song Poems examined free. Broadway Song Service, Suite 301-S-10, 1650 Broadway, New York City.

PLAY Piano By Ear! Simplified. Particulars. Box 475-H, Lomita, California.

FREE poem examination. Hear what music we can write to Your poem! Order our song hit, "You Can't Make Honey." Record \$1.25. Music copy 50c. Song Service, 333 W. 56th, Dept. P.S., New York 19, N. Y.

ELECTRIC Guitars, accordions, amplifiers. Wholesale. Free catalog. Carvin, Baldwin Park, Calif.

36 RADIO, TELEVISION, SUPPLIES & EQUIPMENT

MAKE simple, tubeless, batteryless, distance-getting crystal radios. Crystal and illustrated instructions 25c postpaid. Allen, 427-S, Clinton, Mo.

BUILD 15 Radios—Only \$1.30 Each. Experience Unnecessary. Home Radio & T.V. Course, includes Trouble-Shooting and Servicing Lessons, Radio Principles, Code Instructions, Practical Radio Building and Repairs. You build and keep Receivers, Transmitters, Amplifiers, Test Equipment, Code Oscillator. All parts, tools, instructions supplied including Radio Tester and Electric Soldering Iron. Write for full particulars and receive absolutely Free your copy of "Radio & TV Repair Guide". No obligation. Progressive Electronics Co., 497 Union Ave., Dept. PS-23, Brooklyn 11, New York.

FREE 236 Page 1953 Television-Radio-Electronic Catalog! World's largest stocks, lowest prices. Complete supplies for builders, experimenters, amateurs, servicemen. Latest television, radios, phonos, recorders, sound equipment. Thousands of parts, tubes, test instruments, books, diagrams. Top quality money saving values. Get yours now! Allied Radio Corp., 833 W. Jackson Blvd., Dept. 31-K-2, Chicago 7, Illinois.

MAKE Distance-Getting crystal radio that works. Fully illustrated booklet fifteen cents. Money back guarantee. Francis, Box 5963, Cleveland, Ohio.

DEALERS, Servicemen, Agents Wanted: We seek men in all parts of the country to sell Radio and Television Tubes. All those selected will be given the best prices and warranty deal. We Want active people on our side! The Rose Co., 98S Park Place, New York 7, N. Y.

ELECTRONIC Problems, devices, advice. Free information. Registered Engineer, 5208-F Onacrest, Los Angeles 43.

TUBES, Etc. Free List. Wholesale Electronics, 224 E. 204th Street, New York City.

BUILD Television antennas costing less than \$1.00. All channels, six types, send \$1 for Antenna Instructions. LP & Engineering Co., Box 7824, Indianapolis, Ind.

AMAZING "electric eye." Unlimited uses. \$3.50 postpaid. Instructions included. Springfield Enterprises, Box 54-A9, Springfield Gardens 13, New York.

LONG-Distance (R.F. amplification), Single-Tube, Loudspeaker Radio; circuit-instruction 30c. Serco, X261B, Waltham, Mass.

37 BUSINESS OPPORTUNITIES

GOOD Paying Business Silvering mirrors, plating autoparts, reflectors, bicycles, bathroom fixtures, etc., by late methods. No tanks or shop required, outfit furnished. Free Booklet. Gunmetal Co., Ave. E, Decatur, Illinois.

LIQUID Molding rubber, \$2.95 quart, \$9.95 gallon prepaid! Plastercraft Supply Company, 3051 St. Clair Ave., Cleveland 14, Ohio.

EXTRA Money—No Selling—operate vendors. Amazing profits, details Free. Silver King, Suite 221, 622 Diversey, Chicago 14.

OPERATE profitable mail order business. Write Walter Service, 4159-B East 112th, Cleveland 5, Ohio.

MAKE money addressing envelopes. Our instructions reveal how. Glen Glenway, 5713 Euclid, Cleveland 3, Ohio.

HOW and where to obtain Capital? Free details. Star Service, Wapakoneta, Ohio.

RECAST old batteries into new. Latest achievements. Battery Laboratories, Minneapolis.

MAKE \$3.00 Hour At Home—I do—making sandals. George Youngs, 1308 South First, Arcadia, California.

\$5 AN Hr. & more possible in your home. You Can Paint It With Suede—Fabulous new business—spare or full time. Spray on rainbow colors—Auto dashboards and trunks—Signs—Radios—Toys—Figurines—Lamps—etc.—beautified with amazing new 3rd dimensional plush-like finish with touch-appeal as well as eye-appeal. I'll send you complete, step-by-step plans and equipment, including high-velocity spray gun for no-risk examination in your own home. Send no money—just name and address. Coast, 1004-AC S, Los Angeles St., Los Angeles 15.

START Mailorder Bookshop—Build your future. 25c brings booklet, samples, exciting ideas. General Publications, Ossining 1, New York.

ELECTRO Plating equipment—New and used. Complete assemblies. All sizes for all types of plating. Baby shoe metallizing sets. Mounts, supplies, instructions. Free catalog. Hollywood Bronze Supply, Dept. R, 1624 E. First Street, Los Angeles 33, Cal.

MAKE Money spare or full time, casting Metal Toys and Novelties. Big wholesale and chain store demand for Autos, Soldiers, Ashtrays, Banks, etc. keeps manufacturers busy. Production moulds furnished for up to 100 and more castings per hour. No experience or special place necessary. Write for information and illustrations of patterns needed. Metal Cast Products Co., Dept. E, 1696 Boston Road, New York 60, N. Y.

ENVELOPES addressed accurately, reasonably. Fast Service. We have capable addressers in your city. Glenway System, 5713-X Euclid, Cleveland 3, Ohio.

EARN Extra Money weekly mailing circulars for advertisers. Complete instructions—25c. Siwaslian, 4317-B Gleane Street, Elmhurst 73, New York.

NATURAL Molding Latex, Extra thick. Free sample. W. Wooley, 115B Donald, Peoria, Illinois.

BIG Money and fun growing Live Miniature Ming Trees on your window sill. Write for Free rare tree seed and plan. National Nursery Gardens, 8463 South Van Ness, Inglewood 4, Calif.

VENDING Machines—A post card may bring you the opportunity you are waiting for. No experience necessary. Stamps, nut, candy, gum and others. Small investment. Write Schoenbach Enterprise, Dept. 9, 1645 Bedford Ave., Brooklyn 25, N. Y.

MAKE Money at home—mailing literature—running Ads. Pleasant and profitable. Write Miller, 1772-R Carlyon Road, East Cleveland 12, Ohio.

EARN \$15,000-\$30,000 annually. Franchise protected. Guaranteed minimum \$12,500 or money back. Live at home. No merchandise to buy. Selfemployed. One of most exclusive and noncompetitive businesses in United States. Send 50c for explanatory book. Money refunded when book returned. Harrell & Company, Box A-2, Louisville, Illinois.

MAKE Rubber Stamps, repair dolls, learn invisible reweaving, repair sewing machines. Catalogue of "40 Ideas." Universal, Box 1076-B, Peoria, Ill.

IMPORT-Export! Opportunity, profitable, world-wide, mail-order business from home, without capital; or travel abroad. Established World Trader ships instructions for no-risk examination. Experience unnecessary. Free details. Melinger 1A, Los Angeles 24.

WATERLESS Hand Cleaners. Highly profitable home mail order and mfg. business. Simply add water to concentrates or ready-packed under your own label. Everything furnished. Western G Aircraft, Los Angeles 19.

LEARN Sewing Machine Repair, Electrify, Rent, Sell Spare Time. Make "Big Money" like our other Men-Women do. New machines, motors, parts wholesale. Details free. Taylor Service, Hamilton PS-10, Ohio.

LEARN metalizing baby shoes, jewelry, gifts. Bronze, gold, silver. Complete success plan free. Kiktavi Building, 7217-PS South Broadway, Los Angeles 3.

VENDING Machines earn big money! An investment as low as \$10.50 will start you in this fascinating profitable business that can lead you to the road of success and independence. Routes can be established and operated in either full or spare time with no experience needed. Write for full details and our Free catalog illustrating our nut, candy, gum and stamp vendors; also pin ball machines, music boxes, etc. Write immediately to Parkway Machine Corporation, Dept. 9, 715 Ensor Street, Baltimore 2, Maryland.

MAKE Money At Home as renewal headquarters for all magazines. Big Christmas sales profits now. Liberal commissions. Supplies furnished. Write for Free Catalog. McGregor Magazine Agency, Dept. 510B, Mount Morris, Illinois.

"MAKE Perfume" Profitable Mailorder business—Catalogue Free. "International," 6347 Parnell—PS-10, Chicago 21, Ill.

ALL Profit: Get manufacturer's, distributor's, dealer's profits yourself by making, selling, installing important heating specialties. Details free. Harrington, Box 103SE, St. Matthews, Kentucky.

MAKE Perfumes At Home. Write, "Carey Laboratories," 1914 Chouteau PS-10, St. Louis 3, Missouri.

"PROFITABLE Decorating Business." Fascinating! Instructive. Only \$1.00. Fran Council, Box 150-P, Wildwood, New Jersey.

EARN Money At Home With Your Typewriter! Spare time! Details free. Edwards, Publisher, 3915-PS, 12th, Des Moines 13, Ia.

BUY Wholesale thousands nationally advertised products at big discount. Sent free. "The Wholesale Plan." American Buyers' Service, 629-S Linden, Buffalo, N. Y.

CLEAN automobiles, wash walls, carpets, upholstery. Complete outfit and instructions. One gallon concentrate—special gun only \$9.95. Zipp-reme Chemical Co., Dept. P, Greensburg, Pa.

NATURAL Molding Rubber free sample. Tribby Supply, Post Office Box 3091 Station F, Jacksonville, Florida.

BIG money in your own business. Details free. How, Box 684-B, St. Louis, Missouri.

TO \$35.00 Weekly. Spare Time. Home Operated, Mailorder Business. Successful "Beginner's" Plan. Everything supplied. Lynn, 10420-C National, Los Angeles 34, California.

MAKE wishing wells, game of skill, start route, cafes, taverns, sell for home banks, easy to make, keeps winners separate, locked securely, inexpensive, pays for itself over and over again. Complete instructions, diagram \$1.00. Albright Sales, P.O. Box 241, Waukegan, Illinois.

THRILLING Profitable Home Business. Make fast-seller chenille monkey trees, dolls, flowers. Terrific holiday demand. Information free. Velva, Bohemia 17, N.Y.

MONEY in new greaseless doughnuts. Start in kitchen. No smoke. Sell stores. Free recipes. S. Ray Co., 3605 South 15 Ave., Minneapolis 7, Minn.

MAKE Gifts, Novelties, Jewelry, from sea shells, fish scales, plastics! Wholesale, illustrated catalog 10c. Giftcrafts, Box 4550-PP Coral Gables, Florida.

POPULAR SCIENCE OPPORTUNITIES

FOR an extremely profitable lifetime business, operate a Collection Agency. Quickly learned. Write Cole Associates, Syracuse 2, New York.

MAKE \$6.73 Every Time You sell one— and they're amazingly easy to sell! We have new Adding Machines in original factory cartons you can sell for only \$14.95 and you make 45%. They're executive model portables, precision built with automatic clearance, direct subtraction, fully guaranteed. Send for life size color photo with full details. Write today to Lightning Adding Machine Co., Inc., Dept. PS-6, 1260 West Second Street, L. A. 26, Calif.

START your own Mail Order business with hundreds of repeat, sales proven, hobby-craft items. No stock to carry, no shipments to make. We pack and ship for you. For details and instructions send 25c. Mail Order Service, Dept. PS25, 845 S. Wabash, Chicago 5, Illinois.

EXCLUSIVE distributors. Amazing new DDT moth-resistant genuine crushed redwood cedar! Prevents moth damage to clothes, fabrics. Makes fragrant cedarized closets, drawers. Applied like paint; laboratory tested. Hardware, paint, building supply dealers, contractors buy quantities. Tremendous profit potential! Low priced; attractively packaged. Write for details, Millenco, 90-H Summit, Brookline, Mass.

SPARE time business! Sell colorful Decalcomania Home Decorations for kitchens, bath, nurseries, gifts, etc. Friends, neighbors buy on sight. Millions sold every year. Start earning real money now. Up to 100% profit. Send postcard for sales plan plus test assortment on approval. Send no money. Decal Art Co., Dept. PS-10, 344 N. Lorel, Chicago 44, Illinois.

\$25 WEEKLY Working two hours daily. No canvassing. No manufacturing. Lycke, Box 2471-B, Cleveland 12, Ohio.

ADVERTISING book matches—Cash in on big demand—sell Union Label matches. Cuts for all businesses and political parties—Free powerhouse selling kit—low prices—protection guaranteed on repeat orders—Cash commissions. Superior Match Co., Dept. PX-1052, 7530 Greenwood, Chicago.

SELL by mail; free details; instructive booklet 25c. Manhattan House, Box 51-L, St. Albans 12, New York.

WANTED! Home Producers, by Manufacturers in our Contact Service. Become a sub-contractor, casting plastic products for these companies. Thousands of easy-to-make items required. Cash in at home, without previous experience. Write for Free list of 100 most wanted items. Plastic Service Associates, Dept. PS9, East Boston 28, Mass.

LIQUID Rubber, make flexible molds. Free Sample. Chaney, 1130 E. 16th St., Jacksonville 6, Fla.

RAISE Goldfish—Big profits. Send \$1.00 for Breeder's Manual, Noble Fisheries, R.F.D. #1, Midlothian, Virginia.

MAKE flexible molds! Cast plaques, bookends, figurines! Free sample! H. Tooker, 630-A Chestnut, Hamilton, Ohio.

OPERATE Profitable Mailorder Business. Particulars Free. George Lenhoff, Lincoln 1, Nebraska.

BE A Jobber without investment, without inventory. Discounts 50% and more—even on small orders. Draw from \$250,000 stock. Sell stores, individuals. Profits up to 100%. Terrific line of toys, novelties, Jewelry. Free Catalog. Modern Merchandise, Dept. 17, 169 W. Madison, Chicago 2, Illinois.

SELL! Buy! Trade! anything. Read, "Trading Post Magazine" 20c. Thorne's, 525 Dewey, Jackson 45, Mich.

APPLIANCES, Radios, Jewelry, Gifts. Wholesale Pricelist, Belmont, 200-2 Hinsdale St., Brooklyn 7, N. Y.

MAIL Selling opportunities galore! Free! Wehner, Box 142-E, Roxbury 19, Mass.

INCOME from local information. No selling. Write—Neherco, La Verne 6, Calif.

ETCH initials, designs on glass. Sensational profits! Outfit \$2.00. Free details. Beardsley, 2045 Chestnut, Philadelphia, Pa.

SPECIALIZED Magazines covering your field will help You to success. Get latest copies through our Easy-to-Get-Acquainted Service. Hundreds of business, trade, professional, educational, farming, sport, hobby, pets, stationery, store display, sign, textile, tobacco, window display, wood-working, writer and others covering All interests. Send for List today. It's Free. Commercial Engraving Publishing Company, 34S North Ritter, Indianapolis 19, Ind.

MEN'S, Children's Sox unconditionally guaranteed for full year. Send 25c for information. Salesmen's Inquiries welcomed. R. K. Chilson, 3120 Nevin Ave., Richmond, California.

HOW to Earn Money as a Manufacturers Agent. Free details. International Trading Center, 1900-E Euclid Ave., Cleveland, O.

NEW Kind Mail Order Home Work! Carry no merchandise. No selling, manufacturing, experience, advertising investment, capital necessary. Eye-opening proof 3c stamp. P. Torrey, Melrose 76, Mass.

THROWN Away! Tons of ground rubber by recappers. Make it into Plastic Rubber! 1,000 uses! Easy! Inexpensive! Start profitable business! Instructions, samples \$1.00. Ceeten Products, 506-S, Cornelia, Ga.

SELL By Mail to automobile owners. Millions of prospects. Fast selling items. Everything furnished. Write: Eastern, Box 142-S, Dorchester 24, Mass.

GET Dollar Orders by Mail—keep 90c. \$10 starts You. Details free. Genmerco, Box 142-K, Dorchester 24, Mass.

POPCORN and Potato Chip equipment. Long Eakins Company, 5263 High, Springfield 99, Ohio.

SMALL investment in Artkote molds, puts you in \$5.00 hour stone facing business. Sample mold \$2.00. Dividend Company, Liverpool, New York.

START Business without Capital! Reliance, 15-B Park Row, New York 38, N. Y.

HAVE Home Mail Business—Success assured beginners with \$100 or more. Idea-Mailbox Service, Booklet 25c. Details Free. NMD Agency, Box 88-K, Dorchester 22, Mass.

HOMEWORK—easy—profitable. Rush name. Siegel, Box 183-PS, New York 2.

ADDRESS Envelopes, Postals, at home— longhand, typewriter. Particulars 3c stamp. G. Torrey, Melrose 76, Mass.

BIG profits at home. Mirror resilvering, blue-ing guns, electroplating with chrome, silver, nickel, gold, copper. Portable electroplater, plating salts, formulas, instruction manual, \$5.95. Free booklet. Tyco Metals, Box 13231-CL, Houston 19, Texas.

EXPERIENCED Roof Repairer Franchise Protection. Luster-Kote, 19417 Derby, Detroit, Michigan.

FIX typewriters. Free booklet describes our modern, inexpensive home-study course. Factory methods taught. Write: Typewriter, Building 4, Tarentum, Penn.

\$46 FROM Square Foot Plywood; Jigsaw necessary. Write: Woodart, Bridgewater, Massachusetts.

\$4,000 PROFIT in two months reported. No investment. Details 50c. Charles Company, 12-EAH, Norwood, Ohio.

COLORGLAZED Concrete Pottery made without molds. Patented method. Cemetery products, novelties, tiles. Basement leak-sealing. Money-making projects. Booklet, details free. Men only. National Potteries, Grand Rapids, "Minnesota."

SENSIBLE, profitable, delightful business. Trifling capital. Carl Jamer, Manorville 5, New York.

FIGURINES unpainted, free illustrated list. Haverty Products, 822-A 17th Street, Altoona, Penna.

"WISHING Well" Games earn Big Money! Start fascinating, profitable business with investment as low as \$7.50. Easy to place these new Skill Games on counters in Cafes, Fountains, etc., that will handle for you for percentage of weekly collections. Routes can be operated spare or full time—experience unnecessary. Details Free! "Legalshare Coinwel," Box 929, Long Beach 1, Calif.

SELL Printing by Mail! We fill orders. Free plans, samples. Sutton Printing, Box 853-B, Waycross, Georgia.

JOBBER-Dealers. Power mowers—\$39.60. Delivered. '53 models. County agency deal. Rotacut-52, Excelsior Springs, Missouri.

JUMBO Floating Henryburger Territory Franchise. National Food Sensation Small Investment. Wire Airmail for Facts, Jesse and Jesse, P. O. Box P-936, Wichita, Kans.

LEARN Invisible Reweaving! Details free. Harris, P. O. Box 7112, New Orleans, Louisiana.

\$250 WEEK reported! Free book "505 Odd, Successful Businesses." Work home! Expect something Odd! Pacific-36C Oceanside, California.

"HOME Addressing and Mailing Opportunities." Vital Information—\$1. Universal Mail, Box 467, Dept. 6, Huntington, Ind.

MEN-Women—"Everybody Likes Candy." Learn to make professionally at home. Tools and supplies. (Our 42nd year.) Ragsdale Candies, East Orange, N. J.

BUY it wholesale. Manufacturers. Distributors. Over 850,000 items. Literature free. Olsen, 1231-B East Third St., Duluth 5, Minnesota.

DRUG Sundries. All popular brands latex. Fresh stock. Sell to drug stores, physicians and jobbers. Free distributors price list. Sanitary Sales Co., Box 934, Rockford, Illinois.

NEW \$\$\$\$ Fabulous Home-Business "Jewelize" Finish. Free Sample. Free \$\$\$\$ Plan. Pearl-Art, 7216 Bear, Bell, Calif.

MEN-Women! Let us prove how you can make Big Money at home making novelties, spare or full time. Absolutely no previous experience necessary. We supply names of interested buyers for your finished products. (Valuable Liquid Marble information). Send for Free Catalog—"There's Money in Plastics"—Today! Write: Bing Products, PS1052, Watertown 72, Mass.

DID you see our ad on page 60? Purifoy Upholstery Service.

38 MONEYMAKING OPPORTUNITIES

21 POPCORN, Candy Apple Formulas, proven money-makers. Send \$1 today for formulas, catalog of money-making ideas. Concession Supply, 3916 Secor, Toledo, O.

SPARETIME Profits Taking Subscriptions All Magazines. Wholesale Catalog Free. Cassell Publishers, Westfield 1, N. J.

BE Appointed State Notary Public Now! Details; Stationers, Helotes, Texas.

\$10,800 PROFITS! Your own Mailorder Business! No Capital Risk! "Success Plan" (worth \$2) Free! Write today! Treasury, 149 Storer, New Rochelle PS-4, New York.

MAKE Money—Sewing and Assembling at Home. Liebig Industries, Beaver Dam 7, Wisconsin.

DETECTIVES Earn Big Money. Experience unnecessary. Detective Particulars free. Wagoner, P-125 West 86th, N. Y. 24.

PLEASURE and Profit Preserve live flowers to last for years. Details free. Trial size \$1.00. Refundable. Hermansen, 210 Fifth Avenue, New York 10, N. Y., Suite 1102.

SCHOOL Seniors—Earn sensational profits selling classmates America's Most Beautiful Graduation Name Cards. Largest selection. Outsells all others. Free sample kit. Printcraft, Dept. P, 1509 Maple Street, Scranton 5, Pa.

START a buying service, buy wholesale thousands nationally advertised products. Make big profits selling at sizable discounts. Send postcard for details. American Buyers' Service, 631-S Linden, Buffalo, New York.

START home candy kitchen. Interesting information free. Schenck, 717-S W. Penn, Butler, Penna.

LEARN Watch-Clock Repairing at home. While learning we fix your watches. Free information. Modern Technical Supply Co., 55-PS West 42nd Street, New York 36.

POPULAR SCIENCE OPPORTUNITIES

MAKE tremendous profits with fast-selling Costume Jewelry! Buy Direct! Sell your friends, neighbors and customers at big savings to them! Write for our Free Catalog! Penn Jewelry, Dept. 17, 826 W. Lacka., Scranton, Pa.

SILK Screen Printing. Easy to learn. Operate o'vn business. Complete course offered on money back Guarantee. 100 items to Screen print—100 ways to sell. Low cost. Build national, local business. Write, Typecrafters, 510-E West Susquehanna, Philadelphia 22, Penna.

YOU can earn money easily at Home, securing subscription by addressing and mailing Our Literature. Write Martin's Service, Preston, Virginia. Addressed envelope appreciated.

GET Extra Money. Make imported rhinestones into gorgeous jewelry. We furnish everything—show you how! Complete crystal earring and bracelet kit plus "Success Book" only \$1.00. Money back guarantee. Book alone, 10c. Gemcraft, 18131 E. 13th, Cleveland 14, Ohio.

MAKE Money addressing Envelopes! Our information reveals how. Only 30c. Business, Dept. 45-K, P.O. Box 2224, St. Louis, Mo.

WIN contest money. General Contest Bulletin gives hundreds of tips. Lists current contests and rules. Sample 25c. General Contests, 1609-A East 5th, Duluth, Minnesota.

"DUPLISCALER"—Scales anything. Engraving, carving attachment. Sample engraving 25c. Desco, 6334-P Sepulveda, Van Nuys, Calif.

EARN Money Evenings, copying and duplicating comic cartoons for advertisers. Adservice, Argyle 2, Wisconsin.

SELL Titania gems; \$9.75 carat wholesale. More brilliant than Diamonds. Free catalogue. Diamonite, 1404-S Mitchell, Oakland 1, Calif.

CONVERT Junk Batteries into New. Latest Developments. Wertz, 106 Amanda, Pekin, Ill.

MONEY! We buy used tin-cans. Information 50c. Cutler Research, Box 154, Danville, Pennsylvania.

ADDRESS Envelopes! We Pay Cash! Outfit—25c. Hirsch, Spring Valley 3, N. Y.

TYPEWRITER Owners make handsome profits. Get details today. Groves Company, 682, Hastings 3, Nebraska.

\$35 WEEKLY addressing envelopes. Instructions \$1, refundable. Adservice, Spring Valley 36, New York.

\$100,000—CONTESTS. Helpful Books; Services. Inquire. Contests, 13H Earl, Red Bank, New Jersey.

SELL by Mail, 12 tested plans, 25c. Edwards, Box 1067, Allen Park, Michigan.

SELL Books, Merchandise, By Mail. Everything furnished! Free details. Paragon, Box 5-A, Providence 8, R. I.

MANUFACTURE Rhinestone and Pearl Jewelry at home. Latest creations, tremendous profits, no skill needed. Postcard brings illustrated catalog of settings, stones, etc. A. V. Cutt Co., Inc., 210-H Fifth Ave., New York 10, New York.

\$\$\$ IN Personalized Baby Record Books. Sell By Mail Use Same Literature We Do. No-Co-Ro, Oakland 6-P, Calif.

FREE Book "505 Odd, Successful Businesses." Work Home! Expect something Odd! Pacific-35C, Oceanside, Calif.

\$200.00 FOR 12 hours fascinating work at home. Temporary. Orinda Company, Lansdowne 8, Penna.

WE pay you highest rates for hand-decorating greeting cards. Work home. Experience unnecessary. No selling required. Greetings, 100 Madison, Detroit 26.

DID you see our ad on page 60? Purify Upholstery Service.

39 FORMULAS, PLANS, ETC.

BRAND New, Spectacular Chemical and Fireworks Experiments Manual. Complete Set-ups, Formulas, Instructions \$1.00. Chemi-Technix Laboratories, 568B Riley Street, Buffalo 8, New York.

FORMULAS—All kinds. Latest products. Literature free. Kemico, Park Ridge 15, Ill.

500 FORMULAS and Recipes. Riches in Recipes. Tried and Tested processes for home, Factory and workshop. 25c postpaid. Allen, 427-FS, Clinton, Missouri.

BOOK—10,000 Formulas, Processes, \$3.98 Postpaid. Free literature. Kenneth Paullin, Loudonville, Ohio.

STRANGE, Exciting, Unusual experiments. New booklet "Fascinating Chemistry" unusual educational. Only \$1.00. Chester Garlanger, 1019 Pearl St., St. Joseph, Mich.

FOR the best in modern manufacturing formulas, get my literature! Established 1897. Liscombe Miller, Tampa, Florida.

LABORATORY tested formulas. Lists free. Pont, Box 635-PS, Terre Haute, Ind.

40 PLASTICS

LUCITE, Plexiglas. Any size sheets masked Square foot (12 x 12) cost 1/16" \$1.20; 1/8", \$1.40; 3/16", \$1.75; 1/4", \$2.08. Include 10% postage. Almac Plastics, 230 Fifth Avenue, New York 1, New York.

PLASTIC Sheets, Rods, Tubes, etc. Free List. Plastic Supply Co., 2901 N. Grand Blvd., St. Louis 7, Mo.

NEW liquid casting plastic. Clear, colors. Embed flowers, insects, coins. Saw, drill, carve. Send 25c for Wholesale Catalog and New Sales Manual showing how to make money at home. Castolite, Dept. L-102, Woodstock, Illinois.

REINFORCED Plastics replace metals, wood, ceramic products by hundreds already. Start your own shop in spare time with small capital. Send 25c for samples and information. Mardon Reinforced Plastics, Box 489, Glen Cove, N. Y.

PLASTICS, Lucite, Plexiglas, Acetates, complete supplies. Retail-wholesale prices. Catalog 10c. Gem-O'-Lite, Box 686N, North Hollywood, Calif.

41 CHEMICALS & APPARATUS

LUMINOUS Paints will glow in dark. Six colors. Fairmount Chemical Co., 136 Liberty St., New York City 6.

NEW Idea Chemical and Apparatus Outfits for Home Experimenting. Photo-Scales, Microscopes, Chemicals, Biological and Laboratory Supplies in Small Quantities. Catalog 25c. Established 1931. John H. Winn, 124-B West 23rd Street, New York 11, N. Y.

ILLUSTRATED Catalog: Chemistry, mineralogy, biology, 10c. Tracey Laboratories, Evanston, Illinois.

SAVE Money! Supplies Catalog 20c, refundable. Laboratory Sales, Box 161-G, Brighton, Mass.

LABORATORY Apparatus, Chemicals, Microscopes, Complete Chemistry Sets, Minerals, Uranium Ore. 10c brings catalog. Porter Chemical Company, Hagerstown 2, Maryland.

BRAND New, Spectacular Chemical and Fireworks Experiments Manual. Complete Set-ups, Formulas, Instructions \$1.00. Chemi-Technix Laboratories, 568B Riley Street, Buffalo 8, New York.

SPECTROSCOPE for quick chemical analysis \$3.00. Cutting Sons, Los Altos, Calif.

CHEMICALS and apparatus for industrial, analytical, and private laboratories. Catalog 20c. Dept. M-26, Biological Supply Co., 1176 Mt. Hope Ave., Rochester 20, N. Y.

AMAZING New Book of Science. Experiments, Formulas and catalogue of Laboratory Supplies. Only 25c; National Scientific Co., Dept. 15, 2204 W. North Ave., Chicago 47, Illinois.

42 HELP WANTED

FOREIGN & Latin American Employment 1952 "Foreign Service Directory" gives Up-To-Minute Facts on Military & Civilian Construction, Government Jobs, Major Oil Listings, Aviation, Transportation, Steamship Lines, Mining, Importers, Exporters, How-When-Where to apply, application forms, Hot List Firms Hiring. \$1.00 post-paid. Global Reports, P.O. Box 883-S, Hollywood 28, Calif.

\$1,000,000 CONSTRUCTION Projects. "World Wide" printed Monthly Foreign & Domestic employment. Free application blanks tells How-When-Where to apply. \$1.00 complete. Global Reports, P.O. Box 883-PX, Hollywood 28, California.

FOREIGN Employment Construction men, building trades, helpers, office men, others, interested in Foreign Projects. High wages, quarters, transportation. Send \$1 for Foreign Construction Compendium and Application Forms. Foreign Service Bureau, Dept. PS-10, Metuchen, New Jersey. (Not an employment Agency—no fees.)

CONSTRUCTION Job List. Published Monthly. \$1.00. Dempster's Construction Scout News, Dept. 268-DR, Bridgeport, Illinois

SHINE Shoes Without "Polish". New invention. Lightning seller. Shoes gleam like mirror. Samples sent on trial. Kristee 176, Akron, Ohio.

INTERESTED in foreign employment? Hundreds of jobs worldwide. Latest information and applications \$1.00. Overseas Jobs, Dept. 335-B2, Baton Rouge, La.

ALASKA—Last American Frontier. \$1.00 brings 1952 Business Directory, Government Map, Construction Projects Military & Civilian, Homestead & Highway facts, Hunting-Fishing-Game Rules, Mining, Aviation. List of firms hiring. How-When-Where to apply. Alaska Opportunist, P. O. Box 883-S, Hollywood 28, California.

FOREIGN Jobs, Contracts underway and soon starting in Africa, South America, Canada, England, Europe, South Pacific, Middle East, Mexico and Alaska. Send \$1.00 for foreign job news information, application forms, etc. DCS Foreign Job News, Dept. 268-DQ, Bridgeport, Ill.

TIRED of no money, second rate jobs? Like to start a real career with a lifetime of high salaries? Write me about two growing fields that need men. Ed Howes, Dept. 5102, 456 W. Santa Barbara Ave., Los Angeles 37, Calif.

OVER \$1000 a month are the wages of common laborers on some construction jobs. The most complete world wide listings may be had at small cost. For information contact us immediately. Construction Workers Service Co., 1111 Commerce Bldg., St. Paul, Minn.

EARN \$1000.00 month in Bookkeeping or Income Tax Business. Details Free. Universal, Box 664-P, Springfield, Mo.

MICHIGAN Employment opportunities—All types—all areas—lists \$1.00. F. Maday, 322 Shearer Bldg., Bay City, Mich.

CALIFORNIA—There is a job waiting for you in California. Critical manpower shortage in Los Angeles area. All classification now open. Send \$2.00. California Job Information Service, Box 556, North Hollywood, Calif.

GREENLAND airbase job. Hiring hundreds monthly. Laborers earn \$1100/month, skilled more. Full information, 50c. Jobservice, Box 1565, Billings, Mont.

43 AGENTS WANTED

NEW Jobs open in selling! Send name, address for five free issues of Opportunity Magazine's money-making guide, listing hundreds of companies who'll pay you well, full or part-time. No experience needed. Opportunity, 28 E. Jackson, Dept. 18, Chicago 4, Illinois.

MAKE Wedding Profits. Sell invitations, napkins, matches. Samples free. Dunbar's, Middlebush 5, N. J.

PRINTING — Salesbooks — Envelopes. Free Illustrated Catalog—Ersco, Dept. S, Bronx 72, New York.

GOLD Lacquered and silver sign letters. Windows, doors, trucks. Standard Sizes. Penny and up. Samples. Atlas-G, 544 West 79th, Chicago 20.

START Your Own Business on credit. Your own boss, 1586 of our Dealers sold \$5,000 to \$27,500 in 1951. We supply stocks, equipment on credit, 200 home necessities. Sales experience unnecessary. Pleasant, profitable business backed by world-wide industry. Write Rawleighs, Dept. J-U-PSC, Freeport, Ill.

POPULAR SCIENCE OPPORTUNITIES

AGENTS—300% profit selling genuine gold window letters; stores and offices. Free samples. Metallic Sign Letter Co., 431-E North Clark, Chicago.

DO You Need Money? \$35.00 is yours for selling only 50 boxes of our 300 Christmas Card line. This can be done in a single day. Free samples. Other leading boxes on approval. Many surprise items. Experience unnecessary. Free samples Personalized Christmas Cards, Stationery, Napkins. Write today. It costs you nothing to try. Cheerful Card Co., 10 White Plains, New York.

FAST sellers. Big demand. Catalog. Parker Drug Co., Hoboken 6, New Jersey.

FREE Book where to buy 800,000 articles from manufacturers at Wholesale Prices. Save up to 50% on Nationally Advertised Merchandise. Rush name for Free copy. Glass Pub. Co., Ellwood City 1, Penna.

MAKE Money Introducing World's cutest children's dresses. Big selection adorable styles. Low prices. Complete display free. Rush name. Harford, Dept. H-4341, Cincinnati 25, Ohio.

SHINE Shoes Without "Polish." New invention. Lightning seller. Shoes gleam like mirror. Samples sent on trial. Kristee 150, Akron, Ohio.

BIG Bargains! Terrific Profits! Selling new-used Clothing. Suits \$1.75. Pants 35c. Topcoats \$1.00. Dresses 20c. Shoes 20c. As little as \$10 starts you. No experience necessary. Free Wholesale Catalog. Superior, 1250-B Jefferson, Chicago 7.

QUICK Extra Cash! Sell America's outstanding line of Christmas box assortments and personalized lines. Plus hundreds of extra profit-items. Monogram playing cards, wedding invitations, gift items, deluxe album of exclusive cards, nylon hosiery. Write today for 60 free samples in six beautiful portfolios. Gift catalog included. Elmcraft Chicago, Dept. 9, 5930 So. Western Ave., Chicago 36, Ill.

I'LL put a "Shoe Store Business" in your pocket! Nation's Leader trains you to make Big Money! Fit men, women. Free Sample Outfit—Write Today! Mason Shoe Co., Dept. MA-15, Chippewa Falls, Wis.

CALIFORNIA sweet smelling beads, sensational sellers. Particulars free. Mission, 2328P West Pico, Los Angeles 6, Calif.

NEED Extra Cash? Free Sales Kit. Sell personal initialed buckles with belts, cap badges, tie clasps, etc. Choose from 3000 emblems. Hook-Fast, Box 1425PS, Providence, Rhode Island.

ANYONE can sell Hoover DuPont Nylon Uniforms for beauty shops, waitresses, doctors, nurses, others. In white and colors. Exclusive styles. Top quality. Low priced. Exceptional income. Real future. Equipment free. Write fully. Hoover, Dept. G-101, New York 11, N. Y.

BIG profits selling ties (\$2.00 values) \$6.50 dozen. Free catalog. Empire Cravats, 648A Broadway, New York 12.

BE A Money Maker. Represent magazines year around. Wonderful home work. Big Christmas profits now. Liberal commissions. Everything furnished. Write for Free Catalog. McGregor Magazine Agency, Dept. 510A, Mount Morris, Illinois.

VALUES Galore—100 blades 45c. Gross needlebooks \$4.80. Automatic cigarette lighters \$7.20 dozen. Fullsize 25c Ball Pens \$8.40 gross. Bargain Catalog 5001 items free. Cutrate Wholesalers since 1916. Mills Sales Co., 26 West 23rd St., New York.

TAKE Large Unit Orders for Wool Uniforms, Caps, Shirts, Ties, Wallets, Personal Initialed Buckles With Belts, Cap Badges, 3000 Emblems. Send For Free Outfit Now! Hook-Fast Co., Dept. PS, Roanoke, Virginia.

BUY Wholesale thousands nationally advertised products at big discount. Sent free "The Wholesale Plan." American Buyers' Service, 627-S, Linden, Buffalo, N. Y.

MAKE big money now with marvelous new roll knife sharpener. Big profits. Full or spare time, side line. Protected territory. Write today: Alden Speare's Sons Co., 136D Sixth St., Cambridge 42, Mass.

"FOG-Stop" Windshield Cloth. Instantly removes blurry Mist, Frost, Sleet, Snow. Stops windshield fogging. Samples sent on trial. Kristee 153, Akron, Ohio.

BUY Wholesale—25,000 items—Catalog 25c. Matthews, 1472-A1 Broadway, New York City 36.

\$200 WEEKLY. New invention. Amazing 4-second Presto Emergency tire chains, fit all modern auto wheels. National advertising building big demand. 3 sales daily to oil stations, dealers, etc., make \$200 or more weekly. Territory going fast. Write Presto Chain Co., P-16, Des Moines 2, Iowa.

MEN! Make extra money in your spare time. No house-to-house canvassing required. New car given as bonus. Amazing nylons guaranteed as long as 9 months depending on quantity, against runs, snags, holes, or replaced free. Rush name and hose size for simple money making plan. Lowell Wilkin, 20210 Wash., Greenfield, O.

SELL New Automatic Floor Waxer. Retail \$2.95. Profit 125%. Write for Guaranteed Sales Plan. Smith Corp., Greenfield 6, Mass.

EARN Big Money Fast! Sell advertising work uniforms to garages, factories, every business! Finest tailoring, fit and fabrics including miracle Orion! Outfit Free. Topps, Dept. 5410, Rochester, Indiana.

MAKE Extra Money—for yourself, club or church. Up to 100% profit selling big value Christmas, All-Occasion greeting card assortments to friends, others. 7 leading 21 card \$1.00 boxes. Religious and Novel cards, Gift Wrappings, Ribbons, Stationery, Napkins, Animated Books, Sewing Kits, unusual gifts. Over 150 items. Bonus plan. Experience unnecessary. Write for samples on approval. Special Offers. Hedenkamp, 361 Broadway, Dept. PS-21, New York.

CALENDARS. Advertising Novelties, Matches. All styles, including Religious, Varnished, 12 Sheet, Girls, Hundreds of Advertising Novelties, Book Matches, etc. Fleming Calendar Co., Promotional Division, 6539 Cottage Grove, Chicago 37, Ill.

EXTRA Money! Make up to \$1.00 a box selling amazing value Christmas, All Occasion greeting cards, gift wrappings, gifts, Bonus, Surprise Offer. Experience unnecessary. Request Feature samples on approval, free samples Name imprinted Christmas Cards, Stationery, Napkins and free catalog. New England Art Publishers, North Abington 720-A, Mass.

BARGAINS—Terrific Savings—Job Lots—Close-outs! Also save up to 50% on complete lines of Drygoods, Clothing, Hosiery, Notions, Drug Sundries, Toiletries, Novelties, Gifts, Jewelry, Television, etc. 2000 items. Send 25c for Illustrated Wholesale Bargain Catalog. Close-out Flyers, and Special "Get-Acquainted" offer. Valuable merchandise certificate (worth many times 25c) included Free. Reliable Jobbers, 311-J North Desplaines, Chicago 6.

SALESMEN. Distributors, fast selling costume jewelry direct from factory. Big picture catalog free. Pickcraft, C-19 Bank, Attleboro, Massachusetts.

ABSOLUTELY Free! Big package actual sample fabrics and style presentation of dresses, lingerie, hosiery, etc. Take orders. Commission big. Send no money. Melville Co., Dept. 7614, Cincinnati 25, Ohio.

GET Into Toys! Big Money. Show Free toy-gift line full or spare time. Take orders, pocket juicy profits. Styleco, Dept. E324, Cincinnati 10, Ohio.

SELL new clothing. Lowest prices. Operate from home, auto, store. Enormous profits. Big catalog Free. S&N, 605-D 12th Place, Chicago 7.

OPERATE "Escalator" Mailorder system, selling our products or any products. Fastest, most revolutionary mailorder system known. Write: Selbyco, Decatur 173, Ill.

AGENTS. Very profitable household item to sell with your present line. A sensational seller at \$1. You make 60c. Over 375,000 sold in Midwest. Guaranteed. Free sample to agents. Write Perma-2, 609 Leonard, Waterloo, Iowa.

MAN to earn \$90 week up. Long needed invention. Advertised Saturday Evening Post, Country Gentleman, Prospects everywhere. Full, part time. Exclusive. No investment. Free samples. Write Red Comet, Inc., Dept. 56-C, Littleton, Colorado.

POSITIVELY Make \$50.00 a day and up selling brand new item going to every type of Food and Beverage Store, Factories, Laboratories, Hospitals, etc. Samples furnished. Utility Durawear, 53 West Jackson Blvd., Dept. PS-10, Chicago 4, Ill.

FREE book "505 Odd, Successful Businesses." Work Home! Expect something Odd! Pacific-38C, Oceanside, Calif.

IS \$210 a week worth a postcard to you? Then rush card with name and address for special Free Trial Plan that sells amazing new Automatic Refrigerator Defroster "like hot cakes!" Write to Mr. Lewis, D-Frost-O-Matic Corp., Dept. N-103, 173 W. Madison, Chicago 2, Illinois.

LOOK! High School Seniors Only! 25c buys \$1.50 value of 50 fancy graduation name cards for exchanging, etc. Your name printed in sensational raised rose gold. Offer limited . . . only one Senior in your class. No order accepted without school name mentioned. Better hurry! Craftcards, Box 235-MS, Pittsburgh 30, Penna.

IMMENSE profit selling products our way, our new Booklet Tells How. Alliance Sales, 568-D, Alliance, Nebraska.

BUY it wholesale. Manufacturers. Distributors. Over 850,000 items. Literature free. Olsen, 1231-B East Third St., Duluth 5, Minnesota.

BECKER will pay twenty-five dollars a day for your part time. Becker Paint & Varnish Co., 1821 Woodside Ave., Bay City, Michigan, P.O. Box 54.

SELL Big Money-Maker to Men and Women. Easy handwork makes fast-selling useful articles. Sample free. Sunmade Company, Brockton 64, Mass.

MEXICAN Feather Pictures. Sell on sight; 200% profit! Free details. Sample 20c stamps. (No Coins). Sylvias, Apartado 9036, Mexico City.

MAN to earn \$500 month up. National Company opening exclusive areas. Full or part time. \$10 sale earns you \$6.00. Prospects everywhere. Write Superior Products, Inc., Dept. 104, 3410 Main Street, Kansas City, Mo.

44 HIGH-GRADE SALESMEN

MAKE Money with fast-selling Bostonian Skirts, Blouses too. Spare time, full time. Sales Kit Free. Bostonian, 89 Bickford, Dept. R-11, Boston 30, Mass.

ADVERTISING book matches—Cash in on big demand—sell Union Label matches. Cuts for all businesses and political parties—Free powerhouse selling kit—low prices—protection guaranteed on repeat orders—Cash commissions. Superior Match Co., Dept. P-1052, 7530 Greenwood, Chicago.

ALUMINUM Awnings big profits. Sci Kramer, 321 So. Anita, Los Angeles 49, Calif.

WRITE 3 Words—Collect \$7.65 on 10-second Demonstration to merchants—write on glass with Amazing Magic Crayon—Presto!—5-color advertising message takes fire—glows like brilliant Neon. Three sales daily bring \$22.95 profit. Rush postcard for details.—Complete Sales Kit. Free. Maxilume Co., 125 W. Hubbard, Dept. CL-9-S, Chicago 10, Illinois.

AD Matches! Sell Amazing Designs—20, 30, 40 and 240-light book matches. Biggest spot cash commissions; every business a prospect. Low prices for high quality. Repeats. Start without experience; men, women; full, part time. Buy Nothing! Sales kit furnished. Match Corp., Dept. PS-34, Chicago 32, Illinois.

45 EDUCATIONAL & INSTRUCTION

PIANO Tuning Pays. Learn this profitable profession at home. Our Tonometer and mechanical aids make learning easy. No knowledge music necessary. Diploma granted. Largest and oldest school—51st year. G. I. Approved. Write for booklet. Niles Bryant School, 77 Bryant Bldg., Washington 16, D. C.

POPULAR SCIENCE OPPORTUNITIES

INCREDIBLE! Unprecedented! Look under "Personal"! Bijou, Box 1727-VX, Hollywood 28, California.

LEARN Piano Tuning, Repairing—at home in 30 days. Unlimited income. Phonograph recordings, tools and instructions furnished. Write Capitol City Tuning School, Department C-1033, 129 East Michigan, Lansing 16, Michigan.

USED Correspondence Courses and Books sold and rented. Money back guarantee. Catalog free. (Courses Bought.) Lee Mountain, Pisgah, Alabama.

HIGH School—No Classes. Study at home. Spare time. Diploma awarded. Write for Free catalog. HBA-17, Wayne School, 2527 N. Sheffield, Chicago 14, Ill.

WANT A Diesel Job? New Opportunities to increase income. Higher Pay. More Money. We can help you Qualify. Tools. Shop method home training. Write today! Diesel Tractor Heavy Equipment Division, Interstate Training Service, Dept. 2-K, Portland 13, Oregon.

BECOME a Doctor of Psychology or Metaphysics. Learn secret of contentment, happiness. Win degree of PsD. or MsD. Solve mental worries. Free book. College of Universal Truth, 5153-K N. Clark, Chicago.

MEDICAL Laboratory Technicians in great demand. We train you in your own home. Catalogue free. Imperial Technical Institute, Box 973-B, Austin, Texas.

DIE? Suffer? Look under "Personal"! Bijou, Box V6-1727, Hollywood 28, Calif.

BECOME AN Accountant. No previous bookkeeping experience required. We train you at home spare time. low cost. Ask for free booklet. "Accounting, the Profession That Pays." LaSalle Extension University, a correspondence institution, 417 South Dearborn Street, Department H116, Chicago 5, Illinois.

READING Courses and Books. "The Mysteries." Self-Unfoldment, Yoga, Metaphysical Philosophy, Theosophy. Catalog free. Jordan's, 1130 Keller Avenue, Louisville 13, Kentucky.

BOOKKEEPERS! Increase your earnings! Operate your own simplified "Dollar-A-Week" Bookkeeping and Tax Service. Full or spare time. Details Free. No obligation. Ellis, Box 203-K, Cedar Grove, N. C.

HYPNOTIZE! Free Picture Booklet describes fast, practical course. David Stewart, Dept. 52, Post Office, Malvern, Ontario, Canada.

YOU For President Of Your Own Credit-Collection Business. Many who answered our ads now have their names on office doors. Franklin Credit, Roanoke 7, Va.

WELDING training pays at Hobart Welding School, Box P-1022, Troy, Ohio. VA Contract. Best equipment. Catalog Free.

LEARN Drugless Healing in six Faith, divine. Suggestive lessons. Perfect Satisfaction or Money Refunded. \$1.00 gets particulars. \$4.00 gets first lesson plus "Old Indian Health Habits" that may help you live 100 years. William Cartier, 516½ Carlisle, Cincinnati 3, Ohio.

COMPLETE Your High School at home in spare time with 55-year-old school. Texts furnished. No classes. Diplomas. Information booklet free. American School, Dept. X746, Drexel at 58th, Chicago 37, Ill.

TIRED of no money, second rate jobs? Like to start a real career with a lifetime of high salaries? Write me about two growing fields that need men. Ed Howes, National Schools, Dept. 7102, 4000 S. Figueroa St., Los Angeles 37.

BARTENDING and management. American Bartending School, P-334 S. Wabash, Chicago, Illinois.

BARTENDER'S Guide 32 pages, 120 recipes \$1.50 Postpaid. Peerless Specialties, Phoenixville 1, Pa.

USED Correspondence Courses and Educational Books Bought, Sold, Rented. Catalog Free. Educational Exchange, Summerville, Georgia.

HYPNOTISM—Homestudy! Diploma! Hypnology Institute, 235 S. Brevard, Charlotte, North Carolina.

PHOTOGRAPHIC Memory developed quickly, easily. Amaze yourself and friends. Course \$2.00. Wm. Lovelady, Jr., 3859 No. Dorgenois, New Orleans, La.

BECOME a Tax Expert. Details for dime. Murphy, Box 2665-PS, Lakewood, O.

ESTIMATING Building Construction. Home study course. For full particulars write. Quantity-surveyor, 1016 Coolidge Drive, San Gabriel, California.

GET A Gov't Job! Start high as \$73.00 week. Thousands of secure positions available now. Experience usually unnecessary. Get Free 32-page Civil Service book showing jobs, salaries, requirements, sample tests. Write today: Franklin Institute, Dept. P-22, Rochester, New York.

CASH in on coming Income Tax boom. Become a Tax Expert. Earn \$50 and more daily preparing Tax Returns spare time. Experience unnecessary. Free particulars. Union Institute, Lakewood 3, New Jersey.

CURE screwdriver struggles. Detailed instructions 25c. Brush Mechanical Products, 381 N. McMillen St., Portland 12, Ore.

BOOKKEEPING—Teach yourself at home. Complete self-check course only \$9.95. Consultation privileges with Certified Public Accountant. If not delighted after ten day trial, money refunded. Or send \$5.00 in coin for special bookkeeping aptitude test including grading service. P. D. Lipscomb, 6609 Avondale Drive, Oklahoma City, Okla.

"HOW To Buy A Used Car." See Automobiles-Classified.

HYPNOTISM. Sample lesson Free! Write Baltimore School of Hypnotism, Dept. 210A, 4214 Belmar Avenue, Baltimore 6, Md.

46 CONTESTS

TIE-Breaker picture puzzles exposed. \$2.00. Wenograd, Box 1495, Philadelphia 5, Penna.

ONLY sure system, win unicorn tie-breakers, send stamped envelope. Box 1174, Chicago 90, Illinois.

HOW To Win Prize Contests. Booklet 50c. Columbia Mailers, Box 644, Springdale, Conn.

\$100,000—CONTESTS. Helpful Books; Services. Inquire. Contests, 13H Earl, Red Bank, New Jersey.

WIN Contest Money! National Contest Bulletin gives many tips. Lists Current Contests, Rules, Qualifier course, etc. Sample 25c. National Contests, 1211-PS Bryden, Columbus 5, Ohio.

47 DETECTIVES

DETECTIVE Training. Phillips Secret Service System, 1917-C North Kenneth, Chicago 39, Ill.

DETECTIVES—Work home—Travel. Experience unnecessary. Detective Particulars free. Write, Wagoner, P-125 West 86th, New York 24.

INVESTIGATE. Be our Associate, we train, Diplomas Awarded. Details 25c. Virginia Detective Agency, Hampton, Va.

48 LANGUAGE OUTFITS

LISTEN. Learn A Language by Linguaphone At Home, quickly, easily, master Spanish, French, German, Russian, Japanese—any of 29 languages through Natural Linguaphone Conversational Method. Add to service, job, travel opportunities. Send for Free book. Approved for Veterans' Training. Linguaphone Institute, 5410 Radio City, N.Y.C.

49 REWEAVING

\$5.00 HOUR possible, spare, full-time at home. Instructions shipped by recognized authority for no-risk examination. Men-women reweave burns, tears, moth-holes, like new. Free details. Skil-Weave 37A, Los Angeles 4.

50 BUSINESS SERVICE, INFORMATION, NAME LISTS

MAILING Lists. All kinds 1000 \$5.00. Dixie Service, King, N. Carolina.

REMEMBER Special Occasions. Send Dates. \$2.00 year. Reminders Service, Box 66, Sta. D, Toronto, Canada.

RAISE capital for any legitimate business. Explain your need. Tucker, 3633 Warder St., N.W., Washington 10, D. C.

LETTERS Retailed, forwarded, 25c. Rates, 20 view-cards, Texas tropical paradise, \$1.00. Johnson, Box 657, Rio Grande City, Texas.

51 SPECIAL SERVICES

ENGRAVED Metal Address, Returns Lost Articles. 50c Five \$2.00. Box 676, Springfield 1, Massachusetts.

ALASKAN remails—Fairbanks, Anchorage, Nome, Ft. Yukon. Your stamped letter remailed 50c. Use airmail. Arctic Remail Service, Box 254, College, Alaska.

WE can locate and purchase hard to get items. No item too difficult to procure. War surplus items at bargain prices. Write us for quick action. M. M. Maxwell Co., 422 N. Hart St., Chicago 22, Illinois. Dept. B102.

52 AUTHORS SERVICE

I Want New Writers to cash checks of \$1 to \$100 offered daily. The easiest way to write for pay. No previous experience necessary. Free Details. Saunders M. Cummings, 468-15 Independence Bldg., Colorado Springs, Colorado.

BEGINNING Writers: Let us show you How to get \$1 to \$20 checks in your daily mail doing simple spare time writing. Experience unnecessary. Details Free. W. Herwell, 7016 Euclid, Cleveland 3, Ohio.

53 ADVERTISING

ADVERTISE: 24 words, 100 Canadian Newspapers, \$5.50. Lists Free. Advertising Bureau, 10511-P Springfield, Chicago 43.

ATTENTION Swappers, Traders, \$3.00 puts your 30 word ad in "The Texas Trader", Rio Hondo, Texas.

LEARN Advertising by practicing in spare time. Amazingly simple, short-cut method. No tiresome textbooks. Send for Free Aptitude test. Dawson System, Box P-161, Lyndon, Kentucky.

54 CARTOONING, SIGN PAINTING, CHALK TALKS

"HOW To Make Money With Simple Cartoons"—A book everyone who likes to draw should have. It is free; no obligation. Simply address Cartoonists' Exchange, Dept. 1910-C, Pleasant Hill, Ohio.

LEARN Sign Painting at Home. Test Lesson Free. Ben Kerns, Box 812-PS, Greenville, South Carolina.

IF you can do simple, pen lettering you can make to \$4.50 per hour, spare time, operating our sensational, new service in your community. National Artists, 801-C North Marsalis, Dallas 3, Texas.

FREE copy. Cash buyers Galore! "Cartoonists' Market Letter", La Habra, Calif.

BE A Cartoonist! Talent not required. Learn easily at home. Complete course. Market Guide, \$1.00 Ppd. Kirk's Art Exchange, Dept. 11-D, 2821 Idalia, El Paso, Texas.

CHALK Talks, Laugh Producing Program, \$1.00, Illustrated Catalog 10c. Cartoonist Balda, Oshkosh, Wisconsin.

55 TYPEWRITERS & OFFICE MACHINES

TYPEWRITER \$22.50. Adders, Duplicators \$12.95. Meier's, 118 Spruce, Wichita 7, Kansas.

TYPEWRITERS. Printing Devices, Office Machines supplies appliances. Dixie Graph, King, N. Carolina.

TYPEWRITER Sale! Adding Machines! Save up to \$20—New Portables, reconditioned typewriters. Send 10c for catalogues. Apple, 993A Westchester Ave., New York 59, N.Y.

56 RUBBER STAMPS & OFFICE SUPPLIES

BETTER Stamps! 3 lines, \$1.00; Line, 40c. Catalogue. Johnson Press, Box 6-B, New York City 26.

57 PRINTING, MULTIGRAPHING, ETC.

PRINTING—Lowest prices. Free samples. Weeks, 342 Woodycrest, Nashville 11, Tenn.

POPULAR SCIENCE OPPORTUNITIES

DISTINCTIVE Printing, free samples, prices. McDonald, 545 North Oakland, Pasadena 4, California.

1000 **BUSINESS** Cards \$2.50 Prepaid samples Free. Reliable Print Shop, 907 East Jefferson, Louisville 6, Ky.

100 8½x11 **LETTERHEADS**, 4 lines, with 100 envelopes, \$2.00. Benneville Printing, Box 1931, Pittsburgh 30, Pa.

SPORTSMAN'S Personal Stationery—for Business, Hobby, Gifts. Features your name and favorite sport (hunting, fishing, golf, skiing, photography) cleverly, colorfully illustrated. Send 10c for samples, state choice of 2 hobbies. Hobbycraft Stationers, Box 475P, Auburn, N.Y.

1000 **GENESEE** Bristol Business Cards—7 lines \$3.25. William Anderson, Box 855P, Mountain Home, Tenn.

FINE Printing—Prompt service—Wide selection modern type styles, colors, cuts. Free samples, prices. Wilcox, Nicholls, Ga.

8½x11 **LETTERHEADS**, 1000—\$4.00. Convincing samples. D'Yarmett Service, Newark, Ohio.

125 8½x11 **LETTERHEADS** and 125 Envelopes \$2.00 Postpaid. 24 Hour service. Samples Free. Catalpa Press, 5519 N. Clark, Chicago 40, Illinois.

PROFESSIONAL Processed Embossed Letterheads, 1000, \$8.65. Envelopes, \$8.70. Noteheads, \$6.15. Plastic Craft Business Cards, \$4.75. Standard Specialties, Box 4382, San Francisco.

100 8½x11 **LETTERHEADS** \$1.00 Postpaid. Envelopes same. Race Printing, Hudson, New York.

1,000 **BUSINESS** Cards, \$2.35 postpaid! Other Printing! Dornfeld, Iron Ridge 24, Wisconsin.

BETTER Printing at lower prices! Try us first! Sutton Printing, Box 853-S, Waycross, Georgia.

1000 **THINPLATE** business cards \$3.95 prepaid. Box 134, Sta. "C," Atlanta, Ga.

1000 **EMBOSSSED** Business cards \$3.95 prepaid. Price list with order. Bernard P. Lefferman, 237 East 87th Street, New York 28, N. Y.

58 PRINTING OUTFITS, SUPPLIES

DO your own printing. Save money. Simple rules. We supply everything. Print for others; good profit. Raised printing like engraving, too. Have home shop. Details free. Kelsey Presses, V-8, Meriden, Conn.

MAKE your own, self-molding, rubber printing cuts. Plexirubber, Argyle 2, Wisc.

PRINTING Presses, Type Supplies, Lists 3c. Turnbaugh Service, Loysville, Penna.

PRESSES, Supplies, Paper catalog 10c. Custom, Box 211-S, Springfield, Missouri.

59 PATENT ATTORNEYS

INVENTORS: Without obligation, write for information explaining the steps you should take to secure a Patent. John N. Randolph, Registered Patent Attorney, 207 Columbian Bldg., Washington 1, D. C.

C. A. Snow & Co.—S-427, Snow Building, Washington 1, D. C. Registered Patent Attorneys. Write for information.

INVENTORS. For "Invention Record" form, contact Carl Miller, Registered Patent Attorney, Woolworth Building, New York.

INVENTORS: When you are satisfied that you have invented something of value write me, without obligation, for information as to what steps you should take to secure a Patent. Write Patrick D. Beavers, Registered Patent Atty., 938 Columbian Bldg., Washington 1, D. C.

"**INVENTOR'S** Guide" free. Frank B. Ledermann, Registered Patent Attorney, 154 Nassau Street, New York.

INVENTORS—If you believe you have an invention, we can make a preliminary search on your invention and advise you whether we think it can be patented. Send for copy of our Patent Booklet "How to Protect Your Invention" and "Invention Record" form. No obligation. McMorrow, Berman & Davidson, Registered Patent Attorneys, 143-X Victor Building, Washington 1, D. C.

INVENTORS—Send today for booklet "Patent Protection for Inventors" giving detailed patent information and preliminary steps to take toward patent protection.—also "Evidence of Invention" form. Victor J. Evans & Co., 741-L Merlin Building, Washington 6, D. C.

INVENTORS: Learn how to protect your invention. Special booklet "Patent Guide for the Inventor" containing detailed information concerning patent protection and procedure together with "Record of Invention" form will be promptly forwarded to you upon request—without obligation. We are registered to practice before the U.S. Patent Office and prepared to serve you in the handling of your patent matters. Clarence A. O'Brien & Harvey Jacobson, Registered Patent Attorneys, 22B-K District National Building, Washington, D.C.

PATENTS—Irving L. McCathran, 316 McLachlen Bldg., Washington 1, D. C. Registered Patent Attorney.

FREDERICK A. Zoda—Registered Patent Attorney, 202 Kellogg Building, Washington 4, D. C., offers services.

60 FOR INVENTORS

SEARCHES—Put your patent searches in the hands of a Registered Patent Attorney or Agent, as he qualifies to give a worthwhile patentability report. Record of Invention form upon request and information on patent protection. Patrick D. Beavers, Registered Patent Attorney, 939 Columbian Bldg., Washington 1, D. C.

INVENTORS. For "Invention Record" form, contact Carl Miller, Registered Patent Attorney, Woolworth Building, N. Y.

INVENTORS: Without obligation, write for information explaining the steps you should take to secure a Patent on your invention. John N. Randolph, Registered Patent Attorney, 206 Columbian Bldg., Washington 1, D. C.

INVENTORS: If you have an invention for sale, patented or unpatented, write Institute of American Inventors, Dept. 30A, 631-E St., N.W., Washington 6, D. C.

INVENTORS! For "Copyright, Design & Patent Guide" contact Mr. Metzler, 11 West 42nd, New York 18.

INVENTIONS Sold—hundreds of manufacturers need ideas, patented or unpatented, list free. Invention Bureau, 208-S Clinton, Oak Park, Illinois.

INVENTORS—We want to manufacture patented items made of cardboard or paperboard. Royalty basis. Write Box 1291, Dallas, Texas.

INVENTORS—If you believe you have an invention, we can make a preliminary search on your invention and advise you whether we think it can be patented. Send for copy of our Patent Booklet "How to Protect Your Invention" and "Invention Record" form. No obligation. McMorrow, Berman & Davidson, Registered Patent Attorneys, 143-W Victor Building, Washington 1, D. C.

PATENT searches \$5.00, including patent copies. 48 Hour Airmail service. "Record of Invention" free. Same careful, reliable searches conducted for patent attorneys. Capitol Patent Service, Box 664-S, Washington 4, D.C.

INVENTIONS Promoted, Patented or Unpatented. Established 1911. Write Adam Fisher Company, 183 Enright, St. Louis, Mo.

INVENTORS: Learn how to protect your invention. Special booklet "Patent Guide for the Inventor" containing detailed information concerning patent protection and procedure together with "Record of Invention" form will be promptly forwarded to you upon request—without obligation. We are registered to practice before the U.S. Patent Office and prepared to serve you in the handling of your patent matters. Clarence A. O'Brien & Harvey Jacobson, Registered Patent Attorneys, 22A-K District National Building, Washington, D.C.

INVENTORS Sell your invention direct to manufacturers. Without obligation write National Patent Sales Co., Dept. L, Box 370, Richmond, Virginia.

"**INVENTOR'S** Guide" free. Frank B. Ledermann, Registered Patent Attorney, 154 Nassau Street, New York.

PATENT Searches, \$5.00, including patent copies. Same reliable search as conducted for patent attorneys. Free protection forms, 48 hour service. Patent Service Institute, 945-B Pennsylvania Avenue, Washington 4, D. C.

INVENTORS: Be more certain of a market for your inventions. Get our latest survey, What's Needed, describing 200 wanted inventions, for \$1.00. Taren Invention Service, 6060 Sunset Boulevard, Hollywood 28, California.

PATENT Searches \$5.00. 48-hour service. Patent Applications and Drawings prepared. Record of Invention forms free. Write Miss Ann Hastings, P.O. Box 176, Washington 4, D.C.

SPECIAL Machine Parts, Plastics, Dies, Jigs, Tools; Free Estimate. Immediate Delivery. Harry Smith Specialties, Box 9378, E. Akron, Ohio.

JOIN The National Inventors Institute, 5511 Euclid Ave. Cleveland 3, Ohio. Only \$5 per year. Write for free literature.

INVENTORS—If you consider your invention to be something of importance, take steps to protect it with a United States Patent which gives you the right to exclude others from making, using and selling your invention as claimed. "Patent Protection for Inventors" outlines steps to take to secure patent protection. Mailed promptly without obligation. Victor J. Evans & Co., Merlin M. Evans, Registered Patent Attorney, 742-L, Merlin Building, Washington 6, D. C.

61 INVENTIONS WANTED

INVENTIONS Promoted, Patented or Unpatented. Established 1911. Write Adam Fisher Company, 183 Enright, St. Louis, Mo.

INVENTORS: Hundreds of manufacturers have requested our assistance in locating marketable new products. Complete information, free. Institute of American Inventors, Dept. 30C, 631-E Street, N.W., Washington 4, D. C.

MARKETING Aid—Nation Wide. Patented, patent pending. Booklet free. Market Contacts, 719-B2, Magnolia, Tupelo, Mississippi.

PROTECT and sell your inventions. Details of our unique 4-point program and list of needed inventions free. Inventors Sales, 208T Clinton, Oak Park, Illinois.

INVENTIONS Wanted. Patented or Patent Pending. 21 years experience Promoting Inventions. National Service Bureau, 3122 Meramec, St. Louis 18, Mo.

INVENTIONS wanted. Patented; unpatented. Tremendous Manufacturers lists. Global Marketing Service, 1404 Mitchell, Oakland 1, Calif.

INVENTIONS Wanted. Patented, Pending only. Inventors Patent Exchange, Hartford 1, Conn.

64 MODELS, MODEL SUPPLIES

SHIP and Yacht model fittings: blueprints. Send 25c for illustrated catalog No. 27—Listing hundreds of items. A. J. Fisher, 1002-2 Etowah, Royal Oak, Mich.

SHIP Model and yacht supplies, complete large 64 page catalogue, 30c. Wm. Wild, 510 E. 11th St., New York City.

LIONEL, American Flyer, HO Trains, and accessories at sensational discounts from nation's largest train stock. Send 25c for catalogue. Northern Hardware Company, Broad & Rockland Streets, Philadelphia, Pa.

STAGECOACH surrey, horses, 20 kits. Folders 10c. Sample buckboard \$1.00. Tontz' Country Store, Elsinore 9, Calif.

TOYS, Electric trains, model airplanes, boats, race cars, beads, sequins, model and hobby supplies, send 10c for catalog. Northeast Toy And Hobby Center, 4825 Independence Ave., Kansas City, Missouri.

POWER Models. Unusual steam, gasoline and traction engines. Metals, tools, accessories. Catalog 50c. Charles Cole, Ventura, Calif.

POPULAR SCIENCE OPPORTUNITIES

LIONEL or American Flyer Catalog 20c. Shannon's, 505-S Franklin, Nutley 10, N.J.

BUILD miniature homes with our accurately-scaled materials. Send 25c for booklet and samples. Architectural Model Materials Inc., Dept. S102, 4208 Armitage Avenue, Chicago 39.

STEAM engines, boilers, castings. Catalog 25c. Anton Bohaboy, 2297 Price, Rahway, New Jersey.

WORLD'S Finest Illustrated Catalog-Handbooks. Railroads 84 pages 35c. Airplanes, Boats, Crafts, Hobbies, Tools 60 pages 25c. No Stamps. Print Name, E and H Model Hobbies, Room 80, 130 W. Chelton Avenue, Philadelphia 44.

1952-53 LIONEL, American Flyer Catalog illustrated. Trains, accessories from America's largest stock. Building, operating, track layout ideas. New! Different! Send 50c Today (money refunded with purchase). Hobby House Inc., Dept. AX, 800 Huron, Cleveland 15, Ohio.

MODEL railroaders—New live steam catalogue, 3/4, 1 inch and 1 1/2 inch scale rough casting and working blueprints. Write 88A High Street, Danvers, Mass. Catalogue is 25c.

65 HOME CRAFTSMAN

LEATHER tools, lacing, supplies. Free Catalog. National Handicraft, 199 William St., New York 7.

OUR biggest Leather and Craft Catalog yet! 1000's of items. Send 25c (refunded with 1st order). Russo Handicraft Supplies, Dept. 101, 245 S. Spring, Los Angeles, California.

90 ALL new, full size lawn ornament and novelty patterns, up to 20" high. Only \$1.00. Mastercraft 102S, 7041 Olcott, Chicago 31, Illinois.

"PRACTICAL Painting, Wood Finishing" shows how to get professional results. Furniture finishing, workshop projects, home decorating. Complete Modern brush and spray methods. Tricks you've never seen. Write Home Craftsman, 115-F Worth St., N Y. 13.

LEATHERCRAFT, Copper Tooling, Textile Painting, Beadcraft, Shellcraft. Many other crafts. Big Free catalog shows everything you need. Kit Kraft, 7373 Melrose, Hollywood 46, Calif.

VIOLINMAKERS. Amateurs. Professionals. Fine tone European wood, materials, supplies, instructions. Tools. Patterns. Illustrated catalogue 10c, refunded. Premier Violin Supplies, Dept. VPS, 430 South Broadway, Los Angeles 13, California.

ATOMIC Saw. Fits 1/4" drill motor. 6" blade cuts 2x4 without turning. Information. Willard's, Canoga Park 102, California.

LEATHERCRAFT. New Stylecraft folder Free. New Kits illustrated. Filigree Belts, Billfolds, Purses, etc. Send 25c new catalog. Refunded first order. Apache Leather Co., 2804 East Washington St., Phoenix, Arizona.

WILD Animals! Ancient Locomotives! Six-foot Train! 34 quality Jigsaw Wall Patterns. 50c! Pauls Plans, 2233A N. 35th, Milwaukee 8, Wisconsin.

100 FULL size Jig Saw patterns up to 20" high, only \$1.00. Pattern Service, Medway 8, Mass.

JIGSAW Owners attention! Start earning money at home cutting out wooden novelties and souvenirs. Write H. Cook, Dept. C, 4407 S. Normal Ave., Chicago 9, Illinois.

LEATHERCRAFT For Pleasure or Profit. Make easy-to-assemble purses, belts, gloves, wooskin toys, 100 other items for gifts or to sell. Send 10c today for big catalog. Largest Leathercraft stock in U.S. J. C. Larson Co., 820 S. Tripp, Dept. 2554, Chicago 24.

89 FULL size Jig Saw patterns of beautiful shelves, ornaments, toys, novelties. Plus "How, Where to Sell." Only \$1.00. Mastercraft 104S, 7041 Olcott, Chicago 31, Ill.

KNOCKDOWN Cedar Chest, Lumber and Veneers. Free Price List. Giles Co., Brownsboro, Alabama.

LEATHER Grab Bag! Direct from tannery. Chock full of beautiful pieces, all sizes, colors. Have fun, earn money making coin purses, key cases, dozens of other useful items for gifts or sale. Amazing Value only \$1. No C.O.D.'s. Moneyback Guarantee. Dept. 15, Tannery Outlet, 145 South St., 3rd Floor, Boston, Mass.

93 "ORIGINAL Idea" Jig Saw patterns \$1.00. Professional drawing, quality printing. Full size shelves, toys, lawn ornaments, novelties. Walker Studio, PS10, 4343 Lindell, St. Louis 8, Mo.

TOOLING Copper. Free Instructions, Flock, Tools, Finishes. Bestcraft, 949 Kenwood, Inglewood, Calif.

FLORIDA Cypress Knees make beautiful lamps. Particulars, photos 25c. Craft-Mart, 316-P West Oakwood, Bucyrus, Ohio.

WAX, Candles, formulae, write for prices. American Wax & Supply Co., 2422 Hutchinson, Chicago 18, Illinois.

LEATHERCRAFT Tools, Lacings, H. Byrd, 3406 Montrose Avenue, Richmond, Va.

PLANS for remote control non-electronic relay to operate your automatic garage door from your car. \$2.00 cash, M.O. J. Saliger, Box 2776, Hollywood 28, Calif.

SQUAREKNOTTERS: Make belts, handbags, lanyards, dog leashes, etc. Special offer! Beginner's book, catalog and quality cord samples 15c. P. C. Herwig Co., Dept. P41, 121 Sands St., Brooklyn 1, New York.

LEATHERCRAFT Tools, Leather Embossing Plates, Craft Accessories, Dies. Catalogue 10c. Louis Jones Engineering Company, 1613 Main, Fort Worth, Texas.

LEATHERCRAFTERS: Big illustrated catalog of materials, tools, kits, 10c. Art's Leather, 411 Joseph Ave., Rochester 5, New York.

BUILD artificial fireplace logs. Action unit gives effect of real flames. Make into Christmas displays, homes, clubs. Instructions and action unit (less Bulb), \$2.00. Stewart, Box 31, Indianapolis, Indiana.

TRY Leathercraft. It's new. It's easy. It's educational. Make your own belts, billfolds, purses, hats, dresses, blouses, from durable low-priced leathers. Free Catalog tells how. Tandy Leather, Box 397-D, Tulsa, Oklahoma.

ANYONE can make professional repairs on plastic dental plates. Complete kit makes many repairs. \$2.49. Arrow Laboratory, East Rockaway, New York.

TOY patterns, educational, action, unusual. Folder 10c refunded first order. Donart, 1535 North 23rd, Melrose, Park, Ill.

TURN Workshop Into Cash. Send Dime for new 32-page catalog describing hundreds of things to make for fun, profit. Craftplans, 1321-B South Michigan, Chicago 5.

66 BUILD IT YOURSELF

BUILD Your Own "Tractor". Free information. Eltraco D-5, Camptonville, Calif.

SEND for big, new 1952 illustrated catalog that will show you how to turn your spare time into cash—making quick-selling, highly profitable lamps. Every home a prospect. Hundreds doing it—you can, too. No experience or special tools required. Catalog No. 7 contains 56 pages filled with shades, shade frames, figurines and bases, oil lamp converters, boring compound, and dozens of similar items. Also all kinds of sockets, cords, pipes, harps, finials, bases, and hundreds of other parts—everything you need. Special 8-page section shows 6 beautiful lamps in kit form—ready to assemble. You buy wholesale, sell at retail—make Big profits. Send 25c today for new 1952 catalog and wholesale price list—you'll be glad you did. The 25c will be refunded on your first order. Gearon Co., Dept. 500-A10, 28 S. Desplaines, Chicago 6, Ill.

GRANDFATHER Clock shop-tested plans dollar. Thousands built. Kuempel Clocks, Minneapolis 16.

BUILD your own power tools, save 90%. handbook 25c. Robert Fellows, Caledonia 4, New York.

STREAMLINED. Built-in kitchen cabinets fit any kitchen. Illustrated manual describes designing and construction. All for \$1.00. Thombert Company, Newton 11, Iowa.

BUILD Inexpensive fast production. Concrete Block Machine. Motor or hand. Write, Clyde Lee, Mountain View 1, Okla.

NEED Extra money? Make wishing wells. see Business Opportunities column.

BUILD with Concrete, Fieldstone, Earth. Movable Form System cuts costs. Construction simplified. Free literature. Smith PS, Box 36, Eagle Creek, Oregon.

"CONCRETE Block Homes." 32-page booklet, on how to build. \$1.00. H. C. Lightfoot, Civil Engineer, Richboro, Penn.

CHRISTMAS presents—make your own—60 Patterns, toys, furniture, shelves, novelties, plus 88 page Hobby Book, \$1.00. Crafters of Pine Dunes, Oostburg 9, Wisc.

A beautiful, expandable masonry Rancho. 2 bedrooms, Florida dining room; paneled fireplace wall. Complete plans \$12.00 the set. Cash, money order only. C. A. Brister, Designer, 231 West Howry, DeLand, Fla.

POWER Mowers—Tremendous Direct-from-factory savings. Free literature on build-it-yourself parts or complete mowers, including self-propelled rotary models. B-M Mower Company, Box 66P, Blue Mound, Kansas.

SAVE with Monarch mower kits. Write for prices. Monarch, 2008 South Holbrook Street, Ft. Scott, Kansas.

AUTOMATIC switch for your turn signals, drawings, instructions 50c. Armstrong, Box 4001, Northeastern Station, Dearborn, Michigan.

FREE handbook, build sawmills, block machines, freezers, tractors, scooters. Nichols Company, Purvis 3, Mississippi.

FASCINATING Geological Geiger Counter. Easy Instructions \$1.00. Technicraft, Box 1166, Boston 3.

BARGAIN Package—Jr. and adult full-size furniture patterns—\$2.50 value for \$1.00. Tom Tot Furniture, Box 741, Helena, Montana.

67 OLD GOLD, JEWELRY, WATCHES, ETC.

HIGHEST Cash Paid For Old, Broken Jewelry, Gold Teeth, Watches, Silverware, Diamonds, Spectacles, Platinum. Free information. Satisfaction Guaranteed. Rose Smelting Company, 29-Y East Madison, Chicago.

JEWELRY making. Send 20c for illustrated catalog. Milady-Fair Co., G.P.O. 1328, New York City 1.

RHINESTONES, jewelry settings, cameos, sequins, beads. Send 10c for Illustrated Catalog. J & M Novelties, Dept. CL-4, Griffith, Indiana.

WATCHES. Elgin, Waltham, Other Outstanding brands. Expertly reconditioned, priced low for quick, great profits! Send for Free catalog. Plymouth Jewelry, 163-P Canal St., New York 13, New York.

HIGHEST Prices paid for old gold, silver, platinum, diamonds, watches, gold teeth, spectacles. Cash immediately. Goods returned if offer unsatisfactory. United Smelting Works, (The Old Reliable), 39-A South State, Chicago 3.

OLD Gold Wanted. Highest prices paid on old or broken watches, diamonds, spectacle frames, dental gold and platinum. Cash by return mail. Information free on request. Alamo Watch Company, Second Floor, Melrose Building, Houston 2, Texas.

5000 JEWELRY styles, you can easily make yourself—Pins, Earrings, Bracelets, Rings, matched ensembles. Instructions and catalog 10c. Barrys, 126 Ardsley Court, Newark, N. J.

68 TOBACCO & PIPES

CIGARS—Clear Havana, Handmade. Save \$2.00! \$5.50 for fifty postpaid. Regularly 15c. Check or M.O. C.O.D. (you pay charges). Seco Cigars, Rochelle Park 1, N. J.

PIPE Smokers Blend private aromatic tobaccos, information free. Cozza Phara-cist (2), Pequannock, New Jersey.

POPULAR SCIENCE OPPORTUNITIES

CIGARETTES—Roll 200 guaranteed to please for 75c. Particulars free. Pete Moberly, Box 865, Owensboro, Kentucky.

69 FOR THE HOME

PHOTOMURALS for you by mail. Write for details. Photographic Library, RCS Studios, 123 North Wacker Drive, Chicago 6.

"TRUE-TO" 1952 Election Souvenir Scroll of Eisenhower, MacArthur or Truman, also snappy Truman Song (autographed) Sheet Music 50c! Write: "True-To" Souvenir, 1326 R. E. Lee St., Mobile, Alabama.

CHRISTMAS Candles 12 inch. Any color, 12 for \$1.00 postpaid. American Wax & Supply Co., 2422 Hutchinson, Chicago C18.

70 OF INTEREST TO WOMEN

DRESSES 24c; shoes 39c; men's suits \$4.95; trousers \$1.20. Better used clothing. Free cat. Transworld, 164-AF Christopher, Brooklyn 12, New York.

71 FOR SALE MISCELLANEOUS

NOISE. New ear filter stops loud noises passes ordinary sounds. Protect your hearing, increase efficiency, comfort while working. Not hearing aid, ear-plug. Free details. Anza Co., 3560B 20th St., San Francisco 10, Calif.

100,000 ITEMS Wholesale Sources. Directory 25c. Refundable. Flatwoods, Leesburg, Florida.

HAWAIIAN Shells—50 Assorted for \$1.00. Alwin, Puhi, Kauai, Hawaii.

72 WANTED MISCELLANEOUS

SCRAP Mercury (Quicksilver) Tantalum—Bismuth—Tungsten, Metallurgical Products Co., Established 1909, 35th & Moore Sts., Philadelphia 45, Pa.

WE buy used plating equipment. Send description. Hollywood Bronze Supply, Dept. RR, 1624 East First Street, Los Angeles 33, Calif.

74 RAZOR BLADES, SHAVERS

1000 CLEAN, smooth Shaves from one blade! Sensational new stropper, hones, strops, and automatically turns blade on genuine pigskin strop. Keenly sharpens any make single or double edge blade quickly, easily, safely. Guaranteed! \$2.95 postpaid, or send for Free details. Rowan's, 2351 Linden Avenue, South Plainfield 7, N.J.

75 TATTOOING SUPPLIES

TATTOOING Outfits, Supplies. Illustrated List 25c. Zeiss, 728 Lesley, Rockford, Illinois.

76 DRAWING, SUPPLIES & EQUIPMENT

DRAFTING and artists' materials catalog—thousands of items—25c (deductible first \$2 order). Gordon's, 219 Madison, Chicago.

77 TREASURE FINDERS

TREASURE Hunters! New 11-pound featherweight Model 101 locator for gold, silver and minerals. Money-back guarantee best available. Also Geiger Counters for uranium prospectors. Complete information free. The Goldak Company, 1540 W. Glenoaks Blvd., Glendale 1, Calif.

WHERE to Search for Buried Treasures (Maps—Pictures). Only \$2. Treasure Press, Dept. P, Crown Point, Indiana.

SELECTIVE metal and mineral detector. Revolutionary design. Distinguishes metals from black magnetic sands. Readily detects metals under salt water. Free literature. Gardiner Electronics Company, Department 22, 2018 N. Dayton, Phoenix, Arizona.

TREASURE—M-Scope Geiger Counters—Mineral Locators. Why buy something inferior when you can buy the best at a lower price? Backed by years of experience. Fully guaranteed by factory. Detects minerals, metals, gold, silver, coins. Payment plan available. Proven superior performance. Free 16 page illustrated booklet. Fisher Research Lab., Inc., Palo Alto, Calif.

GOLD, Silver, Metal Detectors, Geiger Counters for Uranium, Mineralights. Sensational new fully guaranteed models. None Finer. Information Free. Detectron Co., 5631 Cahuenga Blvd., North Hollywood, California.

78 WATCH REPAIRING

WATCHMAKERS'—jewelers' tools. Free instructions, catalog. Bengal Company, Culver City, Calif.

"THE Modern Clock." All about clock repair, 502 pages, 173 illustrations. \$4.95, postpaid, 10-day return privilege. North American, Dept. 22K, 2018 North Ave., Chicago 47, Illinois.

WATCHMAKERS Tools, Materials, Supplies, Repairs, Catalog. Gales, Box 1000, Chicago 90, Illinois.

5 ELGIN, Waltham, Illinois, Hampden Gents' wristwatches needing minor repairs, \$18.00. Write for prices. B. Lowe, Holland Bldg., St. Louis 1, Mo.

WATCHES overhauled \$4.50—Guaranteed; free watch catalog. Berkowitz, 1150 Castlehill, New York 61.

CUCKOO Clocks, Sell, Swap, Repair. "Beach's Hobby", 205 S.E. 16th, Portland 14, Oregon.

79 MISCELLANEOUS

RECEIVE mammoth mails, magazines, catalogs! Three months 25c, year 50c. Waddell's Directory, 341-D East 76th, New York 21.

BIG interesting mails three months 25c, year \$1.00. Harvey Teeple, Decatur, Ind.

TOYS—Special Discounts—Free Catalog. Kiddieland, Box 115-B, Hollis 23, N. Y.

MEN-Young Men. Does a carefree life of travel to foreign places, adventure and high income interest you? It will pay you to investigate. No experience necessary. For further information write to J. Frederick Whiting, 265 West 23 Street, New York 11.

YOUR name and address on twelve pencils. One Dollar. Special prices to schools, etc. Russell Savage, 6814 Pineway, Hyattsville, Maryland.

LUMINOUS Paint—glows in the dark. Sky blue, yellow, green, green-blue. Indoor and outdoor. Waterproof. Weather-proof. 2 oz. jar \$1.00 postpaid. Nite Glo, Box 490, New Haven 11, Connecticut.

ADULT Novelties. Asst. \$5.00 express. Tuplers, 1305 Wilson, Chicago, Illinois.

LEATHERCRAFT. Everything needed by beginners, advanced hobbyists and professional leatherworkers. Largest stock of supplies in U. S. Moderate-priced tooling leathers, top quality calfskins, tools, supplies, kits. Send 10c for Big Catalog. J. C. Larson Co., 820 S. Tripp, Dept. 2555, Chicago 24, Illinois.

YOUR Leather Jacket renovated expertly. Free circular, Berlew Mfg. Co., Dept. 7, Freeport, N. Y.

PANNING Gold lesson—Catalogue Beginners supplies, Mining Books, Maps, "Where To Go" Free. Old Prospector, Box 792D2, Lodi, Calif.

IMPORTED Coin purse-wallet-keyring. Genuine leather. Perfect gift for a busy lady. Money, keys altogether. Easy to find in her purse. Red, black, brown, green with gold design. Only \$3.00 tax included. No C.O.D. Jocar, Box 1258, South Bend, Indiana.

RETHREAD bolts, Instructions \$1.00. George Stade, Finlayson Avenue, Victoria, B. C.

MAKE, Sell Artificial Flowers, Corsages, Chenille Dolls, Jewelry, Starting kits, Fibre, Leaves, Shellcraft, Rhinestones, Sequins, Findings, Wholesale Catalog 10c. Profitkrafts, 4508T217 Lorain Ave., Cleveland 2, Ohio.

OUTDOOR Toilets, -Cesspools, Septic Tanks cleaned, deodorized with amazing Paw Paw Odorless. Tried and proved effective by over 150,000 worldwide customers. Easy, safe, economical to use. Saves digging, pumping. Satisfaction guaranteed or money back. Postcard brings Free details. Burson Laboratories, Dept. E-59, Chicago 22, Illinois.

BUY vitamins direct. Amazing savings. Catalog free. Matoska, White Bear Lake, Minn.

SLEEK Black Metal Telephone Stand—A basic household need! Portable—always handy. 20" high. Clamps standard 5 1/4" x 7 1/2" phone. Holds directory. Wonderful Christmas gift! Send only \$4.95 each (postpaid). Money-back guarantee. Dept. P2, American Craftsmen's Guild, Box 5511, Cleveland, Ohio.

(PLASTIC Card Schuffler) Schufflers one to three Decks. Mail one Dollar—Post Office Box 665, Wheeling, West Virginia.

80 PERSONAL

DIE? Suffer? Ridiculous! Unique, thrilling book presents latest wonder drugs, miracle cures, lifesaving knowledge! Free Literature! Bijou, Box V6-1727, Hollywood 28, Calif.

CONFIDENTIAL information for single people, leading to happiness—romance. Write today! Karl Miles, Ph.D., Director, Personal Acquaintance Service, Inc., 601-G South Vermont, Los Angeles 5, Calif.

DETECTIVE'S Opportunities. Detective Particulars free. Write, Wagoner, P-125 West 86th, New York 24.

PSORIASIS Victims: Hopeless? New Discovery! Free Trial offer. Write Pixacol, Box 7097-S, Cleveland, Ohio.

MEXICAN Legal Practice Reliably Conducted. Box 1736, El Paso, Texas.

INCREDIBLE! Unprecedented! Become mental superman overnight! Floor everybody! No studying! "Memoprop" does your thinking! It's uncanny! Revolutionary! Free Literature! Bijou, Box 1727-VX, Hollywood 28, Calif.

JOIN National Guild Hypnotists. Details. Hypnodiscs etc. 10c. Guild, 48B Harlem, Dorchester 21, Massachusetts.

"HOW Can I Find Out?" You Can! Information confidentially developed. Any matter, person, problem. World-wide. Officially licensed. Established 1922. William Herman, 170 Broadway, New York.

ANCIENT Secrets, amazing Mastry Lessons \$1.09. Hinkle Publishers, Dayton, Va.

NEED Gifts? Attractive. Samples 30c. Literature free. Schollmeyer, Box 48, Brooklyn 25, New York.

SKINNY? Amazing bodyweight gains reported! Proven method builds muscle fast! Details. Cambria, Box 26-B, Cambria Heights 11, New York.

SCALP troubles? Avoid baldness. Free details. S. Viggiano, 6556 Ladson, Pittsburgh 6, Penna.

LETTERS remailed 25c. Also private receiving address. Monthly rates. Shanks, Box 3110-G, San Francisco 19, Calif.

BORROW by mail. Loans \$50 to \$600 to employed men and women. Easy, quick. Completely confidential. No endorsers. Repay in convenient monthly payments. Details free in plain envelope. Give occupation. State Finance Co., 323 Securities Bldg., Dept. S-14, Omaha 2, Nebraska.

"INTERESTING Mails"—25c keeps your mail box full three months. Bentz, Desk-H/46, Chatawa, Mississippi.

SURPRISE friends! Pretend visiting California. Scenic cards, with your name, mailed to 5 friends, \$1.00. Ray Lago, 476 Lombard, San Francisco, Calif.

MEXICAN Law, General Practice Attorney, 1203 Arizona Street, El Paso, Texas.

LETTERS remailed, 25c. H. W. Osborne, 525 1/2 La Poblana Rd., Albuquerque, New Mexico.

INFORMATION for single people by Human Relations Consultant, Dr. B. Long, Box 375, Los Angeles 53, Calif.

"HOW To Buy A Used Car." See Automobiles-Classified.

FILES! Tormented with the irritation and discomfort due to files? Write for free important information. Mutal Products, Box 836-P, Cleveland 22, Ohio.

HAPPINESS, Romance, Contentment. Interesting, confidential information sent Free to single persons. Write today. Strone, 2488-PS Concourse, New York 58.

IT'S SO EASY WITH

**AND ONLY
\$1.00
PER CAR!**



Clean the chrome on your car—give it a lasting coat of protection in a jiffy! Chrome-Gard dries crystal clear, adheres indefinitely. Kit includes rust dissolver. All for \$1 at your dealer's or send to Dept. S for prepaid delivery.

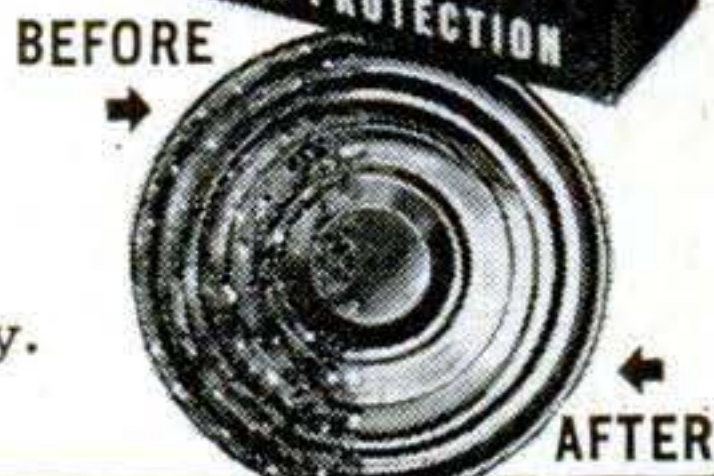

Sales Territories Available

LIQUID GLAZE, INC.
Lansing 6, Michigan

PORTABLE GARAGE

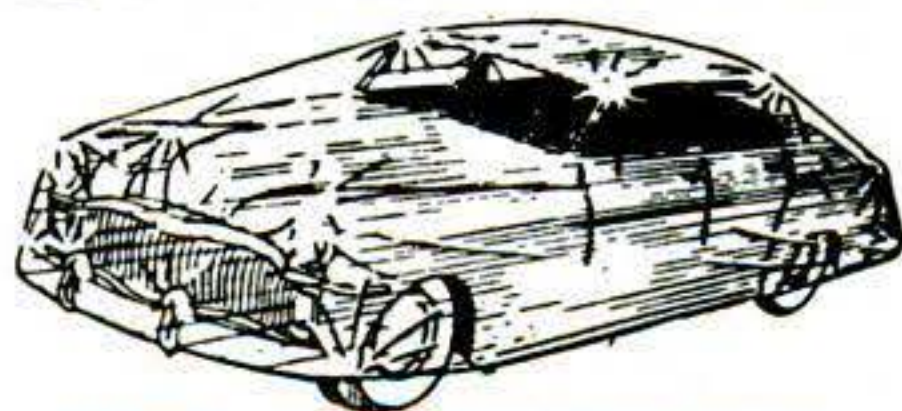

\$6.75

VINYL PLASTIC

USE IT ANYWHERE!

- Goes wherever your car goes • Folds compactly • Keeps rain, snow, dust, salt air, sun or sleet away • Protects your car's finish
- Durably constructed of vinyl plastic that is long wearing and tough • Nylon threads for extra security • Spring-tite, elasticized bottom, holds securely in all kinds of weather • Fits all makes and models • Direct from manufacturer • Enclose check or money order for \$6.75, or sent C.O.D.

10-Day Money Back Guarantee

MARDO SALES CORP.

480 Lexington Ave., Dept. G-658 New York 17, N.Y.

**USE LUBRIPLATE
ON CATCHES AND HINGES
TO CHASE THE SQUEAKS
THE GREASEMAN MISSES**



TRY LUBRIPLATE! It's a new, white and clean, semi-fluid lubricant that stays put. Stops squeaks, prevents rust and corrosion. Works wonders on your car and around your home.

- In handy 35¢ and 95¢ tubes at hardware and auto supply stores.
- Dealers write to LUBRIPLATE DIVISION, Fiske Bros. Refining Co., Newark 5, N.J.

LUBRIPLATE
THE MODERN LUBRICANT

**HOW HOMER DEVILLE of NEW YORK
EARNED \$6,000.00 last year**



**Demonstrating STARK BRO'S
NEW PLAN FOR
Beautifying Homes**



Here's your Money-Making magic! Homer Deville of N. Y. made OVER \$6,000.00 LAST YEAR! B.J. Gilson earned over \$236.83 in just 5 days! Many other exceptional earnings records! These men followed the sensational Stark Bro's Money-Making Plan. Call on home owners and others with demonstration of new Home Beautifying, Value Boosting Plan. Every home in America your prospect for large, profitable Stark orders. Added income taking orders for World-Famous Stark Bro's Patented and Trade-Marked Fruit Trees. No experience needed to earn from very first day. Everything, including Giant new Demonstration Sales Outfit ... given FREE. Rush name, address now!



**FREE
Giant
SALES
KIT**
send name

**STARK BRO'S • Box 2903
Town of Louisiana, Missouri**

French STYLE DUELING SWORDS

**SET \$2.98
OF TWO post paid**

Once used in deadly combat—now an exciting sport! Learn right at home. Fun—safe—educational. These swords are made of fine blue spring steel, polished metal

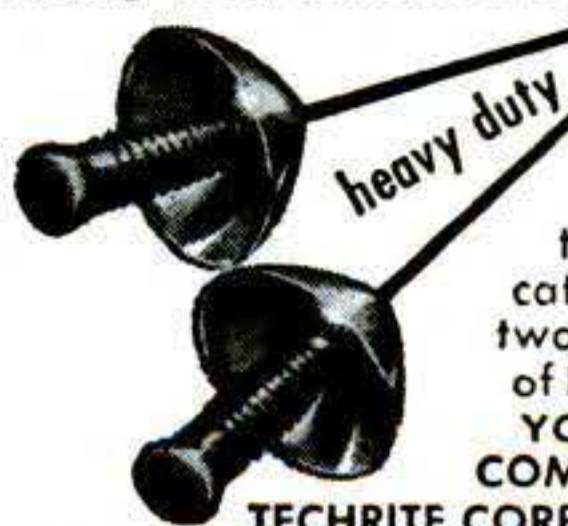

guards, turned handles, rubber safety tips. Fencing teaches quick thinking, develops coordination, posture. Since the Middle Ages, Europeans have enjoyed the sport of dueling. Now advocated by U.S. colleges. Set includes two swords and the booklet, "The Art of Fencing". Special mail order price. **YOUR MONEY REFUNDED IF NOT COMPLETELY SATISFIED** Send \$2.98 to

TECHRITE CORP., Box 12 T, South Pasadena, Calif

"SURE SHOT GUN CASE TREATMENT"

*A new proven chemical process that prevents
RUST ON GUNS*

It's radically different. The case is treated instead of the gun. This odorless chemical vaporizes slowly. The vapor seeks out and attaches itself as an invisible rust preventing film, to all metal gun parts, including the action and bore. Protection is complete. A \$1.00 2 fl. oz. bottle treats one gun case for one year. Money back guarantee. At your dealer or direct from—



**BAYPORT CHEMICAL COMPANY, DEPT. 25
LINDEN HILLS STATION, MINNEAPOLIS 10, MINN.**

HYDROPONICS

**BIG
FREE
Illustrated Book**



Fascinating Hobby! • Profitable Business!

You can grow vegetables, flowers or rare plants WITHOUT SOIL (Hydroponics) every day of the year. Learn the fast, clean, pleasant way to grow any plant indoors or out. No experience needed. Realize BIG RETURNS from a limited space. Amazing opportunity for real profits. Send postcard today for free picture book showing how others from every state are succeeding in this wide open field. Act now! Send for complete facts today.

CHAS. GILBERT CO., Box 22-S, San Diego 6, Calif.

**DRIVING COMFORT at its best!
The New ELECTRIC THROTTLE
With Foot Control**

The electric throttle ("Speed-selector") sets whatever speed you choose electrically—releases instantly at a touch on the toe-button, or by applying foot brake. Banish foot and back strain for good! Install it yourself. Price \$17.50. F. O. B. Check or C.O.D. Ten day money-back guarantee. Several state franchises open. Dealer inquiries invited. Give car make, and year.

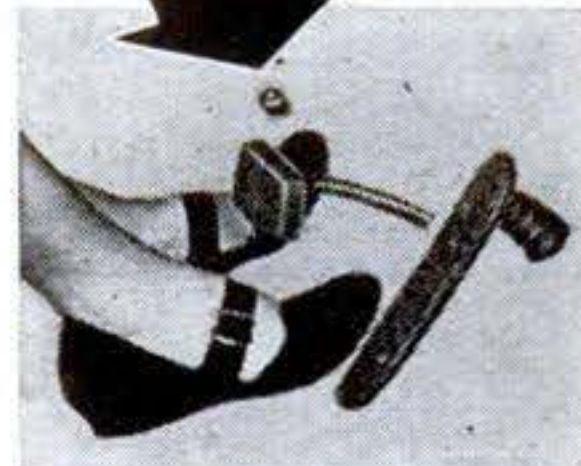

WRITE FOR DETAILS
D & M MFG. CORP., Anderson, Ind.

STOP ANNOYING NOISES AND WASTING WATER



75¢

AT HARDWARE STORES EVERYWHERE

WATER MASTER

with

TOILET TANK BALL
INSTANTLY STOPS FLOW AFTER FLUSHING

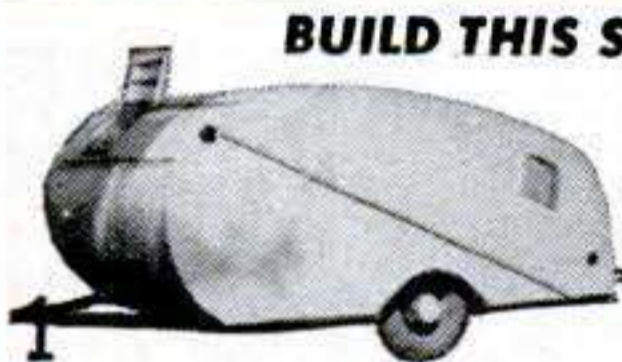

BUILD THIS STREAMLINED, TELESCOPING COMSTOCK TRAILER

Complete Blueprint and Instructions **ONLY \$2.00**

Enjoy camping, hunting, fishing or touring with all the luxury of a big trailer in this compact beauty. Also other models. Information and pictures 10c. Thos. Comstock, Dept. R, 820 N. 17th St., Parsons, Kansas.

Make Money SELLING Eshelman Kulti-Mowers and DOING GARDEN WORK

MAKES PLOWS CULTIVATES HARROWS HAULS SPRAYS SAWS DOZER MOWS CUTS ROLLS SNOW PLOW



ESHELMAN FOR BETTER **LAWNS AND GARDENS** also POWER MOWERS and RIDING TRACTORS Women can operate it.

Low As \$95 Plus Tools also Power Reverse Free Catalog. Write **ESHELMAN CO.** Dept. 294, 119 Light St. Balto. 2. Md.

MAKE IT YOURSELF!

It's easy. Kit includes all wood parts cut to shape. Material for metallic finish included. All you need is a penknife. Nine authentic full scale models from which to choose.



"COLT .44 FRONTIER"

Send 10c in Coin for NEW Illustrated Folder to:

O'BRIEN GUNCRAFT, P. O. Box 657, Madison, Wis.

Ideal for Color and Black & White! TELEPHOTO FOR ARGUS C-3 \$9.95

A \$20.00 value! Screws right into front of Argus C3 lens, is instantly removable, requires no installation, no dismantling. Doubles picture area on negative or transparency, eliminates unwanted background, brings distant objects close with greater clarity. Auxiliary lens is coated, color-corrected, requires no change in exposure or lens opening, comes with simple instructions.

WIDEANGLE aux. lens covers 50% more of subject than normal lens, coated, color-corrected, a must for indoor, landscape, architectural photography. **\$9.95**

Filterholder, fits both lens... \$1.25
Leather Case, for each lens... 75c
Telephoto Mask, shows correct field of telelens... 50c
Wideangle Finder Attachment, shows wideangle view... \$1.95

Similar Telephoto and Wideangle lenses, at the same prices, are available for most other 35mm cameras—Bolsky, Kodak 35, Signet, Pony, Argus A2, C4, Mercury, etc. Shipping Cost 25c.

DEVELOPIX, Dept. PS, 35 Maiden Lane, N. Y. 38, N. Y.

SELF-CONTROL STARTS HERE



AND TO RESTORE CAR PERFORMANCE

OIL-CONTROL STARTS HERE

To Stop oil-pumping, replace worn engine connecting rod bearings

It's the level truth, proved by exhaustive engineering research—WORN ENGINE BEARINGS CAUSE OIL PUMPING!

Here's how: Normally, main and connecting rod bearings "meter" lubricating oil in the exact amounts the engine needs. Worn bearings let excess oil reach the piston assembly, over-burden the piston rings. The rings were not designed to cope with this situation for very long. Result: The oil burns to carbon, which cakes spark plugs, valves, pistons and rings. Performance goes up in smoke!

Give the rings a chance to do their own job! Check for worn engine bearings, too. Replace with genuine Federal-Mogul bearings, engineered for the job of oil control. Ask your mechanic!



FEDERAL-MOGUL SERVICE

(Division of Federal-Mogul Corporation)
DETROIT 13, MICHIGAN

CONTROL OIL-PUMPING

WHERE IT STARTS—REPLACE WITH

FEDERAL-MOGUL

OIL CONTROL BEARINGS

Get **STRYPEEZE**
... the only Guaranteed
PAINT REMOVER

Removes All
Finishes QUICK

STRYPEEZE is guaranteed to stay wet longer and remove more coats of finish per application, indoors or out, than any other remover, or your money back! Clings to upright surfaces.

HARMLESS
to hands

Buy it where you
buy paints.

FREE, Send for Folder
"How to Remove Paints, etc."

SAVOGRAN CO., Dept. 46, 25 Huntington Ave., Boston 16, Mass.



Pint only 75c

For Discriminating Users

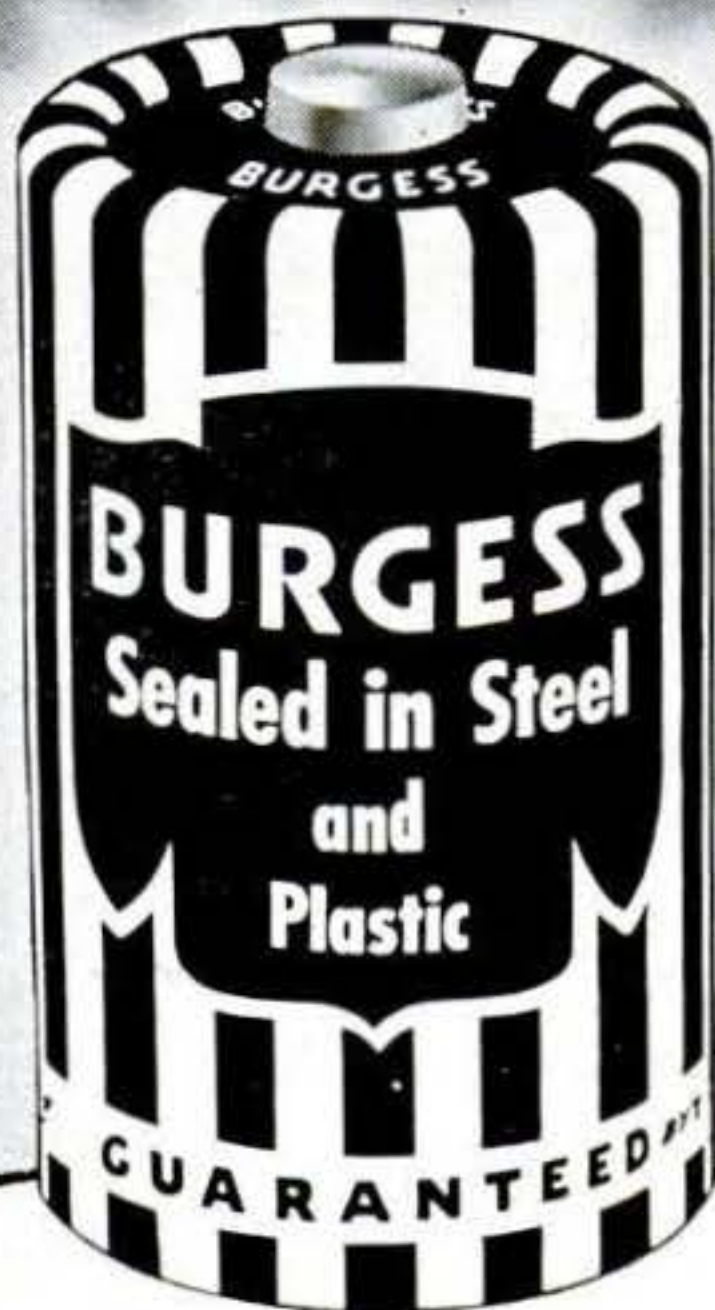

Scientists, explorers and engineers choose Burgess Batteries where lives depend on battery power, because they are recognized as best by the experts. Insist on using Burgess Batteries in your flashlight. Burgess Battery Company, Freeport, Ill.; Niagara Falls, Can.

A Quality Dry Battery For Every Purpose



GIANT BALLOONS

Genuine govt. surplus weather & target balloons. Have fun or make money with 'em. Great sport in back yard or for parties, picnics, dances, fairs, etc. Great attention getters, it'll bring crowds to business events, conventions, exhibitions, trade shows; for lodges, civic occasions or school functions. Thousands of satisfied customers from coast to coast. Order now at these low prices.

3 Ft. Dia. 39c —6 Ft. Dia. 79c —13 Ft. Dia. \$1.39



"Marksman" AIR PISTOL

It's a target pistol but it looks, feels, muzzle loads and cocks like an army .45. You can have fun indoors in rumpus room or basement; or out in the back yard or woods. Make it a test of skill and "out-marksman" your friends. Caliber .177, accurate, high-powered, guaranteed. Complete with free supply of BB's, darts & pellets. Full payment must accompany order. **\$5.95**

EXTRA AMMUNITION AVAILABLE

Darts, 50c doz.—BB's, 15c for 150—Pellets, \$1.50 for 500

• On above items add 10% for handling & delivery
Calif. residents please add sales tax

WAR ASSETS DIV. VOLUME SALES CO.

Dept. S-10-52, 3930 Sunset Blvd., Los Angeles 29, Calif.

Malayan THROWING DAGGER
BALANCED TO STICK! **\$1.98** postpaid

The MALAYAN FIGHTING KNIFE is used for self-defense, killing game, target skill. Powerful, silent, accurate weapon. Splits 1" board at 30 ft.

EASY TO THROW!



Fun, Thrills, Excitement!

Indoors—outdoors. Learn this Sport! Easy

to throw accurately with our clear instructions. Beautiful, heavy-duty 10" knife. Tempered steel. Tough, rawhide-bound handle. Rare souvenir, unusual bargain. Limited quantity. At dealers or send \$1.98

WHOLESALE IMPORT CO. Dept. B, 604 Marengo, Alhambra, Calif

Crosman Pistol... for accuracy

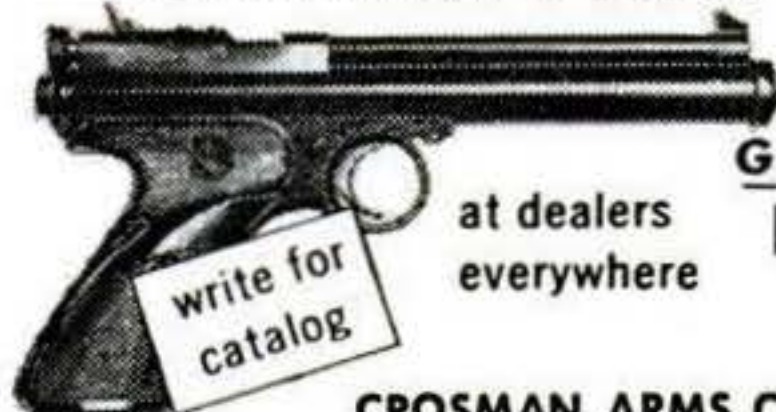

at dealers everywhere

GAS POWERED

Low Cost Shooting
indoors or out

CROSMAN ARMS CO., Dept. 46
Rochester 20, N. Y.

LEARN TO THROW THE BOOMERANG

A Fascinating Sport and Unique Gift

Flight Tested—Guaranteed to Return Golden Red, Jade Green or Natural with Story and Instructions **\$2.00 ea.**

CARVED by Postpaid

COL. JOHN M. GERRISH

4409-P S. W. Parkview Lane-Portland 1, Ore.



BE A FROGMAN!



Join the new national FROGMAN CLUB today. All you have to do is send \$1.00—be sure to include your name and address—and here's what you get:

- 1) A miniature pair of Frog Feet. Can be worn on key chain, lapel or hung on windshield as lucky charm.
- 2) An attractive membership card.
- 3) A Frogman decal to be used on your windshield, bicycle or notebook.
- 4) A booklet on "How To Swim Underwater" and "The Supreme Sport of Spearfishing."
- 5) Periodic bulletins on the latest developments in Frogman equipment and news.
- 6) Complete catalog of Frogman equipment available for purchase.
- 7) A free coupon for \$1.00, which can be used toward the purchase of a pair of regular size Frog Feet, \$6.95 or equivalent in value. This is redeemable at your local sporting goods dealer, drug store, auto supply store or toy departments. If no such dealer available in your area, we will handle direct.

BE A FROGMAN — Send your dollar today!

National Frogman Club

1428 Maple Avenue, Dept. PS-10, Los Angeles 15, Calif.

SAVE UP TO \$25 OVER 100,000 SATISFIED USERS!

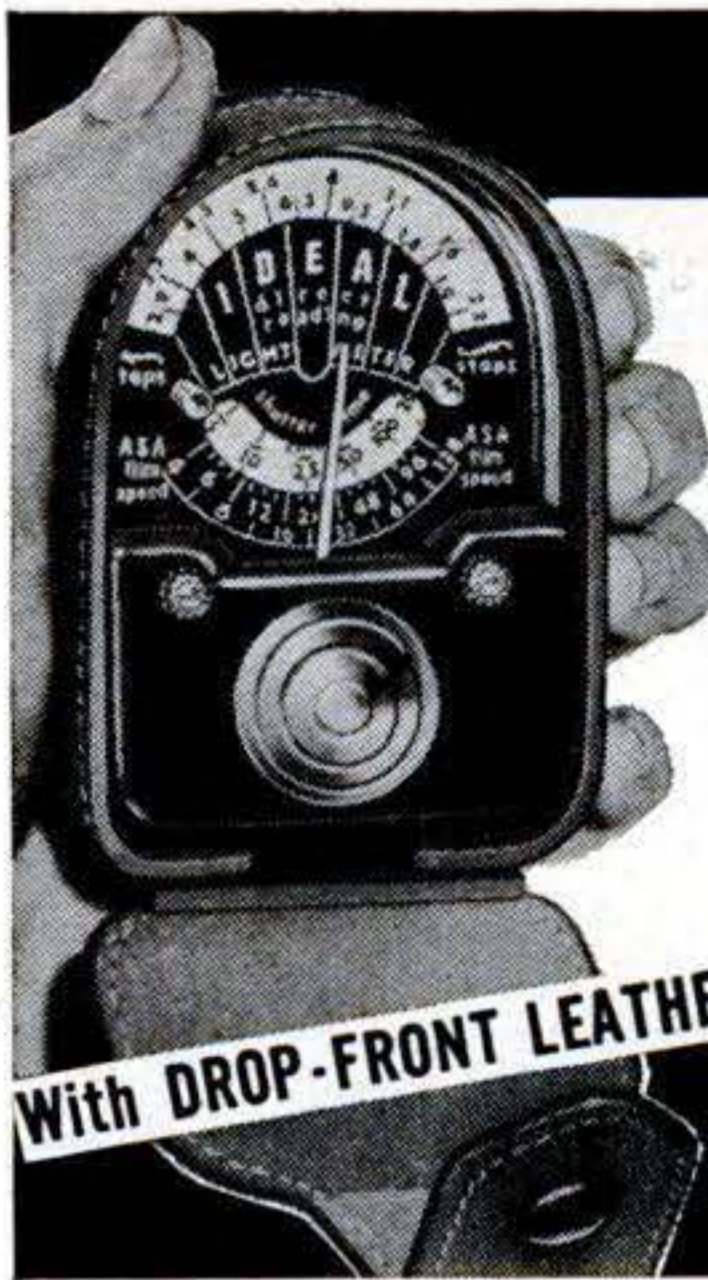

"IDEAL" EXPOSURE METER

Accurate photo-electric light meter, for perfectly exposed pictures. Reads directly in "f" stops,—no calculating. Simple, quick, easiest to use. For all movie and still cameras, regular or color film.

\$9.95

THREE YEAR GUARANTEE

"IDEAL" RANGEFINDER

Precision optical instrument shows exact distance for perfect focusing and clear, needlesharp pictures. Just look through finder and turn knob until double images come together. Specify metric or feet scale.

\$2.95

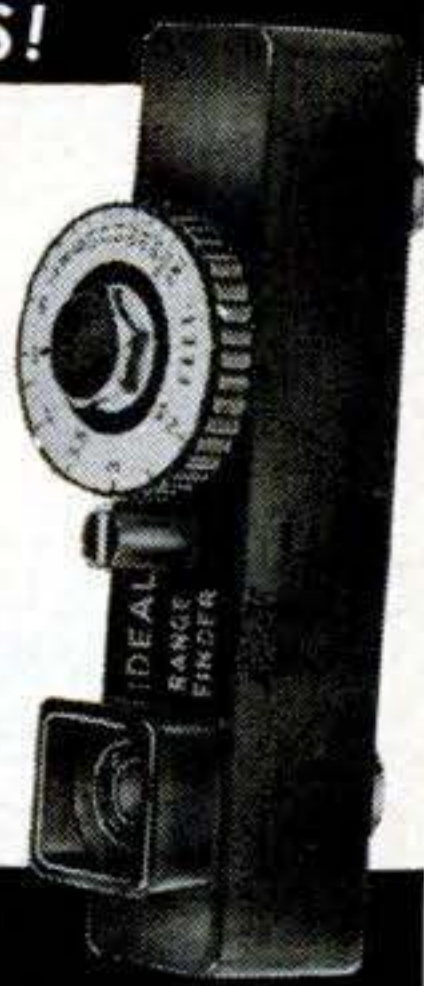

With DROP-FRONT LEATHER CASE

AT YOUR DEALER

Or Send Check Or Money Order Direct. **WE PAY POSTAGE**

FEDERAL INSTRUMENT CORP.

Dept. **PS-10** 14-02 Broadway, L. I. City 6, N. Y.



100% PROTECTION

TEAR GAS

A REAL SURE-FIRE SELLER! THUGS AND THIEVES BEWARE!

Here is a tear gas pencil gun which discharges smothering clouds of tear gas to instantly stop, stun and incapacitate the most vicious man or beast. A safe and effective substitute for dangerous firearms. No permanent injury. Needed in Stores, Banks, Autos and Homes, everywhere to protect Life and Property. No skill required. Handle our tear gas as a side line and you'll soon give it full time. For a quick start send \$4.25 for complete demonstrator outfit consisting of an Automatic Pencil Gun with 10 demonstrators and 3 powerful Tear Gas cartridges fully guaranteed. Many thousands now in use. Order your outfit today. Not sold to minors. **Hagen Supply Corp. Dept. A510 St. Paul 4, Minn.**

New Jet Engine Burns Gasoline



Powers Your Models

FASTER IT MOVES, THE MORE POWERFUL THE THRUST! New fun & thrills for model makers & experimenters. **Ram jet M.E.W. 601** rocket engine has no moving parts. Runs on regular gasoline. (Not a CO2 unit). Gives powerful, continuous thrust lasting 3 minutes. Maximum thrust lasts 1 1/2 min. Easy to start & re-fuel. Lasts indefinitely. Aluminum tail pipe, brass fuel metering nozzle, steel compression tank. With booster tank. 5 3/4-in. long; 1 1/2 oz. Complete, ready to run. Use **\$2.98** alone or in pairs (2 for \$5.45) Each Postpaid.

JOHNSON SMITH CO., Dept. 596, Detroit 7, Michigan
Send 10c for Big Catalog of 3000 Novelties, Gadgets, Funmakers, etc.

Would YOU Like to Make \$1,000 A MONTH?

That's what Stanley Hyman made selling the amazing new PRESTO Fire Extinguisher!



STANLEY HYMAN

OVER 11,000 people died in fires last year. An eager public has been waiting for a practical new kind of fire extinguisher. Now it's here! Tiny "Presto" does the job of bulky extinguishers that cost 4 times as much and are 8 times as heavy. Ends fires fast as 2 seconds. Fits in palm of hand. Never corrodes. **Guaranteed 20 years!** Sells for only **\$3.98!**

You can make good money showing this new discovery to civil defense workers, owners of homes, cars, boats, farms, etc. and to stores for re-sale. Stanley Hyman reports making over \$1000 a month. H. J. Kerr, \$20 a day. William Wydallis, \$15.20 an hour.



Science's New Midget Miracle "PRESTO"

What's the secret of "Presto's" amazing power? It's a new war-born wonder chemical found to be 1.5 to 6 times as effective as chemical contents of other extinguishers on an equal weight basis. Makes possible, for the first time, an extinguisher that is small, light, and amazingly effective. Help supply the demand for this important new discovery. Write for **FREE Sales Kit**. No obligation; no capital required. But don't put it off. Every day you hesitate may cost you \$10, \$15, or even \$50 you could be making. Send postcard or letter to: **MERLITE INDUSTRIES, Inc., Dept. 1110, 201 East 16th St., New York 3, N. Y.** IN CANADA: **Mopa Co., Ltd., 371 Dowd St., Montreal 1, P.Q.** (If you want a regular Presto to use as a demonstrator too, send \$2.50. Money back if you wish. Returnable for **FREE** refills.)



WANT TO SAVE GAS, CUT REPAIR BILLS?

New, Stewart-Warner MOTOR MINDER Shows You How . . . As You Drive Every Mile You Drive!

Made only by Stewart-Warner! Motor Minder tells you at a glance how to get more miles per gallon . . . how to spot engine trouble in advance. Clearly marked, illuminated Motor Minder dial warns against below par performance of spark plugs, carburetors, valves, timing, piston rings, manifold and other troubles. Gives a constant check on engine performance with the same accuracy factory-trained mechanics use in motor tune-ups. Easily attached on instrument panel or steering post. Install yours today.

Now only \$10.95 at Your Local Dealer, or Write:

STEWART-WARNER
Instrument Division, Dept. P-102
1840 Diversey Parkway, Chicago 14, Ill.

POWER like this you've never

ride Harley-Davidson's NEW '53 Twin for the thrill of

ADVANCED ENGINE DESIGN

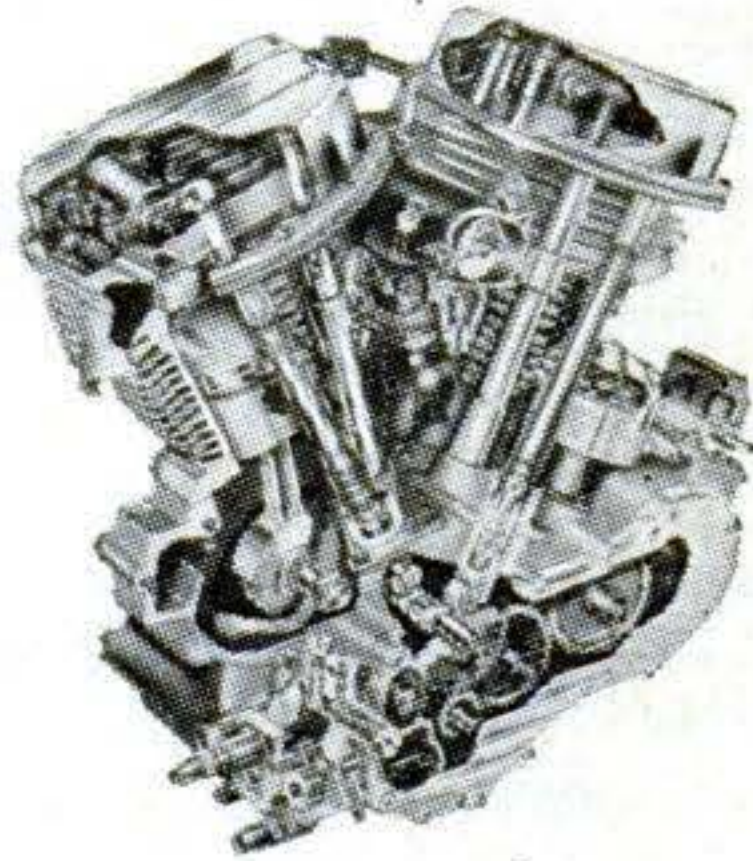

- 45 degree V-type Overhead Valve Engine — 55 horsepower
- The only motorcycle engine in the world with Hydraulic Valve Lifters
- Hemispherical Combustion Chambers for maximum performance
- Valve Rotators prevent carbon on valve seats and hot spots on valves
- Aluminum-bronze cast-in valve seat inserts reduce valve wear and assure proper valve seating

Sensationally new! Another reason why Harley-Davidson continues to lead the field with the newest, smoothest riding, best performing motorcycles in the world. The new '53 Twin sets the pace for thrills with an improved 74 OHV motor . . . a twin that's packed with features that lead the way for the entire automotive industry.

Here's flashing power for swift, fun-packed miles. Tops, too, in comfort, reliability and sleek, streamlined styling. See and ride the sensational Hydra-Glide at your dealer's today. Bring a buddy along. Or send 25 cents for illustrated literature and a copy of the Enthusiast magazine, filled with exciting action pictures and stories.

Harley-Davidson Motor Co., Dept. PS, Milwaukee 1, Wis.

HARLEY-DAVIDSON

HYDRA-GLIDE®

The Old FORD Tin Lizzie Is Now A LAMP

Have you got a soft spot in your heart for things of the past? Remember the old Model T Ford that chugged down the street? It has now been made into a lamp—as cute as can be and a bright spot wherever placed—on a desk, in a den, a pair in living room, as a television lamp, in an office—everywhere: Lamp is authentic replica (3/4" scale) of popular 1917 Ford Coupe—exact and complete, with familiar black body, red wheels, gold trim. Lifetime Fiberglass shade in gay-nineties red color, with black lacing. Brass post.

Overall height—18 inches
Base size—6 x 9 1/2 inches
A lamp to bring back memories and to give pleasure for years to come: To top it all—the price is **\$9.95** only

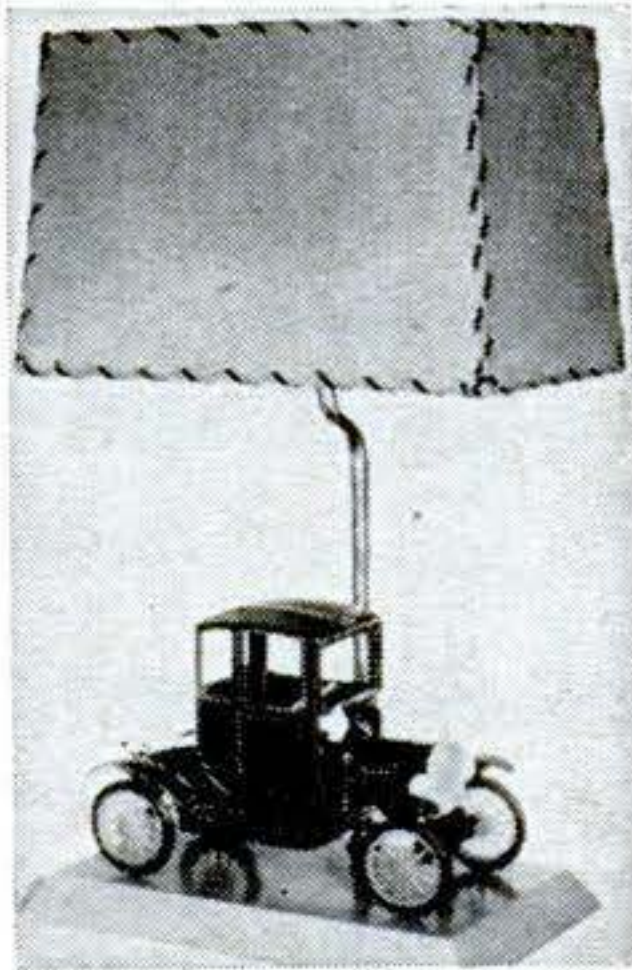

Choice of these 3 other automobile bases, also available:—

1913 Maxwell
2-passenger touring car
(body only illustrated)

1908 Buick 1910 Cadillac
(not illustrated) (not illustrated)

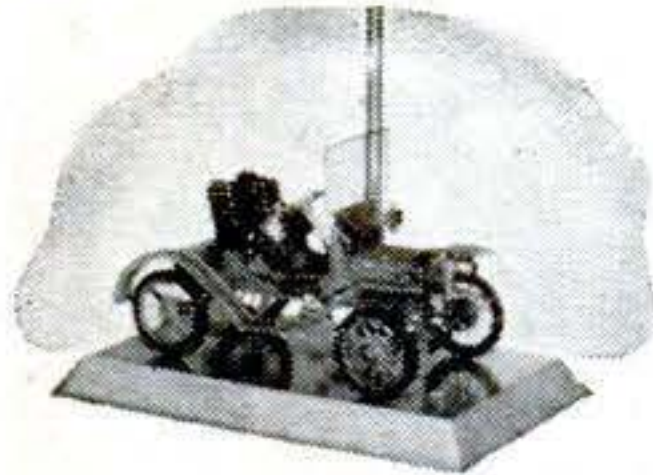

Each one of these is also \$9.95, and is made with the same care in reproduction and is the same size.

Please mail orders—specify model and number of lamps wanted (ideal as gifts for newweds, for new homes, for wedding anniversaries, for Christmas, etc.). If payment is enclosed, we pay shipping; or send COD, plus shipping costs. Money Back Guarantee if not fully satisfied and delighted. Order NOW!

HEMECRAFTS, Dept. CL-722

799 Broadway

New York 3, N. Y.

IT'S A FACT!

No other work shoes of any make are made of triple-tanned, inner-shell horsehide like . . .

WOLVERINE SHELL HORSEHIDES

That's why Wolverines are buckskin-soft, dry soft, STAY soft . . . yet give you many more miles of wear on any work shoe job.



See your Dealer and Try on Wolverine Shell Horsehides

FREE Wolverine Vu-Riter

It's the very newest in ball point pens and it's yours 100% FREE of cost just for asking us "Who is my nearby Wolverine dealer?" Write today to Wolverine—Box UL-10—Rockford, Mich.

seen before

a lifetime

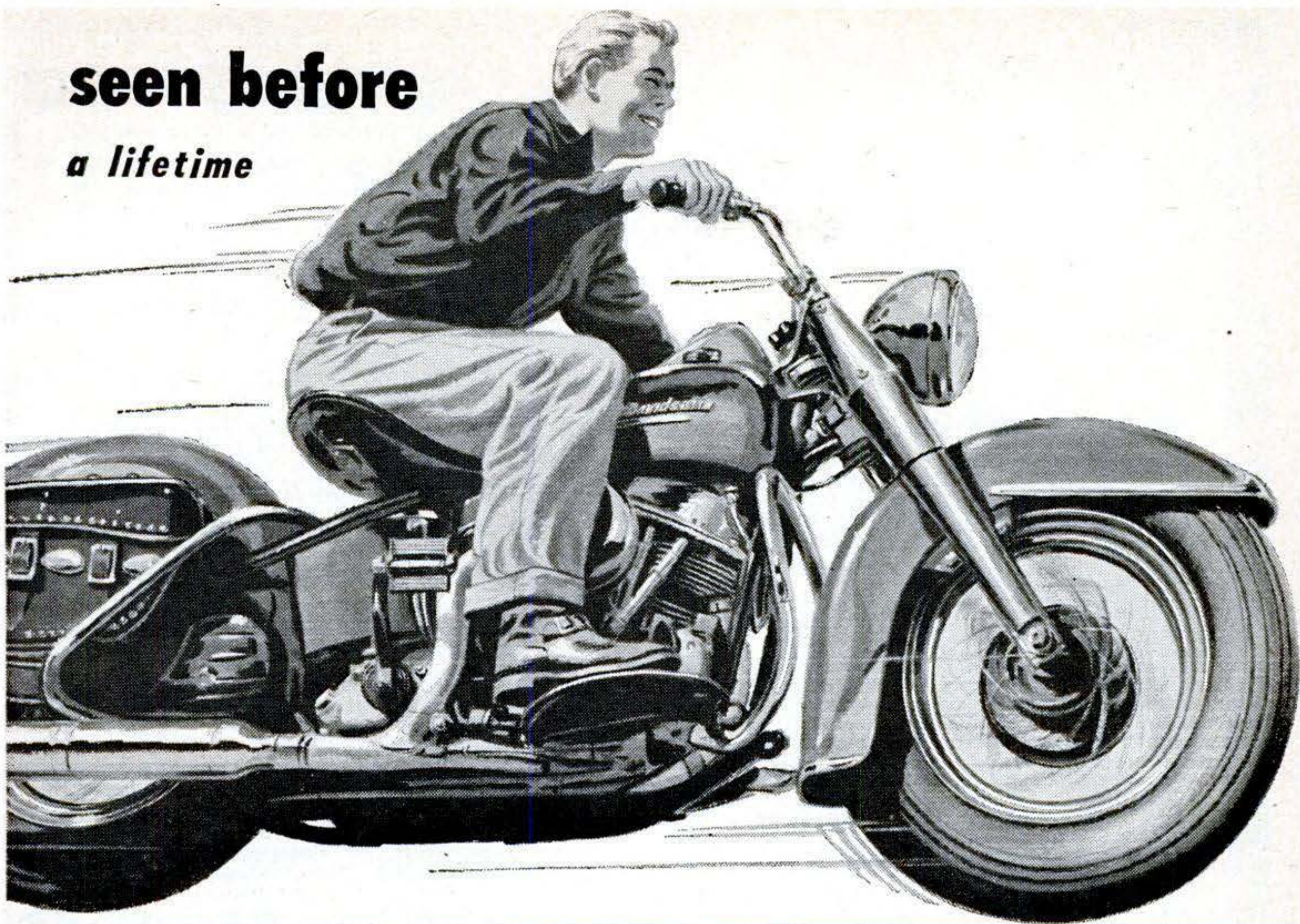

DYNA-MITE POCKET RADIO

POWERFUL! PERSONAL! PORTABLE!

- Covers Full Broadcast Band 550-1600 K.C.
- Selective Dyna-Coil Tuning
- Batteries and All Parts Fit Within Case
- Hearing-Aid Battery Powered, Long Life
- Tiny Acorn Low Drain Tube
- Loud Clear Tone
- Over 1,000 Mile Range
- No Antenna Used for Local Reception
- No Ground Connections Ever Needed
- Picture Diagram for Radio Beginners

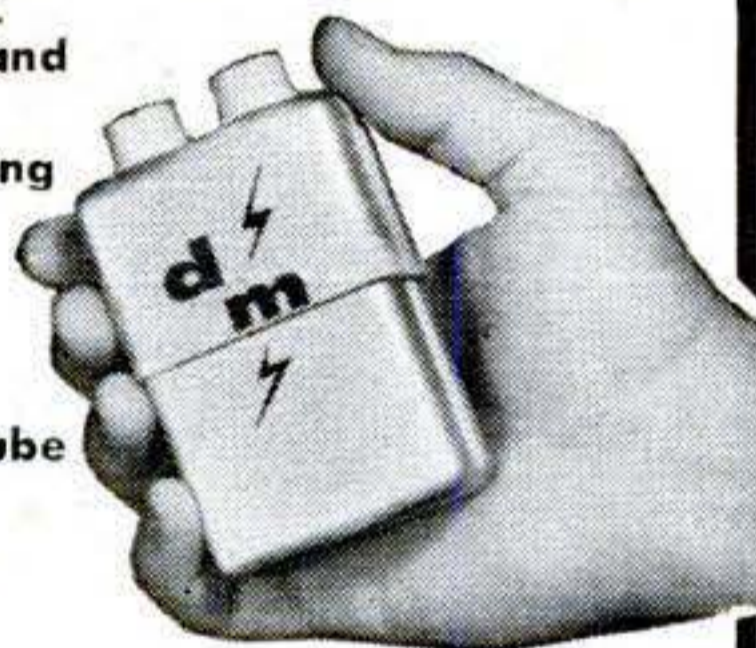

\$5.99
postpaid

"This neatly engineered little KIT was designed to give you a real personal portable radio that you can enjoy anywhere without disturbing others. Use it on camping trips, in bed, in your office or just anywhere. Remember this is not a weak crystal set, it is a **POWERFUL VACUUM TUBE** receiver that will give you good local and long distance reception. SET less batteries **ONLY \$5.99 postpaid!** C.O.D. orders accepted with \$1.00 deposit within United States and possessions. If you desire batteries, we can supply them at only \$1.50 per set **INCLUDING EXTRA "A" BATTERY** or you may obtain them from your local hearing aid concern."

Alnico magnet receiver \$1.25 only, when purchased with KIT. **ALL PARTS GUARANTEED.**

Order Today at this Unbelievable Low Price!

PRECISION ELECTRONICS LABORATORY

DEPT. 1

PLACERVILLE, CALIF.

30 SHOTS

30 Shorts or 20 Long Rifle cartridges—world's largest magazine capacity. Greatest number of sighting combinations available on any rifle. Just two of many reasons for the tremendous popularity of the 146B.

Model
146B

22 cal.

\$2895

(\$29.95 West of Rockies)

YOUR MOSSBERG DEALER WANTS TO SHOW YOU THIS ONE

And when you see it, note the fine quality, the beautiful finish. Compare it with the finest!

No sales at factory

Send for **FREE** catalog



26510 St. John St., New Haven 5, Conn.



**WHY PAY MORE
for an
ELECTRIC SHAVER?**

**WHISK AWAY EVEN A 7 DAY BEARD
WITH THE WHISKER ELECTRIC SHAVER**

Precision-built,
with .002"
thin blade that
shaves all
beards
smoothly,
closely.



Whether you shave once a day,
or once a week you'll like WhiskER Electric Shaver. Its clipper-like blade is designed for all beards, is definitely less irritating. 110v AC model; no TV or radio interference. See your barber or dealer. If he cannot supply you, send \$15.95—we pay postage; or send \$2, you pay balance plus postage and COD. 10-day money-back guarantee.



CADET ELECTRIC HAIR CLIPPER
Cuts hair, removes superfluous hair from legs and under arms. The same fine quality clipper used and sold in many beauty shops. See your shop, or dealer. If you prefer, send \$10.95—we pay postage; or \$2, you pay postman balance, postage and C.O.D.

ELECTRO TOOL CORP., Dept. W532-K, Racine, Wis.

Handy Oil for Handy People!

SAVE with Archer Pol-mer-ik 100% pure linseed oil. Refinishes furniture. Antiques. Brings out beauty of wood grain.

USE IT FOR PAINTING. Levels better. Brushes smoother. Lasts longer.

101 WAYS TO USE. Free booklet shows "Handy Uses Around Home".... "How to Paint", and "How to Save".

**SEND POSTCARD FOR
FREE BOOKLET**

**Archer
Pol-mer-ik
100% PURE SUPER-TREATED
LINSEED OIL**



Archer-Daniels-Midland Co., 604 Roanoke Bldg., Mpls. 2, Minn.

92 POPULAR SCIENCE

6 COLOR PENCIL COMPLETELY AUTOMATIC

NEW! SENSATIONAL VALUE!

LIFETIME GUARANTEE \$1.00

JUST DIAL TO SELECT COLOR
Red, Green, Yellow, Blue, Black, Orange

The world's only 6-color pencil. Precision built—jewelry crafted. Visible lead indicator—you're never caught short. New Roto-Dial selector—no clumsy outside fringes. Built-in shock absorber eliminates lead breakage. Rich 2-tone black onyx and silver. Attractively packaged in beautiful gift box. **SEND NOW \$1.00 OR LIMITED SPECIAL OFFER OF THREE FOR \$2.50.** Immediate delivery.

DEALERS INQUIRIES INVITED

ONLY

**FULL
PRICE**

... covers everything: pencil containing colored leads, postage and handling.

**IDEAL
QUALITY
GIFT
BEAUTIFUL!**

MICHAEL PRODUCTS, Dept. 51, 565 Tenth Ave., N. Y. 36
(SOLE MAIL ORDER DISTRIBUTOR)



WHEN VISIBILITY IS POOR DRIVE CONFIDENTLY WITH A HULL AUTO COMPASS

● Fog, rain, snow, dark of night hide road signs—make driving a headache unless you have a Hull Auto Compass. Hull continually proves the handiest instrument in your car. Write for local dealer's name, literature.

**MORE HULLS IN
USE THAN ALL
OTHERS COMBINED**



HULL MFG. CO. P.O. Box 246-E 10, Warren, O.

BULL DOG HITCHES



Heavy Drop Forge Steel Construction. Strong — Safety-Engineered Reliable

Model No. 1-B
NOW ONLY
\$4.95
Post Paid (when
paid in advance)

Made for trailers with up to 2,500 pounds capacity.
1 3/8" dia. shank Fits 1 1/4" pipe tongue

HAMMER BLOW TOOL COMPANY
Wausau 14J, Wisconsin



REAL LEATHER NAVY HELMET NO HOOKS, TUBES OR HOLES

Brand new NAVY helmet of rich Cordovan Brown leather lined with soft warm fleece. Detachable chin strap. Ideal for flyers, cyclists, farmers, hunters. Children love them! Cost Gov't. \$10.00. Small, medium, large sizes. Send cash, chk., 25% dep. plus postage on COD. Money back guarantee..... **\$2.00 pp.**

GRAND-HAWTHORNE SURPLUS
1439 S.E. Grand, Dept. PS10-52, Portland, Ore.

New Low Cost Electric Water Heater Gives You

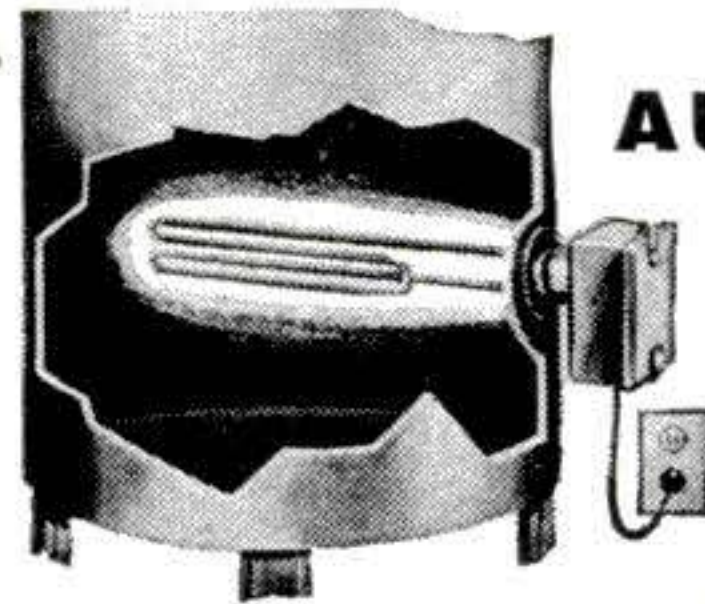

HOT WATER AUTOMATICALLY

From Your Present Tank!

- No dirt, grime, soot, flame!
- SAFE! Every part UL approved!
- Install in 10 Minutes, or less!
- No new tanks or plumbing required.
- Works automatically—saves on fuel bills!

New, UL approved LECTROMATIC changes gas, coal or oil-burning water heater into modern ALL-ELECTRIC unit! Turns on automatically when needed, shuts off automatically when water is heated. To install, simply shut off water.

**Complete—Ready to \$19.95
Plug In—Only**

Remove plug from water tank. Screw LECTROMATIC into opening (as shown), then PLUG IN! Plenty of hot water all day long. Uses only 1/4-1/2c electricity per gal. of hot water. Temp. adjustable from 100 to 180 degrees. Save postage. Send check or money order for \$19.95 now. Money back in ten days if not delighted. Full one year guarantee! ORDER NOW!

**COLLOID EQUIPMENT Co. Inc. Dept. PS-10, 50 Church Street
New York 7, N. Y.**

LEFAX

POCKET SIZE TECHNICAL DATA BOOKS \$1. EACH

Printed on loose leaf, six hole, 6³/₄" x 3³/₄" bond paper, each book contains about 140 pages of technical data, presenting condensed, accurate and essential data for the student, engineer, technical worker and business man.

Architecture	Building Constr.	Piping Data
Home Heating	Radio	Surveying Tables
Illumination	Television & FM	Trig-Log Tables
Electrician's Data	Electricity, AC	Metallurgy
Builder's Data	Electricity, DC	Analytic Chem.
Lumber Data	AC Motors and	Highway Eng.
Air Conditioning	Generators	Mech. of Materials
General Math.	Transformers,	Pwr. Trans. Mach.
Math Tables	Relays, Meters	Thermodyn. Tbls.
Physics	Hydraulics	& Charts
Chemical Tables	Surveying	Phys. & Thermo-
Metals	Mech. Drawing	dyn. Data
Gen. Chemistry	Machine Design	Phys. & Org. Chem.
Reinf. Concrete	Machinists Data	

Write for FREE catalogs (over 2000 listings). See for yourself how helpful LEFAX can be to you. Send \$1 for each book, (or \$5 for any six books listed above) to

LEFAX DEPT. PS-9 PHILADELPHIA 7, PA.

AS MUCH FUN AS A CIRCUS

52 BALLOONS \$1
THAT MAKE GIANT
CIRCUS ANIMALS

Some blow up 3 ft. to 4 ft. Easy to make GIANT CIRCUS ANIMALS—instructions included, 4 ft. Ostrich, 3¹/₂ ft. Giraffe, a yard full of 12" kittens. Make a big SANTA CLAUS and a set of REINDEER. FREE with each \$2.00 order a genuine balloon squawker. FREE with each \$5.00 order 50 plastic toys (A Complete Western Rodeo).

CIRCUS BALLOONS, Dept. PS-10

62 Garth Road, Scarsdale, N. Y.



FIREARMS & SWORDS

You don't want to miss our new thrill-packed catalog. Fascinating background and illustrations of 1300 authentic pieces. Exceptional values in hard-to-find items. For your 120 page catalog #28 simply send 50c to cover postage and handling with your name and address.

ROBERT ABELS, Box PS, 860 Lexington Ave., New York 21, N. Y.



now even better
invest more in
Defense Bonds



SAVE MONEY

AND TROUBLE WITH-
BOWES



STOP-LEAK

Come winter you will have to buy some sort of anti-freeze for your car, or else you won't "run." Anti-freeze is expensive. If your radiator or any part of your cooling system is leaking, you will quickly lose your expensive anti-freeze. Put a can of BOWES STOP LEAK in your radiator today and make sure that you will have "smoother motoring" this winter.

BOWES Stop Leak will not clog your radiator. It's SURE . . . SAFE . . . PERMANENT.

YOUR CAR DESERVES
THE WINTER SAFETY OF
BOWES RADIATOR CHEMICALS

RADIATOR KLEN-ZUR

Removes rust, scale, lime, oil and grease . . . contains no harmful acid . . . gets cooling system clean as new.



RADIATOR RUST-ROUT

Prevents trouble-making rust accumulation in cooling system . . . also lubricates water pump.

DRIVE IN
Where You
See This Emblem...



BOWES "SEAL FAST" CORP., INDIANAPOLIS 7, IND.

OCTOBER 1952 93

14 Reasons Why GRAPHIC Gets Great Pictures!

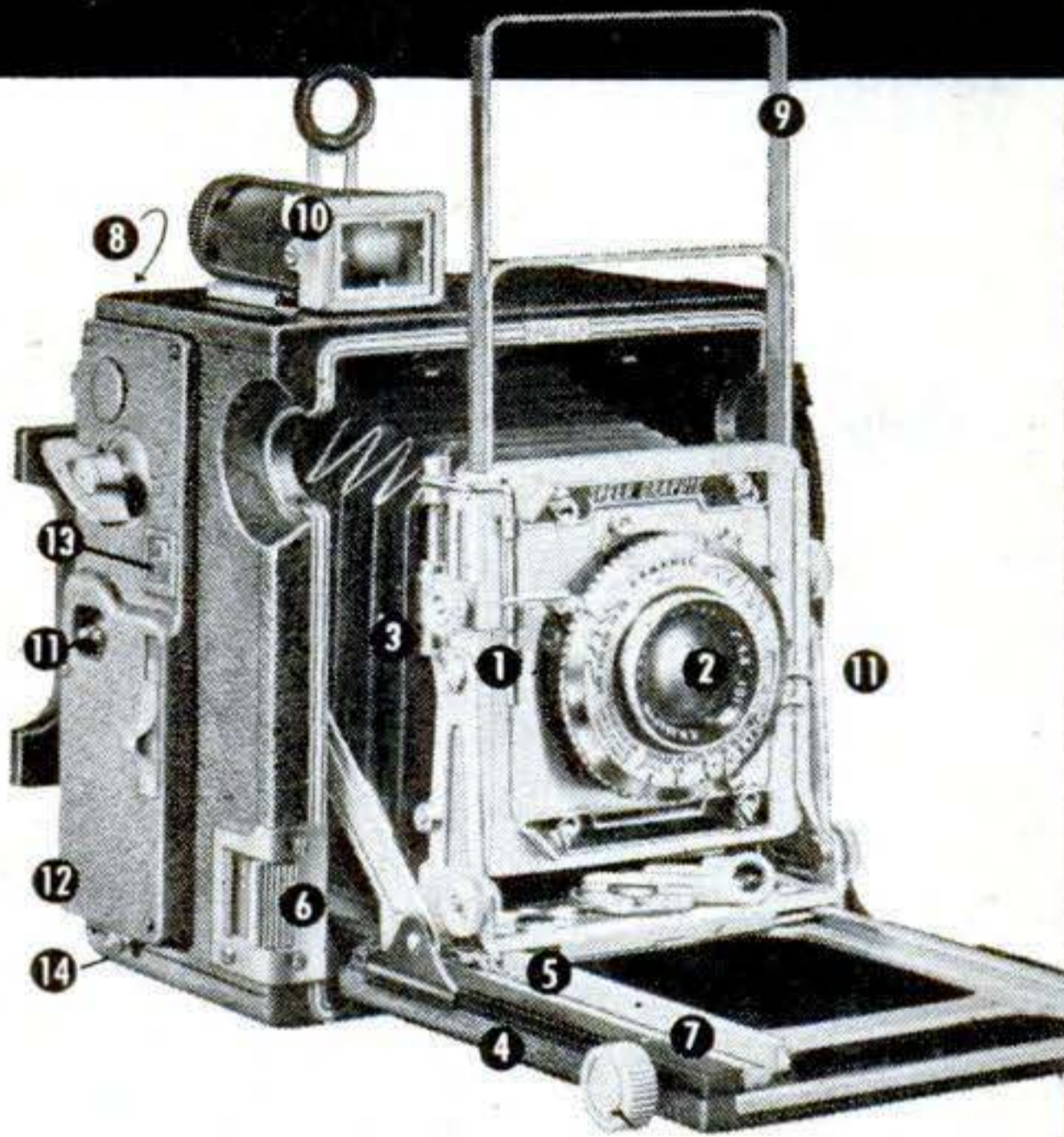

- | | |
|---|---|
| 1. Contortionist Front | 8. Ground Glass Focus |
| 2. Interchangeable Lenses | 9. Open Frame Viewfinder |
| 3. Double Extension Bellows | 10. Optical Viewfinder |
| 4. Drop Bed | 11. Built-in Flash Synch. |
| 5. Folding Infinity Stops | 12. Graflok Back |
| 6. Body Shutter Release with Shutter Selector Control | 13. Direct Reading Focal Plane Shutter Speeds |
| 7. Vernier Focusing Scale | 14. Governor Selector |

Speed Graphic (illustrated) has focal plane shutter with governed speeds to 1/1000th. Crown Graphic is identical, but without focal plane shutter . . . and costs less. Both available on terms as low as \$2.50 a week from many Graflex dealers.



SEE THE POPULAR CENTURY GRAPHIC TOO!

Lowest priced of the famous Graphics — but with many prize-winning Pacemaker features — including ground glass focus; built-in flash; coated, color-corrected lens and fast shutter. 2 1/4 x 3 1/4 . . . ONLY \$108.00

Prices subject to change.

Graflex Inc., Dept. 139
Rochester 8, New York
Please send me details on:
Pacemaker Graphics _____ Century Graphic _____
Name _____
Street _____
City _____
County or Zone _____ State _____

GRAFLEX®

Prize-Winning Cameras

SAVE 50% - THOUSANDS HAVE ASSEMBLED

\$42^{UP} PACKAGED BOAT KITS



27 MODELS

Dinghies, skiffs, racers, inboards, outboards and cruisers. Assemble your own boat, it's easy, it's fun!

All parts pre-cut or pre-fabricated from finest materials. Get all the facts from our big 24 page catalog. See how Packaged Boats are built, how they perform, how exclusive construction features make assembly easy. Includes specifications, performance data plus hardware and paints.

SEND 25¢ for NEW 24 PAGE CATALOG
CUSTOM-CRAFT - DEPT. 5 - BUFFALO 7, N. Y.

BOAT PLANS ▶ Over 50 modern plans and full size patterns. Racing classes, cruisers, inboards, outboards, sail boats. By famous designers. 6' to 30'. DESIGN CATALOG 35¢. Design Catalog and boat building handbook, \$1.00

MARINE MART - DEPT 5 - BUFFALO 7, N. Y.

Any 35mm fan can now own one!

SLIDE PROJECTOR.....\$7.49



What a buy! A streamlined 100 watt projector, sturdily constructed of stamped metal, with a special concentrating condenser and a 4" f:3.5 color corrected lens ready to use. Projects your 2x2" (35mm, 828, taken with Argus, Bolsey, Pony, Bantam, etc.) color slides giant LIFESIZE with clarity, brilliance, sharpness you'd never expect possible at so moderate a cost! Shipping Cost 60c.

beaded, portable, tripod model



30 x 40 PROJECTION SCREEN \$6.89

Customers examining the screen in our store ask disbelievingly: 'Is it really beaded? Does the low price include tripod and screen?' But after learning what they get, they admit that they expected to pay 100% to 150% more! Yes, you pay far below wholesale price for a first rate screen, equally suited for movie (8mm or 16mm) and slide projection. Crystal-beaded pyroxilin surface actually adds brilliance to your films and slides, makes them seem to come to life! Screen raises and lowers on elevating rod, metal can has beautiful scratchproof finish, carrying handle sets for balanced carrying, sturdy, plated tripod has protective rubber tips. Thousands of our screens are in use by churches, clubs, colleges and amateurs.

OTHER SIZE BEADED: 40x40" . . . \$8.19 37x50" . . . \$9.64
TRIPOD SCREENS { 50x50" . . . \$11.89 52x70" . . . \$24.95

Prepay in full or send \$4.00 deposit with C.O.D. orders. Shipment is made Railway Express, shipping costs collect (or you prepay for 11 lbs. pp. and ins. for 30x40, 40x40 screens).

SPIRATONE, 49 West 27th St., Dept. PS, New York, N. Y.



LIGHTWEIGHT

\$370.00

(Fed. tax paid, at factory)

9.5 hp. 4-cycle. 3-speed. Foot-shift. Over 70 miles per gal. Over 60 m.p.h. Write for free circular.

MUSTANG, Dept. PS

635 W. Colorado, Glendale 4, Calif.



ELECTRICITY Anywhere

FOR PORTABLE, EMERGENCY OR HOME USE

ONAN Electric Plants generate 110-volt, 60-cycle current for homes, farms, cabins and resorts beyond the highline. Lightweight, portable plants cut costs, speed work for contractors. Standby plants protect hospitals, homes, civil defense units against power failure. 400 to 55,000 watts. Gasoline or Diesel-powered. Priced from \$219.00.

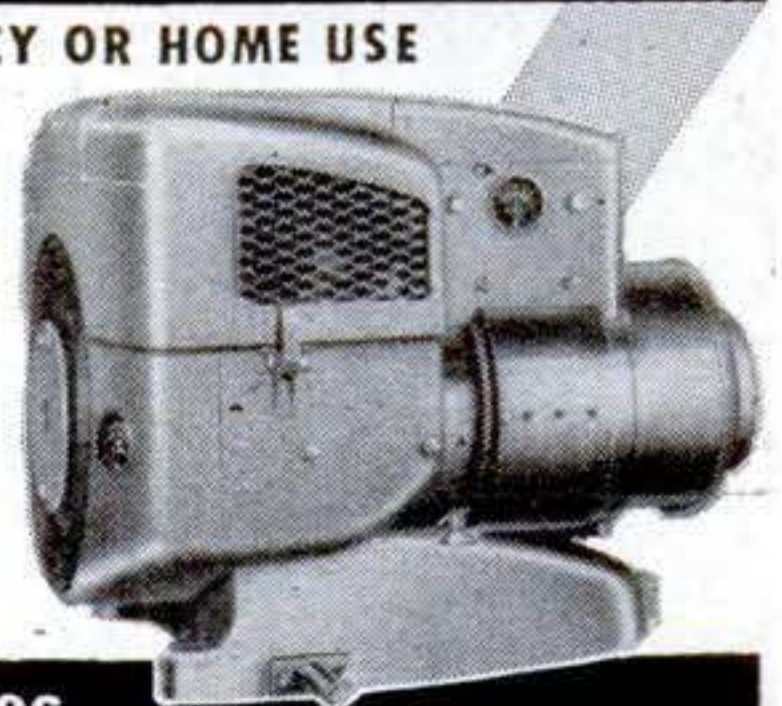

WRITE FOR CATALOG

D. W. ONAN & SONS INC.
6744 UNIV. AVE., S. E., MINNEAPOLIS 14, MINNESOTA

TWO GREAT NEW EXCLUSIVE FEATURES

GIVE THIS
LOW PRICED

H&R

HIGH PRICED
SHOTGUN
ACCURACY!



Sheriff Thomas Geary,
Leading Franklin
County (Mass.)
Sportsman Says:

"I've used every kind
of shotgun, but this H&R is the first
bolt action I've ever been able to
hit targets consistently with!
That Sighting Dome makes
the Gamester sight like my
expensive guns; the Vari-
Choke gives a
really fine pattern."



H & R "Gamester" DELUXE

MODEL 349 • 12 or 16 gauge

3-Shot Tubular Action Repeating Shotgun

Now every discriminating shooter can
have bolt action shotgun economy with
superb shooting performance! **\$3395**

Smartly appointed with Monte Carlo stock; fluted comb;
forestock finger grooves; rubber recoil pad. Perfect
balance, fast, easy handling. See it at your dealer's!

NEW! EXCLUSIVE!

H&R "VARI-CHOKE"



9 different degrees of chokes, cylinder
bore to full, with a simple twist! Spring
tension keeps choke set. Settings visible
for easy reading. Positive stops at both
extremes prevent over-choking.

NEW! EXCLUSIVE!

MULNO SIGHTING DOME

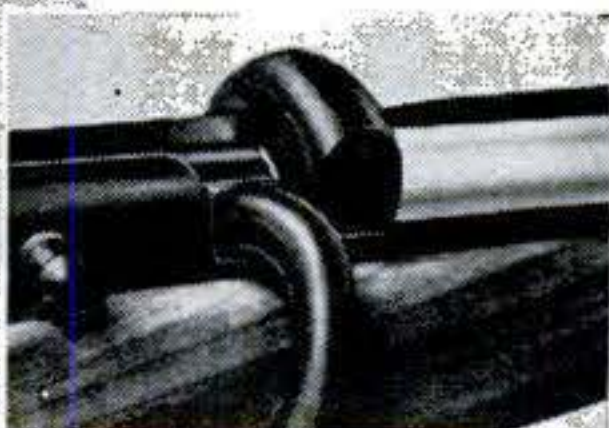

Here is a really great advance in sighting
accuracy for bolt action shotguns. The
Mulno Sighting Dome raises your sighting
line above confusion with absolute accuracy
guaranteed. Demountable.

Harrington AND Richardson

FREE Catalog on all H&R rifles, revolvers, shotguns . . . write to
171 Park Avenue • Worcester 2, Mass.

Canadian Subsidiary: H&R ARMS CO., Ltd.,
Drummondville, Quebec

QUALITY ARMS FAMOUS THE WORLD OVER

a Bit about "Bite"



A "BITE" or snack after a dance, movie, or during a TV show is always fun!



"BITE" in tobacco is never any fun! Prince Albert is specially treated to insure against tongue bite!

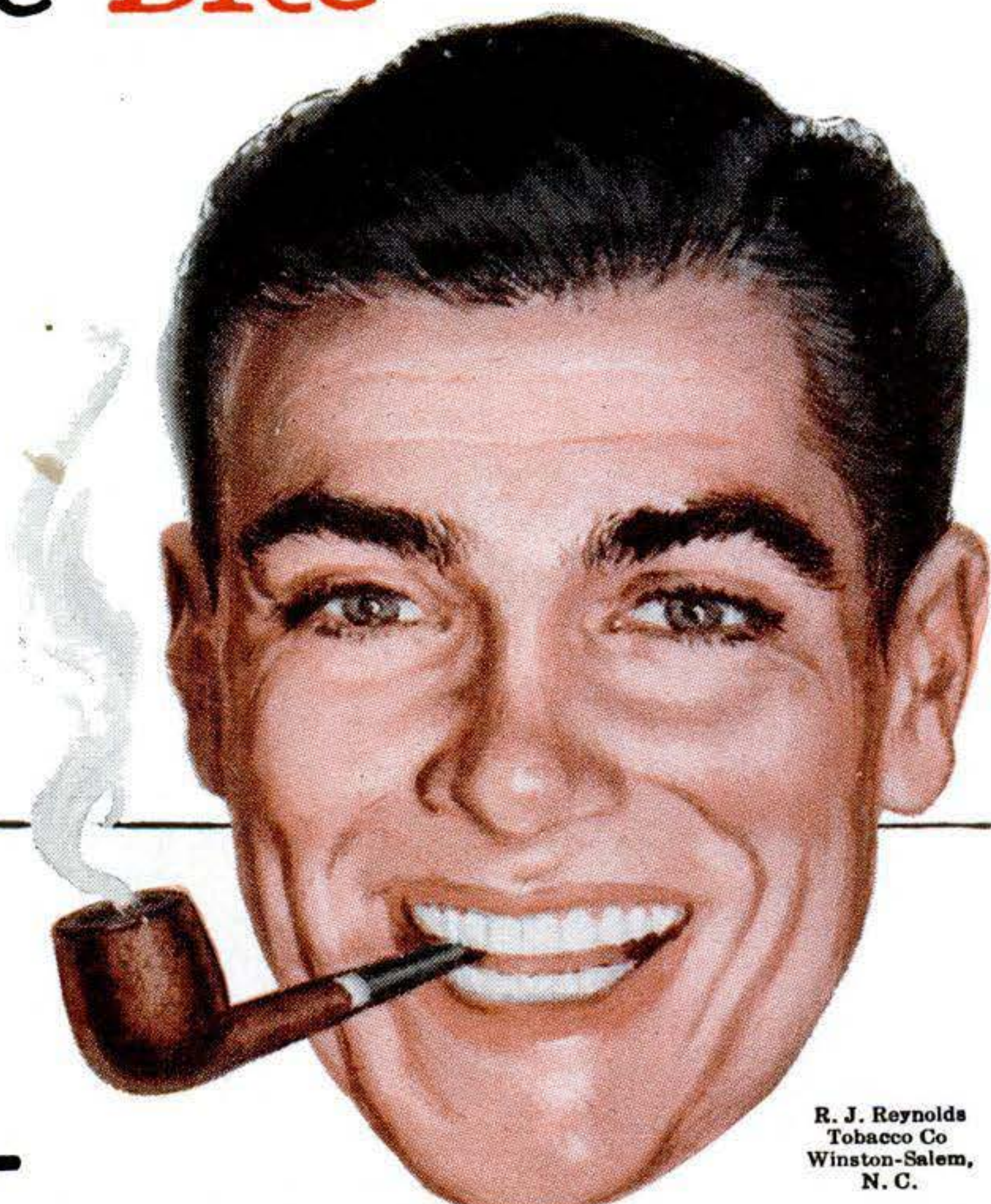

R. J. Reynolds Tobacco Co
Winston-Salem, N. C.

Bite's Out

Pleasure's In

there's more tobacco in every tin

THE NATIONAL JOY SMOKE

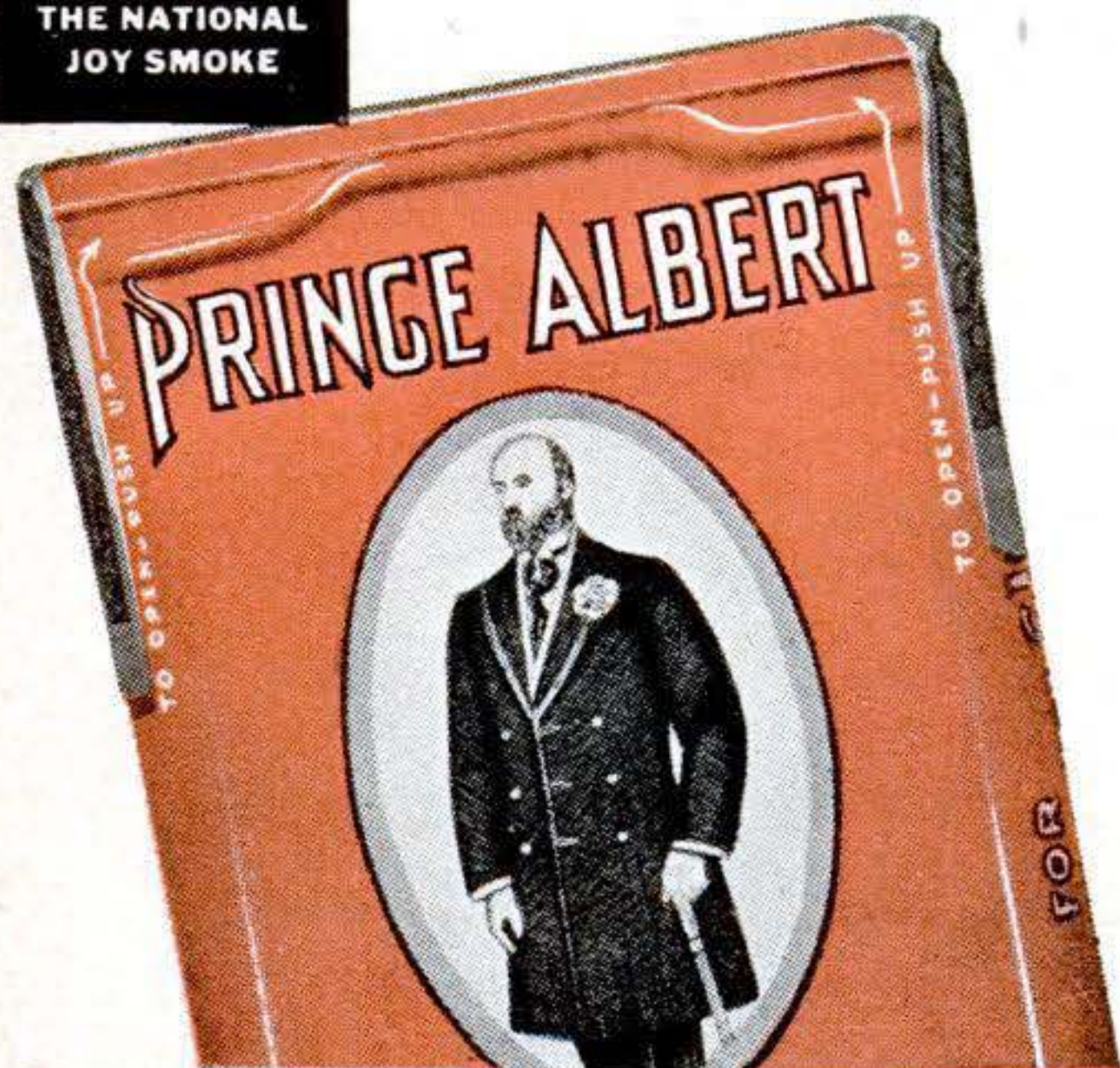

● Once you've tried P. A., you'll never want to smoke any other tobacco! Crimp cut and mild, Prince Albert is treated with the patented* "No-Bite" process to assure you of greater smoking comfort! Whether you smoke a pipe or roll your own, you'll enjoy every puff of P. A.!

*Process patented July 30, 1907

MORE MEN SMOKE

PRINCE ALBERT

THAN ANY OTHER TOBACCO



Radar-type apparatus may one day come to be used for controlling ball games.

MECHANICAL SPORTS ARE COMING

**Radar ump's, foulproof boxers,
motionless dancers
and competing machines are
forecast by a noted scientist . . .**

Prof. A. M. Low

Copyright by the Author

THERE is no sport to which science could not make further contributions in the interests of fair play. The various devices used today in athletics have been taken from the "scientific sports"; electrical timing strips, photo finishes and automatic starting were all introduced by motor racing and aviation.

Sport will inevitably become more sci-



We may see starting blocks in which the runner's heels are electrically locked until

entifically technical, more mechanized and less a matter of chance.

The camera, now extensively used for deciding the winner of a race, will be brought into use for giving decisions in other sports where it is considered that the human eye is too easily deceived. It is now possible to produce a photograph that can be examined in a matter of seconds from the finish of a race, and the future rules for football or boxing may demand that a continuous photographic record is made of the contest so that any decision which is challenged can be decided by the camera.

Once it is admitted that it is important to avoid an error in placing men an inch apart at the end of a race, it is essential to decide whether they started at the same moment. The present method of starting is nearly as crude as the old method of timing.

THE AUTHOR of this forecast of what's ahead in sports, Prof. A. M. Low, is a distinguished British scientist, inventor and popular writer with an amazing record of making predictions that come true. Twenty-five years ago his first book, *The Future*, accurately foretold the coming of television, radar, 600-m.p.h. planes, and many other developments now accepted as commonplace. The article on these pages is from his latest book, *What's the World Coming To?*, published in this country by J. B. Lippincott Co.

We may see "starting blocks" in which the runner's heels are electrically locked until the starting gun is fired so that any possibility of "beating the gun" is avoided.

Already, there are miniature attachments for players and runners who can receive instructions while an event is in progress.

Boxers Will Be Wired

In boxing an electrical machine could register those blows struck below the belt which cause so many disputes. There would be no difficulty in producing such a device and it would not encumber the boxers.

Professional boxing is a sometimes dangerous sport against which educated people will probably revolt. It will be quite simple for scientists to save the sport from extinction and make it much more dependent upon skill. The boxers will have to wear special

Electronics can be used to detect fish.

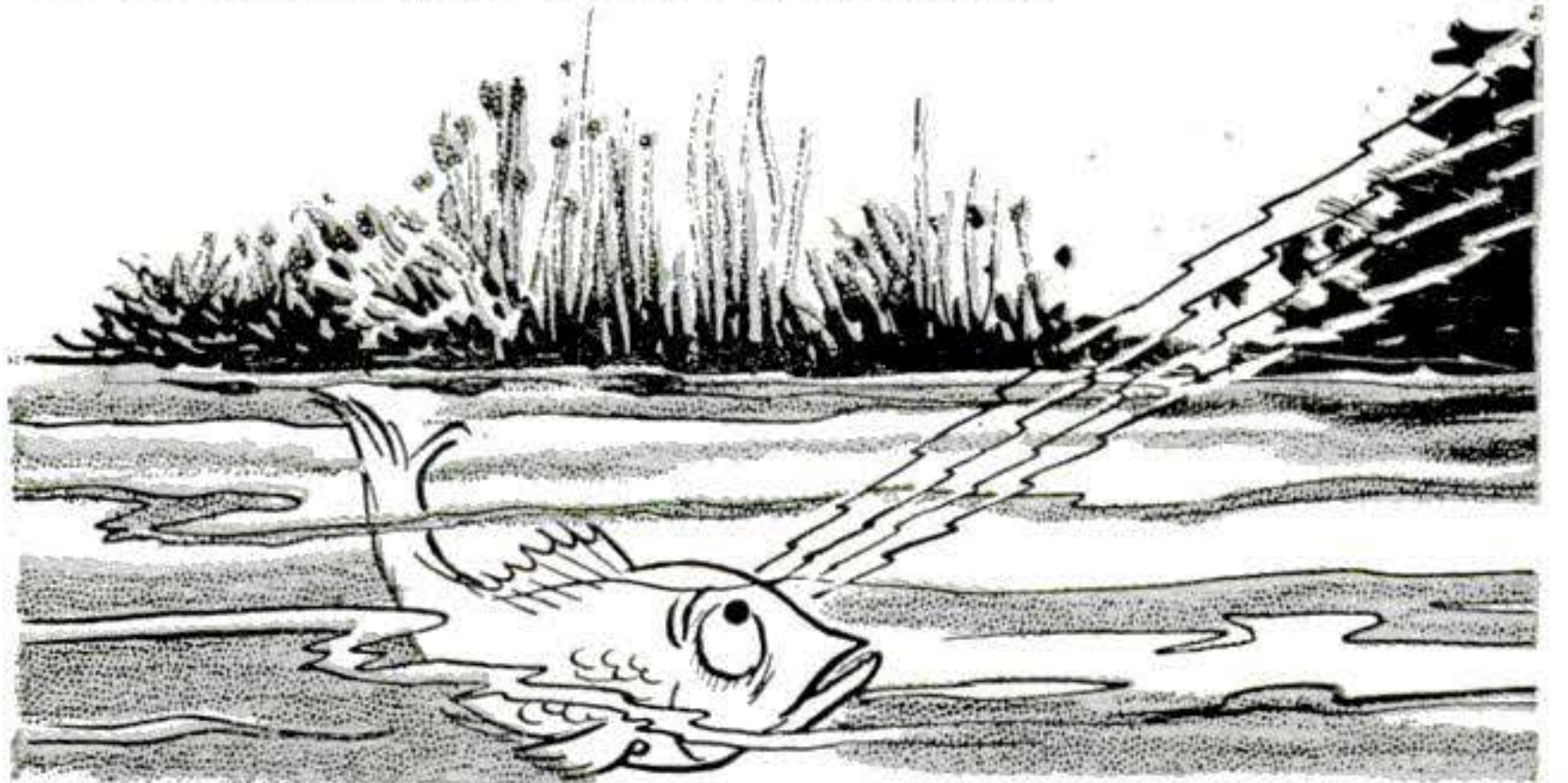



the starting gun is fired.

light clothing in which electrical contacts will be concealed. Every blow received will be registered and will be flashed to a board so that the spectators can follow the progress of the fight.

Thus boxing would follow the development of fencing which, from an art concerned with running an opponent through in battle or a duel, has become a blameless

sport in which recording methods are becoming quite popular.

Radar-type apparatus may one day come to be used for controlling ball games. It would not be difficult to provide an invisible "net" that would decide whether a ball in baseball was good or not.

To what lengths the glorification of professional sport will be carried is difficult to forecast. Rapid transport makes it possible to consider "world championships." The tendency is toward a world league.

In the last few decades there has been an enormous increase of public interest in motor racing of various kinds, a sport which is "useful" in a way that cricket and football could never be. Many of the major improvements in cars and motorcycles, such as supercharging, overhead valves and improved fuels, have come as a result of racing and record breaking. The success of a dirt-track rider depends to some extent on his

[Continued on page 290]

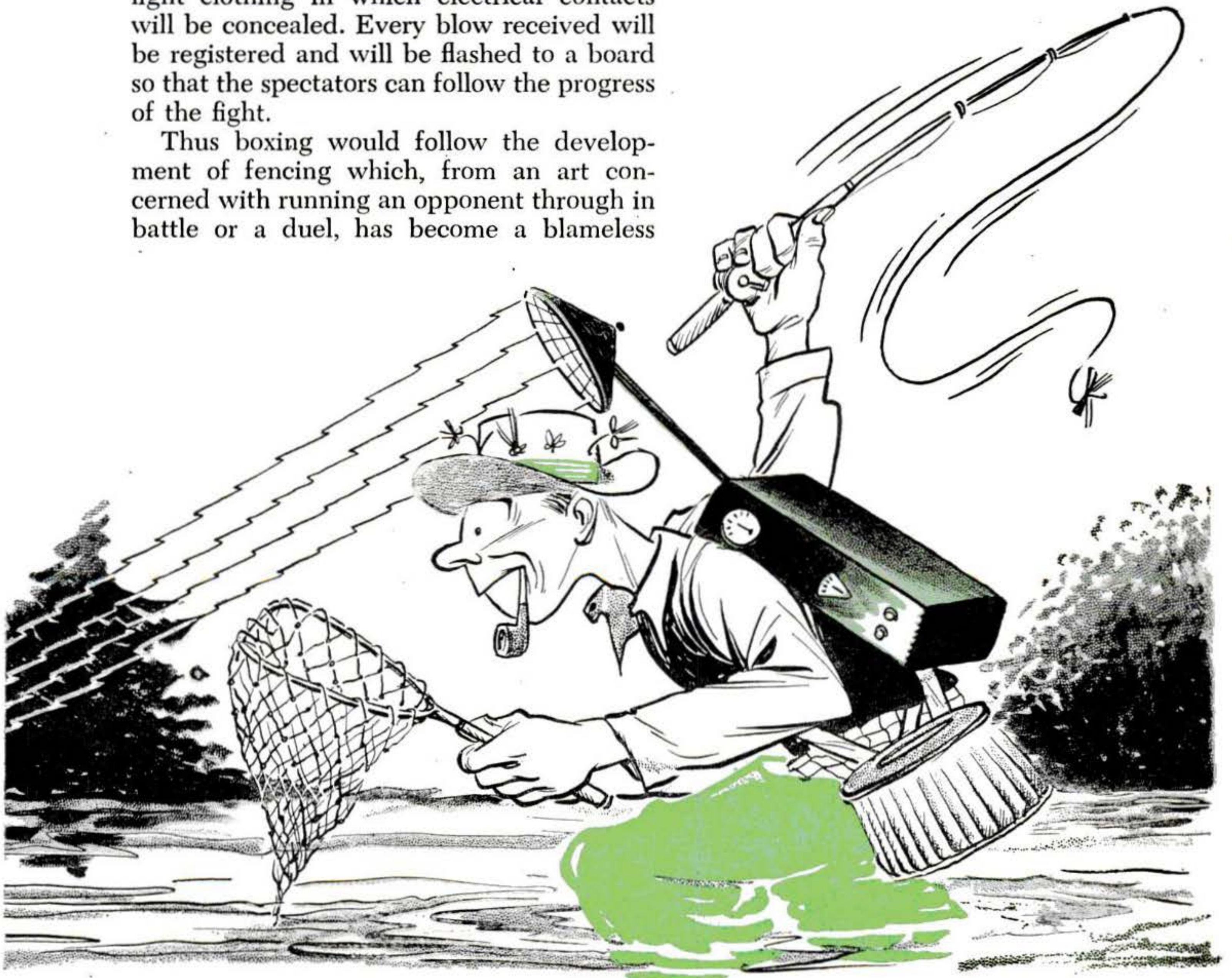

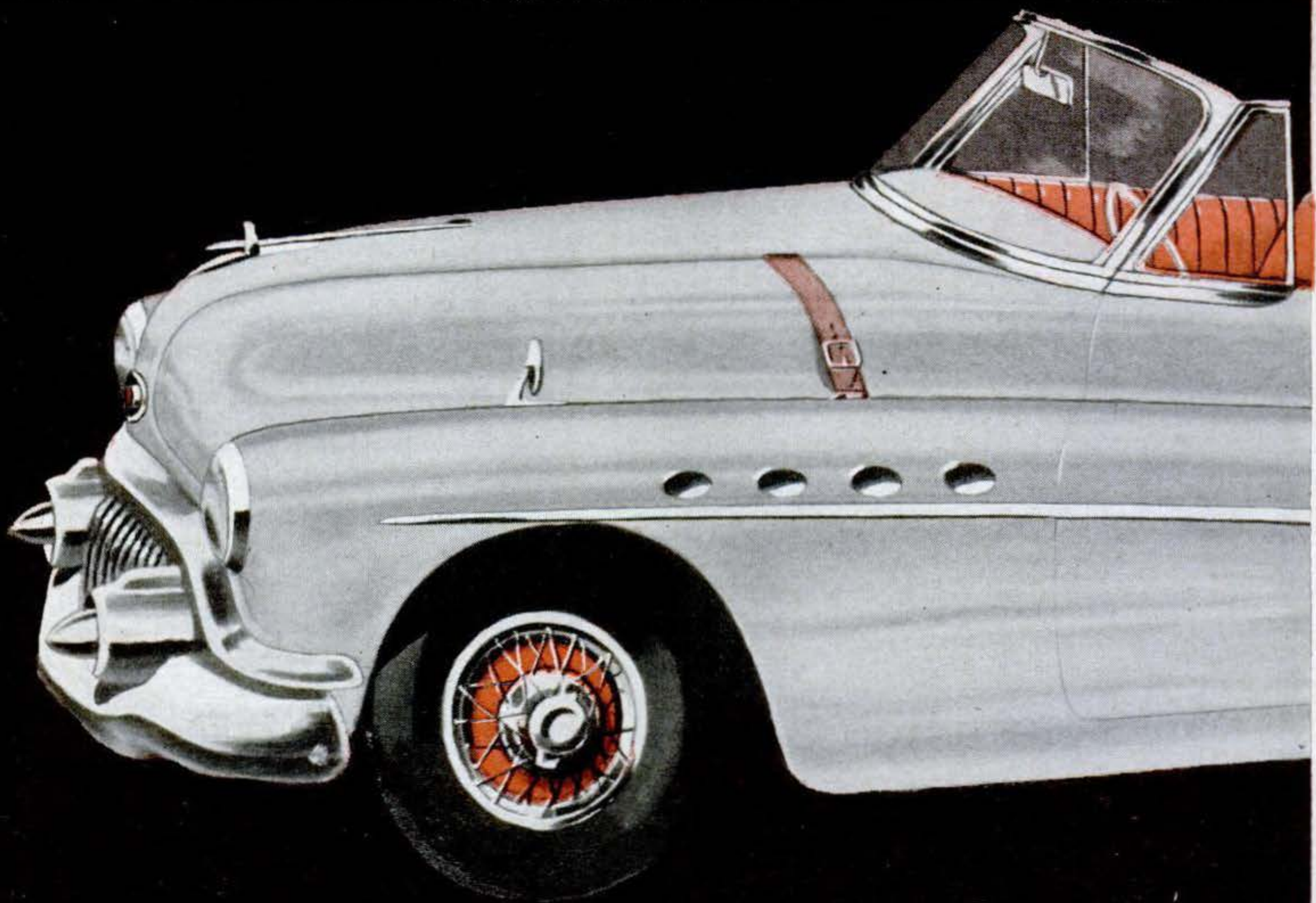

Original Sketch for

REPORT FROM THE



DRIVER'S SEAT ...

Wilbur Shaw Reports:

Buick Sets New

BUICK has a really hot one coming up—the Skylark. It's the first truly original-looking American convertible since the late Thirties. I think it will launch a brand-new style trend in U.S. car design.

The minute I saw it I said to myself, "There's a sports-car bug behind this job." And I tracked him down. But first let me tell you how this new convertible with the foreign flavor looks and how it feels to drive.

The Skylark I drove is not exactly like the ones that a few lucky sons-a-guns with five or six thousand bucks in their jeans are probably going to be able to buy sometime next year. I took the hand-built pilot model out for a spin. There'll be some changes made.

The pilot model has a white body with red leather upholstery and a white nylon top. It has a 1952 Roadmaster chassis powered by Buick's 170-horsepower, over-

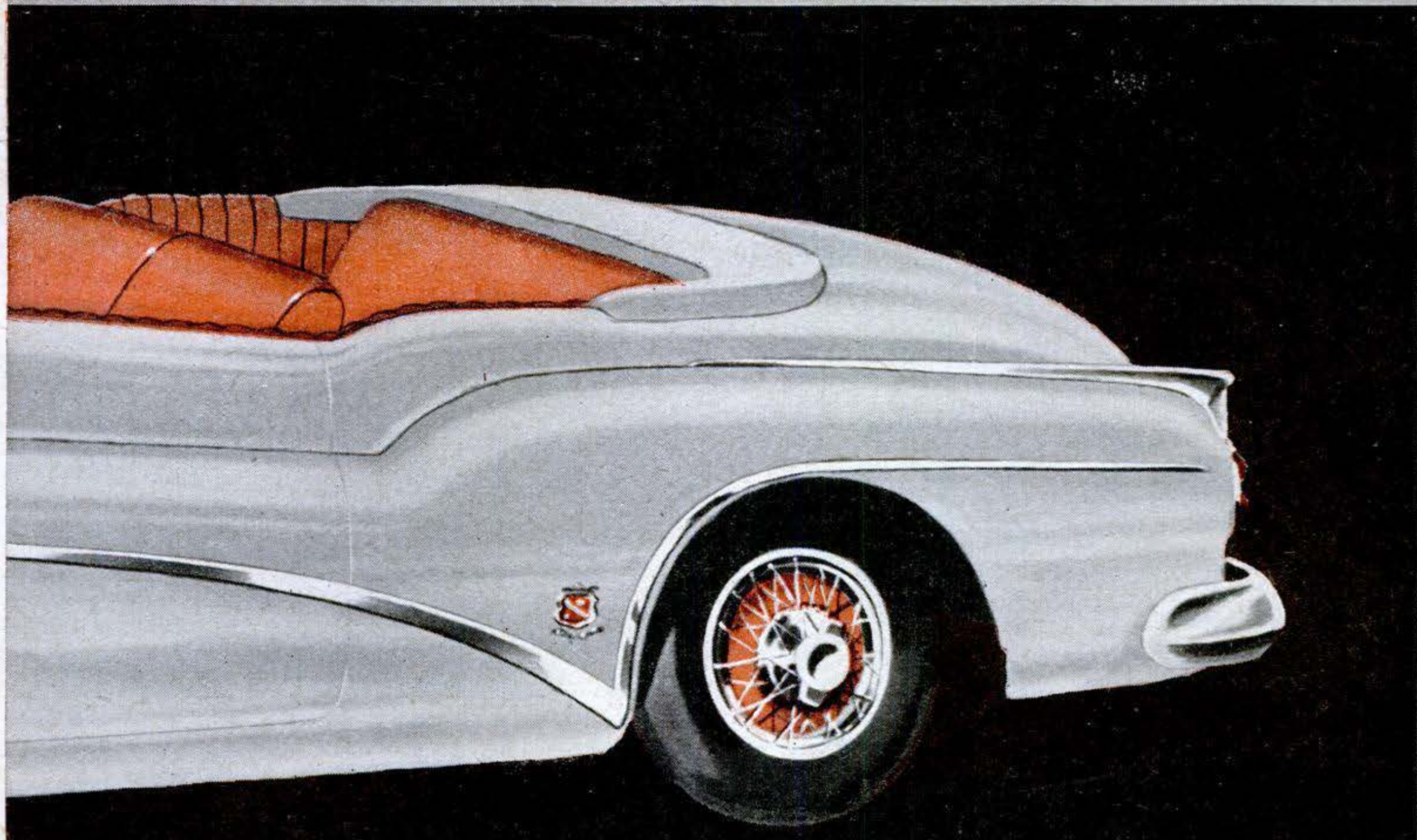

Buick's "Skylark" by Ned F. Nickles, May 3, 1951

Style for 1953

ONLY MINOR CHANGES were made to translate preliminary sketch into car I drove (below).



1952 ROADMASTER

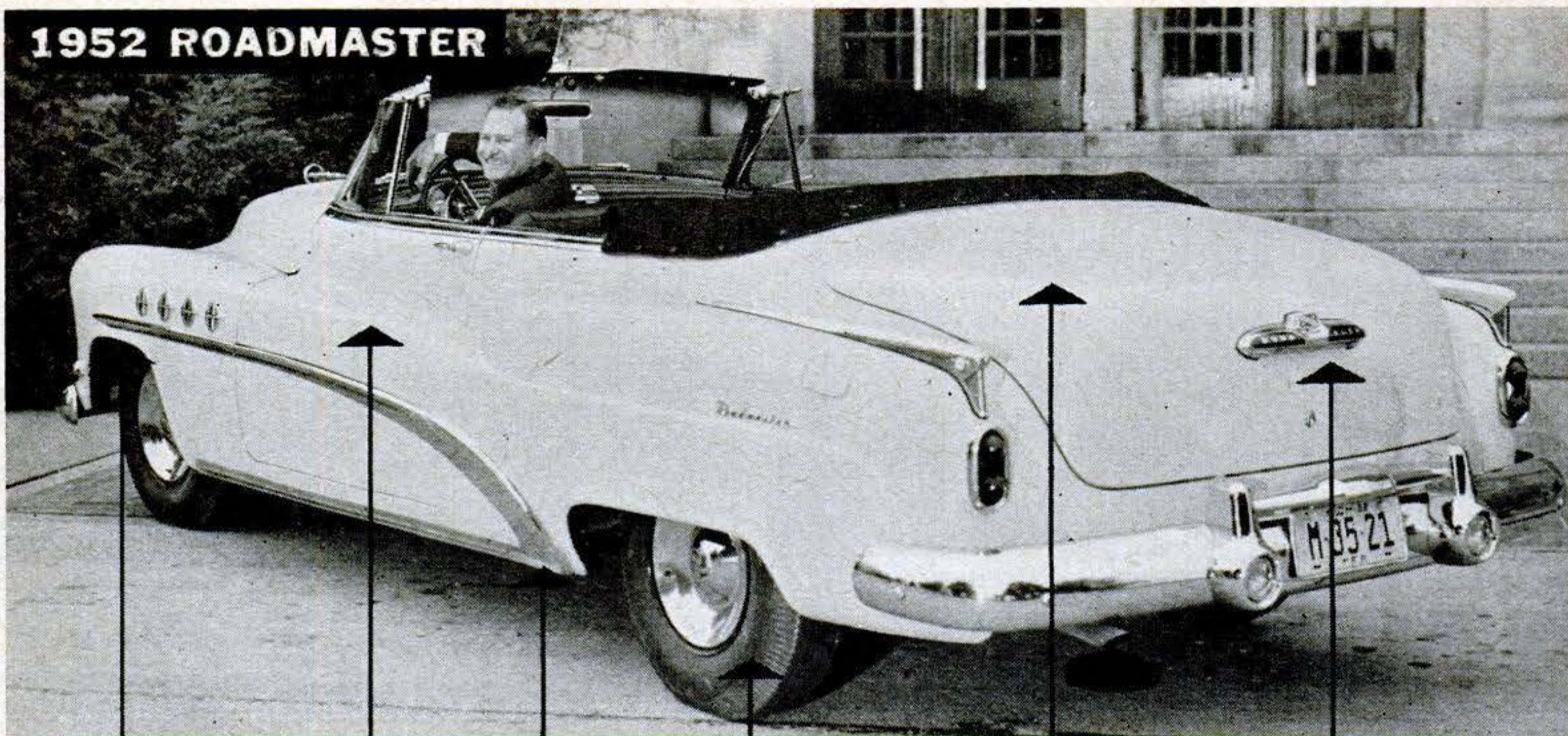

WHEEL-SIZE
FENDER
OPENINGS

TAPERED DOORS,
CUT-DOWN
SEATS

SLENDERIZED
CHROME
TRIM

DIFFERENT
WHEELS

"FASTER"
SLOPE

LOWER, SMALLER
TRUNK HANDLE

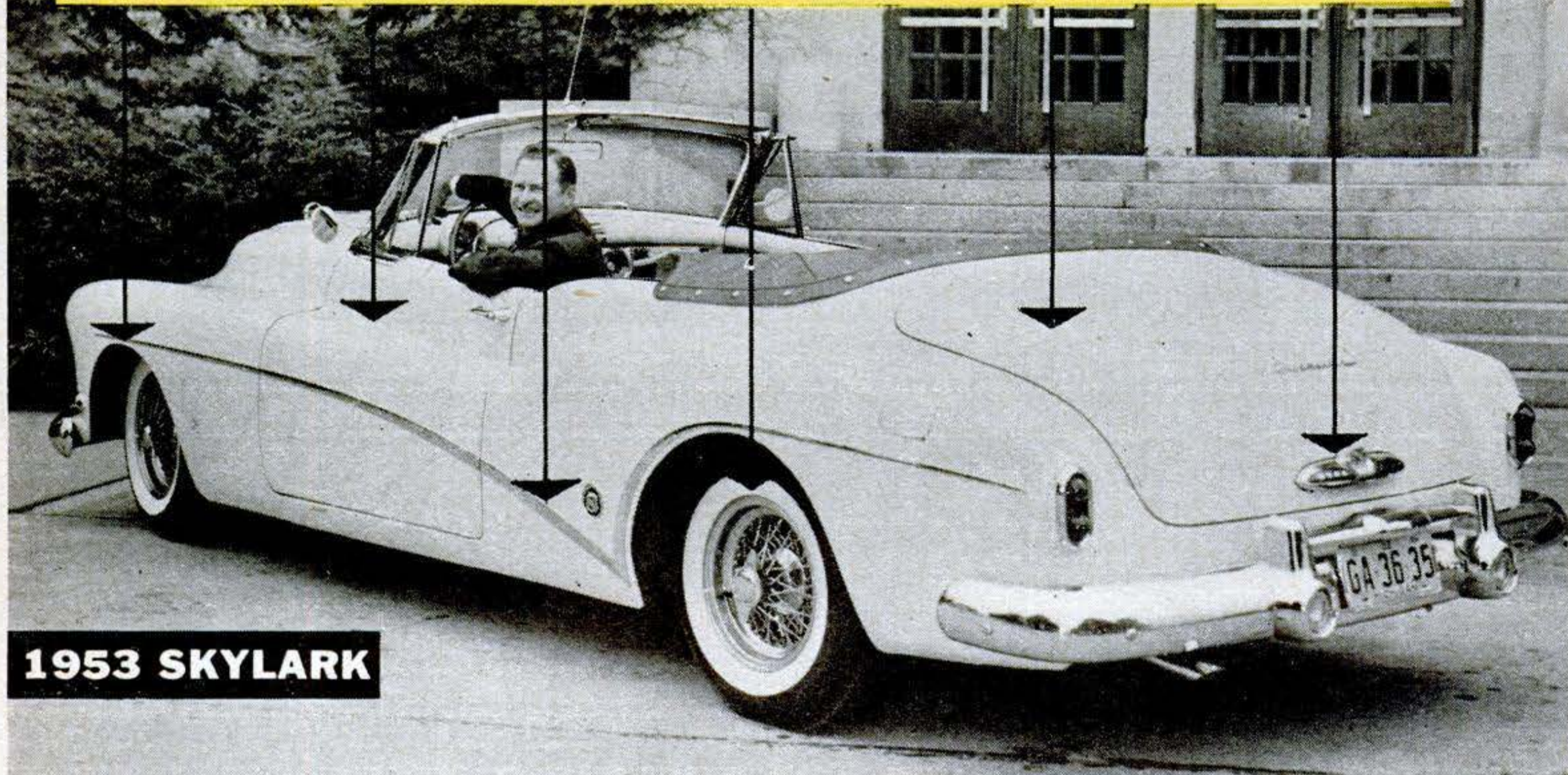

1953 SKYLARK

IT WAS FASCINATING TO ME to see how simply, and yet effectively, the 1952 Roadmaster body design was altered to give the pilot-model Sky-

head-valve Fireball eight. What it will have if it goes into production is still a well kept secret. I'm going to make a guess or two—but later on.

Only a few changes have been made in the original Roadmaster body design. But what a whale of a difference those few changes make!

The change that first catches your eye is in the doors. They have been cut down

lark its sports-car look. Lowering the body an inch and a half was one of the important changes. Arrows above point out a few others.

three inches, and their tops follow the slope of the fender line. This single change gives the car European dash. It also makes the rear end look slightly hunched forward, like the rear of a racing car.

Next you notice the wheels—for two reasons. One, they are Rudge wire wheels, which all sports-car fans are nuts about. Two, the fenders have been cut out to show them off fully.

These particular wheels came from a little old shop up a back alley in Italy. They cost \$150 apiece and took six and a half months to get.

If the Skylark goes into production, it will almost certainly have American-made wire wheels. They have larger, much shorter spokes than those on the Italian wheels, but they are good-looking, and they are more rugged and a lot less expensive than the imports.

Comfortable Cockpit

The backs of the Skylark's front seats are shorter than those in a conventional convertible. Their tops are flush with the tops of the doors. I liked this as soon as I slid under the steering wheel. My seat gave me all the support I wanted where I needed it, but left me with a good, free-and-easy feeling about my shoulders.

The Skylark has a chummy little cockpit. For once you feel as if the people in the front seats and the people in the back seat are in the same car. The back seat, though lower than normal, is a little higher than the front ones. Whoever is sitting back there has a clear view of the instrument panel which is chrome-plated all the way across. He can also easily talk to the people in front without having to lean forward and hang over their shoulders.

I felt right at home with the bright red, narrow-pleated cowhide that covers the seats and side panels. I had the same kind of upholstery in my racing car in 1937, and I still think it's beautiful. The carpeting is red, too. It's a special needlepoint vulcanized to a sponge-rubber base.

What Would a More Powerful Engine Do?

The whole car has been lowered an inch and a half below the 1952 level. That's all to the good. Actually, there is no real point in having cars as high as they are. The Skylark was let down by shortening its springs. That makes it look racier. It also lets you feel the expansion joints in the road as you cross them. But that's intentional. This is no old matron's automobile. There's a continental crispness in the ride it gives you. That's what the sports-car boys love.

I took the Skylark up to 85 without any trouble, and that got me to wondering what it would be capable of with a more powerful engine. I feel sure it's going to have one. Buicks have had valve-in-head engines for 50 years, and their straight eights have been



"BUICK WAS THE FIRST American car to 'marry' the front fender to the back one," Ivan Wiles told me. "Our taper-through fender line made its debut in 1942." That's the model at top above. "Now we're the first to divorce the convertible from the two-door sedan," he continued. "Except for the tops, they've had the same contours up to now, you know."

Lower picture above is another view of the Skylark. Note how natural it was to taper the doors and thus parallel that fender line.

EXPERIMENTAL BUICKS have a way of developing into production-line models. The top picture below is of a "dream car" that Buick built in 1939. Today's Roadmasters nearly duplicate it in all details except the fender line.

The bottom picture below shows the ultra-modern front end of Buick's XP-300, built as an experiment in 1950. If the company uses its flatter, shorter V-8 engine in the 1953 line, the Skylark may go into production as almost a dead ringer for the XP-300.



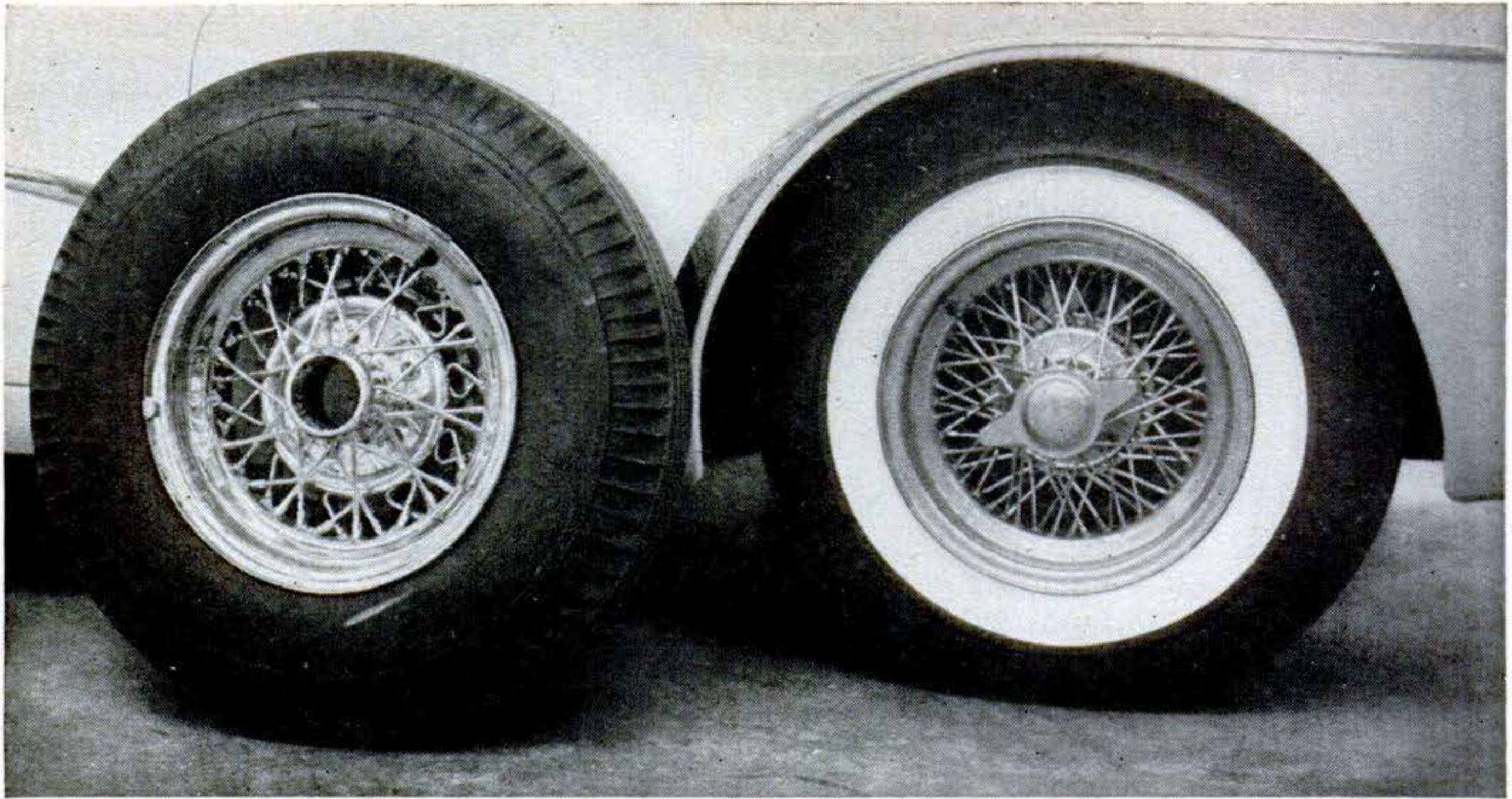

ITALIAN-MADE WIRE WHEELS now on the Skylark will probably be replaced by American-

built type shown leaning against the car above. It looks better in motion and costs a lot less.

developed to such a high degree that the Buick people probably hate to give them up. But their engineers for four years have been showing what outstanding V-8 engines they can produce. The one they built for the XP-300, for instance, has a compression ratio of 10 to 1 and was designed to develop 300 horsepower. Actually, it pulled as much as 335 on the dynamometer.

The more powerful an engine is, the more power it loses internally, unless at the same time it is made shorter and stiffer. This calls for a V-8 engine, which has the additional advantage of being flatter.

So I'll bet you that Buick will modify its experimental V-8 engine for the Skylark, relieving the pressures and cutting back the horsepower to around 180.

Then, with a flatter, shorter engine, the Skylark could be made to look even more unconventional. It would show a closer resemblance to the experimental XP-300.

Shorter Wheelbase with V-8 Engine

Because the V-8 engine is shorter than a straight eight, the Skylark's seats could be moved forward, or its wheelbase shortened, or both. A shorter wheelbase would make the car lighter and easier to park. Moving the seats forward would make the car more comfortable, because passengers would be sitting nearer to the center.

I told you that I guessed there was a sports-car bug at the bottom of the Skylark. He turned out to be Ned F. Nickles,

the big, rangy, Wisconsin-born head of Buick's design studio. Ned has owned three MGs—two of the TD series and one TC—and a Siata. The Siata nearly gave him sciatica. He drove 600 miles in it once, all the while sitting in a pool of rain water, and had to stop at 17 garages in the course of the trip. That, as much as anything, convinced him that foreign cars are better to look at than to drive. He's still wild about their lines, though, and feels strongly that lots of Americans would love to own a car that com-

[\[Continued on page 264\]](#)

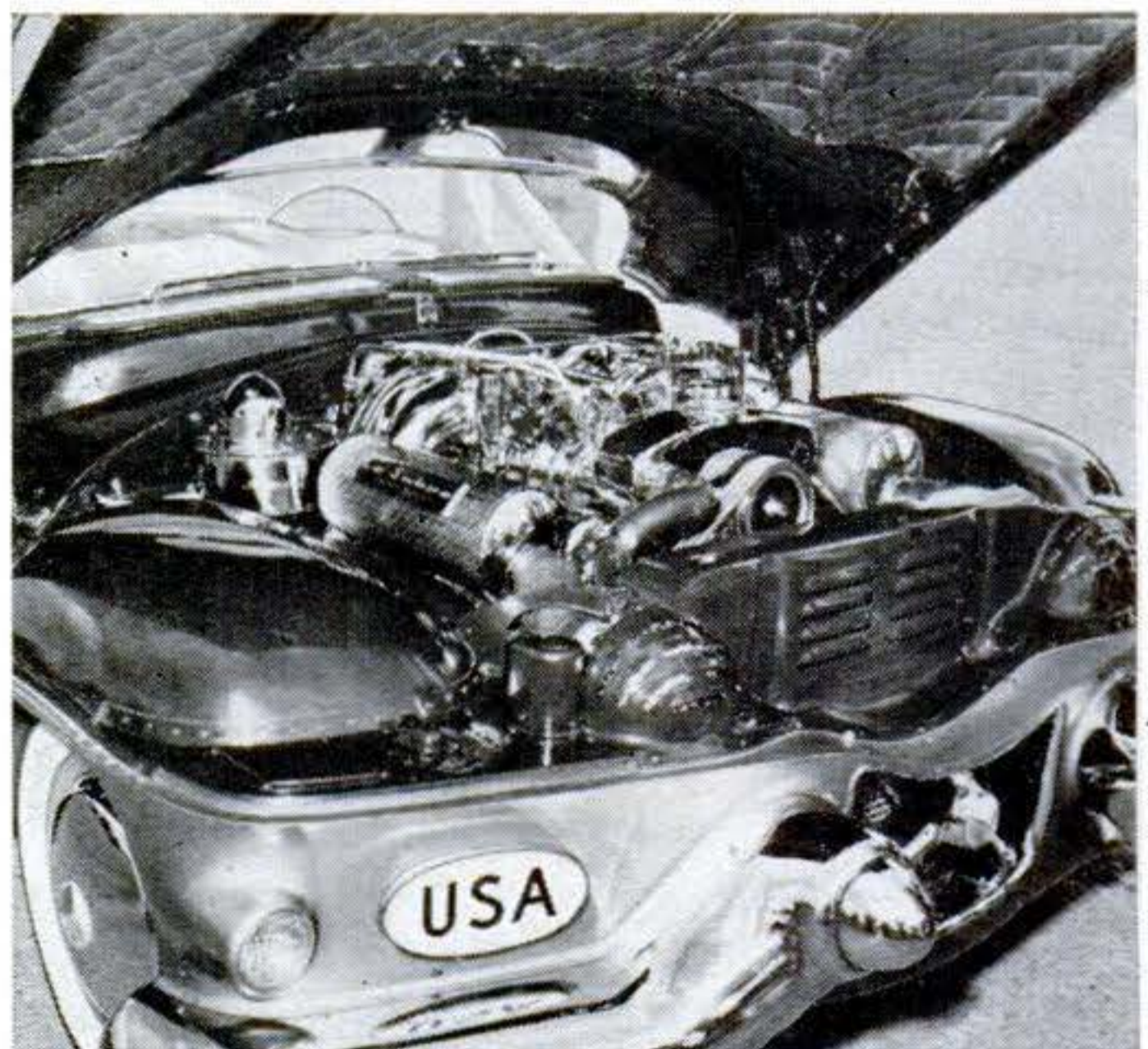

I'LL BET BUICK'S ENGINEERS will modify the 90-degree V-8, 300-horsepower engine they built for the XP-300 and Le Sabre (above) and use it in the Skylark, hinging the hood like this.

When It's a Hot 100° Outside It Will Be Only 75° Inside

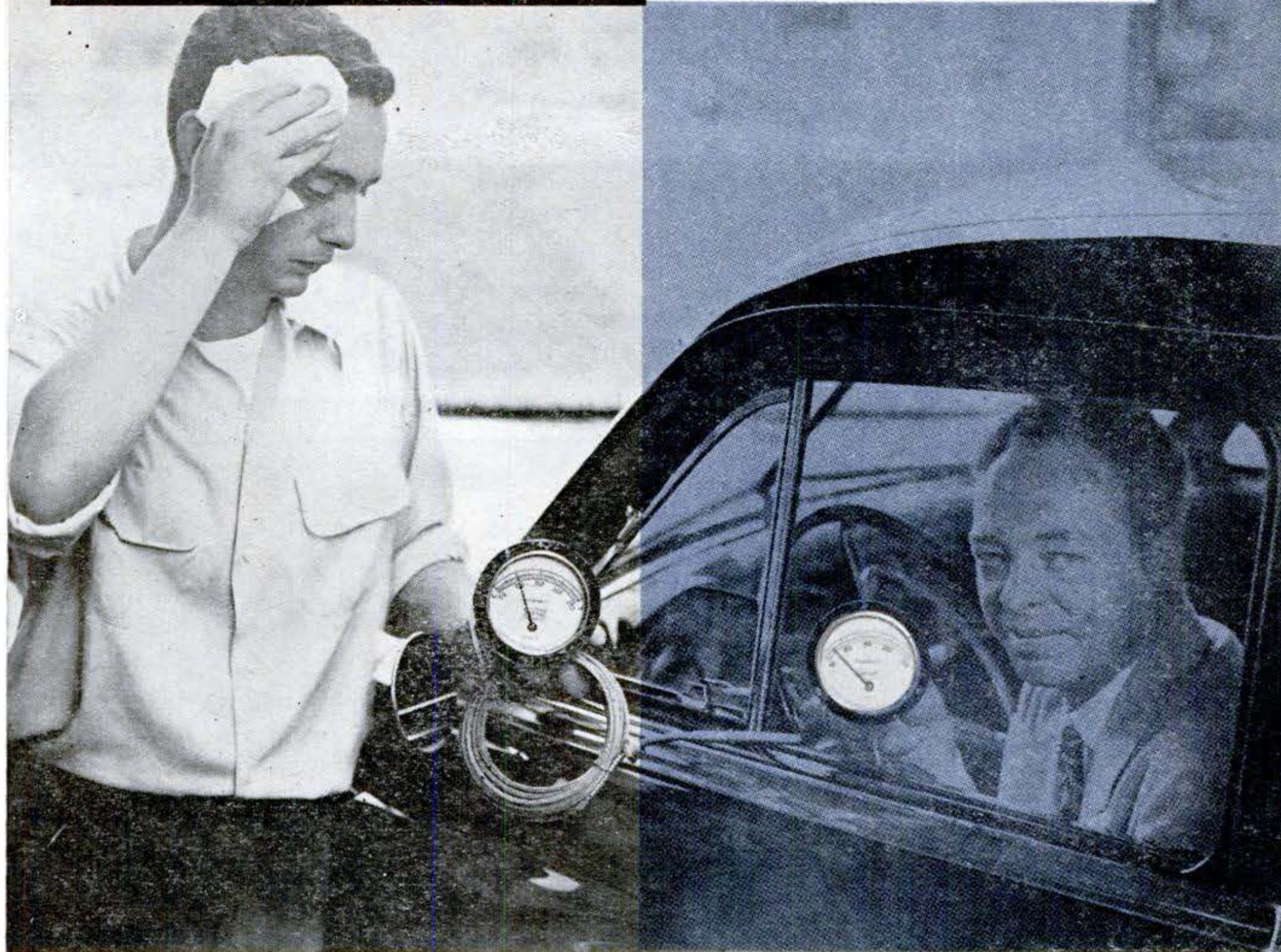

Air conditioning made this 25° difference outside and inside a car on a hot summer day.

1953 Cars Will Have Built-In Air Conditioning

When an egg will fry on the hood, you'll be comfortable inside—cooled, ventilated and dehumidified by a small box in your trunk.

By Devon Francis

IT WAS a boiling-hot day. The temperature in the sun was 100°. Inside the car, which had been standing for 10 minutes with the windows closed, it was 115°.

As I slid into the right side of the front seat, alongside a refrigeration engineer, my light summer suit was soaked with sweat.

Then we began to roll. Within a city block the thermometer reading was less

than 100°. In two blocks it was 80°-plus; in four, 75°.

This was a preview of automobile air conditioning—perhaps the same kind you will be able to buy in at least two 1953 cars next summer.

Once the car was cool, a blower running at only half-speed kept it that way. It stayed cool during a 10-minute stop in the hot sun with the engine idling.

The system not only cools the car. It also

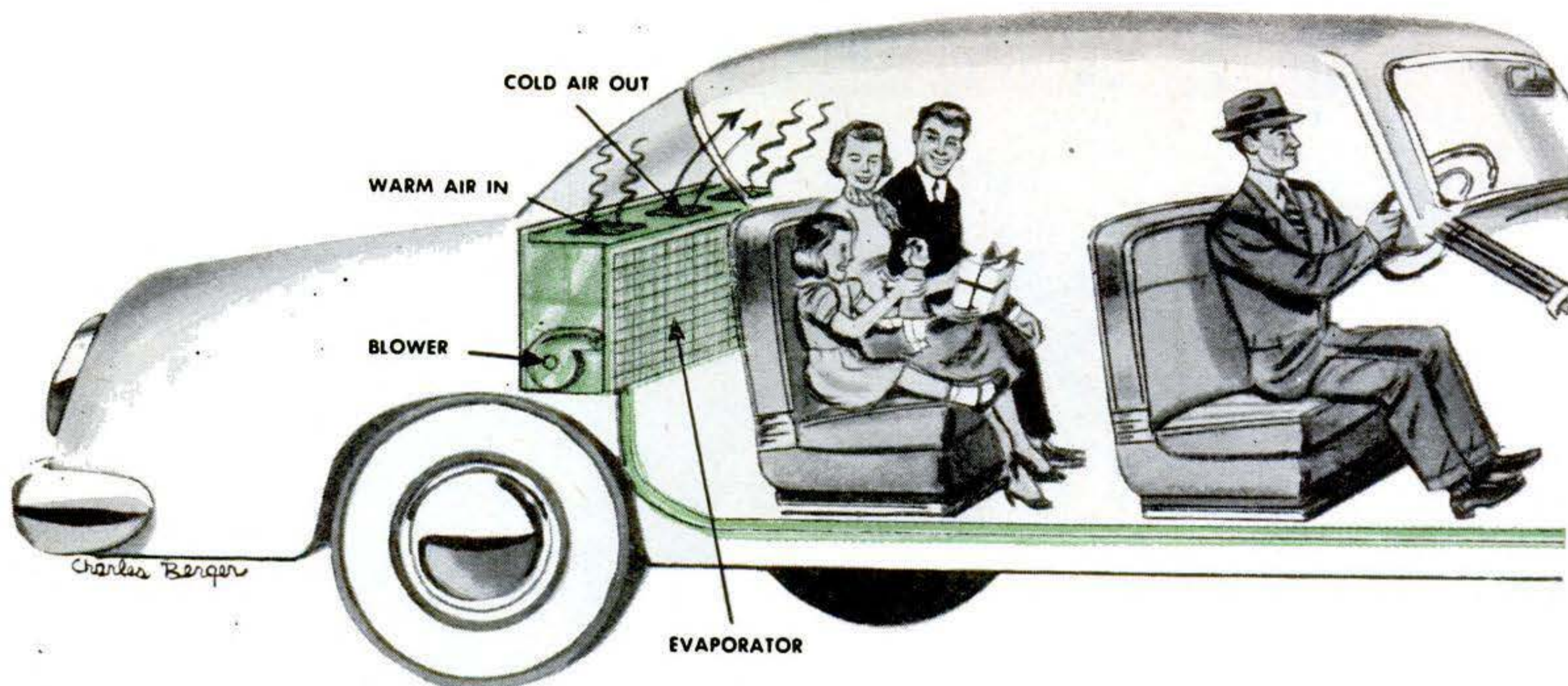

HOW SYSTEM MIGHT WORK on a 1953 car is shown above. Total weight probably will be

less than 200 lb. It will take about five horsepower to run it at top speed, less than one

takes the moisture out of the air. Besides the engineer and me, there were two other passengers in the car. Three of us were smoking. Yet the air was clear and dry.

car is out in the open where the sun beats on it. Its windows admit the sun's infrared (heat) rays. The passengers themselves contribute heat and moisture. And engine heat drifts into the car.

Air-conditioning automobiles is like air-conditioning railway coaches and produce trucks. You compress gas. Usually it's dichlorodifluoromethane, known commercially as Freon 12. Then you cool it. That liquefies it. Then you squirt it out, releasing the pressure. When the pressure is released, the Freon borrows heat from its surroundings to become gas again. Ergo: refrigeration.

That's one of the reasons why air-conditioning units offered by Chrysler, Cadillac and Packard before World War II—yes, they were available more than a dozen years ago—never sold in large numbers. They just didn't have the capacity to handle all that heat. So Chrysler proceeded to beef up its system. It devised a unit with a capacity almost three times that offered before the war.

It Has to Be Small

But air-conditioning an auto is more difficult than air-conditioning a railway car, as engineers of the Chrysler Corp. will tell you.

There was only one problem in getting the machinery into the car. The gas compressor, belt-driven off the engine crankshaft, fitted nicely on top of the block. An evaporator—where the liquid Freon becomes gas again and chills the supply of air to the passengers—and a blower to circulate the air were snugged onto the little shelf at the back of the luggage compartment.

It was a Chrysler experimental car that I rode in. The company isn't ready to say when it will offer air conditioning for its cars, but General Motors has announced that such systems will be available at extra cost on Cadillacs and Oldsmobiles in 1953. It's a good bet that Chrysler—and Lincoln, too—will be ready to cool their cars the next time the pavements turn hot.

Condenser a Problem

The gimmick in cooling a car is getting a refrigerating unit small enough to fit into a vehicle already pretty crowded with machinery. Chrysler now figures that it has this whipped. Its refrigerating unit is smaller than that in a home freezer.

But the condenser was something else again. The condenser is the heart of the whole system. Here's why:

But size is only part of the problem. A

The gas must be compressed from a point where it won't condense to a point where it will—at available air temperatures. Freon 12 at the normal system pressure of 35 pounds per square inch will condense only when its temperature gets down to 38°.

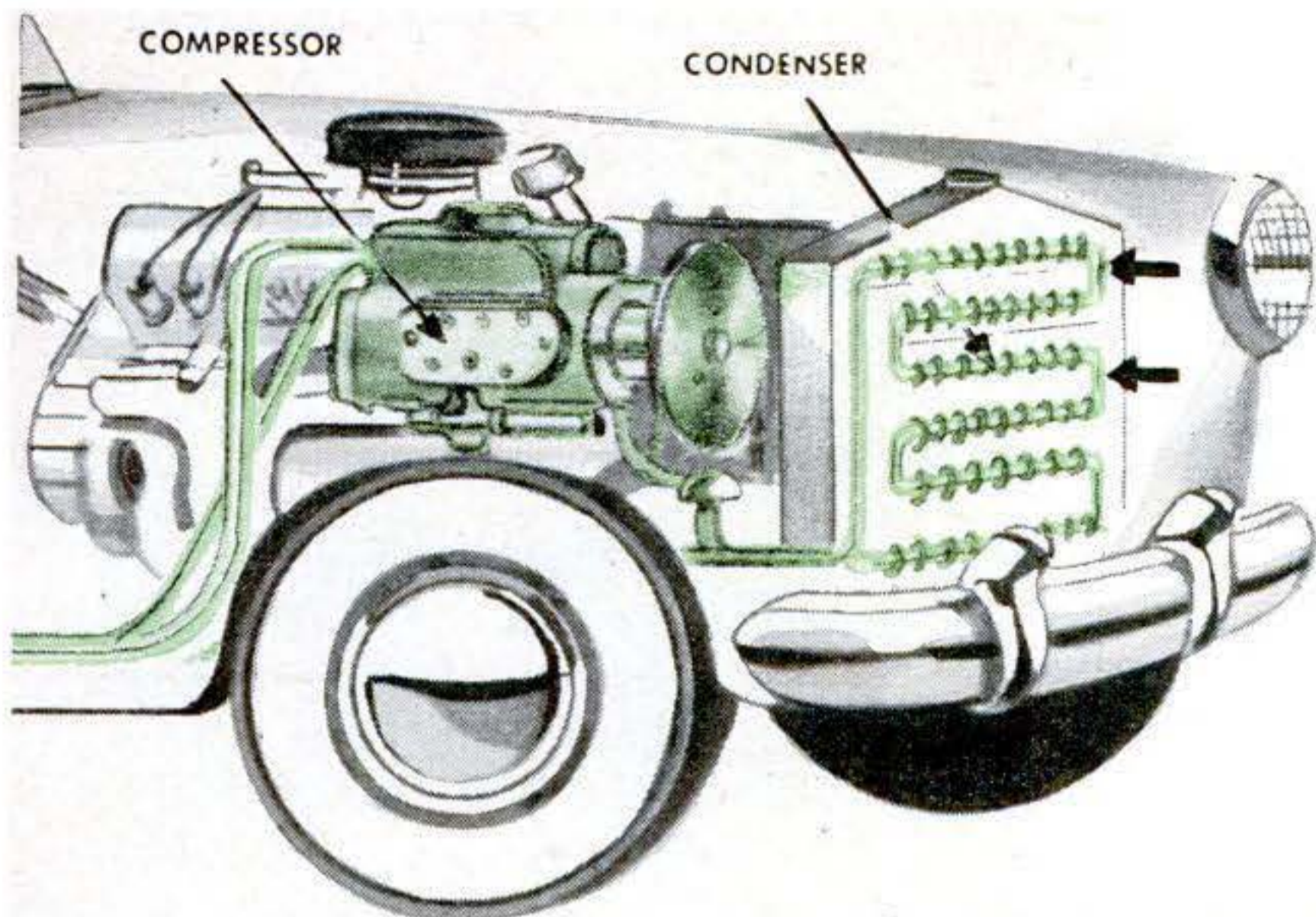

horsepower when it is idling. Six pounds of Freon 12 will be used at a pressure of 180 lb.

Raising the pressure to 180 pounds, however, will make it condense at 130°.

Compressing the gas heats it up some 200°. And it's already pretty warm from the heat it has collected in the evaporator.

That's where the condenser comes in. It has to liquefy the Freon before the gas can start its job of cooling the car. But when the engineers put the condenser in front of the radiator to cool it, the coils blocked off so much air that the radiator soon overheated.

They finally solved that one, but just how is a secret.

A Detachable Unit?

Getting rid of the excess moisture in the air ("It isn't the heat, it's the humidity") was a natural. The cold coils in the evaporator chill the air. Chilled air drops its moisture.

That leaves only one problem—the system requires extensive plumbing from the compressor and condenser to the evaporator, and that means a costly permanent installation.

Now a Chrysler engineer thinks he has the answer to that one, too. He wants a package deal, a refrigerating unit that can be bolted into the trunk in 30 minutes and transferred to a new car when a man trades in his old jalopy.

That would mean supplying power to electric motors to turn the compressor and feed air to the condenser. It would require a better electric generating system.

And that may also be in the works. END

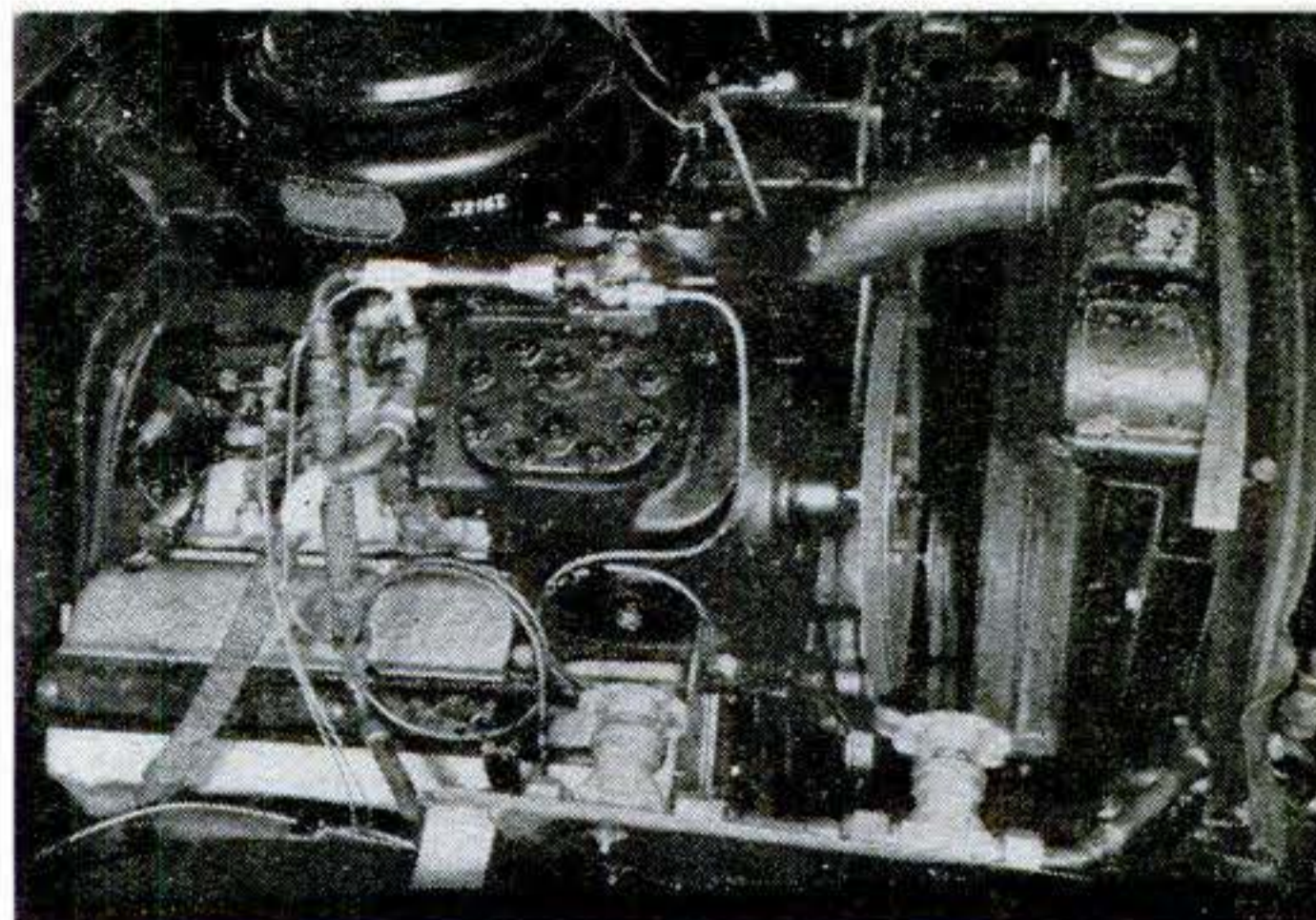

COMPRESSOR on Chrysler experimental air conditioner is piston type mounted on engine block and turned by belt from crankshaft. GM will use a rotary type for Cadillac, Olds.

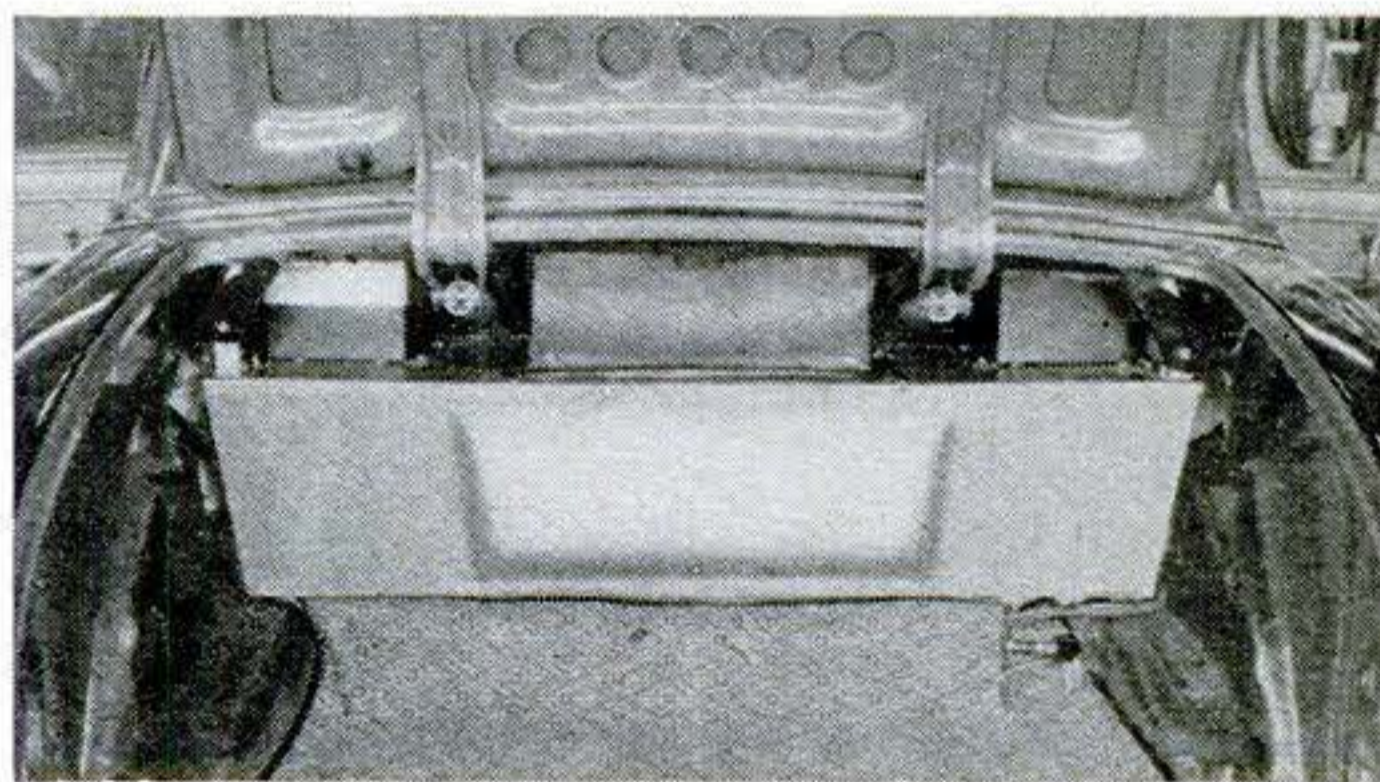

EVAPORATOR, where air is cooled for delivery to car interior, and blower occupy full width of trunk but only a few inches of its depth. No room normally devoted to luggage is used.

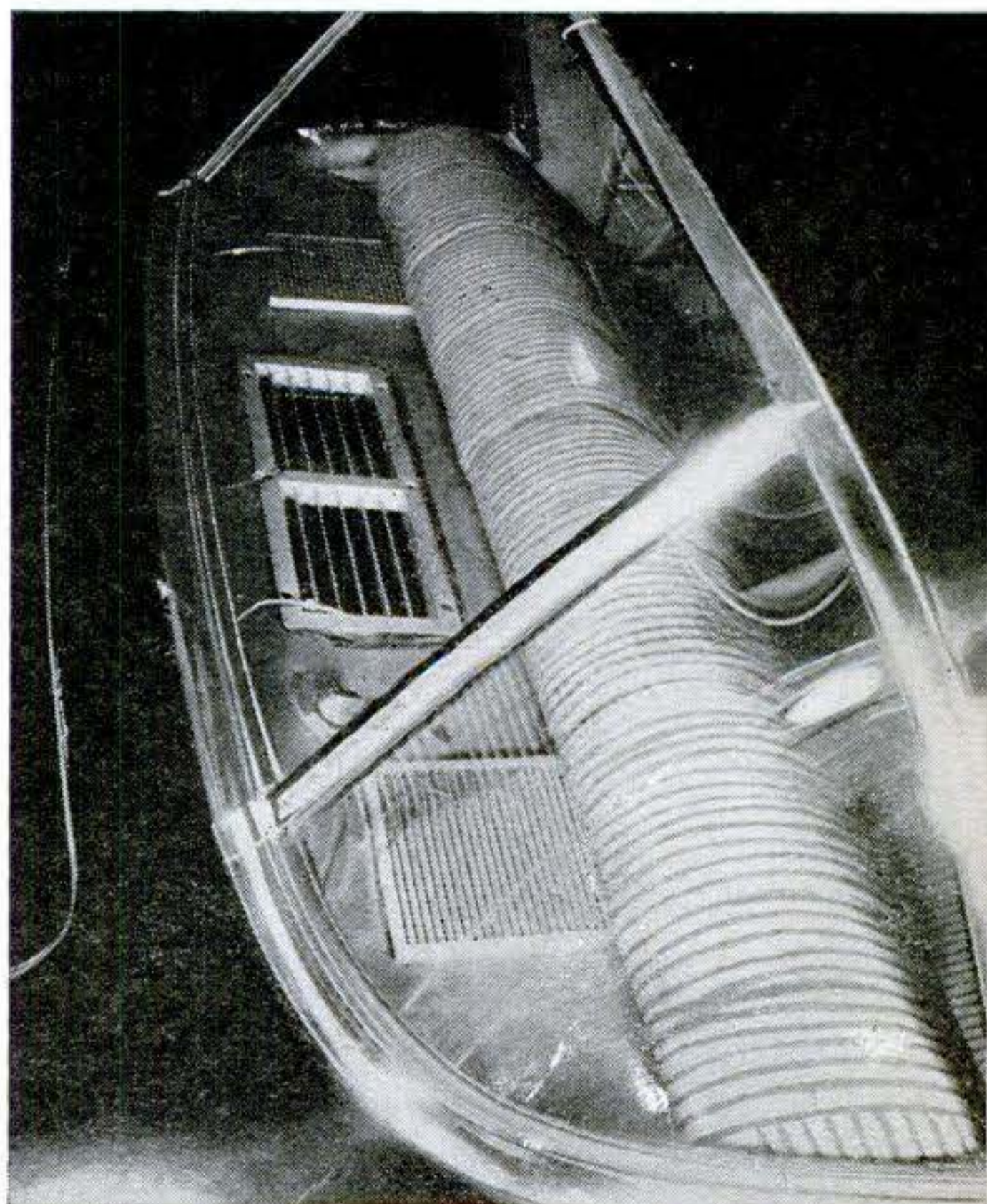

COOL AIR comes from vents behind rear seat. Air is one-fourth fresh, three-fourths recirculated to reduce load on cooling system. Control on dash regulates volume delivered.

1953 Cars

High-priced makes will lead the

By Wesley S. Griswold

NEXT year's models of at least one well known, high-priced American car will come off the assembly lines with a full set of five tubeless tires. That, leading tire makers agree, will start a stampede. They predict that by 1954 you'll be able to get tubeless tires as original equipment on any new car you buy.

A tubeless tire is a casing with an airtight lining. The rim necessarily becomes one wall of the tire. The valve is firmly seated in the rim, with rubber and metal washers holding it in place on both sides and providing the vital air seal.

Goodrich has been making tubeless tires since 1947, Firestone since early in 1951, but until this summer both companies' tubeless tires were premium-priced. In July, these two manufacturers simultaneously announced new models that will be closer to

..... **Here's All**

ONLY THE VALVE REMAINS, and for tubeless tires it is attached to the rim, as demonstrated below with a cross-section of tire and rim.

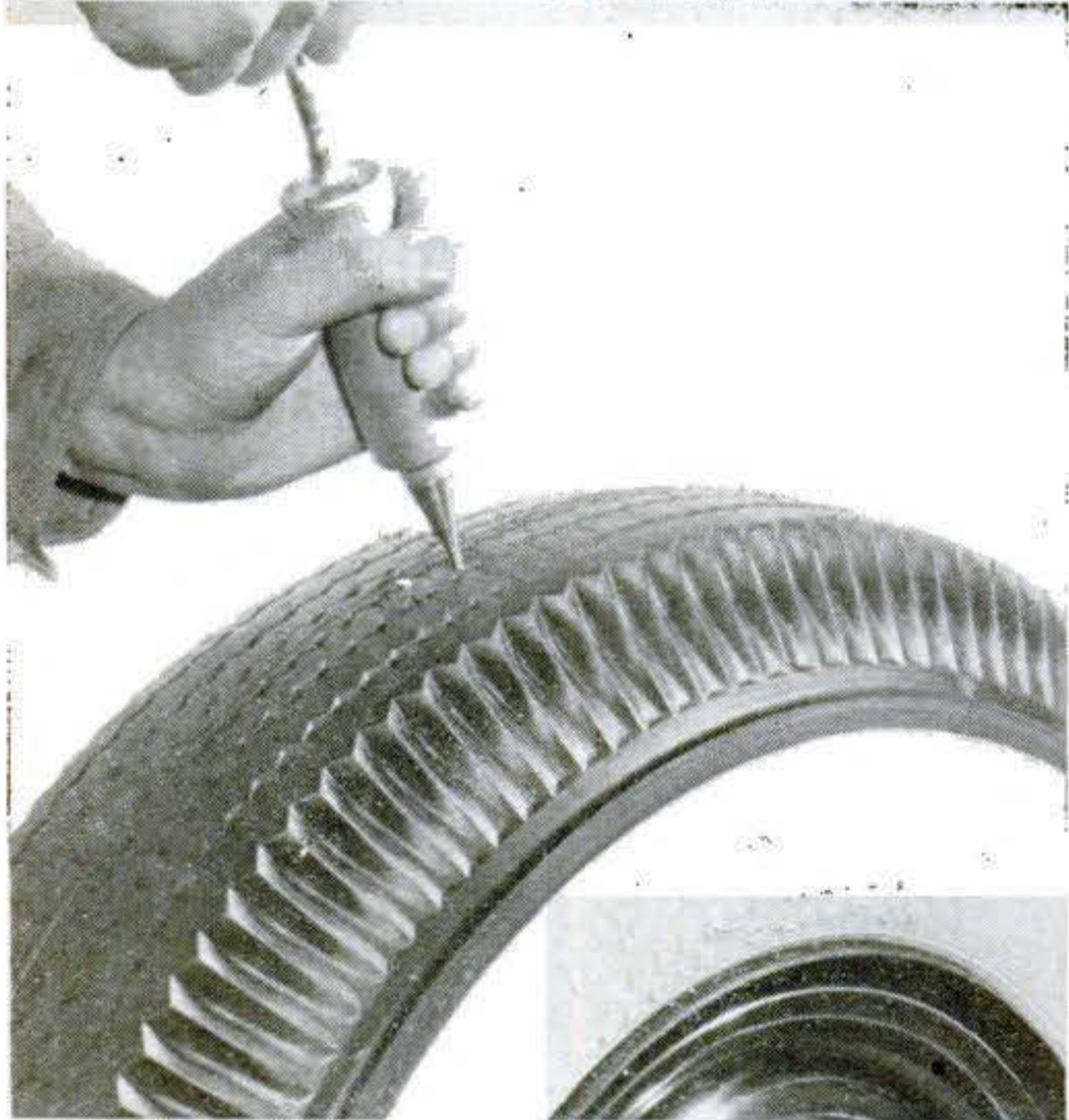
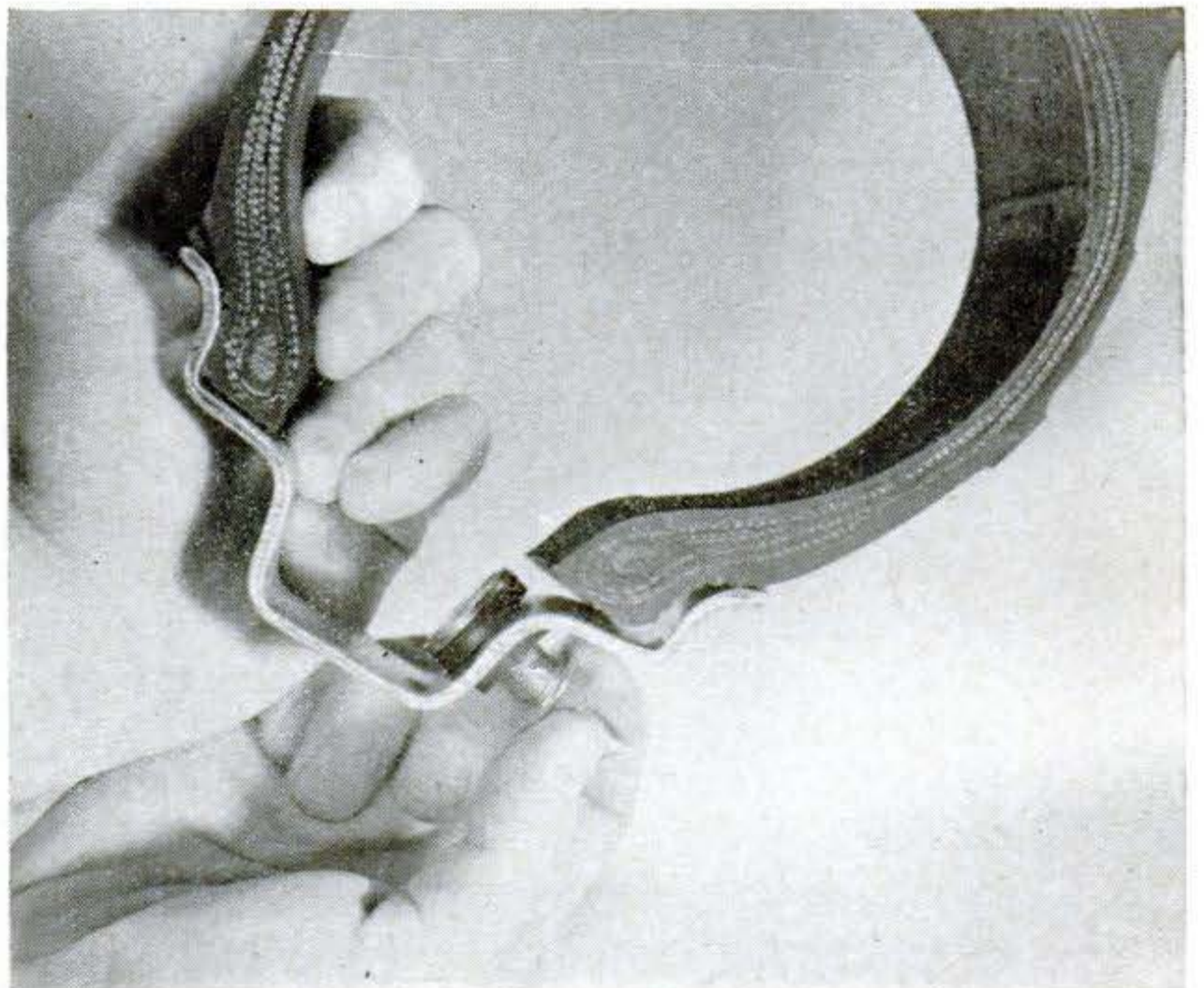

NO AIR ESCAPES when a nail is driven into one of Firestone's new Champion tubeless tires. It leaks out slowly even when the nail is removed. Repair takes only a few seconds with the device at bottom, which forces an air-curing, self-sealing liquid rubber into hole.

Will Have Tubeless Tires

way, setting off a rush to put them on everybody's car by 1954.

the cost of standard tires. U. S. Rubber says that if auto makers want to equip new cars with tubeless tires, U. S. Rubber will be ready. And Goodyear, fourth of the four big tire companies, admits that it, too, has made and tested a lot of tubeless tires.

One of the three major producers of popular-priced automobiles would like to put tubeless tires on his entire 1953 output. He likes the sample that one of his suppliers has offered, and wants to use it. All that is holding him back is this: Can the other suppliers produce a tire that will match it in quality and price, and soon enough?

Four Good Reasons

Why should anybody want to buy tubeless tires?

The men who design and build them say:

- They are safer than conventional tires.
- They provide a softer ride.
- They keep cooler at high speeds.

- They give up to 10 percent more mileage.

The tires that they are talking about are their latest, lowest priced models—the ones most likely to become original equipment on 1953 cars. They are practically immune to punctures and they're unusually hard to blow out. The reason is their lining, a butyl composition.

Tough, tightly knit, man-made butyl is 10 times as resistant to air seepage as natural rubber. Moreover, in tubeless tires it is vulcanized to the inside of the cord body, where there is no tension on it. When a nail pierces this lining, the butyl does not pull away from the puncture, the way the stretched skin of an inflated inner tube does. Instead, the butyl grasps the nail tightly. Air does not escape unless the nail is pulled out. Even then it takes its time. You could drive for miles with a nail in one of your tubeless tires and never know the difference.

You *can* blow out a tubeless tire, but

That Is Left of the "Old-Fashioned" Inner Tube

SIX PARTS make the assembly of the conventional valve for tubeless tires (left below) a time-consuming job. One solution offered is

the experimental hard-rubber valve (right below). It has but two parts and is snapped into place mechanically from inside rim.



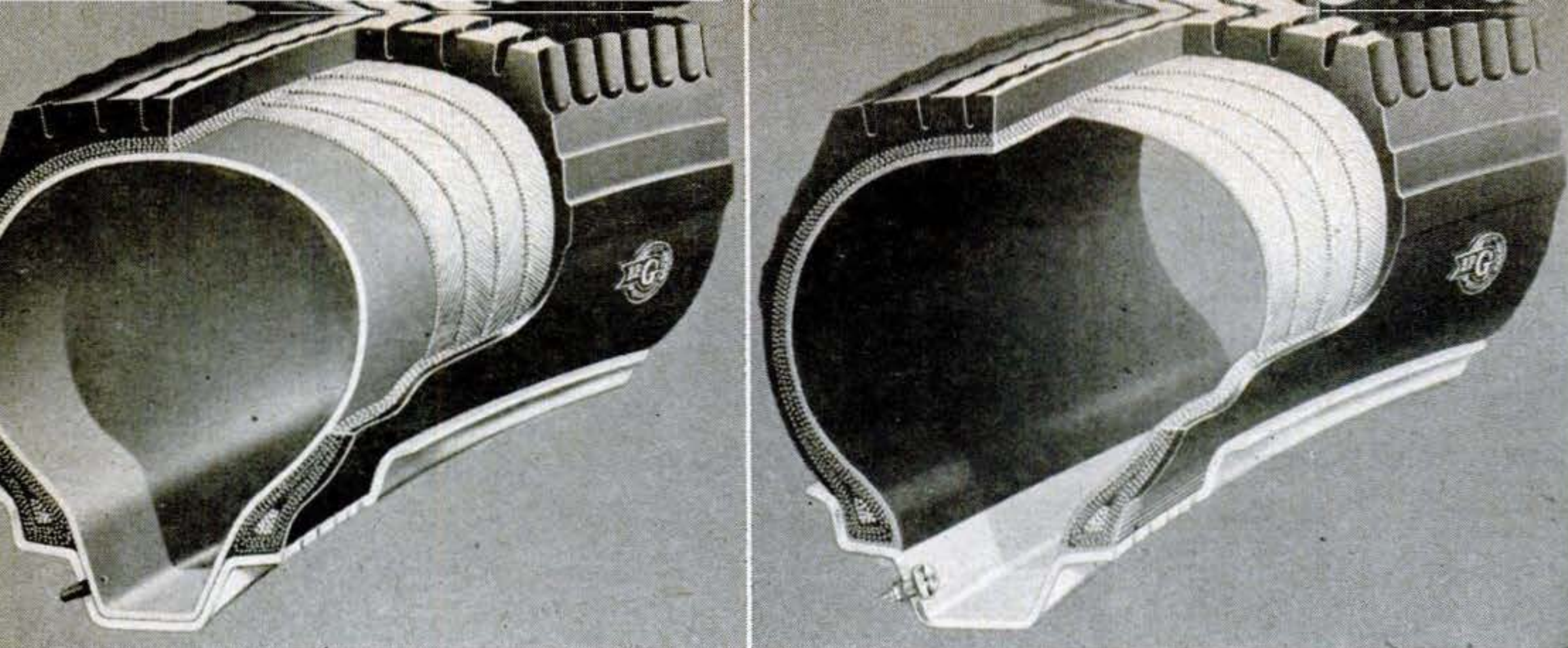

THE INSIDE STORY of the difference between a conventional tire and tube (left above) and a tubeless tire is told in these drawings of two Goodrich products. They illustrate clear-

ly how an inner tube insulates the rim, bottling up heat that in a tubeless tire (right above) can escape through the metal. The latter fact is why tubeless tires run cooler.

not easily. Blowouts usually are caused by a violent pinching of the inner tube when the cord body of the tire is ruptured. This is most often the result of hitting a rock or a pothole at high speed. When such a rupture occurs in the body of a tubeless tire, the butyl lining, being vulcanized to the casing, can't be pinched. At worst, it will crack, thus letting the air out slowly rather than explosively.

The surest way to blow out a tubeless tire is to run it over a section of angle iron, or any other object guaranteed to cut a long, deep gash in it. A badly damaged rim will let the air out of a tubeless tire, but Firestone's testers have repeatedly driven tubeless tires against curbs and similar objects that an average driver might hit without ever knocking the air out of anything but themselves.

Reduced Friction Improves Ride

Almost everyone who has driven on tubeless tires reports that they ride easier. This is despite the fact that they are inflated to the same pressure—28 pounds—recommended for conventional super-balloons. Engineers say it is because inner friction disappeared with the inner tube.

The new tires run cooler at high speeds partly for this reason, partly because they are lighter (by almost the full weight of the average inner tube). But the chief cause of their coolness is the rim, which conducts heat away from the inside of the tire faster than it can when it is smothered by the inner tube of a conventional tire.

Taking the heat out of tires makes them

last longer. The increased mileage promised for tubeless tires also will come from the greater strength that improved carbon blacks, cold rubber and new chemical compounds have given them.

Car makers are going to have to make certain that the butt welds on their rims are smoother, so that air can't escape by that route. Rims may have to be machined to closer tolerances to provide a tighter seat for tire beads. Assembly-line workers and the staffs of more than 100,000 service stations will have to learn how to install the special valve that tubeless tires now use.

But the enthusiastic prophets who say that tubeless tires for everybody are coming fast brush aside these obstacles as unimportant. They already can see the day when inner tubes will be as obsolete as the solid-rubber tires they replaced. **END**

Do You Remember ?

Many early gas buggies retained the horse whip. Came in mighty handy for chasing curious canines away.

In the front-wheel-drive "Electrobat" (circa 1895) the back wheels did the steering. In motion, the vehicle appeared to be advancing to the rear.

One early auto, the Carter "Twin-Engine," carried a spare power plant: if one failed, the other got you home.

1953 Forecast

By **Ralph R. Watts**

Automotive Writer, *The Detroit News*

DIRECT FROM DETROIT

Here is what's being talked of for the new-model automobiles.

BUICK Overdue for restyling, the Buick is going to look a lot different. The hood will be shorter, the visibility better. That new V-8 engine, which but for Korea would have been here a year ago, will replace the famous old valve-in-head straight eight in at least the Roadmasters. The car will have more snap at take-off.

CADILLAC Power brakes are talked of to supplement its power steering. There'll be a new look. And (see p. 105) summer air conditioning by an actual refrigeration unit like that used in offices.

CHEVROLET Perhaps the biggest news in automobiles—because people buy more Chevrolets than any other brand of car—will be a complete overhauling in style, transmission and engine. Chevy will have a new six to replace the engine that hasn't been changed much in 20 years. The Powerglide automatic transmission will have more oomph when the light turns green. Rumors of a new V-8 refuse to die.

DODGE A new V-8 engine to supplement the sturdy six is an open secret in Detroit. And a new automatic transmission may replace the semiautomatic.

FORD To its overhead-valve six—described by some authorities as the best in its class—Ford is going to add an overhead-valve eight, replacing the L-head that hasn't been changed much since the early 1930s. The new eight just missed '52.

HUDSON A "little" Hudson, not so little as the little cars but littler than the standard Hudsons, will make its appearance in the showrooms. It will be nothing like the Nash Rambler or the Henry J—nor will it be much cheaper than the big-three small cars. It will be a "big-little" car.

LINCOLN Look for both power brakes and power steering. Lincoln, like Chrysler and Cadillac, has been fiddling with air conditioning, but whether it will be added in 1953 is undecided.

MERCURY Like Ford, its smaller brother, this car will have a spanking new V-8 overhead-valve engine.

NASH The Rambler is going to get the works in the styling department.

OLDSMOBILE Power brakes are talked of and may become available.

PACKARD A new, and perhaps simplified, power-steering unit will be added to supplement the power brakes that Packard introduced this year. It's designed to meet the criticisms of existing power-steering systems—a wheel that turns too "fast" and boosters that respond too slowly.

PLYMOUTH The third of the small cars, the Plymouth will be new from front bumper to exhaust pipe. Don't be surprised if it undergoes changes in engine and transmission.

PONTIAC A new V-8 is beginning to emerge. It may take some time before a full view is seen.

STUDEBAKER That snub-nose look to the current Studebaker was a stopgap when a shortage of materials forced postponement of complete restyling in 1952. Now, all the changes are planned for '53. An overhead-valve six is on test stands.

• • •
Modifications also due in Chrysler, De Soto, the Henry J, Kaiser, the Nash Statesman and Ambassador, and the Willys.

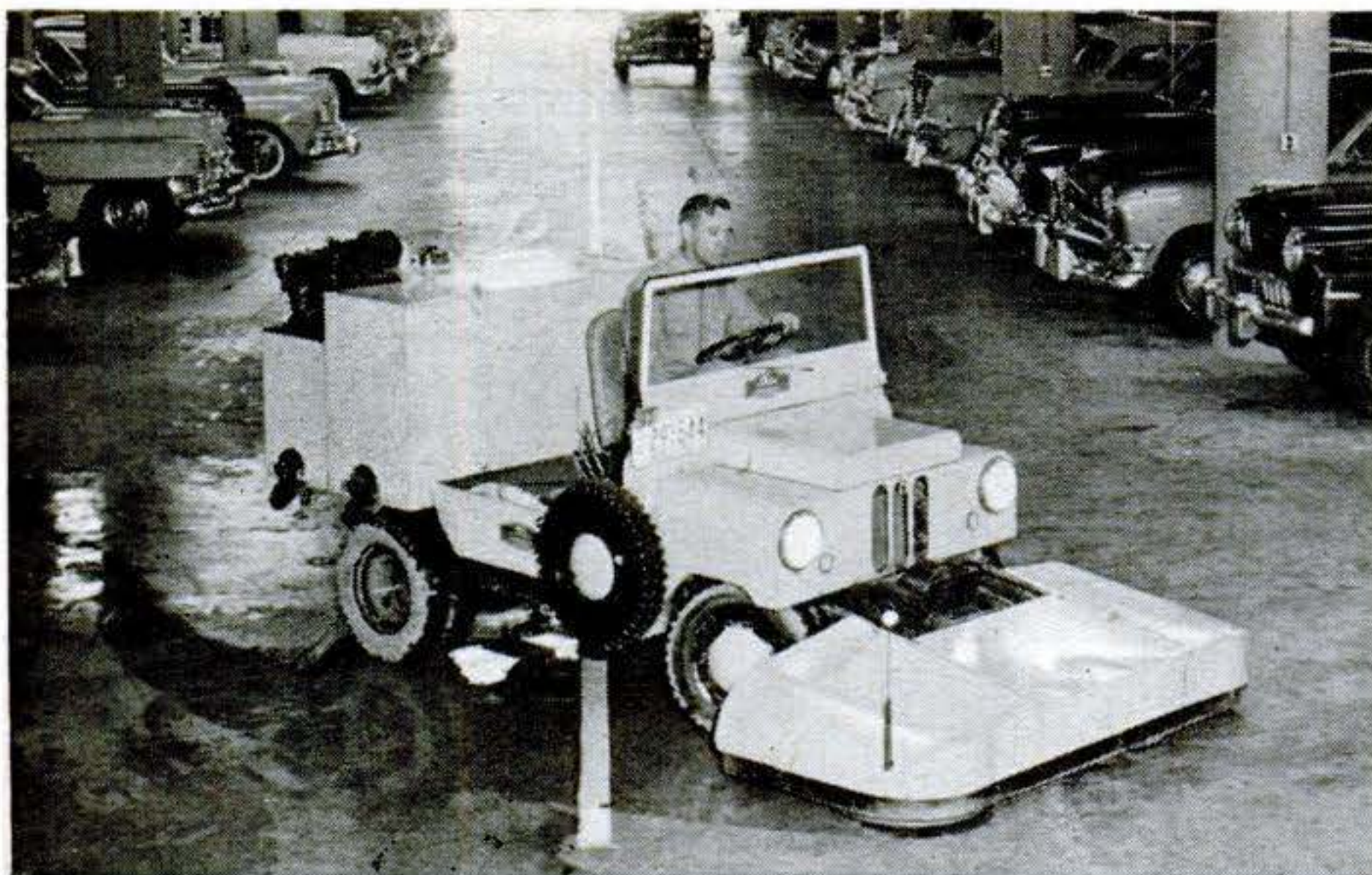

Jeep Scrubs Floors of 14-Acre Garage

ONE man riding this jeep scrubs more than 14 acres of floor in two days in a Los Angeles garage. A gas engine at the jeep's rear turns four brushes at the front while a tank feeds out scrub water. A squeegee behind the rear wheels gathers the dirtied water, which is then sucked up into a second tank. The Finnell System, Elkhart, Ind., makes the scrubber.

Power Jacks Raise Either End of Auto

FLIP a switch on the car at right and you can raise or lower either end of it on a built-in hydraulic jack. The car's two lifts, operated by a motor under the hood, draw up behind the bumpers when not in use. Turning the switch also sets the car's brakes. Vincent R. Paolucci, South Euclid, Ohio, invented the system.

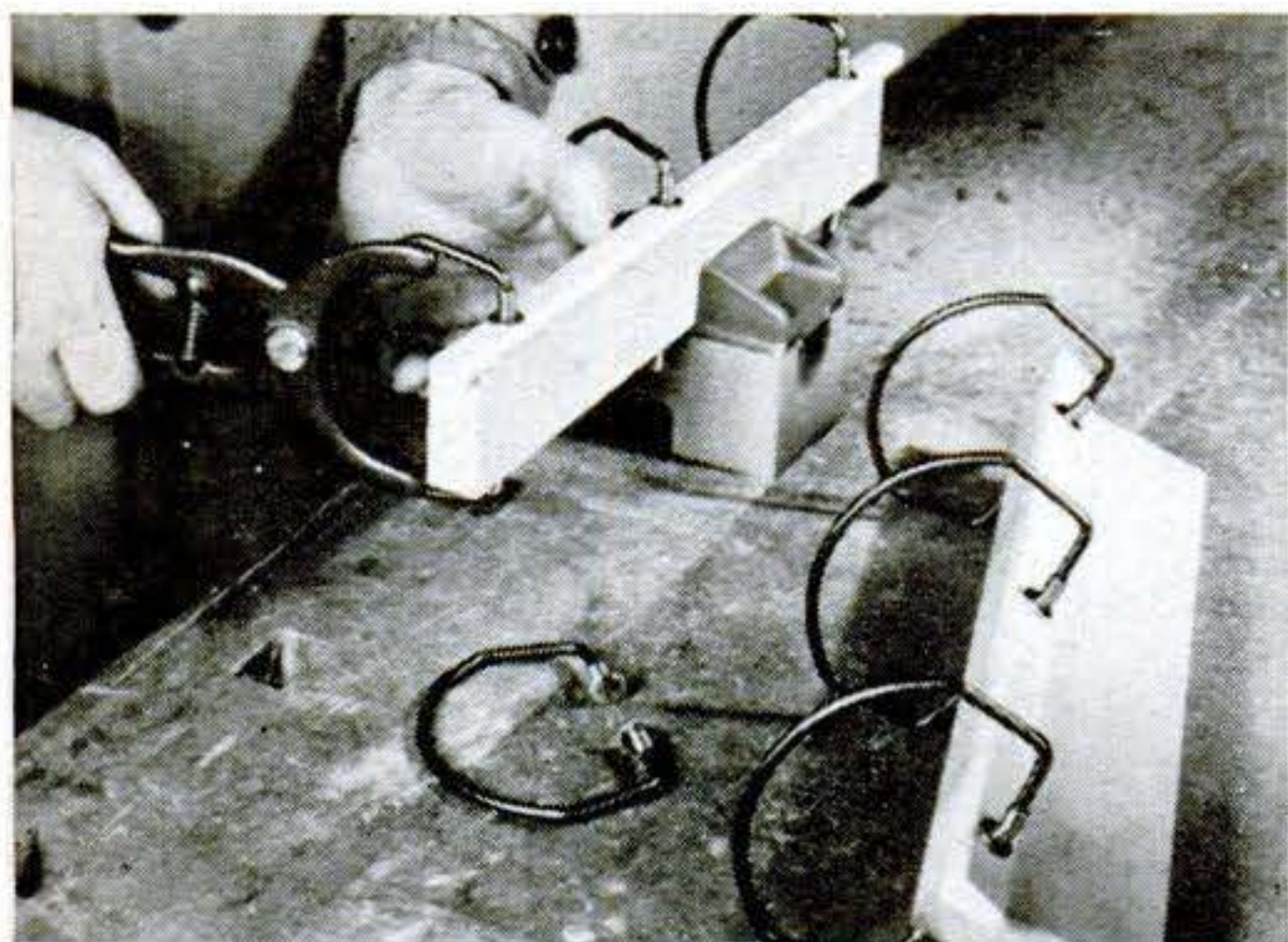

Spring Clamps Aid in Gluing

LIGHT gluing operations are made easier with these spring-steel clamps. They can be forced open and snapped onto the work with mounting pliers, leaving the craftsman one hand free to hold the glued part in position. Movable pressure plates on the jaws permit clamping beveled pieces. Georg Ott of Ulm an der Donau, South Germany, makes them in several sizes to take different thicknesses of wood.

Pen Takes Ink Through 'Straw'

THIS pen carries a gold "drinking straw" to sip up ink when it needs refilling. The tube pops out from behind the nib when the cap on the top of the pen is unscrewed. Ink is drawn up as the lifted cap is pressed down, and screwing the cap back on retracts the tube. The nib is never touched by ink. Sheaffer calls the new fountain pen the Snorkel.



Two-Part Rocket to Outfight Fighters

THE British believe their newest guided missile is so good that it will make fighter pilots obsolete. Directed by radar beam, or steered by its electronic brain, it can outmaneuver and outfight the fastest fighter planes. It is said to be able to "hunt" a target at 2,000 m.p.h., chasing it as high as 10 miles and rapidly altering course to intercept it no matter how the quarry twists and turns.

Rocket motors on the outside, seen firing in the photo, give it an added boost at the take-off. They drop off seconds later and the missile continues on, powered by the main rocket motor, which is located inside.

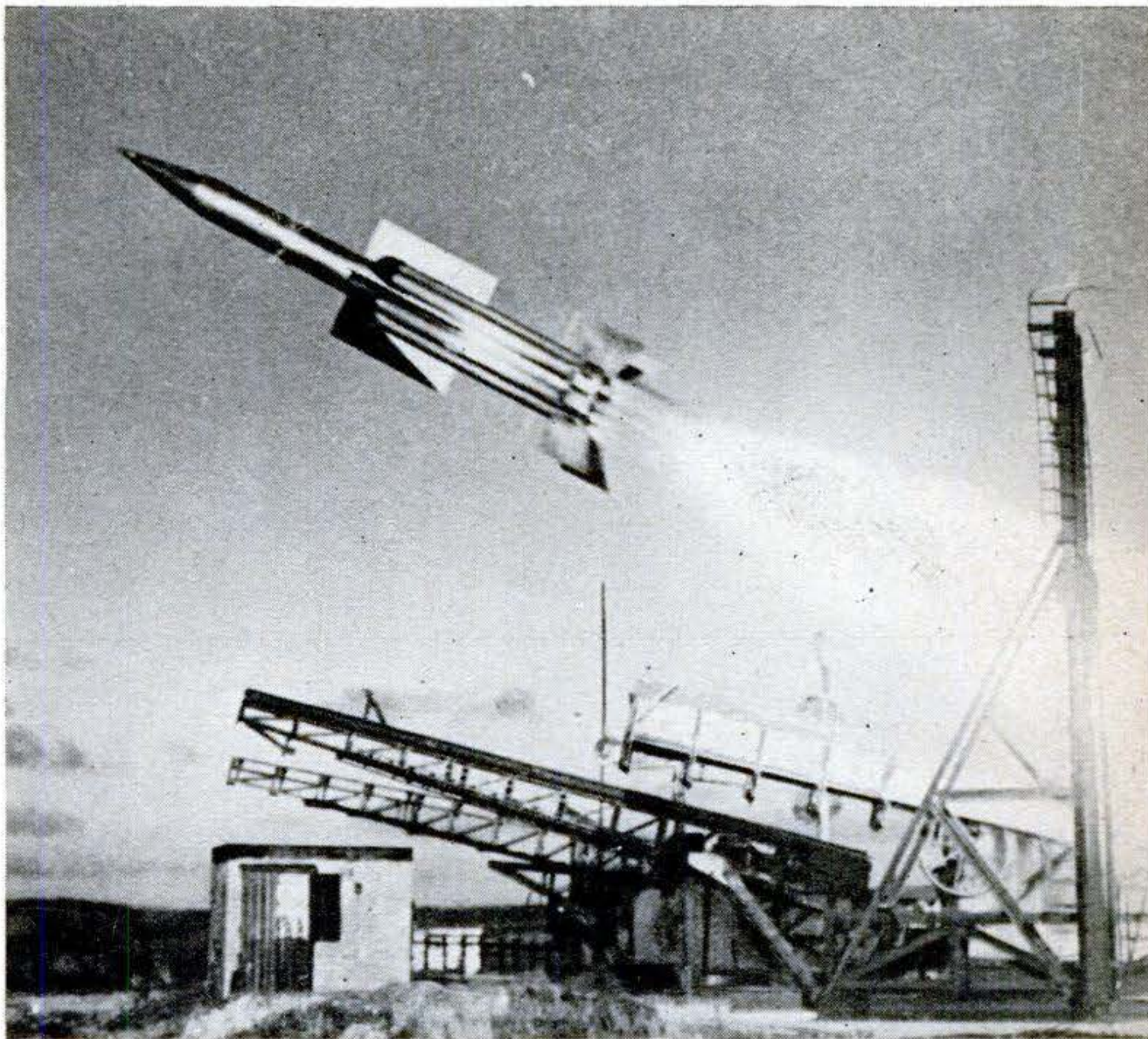

Radar Backstops Watchman

IF THE gateman above takes his eyes off the road, an "electronic cop" watches for him. The reflector in the window aims a shortwave radio beam down the road. Any object moving in the beam will bounce the waves back to the transmitter and ring a bell. A car sounds the alarm hundreds of feet away; a pedestrian 100 feet away. The system guards the GE Research Laboratory.



75 years ago this month

Popular Science Monthly reported:

"IT IS only with the mouth open that snoring can be accomplished during sleep. It follows that any device which prevents the lower jaw from dropping down, during the relaxation of sleep, and opening the mouth, will prevent snoring. The apparatus represented, which consists of a simple cap, fitting the head snugly, and a piece of elastic webbing, can be made more or less tense as may be required to effect the closure of the mouth."

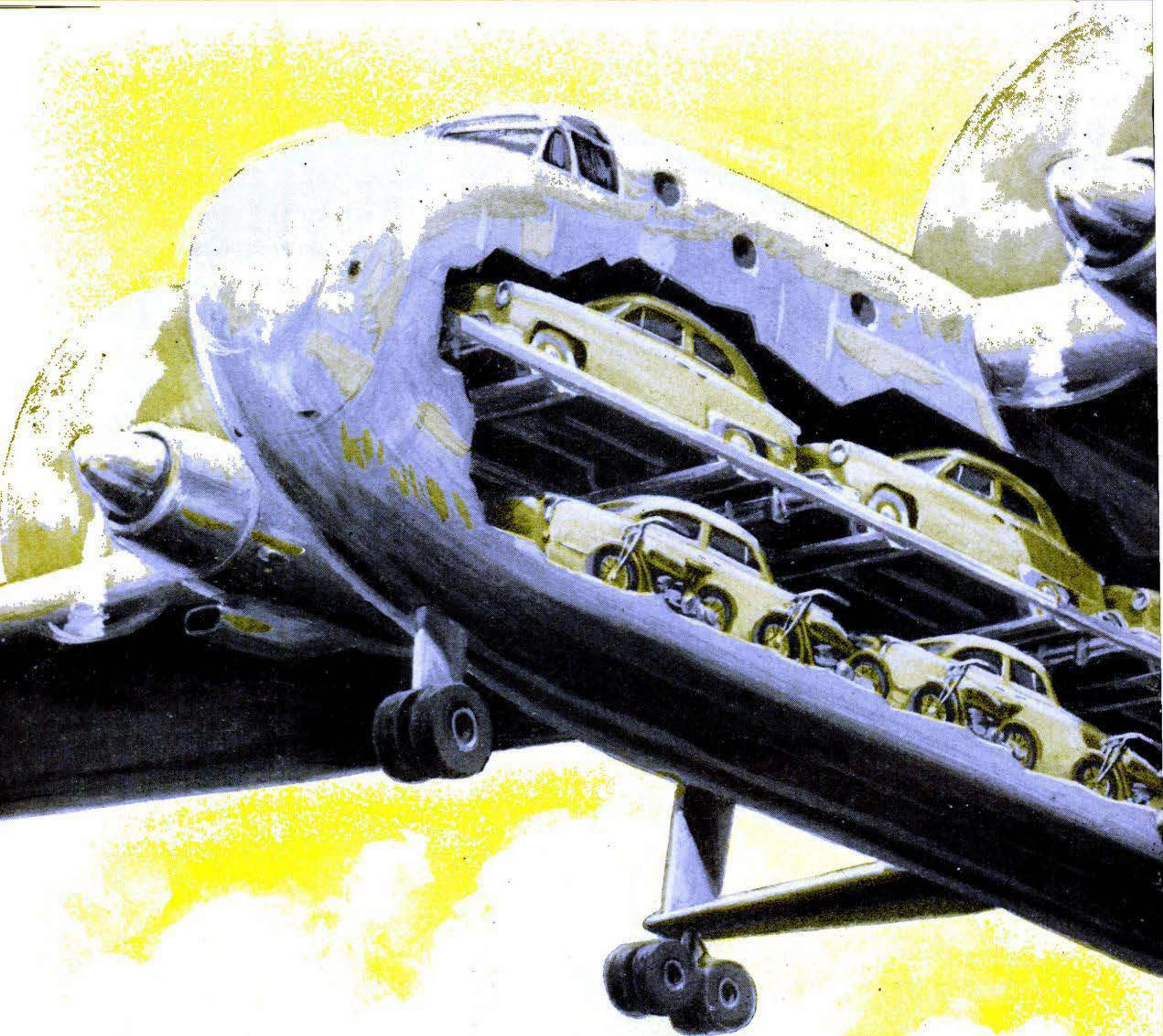

Triple-Decker to Ferry Cars and Passengers

Redesigned model of Europe's largest air freighter will carry autos in aerial "hold" and passengers in a luxury tail cabin.

A BUILT-IN elevator will raise automobiles to the upper fuselage deck of a new version of the Blackburn Universal Freighter now being built in England. The two cargo decks will hold six to eight cars, depending on size. There also will be room for motorcycles and bicycles at one side of

the lower deck. The upper deck in the tail, reached by a staircase, will accommodate 42 passengers. With this arrangement, it is claimed that the 55-ton plane can carry three times its present payload. The 180-mile-an-hour Freighter can land on and take off from grass fields.

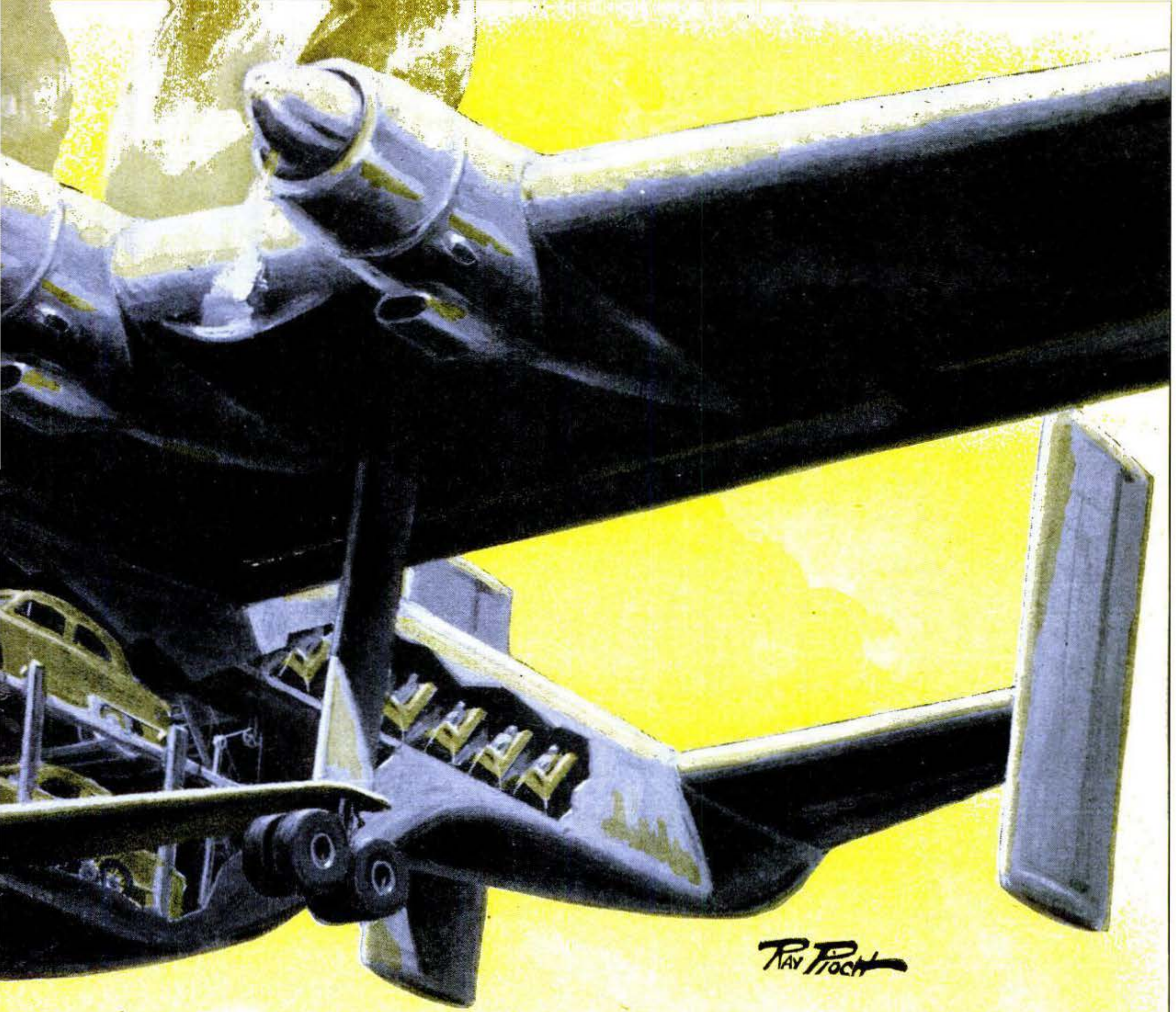

Clamshell doors and loading ramp of the present version of the Freighter are shown below.

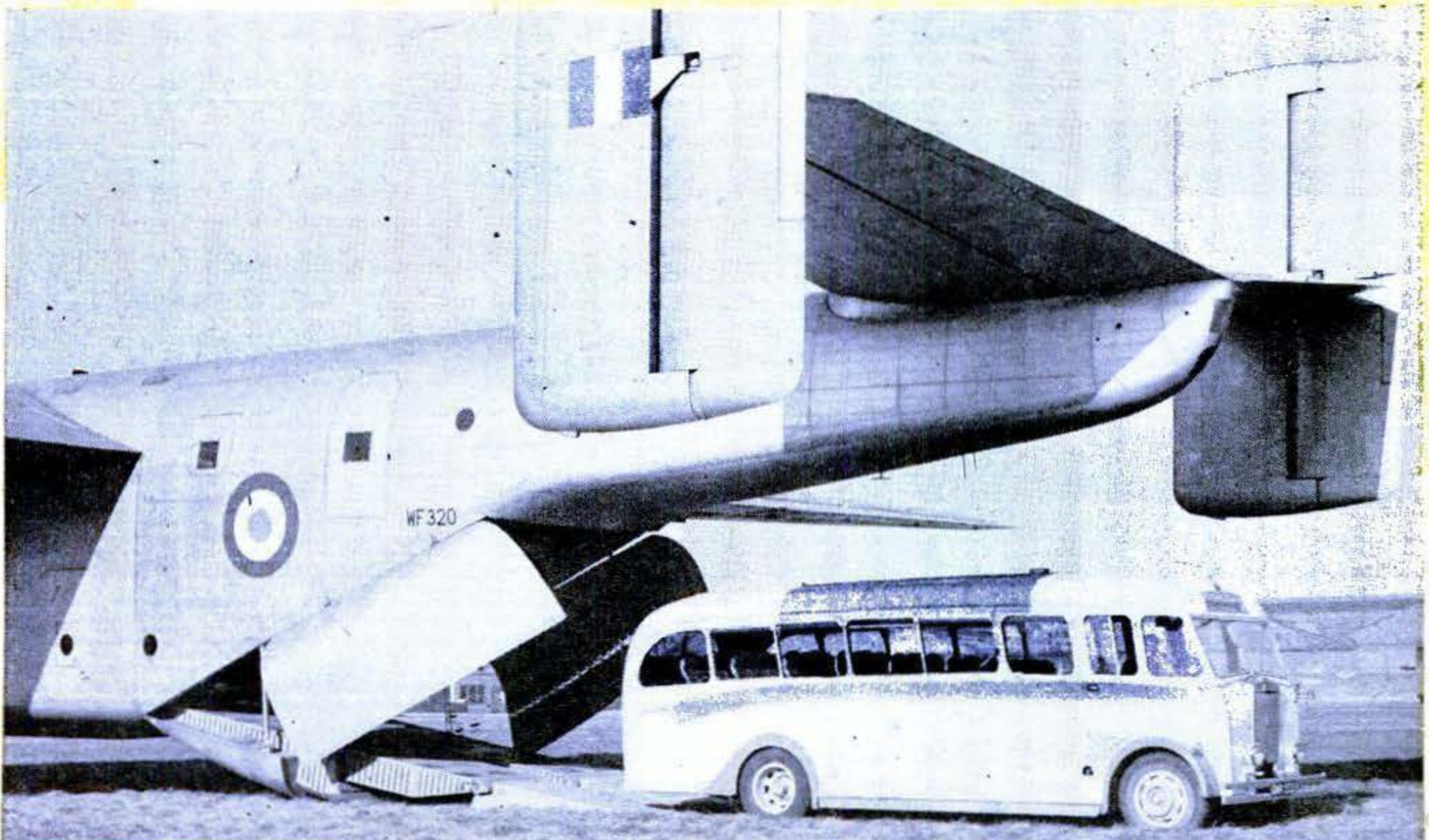

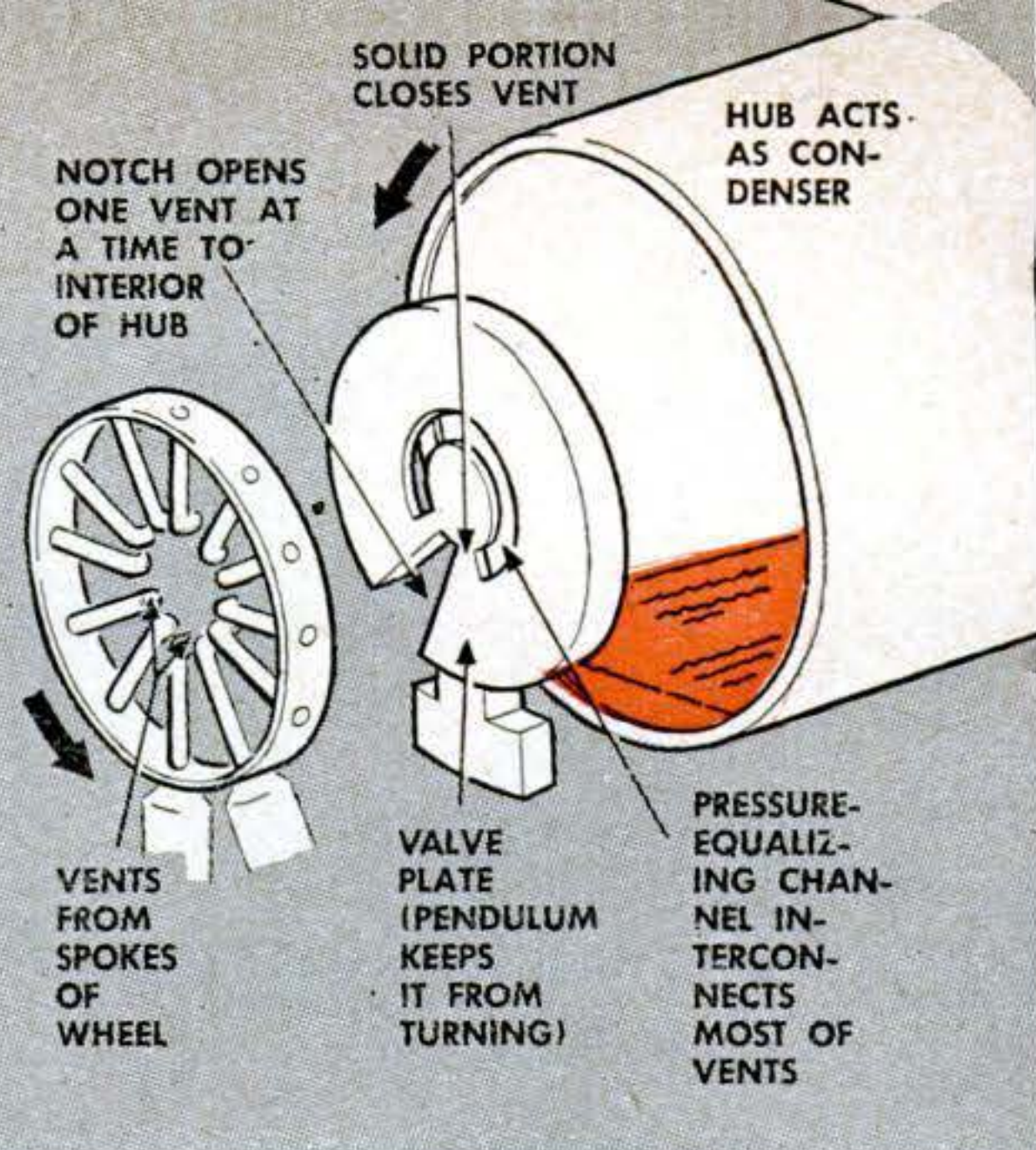
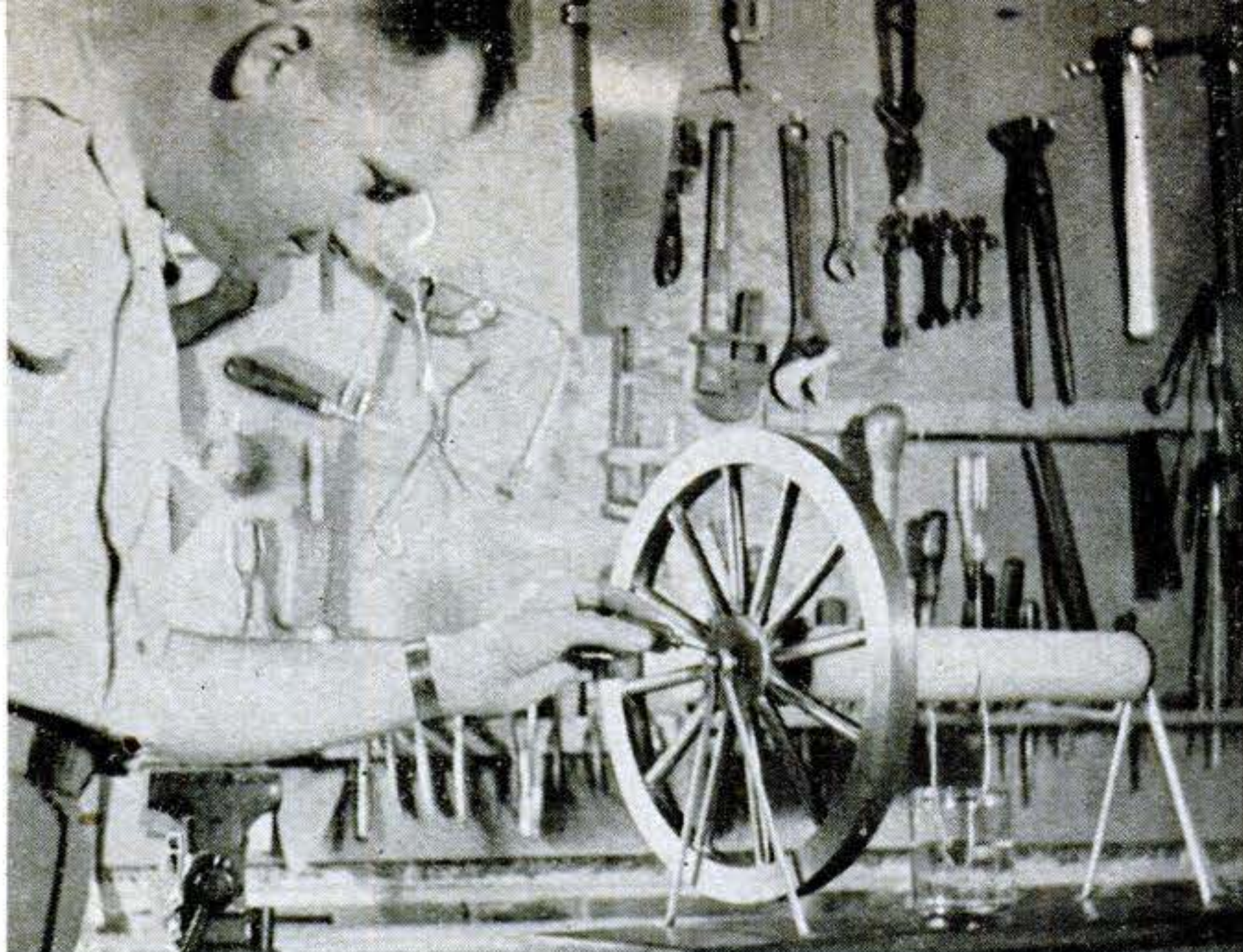

Inventor's Mysterious Motor Runs on Power Drawn from Atmosphere

WHEN Cmdr. Ivan Monk, who designs big turbines for the Navy, is pestered by inventors of perpetual-motion machines, he points to a device on his desk that goes them one better—for it works. It is a wheel that spins with no apparent source of power. Commander Monk built it in his spare time, and patented it, since it may find use in clocks, toys and advertising displays.

Actually it is a rotary heat engine, run by temperature difference between its parts. The wheel is at room heat; the long cloth-covered hub, kept dampened with water, is cooled by evaporation. A low-boiling-point liquid, Freon, circulates between wheel and hub, vaporizing in the wheel and condensing in the hub. Valves maintain an unequal weight of liquid on opposite sides of the wheel—and gravity does the rest, to turn it.

Prospecting Trucks Aid Hunt for Uranium Buried in the Earth

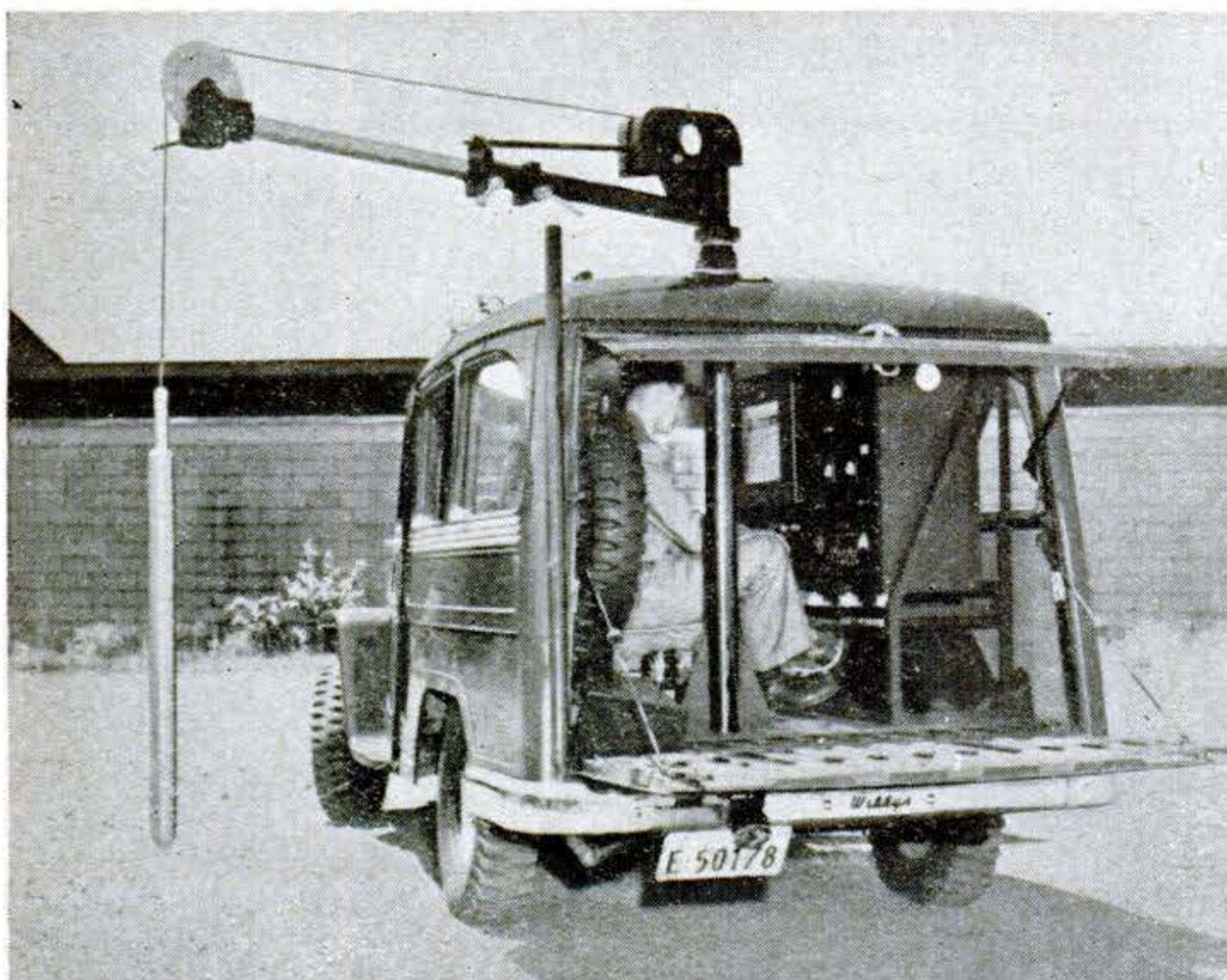

FOUR trucks like the one at left are speeding uranium prospecting in the western U. S. Backed up to a drill hole, a truck lowers down it a 2½-foot-long steel cylinder with winch, boom and cable. Wires connect a scintillation counter in the cylinder, which detects rays from uranium ores, to an automatic recorder that charts their levels. Built for the Atomic Energy Commission by Bogue Electric Mfg. Co., Paterson, N.J., the trucks save the time of taking and testing core samples.

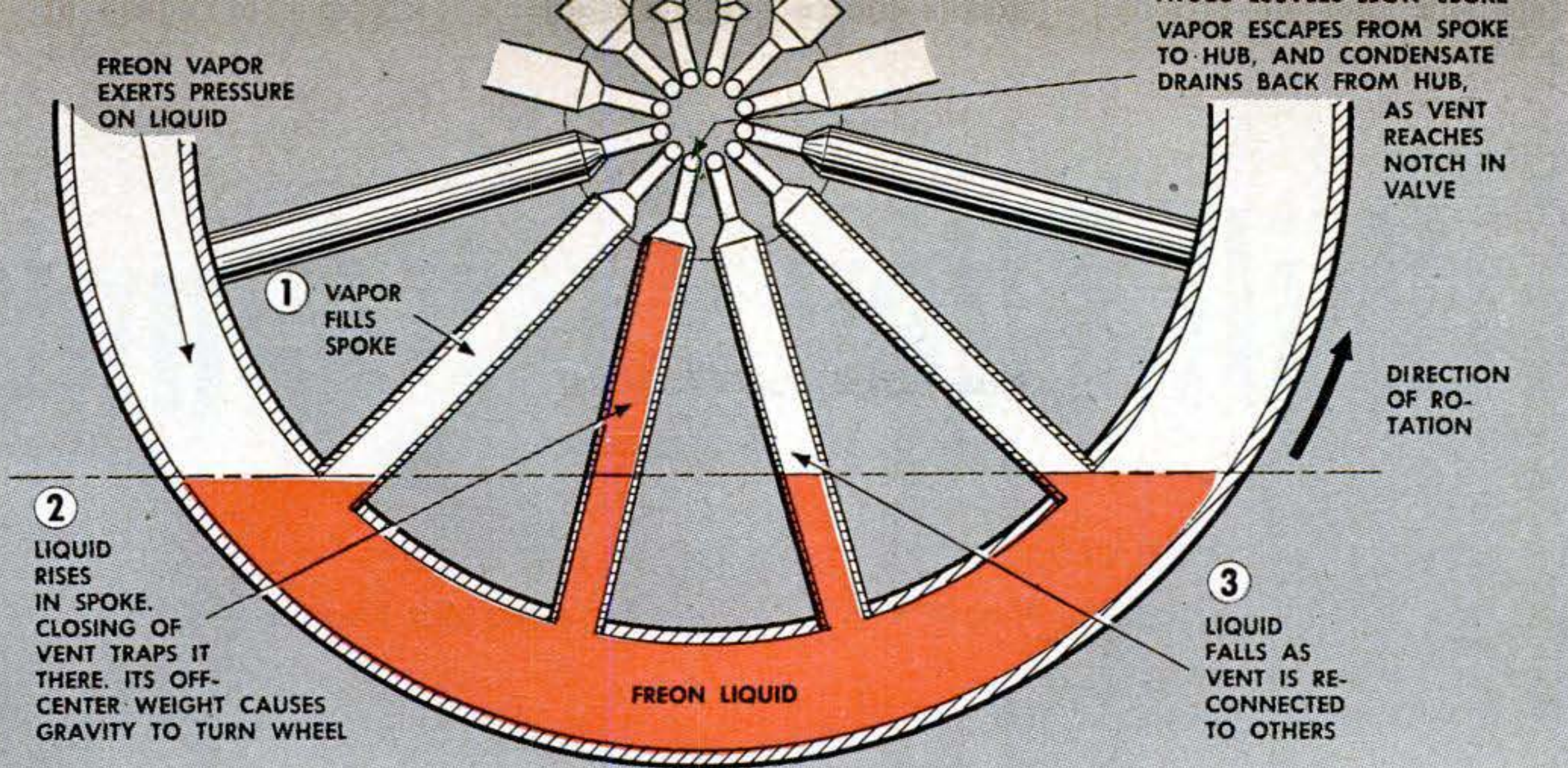

SECRET of mystery motor (at far left with inventor) is revealed above. Spoke nearing bottom fills with Freon liquid, which valve mechanism (left above) briefly traps in it. Resulting excess weight of this spoke turns the wheel.

MOTOR SPINS with no visible power source. Actual source, heat from atmosphere, evaporates water to cool elongated hub acting as condenser. Endless loop of string, dipping in beaker of water, keeps cloth-covered hub moistened.

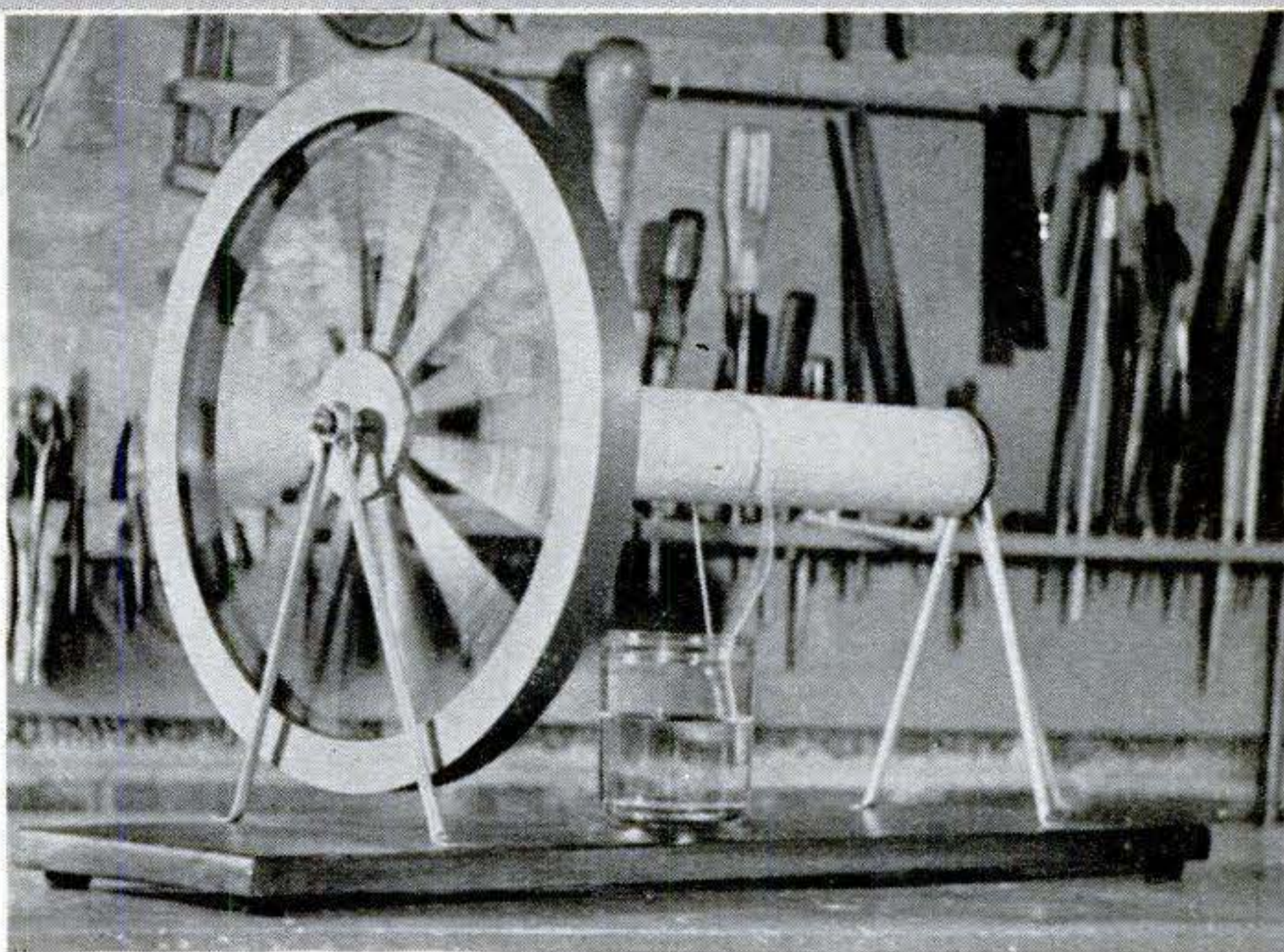

Tool for Blind Drives Brads

INSERT a brad at the tip of this tool (below), and a magnetized plunger holds it. Pressing the handle drives it by extending the plunger against a spring. Wellman Products, Cleveland, makes the tool for the American Foundation for the Blind.

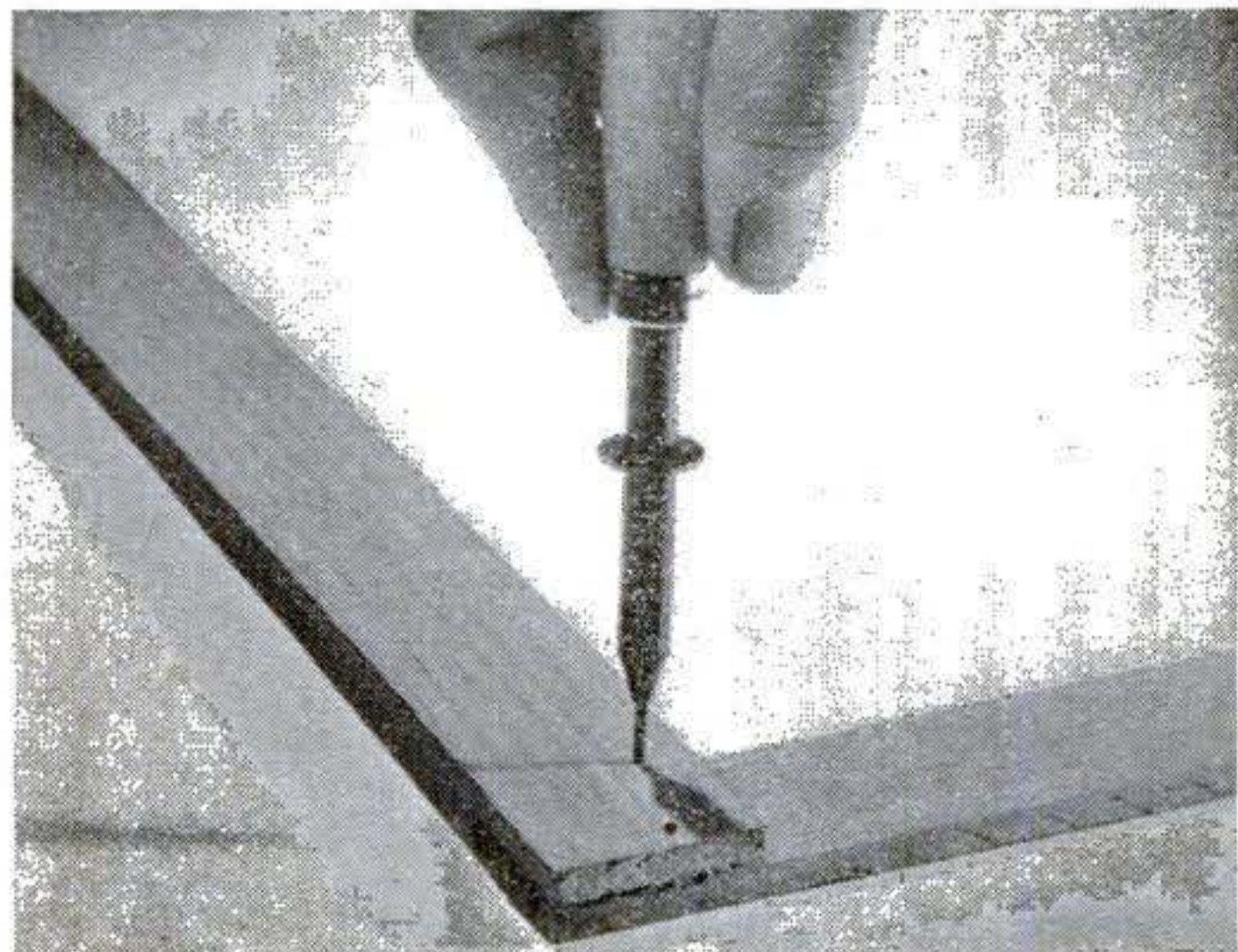

Tune Tells When Wash Is Dry

LAUNDRY automats now play a tune to announce that the wash is dry. Commissioned to fit an electric clothes drier with a music box, a Westinghouse engineer devised one whose five tone bars render the air of "How Dry I Am."



Will They Ever Climb

The man who came closest gets set to try again this month. Here's why even he doubts that he'll make it.

By Gardner Soule

IF, BY some miracle, you landed by parachute on the 29,002-foot summit of Mount Everest, you would remain conscious, without extra oxygen, about 1½ minutes. With oxygen, you might stay conscious for several hours. But the cold (as low as minus 65°), the winds (up to 150 m.p.h.) and the thin substratosphere would kill you before you could get down.

Yet only last May, Ramond Lambert, a Swiss mountaineer, and Sen Tensing, a native Sherpa porter, lived through a night 27,550 feet high up on Everest. They were in a tent but had no sleeping bags. They slapped each other all night long to maintain circulation. The next day they climbed up to 28,215 feet—the highest point on Everest man has reached, and lived.

Lambert could survive up there where you couldn't because his body and mind were acclimatized—that is, gradually adjusted to altitude by a long, slow climb from sea level. This trip is necessary if you want to live on Everest at all, and that is why you can't drop from a plane or helicopter.

He'll Try the Impossible

Lambert is going to try for the summit again this month. He will try despite the conclusion of the expedition leader that 28,500 feet—502 feet from the top—is the place where body and mind can take no more, and the climber must turn back or die. This is the point, he thinks, of complete

exhaustion, even after acclimatization and with oxygen.

His team doctor agrees.

In his determination to try again for the impossible, Lambert is following exactly the reasoning of all Everest climbers:

- It cannot be done.
- We'll try.

Other men besides Ramond Lambert are getting set. Now in the Everest area, making preparations for an attempt to lick the world's toughest peak in May, 1953, is Eric Earle Shipton, an Englishman, who has climbed in the Himalayas for 20 years.

Shipton, known for his reconnaissances, in October, 1951, discovered a new, southern route toward the summit. In the spirit of the Everest tradition, he turned over all his information to Lambert, who has a chance to beat him to the top before Shipton's next try in 1953.

They Know They May Fail

Shipton is as aware of the difficulties as Lambert. He knows that if Lambert fails he himself may be the one to

make it. On the other hand, says Shipton, "there may be another 20 failures."

For even with the latest equipment, the odds still favor failure.

The hazards of climbing five miles up Mount Everest actually start near sea level in Nepal, an independent kingdom in north-east India, where Everest is located. Here you face jungle and disease and heat. And you have a 160-mile trek just to reach Everest, over mountain ranges, down through gorges, along unmarked and un-



EVEREST CLIMBER whiffs oxygen from tube in sketch of new lightweight equipment. For details, see page 121.

Mt. Everest?



British Mosquito bomber skims past cloud-veiled Mt. Everest in this rare view of the peak.

Below: Model shows route of Swiss mountaineers who climbed within 800 feet of top last May.

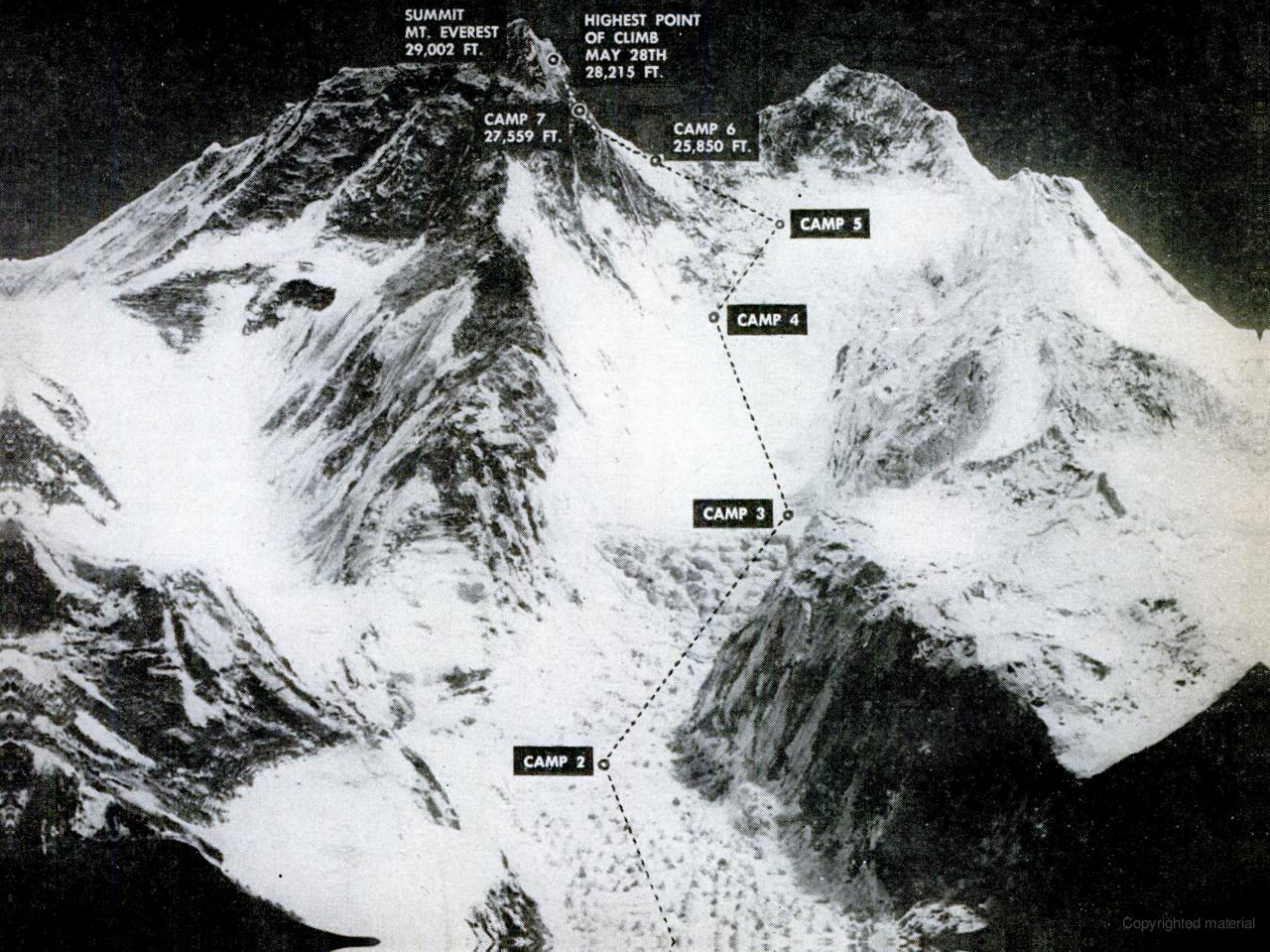

mapped paths. You walk it all. Nepal is too rugged for horses.

The climate changes from tropic to arctic within 20 miles, as you climb 10,000 feet. At 10,000, at 17,000 and at 20,000 feet you may get mountain sickness (nausea). Each day more men of your party reach their limit and must turn back. After 20,000 feet only a few stay with you.

Himalaya—Abode of the Snow

Around 16,000 feet, higher than the highest peak in the Rockies, you enter the perpetual Abode of the Snow, a translation of the native word Himalaya. As your men fall back, so too do other forms of life. You are getting up where nothing lives.

At about 20,000 feet you are likely to see in the snow the tracks of the last land animal. These are the 12-inch footprints, each with two broad toes and a thumb, of the creature the natives call the Yeti. Almost every Everest climber—there have been about 40, in nine expeditions since 1921—has seen the tracks. Both Lambert and Shipton have. But no man has seen the Yeti.

The Yetis are, some natives say, a race of wild, hairy men, about five feet six inches tall, who live in the snow fields. That the Yetis have not been seen other natives easily explain: you cannot look upon a Yeti and live. Some day an Everest mountaineer may see and identify the Yeti. Meantime, he has been named, by the white man, the Abominable Snowman.

Up Where the Lammergeier Lives

Beyond the dwelling place of the Abominable Snowman, your camps will be visited by a few ravens and crows. Then they too fall back. One living thing still is with you: the lammergeier, the bearded vulture of the Himalayas with his seven- to 10-foot wingspread. He sticks around hopefully till beyond 23,000 feet. Then he too falls behind. Still you must climb, above the lammergeier, that last lifeless mile.

You try the last mile, the longest on earth because no one has reached the end of it and lived, with only the few members of your party who are left. Porters now carry only 10 pounds each. That is one reason why Everest is not likely to be conquered by heavy equipment; men cannot carry it up here, and a primus stove and oxygen are about all a climber can manage.

Your problems now become the greatest of the journey—so great that they have killed



BRITISH EXPLORER Eric Shipton (left) looks over model of Mt. Everest, 10 inches to the mile, based on his discovery of new approach he'll try next spring if Swiss fail this fall.

white and brown men and have forced back everyone they didn't kill. The big, final problems are:

- The mountain itself.
- The weather.
- Your body.
- Your mind.

Above 24,000 feet Everest presents her own greatest defenses: Ice cliffs as straight up as a battleship's bow. Crevasses that open to show blue-black space for thousands of feet. Loose snow that can trap a man to his armpits. Glaciers, always moving, that carry 70-foot icebergs on their surfaces. Ice-falls—avalanches of ice. And ridges, narrow as a knife-edge, along which you must walk.

The very summit, the last 1,000 feet, appears to be simply reddish yellow rock with snow and ice on part of it and the rest kept bare by the constant wind. It looks fairly simple to climb—if you have strength enough left after the ramparts below. But here there is in the air only one-third of the oxygen you get at sea level. Even carrying cylinders of oxygen, your body still almost starves for more.



NEW OXYGEN SUPPLY for Everest mountaineers, sketched by G. H. Davis of *Illustrated London News*, weighs five pounds, compared to 40 pounds for old apparatus. Climber regulates intake by clenching and relaxing his bite on tube. Struggling up a steep slope at

28,000 feet, he uses four times the volume of air required during violent exertion at sea level. On Everest, just existing is violent exertion, and heavy mechanical equipment cannot be brought along. Thus lighter oxygen supply may be deciding factor in attaining peak.

Atop Everest there is no good weather, only bad and worse. The arctic and tropic climates of the area clash continually to produce conflicting winds, storms, monsoons, blizzards. The temperature changes instantaneously. This changes snow conditions. In an instant an avalanche can bury you. In the wind, at night, you and your companions must fight to hold down the tent floor. If it gets under the floor, the wind can hurl tent and contents into a glacier thousands of feet below.

Deterioration Is Rapid

Despite acclimatization, your body deteriorates on Everest's last mile, and the painfully slow race toward the summit is a race between you and deterioration. Deterioration has, so far, always won, as Lambert thinks it will again.

Your arms and legs may become paralyzed. A headache can seem to split your brain in two. The slightest exertion, like tying a shoe lace, leaves you breathless. Fatigue glues muscles—in a place where to stand still is to freeze to death. Your legs

may collapse under you—in an area where once you start sliding you can go down for miles.

Few men can sleep up here. If you can sleep, without rolling off the slanting rock ledges to drop a mile or two, you wake up feeling suffocated. You lose weight fast. You first cannot eat meat, then you cannot eat anything solid. You are thirstier than anywhere else on earth. An Everest mountaineer once drank 17 cups of tea without moving. You may have diarrhea while your kidneys function once in 24 hours. Dry air is the reason you stop discharging liquid.

Your face and lips turn blue. Your frost-bitten fingers stiffen around the handle of your ice axe and must be pried open. Your eyes sink in their sockets. You see double where you must watch every step. You are likely to be blinded by the glare from snow or the rocks if you have to remove your goggles, which you must if they freeze over. One snow-blinded mountaineer had to be led off the mountain before he recovered sight. Getting him down was an incredible feat both for him and his companions. But

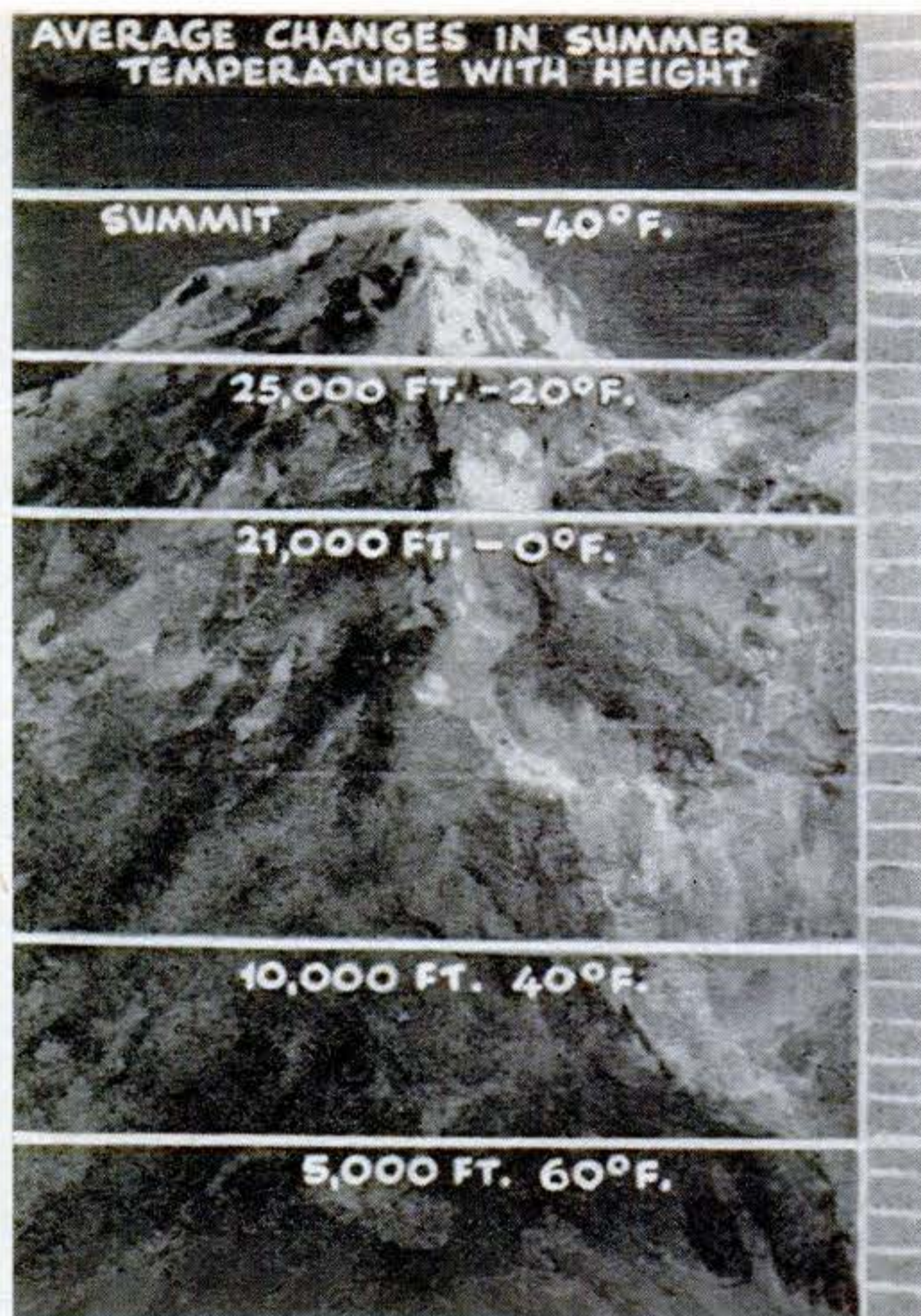
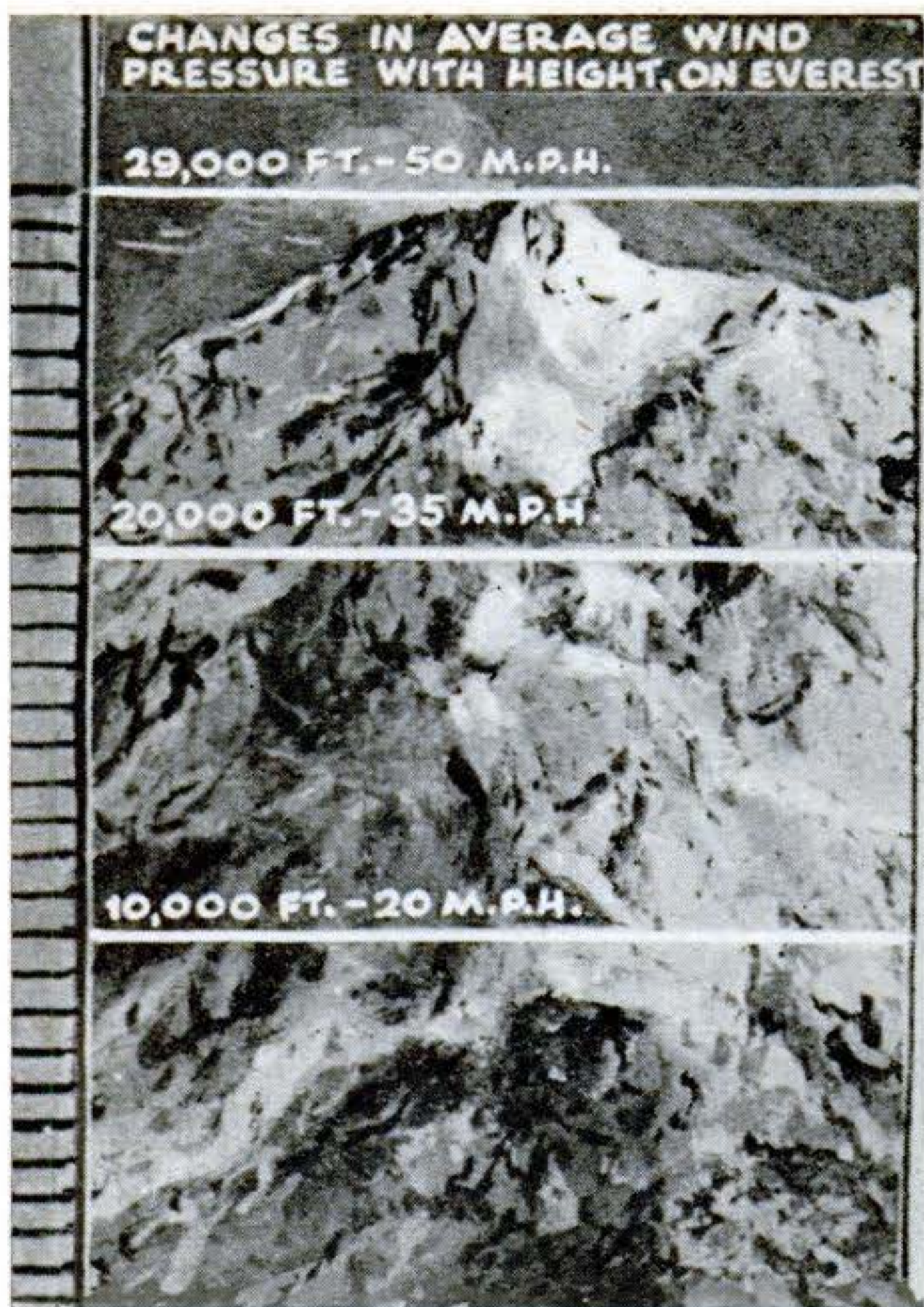

on Everest acts of heroism are routine.

Your teeth turn brittle. Your heart enlarges and pounds. You get altitude sore throat, an extremely painful experience caused, like your failure to urinate, by the dry air.

Like your body, your mind becomes another great problem. Despite rapid deterioration of the body, some think the mind goes out first.

You Want to Die

You may get irritable. You can force yourself to be cheerful, but you may have to get a few steps away by yourself and bawl like a baby. You want to die. You may think you are dead. A porter became so convinced he was dead that he refused to move and actually had to be forced down the mountain by his teammates. He argued volubly that he was dead till he had descended a couple of miles.

Your judgment becomes shaky. Your memory fades. Your will power evaporates. Without taking a drink, you get drunk. Shipton says the mountaineer on the upper slopes of Everest is "like a sick man climbing in a dream."

Then all at once you may suddenly have a great surge of pleasant feeling, a belief that everything is going well. At that dan-

gerous moment you are most likely to fail.

"A man who knows how to get to the top may be an expert climber," the mountain men say, "but a man who knows when to turn back is a mountaineer."

When he was 792 feet from the summit last May, going upward at the rate of three steps before each pause for rest, Lambert got this feeling. "I felt magnificent," he said. It was then he knew he had to turn back. He did.

You turn down. There is no relief. In the Alps and on most other mountains one immediately regains strength and sanity after a short descent. You do not on Everest. This is one reason it may be impossible to reach the summit and live: the descent is as fatiguing as the ascent, and the descent may drain away the life that remains in you. Everest takes every dreg of your strength. Only over months can you get it back.

Who climbs Everest? Athletes? No. Truck drivers? No. Stevedores? No. Schoolteachers do. College professors. Army officers. Photographers. Writers. Doctors. Civil servants. Shipton was a British consul. Artists. On the record, it is the poets, the philosophers, the thinkers and the dreamers. Most have been not men of brawn or muscle, but slightly

[Continued on page 262]

Cockpit Takes Off at 760 M. P. H., Parachutes Safely to Earth

COCKPIT CAPSULE is set for a take-off on two-mile test track. Rocket at rear gives big push for 760-m.p.h. trip, simulating actual flight in the air.

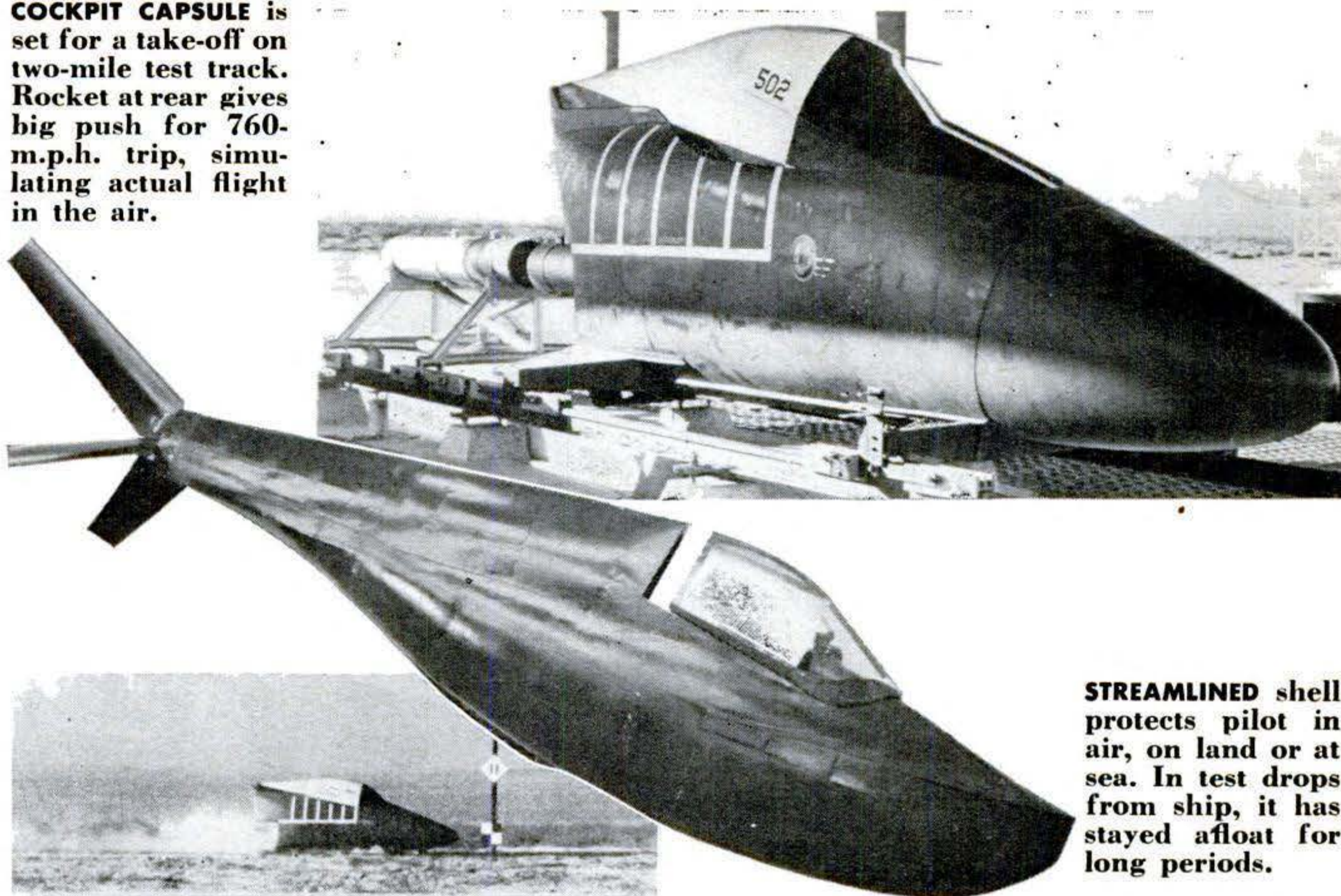

STREAMLINED shell protects pilot in air, on land or at sea. In test drops from ship, it has stayed afloat for long periods.

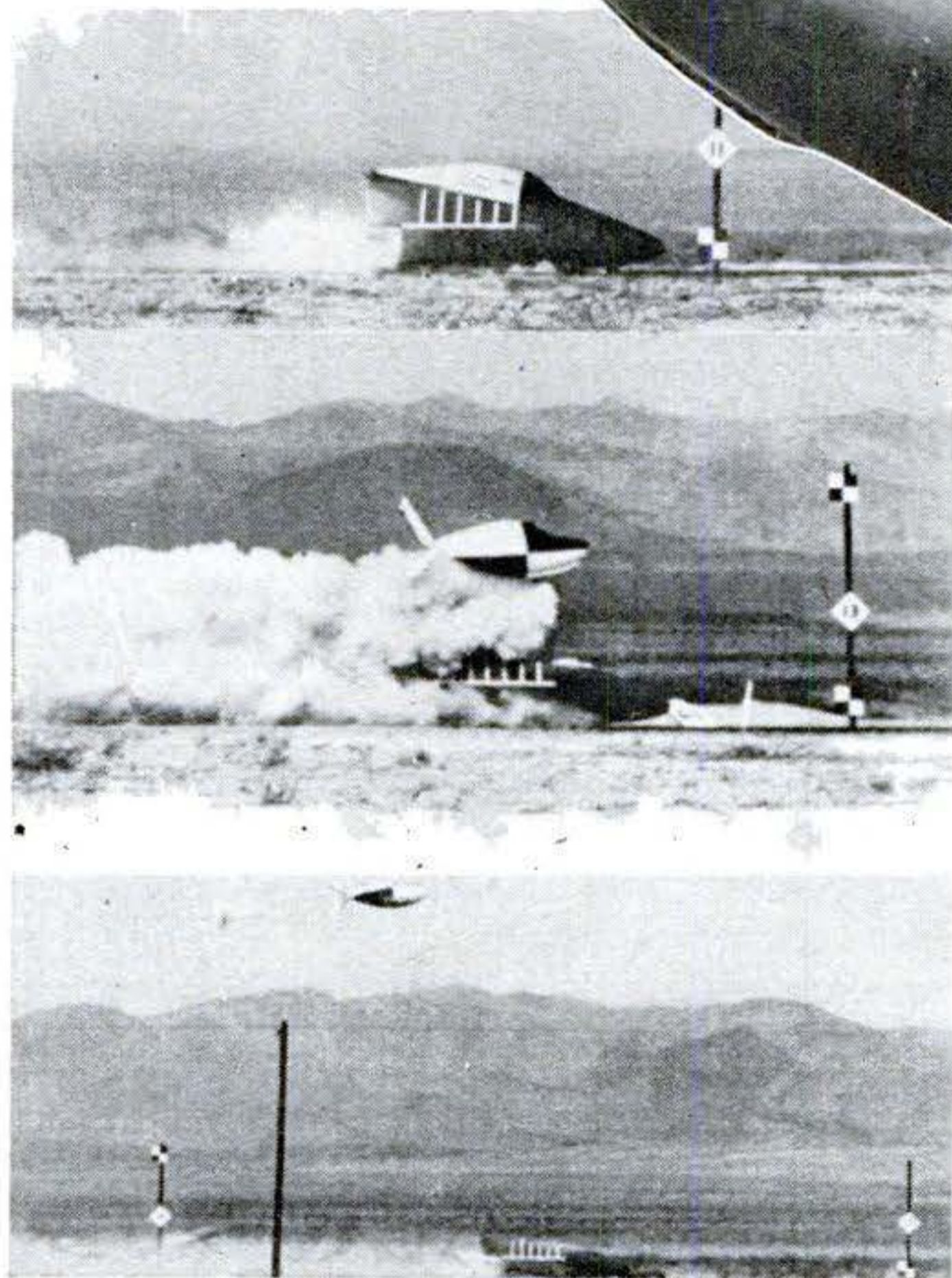

"FLYING" on test track, capsule is ejected by rocket, then unfolds stabilizing fins. Bottom frame of movie strip shows first 'chute blossoming out to slow capsule's fall.

Gas Cap Sticks to Hose

WHEN Ellis Sharp, a gas-station operator of Kansas City, Mo., gets a call to fill 'er up, he puts the car's gas cap on a magnetic holder fixed to the hose. Since it is right under his eye, he can't forget where he laid it or fail to put it back on the car.

PILOTS of supersonic fighter planes will fly without parachutes. If one has to bail out, he will touch off a cartridge to make the whole cockpit take off on its own. In an unmanned model that the Navy is now testing at Inyokern, Calif., as shown in the pictures at left, three fins unfold to stabilize the cockpit capsule in the air. Parachutes, first a small one, then a larger one, open out to slow its fall, and the sealed and pressurized compartment rides safely down. If it comes down on water, the parachutes are quickly unhooked and a boom holding the plane's storage battery is lowered to keep it upright.

Douglas engineers at El Segundo, Calif., developed the capsule.

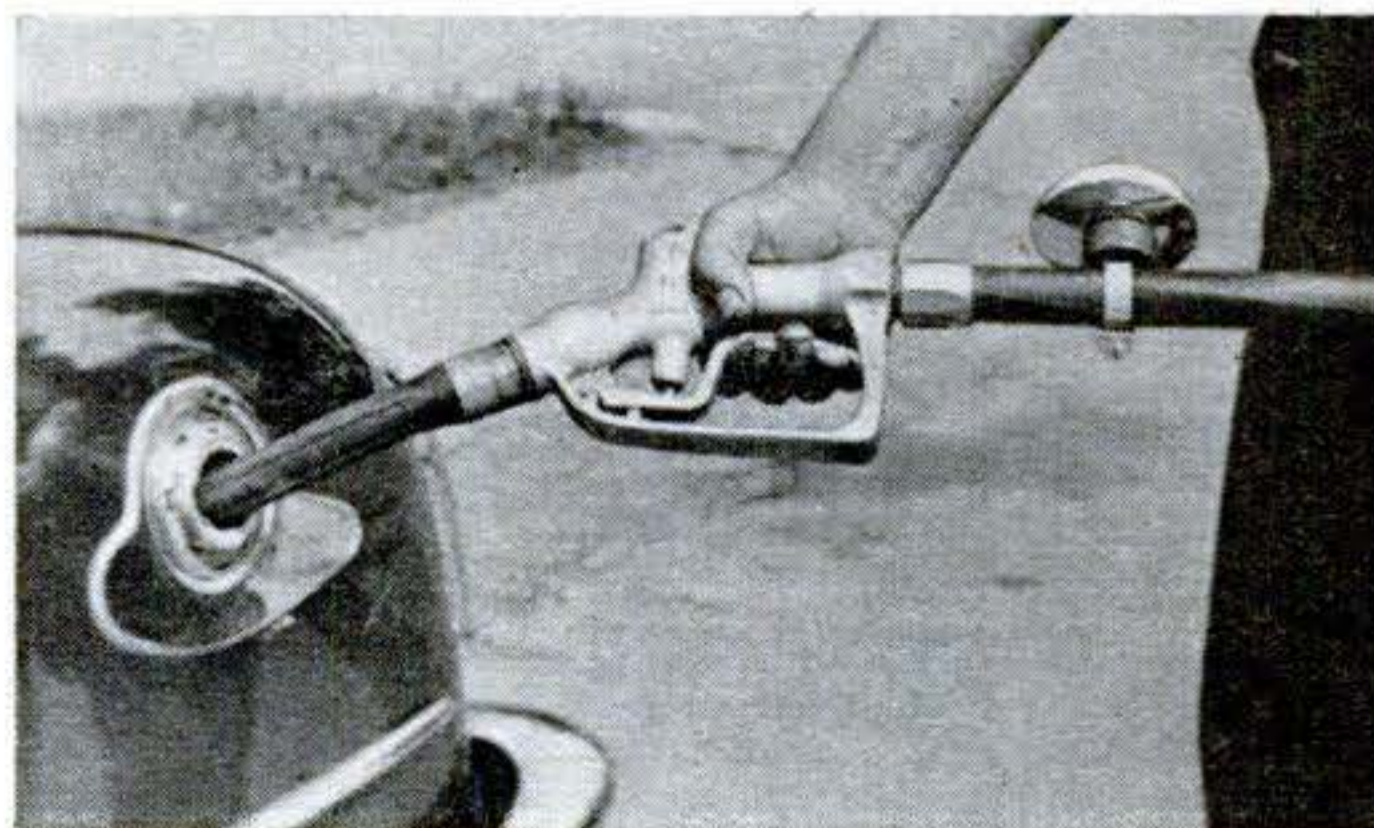

'Space Men' Make College Men Think

MIT students design home gadgets for imaginary creatures living on a distant planet.

By Hartley E. Howe

THIS fall some 20 of the brightest students at famed Massachusetts Institute of Technology are designing products for export to the Methanians. This birdlike but intelligent race, as you may not remember, lives on the fourth planet of the star Arcturus, 33 light-years away. As a result, the problems faced by the MIT designers are a little out of the ordinary. For example:

- Everything on Arcturus IV weighs 11 times as much as on earth, because of the great mass of that planet.
- The atmosphere is methane, and the inhabitants use ammonia instead of water.
- The Methanians themselves, having evolved from birds instead of mammals, are built rather like gigantic King penguins.

Imaginary People Offer Real Problems

Pretty fantastic? Right out of H. G. Wells or the latest issue of *Utterly Unbelievable Stories*? Don't worry, the learned professors at MIT haven't gone off their rockers from reading too much science fiction. The existence of the Methanians and their planet may be hypothetical, but their part in training a new breed of scientist is very real.

For John E. Arnold, who dreamed up the Methanians, believes that colleges should teach more than the technical skills and analytical ability of a good scientist or engineer. An associate professor of mechanical engineering at MIT, he believes it important to develop the students' ability to think creatively, to see beyond the limits of

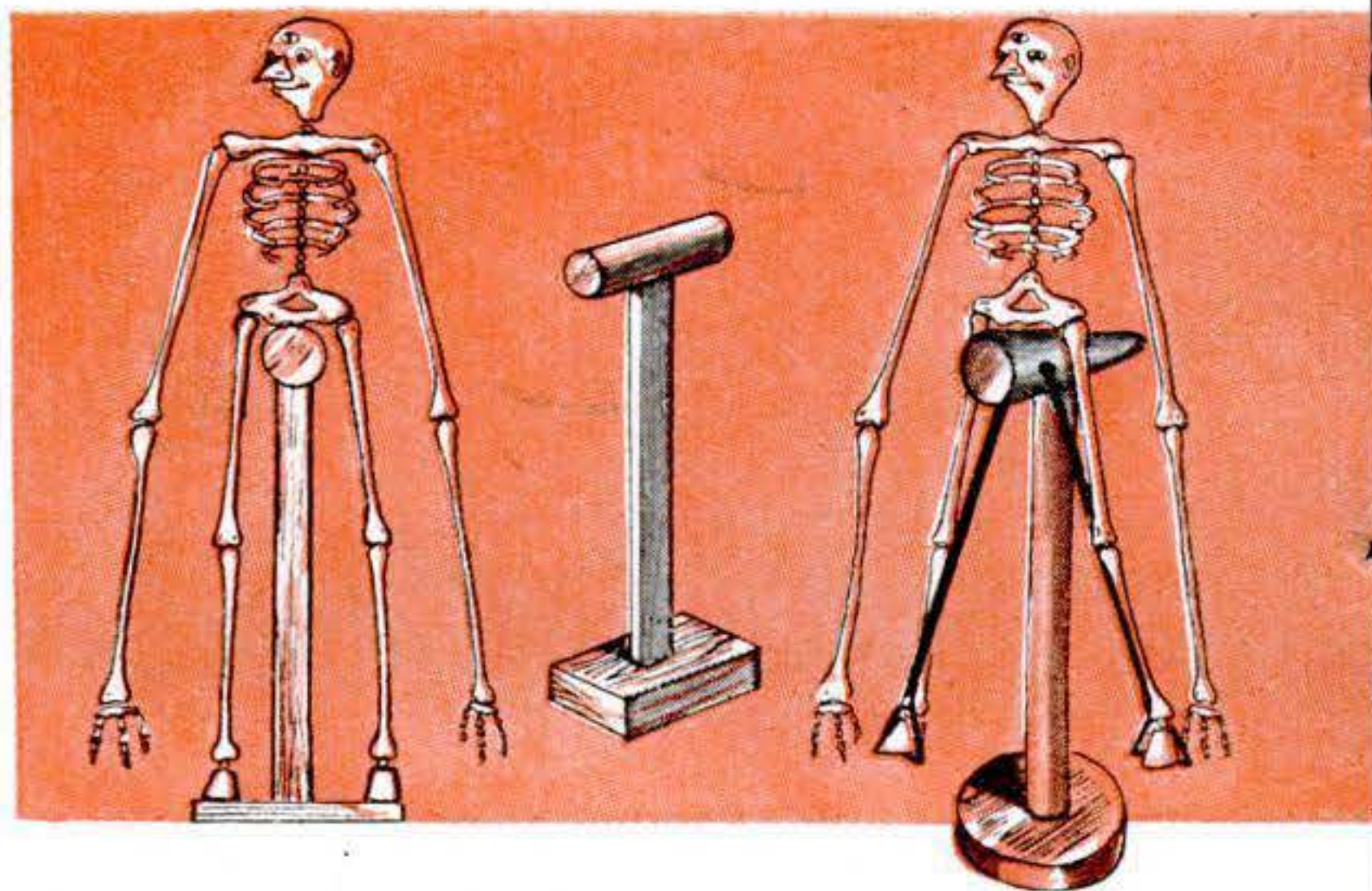

NATIVE METHANIAN CHAIRS are straddled because of awkward length of imaginary Methanian's arms and legs. Type at right above has stirrups, is perhaps used as bar stool.

our present achievements. Professor Arnold wants to develop men who can find drastic new solutions to old problems—and discover and solve new problems not yet recognized.

So Arcturus IV and its inhabitants appear in Professor Arnold's course in Product Design for very definite reasons. When a student starts the Arcturus project, he enters a whole new world where it is useless to try to copy the conventional and accepted. He must use his imagination and think creatively whether he wants to or not—or he won't solve his problems.

Equally important, designing for the Methanians forces the student to think about a host of physical factors that we all take for granted when we think about the human race and our familiar earth. Climate, gravity, physical structure, cultural habits—all that must be taken into account.

He quickly learns, for example, to think of weight as an important factor in any tool or appliance. A 10-pound object on earth

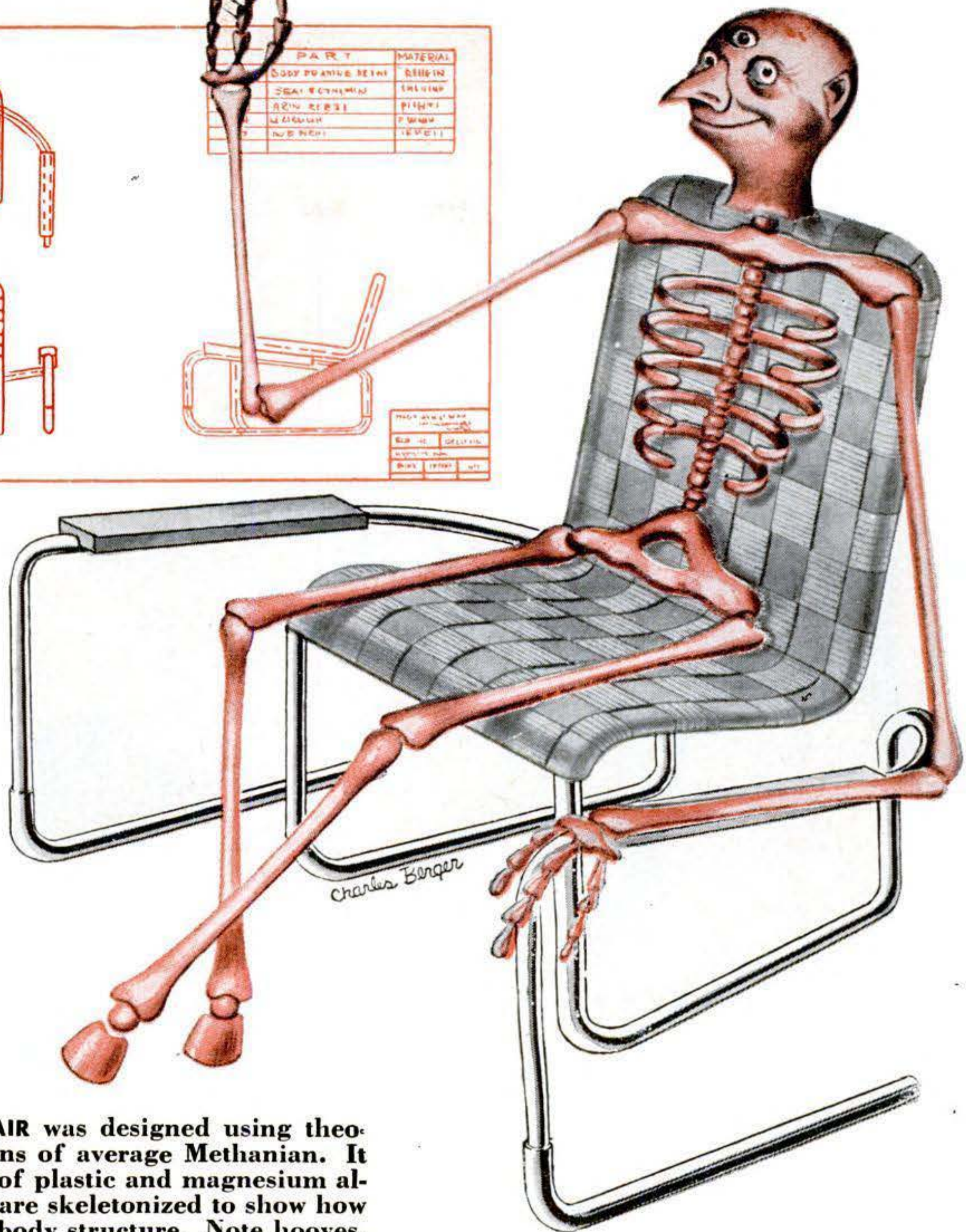
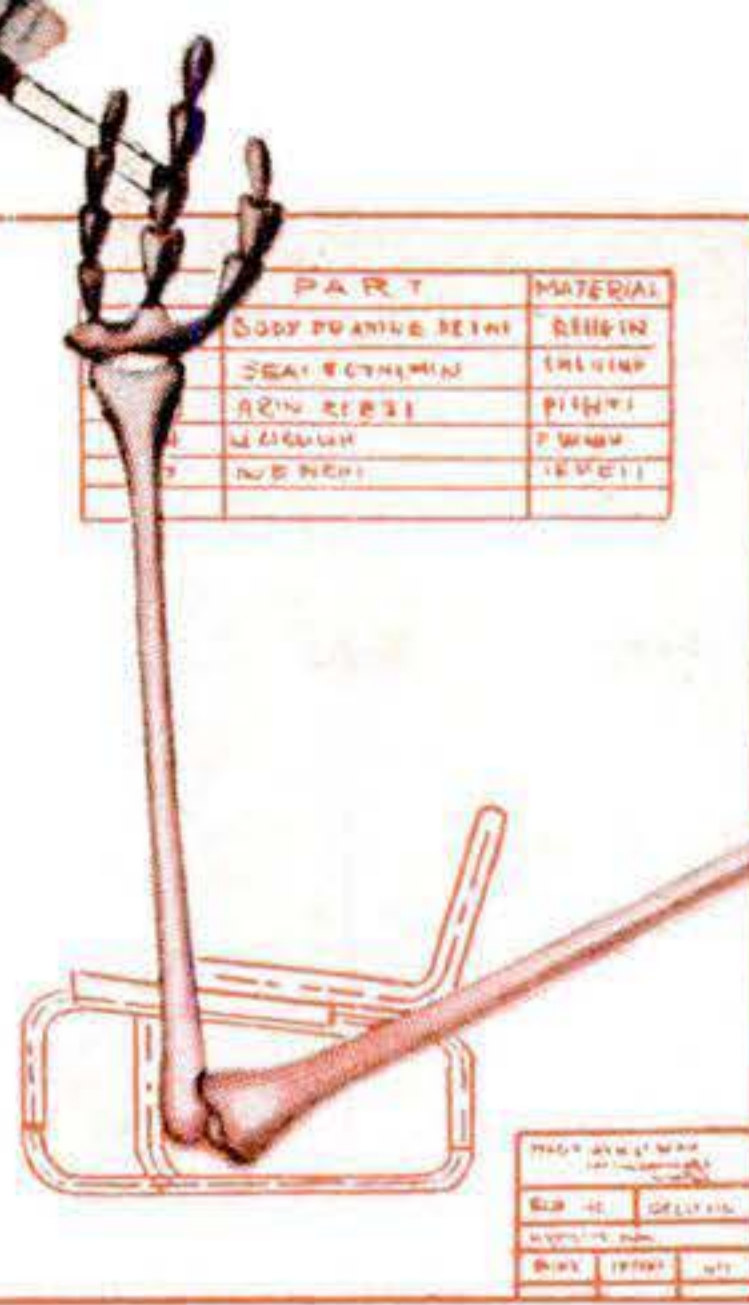
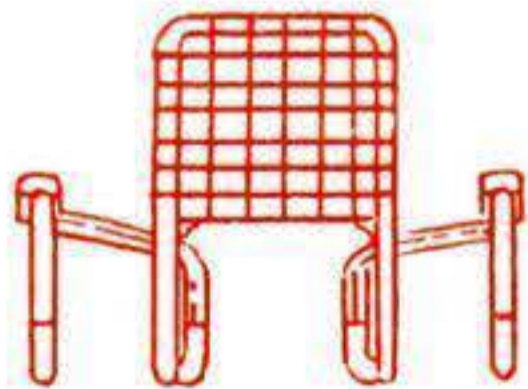
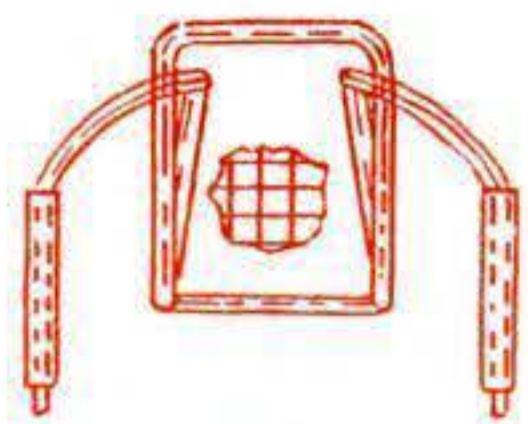

MIT LOUNGE CHAIR was designed using theoretical dimensions of average Methanian. It would be made of plastic and magnesium alloy. All figures are skeletonized to show how design matches body structure. Note hooves.

weighs 110 pounds on Arcturus IV. Like human beings, the Methanians can lift only about twice their own weight. Since the heaviest Methanians would weigh only about 17 pounds here on earth (187 pounds on Arcturus IV), this limits their tools and utensils to 35 earth pounds.

Life in the 30th Century

The student gathers this information from an impressive collection of photostated letters and memoranda dated 2951, an era when the exploration of outer space has become commonplace. These facts are gathered into a workbook, which opens with a solemn warning from the general manager of Massachusetts Intergalactic Traders, Inc., typed on his own letterhead, that "any per-

son not cleared who reads further in this file does so at their own risk and is subject to the extreme penalty of the law."

From there on, the student finds himself in the world of 2951 A.D. A confidential memo from Massachusetts Intergalactic Traders to Terran Exporting Counsel Headquarters asks for further information about the newly discovered Arcturus IV for use in designing articles to export to that new market. Letters, memoranda and research reports, all on 2951 letterheads, tell how exploring parties visit the Methanians at their great city, Snafu, (pop. 15,500,000), learn their language, study their life and do market research on their needs.

With this to guide him, the student quickly becomes an expert on Arcturus IV. The

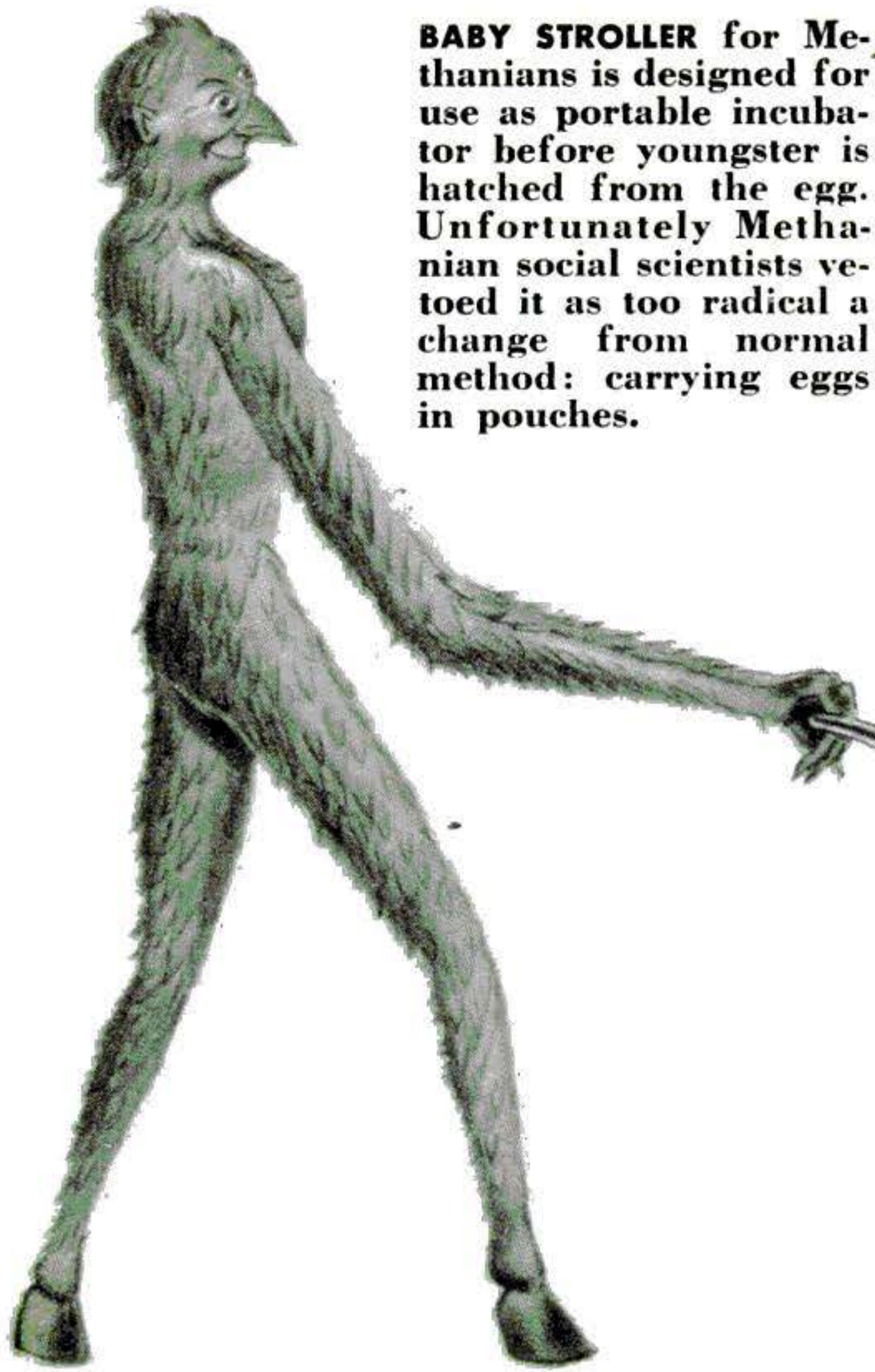

BABY STROLLER for Methanians is designed for use as portable incubator before youngster is hatched from the egg. Unfortunately Methanian social scientists vetoed it as too radical a change from normal method: carrying eggs in pouches.

slowly and react slowly. Their normal walking pace is about a quarter of a mile an hour, although they can sprint two miles an hour in short bursts. Their reaction time is two seconds—a major problem is designing machine controls.

The Methanians use atomic power to generate electricity, but know nothing of electronics. Steel and iron are too heavy for wide use in building and manufacturing, which depend on aluminum, magnesium, titanium and the plastics. Lithium is scarce but greatly valued because it is so light.

The “day”—the time in which Arcturus

Methanians are so light, for example, apparently because their bones are hollow and are filled with hydrogen or helium. The females are about four feet tall, the males a foot taller.

Bird People Have X-Ray Eye

Their bird ancestry is shown by their long arms, once wings, tipped with two clawlike fingers. Their faces are somewhat like birds, with a nose like a beak. Besides two highly sensitive eyes that can see infrared and ultraviolet as well as ordinary light, a Methanian has a third eye in the middle of his forehead that gives him X-ray vision.

The “reports” reveal that the average winter temperature on Arcturus IV is about 166° F. below zero. Although in summer the mercury climbs to a torrid 58° below, it is not surprising that Methanians have a warm coat of feather-like fur. They wear clothing besides, but their normal body temperature is still about 40° below.

The Methanians have an alphabet, and a number system based on six. They are reported to be patient, intelligent, monogamous and interested in the arts. By our standards, however, they move slowly, think

IV revolves once around its own axis—is 159 earth hours long. It takes 2,720 of these days for the planet to complete one trip around its sun, so that one Methanian year equals about 49 of ours. Methanian babies are born in eggs, mature in an Arcturan year and are very old after 10 years. Because of the bleak environment, few reach extreme old age. (Though 490 earth years are not to be sneezed at.)

In general, the Methanian civilization is described as of a “somewhat backward culture—early 20th century.” Which in 2951 is going to look pretty backward indeed.

Designs Must Really Work

Fortified with this basic information, the student is commissioned by MIT—Massachusetts Intergalactic Traders, of course—to design some machine or household equipment for the Methanian market. Right here, rigid engineering standards take over. The product must be designed to be made with accepted materials and methods, and to work.

So far—the course has only been given one year—the students have confined their projects to equipment for the Methanian household. An MIT chair provides arm sup-

ports and a contour shape that lets the Methanians sprawl at ease. Methanians have never had clocks, depending on a system of sound signals to give them an approximate idea of the time. Now a Tech clock has been designed with three dials numbered with the complicated Methanian units.

Machine "Mows" Upside-Down Plants

An MIT kitchen mixer is made with the motor in the base—the average Methanian housewife isn't strong enough to lift a motor arm. A cigarette lighter has a throw-away cartridge of oxygen for use in the methane atmosphere of Arcturus IV.

One of the most complicated of the MIT appliances is a machine that does the work of a lawn mower. In Arcturus IV, vegetation grows downward, taking carbon, silicon and some oxygen from the soil. The roots are in the air, taking oxygen from CO₂, extracting nitrogen and hydrogen, and giving off methane. For their lawns, the Methanians have developed a plant called "Herbivorous carnivorous arnoldious."

To quote a report to the Massachusetts Intergalactic Traders: "There is one serious drawback to the use of this species of lawn

[Continued on page 266]

U.S. MARKET is also considered by MIT students of product designing. Here are some of the new tools and appliances they have come up with—some of which may eventually

Professor Fathered Methanians

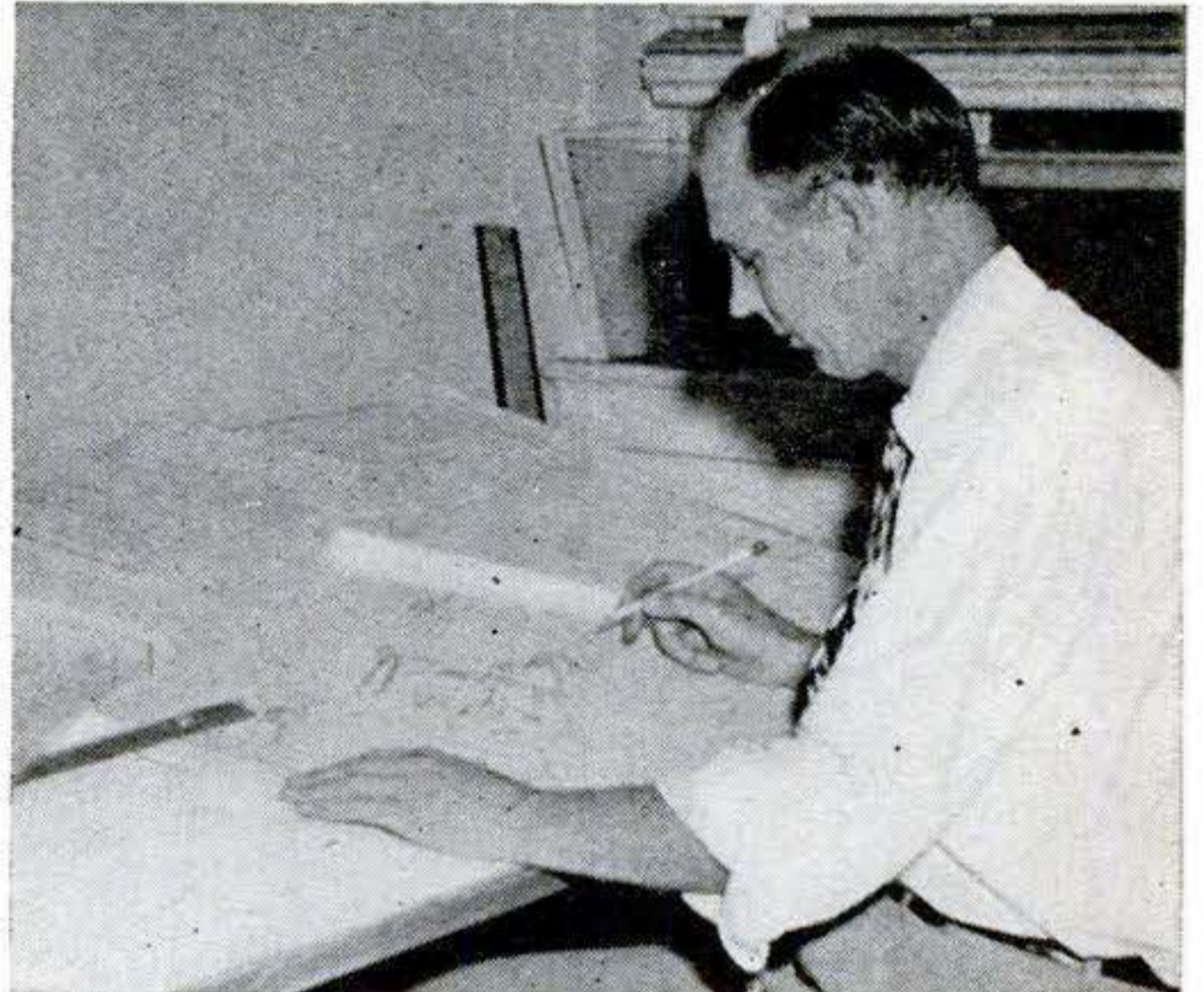

Associate Professor John E. Arnold, above with Methanian mixer design, is the Father of Methania. Trained in English and psychology, he worked in a factory during the depression, became a draftsman by buying a set of tools and sitting up all night with a textbook. Later he did five years' work at MIT in three, became a mechanical engineer.

be produced. Courses emphasize creativity, but designs must be technically practical. Some products are developed by individual students; others are group problems.

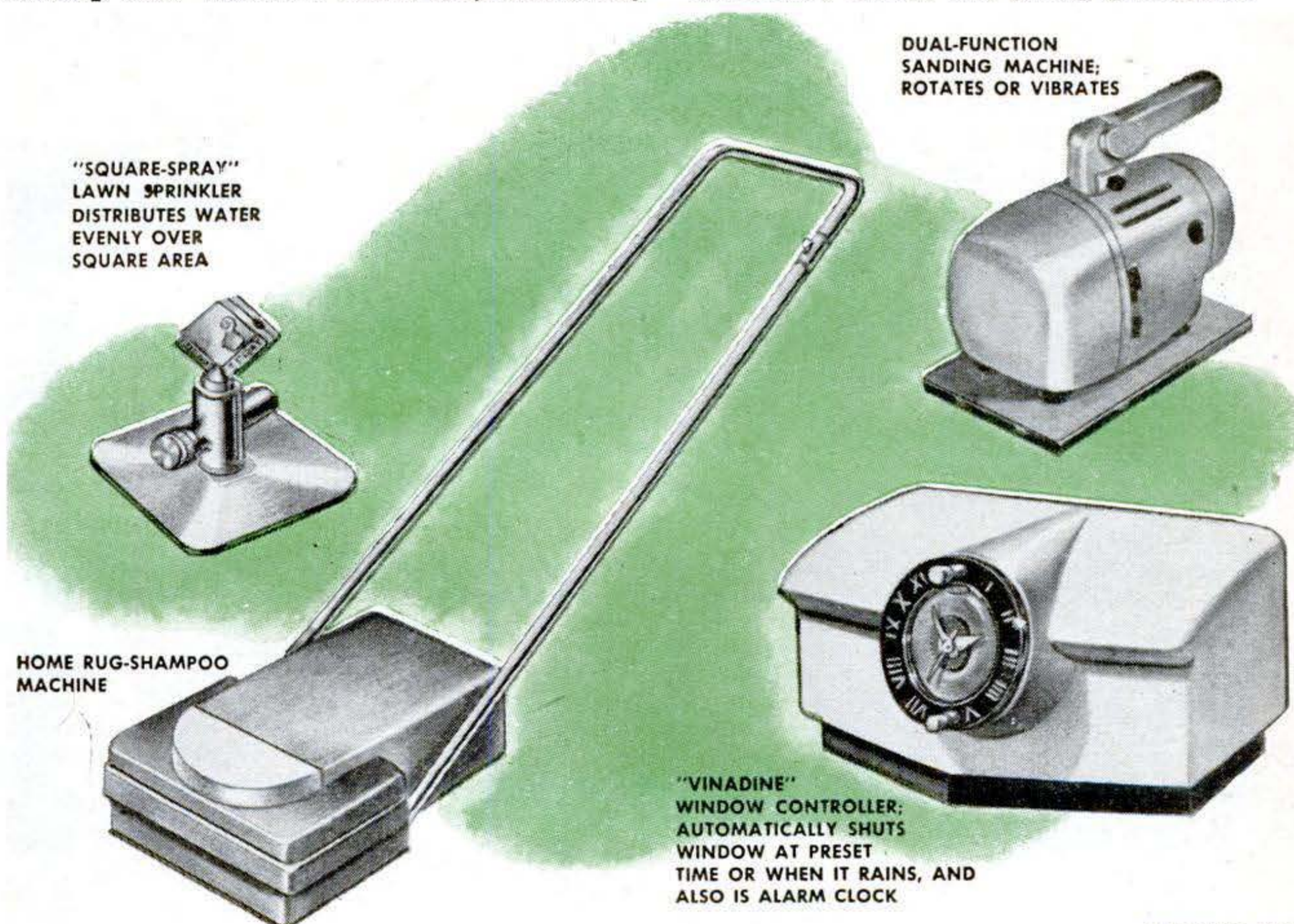

"SQUARE-SPRAY"
LAWN SPRINKLER
DISTRIBUTES WATER
EVENLY OVER
SQUARE AREA

HOME RUG-SHAMPOO
MACHINE

DUAL-FUNCTION
SANDING MACHINE;
ROTATES OR VIBRATES

"VINADINE"
WINDOW CONTROLLER;
AUTOMATICALLY SHUTS
WINDOW AT PRESET
TIME OR WHEN IT RAINS, AND
ALSO IS ALARM CLOCK

Wingtip Shotguns

Fire Rocket Salvo

IF A hunter were a superhuman marksman he could use a rifle to down flying ducks. But being human, his aim at a moving target is not accurate enough. So he uses the blanketing effect of a shotgun shell to increase his probabilities of a kill.

For the same reason—that even our latest electronic aiming and firing devices are not accurate enough—the Air Force's newest jet interceptor, the Northrop F-89D Scorpion, fires a salvo of deadly Mighty Mouse rockets from each wingtip with the spreading blast effect of a double-barreled shotgun.

The Air Force will not reveal the effective range of its new rocket weapon, the method of approach and attack, details of the launching mechanism, or the number of rockets.

But in those twin pods are destructive, folding-fin 2.75-inch Mighty Mouse missiles. One hit by one rocket is all that is needed to send an enemy bomber hurtling earthward in flames, disintegrated by its own bomb load. And kill probabilities are high "since the target area blanketed when all rockets are fired is extensive." The F-89D, designed for all-weather, day-and-night operations, has a speed in excess of 600 miles an hour and can fly above 40,000 feet.

The Scorpion, weighing more than 40,000 pounds, carries a crew of two: pilot and radarman. But when it comes to the actual shooting, they are along for the ride. They just watch the radar and electronic equipment that picks up the enemy while it is still out of sight, locks onto it, tracks it and adjusts speed and course. Aiming is automatic and an electronic device triggers the rocket-firing mechanism.—*Herbert O. Johansen.*

America's Latest Answer to the Threat of Enemy A-Bombers

The sting of this Scorpion means death to the largest bomber. Shown below salvoing its arsenal of rockets from wingtip pods, the Northrop F-89D is our most potent aerial weapon against any enemy who might try to penetrate our shores or borders. The new Air Force interceptor has a speed in excess of 600 miles an hour. Inset (lower right) shows rocket pods more clearly.



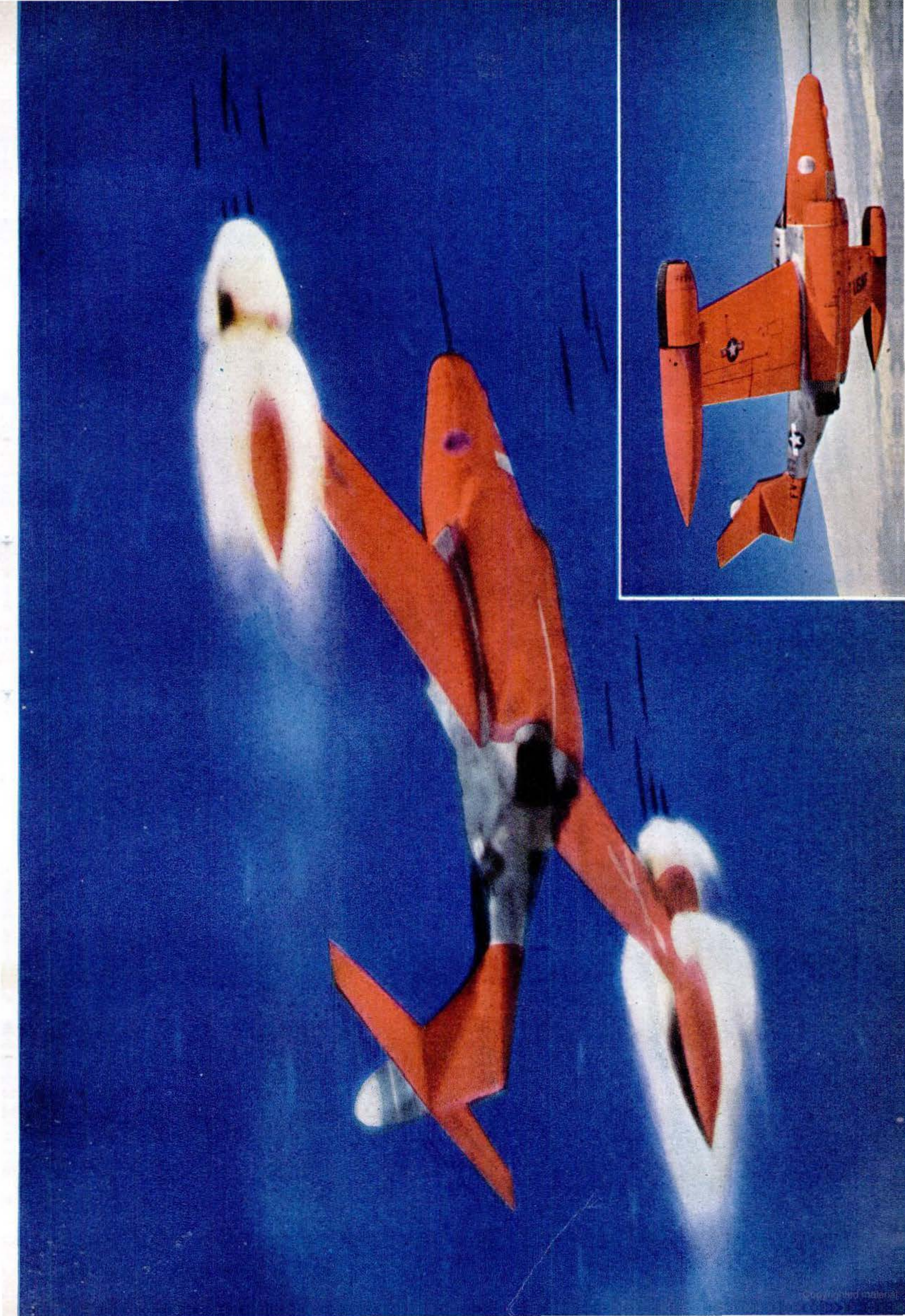



Hand-Tooled Sportster

Built in Basement

ONE of the smartest-looking new cars on the road this fall is a crazy quilt of parts from six other automobiles, ranging in date from 1940 to 1951. Its owner and builder, St. Louis sports-car fan James P. Broadwell (shown above leaning over his handsome creation) put it together without help, model or drawings in his basement workshop. The fact that his shop is stocked with \$10,000 worth of tools came in very handy. Fortunately, also, he had had the forethought to provide the basement with a door wide enough to move the car through when it was finished. Building the car took most of his spare time for three and a half years and used up about \$3,000 worth of materials.

Starting out with the wreck of a 1942 Studebaker Champion, Broadwell saved only the chassis. This he lowered, shortened and rewelded before clamping to it the front fenders of a 1946 Chevrolet, the rear fenders of a 1940 Buick and the trunk lid of a 1941 Buick. He then built a frame to support the fenders and lid in their proper positions. "The rest of the lines," he says, "just fell in." Broadwell hand-shaped most of the body contours from cold-rolled sheet steel on a homemade metal-curving machine. He shaped the hood from aluminum.

The engine, which develops around 125 horsepower and can drive the car to 115 miles an hour, is a Broadwell product, too, from the bottom—the original Studebaker block—up. He rebored the cylinders, changed the angle of the intake valves, installed a special camshaft, aluminum cylinder head and two synchronized carburetors.

Broadwell gave his low-slung hybrid a name, too, made up of parts of others. He calls it the Jabro, a combination of letters from his own first and last names.

END

BODY BUILDING IN PROGRESS. Broadwell is shown welding a tubular frame that will connect the unmated fenders and trunk lid to the chassis.



WIRING, of which there was 250 feet altogether, was completed outdoors. Steering wheel, cut from one piece of aluminum, has a walnut rim.

OCTOBER 1952 [3]

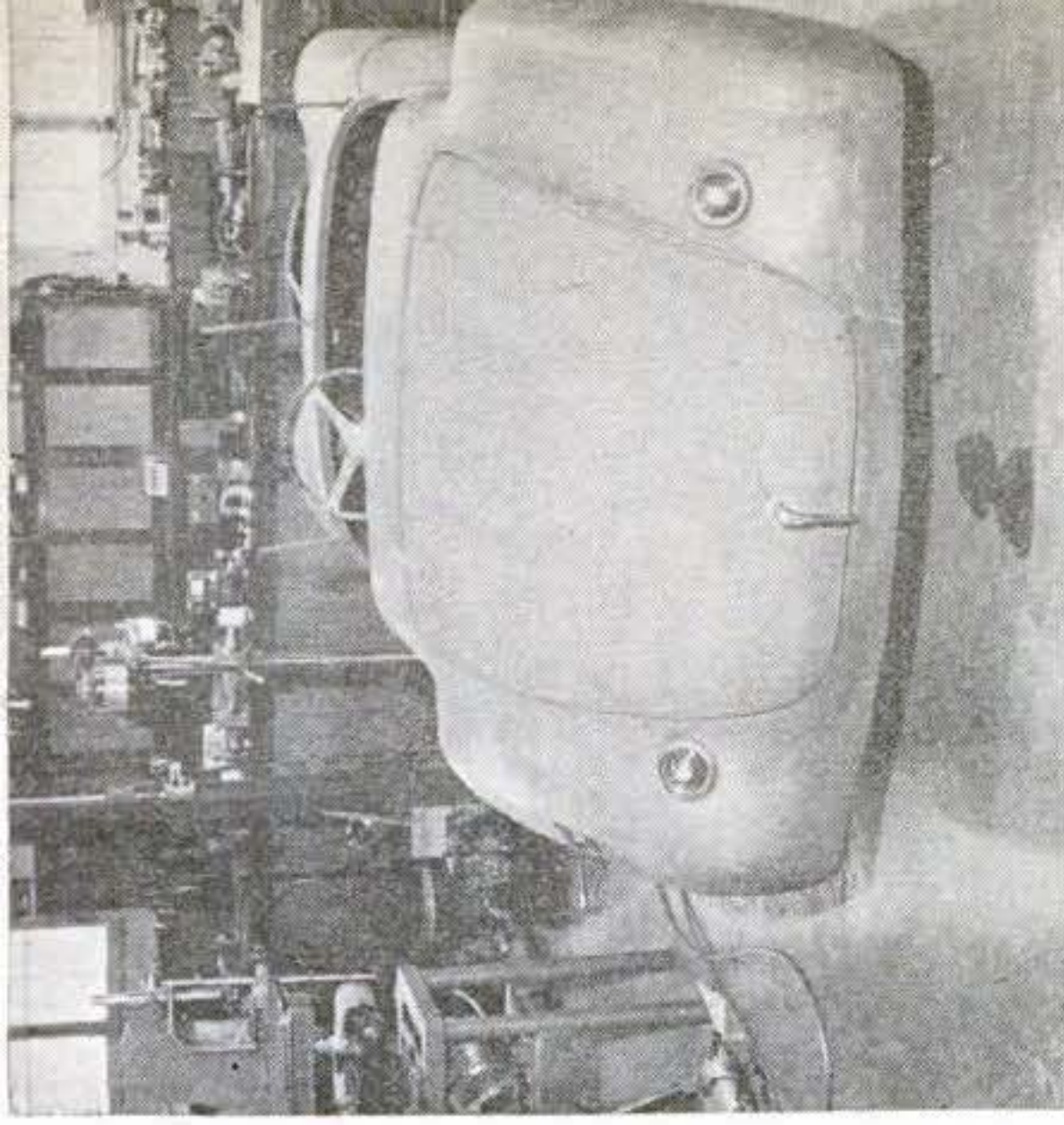

THE JABRO'S BODY, with its priming coats on here, was continuous-seam welded into a single piece, which was then welded to the frame.

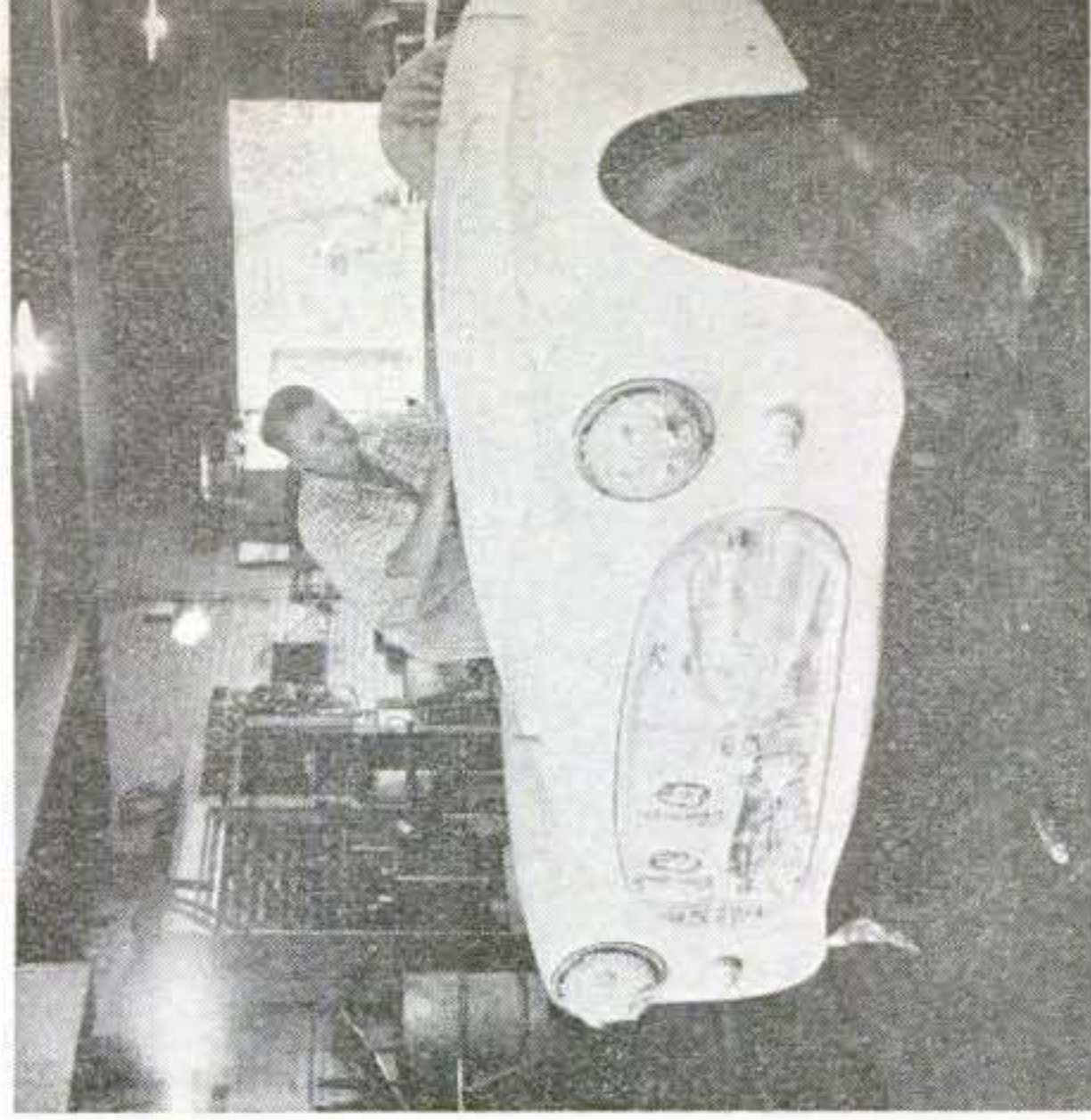

MINUS WINDSHIELD, which Broadwell designed and built from scratch, the Jabro is rubbed down after six coats of lacquer had been applied.



Italian Inventor's Midget Flying Saucer Hits 87 M.P.H.

TO PROVE that a perfectly round plane can fly, Piero Gnesi, an aeronautical engineer of Pisa, Italy, built the model above. He says the 30-inch disk of paper-covered balsa wood flies fine, whizzing along at 87

miles an hour. A special gasoline mixture fuels the tiny motor, and the craft is controlled from the ground with wires. Gnesi, a European model-plane champ, has kept it aloft for nearly three minutes.

Snap-On Clips Replace Tire Chains

THESE cradle-like clips clamp to a tire to give a car traction on snow, ice or mud. Joseph La-Rocca of Cleveland tried for eight years to interest manufacturers in his invention. This year it will be marketed by a company formed by James H. Rand III, inventor and research consultant of Bratenahl, Ohio.



TIRE CLIP snaps into place when the car is backed over it. Three of the spring-steel clips are fitted to each rear wheel. Pulling on the sides of the clips easily springs them back open for quick removal. Planned for production this fall, they are expected to cost less than tire chains.

I'd like to see them make...

Everyone has his own pet idea of some gadget he would like to see in general use. What is YOURS? *Popular Science Monthly* will pay \$5.00 for each one published. Use government postcards only. Contributions cannot be acknowledged or returned.

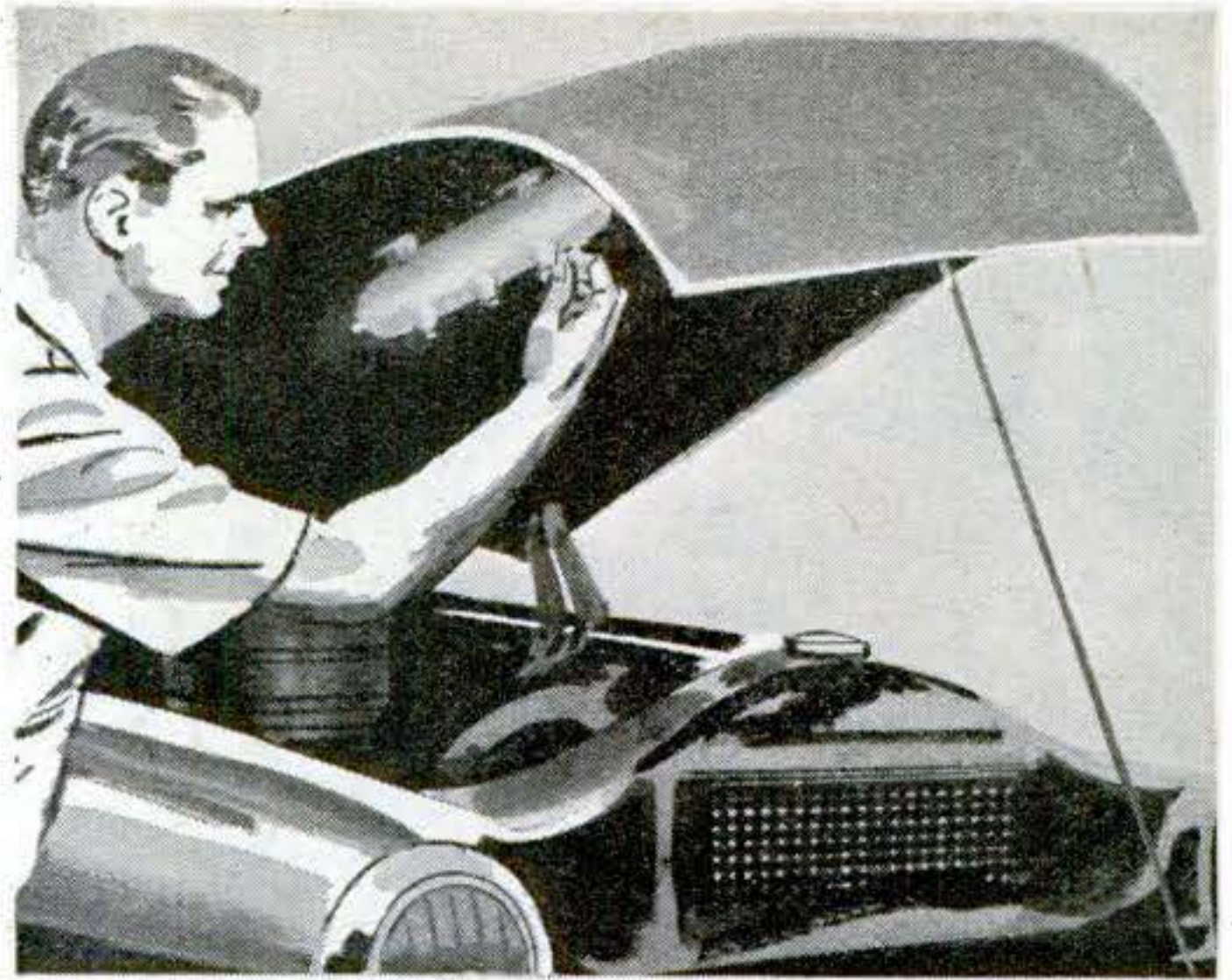

A FIRE EXTINGUISHER, mounted on the inside of the hood of a car, that would go into operation automatically in case the engine caught fire.—*Robert P. Hoffman, San Francisco.*



A BATHROOM SCALE that would *not* return to zero when you stepped off—so you could check your weight more closely. A push button would put scale back to zero.—*Myron Steir, NYC.*



THEATER SEATS WITH HEADRESTS similar to those on a barber's or dentist's chair. You could pull up the headrest, lean back and enjoy the movie.—*John Shork, Jewett City, Conn.*



A VENETIAN-BLIND AUTO TOP for controlling sunshine, air and visibility. Waterproof when shut, it would be operated by a crank on the dashboard.—*Irving Surdam, Winsted, Conn.*



A STOVE with heating units that would turn on when a pot was placed on top of the burner—shut off when the pot was removed.—*Mrs. Ann Dickinson, Buena Vista, Ga.*

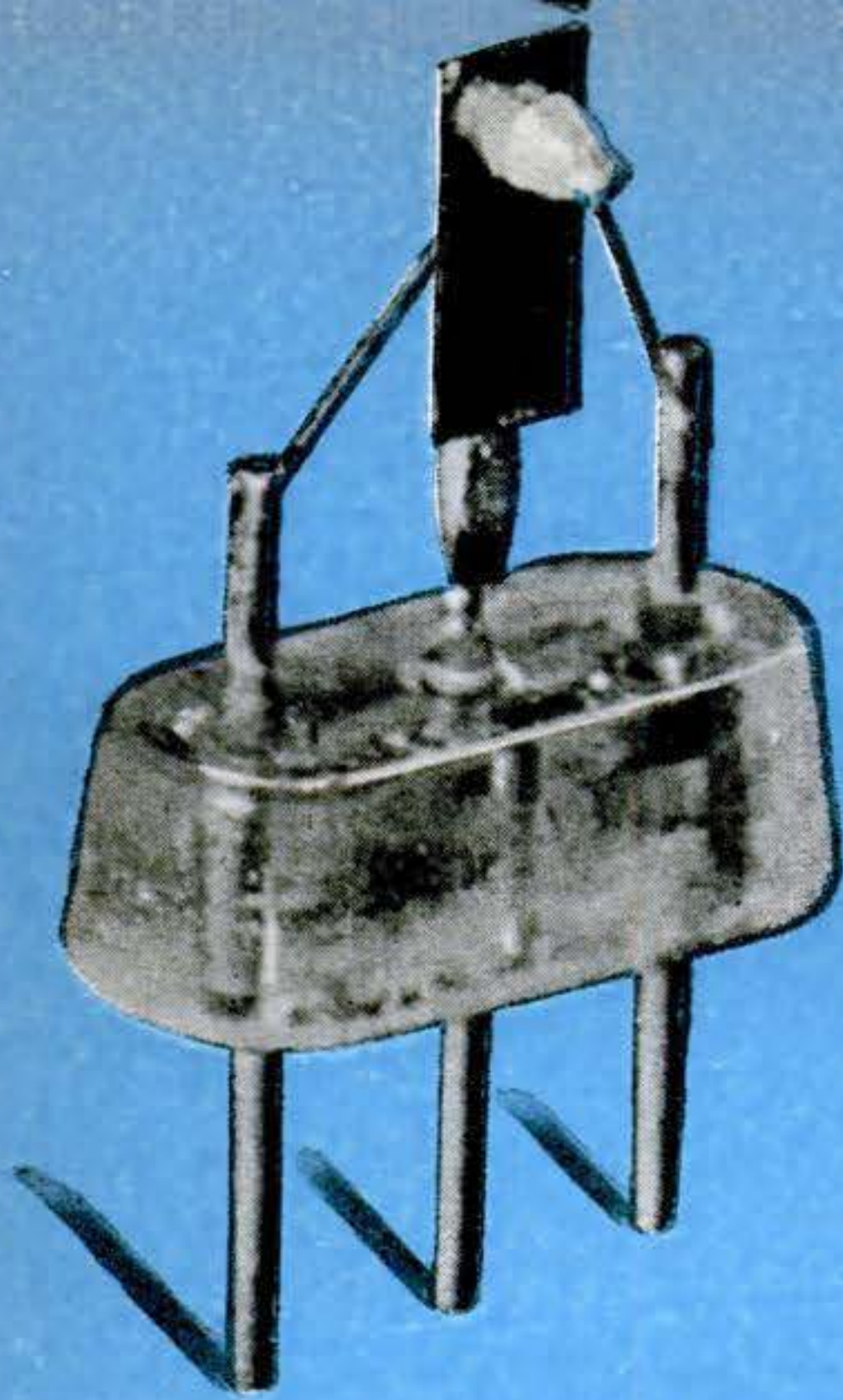

Industry Speeds Production of Midget Brains for Mechanical Men

Uncle Sam has first call on transistors now, but look for them soon in pocket radios and TVs almost that small.

By George H. Waltz Jr.

A ROBOT chess player that took on all challengers, and generally beat them, had the Nineteenth Century world in a tizzy. All went well until the "machine's" human operator, a midget chess wizard named William Schlumberger, forgot one

MICROSCOPIC WELDING JOB. Cat's-whiskers, no larger than human hairs, are bonded to germanium pellets on GE's transistor assembly line, then embedded in plastic.

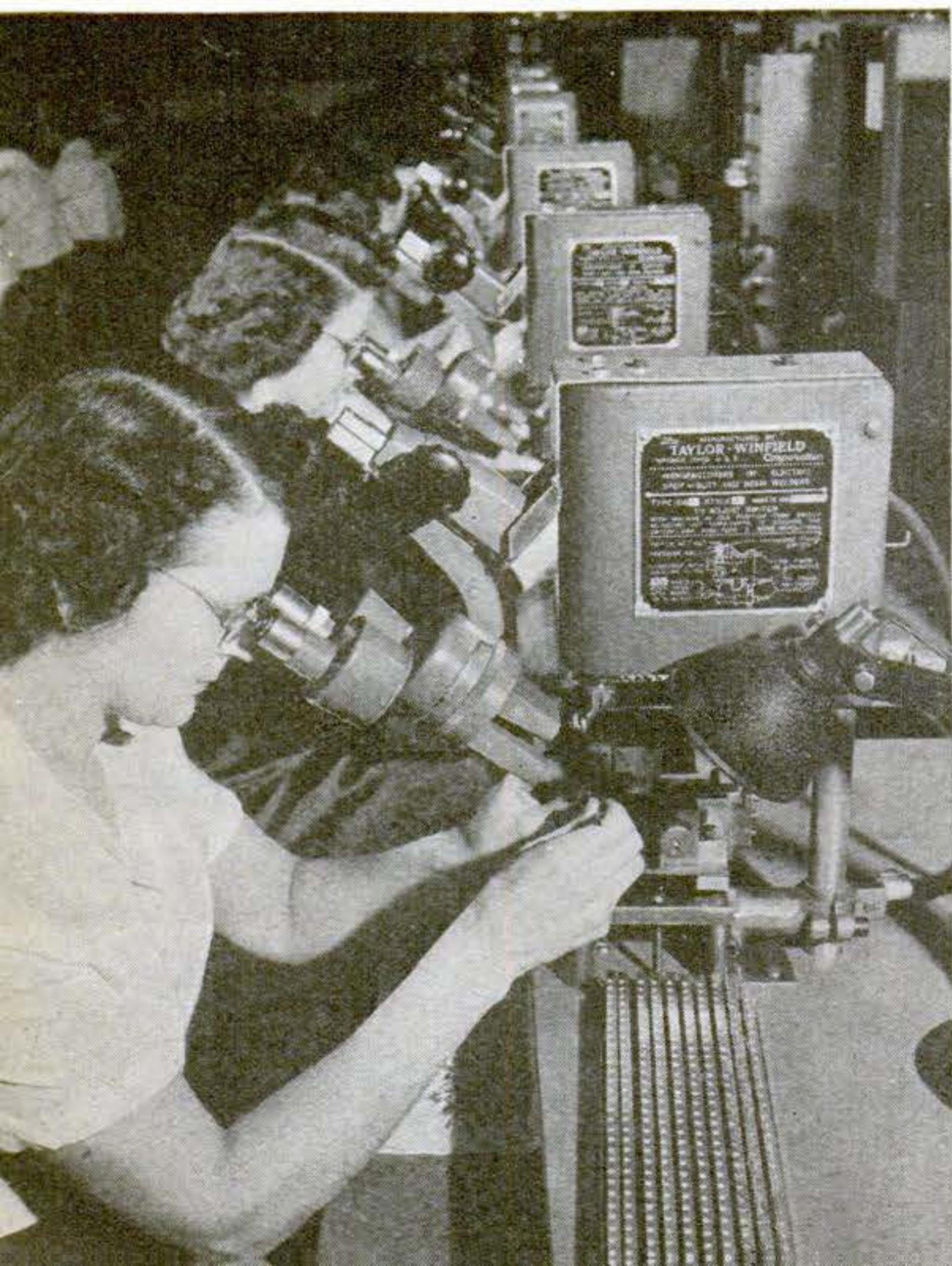

day and raised the lid of the box in which he hid.

When the lids are lifted on tomorrow's mechanical men—super-electronic calculating machines, remote-controlled locomotives and automatic factories, you will find no Schlumberger at the controls. In his place will be tiny electronic operators, each the size of a kernel of corn.

They will be transistors. Four years ago these Tom Thumb power amplifiers were laboratory curiosities (PSM, Sept. '48, p. 117). Now, although it is still too soon to make full use of their possibilities, the transistors have taken out their working papers and passed a rigid armed services' physical. Uncle Sam wants nearly every transistor that can be made.

Practically Indestructible

Until now only two basic types have appeared. The older design, known as the "point-contact" type, consists of nothing more complicated than three wires attached to a sliver of germanium metal. One model of the second, or "junction," type sandwiches germanium between two thin layers of indium which serve as contacts. In each case the germanium, a unique metal that can be recovered from chimney gases, is used because it has natural rectifying properties, allowing electrons to be controlled much as they are by a vacuum tube.

What has the transistor got to account for the demand? These mighty midgets do

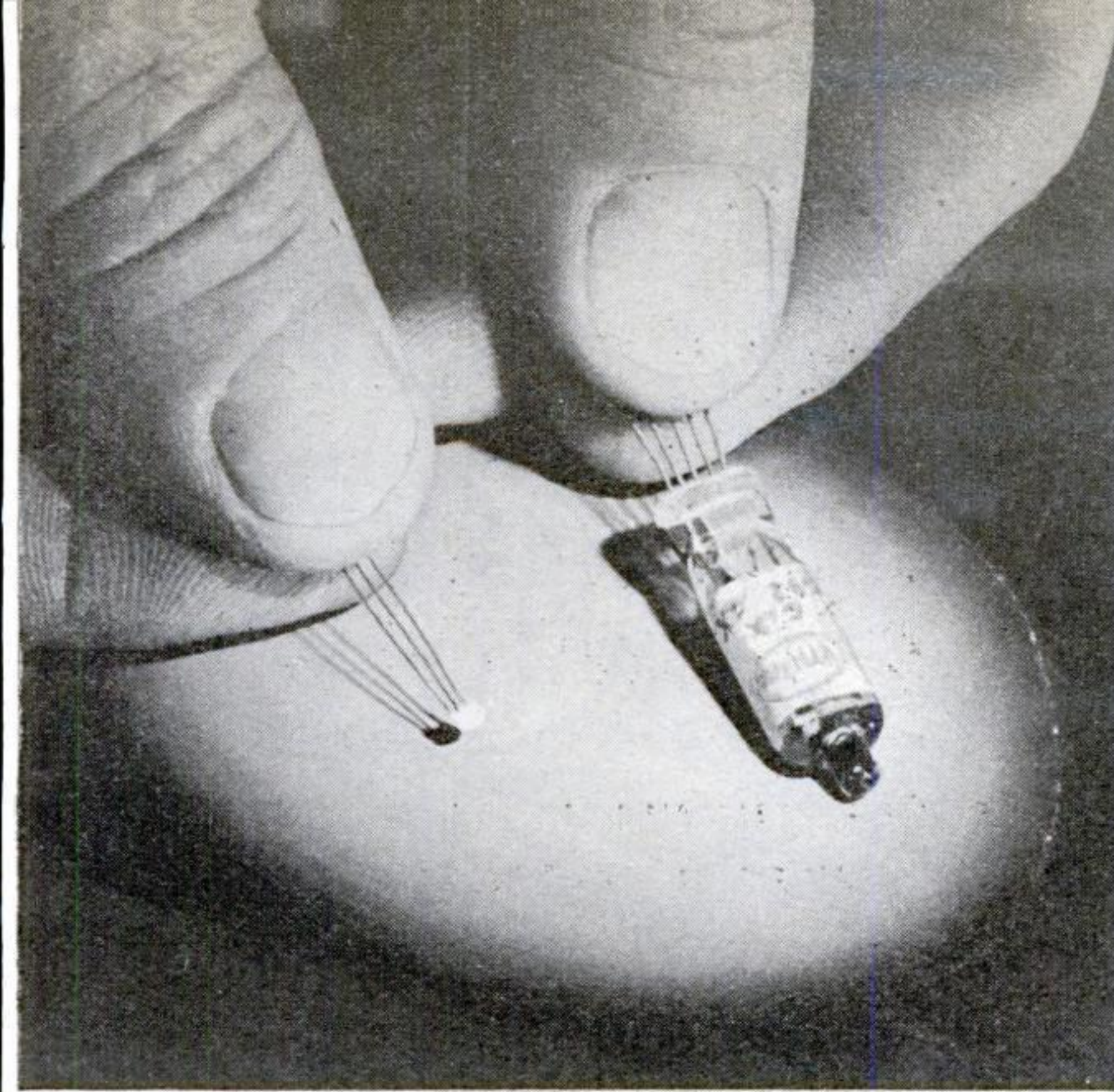

CONTRAST IN MINIATURES. Junction transistor takes only twentieth the space of smallest electronic tube (right), and scientists say that future germanium midgets may be smaller.

much of the work of electronic tubes but require no warm-up time, and because they don't heat up, they last much longer than tubes. There is no glass-enclosed vacuum; their elements are simply encased in a plastic jacket, making them practically indestructible.

Work on Flea Power

The energy expended by a flea jumping once each minute would be enough to keep a transistor perking. As a result, they are normally powered by lightweight, long-lasting batteries. Sometimes, even light striking a photocell, or the heat of the human body, provides power enough.

It is this, plus the Lilliputian size and weight—20 could fit inside one miniature vacuum tube—which excites the military designers. Imagine every GI carrying a two-way radio inside his helmet, receiving orders through bone-conduction phones, and switching off a throat-type microphone to express his personal reactions.

Better brains for guided missiles, really portable radar equipment, easily concealed beam generators to guide fast attack bombers to their objectives, and even lightweight electronic computers that would tell the brass their chances of victory long before a battle were fought—these are among the intriguing possibilities.

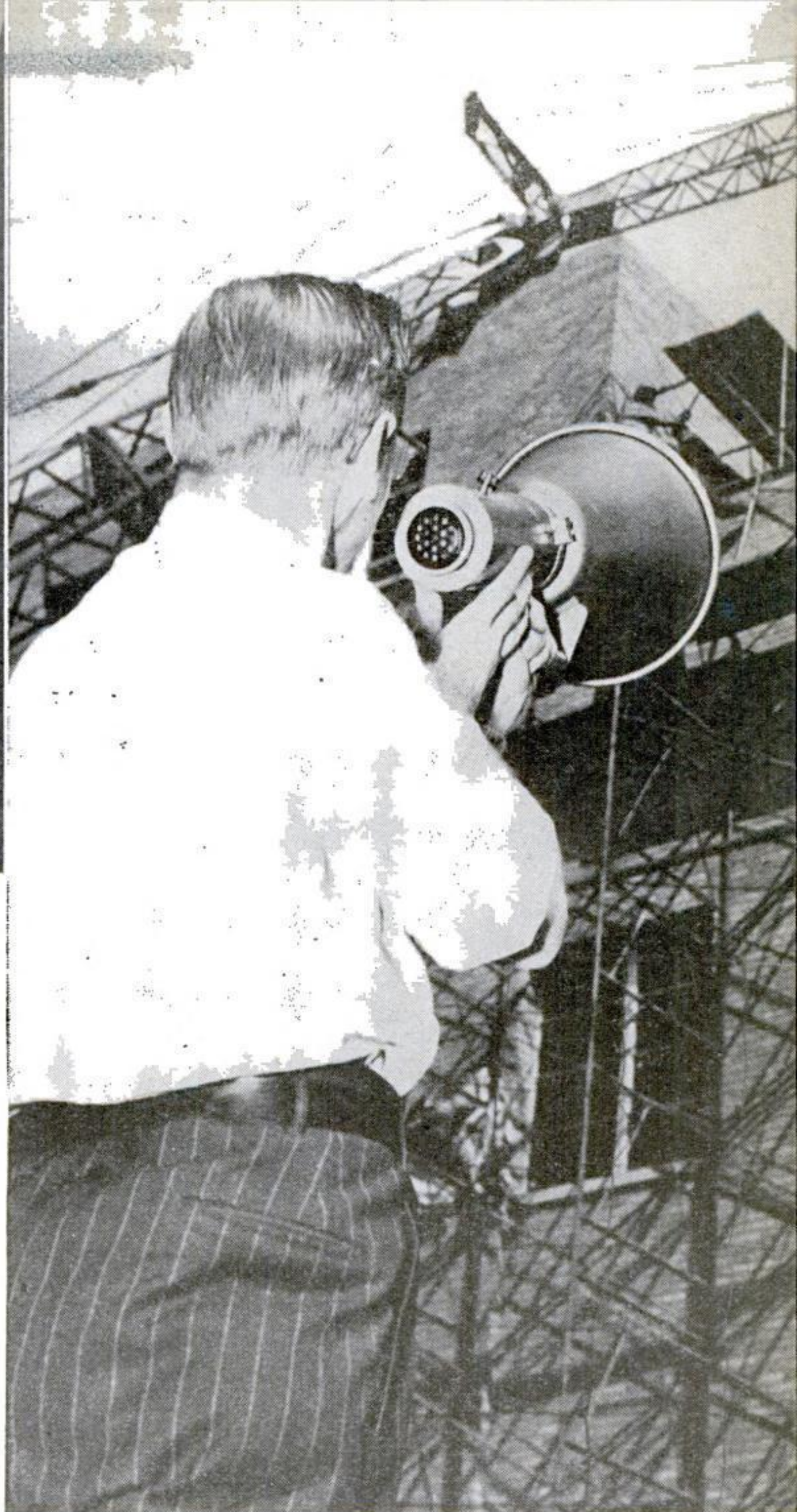

HEAVY BATTERIES ARE ELIMINATED with this transistor-equipped megaphone, which can throw a normal speaking voice a city block. One small dry cell supplies the current.

One of the most intricate electronic "brains" built to date—the IBM selective-sequence computer—occupies three sides of a huge and specially designed hall. In its maze of circuits and relays are 6,000 electron tubes. The heat which they generate calls for air conditioning, and the power demands are enormous. What's more, this super calculator is a temperamental machine, subject to nervous breakdowns every time a tube burns out. But by substituting husky little transistors for the vacuum tubes, the control area could be reduced to less than one-fifteenth of its present area. With space savings like that it is altogether likely

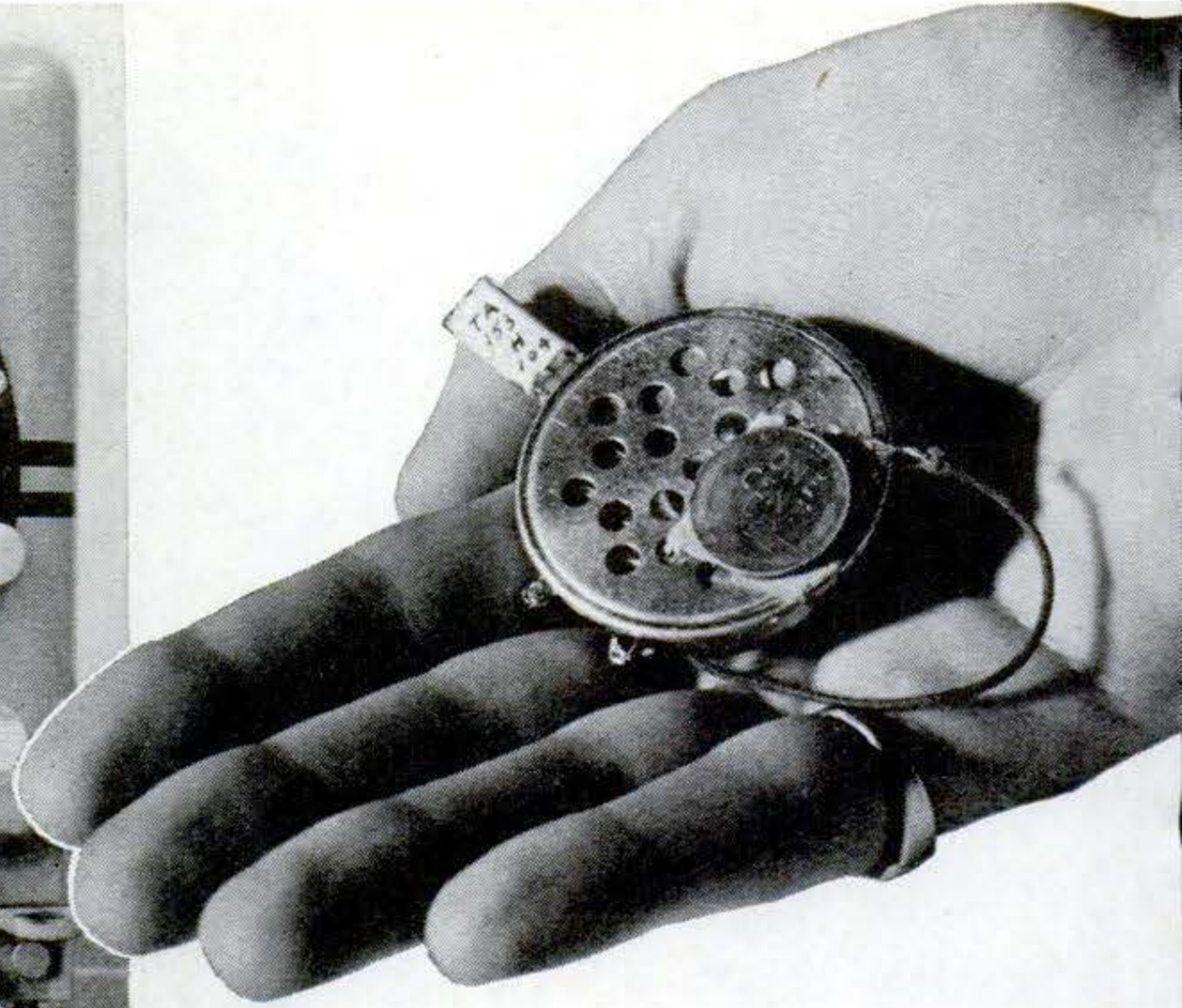
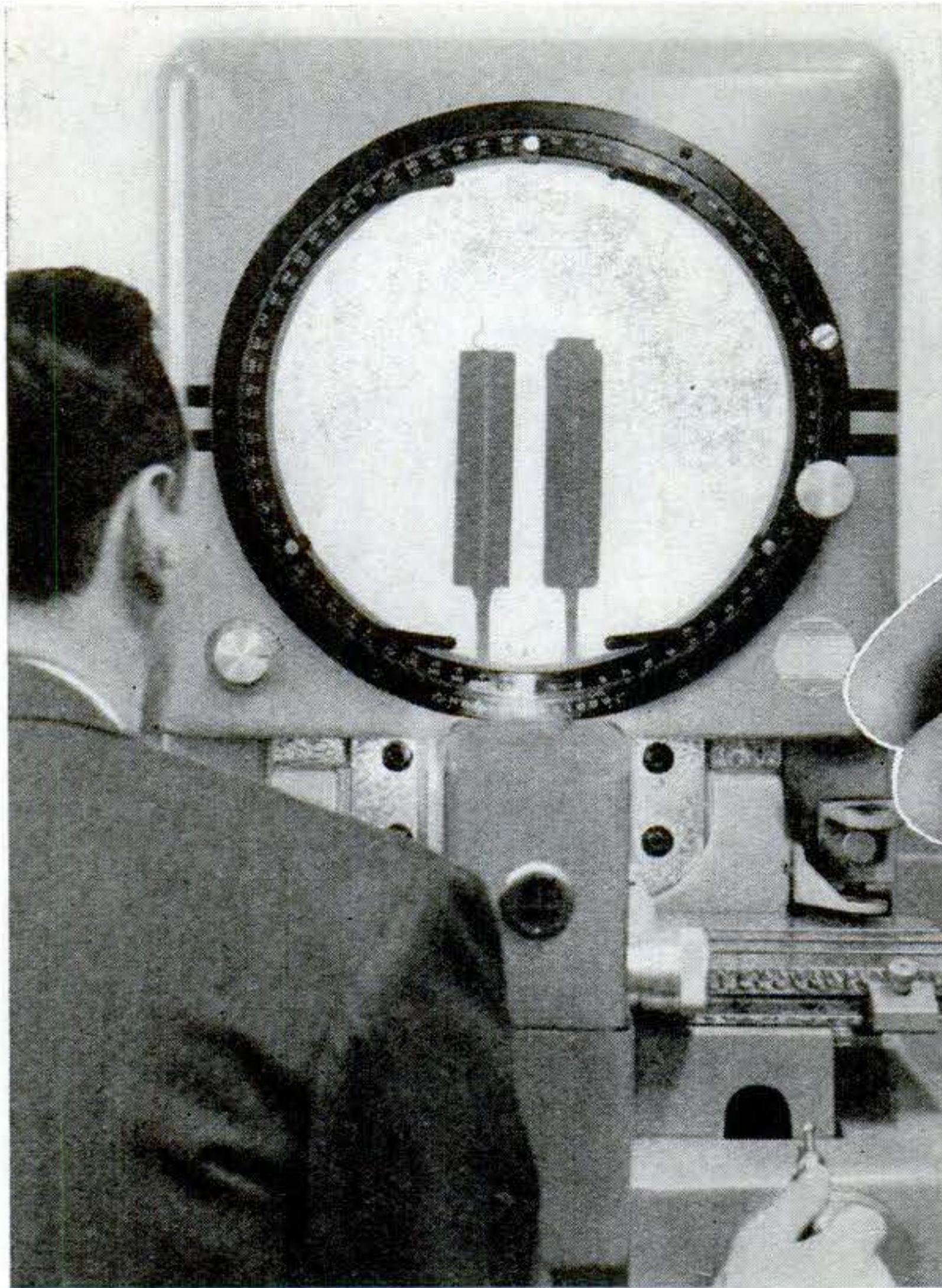

PENNY, separated from a speaker case by a wet blotter, makes a battery powerful enough to operate transistor audio oscillator (above).

FLEA'S-EYE VIEW of transistors is provided by contour projector (left). Technician is checking crystal structure of germanium.

that tomorrow's businessman may add an electronic computer to his desk-top equipment.

Almost completely automatic manufacturing plants with electronic brains making routine decisions and then carrying them out, are envisioned. In that event we can expect to see transistors controlling the machines which will turn out still more transistors.

Featherweight hearing aids even smaller than the postwar models are another possible application for transistors. And in the field of home radios and television sets, we are told to look for pocket-size models which will duplicate the performance of the most modern console chassis. (A transistor radio that you can make yourself is described on page 237.)

Higher Frequencies Sought

There are still problems to be solved, however, before transistors become as common as tubes. One is "noise" (the hissing heard when a radio is turned up loud). Another is frequency. Until a few months ago few experimental transistors could be made to work at frequencies above those

involved in audio circuits. But RCA has just announced that it has boosted the frequency of several units high enough for use in FM radios and TV sets. It is even possible that some day the electronic picture tube might be replaced by a descendant of today's transistor—a simple, long-life unit which will produce the TV image by a flow of electrons in a rugged solid.

What about cost? You can't run down to the local radio shop and pick up a handful of transistors, but Western Electric does sell experimental models for about \$6. Eventually, many technicians believe, the units may sell for as little as a dime. **END**

Quotes

- "We must sit down before facts like a little child, and follow wherever they may lead."—*Thomas Huxley.*
- "The future of our civilization depends upon the widening spread and the deepening hold of the scientific habit of mind."—*John Dewey.*
- "By research today we can insure prosperity tomorrow."—*Karl T. Compton.*

New Ideas from the Inventors

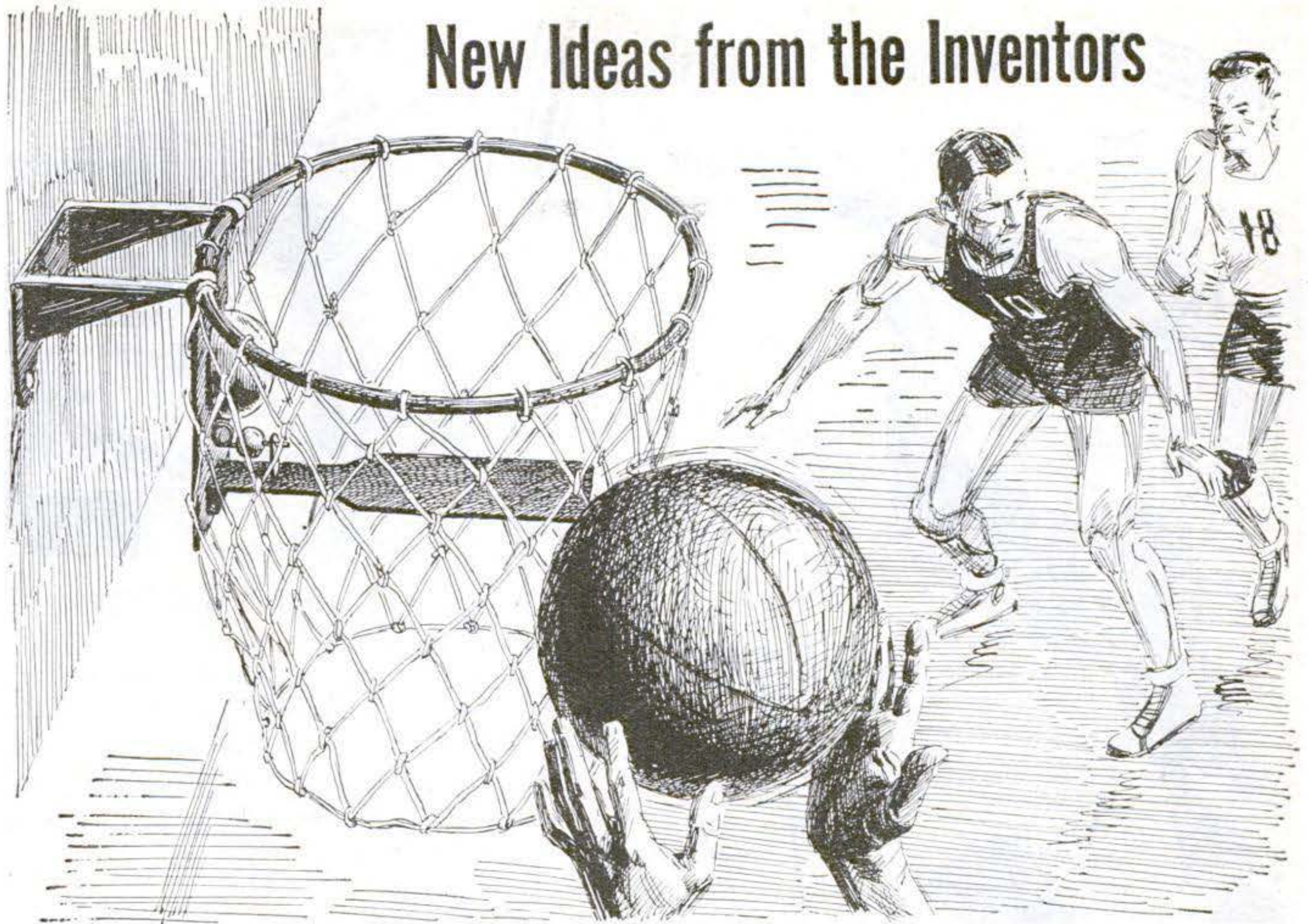

1 Basket to Signal Scores. Neither players nor spectators would be in doubt about close basketball shots if the basket rang a bell. A ball passing through this hoop would depress a paddle and release a spring-

held clapper. Springs would automatically reset the clapper and paddle after each score, holding them poised for the next play. The bell ringer would not be affected by side swipes.

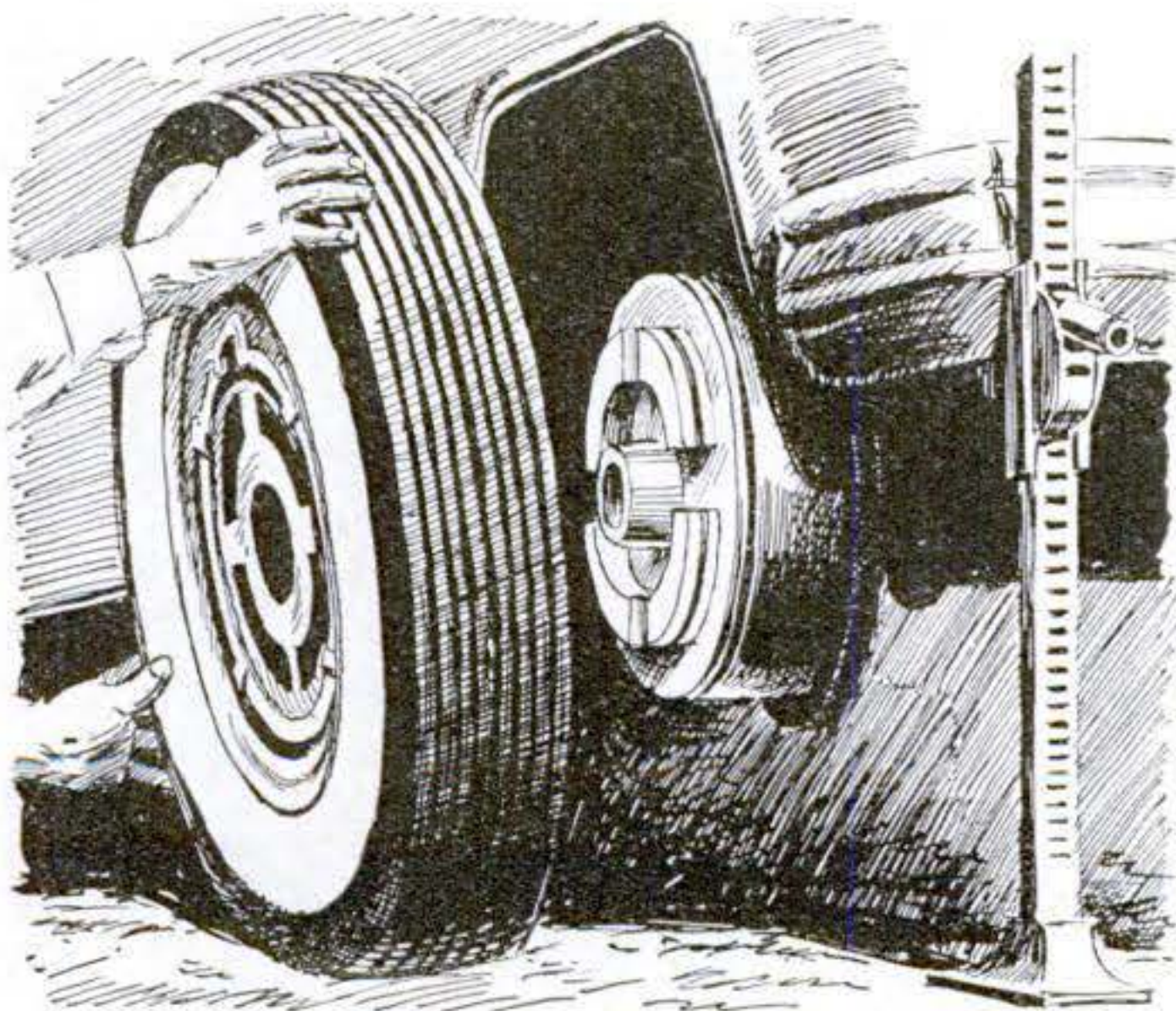

2 Quick-Change Wheel to Clip on Rim. You would only have to pull a lever to free this wheel from its drum. Curved slots in the wheel would slide over grooved projections on the drum. A tapered ring wedged into the grooves would lock the wheel on. The lever would pry the retaining ring out of the grooves to free the wheel.

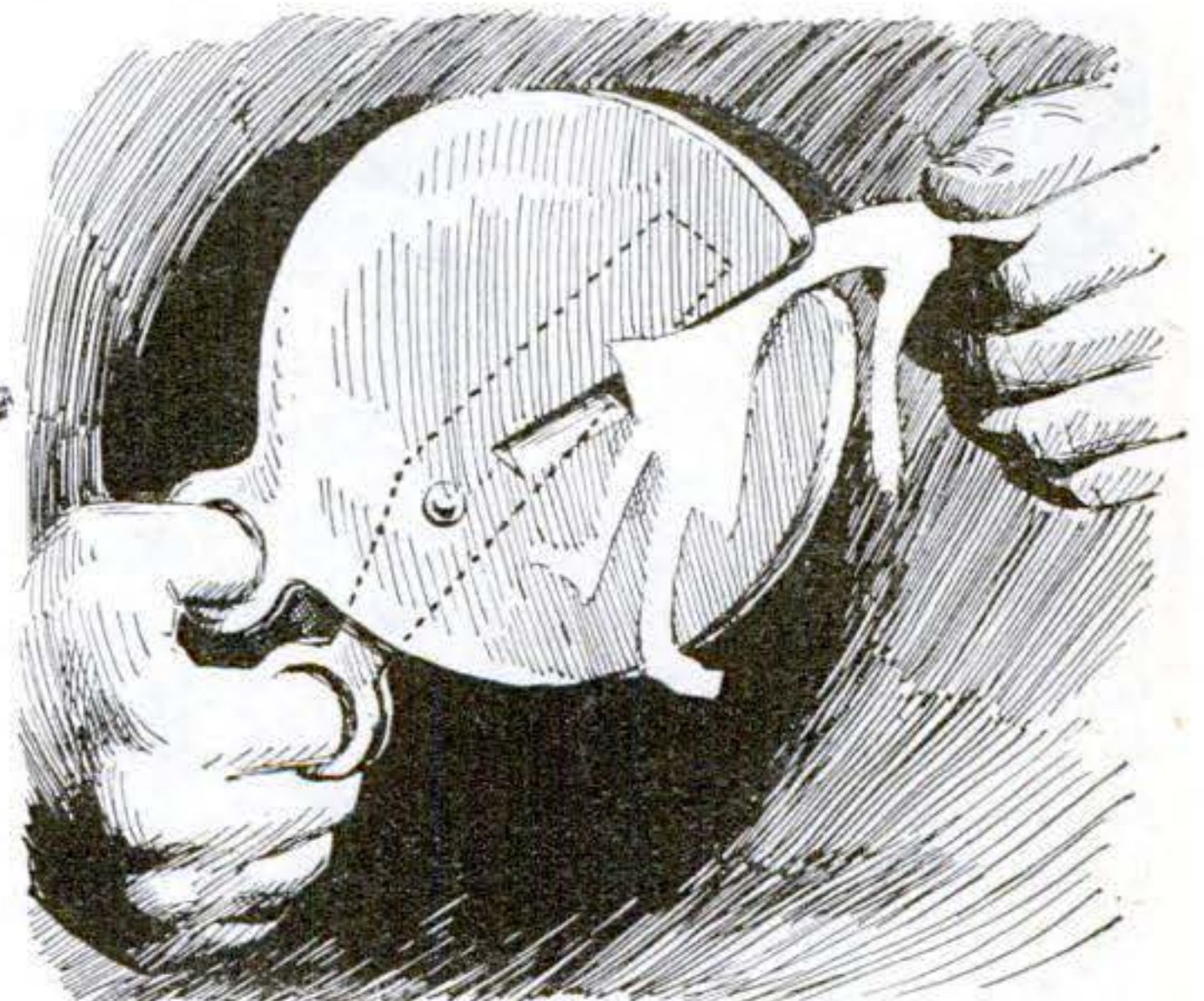

3 Child's Scissors to Guard Fingers. It would take a determined child to hurt himself on this paper cutter. The scissors would have one conventional blade and one formed as a slot in an oval plate. The narrow slot would admit paper and other thin material but keep out fingers, clothing and the like.

Please turn the page for more new ideas.

OCTOBER 1952 137

MORE New Ideas from the Inventors



7 Drag to Retrieve Ducks. When game is shot down in the water, the aid sketched above would save wading or going after it in a boat. The folded wood frame would be thrown like a javelin. A tug on a line would release a spring to unfold the T-shaped float, which would rake the duck in.



4 Mirror to Signal Turns. This rear-view mirror would serve as a turning signal, too. The surface of the mirror would be thinly silvered and a pointer outline would shine through when illuminated by a bulb within. A pair of the mirror signals, operated by a hand switch, could be attached to doors on each side of a car.

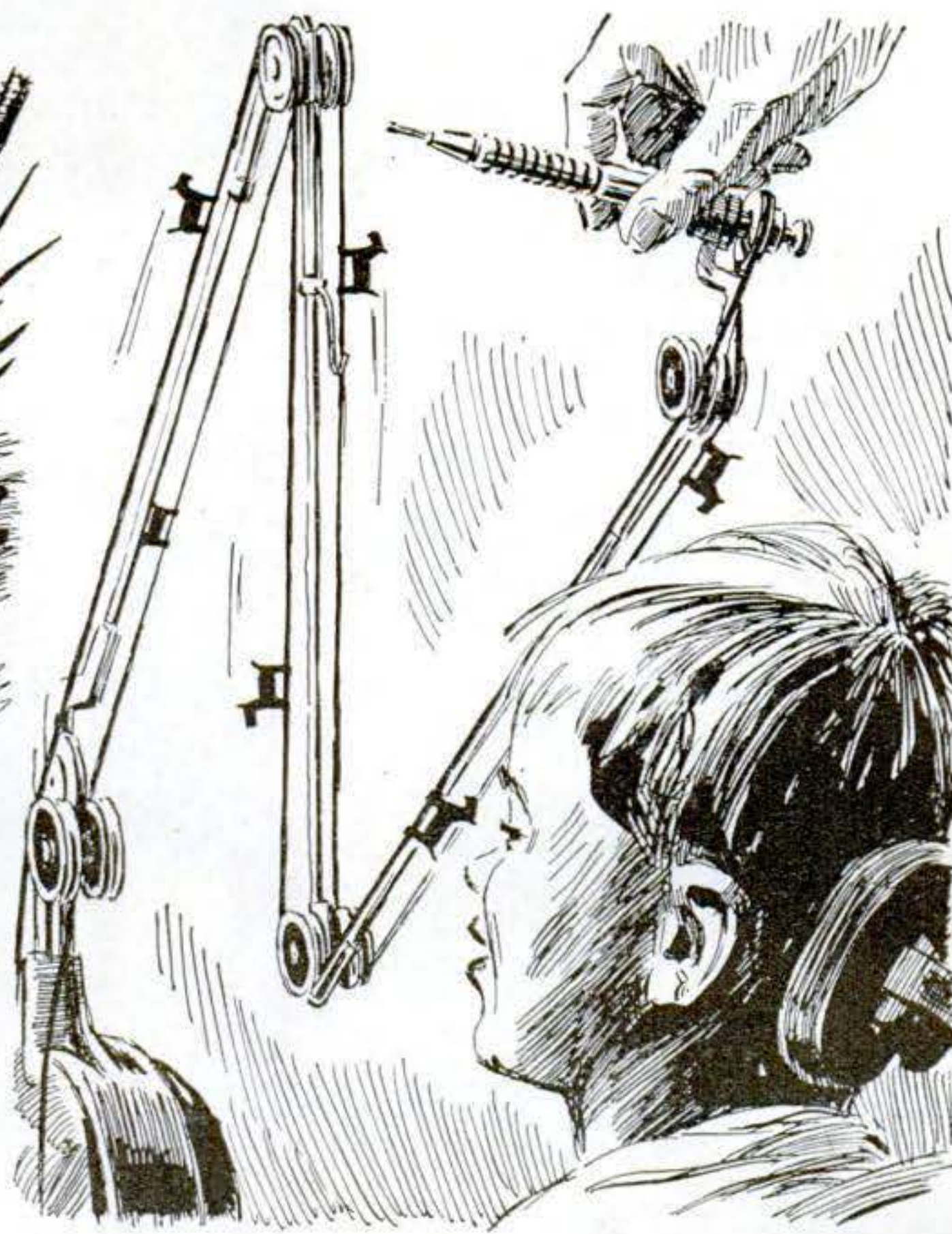

8 Drill to Entertain Kids. Watching dogs or rabbits chase each other along the drive cord of a dentist's drill would help to calm jittery children—and perhaps grownups. To be made of thin sheet rubber and wired to the cord, each toy animal would take the turns around pulleys in its stride.



5 Flashlight to Power Fan. Substituting a small attachment for the lens, lamp and reflector of an ordinary flashlight would provide a pocket-size electric fan for hair drying or just cooling off. A midget motor, powered by the regular batteries, would spin a tiny fan blade within a perforated cover when the light switch was pressed.

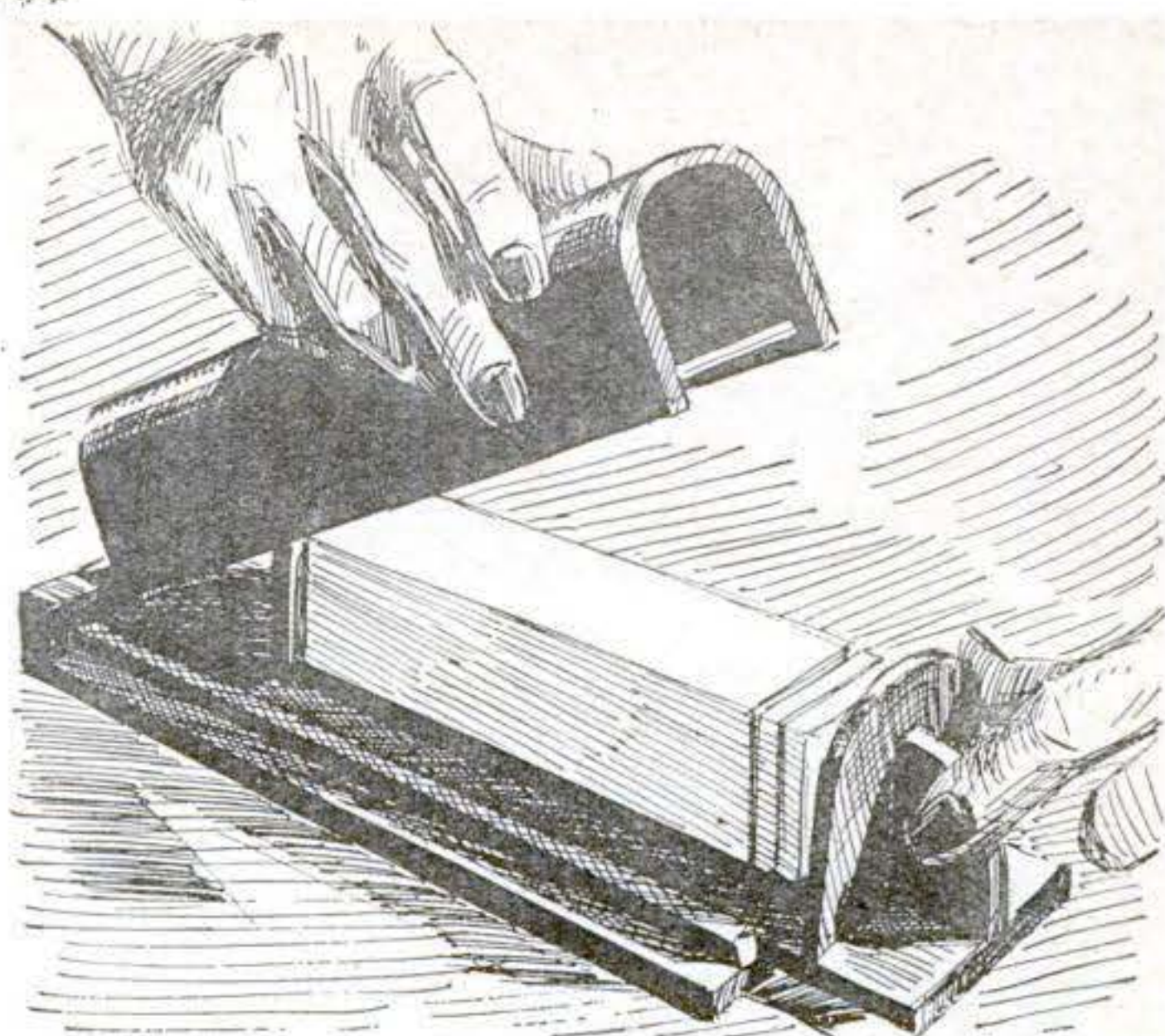

6 Dish to Cut Butter. This handy dish of glass or plastic is intended to keep butter in the refrigerator—and then to slice it in the kitchen or at the dinner table. A cutting wire in the hinged cover would make the slices, their thickness depending on how far out the sliding tray carrying the butter was pulled.



9 Curtain to Soften Crashes. A sponge-rubber mat that would whiz across windshield and instrument panel could save a car rider from injury when hurled forward

in a crash. Springs would eject it when any one of five electric switches, responding both to direct impact and sudden deceleration, actuated a trigger.

Patents on these inventions have been granted to: 1. A. Holmdahl, Kellogg, Iowa; 2. W. Peck, Detroit; 3. W. and G. Stilwell, Vermillion, S. D.; 4. P. F. Calihan, Red Wing, and S. A. Mortenson, Minneapolis, Minn.; 5. J. E. Popovich, Oakland, Calif.; 6. C. W. Paul, NYC; 7. J. D. Caslor, St. Vital, Manitoba; 8. C. J. Gardetto, Milwaukee; 9. A. B. Joncas, Detroit.

Super Service for Truckers



This enormous service station for trucks, 112 miles north of Los Angeles, covers 10 acres.

The world's biggest roadside stand for the care and feeding of freight haulers and their drivers grosses \$2,000,000 a year.

A COUPLE of fellows with a shrewd appreciation of human nature have parlayed a towel and a bar of soap into the world's biggest service station for trucks.

If that's stretching the truth a bit, it's only because the towel and soap are first on the list of services supplied to truck drivers who roll into their 10-acre, million-dollar establishment on Highway 99 on the outskirts of Bakersfield, Calif.

Walter Jaynes and Dick Stricklen, the owners, figure that a free bath for their customers is one of their big assets. It's one of the reasons they dispense 200,000 gallons of fuel a month and bank \$2,000,000 a year.

OILERS Four grades of lubricating oil are pumped at 150-lb. pressure. Outlets in foreground carry oil, water. Station has two such systems.

Truckers, dog-tired and dirty, get a bath—and far more.

Take gearjammer Paul Hendricks. He air-brakes his 50-foot-long truck-trailer to a halt between two rows of fuel pumps.

"Gimme the works," he says. "Got to be rolling in a half-hour."

An attendant hands him towel and soap. He points toward the shower room, then in the direction of a spick-and-span coffee shop. As Hendricks steps out, three men jump to their jobs servicing the truck-trailer. Two of them feed 110 gallons of Diesel fuel into tanks on opposite sides of the truck. A third pours five quarts of lube oil into the

CALL BOARD No need for a trucker to take off empty. Part of service is passing business tips on to the customers.

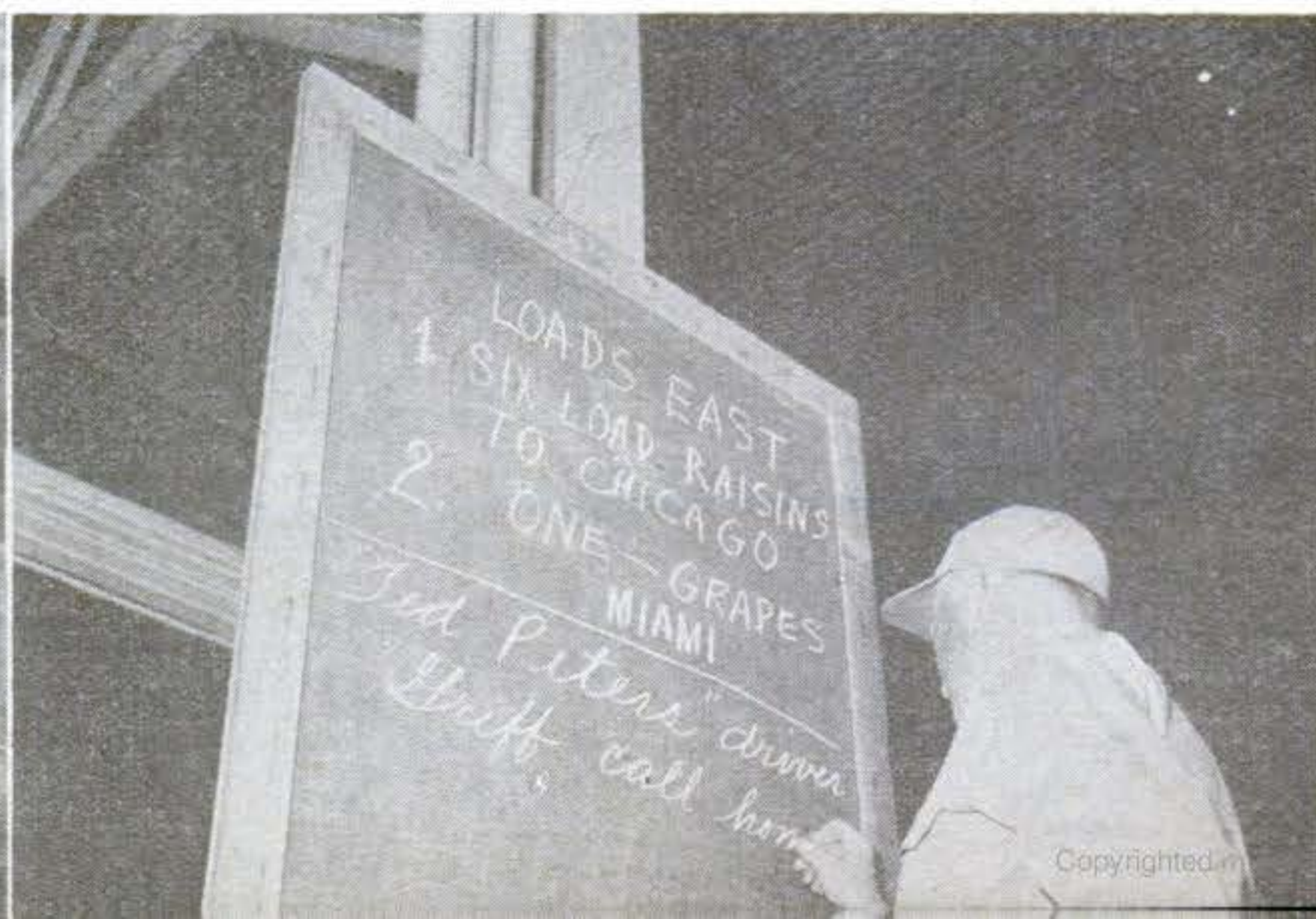
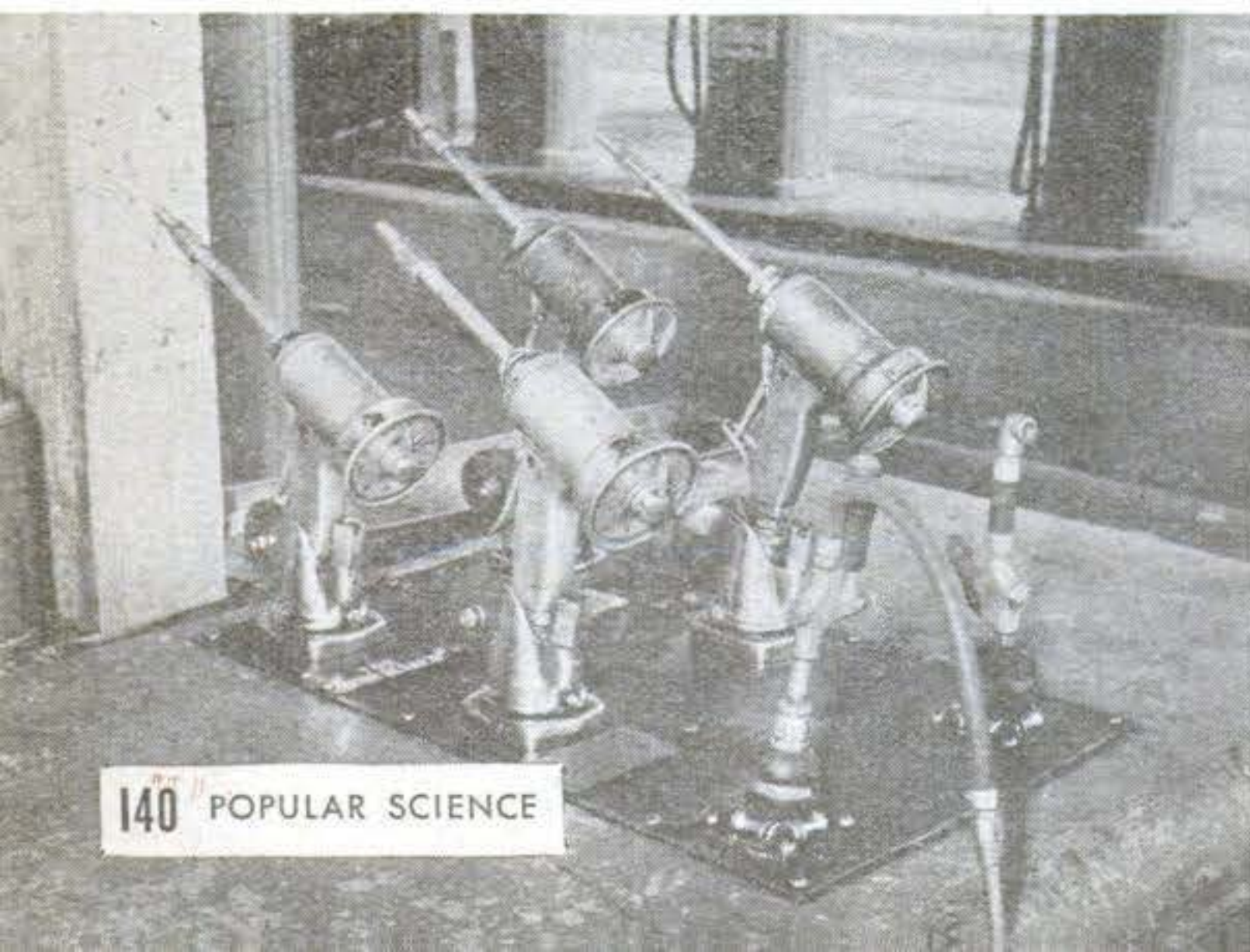

Pays Super Profits

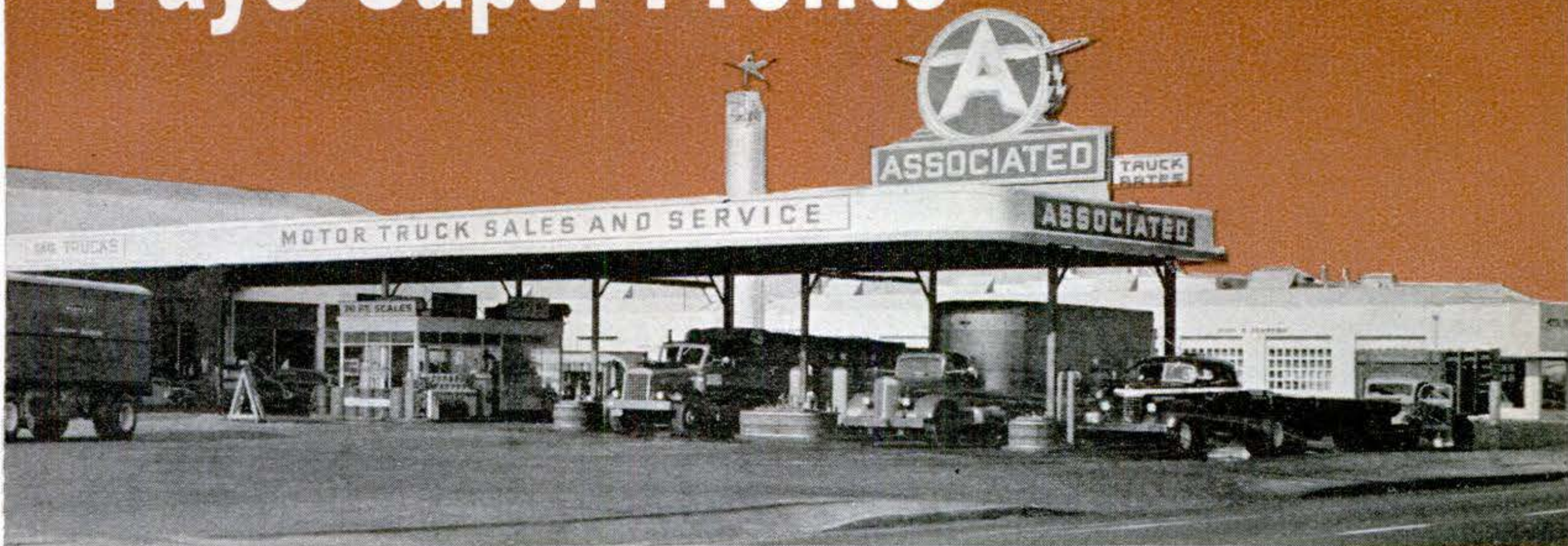

Heated in winter and cooled in summer, it sells fuel and oil, makes repairs, builds bodies.

engine, washes the windshield, brushes out the cab and thumps all the tires with a tire iron to test for flats.

Before Hendricks has completed showering, one of the uniformed attendants drives the big rig over a lube pit, where grease is squirted into the fittings.

Twenty minutes from the time Hendricks spotted the station's neon signs, the rig is ready to roll on. As he unpeels a roll of bills, the night manager says, "I see you're from Florida. Better look at the bulletin board before shoving off."

Bulletin Board Pays Off

At one end of the pump island a notice is chalked on a blackboard: "Load of grapes for Miami." And so Hendricks, who has hauled a load of molasses across the conti-

ment, gets a profitable return load—all for free.

The station, called practically, if unromantically, Motor Truck Sales and Service, is only a little more than seven years old. No longer ago than 1945 Jaynes and Stricklen took note of an interesting fact—each 24 hours 2,000 trucks were rolling by Bakersfield, on the main route between Los Angeles and San Francisco. During the peaks of cotton, produce and fruit harvesting, par for the day reached 4,000.

And nowhere on that stretch of highway was there a service station devoted exclusively to trucks.

The partners were savvy. Jaynes had taken over the management of his father's Bakersfield garage when he was graduated from the University of California. Stricklen

MACHINE SHOP Emergency parts for ailing trucks can be made or supplied from \$100,000 stock.

PAINT JOB Trucks and trailers can be painted by spray-gun method and then dried quickly in constant-temperature oven.

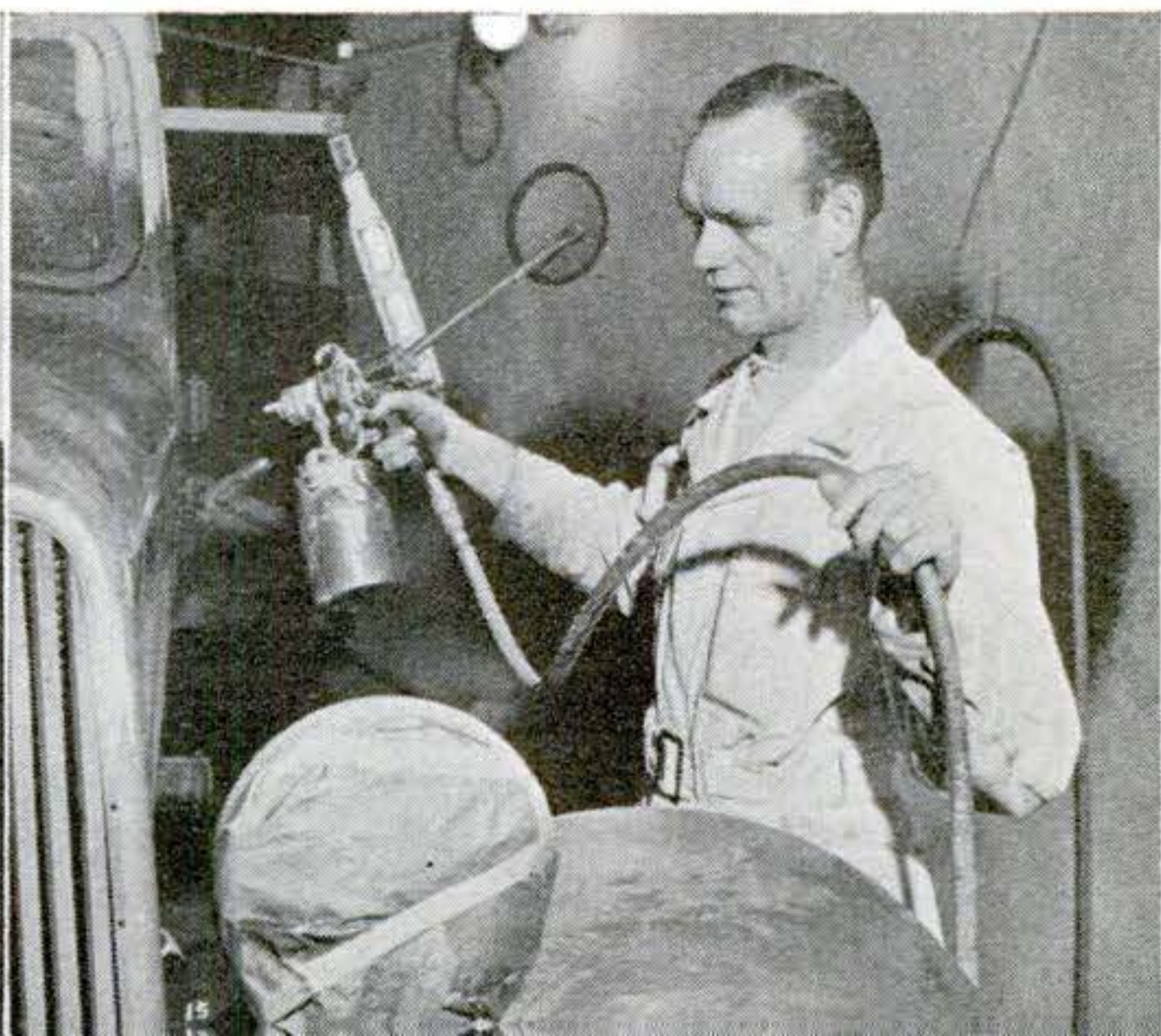
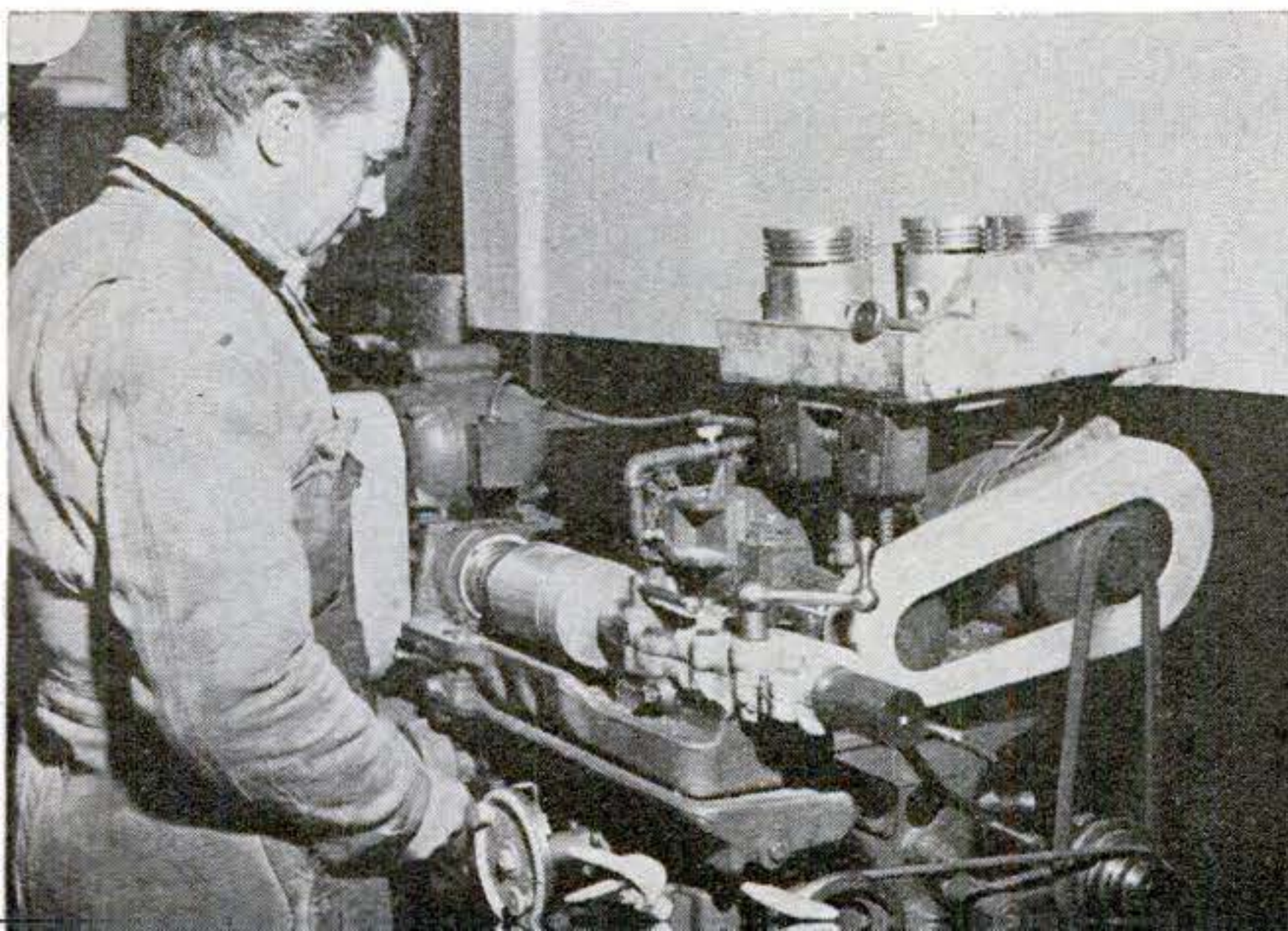



CUSTOM CUT Bodies are built to order to fit customers' trucking needs. Special job above is for a light truck.

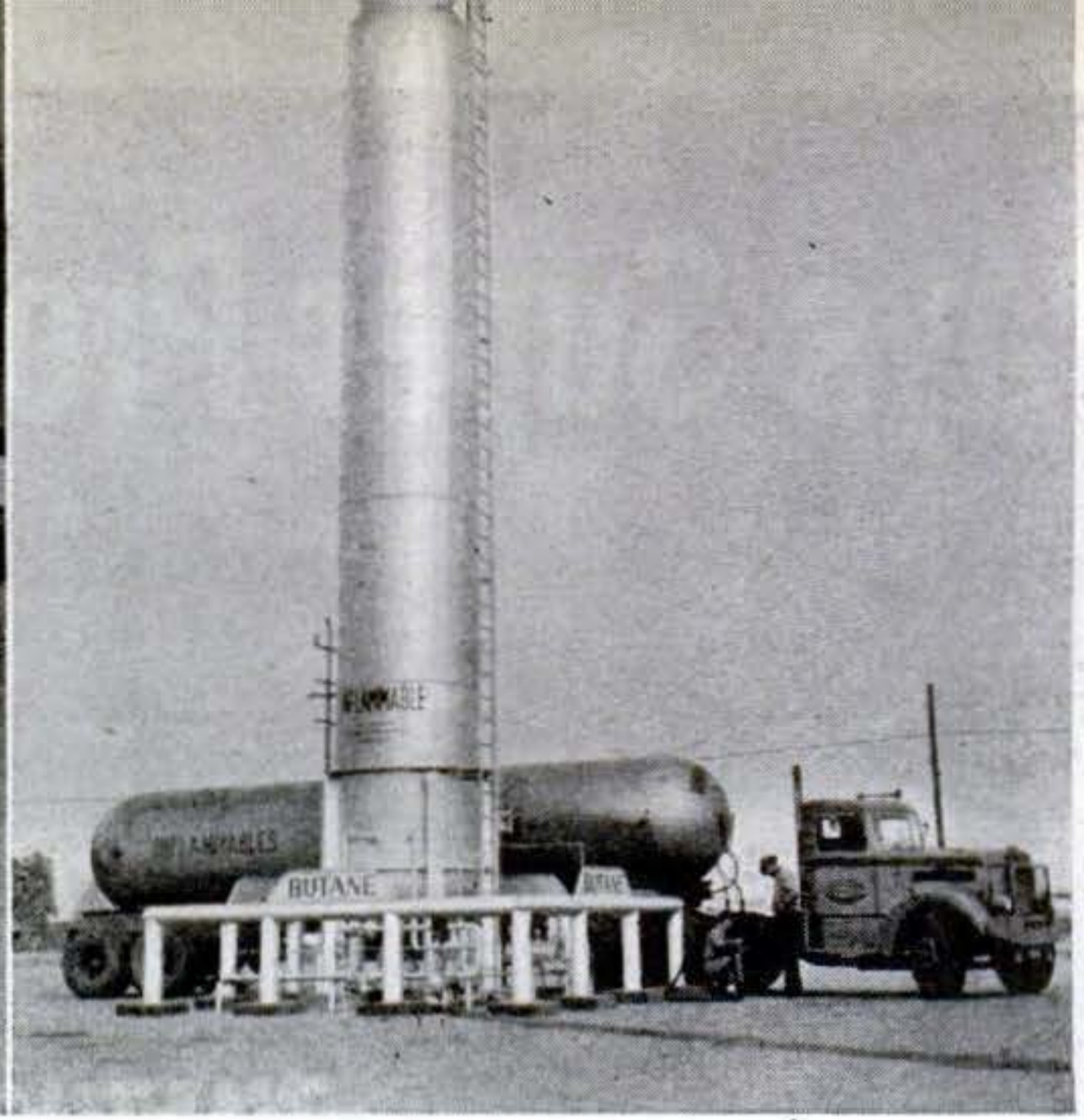

BUTANE This 10,000-gallon, 60-foot butane tank fuels trucks at 40 gallons a minute. Set vertically to attract attention, it weighs 17 tons.

had sold automobiles—including that mourned vehicle, the Peerless—since the year 1924.

They mapped a 10-year building program. They bought 10 acres of ground with 600 feet fronting on the highway and optioned 88 more for expansion.

But not one spadeful of earth was turned for six months. The two men took off on a tour of the United States to see how other people serviced trucks. They separated so that they could cover more territory. In all, they visited 150 service stations.

Back home they compared notes. Not one station visited had been laid out specifically for the most efficient handling of big units.

They knew what they had to have: fast, friendly service, a better-than-average restaurant, machinery and tools to repair breakdowns, enough room to drive the biggest truck into any of their buildings without backing to maneuver, free help in getting revenue loads for truckers and—for the drivers—soap and towels.

Room Enough for Everybody

The planning has paid off. Business is booming. In the gas island is a scale that can take a truck 70 feet long. The nearby lube building is cocked 15 degrees toward the fuel island. That's so the longest rigs can go from the pumps to the grease pit without backing up to maneuver. Twin pits are each 70 feet long. Trucks can swing into the other service buildings going away,

as the saying goes, and move right out the opposite side following repairs.

On the back lot stands a trouble truck to help truckers—and farmers, too—when they have breakdowns. In a vault are thousands of dollars in cash—customers often want to cash checks.

Nights Are Busy

The \$6,000 a day that goes into the till isn't all from servicing combos. The partners also sell two makes of trucks, farm tractors, cotton pickers and hay balers. And they build bodies. Doors are open 24 hours a day. You can buy gas or gaskets at three in the morning. Most of the business, in fact, is done at night.

The station is known from coast to coast and even abroad, but Jaynes and Stricklen are still looking ahead. By interviewing state engineers, they learned that highways and bridges are being beefed up. That means that bigger trucks and heavier loads—existing California laws limit trucks to 60 feet and 76,000 pounds on six axles, highest in the U. S.—are coming.

The place on Highway 99 started getting ready for them years ago. END

Use of Titanium Saves Chromium

SUBSTITUTING titanium for stainless steel in one jet engine saves enough chromium to finish the radiator grilles, bumpers and trimmings of 33 automobiles.

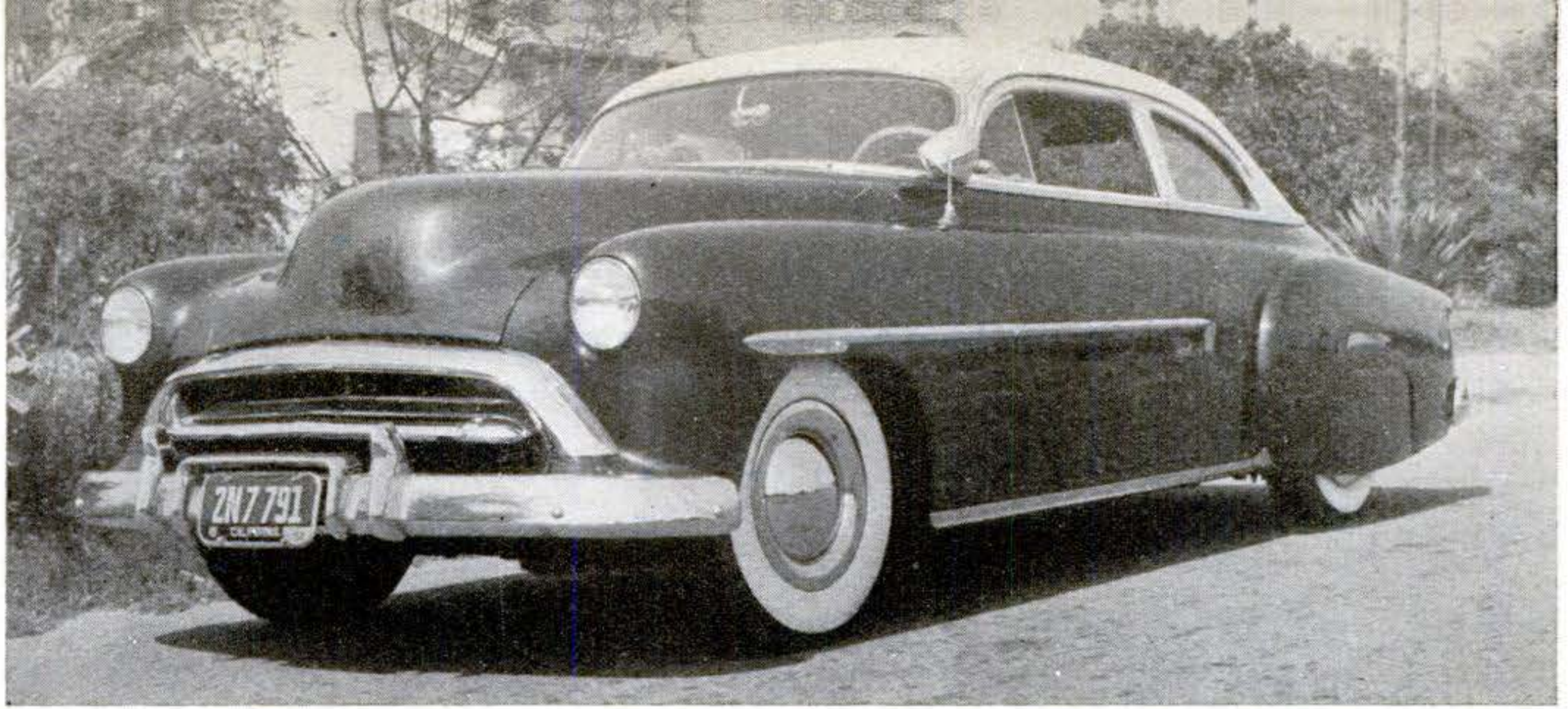

Recognize this Chevy? It's now mostly Olds with parts of an 88 and a 98 fitted in the body.

Olds Makes Old Chevy New

ONCE upon a time this car was a 1949 Chevrolet—a two-door Styline sedan. Now, \$1,500 later, you can't identify it. But if you scratch beneath the surface of the purple and off-white paint job, you'll find a patchwork of new parts lifted from an 88 and a 98 Olds.

George Cerny of Los Angeles, who makes a business of glamorizing low-priced cars to make them look like what they ain't, did the job. He lowered the top three inches and added three inches to the bottom of the skirt and fenders. The revamped grille includes a '50 Olds top bar and a '51 floating center bar. The lengthened rear fenders are part Chevy, part Olds 88, and the windshield was swiped from an 88. Most of the Chevy's chromium trim was eliminated and the new hub caps were specially made.

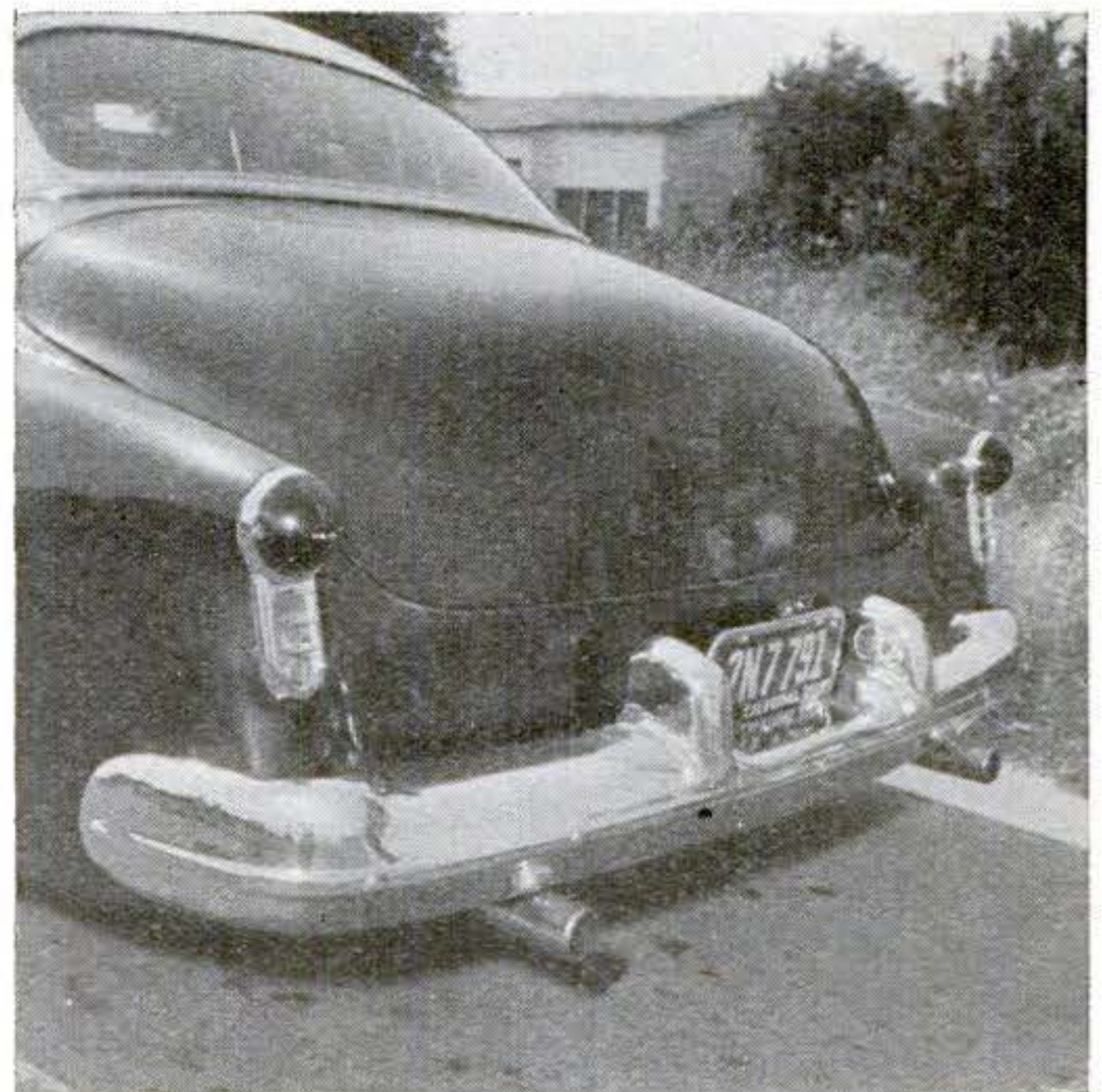

DECK LID of Chevy has been squared off by reshaping original. Rear fenders are longer.



New Lightplane Is All-Metal

BILLED as the world's first all-metal, single-place flying flivver, the new Honey Bee (above) is 17 feet long, has a wing span of 28 feet, and weighs only 550 pounds. The

65-hp. lightplane is said to take off at 45 m.p.h., climb 1,100 feet a minute, and hit a top speed of 120 m.p.h. Beecraft Associates, San Diego, will also supply the airframe only and fit it with your own engine.

**This new Diesel-powered giant has
the right of way over every train on the railroad
when wreckage must be cleared.**

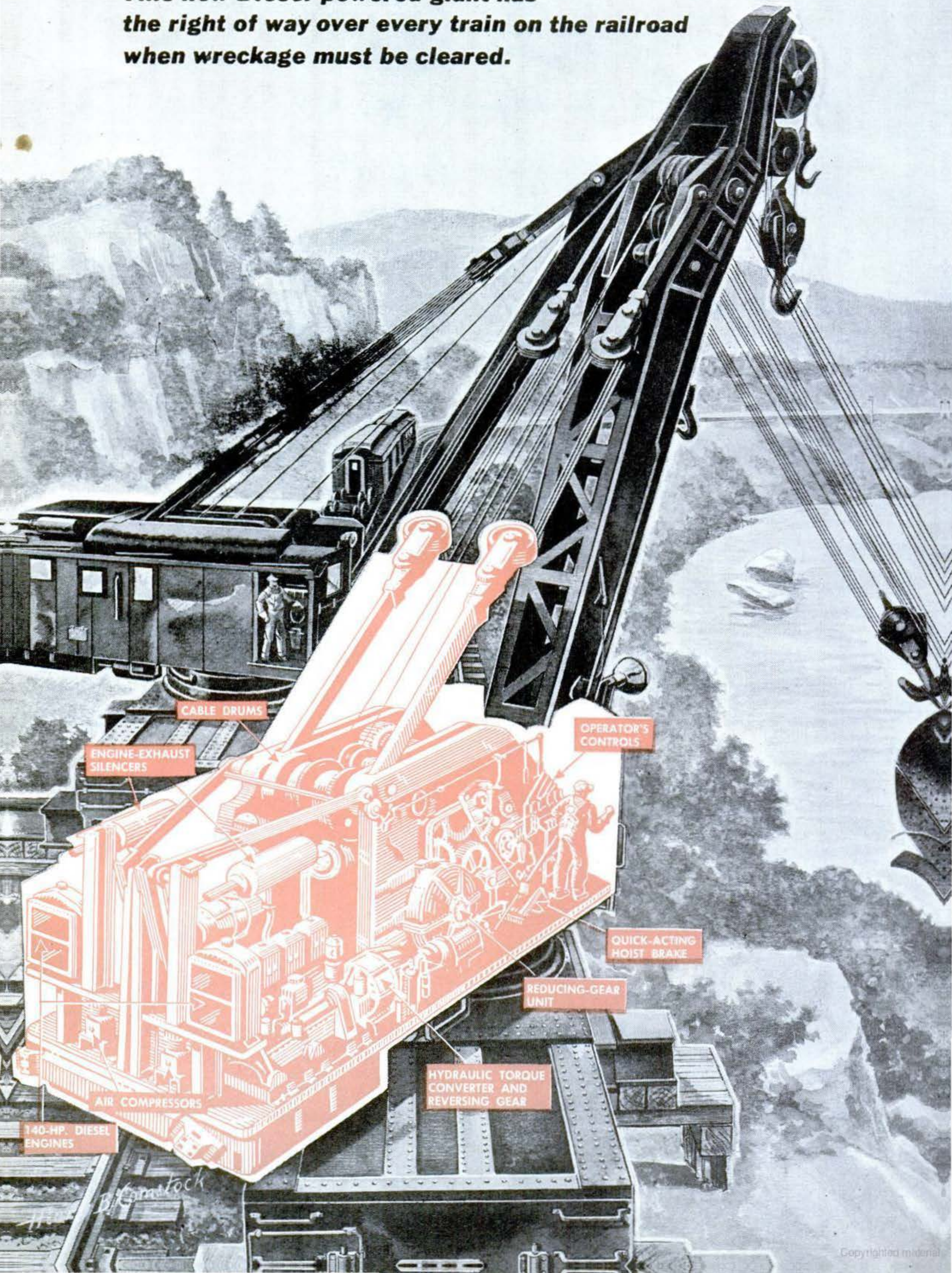

COOL in summer, hot-water heated in winter, the Diesel-crane engineer's cab is comfortable. Controls duplicate those of steam hooks.

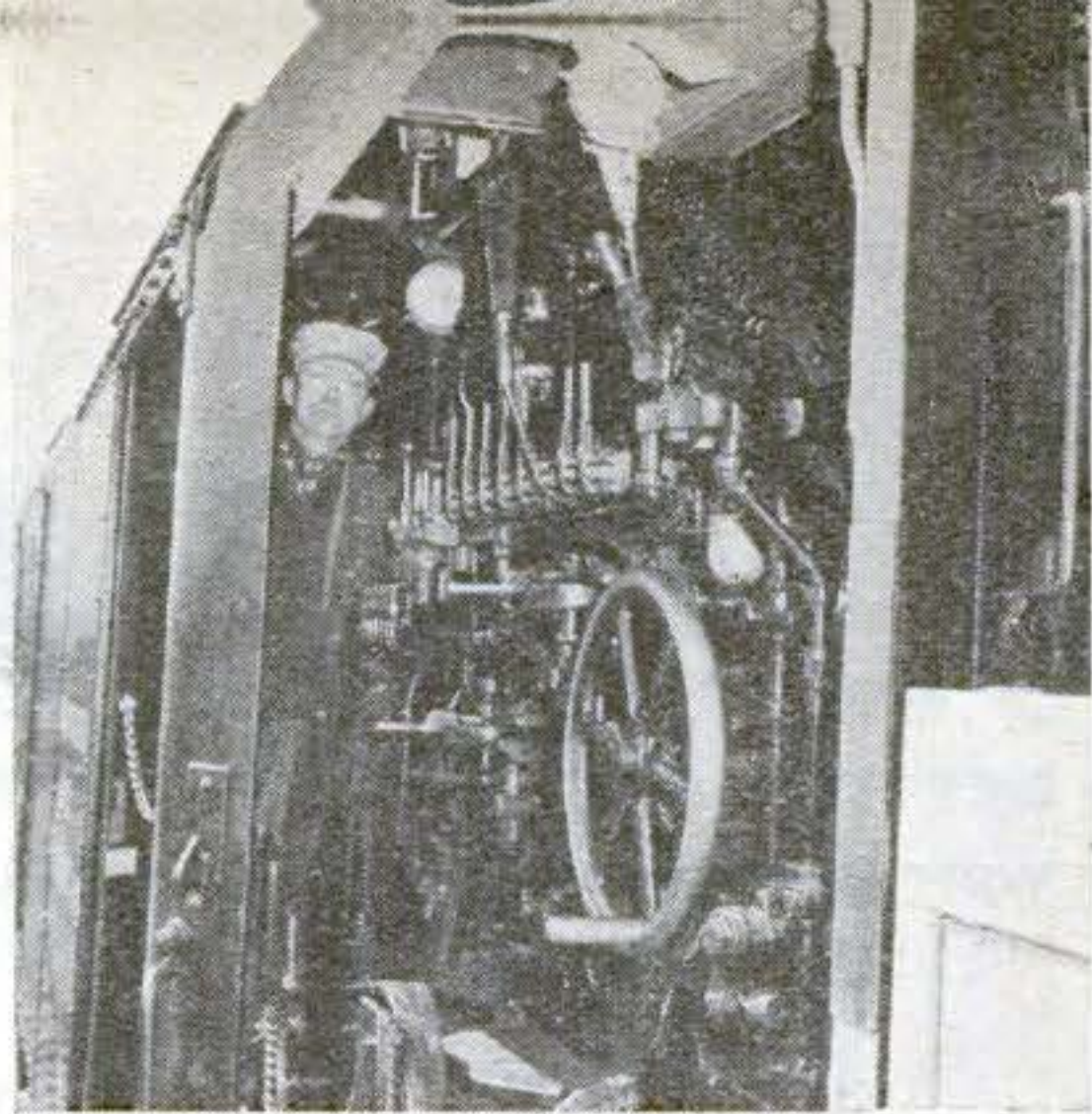

The Crane That Saves \$2,000 a Minute

By Henry B. Comstock

WHEN a busy main line is tied up for as much as three hours by a train wreck, any additional delay may set a railroad back as much as \$2,000 a minute in lost revenues.

That is why a modern, high-capacity wrecking crane, which costs as much as a two-unit Diesel engine, three luxury-train diners or four streamlined roomette cars, is considered a sound investment. Brass hats who expect 23-hour-a-day service from their locomotives do not object to footing the bill for this "Big Hook's" maintenance, even if it goes from one year to the next without once hoisting a boxcar out of the ditch.

The "wrecking train" which includes this

BACK ON THE RAILS goes a smashed locomotive, lifted by the carefully coordinated efforts of two cranes (drawing shows one in cut-away view to indicate the working parts).

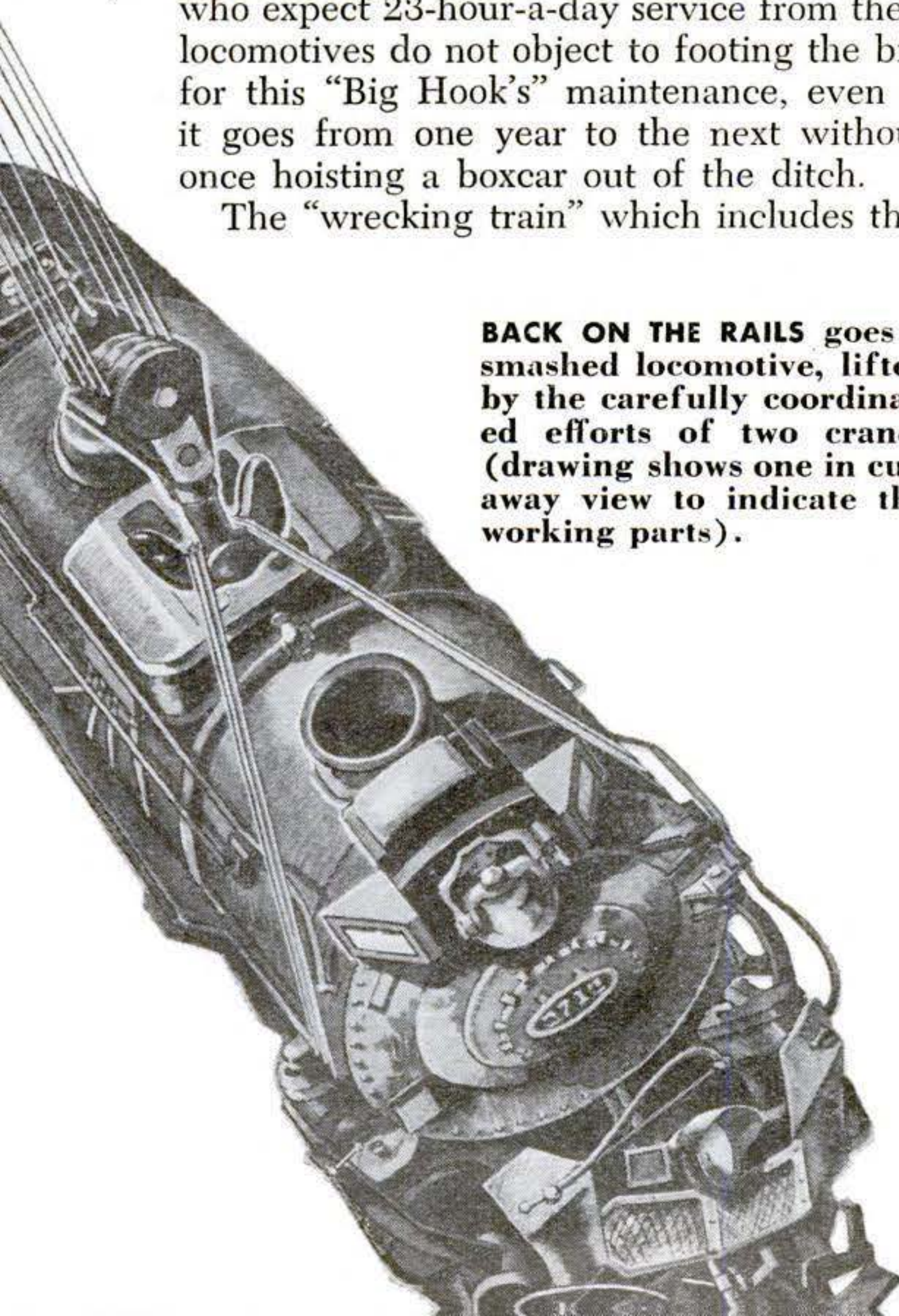

big crane should really be called a re-railing train. It looks like a saw-toothed tramp, with its dingy old crew cars and flatcar loads of replacement parts. But when a terse "W-K" (wreck) signal crackles over the dispatcher's wire, it suddenly becomes a prince in rags, with running rights over all trains, including the road president's private buggy.

You might expect some day to see it roaring over the rails at top speed. But fiction writers to the contrary, it rolls along at a conservative 45-mile-an-hour gait. Anything faster than that would be an invitation to double trouble, for in spite of good design, the hook is an unwieldy machine.

The wreckers rank second only to locomotives in dramatic appeal. Yet public relations' men clam up like a delegation of Russian diplomats when asked about their lines' wrecking trains.

Wrecks Are Too Obvious

As one of them put it when I tried to crawl under the iron curtain of reserve:

"We pay a cockeyed price for running the world's safest transportation system. It all boils down to 'Iron horse bites man—that's news.' As a result, a railroad gets a million dollars' worth of damaging headlines whenever a train takes to the tall corn.

"Even the life-protecting strength of our equipment works against us. You can mop up the worst automobile smash in a matter of minutes. A shattered airplane on a mountain top is hard to photograph. A sinking ship soon disappears. But when our heavy steel cars leave the rails, it may be a couple of days before the wrecking gang gets the

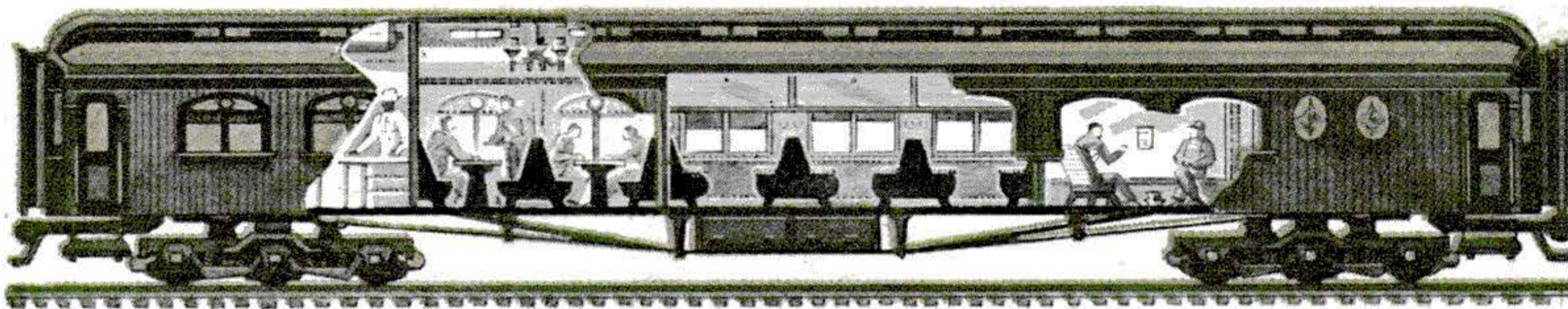

WRECKING CREW CAR provides office, bunks and dining quarters for the wrecking boss

and a crew of 12. From its kitchen come the best meals served anywhere on the railroad.

landscape back to normal. Meanwhile, we have a Cecil B. DeMille extravaganza on our hands, and it's generally strung out for half a mile beside a crowded highway."

I was frankly surprised when he gave me clearance to talk with veteran wrecking boss Bill Tracy. The only stipulation was that I not name the railroad he serves.

Tracy proudly showed me his brand new Diesel crane. It is a robot weight lifter measuring more than 70 feet from its rear coupler to the tip of its lowered boom. A giant which, at the touch of a lever, can just about lift the heaviest passenger locomotive ever built. The railroad's initials are neatly stenciled on it, but you could admire this crane for hours without noticing them.

A Foreman's Dream

I am fairly familiar with steam-powered cranes, but this Diesel was an eye-opener to me. A product of Industrial-Brownhoist, it has practically revolutionized the railroad-crane-building industry. Although this 250-ton-capacity Diesel job was introduced only four years ago, you'd need a special order to buy one of the old flame throwers now.

Tracy's explanation is simple.

"This Diesel," he told me, "is a wrecking foreman's dream come true. Time was, and not so long ago, when we kept an engineer pattering around our steam hook all the time—shoveling in coal, cracking up clinkers, patching leaky flues and trying to keep the pipes from freezing in winter. Hard water gave us plenty of trouble, too, even with

chemical treatment. Then, when the division switched over to Diesel locomotives, handling coal for the hook became a special problem. But all those standby losses went out the window when we got the Diesel."

"How about starting those big engines on a cold night?" I asked him. "I see you don't keep them idling."

"Easy enough," he grinned. "Notice the plug-in stations on the side of the cab? When the temperature starts to drop we hook them up to a 115-volt power line. One circuit feeds a 500-watt heating unit under the oil pan on each engine. The other goes to a ring heater coiled around the bottom of the fuel tank. That keeps the oil thin, and we can kick a unit over as fast as you can start your car in a heated garage."

Climbing into the operating cab, I saw that the controls differed very little from those found in the earlier steam models. There were the usual levers, wheels and foot treadles. They swing the cab through a complete circle, eliminating turn-arounds; raise and lower the massive boom; hoist any one of four hooks hung at intervals along the upper length of the boom; apply positive braking at the cable drums; and inch the crane along at a three-mile gait when it is operating independently of the wrecking-train locomotive. Even the jack beams—giant telescoping arms which are drawn outward from the frame of the crane car and blocked up with timbers to provide a widened base for the crane when it is hoisting heavy loads—are operated remotely.

TRUCK CAR. Undergear takes a beating in most railroad wrecks. Using replacement units from this flatcar, crane engineers and crewmen can re-truck a boxcar from a freight-train smashup in as little as 20 minutes.

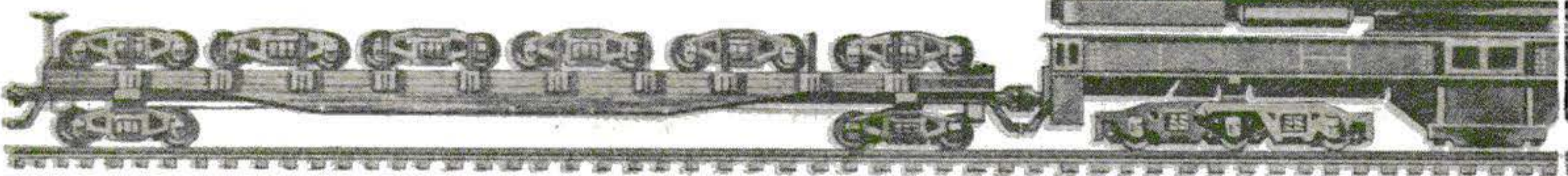

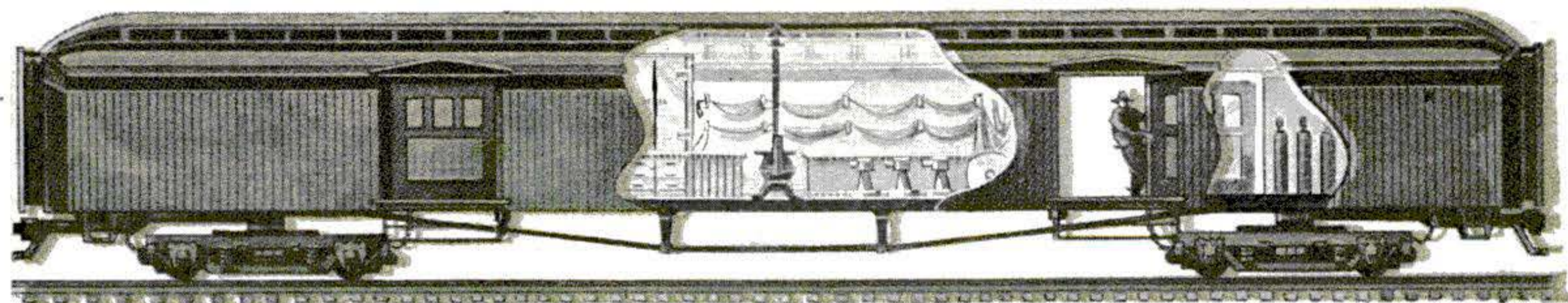

TOOL CAR contains more than 750 items, ranging from a quarter of a mile of rope to

a portable telephone. It is also a mobile machine shop, for making on-the-spot repairs.

But the similarity ended there. The day Tracy showed me this crane, the thermometer outside the yard office hit 90°. In such weather, the heat under the low roof of a steam crane would have been almost unbearable. Yet I noticed little difference in the temperature inside this crane's cab.

My next question was not too bright.

"With a hook like this, and a veteran crew," I said, "how long would it take you to whip the average freight car out of a wreck and set it on a new pair of trucks or on the deck of a flatcar?"

Each Wreck A New Challenge

"That," he told me, "is like asking 'how long is a piece of string?' I've never seen two cars, or two wrecks, which could be handled exactly alike. Sometimes a load is impossible to handle with a direct haul. In that case we bury a heavy timber—a 'dead-man,' we call it—deep in the earth, anchor a sheave, or pulley wheel, at its center, and pass a line from the car through the sheave and back to the crane hoist. Getting set for an indirect pull like that takes a lot of time. But you could say we hold the time for most hoists to 20 minutes per freight car.

"Passenger equipment? That's something else again. There you are dealing with expensive stuff, and the brass doesn't like to have it tossed around."

250-TON CRANE has cab set far back on its bed plate to counterbalance weight being hoisted. Four hooks handle everything from locomotives to divers trapped in quicksand.

"How about locomotives?" I asked the big Irishman. "Seems to me I saw a picture, once, of five cranes hoisting a freight engine out of a gully."

Cranes Come 400 Miles

"That might well have been our wreck at ———," Tracy nodded. "We brought in the hooks for that headache from division points as far as 400 miles away. Took us some time to get a footing of piles and timbers under our outriggers. But when we were finally ready, four hoists, in as many hours, saw that Mallet engine up 50 feet of a 40-degree incline and onto the rails again.

"You might ask why it took five cranes with a combined lifting capacity of 1,250 tons to handle a 300-ton locomotive. The answer is that you can't always have the booms drawn up to their shortest radius and working on a load that is directly under them.

"With this crane, for example, we get our maximum lifting capacity when the main hoist is 17½ horizontal feet from the pivoting point of the cab. When you lengthen that radius to 26 feet—and you don't have to lower the boom very far to get there—its effectiveness is cut exactly in half."

"Do the cables ever snap?" I doubted whether he would answer this one.

[Continued on page 254]

At right below is the idler car, which provides a protecting platform for 30 feet of projecting boom when the crane takes to the road. Shelter at the rear is pint-size caboose.

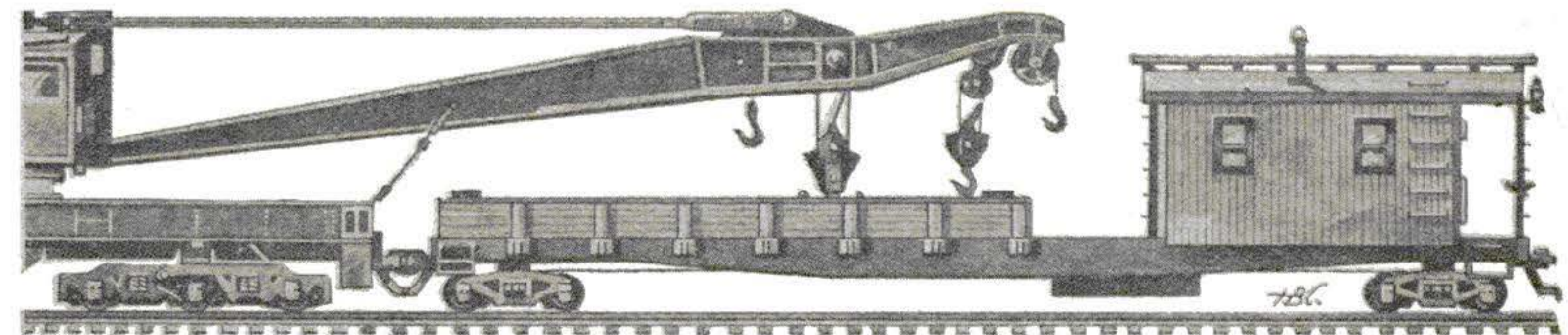

How Electric Blankets

THE grandpappy of the electric blanket was an electrically heated flying suit that didn't work. There wasn't anything wrong with the suit itself—it was developed during World War I and the planes of that day couldn't provide enough juice to keep it warm.

Extending this idea to blankets may seem like a simple step, but not until 1936 was the first electric blanket offered, to a completely unenthusiastic public. Then came

World War II. Millions of electrically heated casualty blankets and flying suits—that did work—were used, the manufacturers learned some new tricks, and the public's attitude changed. Now the blankets are displayed in a wide variety of types on department-store counters from coast to coast.

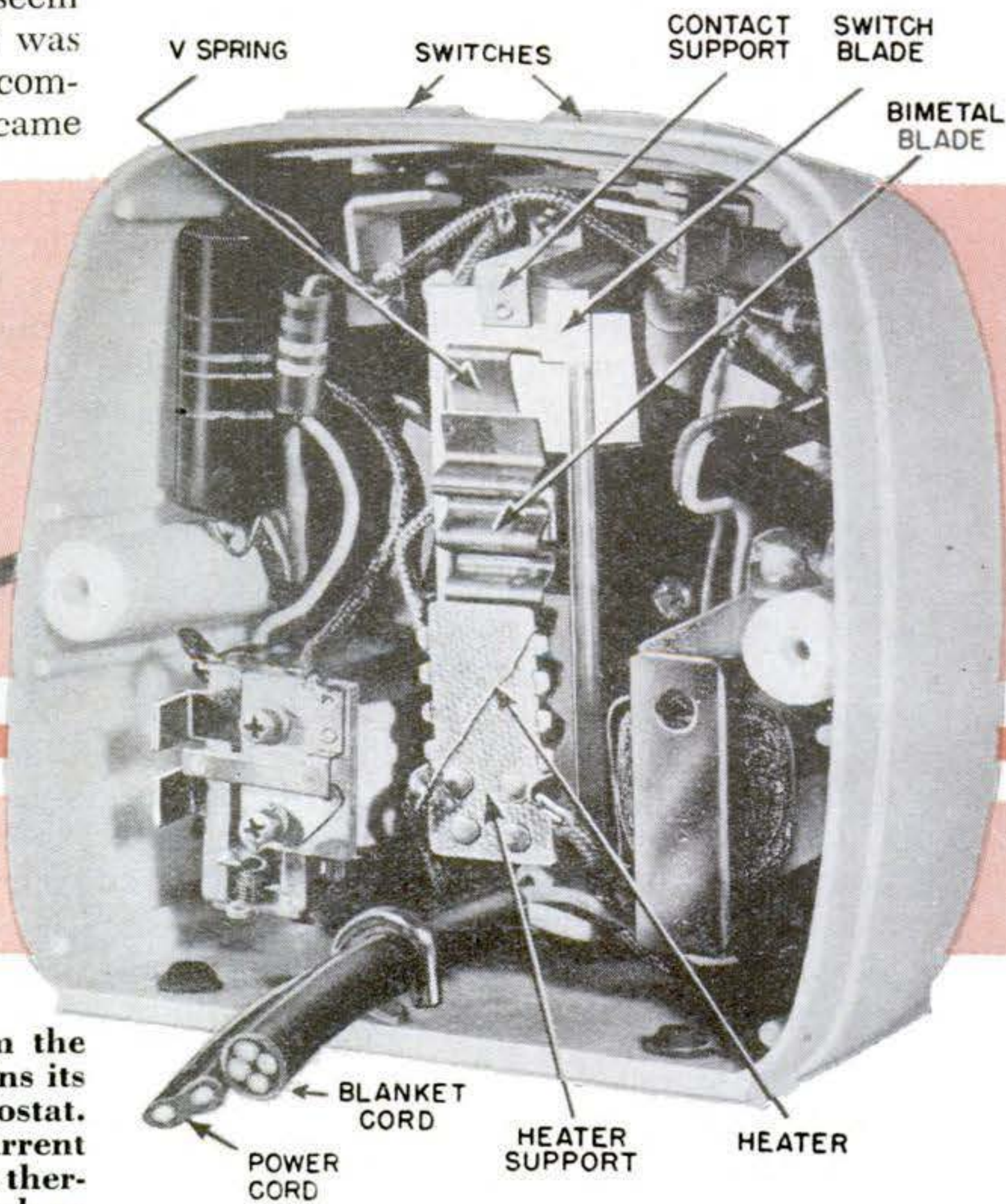

THIS BEDSIDE CONTROL knows how warm the blanket is keeping you because it contains its own heating element attached to a thermostat. Current flows in this heater whenever current flows in the blanket wires, warming the thermostat at the same time and just as much as the blanket warms you. The control will maintain temperature to within one degree. At setting 5, it will turn current on if the temperature falls below 71°, shut it off at 72°.

INGENIOUS SAFETY DEVICE to prevent overheating is built into the wire of General Electric blankets. It makes use of the way nylon's electrical characteristics change with temperature: nylon, normally a good insulator, will let some current pass when it gets hot. GE's heater wire (right) has a nylon jacket around which is coiled a "signal wire." If the heater-wire temperature exceeds a safe limit, the nylon jacket's electrical impedance will drop enough to let current leak to the signal wire, and thus to a relay that turns the blanket off.

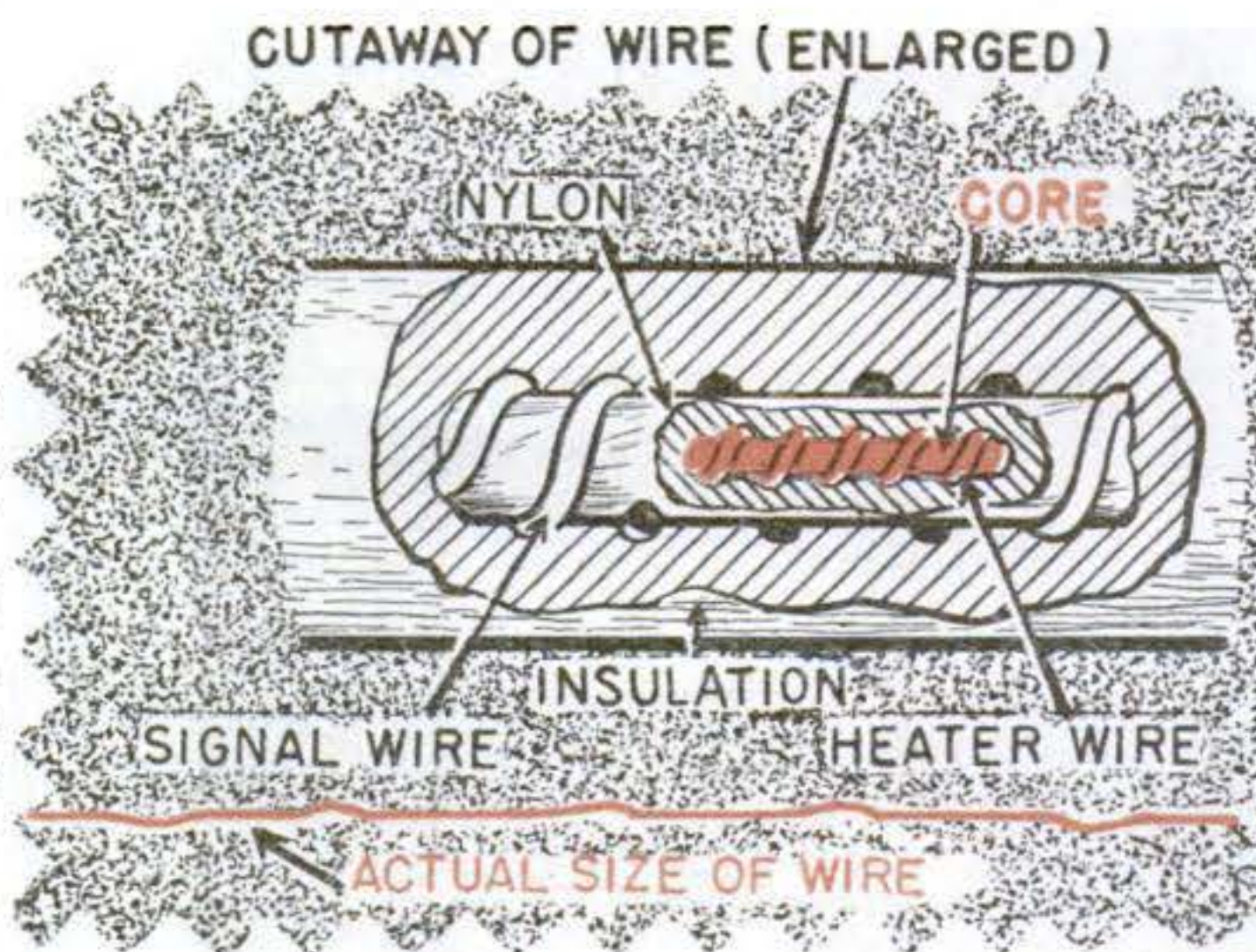

Work

SINGLE-BED ELECTRIC BLANKETS (right) are the most popular size. The fine, highly flexible heater wire lies in channels sewn into the body of the blanket. The channels roughly follow the pattern in the drawing, but they are invisible.

Users are warned not to place the control box near a radiator or an open window, and not to double up the blanket or pile pillows on it, for that will cause it to get unduly hot in one spot and the safety device will shut off the current.

HARMONY IN A DOUBLE BED is possible with an electric double blanket, which provides separate heating circuits and controls for its two halves. There is a slight hitch, though. Whoever handles the master control, shown near the occupied side of the bed below, can shut the current off altogether. The other control is a thermostat only.

One of the main advantages of an electric blanket is its light weight—about the same as that of one ordinary blanket, yet taking the place of two or three.

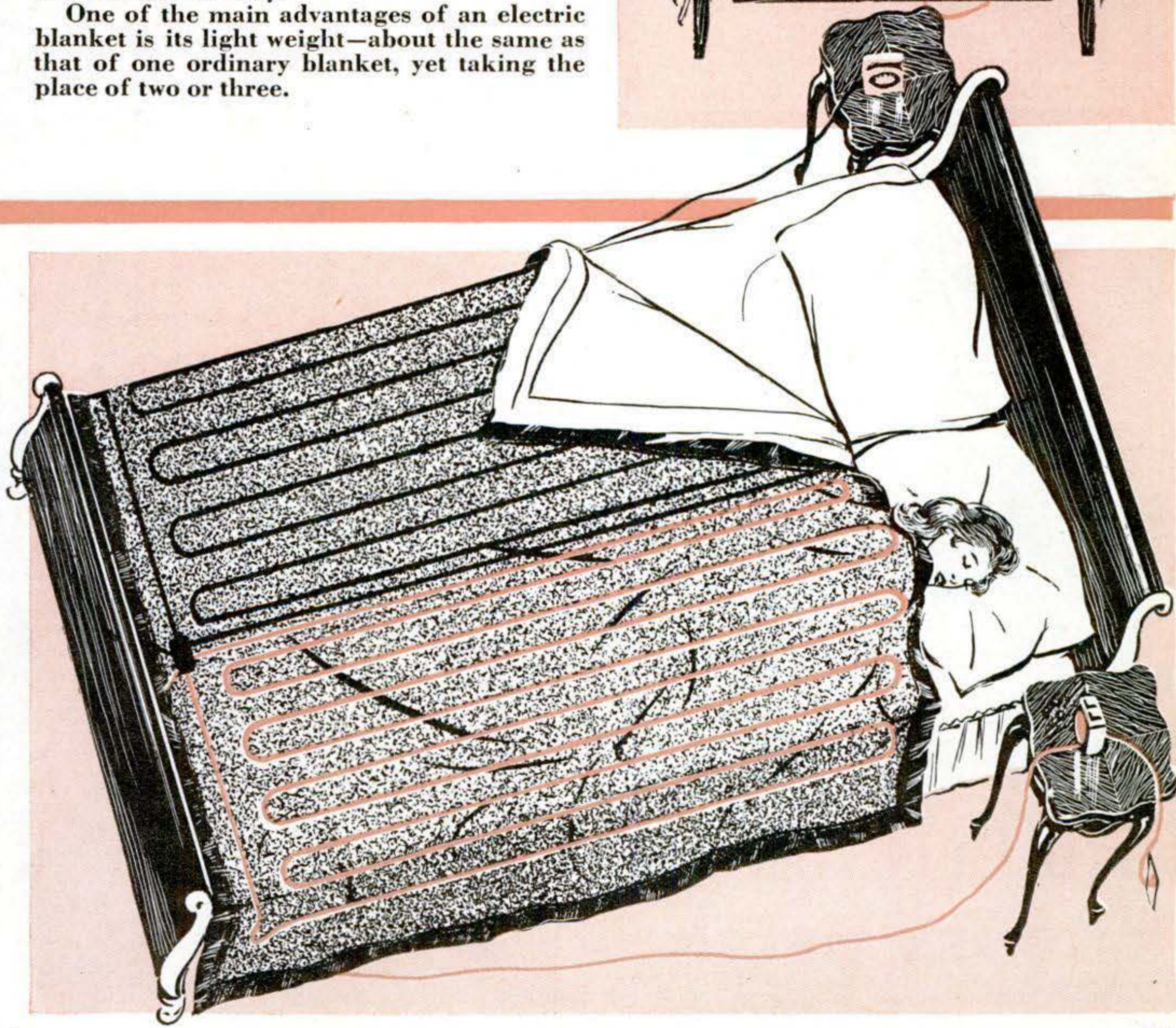

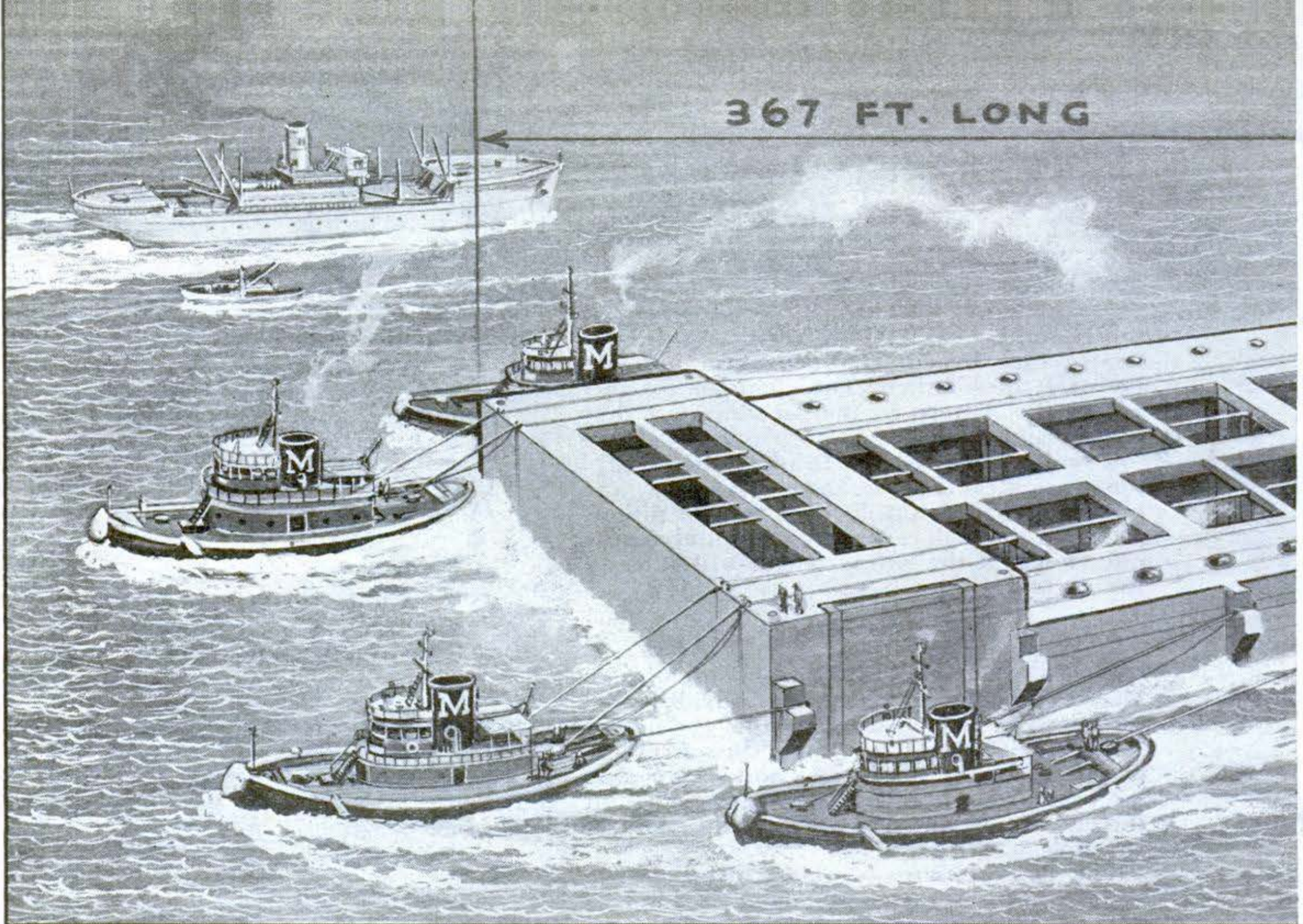

1. SAILED TO LOCATION.

2. SUNK INTO POSITION

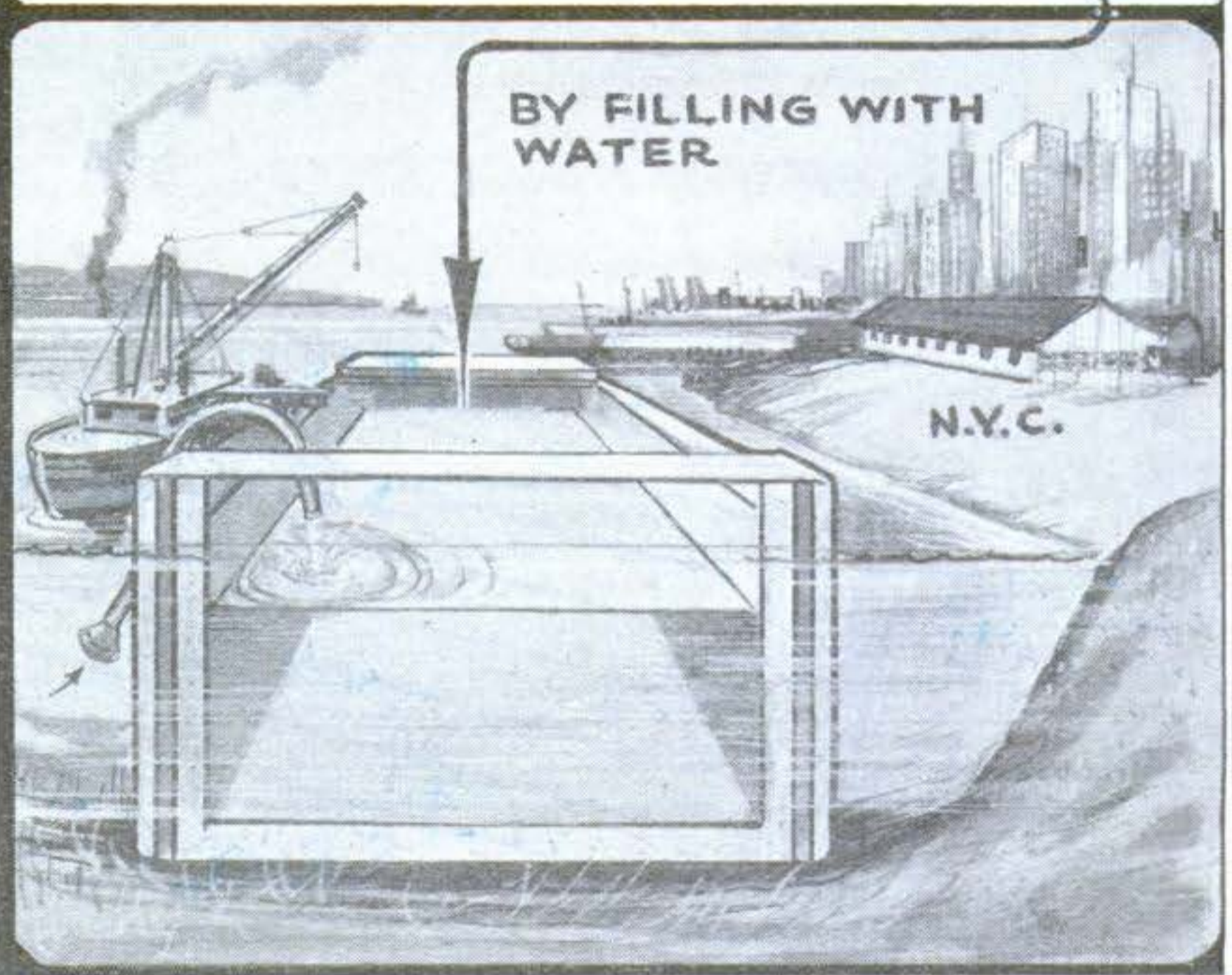
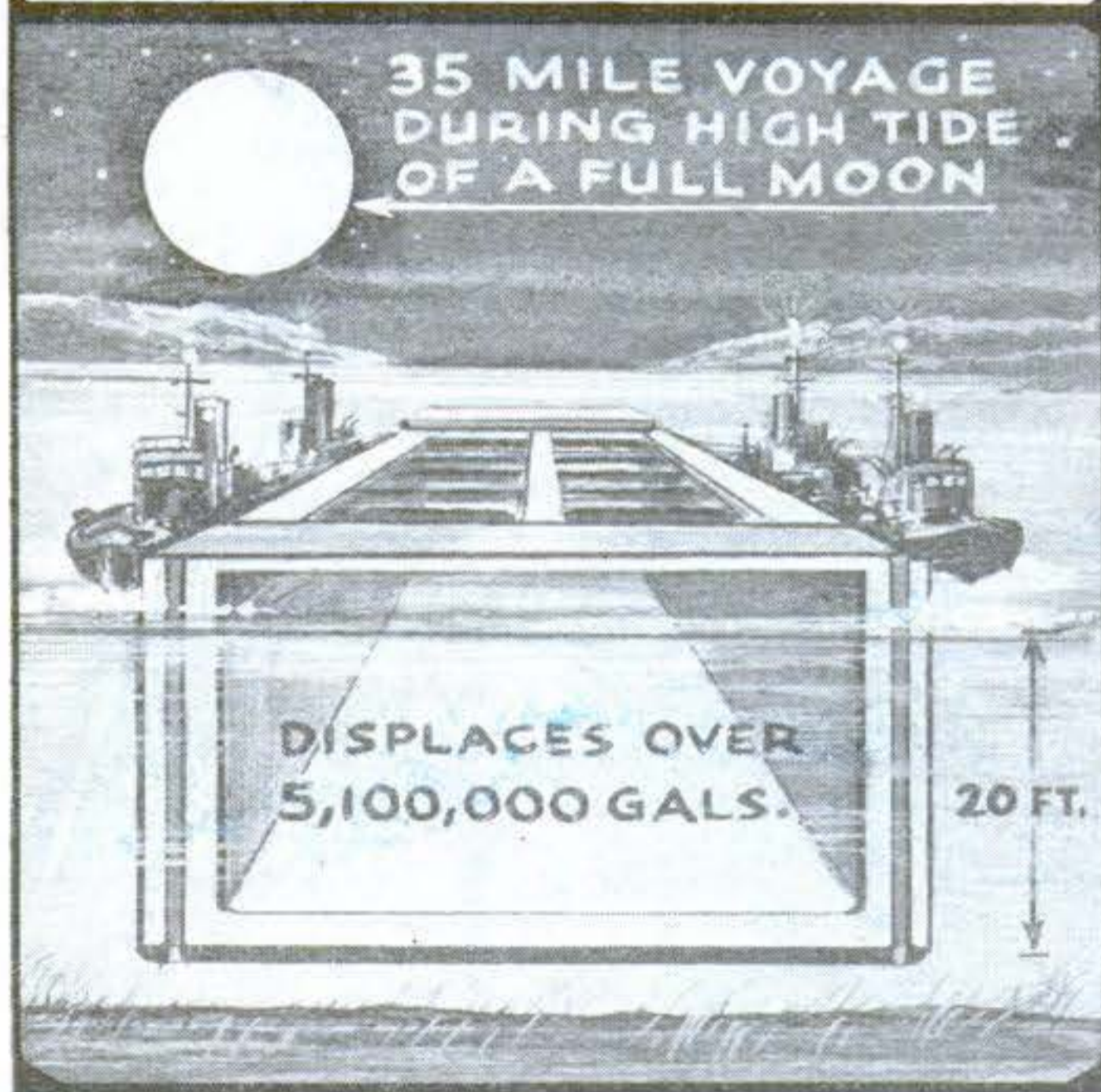

How N. Y. Pier Rode 35 Miles to Its Berth

THE strangest craft ever to sail the Hudson were three huge, rectangular concrete-and-steel caissons that were floated 35 miles downriver recently to form the foundations and basement of New York City's newest and most unusual steamship pier. They were built in an abandoned clay quarry, to which the river was then admitted by knocking out a 50-yard-wide wall.

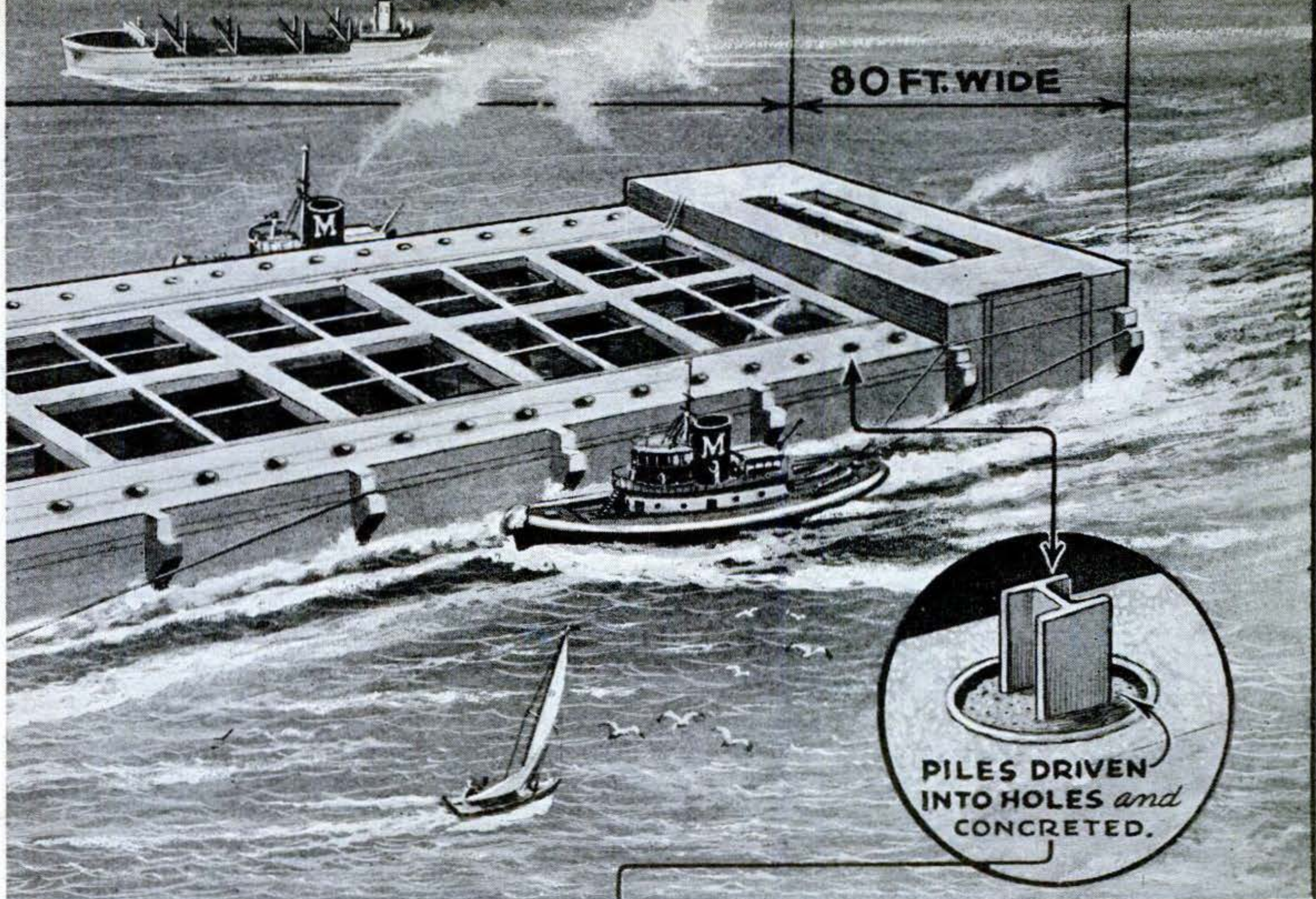

3. FASTENED TO BOTTOM

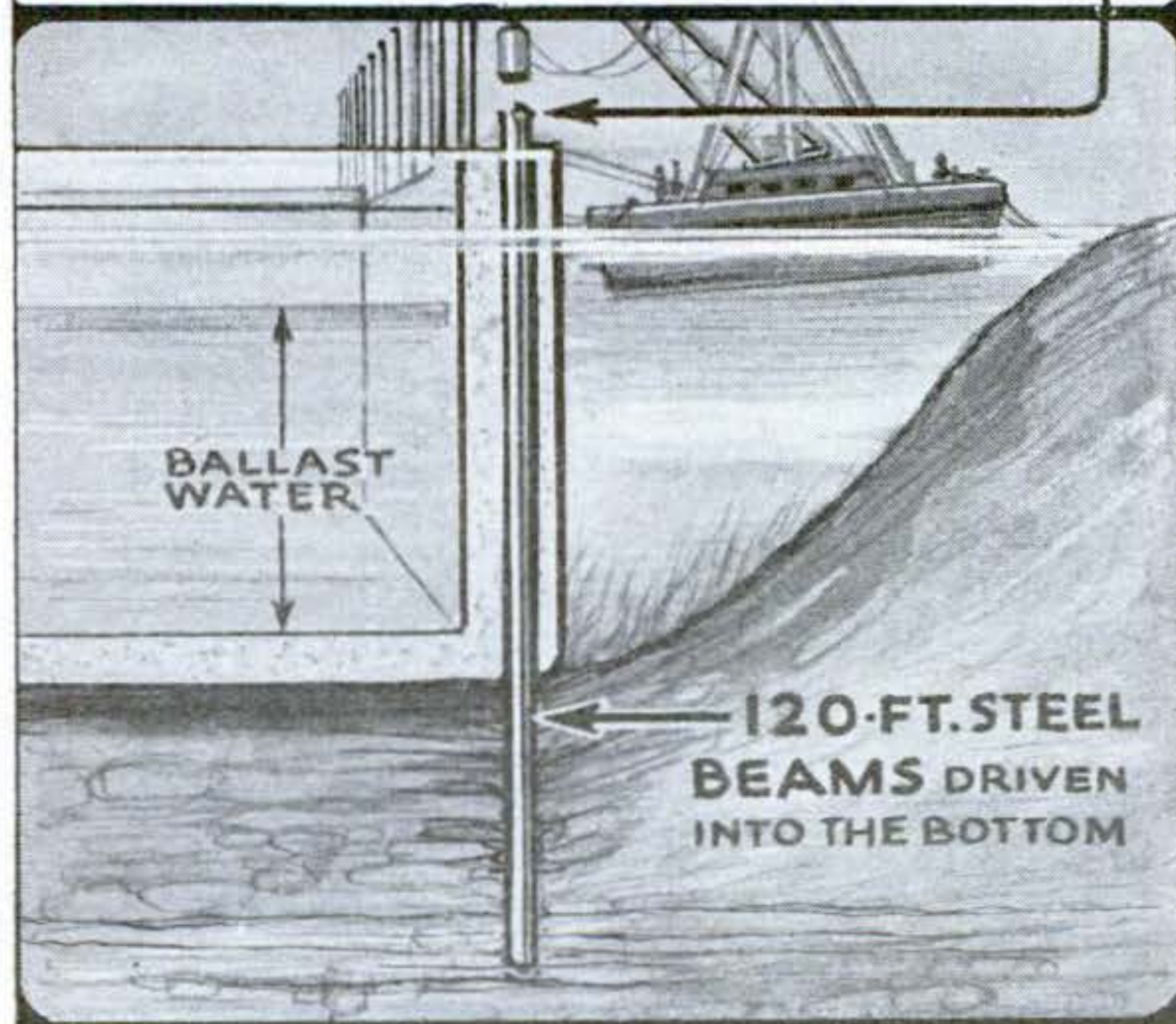

4. PUMPED OUT, AS WEIGHT OF PIER IS ADDED.

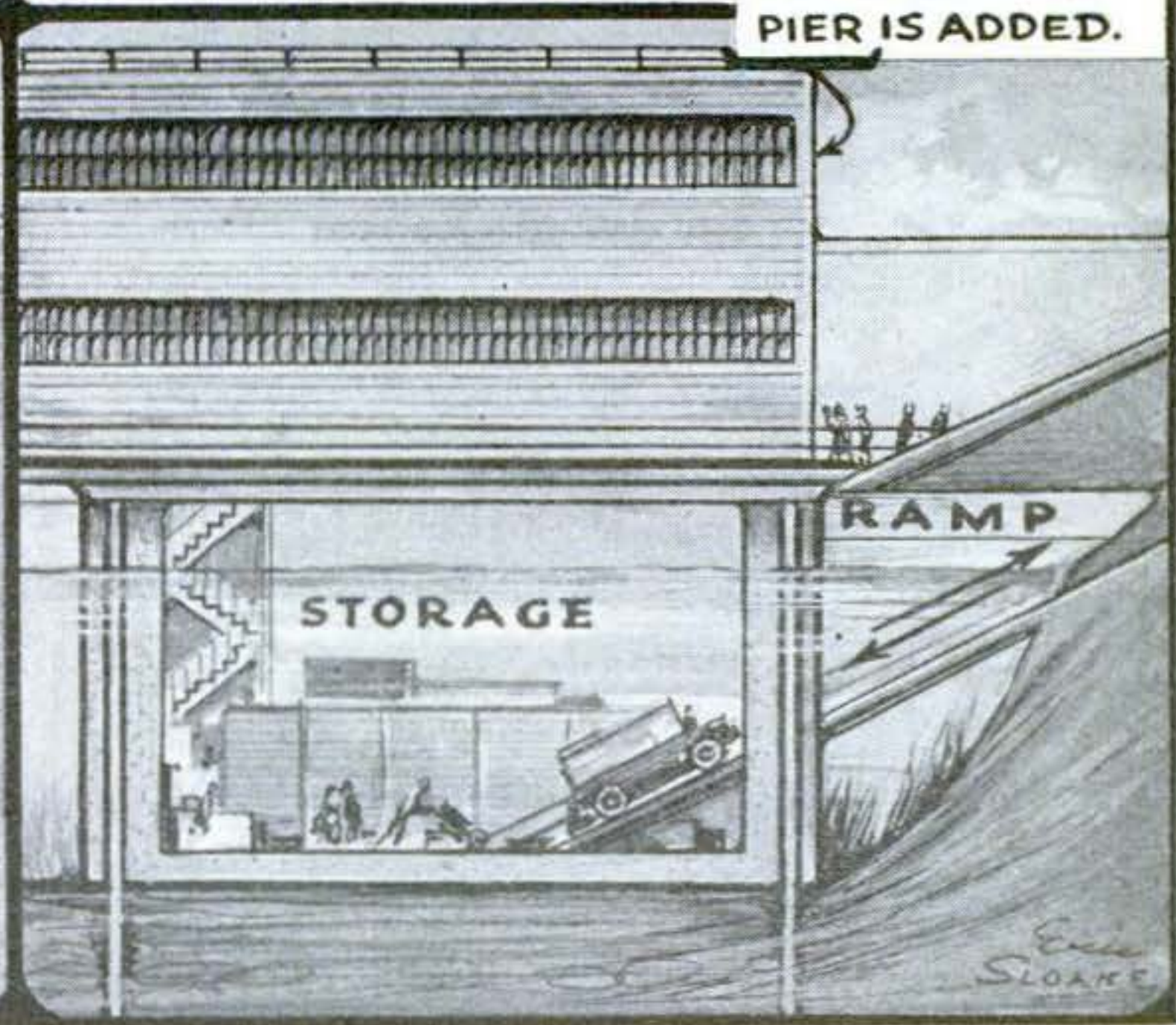

Each section of the fireproof, borer-proof, prefabricated pier was hauled separately to its New York City location at the foot of 15th Street. There the three caissons were assembled in the shape of a T with its head against the shore. The drawings above show how the first unit of the pier was moved to its destination, how it was anchored and how it will be used.

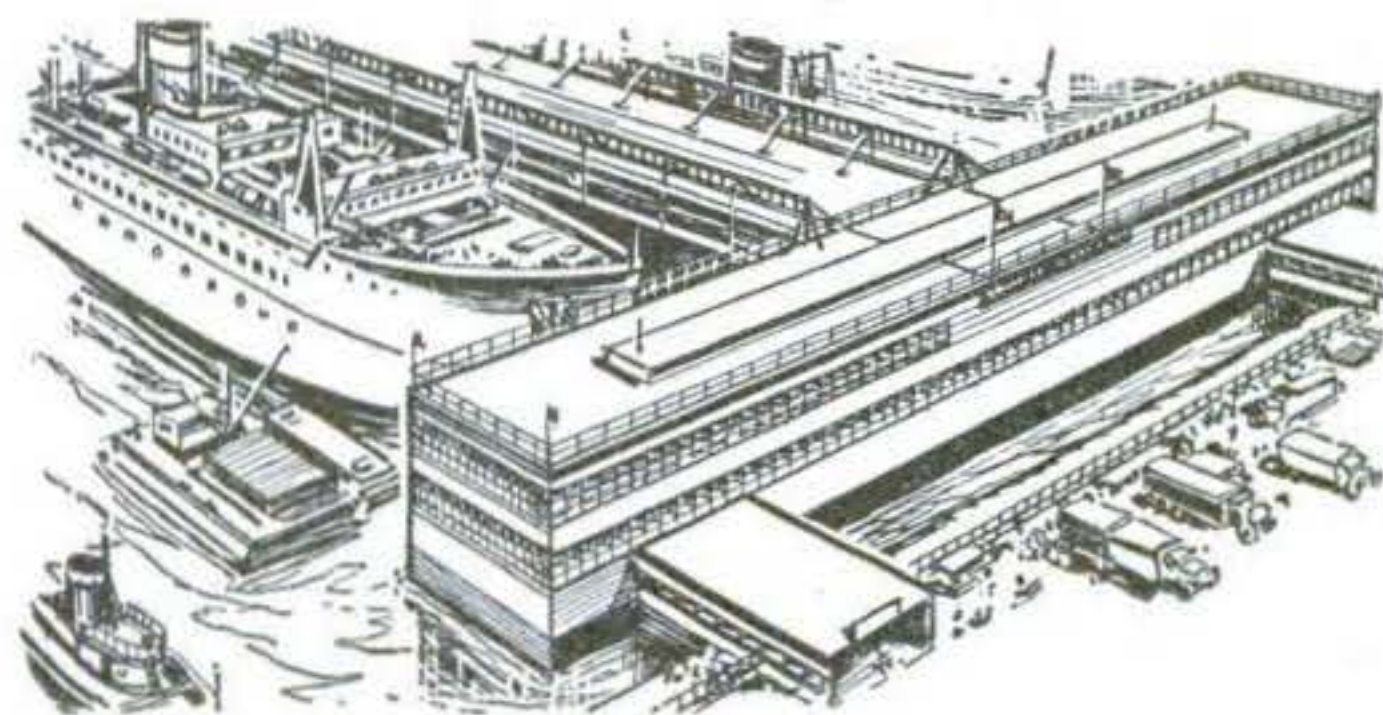

What's Cooking for Cooks

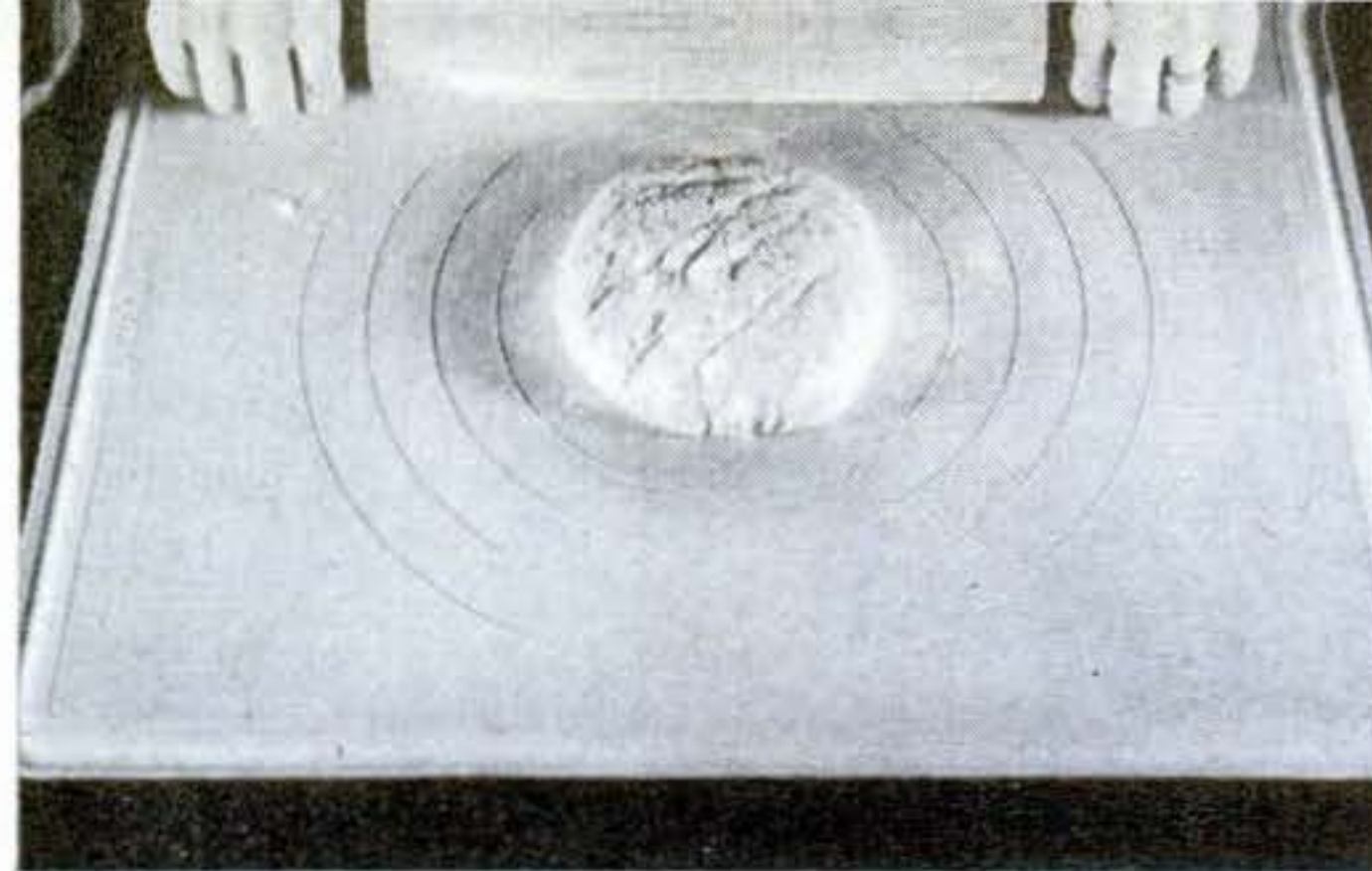

1. Pastry Tray. A rubber tray with a cloth-like texture takes the place of the old pastry board and cloth cover. Concentric circles make it easy to gauge size of crust.

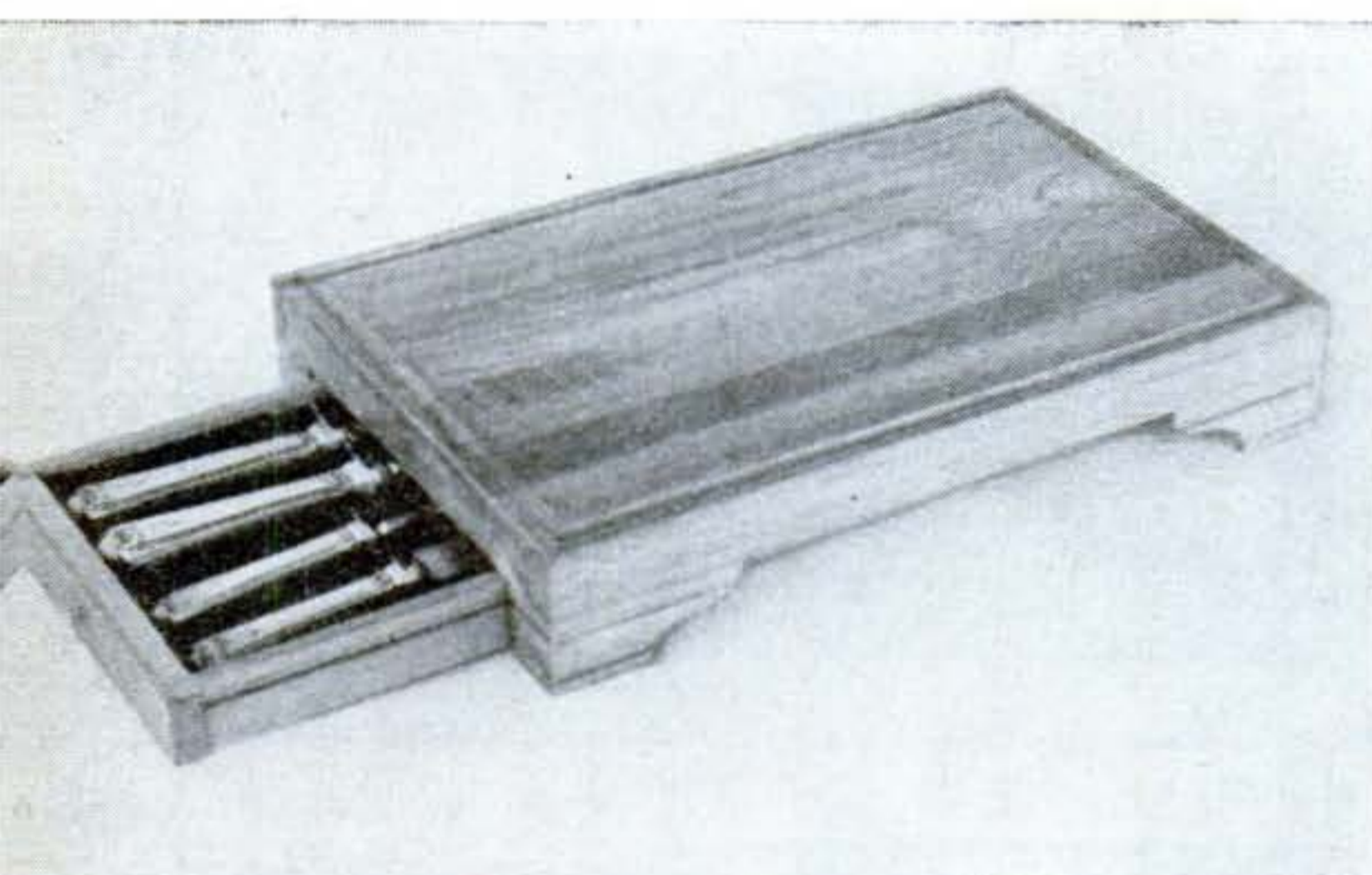

3. Meat Carver's Toolbox. When you bring this carving board to the table you don't have to search out the carving tools. A built-in drawer holds the cutlery.

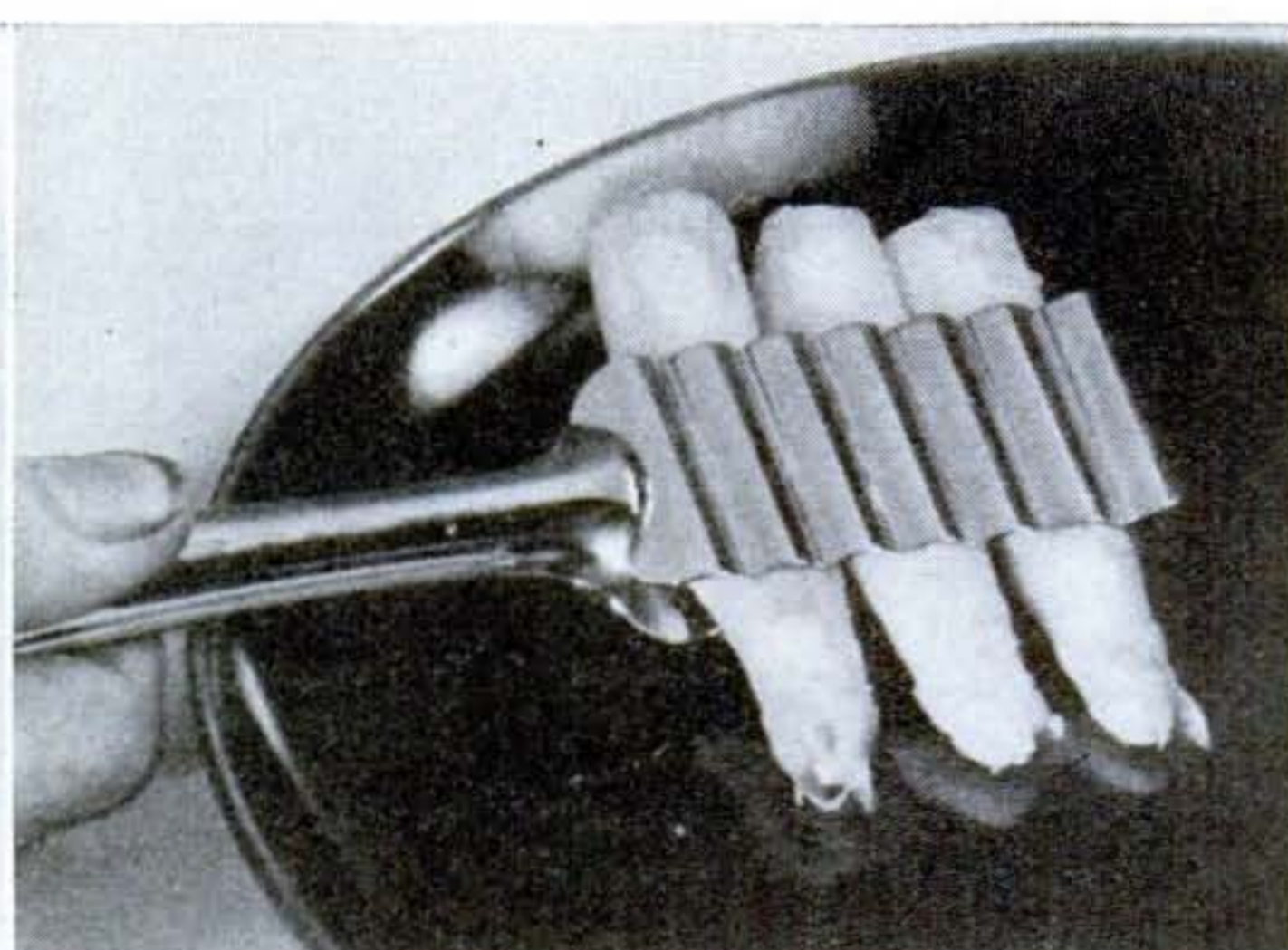

4. Food Server. Chromium-plated tongs are fluted to grip asparagus, sausages or whole carrots. They will lift flat foods like meat patties, too.

Further information on these products can be obtained from: 1. Wooster Rubber Co., Wooster, Ohio; 2. Live-Pak Corp., 35 India St., Boston 10; 3. Richard Auldridge, Box 12, Ridgeway Station, Stamford, Conn.; 4. Heller Hostess-Ware, White Plains, N. Y.;

6. Pot-Lid Rack. Lid-Crib is designed to hang on a door or stand on a pantry shelf. There's a similar wire crib for metal or glass pie pans and ovenware.

7. Butter Warmer. When a lighted candle is placed under this sauce boat, its cargo—melted butter, hollandaise, hot fudge or gravy—will stay hot throughout the meal.

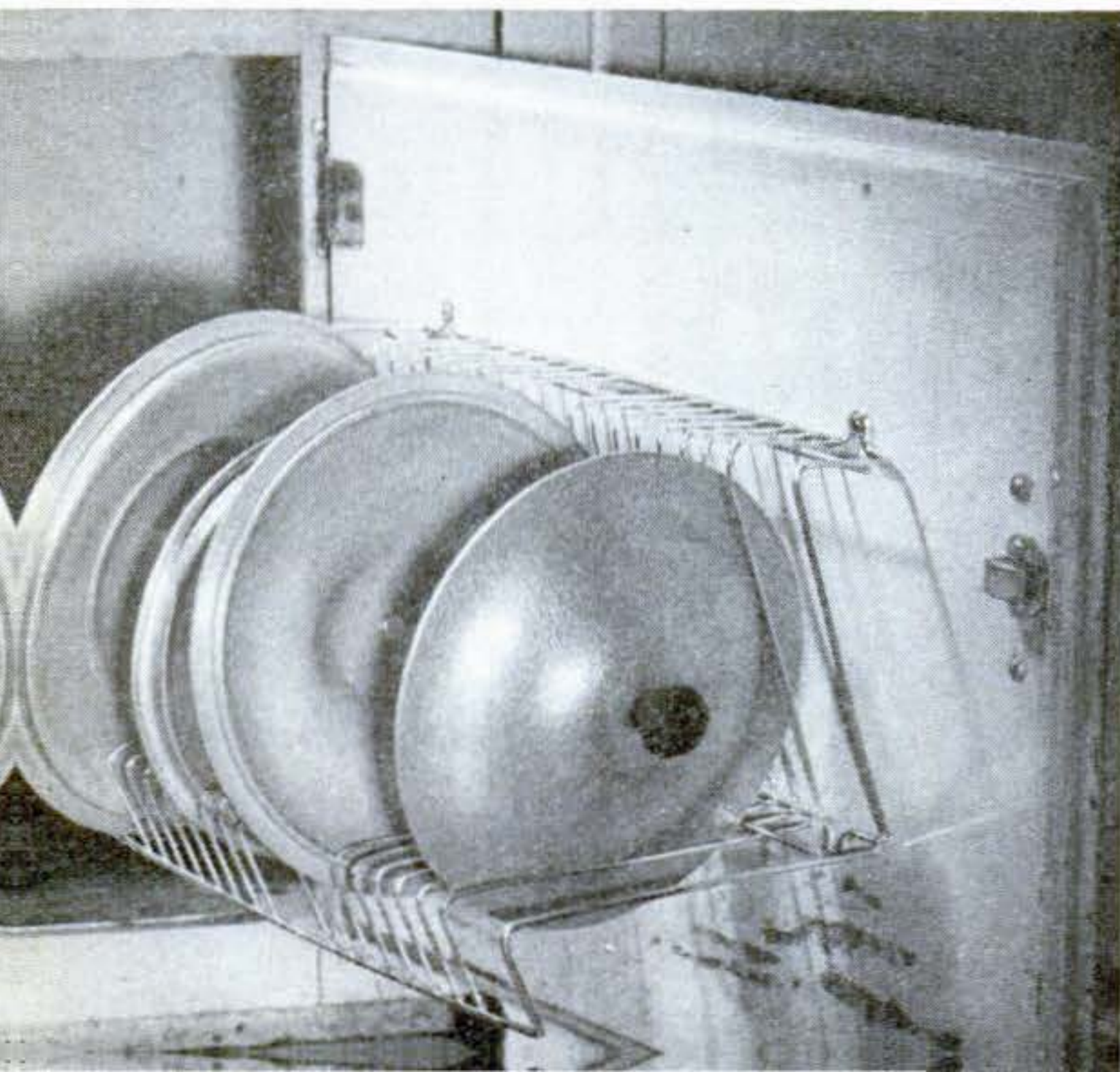

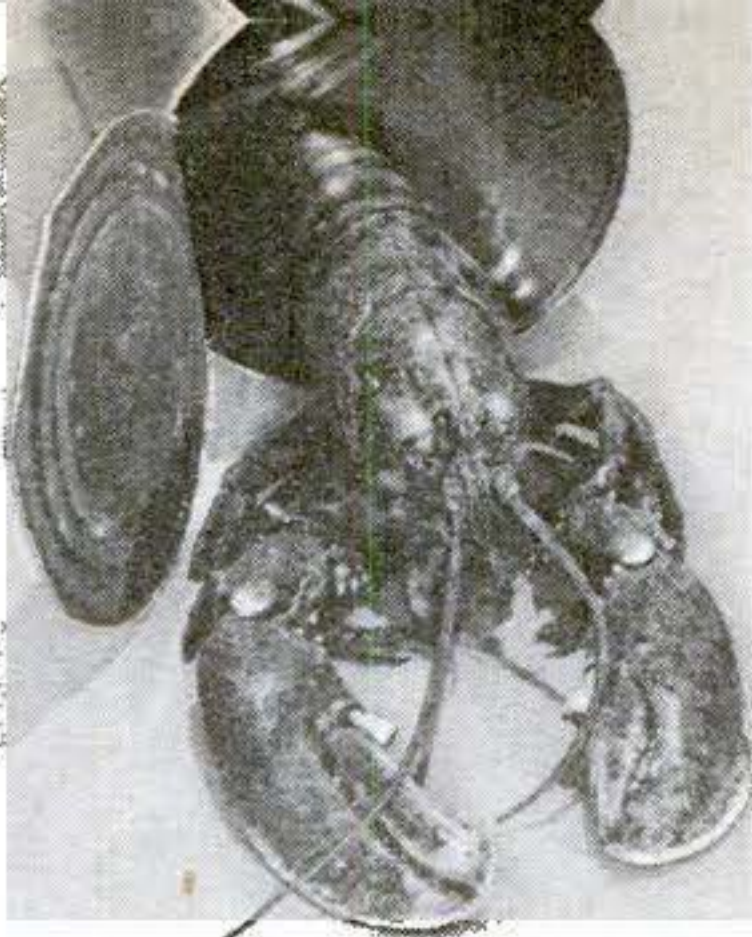

2. Lobster in Cans.

Boston fishermen are sealing wriggling lobsters into cans now. You order them direct from the packer, specifying the date you want them. When the can is opened on arrival, out crawl two lobsters, alive and kicking.

5. Four-Sided Sink.

This center-of-the-floor sink lets the housewife walk all around it and use it from all four sides, saving many steps.

The Midway, a double sink mounted on a steel cabinet, measures 44 by 37½ inches.



5. American Radiator & Standard Sanitary Corp., Pittsburgh 30; 6. Elgin Novelties, Provincetown, Mass.; 7. Susi Press Co., Whitinsville, Mass.; 8. Wilco Products, Box 905, Louisville, Ky.; 9. International Allied Industries, Hialeah, Fla.

8. Grease Guard. Fitted on any nine- to 12-inch skillet, this shield leans inward over the pan to catch spatters. It also can be placed on the stove around smaller pans.

9. Egg Poacher. Lowered into a skillet of water on this tray, eggs are poached in four watertight rings. Once cooked, it's no job to get them out of the pan.

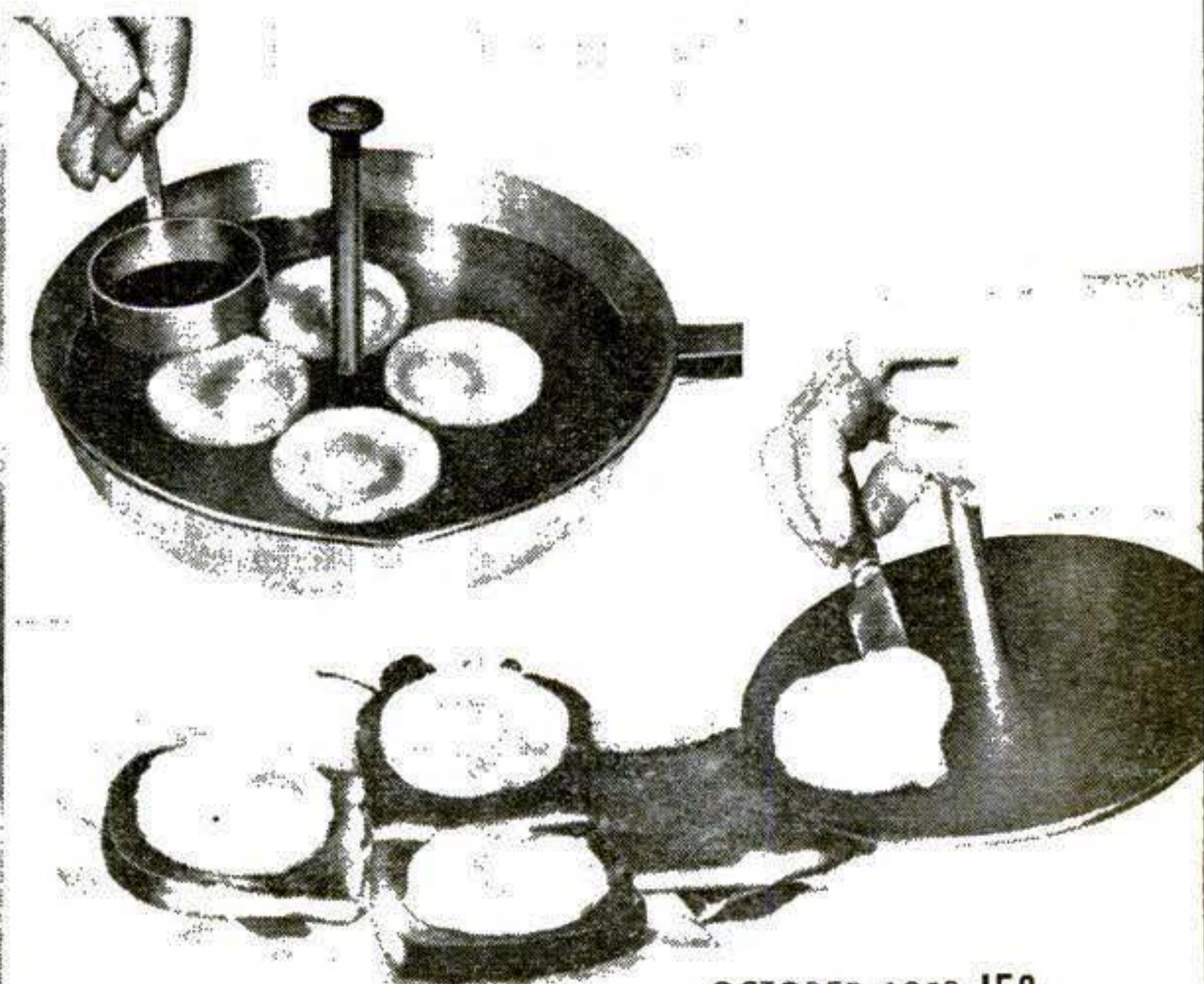
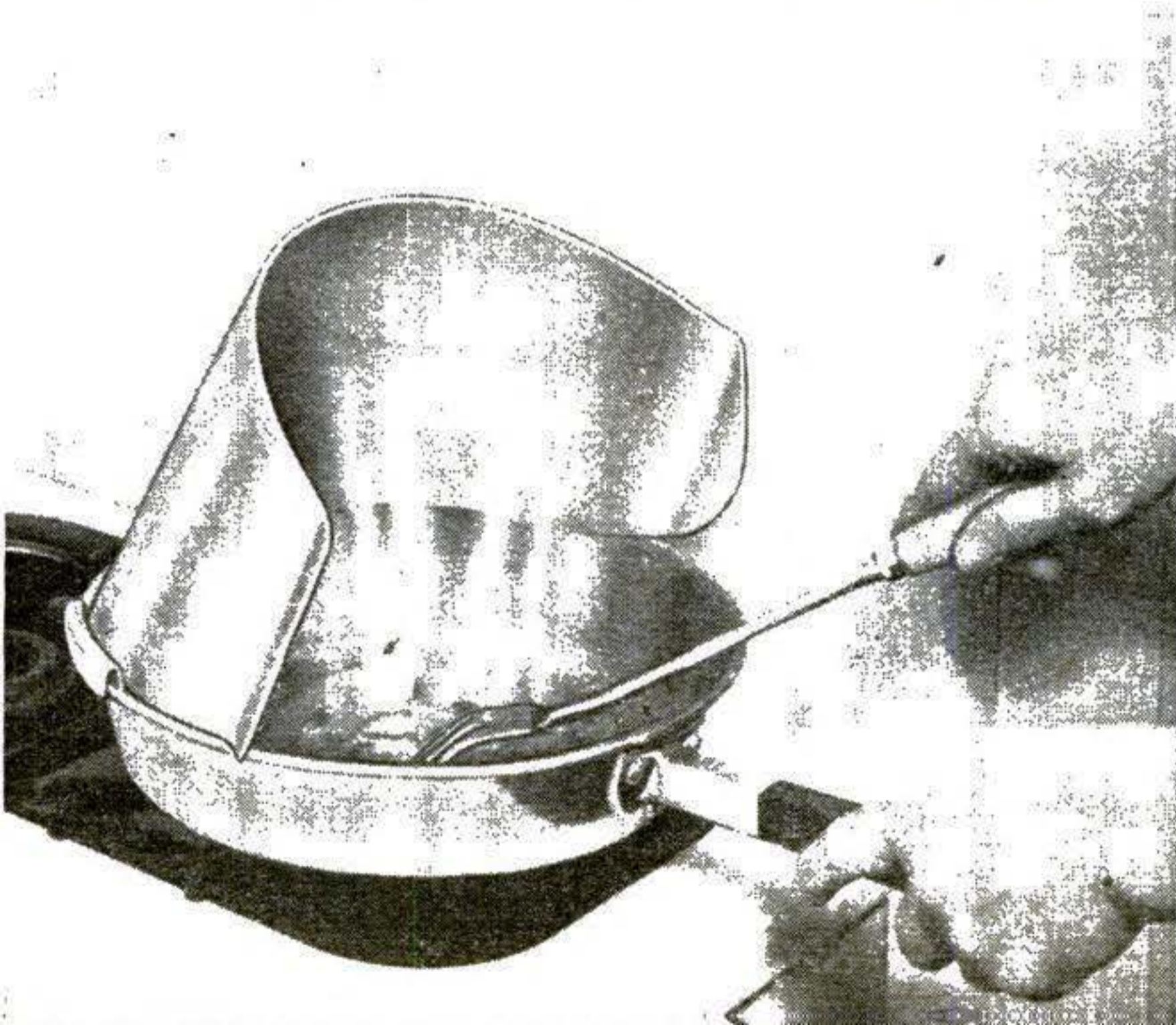

Nylon-Glass Armor Saves American Lives

**Enthusiastic reports from Korea say 8-pound vest of plastic—
tougher than ancient coat of mail—cuts battle casualties in half.**

By Thomas R. Henry



A NEW knight in armor is appearing in battle—the American infantryman.

The soldier with war's most dangerous and essential job is going into conflict with almost his entire torso covered by a relatively light vest made of glass fiber and nylon. It will effectively stop more than half of the missiles that normally cause battle wounds.

He doesn't look much like Sir Galahad or the Chevalier Bayard—but Galahad or Bayard encumbered by their 40 or 50 pounds of hand-wrought steel wouldn't have lasted long under a mortar barrage in Korea's icy mountains.

The looks of the new mailed soldier, in fact, don't differ materially from that of the infantryman of the last war, except that he seems a little bulkier around the chest and stomach.

This armor is not absolute insurance against death in battle, but some of the more enthusiastic advocates estimate that it

Wearing new body armor, machine gunners of First Marine Division fire on enemy in Korea.



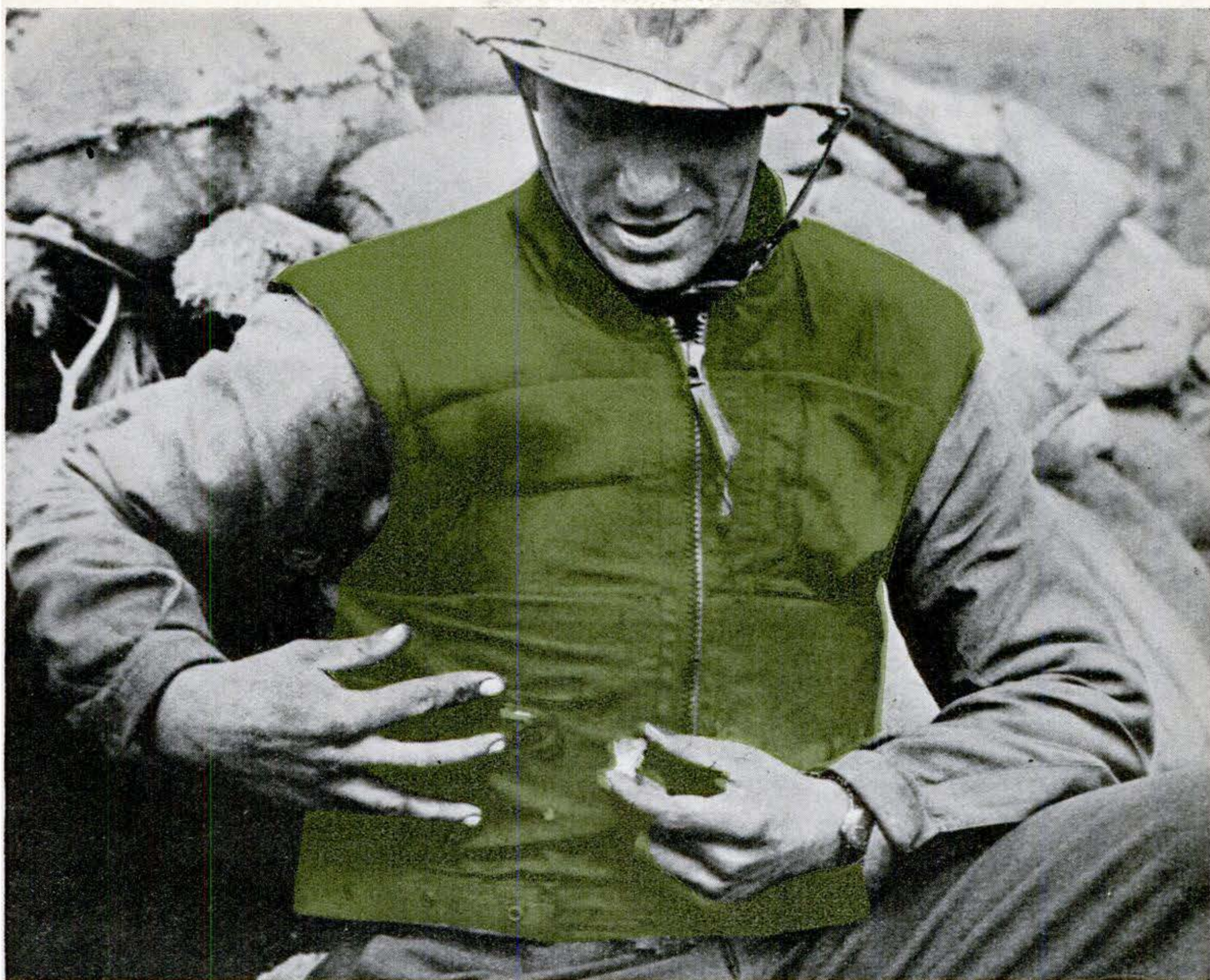

Knocked down but unhurt, Marine in Korea shows shrapnel piece stopped by armored vest.

may reduce combat deaths and serious wounds as much as 70 percent.

The most whole-hearted armor advocates are the Marines. Their enthusiasm is based on actual combat experience. The Corps has a slightly different type of armored vest from that of the Army, although the principle is the same. It was developed at the Naval Medical Field Research Laboratory.

Most Wounds from Fragmentation

The Marine armor is a sleeveless vest reaching below the waist, with a zipper in front. It weighs 7¾ pounds. The protection comes from contoured, overlapping plates of plastic, laminated glass fibers and a multi-layered nylon fabric.

This armor is not bulletproof in the sense that it will stop a rifle bullet at close range. But relatively few casualties in battle are caused by rifle bullets. It stops .45-caliber bullets from pistols or Tommy guns and

fragments from exploding shells, which travel comparatively slowly. At least 70 percent of World War II battle wounds were caused by fragmentation ammunition.

Some of the estimates for Korea are astounding. Maj. Gen. John T. Selden, commander of the First Marine Division, says that in one action the number of dead would have been quadrupled had it not been for the vest. Navy Capt. Louis P. Kirkpatrick, the division surgeon, estimates that the vest has been 90 to 95 percent effective in preventing wounds of the torso, which previously suffered approximately 80 percent of all wounds.

A typical experience was that of a Marine private hit in the chest with a four-inch-square chunk from an 88-mm. mortar shell.

"I was just knocked to the ground with great force and had the wind knocked out of me," he says.

Another Marine lived despite a close

mortar blast which embedded 41 fragments in the armor.

This, of course, is not the whole story. The Army is not entirely committed to armor of any kind. Some of its problems were discussed before the American Medical Association a few weeks ago by Lieut. Col. Robert H. Holmes.

Use of Armor Poses Weight Problem

Two trends conflict, he explained. In modern warfare top priority, especially among Americans, is given to speed of maneuver. This has led to all possible efforts to reduce the weight carried by the infantryman. At the same time there has been a tremendous increase in firepower, in which shell fragments are a more and more important element. Some compromise must be reached between the two opposing trends.

Armor of a less efficient type than that now proposed was standardized by the Air Forces during the last war. It was 50 per cent effective in preventing injuries. Weight, however, is not so important to air crews.

Army experiments are being conducted at the Army Chemical Center at Edgewood, Md., with a somewhat lighter combat vest. The results, Colonel Holmes said, "are encouraging." Enormous strides in combat medicine and surgery have reduced the death rate among men wounded in action in Korea nearly 50 percent below that of the Second World War, he explained, adding that this advance soon will meet a saturation point, where very little further reduction can be expected from medicine alone, and more attention must be given to quick evacuation by helicopter and to body armor to prevent wounds. END

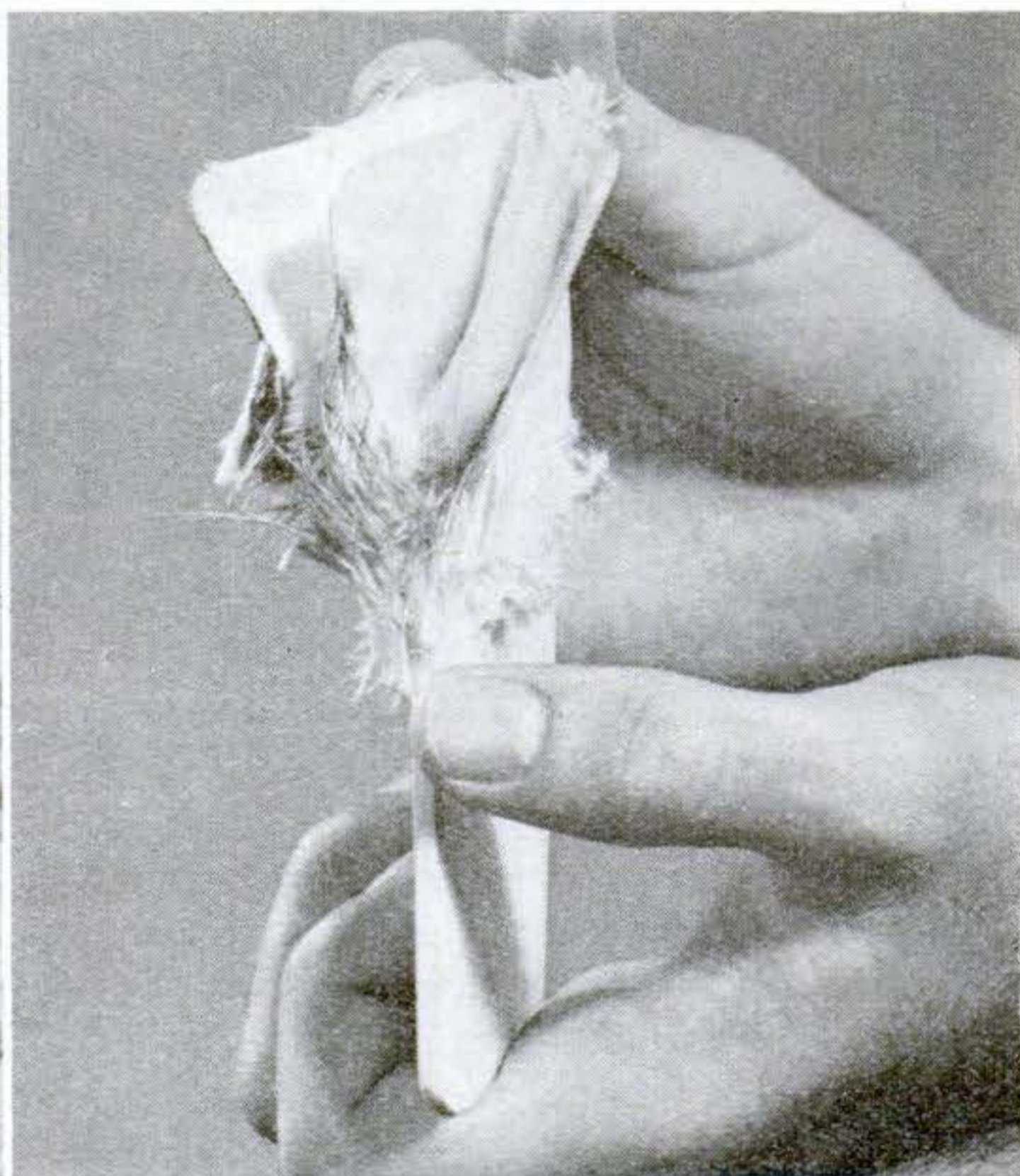

HOW NEW ARMOR STOPS BULLETS: Demonstrator at left above fires .45-cal. submachine gun point-blank at dummy wearing Marine Corps armored vest. Photo at right shows

nylon-glass armor plate shredded but not penetrated by bullet. Below, three flattened .45-cal. slugs removed from vest after trial are contrasted with original slug (left).



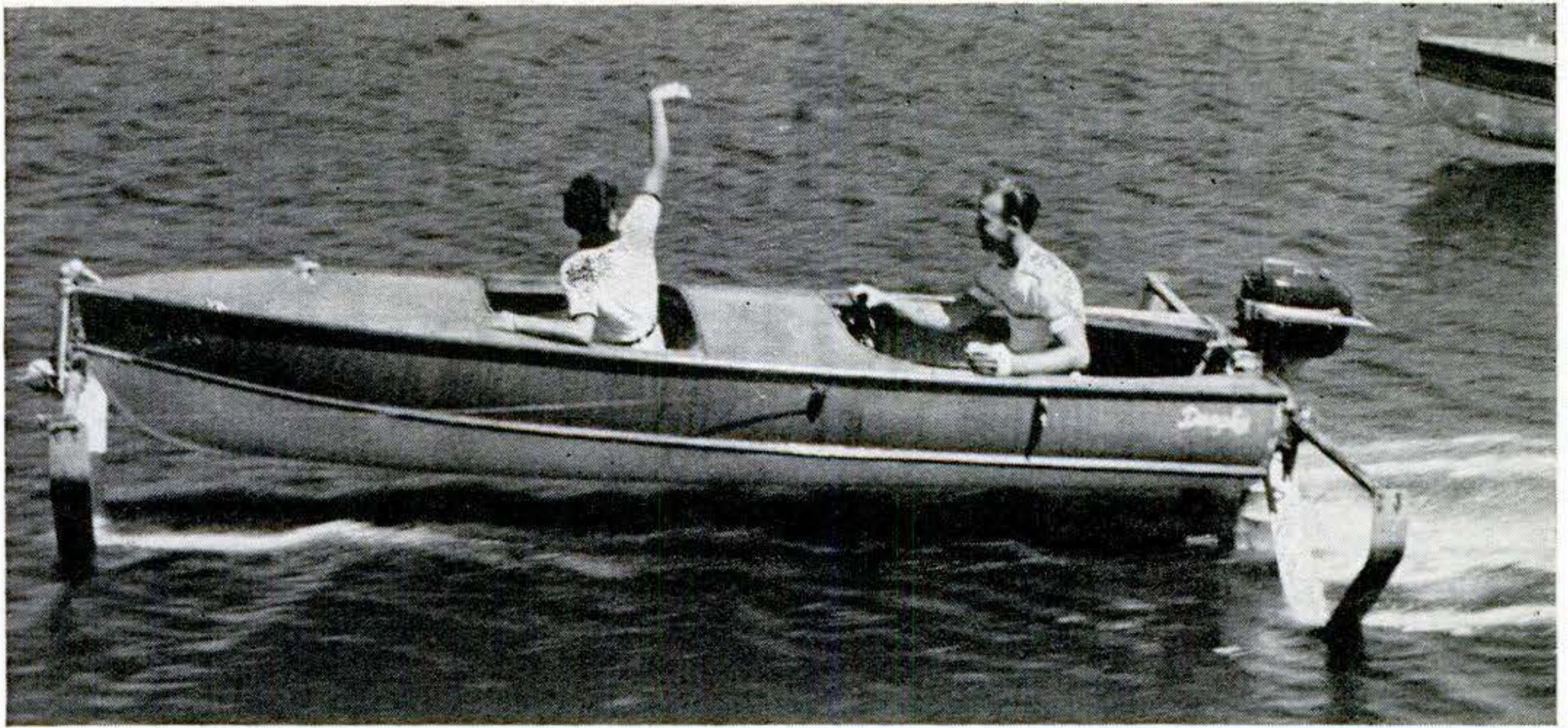

Boat Skims Over Water Like Plane Rides the Air

HYDROFOIL "legs" on this motorboat lift it about 18 inches above water while an extra-long drive shaft on the outboard motor keeps the prop under water. Water flowing over the hydrofoils lifts them the same way

air lifts a plane wing. The boat is said to skim along at 35 m.p.h. with motor at half throttle, turning safely without slowing and with little banking. The Baker Mfg. Co., Evansville, Wisc., makes the hydrofoils.

Demagnetizer Is Portable

TOOLS, dies and parts are demagnetized just by sliding over them the electrical instrument shown at right. Three poles of laminated silicon steel are mounted in the plastic case, flush with the bottom surface. When the switch is pressed, the current is closed, setting up a field which neutralizes magnetism. Releasing the switch automatically shuts off the unit. The Enco Mfg. Co., 4520 W. Fullerton Ave., Chicago 39, makes the Miti-Mite.

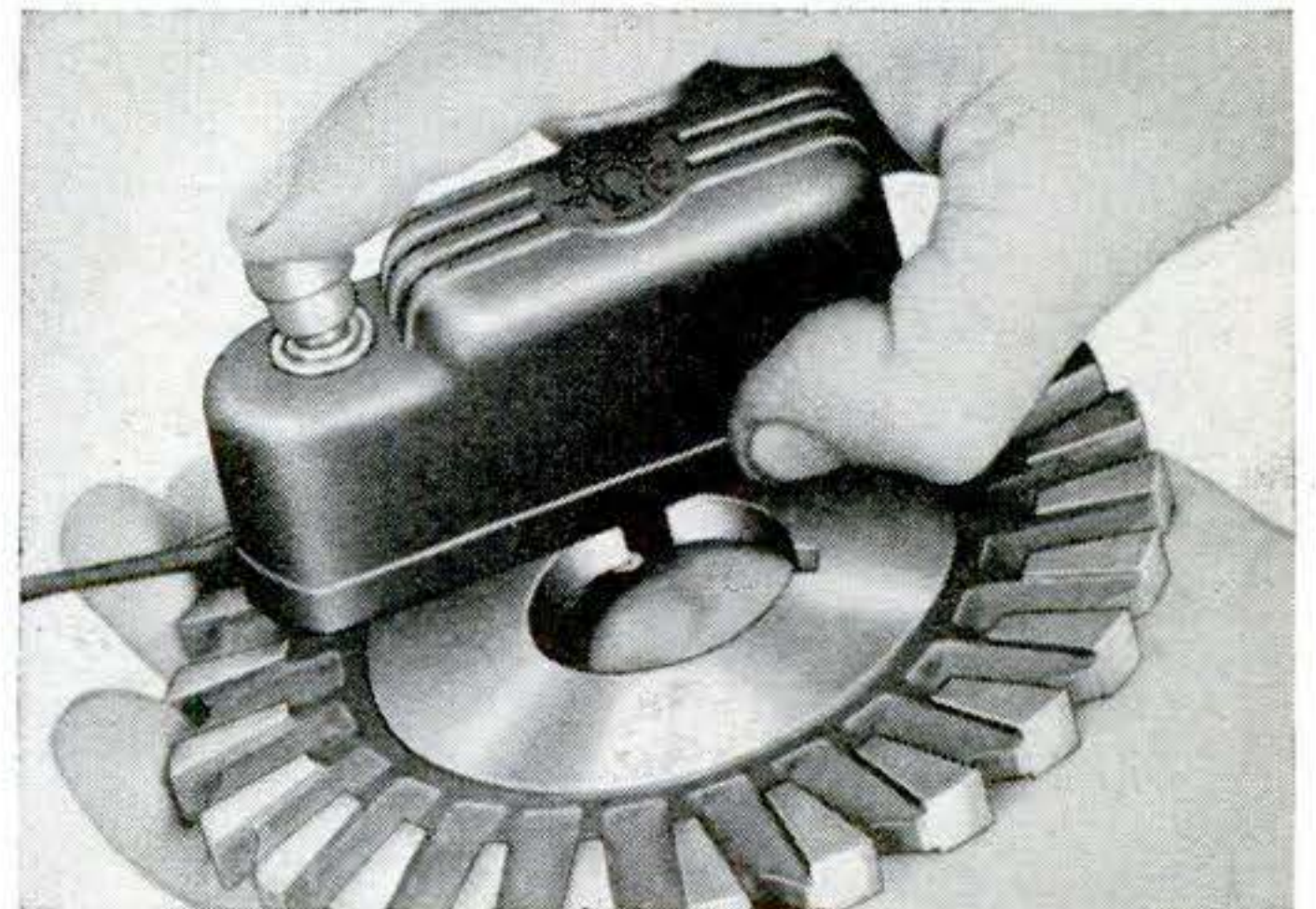

Rig Loads Truck in Six Minutes

WITH this setup, T. H. Holt of Greensboro, N. C., gets bricks aboard his trucks five times faster than by hand loading. The steel frame (left above) is placed over 3,000 specially stacked bricks and its sides are

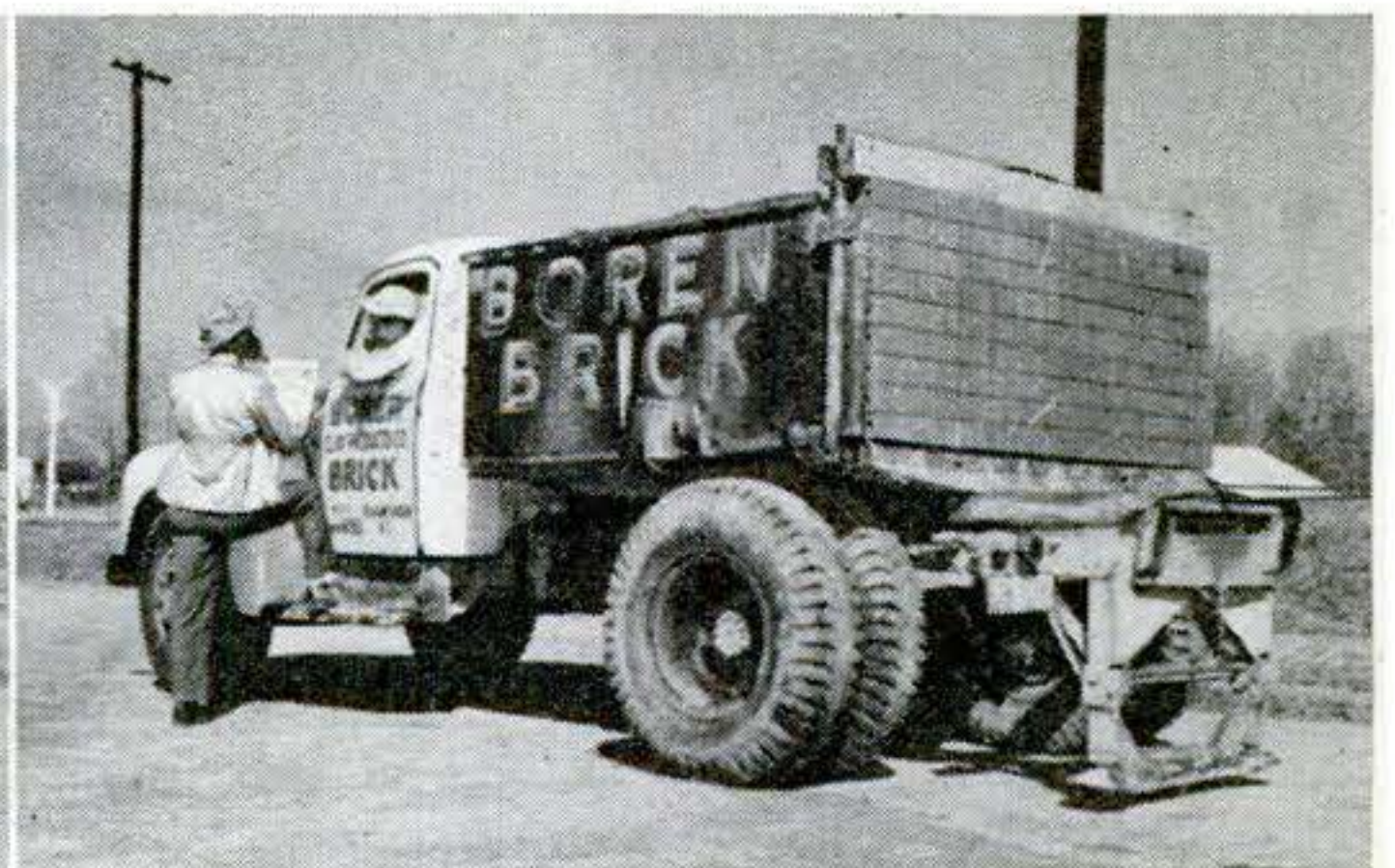

squeezed tight against the bricks by hydraulic pressure. The solid 14,000-pound mass is lifted into position by a hydraulic cylinder operating on a power take-off. After the rear support is folded up (right above), the loaded Ford is ready to roll.

What Jets Have Done to Our Air Power

In 10 fast years, these engines have thrust speeds and altitudes farther into the "wild blue yonder."

By Herbert O. Johansen

TODAY America is well on the way to having an all-jet Air Force. Yet it was just 10 years ago this month that the roar of America's first jet airplane was first heard over the desert of California's Muroc Dry Lake.

In 10 years, jet engines have almost doubled the top speed of our fighters. Only a few years ago it was generally believed that no human being could fly through the sonic barrier and make a happy landing. Now it is routine for Air Force pilots to pass that barrier and fly faster than sound.

Jet power also has enabled our pilots to ascend 45,000 feet, into the stratosphere. And they can climb there almost straight up—at speeds unheard of when World War II broke out—to intercept enemy planes before they reach their targets.

The attainment of such speeds and altitudes, however, has posed problems, and

these problems have brought about changes in planes which are almost as startling as the new power plants. Needle-nosed shapes and swept-back wings have become commonplace. Cockpits now are air-conditioned against extreme heat at low altitudes and extreme cold at high altitudes. The pilots' seats have to be ejected automatically in emergencies. Rear-released parachutes are used as brakes for hot landings. And the electronic equipment of a jet would give a World War II pilot who was suddenly placed in such a plane for the first time the screaming meemies.

Jockeying a hot fighter plane used to be considered a young man's job, because a person's reflexes and reactions slow down shortly after he passes the voting age. In World War II, the average age of pilots was 24 years. How were you going to get them any younger?

That question is academic now. The average age of jet pilots today is 30 years—

1942 ORIGINAL U.S. jet engine, the I-A (right) was developed by GE from study of pioneer British Whittle engine. Two of them powered P-59 Airacomet (below), first jet airplane to fly in this country. It had 1,300-pound thrust, 400-m.p.h. speed.

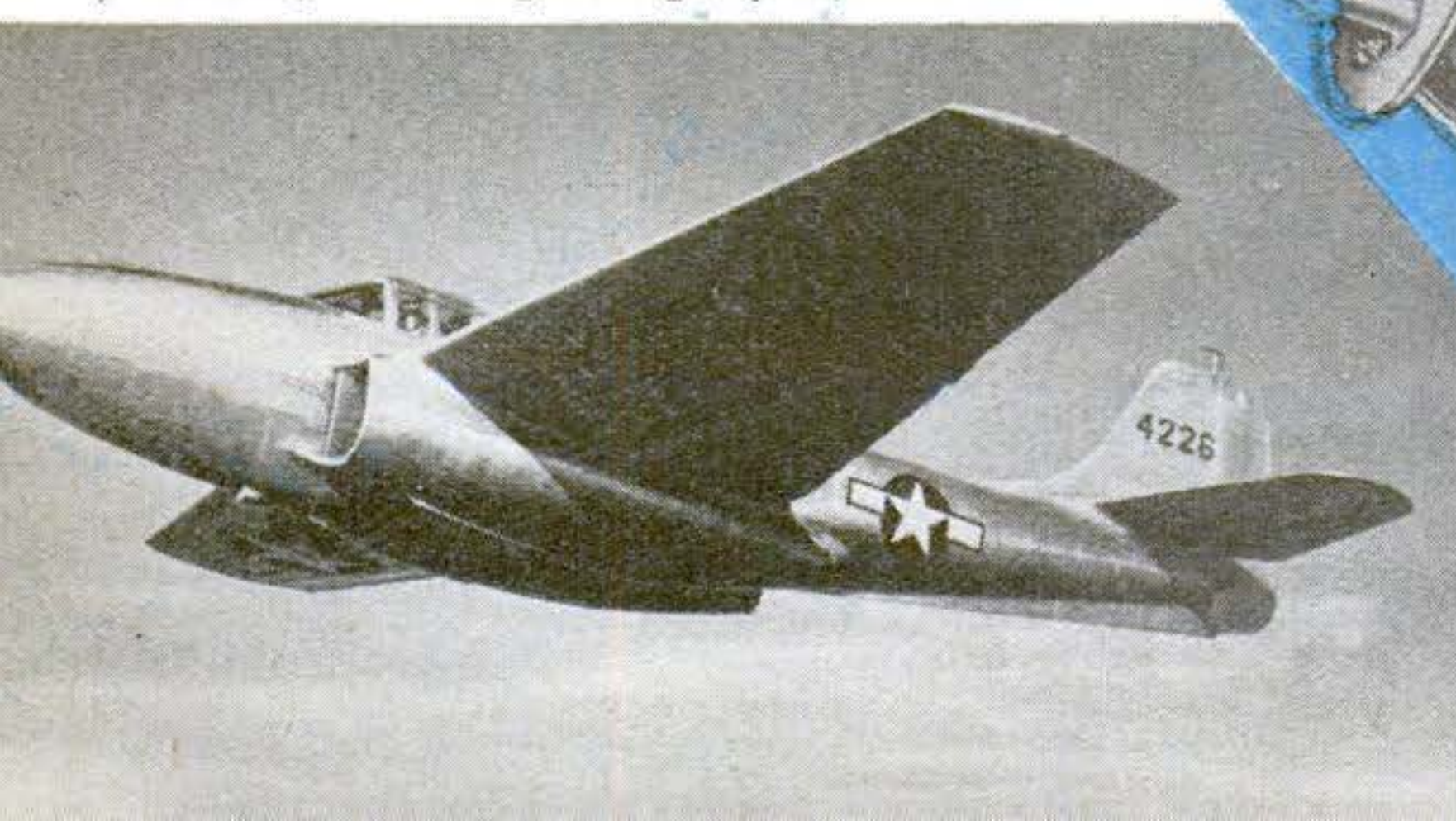
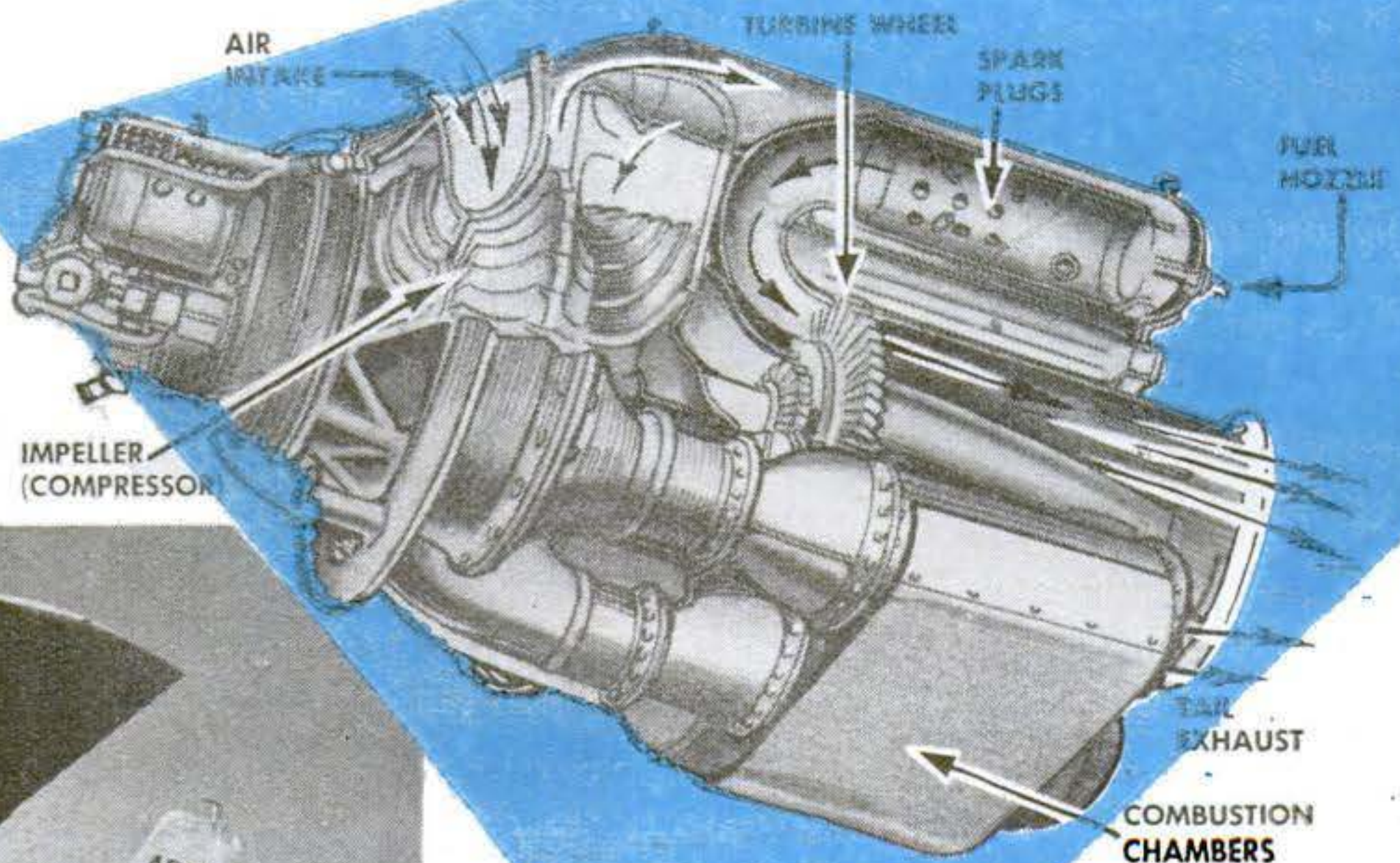

1952 TODAY J-47 jet engine (below), with more than 5,800 - pound thrust, is powering our fastest fighters and bombers, such as the Stratojet (right), which can exceed 600 m.p.h.

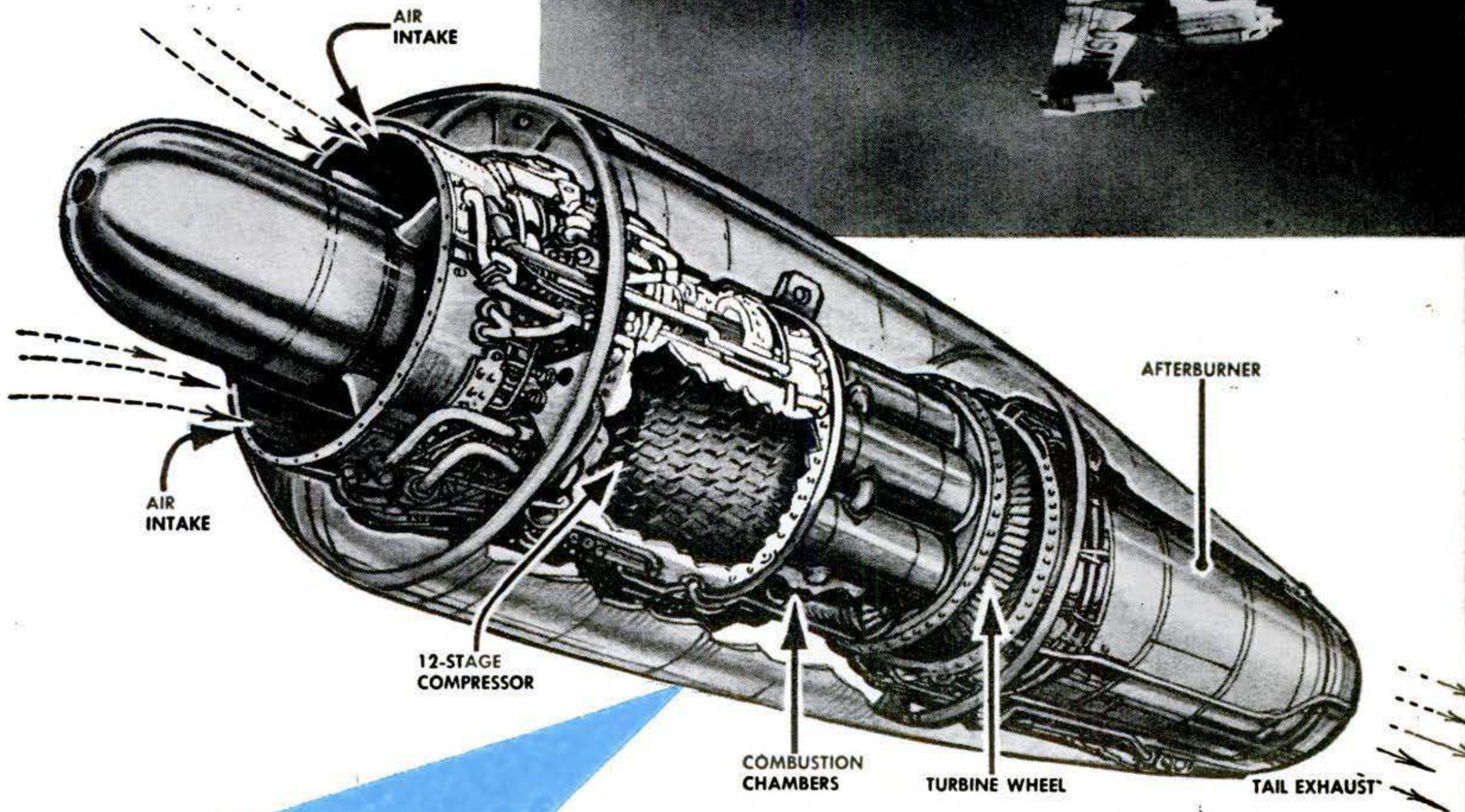

and of our Air Force's jet aces, 29 years.

The explanation is not that supersonic jets are easier to fly. Instead, the explanation is that *no* human reflexes and reactions are fast enough to be relied on in a jet plane.

Electronic and automatic controls, which used to serve as a co-pilot occasionally, are literally the pilots in today's jet. The auto-

matic pilot that once took over to relieve the human pilot in tedious, long, level flight now is left at the controls during loops, rolls and other combat maneuvers.

Electronic devices also aim and fire the guns, cannon and rockets.

Yesterday the radarman was usually on the ground, scanning the skies for enemy

How a Jet Engine Works

AIR is drawn into a compressor, where its pressure is raised. The compressed air is then forced into a combustion chamber. There fuel is sprayed in by high-pressure pumps, and ignited. Combustion greatly expands the air. The hot gases need more room, and as they rush out toward the tail exhaust they pass over a turbine wheel which is mounted on the same shaft as the compressor. Thus, the turbine turns the compressor, sucking in

still more air to be burned and expanded.

But not all the air is needed for this job. The rest of the pressure energy spews out through the tailpipe at very high velocity, creating the jet reaction that speeds the plane forward.

Some jets have an extra tail unit, called an afterburner, where gases that otherwise would be wasted are reheated to increase the jet reaction—or thrust—giving more speed and power.

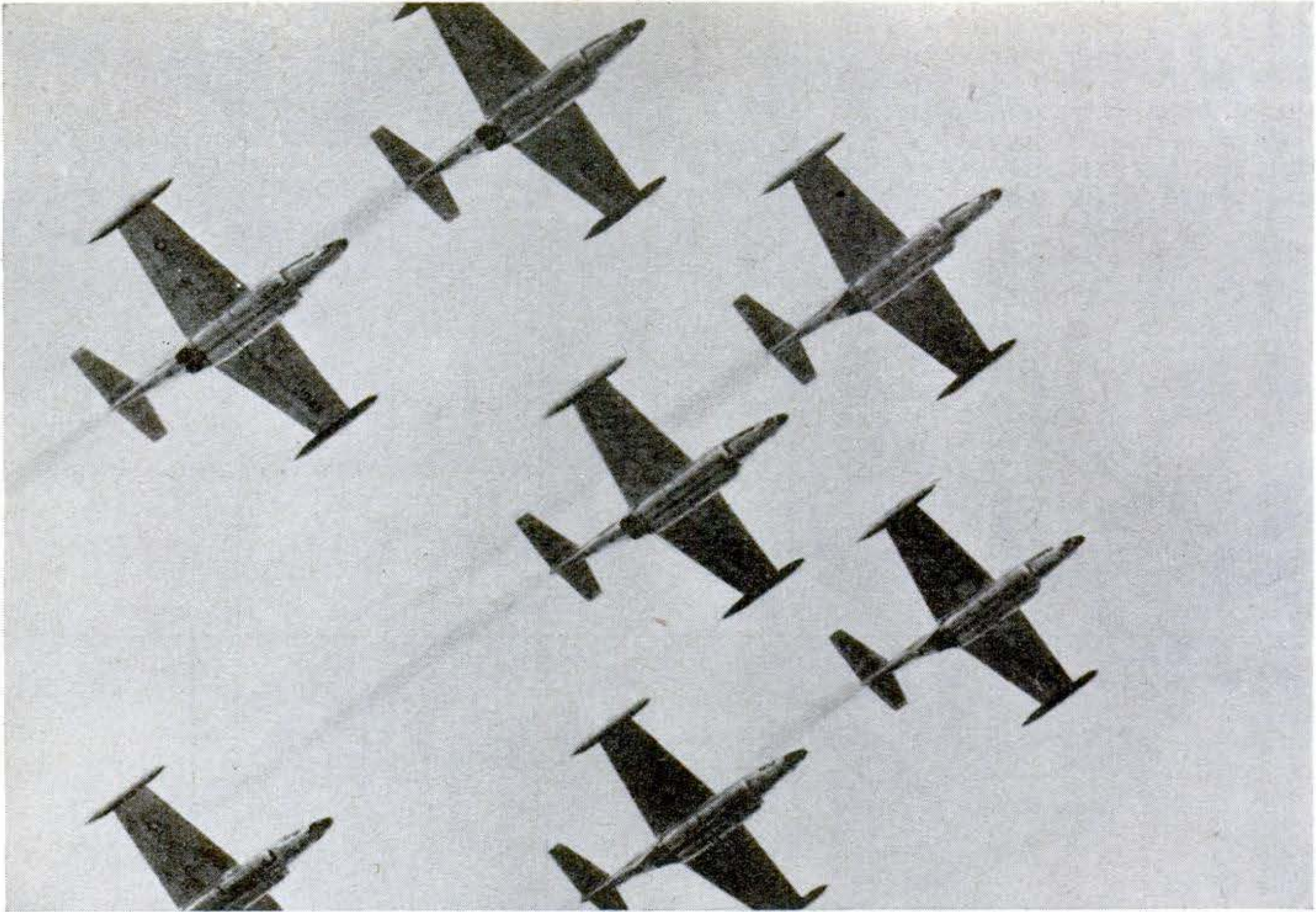

JET POWER symbolized by flight of F-89 Scorpion interceptors. To strike at enemy targets

anywhere in the world, we are building eight-jet, 10,000-mile, atomic bombers.

attackers. Jet engines have made it necessary to put him in the cockpit.

Ten years ago we had pursuit planes to chase enemy skyraiders—usually after they had done their damage. Then came fighter planes that went up to do battle over the target. Now we have all-weather, radar-

nosed, electronics-packed interceptors to shoot down attackers on their way to a target.

The great limitation of jet planes at first was their range. But now we can intercept an enemy long before he reaches us—if we are alerted in time—or deliver jet-borne

How Air Force Compares

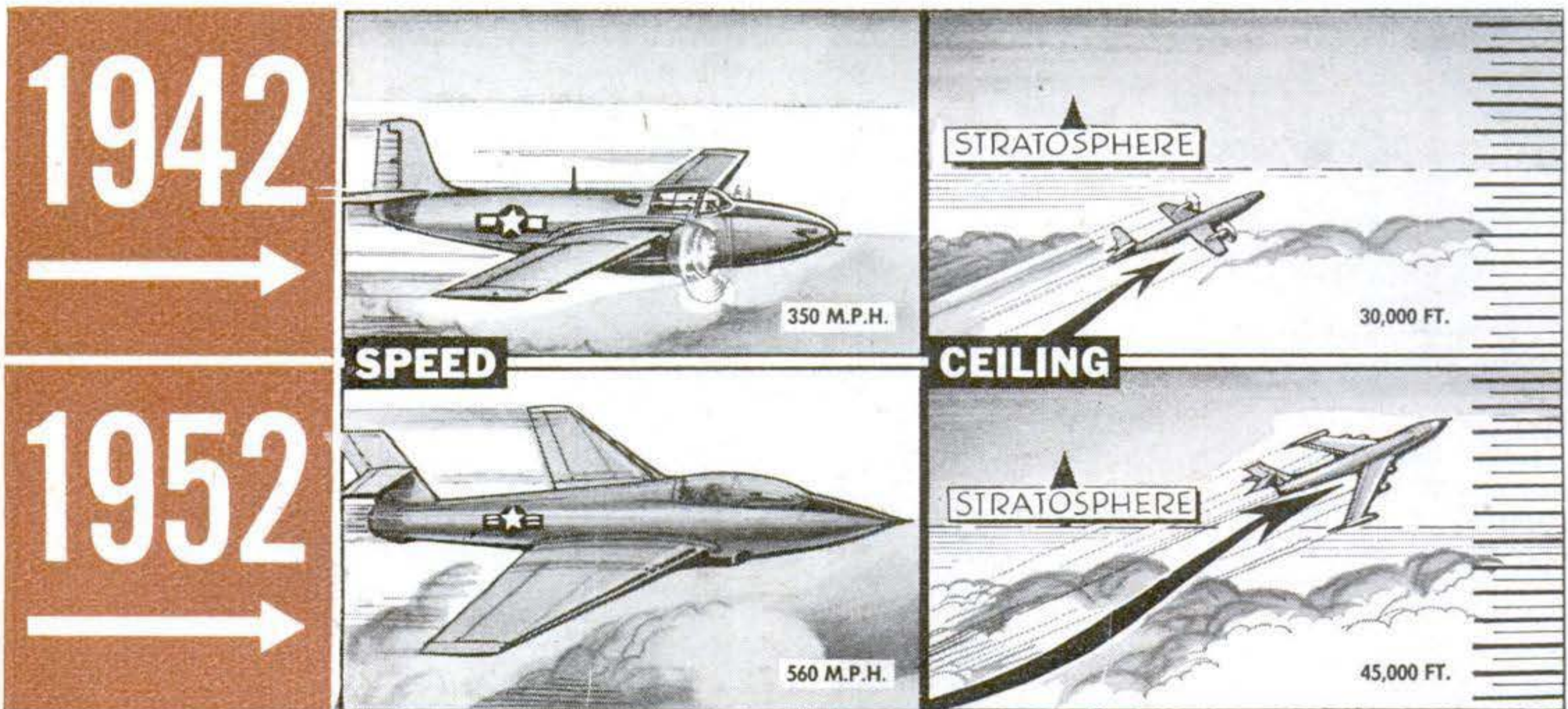

bombs, bullets or rockets far behind an enemy's ramparts.

No distance is too great for fighters and interceptors now. That was proved last July when a squadron of Air Force F-84 Thunderjet fighters, refueling in mid-air over the Pacific, flew 2,400 miles non-stop from California to Honolulu.

When the late General "Hap" Arnold, World War II chief of the Army Air Forces, told his staff in 1945 to "throw everything you have learned about aviation out of the window," he was thinking of jet speeds, push-button warfare.

Jet engines have brought about changes in both the tactics and strategy of aerial forces, and fighting at supersonic speeds now is pretty close to push-button warfare.

Peering into the future, Maj. Gen. Donald L. Putt of the Air Force sees even more rapid developments in the next 10 years than in the last. "We foresee," he says, "jet engines that will develop thrust in the 20,000- to 30,000-pound range . . . By 1955 they should be operating at speeds of more than 1,000 miles an hour and at altitudes in excess of 50,000 feet." END

How Jet Thrust Compares with Horsepower

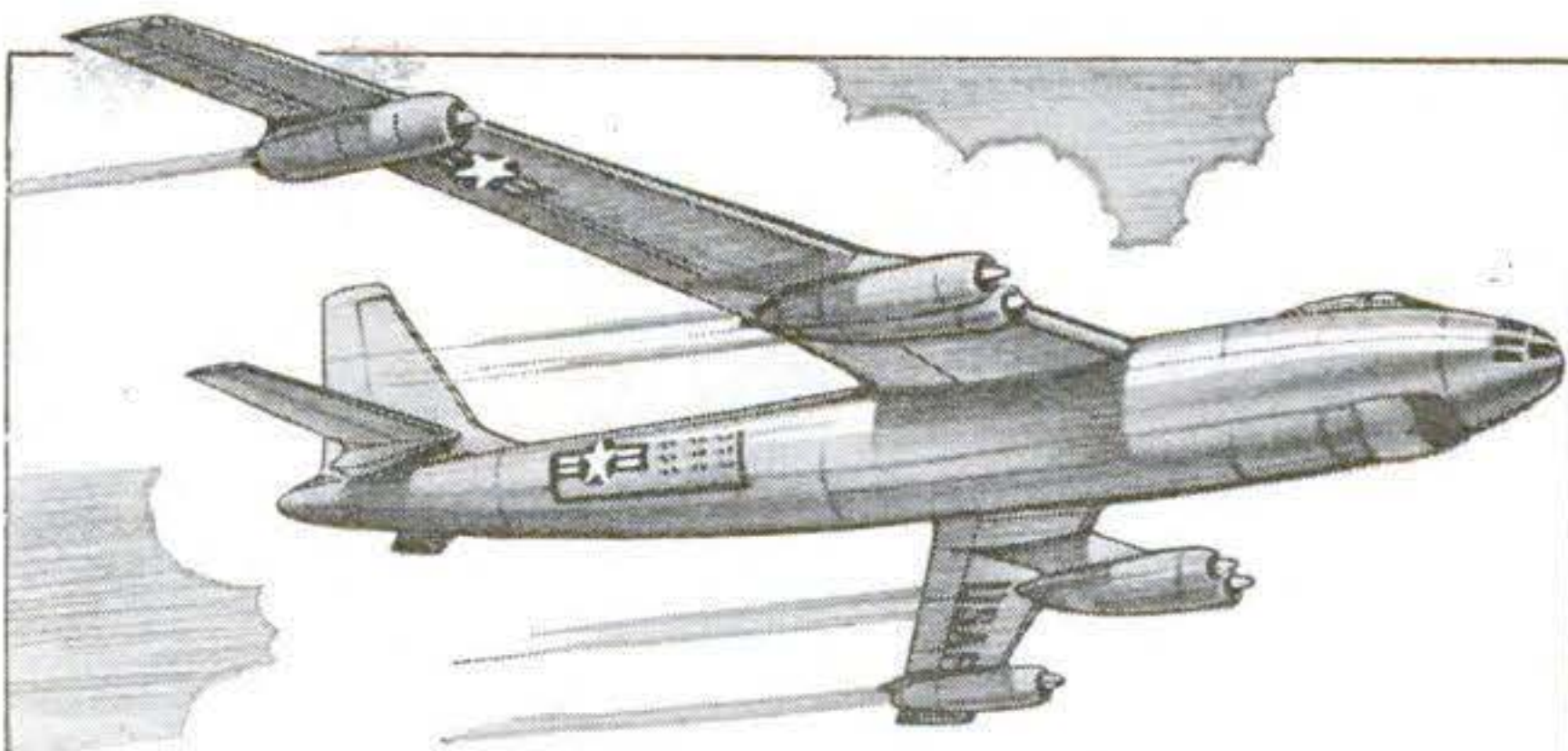

JET power is rated in pounds of thrust. Roughly, one pound of thrust is equal to one horsepower at a speed of 375 miles an hour. Thus, to equal the peak 54,000-pound thrust of the B-47 Stratojet (above) at 600 m.p.h., would require 24 piston engines of the World War II type (below).

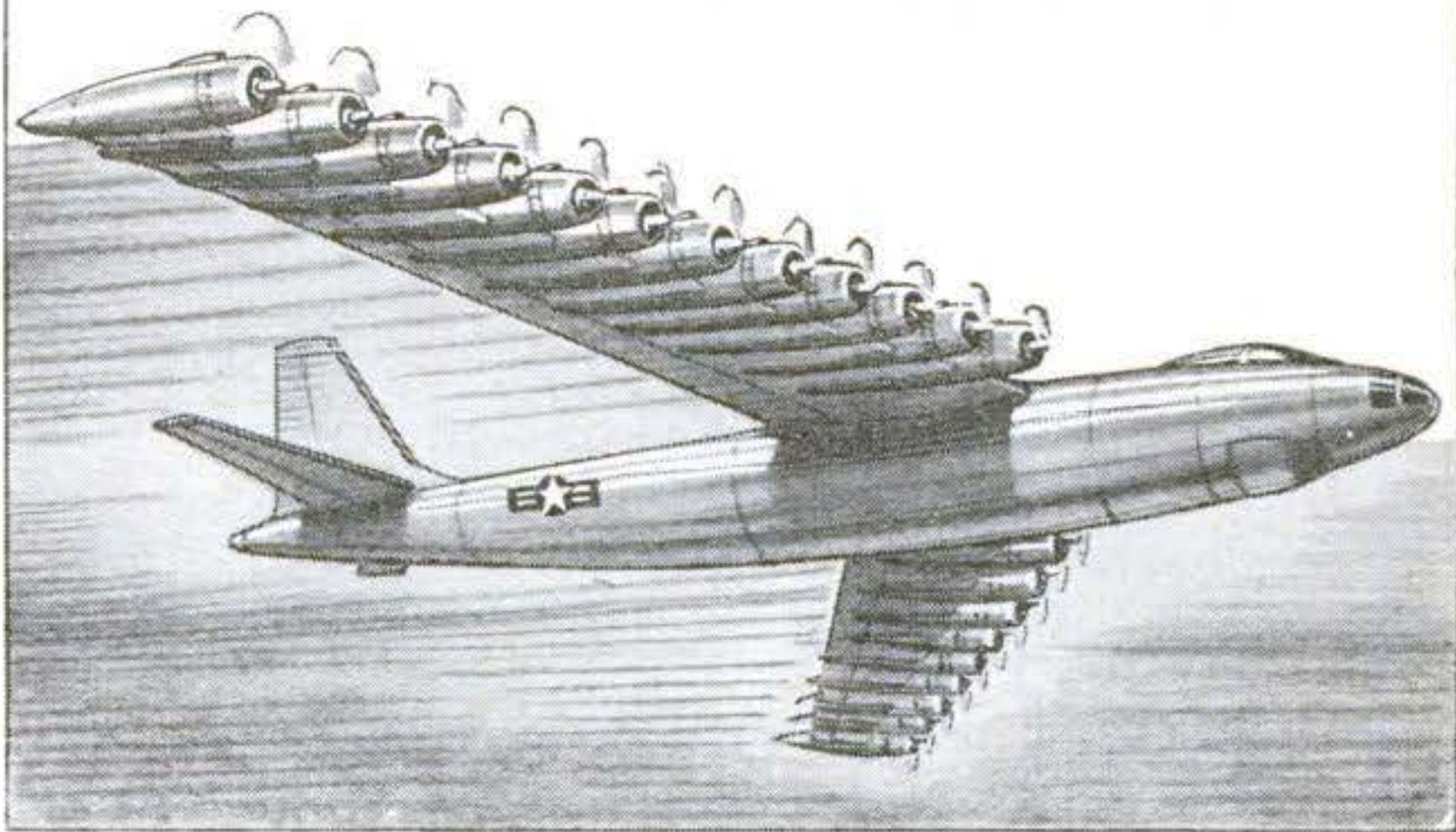

After 10 Years of Jet

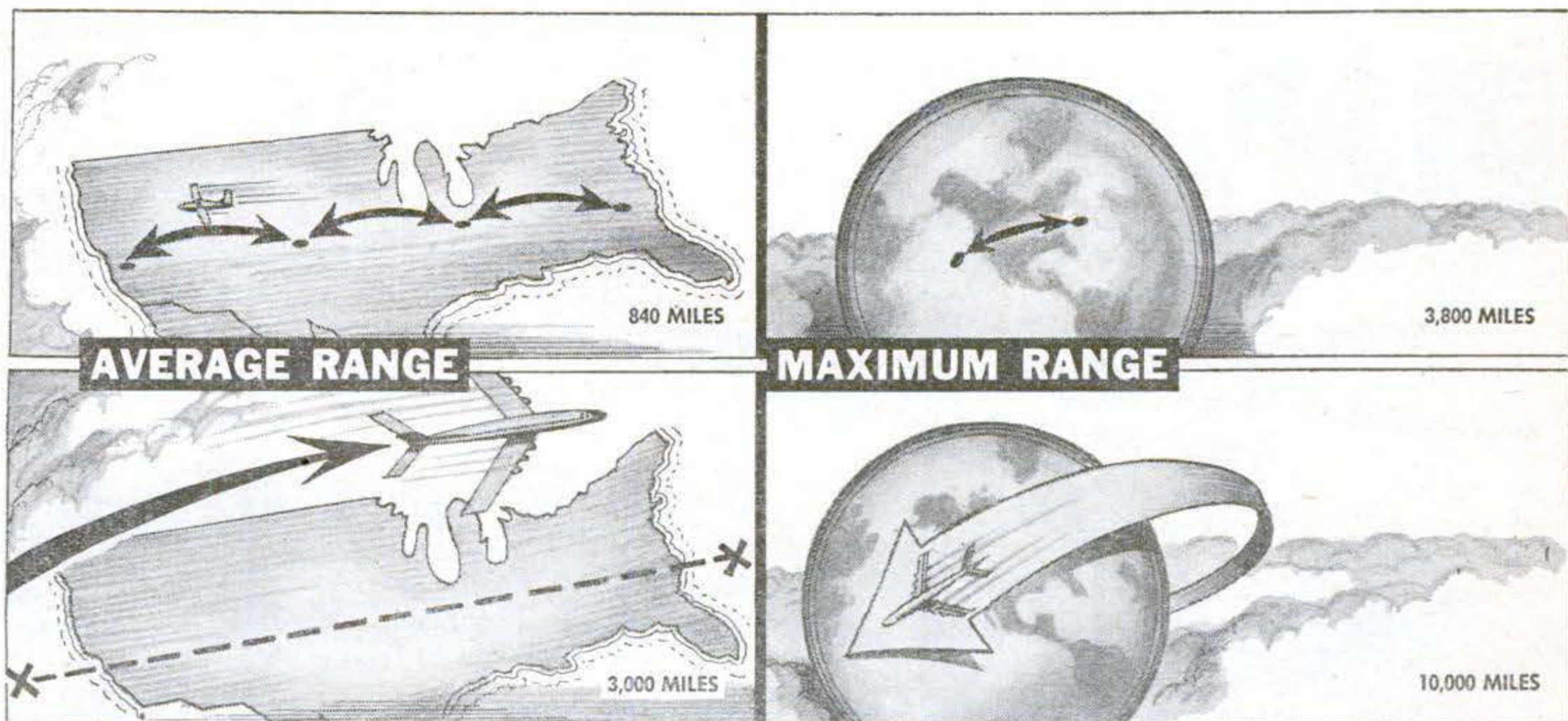

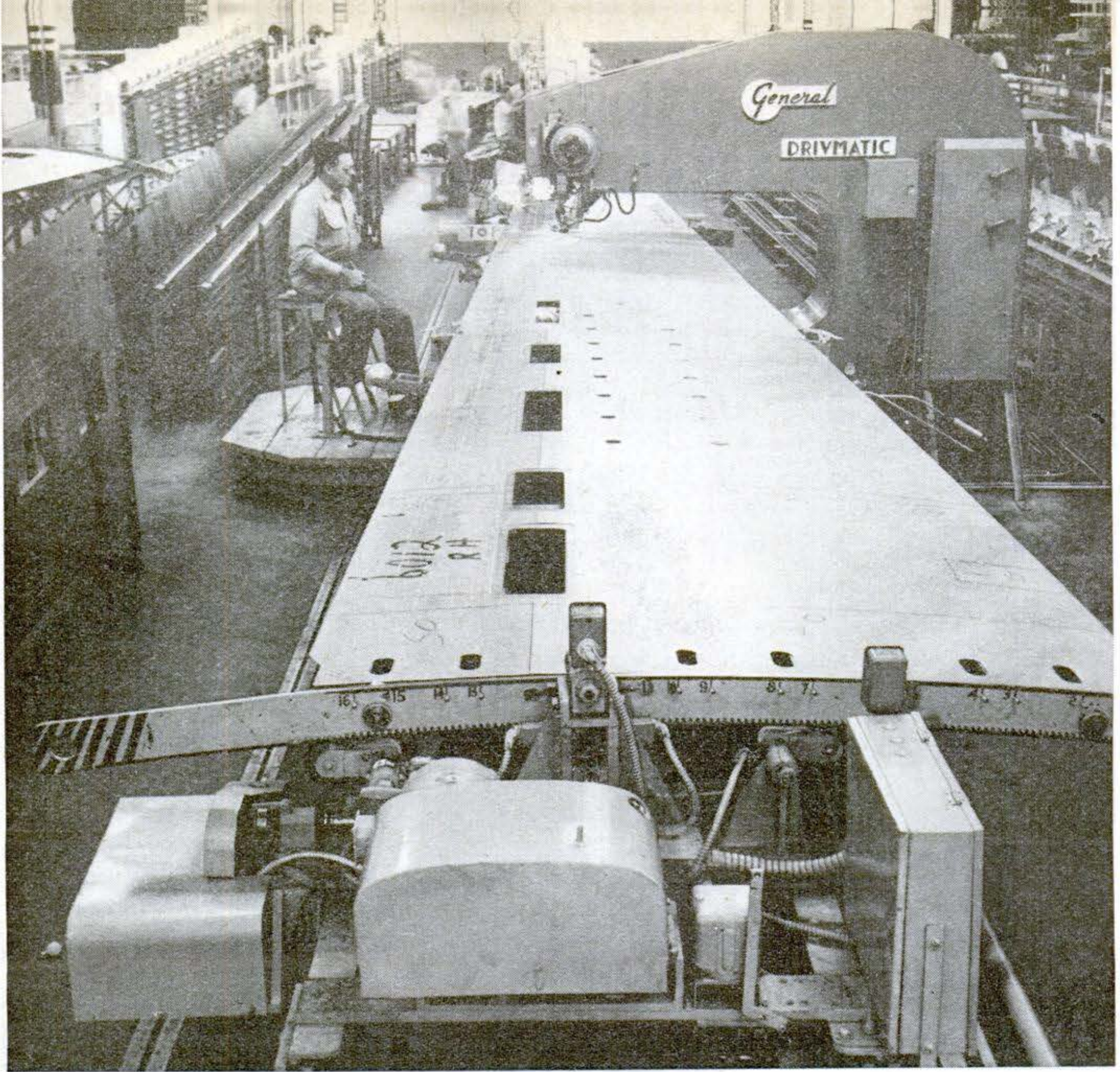
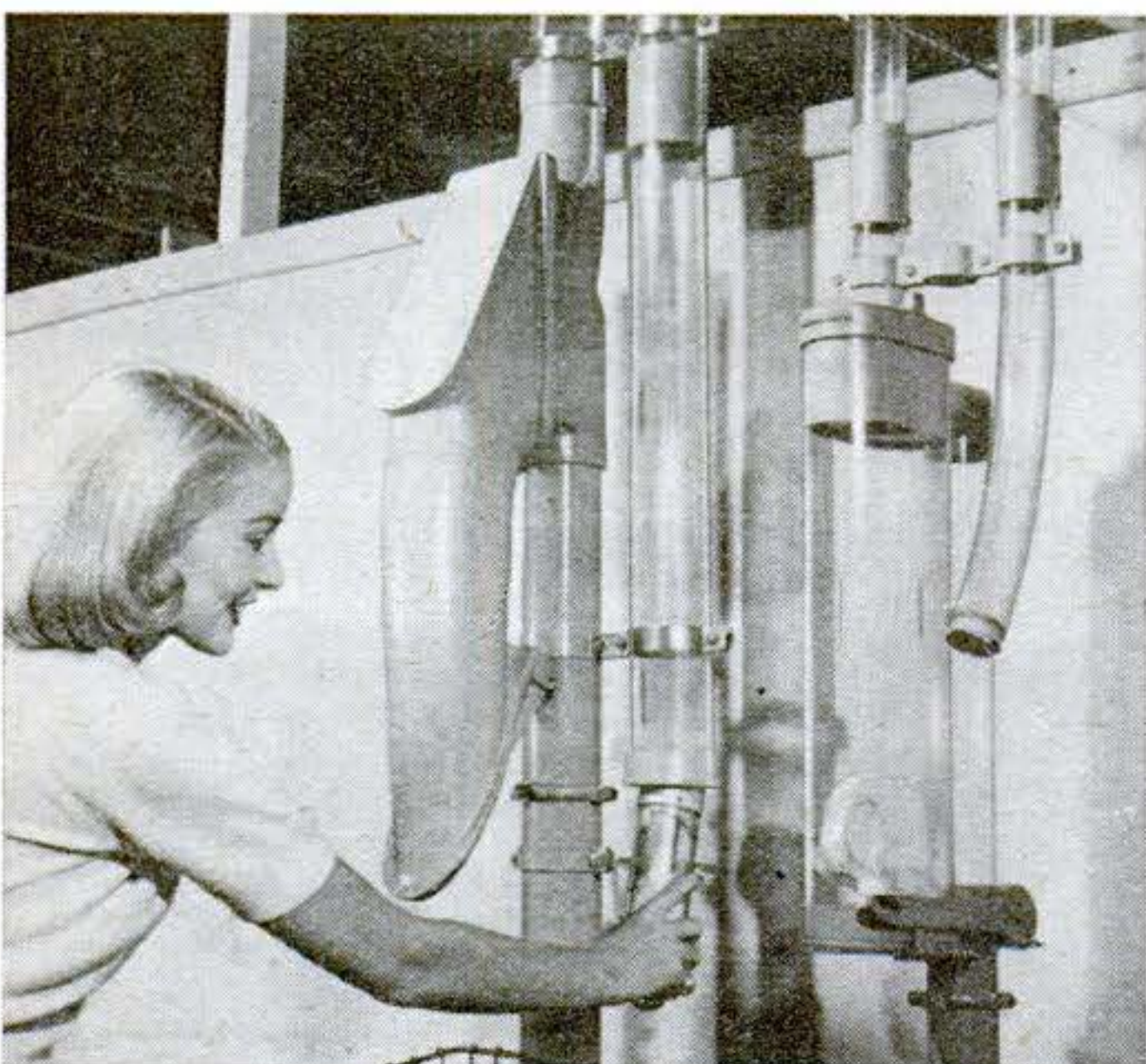

Table Brings Work to Riveter

THE worker riveting this aircraft wing panel need not move from his seat to do the job. Push buttons on the work table move a wing forward, backward and sideways so

that the work area is always under the riveting machine. Designed by Lockheed and Temco aircraft corporations, the new setup saves hours on each panel, increases accuracy, reduces operator fatigue.



Plastic Pipes Carry Messages

OBSTRUCTIONS are quickly located in a pneumatic conveyor system (left) in which both pipe lines and carriers are made of tough, transparent Tenite. The new system is also said to be easier to install.

Tiny Device Spots Radiation

THIS pocket Atometer is filled with a liquid that changes color when exposed to atomic radiation. The degree of exposure is found by comparing the color with a chart. The Magnex Corp., Jamaica, N.Y., makes it.



Week-End Railroad Run Like Real One

By Robert Lasch

DONALD MILLER of St. Louis has a simple formula for organizing a railroad. First, you find an old locomotive lying around in somebody's basement. The rest comes easy.

That's just what he did, 13 years ago.

He got wind of a 12-inch gauge engine gathering dust in a neighbor's basement, and, with a couple of dozen friends, train cranks like himself, parlayed it into a full-fledged narrow-gauge railroad system.

The Wabash, Frisco & Pacific, they call it—after the three major railroads of St. Louis. The namesake lines, like others in

The pride of St. Louis' midget railroad is Number 400, a 5,000-pound, coal-burning Pacific.

St. Louis rail fans operate the Wabash, Frisco & Pacific (one-foot gauge) by the Book of Rules—and on time.



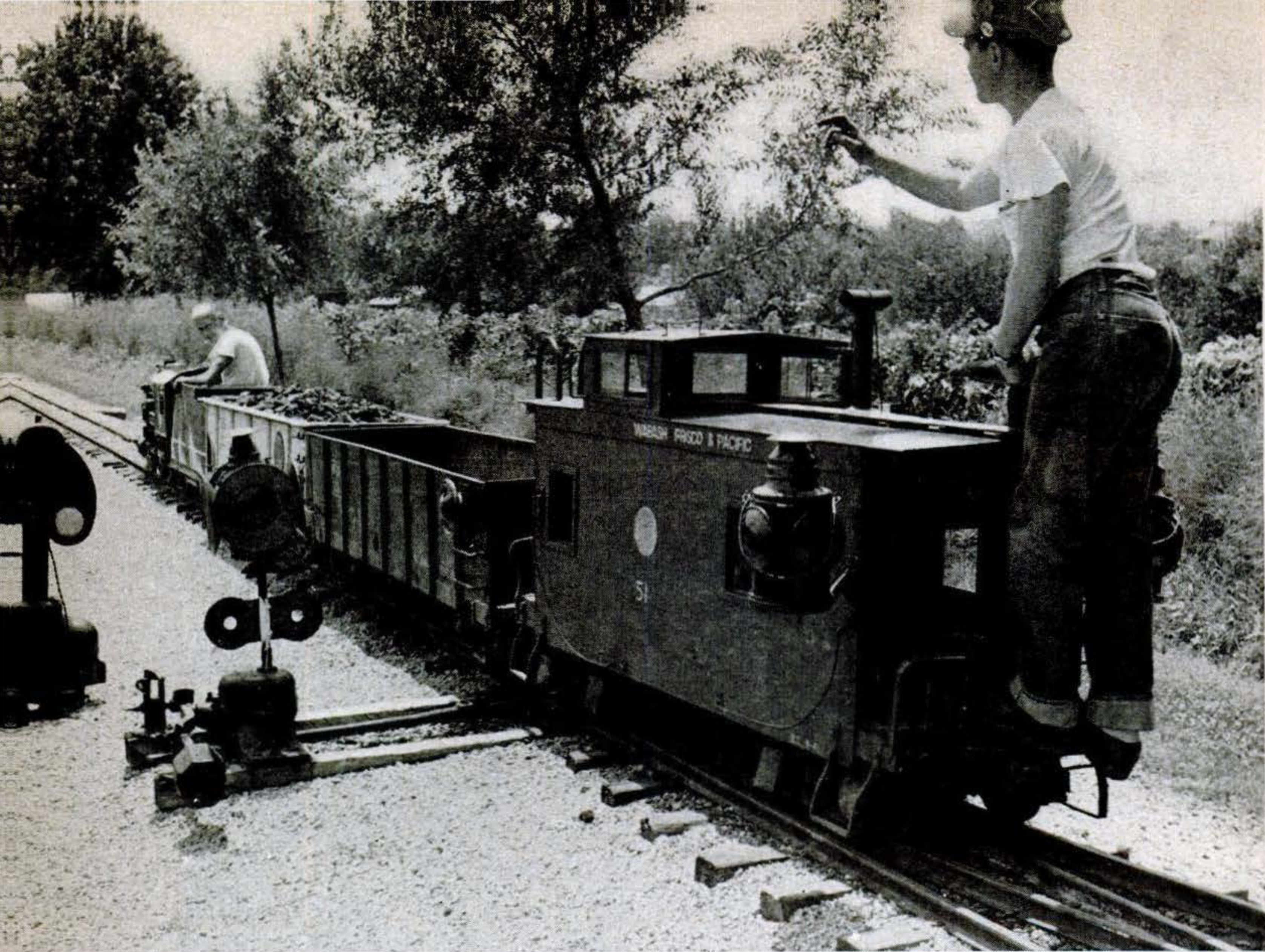

Brakeman's signals are full-scale; so are the marker lamps, switch stand and semaphore.

the nation, have suffered at least one interruption in service during the last 12 years. But the WF&P—whose officers, owners and workers all toil happily without pay—has never missed a Sunday since 1940.

Thirty-five businessmen, professional men, students and teachers now belong to the association which owns and operates the system on research chemist Carlisle Schade's 30-acre farm in St. Louis County. They have well over \$20,000 sunk in three locomotives, 11 freight cars, a caboose, two passenger coaches, a mile of 12-inch gauge track, three stations, telephone and telegraph lines, shops, 22 switches, regulation signals, a turntable and a pint-size gasoline-driven section car.

The Wabash, Frisco & Pacific takes itself so seriously that trains run on a timetable, subject to written orders, in charge of crews who have passed examinations based on the standard code of operating rules for the Association of American Railroads.

On one memorable Sunday when the

EIGHT-WHEELED NUMBER 180 takes a short one for the road. In heavy passenger service she evaporates 23 gallons of water on a double circuit of the one-mile pike.



St. Louis area was glazed with a thick sheet of ice, the semi-pro railroaders had to attach a steam hose to the locomotive and melt the ice on the 12-pound rails out ahead. By the time they cleared a stretch of track, the locomotive would have to back up to the shops for coal and water, then tackle the grades anew. It took eight hours to make the run normally scheduled for a slow freight at 13 minutes—but they made it.

How You Assemble a Railroad

The original WF&P locomotive—Engine No. 171—had seen years of amusement-park service before retirement to its basement corner. It is a 4-4-0 type with tractive force of 225 pounds, 10¾-inch drivers, 2½ by 3½ cylinders, steam pressure 130 pounds, weight 1,400 pounds. The WF&P rebuilt it completely, added a tender, and right away started looking for another locomotive.

Engine No. 180, slightly larger, with 300 pounds of tractive force, was bought—in non-operating condition—from a nearby amusement-park operator for \$450. It, too, was rebuilt.

But the railroad's collective emotions really churned when its officers located what was to become the prize of the line—a 4-6-2 locomotive, tractive force 770 pounds, weight 5,000 pounds.

This was a working scale model of the Canadian Pacific's 2300 class, three feet high and 15 feet long including tender. It had been built in England in 1925, and had seen service at England's Wembley Exposition in the Twenties. It emigrated to this country for the Philadelphia Sesquicentennial Exposition, and the WF&P found it at an amusement park in Denver.

The only hitch was finance. The engine had a price tag of \$3,500 on it. The WF&P had been spending between \$1,000 and \$1,500 a year on the system but couldn't see that kind of money. But just when hopes were lowest a mysterious financier let it be known that a loan could be had on terms of strict anonymity. The deal was closed and the loan for No. 400 later paid off.

Rails Are Junkyard Salvage

Rails were picked up in nearby junkyards, which had taken them in as scrap from abandoned narrow-gauge mine tracks or amusement parks. Four-by-four ties 24 inches long were cut from oak timbers and creosoted free by a tie firm. Ties and rails

[Continued on page 248]



FREE TICKETS boom traffic, but Dad and Junior are no deadheads. They'll drop a contribution into a special box to help keep the \$50,000 railroad running in the black.

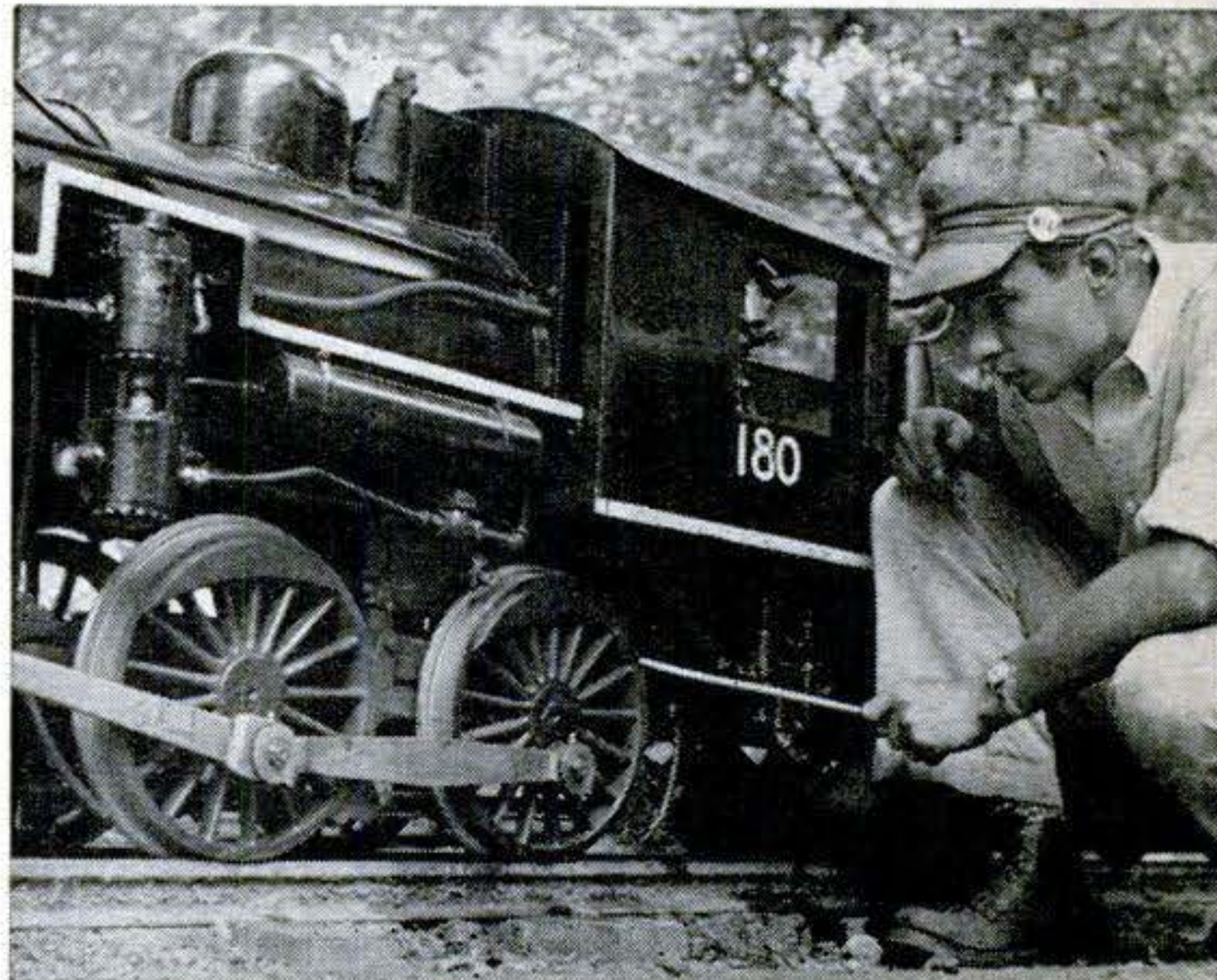

LOCOMOTIVE HOSTLER knocks the fire. Good fuel and careful servicing pay off in top performance. Besides, a black exhaust is frowned on by the management.



DISPATCHER'S OFFICE is less formal than most, with brakemen receiving their orders directly from the "delayer." All movements are recorded on a standard train sheet.

How to Choose Your

A good tree lasts a lifetime. To help you pick the right ones, Popular Science has consulted experts all over the country.

TREES can do a lot to make your house more valuable—if you pick the right trees. But picking the right tree isn't as easy as it looks. There are more than 3,000 kinds in the United States—and they come in every shape, size, color and hardiness.

What's more, they come with all kinds of habits, good and bad, that you might not find out about until you've lived with them for a time. Some handsome trees have arboreal halitosis—they smell terrible. Others are untidy, dropping messy fruits or seed pods on the lawn. And some respectable trees have bad companions—bugs that raid your house, or blights for other trees.

Some Are Invalids

Some trees are likely to be chronic invalids, keeping you broke pouring asphalt cement into them. Trees that start out growing like Jack's beanstalk may get discouraged and die on your hands after a few years. There are trees that are roughnecks, out of place in the suburbs but useful in grimy cities where their gentler rivals would die. There are even thorny trees that are dangerous to pets and children.

To help you choose the best kind of trees

to plant around your home, POPULAR SCIENCE MONTHLY has asked tree experts at agricultural experiment stations all over the country for advice. We also asked similar questions of leading members of the American Association of Nurserymen.

We made it a point to have the survey nationwide because the climate and soils of the different parts of the country vary so much that no single list of trees makes sense. With experts reporting from every section, more than 350 trees have been suggested. You'll find the most popular ones on the chart on the next two pages.

Maples Are Favorites

You'll notice that some names appear over and over again. Of course not even these trees can be used everywhere, but they are, in general, the trees that experts like best—for you.

Among them, the Sugar Maple leads the field. Sugar Maple sap makes maple syrup, but the experts like the tree because it is handsome and fine for shade. Strong and easy to care for, it eventually grows to 90 feet—and sometimes as much as 110.

The Red and Norway Maples also drew

IN BUYING TREE, choose a reputable nursery that follows standards of American Association of Nurserymen. Shade tree should have at least minimum height for diameter. Sugar Maple should be five feet high for ½-inch tree, 18 feet for five-inch-diameter specimen.

SIZE OF BALL IS IMPORTANT. For nursery-grown Sugar Maple, ball should be at least 18 inches across for 1¼-inch-diameter tree; four feet for five-inch-diameter. Natural-grown trees need one-third larger balls. Small trees are usually sold bare-rooted.



166 POPULAR SCIENCE

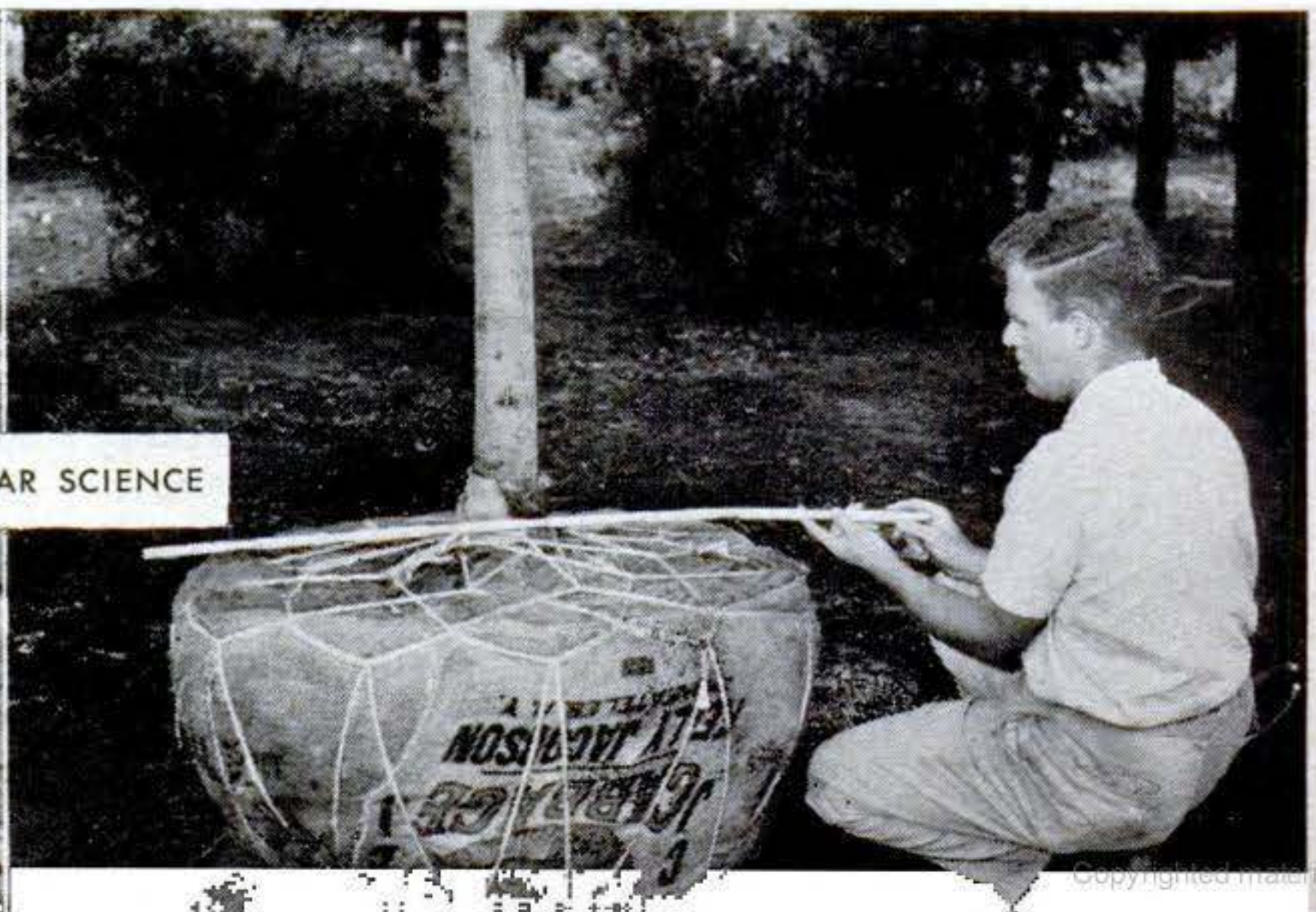

Trees

PROSPECTIVE BUYERS inspect a Sugar Maple at Rosedale Nurseries, Eastview, N. Y. Trees this big are expensive. In comparing costs, check whether price includes balling, delivery and planting. These can add a lot of dollars.





Pick Your Trees by Where You Live

THE chart below combines suggestions by horticulture experts at state agricultural expe-

REGION	SHADE	WINDBREAK	PRIVACY
1 Pacific Northwest WASH., ORE.	Norway Maple, Pin Oak, Red Oak, White Birch, American Linden.	American Arborvitae, Lombardy Poplar, Siberian Pea Shrub.	Common Lilac, Japanese Quince, Willow, Siberian Pea Shrub, Japanese Snowball, Wayfaring Tree.
2 California CENTRAL VALLEY So. Calif. SEASHORE So. Calif. NEAR COAST So. Calif. MOUNTAIN So. Calif. DESERT So. Calif. INLAND VALLEY	Hackberry, Chin. Pistachio Australian Tea Tree Brazilian Pepper Tree California Sycamore Texas Umbrella Tree Modesto Ash	Aleppo Pine, Olive Myoporum laetum Catalina Cherry Incense Cedar Oleander, Tamarisk Catalina Cherry	Modesto Ash Myoporum laetum Catalina Cherry Incense Cedar Oleander, Tamarisk Catalina Cherry
3 Rocky Mountain States IDAHO, COLO., N. M., MONT., WYO., NEV., UTAH, ARIZ.	Green Ash, Thornless Honey Locust, Fruitless Red Mulberry, Norway Maple, Pin Oak, Bur Oak, Plane Tree.	Siberian Elm, Arizona Cypress, Green Ash, Ponderosa Pine, Eastern Red Cedar.	Flowering Crab Apple, Colorado Blue Spruce, Lombardy Poplar, Silverleaf Poplar.
4 Extreme Cold Area ME., VT., N. H., N. Y., MICH., WIS., MINN., N. D., S. D.	Norway Maple, Sugar Maple, American Elm, Red Maple, Green Ash, Thornless Honey Locust.	Norway Spruce, White Pine, Norway Pine, White Cedar, Austrian Pine, Arborvitae, White Spruce.	Hemlock, Arborvitae, Willow, Upright Japanese Yew, Russian Olive, White Cedar, Black Hills Spruce.
5 Great Temperate Area CONN., MASS., N. J., N. Y. AND I. I., R. I., PA., DEL., MD., W. VA., VA., KY., TENN., IND., ILL., IOWA, MO., ARK., NEBR., KAN., OKLA., OHIO	Sugar Maple, Northern Red Oak, American Elm, Thornless Honey Locust, London Plane Tree, Red Maple, Tulip Tree, American Ash, Sweet Gum, European Linden, Norway Maple, Pin Oak.	Norway Spruce, Red Cedar, White Pine, Katsura, Austrian Pine, Norway or Red Pine, Hemlock, Douglas Fir, American Ash, Pin Oak, Upright Japanese Yew, Arborvitae.	Arborvitae, Canada Hemlock, Amur River Privet, Red Cedar, Chinese Juniper, Holly, Crimean Linden, Purple Beech, Katsura, Dolgo Crab, Ginkgo, Norway Spruce.
6 Southern and Gulf States ALA., GA., LA., MISS., N. C., S. C., TEX.	White Oak, Water Oak, Live Oak, Willow Oak, Magnolia, Tulip Tree, Laurel Oak, Pecan, Winged Elm, Cedar Elm.	Carolina Laurelcherry, American Holly, Loblolly Pine, Southern Magnolia, Arizona Cypress, Photinia.	Red Cedar, Carolina Laurelcherry, Holly, Southern Magnolia, Photinia, Arizona Cypress, Glossy Privet.
7 Florida NORTH & CENTRAL SOUTHERN	Laurel Oak, Water Oak Jacaranda, Fig Tree	Laurelcherry, Oak Casuarina	Laurelcherry, Wax Myrtle Australian Pine, Camphor

many votes. The Red, often called Swamp Maple, has striking autumn foliage. The Norway, smaller than most maples, is better scaled for small houses. Both trees, however, are hard to grow grass under because of their dense shade and shallow roots.

The tree that draws most blackballs is also a maple—the Silver Maple, which gets its name from the silver gleam of the underside of the leaves when ruffled by the wind. Although some experts and nurserymen like it for its handsome shape and size, and

riment stations all over the country with those of leading members of the American Association of Nurserymen. Trees most often suggested are listed first. Some trees rarely mentioned are omitted for lack of space. Among the factors considered in making these

choices were availability, price and amount of care required. Remember suggestions are generalized for large areas. For data on your neighborhood write your own state agricultural experiment station and ask local nurserymen and neighbors for advice.

FRUIT AND NUTS	FLOWERS	LANDSCAPING	AVOID
Apple, Sweet Cherry.	Flowering Crab Apple, Flowering Plum, Dogwood.	European White Birch, Cutleaf Weeping Birch, Flowering Plum.	Chinese Elm.
English Walnut	Pomegranate, Kumquat	Chinese Hackberry	Lombardy Poplar
Apricot, Seckel Pear	Flame Eucalyptus	Aust. Tea Tree, Holly Oak	Native Oaks, Pepper Tree, Moreton Bay Fig, Canary Island Palm.
Anaheim Avocado	Sharpleaf Jacaranda	Podocarpus gracilior	
select under local advice	Mountain Ash •	Lawson Cypress, Inc. Cedar*	
Grapefruit	Golden Rain Tree	Modesto, Montebello Ash	
Lemon, Apple	Flow. Plum, Peach, Apple	Sweet Gum	
Dwarf Apple, Pear, Plum, Pecan, Apricot, Black Walnut.	Flowering Crab Apple, Bechtel's Crab, Flowering Peach, European Mountain Ash, Flowering Cherry, Flowering Plum.	Thornless Honey Locust, Norway Maple, Modesto Ash, Flowering Crab Apple, Green Ash, European Weeping Birch.	Chinese Elm, Silver Maple, Box Elder, Eastern Flowering Dogwood, Redbud, Arborvitae, Hemlock (Colo.), Poplar (Idaho), Tulip Tree.
Black Walnut, Apple, Hickory, Sour Cherry, Plum, Butternut.	Crab Apple, Thornless Honey Locust, Horse Chestnut, Black Locust, Hawthorne.	Norway Maple, European White Birch, Thornless Honey Locust, American Beech, Sugar Maple.	Chinese Elm, Silver Maple, Box Elder, Poplar, Tree of Heaven, Tulip Tree, Dogwood, Magnolia.
Apple, Pear, Black Walnut, Shellbark Hickory, Cherry, Peach, Crab Apple, Chinese Chestnut, Butternut.	Dogwood, Flowering Crab Apple, Redbud, Magnolia, Flowering Cherry, Hawthorne, European Mountain Ash, American Holly, Empress Tree (south of NYC), Dolgo Crab, European Beech.	Sugar Maple, Red Pine, American Elm, Pin Oak, Dogwood, Sweet Gum, Norway Spruce, White Pine, Red Oak, Flowering Crab Apple, Star Magnolia, Water Oak (south of NYC), Ginkgo, Linden.	Chinese Elm, Box Elder, Silver Maple, Poplar, Sycamore, Mulberry, Tree of Heaven, Catalpa, Gray Birch (Dogwood, Tulip Tree not hardy in Iowa).
Pecan, Common Fig, Persimmon, Cherry, Peach.	Flowering Dogwood, Eastern Redbud, Southern Magnolia, Crape Myrtle, Holly, Silktree Mimosa, Fire Thorn.	Sweet Gum, Southern Magnolia, Willow Oak, Winged Elm, Flowering Dogwood, Magnolia Grandiflora.	Lombardy Poplar, Siberian Elm, Black Cherry Chinaberry.
Orange, Pecan, Peach	Magnolia, Dogwood	Flowering Magnolia	*For South Atlantic mountain areas, use group 5 lists. For Georgia and Gulf Coastal areas, use Northern Florida lists.
Guava, Avocado, Mango	Golden Shower Tree	Magnolia, Braz. Pepper	

particularly because it grows rapidly, many horticulturists turn thumbs down. The wood of the Silver Maple is so weak and brittle that branches are likely to come crashing down in wind or ice storms. And it is apt to die comparatively young (young for a

tree, that is—which may mean 75 years old.) The oaks have even more members on the recommended list than the maples. The Northern Red Oak is an especial favorite—not only for its shade and beautiful fall color, but because it grows faster than

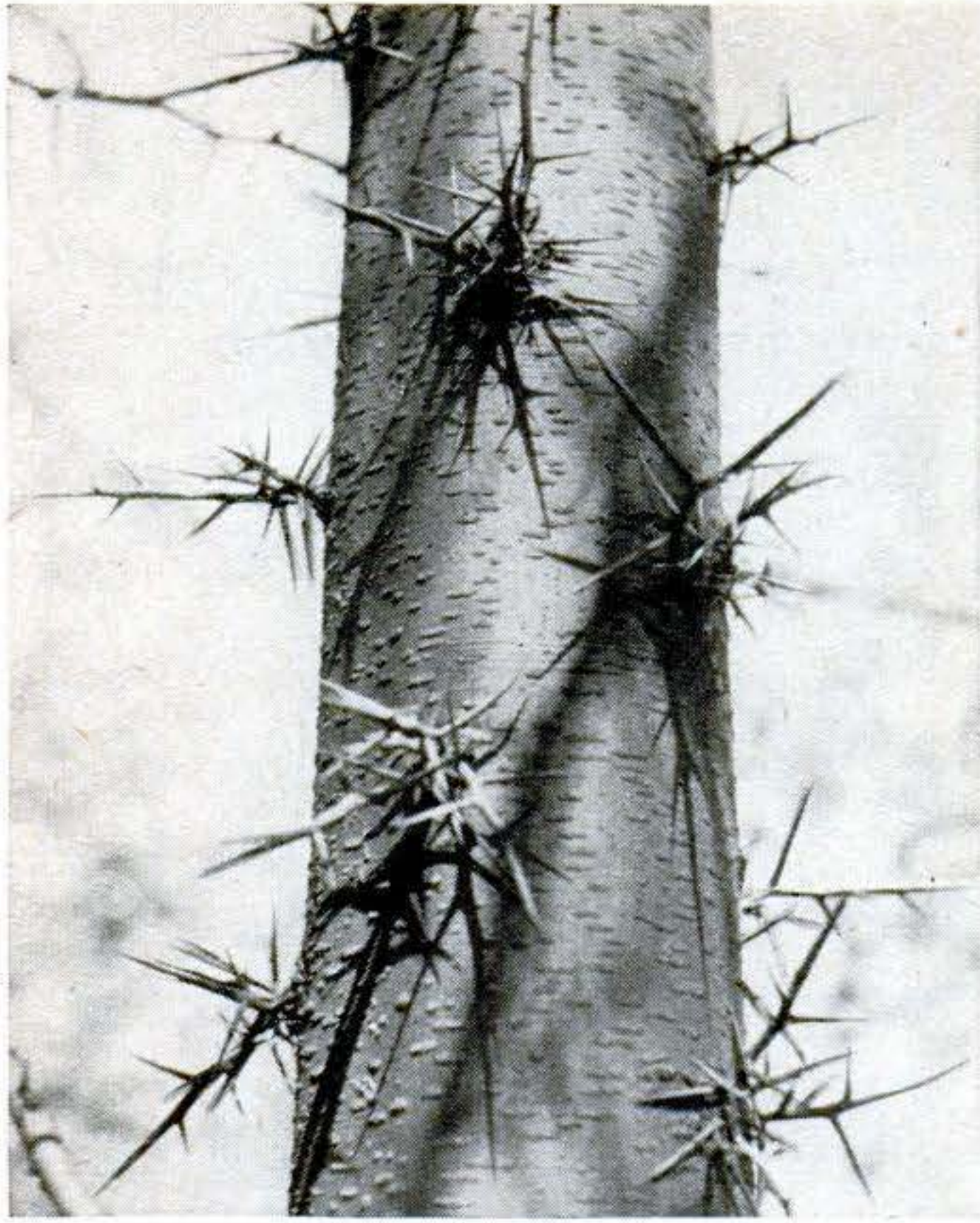

TREES FOR HOMEOWNER TO AVOID include ordinary Honey Locust, whose spikelike thorns endanger children and pets. Same tree has now been bred without thorns or seed pods that must be raked up. Thornless type is hardy, disease-resistant, considered a promising new shade tree. It rates high on the "recommended" list.



RATE OF GROWTH AND EVENTUAL SIZE of Sugar Maple are shown in drawing. Rate is typical of many good shade trees. Sugar Maple's eventual height suits two-story houses better than modern one-story ranch types. Keep eventual size in mind when picking a tree to avoid overgrown look later on.

other oaks. It reaches 70 to 90 feet—like the maples, big for today's average home.

Southern tree men urge the merits of the Live Oak—the massive giant found along the South Atlantic coast. Another favorite, particularly in the Middle West, is the Pin Oak. This makes a fine shade tree.

Beware of the Elm

The oaks would have gotten more votes except for the threat of oak wilt in the north central states. For similar reasons many horticulturists steered clear of the most famous American shade tree, the elm. The Dutch Elm disease—a fungus infection carried by a beetle—has been spreading ever since it was brought to this country in veneer logs a quarter century ago. In some areas elms are also threatened by a destructive virus called phloem necrosis. But some experts recommend this famous tree anyway as "still the best of its kind for those willing to protect it."

Among evergreens, the pines lead in popularity. The White Pine—the tree on the pine-tree flag flown by Yankee minutemen—is recommended for windbreaks. It's the second largest pine, growing 80 to 90 feet high, but you can keep down its size by shearing it. In good soil, it grows as much as a foot a year for the first 20 years. But look out for White Pine blister rust, carried by currant bushes.

Evergreens Make Good Windbreaks

The Red or Norway Pine, often found with the White Pine in our native forests, is another tree urged for windbreaks. Evergreens get the nod for this job because winter foliage is needed to make a dense wall. The Norway Spruce and the so-called Red Cedar—really a juniper—that takes over abandoned New England meadows are also recommended. Although rather slow-growing, the Red Cedar with its fragrant wood and bark is suggested for privacy screens. But keep it away from apple orchards; it carries the cedar-apple rust.

And the apple is pretty important in the eye of the experts. Not only is it way ahead among suggested fruit trees, but it is a good tree for kids to climb. One expert urges getting little apple trees and grafting on several varieties yourself. He also suggests one- or two-year-olds, rather than the more expensive ones of bearing age. Many horticulturists, though, are cool toward the

[Continued on page 250]

Trolleys Power German Tugboats

ELECTRIC tugboats powered through trolley poles riding overhead wires are being tested on a German canal between Zehdenick and Berlin. Batteries, charged by the trolleys, take the tugs through locks and any other spots where the trolleys can't be used. The builders hope to install the system on the Mittellandkanal which crosses all of Germany.

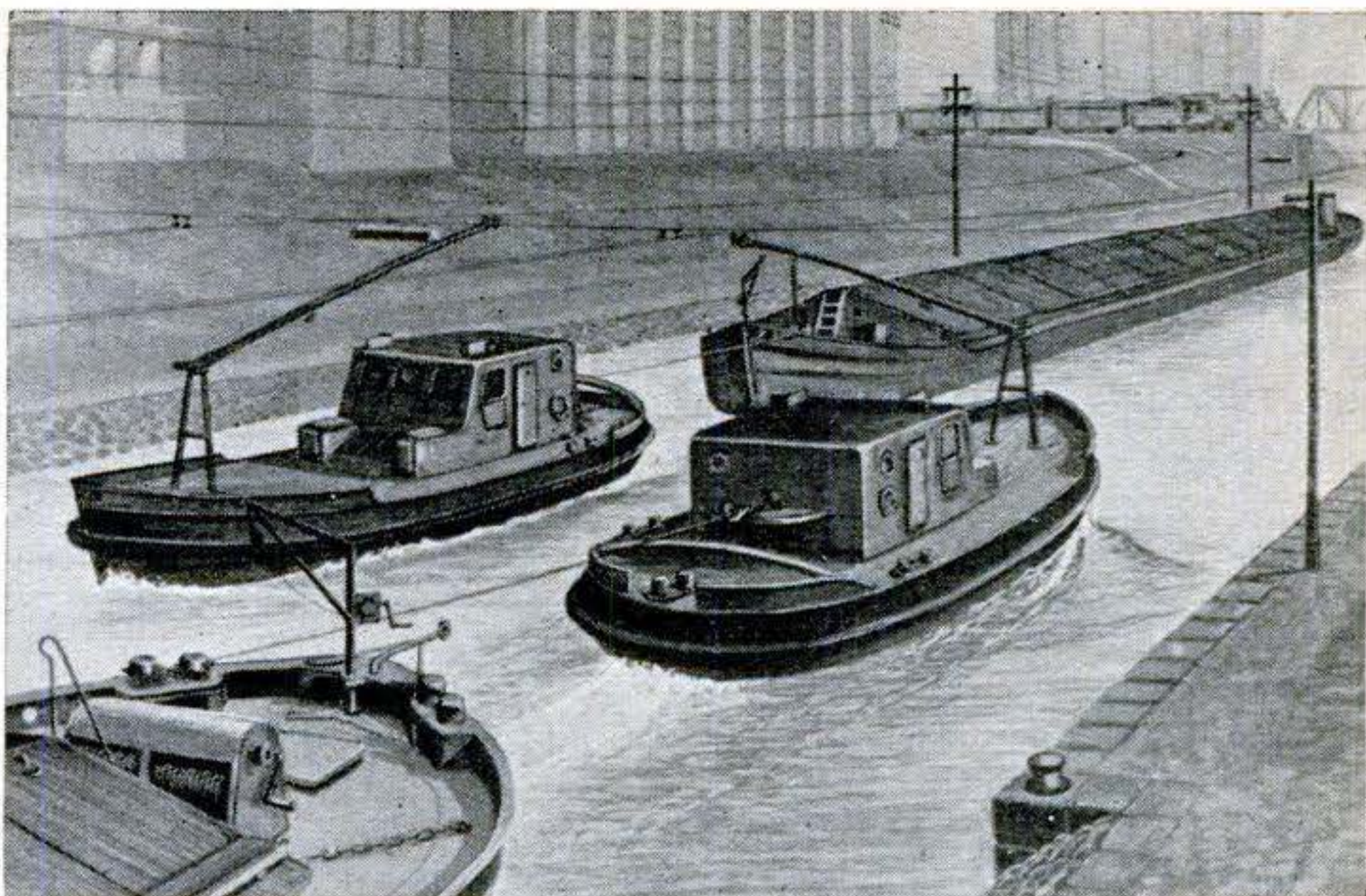

Giant Generators Ride the Rails on Heavy-Duty Flatcar

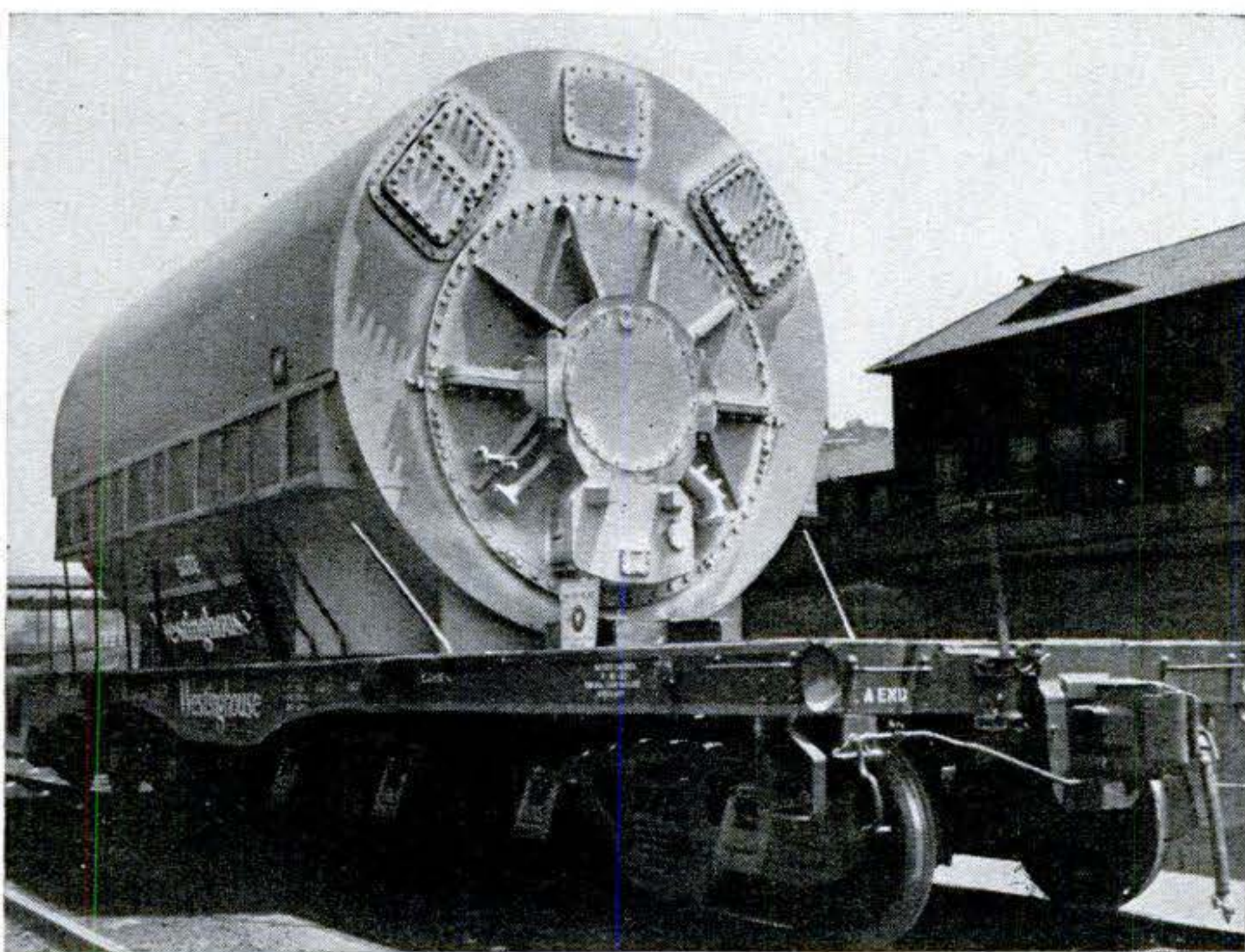

AN ATLAS of the rails, the 106,000-pound flatcar shown at left can shoulder more than four times its own weight. Sixteen wheels on four trucks beneath the flatcar bed won't buckle under a load of 493,000 pounds—more than 246 tons.

The car is used for shipping huge stators and generators and carries all but the very largest generators completely assembled for use. It was built for Westinghouse by the Thrall Manufacturing Co. of Chicago Heights, Ill.

All-Purpose Garden Clipper Runs on Compressed Air

THIS English clipper is driven, cleaned and lubricated by compressed air. It is said to mow a 15-inch swath, trim 2,000 square feet of hedge in an hour and cut one-inch tree limbs. A notch at the tip lops off branches. The entire tool, with its 10½-ounce motor, weighs less than three pounds. R. M. Marples and Son, Parkstone, Dorset, make the clipper, called a Shearomatic.

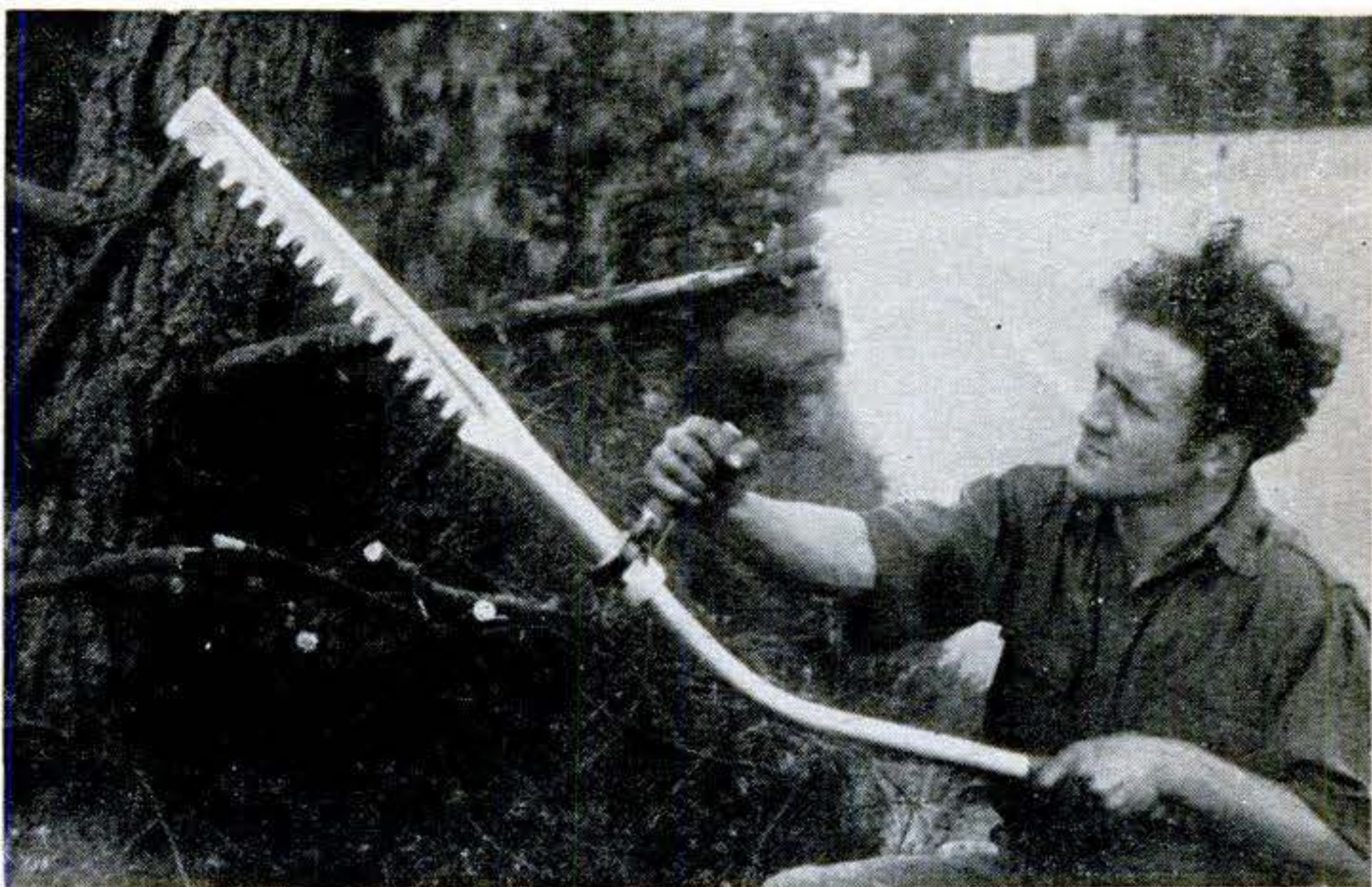

They're sleek, slick, dependable, with twice the horses under the chrome that the old-timers had.

By E. F. Lindsley

Look What They've Done to Motorcycles

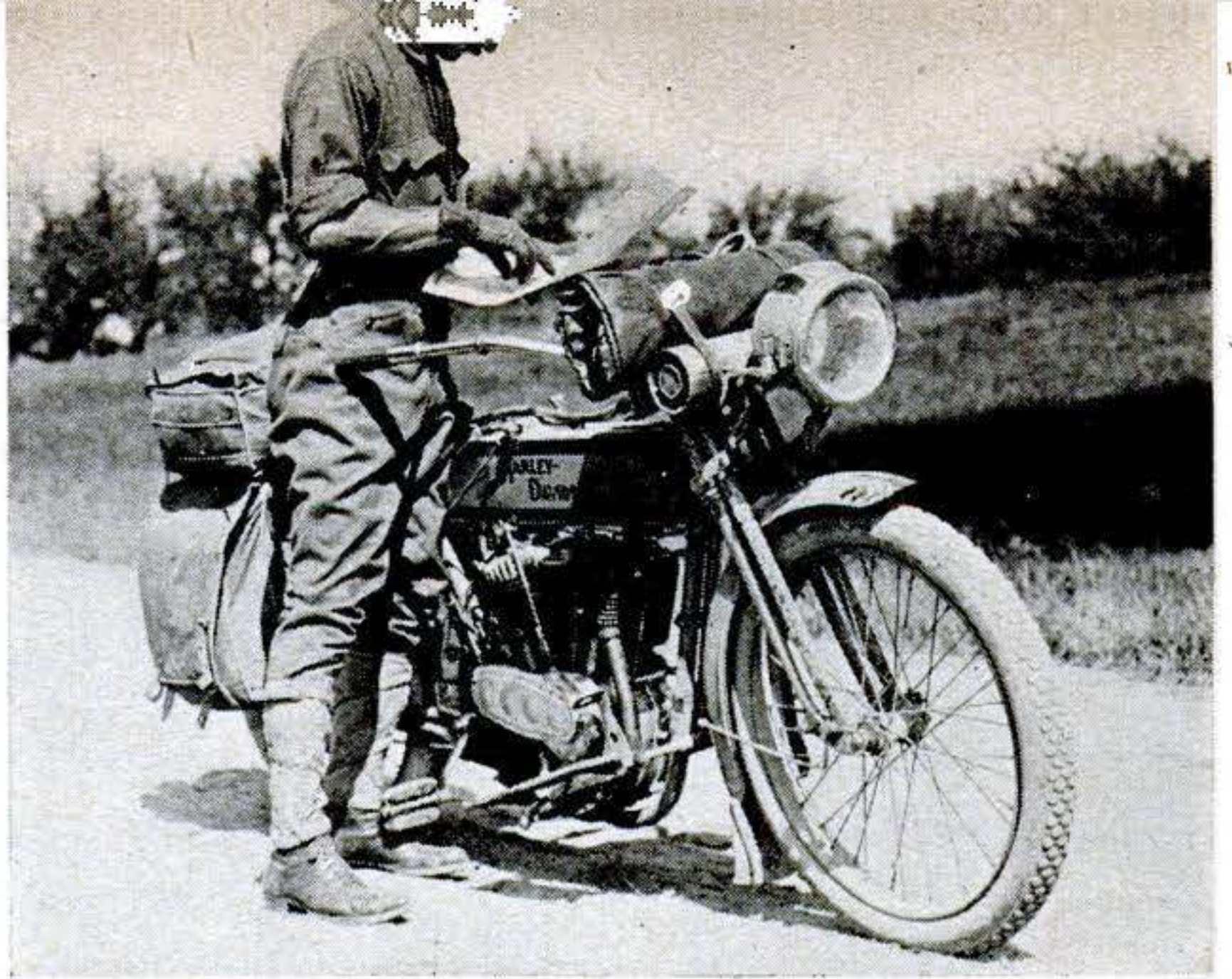

Then Old-time cyclists had to be a rugged, wrench-wise lot. Above, sports-writer Hamilton M. Laing rode this 1914 Harley, with acetylene light and exposed valve rods.

MY FIRST motorcycle, a roaring, smelly, kidney-kicking mechanical bronc, was a 1921 Harley-Davidson. Don't guess my age from that. The bike was older than I was. But it taught me, as such seventh-hand

motorbikes taught thousands of American boys, what made gas engines go.

Sporting a 61-cubic-inch motor with naked push rods and rocker arms, this job was once advertised to have "all the speed



EDITOR'S NOTE:

Back in 1901 two Milwaukee schoolboys dreamed of putting an engine on a bicycle. With the help of Walter Davidson, a railroad machinist, Bill Harley and Arthur Davidson cast and machined the parts for a three-horsepower engine. Their motorized bike ran, others wanted machines like it and the boys soon found themselves in business.

From that start in a 10- by 15-foot shed workshop, the Harley-Davidson Motor Co. has expanded to three modern factory buildings and built more than 682,000 motorcycles to date.

To learn how a former rider would react to the newest machines, we asked E. F. Lindsley, who hadn't ridden a motorcycle in years, to try the new Harley-Davidson Model K. Here's what he found.

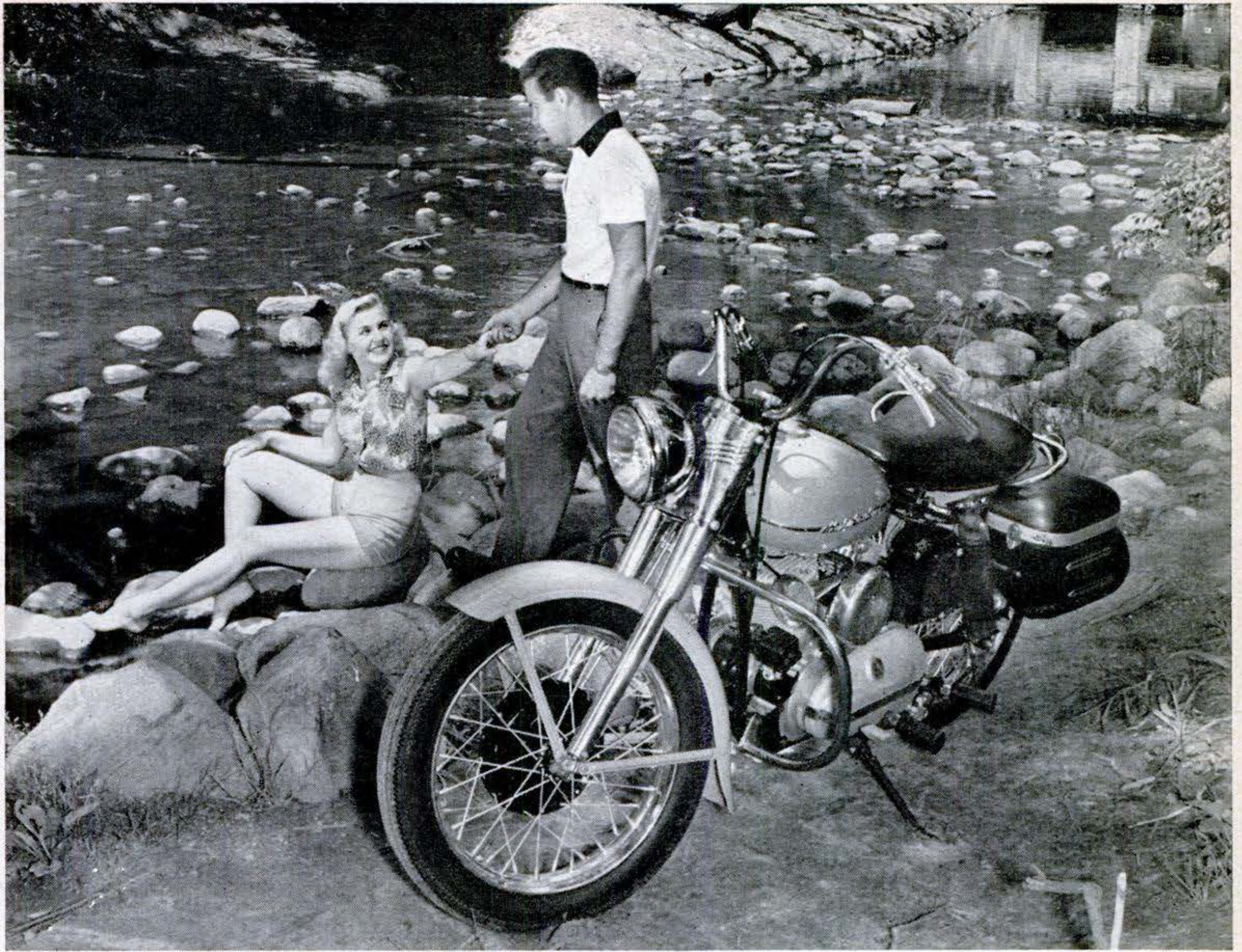

Now This sleek Model K Harley-Davidson, a 45-cubic-inch twin, has twice the power of old machine at left, plus a four-speed, foot-shifting transmission, hand-oper-

ated clutch, swinging-arm rear suspension, hydraulic shocks and complete battery-generator electric system. You don't have to be a bronco buster-mechanic to ride nowadays.

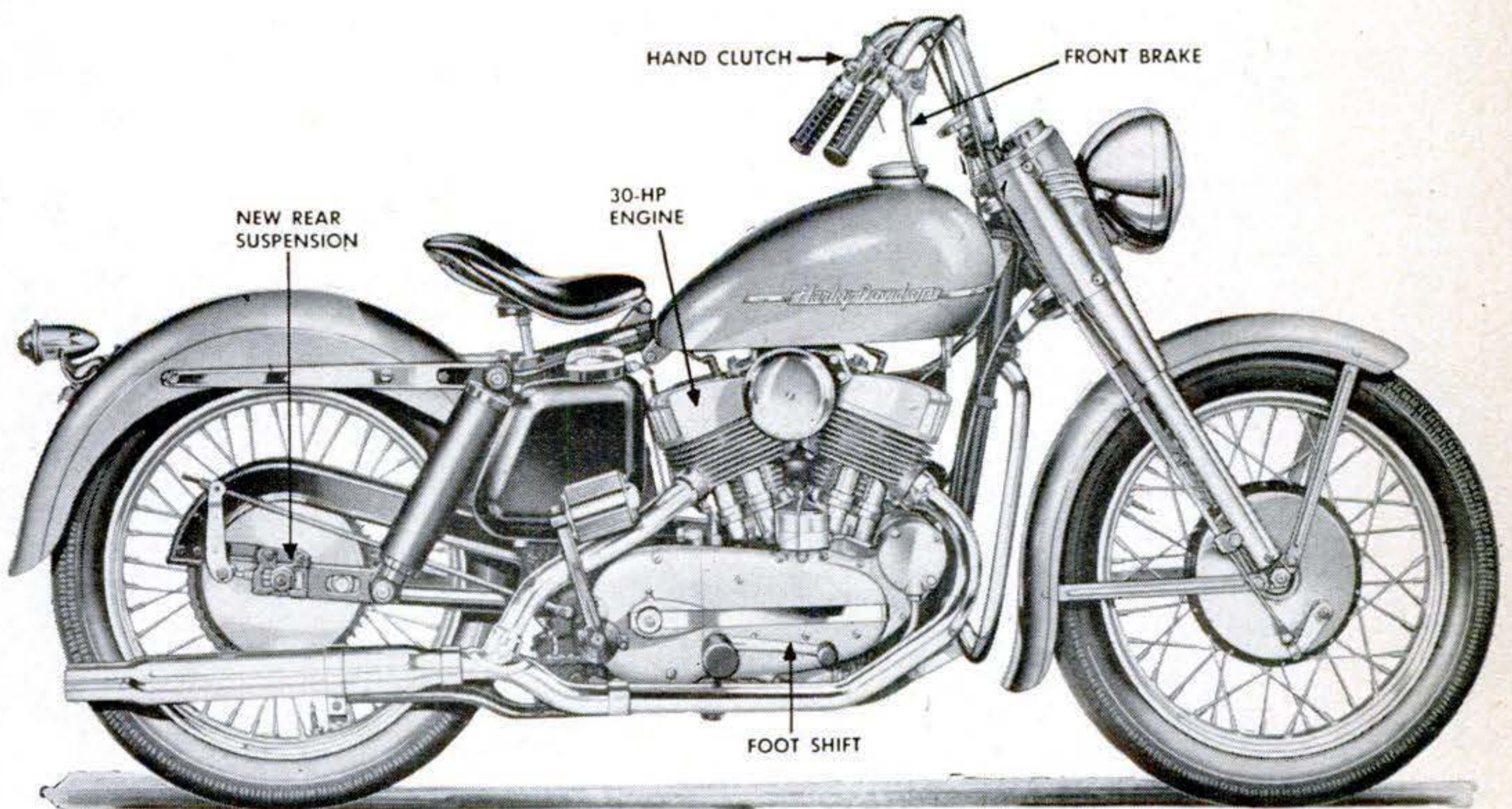

anyone could desire." So it had; your yen for scat was tempered by the spine-jolting ride it delivered. What finish was left on it had once been (the catalogue said) an attractive olive drab.

Without getting out of my four-door sedan, I could tell that today's motorcycles are chrome-and-color beauties. But I had to get one between my knees to find that the real difference just starts there.

The one I tried out was the new Model K Harley-Davidson. This 45-cubic-inch twin is not only miles ahead of that ancient 21-J but far out in front of earlier postwar models.

The factory rolled out a machine for me and I eased into the saddle. They've done marvelous things to that upholstery you steer with (as any rider knows, it's done by the seat of the pants). Foam rubber, two sprung seat posts, and anatomy-wise contouring do the trick.

Where's the Shift?

Looking for something familiar to show I was no beginner, I latched onto a lever grip on each handle bar. "Front and rear brakes, eh?" I said.

Sammy Greco, the Harley man who was checking me out, chuckled at that. "Left one is the clutch. It gives you a faster shift than the old foot type."

My left foot groped speculatively where the clutch used to be. Then it settled down on a comfortable footrest just above a husky pedal. This was the rear brake. The right-hand grip was the front brake.

Facts on Model K 45 Twin

Engine: two-cylinder, air-cooled, four-cycle V type; piston displacement, 45 cu. in.; compression ratio, 6.5 to 1; bore 2 $\frac{1}{4}$ "", stroke 3 $\frac{13}{16}$ "; 30 hp. at 5,200 r.p.m.; torque 32 lb. ft. at 4,000 r.p.m.

Weight: 446 lb. (no load); per hp., 14.9 lb.

Transmission: four-speed constant-mesh; sliding-dog clutches.

Gear ratio: 4.77 to 1 (in high gear).

Clutch: multiple dry-disk type.

Drive: motor to transmission, $\frac{3}{8}$ "-pitch triple chain; transmission to rear wheel, $\frac{3}{8}$ "-pitch single-row chain.

Rear suspension: swing arms pivoted on preloaded Timken bearings.

Front fork: load transmitted by long helical springs, hydraulically damped.

Top speed: 85 m.p.h.

Tire size: 3.25 by 19.

"What am I supposed to shift with, my teeth?"

Patiently they told me. "Biggest change in years. You shift with your right toe." I looked down and found a pedal I hadn't shoved yet.

"Hook your toe under the pedal and pull up." I flipped my toe and felt the constant-mesh gears do their stuff smoothly.

"You've got four speeds," Greco explained. "The lower gears give better acceleration. Top gear is a honey—a sort of overdrive for cruising."

30 Horses Have Zip

I knew the model K nudged the scales at nearly 450 pounds, so Greco's last words raised my eyebrows. "An overdrive ratio with a 45-cubic-inch engine?"

"Try it," said Chris Spexarth, Harley's assistant chief engineer. "I think you'll find 30 horsepower plenty hot."

"You mean 30 horses stripped down, without accessories, on the test stand?"

"No, sir," he snapped. "We mean 30 horsepower with full accessories, at a 6.5-to-1 compression ratio, on regular gas."

Later I saw the test curves. Horsepower peaked at 30 at 5,200 r.p.m. My old 21-J hit 16 hp. at a screaming 3,250 r.p.m. and fell off after that.

Closing the choke a bit, I retarded the spark (left handle-bar grip), opened the throttle slightly (right handle bar) and turned on the ignition. Then I booted the kick starter, and the engine boomed into a smooth rumble on the first try.

Left hand on clutch, flip into low with right foot, and let in the clutch. Smoothly the K took off. Grip the clutch, flip up right toe into the next gear, and ease in the clutch. The foot shift was fine.

Takes Bumps with No Bounce

I was musing on the nice handling and extra zip in third gear when I found myself almost on a big hummock, where concrete had buckled from the heat. There was no chance to swerve. Instinctively I rose off the seat to soften the jolt.

It came as a ripple. No jolt, no slamming wallop from the rear wheels. This was new, too—automobile comfort with motorcycling zest.

With traffic thin, the four-lane highway west of Milwaukee invited speed. Acceleration was excellent as I opened up, but top speed seemed a bit low and the engine was

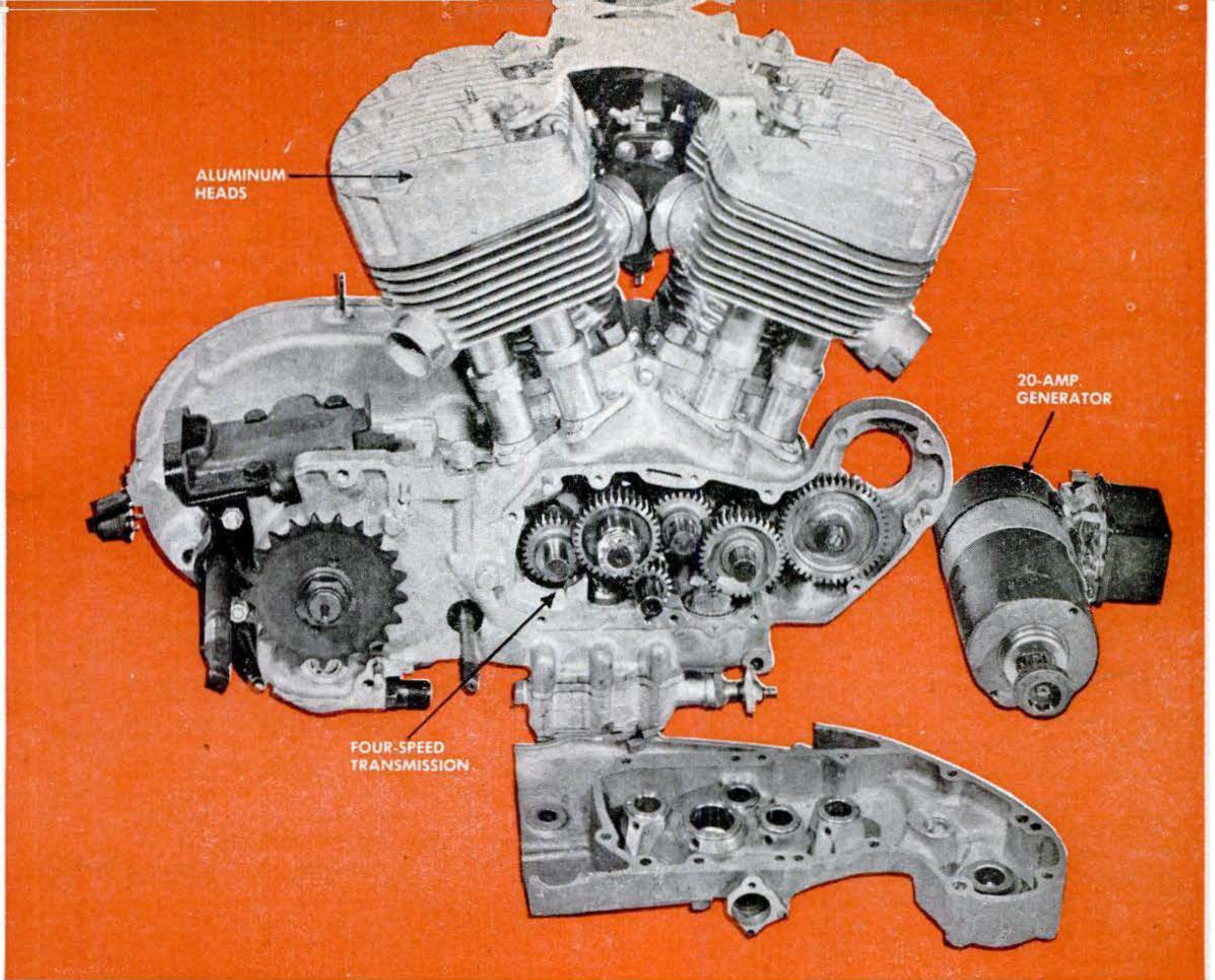

NEW ENGINE develops 30 hp. Open crankcase above shows integral constant-mesh four-

speed transmission. Cylinder walls are oiled by .040-inch jet. Generator gives 20 amps.

winding up hard. Then I remembered that fourth gear.

The shift was a revelation. Opening up, I hit top speed (85 m.p.h.) easily, then settled back to the 65-mile speed limit.

A short stretch of gravel roughened by storms again demonstrated the effectiveness of the new rear suspension. Two swinging arms, pivoted on roller bearings, have a full five inches of travel, with coil springs and hydraulic shocks to soak up the bumps. I found no sloppiness or fishtailing.

Back at the plant, chief engineer Bill Harley showed me through the modern testing department that puts machines and accessories through their paces before the riders do. His point—and he convinced me—was that you don't have to be a mechanic to ride a motorcycle these days.

Looking the new machines over, I still find a soft spot for the old 21-J. It was one of a long line of honorable ancestors, and it has some kids it can be proud of. **END**

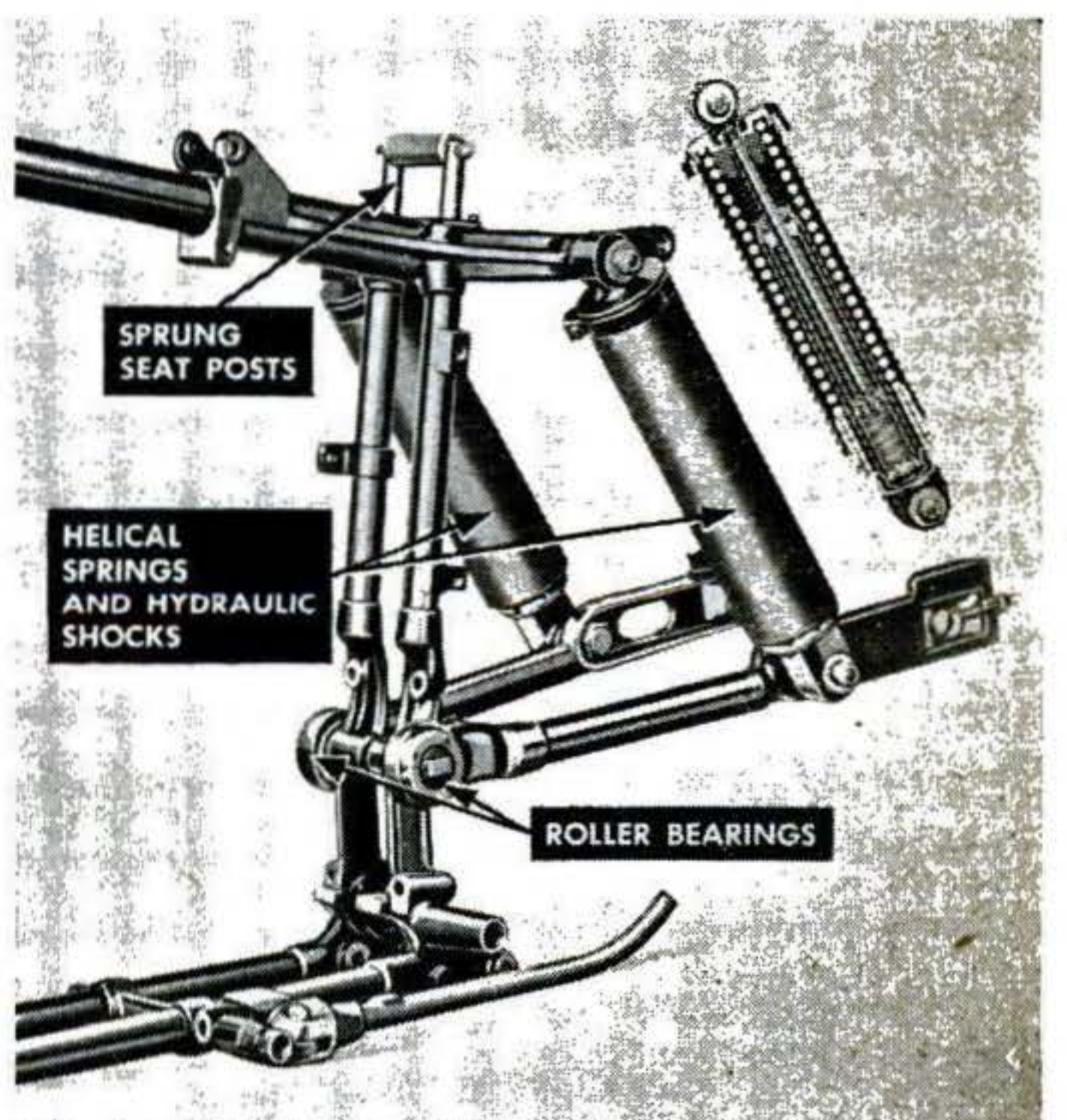

REAR SUSPENSION, a rigid fork on old machines and a sliding mount with 1½-inch travel on later models, now consists of two roller-bearing pivoted arms.

P.S.

Last minute news & notes...

U.S. AIRCRAFT CARRIERS will make oxygen for their high-flying pilots. Special plants for extracting liquid oxygen from the air are being installed on vessels of the Midway, Essex and Forrestal classes.

PERMANENT MAGNETS of a new kind, among the most powerful ever made, have been produced without using any critically scarce nickel or cobalt. Naval Ordnance Laboratory scientists make the material, called Bismanol, by treating powdered bismuth and manganese at high temperatures.

A SELF-LIGHTING CIGARETTE, talked about for years, may at last reach the market. A company in California plans a million-dollar plant to make cigarettes that would be lighted by rubbing their emulsion-coated tips along the side of the package.

URANIUM will be produced as a by-product by six of South Africa's famous gold mines beginning this fall. Treatment of waste "slime" from gold production will yield uranium oxide, atomic raw material.

ANTIBIOTICS are usually thought of as lifesaving medicines--but last year \$17,500,000 worth went into hog and poultry feed, too. For reasons still not completely understood, the germ killers make livestock grow faster and fatter.

SUBMARINES of France's new Narval class, advance tips say, will be faster underwater than afloat--and are expected to be able to dive far below the traditional depth limit of about 250 feet.

MOLTEN SULFUR will be the unusual cargo of a newly launched barge, which will carry it from a mine near Liberty, Tex., to Houston for making sulfuric acid. Shipping the sulfur in the molten state will save later

reheating. The barge's 167-foot insulated tank will keep 1,000 tons of the chemical at 300°.

GERM WARFARE is being waged against that scourge of Australian farmers--the rabbit. A virus called myxomatosis, intentionally spread in test areas, killed tens of millions of the pests in 15 months. The disease does not affect other animals.

WANTED: "Middle-aged" water--at least five years old, no more than 20--by Prof. W. F. Libby, University of Chicago, who seeks at least 30 gallons to test its content of radioactive tritium. He obtained some, but not enough, from an undertaker's fire extinguisher and a housewife's water jug. He hopes to find larger amounts in old hot-water heating systems, the kind that keep circulating the same water over and over again.

BRIGHT SCARLET LIFE RAFTS are likely to become the latest U.S. Navy style. Tests show that they can be spotted more easily by rescuers than the present chrome-yellow ones.

HOME RADIO SETS now can be mass-produced mechanically from start to finish. Formerly electrical connections had to be hand-soldered. Now even this has been eliminated, Motorola Inc. announces, by its adoption of completely "plated" circuits.

LIQUID METAL, which acts as a heat-transfer medium in modern atomic-reactor designs, may serve the same purpose in future steam power plants, too. Molten sodium, a metal of low melting point, carries heat for superheating steam in a power-plant design proposed by two engineers of the Knolls Atomic Power Laboratory, R. H. Shannon and J. D. Selby.

THE NATION'S FIRST high-power, ultra-high-frequency TV station, now under construction by GE, will be delivered for erection at Reading, Pa., this December. The 261-kilowatt station, WHUM-TV, will cover most of eastern Pennsylvania and parts of Delaware, New Jersey and Maryland.

The Editors

MECHANICS *and* HANDICRAFT

REG. U. S. PAT. OFF.

5 Ways to House Your TV Set

BUILT INTO WALL, TV set takes up no space in room, is hidden when not in use. Wall also houses radio, phonograph and speaker, stores records and books.

More people spend more time looking at your television set than at any other piece of furniture. You can improve its looks.

**By Robert Gorman
and Joseph Aronson**

YOU parked that shiny new 20-incher in a place where it's in your way. Now you're wandering around the living room trying to find a suitable place to put it.

Or maybe you haven't bought one yet, and you're trying to decide what type to get. A console would look nice but cost a lot. Maybe you already have the radio-phonograph part anyway.

A table model would be ideal—but where to put it? It has to go where it can be seen by a number of people, and it ought to be 25" to 30" from the floor for proper viewing. That usually means putting it on top of

something you already have. It would be bulky, it probably wouldn't match anything in the room, and it would steal valuable table space.

Actually, table sets are not only considerably cheaper than consoles, but they are vastly more flexible. The average modern set is roughly a cube measuring 20" each way. That means you can squeeze it into some mighty small spaces. With a little ingenuity and work, you can put it on its own harmonizing table, fit it into a bookshelf, hide it in a wall, even cart it from room to room on a wheeled tea table.

1. Tables. A small table built to match or complement the receiver will make it look at home against a wall, in a corner or

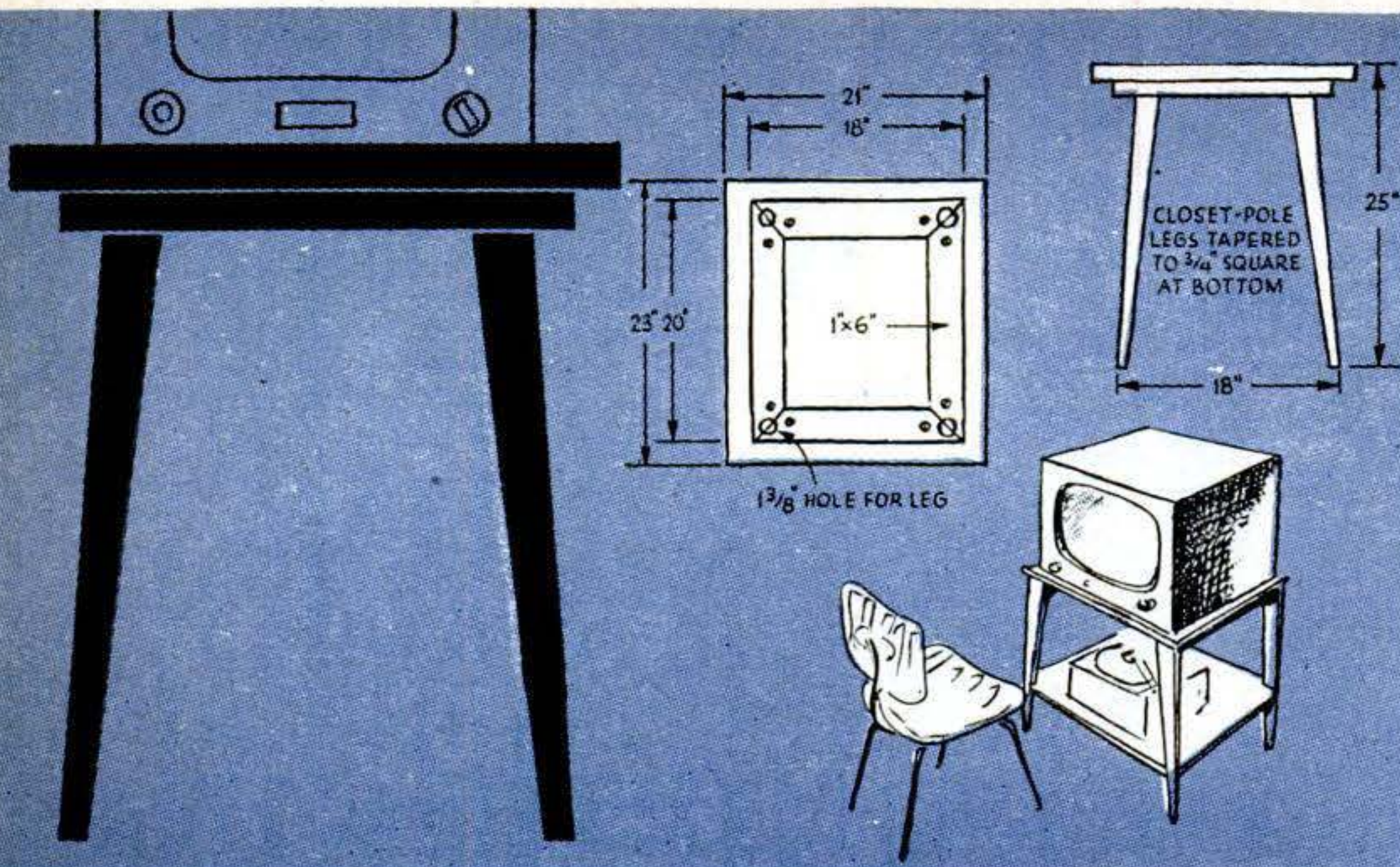

1 TABLES. Take your pick of the simple one above or the more versatile one on the facing page. Top for table above can be $\frac{3}{4}$ " plywood, or pine boards edge-glued together. Mitered frame, glued and

screwed to underside, strengthens top and provides holes for closet-pole legs. Table is designed for 20" set; for smaller models, lengthen legs to raise set to proper height. Alternate version (above center) adds shelf.

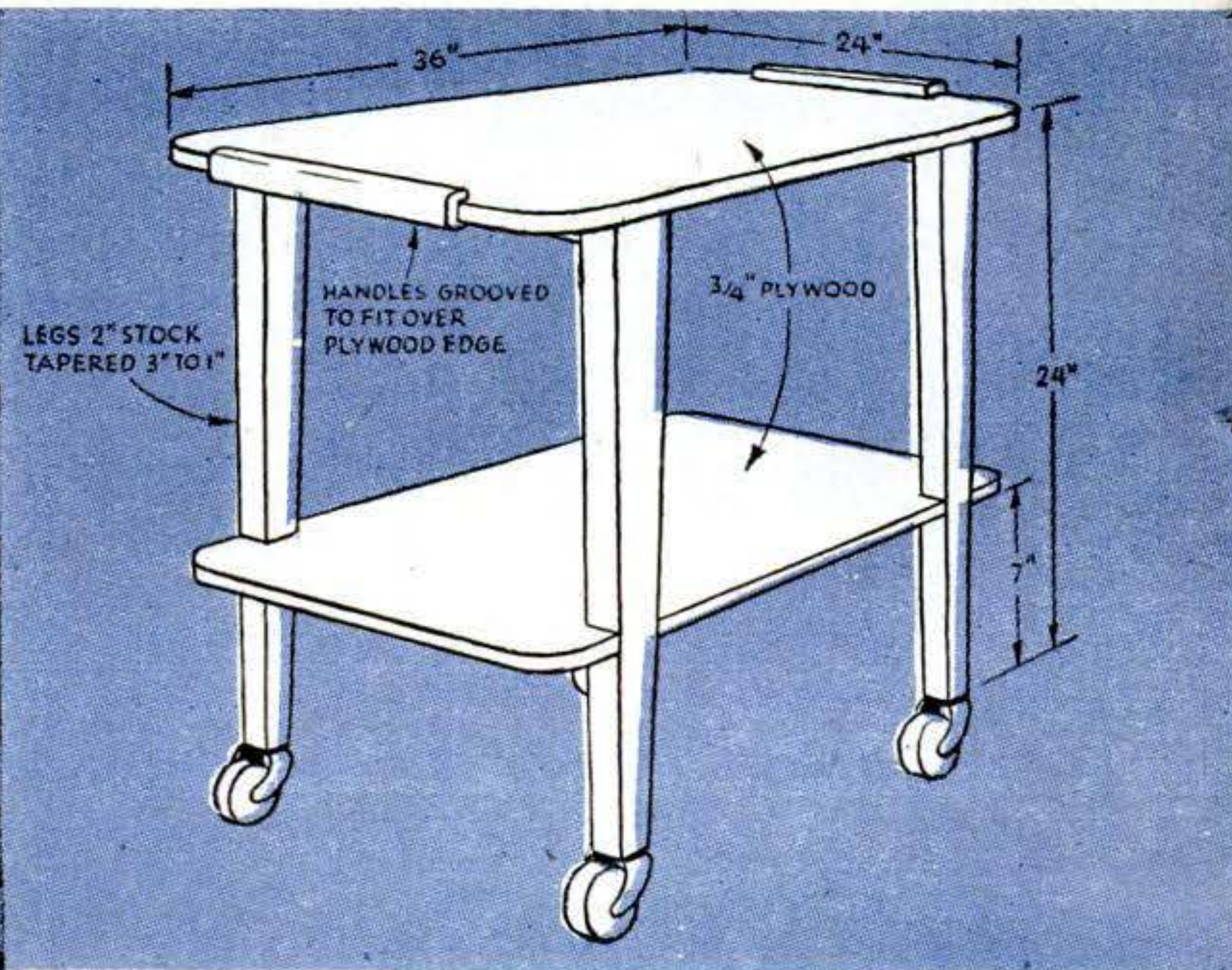
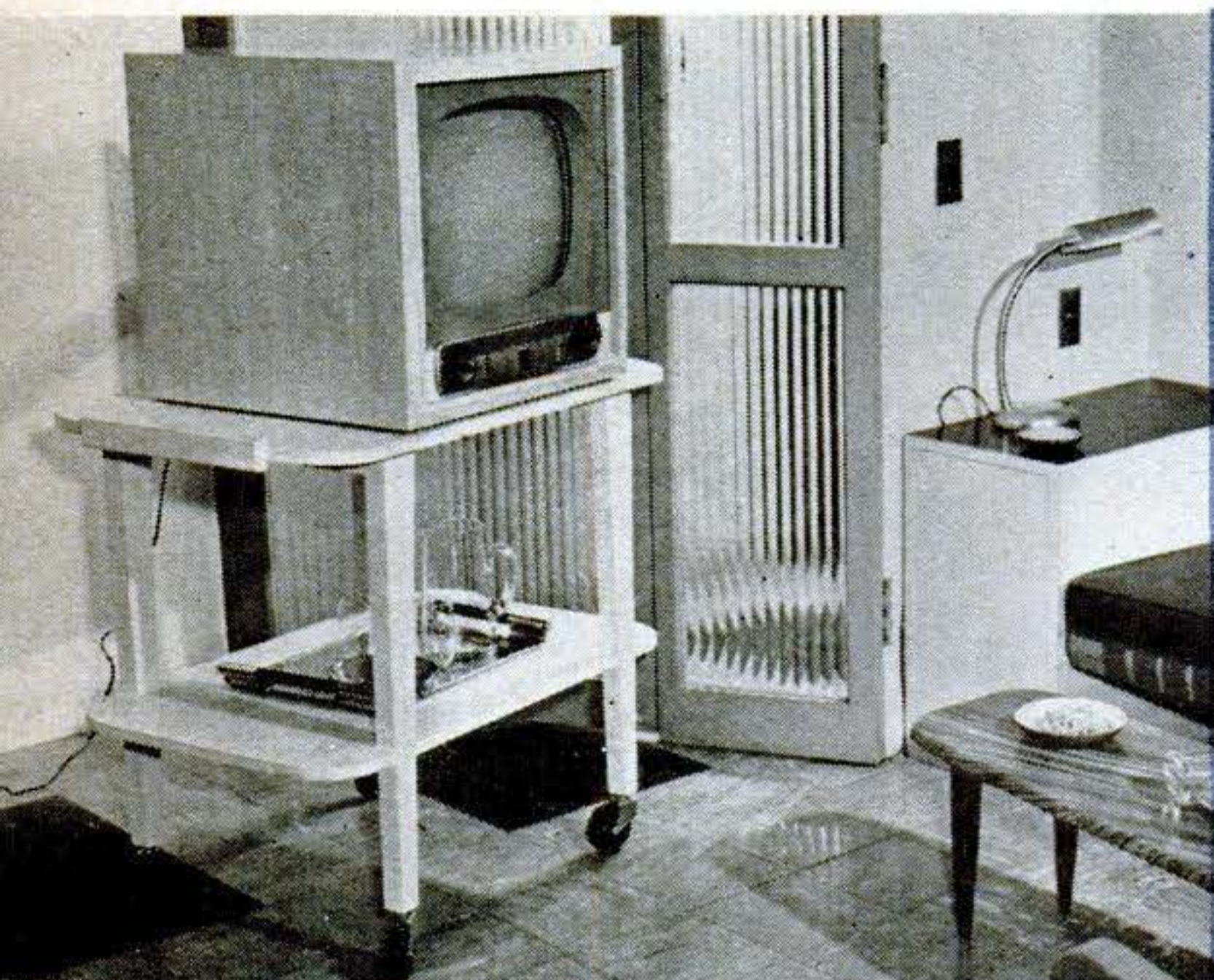

2 PORTABLE TV. A wheeled cart will roll out your set when you want it, then store it neatly out of the way when you don't. This one is made of birch plywood with solid-birch legs to match birch TV cabi-

net. For a painted cart, use less expensive fir plywood. Legs are glued and screwed to two cross pieces to which top is then glued and screwed. Shelf, notched to take legs, is doweled and glued in. Casters are 3" in diameter.

even in the middle of the floor to divide off two parts of a large room. The photos and sketches on this and the next page show basic tables that can be built to meet a variety of needs.

The first is little more than four legs and a top. The second adds a small drawer to keep TV schedules handy and has a swivel base so that the set can be viewed from any part of the room. On either one, make the top 2" larger than the set, including any

picture-tube overhang in back of the set.

2. Portable TV. If you don't want to give up wall space for your set, you still have lots of choices. A wheeled cart will serve up television as easily as tea—and give you both wherever you want them.

It is an ideal answer to the very common complaint that the best place to *keep* a set is not the best place to *view* it. Maybe you have an alcove in a hall that's going to waste. The tea wagon will fill the space

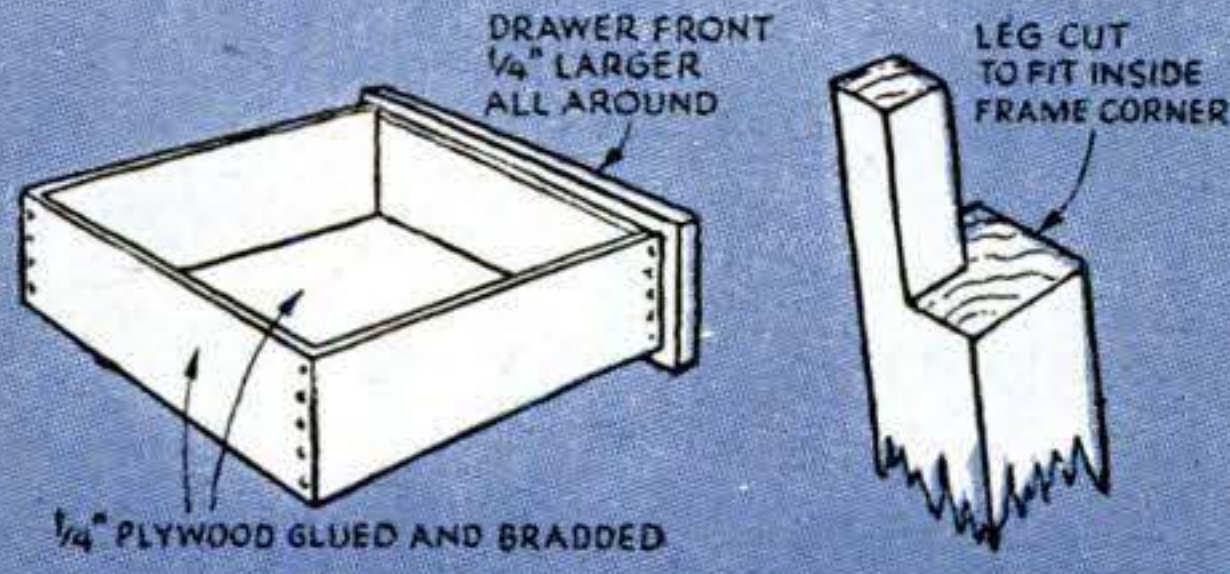
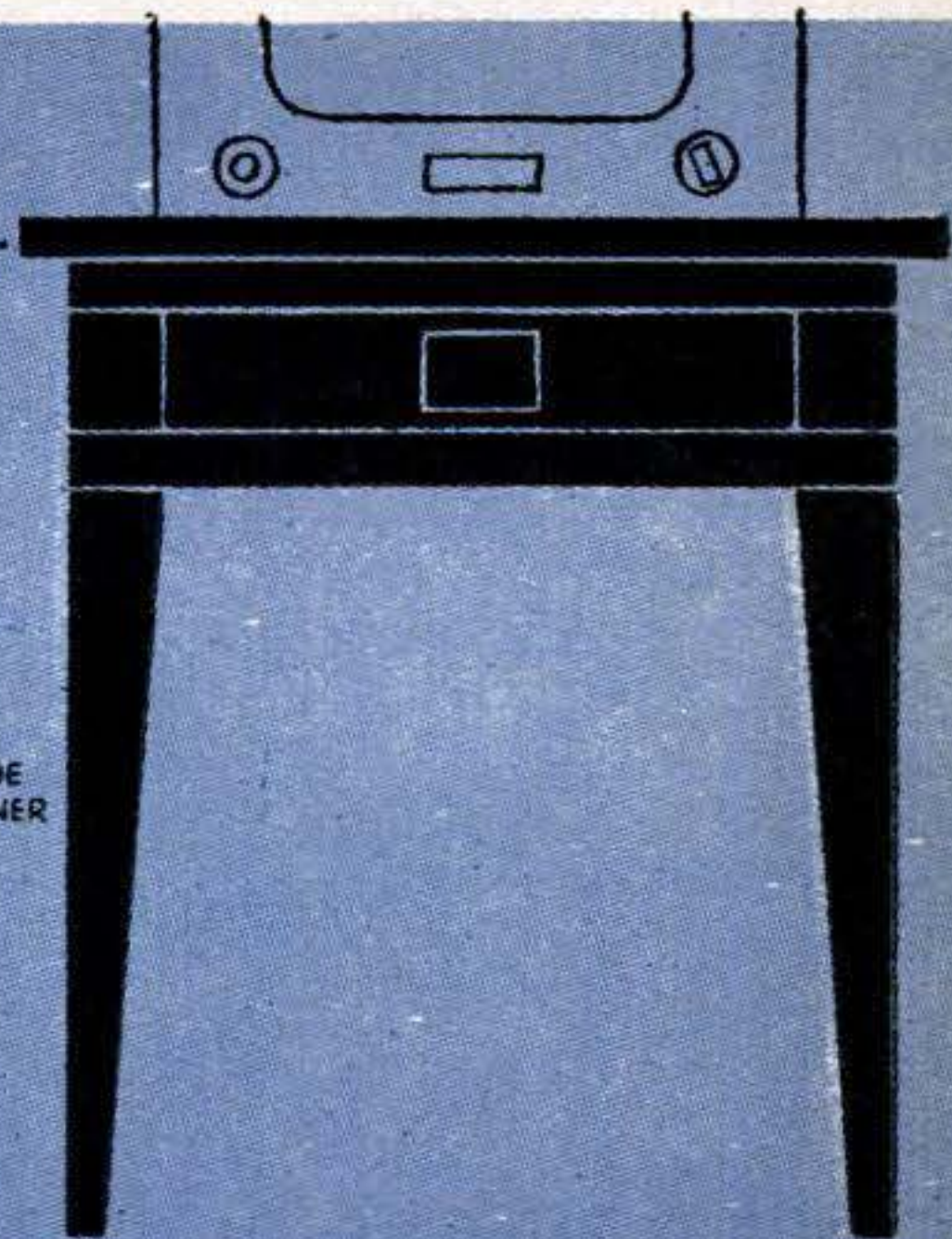
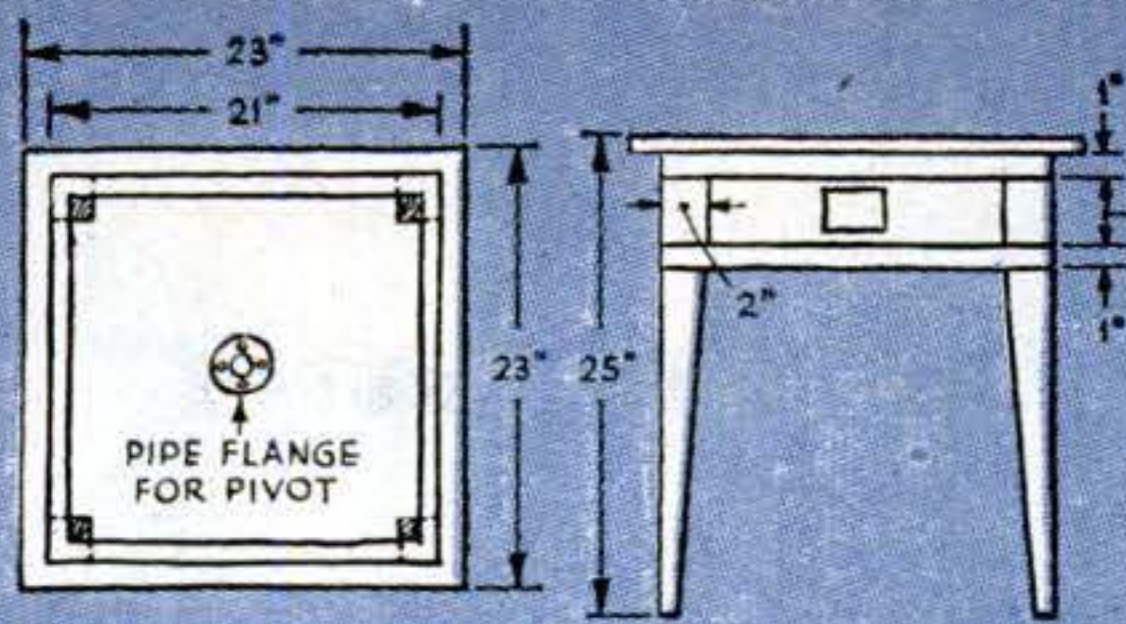
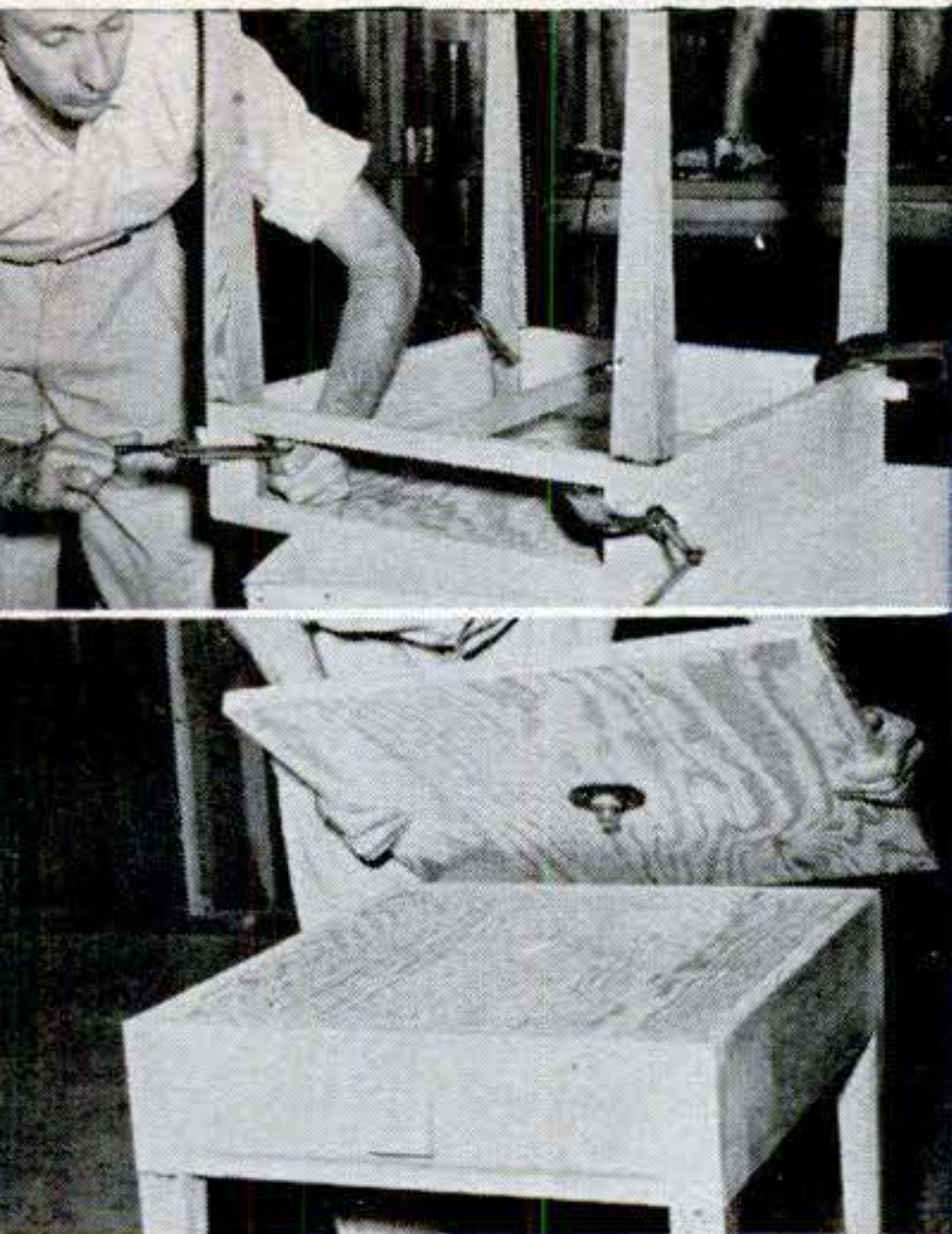

TURNTABLE BASE and storage drawer make this table do several jobs. Top is $\frac{3}{4}$ " plywood glued and screwed to $\frac{3}{4}$ "-pine side frame. Notched legs are glued into frame, using C clamps and V blocks to hold them securely

during drying (upper left). Rotating base pivots on short length of pipe screwed into pipe flange and inserted in hole in table top. Table shown here and one on facing page were designed by John Rogers of Dallas.

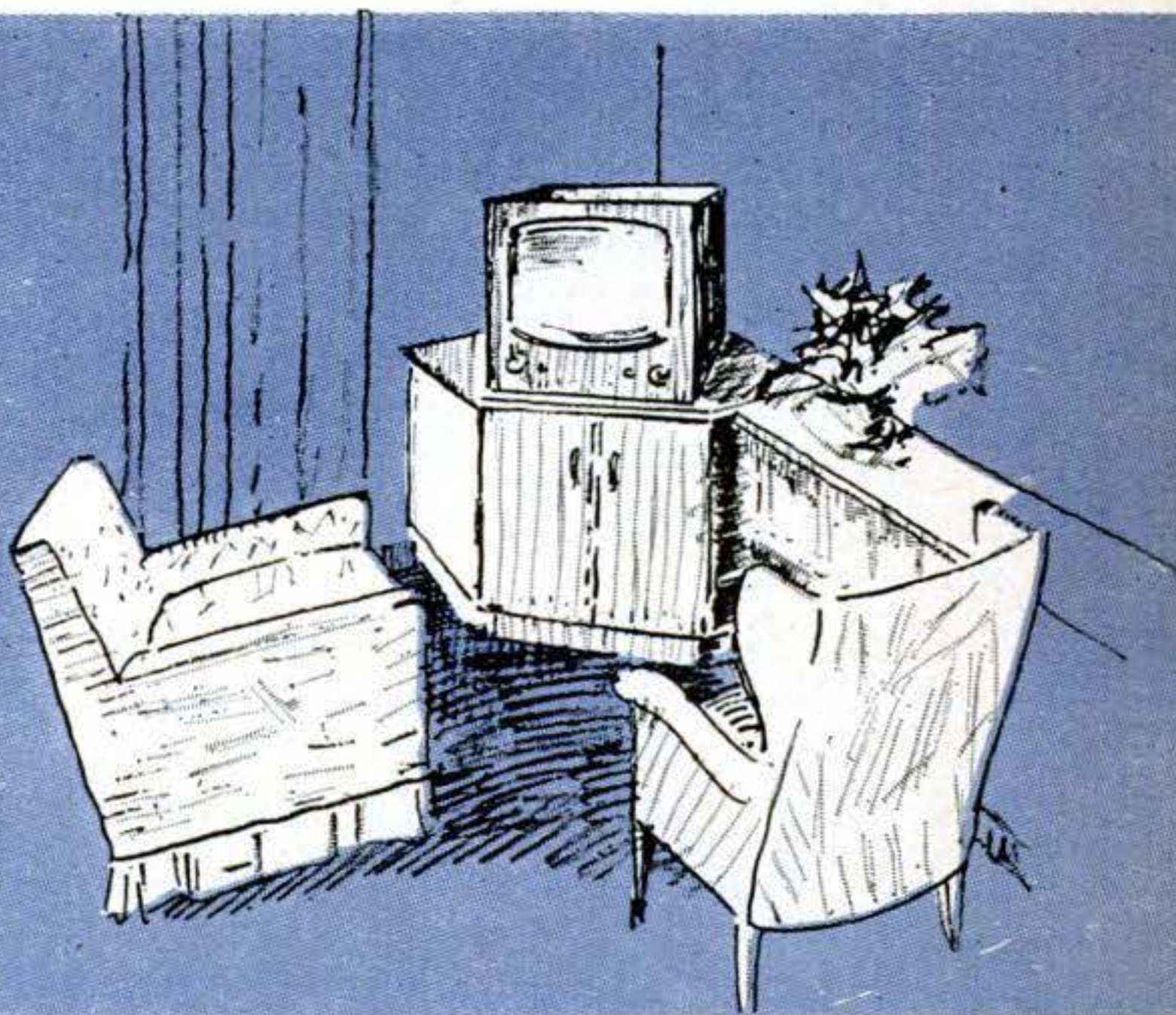
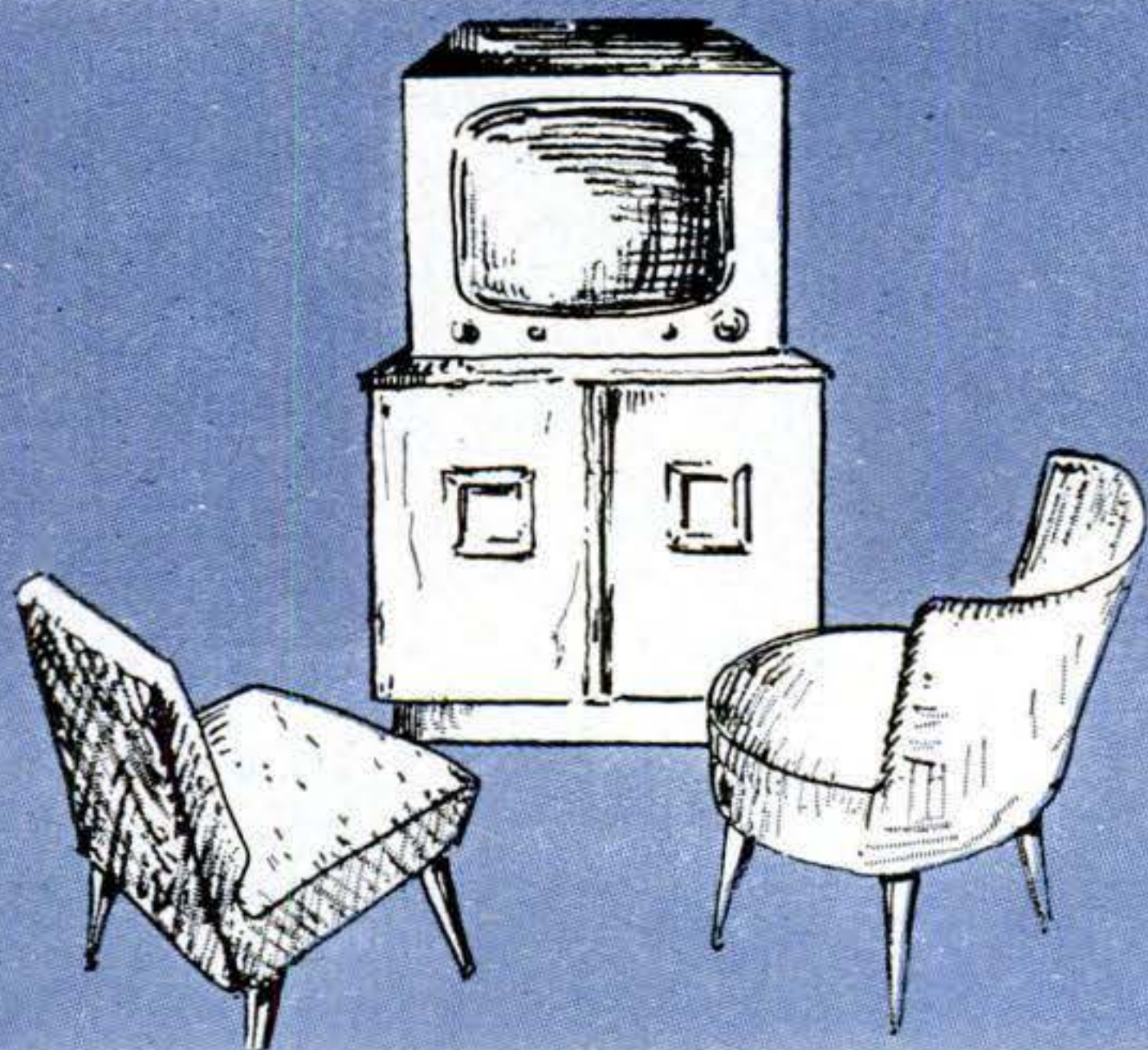

3 CONSOLE BASE, essentially just a box made of $\frac{3}{4}$ " plywood, is easy to build, provides a lot of storage space below set. For best appearance, miter corners to conceal plywood edges. Toe recess should

be about 2" deep, $2\frac{1}{2}$ " high—higher in back if you want cabinet to clear baseboard and sit flush against wall. At right is similar cabinet designed to fit in a corner. Bases should be 25" to 30" high, depending upon size of set.

attractively during nonviewing hours, and when you want to watch a program all you have to do is wheel it into the room.

You can angle it toward your favorite chair and shift it around as others join the audience. You can roll it into the dining room so that you can watch it while you're eating, take it outdoors with you on hot summer evenings, and if you have a one-floor house, even move it into the kids' room so that they can have it when company

comes and you don't want to be disturbed.

If you use an outdoor antenna on your portable receiver, tap the lead-in at several points and install twin-lead connectors so that you can plug in the antenna when you plug in the set.

3. Console base. Made of $\frac{3}{4}$ " plywood, this is actually a simpler construction job than the tables. It blends well with the more massive modern furniture and has the advantage of making use of the space below

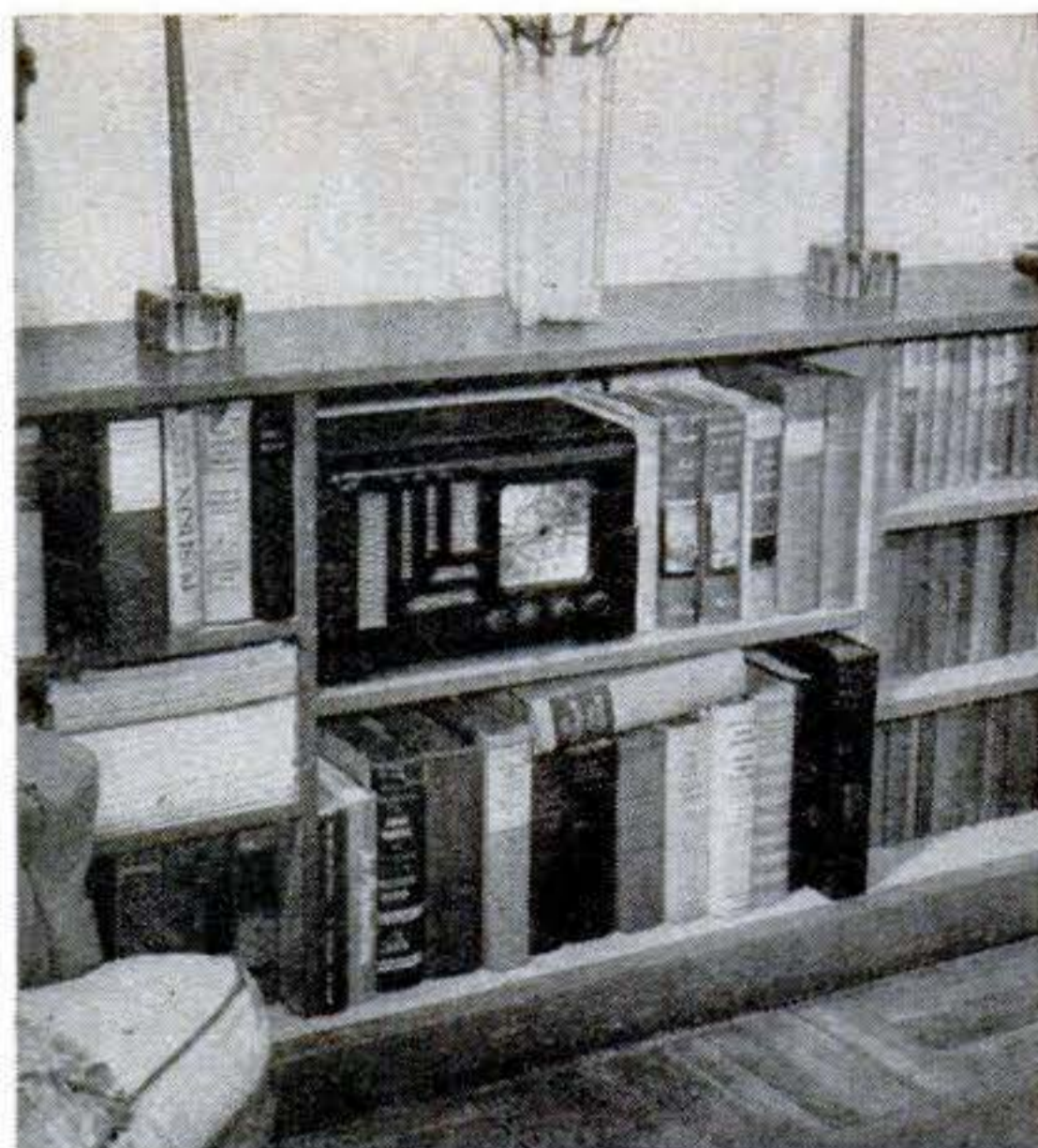

4 EXPANDING A BOOKSHELF is easy way to fit TV set into existing room arrangements without stealing much space. Here center section of old bookcase (right) was built out with plywood at the original

height to take the set. Shelves and doors were then added to house radio and phonograph inside. Bookshelves blend well with set, add horizontal lines to reduce massive appearance. For another version, see below.

the set. You can house a radio and phonograph in the lower portion or just use it for extra storage.

If your furniture layout leaves no room along a straight wall, either a table or console base can be adapted for use in a corner.

A screen slanted across a corner usually faces the longest dimension of the room so that it can be seen by the most people in the greatest comfort. Angling any piece of furniture, however, is likely to make it somewhat conspicuous. Where possible, a corner table or console base should continue the lines of other furniture in the room. The sketch on the preceding page shows how a console base is tied in with a bookcase so that both seem to form a single unit.

A triangular cabinet wide enough to take the full depth of most sets would measure about 60" on each side. An installation as

big as this would overpower most average-size rooms, beside wasting wall space. Lopping off the points of the triangle at the sides, as shown in the sketch, not only cuts much of the bulk but also provides flat sides against which you can place bookshelves, storage cabinets or other furniture.

4. Expanding a bookshelf. If you have bookshelves along a wall, you can borrow a little of their space without altering the original plan—and without banishing your books to the cellar.

The low bookcase shown was originally divided into three sections by vertical partitions. The center section, just the right width for the TV set, was built out to double depth with plywood panels glued and screwed to the existing uprights, forming a support for the set.

The full, floor-to-ceiling bookcase gave up parts of four shelves to create a shallow

PULL-OUT CABINET fits in shallow alcove made by removing four shelves from center of tall bookcase. Cabinet, made of $\frac{3}{4}$ " plywood with space inside for radio and phonograph, has non-castering wheels that let it roll straight

in and out without turning. Wheel mounts are screwed to underside of raised bottom, and sides are carried down almost to floor to hide them. Turntable on top permits set to be angled when cabinet is extended.

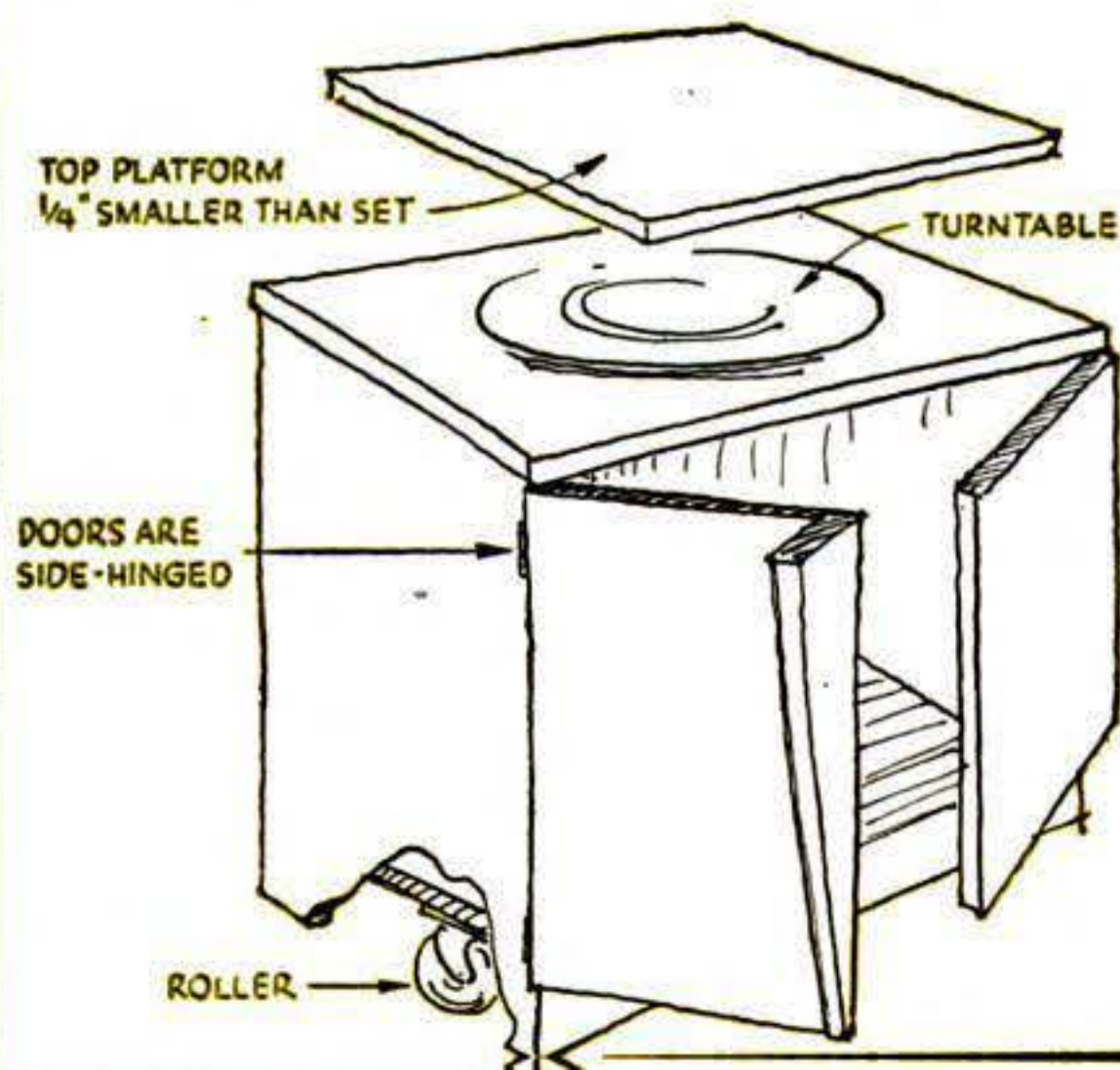

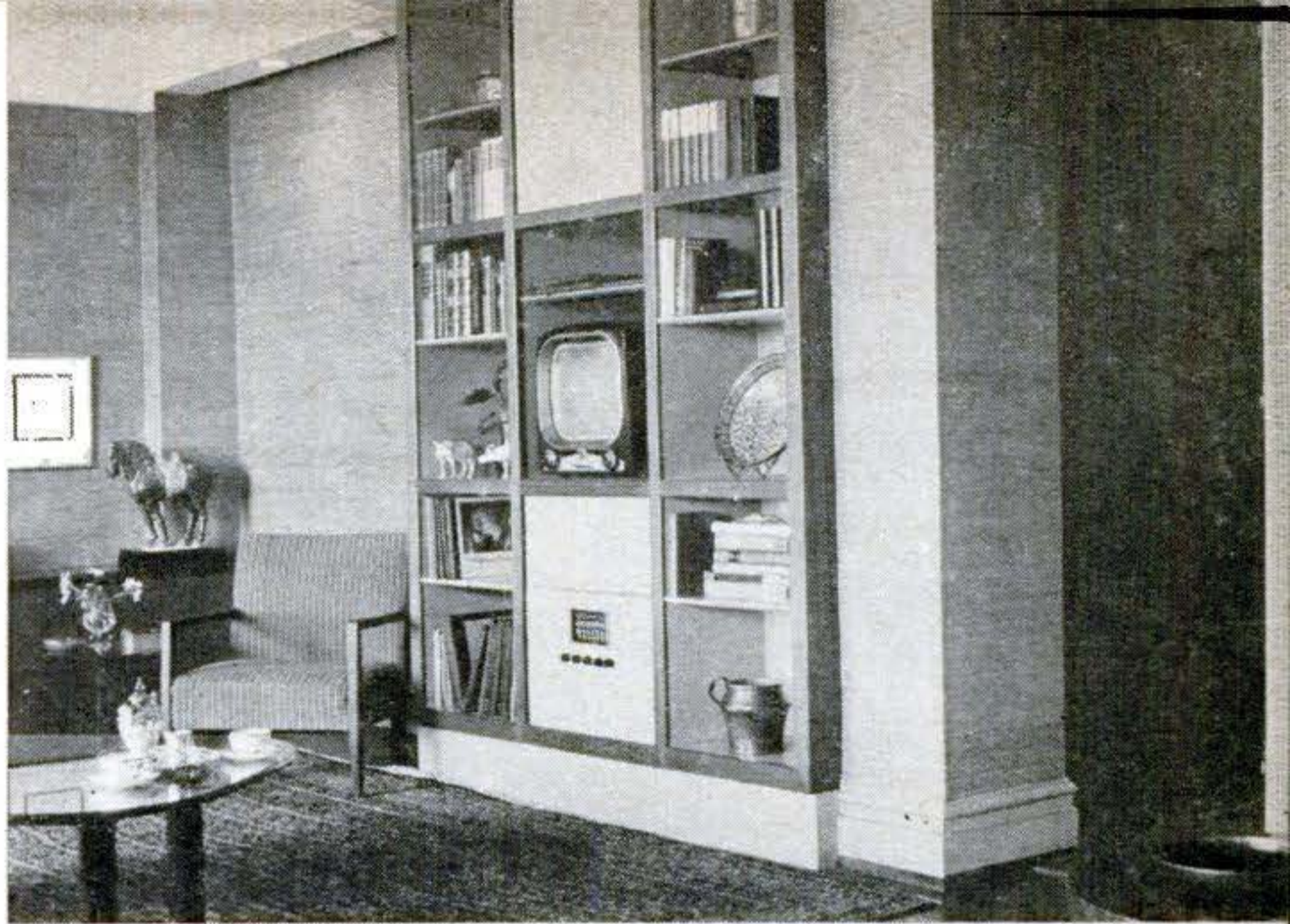

5 **STORAGE WALL**, built to fill part of wide, unused archway, houses complete home entertainment center, also serves as room partition. Since wall bears no load, construction can be simple bookcase type.

Shelves holding heavy radio and TV units should be dadoed into uprights or supported on husky cleats, but others can just be nailed in or held by adjustable peg-type shelf hooks. Door at rear (left) gives access to units.

alcove for a wheeled table that rolls easily out for viewing, then back in for storage.

5. Storage wall. If you feel that your TV screen stares out at you like the single eye of a Cyclops, you may want to hide that eye when you're not looking at it. Building a simple bookcase-type storage wall to house the set will not only get it out of the room but will add valuable space for a radio and phonograph, record albums, books and other articles. Adding doors to the sections holding the electronic units will permit them to be hidden when not in use.

One trick for building in a full-height bookcase or storage wall is to make it slightly short of the ceiling, so that it can be moved easily into place, then wedge in blocks to fill the gap. Snugged in this way, the wall need not be attached to the floor or ceiling and can be taken down anytime without leaving permanent marks. Strips of molding nailed around the upper edges will conceal the gap. END

Model trains get the highball next month. See the tips on how you can dress them up and improve their operation.

ELECTRIC FOOD MIXER

If it does not run, the circuit is open. First check the wall outlet itself to make sure the house circuit is not at fault. The open could be in the cord or plug, in the speed-governor switch, or in the motor itself. A broken lead or loose connections could cause the trouble. In the motor, the field or armature could be open or the brushes stuck or worn.

If it does not run but hums, the beater gears may be jammed. Dry or worn bearings may freeze the shafts so the beaters cannot turn. If gears or gear pins break, the motor may run but not turn beaters.

If it is noisy, it may just need lubrication. Worn bearings or gears will also cause noise. If the speed governor is off balance, it will vibrate.

If it jerks and vibrates on a low-speed setting, the speed governor may be defective. The governor condenser or the resistor may be open.

If it has no power, it may require lubrication. Worn bearings or gears may produce enough friction to use up most of the motor power. Dirty governor contacts or a dirty motor armature commutator will prevent sufficient current from flowing.

If it runs at high speed only, the chances are the governor contacts are welded, the governor condenser is shorted, or the governor is not operating.

If it will not shut off, the switch is defective or the linkage to the switch is out of adjustment. (From *Electrical Appliance Servicing*, by William H. Crouse.)

FOR YOUR POPULAR SCIENCE MONTHLY INFORMATION FILE

Do You Play with Fire?

Among workshoppers, only the smart alecks do. But some of the rest of us tend to forget the flame and explosion hazards that always surround us. Some of them are suggested here.

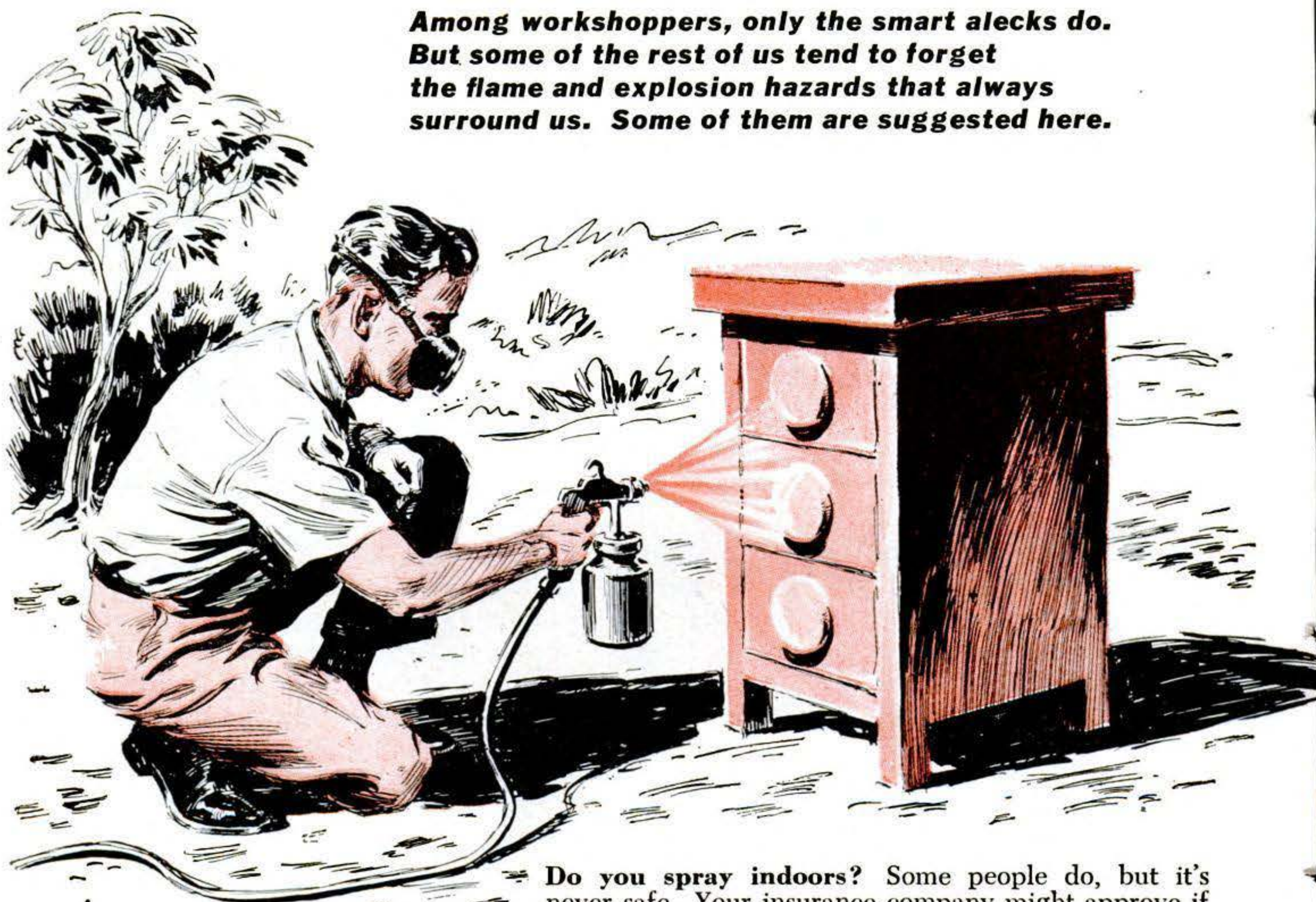

Do you spray indoors? Some people do, but it's never safe. Your insurance company might approve if you worked in a well ventilated booth—but that isn't practical in most home shops. Even spraying beside an open window doesn't put you in the clear, for the explosive atmosphere created by the paint could be set off by an electric spark, perhaps by a motor on the opposite side of the shop. Only safe way is to work outdoors, preferably with a mask to prevent poisoning or asphyxiation.



Do you stuff oily rags in a drawer? Putting a cloth soaked in linseed oil inside a closed compartment is a sure invitation to spontaneous combustion. Keep a closed metal container in your shop, perhaps a small garbage can, for disposal of all oily rags. Some workshoppers store machine-wiping rags in a coffee can.

Do you weld near combustibles? The flying sparks can cause sawdust and chips to smolder, perhaps to burst into flame hours later.





Do you leave litter on floor? Waste and wood chips left underfoot, to be swept up some day when you have more time, may bring a day when you'll have no shop—or home.

Do you smoke while spraying paint? One gent we know once turned the spray upon a burning cigarette to see what would happen. Nothing did—but his luck won't continue.

Is your wiring makeshift? Shop wiring should be heavy duty, at least equal to what comes with your motors. Stick to prescribed fusing. Never over-fuse to handle starting loads.

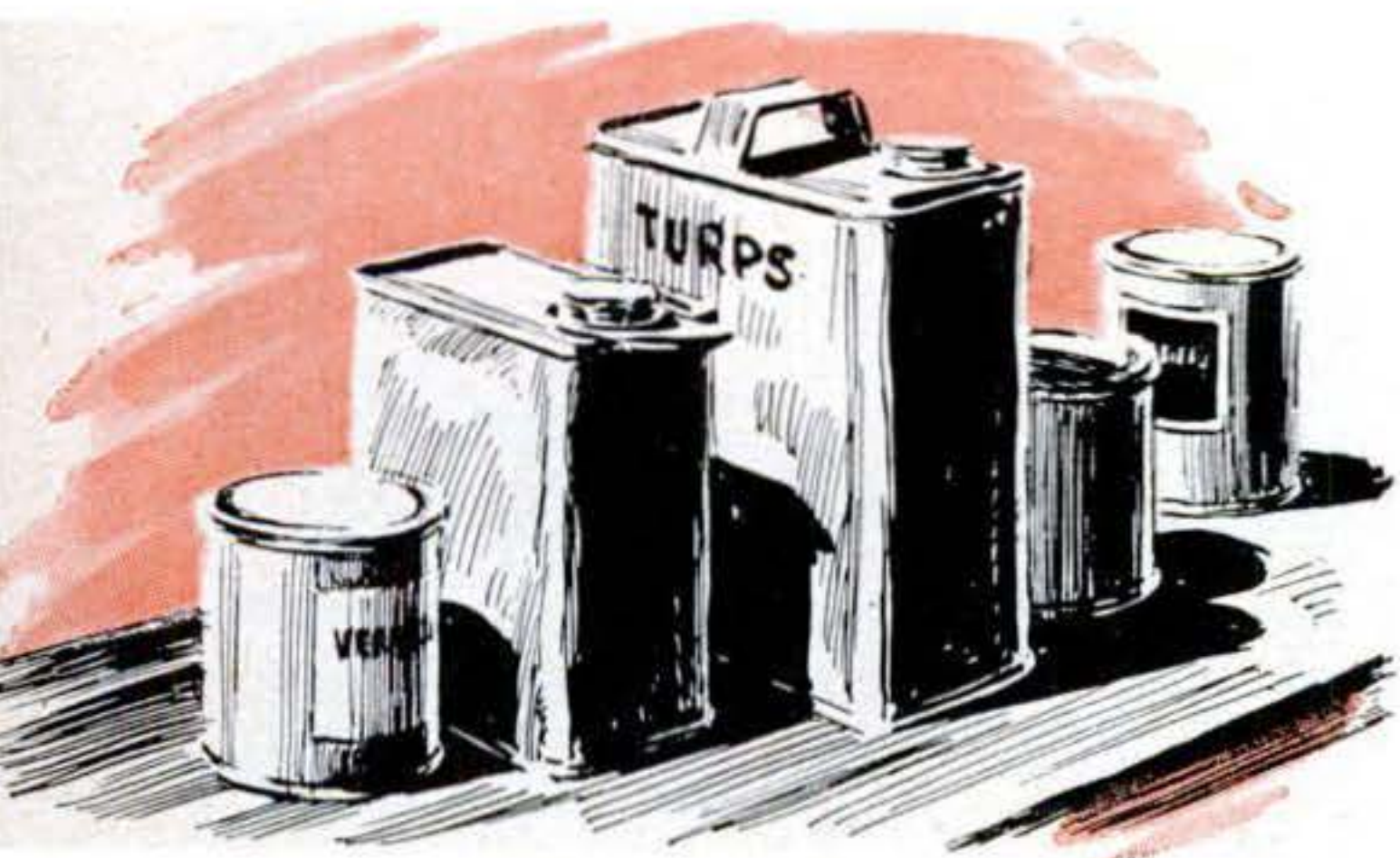

Are your solvents left uncovered? All paint thinners are volatile and an explosion hazard. Keep them tightly capped and store them in a spot away from extreme heat. This applies also to blowtorches. Gasoline should go outside.

Kite Launches Glider in Flight

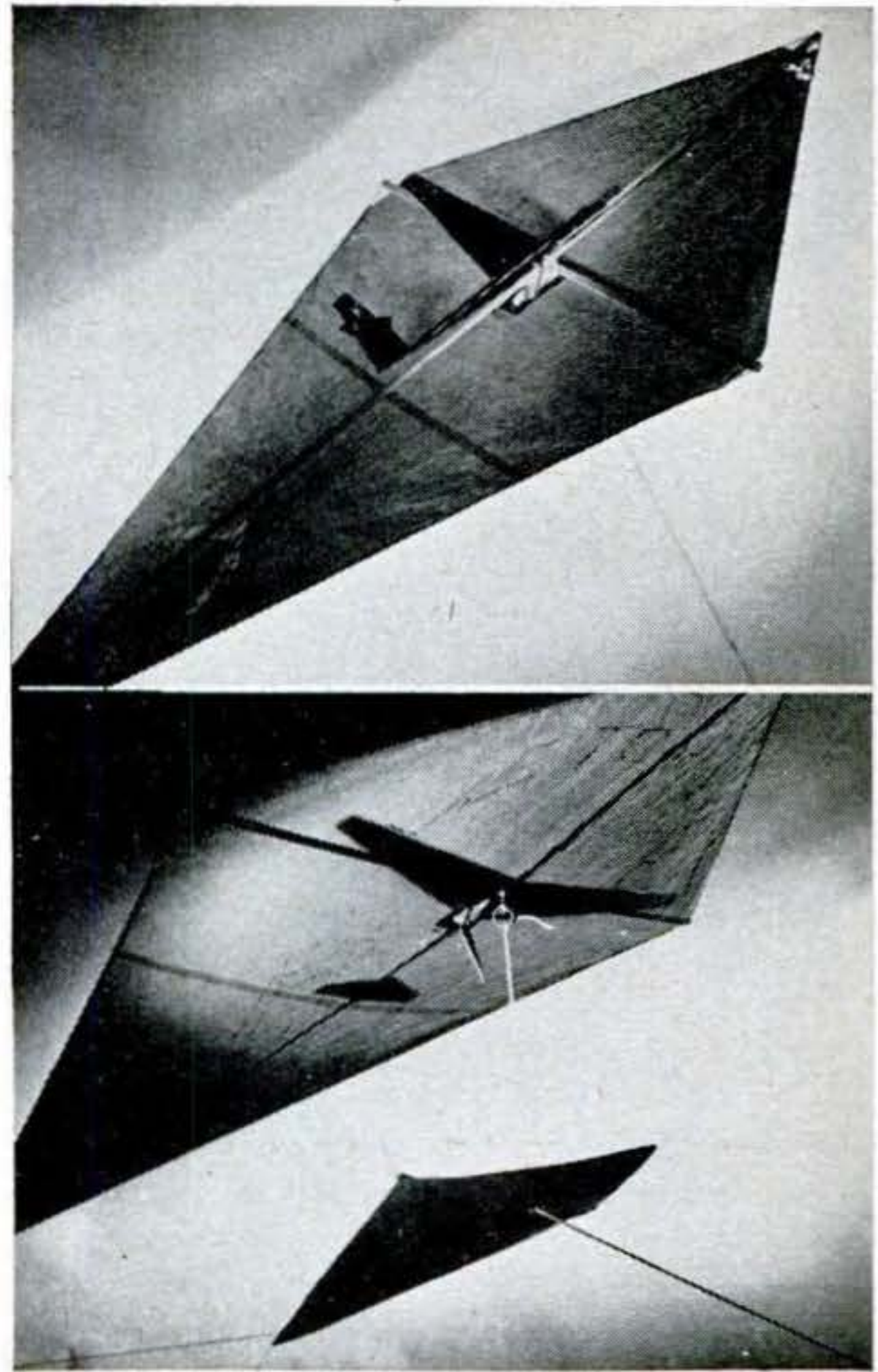

JETO-KITE, the invention of a Canadian woman, adds a new note to the old sport of kite flying.

The kite is launched with a sleek balsa glider cocked on its back under rubber-band tension (top). When the kite is flown out to maximum altitude, a small release kite is sent up along the string Ben Franklin style. This kite climbs the string with sufficient momentum to trip the trigger on the carrier kite, sending the glider off into a steep loop followed by a long glide back to earth.

Mrs. G. D. McKay of Montreal has applied for a patent on the kite and plans soon to put it on the market.

Caster Positions Calking Gun

THIS simple attachment is a rolling rest that always keeps a calking gun at the correct angle. Shape a wooden block to fit the gun barrel and drill it to take the shank of a caster. Fasten the block to the gun with some wire. — Ken Murray, Colon, Mich.

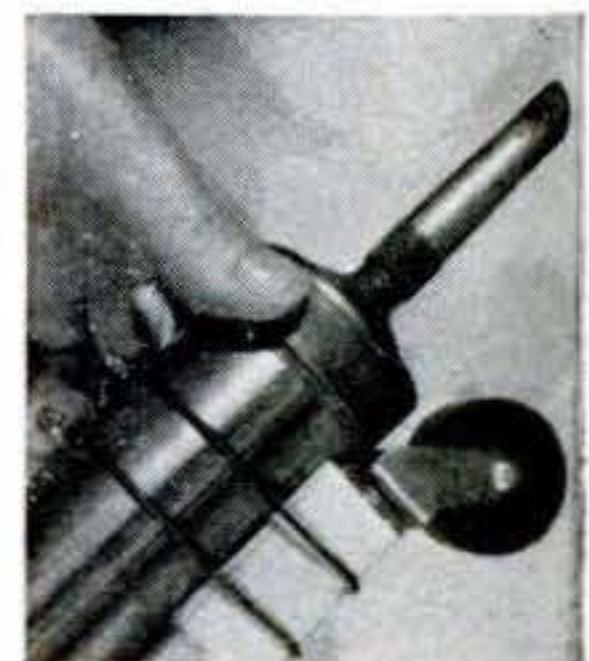

One Evening Shop Projects

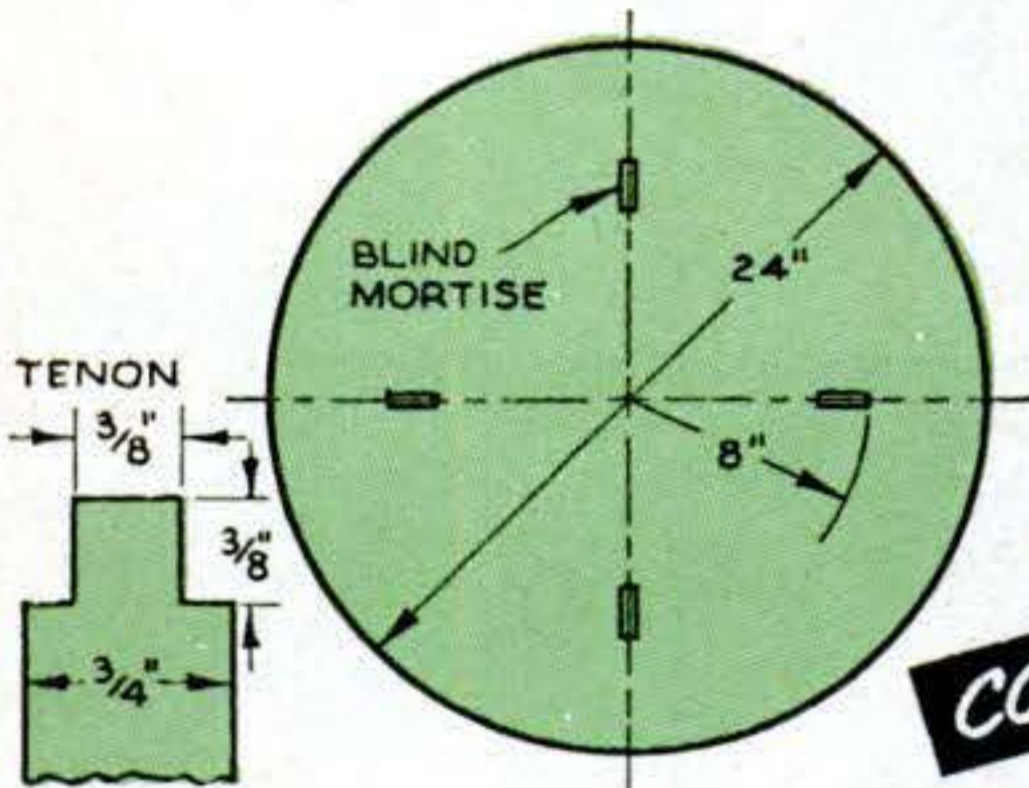

COFFEE TABLE

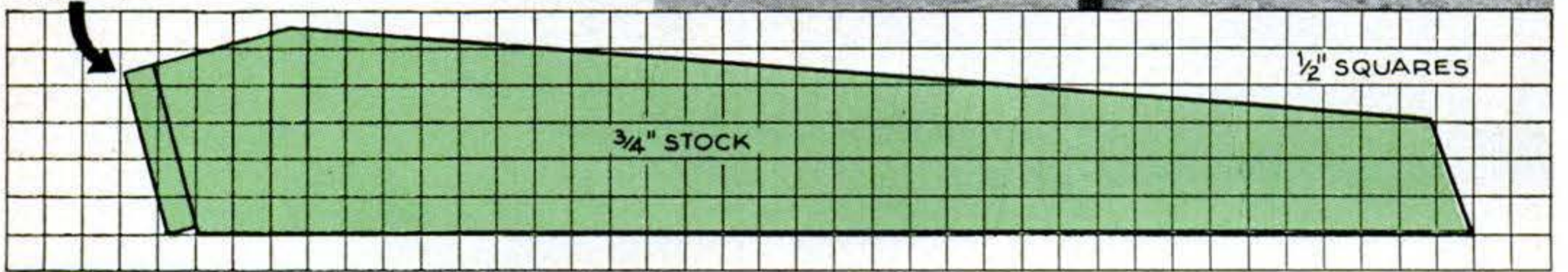

For the living room. Simple lines make a low table that harmonizes with almost any type of furniture. I built this one of walnut, but other woods such as birch, maple or pine would be equally satisfactory. For the top, edge-glue $\frac{3}{4}$ " stock to make a piece a little more than 24" square. Then bandsaw a 24"

disk. Blind mortises for the leg tenons can be made by drilling $\frac{3}{8}$ " holes and then chiseling away the rest. Glue the tenons in and strengthen the legs with angle brackets. Finish the table to match the other furniture in the room.— *M. S. Schroeder, Mundelein, Ill.*

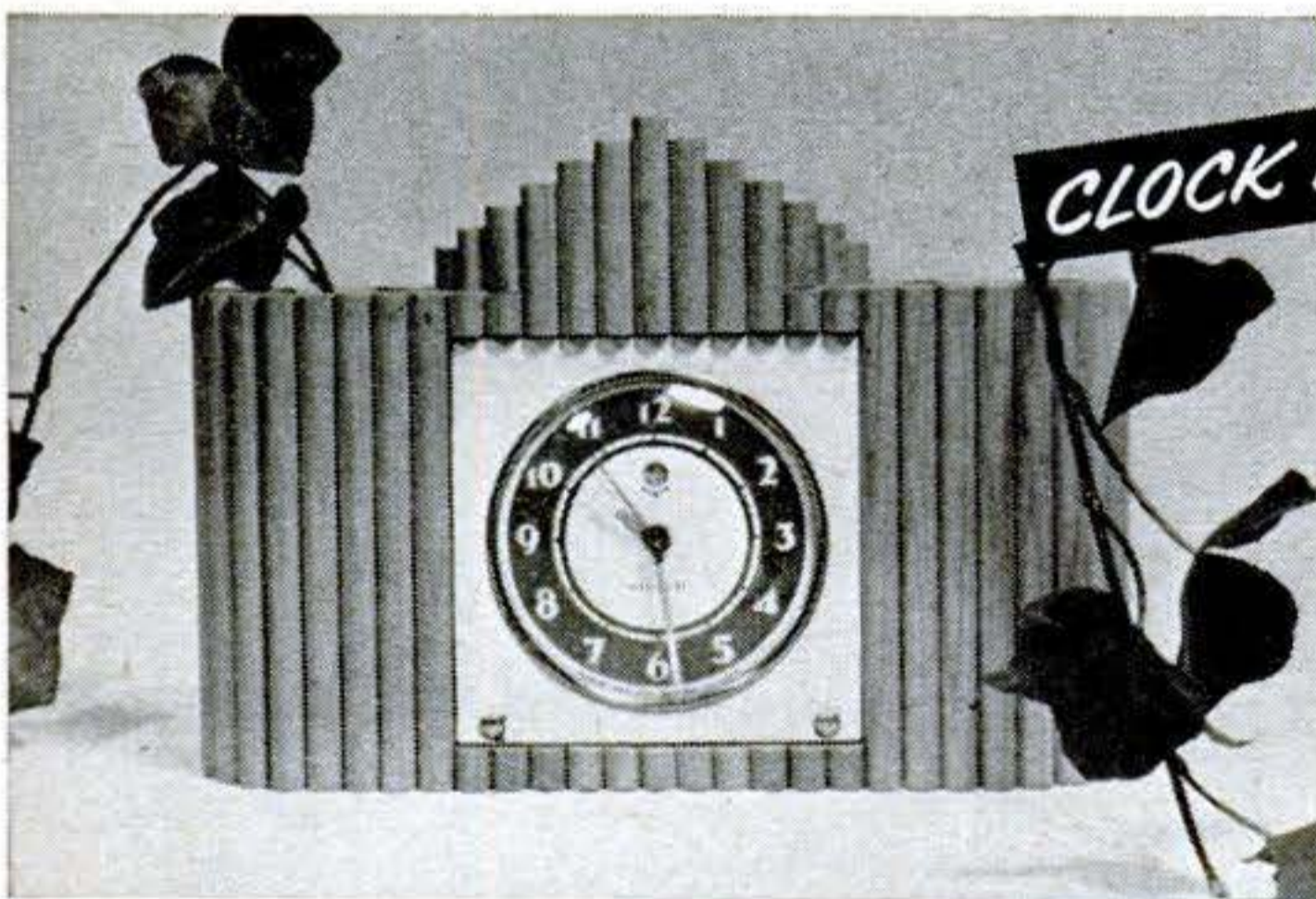

CLOCK PLANTER

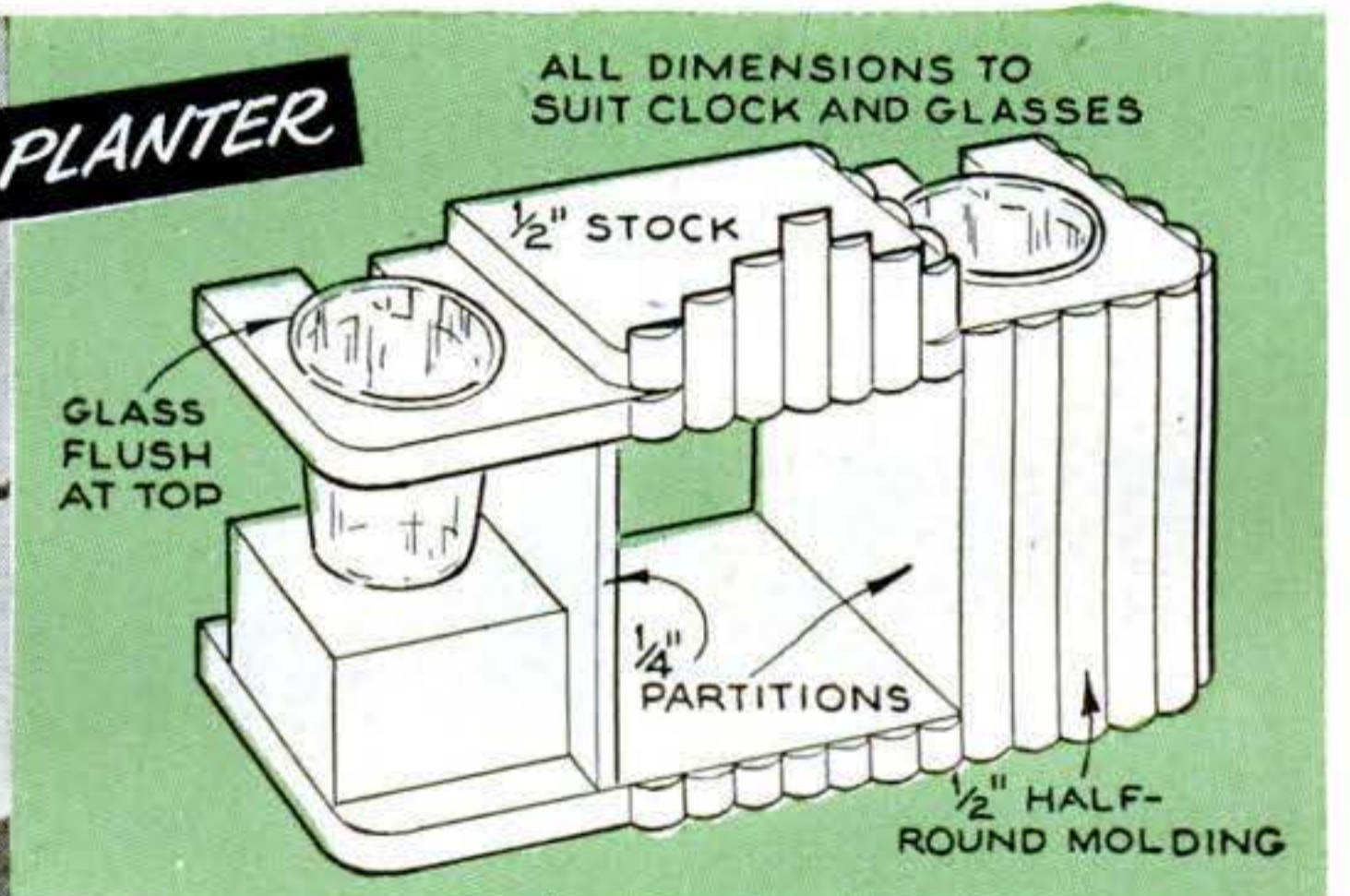

For the dining room. A plain kitchen clock becomes an attractive wall decoration when it is housed in a plant holder like this. Most of the dimensions must be laid out to suit the clock you use.

Begin by cutting the upper and lower shelves. Join them with partitions of $\frac{1}{4}$ " stock to form the box that holds the clock. Then add the smaller shelf on top of the

upper shelf. Brad and glue blocks to the lower shelf to support the glasses or pots that hold the plants.

Face the assembly with $\frac{1}{2}$ " half-round molding, nailed in place, and screw two angle brackets under the top shelf to hold the unit to the wall. The planter can be painted or enameled to match the trim in the room.— *John G. Voelker, Baltimore.*

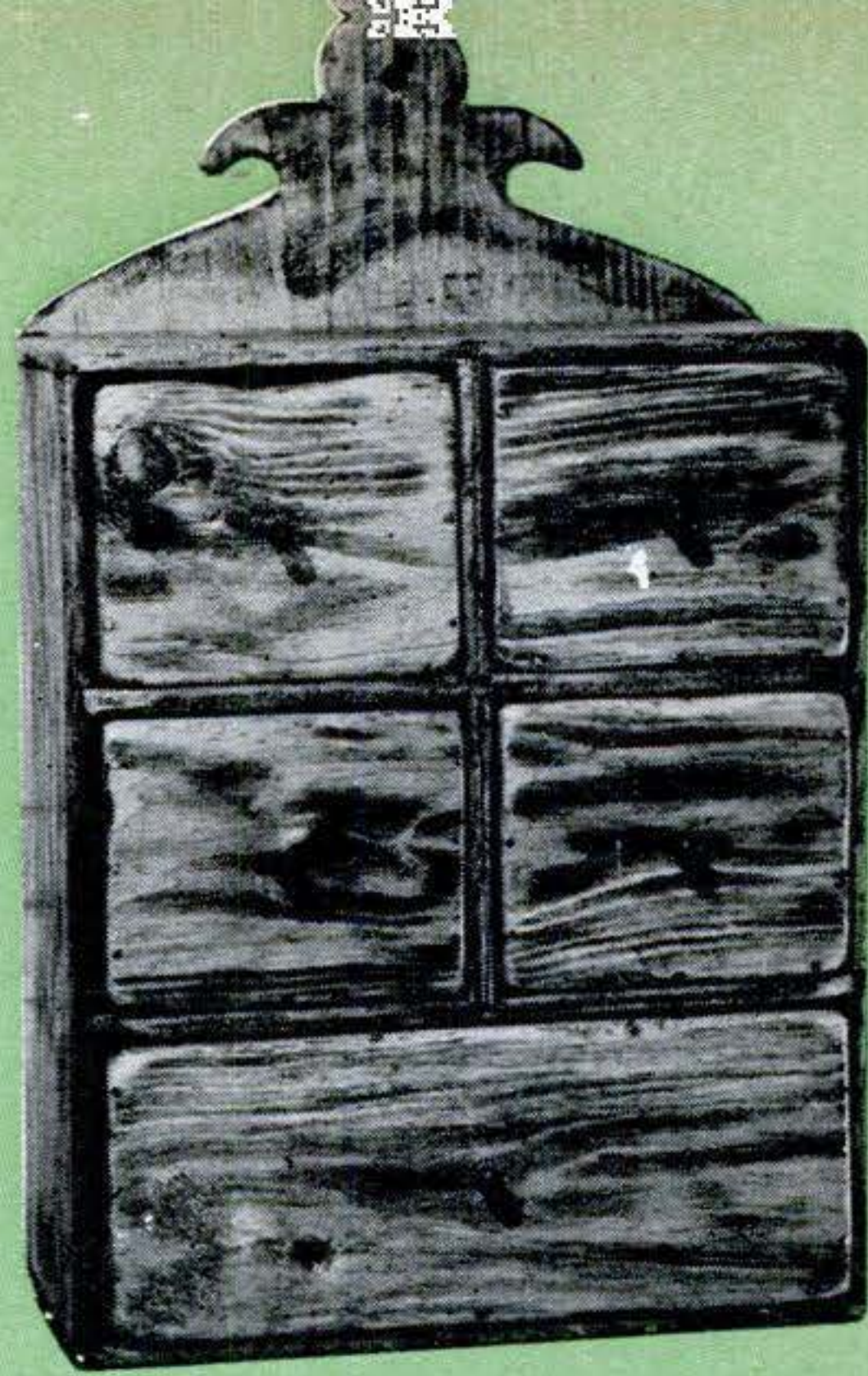
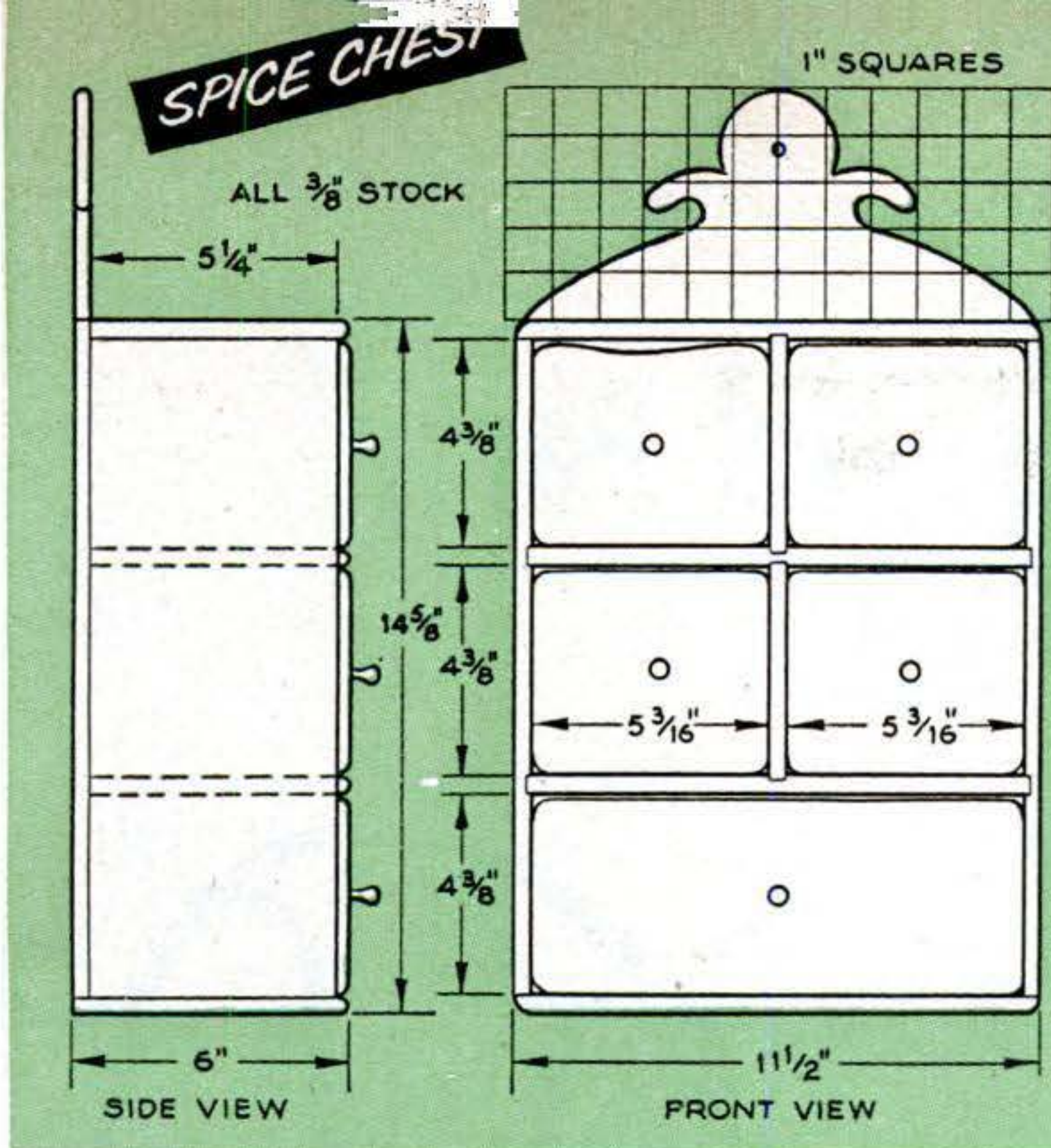

For any wall. My most expensive item for this reproduction of an early American spice chest was the knotty pine. Two 10' boards—one $\frac{3}{8}$ " by $5\frac{1}{2}$ " and the other $\frac{3}{8}$ " by $11\frac{1}{2}$ "—cost \$3. Finishing materials and nails came to less than \$2, bringing the total cost of the chest to less than \$5.

Cut out the parts and nail and glue them together. A coping saw will handle the curves at the top. Aging the chest to give it that 150-year-old look is next. Peck it with an ice pick and round the corners with a file and sandpaper. Then scrub it here

and there with a wire brush, being sure to brush with the grain.

Staining comes next. Mix a little Van Dyke oil color with about two ounces of turpentine and a little linseed oil. More turpentine will make the stain soak in faster; more oil will slow the process. Try it on a scrap until you are satisfied and apply the stain with a cloth or brush.

When dry, sand all parts lightly with fine sandpaper. Then brush on two coats of dull varnish with a light sanding between coats.—*Carlton Strickland, Roanoke, Va.*

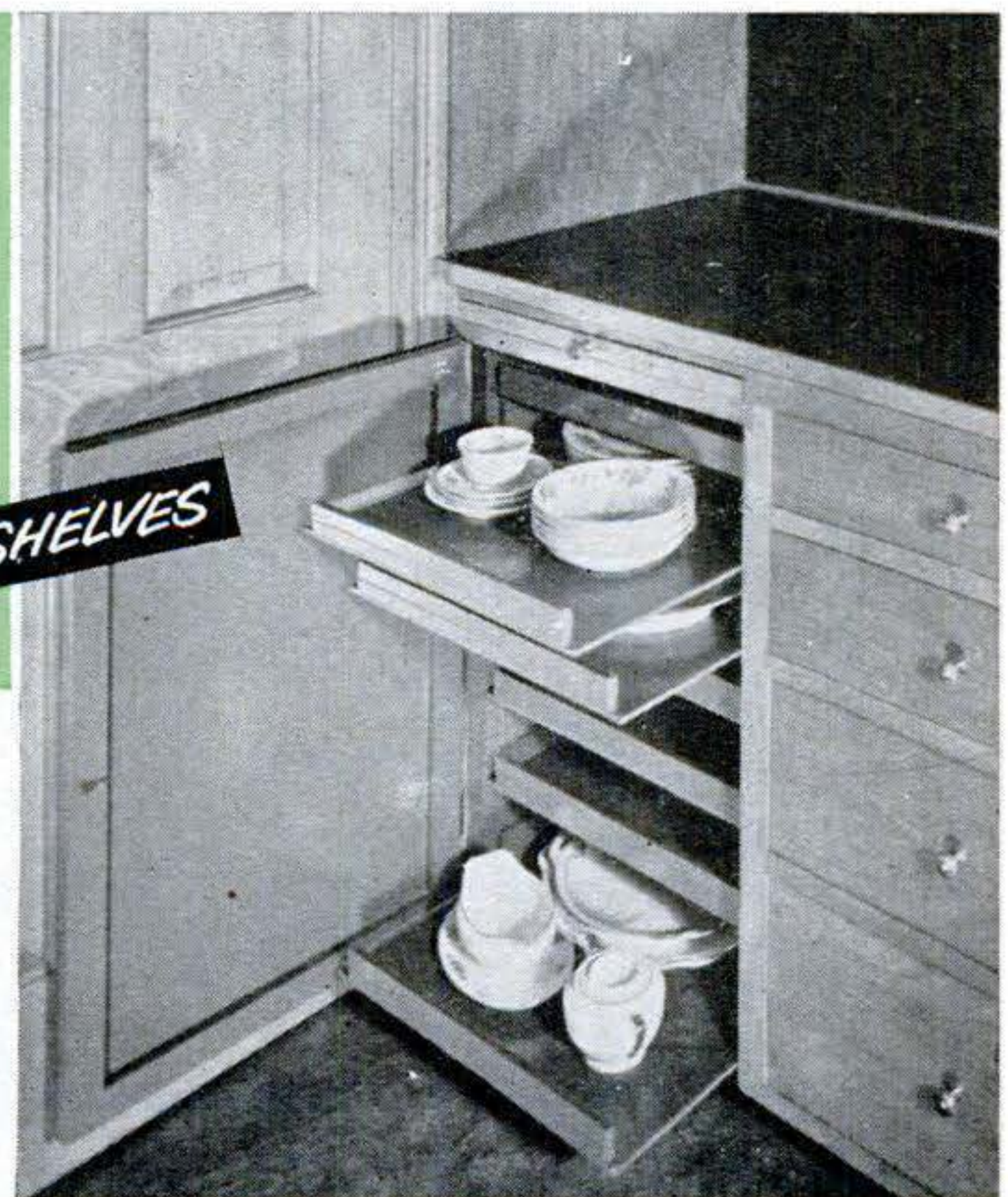
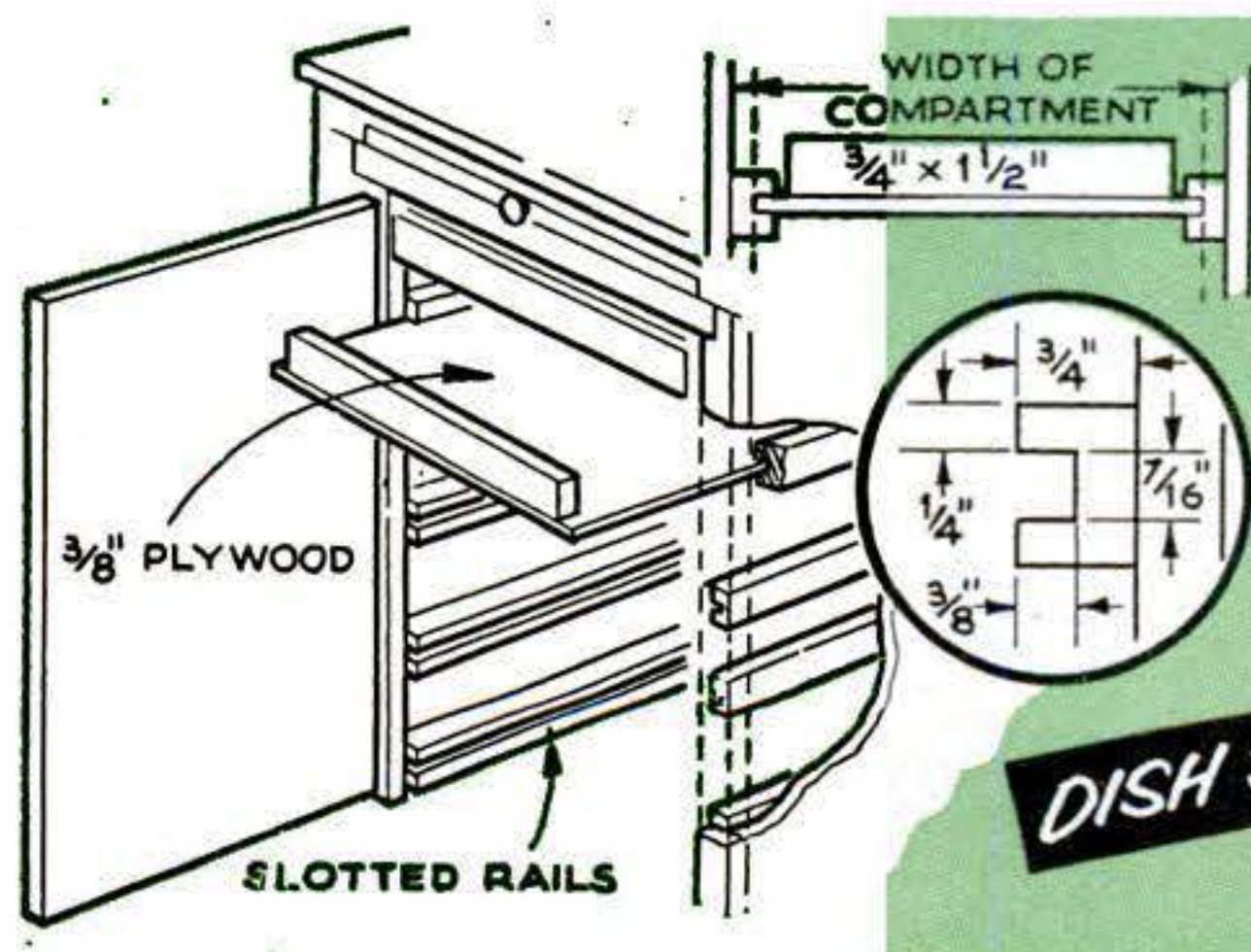

For the kitchen. These simple racks, installed in an existing cabinet, make dishes quickly accessible. Each sliding shelf is a piece of $\frac{3}{8}$ " plywood with a narrow strip nailed and glued across the front to keep dishes from sliding off. Screw the slotted rails to the cabinet walls at spaces that will accommodate the dishes to be stored.—*Hi Sibley, Nuevo, Calif.*

Donkey Stands Up for Party

EARS

① BEND 13" LENGTH OF $\frac{3}{32}$ " ROD AT CENTER

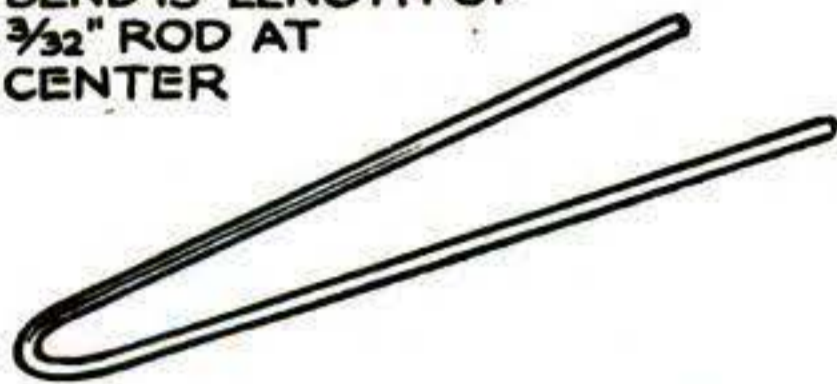

② SHAPE TOP OF EARS

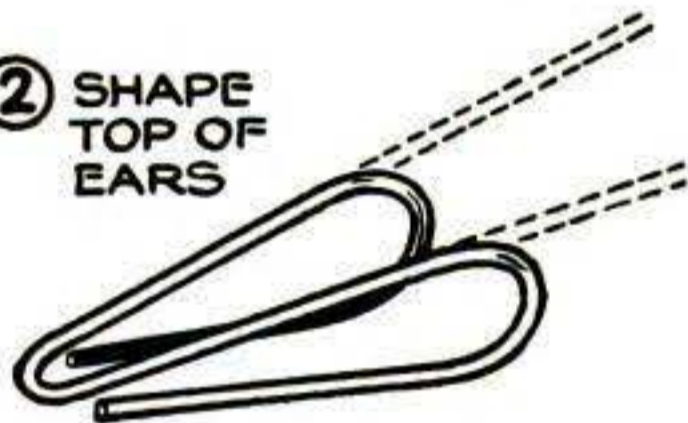

③ OPEN EARS OUT

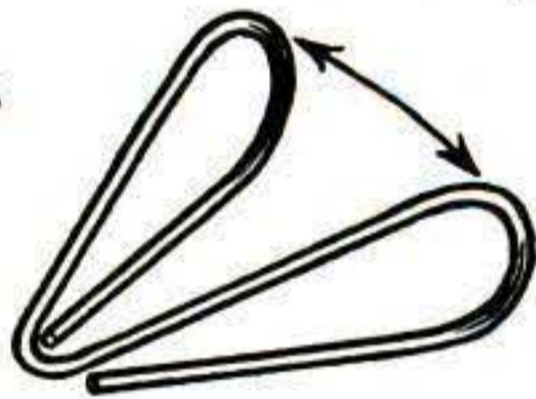

How to Make

WITH the campaign waxing hot, here's a standing vote you can register for your choice. Besides reminding you of important radio or TV dates, such a memo holder serves as a center for family notes.

If welded, brazed or silver-soldered, the pieces will stand handling well. Any gas torch or blowtorch will do for silver-soldering the parts. If only soft-soldered, the pieces will serve as ornaments but will not bear much handling.

Lay out a full-size pattern as a bending guide. Shape the backbone and legs from $\frac{3}{16}$ " steel rod, such as curtain rod. For a bending jig, drive two short $\frac{1}{2}$ " pins into a metal block, spacing the holes to leave $\frac{3}{16}$ " between the pins.

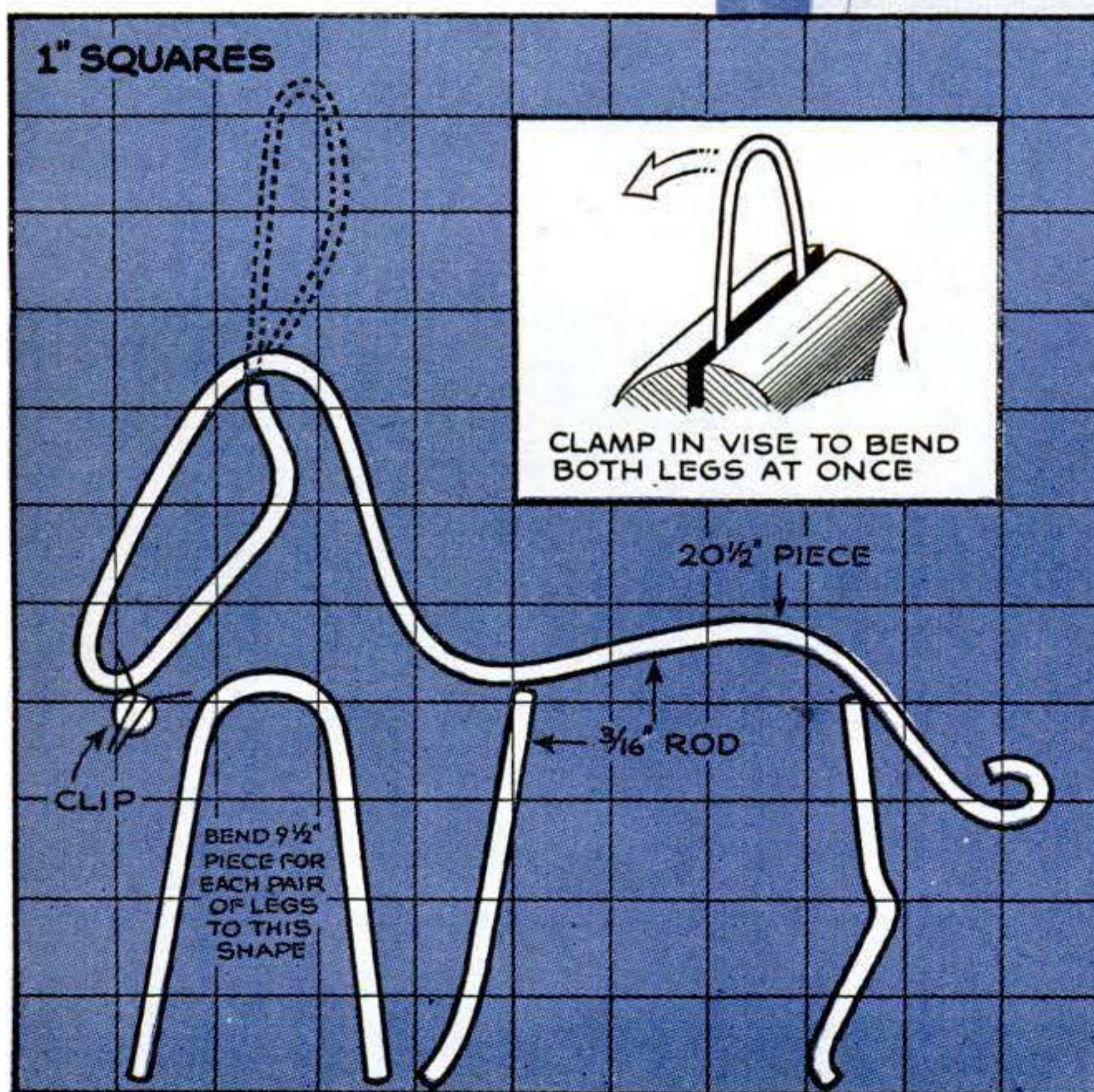

This Elephant Never Forgets



Memo Holders

Clamp the jig in a vise when bending stock in it.

One piece of rod forms each pair of legs. Bend it at the center first. Then clamp the two legs in a vise to make all the other bends in both legs at once. Make ears of lighter rod to avoid overbalancing.

To hold the parts for welding or soldering, insert the donkey's feet in holes in a piece of wood. Clamp the elephant's to a flat surface. Clamp the backbone to one pair of legs while joining to the other.

Spring-type paper clips are only soft-soldered on (so as not to take the temper out of the spring), the finger grips being bent to provide free action.

EARS

- ① CUT $\frac{3}{32}$ " ROD 2 $\frac{1}{2}$ " LONG
- ② BEND BACK 8"
- ③ SHAPE EARS FROM DOUBLED PART
- ④ BEND TRUNK
- ⑤ PULL EARS APART

FEET

- ① HAMMER END OVER AN EDGE
- ② BEND AROUND $\frac{1}{2}$ " PIN
- ③ CLAMP IN VISE AND BEND 100°

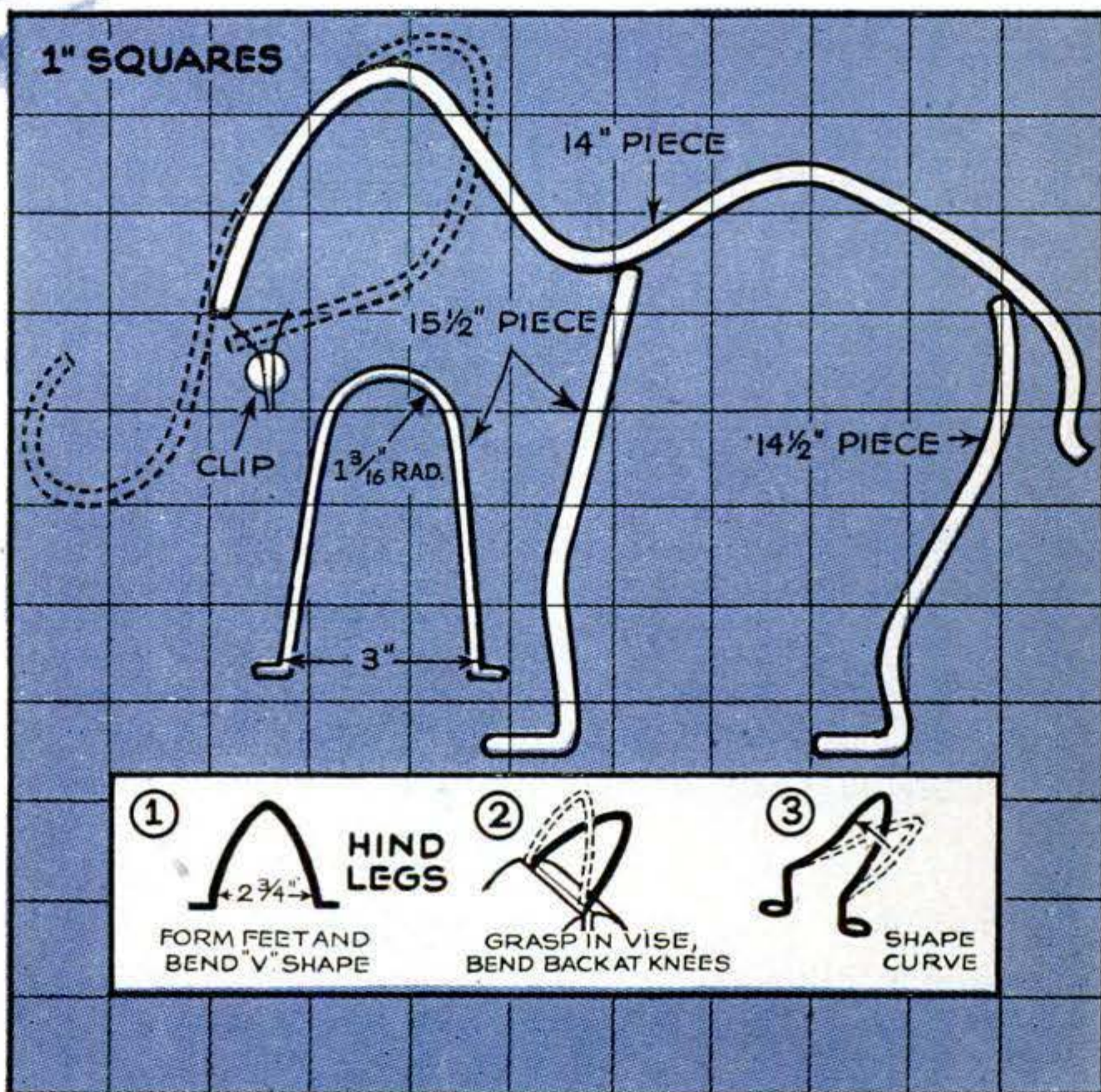

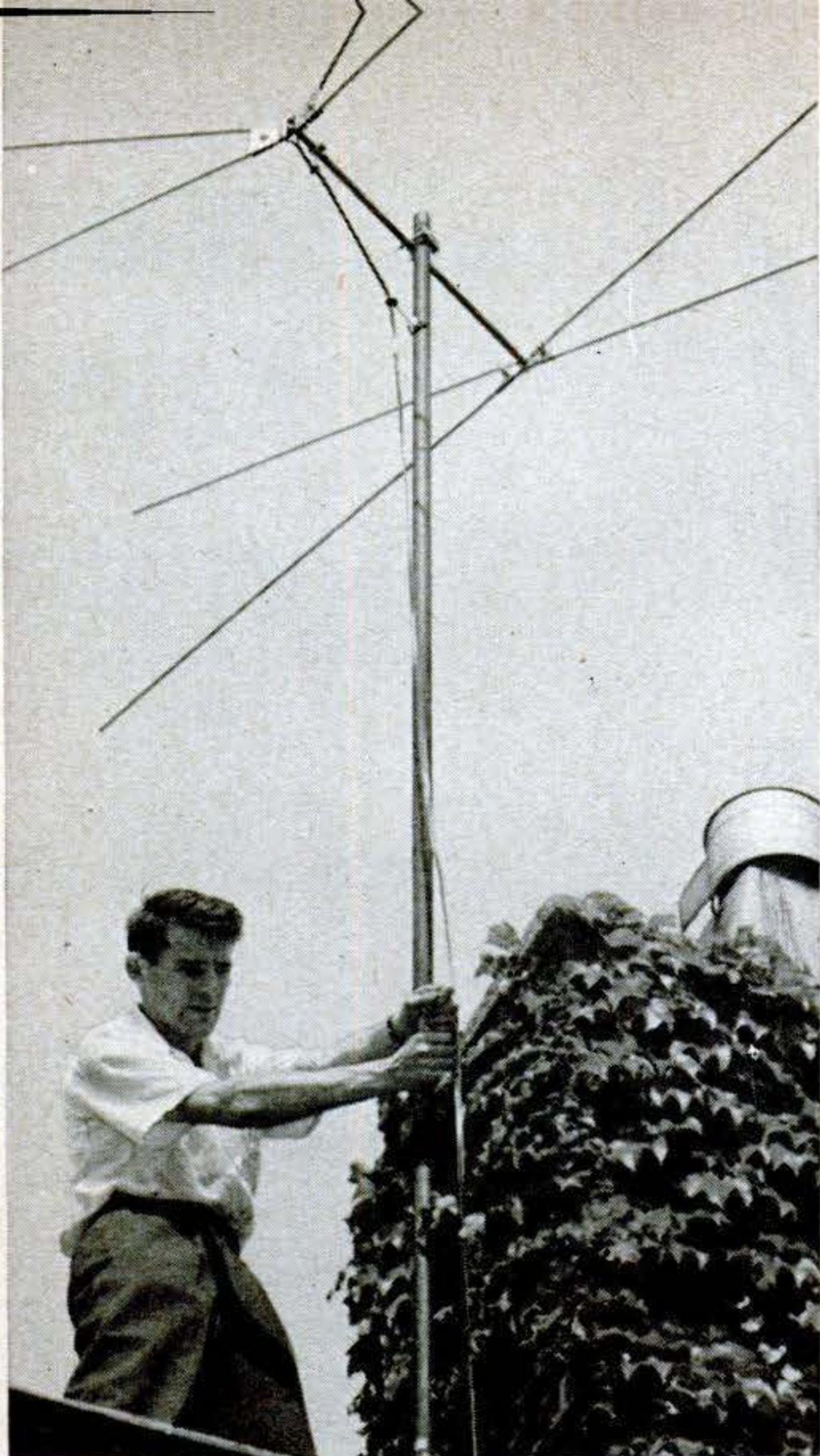

CHECK MOUNTING BRACKETS and replace if loose or corroded. If mast is more than 10' high, brace it with guy wires. Aim wired arm at transmitter. Then, with someone at the set to advise you, rotate it slightly to chase ghosts and bring in full signal. If there are several possible locations on roof, try all.

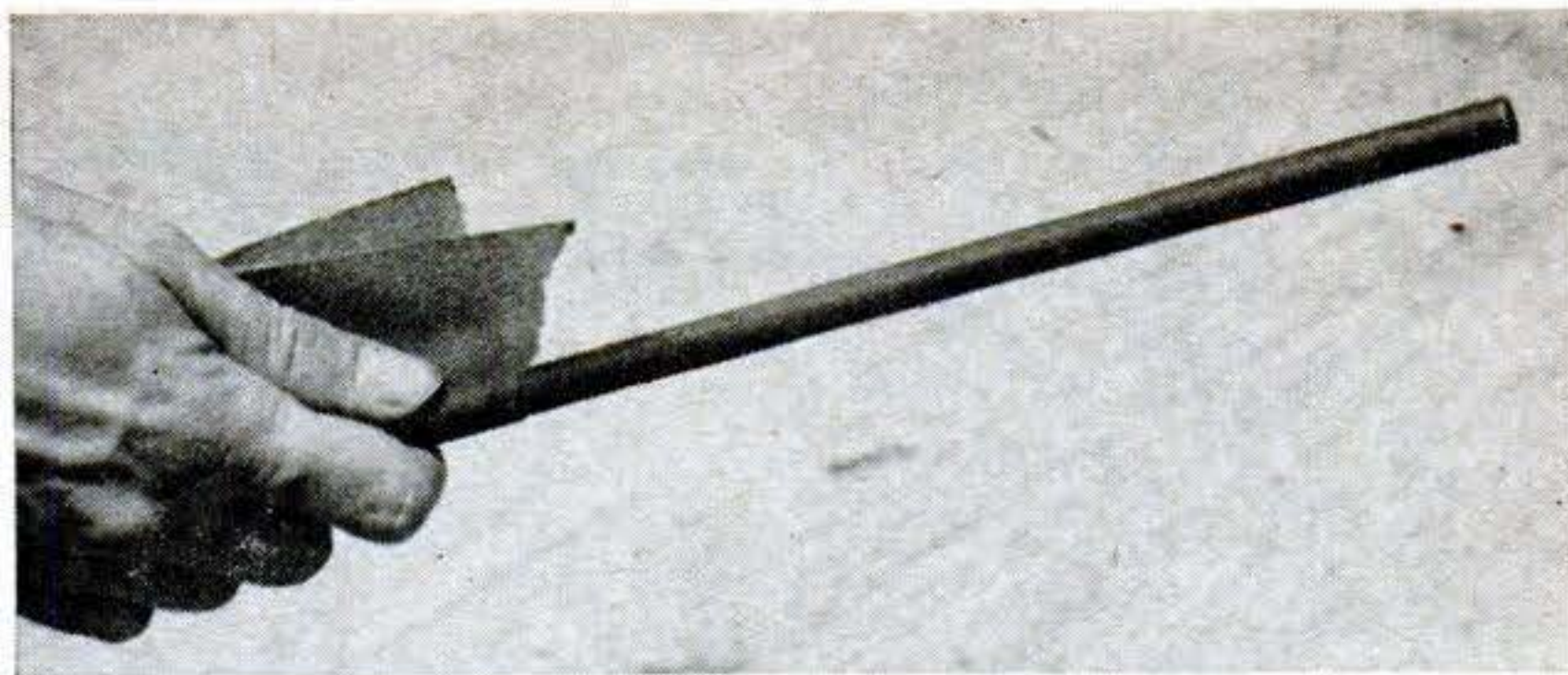

CLEAN UP PARTS with emery cloth and steel wool. Take antenna down rather than try to reach up to it. Elements must be thoroughly brightened at joining ends. Other parts of rods can be cleaned for appearance.

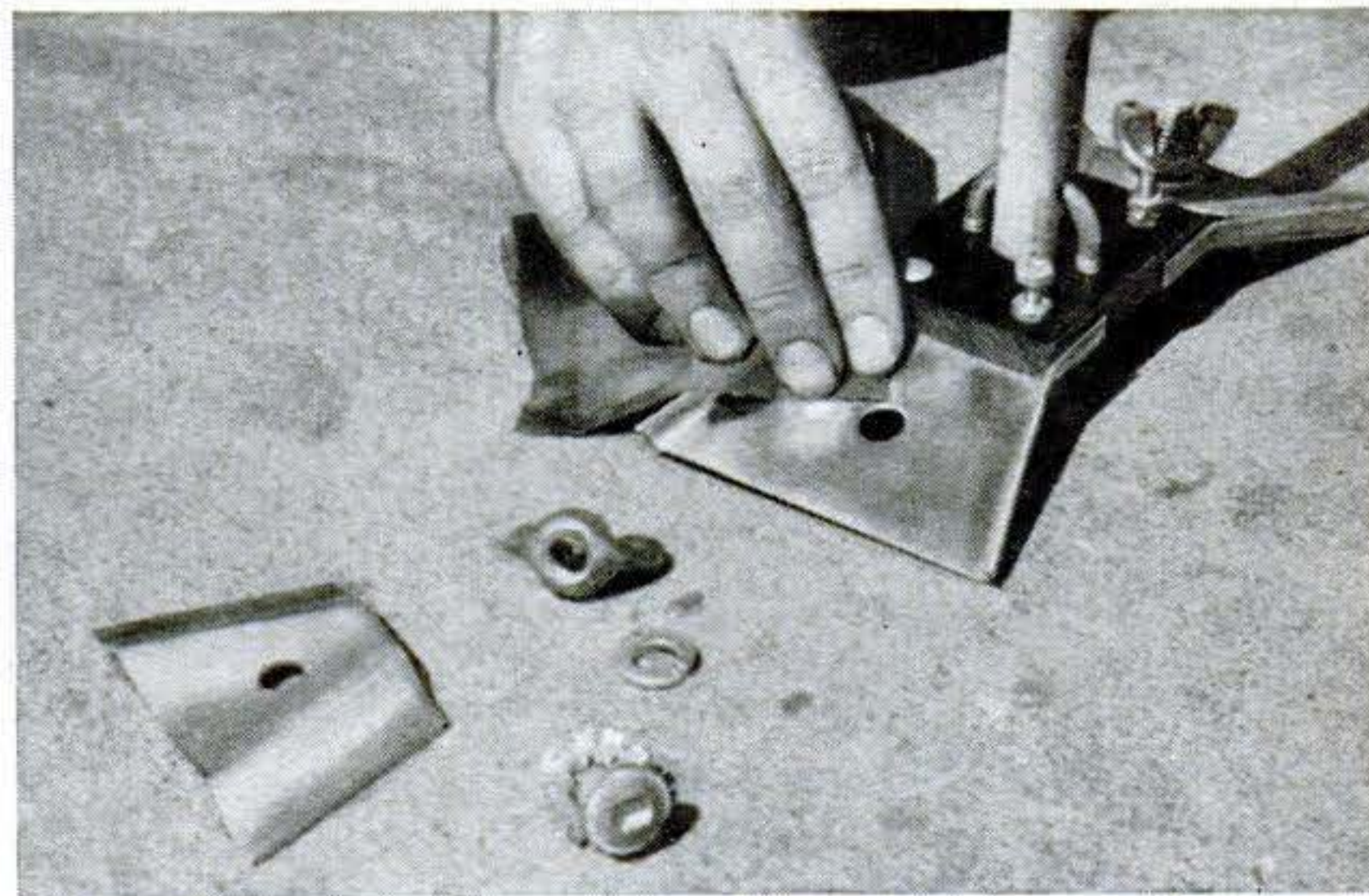

BRIGHTEN INSIDE SURFACES of bracket so that it will make good electrical contact with the rods. Clean the insulating block with carbon tetrachloride. (Don't use sandpaper on the block; it will leave scratches that soon will accumulate dirt.) Disassemble the bracket completely before beginning job of cleaning.

TV Reception Slipping? It May Be Your Antenna

One rusty terminal screw can sabotage a chassisful of new tubes.

By John P. Kenneally

*Rocket ships from "out there,"
Wrestlers flying through air,
Gave proof through the night,
That our antenna was still there.*

YES! It's still there, but months of weathering may have reduced its efficiency slowly and imperceptibly, eating away at your picture quality and bringing you snow in September.

It's time now, before winter moves in, to get up on the roof and check the other half of your TV set. The antenna has an important job to do; it must reach up and catch the TV signal from out of the air and feed it to the lead-in wire for delivery to the set. To do this, it must be in top condition both mechanically and electrically.

The best and safest idea is to loosen the mounting brackets and take the whole works, mast and all, down to the ground where it can be worked on more easily.

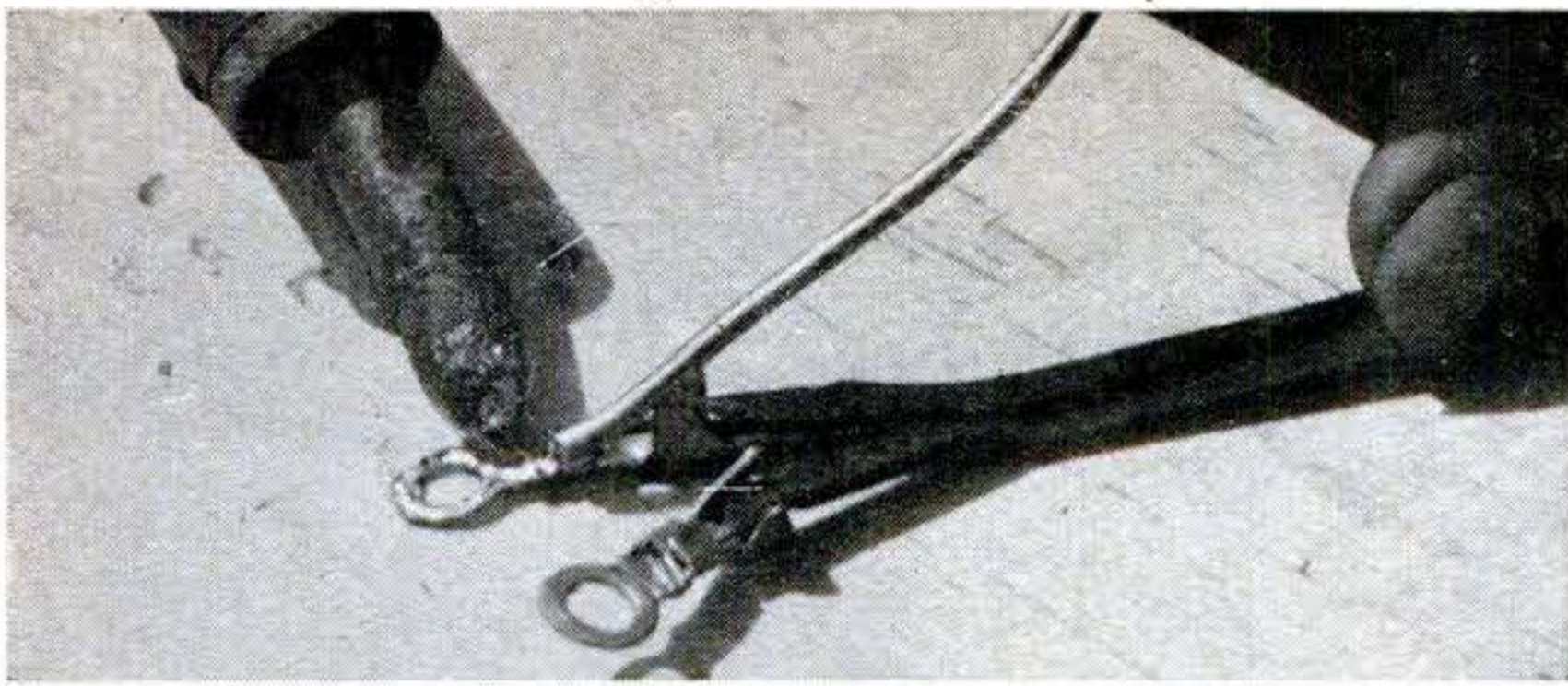

SOLDER CONNECTIONS with resin-core solder to prevent loosening and insure good electrical contact. Antenna is only as strong as its weakest point, so don't overlook anything. New lead-in wire will help if old is weathered.

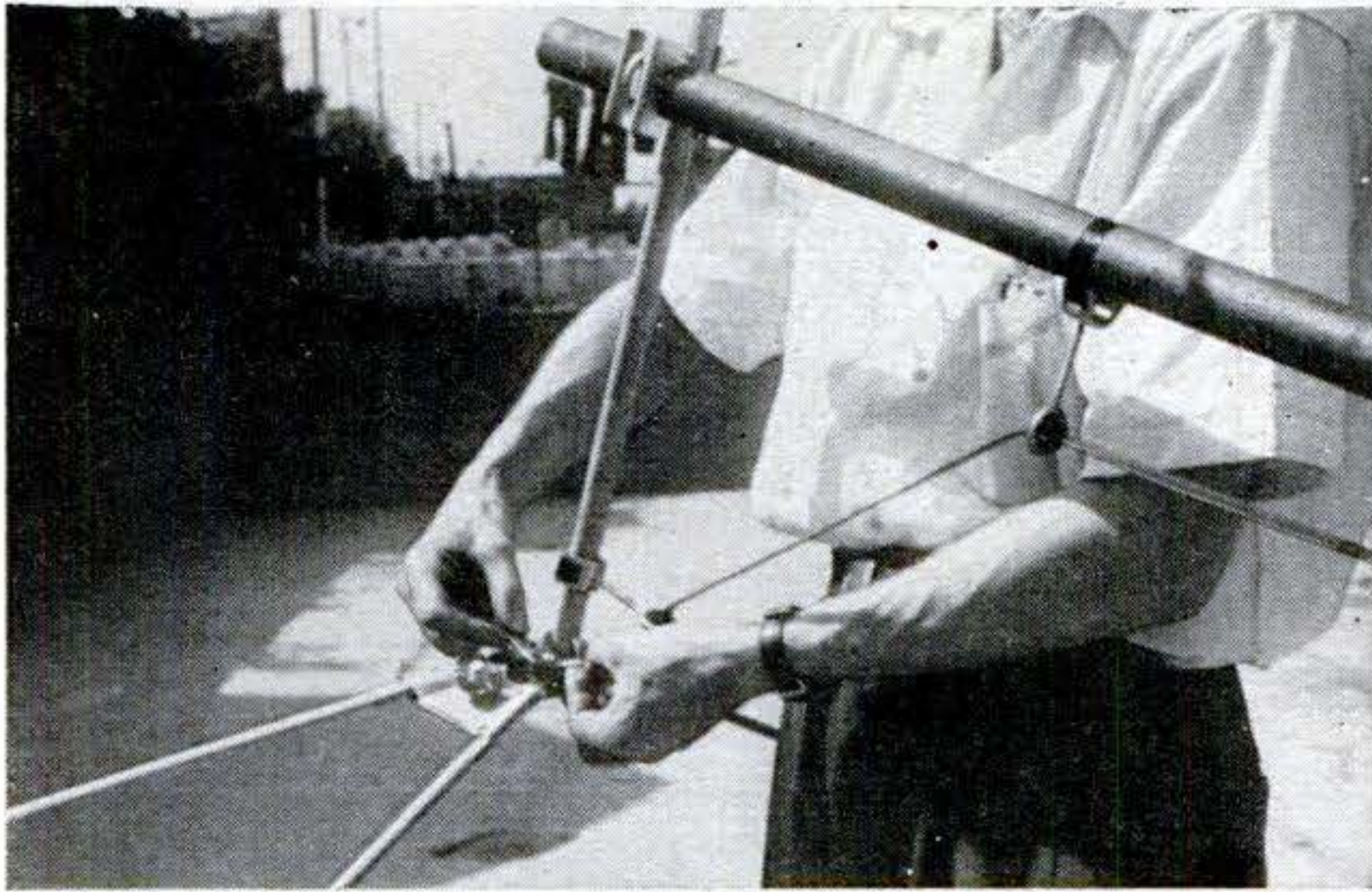

REASSEMBLE ANTENNA and replace all rusty screws, especially the terminal screws, with brass or cadmium-plated ones. Use clamp-type stand-off insulators to support the lead-in wire along the mast. Place the first insulator close to the terminals to prevent the wire from whipping in the wind.

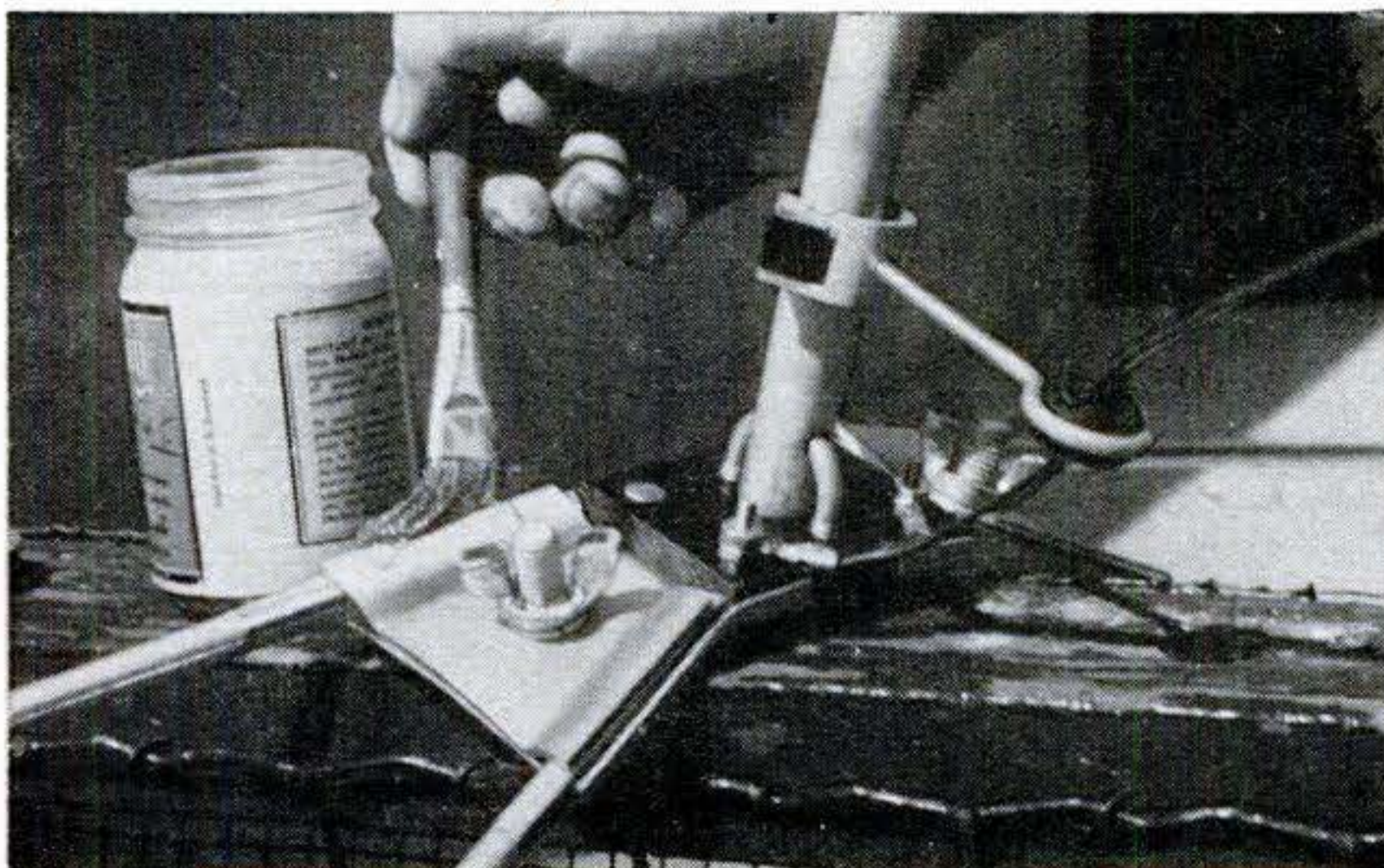

SHELLAC ALL JOINTS and connections after tightening them securely. Flow shellac between bracket parts and coat wing nuts to retard corrosion. Note very short length of unsupported wire between first stand-off insulator and terminals; this is important as wires will break if constantly flexed by wind.

Pen Creases Cardboard

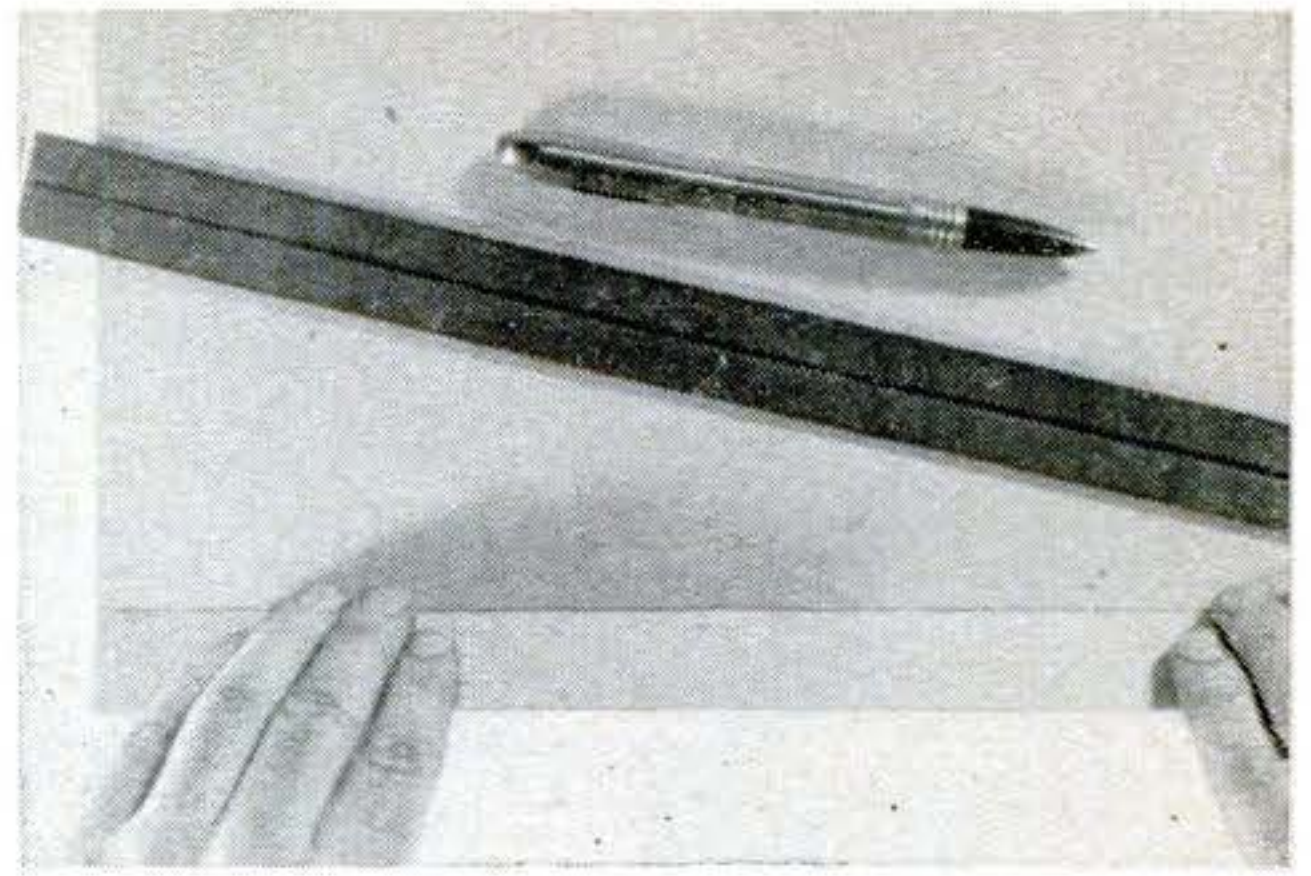

WHEN working with cardboard, a ballpoint pen is a good tool to scribe creases for folds. The point won't scuff or cut the cardboard. If you don't want the lines inked in, insert an empty cartridge in the pen.—*Andrew Brennan, Philadelphia.*

Stair Tread Pads Vise

A RECTANGULAR section cut from an old rubber stair tread makes a neat, no-slip, no-gouge pad for a small vise. A wide slot cut in the center of the pad will let it slip over the vise-tightening screw.—*R. F. Donovan, Guttenberg, N. J.*

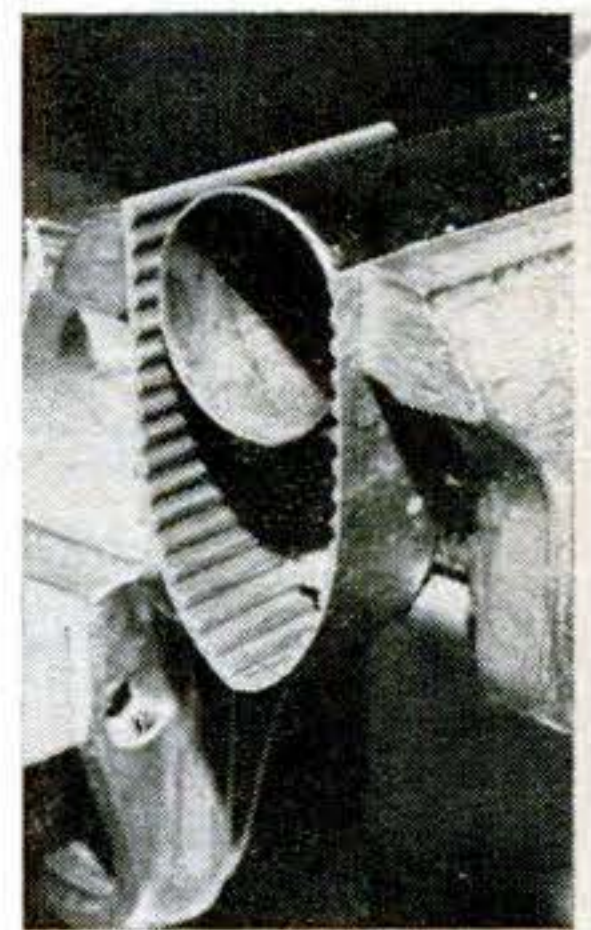

Bumper Jack Supports Hitch

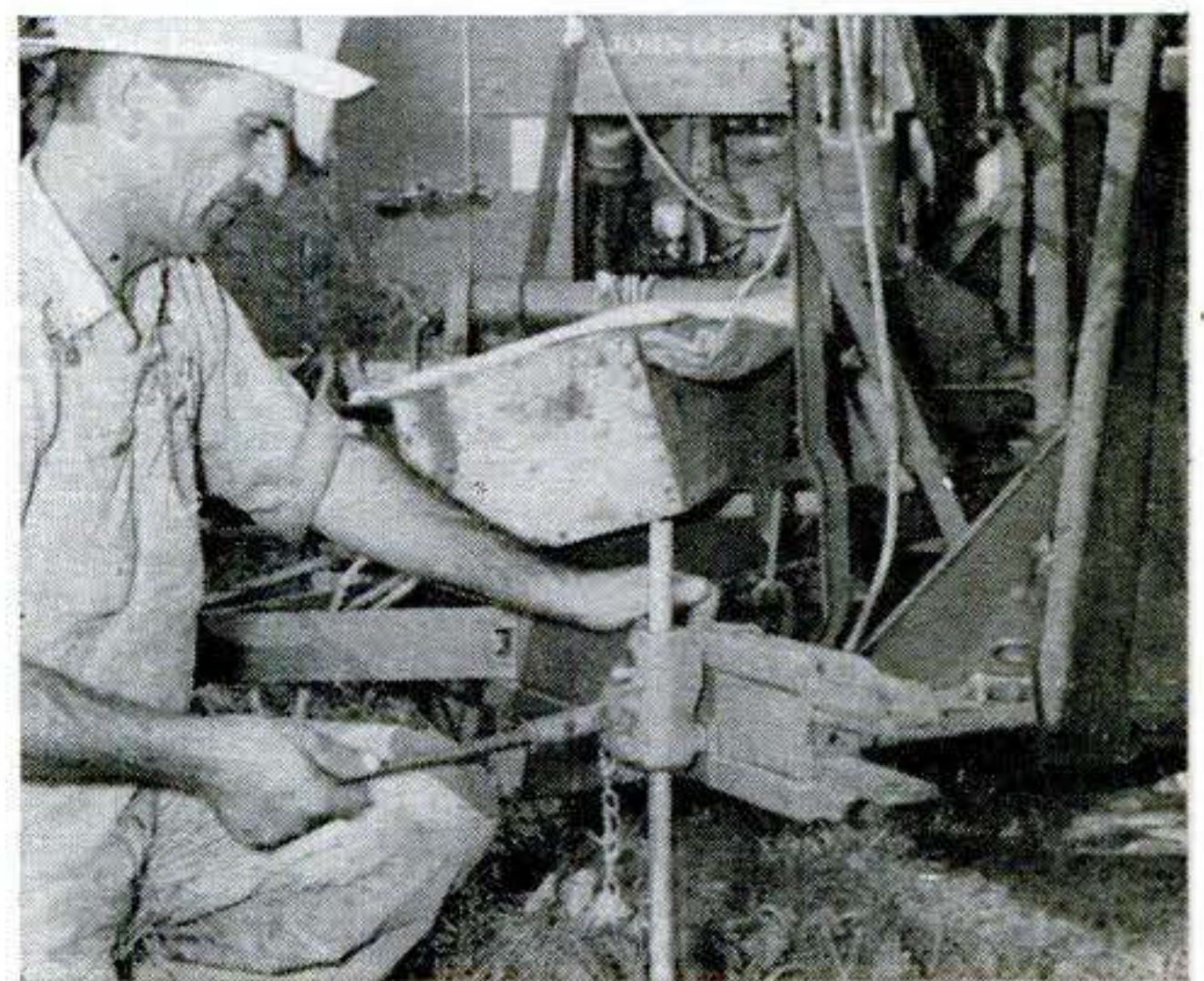

CARL BIERI of Latham, Mo., bolted a bumper jack to the hitch of his combine. This makes it easy to align the hitch with the tractor. It also supports the hitch when the combine is not being used.—*L. H. Houck, Jefferson City, Mo.*

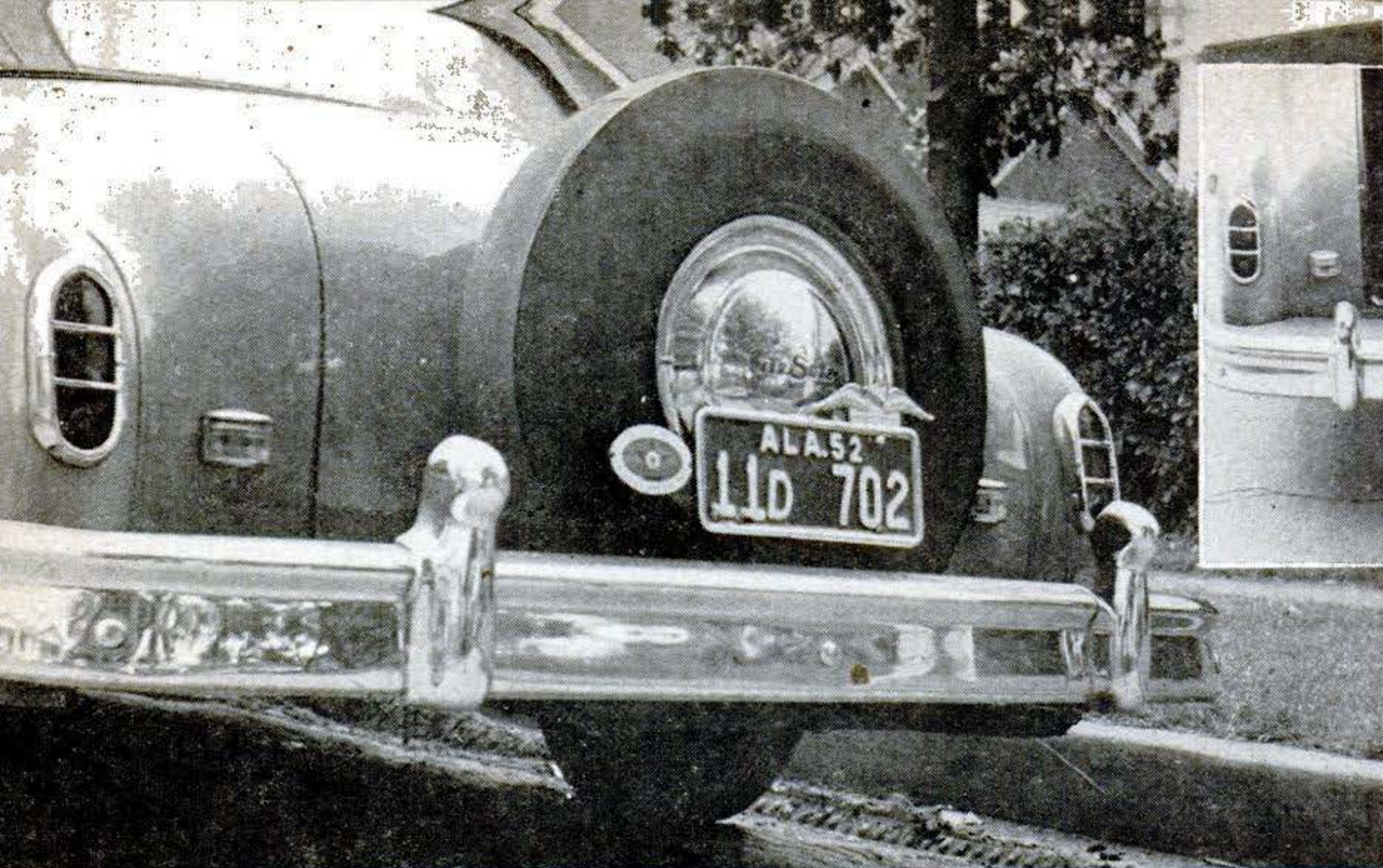

How I Gave My Car That Continental Look

Here's how to build a carrier that puts the spare tire out in back.

By Roland Loewen

MOUNTING the spare tire behind the deck gives any car something of the racy swagger of the famous Lincoln Continental. It also leaves more room in the luggage compartment.

This is a popular customizing stunt nowadays, and several companies make a business of supplying necessary parts. But you may prefer to start from scratch, as I did, and save yourself money.

I added a Continental spare-tire carrier to a DeSoto convertible. The principles, if

not the dimensions, could be applied to any other car. I moved the bumper back 6" and added a new gravel pan to fill the increased space. A hinged bracket allows the tire to swing down for access to the luggage compartment. The bracket runs through a slot cut in the extra hub cap I bought, and the cap is bolted permanently to the bracket. Loosening one nut frees the wheel and tire. Instead of buying a metal tire cover, I chose one made of convertible-top fabric.

A machine shop did the bending and welding. An auto-top shop made the tire cover. Even so, my expenses ran less than \$30.

1 BUMPER WAS MOVED BACK 6" by sawing out center section of old bracket and bolting on new parts made of $\frac{1}{2}$ " by 2" iron. Ends of old bracket were left bolted to car frame. Parts were assembled with $\frac{1}{2}$ " bolts, and other $\frac{1}{2}$ " holes were drilled for bumper bolts.

2 NEW GRAVEL SHIELD to fit wider space between the car body and bumper was cut from 18-gauge sheet metal. Old shield was used to make a cardboard pattern first. After shield had been bent down to form tire well, another piece was welded to the front edge.

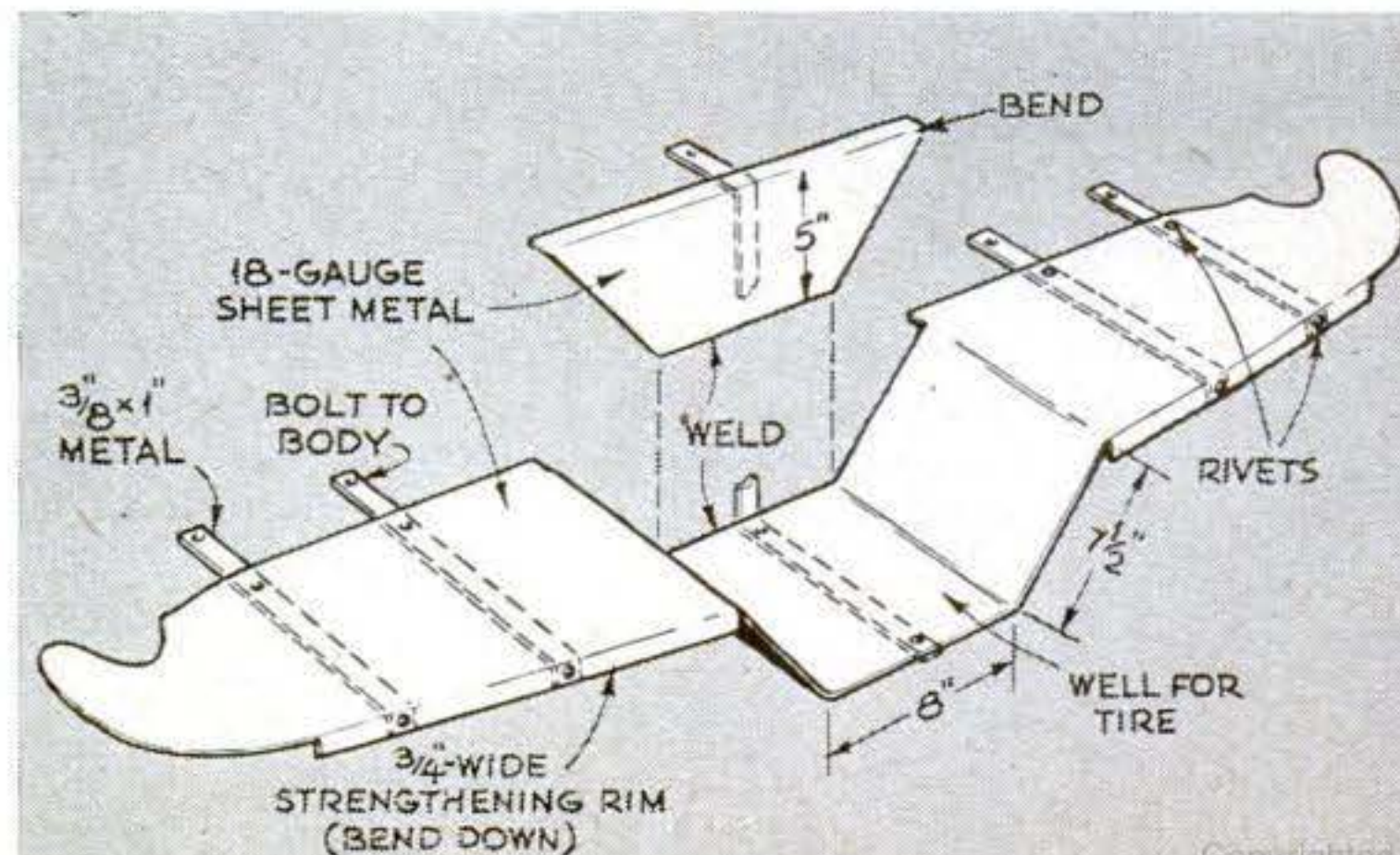
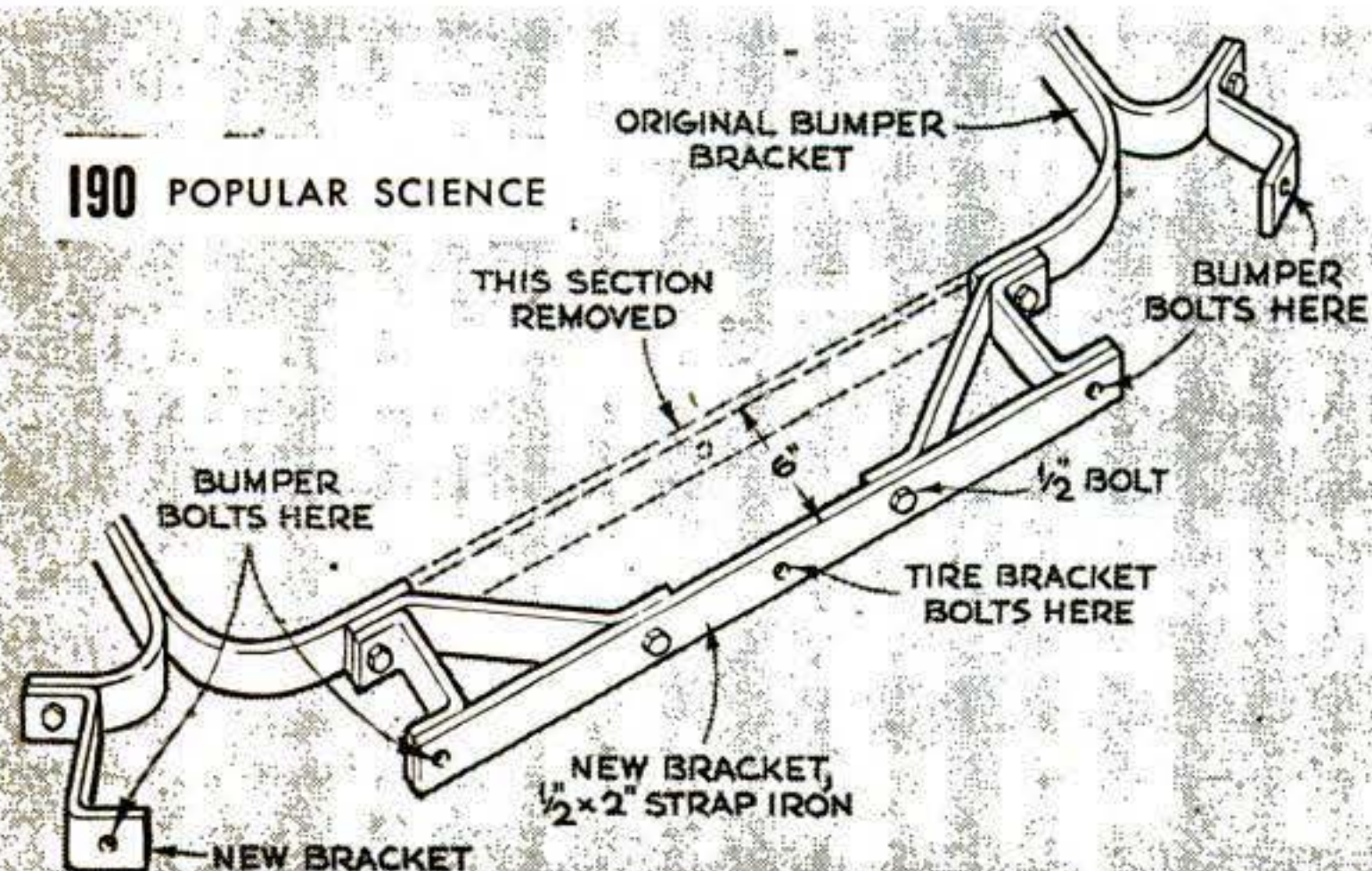

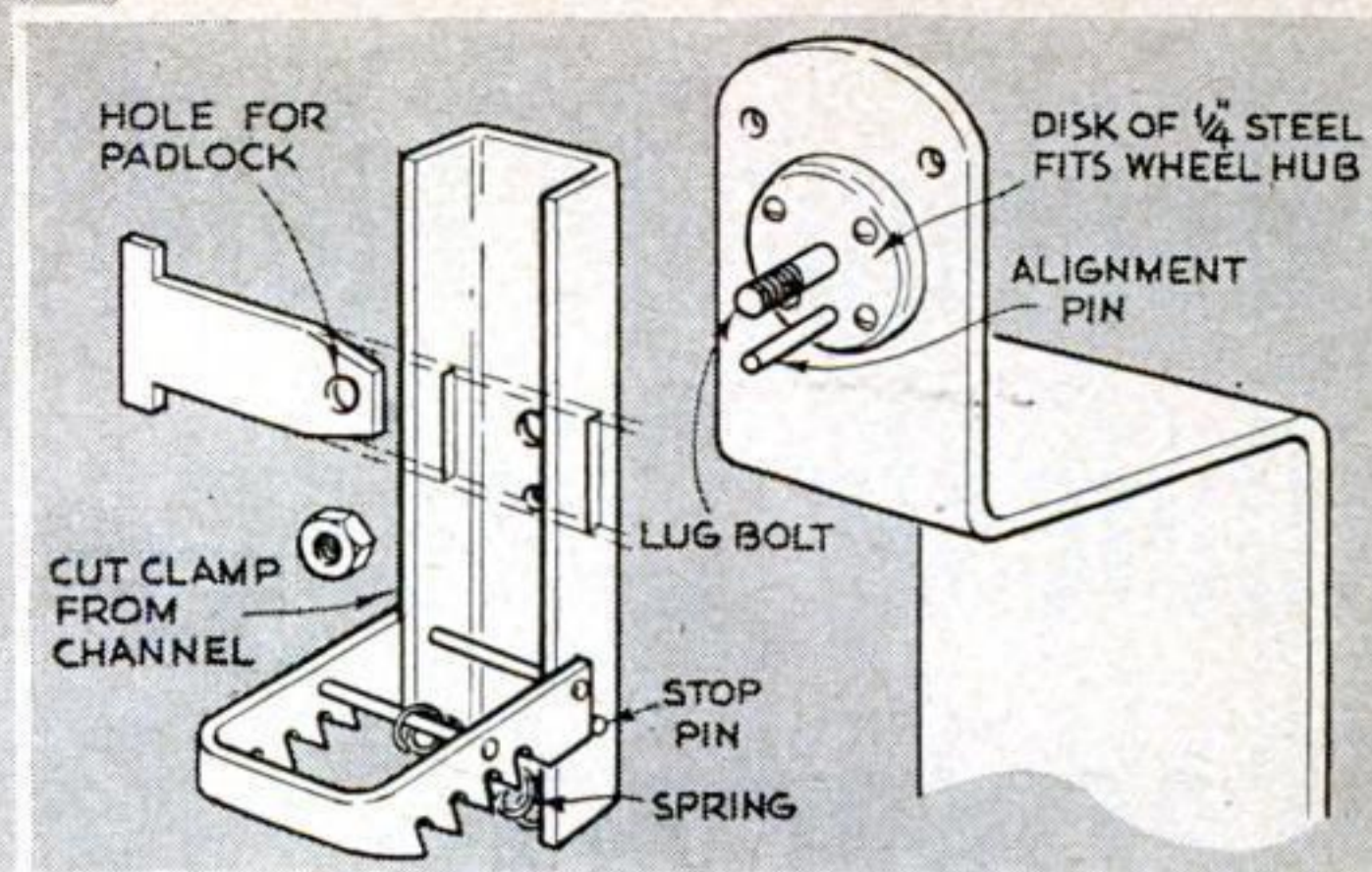
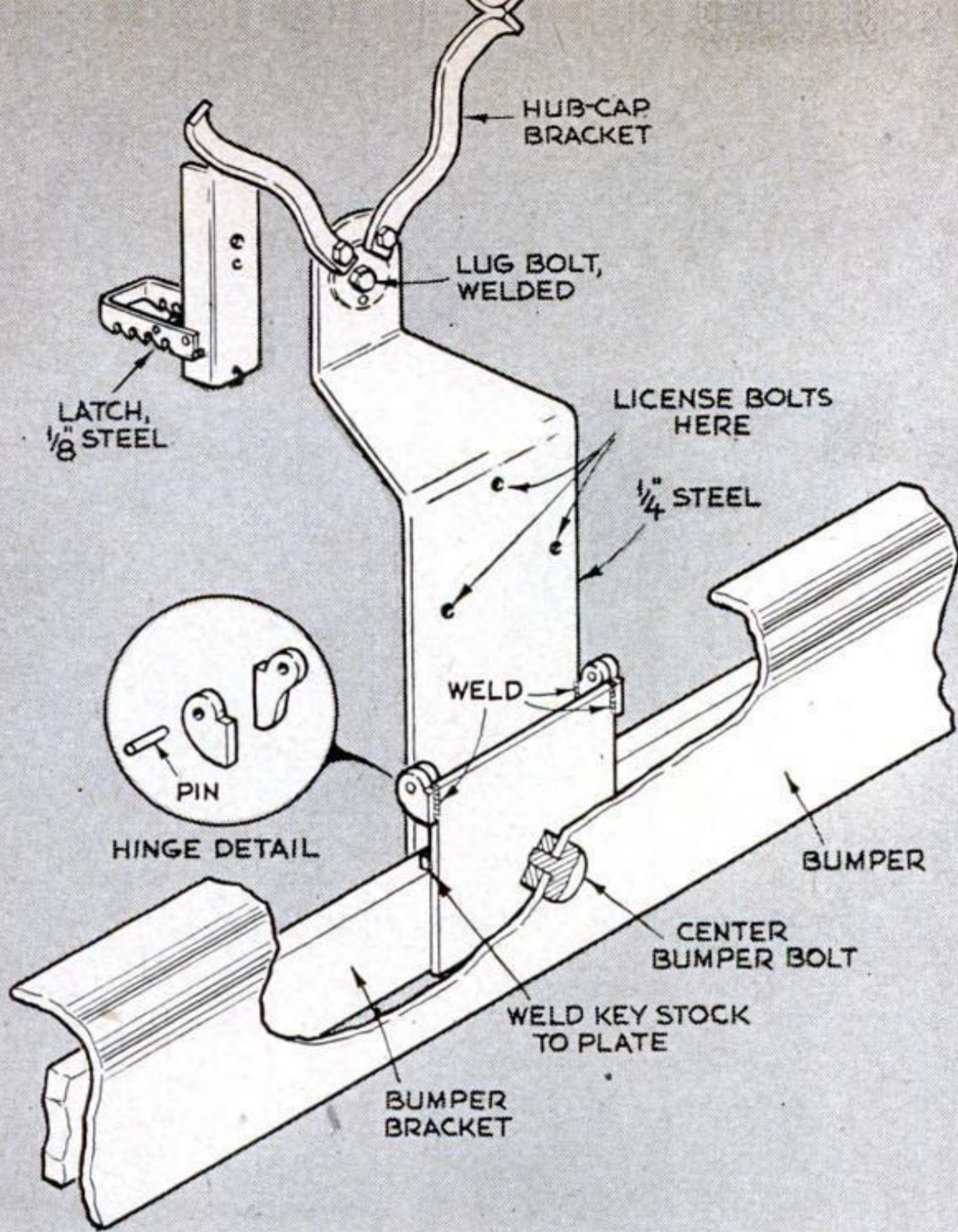

3 HINGED BRACKET made of $\frac{1}{4}$ " by 6" steel supports tire. A 6" piece of key stock welded to bottom plate keeps assembly square with bumper bracket. Size of carrier bracket was found by setting wheel in gravel-shield well. Steel disk bolted to front face keeps wheel in position, lug bolt welded through disk center keeps spare secure when nut is drawn up against clamp. Latter was cut from piece of channel. Pilot pin just below lug bolt keeps clamp vertical. Spring pulls latch against stop pin, and a lock prevents theft.

4 SLOT WAS CUT IN HUB CAP to slip the carrier through. Slot was made by drilling $\frac{1}{4}$ " holes and finishing with hacksaw and file. A bolt at bottom and bolted radial supports at top fasten cap to carrier. The supports, bent to conform to the tire, are joined at top by strip of sheet iron. License plate attached high on carrier hides slot in cap. Setscrews in bottom end bear against bumper bracket and keep the carrier and spare tire vertical.

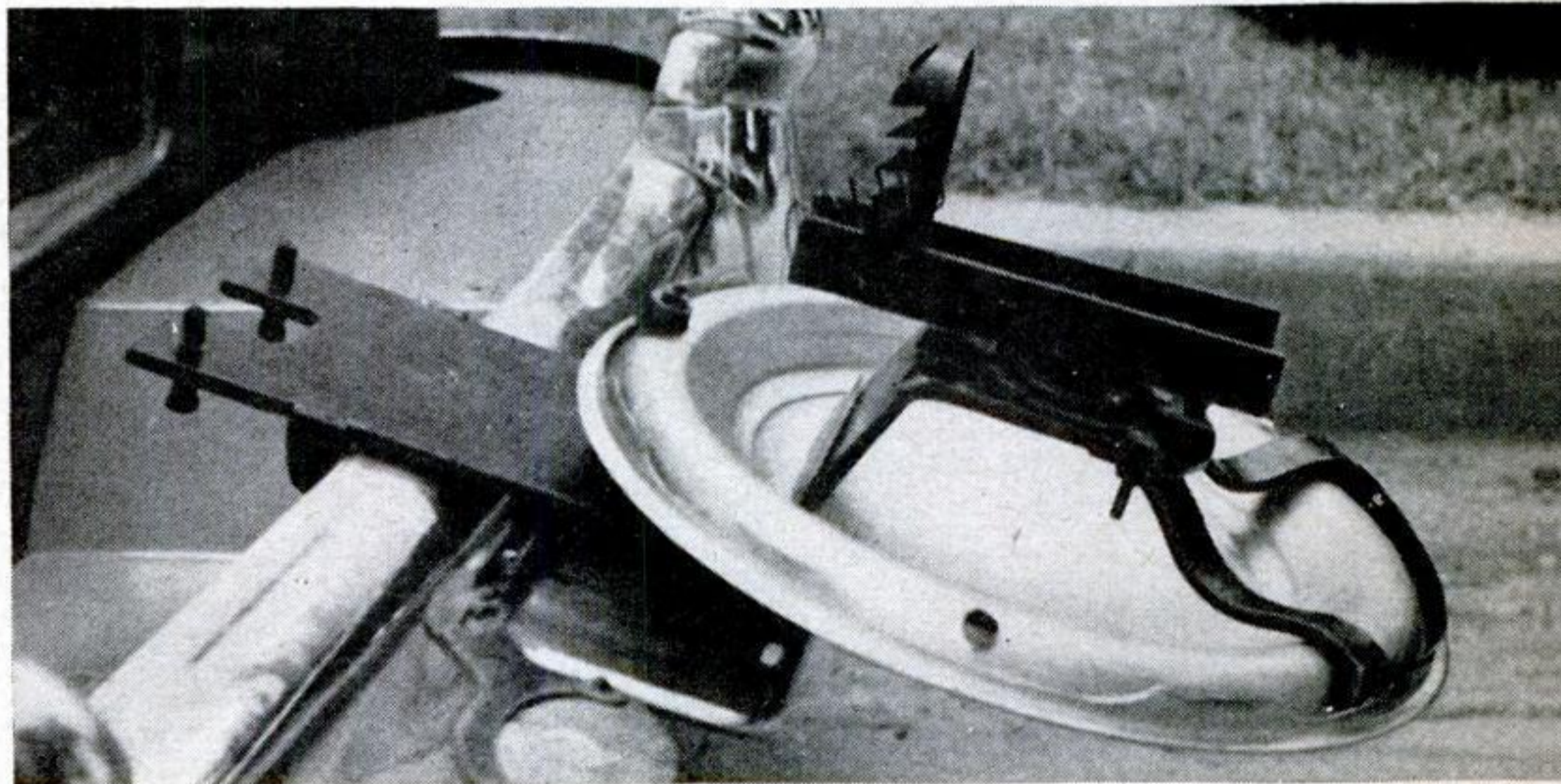

5 NOTCHED LATCH ENGAGES CLIP bolted to deck lid to hold tire in running position. Deck fitting was removed and depressions filed out to take the drilled ends of brackets made from $\frac{1}{8}$ " by 1" iron. Rubber stoppers at ends of anti-rattle bar bear against wheel. Gravel shield and all parts of carrier were painted to match the car. License plate should have a shielded white light directed on it to meet legal requirements of most states.

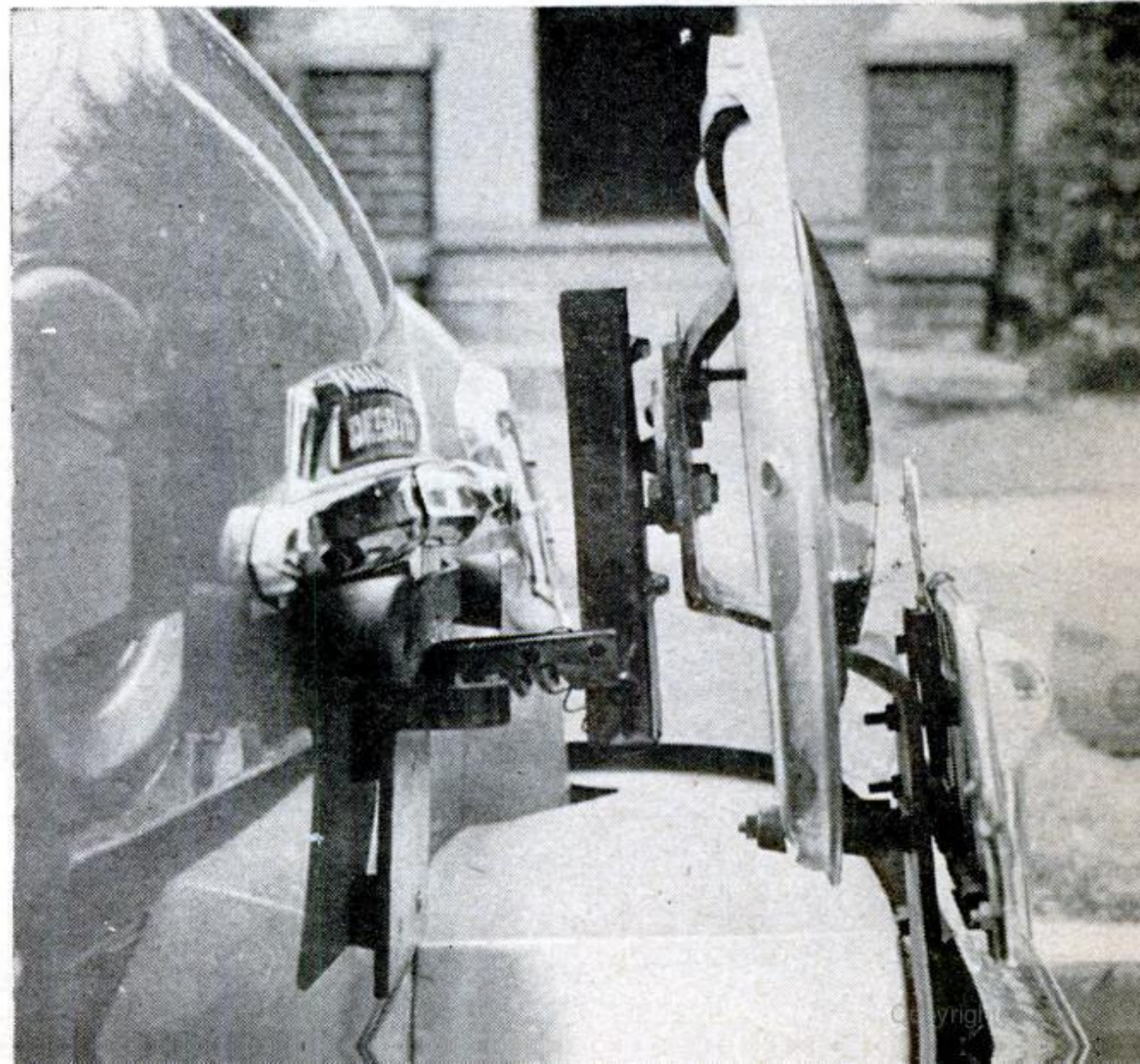
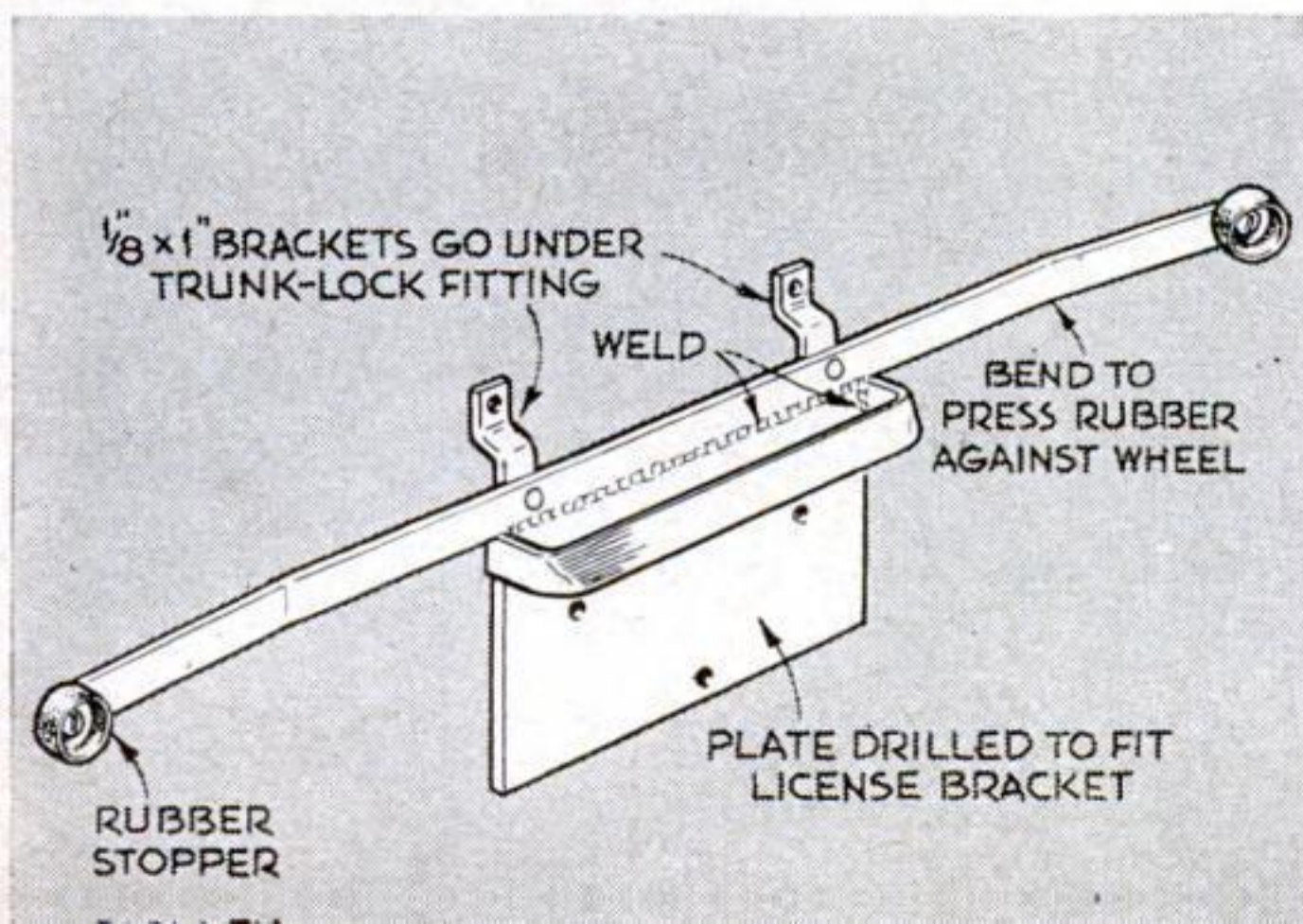

Homemade Meter Quickly Checks Car Battery

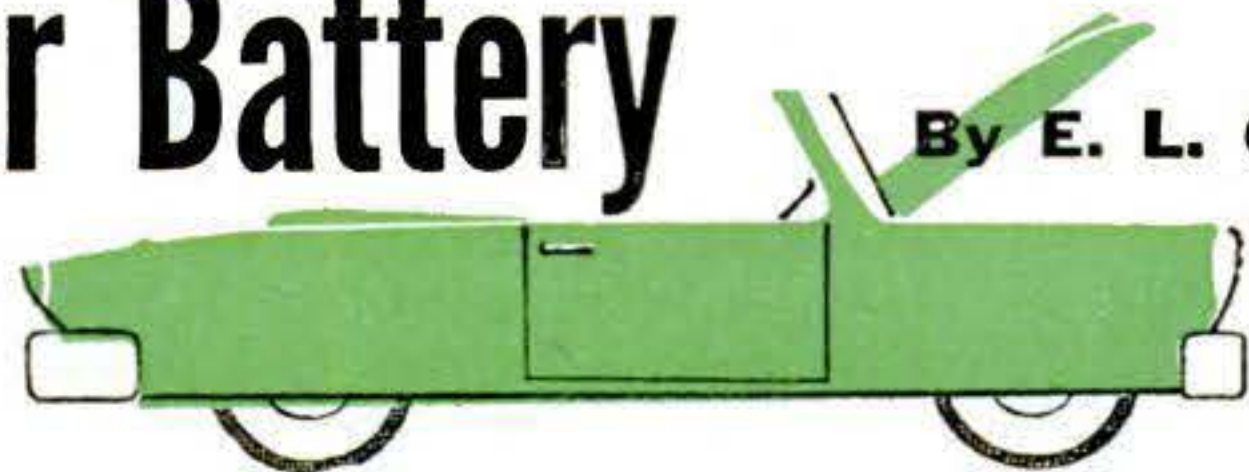

By E. L. Garrett



Modeled after a military tester, it measures voltage changes.

I HAVE a new way of checking my car battery. My homemade tester will do everything a hydrometer will do—and more—without spilling a drop of acid. It measures



Mounted in car, homemade tester gives a quick check on battery condition. For this use, it is permanently connected to one "pilot" battery cell through a push-button switch.



Signal Corps tester is more complex than home-built one. It has scales for tropic, normal and arctic batteries, all of which have different specific gravities. It tests open-circuit, light-load, and cranking and charging voltages and battery freezing point.

hairline voltage changes instead of chemical variations in the electrolyte.

I built the tester, which is patterned after a Signal Corps design, for around \$3.50, using surplus parts. With it, I can:

- Check the charge in each cell more quickly and easily than with a hydrometer.
- See how the battery stands up when the starter sucks out juice in fast-draining gulps—and get a tip of future trouble.

My tester is a voltmeter, but it gets down to much finer readings than those you see in garages. Voltage may be a tip-off if you can read the difference between the 2.12 volts of a fully charged cell and the 2.00 (at no load) of a discharged one. On the ordinary low-range voltmeter this .12-volt range may move the needle only 1/16".

The Signal Corps meter overcomes this difficulty by using a "suppressed zero" and an "expanded scale." This means that the pointer doesn't move until the voltage climbs past 1.5 and that the useful part of the scale, between 2.00 and 2.12 volts, is stretched out to almost half the total length. My meter, too, is stretched out, and on the scale each tenth of a volt is divided into five readily visible parts.

Construction. I built my tester around a surplus item called an ANP-1 Indicator*. This originally was a radio-altimeter indicating device used in planes. You must adjust the hairspring arms to spread out the scale, wire a couple of resistors in the circuit to push the voltage range upward, and make a new scale and calibrate it.

If you can't borrow a good voltmeter to calibrate a new scale, you can get a good

*I bought mine from Photocon Sales, 1060 N. Allen Ave., Pasadena 7, Calif.

HOW TO BUILD THE TESTER

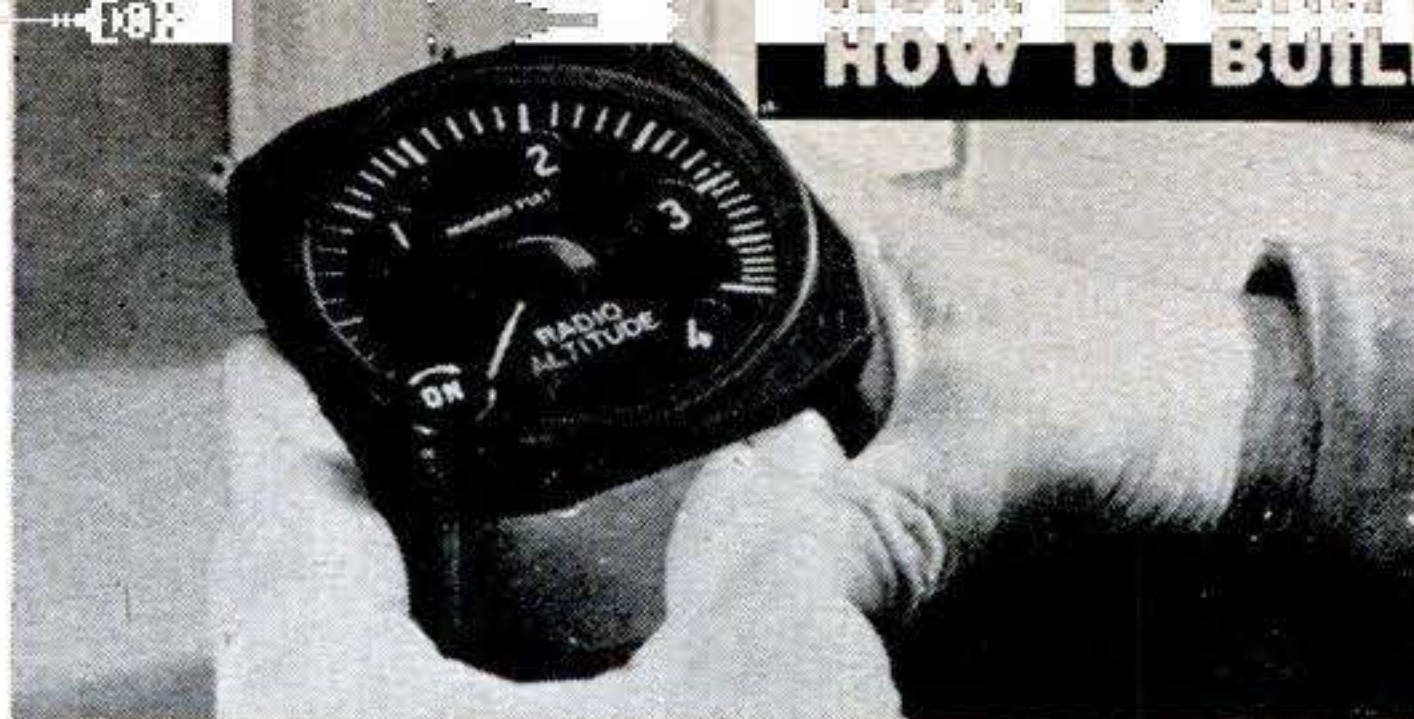

1 Basis of tester is this surplus ANP-1 indicator, bought by mail for \$2.95. Basically it's a sensitive milliammeter.

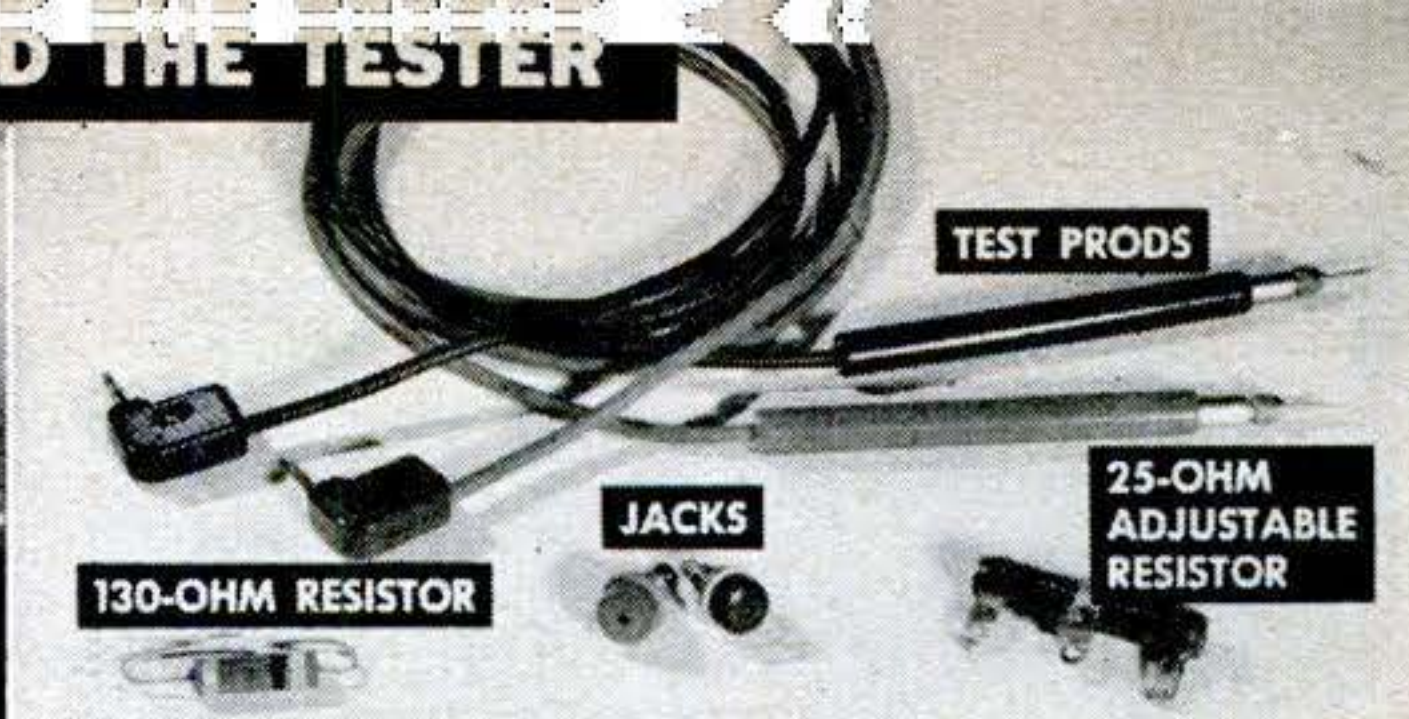

2 Other parts required are pictured here. You can get these from an electrical or radio-parts store. You also need a case.

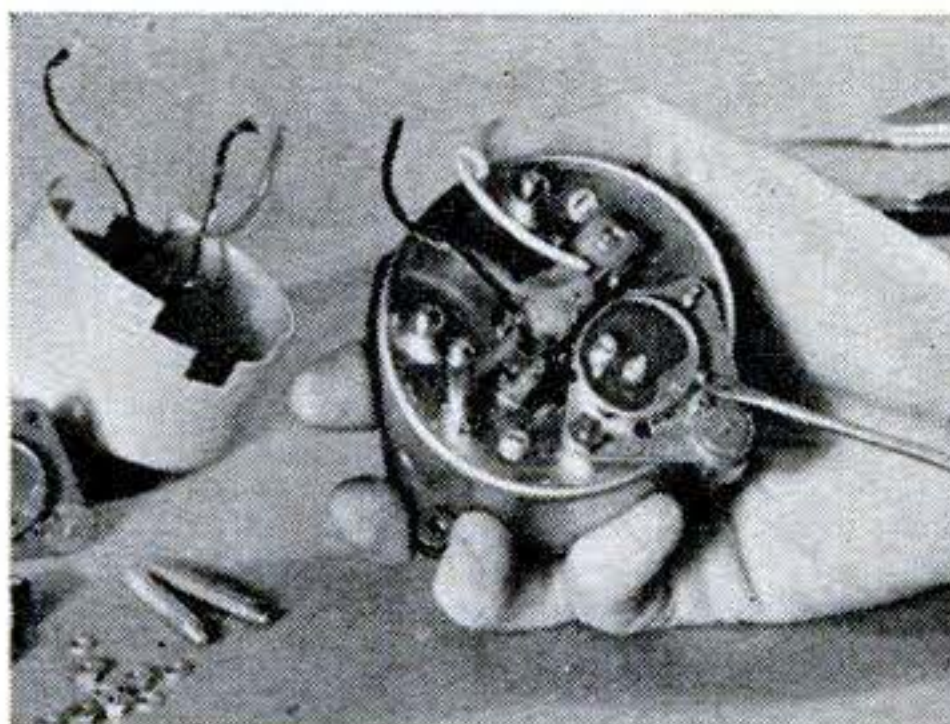

3 Clip off all wires leading to the connector, after removing back cover. Take out one of the two switches that you'll find on back.

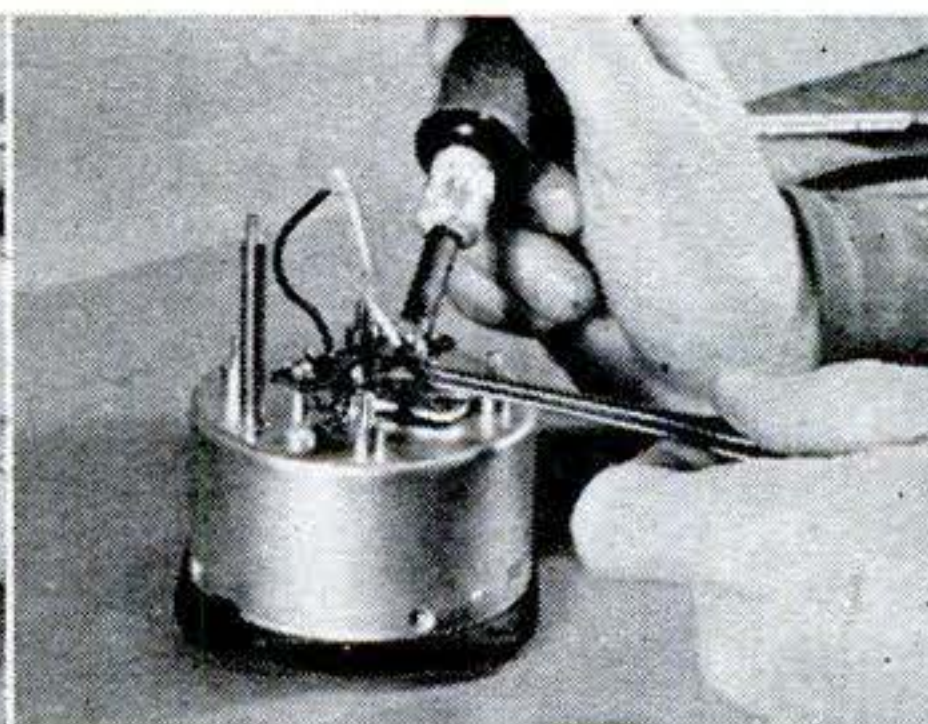

4 Unsolder the two leads from terminal strip to inside of case. Take out four flathead screws. Roundhead screws at rear release works.

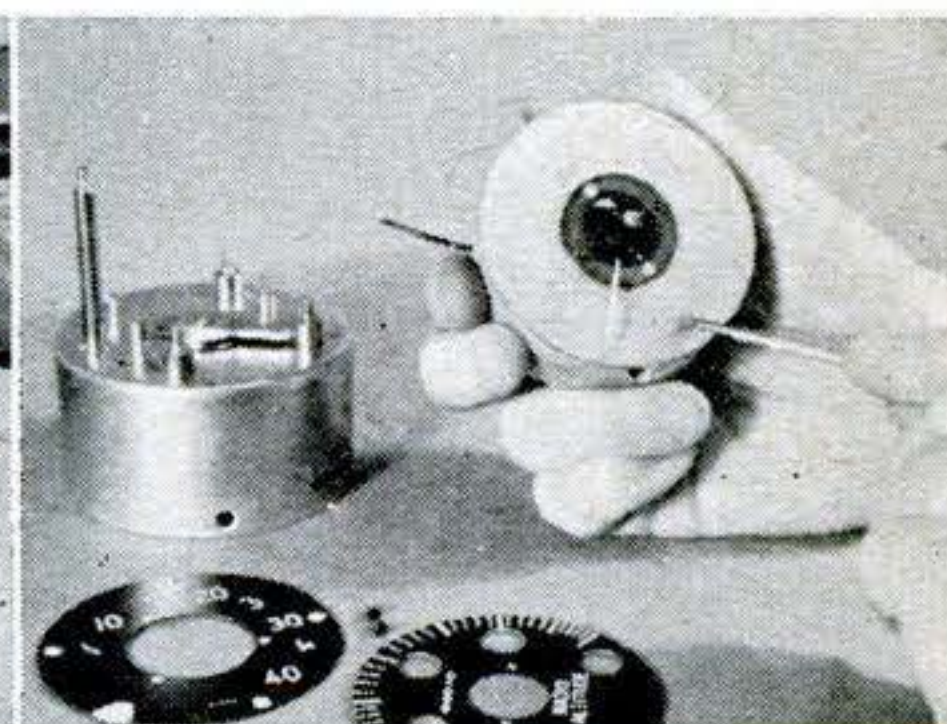

5 Discard original dial and movable disk under it. Your new paper dial will be glued to the plain metal facing indicated here.

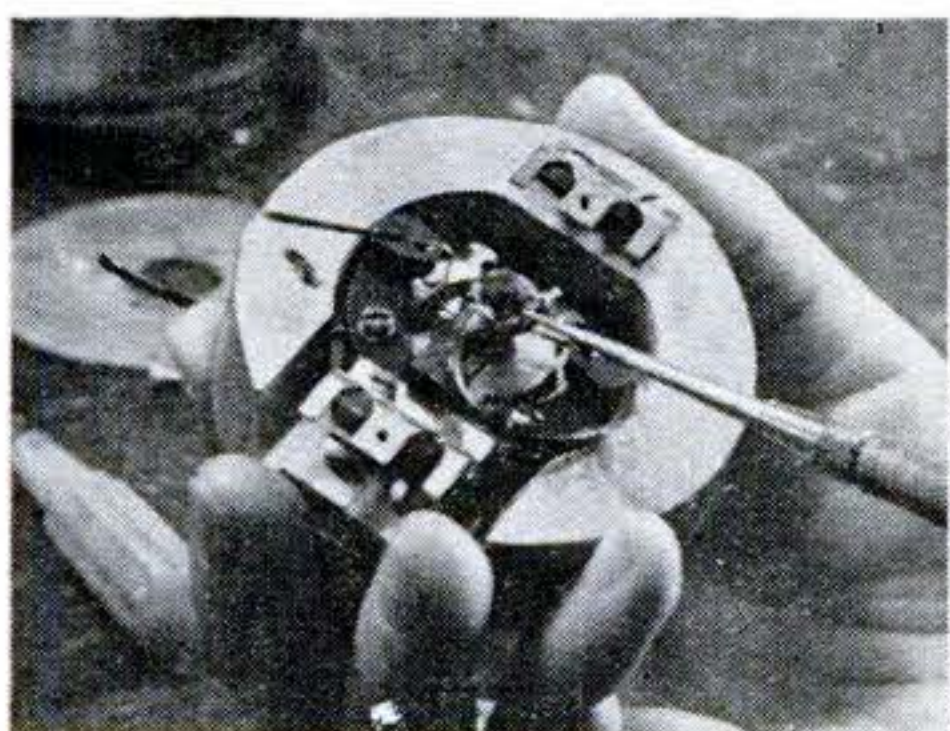

6 Scrape black paint off star-shaped washer and off bottom bearing screws, using a sharp scribe. Then rotate upper hairspring arm fully counterclockwise, bottom one fully clockwise. This expands scale.

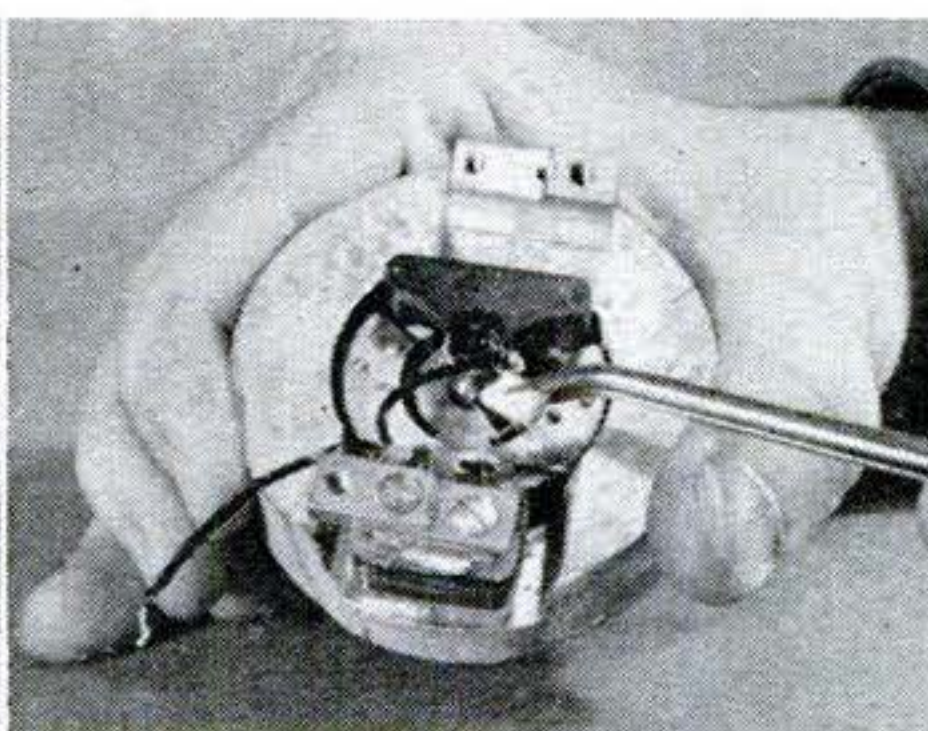

7 Insert tiny squares cut from new foam-rubber powder puff to cushion the two moving coil windings when they snap back to the low-scale position. This step is very important.

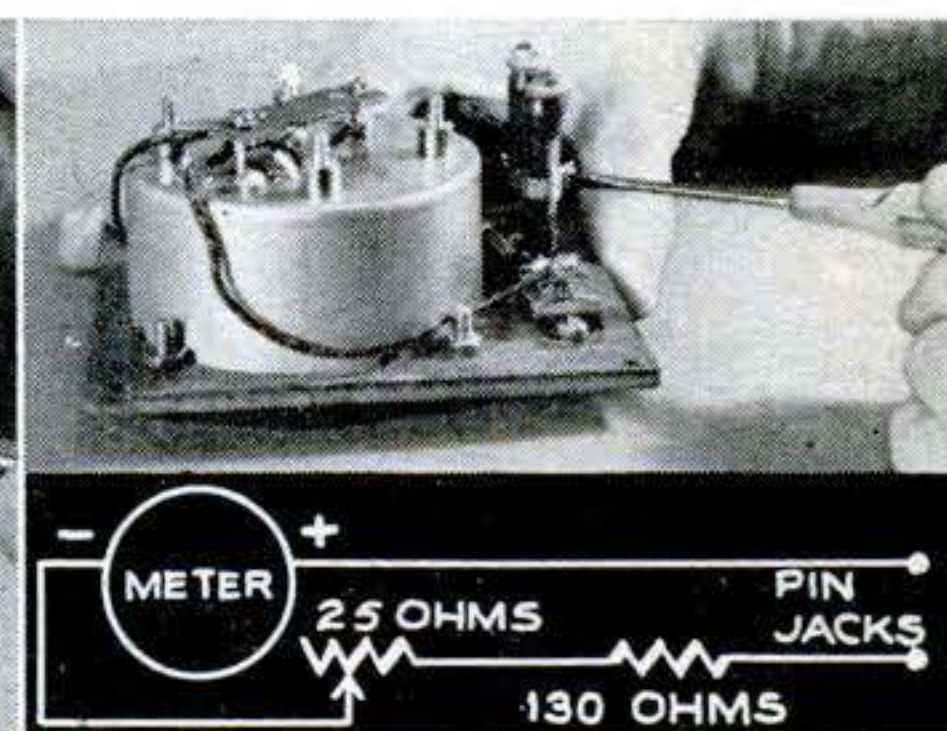

8 Connect parts as diagram shows and assemble on a panel. Calibrate a new scale as shown on next page after taping paper disk to meter face. (Please turn page for finish of job.)

idea of the open-circuit voltage points by checking several fully charged and discharged batteries with both a hydrometer and your tester. This will enable you to set enough points to complete the scale.

How it is used. The simplest test is to take readings across each of the three cells separately when there is no load on the battery. Experts do not agree on the value of this test, but I find it gives a quick report on how nearly charged the battery is (see voltage figures on next page). *Never connect the meter across the whole battery: six volts will damage it.*

Another procedure, the load test, is the best way of finding if a battery still has moxie. Warning of future failure shows up sooner on a load test than on an open-circuit one.

Simply take quick readings across each cell while the starter motor is turning the warm engine over with the ignition off. But make this test *only if the battery specific gravity is 1.250 or higher*. Don't run the starter more than 15 seconds at a time or you may damage it. The table on the next page shows you how to evaluate the voltage drop.

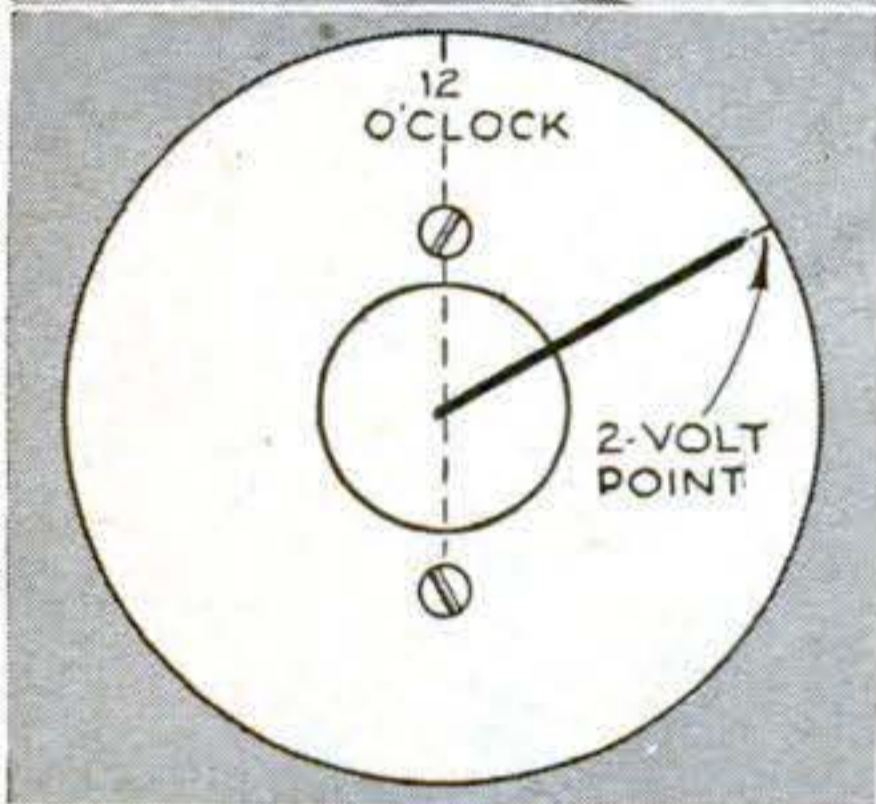
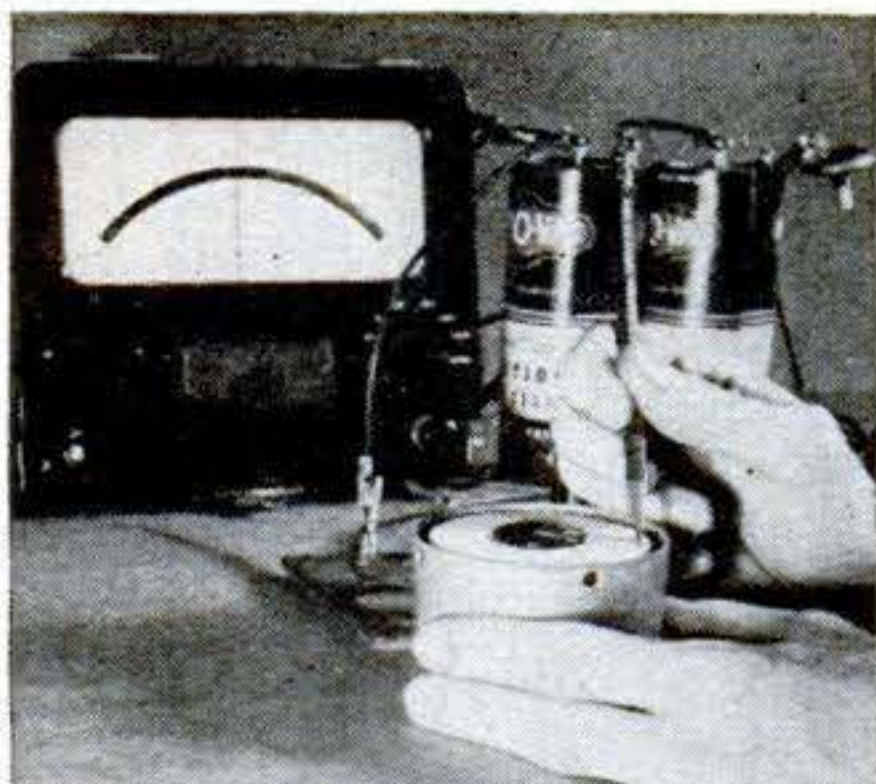

9 Best way to calibrate scale is to borrow a long-scale voltmeter, a potentiometer (about 0-1,000 ohms) and an adjustable rheostat (about 0-30 ohms). Hook these, the 25- and 130-ohm series resistors and two dry cells to your meter as at right. Set slider of 25-ohm resistor to mid-position. Adjust potentiometer to bring pointer to about two o'clock on blank scale (left) with exactly 2.00 volts going into meter. Mark the 2.00-volt point on dial. Then, to calibrate scale points above and below, adjust both potentiometer and rheostat. Mark points, remove dial and finish with India ink. Now assemble all parts on panel. As final step, again connect tester into calibrating circuit at right and adjust 25-ohm resistor to bring needle to 2.00-volt point after previously setting calibrating meter to 2.00-volts. Then clamp resistor slide permanently at this point.

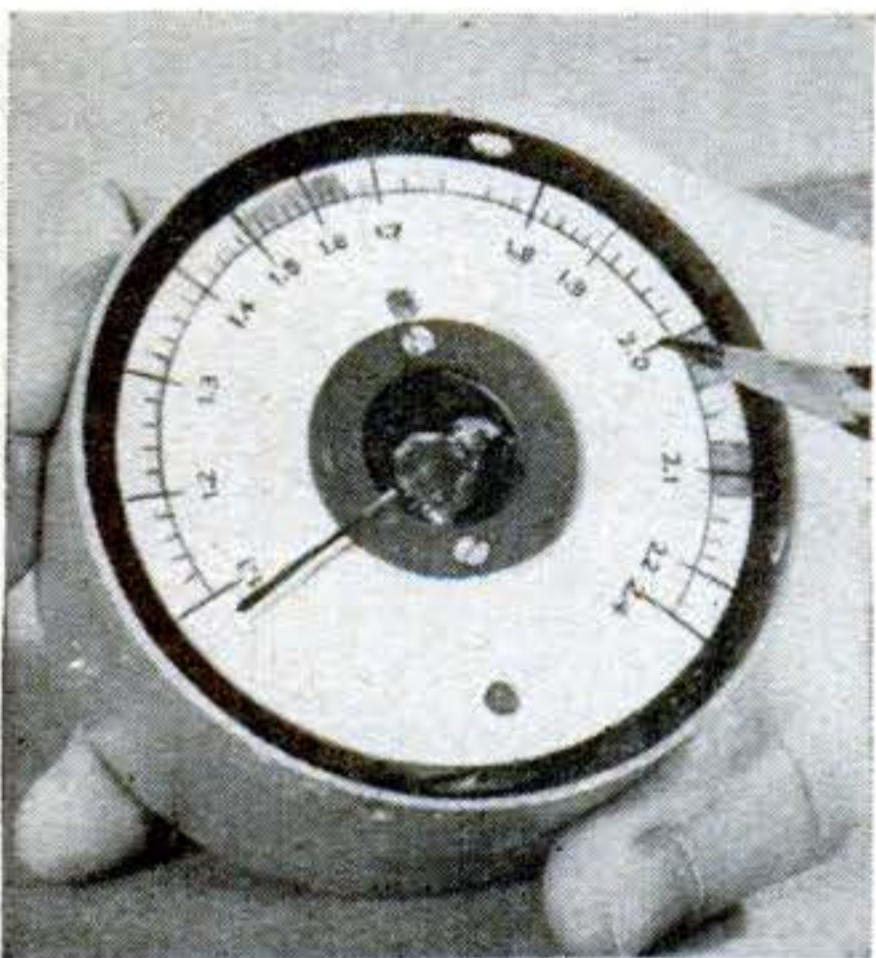
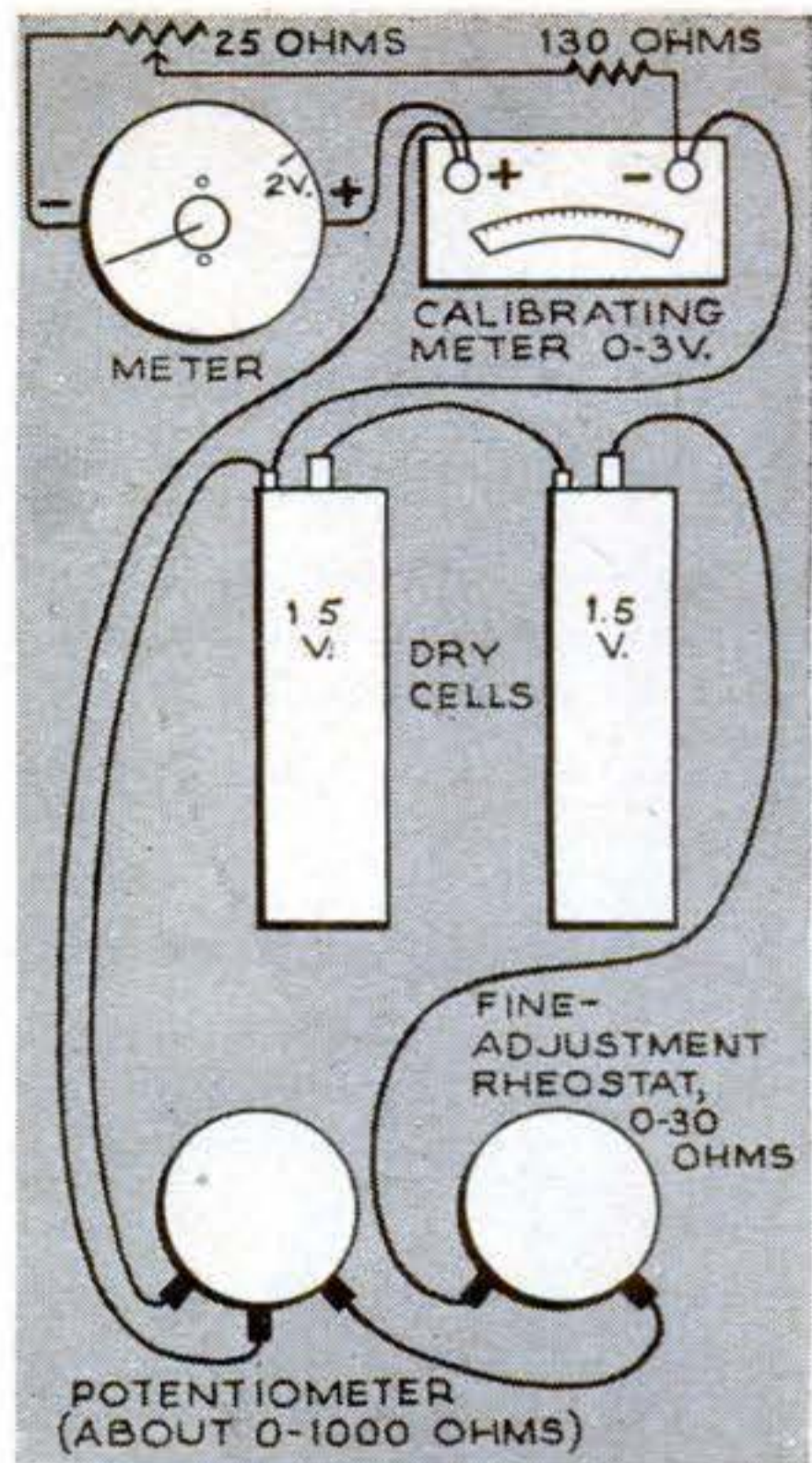

10 Finished dial has two color scales, each divided into three parts. Color scale (left) beyond 2.00 volt mark shows poor, fair and good results for open-circuit tests. Color scale at left side of dial shows the same for cranking-load test.

11 Mounted in a case, the meter can be used this way to make open-circuit check of individual cells. For a cranking test, have helper step on the starter with ignition off.



CAR BATTERY TESTS

(Source: Signal Corps)

Hydrometer or Open Circuit		Battery Condition
Specific Gravity (at 70° F.)	Voltage (no load)	Good
1.280	2.12	Fair
1.260	2.10	
1.210	2.05	
1.180	2.03	Poor
1.150	2.00	

Cranking-Load Voltage		Battery Condition
	1.66-1.48	Good
	1.48-1.32	Fair
	Below 1.32	Poor

Electrolyte Freezing Points		Battery Will Freeze at:
If Specific Gravity Is:	Or Cell Voltage Is:	10°F.
1.141	1.89	0°
1.182	2.03	
1.214	2.05	-20°
1.232	2.08	-40°
1.246	2.10	-60°
1.260	2.11	-75°

FOR YOUR POPULAR SCIENCE MONTHLY INFORMATION FILE

How to Travel Like a Gypsy

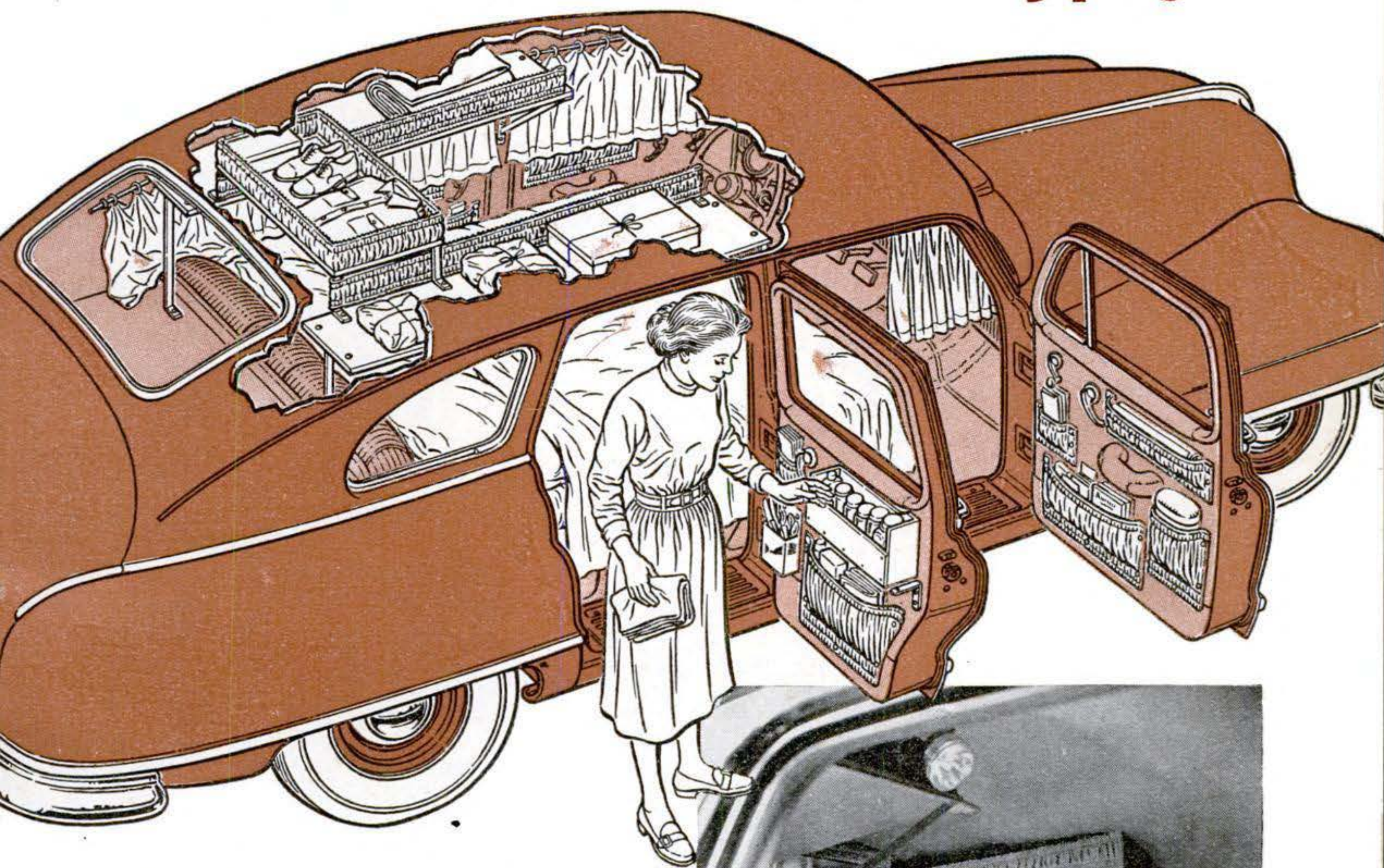

Besides a bed for two, this car has other built-in conveniences that make it a real home on wheels.

PLENTY of Nashes have been sold with built-in beds. But in the 1949 model owned by Lucius Sheets of Huntington, Ind., a place to sleep is just the beginning of home conveniences. He can *live* in his. On a gypsy tour, gas, oil and food are his only expenses.

The right rear door is the meal center. Containers for coffee, tea, salt, pepper, sugar and flour fit into a narrow plywood box mounted just below the window. Silverware goes into a small box below. Such items as paper towels, napkins, dish towels and a tablecloth are carried in the two pockets. Perishable food is packed into an insulated picnic box.

A piece of plywood, stored under the seat, hooks to two brackets under the food shelf and serves as a table. Mr. and Mrs. Sheets find standing to eat a restful change from sitting while riding.



ALL SET FOR THE NIGHT. Curtains are drawn for privacy, and light overhead gives illumination for reading in bed. Pajamas and such are tucked into pockets at head of bed.

Pockets on other doors hold miscellaneous items—stationery, pen and pencils, business papers, maps, magazines, screens for the car windows. Sliding curtains hang on $\frac{1}{2}$ " rods, giving night privacy.

The Sheets need no suitcases, for three shelves near the roof of the car offer space for clothing and toilet articles. The side shelves are 12" wide and 9' long. Elastic fabric keeps items on the shelves, which are supported by metal brackets. END

Gus Gets the Pitch

"Hurry, hurry, hurry!" spieled the carnival pitchmen, but the Model Garageman kept stalling as mysteriously as their new car.

By Martin Bunn

A HORN honked impatiently outside the Model Garage.

"I'll get it," Gus called back to Stan Hicks, his helper. "You'd better stick with that valve job for Mr. Landsdowne."

Two cars were parked out on the concrete by the gasoline pumps. A frayed knotted tow rope linked them. Gus recognized the tow car as the battered coupe belonging to old Jim Barstow who ran a sizable farm about 10 miles out of town. The car being towed looked as if it had just left the showroom.

"Newfangled Buggy" Breaks Down

"Got customers for ya," greeted Barstow as he unhooked a piece of baling wire and pushed open his door. "Broke down on the road out by my back 10. Happened to be cultivatin' and offered to tow 'em in."

"Thanks, Jim."

"Yep, that's the trouble with these newfangled buggies," Barstow rambled on. "Too many gadgets to get out of kilter. Well, I'll be seein' ya."

He tossed the tow rope into his car and clattered off down the road.

"Quite a character," said Gus with a chuckle to the two riders in the new car. "Now, how did your car happen to stall?"

"Just stalled, that's all," said the big man behind the wheel, in a voice like a saw sharpening a file.

"Yeah," echoed a small man sitting beside him, in equally rasping tones. "We were



"I'll just road-test it,"

breezin' along in fine style when all of a sudden no motor. It was like Chick, here, had turned off the ignition. I says to Chick—"

"Can the spiel, Sparks. We got no time for chatter. Let's get the car fixed and hit the road." He turned to Gus. "We're pitchmen, mister—you know, spielers—for the big carnival that's opening in the city and we gotta be there tonight to help stake out our act. Think you can help us in a hurry?"

"Try to," said Gus.

The big man eased his bulk out of the



said Gus, as he backed the car quickly out of the shop.

car and Gus slid in under the wheel. There was plenty of gas. The mileage showed less than 1,200—the car still had that new smell about it. But nothing would coax even a cough out of the engine.

Pitchman Tells Gus How to Fix It

“Let’s push her into the shop,” Gus said after a few tries, “where I can put some test instruments on her.”

“Now, wait a minute,” the man called Chick said. “This should be an easy thing to fix. I know a little about cars myself. It’s

plain enough that the engine just ain’t getting any gas. Trouble’s obviously somewhere in the carburetor, the fuel pump or the feed line. You ought to be able to find it there quick enough. We ain’t got time for a fancy tune-up, so just check the fuel system and get us moving as quick as you can, huh?”

“You may be right,” returned Gus evenly. “But I have to look a car over before I can spot the trouble.”

“Okay, okay, let’s get her inside.”

The three men, with Gus reaching in

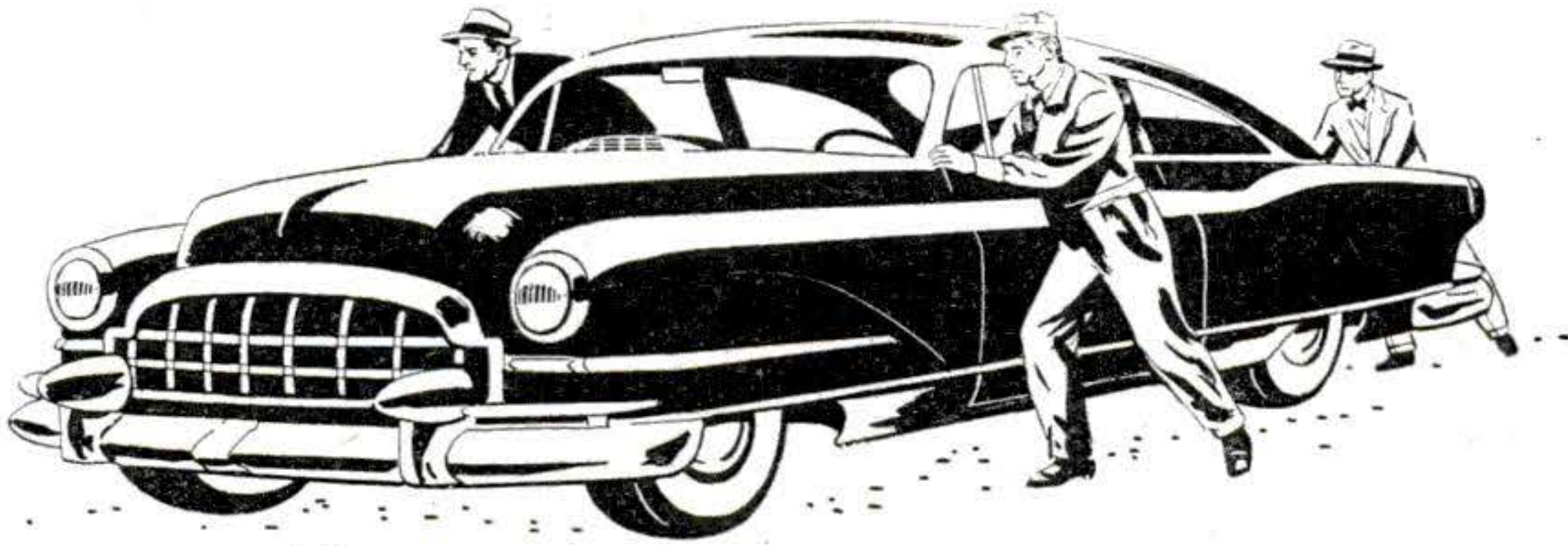

through the driver's window to steer, soon had the car parked beside Gus's bench.

"Ever have any trouble before?" asked Gus.

"Nope," answered Chick curtly.

"Been in a repair shop for a check-up?"

"Nope."

As Gus rolled his test panel over, the pitchman moved away and began to pace the garage nervously. His little sidekick paced right along with him. They seemed to be discussing something important in confidential tones. Gus began checking the ignition system—he felt sure the trouble was there somewhere.

After a few minutes, the little guy, Sparks, called out: "Making any progress, Pop?" He looked at a potato-size gold watch anchored to his vest by a heavy gold chain.

Gus ignored the little spieler and kept about his work of checking every wire and connection. On the surface everything seemed perfect, yet the ignition system was completely dead. The test rig bore him out.

There was only one thing to do, check each unit separately, so Gus started out with the battery leads.

Gus's Behavior Mystifies Stan

"Got an oversize battery in here, haven't you?" he asked, tapping the case with the tip of his screwdriver.

"Yeah, yeah," Chick said shortly. "Do a lot of cold-weather driving. . . . But never mind that. Haven't you located the trouble yet?"

Gus was checking the distributor now and he had an odd gleam in his eye. "Listen, mister," he said finally, "give me a little time, will you? This engine is new to me—I've never worked on a model like it before."

Over in the corner of the garage where he was working on the Landsdowne car, Stan glanced up in surprise. What did Gus mean by saying he wasn't familiar with that car? Doc Hanson had one just like it and they'd had it in the shop for a tune-up only

last week. Gus's voice sounded funny, too—kind of Milquetoasty, as if he were extra anxious to please the big loud-talking pitchman.

But it seemed to suit Chick. For the first time he sounded almost genial when he said, "Well, all right, old-timer, but shake it up, will you? We're busy men and time's a-wastin'."

Road Test Rouses Carny Men's Wrath

Ten minutes later, after several trips to the stock room, Gus snapped the distributor cap into place and slid into the driver's seat. The engine started up smoothly.

"I'll just road-test it," he called out to the pitchmen and backed the car quickly out of the shop. Both men started to protest that they couldn't spare the time, but Gus was already headed down the road.

When Gus got back to the garage, he was greeted by two red-faced, fuming men, who, judging from the look on Stan Hicks' face, had been venting their anger on him.

"What's the idea?" Chick shouted. "You knew what a hurry we're in!"

"No idea. Just routine in this shop. We don't like customers to get a few miles down the road and find that what we thought we'd fixed isn't right after all. Matter of fact, she needs one more minor adjustment." Gus popped open the hood again. "Stan, come over here a minute, I've got a job for you." Gus whispered briefly. Stan nodded and left the garage.

After a few minutes Gus closed the hood again. "There she is, boys, as good as new. That'll be \$12.50."

"Well, it's about time," snapped Chick. The little fellow was already in the car when the big guy slid in and started backing out. Suddenly he stopped. "Hey," he yelled, "get that grease monkey of yours to back that tow truck out of the driveway. How in blazes do you expect me to back out?"

Stan climbed up into the driver's seat and

[Continued on page 246]



Hints from the Model Garage

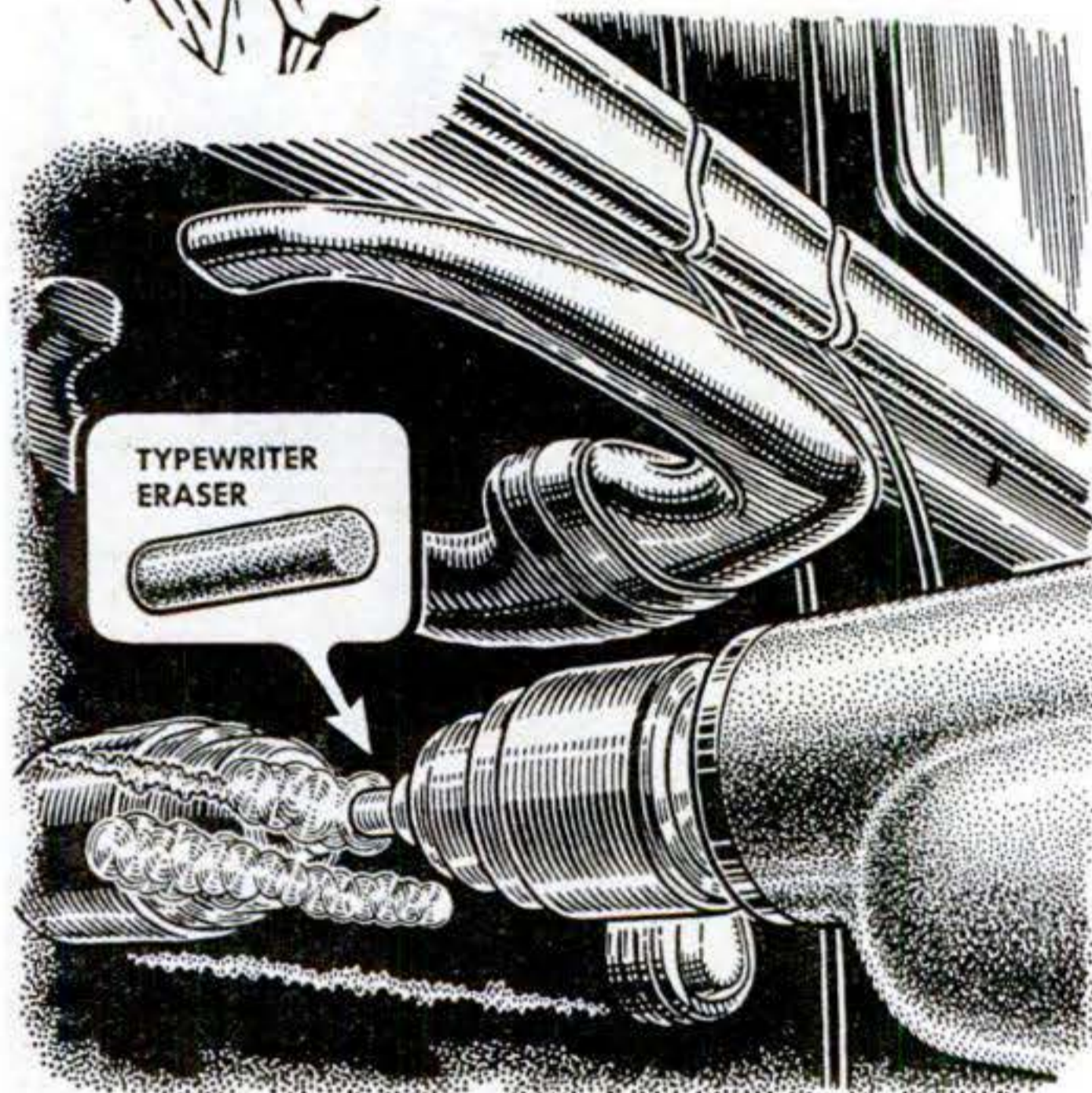

Chucked in an electric drill, the gritty core of a pencil-type typewriter eraser makes it easy to touch up tiny rust spots on a car body without scratching the adjoining paint. The eraser will quickly remove the rust and clean the metal for painting.

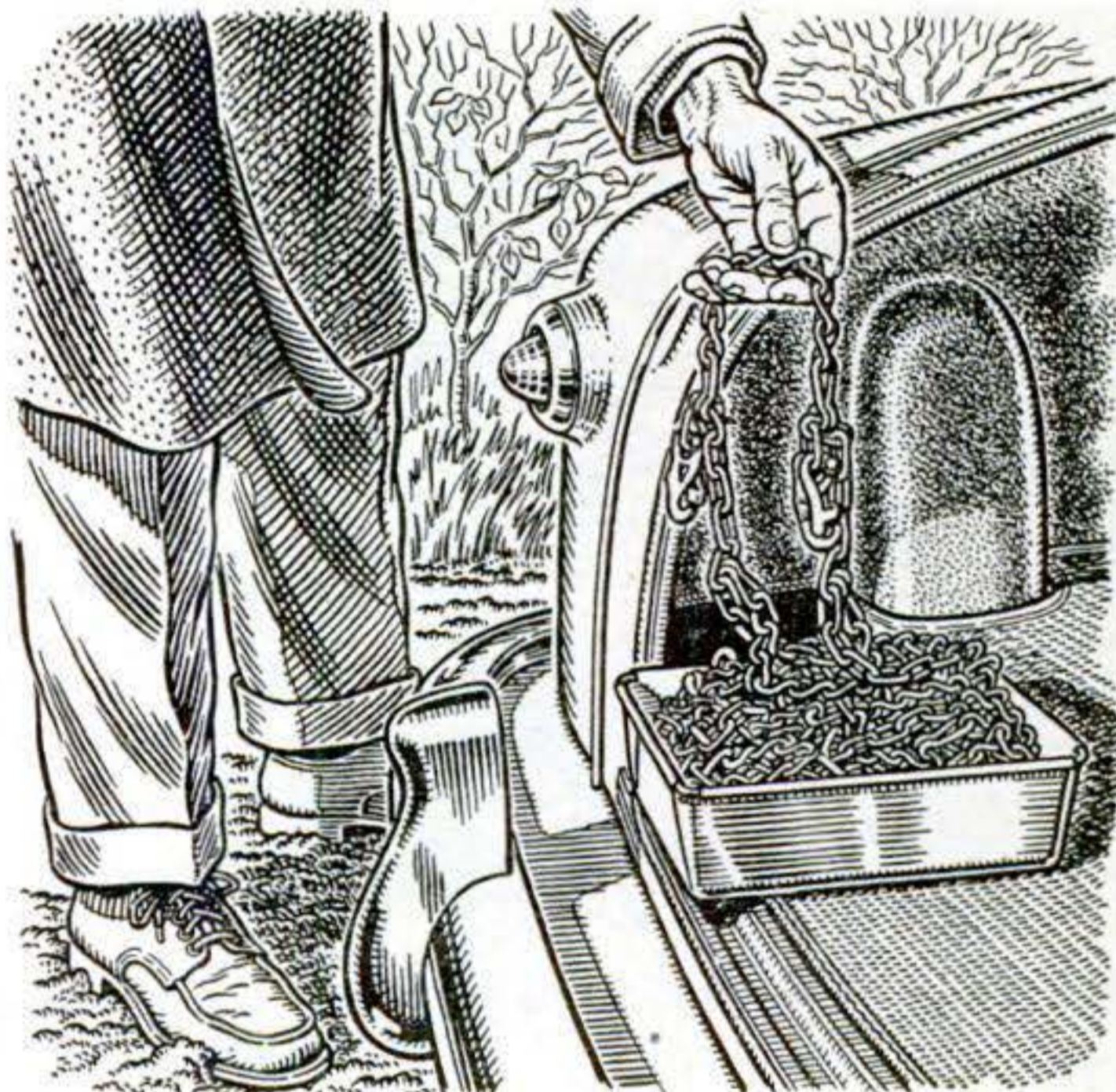

A large baking pan kept in the trunk of your car is a neat container in which to place wet and muddy tire chains if you have to remove them along the road. Your wife may have an old battered pan that she would be willing to discard.

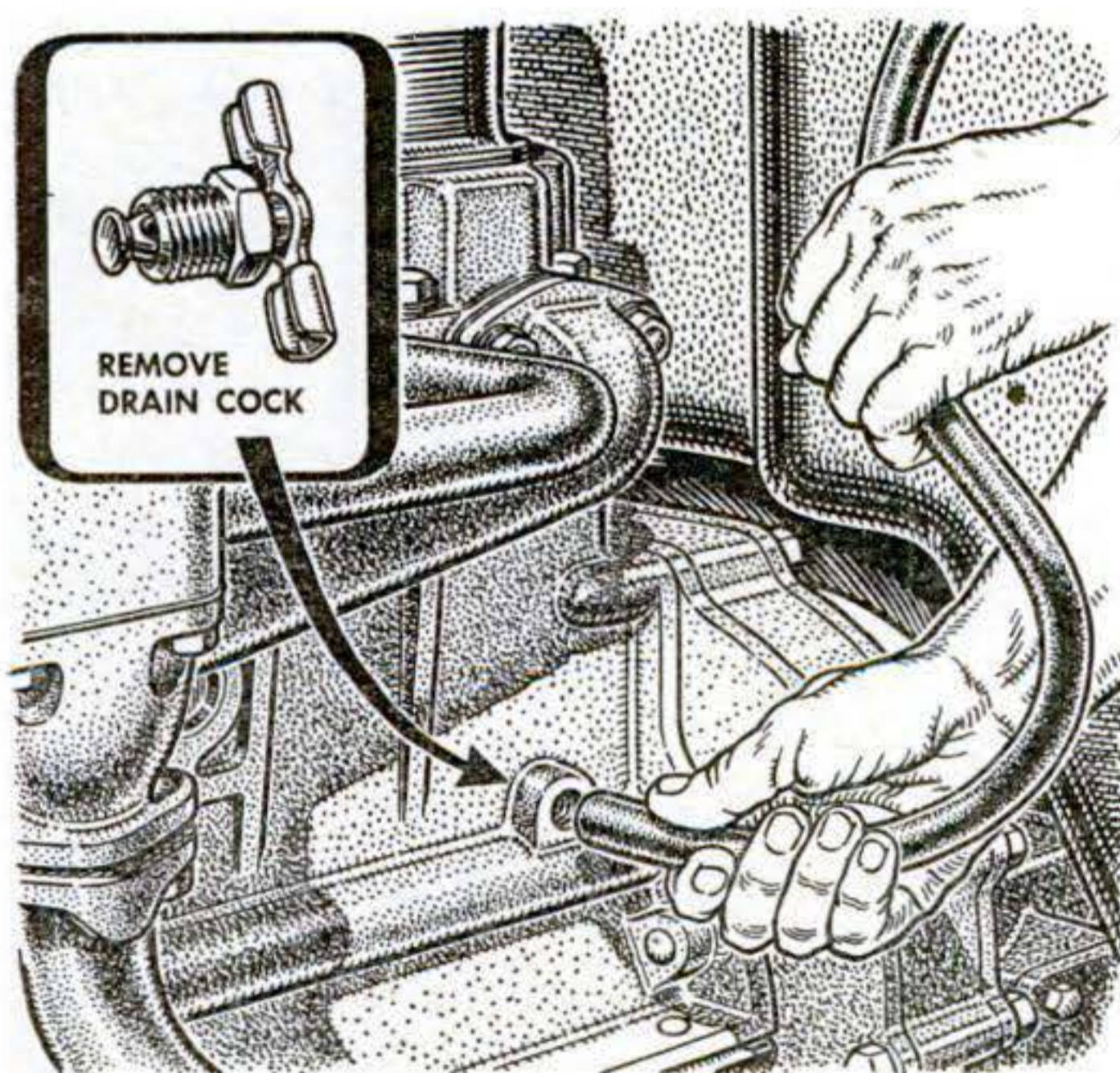

When draining coolant in cold weather, be sure a good stream runs freely from the block or you may have a costly freeze-up. If the water just dribbles out, remove the cock and use the blast from an air hose to loosen the sediment that can block drainage.

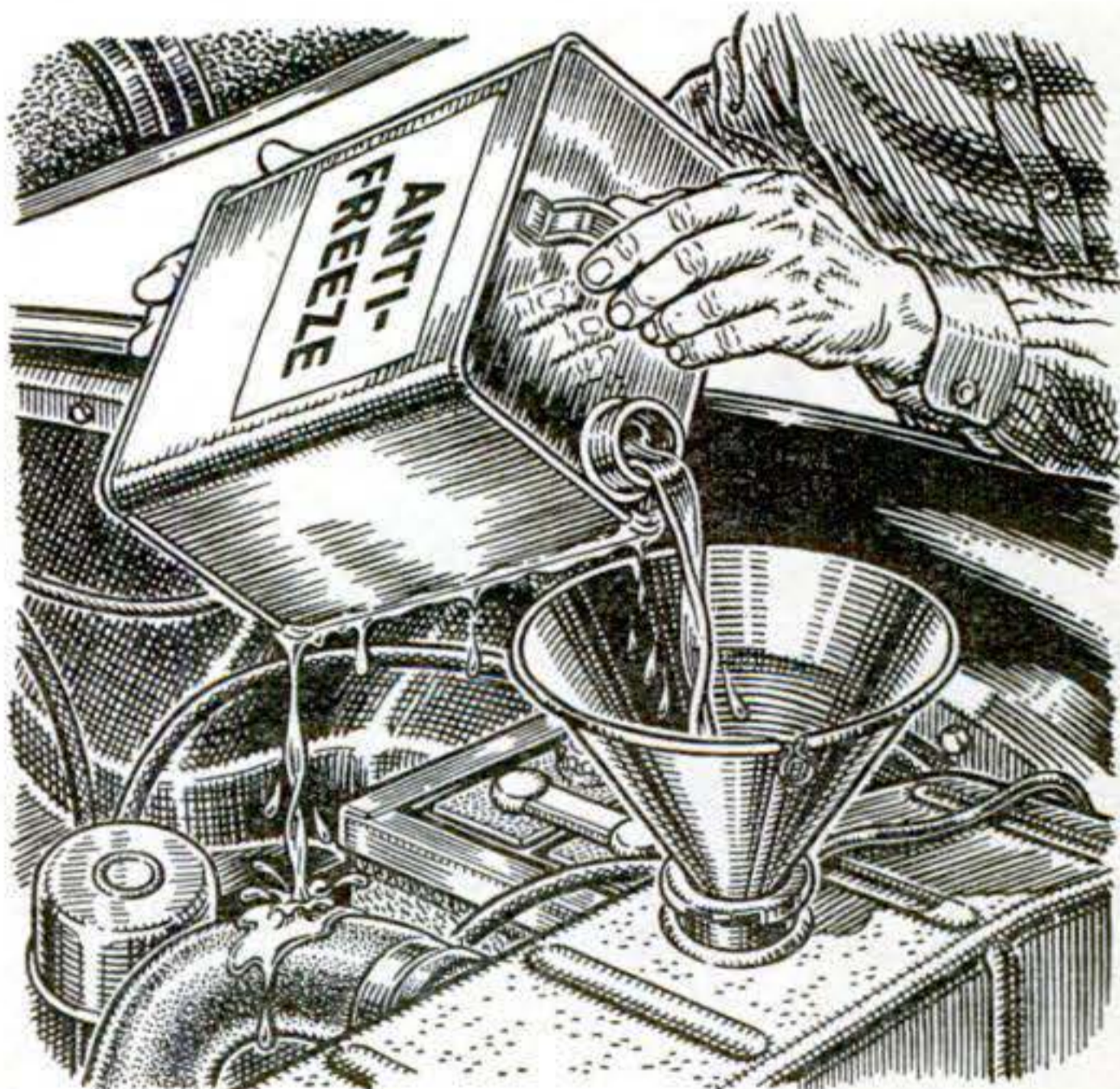

To pour antifreeze into the radiator from a large can, stand at the side of the car with the can extending into the engine compartment so that any dribbles get on the engine and not the body. The fluid won't hurt engine parts, but damages paint.

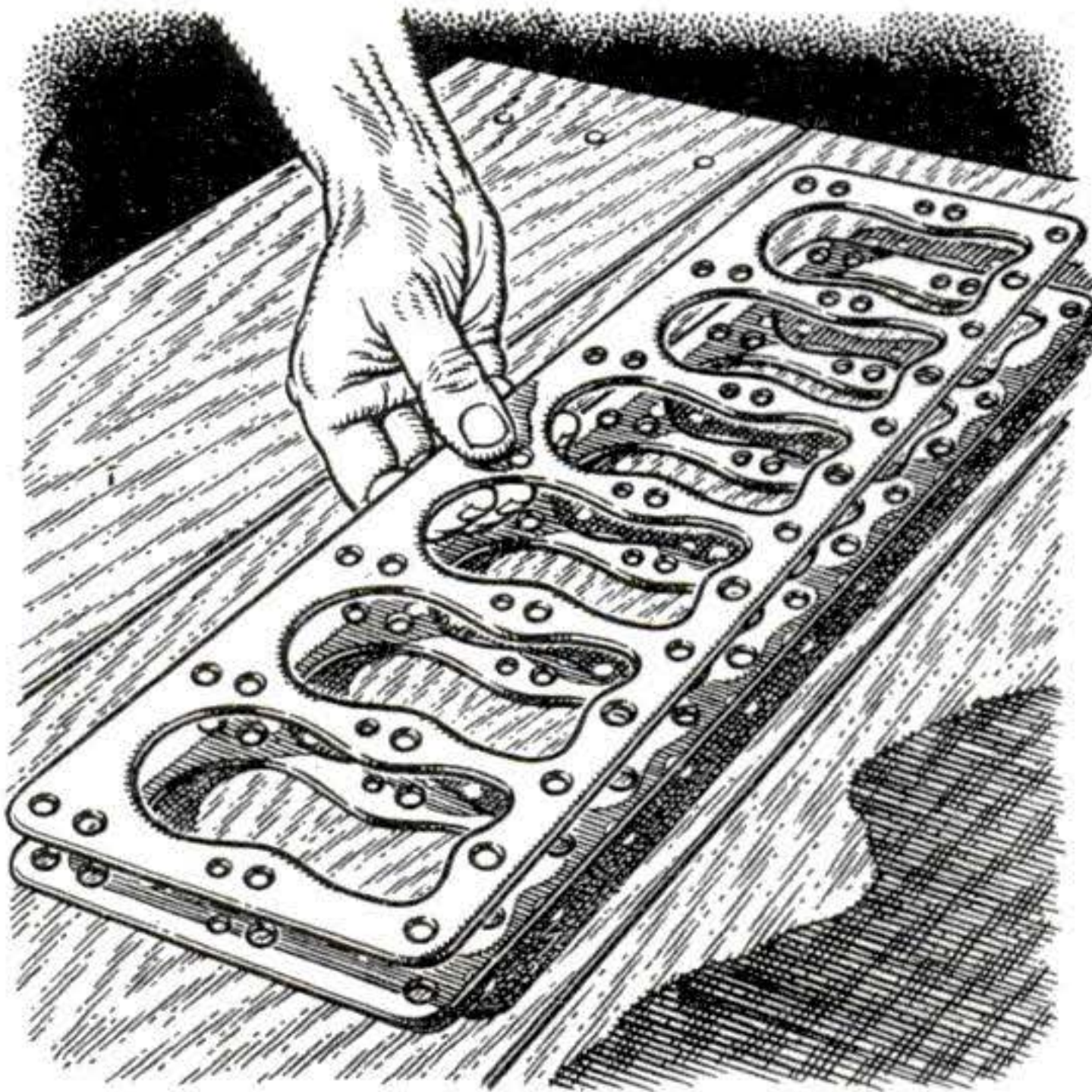

Check a new cylinder-head gasket before installing by matching it with the old one. If they are not identical, a vital water passage might be sealed off with disastrous results. Also, a black area on an old gasket indicates it has not been gastight. So be sure to tighten the head nuts according to specifications.

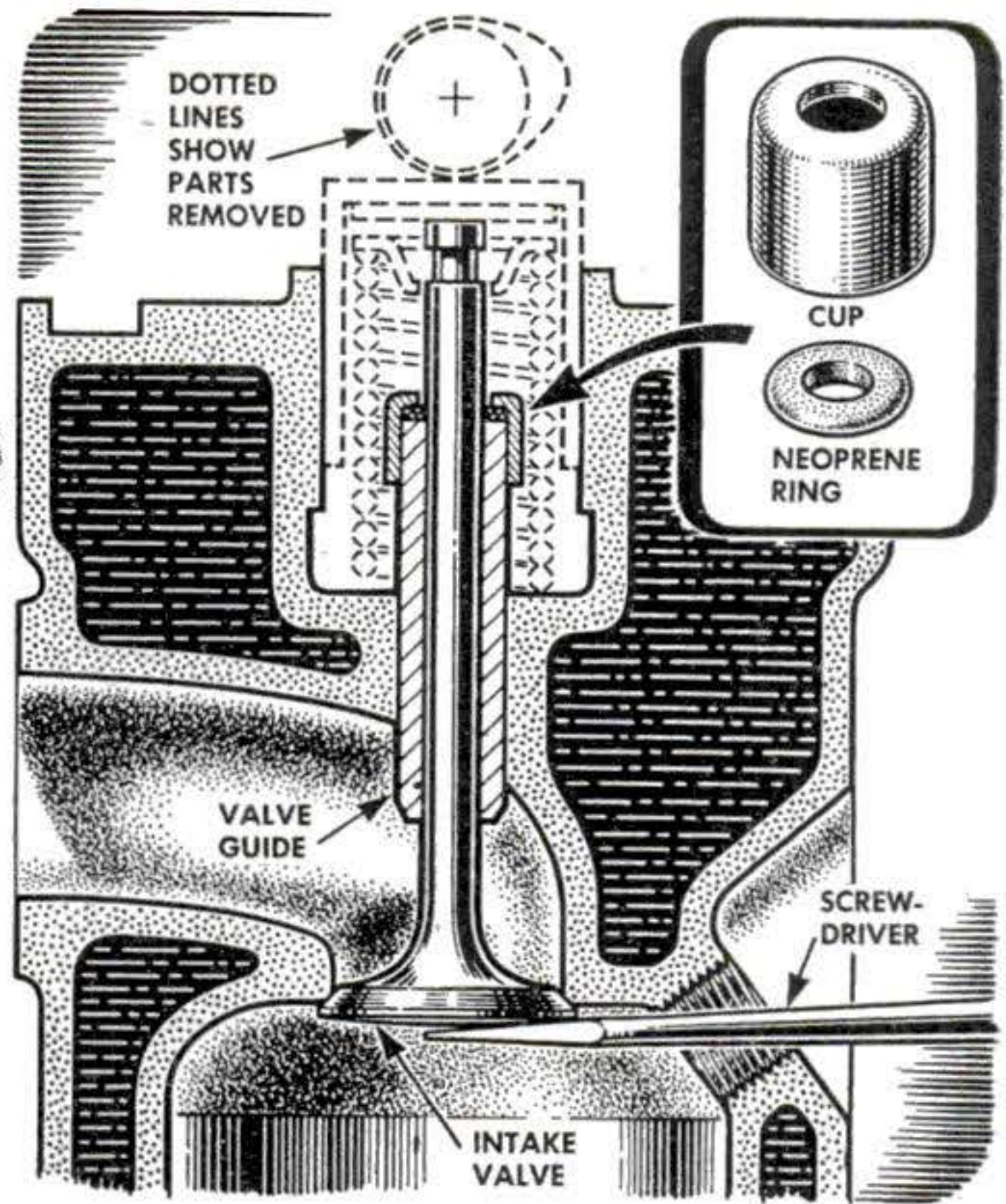

Oil consumption can be cut in a Crosley engine that has a cast-iron cylinder block by installing intake-valve seals just developed by the company. By removing the parts indicated, you can slip the neoprene sealing ring and steel retaining cup down against the guide. A screwdriver through the spark-plug hole will hold the valve up.

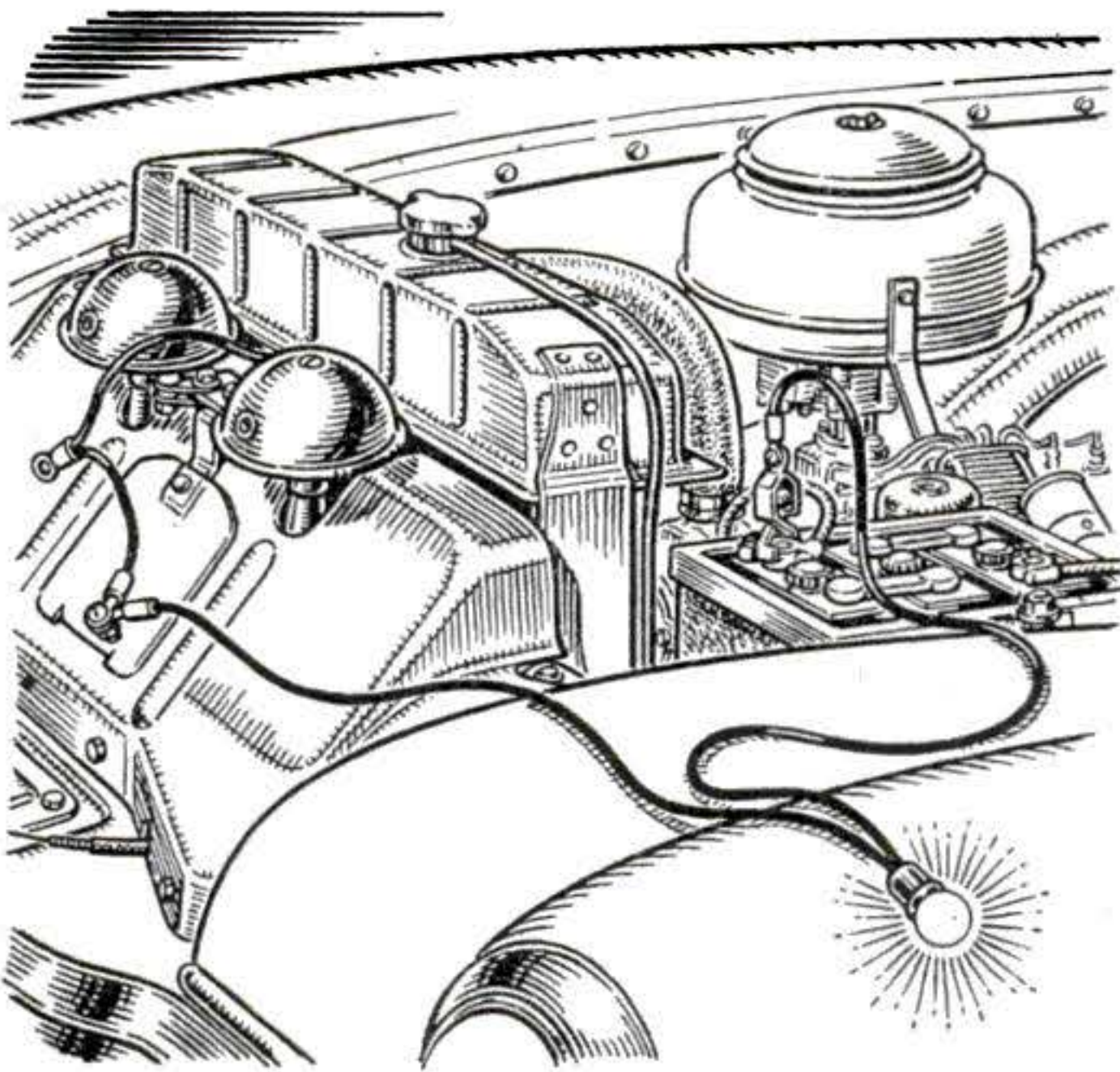

In repairing horn wiring, you can avoid the annoyance of frequent test blasts if you disconnect the wire leading to the horns and connect a test lamp to it and the battery. Use long leads to place the test lamp where it can be seen easily.

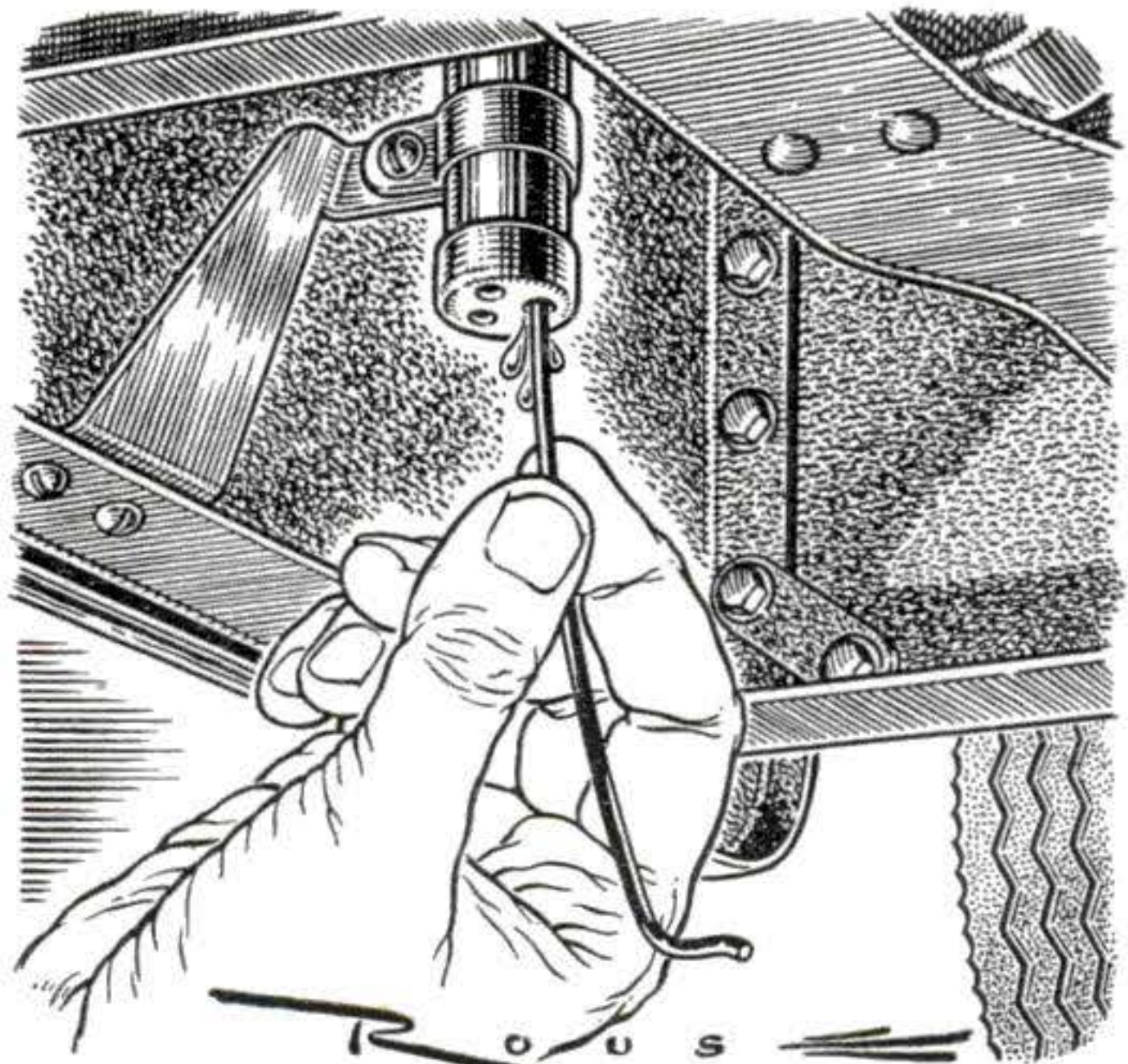

Drain holes in the base of a whip antenna sometimes get plugged with dirt, letting water accumulate in the tube. Poking a stiff wire through the holes will release the water and prevent possible interference with the operation of the radio.

Tests by experts show what special tires can do on snow and ice.

WINTER tires are a good buy if you don't expect too much of them. But they never will enable you to drive on snow and ice as freely as on a dry road.

When highways are slippery, tires have a tough time giving traction on hills, gripping the road when you apply the brakes and resisting corner skids.

Several years ago the National Safety Council set out to find how representative winter treads compare with conventional tires in these three jobs. Mounting winter tires on the rear wheels of the test cars, the drivers tried them out on all winter highway conditions you might encounter—glare ice, rough ice, loosely packed snow and hard-packed snow. After the tests, the Council announced that:

- Progress has been made toward producing safer winter tires.
- Several specialized tires show definite improvements for specific conditions, but the over-all improvement is not enough to warrant less care on slippery surfaces.
- Several show some improvement under specific conditions, but they are no better under other conditions—and in some cases even worse—than conventional-tread natural-rubber tires.
- Natural-rubber tires are generally better than cold-synthetic ones.
- For the greatest safety and best traction under severe snow and ice conditions you still should use chains.

Types of winter tires. For its tests, the National Safety Council classified winter tires into three groups—winterized tires,



DIRECTION OF ROTATION is important with some mud-snow tires. If tread includes arrow-shaped knobs or similar pattern, mount tire so that points of arrows touch pavement first when wheel turns forward. This will throw mud and snow out of tread instead of letting it accumulate to destroy tire's traction.



Save
This Issue
for the Winter
Ahead

Here's the Dope on Winter Tires

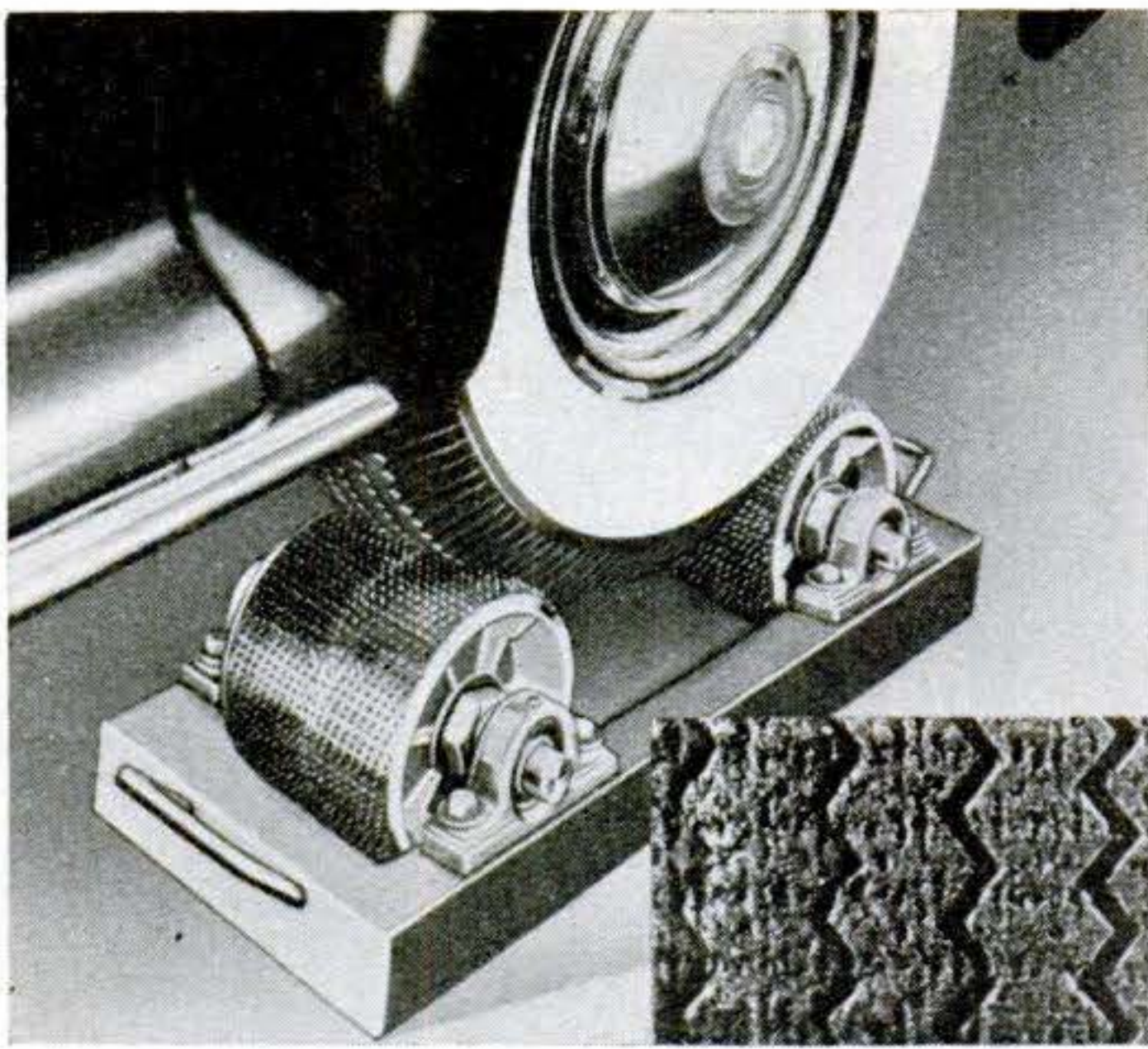

TACK MACHINE winterizes conventional tires by making thousands of tiny holes in tread rubber. Sharp edges of these holes increase traction but tires will wear out faster. Tires also are sometimes winterized by grooving and slitting tread rubber to divide it into squares.

mud-snow tires and winterized mud-snow tires.

Winterized tires are essentially conventional ribbed tires with salt, sawdust or other fine particles embedded in the tread or having fine cuts or lacerations in the tread. Mud-snow tires have a special tread design—deep treads, studs or knobs. The third type is a combination of the other two—mud-snow tires that have been given a winterizing treatment.

Which is best? For the individual, there is no easy answer to this question. A tire's performance cannot be judged by its tread pattern or appearance. Within each of the three types, the Safety Council found varying performances.

But on the basis of test-result averages, a set of winterized mud-snow tires would be your best bet for all-around use, with mud-snow tires next, and the winterized type last. On glare ice, rough ice, and loosely packed snow winterized mud-snow tires showed an average improvement of about 25 percent over conventional tires. On hard-packed snow they proved to be 17 percent better in stopping ability and 19 percent better in traction.

Winterized mud-snow tires lagged a bit behind straight winterized tires, however, in stopping ability on glare ice. Of the winterized tires, those with lacerated treads came out better on glare ice and loosely packed snow than those with embedded materials. But winterized tires had less traction ability

on hard snow than even conventional tires.

Mud-snow tires, as their name suggests, are of greatest value in loose snow, mud and, to a lesser extent, on packed snow. In general, tires of this group give you no benefits on glare ice.

Synthetics excel on corners. As the base line for its comparisons, the Council used conventional natural-rubber tires.

These were compared, too, with cold-synthetic tires. On glare ice and loose snow, natural rubber was 10 percent better in stopping performance and from 16 to 50 percent superior in traction. In cornering ability on glare ice, however, cold synthetic was seven percent better.

Chains are best. Even the best winter tires do not begin to give you the safety and traction of a good pair of chains. In comparison with conventional tires, the Safety Council found that reinforced chains improved stopping ability an average of 46 percent while traction went up a whopping 475 percent. So carry chains for severe conditions, even if you have winter tires.

Tire chains can be divided into three types—regular, reinforced and emergency. Regular chains have cross chains of a twisted-link construction familiar for half a century. In the reinforced type, the central half-dozen or so links of the cross chains are twisted more or have projecting teeth welded on. Emergency chains are cross links that wrap around the tires as a means of getting out of a difficult spot, like a mud hole.

Reinforced chains are rated highest because the design gives more traction, the added material lengthens the life expectancy of the chains, and the welded pieces, usually placed crosswise on the links, reduce skidding.

How fast to drive? As a guide for motorists, the National Safety Council has converted its test results into equivalent speeds. Using chains, you would have to hold your speed under 25 m.p.h. on glare ice and 35 on packed snow to have the same stopping ability you would at 50 m.p.h. on dry concrete with conventional tires.

With tires, conventional or any of the winter types, you would have to drop down to 15 m.p.h. or less on glare ice and down to 27 or 30 on packed snow. Even so, you probably would still be traveling too fast for safety.

No rule can be made that will tell how fast it's safe to drive under all conditions. That's something only you can judge.

Save
This Issue
for the Winter
Ahead

How to Drive on Snow and Ice

When your tires have trouble keeping their grip, these rules will help carry you safely to your destination.

Get the feel of the road when you first start out. Driving slowly on a stretch of traffic-free road or street where you won't hit other cars, apply the brakes quickly enough to cause the wheels to skid. This will give you a feeling of just how slippery the surface is. But don't depend too much on this. The nature of the road surface may change unexpectedly. Watch especially for patches of glare ice ahead.

Never change speed or direction suddenly. Take it easy. If you hit the gas hard or let the clutch in with a jerk, your tires will spin because they'll lose what frictional grip they had. If you lock the wheels in trying to stop, you'll slide. If you take a turn too fast, centrifugal force may throw you into a skid. On ice, the best traction will be obtained if you keep the wheels from slipping. Tests have shown that spinning the tires reduces traction as much as 50 percent.

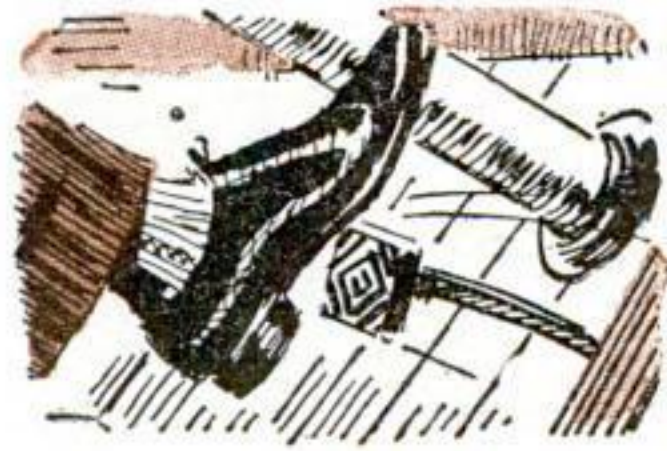

Pump brakes rapidly when you stop. It takes practice to do this effectively. Try it out on a dry road. Experienced drivers can do it with the rapidity of a machine gun. Leaving the

clutch engaged, step on the brake, release it quickly and completely, and repeat the cycle until the car is so nearly stopped that you can keep the brake on and release clutch without causing a skid. Brakes must be in good condition so that they engage and release rapidly. In cars with conventional gearshift, there is a hazard in this method, however. Quick brake application may lock wheels momentarily. Since clutch is engaged, engine may stall, causing a bad skid. Skillful easing of the clutch may prevent stalling. This, too, deserves some practice on dry roads.

Adjust speed to road and weather conditions. On glare ice, with the best type of winter tires, it will take you around eight times as far to stop as on dry concrete. Even with chains the stopping distance is 3½ times as far. On packed snow, tires will carry you three times as far as on dry concrete before you stop, chains twice as far.

Watch the thermometer. Around 32°—the freezing temperature—glare ice is twice as slippery as it is at zero. This is because from about 25° up, the heat of tire friction spreads a thin film of water on the ice. In a series of tests, the National Safety Council found that stopping distances at 20 m.p.h. on glare ice may range from about 110 feet at zero to nearly 250 at temperatures near freezing. Council's tests of winter tires on glare ice described on the previous two pages were all made at a temperature of 20° to assure uniform slipperiness.

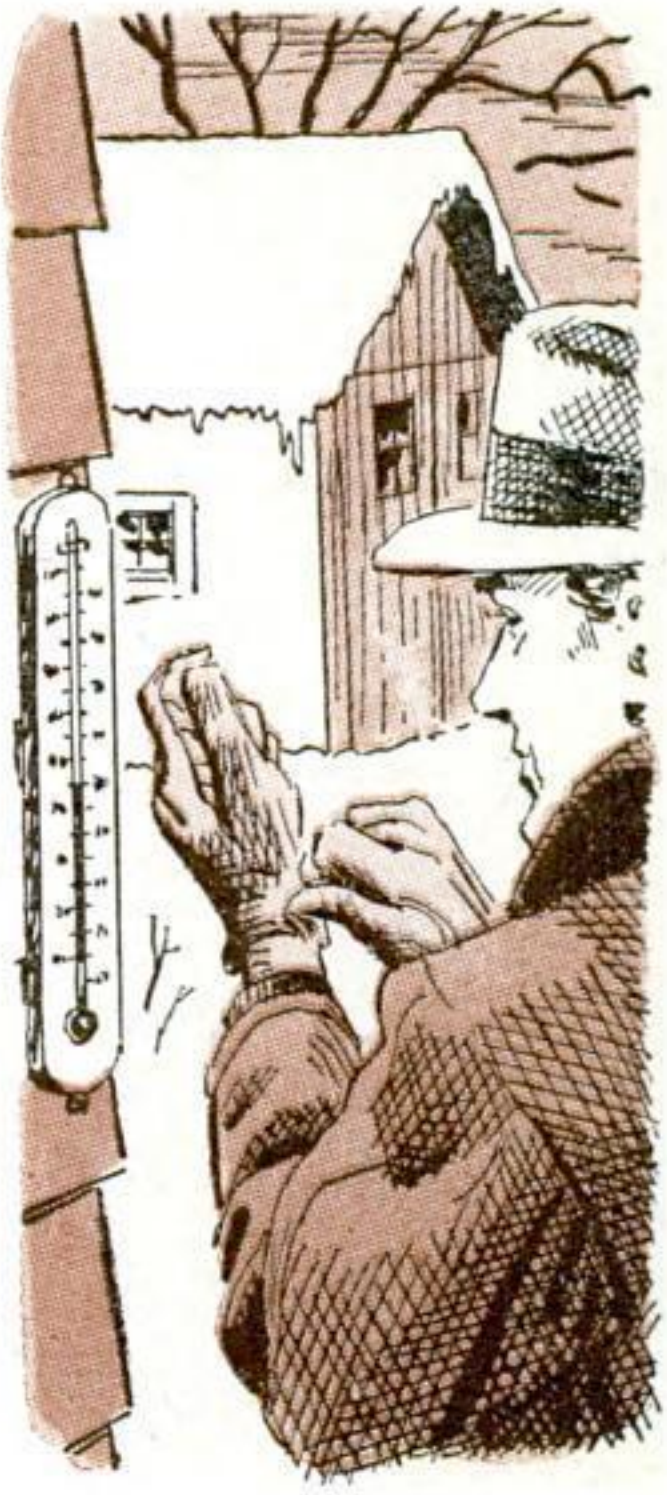

If you get stuck, you'll find it handy to have a short-handled shovel and a bag of sand, gravel or salt in the trunk. Don't wear out tires spinning them uselessly on a slippery surface. You can soon grind away a lot of rubber.

Bad driving conditions don't last forever. So, if at all possible, leave your car in the garage or travel another way.

How speed increases stopping distance is seen in this chart, based on National Safety Council figures. When you double your speed you don't just *double* the stopping distance. Stopping distance increases about in proportion to the square of the speed. Failure to heed this rule has brought many drivers to grief. One big point it means: don't follow too closely behind other vehicles.

20 M.P.H.	PACKED SNOW	97'
	ICE	205'
30 M.P.H.	PACKED SNOW	202'
	ICE	445'
60 M.P.H.	PACKED SNOW	741'
	ICE	1,716'

Please turn the page for more on winter driving.

Copyrighted material

Save
This Issue
for the Winter
Ahead

It's Easy to Put on Chains

When this job confronts you, knowing the right way will save you time and effort. Here are approved procedures.



1 If you can get your hands over top of tire, spread out chains on ground beside wheels, like this, removing tangles and putting fasteners at rear. Put outside of chain up.

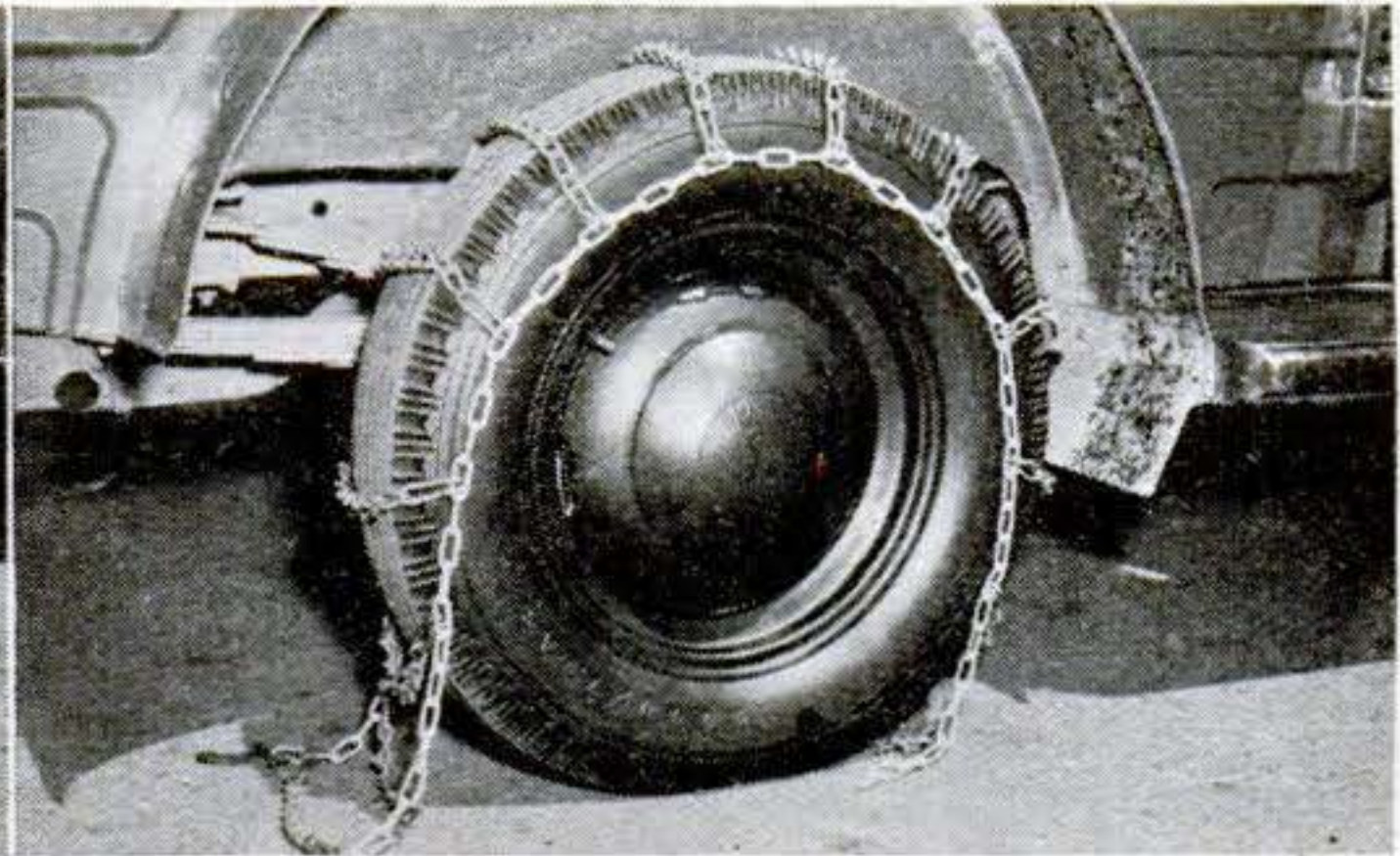

2 Then put your hands under middle of the chain, lift it up and drape over tire, like this. Adjust so first cross chain touches road in front of tire. Drape opposite chain same way.

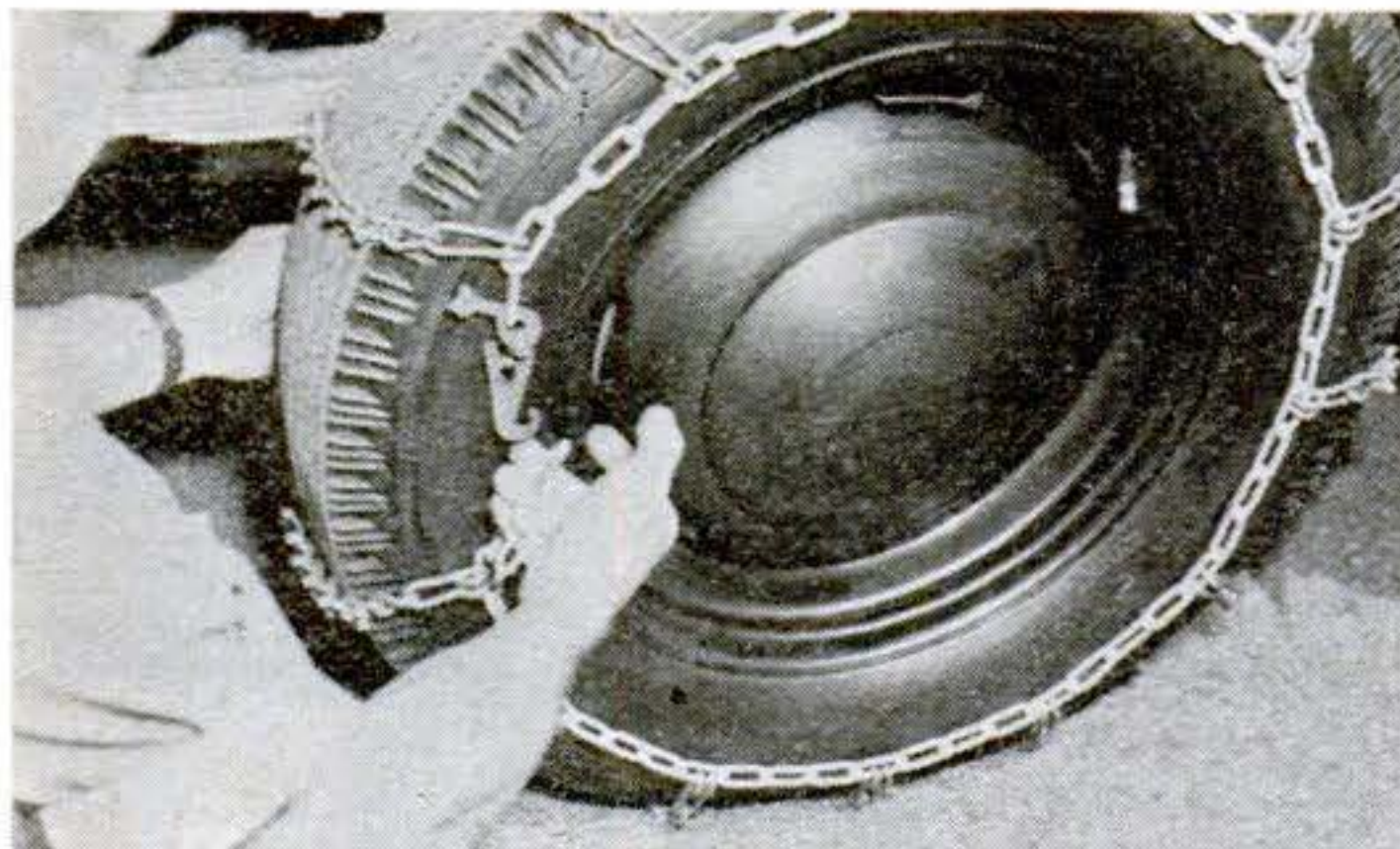

3 Drive vehicle forward until fasteners are about axle high or slightly under fender line. Then hold up *both* ends of chain to find proper links for hookup. Usually some end links must be dropped for proper hookup. Keep bottom cross chains straight across the tire.

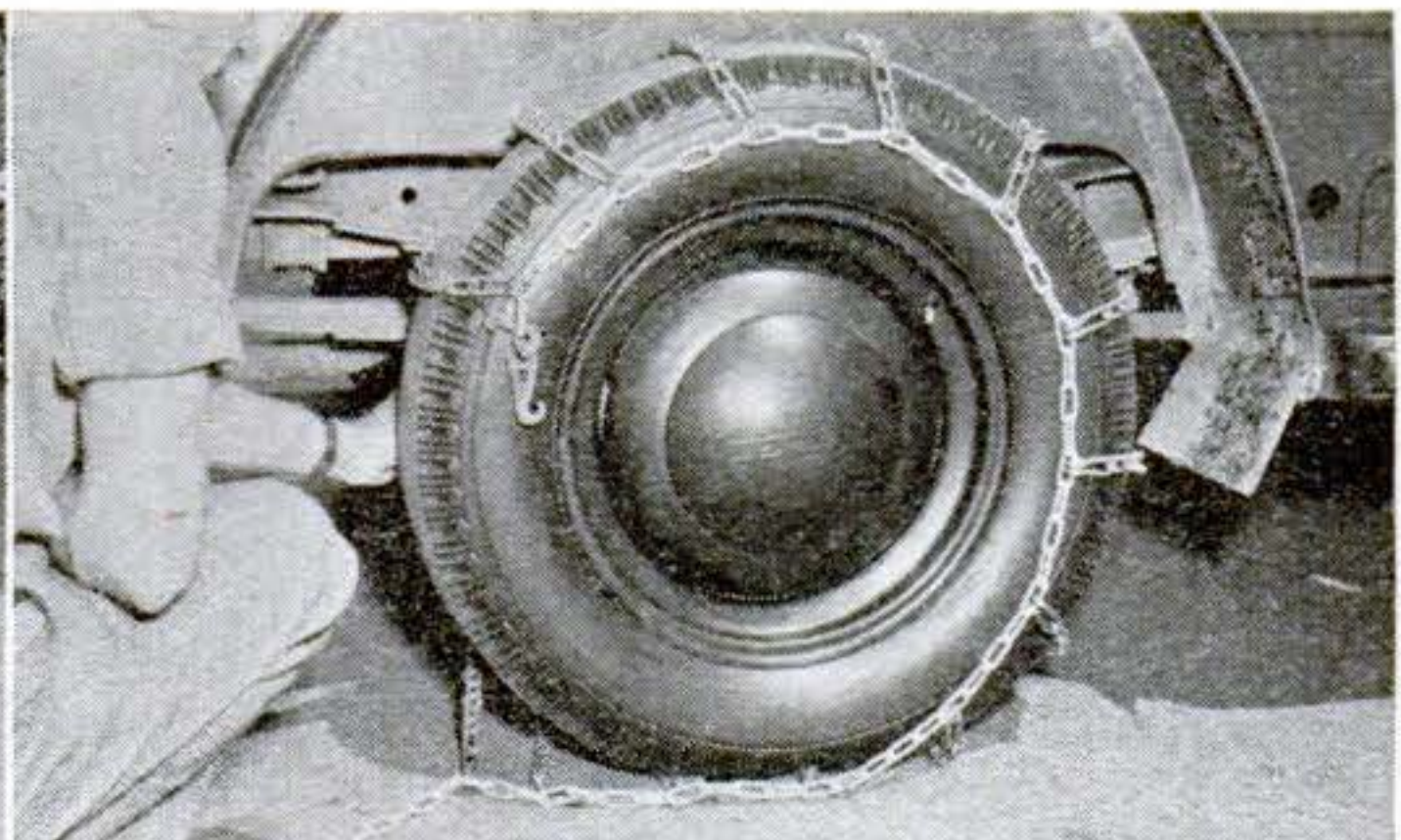

4 Hook inside fastener into selected side chain link first. Then attach outside fastener, pulling chain as tight as possible by hand. Forcing a chain with tools or deflating and then inflating tires may damage tires. Chain should be free to work around tire.



1 Using a chain applicator is best way if it's difficult to reach top of tire. Stretch out chains behind wheels, again with outside up and the fasteners to the rear.



2 Hang ends of chains on applicators and snap on the tires. Apply both chains at equal height and gather them close to tires as shown so they won't snag when car moves.

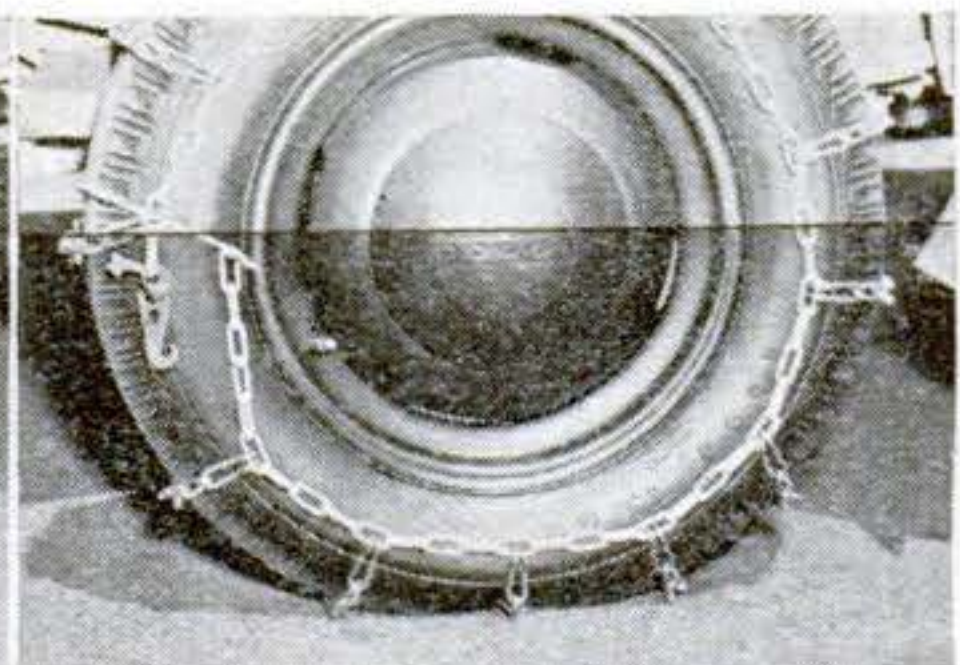

3 Roll car forward until fasteners are slightly under fender line (fender is removed here for clarity). Then remove applicator, check for correct links and fasten chain tightly.

Foresight Assures Good Vision

Save
This Issue
for the Winter
Ahead

When you drive under hazardous conditions you have to see danger before you can avoid it. These tips can help.



Carry windshield scraper in glove compartment to remove ice. Plastic scraper does good job without scratching glass. Garages and gas sta-

tions offer these as advertising giveaways. While parked, protect windshield with a cover, two squares of cardboard if nothing else.



Keep glass free of fog. When it tends to build up on inner surface of windshield, drive with vent pane open. Be sure the defroster is fully efficient. A sponge taped to back of one of your driving gloves will enable you to wipe windshield easily and quickly. But try to avoid driving with just a front peephole. Danger can come from the sides and rear, too.



Windshield wipers must exert more push to clear away snow. Weak wipers that serve satisfactorily during rain may stop completely when snow comes. So be sure that they are getting full vacuum, that the hose is good, that the mechanism is clean and oiled, that the blades make correct contact. Clean oil and scum from blades occasionally with a piece of cloth or paper.

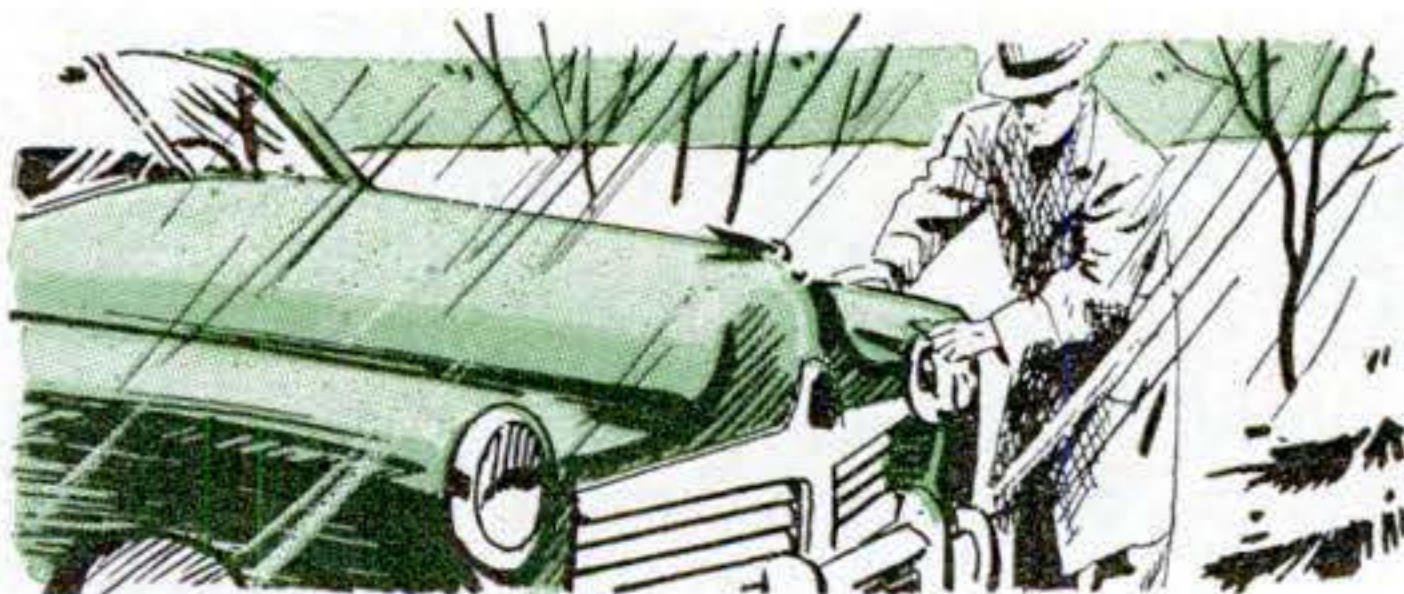

Keep the headlights clean by washing away road spatter. And if ice builds up on windshield remember it may be blocking the light lenses, too. Don't let snow cover rear lamps.

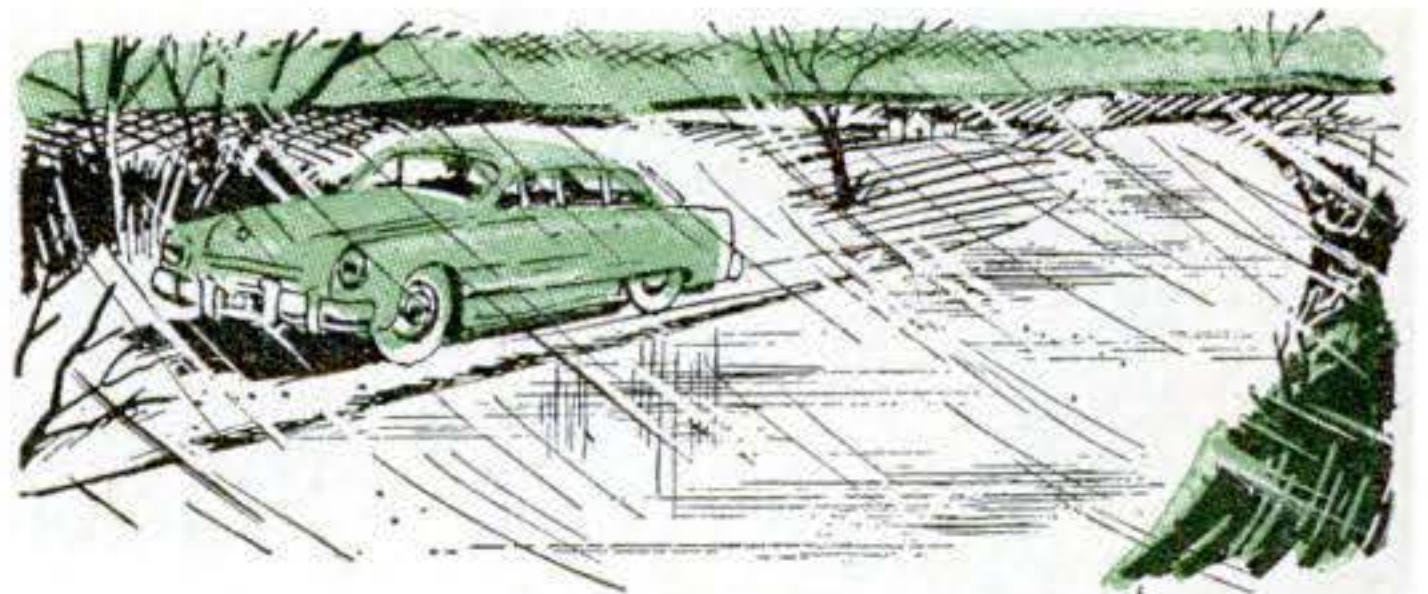

If swirling snow or driving rain reduces visibility almost to zero, get off the highway. Chances are conditions will improve shortly. You are not in that much of a hurry.

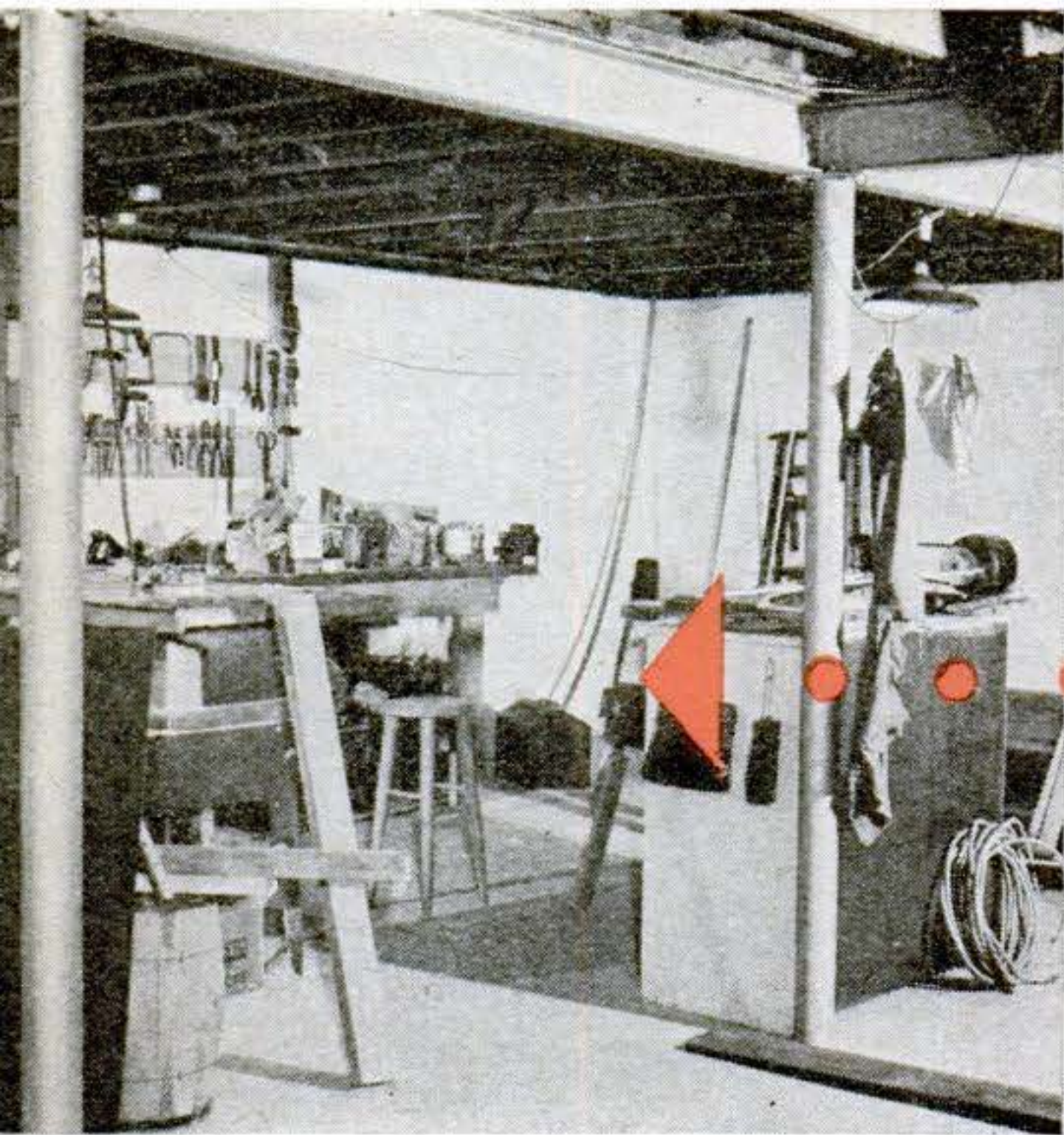

There's plenty of space in most basements. Here's how to turn it into rooms that add to the pleasure and value of your home.

How to Make a Basement More Useful

By Bernard Gladstone

ONE day I walked down into our basement and stumbled over an old suitcase. The barked shin wasn't pleasant, but it did start me looking at and thinking about the cellar.

Here was almost half of the cubic space of our home. Mostly it was being used—if you can call it that—as a general catch-all for junk, like the suitcase I had just kicked aside. Along one wall I had my workbench and power saw. In a corner was the heating unit. On the other side of the basement was the laundry. The area in between was either littered with odds and ends or wasn't used at all.

That did it. I gave the suitcase another kick for good measure, climbed back up the stairs and started planning.

The result of the planning and a couple of months' spare-time work was a real basement. Now, instead of a smörgasbord of junk, I've got the following: a big playroom, a combination laundry-darkroom, a combination utility-storage room, a shop, a big walk-in closet for storing off-season clothing, and another closet for the kids' toys. The playroom serves a double purpose—it gets the kids out from under foot on rainy days, and in the evenings it's a fine

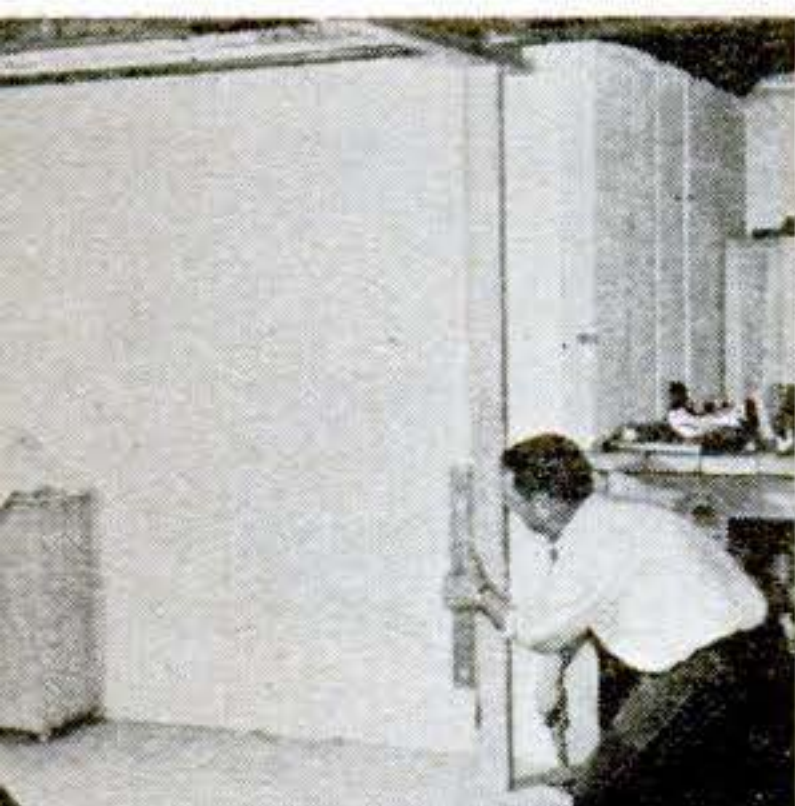

END STUDS go up first. When they are placed under a steel beam make them a tight fit. Use level to plumb studs both ways.



PLATE should be a snug fit between the two end studs. Cut it long enough to be tapped into position and nail it to end studs.

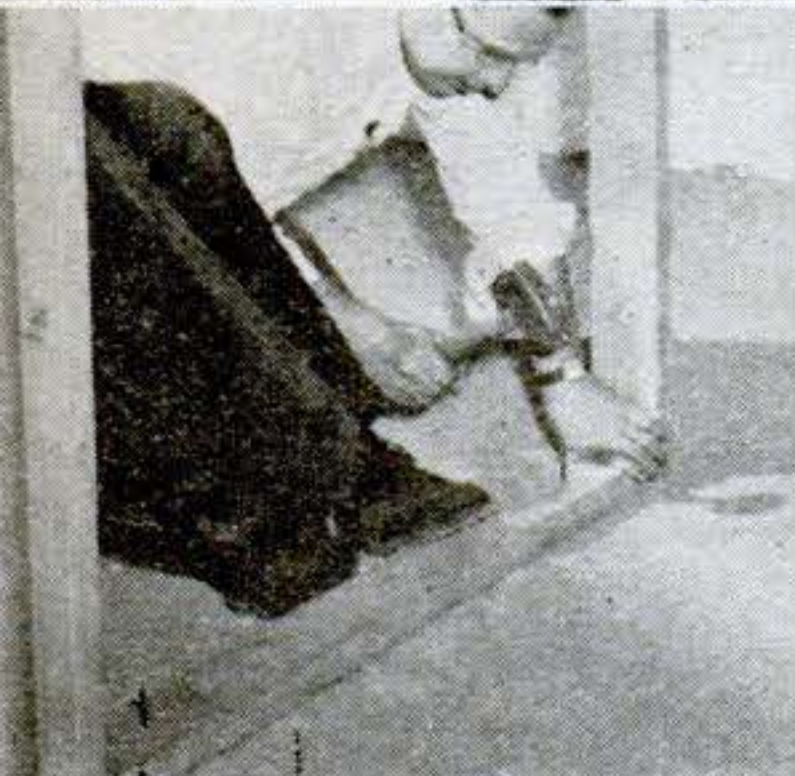

SOLE also should be snug fit. Anchor it to concrete floor with cut steel nails. Then put up studs between the two end studs.



spot to entertain friends. It is warm in the winter and cool in the summer.

Assessing your basement. Before you pick up a tool, stop and consider your basement. You'll find there are lots of points to think about.

- Is it big enough? This means both vertically and horizontally. If the cellar is a little crypt to be crept into, you might as well forget it. But if it has adequate head-

room throughout most or all of it, you have a good start—especially if it's a full basement.

- Is your basement damp? Naturally, if you find a spring under the basement floor, it can cost you plenty to seal off the water. (This happened to a friend of mine. He broke open the concrete floor where the water was seeping through, put in a sump pump and piped it outside to a ditch. He says the contractor promised him a full

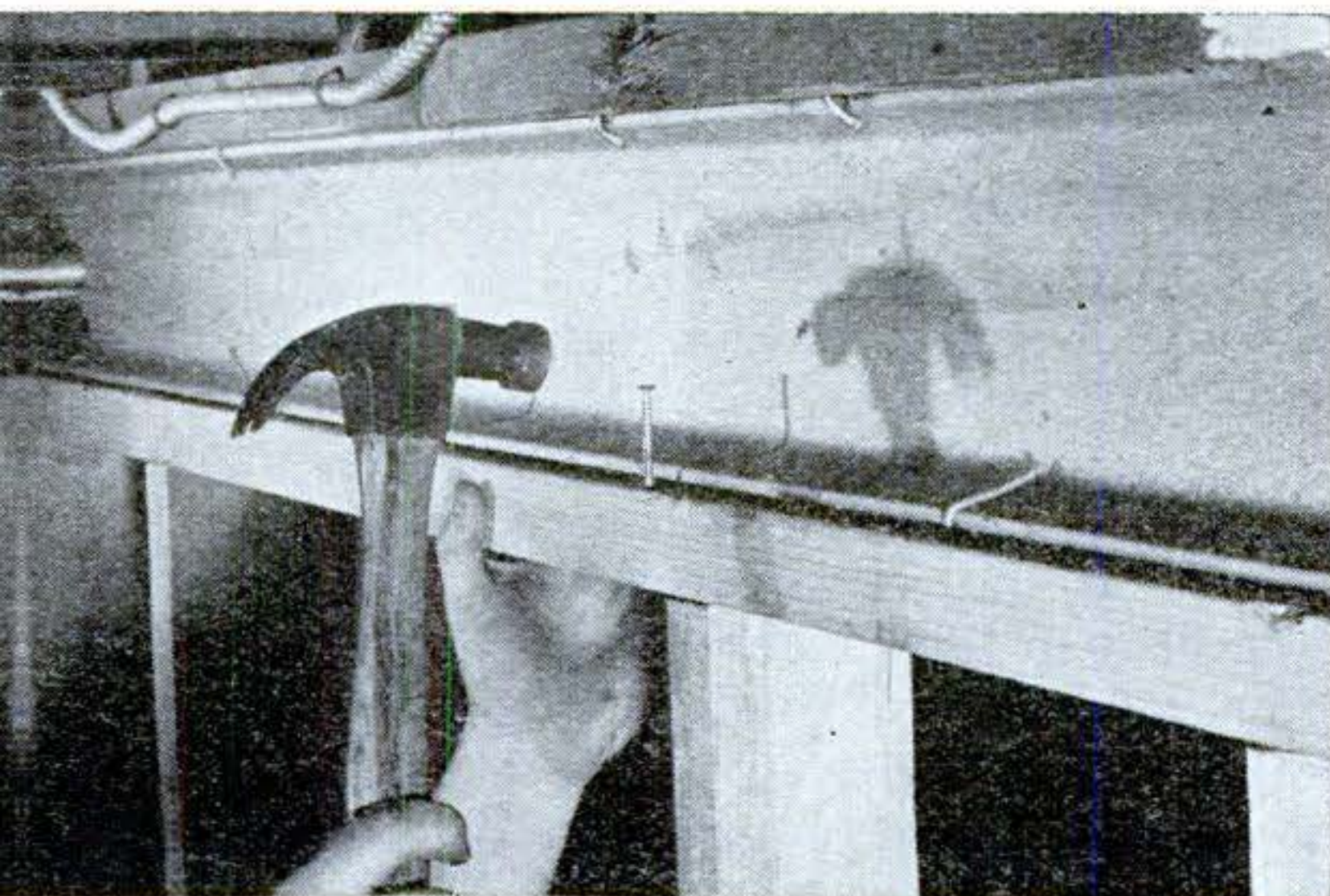

TENPENNY NAILS driven in plate and bent over flange will hold plate to I beam. If beam is wood, nail through plate and into beam.



BOLTS through plate are another method of holding it to I beam. Use large washers under nut so they overlap flange.



PLATES that parallel but fall between joists can be secured by nailing them to short pieces that have been spiked between joists.

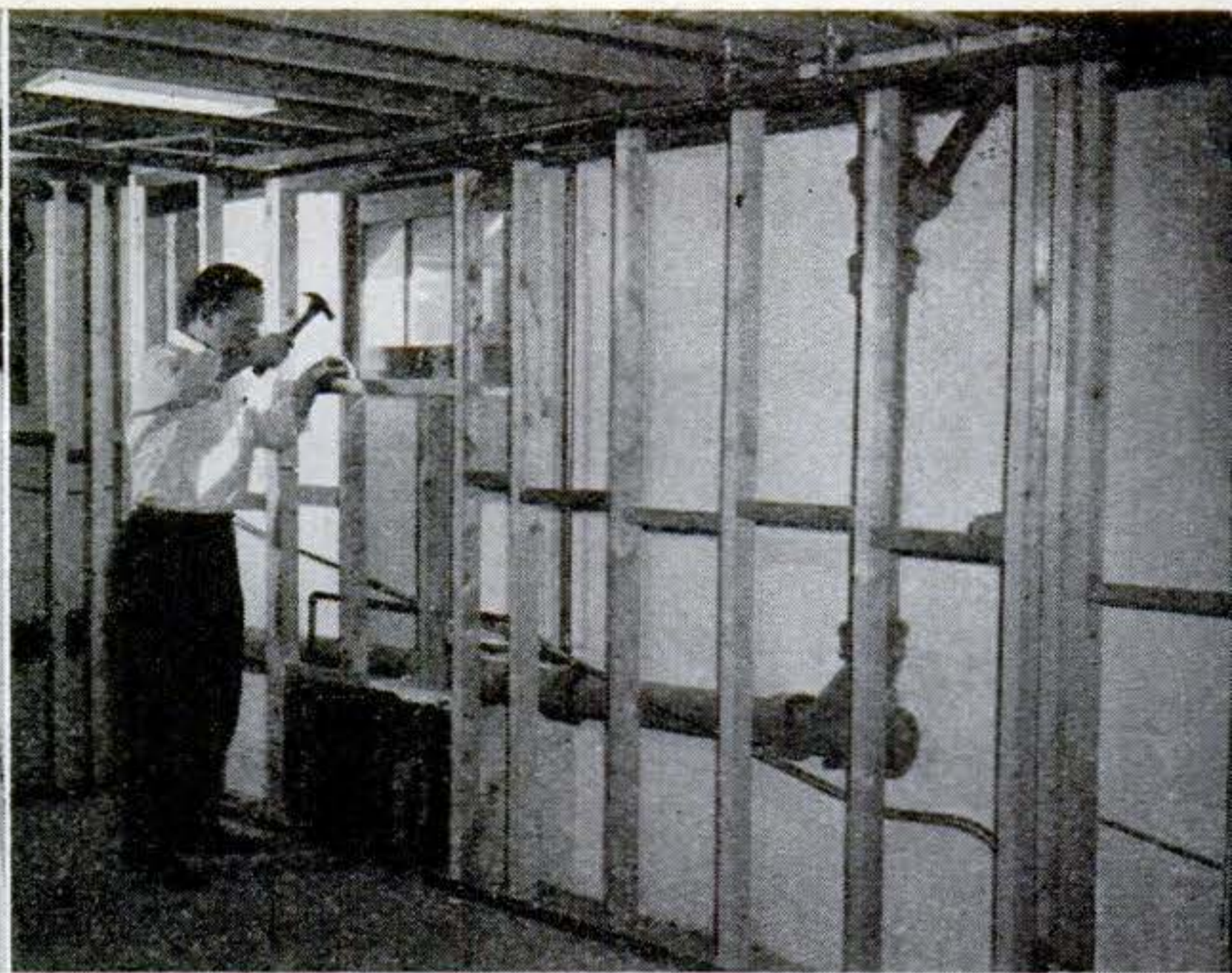

HORIZONTAL BLOCKING, also called firestopping and cats, is staggered so they can be end-nailed through the studs.

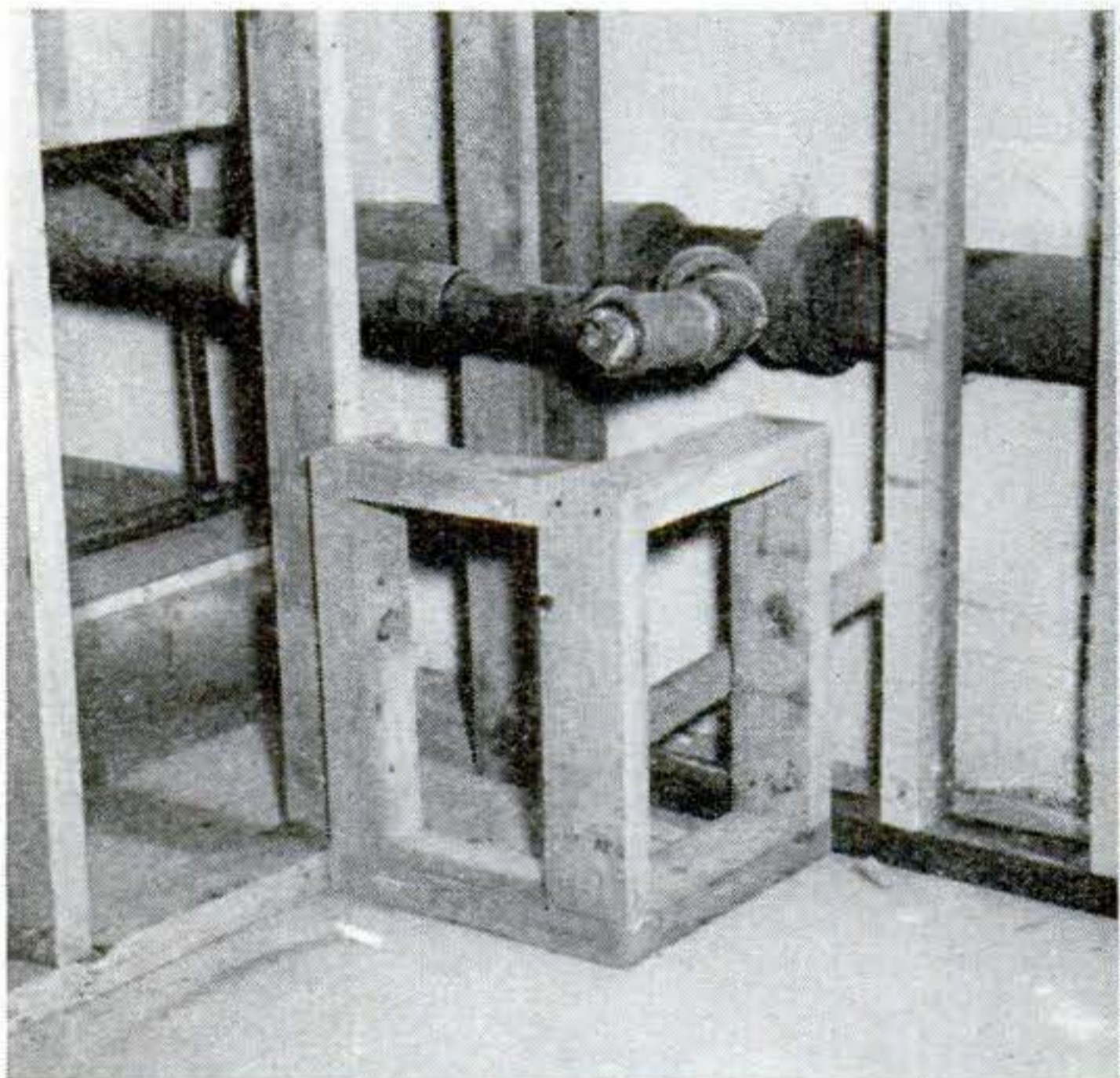

OBSTRUCTIONS should be utilized. Framing around projecting pipe will become corner table with removable top to get at waste plug.



BUILT-IN BENCHES flank corner table. Screws and angle bracket tie framework together. Cut steel nails anchor bottom pieces to floor.

basement and he would have it if it weren't for the pump.)

But if you have only some dampness—maybe a little seepage here and there—you probably can stop it by patching cracks with waterproof cement and giving the walls two coats of a waterproofing compound.

- What about pipes? Are they high enough or off to one side along a wall so they can be concealed, as mine were? Or do they have to be moved up between and through joists?

- Where are the basement windows? Outside light doesn't make any difference in a

darkroom, but windows are certainly nice in a shop or laundry. So consider window locations when you make your plans.

- Is your basement warm enough? Many of them are, the heating plant radiating enough heat to keep the area comfortable. Then, too, the walls and ceiling you'll put in will help hold basement heat. I didn't think my basement would be warm enough, so I stuck a couple of radiators in the playroom. As it has turned out, I've seldom used them.

Drawing plans. Lay out a simple floor plan, indicating walls, columns, laundry

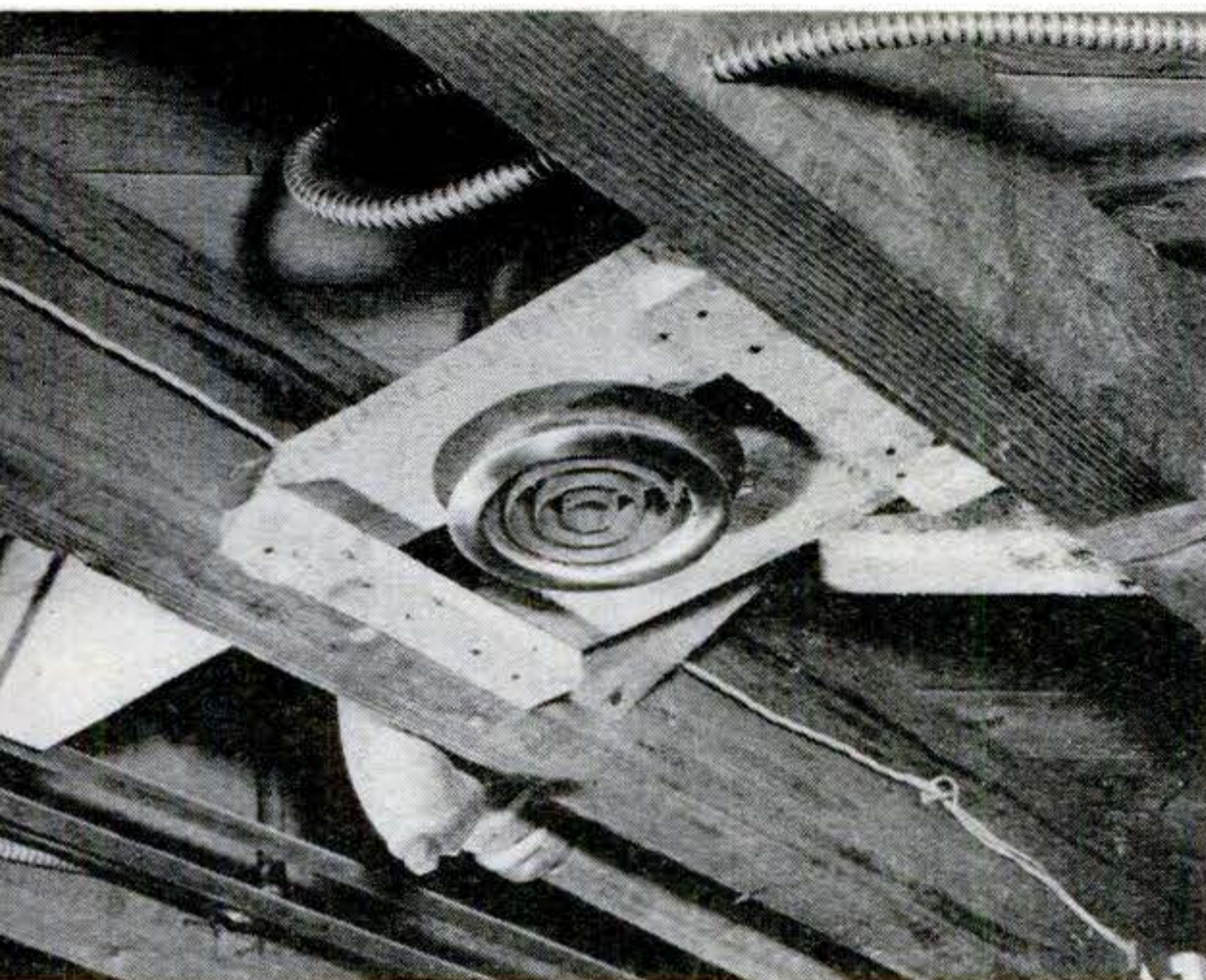

SPOTLIGHTS, sometimes called "high hats," are best located between joists. Simple framing of scrap lumber will hold them in place.

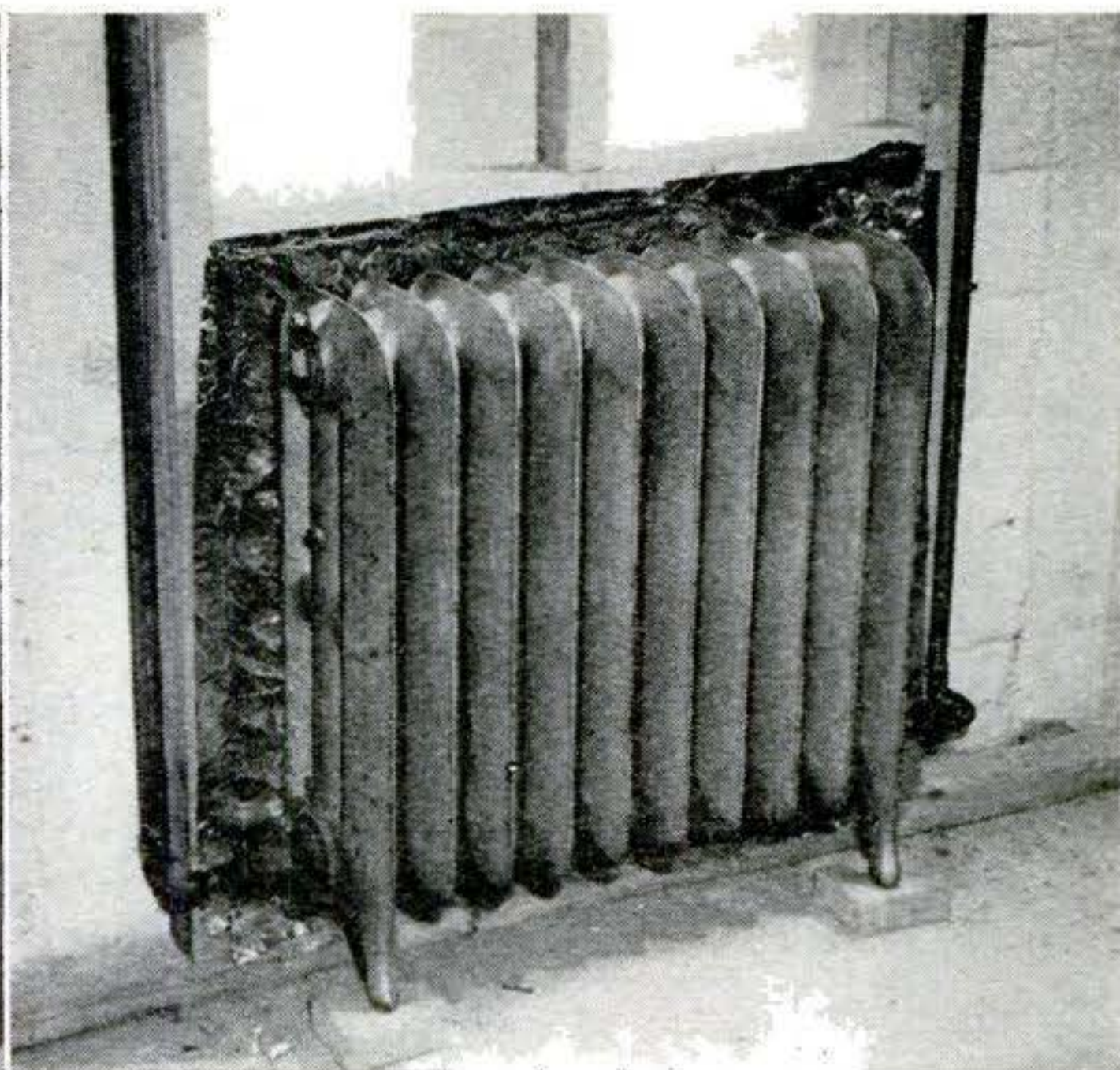

FRAME around openings for fuse boxes, radiators, windows and doorways. Aluminum foil behind radiators will throw heat out into room.



SHEETS of plasterboard can be nailed overhead by one man with the help of a T made of two-by-threes to hold up one end of sheet.



TAPE AND CEMENT cover plasterboard joints. Cement is spread along joint and tape pressed over it. More cement covers the tape.

equipment and the heating plant. Figure out how many rooms you want and how big they will be. Indicate where you want doors, partitions, closets and electrical outlets. Play around with different ideas by inking in the basement outline and sketching in the various possibilities on tracing paper.

Framing and walls. Two-by-threes are plenty big enough for studs, soles and plates. After all, the walls you will put up are not bearing walls—only partitions. How far you space the studs depends on what you use for walls. However, most standard wall

coverings like plywood, plasterboard and hardboard come in 48" widths. This means that studs spaced on 16" centers—the usual spacing—will handle any of the standard boards.

I used Plankweld¹ for most of my walls. This comes in 16"-wide edge-grooved panels that lock together. The panels are made of various woods and are finished at the factory. You just put them up and have a finished wall—no painting or staining.

Wiring. In most towns it is acceptable for a homeowner to do his own wiring—

1. Made by United States Plywood Corp.

if he uses methods and materials that have been approved by local codes. Some communities also require a permit for electrical work and an inspection after it is finished.

Whether you have the work done or do it yourself, see that there are plenty of outlets (PSM, May '52, p. 210). And run separate circuits to shop motors, the washing machine and drier. Wiring, of course, must be done after the studding is up but before the walls and ceiling are installed.

As soon as I had my combination utility-storage room walled, the first thing I did was to stow away the old suitcase. It didn't do much good, though. One of the kids dragged the suitcase back out and, of course, I fell over it again.

Finishing touches—trim, closets, built-in furniture, hiding pipes and columns—will be detailed next month.



PLYWOOD panels were unpacked and spread out leaning against walls. Then they were shifted for the most pleasing grain effect.



STARTING in a corner, edge of first Plankweld panel is face-nailed to a stud. I used $\frac{3}{4}$ " No. 18 wire brads. Heads are slightly countersunk.

GROOVED EDGES of two panels overlap and lock together. The clips, hidden by panels, lock the grooves together tightly.



METAL CLIPS are inserted in opposite grooved edge and nailed to the next stud. Clips should be spaced about 19" or 20" apart.

NEXT PANEL is tapped into place. Scrap of Plankweld with grooved edge is used as block so hammer won't damage edge of the panel.

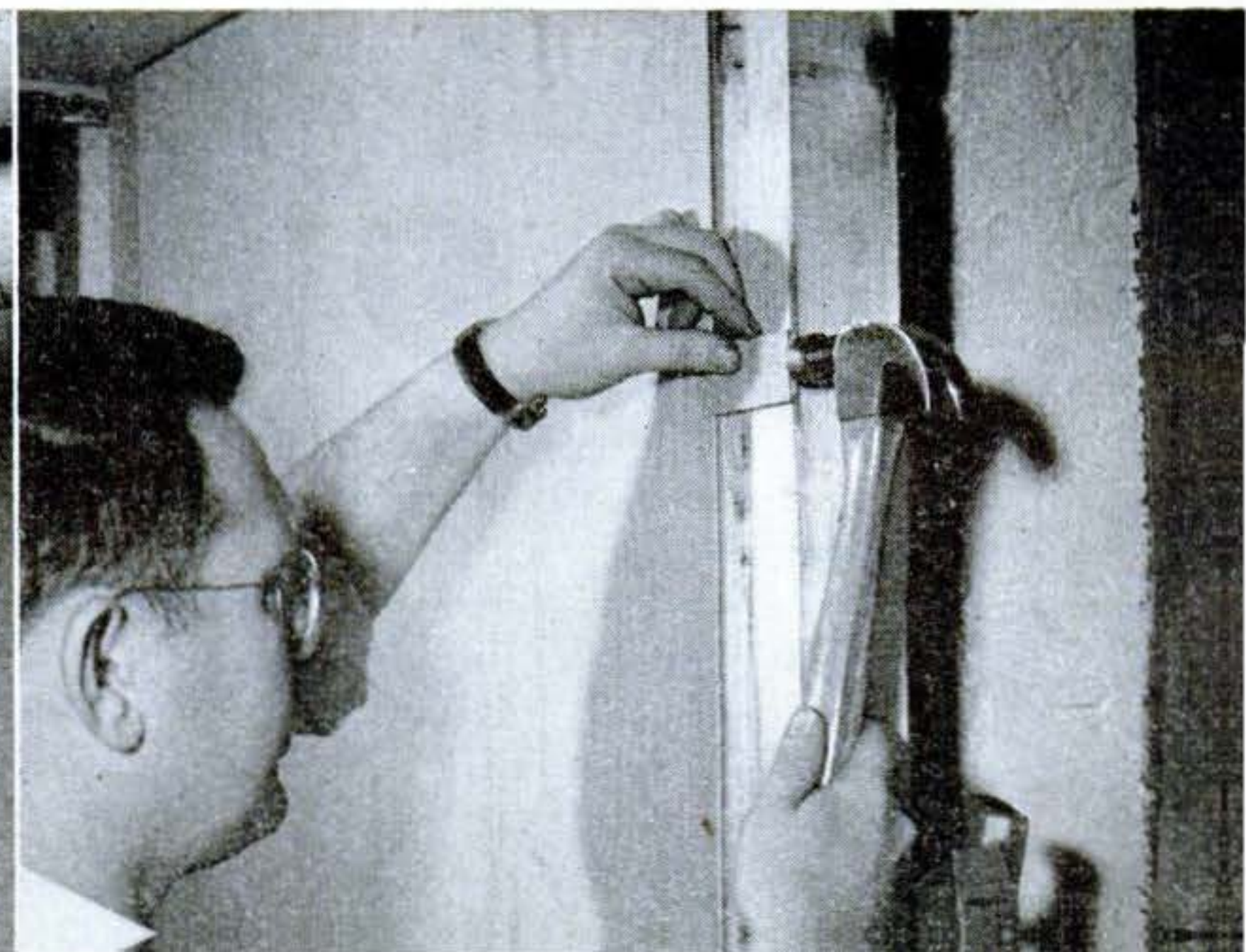
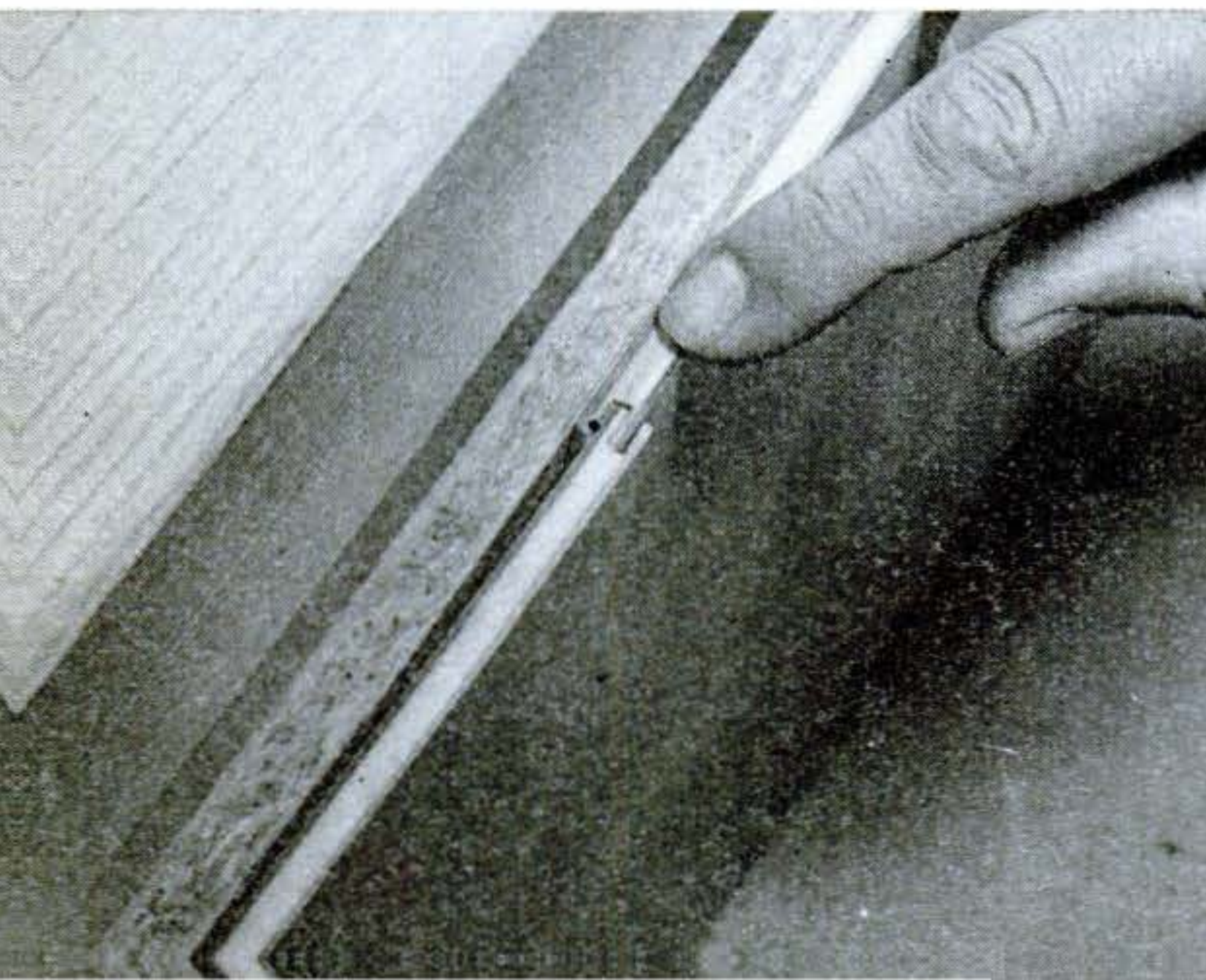

Hoe Extends Paintbrush

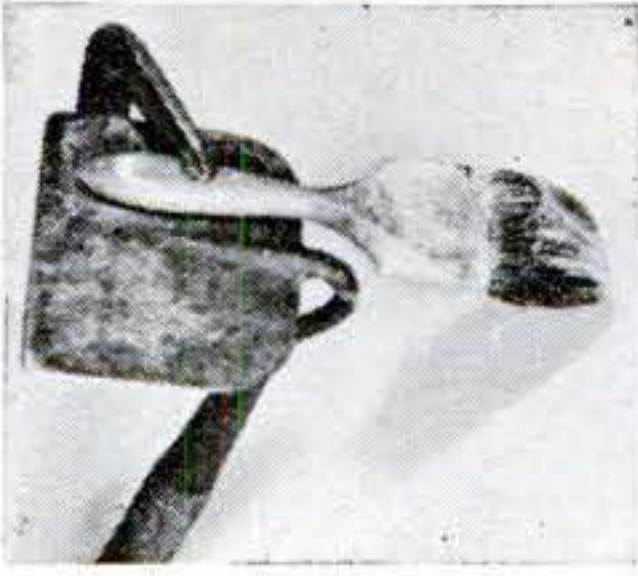

FOR the occasional paint job that is too high to reach from the floor, clamp the brush handle to a hoe or other long-handled tool. This may save setting up a ladder for only a small area.—*Hugh Lineback, Stillwater, Okla.*

Suction Removes Wallpaper

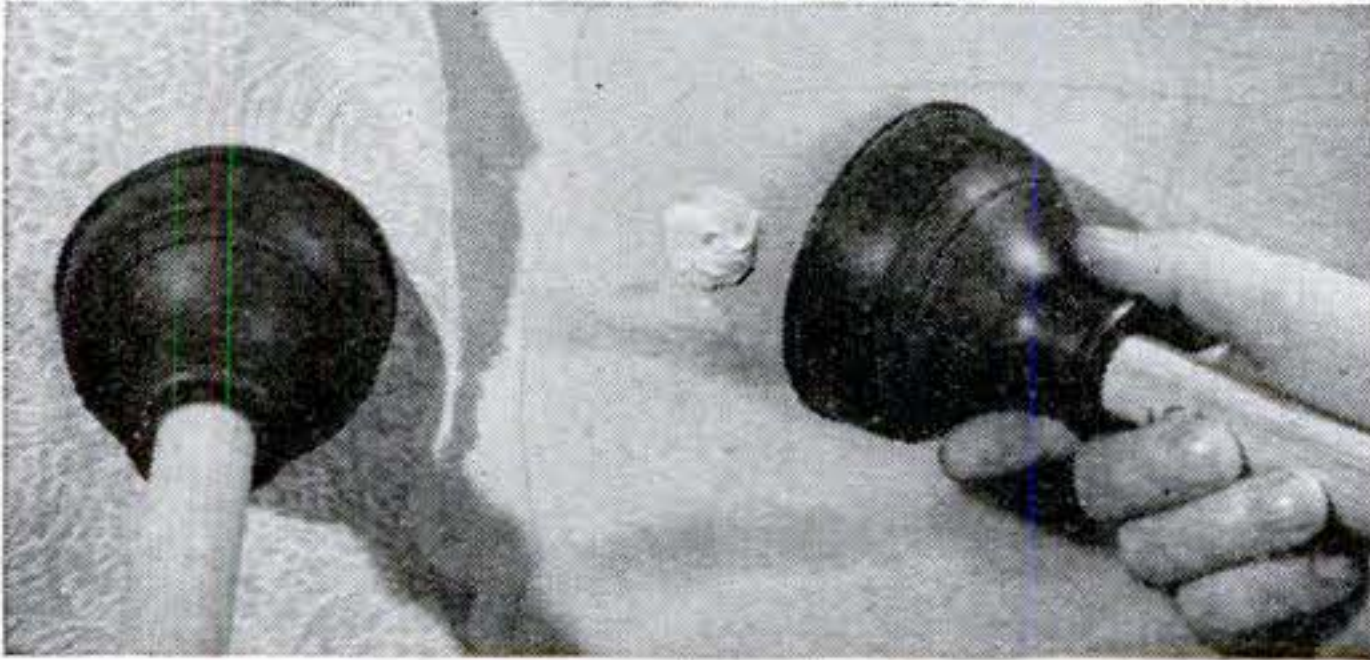

STUBBORN patches of wallpaper can be loosened with a plumber's suction cup. Just pump the cup repeatedly over the wet paper, as at left above. Another use is to help bond small plaster repairs (right). Fill the hole with patching plaster, force the cup over it, and then pry up one edge to kill the vacuum. Air pressure will force the patching material into all pores and crevices.—*Kenneth Murray, Colon, Mich.*

Toy Chest Closes Safely

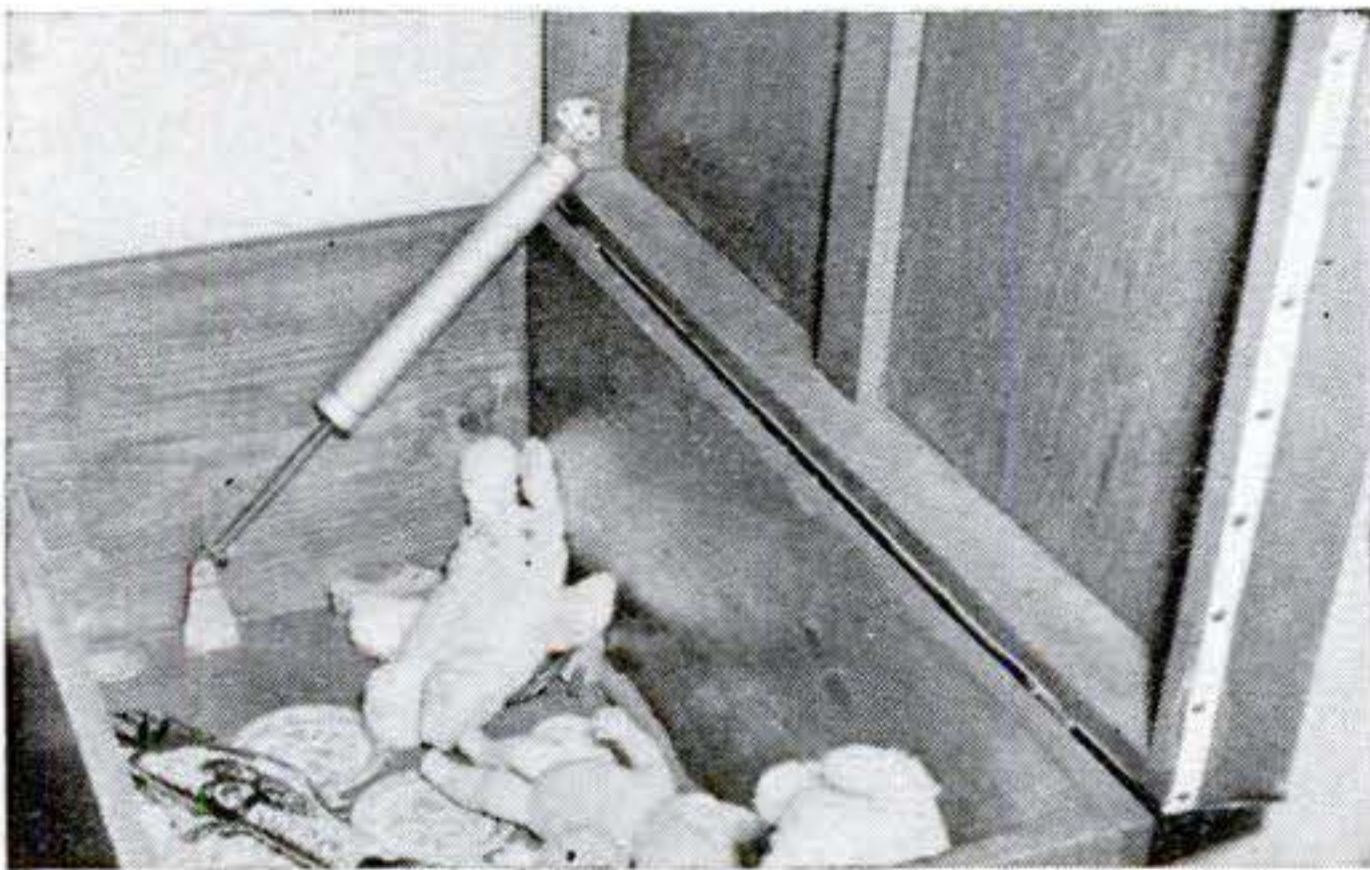

NO MORE pinched fingers or painful bumps when the lid of this toy chest is closed. The safety gimmick is a plunger-type screen-door closer with the heavy spring removed. The light inner spring was left in place and nicely handles the weight of the lid. The closer is adjusted to lower the top slowly, eliminating slamming.—*John G. Voelker, Towson, Md.*

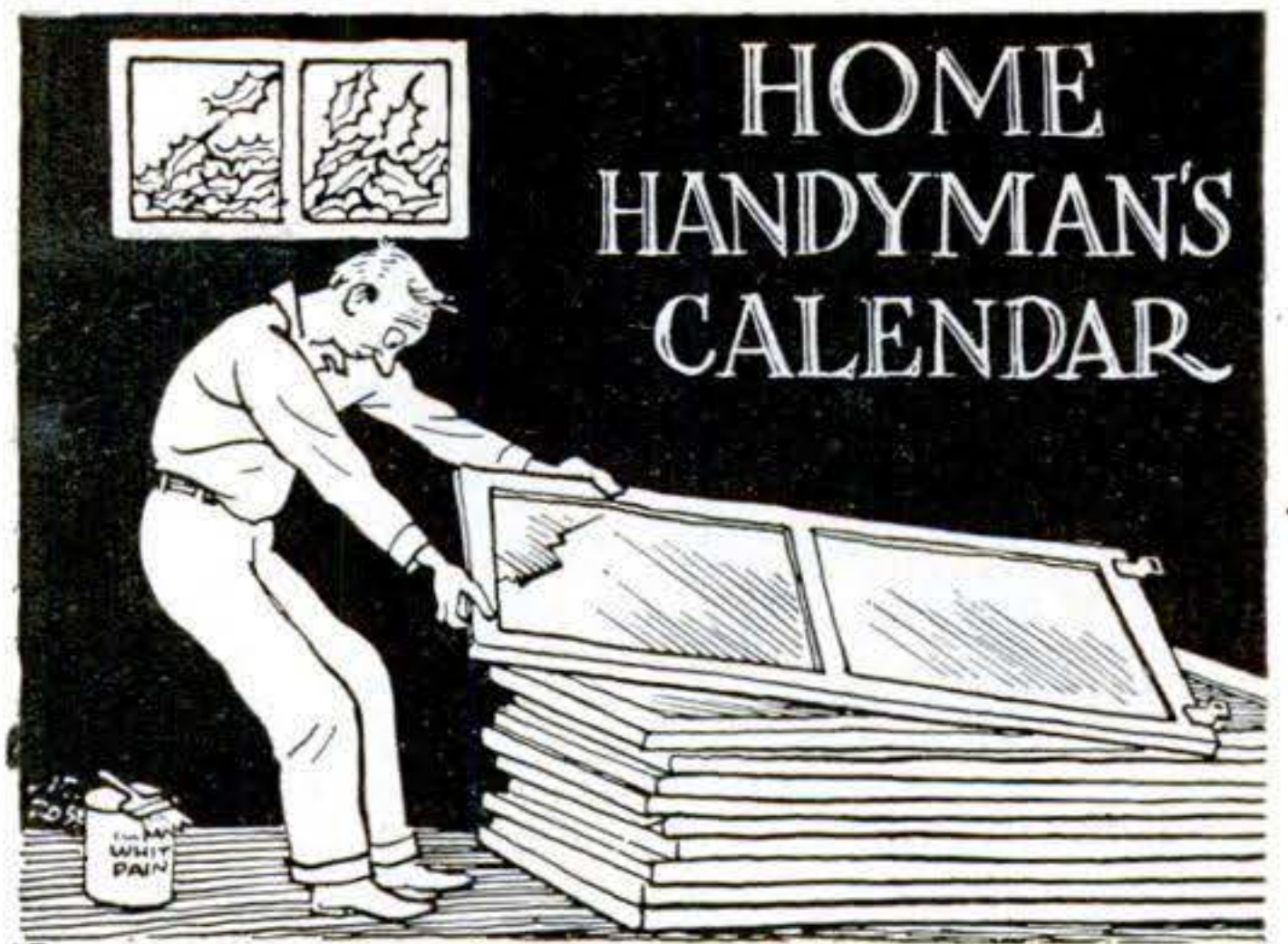

October Month of balmy days and autumn foliage, this is also the time to prepare in earnest for winter.

- Replace the screens with storm sash, and watch out for a stiff back in the bargain. Examine the weatherstripping, first checking the article on p. 230.

- Climb up on your roof for a thorough inspection. Look for loose shingles and nail down any you may find. Check trees for possible hazards over walks, driveway and utility lines. Ice storms or high winds can cause branches to snap, breaking light and phone lines, or even injuring someone. Clean leaves and twigs out of gutters, downspouts and drains. Examine the connections where gutters, leaders, downspouts and ground drains meet. Make sure they are tight. Paint galvanized sheet metal and canvas roofing. See that exterior drains, area drains and catch basins are clear of debris.



- Repair worn electric cords. Tighten or replace electric plugs on appliances. Replace darkened lamp bulbs. Clean and oil electric fans before you put them away for the winter.

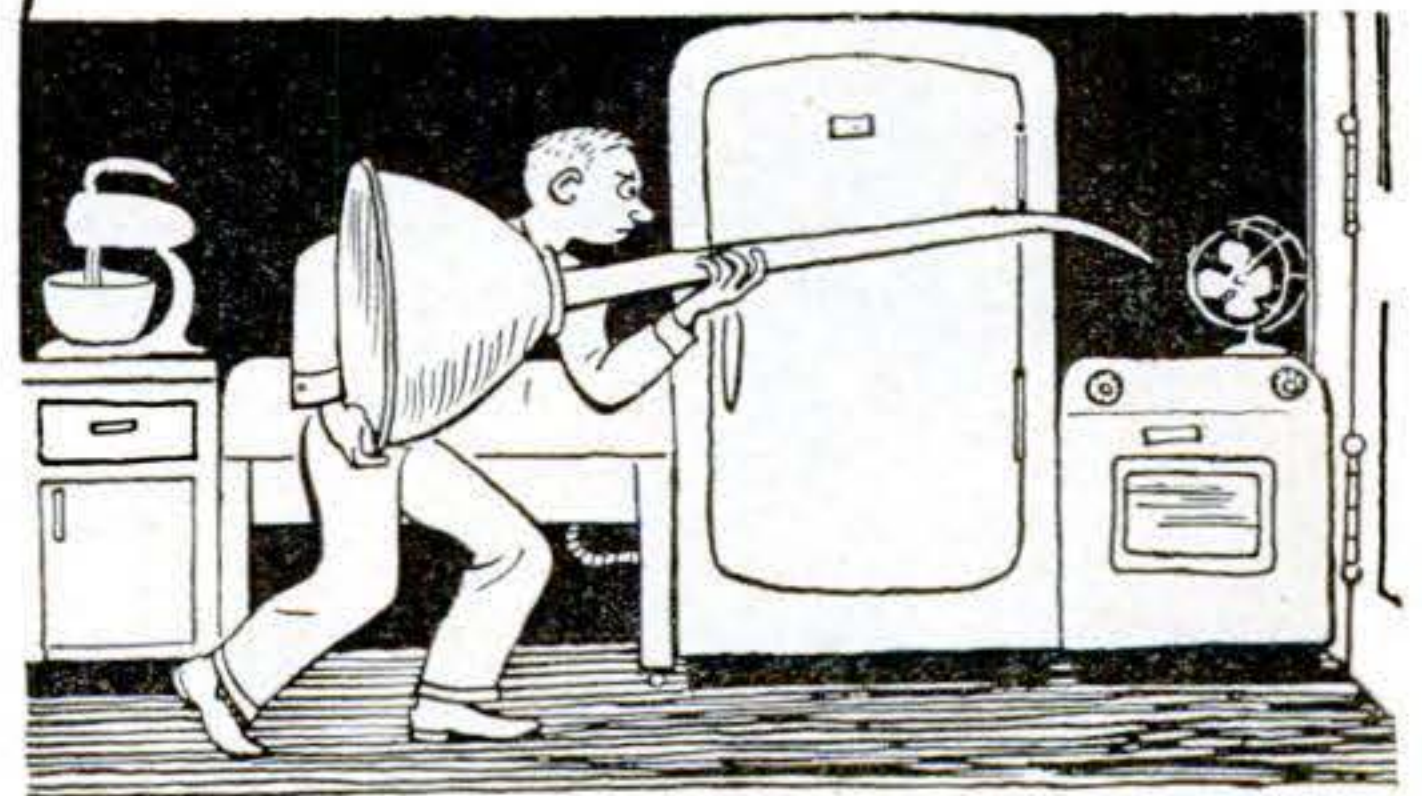

How to Prevent Plumbing Freeze-Ups

By E. F. Lindsley



DIGGING UP FROZEN LINES is no outdoor sport. Only insurance against it is to lay pipes well below frost line. If it happens, electric thawing may save you lots of work. But it should be done by experts.

Keep Jack Frost out of your plumbing and your pocketbook by looking around now to forestall cold-weather trouble.

IT SHOULDN'T happen to your worst enemy. So let's invent a fictitious joker we'll call Emil J. Coeslaw. Emil and his wife decide on a midwinter vacation. Light-heartedly they turn off the gas, shut down the furnace, leave a note for the milkman and go off. The weather goes from mild to bitter and back again. They return to find:

- They need a new furnace. The boiler froze and burst.
- So did a pipe in the basement, which is knee deep in water.
- One toilet bowl has come to the parting of the ways, in three parts.
- The cracked flush tank is leaking water onto plaster in the room below.
- A puddle under the automatic washer can be traced to its pump, which will never

be the same again and must be replaced.

- The electric well pump isn't working.

Although you won't have all the bad luck Emil did, even one chunk of it could be tough. The best job of pipe thawing is still the poorest kind of fun. So let's see what you can do to forestall those frozen-pipe blues.

Where is your lead-in? The lead to the house should be below the frost line, which varies from 1' in Florida to 9' in North Dakota. If somebody skimped on the pick-and-shovel detail, there isn't much you can do immediately except draw a map that will help you dig when there is snow on the ground, and pile insulating material along the route when the cold snaps are due.

Most freeze-ups occur when the bottom



SURPRISE LEAKS like these may be yours if you forget to shut off sill cocks for the winter. The first thaw tells the sad news. Valves seldom can be repaired, must be replaced. Hose can be ruined this way, too; drain and store it.

COLD-COUNTRY PRACTICE is to bring in a well lead through 4" casing welded into well casing. This conducts warm air from indoors to the pipe. A screen over casing keeps out mice.



drops out of the thermometer and a high wind is blowing. Make a note of all spots where pipes are exposed. You may find some under crawl spaces, close to door or window openings, running through outside walls or between the house and garage.

In a brief cold snap, it may be practical to set up a small electric heater, an infrared bulb, or even an ordinary lamp bulb rigged to reflect heat on the pipe. But remember that any heat may create a fire hazard.

Keep them warm. You can pack exposed pipes with rock wool, cover them with asbestos paper or cement, or warm them with heat from the house. A good dodge for pipes in outside walls is to run in hot air from a cellar duct, using a 3" conductor pipe up between the studs. So long as the furnace is going, the pipes will be safe.

Storm sash and weatherstripping can protect pipes running along a window opening. And don't shut off the heat in an unoccupied room if water pipes run through its outside wall.

In a pinch, there is the old dodge of letting the water run. A trickle should be enough. But don't do this if you have an electric pump, or you may find yourself with a burned-out motor.

Sometimes an outdoor line can be fitted with a shutoff valve and vent at the inside end. Then the outlet end in the garage or barn can be left open and the water drained, provided the pipe was laid with some down pitch, as it should have been.

Pipe through a barnyard can be kept open by stacking active manure along it. Leaves and compost-heap material will also serve. Even dry straw, shavings, wood chips, crumbled cork or vermiculite will help when the weather is not extreme, especially if the snowfall is early. Snow piled over insulating material adds considerable warmth-keeping ability of its own.

Going away? First of all, make sure you have a tight shutoff valve in the main supply line. A leaky one may slowly feed water to the flush tanks, water heater or automatic washer you left drained. If pipe drains are left open, you may come home to a flooded basement.

Draining water left in plumbing is as important as shutting off the supply. Pictures on the following pages show how to empty pipes and protect tanks and traps.

Thawing a freeze-up. Once old man winter has taken a bite on one of your pipes, the problem is to thaw it out. Where

TIPS ON THAWING

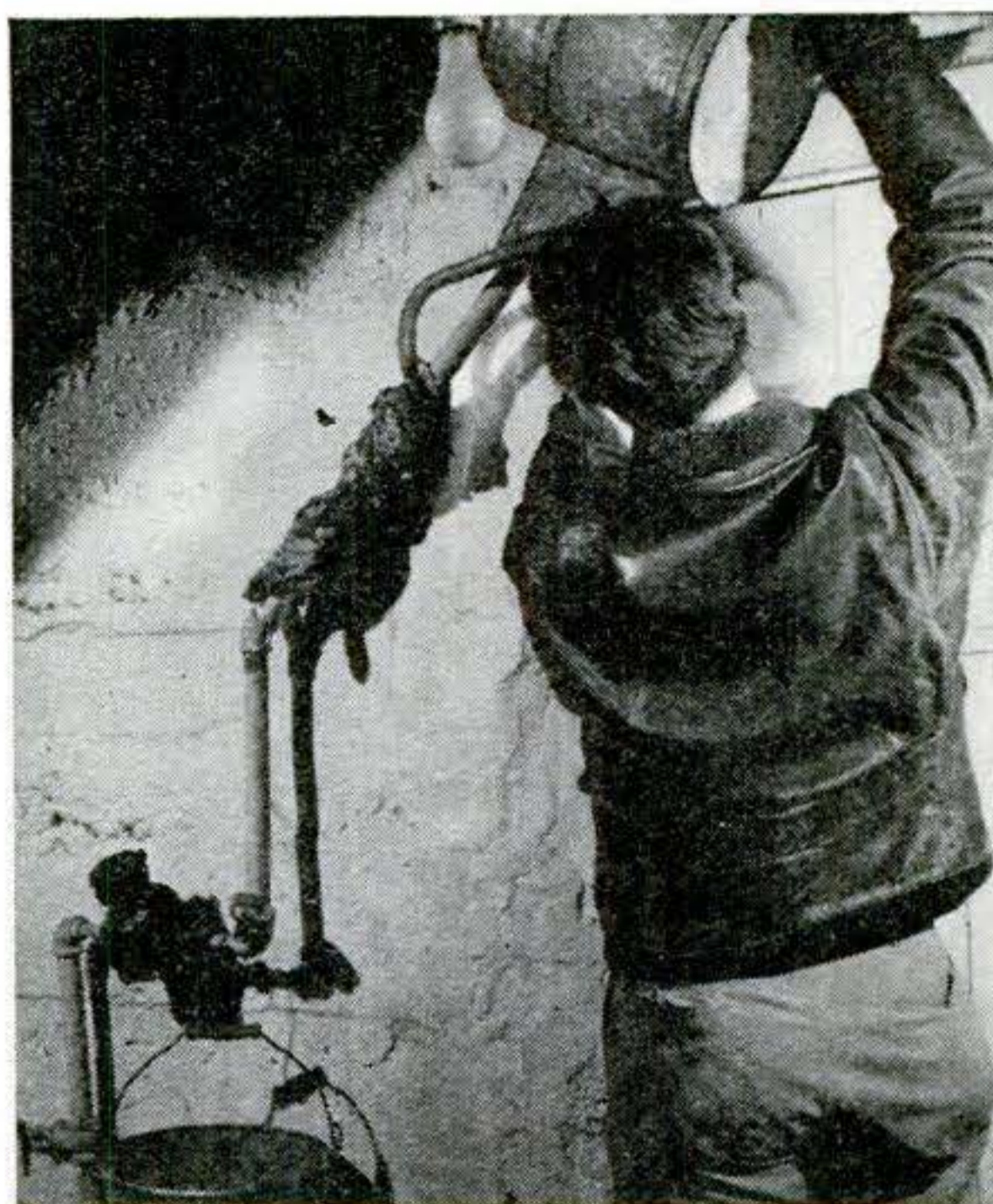

HOT WATER poured on rags wrapped around the freeze-up is a safe, time-honored method. A pail below catches runoff. Photo or infrared lamps might turn the trick here, too.

BLOWTORCH works fast, but be sure to locate freeze-up and work from faucet end back toward supply. Heating back of a blockage creates a sealed "boiler" not healthy to stand next to. Fire is a real hazard when torch is used. Sheet metal held as shown will protect wood and other combustible surfaces.

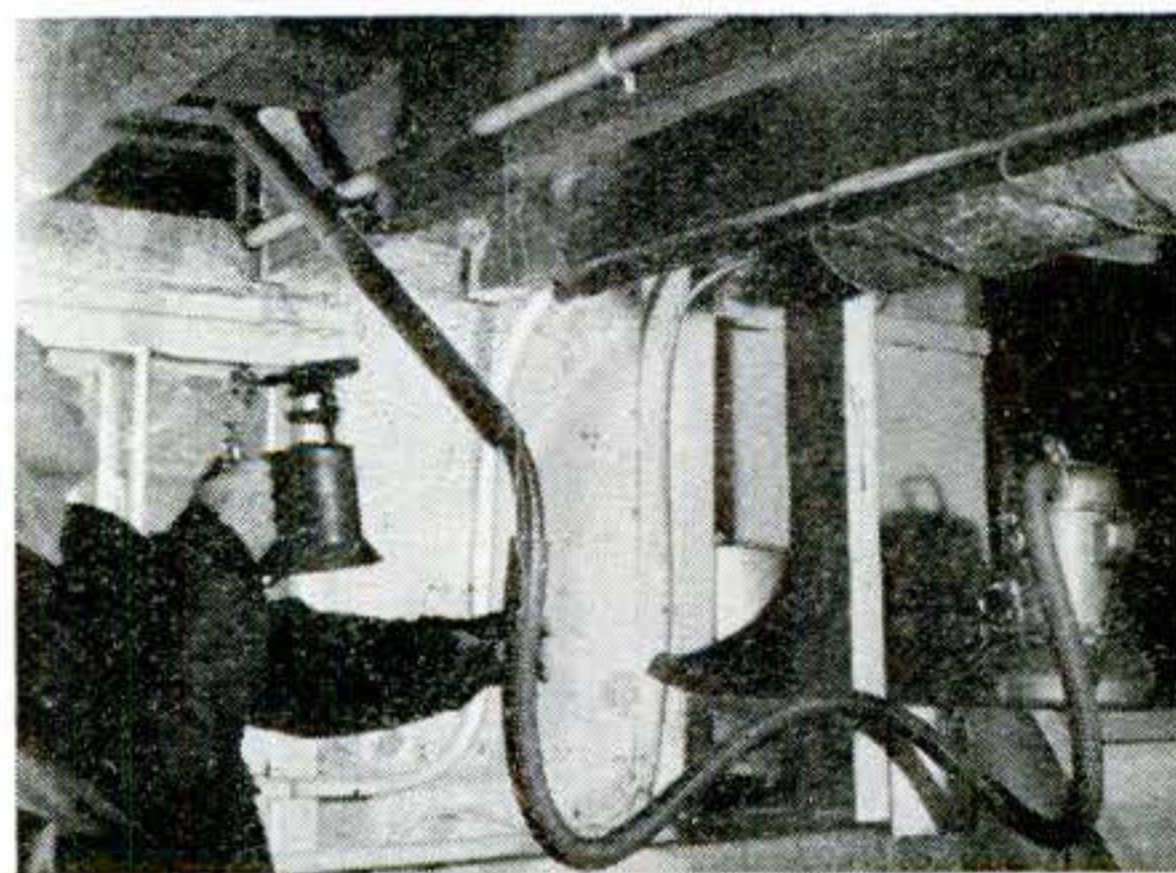

FROZEN PIPE IN AN OUTSIDE WALL is hard to reach. Flame can't be used because of fire hazard, but hot air can. Hook vacuum-cleaner hose to blower side and insert end into a pipe pushed up between studs. Apply a blowtorch to the pipe, which heats the air.

the block is can often be determined by feeling with your hands for the coldest spot. If you see a crack there, be prepared to stop the flood after thawing. Should there be no shutoff valve in the line, you'll have to close the main valve as soon as the pipe is thawed.

Small cracks can be wrapped with rubber tape and further sealed with roofing compound. Rubber hose, split and wired tightly around the break, may hold for a time. But if the break is serious, better not thaw it until you're prepared to install new pipe or cap off the run. If a valve is damaged, count on installing a new one.

What kind of heat? If the area around the pipe is still cold, first warm it up by whatever means you have. Even a portable

oil stove will help make thawing easier and keep the pipe from freezing again.

Leave the water supply turned on while thawing, as the pressure will help unblock the pipe. A pail should be on hand to catch dribbles from a cracked pipe. Also open the faucet to show when water runs again.

Anything from a blowtorch to a hot-water bottle can melt ice, but the danger of fire should be kept in mind—there's no percentage in thawing a pipe by burning down the house. *Always apply heat from the outlet end of the freeze, never behind it.* Otherwise you'll expand water behind the block and may burst the pipe.

Can I thaw pipes underground? This can be tough. If hot water or steam can be

WHEN YOU'RE GOING AWAY

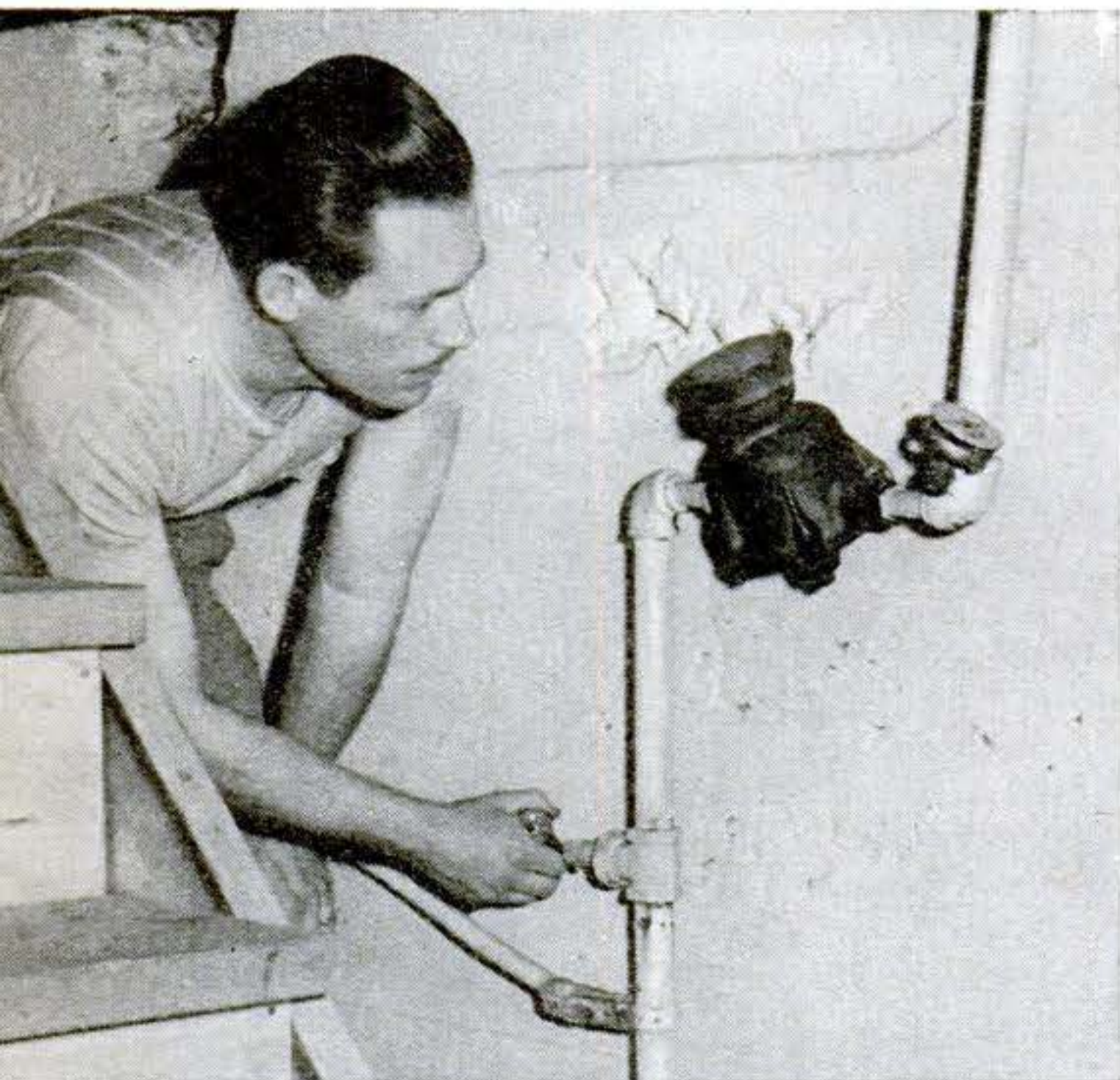

SHUT OFF MAIN VALVE FIRST. This installation is poor because lead-in and valve shown will remain full of water and may freeze. Valve with drain is better, shutoff being made at street valve. Be sure house valve is fully closed; corrosion may cause faulty seating, but tapping stem will usually make it seal.

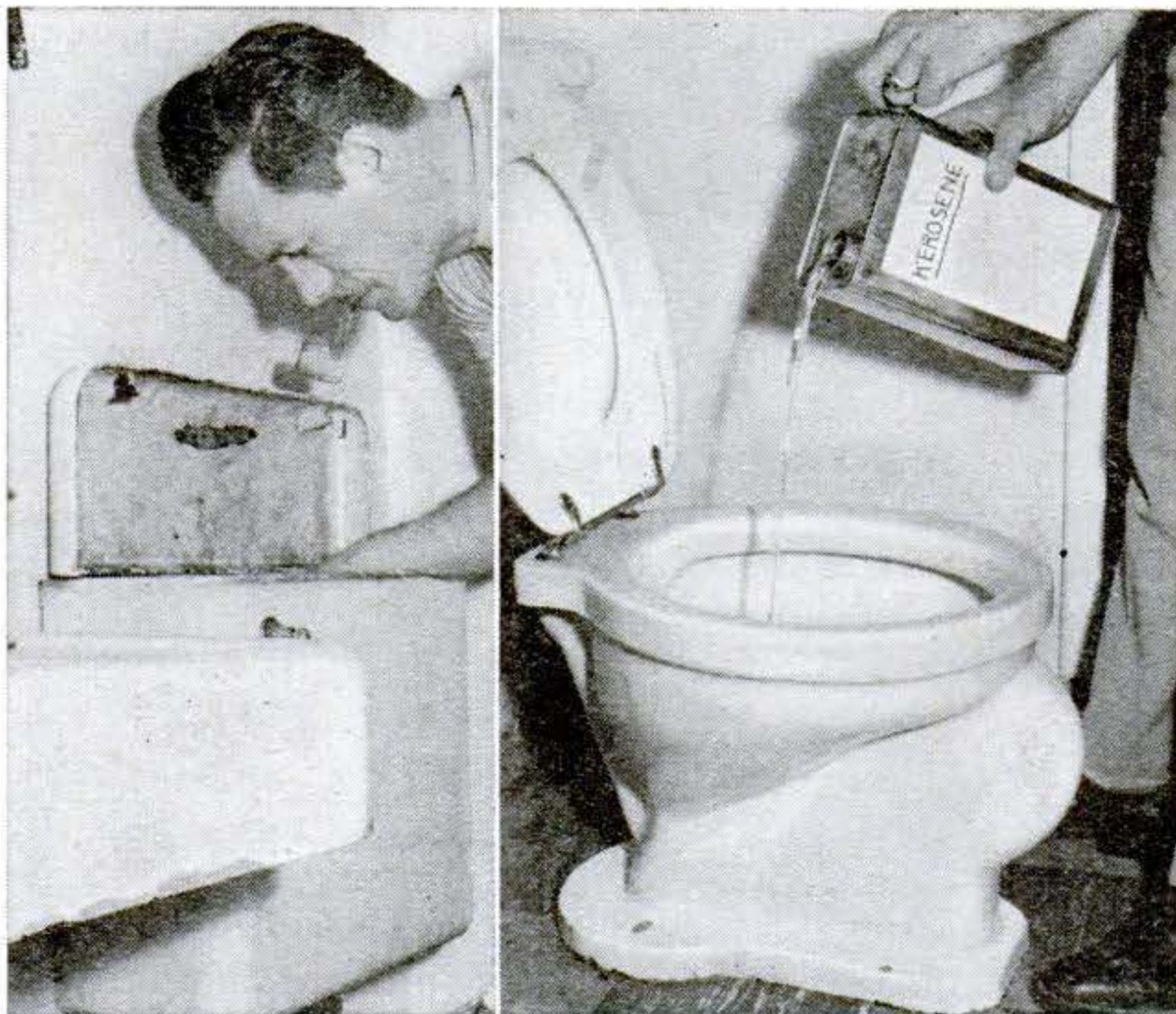

EMPTY TANK by flushing toilet after house water supply is shut off and pipe drains in cellar are open. Then remove water from bowl with a siphon or rags and pour in antifreeze as a seal against sewer gases. Open lavatory faucets to admit air and let water in pipes out through pipe drains.

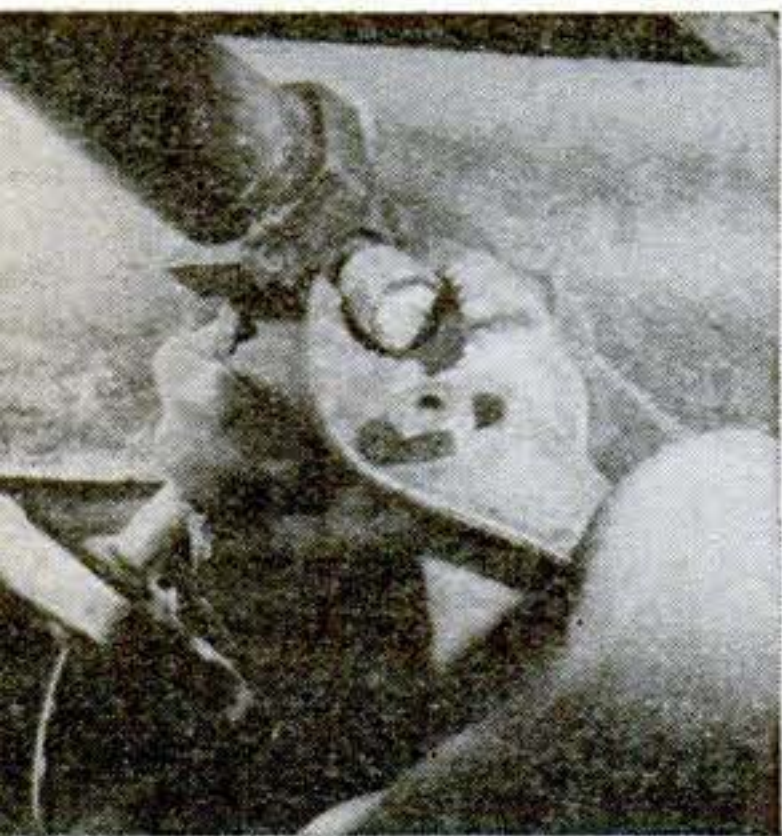

ALL PIPES should have drains at low points so that they can be emptied. This one is part of the shutoff valve. Drains may be hidden by ducts or partitions. Be sure to find them all. Use a wire to clean out rust or scale that may keep some of the water from draining.

FREEZEPROOF all traps under sinks and basins by opening plug to drain them. Be sure to add kerosene or other antifreeze to seal the traps against sewer gases. A one-to-three solution of alcohol, or low-grade lubricating or vegetable oil, may be used as antifreeze.

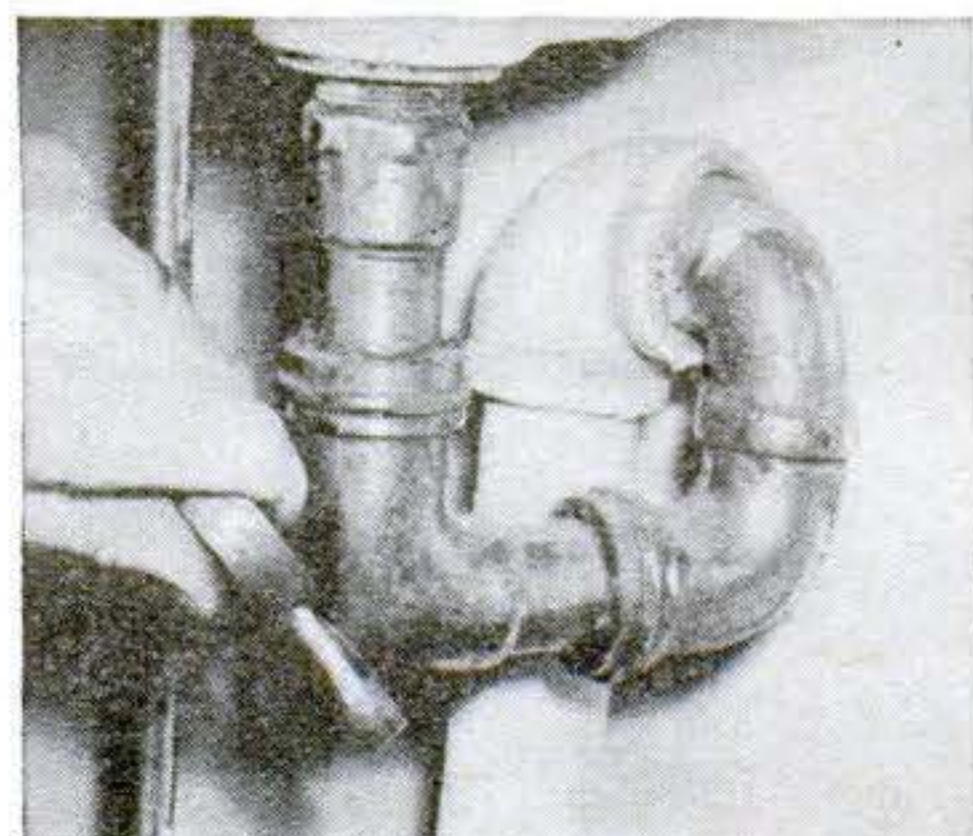

forced into the pipe, and the freeze-up is not too far away or extensive, it may thaw. The best bet is electric thawing. This calls for a heavy-duty arc welder (don't plan on doing anything ingenious with your house current). It also calls for expert know-how.

If the main line is frozen hard, you will probably do well to call the water company or a welder who can come around with a 300-ampere portable generator. He can shoot high amperage through the pipe, which will heat it up all along because of its resistance to the current. And he'll be wise to the pitfalls of the procedure, which include the risk of setting up a parallel circuit in a gas pipe or of melting a lead pipe fitting. END



IN MILD CLIMATES surface lines can be protected with insulating material and a water-shedding housing, here made of boards nailed into a trough form. Mica or vermiculite is cheap and, unlike straw, won't harbor vermin or lead them into the house. If snow falls, heap it up over the housing for extra insulation.

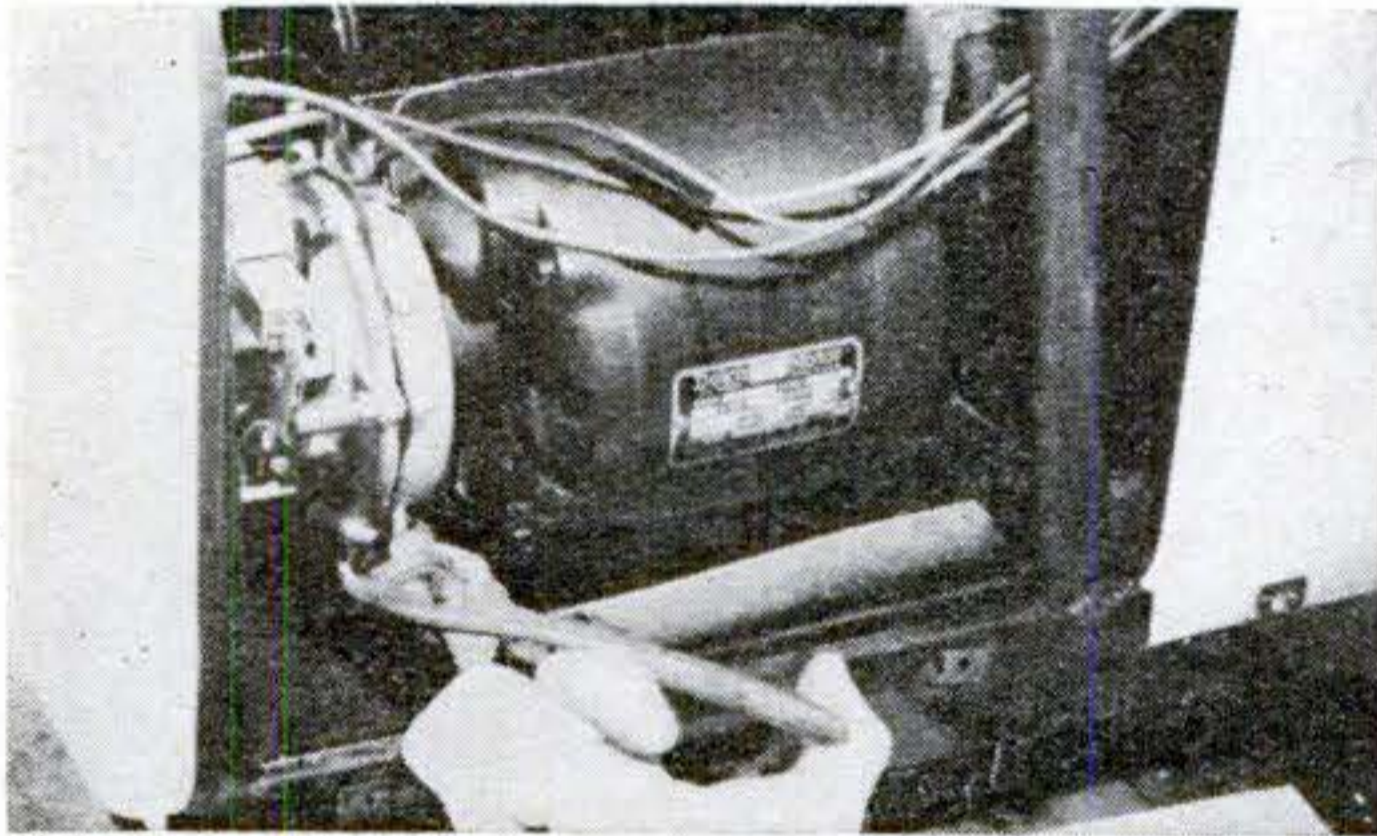

LOVE THAT AUTOMATIC WASHER? Then don't overlook water that may be left in the pump. If it freezes, the pump might be ruined. The easiest way to drain this one was to loosen its lower hose coupling as shown.

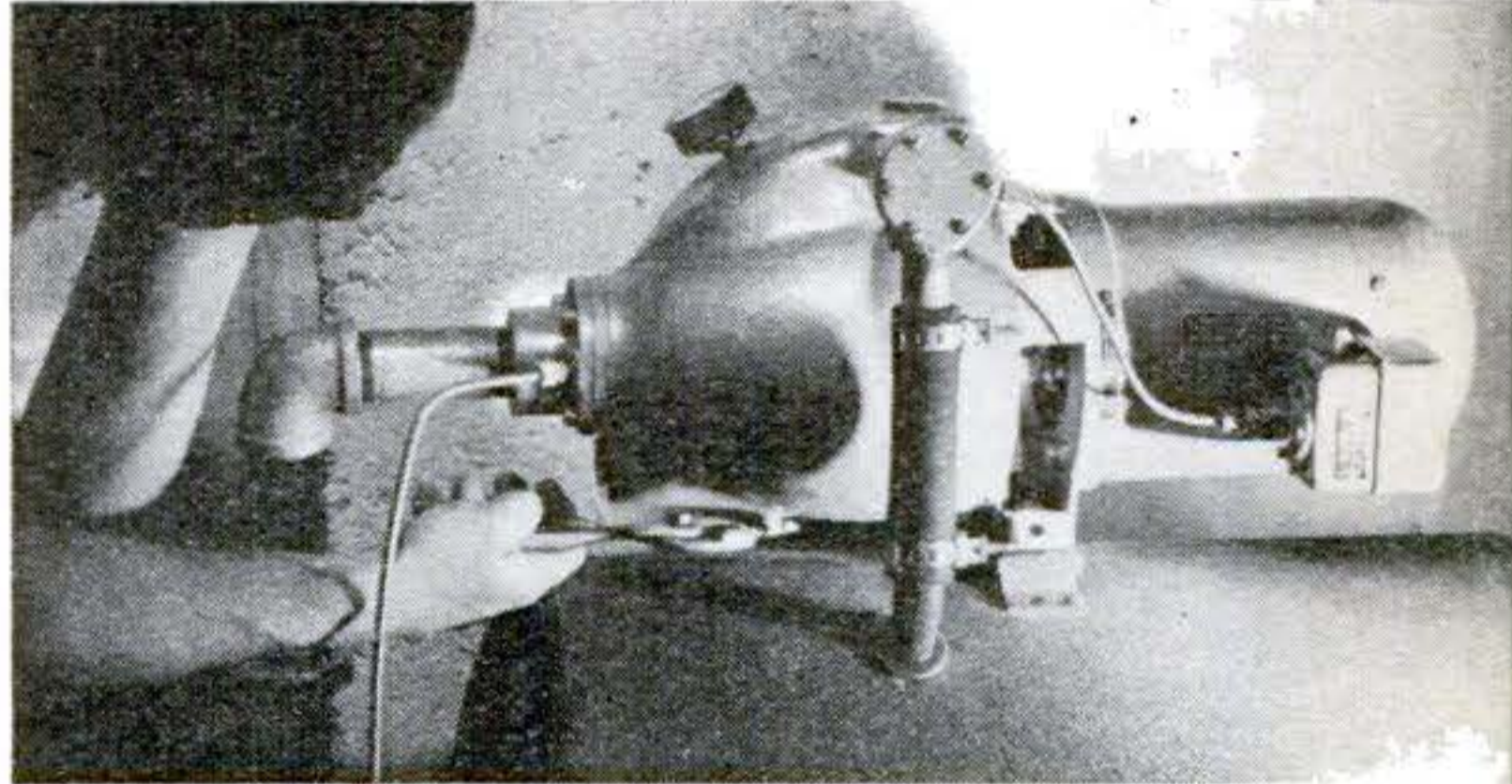

A WELL PUMP left full of water may freeze up and require costly repairs. Look for a drain valve or plug. Also open coupling at well to let water above soil drain back into well. Foot valve may hold some water in line.

DRAINING PLUMBING

Water left in pipes, traps, toilet bowls and flush tanks, washing machines or drains may freeze when a house is left unheated during cold weather. Even if an automatic heating system is left on, power or fuel failure may shut it down. It is

safest to shut off the water supply and drain all pipes and receptacles. Check action of shutoff valve to make certain it cuts the supply off positively, and does not allow water to seep back and refill the lines you have drained.

Check List

- Shut off main supply valve at street or in cellar
- Open all faucets
- Open pipe drains
- Disconnect pipes without drains
- Empty toilet flush tanks
- Remove water from toilet traps; add kerosene or other antifreeze
- Drain sink and lavatory traps; add antifreeze

- Drain steam boiler or hot-water heating system
- Turn off gas or electric water heater
- Drain water heater
- Drain water softener
- Drain furnace humidifier
- Drain water-fed home appliances such as washers and dishwashers
- Drain supply pump and tank; shut off power to well pump

FOR YOUR POPULAR SCIENCE MONTHLY INFORMATION FILE

Craftsmen in Uniform



Bus into Auto-Home.

The handsome motorized house at right started life as a 1941 Ford bus. Capt. Thomas A. Chrones, Air Force, stripped the bus, cut it apart (above) and inserted a new center section, increasing the over-all length to 35'. He installed a complete bathroom and kitchen and laid a rubber-tile floor. The interior is lined with spun-glass

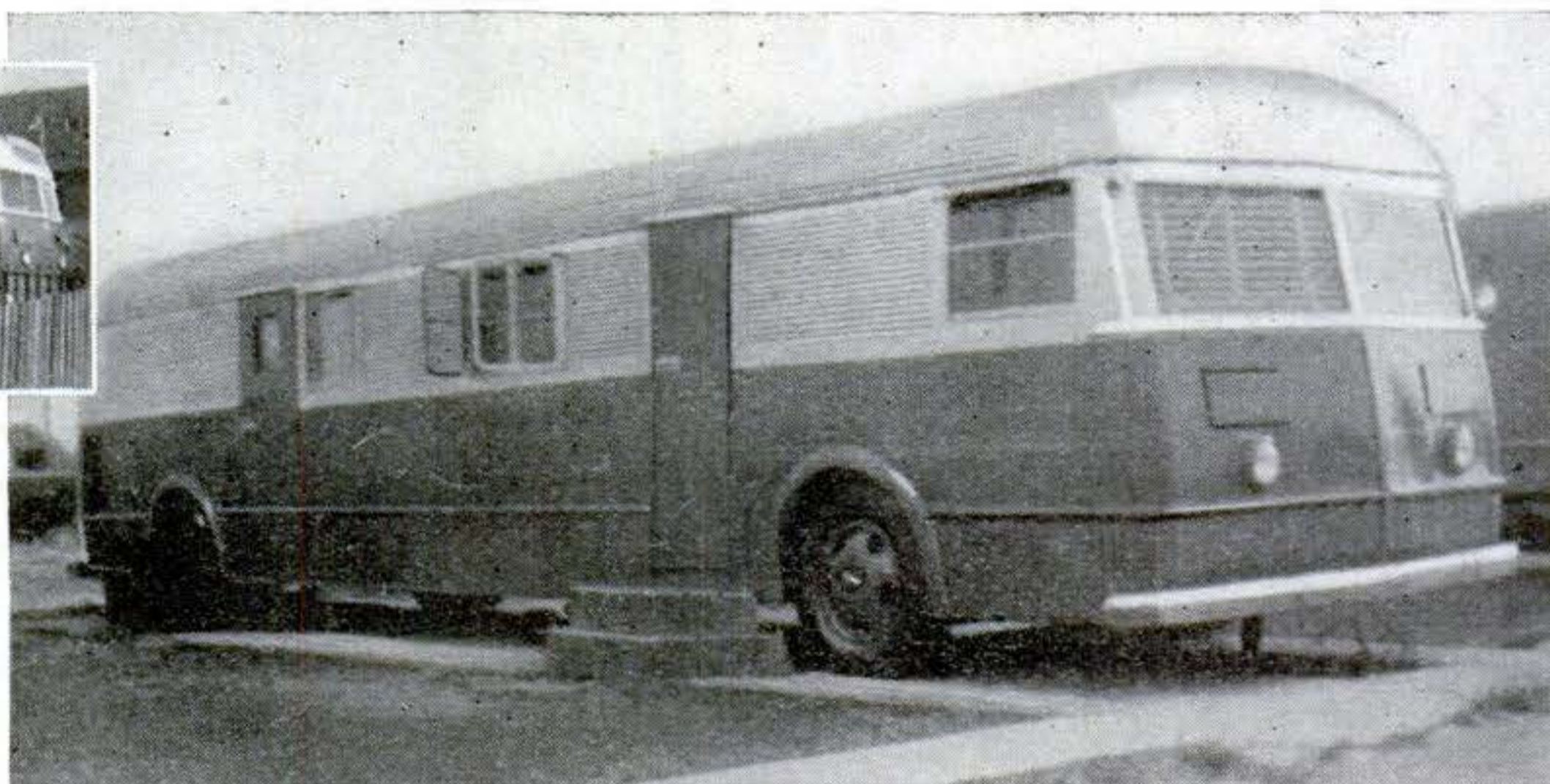

insulation, plywood-covered. The engine is a 112-hp. Mercury. His only power tools an 8" table saw and an electric drill, Captain Chrones spent 1,600 hours and \$3,100 on the job. He's at Lowry Base, Colo.

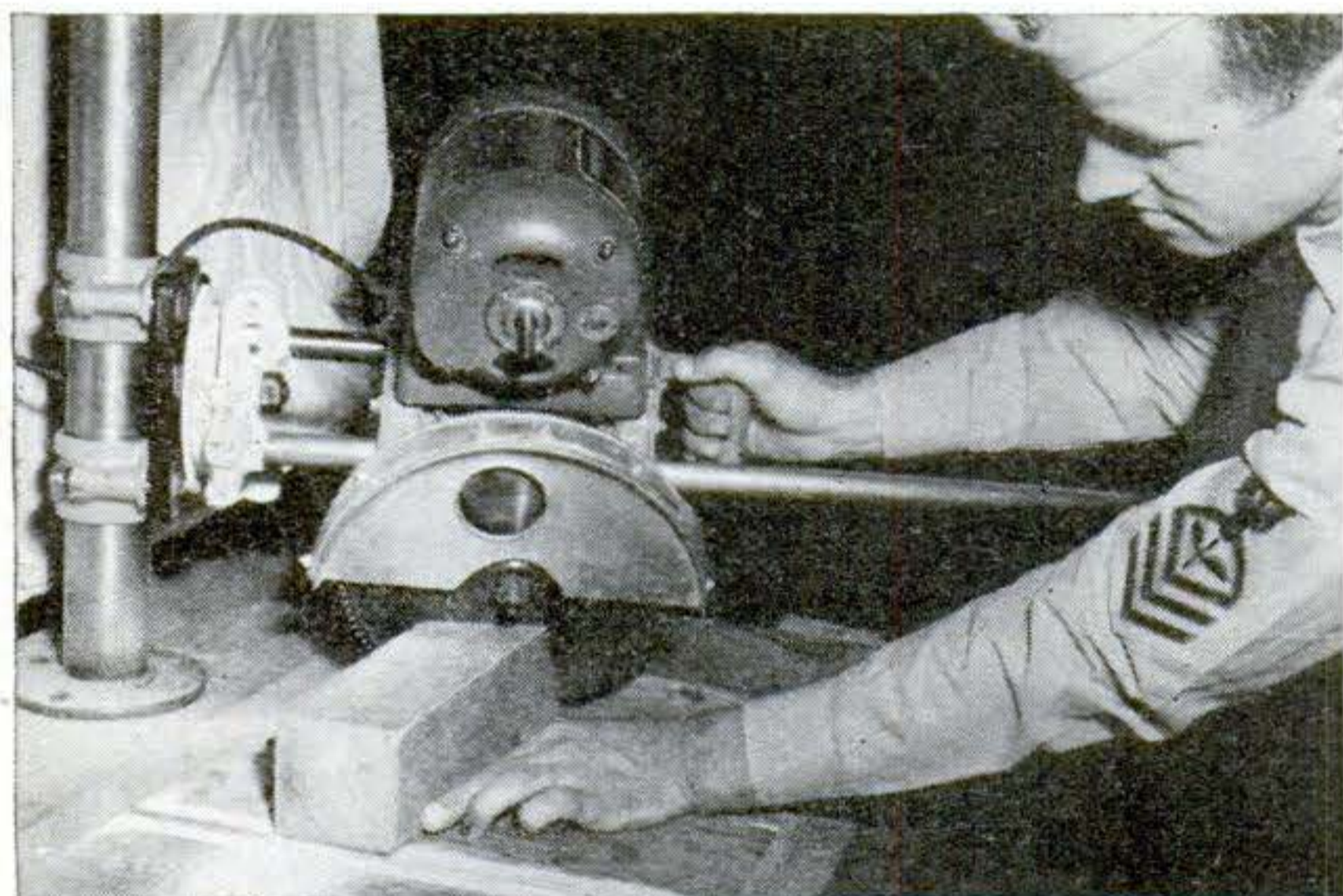

Plane Turret into Power Saw.

A ball turret from the scrap heap of an aircraft-salvage company supplied most of the parts for the 10" power saw at left. James Jurel, Chief Aviation Machinist's Mate, USN, got the idea from a new tool that he saw in PSM. The upright is extra-heavy pipe; the blade guard was the top of an oilcan. The saw will rip, cut off, shape, plow, rabbet, dado, disk-sand, wire-brush and grind. It has a 21" movement. Jurel spent \$7.50 on parts, other than motor, mandrel and blade.

Pictures in Leather. When M/Sgt. Ben P. Moody creates a picture he uses leather. The panel set into the top of the coffee table below was carved, then worked from

behind to raise the relief to 1". It is covered with glass. Sergeant Moody, in Germany with the Army Medical Corps, has twice won world-wide Army crafts contests.

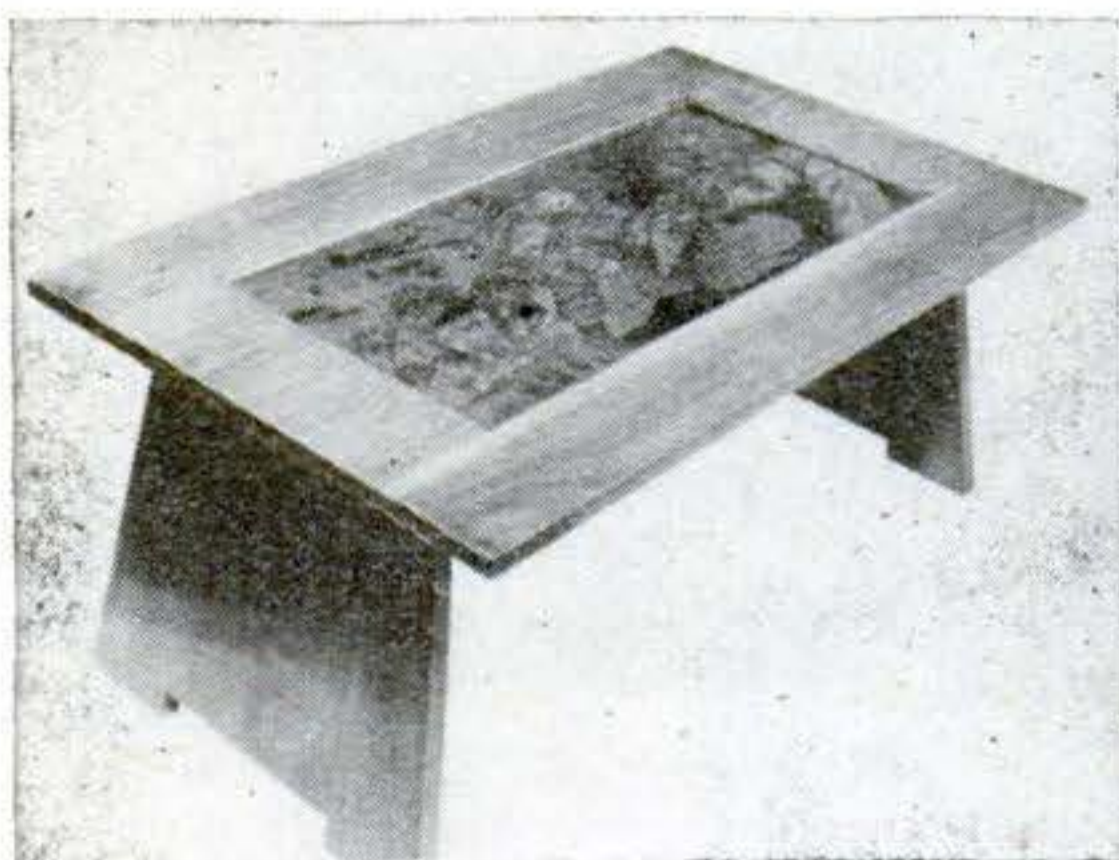

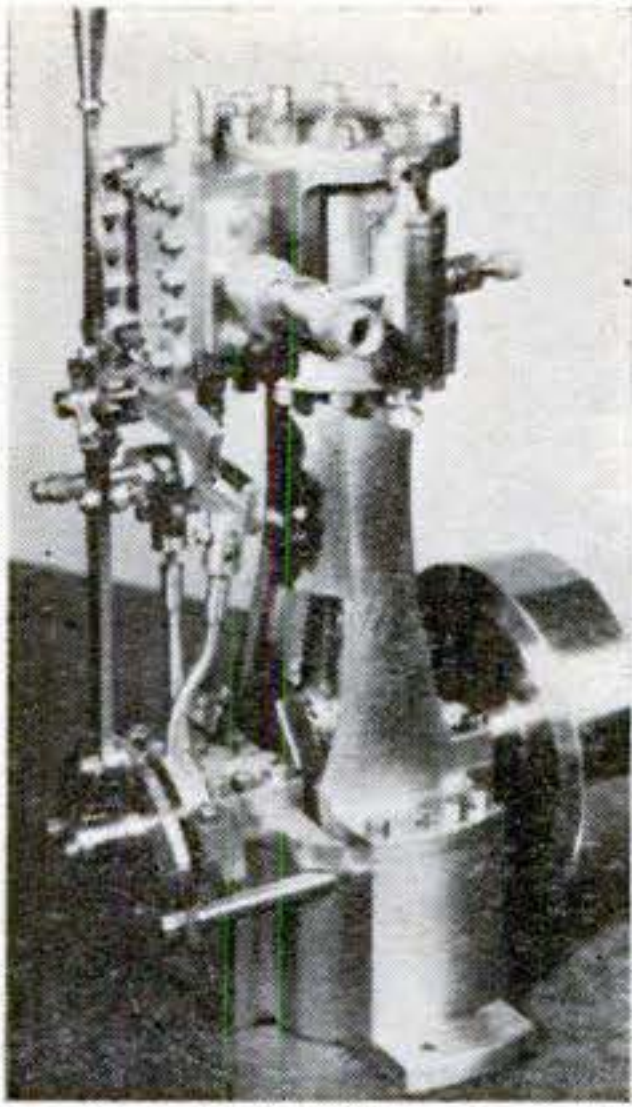

Iron Pony. The midget steam engine at left develops almost one horsepower when run at 1,500 r.p.m. with 100-lb. steam pressure. It stands just 7 $\frac{3}{4}$ " from base to top of cylinder cap, has a 1 $\frac{1}{4}$ " bore and a 1" stroke. The cylinder is cast iron; the standard, brass; the crankshaft, steel. Herbert Grathwohl, Machinery Repairman Third Class, USN, machined parts from solid stock. Steam at 125-lb. pressure comes from a coal-fired 21-tube copper boiler, also built by Grathwohl, who is serving aboard the USS *Arcadia*. The whole job, including a water pump, valves and accessories, took him a year's spare time.

machinery Repairman Third Class, USN, machined parts from solid stock. Steam at 125-lb. pressure comes from a coal-fired 21-tube copper boiler, also built by Grathwohl, who is serving aboard the USS *Arcadia*. The whole job, including a water pump, valves and accessories, took him a year's spare time.



Living-Room Photo Lab. Shown opened out ready for use, the portable darkroom set-up above folds compactly into the central base unit when not needed. It was built by H. D. Stewart, Chief Parachute Rigger, Naval Air Station, Lakehurst, N. J.

King Midget Winner to Be Announced

WHICH of the many items that have appeared in this department since last spring do you consider the finest example of craftwork by a man in uniform? That's the question the judges are pondering

now. Next month their decision will be announced—and a King Midget automobile will be shipped immediately to the lucky fellow. The manufacturer will send it anywhere in the continental U. S.

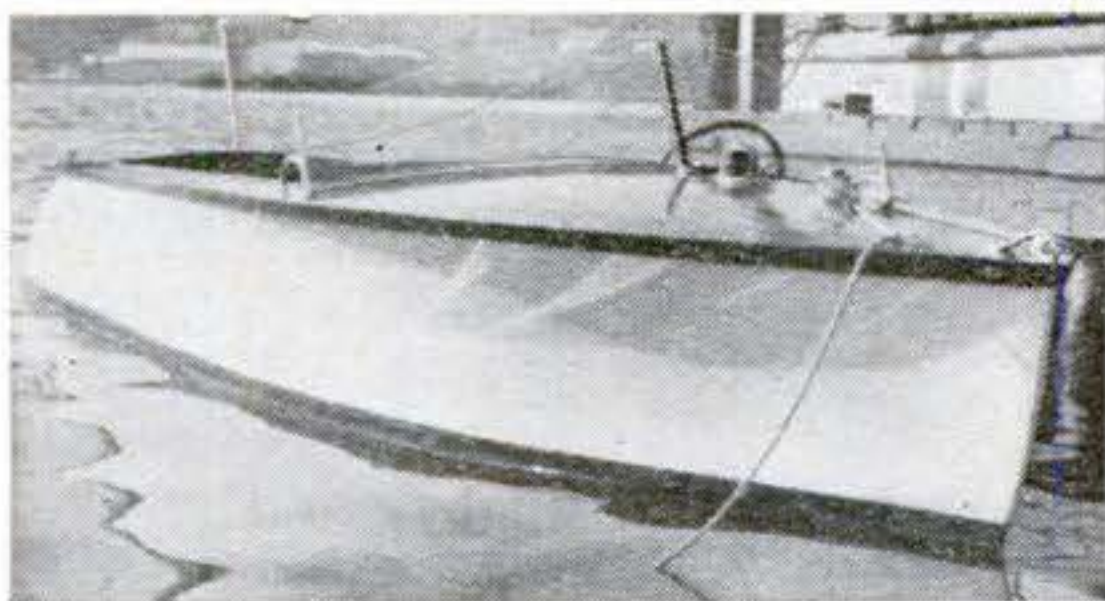

One Man's Navy. When Lt. R. T. Higgins, USN, is not afloat for the Navy he can go to sea in his own craft—the 16' V-bottom inboard runabout above. It's framed with white oak, the planking is Douglas Fir, topsides and cockpit are mahogany. When stationed at Guantanamo, Cuba, Lieutenant Higgins spent 15 months of off-duty hours—plus three weeks' leave—on the project. A four-cylinder, 47-horsepower converted Hercules IXB-5 drives her at an estimated 25 knots.



Boy-Powered Crane. A young operator can climb into the cab of this "Kiddie Crane" and run it himself. Foot pedals rotate the carriage, raise the boom and maneuver the hook, separately or together. Lt. Comdr. J. V. Bartlett, of the Navy's Civil Engineer Corps, built the crane. He lives in Falls Church, Va.

Keeping the Home Shipshape

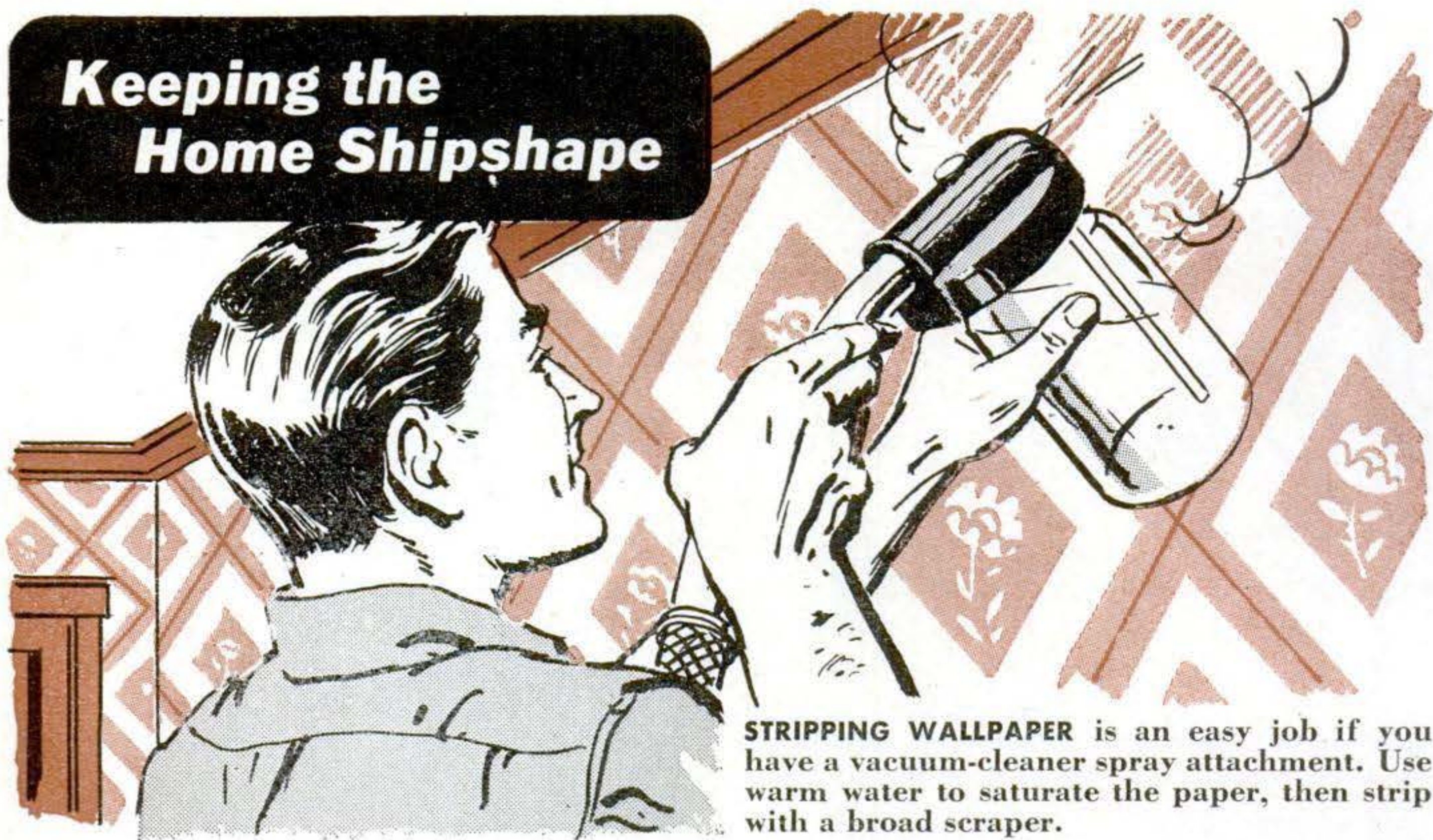

STRIPPING WALLPAPER is an easy job if you have a vacuum-cleaner spray attachment. Use warm water to saturate the paper, then strip with a broad scraper.

TOASTER KNOBS sometimes break after much use. Solderless connectors, used in electrical wiring, make good replacements and can be screwed right on.



NO BASEMENT LAUNDRY TUB? A worn-out washer with works removed and hole plugged will do the same jobs. Install wall faucets for filling the tub; it will roll to the basement drain for emptying.

DRAWERS that ride in too far will fit flush if two screws are driven part way into the back of the drawer, one at each side. Turn the screws in or out until the front is stopped just flush.

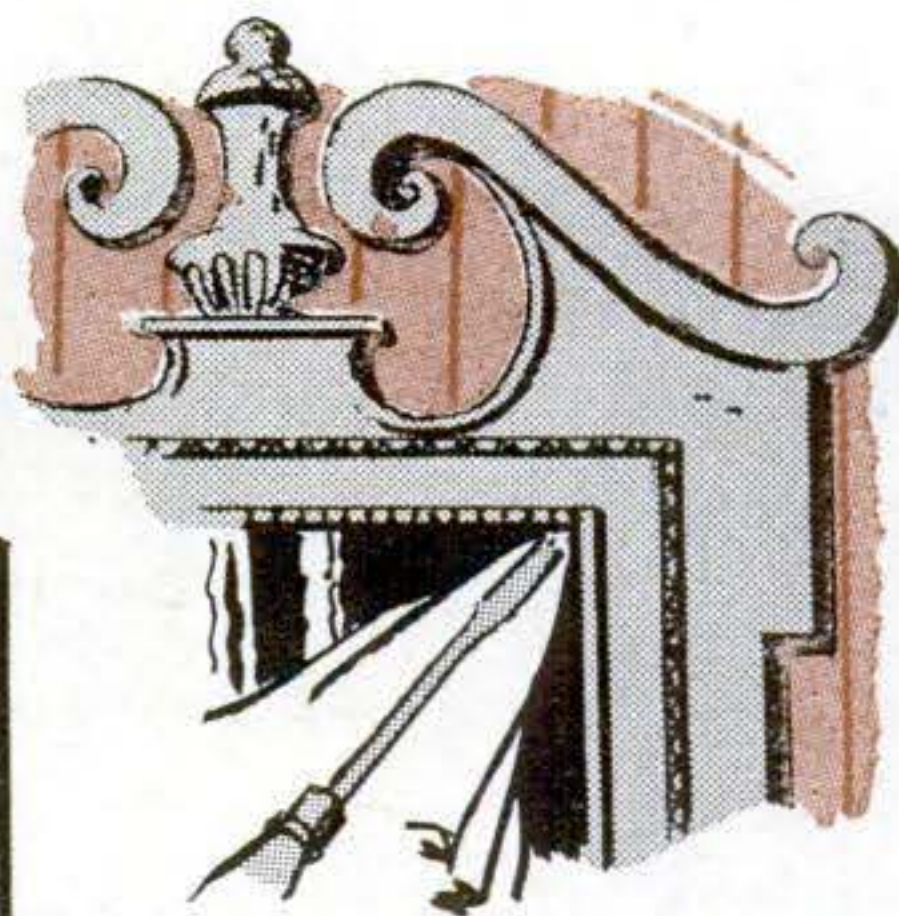
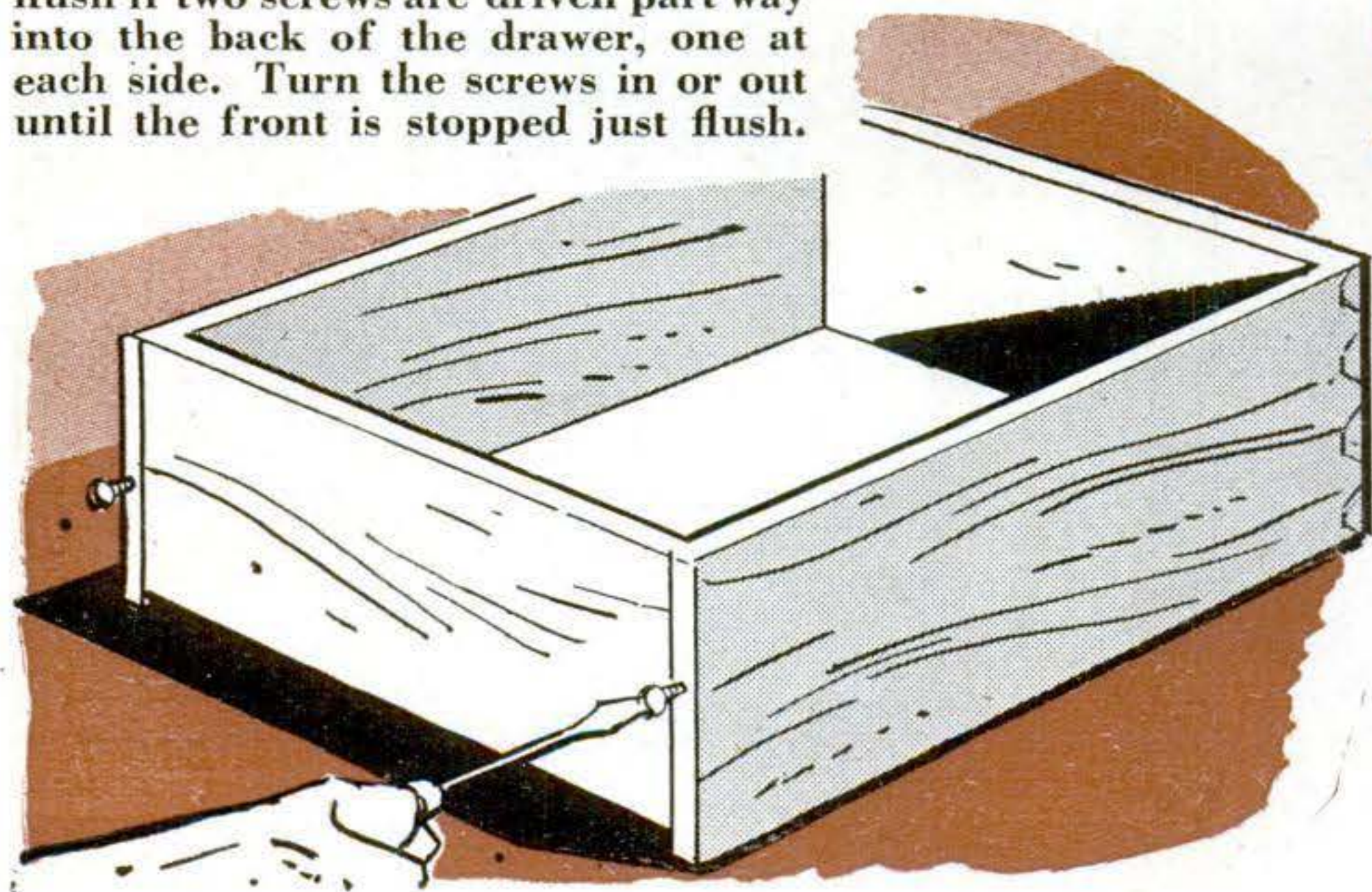

FOR CLEANING MIRRORS, a small screwdriver folded inside a chamois reaches into corners better than blunt fingers and cleans up to glass edge without touching a delicate frame.

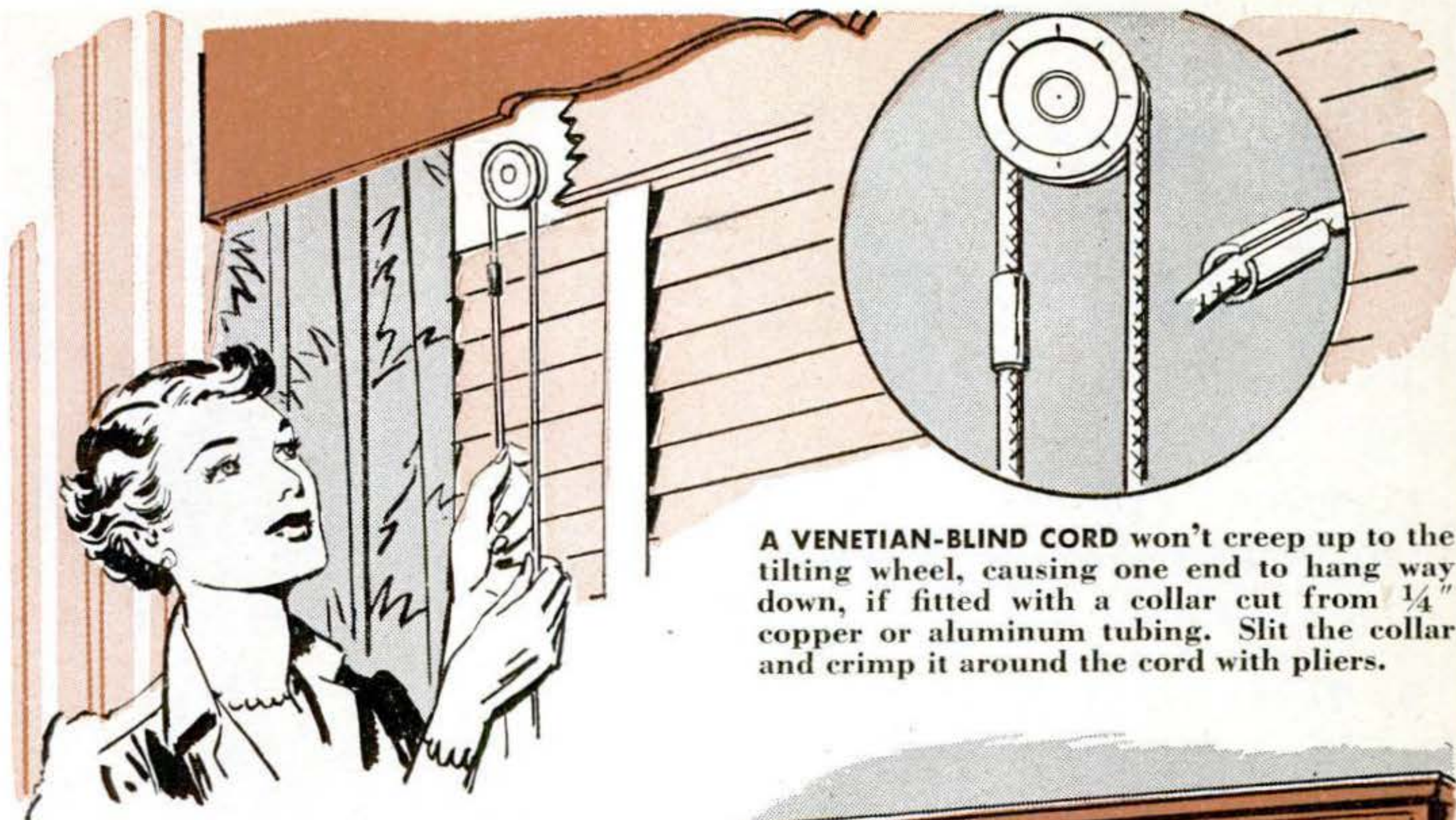

A VENETIAN-BLIND CORD won't creep up to the tilting wheel, causing one end to hang way down, if fitted with a collar cut from $\frac{1}{4}$ " copper or aluminum tubing. Slit the collar and crimp it around the cord with pliers.



CHAMOIS SKINS for window and car washing can be cut from old jackets of thin suede. Clean the leather in heavy suds, then soak to remove any unfixed dye.



CHEAP STENCILS for spray painting jobs can be made from lace paper doilies. Cut apart and taped to the surface to be painted, they form borders or corner designs.

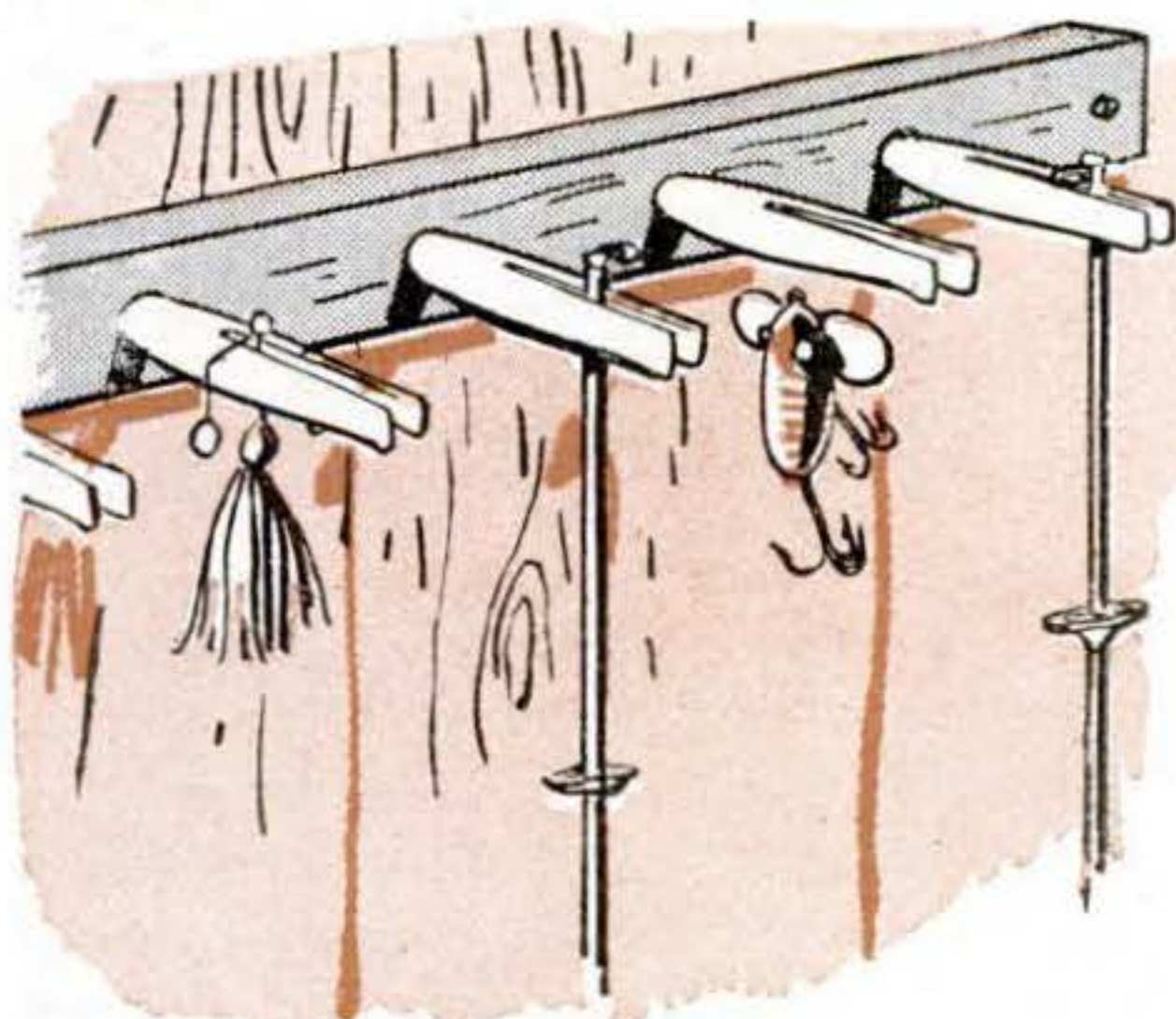

THIS FISHERMAN'S RACK is simple to make. It's just a strip of wood with headless clothespins inserted.



A TABLE TROUGH cut down from an old end table will keep the family reading tidily at hand. Or it will hold a generous supply of popcorn or fruit for between-meal snacks.

How Karsh Pictures Celebrities

BY APPOINTMENT



Focusing on the famous took this Ottawa photographer to the top of the heap himself.

By Devon Francis



YOUSUF KARSH of Ottawa, the world's most celebrated portrait photographer, is a mild-mannered little fellow who probably has taken more abuse than any other man in his business.

"Here I am, 8:07 in the morning," Lord Tedder, then Marshal of the Royal Air Force, grumbled to Karsh when he arrived for a sitting in London. "I'm late and I hate your guts."

Karsh has been similarly castigated, sometimes without overtones of affection, by John L. Lewis, Lord Beaverbrook and a fair percentage of the hundreds of other famous men he has etched on film in the last decade. He doesn't mind. In fact, he encourages it.

They All Pay Homage

And by some perverse alchemy the most difficult of his subjects wind up paying homage to him. It was Beaverbrook, by turns angry and arrogant at his sitting, who gave Karsh the ultimate accolade when he saw the results:

"Karsh, you have immortalized me."

Karsh has a gift for waspish riposte. Artur Rubinstein, the pianist, arriving in Ottawa at 1:30 in the morning, telephoned Karsh at home to say that his plane had been late.

"How long will this sitting take?" asked he impatiently.

"Until we are both exhausted!" snapped Karsh.

It was a subdued Rubinstein who showed up at the studio a few hours later.

That's only one side of the man Karsh. By nature he is gentle. He abhors conflict. He is courteous to a fault. No man ever followed him through a doorway. His occasional barbed tongue is a product of his interminable worry over his work.

He is never satisfied. Before a major sitting he is likely to walk the floor all night. That, oddly, he finds is good—he is at his best when he is tired and taut.

The man who took the world-famous picture of Winston Churchill without his cigar is an artist, but he is more. He is an actor, psychologist and superb technician as well. Tailoring his mood to that of his subject, he can wheedle, glower in anger, coax, threaten or dissolve in speechless indignation, all in a matter of minutes. None of this is synthetic. It is a part of him.

How He Prepares for a Sitting

If there is any one secret to Karsh's success, it is his meticulous study of his subject before he loads his camera. He reads up voraciously on his man, sometimes for weeks, beforehand. When the time comes for the sitting, Karsh knows not only whether his subject reacts to a discussion of rural electrification or Renoir, but how, and what he eats for breakfast. More, he knows what expression will kindle the personality.

The faces of people seated before the



Pose of Churchill in belligerent mood in dark days of 1941 first put Karsh in the limelight.



HER MAJESTY Queen Elizabeth II, photographed by Karsh at Clarence House just before her North American tour—while she was still Her Royal Highness the Princess Elizabeth.



HUMPHREY BOGART. Instead of a villain of the films, Karsh found a gracious and suave host. "I found nothing of the rugged low-brow of his movie roles," said Karsh. "So I tried to portray him with the modulations of tone which bring out his interesting features."

Karsh camera are brought alive by pointed questions from the man behind it. Photographing Jean Sibelius, the great Finnish composer, Karsh brought the magnificent face into relief by telling him how his fellow Finns obtained a rebirth of spirit in troubled hours by listening to his epic work *Finlandia*.

The resulting picture was good, but something was lacking. Karsh had not characterized his man. He was in agony. What was wrong? Then, like a flash, he had it. Seeking words to express himself, Sibelius kept closing his eyes. Karsh caught him that way. Some critics consider it his finest picture.

How He Became a Photographer

The Karsh story is pure Horatio Alger—Immigrant Boy Makes Good. Born 44 years ago in Turkish Armenia at a time when massacres of Christians were politically fashionable, Karsh at 15 emigrated to Canada to live with an uncle named Nakash in Sherbrooke, Que. He wanted to be a doctor. The uncle was a photographer. Karsh began dabbling.

When he won \$50 in an amateur photo contest in Toronto, he was lost to medicine forever. Later he studied with the late John H. Garo in Boston. Aside from being a fine photographer, Garo was a man with a heart.

"I learned the humanities from him," remarks Karsh. "I also got a tremendous technical discipline—I learned light control."

Karsh established a little studio in the Dominion capital in 1933. He borrowed \$150 to buy his equipment. Business was slow. He had to ask his secretary for \$17 toward the first month's rent. Things rocked along indifferently for him until 1939 when he married a French girl named Solange Gauthier.

Churchill Portrait Made Him Famous

Madame Karsh had a shrewd business head. She also had charm and a flair for the dramatic. Business began picking up. Karsh began meeting the right people. Both the Karshes had been interested in the Ottawa Little Theater, where Karsh had been studying stage lighting from a camera standpoint, and it was there that he became acquainted with Lord Duncannon, son of the then governor general, Lord Bessborough.

Presently he had his first major assignment—photographing the governor general and his lady. Other big jobs followed. In 1941 he made the famous Churchill study,

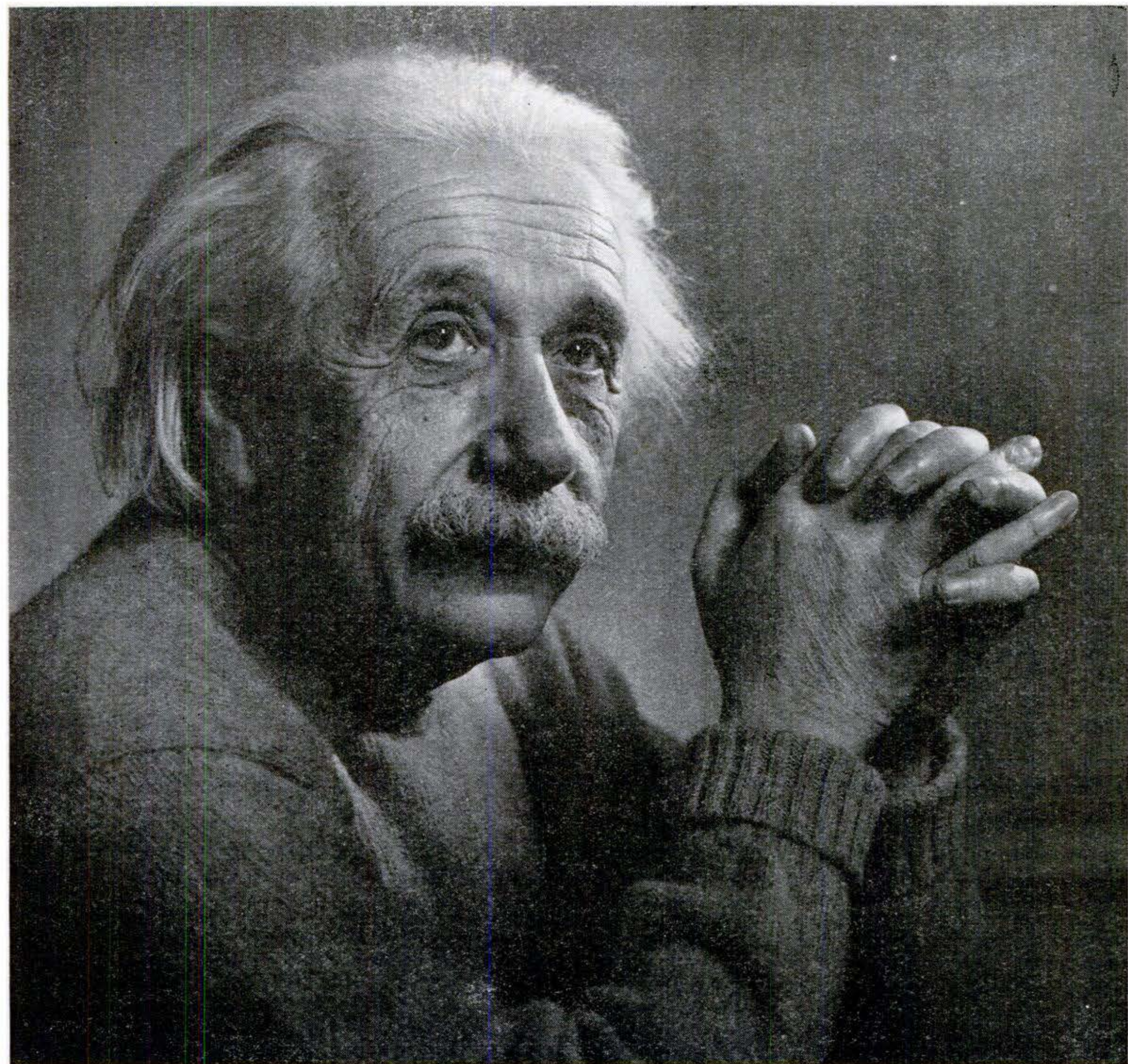

ALBERT EINSTEIN. Hands frequently are prominent in Karsh photos and that is how he chose

to portray the great mathematician in this eloquent portrait made at Princeton.

and almost overnight Karsh found himself not Yousuf Karsh, the Ottawa photographer, but Karsh of Ottawa, internationally known photographic portraitist.

Planning Is Torture

Yet planning a portrait is torture for him. He is haunted by the thought that he won't get what he wants. He is so profoundly affected in the midst of a big job that he has, on occasion, lost his voice. That happened when he photographed Pope Pius XII. His excitement reached such a pitch that he almost fainted.

Yet he can go home in the afternoon, an-

nounce that he is going to take a 45-minute nap, and sleep like a baby.

The Karsh home on the Rindeau river a few miles from Ottawa, with immense expanses of glass in the walls, is a show place. It is balm for his soul, from its big stands of white birches, Lombardy poplars, Norway weeping spruces and one European larch to the door on his two-car garage which opens automatically by radio signal when he flips a switch in his car.

None of his pictures adorns his walls. He says that nature provides better pictures through his windows than those he can make.

Karsh is on the road most of the time

taking pictures, and with him is Madame Karsh who doubles in brass as wife and business manager. When they return to the sanctuary of their home, called "Little Wings," he gets up at 4:30 in the morning just to roam over his five acres and listen to the birds and look at his trees.

He Also Makes Speeches

Despite only four months of formal Canadian schooling, Karsh has a command of the English language that would shame a native. His sentences have a poetic quality. In a recent speech—he is in great demand as a speaker—he said, "I had not the good fortune to be a son of this land."

To a class in press photography at Ohio's Kent State University last year he said:

"The portrait should tell not just that X has a heavy jaw and Y drooping eyelids; it should convey the message that here we have a man of will power, iron determination, singleness of purpose; that here is a thoughtful, perhaps calculating, perhaps careful man who weighs and ponders before he makes up his mind . . .

"There is infinite subtlety, limitless range in the shades of complex meanings lights and shade can produce. They are the portraitist's tools . . ."

JEAN SIBELIUS, famous Finnish composer, has a habit of closing his eyes as he seeks words to express himself. Karsh selected this moment as most characteristic of the man.

And of his own work: "My great hope is that these portraits will be considered as contemporary historical documents."

A linguist, Karsh is equally fluent in French and Arabic. But because he learned his English by ear, his spelling of it is phonetic and consequently abominable. His French and English come out with a Near East accent.

Karsh is as impeccable in his appearance as in his grammar. His attire is simple but flawless. It clothes a dignity that produces anything but incongruity with his less-than-average height. Only his intimates feel secure in calling him by his first name.

Karsh of Ottawa is also Karsh of New York and London. He keeps identical equipment in the other two cities. When he takes a trip into the hinterlands, his gear folds neatly into half a dozen boxes weighing exactly 250 pounds.

He always travels by air. Arrived, he orders a suite with two bathrooms. One becomes a darkroom. He can't wait to get home to see how his pictures turn out.

The Karsh studio in Ottawa is in the Hardy Arcade at 130 Sparks St. At the Arcade entrance is a simple business announcement: "Karsh." A current portrait flanks it. The two-story building is a walk-

FRANK LLOYD WRIGHT. "Your wonderful portrait makes me the American Voltaire," the famous architect told Karsh. Smoking is one way Karsh gets his subjects to relax.

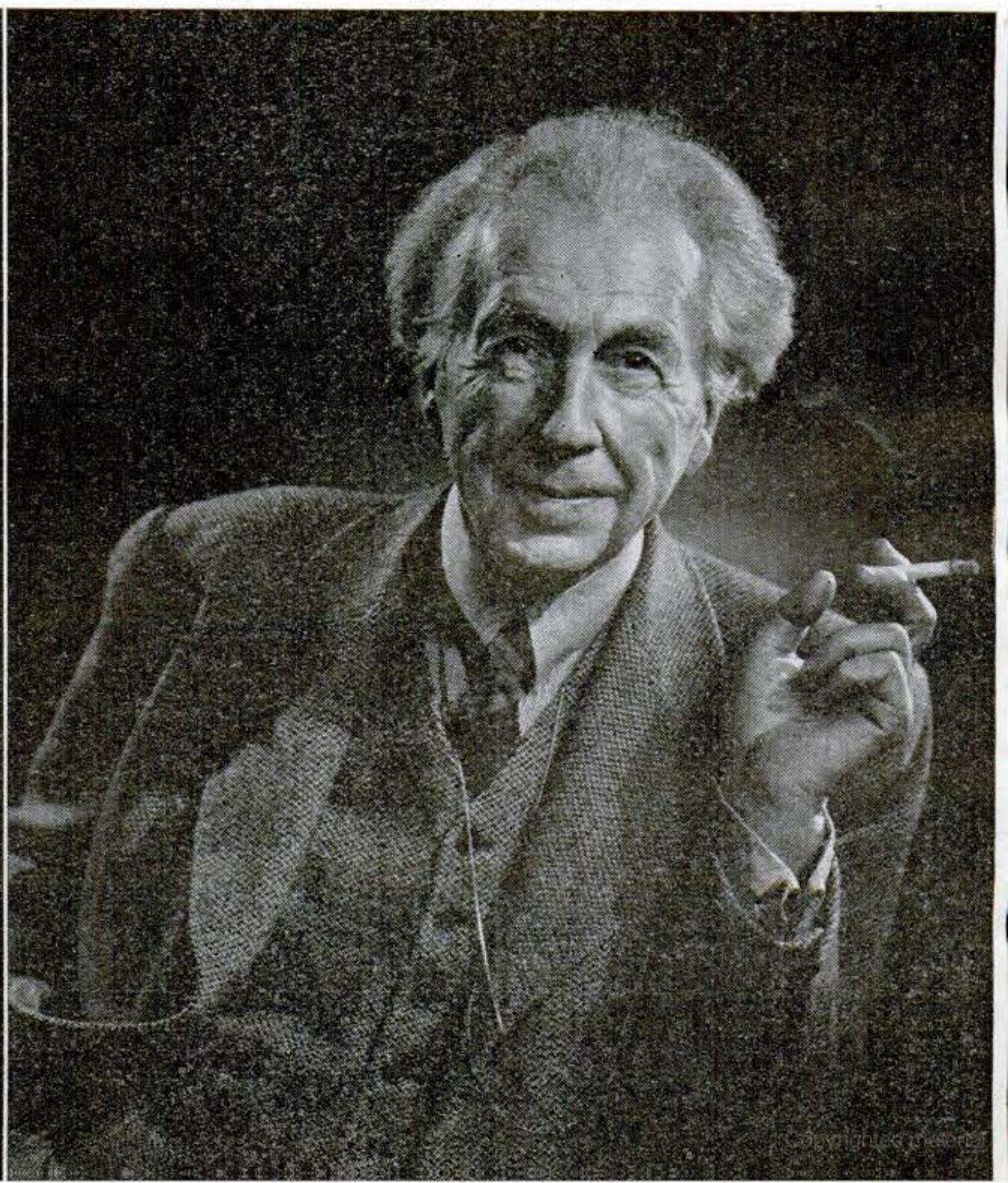
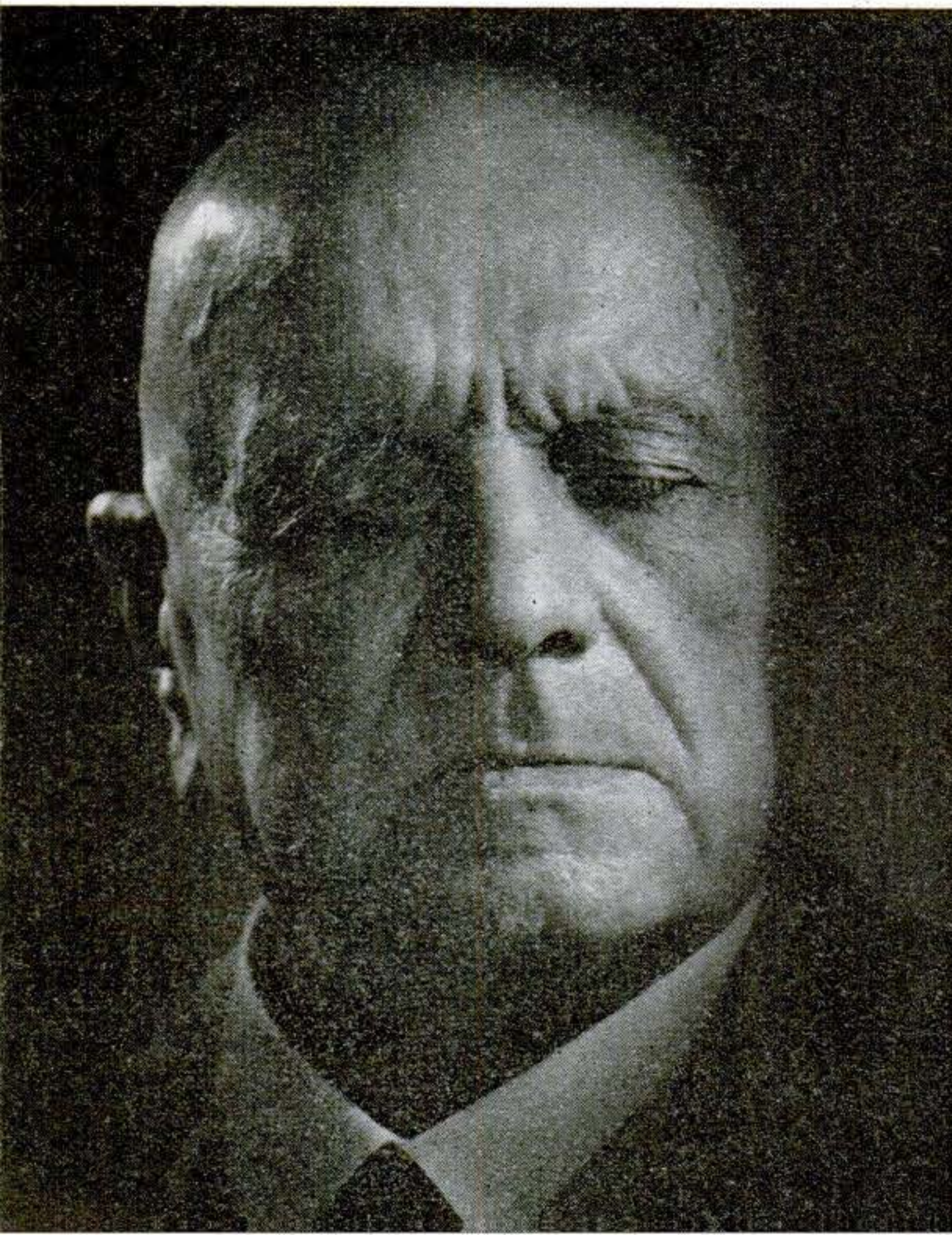



INGRID BERGMAN was completely "unmade up" when the Ottawa photographer visited her home for this informal picture.

up. In the second-floor directory, sandwiched in among such firms as Moto-Mix Concrete, Ltd., and the Bruce Coal Co., is the studio room number.

His reception room, with a red rug, is unpretentious. Somewhat small, it has panels of 15 representative Karsh portraits on three of its four walls.

Two tiny cubicles house Mrs. Joyce Large, his executive secretary, and Lois Muir, her assistant.

Occasionally, natives of Ottawa, affording no honor to one of their own, wander in to ask Karsh to develop snapshot film.

A stairway at the fourth wall leads to the studio proper. Except for screens, a table, a chair and two view cameras, the studio is bare. The larger of his two cameras is

ivory-colored. He dislikes black cameras. He feels that they depress his subjects. For the same reason, his focusing cloth is crimson, lined with gold. His second camera is silvered.

How He Takes a Portrait

At work, Karsh sits his subject, arranges his lights and carries on a disarming patter of conversation. Dredging up astonishingly intimate bits of information about his subject that may have occurred as the merest fragment of an earlier conversation is part of his act.

"You like Drambuie," he says. "It has a piquancy." Then: "You hold your hands like this. It's part of you. Will you do that now?" Or, "You tilt your head when you listen. Try it." Or, "I want that animation in your face that you showed yesterday when we were discussing your faith."

It's things like that that bring the exclamation, "This picture is a wonderful likeness." It has to be. It's natural.

Now he loads his camera. Ostensibly he relaxes so his subject will relax.

"Did you know," he says, "that you really have to be a Presbyterian to be a successful publisher? Beaverbrook and Henry Luce and DeWitt Wallace are Presbyterians—"

Click! As his subject responds with a face lighted by an interest in what he says, he takes the picture.

Insists on His Own Way

Most always, he seats his subject uncomfortably.

"A person who is comfortable is not interesting," he says.

He is chary of taking too many pictures.

"If you can't get a personality in the first 12 shots, the spontaneity is lost."

He is gently insistent on having his own way. A famous, aging actor asked him not to

[\[Continued on page 256\]](#)

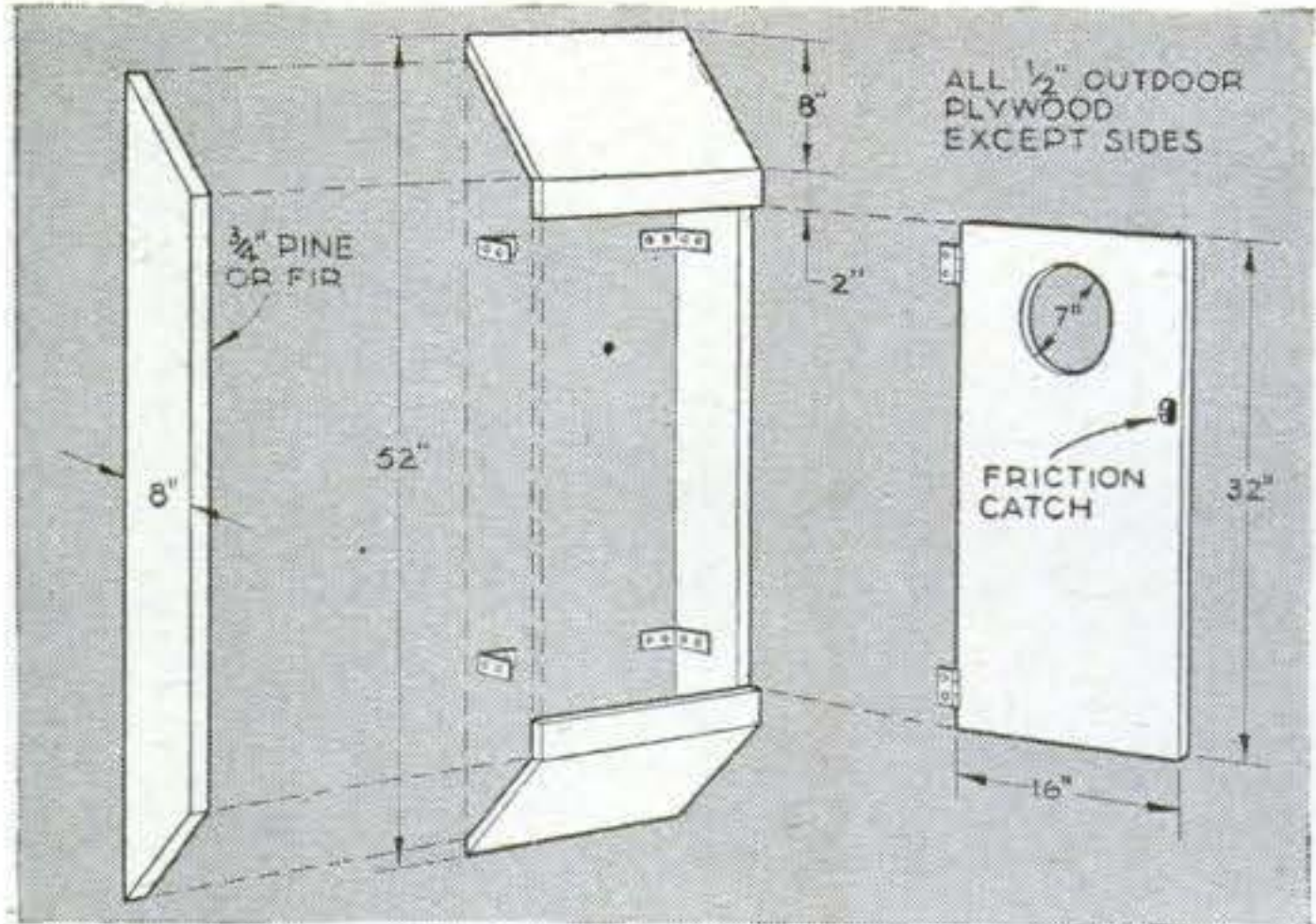
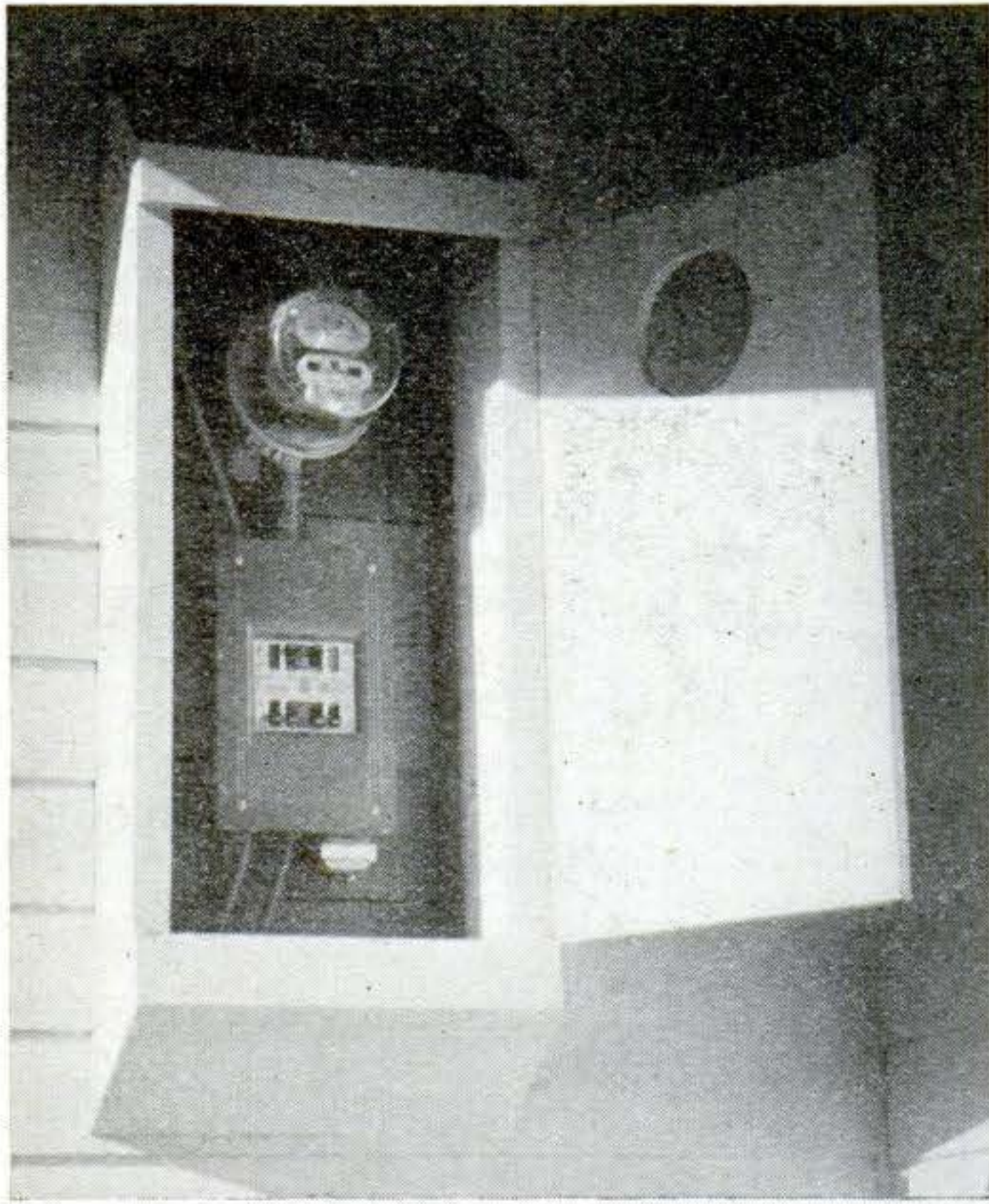

Meter Is Neater in a Box

THE electric meter and its fuse box, crawling up the side of a house, are not exactly scenic assets, but they can be nicely concealed with an enclosure like this. You may have to alter the dimensions to suit the size of your meter and fuse box.—*Hi Sibley, Nuevo, Calif.*

Grease Threads to Stop Rust



KEEP the threads on adjustable basement posts well covered with cup grease. The grease will prevent rust and permit easier adjustment of the posts when needed.—*H. Leeper, Canton, Ohio.*

R.P.M. Counter Keeps Score

A TACHOMETER of the type used with a watch will also serve as a counter, to tally the number of persons or cars, say, that pass a given point. Bend one end of a narrow strip of metal into a loop that will be a push fit on the shaft of the counter (below). To use, flip the strip around once for each unit.—*Ken Murray, Colon, Mich.*

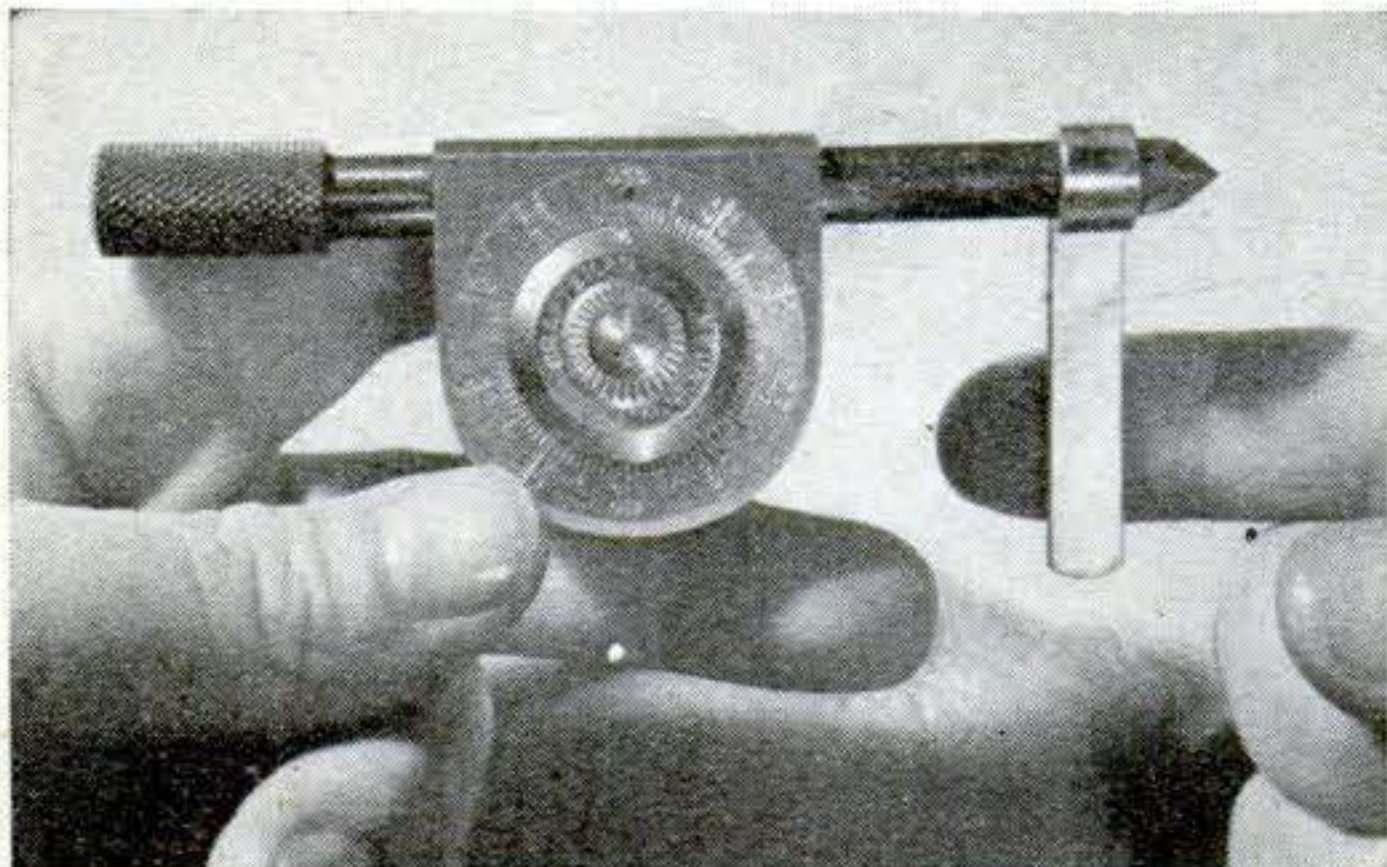

Level Adapted to Suit Pitch

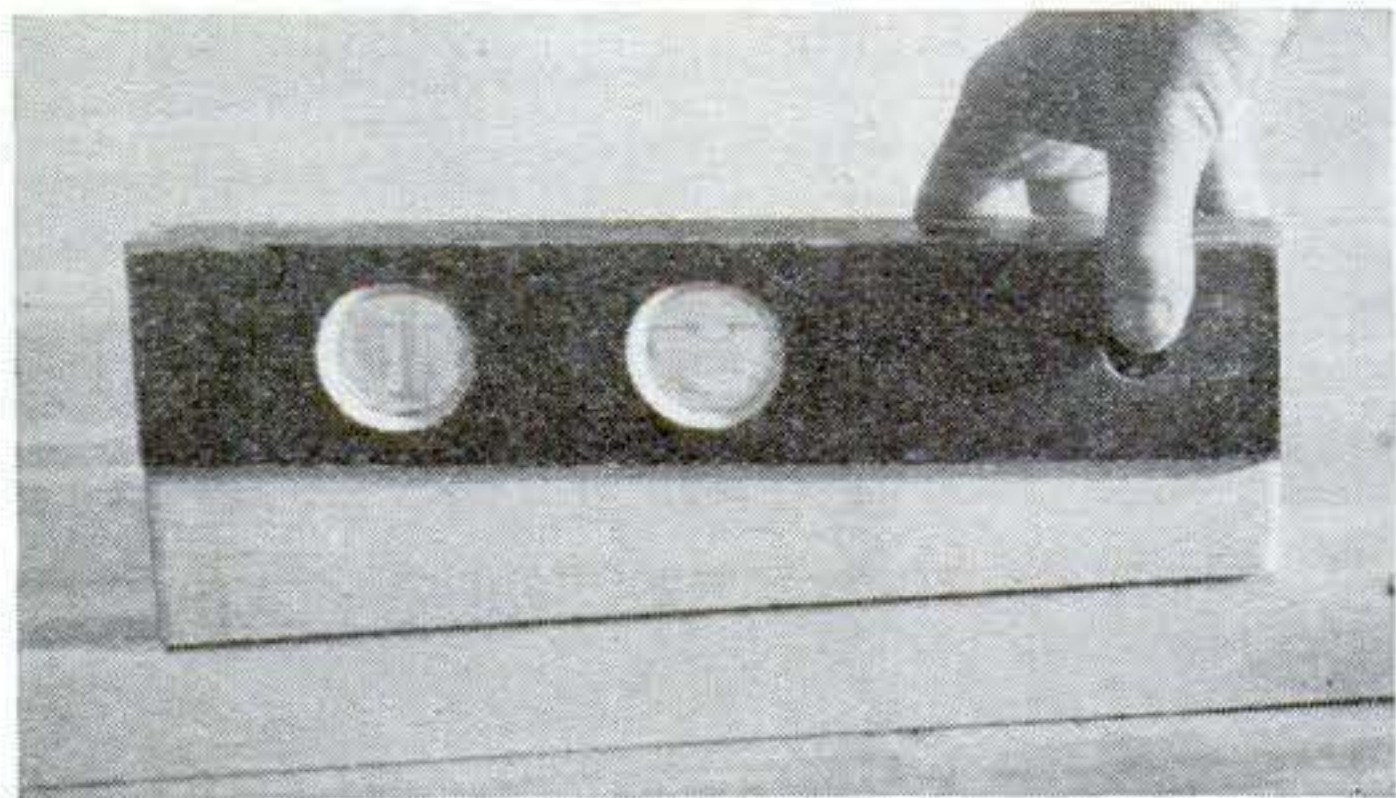

IF you have a job that calls for a particular slope, you will save time by adapting a level for the slope. Taper one edge of a block to match the pitch. Then screw the level to the other edge of the block (above). Among the uses I've found for this dodge are laying drain tile, installing pipes, repairing a roof and building concrete forms.—*Darrell Huff, Sonoma, Calif.*

Bolt or Screw Serves as File

LACKING a round file for working on wood, plastic or soft metal, you often can substitute a bolt or large wood screw. To make it easy on your fingers, turn the first few threads of the bolt or screw into a wooden handle.

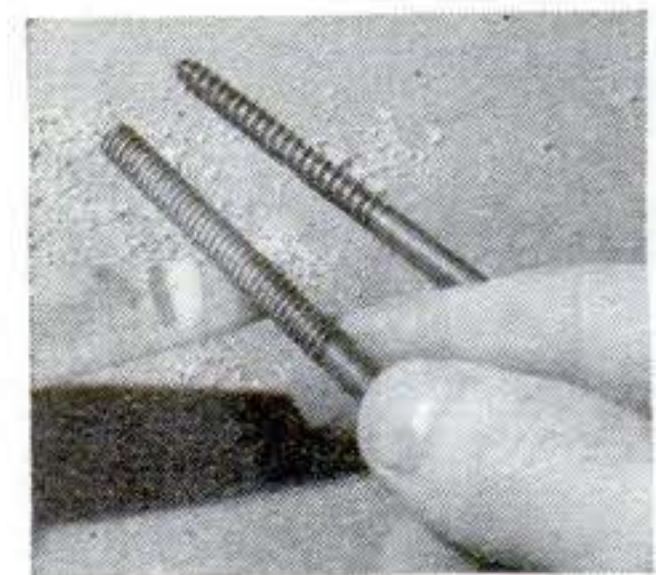

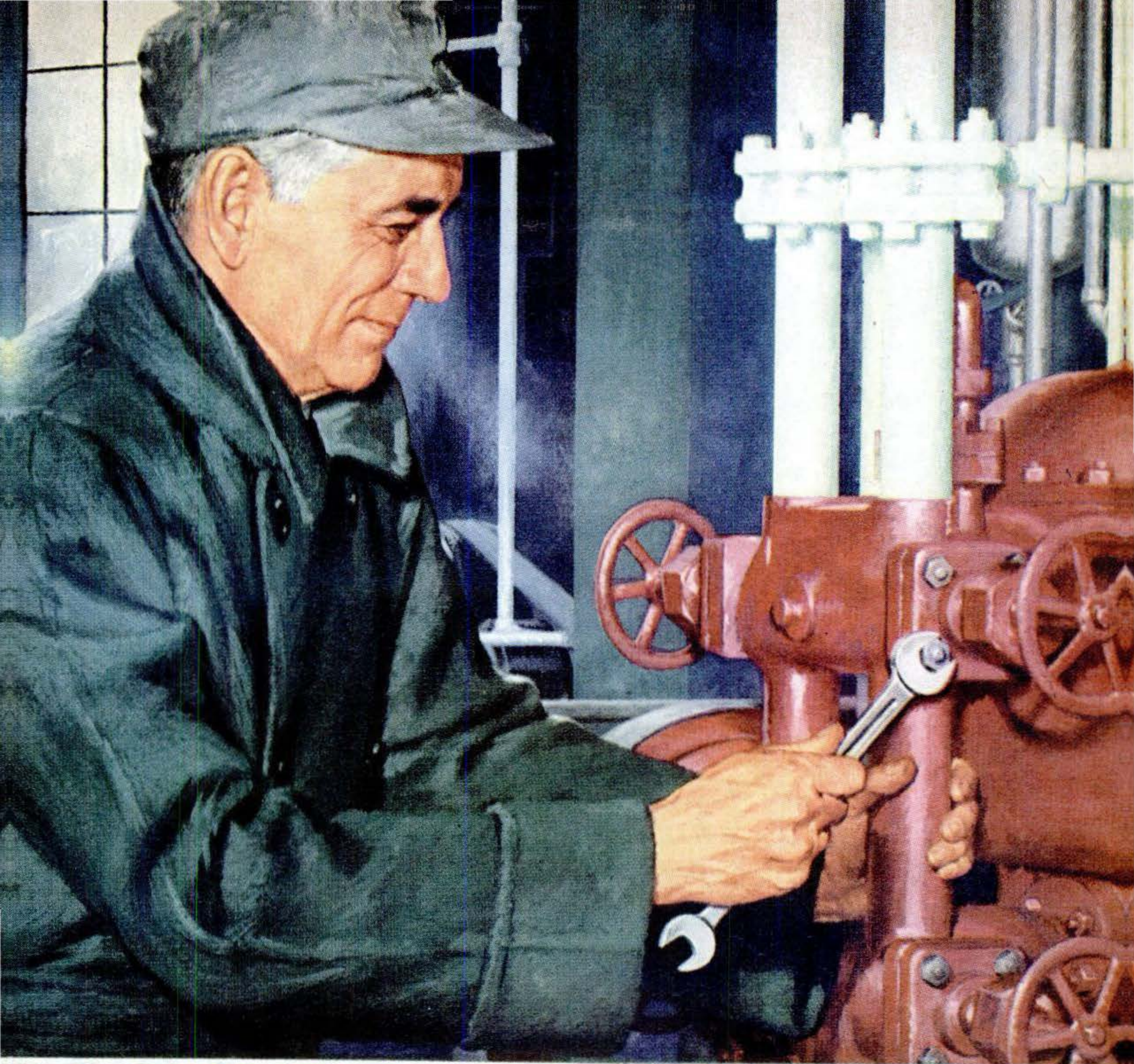

PERSISTENT IN PERFECTION . . .

Your goal is a perfect job. Only the best of materials, the most careful workmanship, and the finest of tools are good enough for you. And you are quick to recognize the work of other real mechanics who, like yourself, are persistent in perfection.

Perfection is the standard to which Bonney wrenches are made. Mechanics call them America's finest — unmatched for lightness, strength, balance, and precision.

Bonney wrenches are the pride of the men who make them . . . the pride of the men who use them.

BONNEY FORGE & TOOL WORKS

Виробництво Вощевальничих



Persistent in perfection, refrigeration equipment manufacturers like Carrier, Frick, Norge, York, Refrigeration Corporation of America have revolutionized the processing and preservation of food.

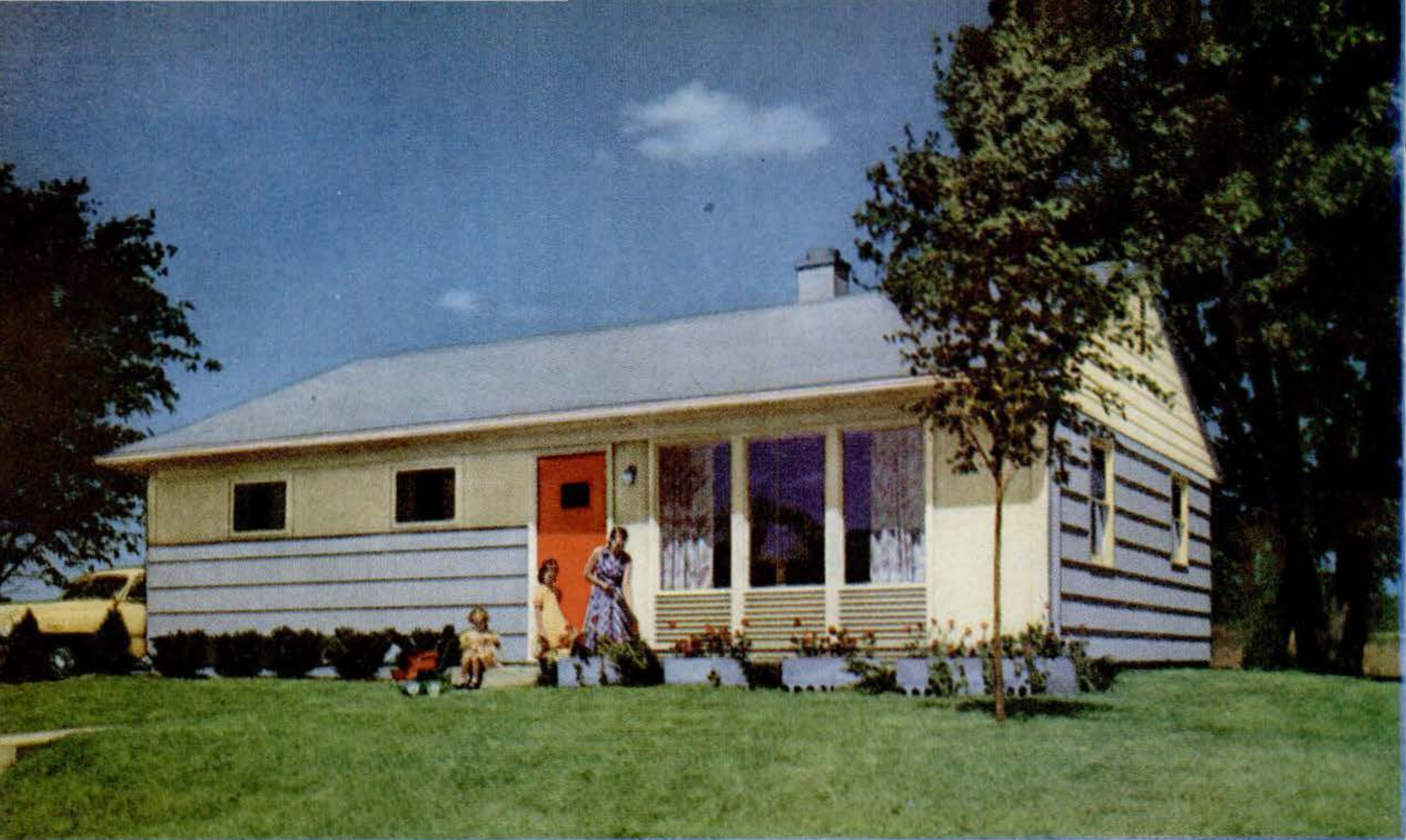

Today's most spectacular Home-Buy!

This 3-Bedroom Ranch-Type House can be Yours for as Low as

\$8,995 to \$9,995*

(DEPENDING ON LOCAL COST VARIATIONS)

This new 3-bedroom National Home . . . the Saratoga Design, is the most outstanding home buy in America today. For beauty . . . livability . . . economy . . . durability and dollar-for-dollar value, no other home offers you so much for so little!

Look! Compare! Buy and Save!

*This home is built complete, ready for occupancy, on an insulated concrete floor. Cost of lot is not included. Wood floors with or without basement may be had at slight additional cost. National Homes are available in many different designs in 2-, 3-, and 4-bedroom sizes and may be had with porches, breezeways and garages.

Send 25c to Department PS1, National Homes Corporation, Lafayette, Indiana, for a copy of Your National Home Magazine, for complete information.



"National Homes prefabricated panels and structural parts are commended by Parents' Magazine as advertised therein."

©1952 N.H.C.

National
HOMES

NATIONAL HOMES CORPORATION
LAFAYETTE, IND. • HORSEHEADS, N.Y.

TOOL HOLDER. Holes in one cup at right hold hand-grinder accessories. Cup inside another keeps jigsaw blades. Inner cup holds chuck wrench.



TOOL COOLER. For grinding without burning tool edges, make a hardboard or plywood holder with a hole for a water cup, and slot other end for a bolt.



GLUE GUN. Snip off tip of conical cup and use it as glue gun by rolling lip around pencil. Conical cup with tip cut off also makes funnel.

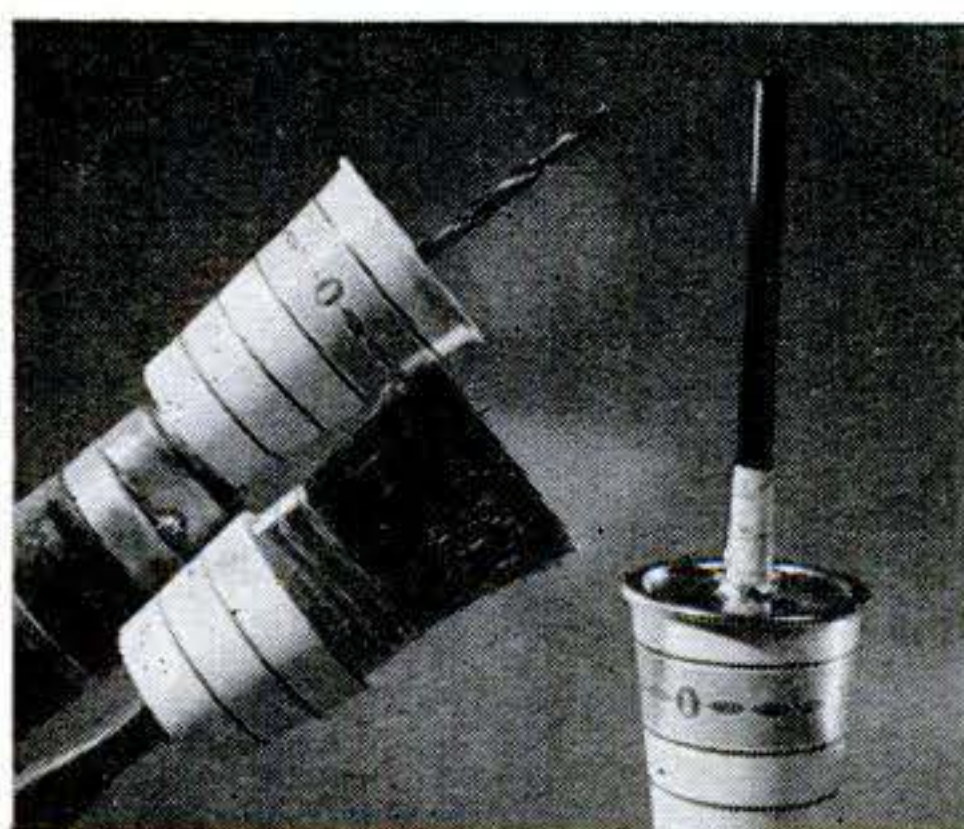

CATCHALLS. When doing overhead work, cups will catch drill chips and paint drips. Lid for glue cup can be made from disk of Mason-jar lid.

FLOCK GUN. Blow into the inlet to expel flock from upper tube. Rolled and glued paper makes the tubes. You have to hold the lid down when you blow.

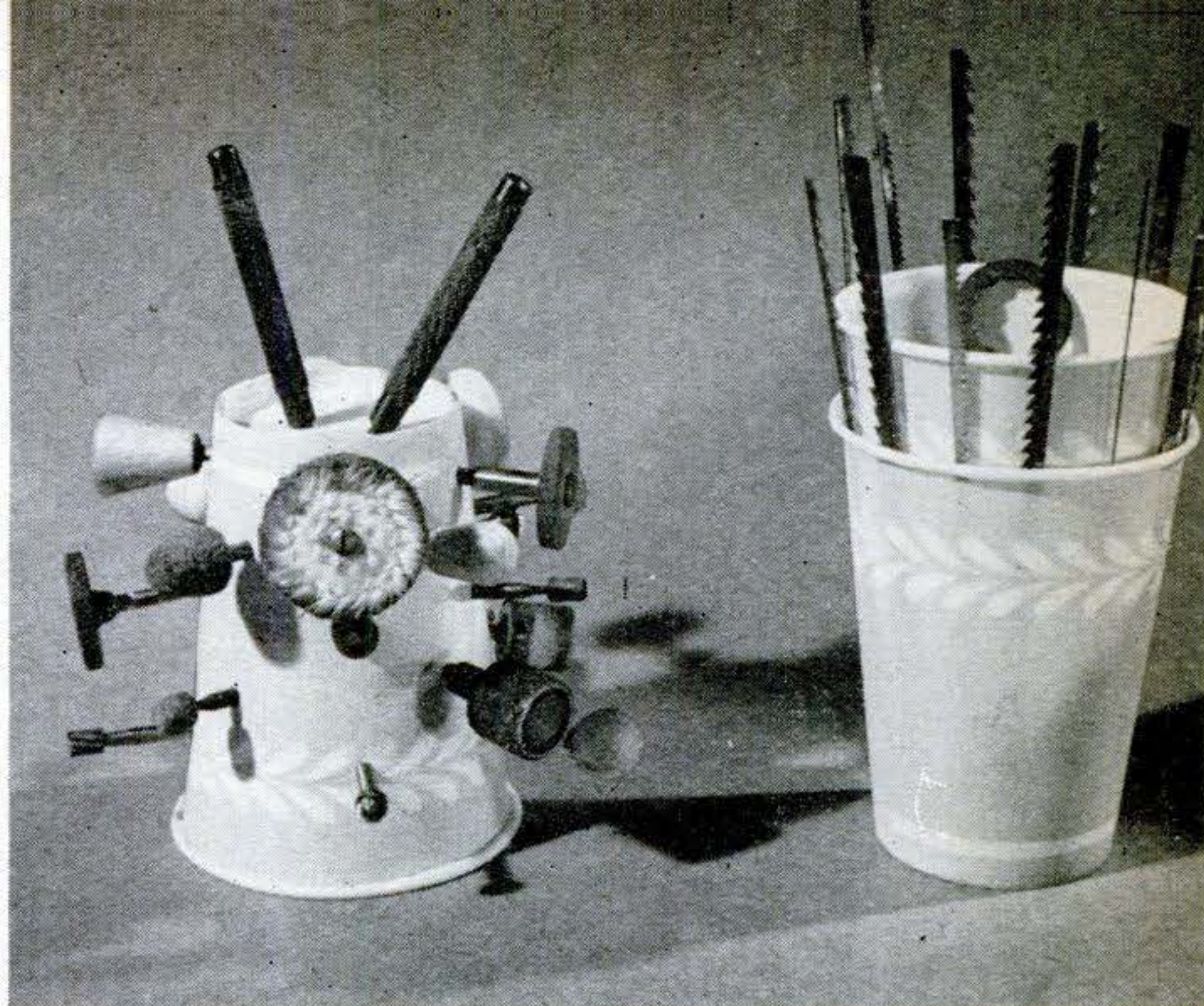

There's a Place for

Paper Cups in Your Shop

Low-cost cups are naturals for dozens of time- and work-saving shop jobs.

PUT paper cups to work in your shop. They are disposable and cheap. Unlike cans, they don't rust and unlike bottles, there is no cleaning bother.

They can be held to many surfaces by thumbtacks or they can be dropped into holes cut in thin wood or cardboard so you can carry them as kits. Besides holding small odds and ends, you can use the unwaxed type for mixing paints and the waxed ones for mixing glue.—*Kenneth Murray, Colon, Mich.*



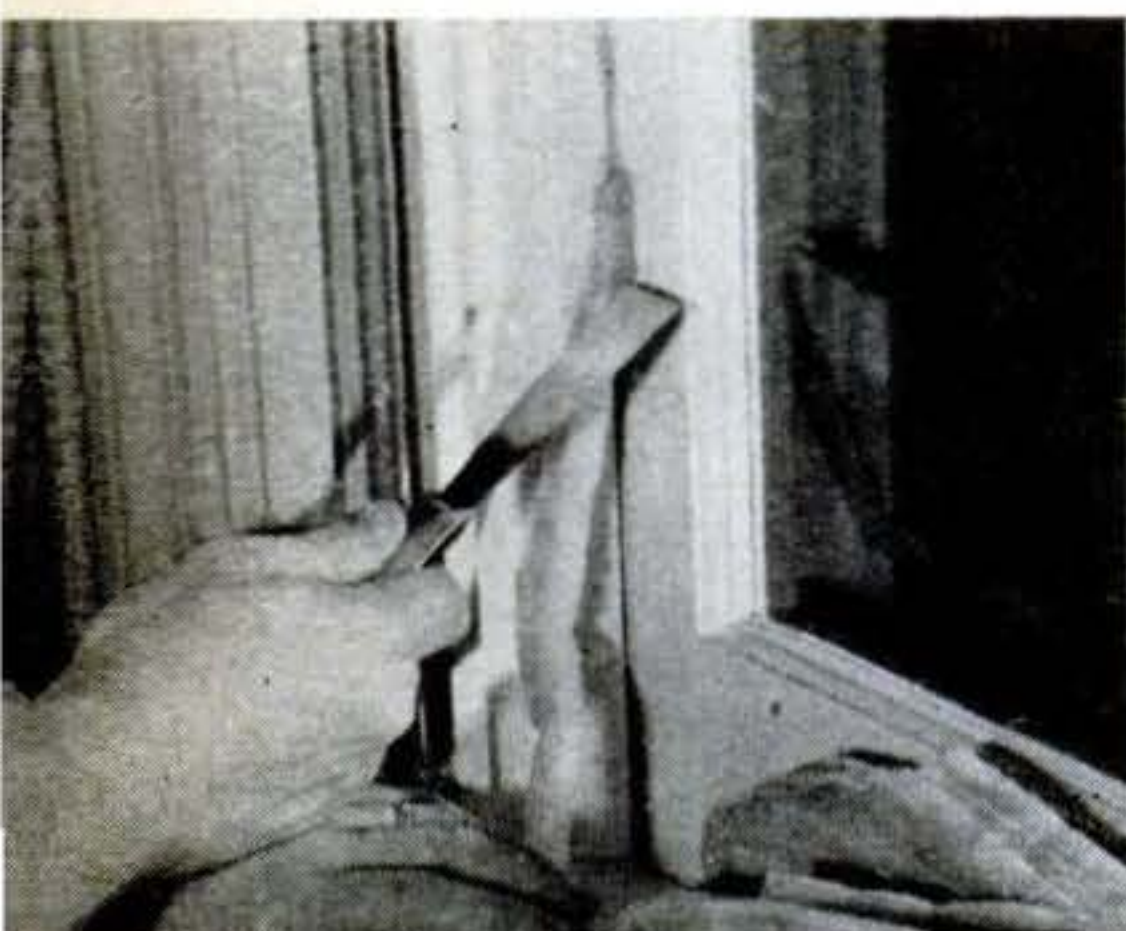
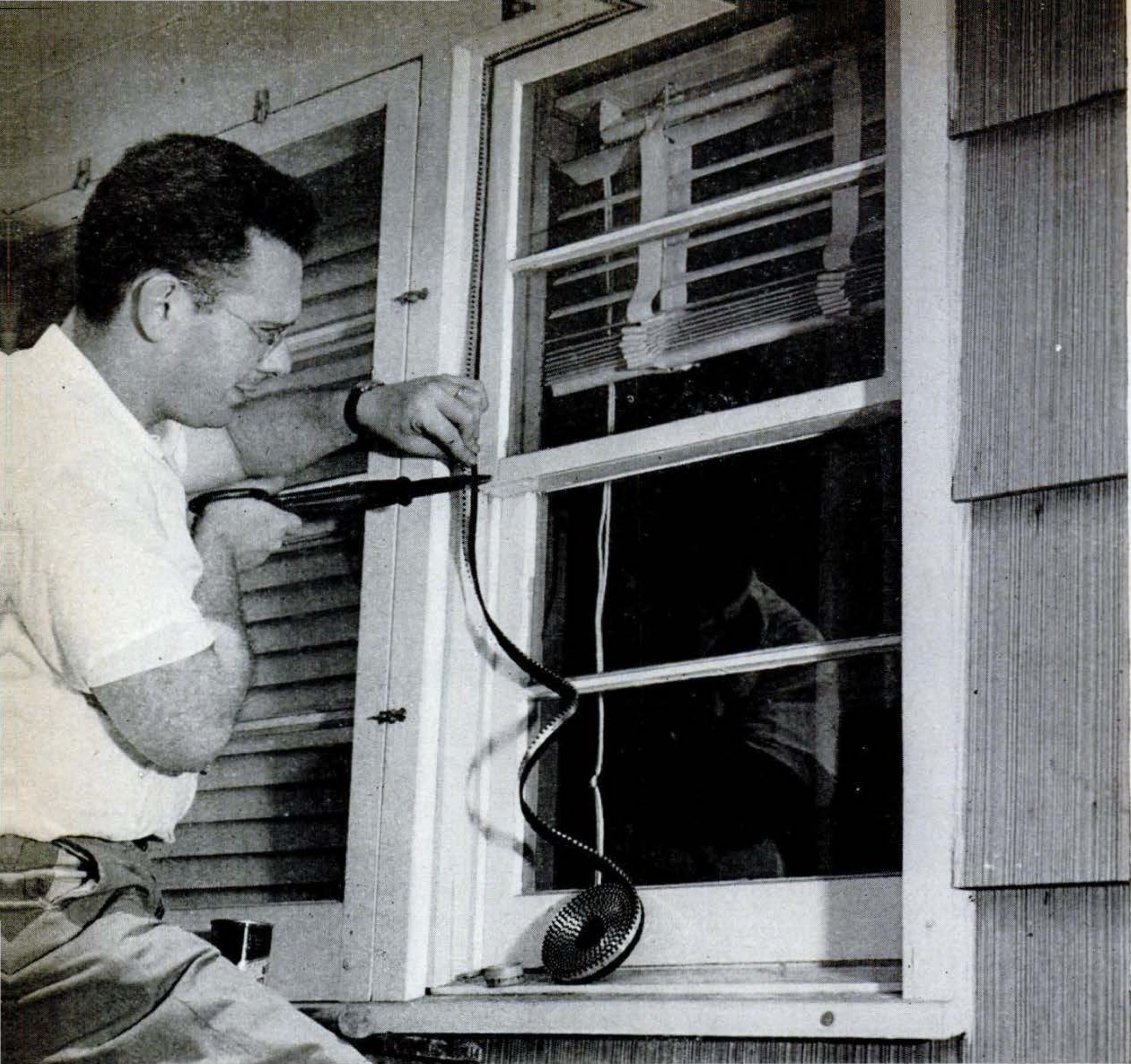

SPUN GLASS (above) and wool felt are installed like calking—forced into openings around windows with edge of putty knife.



HAIR FELT is tacked to window frame so it presses against sash snugly but loosely enough to permit sash to be raised and lowered.

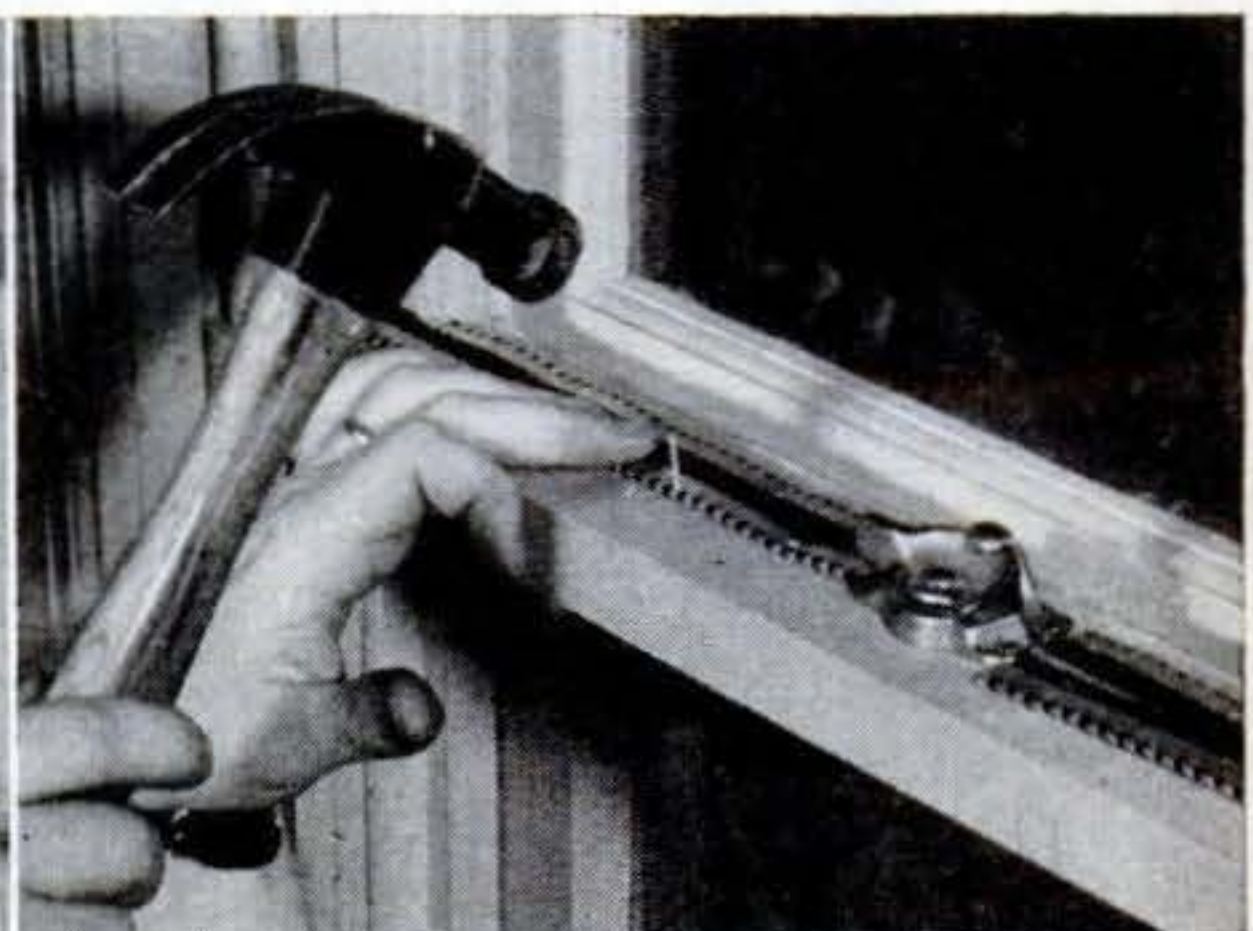

ZINC-AND-FELT type has felt backed by notched zinc strip. It can be bent to fit in corners. The zinc strip has holes for brads.

Now's the Time to Weatherstrip

Cut your fuel bill this winter by stopping heat leaks with weatherstripping. You can apply most types yourself.

SUPPOSE a wall of your home had a hole in it big enough to put your head through. You'd certainly waste no time in repairing it. Yet unless your home is weatherstripped, you already have the equivalent of such a heat leak.

Add up all the crack areas around windows and doors and that's about what they'll equal. A crack little more than 1/32" wide all around one large window is equivalent in area to a hole as big as your fist. And many loose-fitting windows and doors have cracks wider than 1/32".

Storm windows are, of course, important—a must in many parts of the country. However, every window and door in your house should *also* be sealed with weatherstripping. A good weatherstrip job can reduce your heat loss by as much as 20 percent—even without storm windows.

There are many types of weatherstripping available at hardware stores or lumberyards. They can be separated into three basic groups, according to the service which they are designed to give. First, there are those intended for use only one year. Next there are semipermanent types, which last for some years under normal conditions. The third group, more costly to install, in-

cludes weatherstripping that is permanent.

Temporary types. These include the familiar hair-felt weatherstrip, one of the cheapest kinds. The felt should not be used on a window that will be raised frequently.

This material can also be used around entrances, though it does not stand up well on a frequently used door. It is installed in the same way as around a window. Just nail it to the door-stop molding so the door closes snugly against it.

Other types in this group include wool felt and spun glass. They are forced into cracks or seams like calking. Wool felt comes in rolls like hair felt, but generally is used to calk around loose-fitting windows which will not be opened until spring.

Spun glass—called Frost King Fiberglas'—is used to fill cracks in the same way. It is rot-proof and fireproof, and it expands after installation to form a tight seal. Use a dull putty knife, a wide-bladed screwdriver, or even the back of a table knife to tuck the spun glass in place. Both spun glass and wool felt are also used to keep loose-fitting windows and doors from rattling. Both of these are only temporary

1. Thermwell Products Co., 1261 Broadway, NYC.

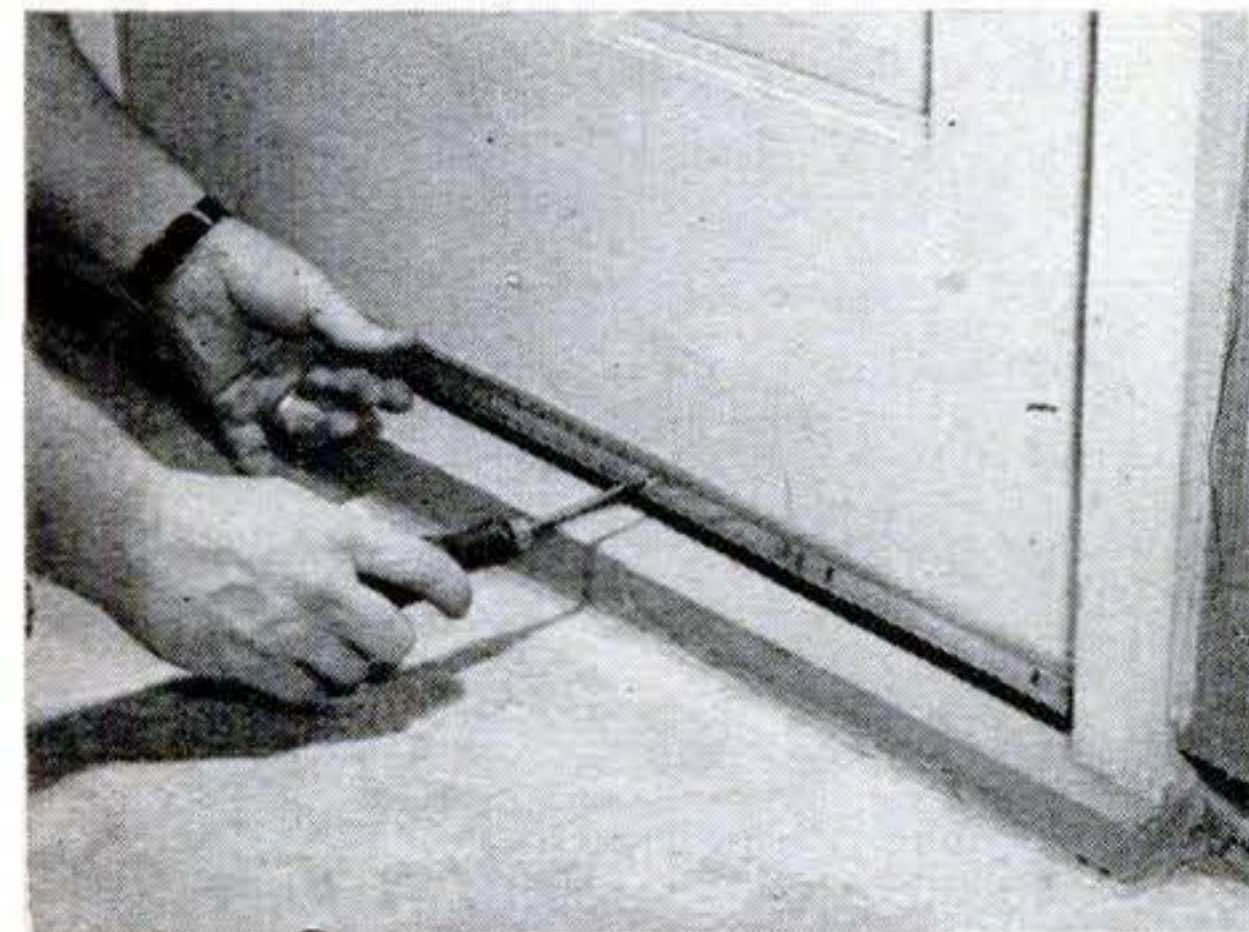

DOOR BOTTOM is a rigid strip of brass and felt or zinc and felt that is screwed or nailed to bottom of door on the side toward which it opens.



WOOD-FELT type is bradded around windows and doors like molding. Corners should be mitered. This type can be painted to match trim.

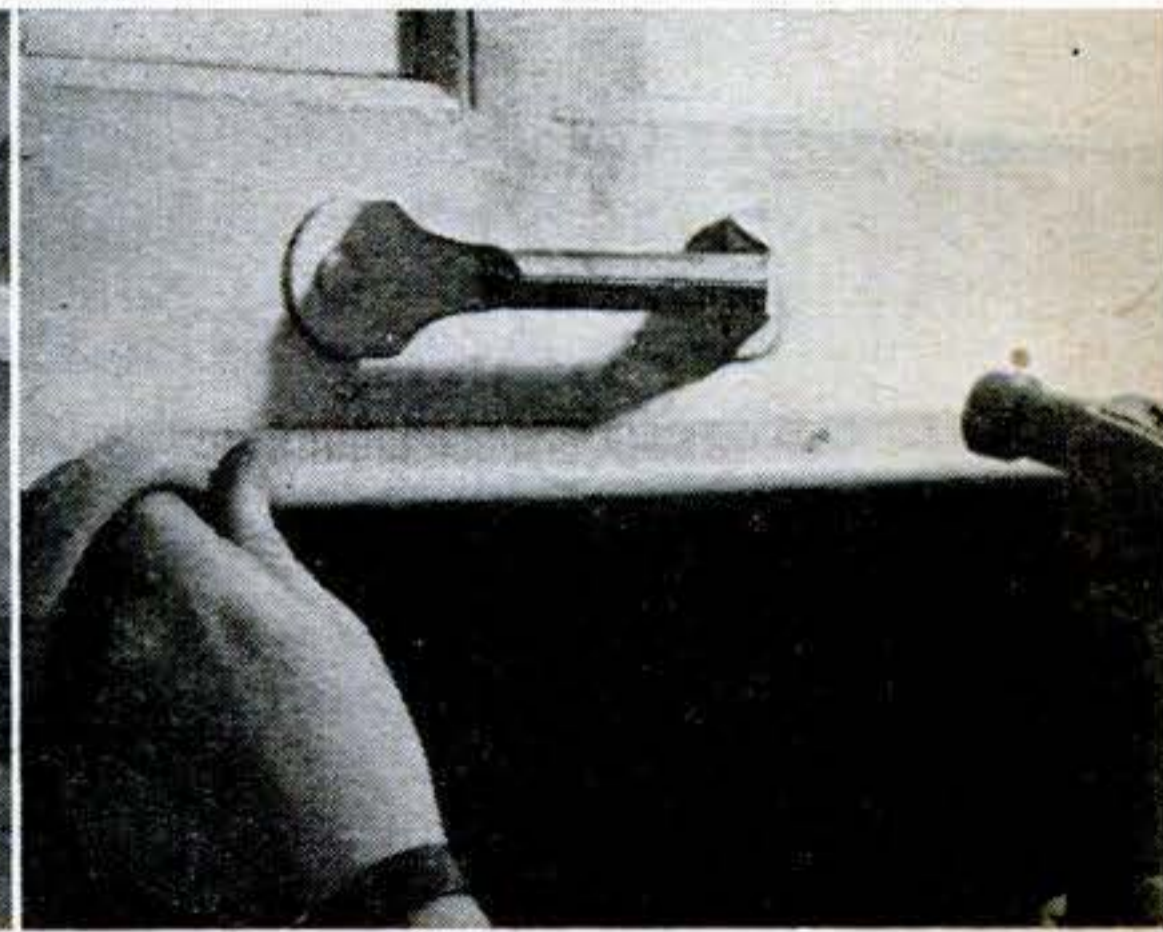

SPONGE-RUBBER GASKET, like that around refrigerator doors, is tacked on cellar doors and windows and on garage door as shown above.

and must be removed the next time that the window or door is to be opened.

Semipermanent types. Zinc-stiffened felt comes in rolls with its own tacks and is suitable for almost all weatherstripping jobs. To install this around a door, tack it to the door-stop molding so that the felt presses snugly against the closed door. For a good fit, install this weatherstrip with the door closed. It is also best to install it all in one piece.

Start at the bottom of one side, work to the top, then across and down the other side. Drive the tacks into the holes in the zinc, making sure to put one into each hole.

A special type is made for the bottom of the door. Called door bottom, it is a wider, rigid strip, and comes in lengths of 32", 36" and 42". A bottom should generally be installed on the side of the door toward which it opens. Measure and snip the bottom to the length needed, less about $\frac{1}{4}$ ". The felt should just touch the saddle when the door is closed.

Zinc-felt strip is fitted around a window

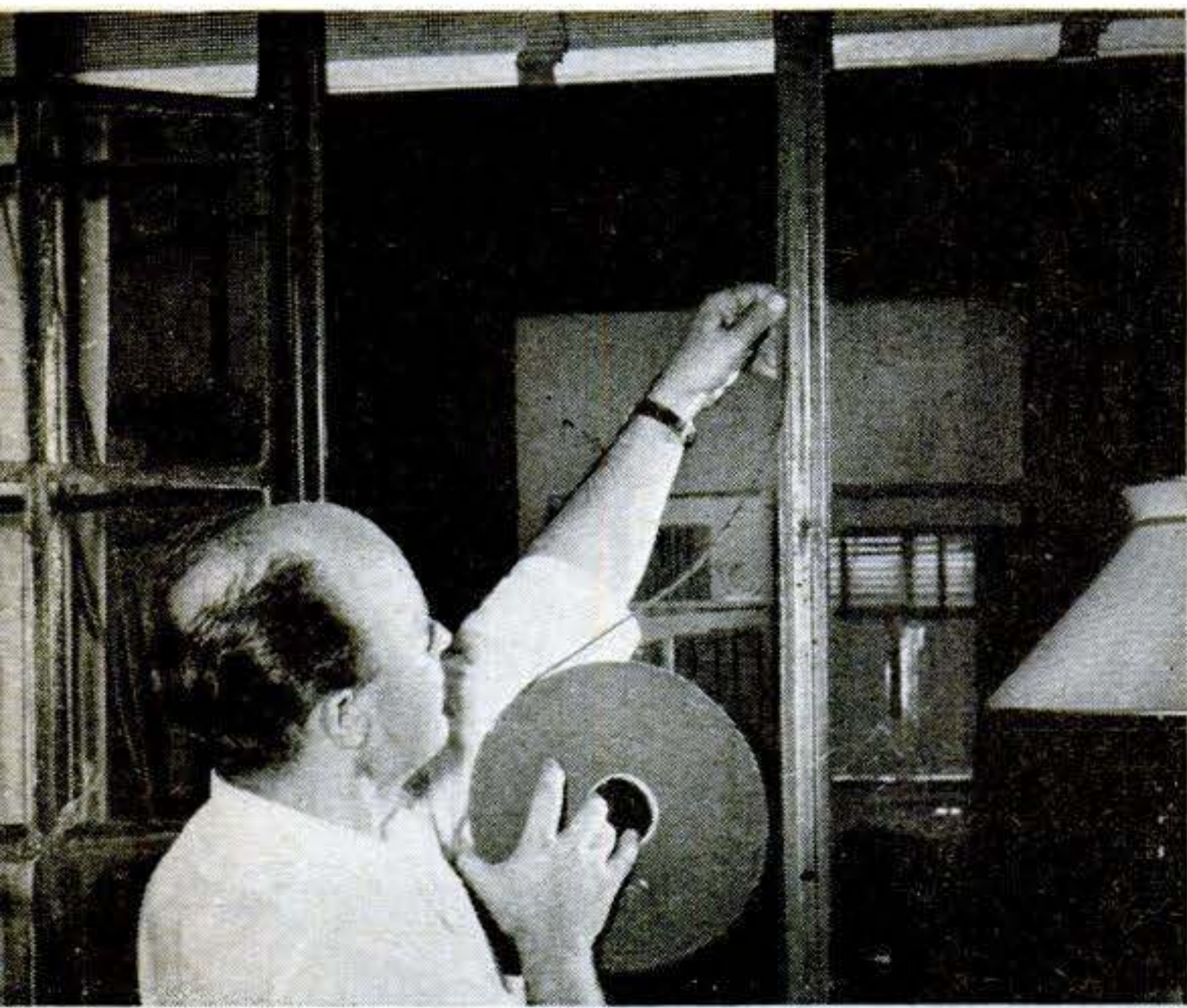

SELF-ADHERING WOOL FELT is particularly suitable for metal casement windows. It comes in a roll and is simply pressed on window jamb.

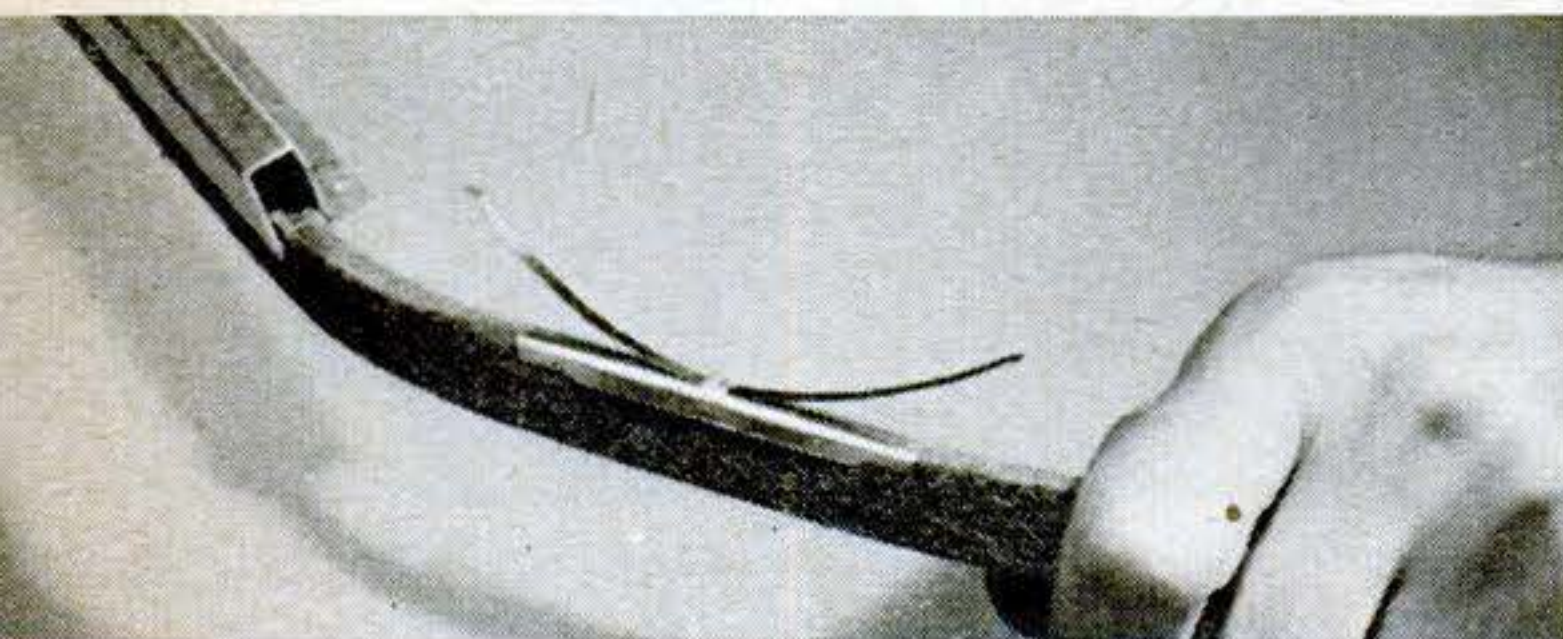

STEEL SPRINGS force the felt strip of Flexseal into contact with door or sash. Felt has been pulled out of channel to show springs.

in the same manner as hair felt. First tack it to the frame around the inside so that it bears against the sash, yet permits easy sliding. For the top sash it is generally better to tack it around the exterior of the window frame. If the weatherstrip were tacked around the inside of the top sash there would not be clearance between the two sash when the lower one was raised.

After tacking the weatherstrip in place around both the upper and lower sash, seal the crack between the top of the lower sash and the bottom of the upper sash when the window is closed. First tack a piece to the top of the bottom rail on the upper sash. The felt edge should be just about even with the inside edge of the upper sash. Then nail another piece to the top of the rail of the lower sash. The felt edge should touch the edge of the first piece when the window is closed.

In addition to zinc and felt there is also a rigid wood-and-felt stripping. It comes in 7' lengths and in various widths, from $\frac{1}{2}$ " to 1 $\frac{1}{2}$ " wide. The narrow ones are for windows, and the wider ones for doors and door bottoms. Since it can be painted, wood-and-felt stripping is less conspicuous than the zinc type. It costs a bit more than metal and is a little more work to install.

Another semipermanent weatherstrip is the sponge-rubber gasket. This is a welting of plastic-covered sponge-rubber with about $\frac{1}{2}$ " of plastic on one side to give you a tacking surface.

This weatherstrip was developed for sealing car and refrigerator doors and was found to be so efficient and durable that it has gradually crept into use in homes. It is especially useful around cellar windows where grit and sand soon make the usual felt weatherstrip ineffective.

Another new weatherstrip, for metal casement windows, is a very thin, self-adhering, wool felt called Feltseal², that comes in 50' and 100' rolls. It has a pressure sensitive adhesive on the back, and all you do is press it firmly right on the jamb, so that the edge of the window will close against it. Be sure that the metal is clean and dry. Start at the top and work your way down the side of the frame. When you reach the bottom use a razor blade or sharp knife to cut it off square. Then continue around the other sides,

Another new stripping—Flexseal³—is de-

2. Thermwell Products Co., 1261 Broadway, NYC.

3. U.S. Weatherstrip, Inc., 24 W. Broadway, Salt Lake City 1.

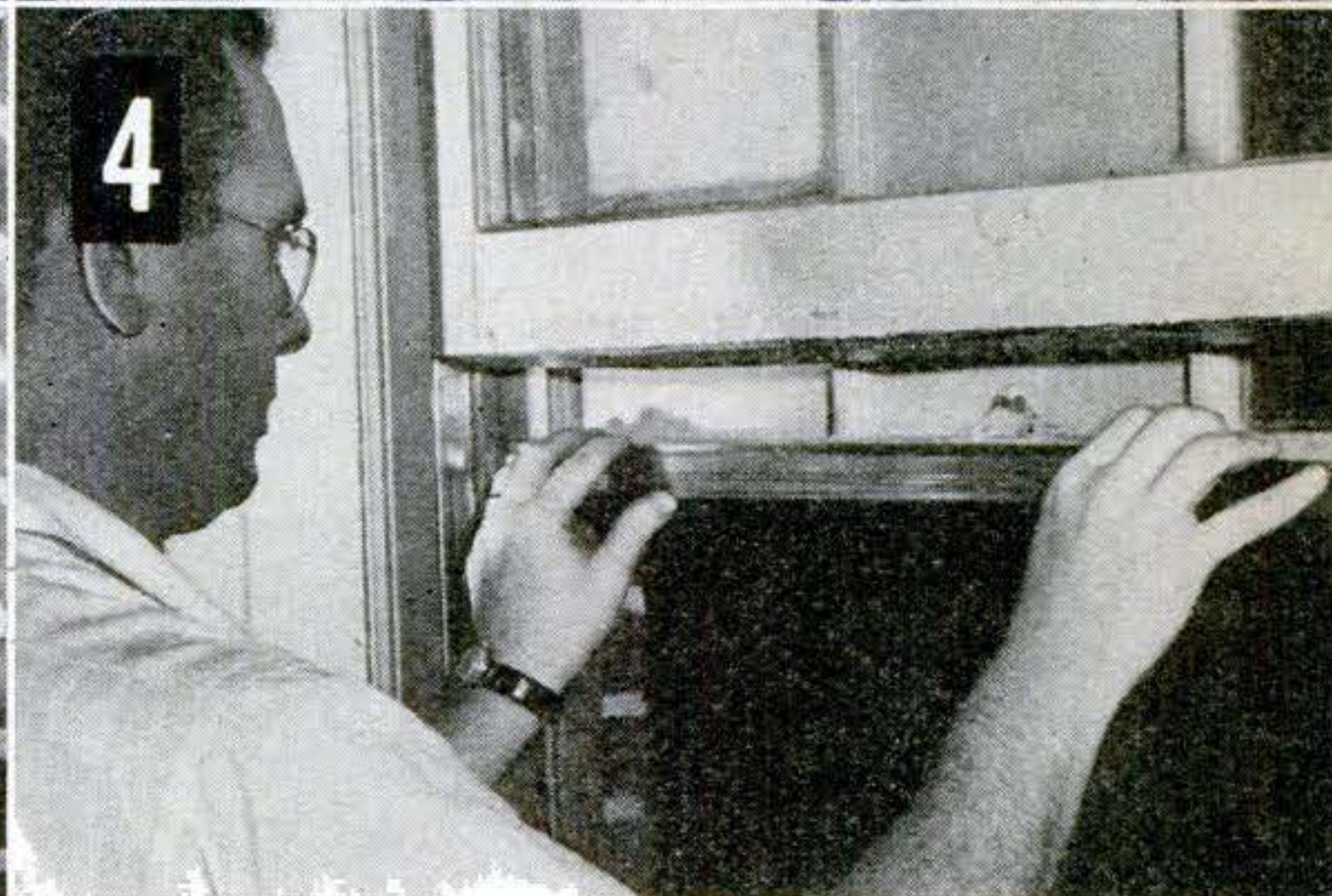

SPRING BRONZE, a friction weatherstrip that doesn't show when both sash are closed, is installed in four steps: 1, in the channels in which the lower and upper sash ride (strips should be $\frac{1}{2}$ " longer than the sash is high);

2, on bottom edge of lower sash; 3, on top of upper sash; and 4, on inside edge of the lower rail of the upper sash. In first three steps, edge of spring bronze that has nail holes is faced toward inside of house.

signed to be nailed around windows and doors and consists of a strip of felt that rides on steel springs in an aluminum channel. The springs, pushing between the back of the channel and the felt, keep the felt strip in contact with the door or window.

Permanent types. Grooved weatherstrip is either a metal strip or track on the window casing which slides in a groove in the sash. In the case of a door it consists of two interlocking metal strips—one in the door casing, and one rabbeted into the door. With this goes a special metal weatherstrip saddle which locks with a strip on the bottom of the door.

These interlocking or sliding metal weatherstrips are efficient and permanent, but they are no job for the amateur to tackle, requiring special tools for a smooth installation.

Spring bronze is almost as good as the grooved type and can be installed by almost anyone. It is a permanent type of installation like the interlocking kind and requires nothing more than a pair of snips, a ruler and a hammer. It is available in 100' rolls, and also in sets of precut lengths.

Start by cutting pieces for the sides of the sash. Slip the strips into the exposed window channel, leaving $\frac{1}{16}$ " between the bottom end of the strip and the window sill. Then start nailing at the top with the rustproof nails provided, driving them into the holes in the strip. Position the strips in the channels so that the unnailed edge almost, but not quite, touches the divider between the window channels when the strip is pressed flat.

Drive nails into every other hole first, pressing the strip flat as you go. Then double back and drive nails into the remaining holes. This system prevents any buckling or warping of the bronze.

The piece for the inside edge of the lower rail of the upper sash should be $\frac{1}{2}$ " shorter than the width of the window. Fasten this with the nailed edge toward the top. Now close both halves of the window. This piece should just rub against the outside face of the lower half when the window is completely closed. If it doesn't, spring the grooved edge out slightly.

The installation of spring bronze around a door is equally simple. First cut side

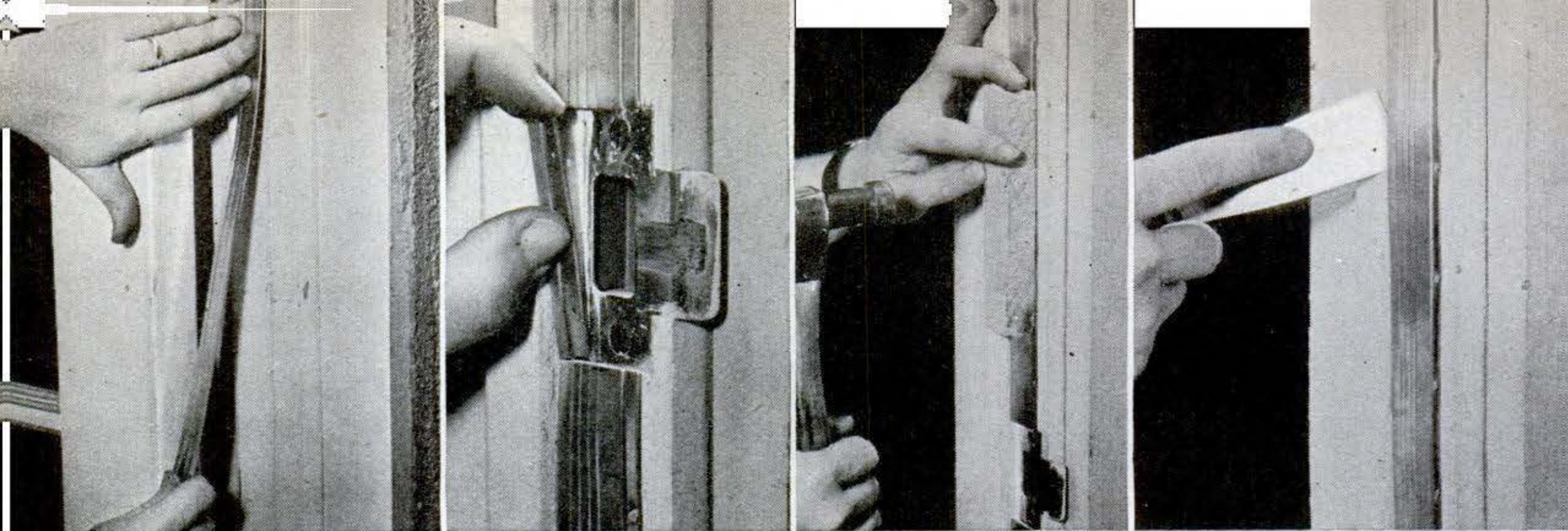

DOORS can be fitted with spring bronze. Strips are nailed to jamb on sides and at top of door with springy edge toward door-stop molding.

STRIKE PLATE calls for careful fitting. Cut piece of spring bronze to fit between edge of strike plate and door-stop molding.

TIGHT-FITTING spring bronze can be loosened by tapping block held against it. If stripping is too tight, door or window is hard to open.

LOOSE-FITTING spring bronze can be made to fit by springing up unnailed edge with knife. Loose stripping lets air leak in and wastes heat.

pieces $\frac{1}{2}$ " shorter than the height of the door. Nail these in place against the door jamb. Put the nailed edge toward the direction in which the door opens, with the grooved edge near the door-stop molding. Work from the top down, and follow the same system of nailing as you did on the windows. Position the bronze strip so that when the

strip is pressed flat, as it would be when the door is closed, the unnailed edge will be as close as possible to the door stop without actually touching it. After fitting both of the sides, put a piece across the top of the door jamb. For the bottom of the door, use a zinc-and-felt door bottom.—Bernard Gladstone.



CIGAR-BOX QUIZ

Dig into the cigar box and try to identify these tacks. Invert the page to score yourself.

By C. B. Colby

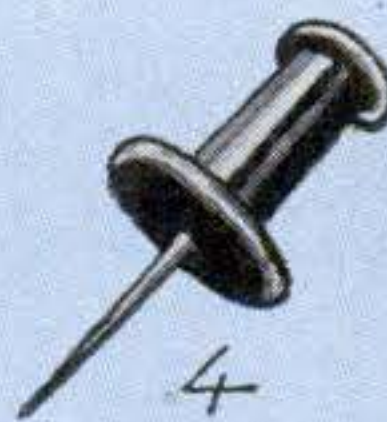

1. Double-pointed; 2. bill poster's; 3. upholsterer's gimlet; 4. drafting; 5. upholsterer's; 6. wire upholsterer's; 7. insulated; 8. thumb.



New for the Handy Man

1. Liquid Sets Level Fast. Foundation building and other construction work is simplified with this level. It consists of a 50' transparent plastic tube that is filled with a red liquid. Above, the tool is shown being used to level a parking lot. Clamps

that come with the level are fixed to up-rights (inset). The liquid at both ends of the tube then gives a perfectly level line. By measuring from the ground to the liquid level in the glass, the degree of slope can be determined very quickly.

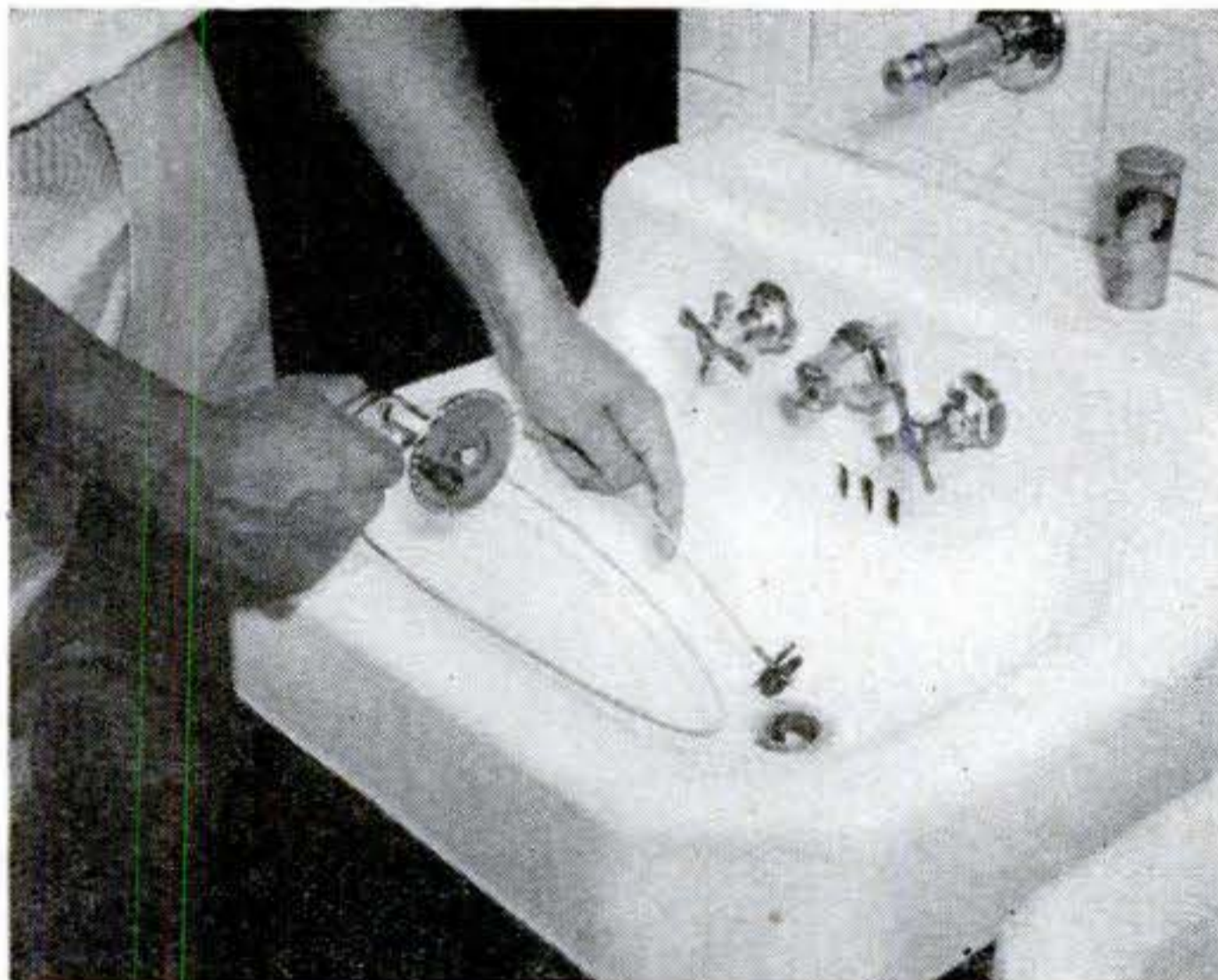

2. Junior Snake Cleans Drains. A brush on the end of a 42" flexible shaft clears clogged drains when you crank the wheel. As the drain begins to open, the shaft is pushed in farther. Pulling the shaft back and forth while cranking insures a thorough cleaning. The maker says it will open drains that are clogged by paper, hair, matches, hairpins and other small articles.

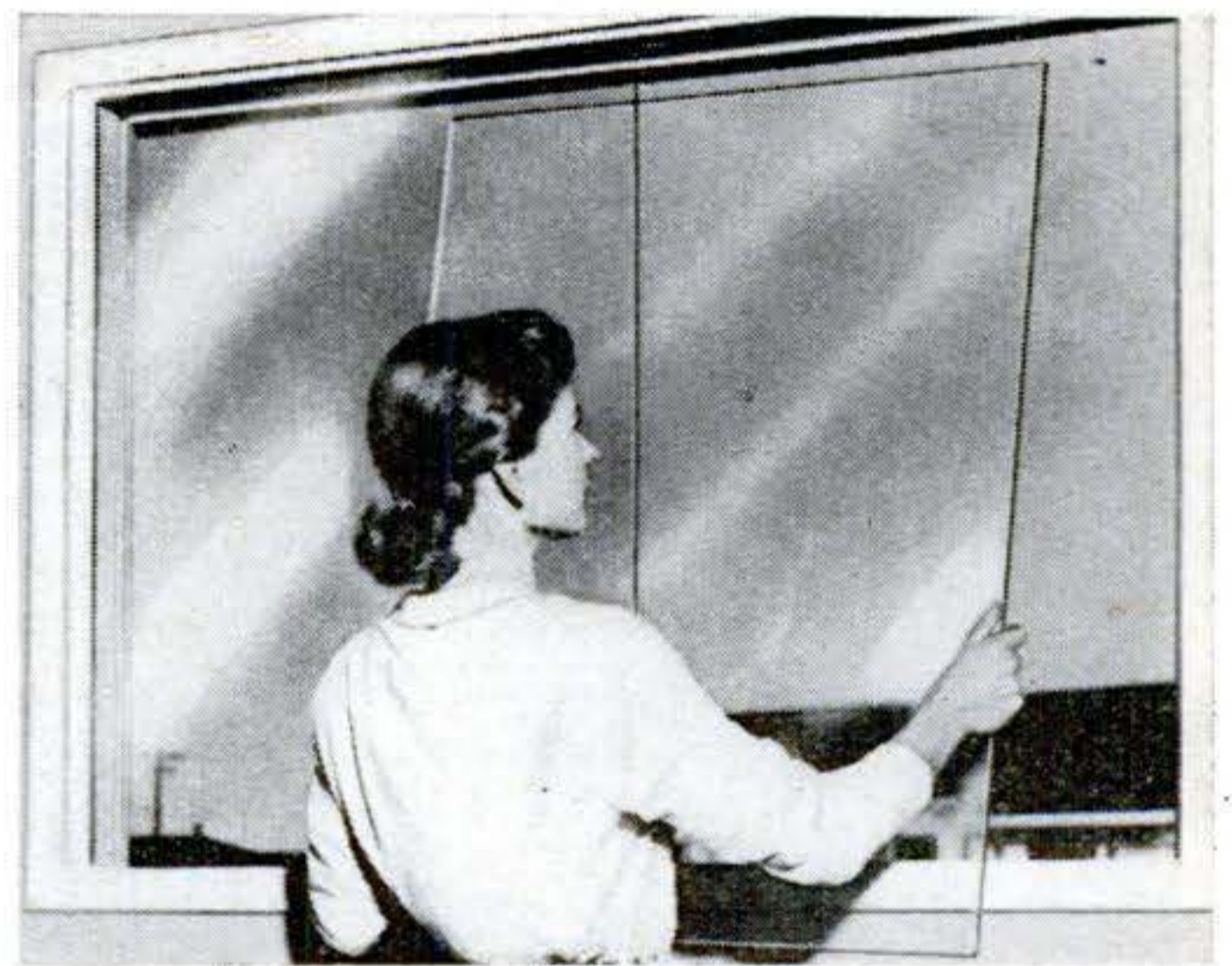

3. Window Has No Sash or Putty. Only one piece of hardware is used with this window—a pull latch that locks the window closed or partly open. The unit consists of pre-cut redwood pieces that are nailed between studs to form a frame. Then the panes, which slide in grooves in the frame, are inserted. The unit comes, without glass, in 23 sizes.

Please turn the page for more handy-man aids

OCTOBER 1952 235

New for the Handy Man



4. Adhesive and Tape Join Carpeting.

Flat, almost invisible seams are now possible when this fabric-and-paper tape and a rubber-base adhesive are used to join carpeting. Tacking and sewing are eliminated. Needle-like metal grips in the tape help hold the two pieces of carpeting together. First step (left above) is to lay tape

and apply adhesive. Then the first piece of carpet is pressed on tape and adhesive applied to edge of carpet to seal in the pile. Final step (right above) is to press the second piece of carpet down on tape and against the edge of first piece. The carpet can be walked on within an hour. Tape and adhesive are to be available soon.

5. Cans Clean Paint Rollers.

Paint rollers are easy to clean with either of these two cans. Spin Clean (at left and center in photos at right) uses the old Yo-Yo principle. The roller is slipped on the spindle and put in the can. Then the cord is wound around the shaft. After each pull, the cord rewinds on the shaft.

After excess paint is spun off the roller, the paint is poured out of the can and solvent poured in the can. The roller is replaced and spun in the solvent until it is clean enough to be stored.

With Roller Cleaner (far right), the roller is placed in the can of solvent, the lid replaced, and the can shaken vigorously

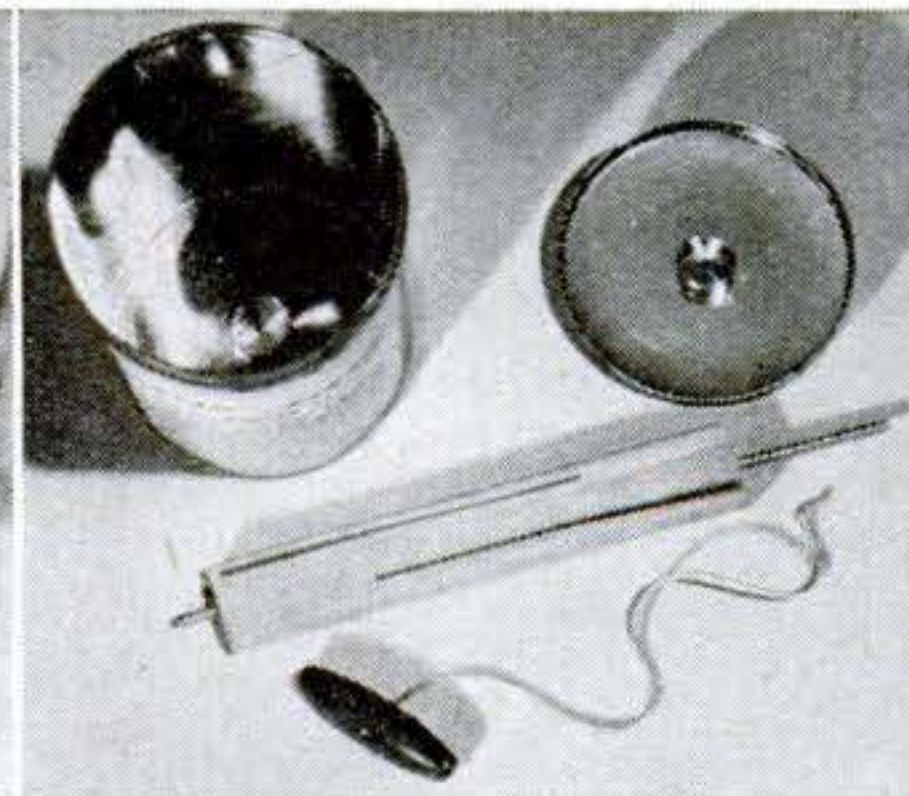

for 30 seconds. After cleaning a roller, the solvent is allowed to stand until the paint settles to the bottom. The solvent then is poured off and the paint sediment cleaned from the bottom of the can. The solvent can be used again. If the roller with its axle won't fit in the can, the axle can be removed from the roller.

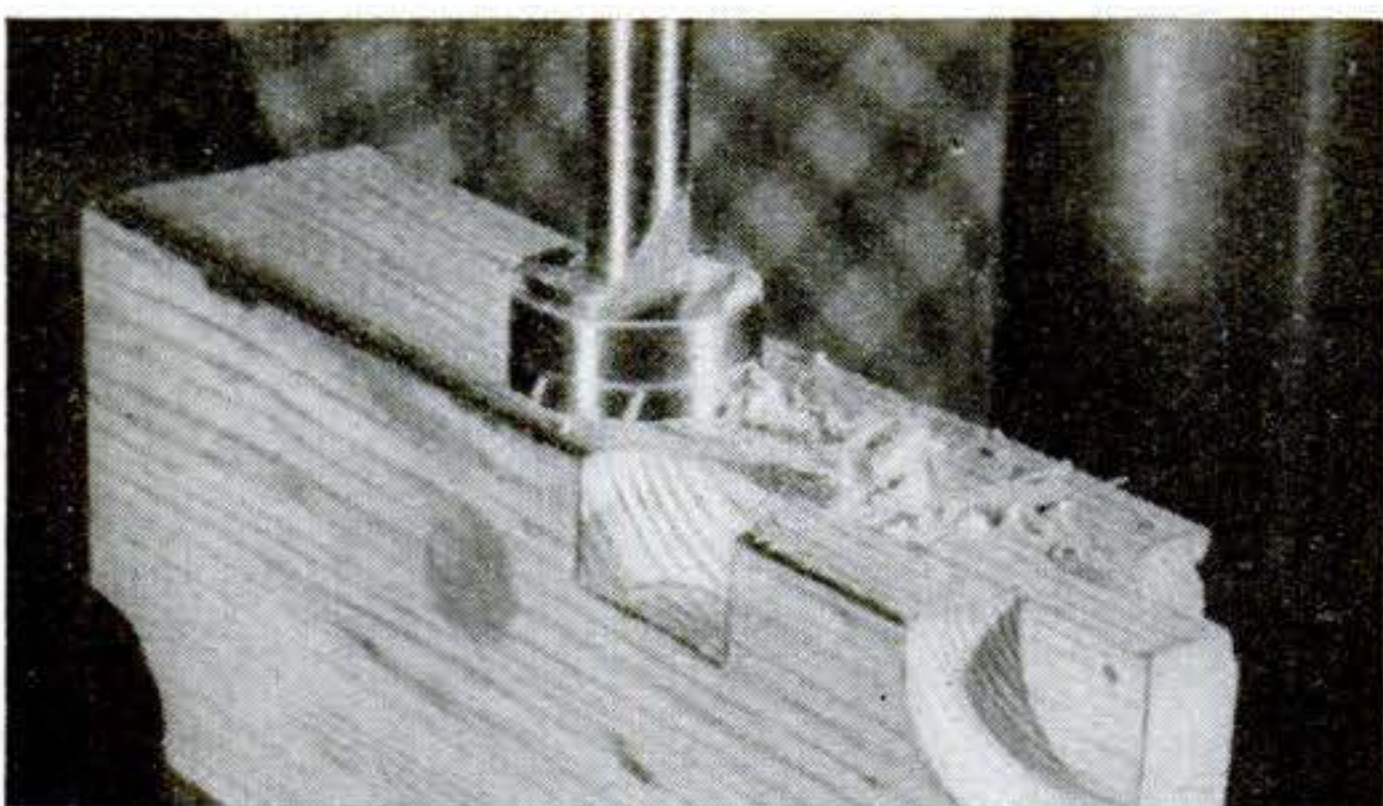

6. Two-Part Bit Drills Arcs.

This bit is said to drill wood of any grain structure and at any angle without splitting it. Even arcs of a circle can be cut without tearing the wood. The ring and the cutter it encloses are both detachable so that they can be sharpened separately on a grinding wheel. A cone-shaped wheel is used to sharpen the ring and a standard wheel for the cutter.

1. Levelall Co., 81 Webster St., Rockland, Mass.; 2. Home Necessities, Inc., 1129 S. Queen Anne Pl., Los Angeles 19; 3. Ernest Pierson Co., Eureka, Calif.; 4. United States Rubber Co., 254 Fourth Ave., NYC; 5. Spin Clean Products Co., 979 N. 39th St., Milwaukee 8, and Wilson-Imperial Co., 115 Chestnut St., Newark, N. J.; 6. PTI, Inc., 401 Broadway, NYC.

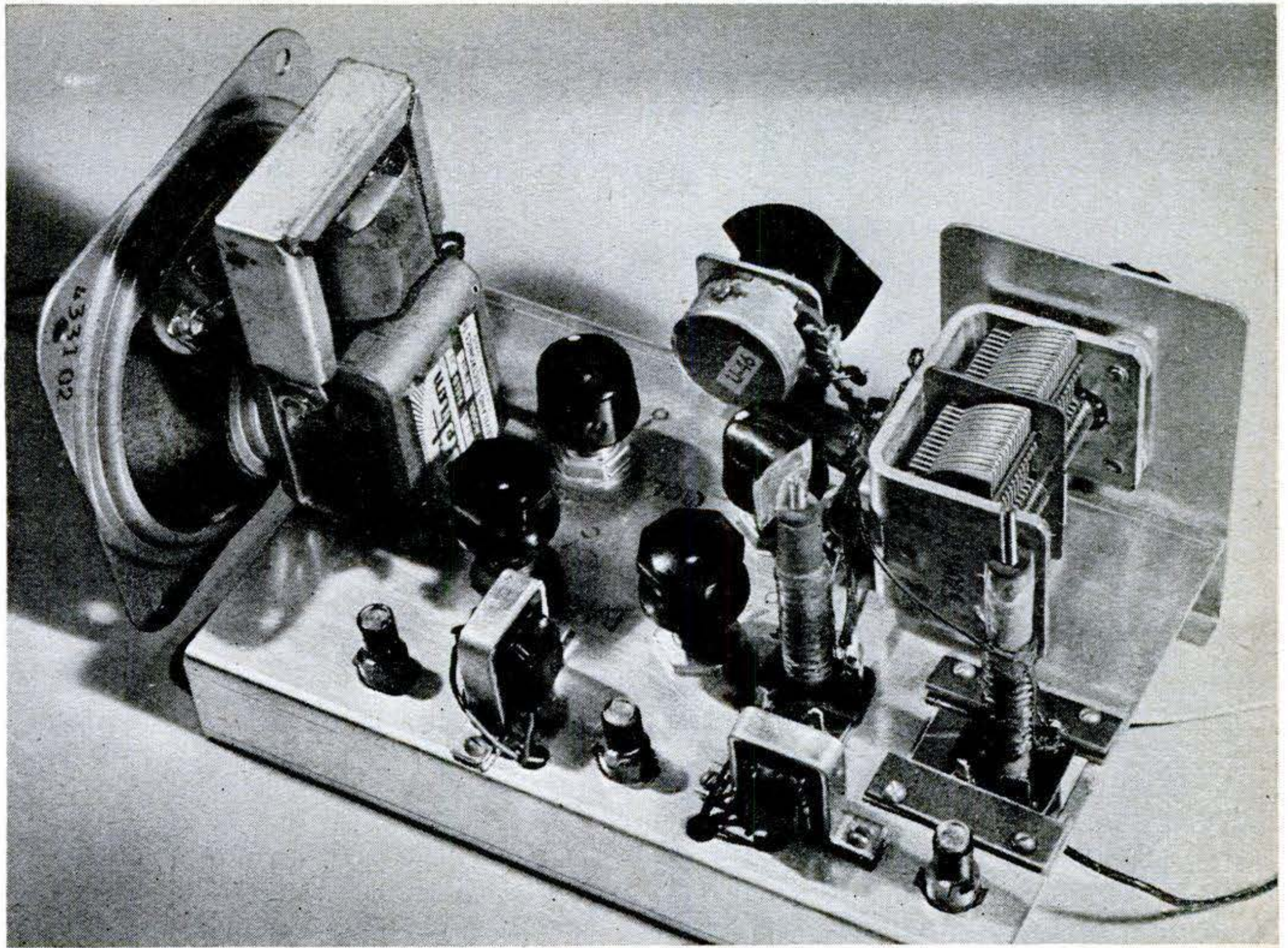

PREVIEW OF SETS TO COME, this tubeless receiver gives good headphone reception with three transistors and even works a speaker on local stations. Comparison of matchbook with transistors (in foreground, right) shows size. Sockets are behind.

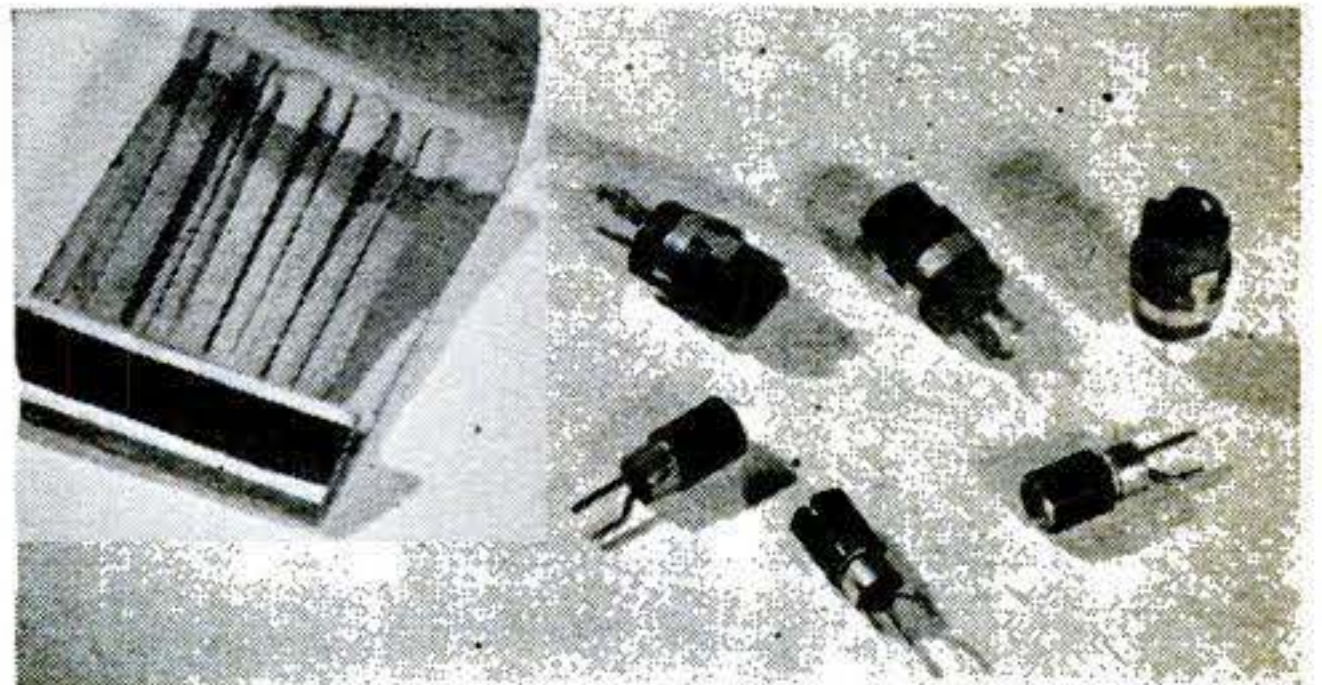

Now You Can Build a Transistor Radio

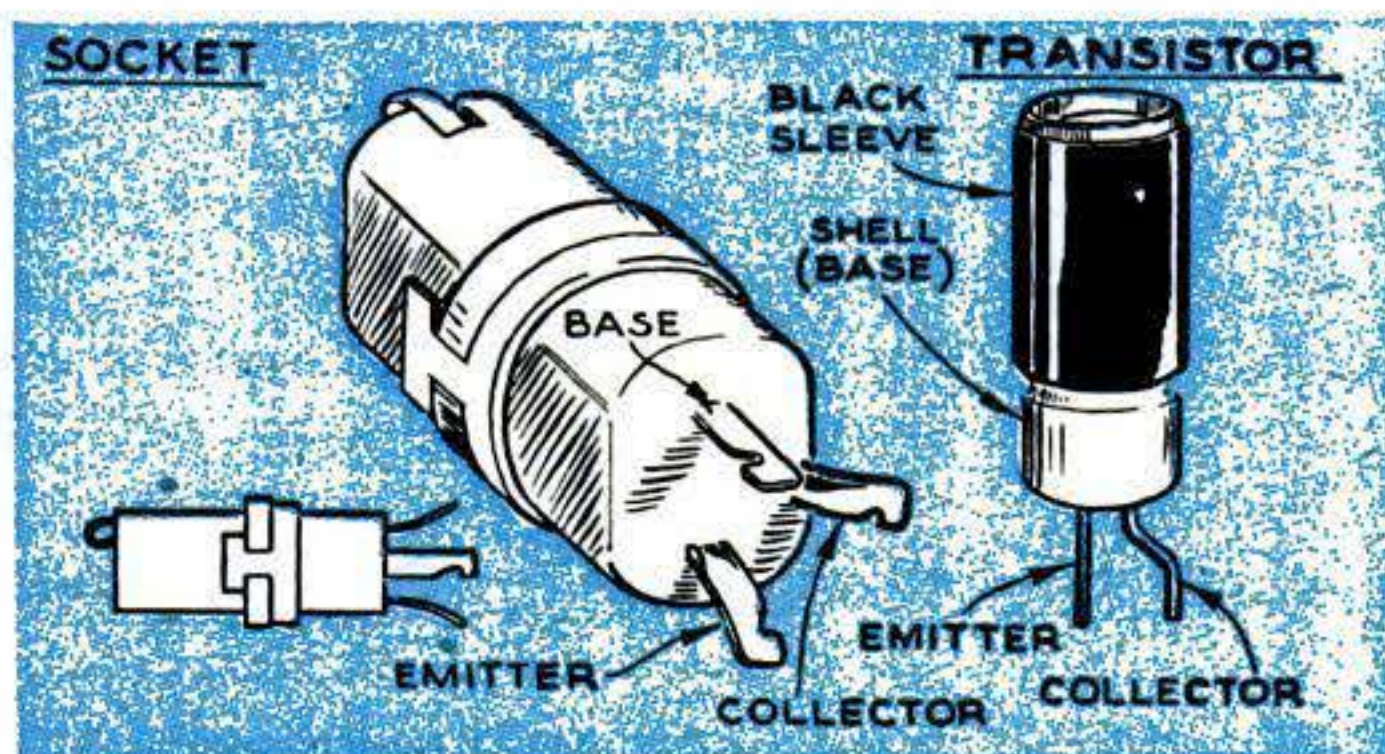

DRILL HOLES for the sockets, insert them from beneath, and bend tabs over on top to hold them. Base lug is aligned with a looped clip that grips the transistor. Scratch the letters B, C and E on bottom of socket as wiring aid.

Miracle crystals that need no A battery and last for years do the work of vacuum tubes in this experimental receiver.

By Howard G. McEntee

ANY experimenter's blood must tingle to the challenge of transistors—those tiny germanium gimmicks that make like vacuum tubes. They have so many advantages that they are sure to replace tubes in hundreds of applications (see page 134). Pint-size television sets and wrist-watch radios are likely to come when transistors take over.

But you needn't wait. You can buy at

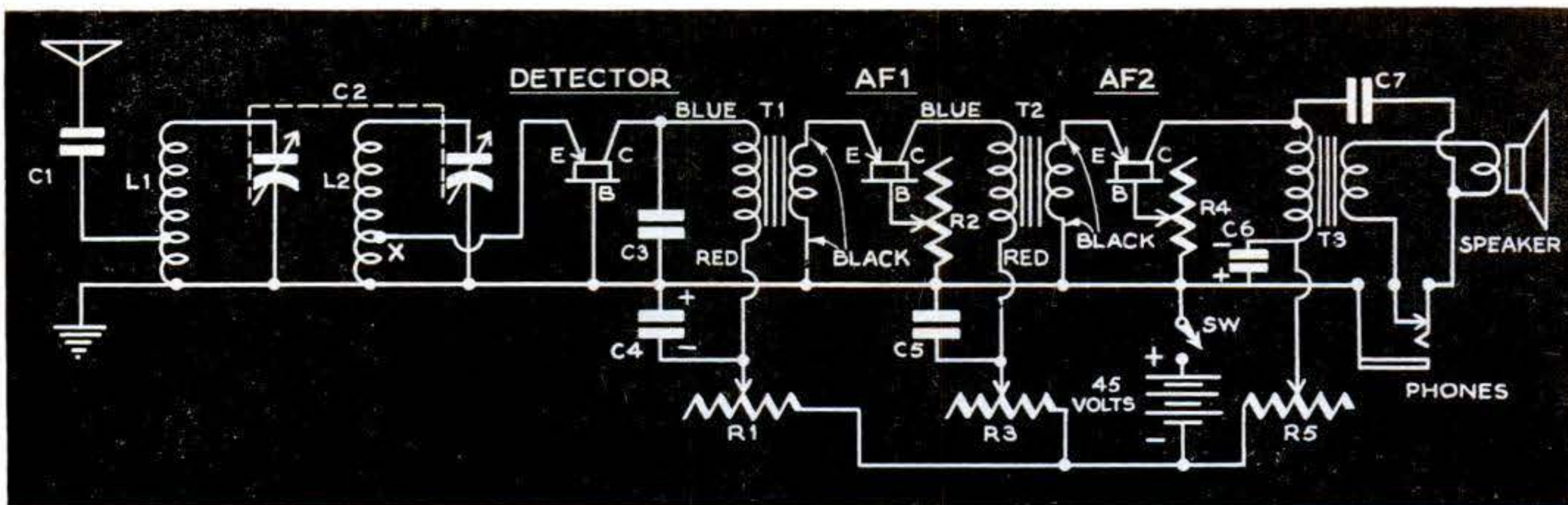

LIST OF PARTS

C1: .001-mfd. mica
 C2: two-gang tuning, 365 mmf. per section
 C3: .01-mfd. mica
 C4, C6: 5-mfd., 100-volt midget electrolytic
 C5, C7: .1-mfd. midget paper
 R1: 250,000-ohm potentiometer
 R2, R4: 500-ohm variable resistor

R3, R5: 10,000-ohm variable resistor
 L1, L2: Antenna coils (Miller A-121-A)
 T1, T2: Midget plate-to-line transformers (UTC SO-3)
 T3: Output transformer (Thordarson 24S54)
 3" midget PM speaker (optional)

Transistors (Western Electric A-1698) 3 req.
 Transistor sockets (Cinch 54AZ17431) 3 req.
 Closed-circuit phone jack
 SPST toggle switch
 Chassis, 1" by 4" by 6" (IC/A 29085)
 B Battery, 45 volts

least one type of transistor right now and build a radio that will work a speaker on strong stations. In the process you'll learn a lot about the latest thing in electronics.

Where to get them. Still costly compared to vacuum tubes, the cheapest transistors available will cost you about \$6.50 each from the Western Electric Co. at Allentown, Pa. These are point-contact transistors, not the latest junction type, and are made for computer and telephone circuits.

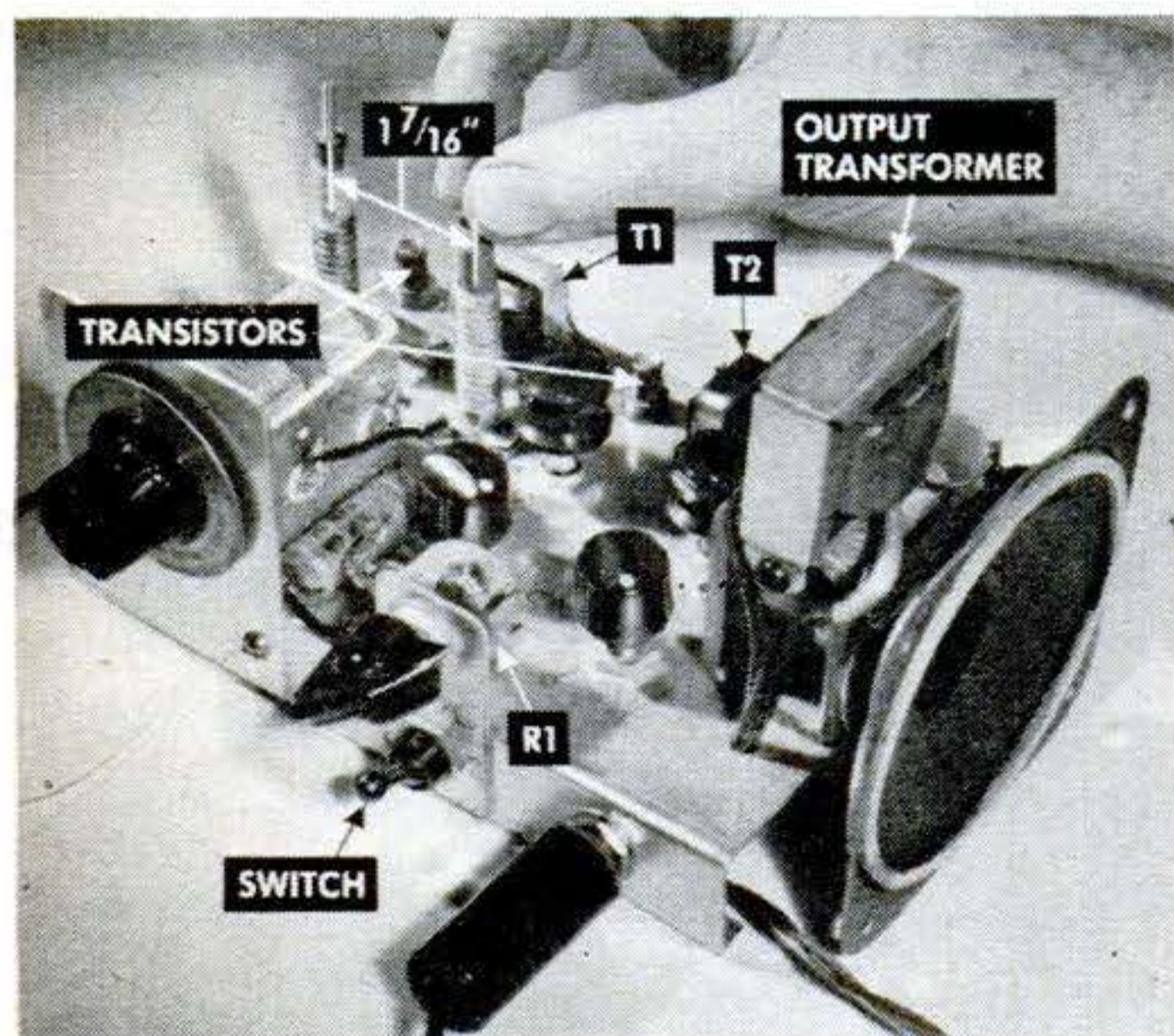

DISCARD COIL CASES and mount one coil adjustably on the chassis. The spacing shown gave best results; closer coupling produced double-hump tuning. As tuning condenser had no trimmers, the two circuits were aligned by moving coil slugs as shown, the screws in them being insulated with tape. Once aligned, slugs were held in sleeves with cellulose tape.

But they'll work a radio and will last for years if not abused.

Still in the development stage, transistors have a higher noise level than tubes, draw more plate current (although no filament juice), and are far from uniform. Some work better as detectors, others as amplifiers. You take pot luck when you buy, but that's the price of experimenting—and part of the fun.

What's performance like? Although it won't replace your living-room superhet, this three-transistor set is fine for listening after others are asleep, or for keeping Junior occupied—and quiet—when he wakes up ahead of the rest of the family.

Headphone volume is all you could want, and reception is dependable. Speaker volume is modest, suitable only for quiet locations. Because of the high noise level (heard as a hiss), the set must have a strong signal. It requires a good antenna and ground.

Building the rig. An ordinary aluminum chassis is the backbone of the set. The tuning condenser and R1 (which serves as a volume control) are mounted on a plate attached to the front of the chassis.

Sockets for transistors are made by the Cinch Mfg. Corp., Chicago 24, Ill. If you don't want to wait for them, you can mount one end of an ordinary automobile-fuse clip to hold each transistor and bend tiny clips of spring brass to grip the prongs. *Don't solder leads directly to the prongs.* The heat will ruin the crystal.

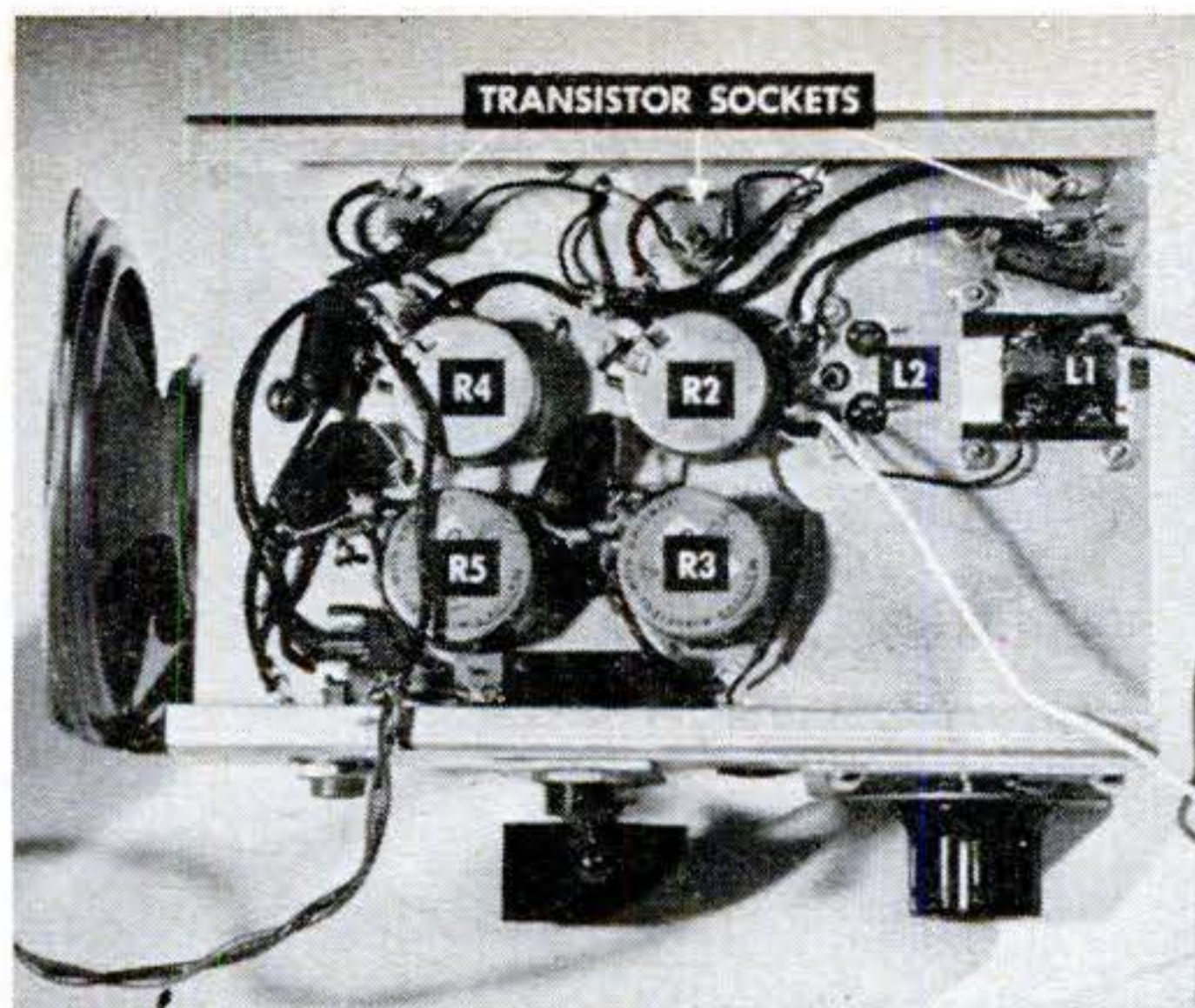

UNDER-CHASSIS VIEW shows sliding mount for first coil (L1) and the four adjustable resistors. Once set, these will require no further adjustment unless transistors are changed.

Mount the interstage transformers at right angles as usual. Those shown are mid-plate-to-line units, mounted with aluminum strips. But ordinary 3-to-1 audio transformers will do as well. If you care to dispense with the speaker, you can save the price of the output transformer, too. Use high-impedance magnetic earphones for best reception.

Two tuning coils give excellent selectivity. If you are in a fringe area, you may not need that much, and can use a single coil, hooking the antenna to the tap marked X in the drawing.

Watch your polarity. That positive ground shown in the diagram is no mistake. Be sure you ground the plus side of the power supply. If you follow tube practice and ground the negative, you'll be out of business to the tune of three ruined transistors. For this reason a polarized battery plug is a good idea.

The interstage transformers are also hooked up backwards from what they would be in a tube circuit. The low-impedance winding goes to the emitter (which in this circuit acts like a grid) and the high-impedance side to the collector (or plate equivalent).

The electrolytic condensers C4 and C6 must as usual be installed with due respect to polarity. If they have metal cases, these will be negative, so insulate them from the positive chassis with a wrapping of cellulose tape.

Checking transistors. If you have a zero-to-10 milliammeter, connect it in series with the battery to try out the set. With

R2 and R4 at zero resistance, and R1, R3 and R5 about midway, put only the second AF transistor in. Turn R5 slowly toward zero until the meter reads two milliamps and leave it there.

Then insert the first AF transistor and finally the detector, adjusting R3 and R1 in turn to give a total of 4 and 6 ma. respectively.

Lacking a milliammeter, you can listen with the earphones as you adjust the resistors. A loud click and a sharp reduction in hiss indicate the point at which plate current shoots up. Back off the resistors below this point, for no signal will pass above it.

With all transistors in, you should hear a loud hiss. Hold the antenna temporarily at X on coil L2 to tune in a station. Then transfer the antenna to C1 and move the core of L1 or L2, or adjust the trimmers if the tuning condenser has them, until the signal comes through at maximum strength.

Finally, adjust the five resistors to give maximum volume. Once set, the chassis-mounted ones won't have to be changed unless you shift transistors around.

Try them all ways. Be sure to try each transistor in each of the three positions. Some work much better as a detector than others. Some seem to oscillate strongly, and R1 may be turned to a point at which the collector current suddenly jumps. Just before this the signal gets much louder, as in regenerative circuits.

If you use a speaker, be sure to mount it on a baffle. A square foot of corrugated cardboard with a 3" hole in the center adds surprisingly to the volume.

Since even distant lightning may induce enough current in an aerial to burn out the transistors, it's a good idea to disconnect the set when you are not listening. **END**

Workshop Wisdom



*On his circular saw Dan McCrumb
Meant to cut a cleat square and quite plumb.
But guess what the hitch is
That left him in stitches . . .
He backed up the kerf with his thumb.*

New Shop Ideas

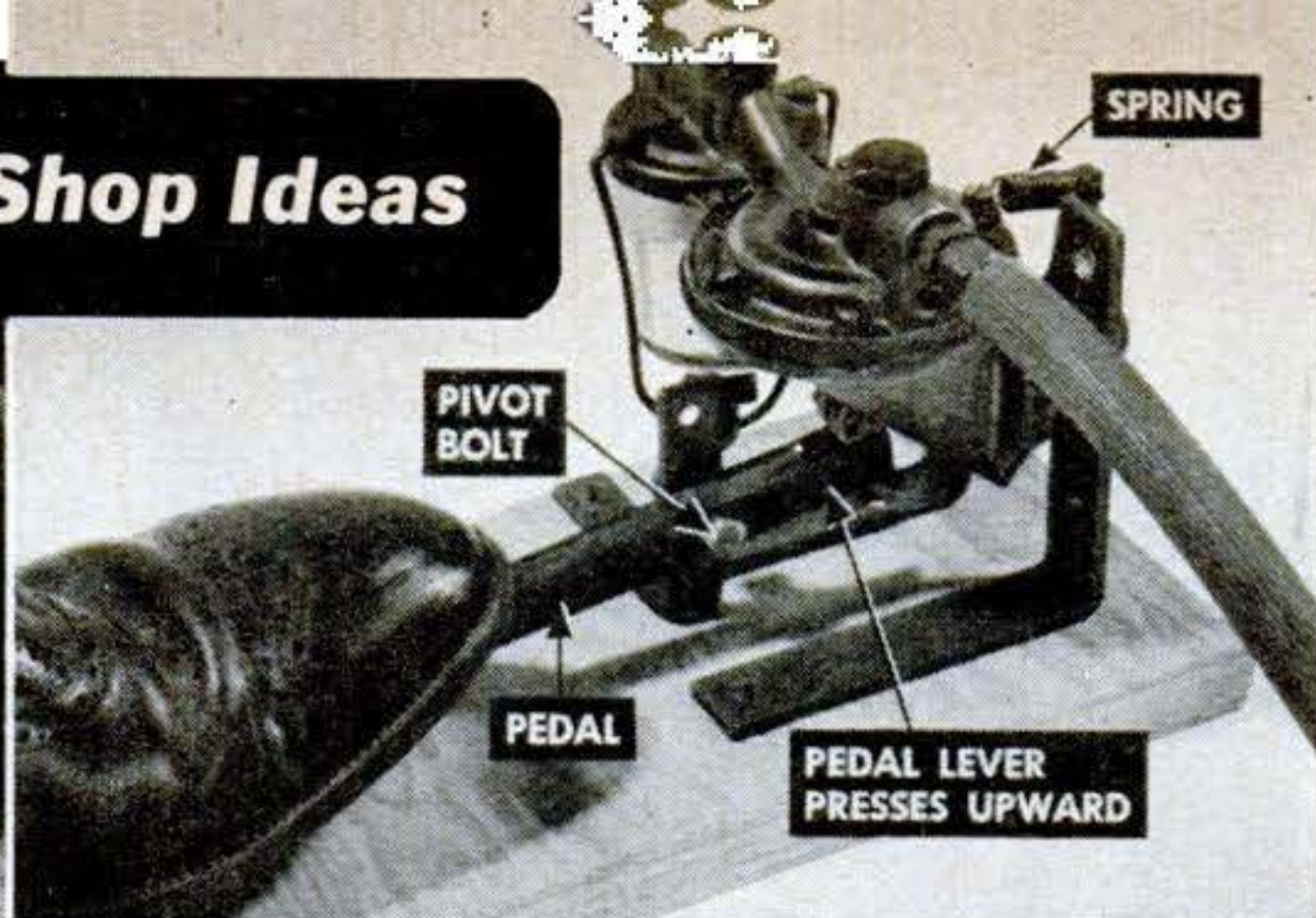
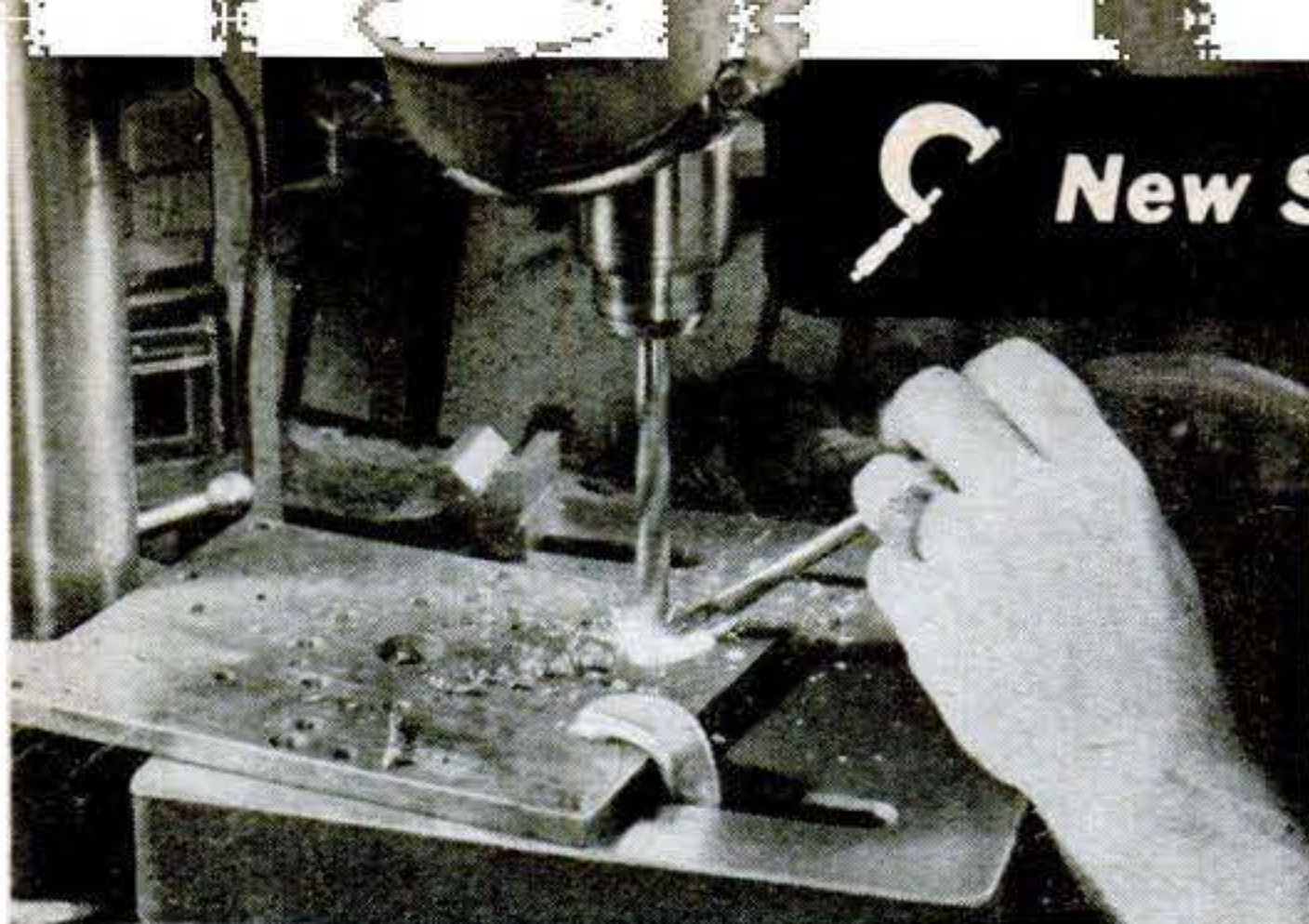

Foot Feeds Cutting Oil. A salvaged auto fuel pump and some angle brackets will feed cutting lubricant to your lathe or drill press. This foot-powered rig spouts juice only at the time you want it, leaving the work clear when you want to see what's going on.

Bolt the pump to two husky brackets on a wooden baseboard. Mount a third bracket at right angles so that the pedal lever can be pivoted on it and will press up the dia-

phragm linkage from beneath. (On the pump shown, the linkage is exposed by removing a cover plate.) Add a short spring to pull back the lever originally worked by the engine camshaft.

The intake hose is dropped in a can of cutting fluid set on the floor. For drilling, a cheap hollow-handled glue brush makes a good applicator. Just slip the delivery hose on the handle.—*Floyd McGuckin, Ridgewood, N.J.*

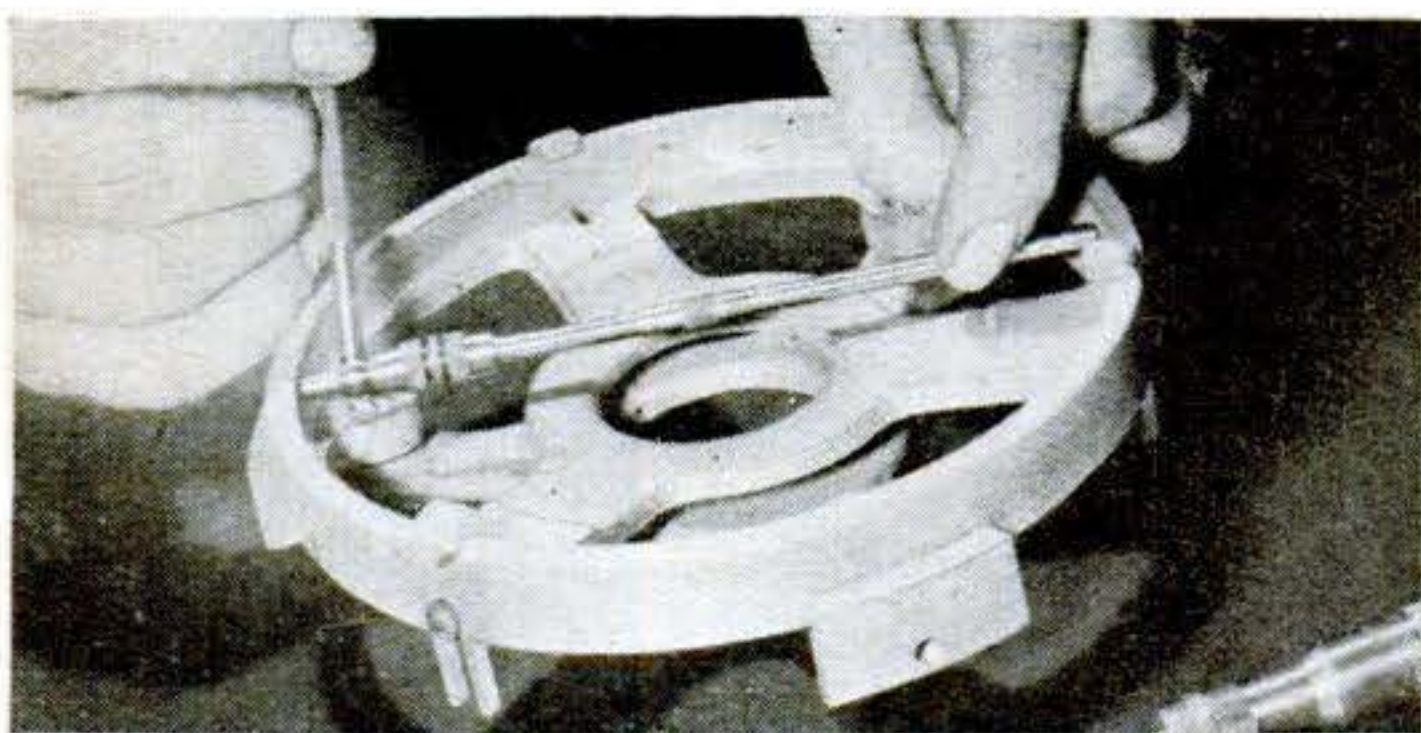

Rods Mike Big Diameters. One telescoping gauge with a $\frac{3}{4}$ " to $1\frac{1}{4}$ " range, plus homemade extension rods and a 2" micrometer, will give precision measurements to 6" and check taper and out-of-round in holes up to that size.

The set shown consists of seven rods $\frac{1}{2}$ " to $3\frac{1}{2}$ " long, in $\frac{1}{2}$ " steps. Cut them slightly over length from $3\frac{1}{16}$ " drill rod, and turn a small radius on each end. Lap to length

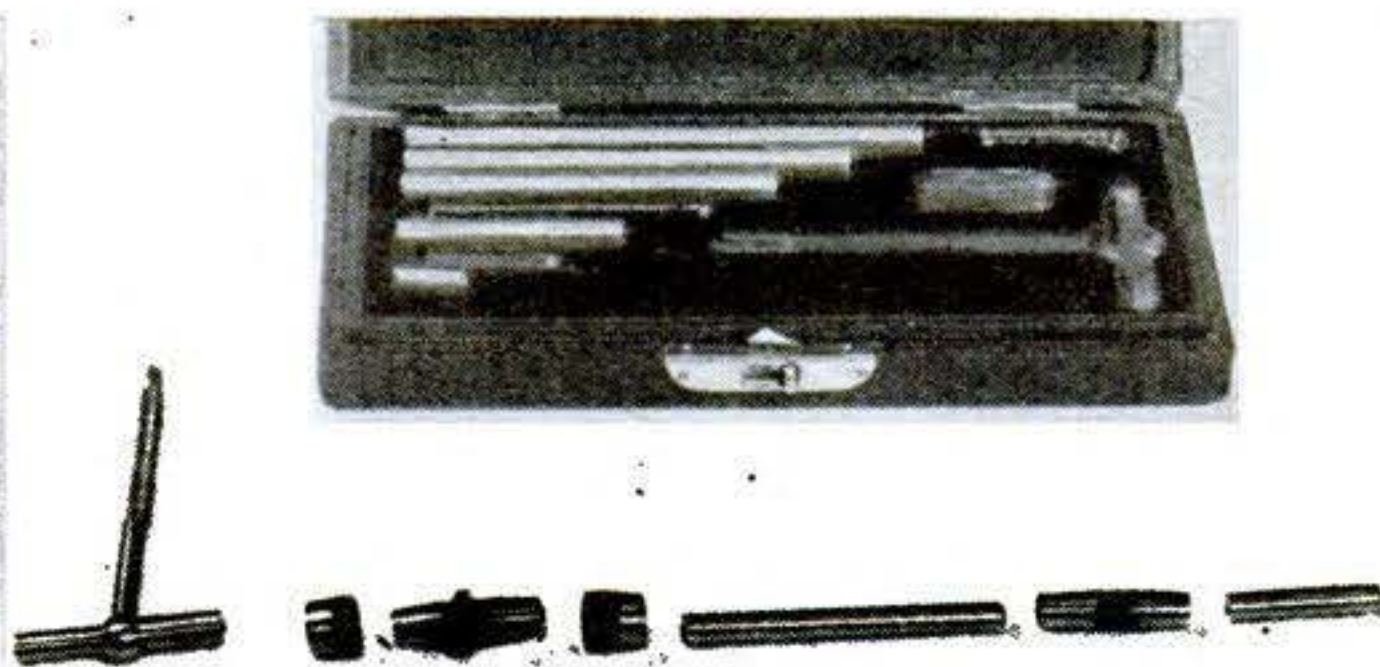

with an oilstone, removing the rod from the lathe often to check length with a large micrometer or vernier calipers. If you start with the longest, any lapped undersize can be salvaged for the next smaller.

Thread the coupling body full length first. Drill and ream the two bores, turn the end tapers, and cut off. Cut four slots from each end within $\frac{1}{16}$ " of the center, offsetting those at one end 45° from those at the other.

Drill the closers tapping size not quite through; then drill clearance size for the rod or gauge leg. Run a $\frac{5}{16}$ "-32 bottoming tap within $\frac{1}{16}$ " of the end. Knurl and taper if desired, and cut off.

The connector is simply reamed $\frac{3}{16}$ " and slotted for spring tension in the same way as the coupling. As the photo shows, the coupling connects one rod to the gauge, and the connector adds a second rod if necessary.

Hold the assembly as in the photo at left above when you take a reading.

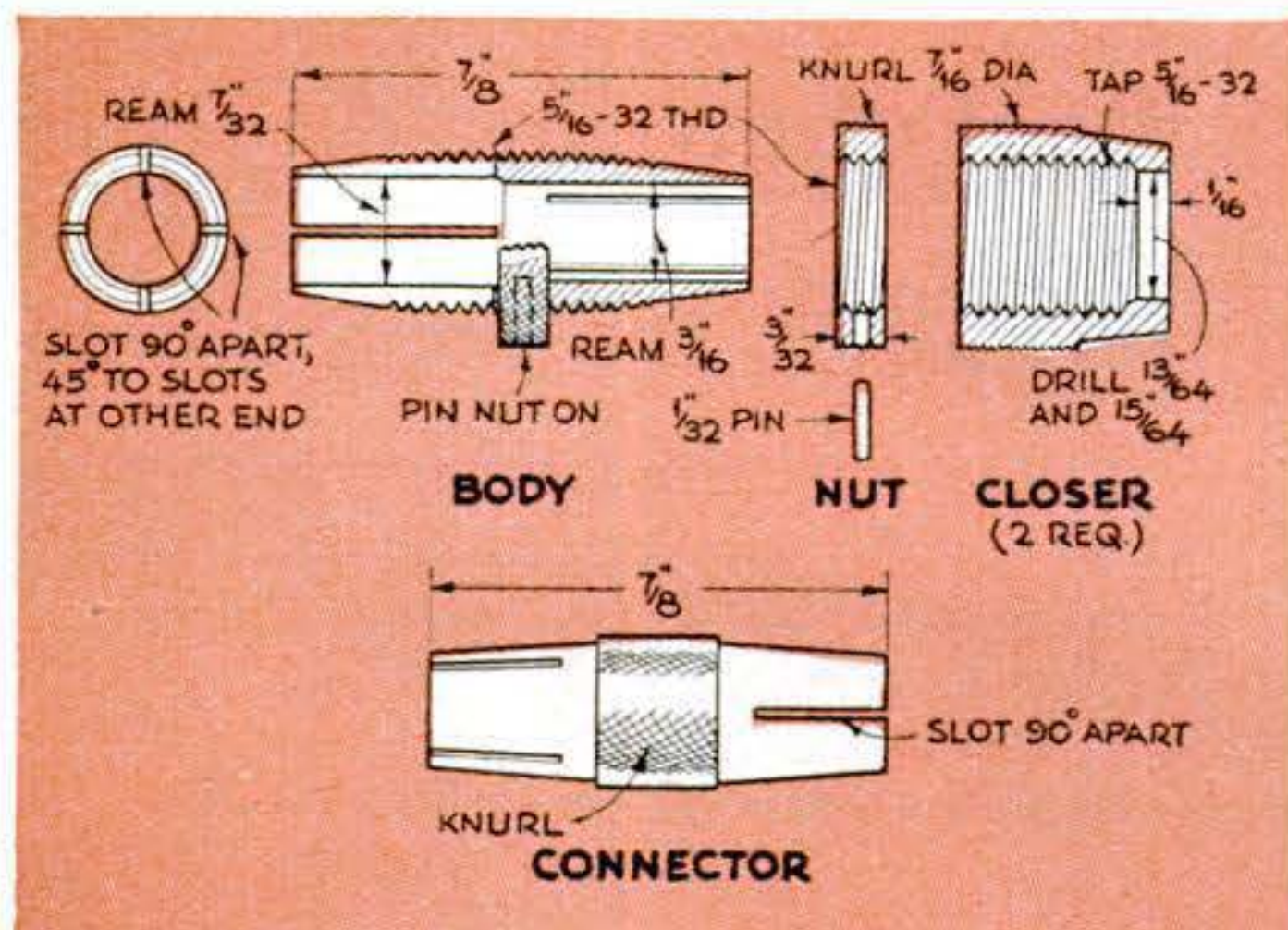

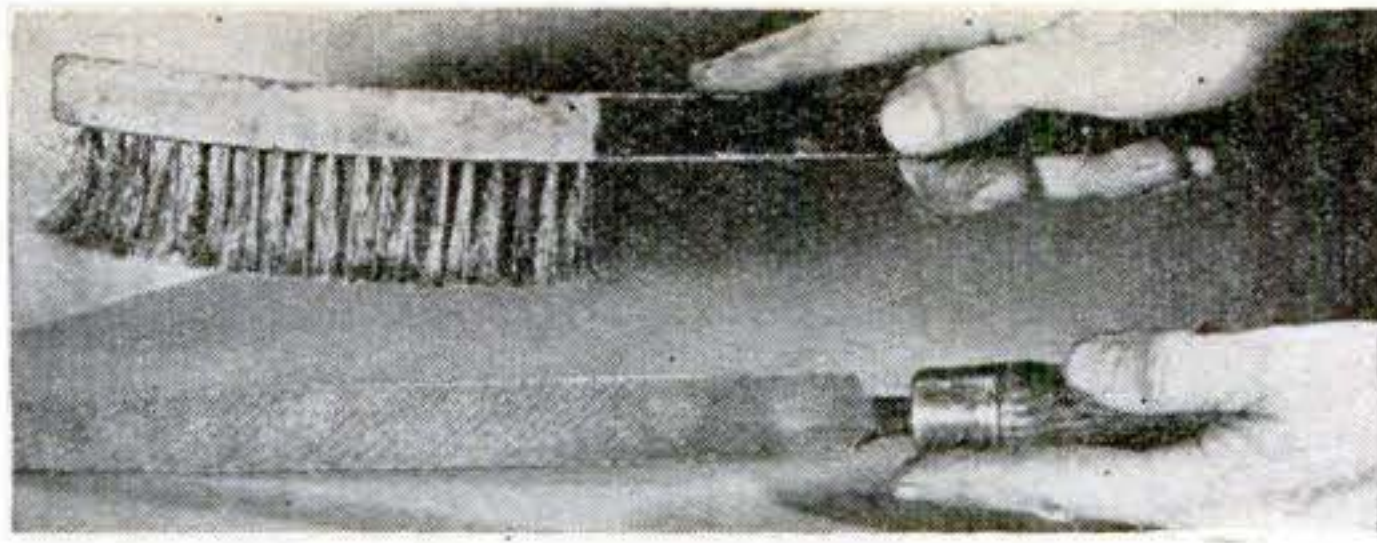

Brush Blows Clean Files. Lead and other soft material hard to remove from file teeth will usually surrender if you use a wire brush like a hammer. Rest the file on a solid support. Swing the brush so that the wire bristles strike the file at an angle of about 45° and approximately in line with the cut of the teeth. A minute or so of this usually cures the most stubborn case of clogging.—*Walter E. Burton, Akron.*

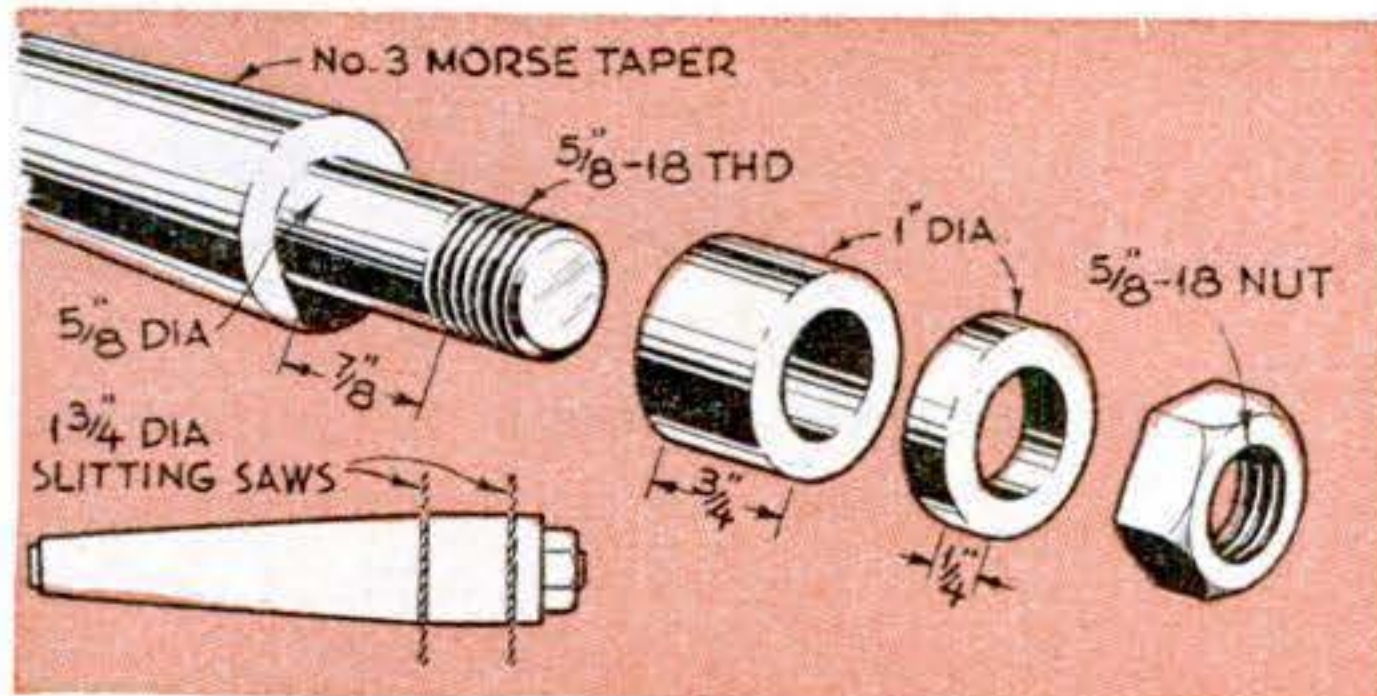

Dual Saws Speed Slotting. This arbor holds two slotting saws at once and saves setup time. Just push it into the spindle and you can cut slots of two sizes. Two such arbors, with saws .020", .030", .040" and .050" thick permanently mounted on them, will do almost any slitting job that turns up. With a suitable collar, two precisely spaced cuts can be made at once.

Turn the shoulder a close fit for saws, and be sure all collar faces are square so that the saws run without wobble. Use the thinner saw on the outside.

Steady-Rest Lube System. Intent on a lathe job, you can easily forget to oil work in the steady rest—until it overheats and scores. To solve that, put a grease cup on the upper pad of each steady rest.

A hole is drilled in the pad to make a force fit for a short steel rod. The rod is tapped for a standard grease cup and drilled through. A second grease passage is drilled up from the work-bearing end of the pad. Cut at an angle, the rod is driven to this passage.

Grease melts and flows faster than oil if the work heats up, and so compensates for any oversight.—*Clifford T. Bower, London.*

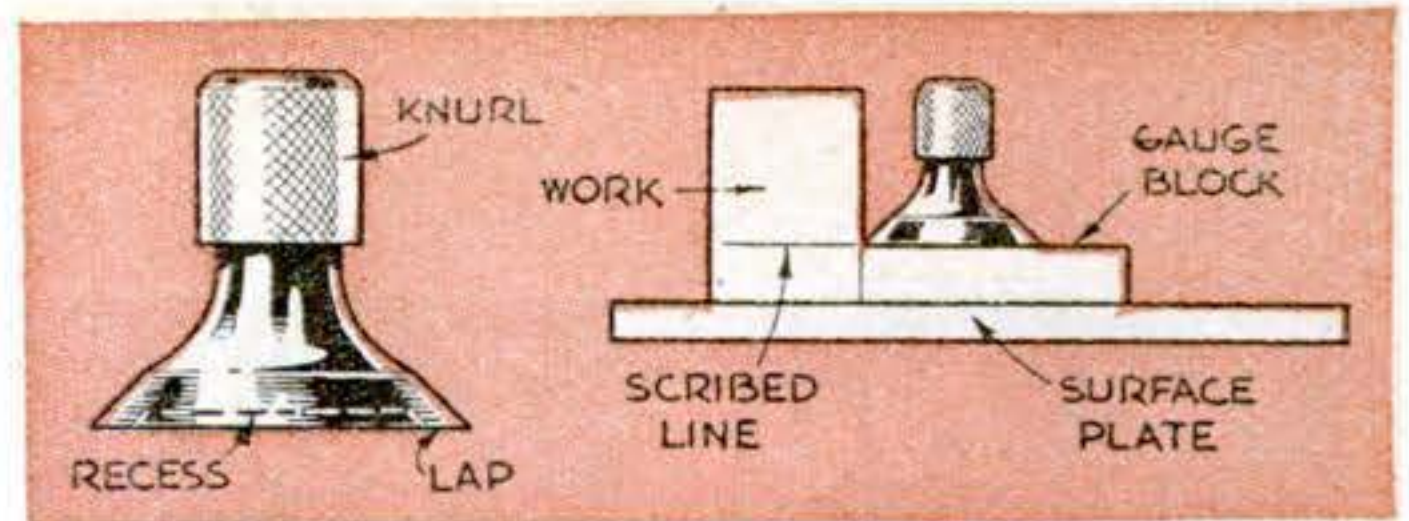

Self-Renewing Scriber. A scriber you'll never find dull is easily turned from drill rod. Knurl the knob for easy handling; then face and recess. After hardening, lap the bottom on an oilstone or with compound.

The drawing shows how the scriber is used with gauge blocks to scribe dimension lines from one face of the work. Since the entire circumference scribes, a turn renews the edge.—*A. R. Morgan, Naugatuck, Conn.*

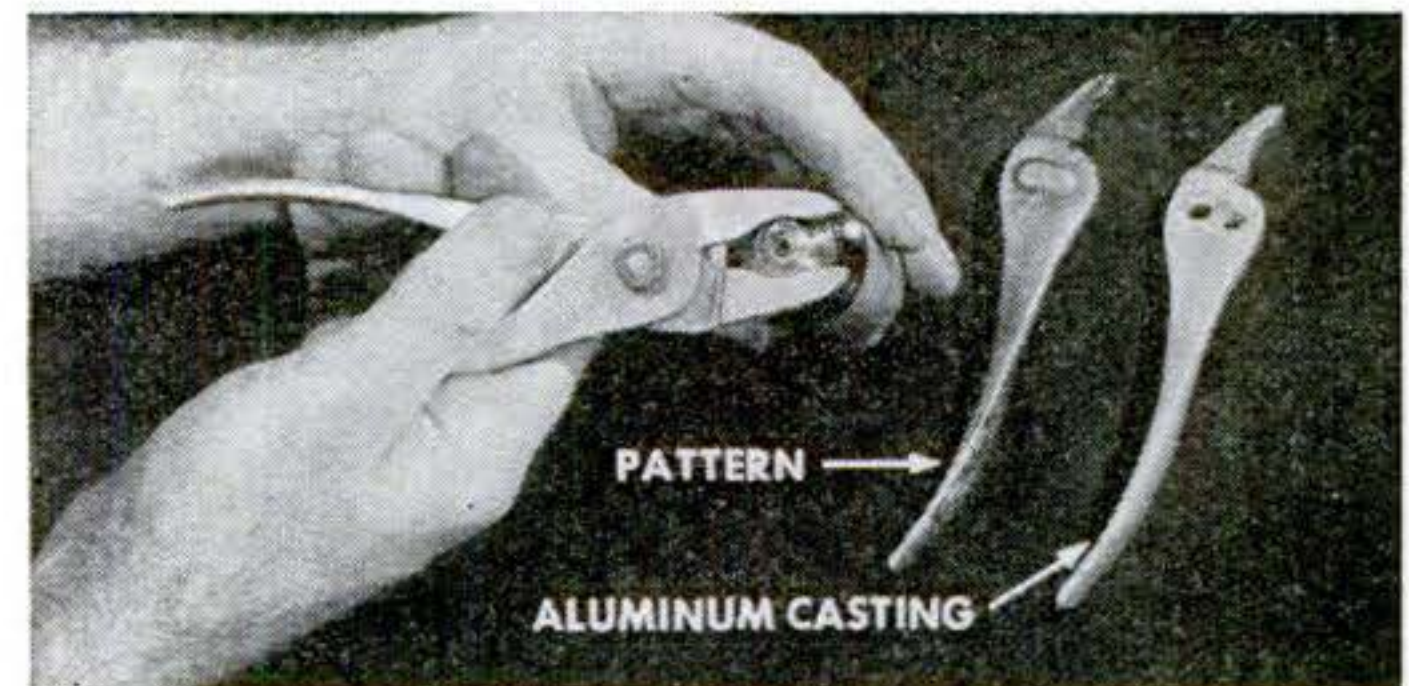

Pliers for Knurled Nuts. Sometimes a stubborn knurled part must be turned with pliers. Copper slip-on jaws are commonly used on pliers to prevent marring, but aluminum pliers are surer and make a nice addition to your tool rack.

Take apart a pair of ordinary pliers and fill the hole or slot in one leg with wood putty. Use this leg as a pattern to cast two of aluminum. Since the usual slip-joint slot would wear fast in such soft metal, drill two holes in one leg instead. For the wide-jaw setting, switch the pivot bolt.

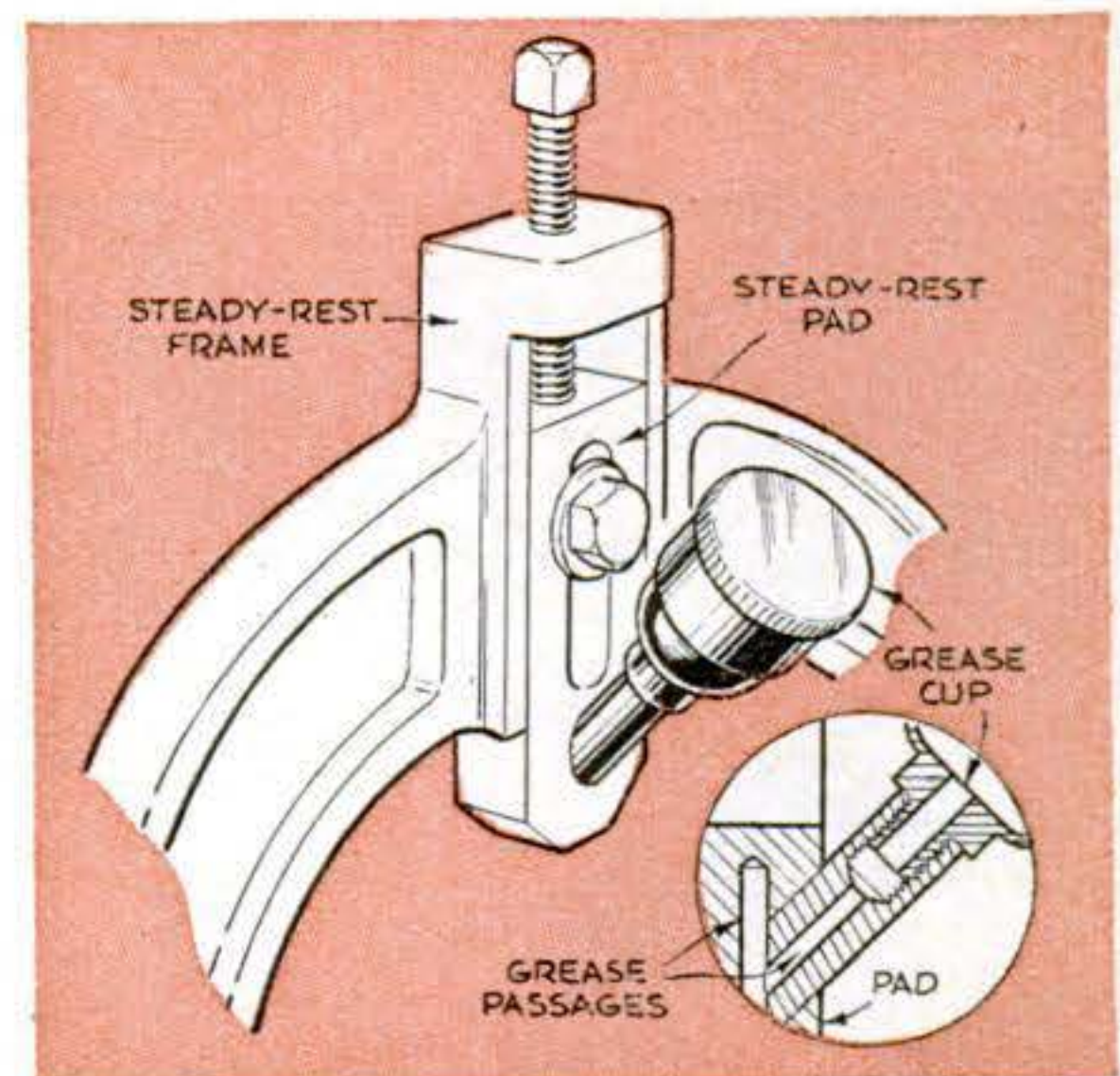



New Tools

1 Turret Head for Drill Press.

Drilling, reaming and tapping or sequence drilling can be done rapidly on a single drill press when this three-spindle turret head is used. It is indexed with a handle in front that can be turned without stopping the motor. An adjustable torque-control clutch on one spindle protects taps, and speed can be varied at each spindle to suit the tool being used. Capacity of all spindles is $\frac{3}{8}$ ".

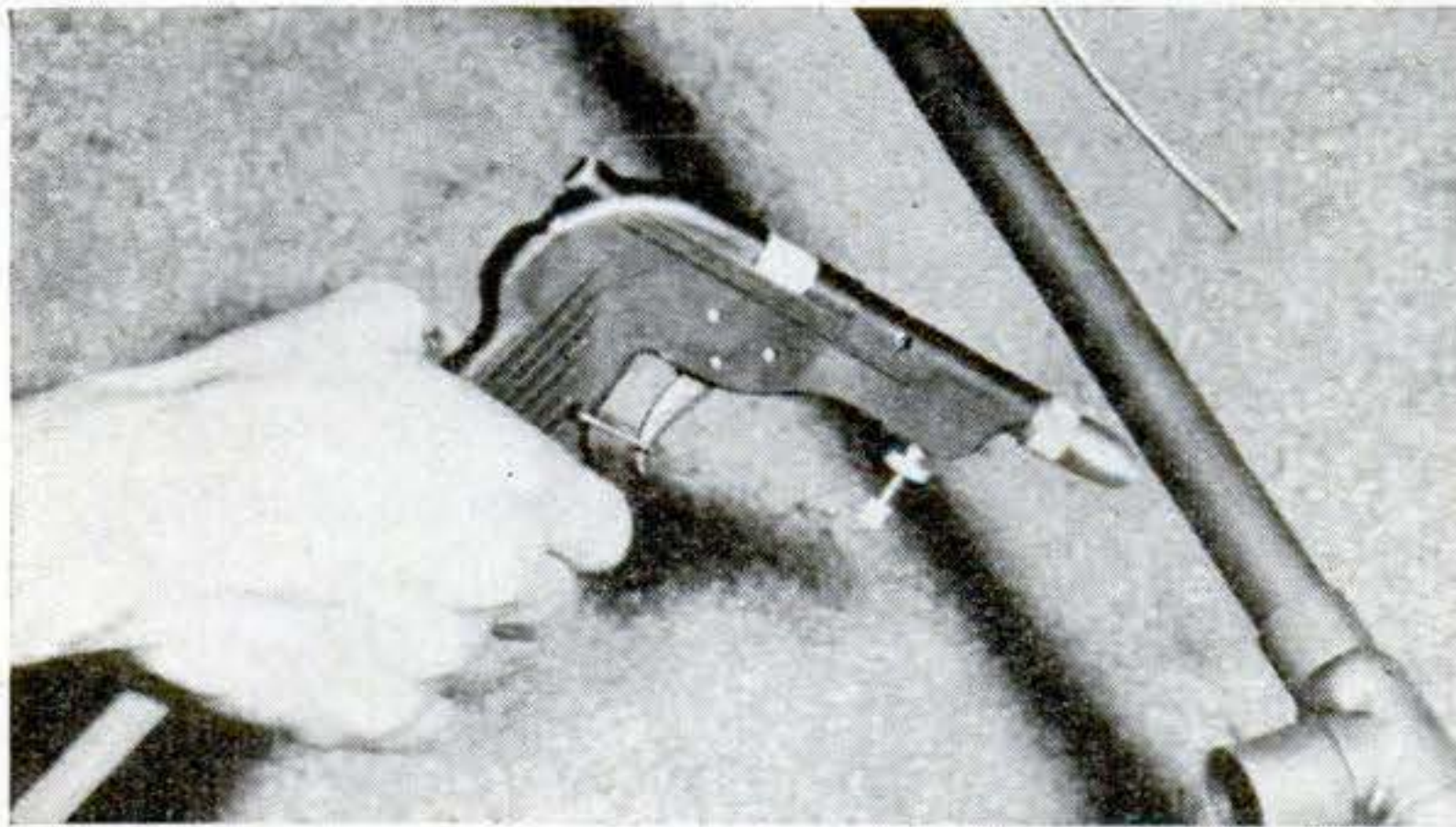
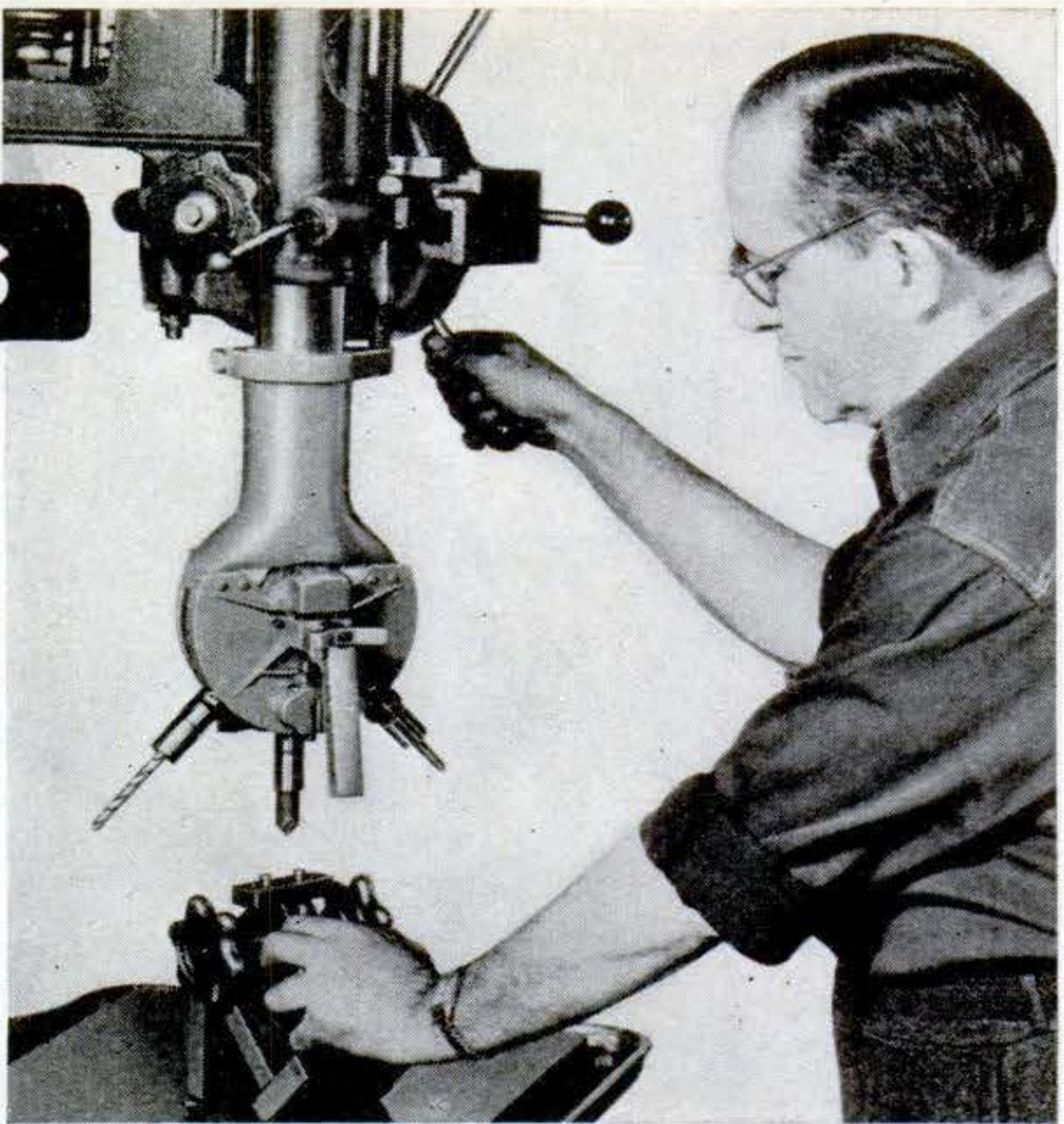

2 Acetylene Torch Is Automatic.

Squeezing the spring-loaded trigger of this torch opens the gas valve and also sparks a heavy-duty flint for ignition. Releasing the trigger shuts off the flame. For a continuous flame, the trigger can be locked open. The torch is said to be especially suited for on-and-off work such as in many plumbing, heating and refrigeration jobs, and for loosening nuts and bolts, removing paint or heating tile mastic.

3 Clamp Holds Miterers for Joining. Miter and butt joints can be held securely for joining with this 7" by 7" corner clamp. It also will serve as a glue clamp for setting mortise and tenon joints. Made of steel, it takes stock up to 2½" wide. The sides, top and bottom are open for nailing.

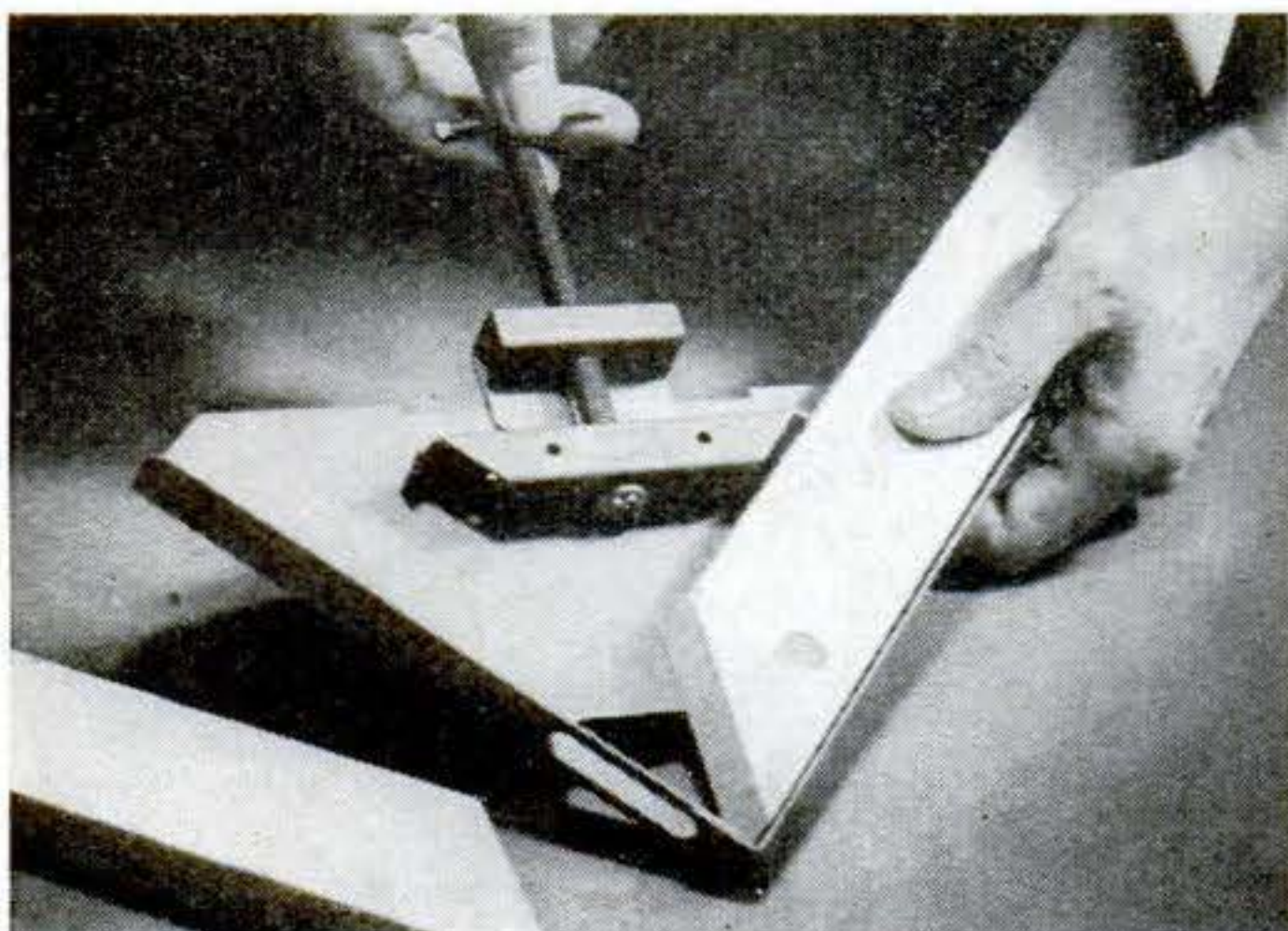

4 Screwdriver Set. These six magnetized screwdrivers range in size from a $\frac{1}{8}$ " by 2½" blade to a $\frac{3}{8}$ " by 8" blade and carry an unconditional guarantee for replacement of any of them that are broken in use. The plastic handles are shatterproof. The set is priced at \$2.49.

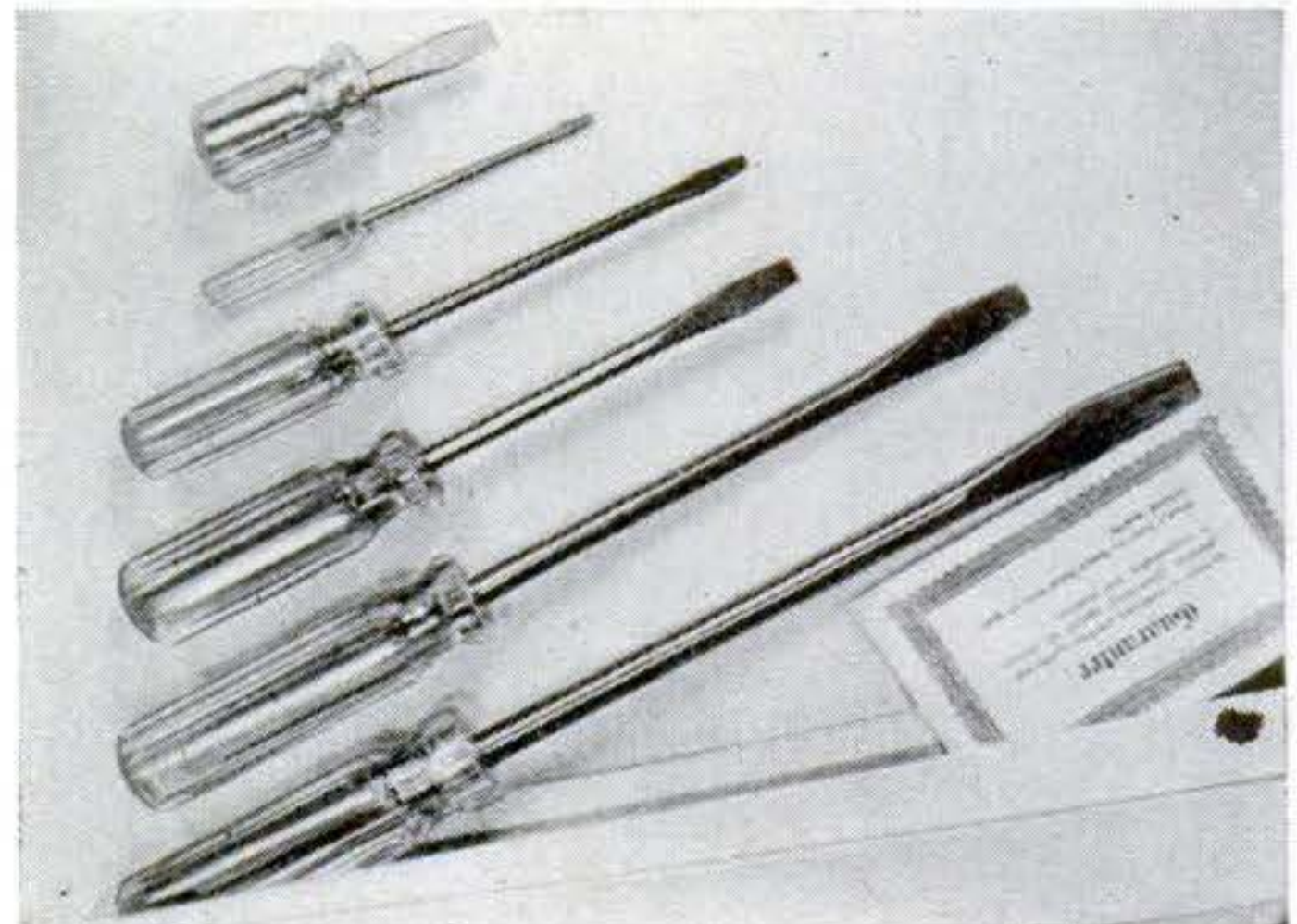

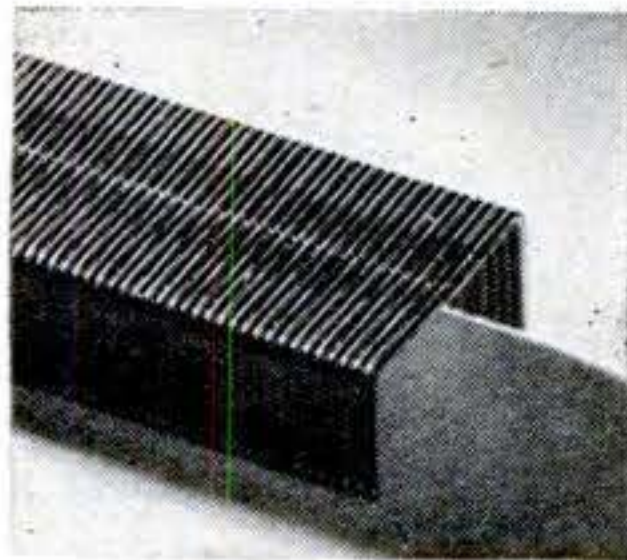
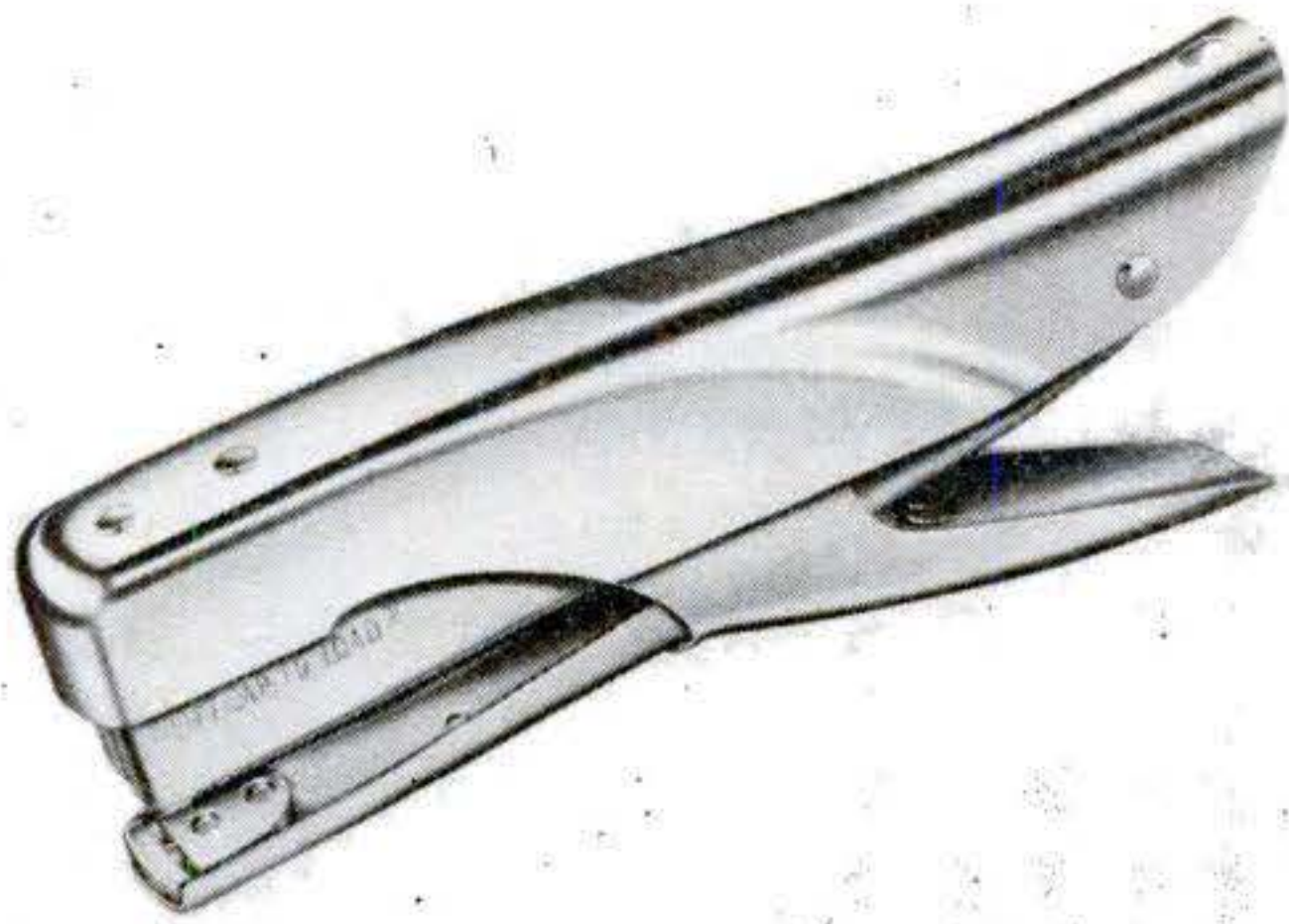

5 Nicked Staples Easy to Extract.

To remove one of these new staples, you bend it and it snaps at the nick in the center. The halves then come out easily. The

staples were designed especially for use on fabric, but can be used as conventional fasteners. The stapling gun swings open for use as a tacker.

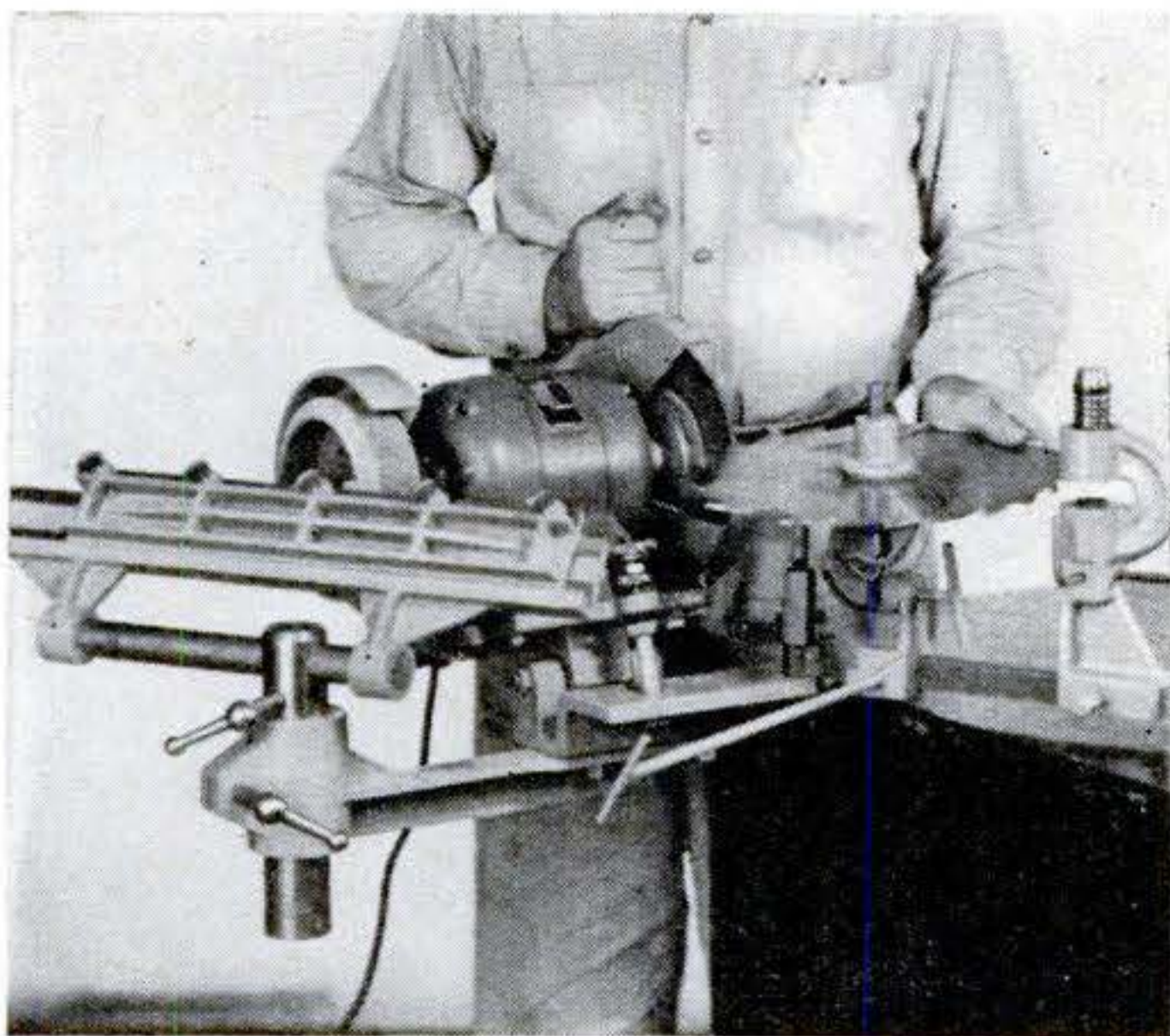

6 Tool Sharpens and Sets. Planer and jointer knives, plane irons, circular-saw blades and wood chisels can be sharpened with the Sharp-Smith. It takes saw blades from 4" to 48" and planer and jointer knives up to 24" in length. It has positive setting action to grind each tooth or blade uniformly.

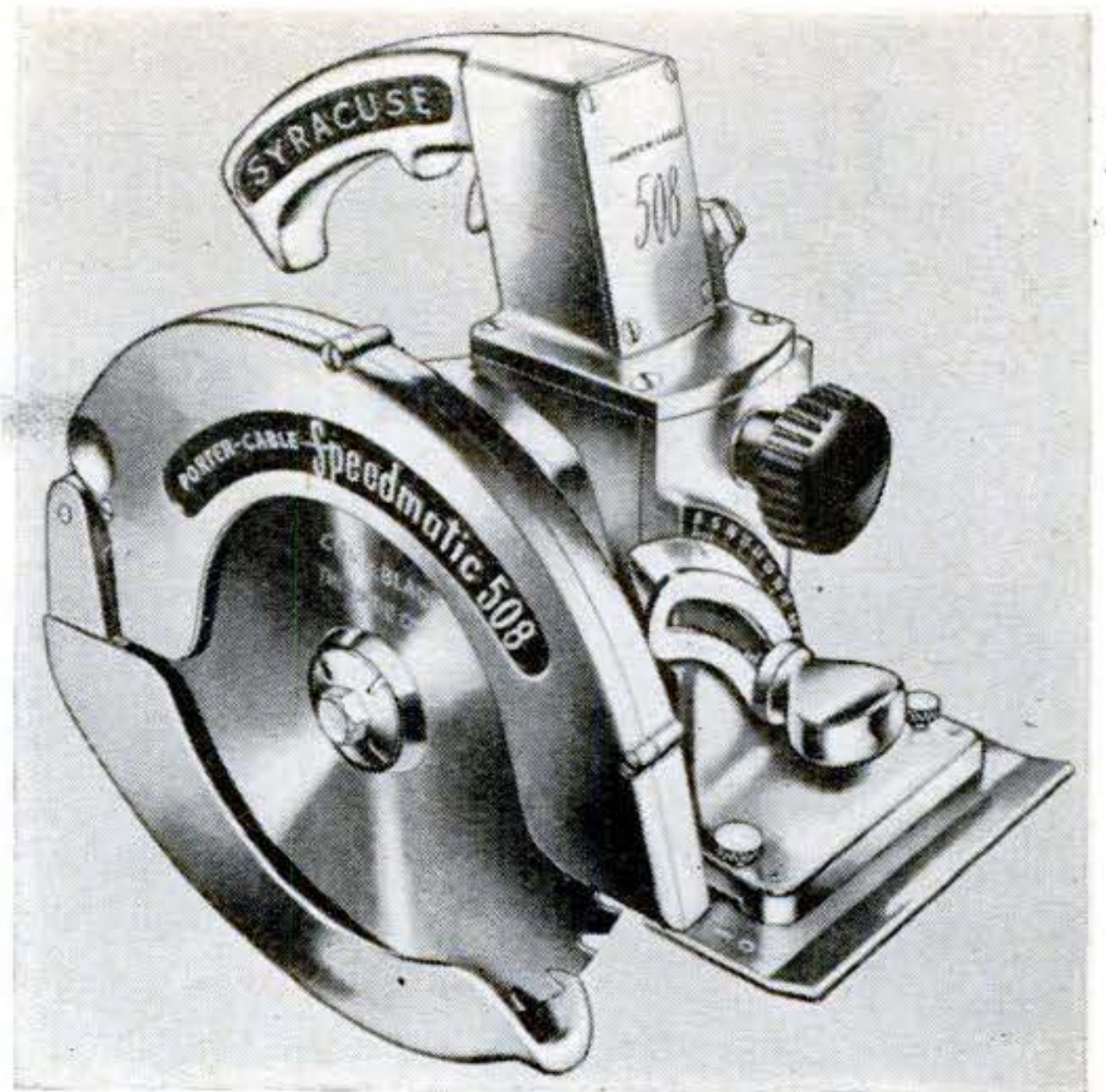

7 Saw Has Kickproof Clutch. The friction clutch in this saw lets the motor turn even though the blade binds in the cut. It comes in two models—with a 7½" blade and a 2½" depth of cut and an 8" blade, 2¾" depth of cut. Both operate at 4,500 r.p.m. under load. Weights are 15 lb. and 17 lb. respectively.

8 Long-Distance Drill. Holes from ⅝" to 1" can be bored through 27' of studding or joists or through 56" of solid wood with this boring set. Extensions of 6" or 12" lengths can be added without removing the bit from the work. The set includes four bits—⅝", ¾", ⅞" and 1". The points of the bits have a front rake which, it is said, requires from half to a third less power. According to the maker, a ¼" drill will operate the tool. Because of the rake, the bits also can be used to power-drill low-melting-point plastics.

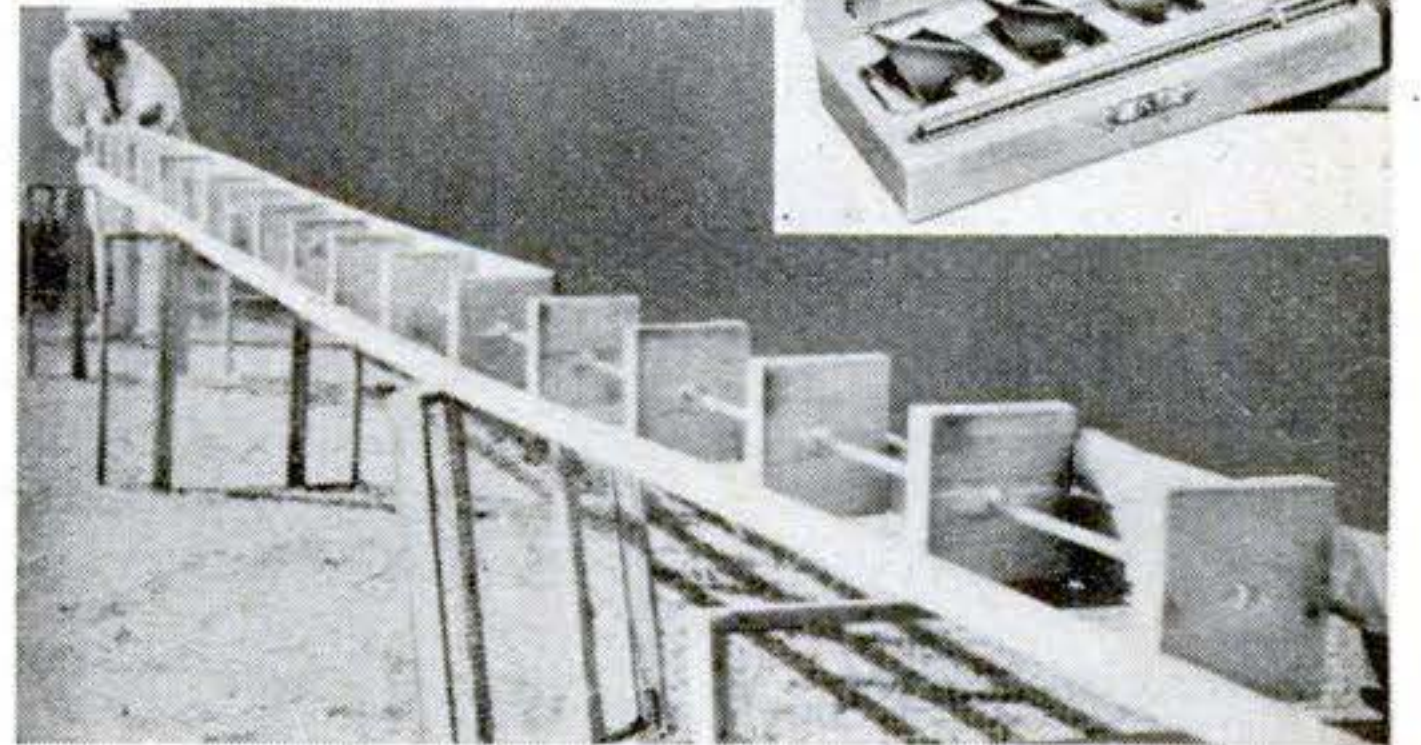

Further information on these products can be obtained from: 1. Commander Mfg. Co., 4225 W. Kinzie St., Chicago 24; 2. Velocity Power Tool Co., 7505 Thomas Blvd., Pittsburgh 8; 3. Eagle Products, Box 84A, Meriden, Conn.; 4. Terry Products, Box 581, Merrick, N.Y.; 5. Speed Products Co., 32-01 Queens Blvd., Long Island City 1, N.Y.; 6. Belsaw Machinery Co., 315 Westport Rd., Kansas City 2, Mo.; 7. Porter-Cable Machine Co., Syracuse 8, N.Y.; 8. Time Saver Tools, Inc., Mundelein, Ill.

Developing, Printing, Enlarging ...a fascinating hobby

So easy to begin, too—and inexpensive

DID YOU KNOW that Kodak offers a complete printing kit for only \$4.95 (see opposite page)—that for this small amount you can have the thrill of making prints from your own negatives? Taking the picture is really only half the fun. Developing and printing can double your enjoyment from photography. And for less than \$50 you can acquire a fine enlarger that will let you select the ideal portion of your picture . . . eliminate unwanted areas . . . make the final print even more than what you hoped for when you clicked your camera shutter.

On these pages you see just a few examples of a wide choice of equipment now on display at your Kodak dealer's. He will be glad to start you off right and help to keep you within your budget.



Easy to set up—
Simple design gets the "Hobbyist" into action fast.



Rotary negative carrier—
Open-frame, open-hinge type. Loads quickly.

Complete enlarger—less than \$50. The Kodak Hobbyist Enlarger uses cold-light illumination—perfect protection for negatives. Only reflected light reaches negatives. Integrating-sphere lamphouse, together with specially created interior reflective coating, results in even light distribution. Newly designed negative carrier loads easily. Knobs are provided for locking both elevation and focus. Enlarges up to 7 times. Kodak Enlarging Ektanon Lens, 89mm., $f/6.3$, helps produce crisp, sharp enlargements. For negatives through $2\frac{1}{4}'' \times 3\frac{1}{4}''$. \$44.



Fine, versatile enlarger—the Kodak "Flurolite"—\$99.50 (without lens). Advanced design . . . integrating-sphere light source for even illumination . . . easy-loading rotary negative carrier. Focusing and elevating knobs may be used at the same time. With accessories, the $2\frac{1}{4}'' \times 3\frac{1}{4}''$ "Flurolite" quickly converts for copying and many other uses.

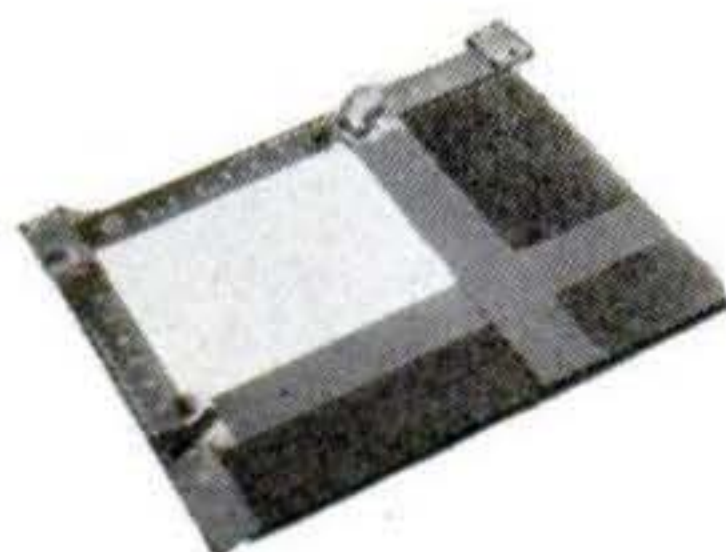

Eliminate unwanted areas in enlargements—Select ideal portions with the help of Kodak Masking Easel, 11 x 14. For use with any vertical enlarger. Can be adjusted for $\frac{1}{4}''$ - to $\frac{3}{4}''$ -inch margins. \$9.60.



Everything you need for printing—Kodacraft Printing Kit contains rocker-type trays, printing frame, paper, graduate, Kodak Tri-Chem Pack, thermometer, stirring rod. \$4.95.



For developing and printing — Kodacraft Photo-Lab Outfit includes printing frame with masks for popular negative sizes, Kodacraft Roll-Film Tank, other essentials. \$8.75.



Includes metal printer — Kodacraft Advanced Photo-Lab offers complete developing and printing equipment. Everything can be packed in printer for handy storage. \$14.10.

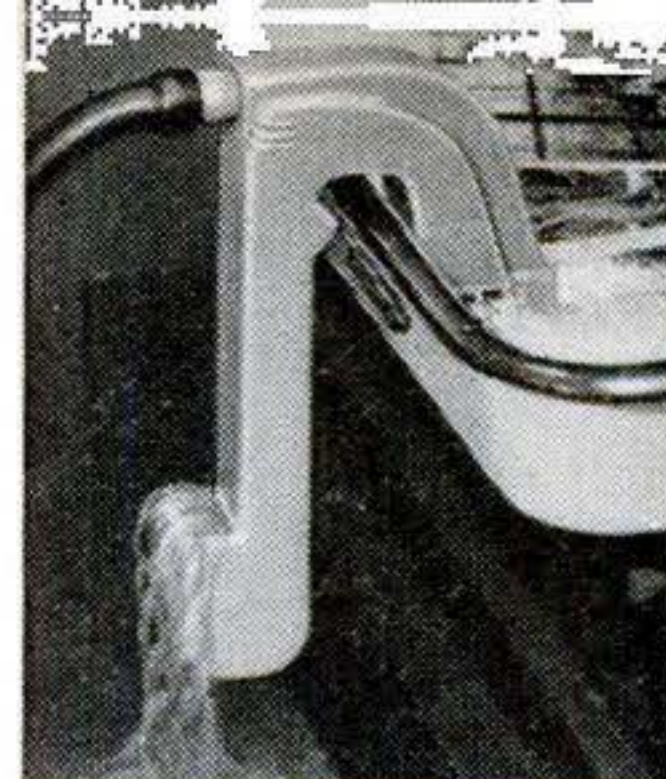

Converts ordinary tray into effective washer—Kodak Automatic Tray Siphon. Washes prints and films automatically. Hypo-laden water is siphoned out as fresh water enters. \$4.50.



Kodacraft Roll-Film Tank (left) is easy to load, pour; holds 16 oz. of solution. After loading, it can be used in lighted room. Includes aprons for 620-120, 616-116, and 127 films. \$2.53. **Kodacraft Miniature Roll-Film Tank (right)** permits simultaneous development of two rolls of 35 mm. film or Bantam-size film (828). \$2.53.



A Safelight that adjusts quickly—Kodak Adjustable Safelight Lamp (left) has double-swiveled shank and bracket. \$7.40. **The new Kodak 2-Way Safelamp (right)** provides either direct or indirect illumination—or both. For light in two directions, simply take out removable metal panel in back and replace with a safelight filter. \$4.50.

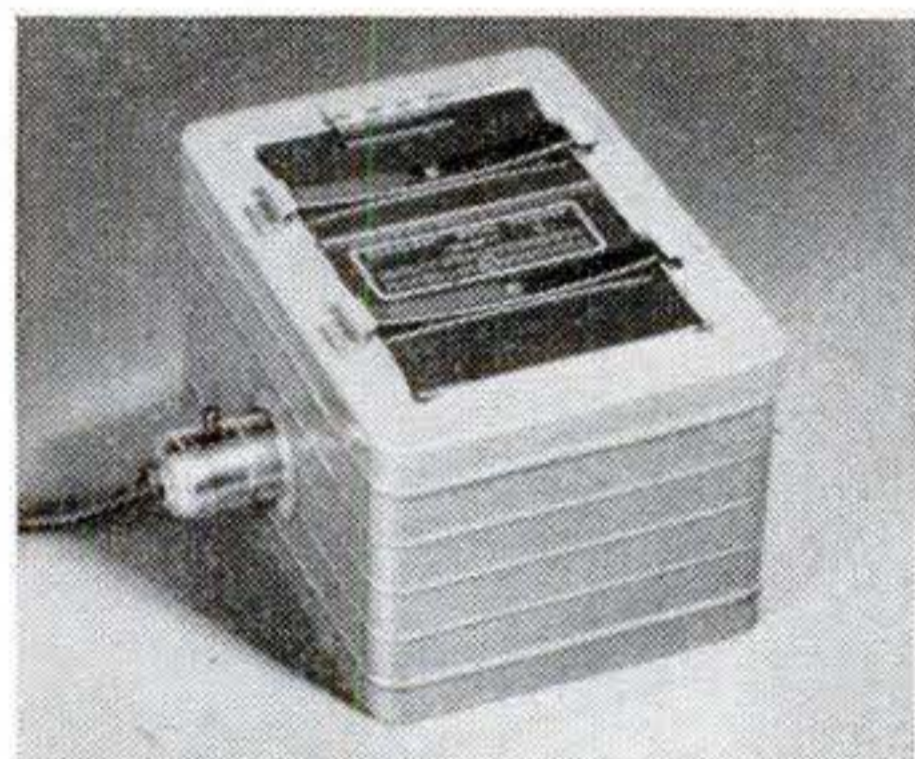
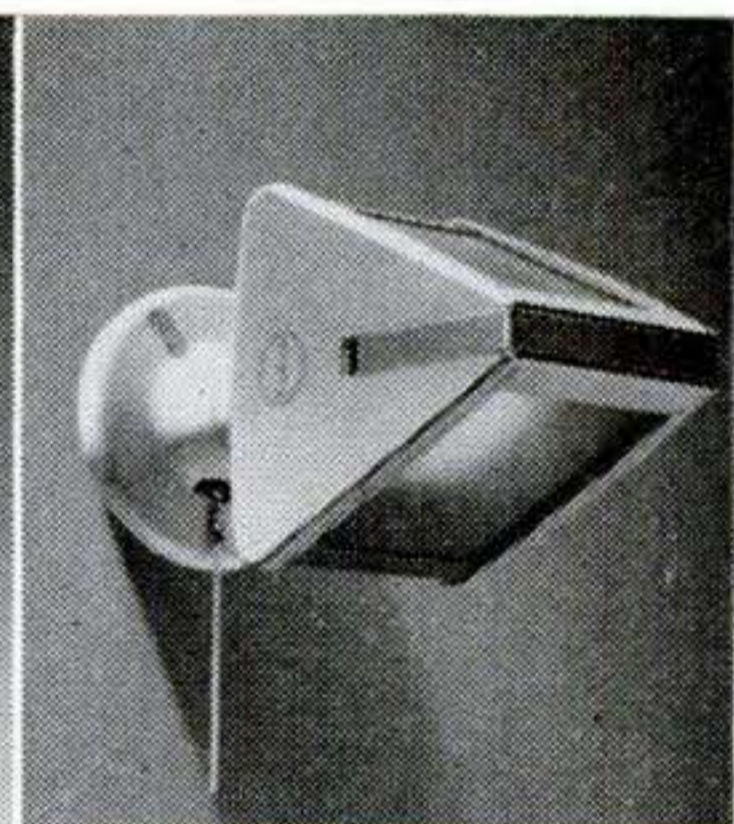

Kodacraft Metal Printer, Model A—accepts negatives from 35mm. up to 4 x 6 inches. Metal construction with hinged platen. An easy-to-follow folder of instructions is supplied. \$6.95.



For timing contact and projection printing — Kodak Electric Time Control. The printer or enlarger plugs into the control. Automatic timing 1 to 57 seconds. Repeat timing possible. \$13.50.



Spring-wound Kodak Timer—covers all intervals up to 60 minutes, has both minute and split-second hands. Tilting base permits adjustment to any angle. \$7.20.

Your Kodak dealer will be glad to demonstrate this equipment for you. Make his store your headquarters for all your photo needs.

Prices subject to change without notice

EASTMAN KODAK COMPANY, ROCHESTER 4, N. Y.

Kodak
TRADE-MARK

started the engine. As the tow truck eased back out of the way it revealed a state police car also parked crosswise of the entrance.

Sgt. Jerry Corcoran was standing in front of it with his right hand resting firmly on the butt of his gun.

"Okay, you fellows," ordered Jerry, "might as well make it easy for all of us. Slide out of the car with your hands in back of your heads."

Gus Gives Stan the Inside Dope

At that moment, two more state cops appeared from behind the tow truck and had handcuffs on the startled pair before they knew what was happening.

"Thanks a million, Gus," said Jerry, after he'd herded the handcuffed pair into their own car with a trooper at the wheel and another in the back seat. Then he climbed into the police car and started the engine.

"What gives with the carnival guys?" asked Stan as he and Gus watched the two-car caravan pull away. "Fleece a local yokel at the last stand?"

"Nothing as simple as that," said Gus. "That car of theirs has more built-in secret compartments than a Chinese puzzle chest."

"Jewel smugglers?"

"Dope peddlers."

"Then they weren't really carnival men at all."

Pitchmen Put Up a Good Front

"Sure they were. They've been using that as a front to sell dope to local peddlers around the country. That car of theirs is a rolling narcotics warehouse."

"Gosh, how did you spot it?"

"Well, if the trouble hadn't been in the ignition I probably wouldn't have stumbled on it. In checking it over on the first go-around, it seemed as if everything was over-size—the battery, the oil cleaner, even the coil. Incidentally, the trouble was in the distributor."

"What was it?"

"You know that small carbon brush in the center terminal of the distributor cap that serves as the contact for the spring on top of the rotor?"

Stan nodded.

"Well, it had cracked and a piece of it had dropped down into the breaker-arm assembly. It was shorting out the breaker arm,

and keeping the breaker points from closing, too."

"What was suspicious about that?"

"Nothing. But after I dislodged the piece and began replacing the broken brush with a new one, the coil caught my eye. I noticed that it seemed higher than most. I twisted the top and it came off in my hands. The outer shell was a very neat dummy. Inside was a standard coil and wedged in around it were dozens of tiny white paper packets."

"And that's when you decided to road-test the car," put in Stan.

Gus Helps Smash a Syndicate

"Right. I wanted Jerry and the boys at the barracks to back me up. The paper packets contained dope, all right—'uncut heroin' they said—and a concealed drawer at the back end of the battery case was filled with marijuana. What the narcotics boys'll find when they really go to work on it is anybody's guess."

"Nice haul for Jerry," said Stan.

"Oh, both the state and the federal boys knew that some syndicate was doing a fast job of distributing dope around the country, but they didn't know about this car. Now they think there might be more than one, part of a big network run by some mechanically minded guy who thought up this gimmick of stashing the dope away in car parts rather than under the seats and in built-in compartments cops are wise to."

Sometimes It Pays to Play Dumb

"But wouldn't any wise mechanic like you catch on?"

"They probably have their own garage where they go for repairs, most likely the same place where the changes are made. Fortunately, the mechanic, whoever he is, cracked that distributor brush." Gus grinned. "And maybe you noticed I played kind of dumb."

"You sure did. Maybe you ought to be in show business yourself." END

Next month: Gus goes hunting for trouble.

Tipsy Tip

A GUY went into a bar and ordered three buckets of beer for his horse, hitched outside. Bartender says, "All that beer for the horse? How about you?" "Not me," says the guy, "I'm driving."
—Clues.

"Does
5 ^{KINDS} OF JOBS
Well!"

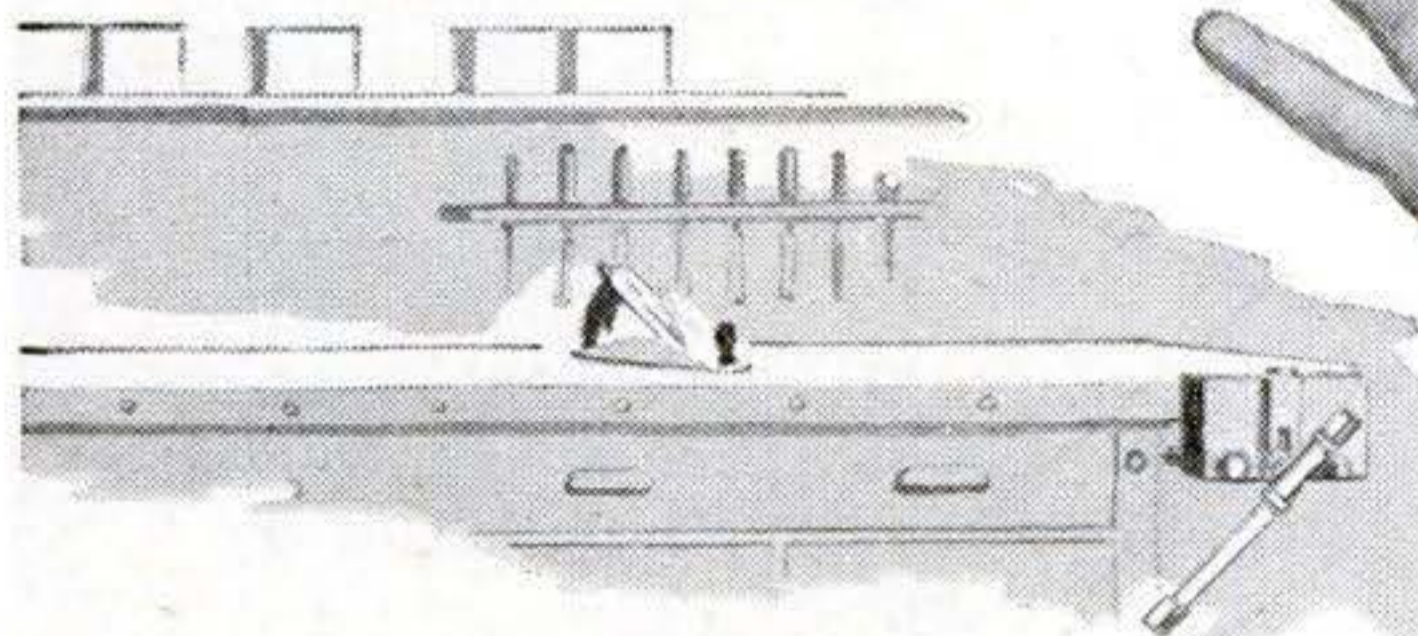

Buy a plier that's
sure to be "the HIT of Your Kit"

The SARGENT PARALLEL-ACTION PLIER!

(The Mechanical Hand)

What a plier! Actually *three* tools in *one* . . . plier, wrench, and wire cutter.

You'll quickly discover this Sargent to be the most useful tool you've ever had for jobs around the house.

Look what it does:

1. Grips like a vise

. . . compound leverage multiplies power along entire length of the parallel jaws.

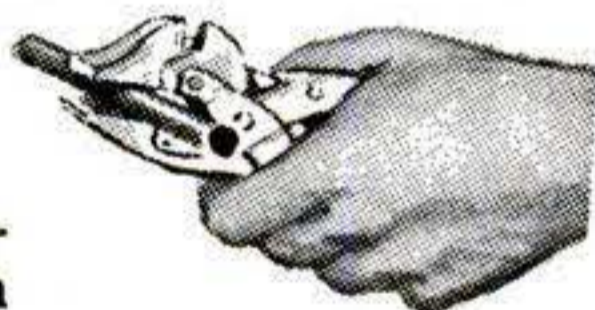

2. Cuts wire easily

. . . outside cutters cut wire even when it tightly hugs a flat surface.

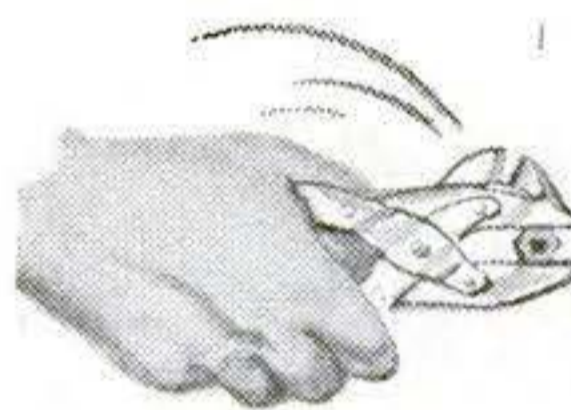

3. Holds nuts like a wrench

. . . powerful parallel jaws and extra leverage prevent rounding corners.

4. Gets into tight spots

. . . and gets you out of them. Small nose permits probing in close quarters.

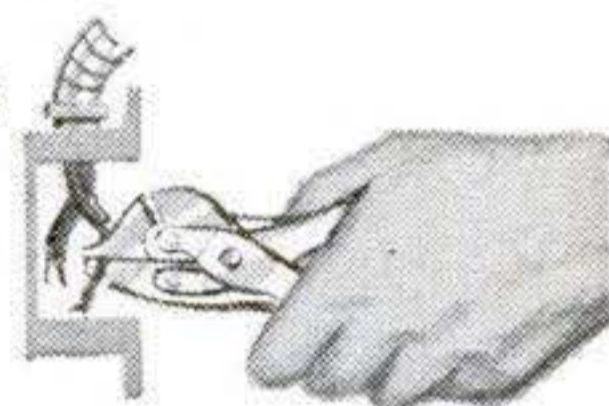

5. Unkinks wire

. . . open throat permits running the wire between jaws, from either end, to straighten or pull it.



Go to your hardware dealer . . . get your hands on one of these sturdy, all-purpose tools. You'll never let it go . . . especially when you hear

For further details, write Dept. 26 K!

its price. You'll be delighted with your low-cost investment in a high-grade plier. Available in 4½", 5½", 6½" and 8" lengths.

Sargent and Company, New York • NEW HAVEN, CONN. • Chicago

Builders Hardware and Fine Tools since 1864

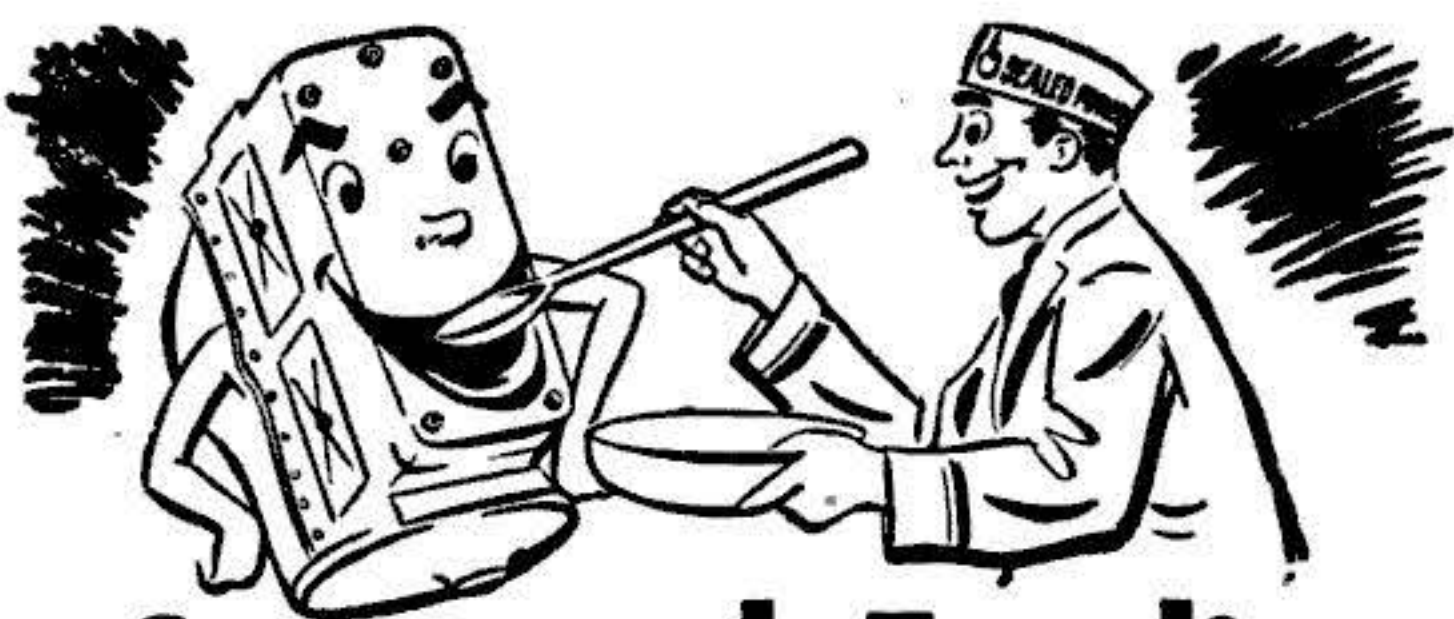

Care and Feeding of Engines

BY S. P. CORP

THE CASE OF THE SLOW WINDSHIELD WIPER

Most cars have a windshield wiper booster pump mounted on the fuel pump. Any time your wiper operates at less than 80 strokes per minute, check this

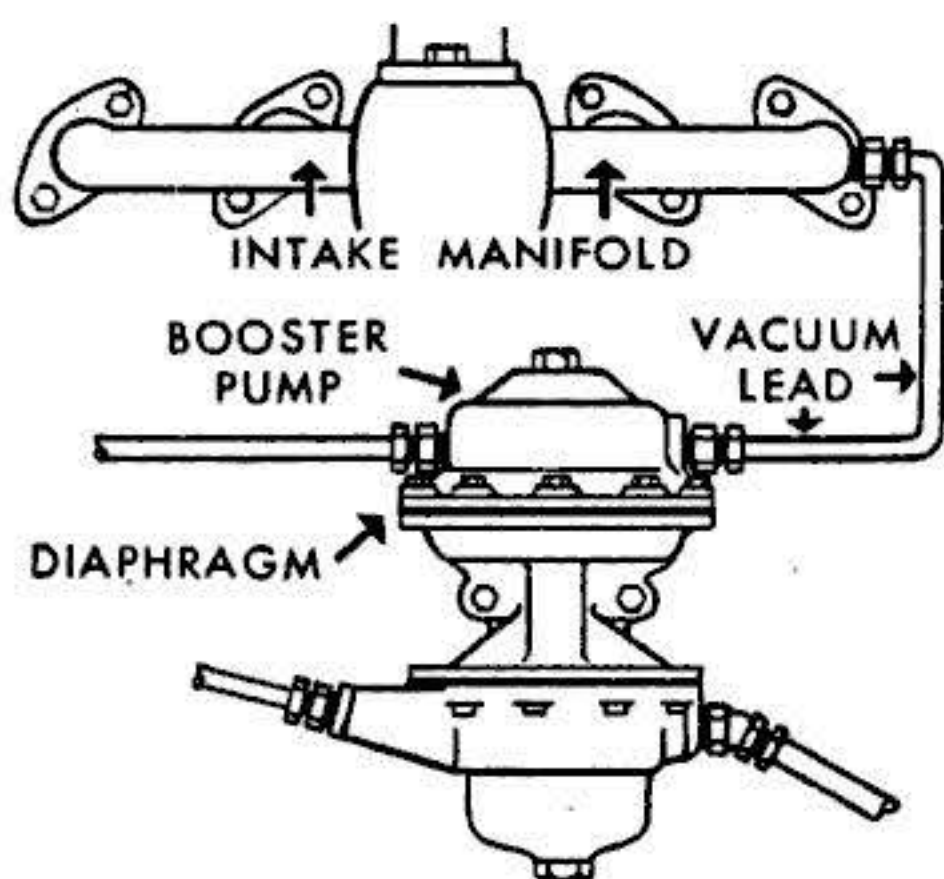

booster pump for trouble—because such trouble can affect engine operation.

For example, an air leak in the vacuum line (see arrows) will cause a lean mixture at the end of the intake manifold, making the engine miss when idling. Such a leak, if neglected, will cause sluggish-

ness in the valves of the end cylinder, eventually burning the valve seats.

Remove vacuum line at intake manifold. Plug the hole in the manifold and run the engine. If engine idles smoothly (when it missed before) the trouble is in booster pump or vacuum line. If there is any trace of oil in the line, your booster pump needs a new diaphragm—because a cracked or damaged diaphragm has been causing oil waste. The oil you see has been sucked up from the crankcase and delivered to the intake manifold, to be burned with fuel.

If your windshield wiper seems slow, at any engine speed, check the booster pump!

TEST SHOCK ABSORBERS

Shock absorber trouble can cause hard steering, pitching on turns, and hard riding. Check each corner by trying to bounce the car, holding the end of a bumper. If it bounces several times before coming to rest, the shock absorbers need attention. To remove, take off upper and lower holding nuts from rubber bushing on studs. Lock lower end of absorber in a vise, and pump up and down full length of travel. If it sticks at any point, or is hard to pull, it should be replaced. If there is no resistance, valves are leaky and it should be replaced. Normally, there should be more resistance in extending than in compressing.

NEW FREE BOOK ON CAR CARE

Send for your free copy of the new illustrated booklet, "MORE POWER, Less Oil, Less Gas" which tells you how to keep your car running better. It also tells you all about Sealed Power KromeX Ring Sets, engineered especially to fight heat, friction, abrasion, and corrosion in late-model cars and trucks. Sealed Power Corporation, Dept. H-10, Muskegon, Michigan.

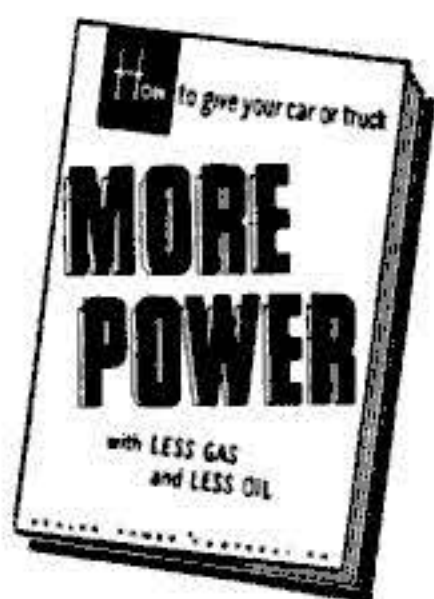

Week-End Railroad

[Continued from page 165]

were laid on ballast of cinders or crushed limestone. The road now has more than half a mile of main line with equal trackage in sidings, industrial spurs and yards.

Most of the rolling stock has been built from scratch. Even the trucks for the freight cars were built at the shop of a machinist member, from WF&P patterns and castings.

Crowds Forced Passenger Service

The small fry around St. Louis soon heard about the road. Nowadays 200 to 300 passengers are carried on a Sunday. Each one gets a printed ticket, properly punched by the conductor, and everybody obeys the rules. No tickets are sold, but a contribution box is handy for those who wish to pay. Rigid safety rules prevent accidents.

Bug-eyed youngsters bitten by railroad zeal beg to be taken on as crew members, and those who qualify are given the high privilege of working up to trainmen and conductors. The WF&P weeds out the true railroaders through the simple process of putting the beginners at track work.

Over the years the emigration of members has built up a class of alumni scattered about the country, so that the WF&P now has "general agents" stationed at San Luis Obispo, Calif., Amory, Miss., Evanston, Ill., Baton Rouge, La., Green Bay, Wis., and Mexico City. Some of the alumni commute to St. Louis several times a year to keep their hands in. Currently the most remote member is an airman in Korea.

The president, Joseph L. Christen, is an official of the Pullman Co. at Chicago. Others active in the management include two research chemists, a machinist, two engineers, an embroidery manufacturer, a travel agent and a college instructor.

The WF&P intends to go right on expanding and meeting all schedules every Sunday. All it asks of the public is that nobody refer to it as cute. END

Milk Express

WHEN the 4:15 local from Squeedunk suddenly stopped in the middle of its run, the conductor reassured the passengers: "Just a cow on the tracks."

A few miles farther on, the train squealed to a halt again. Explained the harassed conductor, "We caught up with that cow again."

For preparing
new
surfaces



smoothing seams
and
joints



removing old paint



refinishing furniture

4 EXCLUSIVE
FEATURES



KING-SIZE BOTTOM PLATE
extends beyond body of tool
for sanding in very close
quarters.

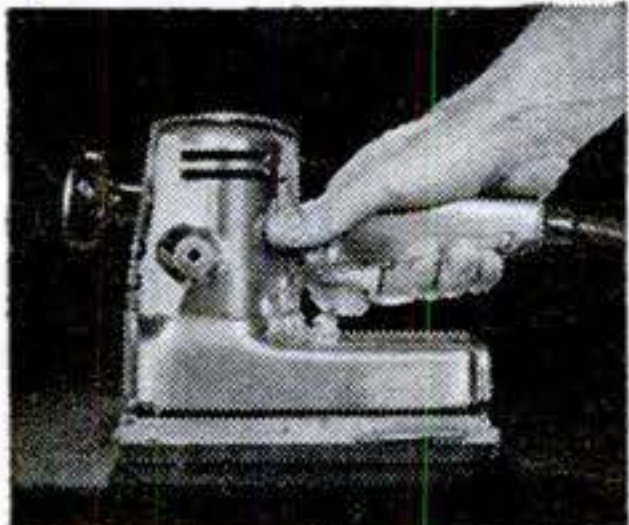

MODERN SWITCH HANDLE
is located close to housing for
better control, less operator
fatigue.



AUXILIARY KNOB HANDLE
gives choice of three positions
for ease in sanding close to
obstructions.



UNIQUE PAPER HOLDER
stays open when attaching or
detaching paper, frees both
hands for job.



NEW
Black & Decker
Utility
No. 44 SANDER
only \$46.95

- "Satin-Smooth" Finish, every time, in any direction, because tool produces small $\frac{3}{16}$ " orbit 4250 times per minute!
- Ten Times Faster than hand sanding on wood, metal, plastics, compositions!
- Light Weight, only 5½ lbs., easy to use . . . helps even beginner do professional jobs!

Black & Decker
UTILITY **PORTABLE**
TOOLS **ELECTRIC**
TOOLS



Bob Davis says:

"Take it from a guy who cut his eyeteeth on tools, this new B&D Utility No. 44 Sander is a top buy! It's smooth-running, gives a finish like satin and it's priced below tools of comparable quality! Just attach a $3\frac{1}{2}$ " x 9" sheet of abrasive paper; plug it in any electric outlet (A.C. or D.C.); and you're ready for the finest finish sanding — no final hand sanding needed! When you want a real tool, not a mere toy, pick the brand the experts choose . . . BLACK & DECKER!"



WRITE FOR FREE BOOK!
Packed with helpful, money-saving hints on home jobs!
Send to: Home Service Dept.
H10S, THE BLACK & DECKER
MFG. Co., Towson 4, Md.

Name.....

Address.....

City & State.....

Good starting trio



Starting a home workshop—for hobby-crafting, household fix-ups, or developing your skill as a professional mechanic? Here are three basic files you really need. Smart move for a good initial assortment of file types and cuts!

1. **MILL FILE** — For smooth-finishing metal and tool sharpening. Popular lengths, 8" and 10".
2. **SLIM TAPER** — Slender triangular file for saw sharpening and general filing in corners of 60° angle and wider. Popular lengths, 6" and 7".
3. **FOUR-IN-HAND File-Rasp** — Four different cutting surfaces! One side flat, other side half round. Half of each side file cut, other half rasp cut. For flat or curved surfaces of wood, brass, lead, etc. Popular length, 8".

Don't consider anything less than Nicholson or Black Diamond brand—the world's finest file quality. *At good hardware stores.*

FREE 48-page illustrated book, "File Philosophy," on kinds, use and care of files. Write for it.



NICHOLSON FILE COMPANY
19 Acorn Street, Providence 1, R. I.
(In Canada, Port Hope, Ont.)



NICHOLSON FILES FOR EVERY PURPOSE

How to Choose Your Trees

[Continued from page 170]

whole idea of growing fruit trees at home.

Among flowering trees, the experts' favorite is the Crab Apple, with nine varieties suggested. Says a middle-western horticulturist: "There is practically an unlimited selection of flowers, fruits and leaves."

Chief rival of the Crabs among flowering trees is dogwood, a popular favorite since George Washington's time. Some experts consider it the best native ornamental tree in the northern United States. Not only does dogwood have beautiful flowers, but also handsome summer leaves, berries and red foliage in the fall. "Fit for a palace or a rural setting" is the way one New England horticulturist describes it.

In the South the traditional evergreen Southern Magnolia is highly thought of not only for its flowers, but also for shade, screening, windbreak and its general appearance on the grounds. It's even recommended for planting along the seashore.

Pecans Lead the Nut Parade

Pecans lead all the nut trees by a big margin. The fastest growing of the hickories, the pecan not only has thin-shelled nuts, but makes a fine shade tree where it's hardy. Its only rival among the nut trees is the giant Black Walnut—the tree Grandma's commode was made out of—but the Black Walnut is pretty big to have near a house. And it has to be kept away from other trees since its roots give off a poisonous substance that kills many other kinds of plants if they get too close.

A favorite shade tree with nurserymen—and one that looks like a comer—is the Sweet Gum. It has fine fall color. A comparatively new tree for home use is the Thornless Honey Locust, being actively pushed as a replacement for the disease-ridden elm. This tree not only stands up well under city conditions, but grass flourishes under it.

The shade that it casts is just dense enough to keep the hot summer sun from burning the sod.

The experts scattered their shots widely in suggesting trees to avoid, but some names showed up repeatedly. Most of them are fast-growing trees that lack the strength of their slower fellows, and are weak-branched, or easily uprooted, or short-lived, or susceptible to blights and insects.

The poplars lead the unpopularity con-

[Continued on page 252]

There is a difference in sealed-beam headlamps

...and this
is it →

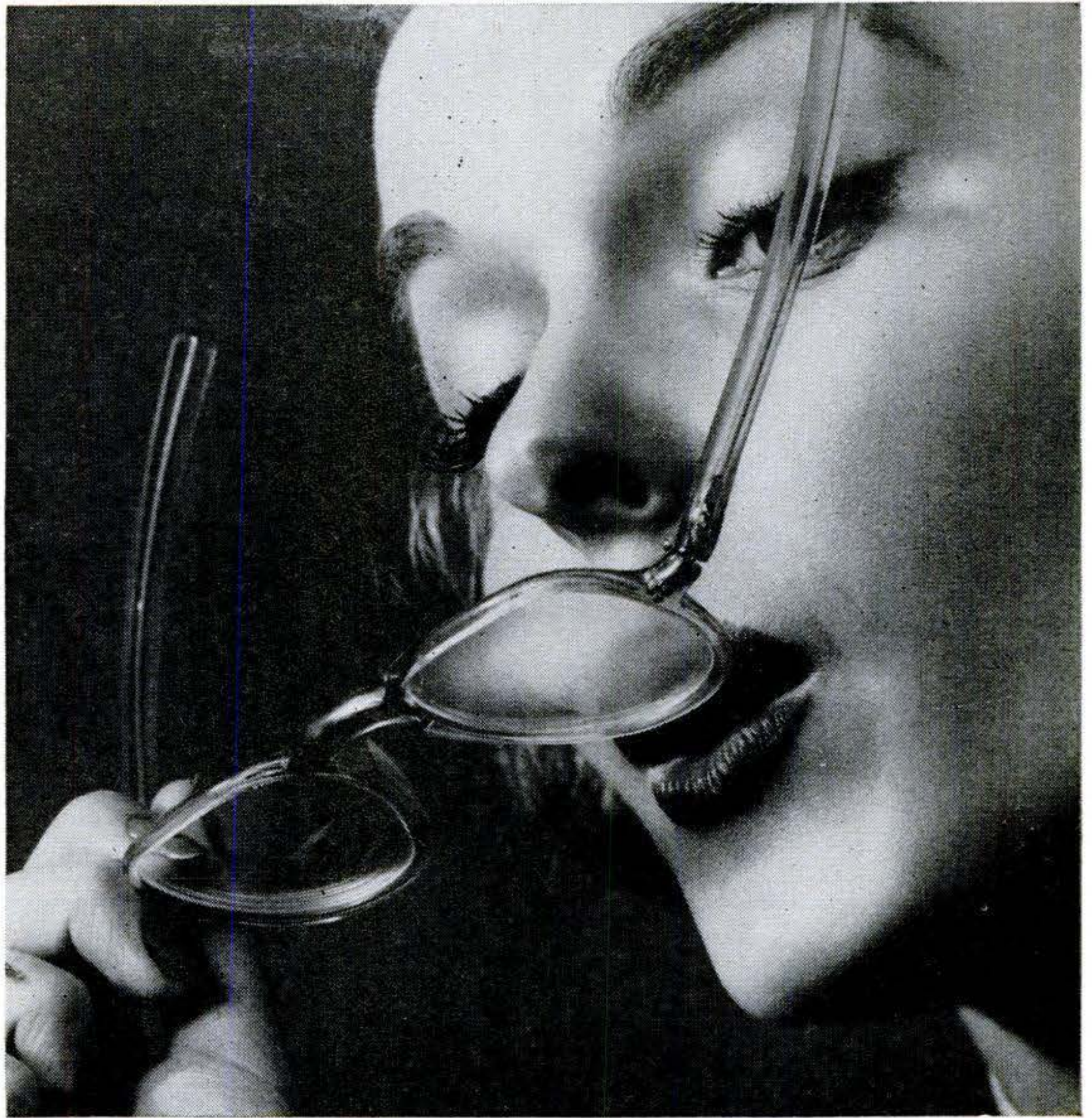

All-Glass sealed-beam headlamps do not grow dim

One-piece All-Glass construction. Dirt and moisture can't get in.

Filaments held in vise-like grip. Can't shake loose.

Mirror-like, built-in reflector. Stays bright.

Rugged, hard-glass precision lens to put light where you want it.

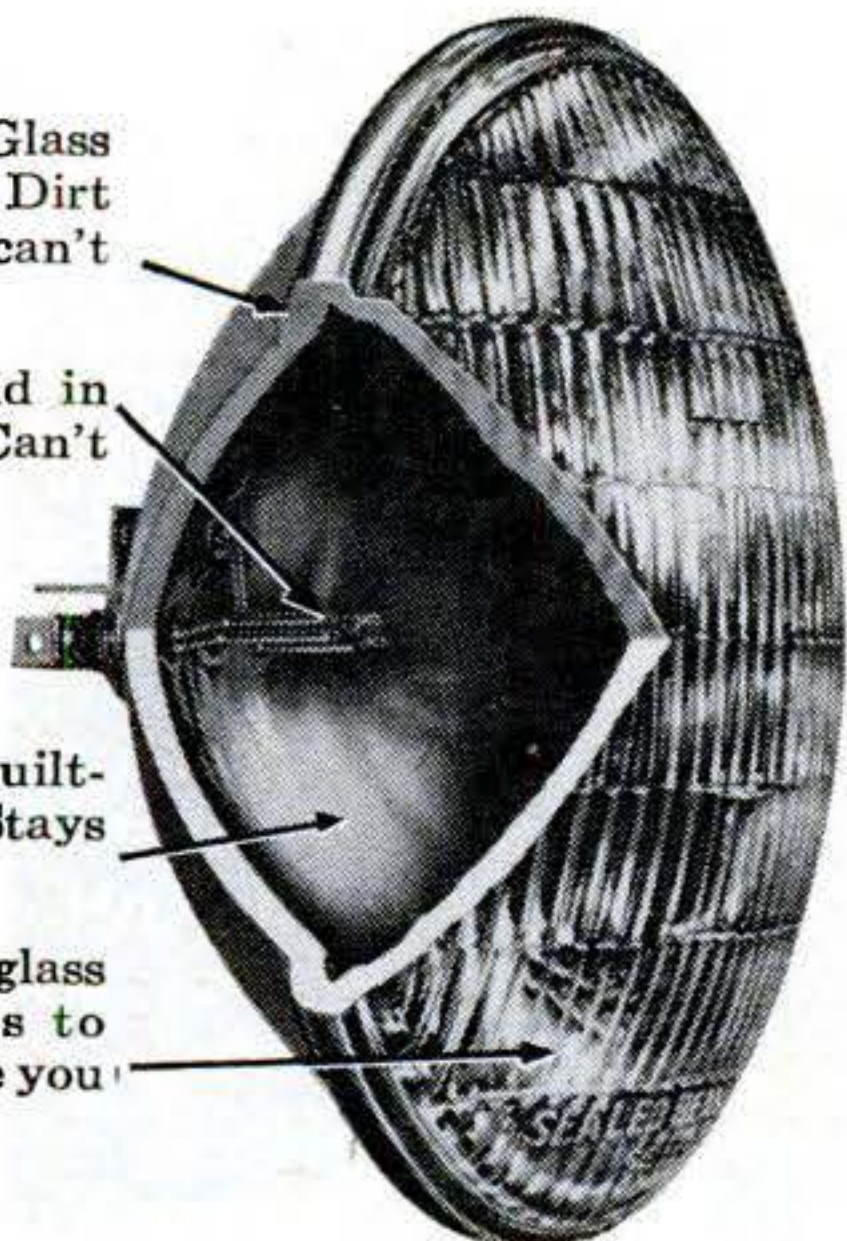

WHEN YOU BLOW ON YOUR GLASSES, moisture condenses on the lens. When moist air gets inside some types of sealed-beam headlamps, the same thing happens. It condenses on lens and reflector. And as the water deteriorates the reflector, the lamp grows dimmer.

Moisture *can't* get into General Electric sealed-beam headlamps because they're All-Glass and all one big bulb. Tests show they average 99% as much light after years of use as when new. To drive and enjoy it—knowing you can see safely—get General Electric All-Glass headlamps.

You can put your confidence in—

GENERAL  ELECTRIC

OCTOBER 1952 251

How to Choose Your Trees

[Continued from page 250]

test for these reasons, even though nursery-men sometimes recommend them for screens and windbreaks because of their quick growth—as much as 21 feet in two years.

But the poplars have some friends on the Great Plains, where they are among the few trees that will endure drought and wind. Another is the Box Elder, which is also avoided by horticulturists in other sections because of its weak structure and poor appearance. It also brings a host of brightly colored little bugs that swarm up the nearest house to lay their eggs inside.

Trees for the City

Some trees are useful only where conditions are so bad that other trees do not survive. The Catalpa will grow in the heart of cities, for example, but it's a weed tree elsewhere. So is the rugged Tree of Heaven, which spreads at the drop of a seed pod, but has vile-smelling flowers. The Ginkgo, most nearly disease-resistant of all our common trees, and able to endure city conditions, is unpopular with some because its fruit has an unpleasant smell when crushed.

The seashore, with sandy soil and flying spray, presents its own problems. Live Oaks are the favorite in the South. Willows and birches are often mentioned elsewhere. The common kinds of pine, like the Jack Pine, are also suitable for seashore planting.

The experts all emphasize that it's pretty hard to pick the best *single* tree for any use. Even when you narrow down to trees suited to your own property with its special climate and soil, you'll still have a choice to make—and your answer will depend on your personal likes and dislikes.

So use the chart as a general guide to start you finding the tree you want among the 3,000 available. But when you come to your final choices, consult people who are familiar with your neighborhood.—*Hartley E. Howe.*

Lucky Guy

Wife: "I've made my husband a millionaire."
Friend: "What was he before you married him?"
Wife: "A multimillionaire."



SAVE YOUR CAR—IT MAY HAVE TO LAST A LONG TIME

Mechanics agree that most engine wear occurs because oil drains into the crankcase during stops. This gives acids a chance to attack unprotected metal and is the cause of DRY STARTING which wears out engines . . . leads to costly repairs.

To prevent "Engine Ulcers," use Miracle Power in gas and

oil. Miracle Power contains colloidal synthetic graphite in suspension. This graphite clings to metal . . . holds oil . . . lubricates parts even if oil is absent . . . protects them against DRY STARTING and acid etching. And you save gas and oil because better lubricated parts waste less power.

Try Miracle Power next time you get gas.

Miracle Power Division

THE AP PARTS CORPORATION
860 AP BUILDING, Toledo 1, Ohio

THE AP PARTS CORPORATION

860 AP Building, Toledo 1, Ohio

Enclosed find \$_____ for which please send me *postpaid*:

_____ trial cans of Miracle Power at 75c each (1 for gas, 1 for oil)

Please send me free literature on making my car last longer.

Name _____

Address _____

City _____ Zone _____ State _____

At gas stations, garages, Kaiser-Frazer, Ford and other car dealers or use this coupon for introductory offer.

YOU CAN WIN A "SUGGESTION BOX" BONUS

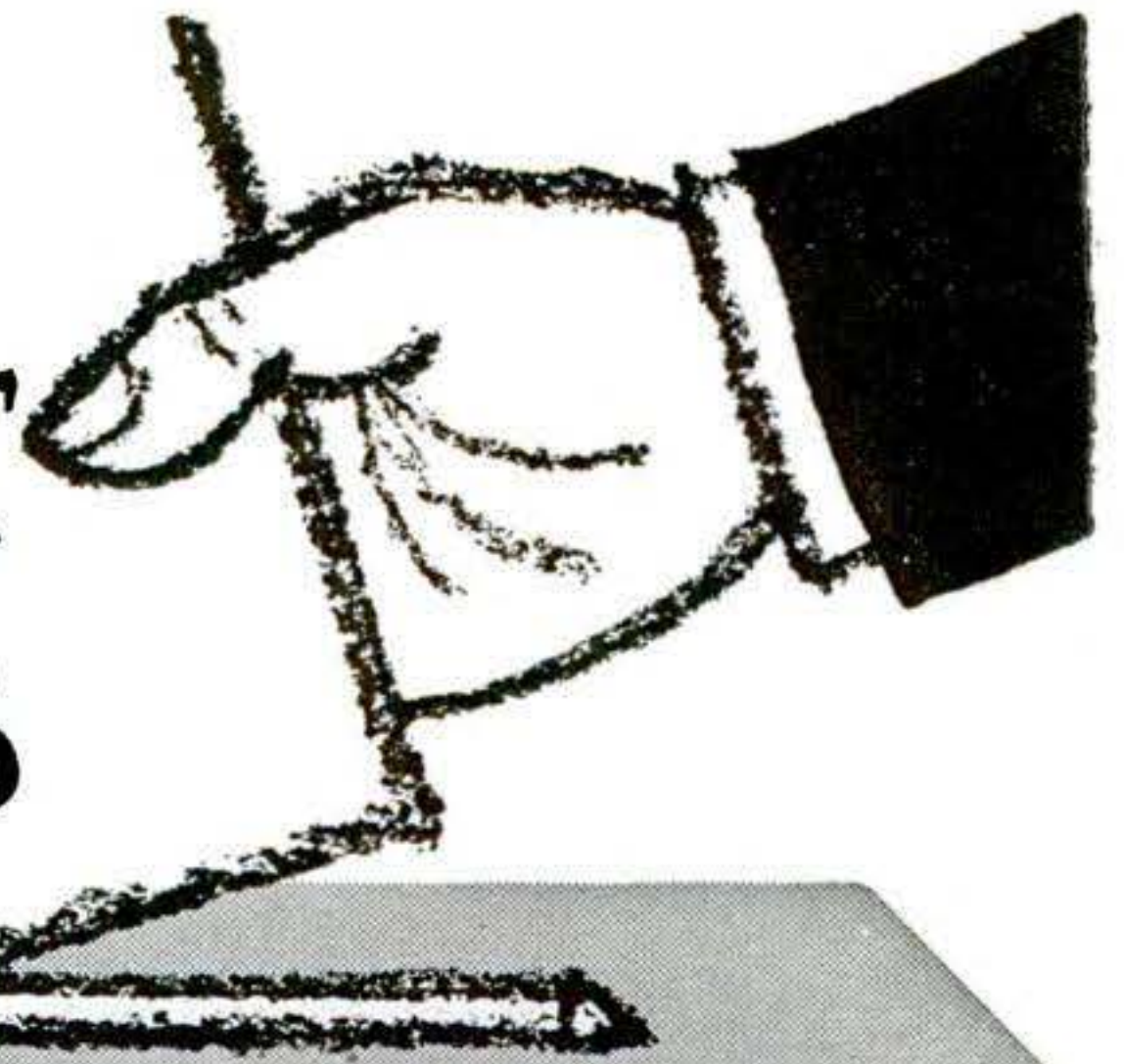

"Company pays \$1200 for cost-cutting idea!"
"Employee wins \$350 for suggestion!" Ever wonder how *you* can cash in on *your* company's suggestion system? Check these Bostitch case histories. There may be an idea here for *you* — and *your* company.

BUSINESS: Cabinetmaker
SUGGESTION: Fasten bottoms and sides of small chests with Bostitch foot-powered stapling machine and $\frac{3}{8}$ " staples.
RESULTS: Five times faster than old method of nailing. Stapling more secure. Workers like it better.

BUSINESS: Gasoline Pump Manufacturer
SUGGESTION: Instead of solder, use $\frac{3}{8}$ " staples to fasten No. 8 mesh on foot valve bottom of pump.
RESULTS: Production jumped from 20 an hour by soldering to 90 an hour with Bostitch.

BUSINESS: Tile Contractor
SUGGESTION: Instead of nailing metal lath to wood studs and joists, use Bostitch hammers and tackers.
RESULTS: One man can now lath 4 bathrooms in $2\frac{1}{2}$ hours compared to 5 hours the old way.

BUSINESS: Garage Door Manufacturer
SUGGESTION: Metal stitch aluminum panels together with Bostitch wire stitcher. Old method: drill and screw.
RESULTS: Plant turns out 500 doors a day as against 50 before. Stitcher and special table jigs for positioning panels save space, material.

BUSINESS: Vacuum Cleaner Manufacturer
SUGGESTION: To fasten metal discs inside fiber cylinders, use Bostitch metal stitcher instead of punching holes and riveting.
RESULTS: Manufacturer saved \$6250 the first year.

BUSINESS: Frozen Food Locker
SUGGESTION: Replace cellophane tape with Bostitch desk-type stapler for fastening ends of frozen food packages.
RESULTS: Labor and material costs cut 50%. Bostitch method gives tight, permanent seal. Unlike tape, will not loosen at low temperatures.

TO HELP YOU find ways to apply Bostitch savings to *your* business, send for the 16-page illustrated booklet, "Time and Money-Saving Case Histories." It's *free*—and full of cost-cutting ideas!



BOSTITCH 530 Mechanic Street, Westerly, R. I.

Please send me a free copy of the Bostitch book of case histories.

Name _____

Address _____

City _____ State _____

Company _____ Position _____

Starrett

FRICITION THIMBLE* MICROMETERS

Give You

- UNIFORM PRESSURE
- UNIFORM READINGS

Every Time



Starrett
Satin Chrome
Micrometer
No. 231-F
Range 0-1" by
.0001",
shown above.
Friction Thimbles
also available in
other sizes and styles.

*An improved friction stop mechanism built right into the thimble permits easy, one-hand operation — insures uniform contact pressure for every measurement. You get the same sure accuracy every time . . . plus 12 other big Starrett features including Satin Chrome Finish, Tapered Frame, Hardened Threads ground from the solid and stabilized and Hi-Micro Mirror-Lapped Finish on contact faces. See it at your Starrett Tool Distributor's.

SEND FOR IT — ONLY 10¢
Starrett "Tools and Rules" Book shows the right tools for any measuring job. 50 pages, 100 pictures, helpful reference tables. Address Dept. PS



THE L. S. STARRETT COMPANY · ATHOL, MASS., U.S.A.



MECHANICS' HAND MEASURING TOOLS AND PRECISION INSTRUMENTS
DIAL INDICATORS • STEEL TAPES • PRECISION GROUND FLAT STOCK
HACKSAWS, BAND SAWS and BAND KNIVES

254 POPULAR SCIENCE

Crane That Saves \$2,000 a Minute

[Continued from page 147]

For a minute he looked right through me. "I've only seen it happen once," he said at last, "and that was a long time ago. We had a good crane engineer—all of them are. Generally they can sense the strain of a load, but that time there was no warning. The strands let go so fast he had only one chance. That was to flop on his face and wait for the cable to stop lashing around the cab. The wrecker was a shambles when the drum finally stopped spinning. But by some miracle he was never even touched.

"No, we don't worry too much about the cables. But there is always the chance of a load shifting, or coming free sooner than you expect. That's why we seldom depend on those ice-tong-like clamps you see hanging from the ends of the car. We may anchor them to the rails to lift the light stuff, but when we have a tough assignment, we count 100 percent on the outriggers.

Wrecking Crew Skilled Unit

By now I was beginning to suspect that the judgment of a wrecking boss was worth as much as the half-million dollars spent on the machine. Tracy modestly denied it, but paid high tribute to his crew.

"I've got 12 men," he said. "Crane operators, cutting-torch experts and skilled car repairmen. They can put a railroad back in business faster than all the financial wizards on Wall Street. Some of them don't look like much when you see them working around the rip track or the Diesel engine house, which is where they draw their regular pay. But when the car-shop whistle gives with its four long blasts—that's our signal to go into action—they come running like a bunch of minutemen. Or two-thousand-dollar minutemen, you might say. They never beef when you ask them to do the impossible. All they ask for, in return, is good food when they are out on the road, and decent bunks when they can grab a bit of shut-eye. And, when they're not on duty—well, I never knew a crane operator yet whose hobby, believe it or not, wasn't fishing!"

END

Things Are Tough All Over

Mr. Gotrocks: "I feel like a million dollars today."

Mrs. Gotrocks: "Why so depressed, dear?"



THE MOST

Versatile **TOOL**

ON YOUR BENCH!

CHANNELLOCK PLIERS

Made only by CHAMPION DEARMENT

In almost any job you can think of—Pliers are necessary—and Channellock pliers are the best you can buy. Whether you are working on your car, electrical repairs, plumbing work or just tightening nuts and bolts Channellock pliers do it better.

And remember, Only Champion DeArment makes Channellock—More than 3/4 of a Century of experience in producing highest quality tools. Send for Catalog 14, —today.

CHAMPION DEARMENT TOOL CO.
Meadville, Pa.

Channellock pliers are listed in the Yellow Pages of most Telephone Directories

under "Tools"

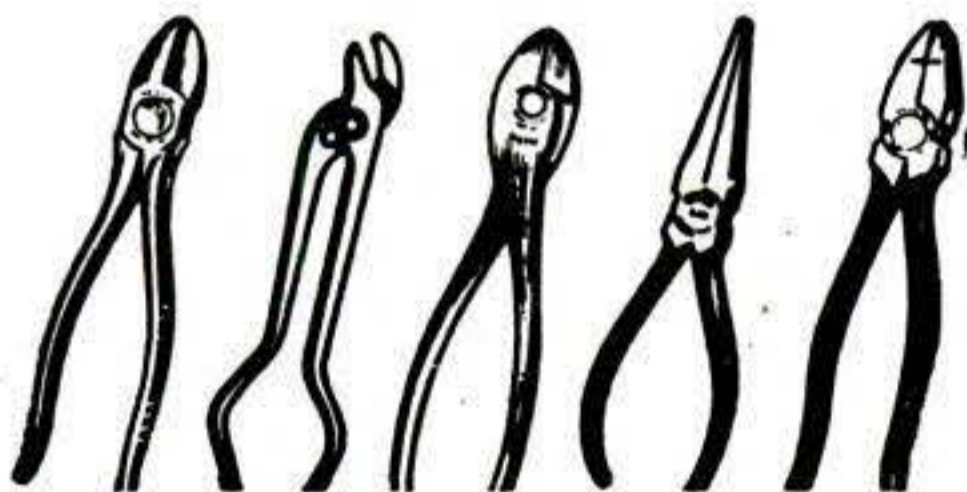

ONLY Champion DeArment makes

CHAN NEL LOCK

TRADE MARK REG.

U. S. PATENT OFFICE



BETTER LIVING

... at new low cost!

Join thousands of happy, worry-free and rent-free New Moon owners. Move to top paying jobs, enjoy travel and vacation fun — a home completely furnished and ready to live-in, including kitchen, bath and automatic heating system. Own a New Moon on our rent-like payment plan and enjoy all the comfort and advantages of genuine home ownership at once. **Free!** Write today for literature describing the complete line of New Moon apartment homes.

Member of



REDMAN TRAILER CO.
38 BRIDGE ST., ALMA, MICH.

send for **FREE CATALOG**



America's Foremost *money-making* **MECHANICS' TOOLS**

It's easy to own the same "pay-off" tools used and endorsed by America's top-earning mechanics throughout the automotive, aviation and industrial fields! Snap-on tools help you handle every repair job faster, easier, better. And they LAST... pay for themselves over and over again! Start building your own tool set now with basic Snap-on units—add others any time. Genuine Snap-on tools are never sold in stores—direct to users only. Mail coupon for free catalog.



SNAP-ON TOOLS CORPORATION

8060-J 28th Ave., Kenosha, Wisconsin

Send me free catalog of Snap-on tools.

Name _____

Address _____

City _____ Zone _____ State _____

OCTOBER 1952 255

include his hands, gnarled by arthritis, in his portrait.

"But they are part of your character, part of your greatness," urged Karsh. "Generations of theatergoers have delighted in the expressiveness of those hands. Let me try."

With his lights, Karsh put the hands in shadow. Even the actor conceded that the picture was a triumph.

He works for 10 minutes at a stretch, then gives his subject a rest. A sitting may require an hour. It may take all day. He refuses to commit himself to more than two sittings a day, and he prefers to work before noon. A subject scheduled for an afternoon sitting may have had a cocktail at lunch.

"It shows in the eyes," says Karsh.

He Does His Own Developing

Karsh appointments are hard to come by and, once obtained, are seldom broken. Jeannette McDonald did fail to keep a Karsh date in Hollywood—and hurriedly dispatched flowers to Madame Karsh in expiation of her sin.

Off the studio is the darkroom. Karsh does

all his own developing. He develops by inspection—alternately dipping his film in the developer and holding it up to his safelight to mark his progress. He dislikes color film because developing it is purely mechanical.

When Karsh has done an outstanding picture, it becomes, in shop parlance, "The Churchill" or "The Sibelius" or "The Eisenhower." Such negatives are kept in a vault at a branch of the Bank of Nova Scotia.

In a little more than 10 years Karsh has photographed most of the famous men of the Western world. King George VI sat for him. So have Queen Elizabeth and her consort. All those pictures of the royal pair released for publication when they visited Canada and the United States last year as the Princess and the Duke of Edinburgh were by Karsh. Harry Truman, Bernard Baruch and even Vyacheslav Molotov have been Karsh subjects. Karsh has tried several times to make an appointment with Stalin.

"I once got as high as three commissars just under Stalin," he reports hopefully.

Karsh has even been reproduced on

[Continued on page 258]

UNCLE WALTER

IT SMELLS GRAND



AROMA PROMISING SWEET RELEASE

IT PACKS RIGHT

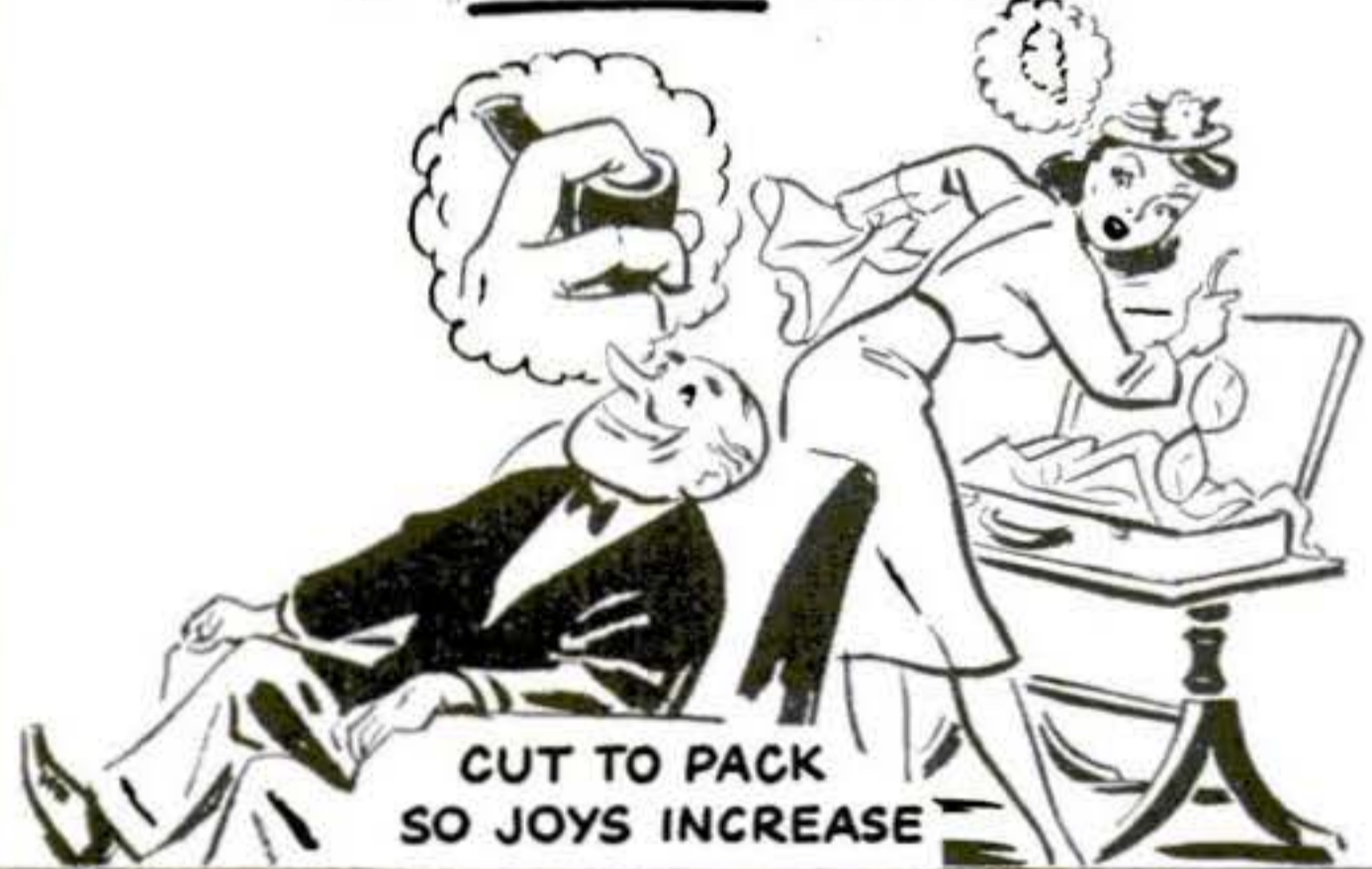

CUT TO PACK
SO JOYS INCREASE

IT SMOKES SWEET



MAKES EVERY PIPE
A PIPE OF PEACE!

IT CAN'T BITE!

SIR WALTER RALEIGH'S BLEND OF CHOICE KENTUCKY BURLEYS IS EXTRA-AGED TO GUARD AGAINST TONGUE BITE. STAYS LIT TO THE LAST PUFF. AND NEVER LEAVES A SOGGY HEEL IN YOUR PIPE.

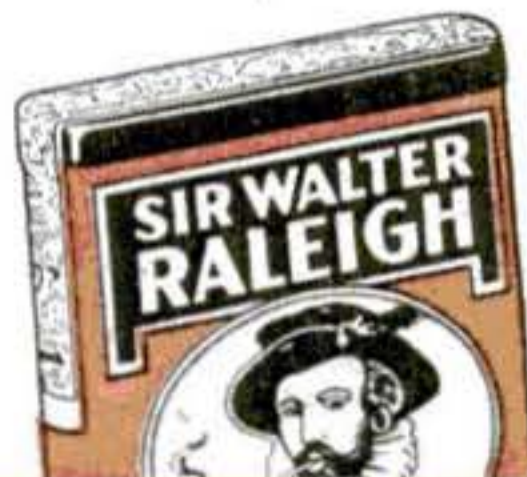

*It costs
no more
to get
the best!*

TAKE LESS THAN 1 MINUTE TO

Keep Paint Brushes
Like **NEW!**

Store Them Dry.
They Stay Soft
and Flexible
**READY FOR
INSTANT USE!**

PROCESS 33

INSTANT PAINT BRUSH CLEANER

- Quickly cleans fresh paint from a paint brush or roller.
- You can paint instantly with another color—or store brush dry—it will stay soft.
- Economical—can be used again and again.
- Safe for all brushes and rollers.

Pint 59¢ Quart 98¢ G. N. COUGHLAN CO.
WEST ORANGE, N. J.

Wherever Paint is Sold

CHOOSE FROM PROFESSIONAL QUALITY

WESTCRAFT TOOLS

AT WESTERN AUTO

LESTO Electric HAND SAW

NO OTHER DOES

SO MUCH

SO FAST

SO WELL

WITH PLANETARY GEAR

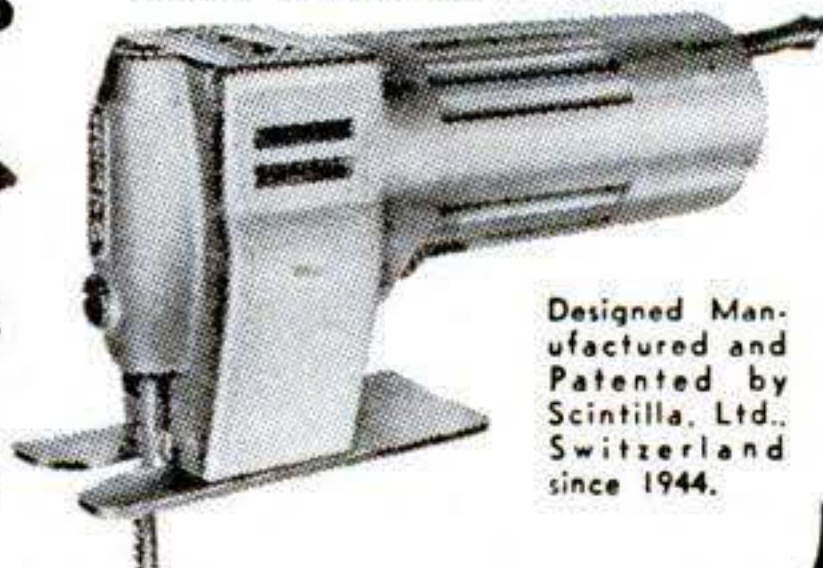

Designed Man-
ufactured and
Patented by
Scintilla, Ltd.,
Switzerland
since 1944.

At Last — a rip, scroll, band, jig, crosscut, coping, and keyhole saw — all in one. Quick, easy, ideal for curves and fanciest shapes. Cuts inside holes without drilling starting hole. Users say there's nothing to equal it on wood, sheet metal, bone, plastics, hard rubber, cement sheets, pressed wood, etc. For factory, home workshop, carpenters, decorators, etc.

FREE
Illustrated Litera-
ture. Write for
Yours Today.

Sold & Serviced in Principal Cities
Throughout U.S.A.

VICTOR J. KRIEG, Inc.

Sole U.S. Representative
for Scintilla, Ltd. Switzerland
51 West 52nd St., New York 19, N. Y.

New Tools from Millers Falls

Most Versatile Power Tool You Can Buy

Sand, polish, drill, grind, wax, wire brush, mix paints — you can do them all with this powerful new 6-inch Millers Falls No. 966. And it's the only rotary sander-polisher that can be equipped with an orbital attachment for fine finishing.



A Rugged Husky for Tough Cutting

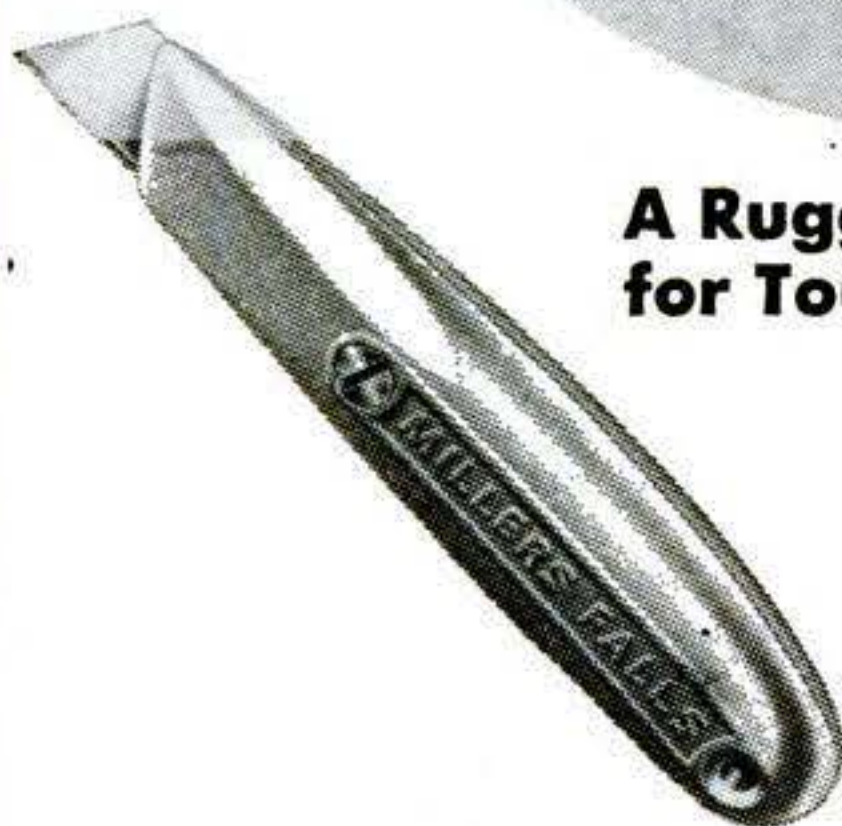

Razor sharp — with large, palm-fitting handle that lets you really bear down, this new No. 333 Utility Knife belongs in every tool kit. Unexcelled for heavy cutting in wood, linoleum, leather, cardboard, etc. Complete with 5 blades.

Biggest Saw Value on the Market

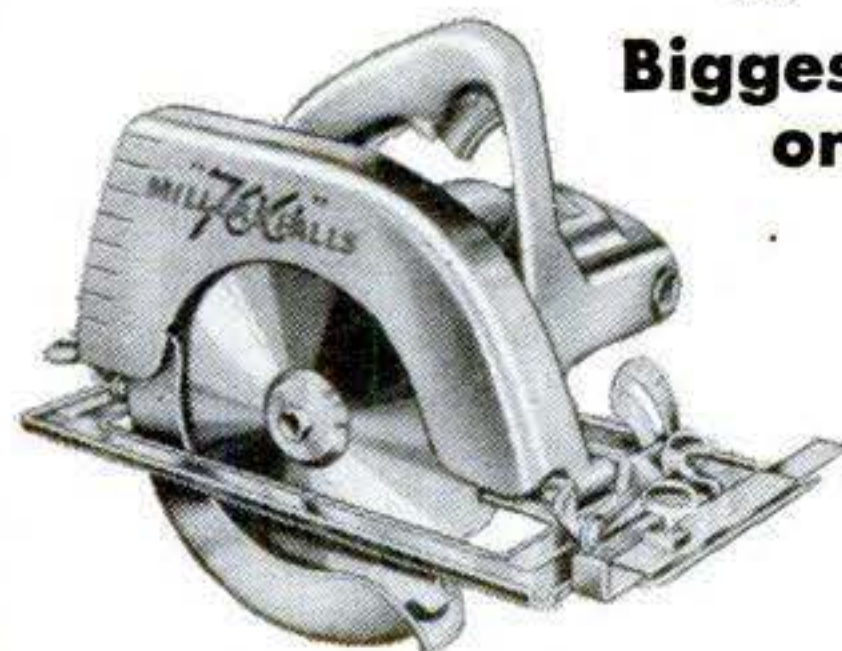

Big enough to cut finished 2x4's at 45° mitre, yet weighing only 11 lbs., this new 7-inch Millers Falls No. 700 packs a full 1/2 h.p. wallop. It's sturdily built, compact, safe to use. Easy to handle and control—with all the capacity you need for practically any sawing job.

See these great new Millers Falls tools at your hardware dealer's soon. They'll save you time and work on countless jobs — and they're priced to give you top value for your dollar in every way.

Millers Falls Company, Greenfield, Mass.

MILLERS FALLS TOOLS

SINCE
1868

The Mark of Superiority

OCTOBER 1952 257

A Leaky



A heater cannot warm your car comfortably when a dirty, damaged or over-age thermostat prevents the engine from warming up properly. A faulty thermostat can also cause the engine to over-heat and boil away anti-freeze, wasting gas and oil.

Remedy this wasteful condition by getting your service man to check the motor thermostat. And if a new one is needed —

Replace with
Autostat®
 motor
 thermostat
 by Fulton Sylphon

For faster starts and faster warm-ups, more miles per gallon, more comfort per mile. Save oil and reduce maintenance costs. Types to fit every make and model.



In home, industry, and transportation,
EVERYTHING'S UNDER CONTROL

Robertshaw-Fulton
 CONTROLS COMPANY

FULTON SYLPHON DIVISION
 KNOXVILLE, TENN.

BRIDGEPORT THERMOSTAT DIVISION
 BRIDGEPORT, CONN.



How Karsh Pictures Celebrities

[Continued from page 256]

stamps. It was a Mackenzie King Karsh that appeared on a Canadian stamp and a Harlan Stone Karsh on a U. S. stamp.

"I have an insatiable appetite for giants," he has said.

What distinguishes a Karsh from other photographs is something that perhaps Karsh himself could not explain adequately. Critics mention only bits and pieces of his art. One said Karsh has an instinct for composition, but that doesn't adequately describe Karsh.

The Equipment He Uses

He uses the customary equipment—spotlights and floodlights, one 4" by 5" and one 8" by 10" view camera with Ektar lenses of different focal lengths, plus two reflex cameras, one loaded with color and one with black-and-white. Occasionally he uses a 35-millimeter camera when he wants to take pictures "discreetly." The reflex cameras are mostly for outdoor work such as the multiple portrait of a city—Vancouver, B. C.—on which he has recently worked.

For indoor portraits he uses a diaphragm opening of f/11 or f/16 and a shutter speed of about a tenth of a second. His film is Super XX.

For portraits of the face, Karsh is addicted to dark monochrome backgrounds. Now and then he will use a prop. An upthrusting of pencils appears unobtrusively in the lower-right-hand corner of a portrait of Henry Luce. He photographed Admiral William Leahy against a map, Charles Evans Hughes against a leaded glass window and Madame Chiang Kai-shek against an ornate Chinese screen.

That's as much as anyone knows about the Karsh technique. Now and then a little light is thrown on the gentle mystery of his thinking. In a telephone conversation he will remark: "I need some radar atmosphere. This man is a modest person, and I need to show his real stature."

Industrial Pictures, Too

Lately Karsh has branched out into industrial photography. He doesn't want to be typed as a portraitist. But, inevitably, because he is fascinated by the human countenance, his pictures of factory interiors have workmen's faces in the foreground. They are fine faces, reflecting the dignity of hu-

[Continued on page 260]



Piston Rings wear out, too

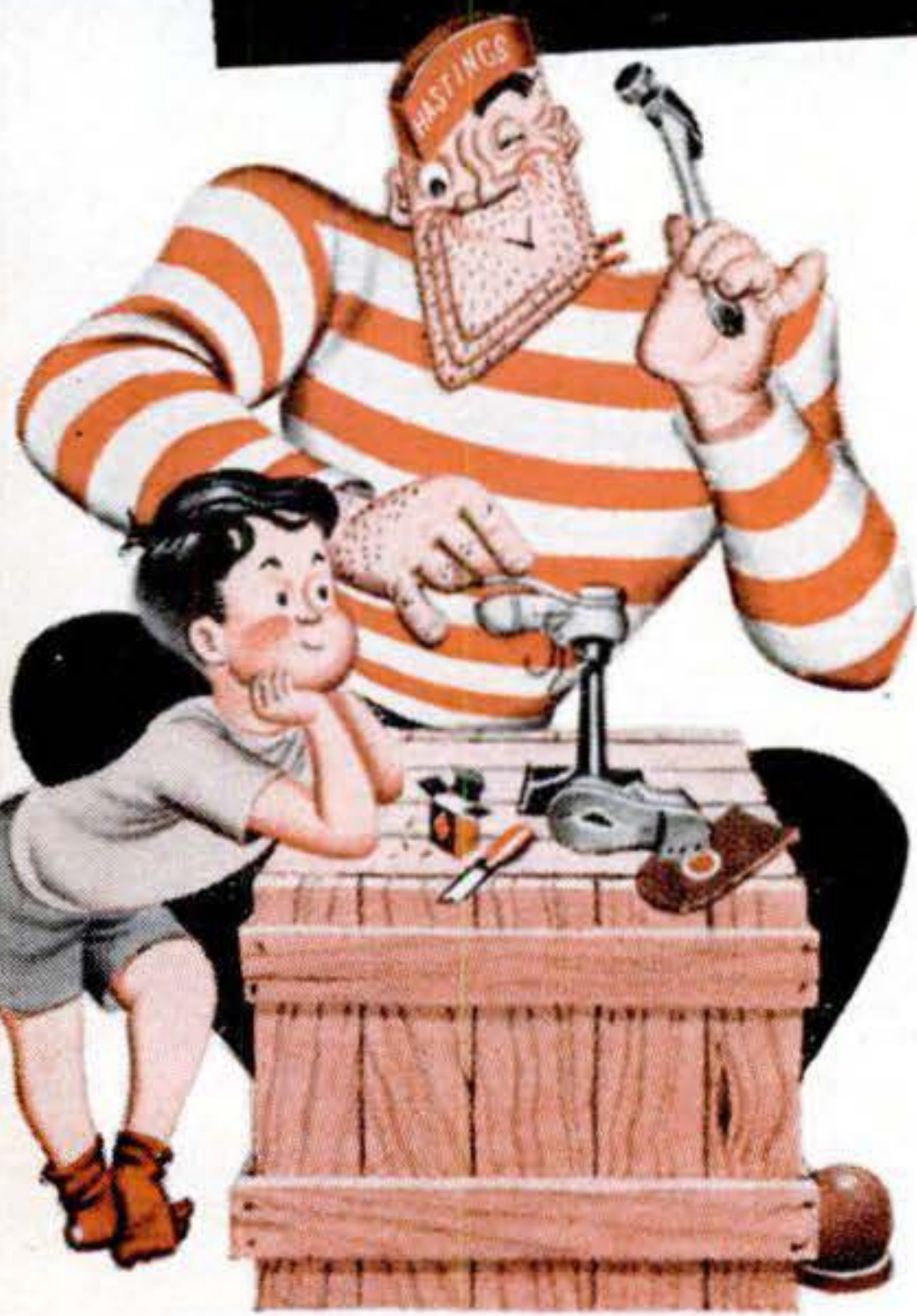

TOUGH..but oh so gentle !

TOUGH on oil-pumping
GENTLE on cylinder walls

And there's just one thing to do about worn-out piston rings—replace them! Fortunately, piston rings warn you when they begin to wear. You start using too much oil. Your engine begins losing power. The more you delay the more you'll pay.

Naturally you want the rings that are *tough* on oil-pumping, *gentle* on cylinder walls. You want the rings that will stretch out your engine's life. You want Hastings Piston Rings—the rings that are engineered exclusively for replacement service. They *stop* oil-pumping, *check* cylinder wear, *restore* engine performance—for a long, long time—and at surprisingly moderate cost. It's the best money you can spend on your car.

Play safe. Avoid a major overhaul later on. Go to your motor specialist and ask him for a piston ring check-up now.

HASTINGS MANUFACTURING CO., HASTINGS MICHIGAN; HASTINGS LTD., TORONTO
Makers of Piston Rings, Spark Plugs, Oil Filters, Casite, Drout

HASTINGS

MOTOR-ENGINEERED PISTON RINGS

Featuring Chrome for Heavy-Duty Service
IN PACKAGED SETS FOR CARS, TRUCKS, BUSES AND TRACTORS



Copyrighted material

Arc Welding

pays big with the new
Hobart



Hundreds of dollars
extra profit monthly
can be yours with this

← **LOW COST**
250 amp. (full size)
ARC WELDER

**HOBART ARC WELDERS
ARE SIMPLIFIED**

Be independent! Set up your own welding shop and start earning big money. With a Hobart "Simplified" Welder, that is easy to use—a welder that will let you go out after the big pay jobs for farmers, contractors, factories, builders, etc.

Hobart Welders are rugged, dependable, economical — let you handle all types of work — assure low cost, high quality welds. That's why they're used in America's leading production plants. Hobart Welders give you 1000 combinations of welding heat—let you make fine welding adjustments right at your work, without returning to machine. Auxiliary power outlet lets you operate lights, tools, etc. Available in gas and electric models, portable and stationary. **Check coupon for complete details.**

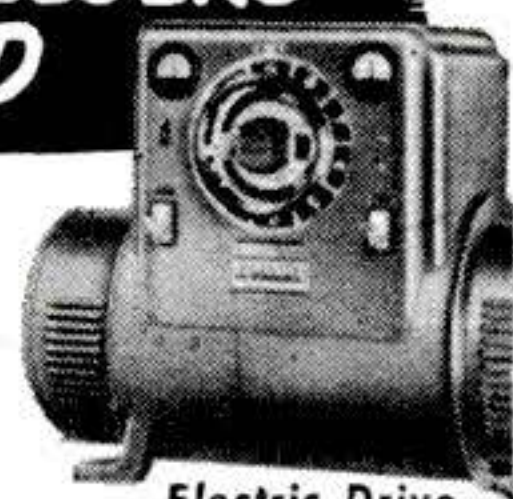

Electric Drive
DC Welder



Complete Text and Lessons Book. Covers all welding work. 544 pages, over 600 illus. **\$3.00**

Lessons Book. Complete operator's training course. 200 pages, fully illus. **\$1.00**

Practical Design. Hundreds of welding ideas in design form. 3 vols. 100 designs each. Single vol. . . . **\$3.50**
Set of 3 **\$10**

Learn QUICKLY at the Hobart school

Earn big money doing all kinds of welding work. Learn quickly, easily, at low cost in modern non-profit Hobart Trade School. Complete or partial courses. Best equipment, thorough training, experienced instructors.

Check coupon and MAIL TODAY!

HOBART BROTHERS CO., Box P-102, Troy, Ohio
"One of the world's largest builders of arc welders"

HOBART BROTHERS CO., Box P-102, TROY, OHIO
Send complete details on items checked.

Electric Drive Welders Gas Drive Welders
 Hobart Trade School
Send books checked Complete Text
Practical Design: Vol. 1 Vol. 2
 Vol. 3 Set of 3 Vols.
 Lessons Book Cash encl. C.O.D.

FREE new booklet "Guide to Better Welding"

NAME _____
ADDRESS _____
CITY _____ STATE _____

How Karsh Pictures Celebrities

[Continued from page 258]

man labor. The pictures have a heroic, mural-like quality.

The Karshes are not wealthy. They chose not to be. Early in their marriage they sat down and posed themselves the question: Shall it be fame or fortune?

"By fame," Karsh explains, "we meant recognition for my work."

For several years, inflation notwithstanding, he has charged \$350 for a portrait sitting, plus \$25 for a master print. Subsequent prints cost \$10 and up, depending on the work involved. Trips out of town are on a basis of the fee plus expenses. New York is not considered out of town.

Karsh could ask far more money, and get it. He won't bother. He and his wife have enough money to do with. That's all they want. In return, they have an independence that a straitjacket schedule, keyed to amassing money, could never give them.

He Just Says No

When Karsh wants to refuse a sitting, he simply says no. That's the end of it.

A lot of his earnings are dissipated in expenses. He dropped \$20,000 on one safari to Europe, undertaken without assignment for the sheer pleasure of finding some more important faces to photograph. His prodigality, as befits the man, is not all for his own fun. Given a substantial honorarium for his appearance at Kent State College, he turned it back to establish a photographic scholarship.

Karsh has no regrets for the way Madame Karsh and he decided to arrange their lives together.

"So long as a man lives," says Karsh of Ottawa, "he can alibi his mistakes. When he is dead, only his work speaks for him." **END**

OOH! What You Said . . .

THEY have been having tests of atom bombs and such things in the patient state of Nevada, and the following story has come out of the area which is used to taking a chance.

There was an Indian on one hill and an Indian on another hill and they were chatting to one another by means of smoke signals.

Pop went an atomic bomb, sending up its varicolored cloud blast into the bright desert sky.

"Gad," one of the Indians exclaimed, "I wish I'd said that."—*Hy Sheridan in Flying.*

YOU CAN'T DO A BAD PAINT JOB

with New Gold Bond Velvet!

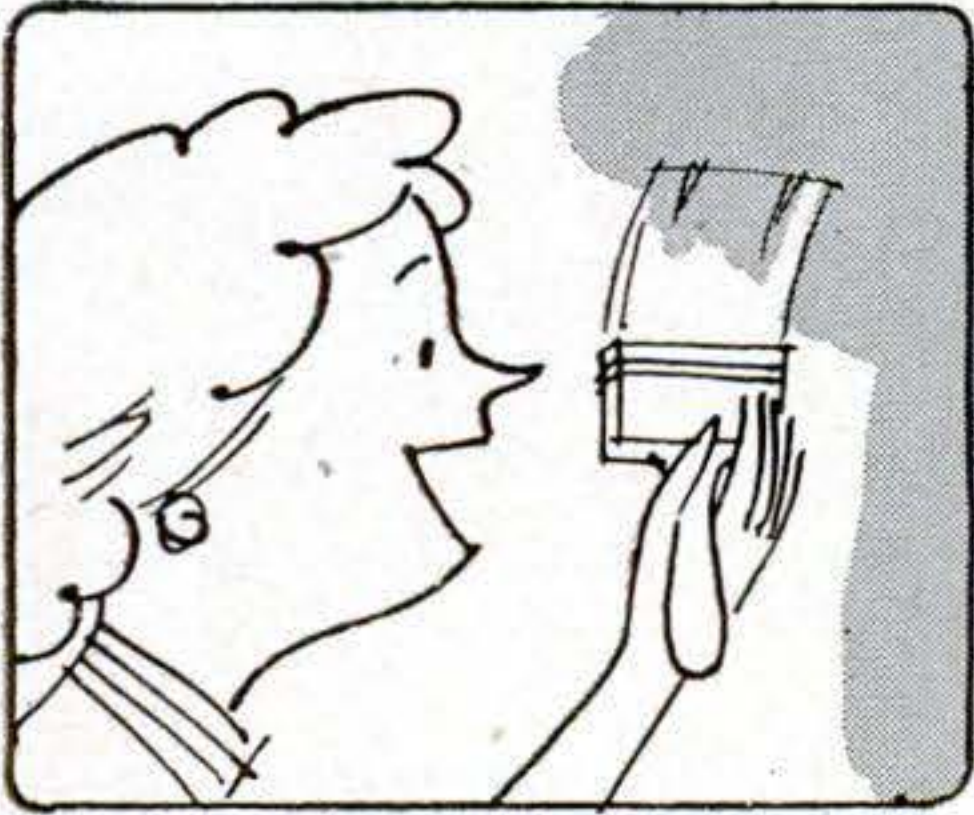

GOLD BOND VELVET is the easiest-going wall paint you ever used! Ready-to-use. No primer needed. Dries in minutes to a velvet smooth surface that won't crack, chip or peel.

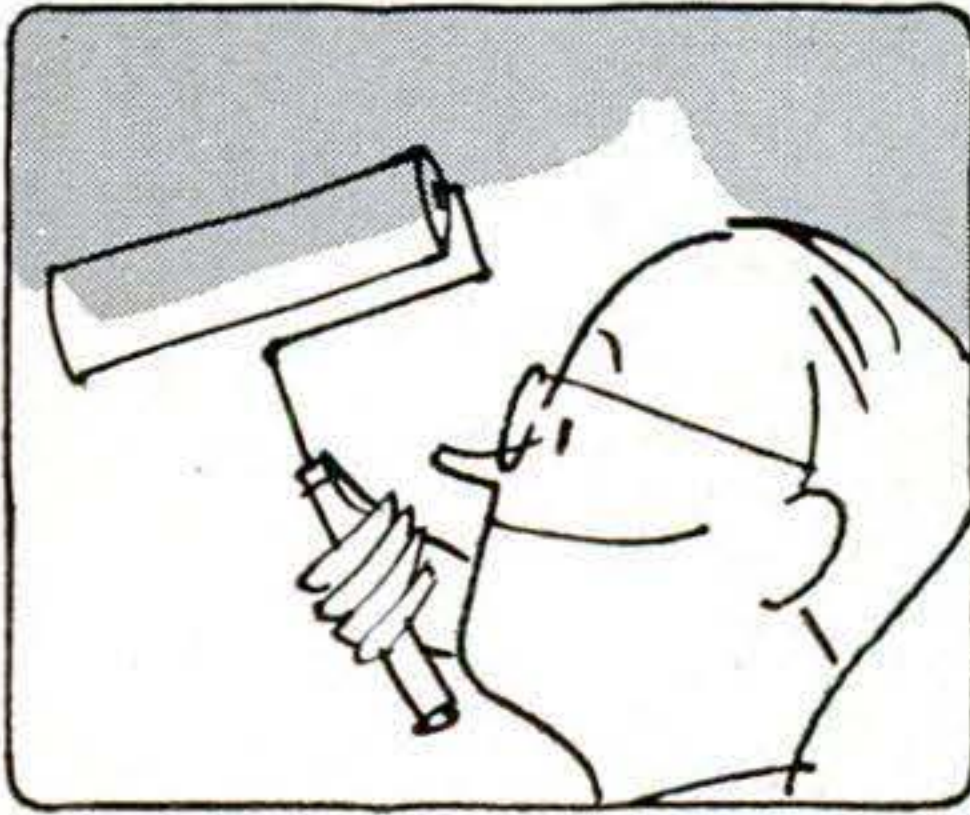

FLOWS ON! Just dip your roller or brush in odor-free Gold Bond Velvet and see how it goes on almost by itself! It eliminates what professional painters call "drag," which is so tiring.



WITH ORDINARY PAINT you have to guard against lap or brush marks, touch-up spots. No worry with Gold Bond Velvet! This latex-base paint blends perfectly... you can't do a bad job!

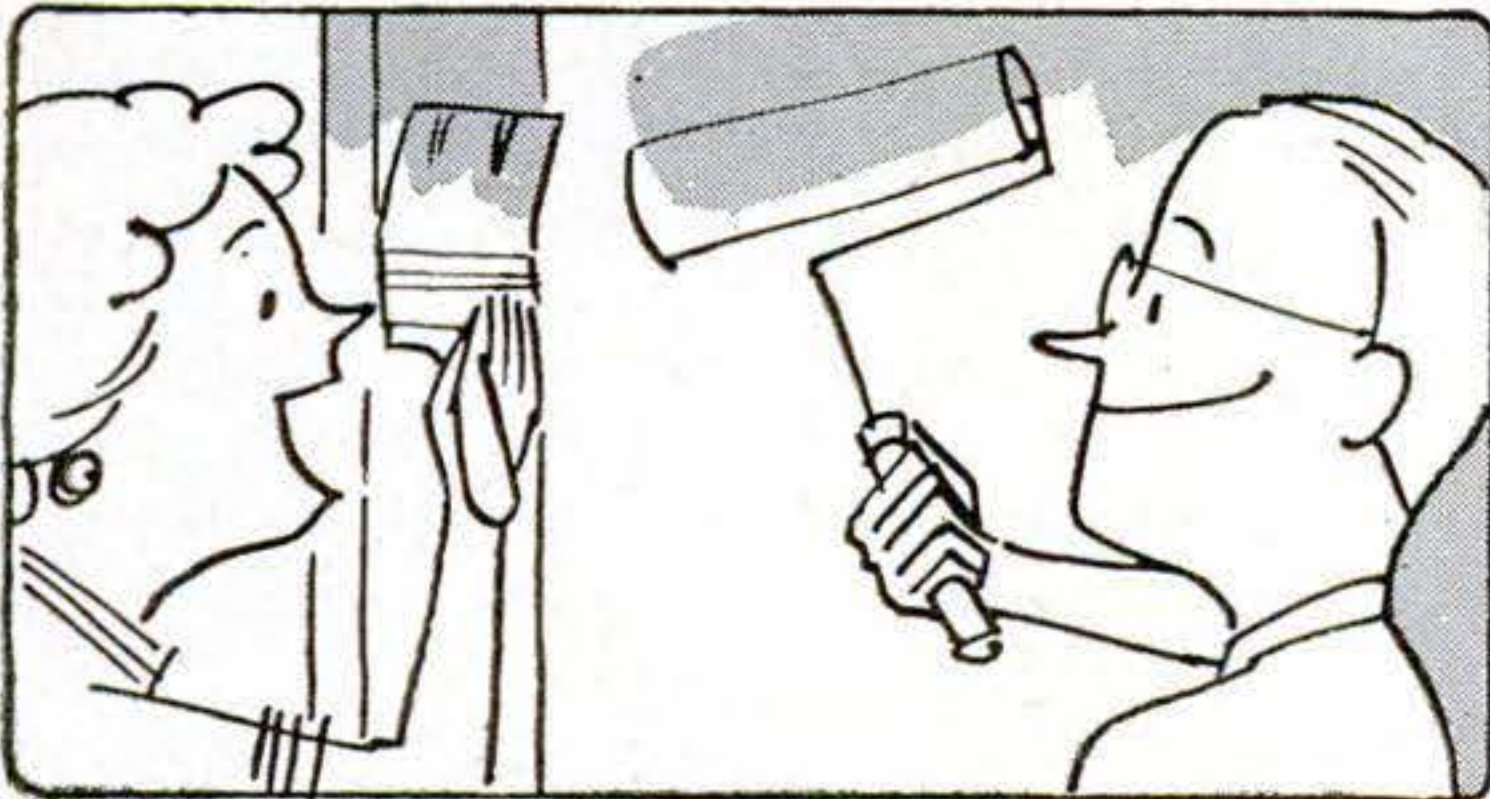

COVERS WALLS AND WOODWORK, TOO! Use Gold Bond Velvet over paint, plaster, wallboard and even over most wallpaper... without an undercoater.

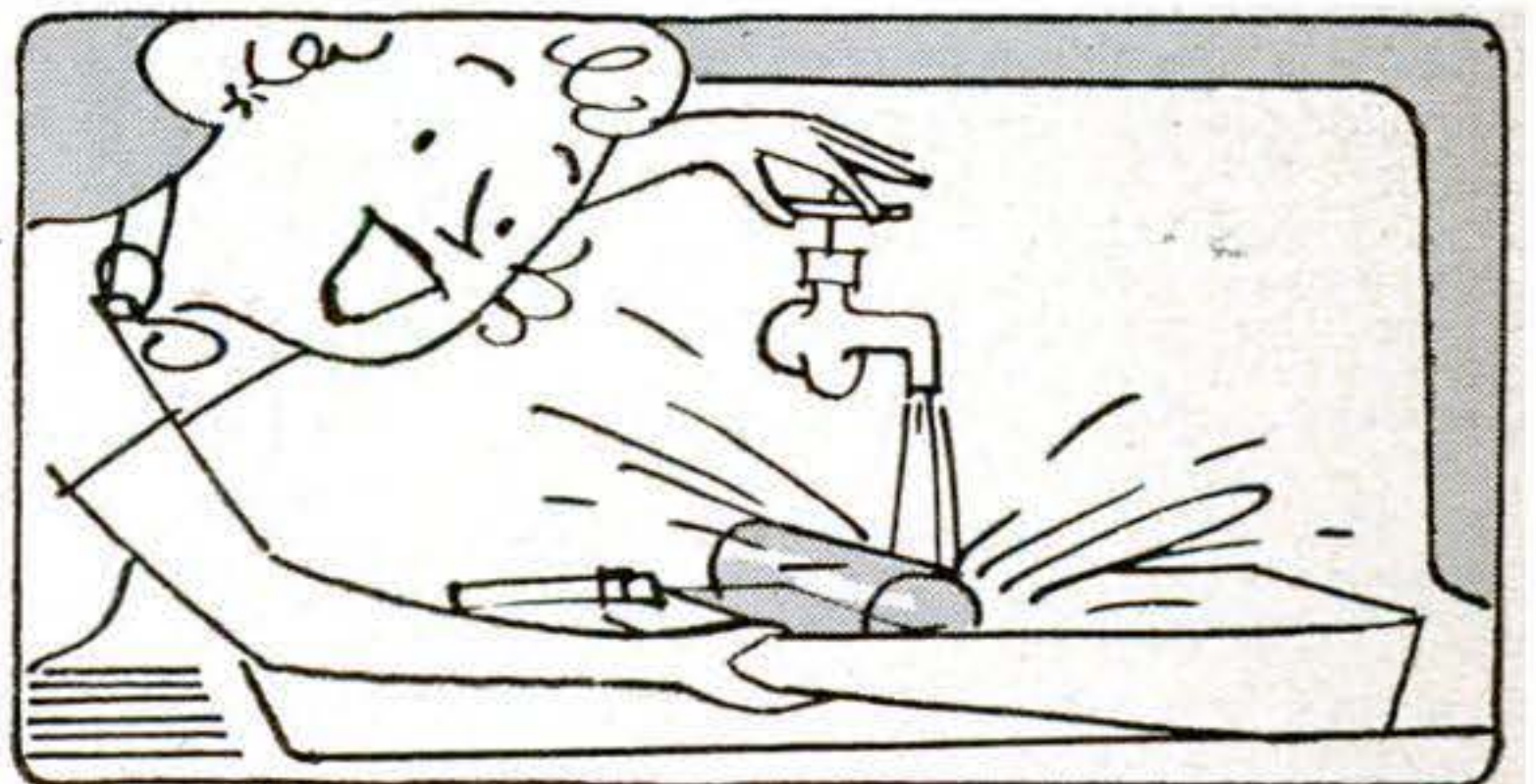

EASY TO CLEAN UP! Brush or roller cleans off with plain water. Spatter or splash marks clean up with a damp cloth. No turpentine needed.

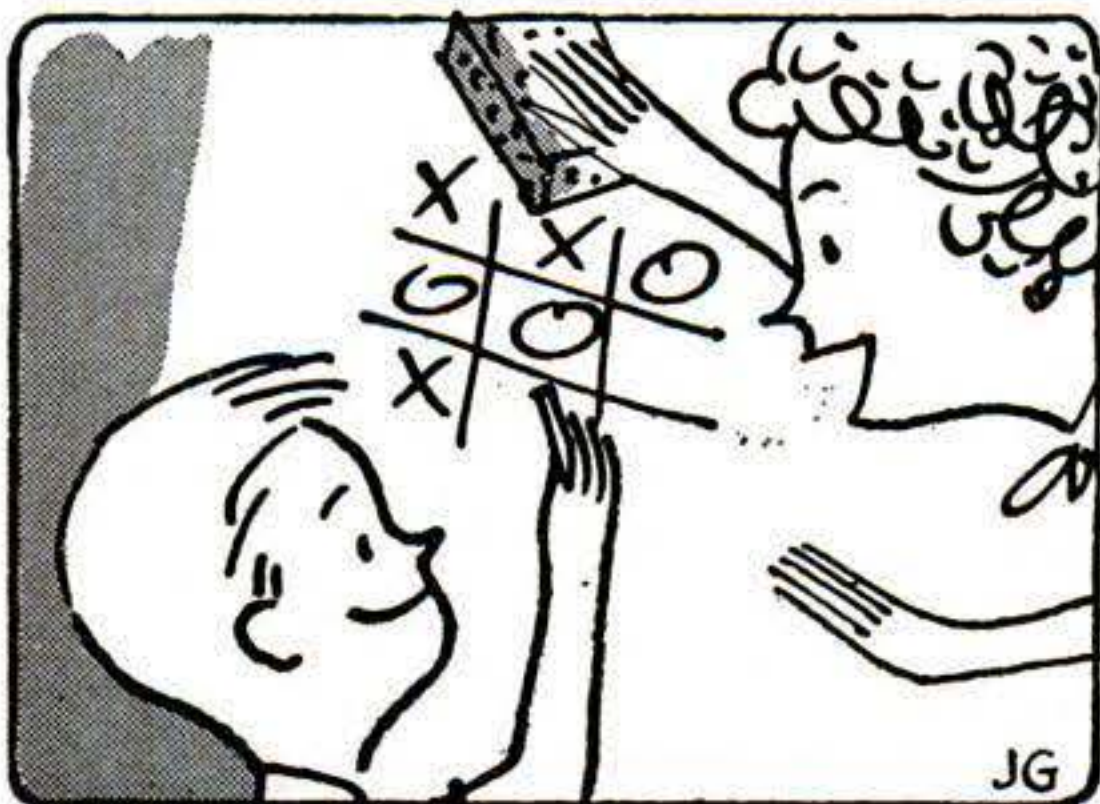

SCRUBABLE! Durable Velvet can be scrubbed year after year without harm. Pencil, crayon, finger marks and food smears wipe right off!

Ask your local Gold Bond paint dealer or lumber and building material dealer to show you the 12 new Velvet colors. The orange and tan label is your assurance of another top quality National Gypsum Company product.

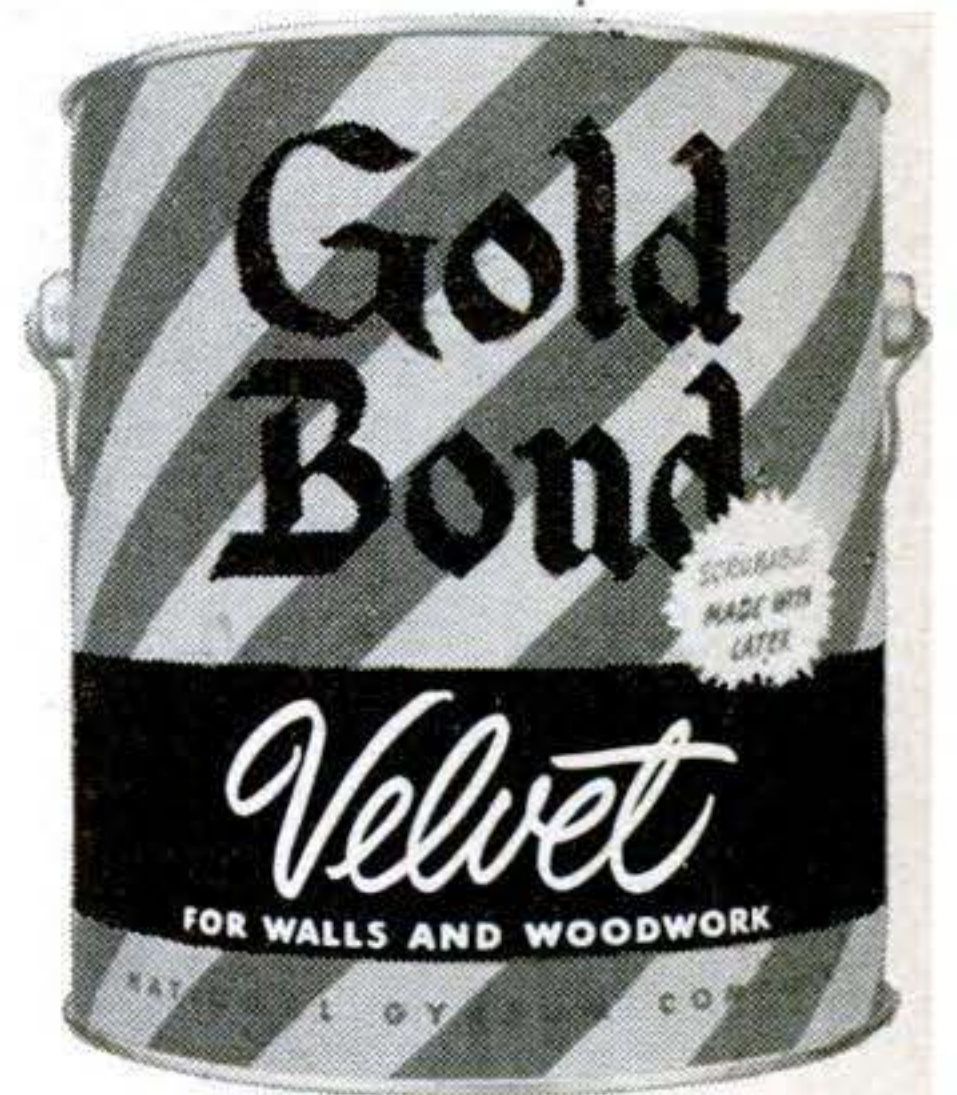

NATIONAL GYPSUM COMPANY • BUFFALO 2, NEW YORK

OCTOBER 1952 261

Most versatile folding rule—

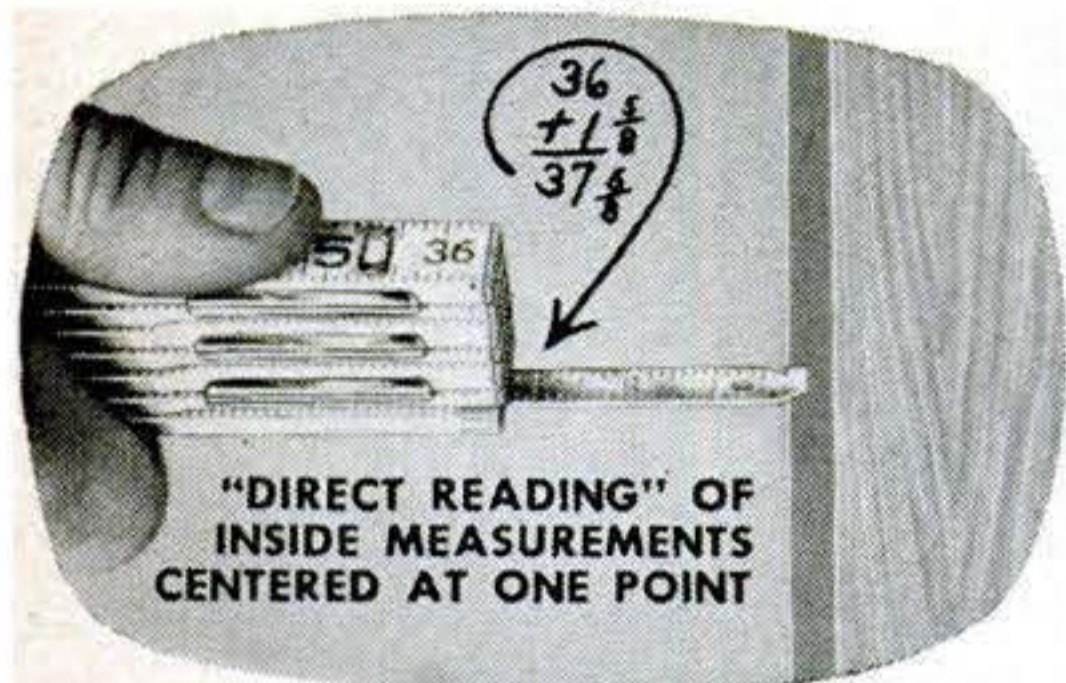

NEW STANLEY "100 PLUS" EXTENSION RULE No. X226

Make no mistake, the new Stanley "100 Plus" Extension Rule is the handiest, most versatile folding rule you can buy.

Read it four ways—on inside measurements using slide, entire reading is centered at one point—no chance for errors; may also be used as an ordinary extension rule for inside measurements, and as a regular folding rule reading from either end.

Use it as a marking gauge for measurements in 2" and 4" multiples.

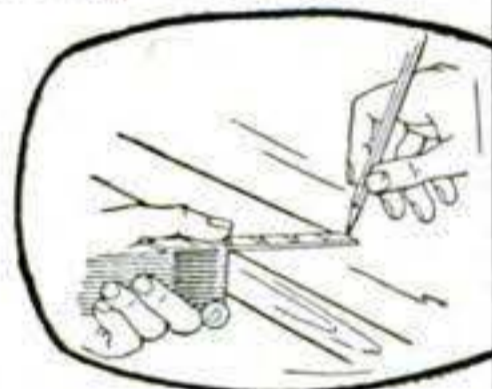

CHECK THESE "100 PLUS" RULE FEATURES:

- Easy to read Big Black Numbers on White Sticks.
- Square ends—butt flush with work.
- Opens to even inches at end of each stick.
- Handy for end-to-end measurements—opens in 6" multiples to full length, 72".
- 8-inch Brass slide removable for use as depth gauge.
- New plastic finish wears four times longer.
- Extra Thick Rock Maple Sticks graduated all edges.

For real rule value ask for the X226 at your hardware dealer's. \$2.65 each.

STANLEY TOOLS, New Britain, Connecticut

THE TOOL BOX OF THE WORLD



Reg. U.S. Pat. Off.

Hardware • Tools • Electric Tools • Steel Strapping • Steel

TOY PATTERNS—6 for 25c
Ideal gifts for the youngsters.

Two sets—6 full-size patterns in each.



P1



P2

SEND TOY PATTERNS NOW!

Stanley Tools, 4102 Elm St., New Britain, Conn.
(In Canada: Stanley Tool Co. of Canada, Ltd.,
4102 Stanley St., Roxton Pond, Quebec)

Enclosed is.....Send Patterns checked

.....Patterns P1 (25c)Patterns P2 (25c)

Name.....

Address.....

City and State.....

Will They Ever Climb Mt. Everest?

[Continued from page 122]

built men. Lightweights. So frail do their bodies appear, that on some expeditions they have kidded each other about their lack of physique. But they are wiry, supple, able to balance themselves anywhere. Many are middle-aged; Shipton is 44. They acclimatize better than men of around 20.

Why do they climb? The most often quoted answer was from George Leigh-Mallory, an Englishman who was on the first three Everest expeditions, in 1921, 1922 and 1924. In 1924 he and Andrew (Sandy) Irvine set out to climb the last 2,000 feet to the summit. A man in their party watched, saw the two within 800 feet of the top, still climbing. Then a cap cloud hid the summit, like a curtain closing across the stage at the end of a play. Leigh-Mallory and Irvine never were seen again.

Why They Climb

Before this last attempt, Mallory had been asked, "Why do you want to climb Everest, anyway?" He answered slowly.

"Because it is there," he said.

Are there other reasons? Yes. For fame? No. Mountaineers do not become famous. Money? No fortune was ever made on a mountaintop, and the climbers lecture to pay expenses. The view? You may not get a view, because of snow blindness, or fog, or cloud, or because you are too exhausted to look. To build physique? Everest pulls you to pieces, and climbing her is neither sport nor exercise.

Shipton, like Mallory, answers the question—"Why?"—with the famous understatement of the English race. "We go to the mountains because we like it there."

All mountaineers agree, despite the fact survival looks impossible on the summit, that Everest one day will be climbed. Someone will lick all the problems—and conquer himself as he does. Maybe Lambert will do it this month, or Shipton next May. Whoever it is, he will have climbed the mile that marks the physical limits of the earth, the mile where nothing lives—no bug, no blade of grass. And, so far, no man. END

Supersonic Sounds

A JET that flies at twice the swiftness of sound begins to approach the speed of rumor.—Buffalo Evening News.

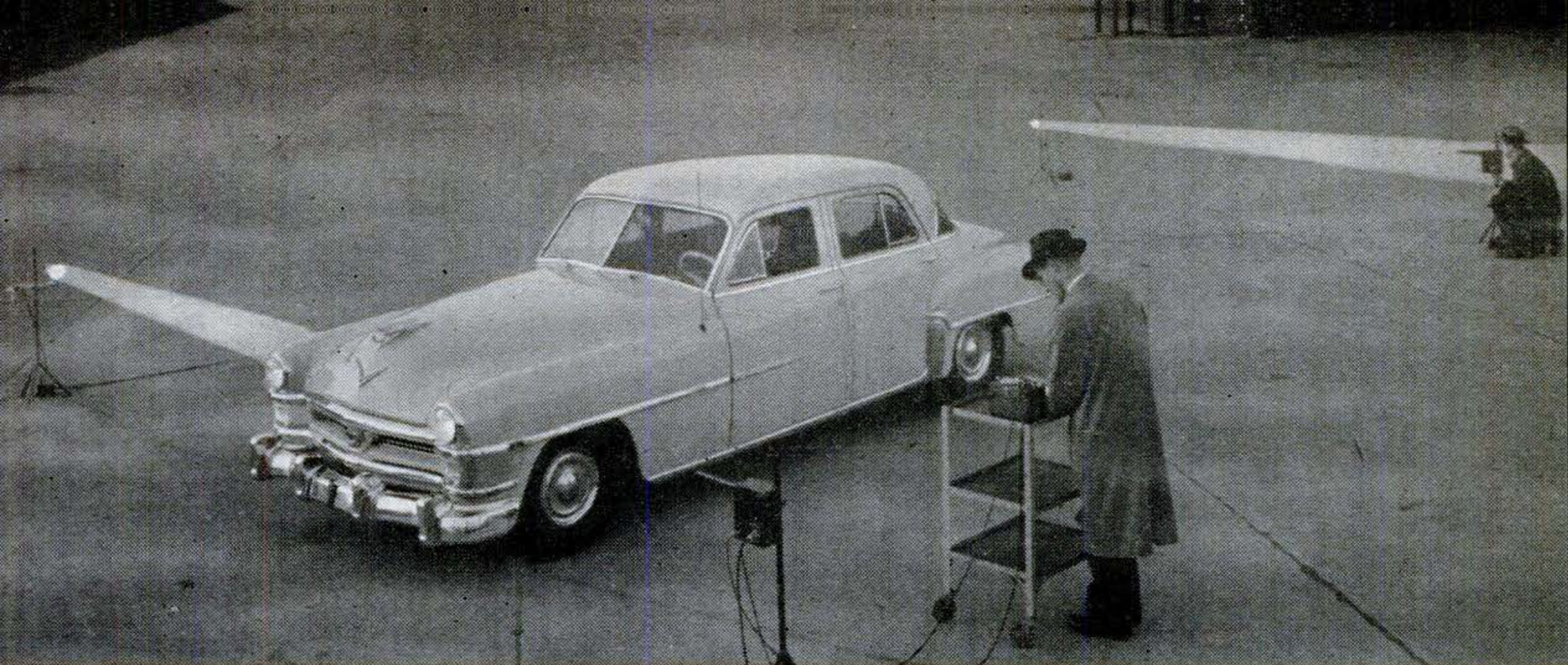

GETAWAY TIMED BY ELECTRIC EYE. This Chrysler breaks light beams at start and finish of getaway test, while electronic machines measure time. Such quickly responsive engine power makes for sure, safe driving.

CHRYSLER CORPORATION'S **NEW DEEP-BREATHING ENGINES** GIVE YOU MORE POWER FROM FUEL

Athletes take deeper breaths to get top performance. Chrysler Corporation's new car engines do the same thing. They *breathe* deeper to give you more power and brilliant response.

These compact, low-friction engines inhale and utilize air and fuel more efficiently because of dome-shaped combustion chambers . . . larger

valves that open wider . . . straighter channels for the fuel mixture to flow through . . . spark plugs that fire directly above the pistons.

It is an exciting experience to drive the new Chrysler FirePower and DeSoto FireDome cars — or *any* car that Chrysler Corporation builds. *All* have high-compression power plants.

CHRYSLER CORPORATION engineers and builds PLYMOUTH, DODGE, DE SOTO, CHRYSLER CARS & DODGE TRUCKS

Chrysler Marine & Industrial Engines • Oilite Powdered Metal Products • Mopar Parts & Accessories
Airtemp Heating, Air Conditioning, Refrigeration • Cycleweld Cement Products

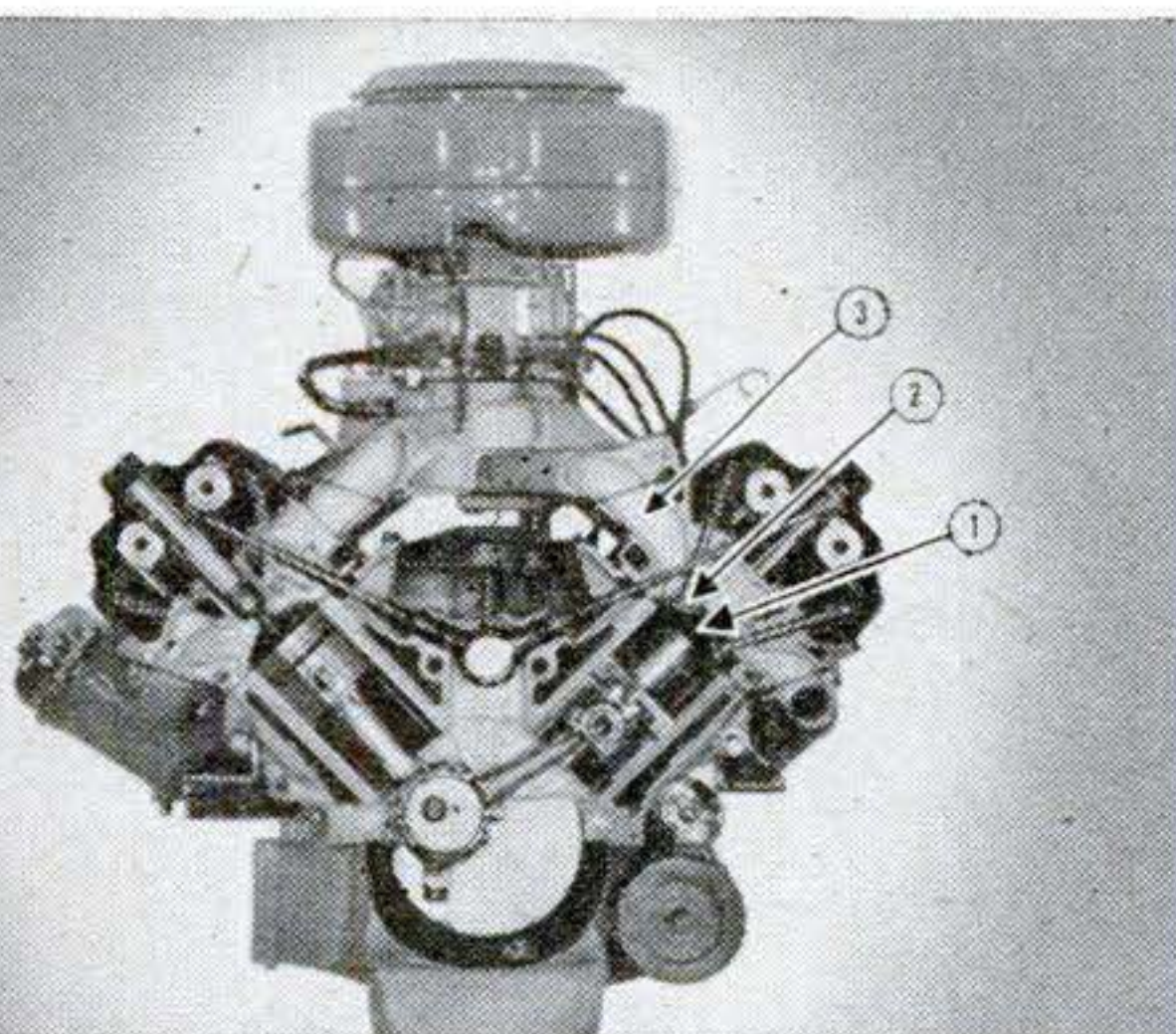

HEART of new De Soto engine. Arrow No. 1 points to dome-shaped combustion chamber. This design permits bigger, high-lift valves (shown by No. 2). No. 3 is wide channel for fuel passage. Note absence of sharp bends that could slow down "breathing."

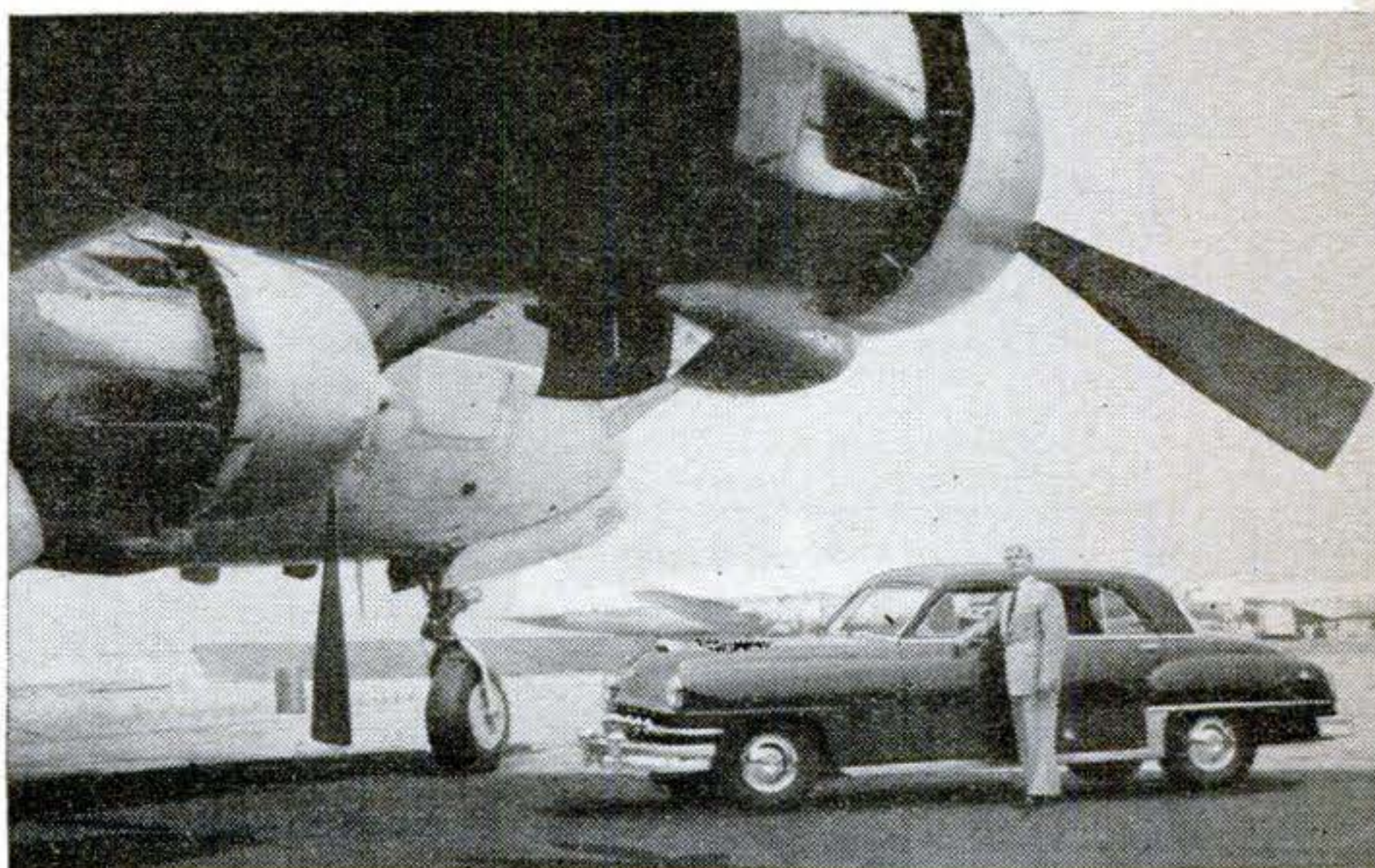

FROM PLANES INTO CARS. Once only some airplanes and expensive, "custom-built" car engines had dome-shaped combustion chambers. Then Chrysler engineers worked out methods that made it possible for the first time in quantity production.

"This modern furniture worth \$490 cost only \$187"*



I saved \$303 with my SKIL Home Shop Saw!



Everyone asks where we bought our beautiful new living room furniture. Buy it nothing! I *built* it in spare time, with my SKIL Home Shop Saw doing the work. And there's no trick to it if you just follow the simple directions—what to do, and how to do it—in SKIL Chart No. 110.

You'd be surprised how much fun it is, how easy it is to miter and rip up to 2-inch lumber with a SKIL Home Shop Saw. All adjustments are so simple and quick that even amateurs do professional-looking work! And there's no end of ways your SKIL Home Shop Saw will pay for itself in building an extra room, a garage, and doing odd jobs around the house. Why don't you begin with this swell modern furniture? Send coupon and 10¢ for plans!

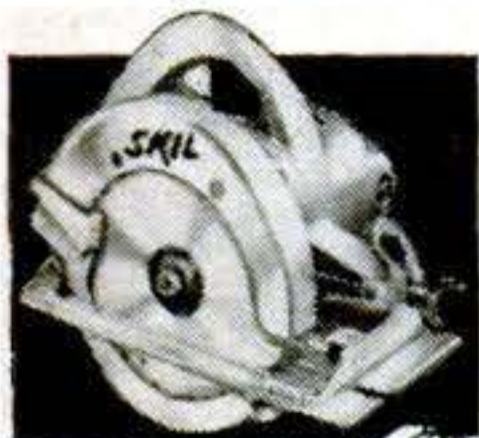

SKIL Deluxe Home Shop Saw—Model 586—\$59.50. 6" saw. SKIL Saw table and accessories easily convert this saw to tilting arbor bench saw, sander and shaper.



SKIL Home Shop Belt Sander \$68.00



Prices subject to change without notice. *For materials only. Local prices vary.

Made only by SKIL Corporation, 5033 Elston Avenue, Chicago 30, Ill.
In Canada: Skiltools, Ltd., 3601 Dundas Street West, Toronto 9, Ont.

**SKIL Corporation, Dept. D-102
5033 Elston Ave., Chicago 30, Ill.**

I enclose 10¢. Please send SKIL-Chart No. 110 showing how to build the above modern furniture.

Name _____

Street _____

City _____ State _____

Buick Sets New Style for 1953

[Continued from page 104]

bined the foreign sports-car look with the comfort they are used to in their own production models.

With this in mind, he sat down one day in the late spring of 1951 to do what most American automobile designers do when they buy a new model—figure out how it can be altered to look different from everybody else's. Ned had just acquired a Buick Roadmaster convertible. He picked up a pencil and began to sketch a Roadmaster that, with minor changes in contour, took on a continental appearance. The changes had to be minor because he was going to have to pay for them himself when he had them made in a body shop, and he wasn't feeling flush.

Makes Hit With Brass

The next day, Ivan L. Wiles, the Phi Beta Kappa who is general manager of Buick, dropped in. He spotted the sketches and walked over to stare at them.

"Say," he exclaimed, "I want one of *these* cars!"

Nickles, a bit chagrined at having somebody else pick up and start carrying the ball he had in play, nevertheless was gratified at high-brass approval of his ideas. He was even more pleased when Wiles had a car built to the specifications of the sketches he had drawn.

This was the pilot-model Skylark that I drove.

Fewer Die Changes Necessary

Wiles decided to announce the Skylark to the press, and probably to produce it in very limited quantities as a premium car in 1953. Fewer die changes will be required than are usual in building a new model, because of the lucky circumstance that Ned Nickles tailored the design changes to fit his own pocketbook.

I am completely confident that the demand for this beautiful new car will far exceed expectations. I'm also sure that it will set off fireworks in every design studio in the industry. END

Choose Your Weapons

"You could have knocked me over with a feather," said the pedestrian, getting up from in front of the truck, "and I wish you had."—Clues.

SURPLUS MACHINE SHOP TOOLS AT PRICES YOU CAN AFFORD

HIGH SPEED STRAIGHT SHANK DRILLS



SET 30 selected H. S. Straight Shank Drills from 1/8" to 7", lengths up to 7". \$15 value, only **\$2.98**

SET 12 different size H. S. Straight Shank Drills, 1/4" to 1 1/2", lengths up to 7", only **\$3.98**

HIGH SPEED DRILLS

1/4" TO 1 7/32" WITH 1/4" SHANKS!

SET 6 different size H. S. Drills, 1/4" to 1 7/32" all with 1/4" shanks. PPD. **\$2.98**

SET 10 of above, 36F PPD. **\$4.95**

Sets 35F and 36F will fit any 1/4" drill.



HIGH SPEED DRILLS

1/2" TO 1-3/16" WITH 1/2" SHANKS!

5 Drills for less than the price of one new Drill!

SET 5 different size H. S. Drills 32F 1/2" to 1-3/16" **\$7.95**

SET 10 different size H. S. 33F Drills 1/2" to 1-3/16" **\$14.50**

These new and used H. S. precision Drills with 1/2" shanks can be used in a 1/2" elec. drill or a 1/2" capacity lathe or drill press.

HIGH SPEED MORSE TAPER SHANK DRILLS

SET 15 Different Size High Speed Morse Taper Shank Drills up to 9/16" with No. 1 and 2 tapers. New and used. \$50 value. Priced at only **\$6.49**

SET 20 Different Size High Speed Morse Taper Shank Drills from 1/4" to 1". New and used. \$70 value. Priced at only **\$12.95**

SET 10 Different Size High Speed Morse Taper Shank Drills from 1/2" to 1 1/4". New and used. \$50 value. Priced at only **\$9.95**

SET 8 Different Size High Speed Morse Taper Shank Drills from 1" to 2" with No. 3, 4, and 5 tapers. New and used. \$125 value. Priced only **\$29.95**

6 SLITTING SAWS WITH MANDREL

SET 6 Different Size High Speed Slitting Saws, 5 pcs. 2 3/4" dia. x 1" arbor, plus 1 pc. 5" dia. x 1/2" arbor—thickness from .040 to .071. Cuts wood, aluminum, brass, steel, etc. PLUS SPECIAL MANDREL which enables use of saws in 1/4" or 1/2" elec. drill. \$25 value. PPD. Only **\$4.95**

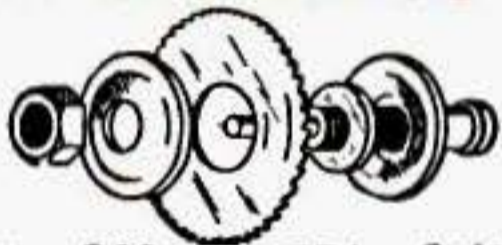

7 selected, sharp H. S. Slitting Saws as above to use on your own mandrel or milling machine. New and used. PPD. **\$4.95**

HIGH SPEED WOODRUFF KEY SEAT CUTTER

SET 5 different size cutters. Can be used as mounted milling cutter or circular saw. All with 3/8" and 1/2" shanks, widths up to 1/4", dia. up to 1". New and used. PPD. **\$3.95**



NEW MOUNTED STONES

SET Mixture of 27F 12 Mounted Stones with 1/4" shanks. PPD. **\$2.49**



NEW BUFFING WHEELS

Approx. 5/16" thickness, PPD!

5 pcs. 7" dia. **\$1.70**

5 pcs. 8" dia. **1.70**

5 pcs. 9" dia. **2.00**

5 pcs. 10" dia. **2.50**

5 pcs. 12" dia. **2.50**

Large quantity available at great savings.

New Carbide Tip Masonry Drills

Carbide tip goes through any masonry. Set of 5 bits containing two 7/32" & three 1/4", all five, \$10 value, only **\$2.75**



NEW ROTARY FILE MIX

7 different pcs., High Speed 1/4" shank. PPD. **\$4.49**



SET 14 different pcs. 22F as above, PPD. **\$8.79**

DOUBLE-END END MILLS

SET 4 right hand H. S., 3/8" straight shank End Mills up to 3/8" dia. **\$3.98**

LARGE SAW BLADES

These large semi-high speed steel, flat ground, circular blades are in excellent, usable condition. Excellent for cutting brass, copper, aluminum and other soft metals, bone, plastics, rubber, paper, etc.

8x1/16x5/8 arbor **\$2.50 ea.**

10x3/32x1 arbor **2.50 ea.**

12x3/32x1 arbor **2.50 ea.**

14x3/32x1 arbor **2.50 ea.**



HIGH SPEED STRAIGHT SHANK CHUCKING REAMERS

SET 20 Different Size High Speed Straight Shank Chucking Reamers up to 1/2". New and used. Priced at only **\$7.95**

SET 15 Different Size High Speed Straight Shank Chucking Reamers from 1/4" to 1". New and used. Priced at only **\$7.95**

HIGH SPEED HAND TAPS

SET 8 different size H. S. Std. Thread Hand Taps up to 5/8", including 2 Std. H. S. Pipe Taps. **\$2.95**

SET 40F 16 same as above... **\$4.80**

NEW NORTON CUT-OFF WHEELS

80-grit M5L. Will cut stone, steels, plastics, etc.

3x1/16x1/8 arbor 3 pcs. **25c**

3x1/16x1/4 arbor 3 pcs. **27c**

4x1/16x1/8 arbor 3 pcs. **30c**

4x1/16x1/4 arbor 3 pcs. **30c**

4x1/8x1/2 arbor. **25c ea.**

8x1/8x5/8 arbor. **70c ea.**

TAP HANDLE

No. 6 (5/32" to 3/4 Cap.) Only **\$2.75**

Discounts on quantity

BARGAIN TOOL & SHOP MIXES—PPD

● 30 GRINDING WHEELS 1/4" arbor, 4" diameter max. **\$3.29**

● 12 FILES up to 12" length, a buy at **\$3.49**

● 2-8" WIRE WHEELS coarse and fine, 1" thick, 5/8" bore. Pair only **\$2.29**

● 300 SPRINGS all types and sizes **\$1.79**

● 100 MOUNTED POINTS 1/8" and 3/32" shanks. Various shapes. **\$8.98**

SURPRISE MIX: Over 50 pcs. for your 1/4" elec. drill including rotary files, drills, bits, reamers, grinding wheels and arbors for our customers who like pleasant surprises. Your money back if you aren't satisfied. **\$2.98**

● BEARING MIX: About 40 needle, ball and roller bearings, new and used. Up to 2 1/2" dia. approx. 5 lbs. Outstanding buy at **\$2.95**

● RIVET MIX: 5 lbs. assorted rivets; cherry, explosive, etc. Hundreds of rivets **\$2.29**

NEW 360° SWIVEL TYPE TOOL HOLDER & BORING BAR

Here is a tool that will do the work of a left, right and straight tool holder, plus a boring bar, all for a fraction of its original cost. PPD to you.

● TOOL A takes a 5/16" sq. bit or 5/16" dia. boring tool. Shank size 9/16"x1"x4 3/4". PPD. Only **\$3.29**

● TOOL B takes a 3/8" sq. bit or 3/8" dia. boring tool. Shank size 5/8"x1-3/16"x5 3/4". PPD. Only **\$3.95**

● TOOL C. Cut-off blade holder for 3/32"x 3/8" blade. Shank size 1/2"x1"x4 1/2" (can be changed to fit other size cut-off blades). PPD. Only **\$2.25**

● TOOL BIT SPECIAL: 12 H. S. 3/16" sq. x 2 1/2" new tool bits. PPD. **\$1.95**

Money-Back Guarantee On RECEIPT of Merchandise. All mdse. mixture of new and reconditioned unless specified new. All orders (Except those specified F.O.B. Tulsa) are shipped Post Paid, saving you up to 25% on total delivered cost!

Write For Free Catalog Describing Thousands of Bargain Cutting Tools.

New Hydraulic Hose!!

2000-ll. Test

● Any length ● Std. Pipe Connections 3/8" and 1/2" I.D. available

3/8" hose has 3/8" male pipe connections and 1/2" hose has 1/2" male pipe connections.

Length in feet	Price 3/8" ID	Price 1/2" ID	Length in feet	Price 3/8" ID	Price 1/2" ID
1	\$1.50	\$1.65	6	\$3.60	\$3.75
2	2.25	2.40	7	3.75	3.95
3	2.75	2.95	8	3.95	4.10
4	2.95	3.10	9	4.25	4.40
5	3.40	3.60	10	4.50	4.65

11 to 50 ft. lengths available at 40c per ft. for 3/8" ID hose and 45c per ft. for 1/2" ID hose. All lengths priced complete with connections! Finest construction. Double wire internal braid.

Note: Large quantities available at additional discounts.



NEW VICKERS MF9, 6 H. P.

Hydraulic Motor

Unit is compact, powerful. Displaces .507 cu. in. per revolution, 6 gal. per min. at 3000 RPM, 1500 PSI. Positive displacement. Angle type. Rated at 6 H.P. Rotates either direction. Unit can also be used as a pump. Here is the finest hydraulic motor available at a fraction of its new cost of over \$200. Our price only **\$29.50**

NEW VICKERS HYDRAULIC MOTOR; serial no. MF1071130BCF2, cu. in. displacement per rev. .378, 3600 RPM 1000 PSI, (unit similar to above only a smaller displacement and H.P.) only **\$24.50**

NEW MASTER HYDRAULIC CONTROL VALVE

For controlling two single or double action cylinders separately or simultaneously. Valve is close center type. 1500 PSI rating, only **\$9.98**

PESCO HYDRAULIC GEAR TYPE PUMP

Rated at 3 GPM, 3750 RPM, 1500 PSI. 1/2" drive spline. Gov't cost over \$90. Yours for only **\$9.49**

GENERATORS!

P1 GENERATOR 200-amp. 24-volt, continuous duty. Wt. 48 lbs. Special Close-out price. F.O.B. Tulsa. **\$14.98**

ESA GENERATOR: 50-amp. 12 volt continuous duty. Wt. 21 lbs. F.O.B. Tulsa. Only **\$9.98**

These used, guaranteed serviceable aircraft quality generators are easily convertible for welders, power plants, boats, platers, etc.

1/20 H.P., 110-VOLT MOTOR:

1550 RPM bronze bush bearing. 5/16" shaft. Used, guaranteed serviceable. Wt. 4 lbs. Only **\$2.49**

24-VOLT TRANSFORMER: 110-volt A.C. to 24-volt, 3 amps. Just the thing for your small 24-volt motors. **\$1.95**

NEW GEAR BOX TRAIN:

6 to 1 gear ratio to two flex shaft outlets; one 1 1/4" flex shaft included. Unit includes 8 gears and 7 precision bearings.

Many other gear ratios possible. Wt. 10 lb. PPD! **\$8.49**

AIR TANK—REGULATOR—MASK

● A4 Tank, 5" x 8". 104 cu. in. vol. 500 PSI **\$1.50**

● D2 Tank, 6 1/2" x 24". 500 cu. in. vol. 500 PSI **\$4.25**

● Demand Type Regulator complete with 500 PSI pressure gauge. Fits above tanks **\$1.50**

● Mask complete with 14" of hose. Outlet valve. Fits above regulator **\$1.60**

Above equipment suitable for air tanks, compressors, respirators, diving units, etc.



T & T TOOL 221 W. SECOND TULSA, OKLA.

Every Time You Use It...

YOU'LL VALUE ITS CAPACITY AND VERSATILITY!

Atlas
8" TILT / ARBOR SAW



SPECIFICATIONS

Max. Depth of Cut	2 3/8"
Table Ahead of Blade	10 3/8"
Rip to Center of	19" panel
With one extension	36 1/2" panel

Saving you time, money and improving work accuracy every time you rip or crosscut a board to size is just the beginning of this saw's usefulness.

It handles easily and accurately such sawing operations as cutting angles, double angles, chamfers, bevels, tenons. And with low cost Atlas accessories it cuts all dados...handles a host of straight shaping and moulding operations.

Atlas is the saw for your shop. Its double-locking patented fence is the best you'll find on any saw. Blade tilts—your work stays flat—for safe accurate angle sawing. Has

sealed-for-life ball bearings. Precision-ground grey-iron table. Grill extensions, original with Atlas, for handling big stock. See these and many other features at your Atlas dealers, or send for catalog today.

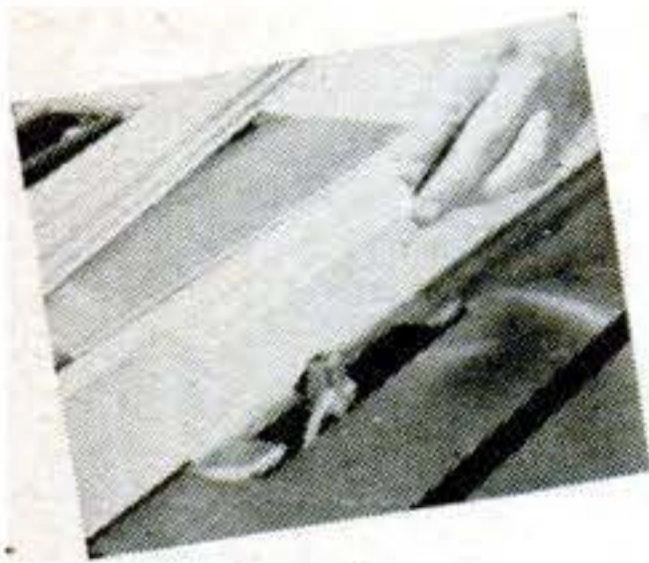

1 — Shapes



2 — Cuts tapers

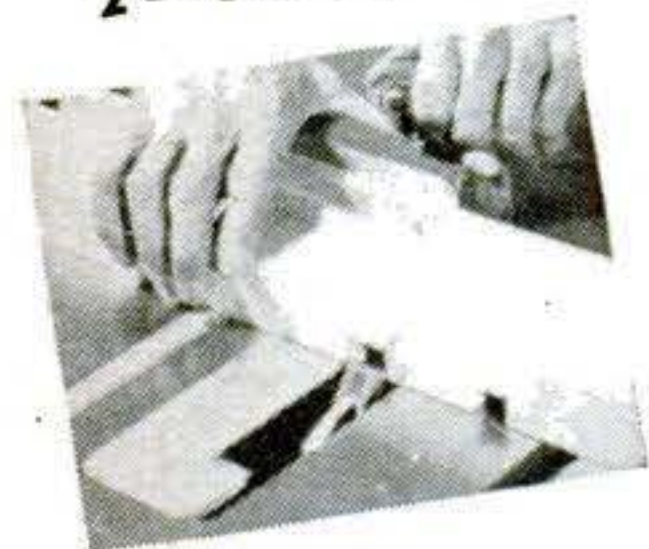

3 — Dados

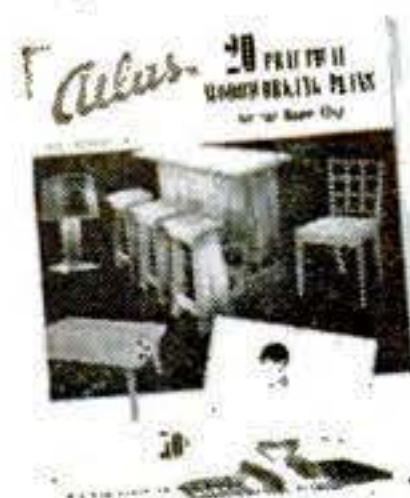

**NEW 20-PLAN BOOK
ONLY 50¢**

20 original, practical projects for your home and family... drawings photos, step-by-step instructions. Send check or cash (no stamps) \$.65 outside U.S.A.

ATLAS PRESS COMPANY
1025 N. PITCHER ST., KALAMAZOO, MICH.

266 POPULAR SCIENCE

'Space Men' Make College Men Think

[Continued from page 127]

covering. . . The plant continually sends up new shoots which grow from the fibrous base and contribute to the density of the surface area. After a period of one year, the surface is so clotted with fiber that it becomes coarse and undesirable, and soon a mass dying takes place. The roots in an area of three or four square feet die simultaneously because of strangulation, leaving bare, unsightly spots upon the lawn, dotted with the large dead fibrous roots. . .

"The only solution is to pull out areas of the grass to allow for new growth. This must be done at randomly spaced intervals to insure a uniform root surface, and the amount pulled out must be very small. Because of the toughness of the roots in tension, pulling too large a clump will uproot—oops, upstem—a large portion of the plant and the result is an open space to be planted again. The vertical force to be applied to the surface fiber to upstem it cannot exceed six pounds. . .

"When one heads home from work after a hard day at the office, he sees one Methanian after another plucking away at their lawns, most of them using their own wonderful cussing that they've developed. . ."

Students Build Models

With these stringent requirements, a student designed a fancy machine called the Clean-Pull Lawn Conditioner that would pull up 40 tufts of root, put the tufts in a drawer, and smooth and ruffle the surface to make it more attractive. It is powered by a hydraulic system activated by a hand-pumped cylinder. Wherever possible, light metals are specified to make it light enough for the feeble Methanians to lift.

No report on sales is available.

Does this sort of thing actually help in creative thinking? Professor Arnold points out that the best students, as shown in their over-all college records, do the best with the Arcturus project. They are stimulated and interested by it, while less gifted students are often bewildered and tend to dismiss the whole idea as silly.

The Arcturus project is of course only a quarter of the whole seminar on project design. Another portion is devoted to the design of new tools and the improvement of existing ones. Students have designed such useful new machines as a sander that either

[Continued on page 268]

OTHER FAMOUS SHOPMASTER ACCESSORIES



Rip fence assembly.



Dado sets.



Sanding drum. 2" diameter.



8" Circle saw blades

Lathe turning tools.



Jig saw blades. Six to an envelope.



Chucks for lathe.

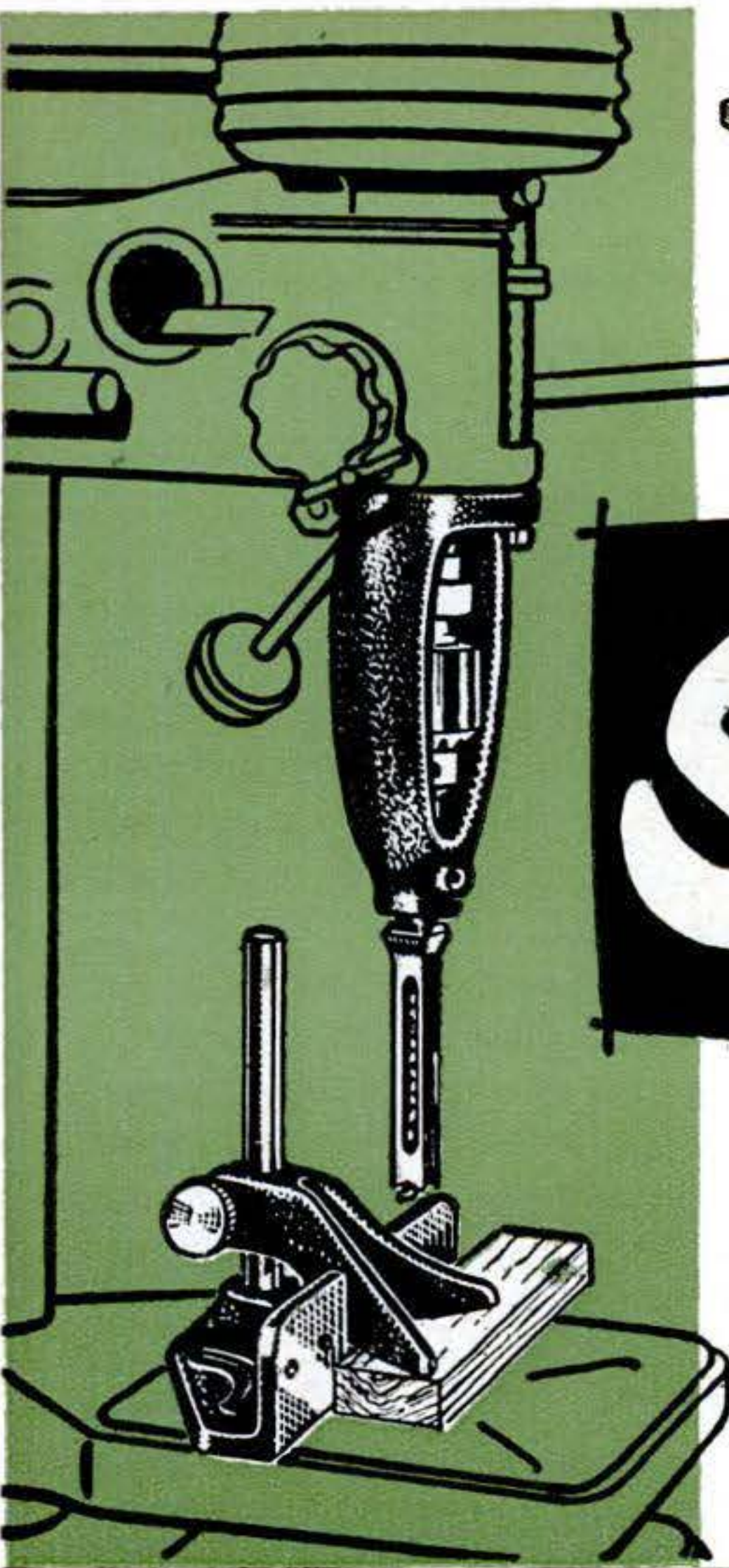

SAVE HOURS OF HARD LABOR CUT SQUARE OR RECTANGULAR HOLES WITH A **SHOPMASTER** MORTISING KIT

Save hours of unnecessary work of hand chiseling with a handy Shopmaster Mortising Kit. Cut square or rectangular holes with your present drill press... easily attachable... easy to remove too. Just one of the many famous accessories available by Shopmaster.

\$14⁵⁰



FREE Complete catalog of the famous quality Shopmaster tools and accessories... Write Department PS10

1214 Third St. South, Minneapolis, Minnesota

GIGANTIC EXPANSION MAIL SALE

WAR SURPLUS EXCESS INVENTORY BANKRUPT STOCK

POWER PLANTS and GENERATORS

- Master Plants, 5KW, 115-230-v, 60-c, 4-cyl. engine, manual start. Cost over \$1100.....\$531.70
- Onan Plants, 5KW, 115-v, 60-c, 4-cyl. engine, push button start. Cost over \$1400.00.....\$689.50
- Burdex Plants, 2KW, 115-v, 60-c, Special.....\$297.50
- Homelite Plants, 1.5KW, 115-v, 60-c. Special.....\$199.50
- Kato Generators, 5KW, 115-v, 60-c, with control panel, drive pulley, etc. 1800 RPM. 1 phase. Cost \$550.....\$259.50
- Burdex Generators, 115-v, 60-c. Ball bearing. 500-w, \$94.50; 1000-w, \$134.90; 200-w, \$159.50
- Many other plant bargains in catalog.

WINCHES—CLUTCHES—BLOCKS

- Boat, dock, business hand winch, 1-4 gear ratio. Special... \$19.95
- Farm-Truck-Contractor heavy duty hand winch. Dual ratio 1-3, 1-9. Finest cast steel construction. Special.....\$29.98
- Chain Hoist. Lever type. 3000 lb. capacity.....\$19.48
- Winch Cable. 1/4" super-flexible (4000 lbs. cap.) 50' with load hook.....\$9.90
- Army Snatch Block. 13,000 lb. List \$19.40.....\$12.95
- Clutch, 6 H.P. Many uses.....\$14.95

WELDING GENERATOR KITS

- \$276 Aircraft 200-250 amp. 28-v, generators. Complete with cooling fan, field rheostats and "How to Build" welder instructions.....\$24.65

PHONES—CITY and RURAL

- Rural Magneto. Compact oak case. Wall, (a) 3 bar, 1000-ohm, \$9.95; (b) 4-5 bar, 1600-ohm, \$13.90. CITY upright desk, with bells \$4.99. Phone only, \$2.69.

AIR POWER GREASE GUNS

- Super special genuine Lincoln automatic air power grease guns. Ideal for farmers, contractors, etc. Operates off any compressor. List \$60.80. SALE.....\$23.95

BURDEN PAYS ALL SHIPPING CHARGES

AIR COMPRESSOR UNITS

- Paint, blow up tires, control termites, clean greasy engines, blow dust, etc. Build your own or buy ready-built units.
- DeLuxe Air Kit. Consists stainless tank 12"x24", finest 1-cyl. 3 cfm piston compressor, valves, gauge, fittings, hose, excellent paint gun, blow gun, pressure regulator, chuck and "How To Build Portable Outfit." Special.....\$45.49
- Economy Air Kit. Same as above except 6"x24" tank and no regulator or paint gun. Each.....\$31.90
- Air Components. Top quality. 1-cyl. piston comp. \$20.50; 2-cyl. pis. comp. \$49.50; Adj. Auto. pressure switch, \$4.95; pressure regulator, \$2.65; Adj. safety valve, \$1.95; Pressure gauges, 0-160 lbs. \$1.89.

Write for interesting Air Data-Catalog

TRACTOR WEED SPRAY OUTFITS

- Leading make. All stainless steel. 7-row outfit. Guaranteed finest unit made. List \$225.50. Buy now to save on this year's taxes. Special Fall Closeout.....\$129.50
- 5-row all-brass outfit.....79.50

SUPER BARGAINS

- Duro 110-v Hand Hi-Speed Ball Bearing Grinder and Kit. List \$24.50. Sale.....\$13.40
- Hydraulic Tractor Contour Level. Mounts on tractor. Plow on perfect contour. No surveying. List \$46. Sale.....\$16.90
- Polished Laminated Plane Propellers (New). Many uses—snow sleds, boats, etc. Cost over \$150.00. Sale.....\$12.95
- Electric and Gas Chain Saws. Write for prices.

SPECIAL FOR THE MONTH BATTERY CHARGER (6 Amp.)

- Leading make 110 v, 60c, 6 amp. chargers. Install in garage, keep car battery fully charged for easy winter starting. List \$18.95. SALE \$12.15
- Battery Trickle Chargers, list \$9.95. Special...\$4.95



WATER PUMPS and SYSTEMS

- Save up to 60%. Ask us for expert advice on your problem. Pumps for wells, basements, weed spraying, septic tanks, garden irrigation, etc.
- Centrifugal Pumps. Cast iron, stainless steel shaft, bronze impeller, ball bearings. No. 75, 3/4", \$18.90; No. 100 1", \$28.90; No. 150, 1 1/2", \$35.60.
- Bronze Rotary Pumps. Low pressure type. (25 lbs. max.) Self priming. No. 12, 1/2", \$12.75; No. 34, 3/4", \$16.95; No. 101, 1", \$22.95; Hi-Pressure type (150 lbs. max.) No. 612, 1/2", \$14.50; No. 634, 3/4", \$20.95; No. 610, 1", \$27.95.
- Irrigation War Surplus Pump. 10,000 g.p.h. 2 1/2" intake. Two 1 3/4" outlets. Special....\$39.50
- Burdex Shallow Well System. 110-volt, 60-c. 300 g.p.h. 40 lbs. pressure, fully automatic. Easy to install.....\$69.50
- Adj. Auto Pressure Switch, \$4.95; 3/4" foot valve, \$2.49; pressure gauge 0-60 lbs. \$1.89; also hose, strainers, etc. at real savings.
- Hand Pump. Lever type, high capacity, Pump basements, tanks on farms, etc. Cost \$35, \$27.80

Write for useful Water Pump Data-Catalog

ARMY HOT AIR HEATERS

- Forced air type. Burns gasoline, kerosene or fuel oil. Thermostatic control. 110-v. blower. Tremendous heat output (40,000 BTU.) Compact portable size 17 1/2" high, 21" long. Wt. 44 lbs. Cost over \$190.00. Sale.....\$59.50

Miscellaneous Surplus Bargains

- Tachometer, 0-4000 r.p.m. Direct rd. \$6.79
- Drawing Sets. Finest quality, 13-pc... 9.89
- Clock Timer Switch. 110-v, 60-c..... 4.72
- Heater Elements, 110-v, 2000-w..... .99
- Imersion Heater, 110-v, 800-W..... 3.95
- Guy-Turnbuckles, 12' Army. Useful. 10 for 3.89
- Motors, 110-v, 80 r.p.m..... 8.95
- Hydraulic 19" Cylinders (Cost \$90)...18.49
- D-C Welding Generators (250 amp.) 99.90
- Magneto Farm Telephones, 1600 ohm 13.90
- Engineers Hand Level..... 5.84
- Hundreds other bargains in tools, etc.

ORDER FROM AD, or Write for 4 FREE Catalogs!
OUR 30-YEAR POLICY: ● Everything Guaranteed Satisfactory
● We Pay Shipping Charges in U.S.



BURDEN SALES COMPANY

832 "O" St.

Lincoln, Nebraska

New, faster way to strip off finishes



Non-inflammable
KLEAN-STRIP
peels off paint,
varnish, lacquer,
enamel, synthetics.

IT'S CLEAN—NO AFTERWASH!

Sold at leading paint, hardware and
department stores.

Product of

The KLEAN-STRIP Co., Inc.
2340 S. Lauderdale, Memphis 6, Tenn.

Introducing

NOVA PRECISION-BUILT WALL UNITS

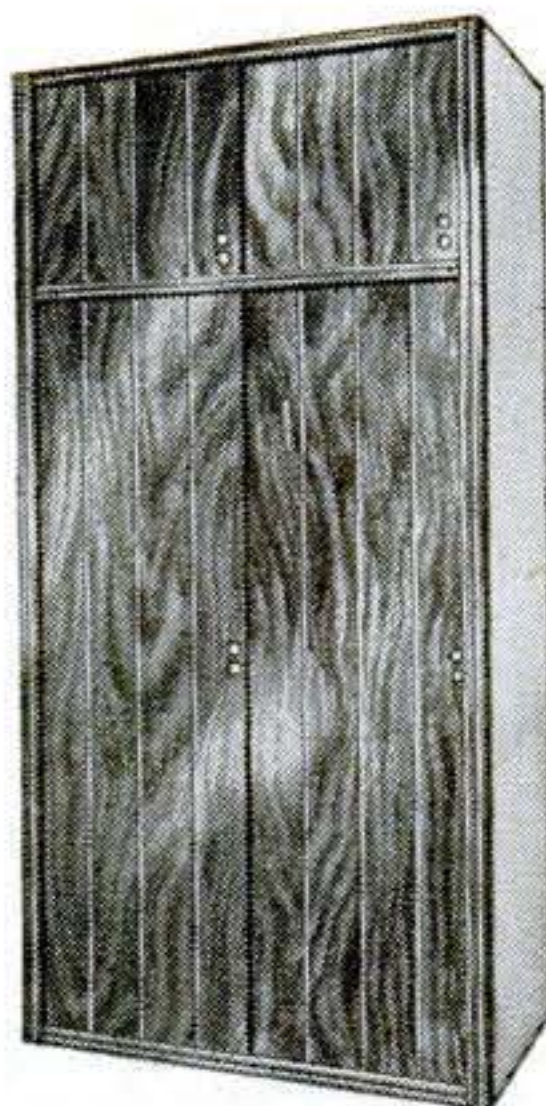

Space-savers—money-savers!
**Precision-built—assembled in
30 minutes!** Here are wardrobes,
vanity units, dressers, desks,
bookshelves, storage walls—
each a beautiful piece of
furniture in itself; used in
combination, there is no sense
of sectionalizing.

10" to 26" in depth—they can even
take the place of a wall, save as much as 5 feet in total
house length. Wide choice of woods—unfinished, or
with prime coat, paint, stain or furniture finish. Inner
walls and backs are insulating, sound-deadening, mil-
dew-proof. Write for free fully illustrated literature.
Dept., 64B—NOVA SALES CO., Trenton 3, N. J.

'Space Men' Make College Men Think

[Continued from page 266]

oscillates or rotates, as desired, and a two-speed power hand drill.

This fall Arnold added a new workshop to his setup, so that his students can actually build their machines—or models or mock-ups—whether designed for 2951 or 1952.

Professor Arnold is convinced of the need for creative thinkers—and for what he calls product designers. Taking an existing product, the product designer first tries to make it more efficient and also more versatile. He simplifies the design so that it is cheaper to make. Finally he tries to improve its appearance and sales appeal. The same technique applies to new products.

Creativity, Professor Arnold believes, is not necessarily something you have to be born with. In fact his whole course is based on the idea that it can be taught. Partly, he believes, it's a matter of day-dreaming, or of speculative thinking. All too many scientists don't care to speculate; they leave that to the science-fiction writers.

Arcturus Designs Pay Off in Earth Money

Industry seems to agree with Arnold that it needs product designers. His students find a wide choice of jobs offered them on graduation; the demand is greater than the supply. One man last year got a \$7,800 job right after commencement—so Arcturus IV apparently pays off in good earth dollars.

Meanwhile the design of new products for the Methanian market goes ahead. Rapid transportation needs—automatic controls are called for because of the Methanians' slow reaction time—are still to be met. Something must be done about the burrowing animals that eat the Methanian crops. Methanian agriculture in general is still mostly hand work; all sorts of farm machinery are needed to raise the standard of living.

The industrial designers of Massachusetts Intergalactic Traders—MIT to you—have plenty to do. Whenever our space explorers really get going, they'll find the products ready for an export drive such as the Milky Way has never seen. **END**

Watch Out

BROWN: "How is the new stenographer you've got?"

GREENE: "Fine, except she's a little clock-eyed."
—*Baltimore & Ohio Magazine.*

FOR EASIER SCRATCH-FREE SANDING USE DREMEL STRAIGHT-LINE ACTION SANDERS

MODEL 2000

A high-speed, fast-cutting production sander for home and shop use. Its straight-line, with-the-grain action is ideal for redecorating jobs, furniture and cabinet making, boat building or refinishing, etc. Recommended by painters and carpenters for sanding woodwork, doors, stairways, dry wall joints, etc. Weighing less than 5 lbs., it is perfect for difficult vertical and overhead sanding jobs. Has 21 sq. in. (3 1/8" x 7") sanding pad surface.

Price includes this sturdy steel storage case (shown below) with handy carrying handle; 25 assorted abrasives; 1 sheepskin pad **\$24.50**

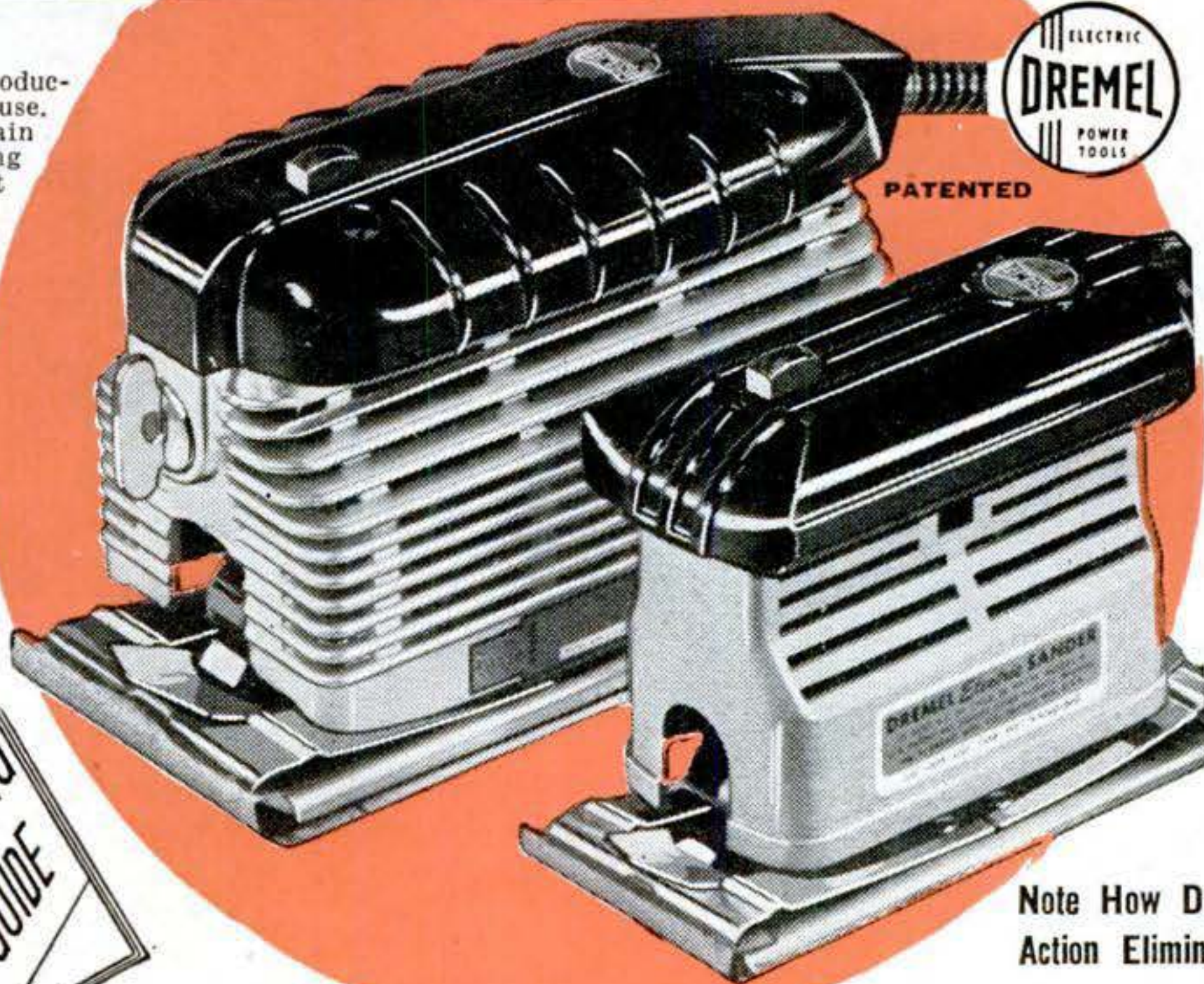
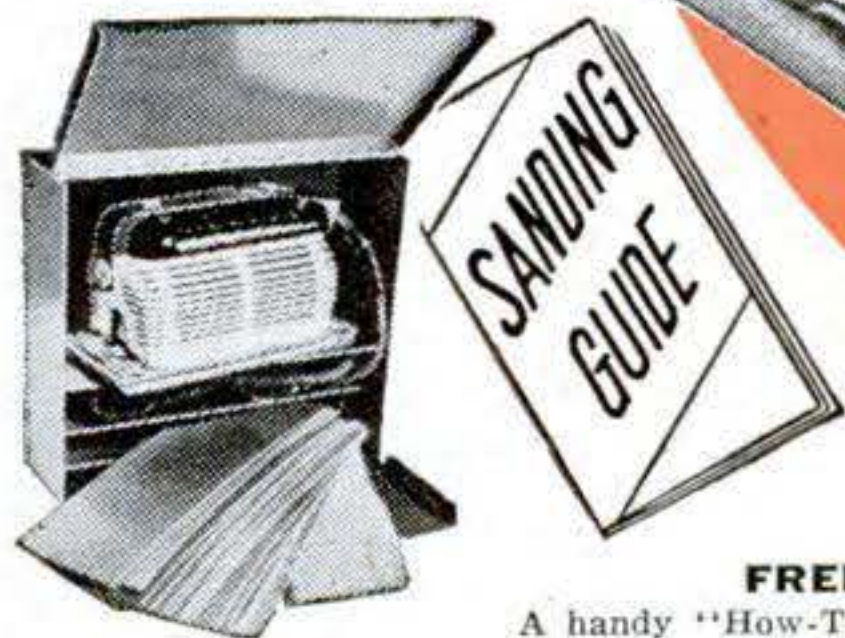

PATENTED

MODEL "A"

The lighter capacity Model "A" Sander is an excellent all-purpose household sander for home maintenance, furniture finishing, hobby projects, etc. Wonderful wax polisher. Perfect for massage use. Weighs only 2 1/2 lbs.; has 12 sq. in. (2 3/8" x 5 3/8") sanding pad surface. **\$14.85**

Price includes:
6 sandpapers,
1 sheepskin,
1 felt pad.

To produce flawless work of professional quality, all sanding must be done with the grain of the wood. Therefore when selecting a Sander, it is important to remember that only Straight-Line, with-the-grain action is suitable for finish sanding operations. For the finest finishes, insist on a Dremel.

Note How Dremel With-The-Grain Action Eliminates Cross-Grain Scratches

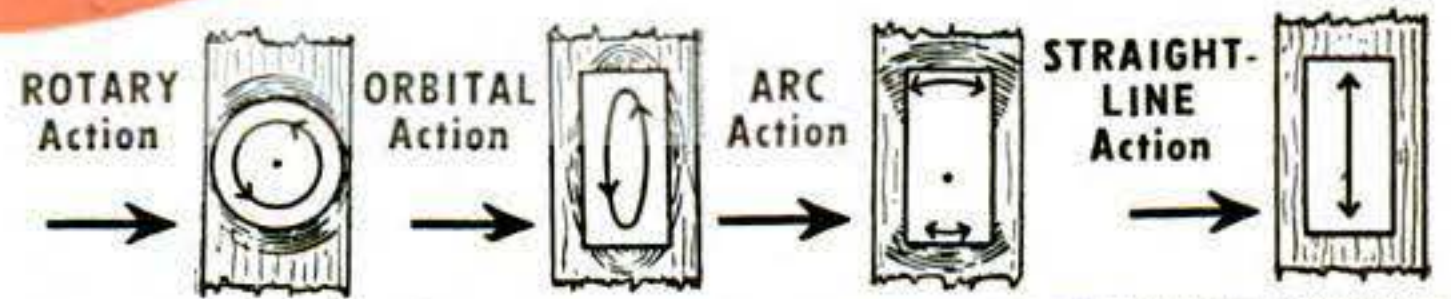

FREE SANDING GUIDE

A handy "How-To-Do-It" booklet containing helpful hints on sanding and refinishing procedures is packed

free with each Dremel Sander. Extra copies available for \$.25.

BOTH MODELS FEATURE: Only 2 moving parts; easy one-hand operation; 10-second paper change; 14,000 strokes per minute; 110-120 V., 60 cycle, A.C.

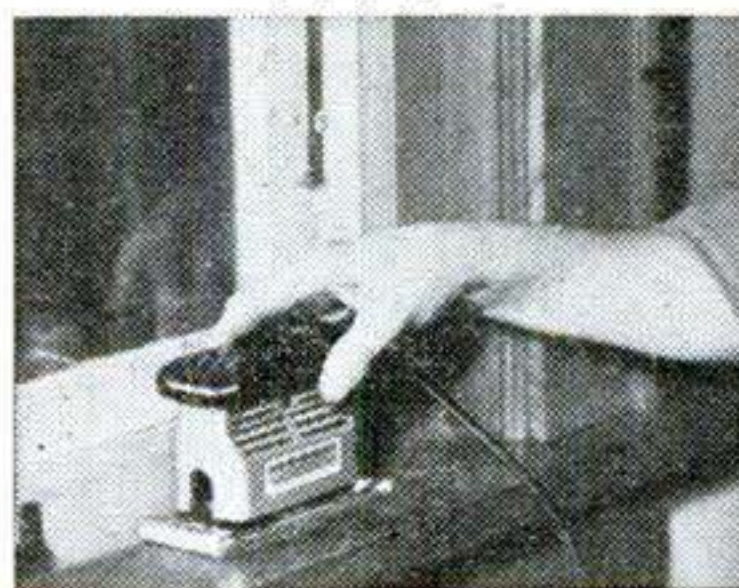

A "must" for sanding dry-wall joints. Fast—cuts refinishing time in half. Sands right into tight corners. Prepares furniture for repainting.

GRINDS • CARVES • DRILLS • ROUTS • ENGRAVES • SHARPENS DREMEL Electric MOTO-TOOL



FASTEST MOST POWERFUL TOOL IN ITS CLASS—APPROX. 27,000 R.P.M.

Most practical tool a man can own—more powerful than any similar tool you can buy. Works well in wood, plastics, and metal. For home maintenance jobs you'll wonder how you got along without it. For model making it's a must. And for general shop operations it saves time and money. Compare it, try it, buy it. You be the judge.

Check These Important Features: Oilless sealed bearing • Dynamically balanced armature • Shockproof, Bakelite housing • Dust-filtered air cooling system • Sturdy 110-120 V., A.C.-D.C. motor • Wt. only 13 oz. • A precision tool widely used in industry for many years.

KIT NO. 2. Includes Model 2 Moto-Tool and 23 Accessories (High-Speed Steel Cutters, Grinding Wheels, Polishers, etc.). Packed in sturdy hardwood case. **\$23.50**

KIT NO. 1. Includes Model 1 Moto-Tool and 34 Accessories (Steel Cutters, Grinding Wheels, Polishers, etc.). Packed in attractive lacquer-finished wood case. **\$17.50**

MOTO-TOOL NO. 2. Offers more convenience and long life features for the money than any other hand grinder. Thousands of satisfied users. Moto-Tool No. 2 (With 1 emery wheel point) **\$16.50**



SEE YOUR LOCAL DEALER. Dremel Tools are sold at better dealers everywhere. If your dealer can't supply, order direct on a five day trial, money-back guarantee. Remit in full, and we will ship postpaid. Or, send only \$2.00 now, pay postman balance plus postage and C.O.D. fee.

DREMEL MANUFACTURING CO.

Dept. 122-K

RACINE, WIS.

Pointers for Home Painters Floors:

Remove wax and polish by washing floor with turpentine. Wipe dry. Unless this is done, finish coats may not dry or stick properly.



Paint in areas about four feet square. Start in far corner and work toward door. For best results use wide nylon-bristled brush—one designed for the job.



On open-grained floors, brush wood filler into pores. Rub across grain with burlap to remove excess. Let dry. Sand lightly with grain. Clean with cloth moistened with turpentine.

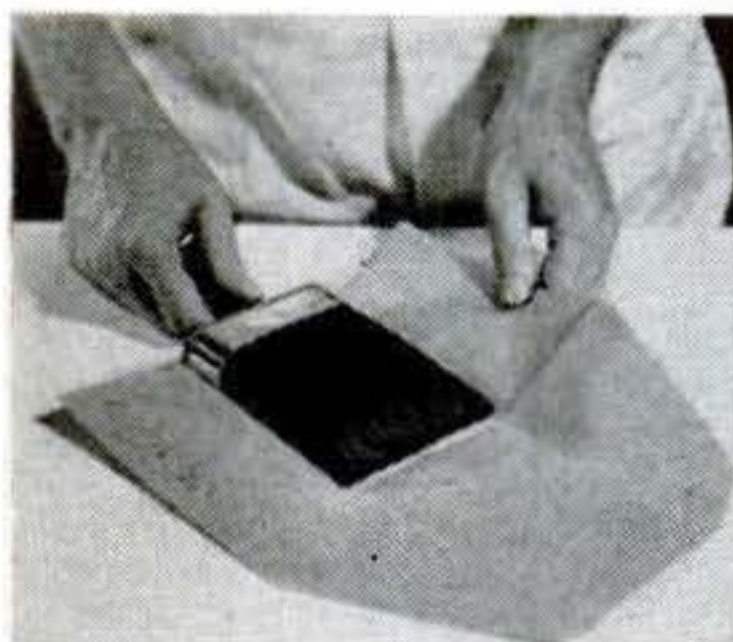

To store brushes for long periods, clean thoroughly and wrap securely in manner shown here. Brushes stay in better condition when they're kept in good shape.

JOB AFTER JOB, you'll get best results with a well-tipped nylon paint brush. Durable Du Pont nylon bristles paint smoother . . . are clean and sanitary . . . never get brittle . . . don't break off even under the roughest treatment. And nylon bristles last from 3 to 5 times longer than ordinary bristles. Leading manufacturers make nylon paint brushes in all types and sizes. Look for the name **NYLON** on the handle. Be sure to pick the size brush designed for the job . . . and demand Du Pont nylon bristles.

150th Anniversary



Better Things for Better Living
... through Chemistry

The best brushes have
**DU PONT NYLON
BRISTLES**

Lightning Goes Down and Around

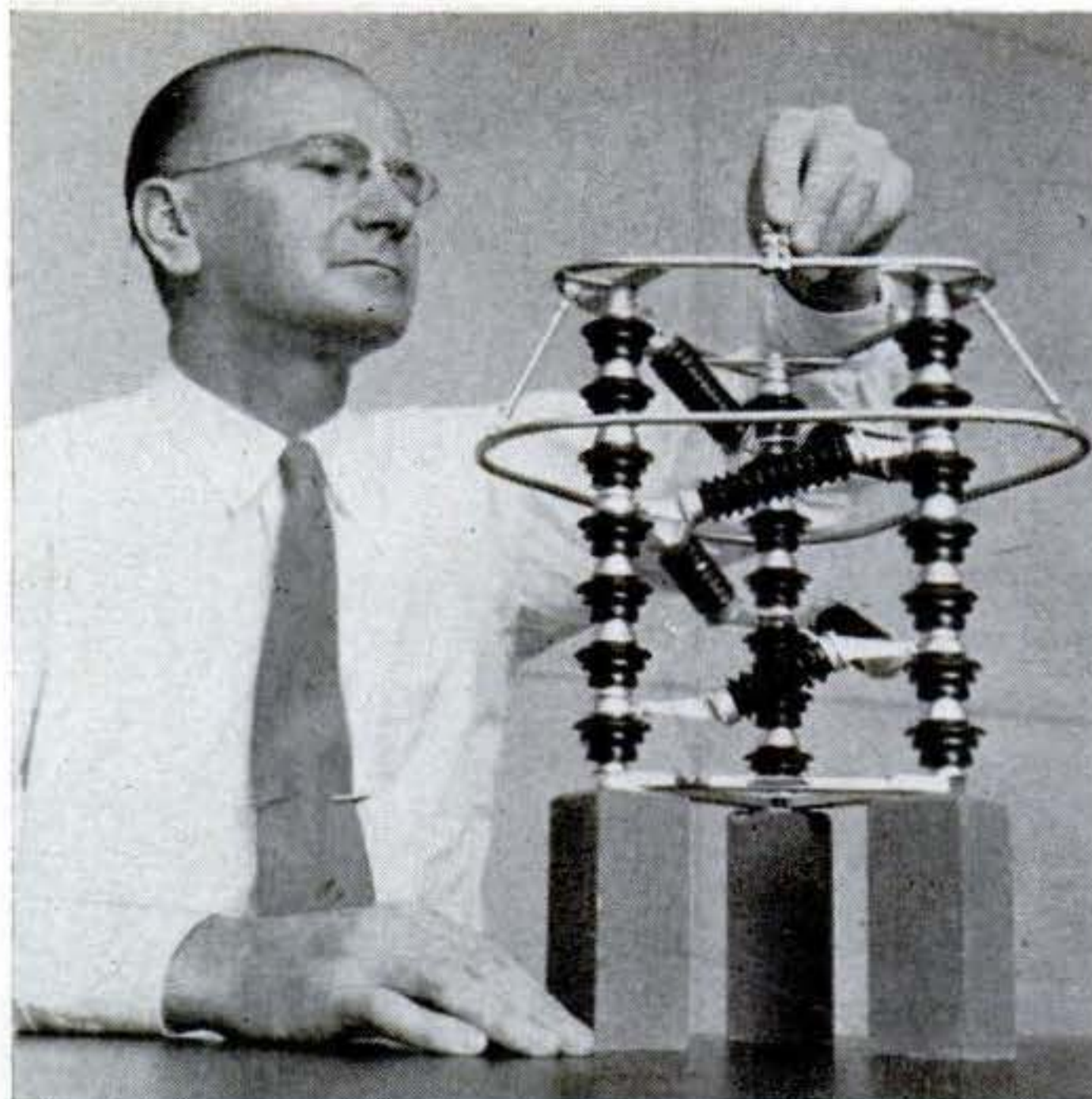

A NEW high-voltage lightning arrester sends lightning down a "spiral staircase" to keep it from damaging equipment at power stations. Conductors angling between the three vertical columns carry the lightning groundward. The arrester was designed by A. M. Opsahl, Westinghouse engineer, shown above with a model. A full-size installation will stand 10 feet high, only half as tall as former high-voltage arresters, which required large structural-steel supports.

Motor Taps Sun for Power

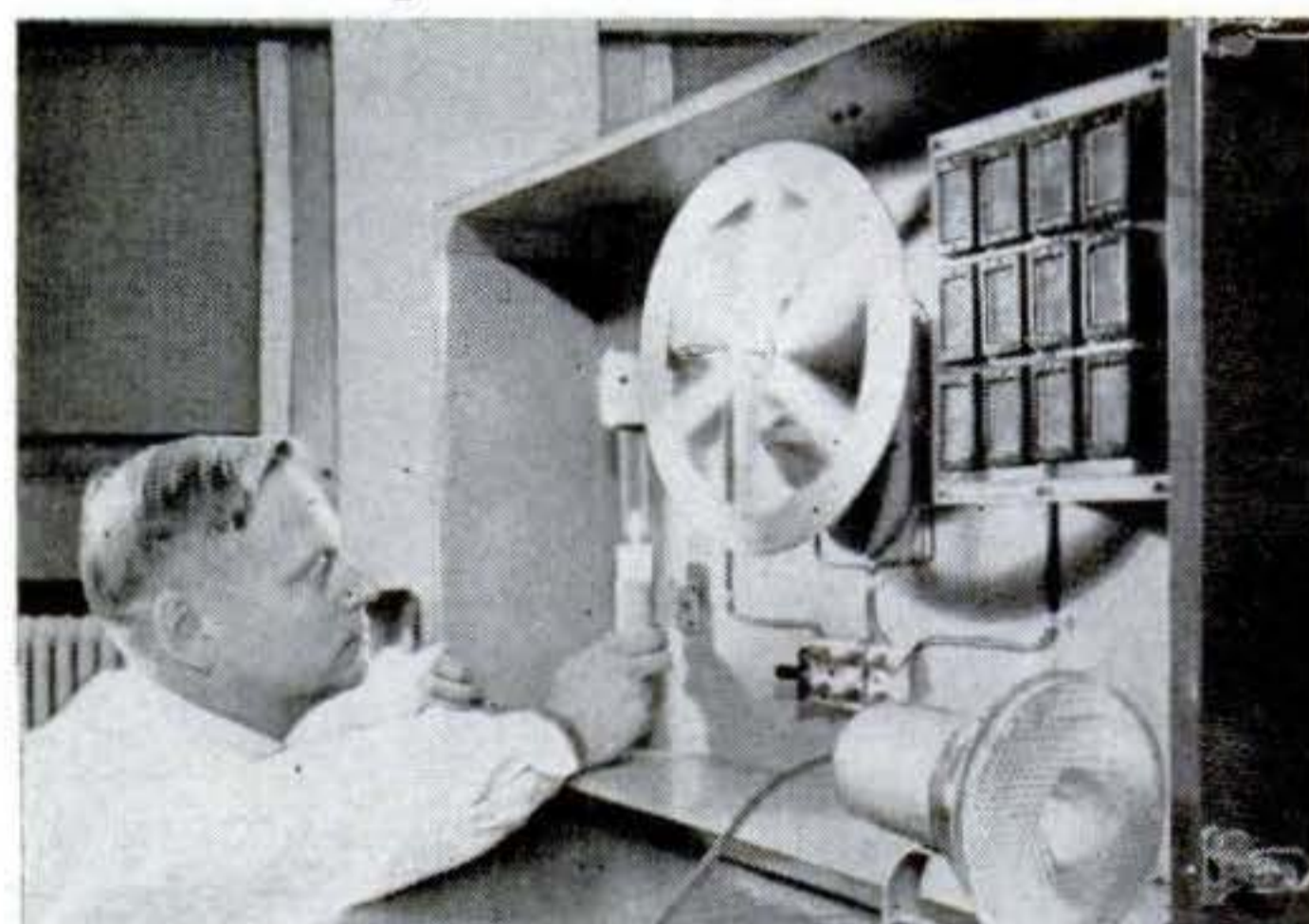

THIS solar generator converts sunlight into enough electrical energy to spin a balsawood wheel on the shaft of a small motor. Light falling on photoelectric cells generates the current.

If sunlight is not available, heat from a burning candle or a 150-watt electric bulb can do the trick. The heat is converted into electrical energy by a bank of thermocouples. The "grownups' toy" was built by General Motors engineers to demonstrate solar power in their science shows.

NOW! YOU SAVE UP TO 50% on AUTO PARTS, ACCESSORIES

EVERYTHING you need for your car—50,000 items including thousands of **HARD-TO-GET PARTS** plus many unusual accessories offered for the **FIRST TIME—all at wholesale prices!**

LOOK! Just a few of the 50,000 Sensational Values in this Catalogue

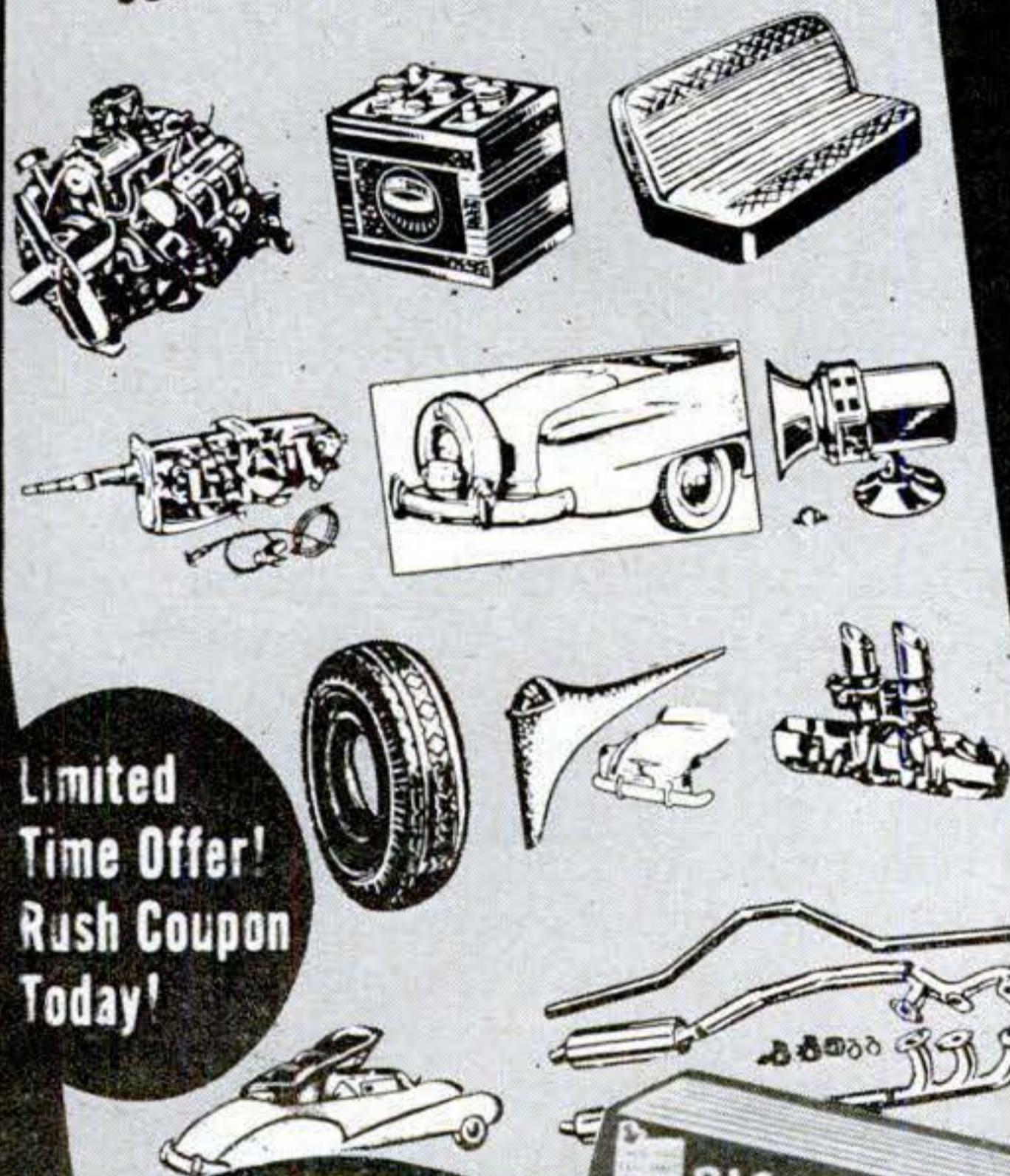

Limited Time Offer! Rush Coupon Today!

GIANT CATALOGUE →

Just off the Press

124 illustrated pages, jammed with 50,000 automotive items at wholesale prices. Value \$1.00. For limited time only, it can be yours for just 25c—which will be credited on your first \$5.00 order. It's like getting this valuable bargain packed catalogue **FREE!** Send today for **YOURS.**

J. C. WHITNEY & CO.
1917-PA Archer Ave. • Chicago 16, Ill.

Take advantage of this big opportunity to get *everything* you need for your car—even many hard-to-find parts and accessories you can't buy in stores! You can get them at wholesale prices—save up to 50%. You'll find these 50,000 thrilling bargains described and illustrated in a giant new wholesale catalogue, jam-packed with exciting values.

Biggest, Most Complete Line in All America for Cars, Trucks, Taxis... from the oldest to latest models

In this amazing catalogue you'll find a big choice of automotive accessories and parts—*everything* you want. Also thrilling values in custom-styling accessories—high-speed parts and accessories to soup up stock engines for top speed, acceleration and economy. Catalogue also includes new style Hollywood accessories different from anything you've seen in stores. Other exciting buys at wholesale prices include:

- Auto radios
- Mufflers and pipes
- Custom-styling accessories
- Engines and parts
- High speed equipment
- Transmissions and parts
- Tires and tubes
- Tools
- Body parts
- Radiators
- Springs and shocks
- Ignition parts

New, used, rebuilt parts and accessories for all makes, years, models of all autos, trucks and taxis.

Exciting get-acquainted FREE GIFT OFFER

Amazing, valuable new scientific check chart that shows you exactly how to know if your car is safe—sent as a **FREE GIFT** with every catalogue. It explains how you can easily make your car safe. Offer limited, so rush coupon today.

MAIL THIS COUPON TODAY!

J. C. Whitney & Co.
1917-PA Archer Ave., Chicago 16, Ill.

Please rush me your giant catalogue, \$1.00 value, that describes 50,000 automotive items I can get at wholesale prices. I enclose 25c to cover part of cost—which I understand will be credited to me on my first \$5.00 order. Also send me **FREE GIFT.**

Name.....

Address.....

City.....Zone.....State.....



Handy Hank says:

"Try these slick tricks with PLASTIC WOOD"

**HANDLES LIKE PUTTY
HARDENS INTO WOOD!**

Fill Holes Around Pipes!

Handy Plastic Wood seals cavities to prevent dust, drafts, bugs, mice from coming through. Has dozens of uses all through the house.

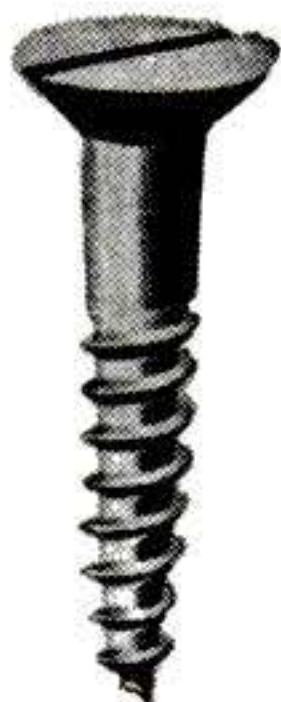

RESET LOOSE SCREWS

Clean and fill old screw holes with Plastic Wood. Let dry and drive screws back into place. Plastic Wood holds firmly, lastingly. Won't crack or pull away. And it's so easy! *Handles like putty... hardens into wood!*

MEND BROKEN TOYS

Plastic Wood sticks firmly to most common surfaces... wood, metal, plastic, fabric, plaster and composition. Plastic Wood is a real toy saver!

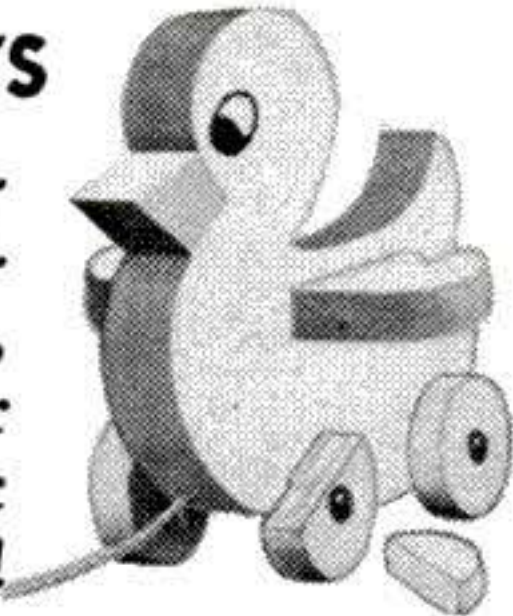

Plastic Wood makes dozens of home repairs *easy!* Can be sawed, sanded, carved or drilled. Will not chip, crack or peel. You'll want Plastic Wood Solvent, too, for controlling the consistency of the Plastic Wood, and for cleaning hands and tools.



Science Explains Why Minerals Glow When Heated

BY LEARNING what makes some mineral crystals glow in the dark when heated, University of Wisconsin scientists have solved a long-standing mystery.

The strange phenomenon is known as thermo-luminescence. Unlike ordinary incandescence—the familiar glowing of any object when raised to red or white heat—thermo-luminescence takes place at a lower temperature and lasts only a moment or so. It is more common than is generally realized. Anyone may observe thermo-luminescence by grinding a small piece of limestone into powder, putting the powder in a frying pan, and heating the pan nearly red hot in the dark.

Radioactive Minerals Are Cause

What makes minerals thermo-luminescent, the scientists found, is radioactivity of uranium and thorium scattered throughout the earth's rocks. The radioactivity drives electrons into "traps" in the lattice-like structure of crystals. When the crystals are heated slightly, the electrons escape from the traps and emit light in the process. Because most minerals contain only an infinitesimal amount of uranium or thorium, centuries are required for the trapping of enough electrons to give a few seconds' glow.

No practical use of this phenomenon has been made up to now, but the Wisconsin group proposes one. During an atom-bomb blast, its report suggests, radioactivity would be so intense that crystals of lithium fluoride would trap sufficient electrons in a few seconds to glow when heated. If a person were wearing a "dog tag" of this material, the amount of radiation striking him would determine the intensity of the glow. The Wisconsin scientists have designed a thermo-luminescent apparatus to heat the crystals and measure the amount of light emitted. Using such a device, authorities could quickly divide a population exposed to A-bomb radiation into groups requiring similar medical treatment.

Renewing Car Upholstery

MOHAIR upholstery in a car may eventually mat down. If so, place a damp cloth over the matted area and run a hot flatiron over the cloth. Then brush the nap upright.

How to clean CARBURETORS "on-the-engine"



A lot of time and money is wasted checking timing, adjusting spark plugs, replacing points—even making major replacements—in an effort to correct engine troubles curable only by carburetor cleaning.

Today, there is no excuse for neglecting this all-important job. With GUMOUT, you can clean the carburetor of all dirt, muck, moisture, gum, and varnish in less than twenty minutes. It's easy to do the job *right on the engine*.

Keep your engine tuned to perfection... get peak performance and save gasoline. Clean your carburetor at the first sign of engine trouble; with every tune-up; at least twice a year.

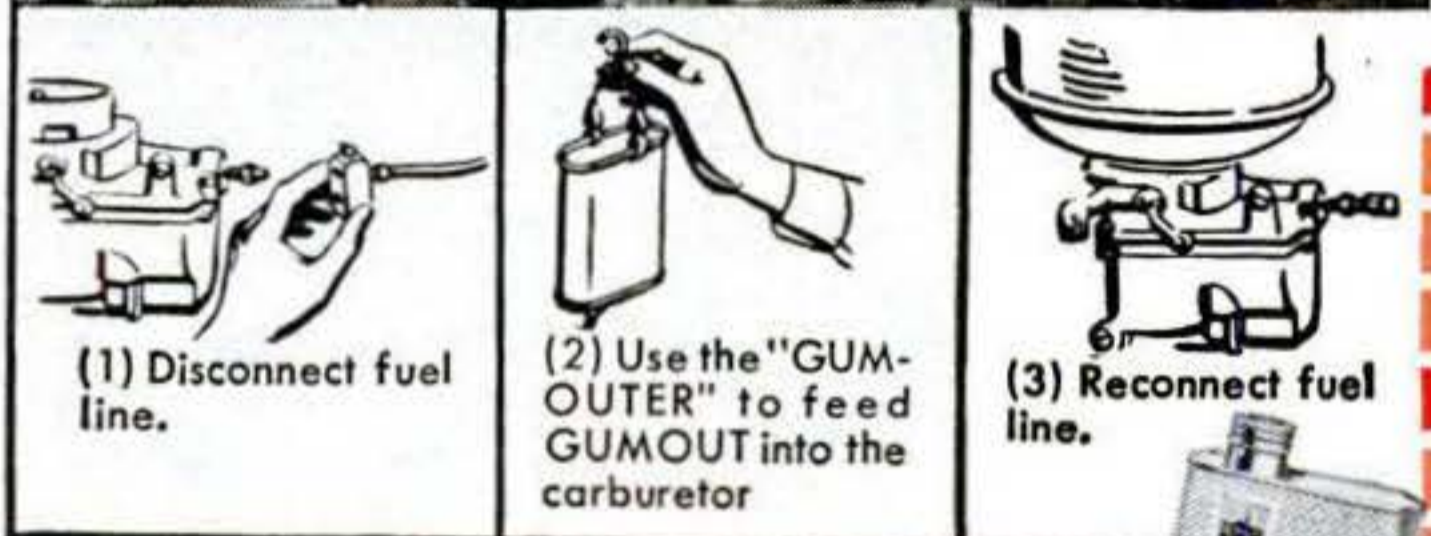

Get GUMOUT from your favorite dealer today. Or use the coupon to order direct. A copy of the valuable *Carburetor Handbook* is yours for the asking.



GUMOUT DIVISION, Pennsylvania Refining Co.
2686 Lisbon Road, Cleveland 4, Ohio

Please send:

P-10-2

- _____ Pints of GUMOUT @ \$1.50
- _____ GUMOUT @ 4.75
- _____ Carburetor Handbook free

Name _____

Address _____

City _____ Zone _____ State _____

YOU CAN START A \$40 A DAY BUSINESS IN YOUR SPARE TIME!



Andy Phillips says:

"MY BELSAW CIRCULAR SAW SHOP gives me BIG PROFITS at LOW expense... I can run 35 to 40 saws in an 8-hour day... That makes me \$40 cash."

FREE BOOK TELLS HOW

You can start this REPEAT CASH business in your own home or garage, while you are working at your regular job. Easy to operate, no experience needed. "Pays for itself from just 65 saw jobs." — *Harvey Jensen.*

For as little as \$15 down payment, you can get your BELSAW CIRCULAR SAW SHOP rushed to you.

You can make \$4 to \$5 an hour in your SPARE TIME sharpening and setting CIRCULAR SAWS for builders, lumber yards, factories... No *Extra* Equipment needed, no canvassing. Send postcard today for your *Free* copy of "Life Time Security."

BELSAW MACHINERY CO

4405 Field Building

Kansas City 11, Mo.

LIFE-TIME SECURITY WITH YOUR OWN BUSINESS

like modern?



No special skill is needed to build modern furniture with Weldwood® Plywood and Easi-Bild* patterns. Have fun, save money — build it yourself.

Use easy-to-work Weldwood Plywood in handsome cabinet wood that matches your present furniture. If you can nail, saw, and spread glue you can make this rich-looking coffee table, easily.

Send 35¢ in cash or money order for Pat. No. 309. Send 35¢ additional for catalog showing 180 Easi-Bild Patterns.

UNITED STATES PLYWOOD CORPORATION
World's Largest Plywood Organization
Pattern Dept., P. O. Box 215, Pleasantville, N. Y.

*Trade Mark, Easi-Bild Pattern Company

OCTOBER 1952 273

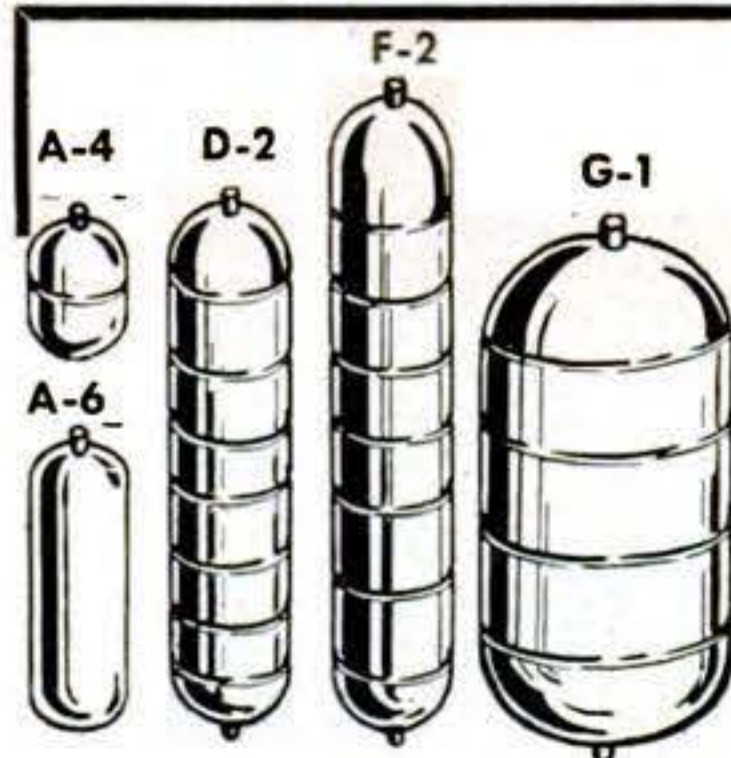

STEEL AIR TANKS

Steel pressure tanks suitable for compressors, pneumatic units, gases, hydraulics, and liquids. Rated at 500 lbs. per square inch pressure. 1/4" standard pipe thread openings on tank ends as shown.

		Size	Wt. Lbs.	Internal Volume	Price
A-4	Stainless Steel—New	7 1/2"x5 1/4"	1 1/2	104 cu. in.	\$1.50
A-6	Carbon Steel—New	14 1/2"x5 1/2"	3 1/4	280 cu. in.	3.50
D-2	Stainless Steel—New	24"x6"	5	500 cu. in.	5.50
D-2A	Carbon Steel—New	24"x6"	5	500 cu. in.	4.50
F-2	Stainless Steel—New	45"x6"	11	1000 cu. in.	9.50
F-2A	Carbon Steel—New	45"x6"	11	1000 cu. in.	5.50
G-1	Stainless Steel—New	24"x12"	18	2100 cu. in.	11.50
G-1A	Stainless Steel—Used	24"x12"	18	2100 cu. in.	9.50

Prices F.O.B. Chicago. Include approx. postage on orders paid for in advance. C.O.D. orders enclose 25%, balance sent C.O.D.

U. A. S. Corp.

Dept. PS-10, 5637 W. 63rd Pl.
Chicago, Ill.

OWN YOUR BUSINESS

Start in Spare Time with a FOLEY SAW FILER

Here is a steady repeat CASH business you can start at home in your basement or garage, while you are working at your regular job. No experience is necessary to turn out perfect cutting saws—"the first saw I sharpened came out 100%. I think the Foley Saw Filer is a marvel of perfection," writes Clarence E. Parsons. Every saw you sharpen will bring you new customers. You will find you can make up to \$3 or \$4 an hour—\$20 to \$30 a week in your spare time as a starter. With a Foley Saw Filer you can file all hand saws, also band and cross-cut circular saws. It is easy to operate—simple adjustments—no eyestrain. Patented jointing principle evens up all irregular teeth and makes an old saw cut just like new.

This Free Book Shows How to Start

"MONEY MAKING FACTS"

shows you how to get plenty of saws to file without canvassing, and how you can develop into a general repair shop that will be your own business. This is a helpful, practical book that tells just what to do—send for your free copy today. No salesman will call.



Send for FREE BOOK

FOLEY MFG. CO., 1019-2 Foley Bldg., Minneapolis 18, Minn.

Send me free book "MONEY MAKING FACTS"

Name.....

Address.....

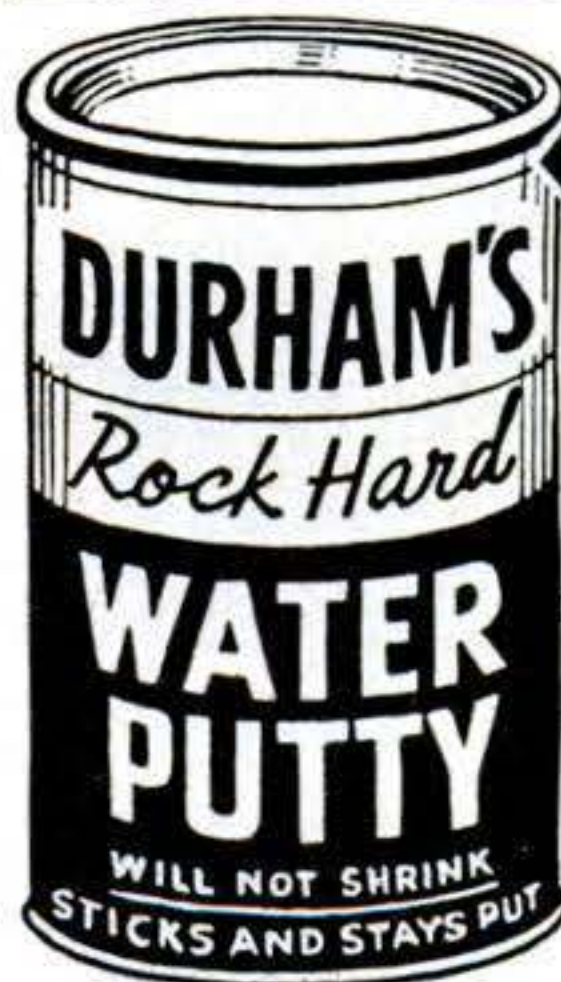

The Modern PLASTIC for lasting Home Repairs

PERMANENTLY mends cracks or holes in wood, tile, stone or plaster. Sticks and stays put—Does not chip, shrink or fall out. Easy to use. Economical. Mold it, chisel it, polish or paint it. If unobtainable from your lumber, paint or hardware dealer, the big 4-lb. can will be sent you post-paid (in U.S.) for only \$1.25. Full money-back guarantee, order now.

DONALD DURHAM CO.

Box 804-V, Des Moines, Iowa

NEW MIDGET OILER!

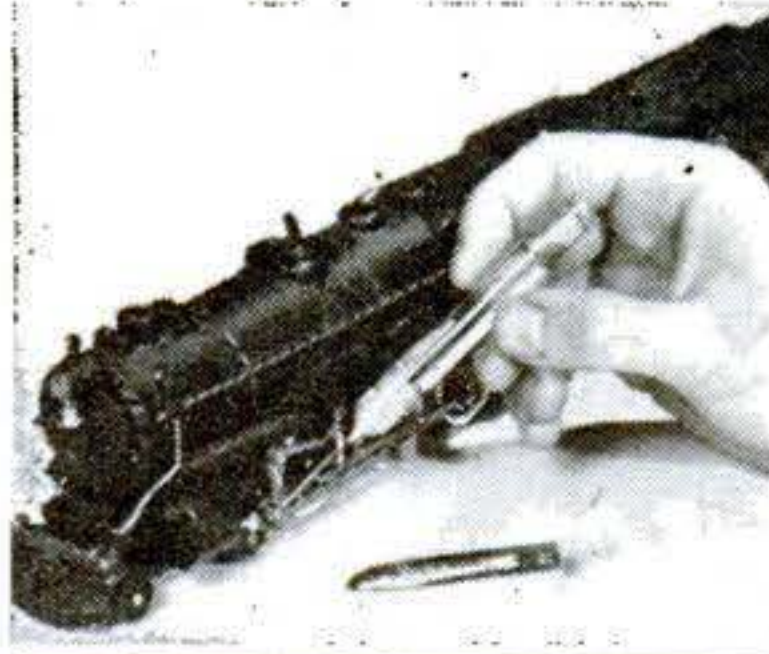

IDEAL for lubricating hard to reach parts of model machinery, delicate instruments, and small working parts of all types in home, office, or shop. "HYPO-OILER," pen size, has a fine hypodermic needle. To use, simply squeeze the transparent oil chamber for the desired amount. Attractive cap with pocket clip protects needle when not in use. Get your "HYPO-OILER" today at your hobby store or order direct. ASK US FOR FREE CIRCULAR ON OTHER \$1 UNUSUAL ITEMS.

postpaid

GAUNT INDUSTRIES
827 Irving Park Blvd., Chicago, Ill.

Make lasting Metal Repairs

WITH →

FREE: "Soldering Simplified." 16 page illustrated booklet. Get your copy now.

Kester Solder Company
4254 Wrightwood Ave.
Chicago 39, Illinois



Built for economy-minded hobbyists who demand . . .
QUALITY PLUS!

SHOPMASTER

8" TILTING ARBOR SAW

\$49.95

Slightly lower Zone 1

A new Shopmaster tool at a new low price. Durably constructed of rugged cast aluminum alloy with large table working surface. Has visible and convenient operating mechanism. It's an excellent all-around tool for the new hobbyists' workshop.

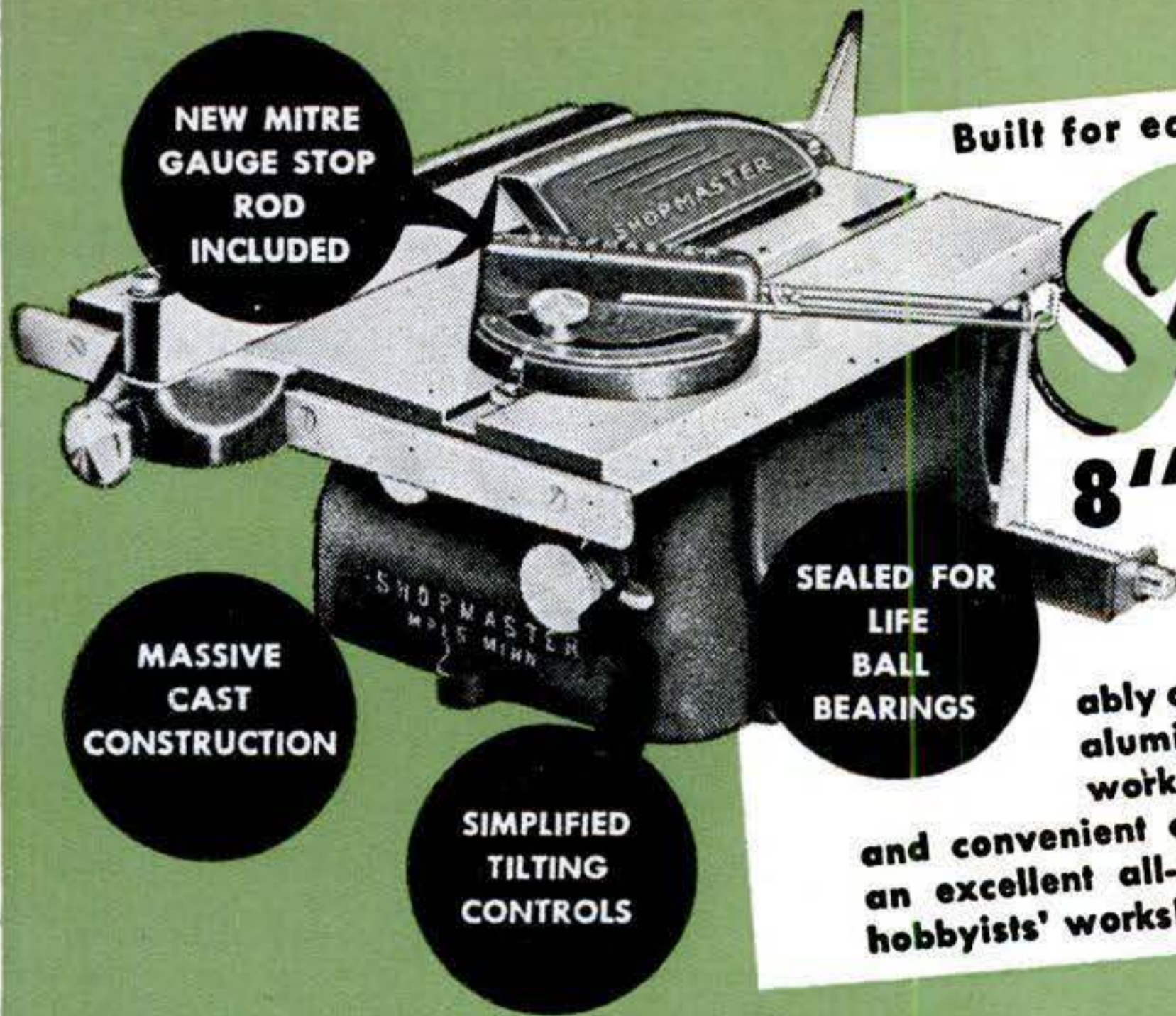

NEW MITRE GAUGE STOP ROD INCLUDED

MASSIVE CAST CONSTRUCTION

SIMPLIFIED TILTING CONTROLS

SEALED FOR LIFE BALL BEARINGS

FREE Complete catalog of the famous quality Shopmaster tools.

Other famous SHOPMASTER TOOLS

20" TILTING TABLE JIG SAW	TABLE SIZE SPINDLE SHAPER	20" TABLE SIZE SABER SAW	12" DRILL PRESS
BELT AND DISC SANDER	10" SWING WOOD TURNING LATHE	12" TILTING TABLE BAND SAW	10" TILTING ARBOR SAW



1214 THIRD ST. SOUTH • MINNEAPOLIS, MINNESOTA

STOP FURNACE LEAKS

Save Fuel Costs

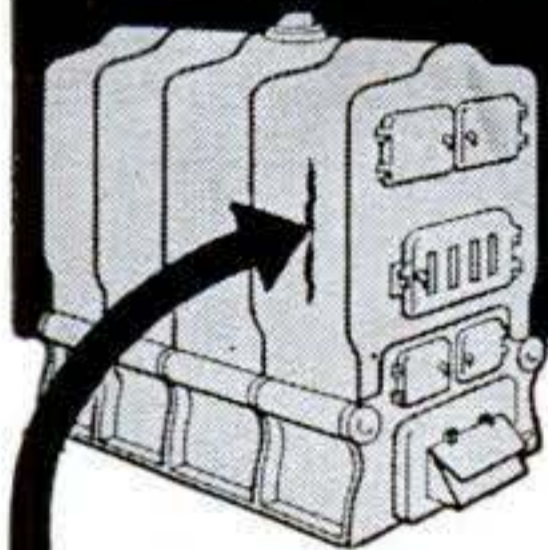

Seal up every heat-wasting crack, opened seam and other leak in your furnace, boiler, tank, radiators and piping tight—as professional repair men do—with Smooth-On No. 1 Iron Cement. Do it yourself—now—and cut this winter's fuel bills. You apply Smooth-On like putty, it hardens like metal, and stays tight, because it expands slightly as it sets. Buy Smooth-On No. 1 in 1 3/4-oz., 7-oz., 1-lb., or larger sizes at your hardware store. If they haven't it, write us.

FREE Repair Handbook

40 pages of ingenious, tested, short-cut repairs. Simple directions. 170 illustrations. Write today for YOUR free copy of the Smooth-On Handbook.

SMOOTH-ON MFG. CO., DEPT. 58-K
570 Communipaw Ave., Jersey City 4, N. J.

Do it with
SMOOTH-ON

THE IRON REPAIR CEMENT OF MANY USES



STOP!

- ✓ BURNING OIL
- ✓ PISTON SLAP
- ✓ POWER LOSS

OVERHAUL YOUR MOTOR IN 10 MINUTES with a **MOTOR RENEW KIT**

CLEANSE with "MOTOR PURGE"

In the FIRST step of the famous Motor Renew treatment, the "Purge" formula cleans, quiets and frees rings, valves and pistons from efficiency and power robbing carbon, gums and varnish. Pour this miracle solvent into the cylinders, run your motor and watch the combustion residue billow out your exhaust pipe.



RENEW with "COMPRESSION SEAL"

RESTORE COMPRESSION... GET NEW POWER, SPEED AND ECONOMY with "Compression Seal"! As the SECOND step of the Renew treatment, squeeze this self expanding mineral compound into your cylinders where it can fill worn spots (which cause compression leaks) between cylinder walls and pistons. Thus it restores compression... cuts oil-gas waste and eliminates costly engine overhaul and ring jobs.



100% MONEY BACK GUARANTEE! A \$100,000 insurance policy guarantees that this "Renew" treatment will not harm the finest engine.

DEALER INQUIRIES INVITED!
FREE Auto Manual With Each Order!
Kit treats all cars and trucks
\$6.95 (Or send \$1 deposit, POSTPAID balance C.O.D.)

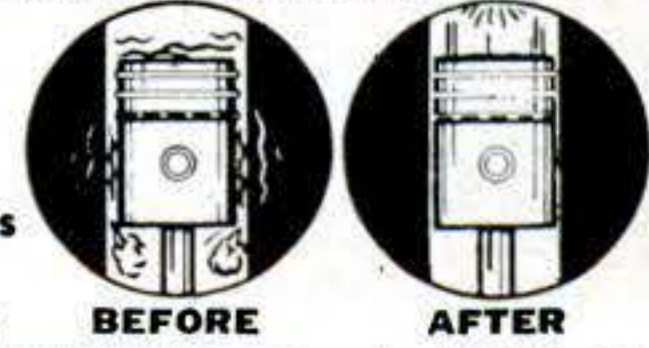

CONSOLIDATED ENGINEERING, Dept. PSK-10
10407 W. Washington Blvd., Culver City, Calif.

World's Most Complete! 1953 ALLIED TV & RADIO CATALOG

FREE!

Everything in TV & Radio
At Lowest Prices

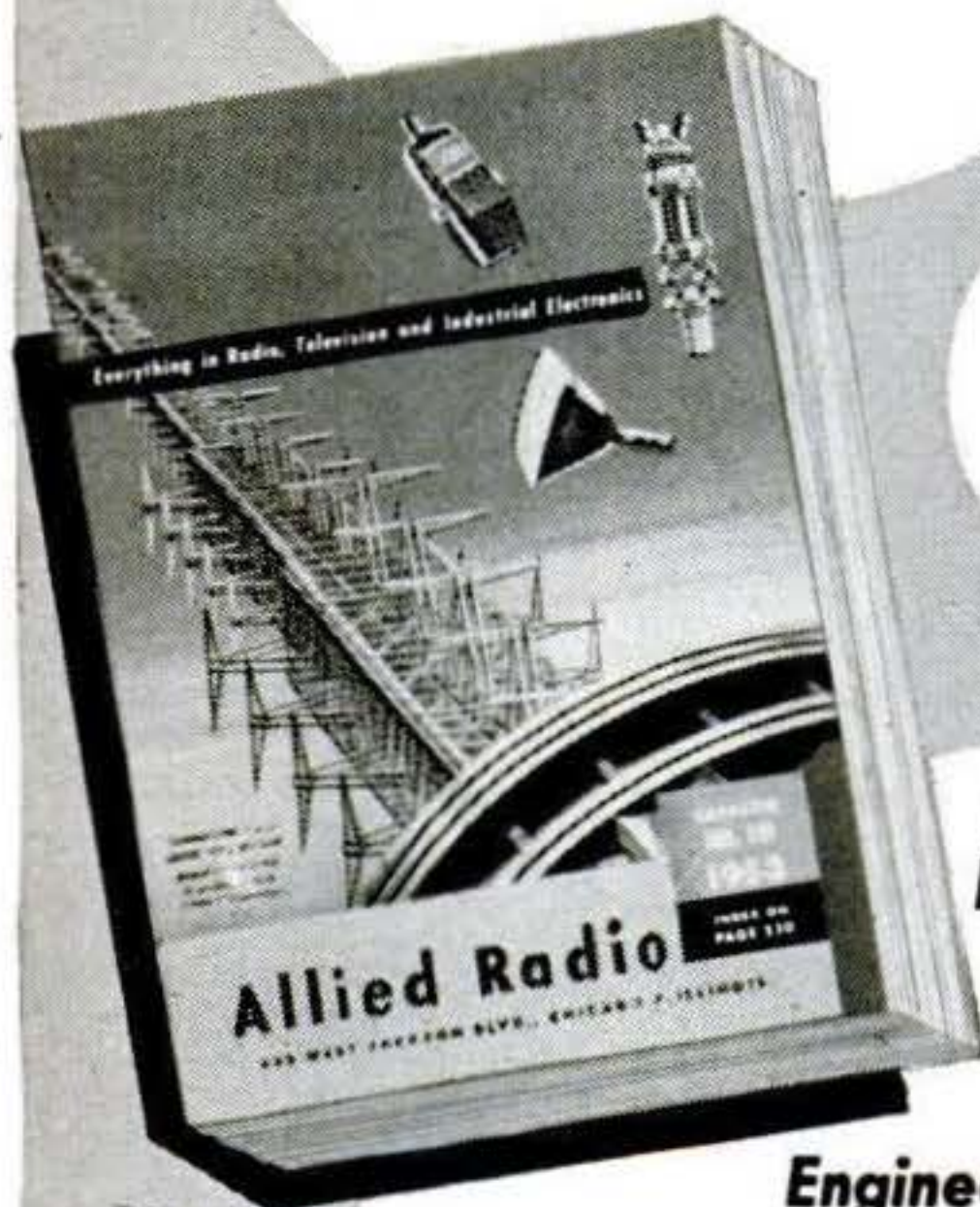

236 PAGES
VALUE-
PACKED

Everything for
Experimenters,
Builders,
Amateurs,
Servicemen,
Engineers, Soundmen

Send for ALLIED's big 236-page 1953 Catalog, the value-packed guide to everything in TV and Radio! Latest home radios, TV equipment, Amateur supplies, High-Fidelity Sound, P.A. Systems, new recorders, test instruments, builders' kits—plus the world's largest stocks of electronic parts, tubes, tools and books. Get more for your money—send today for your FREE 1953 ALLIED Catalog!



SEND FOR
FREE
CATALOG

ALLIED RADIO

ALLIED RADIO CORP., Dept. 7-KK-2
833 W. Jackson Blvd., Chicago 7, Illinois

Rush FREE 1953 ALLIED 236-Page Catalog.

Name _____

Address _____

City _____ Zone _____ State _____

STOPS LEAKS PERMANENTLY

Cut your fixture replacement, water and fuel bills with Economy Renewable Seats. Make economical, permanent repairs quickly and easily with the Junior Kit (illus.). Repair bathroom, kitchen and laundry fixtures. Everything you need included in steel box. This is a natural for the "Fixit" shops—get extra income from making permanent repairs on your customers' faucets.

Senior Master Kit also available—repairs faucets and valves up to 1" pipe.

Write for illustrated circular
JUNIOR KIT, only \$22.50
with 15 assorted Renewable Seats
"Less than the cost
of a set of kitchen
sink fixtures."



ECONOMY VALVE SEAT CO.

1426 N. Keating Ave., Chicago, Ill.

WANT TO
SAVE GAS? ^{1/2} MILLION
NOW USE GANES

AMAZING
GANE | TRY ONE **FREE**
NEEDLE | IN YOUR CAR!

TRY BEFORE YOU BUY!

MANY GANE NEEDLE USERS REPORT UP TO 25% more mileage, faster pickup, easier starting and smoother idling.

NOW TEST A GANE NEEDLE IN YOUR CAR for ten days, then compare your mileage and performance. If satisfied, send \$1.50 per needle (8 cyl. cars take 2). If not satisfied, just return it—fair enough? Since authorities differ on its merits and some users report no improvement, TRY BEFORE YOU BUY! (Gane Needle replaces idling adjustment screw in carburetors—easily installed in a few minutes.)

WRITE TODAY. ENCLOSE NO MONEY. PAY POSTMAN NOTHING. Just send us your name, address, and make and year of car.
NATIONAL AUTOMOTIVE RETAIL CORP., Dept. H-10
350 W. Washington Blvd. Venice, California

FREE Auto Economy Manual

Tells how to save gas, tires, brakes, etc. Also introduces many new economy products. (Sent absolutely free to all who try Gane Needles.)

TO LOCATE THE WOOD STUDS IN YOUR WALL

USE A DOWSER *

When hanging mirrors, pictures, shelves. Also when repairing or altering.

\$2.00 Ppd. Money-back guarantee.

The Roll of the Ball Finds the Stud in the Wall

You May Need One Tomorrow!



*PATENTED

FORD PRODUCTS, Dept. R-1, Tuckahoe, N. Y.

IMPORTED ENGLISH Sheffield Steel PLIERS

The finest in tools! Magnificently machined. Surfaces highly polished. Satisfaction absolutely guaranteed or your money back. Send Cash, Check, M. O. or sent C.O.D. (25% with order). We pay all freight and postage.

A Round Nose
6 in. \$1.55

B FLAT NOSE—
1/16 in. thick,
tip 3/16 in.
wide, 5 in. \$1.95

C LINESMAN'S
with side cut-
ter and wire
stripper, 6
in. \$1.75
& 8 in. \$1.95

D DUCK BILL NOSE
5 1/2 in. long.
Nose 5/16 in.
wide closed \$1.85

E DIAGONAL
Side cutters
with spring
for speed, 5
in. \$1.90

F DIAGONAL
Side Cutters,
6 in. (Not
Shown) \$1.90

G NEEDLE NOSE
—with side
cutter, 6 1/2
in. (Not
Shown) \$1.80

Special Discounts for
Quantity Orders

RELIANCE MERCHANDIZING CO.
2211 Arch St. Philadelphia 3, Pa.

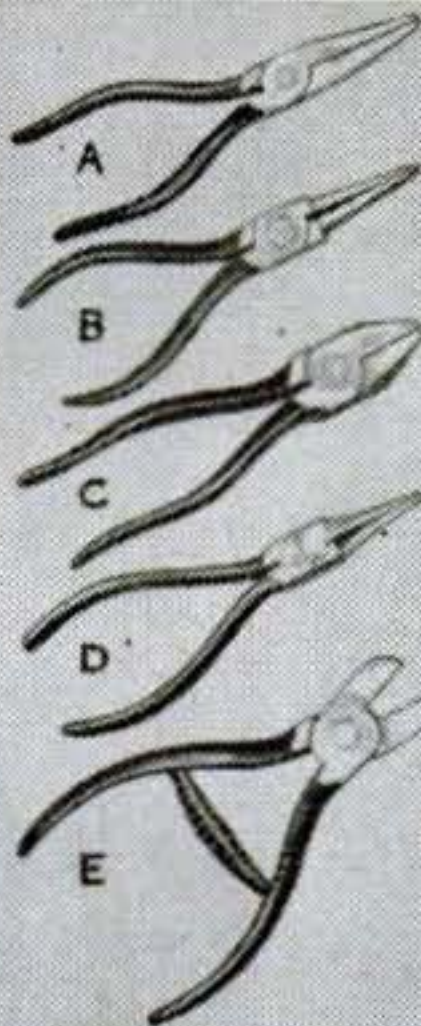

\$ SAVE \$

ORDER BY MAIL

From

**NEWHOUSE
AUTOMOTIVE**

WORLD'S LARGEST DISTRIBUTORS
OF SPEED AND POWER EQUIPMENT

CUSTOMIZE YOUR CAR WITH A CONTINENTAL KIT

SPECIAL! Ford-Chevy Economy Kit only \$24.95

New all-metal, 2 piece economy unit. (Tire stays in trunk.) Installs easily by drilling 1/4" holes, no alterations required. (Inc. chrome wheel disc at no extra cost). Fits all 1949-52 Ford and 1949-52 Ford and 1949-52 Styleline Chevy cars.

ALSO DELUXE KIT MODELS

Install them yourself and save! Kit is complete with gravel guard pan, metal tire cover, remote control lock release, chrome welts, special hub cap, license light, safety lock assembly, wheel mount bracket, bumper extension, and all necessary bolts and nuts for installation.

All 1950, 51, 52 Fords.....\$79.50
Chevrolet (Styleline body), tire size 670 x 15, 1949-52\$89.50

OTHER KIT PRICES

Kaiser (1947-52) ..\$134.50 Packard (1951-52) ..\$159.50
Cadillac (1950-52) ..\$159.50 Studebaker
Mercury (1951-52) ..\$149.00 (1951-52)\$139.50
Oldsmobile (1949-52)\$149.50

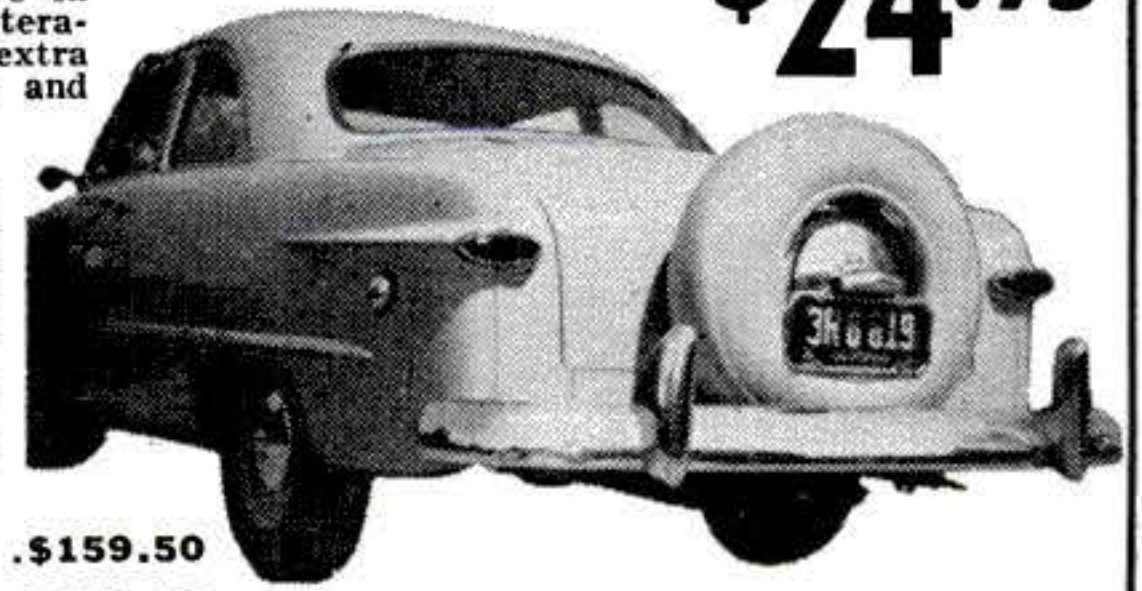

Send only \$10.00 deposit, balance C.O.D.

**CUT GAS COSTS
UP TO 25%**

**WITH A
FUEL PRESSURE REGULATOR!**

**STOP: Power Loss Fuel Waste
Carburetor Flooding**

MANY USERS CLAIM UP TO 25% BETTER MILEAGE as this revolutionary new accessory stops gas waste caused by fuel pump pulsation. It eliminates carburetor overflowing and fuel "surge." Stops the annoyance and danger of "motor cut-out." As this precision regulator s-m-o-o-t-h-s fuel flow, it also prevents vapor lock and percolating. It pays for itself ten-fold with gas savings, by eliminating frequent carburetor adjustment and by reducing engine and carburetor wear. Fits all cars and trucks. 30 day "money back" guarantee! Postpaid..

(Or send \$1.00, balance C.O.D.)

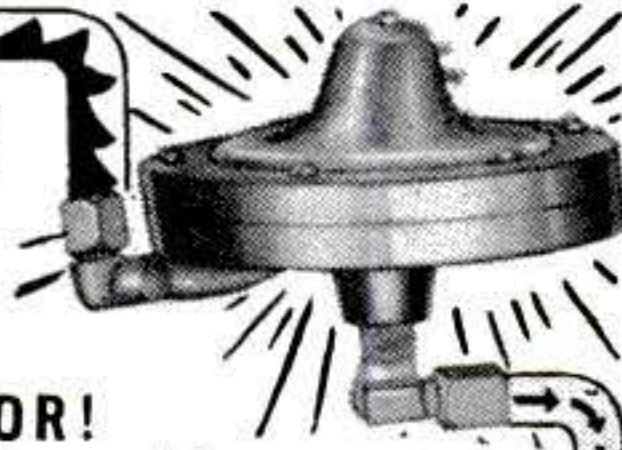

BEFORE AFTER
\$5.95

DON'T RIDE WITH DEATH!



with



without

**USE AIRPLANE
STYLE
SAFETY BELTS**



Records show that being thrown against the dash or windshield and being thrown out of the car in accidents are the chief causes of fatalities and serious injuries. In most cases, use of a safety seat belt would have prevented those deaths and injuries. Safety seat belts reduce body fatigue on long drives and increase your control over your car. Belt has instant release buckle. Your choice of blue, black, grey, green, yellow or red webbing. Meets all government safety standards. Easily installed on any car seat.

Single Belt Assembly.....\$8.95 ppd.
Double Belt Kit\$14.95 ppd.
Four Belt Kit (4 passengers).....\$24.95 ppd.

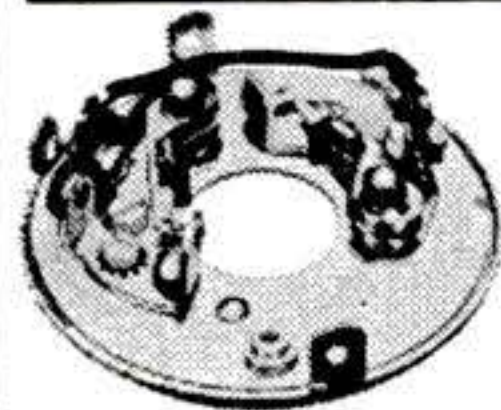

**STOP MOTOR
SKIP BUCK And ALSO
with a
DUAL POINT BREAKER PLATE**

Replace your present stock (single point) ignition with a dual point breaker plate. It increases cam angle from 31 degrees to 36 degrees dwell and also increases coil saturation to full capacity. This plate produces a hotter spark... giving better mileage, easier starting and smoother performance. Features "super" size dual tungsten points. The only 8 cyl. plate available with 50 precision ball bearings. Fits: '37 to '52 Oldsmobile 8's, Pontiac 8, Buick 8, Studebaker V8, Cadillac V8, also Packard '51 to '52 (with Delco Dist.). \$11.95 Postpaid

Also non-ball bearing dual point conversion plates for '49-'52 Ford 6, '37-'52 Chevy, '49-'52 Ford V8 and Mercury, '50-'52 Lincoln: Specify. Postpaid \$6.95

STOP WASTING MONEY!

**NEW OIL FILTER ELEMENT
NEVER NEEDS REPLACING
GUARANTEED FOR 10 FULL YEARS**

Famous Filteral filters 100% of your oil through bronze cone which never needs replacing. This new porous oil filter will pay for itself by saving the cost of stock oil filter cartridge replacements. Gives maximum motor protection by removing all foreign matter the moment engine starts. No oil is lost or bypassed, regardless of temperature, and valuable protective additives are retained. To clean, just rinse the filter in gasoline. Complete filter unit \$12.95 ppd.
Cartridge only (to fit your filter).....\$6.95 ppd.
(List make and model of present filter and car)

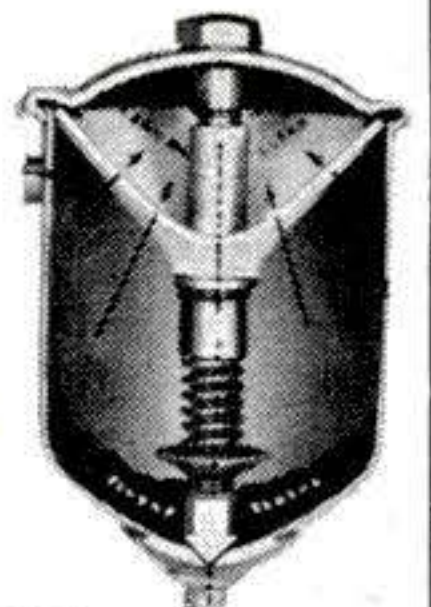

NEWHOUSE AUTOMOTIVE, Dept. AX-10, 5805 E. Beverly Blvd., Los Angeles 22, Calif.

Build your own SMITH Compressor

Operates spray guns, rock drills, tampers, paving breakers, sandblasting... Uses only 1 gallon of gas an hour!

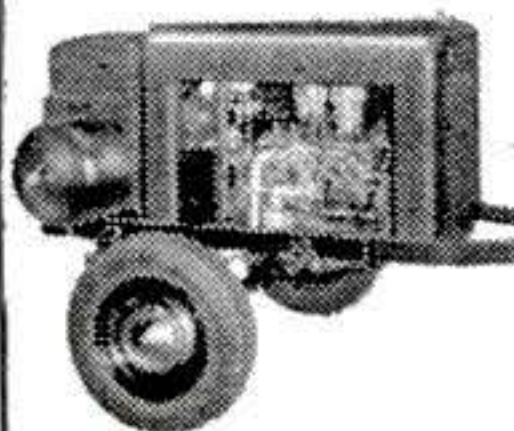

Save Money—build your own Smith Air Compressor! Famous the world over! Capacity 60 cu. ft.; pressure up to 100 lbs. per sq. inch. Just order the Smith Compressor Head and Accessories with complete instructions for assembling. All you need is a Ford Motor and shop facilities. Head equipped with high speed compressor valves; automatic unloading and idling.

Write for complete information!

GORDON SMITH & COMPANY, Inc.
405 College Street • Bowling Green, Ky.



PERFECTLY ACCURATE ONE-MAN LEVEL

UP TO 50 FEET OR MORE

LEVELALL

Packed in husky wooden carrying case 12 x 11 1/4 x 3 1/4". Only 6 pounds, easily carried.

\$7.45

FASTER THAN \$100 ENGINEER INSTRUMENTS!

New and improved! The most inexpensive water level giving perfect level with easy one-man operation. Ideal for footings, foundation forms, sills, floors, road gradings, drainage, all general construction normally needing \$100 instruments. Simple, accurate, foolproof! Fast, weather-hardy, sturdy! 50-foot best quality transparent vinyl polychloride tube, filled with red Level-Flo liquid. 2 heavy steel brackets for easy 1-man use. Husky carrying case.

THE DELUXE LEVELALL is also offered with 75' of tubing — an extra supply of Level-Flo fluid — and a Handsome Deluxe Carrying Case.

DEALER INQUIRIES INVITED.

LEVELALL

81A Webster St., Rockland, Mass.

Mail me..... Levelall instruments at \$7.45.

Mail Me..... DeLuxe Levelall at \$12.45.

You guarantee satisfaction or money back upon return of Levelall within ten days.

NAME.....

ADDRESS.....

CITY..... ZONE..... STATE.....

Send C.O.D. I will pay postman full purchase price plus delivery charge on arrival.

Full purchase price is enclosed. Send postpaid.

Wellworth AIR COMPRESSOR

For Farm and Home Workshop

Compressor has 2" bore, 1 3/4" stroke, 2.8 cfm up to 150 lb. pressure. Motor required: 1/4 h.p. at 100 lbs.; 1/2 h.p. at 125 lbs.; 3/4 h.p. at 150 lbs. or equivalent gas engine. V-belt cast iron pulley, intake muffler and cleaner, bronze bearings, splash lubrication. Wt. 16 lbs. Price of compressor, as described



\$20.50

MODEL W200 COMPRESSOR

2 1/2"x2". 2.55 to 4.80 c.f.m. up to 150 lb. pressure. Operates with 1/3-1/2-3/4 HP motor. Reg. price \$36.50. Special price..... **\$27.95**

Wt. 24 lbs.

MODEL W7 COMPRESSOR

2 cylinder 2 1/2"x2". 5.10 to 8.50 c.f.m. up to 150 lb. pressure. Operates with 1/2-3/4-1-1 1/2 HP motor. Reg. price \$67.50. Special price..... **\$54.50**

Wt. 45 lbs.



"Wellworth" BLOWER BARGAIN

Quiet operating. Double wheel inlet, double width blower. For heating, ventilating, cooling, air washing, exhausting and forced draft. DIMENSIONS: 10" wheel; outlet 13 1/8"x11 3/8"; inlet 8 3/4". Height 19". Width 18". Depth 16 1/2". C.F.M. 1/4" S.P. 1600; outlet vel. 1575. Wt. 45 lbs. **BLOWER LESS MOTOR AND DRIVE..... \$27.50**

With 1/4 h.p. motor, **\$45.00**

With belt and variable speed pulleys, \$2.50 extra.

CONTINENTAL GAS ENGINE



Red Seal. 1 1/2 HP with 6 to 1 reduction gear. Operates at 450 R.P.M. For lawn mowers, scooters, garden tractors, pumps, compressors, etc. List Price **\$79.50**

Shipping wt. 54 lbs.

SPECIAL PRICE..... **\$47.50**

WISCONSIN GAS ENGINE

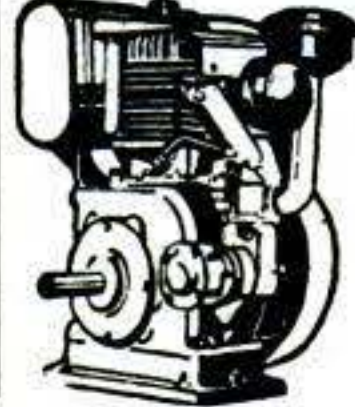

Big Saving. 1952 model. A.K.N. 4 to 6 H.P. Wt. 75 lbs.

\$89.50

Automatic Compressor Units, Light Plants and Generators at BARGAIN PRICES. Write for descriptive folders.

PRICES F.O.B. CHICAGO. MONEY BACK GUARANTEE. SEND CHECK OR MONEY ORDER TODAY. PROMPT SHIPMENT. WRITE FOR OUR FREE CATALOG.

WELLWORTH TRADING CO.

1832 S. Wabash Ave., Dept. B-1052, Chicago 16, Ill.

BUILD YOUR OWN POWER TOOLS—TILT/ARBOR SAW

Exclusive GIL-BILT Build-It-Yourself Features

- No machining—build easily with hand tools only
- No blueprint reading—step-by-step pictorial plans, full scale patterns, actual photographs
- Sturdy wood, aluminum and steel construction
- Capacity and performance of commercial saws selling for \$60 and up

BANDSAW BELT SANDER SAVE \$50. OR MORE

GIL-BILT 10-INCH TILTING ARBOR SAW



- 27x28 in. table, 13 1/2 in. capacity in front of blade
- 10 in. blade cuts 3/4 in. deep, tilts full 45 degrees
- Floor model 34" high, table always stays level
- New Departure ball bearing arbor, 3/4" precision shaft turned down for 5/8" bore blades, alum. housing, shipped ready to run
- Jackscrew and 1 1/2 in. dia. handwheel lowers and raises blade
- Cast aluminum miter gauge and self-aligning rip fence guide

GIL-BILT Metal Parts Kit includes Plans, ball bearing arbor, miter gauge and bar, rip fence guide, dado insert, lock knobs, jack screw mechanism and handwheel, and all other metal parts (less blade) **\$20.95**
Same Kit with 10" Combination Blade... **\$24.90**
Same Kit with 8" Combination Blade... **\$23.90**

GIL-BILT 12-INCH BAND SAW



- Cuts to center of 24 inch circle
- Handles stock up to 6 inch thick
- 18x18 inch table tilts 45 degrees
- Lower wheel and drive pulley runs on sealed New Departure Ball Bearings; Upper wheel runs on two 5/8" bore Oilite Bronze bearings.
- Upper wheel tension and tilt mechanism of cast aluminum, completely assembled
- Upper and lower blade guides. Each has ball thrust bearing, self-lub bronze jaws
- Rigid cast aluminum wheels fully machined ready-to-install. Heavy rubber tires.
- Uses standard 78 inch blades up to 3/8 in. wide
- Fully enclosed mechanism for utmost safety

GIL-BILT Metal Parts Kit includes Plans, rubber tires, aluminum wheels, 1/4 in. blade, ball bearing spindle, tilt mechanism, blade guides, table tilt segments, and all other metal parts... **\$21.95**
Return Kits in 10 days for refund if not satisfied.

(Prices include postage within 300 miles. Over 300 add 5%)
Also available—Plans and Parts Kit for Belt Sander and 8" Tilt/Table Saw. Order Plans at \$1.00 each—Send postpaid anywhere in the world or write for FREE descriptive catalog.

GILLIOM POWER TOOLS

P.O. Box 1-VK, Lambert Field St. Louis 21, Missouri

WOW!
ONCE IN A LIFETIME

COMPLETE PORTABLE ELEC. HOBBY SHOP

We GUARANTEE this an \$85.00 Value

Has everything! Beautiful hammered gold all metal carrying case. Famous Zephyr 1/4" Drill with mirror chrome finish. Hi-speed rotary files; buff, polish kit; grinding wheel, drills, discs, etc. Tools for every use.

100-Pc. ELECTRIC DRILL SET

27⁵⁰



TOOL-MAKERS'-MACHINISTS' PRECISION TOOLS

Atomic, Aircraft & Jet Plants use for most precise work Compare to any selling 2 & 3 times our price.



HELIOS 6" Vernier CALIPER



Cash Orders Postpaid 50% Dep. on C.O.D.'s.

Hardened tool steel; friction lock; inside, outside & depth measurements in 1000ths. 22.50 value. **8⁹⁵**

UNCONDITIONAL MONEY-BACK GUARANTEE

TRANSCONTINENTAL SALES CO., INC.

Dept. P510 947 S. Broadway, Los Angeles 15, Calif.

SAVE UP TO \$100.00

on your STORM WINDOWS

Assemble Combination Redwood or Aluminum Storm Windows Yourself!

These patented storm windows regularly sell for \$22.75 assembled. Now only \$6.50 knocked-down and shipped

to you. With only screen cloth and glass to buy locally, your total storm window cost is only about \$8.50 each. Upper and lower sash snap out from inside for easy washing. Screen replaces top or bottom sash during warm months—self storing in upper portion in winter. Frame stays in year 'round. No storage problem whatsoever. Only top-quality kiln-dried redwood. All standard window sizes. Write for descriptive



\$6.50* each
*Redwood 24/24 Glass—others, slightly higher

DEALERS: A few choice areas are still available

BUCKEYE SCREEN & WEATHERSTRIP CO.

1378 S. 22nd Street, Columbus, Ohio



MAGNETS LIFT 225 lb.
GENUINE ALNICO—NEVER WEAKENS

AMAZING, PERMANENT MAGNETS—WILL NOT WEAKEN! NON-ELECTRIC Retrieve guns, tackle, tools and other steel items from lake, river, plating tanks, drains or other hard-to-reach spots. Recover drills, taps, etc. from sweepings. Clear alley of harmful tacks, nails. Many other uses. Pays for itself quickly. GUARANTEED. Try any magnet one week. Money refunded if you are not well pleased.

No. S-725 (Weights 54 oz.) Has pull of 225 lbs. on steel block **\$15.00**
No. S-675 (Weights 49 oz.) Has pull of 175 lbs. on steel block **\$10.50**
No. S-650 (Weights 41 oz.) Has pull of 150 lbs. on steel block **\$ 8.50**
No. S-30 Hobbyist assortment of six small magnets..... **\$ 1.50**

Send Money Order or check. We pay postage. No C.O.D.'s.
MIAMI MAGNET COMPANY, 3240 N.W. 27th Ave., Miami 42, Fla.

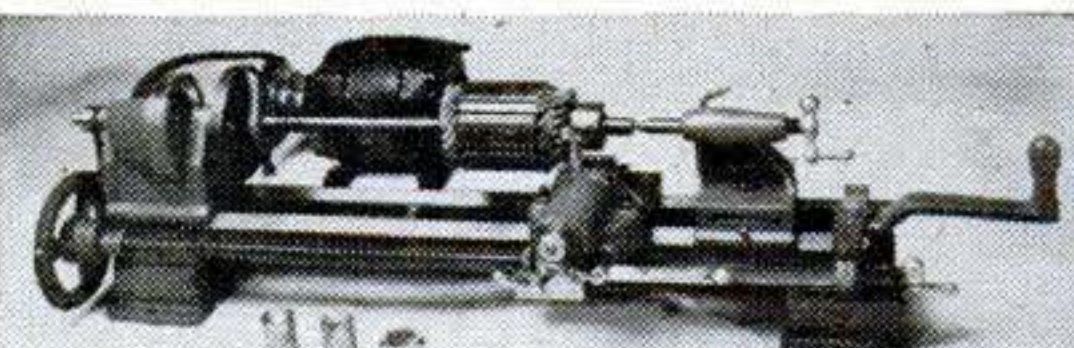

ONLY \$65.00
FREIGHT PREPAID

WE SEND YOU A LATHE—NOT LITERATURE

To Prove by Trial the Biggest Lathe Value Ever Offered

You've read about other lathes—seen attractive color photos, but you can't machine a thing with words or pamphlets. We won't send you literature but we will send you a brand new, top quality lathe, freight paid. We let you see our lathe—feel it—actually machine with it while you make up your mind to keep it or shove it back in the crate and return it freight collect. And what a lathe it is! Sturdily built with bed ways machined with double V to 60°. The compound swivels 360° on a center pilot and is locked with 2 T-slot bolts. Lathe may be operated with a 1/4 h.p., 1750 r.p.m. motor. Bed length 26" with cutting range 18 1/2", 6" swing. Sent complete with hand undercutter and lever hand feed, 2 female centers, 2 male centers, driving dog, arbor attachment and grinding wheel, V-belt, 2 power feed belts, tool bit, face plate and dog. The lathe is precision and sturdily built to handle every metal or wood job within its dimension cap. Ideal for factories, hobby and home workshops or as armature lathe for garages. Full price freight paid only **\$65.00**. 10 day free home trial—you must be satisfied or return it at our expense for your money back in full. Immediate delivery while they last. Send check or money order for **\$65.00** to: **HAMILTON PRODUCTS, INC., 12416 Euclid Ave., Cleveland 6, Ohio**

MOST POWERFUL SAW of its kind!

SAFE! Blade Does Not Pull Fingers Toward It!

No other electric jig saw is so powerful, so large, so sturdily built, so efficient as safe Syncro No. 201! No other gives you a GUARANTEE against burn-out of this type Power Unit! Syncro cuts 1" soft wood, thin metal, plastic—tiles of rubber, asphalt, metal—linoleum, etc. Portable. Quiet. SAFE even for children. Arm adjusts for any length cuts. THOUSANDS used in schools, home-shops, institutions. Get this GUARANTEED Saw, precision-made for years of service. Complete with Built-In Reactance Electric Motor, at dealers or postpaid, \$24.95.

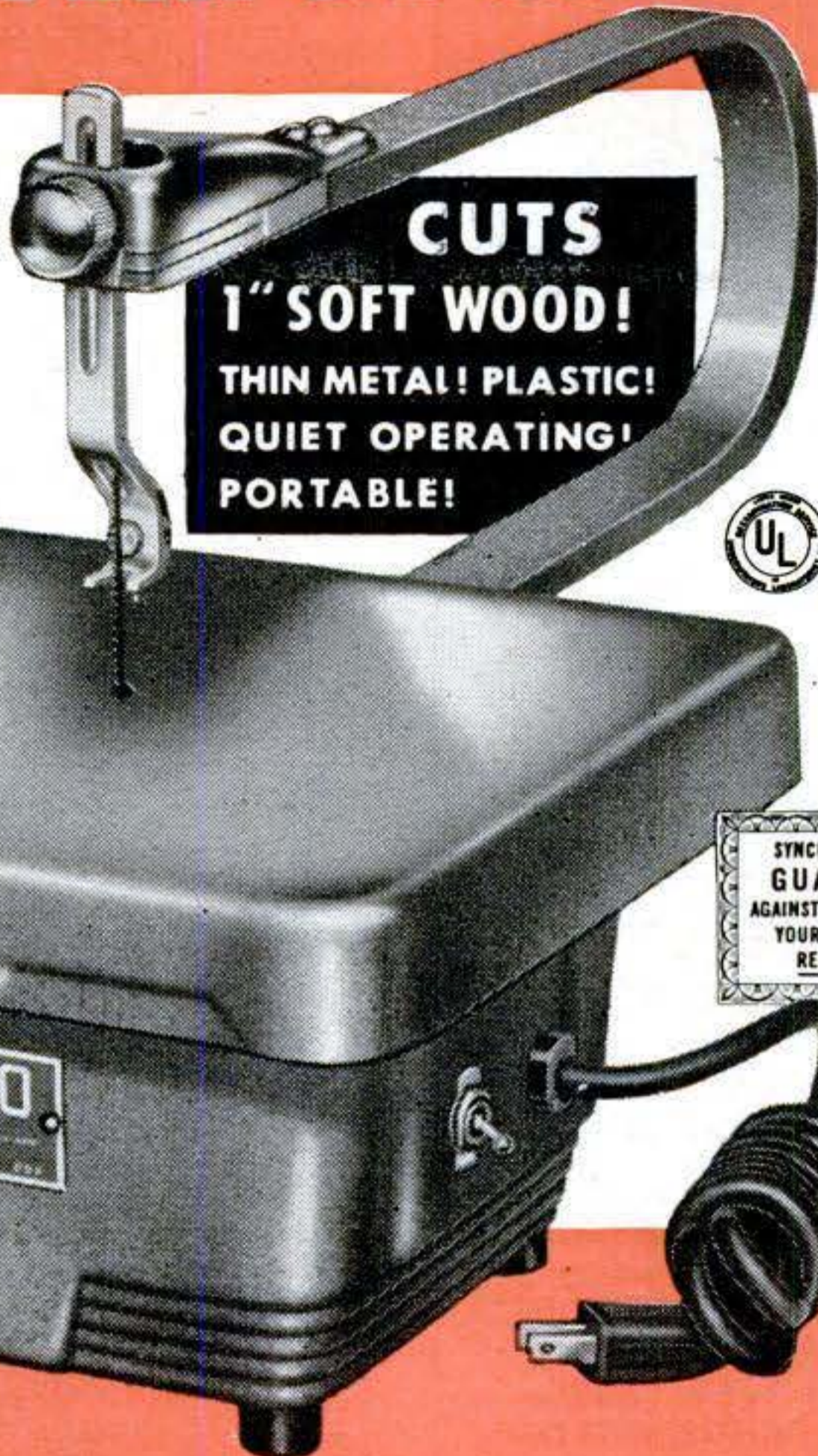

NO. 201
\$24.95

Quality Products of
SYNCR0 CORPORATION
Dept. G-102
OXFORD, MICHIGAN, USA.

ANOTHER NEW SYNCRO!

RED ROCKET JIG SAW



No. 801
only **\$14.95**
motor included

**CUTS
1" SOFT WOOD!
THIN METAL! PLASTIC!
QUIET OPERATING!
PORTABLE!**



SYNCR0 POWER UNITS
GUARANTEED
AGAINST BURN-OUT DURING
YOUR OWNERSHIP OR
REPLACED FREE!

IT'S SAFE!

Cuts 1/2" wood, thin metal, plastic. Perfect for children and perfectly safe! Portable. Table top solid casting—will not bend! Sturdy precision-made—cuts so smooth no sanding necessary—not a piece of "junk!" NO OTHER SAW does so much yet costs so little. At dealers or postpaid, only \$14.95.

SYNCR0
ELECTRIC
JIG SAWS

STOP THOSE DRAFTS!

STOP BEING ROBBED BY BIG FUEL BILLS. ASK YOUR HARDWARE MAN FOR KORD. IN A FEW MINUTES TIME YOU CAN SAVE MONEY BY GETTING EASY-TO-USE KORD.

KORD

THE MODERN WEATHERSTRIPPING



Has hundreds of uses around the house, the workshop . . . Caulk your boat. KORD is the new, lasting way to weatherproof or seal against cold air, moisture, insects and dust.

KORD IS MADE BY THE CREATORS OF THE FAMOUS STERLING ELASTIC GLAZING COMPOUND.

See your dealer or write for folder.

STERLING PAINT & VARNISH CO.

185 Commercial St.

Malden, Mass.

Send for this
BIG NEW
Hunt's
WOODWORKERS
CATALOG NO. 19

ONLY **15c**

NEW LOW PRICES

Offers greatest selection of fine domestic and imported woods—and hundreds of woodworkers items at bargain prices!

You'll save time and money with this big, new catalog. Contains everything wood craftsman needs. Shows 32 rare and fancy woods in color...43 veneer designs...275 scroll patterns...multicolor inlays, overlays, bandings...all kinds of tools, machinery, cabinet hardware, ornaments, mouldings...and pages of valuable tips, ideas, information, instruction. Send for your copy NOW. Only 15c--refundable on your first order.



144 PAGES
QUICK
DELIVERY

- on maple, poplar, oak, mahogany, red cedar, cherry, walnut, and many others—
- all properly seasoned and kiln dried.

MAIL THIS COUPON--TODAY!

CRAFTSMAN WOOD SERVICE CO.

2729 S. Mary St., Dept. B10
Chicago 8, Illinois

Send me the big, new, money-saving Catalog No. 19. Enclosed is 15c--refundable on my first order.

Name _____

Address _____

City _____ Zone _____ State _____

**EVERY ELECTRIC DRILL
A POWERFUL PORTABLE SAW**

**JOIN THE THOUSANDS who
SAVE WORK — SAVE TIME
and do the job BETTER with**

OVER 100,000 SOLD
'ARCO SAW'

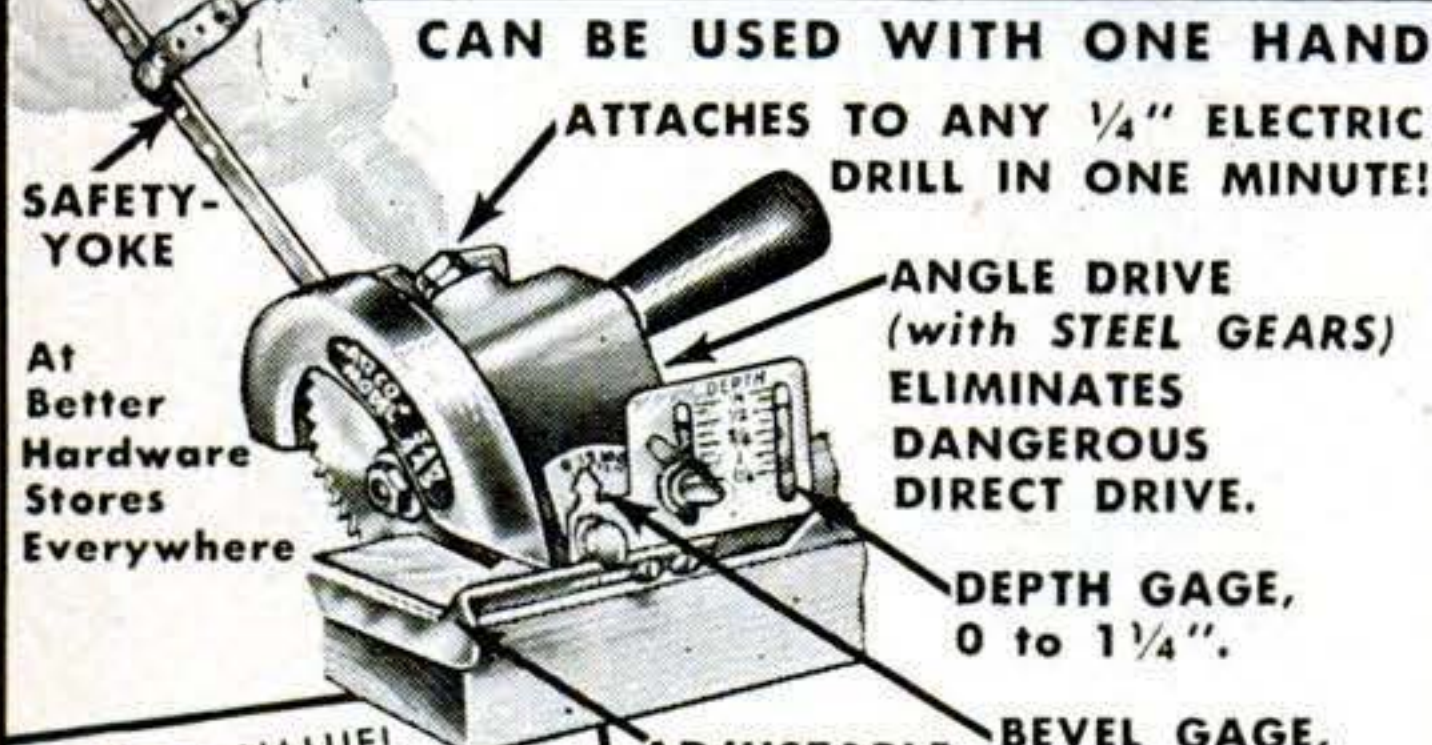

At Better Hardware Stores Everywhere

CAN BE USED WITH ONE HAND

ATTACHES TO ANY 1/4" ELECTRIC DRILL IN ONE MINUTE!

ANGLE DRIVE (with STEEL GEARS) ELIMINATES DANGEROUS DIRECT DRIVE.

DEPTH GAGE, 0 to 1 1/4".

ADJUSTABLE BEVEL GAGE, 0 to 45° ANGLE. RIP GAGE.

Also has **VISUAL GUIDE (not shown).**

CUTS 1 1/4", or 2x4 by turning over

90-DAY FACTORY GUARANTEE

WHAT A VALUE!
No. 445 "ARCO-SAW" (shown) **11.50** with ALL GAGES & 4" "HYCARBON" Cross-cut Blade.
No. 444 "ARCO-SAW" — same as above, less gages. **9.95**
Has accurate visual guide

READ WHAT ENTHUSIASTIC "ARCO-SAW" USERS SAY:

Best of all my tools. H.D., Wauwatosa, Wisc.
...a wonderful time saver...very simple to operate. M.H., L.I., N.Y.
...haven't used a handsaw since I purchased the "ARCO-SAW".
D.S., West Roxbury, Mass.

If not available at your dealer, TRY "ARCO-SAW" on our **FREE 10-DAY NO RISK GUARANTEE**. If you are not completely satisfied, simply return "ARCO-SAW" for a full refund.

GET "ARCO-SAW" TODAY at your dealer or send us check or M.O. (Postpaid). C.O.D.'s —

DEALERS: Write for nearest wholesaler. postage extra. Write for literature of other tools.

ARROW METAL PRODUCTS CO.

DEPT. PS-10, 140 WEST BROADWAY, N. Y. 13, N. Y.

4 TOOLS IN 1
The Complete METAL WORK SHOP FOR HOME AND PLANT

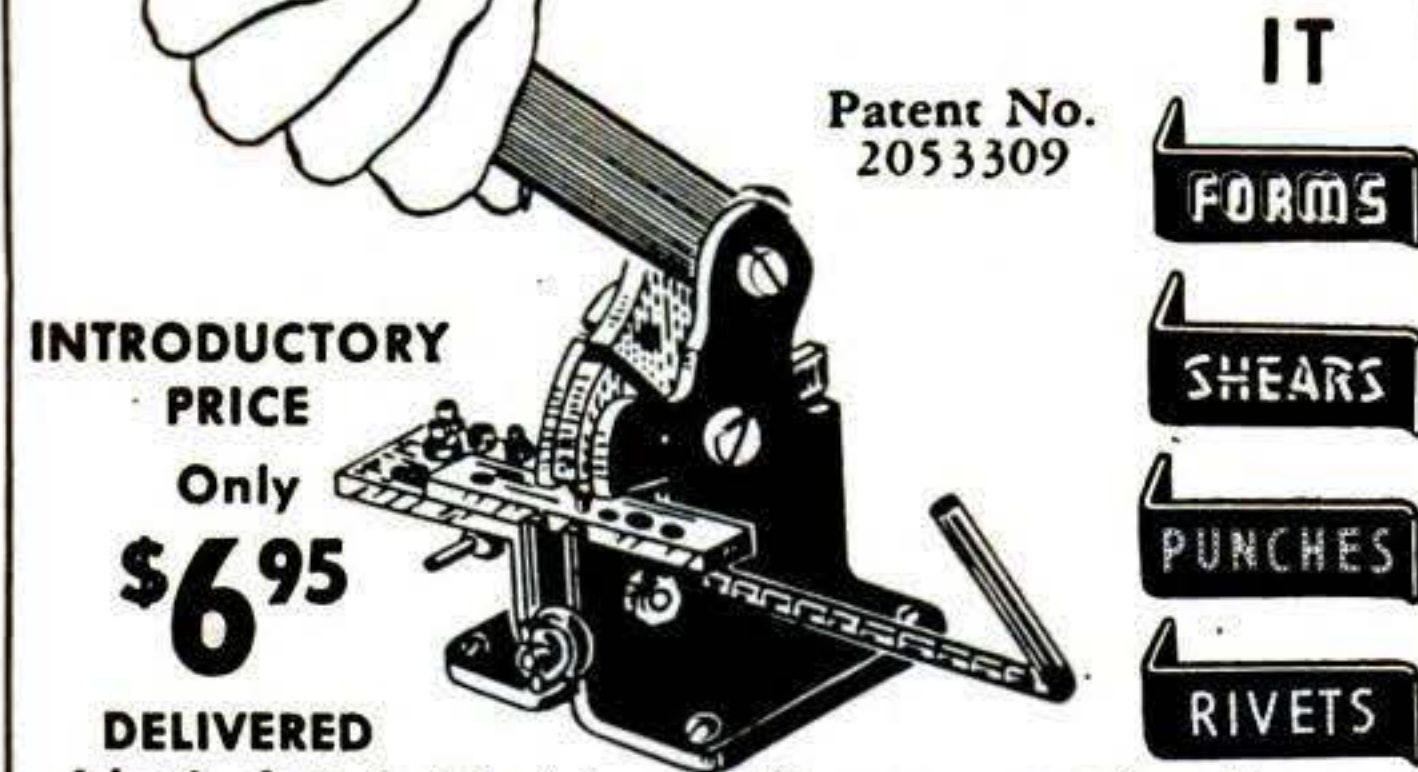

INTRODUCTORY PRICE
Only **\$6.95**

DELIVERED

Ideal for hobbyists, craftsmen, repair shops, garages, model mfgs., experimental labs, etc. Handles metals up to 1/4" thickness depending upon hardness. Shipped complete with 1/8", 3/16" and 1/4" punches and riveting dies. Check or money order must accompany order. No C.O.D.'s. Money will be refunded if not fully satisfied.

ALBERT J. TATU CO.

85 Columbia Dr. Dept. G2 Williamsville 21, N. Y.

**It's NEW, BIGGER, Better
The DELTAGRAM...**

• 6 GREAT ISSUES Only \$1.00 •

Priceless information at a wonderful bargain price—The New, Bigger, Better Deltagram!—With more than 100 shop-tested projects, complete plans, "how to do it" instructions—6 times yearly all for only \$1. Nothing like it at any price!

Subscribe now... write to **DELTA POWER TOOL DIVISION**
Rockwell Manufacturing Company
504L N. Lexington Avenue
Pittsburgh 8, Pennsylvania

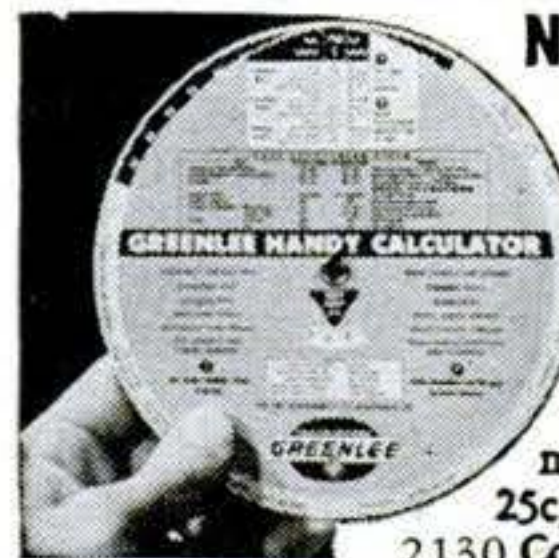

NEW, IMPROVED CALCULATOR FOR WOODWORKERS only 25c

Instantly gives information on lumber, nails, concrete mixes, painting materials, etc. Convenient, simple to read. Just set dial for nail specifications, to convert linear to board feet, find bit sizes for screws, compare characteristics of woods. 6" diameter heavily varnished cardboard. Send 25c, no stamps, please to Greenlee Tool Co., 2130 Columbia Avenue, Rockford, Illinois.

SAVE MONEY-ON PAINTING

FREE BOOK TELLS how to get better paint results at no extra cost. Given free by America's leading aluminum producer so you can get full value and satisfaction from aluminum paint. Written by experts... packed with facts... write for "Paint it Bright."

Aluminum Company of America, 1717K Gulf Bldg., Pittsburgh 19, Pa.



SUPER DRILL GRINDER

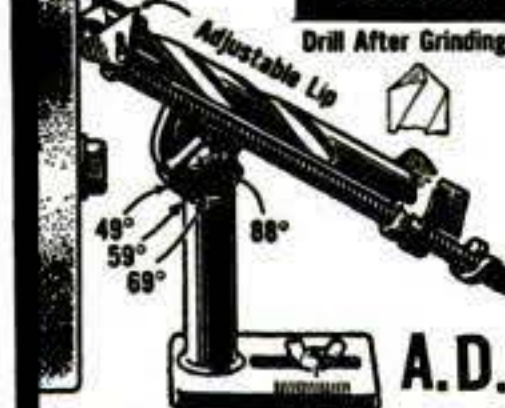

Sharpens round shank drills from 3/32" to 1/2" in diameter, up to 6" long. Grinds old drills like new in 4 different point angles, using hand or power grinding wheels. Money-back guarantee, only **\$2.95**

At Dealers or Postpaid
A.D. McBURNEY 317 E. 4th St., Dept. S-22
Los Angeles 13, California

BUILD ARC WELDER FROM OLD GENERATOR
WE SHOW YOU HOW

Light or Heavy Work

Produces 75-200 amperes. Takes no previous experience or hard work to make one of these welders. Complete plans 35c. Send for your **PLANS** today and we'll include **FREE** our Big NEW Catalog listing hundreds of electrical bargains.



LEJAY MFG., 1323 LEJAY BLDG., MINNEAPOLIS, MINN.



40 TO 600 POWER

15 Combinations! Professional MICROSCOPE \$29.95 Ppd.

Model #635

Ppd.

At last! The FIRST instrument with this range of performance ever offered under \$125. Every feature needed for advanced university, pre-med and medical school use. Triple revolving turret containing 10X, 20X and 40X achromatic objective lenses. Achromatic condenser, 6-aperture revolving iris. Two-side plano and concave substage mirrors. Solid base, excellent precision construction. Complete with fitted hardwood case. With 15X eyepiece (giving 150X, 300X & 600X) less mechanical stage.

SET OF EXTRA EYEPIECES \$9.95 Ppd.

For above model #635 microscope. 4X, 5X, 8X, 12X interchangeable eyepieces in hardwood case, giving a total in all of 15 different powers from 40X to 600X. Complete set of 4 in case.

MODEL #400 MECHANICAL STAGE \$14.95 Ppd.

Shown on model #635 microscope. Made only for this instrument. This is an optional accessory which allows you to move the slide microscopically right, left, up or down without touching slide. This calibrated stage cannot be duplicated for less than \$45. (If microscope is ordered without mechanical stage, we will fit your instrument with fine spring steel, clip-type slide holders.) Shipped in fitted hardwood case.

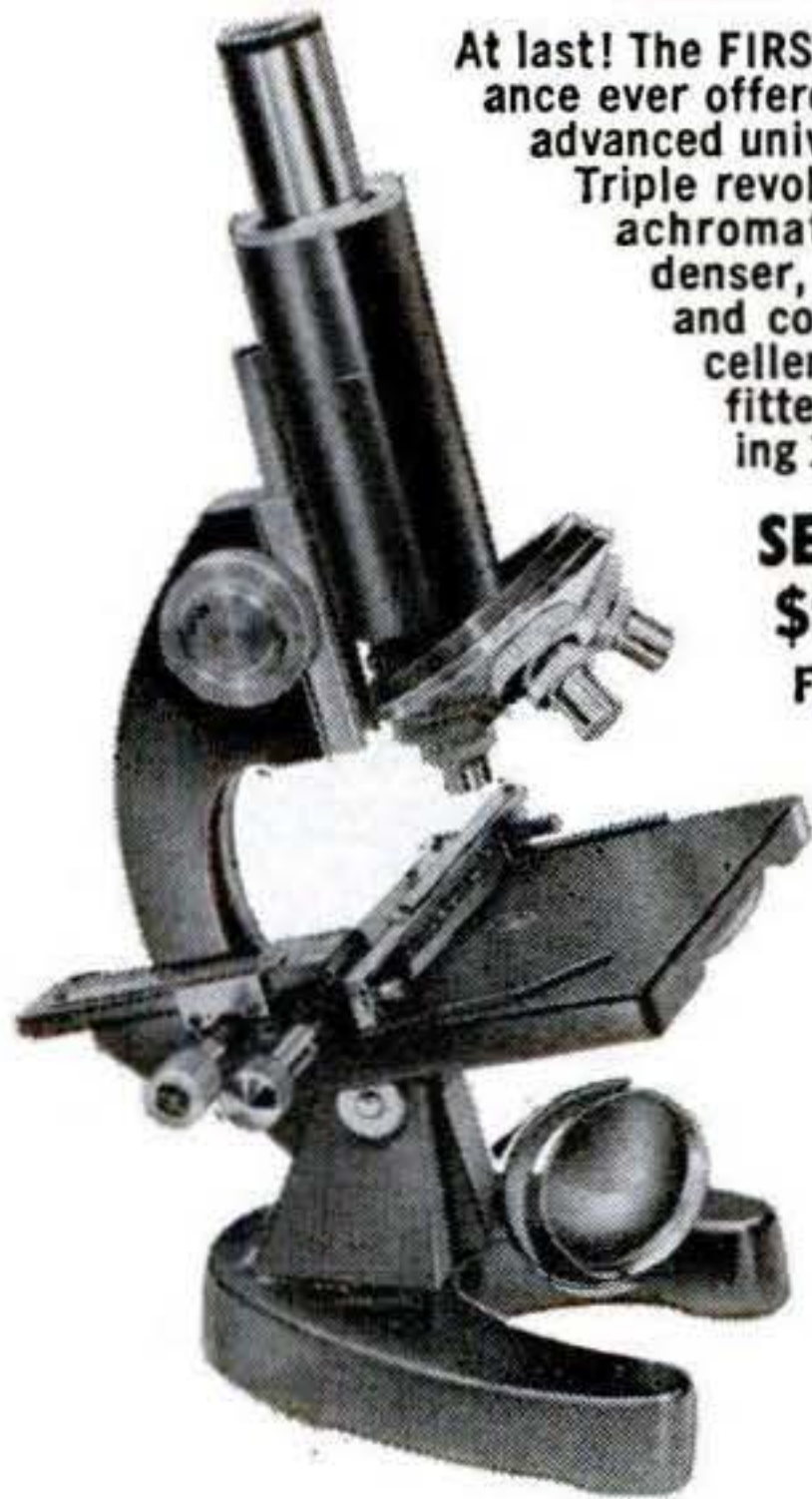

100 200 300 POWER

Triple Turret MICROSCOPE \$14.95 Ppd.

Laboratory Model — The instrument that amazed biology instructors. Excellent optical qualities, adjustment, solid construction. A lifetime bargain for students, schools, labs, amateur researchers. **Anyone can now own one!** (Performance cannot be duplicated for \$75.) Uses: animal, plant and mineral research. Study plant cells, microscopic animal life, crystal structure. See the complex anatomy of tiny insects, larvae, eggs. An absolute necessity in hundreds of fascinating fields. Shipped in hardwood cabinet.



NAVY TYPE MARK XX

20 POWER TELESCOPE



\$9.95 Ppd.

\$30 value. Fine optically ground achromatic lenses, fully coated. Same power as standard artillery observers spotting scope. Precision all metal construction. Rust and salt spray resistant. A valuable ship and boat owner's possession at a price everyone can afford. Excellent scope for rifle range or hunting. Shipped in choice of pigskin case or hardwood cabinet.

8 x COATED PENSCOPE

\$4.95 Ppd.

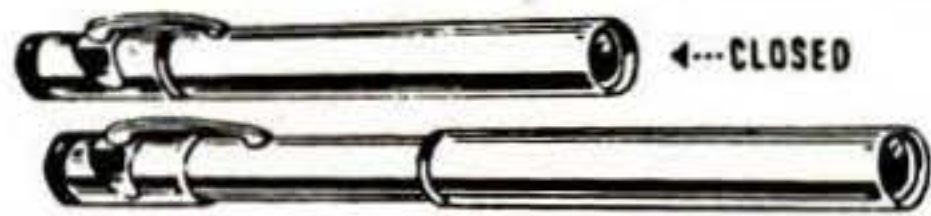

Pocket telescope fits in your pocket like a pen, extends to form a powerful scope for spotting game, watching sports. 8 power coated lens, more powerful than standard army binocular.

SEND FOR FREE 32-PAGE CATALOG

World's greatest values in hobbyists, students, and professional research microscopes, complete accessories, mechanical stages, eyepieces, prepared slides, dissecting microscopes, ore, mineral, metal and gem microscopes, binoculars, telescopes, magnifying glasses of all types. Every item a bargain — with money-back guarantee!

the AKRON 4400 SUNSET BLVD. LOS ANGELES 27, CALIF.

Dept. 10-S

HOME WORKSHOP

DEALER INQUIRIES INVITED

New Gimlet

Patent Pending

14 1/2 IN. LONG

only \$3.50 Postpaid

HOLE SAW

AND CUTTING TOOL

A 5-in-1 hand tool with a hundred uses. Drills, saws, reams, rasps, files all wood, conduit and plastic. Praised by electricians, hobbyists, plumbers, carpenters. Has a tough plastic handle—drill point —8 inch case-hardened carbon steel spiral cutting blade. Money Back Guarantee. Send cash, check, or money order to . . .

THE A & F MANUFACTURING CO., BOX 323A, ST. JOSEPH, MICHIGAN

GET MORE POWER

FISHER'S COMPRESSION SEAL

- ★ Stop Burning Oil!
- ★ Restore Compression!
- ★ Save Gas!

\$3.95

POSTPAID

A small amount of Fisher's Compression SEAL in each cylinder bore will give you the economies of smooth, powerful (new car) performance and reduced oil consumption. \$25,000 indemnity insurance is your assurance it cannot harm the finest engine. Old cars may not need expensive overhauling.

SATISFACTION GUARANTEED

Only Fisher's Compression SEAL offers you their exclusive Satisfaction Guarantee. Return the used tube, if not completely satisfied. Only \$3.95 postpaid. Free illustrated folder. Send cash, check or money order today. Dealers, a postcard will send our representative to your door.

ADVANCED ENGINEERING

POWERLESS PISTON (Before Application)

DYNAMIC POWER (After Application)

Dept. PS-10, Box 7013 Los Angeles 37, Calif.

WAR SURPLUS AND OTHER BARGAINS SAVE UP TO 90%

METALMITRE makes mitering of metals easy

Unique hand tool mitres metals with ease and precision. Takes place of heavy, stationary machines. Can be carried on job, saves 1000's of unnecessary steps. Makes job easier, neater, faster. Gives clean and accurate cuts with simple squeeze of handle. Snap-in dies go on tool to permit burr-free mitering, notching and slotting of non-hardened steel up to 1/32", as well as metals like copper and aluminum up to 1/16". 2 lb. tool has built-in 15 to 1 pressure ratio, high leverage. Nothing like it for working with moulding, sheet metal, fiberboard, plastics and masonite. Unconditionally guaranteed with proper use. This sturdy-made tool will last a life-time. New wonder tool of the metal industry, a \$50 value—INTRODUCTORY OFFER, complete with heavy gauge steel carrying case and 4 snap-in dies, postpaid, only \$33.50.



WILLARD WET PLATE BATTERY

Extra-long life, rechargeable battery. 2 V., 20 Amps. Great for portable radios, mobile units, bell circuits, alarm systems, rural telephones, Strobe bulbs, etc. Only 5" high. Visible ball float hydrometer built in Lucite case. Shipped dry (wt. 3 1/2 lbs.) . . . any battery service will supply standard battery electrolyte. Used singly or in multiples. ALL NEW! Now only \$1.95 ea.



D. C. GENERATORS

Finest aircraft quality . . . heavy duty . . . lifetime grease-sealed ball bearings. Terrific for truck and marine use, for welders, plating, D. C. Appliances, lights, etc. Type P-1 Mfd. by Ford, General Electric, Westinghouse & Delco-Remy. Rated 200 Amps., 28 Volts, 2500 RPM., can be "reved" up to 300 Amps. Shpg. Wt. 53 lbs. Approx. Govt. Cost \$350 . . . New to you. . . . \$21.50

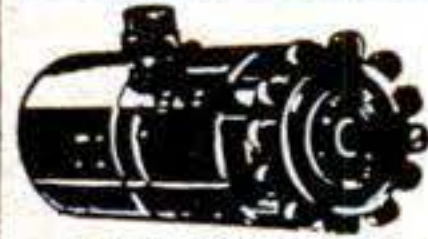

FLEXIBLE SHAFT MAGNET

For picking up coffer pins, nuts, wrenches, etc., from inaccessible places. Removes Bobbie Pins, etc., from drains. Lifetime Magnetism Guarantee. Highly polished magnet and handle. \$2.00 postpaid. Strong ALNICO V Magnet on 18" flexible Cadmium Plated shaft.

MICROMETERS

Chrome plated, precision engineered, carefully tooled to give long life. All new 0-1" capacity—\$2.25 ea 1-2" capacity—\$3.50.



Send 25c for 1952 catalog. Bargains for everyone. Check, Money Order or Cash. 25% deposit on C.O.D. orders. Prices F.O.B. Culver City, Calif., unless otherwise stated.

AIRBORNE SALES CO., INC., Dept. PS 1052
8501 Stellar Dr. Culver City, Calif.

**DRIVE FOREVER
AND NEVER CHANGE
YOUR OIL!**

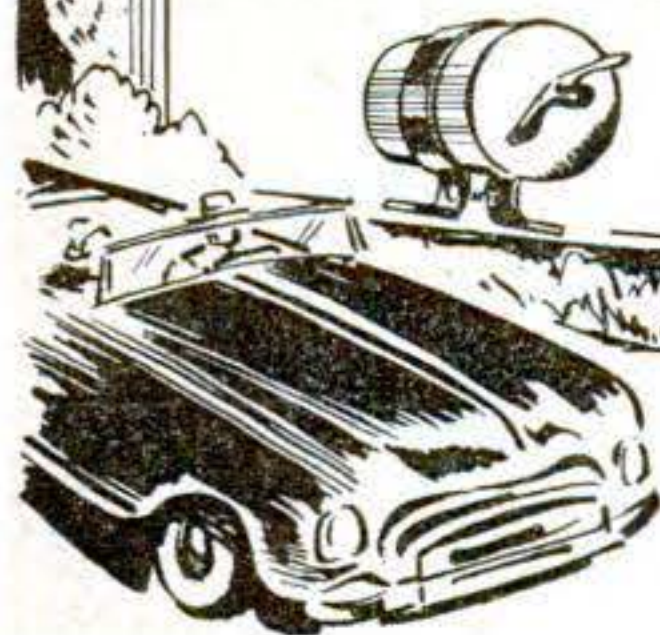

WITH AMAZING,
FULLY GUARANTEED
TISSU-PAK
OIL FILTER

Keeps engine oil sparkling clean. Eliminates expensive oil changes and costly element replacements. Inexpensive to buy. Easy to install on all gasoline engines up to 14 quarts crankcase capacity—automobiles, trucks, tractors, stationary and marine engines.

Enthusiastic testimonial from thousands of individual and fleet users. Write today for FREE "Tissu-Pak Facts." Mailed immediately.

HENDERIZE, INC. • 5667 - E2 FREEPORT BLVD.
SACRAMENTO, CALIF.

**PAINT ROLLERS
cleaned in seconds**



Just put the roller cover into a can of Imperial Roller Cleaner and shake. In 30 seconds it is completely cleaned! Remove, wipe dry and you can re-use immediately. Same fluid may be used for as many as 6 cleanings. Safe for roller cover and your hands. At better paint and hardware stores.

IMPERIAL Roller Cleaner

Write for leaflet

Wilson-Imperial Company, 121 Chestnut St., Newark 5, N. J.

HOBBYISTS! SHOPMEN! Special ONLY \$54.50

PALMGREN "HOBB-E" Rotary, Index, Milling Table

Ideal for Model Parts or Shop Work

Mill-Grind-Drill-Index-Rout curved or straight. Rabbet and Mortise on drill press or lathe. 8" Table, 4" Cross Feed, 360° Rotation, Accurately Graduated. Bolts to table. Order NOW! SAVE \$100. Only \$54.50. Less Rotary Feed \$43.75. Write for "HOBB-E" Tool Circular.

CHICAGO TOOL and ENGINEERING CO.
8396 South Chicago Ave. Chicago 17, Ill.



x-acto®

HOBBY KNIVES and TOOLS

SEND 15¢ TO COVER POSTAGE FOR NEW ILLUSTRATED 28-pg. CATALOG
X-ACTO CRESCENT PRODUCTS CO. INC., 440 FOURTH AVE., N. Y. 16, N. Y.

NEW Saw Sharpener

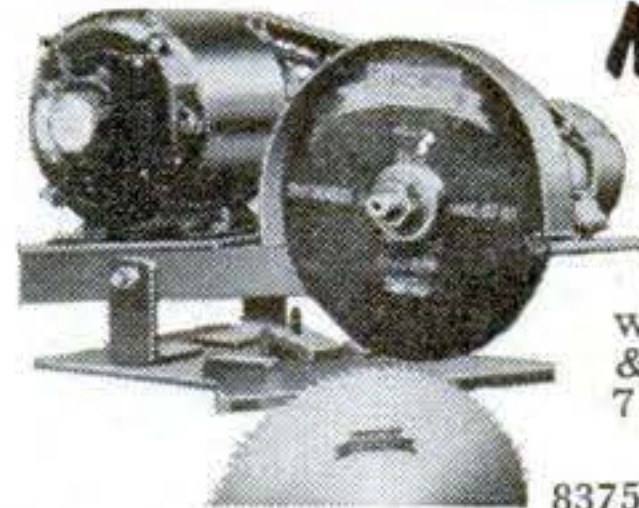

Improved #64 Hand Gummer sharpens all types circular saws 4" to 20" diam. Ideal for saw shops. Self-Centering adjustment for quick, easy set-ups. Complete with 1/4 HP motor, 1 grinding wheel & cord. \$79.50 FOB Portland. Wt. 70#. SEND FOR FREE LITERATURE.

P. T. HOBBS MACHINERY
8375 N. Interstate Ave. PS-102, Portland 17, Ore.

TRANSFORMER WELDER \$18.95 FOR QUINCY



Complete with everything. Ready to plug in. 110 volts A.C., 15-30 amps. 3 heats. Welds metal from 1/16" to 1/4" using 1/16" to 3/32" standard rods. Guaranteed unconditionally. 10-day trial. No C.O.D. We also make welder for 16-22 gauge metal, \$3.95; 1/8" metal \$6.45.

ESSAY MFG. CO., INC., Dept. 47, Quincy 69, Mass.

KING MIDGET

WORLD'S LOWEST PRICED
2 PASSENGER AUTO



Drive it for 75c per week. Amazing performance. Surprising comfort. All steel construction. Ready to run or assemble it yourself with our bolt together parts. Rider Agents wanted, earn your car Free. Send 25c for detailed literature or \$1 (refunded first order) for actual assembly book and service manual filled with photos, drawings, specifications, etc.

MIDGET MOTORS MFG. CO. ATHENS, OHIO

GENERATING PLANTS

FROM 350 WATTS TO 25 KVA
Item #183—3000 to 4000
WATT GENERATOR
SET



ITEM #183

115 volt, 60 cycle, 3,000 to 4,000-watt generator. Furnishes either single or three-phase power, 2 or 3 wire. Panel contains oil gauge, voltmeter, ammeter, circuit breaker, voltage regulator, start button. Today's Cost Over \$1,200.00. SALE PRICE F.O.B. Chicago **465.00**

BRAND NEW

General Motors—Allison CENTRIFUGAL PUMP

200 GALLONS PER MINUTE

● For Draining Basements ● Fire-Fighting ● Irrigation ● Fuel Transfer ● Swimming Pools ● Home Water Systems ● Dewatering

This General Motors-Allison Centrifugal Pump—designed for use on U.S. Air Force Mustang Fighters, now converted for commercial, home, and industrial high volume pumping applications. Inlet, 2 1/2" standard pipe thread, twin outlets with 1 1/4" pipe thread, ball bearing supported 3/4" shaft. Easy, fast simple priming. Rotation, counterclockwise facing shaft. Shipping wt. 35 lbs. Gov't acq. cost \$145.00. F.O.B. Chicago. NOW ONLY **39.50**



(ITEM #130)

shaft. Easy, fast simple priming. Rotation, counterclockwise facing shaft. Shipping wt. 35 lbs. Gov't acq. cost \$145.00. F.O.B. Chicago. NOW ONLY **39.50**

HYDRAULIC SPEED REDUCER

WITH FINGERTIP CONTROL

USE FOR: ● Reamer Drives ● Midget Cars ● Feed Mills ● Canning Machines ● Conveyors ● Lathes ● Milling Machines ● Motor Boats ● Cream Separators ● Garden Tractors ● Pumps

Variable output speeds from 0 to input speed available by moving control handle. Locking handle maintains setting. Use input power of 1/4 to 1 1/2 H.P. This Westinghouse-Oil Gear Unit consists of a variable displacement hydraulic pump feeding a fixed displacement hydraulic

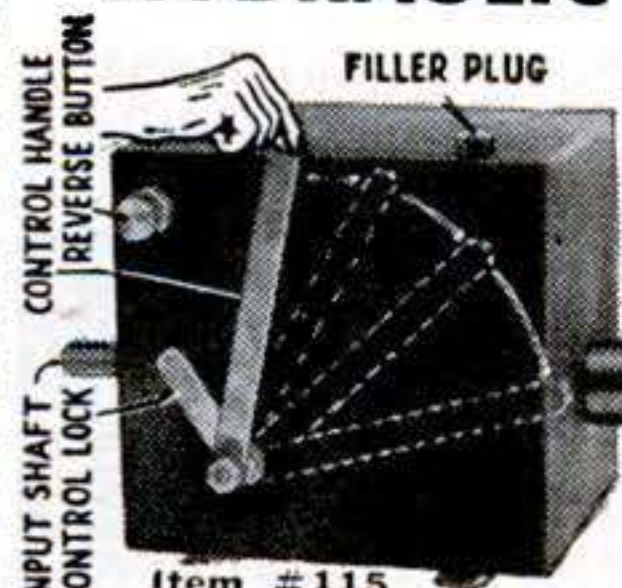

Item #115

motor. Adjustable relief valves set at factory for 100 inch pounds of torque may be reset up to 180 inch pounds. Independent reverse control allows full output power and speed selection in either direction of rotation. Shafts measure 5/8" diam. include keyway. Input rotation is counterclockwise facing shaft. Recommended input speed not to exceed 750 R.P.M. Over-all dimensions, 7 1/2"x7 1/2"x11 1/2". Gov't. acquisition cost, \$428.00. Ship. wt. 31 lbs. Complete with 2 qts. of oil and full instructions. F.O.B. Chicago. **54.50**

WAR SURPLUS SPECIALS

ALL ITEMS ARE UNCONDITIONALLY GUARANTEED

Aircraft Quality HYDRAULIC EQUIPMENT

ITEM #160—PESCO GEAR TYPE HYDRAULIC PUMP—Compact—Powerful—Reliable. Especially designed for belt drive from fan belt, power take-off, drive pulley, electric motor or small gas engine. Equally suitable for direct coupling. Pedestal type mounting with two bolt holes for 3/4" hold-down bolts. Standard 1/2" pipe thread inlet and outlet ports. Delivers 4.5 GPM at 1000 PSI at 2800 RPM with 3 HP. Will actuate one Item #6, 3" bore, 24" stroke cylinder in 10 seconds. Hardened steel gears turn in dense oilite bronze bearings. Rotation—clockwise facing shaft. Guaranteed trouble-free service. Ship. wt. 6 lbs. F.O.B. Chicago. **22.50**

ITEM #126—Four-way, open center control valve with built in adjustable relief valve. Factory set at 1000 P.S.I., spring loaded neutral position, for use with one double acting cylinder. In neutral position cylinder is locked and pump unloaded. Fully balanced plunger type, smooth, positive, easy operation, can be used as single unit or mounted in series of any combinations desired. Has 3/4" pipe thread inlet and outlet, 1/2" pipe thread cylinder ports. Newly manufactured to our specifications. Shipping weight 8 1/4 lbs. An outstanding Buy! F.O.B. Chicago. **21.50**

ITEM #42—Double action hydraulic cylinder, 4" bore, 18" stroke. Rated lift capacity with 1000 PSI line pressure is 12,500 lbs. Ship. wt. 30 lbs. F.O.B. Chicago. An Excellent Buy for... **32.50**



Item #126



Item #160

NEW MODEL 353—DUAL RANGE D. C. ARC WELDER

for Stationary or Portable Use. Heavy DUTY RANGE TO 250 AMPS. NEW 'MAGIC TERMINAL' FOR LOW CURRENT 30 TO 100 AMPS. IDEAL FOR ● FARM ● FACTORY ● GARAGE ● WORKSHOP

These precision engineered D.C. Arc Welders contain the highest quality War Surplus aircraft components built to exacting government specifications. They are light in weight, have over-sized lifetime grease-sealed ball bearings, air cooled commutator, dial type rheostat for easy pin-point control, a high-low rheostat switch, reactor coil for even arc and the new 'MAGIC TERMINAL' low current welding range for welding lighter materials. Designed for many years of trouble-free service. Run welder from drive pulley or power take off of a tractor or Jeep, 7 1/2 HP electric motor or 10 HP gas engine at 2500 R.P.M. Uses two V-belts or flat belt. Continuous output rating 200 amps. Intermittent welding rating 250 amps. 30 volts. This sensational price includes double V or flat belt pulley and complete operating instructions. Ship. wt. 107 lbs. \$350.00 Value. Item #65. F.O.B. Chicago Now only **119.50**



Welds Anything From Auto Fenders To Tractor Frames

FREE: NEW 48-PAGE BARGAIN CATALOG. Write Today!

ORDER DIRECT FROM AD—SEND PAYMENT OR PURCHASE ORDER TODAY—SATISFACTION GUARANTEED

GROBAN SUPPLY CO. DEPT. PS-10
1139 SO. WABASH AVE., CHICAGO 5, ILL.

CONTINENTAL KIT

NEW DRESS UP KIT that is FLASHY & RACY

FOR Ford, Chevy, Mercury, Olds & Pontiac

DOES NOT Hold a Tire

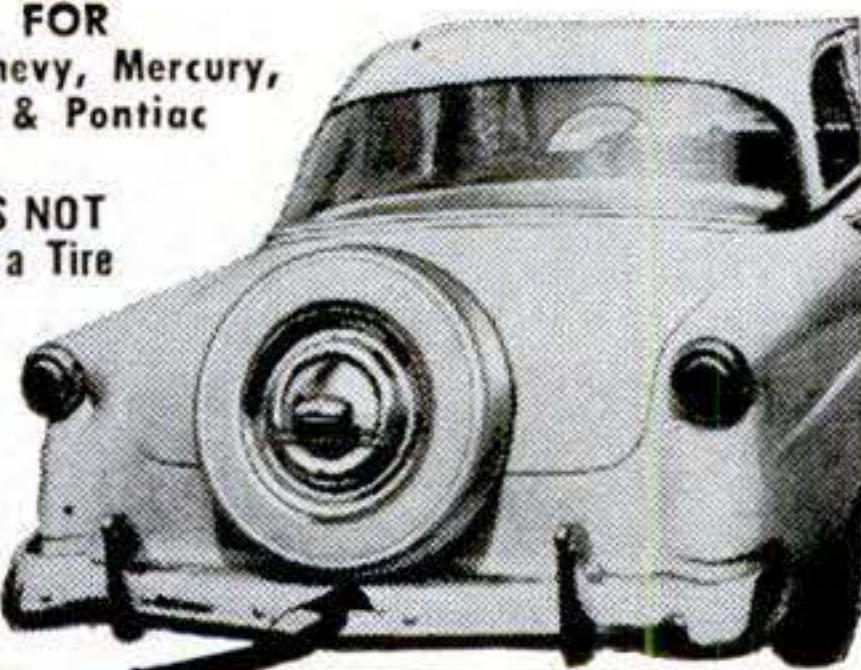

Simple Installation Gives that exclusive CONTINENTAL look at an inexpensive price. Creates a smart, swanky appearance.

This Kit creates that "Continental Look" at a price you can afford. Gives the impression of being built into the trunk and has that long sweeping appearance. As it does not hold a tire, it eliminates expensive installation. Easy to install. Just remove the Name Plate off Trunk Lid. Easy access to Trunk Handles, and on the 1952 Ford and Mercury to Gas Cap by lifting the Chrome Cap. FITS ON 1949 TO 1952 FORDS, 1952 MERCURY AND CHEVROLET 1949 TO 1952 (EXCEPT STREAMLINE) WITH NO HOLES TO DRILL. ALSO FITS 1949 TO 1952 PONTIAC—ALL MODELS, OLDSMOBILE 1952 MODEL 88 CONVERTIBLE AND HARD TOP, OLDSMOBILE 98, 1952—ALL MODELS. In addition to tire and wheel cover the kit includes chrome cap, chrome license light, license holder and all fittings. Send 25% cash with order. Complete Kit only **\$29.50**

← Send For Our New Catalog



The World's Largest Auto Accessory and Parts Catalog. Save Money on "Everything Automotive". Over 50,000 items, including Hollywood Accessories, Hi-Speed Equipment, Rebuilt Engines, all parts and accessories for all cars and trucks. We have that hard-to-get part. Over 100 pages, completely illustrated. Send 50c (refundable).

J. C. WHITNEY & CO.
1917-CJ. Archer, Chicago 16

EASY TIME PAY PLAN

What? POWER TOOLS only \$16 EACH!

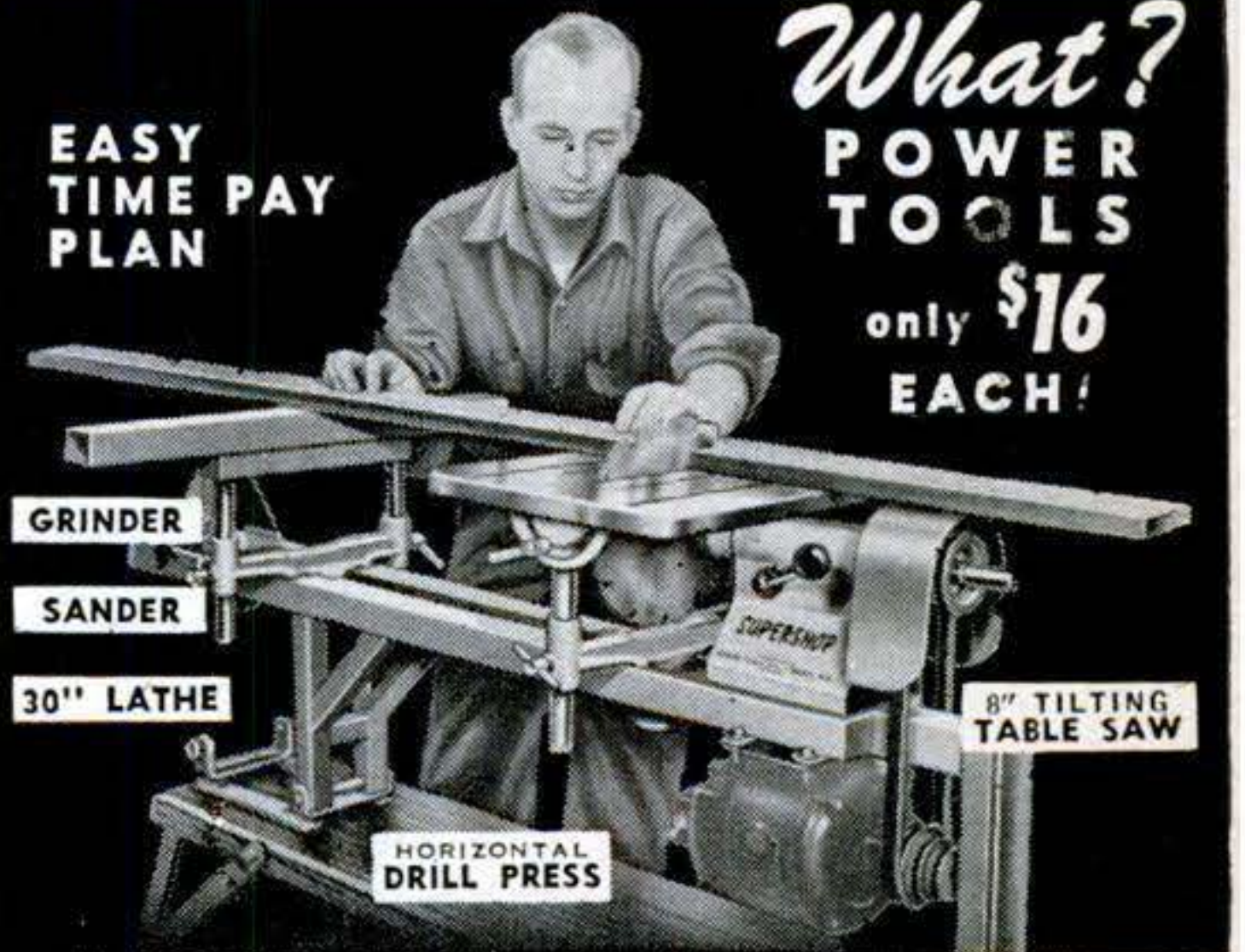

5 POWER TOOLS IN ONE

FACTORY TO YOU \$79.95

SUPERSHOP offers you a precision-built complete power tool workshop. 100% ball bearing. RUGGED. Accurate. Big capacity. 15 day FREE trial. Money back guarantee. Mail postcard for FREE catalog. Buy on easy pay plan.

POWER TOOLS, INC.

240 Yates Ave. Beloit, Wisc.

VERTICAL DRILL PRESS

STOP WASTING MONEY ON NEEDLESS OIL CHANGES!

YOU CAN EVEN USE CRANKCASE DRAININGS!

"RECLAIMO"

Amazing Invention Refines Oil As You Drive—Fits Any Car!

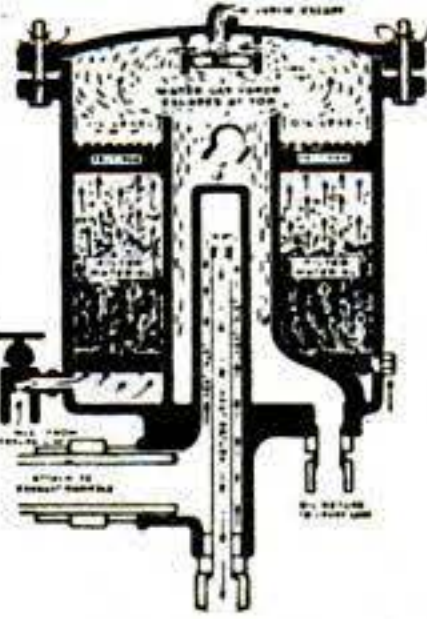

U. S. Bureau of Standards says, "Oil never wears out mechanically." Why change it? Just purify it! RECLAIMO uses engine heat to refine oil continuously. Removes not only impure solids, but also water and dangerous dilution, that causes formation of sludge and corrosive engine acid. Be safe and sure . . . all year round . . . with RECLAIMO . . . Yet never again spend dollars on oil changes! Write today for details of our 90 DAY MONEY-BACK GUARANTEE OFFER.

GET THIS VITAL BOOK

32 page "OIL FACTS" opens your eyes to lubricating facts you never dreamed of! Why and how big users like Greyhound use oil for 200,000 miles, etc. etc. Send 25c for book, refunded if you order RECLAIMO. Write to P-9



RECLAIMO MFG. CO.

5083-85 Elston Avenue, Chicago 30, Illinois
Wm. Schwalge, U. S. Pats. 1757223, 1834654, 2068473

WELD IT YOURSELF! IN A JIFFY!

Weld, Cut, Braze, Solder IRON, STEEL, BRONZE, BRASS, ALUMINUM & OTHER METALS

Tool and Equipment breakdowns are always annoying and costly. Don't let them bother you. Get a Dynamic Arc Welder. You can do expert work on your very first job. Welders operate from any properly wired 110 V. AC line. The handiest "tool" in your workshop. A Dynamic Welder will save its low cost over and over again in time and money.

DYNAMIC INDUSTRIAL type transformer Arc Welder 75 amp. output for Industrial or Workshop use.

DYNAMIC WELDER CO.

Dept. D3-KC, 15 E. 23rd St. Chicago 16, Ill.



Everything YOU NEED

One low price gives you a complete welding outfit ready to use. Save Money! Buy direct! Sold on 10 day money back guarantee. Send today for FREE details.

Free Details and "How to Weld"

HOLD-E-ZEE

The Original **AUTOMATIC GRIP SCREWDRIVERS**

Hold, start and set up screws in unhandy places. Gripper instantly released by SPRING ACTION, sliding up out of way when not in use. Highest quality throughout.

New Models FOR RECESSED HEAD SCREWS 

UPSON BROS., INC., ROCHESTER 4, N. Y. At Leading Dealers Everywhere

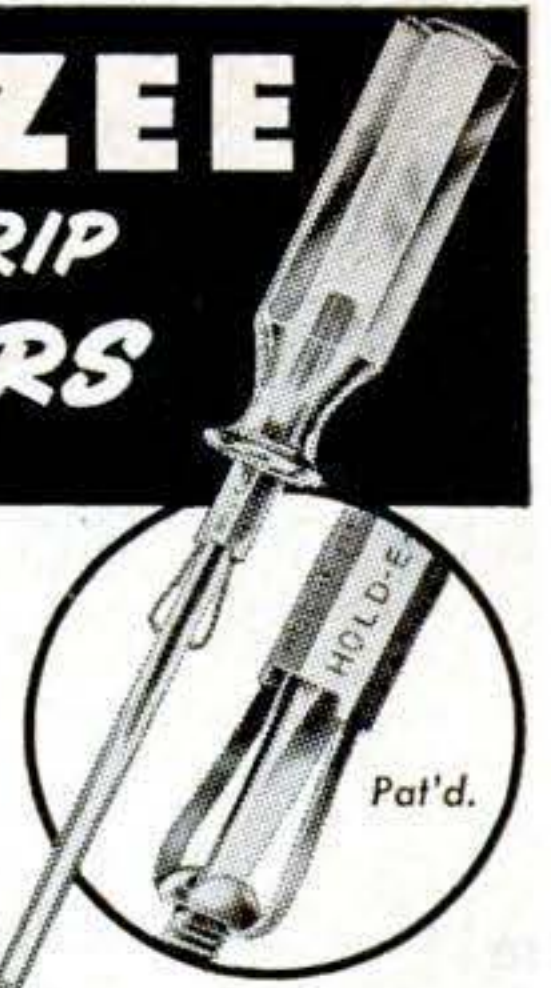

6 GREAT SHAW DU-ALL

Plow
Plant
Cultivate
Mow
Rake
Cut
Trees
Saw Wood

SHAW Mfg. Co.

Walking or Riding Tractors
1½, 3, 5 H.P. walking models, 5, 8, 12 H.P. riding tractors. Get just the power you need in Shaw extra strength superior traction machines. All wanted tools, attachments. Dependable for nearly 50 years. See a Shaw dealer. Write for FREE literature, low prices—today.

5710 Front St., Galesburg, Ks.
668-PSN. 4th St., Columbus, O.

ONE-MAN SAWMILL LOW \$50.00 DOWN AS...



Take BELSAW Portable Sawmill right to the trees—turn out valuable lumber for local yards—do "custom sawing" for neighbors. BELSAW lasts a lifetime. No crew needed. Power with old auto engine. Beginners get excellent results. Send postcard for FREE BOOK, "How To Make Lumber."

BELSAW MACHINERY CO.
8464 Field Bldg. Kansas City 11, Mo.

ROUTING WOOD IS EASY ON YOUR DRILL PRESS



With these useful precision ground routing cutters made from Heat-Treated Alloy Steel. Will cut limitless widths of straight or curved recesses, channels and shoulders. These routers will automatically follow any set profile to full shank depth. Can be easily sharpened again and again, or can be modified for special shapes. Set of three routers 1/4", 3/8" and 1/2" diameters. Sent postpaid \$2.95

EDWARDS & MORTON CO.
P. O. BOX 1828 HARTFORD, CONN.

DRAINS Cellars, Laundry Tubs; CIRCULATES Oil; IRRIGATES Gardens

Original "Type P" Pump has 2400 GPH capacity. 360 GPH 75' high, or 1500 GPH from 25' well. Use any 1/8 to 1/2 HP motor. DOES NOT CLOG. See Popular Science, August, Page 200

Only \$6.95 postpaid if cash with order. (West of Mississippi, add 50c.) **\$6.95** Motor coupling included.

LABAWCO PUMPS, BELLE MEAD 3, N. J.



When Writing to Advertisers, Please Mention Popular Science



DOES 11 THINGS NO OTHER 6-INCH SLIDE RULE EVER DID!

Get the jump on your fellow workers by using the Slide Rule that solves the most difficult mathematical problems AT LEAST 25% FASTER. Faster because the scales are much better related . . . MORE ACCURATE because needle-sharp markings are easier to align . . . FASTER because fewer settings are required. Used and taught in engineering schools! All-metal construction gives accuracy under most severe temperature variations. Free, 28-page instruction manual included; clear, easy to use. SPECIAL—your name imprinted on genuine leather pocket carrying case FREE—act now!

No. 600 THE MOST POWERFUL POCKET RULE EVER OFFERED
Write for FREE FOLDER showing 17 famous Pickett & Eckel Rules . . . over 350,000 now in use . . . sold in leading stationery stores.
30-DAY MONEY BACK GUARANTEE
Order today . . . we'll refund money if you are not 100% satisfied. Rule, leather case and manual complete . . . only \$8.85. (West of Denver—\$9.75)
Order NOW . . . TODAY!



GIVES YOU A GRIP ON THE TOUGHEST PROBLEM

BAUER-LEE & CO., SIERRA MADRE 5, CALIFORNIA

BUY from C&H - you'll save and be sure!

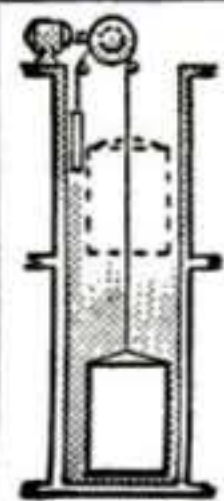

BUILD YOUR OWN INCLINE OR DUMB WAITER ELEVATOR

Get all the convenience of a dumb waiter elevator for store, shop, restaurant and home—or the convenience of an incline elevator on steep lake shores, hills, ravines, etc. at lowest cost. We furnish complete parts. Steel Car-Guide Rails - Worm Gear-Limit Switches-Electrical Control-Steel Cable. Send 25c for completely diagrammed instructions with list of parts, kits and prices.

ALARM HORNS • SIRENS

Motor driven (not a vibrator). Heavy duty with great power and long life. Adjustable for high, medium or low tone. 110 v. AC current. Weather proof. For alarm or signal horn on boats, school yards, factories, air raid siren, etc. Lists at \$47. Our price NEW



\$24.95

POWER and HAND WINCHES

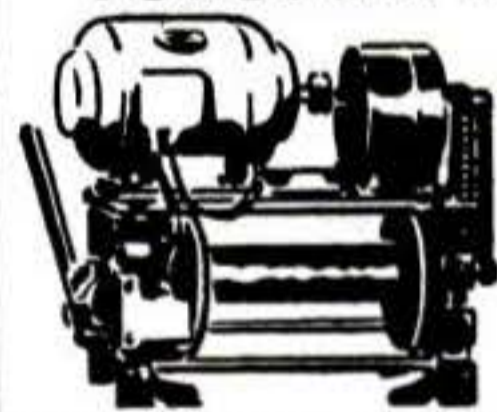

For—BOATS, TRUCKS, FARMERS, LOGGERS, CONTRACTORS, ETC.

Hand winch, 3-1 ratio, 600 lb. pull, drum has 1 5/8" spool, 6" flange, takes 75' of 3/16" cable, stop locking pawl, wgt. 26 lbs. \$16.95
Ball bearing Hand winch, low ratio 1-1.

high ratio 3-1, 600 lb. pull. \$29.50
Same as above with bronze worm gear, 2 speeds, 1-1 & 12-1, and hand brake—\$39.50
1/2 HP, electric ball bearing model; releasing brake starts motor, brake on-motor off; compact gear box, 12 rpm drum speed. \$135.00
3/4 HP, same as above, 3" drum. \$165.00
Heavy duty, 10-1 ratio, double drum model with jaw-type clutch, wgt. 280 lbs. \$49.95
CABLE, 1/4" preformed stainless steel aircraft, 100 ft. or less. 17c/ft.
Over 100 ft. 15c/ft.



BOOSTER FANS fit any 8", 9", 10" furnace pipe. 1500 rpm motor with 6" cord, mounting frame, 7" blade. Motor 110 volt 60 cycle 1550 rpm. Easy to install. Silent operation. Warm those rooms with long runs. List \$11.95. Our price... \$6.95

High Volume BLOWERS

Top performance for forced draft, ventilating, exhausting, cooling and drying. 110 v. AC.

75 cu. ft. per min. \$10.95
150 cu. ft. per min. 13.95
300 cu. ft. per min. 17.95
500 cu. ft. per min. 36.00



ELECTRIC HAND SAWS

Compare these sensational prices! All NEW Brand Name SURPLUS Electric Saws, 110 v. AC-DC fan cooled motors, lightweight design, balanced for easy handling in any position. Can be adjusted for depth and angle of cut. Ripping guide included.

6 1/4" \$32.50
7" 42.50
8 1/4" 59.50



HEAVY DUTY RUBBER ELECTRIC CABLE

(Nothing less than 50 ft.)

4 Wire #18 Neoprene standard, per ft. 7c
2 Wire #14 18 ft. with plug. \$3.00
2 Wire #14 50 to 225 ft., per ft. 16c
2 Wire #12 12 ft. with plug. \$3.50
3 Wire #10 75 ft., per ft. 28c
3 Wire #10 80 to 225 ft., per ft. 30c
4 Wire #10 75 ft. length, per ft. 35c
2 Wire #6 150' with connector. 90c
2 Wire #4 75' reel and connectors. 70c
2 Wire #4 Concentric 50 to 250 ft. underground, per ft. 60c
1 Wire #1.0 Rubber 50-500', per ft. 94c
15 Cond. #18 G.E. Stranded 50-300' O.D. 13/16", per ft. 50c

RUBBER HOSE

Long wearing GOODRICH 2 ply 2" I.D., 25 ft. lengths worth \$25. Only \$4.95; 3 lengths for \$12.00



SAVE OVER 50%

ON THESE BRAND NEW WAR SURPLUS POWER UNITS



BE PREPARED

for any emergency!
300 WATT 110-220 volt AC, 60 cycle light plant powered by 1 HP gas engine, direct drive, mounted base, wgt. 40 lbs. Ideal for campers, P.A. systems, house trailers, etc. Equipped with handle for easy carrying. \$99.00

750-1000 WATT 110 volt AC, powered by Briggs & Stratton gas engine. \$169.00

1000-1200 WATT 110 volt AC. \$194.00

2000-2500 WATT 110 volt AC, 60 cycle, slow speed generator, 5.10 HP Briggs & Stratton gas engine, NEW. \$294.50

To make 110-220 add \$40, for transformer.

2500-3000 WATT 110 volt AC, 60 cycle, Leland generator—runs at slow speed (1800 r.p.m.) for longer life, 8.25 HP Briggs & Stratton gas engine. You can rely on this plant for all average home needs—freezer, stoker, pump, hot plate, radio, etc.—and overloads from starting motors. Reconditioned and fully guaranteed. \$295.00. NEW \$345.00

Plants same as above, built in 1951, with tools and spare parts. Lists at \$790. Our price \$426. To make 110-220 add \$48 for transformer.

3000 WATT 110-220 volt with push button starter. Starter battery is automatically charged by plant. Gas engine same as in plant above \$465.00

5000 WATT, 120 volt, 60 cycle AC, Hercules 4 cyl. gas engine, Hobart generator, completely automatic, radio and TV filtered, power cable plug, exhaust pipe and manual. Lists at \$1,800. Our price \$795. Extra parts and tools \$25. 150' reel 2-wire #6 rubber cable with connectors \$90. 150' 3-wire remote control cable & switch \$25. Plant complete with parts & 2 reels of cable \$895. To make plant 110-220 V., add \$75 for transformer.

7500 WATT 110 v. AC, 4 cyl. gas engine NEW \$995.

10,000 WATT 110-220 v. AC. Reconditioned. \$1195. NEW \$1495.

25,000 WATT 220 v. AC, 3 phase or 110-220 v. single phase. Reconditioned \$1995, New \$2495.

35,000 WATT 110-220 v. AC, Diesel. Rebuilt \$2995

50,000 WATT 240 v. AC, 3 phase Diesel. NEW \$5900.

ORDER DIRECT from this ad! All prices F.O.B. Milwaukee. 25% deposit required on all C.O.D. orders. No C.O.D.'s under \$10.00. Many other bargain items not listed. Write for our FREE CIRCULARS!

C&H ELECTRIC MACHINE Co. Inc.

438K W. Juneau Ave., Milwaukee 3, Wisconsin

GET INTO

SAW SHARPENING

A BIG PROFIT "ONE-MAN BUSINESS"

Start Your Own PROFITABLE BUSINESS At Home Full-Spare Time. No Previous Experience Needed. BIG PROFIT, repeat orders come from contractors, hardware stores, carpenters, cabinet shops, home owners, farms—mail orders too! L. Leclerc in New Hampshire says: "Sharpened 7 saws in one hour — made \$7.00 cash!" FREE: Write now for BURR'S "Pay-as-you-Profit" Income Plan that shows you how to start small without overhead and grow to full-time saw repair shop with lifetime security. Send no money — just your name and address BURR MFG. CO., 8943-D Venice Blvd., Los Angeles 34, Calif.

D. H. in Wash says:

"BURR'S PLAN MADE ME \$1500 SPARE TIME LAST YEAR"



Unlimited Capacity

Only SHOPSMITH has horizontal drill, with 4" quill feed, time-saving jigs, unlimited capacity. Rugged unit converts to saw, sander, lathe and vertical drill press. Write for free catalog.

SHOPSMITH, Dept. 226-A
12819 Coit Rd., Cleveland 8, O.



SHEET METAL BRAKES

Angles, flanges, Pittsburgh locks, 24 G. steel, heavier aluminum. Cam locking, mount on bench, truck or floor stand. Truss braced steel. Express collect. 30", 65 lbs. \$28.50. 36", 75 lbs. \$33.00. 48", 100 lbs. \$48.00. Portable stands, 32" hi, 35 lbs. \$8.00. 12" BRAKE



fits in vise, forms compound bends in 20 G. steel. Not illustrated. Express collect. \$12.00

IRON BENDER forms hooks, angles, eyelets, etc. Capacity 1/4x2", 5/16x1 1/2", 10 parts, all steel. Express Collect. \$9.50

24" CURVE FORMER. Forms straight and tapering pipes 2" to 2 ft. dia. 16 Gauge. Express collect. \$9.50

(Immediate delivery. Order direct, cash or C.O.D., or send for folder.)

VYKE BRAKE CO., S-1116 So. 27th ST, Omaha 5, Nebr.



A Man's GIFT!

For that man among men who works with his hands. He's always wanted power tools, but he's been too unselfish to buy them for himself. Give him a PET Power Tool for Christmas!



Mirror finished 1/4" drill. In gift box, \$19.95



Gold-tone finished 1/4" drill. In gift box, \$20.95



Chromium and satin finished 1/4" drill. In gift box, \$14.95

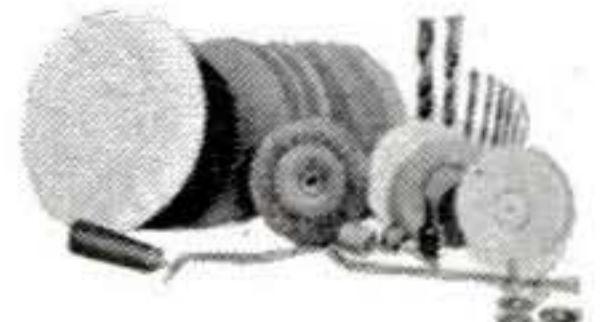

35-pc. attachment set Fits any 1/4" drill. Sands, grinds, polishes. In gift box, \$7.95

Zip-Sawer Jr. converts any 1/4" drill into a portable saw. In gift box, \$7.95

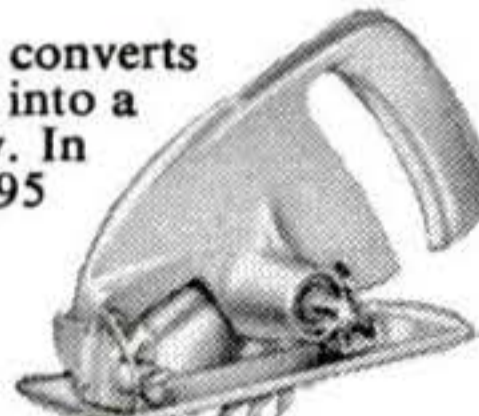

Favorite of "DO-IT-YOUR-SELFERS"



PORTABLE ELECTRIC TOOLS, INC.

320 W. 83rd St., Chicago 20, Ill.

In Canada: Portable Electric Tools, Ltd., Toronto, Ontario

Half-worn BRAKES MADE BETTER THAN NEW!

Double new lining life!

Apply **COP-SIL-LOY**—the brake conditioner proved at Indianapolis; on road racing cars, busses, trucks, taxis, passenger cars. NOW AVAILABLE FOR USER APPLICATION.

ANDY LINDEN SAYS, "Cop-Sil-Loy helped me break the track record at Indianapolis this year. I could drive farther into the turns because I could depend on my brakes. With Cop-Sil-Loy, there was no fade, no wear. I had brakes to spare." (Cop-Sil-Loy was used on 3 of the 4 cars that broke the qualifying record.)



Cop-Sil-Loy impregnates linings and drums with Copper-Lead Alloy. It's a dry lubricant—stops squeal. It prevents overheating—stops "fade." It provides a smooth, effective braking surface—greatly reduces wear and scoring. It waterproofs brakes—gives instant recovery from wet brakes. It provides **SMOOTH, SILENT, POSITIVE BRAKING** for twice the life of your present linings. **EASY TO APPLY**—No special skill, no special tools required—rough up linings, brush on Cop-Sil-Loy, "bed in" by driving. **IT'S THAT SIMPLE.** Nothing like it ever before. Now your car can have the super-braking that Cop-Sil-Loy gives costly speedway and road racing cars.

ORDER TODAY ON MONEY-BACK GUARANTEE

Cop-Sil-Loy Kit contains more than enough to treat brakes on any passenger or race car. Apply Cop-Sil-Loy as directed. If not delighted with results, write for refund by return mail. **YOU BE THE JUDGE.**

Send \$1 cash, money order or personal check. Pay postman \$3.95 plus postage and C.O.D. on delivery. Or, send \$4.95 for prepaid delivery. **POSITIVE SATISFACTION OR YOUR MONEY BACK.**

ABBOTT-KIPLE CO. 11001 W. Santa Monica Boulevard West Los Angeles 25, California

LOOK FOR THIS SELF-SERVICE DISPLAY

Every fine Fuller steel screw driver and wood chisel has our famous unbreakable amber handle. Fully guaranteed. At hardware stores everywhere. Wholesale Distributors! Write for Catalog Pages & Prices.

FULLER TOOL COMPANY, INC. 3522 Webster Ave., Bronx 67
World's largest makers of Amber-Handle Tools
EXPORT SALES DEPT., JOHN H. GRAHAM CO.,
105 Duane Street New York, U. S. A.

Now! With NEW "Blisterproof" DOME

NOW-FIXIN' IS FUN

... WITH THE GRIPPING STRENGTH OF MORE THAN

10 MEN

IN YOUR HAND!

VISE-GRIP WRENCH

Model 10-W \$2.60

Imagine the tough jobs you can tackle with TON-GRIP in your hand! Only VISE-GRIP locks with such tremendous power. Won't slip. Holds, turns, twists, pulls, cuts . . . easily adjusts to ratchet action. A locking wrench, super-pliers, vise, pipe wrench, end wrench—in a **SINGLE TOOL!** 7" and 10", with or without cutter. Only \$1.85 to \$2.60 at your hardware dealer.

Manufactured Only By

PETERSEN MFG. CO., Dept. M-10, DeWitt, Nebr.

NOW—40 different CUTS with AMAZING, NEW



Warren

DADO SAWING WASHERS On Your Saw Blade

Just dial widths to cut parallel grooves perfectly smooth. No warp, vibration

or trick screws. Strengthens blade, perfect balance. **GUARANTEED!** At your dealer's or order direct. Give arbor size— $\frac{1}{2}$ ", $\frac{3}{8}$ ", $\frac{3}{4}$ ", 1".

Send for free booklet

WARREN WASHERS COMPANY
Dept. 50, Box 98, North End Station, Detroit, Mich.

ONLY \$4.95 PER SET

Scrape paint quickly
ask your dealer for
Red Devil
Wood Scrapers



RED DEVIL TOOLS, IRVINGTON 11, N. J., U. S. A.

SpeedWay Speed Sander

SANDS, SMOOTHS, CLEANS, BUFFS, POLISHES

This motor-driven, all-ball-bearing, orbital motion finishing sander works any wet or dry abrasive—3 covers from standard sandpaper sheet makes it easy to finish or refinish furniture, woodwork, walls. Ask your dealer to demonstrate.



\$34.50

Write for electric tool catalog.
SpeedWay Mfg. Co. 1864 SO. 52ND AVE. CICERO 50, ILLINOIS

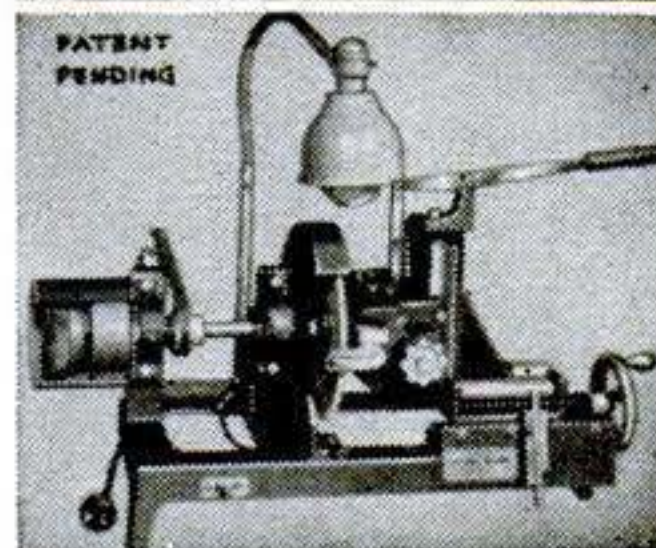

Start a NEW BUSINESS!

or Add to your present Repair Business

SHARPEN DULL PIPE WRENCHES

PIPE TAPS & DIES
"GUM" CIRCULAR SAWS

Write for Information

J. C. MOORE INDUSTRIES
BOX 5 276, Fredonia, Pa.



BRONZE FOUNDRY

Schools and Home Workshops
Make your own castings of aluminum, copper, bronze, silver. Foundry sets are available in three sizes including 2400 Deg. F. blast Furnaces, \$22.50; \$29.50; and \$42.00. f.o.b. Kansas City. Free Circular.

KANSAS CITY SPECIALTIES CO. P. O. BOX 6022, Dept. S-10 KANSAS CITY, MO.

powerful • portable • pocket size

NEW JZ HACK SAW FOR 1/4" ELECTRIC DRILL



Easy as breathing! Simply attach saw to drill or drill press. No holes to drill. Cuts directly into wood and plaster. Ideal for metal. No gears or bearings. No exposed moving parts except blade. All-metal construction. Folds up to 1 x 1 1/2 x 4" Weighs only 11 oz. Complete, ready to use.

LIFETIME GUARANTEE

RUSH ORDER TODAY TO DEPARTMENT A-16

\$4.95

POSTPAID

J. Z. COMPANY, 4818 Prospect Av., Kansas City, Mo.

General SALVAGE CO. SURPLUS Bargain SALE! BUY DIRECT FROM THIS AD!

BUILD YOUR OWN ARC WELDER OR LIGHT PLANT

Save \$250 to \$500



\$15.50 Instruction included. Rated 200 Amps, 28 volts, 2500 R.P.M. Ship. Wt. approx. 50 lbs. Stock No. 707.

PRICE F.O.B. K. C., MO.
CONVERTS TO ARC WELDER 200-250 AMP. OR LIGHT PLANT CAP. LOAD 5000 WATTS

Stock No. 711 D. C. Generator R-1 Jack & Heintz, rated 300 Amp. 30 Volts. Gov't cost \$300.00. Instruction for converting to welder or light plant incl. Also instructions and diagram for converting the R-1 or Delco generator to **Combination Welder and Light Plant Included, Only \$25.50**

Carbon Pile GENERATOR VOLTAGE REGULATOR For use with 24 or 32 Volt D.C. Generators. Also recommended for the P-1 and R-1 type generators in "build your own" Light plant. Postpaid. **\$6.95**

R-21 HEAVY DUTY RHEOSTAT Brand New for regulating voltage on ELECTRIC WELDERS, model trains, electric blankets, lights, control photoflood lamps, etc. Rated 16-32-ohms. Size 3 1/2"x2 1/2" postpaid. **\$6.95**

Valuable Gears — Bargains — Speed Reducers 10-1 or 5-1 ratio, 90 degree angle. Shaft driven 1/2" spline Shaft with 3 mounting holes 5/16". Gears held in forged and machined aluminum housing with two needle bearings, one bronze bearing, and three high speed shielded bearings. Rated 2 H.P. at 1750 R.P.M. **\$5.95** post paid

CUNO OIL FILTER — Brand New Aircraft type. Filters oil without cartridge replacements. Just turn handle and cartridge is clean. Standard 3/8" inlet and outlet ports to accommodate 12 gallons per minute. STOP CHANGING OIL. Instructions incl. **\$4.95** post-paid. Send check or money order. Prices FOB

ELECTRIC MOTORS Stock No. 4949 is 1/8 H.P. 24 V. D.C. 2000 R.P.M. Mfg. by Pesco applicable for 115 V. A.C. Instructions incl. Base mounted... **\$3.50**

DELCO MOTOR 6 Volt DC handles 6" fan blade. Use as windshield wiper, toy application, etc. Shaft is 1/2" in dia., 1 1/4" long. Size 5"x3" two mounting studs. 1200-2000 RPM. **\$2.35** (add 50c postage)

BEAM ROTATOR MOTOR Brand New with instructions for use on 110V. 60 cycles. Powerful highly geared motor for TV aeri-als, ham, FM, etc. Light weight. Ideal for ventilating louvers, furnace dampers and check drafts. \$35.00 value... **\$7.95**

ROTARY PUMP For pumping WATER FROM BASEMENTS, SUMPS, lubricants. For lawn sprayers. For use with hydraulic cylinders, dental lab, etc. Capacity 180 G.P.H., 200 lb. pressure, 29 in. vacuum. Steel shaft std. 1/2 in. Stock #101. Instr. incl. **\$6.95** (Add 50c postage)

PESCO CENTRIFUGAL HEAVY DUTY PUMP Including built in motor. Applicable for 24 V. D.C./A.C. or 110 V. A.C. The motor is explosion proof constructed for gasoline fuel, oils, water, fuel booster, etc. 3/4" hose connection. Rated capacity 400 G.P.H. Instructions incl. Gov't cost \$172.00 Stock #659 **\$9.95**

PESCO FOUR VANE ROTARY LARGE VOLUME UTILITY PUMP For Water, Oil, Insecticides, etc. including built in relief and by pass valve. Capacity 400 G.P.H. 1/2" drive spline shaft. 3/4" pipe inlet and outlets. Rotates either direction or in any position. Engineering data incl. (Stock #600) only **\$7.95**

SENSATIONAL SELSYNS Two or more connected together, work perfectly on 110 V. A.C. For weather vanes, rotating directional antennas or controlling distance operations. Complete with diagram and instructions. Wt. 3 1/2 lbs. PER PAIR **\$7.95** Postage paid

Stratopower Constant Displacement For operating Hydraulic cylinders, motors on tractors, Bulldozers, Construction machinery, Lifttrucks, etc. Delivers up to 400 G.P.H. at 3750 R.P.M. Rated 1250 to 1400 P.S.I. HAS BUILT IN RELIEF. Rotation either direction. \$100.00 value. Engineering data and instr. incl. Stock #37. Wt. 8 lbs. **\$15.50**

Stock No. 512. Double action hydraulic cylinder 2 1/8" Bore, 4" Stroke, Dia. 3/4" shaft including built in Hydraulic control valve which may be operated with rod or lever, Clevis mounting. Overall length shaft retracted 14". \$75.00 value. Wt. 9 lbs. **\$9.95** f.o.b. K.C.Mo.

Stock No. 472—Double action with built in overload relief. 1" bore, Stroke 4", Shaft 7/16" dia. Length 8 3/4". A tremendous bargain. **\$4.50** paid

Stock #303—Double Action 2" Bore, Stroke 1 1/4", Dia. 1 1/2". Overall length shaft retracted 23". 2000 lbs. capacity with 1000 PSI gives 2800 lbs. with our STRATOPOWER. Wt. 14 lbs. **\$14.95** f.o.b. K.C.Mo.

Stock No. 12 Hydraulic Cylinder Double Action output 12560 lbs. with 1000 PSI input. Gives 17584 lbs. with our STRATOPOWER PUMP 1400 PSI. 4" Bore, 10 3/4" Stroke, 1-5/16" Shaft, clevis mounting. Gov't cost \$300.00. **\$25.50** f.o.b. K.C.Mo.

FOUR WAY HYDRAULIC CONTROL VALVE Poppet type Valve shuts off on neutral position. Has 3/8" A.C. Tube ports -9/16-20 thread, capacity 1500 P.S.I. Brand new Stock #1032. **\$5.95** paid

Large Volume hydraulic pressure relief valve. 3/4" ports, spring loaded. Range 1250 P.S.I. adjustable up to 3000 P.S.I. Brand new **\$4.95** postpaid

VICKERS CONSTANT DIS-PLACEMENT HYDRAULIC PUMPS. Brand New Stock No. PF-713-20. For any type liquid pumping job, 375 gal. per hr. at 3750 R.P.M., 1000 P.S.I. .410 cu. in. rev. Gov. cost \$100.00. **\$17.50** paid

GENERAL SALVAGE CO., 2922 E. 27 St., Dept. 329 Kansas City, Mo.

New Thrills for Model Railroaders!



Hundreds of new ideas that will save you money and make model railroading more fun than ever! Shows how to lay your own track, how to make automatic signal systems, culverts, roundhouses, tunnels,

switches and other modern railroad equipment. It's easy to follow the clear, simple instructions and diagrams in this new book. Shows how to make freight cars, baggage cars, pullmans and day coaches. In addition, there are complete instructions and blueprints for building a Pennsylvania R. R. type locomotive.

SEND NO MONEY

Just write for your copy of MODEL RAILWAYS today, and pay the postman only \$2.49 plus a few cents postage on delivery. If you prefer to remit now we pay postage. Money back if not satisfied. Address

POPULAR SCIENCE MONTHLY—Dept. 1052

353 Fourth Avenue New York 10, N. Y.



Dustite GASKET

SEALS METAL CASEMENT WINDOWS
SAVES FUEL! ADDS COMFORT!
Flexible sealing lip controls Dust, Draft, Rain, Bugs. Seals and insulates metal contact between frame and window. Controls condensation where storm windows are used. Ideal for air-conditioned homes. Write for sample.

DUSTITE PRODUCTS COMPANY
6 CANTERBURY DRIVE, DAYTON 9, OHIO

Amazing HUNTER SCREW HOLDING SCREW DRIVER

Here's one tool every craftsman, carpenter and mechanic needs...the original non-slip, screw-holding screwdriver by HUNTER. Simply place tip in screw slot and push gently: screw is firmly wedged to blade tip. Easy to start screws in most difficult places. Holding mechanism is all internal, fully automatic. Tough 4140 Chrome Moly shaft, Shockproof, plastic handle. 8 1/4" long, .040 thick point for #7 to #10 screw slots—best for most uses. Fully guaranteed.



\$1.98 POSTPAID

Smitty DRIVER for ALLEN HEADS



CARRY IN YOUR POCKET

"Wouldn't sell mine for \$5 if I couldn't get another" —say thousands of daily users. Fits all standard Allen type or socket-type bolts and screws. Handle gives great leverage. Equal to a whole kit of socket head wrenches. 5 sizes of shafts, each swing out like a knifeblade. Fits setscrews #10 to 7/16" inclusive, cap screws #5 to 5/16" inclusive. **\$1.50** SATISFACTION OR REFUND. SEND TODAY. POSTPAID

HUNTER TOOLS
BOX 7395 LUGO STATION • Los Angeles 23, California

CAR HARD TO START?

Get **EASY STARTING**
... Smoother Engine
Performance... Save Gas!
with **SENSATIONAL NEW**
SISSON
Electrimatic
CHOKE



Positive, dependable electric choking gives quick, easy starts every time in any weather. Smoother warm-up... no stalling... no flooding... no seasonal adjustment! Fits any car equipped for automatic choking. \$5 complete.

INSTALL IT YOURSELF
Get **FREE** Illustrated Folder

Sisson Choke, 1654 Ohio Avenue
Anderson, Indiana

- Please send me **FREE** illustrated Electrimatic folder
- I enclose \$5 (check or money order) for one Sisson Electrimatic Choke with complete instructions

Car Make _____ Year _____ Cyl. _____
 Carburetor Make _____
 Name _____
 Address _____
 City _____ Zone _____ State _____

DRILL PRESS OWNERS!

HERE'S 1 TOOL WITH 5 DISTINCT USES



THE BARRON MULTI-PURPOSE ROTARY WOOD PLANER

PLANES & SURFACES • PANELS & BEADS
ROUTS & GROOVES • RABBETS • TENONS **\$750** COMPLETE

Finest precision performance—certainty of skilled workmanship—time-saving, money saving short cuts—yours with world famous Barron Drill Press Tools. Fifteen important operations—all available on any standard drill press—with Barron Accessories. Equip your shop with these versatile exclusively designed tools—and save up to \$500. 200,000 Barron owners have bought on our liberal 10 day full money back guarantee. Order, or write for catalog.

FREE Workshop Guide & Catalog

BARRON TOOL CO. INC.
356 Architects Bldg., Detroit 1, Mich.

FILE SAWS THE RIGHT WAY

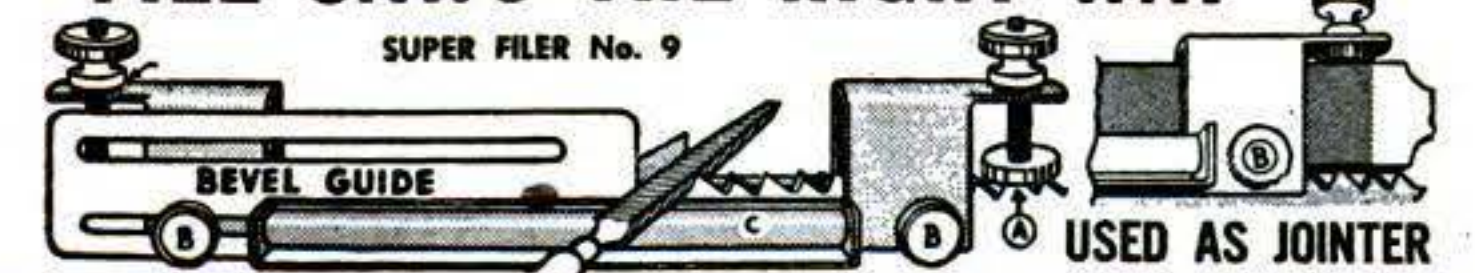

SO EASY: With this new filing jig and jointer anyone can now sharpen any handsaw like new! When file hits hardened steel rollers teeth are finished and **EXACTLY SAME HEIGHT**. All teeth cut and saw runs true and smooth. Jig and instructions \$2.95 postpaid. Free literature.

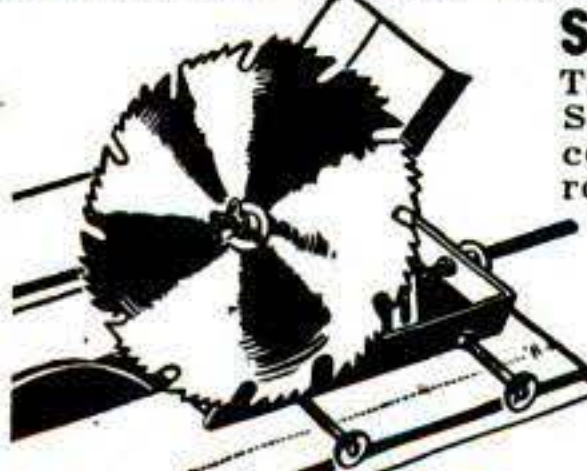

SHARPEN YOUR CIRCULAR SAWS
The **RIGHT WAY** on your own saw table. Sharpens rip, cutoff, hollow ground and combination blades—6" to 10". Saws stay round with correct bevel. Precision made, easy to use. **GUARANTEED**. Only **\$8.95**. Includes \$3.00 Grinding wheel. **"TRU-CIRCLE"** saw set automatically sets teeth at 10° or more **\$2.95**.

AT DEALERS OR POSTPAID

A. D. McBURNEY 317 E. 4th St., Los Angeles 13, Calif. Dept. S-22



INSIDE-OUTSIDE PAINT PEELER

"Paint-Dozer"

\$995 complete

Strip paint to bare wood at rate of 6-10 feet per minute! Big 16 sq. in. heating area blisters paint... attached rear blade strips it off in *one continuous motion!* Ideal for house exteriors, boats, cabinets, all woodwork. Excellent painter's tool! Faster, neater than blowtorch! Operates on household electric current. Even beginners do fast, clean work with "Paint-Dozer". Has long-lasting ceramic 1,000° Hi-Temp heating element; heavy stamped-steel construction; Marinite insulation; pistol-grip hardwood handle. Complete with front and rear detachable blades and skids; groove and ridge cleaners; 8 ft. neoprene cord; safety stand; attachable front guide handle for horizontal work. *Fully guaranteed!* Order from your dealer, or write today for this professional tool. *Fast shipment.*

OTTO KONIGSLOW MFG. CO., DEPT. S2
3610 PERKINS AVENUE • • • CLEVELAND 14 • OHIO

DO MORE PLANING JOBS WITH LOW-COST BELSAW \$215.00

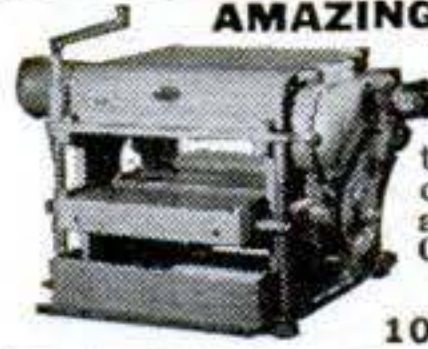

AMAZING 12 1/4-IN. PLANER Does All Ordinary Planing Mill Jobs. Provides attachments for Jointing, Rabbeting, Tongue, Groove, Matching. 12 1/4 x 6-in. capacity, 3-knife solid round all-steel cutterhead. Power feeds at 24 feet per minute, 42 cuts per inch. Provides for full line of accessory attachments—Grind and Joint knives **IN THE CUTTERHEAD WITHOUT REMOVING.**

FREE BOOK

BELSAW MACHINERY CO
1022 Field Bldg., 315 Westport Rd., Kansas City 11, Mo.

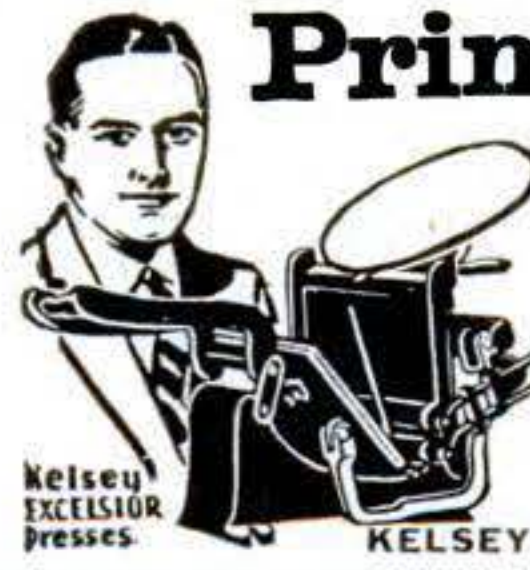

Print Your Own

Cards, Stationery, Advertising, labels, circulars, photo and movie titles, church work, tags, etc. Save money. Sold direct from factory only. Raised printing like engraving, too. **Print for Others, Good Profit.** Have a home print shop. Easy rules supplied. Pays for itself in a short time. Write for free catalog of outfits and all details.

Kelsey EXCELSIOR Presses

KELSEY PRESSES, N-33, Meriden, Conn.

VARIABLE SPEED HYDRAULIC POWER TRANSMISSION



It has Infinite Speeds 0 to 550 Reverse Automatic Overload Protection; Adjustable Torque up to 180 inch pounds. 5/8" Input and Output Shafts. It will handle 1/4 to 1 1/2 H.P. Motor. Case measures 7 1/2" long 7" high 6 1/2" wide. **VALUE OVER \$300.** Shipping Wt. 25#. On C.O.D. Orders we require **only \$54.50** a 10% Deposit. **Fob. Chicago**

DIRZIUS MACHINE SHOP "S" 1423-25 So. 52nd Ave., Cicero 50, Ill.

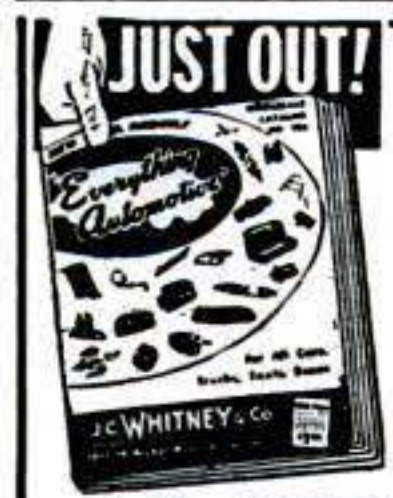

1953 EDITION

It's New! It's Different! Get world's largest Auto Accessory & Parts Catalog and save money. Over 50,000 items, including Hollywood Accessories, Hi-Speed Equipment, Rebuilt Engines, all parts & accessories for all cars & trucks. We have that **Hard-To-Get part!** Jam packed with bargains. Completely illustrated. (100 pages) Send 50c (refundable).

J. C. WHITNEY 1917-F Archer Chicago 16

WELD ONLY \$1475 F.O.B. complete!
BRAZE, SOLDER, and CUT →

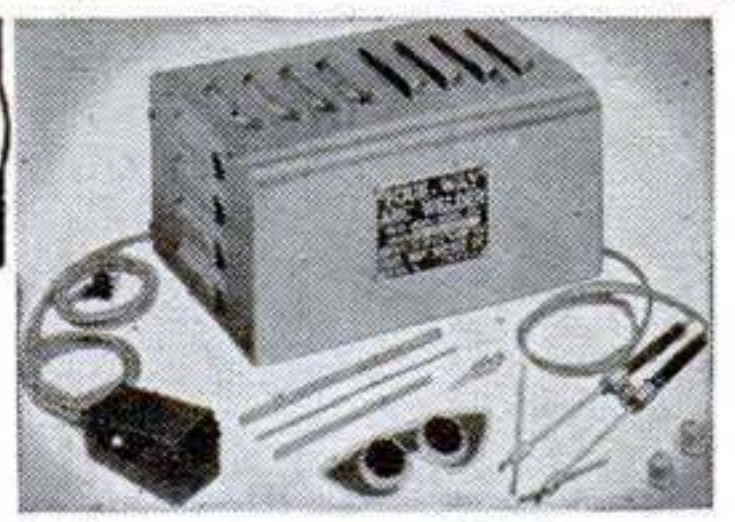

No experience needed. Follow simple instructions, weld on iron, steel, bronze, brass, aluminum, and other metals. Plugs into any properly wired 110 volt A.C. or D.C. line. Make or save time and money doing repair work for yourself and others. Repair men, farmers, tinsmiths, home and auto owners, hobbyists, etc., say **FOUR-WAY** pays for itself over and over. Order today or send for Free details.

FOUR-WAY WELDER COMPANY, Dept. F3-KC
2326 So. Michigan Ave. • Chicago 16, Illinois

ORDER NOW
10 DAY TRIAL

LARGER EQUIPMENT AVAILABLE ON REQUEST

SAVE FOR CHRISTMAS

Genuine **ARMY AIR FORCES**

SUNGLASSES
HERE'S THE REAL McCOY!

ARMY AIR FORCE 6 base, Precision Polished & Ground, Glare-free calabar lens with leather case can be attached to belt. Gold plated adjustable frame. Pearlized, sweat bar and pads. NOW ONLY

375
AVIATORS (AN-6530) WINDPROOF & DUSTPROOF **GOGGLES**

Chamois lined, rubber covered frames. Replaceable ground lenses in either clear, green or amber. Has non-fogging breather slots in frame. Adj. nose bar. Specify lens color. **NEW 275 USED 195**
Extra lenses-clr., grn. or amber \$1.39 pr.

HAND WARMER
The perfect GIFT! Temperature of 120° maintained from 16-24 hours by radiation. Uses Pocket Warmer fluid, lighter fluid or white gas as fuel. Metal Chrome finish with velvet pouch. Ideal for Hunting, Skiing, Fishing, Golfing, etc.

AIR CORPS TYPE RED HUNTER PARKA
A REAL HUNTER'S FRIEND! You'll "play safe" in this top quality, Hunter's RED Parka. Same design as the Air Corps B-9 Parkas. Outside is fine count, windproof, water repellent poplin. Inside is quilted sateen with 100% wool innerlining. Has 2 deep slash pockets and 2 side pockets - all with storm flaps. Front has full zipper closure with inner storm flap. DUCK and DEER HUNTERS are PRAISING THIS GARMENT. Sizes: Small, medium, large.

AIR CORPS TYPE LEATHER CAP
Special! For Hunter, Camper, Farmer. All leather with soft, warm sheepskin lining. Has turn-down flap for ear protection. Leather covered long visor. Sizes: Small, med., lg.

MITTENS
Sheepskin lined. Leather outer cover. Ideal for all types of winter work. Small, med., large.

AIR CORPS TYPE Sheeplined BOOTS
A REAL BARGAIN! All NEW. 100% waterproof and designed to be worn with or without shoes. Lined throughout, including tongue, with soft fleece sheepskin. Water repellent leather uppers with waterproof rubber lowers. Heavy non-skid tread on soles. Full zipper closure. Height approx. 12". Sizes: small, med., large.

COMPLETE UNIT MAKE YOUR OWN POWER DRIVE
AS SEEN IN AUGUST ISSUE OF POPULAR SCIENCE
Here's a unit PACKED WITH BRUTE FORCE! Does all those hard, heavy jobs that ordinary power tools cannot handle. Easily made from a vacuum cleaner type motor, a gear reduction drive and a few homemade parts. Can be used for turning large nuts & bolts, digging post holes, drilling large holes in wood or metal, driving power tools & machinery, lifting, pulling, pushing, and any job where a slow speed with high torque is required. YOU CAN'T STALL IT! Lightweight, easy to handle. Has 1000's of uses in home, garage, shop, factory. We supply complete instructions as compiled by Popular Science Mag.

4 TAKE-OFF DRIVE UNIT
Has many uses where 1 to 4 different take-offs are needed. All four drives turn in unison from the common power input. Drive is adaptable to use with 9/32" flexible drive shafts & accessories.

SAVE UP TO 85% IN WAR SURPLUS

FAMOUS RICOHFLEX IV CAMERA
10 DAY FREE TRIAL—MONEY BACK GUARANTEE
RECOMMENDED AS A TREMENDOUS "BUY" by a leading independent research firm. Produces results comparable to most expensive reflex cameras. Foolproof to operate. Has all-metal body - leather covered. 80mm precision matched f:3.5 color corrected, coated lenses. Built-in wide field magnifier. ASA synchronized shutter. Speeds: 1/25, 1/50, 1/100 and B. Reflex focusing. Built-in flash synchronization for all standard equipment. Takes 12 exposures, 2 1/4" x 2 1/4", on 120 film. Price includes genuine leather case with "snap-off" front.

9 PIECE DRAWING SET
Suitable for the architect, student, draftsman, artist etc. Contains 9 separate pieces including: one 5 1/2" compass with pen & pencil ports; one 5 1/4" divider; one each - 3 1/4" bow divider, bow pencil & bow pen with wheel adjustment & reversible needle point; one 4 1/4" ruling pen with extra handle; capsule of extra leads. All in a 2 flap, velvet lined pocket book case.

GENUINE ARMY SKI PATROL PARKA
Made of heavy, white duck. Wind and water resistant. Slip-over type with draw strings on cuffs and around waist and hood. Neck has 4 tie straps for adjustment. Body is finger-tip length with 2 large outer pockets. Designed to be easily worn over other clothes. Ideal weather protection for the outdoor sportsman, hunter,

MARCHING COMPASS
Here is a precision compass of unusual accuracy & dependability. Has a prismatic, hair-line guide for sighting at distant objects and at same time reading degree of setting. Needle is jewel mounted. Has luminous dial for night use and canvas carrying case.

AIR CORPS PARALLEL RULER
A valuable asset to the navigator, engineer, draftsman or mechanic. Heavy, durable plastic with guide knobs on top. Has rubber pads on bottom to prevent slipping. Beveled edges for use with pencil or pen.

100-200-300 POWER MICROSCOPE
A VALUE UNSURPASSED ANYWHERE! Has a triple objective revolving turret. Extra fine micro adjustment. Adjustable plano substage mirror. Body inclinable through 90° for microprojection. in dovetail hardwood case.

600 POWER MICROSCOPE
Has all the features needed for the finest work. Comes with 3 eyepieces (5x, 10x, 15x). Triple revolving turret has 4x, 10x, 40x achromatic objective lenses. Gives power combinations from 20x to 600x. Also has a square 90 degree inclination stage. Two-side plano & concave substage mirrors. Solid base, precision construction. A regular \$150 Value. OUR PRICE complete with fitted hardwood case.

50 POWER POCKET MICROSCOPE
A Palley Bargain! Has extremely sharp 50 power magnification. Compact, clips into pocket. 4 lens compound optical system. Now examine insects, stamps, minerals, gems, etc. Comes ready to use.

20 POWER TELESCOPE
Top quality import. Coated Lenses. Bright, clear image & wide field of view.

EYE LOUPES
An indispensable aid in fine inspection work. Available in 2 1/2, 2 3/4, 3 1/4, 4 & 5 power. . . . each

NEW! HY-SCORE .177 CAL. AIR PISTOL
Recommended by General J.S. Hatcher in April '52 issue of American Rifleman. No pumping necessary - just cock and fire. Has ALL STEEL rifled barrel, 7-3/4" long. Gives higher muzzle velocity than any other Air gun. Shoots .177 caliber pellets or darts. Ideal for use in shooting small game or targets. Also available in 22 cal. or BB. Write for information on other models.

NAVY Sealed Beam SPOT LAMP
U.S. NAVY Portable Search-spot light. Has pistol grip & aiming sight. Makes an ideal search, spot or emergency for auto, boat, camp, etc.

ORDER BY MAIL TODAY

RADIO MIX
A veritable "TREASURE CHEST" for "ham" operators and experimenters. Contains: Headset, Mike Button, Trans. Wire, Insulators, Switches, Condensers, Rheostats, Terminals, Jump Cable, etc. Approx. 8 packed lbs. for ONLY - **249**

USAF THROAT MICROPHONE
Genuine USAF type T-30-0 Gives distinct voice reproduction for aircraft or amateur radio broadcasting. Consists of two microphones, mounted on rubber neckpiece elastic neck band. Operates between 100 & 300 ohms . . .

MICROPHONE
Popular telephone type, highly sensitive. Has excellent, clear tone. This was the Signal Corps favorite. An ideal instrument for the Radio "ham" and professional recording studio, for broadcasting, home recording, public address systems, etc. Comes complete with cord & plug.

SIGNAL CORPS TEL. KEY
The new model J5A with ball type, flame-proof, metal key. perfectly balanced to permit positive contact with minimum effort. An ideal instrument for "ham" or professional use. A BUY at . . . NEW!

ALNICO SPEAKER
Permanent magnet type. 4" diameter. 2 wire hook-up. Ideal for small radios, inter-com systems, test equipment etc.

SURPLUS JEEP CANS
FOR RESERVE GAS SUPPLY - Holds 5 GAL. Has screw top and will take standard flexible nozzle. ONLY FLEXIBLE NOZZLE

ELECTRIC MOTORS
606 - DELCO MOTOR
1/50 HP, 24v DC, 1.6 amp. turns 3000 RPM. Has adj. overspeed contactor to stabilize and control speed. Length 5 1/2". Diam. 3".

SAMSSELL MOTOR
27 volts, 16 amps, 1/5 H.P. reversible, series wound on motor. 3800 RPM, shaft 9/32" diameter. 12-spline. 4-1/8" x 2-3/8".

SURPLUS MOTORS
No. 500 - Used 1/2 HP - 27 volt, DC-AC. This motor can be readily adapted to deliver up to 1/2 HP on 110 volts AC by the simple method of rearranging armature brush-leads. Free Diagram with each order. A SENSATIONAL VALUE.

230 PAGE CATALOG
1000's of ITEMS! Fully ILLUSTRATED! For the MECHANIC, SPORTSMAN, HOBBYIST, HOME OWNER, etc.
War Surplus - Factory Closeouts and General Merchandise Values! Save on Hardware, Hand & Power Tools, Gadgets, Sports Equipment, Hydraulics, etc. SEND 50c for HANDLING & MAILING.

Palley SUPPLY CO. 2263 EAST VERNON AVENUE DEPT. PS-10 LOS ANGELES 58 CALIF.

Mechanical Sports Are Coming

[Continued from page 99]

skill in preparing his machine as well as his skill in handling it. In the near future we may expect developments of great interest by such things as the use of rockets to gain rapid acceleration in all kinds of motor racing.

"Speeding up" is only another phrase for civilization and we are observing its effects even in the more conservative sports, such as fishing where "radar" has been used to detect fish. Deep-sea fishing has been conducted with radio attachments to a harpooned fish and there seems no reason why such an apparatus should not be attached to a fox.

It is, perhaps, a pity that the tradition of "working sport" has almost died out. Covent Garden porters used to test their skill in carrying baskets; Paris waiters, their speed and sense of balance in racing with loaded trays. Tree-felling has become an established sport down under in Australia and log-rolling is popular in Canada.

There are great possibilities for the development of more mechanized sports in connection with industry. We may yet see competitions between giant grabs removing a pile of debris. It is plain from the crowds of "rubbernecks" who watch "men at work" that this kind of thing has a certain spectacular appeal and it has the advantage over older sports in that it is useful. As in motor racing, manufacturers would be stimulated to produce faster, more reliable and more efficient machines.

The Floor Will Dance

Or we may see races between radio-controlled planes in which there will be a test not only of mechanism but of the skill of the controllers. The development of such sports seems to be foreshadowed by the extreme interest of the younger generation in such things as powered aircraft models. Young men would take more readily to the sport of kings if the electronic jockey became fashionable.

Human beings are less and less inclined to physical effort and it has been said that one day a dancer will expect to stand still while the floor does the work. All motion, we shall be told, is relative.

It is very much more useful and sensible to engage in sports which stimulate quality and research that can be applied in industry. Science has contributed a great deal to all sports. Tennis balls are now kept in refrigerators so that they will have uniform bounce.

Football balls are tested for their bounce by ingenious machines instead of by the naked eye. New methods of making golf balls have been devised which make them travel farther and truer. Even fishing reels have been improved so that errors on the part of the angler do not result in overrunning or breakage. In the not-distant future we may



In boxing an electrical machine could register blows struck below the belt.

see the same urge applied to sports derived from more productive industry.

Sport Aided Aviation

There are many precedents. The bullfight and, more recently, the rodeo, evolved from purely utilitarian practices into pure "sports." Early aviation was greatly stimulated by the sporting element; the development of the aircraft for military and commercial purposes came much later. Without the early races and meetings the airplane might have remained for many years as a clumsy and useless affair of "bamboo and string."

We are approaching the time when the majority of human beings will belong to the "idle classes." It will be a tragedy indeed if, science having provided the leisure, men and women can find no better use for it than a search for forgetfulness. END

How Pig Can You Get

THE price of hogs has been steadily advancing, but the road hogs are as cheap as ever.

—*Fireman's Fund Record*

BUY WHOLESALE FROM FACTORY SAVE 50-85%

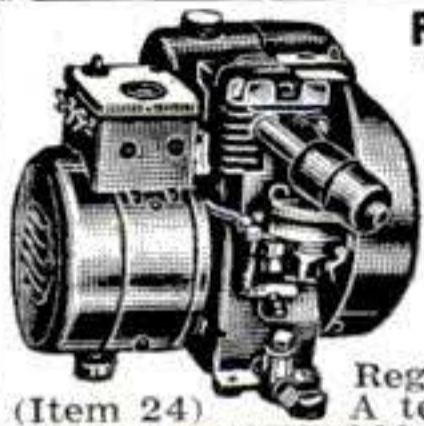

PORTABLE LIGHT PLANTS
350 watts—115 v. D.C. powered by a sturdy, easy-starting 1 1/2 hp. Briggs engine, perfect for lights, radios, razors, etc. in cabins or trailers. Use standard light bulbs. Built-in control box with receptacle—just plug in. Weighs only 65 lbs. Item 273. Reg. price \$199.50. **\$99.75**

(Item 24) **PUSH BUTTON START A.C. PLANT**
500-700 watts—115 v.—60 cyc. A.C. Powered by a rugged 2 hp. easy-starting Briggs gas engine. No wiring necessary, just plug in and operate. Plenty of current for any oil burner, freezer, brooder, pump, emergency lights, etc. which require up to 700 watts. Ideal for Civil Defense, Fire Depts., trailers and camps. Complete with Voltmeter and built-in winding to charge 6 v. auto batteries. Item 24. Wt. 85 lbs. Fully guaranteed. Be prepared if war or storm knocks out power lines. Reg. \$275 value. **\$143.50**
700-800 Watt Plant (Item 44) same as above but larger engine. **\$169.95**
1000-1200 Watt Plant (Item 45) same as Item 24 but larger generator and engine. **\$199.50**

GIANT 2000-2500 WATT PLANT
110-120 Vo 60 cyc., A.C. Absolutely the best made—exclusive dynamically balanced armature; heavy windings develop up to 5000 watt overload for motor starting. Skid-mounted—portable. Powered by easy starting Briggs or 6 hp. Wisconsin engine—complete with all accessories; engine easily disconnected for other uses. Big outlet box, voltmeter, no wiring necessary. Ample current for all purposes. Factory warranty and instructions included. Wt. 220 lbs. Reg. \$585.00. Special at... **\$299.50**
With Electric Self Starter (Item 179) **\$359.50**
GENERATOR ONLY and control box. **\$169.50**
Drive it with your engine or tractor.



3000-3500 WATT PLANT
(Item 198) 110-220 v.—60 cyc. A.C. with Wis. Engine, push button start. Wt. 370 lbs. Heavy duty. **\$399.50**
Generator only for belt drive, Wt. 115 lbs. (Item 198A). **\$239.50**

HI-LINE 6000 WATT PLANT
(Item 162) Push Button Start, 115-230 v. 60 cycle A.C. A brute of a power plant with a rugged 13 hp. Wisconsin engine. Plenty of electricity for ranges, water heaters, freezers, pumps, machinery, etc. Affords both 110 and 220 volts. Ideal where heavy current is needed. Wt. 590 lbs. Easily worth \$995.00. With self starter. **\$645.00**
Factory Spec. **\$345.00**
Generator and control box only, belt driven. Use your engine or tractor. Wt. 240 lbs. **\$345.00**
Write for information on any sizes not listed. Buy Wholesale—Direct From Factory—World's Largest Direct Selling Light Plant Factory. You can pay more—but you can't buy better.

MASTER AIR COMPRESSOR
(Item 209) High pressure type for large volume of air for heavy duty service. For paint spraying, inflating truck and auto tires, greasing, and the hundreds of other jobs done by compressed air. Piston type. 2" bore compressor with built-in air filter. Master built with high-strength alloys and precision bearings. Stainless steel tank, 12" x 24". 2100 cu. in. cap. Safe up to 500 lbs. Equipped with automatic switch that starts and stops motor to maintain desired pressure (up to 150 lbs.) and check valve, safety valve, gauge, shut-off valve, 20 ft. air hose and tire chuck. Beautifully balanced on ball bearing wheels and rubber tires. Note low factory prices. With 1/3 hp 110 v. A.C. motor (Reg. \$175.00) (Item 209). **\$98.50**
With 1/2 hp motor (Reg. \$199.50) (Item 209A). **\$119.50**
With 2 hp Briggs Gas Engine (Reg. \$199.50) (Item 209B). **\$109.50**
Compressor only (2"x13 1/4") (top quality) (Item 209C). **\$20.50**
Larger Compressor (2"x2") (none better) (Item 209D). **\$24.50**
Giant Compressor (twin 2 1/2"x2") (Item 209E). **\$54.50**
A complete line of spray guns and air tanks available at factory prices.

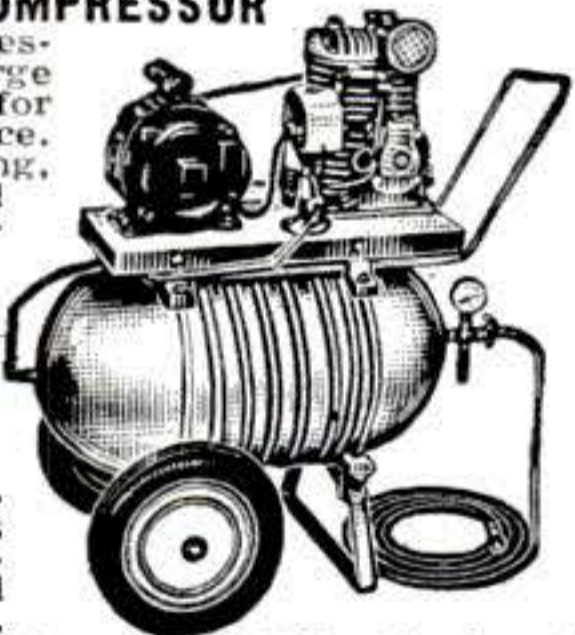

IMMEDIATE DELIVERY—ALL ITEMS HEAVY DUTY D-C ARC WELDER



(Item 38) Use as portable or shop welder. Up to 300 amps. Senior model. Made for years of trouble-free, continuous service. Will handle light or heavy jobs. Easily welds up to 3/4" plate using 1/4" rods. Built-in air cooling system. Arc is easy to strike and hold, because of specially designed arc stabilizer. Hi-lo switch and dial control gives wide range of welding heats. Run welder at 2600 rpm. with tractor, jeep or 15 hp. gas engine, or 7 hp. elec. motor. Complete with instructions, guar. and double V belt or flat pulley. You can pay more, but you can't buy a better welder. Wt. 110 lbs. \$400 value at. **\$99.75**
DUAL CONTROL MODEL same as above but with built-in dual rheostat for low heat soldering, brazing, welding. Spec. **\$119.50**
WELDING KIT. Two 10 ft. leads, welding helmet, electrode holder, ground clamp. Sold only with welder at... **\$10.50**

EXTENSION CORD
(Item 16) 40 ft. heavy duty, made of specially insulated No. 14 2-conductor wire. So tough that you can drive over it and yet flexible and easy to handle. Resists oil, grease or water. Extends electricity up to 400 ft. without voltage drop. Use indoors or out. Complete with heavy rubber plug and outlet. Wt. 2 1/2 lbs. Usually \$4.50—Special 40 ft. **\$1.99**
Comb: 2-40 ft. and 1-20 ft. (total 100 ft.) **\$4.95**
100 foot length (one piece) **\$4.85**
WIRE ONLY (Item 50) No fittings, 100 ft. **\$4.00**

HEAVY DUTY POWER CABLE
#12-2 Cond.—stranded, very flexible, rubber covered, special outside conductor for grounding power tools, etc. Finest heavy duty power cable made. U.S. Surplus. 50 ft. (Wt. 8 lbs.) Item 199. **\$6.95**
100 ft. (Wt. 16 lbs.) Item 200. **\$12.95**

79 Pc. CARPENTER'S TOOL SET

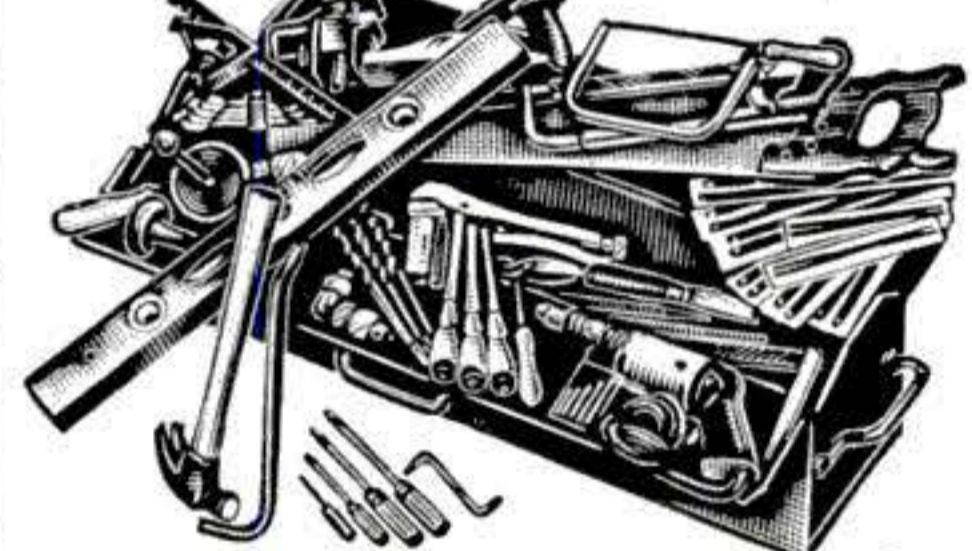

Professional quality. A complete set of Master Mechanic tools featuring the famous Stanley brand. All neatly arranged in a beautiful sturdy 32" hvy. steel tool box. Set includes: Powerful 1/4" Electric Drill (optional), 3 Stanley Wood Chisels, 29" Spring Steel Saw, Steel Bench Vise, Tin Shears, 9 Drill Bits, Sharpening Stone, 8" Plane, 24" Stanley Level, Hack-saw, Stanley Rule, 5 Double End Wrenches, 13 Ass't'd. Hacksaw Blades, Stanley Hand Drill, 10" Vise Wrench, Comb. Square, Stanley Hammer, Stanley Ratchet Brace, Coping Saw, 7 Coping Saw Blades, Steel Wrecking Bar, 4 Screw Drivers, Offset Screw Driver, Nail Set, 4 Ass't'd. Files, 8 Pc. Allen Wrench Set, Auger Bit Set and many other tools. Worth at least \$150.00 if purchased separately. Save cost of tools on one or two jobs. A terrific value. Item 242. Wt. 41 lbs. (without Electric Drill) **\$39.50**
Item 242A. Wt. 45 lbs. (incl. Electric Drill) **\$49.50**
Tool box only **\$8.95**
Item 243. Wt. 15 lbs. **\$8.95**

POTTER'S WHEEL
Power Driven—Foot pedal speed control. New compact modern design. Precision built to meet exacting requirements of professional artists—the finest wheel ever built. Mechanism fully enclosed for safety and to exclude moisture and clay. Foot-controlled variable speed drive provides instant, smooth speed range of 30 to 150 rpm. Equipped with adjustable arm rests. Easy to operate—even for handicapped persons. Reversible 10" throwing head—back side recessed for casting plaster bats. Larger 18x18" throwing table; wedging wire attached; removable water cup inside. Heavy bronze bearings pre-lubricated, sturdily built for long, dependable service. Use 1/4 hp motor (not incl.). Shipped fully assembled—just mount wheel and motor on table or sheet of 3/4" plywood. Self storing—tip up on edge. Wt. 45 lbs. List price \$125. Factory special. **\$64.50**

and to exclude moisture and clay. Foot-controlled variable speed drive provides instant, smooth speed range of 30 to 150 rpm. Equipped with adjustable arm rests. Easy to operate—even for handicapped persons. Reversible 10" throwing head—back side recessed for casting plaster bats. Larger 18x18" throwing table; wedging wire attached; removable water cup inside. Heavy bronze bearings pre-lubricated, sturdily built for long, dependable service. Use 1/4 hp motor (not incl.). Shipped fully assembled—just mount wheel and motor on table or sheet of 3/4" plywood. Self storing—tip up on edge. Wt. 45 lbs. List price \$125. Factory special. **\$64.50**

Factory Prices on Catalog Items
Send 10¢ for **BIG 1953 catalog.**
Hundreds of bargains

All items brand new. Prices f.o.b. Chicago area. 10 day Money back guarantee. Send check or M.O.
MASTER MECHANIC MFG. CO., DEPT. 8B, Burlington, Wis.

MASTER SNOW BLOW SELF-PROPELLED

It's a lawn mower It's a plow
It's a power sickle It's a bulldozer
It's a cultivator It's a rotary tiller

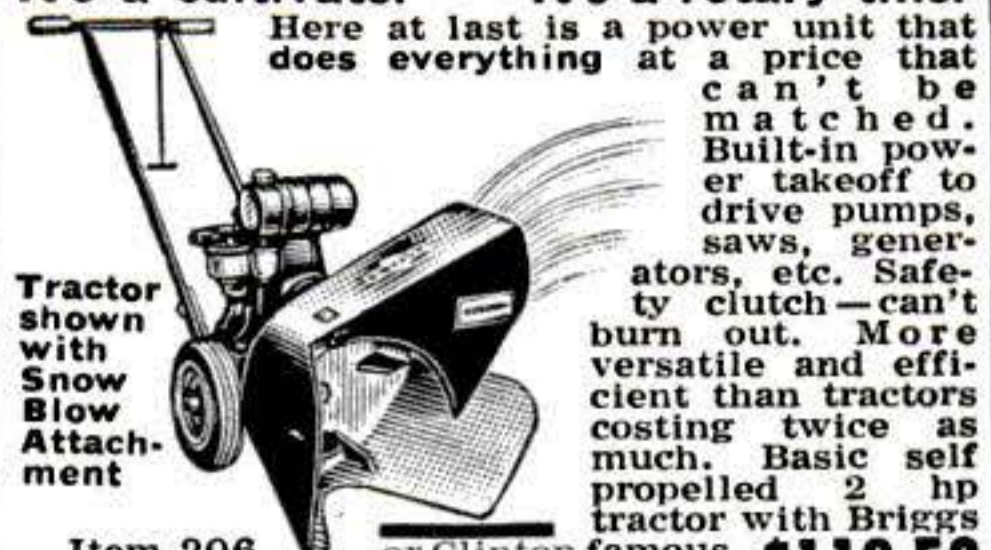

Here at last is a power unit that does everything at a price that can't be matched. Built-in power takeoff to drive pumps, saws, generators, etc. Safety clutch—can't burn out. More versatile and efficient than tractors costing twice as much. Basic self propelled 2 hp tractor with Briggs engine. Only... **\$119.50**
Snow Blow... **\$29.50** Bulldozer... **\$11.25**
Rotary Tiller... **\$42.50** Lawn Mower... **\$ 4.50**
Sickle Bar-Hitch... **\$ 8.75**
Mower... **\$42.50** Cultivator... **\$ 8.75**
Freight prepaid to most areas. Easy payment plan available.

COMMANDO MOTOR BIKE

"The Winged Wheel, with the Magic Feel". New, super-modern 1953 Model. This job is the Cadillac of all motor bikes. Sensational automatic drive permits idling or infinite speed range, merely through use of throttle. Engine drives on rear wheel through Dynarotor—no belts or chains. Free wheeling control permits pedalling if desired. Perfect balance and comfort. Mounted on famous Schwinn bike, America's finest. Sturdy, dependable, easy starting, light weight engine provides surging power, up to 150 miles per gal. Plenty fast, too. Fully guaranteed. Wonderful for vacation trips... Use pedals for exercise and motor for speed and distance. Ride one to work and save. Men's or Women's models. **Commando Captain**, 1 Cyl.—1 1/2 hp., with elec. headlite, item 90B... **\$199.50**
Commando General, 2 Cyl.—3 hp., with elec. headlite, item 91B... **\$249.50**
Commando Motor only, with complete mounting kit and instructions (can easily be installed on any bike in an hour). 1 cyl., item 90... **\$125.00**
2 cyl., item 91... **\$149.50**
All Commandos shipped prepaid in U.S.

32 pc. SOCKET SET

32-pc. Socket Set (Item 59) Highest quality guar. non-breakable sockets made by Husky. Beautiful, matched chrome alloy, absolutely the best. Complete range of 21 sockets from 1/4" thru 7/16" in 1/4" drive and 7/16" thru 1-1/16" in 1/2" drive; 2 extensions, reversible 1/2" ratchet, adaptor bit, slide head, all angle coupling, 2 end wrenches, 1/4" speeder handle and sturdy metal tool box. For prof. mechanics who want the best. Wt. 14 lbs. Easily worth \$41.50. While they last. **\$16.95**

45 pc. SOCKET SET

(Item 205) Contains a complete set of sockets in 1/2" drive, 3/8" drive and 1/4" drive, plus all necessary extensions, handles, speeders, reversible ratchets, etc.; all uncond. guaranteed against breakage. Beautiful matched chromed thin wall alloy sockets in a sturdy handsome steel tool box. Wt. 17 lbs. **\$26.95**
List Price \$62.90. Factory Special... **\$26.95**

3/8" DRIVE 15 Pc. SOCKET SET

(Item 201) Same top qual. as above—includes 7 sockets 3/8" thru 3/4", reversible ratchet, extension, flex. handle, cross bar, 3 punches, metal tool box. Wt. 5 lbs. **\$9.95**
List Price \$18.96. Our Spec... **\$9.95**

HYDRAULIC JACKS

(Item 208) Heavy duty, precision built, smooth, positive acting with built-in relief valve. Hi-Lift with screw extensions. Govt. surplus at a fraction of orig. cost. (Handle included.) 1 1/2 ton (Item 208) **\$6.45**
Wt. 11 lbs. **\$9.45**
3 ton (Item 208A) **\$9.45**
Wt. 15 lbs. **\$11.45**
5 ton (Item 208B) **\$11.45**
Wt. 17 lbs.

HEATING & VENTILATING FAN

(Item 10) Easily installed in furnace pipes. Forces even heat to all rooms. Over range, removes kitchen smoke and odors. Powerful continuous duty motor, 110-120 v. A.C. Quiet, super efficient fan moves huge volume of air (400 to 600 c.f.m.) 8" Fan, wt. 5 lb. **\$6.35**; 9" Fan, wt. 6 lbs. **\$7.45**; 10" Fan, wt. 7 lb. **\$8.45**; 12" Fan, wt. 8 lbs. **\$9.45**. Heavy-duty 12" fan, enclosed motor, suitable for spray booths, restaurant exhausts, poultry houses, and other difficult applications. Wt. 12 lbs. Item 10D... **\$12.95**



SOUTH BEND 14½" LATHES

Make Tough Jobs
EASY

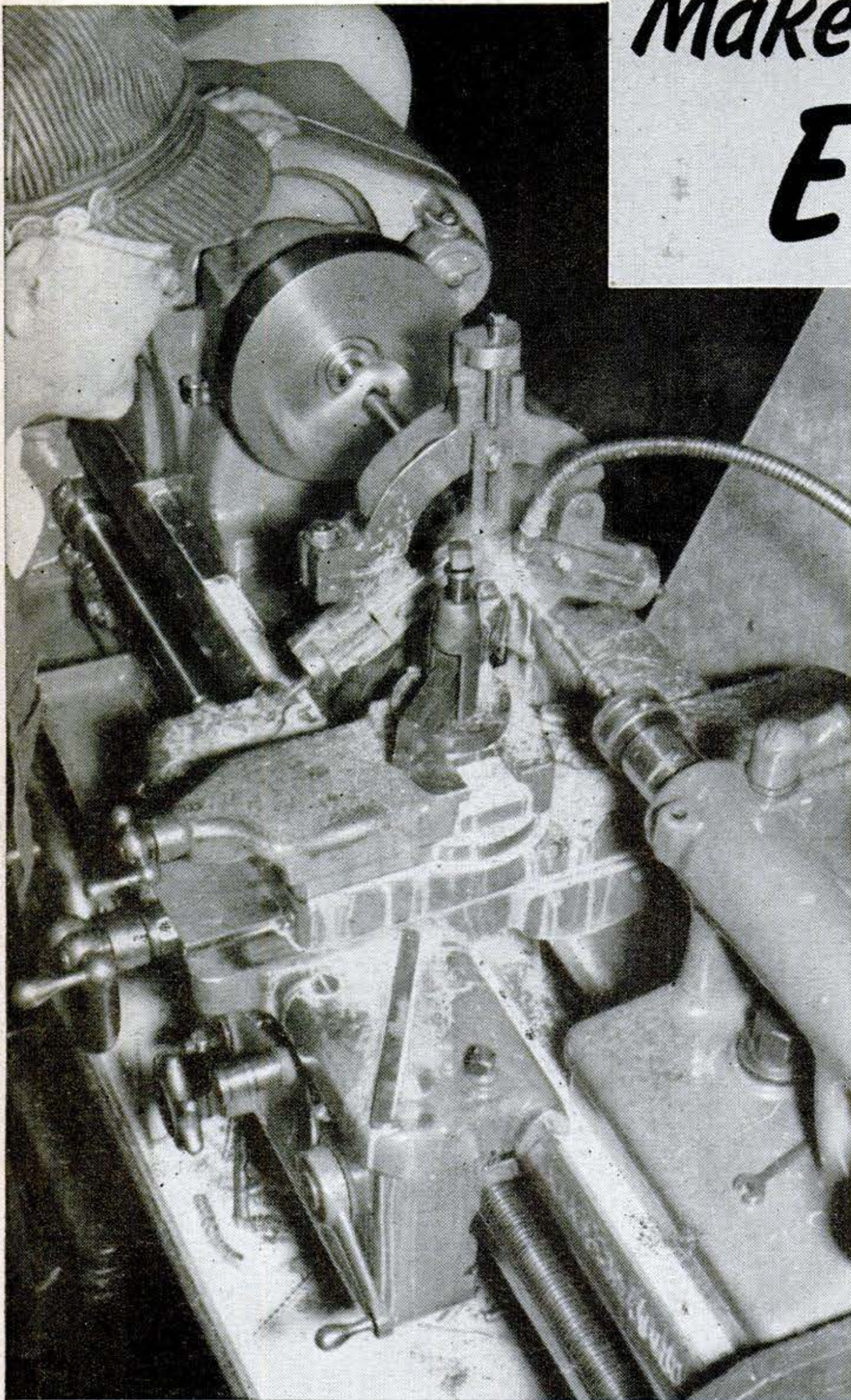

When tolerances start slowing up output, then is the time you need South Bend 14½" Lathes. Many plants have found they can save manhours and material by running the tough operations on these precision lathes — this is the type of work they do best. Their versatility enables you to keep them busy on a wide variety of work with a minimum of set-up time. Many attachments are available for special classes of work. Find out now how these lathes can give you efficient machining — *mail the coupon below today.*

SPECIFICATIONS

SWING: 14½" over bed and saddle wings; 10¼" over saddle with chip guard removed.

BED LENGTHS: 5, 6, 7 and 8 feet.

DISTANCE BETWEEN CENTERS: 24⅞ to 60⅞ inches.

COLLET CAPACITY: 1 inch.

SPINDLE BORE: 1⅜ inches.

SPINDLE SPEEDS: Eight . . . 30 to 875 r.p.m.

POWER LONGITUDINAL FEEDS: 48 R.H. or L.H., .0015" to .0841".

POWER CROSS FEEDS: 48, .0006" to .0315".

THREAD CUTTING: 48 R.H. or L.H. pitches, 4 to 224 per inch.

CROSS SLIDE TRAVEL: 10 inches.

SEND INFORMATION
CHECKED:

TOOLS & ATTACHMENTS



9" and 10" BENCH LATHES

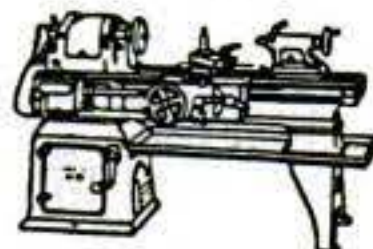

10" to 16-24" FLOOR LATHES

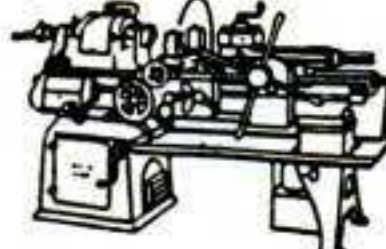

½" and 1" Collet TURRET LATHES



14" DRILL PRESSES



7" BENCH SHAPERS

Name _____

Company _____

Street _____

City & State _____

Building Better Tools Since 1906 • SOUTH BEND LATHE • South Bend 22, Indiana



I'll Train You *HOME* in Spare Good Jobs in RADIO-TV



America's Fast-Growing Industry Offers You

1. EXTRA MONEY IN SPARE

Many students make \$5, \$10 a week and more EXTRA neighbors' Radios in spare time while learning. The day you I start sending you SPECIAL BOOKLETS that show you Tester you build with kits I send helps you make extra servicing sets, gives PRACTICAL EXPERIENCE on common to Radio and Television. All equipment is yours. Send postage-free card today for Actual Lesson and 64-page

2. GOOD PAY JOB

What will you be doing a year from today... be on your way toward a good job or a business of your own? Radio-Television? NRI Courses lead to these and many other jobs: Radio and TV servicing, P.A., Auto Radio, Lab, Factory and Electronic Controls Technicians, Radio and TV Broadcasting Ship and Airways Operators and Technicians. The United States has over 105 million home and auto Radios—over 2,900 Broadcasting Stations. Radio is growing, more expansion is on the

3. BRIGHT FUTURE

Think of the opportunities in Television. It now has over 15,000,000 TV sets now in operation from coast to coast with over 15,000 TV stations operating. This means good pay jobs with bright futures for operators, installation and service technicians. It's the time to get ready for a successful future. My lessons cover both Radio and Television principles and equipment I furnish you practice on circuits common to both Radio and Television.

Television is Today's Good Job Maker

Over 1800 additional Television stations have been authorized with more expecting to be operating in 1953. That will cause the sale and use of sets to boom in areas where there is no television now. All this

is an opportunity, good pay, if you act to prepare yourself now. Qualified Radio-Television technicians are making very good money. Now the money will increase; the field is

Find Out What Radio-Television Offers

Keep your job while training at home. Hundreds I've trained successful Radio-Television technicians. Most had no experience, many no more than grammar school education. Decide now that you are going to know more and earn more. This is the important first step toward a career and security.

MAIL CARD NOW

Send the postage-free card for my FREE DOUBLE LESSON. You get Actual Servicing Lesson. Also my 64-page booklet "Be a Success in Radio-Television." Read what radio and television are doing, earning; see the equipment you practice with. Mail card now. J. E. Hoover, Pres., National Radio Institute, Washington 9, D. C. Our 35

YOU LEARN BY PRACTICING in Spare Time WITH KITS I SEND

With both my Communications Course and my Servicing Course I send you many kits of parts you use to build equipment for practical experience. They "bring to life" my easy-to-understand, illustrated lessons. Shown here are just a few pieces of equipment you build. You use them to make many tests, experiment with circuits common to both Radio and Television. Read about and see photos of other equipment in my FREE 64-page Book. All equipment is yours to keep! Mail card now. No Postage Needed.

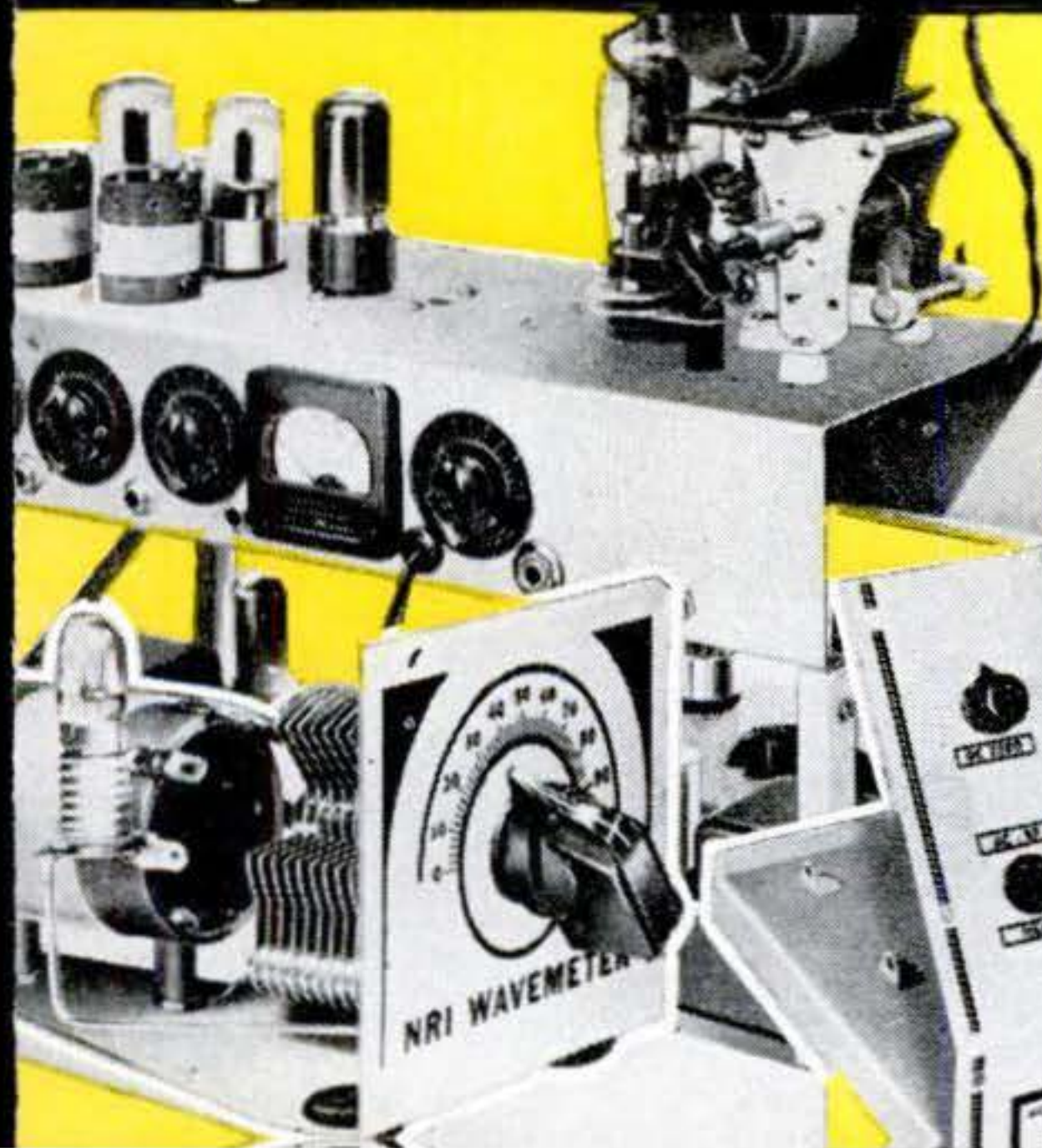

The Tested Way to Better

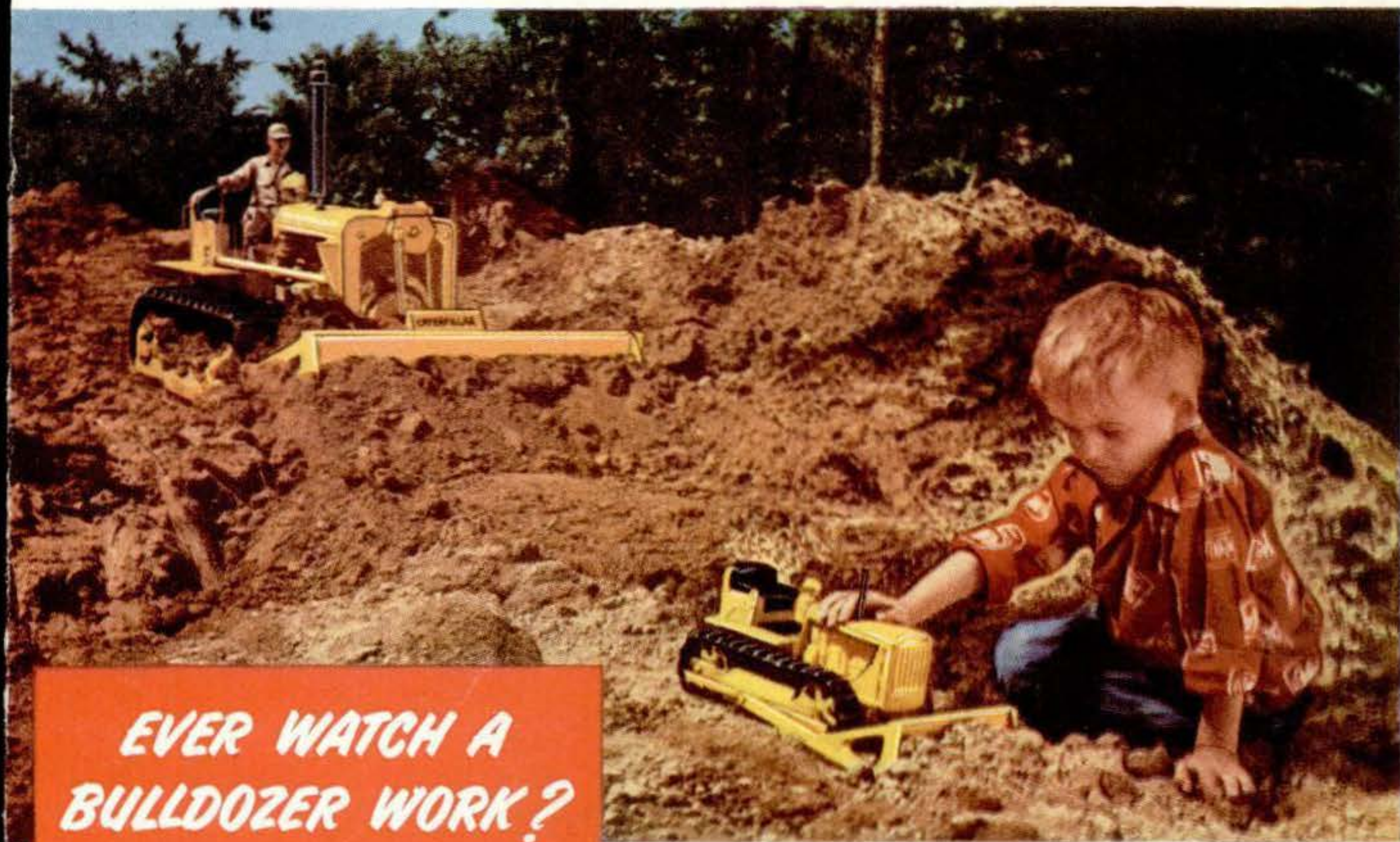

EVER WATCH A BULLDOZER WORK?

Breaking through earth, brush, trees, it's a demonstration of mechanized might that fires the imagination of every red-blooded boy, turns his interest from cops and robbers to the he-man activities of a construction engineer.

Here, in the newest Model Toy, is an authorized, working reproduction of the famous

CATERPILLAR* D6 TRACTOR & BULLDOZER

*Reg. U. S. Pat. Office

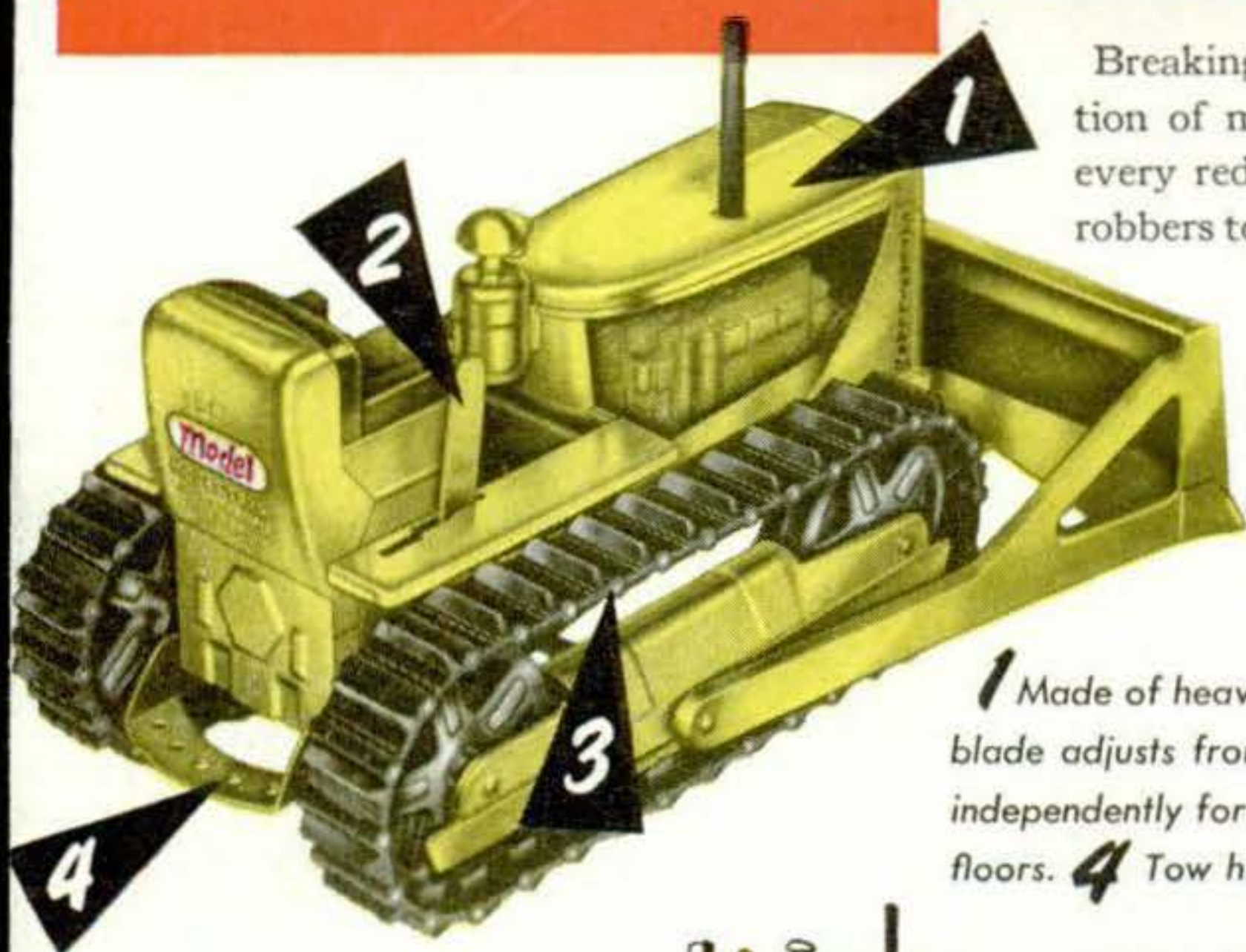

1 Made of heavy-gauge steel to outlast other toys **3 to 1**. **2** Scraper blade adjusts from driver's seat. **3** Heavy-duty Tenite treads operate independently for sharp turns, dig into rough ground, yet will not scratch floors. **4** Tow hitch for pulling other Model Toys.



Realistic "Diesel" engine looks just like the powerful "Cat" engine.

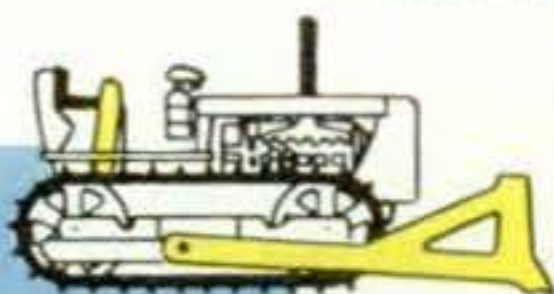

With the blade lowered, bulldozer levels roadways and airports.

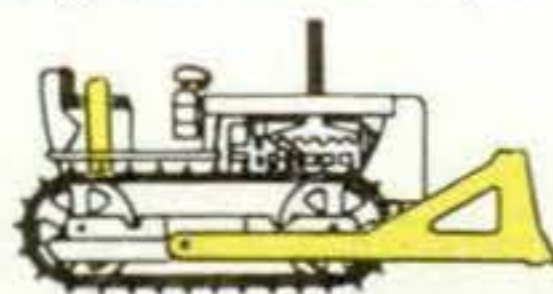

With blade in up position, tractor is used to tow other Model Toys.

Operating lever adjusts scraper blade to three positions.

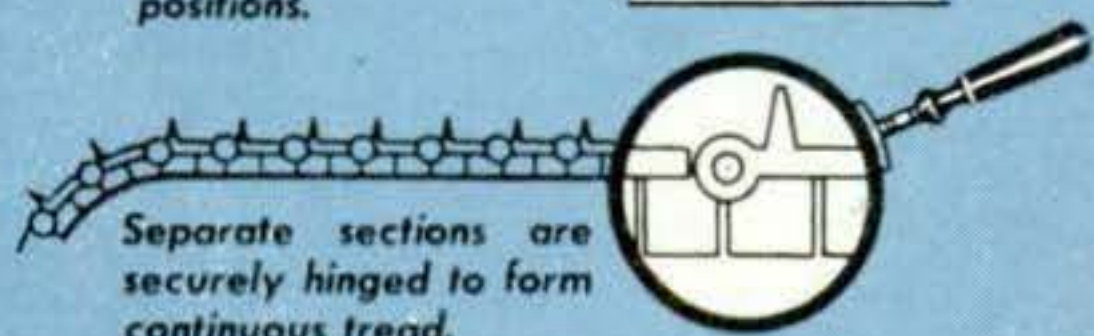

Separate sections are securely hinged to form continuous tread.

\$12.95

O.P.S. Ceiling Price
11 Western States—\$13.75

Write for free catalog describing all Model Toys.

THE CHAS. WM. DOEPKE MFG. CO.
ROSSMOYNE 1, OHIO

